

Cooperative Agreement

No. DTFH61-99-X-00104

Intelligent Vehicle Initiative (IVI) Field Operational Test Program

Final Report

Volume 2 of 4

**Freightliner Trucks Field Operational Test:
The Freightliner/Meritor Wabco Roll Stability
Advisor and Control at Praxair**

By

**The University of Michigan
Transportation Research Institute
2901 Baxter Road
Ann Arbor, Michigan 48109**

For

**U.S. Department of Transportation
Federal Highway Administration
Washington, D.C.**

September, 2002

Technical Report Documentation Page

1. Report No.	2. Government Accession No.	3. Recipient's Catalog No.	
4. Title and Subtitle Field Operational Test of the Freightliner/Meritor WABCO Roll Stability Advisor & Control at Praxair		5. Report Date September 2002	
		6. Performing Organization Code	
7. Author(s) C. Winkler, J. Sullivan, S. Bogard, R. Goodsell, M. Hagan		8. Performing Organization Report No. UMTRI-2002-24	
9. Performing Organization Name and Address The University of Michigan Transportation Research Institute 2901 Baxter Road, Ann Arbor, Michigan 48109-2150		10. Work Unit No. (TRAIS)	
		11. Contract or Grant No. DTFH61-99-X-00104	
12. Sponsoring Agency Name and Address Federal Highway Administration (FHWA) U.S. Department of Transportation 400 7th Street S.W. Washington, D.C. 20590		13. Type of Report and Period Covered Final Report October 1999 to September 2002	
		14. Sponsoring Agency Code	
15. Supplementary Notes This research was funded by the Federal Highway Administration (FHWA) and was conducted under a cooperative agreement between FHWA and Freightliner LLC as part of the Intelligent Vehicle Initiative Field Operational Test (FOT) Program. The University of Michigan Transportation Research Institute conducted this FOT under subcontract to Freightliner. Other partners in the project were Praxair Corporation, Meritor WABCO, and DaimlerChrysler Research and Technology North America.			
16. Abstract This document reports on the conduct and findings of a naturalistic field operational test (FOT) of the Freightliner/Meritor WABCO Roll Stability Advisor and Control (RA&C). The broad intent of RA&C is to reduce the risk of rollover by improving driver performance through in-cab advisory messages and, when deemed necessary, by slowing the vehicle through direct control of the engine throttle and retarder. The primary goal of the FOT was to evaluate the effectiveness of the system, especially as it relates to modifying driver performance in turns to reduce the risk of rollover. The test fleet consisted of six tractor semi-trailer combinations hauling liquid nitrogen in the Great Lakes region. The test ran from November of 2000 through November 2001. Some 10,000 hours and 772,000 km of driving were monitored resulting in 25 giga-bytes of data from the vehicles. Twenty-three drivers participated; fourteen remained in the study through its entirety and became the subjects of the statistical analysis. The drivers operated without RA&C during the first half of the study and with RA&C during the second half. Evaluations of the influence of RA&C were done for each driver and then pooled. The primary means of evaluation was a multifactor analysis that accounted for other influential factors such as weather, lighting (day/night), loading condition, and turn direction and severity. These factors were all found to have a main effect on turning performance. Results on the influence of RA&C were mixed. No main effect of the presence of RA&C was found, but an encouraging pattern of statistically-significant interactive influences was observed that suggests lower risk of rollover with RA&C. Also, individual advisories were found to have a relatively-short term, but statistically significant influence on performance reducing risk of rollover. The range of performance between individual drivers was found to be larger than the influence of any other factor examined. The report describes the RA&C system tested, the experimental design, the instrumentation and data acquisition system, and the structure and content of the resulting database. The analyses of the data are presented in the form of descriptions of the exposure of the fleet, the overall lateral behavior of the fleet and of individual drivers, the performance of RA&C, and the evaluation of RA&C and other factors on turning performance. Findings are reviewed and recommendations given.			
17. Key Words Roll, Rollover, Stability, Advisor, Control, Device, Lateral, Truck, Semi-trailer, Field, Operational, Test, Safety, Driver, Performance, Behavior		18. Distribution Statement Unrestricted	
19. Security Classif. (of this report) None	20. Security Classif. (of this page) None	21. No. of Pages	22. Price

EXECUTIVE SUMMARY

A field test was conducted for the purpose of evaluating the effectiveness of the Freightliner/Meritor WABCO Roll Stability Advisor and Control (RA&C) in reducing the risk of rollover crashes. This summary introduces the RA&C system, describes the experiment and provides an overview of findings and recommendations.

RA&C is a system in continuing development. This summary, as well as the full technical report, applies only to that version of the system tested in this FOT.

Roll Stability Advisor and Control—RA&C

RA&C is a composite system whose primary elements are Roll Stability Advisor (RSA), Roll Stability Control (RSC), and Hard Braking Event Detection (HBED). Each of these systems provides advisory messages to the driver via a Driver Message Center. Advisory messages are accompanied by an audible tone.

- RSA is an in-cab training aid that presents an advisory message to the driver whenever the system observes conditions judged to have presented a significant risk of rollover. The intent of RSA is to modify driver performance through training; RSA is not a rollover-warning device. Accordingly, RSA messages are not delivered immediately upon detecting a risk of rollover but are delivered a short time after the risk has subsided. There are three levels of RSA advisories.
- RSC is an active control system intended to prevent rollover. When RSC detects an exceptionally high risk of rollover, it sends a signal to the engine's electronic control unit to reduce engine power and, if deemed appropriate, to apply the engine retarder. An advisory message is delivered simultaneously with RSC control.
- HBED, like RSA, is a training aid that advises the driver when an unusual braking event has been detected. There are three levels of HBED advisories.



Driver Message Center Figure provided by Freightliner

The experiment

This FOT was primarily a human-factors experiment intended to determine whether or not the introduction of RA&C could be *objectively* related to changes in drivers' behavior in negotiating turns and whether such changes reduced the risk of rollover crashes. The experiment was structured such that the drivers were first observed operating vehicles in a baseline condition without RA&C for approximately six months. (During this baseline phase, RA&C was installed on the vehicle but was not activated nor

evident to the drivers. Moreover, the drivers were not yet aware of the nature of the system to be tested.) Later, RA&C was activated, and the drivers were given an introductory briefing on the system. Their driving behavior with RA&C was then monitored for another six months. Changes in driving behavior of individual drivers were evaluated and then pooled. Other factors which could influence driving performance—weather, lighting (day/night), turn severity, etc.—were monitored throughout the test and included in the analyses.

The field test

The field test took place within the naturalistic context of everyday operations at the facilities of Praxair Corporation in La Porte, Indiana. Six, five-axle tractor-semitrailer vehicles, each composed of a Freightliner Century Class, day-cab tractor hauling a Praxair cryogenic, liquid-nitrogen semitrailer, made up the test fleet. Twenty-three Praxair drivers participated; 14 remained in the study for its entirety and became the subjects of the evaluation.



FOT test vehicles

On board the vehicles, data were collected describing the motion, location, and operating state of the vehicle, control inputs of the driver, ambient conditions, and, of course, the functioning of RA&C. Praxair provided logistical data for identifying individual drivers, terminal and customer locations, and payload transfers. By the end of the field test, some 25 gigabytes of data had been collected, most in the form of time histories from the vehicles. After creation of additional variables through post processing, the database used for analysis grew to over 60 gigabytes.



Routes of the FOT fleet

Exposure of the fleet

The field test began in November, 2000, and ran through November, 2001. During that time data were collected on approximately 770,000 kilometers and 10,000 hours of travel. As shown in the histogram to the right, most fleet travel was in the fully loaded or empty condition, and most was

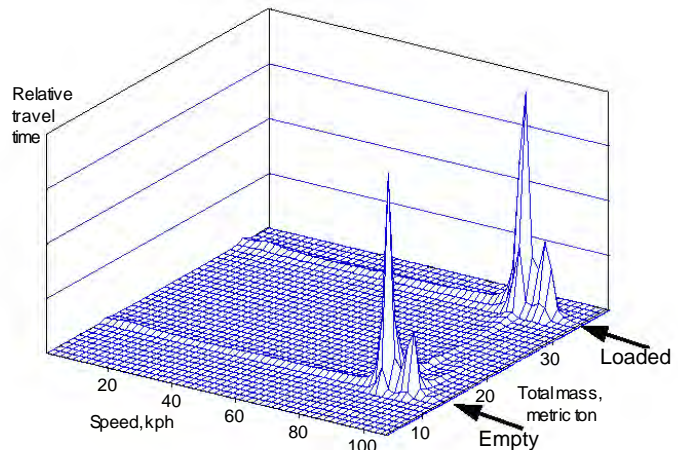

Two-dimensional histogram of fleet travel by mass and speed

at highway speeds. About 65 percent of travel was on freeways.

RA&C was activated in June of 2001. Total travel time and distance were split rather evenly between the two phases of the experiment. Most other physical exposure variables were reasonably well balanced across phases with some notable exceptions. Phase 1, as would be expected, had more travel in bad weather and more in darkness. Although the average length of a trip remained nearly equal from phase to phase, the mix of delivery points changed because the product demand of individual customers changed and because some new customers were gained and some old customers lost during the test. Most importantly, the mix of drivers changed between phases. Some drivers left the study altogether. Even among the drivers who participated in both phases, the distribution of travel between the more conservative and the less conservative drivers changed.

Overall turning behavior of drivers and the risk of rollover

The turning behavior of drivers was examined on the basis of two measures: lateral acceleration at the driver’s position, which was taken as a measure of the driver’s own experience, and rollover ratio, which is a measure of the actual risk of rollover. (Rollover ratio ranges from zero to one. A value of one indicates impending rollover.)

Of all the factors monitored in the test, the one with the strongest influence on turning performance was the driving style of the individual. Although exact differences depended a great deal on the specific driving circumstance, it is fair to say that the measures of turning behavior of the least conservative driver had roughly twice the magnitude of those of the most conservative driver. Among all the drivers in the test, the performance of the most conservative driver stood out markedly from the group, while the performance of the least conservative could be better described as lying at the upper edge of the group.

Judged in terms of the driver’s lateral-acceleration experience, turning performance was more conservative with loaded vehicles than with empty vehicles, suggesting that drivers are aware that loaded vehicles are less stable and that they attempt to compensate for that lower stability with a more cautious driving style. Subjective data gathered through interviews and periodic surveys of the drivers support this view. However, when

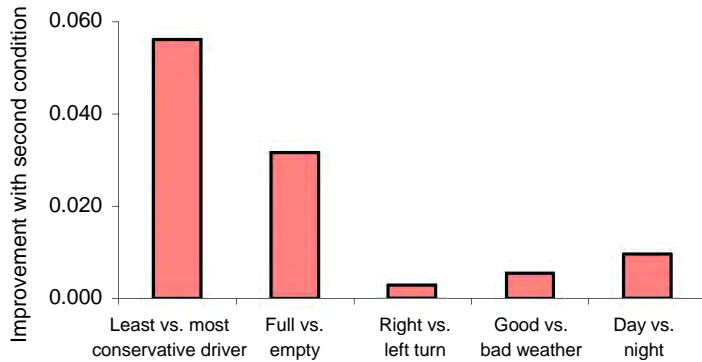

Relative strength of several influences on rollover ratio in turns

judged in terms of the actual risk of rollover, turning performance was *less* conservative with loaded vehicles. Although drivers modified their turning behavior depending on load, they did not fully compensate for the reduced stability of loaded vehicles. This observation is in keeping with accident studies which show rollover to be far more likely for loaded trucks.

Measured either by the driver’s own lateral-acceleration experience or by the risk of rollover, turning behavior was less conservative at lower speeds. This agrees with reports in the literature showing that passenger-car drivers also tend toward higher lateral accelerations at lower speeds. (Most such observations derive from contrived experiments rather than field tests.) In this FOT, this trend in driver behavior may have been augmented by simple opportunity (i.e., well designed, high-speed roadways generally do not offer the opportunity for high-acceleration turning) and perhaps by the drivers’ perception of the stabilizing influence of off-tracking of the trailer in low-speed, tight-radius turns.

Other factors were also seen to influence turning behavior. Turning was more conservative in bad weather than in good, more conservative in darkness than in daylight, and more conservative in left turns than in right turns. The latter probably is related to road geometry. That is, at intersections, right turns generally require tighter radii than left turns and far more freeway ramps are to the right than to the left.

RA&C advisories

There were 379 advisory messages issued by the RA&C systems during the second phase of the FOT. Ninety percent were RSA or RSC advisories. The large majority of RSA and RSC advisories were issued during relatively simple episodes involving just one advisory. However, some episodes were more complex and included as many as five advisories. The HBED advisories were all of a type issued for ABS activity only, not for rapid deceleration. In all but one case, HBED advisories and RSA/C advisories occurred in separate, isolated episodes.

Number of RA&C advisory messages

<i>RSA-1</i>	<i>RSA-2</i>	<i>RSA-3</i>	<i>RSC</i>	<i>All RSA/C</i>	<i>HBED-1</i>	<i>Total</i>
241	65	6	29	341	38	379

Although RA&C was intended to be sensitive to the total vehicle mass and, hence, to the prevailing roll stability of the vehicle, in this study RSA and RSC advisories appeared to be issued on the basis of lateral acceleration alone. As a result, and because the drivers were less conservative in driving empty vehicles, over 80 percent of RSA/C advisories were issued under empty or nearly-empty loading conditions. All RSC actions were in

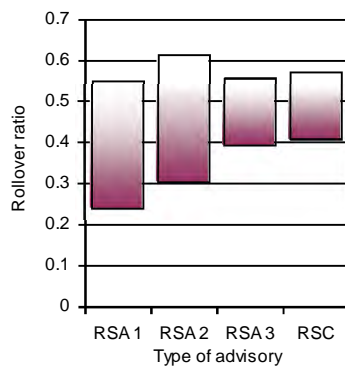
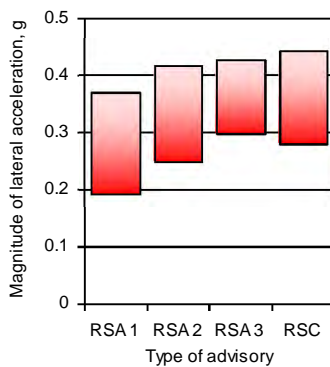

Ranges of peak lateral acceleration and rollover ratio associated with RSA/C advisories in the field test

empty vehicles. The actual acceleration thresholds that triggered advisories were relatively conservative for loaded vehicles and highly conservative for more stable, empty vehicles. Overall, 93 percent of RSA/C advisories were issued during episodes in which rollover ratio did not exceed 0.5. In their subjective evaluations, many drivers commented that the RA&C

did not appear to account for loading and that such capability would enhance the value of the system. Some drivers commented that the RA&C appeared to be too sensitive.

RSA/C episodes were not evenly distributed across drivers. Of the 19 drivers who participated in the second phase of the study, two accounted for 39 percent of all RSA/C episodes; the “top” seven drivers accounted for 75 percent of all episodes. On the other hand, six of the 19 drivers had none or only one RSA/C episode.

By location, RSA/C episodes tended to be concentrated on freeway ramps and at intersection turns. Two specific locations stood out. One, a 90-degree right turn at an intersection between major urban arterials had 28 episodes. The second, a 270-degree, right turn on a freeway interchange ramp had 22 episodes. Five other locations had ten or more episodes. Regarding such locations, however, it is important to note that (1) the locations with the highest *counts* of episodes did not necessarily have the highest *rates* of episodes (i.e., episodes per pass), and (2) locations had high counts partly because they had many passes with *empty* vehicles.

The influence of RA&C on turning performance

As described above, RA&C is a composite system including RSA, RSC, and HBED functions. The influences of RA&C on driver behavior observed in this study can only be ascribed to the *entire* system. The influence of individual elements could not be determined objectively.

Several approaches were taken to determine if RA&C had a significant influence on turning behavior that would reduce rollover risk. The simplest analysis examined the change in overall turning behavior of the comparable drivers from phase 1 (without RA&C) to phase 2 (with RA&C). The analysis did show a small, but statistically-significant change in high-acceleration turning between phases that suggests a lower risk of rollover in phase 2. However, this analysis did not rigorously account for all the factors, other than the presence of RA&C, which might have also changed with phase. Thus, it can not be asserted that the change observed was definitely the result of introducing RA&C.

Multifactor statistical analyses were also undertaken that did account for other factors. In addition to phase, these analyses considered load, weather, lighting, and curve severity. In these analyses, no statistically-significant *main effect* (i.e., overall effect) of RA&C could be found, but certain significant *interaction effects* that suggest a positive influence of RA&C *in opportune situations* were found. For example, small but significant reductions in rollover ratio in phase 2 (with RA&C) were found in the most severe turns in good weather and also in the most severe turns to the right.

A separate analysis examined the change in turning performance that followed soon after RA&C advisories. Turn performance in relatively severe turns coming within a prescribed distance following advisories was compared to performance in similar situations before advisories. Results showed that behavior in severe turns was significantly more conservative following advisories, especially within the first 250 km.

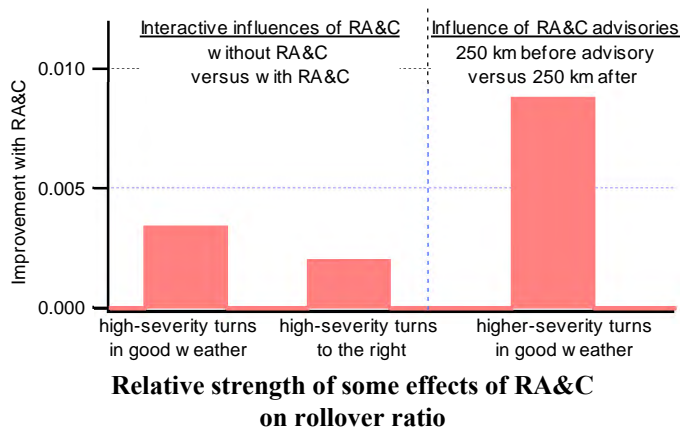

Overall, the results of all these objective analyses were decidedly mixed. (In addition to the positive results mentioned here, some statistically-significant, but negative, results were also found.) However, the picture seems to be generally encouraging with respect to the potential of RA&C-like devices, particularly since the device

studied in this FOT was not as sensitive to the actual stability of the vehicle as intended, and the drivers who participated were a rather mature and experienced group.

Subjectively, the drivers appeared to embrace the utility of RA&C but, at the same time, reported that it had only “some or little” influence on *their* driving. However, they thought the system would work well with *inexperienced* drivers. Drivers found the system to be simple to understand and indicated that the messages were clear, legibly presented, and produced minimal distraction while driving.

Recommendations

Major recommendations based on the facts and the experiences of this field operational test are as follows.

- RA&C-like devices should be made more sensitive to the prevailing roll stability of the vehicle and should generally be less conservative than was the case in this FOT.
- Future field testing of RA&C-like devices should include evaluation of the device *with feedback to drivers from their managers*, and the fleets studied should have less experienced drivers and more variation in vehicles and/or loading conditions.
- To the extent that an FOT is intended to research the driving process or to evaluate a particular concept such as RSA, the technology *package* studied should be less complex than the 3-component RA&C of this FOT.
- In designing FOTs, researchers should be very attentive to the broad range of behavior typically exhibited across the population of drivers.
- Consideration should be given to further mining of the rich database that was generated in this federally-sponsored field test.

TABLE OF CONTENTS

Executive Summary	i
Table of Contents	vii
List of Figures	xi
List of Tables	xix
Acknowledgements	xxiii
1. Introduction	1
2. Background and Objectives	3
2.1 The participants	3
2.2 The RA&C system	5
2.2.1 Driver message center	5
2.2.2 Roll stability advisor	5
2.2.3 Roll stability control	7
2.2.4 Hard braking event detection	7
2.2.5 Trip and leg performance log	7
2.2.6 Implementation	8
2.3 Rollover crashes addressed by RA&C	9
2.4 The objectives of the FOT	11
3. The Field Test	13
3.1 The fleet operations	13
3.1.1 Praxair and the La Porte facility	13
3.1.2 Delivery and service region for the La Porte operation	14
3.1.3 The FOT vehicles	15
3.1.4 Drivers	16
3.1.5 The operations	17
3.2 The experiment	18
3.2.1 The structure of the experiment and constraints of practical realities	18
3.2.2 Confounding variables	20
3.2.3 Schedule	21
3.2.4 Drivers —RA&C introduction and training	22
3.2.5 Comparable and non-comparable drivers	23
3.3 Data collection	23
3.3.1 Tractor-installed sensors and hardware	24
3.3.2 Data collection hardware, software, format, and recovery	28
3.3.3 Tractor based objective data	32
3.3.4 Other objective data	34
3.3.5 Data collection problems	42
4. The Data Set	45

4.1 Objective database structure and content.....	45
4.2 Objective data processing	46
4.2.1 Trip-level data.....	46
4.2.2 Calculated variables—five-minute table.....	47
4.2.3 Calculated variables, 2 Hz	51
4.2.4 Lateral acceleration.....	54
4.2.5 Curves	64
4.2.6 Histograms	71
4.3 Subjective data set.....	72
4.3.1 Structure and content	73
4.3.2 Processing	75
5. Exposure of the FOT Fleet.....	77
5.1 General and physical qualities of the exposure of the fleet	77
5.2 Exposure of individual drivers.....	85
6. Overview of Lateral Performance.....	89
6.1 Formats for presentations of lateral-performance Data	89
6.2. Lateral acceleration experienced for all travel.....	90
6.2.1. The influence of loading condition.....	90
6.2.2. The influence of speed.....	91
6.2.3. Asymmetries in lateral-acceleration experience	93
6.3. Lateral acceleration and rollover ratio experienced in turns.....	95
6.3.1. The influence of off-tracking.....	95
6.3.2. Lateral acceleration and rollover ratio	97
6.4. Differences in lateral performance among individual drivers	102
7. RA&C Advisories and Control Actions	105
7.1 Types of RA&C messages	105
7.2 Numbers and general qualities of RA&C episodes and messages	106
7.3 Lateral acceleration, rollover ratio and the RSA/C episodes.....	112
7.4 RSA/C episodes and messages by driver.....	119
7.5 RSA/C episodes by location	124
8. The Influence of RA&C on Turning Behavior.....	129
8.1 Comparison of the lateral-performance of comparable drivers across phase	129
8.2 Overview of the multifactor analysis.....	137
8.2.1 Subjects.....	138
8.2.2 Dependent variables: <i>RRSM</i> and <i>AyDSM</i>	138
8.2.3 Independent variables: phase 1 and 2	139
8.2.4 Quasi-independent variables.....	139
8.2.5 Exploratory statistics versus explicit hypothesis testing.....	146
8.3 Influence of phase on performance over curves of comparable severity....	147

8.3.1	Results—sustained maximum rollover ratio (<i>RRSM</i>).....	148
8.3.2	<i>RRSM</i> among drivers with exposure to RA&C advisories	154
8.3.3	<i>RRSM</i> excluding curves with known RSC intervention	155
8.3.4	<i>RRSM</i> by light condition.....	157
8.3.5	Results—sustained maximum lateral acceleration (<i>AyDSM</i>)	157
8.3.6	<i>AyDSM</i> among drivers with exposure to RA&C advisories.....	163
8.3.7	<i>AyDSM</i> excluding curves with known RSC intervention	164
8.3.8	<i>AyDSM</i> by light condition.....	165
8.4	Curve-performance analyses of other dependent measures.....	165
8.5	Off-roadway performance.....	168
8.5.1	<i>RRSM</i> performance	169
8.5.2	<i>AyDSM</i> performance.....	170
8.6	Curve performance before and after advisory messages	172
8.7	Curve performance on specific curves before and after advisories	178
8.8	Tail estimates of <i>RRSM</i> distributions.....	180
9.	Perceptions and Opinions of RA&C.....	181
9.1	Driver attitudes toward high-tech safety systems and RA&C	181
9.1.1	Driver attitudes expressed before exposure to RA&C.....	181
9.1.2	Driver attitudes expressed during and after exposure to RA&C	182
9.2	Driver reports about the operational characteristics of the RA&C system.....	184
9.2.1	Reported comprehension of the system operation	184
9.2.2	Perceived accuracy of advisories	185
9.2.3	Opinions about message presentation.....	188
9.2.4	Perceived level of distraction produced by the system.....	189
9.2.5	Driver ability to distinguish between system components	190
9.3	Driver perception of the effectiveness and utility of the RA&C system	190
9.3.1	Perceived influence on driving behavior	190
9.3.2	Perceived influence of RA&C on risk reduction	192
9.4	Final driver opinions.....	194
9.4.1	System Function.....	194
9.4.2	Perceived validity/accuracy of the RSA	196
9.4.3	Perceived effect and value	196
9.4.4	Overall acceptability of the system.....	197
9.5	Local management opinion survey	197
10.	Summary of Findings.....	199
10.1	General observations on the turning performance of the drivers.....	200
10.2	Observations on the RA&C device.....	202
10.3	Observations on the effect of RA&C on turning performance.....	204
10.3.1	Results of multifactor analyses	204
10.3.2	Results of other analyses.....	206

10.4 Drivers' subjective impressions of the RA&C device	206
11. Recommendations	209
11.1 Recommendations on RA&C-like devices	209
11.2 Recommendations for future research on RA&C-like devices.....	210
12. References	215
Appendix A-A. The Target Population of Rollovers for RA&C	217
Appendix A-B. Estimating Weather	235
Appendix A-C. Tilt-table Testing	241
Appendix A-D. Solar Zenith Angle	247
Appendix A-E. The Primary Lateral-Acceleration Measurement	249
Appendix A-G. Curves with RA&C Events	265
Appendix A-H. Exposure by Distance.....	279
Appendix A-I. Subjective Data Forms, Summaries, and Questionnaires.....	287
Appendix A-J. RA&C Database Tables	319

LIST OF FIGURES

Figure 2-1. The participants in the RA&C FOT	3
Figure 2-2. Location and appearance of the Driver Message Center	5
Figure 2-3. RSA concept and advisory messages.	6
Figure 2-4. RSC advisory messages.	7
Figure 2-5. HBED advisory messages	7
Figure 2-6. Trip and leg performance log messages.....	8
Figure 2-7. Time histories from an episode involving an RSA advisory	9
Figure 2-8. Time histories from an episode involving RSC and RSA advisories	10
Figure 3-1. Praxair’s La Porte, Indiana production and distribution facility.....	14
Figure 3-2. Overall distribution and service region for the La Porte facility (left) and destinations with over 100 deliveries during the FOT (right).....	15
Figure 3-3. The FOT vehicles.....	16
Figure 3-3. The FOT schedule	22
Figure 3-4. Location of air-spring pressure transducer.....	25
Figure 3-5. Location of brake-pedal pressure transducer	25
Figure 3-6. Location of GPS and yaw-rate transducer	25
Figure 3-7. Location of wireless network and GPS antennas.....	26
Figure 3-8. Location of Lane Tracker System.....	26
Figure 3-9. Location of the lateral acceleration and temperature transducer	27
Figure 3-10. Location of RA&C ECU	27
Figure 3-11. The DAS system including vehicle, La Porte, and Ann Arbor components	28
Figure 3-12. Installed UMTRI on-board data acquisition system	29
Figure 3-13. Control modes and logic for the FOT DAS	30
Figure 3-14. Plane view of the Praxair facility at La Porte	32
Figure 4-1. Gear versus gear ratio.....	52
Figure 4-2. Locations of calculated lateral accelerations.....	56
Figure 4-3. Example of low-speed off-tracking.....	59
Figure 4-4. Path of the tractor in a 90 degree small radius turn.....	60
Figure 4-5. Time-history plot of a 90 degree right-hand turn.....	60
Figure 4-6. <i>AyTotal</i> as a function of time	61
Figure 4-7. Path of the tractor in a 180 degree large-radius turn.....	61
Figure 4-8. Time-history plot of a 180 degree right-hand turn.....	62

Figure 4-9. Lateral acceleration based on yaw rate and speed	64
Figure 4-10. Curvature thresholds to define a turn	66
Figure 4-11. Map showing the actual curvature for the ramp from highway 239 N to I-94 E	66
Figure 4-12. Example of the triangulation component of the curve definition routine ..	67
Figure 4-13. Example curve with 167 passes	68
Figure 4-14. Example calculation of maximum and sustained maximum for curve performance	69
Figure 4-15. Example of an off-roadway curve.....	72
Figure 5-1. Accumulation of FOT travel distance in time.....	77
Figure 5-2. Histogram of trip distances	78
Figure 5-3. Travel routs of the FOT fleet	79
Figure 5-4. Histogram of travel time by road type and phase	80
Figure 5-5. Distribution of travel time by speed for each road classification.....	80
Figure 5-6. Histogram of travel time by speed	81
Figure 5-7. Histogram of travel time by total vehicle mass.....	82
Figure 5-8. A two-dimensional histogram of travel time by mass and speed.....	82
Figure 5-9. Cumulative histograms of path curvature	83
Figure 5-10. Distribution of distances from La Porte to delivery points by phase.....	85
Figure 5-11. Percentage of all driving time spent in RA&C FOT tractors, driver by driver	86
Figure 5-12. Total distance traveled in phase 1 and phase 2, driver by driver	86
Figure 5-13. Average distance of delivery legs in phase 1 and phase 2, driver by driver	87
Figure 5-14. Comparing the fractions of driving in daylight in phase 1 and phase 2 for the comparable drivers	88
Figure 6-1. Histogram of travel time by lateral acceleration for three load ranges	90
Figure 6-2. Cumulative histogram of travel time by magnitude of lateral acceleration for three load ranges	91
Figure 6-3. Histogram of travel time by lateral acceleration for four speed ranges	92
Figure 6-4. Cumulative histogram of travel time by magnitude of lateral acceleration for four speed ranges	92
Figure 6-5. Histogram of travel time at small lateral accelerations for four speed ranges	93

Figure 6-6. The asymmetry parameter for travel time as a function of lateral accelerations for four speed ranges and all speeds	94
Figure 6-7. Cumulative histogram of travel time in curves by magnitude of lateral acceleration	96
of the tractor (<i>AyDriver</i>) and the trailer (<i>AyTrailer</i>).....	96
Figure 6-8. Cumulative histogram of travel time in curves by magnitude of lateral acceleration of the tractor (<i>AyDriver</i>) and the trailer (<i>AyTrailer</i>) for low and high speed ranges	97
Figure 6-9. Cumulative histogram of travel time in curves by magnitude of lateral acceleration of the tractor (<i>AyDriver</i>), the trailer (<i>AyTrailer</i>), and for the total vehicle (<i>AyTotal</i>) at two loads and at high and low speeds	98
Figure 6-10. Cumulative histograms of travel time in curves for lateral acceleration (<i>AyDriver</i>) and rollover ratio by loading condition	99
Figure 6-11. Cumulative histograms of travel time in curves for lateral acceleration and rollover ratio by speed range.....	100
Figure 6-12. Cumulative histograms of travel time in curves for lateral acceleration by speed and load.....	101
Figure 6-13. Cumulative histograms of travel time in curves for rollover ratio by speed and load.....	101
Figure 6-14. Cumulative histograms of travel time in turns by magnitude of lateral acceleration comparing the most and least conservative drivers	102
Figure 6-15. Cumulative histograms of travel time by magnitude of lateral acceleration comparing all drivers in phase 1	104
Figure 7-1. Simplified flow diagram of the messages of the RA&C system	105
Figure 7-2. Counts of RA&C messages during phase 2	107
Figure 7-3. Counts of RSA/C episodes by number of advisory requests in the episode	108
Figure 7-4. Time history of a complex RSA/C episode with five advisory requests ...	110
Figure 7-5. Comparing distributions by speed of RSA/C episodes and travel time	111
Figure 7-6. Comparing distributions by total mass of RSA/C episodes and travel time	111
Figure 7-7. Counts of speed-change advisories by speed and RSA advisory level.....	112
Figure 7-8. Progressive treatments of maximum lateral acceleration signal from RSA level-1 episodes.....	113
Figure 7-9. Maximum lateral acceleration at the ECU by speed and load for RSA episodes.....	115

Figure 7-10. Time histories from a simple RSA-2 and a simple RSA-1 episode.....	116
Figure 7-11. Maximum rollover ratio by speed and load for RSA episodes	117
Figure 7-12. Maximum lateral acceleration at the ECU and maximum rollover ratio by speed and load for RSC episodes.....	118
Figure 7-13. Speed-reduction advisories as a function of lateral acceleration and forward speed.....	119
Figure 7-14. RSA/C episodes by driver.....	120
Figure 7-15. Counts of complex RSA/C episodes by driver	121
Figure 7-16. Counts and rates of driver-acknowledge messages by driver	121
Figure 7-17. The accumulation of RSA/C episodes during phase 2.....	122
Figure 7-18. The accumulation of RSA/C episodes by individual drivers	123
Figure 7-19. Location of the greatest number of RSA/C episodes of the FOT	125
Figure 8-1. Comparison of phase-1 and phase-2 lateral performance in turns of driver 2020.....	130
Figure 8-2. Comparison of phase-1 and phase-2 lateral performance in turns of driver 2021	130
Figure 8-3. Comparison of phase-1 and phase-2 lateral performance in turns of driver 2022.....	131
Figure 8-4. Comparison of phase-1 and phase-2 lateral performance in turns of driver 2023	131
Figure 8-5. Comparison of phase-1 and phase-2 lateral performance in turns of driver 2024.....	131
Figure 8-6. Comparison of phase-1 and phase-2 lateral performance in turns of driver 2026.....	132
Figure 8-7. Comparison of phase-1 and phase-2 lateral performance in turns of driver 2028.....	132
Figure 8-8. Comparison of phase-1 and phase-2 lateral performance in turns of driver 2029.....	132
Figure 8-9. Comparison of phase-1 and phase-2 lateral performance in turns of driver 2030.....	133
Figure 8-10. Comparison of phase-1 and phase-2 lateral performance in turns of driver 2031	133
Figure 8-11. Comparison of phase-1 and phase-2 lateral performance in turns of driver 2032.....	133
Figure 8-12. Comparison of phase-1 and phase-2 lateral performance in turns of driver 2033.....	134

Figure 8-13. Comparison of phase-1 and phase-2 lateral performance in turns of driver 2034	134
Figure 8-14. Comparison of phase-1 and phase-2 lateral performance in turns of driver 2035	134
Figure 8-15. Normalized distributions of <i>RRSM</i> observed among non-comparable drivers on selected curves	141
Figure 8-16. Relationship of sampled curves to the population of curves.....	142
Figure 8-17. Average speed within each curve-severity quartile (by <i>RRSM</i>) for full and empty trailers.....	142
Figure 8-18. Distribution of curve types among the <i>RRSM</i> quartiles	143
Figure 8-19. Normalized distributions of <i>AyDSM</i> observed on curves among non-comparable drivers.....	144
Figure 8-20. Average speed within each curve-severity quartile (by <i>AyDSM</i>) for full and empty trailers.....	144
Figure 8-21. Distribution of curve types among the <i>AyDSM</i> quartile	145
Figure 8-22. Main effects of load, turn direction, and weather on <i>RRSM</i>	149
Figure 8-23. <i>RRSM</i> observed among the comparable drivers over curve severity derived from the <i>RRSM</i> performance of non-comparable drivers	149
Figure 8-24. The interaction between weather and curve severity	150
Figure 8-25. The interaction between load and curve severity	151
Figure 8-26. The interaction between turn direction and curve severity	151
Figure 8-27. Three way interaction between load, turn direction, and curve severity	152
Figure 8-28. Three way interaction between phase, turn direction, and curve severity	152
Figure 8-29. Three way interaction between weather, phase, and curve severity	153
Figure 8-30. Three way interaction between weather, phase, and turn direction	153
Figure 8-31. Main effects of light condition and trailer load on <i>RRSM</i>	157
Figure 8-32. Main effects of load, turn direction, weather, and phase on <i>AyDSM</i>	159
Figure 8-33. Main effect of curve severity indexed by <i>AyDSM</i> quartile	159
Figure 8-34. Interaction between vehicle load and weather	160
Figure 8-35. Interaction between weather and curve severity	161
Figure 8-36. Interaction between turn direction and curve severity	161
Figure 8-37. Three way interaction between load, phase and turn direction	162
Figure 8-38. Three-way interaction between weather, phase, and <i>AyDSM</i> quartile.....	162

Figure 8-39. Interaction between phase and weather among drivers who received RA&C advisories	163
Figure 8-40. Two-way interaction between turn direction and curve severity on <i>AyDSM</i> quartile.....	164
Figure 8-41. The main effects of load, turn and phase on curve-entry speed.....	166
Figure 8-42. Curve-entry speed by curve severity bin.....	166
Figure 8-43. Interaction between turn direction and trailer load	167
Figure 8-44. Three-way interaction between load, phase, and turn direction.....	167
Figure 8-45. Main effects of phase, load, and turn direction on <i>RRSM</i> in off-roadway turns.....	170
Figure 8-46. Two-way interaction for turn direction and load on <i>RRSM</i>	170
Figure 8-47. Main effects of phase, load and turn direction on <i>AyDSM</i>	171
Figure 8-48. Interaction between load and turn direction on <i>AyDSM</i>	171
Figure 8-49. Main effects of exposure to advisory messages and load on <i>AyDSM</i> in the interval 250 km before and after an advisory	173
Figure 8-50. Main effects of exposure to advisory messages and load on <i>RRSM</i> in the interval 250 km before and after an advisory	173
Figure 8-51. Main effects of exposure to advisory messages and load on <i>AyDSM</i> in the interval 500 km before and after an advisory	174
Figure 8-52. Main effects of exposure to advisory messages and load on <i>RRSM</i> in the interval 500 km before and after an advisory	175
Figure 8-53. Main effects of exposure to advisory messages and load on <i>AyDSM</i> in the interval 750 km before and after an advisory	176
Figure 8-54. Main effects of exposure to advisory messages and load on <i>RRSM</i> in the interval 750 km before and after an advisory	176
Figure 8-55. Significant changes in performance by interval after advisory.....	178
Figure 9-1. Average driver opinion on the benefit of using high-tech systems in driving.....	183
Figure 9-2. Average driver opinion on the benefits of high-tech systems to experienced drivers	184
Figure 9-3. Drivers reported generally high levels of comprehension throughout the field test.....	185
Figure 9-4. Relationship between RSA/C advisory episodes and drivers' opinion about false alarms and misses	187
Figure 9-5. Relationship between RSA/C advisory episodes and perceived inaccuracy of the RSA/C in detecting severe maneuvers	188

Figure 9-6. Relationship between RSA/C advisory episodes and rated distraction among drivers.....	190
Figure 9-7. Drivers' expectation that the RSA will change their driving behavior	191
Figure 9-8. Relationship between RSA/C advisory episodes and expected change in driving	192
Figure 9-9. Driver opinions of expected risk reduction.....	193
Figure 9-10. Drivers' perceived usefulness of the Roll Stability Advisor over the course of the FOT	193
Figure 9-11. Actual and estimated number of RSA advisories by individual drivers ..	195
Figure 9-12. Actual and estimated number of HBED advisories received by individual drivers	195
Figure 10-1. Relative strengths of different factors on turning performance	200
Figure 10-2. Ranges of the maximum magnitude of lateral acceleration and rollover ratio associated with RSA/C advisory messages	203
Figure 10.3. Relative strength of (1) interaction effects of RA&C and (2) short-term effect of RA&C advisories on rollover ratio (<i>RRSM</i>).....	205

LIST OF TABLES

Table 3-1. Count and fraction of trips with each nitrogen trailer	16
Table 3-2. Files generated for each trip in the FOT	32
Table 3-3. Total size of the FOT raw data files	33
Table 3-4. List of all non-proprietary channels logged by the DAS.....	35
Table 3-5. Trip level histograms logged by the DAS	37
Table 3-6. List of styles used to define recorded byte values by the DAS	38
Table 3-7. Summary of actual versus collected distance	42
Table 3-8. Details of data loss due to disk problems	43
Table 3-9. Other notable data collection problems	44
Table 4-1. Gear factor used in calculating the drive axle mass	49
Table 4-2. Coefficients used to derive total vehicle mass	50
Table 4-3. 2-Hz histogram fields	53
Table 4-4. Short and long survey schedule rotation dates.	74
Table 4-5. Grouping of survey items based on factor analysis used to pool together answers to similar questions.	76
Table 5-1. Definitions of loading conditions	81
Table 5-2. Comparison of exposure measures for phases 1 and 2.....	84
Table 5-3. Exposure properties of distance by comparable drivers by phase.....	87
Table 6-1. Contrasting observations on driving behavior in turns judged on lateral acceleration and rollover ratio	100
Table 6-2. Comparable (C) and non comparable (NC) drivers by lateral performance ranking	104
Table 6-3. Percent of comparable distances by driver and phase	104
Table 7-1. Counts of RA&C messages during phase 2	107
Table 7-2. Advisory-request content of complex RSA/C episodes	109
Table 7-3. Counts of RSA/C episodes by location	124
Table 7-4. RSA/C episode counts by type of curve.....	126
Table 7-5. Statistics from phase 2 for curves where more than one RAS/C episode took place	127
Table 8-1. Phase-1 to phase-2 performance-change numerics for comparable drivers for all driving in turns by load	135

Table 8-2. Results of t-tests on performance-change numerics for all driving in turns, by load.....	136
Table 8-3. Results of t-tests on performance-change numerics for driving in turns in daylight and good weather, by load.....	137
Table 8-4. Quartile limits for <i>RRSM</i> for curve-driving performance among non-comparable drivers.....	141
Table 8-5. Quartile limits for <i>AyDSM</i> (in g's) for curve driving performance among non-comparable drivers.....	143
Table 8-6. Summary ANOVA results for main effects on observed <i>RRSM</i>	148
Table 8-7. Summary of two and three-way interactions between each factor and observed <i>RRSM</i>	150
Table 8-8. Summary ANOVA results for main effects observed on <i>RRSM</i> for drivers who received RA&C advisories	154
Table 8-9. Mean <i>RRSM</i> observed among main effects for all drivers and for drivers who received RA&C advisories	155
Table 8-10. Summary of two- and three-way interactions for drivers who received RA&C advisories	155
Table 8-11. Summary of analysis of variance excluding all RSC events.....	156
Table 8-12. Summary of analysis of light conditions	157
Table 8-13. Summary of main effects and interactions	158
Table 8-14. Summary of analysis of variance results for drivers who received RA&C advisories	163
Table 8-15. Summary of analysis in which curves that triggered RSC events were removed.....	164
Table 8-16. Summary of analysis of variance for examining light condition	165
Table 8-17. Summary of analysis of variance of initial speed on entering a curve.....	166
Table 8-18. Summary of analysis of variance of maximum sustained curve speed.....	168
Table 8-19. Summary of analysis of variance of brake-on time.....	168
Table 8-20. Summary of analysis of the <i>RRSM</i> in off-roadway turns	169
Table 8-21. Summary of analysis of the <i>AyDSM</i>	171
Table 8-22. Analysis of influence of advisories on <i>AyDSM</i> and <i>RRSM</i> in the 250 km intervals before and after and advisory.....	174
Table 8-23. Analysis of influence of advisories on <i>AyDSM</i> and <i>RRSM</i> in the 500 km interval before and after and advisory	175
Table 8-24. Analysis of influence of advisories on <i>AyDSM</i> and <i>RRSM</i> in the 750 km interval before and after an advisory	177

Table 8-25. Mean change in performance in <i>AyDSM</i> and <i>RRSM</i> by interval after advisory.....	178
Table 8-26. Average difference in curve-performance measures on the same curve before and after an advisory was issued	179
Table 8-27. Results of t-test examining whether curve performance before and after an advisory on the same curve showed a change in performance	179
Table 9-1. The average subjective rating of each factor (maximum score is 2, the minimum is -2, and 0 is neutral)	182
Table 9-2. Advisories and control events by driver.....	186
Table 10-1. Statistically-significant changes of lateral acceleration and rollover ratio from phase 1 to phase 2	210

ACKNOWLEDGEMENTS

The success of this field operational test depended heavily on the cooperation of many organizations and many individuals. The authors of this report wish to acknowledge that cooperation enthusiastically and extend our sincere thanks to all who were involved.

First and foremost was Praxair Corporation, whose fleet and personnel played the major role in the day-to-day success of the field operational test. For these people, the project meant a fair amount of work and a substantial logistical burden on top of their normal operations, all for little direct return. Of special note, we would like to thank the following Praxair volunteers: Rich Cipolla, Paul Clymer, Mark Fischer, Theodore Koch, Roger LaGart, Chuck Stout, and Tom Rule (retired). The authors would especially like to thank the Praxair drivers involved in the study. Although, these drivers were specifically instructed not to extend their efforts beyond what they do normally, their role was obviously fundamental to the scope and depth of the research presented here. Our appreciation also extends to the La Porte facility mechanics from Ruan Fleet Services: Darrell Hobgood and Ed Willoughby

The authors would like to thank Freightliner Corporation, the lead partner in the study, and its parent company DaimlerChrysler. It was the collaboration of many individuals from these organizations that resulted in a data set and level of understanding of those data, which extends beyond what was merely collected on the vehicles. Of note, the following individuals made meaningful contributions to the research presented within: Thomas Connolly, Jim Ehlbeck, Thomas Fechner, William Gouse, Gary Holse, Paul Hynes, Chris Kirn, Andrew McLandress, Alan Pearson, Gary Rossow, Tom Shikina, Scott Smith, Steve Wreggit, Jamie Gertsch, Seth Rogers, and Wenbing Zhang.

Lastly, the authors wish to acknowledge the contributions made by Meritor WABCO. On many occasions, individuals from this organization made the work proceed smoothly and expeditiously. A special thanks to: Joerg Helmer, Volker F. Huefferman, Alan Korn, Joerg Moellenhoff, Susan M. Nickels, and Gerhard Ruhnau.

1. INTRODUCTION

This document constitutes Volume II of the Final Technical Report on a Field Operational Test (FOT) of Roll Advisor and Control (RA&C). This FOT was conducted under cooperative agreement no. DTFH61-99-X-00104, entitled “Intelligent Vehicle Initiative (IVI) Field Operational Test Program,” an agreement between Freightliner Corporation (Freightliner) and the Federal Highway Administration (FHWA) of the U.S. Department of Transportation. This volume was prepared by the University of Michigan Transportation Research Institute (UMTRI). Parties participating in this FOT along with Freightliner and UMTRI include Praxair Corporation (Praxair), Meritor WABCO, and DaimlerChrysler Research and Technology North America (DaimlerChrysler).

RA&C is a safety system by Freightliner developed in conjunction with Meritor WABCO.¹ The broad intent of the system is to reduce the risk of vehicle rollover by improving driver performance through in-cab advisory messages and, when deemed necessary, slowing the vehicle in turns through direct control of engine performance. RA&C also issues advisories associated with hard braking. The FOT was structured primarily to evaluate the effectiveness of the system, especially as it relates to modifying driving performance in turns to reduce rollover risk. This volume reports on the FOT as conducted by UMTRI including the experimental design, the structure and conduct of the field activity, data gathering and processing, and the evaluation of RA&C. The FOT also covered other safety systems under development or being considered by Freightliner or DaimlerChrysler: Lane Tracker, a Roadway Geometry Mapping algorithm, and Rollover Warning. Data gathering relating to these systems is covered in this report, but the analyses of these data are presented in other volumes.

The primary purpose of the FOT, which is the subject of this volume, was to evaluate the potential of RA&C for reducing the occurrence of rollover crashes of heavy commercial vehicles. This evaluation was carried out by the objective comparison of the turning performance of fourteen drivers operating six test vehicles, first in a baseline condition without the RA&C system active and, later, operating the same vehicles with the RA&C system active. The comparison was based on data gathered within the naturalistic context of the every-day operations of Praxair at its facility in La Porte, Indiana. Six, five-axle tractor-semitrailer combination vehicles operated by Praxair made

¹ RA&C is a system in continuing development. Indeed, development took place before and during the data-gathering portion of this project and has continued since then. Therefore, it is important to keep in mind that this report addresses only the one, specific version of RA&C that was installed in the FOT test vehicles during the period of this study in which the RA&C system was active. Changes and improvements have been made to RA&C since that time can not be addressed herein.

up the FOT fleet. All of these vehicles were composed of Freightliner Century Class, day-cab tractors hauling Praxair's cryogenic, liquid-nitrogen tank trailers. Data gathering in the FOT began in early November 2000 and ran through the end of November 2001. Data were gathered for approximately 770,000 kilometers of travel, split rather evenly between driving with and without the RA&C system.

This report is organized into 11 chapters plus appendices. Following this introduction, chapter 2 presents the background and objectives of the FOT, including the participants and objectives of the field test, a description of the RA&C system, and the scope of the rollover problem which RA&C addresses. Chapter 3 describes the structure and operation of the field test. The chapter includes a brief description of the operation of the FOT fleet, the design of the human-factors experiment, and the processes for the collection of objective and subjective data. Chapter 4 describes the full set of data derived from UMTRI's portion of the field test. The chapter describes the primary objective performance data gathered on-board the vehicle, logistical and other primary data, the methods used in processing these data, and the extensive set of secondary objective data derived thereby. The subjective data and its processing are also described. Chapter 5 presents the first level of evaluation of the objective data, namely, a description of the operating conditions, or exposure, of the fleet during the FOT. Travel time and distance are described according to such factors as road class, load, speed, path curvature, weather conditions, day or night, destinations, and the numbers and lengths of individual trips. Comparisons of exposure factors are made across phases of the FOT and among individual drivers. Chapter 6 presents an overview of the lateral behavior of the fleet. The presentations of this chapter are based on histograms of lateral acceleration and of rollover ratio experienced by the fleet. The influences of loading condition and of speed on both of these performance measures are explained. A very broad range in the performance of individual drivers is observed. Chapter 7 describes the experience of the FOT fleet in terms of the RA&C advisories and control actions. The number and the general qualities of episodes involving RA&C activity are presented. The lateral performance properties that were observed to elicit the several types of RA&C activity are described. RA&C activity is examined vis-à-vis individual drivers as well as in relation to roadway qualities and locations. Chapter 8 presents the evaluation of the influence of RA&C on the turning behavior of the subject drivers. The evaluation is accomplished largely through a multifactor analysis comparing lateral accelerations and rollover risk accrued during turning with and without RA&C. Chapter 9 describes the subjective evaluation of the RA&C according to the opinions of the FOT drivers and their managers. Chapter 10 provides a brief summary of the findings and recommendations are given in chapter 11.

Table of Contents

2. Background and Objectives	3
2.1 The participants.....	3
2.2 The RA&C system.....	5
2.3 Rollover crashes addressed by RA&C.....	9
2.4 The objectives of the FOT	11

List of Figures

Figure 2-1. The participants in the RA&C FOT	3
Figure 2-2. Location and appearance of the Driver Message Center	5
Figure 2-3. RSA concept and advisory messages.....	6
Figure 2-4. RSC advisory messages.	7
Figure 2-5. HBED advisory messages	7
Figure 2-6. Trip and leg performance log messages.....	8
Figure 2-7. Time histories from an episode involving an RSA advisory	9
Figure 2-8. Time histories from an episode involving RSC and RSA advisories	10

2. BACKGROUND AND OBJECTIVES

Rollover of heavy commercial vehicles is a highway-safety problem of significant proportions. Estimates based on the accident record suggest that there are an average of 14,880 rollover crashes per year in the U.S. and that over 50 percent of these crashes result in either an injury or fatality to someone directly involved in the crash. RA&C is a vehicle safety system intended to help reduce the occurrences of rollover crashes of commercial vehicles. RA&C primarily addresses that portion of rollover crashes that can be avoided through driver training centered on the risk of rollover during cornering. This FOT was undertaken to evaluate the potential of RA&C for reducing rollover crashes.

The first section of this chapter identifies parties participating in the field test and their roles. In the second section, the RA&C system concept is described. Section 2.3 identifies the population of rollover crashes that the RA&C system might address. The final section outlines the broad objectives of the field test.

2.1 The participants

Participating parties in the RA&C FOT and the roles they each played are presented in figure 2-1.

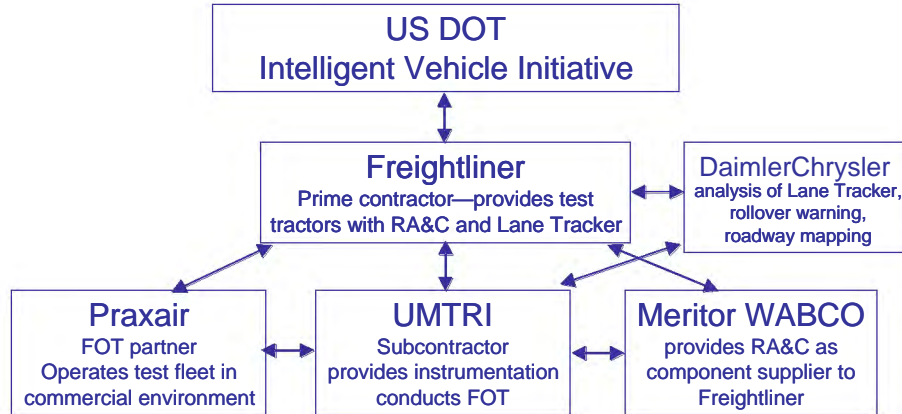

Figure 2-1. The participants in the RA&C FOT

Freightliner Corporation is the largest manufacturer of Class 8 commercial vehicles in the United States. Freightliner participated in the FOT as the prime contractor to the US DOT. The primary purpose of the FOT is to evaluate the effectiveness of Freightliner's RA&C system. The secondary purpose is the evaluation of other advanced technologies of interest to Freightliner and DaimlerChrysler including Lane Tracker and Rollover Warning and Roadway Geometry Mapping. Freightliner's primary role in the technical structure of the FOT was to provide six tractors equipped with prototype RA&C systems.

Freightliner also equipped these vehicles with Lane Tracker and global positioning systems (GPS) and certain components of the instrument system.

Meritor WABCO is a major component supplier to automotive and commercial truck OEMs. Meritor WABCO provides ABS systems for Freightliner vehicles and is the development partner and potential supplier of RA&C with and for Freightliner. In the FOT, Meritor WABCO participated with Freightliner in developing and supplying RA&C systems and supported UMTRI in the maintenance and operation of those systems during the field test.

Praxair is the largest manufacturer of cryogenic liquids and industrial gas products in the U.S. Praxair's role in the FOT was the operator of the test fleet. The fleet was composed of the six tractors supplied by Freightliner coupled with six of Praxair's standard cryogenic nitrogen tank semi trailers. The fleet operated from Praxair's manufacturing and distribution facility in La Porte, Indiana. All FOT fleet activity took place within the context of Praxair's normal commercial operations. Drivers and management at La Porte facilitated and cooperated in the data gathering process both with respect to the objective data taken on-board the vehicles and the subjective data in the form of driver and management opinions. Praxair's home offices in Tonawanda, New York also supported the FOT by providing logistical data such as tractor, trailer, and driver ID numbers, payload volumes, and delivery locations.

UMTRI was responsible for the conduct of the FOT. UMTRI's Human Factors Division was responsible for the experimental design, the collection of subjective data, and for the eventual analyses of both objective and subjective data for the purpose of evaluating the RA&C. UMTRI's Engineering Research Division was responsible for the engineering components of the FOT. Central to this was the design, fabrication, and installation of the data acquisition systems (DAS) used to collect the objective data set. The primary components of the DAS were the instruments and computer systems installed on the vehicles, but DAS also included special servers and related software installed at Praxair's La Porte facility and at UMTRI in Ann Arbor. The total system served to collect and transmit data in an automated fashion which was nearly transparent to the drivers and other Praxair personnel at La Porte. The Engineering Research Division operated and maintained the system during the FOT and was responsible for processing, reduction, and analysis of the data from the vehicle-dynamics perspective.

DaimlerChrysler's role in the FOT was twofold. On a continuing basis throughout the data gathering process, it received vehicle location data (GPS latitude and longitude) from UMTRI, processed that data and returned associated map-matching data files to UMTRI. DaimlerChrysler also performed analyses of objective data in relation to its and Freightliner's interest in Lane Tracker, Rollover Warning and Advanced Roadway

Geometry and Mapping. These analyses and their results are covered in other volumes of this report.

2.2 The RA&C system

RA&C is a composite system whose primary elements are Roll Stability Advisor (RSA), Roll Stability Control (RSC), and Hard Braking Event Detection (HBED).[1] Each of these systems provides advisory messages to the driver via the Freightliner Driver Message Center (DMC). RSC also provides for active slowing of the vehicle via the electronic engine controller. The system includes a Trip and Leg Performance Log for logging and review of travel distance and time, and the number of roll and braking advisories, respectively.

2.2.1 Driver message center

The DMC, shown in figure 2-2, is located at the top center of the instrument panel. It presents a two-line display of text to the driver. (The DMC is used to display many messages associated with the operation of the tractor other than RA&C advisories.) The display is accompanied by push buttons for various selection and control functions. In the context of the RA&C, the primary functions of the push buttons are to allow the driver to acknowledge, and thereby turn off, RSA and HBED advisory messages, and to access and reset the Trip and Leg Performance Log. (In the absence of driver acknowledgment, advisory messages turn off after a prescribed duration of display.)



Figure supplied by Freightliner

Figure 2-2. Location and appearance of the Driver Message Center

2.2.2 Roll stability advisor

Roll Stability Advisor is a training aid intended to advise the driver that he or she has operated the vehicle under conditions that presented a significant risk of rollover. The

intent of RSA is to modify driver performance during turning through real-time driver training; RSA is not intended to deliver immediate warning of rollover. Accordingly, advisory messages are not delivered immediately upon perceiving a risk of rollover, but are delivered a few seconds after the risk is perceived to have subsided.

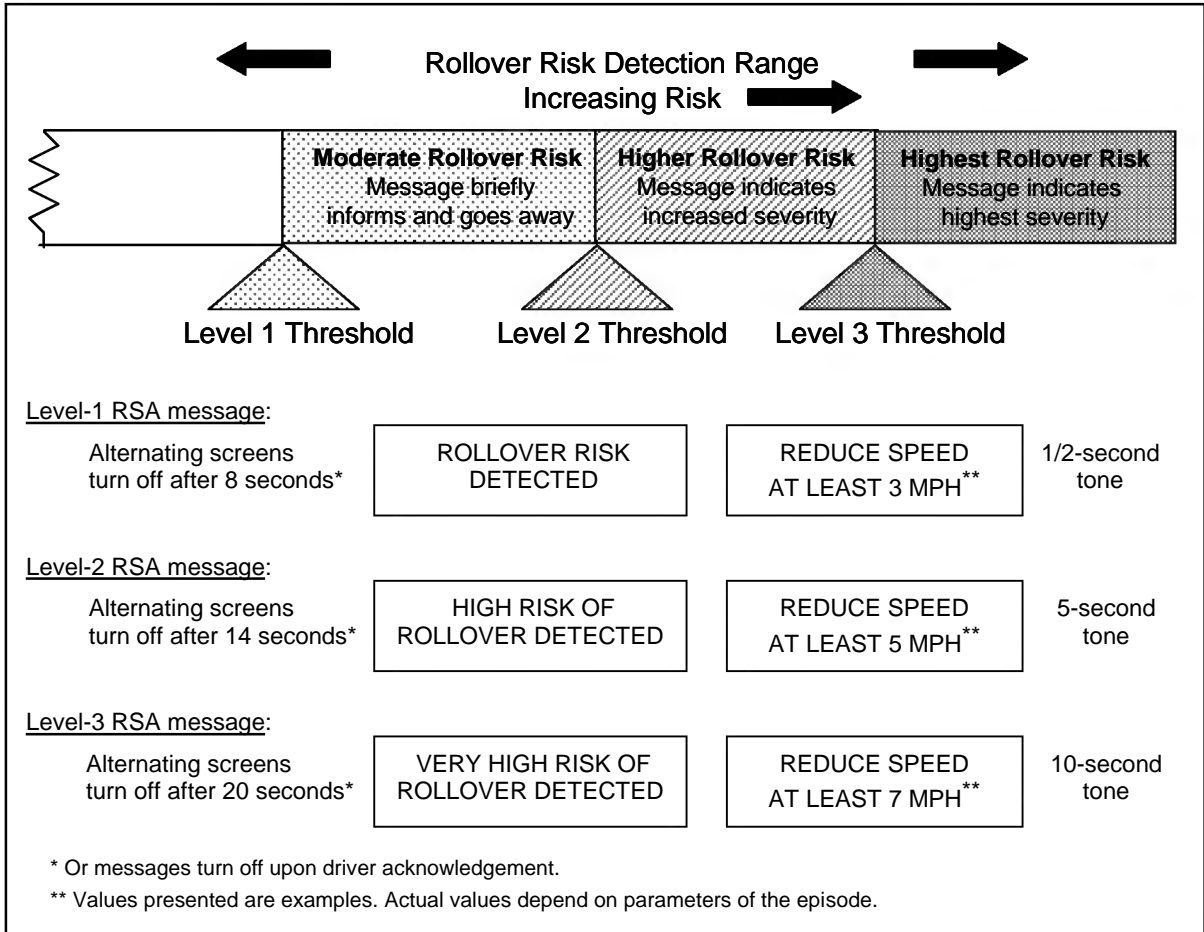

Basis for figure supplied by Freightliner.

Figure 2-3. RSA concept and advisory messages.

Three levels of RSA advisories are defined and communicate increasing severity with increasing potential for rollover. The concept and the specific messages are presented in figure 2-3. Increasing severity associated with the three levels of risk is communicated through the wording of the message, the length of display time, and the duration of an audible alert. The text messages are displayed on two alternating screens: the first presents the qualitative advisory on risk, the second a quantitative advisory for reduced speed. The speed reduction is variable and is calculated based on the observed speed and lateral acceleration during the risky turn. RSA advisories are inhibited whenever vehicle speed is less than 21 kph (13 mph).

2.2.3 Roll stability control

Roll Stability Control is an active control system intended to prevent rollover. When the RA&C system perceives an exceptionally high risk of rollover, it sends a signal to the engine's electronic control unit to reduce engine power and, if deemed appropriate, to apply the engine brake. RSC control is accompanied by an advisory message.

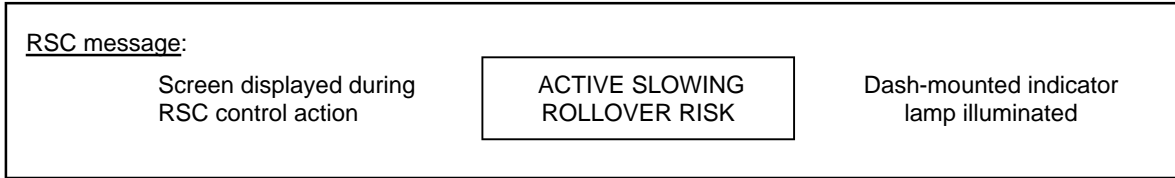

Basis for figure supplied by Freightliner.

Figure 2-4. RSC advisory messages.

2.2.4 Hard braking event detection

Hard Braking Event Detection (HBED), like RSA, is a training aid that advises the driver via the DMC when an unusual braking event is detected. There are three levels of HBED advisories associated, respectively, with ABS activity alone, high deceleration alone, and the combination of ABS activity and high deceleration.

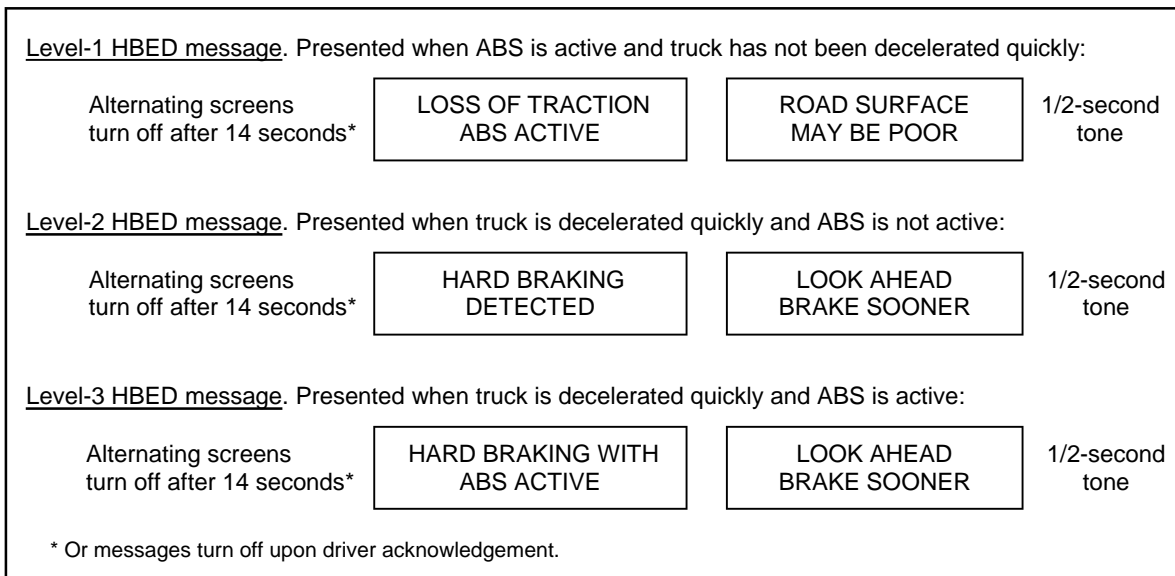

Basis for figure supplied by Freightliner.

Figure 2-5. HBED advisory messages

2.2.5 Trip and leg performance log

The Trip and Leg Performance Log is a memory function providing a record of travel distance and travel time plus the counts of roll and braking advisories during a trip or leg.

The driver may recall this information through use of control buttons associated with DMC. The driver may reset these logs to zero to define the start of a new leg or trip.

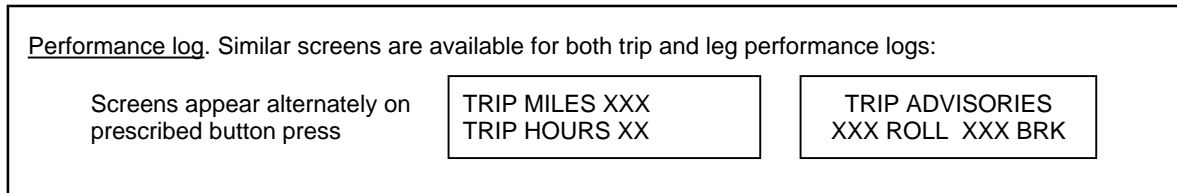

Basis for figure supplied by Freightliner.

Figure 2-6. Trip and leg performance log messages

2.2.6 Implementation

As reported in [1], the basic approach of the RA&C system with respect to roll stability advisories and control is one in which the system first establishes an estimate of the vehicle's roll stability level based on a determination of the vehicle's total mass and a prescribed rule relating mass to stability. Having established the reference acceleration, lateral acceleration of the vehicle is monitored and advisories and control actions are issued essentially on the basis of pre-established thresholds for actual acceleration as a fraction of the reference.

The RA&C function is implemented as an integral part of the tractor's ABS system, supplied to Freightliner by Meritor-WABCO. The electronic control unit (ECU) for the ABS/RA&C is mounted to the tractor frame just forward of the rear suspension (see figure 3-10). In addition to all the signals normally available to the ECU via the ABS sensors (wheel speeds, etc.) and the standard communication buses (vehicle speed, engine speed, engine torque, and many more), RA&C also receives lateral-acceleration information from a laterally oriented accelerometer mounted within the ECU chassis.

According to [1], the RA&C estimates vehicle mass by algorithms "using longitudinal acceleration and propelling force data already available on the vehicle," i.e., change of forward speed and engine torque and speed. Operating lateral acceleration is estimated from the base signal of the RA&C's accelerometer plus analysis of the individual wheel-speed signals. This estimate is processed through proprietary, digital filtering algorithms and an algorithm to estimate trailer acceleration. These algorithms are applied differently to RSA and RSC; RSC, being a control function requires faster response than RSA, which issues advisories only after the event. The processed results are compared to the established reference acceleration. Results that exceed established thresholds trigger the RSA or RSC advisories or actions. Other algorithms establish the speed reduction advisory and the specific RSC control commands which are output to the engine controller. (Note that the ECU also issues engine control commands as part of the normal ABS function.)

Time histories taken from two examples of relatively simple RSA and RSC episodes are presented in figures 2-7 and 2-8, respectively. In figure 2-7, the vehicle is traveling about 70 kph when a left-hand turning maneuver causes the lateral acceleration at the ECU to rise to about 0.27 g and then fall back close to 0 g. The maneuver takes a total of about 7 seconds. When lateral acceleration has declined, and RSA level-2 advisory is issued and is displayed for about 14 seconds. Figure 2-8 shows a similar event. Here the vehicle makes a right turn (negative values of lateral acceleration) and the initial speed is about 90 kph and declining. The maneuver gives rise to a magnitude of acceleration approaching 0.3g. This causes an immediate issuance of an RSC advisory and a series of RSC control messages to the engine controller. The RSC advisory is turned off as soon as the RSC control stops. After the event and RSA level-2 advisory is issued and is displayed for about 14 seconds. An extensive review of RA&C episodes and performance qualities is presented in chapter 7.

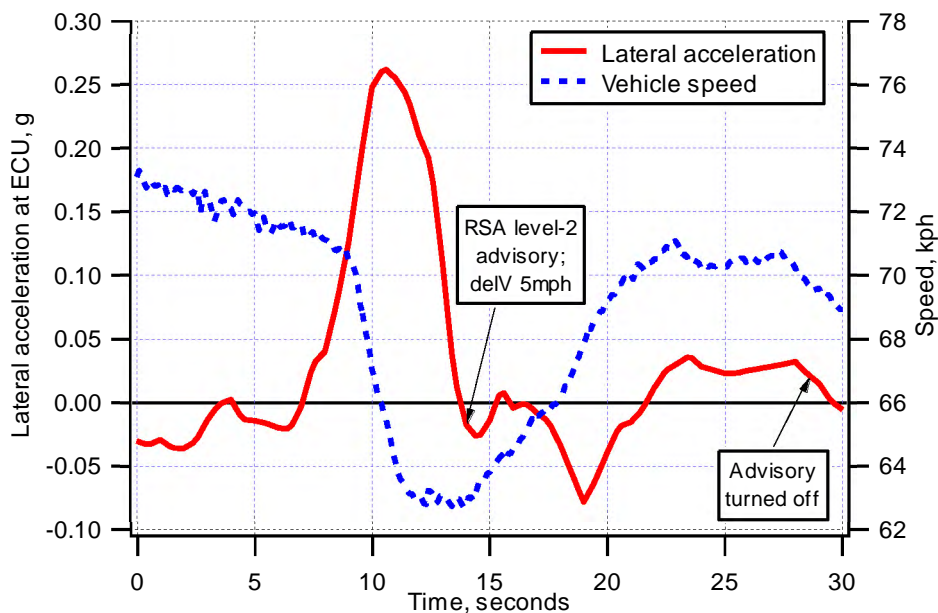

Figure 2-7. Time histories from an episode involving an RSA advisory

2.3 Rollover crashes addressed by RA&C

Heavy truck rollover is a nationwide problem that not only affects those involved in the crashes, but also has far-reaching implications for the country's economy and productivity. Estimates based on the accident record suggest that there are, on average, 14,880 rollover crashes of commercial trucks per year and that over 50 percent result in either an injury or fatality to someone directly involved in the crash.

The UMTRI Survey and Analysis Division conducted analyses of rollover crash data that suggest that approximately 40 percent of rollover crashes (about 6000 annually) constitute the population of rollover crashes which could be addressed by a device such

as the RA&C system involved in this study. Note that this assessment is not a prediction of the actual reduction of rollover crashes which would accrue through the use of this or similar devices. Rather it is an estimate of the entire population of rollover crashes subject to reduction through the use of such devices. Moreover, it is, of course, subject to the limitations inherent to this type of statistical analysis.

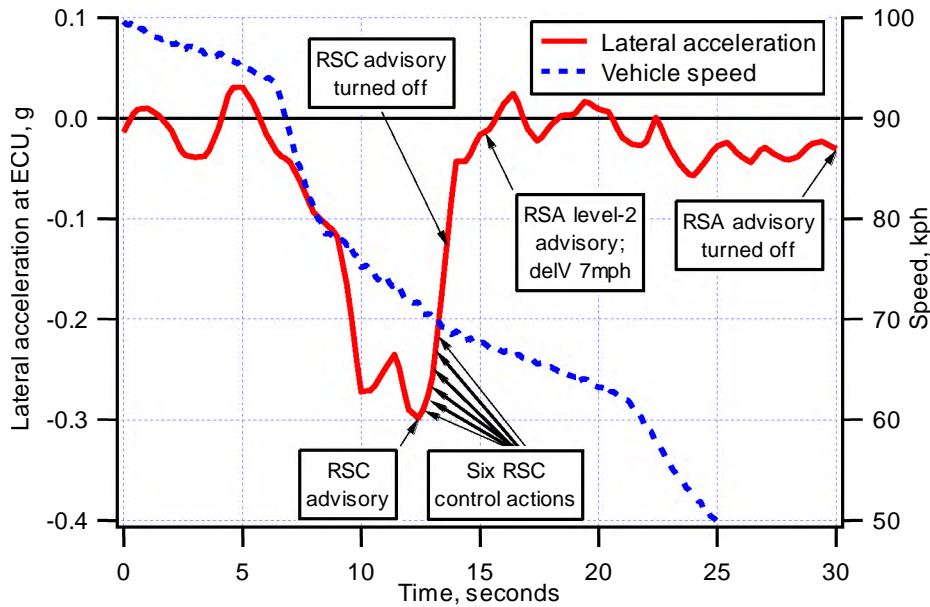

Figure 2-8. Time histories from an episode involving RSC and RSA advisories

Like most problems, truck rollover may seem simple at first but is actually a complex problem that involves interactions between factors that are often difficult to measure and quantify, such as: driver behavior and distraction, road and vehicle design, inter-vehicle environment, weather and visibility, etc. Of course, the data record is not adequate to methodically capture all the relationships between these variables. However, some of these elements have been made part of the accident record that constitutes the national archives of truck-related crashes. These were used in this analysis to make a first-order estimate of the potential impact of a rollover device on mitigating truck rollover.

The primary purpose of the RA&C device is to educate the truck driver about the rollover risk associated with aggressive cornering and, in limited cases, to slow the vehicle during overly aggressive cornering to prevent rollover. Accordingly, the accident data analyses assumed that such devices could be most effective against rollovers that occur as the first event in single-vehicle crashes. These rollovers are most directly the result of a mismatch among the roadway geometry, the maneuver that the truck driver is attempting, and the rollover threshold of the truck. The analyses also assumed that an RA&C-like device may be somewhat beneficial in scenarios in which rollover is not the first event, but follows a run-off-the-road event. On the other hand, it is assumed that

rollovers that occur after a collision with another vehicle or after an evasive maneuver to try to avoid a collision are not likely to be prevented by an RA&C-like device.

Two analyses were conducted. The first analysis was based on UMTRI's *Trucks Involved in Fatal Accidents* (TIFA) file and the national *General Estimates System* (GES) file.[2,3] Both of these archives have national coverage but limited detail. The second analysis was based on more in-depth reports on rollover crashes in North Carolina with the results then projected onto the national truck population.[4] In both cases, the results suggest that approximately 6,000 rollovers or 40 percent of all rollovers, may be prevented by a rollover device. More specifically, the national archive showed 4,404 rollovers annually when rollover was the first event, and an additional 1,830 rollovers when the truck ran off the road prior to rolling over (i.e., rollover was the second event). Similarly, the review of North Carolina police reports yielded a national estimate of 6,086 rollovers that might be addressed by an RA&C-like device. A more extensive review of each of these analyses is presented in appendix A-A.

2.4 The objectives of the FOT

The primary goal of the RA&C FOT was to evaluate the effectiveness of the RA&C as a means of reducing rollover crashes.² This objective is addressed through a rigorous evaluation of whether RA&C changes the turning performance of drivers and whether those changes reduce the risk of rollover crashes.³ (Chapter 8 of this document focuses directly on this objective.) This objective evaluation is augmented with a subjective evaluation based on the opinions of drivers in the study and of their managers (chapter 9).

Complementary to this primary goal, this study sought (1) to enhance the general understanding of the turning performance of commercial truck drivers and (2) to characterize the operation of the RA&C in terms of the physical measures of turning behavior. The first of these complementary objectives is met in part through the detail characterization of the lateral performance of the fleet, and of individual drivers, as set forth in chapter 6. In addition, in chapter 8 the analyses aimed primarily at evaluating RA&C also reveal other important factors influencing turning behavior. The physical

² RA&C is a system in continuing development. Indeed, development of RA&C took place before and during the data-gathering portion of this FOT and has continued since then. Therefore, it is most important for the reader keep in mind that these objectives can only be addressed with respect to the specific version of RA&C that was installed in the test vehicles during the phase of this FOT in which the RA&C system was active. Changes and improvements made in RA&C since that time can not be evaluated in this report.

³ Originally, it had also been a goal of this FOT to evaluate the effectiveness of a third condition, namely RA&C on the vehicle combined with management feedback to the driver based on the reporting of RA&C activity. Difficulties with schedule precluded conducting a third phase of testing which would have formed the basis of this comparison.

characterization of the performance of the RA&C system, *as it was deployed in this field test*, is presented in chapter 7.

The objectives of this FOT also included the investigation and evaluation of other new technologies: Lane Tracker, Rollover Warning, and Roadway Geometry Mapping. This volume deals with these objectives only to the limited extent of describing the data, and the acquisition thereof, that were gathered on-board the test vehicles to service these investigations.

3. THE FIELD TEST

The details of the FOT are covered in this section of the report. Included here are discussions of the fleet operations, the experimental design, and the objective and subjective data collected during the FOT.

3.1 The fleet operations

This section of the report contains background information on the FOT fleet. It is intended to broadly characterize the overall philosophy, practice and operation of the fleet as they pertain to this study.

For purposes of this report, the following terminology is used to define the different segments of the product distribution procedure:

- *tour*: a driver's work shift which may involve multiple legs;
- *leg*: a period over which the product load is constant, which may involve multiple trips;
- *trip*: a period from ignition on to ignition off.

3.1.1 Praxair and the La Porte facility

Praxair is a global, Fortune 500 company with annual sales of \$5.1 billion. The company supplies atmospheric, process and specialty gases, high-performance coatings, and related services and technologies. Praxair's primary products are: oxygen, nitrogen, argon and rare gases (produced when air is purified, compressed, cooled, distilled and condensed), and process and specialty gases -- carbon dioxide, helium, hydrogen, semiconductor process gases, and acetylene (produced as by-products of chemical production or recovered from natural gas).

The fleet involved in this study delivered only liquid nitrogen and was dispatched from Praxair's La Porte, Indiana facility. This facility is located in northwest Indiana approximately 10 miles south of the Indiana/Michigan state line. The facility is a self-contained production and distribution center. Onsite at the facility are all the services and products necessary to maintain and operate heavy-trucks and cryogenic trailers. These services include a maintenance shop, fueling station, weigh scale, driver's building, and associated communications lines that connect this remote operation with the control and dispatch center in Tonawanda, NY. A plan-view of the La Porte facility is shown in figure 3-1.

3.1.2 Delivery and service region for the La Porte operation

The delivery and service region for the FOT was comprised of six states. The great majority of the distance traveled was in Indiana and Michigan, with most travel occurring in the relatively flat regions of northern Indiana and southern Michigan. There were occasional trips to the hillier regions of northern Michigan and southern Indiana and Illinois, but there was no mountain driving. Figure 3-2 shows two maps. The map on the left shows all the roadways traveled during the FOT. The most heavily-traveled routes were:

- I-94 between East Chicago and Benton Harbor, Michigan
- I-196 between Benton Harbor and Grand Rapids, Michigan
- US-31 north of Holland, Michigan
- I-80 between La Porte and South Bend, Indiana
- I-80/90 between La Porte and East Chicago
- US-20 between La Porte and South Bend
- State routes 2 and 39 and US-35 (roads in the immediate vicinity of the La Porte facility)

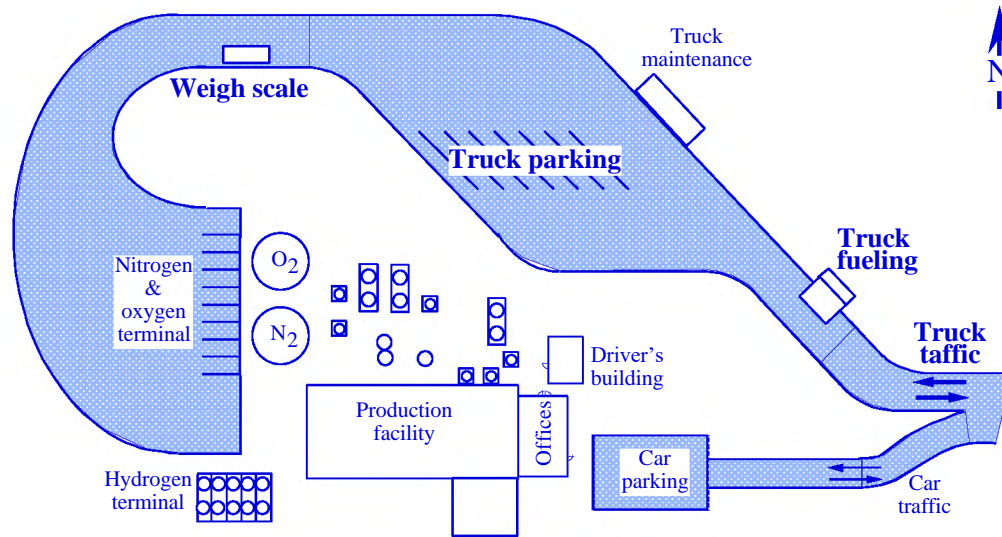

Figure 3-1. Praxair's La Porte, Indiana production and distribution facility

In all there were 1,870 tours during the FOT. Destinations with more than 100 deliveries are shown in the right-side map of figure 3-2. Other interesting statistics related to deliveries and distances traveled include the following:

- Farthest with less than 100 deliveries: Petoskey, Michigan; 440 km; 19 deliveries.
- Farthest with more than 100 deliveries: Kalkaska, Michigan; 378 km; 213 deliveries

- Closest with less than 100 deliveries: La Porte, Indiana; 5 km; 49 deliveries
- Closest with more than 100 deliveries: South Bend, Indiana; 37 km; 1,091 deliveries
- Most: Holland, Michigan, 138 km; 1,558 deliveries
- Total distance traveled: 772,203 km
- Average tour distance: 413 km

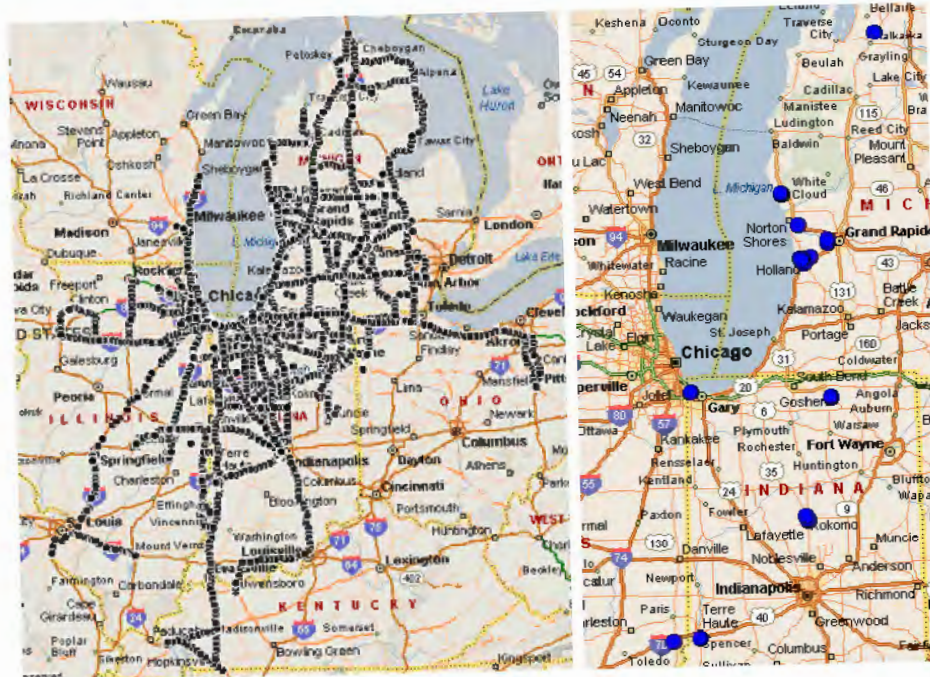

Figure 3-2. Overall distribution and service region for the La Porte facility (left) and destinations with over 100 deliveries during the FOT (right)

3.1.3 The FOT vehicles

For the FOT, Praxair brought six newly-built Freightliner Century Class tractors into its La Porte operation fleet of eighteen tankers. Three of the FOT vehicles are shown in figure 3.3. At the start of this project, the eighteen tankers were comprised of six oxygen, one argon, and eleven nitrogen tankers. Of the eleven nitrogen trailers, however, two were used for long-haul service and one appears to have been removed from service some time prior to the launch of the FOT. Consequently, the remaining eight nitrogen trailers were used in the FOT (the RA&C tractors were restricted to hauling nitrogen tankers only). The distribution of trips for each of the eight trailers is shown in table 3-1.



Figure 3-3. The FOT vehicles

Table 3-1. Count and fraction of trips with each nitrogen trailer

<i>Trailer</i>	<i>Number of Trips</i>	<i>Fraction of all Trips</i>
1	480	.063
2	388	.051
3	794	.104
4	1325	.173
5	1312	.171
6	1152	.150
7	721	.094
8	1484	.194

The general practice at La Porte is to “marry” tractors and trailers. That is to say, unlike many fleets where power units and trailers are interchanged regularly, the La Porte units stay coupled for extended periods and normally are not switched unless a unit needs to be removed from service.

While the restriction of the RA&C device to one kind of tanker was of some benefit, i.e., it reduced variability in the stability characteristics of the vehicles and simplified the rollover stability determination, it was also limited in the sense that little can be said about the device’s general adaptability to other types of trailers.

3.1.4 Drivers

The drivers in the Praxair fleet at La Porte were generally aware of roadway safety concerns. This was clear from informal discussions with drivers at the facility and from

the numerous driver-safety reminders posted on the walls around the driver's area. Praxair is a safety-oriented operation and the company culture appears to take exceptional pride in its awareness of safety issues and maintenance of a good safety record. Corporate-level safety policies, explicitly noted in the Praxair driver's handbook, reinforce this attitude. One policy relevant to the RA&C FOT specifically dictates that drivers negotiate ramps at speeds 10 mph lower than is posted for the ramp. Praxair requires prospective drivers to have a minimum of three years tanker driving experience. Driver compensation levels are high, competition for a Praxair job is great, and driver turnover is low. It is judged that the drivers who participated in the FOT are a mature and skilled group.

At the outset, 23 drivers were involved in the FOT. However, primarily due to layoffs associated with the economic downturn of 2001, eight of these drivers left the program substantially before its completion. Additionally, one driver was excluded from analyses because his involvement in driving operations was approximately 20 percent that of the other drivers (8,380 km versus 41,670 average km). This driver also served in a role as a safety trainer and liaison between management and drivers. Thus, the FOT ended with fourteen subjects with relatively consistent driving exposure throughout the study.

At the start of the field test drivers ranged in age from 37 to 56 years with a median age for the group of 47.5 years. Their truck driving experience ranged from a minimum of eight years to a maximum of 33 with a median experience of 22 years. Specific experience with tankers ranged from three to 23 years (median: 8.5). Most of the drivers reported their specific experience with cryogenic tankers was obtained at Praxair or at Liquid Carbonic, the owner of the facility before it was purchased by Praxair.

3.1.5 The operations

The operations at the La Porte facility are continuous. That is, drivers arrive from and leave for tours at any hour of the day, seven days per week. All tours made from the La Porte facility are scheduled remotely from Praxair's headquarters in Tonawanda, NY. The drivers in the La Porte facility utilize what is commonly called a "bid starting time," that is, they choose their starting time and days of the week to work based on seniority. A typical tour averages about 12 hours from the start to the end of the shift. In general, the majority of product delivery tours made from this facility are accomplished by a single driver in a single shift. The following briefly outlines the normal operation of such a tour.

- At the start of a shift, the driver obtains dispatch instructions from a computer in the driver's building. Instructions include the product to be delivered, identifications and locations of one or more customers to be serviced, a suggested driving route, and the identification of the cryogenic trailer to be used for the

delivery. (Praxair schedules delivery of product by trailer number and does not track power units.)

- The driver proceeds to the truck parking area to identify an appropriate truck for his tour and performs a pre-tour check of the vehicle. The truck's fuel tanks will have been filled at the end of its previous tour, but in most cases the nitrogen tank will not be filled².
- The driver then maneuvers the vehicle to the nitrogen terminal, stopping on the way to weigh the vehicle on the scales. At the product terminal, the vehicle is turned off and product is loaded into the tank. The loading process takes about an hour. The driver then drives the vehicle back to the weigh scales. Both pre- and post-loading weights are recorded and electronically sent to Praxair's main data center in Tonawanda, NY. These scale readings are critical for the business aspect of Praxair's operations since they are the means to accurately determine the amount of product loaded into the tanker.
- The driver then proceeds from the facility to make the deliveries. At each delivery point, the amount of product off loaded is measured by volume using gages on the truck and/or by weight or volume using the customer's facilities. A tour typically requires the majority of a shift. The vehicle ignition may be turned on and off several times as the driver stops for deliveries, regular tire checks, meals, etc.
- The driver returns to the La Porte facility and proceeds directly to the truck-fueling station. The vehicle is turned off and fueled.
- After fueling, the vehicle is moved to the parking area and turned off. The driver then proceeds to the office to complete the paper work and reporting associated with the tour. The vehicle will typically be turned off in the parking area for at least 30 minutes before it is started for another tour.

3.2 The experiment

3.2.1 *The structure of the experiment and constraints of practical realities*

The RA&C FOT is essentially a human behavioral experiment. The central question of that experiment is whether or not the presence of RA&C alters the way drivers operate their vehicles. Of course, the very important analytical extension of that question is: Does RA&C alter driving behavior in a manner to improve safety; specifically, does it reduce the risk of rollover crashes?

² Generally, the trailers were loaded at the La Porte terminal. However, many times during the FOT the drivers were instructed to stop at the Praxair production facility in East Chicago to pick up product. When and how often this occurred depended entirely on the business economics and production capability of these facilities. Although this was somewhat unexpected in the study, it was serendipitous since it resulted in more passes over the same roadway in both loaded and empty conditions.

Conceptually, the prime question might be addressed by an experiment of either a *parallel* or a *serial* form. In a parallel form, two groups of drivers would be involved. Simultaneously, one group would operate trucks without RA&C while the other was operating trucks with RA&C. In a serial form, a single group of drivers would be observed driving first without RA&C and later, with RA&C.³ In either case, data gathering and analyses would be undertaken to attempt to observe significant differences in driving ascribable to the introduction of RA&C.

The parallel form of experiment was dismissed as not workable under the practical constraints of the FOT. Due to our previous experience in conducting a field test examining driving behavior, UMTRI has become acutely aware that the range of behavior across individual drivers is immense. [5] (A fact which was once again observed in this FOT. See section 6.4.) The influence of RA&C on driving, while hoped to be appreciable, was not expected to be large. The immediate implication of these observations was that a parallel experiment would require many subjects in order to have sufficient resolution. But the project was funded for tracking only six vehicles. Moreover, the attractive conceptual quality of a parallel experiment is that the two groups are studied simultaneously and, at least implicitly, under similar circumstances. However, in this FOT, the two groups of subjects would have to be isolated to avoid cross contamination through ordinary conversation about RA&C. That could not be reasonably achievable if the two groups were to both operate from one terminal of a real commercial trucking activity. The two groups, rather, would have to operate from two facilities, and, therefore, run different routes in different weather with different traffic, etc. Additionally, the limited fleet of instrumented vehicles would necessarily be split.

The serial form of experiment was therefore implemented. The experiment would consist of an initial, baseline period (phase 1) in which the driving performance of the subject drivers would be observed without RA&C. Following this baseline period, RA&C would be introduced and the performance of the same drivers would again be observed for a period of time (phase 2). The whole of the observational period would cover approximately one year (see section 3.2.2).

Under this approach, each driver would be thought of as an “experimental unit” that is measured once without *treatment* (baseline driving with no RA&C) and again *with treatment* (with RA&C). Comparisons of driving behavior would then be made between the treated and untreated conditions. Evaluations would be made on a driver-by-driver basis. The pooled set of individual observations of change would be tested for statistical significance.

³ This chronological order is required, of course, since driving without RA&C was the standard condition for drivers prior to the FOT.

However, this serial form of experiment obviously has its own significant drawback, namely that it simply can not be undertaken—within the constraints of real commercial trucking and a one-year time window—without introducing confounding influences. In a perfect experimental design, all factors other than the absence or presence of RA&C (the treatment) that might affect driving performance would be maintained constant across the two phases of observations so that changes observed could be unambiguously attributed to RA&C only. Unfortunately, that is not practical in a field test that takes place in the midst of a real commercial trucking operation. Obviously, projected over a single year, weather and lighting (relative length of day and night) will differ in the two phases. Product demand may vary seasonally or customers may come and go causing different delivery routes to prevail in the two phases. Traffic conditions may vary seasonally. Readers can surely add any number of items to this list.

There are two acceptable choices when dealing with potential confounds: control them or measure and account for them. Since the former was not possible, the latter was undertaken. To maximize the likelihood of observing an effect of RA&C, many sources of variability were measured and considered in the analyses of the performance data.

3.2.2 *Confounding variables*

In a sense, the logic of any experimental design can be understood as an attempt to determine the relationship between the inputs to a system and the outputs of the system. To understand confounding, suppose that two inputs into a system are varied and the changes in output are measured. If the two inputs happened to be correlated with each other, it would not be possible to determine whether one, the other, or both inputs affected the output. The inputs are thus *confounded* with each other. On the other hand, if the two inputs varied independently of each other while the output is measured, it would then be possible to establish a relationship between the inputs and the output of the system.

In this field test, the driver is *the system* under study; the *inputs* are virtually everything the driver experiences during the field test: curves, weather, darkness, trailer loads, activation of the RA&C, different start times, turn directions, ambient temperature, the radio station he is tuned to, other drivers on the roadway, familiarity with the tractor, and other incidental life experiences. The *outputs* we are particularly interested in are measures of driving performance related to the risk of rollover. Obviously, it is impractical to measure all the inputs; we focus only on those that we can reasonably expect to have substantial influence on the driver's performance and that we can reasonably monitor. In this field test, our particular interest is on the effect of the RA&C system on driving behavior, but we also monitored trailer load, curve severity (a surrogate for routing), weather conditions, light conditions, turn direction, and other

variables in the event that they influenced driving behavior independently or in interaction with RA&C.

In particular, it should be recognized that some of these independent variables were, of course, expected to be moderately confounded with phase (i.e., the introduction of RA&C) in ways that would require careful consideration before drawing conclusions about the influence of RA&C. For example, weather conditions and RA&C introduction would probably be moderately confounded because phase 1, the baseline period, would run during winter through late spring while phase 2, when RA&C was activated, would run during late spring through fall. To manage the confound, weather conditions were monitored so that periods before, during, and after active precipitation were identified as “bad” weather; while the other periods were identified as “good”. The rationale was that the “good” weather from each phase would be compared; and that “bad” weather from each phase would be compared—each separately. Likewise, seasonal variation in the solar cycle might influence driving behavior differently between phase 1 and phase 2. In phase 1 daylight hours lengthen as the seasons change from winter to spring; in phase 2, the daylight hours shorten as the seasons change from summer to fall.

The potential confounding influence of routing provided special concern. Within the context of the commercial operation, the obviously important factor of routing could not be controlled but could well be confounded with phase. The drivers in this FOT were dispatched each day based on the varying demands of the market for liquid nitrogen. There was no pre-established timetable for deliveries; delivery destinations were established based on current demand of individual customers. Even with delivery requirements established, drivers were given only a suggested route; specific routing was at their discretion. Seasonal changes in nitrogen consumption or the turnover of customers might influence delivery routes so that drivers’ exposure to risky curves was not uniform across phases. Curve severity was the measure used to monitor the influence of routing. Accordingly, the broad approach was to identify individual curves, rank each according to an independent measure of severity, and eventually to account for turn severity when comparing driving with and without RA&C. (See chapters 4 and 8.)

3.2.3 Schedule

The schedule under which the FOT took place is illustrated in figure 3-3. The project began on October 1, 1999 and concluded September 30, 2002. The central, field activity began in early November 2000 when the first of six test vehicles began service at La Porte with an active data acquisition system. The remaining five vehicles were brought into service over the next several months and were all in operation by late February 2001. At this point, RA&C was physically installed on the vehicles but its operation was fully

inhibited from the point of view of the drivers.⁴ The vehicles operated in this state, designated as phase 1 (Ph 1 in the figure) until the end of May 2001. At that time, phase-2 operation was initiated by installing the necessary driver-interface hardware and fully active RA&C ECUs. Phase 2 of data collection was completed at the end of November 2001.

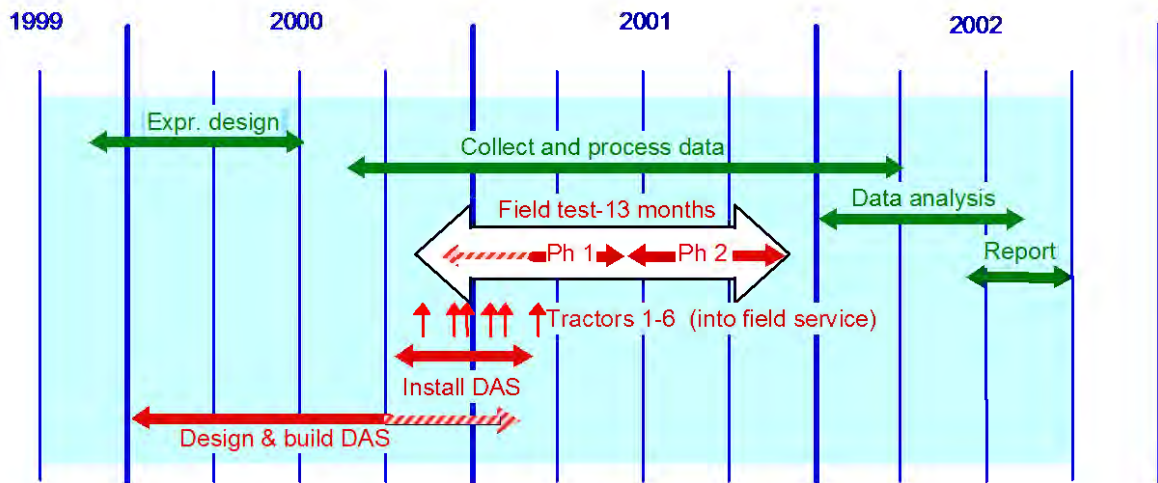

Figure 3-3. The FOT schedule

3.2.4 Drivers —RA&C introduction and training

Characteristics of the drivers in the Praxair fleet have been described earlier in section 3.1.4. At the start of the field test, all drivers were provided with a broad overview of the research goals of the study along with consent forms which stipulated the voluntary nature of their participation in the research. Drivers were initially informed that the study involved an assessment of new safety technologies, but they were not told that the focus was on rollover, nor were they given any knowledge of or information about RA&C specifically. This was done to prevent possible contamination of the baseline performance. That is, we were concerned that drivers' heightened awareness of our interests in rollover hazards might influence their driving so that their baseline driving performance would not be a valid basis for later comparison. We note, however, that the drivers had access to many other sources of information and may well have been more aware of the purpose of the study than was initially revealed, albeit lacking many of the details.

⁴ During phase 1, RA&C ECUs were installed on the vehicles, but driver-interface hardware specific to RA&C was not installed, and RA&C advisories and control functions were not active. That is, in phase 1, RA&C was completely "out of sight" from the drivers' point of view. Data describing the potential behavior of RA&C were gathered during phase 1 and delivered to Freightliner. Adjustments to RA&C algorithms were made by Freightliner and Meritor WABCO, and several versions of RA&C ECUs were installed on the test vehicles during phase 1. When RA&C was activated for phase 2, no further changes were made; the driver's were exposed to only one version of RA&C.

Just prior to the start of activation of the RA&C (in phase 2) each driver attended a 45-minute presentation produced by Freightliner Corporation describing the operation of RA&C. In the presentation, the detailed functions of the Roll Stability Advisor, the Roll Stability Control, the Hard Braking Event Detector, and the performance logging facility were described. A supplemental section to the tractor owner's manual was also provided. Once fully informed of the nature of the RA&C, drivers were reminded that their participation in the FOT was voluntary.

No "hands-on" training occurred when the RA&C was introduced because the RA&C was designed to be simple enough to use that required training would be either minimal or unnecessary. Indeed, it was thought that, should RA&C enjoy wide introduction into US trucking, it would require minimal or no training (or, more to the point, would probably take place with little or no training whether or not training was desirable). However, to fulfill our obligation to inform participants in the study, a formal orientation was conducted with the assistance of Freightliner.

3.2.5 *Comparable and non-comparable drivers*

A distinction is made in this report between *comparable* drivers and *non-comparable* (or excluded) drivers to distinguish between drivers whose data constitute the core analysis of the effect of the RA&C on driving behavior (comparable drivers) and those drivers whose data are primarily used to characterize curve severity (non-comparable drivers). These two categories of drivers were created by necessity in the wake of two waves of driver layoffs and other attrition which halted data collection on some drivers. Because non-comparable drivers received only partial exposure to the RA&C or none at all, their phase-2 data were not directly comparable to the other drivers in the study. Thus, these data were excluded from the main analyses of driving behavior. (We note that layoffs were based on driver seniority with Praxair and not systematically related to driver performance.) Although the *non-comparable* driver data were excluded from the analyses of driving behavior, these data were used (1) in describing the overall exposure and experience of the fleet in chapters 5 and 6 and (2) to establish the curve severity measures described in chapter 8.

3.3 Data collection

Data collection for this FOT consisted of both objective and subjective information. The objective data were derived from many sources including newly installed and existing sensors and electronic control units (ECUs), GPS, the internet, and Praxair's logistical and fleet management system. The subjective data collection consisted of driver and management opinion on heavy-vehicle safety and driving, along with substantive feedback on the installed RA&C device. The objective data were primarily collected by the data acquisition system (DAS) while the subjective data were collected in the form of

personal interviews, periodic written questionnaires, and a final debriefing. This section of the report presents the details of this data collection task. The subsections that follow cover the subjects listed below:

- Tractor-installed sensors and hardware
- Data collection hardware, software, format, and recovery
- Tractor-based objective data
- Other objective data
- Hardware related data collection problems
- Data collection problems
- Subjective data

3.3.1 Tractor-installed sensors and hardware

The sensors and hardware on each FOT vehicle were installed to monitor and measure four broad areas of interest: vehicle driving performance, RA&C performance, driver activity and operating environment. Some of the information needed in the study already existed on the controller area network (CAN) of the tractors and was readily available to the DAS. However, a number of sensors had to be installed specifically for this study. These were:

Air-spring pressure transducer—installed to calculate the static drive-axle suspension load and estimate the total vehicle mass. This transducer is shown in figure 3-4 below.

Atmospheric pressure transducer—used by Freightliner to measure the atmospheric pressure for monitoring short-term changes in road elevation.

Brake-pedal pressure transducer—used to measure the air-brake pressure at the treadle valve. This transducer is shown in figure 3-5.

Driver acknowledge switch—a button on the driver/vehicle interface (DVI) to acknowledge a RA&C message and terminate the RA&C visual and audio advisory.

GPS—an independent GPS unit and antenna. The unit itself was incorporated into the DAS box and the antenna was mounted in the center of the cab roof toward the rear (see figure 3-6 and figure 3-7).

Ignition switch—a wire tap on the ignition used as a logical signal to indicate vehicle ignition state.

Lane Tracker system—a vision-based system that measures the lateral offset of the vehicle from the forward-lane boundary demarcations. This device was installed in the headliner of the cab (see figure 3-8) and the camera was mounted in the upper portion of the windshield (within the sweep of the wiper) 21 cm to the passenger-side of the tractor centerline.



Figure 3-4. Location of air-spring pressure transducer

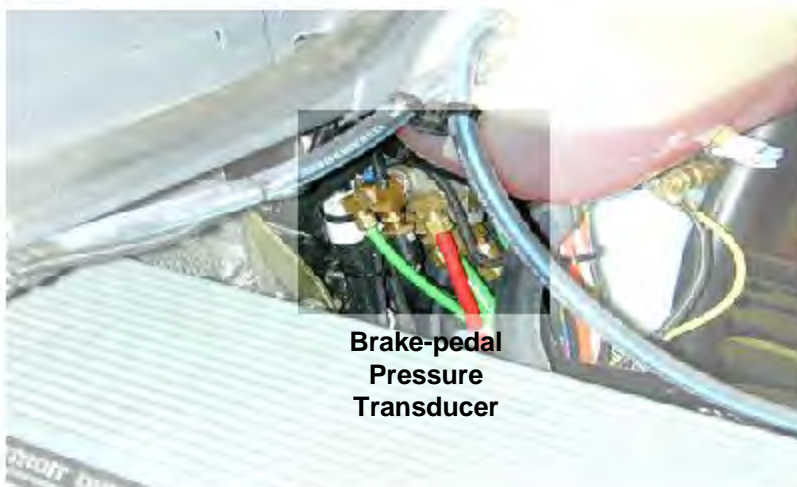

Figure 3-5. Location of brake-pedal pressure transducer

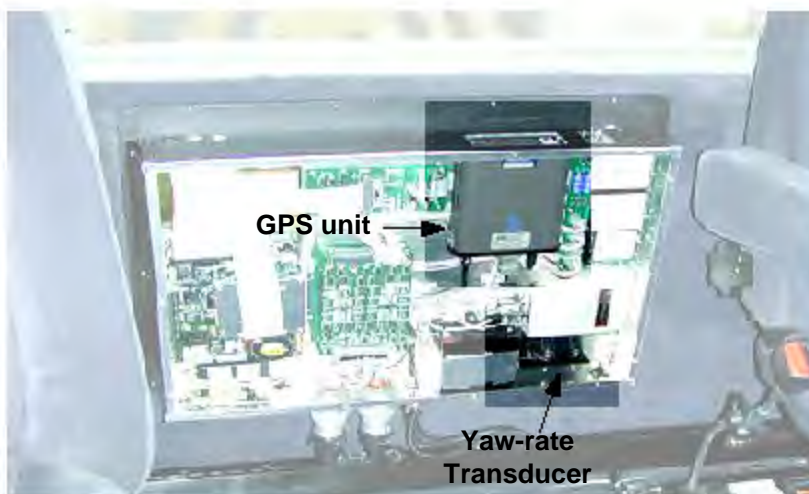

Figure 3-6. Location of GPS and yaw-rate transducer

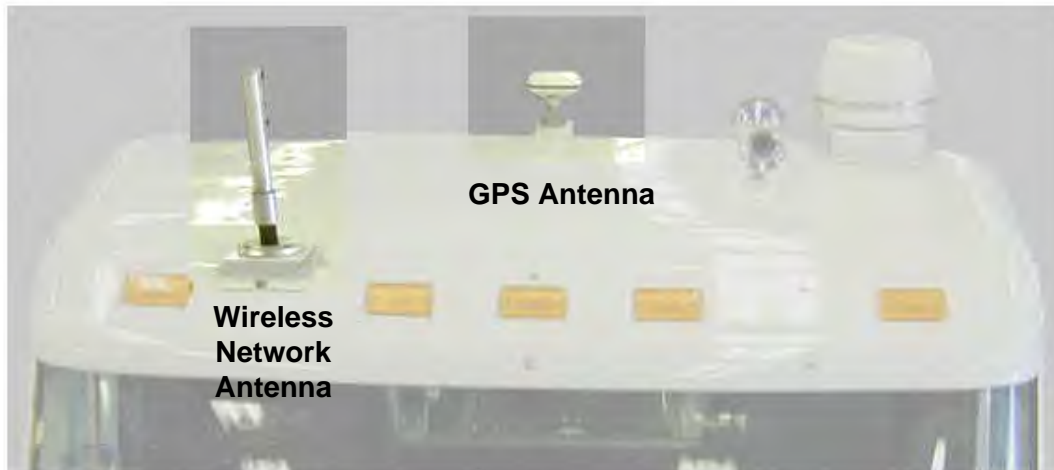

Figure 3-7. Location of wireless network and GPS antennas

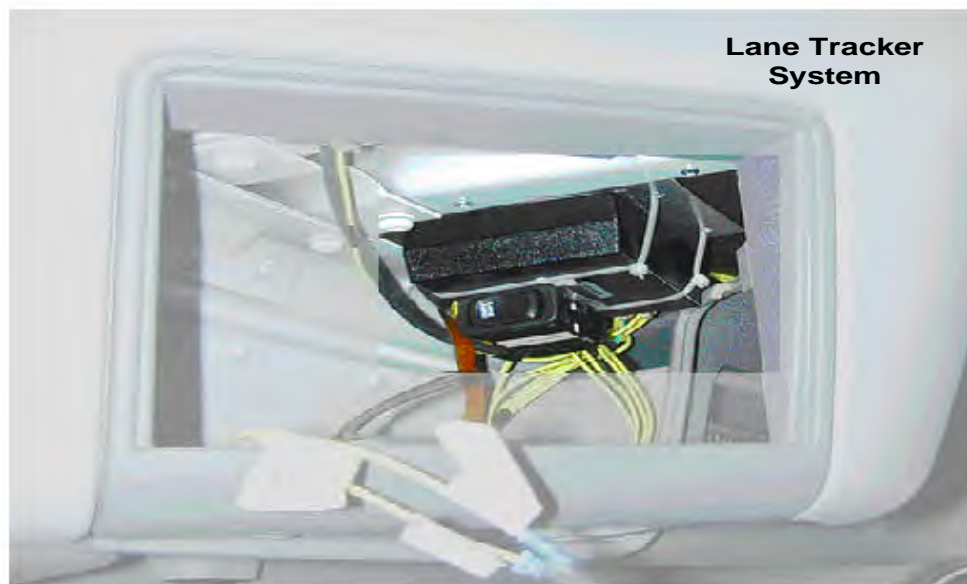

Figure 3-8. Location of Lane Tracker System

Lateral-acceleration transducer—this transducer was mounted on the front axle and was used to provide, as nearly as practicable, a measure of the acceleration lateral to the vehicle and parallel to the road surface. The transducer is shown in figure 3-9.

Load-transfer transducer—this transducer, installed and used by Freightliner, measured the side-to-side load transfer of the tractor's drive-axle suspension. The signal was derived by measuring the torsion in a light-gage anti-sway bar.⁵

RA&C electronic control unit—this system was incorporated as part of the ABS controller in a black box mounted on the inside of the right-frame rail near the fifth wheel (see figure 3-10).

⁵ These devices failed relatively early in the field test and were not replaced.



Figure 3-9. Location of the lateral acceleration and temperature transducer



Figure 3-10. Location of RA&C ECU

Temperature transducer—used to measure the temperature of the lateral-acceleration transducer on the front axle. This sensor was used to compensate for the influence of temperature on the lateral-acceleration transducer.

Wiper state switch—used to indicate the state of the windshield wipers from a hard-wire input direct from the wiper switch on the DVI.

Yaw-rate transducer—used to measure the vehicle yaw rate. This transducer was mounted in the DAS, close to the center-of-gravity of the tractor. This transducer is shown in figure 3-6.

3.3.2 Data collection hardware, software, format, and recovery

The data collection hardware for this FOT was comprised of three main components: the DAS on-board the RA&C test vehicle, the La Porte network and server, and the Ann Arbor network and server. The relationship and connectivity of these three elements is shown in figure 3-11.

The elements on the test vehicle included the DAS computer with its CPU, various interfaces and a flash disk, GPS, several transducers, power supplies and signal conditioning equipment⁶, and a wireless Ethernet unit for transmitting data files from the vehicle to the La Porte server. From there, the data files were automatically copied to the Ann Arbor server via a dedicated, leased communication line. The shaded elements in the figure were provided and installed by UMTRI; the open elements were provided and installed by Freightliner. A more substantive discussion of these three data collection components follows.

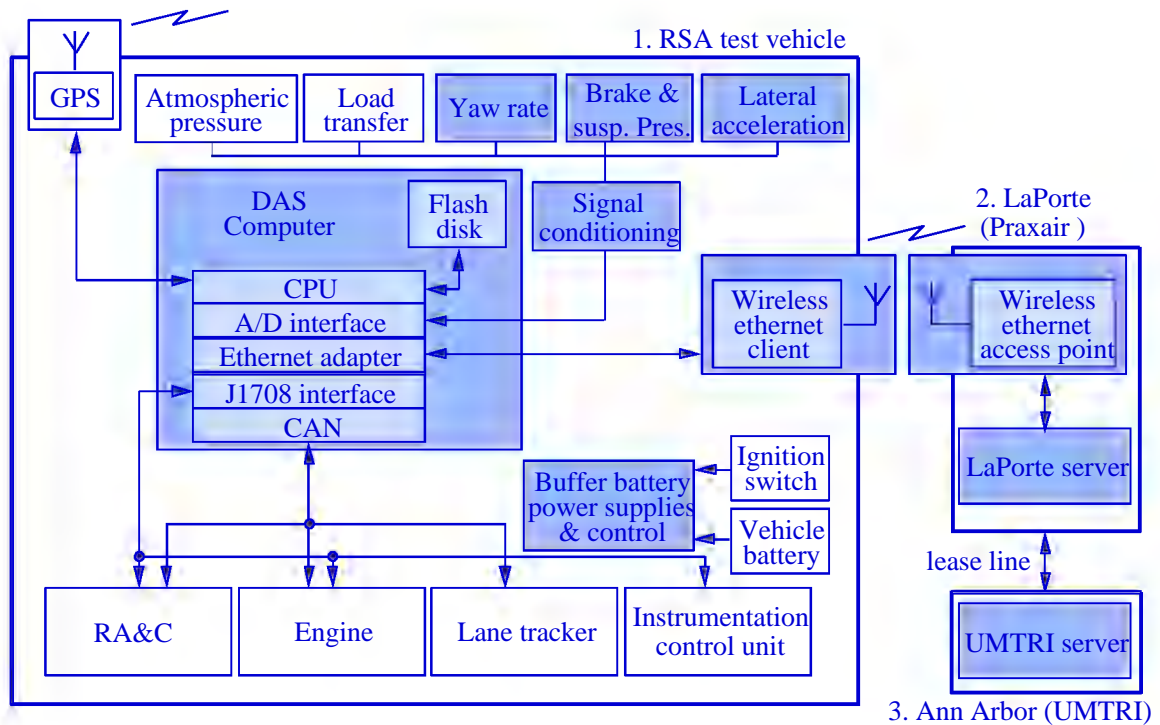

Figure 3-11. The DAS system including vehicle, La Porte, and Ann Arbor components

The RA&C test vehicle

In this study, the primary component responsible for the success of the FOT was the DAS computer. This system was the core of the test vehicle and performed many critical functions. Foremost, it interfaced with sensors and data buses to gather, process, and log

⁶ All analog channels had a 4-pole Butterworth filter with a cut-off frequency of 2 Hz.

the measures critical for the documentation of the vehicle motions and driver performance. A picture of the DAS, as installed in each FOT tractor, is shown in figure 3-12. The main components of the DAS were a 266 MHz CPU with 128 MB of random access memory and a 320 MB flash hard drive.

By design, the DAS was transparent to the driver in that it did not require any external manual control and was fully automated in terms of start-up, shut-down, networking, file creation/deletion, and transfer.

Typically, the DAS on the test vehicle was on when the vehicle was on and off when the vehicle was off, booting up when the ignition was turned on and shutting down in an orderly fashion when the ignition was turned off. The DAS reads and processes all the data channels whenever the vehicle ignition was on. The control logic to handle these tasks is shown in figure 3-13. The figure shows the various paths the DAS logic follows to ensure proper functioning and to minimize the potential for lost data, either through corrupted files or interrupted processes.



Figure 3-12. Installed UMTRI on-board data acquisition system

The most common path in figure 3-13 starts with an ignition-on event that initiates boot-up of the DAS computer. After boot-up, a trip counter is incremented, variables are initialized, and new files are opened for the trip. In most cases, this is followed by an ignition-off event, offsite of the La Porte terminal (i.e., upload is false), which causes the DAS to write and close relevant files, complete shutdown procedures, and turn itself off.

However, if the ignition-off event occurs within the parking area of the La Porte terminal, as determined by the GPS latitude and longitude, DAS begins an upload procedure that closes all relevant files, starts the networking services, searches and connects to the La Porte data server, and uploads new files to the server. Following the upload, the DAS deletes selected files from its memory using a list generated by querying a database that resides on the La Porte server. Then, if the ignition is still off, the DAS begins shutdown procedures and turns itself off. Although not shown in the DAS logic, a fail safe mode was programmed into the system. In the event that the DAS computer malfunctioned and could not shut-down properly, power to the computer would automatically be shut off after 20 minutes. This prevented both the DAS battery and the vehicle batteries from being inadvertently drained if the vehicle was parked for a long time with the DAS computer running and locked up.

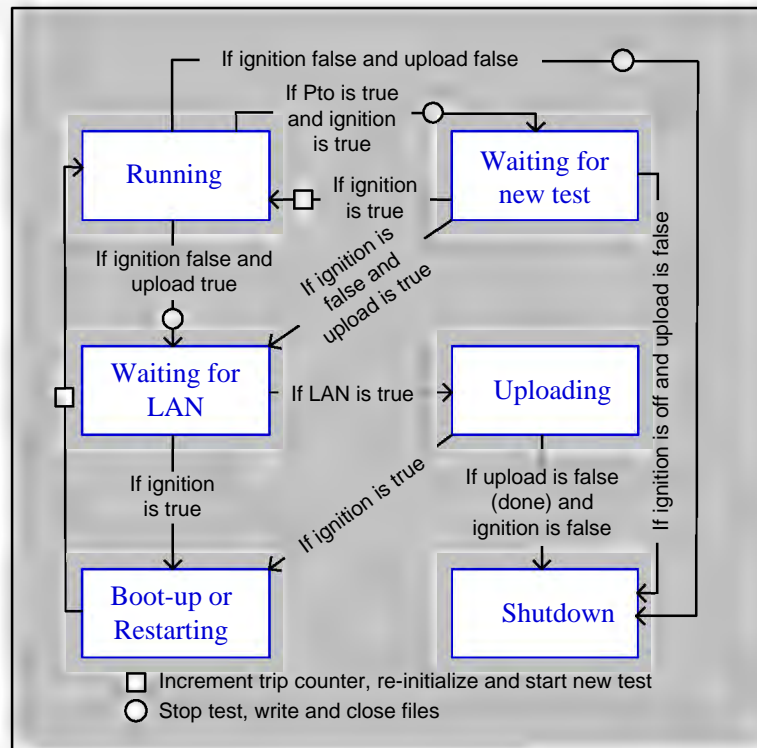

Figure 3-13. Control modes and logic for the FOT DAS

The logic gets more complicated when the ignition comes on during the time when the DAS is either connecting or uploading to the server. (These events can take many minutes.) If this occurs the current process is interrupted, the operating mode changes to restart, and a new test is started.

There was one exception to the ignition-cycle event that starts a new trip on the DAS. When deliveries were made, off-loading product was done by running a pump powered by the tractor power-take-off (Pto). To operate the Pto the tractors had to be running, and since there was a general desire to segregate trips by load condition, a special rule was

added to the DAS control logic that would start a new test if the Pto was on for more than 15 minutes (near the minimum time required to off-load product).⁷

The DAS also had a maintenance mode of operation. When a special key was inserted on the bottom of the DAS, the computer started in manual control mode. This mode was for updating and troubleshooting tasks required during the FOT. Since all elements of the data collection system were on the same network vis-à-vis the wireless and lease-line, updating and maintaining the DAS computer could be, and usually was, accomplished remotely from UMTRI in Ann Arbor. (UMTRI engineers would call the Praxair on-site mechanics and have them insert the key and start the tractors.) This offsite control of the on-board computers was enormously beneficial to productivity in that it reduced the number of trips to La Porte and, more importantly, minimized interruption to Praxair's business.

La Porte and Ann Arbor network and servers

Two servers were installed specifically for this FOT: one in the offices of the La Porte terminal and one at UMTRI in Ann Arbor. In La Porte, the primary function of the server was to receive and temporarily store data files collected by the DAS. These files were automatically copied from the DAS to the server via a wireless network whenever the tractors were parked in the designated parking area of the La Porte terminal (see figure 3-14). The La Porte server also maintained a catalog of information on the state the FOT files (downloaded, copied to UMTRI, loaded into the database, backed-up to tape, flagged for deletion, etc.) and allowed software running remotely at UMTRI to manage and control the existence of files on-board the DAS of each tractor.

The Ann Arbor server located at UMTRI connected to the La Porte server via a dedicated lease-line. This level of network connectivity was important in terms of both data transfer rates (over 25 GB came off the FOT tractors) and continuous connection between Ann Arbor and La Porte. Scheduled procedures running on the Ann Arbor server would automatically "look" at the La Porte server for new files and copy them to Ann Arbor. Then loading programs would process the files, uploading them into the appropriate tables in the main FOT database residing on the Ann Arbor server. The files would then automatically be moved to a different folder for archiving. Upon successful completion of the file managing and loading tasks, the procedures on the Ann Arbor server would update the file status flags on the La Porte server so that the DAS operating system could delete the appropriate files the next time it connected to the La Porte server.

⁷ The decision to use 15 minutes was a compromise in the sense that there were many times when new trips were generated even though no product was delivered. Apparently, it is common practice for the Praxair drivers to turn on the Pto, without the pump, when they want their tractor to idle for an extended period of time.

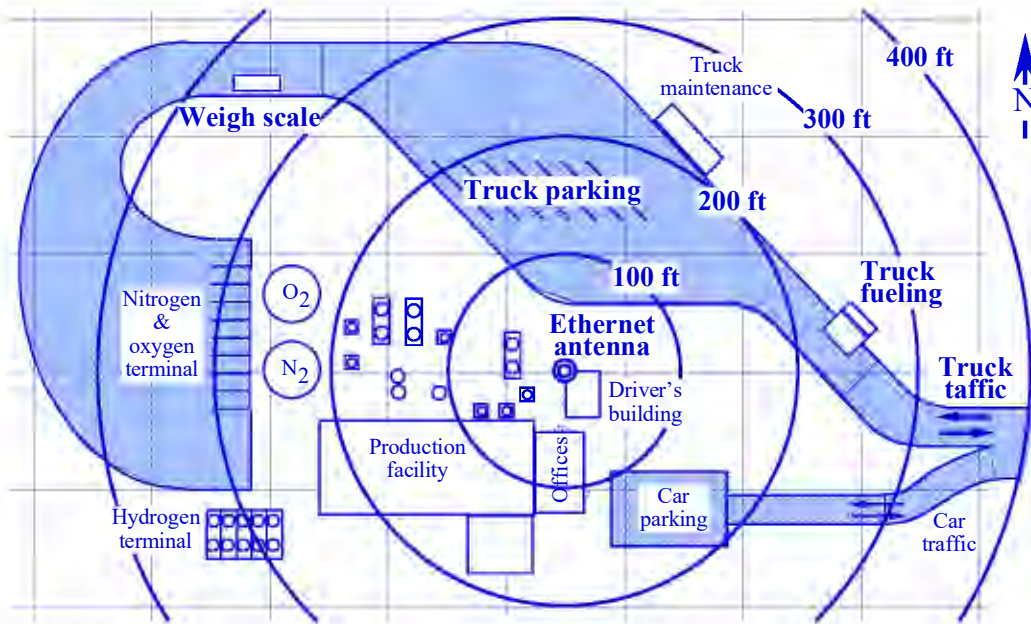

Figure 3-14. Plane view of the Praxair facility at La Porte

Clearly, 24-hour automation was important for the efficient operation and maintenance of the entire data collection process. After all, the Praxair fleet operates on a fulltime schedule with tractors (and consequently FOT data files) arriving at the distribution terminal at all times of the day and night and on any day of the week. Furthermore, the DAS flash memory hard disk (a choice driven by their broad temperature specification) had a relatively limited memory size (320 MB), making the task of file management important to avoid losing data due to insufficient disk drive space. Calculations done shortly after the start of the FOT showed that a typical tractor could collect data for 7 to 10 days before the flash disk memory was exceeded.

3.3.3 Tractor based objective data

Data collected on the FOT tractors were organized by trip, where a trip was defined by an ignition cycle or a Pto event lasting more than 15 minutes. For every trip six different files were generated, uniquely named and saved to disk by the DAS. Table 3-2 shows the six different files, their format, and an example file name (tractor 4, trip 25).

Table 3-2. Files generated for each trip in the FOT

<i>File Type</i>	<i>Format</i>	<i>Example Name</i>
Ten	Triggered series	Ten_4_00025.bin
Two	Triggered series	Two_4_00025.bin
Byte	Transition	Byte_4_00025.bin
Float	Transition	Float_4_00025.bin
Summary	Summary	Summary_4_00025.bin
Summary2	Summary	Summary2_4_00025.bin

A description of each format follows:

Triggered series—these files are time-history in nature (i.e., records are written to the file at a constant frequency). The data written to the Ten file was recorded at 10 Hz., while data written to the Two file was recorded at 2 Hz. Both of these triggered series files were gated by the parking brake channel. In other words, the data channels in the Ten and Two files were not saved to disk when the tractor parking brake was on.

Transition—data are logged to these files upon a transition in value. The name of the transition file indicates the format of the logged value. Byte-transition events can have a value between 0 and 255, while Float transitions can have values between -3.40E+38 and 3.40E+38. The data actually logged for each transition event are the channel identification number, the transition value, and the time that the value changed.

Summary—these files contain histograms and trip-summary numbers. The data in the summary formatted files are stored as one record and are only saved to disk at the end of a trip. The structure and mapping of a summary file is complex as this type of file contains a mixture of data types.

The total size of the FOT raw data files is shown in table 3-3. In all, the DAS recorded data for 10,219 trips and for a total of more than 25 GB of data. The Ten and Two files were the bulk of the 25 GB comprising just over 99 percent of the total data set from the FOT tractors.

Table 3-3. Total size of the FOT raw data files

<i>Name</i>	<i>Bytes/Record</i>	<i>Records</i>	<i>Total Size, MB</i>	<i>Percent</i>
Ten	53	374708212	19859.5	79.37
Two	67	74261849	4975.5	19.88
Byte	10	2974153	29.7	0.12
Float	13	144493	1.9	0.01
Summary	1408 1	10219	143.9	0.58
Summary2 ⁸	1553	7744	12.0	0.05

The relationship among the six different file types shown in table 3-2 and all the measures from the various sensors and hardware on the tractors is shown in table 3-4⁹. This table is a complete list of all logged measures sorted by file type and channel name. The columns of table 3-4 are defined as:

- Id—a unique identification number

⁸ The Summary2 file was added to the set of collected files in March, 2001. Consequently there were only 7,744 Summary2 files versus 10,219 Summary files.

⁹ This table lists only those channels that were saved to disk.

- File Type—indicates in which file the data are stored and consequently their format and frequency, i.e., 10 Hz, 2 Hz, transition or summary
- Channel Name—a unique name that generally maps into the field name of the relational database
- Data Type—the size and type of the logged measure
- Units—the units of the channel as logged, where applicable
- Description—a short note that describes the channel in words
- StyleId—a pointer into table 3-6. StyleId only applies to channels of the data type Byte and is used to relate a number between 0 and 255 with a particular state. For example, the channel GpsFix (File type Two; Id 53) has a StyleId = 17, which means a value of 1 for this channel indicates a differential GPS. A value of 0 is base GPS.

Table 3-5 defines the histograms that were saved to disk during the FOT. The fields of this table are defined as:

- Name—a unique name
- Id—a unique identification number
- Description—a short note that describes the histogram in words
- SourceName—the name of the source channel that constitutes the histogram
- GateName—the name of the channel that must be “true” in order for the source channel to be binned into the histogram
- SortName—the name of the categorical sorting channel. For example, if the source channel is Air-Spring Pressure and the sorting channel is Gear, a separate Air-Spring Pressure histogram will be made of for each value of Gear.
- Center—an example bin-center value
- Width—the bin width value
- Min—the minimum bin value
- Max—the maximum bin value

3.3.4 Other objective data

A substantial amount of data was collected from sources other than the on-board DAS. This section, describes these other sources of information including:

- Praxair product fill and scale data
- The on-board Fleet Advisor system that is used by the drivers and Praxair management to document and monitor driver hours and activity while delivering product
- Praxair delivery and customer location data
- U.S. Weather Service data and maps for estimating the weather conditions in the location of the FOT vehicles while on the road
- GPS-based map matching information to identify different road types

Table 3-4. List of all non-proprietary channels logged by the DAS

<i>Id</i>	<i>File Type</i>	<i>Channel Name</i>	<i>Data Type</i>	<i>Units</i>	<i>Description</i>	<i>StyleId</i>
88	Byte	AtcActive	Byte	none	Automatic traction control active	11
28	Byte	CruiseEnable	Byte	none	Cruise enable switch from J1939 VSC1	2
34	Byte	CruiseState	Byte	none	Cruise state from J1939 VSC1	12
76	Byte	DriverAcknowledge	Byte	none	Driver has acknowledge a RA&C message by pressing the key	1
134	Byte	Gear	Byte	none	Calculated gear via engine speed and speed	27
160	Byte	MessageDisplayed	Byte	none	True if RA&C message was displayed	1
91	Byte	OnScales	Byte	none	True if tractor is near (50 ft radius) the scales.	1
24	Byte	ParkingBrake	Byte	none	Parking brake status from J1939 VSC1	11
152	Byte	Pto	Byte	none	True if Pto governor is on	11
77	Byte	RscActive	Byte	none	On if RA&C is controlling torque	11
161	Byte	TorqueLimitSource	Byte	none	Source of torque limit command	31
145	Byte	TurnSignal	Byte	none	Filtered TurnSignalRaw to remove the blink.	11
74	Byte	WarningMessage	Byte	none	Advisory message number from abs MID 226	21
37	Byte	WiperState	Byte	none	Wiper state from digital input	15
89	Float	AtcCommand	Single	%	Automatic traction control torque limit command	0
75	Float	DeltaV	Single	kph	Delta v reported by abs RSA advisory message	0
141	Float	MaxRsaScore	Single	%	Maximum RSA score when RSA score goes above 70	0
163	Float	RetarderCommand	Single	%	Engine retarder command	0
78	Float	RscCommand	Single	%	Torque limit command from TSC1_E 1939 message	0
33	Float	SetSpeed	Single	kph	Set speed from J1939 VSC1 resolution = 1kph	0
162	Float	TorqueLimitCommand	Single	%	Engine torque limit command	0
111	Summary	AccelPedalHist	Histogram	none	Histogram of accelerator pedal	0
135	Summary	AirSpringHist	Histogram	none	Histogram of filtered air spring pressure	0
115	Summary	AyHist	Histogram	none	Histogram of lateral acceleration with large bins	0
118	Summary	BrakePressureHist	Histogram	none	Histogram of brake pressure	0
136	Summary	Distance	Single	km	Integral of speed	0
151	Summary	DistanceEngaged	Single	km	Distance with cruise on	0
150	Summary	DistanceWipers	Single	km	Distance with the wipers on	0
119	Summary	EngineSpeedHist	Histogram	none	Histogram of engine speed	0
120	Summary	EngineTorqueHist	Histogram	none	Histogram of engine torque	0
121	Summary	GpsSpeedHist	Histogram	none	Histogram of speed from GPS	0
99	Summary	LeftOffsetHist	Histogram	none	Histogram of LeftOffset from Lane Tracker.	0
123	Summary	LoadTransferHist	Histogram	none	Histogram of load transfer	0
100	Summary	RightOffsetHist	Histogram	none	Histogram of RightOffset from Lane Tracker.	0
86	Summary	SpeedHist	Histogram	none	Histogram of speed	0
149	Summary	TripDay	Double	none	Day of trip in access date/time format	0
129	Summary	YawRate25to50Hist	Histogram	none	Histogram of yaw rate for velocity btw 25 and 50 kph	0

<i>Id</i>	<i>File Type</i>	<i>Channel Name</i>	<i>Data Type</i>	<i>Units</i>	<i>Description</i>	<i>StyleId</i>
130	Summary	YawRate50to75Hist	Histogram	none	Histogram of yaw rate for velocity btw 50 and 75 kph	0
131	Summary	YawRateGe75Hist	Histogram	none	Histogram of yaw rate for velocity above 75 kph	0
132	Summary	YawRateLt25Hist	Histogram	none	Histogram of yaw rate for velocity below 25 kph	0
157	Summary2	AyNarrowHist	Histogram	none	Histogram of lateral acceleration with large bins	0
155	Summary2	FirstDeltaTime	Long Int	dsec	Difference between TestTime and GpsTime at beginning of test	0
153	Summary2	FirstTestTime	Long Int	dsec	TestTime at start of test	0
156	Summary2	LastDeltaTime	Long Int	dsec	Difference between TestTime and GpsTime at end of test	0
154	Summary2	LastTestTime	Long Int	dsec	TestTime at end of test	0
22	Ten	AccelPedal	Single	%	Accelerator pedal from J1939 EEC2 resolution = .4%	9
83	Ten	AirSpringPressure	Single	kpa	Pressure of air spring	0
85	Ten	AtmPressure	Single	bar	Atmospheric pressure via pressure transmitter	0
92	Ten	Ay	Single	g's	AyRaw corrected for temperature.	22
80	Ten	AyTemperature	Single	deg C	Temperature of Ay sensor	0
27	Ten	Brake	Byte	none	Brake pedal from J1939 VSC1	10
82	Ten	BrakePressure	Single	kpa	Brake treadle pressure measured by pressure transducer	0
136	Ten	Distance	Single	km	Integral of speed	0
25	Ten	EngineSpeed	Single	rpm	Engine speed from J1939 EEC1 resolution = .125 rpm	13
26	Ten	EngineTorque	Single	%	Engine torque from J1939 EEC1 resolution = .1% offset = -125%	14
84	Ten	LoadTransfer	Single	fsc	Lateral load transfer	30
148	Ten	Speed	Single	kph	Speed via corrected SpeedRaw	8
17	Ten	TestTime	Long Int	dsec	Time since midnight utc in deciseconds	0
96	Ten	YawRate	Single	deg/sec	YawRateRaw - YawRateZero	24
53	Two	GpsFix	Byte	none	Indicates type of position fix from POS message. Raw=0, Differential =1	17
49	Two	GpsSpeed	Single	kph	Ground speed from GPS	8
52	Two	GpsTime	Long Int	sec	Time since midnight utc in deciseconds	0
54	Two	HDOP	Short Int	none	GPS horizontal dilution of precision times 10	0
47	Two	Heading	Single	deg	Heading from GPS	0
46	Two	Height	Single	m	Height above the ellipsoid from GPS	0
43	Two	Latitude	Double	deg	Latitude from GPS	18
72	Two	LeftOffset	Single	m	Offset from left lane edge - Lane Tracker message byte 5 - 2cm steps	20
44	Two	Longitude	Double	deg	Longitude from GPS	19
48	Two	NumberOfSats	Byte	none	Number of satellites used in fix	0
73	Two	RightOffset	Single	m	Offset from right lane edge - Lane Tracker message byte 6 - 2cm steps	20
67	Two	TrackerStatus	Byte	none	Status byte from Lane Tracker	0
55	Two	VDOP	Short Int	none	GPS vertical dilution of precision times 10	0

Table 3-5. Trip level histograms logged by the DAS

<i>Name</i>	<i>Id</i>	<i>Description</i>	<i>SourceName</i>	<i>GateName</i>	<i>SortName</i>	<i>Cente</i>	<i>Wid</i>	<i>Min</i>	<i>Ma</i>
AccelPedalHist	111	Histogram of accelerator pedal	AccelPedal	MovingNoCruise	SpeedState	1	2	0	100
AirSpringHist	135	Histogram of filtered air spring	AirSpringFiltered	NoBrakeTorque	Gear	70	14	35	735
AyHist	115	Histogram of lateral acceleration	Ay	Moving	SpeedState	0	.01	-.4	.4
AyNarrowHist	157	Histogram of lateral acceleration	Ay	Moving	SpeedState	0	.00	-.2	.2
BrakePressureHist	118	Histogram of brake pressure	BrakePressure	Brake	SpeedState	7	14	0	700
EngineSpeedHist	119	Histogram of engine speed	EngineSpeed	Moving		350	100	350	250
EngineTorqueHist	120	Histogram of engine torque	EngineTorque	Moving		0	10	-	120
GpsSpeedHist	121	Histogram of GpsSpeed	GpsSpeed	Moving		12	4	6	128
LeftOffsetHist	99	Histogram of LeftOffset	LeftOffset	LeftTracking	SpeedState	.05	.1	0	4.0
LoadTransferHist	123	Histogram of load transfer	LoadTransfer	Moving	SpeedState	0	.05	-1	1
RightOffsetHist	100	Histogram of RightOffset	RightOffset	RightTracking	SpeedState	.05	.1	0	4.0
SpeedHist	86	Histogram of speed	Speed	Moving	CruiseEngaged	12	4	6	128
YawRate25to50Hist	129	Histogram of yaw rate for velocity	YawRate	SpeedGe25AndLt50		0	1.5	-36	36
YawRate50to75Hist	130	Histogram of yaw rate for velocity	YawRate	SpeedGe50AndLt75		0	1	-24	24
YawRateGe75Hist	131	Histogram of yaw rate for velocity	YawRate	SpeedGe75		0	.5	-12	12
YawRateLt25Hist	132	Histogram of yaw rate for velocity	YawRate	SpeedLt25		0	2	-48	48

Table 3-6. List of styles used to define recorded byte values by the DAS

<i>StyleId</i>	<i>StyleName</i>	<i>Value</i>	<i>CategoryName</i>
1	TrueFalse	0	False
1	TrueFalse	1	True
2	EnabledDisabled	0	Disabled
2	EnabledDisabled	1	Enabled
10	Pedal	0	Released
10	Pedal	1	Pressed
11	OnOff	0	Off
11	OnOff	1	On
12	CruiseStates	0	Off
12	CruiseStates	1	Hold
12	CruiseStates	2	Accelerate
12	CruiseStates	3	Coast
12	CruiseStates	4	Resume
12	CruiseStates	5	Set
12	CruiseStates	6	AccPedal Override
12	CruiseStates	7	N/A
15	Wipers	0	Off
15	Wipers	1	Low
15	Wipers	2	High
17	GpsMode	0	Raw
17	GpsMode	1	Differential
21	AdvisoryMessage	0	No Message
21	AdvisoryMessage	1	Fault
21	AdvisoryMessage	2	Rsc Event
21	AdvisoryMessage	3	Rsa Level 3
21	AdvisoryMessage	4	Rsa Level 2
21	AdvisoryMessage	5	Rsa Level 1
21	AdvisoryMessage	6	HBED Level 3
21	AdvisoryMessage	7	HBED Level 2
21	AdvisoryMessage	8	HBED Level 1
27	Gears	0	Clutch Pressed
27	Gears	1	1st Gear
27	Gears	10	10th Gear
27	Gears	11	Reverse
27	Gears	12	No Gear
27	Gears	2	2nd Gear
27	Gears	3	3rd Gear
27	Gears	4	4th Gear
27	Gears	5	5th Gear
27	Gears	6	6th Gear
27	Gears	7	7th Gear
27	Gears	8	8th Gear
27	Gears	9	9th Gear
31	LimitSources	0	None
31	LimitSources	1	ATC
31	LimitSources	2	RSC
31	LimitSources	3	Both

Objective data via Praxair's data center in Tonawanda, NY

Praxair sent UMTRI five types of files during the FOT. These files were used, among other things, to:

- Relate tractor and trip numbers with a particular driver identification number (a very important relationship given that driver performance had to be linked to specific trips from each of the DAS)
- Identify which of the nitrogen trailers were married to each of the study tractors (also an important relationship, since most of the fill and scale data from Praxair was associated with trailer identification numbers, not tractors)
- Provide scale and product information from the La Porte terminal as well as at other locations, including customers terminals

Two of these file types originate on-board the tractors and are generated by the Fleet Advisor computer, which was used by the driver to record all pertinent information and activity before and during his tour. The other three files, namely the fill, delivery, and customer files, were also from the Praxair facility in Tonawanda, NY, but often originated from data keyed in at the La Porte and East Chicago distribution facilities.

Three of the file types, namely the session, transaction and fill files, were automatically generated daily and transferred to UMTRI, via the internet, by procedures running on Praxair computers in Tonawanda. Similarly, at UMTRI, scheduled procedures would process and load the pertinent contents of the files into the database, making the entire process virtually automatic and operational seven days per week throughout the study period.

The five file types from Praxair are as follows:

Session files—these files originated on-board the tractors and were generated by the Fleet Advisor computer, which was used by the driver to record all pertinent information and activity before and during his tour. The file provided both summary and activity information about sessions. Here a “session” is more or less synonymous with a tour, and is performed by a single driver starting at La Porte and making one or more deliveries to customers. (Note: Occasionally, a session included refilling product at the Praxair facility in East Chicago, before returning to La Porte⁹.) The information in this file pertinent to the FOT included driver identification number, the start and end times for the session, and total distance and time. Activity information included the time, location, and nature of activities

⁹ Also, occasionally there were tours or sessions to simply pick-up product from East Chicago and return to La Porte without stopping at any customers.

such as product deliveries, en-route delays, tire checks, meals, breaks, lay-over, etc.

Transaction files—these files also came from the on-board Fleet Advisor computer. They provided the details of product delivery, and included either a gauge or (when available) a scale reading to indicate the amount of product delivered to each customer. These files also identified the trailer used in the tour. As mentioned above, trailer identification was important; however, this information was not always reliable as it was often missing, incomplete or inaccurate. Fortunately, however, the tractors and trailers in this FOT generally stayed married for long periods of time. This fact, along with the ability to identify the points in time when the tractor was operated bobtail (as indicated by air-spring pressure), allowed the implementation of a system for checking and filling in missing trailer identification data.

Fill files—these files gave the scale weights before and after product fills at the La Porte and East Chicago terminals. These data, along with the gauge data from the transaction files, provided a means to establish the total mass of the vehicle. It was assumed that the scale weight of a rig before loading product was the weight of the rig on the return trip to La Porte for a previous tour. Hence, trips from La Porte to a customer and trips from a customer to La Porte could be related to a scale reading. Total mass during trips between customers could be inferred from the gauge reading indicating the amount of product transferred at customer facilities. Unfortunately, these data were also often incomplete. Accordingly, they were used primarily to develop an algorithm to estimate vehicle mass based primarily on air-spring pressure. This algorithm, in turn, was used to determine total vehicle mass for all trips. (See section 4.2 for details)

Delivery and customer files—these files were given to UMTRI periodically throughout the study. The delivery files listed driver and customer identification numbers, the product type, and the date and time of delivery. The customer file contained a list of all the Praxair customers serviced by the La Porte and East Chicago terminals, their address and identification number, and their location (latitude and longitude). The data were used together along with the date, time, and GPS data logged by the DAS to identify missing driver numbers that occurred when the session and transaction files were incomplete.

Weather data

To estimate the local weather for each vehicle in the FOT in as close to real time as possible, a comprehensive weather algorithm was developed using reports and precipitation maps that were continuously downloaded from the National Weather Service to the UMTRI server. A description of the report and the map are given below. A

discussion of the data processing used to estimate the local weather across the entire FOT region is given in section 4.2, Data Processing.

METAR—these reports are defined by the international standard code format for hourly surface weather observations. They contain a date/time stamp, station identification number, wind direction, wind-speed, visibility, temperature, dew-point, barometric pressure, and precipitation.

Precipitation maps—these radar maps (bitmaps) use 14 different colors to indicate the level of precipitation for different geographical areas outlined on the map.

GPS-based map matching

The entire FOT database of GPS position information was processed by DaimlerChrysler (owner of Freightliner) using the NavTech geographical, navigable database. After loading the Two files into the FOT database, a specialized procedure would generate an input deck for the map-matching routines. These input decks would be transferred to DaimlerChrysler over the internet and the results of the matching process would then be returned to UMTRI for inclusion into the FOT database. The map-matching process yielded the following fields:

- Link—a unique identification number indicating a geometric representation of a road. The shape of a link is described using geographical latitude and longitude points called shape points.
- Node—the starting physical position on a link. It also has a unique identification number.
- MapTime—the time, in seconds, that the vehicle began traversing the current link.
- TimeOnLink—the time, in seconds, that the vehicle was on the current link
- TimeStopped—the time on the link that the vehicle was stopped, in seconds.
- TimeEstimate—an estimate of the time to traverse the current link, in seconds.
- MapError—an estimate of the accuracy of the map-matching results, in meters.
- RoadClass—a bitmap with the following decoding:
 - Mask 0: walkway (not passable for vehicles).
 - Mask 1: pedestrian zone
 - Mask 2: entrance/exit to a car park or service drive
 - Mask 4: freeway and highway ramps, neighborhood streets, country roads, etc.
 - Mask 8: local or regional road—generally high-volume, moderate-speed roads.
 - Mask 16: arterial—roads that connect highways and provide high traffic volumes
 - Mask 32: highway—a high-speed and high-volume road between freeways
 - Mask 64: freeway—a high-speed, high-volume, limited-access road between and through metropolitan areas
- RoadName—the name associated with current link.

3.3.5 Data collection problems

This section of the report describes the hardware- and software-related data collection problems that occurred during the FOT. In general, these problems did not greatly influence the quantity of information collected during the FOT based on an analysis of the distance traveled versus distance collected during the FOT. Using periodic odometer readings, a total of 848,000 km were traveled by the test tractors. This ranged from a high of 155,000 km on tractor 3 to a low of 100,000 km on tractor 6. The distance traveled as measured by the DAS for all six tractors was 772,000 km or approximately 91 percent of the actual distance traveled. On a per-tractor basis this ranged from 83 percent for tractor 1 to 96 percent for tractor 5. The majority of the lost 76,000 km was directly attributable to failed DAS hard disks. Table 3-7 summarizes the actual versus collected distance for each of the tractors and for the FOT as a whole.

Table 3-7. Summary of actual versus collected distance

Tractor	Kilometers			Percent collected
	Vehicle travel	Data collected	Lost	
1	152,176	126,942	25,234	83
2	145,477	135,047	10,429	93
3	155,548	148,421	7,127	95
4	148,137	135,036	13,101	91
5	147,192	141,239	5,953	96
6	100,285	85,809	14,476	86
Total	848,815	772,495	76,320	91

The subsections below describe the most common hardware and software problems that occurred during the FOT. Most of these problems were tracked and documented using a problem database and a master calendar of events that showed when maintenance and repairs were done to a DAS unit, a sensor, or a tractor. Following the discussion of the most common problems, table 3-9 describes some of the less critical problems along with the number of trips and total distance they affected.

Failed flash drives. There were eight failed flash disks during the FOT. The source of the failures was never completely understood or identified. Many modifications were made to the DAS to address this problem and service events were logged to see if they correlated with failures. (For example, did trips to the dealership seem to result in a disk failure?) Five months into the study the supplier/manufacturer of these disks replaced them with new ones, after which the frequency of failures dropped significantly.

An analysis was done of the lost days to help quantify the disk drive problem for the entire FOT. Table 3-8 shows that a total of 152 days were lost due to failed drives and one disk overflow event (the overflow occurred because files were not being deleted from the DAS in timely manner). This meant that about 92 percent of the

FOT days were covered by the DAS for the entire FOT. The bottom of table 3-8 shows how many disk failures occurred on each unit and the date and number of lost days for each failure. Interestingly, tractors 3 and 5 never had a failed disk. Clearly, much of the lost distance shown in table 3-7 is explained by these lost days.

Table 3-8. Details of data loss due to disk problems

Tractor	Number of days			Percent collected
	Vehicle travel	Data collected	Lost*	
1	389	307	82	79
2	362	354	8	98
3	348	344	4	99
4	324	279	45	86
5	303	303	0	100
6	279	266	13	95
Total	2,005	1,853	152	92

*Causes of lost days		*Schedule of lost days	
Tractor	Cause	Month	No of days
1	3 failed flash disks	Nov-00	20
2	1 failed flash disks	Dec-00	17
3	disk overflow	Jan-01	35
4	3 failed flash disks	Feb-01	6
5		Mar-01	12
6	1 failed flash disks	Apr-01	9
		May-01	13
		Jun-01	13
		Jul-01	27

Failed air-spring pressure transducers. Two air-spring pressure transducers failed in the Spring of 2001 on tractors 2 and 3, respectively. These transducers were replaced and in-line filters were installed on all the pressure transducers (both brake treadle and air-spring). These two failures affected a total of 64 trips and a distance of about 6,500 km. These data were not discarded from the FOT since only the air-spring pressure channel was affected.

Severed ABS wires. There were several problems in which the ABS sensor wires were severed during the FOT. These problems were a result of the mechanism of the load-transfer seizing and failing during the study. These mechanisms had a laterally-positioned, light-weight torsion bar that connected to two trailing arms that were then connected by vertical links to the rear axle of the drive suspension. Failure occurred in the weld between the torsion bar and the trailing arm, resulting in the trailing arm being free to bounce around while still connected to the tractor by the vertical link. Unfortunately, the routing of the ABS wheel-speed sensor wire was such that the wire was damaged by the loose trailing arm. Once this problem was discovered, the load-transfer transducers were removed from each of the FOT tractors.

Vibration problems with RA&C mounting brackets. All mounting brackets for the RA&C units were replaced with stiffer ones when it was discovered that vibration of the older bracket was influencing performance measures within the RA&C units.

Lane Tracker. One Lane Tracker unit was replaced when it failed during the FOT.

Wiper wiring. An incorrect wiring harness resulted in the low-speed wiper signal being logged as high-speed on tractor 5.

Cruise control anomaly. It was discovered that when the torque limit control is reached on the FOT tractors, the engine status (a number used to determine if the vehicle is engaged in cruise control) changes, causing oscillations in cruise states between zero and one. This problem was corrected after-the-fact in the RA&C database.

Table 3-9 describes some of the other, less notable problems that were discovered during the FOT. When possible, the data associated with many of these problems was corrected after-the-fact in the database. Other data anomalies listed in the table resulted in partial trips or inaccurate channels that were subsequently culled from the database to avoid corrupting any calculations done using the suspect channels.

Table 3-9. Other notable data collection problems

<i>Id</i>	<i>Name</i>	<i>Description</i>	<i>Distance, km</i>	<i>Trips</i>
1	Speed Gain	Installed a new baseline ECU (V210) on tractor 1 (5552) on 12/5/00. In the new ECU supplier changed the radius value from 509 mm to 493 mm.	4844	56
2	Missed GPS	Missed records due to a checksum software feature.	9165	100
3	Wiper distance	When the driver selects intermittent wipers, each event (pass of the wiper blade) is logged to the transition table. Problem fixed after-the-fact.	181764	2102
5	Bad Data	Fields from J1939 and J1587 are zero	935	3
8	GPS data repeated	Differential fix is lost resulting in duplicate values of all data from GPS.	341	1
13	Analog failure	Analog boards were not initialized correctly and therefore the wrong offsets and/or gains were used.	226	1
16	Speed > 0	Trip ended with a speed > 0 kph	462	1
19	Duplicate Time value	Duplicate GPSTime causes key violation. Problem is fixed by adding 1 to the GPSTime and entering the data into the database.	711	10
20	Lane tracker	Invalid or no data being reported by Lane Tracker device.	1633	14
21	Duplicate Time value	Unlike Note Id 19, these duplicate time values are non-sequential so the fix used in 19 does not work.	1135	7
22	Spikes in GPS Speed	Anomalous spike in GPS Speed resulted in poor correlation with Speed. Corrected by replacing GPS Speed values greater than 130 kph with corresponding Speed values.	4934	27
23	GPS data files missing	These trips are unique in that there was no GPS file. Either it wasn't collected or is still on the truck and was not moved.	693	8
24	Spurious RA&C	These events are false and were caused by hi-frequency vibration of the ECU on tractor 1. These data were corrected.	1678	10
25	ASP bad	Air-Spring Pressure Transducer gone bad	6479	65
26	Ten Hz data corrupted	Ten file is filled with zeros. This problem is probably caused by an interruption during the download process.	574	2
29	ABS Fault	Known trips where the ABS was not working. This results in faulty RA&C data.	19089	231
30	No Two File	No Two file entry in the RSA Catalog. These trips did have a distance > 1 km and Ten Hz data.	1902	19

Table of Contents

4. The Data Set	45
4.1 Objective database structure and content.....	45
4.2 Objective data processing	46
4.3 Subjective data set.....	72

List of Figures

Figure 4-1. Gear versus gear ratio.....	52
Figure 4-2. Locations of calculated lateral accelerations.....	56
Figure 4-3. Example of low-speed off-tracking.....	59
Figure 4-4. Path of the tractor in a 90 degree small radius turn.....	60
Figure 4-5. Time-history plot of a 90 degree right-hand turn.....	60
Figure 4-6. <i>AyTotal</i> as a function of time	61
Figure 4-7. Path of the tractor in a 180 degree large-radius turn.....	61
Figure 4-8. Time-history plot of a 180 degree right-hand turn.....	62
Figure 4-9. Lateral acceleration based on yaw rate and speed	64
Figure 4-10. Curvature thresholds to define a turn	66
Figure 4-11. Map showing the actual curvature for the ramp from highway 239 N to I-94 E	66
Figure 4-12. Example of the triangulation component of the curve definition routine	67
Figure 4-13. Example curve with 167 passes	68
Figure 4-14. Example calculation of maximum and sustained maximum for curve performance	69
Figure 4-15. Example of an off-roadway curve.....	72

List of Tables

Table 4-1. Gear factor used in calculating the drive axle mass	49
Table 4-2. Coefficients used to derive total vehicle mass	50
Table 4-3. 2-Hz histogram fields	53
Table 4-4. Short and long survey schedule rotation dates.	74
Table 4-5. Grouping of survey items based on factor analysis used to pool together answers to similar questions.	76

4. THE DATA SET

The data set used as the basis for all the analyses that follows in this report can be divided into three major subsets: primary data, derived or secondary data, and subjective data. The primary data set consists of those data collected on-board the test vehicles, as well as fleet logistics information from the Praxair Corporation and climate reports from the U.S. Weather Service. These data are considered primary because they were meaningful as received and required little or no processing prior to being loaded into the database. For additional information on the primary, objective data set, see section 3.3, Data Collection. Secondary data, on the other hand, consists of channels that have been derived from the primary data using some substantial form of processing or analysis. These data are also stored in tables within the database. Examples include:

- GPS-map matching results
- Events¹²
- Summary numbers like counts, averages, maximums, etc.
- Derivatives and smoothed time-history measures
- Sub-sampled or decimated time-history data
- Estimated real-time weather for the FOT region
- Simulation results
- Histograms

The subsections below discuss the structure and content of the RA&C database as well as the processing that was done to produce the tables of secondary data. The last section, 4.3, covers the mechanisms of processing the subjective data that were collected throughout the FOT.

4.1 Objective database structure and content

The RA&C database contains approximately 60 GB of data and is a collection of many primary, secondary, or derived tables. The structure of the primary tables was discussed in detail in the section 3.3, Data Collection. The structure of many of the secondary tables is discussed below. To complement the presentations in section 3.3 and this section, a list of database tables, their field names, and engineering units appears in appendix A-J.¹³

¹² Explicit pointers into the whole archive that define the start and end of an event, such as a brake pedal application.

¹³ Please refer to table 3-4 and appendix A-J for the engineering units of all the primary and secondary measures.

Regardless of the table type, whether primary or secondary, most tables share similar fields that constitute the primary indices of the database. Most often, these primary indices are *Tractor*, *Trip*, and *Time*¹⁴ where *Tractor* is a number from 1 to 6, *Trip* is a sequential number indicating an ignition on/off cycle, and *Time* is an integer number representing the number of deciseconds since midnight UTC. The fact that relationships (joins) can be formed between similar fields, such as these, allows data from different tables to be “connected.” This connection is the backbone of the concept of the relational database.

Since this report was not intended to be a primer on the use of relational databases, the level of detail regarding the implemented structure of all the tables and other objects in the RA&C database is limited. However, it is intended that this report document the content of the objective data set so that it can be used as a reference for further analyses of these data.

4.2 Objective data processing

Substantial data processing was done to derive the secondary fields and tables in the database. In most cases this processing was done after the data were loaded into the FOT database, but a certain level of processing occurred in the DAS on-board the vehicles. This chapter addresses the processing done after the data were recovered from the vehicles. Section 3.3.3 discusses the on-board data processing.

4.2.1 Trip-level data

Trip-level information is defined as data that are constant or pertinent for an entire trip. Examples include: distance, start day, driver and trailer identification numbers, RA&C version number, etc. Some of these data are collected on-board the test vehicle by the DAS and loaded directly into the database, while other data had to be culled from sources outside of the DAS environment. In some cases, the data that came from other sources was incomplete or missing and required processing to infer the correct values based on logical analysis of other data sources. Most important among these trip level numbers were the identification of the driver and trailer for a given trip. Tables entitled Summary, Summary2, and TripList contain the trip-level information. Many of the fields in these three tables are primary data and their meaning is clear from the field name. Fields that required post-collection data processing or require some explanation are discussed below.

¹⁴ Most tables have a *Time* field; however, the name used for the field does vary for different tables, but always includes the word time. Example names of the *Time* field include: *TestTime*, *GpsTime*, *StartTime*, *StartGpsTime*, *MapTime*, etc.

Driver. The primary source of driver identification came from the session information described in section 3.3.4. However, since there were some tours for which we did not receive session files, some “virtual” sessions had to be created. For these sessions, the driver number was determined using supplemental delivery files obtained from Praxair. The delivery data listed driver and customer identification numbers along with the product type and product delivery date and time. Post-processing algorithms were developed that matched the delivery records with the “virtual” session data based on customer location along with the session date, start time, and end time.

Trailer. Relating trips to a particular trailer was important for a number of reasons. Foremost was the verification that the FOT tractors were connected to trailers carrying nitrogen. Although the La Porte facility produces nitrogen, oxygen, and argon liquids, the trailers in the fleet are designed specifically for transporting a given product and thus, have different performance characteristics. Identification of the trailer allowed UMTRI to exclude from the data analysis any trips with non-nitrogen trailers. Secondly, all the scale-weight data collected at the La Porte and East Chicago production facilities are uniquely identified within the Praxair database using a date/time stamp and trailer number. The scale data provided by Praxair were automatically matched with trips using trailer numbers and the date/time stamps.

FirstTime and LastTime. These two fields from the Summary2 table were used to check the synchronicity of time between the GPS module and the DAS clocking source.

4.2.2 Calculated variables—five-minute table

The five-minute table (called *FiveMin* in the database) contains fields and derived measures recorded in five-minute intervals.¹⁵ This table is composed of fields that pertain to weather, trailer load condition, derived static rollover threshold, solar zenith angle, etc. These fields and the data-processing routines to calculate them are discussed below:

Temperature, Pressure, Visibility, WindSpeed, and WindDirection. These fields were calculated from weather data downloaded from the National Weather Service using the following method:

- Locate all weather stations within 50 miles of the target location.
- Determine the distance, d_i , from the target location to these stations.
- For each station within 50 miles, find the most recent report taken before the target time, and the first report taken after the target time.

¹⁵ The measures in the five-minute table were calculated across five-minute intervals. The *GPSTime* value associated with each entry in *FiveMin* is the central time of the interval (in UTC deci-seconds).

- Interpolate the weather conditions between these times to the target time. If a report was taken at the target time, use it by itself.
- Use the squared reciprocal of the distance for each station:

$$Ri = \frac{1}{di^2} \quad 4-1$$

as a relevance measure and weighting factor, Ri , for each observation.

- Estimate weather conditions as a weighted average. For example: $\text{Test} = (R1T1 + R2T2 + \dots + RnTn) / (R1+R2 + \dots + Rn)$

The quantity $R1+R2 + \dots + Rn$ is a relative measure of the reliability or relevance of the weather estimate. Larger numbers would indicate a higher reliability on the estimates when compared with other locations or times.

For wind speed and direction, the speeds and directions reported by the stations are broken into their north-south and east-west components. These components are then processed separately and recombined to give the estimated speed and direction. An example of the weather estimating algorithm is given in appendix A-B, Weather.

PrecipIntensity. This unit-less value is a measure of precipitation intensity derived from the color coding used on National Weather Service radar maps, which were downloaded throughout the time of the FOT. The maps come in two sensitivity levels—one for days with little precipitation, the other for more stormy conditions. The same colors are used in both types of maps, but they indicate different levels of precipitation. The first task in using these maps was to select the map closest in time and location to the tractor at each five-minute interval. Then, the color key on the side of the map was analyzed to determine which type of sensitivity level, and therefore what level of precipitation each color indicated, was used. Five different regional maps which were used (based on five radar stations). Each regional map was carefully calibrated so that latitude and longitude coordinates could be mapped to specific y and x pixels in the computer representation of the map. Using this mapping, the color of the pixel closest to the tractor’s current location was read and matched to the key. If the color was one of those representing no precipitation, a value of zero was entered for precipitation intensity in the five-minute table. Each level above the no-precipitation level was given a number from 1 to 12, with 12 being the most intense level of precipitation registered by the radar.

For more information and an example see appendix A-B.

Weight. This field contains the estimate of the total mass of the tractor-semitrailer combination based on Praxair’s scale weight and product gauge readings, which are described previously in section 3.3.4. Because of missing data, this *Weight* measure could only be determined for about 80 percent of all five-minute periods.

DriveMass. This field contains an estimate of the portion of vehicle mass supported by the drive axles. This estimate is based on the following calculation:

$$DriveMass' = 1432 + 31.60 * ASP + GF * ET, \quad 4-2$$

where

- ASP* is the air-spring pressure of the drive-axle suspension,
- GF* is the gear factor and is given by table 4.1 below, and
- ET* is the engine torque in percent.

DriveMass', as defined in equation 4-2, is initially calculated at each 0.1 second interval (i.e., at 10 Hz) at which (1) the brakes are not on and (2) the vehicle is in a gear from gear 3 through 10. *DriveMass* as entered in the five-minute table is the average of *DriveMass'* over the reference five-minute period (where, of course, moments not meeting conditions 1 and 2 are not considered in the average).

Table 4-1. Gear factor used in calculating the drive axle mass

<i>Gear</i>	<i>GF</i>
3	35.2
4	28.3
5	20.0
6	17.8
7	12.6
8	9.9
9	8.0
10	6.1

The values of the gear factor and the two constants in equation 4-2 were all derived from regression analyses of data gathered in preliminary road tests conducted by UMTRI prior to the field test. The road tests were, of course, conducted under a variety of loading conditions in which the true value of *DriveMass* was known.

TotalMass. *TotalMass* is the estimate of total vehicle mass that was used in the analyses of the field test data. *TotalMass* is calculated as follows:

$$TotalMass = \left(\frac{DriveMass}{(A + B * DriveMass)} \right) / 1000 \quad 4-3$$

where the regression coefficients, A and B, were determined for each tractor using *DriveMass* and *Weight* as described above. Using *TotalMass* as the reference measure of total vehicle mass allowed “filling in” the majority of five-minute time periods in which *Weight* could not be determined. Also, *TotalMass* is likely a more consistently accurate estimate of the actual total mass of the vehicle than is *Weight*, as the precision of mass estimates based on gauge readings is probably not high.

Table 4-2. Coefficients used to derive total vehicle mass

<i>Tractor</i>	<i>A</i>	<i>B</i>
1	0.3103	7.092E-06
2	0.3151	6.956E-06
3	0.3183	7.190E-06
4	0.3087	7.304E-06
5	0.3101	7.088E-06
6	0.3114	7.032E-06

Rollover. This field contains the reference static rollover threshold of the vehicle during the five-minute period. *Rollover* is determined according to the following equation:

$$Rollover = 0.3571 + 1.794 * e^{(-0.119424 * TotalMass)} \quad 4-4$$

where the form of, and constant in, equation 4-4 is determined by the relationship between total vehicle mass and static rollover threshold observed in the results of a tilt-table test of one of the FOT vehicles (see appendix A-C).

CurrentSessionDistance and TotalSessionDistance. In this FOT, a session is a round trip made by a single driver in a single tractor, starting and ending at Praxair’s La Porte facility. It typically consists of several trips. The *CurrentSessionDistance* field indicates the distance traveled by the driver/tractor since leaving La Porte. The *TotalSessionDistance* is the distance of the entire session, start to finish, and therefore does not change within a trip or between trips that are part of the same session. The purpose of these fields is to enable the calculation of a refined weight estimate based on fuel consumption.

WiperIntensity. This field was used in preference to the precipitation intensity field as a more reliable indicator of precipitation. The DAS recorded a 1 for low-speed wiper on, a 2 for high-speed wiper on, and a 0 for wiper off. Intermittent wiper settings were recorded as alternating 1s and 0s. To complicate the issue, the 0s in the intermittent settings followed the 1s by only 0.5 seconds, even though it took approximately 1.7 seconds for a complete cycle of the wipers. For example, an intermittent setting that caused the wipers to cycle every 3.4 seconds would actually have the wipers active one-half of the time, but the DAS would record the wipers as being on only 0.5/3.4, or less than 15 percent of the time. To account for this, a routine was developed that attributed 1.7 seconds of wiper-on time for each wiper-on signal observed in intermittent use. This routine was made part of the program that generated the five-minute table. The *WiperIntensity* field is a time-average of these adjusted values. If the wipers were on low for the entire five-minute period, *WiperIntensity* is 1. If they were on high, it is 2. If they were on a 17-second intermittent setting, the value is 0.1 (=1.7/17). If the setting was changed during the five-minute period, the various settings were time-averaged.

AvgAirspringPressure. This field is the average value of the measured air-spring pressure over the five-minute period. It was incorporated into the five minute table for two reasons—first, an average gives a more accurate indication of the actual weight on the drive axles by smoothing out variations due to bumps and turns, and second, it simplifies the calculation of *Weight* and *TotalMass* as detailed above.

SolarZenithAngle. This field determined whether a tractor was traveling in daytime or at nighttime. *SolarZenithAngle* is the angle from vertical to the sun. An angle of 96 degrees or greater is considered night for the purpose of this FOT (atmospheric refraction and reflection provide adequate daylight shortly before sunrise and after sunset). The angle was calculated using formulas obtained from the National Oceanic and Atmospheric Administration. See appendix A-D

MinSpeed and *MaxSpeed*—these fields are the minimum and maximum speeds for the tractor during the five-minute interval.

DistInFiveMin—is the distance traveled by the tractor during the five-minute period.

BadWeather—is a simple Boolean field derived from the *Visibility* and *WiperIntensity* fields. A value of 1 indicates that either *Visibility* was less than 2 or *WiperIntensity* was greater than 0.1.

4.2.3 Calculated variables, 2 Hz

Tables containing secondary time-history variables calculated at 2 Hz were produced for each tractor in the FOT. The tables are identified as *TwoCalcX* where $X = 1$ to 6. The fields in these tables were generated from calculations based on either the primary, 10-Hz time-history data or on transition data (with 10-Hz-like time resolution). Typically, the calculations included substantial digital filtering allowing decimation to 2 Hz. Moreover, the frequency content of interest is that of the yaw motions of these vehicles, certainly no more than 0.5 Hz.

The content of these tables evolved over the analysis phase of this study, and many of the fields are described more completely in subsequent sections of the report. This is particularly true of the derived lateral-acceleration fields, which are explained in considerably more detail in section 4.2.4, and the so-called histogram fields which are discussed in section 4.2.6. The fields of the *TwoCalc* tables are as follows.

CruiseState. This field indicates if the vehicle's longitudinal velocity is being maintained by the driver or the cruise-control system. The field is derived from the cruise control transition events that were logged in the *BTrans* transition file. Numerical states for the field are: 0 = off; 1 = hold; 2 = accelerate; 3 = coast; 4 = resume; 5 = set; and 6 = accelerator pedal override.

AySmooth. This field is calculated using a 1.7-second (or 17 point) binomial digital filter on the lateral-acceleration signal measured at the front axle (*Ay*). (See section 4.2.4.)

Curvature. This field is calculated from the ratio of yaw rate and speed. It is only valid for speeds above 5 kph.

AySmoothCor. This field is derived from *AySmooth* and is corrected for long term drift of the transducer signal. (See section 4.2.4.)

Gear. This field is based on the gear transition events. *Gear* was determined indirectly by analyzing the ratio of engine speed to vehicle speed. A plot of the derived gear ratios is shown in figure 4-1. These ratios defined the *Gear* channel in the DAS and calculated gear ratio values that were between the ones shown the figure were assigned to the closest gear provided the clutch was not depressed. When the clutch was depressed, *Gear* was set to zero.

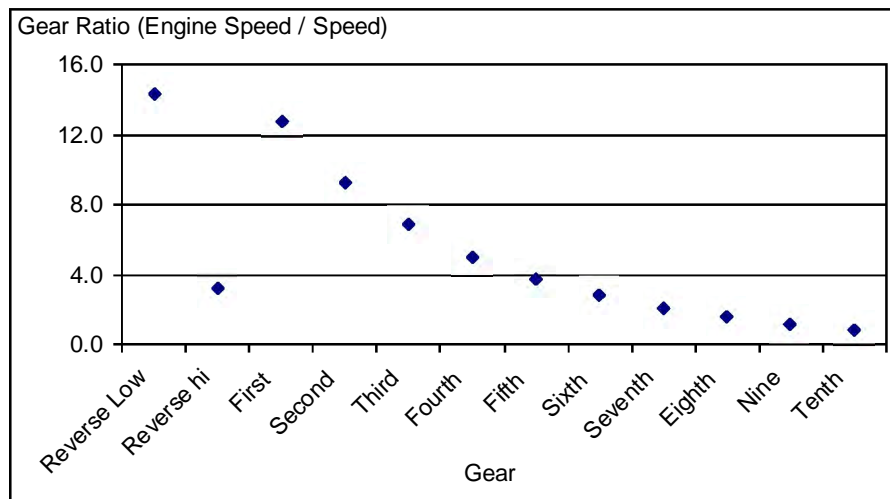

Figure 4-1. Gear versus gear ratio

YawRateDot. This field is the smoothed derivative of *YawRate*. The smoothing and differentiation were accomplished simultaneously in a calculation that combined a 1.7-second binomial filter with the differentiation.

AyDriver. This is an estimate of the lateral acceleration at the longitudinal position of the driver's seat. It is also used as an estimate of the lateral acceleration of the c.g. of the tractor. (See section 4.2.4.)

Ay465. This is an estimate of the lateral acceleration at the longitudinal position of the drive suspension of the tractor. It is used both in representing lateral acceleration at the fifth-wheel and at the RA&C ECU. (See section 4.2.4.)

Speed. This is a smoothed version of the 10-Hz *Speed* measure.

Rollover. This is the static rollover threshold as defined by equation 4-4.

Along with the fields presented above, another set of 2 Hz fields was generated for the simulated trailer lateral-acceleration experience during the FOT. These fields appear in the *AyTrailerX* tables (where X = 1 to 6). These fields are different from those listed above because they are only populated when a lateral-acceleration value for the trailer was obtained from the vehicle simulation algorithm. That is, the fields presented below are more or less restricted to times when the FOT vehicles were in curves of less than 1000 m in radius.

AyTrailer. This field contains estimated lateral-acceleration values for the semi-trailer. (See section 4.2.4.)

AyTrRolloverRatio. This is the ratio of *AyTrailer* to *Rollover*.

AyTotal. This is a weighted average of the lateral acceleration of the tractor and trailer. (See section 4.2.4.)

Histograms. These fields represent an intermediate step in the generation the histograms used in the analysis section of this report. The fields are populated with an integer bin number that is representative of the corresponding range of the variable of interest. The bin numbers were calculated using the formulas given in table 4.3 below. *RoadTypeHist* is based on the GPS mapping results and is a bitmap. The coding for this histogram field is also given in table 4.3. Here the cast function changes a float point number into an integer value by always rounding down to the nearest integer. The numbers in the formulas represent the lower edge of the minimum bin (in the numerator) and the bin width (denominator), respectively.

Table 4-3. 2-Hz histogram fields

<i>SpeedHist</i>	$\text{Cast}(((\text{Speed}-2.5)/5.0) \text{ as int}) + 1$
<i>AyDriverHist</i>	$\text{Cast}(((\text{AyDriver}-(-.405))/0.01) \text{ as int}) + 1$
<i>Ay465Hist</i>	$\text{Cast}(((\text{Ay465}-(-.405))/0.01) \text{ as int}) + 1$
<i>AySmoothCorHist</i>	$\text{Cast}(((\text{AySmoothCor}-(-.405))/0.01) \text{ as int}) + 1$
<i>Ay465NHist</i>	$\text{Cast}(((\text{Ay465}-(-.10125))/0.0025) \text{ as int}) + 1$
<i>AySmoothCorNHist</i>	$\text{Cast}(((\text{AySmoothCor}-(-.10125))/0.0025) \text{ as int}) + 1$
<i>AyDriverNHist</i>	$\text{Cast}(((\text{AyDriver}-(-.10125))/0.0025) \text{ as int}) + 1$
<i>CurvatureHist</i>	$\text{Cast}(((\text{Abs}(\text{Curvature})-(1.0))/1.0) \text{ as int}) + 1$
<i>AyTrailerHist</i>	$\text{Cast}(((\text{AyTrailer}-(-.405))/0.01) \text{ as int}) + 1$
<i>RollRatioAyTrailerHist</i>	$\text{Cast}(((\text{AyTrailer}/\text{Rollover})-(-.81))/0.02) \text{ as int}) + 1$
<i>AyTotalHist</i>	$\text{Cast}(((\text{AyTotal}-(-.405))/0.01) \text{ as int}) + 1$
<i>RollRatioAyTotalHist</i>	$\text{Cast}(((\text{AyTotal}/\text{Rollover})-(-.81))/0.02) \text{ as int}) + 1$
<i>RoadTypeHist</i>	1 = pedestrian zone 2 = entrance/exit to a car park or service drive 4 = freeway and highway ramps, neighborhood streets, small country roads, etc. 8 = local or regional road—generally high-volume, moderate-speed roads 16 = arterial—roads that interconnect highways and provide high traffic volumes 32 = highway—a high-speed, high-volume road to channel traffic between freeways 64 = freeway—a high-speed, high-volume, limited-access road between and through metropolitan areas

4.2.4 Lateral acceleration

The primary objective measure for evaluating driver behavior and the potential influence of the RA&C device, at least as it pertains to reducing likelihood of rollover, is the lateral-acceleration behavior of the vehicle as it is driven by the individual drivers participating in the FOT. This section defines the term “lateral acceleration” as used in this report, and describes the methods used to derive several different measures of lateral-acceleration experience from the signals of the relevant transducers. In that regard, the primary transducers were an accelerometer mounted laterally on the front axle of the tractor and yaw-rate transducer in the tractor cab (along with vehicle speed from the vehicle’s own data bus).

Definition of lateral acceleration

This report presents the “lateral-acceleration” experience of the FOT vehicles. Quotation marks are used here because the definition of lateral acceleration used in this report is somewhat different from the formal definition according to the International Organization for Standardization (ISO) and the Society of Automotive Engineers [6,7]. Those definitions do not account well for the influence of cross slope of road surfaces.

For this reason, our definition is as follows:

lateral acceleration: the component of vehicle acceleration, including (or with the addition of) the component of gravitational acceleration, perpendicular to the longitudinal axis of the vehicle, at a specified point in the vehicle *and in a plane parallel to the road surface*.

The polarity convention for lateral acceleration herein is similar to that of the ISO, i.e., positive accelerations are to the left and typically result from left turns and, for this definition, roadways sloping downward to the right.

The salient point regarding this definition is that it “automatically” includes the influence of cross slope of the road surface in a manner appropriate for the consideration of vehicle rollover. For example, two vehicles, one moving in a straight line, but on a road with a cross slope of five percent, the other on a flat road surface but in a steady turn generating 0.05 g lateral acceleration, would be experiencing identical situations vis-à-vis rollover potential (ignoring for the moment, potential complications of large articulation angles), and would, by this definition, both experience a lateral acceleration of 0.05 g.

Lateral acceleration at various locations on the vehicle

The primary measurement of lateral acceleration was obtained by an accelerometer mounted laterally at the center of the front axle of the tractor. The choice of this location was a direct result of the observation made above regarding the appeal of determining lateral acceleration parallel to the roadway surface for purposes of the analysis of

rollover. Because of suspension and frame properties, and the fact that payloads are carried toward the rear of the vehicle, the front suspensions of commercial vehicles typically suffer very little roll moment. Consequently, the solid front axle typically remains rather parallel to the road surface even during severe turning where chassis and drive axles may roll appreciably. (This applies to frequencies associated with yaw and roll motions, if perhaps not to higher frequencies associated with ride disturbances and road roughness.)

The accelerometer was combined in a transducer that included temperature sensing. This signal (*AyTemperature*) was used on-board the vehicles for temperature compensation of the base acceleration signal (*AyRaw*) to produce the primary lateral-acceleration measure at the front axle (*Ay*).

Figure 4-2 provides an overview of the processes by which *Ay* was used to produce several lateral-acceleration time histories associated with different locations on the vehicle. As noted in the previous section, *Ay* was processed later to produce *AySmooth*. However, both *Ay* and *AySmooth* are affected by long-term offset drift of the transducer signal. A very substantial post-processing effort was applied to remove this drift, the resulting variable being *AySmoothCor*. Descriptions of the process from installation and calibration of the transducer through correction for drift are presented in appendix A-E. *AySmoothCor* and other transduced signals (*YawRate* and *Speed*) were then used to calculate other measures of lateral acceleration.

The primary lateral-acceleration transducers were mounted on the front axle of the tractors for reasons already described. Thus, *Ay*, *AySmooth*, and *AySmoothCor* are all associated with lateral acceleration at the front axle. However, from an analysis point of view, this location is not ideal. Whenever articulation angles are large (i.e., particularly in lower-speed, tighter-radius turns) the lateral acceleration at the front axle may not be very representative of the lateral acceleration elsewhere on the combination. Accordingly, time histories of lateral acceleration at other positions along the length of the vehicle were calculated.

Ultimately, six different estimates of lateral acceleration were derived from the primary *Ay* measure. They are each discussed below. Note that since they all are based initially on *Ay*, all are estimates of lateral acceleration *parallel to the roadway*, i.e., including the influence of gravity due to roadway cross slope but not subject to the influence of chassis roll.

AySmooth. Sampled at 2 Hz and located longitudinally at the front axle, *AySmooth* was calculated using a 1.7 s (or 17 point) binomial filter on *Ay*. The binomial algorithm smoothes the measure using weighted coefficients that derive from a normal Gaussian distribution.

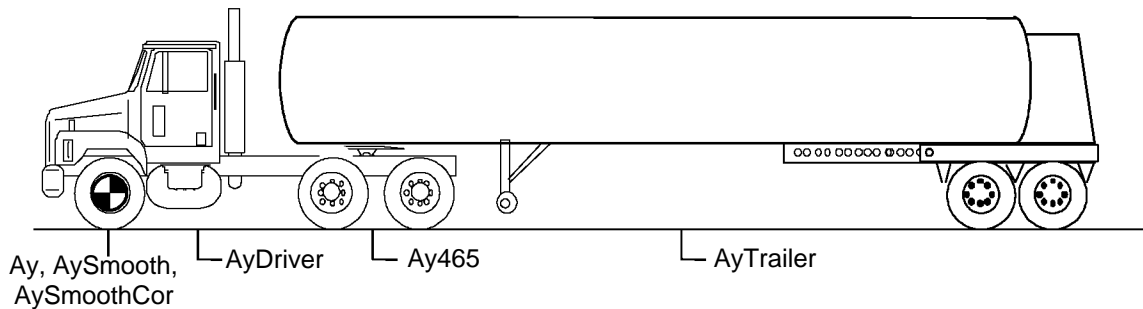
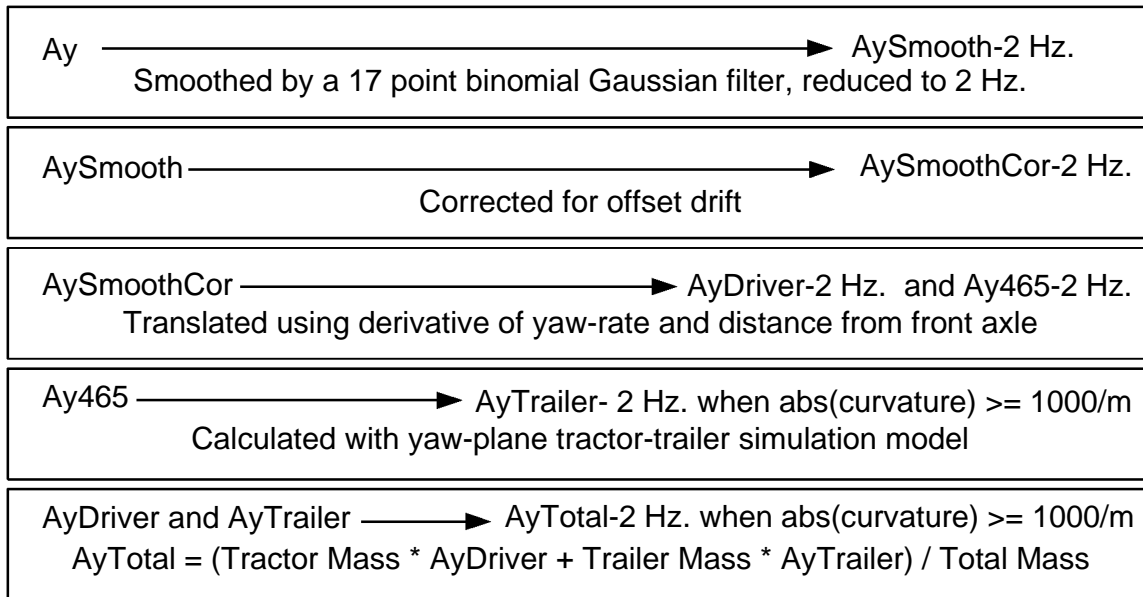

Figure 4-2. Locations of calculated lateral accelerations

AySmoothCor. Also located at the front axle and sampled at 2 Hz, this measure is derived from *AySmooth* by removing the long-term drift (offset). *AySmoothCor* represents the most accurate estimate of lateral acceleration at the front axle. A detailed discussion of the procedure to determine the offset correction values can be found in appendix A-E.

AyDriver and *Ay465*¹⁶. Sampled at 2 Hz and located longitudinally at the driver’s seat and fifth-wheel (and RA&C ECU), respectively. These measures were calculated by

¹⁶ The notation, *AyDriver*, derives from the fact that this variable was first created to represent lateral acceleration at the longitudinal position of the driver. This same variable is also used as an approximation of lateral acceleration at the longitudinal position of the center of gravity of the tractor. The notation, *Ay465* derives from the fact that this variable represents lateral acceleration 4.65 meters aft of the front axle. This one variable was used as an approximation of lateral acceleration at the RA&C ECU and at the fifth wheel.

translating *AySmoothCor* to other locations on the tractor. This was done using the following equation:

$$A_{yi} = \frac{A_{ySmoothCor} - (YawRateDot * li)}{9.8} \quad 4-5$$

where

- AySmoothCor* is the lateral acceleration as measured at the front axle, gs,
- YawRateDot* is the derivative of *YawRate*, rad/s²,
- li* is the longitudinal distance from the front axle to the point of interest, i.

AyTrailer—located at the approximate longitudinal position of the center of gravity of the trailer and sampled at 2 Hz. When a tractor-semitrailer combination performs turning maneuvers involving small radii, such as the turns that often take place at urban intersections or in parking-lots, the tractor and the semitrailer typically experience very different lateral accelerations. Such turning maneuvers generate large articulation angles and substantial in-board off-tracking of the trailer. The c.g. of the tractor and c.g. of the trailer travel on different paths and at different velocities and, as a result, have substantially different lateral accelerations. Typically the trailer acceleration is lower in magnitude.

Since no instrumentation was mounted on the trailer, *AyTrailer* was estimated using a very simple, yaw-plane simulation of the semitrailer, the input to which was the yaw-plane motion of the fifth-wheel as determined from signals of the tractor-mounted instruments. The potential volume of calculation made determining *AyTrailer* for the entire travel time of the fleet (approximately 10,000 hours) out of the question. Accordingly, *AyTrailer* was determined only for the approximately 1,000 hours of travel in which the FOT vehicles operated in curves with a path radius of the front axle of less than 1,000 m (see section 5).¹⁷ Even so, the simulation was necessarily very simple as the volume of related calculation was very large. Accordingly, *AyTrailer* should not be considered as precise as any of the lateral-acceleration measures on the tractor. Nevertheless, it and *AyTotal*, which is based in part on *AyTrailer* (see below), are believed to form a superior basis for estimating actual rollover risk than do any of the tractor-based accelerations, especially in turns of small radii when off-tracking of the trailer is significant.

¹⁷ In some cases, the time window of the simulation program was extended to account for the fact that the peak trailer lateral acceleration may occur significantly later in time than that of the tractor. This is particularly evident in low-speed, “tight” turns in which the tractor completes the turn while the trailer is still experiencing significant lateral accelerations.

AyTotal. This variable is a weighted average of *AyDriver* and *AyTrailer* according to the following equation:

$$AyTotal = \frac{AyDriver * m_1 + AyTrailer * m_2}{TotalMass}, \quad (4-6)$$

where m_1 and m_2 are the masses of the tractor and trailer, respectively, and *AyDriver* is taken as a close approximation of the lateral acceleration of the c.g. of the tractor.

This weighted measure is appropriate for use in evaluating rollover risk. That is, tractors and trailers do not roll independently of one another but rather are coupled in roll by the fifth-wheel. Hence, evaluation of rollover risk should be based on the overall lateral-acceleration experience of both the tractor and trailer, relative mass being the appropriate weighting function. (Note that, when large articulation angles prevail, *AyDriver* and *AyTrailer* may not be in the same direction. No attempt to account for this influence is made here and would not be appropriate as the reference measures of vehicle roll stability to which *AyTotal* are compared come from tilt-table tests in which the vehicle was not articulated.)

Relationship of the various measures of lateral acceleration

The overall lateral-acceleration experience of a tractor semi-trailer combination is determined fundamentally by speed and curvature. However, there are many instances where the lateral acceleration, as measured at various points on the vehicle may vary substantially. This is especially true during low-speed, large-articulation maneuvers such as 90-degree turns at urban intersections. In such maneuvers, the front axle of the tractor takes a different path than the tandem of the trailer or even the drive axles of the tractor. An example of this is shown in figure 4-3. The direction of the turn is to the left and the figure shows the estimated path for the tractor front axle and the trailer tandem pair. The figure also shows the estimated radius of tractor and trailer path as R1 and R2, respectively. For this example the minimum instantaneous radius of the trailer is about 15 per cent larger than that of the tractor.

Additionally, because it is both the tractor and trailer that determine the overall lateral-acceleration experience, and, consequently, the likely-hood of rollover, the phase relationship between the two units must be considered.

An example of the vehicle performance in a small-radius, transient turn is illustrated in figures 4-4, 4-5, and 4-6. Figure 4-4 presents an x-y plot of the path of the vehicle (as measured by the position of the GPS antenna) where the initial position of the vehicle is at the origin of the plot. This figure shows that the maneuver is a right-hand, 90-degree turn with a radius of roughly 10 meters.

Figure 4-5 and 4-6 present time histories of several motion variables. Figure 4-5 is divided into two time-history plots. The abscissa for both plots is time in seconds and is shown along the bottom of the figure. The upper plot shows four different measures of lateral acceleration. The traces are ordered according to their longitudinal position on the vehicle. The plot shows that in the first half of the maneuver, from 0 to 4 seconds, there is a clear lag in lateral acceleration as a function of the position on the vehicle. For example, at approximately 3.5 seconds, *AySmoothCor* and *AyDriver* have reached their maximum values while *Ay465* and *AyTrailer* peak at 4.3 and 6.0 seconds, respectively. Similarly, as the tractor comes out of the turn the *AySmoothCor* leads with an increasing larger lag for *AyDriver*, *Ay465* and *AyTrailer*. Also, note that the lateral acceleration at the front axle (*AySmoothCor*) reaches the highest peak magnitude (absolute value), but magnitude is attenuated at the trailer. Both are consistent with expectations for a low-speed, small-radius turn with substantial off-tracking. The lower time history plot, in figure 4-5, shows the tractor yaw rate, speed, and derived path curvature. The driver is accelerating around the curve as speed increases from approximately 8 to 24 kph. The peak curvature value is equivalent to approximately a 10 m radius turn, which, of course, agrees with the path shown in figure 4-4.

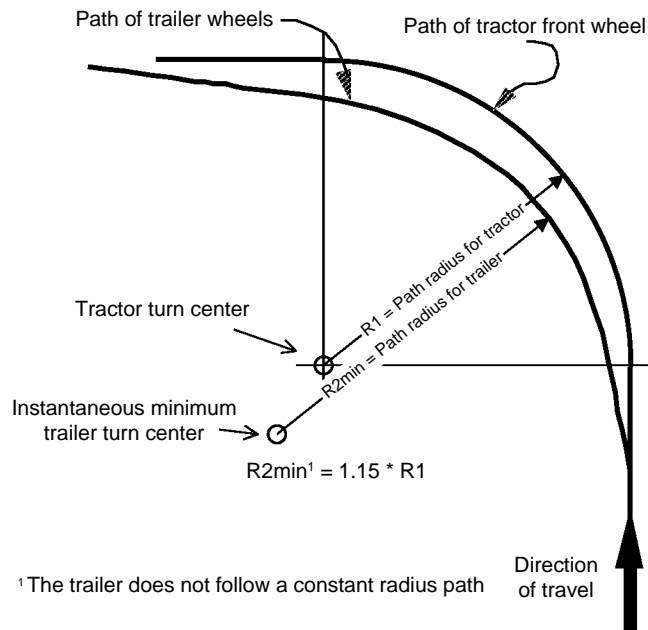

Figure 4-3. Example of low-speed off-tracking

Tractor 5. Trip 811. 6/8/2001. Time(0)= 5:46:05 AM central standard time.

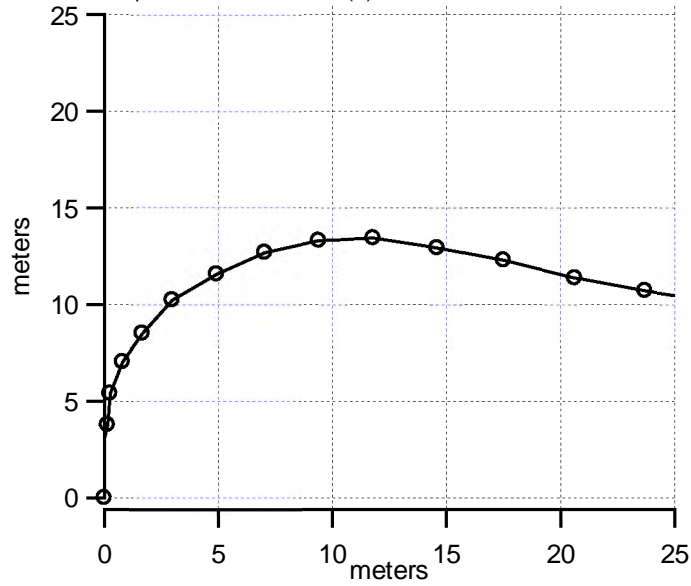

Figure 4-4. Path of the tractor in a 90 degree small radius turn

Tractor 5. Trip 811. 6/8/2001. Time(0)= 5:46:05 AM central standard time.

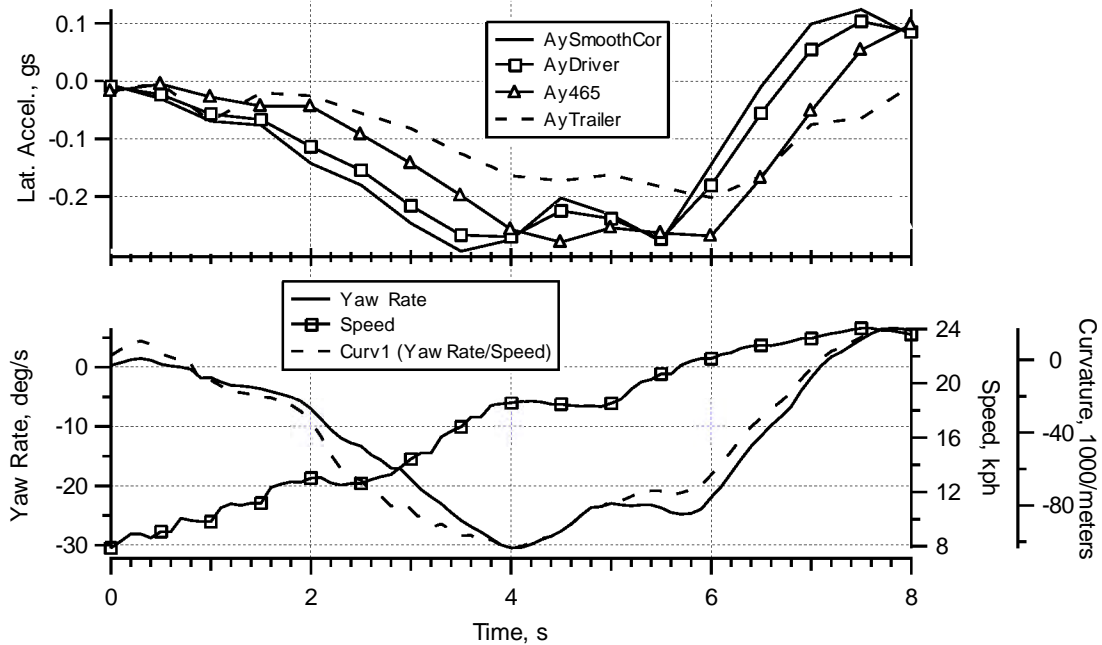

Figure 4-5. Time-history plot of a 90 degree right-hand turn

Figure 4-6 shows the relationship between Ay_{Total} and Ay_{Driver} . In this example, the mass of the tractor and trailer are approximately the same (i.e., 7.3 metric ton).

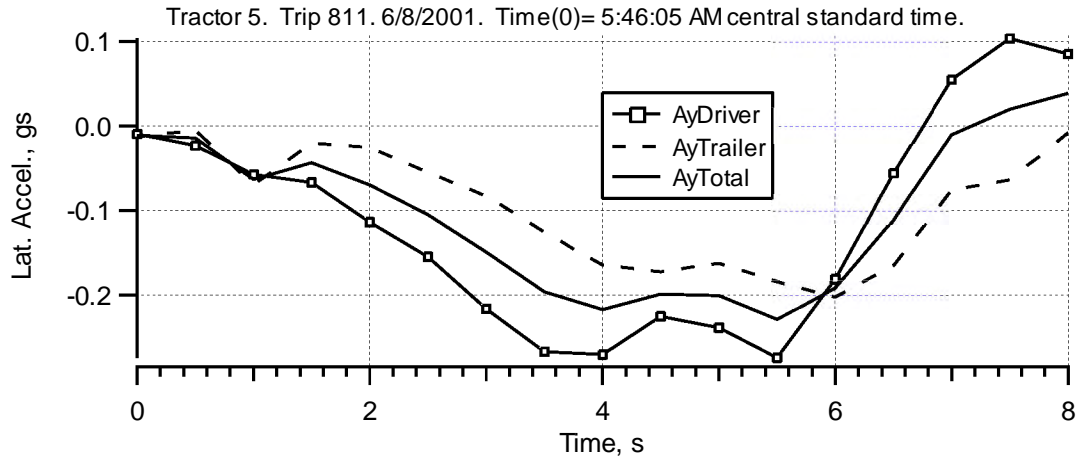

Figure 4-6. Ay_{Total} as a function of time

For less transient turns, the distinction between tractor and trailer lateral acceleration is less important, at least in terms of their absolute or sustained values. Figure 4-7 shows the path of the tractor in an exit-ramp turn that is long in duration and distance traveled (442 m). The turn is characterized by about a 180-degree heading change on a large radius of about 115 meters. Figure 4-8 presents time histories from this maneuver. In the upper part of this figure, the phase difference between the tractor and trailer lateral acceleration is only apparent in the transient sections of the turn. That is, the lateral acceleration traces are only distinguishable from each other during periods of changing curvature. When curvature is roughly constant, from 5 to 28 seconds, all the lateral acceleration measures agree closely in both phase and magnitude.

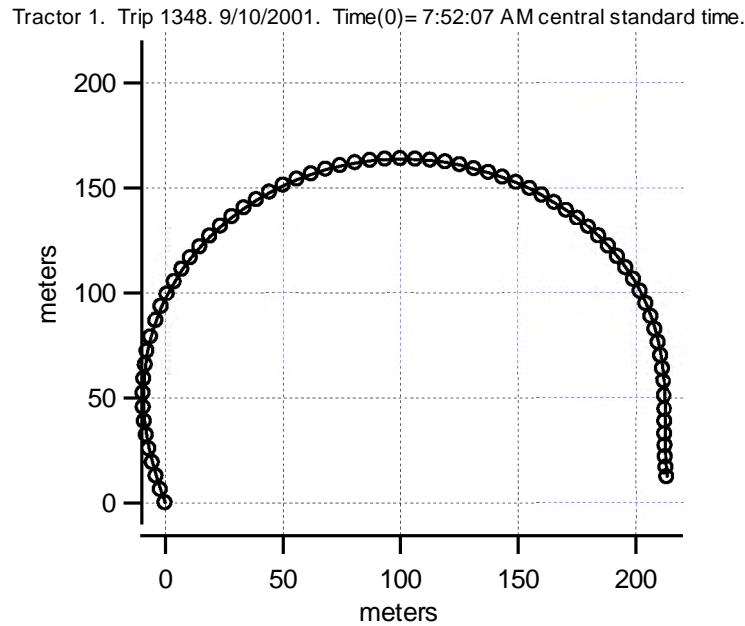

Figure 4-7. Path of the tractor in a 180 degree large-radius turn

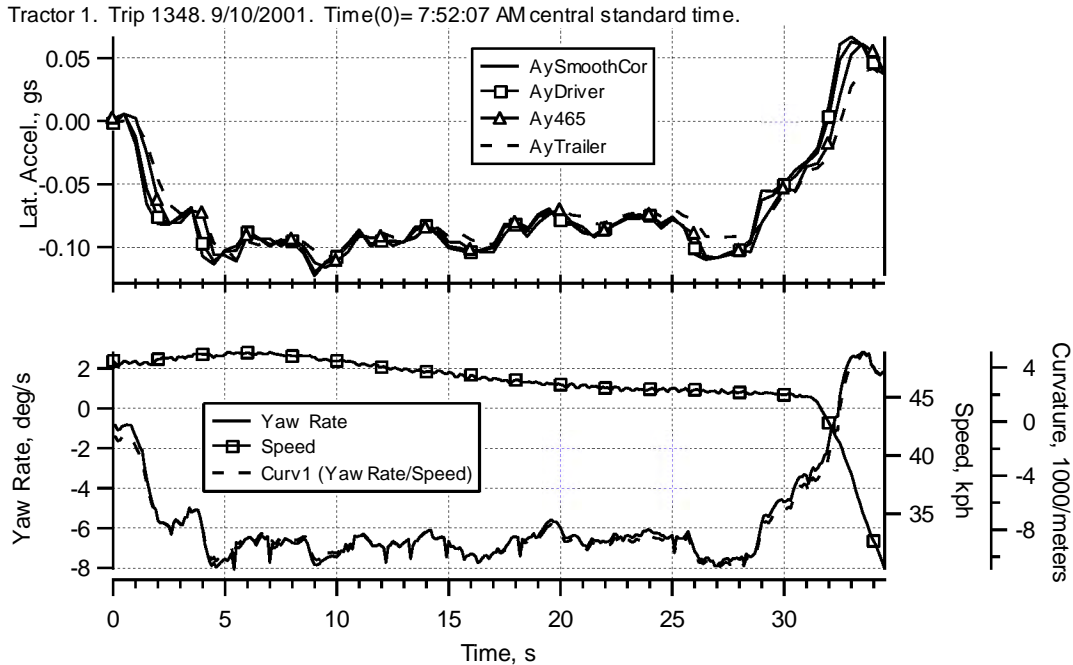

Figure 4-8. Time-history plot of a 180 degree right-hand turn

Much of the analysis done in this report uses both *AyDriver* and *AyTotal* to represent meaningful lateral accelerations for the evaluation of driving performance, at least as it pertains to the RA&C device. The rationale for the use of *AyDriver* comes from the notion that this is the lateral acceleration felt by the driver and therefore is likely to be the one that the driver responds to or is most aware of. *AyTotal* on the other hand is a weighted measure of total lateral acceleration. It is intended to represent the acceleration that may actually cause a rollover event and therefore is related to the real risk of rollover. In the analyses of rollover risk, *AyTotal* is not used directly but is used to calculate the vehicle's rollover ratio. Rollover ratio is simply the ratio of *AyTotal* to the estimated static rollover threshold as measured by tilt-table experiments (see appendix A-C). It can be thought of as a number from 0 to 1 that represents the available rollover margin of the vehicle in its current load condition. A rollover ratio of 0.5 indicates that the lateral-acceleration experienced by the combination reached half of the available rollover margin; a rollover ratio of 1 means rollover is imminent.

Lateral acceleration and superelevation

An estimate of the lateral acceleration of the tractor can be derived using the measures of speed and yaw rate. This estimate, noted as Vr and measured in gravitational units, is shown by equation 4-7 below:

$$Vr = \frac{(r * (\frac{180}{\pi}) * (\frac{V}{3.6}))}{9.8} \quad 4-7$$

where

r is yaw rate in degrees per second, and
 V is speed in kph.

However, because this is an estimate based on yaw rate it is notably insensitive to the effects of gravity that derive from cross slopes or superelevations typically present on highways and highway ramps.¹⁸ This can be a critical distinction in the analyses of rollover, particularly when superelevation is designed into the roadway to enhance stability in turning. Moreover, the difference between these measures of acceleration can be used to estimate cross slope and superelevation.

To illustrate the difference between a yaw-rate derived lateral acceleration and that measured by the front-axle accelerometer, consider figure 4-9. This figure is identical to figure 4-8, except it starts 30 seconds earlier. The point of the additional preview time is to show how a yaw-rate based lateral acceleration can be a reasonable approximation in some instances and dramatically wrong in other circumstances. For the first 30 seconds in the figure, the tractor is on a high-speed, straight road, as can be seen by the curvature (Curv1) and speed measures presented in the lower part of figure 4-9. During this time the *AySmoothCor* (which the authors believe is the most accurate lateral acceleration) and *Vr* are different by 0.01 g, which is very close to typical highway design cross slope specification for rainwater drainage. (Please note: the horizontal straight lines drawn through each of the measures, is a best-fit line of the measures for the time that they cover in the figure.) However, when the tractor enters a sweeping, high-speed turn, as shown between 35 and 60 seconds in figure 4-9, the difference between the two estimates is 0.065 g, which is considerable. The bulk of this difference, of course, is due to the superelevation designed into the high-speed ramp to provide both adequate drainage but more importantly, reduced likely-hood of excessive lateral-acceleration induced rollovers and road departures. Hence, the important observation is that, when estimating lateral acceleration and rollover margin of any vehicle, care must be taken to account for road slope in situations where it can have a significant influence on the performance of the vehicle.

Although not a significant topic in this report, an estimate of roadway superelevation or cross slope can be calculated by taking the difference between the transduced lateral

¹⁸ Superelevation, cross slope, and body roll angle, do have a minor influence on measured yaw-rate, but it is quantified as a cosine effect on the measure. That is to say, the gravitational influence from these angles on the measured yaw-rate is determined by taking the cosine of the angle, which is virtually negligible for small angles. For example, for the gravitational influence to have a 1 percent effect on yaw-rate, a slope of over 8 percent is required, this is virtually unheard in the purposeful design of any public roadway.

acceleration and that derived from yaw-rate.¹⁹ Note, however, that the accuracy of this calculation depends on the steady-state nature of the signals and inaccurate values may be calculated during times of transient turning. However, averaging of time and over many vehicle passes can yield a good measure of superelevation.

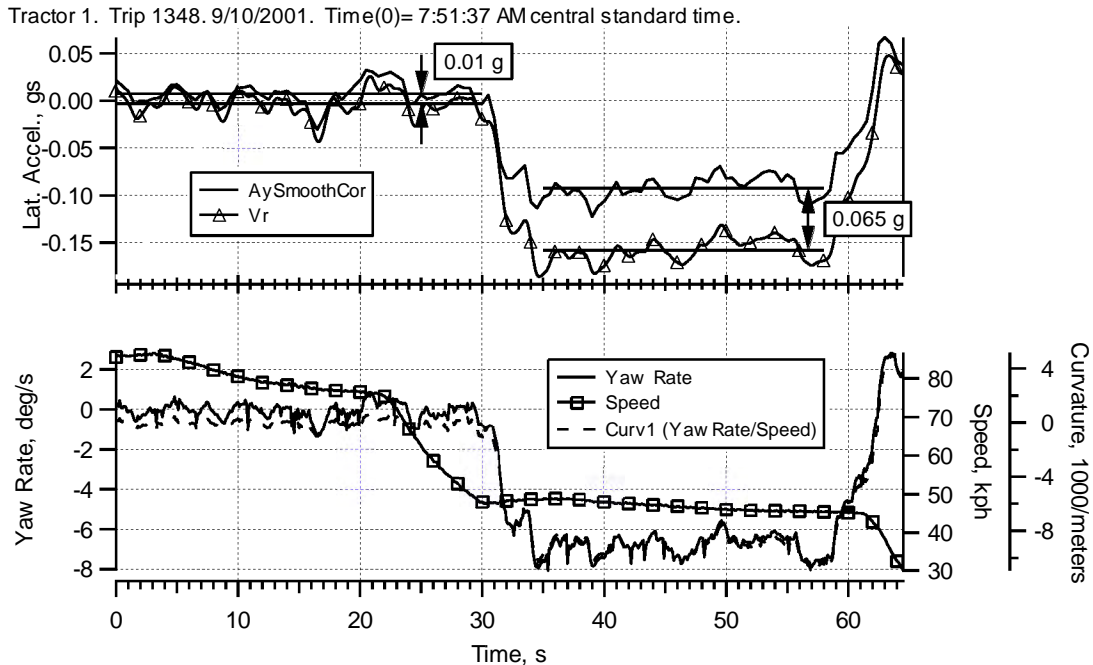

Figure 4-9. Lateral acceleration based on yaw rate and speed

4.2.5 Curves

This section of the report discusses the data-processing routines that were used to define, identify and characterize curves in the RA&C data set. Clearly, a major element in trying to quantify the influence of the RA&C device on driver behavior has to derive from comparable measures of vehicle performance over discrete sections of roadway that involve turning and, hence, lateral acceleration. Furthermore, the statistical quality of any finding depends on the number of observations and the ability to control for confounding variables that may also influence on driver behavior. It is these considerations that make the consistent identification and processing of events on curves in the RA&C database critically important. This section of the report details the process used to find and characterize curves in the RA&C database. Also in this section is a discussion of the performance measures used to characterize for each curve pass (1) the vehicle's kinematic behavior, (2) driver actions, and (3) influences on behavior, such as weather, time-of-day and vehicle load condition.

¹⁹ Road cross slope was used extensively in the Ay drift correction and is discussed in appendix A-E. For this correction, the cross slope was measured independently of the tractors.

It should also be mentioned that defining curves was done using the underlying geometrical and geographical properties of the curves themselves, as opposed to using the vehicle performance data to identify areas of perceived rollover risk. Use of measures of the dependent variable (the performance data) to select curves for evaluation would create a linkage between the dependent and independent variable potentially invalidating the analysis.

In a simple case, suppose “hot-spots” were identified in phase 1 as target locations to best observe the effectiveness of the RA&C—curves with the riskiest performance measures in phase 1 are then monitored in phase 2 for a change. It is extremely likely however that a reduction in risk would be observed even if nothing whatsoever changed in the driver’s environment. By selecting the riskiest curves in phase 1, further observations in phase 2 are bound to be lower. This is an admittedly simple case of regression to the mean. However any linkage between the dependent and independent variables risks the false identification of association between the two variables when none exists. (Alternatively, selection of only the phase 1 hot spots also neglects the possibility that risk could increase in phase 2.)

A means of characterizing curves was sought that was not based on the dependent measures. Thus this section of the report presents a global approach to identifying all curves, based upon their physical characteristics and not upon driver or vehicle performance. Of course, once the curves were defined, the vehicle/driver behavior of each pass through each curve constituted the basis for the phase 1 versus phase 2 analysis of lateral performance.²⁰

Curve Definition and Identification

The first step in the curve-analysis process was to build a table of events that explicitly identified all the time that the FOT vehicles were “in curves”. The condition that identified a “curve” was an absolute curvature $\geq 1.0 \text{ km}^{-1}$ (i.e., a curve with a radius $\leq 1 \text{ km}$) continuously for at least 3 seconds. A second table, called PreCurves, was defined. The core fields (other fields were added later during the analysis of curves) of this table included tractor, trip, start and end time, and the signed value of the maximum magnitude of curvature during the turn. (The sign of this value indicated the direction of the turn, i.e., negative was a turn to the right.) Over 330,000 turn events were identified for the entire FOT. An example, of three turns for tractor 1 on trip 1279 is shown in figure 4-10. In this example, the vehicle is transitioning from a rural highway to a limited access freeway. The figure shows curvature as a function of time in seconds. The first right turn starts at 10 and ends at 21 seconds which is followed by a short period when

²⁰ Note that the independent variable, curve severity, used in later analyses is indeed based on curve performance data, but these measures are taken from the data of drivers excluded from the study.

the vehicle is traveling straight before entering a left turn from 22 to 30 seconds. The final right turn starts at 31.5 and ends at 46 seconds. All three turns meet the requirement for 3-second duration. The maximum curvature values for each turn are -7.2 , 5.8 and -5.3 km^{-1} , respectively.

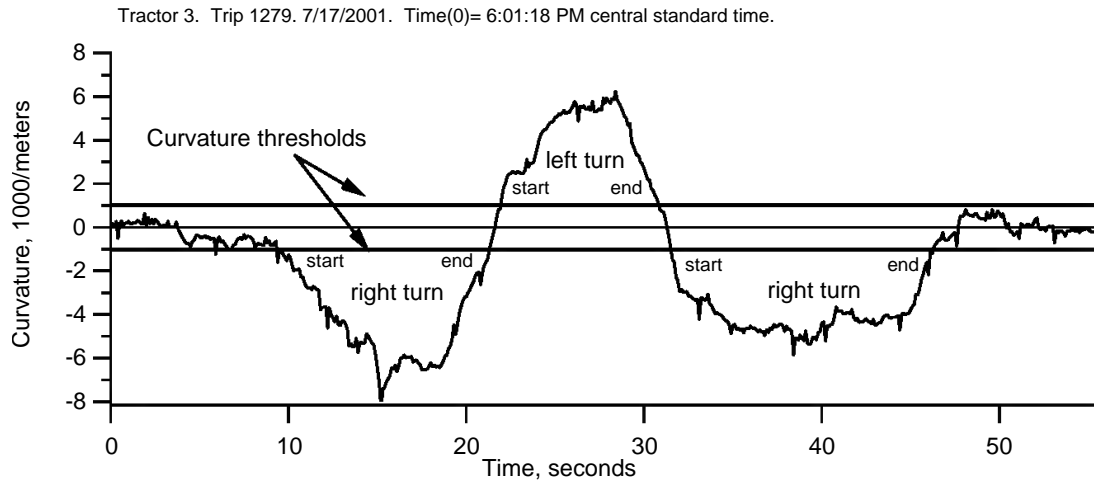

Figure 4-10. Curvature thresholds to define a turn

A map of the ramp and the three turns is shown in figure 4-11. The direction of travel is from 239 N to I-94 E. Each of the turns is shown with a different symbol on the map. The symbols are placed on the map using the latitude and longitude coordinates from the on-board GPS.



Figure 4-11. Map showing the actual curvature for the ramp from highway 239 N to I-94 E

At this point in the curve-definition process, curves were only defined in terms of individual events, or “passes.” The next step was to group passes by location to identify the curves themselves. The grouping was done using both numerics that summarize the entire turn, such as, heading change, distance traveled and turn direction, as well as, start and end geographical characteristics like heading angle and location. The start and end location of each pass were defined and grouped together using a triangulation method. Basically, for the start and end coordinate of each turn (i.e., longitude and latitude) a

distance was calculated from three distant points. This is shown conceptually in figure 4-12. The figure shows the actual geographical locations of the three triangulation points as black squares. The start of a turn is shown as a black circle, again conceptually since the scale of the map and icons is exaggerated, and the distance to each of the triangulation points is shown as D1, D2, and D3.

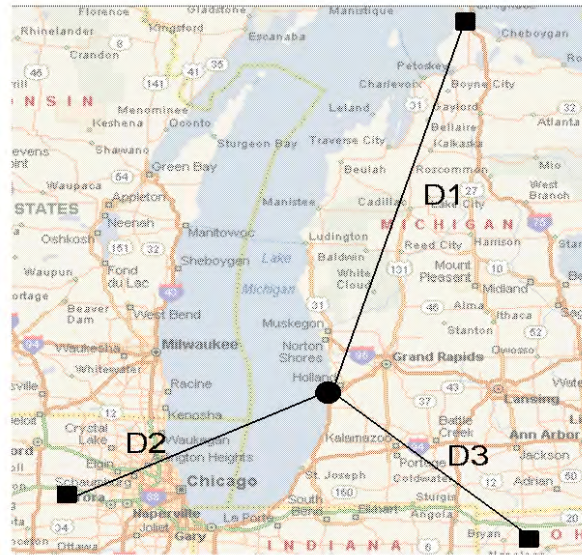

Figure 4-12. Example of the triangulation component of the curve definition routine

Tolerances are used in the grouping routine. The tolerance for start, end and total heading change was ± 4.0 degrees and for the start and end triangulation distances was ± 45 meters. Also, the grouping routine used complex conditional statements to account for the discontinuity in heading angles about due North (i.e., 360 to 0 and visa versa).

The primary result of the grouping routine was the assignment of a curve identification number to all the turn passes that met the heading, distance, and direction criteria outlined above and had three or more passes. Each curve was then defined by calculating the average characteristics of the individual passes and assigned a unique curve identification number. Over 24,000 curves were identified in the averaging process. These intermediate curves were then written to a preliminary curves-definition table that was used to in a computationally intensive process to search the entire FOT data set for all the passes over each of the curves. Again, a successful pass over a given curve required that the start and end heading, start and end location, and overall heading change and direction agree, within given tolerances, with the underlying curve definition. The results of this search and matching routine identified explicitly in the FOT data set the tractor, trip, and the start and end times for all passes over any given curve. Also, during this step passes and curves found to be in duplicate were eliminated from the analysis. This had the effect of reducing the total number of passes to 184,101 over a total of 6,014 curves.

As an example, figure 4-13 shows one such curve. The left side of the figure shows the GPS points from all 167 passes along with the symbols, circles in this case, that show the start (0,0) and end (78,-230) gates of the curve. This figure is representative of the general quality of the curves with respect to the consistency and general scatter of the GPS data. The right side of the figure shows the curve location on the map.²¹

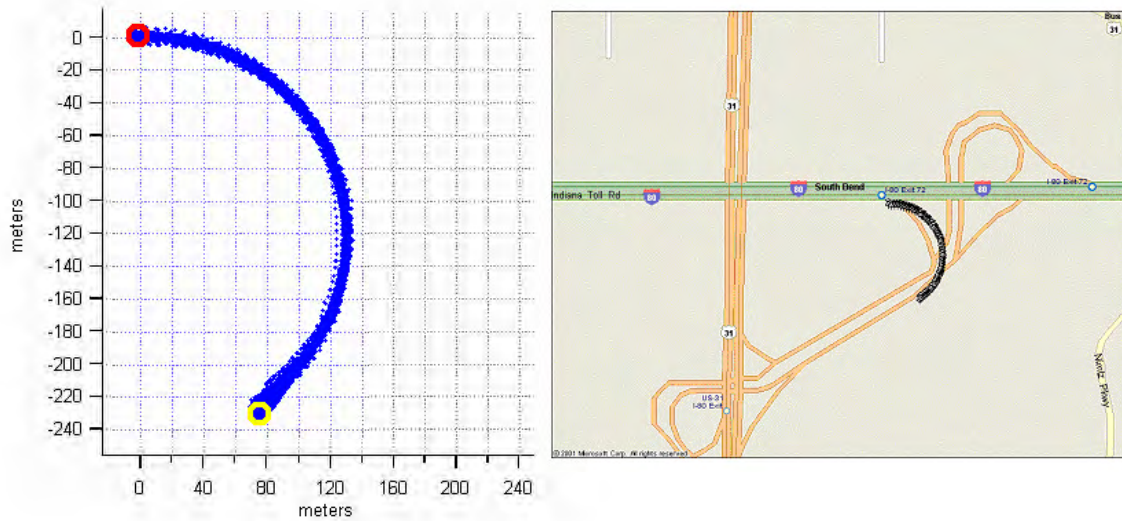

Figure 4-13. Example curve with 167 passes

Performance Measures in Curves

Once the set of curves had been identified, a table was created that contained an exhaustive list of performance metrics for every pass through each curve. Also added to the table were exposure fields. These fields, of course, were used to control for the influence that weather, load, time-of-day, etc. on the lateral performance of the vehicles in curves. This table, called *CurvePerformance*, constituted the primary set of measures used the analyses presented in chapter 8.

Several of the fields in the *CurvePerformance* table are sustained values. A sustained maximum value is the largest value of the corresponding data field which was met or exceeded for an interval of three seconds. For the various lateral-acceleration and curvature measures, the magnitude was used to aid in the search for the maximum sustained value. The maximum sustained times in the table are the start time, in deci-seconds, of the three-second interval. Figure 4-14 below is an example of the sustained and maximum values for *AyDriver* on curve number 4163 for tractor 5, trip 1124.

²¹ Clearly, the GPS points representing the actual path of the curve do not align well with the road segments shown on the map. This is due to location inaccuracies in the map program, since the overall quality of the GPS points is supported by the repeatability shown in the left-side representation of the curve.

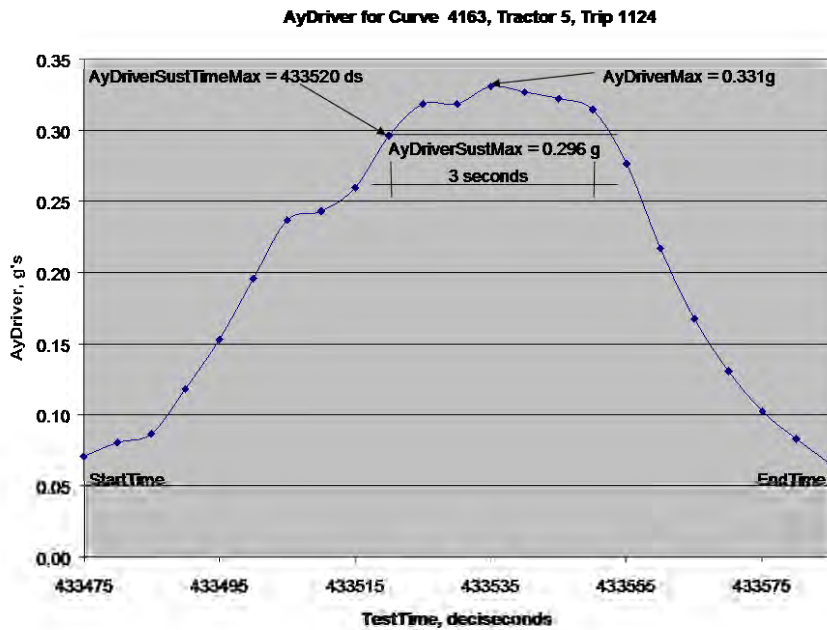

Figure 4-14. Example calculation of maximum and sustained maximum for curve performance

An itemized list of fields and associated definitions from the *CurvePerformance* table is shown below. (Note “maximum” generally refers to the signed value of the maximum amplitude.)

Ay465Max—the maximum *Ay465* value, in gs.

Ay465SustMax—the time at which the maximum sustained *Ay465* window begins, in deci-seconds.

Ay465SustTimeMax—the time at which the maximum sustained *Ay465* window begins, in deci-seconds.

AyDriverMax—the maximum *AyDriver* value, in gs.

AyDriverSustMax—the maximum sustained *AyDriver* value (signed) over a 3-second window, in gs.

AyDriverSustTimeMax—the time at which the maximum sustained *AyDriver* window begins, in deci-seconds.

AyTotalMax—the maximum *AyTotal* value, in gs.

AyTotalSustMax—the maximum sustained *AyTotal* value over a 3-second window, in gs.

AyTotalSustTimeMax—the time at which the maximum sustained *AyTotal* window begins, in deci-seconds.

AyTrailerMax—the maximum *AyTrailer* value, in gs.

AyTrailerSustMax—the maximum sustained *AyTrailer* value over a 3-second window, in gs.

AyTrailerSustTimeMax—the time at which the maximum sustained *AyTrailer* window begins, in deci-seconds.

BrakeOnCount—the number of deci-seconds with the brake on.

BrakeOnEndTime—the time of last release of brake before the end of the curve, in deci-seconds.

BrakeOnStartTime—the time preceding the curve where brake was first applied and not released for more than 5 seconds, within 100 seconds of start of curve, in deci-seconds.

CountRSC—the count of RSC messages during the curve.

CurveAyDriverSust—the curvature at *AyDriverSustTimeMax*, in km^{-1} .

CurveAyTotalSust—the curvature at *AyTotalSustTimeMax*, in km^{-1} .

CurveDistance—the distance traveled between on the curve, in km.

CurveNumber—a unique integer number for each curve defined in the curve definition and identification process.

CurveSustMax—the maximum sustained curvature value over a 3-second window from the *TwoCalc* table, in km^{-1} .

CurveSustTimeMax—the time at which the maximum sustained curvature window begins, in deci-seconds.

DecelMax—the largest magnitude deceleration during braking in the curve, in gs.

DecelSustMax—the maximum sustained deceleration value over a 3-second window, in gs.

DecelSustTimeMax—the time at which the maximum sustained deceleration window begins, in deci-seconds.

Driver—the UMTRI driver identification number.

ECU—the software version of the RA&C ECU.

HeadingChange—the total change in direction as determined by integrating yaw rate, in degrees.

MaxCurvature—the maximum curvature (signed) from *TwoCalc* table, in km^{-1} .

MaxRSALevel—the maximum RSA alert level during the curve.

Night—flag indicating day or night. Night = 1 if the solar zenith angle > 96 degrees, otherwise Night = 0.

ParkingLot—a flag to distinguish curves meeting the criteria for off-roadway 1=off the roadway, 0=on the roadway.

PhaseDistance—the distance to date for the driver in the current phase (1 or 2), in km.

Rollover—the estimated static rollover threshold as measured by the tilt-table, in gs.

SessionDistance—the distance traveled so far in session since departing La Porte, in km.

SpeedAvg—the average speed of the tractor while in the curve, in kph.

SpeedAyDriverSust—the speed at *AyDriverSustTimeMax*, in kph.

SpeedAyTotalSust—the speed at *AyTotalSustTimeMax*, in kph.

SpeedBrakeEnd—the speed at *BrakeOnEndTime*, in kph.

SpeedBrakeStart—the speed at *BrakeOnStartTime*, in kph.

SpeedFinal—the speed of the tractor at exit time of the curve, in kph.

SpeedInit—the speed of the tractor at the start of the curve, in kph.

SpeedMaxCurvatureSust—the speed at *CurveSustTimeMax*, in kph.
SpeedMax—the maximum speed attained during the curve, in kph.
SpeedMin—the minimum speed on the curve, in kph.
SpeedSustMax—the maximum sustained speed for 3 seconds, in kph.
SpeedSustTimeMax—the time at which maximum sustained speed window begins, in deci-seconds.
TimeSinceBadWeather—elapsed time since bad weather, defined by *WiperIntensity*>0.01 or *Visibility*<2, in deci-seconds.
TimeUntilBadWeather—elapsed time until bad weather, defined by *WiperIntensity*>0.01 or *Visibility*<2, in deci-seconds.
TotalMass—the total vehicle mass, in metric tons.
TripDistance—the current distance traveled for the trip, in km.

Off-roadway curves

Some curves identified in this study were flagged as off-roadway or parking lot curves. These curves were separated from road curves because the path the driver can take in off-roadway situations is generally less restricted compared to road curves where there are clear constraints on path. This is a critical distinction in the analyses to be presented in chapter 8.

An example of an off-roadway curve is shown in figure 4-15. In this example, 22 passes met the criteria of the underlying curve definition in terms of heading, heading change and start and end locations. The figure shows that the path does vary considerably on a pass-by-pass basis. The right side of the figure confirms that the curve does lie off the mapped roadway system. Off-roadway curves were flagged in the *CurvePerformance* data using three rules. In short, these rules were that:

- All curves identified in trips with a distance of less than 1.0 km were flagged as off-roadway curves.
- If the first curve at the beginning of a trip had an average speed ≤ 9 kph, that curve and all consecutive curves with an average speed ≤ 9 kph were flagged as off-roadway curves.
- Similarly, if the last curve at the end of a trip had an average speed ≤ 9 kph, that curve and all preceding-consecutive curves with an average speed ≤ 9 kph were flagged as off-roadway curves.

4.2.6 Histograms

Histograms were used extensively in some of the analyses done for this study and reported here. Many of these histograms were generated after all the data were collected in the FOT and following the transformation and recalculation required to properly represent the lateral-acceleration experience as actually occurred in the field. The methodology and processing to generate the new histograms, although certainly

not new nor revolutionary, was very computationally efficient and thus deserves a brief explanation.

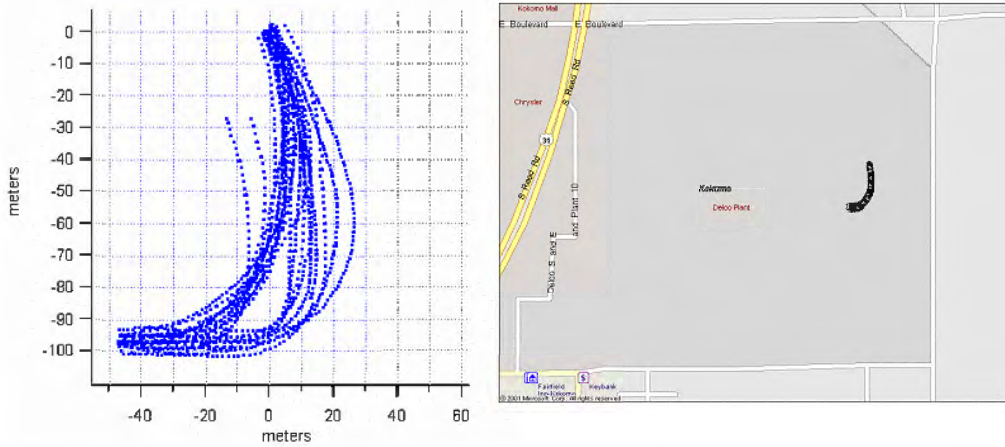

Figure 4-15. Example of an off-roadway curve

The generation of new histograms was a two-part process. First, all new histograms were created and binned as a function of speed. That is to say, these histograms can be thought of as being three-dimensional in the sense that the primary measured variable is one dimension, speed is the second dimension and bin counts constitute the third dimension. To efficiently create and populate the histograms, additional fields were added to some of the secondary tables (these fields are usually denoted with field names that end in *Hist*). The fields were populated, not by the actual values of speed or the primary measure, but by their corresponding bin number. The calculation to do the transformation is shown in table 4-3. The advantage of this transformation is that it converts what is often a 4-byte real number in to a 1-byte integer that can then be indexed for use by very efficient searching routines.

The second step in the process was to build and execute a Structure Query Language (SQL) input deck that automatically created the histogram table, populated all the fields and records of the table and contained the update commands for each cell of the histogram. These input decks were typically thousands of lines long and were automatically generated by programs written specifically for generating SQL text.

The net result of this effort was an order of magnitude decrease in the time needed to make histograms with data collected from the entire FOT. In other words, what began as a computational task that took over 20 hours was reduced to one that could be done in roughly 2 hours.

4.3 Subjective data set

Although the primary focus of this analysis is on change in driving performance, it is important to consider less objective sources of information to provide some alternate

measures of the RA&C from the driver's perspective. Such measures provide useful hints and insights about factors which might be too subtle to have been observed in the objective data, as well as provide additional context in which to assess how the safety system integrates into the driver's daily routine.

To build this picture, just prior to the activation of the RA&C system (in phase 2), an initial survey of driver opinion was taken to assess expectations, experience with safety systems, and general opinion about the introduction of new technologies into the driving environment. Following activation, periodic surveys were administered to monitor evolving driver opinion about the system, and to keep abreast of any potential problems that might develop with the new system. Finally, after the completion of phase 2, each driver was interviewed using a structured interview script to obtain a final perspective on the value of the RA&C to each driver.

Some subjective data was also collected in a more speculative manner to serve as a possible basis for partitioning drivers into separate groups. A decision-making survey, moderately predictive of accident involvement, was also given to all drivers with the expectation that perhaps the safety system might have different influence on those drivers as a function of accident inclination.

4.3.1 Structure and content

After collection of baseline data during phase 1, each driver was provided with a one-hour orientation about the operation of the RA&C, prior to its activation. In the week after the orientation, drivers were privately interviewed to solicit their general opinions about their driving experience, opinions about technology, and expectations about the effectiveness of safety systems in general. The primary purpose of this survey was to understand whether drivers approached the field test with any strong biases against technology that might color their later perceptions of the system.

Periodic surveys were given both to monitor evolving driver opinion and to establish an active mechanism by which any concern or difficulty a driver might have with the safety system could be immediately addressed. Two surveys were produced. A short, single-page survey containing 7 multiple-choice items soliciting driver opinion about each of the RA&C subsystems (advisor, control, and hard braking systems), and their recollections about each subsystem's activation. A longer survey was administered periodically to obtain more detailed opinions about the perceived utility and safety benefit of the system, the accuracy of the advisories, and the general impact of the device on the driving environment. Of particular interest was the driver's opinion about whether he found the safety system distracting. This survey was largely comprised of items requiring drivers to rate their extent of agreement or disagreement on a seven-level scale with a variety of statements. This is known as a Likert scale. It is commonly used in

survey materials and is amenable to quantitative reporting although it imposes some structure on the respondent.

The periodic surveys were delivered to the Praxair facility and distributed to the drivers as part of each driver’s regular monthly safety training. (Note, because of the staggered driving schedules, drivers are rarely assembled together in one place at one time.) The short periodic survey was initially scoped for a two-week turnaround schedule; the long survey was intended to cycle on a 4-6-week interval. It later became clear that the best chance for gathering a complete record was to rely on the existing regularly scheduled safety meeting cycles. Consequently, the short survey was dropped both to simplify driver reporting and because the information provided by the short survey was minimal. After September 24, focus was placed exclusively on the long survey. Thus, although a short survey was distributed on September 24, it was cancelled to avert confusion among the fleet drivers which might have interfered with the Long Survey distributed on October 4.

Table 4-4. Short and long survey schedule rotation dates.

<i>Survey Type</i>	<i>Sent</i>	<i>Received</i>
Short	July 9, 2001	Aug 8, 2001
Short	Aug 9, 2001	September 8, 2001
Long	September 6, 2001	September 19, 2001
Short	September 24, 2001	(cancelled)
Long	October 4, 2001	October 30, 2001
Long	November 2, 2001	December 5, 2001

At the end of phase 2, each driver was interviewed by the experimenter for 45 minutes to obtain their final appraisal of the overall functioning of the RA&C, the perceived benefits of the system for themselves and for other, less experienced drivers, suggested improvements in the system, and a comparative assessment of the RA&C to other safety systems. For completeness, the interviewer followed the detailed script provided in appendix A-I.

Drivers were also asked to complete a decision-making questionnaire at the start of the study based on one used by [8]. The purpose of this questionnaire was to obtain covariates that might be predictive of their driving style.

French et al. [8] found a modest association between two of the derived decision-making factors and drivers’ annual involvement in traffic accidents. The factors were identified as *Instinctiveness* and *Thoroughness* and were weakly correlated to accident involvement ($r = 0.08$ and, -0.09 respectively). We anticipated that drivers’ answers on the same questionnaire (adapted for US drivers) could provide a means to partition drivers into groups more or less disposed toward accidents. Such partitioning of the subject pool could be useful if the RA&C differed in its effectiveness with each driver-population.

Overall, RSA drivers' scores were similar to the scores obtained by French et al. [8], albeit slightly higher (mean score *Instinctiveness*: 8.8, *sd.* = 1.7 versus 7.2; mean *Thoroughness*: 20.3, *sd.* = 2.22, versus 17.7). When these scores were compared to overall message counts obtained during phase 2, a strong negative correlation was found between *Instinctiveness* and the frequency of advisories ($r = -.54$, $p = .038$). That is, the higher the rated *Instinctiveness* of the driver, the less likely the driver was to trigger an advisory. This is counter to the expectation that accident rate is directly related to *Instinctiveness* found in [8] and suggests that the already weak predictive power of the instrument among the *average non-professional* driver population may have dubious value applied to the professional drivers in the Praxair fleet.

4.3.2 Processing

Answers to survey questions were compiled in several ways, depending on the format of the question. Surveys containing choices based on ordinal levels were encoded using ordinal values; verbal responses and free-written responses were also transcribed into the data record. Detailed item-by-item summaries of the Initial Survey, the Long Periodic Survey, and the Final structured interview are provided in appendix A-I.

Some survey items were asked repeatedly throughout the field test in order to chart changes in opinion that might develop over the course of the field test. These items included questions about technology acceptance, expected/experienced benefits of the RA&C, and comprehension of the system's operation. Answers to these items were combined, adjusting for polarity differences and scaling, and charted over time.

A factor analysis was also performed on each drivers' answers to the long periodic survey questions to produce groupings based on the patterns of responses to the survey items. Eight factors were isolated from thirty of the Likert-scale questions found in the long surveys. In most cases, the factor groupings followed our general intuitions about which survey items were similar to each other. There were a few exceptions. For example, the level of a driver's understanding of the RA&C appear to be inversely related to his level of acceptance of the safety device. To the extent a driver affirms his understanding of the RA&C, he appears to disagree that high-tech systems are not needed. Although on the surface these questions are not related, they appear to be answered in a manner that links them together—the stronger the agreement that the RA&C is easy to use, the stronger the disagreement about not needing such a system. Put another way, the less a driver feels he understands the RA&C, the more he is likely to feel it is a superfluous piece of technology.

Interpretation of the other factor groupings was straightforward with the exception of the last factor containing two items: one noting the accuracy of the speed reduction recommendations, and the other concerning the RSC intervention. These items were not

collapsed together in the analysis. Data were summarized using the groupings depicted in table 4-5, inverting the scale where necessary and averaging the responses. Thus answers to thirty questions were distilled into ten categories.

Table 4-5. Grouping of survey items based on factor analysis used to pool together answers to similar questions.

<i>Question</i>	<i>Grouping Name</i>
I have a good understanding about how to use the Roll Stability Advisor. I haven't had any difficulty learning how to use these systems. I am learning things about my driving habits from the Roll Stability Advisor and Control systems that I did not know.	Operational Understanding
The messages from the roll over advisory system are easy to read.	
I would be better off driving without these types of high tech advice and control systems. I don't need the Roll Stability Advisor to keep from rolling my truck.	(Need for RA&C system)
The Roll Stability Advisor's messages interfere with my ability to drive safely because they distract me. The advisory messages and alarms do not interfere with my driving. These systems sometimes interfere with my driving responsibilities. I have enough time to safely read the roll advisories.	Distraction Interference
The advisory messages from the Roll Stability Advisor provide useful advice. When I get an advisory message, it is clear what I could have done differently to avoid getting a message. When an advisory message appears, it is easy to determine which maneuver caused it. The information I get from the Roll Stability Advisor about rollover danger is helpful. The advisory messages from the Roll Stability Advisor are easy to understand. The Roll Stability Advisor provides me with information about my vehicle that I would not normally have.	Clarity of Advisories
Since the new safety system was activated, I drive my vehicle more safely with regard to hard braking. Since the new safety system was activated, I drive my vehicle more safely with regard to rollover risk. Advisory messages about hard braking are helpful to me. The Roll Stability Control system can slow my truck safely	Safety Benefit
Roll advisories are sometimes displayed when there is no real rollover risk. I am surprised by some advisory messages that occur during what I think is a safe maneuver.	Advisory False Alarms
I think some of my maneuvers should have produced advisory messages, but none were displayed after the maneuver. These systems often fail to give me an alert when I think they should.	Advisory Misses
Having this system in my truck has reduced the number of accidents or near-accident situations compared to what I would have had without it. I find that having this safety system in my truck reduces the stress and fatigue of driving. With the Roll Stability Advisor, I don't drive any differently than I would drive without it. High tech systems like these really do not help the experienced driver.	Influence on Driving
The Roll Stability Control has come on and slowed me at times I do not think it should have come on. The speed reduction recommendations are accurate.	(Ungrouped)

5. EXPOSURE OF THE FOT FLEET

5.1 General and physical qualities of the exposure of the fleet

The six vehicles of the FOT fleet were phased into service from early November, 2000 through late February, 2001. All six operated in the FOT through the end of November of 2001. During that time, data were collected for approximately 10,000 hours of vehicle service. The vehicles were in motion during approximately 9800 of those service hours. The analyses of this report generally derive from about 9640 hours, some data having been lost to irrecoverable instrument problems.

Figure 5-1 indicates that once all six vehicles were in service, travel distance was accumulated at a rather steady rate despite the economic downturn of the latter half of 2001. The total distance accumulated was a bit over 772,000 km and was split rather evenly between phase 1 and phase 2 (49 to 51 percent, respectively). The figure also indicates that about 74 percent of this total distance was covered with the vehicles operating under cruise control and about 11 percent with windshield wipers on (a surrogate for poor weather).

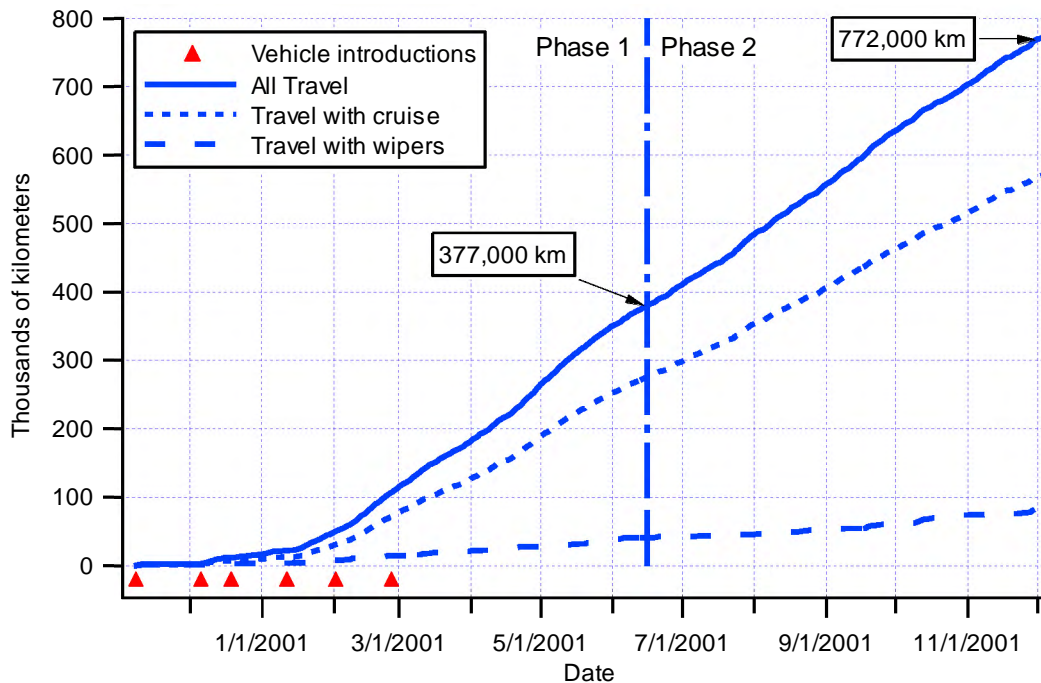

Figure 5-1. Accumulation of FOT travel distance in time

The distances represented in figure 5-1 were accumulated in a total of 9042 FOT *trips*, a trip being defined primarily for data-collection purposes as the period from ignition-on to ignition-off. Figure 5-2 shows a histogram of the number of trips by trip distance. The figure includes an insert with an expanded histogram of just the trips of distances under 5 km. The figure shows that a great many of the *FOT* trips (more than 60

percent) were very short — probably just short moves from one point to another in parking lots and work yards. In fact, the “distance” of quite a few trips was actually zero. The insert shows that the count of trips drops radically at distances greater than about 0.7 km, implying that *real* trips are those which exceed this distance.

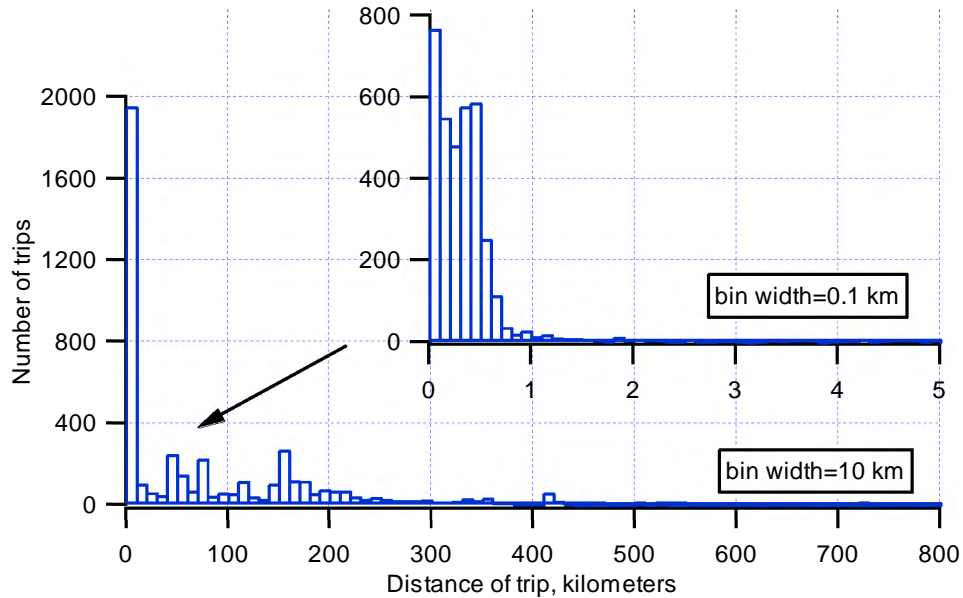

Figure 5-2. Histogram of trip distances

Extremely short trips (less than 0.1 km) often did not produce good GPS data because they were of very short time duration or were entirely in a location “shaded” from GPS satellite signals. Since the GPS clock signal is important in establishing the validity and usefulness of all the data collected, processing the data from these short trips was problematic. To avoid excessive data-processing problems, the analyses of this report are generally based only on those trips whose distance exceeds 0.1 km. This limitation excludes less than 0.1 percent of the total travel distance represented in the data base.

The average distance of those trips exceeding 0.1 km was 93 km. The average distance of trips over 0.7 km was 135 km.

Sixty-five percent of the travel time represented in figure 5-1 took place during “daylight” and 35 percent in “darkness.” The distinction between daylight and darkness was made according to the local solar zenith angle as determined by calculation based on the day of the year, UTC time, and latitude and longitude, all variables derived from GPS. Darkness was assumed for travel whenever the sun was more than six degrees below the horizon—the common definition of civil twilight—and daylight was assumed whenever the sun was higher than six degrees below the horizon. (See chapter 4 and appendix A-D.)

About 83 percent of travel time was in “good weather.” *Good weather* was defined relatively crudely and was determined at 5-minute intervals. Good weather was assumed for any five-minute period in which the *WiperIntensity* parameter was less than 0.01 and *Visibility* was greater than 2 km. (See section 4.2 for explanations of *WiperIntensity* and *Visibility*.)



Figure 5-3. Travel routs of the FOT fleet

Figure 5-3 shows a map of the geographical area over which the FOT fleet operated and indicates the fleet’s routes of travel. These routes are, of course, dictated by a combination of the locations of facilities belonging to Praxair and their customers that, in turn, determine significant exposure factors such as the typical length of trip, distance between deliveries, and the qualities of roads traveled. The average distance from Praxair’s La Porte facility to the product delivery points was 166 km. (This is the straight-line, geographical distance, not the over-the-road, travel distance.) Using a combination of logistical data (for product on- and off-loading) and data taken on board the vehicles (distances), the average driving distance in a single *leg* of driving (i.e., from one product on/off-load to the next) was 136 km. Note that this measure aligns extremely well with the average FOT trip distance for trips greater than 0.7 km (135 km).

The proportions of travel time spent on different road types are presented in the histogram of figure 5-4. (Figures 5-4 and 5-5 are based on only that portion of all travel time in which mapping software could reliably identify road type: about 8200 hours. Most time spent in parking lots, work yards, rest areas, etc. is not included in these two figures.) Road types in this figure are defined as follows:

- freeway: high-speed, high-volume, limited-access roads between and through metropolitan areas;
- highway: high-speed, high-volume roads to channel traffic to and from freeways or between and through metropolitan areas;
- arterial: roads which interconnect highways and provide high traffic volumes;
- local/regional: high-volume, moderate-speed roads through neighborhoods and connecting neighborhoods with higher road classes;
- access roads: freeway and highway ramps, neighborhood streets, small country roads, etc.

About 64.5 percent of all travel time is on limited-access freeways. Figure 5-5 shows the distribution of travel time by speed range within each of the five road classes, respectively.

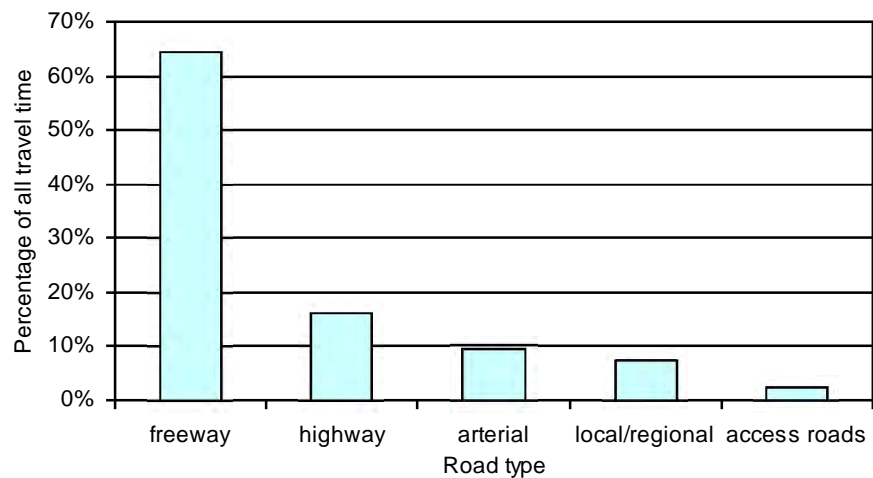

Figure 5-4. Histogram of travel time by road type and phase

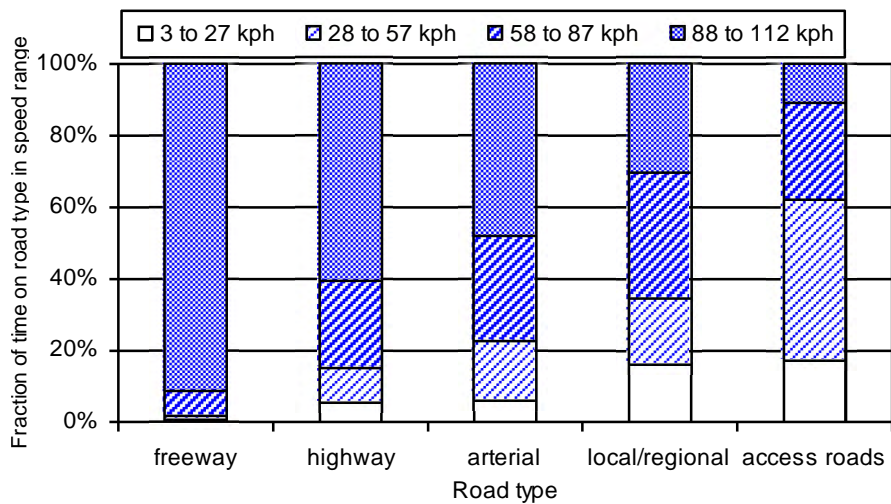

Figure 5-5. Distribution of travel time by speed for each road classification

Figure 5-6 is a histogram showing the broader distribution of vehicle speed for all FOT travel time. Since figure 5-4 showed that most travel time was on freeways and 5-5, that most travel on freeways is at high speed, it is no surprise that figure 5-6 shows that the large majority of FOT travel was spent at high speeds. The figure also shows, however, that a fair amount of time was spent at low speed, presumably on city streets or in work yards or parking lots, time which may be largely unrepresented in figure 5-4.

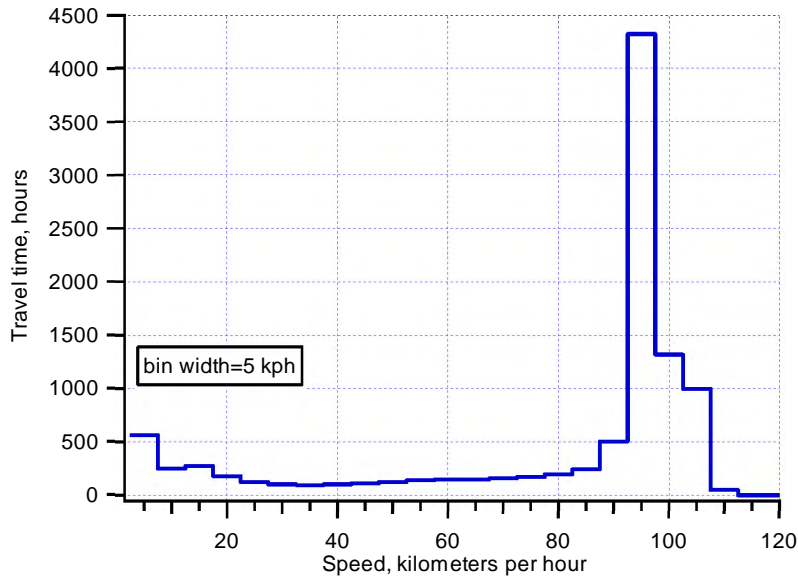

Figure 5-6. Histogram of travel time by speed

Figure 5-7 is a histogram showing the distribution of travel time as a function of total vehicle mass. The histogram shows that travel time was largely split between the fully-loaded (about 36 metric ton) and virtually empty (about 14 metric ton) conditions. Travel at partial loading accounted for only a small portion of travel time. The figure also shows a small portion of travel time tractors without trailers (bobtail). The analyses and other presentations in this report generally omit data from the bobtail tractors.

In the presentations which follow, reference is made to *empty*, *partial*, and *full* loading conditions. These conditions are defined in table 5-1.

Table 5-1. Definitions of loading conditions

<i>Loading condition</i>	<i>Gross vehicle mass metric tons</i>
Empty	>12 and <=17
Partial	>17 and <=33
Full	>33 and <=40

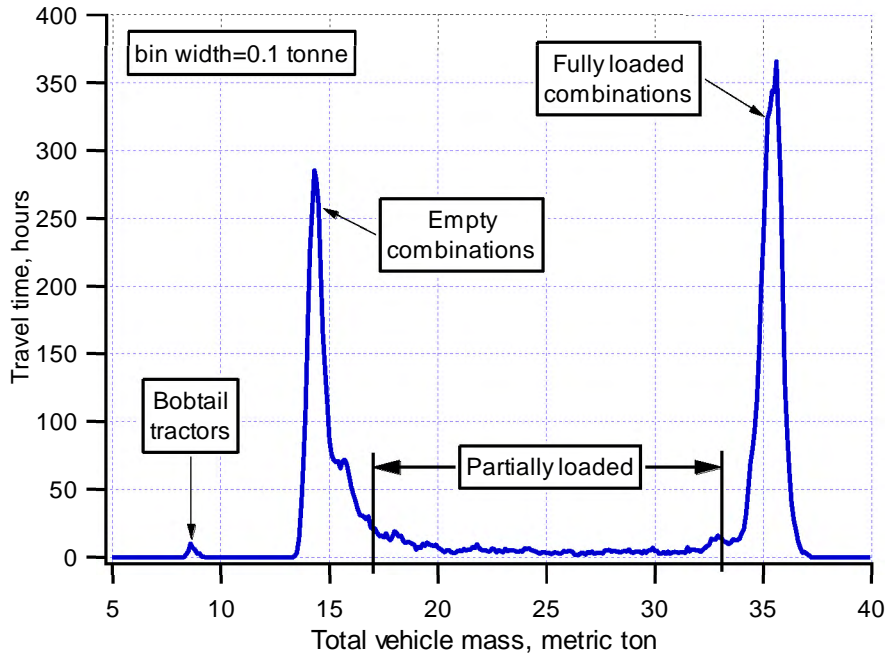

Figure 5-7. Histogram of travel time by total vehicle mass

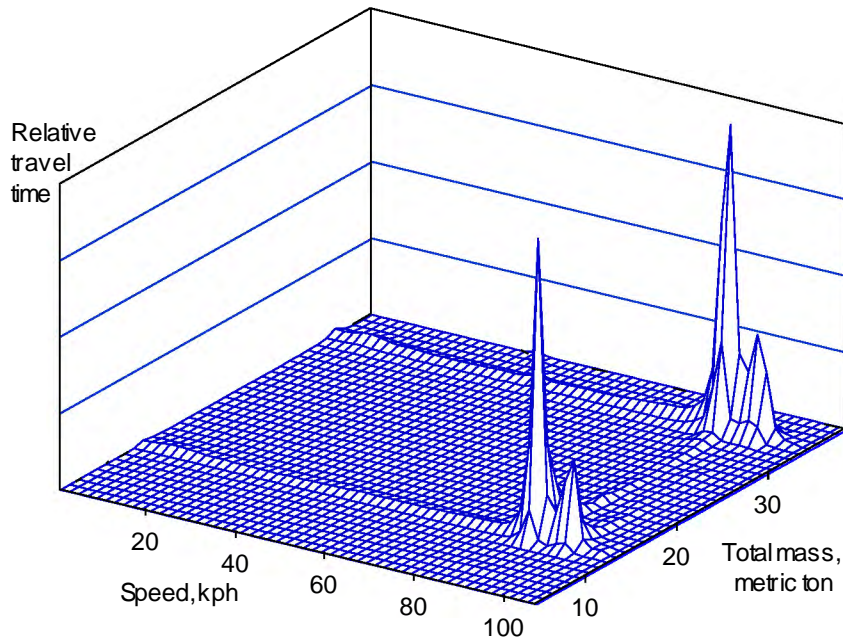

Figure 5-8. A two-dimensional histogram of travel time by mass and speed

Figure 5-8 combines the information of the two previous figures into a three-dimensional histogram. In this figure, it can be seen that the individual velocity distributions in empty and loaded conditions are each similar to the lumped distribution of figure 5-7. That is, the quality of the speed distribution shown in figure 5-6 holds for both of the individual, dominant loading conditions.

It appears from the data that the FOT vehicles could be described as *traveling straight ahead* during about 91 percent of their total of 10,000 hours of travel time and *in turns* for the remaining 9 percent. Figure 5-9 speaks to this point. The figure presents a *cumulative* histogram of travel time (hours) by *magnitude* (absolute value) of path curvature (km^{-1}), i.e., the inverse of turn radius. (Path curvature here is specifically for the path of the steer axle of the tractor.) The graph is in log-log format. The magnitude of path curvature is shown on the abscissa; the time of travel in turns of path curvature of magnitude *exceeding* the abscissa value is plotted on the ordinate. Thus at the far left, as the abscissa value approaches zero (straight-line travel) the time value approaches the total time of the database, about 10,000 hours. As the magnitude of path curvature increases to the right, travel time at or above that curvature declines.

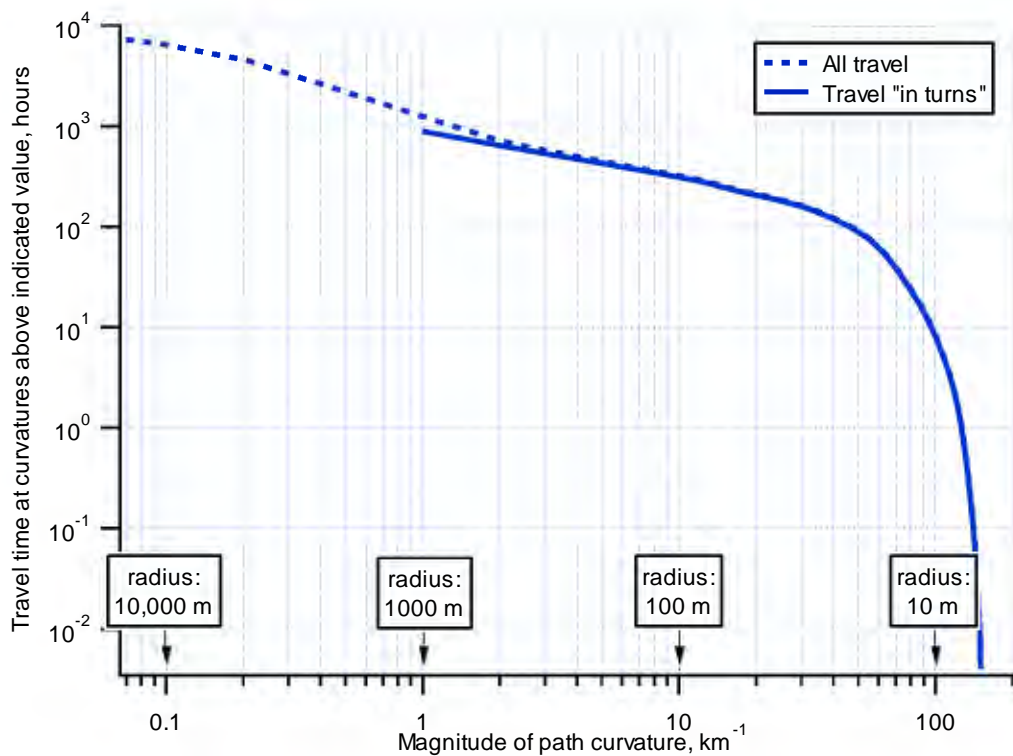

Figure 5-9. Cumulative histograms of path curvature

Two sets of data are plotted. The dashed line is for the entire database (trips > 0.1 km), and it places no restriction on the duration of turning. That is, a value of curvature observed for as brief a period as one half second is included in the generation of this curve. The solid line is a cumulative histogram for just that portion of travel in which the vehicles were considered (for purposes of this study) to be *in a turn*, where being *in a turn* is defined as sustaining a magnitude of path curvature of 1 km^{-1} or greater for a minimum duration of 3 seconds. Comparing the two plots seems to indicate that this definition is, in fact, reasonable. That is, the two curves are virtually identical for curvatures exceeding 2 km^{-1} , suggesting that virtually all activity above this threshold

constitutes deliberate, sustained turning. Below this threshold, the curves begin to separate, perhaps suggesting that “straight” driving is composed of brief periods of travel at curvatures in this lower range.

The graph shows that, by this definition, some 900 hours (9 percent) of travel was *in turns*. Moreover, about 100 hours (1 percent) of travel was in truly tight turns having path curvatures in excess of 50 km⁻¹, that is, having radii near to or less than the nominal length of the vehicle (20 m or less).

Table 5-2 presents many of the exposure measures discussed in this section individually for phases 1 and 2. The table indicates that most of these exposure measures are rather well balanced between phase 1 and phase 2. Perhaps the two most significant change in phase 2 relative to phase 1 is the increase in percentage of travel time in daylight. This, of course, simply results from the arrangement of the study within the calendar year. Also note that the fraction of time at high speed was greater in phase 2.

Table 5-2. Comparison of exposure measures for phases 1 and 2

		Phase 1	Phase 2	Change
Total distance		376,857 km	395,276 km	18,419 km
<u>Average distances</u>	of trips > 0.1 km	95.1 km	91.6 km	-3.4 km
	of trips > 0.7 km	137 km	133 km	-4 km
	of leg of delivery tour	136 km	136 km	0 km
	La Porte to delivery point	166 km	166 km	0 km
<u>Road type</u>	Percent of travel in phase on:			
	freeway	65.0%	64.0%	-1.0%
	highway	16.0%	16.4%	0.5%
	arterial	9.1%	9.6%	0.5%
	local/regional	7.4%	7.5%	0.1%
	access roads	2.5%	2.5%	0.0%
<u>Day/night</u>	Percent of travel time in daylight	63%	67%	4%
<u>Weather</u>	Percent of travel time in good weather	82%	84%	2%
<u>Loading</u>	Average Mass, metric ton	26.1	25.8	-0.3
	Percent of time: empty	37.1%	38.7%	2%
	partial	14.5%	11.9%	-3%
	full	48.0%	49.0%	1%
<u>Speed</u>	Average speed in motion, kph	78.6	78.9	0.3
	Percent of time: 3 to 27 kph	9.7%	9.4%	-0.3%
	28 to 57 kph	7.6%	7.2%	-0.4%
	58 to 87 kph	14.7%	14.4%	-0.3%
	88 to 112 kph	68.1%	68.9%	0.9%
<u>Curves</u>	Percent of travel time in curves	9.4	9.1	-0.3%

An additional difference between phase 1 and phase 2 exposure of potential importance is the mix of delivery points. While the average distance to delivery points and the average distance of delivery legs were rather constant across phase, it is known that there was substantial change in the actual mix of delivery points as individual customer demand changed between phases. (See appendix A-F for counts of deliveries to

specific points in phase 1 and in phase 2.) Figure 5-10 partially illustrates the impact of this fact by showing that, while the average distance to delivery points was the same across phases, the distribution of those distances varied. Moreover, the specific mix of turns—by location and number of passes per location—changed across phase. Some 6,000 specific turn locations and 184,000 individual passes through those turns have been identified in the database for analysis. (See chapters 4 and 8.)

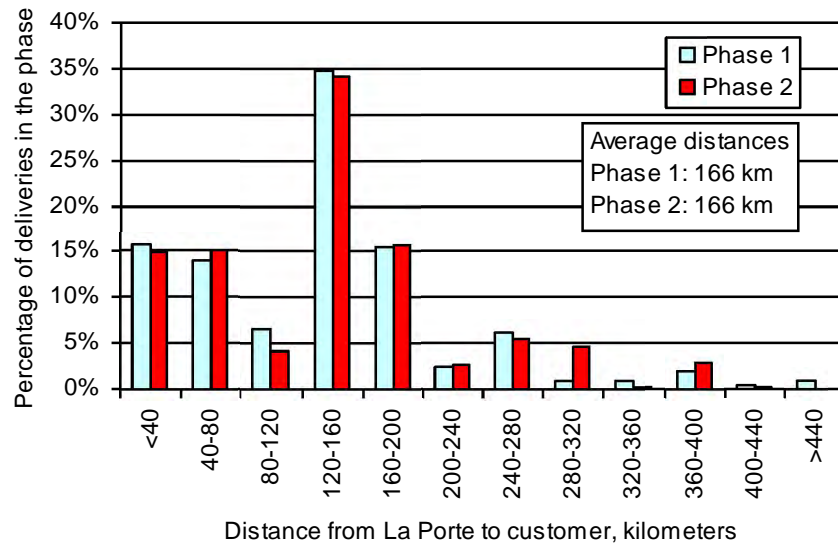

Figure 5-10. Distribution of distances from La Porte to delivery points by phase

5.2 Exposure of individual drivers

The Praxair operation at La Porte is of the so-called *slip-seat* variety, meaning that drivers are not assigned to a specific vehicle but may drive different vehicles on different days. By this arrangement, twenty-three drivers drove the six FOT tractors during the study, but all of them also drove other vehicles during the same time period. Figure 5-11 presents the percentage of their total (Praxair) driving time spent operating FOT vehicles during the field test. Percentages are given for each phase for each individual and, on the far right, for all the drivers as a group. In phase 1, these drivers spent approximately twenty-nine percent of all their driving time in the six field-test vehicles; in phase 2, when the RA&C system was activated, they spent on average of about fifty-one percent of their driving time in the FOT vehicles. Across both phases, they averaged about thirty-six percent.

Figure 5-12 shows how the travel distance accumulated in the FOT was distributed among the drivers. (Appendix A-H contains a complete presentation of the distance data which lies behind figure 5-12 and other figures that follow in this section.) The figure shows that several drivers (2036 through 2041) who participated in phase 1 either drove much less or not at all in phase 2. Other than for these drivers and for driver 2019, who

drove very little in either phase, the distribution of distance across drivers is fairly even. Finally, figure 5-12 also shows that some of the distance accumulated could not be assigned to a particular driver (see the *unknown* category on the right). The bulk of this unknown distance was in phase 2 and resulted from about a one-month period in which the logistical data needed to identify the drivers was not available for one of the tractors.

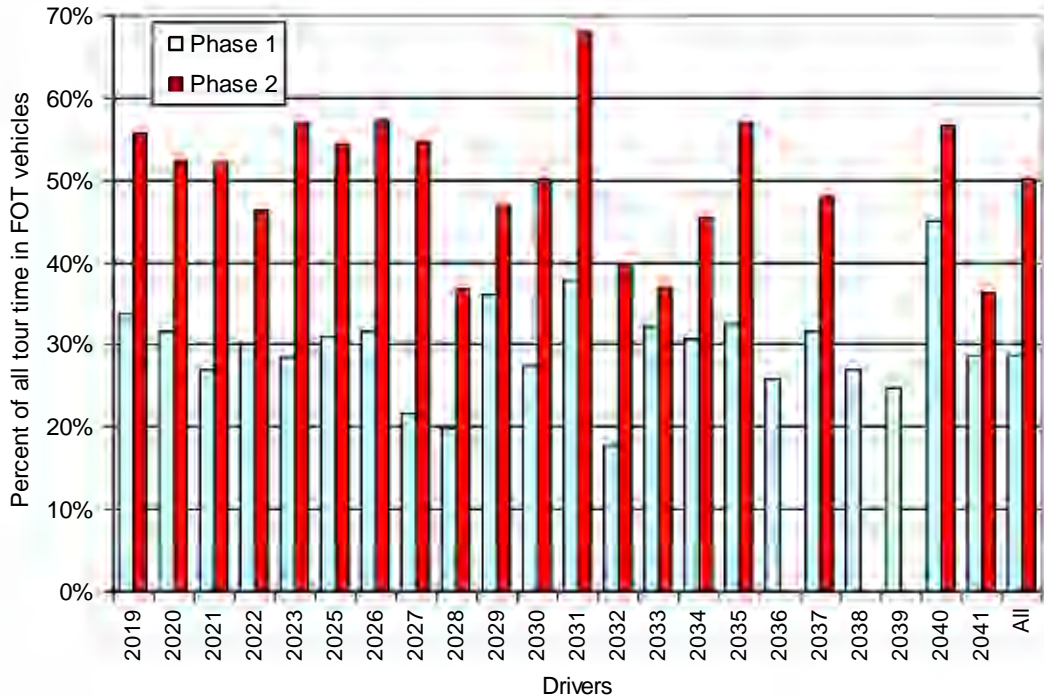

Figure 5-11. Percentage of all driving time spent in RA&C FOT tractors, driver by driver

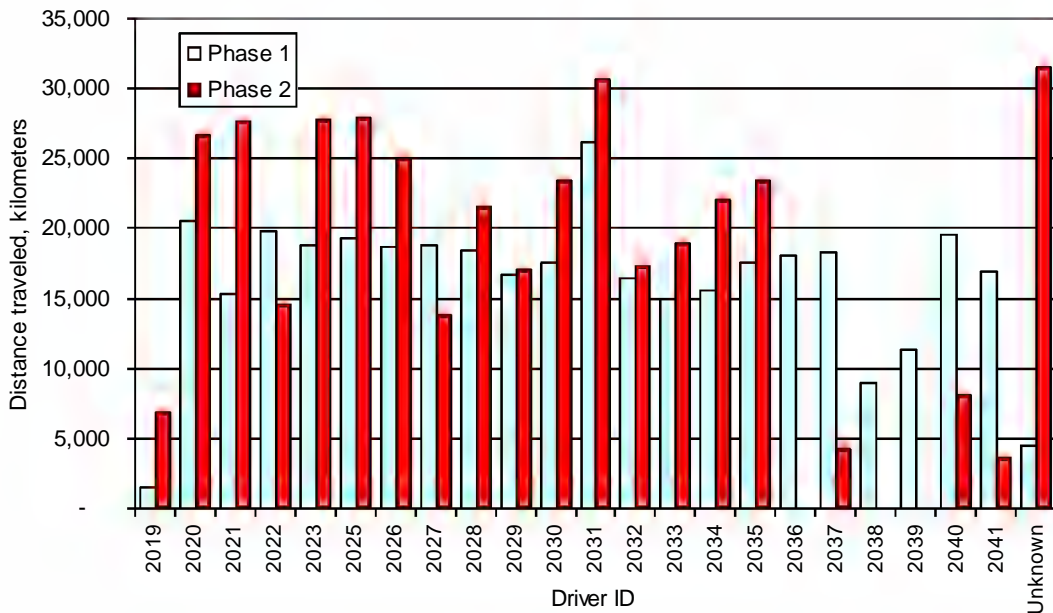

Figure 5-12. Total distance traveled in phase 1 and phase 2, driver by driver

The drivers identified in figure 5-12 as 2020 through 2035, with the exception of 2027 (who also left the study in the midst of the second phase), are the so-called *comparable* drivers of this study. Data gathered from the other drivers, including the unknown drivers, is considered *non comparable*. As was discussed in section 3.2.5, both the comparable and non comparable data play a significant roll in the analysis of the influence of the RA&C device on turning behavior.

Figure 5-13 presents and compares the average distance per leg of a tour in phase 1 and phase 2, driver by driver, and, at the far right, for all the drivers. While the average for all drivers is very consistent between phases, this value does change substantially across phases for individuals, another indication that the qualities of routes may have changed.

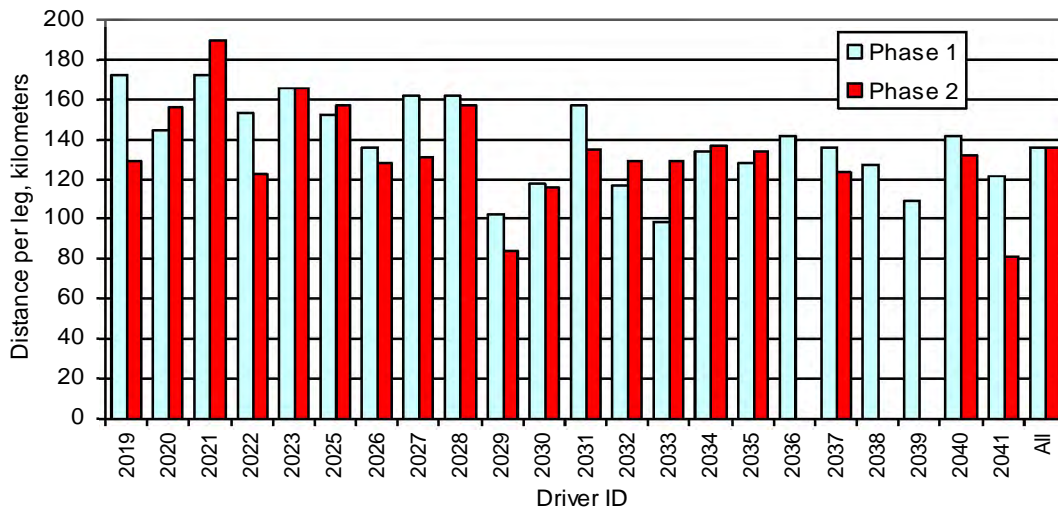

Figure 5-13. Average distance of delivery legs in phase 1 and phase 2, driver by driver

Table 5-3 and figure 5-14 provide additional details on the distance traveled by the comparable drivers.

Table 5-3. Exposure properties of distance by comparable drivers by phase

	Percent of all distance by comparable drivers in phase		Change
	Phase 1	Phase 2	
All trips	100	100	100
All trips > .1 km	> 99.9	> 99.9	0.0
>.1 km in good weather	83.9	84.2	0.3
>.1 km in daylight	64.7	67.0	2.3
>.1km in good weather and daylight	55.3	57.7	2.5

The analysis of the influence of the RA&C device on the turning behavior of the drivers, presented in chapter 8, is generally restricted to driving in good weather. Table 5-3 shows that the majority of distance traveled (about 84 percent) was in good weather.

The table also shows that about two-thirds of distance traveled took place in daylight and that about two thirds of good-weather distance was in daylight. The table also shows that the portion of good-weather distance was just bit larger in phase 2 than in phase 1 and the fraction of daylight-distance was appreciably larger in phase 2.

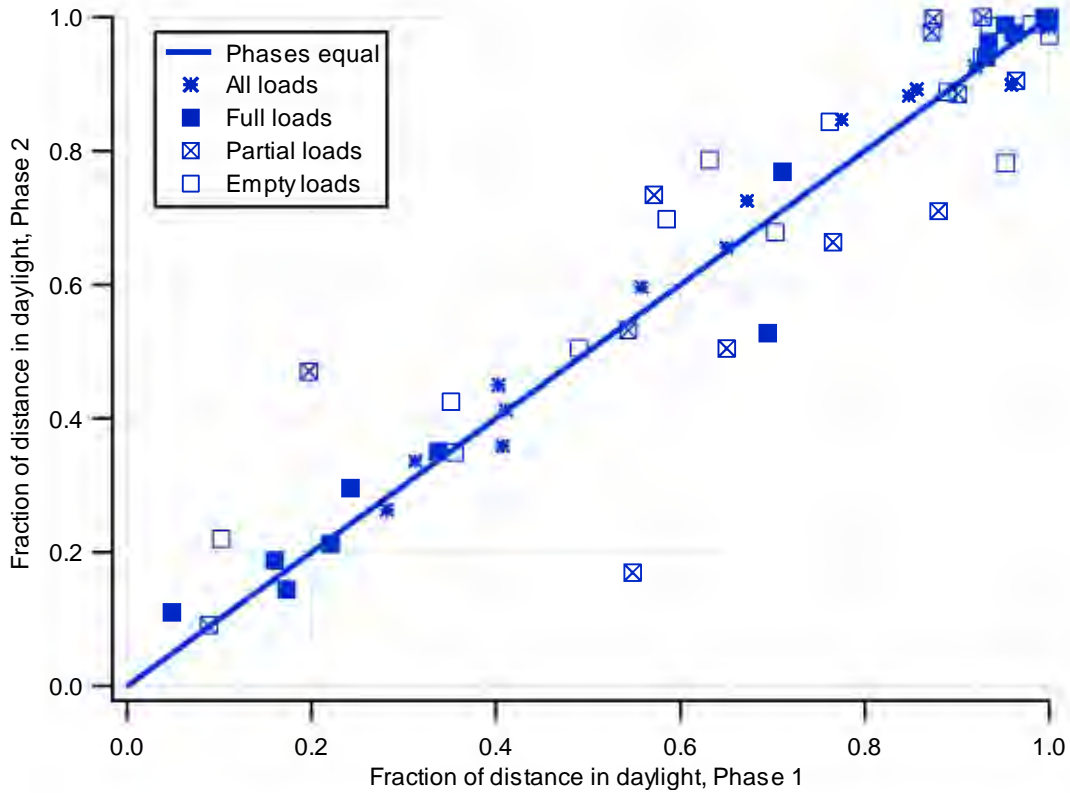

Figure 5-14. Comparing the fractions of driving in daylight in phase 1 and phase 2 for the comparable drivers

Figure 5-14 also speaks to the similarity of exposure between phase 1 and phase 2. This figure plots the fraction of daylight driving (in good weather and on trips longer than 0.1 km) in phase 1 versus the same fraction for phase 2. Data are presented individually for each comparable driver operating in each of the three loading conditions. A reference line is also plotted. If the respective fractions of daylight driving in phase 1 and in phase 2 were exactly the same (i.e., for a given driver in a given load condition), the associated data point would fall on this reference line. The figure indicates that, in large measure, the daylight/darkness mix of driving was very similar for each individual in the two phases. The most significant departures were for partial loading conditions, but as will be shown, very little driving occurs in the partial loading condition. It is also apparent from the graph that some individuals did most of their driving in daylight while others did almost all of their driving at night.

6. OVERVIEW OF LATERAL PERFORMANCE

6.1 Formats for presentations of lateral-performance Data

The majority of the figures presented in this section are either histograms or cumulative histograms describing the lateral-performance experience of the six test vehicles or the drivers. Before examining these figures individually, consider their general form.

All of the figures in question show travel time on the ordinate and lateral acceleration or rollover ratio on the abscissa. Lateral acceleration is always given in gravitational units (g); rollover ratio is dimensionless. Lateral acceleration may be taken from different longitudinal positions on the vehicle (most often at the driver's position, i.e., *AyDriver*); rollover ratio always refers to the ratio of lateral acceleration calculated for the total vehicle (*AyTotal*) to the static rollover threshold of the vehicle (*Rollover*).

The histograms present the *signed value* of lateral acceleration or rollover ratio on the abscissa. The cumulative histograms present the *magnitude* (absolute value) of the variable on the abscissa. In all cases, the scale of the abscissa is linear. For the histograms, the bin width of the abscissa is generally noted on the graphs. The bin width is usually rather fine such that the plots are typically presented as continuous curves rather than as column graphs.

Generally, travel time is shown on the ordinate in normalized form, that is, as a fraction of some *total* time appropriate to the specific purpose of the graph. The applicable total time is usually given in hours in the key for the graph. The ordinate is always presented with a logarithmic scale in order to reveal the "tails" of the distributions. In the *histograms*, the ordinate is "fraction of travel time at the indicated acceleration," i.e., the fraction of total time the vehicle(s) spent at (i.e., *within the bin whose center is*) the indicated abscissa value. For example, in figure 6-1, the solid curve crosses +0.2 g at a fractional travel-time value of 10^{-5} . Thus, in 9640 hours of travel, the fleet spent about 0.96 hours, or a bit less than 6 minutes, within ± 0.005 g of +0.2 g while in the fully loaded condition. In the *cumulative histograms*, the ordinate is "fraction of travel time above" the (magnitude of) the abscissa value. For example, in figure 6-2, all plots begin at the far left at a value of 1 since, by necessity, all travel takes place at a magnitude of lateral acceleration equal to or greater than zero. Also in figure 6-1, the solid line passes through 0.1 g at an ordinate value of about 0.009 implying that the fleet spent about 42 (0.009×4660) hours at accelerations of magnitude greater than 0.1 g when traveling in the fully loaded condition.

6.2. Lateral acceleration experienced for all travel

6.2.1. The influence of loading condition

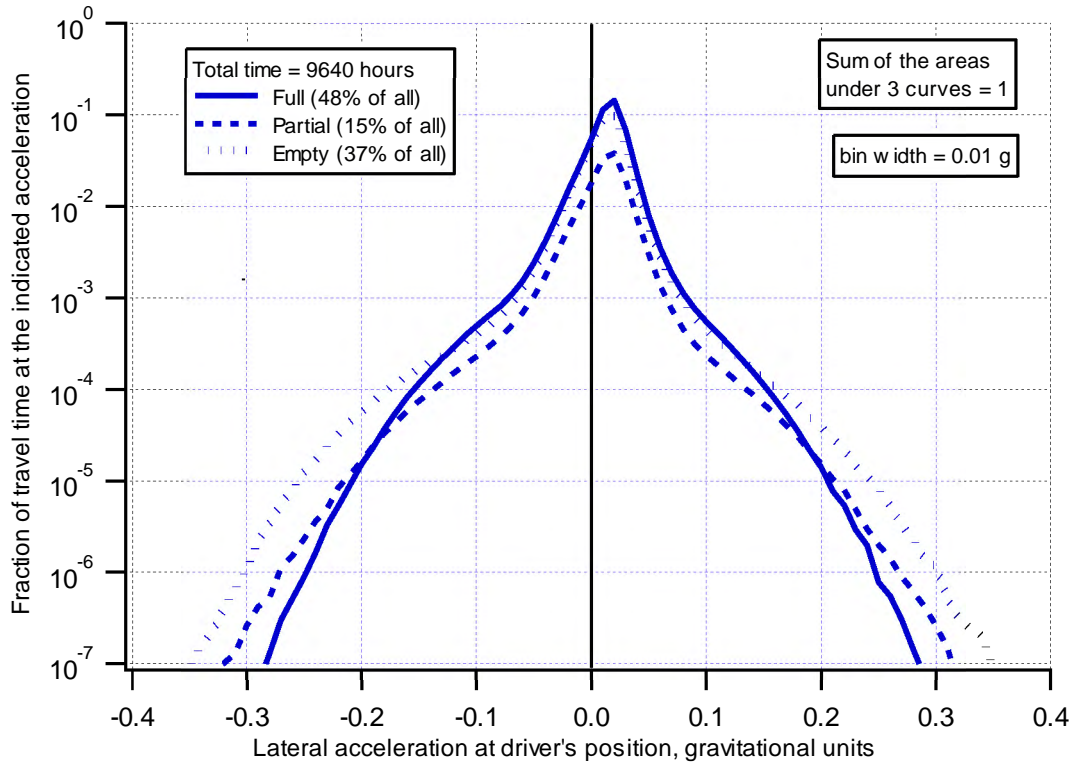

Figure 6-1. Histogram of travel time by lateral acceleration for three load ranges

Figure 6-1 presents the distribution of travel time of the FOT fleet by lateral acceleration (at the driver's position) for three load states, viz., empty (10 to 17 metric tons), partial (17 to 33 metric tons) and full (33 to 40 metric tons). The ordinate represents the fraction of the time of all travel of the fleet in trips longer than 0.1 km (about 9640 hours). Thus, the curves reflect the relative amount of time spent in each loading condition as well as the distribution of lateral acceleration. The graph clearly reflects the tendency of the drivers to spend a larger portion of time at higher magnitudes of lateral acceleration in the lighter loading conditions. Figure 6-1 also shows some interesting qualities of asymmetry which will be discussed later.

Figure 6-2 further highlights the tendency for more driving at higher lateral acceleration while lightly loaded. This graph is a *cumulative* histogram, and travel time in each load condition is normalized individually to the total time *in that load condition*. The graph shows that, for each load condition taken individually, about 10 percent of travel time is spent above 0.04 g and about 1 percent above 0.1 g. However, at still higher accelerations, caution seems to take hold and the fraction of time for full loads drops relative to empty and partial loads. For example, the fleet spent just a bit more than 10^{-4}

of its travel time at full loads (about 30 minutes of 4660 hours) above 0.2 g, but about 10^{-3} of its empty travel time (3.5 hours of 3560 hours) above 0.2 g.

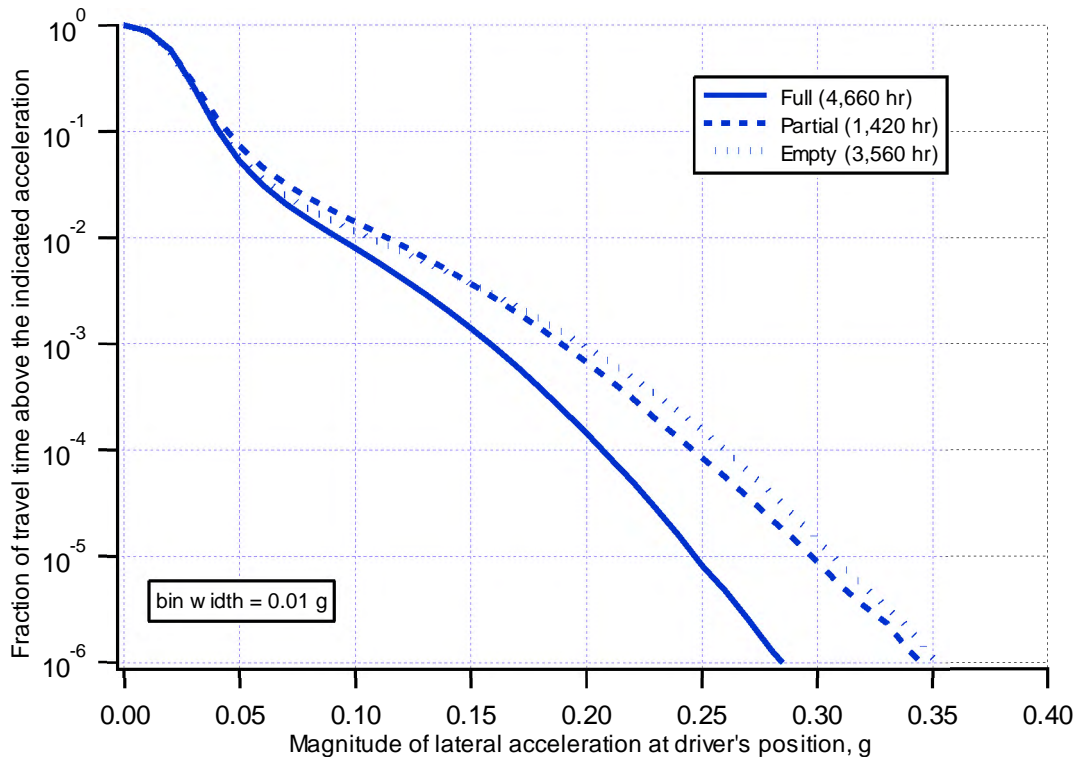

Figure 6-2. Cumulative histogram of travel time by magnitude of lateral acceleration for three load ranges

6.2.2. The influence of speed

Figure 6-3 is histogram of travel time by lateral acceleration with individual curves shown for four speed ranges. The figure shows a very clear tendency for driving at more elevated accelerations while at lower speeds than while at higher speeds.²² Asymmetries similar to those of figure 6-1 are also very apparent. (See the following subsection.)

Figure 6-4 presents cumulative histograms segregated by the same speed ranges. The tendency to drive at higher magnitudes of lateral acceleration (at least as experienced at the driver's position) is striking. The distinction between performance at different speeds begins at very low magnitudes. The probability of exceeding 0.1 g is about 100 times greater at low speeds than at high speeds. By 0.2 g, this comparative figure grows to about 1000.

²² For the sake of brevity in the following text, expressions such as “more *conservative*” and “less *conservative*” will be used to imply “more time spent at elevated accelerations” and “less time spent at elevated accelerations,” respectively.

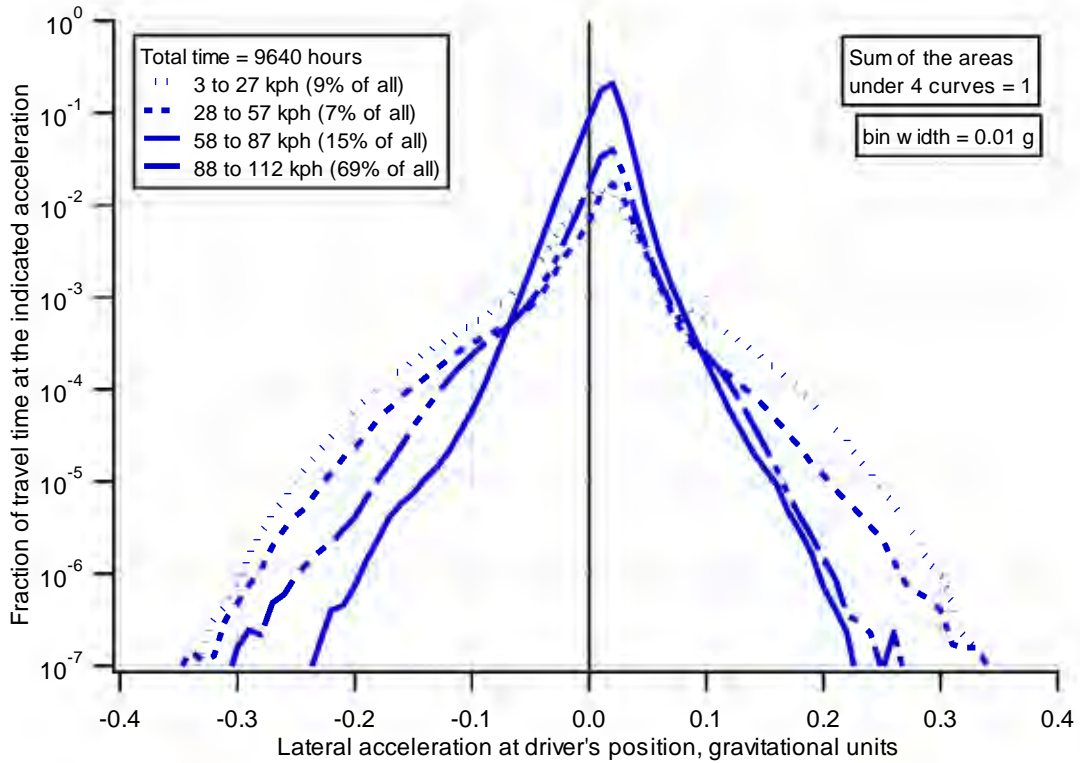

Figure 6-3. Histogram of travel time by lateral acceleration for four speed ranges

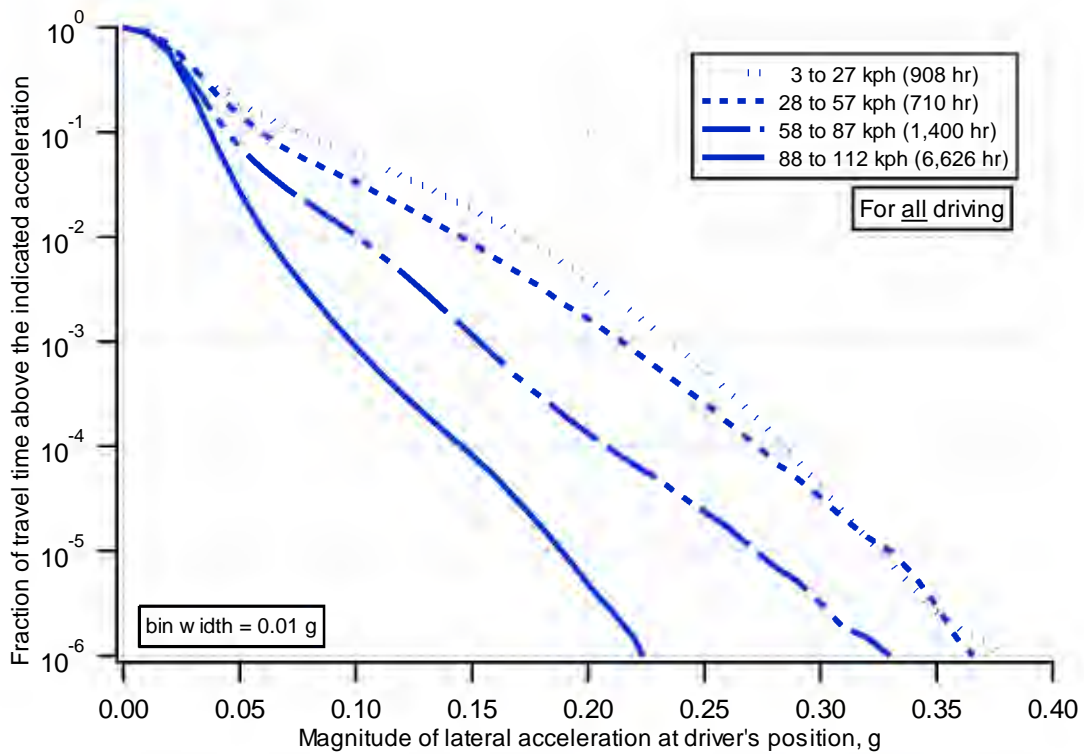

Figure 6-4. Cumulative histogram of travel time by magnitude of lateral acceleration for four speed ranges

Three possible explanations come to mind. One is that it has been observed for some time that drivers, at least passenger car drivers, tend to generate higher lateral accelerations in turns at low speeds than in turns at high speeds, e.g., [9,10]. Another is that truck drivers may well understand that, in low-speed maneuvering, the semitrailer typically experiences lower lateral accelerations than the tractor due to off-tracking. (See sections 4.2.4 and 6.3.1.) Finally, the simple matter of opportunity may be involved. That is, well-designed, high-speed roadways offer little opportunity for turning at high magnitudes of lateral acceleration.

6.2.3. Asymmetries in lateral-acceleration experience

Asymmetries of lateral-acceleration experience were evident in figures 6-1 and 6-3. The most obvious of these is that the peak, or most-likely value, of each curve of those figures appears at a small positive value of lateral acceleration (about 0.02 g).

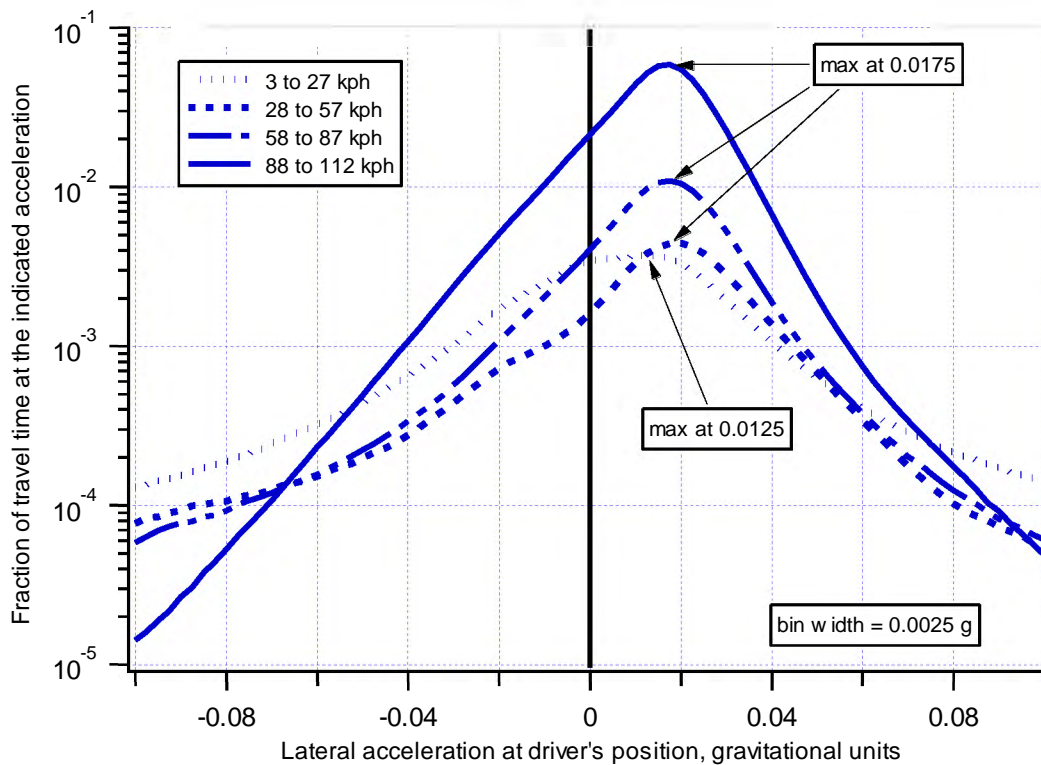

Figure 6-5. Histogram of travel time at small lateral accelerations for four speed ranges

This property is highlighted in figure 6-5 which presents a more detailed view of the low-acceleration region from figure 6-3. (Note that this graph uses bin widths of 0.0025 g; fractional values of travel times are therefore about one quarter of comparable values from figure 6-3.) This graph shows the most-likely value of lateral acceleration to be 0.0175 g for all but the lowest speed range. This, of course, suggests that the most common cross slope on straight roads in the region is about 1.75 percent (plus or minus the effective half-bin width of 0.12 percent). On the other hand, the most-likely value of

lateral acceleration at the lowest speed is 0.0125 g. This probably reflects the fact that a larger portion of low-speed driving is in parking lots and work yards which tend to be flatter or to present cross slopes to the vehicle in a more random manner. Note also in this figure that at the ± 0.1 g extremes, the ordinate values of the low-speed data are nearly the same, but the data for the higher three speed ranges retain progressively greater asymmetry.

There are also interesting asymmetries in the data of figures 6-1 and 6-3 at higher accelerations. They are not easily seen in figure 6-1. However, in figure 6-3, notice the distinct asymmetry of the data for the two central speed ranges (28 to 57 kph and 58 to 87 kph) in the vicinities of ± 0.2 g. For these data, time in right-hand (negative) 0.2-g turns is distinctly greater than time in left-hand (positive) 0.2-g turns.

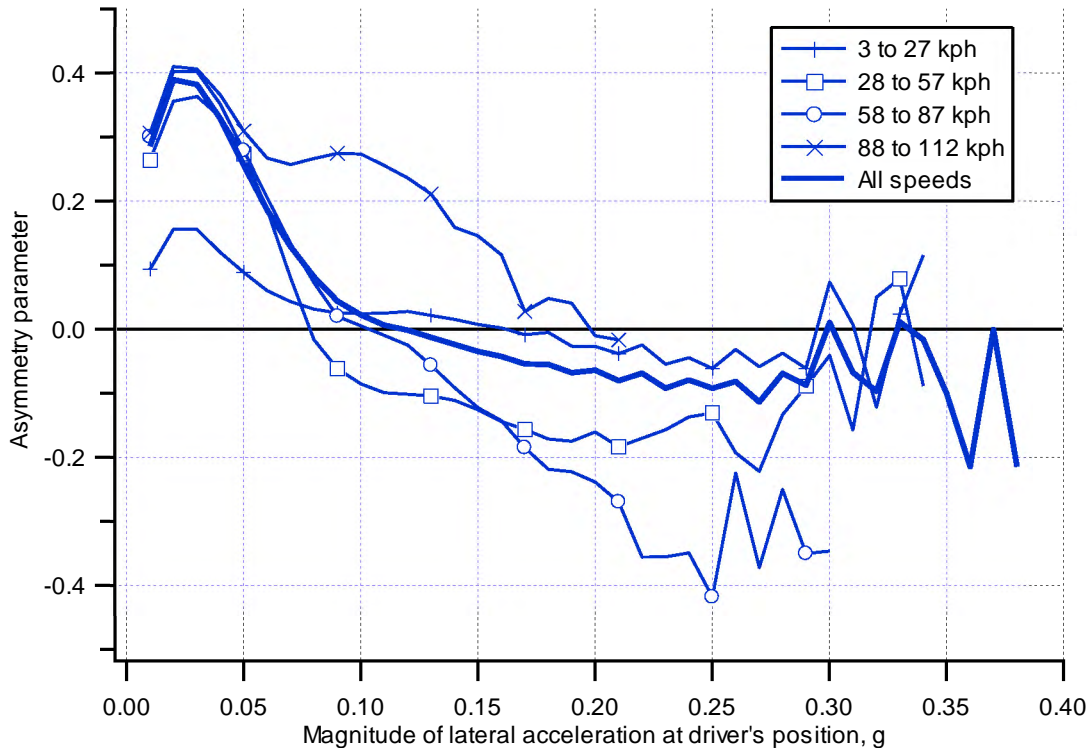

Figure 6-6. The asymmetry parameter for travel time as a function of lateral accelerations for four speed ranges and all speeds

The asymmetries of the data of figure 6-3 are made more apparent in figure 6-6. This figure plots an *asymmetry parameter* on the ordinate and the magnitude of lateral acceleration on the abscissa. The asymmetry parameter is defined as

$$\text{asymmetry parameter} = t(b_a) / [t(b_a) + t(b_{-a})] - 0.5 \quad (6-1)$$

where $t(b_a)$ is the time count of the bin for lateral acceleration, a , and $t(b_{-a})$ is the time count of the bin for lateral acceleration, $-a$. If, for a given magnitude of acceleration, the time in the negative-turn bin is equal to the time in the positive-turn bin, the asymmetry

parameter is zero. If time is larger in the positive bin, the asymmetry parameter is positive. The parameter can range from -0.5 to 0.5.

Figure 6-6 shows plots of the asymmetry parameter versus magnitude of acceleration for all the data (i.e., all speeds) and for the four individual speed ranges. The plot for all the data (heavy line) shows the clear trend for positive asymmetry at low accelerations and negative asymmetry at higher accelerations. The plots of the individual ranges show that the positive, low-acceleration asymmetry is similar at all but the lower speeds but that the mid-range speeds (light lines with open symbols) dominate in the trend toward negative asymmetry at high accelerations.

The positive asymmetry at low accelerations is, as was discussed, driven by common roadway cross slopes. The negative, or right-turn bias seen in the higher-g data is presumably the result of a right-turn bias associated with the exit, entrance, and especially the interchange ramps of limited-access highways—and the fact that the operation of the FOT fleet involved a good deal of travel on limited-access highways (see figure 6-4). The fact that it is the middle speed ranges which dominate the phenomenon clearly supports this view. That is, the large majority of simple exit and entrance ramps involve a right hand turn at moderate speed, while they may or may not have a left hand turn. The long, sweeping 90- and 270-degree ramps which characterize many freeway-to-freeway interchanges are more often turns to the right than to the left. Moreover, traversing such interchange turns requires rather long periods of time at elevated lateral acceleration and moderate speed and can therefore account for a significant fraction of the total time spent under these conditions.

6.3. Lateral acceleration and rollover ratio experienced in turns

6.3.1. The influence of off-tracking

During a turn, the several axles of a vehicle, and especially of a tractor-semitrailer combination, do not typically follow exactly the same path. This property, known as off-tracking, is well known and long established in the literature e.g., [11, 12]. In turns where the radius approaches, or is even shorter than, the length of the vehicle, path radii traveled by various points on the vehicle may be very different and, therefore, lateral acceleration experienced at those points may be quite different. The strongest such influence is typically in turns of tight radii that are also of limited heading change (e.g., 90-degree intersection turns) where steady state is not established and *transient* off-tracking results in much larger turn radii for the semitrailer than for the tractor [13].

As was shown in figure 5-7, the FOT fleet spent about 900 hours (about 9 percent) of their travel time in deliberate turning maneuvers where the path curvature (at the front axle) of 1 km^{-1} or greater was sustained for 3 seconds or longer. As was discussed in section 4.2.5, lateral acceleration at the center of gravity (c.g.) of the trailer ($A_{yTrailer}$)

was calculated for these turning maneuvers (as apposed to accelerations at various points on the tractor which were determined for all travel time). Moreover, with acceleration at the trailer c.g. known, rollover ratio was also determined for the 900 hours of turning.

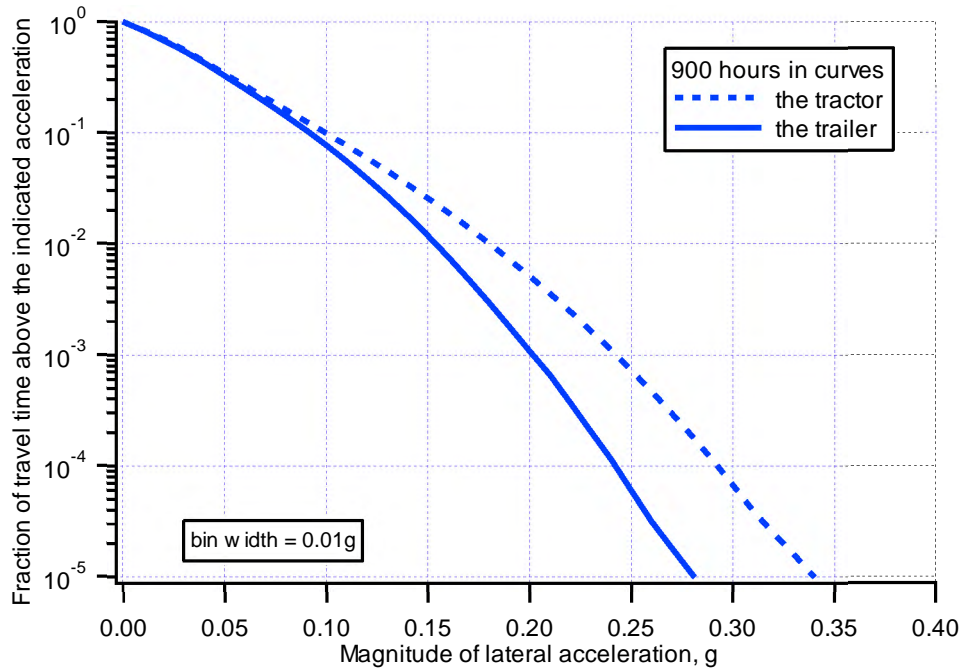

Figure 6-7. Cumulative histogram of travel time in curves by magnitude of lateral acceleration of the tractor (*AyDriver*) and the trailer (*AyTrailer*)

To illustrate the importance of off-tracking, figure 6-7 presents a cumulative histogram of lateral acceleration for the 900 hours of turning where lateral acceleration is determined for the tractor (*AyDriver*)²³ and at the center of gravity of the trailer (*AyTrailer*). Since a substantial amount of the high-g turning takes place in tight radius, low-speed turns, the off-tracking influence is significant and reduces the time spent by the trailer c.g. at higher lateral accelerations.

The point is further emphasized in figure 6-8 in which similar comparisons are made separately for the lowest (3 to 27 kph) and highest (88 to 112 kph) speed ranges. At low speed and high acceleration, radii must be small and, therefore, the off-tracking phenomenon strongly separates accelerations experience at the tractor and at the trailer. At high speeds, radii are much larger and the off-tracking phenomenon is not very influential. Thus there is little difference between the two accelerations at high speed.

²³ The most appropriate lateral acceleration of the tractor for figures 6-7 through 6-9 would, of course, be the lateral acceleration of the c.g. of the tractor. *AyDriver* is, in fact, a close approximation of this as the longitudinal positions of the driver and of the tractor c.g. are quite close to one another.

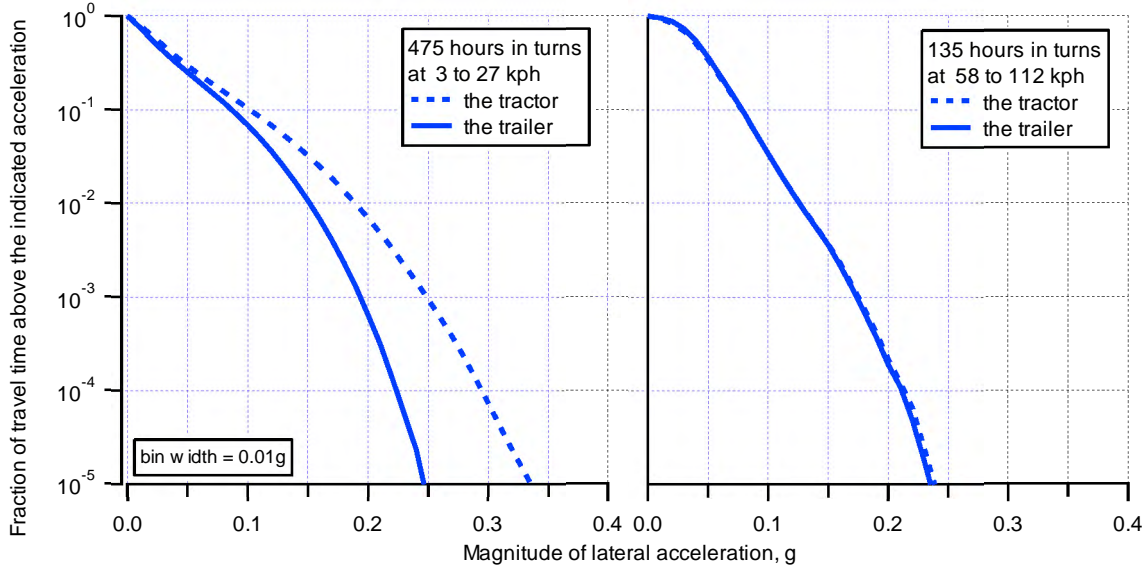

Figure 6-8. Cumulative histogram of travel time in curves by magnitude of lateral acceleration of the tractor (*AyDriver*) and the trailer (*AyTrailer*) for low and high speed ranges

6.3.2. Lateral acceleration and rollover ratio

The left-hand portion of figure 6-8 raises an important point regarding rollover and, in particular, rollover ratio. Loosely defined, rollover ratio is the ratio of the prevailing lateral acceleration “of the vehicle” to the static rollover threshold of the vehicle. However, figure 6-8 emphasizes that, especially at low speeds, lateral acceleration “of the vehicle” is neither the lateral acceleration of the tractor c.g. or of the trailer c.g. Rather, a more appropriate value to describe the total vehicle (and to apply to in determining rollover ratio) is the weighted average of these two measures, where weighting is according to the mass of the tractor and the trailer. That is,

$$Ay_{Total} = \frac{Ay_{Driver} * m_1 + Ay_{Trailer} * m_2}{TotalMass} , \quad (6-1)$$

where m_1 and m_2 are the masses of the tractor and trailer, respectively, *AyDriver*, *AyTrailer* and *TotalMass* were defined in chapter 4, and *AyDriver* is taken as the estimate of the lateral acceleration of the center of gravity of the tractor. The mass of an FOT tractor is about 7.3 metric ton and is treated as a constant of this value in equation 6.1. The mass of the trailer is calculated as *TotalMass* less this constant.

When the semitrailer is fully loaded, its gross mass is about 29 metric ton, so the distinction between lateral acceleration of the trailer and of the total vehicle is fairly small when the vehicle is fully loaded. However, the empty semitrailer actually weighs a bit less than the tractor, so that the distinction becomes significant for the empty vehicle in tight, low-speed turns. Figure 6-9 illustrates these points. Cumulative histograms of lateral acceleration for the empty vehicle are shown in the two upper graphs and for the

full vehicle in the two lower graphs. Low-speed data are on the left and high-speed on the right. At high speeds, the histograms of acceleration of the tractor, trailer, and total vehicle are virtually indistinguishable. At low speeds, data for the tractor and trailer separate substantially and the data for the total vehicle lies in between. For the empty vehicle, the data describing the total vehicle nearly split the difference between tractor and trailer; for the loaded vehicle, the data for the total vehicle lie very close to that of the trailer.

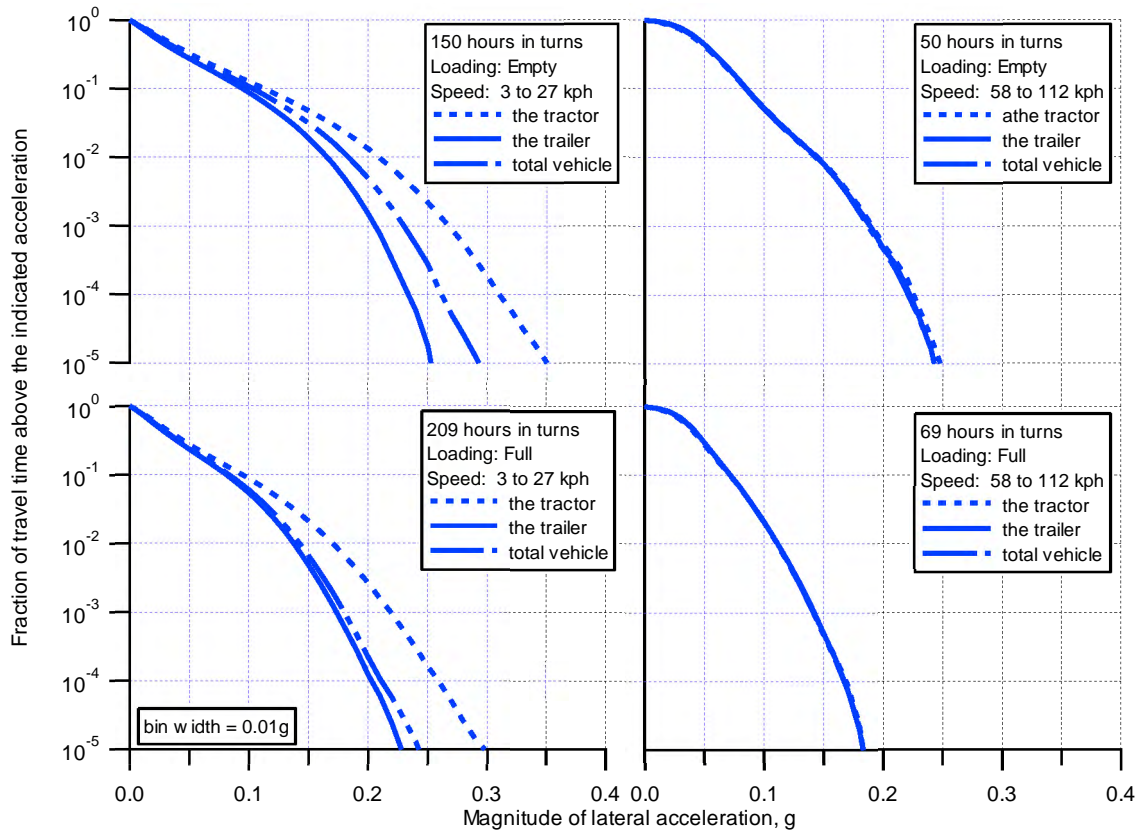

Figure 6-9. Cumulative histogram of travel time in curves by magnitude of lateral acceleration of the tractor ($A_{yDriver}$), the trailer ($A_{yTrailer}$), and for the total vehicle (A_{yTotal}) at two loads and at high and low speeds

While lateral acceleration describes the severity of turning in “absolute” terms, rollover ratio is the better measure for describing risk of rollover. Rollover ratio at any moment ($RolloverRatio$) as used in this study, is

$$RolloverRatio = \frac{A_{yTotal}}{Rollover}, \quad (6-2)$$

where $Rollover$ is the static stability limit of the vehicle in the prevailing load condition.

For this study, $Rollover$ was determined as a function of $TotalMass$ by tilt-table tests of one of the FOT vehicles. (See section 4.2 and appendix A-C.) Those tests revealed that

static rollover threshold is considerably lower for the fully loaded vehicle (about 0.38 g) than for the empty vehicle (about 0.70 g). Accordingly, the manner in which load and speed influence driving behavior (as measured by lateral acceleration) that have been observed to this point can be expected to be a bit different when interpreted in terms of rollover risk (as measured by rollover ratio).

Figure 6-10 contrasts the cumulative distributions of lateral acceleration as experienced by the driver (on the left) and the cumulative distributions of rollover ratio that result. The data are only for driving in curves and are segregated by the three loading conditions. These data suggest that, as judged from the driver’s seat (or, perhaps, “by the seat of the pants”), turning behavior is more cautious when the vehicle is more heavily loaded. However, if the drivers’ intent is to compensate for the reduced roll stability of the vehicle as loading increases, the histograms of rollover ratio indicate that compensation is not complete as higher rollover ratios are experienced in the fully and partially loaded conditions than in the empty condition.

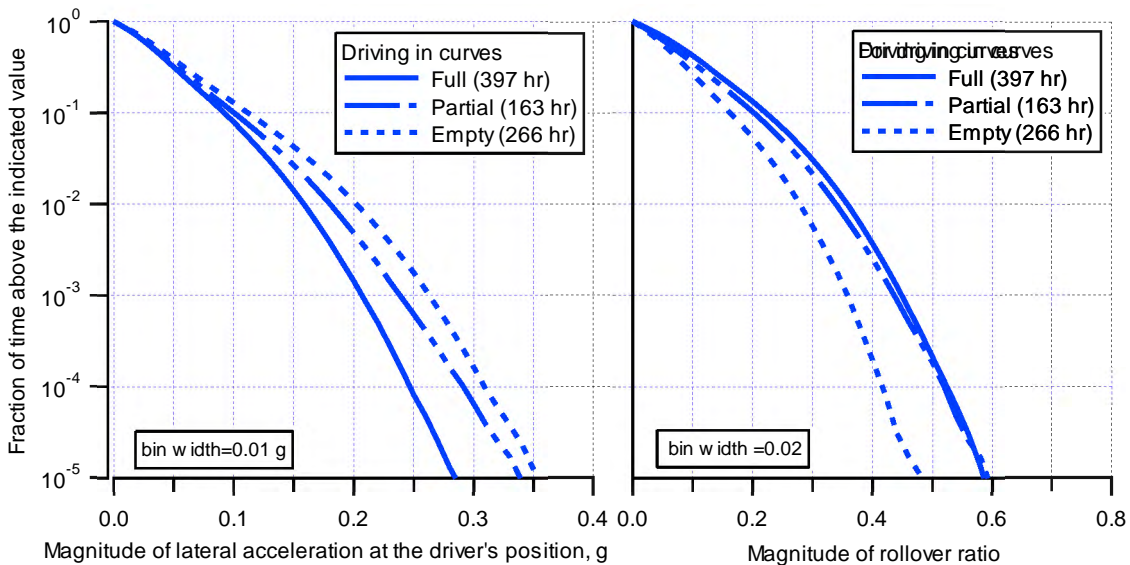

Figure 6-10. Cumulative histograms of travel time in curves for lateral acceleration ($A_{yDriver}$) and rollover ratio by loading condition

The observation that drivers do not fully compensated for the decrease in roll stability that accompanies increasing load has been made here by direct observation of driving performance. It should be noted that virtually this same observation has previously been made through analysis of accident data. As early as 1980 [14] and as recently as 2000 [15], the likely hood of rollover in single-vehicle accidents of tractor semitrailers increase exponentially as roll stability decreases.

Figure 6-11 contrasts cumulative histograms of lateral acceleration at the driver’s position with those for rollover ratio, this time segregated by the four speed ranges, and again constrained to driving time in curves. From the graph on the left, and as noted

previously, the drivers tend to spend more time at higher lateral accelerations when driving at low speed. However, the histogram of rollover ratio on the right shows that the influences of off-tracking in low-speed, tight-radius turns does not “compensate” for this trend and rollover risk remains higher at low and moderate speeds.

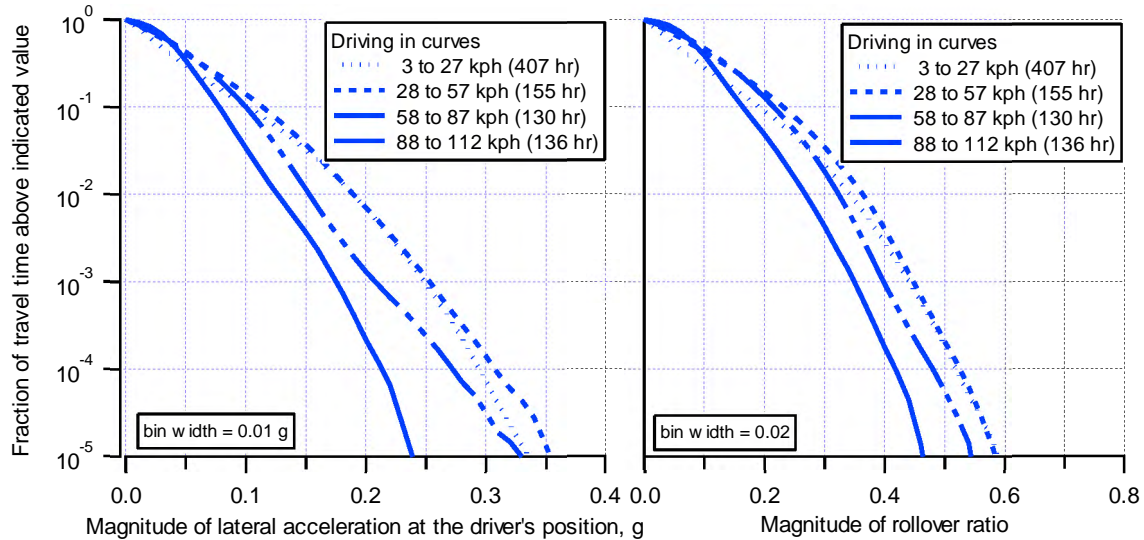

Figure 6-11. Cumulative histograms of travel time in curves for lateral acceleration and rollover ratio by speed range

Figure 6-12 and 6-13 present a final review of this topic. The histograms in figure 6-12 are for lateral acceleration and those of 6-13 are for rollover ratio. The presentations of each figure are segregated by load and speed. Table 6-1 presents observations which derive from the figures.

Table 6-1. Contrasting observations on driving behavior in turns judged on lateral acceleration and rollover ratio

<i>Judged by lateral acceleration, turning behavior:</i>	<i>Judged by rollover ratio, turning behavior:</i>
<ul style="list-style-type: none"> •is less conservative in the empty condition than the full condition in all speed ranges; •in the empty condition, is less conservative throughout the low- and mid-speed ranges; •in the full condition, is least conservative at low speed and declines with speed; •differs most between loading states in the mid-speed ranges and least at low-speeds. 	<ul style="list-style-type: none"> •is less conservative in the full condition than the empty condition in all speed ranges; •in the empty condition, is less conservative in the mid-speed ranges; •in the full condition, is least conservative in the lower speed ranges; •differs most between loading states in the lowest speed range.

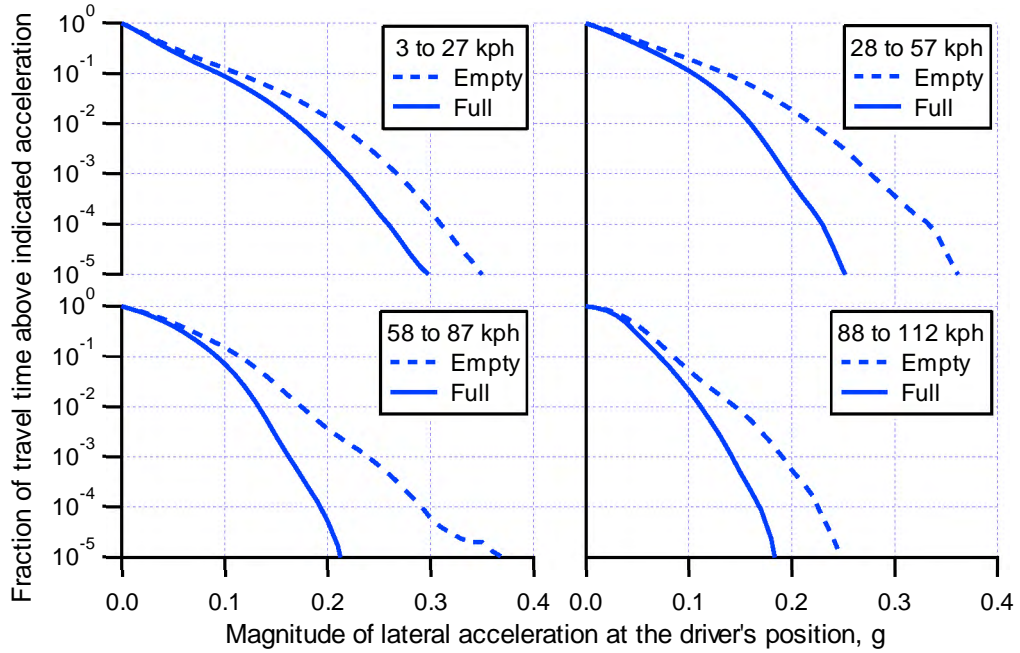

Figure 6-12. Cumulative histograms of travel time in curves for lateral acceleration by speed and load

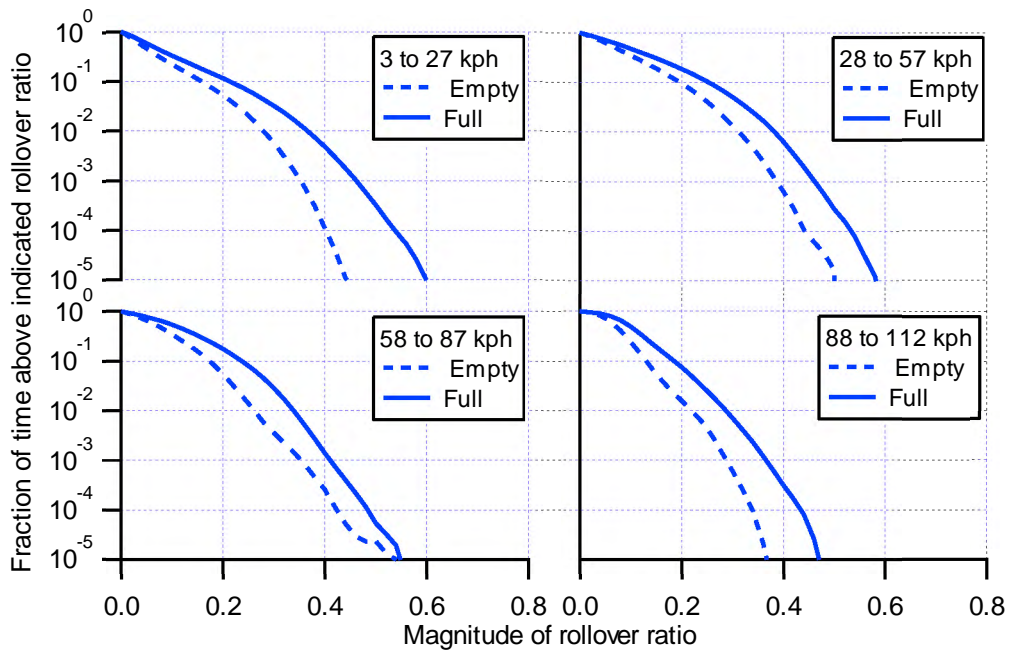

Figure 6-13. Cumulative histograms of travel time in curves for rollover ratio by speed and load

6.4. Differences in lateral performance among individual drivers

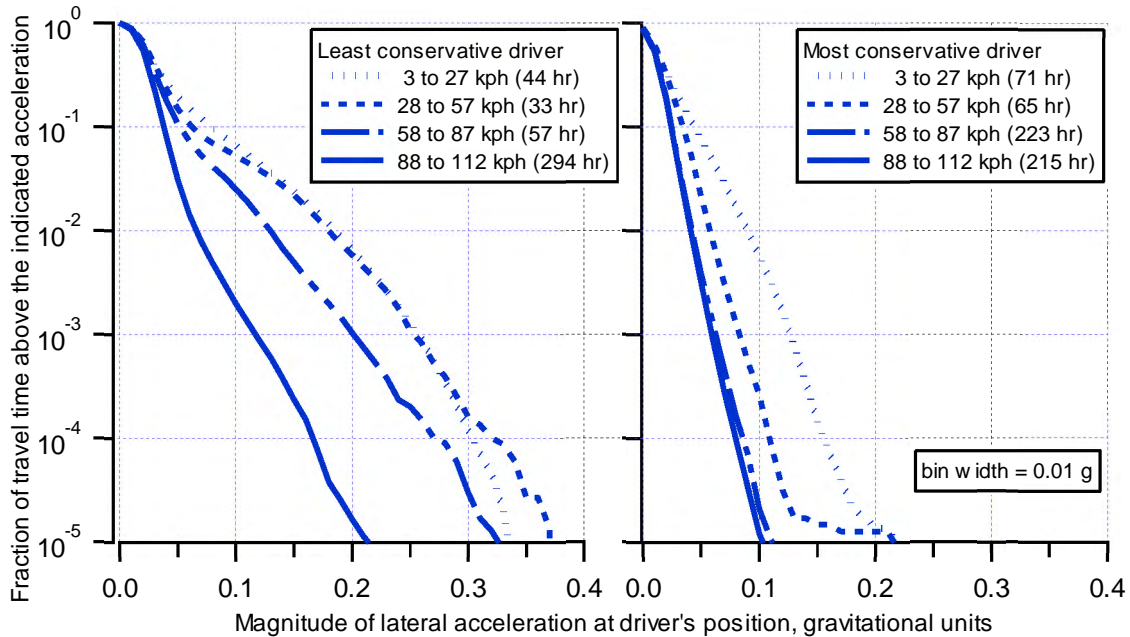

Figure 6-14. Cumulative histograms of travel time in turns by magnitude of lateral acceleration comparing the most and least conservative drivers

The range of driving behavior in turns exhibited by the FOT drivers was remarkably wide. Figure 6-14 presents cumulative histograms for the two drivers participating in the FOT who exhibited the least conservative and the most conservative turning performance (That is, these drivers exhibited the most and least elevated lateral-acceleration behavior in turns, respectively.)²⁴ The data are segregated by speed range. The difference between the two is striking to say the least. Compared at constant fractions of travel time, the less conservative driver typically registers about twice the acceleration of the most conservative driver. For example, comparing the plots for high-speed travel for the two drivers at an ordinate value of 10^{-3} reveals that the most conservative driver spent 0.1 percent of his high-speed travel time above about 0.06 g, but the less conservative driver spent the same portion of his travel time above 0.12 g. Making the comparison at constant accelerations, the difference in probabilities of finding one or the other of these drivers operating at elevated lateral acceleration is typically on the order of 100 to 1. For example, the less conservative driver spent just 10^{-3} of his high-speed travel time above 0.1 g, but the more conservative driver spent more than 10^{-5} of his high-speed travel time above 0.1 g. Depending on the level of acceleration and the operating condition, more

²⁴ As will be shown, there is no question as to which FOT driver was most conservative. Depending on the specific measure, at least one other driver might have been chosen as the least conservative. However, the general points to be made here would not be substantially altered by a different selection.

extreme examples can be found. For example, respectively, these two drivers spent 10^{-2} and nearly 10^{-5} (i.e., a ratio of 1000 to 1) of their low-speed travel times above 0.2 g.

Figure 6-15 presents cumulative histograms of lateral acceleration for all drivers in phase-1 driving. Histograms for driving with full trailers are shown on the left and for driving with empty trailers on the right. The comparable and non comparable drivers are distinguished by the solid and the dashed lines. The magnitude of lateral acceleration that each driver exhibits at the 0.01 percentile of travel time (i.e., the 10^{-4} fractional value indicated with the horizontal dashed line) was used to rank drivers for this discussion. These data also serve to illustrate the range of behavior in turning exhibited by the FOT drivers. Moreover, they indicate that most of the drivers tend to group together at the less conservative end of the scale while a few stand out from the group as decidedly more conservative. (The four most conservative drivers in the two plots are, in fact, the same four individuals.)

Table 6-2 shows comparable (C) and non comparable (NC) drivers as a function of the rankings established in figure 6-15. This table strongly suggest that the aggregate nature of the drivers participating in phase 1 (all the drivers) is likely to be different than that of those in phase 2 (dominated by the comparable drivers). It follows that differences observed in aggregate performance measures of phase 1 and of phase 2 may derive from the driver mix and can not be assumed to derive from other factors (e.g., the influence of the RA&C system).

Moreover, even comparing the aggregate performance of just the comparable drives in phase 1 and in phase 2 is questionable. Table 6-3 compares the relative distance of the comparable drivers in phase 1 and phase 2. There is one row in the table for each of the 14 comparable drivers; the rows are ordered, top to bottom, according to the turn-behavior ranking of the driver (full and empty averaged). The percent of total comparable distance in each phase is given for each driver. The sums of these percentages for the seven most and the seven least conservative drivers, respectively, are given at the bottom of the table. The data show that the less conservative drivers contributed more than half of the comparable distance in phase 1 but less than half in phase 2. Thus, aggregate measures of turning behavior for the comparable drivers could be expected to appear slightly more conservative in phase 2 due to the adjustments of individual contributions alone.

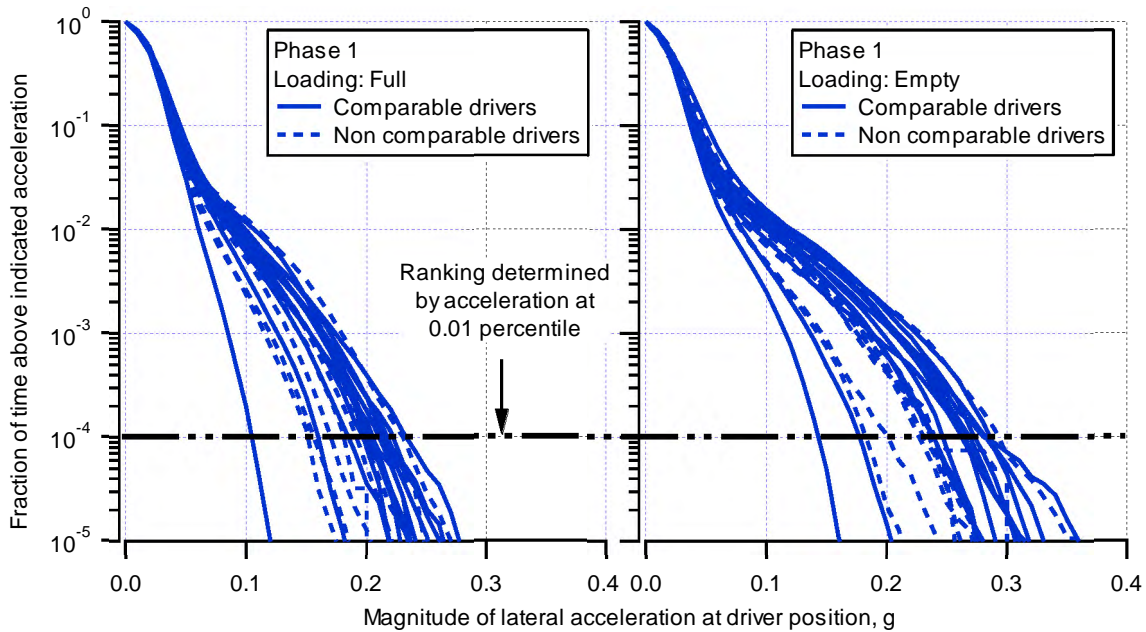

Figure 6-15. Cumulative histograms of travel time by magnitude of lateral acceleration comparing all drivers in phase 1

Table 6-2. Comparable (C) and non comparable (NC) drivers by lateral performance ranking

Rank	←more conservative																		Less conservative→			
	1	2	3	4	5	6	7	8	9	10	11	12	13	14	15	16	17	18	19	20	21	22
Full	C	NC	NC	C	NC	C	NC	C	NC	NC	C	C	C	C	C	C	C	NC	C	C	NC	C
Empty	C	C	NC	NC	NC	NC	NC	NC	NC	C	C	C	C	C	C	C	C	C	C	C	C	NC

Table 6-3. Percent of comparable distances by driver and phase

Comparable drivers by turn-behavior ranking	Contribution of comparable distance in phase, percent		Change, percent
	Phase 1	Phase 2	
1	6.8	7.2	0.4
2	6.1	6.8	0.7
3	6.9	7.2	0.3
4	8.0	8.2	0.2
5	5.8	5.9	0.0
6	7.3	7.7	0.4
7	6.0	8.5	2.5
8	6.5	5.3	-1.2
9	10.2	9.5	-0.8
10	7.7	4.5	-3.2
11	7.4	8.6	1.2
12	7.6	8.6	1.0
13	7.2	6.6	-0.6
14	6.4	5.3	-1.1
All	100	100	
7 most conservative	47.0	51.6	4.7
7 least conservative	53.0	48.4	-4.7

7. RA&C ADVISORIES AND CONTROL ACTIONS

This section will describe the experience of the FOT drivers with the RA&C system in terms of the advisories and actions of the RA&C system in phase 2 of the field test. The section begins with a brief review of the structure of the RA&C system and the relationship of its several messages and actions. Nevertheless, it is assumed that the reader is familiar with the system as described previously in section 2.2. Presentations will then be made describing the number of and physical characteristics associated with advisories, the distributions of advisories and actions experienced by the drivers, and the types of locations at which advisories took place.

7.1 Types of RA&C messages

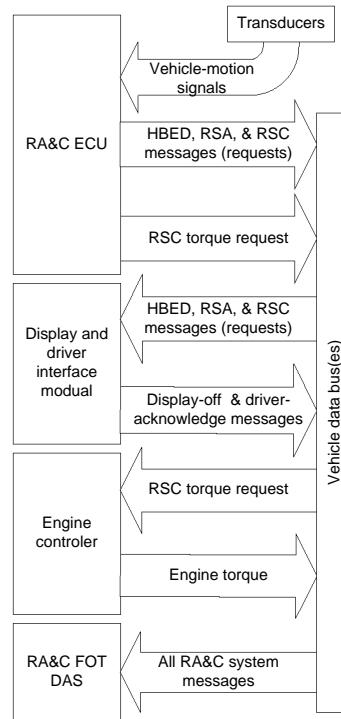

Figure 7-1. Simplified flow diagram of the messages of the RA&C system

As described in section 2.2, the RA&C system is based on a set of seven types of driver advisories and one associated control action. Four advisories deal with roll stability and rollover risk. Of these four, three are purely roll-stability advisories associated with turning judged to involve progressively greater risk of rollover: RSA-1, -2 and -3 advisories. The fourth, the RSC advisories, is associated with the greatest risk of rollover and is accompanied by control action to limit engine speed with the purpose of limiting vehicle speed and, thereby, lateral acceleration. Three advisories are associated with hard braking events: HBED 1, 2, and 3 messages.

Figure 7-1 illustrates the flow of RA&C messages²⁵ which can take place when RA&C advisories and control actions are initiated and executed. (This diagram is by no means complete but is simplified for the purpose of this discussion.) The electronic control unit (ECU) of the RA&C system monitors vehicle motions and determines when an advisory or control action is warranted. The ECU broadcasts the appropriate message on the data bus. This message amounts to a *request* to the driver/vehicle interface (DMC) to display one of the seven RA&C advisories. Requests for any of the three RSA messages are accompanied by a calculated speed-reduction (*deltaV*) value to be included in the advisory. (See section 2.2.) When RSC actions are warranted, the ECU broadcasts an additional message requesting the engine controller to limit engine torque.

Usually, when the ECU broadcasts a message, the requested advisory is displayed to the driver on the DMC. When the advisory has been displayed for the appropriate time, or has been acknowledged by the driver, the DMC broadcasts a display-off message and, if appropriate, a driver-acknowledge message. However, the DMC is required to display many messages other than RA&C advisories, some of which hold higher priority than RA&C advisories. Also, RA&C messages requesting higher priority advisories may be received before display of an earlier advisory is complete. For these reasons, RA&C messages from the ECU are not always followed by a display-off message from the DMC.

The DAS installed in the vehicles for the FOT monitored the vehicle data buses on which all these messages were broadcasts and recorded the occurrence of these messages by logging message type, a numerical value when appropriate (*deltaV*, engine torque, etc.) and of course, the time of the message.

In the following presentations, the terms *request*, *display-off*, and *acknowledge* refer to the type of system message observed and logged. The designations *RSA*, *RSC* and *HBED* refer to the type of advisory these messages requested or are responding to.

7.2 Numbers and general qualities of RA&C episodes and messages

The following discussion will refer to RA&C *episodes* as well as messages. An RA&C episode is a brief time period of maneuvering and/or braking during which an RA&C advisory-request message was generated. An episode may include more than one request message. (Episodes with as many as five request message took place in phase 2.) The terms *simple* and *complex* will be used to distinguish between episodes with just one request message and those with more than one.

²⁵ The term, *message*, is used here to describe the intra-system communications of the RA&C on the vehicle data bus, while the term, *advisory*, is used to indicate a message delivered to the drive via the DMC.

During phase 2 of the FOT, there were 335 RA&C episodes in which 379 advisory-request messages were generated.

Table 7-1 and figure 7-2 both present counts of the types of messages which were sent according to the type of advisory involved. The table and figure show:

- Ninety percent (341 of 379) of the advisories requested were of the RSA or RSC type (RSA/C); only 10 percent (38) were of the HBED type.
- Of the RSA/C request messages, 71 percent (241 of 341) were RSA 1 messages (the lowest roll-over risk advisory).
- Of the RSA/C request messages, 8.5 percent (29) were RSC messages accompanied by an engine-control action.
- All HBED request messages were HBED 1 messages (ABS activity detected);
- Ninety-two percent (349) of advisory requests were accompanied by a display-off message.
- Only 8 percent of advisories known to be displayed (i.e., with a display-off message) were acknowledged by the drivers.

Table 7-1. Counts of RA&C messages during phase 2

Type of message	Type of advisory							Percent of potential
	RSA and RSC					HBED	All	
	RSA-1	RSA-2	RSA-3	RSC	All	HBED-1		
request	241	65	6	29	341	38	379	
Display-off	222	58	5	28	312	36	349	92%
Acknowledged	16	8	0	0	24	4	28	8%

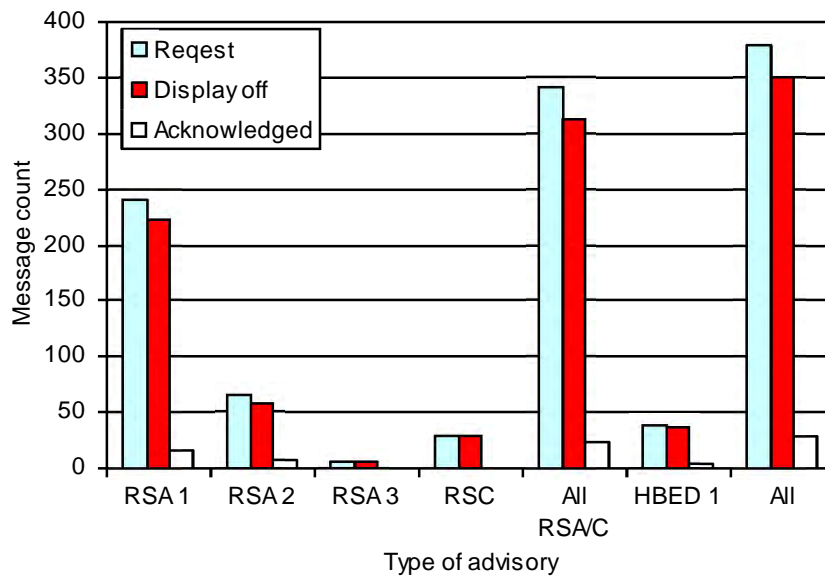

Figure 7-2. Counts of RA&C messages during phase 2

The 335 RA&C episodes were almost completely separated into those containing RSA/C requests and those containing HBED requests, respectively. That is, of the 38 HBED-1 message requests, 37 took place in simple episodes (one request only) that did not involve any RSA or RSC messages. The one remaining HBED-1 request occurred in an episode that also contained a single, RSA-1 request. Given this isolation of episodes involving RSA or RSC messages (RSA/C episodes) and those involving HBED messages, and inasmuch as the focus of this report is on roll stability and rollover risk, the remainder of this discussion will deal exclusively with the RSA/C episodes and messages.

Figure 7-3 shows the number of RSA/C episodes according to the number of advisory-request messages during the episode. Of the total of 294 RSA/C episodes, 89 percent (261) involved only one RSA/C advisory request (and one of these included an HBED-1 request). Of the 33 complex episodes, 24 included two advisory requests, 6 had 3 requests, 1 had 4, and 2 episodes had 5 advisory requests.

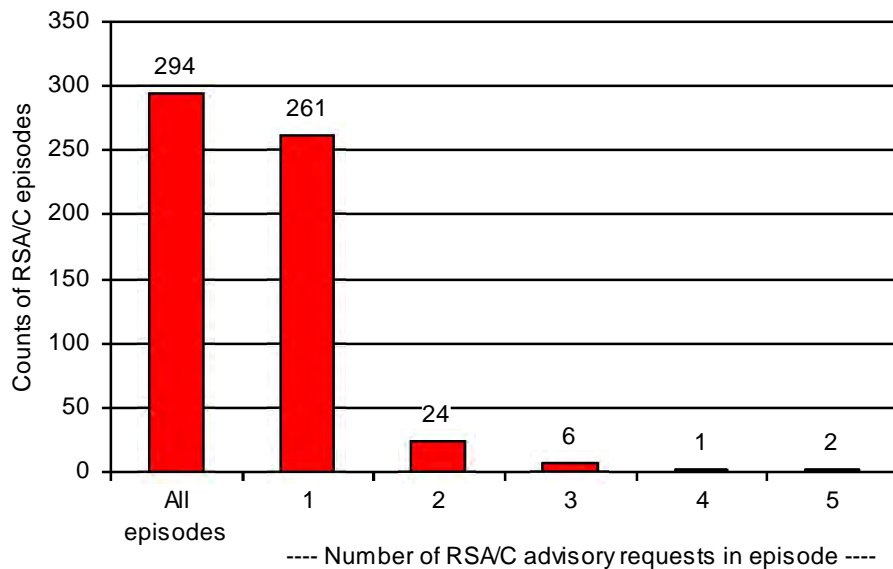

Figure 7-3. Counts of RSA/C episodes by number of advisory requests in the episode

Table 7-2 shows the configuration of the complex episodes in terms of request-message content. By far the most common specific configuration of complex episode was one level-2 RSA advisory request accompanied by one RSC advisory/control-action request. Twelve of the 33 complex episodes (36 percent) were of this specific configuration. An even more common quality of complex episodes is their tendency to include at least one RSC advisory/control-action request. Seventy-three percent (24 of 33) of complex episodes are of this type. From another point of view, 83 percent (24 of 29) of all RSC advisory requests and control actions took place within a complex episode.

Table 7-2. Advisory-request content of complex RSA/C episodes

Count of episodes	Number of advisory requests in episode				
	All	RSA-1	RSA-2	RSA-3	RSC
12	2		1		1
4	2	2			
3	2	1	1		
2	3	1	1		1
2	2	1			1
2	2			1	1
1	5	1		2	2
1	5		3		2
1	4	1	2		1
1	3		1		2
1	3	1		1	1
1	3		2		1
1	3	1	2		
1	2	1		1	

As was indicated in figure 7-2 and table 7-1, 29 of the RSA/C advisory-request messages were not accompanied by a display-off message. The majority of these “missing” display-off messages were related to complex episodes wherein close examination of the episode explains the absence of the display-off message. Consider, for example, figure 7-4 which shows the time history of a complex episode with five advisory requests but just three display-off messages. The episode took place in a 270-degree turn to the right on a freeway ramp. The figure shows the lateral acceleration and speed of the tractor and, below, a time line of the associated messages. From this time history, it can be deduced that:

- The first advisory request (RSC) was probably displayed from the time of the request until the time of the first display-off message.
- The second advisory request (RSA-2) was probably never displayed as it was requested during the RSC display.
- The third advisory request (RSA-2) was probably displayed from the time of the request until the time of the fourth advisory request.
- The fourth advisory request (RSC) was probably displayed from the time of the request until the time of the second display-off message.
- The fifth advisory request (RSA-2) was probably displayed from the time of the request until the time of the third and final display-off message.

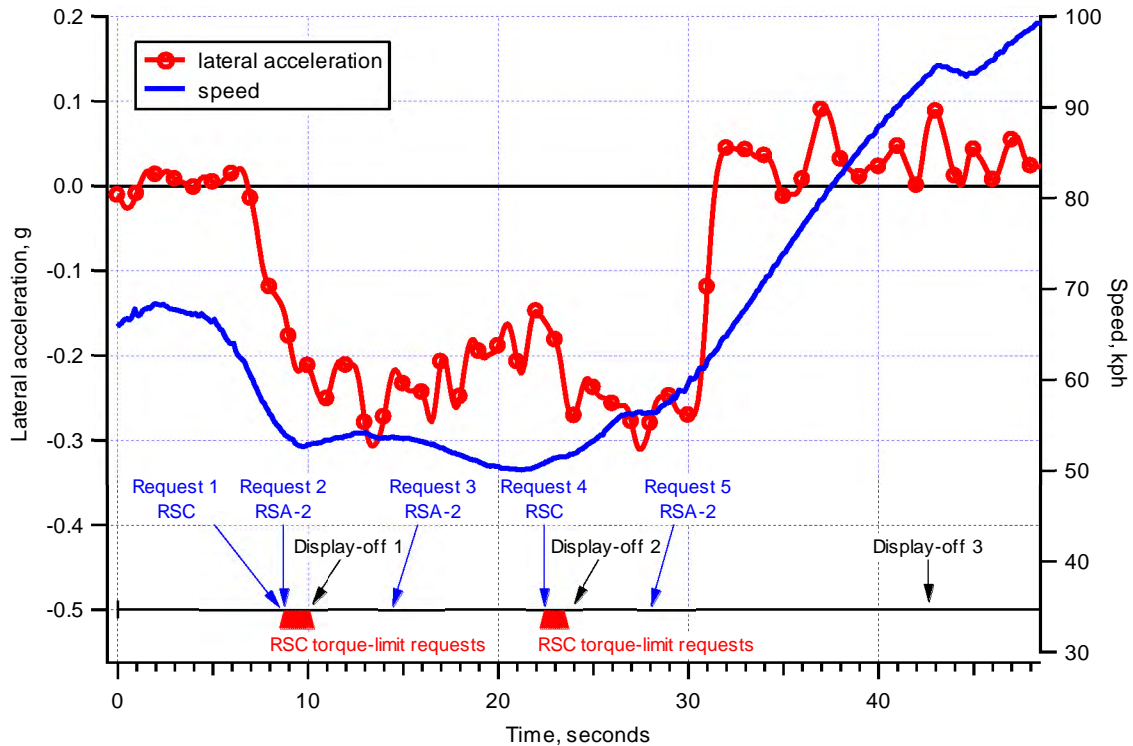

Figure 7-4. Time history of a complex RSA/C episode with five advisory requests

Seventeen of the “missing” display-off messages could be explained in like manner, i.e., they took place in complex episodes wherein the timing of request messages explains the absence of display-off messages. The remaining twelve, however, were missing from simple episodes, and their absence could not be explained by data available in the FOT database.

Figures 7-5 and 7-6 present the distributions of RSA/C episodes according to travel speed and to total vehicle mass, respectively. In each graph, the distributions of episodes are shown by column graphs. For comparison, each is accompanied by the distribution of phase-2 travel time shown with a dashed line (and similar to the presentations of figures 5-6 and 5-7).

Figure 7-5 shows that, even though the great bulk of travel time takes place at speeds above 90 kph or, to a lesser extent, below 20 kph, most RSA/C episodes take place between 20 and 70 kph with the range of 25 to 30 kph being the most likely. This seems in keeping with two other observations, viz., (1) drivers generally tend toward higher lateral accelerations in lower-speed driving (see figure 6-4), and (2) the RA&C device appears to have a lower limit of about 21 kph for the delivery of RSA advisories (an observation which will be made in section 7.3 and which confirms a similar declaration in [1]).

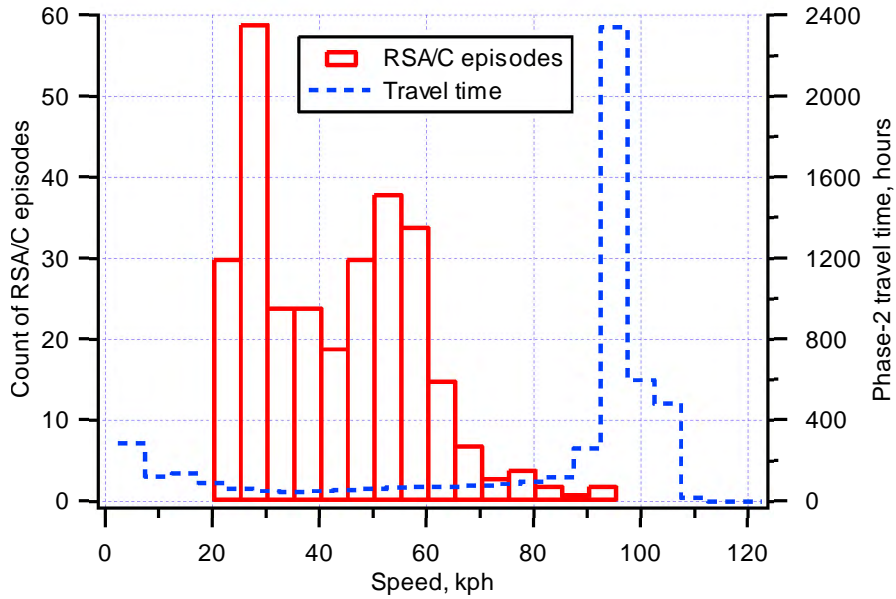

Figure 7-5. Comparing distributions by speed of RSA/C episodes and travel time

Figure 7-6 shows that, although travel time is split more or less evenly between the fully load and empty conditions, the great majority of RSA/C episodes took place with empty vehicles. Indeed, over 80 percent of RSA/C advisories were issued under empty or nearly empty loading conditions. This also seems to be in keeping with to other observations, namely that (1) drivers tend toward higher lateral accelerations with empty vehicles (see figure 7-2) and that (2) in practice, the RA&C device appeared to be insensitive to total vehicle mass with respect to issuing RAC advisories (another observation which will be made in section 7.3).

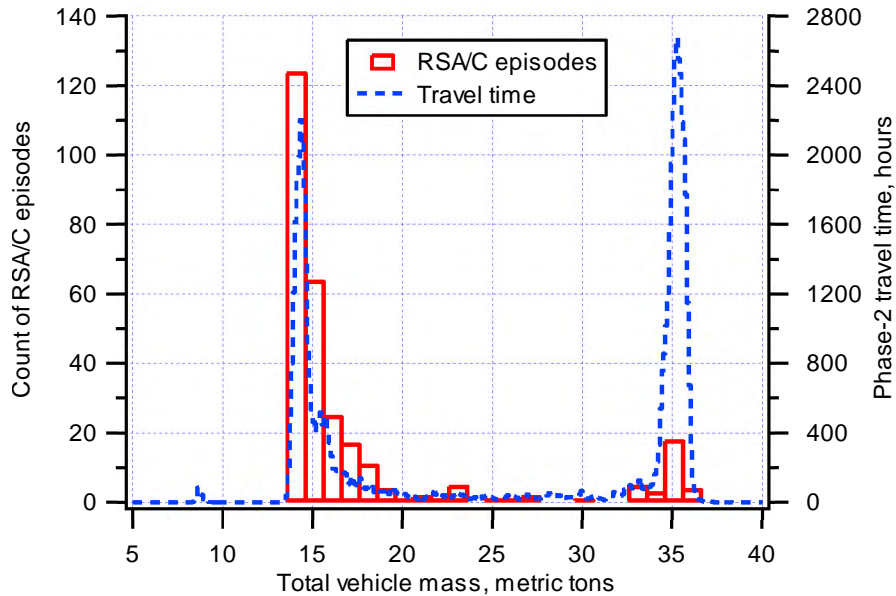

Figure 7-6. Comparing distributions by total mass of RSA/C episodes and travel time

Of the 312 RSA advisory requests, 311 were accompanied by speed-reduction advisory messages. The speed reductions advised ranged from 1 to 7 mph (1.6 to 11.3 kph). Of the 311 advisories, 89 percent (278) advised a minimum speed reduction of 3 mph. Figure 7-7 shows the counts of speed-reduction advisories as they were associated with the three levels of RSA advisories. (Speed-reduction advice is not issued with RSC advisories.) Note that of 240 speed advisories associated with RSA1 advisories, all but 1 were for 3 mph with the one other being for 5 mph.

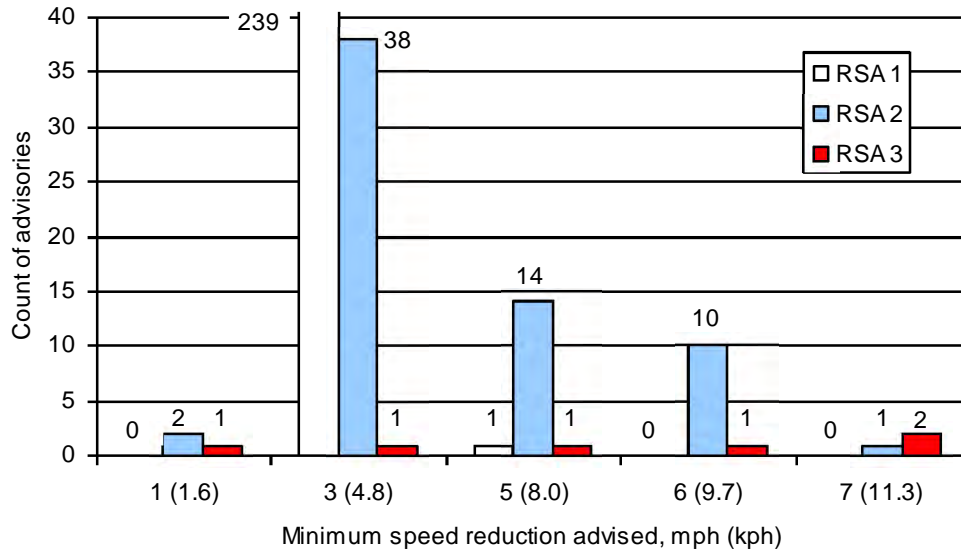

Figure 7-7. Counts of speed-change advisories by speed and RSA advisory level

7.3 Lateral acceleration, rollover ratio and the RSA/C episodes

This section intends to review the physical properties of RSA/C episodes in terms of the relationship between the advisory messages sent and the lateral accelerations and rollover ratio experienced by the vehicle.

Figure 7-8 presents three graphs of the maximum magnitude of “lateral acceleration” which took place in episodes which generated RSA level-1 advisories and only level-1 advisories, i.e., no level-2, -3, or RSC advisories). These values are plotted against the forward speed of the vehicle at the time when this maximum value took place.

In the first (top) of the three graphs, “lateral acceleration” is as determined for the longitudinal position of the RA&C ECU. That is, the filtered signal of the lateral acceleration measured at the front axle (including the component of gravity associated with cross slope of the road) is “translated” to the longitudinal position of the ECU using the time derivative of yaw rate as was described in equation 4-5 (see section 4.2.4). This signal is further modified in the lower two graphs, as will be described below.

Looking first at the top graph of figure 7-8, it is noted that there appears to be a bias in the maximum magnitude of lateral accelerations between RSA-1 episodes involving right turns and those involving left turns, RSA-1 advisories in left turns appearing generally to involve slightly higher lateral accelerations than those in right turns.

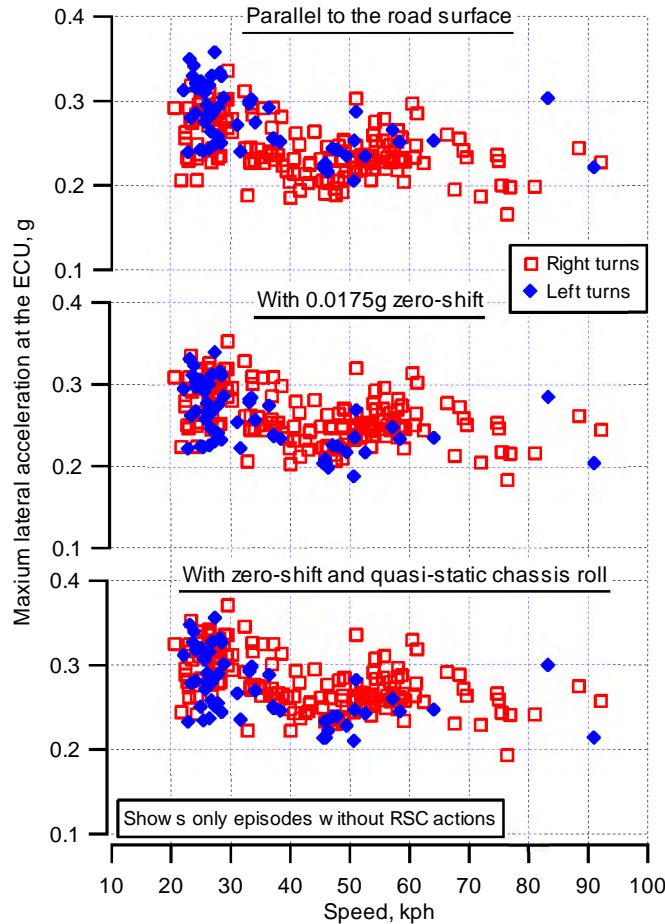

Figure 7-8. Progressive treatments of maximum lateral acceleration signal from RSA level-1 episodes

It is understandable that this would be the case in that the “drift correction” which the RA&C ECU applies to its internal acceleration signal essentially seeks a long-term average of zero g. However, chapter 6 revealed that the long-term average acceleration (parallel to the road and including the gravity component related to side slope) was typically 0.0175g for the FOT fleet (see figure 6-5). In the second graph, a “zero-shift” of 0.0175g is applied to the lateral acceleration measure and the asymmetry is largely removed. Thus, from the “point of view” of an acceleration signal which includes drift correction to produce a long-term average of zero g, there is no apparent left-turn-to-right-turn bias. But from the point of view of lateral acceleration parallel to the road (which is most directly related to rollover), there appears to be a bias of about 0.02 g.

The third graph adds an additional modification to the acceleration measure to produce a result still closer to that which would be measured by the accelerometer of the RA&C ECU. The acceleration values indicated in the first two graphs were both as would be measured parallel to the road. However, the ECU is mounted on the tractor chassis which rolls during maneuvering. That is, an ECU-mounted accelerometer does not remain parallel to the road but rolls with the vehicle. The rolling motion introduces additional gravitational components which tend to increase the magnitude of accelerations measured by such an accelerometer. Data from the tilt-table tests, described in appendix A-C, provide a means to estimate this influence. The third graph of figure 7-8 presents the lateral acceleration measure further modified by equation A-C1 which provides a “correction” accounting for quasi-static roll of the tractor chassis at the location of the RA&C ECU.

Consequently, the third graph of figure 7-8 provides our best estimate of the maximum lateral acceleration observed by an accelerometer in the RA&C ECU in RSA level-1 episodes. The graphs seems to reveal a few interesting properties. (1) There appears to be a hard speed cutoff of a bit more than 20 kph, below which no RSA-1 advisories are issued. (2) Above 20 kph, there appears to be a fairly well defined lower threshold of acceleration of about 0.21 g required to issue an RSA-1 advisory. (3) This threshold does not appear to be speed sensitive. (4) Advisories are spread over the operating speed range (above 20 kph) although with distinctly more taking place below 60 kph.

The third graph of figure 7-8 is reproduced as the upper left hand one of the six graphs appearing in figure 7-9. The six graphs of this figure are as follows: from top to bottom, the three sets of two are related to RSA-1, RSA-2 and RSA-3 episodes, respectively (i.e., episodes in which level-1, level-2, and level-3 advisories are the highest-level advisories issued within the episode.²⁶ In the left-hand graph of each pair, the maximum magnitude of the fully-adjusted acceleration is plotted against speed at the time of the maximum (as in figure 7-8). In the right-hand graphs, the same acceleration is plotted against the total vehicle mass at the time of the episode. The graphs also show what appears to be the lower threshold of acceleration required for each type of message.

Several qualities of these graphs seem significant: (1) The lower thresholds progressive from 0.21 g to 0.25 g to 0.30 g for level-1, -2, and -3 advisories, respectively. (2) These lower thresholds do not appear to be sensitive to either forward speed or to total vehicle mass. (3) Upper thresholds are not well defined. For example, many episodes

²⁶ For clarity, it was desirable not to include in these data, episodes that also involve RSC advisories. This is the case for the graphs for level-1 and level-2 episodes. However, as all but one level-3 episodes involve RSC advisories, all level-3 episodes are included.

which exceed the 0.25 g acceleration level nonetheless produce only an RSA-1 advisory.²⁷ (All of these observations depend heavily on the numerous RSA-1 episodes and become more difficult to make based on the few number RSA-2 and RSA-3 episodes.)

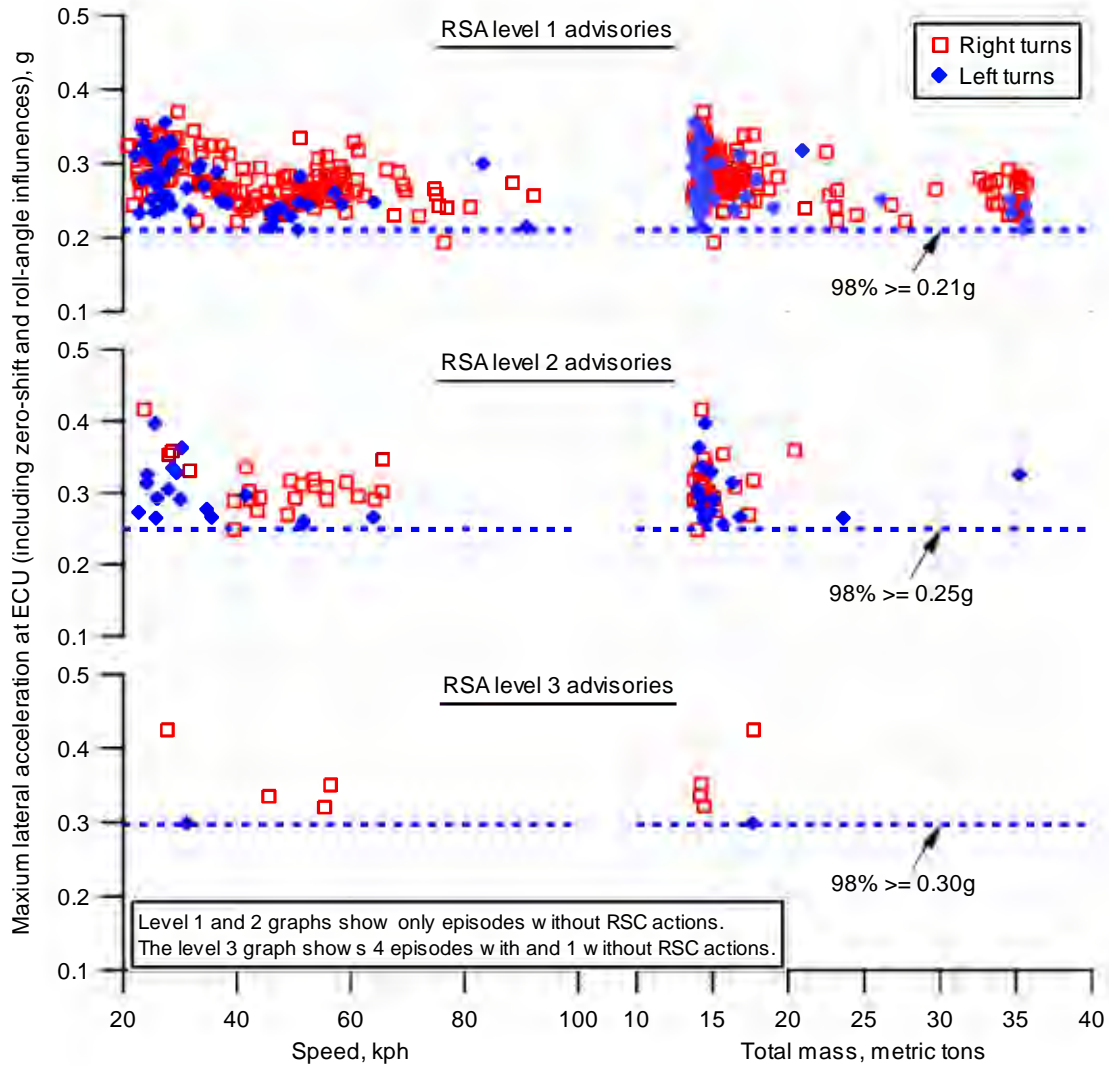

Figure 7-9. Maximum lateral acceleration at the ECU by speed and load for RSA episodes

With regard to this latter point, satisfactory explanations are not readily apparent from examination of individual episodes. For example, consider figure 7-10 which presents time histories of lateral acceleration at the ECU (fully adjusted with zero-shift and the

²⁷ Note that analyses of this type were undertaken with various criteria for the lateral acceleration measure. These included determining maximum “sustained” acceleration where the time period for sustaining ranged from 1.5 to 3 seconds. Approaches like these which could be called “more aggressive filtering” resulted in lower, lower thresholds but did not yield any better definition of upper thresholds.

influence of roll) in the upper graphs and time histories of speed in the lower graphs for two simple episodes. An RSA-2 episode is shown on the left and an RSA-1 episode on the right. In both cases, the vehicles are nearly empty (total masses are 14.5 and 14.3 metric tons, respectively), and the action takes place at speeds close to 25 kph. On the left, lateral acceleration peaks at 0.26 g and is sustained above the (apparent) level-2 threshold of 0.25g for slightly less than 1 second. After the acceleration level declines, this episode produces a level-2 advisory. On the right, lateral acceleration peaks at 0.34 g and is sustained above 0.25 g for slightly more than 2 seconds, yet this episode produces only a level-1 advisory.

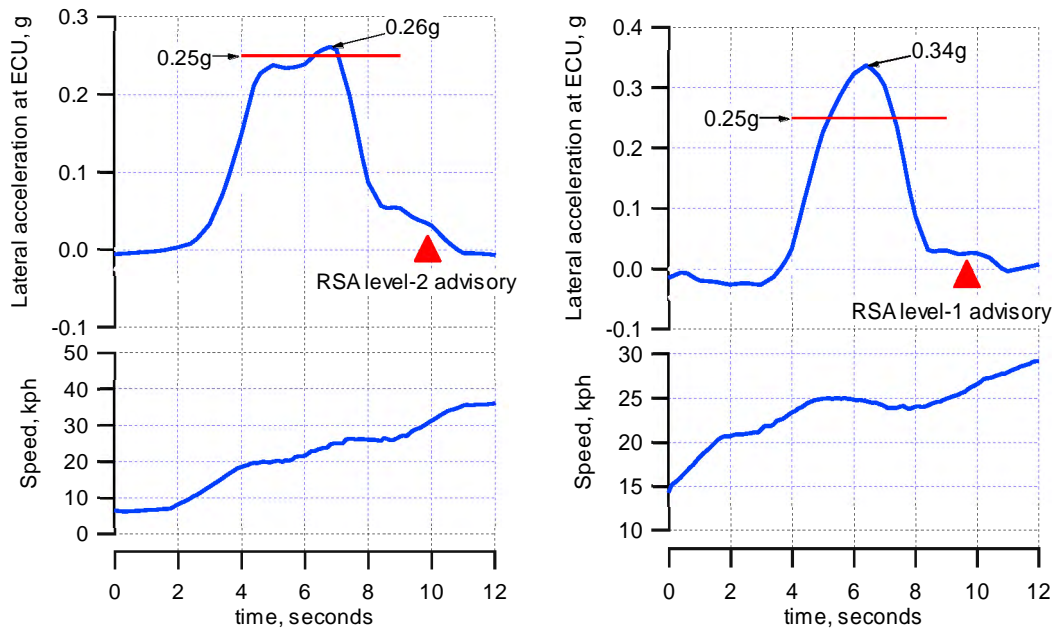

Figure 7-10. Time histories from a simple RSA-2 and a simple RSA-1 episode

In the discussion of figure 7-9, it was noted that the lower threshold of acceleration for a given advisory level did not appear to be a function of either speed or total vehicle mass. However, rollover threshold of these vehicles is, in fact, a function of total mass. Figure 7-11 presents six graphs of the same form as those of figure 7-9, except that the maximum magnitude of lateral acceleration has been replaced with the maximum of rollover ratio (calculated as described in section 6.3.2, equations 6-1 and 6-2)²⁸ experienced in the episode. As can readily be expected, this figure shows (on the right) a substantial relationship between the maximum rollover ratio of the episode and the total vehicle mass. When the vehicle is light and relatively stable, advisories are issued associated with

²⁸ Note that rollover ratio is based on lateral acceleration for the total vehicle and is measured parallel to the ground. Especially at low speed it includes the influence of transient off-tracking of the trailer, but it does not include a zero-shift or the influence of chassis roll as does lateral acceleration at the ECU in figure 7-6.

relatively lower values of rollover ratio. When the vehicle is fully loaded and less stable, advisories are associated with high values of rollover ratio. Looking at the left side of the figure, there remains no apparent relationship between speed and the level of rollover ratio associated with advisories.

Figure 7-11 also reveals that RSA-1 advisories were issued for episode with maximum rollover ratios as low as about 0.24 (empty vehicles only). Maximum rollover ratio associated with the bulk of the advisories for light vehicles fell in the range of 0.28 to 0.46. For heavy vehicles, this range was roughly 0.40 to 0.55. The highest rollover ratio observed in these episodes was about 0.62 and was related to an RSA-2 advisory for a loaded vehicle. All the RSA-3 advisories were issued for light vehicles and the associated maximum rollover ratios ranged from 0.39 to 0.56, the latter being the highest rollover ratio for light vehicles among these episodes. Overall, 93 percent of RSA/C advisories were issued during episodes in which rollover ratio did not exceed 0.5.

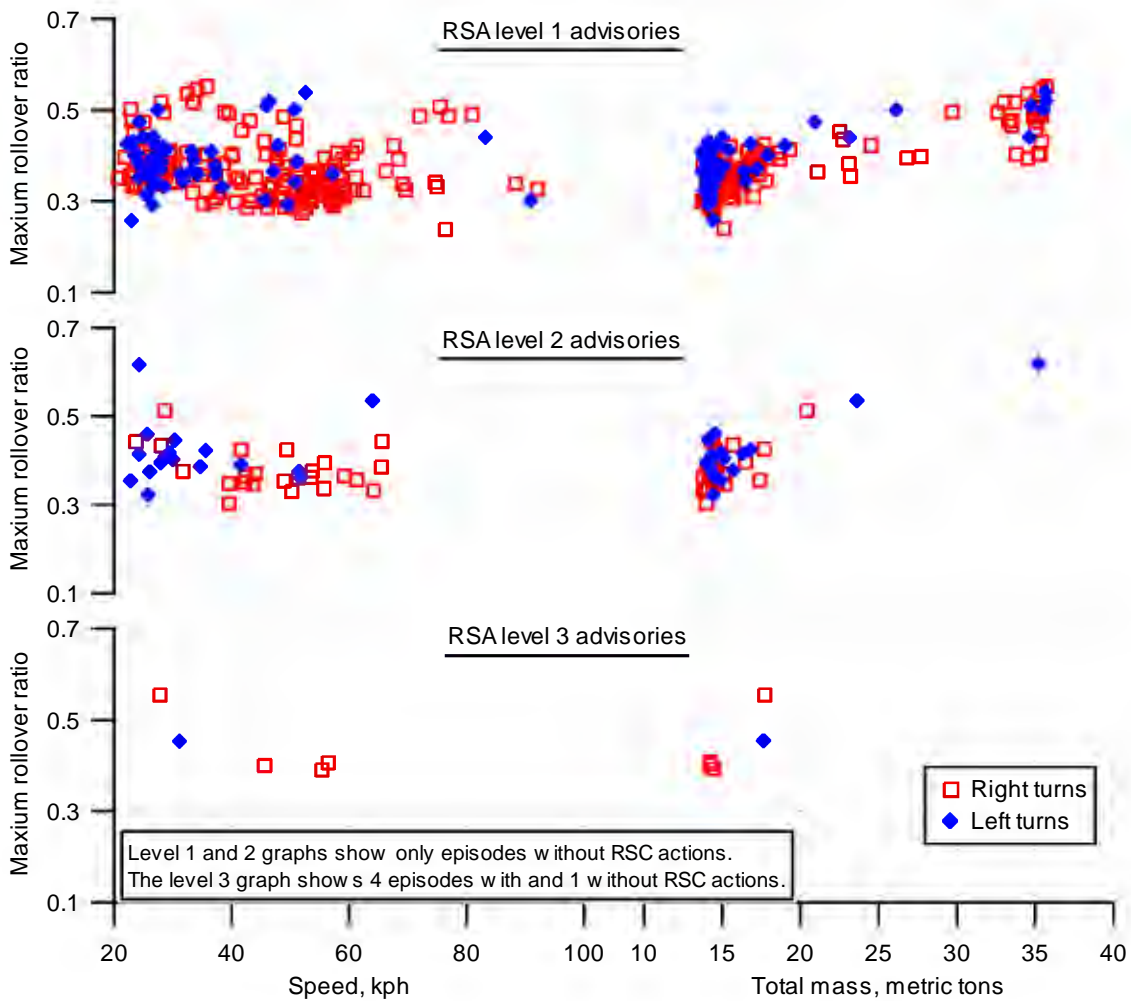

Figure 7-11. Maximum rollover ratio by speed and load for RSA episodes

Figure 7-12 present four graphs relating to episodes which included RSC advisories, which have not generally been included in the preceding discussion. The top two graphs are similar to figure 7-9 in that they present maximum magnitude of lateral acceleration at the ECU plotted against speed on the left and total vehicle mass on the right. The lower two graphs are similar to those of figure 7-11 where rollover ratio replaces lateral acceleration. Unlike the RSA advisories, the RSC control actions (and associated advisories) are intend to respond rapidly to what is seen by the RA&C device as a serious impending threat of rollover. Accordingly, decisions to take RSC action are based on less heavily filtered versions of lateral acceleration as determined by the ECU. In keeping with this, the maximum lateral accelerations at the ECU shown in the upper portion of figure 7-12 are calculated as previously described, but from less heavily filtered versions of lateral acceleration (at the front axle) and yaw rate. These maxima do include the adjustments for zero-shift and chassis roll as per figure 7-9. (Rollover ratio is calculated as always, as the “mechanically filtered” response of the trailer makes this difference in signal filtering largely mute.)

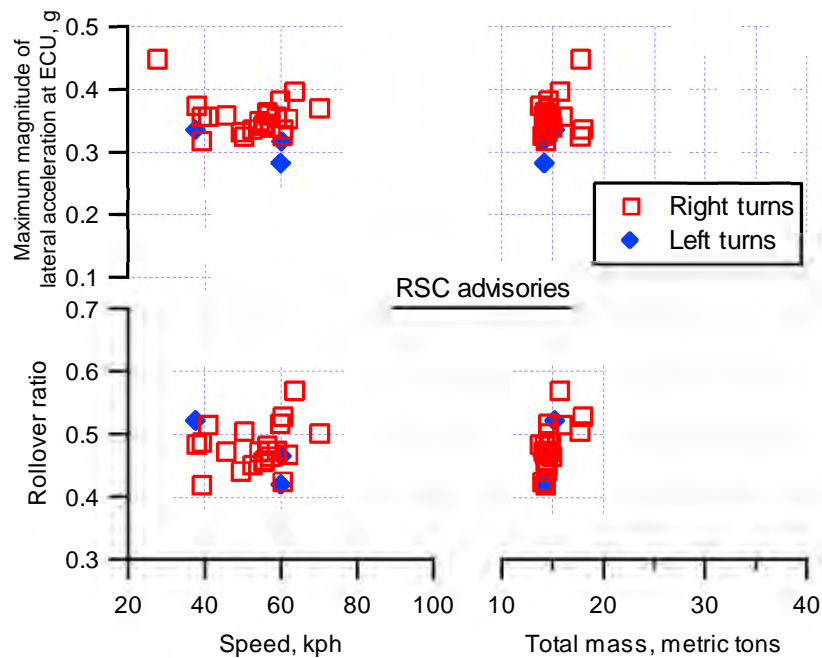

Figure 7-12. Maximum lateral acceleration at the ECU and maximum rollover ratio by speed and load for RSC episodes

Figure 7-12 shows that for RSC actions: (1) all took place with lightly-loaded vehicles; (2) all took place in the speed range of 38 to 70 kph; (3) maximum lateral acceleration at the ECU ranged from 0.28 g to 0.40 g, with all but one maxima above 0.31 g; (4) maximum rollover ratio ranged from 0.42 to 0.57 with all but one maxima less than 0.53.

Figure 7-13 presents data describing the speed-reduction advise presented in association with RSA advisories as a function of maximum magnitude of lateral acceleration (adjusted for zero-shift and roll influences at the ECU) and the forward speed of the vehicle (at the time of the maximum acceleration). (For complex RSA/C episodes, only the one speed-reduction advisory associated with the highest level RSA advisory is reported.) Although there is a good deal of over lap in the regions associated with the four levels of speed advisories, the figure nonetheless shows strong and appropriate relationships between maximum acceleration, forward speed, and the minimum speed-reduction that is advised. That is, advise for greater speed reductions are clearly associated with higher speeds of travel and with higher lateral acceleration. Moreover, the dominance of advisories for speed reduction of 3 mph (see figure 7-7 and the related discussion) is clearly a result of the fact that most RSA advisories are associated with situations involving lower speeds and lower accelerations.

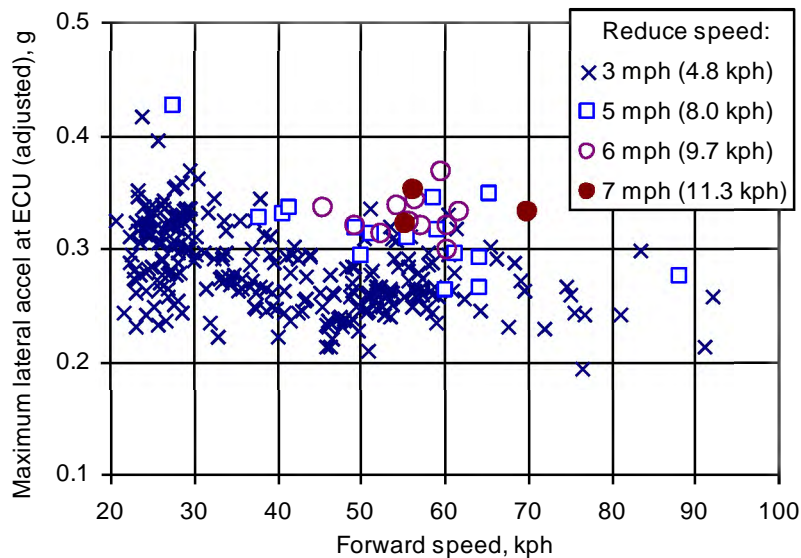

Figure 7-13. Speed-reduction advisories as a function of lateral acceleration and forward speed

7.4 RSA/C episodes and messages by driver

The 294 RSA/C episodes were not, of course, evenly distributed among the drivers, or, for that matter, among the comparable drivers. Figure 7-14 shows both the number and rate (per 1000 km) of RSA/C episodes for each of the drivers who participated at all in phase 2. Driver 2031 had the most episodes with 69, and driver 2032 ran a strong second with 45. These two drivers accounted for nearly 39 percent of all the RSA/C episodes. Five other drivers experienced from 19 to 23 episodes each. These top seven drivers accounted for 75 percent of all the episodes. At the other end of the scale, three drivers had no episodes, three had one, and one driver had just two episodes.

Regarding the rate of episodes, the pooled rates of all the drivers and of all the comparable drivers, respectively, were 0.75 and 0.72 episodes per 1000 km. Driver 2041 stood out with by far the highest rate of 5.9 episodes per 1000 km of travel. However, this driver traveled less than 3700 km in all of phase 2 so that he accumulated just 21 total episodes.

Drivers 2032 and 2031, the two drivers with the highest total counts, were the next highest with rates of 2.6 and 2.2 episodes per 1000 km, respectively. These were the two highest rates among the comparable drivers. Figure 7-15 shows that these same two drivers also account for the majority of the complex episodes. Driver 2032 had 13 complex episodes and driver 2031 had 10, thus accounting for 37 percent and 29 percent of all the complex episodes, respectively. Indeed, these two drivers accounted for both of the episodes with 5 advisory requests (1 each) and five of the six episodes with 3 requests (3 for 2031 and 2 for 2032). (The driver of the one episode with four requests is unknown.) Finally, although it is not apparent from the figures, these two drivers account for 71 percent of all the RSC advisory requests and control actions.

Figure 7-16 displays information on driver-acknowledge messages by driver. Both the counts of driver-acknowledge messages and the rate of driver-acknowledge messages are presented. (Rate of driver-acknowledge messages is calculated as the fraction of display-off messages accompanied by driver-acknowledge messages; the count of display-off messages being taken as the number of opportunities the driver had to acknowledge an advisory message.) Only four of the 16 drivers who experienced advisories acknowledged any of them. Two drivers, 2028 and 2029, accounted for 89 percent of all acknowledgements. They had 7 and 18 acknowledgments, respectively. Individually, their rates of acknowledgment were 57 and 82 percent, respectively.

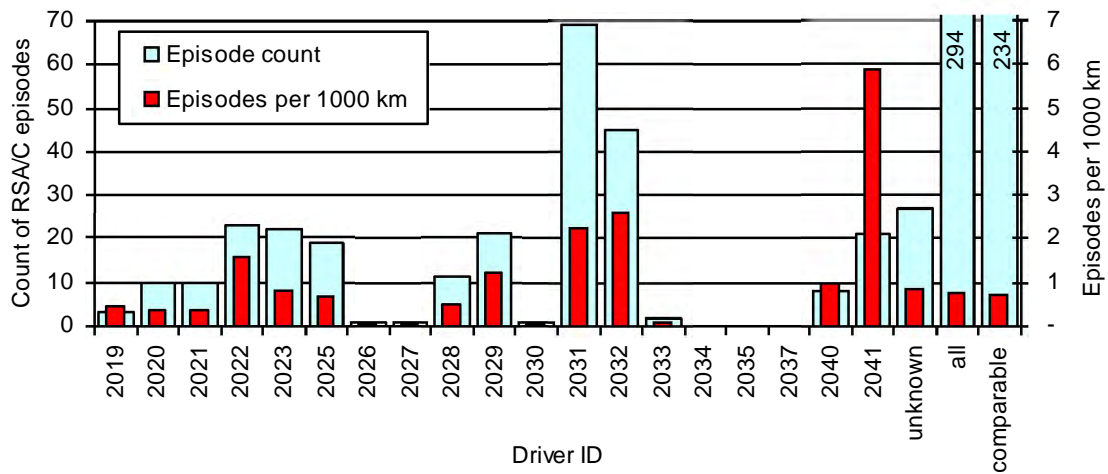

Figure 7-14. RSA/C episodes by driver

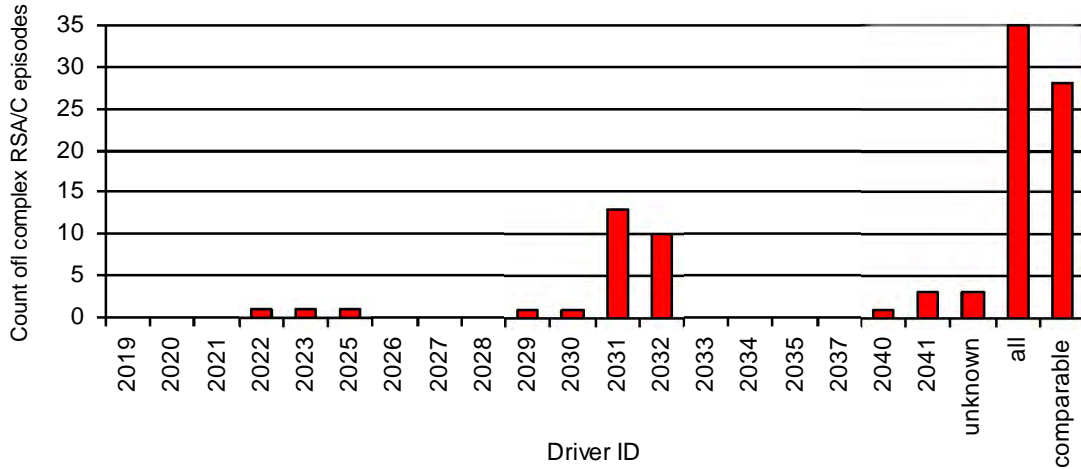

Figure 7-15. Counts of complex RSA/C episodes by driver

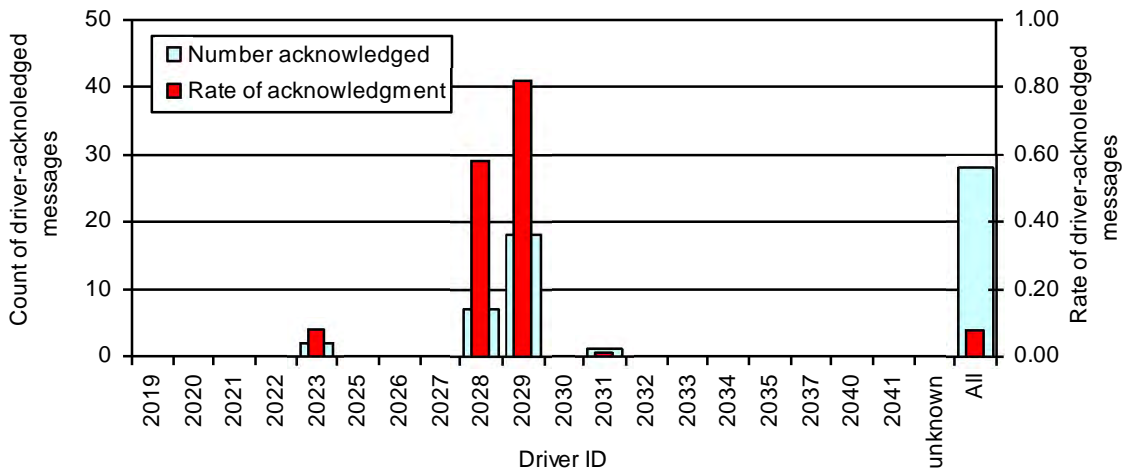

Figure 7-16. Counts and rates of driver-acknowledge messages by driver

Figure 7-17 presents a graph showing the accumulation of RSA/C episodes both by date and by distance over the course of phase 2. The ordinate of the graph is the cumulative count of episodes. Date and distance both appear as abscissa. The actual accumulations by date and distance are shown by the solid and the dotted lines, respectively. The dashed line is a reference showing an accumulation of the same number of episodes spaced evenly over the same time or distance. Comparing the plots of actual accumulation with the reference, it can be seen that the episodes generally takes place close to the reference rate (i.e., the plots of accumulation run parallel to the reference). However, in early July there was a noticeable increase in rate of accumulation and a noticeable decrease in the later portion of October and early November. There was also a noticeable decline and quick recovery of the rate of episodes in the time period of September 11 through 22. (Note that there was no corresponding decline in distance per day in this time period. See figure 7-1.) In general, however, the graph suggests a relatively consistent accumulation of episodes over the course of phase 2.

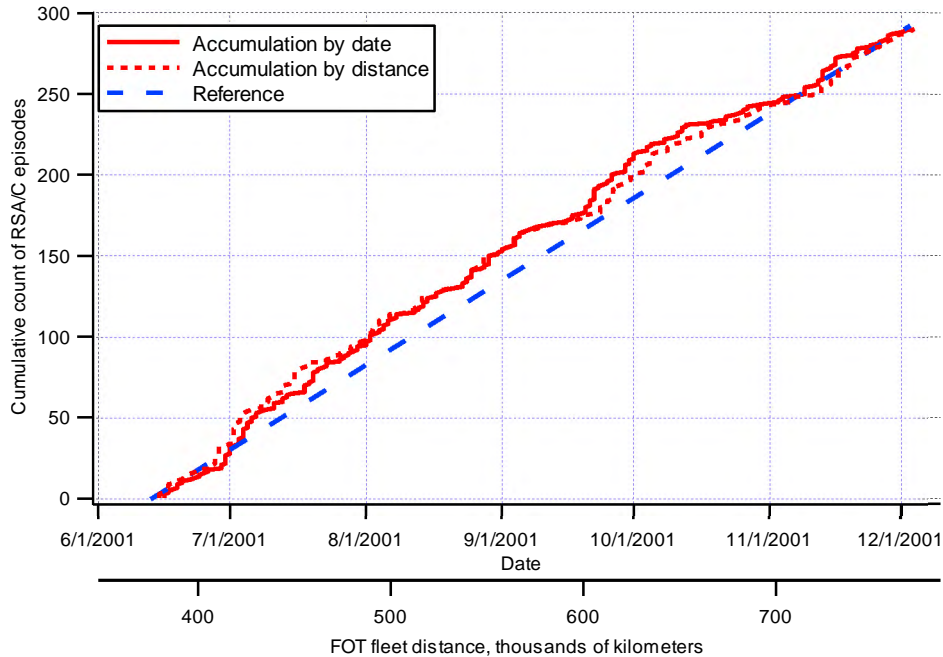

Figure 7-17. The accumulation of RSA/C episodes during phase 2

The rate of accumulation of episodes by distance is examined on a driver-by-driver basis in figure 7-18. This figure presents an individual graph for each of the comparable drivers who experienced at least one RSA/C episode. The reference line shows how the accumulation would appear had the driver spaced his episodes evenly over the distance he traveled in phase 2. The primary point of interest behind this presentation is, of course, the question of an initial period of *learning* (or perhaps inquisitive experimentation) that might be revealed as an initial, high rate of accumulation. Such a situation would tend to produce a graph wherein the accumulation plot was consistently above the reference line.

The individual presentations of figure 7-18 can be characterized as follows:

- The entire cumulative plot lies above (or on) the reference line implying a clear tendency for episodes to occur early relative to distance traveled. Six drivers fall in this category. All three of the drivers with few (1 or 2) episodes are in this group (drivers 2026, 2030, and 2033). Three drives with several episodes (10 or more) are in this group (drivers 2021, 2025, and 2028). In all cases, the “accelerated,” early rate of episodes appears to be within the first 8000 km or less of travel in phase 2.
- The cumulative plot lies near to and/or crosses over the reference line implying relatively even distribution of episodes relative to distance traveled. The remaining six drivers are in this group. Of those three (2020, 2022, and 2031) show particularly even distributions of episodes.

Whether or not these observations are significant is an open question. Nonetheless, it is clear that, while the accumulation of episodes for the entire FOT fleet was relatively consistent over phase 2 (figure 7-17), that was not necessarily the case for individuals. Indeed, some drivers tended to experience RSA/C episodes relatively early in their phase-2 driving and some distributed their episodes rather evenly throughout the phase, but no individual demonstrated a strong tendency to biased episodes toward the end of phase 2.

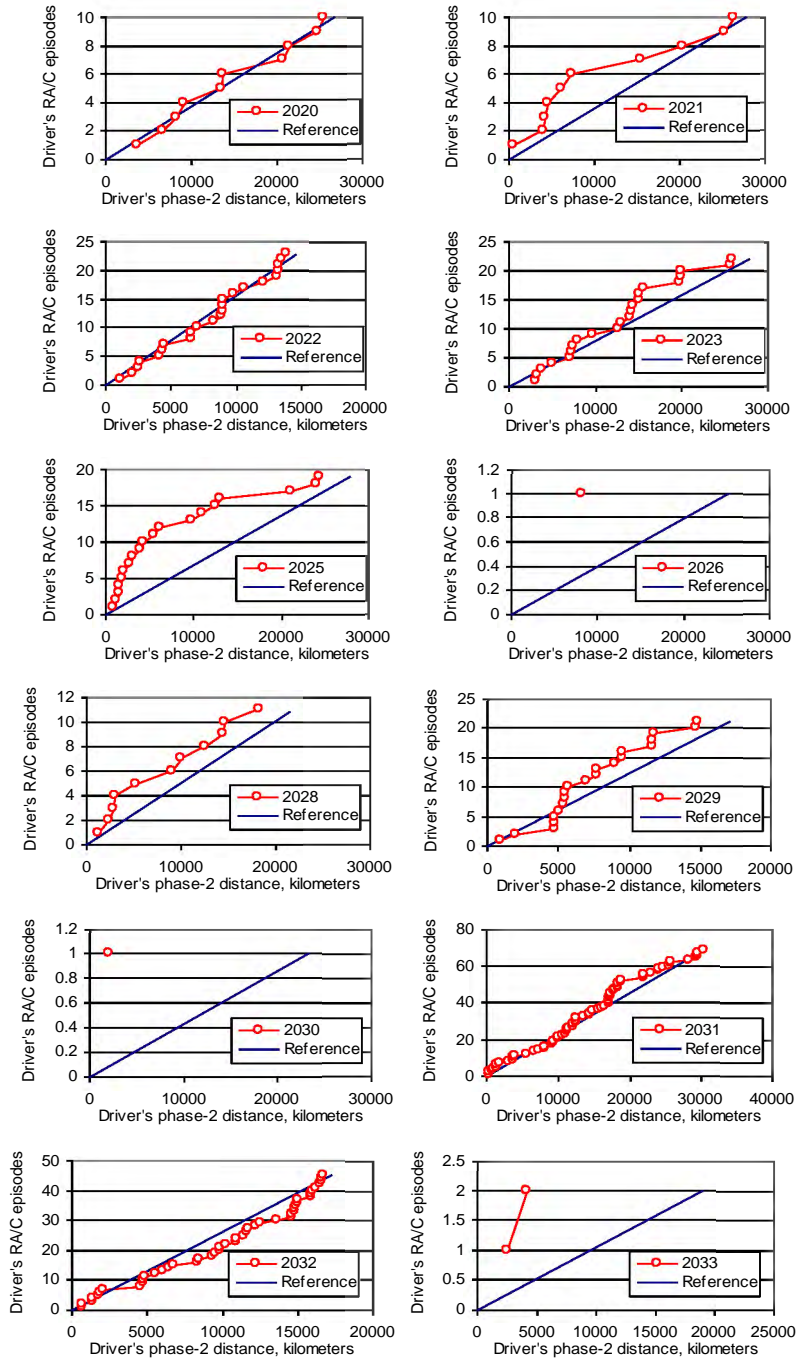

Figure 7-18. The accumulation of RSA/C episodes by individual drivers

7.5 RSA/C episodes by location

The information in this section is provided in order to give as complete a picture as possible of the RSA/C episodes which took place in this field test. However, at the outset it seems appropriate to warn the reader against assuming that these observations necessarily have broad meaning. It seems to us very possible that our observations about the location of episodes may be driven by the specifics of the test fleet's operations (i.e., the location of terminals and customers), by the behavior of the individual drivers (i.e., the locations of most episodes are likely to be on the routes of the least conservative drivers), and by the properties of RA&C (i.e., the locations of most episodes are likely to be on travel returning to Praxair when vehicles are empty).

The 292 RSA/C episodes of phase 2 took place at 146 curve locations. Table 7-3 shows the distribution of episodes by curve. As many as 22 episodes took place in just 1 curve; 13 took place at another; two curves had 11 episodes each; etc. There were 108 curves with just one episode each. Note from the two right-hand columns: 8 percent of the RSA/C episodes took place in the one, most active curve, 12 percent took place in 2 curves, 20 percent in 4 curves, etc. Although not shown in the table, it is also of interest that 26 of the 29 RSC control actions took place in the 42 curves with more than one episode; 8 of these took place in the one curve with 22 episodes.

Table 7-3. Counts of RSA/C episodes by location

<i>Number of curves</i>	<i>Number of episodes per curve</i>	<i>Cumulative count of curves</i>	<i>Cumulative percent of episodes</i>
1	22	1	8
1	13	2	12
2	11	4	20
2	10	6	26
1	9	7	29
1	7	8	32
5	5	13	40
2	4	15	43
8	3	23	51
19	2	42	64
104	1	146	100
146	2	— for all curves	

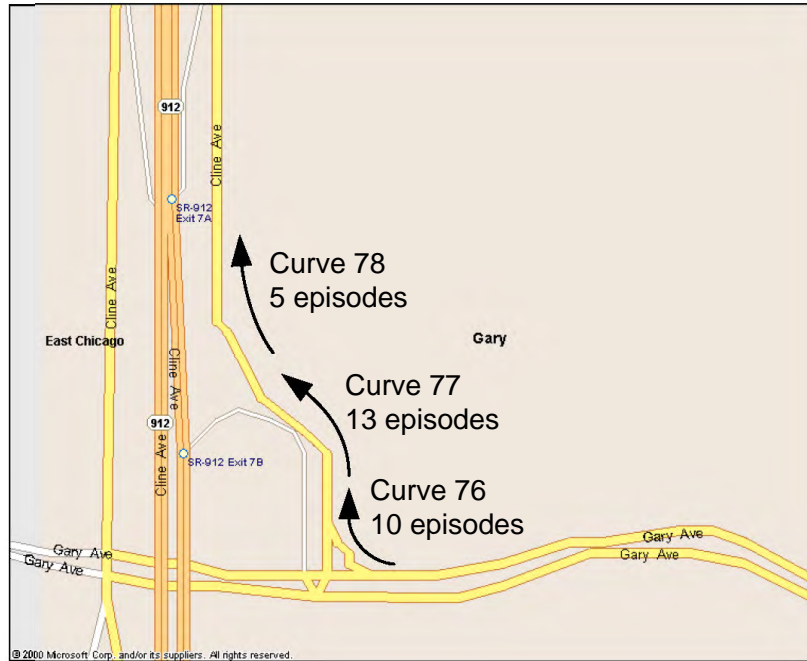

Figure 7-19. Location of the greatest number of RSA/C episodes of the FOT

Because of the way the term “curve” is defined for this report (see section 4.2.5), more than one curve can be involved in what would normally be considered one *location*. Figure 7-19 illustrates the one important example of this with respect to the RSA/C episodes. Here, the curves numbered 76, 77, and 78 are contiguous and successive right-, left-, and right-hand curves. If one were to group all three curves, the combined *location* would account for 28 RSA/C episodes (including 6 RSC control actions).²⁹

Appendix A-G provides detail information, including a pictorial, for all 42 curves at which 2 or more episodes took place. Detailed examination of this appendix will reveal that only one other pair of curves, 2233 and 3446, make up a contiguous set similar to 76, 77, and 78. These successive right- and left-hand curves on a single connector ramp between two interstates account for 4 and 2 episodes, respectively. There are other closely located, but non contiguous curves. For example, they may pass through the same curved stretch of a road but in opposite directions, or they may be a right turn and a left turn at the same intersection. Thus, with the two minor caveats noted, table 7-3 provides an accurate summation of the counts of episodes at what might be called the *problem turns* encountered by the FOT fleet.

²⁹ Combining the individual RSA/C episodes assigned to curves 76, 77, and 78, respectively, would not alter the counts of complex episodes presented in figure 7-3 and table 7-2. That is, when a complex episode did take place in this sequence of curves, the entire episode was assigned to the curve in which the episode was initiated.

Table 7-4 lists 14 classifications of curves and the counts of RA&C episodes which took place at curves of these classes. (For example, curve 76 is a curve at an urban intersection and so is a type-7 curve. Curves 77 and 78 are curves on an urban street and are type-9 curves.)

Table 7-4. RSA/C episode counts by type of curve

Curve type	Description	Counts of episodes in:		
		curves with > 1 episode	curves with 1 episode	all curves with episodes
1	Freeway on-ramp	4	13	17
2	Freeway on-ramp, 270 deg	48	4	52
3	Freeway off-ramp	5	8	13
4	Freeway off-ramp, 270 deg	2	2	4
5	Freeway connector ramp	11	2	13
6	Highway intersection	18	3	21
7	Urban intersection	23	25	48
8	Intersection onto or off of freeway ramp	32	16	48
9	Curve in urban street	28	14	42
10	Urban street on-ramp	3	0	3
11	Highway on-ramp	2	1	3
12	Curve in highway	3	12	15
13	Construction lane shift	2	0	2
14	Highway turn to Praxair lot	7	2	9
15	Parking lot	0	2	2

Table 7-5 provides additional statistics for each of the curves where more than one episode took place.³⁰ In addition to showing the counts of RS/C episodes and messages, this table also presents the number of times the tractors of the test fleet passed through the curves during phase 2 (passes) and then shows the number of passes per episode and the number of messages per episode. The table is ordered from top to bottom according to the number of episodes in the curve.

Review of table 7-5 will reveal that the curves with the greatest *number of episodes* are not necessarily those with the highest *frequency of episodes* (i.e., the lowest number of passes per episode). Note that nearly one third of the curves listed (13 of 42) had an episode at least every 5 passes, some as often as an episode every 1.5 passes. Yet, among the 15 curves with the greatest number of episodes, only two were in this group. In fact, while for each individual curve the quotient of $(Passes)/(Passes\ per\ episode)$ is, of course, exactly the number of episode for that curve, neither component (i.e., *Passes* and

³⁰ The contiguous curves 76, 77, and 78 are shown individually in the table, but for convenience, are also repeated as a single *location* at the bottom of the table.

1/*Passes per episode*) taken individually correlate well at all with the count of *Episodes*. That is to say, in general, the number of episodes at a given curve appears to result as much from how often the test fleet frequented the curve as from how “difficult” or “dangerous” the curve might be. Finally, table 7-5 also shows that, for 30 of the 42 curves, there was just one advisory message per episode. In the other twelve, this rate ranged from 1.14 to 2.

Table 7-5. Statistics from phase 2 for curves where more than one RAS/C episode took place

<i>Curve Number</i>	<i>Episodes</i>	<i>RSA/C Advisories</i>	<i>RSC control</i>	<i>Passes</i>	<i>Passes per episode</i>	<i>Advisories per episode</i>
751	22	40	8	126	5.7	1.8
77	13	15	3	156	12.0	1.2
421	11	14	3	59	5.4	1.3
891	11	11	0	104	9.5	1.0
76	10	14	3	156	15.6	1.4
4044	10	15	4	28	2.8	1.5
653	9	9	0	149	16.6	1.0
37	7	8	1	807	115.3	1.1
78	5	5	0	156	31.2	1.0
124	5	5	0	279	55.8	1.0
233	5	7	1	19	3.8	1.4
236	5	5	0	81	16.2	1.0
4163	5	6	1	49	9.8	1.2
700	4	4	0	147	36.8	1.0
2233	4	5	0	56	14.0	1.3
120	3	3	0	153	51.0	1.0
406	3	3	0	22	7.3	1.0
1249	3	3	0	19	6.3	1.0
2651	3	3	0	19	6.3	1.0
5596	3	3	0	9	3.0	1.0
6142	3	3	0	6	2.0	1.0
7917	3	3	0	21	7.0	1.0
9717	3	3	0	11	3.7	1.0
34	2	2	0	51	25.5	1.0
234	2	2	0	25	12.5	1.0
744	2	2	0	165	82.5	1.0
748	2	3	1	134	67.0	1.5
888	2	2	0	59	29.5	1.0
1259	2	2	0	348	174.0	1.0
2563	2	2	0	37	18.5	1.0
3290	2	2	0	9	4.5	1.0
3464	2	2	0	56	28.0	1.0
4041	2	4	0	17	8.5	2.0
4165	2	2	0	52	26.0	1.0
4176	2	2	0	12	6.0	1.0
8129	2	2	0	7	3.5	1.0
8409	2	2	0	3	1.5	1.0
9224	2	3	0	7	3.5	1.5
15293	2	2	0	4	2.0	1.0
16143	2	2	0	6	3.0	1.0
30100	2	2	0	4	2.0	1.0
30201	2	2	0	3	1.5	1.0
76, 77, & 78	28	34	6	156	5.6	1.2

8. THE INFLUENCE OF RA&C ON TURNING BEHAVIOR

The RA&C system is a composite system including RSA, RSC and HBED functions. Several analyses intended to evaluate the influence of that system on turning performance are presented in this section. The results can only be interpreted as applying to the entire system as tested. The influence of individual functions can not be determined.

The first analysis, presented in section 8.1, is a “broad-brush” analysis comparing the overall lateral performance of the individual, comparable drivers as they performed in phase 1 and in phase 2, respectively. It is conducted after the fashion of the presentations of chapter 6. It compares performance across phase, but does not rigorously account for the many factors other than RA&C which can influence performance and may have changed across phase. This analysis does find a significant difference in performance between phases, but it is not possible to assert that this difference is the result of RA&C.

A series of multifactor analyses are presented in sections 8.2 through 8.5. These analyses compare the performance of individual drivers across phase, but they also rigorously account for, and examine, the influences of other factors. They are based on turning performance in selected curves. (See section 4.2.5 for a discussion of curve identification.) These analyses yield mixed results, some of which show an encouraging pattern regarding the influence of RA&C. Another multifactor analysis is presented in section 8.6. Here, performance before and after individual advisories is compared. A significant, positive influence of advisories is observed. For completeness, the final two sections of this chapter briefly review other analyses which were undertaken but were not productive.

8.1 Comparison of the lateral-performance of comparable drivers across phase

This section presents a comparison of the overall lateral performance of the individual, comparable drivers as they performed in phase 1 and in phase 2, respectively. While the authors believe that the most appropriate means for estimating *the influence of RA&C* on driver performance is via the analyses which follow in later sections, there may nevertheless be interest and perhaps some value in the approach taken here. While the final discussion of chapter 6 suggests that comparison of aggregate performance in phase 1 and phase 2 is not appropriate, it does not argue against comparison of the performance of individuals across phases. Moreover, the reasonable, if not perfect, balance of exposure factors between phases described in chapter 5 suggests such a comparison may be appropriate. Accordingly, such comparisons are made in this section. We reiterate, however, that the analyses of later sections are believed to provide a more reliable assessment of the effect of the RA&C device.

Figures 8-1 through 8-14 present cumulative histograms of the lateral performance *in turns*³¹ of the fourteen individual comparable drivers as exhibited in phase 1 and in phase 2. Each figure presents four cumulative histograms, each with a separate plot for phase 1 and phase 2. The two upper histograms are for the full loading condition; the two lower histograms are for the empty condition. The two on the left are for lateral acceleration at the driver's position, and the two on the right are for rollover ratio. Each figure also contains a notice of the number of RA&C episodes experienced by the driver represented in the figure. (An RA&C episode is a turning maneuver which invoked one or more RA&C messages. See chapter 7.)

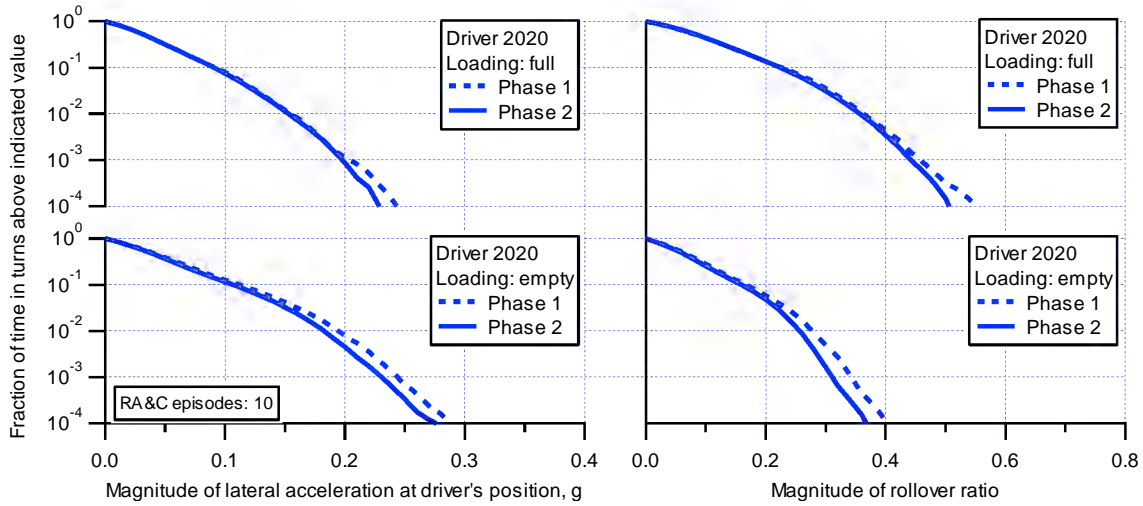

Figure 8-1. Comparison of phase-1 and phase-2 lateral performance in turns of driver 2020

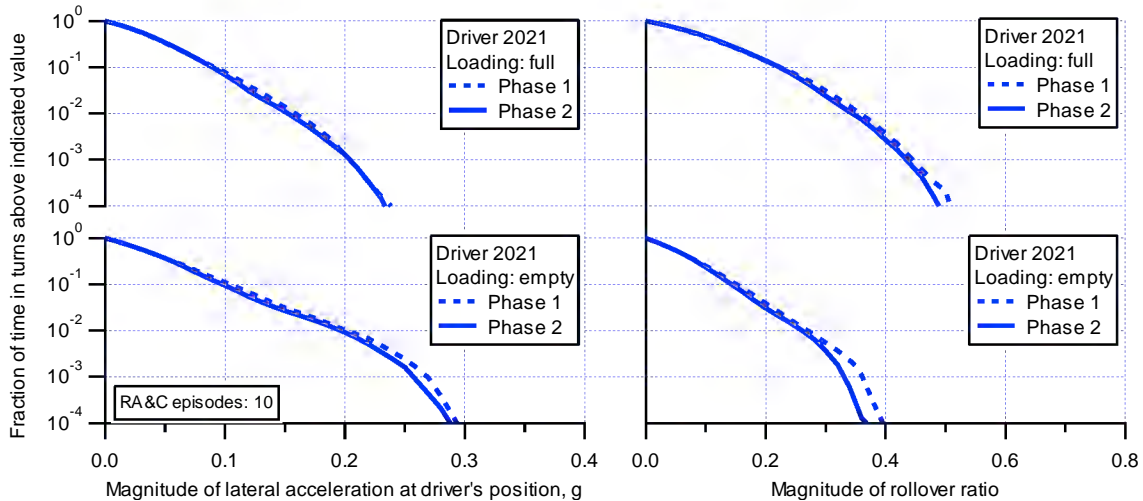

Figure 8-2. Comparison of phase-1 and phase-2 lateral performance in turns of driver 2021

³¹ The term, in turns, was defined in section 5.1. See figure 5-9 and the related discussion. The FOT fleet operated *in turns* for approximately 900 hours.

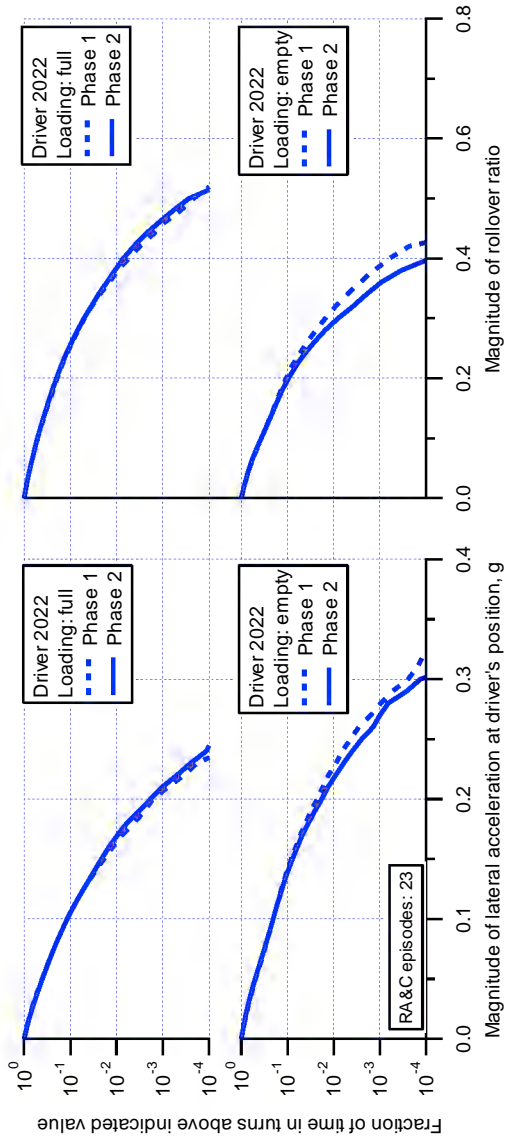

Figure 8-3. Comparison of phase-1 and phase-2 lateral performance in turns of driver 2022

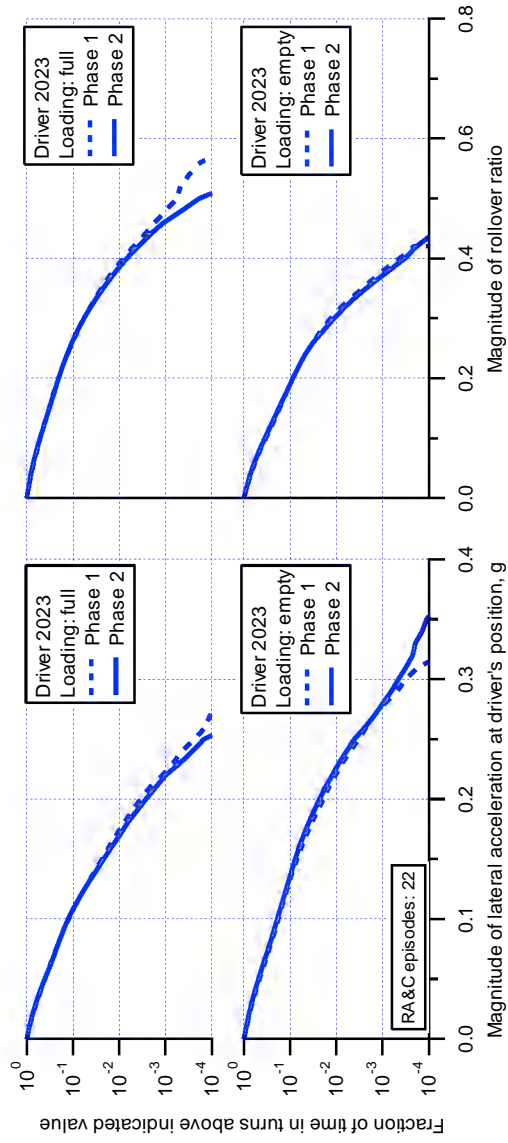

Figure 8-4. Comparison of phase-1 and phase-2 lateral performance in turns of driver 2023

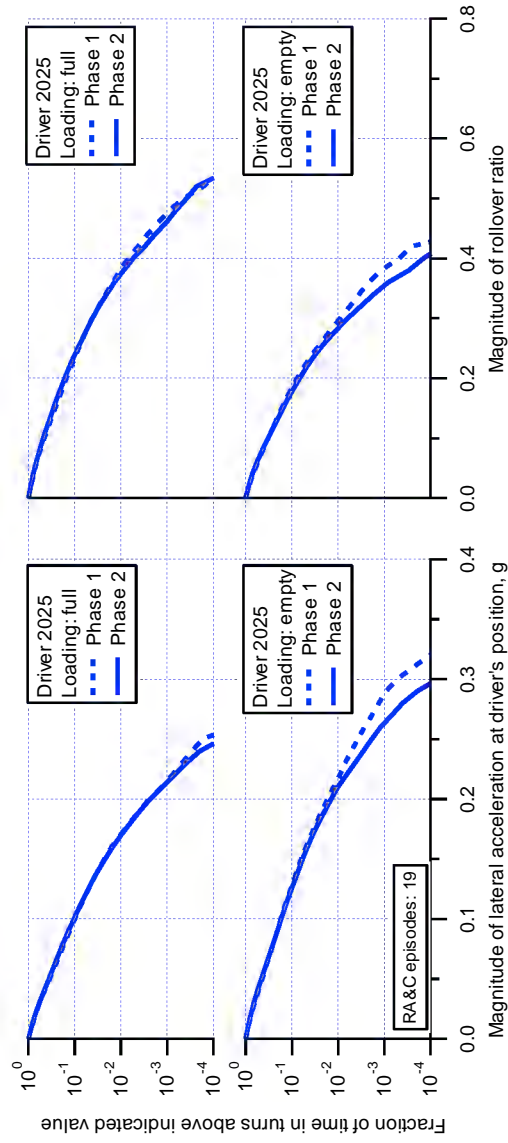

Figure 8-5. Comparison of phase-1 and phase-2 lateral performance in turns of driver 2024

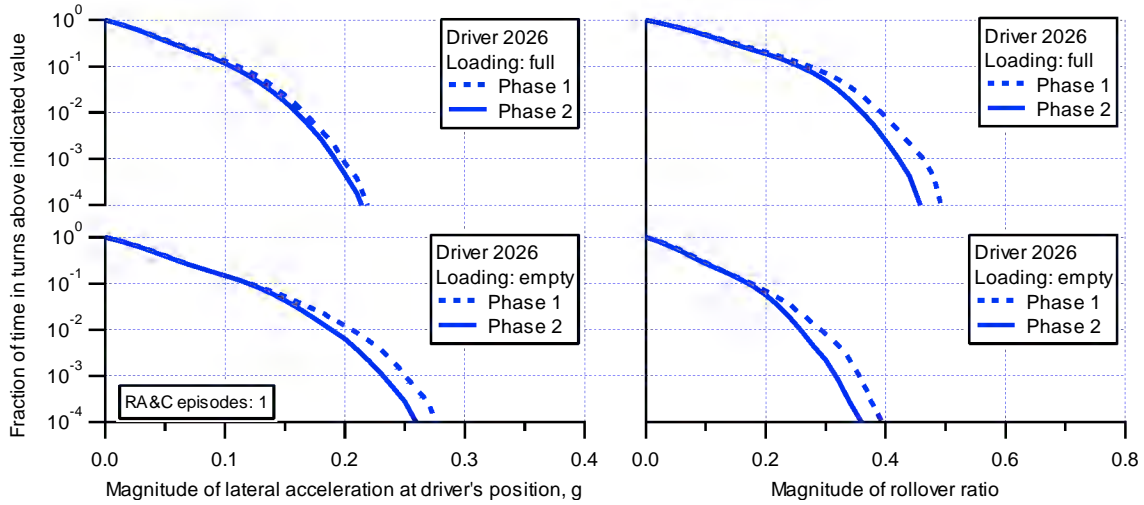

Figure 8-6. Comparison of phase-1 and phase-2 lateral performance in turns of driver 2026

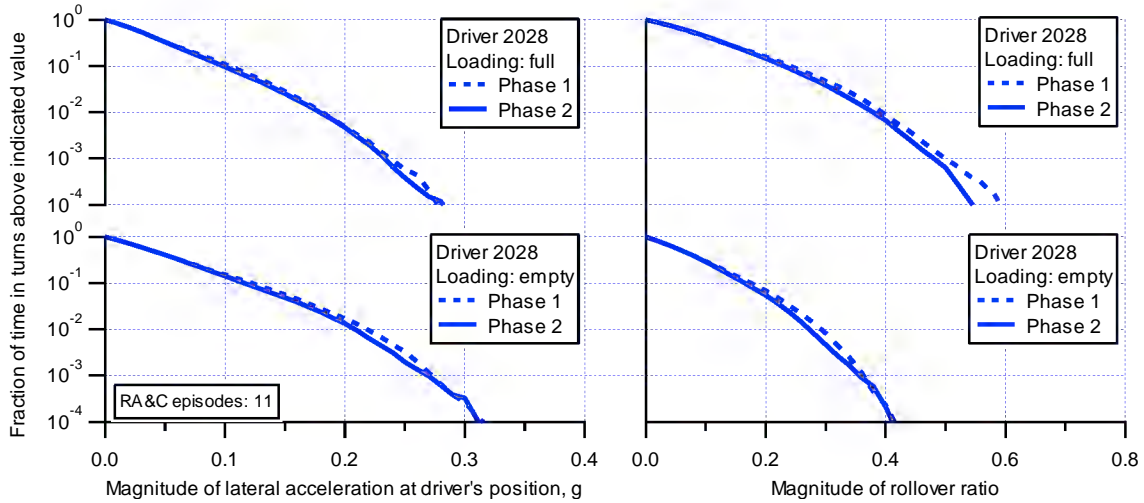

Figure 8-7. Comparison of phase-1 and phase-2 lateral performance in turns of driver 2028

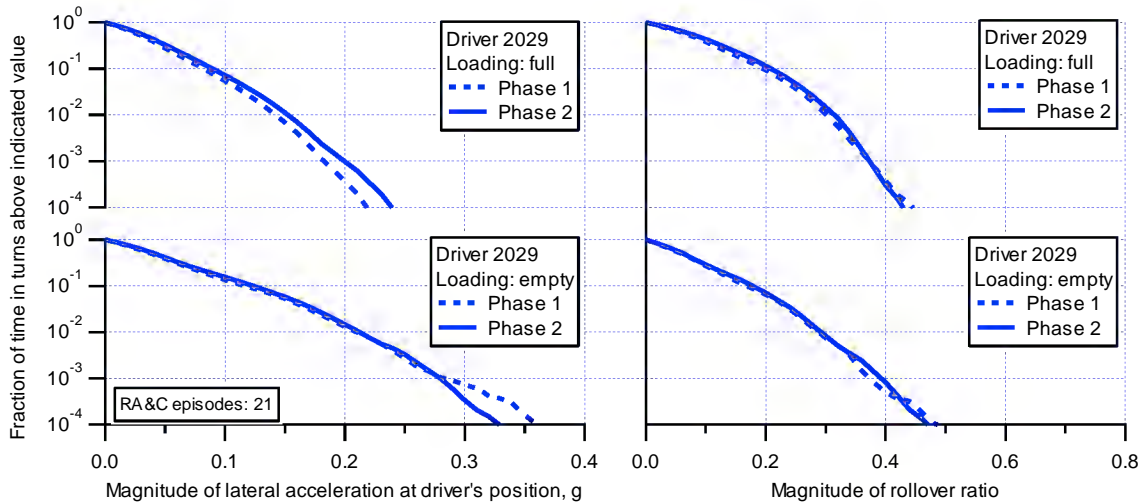

Figure 8-8. Comparison of phase-1 and phase-2 lateral performance in turns of driver 2029

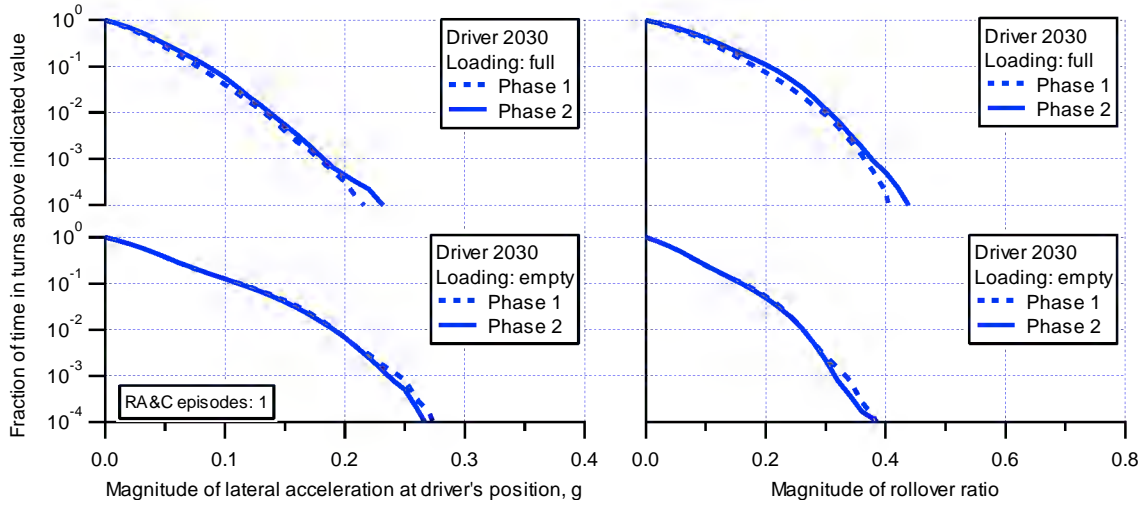

Figure 8-9. Comparison of phase-1 and phase-2 lateral performance in turns of driver 2030

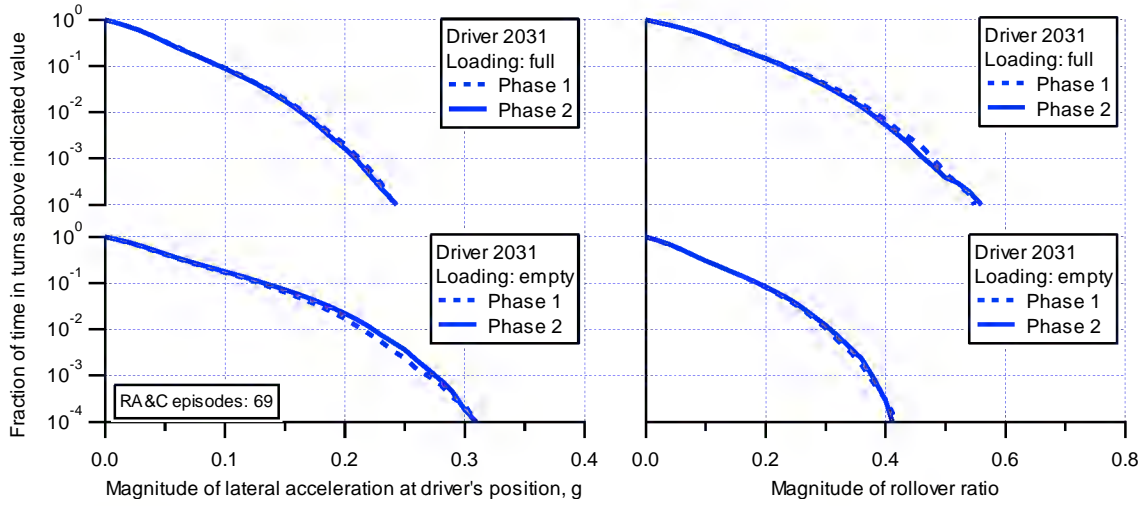

Figure 8-10. Comparison of phase-1 and phase-2 lateral performance in turns of driver 2031

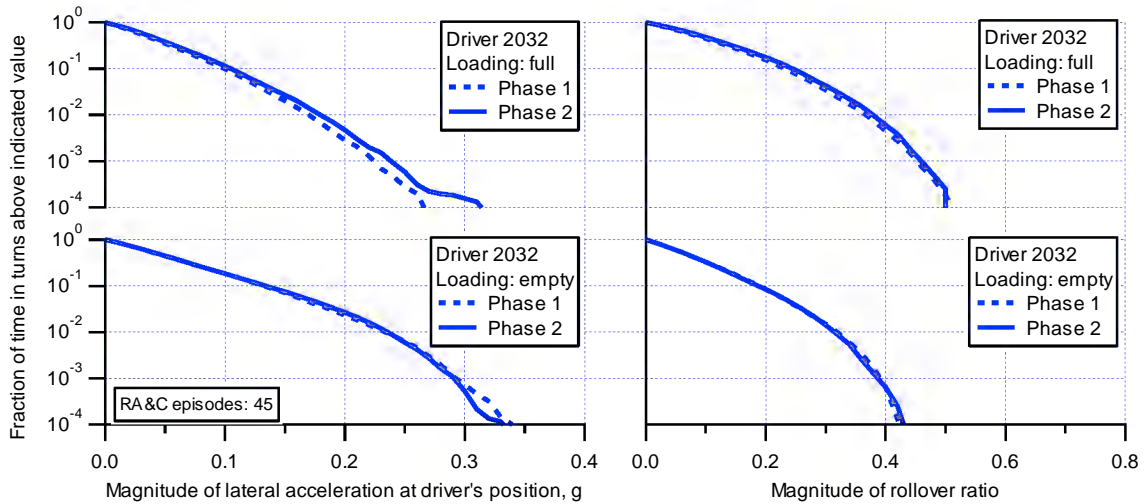

Figure 8-11. Comparison of phase-1 and phase-2 lateral performance in turns of driver 2032

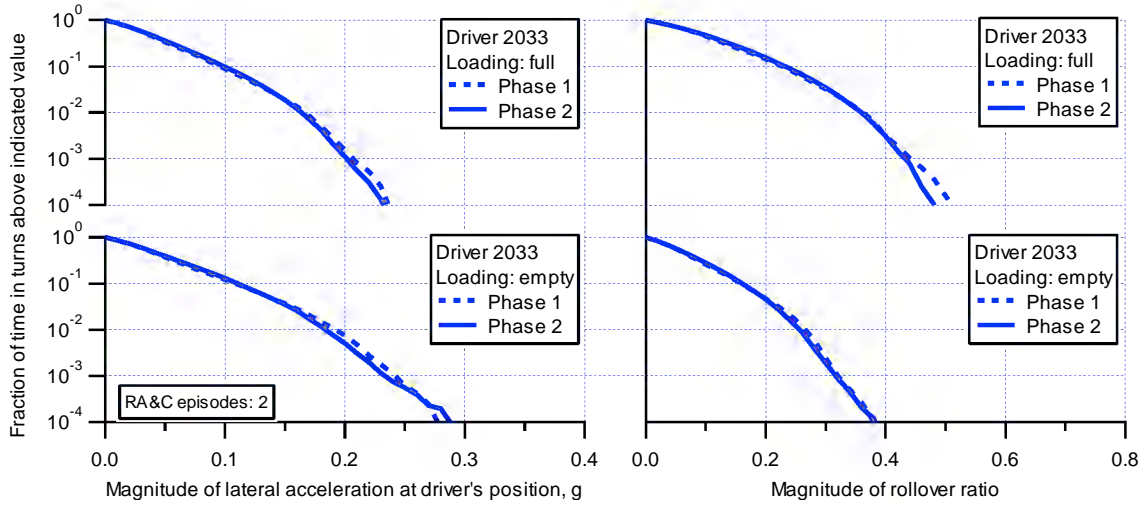

Figure 8-12. Comparison of phase-1 and phase-2 lateral performance in turns of driver 2033

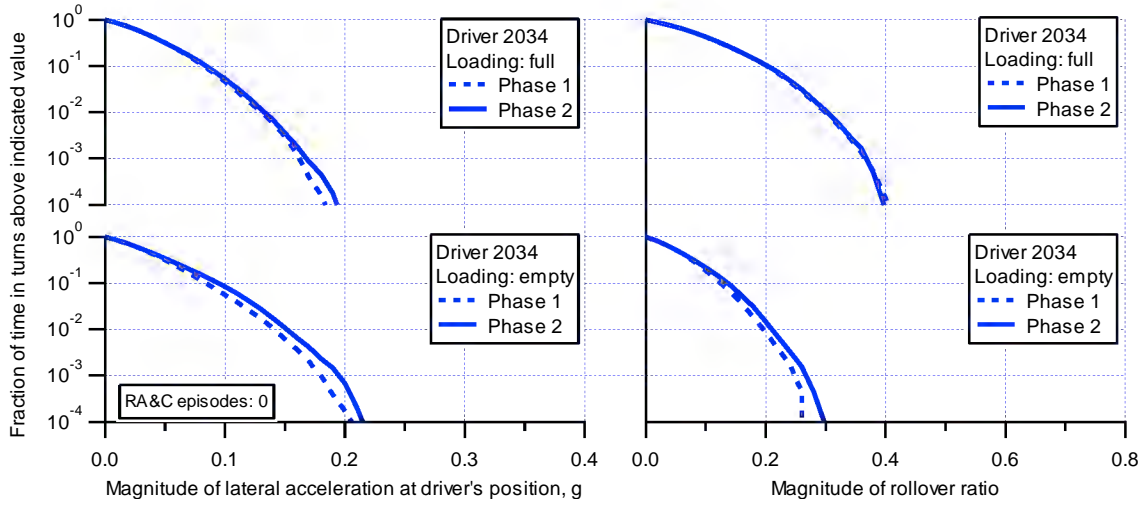

Figure 8-13. Comparison of phase-1 and phase-2 lateral performance in turns of driver 2034

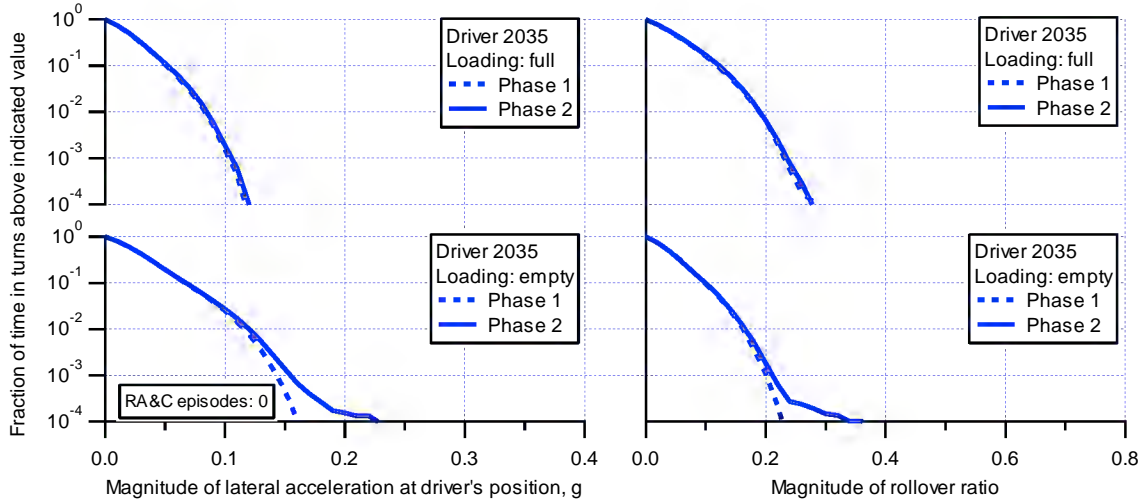

Figure 8-14. Comparison of phase-1 and phase-2 lateral performance in turns of driver 2035

Table 8-1 summarizes figures 8-1 through 8-14 by tabulating one *performance-change numeric* for each of the graphs. That is, four measures are tabulated for each driver. These performance-change numerics are simply the change in the magnitude of the performance measure (lateral acceleration or rollover ratio) at the 0.1 percentile (i.e., at the time fraction 10^{-3})³² from phase 1 to phase 2. A negative value of the numeric (i.e., as results when the phase-2 measure smaller than phase-1 measure) implies an “improvement” in performance.

Table 8-1. Phase-1 to phase-2 performance-change numerics for comparable drivers for all driving in turns by load

Driver	Episode count	Performance-change numerics			
		<i>a_y</i> at driver's position, g		Rollover ratio	
		Empty	Full	Empty	Full
2020	10	-0.014	-0.006	-0.031	-0.015
2021	10	-0.011	0.001	-0.029	-0.010
2022	23	-0.009	0.003	-0.031	0.009
2023	22	0.002	-0.003	-0.006	-0.017
2025	19	-0.024	-0.001	-0.030	-0.015
2026	1	-0.018	-0.006	-0.040	-0.041
2028	11	-0.003	-0.005	-0.007	-0.019
2029	21	-0.003	0.017	0.020	0.001
2030	1	-0.009	0.004	-0.018	0.012
2031	69	0.007	-0.004	0.004	-0.015
2032	45	-0.002	0.014	-0.004	0.006
2033	2	-0.008	-0.005	-0.003	-0.009
2034	0	0.016	0.005	0.018	0.003
2035	0	0.011	0.002	0.012	0.003
Averages:		-0.0046	0.0011	-0.0103	-0.0076

Casual review of table 8-1 seems to show a trend toward a *small*³³ improvement (negative changes shown in bold print) in performance in phase 2. T-tests were conducted on the data of table 8-1 to determine if these apparent trends appear to be significant for the population of drivers. Tests were conducted for each of the four parameters within each of the following two populations:

- all comparable drivers, and

³² Note that, since driving in turns is roughly 10 percent of all driving in the FOT, the 0.1 percentile for performance in turns is very similar to the 0.01 percentile in all driving that appeared in figure 6-15 and was used for ranking drivers.

³³ *Small* is emphasized here particularly because these values of lateral acceleration in table 8-1 are only of a magnitude comparable with the nominal accuracy of the underlying instrument measurements. The changes in rollover ratio are small relative to the accuracy of the entire analysis necessary to determine rollover ratio. On the other hand, these measures derive from hundreds of thousands of individual measurement and calculation samples for which we have no reason to suppose a phase-1-to-phase-2 bias.

- all comparable drivers *exposed* to RA&C (i.e., experienced at least one RA&C episode).

Table 8-2 presents the results of the t-tests.³⁴ The probability values suggest that the trends toward improvement are fairly strong while those away from improvement (the change of lateral acceleration at the driver’s position in the full condition) are weak. Moreover, three t-tests indicate statistically significant performance improvements for the population of drivers with RA&C exposure: lateral acceleration at the driver’s position and rollover ratio in the empty condition; and rollover ratio in the full condition.

Table 8-2. Results of t-tests on performance-change numerics for all driving in turns, by load

Drivers Loading condition	All comparable		Comparable and exposed	
	Empty	Full	Empty	Full
<u><i>a_y</i> at driver's position, g</u>				
mean performance-change	-0.005	0.001	-0.008	0.001
probability (2-tailed t-test)	.142	.584	.010	.785
<u>Rollover ratio</u>				
mean performance-change	-0.005	-0.004	-0.007	-0.005
probability (2-tailed t-test)	.073	.066	.017	.049

To further challenge these observations of phase-to-phase changes, a similar analysis was conducted on performance in turns but only for driving in daylight and in good weather in an attempt to remove the potential influence of the imbalance of exposure to these conditions across phases. (See chapter 6.) Results appear in table 8-3. All four results relating to the empty loading condition are similar to those of table 8-2. That is, all four measures for the empty condition show relatively strong trends toward small improvements and the trends for the exposed drivers are significant. However, the results are different in that none of the four measures for the full loading condition show strong trends at all.

Overall, these results suggest that, from phase 1 to phase 2, there may well have been a real, albeit very small, change in the overall driving by the comparable drivers toward an lower probability of elevated lateral acceleration in the empty condition. In the fully-loaded condition, there is some suggestion of such a change but the results are too weak to support a similar statement.

³⁴ For those not familiar with the t-test, the *probability* parameter indicates the probability that the change of the average resulted from the *scatter* among the individual drivers. Consequently, smaller probabilities indicate a stronger trend, and probabilities less than 0.05 are typically said to indicate that the observed change is *statistically significant*. (Note also, however, that this also implies that, on average, among twenty “significant” observations, one will typically be mistaken.)

Table 8-3. Results of t-tests on performance-change numerics for driving in turns in daylight and good weather, by load

<i>Drivers Loading condition</i>	<i>All comparable</i>		<i>Comparable and exposed</i>	
	<i>Empty</i>	<i>Full</i>	<i>Empty</i>	<i>Full</i>
<u>ay at driver's position, g</u>				
mean performance-change probability (2-tailed t-test)	-0.007 .072	-0.001 .748	-0.010 .010	-0.001 .557
<u>Rollover ratio</u>				
mean performance-change probability (2-tailed t-test)	-0.012 .072	-0.004 .518	-0.017 .012	-0.005 .423

Why any such change took place between phases is not addressed by this analysis and remains an open question. Certainly one possibility is that the RA&C device was in play in phase 2 and not in phase 1. However, there were also small changes in other exposure factors between phase 1 and phase 2 which could have produced this result. For example, this analysis in no way accounts for the change in routes which took place between phase 1 and 2 due to the change in the mix of delivery points (see section 5.1 and appendix A-F). Thus, for example, the changes observed could have resulted from a shift toward slightly more “benign” routes in phase 2. However, the analyses which follow do, in fact, take these and other influences into account by examining lateral performance in specific, spatially-identified, turns using multifactor analyses.

8.2 Overview of the multifactor analysis

The experimental questions addressed by the multifactor analyses are whether or not there were changes *that are objectively related to the activation of the RA&C* in (1) the drivers’ behavior in negotiating turns and/or (2) the actual risk of rollover incurred by drivers in turns. The basic comparison is between a driver’s performance before the system was activated (phase 1), and his performance after the system was activated (phase 2). Other factors are considered to determine if differences observed in the comparison are, indeed, the result of the RA&C.

Notably, the questions specifically address the system’s effect driver by driver, not on the aggregate behavior of the fleet or even the aggregate behavior of a group of drivers. A change in the aggregate behavior of the fleet or of a subgroup could take place, for example, due to a change in the mix of drivers or of the mix of individual contributions to distance (see tables 6.2 and 6.3), or the mix of routes (see section 5.1 and appendix A-F), or the mix of any other situational influence. To conclude that the RA&C modified driver performance, it is necessary to observe a relatively consistent influence on individual drivers operating in similar driving situations.

In this analysis, the experimental unit is the driver and the principal treatment is the presence or absence of the RA&C system. Because other uncontrolled factors (that are likely to influence driving behavior as well) are also present in this quasi-experiment, the

data for each driver have been group according to these factors in order to obtain a better picture of how they interact with driving behavior. Of primary importance is that comparison across phase are made for performance in a subset of curves that are identified (and classified for severity) using only the performance of the so-called non-comparable drivers during phase 1. Moreover, driving performance has been grouped by load, weather conditions, light condition, turn direction, and curve severity. These factors, including phase, provide the overall basis of the analysis of the influence of the RA&C on turning behavior.

Before describing the results of the analyses, each of the components will be clarified: the subjects, the dependent variables, and each independent variable.

8.2.1 Subjects

Data from 14 drivers, called the comparable drives, were included in these analyses. This is smaller than the original pool of 23 drivers present at the start of the study—eight left the driver pool during the course of the study. One driver was also excluded from the analysis because of comparatively low direct involvement in fleet delivery operations; this driver had less than 20 percent of the average operational distance of other drivers in the study.

8.2.2 Dependent variables: *RRSM* and *AyDSM*

In the analyses whose results are presented here, two primary dependent measures were examined: *RolloverRatioSustMax* (*RRSM*), and *AyDriverSustMax* (*AyDSM*).³⁵ These are the *maximum sustained* values of *RolloverRatio* and *AyDriver*, respectively. (See section 4.2.5 and figure 4-14 for details of maximum sustained values in curves.)

In the context of the statistical analyses, *RRSM* is used to answer the question, “*Was rollover risk reduced by the RA&C?*” As described earlier (equation 6-2), *RolloverRatio* is a unit-less estimate of actual proximity of rollover, calculated as the ratio of lateral acceleration of the total vehicle (*AyTotal* in g) to the static rollover threshold of the vehicle (*Rollover*, in g). Similarly, *RRSM* is the ratio based on *AyTotalSustMax*. (See section 4.2.4.)

In the analyses, *AyDSM* is used to ask the slightly different question “*Was driving behavior altered by the RA&C?*” *AyDSM* is a measure of lateral acceleration at the driver’s position in the tractor and is taken as representative of the driver’s own physical sense of the severity of the turning maneuver in question. Although related to *RRSM*,

³⁵ Very similar analyses to those presented in 8.2 and 8.3 were also conducted using the maximum values (i.e., after filtering and at 2 Hz. sampling, see chapter 4) of *AyDriver* and *RolloverRatio* rather than their maximum sustained values. The results were similar, but for brevity, are not presented here.

AyDSM is not directly correlated to it since it does not account for the change in the vehicle's roll stability which takes place with changes in loading, nor for the influence of trailer off-tracking in turns with tight radii. If driving behavior was altered by the RA&C, there may be clearer evidence for it in *AyDSM* than in *RRSM*. That is, a driver may adjust his driving to reduce the level of lateral acceleration he experiences directly while not accurately compensating for load or off-tracking.

Secondary analyses were also performed on more speculative dependent measures including curve-entry speed, deceleration rate, and braking behavior. The rationale for these analyses was that drivers may become better able to anticipate curve hazards and prepare for them earlier resulting in diminished speeds on entry, lower deceleration rates, and less use of the brake.

8.2.3 Independent variables: phase 1 and 2

The principal independent variable in this study was the presence of the RA&C (in phase 2) following an initial baseline period of driving without the system (in phase 1). It is normal practice to manipulate the independent variable independently of other factors so that observed changes in the dependent variable can be unambiguously attributed to the independent variable. However, because this study was constrained to be carried out over the course of one year, seasonal factors are somewhat confounded with phase 1 and 2. Phase 1 began in late fall and continued until early spring; phase 2 began in early spring, and continued until late fall. Phase 1 doubtlessly had more severe weather than phase 2. An attempt was made to mitigate this confound by distinguishing good weather from bad weather in the analysis, allowing a weather effect to be separately estimated. It is unlikely, however, that this accounting for weather was completely successful in de-confounding seasonal variation with phase.

To permit adequate "learning" or break-in exposure to the RA&C, the first 5000 kilometers of phase-2 driving for each driver were excluded from the basic analysis. The number was selected based on inspection of normalized advisory rates among drivers. For some drivers there is a rapid initial accumulation of advisories, suggestive of device testing, followed by a decline to a more constant rate. The point in this decline is approximately 5000 km. Parallel analyses that included the first 5000 km of driving did not produce substantially different results than those reported here.

8.2.4 Quasi-independent variables

Several factors that are likely to be influential in driving behavior were also included in the analysis. Unlike the phase factor, they were not explicitly manipulated. They were gathered and coded during data collection so that they could be included as factors in later analyses that relate them to the dependent variable. These factors more or less function as covariates, although they are treated as independent variables in the following

analysis. Thus, weather is characterized as good or bad, light conditions as either daylight or night, load as either full or empty, and curve severity as one of four levels. Each of these quasi-dependent variables is explained below.

Curve severity. Curve severity was considered an important factor since it seemed likely that it could affect the amount of influence the RA&C might have on driving behavior. That is, the RA&C might exert greater influence on curves of high severity than on curves of low severity. Low-severity curves might be routinely traversed so that *RRSM* and *AyDSM* performance is too small to allow much further reduction. Curve severity was also used to help normalize changes in curve distribution between the two phases. That is, changes in curve distribution between phases would be accounted for by comparing driving performance on curves of similar severity. Thus, if there were 70 severe curves out of 100 in phase 1, and 20 severe curves out of 100 in phase 2, a phase effect could be determined by comparing the average performance on the 70 in phase 1, to the average performance on the 20 in phase 2. If, instead, all the curves in each phase were pooled and the averages compared, differences in curve distribution between the phases would be confounded with phase. Including curve severity as a factor controlled for changes in delivery routes between phase 1 and phase 2 that might be mistaken for the influence of the RA&C system. Driving behavior on curves of similar severity level can be compared across phases of the study.

A curve's severity level was determined entirely from the performance data of the fleet drivers who were unable to complete the study, the non-comparable drivers. For each curve by load combination,³⁶ a non-comparable driver's average *RRSM* and *AyDSM* data were averaged with other non-comparable drivers to produce a grand *RRSM* and *AyDSM* measure for that curve by load combination. Curves with data for fewer than 2 drivers were discarded from the curve sample.

Curves were binned into one of four levels of severity based on the *RRSM* quartiles of the non-comparable drivers. Curves were likewise binned into one of four levels of severity based on the *AyDSM* quartiles of the non-comparable drivers. Thus, there were two curve-severity measures used: one based on *RRSM* and another based on *AyDSM*. Curve-severity measures based on *RRSM* were applied in analyses of the *RRSM* dependent variable; curve-severity measures based on *AyDSM* were applied to analyses of the *AyDSM* dependent variable.

³⁶ Curve severity was based on curve *and* load taken together. This was done because some curves are typically traversed nearly exclusively by full vehicles, and other curves nearly exclusively by empty vehicles. Only a few curves were traversed by a substantial mixture of full and empty vehicles. Consequently, there is a strong dependency between a curve and the vehicle load. And even when a curve is traveled under both full *and* empty conditions, one load condition usually dominates the set of observations. Accordingly, curves were effectively treated as curve-load combinations.

A curve's *RRSM* and *AyDSM* quartile was determined by the distribution of the non-comparable drivers' averaged *RRSM* and *AyDSM* in each curve. Quartiles for loaded and empty curves were computed separately. The quartile limits for *RRSM* are shown in table 8-4 and in table 8-5 for *AyDSM*.

Table 8-4. Quartile limits for *RRSM* for curve-driving performance among non-comparable drivers

<i>RRSM</i> Quartile	Load	
	Empty	Full
1 (0-25%ile)	≤ 0.035	≤ 0.051
2 (25-50%ile)	≤ 0.073	≤ 0.104
3 (50-75%ile)	≤ 0.131	≤ 0.175
4 (75-100%ile)	> 0.131	> 0.175

The quartile limits reflect the shift in the distribution of *RRSM* with a full load to higher values (see figure 8-15). Quartile bins thus normalize the curve-severity measure across load levels. Otherwise, if a single severity criterion were applied, loaded trailers would dominate the higher quartiles, and empty trailers would dominate lower quartiles.

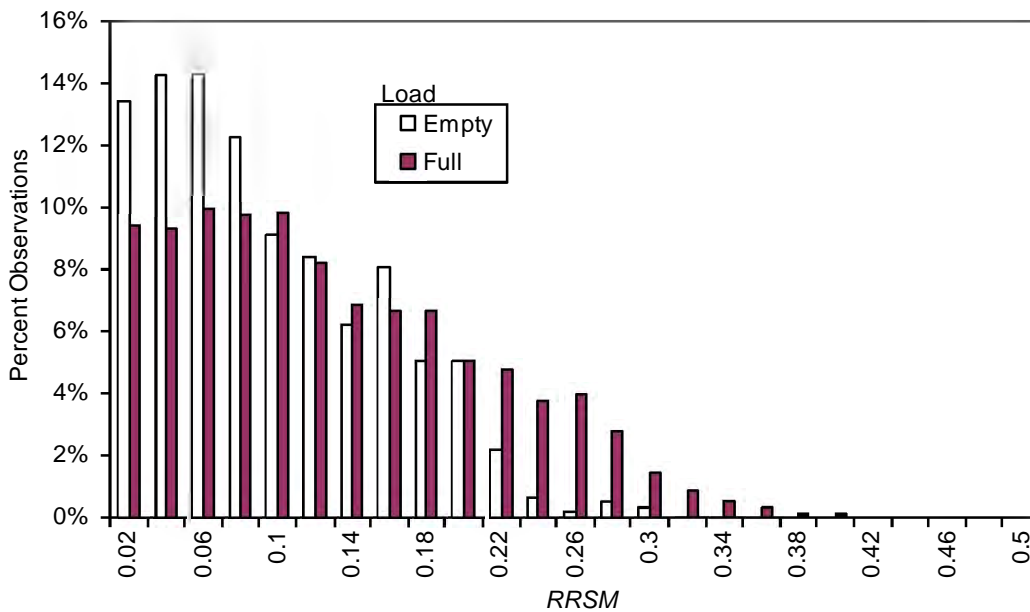

Figure 8-15. Normalized distributions of *RRSM* observed among non-comparable drivers on selected curves

The road types of each curve in the quartiles were also determined using mapping data that distinguished functional classes of roadway—freeway ramps, freeways, highways, and local roadways. The ratio of roadway type in the subset of curves described here was compared to the ratio found across all curves in the field test (shown in figure 8-16). The overall distribution (All Bins) of road types among the subset of curves studied is similar to that found across all curves in the field test. When sorted into curve-severity quartiles, freeway ramps and local roads are seen to dominate the high-severity curves in the 4th quartile (75-100 percent). This is also consistent with the

previous observation made in chapter 6 that found the highest lateral accelerations at lower speeds and with the speculation that the observed right-turn bias might be attributed to the right-turn bias of freeway ramps.

To further characterize the makeup of the curves, the average speed for each quartile was calculated using the performance of the non-comparable drivers on the curves in that quartile (shown in figure 8-17). The figure shows that speeds among the empty trailers are typically higher than among full trailers and that the highest speeds are found in the second curve quartile (25-50 percent).

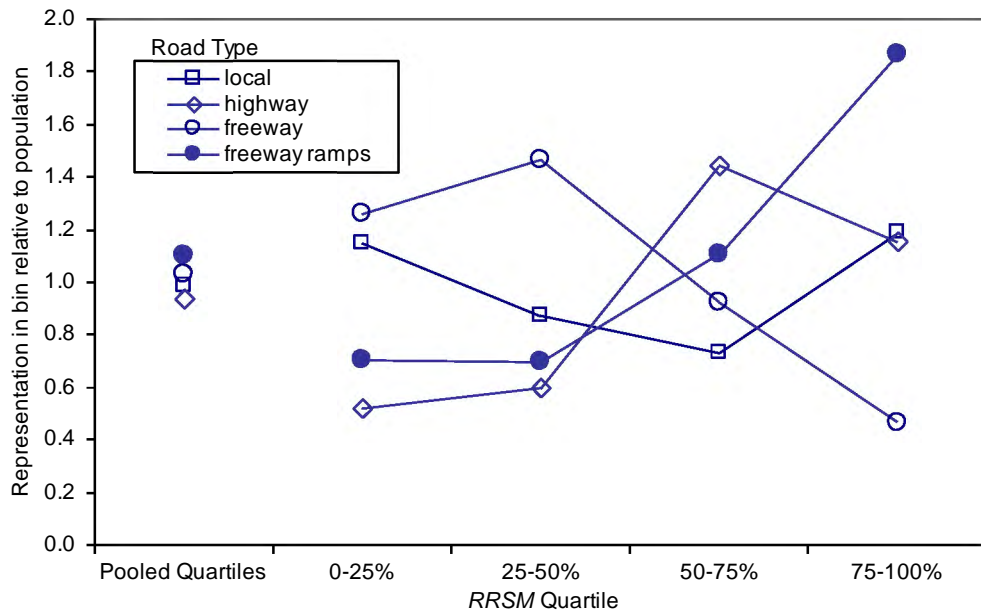

Figure 8-16. Relationship of sampled curves to the population of curves

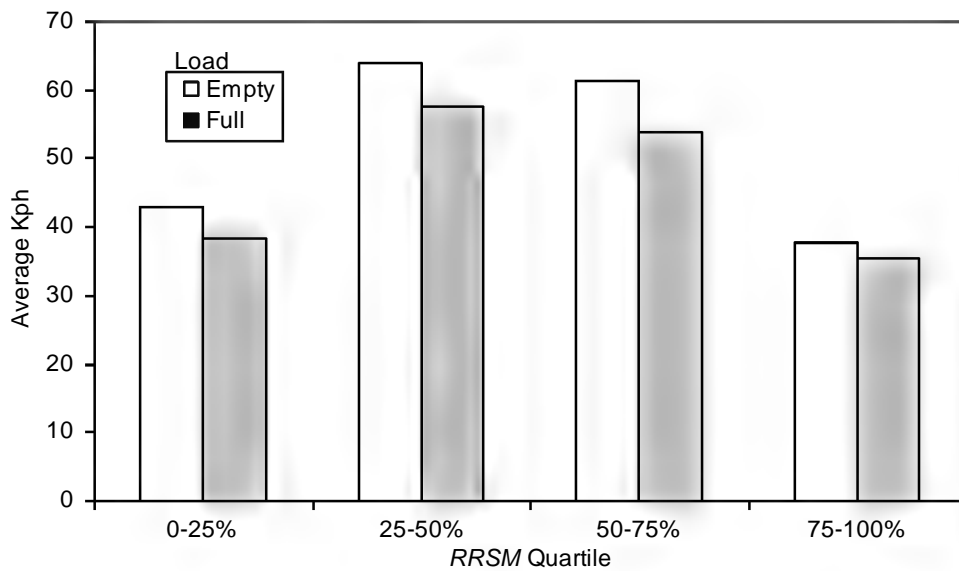

Figure 8-17. Average speed within each curve-severity quartile (by RRSM) for full and empty trailers

The proportion of the road type within each curve-severity quartile is shown in figure 8-18. The most severe curves (75-100 percent) contain the largest proportion of local and ramp curves; the less severe curves (0-25 percent and 25-50 percent) contain the largest proportions of highway curves.

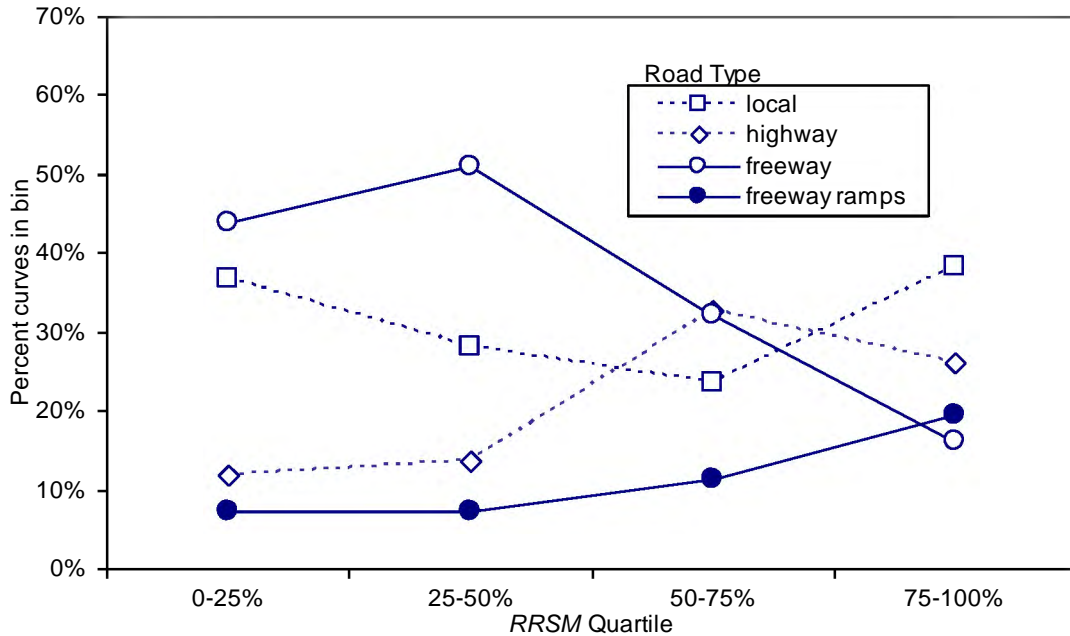

Figure 8-18. Distribution of curve types among the RRSM quartiles

Likewise, quartile limits were also computed based on *AyDSM* for full and empty trailers (table 8-5). As shown in figure 8-19, the distribution of *AyDSM* is shifted down for full trailers, suggesting the need to separately normalize each distribution. The pattern of speed distribution and road type across the curve-severity quartiles determined by *AyDSM* is similar to that found with *RRSM* (see figure 8-20 and figure 8-21). The highest-speed curves tend to occur in the second quartile. The less-severe quartiles contain proportionately more freeway curves, and the more-severe quartiles contain more highway ramps and local curves.

Table 8-5. Quartile limits for *AyDSM* (in g's) for curve driving performance among non-comparable drivers

RRSM Quartile	Load	
	Empty	Full
1 (0-25%ile)	≤ 0.022	≤ 0.019
2 (25-50%ile)	≤ 0.045	≤ 0.039
3 (50-75%ile)	≤ 0.086	≤ 0.071
4 (75-100%ile)	> 0.086	> 0.071

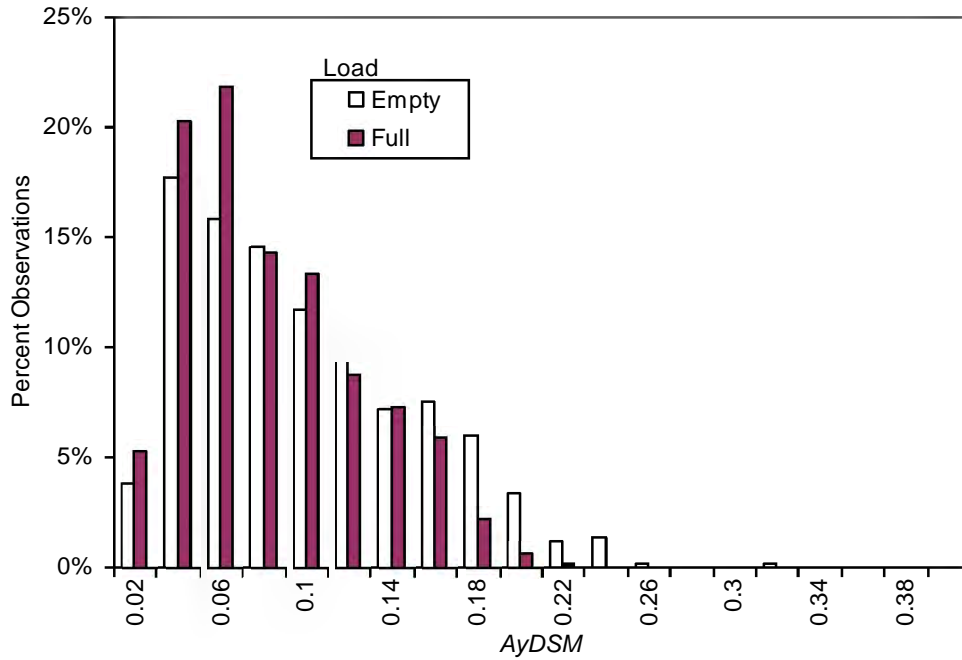

Figure 8-19. Normalized distributions of *AyDSM* observed on curves among non-comparable drivers

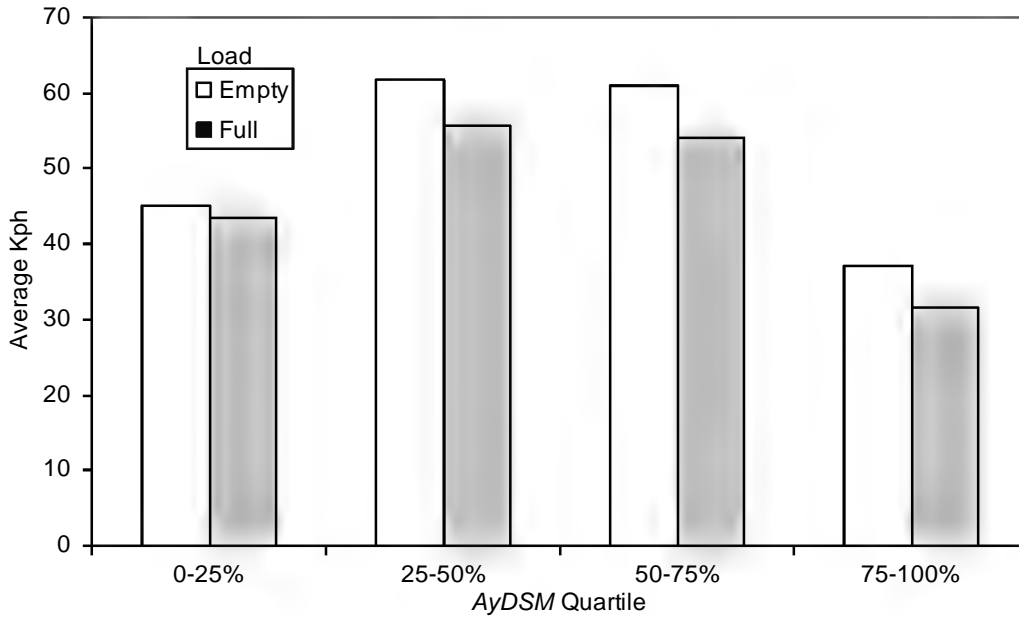

Figure 8-20. Average speed within each curve-severity quartile (by *AyDSM*) for full and empty trailers

Load condition. Two levels of trailer load, full and empty, were identified in the dataset. A trailer was full if the total mass of the trailer was between 33 and 40 metric tons; and empty when the total mass was between 12 and 17 metric tons. Data from partially loaded trailers were excluded from the analysis.

Weather. Weather conditions are likely to influence how a tractor is driven. Severe weather conditions are likely to exert a strong influence on driving behavior such that the influence of the RA&C may be greatly diminished. It is reasonable to expect that drivers would become more conservative in their driving regardless of RA&C availability, perhaps less likely to observe an influence of the safety system. Consequently, weather was retained as a factor to allow for analyses of its influence and for later filtering of bad weather data.

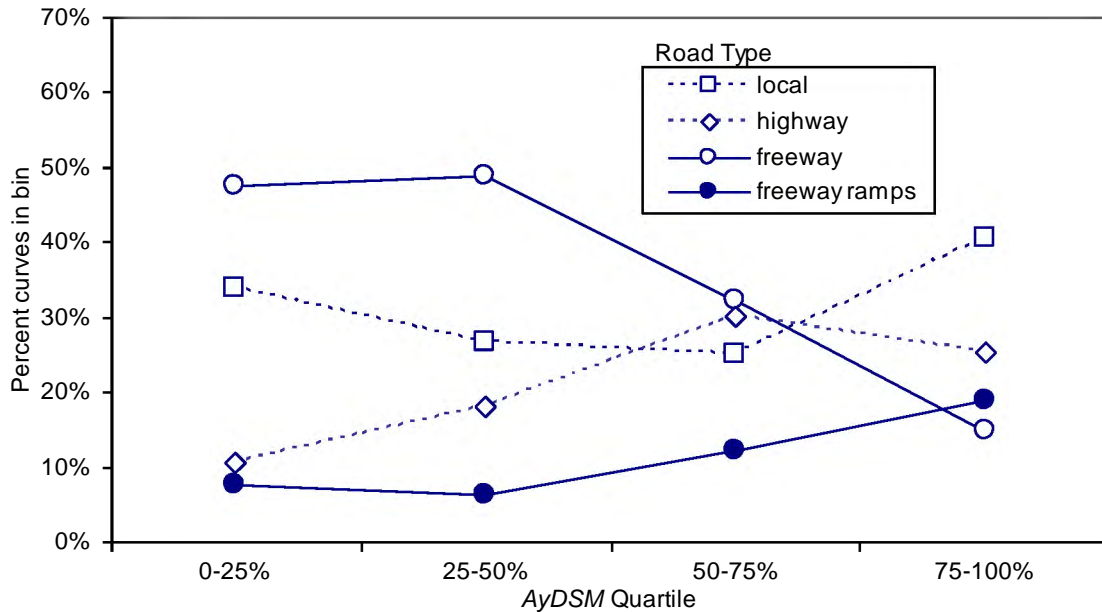

Figure 8-21. Distribution of curve types among the *AyDSM* quartile

Weather conditions were binned as either good or bad using the *BadWeather* flag (see section 4.2.2.). If the *BadWeather* flag was set any time within 15 minutes before to 5 minutes after the time of the pass through the curve, weather for that pass was taken as bad. Otherwise weather conditions for that curve pass were identified as good.

Light condition. Ambient light conditions on the roadway could influence driving behavior. Consequently, the analysis included the factor light level (dark, light) based on *SolarZenithAngle* (see section 4.2.2 and appendix A-D). When the sun position was six degrees or more below the horizon, light level was identified as dark, otherwise light level was identified as light.

Turn direction. The direction of a turn might also play some role in a driver’s turning behavior. Right turns on local streets are generally of higher curvature than left turns. Although there are more freeway ramps to and from the right side of the roadway, those to the left may actually be made at high-speeds and perhaps at different curvature. The analysis identified curves as either left or right based on the polarity of lateral

acceleration. Negative lateral accelerations indicate right turns; and positive lateral acceleration, left.

Driver exposure to advisories. Some analyses were also conducted on subsets of the driver data based on whether the driver witnessed at least one advisory during the field test. Of the 14 drivers in the dataset, 2 never received any advisories throughout phase 2.

Driver subjective report of influence. Some analyses were also performed on subsets of drivers who reported that their driving had been influenced by the RA&C system. Of the 14 participating drivers, 7 reported that their driving had to be affected by the RA&C system.

8.2.5 Exploratory statistics versus explicit hypothesis testing

In examining the analyses reported here, the reader should bear in mind that the nature of statistical tests presented represents an exploratory effort to discover relationships between variables in the data. This deviates from the normal use of statistics wherein specific targeted hypotheses are formulated well before data are collected and only those hypotheses are examined. Instead, for this field test, much of the investigation was driven by what was found by examining the data. Thus, most of the analysis is effectively *post hoc* in nature. In general, formal *post hoc* analysis methods hold data to much higher significance criteria than presented here. Consequently, reported significance levels should be taken with something of a grain of salt, especially if it is near the criterion threshold (.05). They are included in the report for completeness, and for their potential to provide some hints about general trends.

It is also noted that many, many statistical analyses were conducted in the course of the field test. A statistical test estimates the probability of observing the existing data given there are no differences among the observations. If that probability is small enough, customarily less than 5 percent (0.05), then the hypothesis that there are no differences is rejected. This means that you have a 1-in-20 chance of seeing a “significant” result even when there is no significant difference. If you conduct 20 statistical analyses, one analysis is likely to obtain a significant outcome simply by chance. Because of the exploratory nature of the field test, hundreds of analyses were conducted, thus it is likely that some portion of the analyses contain spuriously significant results. Nevertheless, the .05 significance threshold was used as an objective cut point for reporting results with the advisory that especially the marginal results should be considered of limited reliability. In more formal procedures, one would adjust the significance criteria to account for the number of comparisons by making a *Bonferroni adjustment*. To do this, the p-value obtained would be compared to the established criteria (0.05) *divided* by the number of comparisons made. Thus, if 20 comparisons were made, the appropriate significance criteria would be $0.05/20 = 0.0025$.

8.3 Influence of phase on performance over curves of comparable severity

This analysis relates measured performance of comparable drivers on curved sections of roadway (the dependent variables) to levels of independent variables using a repeated-measures analysis of variance. (A repeated-measures analysis compares measures repeatedly taken on an individual under a variety of conditions.) The resulting F-ratios, calculated for each factor, indicate the magnitude of influence each factor has over the dependent variable.

Although several factors included in the analysis may not directly address questions about the effectiveness of the RA&C, they provide some diagnostic value to help gauge the sensitivity of the analyses in detecting influences on driving behavior, and they permit examination of potential interactions between factors that might provide a more complete model of what does influence driving behavior. For example, perhaps the RA&C encourages reduced values of *RRSM* on severe curves but not on mild curves—a main effect of phase might be absent, but an important interaction between phase and curve severity might be found.

It is also noted that, because of the large number of factor combinations included in this analysis, incomplete cells, particularly those involving the dark lighting factor, precluded investigation of all factorial combinations.

The analysis dataset. The analysis described in this section was conducted on a *subset* of the FOT data. That is, various parts of the full dataset were excluded *by design* in order to reduce sources of random error in the dataset or to focus on driving circumstances in which the RA&C was anticipated to be particularly influential. Thus none of these analyses examined data from driving performance on straight sections of roadway because the opportunity to observe rollover risk on straight roads is relatively small. Likewise, data in which cruise control was engaged were excluded because, in this situation, speed control may not be representative of driving behavior under full driver control. Performance data taken with partial trailer loads were also excluded from the analyses because there is insufficient data in partially-loaded conditions to obtain a clear picture of how finer variations in load affect driving performance.

Beyond this broad-based winnowing of the dataset, further selection of data was made for each particular analysis. This section specifically examines performance in curves with independently established degrees of severity. That is, curves were grouped based on their severity so that curve performance in phase 1 could be compared to curve performance in phase 2 under similar severity levels. This was done so that even if the distribution of severe curves changed between phases as a consequence of routing changes, performance between phases was compared on the basis of curves of similar severity. As described earlier, curve severity was determined using non-comparable driver performance data from phase 1. For each driver, average performance (*RRSM* and

AyDSM) on each curve a driver traversed was calculated (in good weather conditions only). A curve’s severity was determined from the average of two or more non-comparable drivers’ average performance on a particular curve. (Curves in which only one or no non-comparable drivers traversed were excluded from the set of curves under consideration). The resulting set of curves was used to evaluate the driving performance of the comparable drivers. That is, the analysis of curve performance of the comparable drivers only included driver performance on curves in which a severity level was computed from the non-comparable driver data.

8.3.1 Results—sustained maximum rollover ratio (*RRSM*)

Light level was initially excluded from these analyses because of the large number of missing cells (i.e., no observations) for driving in darkness. Most driving is performed during daylight hours so it is not surprising that data were unavailable from several drivers in cells crossed with this factor.

Main effects. Main effects were observed for weather, load, turn direction, and curve severity (by *RRSM* bin). All main effects were in agreement with normal expectations. There was no evidence of a main effect of RA&C, i.e., of phase (see table 8-6 for statistical summary). Although not statistically significant, phase will be included in the main effect figures to provide the reader a general sense of the average difference found between phase 1 and 2. As shown in figure 8-22, *RRSM* is reduced (0.00525) during bad weather conditions, suggesting a more conservative driving strategy is employed in response to bad weather.

Table 8-6. Summary ANOVA results for main effects on observed *RRSM*

<i>Effect</i>	<i>F</i>	<i>df</i>	<i>p</i>
Weather	89.92	1,13	< .0001
Load	115.81	1,13	< .0001
Turn Direction	4.94	1,13	<.05
<i>RRSM</i> quartile	389.00	3,39	< .0001
Phase	0.01	1,13	.927

The main effects of load and turn direction are also depicted in figure 8-22. The effect of *RRSM* quartile bin (curve severity) is shown in figure 8-23. *RRSM* is reliably higher through curves in loaded conditions than in unloaded conditions, and it is higher in right turns than in left turns. The latter result is consistent with the earlier asymmetry observed between left and right lateral acceleration in the higher ranges (see figure 8-20). There it was suggested that the right-turn bias at higher lateral acceleration was perhaps due to the right-turn bias associated with exit, entrance, and interchange ramps of limited-access highways.

Note that, although reported as a main “effect,” the *RRSM* quartile was derived from the *RRSM* measures of the non-comparable drivers and, therefore, are expected to be

strongly correlated with the performance of the comparable drivers. Evidence of a main “effect” of this variable merely indicates a correlation between the performance measures for comparable and non-comparable drivers. That is, the non-comparable *RRSM* measures over curves were similar to those for the comparable *RRSM* measures.

For added perspective on the relative strength of the main effects of figure 8-22, the difference in average *RRSM* of the most conservative driver and of the least conservative driver (see section 6.4) was calculated. Differences in the two drivers’ average performance on each ranked curve that they both negotiated were calculated and then averaged. The resulting difference in *RRSM* was 0.058, or nearly twice the strength of the main effect of load.

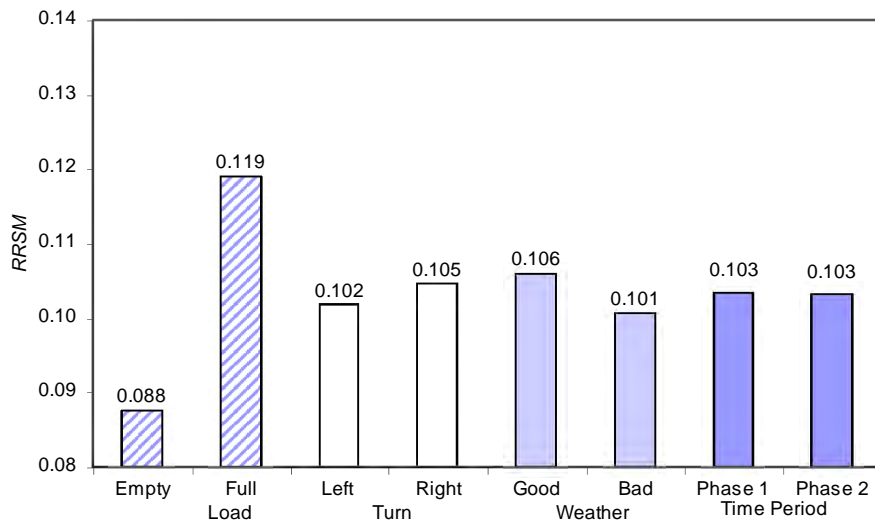

Figure 8-22. Main effects of load, turn direction, and weather on *RRSM*

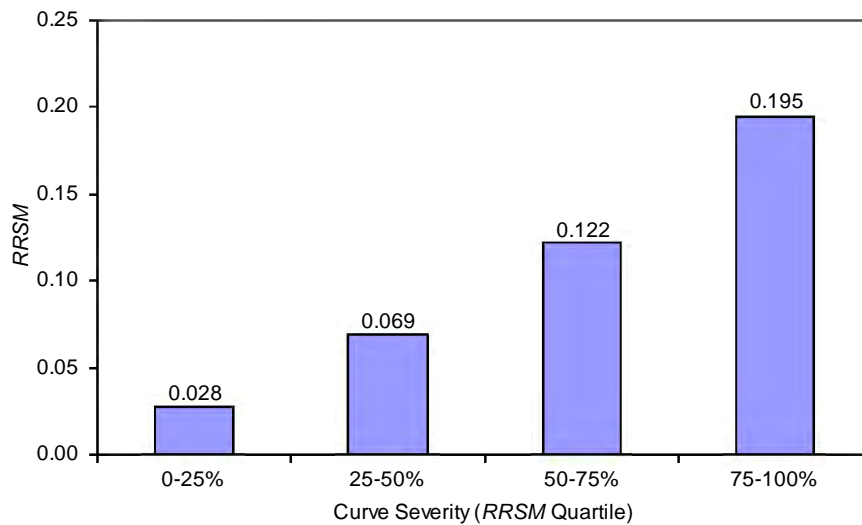

Figure 8-23. *RRSM* observed among the comparable drivers over curve severity derived from the *RRSM* performance of non-comparable drivers

Interactions. Two-way interactions were found between weather and *RRSM* quartile, load and *RRSM* quartile, and turn direction and *RRSM* quartile. Three-way interactions were found between load, turn direction, and *RRSM* quartile; phase, turn direction, and *RRSM* quartile; weather, phase, and *RRSM* quartile; and between weather, phase and turn direction. These interactions are shown in table 8-7.

Table 8-7. Summary of two and three-way interactions between each factor and observed *RRSM*

<i>Two-way Interactions</i>	<i>F</i>	<i>df</i>	<i>p</i>
Weather by <i>RRSM</i> Quartile	14.36	3,39	<.0001
Load by <i>RRSM</i> Quartile	33.77	3,39	<.0001
Turn Direction by <i>RRSM</i> Quartile	5.48	3,39	.012
<i>Three-way Interactions</i>			
Load by Turn Direction by <i>RRSM</i> Quartile	18.55	3,39	<.0001
Phase by Turn Direction by <i>RRSM</i> Quartile	4.06	3,39	.023
Phase by Weather by <i>RRSM</i> Quartile	3.34	3,39	.043
Phase by Weather by Turn Direction	4.97	1,13	.044

The interaction between load and *RRSM* quartile is expected because the factors are not independent—quartiles are calculated separately for empty versus full trailers. Consequently, the measures of *RRSM* for the full-vehicle quartiles are systematically skewed toward higher values in the right tails of the distribution (figure 8-19). If the comparable drivers perform like non-comparable drivers on similar curves, one should see greater differences in *RRSM* measures between full and empty trailers at the highest quartiles.

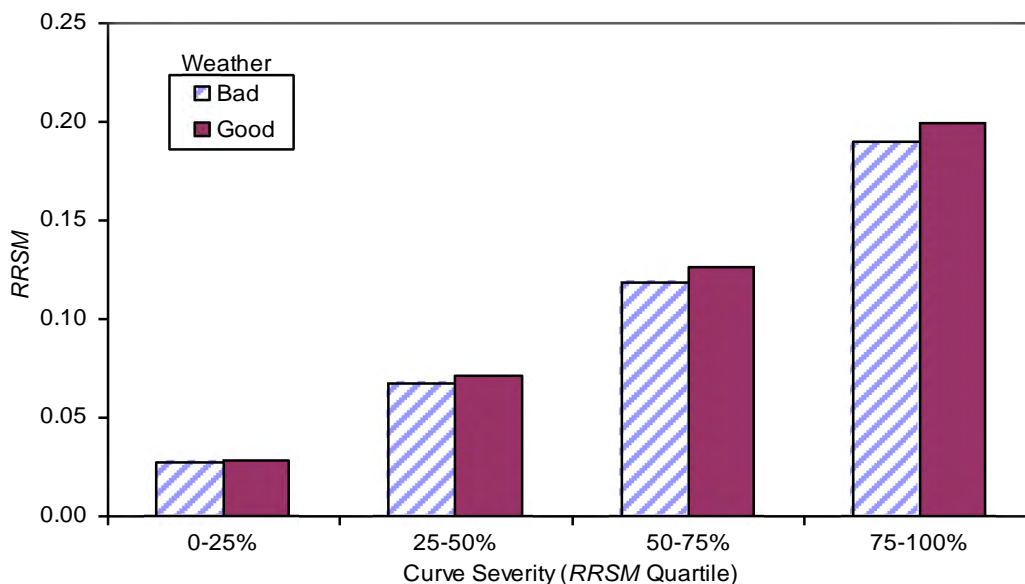

Figure 8-24. The interaction between weather and curve severity

The interaction between weather and curve severity suggests that *RRSM* differences between bad- and good-weather driving are strongest on the most severe curves (figure 8-24). Similarly, the influence of load also appears strongest on the most severe curves

(figure 8-25). These two interactions are as one might expect. That is, difficult conditions (bad weather or less stable vehicle) are likely to generate extra caution on severe curves but not on mild curves. The influence of turn direction, however, appears strongest in the middle curve severities (figure 8-26) and is not so readily explainable.

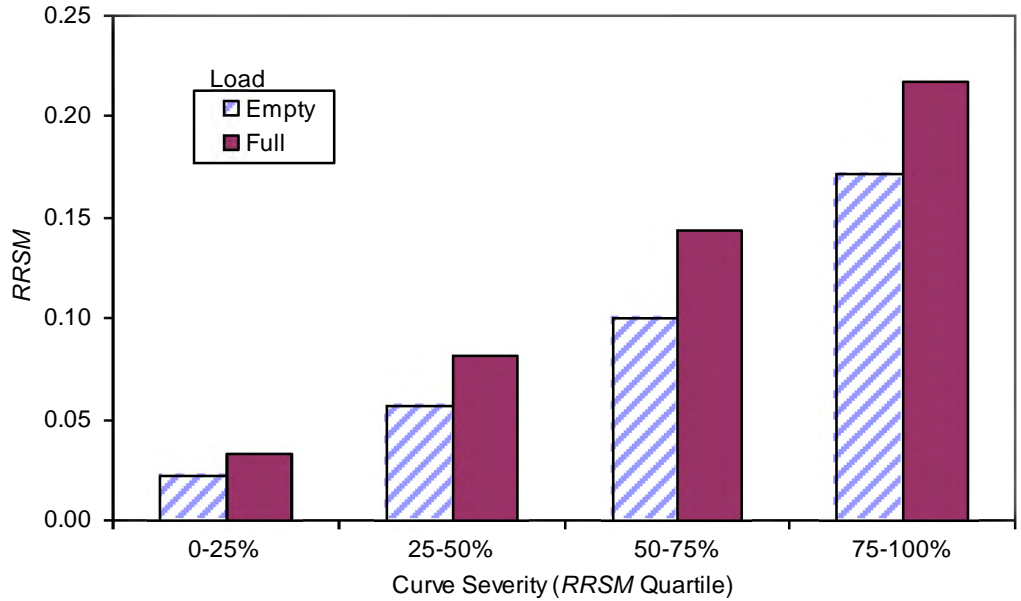

Figure 8-25. The interaction between load and curve severity

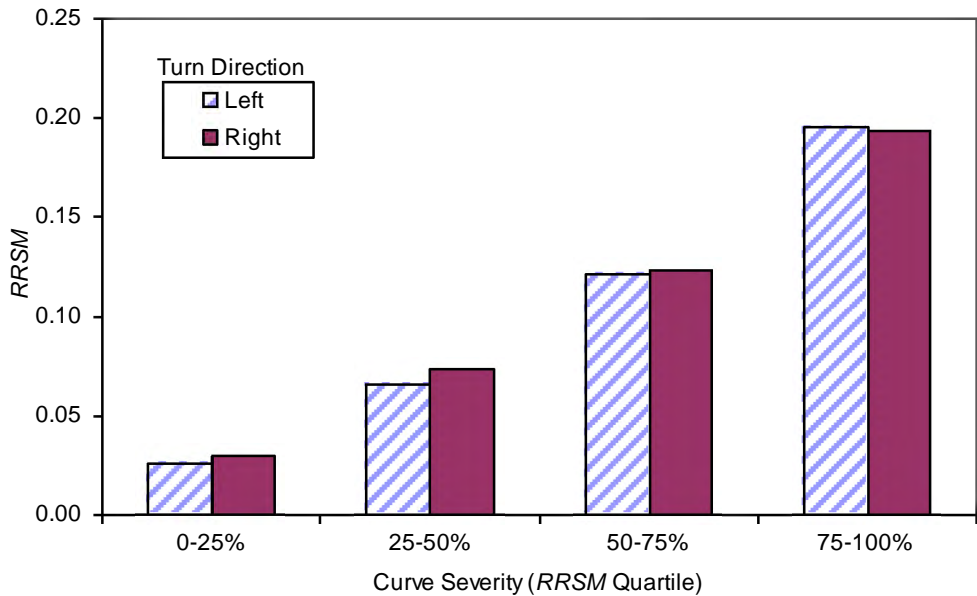

Figure 8-26. The interaction between turn direction and curve severity

The three-way interaction between load, turn direction, and curve severity is depicted in figure 8-27. While right turns appear to produce a higher *RRSM* than left turns for most conditions, it appears that left turns are higher than right turns on high severity curves in loaded conditions.

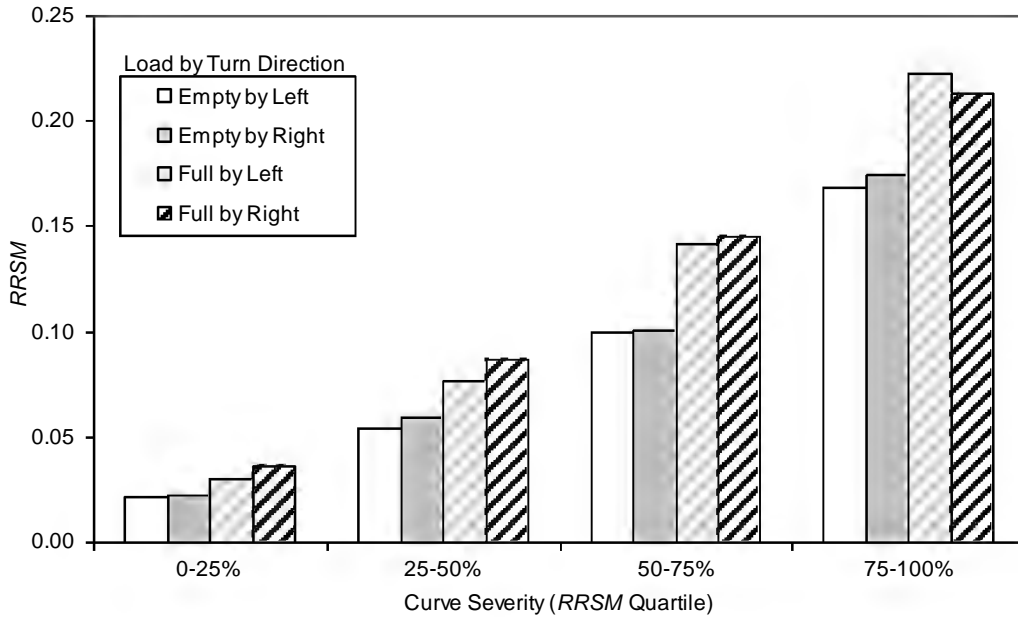

Figure 8-27. Three way interaction between load, turn direction, and curve severity

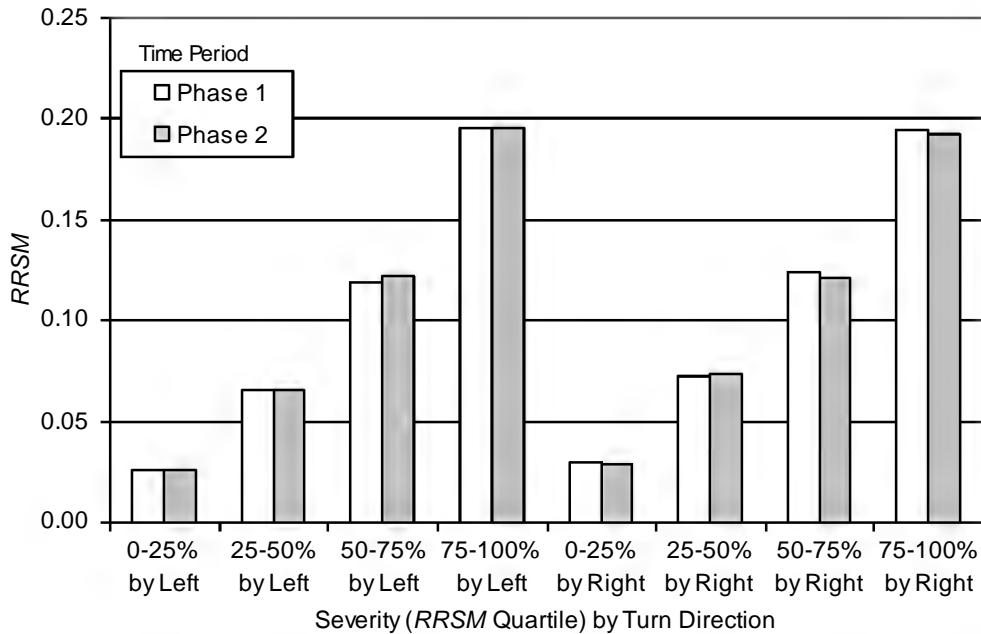

Figure 8-28. Three way interaction between phase, turn direction, and curve severity

There are three, significant, three-way interactions in table 8-7 that include phase (i.e., the influence of RA&C). They are shown in figures 8-28, -29, and -30. (The figures are constructed to highlight phase differences between conditions.)

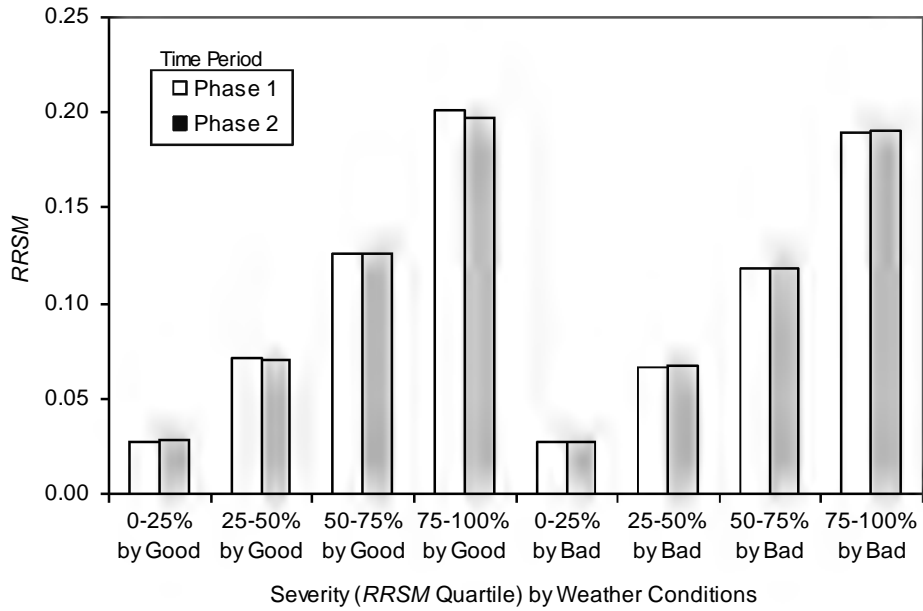

Figure 8-29. Three way interaction between weather, phase, and curve severity

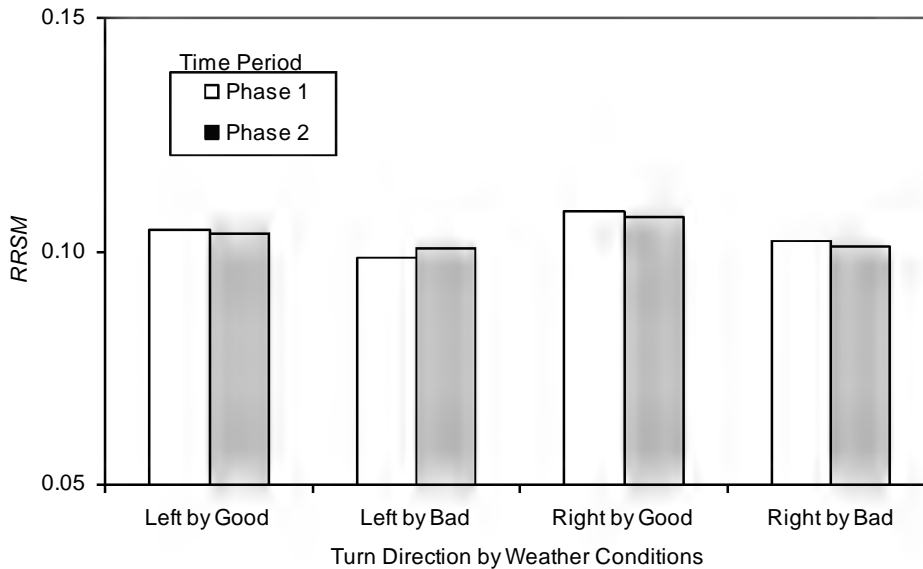

Figure 8-30. Three way interaction between weather, phase, and turn direction

The interaction between phase, turn direction, and curve severity is shown in figure 8-28. There appears to be some reduction in *RRSM* between phase 1 and phase 2 for right turns on high severity curves. Figure 8-29 shows the three-way interaction between weather, phase, and curve severity. There appears to be a modest reduction in *RRSM* between phase 1 and 2 on high severity curves in good weather. Figure 8-30 shows a three-way interaction between weather, phase, and turn direction. In good weather, both left and right turns show a modest decline between phase 1 and 2; in bad weather, there is a similar decline for right turns, but it is reversed for left turns. Taken as a group, these

interactions seem to fit an expected pattern: that the introduction of RA&C induces performance that reduces rollover risk where rollover risk would otherwise tend to be high, i.e., in more severe curves (higher quartiles and right-hand turns) during good weather. Having made that observation, it should also be noted that the evidence is not all that strong. The size of the observed reductions are not large, and the probabilities that the observations are significant are not strong (p ranges from 0.023 to 0.044 in table 8-7).

8.3.2 RRSM among drivers with exposure to RA&C advisories

An analysis of the form already described, but using only those comparable drivers who actually triggered the advisory system, was also done. The rationale for the exclusion of drivers who did not trigger the system is, of course, that these drivers would likely learn little new information about their vehicle’s stability if they never received an advisory message. As a consequence, the driving might not be expected to change. Note that this hypothesis ignores the potential for second-hand learning through comments about the advisory from other drivers in the fleet. That is, even though a driver might not directly receive an advisory by the RA&C system, the driver’s awareness of rollover risk may be heightened by comments about the safety device from other drivers in the fleet who have received advisories.

Of the 14 drivers in the original analysis, two received no RA&C messages over the entire course of phase 2. Arguably, these drivers might already be driving so carefully that little remains to improve in their performance. The curve-performance data for these two drivers was removed from data set and the data for the remaining drivers were reanalyzed.

Main effects. As before, main effects were observed for weather, load, turn direction, and RRSM quartile (table 8-8). All main effects followed the same pattern described in the preceding analysis; magnitudes of the effects observed were similar (see table 8-9 for a side-by-side comparison). No main effect of phase was found.

Table 8-8. Summary ANOVA results for main effects observed on RRSM for drivers who received RA&C advisories

<i>Effects</i>	<i>F</i>	<i>df</i>	<i>p</i>
Weather	78.12	1,11	< .0001
Load	151.12	1,11	< .0001
Turn Direction	6.55	1,11	.002
RRSM Quartile	1436.08	3,33	< .0001
Phase	0.001	1,11	.97

Interactions. As before, two-way interactions were found between load and turn direction, between weather and curve severity (RR Quartile), between load and curve

severity, and between turn direction and curve severity. Finally, two three-way interactions were observed: one between phase, turn direction and *RRSM* quartile and one between load, turn direction, and *RRSM* quartile (table 8-10).

The pattern found in the two-way interactions is similar to the analysis of all drivers' data. However, there is now only one, three-way interaction involving phase. That is, in the previous analysis (of all comparable drivers) three, three-way interactions involving phase were observed and, together, were taken as an encouraging indication of the influence of RA&C. But here, considering only the *exposed* comparable drivers, two of these (and perhaps the two most intuitively pleasing) are lost. Previously, these two were marginally significant (0.043 and 0.044); perhaps their loss is simply a consequence of the removal of data. Regardless, their loss certainly detracts from the previous observations.

Table 8-9. Mean *RRSM* observed among main effects for all drivers and for drivers who received RA&C advisories

		<i>Good</i>	<i>Bad</i>		
Weather	All Drivers	.106	.101		
	Drivers w Advisories	.111	.105		
		<i>Left</i>	<i>Right</i>		
Turn	All Drivers	.102	.105		
	Drivers w Advisories	.106	.110		
		<i>Full</i>	<i>Empty</i>		
Load	All Drivers	.088	.119		
	Drivers w Advisories	.092	.124		
		<i>0-25%</i>	<i>25-50%</i>	<i>50-75%</i>	<i>75-100%</i>
Curve Severity	All Drivers	.028	.069	.122	.195
	Drivers w Advisories	.028	.072	.128	.205

Table 8-10. Summary of two- and three-way interactions for drivers who received RA&C advisories

<i>Two-way Interactions</i>	<i>F</i>	<i>df</i>	<i>p</i>
Weather by <i>RRSM</i> Quartile	10.14	3,33	< .001
Load by <i>RRSM</i> Quartile	37.91	3,33	< .001
Turn Direction by <i>RRSM</i> Quartile	4.53	3,33	.027
<i>Three-way Interactions</i>			
Load by Turn Direction by <i>RRSM</i> Quartile	21.77	3,33	<.001
Phase by Turn Direction by <i>RRSM</i> Quartile	3.73	3,33	.034

8.3.3 *RRSM* excluding curves with known RSC intervention

Because an RSC intervention might physically limit *RRSM* during phase 2, the phase-2 *RRSM* data may not solely reflect driver behavior. If RSC interventions occurred, they

would act to reduce *RRSM*, independently of driver’s behavior, confounding driver behavior with equipment behavior in phase 2. While this is a concern, it is not considered to be highly significant. Among the comparable drivers, there were only 24 RSC incidents, occurring on 12 different curves, involving 8 different drivers. Among the drivers who experienced RSC incidents, two produced 17 RSC incidents, and the remaining 6 drivers produced 7 RSC incidents. It appears that RSC events are not numerous, are restricted to a small number of curves, and are limited to a relatively small set of drivers.

Nevertheless, in order to eliminate confounding, all curves in which an RSC event occurred were removed from the entire analysis for all conditions and all drivers. Overall, 2.4 percent of the data were excluded from the dataset.

The analysis of the remaining curve-performance data followed a similar pattern as before. Main effects were observed for weather, load, turn direction, and *RRSM* Quartile. As before, no main effect of phase was observed. These results are summarized in table 8-11. If anything, this analysis would likely diminish any phase effect attributable to the influence of the RA&C system. That is, activity of the RSC was expected to support a phase effect, not mask one. Removal of this confound was not expected to enhance a phase effect.

Table 8-11. Summary of analysis of variance excluding all RSC events

<i>Main Effects</i>	<i>F</i>	<i>df</i>	<i>p</i>
Weather	100.26	1,13	0.000
Load	115.45	1,13	0.000
<i>RRSM</i> Quartile	396.36	3,39	0.000
Phase	0.08	1,13	0.781
<i>Two-way Interactions</i>			
Weather by Turn Direction	4.90	1,13	0.045
Weather by <i>RRSM</i> Quartile	15.64	3,39	0.000
Load by <i>RRSM</i> Quartile	34.70	3,39	0.000
Turn Direction by <i>RRSM</i> Quartile	10.91	3,39	0.001
<i>Three-way Interactions</i>			
Load by Turn Direction by <i>RRSM</i> Quartile	5.81	3,39	0.011
Phase by Turn Direction by <i>RRSM</i> Quartile	4.26	3,39	0.020
Phase by Load by Turn Direction	7.59	1,13	0.016
Phase by Weather by Turn Direction	7.19	1,13	0.019

A similar pattern of two-way interactions were found as before along with a few additional ones (see table 8-11). For example, an interaction of weather and turn direction was found, suggesting that in bad weather, left and right turns produced similar measures of *RRSM*, but in good weather the average *RRSM* for right turns was about 0.003 higher than left turns. The remaining two-way interactions followed the same pattern described earlier: in the interaction of weather and curve severity, the influence of curve severity on *RRSM* was strongest in good weather; the load-by-curve-severity interaction is, as

described earlier, an artifact of the curve severity scale; and the turn-direction-by-curve-severity interaction shows that right turns produce a higher *RRSM* over left turns, particularly in severity bin 2. The three-way interactions followed the pattern previously described.

8.3.4 *RRSM* by light condition

To analyze the effect of light conditions, it was necessary to collapse factors to pool sufficient data to obtain estimates for each driver in the dark. To do this, only the factors light condition, load, and phase were retained and data were collapsed over the remaining factors. Even after collapsing, some night observations were missing for one driver. As a consequence, this driver’s data were dropped from this analysis. The resulting three-factor analysis of variance revealed a main effect of light condition and load (see table 8-12). Figure 8-31 shows that overall *RRSM* is reduced by about 0.0094 in darkness. The effect of load without the contribution of the dropped driver is similar to the effect shown in figure 8-22 with that driver.

Table 8-12. Summary of analysis of light conditions

<i>Main Effects</i>	<i>F</i>	<i>df</i>	<i>p</i>
Light conditions	11.38	1,12	.006
Load	88.60	1,12	<.001
Phase	2.09	1,12	.174

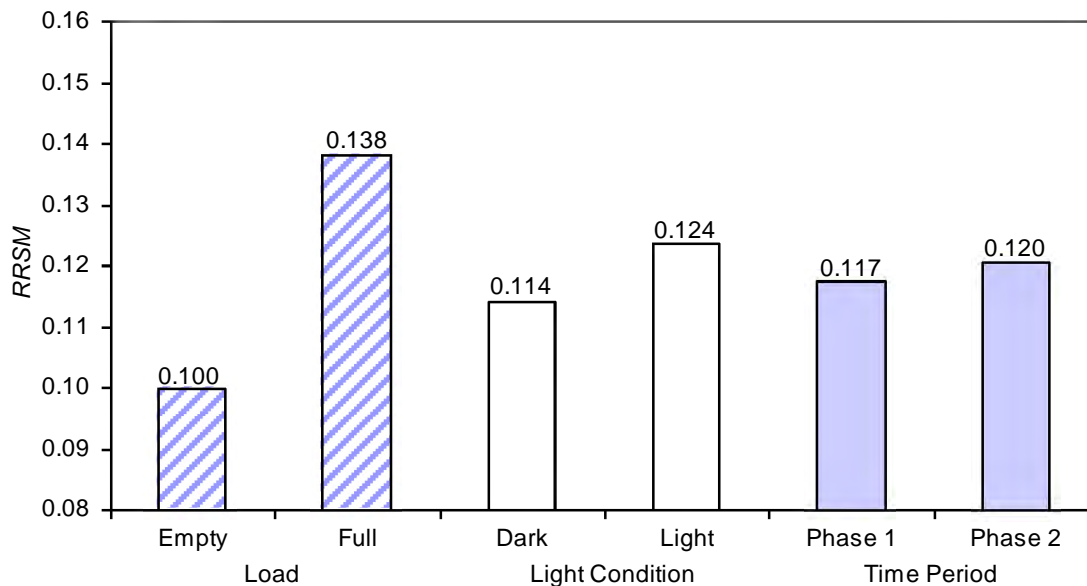

Figure 8-31. Main effects of light condition and trailer load on *RRSM*

8.3.5 Results—sustained maximum lateral acceleration (*AyDSM*)

The same series of analyses described above for *RRSM* were also conducted with the measure, *AyDSM*. The rationale for this choice is that it represents the lateral acceleration

encountered by the driver at his position in the tractor. If drivers principally rely on lateral acceleration in controlling their vehicles through turns, changes in driving performance might be better reflected in the *AyDSM* measure than in the *RRSM* measure. This is not to suggest that drivers ignore vehicle load when negotiating curves—data presented in chapter 6 strongly suggests that drivers certainly produce lower lateral acceleration in loaded conditions. But perhaps drivers only distinguish full and empty conditions such that a driver may consider one level of lateral acceleration safe for an empty trailer and another safe for a full trailer. If curve performance using the *RRSM* measure (which accounts for variation in roll stability) is compared to performance using *AyDSM*, *AyDSM* might be found to be a less variable measure since it removes factors to which drivers may not be reliably sensitive.

Main effects. Main effects were observed for weather, load, turn direction, and curve severity indexed by *AyDSM* Quartile. No main effect of phase was observed. These results are summarized in table 8-13. The pattern of main effects resembles those seen earlier with the *RRSM* measure, except that *AyDSM* is higher with empty trailers and lower with full ones. Drivers apparently try to compensate for load by moderating lateral acceleration under loaded conditions, but the *RRSM* measure suggests they are not completely successful.

Table 8-13. Summary of main effects and interactions

<i>Main Effects</i>	<i>F</i>	<i>df</i>	<i>p</i>
Weather	64.41	1,13	< .0001
Load	43.68	1,13	< .0001
Turn Direction	10.61	1,13	.006
<i>AyDSM</i> Quartile	417.92	3,39	< .0001
Phase	1.00	1,13	.335
<i>Two-way Interactions</i>			
Weather by Load	9.60	1,13	.008
Weather by <i>AyDSM</i> Quartile	8.83	3,39	.002
Load by <i>AyDSM</i> Quartile	60.33	3,39	.000
Turn Direction by <i>AyDSM</i> Quartile	4.11	3,39	.024
<i>Three-way Interactions</i>			
Phase by Load by Turn Direction	12.65	1,13	.004
Phase by Weather by <i>AyDSM</i> Quartile	6.49	3,39	.013

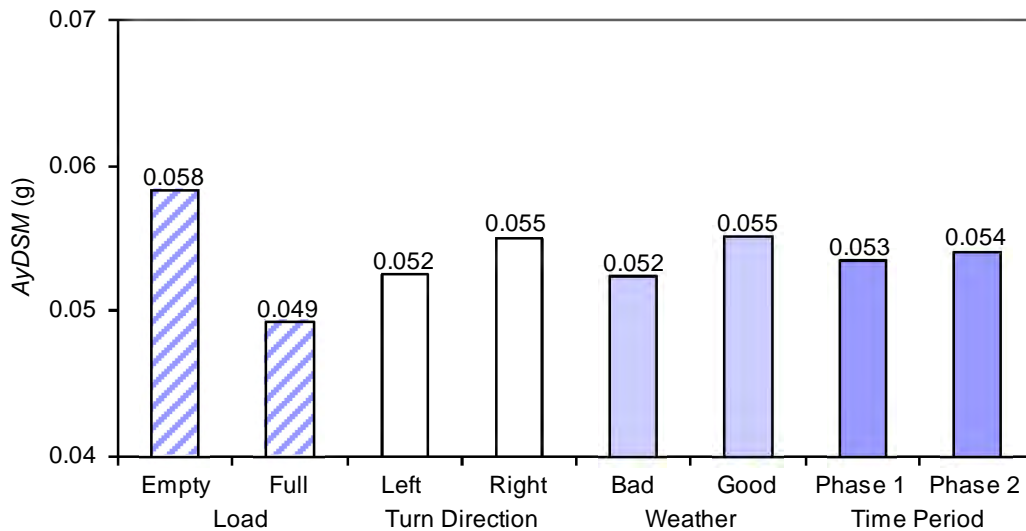

Figure 8-32. Main effects of load, turn direction, weather, and phase on *AyDSM*

The overall difference between the good-weather and bad-weather measure of *AyDSM* was 0.0025 (figure 8-32). That is, *AyDSM* was higher in good weather than in bad weather, suggesting greater overall caution among drivers in bad weather. Drivers reach higher levels of lateral acceleration when driving empty trailers versus full (figure 8-32, mean difference = 0.009). Drivers also produced higher lateral acceleration in right turns (figure 8-32, mean difference = 0.003), and on higher severity curves in the upper *AyDSM* quartile (figure 8-33).

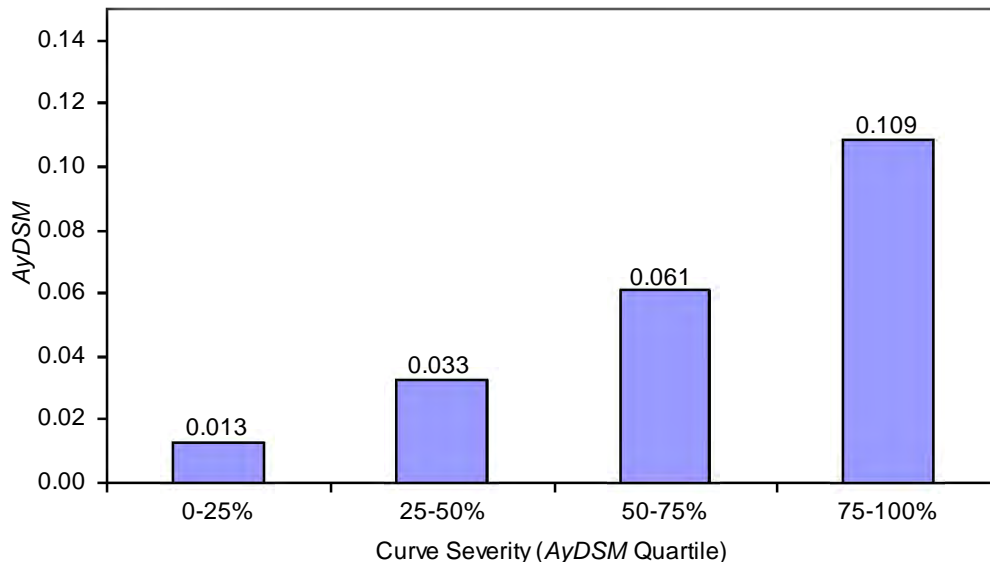

Figure 8-33. Main effect of curve severity indexed by *AyDSM* quartile

For added perspective on the relative strength of the main effects of figure 8-32, the difference in average *AyDSM* of the most conservative driver and of the least

conservative driver (see section 6.4) was calculated. Differences in the two driver's average performance on each ranked curve that they both negotiate were calculated and then averaged. The resulting difference in $AyDSM$ was 0.025, or nearly three times the strength of the main effect of load.

Interactions. Two-way interactions were found between weather and load, between load and turn direction, between weather and $AyDSM$ quartile, between load and $AyDSM$ quartile, and between turn direction and $AyDSM$ quartile (see table 8-13). As described earlier with regard to load and $RRSM$ quartile, this interaction effect is a consequence of the dependent relationship between load and the $AyDSM$ quartile.

Overall, the pattern of interactions observed previously for $RRSM$ is similar to the pattern of interactions found here, with the exception of the added interaction between weather and load. The interactions (excluding load by $AyDSM$ quartile) are shown in figure 8-34 through figure 8-36. The interaction between weather and load suggests that weather conditions more strongly influence driving with empty trailers than with full trailers; with a full trailer, the driver's added conservatism reduces the influence of weather (figure 3-34). The influence of weather is also most noticeable on the most severe curves (figure 8-35). Finally, the interaction between curve severity ($AyDSM$ quartile) and turn direction shows the effect of direction to be greatest in the second severity quartile (figure 8-36).

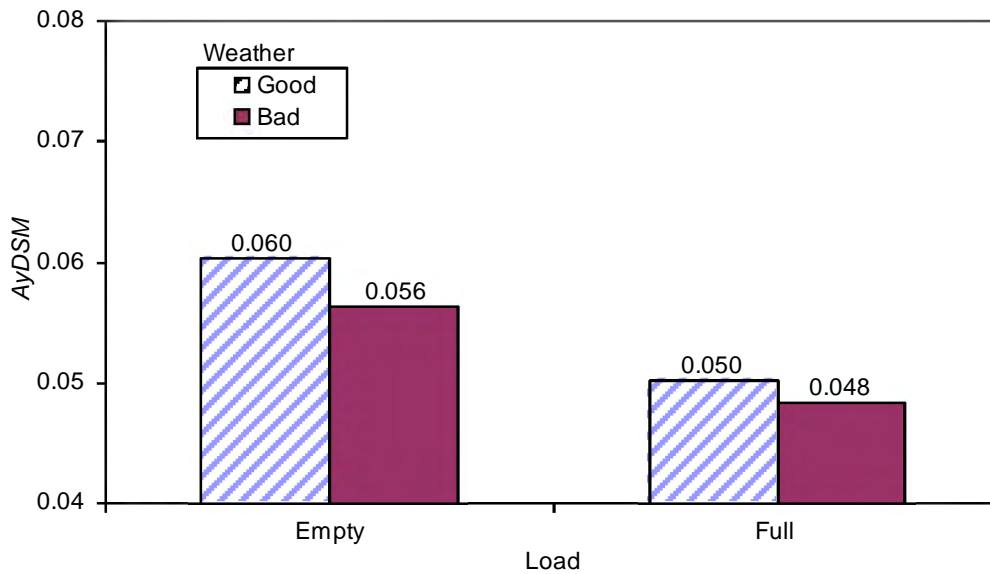

Figure 8-34. Interaction between vehicle load and weather

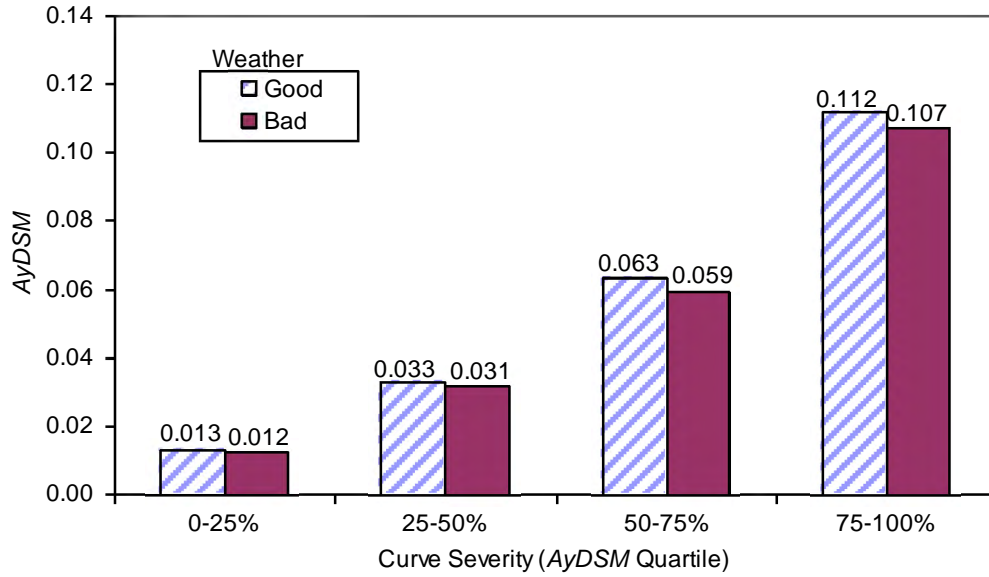

Figure 8-35. Interaction between weather and curve severity

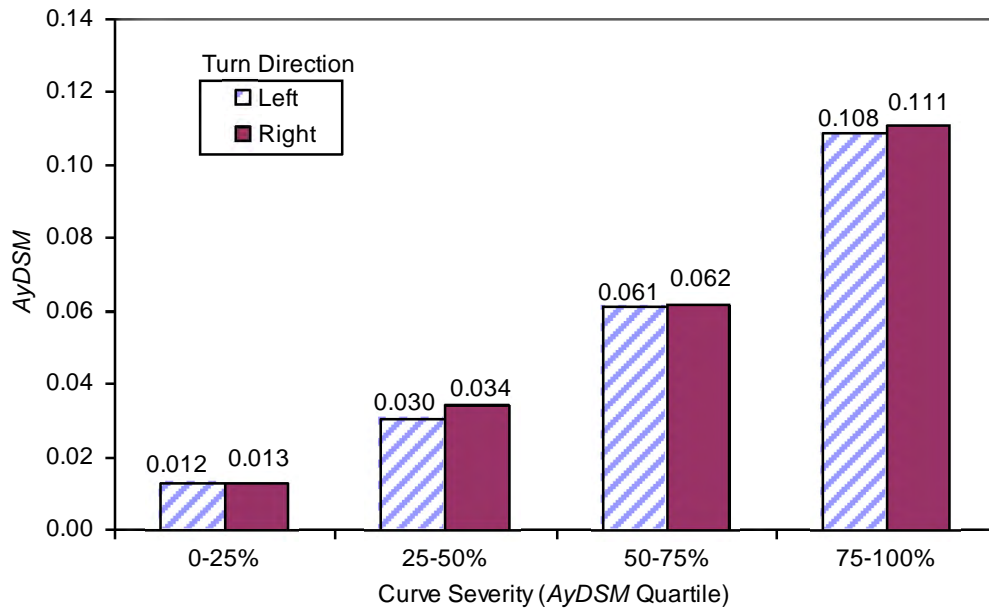

Figure 8-36. Interaction between turn direction and curve severity

The three-way interaction found between phase, load, and turn direction suggests that phase differences are greater for empty trucks in left-hand turns and full trucks in right-hand turns (figure 8-37).

The interaction between weather, phase, and *AyDSM* quartile suggests that the influence of weather on *AyDSM* was greatest on the highest-severity curves during phase 1 (figure 8-38). It appears that the effect might be largely attributable to differences in the severity of the bad-weather conditions between the two phases. That is, the bad weather during phase 1 included snowy and icy road conditions; it is unlikely that the bad weather

during phase 2 was as severe. In a separate analysis of only good-weather driving, no effect of phase was found (phase by *AyDSM* quartile interaction, $F(3, 39) = .419, p = .570$).

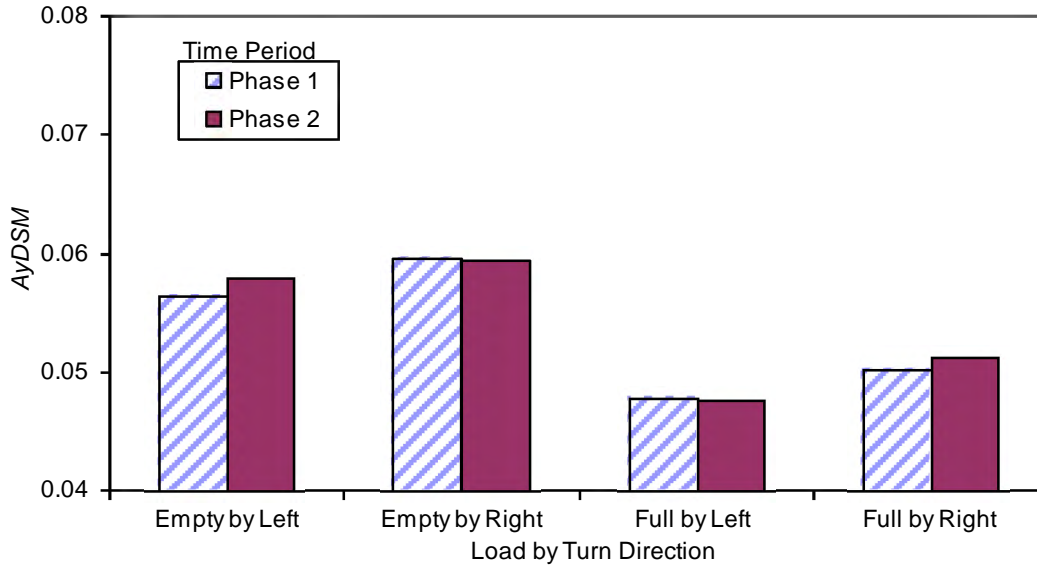

Figure 8-37. Three way interaction between load, phase and turn direction

At best, this analysis seems to present mixed results regarding the influence of RA&C. The encouraging pattern seen in the analysis of *RRSM* is now not readily discernable using *AyDSM*.

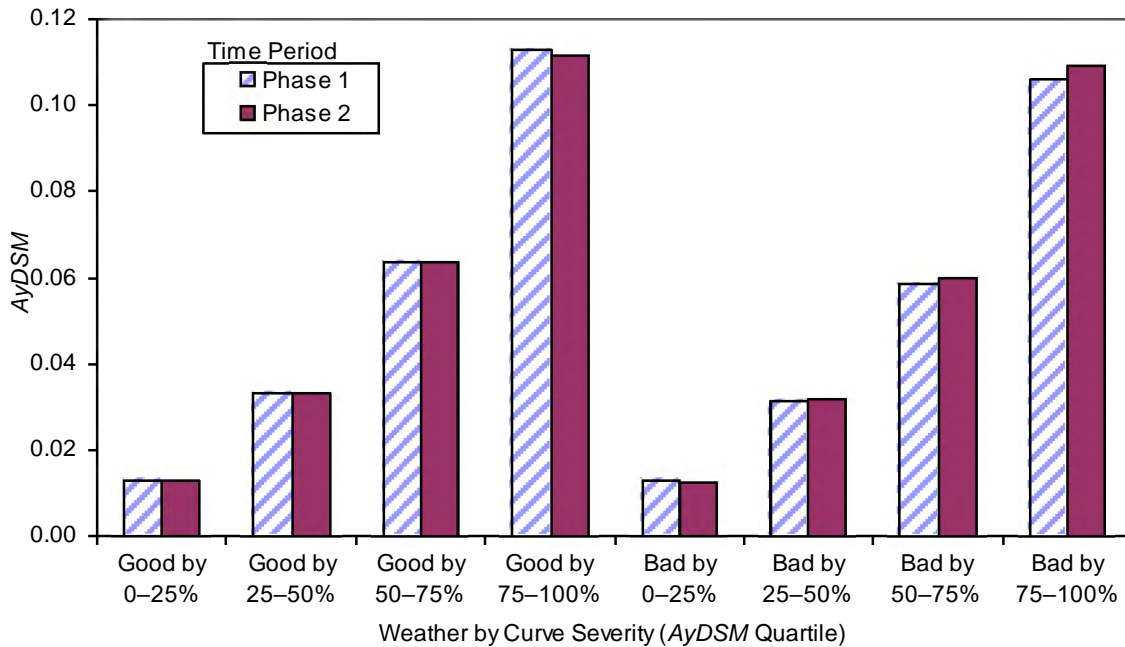

Figure 8-38. Three-way interaction between weather, phase, and AyDSM quartile

8.3.6 AyDSM among drivers with exposure to RA&C advisories

As with the *RRSM* measure described earlier, a separate analysis was conducted without data from drivers who never triggered the advisory system. The same pattern of main effects and interactions were present in this analysis (shown in table 8-14) with the exception that an interaction between weather and phase appeared (shown in figure 8-39), and a three-way interaction between weather, load, and turn direction was found.

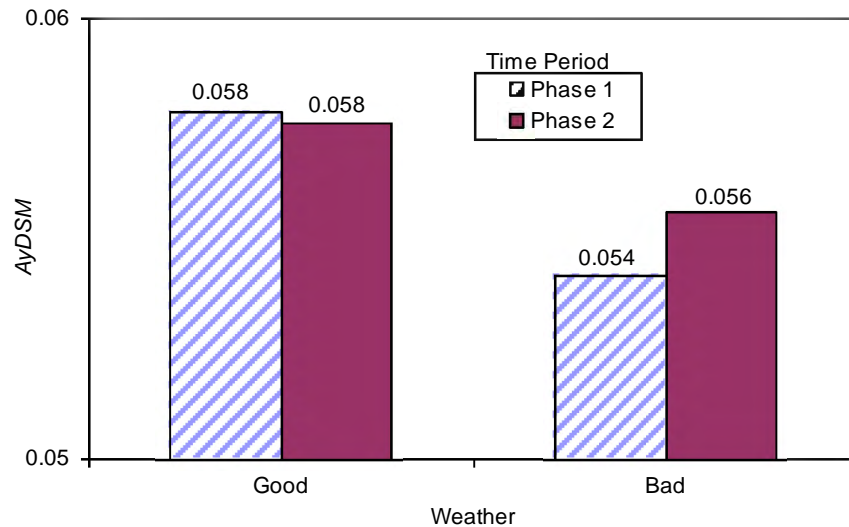

Figure 8-39. Interaction between phase and weather among drivers who received RA&C advisories

Table 8-14. Summary of analysis of variance results for drivers who received RA&C advisories

<i>Main Effects</i>	<i>F</i>	<i>df</i>	<i>p</i>
Weather	47.77	1,11	< .0001
Load	56.89	1,11	< .0001
Turn Direction	15.63	1,11	.002
<i>AyDSM</i> Quartile	1661.52	3,33	< .0001
Phase	0.88	1,11	.369
<i>Two-way Interactions</i>			
Weather by Load	6.35	1,11	.028
Weather by Phase	5.41	1,11	.040
Weather by <i>AyDSM</i> Quartile	5.51	3,33	.018
Load by <i>AyDSM</i> Quartile	63.41	3,33	<.0001
Turn Direction by <i>AyDSM</i> Quartile	5.17	3,33	.014
<i>Three-way Interactions</i>			
Phase by Load by Turn Direction	12.51	1,11	.005
Phase by Weather by <i>AyDSM</i> Quartile	4.66	3,33	.040
Weather by Load by Turn Direction	4.99	3,33	.047

8.3.7 AyDSM excluding curves with known RSC intervention

As described earlier for the *RRSM* analysis, a separate analysis was conducted excluding data taken from curves involved with RSC activation. (The same curves were excluded in both analyses.)

In the resulting analysis, many effects that were present when all curve data were included became marginal when the RSC curves were excluded. Note that most RSC activation occurred when the vehicle was empty, usually on high-severity, right turns. It is no surprise that removal of these observations from the analysis reshuffles some effects along the borderline of statistical significance. For example, some effects associated with turn direction became a marginal effect ($p = 0.07$) perhaps because of the loss of some of the right turn data.

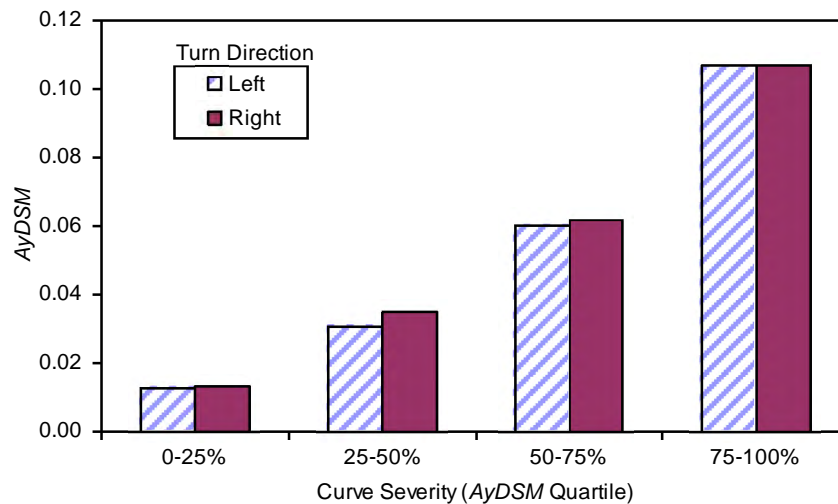

Figure 8-40. Two-way interaction between turn direction and curve severity on *AyDSM* quartile

Table 8-15. Summary of analysis in which curves that triggered RSC events were removed

Main Effects	F	df	p
Weather	68.98	1,13	< .0001
Load	33.36	1,13	< .0001
Turn Direction	4.00	1,13	.067*
<i>AyDSM</i> Quartile	426.04	3,39	< .0001
Phase	0.50	1,13	.490
<i>Two-way Interactions</i>			
Weather by Load	10.475	1,13	.006
Weather by <i>AyDSM</i> Quartile	9.304	3,39	.002
Load by Turn Direction	15.696	1,13	.002
Load by <i>AyDSM</i> Quartile	37.581	3,39	.000
Turn Direction by <i>AyDSM</i> Quartile	3.293	3,39	.049
<i>Three-way Interactions</i>			
Phase by Load by Turn Direction	15.405	1,13	0.002
Phase by Weather by Turn Direction	5.671	3,39	0.033
Load by Turn Direction by <i>AyDSM</i> Quartile	10.944	3,39	0.001

8.3.8 *AyDSM* by light condition

As described earlier, night was excluded from the main analysis because of the large number of missing cells associated with this factor. The influence of night was later examined in an analysis that collapsed over all factors except day/night, load, and phase. One driver was excluded from this analysis due to missing nighttime data in some cells of the design.

In the resulting analysis, a main effect of light level was found as well as a main effect of load (see table 8-16). Overall, drivers' nighttime *AyDSM* measures were 0.008 g less than daytime *AyDSM*; *AyDSM* measures were 0.042 g higher with an empty trailer than a full trailer. No effect of phase was present nor were there any interactions (mean Phase 1-Phase 2 difference = -0.003 g).

Table 8-16. Summary of analysis of variance for examining light condition

<i>Main Effects</i>	<i>F</i>	<i>df</i>	<i>p</i>
Light Conditions	8.24	1,12	.017
Load	163.11	1,12	<.0001
Phase	1.80	1,12	.209

8.4 Curve-performance analyses of other dependent measures

Analyses were also conducted using curve-entry speed, maximum sustained speed on curves, and brake-on time. Even if drivers do not succeed in reducing *RRSM* or *AyDSM* performance, there may be some evidence that preparatory actions were taken to attempt such reduction. It might be found, for example, that curve-entry speed (i.e., the speed at which the tractor-trailer begins the curve) is reduced in phase 2 as drivers become acquainted with difficult curves. The application of braking or the maximum speed reached on curves might similarly be reduced.

The analysis dataset. The data used in this analysis included the set of curves of known severity used in the previous analysis. To simplify things, only good weather performance was examined for each variable and only the factors of phase, load, turn direction, and curve severity (measured by *RRSM* quartile) were examined.

Curve-entry speed. The results of an analysis of variance on curve-entry speed are summarized in table 8-17 and graphed in figure 8-41 through Figure 8-44. Overall the data show that curve entry when full is generally slower than when empty by about 1.29 kph over all conditions. Also, right turns were entered about 3.5 kph faster than left turns. Curve-entry speed did not differ significantly between phases (see figure 8-41). A main effect of curve severity on curve-entry speed was also found, mirroring the roadway distribution for each quartile described in figure 8-18. Local roads dominate the fourth quartile, which has the lowest entry speed; freeways and highways dominate quartiles 2 and 3 which show the highest curve-entry speeds.

Table 8-17. Summary of analysis of variance of initial speed on entering a curve

<i>Main Effects</i>	<i>F</i>	<i>df</i>	<i>p</i>
Phase	.21	1,13	.658
Load	7.95	1,13	.014
RRSM Quartile	564.92	3,39	< .0001
Turn Direction	59.39	1,13	< .0001
<i>Two-way Interactions</i>			
Load by RRSM Quartile	56.71	3,39	< .0001
Load by Turn Direction	77.47	1,13	< .0001
Turn Direction by RRSM Quartile	226.76	3,39	< .0001
<i>Three-way Interactions</i>			
Phase by Mass by Turn Direction	10.03	1,13	.007
Load by RRSM Quartile by Turn Direction	118.19	3,39	< .0001

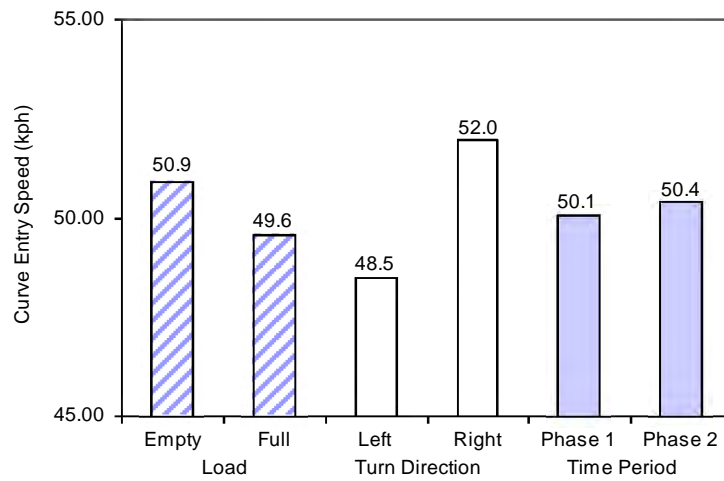

Figure 8-41. The main effects of load, turn and phase on curve-entry speed

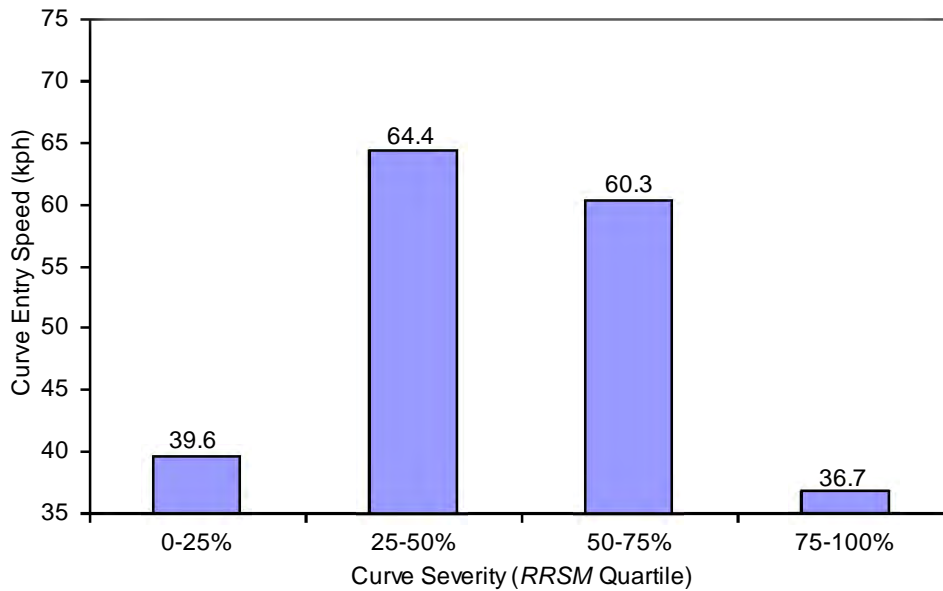

Figure 8-42. Curve-entry speed by curve severity bin

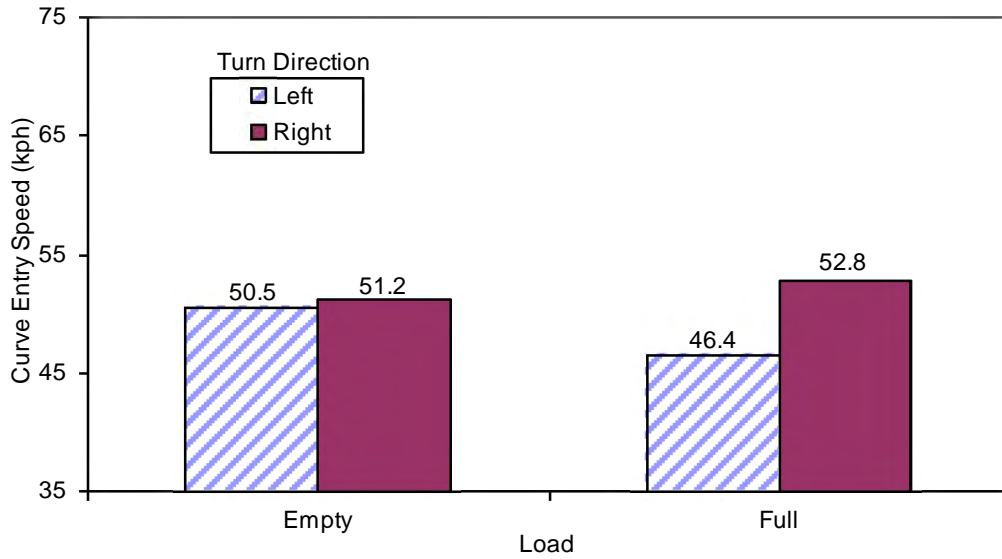

Figure 8-43. Interaction between turn direction and trailer load

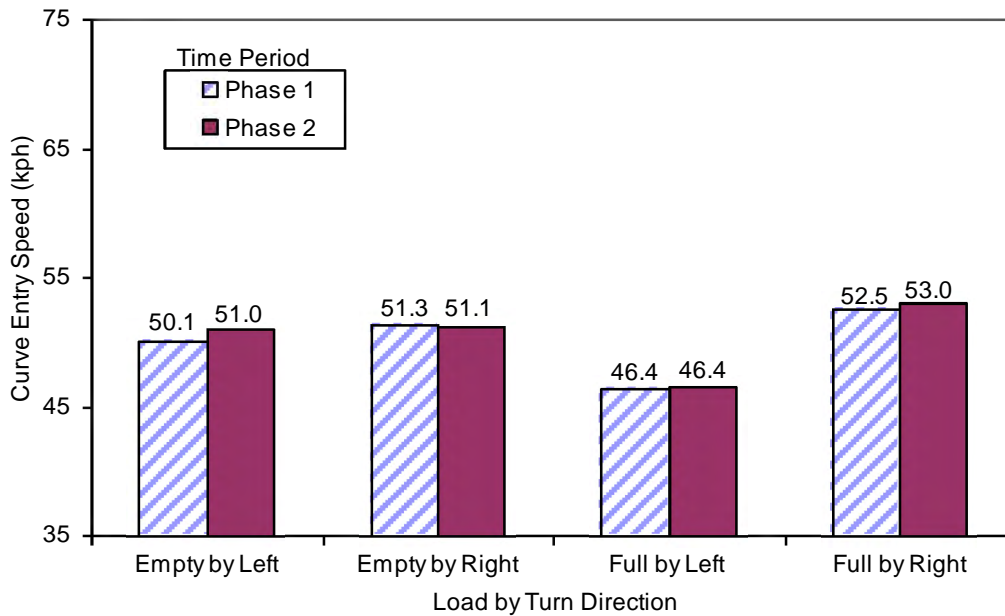

Figure 8-44. Three-way interaction between load, phase, and turn direction

A three-way interaction involving phase was also found (shown in figure 8-44). The entry speed difference between left and right turns appears to vanish for empty trailers in phase 2. Although it is unclear how to interpret this result, it does not appear to stem from added caution in curve driving during phase 2.

Maximum sustained curve speed. Overall, the behavior of this dependent variable was similar to the curve-entry speed measure. The main effects of load, curve severity, and turn direction were like to those found with curve-entry speed; in general, maximum

sustained speeds were 1-2 kph higher than the curve-entry speeds. No main effect or interactions with phase were found.

Table 8-18. Summary of analysis of variance of maximum sustained curve speed

<i>Main Effects</i>	<i>F</i>	<i>df</i>	<i>P</i>
Phase	0.08	1,13	0.7768
Load	17.81	1,13	< .0001
<i>RRSM</i> Quartile	618.79	3,39	< .0001
Turn Direction	24.19	1,13	< .0001
<i>Two-way Interactions</i>			
Load by <i>RRSM</i> Quartile	47.21	3,39	< .0001
Load by Turn Direction	103.49	1,13	< .0001
Turn Direction by <i>RRSM</i> Quartile	235.29	3,39	< .0001
<i>Three-way Interactions</i>			
Load by <i>RRSM</i> Quartile by Turn Direction	94.82	3,39	< .0001

Brake-on time. This variable is a measure of the overall length of time the brake is applied during a turn. It is examined here to investigate the possibility that brake application might be indicative of added caution in negotiating a curve. It should be noted, however, that the measure is highly speculative and is correlated to the overall length of the curve. A summary of the analysis of variance of brake-on time is provided in table 8-19. Not surprising, longer durations of brake applications are found with full loads than with empty loads; the shortest duration brake applications are found in the second *RRSM* quartile, where the most freeway and highway curves are found; the longest brake applications were found in the fourth quartile, where more local roadway and ramp curves are found. No main effect or interactions were found with phase.

Table 8-19. Summary of analysis of variance of brake-on time

<i>Main Effects</i>	<i>F</i>	<i>df</i>	<i>p</i>
Phase	0.29	1,13	0.5965
Load	57.48	1,13	< .0001
<i>RRSM</i> Quartile	269.29	3,39	< .0001
<i>Two-way Interactions</i>			
Load by <i>RRSM</i> Quartile	10.28	3,39	< .0001
Load by Turn Direction	48.67	1,13	< .0001
Turn Direction by <i>RRSM</i> Quartile	23.48	3,13	< .0001
<i>Three-way Interactions</i>			
Load by <i>RRSM</i> Quartile by Turn Direction	18.14	3,39	< .0001

8.5 Off-roadway performance

Off-roadway maneuvers were analyzed separately from the general roadway-curve performance data for three reasons: 1) off-roadway maneuvers are generally performed at low speed, often well below the 20 kph threshold for RSA activation; 2) there is a large degree of path variation in off-roadway maneuvers such that curve identification is not as well constrained as on roadways; and 3) off-roadway situations contain a mixture of tight

constraints (a trailer may be required to be placed in a critical location), and wide latitude (e.g., drivers are often free to choose any path to reach a particular location in a parking lot). It is thus less feasible to equate off-roadway curves on the basis of severity as was done in the previous analyses.

Despite the above limitations, the low-speed and tight turns commonly found off-roadway suggests a substantial rollover risk exists in this particular driving environment. Perhaps the presence of a RA&C advisor raises a driver’s general awareness of the rollover hazards present in this driving environment, encouraging more conservative behavior. Unlike the data taken from roadway curves, which were selected based on the severity levels observed among the non-comparable drivers, these data are not filtered and include all off-roadway activity for each comparable driver.

This analysis examined the role of load, phase, and turn direction, filtering out bad weather and pooling over dark and light conditions.

8.5.1 RRSM performance

The averaged measure of *RRSM* for off-roadway turns are somewhat smaller than those observed in the on-roadway curve-performance data.

The results are summarized in table 8-20. Main effects of turn direction and load were observed such that high values of *RRSM* are generated in right turns, and under loaded conditions (similar to effects found in the curve analysis, see figure 8-45). No main effect or interactions of phase were found. A two-way interaction between load and turn direction was observed (see figure 8-46); the difference between left and right turns appears greater with full trailers.

Table 8-20. Summary of analysis of the *RRSM* in off-roadway turns

<i>Main Effects</i>	<i>F</i>	<i>df</i>	<i>p</i>
Phase	0.76	1,13	.398
Load	108.16	1,13	< .0001
Turn Direction	20.77	1,13	.001
<i>Two-way Interactions</i>			
Load by Turn Direction	37.37	1,13	< .0001

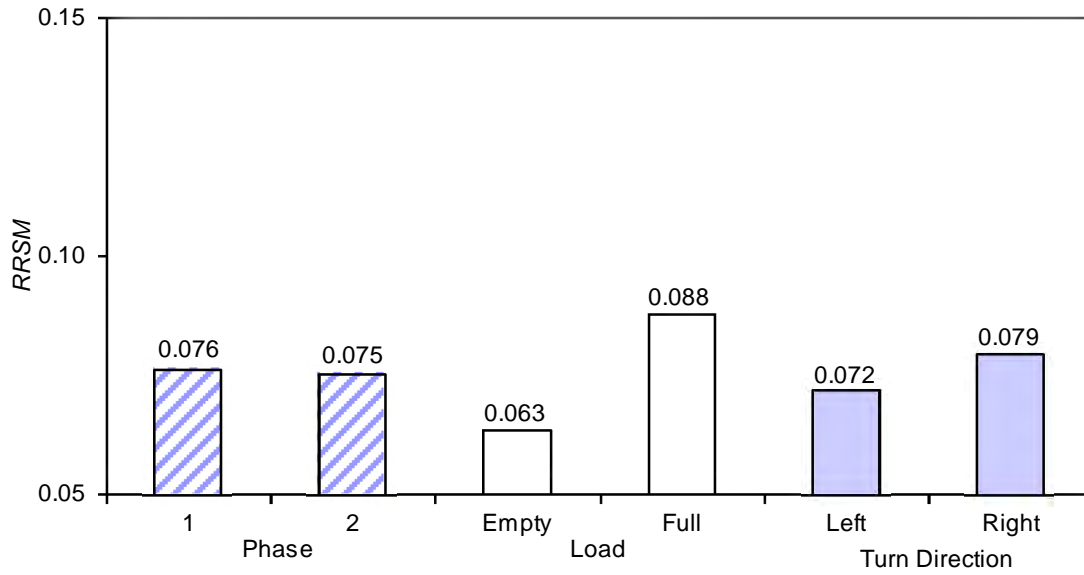

Figure 8-45. Main effects of phase, load, and turn direction on *RRSM* in off-roadway turns

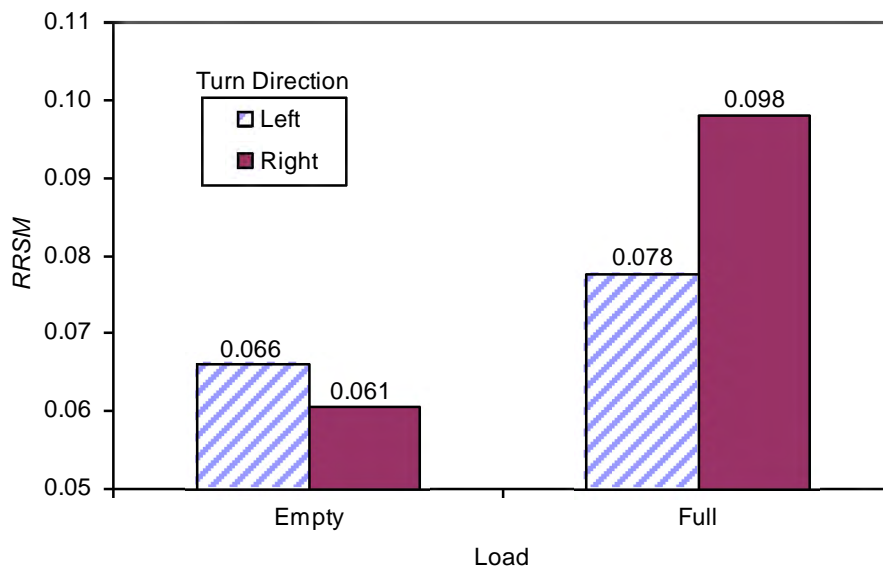

Figure 8-46. Two-way interaction for turn direction and load on *RRSM*

8.5.2 *AyDSM* performance

A similar pattern of main effects and interactions was observed in the *AyDSM* measures (table 8-21). Higher levels of *AyDSM* were measured with empty trailers and on right turns; the size of the turn direction difference increased under fully loaded conditions (see figure 8-48).

Table 8-21. Summary of analysis of the *AyDSM*

<i>Main Effects</i>		<i>F</i>	<i>df</i>	<i>p</i>
Phase		0.14	1,13	.719
Load		29.43	1,13	< .0001
Turn Direction		13.63	1,13	.003
<i>Two-way Interactions</i>				
Load by Turn Direction		30.86	1,13	< .0001

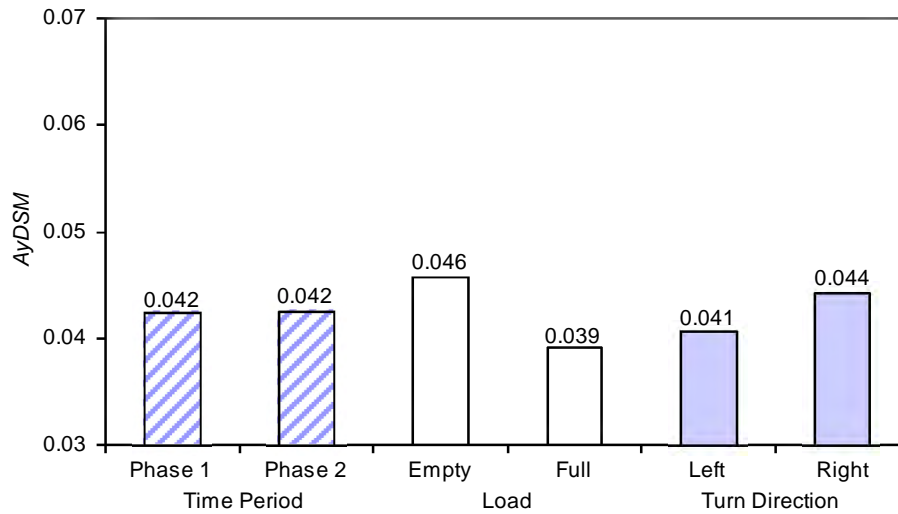

Figure 8-47. Main effects of phase, load and turn direction on *AyDSM*

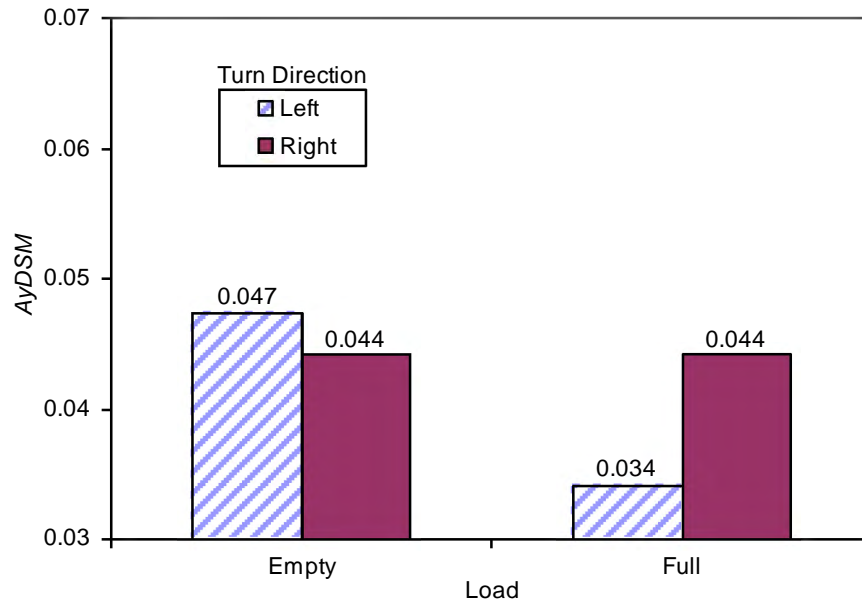

Figure 8-48. Interaction between load and turn direction on *AyDSM*

8.6 Curve performance before and after advisory messages

This analysis examined the curve performance of drivers as indexed by *RRSM* and *AyDSM* before and after an RA&C advisory message was received. To do this analysis, each curve on which an advisory occurred was located. Subsequently, curve performance in specified distance ranges preceding and following each advisory were evaluated. The change in performance across these two ranges was then analyzed. Pre- and post-advisory ranges of 250, 500, and 750 km were used, but with the additional stipulation that the range from 1 km before to 1 km after the advisory was always excluded. Performance on higher-severity curves (i.e., in the third and fourth *RRSM* quartile) is reported here, although analyses were also conducted on all levels of curve severity. These analyses were also restricted to good-weather performance. Each driver's performance was compared using a 2-factor repeated-measures analysis of variance that included time interval (before versus after advisory) and load (empty versus full) as factors.

Overall, the analyses included 12 drivers. Two of the 14 comparable drivers received no advisories throughout the study and could not be included in these analyses. Analyses with empty vehicle included only 11 drivers. One driver had but one advisory, and it was with a loaded vehicle; the trailer was never empty anywhere within the ± 750 km window surrounding that advisory.

It should also be noted that the distance between advisories is different for each driver. For some drivers it averages as little as 378 km between advisories; for others it is as long as 2800 km. This means that, as the pre- and post-intervals around advisories lengthen, they begin to overlap. For example, if a driver receives advisories 1000 km apart and pre and post intervals of 750 km are used, some driving appearing in the post interval of one advisory also appears in the pre interval of the next advisory. Also, if two advisories come only 400 km apart and the pre- and post-advisory intervals are 500 km, the turn involving second advisory takes place within the post-advisory interval of the first advisory. This type of complication in the sample is preferable to the alternative. That is, if performance data in either the pre- or post-advisory time periods were removed or otherwise avoided based on the occurrence of an advisory, instances of aggressive driving would be systematically filtered out of the sample, tending to bias the result. (In general, the criteria for including data in any analysis may not be related to the dependent measure.)

Performance 250 km before and after an advisory. Main effects of load and advisory exposure were observed for both *AyDSM* and *RRSM* and are shown in figure 8-49 and figure 8-50. No interaction between load and time exposure were observed. The reduction of the *AyDSM* and *RRSM* measures after an advisory message is of particular interest. This is evidence that driving performance appears to be moderated in the 250 km following an advisory. The mean magnitude of the reduction is approximately 0.005 g

across all drivers (95 percent confidence interval, .002 to .007); the mean reduction in *RRSM* is .009 across all drivers (95 percent confidence interval, .004 to .0014). See table 8-22 for a summary of the statistical tests.

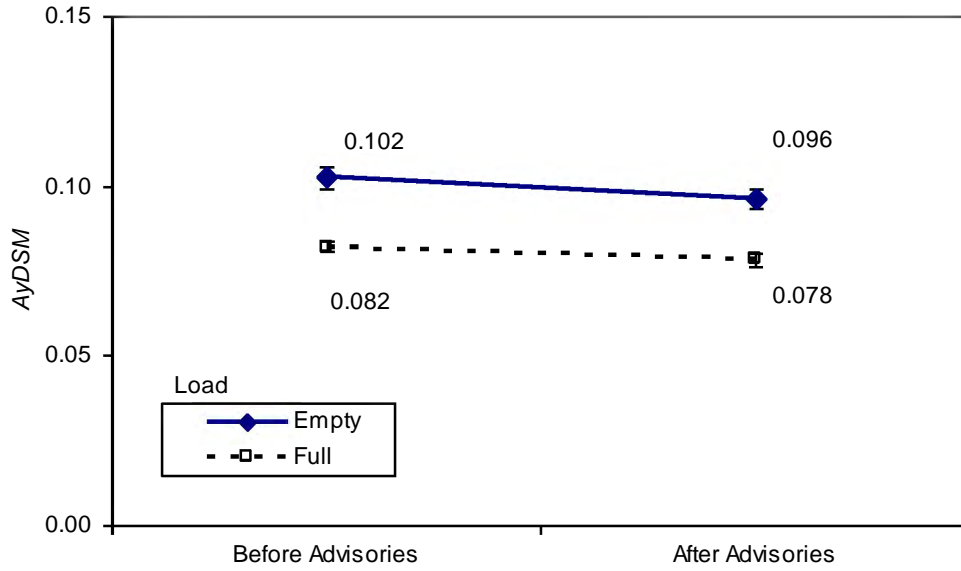

Figure 8-49. Main effects of exposure to advisory messages and load on *AyDSM* in the interval 250 km before and after an advisory

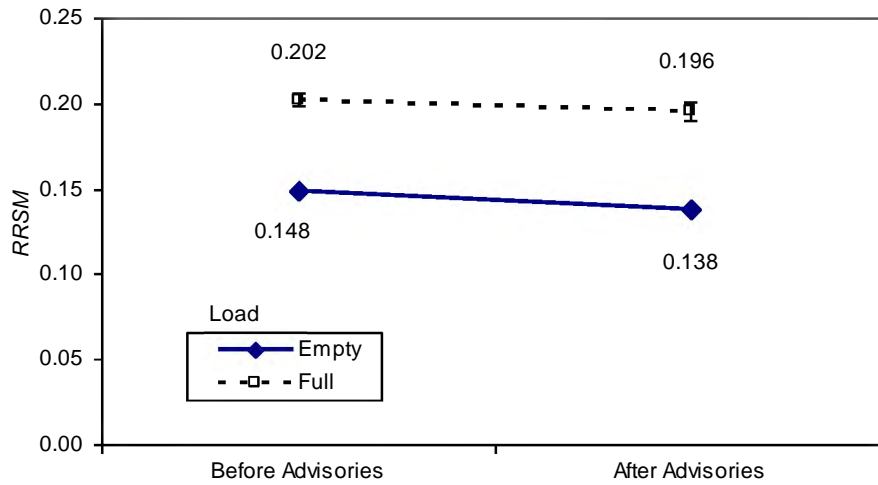

Figure 8-50. Main effects of exposure to advisory messages and load on *RRSM* in the interval 250 km before and after an advisory

Table 8-22. Analysis of influence of advisories on *AyDSM* and *RRSM* in the 250 km intervals before and after advisory

<i>Main Effects on AyDSM</i>			
	<i>F</i>	<i>df</i>	<i>p</i>
Advisory Exposure	14.85	1,10	.003
Load	78.45	1,10	< .0001
<i>Two-way Interactions on AyDSM</i>			
Advisory Exposure by Load	0.16	1,10	.696
<i>Main Effects on RRSM</i>			
Advisory Exposure	16.58	1,10	.002
Load	234.36	1,10	<.0001
<i>Two-way Interactions on RRSM</i>			
Advisory Exposure by Load	0.12	1,10	.736

Performance 500 km before and after an advisory. Main effects of load and advisory exposure were observed for both *AyDSM* and *RRSM* and are shown in figure 8-51 and figure 8-52. No interaction between load and exposure were observed. The *AyDSM* and *RRSM* measures were reduced after an advisory message. The mean magnitude of the reduction is smaller than observed in the 250 km intervals. There was an overall 0.002 g reduction in *AyDSM* across all drivers (95 percent confidence interval, .0008 to .0036) and an .004 reduction in *RRSM* (95 percent confidence interval, .0004 to .007). See table 8-23 for a summary of the statistical tests.

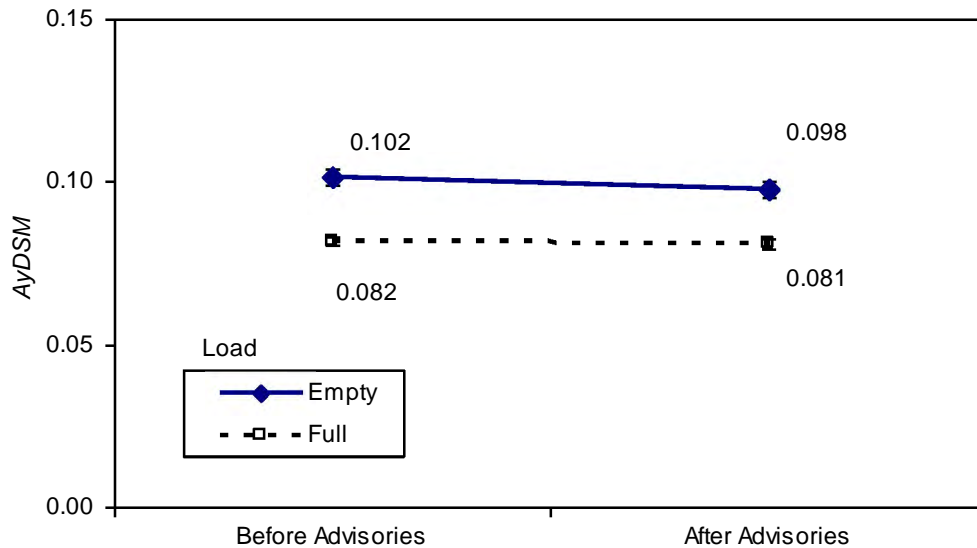

Figure 8-51. Main effects of exposure to advisory messages and load on *AyDSM* in the interval 500 km before and after an advisory

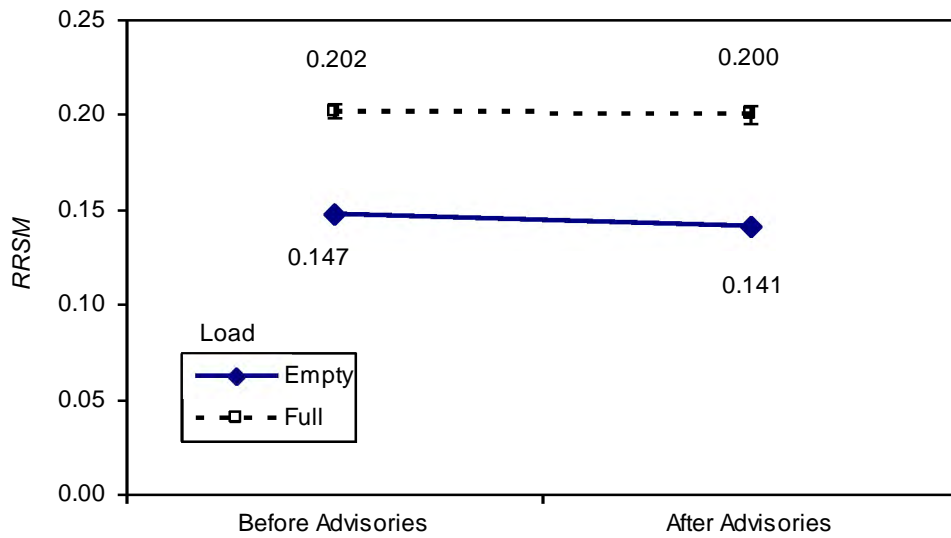

Figure 8-52. Main effects of exposure to advisory messages and load on *RRSM* in the interval 500 km before and after an advisory

Table 8-23. Analysis of influence of advisories on *AyDSM* and *RRSM* in the 500 km interval before and after and advisory

<i>Main Effects on AyDSM</i>		<i>F</i>	<i>df</i>	<i>p</i>
Advisory Exposure		12.45	1,10	.005
Load		90.45	1,10	< .0001
<i>Two-way Interactions on AyDSM</i>				
Advisory Exposure by Load		0.88	1,10	.371
<i>Main Effects on RRSM</i>				
Advisory Exposure		6.34	1,10	.031
Load		349.78	1,10	<.0001
<i>Two-way Interactions on RRSM</i>				
Advisory Exposure by Load		0.52	1,10	.489

Performance 750 km before and after an advisory. A main effect of load was observed for both *AyDSM* and *RRSM*, however a significant effect of time was found only for the *RRSM* measure. The main effect of time on *AyDSM* was marginal (see figure 8-53 and figure 8-54, and table 8-24) suggestive of a weakening of the effect as the distance envelope is extended. No interaction between load and time period were observed.

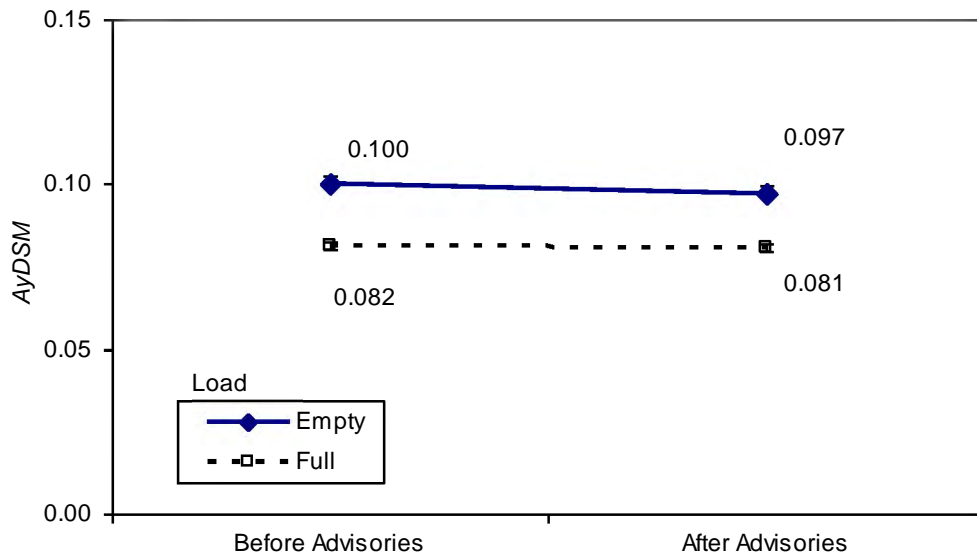

Figure 8-53. Main effects of exposure to advisory messages and load on *AyDSM* in the interval 750 km before and after an advisory

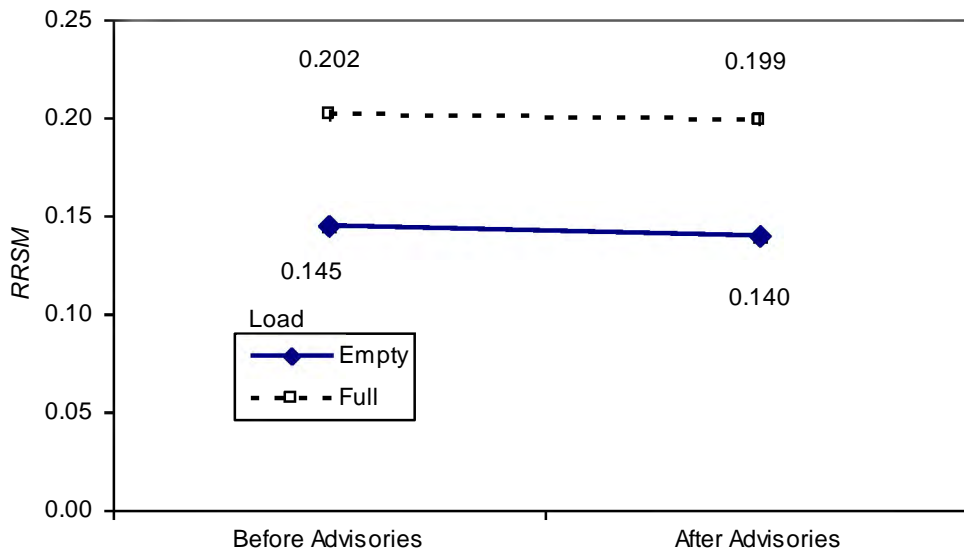

Figure 8-54. Main effects of exposure to advisory messages and load on *RRSM* in the interval 750 km before and after an advisory

Table 8-24. Analysis of influence of advisories on *AyDSM* and *RRSM* in the 750 km interval before and after an advisory

<i>Main Effects on AyDSM</i>			
	<i>F</i>	<i>Df</i>	<i>p</i>
Advisory Exposure	8.63	1,10	.015
Load	66.08	1,10	< .0001
<i>Two-way Interactions on AyDSM</i>			
Advisory Exposure by Load	0.60	1,10	.456
<i>Main Effects on RRSM</i>			
Advisory Exposure	13.83	1,10	.004
Load	241.81	1,10	<.0001
<i>Two-way Interactions on RRSM</i>			
Advisory Exposure by Load	0.305	1,10	.456

In general, advisories appear to moderately alter a driver’s behavior on severe turns that follow the advisory. The effect appears to occur independently of the full or empty condition of the trailer.

Decay of advisory influence. In the above results, the advisory appears to have a stronger influence in the narrow (250 km) interval suggesting, perhaps, a decaying of the influence of the advisory. A further analysis was conducted to examine this issue by comparing each driver’s 500 km performance before an advisory with his performance in four 200 km windows after an advisory (i.e., out to 800 km in 200 km segments). Figure 8-55 shows what appears to be an initial trend toward more conservative driving in the interval immediately following an advisory, followed by a return toward being less conservative in the following interval. The trend was expected to approach zero difference and level off around there. This is not apparent from the figure, although as the interval from the advisory is extended, there is an increasing tendency for overlap with the preceding or the following advisory, as discussed at the outset of section 8.6. It is also unclear why the differences observed appear mostly on the negative side, although 95 percent confidence intervals for differences included zero (see table 8-25). A one-way ANOVA on the post-advisory windows found a main effect of window only for the *AyDSM* and *RRSM* measures with fully loaded trailers.

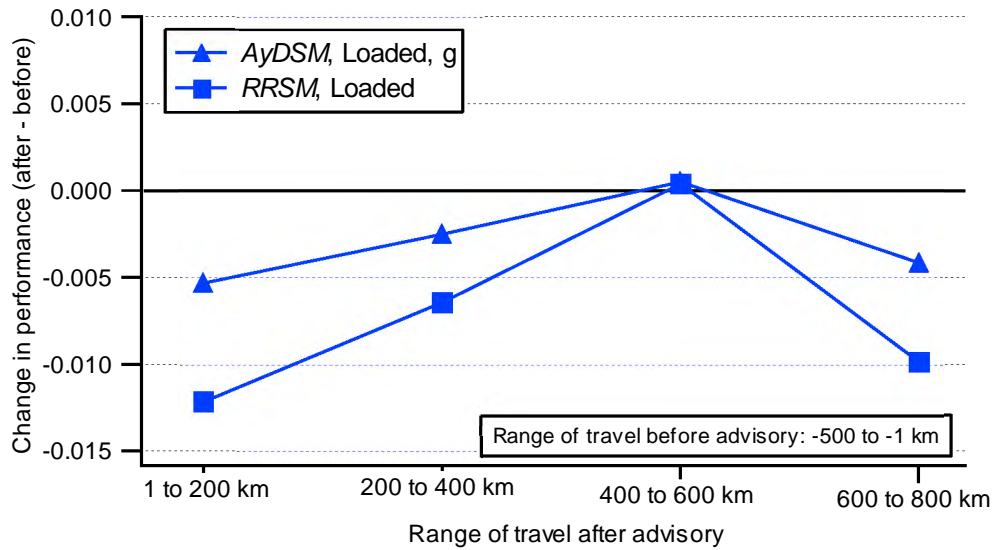

Figure 8-55. Significant changes in performance by interval after advisory

Table 8-25. Mean change in performance in *AyDSM* and *RRSM* by interval after advisory

Measure	Load	DISTANCE	Mean	95% Confidence Interval	
				Lower Bound	Upper Bound
<i>AyDSM</i> (g)	Empty	1 to 200	-0.00328	-0.00686	0.000313
		200 to 400	-0.00108	-0.00924	0.007067
		400 to 600	-0.00313	-0.00947	0.003216
		600 to 800	-0.00466	-0.01065	0.001325
	Full	1 to 200	-0.00531	-0.01019	-0.00044
		200 to 400	-0.00251	-0.00546	0.00044
		400 to 600	0.000488	-0.00225	0.003224
		600 to 800	-0.00416	-0.00675	-0.00157
<i>RRSM</i>	Empty	1 to 200	-0.0048	-0.00973	0.000125
		200 to 400	-0.00469	-0.01232	0.002947
		400 to 600	-0.00584	-0.01383	0.00214
		600 to 800	-0.00626	-0.01397	0.001439
	Full	1 to 200	-0.01213	-0.02254	-0.00173
		200 to 400	-0.00643	-0.0133	0.000449
		400 to 600	0.000366	-0.00448	0.005212
		600 to 800	-0.00984	-0.0145	-0.00519

8.7 Curve performance on specific curves before and after advisories

In this analysis, driver performance was examined on particular curves over which an advisory had been given for that driver. For each driver, and each curve on which that driver received an advisory, the average performance (measured by *AyDSM* and *RRSM*) was calculated before the advisory and after the advisory. The difference between the before and after performance measures was then calculated. For example, if a driver received an advisory on curve A, B, and C, performance data on curve A *before* the advisory was averaged and performance data on curve A *after* the advisory was averaged. Then a before/after difference for curve A was calculated. The same procedure was

applied to curves B and C. Finally, for that driver an average before/after difference was calculated. This procedure was done driver by driver. The analysis required drivers to have had at least one advisory on a curve, along with measures of performance on the same curve *before* the advisory, and measures of performance on the curve *after* the advisory. Of the 14 drivers, only 11 drivers met these criteria; of these 11 drivers, 5 drivers had 3 or fewer curves in their sample. The average differences for each driver in the sample are shown in table 8-26.

Table 8-26. Average difference in curve-performance measures on the same curve before and after an advisory was issued

<i>Driver</i>	<i>Curves in Sample</i>	<i>Average After-Before Difference</i>	
		<i>AyDSM</i>	<i>RRDSM</i>
2020	4	-0.0037	-0.0054
2021	3	0.0111	0.0071
2022	4	0.0064	0.0017
2023	8	0.0073	0.0109
2025	2	-0.0145	-0.0239
2026	1	-0.0307	-0.0505
2028	3	-0.0122	-0.0285
2029	5	-0.0039	-0.0112
2031	17	0.0064	0.0085
2032	11	0.0089	0.0122
2033	1	-0.0121	-0.0241
Mean of all drivers		-0.003	-0.009

T-tests were used to determine whether these observed changes in the mean were significant and they were not (see table 8-27).

A further analysis was conducted to look at second advisories on specific curves with the idea that a second advisory on a particular curve might be more salient to the driver. Unfortunately with this added constraint (2 advisories on the same curve), data from only six drivers could be analyzed. Not surprisingly, no systematic difference in performance before advisories versus performance after advisories was observed.

Table 8-27. Results of t-test examining whether curve performance before and after an advisory on the same curve showed a change in performance

<i>Measure</i>	<i>t</i>	<i>df</i>	<i>Sigma (2-tailed)</i>	<i>Mean difference</i>	<i>95% confidence interval of the difference</i>	
					<i>Lower</i>	<i>Upper</i>
<i>RRDSM</i>	-1.536	10	.156	-.009	-.023	.004
<i>AyDSM</i>	-.858	10	.411	-.003	-.012	.005

8.8 Tail estimates of *RRSM* distributions

Several attempts were made to fit extreme-value distributions to each driver’s curve-performance data for the phase-1 and phase-2 *RRSM* data so that tail characteristics could

be compared between the two phases. In many cases, the likelihood-estimation fitting procedures failed to converge on a set of reliable parameters, suggesting that the data did not derive from a homogeneous, underlying distribution. In our view, to proceed with curve fitting under the circumstances is questionable and extrapolation from poorly fitted distribution functions is likewise questionable. These analyses were therefore abandoned.

9. PERCEPTIONS AND OPINIONS OF RA&C

In this chapter (1) attitudes of the FOT drivers regarding high-technology safety systems in general are reviewed; (2) drivers' opinions about the operational characteristics of the RA&C are described; (3) their opinions about the effectiveness of the system are reviewed; and (4) opinions expressed during the final interview of the drivers are summarized. The subjective data was compiled for the same 14 drivers which were the subject of the quantitative analyses. Note that there are instances of missing data—on occasion, drivers omitted answering some survey items and one driver could not be interviewed for the initial survey just prior to RA&C activation. The results presented here are taken from the following sources³⁷:

- The Initial Survey. This survey was taken shortly after driver orientation.
- Long Periodic Surveys. There were three long periodic surveys given in September, October, and November, 2001.
- Final Structured Interview. This was a comprehensive debriefing of the driver based on a scripted interview.

In addition, some of the results presented here are based on the summary scores for the factors distilled from the Long Periodic Surveys (described in section 4.3.2). These are summarized in table 9-1. The table shows each *factor* for each survey and a fleet score based on the average driver score for that factor (on a scale ranging from +2 to -2). For example, drivers consistently reported that the RA&C produced false alarms (values = 1.0, 0.93, and 0.86 for survey 1, 2, and 3 respectively); they also reported relatively small levels of distraction from the device (values = -0.4, -0.13, and -0.29).

9.1 Driver attitudes toward high-tech safety systems and RA&C

9.1.1 Driver attitudes expressed before exposure to RA&C

Following RA&C orientation but before actually driving with the system, drivers were interviewed in order to develop a picture of their general attitudes toward technology prior to exposure to the RA&C. Overall; drivers reported a general familiarity with computers and a generally positive view toward high-tech safety systems on board

³⁷ There were also two brief surveys used to monitor driver opinion during the field test. This instrument was designed to ensure regular contact with drivers and to provide an active monitoring mechanism for problems drivers might have with the RA&C. As a survey instrument, the short survey was far less comprehensive than the long one. It was later dropped because the turnaround time for this survey was unsatisfactory and interfered with the execution of the long survey.

their trucks. For example, 9 out of 13 respondents reported owning a home computer, although only 5 drivers rated their knowledge of the systems better than their peers.

Table 9-1. The average subjective rating of each factor (maximum score is 2, the minimum is -2, and 0 is neutral)

<i>Factor</i>	<i>Long Survey 1</i>	<i>Long Survey 2</i>	<i>Long Survey 3</i>
Operational Understanding	0.77	0.75	0.60
Need for RA&C	-0.04	-0.11	-0.14
Distraction / Interference	-0.40	-0.13	-0.29
Clarity of Advisories	0.61	0.64	0.51
Safety Benefit	0.05	-0.02	0.07
RSA Advisory Misses	0.07	0.11	0.29
RSA Advisory False Alarms	1.00	0.93	0.86
Influence on driving	-0.48	-0.71	-0.52
RSC False Alarm	0.21	0.14	0.21
Speed Reduction Message Accuracy	0.07	0.36	0.07

Initial expectations about how the RA&C would influence their driving were somewhat non-committal: 4 drivers thought the system would influence their driving, 5 thought it would not, and 3 drivers had no strong opinions. Similarly, when asked to rate their agreement with the statement “*High-tech systems like these do not help the experienced driver,*” drivers were symmetrically split across the range of answers, with a modal response (of 6) at the neutral point. However, when asked to rate their level of agreement/disagreement with the question, “*I would be better off driving without these types of high-tech advice and control systems*”, only 2 drivers agreed with this statement, while 6 disagreed, suggesting a moderately receptive view of the potential for safety enhancement from high-tech systems.

9.1.2 Driver attitudes expressed during and after exposure to RA&C

The FOT drivers were asked to give their general opinions about the usefulness or benefit of high-tech support systems repeatedly throughout the field test to determine if their opinions were altered by their experience. Figure 9-1 tracks drivers’ answers before the RA&C was activated (*Initial*), at three intervals during the field test after activation (*Survey 1*, *Survey 2*, and *Survey 3*), and at a final interview (*Final*). In their respective order, these five surveys were recorded during the months of June, September, October, November, and December of the year 2001.

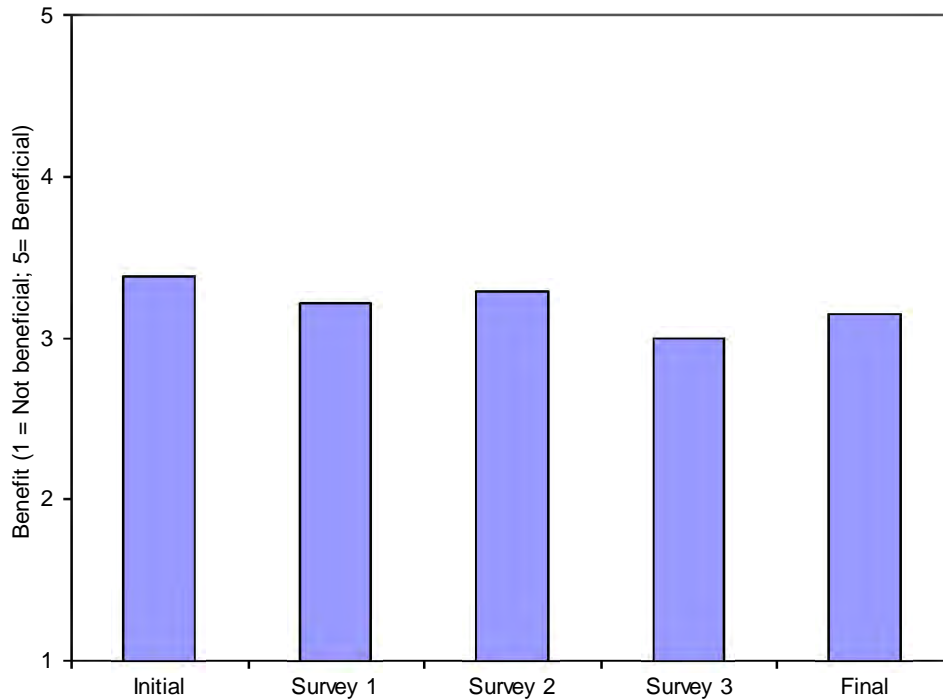

Figure 9-1. Average driver opinion on the benefit of using high-tech systems in driving

In general, drivers’ opinions about benefit (or disbenefit) and utility of high-tech systems were neutral-to-positive at the start and remained so throughout the field operational test. When opinions were solicited about the benefit to *experienced* drivers, a similarly consistent pattern of responses were produced albeit with somewhat lower expected benefit (see figure 9-2). This is not surprising. In the Praxair fleet, drivers have long been familiar with computer-based logistical systems from CADEC and more recently Eaton (*FleetAdvisor*). Besides tracking a driver’s whereabouts, the latter system also monitors and reports incidents of excessive speed and aggressive braking. It is unlikely that drivers with sharply negative opinions about technology would find the Praxair fleet a welcome place to work. Moreover, in the context of the existing technologies that constitute the drivers’ normal work environment, the addition of the RA&C system may not have been seen as a particularly large change.

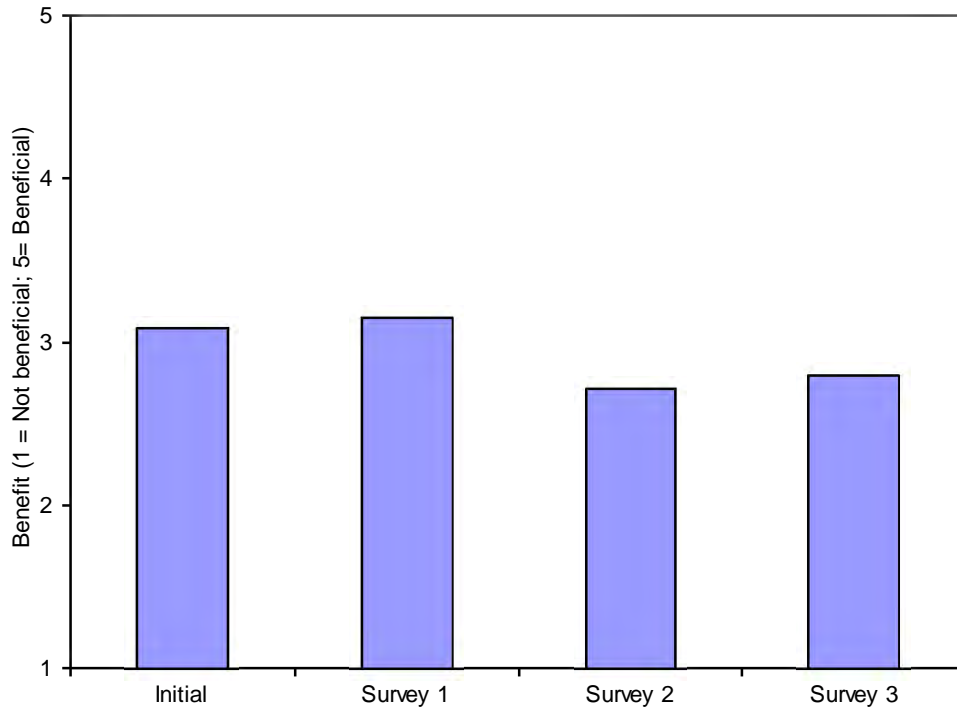

Figure 9-2. Average driver opinion on the benefits of high-tech systems to experienced drivers

9.2 Driver reports about the operational characteristics of the RA&C system

In this section, driver opinions about the functional characteristics of the RA&C system—apart from the driver’s opinions about its direct influence on his driving—are reviewed. In particular, how well drivers thought they understood the operation of the system and their opinions about the accuracy of advisories, the legibility of messages, and whether the RA&C interfered with their driving task is described.

9.2.1 Reported comprehension of the system operation

Drivers were asked to rate their agreement with the statements like “*I have a good understanding about the RA&C system.*” Reported understanding was generally high and remained consistent throughout the field test. On a five-point scale, with 1 being strong disagreement and 5 strong agreement, drivers rated their agreement at 3.7 (sd, 0.7) across the three long surveys (see figure 9-3). Drivers thus appeared relatively confident that they understood the system’s operation.

The high levels of reported comprehension throughout phase 2 were objectively supported by direct questions posed to drivers about the system’s function. Since other on-board systems produced audible warning tones to indicate excess speed or aggressive braking requiring immediate corrective action from the driver, there was particularly interested in knowing whether drivers understood that the advisories from the RA&C occurred *after* an incident and did not require immediate action. Accordingly, drivers

were asked to choose between two alternative meanings of the advisories: one that interpreted the advisory to mean that the driver should slow down *now*, and another which interpreted it to mean that the driver should slow down *next time*. After orientation, 77 percent (10 of 13) of the drivers chose the correct meaning (slow down next time); in the final interview, 62 percent (8 of 13) of the drivers chose the correct meaning, suggesting that some drivers may not reliably remember the meaning of the advisories.

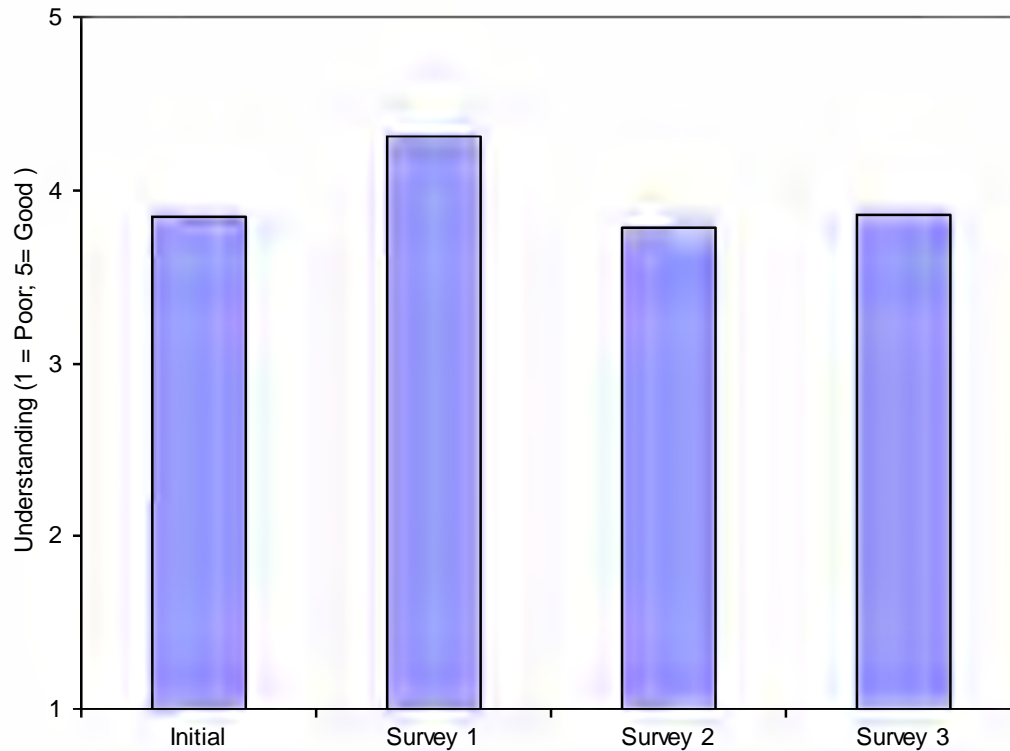

Figure 9-3. Drivers reported generally high levels of comprehension throughout the field test

Pooled answers to survey questions grouped on the factor, Operational Understanding, followed the same pattern and remained consistently positive throughout the phase 2 surveys (see table 9-1).

9.2.2 Perceived accuracy of advisories

In this section drivers' opinions about the accuracy of the RA&C advisories is described. There are two types of opinion about accuracy solicited from drivers. First, drivers were asked if they thought that the advisories were occurring appropriately. Second, drivers were asked if they felt the specific recommendations for reduction of speed provided by the messages were accurate.

As discussed in section 7, most advisories that drivers received were for RSA level-1 events. The distribution of advisories by drivers is given in table 9-2. For the 14 drivers in this analysis, 80 percent of all advisory messages were for RSA level-1 or level-2 events.

The remaining events are split among the RSC (9 percent), HBED level-1 (9 percent), and RSA level-3 (2 percent) events, and are unevenly distributed among the drivers. As can be seen from table 9-2, only 2 drivers were exposed to more than 2 RSC or RSA level-3 events; 5 of 14 drivers received 6 or fewer messages. Thus, some drivers had either no basis or only a modest basis on which to form an opinion about the accuracy of the RA&C. Consequently, drivers were permitted to choose *not applicable* as a survey response whenever they considered their direct experience with the RA&C inadequate to provide an informed opinion. In summarizing driver opinions, *not applicable* responses were recoded as neutral observations.

Table 9-2. Advisories and control events by driver.

<i>Driver</i>	<i>HBED Level 1</i>	<i>RSA Level 1</i>	<i>RSA Level 2</i>	<i>RSA Level 3</i>	<i>RSC</i>	<i>Totals</i>
2020	1	7	3	-	-	11
2021	3	10	-	-	-	13
2022	-	18	3	1	1	22
2023	3	20	2	-	1	26
2025	2	14	5	-	1	23
2026	5	1	-	-	-	6
2027	-	1	-	-	-	1
2028	2	8	2	-	-	12
2030	-	-	1	-	1	2
2031	3	50	17	2	10	82
2032	1	29	12	2	10	54
2033	2	2	-	-	-	4
2034	1	-	-	-	-	1
2035	1	-	-	-	-	1
<i>Totals</i>	24	160	45	5	23	257
<i>Percent</i>	9	62	18	2	9	

In each periodic survey, drivers were asked to comment on the appropriateness of roll advisories (RSA/C advisories) they received, given the circumstance of their maneuvers. This was asked in two ways. In one, drivers were asked whether they thought that the RSA/C gave advisories after *safe* maneuvers (i.e., false alarms); in another, drivers were asked whether the RSA/C failed to make advisories when it should have (i.e., misses).

In general, drivers thought the RSA/C was disposed to making false alarms; and somewhat less disposed to missing events (Advisory False Alarms mean = .93, Advisory Misses mean = .15; see table 9-1). Over time, driver opinion about false alarms appears to become more moderate, while opinion about misses appears to increase.

The relationship between these opinions about accuracy and the drivers' exposure to RSA/C advisory episodes is shown in figure 9-4. The pattern of responses is somewhat unexpected in several respects. For example, the highest reported false alarm rates occurred among drivers who received only a moderate number of advisory episodes (10 and 22 advisories); some drivers who received very few messages appeared to report high false alarms.

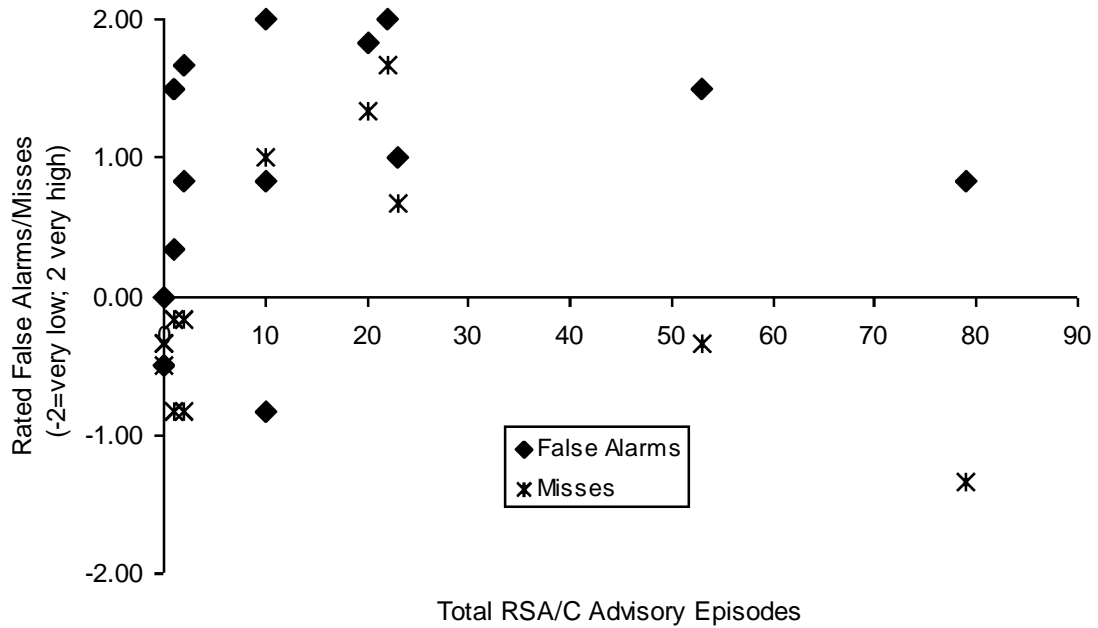

Figure 9-4. Relationship between RSA/C advisory episodes and drivers' opinion about false alarms and misses

Whether drivers considered the RSA/C's behavior as simply a sensitivity issue or as a problem in the reliability of detection can be estimated by adding the false-alarm and miss ratings. For example, a driver who thought the RSA/C had a low-threshold for reporting severe maneuvers, but thought the system reliably detected severe events, would be expected to report high false alarms and low miss rates. Another driver who felt that the system was not at all reliable in detecting severe events might report both high false alarms *and* high miss rates. In the first case, the false alarm rating would be offset by the subjective miss rating. In the second case, no such offset would be apparent. Figure 9-5 plots subjective inaccuracy by the number of RSA/C advisory episodes each driver received. In general, the figure suggests that three of the drivers appeared to regard the RSA/C as inaccurate, while the rest appeared to largely regard it as merely biased toward over reporting severe maneuvers.

Drivers appear to believe that the system is somewhat too sensitive and does not properly take into account the difference in stability between a loaded versus an unloaded tanker. Consistent with this observation, most advisory episodes occurred while the trailer was empty (186 empty RSA/C advisory episodes versus 16 full advisory episodes for the comparable drivers).

In the final interview, drivers were also asked to rate the accuracy of the advisories they received for each subsystem and to describe their recollections about the circumstances in which the advisories were given. Two drivers rated the RSA as very accurate, 4 rated it as somewhat accurate, 1 could not judge, and 6 rated it as inaccurate. No ratings were provided for the RSC because few drivers remembered receiving

messages from this subsystem. Nine drivers out of 13 reported receiving inappropriate messages. When asked to describe the circumstance, 7 reported maneuvers while empty; 2 mentioned receiving a message at a stop, and another driver mentioned receiving a message on gravel or slippery pavement. (In this latter case, the driver did not distinguish whether the message was for hard braking, roll stability, or traction control.)

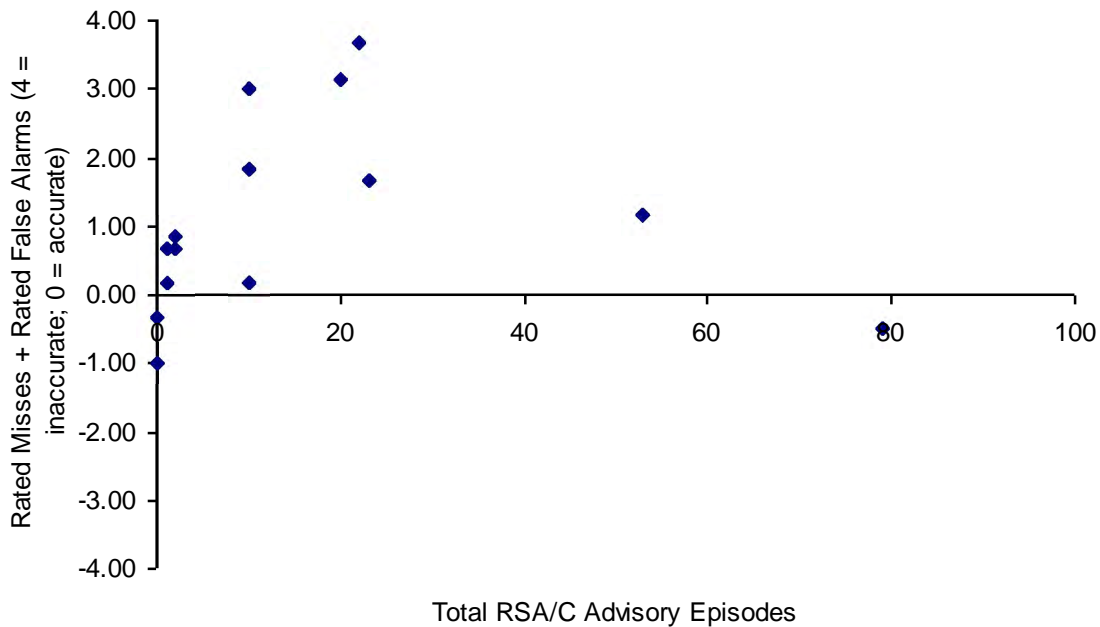

Figure 9-5. Relationship between RSA/C advisory episodes and perceived inaccuracy of the RSA/C in detecting severe maneuvers

The relative performance of the RSA/C when driving with full vehicles in comparison with empty vehicles was also cited by drivers in the final interview when asked to suggest improvements in the system. Some of the comments indicated that drivers thought the system did not differentiate well between empty and full conditions: “[*Make it*] more sensitive to loaded conditions and less when empty”; “Adjust computer to know empty or loaded...”; “Low speed empty [*produced*] unwanted warning.”

Speed-reduction advice. In general, drivers rated the accuracy of the speed-reduction advisories positively in the surveys conducted throughout the field test (mean = 0.17), and in the final interview, 5 drivers reported the messages to be very accurate, 4 reported them to be somewhat accurate, and only 2 drivers thought the messages were somewhat inaccurate. While they may not have agreed that an advisory was needed, drivers generally considered the speed message to be accurate.

9.2.3 Opinions about message presentation

In the periodic surveys, drivers were asked about the RA&C messages presented on the message center display two ways. One question was about legibility of the message:

“The messages from the roll over advisory system are easy to read.” Another question was about understandability: *“The advisory messages from the Roll Stability Advisor are easy to understand.”* The median score for each question throughout the field test was 4.0 (agree) on a scale where 5 indicated strong agreement and 1 indicated strong disagreement.

When asked about message presentation in more detail during the final interview, drivers reported the RA&C messages easy to distinguish from other messages (12 of 13), 11 of 12 drivers reported seeing all or most of the messages, and all the drivers rated the message center as good or very good. When asked about specific conditions they thought would make the message center difficult to read, 6 drivers identified direct sunlight as a possible problem. Notably, only 1 driver (of 12) thought heavy traffic would make monitoring the message center difficult. Drivers appear fairly comfortable with the presentation of advisories on the message center.

9.2.4 Perceived level of distraction produced by the system

Concern over increase in workload and the introduction of new sources of distraction for the driver prompted us to ask several questions related to the effect of the RA&C on the normal driving task. Even though a new safety system might demonstrably improve driving safety in certain respects, this could easily come at the expense of safety in other areas. For example, a lane departure system with very low tolerance for a lane deviation might place such a control burden on the driver that traffic control signs may be overlooked. While the driver may show less inclination to run off the road, he may become more inclined to run stop signs and collide with other road users.

In the periodic survey, four items addressed the question of driver distraction (see table 4-5). In general, drivers reported little distraction with the RA&C, the derived mean distraction score was -0.27. As figure 9-6 shows, even drivers with large numbers of advisories did not find the RA&C to be distracting. One driver with only 2 RA&C messages, however, reported the system to be very distracting. The same driver also rated the safety utility of the system lowest (-1.42), the influence of the system on his driving lowest (-1.75), and was the only driver to report the advisory tones to be too loud. This driver also felt that the tones were not sufficiently distinctive from the other warning sounds present in the tractor. It is possible that the driver may not have reliably distinguished the RA&C from the other on-board systems when he made his ratings, or simply responded in a generally negative fashion wherever possible.

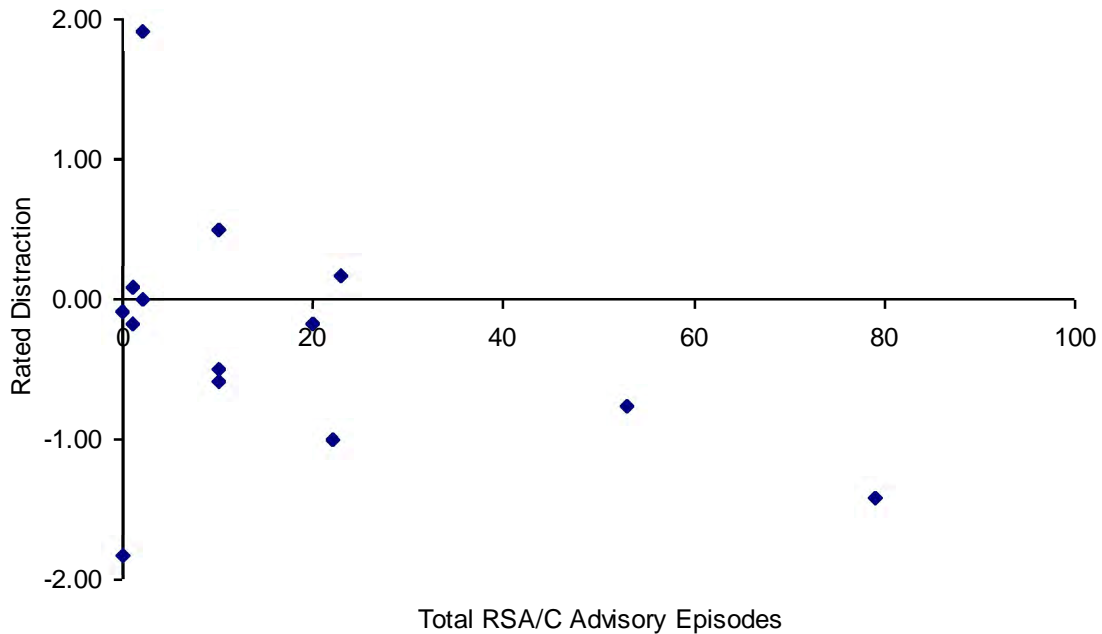

Figure 9-6. Relationship between RSA/C advisory episodes and rated distraction among drivers

9.2.5 Driver ability to distinguish between system components

The pattern of correlations among the survey answers suggested that drivers answered questions about the utility of the HBED advisories in a similar way as they answered questions about the utility of the RSA and RSC advisories. Given the frequency distribution of advisory and control events shown in table 9-2, it is clear that many drivers did not have sufficient opportunity to observe all three functions. Drivers may not have reliably distinguished between the various subsystems when making their responses.

Nevertheless, drivers appeared to be aware of the different functions when responding in the final interview. Thirteen of 14 drivers reported observing RA&C advisories; 12 of 14 drivers actually received advisories. Five of 13 reported HBED advisories; 10 of these 13 drivers actually received advisories. Zero of 10 drivers reported RSC activation; 5 of these drivers were actually subjected to an RSC event. Clearly drivers were making distinctions between the various system components that were somewhat related to the actual distribution of activations among the drivers, although distinguishing RSC advisories and actions was more difficult.

9.3 Driver perception of the effectiveness and utility of the RA&C system

9.3.1 Perceived influence on driving behavior

Drivers were asked their opinions about the extent to which they thought their driving would be or had been influenced by the operation of the RA&C, and whether they thought the system had reduced their risk of rollovers.

In the initial survey, drivers were asked to rate their level of agreement with the statement, “I don’t expect to drive any differently as a result of having the roll over advisory system in my truck than I would drive without it.” In the periodic survey drivers were asked to complete the statement, “In the coming months, I expect the Roll Advisor and Control system to...” with one of the following options: “greatly reduce my chances of having a rollover; somewhat reduce my chances of having a rollover; reduce my chances of rollover a little; make no difference in my chances of a rollover.” Figure 9-7 charts average changes in drivers’ opinion during the field test. Drivers’ expectation was initially neutral at the start, lowered at the first periodic survey, and rebounded somewhat later in the study.

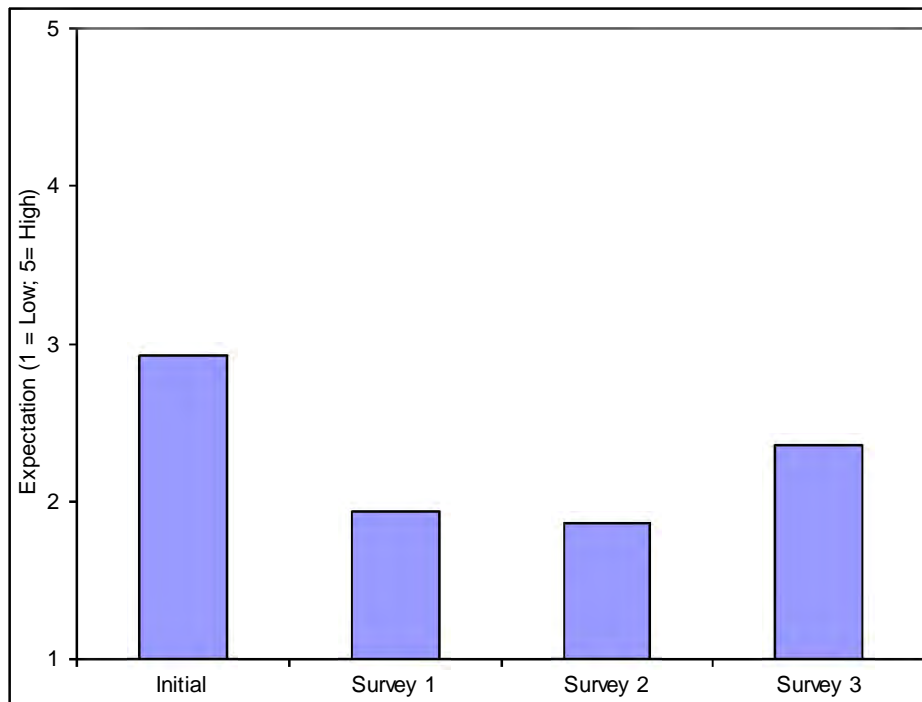

Figure 9-7. Drivers’ expectation that the RSA will change their driving behavior

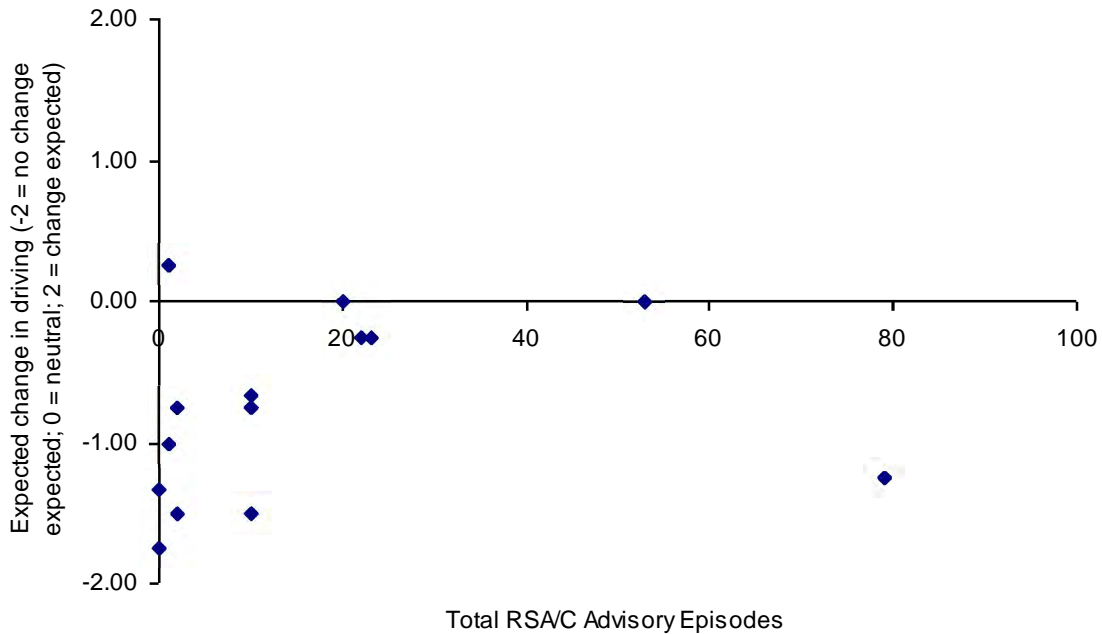

Figure 9-8. Relationship between RSA/C advisory episodes and expected change in driving

Averaged driver opinions as a function of exposure to advisories is shown in figure 9-8. As might be expected, drivers with minimal exposure to the RA&C showed a low expectation that their driving was influenced by the system. However, the driver with the largest number of advisories also seemed somewhat dubious that the advisory system altered his behavior.

9.3.2 Perceived influence of RA&C on risk reduction

In both the initial and periodic surveys drivers were asked to characterize their sense of how much the RA&C system would reduce their risk of rollover on a 4-point scale: where 1 = no difference to 4 = greatly reduced change of rollover. Figure 9-9 shows that drivers begin with high expectations which drop after some direct experience with the system. However, drivers collectively maintained a small, but positive, expectation for risk reduction throughout the field test.

Drivers were also asked to rate the usefulness of the RA&C in the periodic survey with the following sentence completion: *“In general, do you see these systems as: (1) useful to you in driving your truck; (2) creates a problem for you when driving your truck; (3) not useful to you in driving your truck, but not a problem.”* A similar question also appeared in the initial survey soliciting opinions about the usefulness of other control and information systems drivers had prior experience with. (Note that survey questions were re-scored to reflect the ordinal rating of usefulness.) Driver ratings over the field test are shown in figure 9-10. In general, drivers seemed to develop more positive

opinions that safety systems are useful, even if they consider the influence of the current system to be minimal.

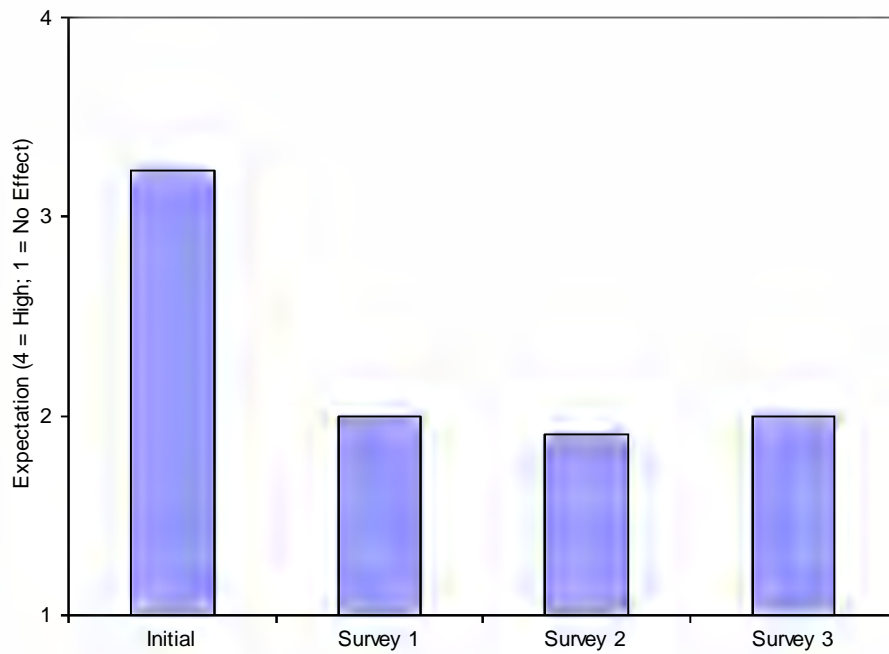

Figure 9-9. Driver opinions of expected risk reduction

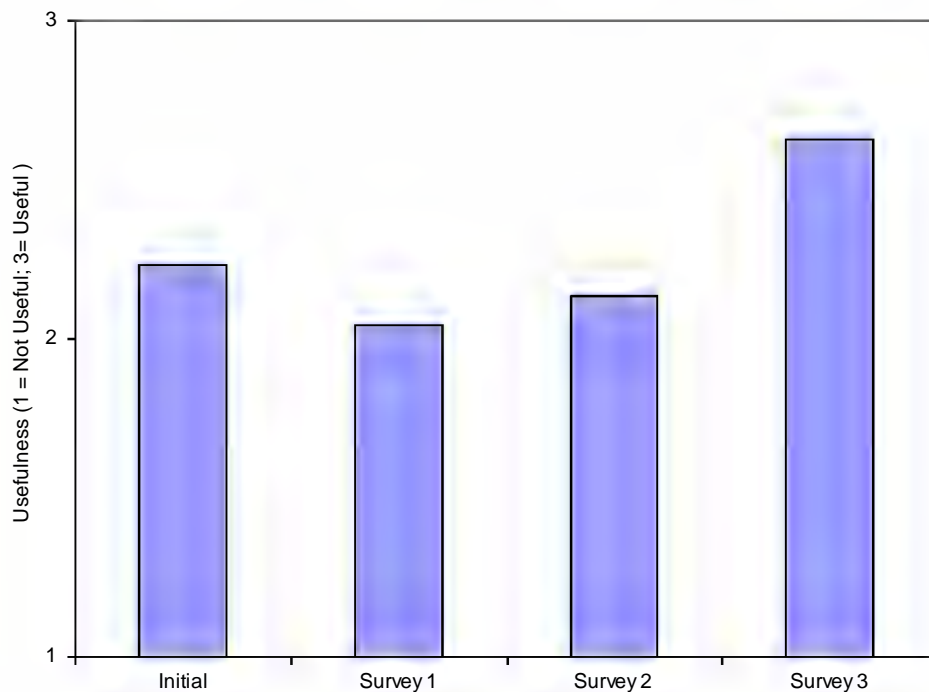

Figure 9-10. Drivers' perceived usefulness of the Roll Stability Advisor over the course of the FOT

9.4 Final driver opinions

The final interview targeted driver opinion in five basic areas: system function, perceived validity, perceived value, acceptability, and driver recommendations.

9.4.1 System Function

Over the course of the field test, drivers were predominantly exposed to the roll advisory (RSA) component of the RA&C (see table 9-2 for driver exposure breakdown), although two drivers received no roll advisories whatsoever. Drivers were therefore invited to comment only on system functions for which they felt they had sufficient experience. Of the 14 drivers, only 13 commented on the RSA, 5 on the HBED, and no driver recalled specific experience with the RSC.

Generally, drivers' recall of messages was closely related to their exposure, although drivers underestimated the number of RSA and HBED advisories they received (see figure 9-11 and figure 9-12).

No drivers recalled any RSC activations over the field test. As a result, no opinions about its operation were collected.

Most drivers recalled receiving only one kind of advisory message (7 out of 12 drivers). Five drivers reported the ability to distinguish different advisory messages, but when pressed to specify what the different messages were, they were not able to clearly identify how the messages were different, suggesting that drivers perhaps judged differences by the advisory tone duration. When explicitly asked how many levels of RSA advisory they recalled, 5 of 8 drivers reported one level and 3 drivers reported two levels. Of the drivers who reported receiving advisories of more than one level, none thought the number of advisory levels was too high; one driver thought there were too few levels.

Advisory message presentation. Most drivers reported they could readily distinguish safety-related messages from other informational messages presented on the message center (12 of 13) and were generally confident that they saw most or all of the messages. All drivers (13) rated the effectiveness of the display as either *good* or *very good*.

Advisory tones. Most drivers reported hearing the warning tones accompanying advisories (12 of 14), although only two drivers thought they heard more than one audible level of advisory. One of these drivers reported receiving three levels when his record shows that he received only 2 level-1 RSA advisories, and 2 level-1 HBED advisories. The same driver was unique in reporting the length of the tones as too long, and the volume too loud. Drivers found the tones to be “*ok*” in volume and duration (9 of 12 and 7 of 12, respectively); 4 drivers thought the tones were too soft. All considered the tones to be helpful in directing their attention to messages.

Logging functions. Nine of 14 drivers reported using the logging functions to track their advisories. Those that did not use it felt there were too few advisories to bother with it, had little use for it, or felt that they had too much other work related to the *FleetAdvisor* to bother with the logging functions. Of those that used logging most tracked both HBED and RSA advisories.

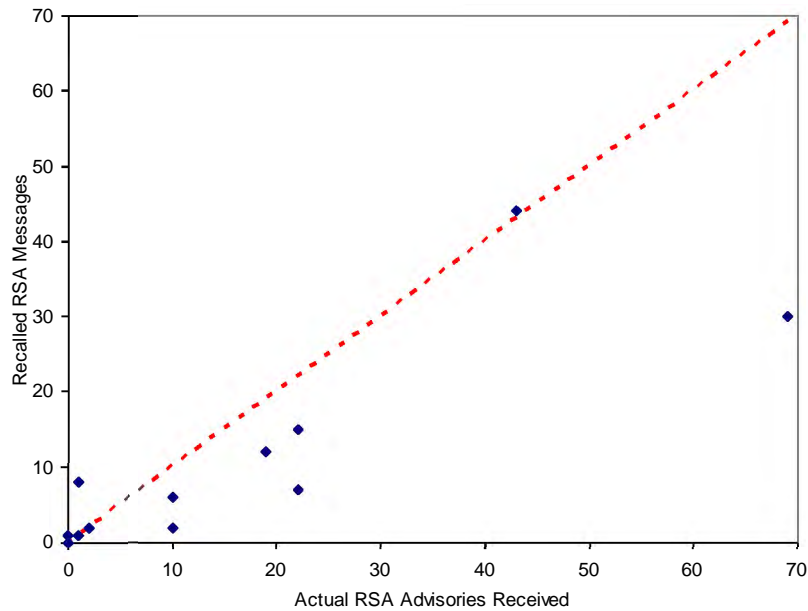

Figure 9-11. Actual and estimated number of RSA advisories by individual drivers

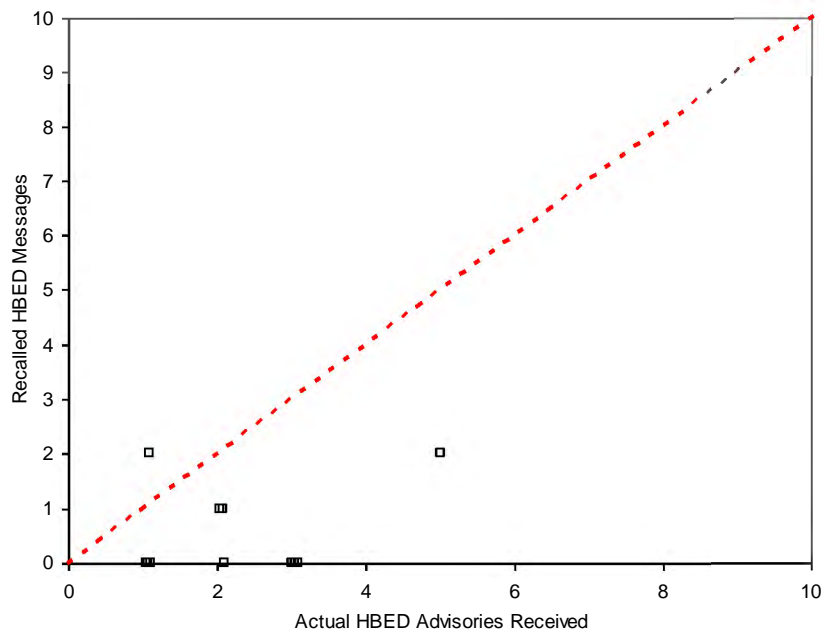

Figure 9-12. Actual and estimated number of HBED advisories received by individual drivers

Acknowledge key. Most drivers (9 of 12) reported they did not use the acknowledge key to dismiss advisories; 6 reported being unaware of the function; one driver chose to

keep his eyes on the road. (Note advisories are automatically dismissed after a prescribed time period.)

9.4.2 *Perceived validity/accuracy of the RSA*

Final driver opinion was divided regarding the accuracy of the RSA. Six drivers rated the system as accurate or very accurate, 6 drivers rated the system as *somewhat inaccurate*, and one driver rated it as neither accurate nor inaccurate. Most drivers (9 of 13) reported receiving incorrect messages, particularly when the trailer was empty. In contrast, speed recommendations were generally thought to be accurate. One possible interpretation of this result is that while drivers often felt an advisory should not have been given, they may have independently regarded the speed recommendation as appropriate. (For example, “*I don’t think that maneuver was risky with regard to rollover potential, but I may have taken that curve too quickly.*”)

Drivers most often cited “sharp” turns with empty trailers as the maneuver which erroneously triggered advisories.

9.4.3 *Perceived effect and value*

Effect on driving. Drivers were asked to evaluate the degree to which the RA&C functioned as a system to make their driving safer. Of the 13 responding drivers, 7 reported their driving to be safer and 6 reported it to be unchanged. When asked to specify how their driving changed, most drivers cited a heightened awareness of curves and ramps. When asked to identify specific driving situations that are handled differently, drivers again identified turns and freeway ramps as key situations in which their driving had changed. When asked whether they *learned* anything about rollover avoidance or special driving situations in which they should exercise more caution, drivers reported a heightened awareness of curves, ramp traversal, and immediate surroundings. That is, drivers did not articulate specific avoidance strategies beyond a heightened situational awareness.

Drivers were also asked if they drove differently in an RA&C-equipped vehicle than they did in other trucks. Twelve of the 14 drivers reported their driving to be no different.

Value of RA&C to drivers. Drivers gave the RA&C system high marks regarding its value to inexperienced drivers: 13 believed there would be *some* or *great* benefit for inexperienced drivers. The judged benefit for experienced drivers was different: only 1 driver thought there would be great benefit, 9 thought there might be some benefit, and 4 thought there would be no benefit.

9.4.4 Overall acceptability of the system

Drivers were asked to describe any undesirable effects of the system. Of the two drivers reporting undesirable effects, one suggested it was distracting (this driver was identified earlier), and another reported not wanting “...*to be bothered by another beep.*” Twelve other drivers reported no undesirable effects. The driver who reported the system as distracting noted that he found it to be distracting only when “...*it shouldn't have come on—slow speed, empty.*”

Drivers were also asked about possible indirect benefits of the system, e.g., reduced fatigue, improved safety beyond rollover risk, and heightened job satisfaction. Driver opinion suggested that the RA&C did not strongly affect any of these characteristics.

When asked if they would be concerned if a record of their advisory messages were reported back to Praxair, 4 drivers indicated they would be concerned. Among these 4 drivers, 3 had the highest total number of advisories (82, 54, and 26) and expressed concern about its use “against” drivers. One had relatively few advisories (6), but cited a general concern about privacy.

Driver Recommendations. Drivers were asked to make suggestions about how to improve the system. Most often drivers cited something about the sensitivity of the advisory system. One driver wanted sensitivity control, another suggested it not trigger when empty or slow, another suggested that it be, “*More sensitive to loaded conditions and less when empty.*” Drivers also suggested that the timing of the advisory be adjusted to occur *before* events. Two comments suggested modifying advisory tones to lengthen them and to make them “...*different from others in [the] truck.*”

Final Driver Assessment. The RA&C was generally met with positive acceptance. Seven drivers found the RA&C acceptable without condition; 7 other drivers found it acceptable provided the changes were made to correct the system's sensitivity to load (5 drivers), signal *before* rollover risk (1), or make the advisory tone more distinctive.

When asked their preference for various comfort and safety-related options, drivers ranked *warning* systems most highly, often mentioning concerns about fatigue while driving. The RSA component of the RA&C was ranked next highest, with the RSC or HBED components ranked lowest. Some drivers mentioned that HBED systems (including the hard-braking warning in the *FleetAdvisor*) were annoyingly blind to the circumstances of the hard-braking events that triggered the advisory or alerting tones.

9.5 Local management opinion survey

At the conclusion of the FOT, a telephone interview was conducted with the local Praxair operations manager to obtain another perspective on how the system integrated into fleet operations. In that interview, the operations manager reported anecdotal driver

comments consistent with the comments made in the driver opinion surveys. Specifically, he reported that drivers questioned the accuracy of the advisories; in particular, advisories appeared to occur when no real danger was believed to be present.

In the view of the operations manager, the system's effectiveness could be improved by coupling periodic reports of driver performance to management reviews.

10. SUMMARY OF FINDINGS

The intent of this chapter is to briefly review the more significant findings of this FOT. At the outset, it is prudent to emphasize that these findings are not necessarily general but may depend, in part, on the conditions under which the data on which they are based were gathered. The following lists just a few of the specific conditions of this FOT which could have influenced the results.

- The study involved just one commercial operation centered primarily around one truck terminal in La Porte, Indiana.
- The study was limited to the geographical area essentially within a half day's truck travel from the La Porte terminal.
- The data derived from driving on a particular set of routes with their peculiar distributions of road types and driving conditions. Moreover, those routes did not remain constant over the entire period of data collection.
- The study involved just six vehicles, all virtually identical tractor-semitrailer combinations and all hauling just one commodity, liquid nitrogen.
- The study involved 23 individual drivers. Of these, only 14 participated throughout the study. Moreover, although this has not been shown objectively, the drivers who participated could reasonably be described as a *mature* and *experienced* group.
- The data derive from essentially a one-year period with its specific variations in weather and economic conditions.

With this important preamble, this chapter will summarize (1) observations on drivers' lateral (turning) performance in general, (2) observations on the performance of the RA&C device, and (3) observations on the influence of RA&C on driving behavior as revealed by lateral performance measures.

As was the case in the expanded discussions of the previous three chapters, the description of lateral performance in this section is presented largely in terms of two primary measures: lateral acceleration and rollover ratio. Reiterating material presented in chapter 3, lateral acceleration refers to the component of acceleration lateral to the vehicle and parallel to the road surface and includes the component of gravitational acceleration parallel to the road surface. This is different from the formal definitions wherein lateral acceleration is taken in the horizontal plane, and thereby does not include gravitational influences [6,7]. The definition used here is seen as more directly applicable to the problem of rollover. Unless otherwise noted, the lateral-acceleration measure in the following represents the lateral acceleration at the longitudinal position of the driver.

Rollover ratio is defined as the ratio of lateral acceleration to the static roll-stability limit of the vehicle given its prevailing loading condition (equation 7-2). In this case, the lateral acceleration in question is of the total vehicle, i.e., the combination of tractor and trailer. A rollover ratio of zero implies zero lateral acceleration; a rollover ratio of one implies lateral acceleration equal to the prevailing static stability limit of the vehicle.

10.1 General observations on the turning performance of the drivers

A number of binary factors were seen to significantly influence the turning performance of the drivers in this study. The relative strength of these factors, in terms of maximum sustained rollover ratio and lateral acceleration are shown in figure 10.1. Each of these factors, plus other general observations, are discussed below.

- *Drivers.* Large differences in the turning performance were observed among the different drivers.

The differences in lateral acceleration experienced among the several drivers of the study were unexpectedly large and were much larger than the performance differences attributable to such factors as load, speed, etc. Depending on the particular threshold value and conditions chosen, the most conservative driver was some 100 times less likely to experience elevated lateral accelerations than was the least conservative driver.

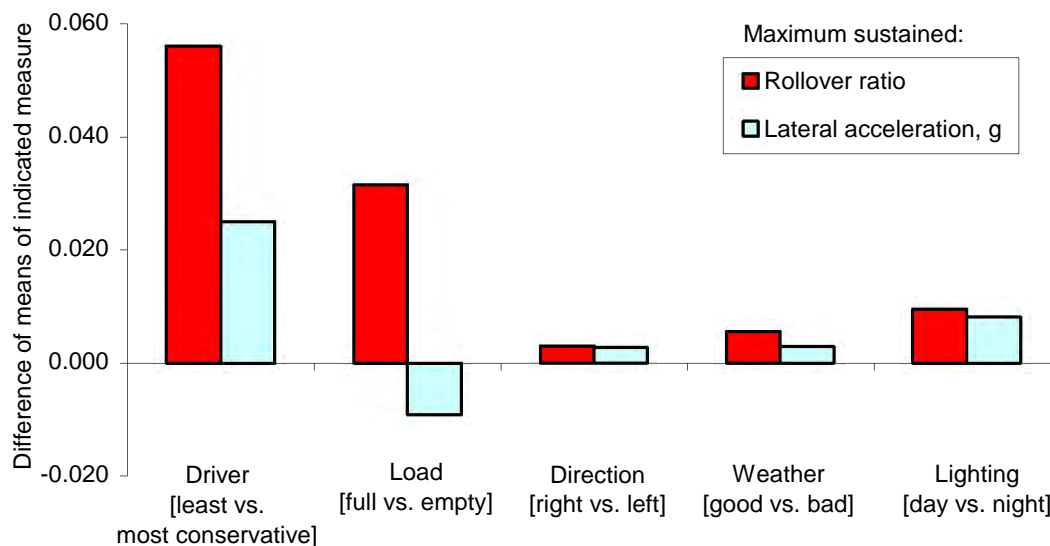

Figure 10-1. Relative strengths of different factors on turning performance³⁸

³⁸ Strictly speaking, these data are not all directly comparable. Measures for load, direction, and weather are main effects from primary multifactor analyses. Measures for drivers come from direct comparisons using the same source data. Measures for lighting are main effects from a secondary multifactor analysis. Nevertheless, the nominal relationships shown by these comparisons are valid.

- *Loading.* Drivers showed a strong tendency to drive loaded vehicles more conservatively than empty vehicles—at least as based on *lateral acceleration*.

Drivers tended toward lower magnitudes of *lateral acceleration* when driving loaded vehicles. However, this tendency was not nearly strong enough to compensate for the lower roll stability of loaded vehicles. The result was that drivers were much more likely to generate higher levels of *rollover ratio* and, thus, assume a higher risk of rollover when driving loaded vehicles than when driving empty vehicles.

- *Speed.* There was a tendency for less conservative turning at slower speeds than at faster speeds.

Higher magnitudes of *lateral acceleration* and *rollover ratio* were both associated with slower speeds. This observation is similar to reports that have appeared in the literature in connection with driving passenger cars [e.g., 9,10]. Whatever motivates passenger-car drivers in this regard presumably also influences truck drivers. Particularly in the case of tractor-semitrailer combinations (as in this FOT), the phenomenon of off-tracking may also influence the driver's perception of rollover margin in slow-speed turns.

- *Weather.* Weather condition (good/bad) was found to have a statistically-significant influence on turning performance in the manner that would normally be expected. That is, turning behavior tended to be more conservative in bad weather than in good weather.
- *Lighting.* Ambient lighting (more precisely, day or night as indicated by solar zenith angle) was also found to have a statistically significant influence on turning performance, again in the manner that would be expected. That is, turning behavior tended to be more conservative at night than during the day.
- *Turn direction.* Turn direction was also found to have a statistically-significant influence on turning performance. Turning behavior tended to be somewhat more conservative in left turns than in right turns.
- Approximately 9 percent or less of all travel time was spent *in turns*.

Here, the term, *turns*, is defined as travel in which path radii smaller than 1000 m are sustained for 3 seconds or more. Virtually all travel on radii less than 500 m fell into this category suggesting that traveling “straight ahead” includes “wandering” with transient radii greater than 500 m.

- The amount of travel time spent in excess of a given magnitude of lateral acceleration declined more-or-less logarithmically with magnitude.

For example, the fleet spent 100 percent of its travel time at magnitudes of lateral acceleration greater than 0.0 g (of course), approximately 10 percent at magnitudes greater than 0.05g, and about 1 percent at magnitudes greater than 0.1 g.

- The magnitude of lateral acceleration experienced by the fleet was distinctly asymmetric with respect to the polarity of lateral acceleration. The asymmetry favored positive values of at low levels of lateral acceleration and negative values at elevated lateral accelerations.

(Positive acceleration is produced either by cross slope downward to the right or by left turns; negative acceleration is produced by cross slope down to the left or by right turns.) The asymmetry favoring positive values at lower levels of lateral acceleration results from the normal cross slope of nominally-straight roads. The most likely value of lateral acceleration was about 0.017 g implying a most-common cross slope of 1.7 percent. The asymmetry favoring negative values at high lateral accelerations appeared to be caused by the preponderance of turns to the right on entrance, exit, and interchange ramps.

10.2 Observations on the RA&C device

It is important to note that RA&C is a system in continuing development. Therefore, the following observations only apply to the specific version of RA&C that was installed in the FOT test vehicles during phase 2 of this field test.

- The RSA and RSC functions of RA&C were seen to be insensitive to the prevailing roll stability of the vehicle combination such that advisories and control actions were triggered primarily on the basis of exceeding certain thresholds of lateral acceleration.

Lateral acceleration thresholds for triggering level-1, -2, and -3 RSA advisories appeared to be approximately 0.21, 0.25 and 0.30 g, respectively. However, there was also a good deal of overlap in the lateral acceleration ranges in which advisories were issued. The threshold for RSC advisories and control actions appeared to be approximately 0.30 g. No RSA or RSC advisories were issued below 21 kph. Otherwise threshold accelerations appeared to be insensitive to speed of travel.

- Due to a combination of driver behavior and the insensitivity of advisories to mass or to the prevailing roll stability, the great majority of RSA & RSC advisories and actions involved lightly-loaded vehicles.

As noted in section 10.1, drivers tend toward higher lateral accelerations when driving more stable, lightly-loaded vehicles. This combined with the

insensitivity of RA&C to mass or prevailing stability resulted in more than 80 percent of the advisories observed being associated with empty or nearly-empty vehicles. This was so even through exposure (by distance or time) was nearly the same for empty and loaded vehicles.

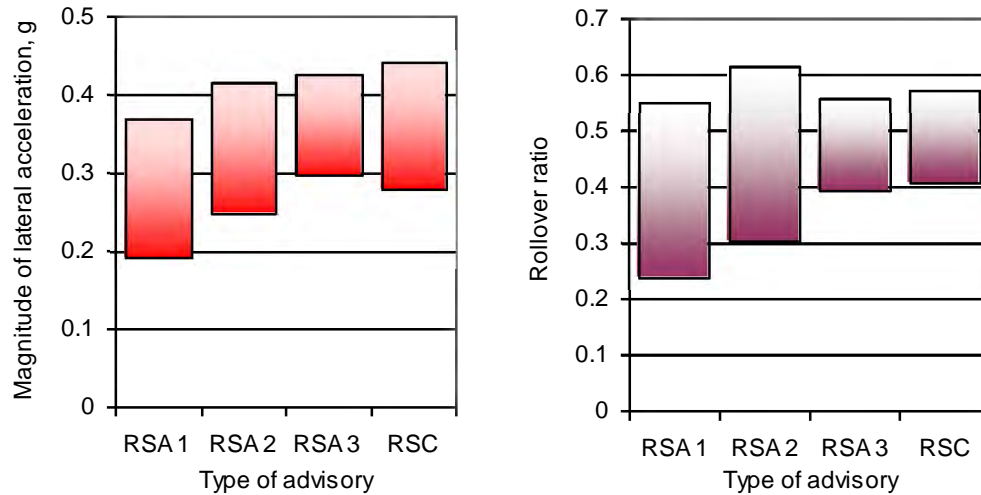

Figure 10-2. Ranges of the maximum magnitude of lateral acceleration and rollover ratio associated with RSA/C advisory messages

- RSA and RSC advisories and actions were judged to be rather conservative. This was especially pronounced for empty or lightly-loaded vehicles, largely because advisories thresholds were insensitive to mass or to the prevailing roll stability.

Some 93 percent of RSA/C advisories were issued during episodes in which the rollover ratio of the vehicle did not exceed 0.5. For lightly-loaded vehicles, advisories were issued during episodes in which the maximum rollover ratio was as low as 0.24 and as high as 0.46. For heavily-loaded vehicles, advisories were issued in episodes where maximum rollover ratio ranged from about 0.39 to 0.62.

- RA&C advisories and control actions were strongly associated with a few individual drivers.

Two of the 19 drivers who participated in phase 2 accounted for 39 percent of all the RSA/C episodes (including 43 percent of all RSA/C messages) but only 12 percent of phase-2 travel. On the other hand, six drivers had none or only one RSA/C episode.

- There were far fewer braking-related advisories than roll-related advisories.

There were 38 HBED advisories and 132 RSA/C advisories issued during phase 2. (Note: there were no snow or ice conditions during phase 2.)

- All HBED advisories issued were level-1 advisories indicating ABS activity without high deceleration.
- Roll-related and braking-related advisories largely took place in separate episodes. Just one episode involved both RSA/C and HBED advisory messages.

10.3 Observations on the effect of RA&C on turning performance

The RA&C system studied in this FOT was a composite system including RSA, RSC and HBED functions (see section 2.2). The observations made below regarding the influence of the system on driver performance can only be interpreted as applying to the entire system as tested. The influences of the individual elements can not be objectively determined.

Separately, the observations listed in this section are mixed, and none show a strong, sustained influence of RA&C on turning performance. Taken together, however, there are sufficient positive and intuitively-appropriate results to be encouraging regarding the potential of RA&C-like technology.

10.3.1 Results of multifactor analyses

The search for effects of RA&C on turning performance was undertaken with multifactor analyses that compared the driving behavior of the 14 comparable drivers before and after the introduction of RA&C (i.e., during phase 1 versus during phase 2). These analyses also included other factors in order to account for their influence on turning. The primary performance measures in these analyses were measures of rollover ratio and of lateral acceleration at the driver's position. The other factors included in the analyses that revealed main effects on turning performance included load condition, weather condition, ambient lighting condition, and direction of turn.

- No statistically-significant, *main effect* of the general presence of RA&C on turning behavior of drivers could be established.
- Five interactions that included the influence of RA&C (by phase) were found to be significant ($p \leq 0.05$). Three derived from the analysis using measures of *rollover ratio* and two derived from the analysis of *lateral acceleration* at the driver's longitudinal position. All five are three-way interactions.

The three interactions relating to *rollover ratio* fit a pattern that appears to suggest more conservative driving behavior with RA&C than without it. In particular, these three suggest that the effect of RA&C depends on conditions in which *opportunity* for high rollover ratios is more likely to be present: i.e., good weather, high-severity curves, right-hand curves. These three interactions are as follows.

- RA&C by Weather by Turn Severity. In this interaction, *rollover ratio* appears to be *reduced* with RA&C in good weather in the most severe curves.
- RA&C by Turn Severity by Turn Direction. In this interaction, *rollover ratio* appears to be *reduced* with RA&C in right turns of the highest level of severity.
- RA&C by Weather by Turn Direction. In this interaction, *rollover ratio* appears to be *reduced* with the RA&C in right turns in good or bad weather and in left turns in good weather.

Turning behavior with and without the RA&C as measured by *driver lateral acceleration* appears to present a somewhat muddled picture. Clearly the two measures, though related, are not correlated. The two interactions relating to *lateral acceleration* are:

- RA&C by Load by Turn Direction. In this interaction, *lateral acceleration* appears to be *increased* with RA&C in left turns with empty vehicles and in right turns with loaded vehicles.
- RA&C by Weather by Turn Severity. In this interaction, *lateral acceleration* appears to be *increased* with RA&C in high-severity curves in bad weather.

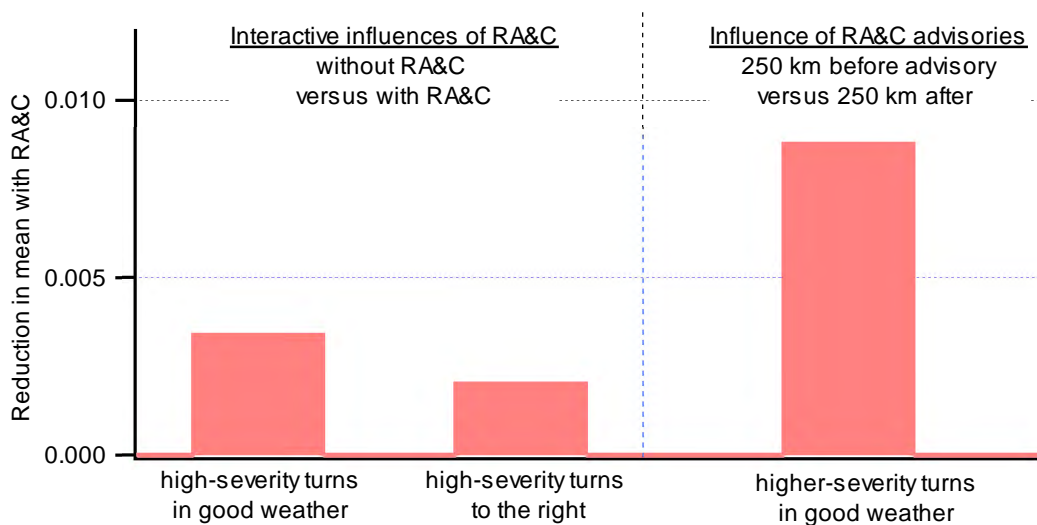

Figure 10.3. Relative strength of (1) interaction effects of RA&C and (2) short-term effect of RA&C advisories on rollover ratio (RRSM)

Similar multifactor analyses were conducted on subsets of the performance data, e.g., the performance of only those 12 comparable drivers who actually experienced RA&C advisories. The results of these analyses were somewhat similar but decidedly mixed.

10.3.2 Results of other analyses

- In a separate analysis, individual RA&C advisories/actions were seen to have a statistically-significant ($p \leq 0.05$) influence on turning performance in that performance in more severe turns following an advisory was more conservative than performance in similar turns preceding an advisory.

The analysis was conducted using several distance envelopes. The influence was found to be strongest in the ranges of 200 to 250 km following advisories and to then generally decay.

- Small, but statistically-significant ($p \leq 0.05$) differences in the overall lateral performance of drivers, which were suggestive of more conservative turning behavior during phase 2, were observed. However, because of the nature of the analysis, *it was not possible to establish that these differences were actually due to the use of the RA&C device.*

These differences were small, and the more significant were related to turning with empty vehicles. The differences were established by comparison of cumulative histograms, and the analysis did not include rigorous treatment of other factors which may have changed between phases. Accordingly, it is possible that the observed differences were due to the influence of RA&C, but equally possible that they were due to one or a more other factors that could have changed between phases.

- Several other analyses based on measures of curve-entry speed, deceleration, and braking behavior, or on extreme-value analyses of rollover ratio and lateral acceleration showed no significant effect of the RA&C function on turning behavior.

10.4 Drivers' subjective impressions of the RA&C device

The opinions of the Praxair drivers provide some useful insight about what it was like behind the wheel of an RA&C-equipped tractor. Although lacking the rigor of experimental measures, driver opinions provide a somewhat broader picture of how well the RA&C fit into their normal work routine.

One key finding is that the Praxair drivers appear to be well aware of the load condition of their trailers and to take load into account while driving. They appear sufficiently confident of their understanding of the influence of load on severity that they judged the accuracy of the RA&C functions by their intuitions. Many drivers commented that the RA&C did not appear to account for whether the trailer was empty or full and suggested that such capability would enhance the value of the system. Other drivers commented that the RA&C appeared to be too sensitive.

Drivers also appeared to embrace the utility of the RA&C device while at the same time they reported that it had only “some or little” influence on *their* driving. However, drivers especially thought that the system would work well with *inexperienced* drivers.

With respect to its operational characteristics, drivers found the system to be simple to understand and the messages to be clear and legibly presented. They also reported that the RA&C produced minimal levels of distraction while driving. This is especially important given the proliferation of warning technologies amid the heightened concern about driver distraction.

11. RECOMMENDATIONS

This chapter presents an annotated list of recommendations that derive from the experience gained in this study. The list is subdivided into recommendations on RA&C-like devices, themselves, and recommendations for future research on such devices.

11.1 Recommendations on RA&C-like devices

- The issuance of RSA/C advisories and control actions should be based on thresholds of rollover ratio.
- The issuance of RSA/C advisories and control actions should generally be less conservative than was the case in this FOT.

The reasons for, and the potential implementation of, these two recommendations are, of course, closely related as indicated by the following discussion.

The RA&C device studied in this FOT appeared to issue advisories and execute control actions essentially on the basis of lateral acceleration alone, uninfluenced by the prevailing roll stability of the vehicle (see figure 7-9). The vehicles, however, have substantially lower roll stability when loaded than when empty (see appendix A-C). The lateral acceleration thresholds upon which RSA/C advisories and actions were executed were judged to be relatively conservative for loaded vehicles and, consequently, very conservative for empty vehicles.

Drivers in the study, on the other hand, clearly had an intuitive understanding—which while not fully accurate, was at least qualitatively correct—that their vehicles were more stable when empty than when loaded (see figure 6-10). Accordingly, they drove less conservatively (in terms of lateral acceleration) when their vehicles were empty than when they were loaded (see figure 6-2).

The result was that, in this FOT, 73 percent of RSA/C advisories were issued when the vehicle was empty. Moreover, 93 percent of RSA/C advisories were issued in episodes during which the rollover ratio of the vehicle did not exceed 0.5 (see figures 7-9 and 7-12).

The drivers were clearly aware of this quality of RA&C. Many drivers commented that the RA&C did not appear to account for whether the trailer was empty or full and suggested that such capability would enhance the value

of the system. Other drivers commented that the RA&C appeared to be too sensitive.

- Consideration should be given to issuing RSA advisories at low speeds.

By design, the RA&C of this study did not issue RSA advisories below 21 kph [1]. However, it appears that drivers underestimate rollover risk at low speed and that, therefore, RSA advisories are warranted in this regime.

It was observed that drivers tend toward higher lateral accelerations while operating at lower speeds (see figure 6-4). This tendency holds for operation of both empty and loaded vehicles (see figure 6-12). Off-tracking of the trailer in low-speed, tight-radius turns does tend to mitigate the consequence of this behavior in terms of rollover risk. Nevertheless, the net result is that the probability of experiencing elevated rollover ratio remains quite high in the lowest speed ranges (see figure 6-11). Indeed, five of the ten highest levels of rollover ratio observed in the FOT occurred at a speed of less than 22 kph.

- Consideration should be given to accounting for the representative cross slope of roadways.

At least along the routes of the FOT fleet, the most likely value of the cross slope of the roadway was about 2 percent, which is equivalent to a lateral acceleration of about 0.02 g (see figure 6-5). However, the RA&C device appeared to correct for long-term drift of its accelerometer on the basis of a most-likely lateral acceleration of 0.0 g (see figure 7-8). Although the resulting bias of 0.02 g seems small, it nevertheless represents approximately 10 percent of the apparent acceleration threshold for level-1 advisories.

11.2 Recommendations for future research on RA&C-like devices

- It is recommended that future field testing of RA&C-like devices include evaluation of the device *with feedback to drivers from their managers*.

This FOT was originally configured to include a third phase in which RA&C, as it operated on-board the vehicle, was to be augmented with summary reports of individual driver's turning performance to management and subsequent feedback to the drivers by management. It was, unfortunately, necessary to abandon this phase due to difficulties of schedule. It seems likely that such an arrangement could substantially enhance the effectiveness of RA&C-like devices in reducing the risk of rollover crashes.

- It is recommended that fleets characterized by less experienced drivers be considered for future field testing of RA&C-like devices.

The Praxair drivers in this study were generally a mature and experienced group. In simple terms, they were already careful drivers who, perhaps, were not particularly in need of the training that RSA is intended to provide. Indeed, had the RA&C been well calibrated with respect to the prevailing roll stability of the test vehicle, the Praxair drivers would have generated very few RSA/C advisories over the course of the field test. This quality in the driver sample may well be part of the reason that the influence of RA&C observed in this study was rather small. Moreover, it was the opinion of many drivers who participated in this study that RA&C would be more valuable to inexperienced drivers.

- It is recommended that fleets characterized by more varied vehicles (or cargo) be considered for future field testing of RA&C-like devices.³⁹

A major premise behind the concept of RSA is that, in general, it is difficult for truck drivers, especially drivers of tractor-semitrailer combinations, to be well appraised of the actual roll stability of their vehicle. Cargo vans carry different kinds and amounts of freight with different densities, total weights and c.g. heights. Often drivers do not even know the nature of the cargo they are hauling. In any event, since the actual experience of the driver is not firmly coupled to the roll motions of the semitrailer, the driver's ability to gauge the vehicle's roll stability in general service is believed to be relatively poor.

This premise does not apply well, however, in the specific case of this field test. Only one type of vehicle was employed to haul only one type of cargo in the FOT. The drivers in the study were all experienced with the vehicle and the cargo. Both the objective behavior and the subjective opinions of the drivers indicated that they had a reasonable qualitative understanding of the relationship between stability and load—although the quantitative inaccuracy of their understanding, even in these circumstances, could be taken as support for the premise.

- It is recommended that simpler systems be considered for future FOT evaluations.

The strength of this recommendation depends upon the philosophical intent of any future FOT that might be considered.

³⁹ As originally proposed, this field test was to examine the potential of the RSA concept by evaluating the effectiveness of an “optimized” RSA device. In that context, the Praxair vehicles used in this study—straight-bore tankers dedicated to a single product—were seen as virtually ideal. That is, since a one-to-one relationship would exist between vehicle weight and roll stability, an RSA system tuned very precisely to the actual roll stability of the vehicle could be achieved quite easily.

The RA&C system evaluated in this FOT was complex in the sense that it included RSA, RSC and HBED functions. RSA advisories were delivered following an event thought to present some risk of rollover but to be less than critical; RSC advisories and control actions were activated immediately upon perceiving an event thought to involve a critical risk of rollover; HBED advisories were delivered following braking with ABS activity. The FOT was only able to evaluate the influence of RA&C as a complete package.

To the extent that the philosophy of an FOT is to evaluate a specific product, the approach of this FOT is fully appropriate. To the extent that an FOT is intended to research the driving process or to evaluate a particular concept, such as RSA, the complexity of such a product “package” serves to confound the findings of the study.

- It is recommended that in structuring future FOTs, researchers be very attentive to the fact that the range of behavior exhibited by individual drivers is likely to be very large.

The intent of this FOT was to evaluate the influence of a particular technology on driving performance. The findings of the FOT showed that the range in driving performance between individual participants was vastly greater than the size of the influence of the technology. A prior field study conducted by UMTRI also revealed great ranges in individual driving styles and performance.[5]

Under this general condition, an experimental structure of a serial, rather than a parallel nature seems desirable. By serial, we mean an experiment in which individual subjects are observed first in a baseline condition and then again later, after the technology is introduced. Influence of the technology is evaluated based on the change of performance of individuals. By parallel, we mean an experiment in which two groups of individuals, one using the technology and one not, are observed simultaneously. Influence of the technology is evaluated by the difference in performance of the two groups. When the range of individual behavior is large, the parallel experiment is likely to require a much larger sample in order to provide adequate fidelity. A serial experiment has its own drawbacks, but they are likely to be manageable with less expense.

- It is recommended that consideration be given to further “mining” of the database generated in this federally-sponsored field test.

The database generated in this FOT is rich indeed, and the analyses conducted to date do not approach being exhaustive. Many of the results presented in

chapter 8 do as much to suggest other avenues of inquiry as they do to answer the questions posed about RA&C. Moreover, the database holds potential to answer a wide range of questions about the truck-driving process that do not even deal with RA&C-like functions.

The government might do well to ask what other questions might be answered by this (and other existing) database(s). Or, reversing the emphasis, when other questions arise, the government might do well to consider whether they can be answered with existing data rather than by a new study.

12. REFERENCES

1. Ehlbeck, J., Kern, C., Moellenhoff, J., Korn, A., Rosendahl, H, and Ruhnau, G. "Freightliner/MeritorWABCO roll advisory and control system." Truck and Bus Meeting and Exposition. Portland, OR. 2000. Society of Automotive Engineers, Warrendale, Pa. Report No. SAE 2000-01-3507.
2. Blower, D., et al. *Trucks involved in fatal accidents*. Codebooks 1992 through 1998, Michigan University, Ann Arbor, Transportation Research Institute, Center for National Truck Statistics. Sponsor: Federal Highway Administration, Office of Motor Carriers, Washington, D.C.
3. *National Automotive Sampling System General Estimates System* (1992 through 1998), National Center for Statistics and Analysis, National Highway Traffic Safety Administration, Washington, D.C.
4. *North Carolina Accident Data*, 1997-1998, University of North Carolina Highway Safety Research Center
5. Fancher, P.; Ervin, R.; Sayer, J.; Hagan, M.; Bogard, S.; Bareket, Z.; Mefford, M.; Haugen, J. 1998. *Intelligent cruise control field operational test. Final report*. Volume I: Technical report. Michigan University, Ann Arbor, Transportation Research Institute. 356 p. Sponsor: National Highway Traffic Safety Administration, Washington, D.C. Report No. UMTRI-98-17/ DOT/HS 808 849.
6. 1991. *Road vehicles — vehicle dynamics and road-holding ability — vocabulary. First edition*. International Organization for Standardization, Geneva, Switzerland. 29 p. Report No. ISO 8855:1991(E/F).
7. 1978. *Vehicle dynamics terminology*. Society of Automotive Engineers, Inc., Vehicle Dynamics Committee, Warrendale, Pa. 21 p. Report No. SAE J670e.
8. French, D. J., West, R. J., Elander, J., & Wilding, J. M. (1993). "Decision-making style, driving style, and self-reported involvement in road traffic accidents." *Ergonomics*, 36(6), 627-644.
9. Ritchie, M. L.; McCoy, W. K.; Welde, W. L. 1968. "A study of the relation between forward velocity and lateral acceleration in curves during normal driving." Ritchie, Inc., Dayton, Ohio. 4 p. *Human Factors*, Vol. 10, No. 3, 1968, p. 255-258.
10. Reymond, G.; Kemeny, A.; Droulez, J.; Berthoz, A. 2001. "Role of lateral acceleration in curve driving: driver model and experiments on a real vehicle and a driving simulator." Renault, Guyancourt (France)/ Collège de France, Paris. 13 p. *Human Factors*, Vol. 43, No. 3, Fall 200, p. 483-495.
11. Jindra, F. 1963. "Off-tracking of tractor-trailer combinations." 6 p. *Automobile Engineer*, March 1963, p. 96-101.

12. Pretty, R. L. 1964. "On the off-tracking of semi-trailers." New South Wales University, School of Traffic Engineering, Kensington. 9 p. Australian Road Research Board. *Proceedings 1964*. Vol. 2. Part 1. Australian Road Research Board, 1964, p. 394-402.
13. Morrison, W. R. B. 1972. "A swept path model which includes tyre mechanics." Oceanics Australia Pty Ltd. 34 p. Australian Road Research Board. Sixth Conference. *Proceedings*. Part 1. Principal Addresses and Invited papers. ARRB, Victoria, 1972, p. 149-182.
14. Ervin, R. D.; Mallikarjunarao, C.; Gillespie, T. D. 1980. *Future configuration of tank vehicles hauling flammable liquids in Michigan*. Volume I - technical report. Final report. Highway Safety Research Institute, Ann Arbor, Mich. 243 p. Sponsor: Michigan Department of State Highways and Transportation, Lansing. Report No. UM-HSRI-80-73-1.
15. Winkler, C. B.; Blower, D. F.; Ervin, R. D.; Chalasani, R. M. 1999. *Rollover of heavy commercial vehicles*. Michigan University, Ann Arbor, Transportation Research Institute. Published by Society of Automotive Engineers, Warrendale, Pa. 73 p. Sponsor: Volvo Truck Corporation, Goeteborg (Sweden); Michigan University, Ann Arbor, Transportation Research Institute, Great Lakes Center for Truck and Transit Research. Report No. SAE RR-004.

APPENDIX A-A. THE TARGET POPULATION OF ROLLOVERS FOR RA&C

*The University of Michigan Transportation Research Institute
Survey and Analysis Division*

*Center for National Truck Statistics
Statistical Analysis*

DATE: September 13, 2000
MEMO TO: Chris Winkler, UMTRI, Jim Ehlbeck, Freightliner
FROM: Dan Blower
SUBJECT: Identifying target population of rollovers for RSA

The objective of this memo is to quantify the likely target population of rollovers that may be addressed by a Rollover Stability Advisor (RSA).

DATA

Two data files were used in constructing the estimates, UMTRI's Trucks Involved in Fatal Accidents (TIFA) file and the General Estimates System (GES) file, produced by the National Center for Statistical Analysis (NCSA) in NHTSA. The TIFA file is produced by an annual survey of medium and heavy trucks involved in a fatal accident in the US. The TIFA file is an enhancement of the information on fatal truck involvements available from NHTSA's Fatality Analysis Reporting System (FARS) file. Trucks are extracted from the FARS file and surveyed to collect detailed information on each truck's physical characteristics. Accident and driver level variables from the FARS file are included in TIFA. The GES file is a nationally-representative sample of police-reported traffic accidents.

For both files, a multi-year file was constructed, combining cases from 1992 through 1998. These years encompass the most recent accident data available for both files. There were few changes in the way the data was collected (and none of significance here) for each file over that span of years, allowing multiple years to be combined reasonably. The purpose of the combined file is to increase confidence in the characterization of rollover by using the maximum amount of data.

In this analysis, TIFA and GES data are combined to take advantage of the strengths of each. The TIFA file covers accidents involving at least one fatality. Though for six out of the seven accident years, cases for the file were sampled, the sampling was very limited (approximately two-thirds of all cases were surveyed) and confidence intervals on estimates from the file are very tight. Population estimates from the file of the number of trucks involved in fatal accidents have been shown to be within one or two of the true

number. The TIFA file provides the best available data on trucks involved in fatal accidents.

While the TIFA file covers fatal accidents, nonfatal truck accident involvements are excluded. The GES data set provides information on nonfatal crashes. GES is nationally-representative of police-reported accidents. However, sample sizes are limited and, for small subsets, sampling errors can be large relative to the associated estimate. In the case of fatal truck involvements, GES estimates have been shown to be significantly and systematically low. For example, the annual number of truck fatal involvements is about 5,000. Estimates from GES however range from about 2,700 to 4,200, with a 95% confidence interval of $\pm 1,600$ to 1,800. On the other hand, samples of the more numerous nonfatal crashes are significantly greater and provide more reliable estimates. Moreover, GES is the only available national data on nonfatal accidents.

Accordingly, in the tables, estimates from TIFA and GES are combined, with the TIFA file providing data on fatal involvements and GES supplying the results for nonfatal accident involvements.

The tables cover all trucks, class 3 and greater, straight trucks as well as tractor combinations. The tables show counts of “involvements,” that is, counts of trucks involved in a traffic accident.

APPROACH

The objective of this memo is to estimate the number of rollovers that may be addressed by the RSA. The first few tables will characterize the size of the rollover problem with respect to all accidents, but then move quickly to exploring how rollover occurs.

Rollover accidents where simple exceedence of the roll stability of the truck is the primary cause of the accident are the most likely candidates for the RSA. Accidents that the RSA will be most effective gains are presumably those in which the driver is unaware of the stability limit of his vehicle until it is too late to take corrective action. Essentially, the driver is attempting what appears to him to be a “normal” maneuver, typically negotiating a turn or curve, but the roll stability of the truck is such that the vehicle is not capable of accomplishing that maneuver at the selected speed. The RSA, by providing feedback as the truck proceeds down the road, will help the driver to become more aware of the stability limits of his vehicle and, thereby, avoid dangerous situations.

Accordingly, the accident data are analyzed to determine where rollover occurred in the sequence of events. The operating assumption is that the RSA will be most effective against rollovers that occur as the first event in a crash, primarily in single-vehicle accidents. These rollovers are most directly the result of a mismatch between the roadway geometry or the maneuver the truck is attempting and the rollover threshold of the truck.

Rollovers in multiple-vehicle accidents, that occur after a collision with another vehicle or after an evasive maneuver to try to avoid a collision, will not be addressed by the RSA.

The accident data are partitioned to identify accidents in which the RSA will have no effect, where it may have some effect, and where the RSA is likely to have a positive effect. In the latter two categories, more information about why the rollover occurred is needed in order to tell whether the RSA would be effective. The purpose here is to identify promising types of accidents and to estimate the proportion of rollovers that may be affected by the RSA. Additional data about the promising accident categories will be collected by reviewing police reports and coding additional detail.

RESULTS

Table A-A1 shows truck accident involvements by accident severity and rollover, 1992 to 1998. The distribution of rollovers by accident severity is shown. Accident severity is measured by the most severe injury in the accident, so that if any person is fatally injured, the involvement is counted in the *fatal* category, and so on. Injuries are classified as fatal, A (incapacitating), B (visible but not incapacitating), and C (complaint of pain). Rollovers tend to occur in significantly more severe accidents than non-rollovers.

Table A-A1. Truck accident involvement by severity and rollover TIFA/GES 1992-1998						
accident severity	no roll		roll		total	
	N	%	N	%	N	%
No injury	1,772,071	72.9	43,039	41.3	1,815,110	71.6
C-injury	258,820	10.7	17,599	16.9	276,419	10.9
B-injury	165,558	6.8	21,999	21.1	187,557	7.4
A-injury	99,606	4.1	16,034	15.4	115,640	4.6
Fatal	28,997	1.2	4,390	4.2	33,387	1.3
Injury, unk. severity	6,963	0.3	375	0.4	7,338	0.3
Unknown	97,588	4.0	723	0.7	98,311	3.9
Total	2,429,603	100.0	104,160	100.0	2,533,762	100.0

Though over 41% of the rollovers occurred in an accident in which no injury was recorded, almost 20% of rollover involvements occurred in an accident that included either a fatality or an A-injury. Over the period covered by the table, there were 104,160 rollovers, for an annual average of 14,880 overturns. Rollover occurred to 4.1% of all trucks involved in an accident. The proportion of rollovers was much higher in more severe accidents. Over 13% of trucks involved in a fatal accident overturned, as did 13.9% of trucks in an A-injury accident and 11.7% of trucks in a B-injury accident.

Table A-A2 shows an alternative way of characterizing rollover involvement: by the severity of the injury to the truck driver. Rollovers pose a much higher risk of serious injury to truck drivers than do other types of traffic accidents. Although 45.2% of rollover drivers suffered no injury in the crash, 2.2% were fatally injured and 13.2% suffered an A-injury. This compares with an 0.1% fatal injury rate to truck drivers in accidents in which their truck did not overturn, and 0.6% A-injury rate. Rollover is a primary factor in fatal injuries to truck drivers in traffic accidents. Of the 4,110 truck drivers killed in traffic accidents over the period from 1992 to 1998, 2,274 (55.3%) died in a rollover.

driver injury severity	no roll		roll		total	
	N	%	N	%	N	%
PDO	2,164,626	89.1	47,077	45.2	2,211,703	87.3
C-injury	61,435	2.5	17,403	16.7	78,838	3.1
B-injury	31,497	1.3	22,439	21.5	53,936	2.1
A-injury	13,632	0.6	13,776	13.2	27,408	1.1
Fatal	1,836	0.1	2,274	2.2	4,110	0.2
Injury, unk. severity	2,157	0.1	481	0.5	2,638	0.1
Unknown	154,419	6.4	710	0.7	155,129	6.1
Total	2,429,602	100.0	104,159	100.0	2,533,761	100.0

Table A-A3 shows the distribution of rollovers by truck configuration. Trucks are classified as “single unit” or combination. Single unit trucks are primarily straight trucks pulling no trailers, though some bobtail tractors are included. Combination trucks are primarily tractors pulling one semitrailer, although doubles, triples, and straight trucks with a trailer are included. This classification of trucks was selected because the GES data do not include sufficient detail to permit more detail. About 40% of rollovers are to single unit trucks. Single-unit trucks rollover at about the same rate as combination vehicles.

Truck configuration	no roll		roll		total	
	N	%	N	%	N	%
Single unit	1,006,805	41.4	40,718	39.1	1,047,523	41.3
Combination	1,389,113	57.2	63,197	60.7	1,452,310	57.3
Unknown	33,684	1.4	244	0.2	33,928	1.3
Total	2,429,602	100.0	104,159	100.0	2,533,761	100.0

The initial distinction to be made in rollovers is between single and multiple-vehicle accidents. Table A-A4 shows that rollover is strongly associated with single-vehicle

accidents. About 20% of all truck accident involvements are in single-vehicle accidents, but 86.6% of rollover accidents involve only the truck. The rollovers that the RSA could be most effective at preventing are very likely to be found among these single-vehicle accidents, and they clearly form the large majority of all rollovers. Further, although it is not as likely that the RSA would have as much effect on accidents involving another vehicle, we will shortly see that rollover does occur as the first harmful event in some multiple-vehicle accidents and that RSA may have some utility in avoiding a subset of those rollovers.

Number of vehicles	no roll		roll		total	
	N	%	N	%	N	%
one	417,529	17.2	90,203	86.6	507,732	20.0
multiple	2,012,072	82.8	13,956	13.4	2,026,028	80.0
total	2,429,601	100.0	104,159	100.0	2,533,760	100.0

Figure A-A1 shows a rollover event tree for fatal rollover accidents. (The fatal injury can be to any involved party in the accident, not necessarily to the truck driver.) The data are from the TIFA file alone. The fatals are shown separately because the proportion of single-vehicle involvements for fatal involvements is quite different than for all truck accidents. In the tree shown, rollovers are partitioned into successively finer categories as the tree expands. At each level, the number of cases falling into the category is shown and, next to that, the proportion that number makes of all rollovers is given. There are 4,390 truck rollovers in fatal accidents, 1992-1998. Of those, 2,061 (46.9%) occurred in single-vehicle accidents and 2,329 (53.1%) in multiple-vehicle accidents.

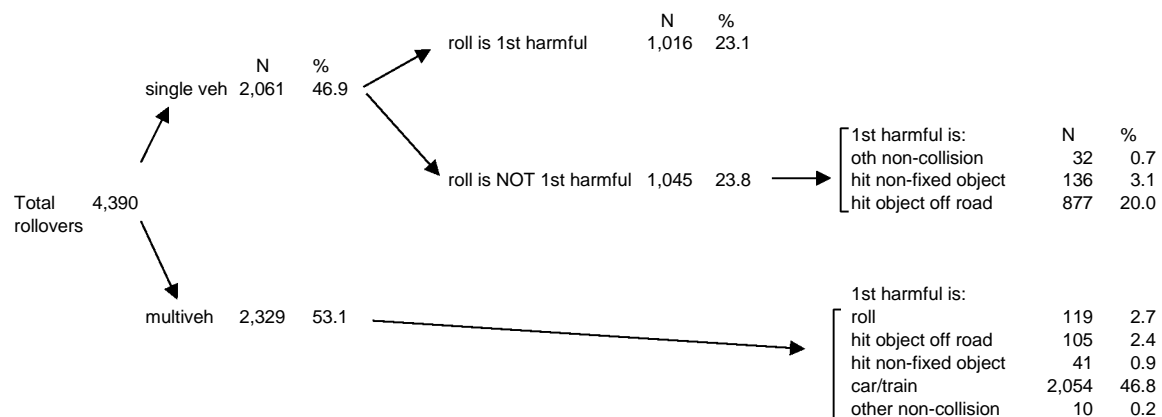

Figure A-A1—Rollover event tree for fatal accidents, TIFA 1992-1998

The single-vehicle branch of the tree defines the cases most likely to be addressed by the RSA. Of the 2,061 single-vehicle rollovers, 1,016 occurred as the first event in the

accident. These cases are the most likely candidates for the RSA, and form 23.1% of all rollovers in fatal accidents.

Of the single-vehicle accidents where rollover was not the first harmful event, 32 involved some non-collision event (like jackknife) prior to the overturn, 136 hit a non-fixed object⁴⁰ on the road first, and 877 (20.0% of all rollovers) collided with a fixed object off the roadway prior to the overturn.

Some portion of the cases where the truck ran off the road before it overturned also may be addressed by the RSA. In reviewing police reports of single-vehicle rollovers, a frequent sequence of events is a truck entering a curve or attempting to negotiate an off ramp at speed, and the truck's momentum carries the vehicle across the curve and off the road, where it might strike a guard rail, embankment, tree, or other fixed object and then overturn. Presumably, if the driver had turned more sharply, he would have overturned on the road. In some cases the rollover started on the road but was not completed until the truck was off the road. This type of rollover might be addressed by the RSA if the RSA serves to alert the driver to the condition of his vehicle as he went around prior, less demanding curves. Estimates of how many of the cases in this category fit the scenario just sketched out cannot be developed only from the information available in existing computerized files, but the review of police reports should help in this regard.

In the multiple-vehicle branch, most (2,054 of 2,329) occurred after a collision with another vehicle. It is hard to think of a plausible scenario where the RSA might be helpful. But in 119 cases (2.7% of all rollovers) the rollover occurred as the first event in the accident. It is possible that some fraction of these might be addressed by the RSA, though they make up only a small proportion of all rollovers.

Figure A-A2 shows the same tree for rollovers in nonfatal accidents. Note that where a fatality is not involved, 88.3% of rollovers occur in single-vehicle accidents. Rollover is the first harmful event in 61.2% of nonfatal rollovers. This is the category that is most likely to be reduced by the RSA. As argued above, rollovers in single-vehicle accidents where the truck ran off the road prior to the overturn may also include cases that can be addressed by the RSA. In the GES data, 24.3% of all nonfatal rollovers occurred in such accidents.

⁴⁰ Non-fixed objects include pedestrian, bicyclists, other non-motorists, parked vehicles, and animals.

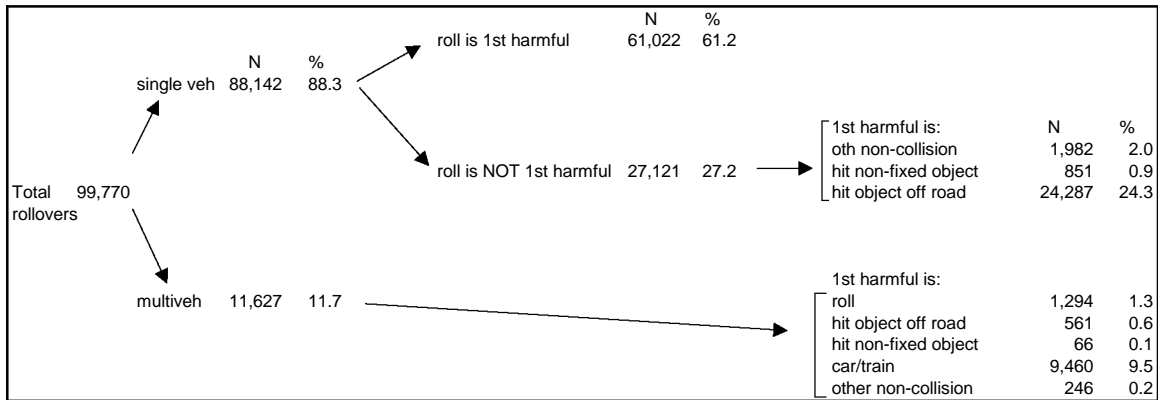

Figure A-A2—Rollover event tree for nonfatal accidents, GES 1992-1998

The final accident tree, shown in figure A-A3, combines information on fatal and nonfatal rollovers to show the distribution of all rollovers across the rollover event tree. Since there are about 23 rollovers in a nonfatal accident for every rollover in a fatal accident, the distribution of rollovers across the event tree follows figure A-A2 closely. Almost 60% of all rollovers are the first event in a single-vehicle accident. An additional 24.2% occur after the truck has run off the road. Some fraction of these may also be reduced by the RSA. These two groups form the set of rollovers that most likely contain the rollovers that the RSA may contribute to reducing. In the remainder of this memo, some of the characteristics of the accidents that will help home in on the target population will be discussed.

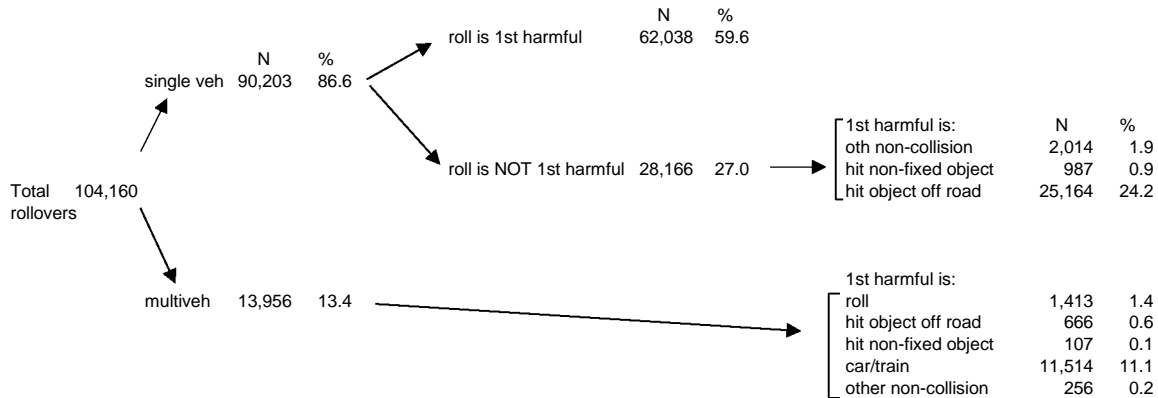

Figure A-A3—Rollover event tree, TIFA/GES 1992-1998

Rollover is strongly associated with curves and grades. Tables A-A5 and A-A6 show that rollover involvements are significantly overrepresented on curves or grades.⁴¹ Both are environments where the dynamic stability of the truck is more critical, as compared with straight, level roadways, and are environments where the RSA may be effective. About 37% of all rollovers occur on curves, compared with less than 10% of

⁴¹ The data files used do not indicate whether the grade was up or down. One would expect rollovers to be more frequent on downgrades.

nonrollovers. Of single-vehicle, first-event rollovers (i.e., the primary candidates for mitigation through RSA), over 40% occur on curves. Further, 38.3% of single-vehicle, subsequent-event rollovers occur on curves.

Roadway alignment	no roll		roll		total	
	N	%	N	%	N	%
Straight	2,066,060	85.0	63,659	61.1	2,129,719	84.1
Curve	236,019	9.7	38,967	37.4	274,986	10.9
Unknown	127,523	5.2	1,533	1.5	129,056	5.1
Total	2,429,602	100.0	104,159	100.0	2,533,761	100.0

Roadway profile	no roll		roll		total	
	N	%	N	%	N	%
Level	1,348,863	55.5	49,246	47.3	1,398,109	55.2
Grade	439,049	18.1	38,738	37.2	477,787	18.9
Hillcrest	28,052	1.2	1,611	1.5	29,663	1.2
Other	4,436	0.2	292	0.3	4,728	0.2
Unknown	609,201	25.1	14,274	13.7	623,475	24.6
Total	2,429,601	100.0	104,160	100.0	2,533,761	100.0

Taking curves and grades together, about 65.5% of single-vehicle, first-event rollovers occurred on a curve or grade or both. Similarly 67.5% of single-vehicle, subsequent-event rollovers occurred on grades or curves or both.⁴²

The information developed thus far can be used to make a preliminary estimate of the proportion of rollovers that might be addressed by the RSA. In the discussion of the accident event trees, it was argued that the two most likely categories for the RSA were single-vehicle, first-event rollovers and single-vehicle, subsequent-event rollovers where the first event was ran off the road. These two rollover types are 59.6% and 24.2% of all rollovers respectively (see figure A-A3). The RSA will likely be most critical on curves or grades. About 65.5% of single-vehicle, first-event rollovers occur on curves or grades, so $65.5\% * 59.6\% = 39.0\%$ of all rollovers are of a type and location where the RSA is most likely to be helpful. The RSA may also be helpful against single-vehicle,

⁴² In calculating these proportions, the unknown category has been eliminated. When several variables are taken together, unknowns proliferate. Cases can be known on one variable but unknown on another. Eliminating the unknowns from the percentage calculation assumes that the distribution of unknown cases is similar to the distribution of the known cases across the variables. This seems like a reasonable assumption here.

subsequent-event rollovers where the first event was ran off the road. About $67.5\% * 24.2\% = 16.3\%$ of all rollovers fall into this category.

However, some fraction of these cases could be due to fatigue, sleep, or inattention. Information about those factors in rollovers is only available in the TIFA file. FARS analysts code a variety of factors with respect to driver condition and actions and this data is included in the TIFA file. No such information is available for nonfatal truck involvements. However, if the incidence of fatigue, sleep, or inattention is similar, or at least not greater, in nonfatal involvements, the proportion of fatigue/inattention crashes from fatal rollovers can be applied to all rollovers to refine the estimate of rollovers that may be reduced by the RSA.

In the TIFA file, the truck driver was coded as fatigued, asleep, or inattentive in 24.3% of single-vehicle, first-event rollovers. It is not likely that the RSA would be helpful in preventing such overturns. With this information, the proportion of these rollovers where the RSA is likely to be helpful can be recalculated as $75.7\% * 39.0\% = 29.6\%$. In single-vehicle, subsequent-event rollovers, 24.6% of the truck drivers were coded as fatigued, asleep, or inattentive. The re-estimate of the proportion of these rollovers that might be addressed by the RSA is $75.4\% * 16.3\% = 12.3\%$.

In sum, then, this analysis suggests that the primary target population of the RSA is the 29.6% of rollovers that are single-vehicle, first-event rollovers that occurred on a curve or grade and where the driver was not fatigued, asleep, or inattentive. Given an average of 14,880 rollovers per year (calculated from table A-A1), that would be 4,404 rollovers annually. The RSA may also be helpful in an additional 12.3% of rollovers, which are single-vehicle, subsequent rollovers where the truck ran off the road as a first event, an additional 1,830 rollovers. These rollovers also happened on a curve or grade and the driver was not fatigued, asleep, or inattentive.

A note on speed

Travel speed is nominally coded in both the TIFA (from FARS) and GES files. However, the data are missing in about 50% of the cases. It appears that missing data is primarily associated with the state where the accident occurred, rather than some other systematic bias. In other words, while the missing data rate is substantial, it does not appear to be biased with respect to accident type. Table A-A7 shows the distribution of travel speed by rollover, taking just cases where travel speed is known. Overall, rollover involvements had a significantly higher proportion of high travel speeds than nonrollover accident involvements. Over half of the trucks involved in nonrollover accidents had speed of 20 mph or less, compared with only 15.1% of rollover involvements. On the other hand, 53.8% of rollover trucks had travel speed greater than 40 mph, compared with 27.7% of nonrollover accident involvements. Considering just the most promising accident types for the RSA, over two-thirds of single-vehicle, first-event rollovers

occurred to trucks traveling at 30 mph or greater. That percentage rises to 76.6% of single-vehicle, subsequent-event rollovers.

Table A-A7. Rollover by travel speed TIFA/GES 1992-1998						
travel speed	no roll		roll		total	
	N	%	N	%	N	%
<=20	485,123	52.0	7,913	15.1	493,036	50.1
21-30	90,596	9.7	6,733	12.8	97,329	9.9
31-40	97,799	10.5	9,633	18.3	107,432	10.9
41-40	96,859	10.4	10,872	20.7	107,731	10.9
51-60	114,791	12.3	9,920	18.9	124,711	12.7
>60	46,933	5.0	7,500	14.3	54,433	5.5
Total	932,101	100.0	52,570	100.0	984,672	100.0

ADDITIONAL WORK

This analysis represents the best estimate available from existing data files of the proportion of rollovers that the RSA might address. It is admittedly speculative. Computerized accident files do not have sufficient detail about the events of the rollover to assign with confidence a particular case to one category or another. That can only be done by reviewing individual cases. We are currently undertaking a review of police reports of rollover cases, from North Carolina. We have over sampled the accident types that seem most promising, in an effort to learn more about what happens in these crashes. This should produce a more detailed description of the promising accident types and an improved estimate of the proportion of rollovers that the RSA may be effective in reducing

*The University of Michigan Transportation Research Institute
Survey and Analysis Division
Center for National Truck Statistics
Social and Behavioral Analysis
Transportation Data Center
Statistical Analysis*

DATE: January 16, 2001
MEMO TO: Chris Winkler
FROM: Dan Blower
SUBJECT: Results of reviewing North Carolina rollover cases

We have completed review of North Carolina rollover cases. The purpose of the review was to estimate the proportion of heavy truck rollovers that might be addressed by a Rollover Stability Advisor (RSA). A sample of police reports on North Carolina truck accidents involving rollover was selected. The diagram, narrative, and other information on each police report was reviewed to record data about the rollover, along with a judgment as to whether the RSA could have been useful in preventing the rollover. This memo presents the results of the case review.

DATA

North Carolina police reports from 1997 and 1998 were selected to review. A sample of 252 cases were selected from three types of accidents in which rollover occurred. Two previous memos, one dealing with rollovers in North Carolina (July 25, 2000) and one on the national picture of rollover (September 13, 2000), identified three general accident types in which rollover occurs. Strata for case selection was defined using these three groups: 1) single-vehicle accidents in which rollover was the first event; 2) single-vehicle accidents in which rollover was not the first event; 3) multiple-vehicle accidents that included rollover.⁴³

⁴³ In the memo identifying a target population of rollovers for the RSA, single vehicle rollovers are allocated between those in which the rollover was the first harmful event (59.6%) and those in which the rollover occurred after some previous harmful event (27.0%). This is shown in figure A-A3 of the September 13, 2000 memo, which described the national rollover picture using Fatality Analysis Reporting System (FARS) and General Estimates System (GES) data. In the discussion of rollovers relying on North Carolina police reported data contained in the July 25, 2000 memo, single-vehicle rollovers are also split into first event and subsequent event, but the proportions are almost precisely reversed. In that memo, the figure on page 5 shows 14.29% of rollovers as the first event in single-vehicle accidents, and 65.59% as a subsequent event in single-vehicle accidents. This apparent discrepancy is explained by differences in how the events are coded in the accident data. Both FARS and GES data record the first harmful event in the accident, that is, the first event that produced some injury to persons or property. The North Carolina data also records the first harmful event in the accident, but includes “ran off the road” as a harmful event. “Ran off the road” is not available as a first harmful event in either FARS or GES, because it does not produce harm by itself. In the North Carolina data, “ran off the road” is recorded for about 70% of single-vehicle rollovers in which the first event

The purpose of the review was to refine estimates of the fraction of rollovers that could be addressed by the RSA. Examining the police reports on the accidents would provide the additional information necessary on the events of the accident to provide a basis for judging whether the RSA would be relevant. Rollovers falling into the first group defined above were judged to be the most likely candidates for the RSA. An rollover-advisory device was thought least likely to be relevant to rollovers occurring in multiple-vehicle accidents. Based on the information contained in the computerized accident record, it was unclear if the RSA would be relevant in the second group of rollovers.

Table A-A8 shows the sampling frame from which cases for review were selected, as well as the number selected in each sampling stratum. A total of 252 cases were sampled for review.

Table A-A8. Sample frame and case selection for review of police-reported rollovers North Carolina 1997-1998		
Selection strata	Sample frame	Number selected
Single-vehicle, first event rollover	333	47
Single-vehicle, subsequent event rollover	1529	153
Multiple-vehicle, rollover	469	53
Total	2331	252

Sample weights were calculated for each sampled case. Case weights were used to weight distributions of the data generated in the case review to produce estimates of population totals.

METHOD

Police reports of rollovers were reviewed. The scene diagram, narrative, and other information on the police report was used to record information about the rollover. The information recorded includes the number of quarter turns, direction of roll, location of rollover with respect to the roadway, trailer yaw, whether the rollover was due to tripping, whether an evasive maneuver preceded the rollover, up to three “causes” of rollover, and up to five events in the accident. In addition, a narrative of the events was recorded along with a judgment as to whether the RSA could have been relevant to preventing the rollover. Finally, as the cases were being reviewed, it was noted that, in

was not the rollover. If these cases had been coded according to the rules of FARS or GES, most would have been shifted to the “first event rollover” category. If that is done now, the two distributions are in reasonable agreement.

many rollovers, the truck ran off the road and then ran back on to the road, either to roll over in the roadway or to run off the other side of the road, where rollover occurred. After all cases were reviewed, the reviewer went back through all the narratives and coded a flag for cases in which the truck ran off the road and then came back on.

The variable recording whether the RSA could have been helpful had five levels: likely yes, maybe yes, neutral, maybe no, and likely no. The judgment on RSA effectiveness was made based on an understanding of how a rollover-advisory device would work. The RSA will be most effective against rollovers that occur in accidents in which the roll stability of the truck is the primary cause. In these accidents, the driver is unaware of the instability of his vehicle until it is too late to take corrective action. In essence, the driver attempts a “normal” maneuver, but the roll stability of the truck will not allow the maneuver to be completed successfully.

Given the understanding that RSA-addressable rollovers occur as a product of a “normal” maneuver, a steering maneuver, either negotiating a curve or turning from one roadway to another, was the essential first event. However, in many of the overturns, the rollover did not happen right after the maneuver. Often the truck ran off the road and rolled over there. The “cause” of the rollover, then, might be that, once off the road, the truck was on a slope and overturned, or it may have struck a ditch bank and rolled. But the original precipitating event was the instability of the truck which caused the truck to go off the road.

As cases were reviewed, it became clear that the “cause” of rollovers is not always a good guide to whether the intervention of the RSA could have prevented the rollover. Thus, if the rollover was part of an accident sequence precipitated by truck instability related to a normal steering maneuver, that rollover was judged a candidate for the RSA. If the original truck instability could have been prevented by the RSA, then the rollover could have been prevented by the RSA.

By the same token, if the steering maneuver was somehow not normal, the RSA was judged to be likely not effective. For example, the RSA was deemed not relevant if the rollover followed a sudden evasive maneuver, as the driver tried to avoid a collision. In these rollovers, the aggressivity of the steering maneuver is likely a product of the driver’s intent to avoid the collision. Similarly, the RSA is not likely to be effective in cases where the driver goes into a curve too fast because his brakes failed or some other mechanical failure occurred. In several cases of rollovers on curves, the truck’s brakes failed as the driver tried to slow for a curve. Clearly a rollover-advisory device is not the critical problem in such rollovers.

Microsoft Access was used for data entry. A screen shot of the data entry form is included in the appendix. The appendix also includes a list of variables and code levels for each variable.

RESULTS

The results are shown in terms of percentage distributions, without frequency counts. The distributions are of interest here rather than frequencies.

Examining the police reports showed that no rollover occurred in 29.4% of the cases selected as rollovers. This is an artifact of the design of the data file as produced by the Highway Safety Research Center (HSRC) at the University of North Carolina. Three variables in the police-reported data can possibly indicate rollover. HSRC adds a variable, called ANYROLL, that records whether any of the three police-reported variables indicate rollover. The ANYROLL variable was used to select cases of truck rollover. But one of the indications of rollover used in generating the ANYROLL variable was top damage. Top damage can occur in a variety of accidents that do not include rollover, such as striking low overpasses and low hanging power lines. Cases in which the police report clearly shows that no rollover occurred are eliminated from the analysis.

Table A-A9 shows the distribution of the applicability of the RSA to rollovers in each rollover type as well as for all rollovers. The results are consistent with the original hypotheses about each rollover type. The RSA was judged to be likely effective for almost half of single-vehicle, first event rollovers. The RSA was considered probably useful in an additional 18.2% of such rollovers. (Rollovers coded as either likely or probably candidates for the RSA will be called RSA-candidate rollovers hereafter.) A lower proportion of single-vehicle, subsequent event rollovers was deemed RSA-candidate rollovers, though the RSA was either likely or probably useful in 41.7% of these rollovers. Taking all single-vehicle rollovers together, 47.4% were classified as either likely or probably preventable by a rollover-advisory device. In contrast, only 9.7% of rollovers occurring in multiple-vehicle accidents were judged RSA-candidate rollovers. Overall, 40.9% of rollovers were judged to be RSA-candidates.

Table A-A9. Distribution of estimated RSA effectiveness by rollover type Heavy truck rollovers in North Carolina, 1997-1998							
rollover type	RSA applicable?						total
	likely yes	maybe yes	neutral	maybe no	likely no	unknown	
single-vehicle, first event rollover	47.7	18.2	4.5	2.3	25.0	2.3	100.0
single-vehicle, subsequent event rollover	36.9	4.9	1.9	9.7	46.6	0.0	100.0
multivehicle, rollover	3.2	6.5	0.0	3.2	87.1	0.0	100.0
all rollovers	33.2	7.7	2.1	7.2	49.4	0.4	100.0

The percentage of RSA-candidate rollovers in multiple-vehicle accidents is low, but it may be surprising that there are any at all. The estimate of 9.7% of multiple-vehicle rollovers addressable by the RSA is based on three cases. Two of the cases are probably mistakenly coded as multiple-vehicle accidents. In one, there is clearly no other vehicle. The truck was rounding a curve to the right too fast, went off the road to the left and rolled over. In the other case that is likely mistaken, the truck rolled over on an Interstate highway. It may have been struck by another vehicle after the rollover but neither the scene diagram nor the narrative indicates such a collision.

The final case in this category genuinely involved two vehicles. A dump truck ran off the road while rounding a curve, over-corrected back onto the road way and across the center line, where the truck struck an on-coming car, ran off the road, and overturned. It is coded as an RSA-candidate because the instability of the vehicle in what should have been a normal steering maneuver led to the rollover. The immediate precipitating event in the overturn was likely the collision with the car. But the first cause here is the truck's instability in a curve. Note that the truck may not have rolled over if it had not struck the car. There are likely other truck loss-of-control accidents like this one where the truck did not happen to overturn as a consequence of a collision. This accident suggests that the RSA may help prevent some nonrollover accidents as well as some rollovers.

Rollovers where the RSA was judged potentially effective showed a common pattern. Figure A-A4 shows an event tree for RSA-candidate rollovers, through the third event. The percentages shown for each branch on the tree are of all RSA-candidate rollovers. In every case, the truck was engaged in a steering maneuver prior to rollover. Most of the maneuvers were negotiating a curve, but in 17.6%, the truck was turning from one roadway to another. The truck either rolled over as a consequence of the steering maneuver, or vehicle instability caused it to run off the road, or the cargo shifted. In the cases where the truck ran off the road, typically the truck either rolled over once off the road or it hit a fixed object (often a ditch) and rolled or the truck came back on the road and rolled over. In the cases where the second event was cargo shift, rollover either followed immediately or occurred after running off the road. Whatever the subsequent event, vehicle instability induced by a seemingly normal steering maneuver caused the truck to go out of control. Subsequent events depended primarily on the nature of the terrain at the scene of the accident.

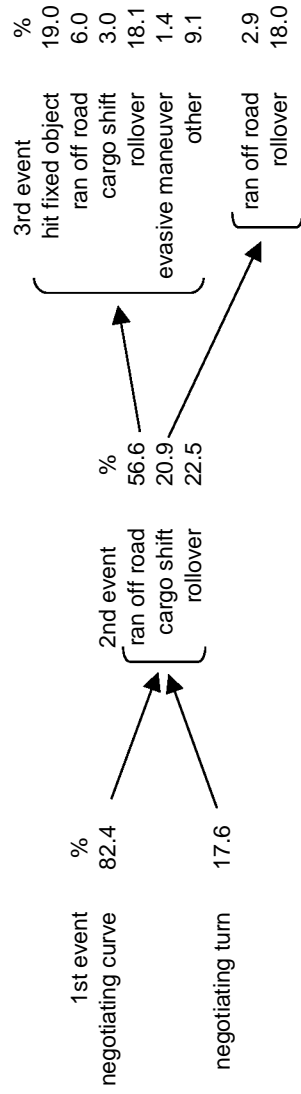

Figure A-A4. Event tree for RSA-candidate rollovers

“Cargo shift” prior to the rollover generally was not taken as inconsistent with the RSA being useful in preventing the rollover. Many of the trailers involved were van trailers loaded with general freight. In these cases, the assumption was made that the movement of cargo and the rollover occurred almost at the same time and that the driver would have difficulty determining which came first. Some cargo shift is expected in a rollover and is a product of the same forces that cause the truck to overturn. In one case the driver reported that straps holding down the cargo broke, allowing the cargo to spill, just prior to the overturn. Clearly it was the turning of the truck that caused the truck to roll, not the cargo shift that was the consequence of the truck’s turn.

Figure A-A5 shows the subsequent events for rollovers judged to be addressable by the RSA.

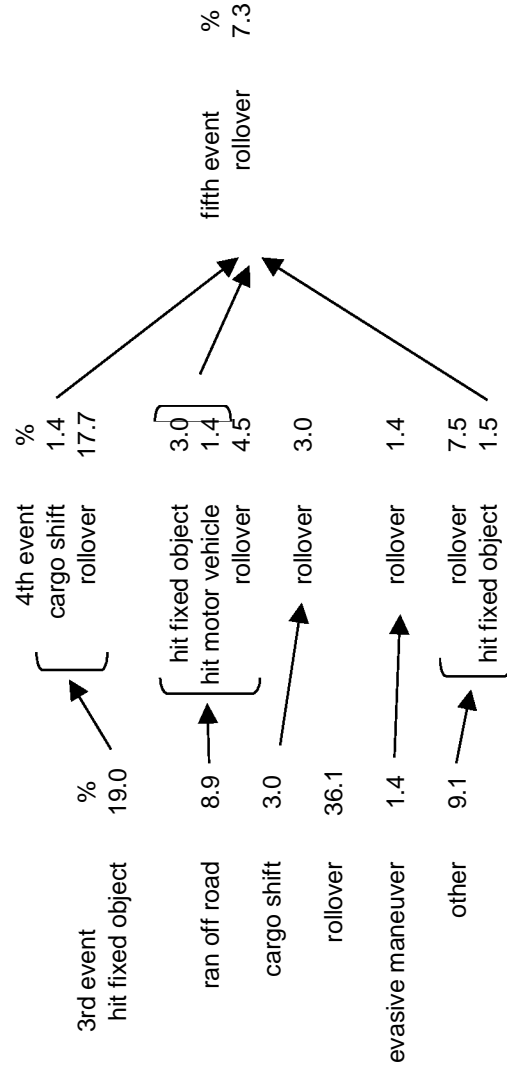

Figure A-A5. Subsequent events for RSA-candidate rollovers

A much wider variety of events led to the almost 60% of rollovers that were judged not candidates for the RSA, as figure A-A6 shows. The percentage columns show the percentages of all non-RSA-candidate rollovers at each branch of the tree. All event paths are not shown in full detail because so many different event paths led to rollover. There was a total of 68 different event sequences among the rollovers that were not RSA-candidates. Second events for “first event negotiating a curve” and “first event

negotiating a turn” were similar and therefore combined in the tree. Third events are aggregated for first event “going straight” and the two first event steering maneuver categories.

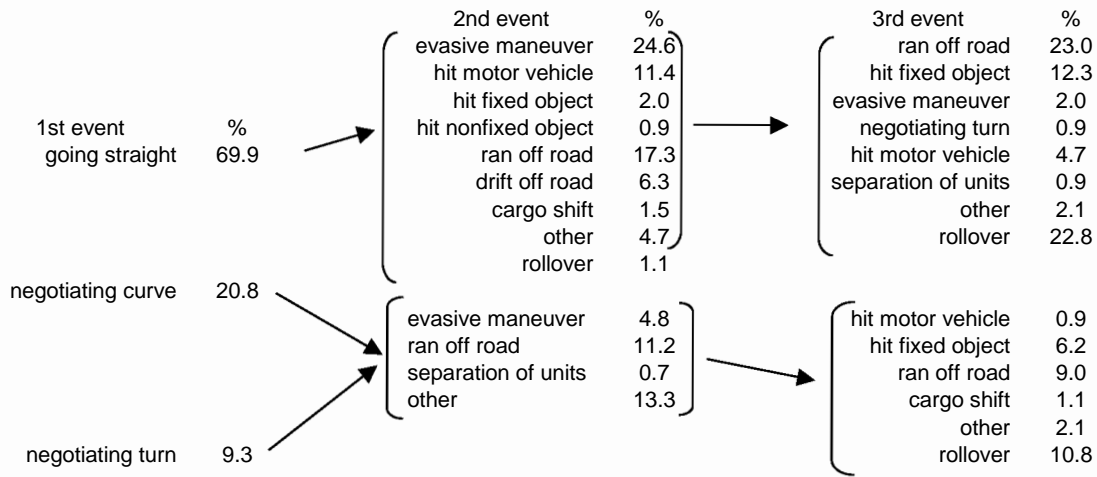

Figure A-A6 Event tree for rollovers not addressable by RSA

For rollovers classified as not addressable by the RSA, the initial event was driving down a straight piece of road in almost 70% of the overturns. The most frequent next event was an evasive maneuver, typically to avoid collision with another vehicle. A collision with another motor vehicle was the second event in 11.4% of the rollovers. “Ran off road” or “drift off road” (a gradual lane departure often seen in fatigue- or sleep-related accidents) were also common second events with a total of 23.6% of rollovers that the RSA will likely not address.

“Negotiating curve” and “negotiating turn” are combined in the tree for the second event. The most frequent second event for these cases is “other.” The “other” category includes cases of brake failure, wheel loss, slick roads, and one case in which an unruly passenger grabbed the steering wheel. “Ran off road” is the other most frequent second event where the first event was a steering maneuver. In these rollovers, the first two events, turning and then running off the road, are similar to those in RSA-candidate rollovers. But the particulars in these crashes are quite different. Often the turning maneuver was a low speed turn and the driver essentially drove off the road onto a slope and rolled over. In some cases, it appears the driver oversteered into the turn and then overcorrected back, losing control and rolling over.

During the process of reviewing these cases, it was noticed that trucks that went off the road due to vehicle instability often came back on the road prior to roll, either to roll over in the road or to go off the road on the other side and roll there. This was observed in 26.9% of cases judged to be RSA-candidates and 18.9% of all rollovers. In these accidents, the truck driver apparently had some opportunity to bring his vehicle under control, but his attempts were unsuccessful. This suggests that some set of vehicle control

devices may be applicable in preventing rollovers, even after the rollover sequence is begun.

CONCLUSIONS

The review was undertaken to improve the understanding of accident event chains that lead to rollover. Overall, about 40.9% of rollovers were judged to be likely or probably preventable by a rollover-advisory device. In these rollovers, the sequence of events indicated that the driver attempted a maneuver that appeared to be survivable, but the instability of the truck prevented the maneuver from being completed successfully. These cases were judged RSA-candidate rollovers because it was assumed that if the driver had been alerted to the instability of his vehicle earlier, he would have attempted the steering maneuver at a slower, survivable speed. Single-vehicle rollovers are the primary target for the RSA, because in these rollovers normal, non-evasive maneuvers of the truck were the cause. Over 47% of single-vehicle rollovers were judged to be preventable by the RSA.

As expected, only a small percentage of rollovers that occurred in multiple-vehicle accidents appeared to be preventable by the RSA. Most rollovers in multiple-vehicle accidents occurred after an evasive maneuver or collision with another vehicle. But about 9.7% of rollovers coded as part of a multiple-vehicle accident were potentially preventable by the RSA. The word coded is emphasized here, because in two of the three cases, it appears that the case was miss-coded as a multiple-vehicle accident. No second vehicle was identified with certainty. In the other case, the involvement of the second vehicle occurred as a consequence of the truck losing control in a normal steering maneuver. If the instability had been prevented, the collision would have been avoided.

In sum, the review of North Carolina rollover cases reinforces the earlier conclusion: that about 40% of rollovers are candidates for a rollover-advisory device. The memo of September 13, 2000, estimated a total of 14,880 truck rollovers annually. The analysis of computerized accident data in that memo suggested that 4,404 single-vehicle first event rollovers and 1,830 single-vehicle subsequent event rollovers might be prevented by the RSA, for an annual total of 6,234 rollovers prevented. Applying the percentage of preventable rollovers from the review of North Carolina police reports to the national estimate of rollovers, an estimated total of 6,086 rollovers might be prevented if all trucks on the road were equipped with a rollover-advisory device.

APPENDIX A-B. ESTIMATING WEATHER

This example demonstrates how the weather estimates in the FiveMin table were derived. The example comes from tractor 5, trip 404, as the tractor traveled near Goshen, Indiana at 6:46 AM GMT on April 1, 2001.

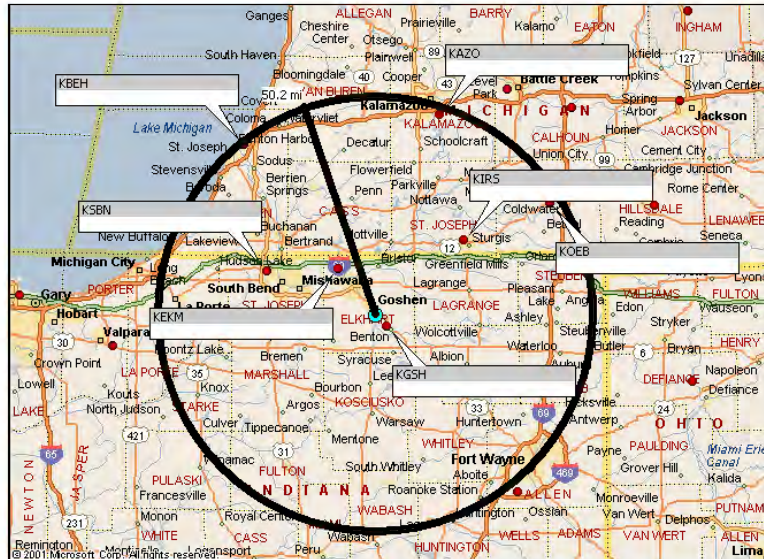

Figure A-B1. Weather estimate example

Figure A-B1 shows the current location of the tractor (center of circle) was within 50 miles of seven National Weather Service recording stations. For each station, the reports immediately preceding and following the target time (6:46) were used in the weather estimate. The twelve reports used in the estimate are shown in Table A-B1. The raw report is in the right column; the other columns show the station, distance of the tractor from the station, time of report, and the observation extracted from the raw report. For example, the first report,

010606Z AUTO 29011KT 10SM OVC011 02/01 A2971 RMK AO2 RAE06 P0000
is interpreted as:

- 01 is the day of the month (April 1).
- 0606Z is the time (6:06 Zulu, or Greenwich Mean Time).
- 290 is the wind direction (degrees clockwise from north, where wind is coming from. In this case the wind is out of the west-northwest).
- 11KT is the wind speed, 11 knots.
- 10SM is the visibility, 10 statute miles.
- 02/01 is the temperature and dewpoint, 2 and 1 degrees C respectively. Dewpoint was not used in this FOT.
- A2971 is the barometric pressure, 29.71 inches of mercury.
- The remaining information in the report was not used in the FOT.

Table A-B1. Example METAR Reports

<i>Station</i>	<i>Distance</i>	<i>Time</i>	<i>Observation</i>	<i>METAR Report</i>
KBEH Benton Harbor, Southwest Michigan Regional Airport (MI) (42.1292N 86.4222W)	48.1 mi 29.6W 38.0N	2001/04/01 06:06	2C 11KT @ 290 deg Vis: 10SM 29.71 in. Hg	010606Z AUTO 29011KT 10SM OVC011 02/01 A2971 RMK AO2 RAE06 P0000
KBEH Benton Harbor, Southwest Michigan Regional Airport (MI) (42.1292N 86.4222W)	48.1 mi 29.6W 38.0N	2001/04/01 06:53	2C 9KT @ 300 deg Vis: 10SM 29.71 in. Hg	010653Z AUTO 30009KT 10SM OVC011 02/00 A2971 RMK AO2 RAE47UPB10E15 SLP063 P0000 T00220000
KEKM Elkhart Municipal (IN) (41.716667N 86.0W)	13.5 mi 8.6W 10.4N	2001/04/01 00:55	8C 10KT @ 110 deg Vis: 5SM 29.73 in. Hg	010055Z 11010KT 5SM -RA OVC050 08/ A2973 RMK LAST
KEKM Elkhart Municipal (IN) (41.716667N 86.0W)	13.5 mi 8.6W 10.4N	2001/04/01 11:55	1C10KT @ 310 deg Vis: 7SM 29.75 in. Hg	011155Z 31010KT 7SM BKN120 BKN200 01/ A2975
KOEB Coldwater, Branch County Memorial Airport (MI) (41.9333N 85.0525W)	46.0 mi 38.7E 24.9N	2001/04/01 06:35	4C 9KT @ 120 deg Vis: 5SM 29.65 in. Hg	010635Z AUTO 12009KT 5SM -DZ BKN032 BKN038 OVC044 04/03 A2965 RMK AO2
KOEB Coldwater, Branch County Memorial Airport (MI) (41.9333N 85.0525W)	46.0 mi 38.7E 24.9N	2001/04/01 06:55	4C 7KT @ 140 deg Vis: 5SM 29.65 in. Hg	010655Z AUTO 14007KT 5SM DZ OVC030 04/03 A2965 RMK AO2
KAZO Kalamazoo / Battle Creek International Airport (MI) (42.2292N 85.5464W)	46.8 mi 14.0E 44.7N	2001/04/01 06:42	3C 8KT @ 190 deg Vis: 2.5SM 29.68 in. Hg	010642Z AUTO 19008KT 2 1/2SM - RA BR OVC020 03/02 A2968 RMK AO2 P0002
KAZO Kalamazoo / Battle Creek International Airport (MI) (42.2292N 85.5464W)	46.8 mi 14.0E 44.7N	2001/04/01 06:53	3C 8KT @ 190 deg Vis: 2SM 29.68 in. Hg	010653Z AUTO 19008KT 2SM -RA BR FEW009 BKN015 OVC021 03/03 A2968 RMK AO2 SLP056 P0003 T00330028
KIRS Sturgis, Kirsch Municipal Airport (MI) (41.8128N 85.4392W)	25.7 mi 19.4E 16.8N	2001/04/01 06:40	4C 8KT @ 220 deg Vis: 3SM 29.69 in. Hg	010640Z AUTO 22008KT 3SM RA BKN020 OVC029 04/02 A2969 RMK AO2
KIRS Sturgis, Kirsch Municipal Airport (MI) (41.8128N 85.4392W)	25.7 mi 19.4E 16.8N	2001/04/01 06:58	3C 3KT @ 180 deg Vis: 2.5SM 29.68 in. Hg	010658Z AUTO 18003KT 2 1/2SM - RA BKN018 OVC025 03/01 A2968 RMK AO2
KGSH Goshen Municipal Airport (IN) (41.5261N 85.7867W)	3.1 mi 2.1E 2.3S	2001/04/01 06:00	3C 15KT @ 300 deg Vis: 7SM 29.71 in. Hg	010600Z AUTO 30015KT 7SM -RA BKN009 OVC020 03/02 A2971 RMK AO2 CIG 007V014 P0000

<i>Station</i>	<i>Distance</i>	<i>Time</i>	<i>Observation</i>	<i>METAR Report</i>
KGSH Goshen Municipal Airport (IN) (41.5261N 85.7867W)	3.1 mi 2.1E 2.3S	2001/04/01 06:53	1C 10KT @ 310 deg Vis: 1.5SM 29.71 in. Hg	010653Z AUTO 31010KT 1 1/2SM - SN BR BKN005 OVC010 01/M01 A2971 RMK AO2 RAE35SNB35 SLP064 P0004 T00061006
KSBN South Bend, Michiana Regional Airport (IN) (41.7072N 86.3164W)	26.3 mi 24.4W 9.8N	2001/04/01 06:12	2C 14KT @ 300 deg Vis: 6SM 29.72 in. Hg	010612Z 30014KT 6SM -RA BR BKN011 OVC016 02/01 A2972 RMK AO2 P0001
KSBN South Bend, Michiana Regional Airport (IN) (41.7072N 86.3164W)	26.3 mi 24.4W 9.8N	2001/04/01 06:54	2C 16KT @ 300 deg Vis: 7SM 29.71 in. Hg	010654Z 30016G22KT 7SM -RA OVC013 02/01 A2971 RMK AO2 SLP065 P0002 T00220011

Temperature at each station at the target time was estimated by linearly interpolating the temperature reports straddling the target time. For example, the 6:00 report from the Goshen station, KGSH, showed a temperature of 3 C. The 6:53 report showed 1 C. The target time, 6:46, is 46/53 of the way from 6:00 to 6:53, so the temperature was interpolated to be 46/53 of the way from 3 to 1. $(3 - (3-1) * 46/53 = 1.26$. Thus, the estimated temperature at Goshen was 1.26 C.

Similar estimations were done for the other five stations, giving the estimates shown in Table A-B2:

Table A-B2. Weighted temperature measurements

<i>Station</i>	<i>Temperature</i>	<i>Distance</i>	<i>Relevance</i>
KBEH	2.0 C	48.1 miles	0.000432
KEKM	4.27	13.5	0.005491
KOEB	4.0	46.0	0.000473
KAZO	3.0	46.8	0.000457
KIRS	3.67	25.7	0.001514
KGSH	1.26	3.1	0.104058
KSBN	2.0	26.3	0.001445

Temperature estimates were then weighted by proximity to the weather station using the inverse square of the distance ($1/\text{distance}^2$) and normalized by the sum of the weights:

$$T = \frac{\sum t_i w_i}{\sum w_i} \quad \text{A-B1}$$

where:

w_i is $1/\text{distance}^2$ from station i
 t_i is the temperature estimate for station i

In the example, the tractor was closest to the Goshen station. Thus the temperature estimate for Goshen was weighted the most. The final calculation of the temperature is as follows:

$$T = \frac{(4.32e^{-4} \times 2 + 5.49e^{-3} \times 4.27 + 4.73e^{-4} \times 4 + 4.57e^{-4} \times 3 + 1.514e^{-3} \times 3.67 + .1041 \times 1.26 + 1.445e^{-3} \times 2)}{(4.32e^{-4} + 5.49e^{-3} + 4.73e^{-4} + 4.57e^{-4} + 1.514e^{-3} + 0.104058 + 1.445e^{-3})}$$

$$T = 1.47C$$

Precipitation

The precipitation indicators in the METAR reports were inadequate to accurately determine when and where precipitation occurred. Instead, radar maps posted by the National Weather were used to estimate precipitation. A continuously running program downloaded and stored weather maps from five NWS radar locations covering the FOT area. Upon receiving the GPS data from a tractor, the location was plotted on the most recent radar map. The map color at that location was saved as a number between zero and 12 reflecting the precipitation level—0 indicated no precipitation; 12 indicated extremely heavy precipitation. Although promising, the method had several limitations. Map colors did not always uniquely identify precipitation levels; the same colors were used to draw roads, state lines, and labels. The update interval between maps was sometimes erratic, the maps sometimes contained only visual noise, and map resolution was generally coarse. Because of the limited reliability of the map-based weather analysis, the weather data used in most analyses were derived from a combination of visibility information provided in the METAR reports and the windshield wiper activity provided by the DAS.

In any case, the map below can be used to demonstrate the method. The location of the tractor at the target time (6:46 GMT on April 1, 2002) is identified by the circle on the map (southeast of South Bend). The color at the center of the circle corresponds to the 25 to 30 DBZ zone on the key at the left of the map. Based on information from the NWS web site (<http://www.crh.noaa.gov/radar/radinfo/radinfo.html#color>), 20 DBZ is a trace level of precipitation; numbers greater than 20 indicate rain or snow and numbers less than 20 indicate no precipitation. The field, *PrecipIntensity*, in the FiveMin table was assigned a value using the color key as follows: a value of zero was assigned to levels less than 20 DBZ; this was increased by one for every 5 steps of DBZ (e.g., 1 for values between 20 and 25; two for values between 25 and 30, etc.). In this example, the value was between 25 and 30; thus two was entered as the *PrecipIntensity* for this five-minute interval.

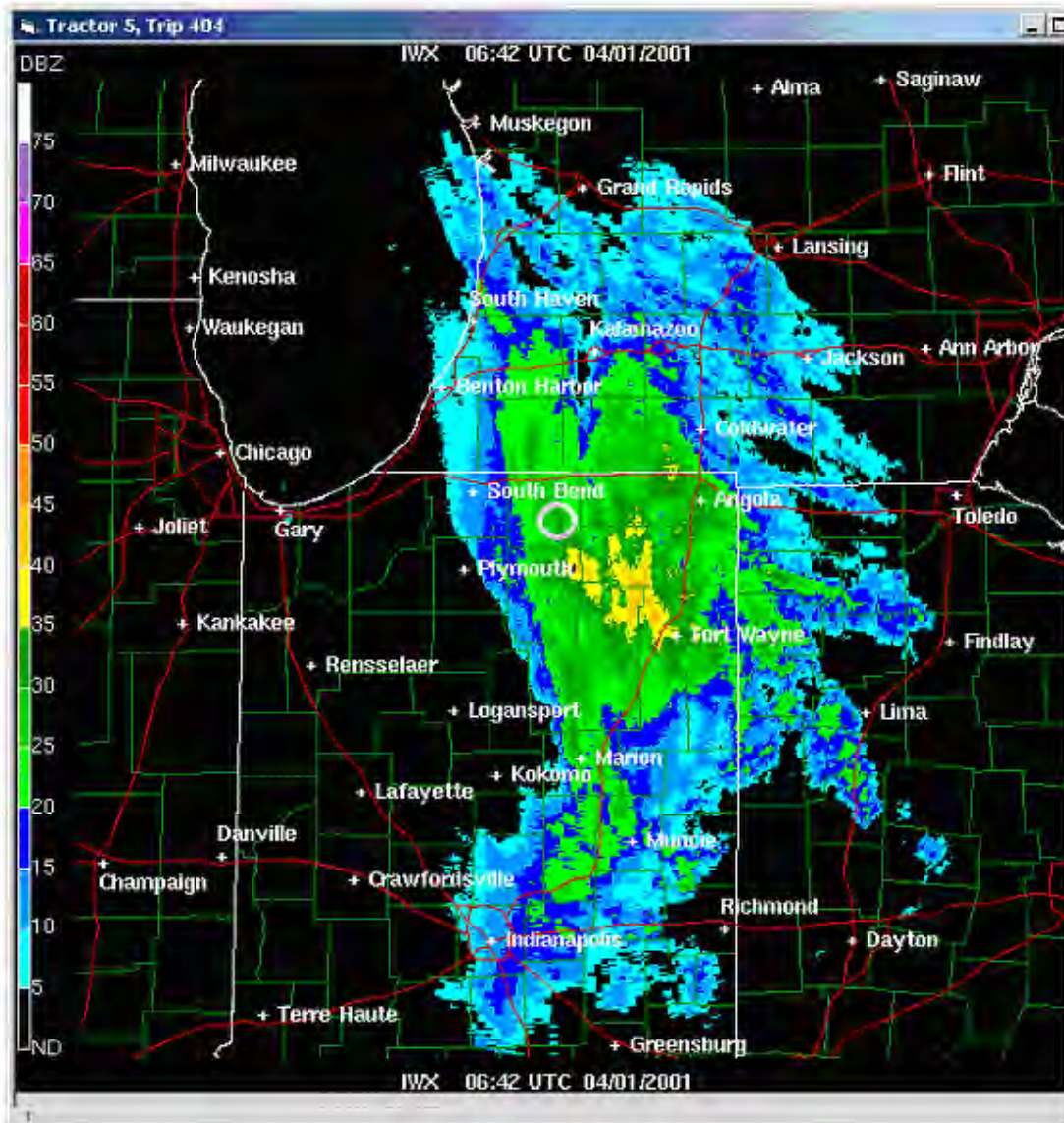

Figure A-B2. Example of a precipitation map

APPENDIX A-C. TILT-TABLE TESTING

The RA&C test vehicle was tested on the UMTRI tilt table to determine its actual static rollover threshold as a function of loading condition. Figure A-C1 is a photograph of the vehicle during this testing.

Tests were conducted in five loading conditions: empty, $\frac{1}{4}$ loaded, $\frac{1}{2}$ loaded, $\frac{3}{4}$ loaded and fully loaded. Three repeats were conducted in each loading condition.

During the tilt-table tests, the vehicle and the table were instrumented with a number of inclinometers. Inclinometers on the table are used to determine the simulated lateral acceleration of the experiment, i.e., the tangent of the tilt angle.

Other inclinometers were mounted on the vehicle. These included inclinometers on the front axle, on the tractor frame at the location of the RA&C ECU, on the tractor frame at the fifth wheel and on the trailer frame. The difference between measurements using these inclinometers and that of the table indicate the roll angle of these components of the vehicle.



Figure A-C1. RA&C test vehicle on the UMTRI tilt table

The vehicle /table combination was also equipped with contact switches at the tire contact points of the high-side, inner-dual tires of each of the drive axles and each of the trailer axles (axles 2 through 5, number from the front toward the rear). These switches provide a record of the occurrence of tire lift-off during the experiment.

Some representative results obtained with these instruments are shown in figure A-C2. The figure shows the roll angle of the trailer and the angular opening of the fifth-wheel coupling, as a function of simulated lateral acceleration. Tire-lift points are also shown on the trace of trailer roll angle. The figure shows that, as the table inclination is

increased to an equivalent of about 0.38 g, the trailer tires are first to lift off the table surfaces. The vehicle remains roll stable at this point. However, shortly thereafter, at about 0.41 g, the fifth-wheel coupling begins to open as the trailer “falls” through the fifth-wheel lash. With the trailer now rolled further outboard, the vehicle is no longer stable and roll motion continues until tires at both of the tractor drive axles lift off the table marking the roll stability limit of the vehicle.

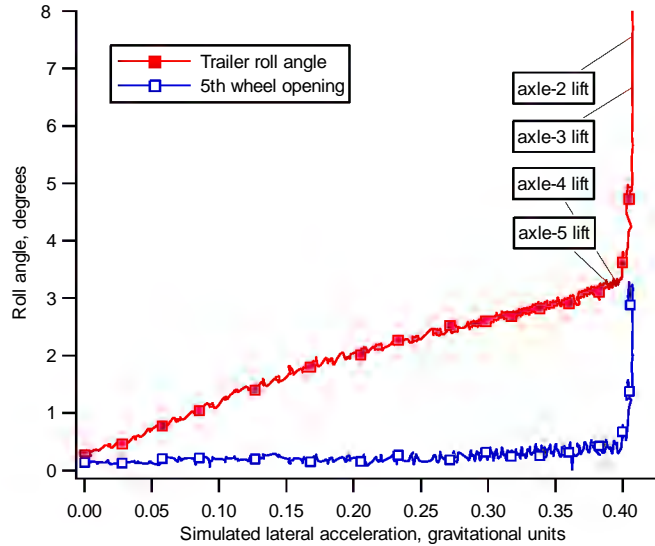

Figure A-C2. Example data from tilt-table test; 3/4 load.

Figure A-C3 presents the primary results of the tilt table tests. The figure presents the static rollover threshold (average of three repeats) of the RA&C test vehicle as a function of its total mass. Table A-C1 presents the results for each individual trial.

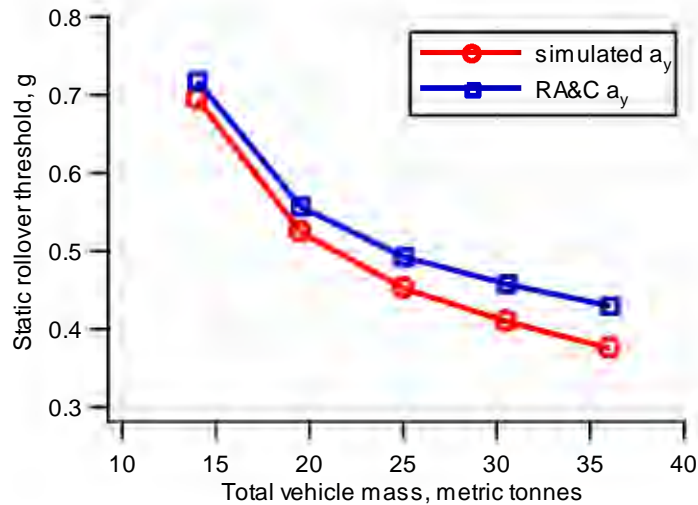

Figure A-C3. Results from the tilt-table tests (averages)

In figure A-C3 and table A-C1, rollover threshold is given by the following two measures:

1. Simulated a_y . Lateral acceleration as simulated by the tilt-table test, i.e., the tangent of the table tilt angle (at the point of static instability) and equivalent to ;

2. RA&C a_y . Lateral acceleration as would be seen by an accelerometer in the RA&C ECU (at the point of static instability), i.e., including the influence of chassis roll at the ECU.

Figure A-C3 presents these results in comparison to the critical lateral acceleration value (according to design intent) of the RA&C device. The figure indicates that the “rule” used to describe the critical lateral acceleration as a function of total mass is relatively conservative for the RA&C test vehicle even with respect to lateral acceleration measured parallel to the road surface (approximated by the simulated a_y measure). Moreover, the critical lateral acceleration is more conservative relative to “lateral acceleration” as measured by the frame-mounted accelerometer of the RA&C ECU.

Table A-C1. Primary results of the tilt table tests

Load condition:	Full	3/4	1/2	1/4	empty	Full	3/4	1/2	1/4	empty
Mass, tonne	36.1	30.5	25.0	19.5	14.0	36.1	30.5	25.0	19.5	14.0
Rollover threshold	Simulated lateral acceleration, g					RA&C lateral acceleration, g				
trial 1	0.37 6	0.410	0.456	0.526	0.692	0.430	0.458	0.496	0.558	0.715
trial 2	0.37 5	0.408	0.453	0.524	0.695	0.430	0.456	0.494	0.557	0.719
trial 3	0.37 4	0.410	0.448	0.523	0.696	0.429	0.458	0.487	0.555	0.720
average	0.37 5	0.410	0.452	0.524	0.695	0.430	0.458	0.493	0.557	0.718

Figure A-C4 presents more data from the tilt table test relating to the differences between several versions of “lateral acceleration” measured on the RA&C test vehicle. Considering only roll-plane influences, acceleration measured parallel to the road is the ideal measure of lateral acceleration for comparison to the static rollover threshold of the vehicle. Because of this, and recognizing that the solid front axles of heavy trucks are exposed to only rather small roll moment, UMTRI mounted its “reference” lateral accelerometer on the front axles of the test vehicles with the expectation that this measurement would be very close to lateral acceleration parallel to the road surface. The RA&C device, however, derives its primary measure of lateral acceleration from an accelerometer internal to the ECU and mounted on the tractor frame just forward of the drive axles. Because the frame rolls appreciably, this accelerometer is generally expected to produce somewhat higher measurements of lateral acceleration. The tilt-table tests were used to provide a quantitative indication of the difference between these three measures of lateral acceleration. (Figure A-C3 and table A-C1 presented some of the related results.) Figure A-C4 presents plots of $\sin(\text{component tilt angle})$ versus $\sin(\text{table tilt angle})$ for tilt tests in all five loading conditions. The “component” in the upper graph

of figure A-C4 is the front axle and in the lower graph, it is the RA&C ECU. It can be shown that the gradient of this plot is a good estimate of the ratio of steady-state lateral accelerations as would be measured by an accelerometer on the rolling component and as would be measured parallel to the ground. Since the front axle bears little roll moment, the front axle tilt angle and the table tilt angle are nearly identical, regardless of loading condition; the gradient of the plot is nearly unity. However, tilt angle of the ECU is typically greater than table tilt angle, and increases with load. Thus the gradient of the plots are greater than one and increase with load.

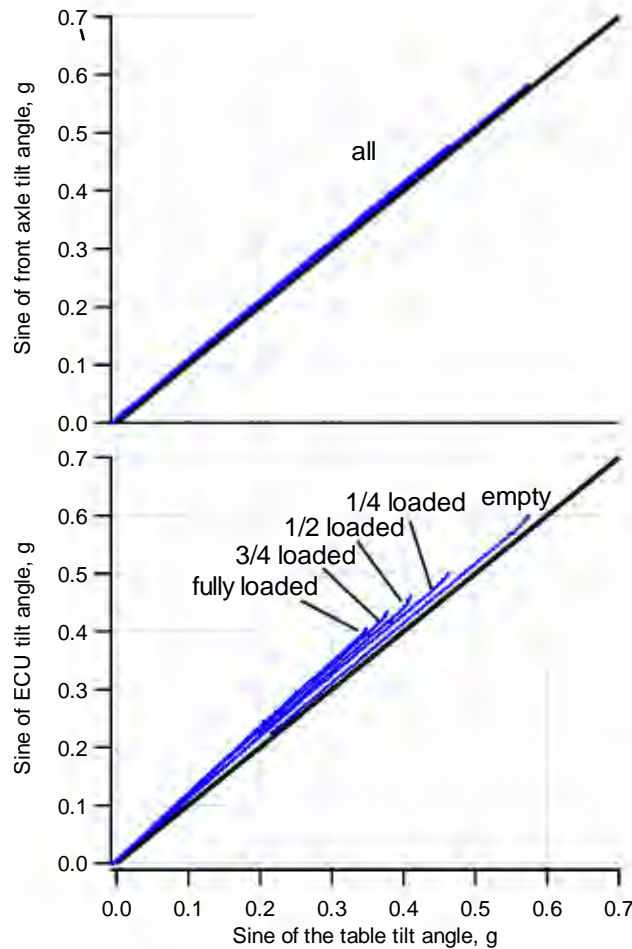

Figure A-C4. Sin(component tilt angle) versus sin(table tilt angle); five loading conditions

Figure A-C5 summarizes the data of figure A-C4 by presenting the gradients as a function of loading condition. The data indicate lateral acceleration measured with the accelerometer on the front axle should be within about one percent of lateral acceleration parallel to the road surface; however, lateral acceleration measured on the ECU can be expected to be from about three percent to about 14 percent high, depending on loading condition. These results were reflected earlier in data of figure A-C3.

Figure A-C5 also shows linear fits to the test data. (These fits are force through the point 1,0 in as much as massless vehicles would, of course, not roll on the tilt table and therefore the ratio of sine of the component tilt angle to the table tilt angle would be unity.) These data suggest, assuming quasi steady state, accelerations measure with the accelerometer on the front axle (A_{yFrnt}) can be used to estimate acceleration which would be measured by accelerometer mount on the frame at the location of the ECU (A_{yECU}), the “correction” calculation being as follows:

$$A_{yECU} = \frac{1 + 0.0037\text{Mass}}{1 + 0.0004\text{Mass}} A_{yFrnt} , \quad (\text{A-C1})$$

where Mass is the total mass in metric tons.

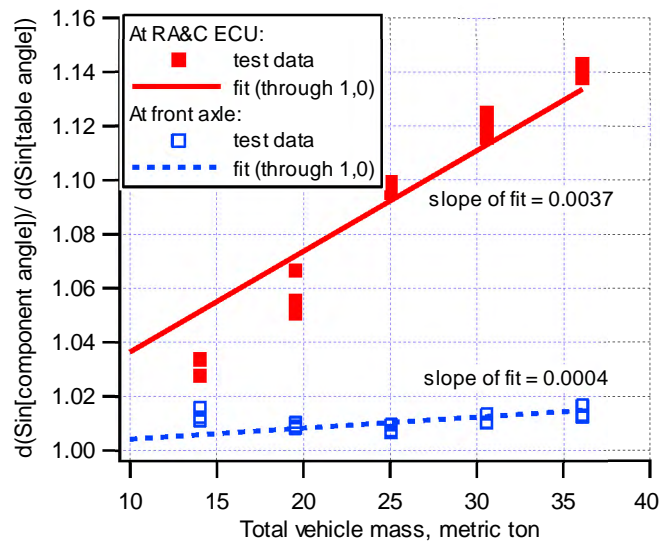

Figure A-C5. $d(\sin(\text{component tilt angle}))/d(\sin(\text{table tilt angle})$ for the front axle and the ECU as a function of total mass

APPENDIX A-D. SOLAR ZENITH ANGLE

Solar zenith angle was used to determine whether a tractor was traveling in daylight or in darkness. Solar zenith angle is the angle from vertical to the sun: 0 degrees means the sun is directly overhead; 90 degrees places the sun near the horizon. A solar zenith angle of 96 degrees is commonly used as the definition of *civil twilight*. For the purpose of this FOT, 96 degrees was used as the threshold between daylight and darkness. Lighting conditions were considered to be “light” for solar zenith angles less than 96 degrees and “dark” for angles equal or greater than 96 degrees.

The solar zenith angle was calculated from latitude, longitude, and universal time, using formulae obtained from the National Oceanic and Atmospheric Administration at <http://www.srrb.noaa.gov/highlights/sunrise/solareqns.PDF>. Solar zenith angle was calculated at five-minute intervals throughout each trip and recorded in the *FiveMin* table. Figure A-D1 plots the calculated solar zenith angle as a function of local time at the position of the vehicle. Each data point represents the angle for one five-minute period for one vehicle. The spread of the band of data points results from (1) the influence of the time of the year, (2) the influence of the range of latitude of the vehicle, and (3) the influence of the east-west location of the vehicle relative to time zone.

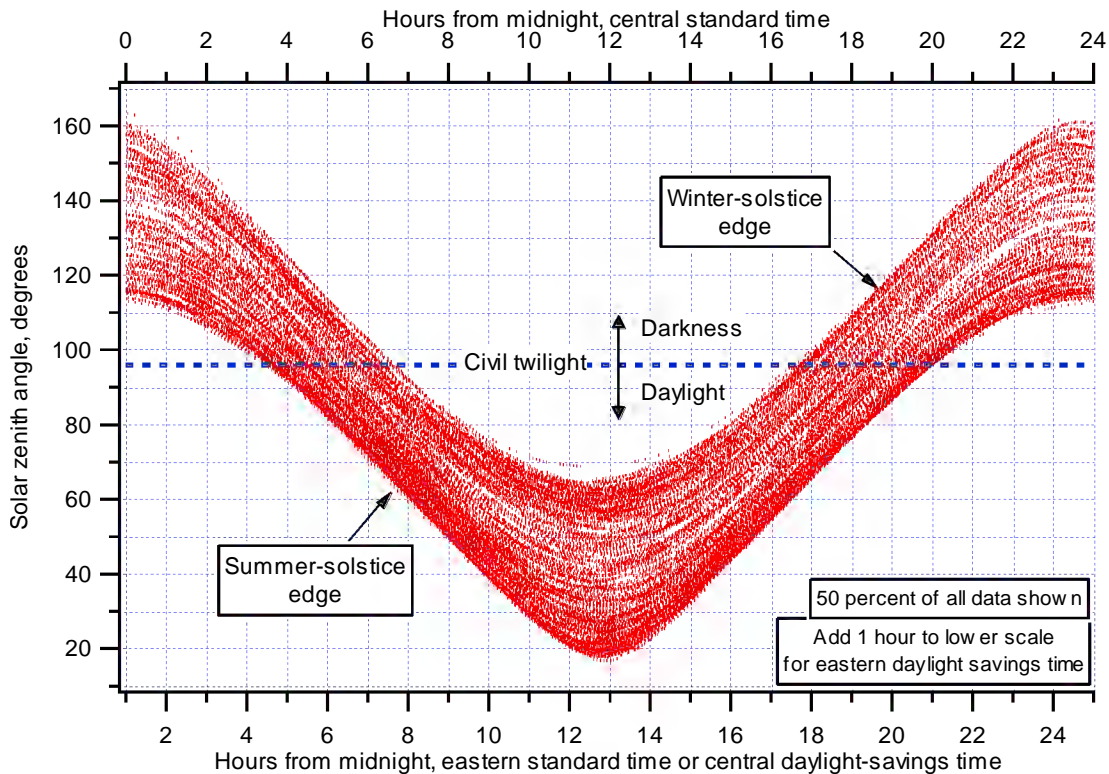

Figure A-D1. Solar zenith angle

APPENDIX A-E. THE PRIMARY LATERAL-ACCELERATION MEASUREMENT

The primary, objective measure for evaluating driver behavior and the potential influence of the RA&C device, as it pertains to reducing the likelihood of rollover, was the lateral-acceleration behavior of the vehicle as driven by the individual drivers participating in the FOT. The primary transducer used to derive this measure was an accelerometer mounted laterally on the front axle of each tractor. This appendix discusses the transducer, its basic calibration, and the signal-processing methods used by UMTRI to correct for temperature sensitivity and for long-term drift. This latter correction was done after-the-fact, in the post-processing and data analysis phase of this study. The final subject of this appendix is a short discussion on identification of lane changes in the FOT data set. Lane position was used in the lateral acceleration offset correction.

The Transducer

The lateral accelerometer used in this FOT was a bi-axle accelerometer made by Summit Instruments (Model 23203A). This instrument was chosen primarily on the basis of its high tolerance to shock and over-range g loading. Although it is biaxial, only one acceleration signal was used. This model also has a built-in temperature sensor to whose signal is intend for external correction of temperature sensitivity. This feature was appropriate for the field test since vehicles were to operate through out the year in the upper midwest and since the transducer was located on the front axle beneath the engine where temperture could rise substantially above ambient when the vehicle was parked and idling.

Initial Calibrations

Each lateral acceleration transducer was calibrated on-the-bench prior to being installed. Calibrations were conducted with the instrument “pre-heated” to temperatures ranging from -20C to +50C. Both accelerometer gain and offset were found to be sensitive to temperature. The results of these bench calibrations were used in programing the DAS computer to proces the raw transducer signals (*AyRaw* and *AyTemp*) on board the vehicle in real time to produce primary lateral acceleration signal (*Ay*).

For installation on the vehicle, the transducer was enclosed inside an aluminum box that was then secured to a steel plate and attached at the vehicle's front axle on its rear-ward side and at its longitudinal center-line. A picture of the final installation and wiring path is shown in figure A-E1. After installation and just prior to introduction of the vehicle into FOT service, the transducer mounting plate was unbolted from the axle and carefully rotated ± 90 degrees while simultaneously verifying via the data aquisition system, that the sensor measured between ± 1 g with the right polairity for each direction

of rotation. Following this test the mounting plate was re-attached to the center of the front axle and the inflation pressure of all tires were set to their proper levels. The tractor was then moved to a level concrete pad and the offset value was adjusted to show zero lateral acceleration. This initial zeroing process was repeated three times with the tractor completely removed from the pad between each test and the average of the three offset values was entered into the data acquisition system as the zero offset for the transducer.



Figure A-E1. Front-axle lateral accelerometer housing, mount, wiring path and location.

Offset Correction of the Lateral-Acceleration Signal in Post Processing

It was expected that accelerometers would show a long-term drift in their zero-offset. The original plan for this FOT was to use the signal from the time when vehicles were parked on scale facility at the distribution terminal to automatically perform periodic zero-calibrations on the lateral acceleration transducer. However, this technique did not prove to be adequate. Some scale events were missed or incomplete due to the time required for the DAS to become fully operational after the tractor had been started; some drivers appeared to drift over the scales rather than coming to a sustained full stop. The time between adequate scale events for a given vehicle can be rather large, ranging up to many days. Given these constraints, a more comprehensive approach to correcting the DC drift was undertaken.

The technique

The final method used to correct for offset-drift was to determine appropriate zero correction factors based on the relationship of average measured A_y and (predetermined)

average cross slope for long straight sections of good quality roadway. Implementing the approach required identifying a set of roadway segments that individually met the needed physical requirements and as a group were numerous and well distributed such that each FOT vehicle would encounter one or another quite frequently. Having identified such a set of roadway segments, each were then be visited and measured to determine the average cross slope which, in term, establishes the reference lateral acceleration for the site. With a reference acceleration for each site thus established, a correction factor for each A_y from each vehicle could be established for each (acceptable; see below) transversal of any segment.

Identification of reference roadway segments

A substantial site-evaluation process was developed that involved analyzing the GPS time-history records for all the FOT data in order to strategically select sites based upon the elapsed time between traversals of any given site as well as on the physical qualities of the sites.

Eventually, eighteen different reference locations were selected for lateral-acceleration drift correction. The Praxair scale was retained as one of the sites, and the entrance/exit drive of the Praxair facility was another. The other sixteen sites were on the public roads, and each had the following qualities:

- straight with a seemingly constant cross-slope,
- length of 500 to 700 m,
- smooth pavement conditions; no pot-holes, large-lateral cracks and rutting,
- no entrance, exit ramps or intersections,
- no traffic signals,
- no or very little grade variation,
- clear lane-boundary demarcation.

Table A-E1 shows the name, the number of lanes at the site (in each direction), the GPS coordinates of the two “ends” of the site, and two heading angles, one for each direction. The locations of the sites are shown in figure A-E2.

Table A-E1. Lateral acceleration offset correction sites.

Site No. ⁴⁴	Site Name	Lanes	Boundary 1		Boundary 2		Heading1, degrees	Heading2, degrees
			Longitude	Latitude	Longitude	Latitude		
0	Scale	1 ⁴⁵	-86.743	41.652	-86.743	41.652	88	268
1	Exit	1	-86.740	41.651	-86.739	41.651	90	270
2	I-90 Toll	2	-86.846	41.609	-86.839	41.613	247	67
3	I-196	2	-86.357	42.238	-86.352	42.244	47	227
4	I-90 Toll	2	-87.370	41.609	-87.362	41.610	272	92
5	I-94	3	-87.393	41.569	-87.385	41.571	270	90
6	I-65	3	-87.321	41.496	-87.318	41.502	180	0
7	US-35	1	-86.623	41.406	-86.620	41.412	180	0
8	US-31	2	-86.143	40.873	-86.139	40.879	161	341
9	I-94	2	-85.841	42.218	-85.831	42.220	84	263
10	US-31	2	-86.212	43.013	-86.209	43.019	336	156
11	US-131	2	-85.488	43.527	-85.484	43.533	0	180
12	I-90 Toll	2	-86.358	41.729	-86.350	41.733	90	270
13	US-41	2	-87.381	40.555	-87.378	40.563	180	0
14	US-131	2	-85.462	44.150	-85.455	44.155	44	224
15	I-90 Toll	2	-85.182	41.755	-85.175	41.757	90	270
16	I-69	2	-84.791	42.592	-84.785	42.598	51	231
17	US-35	1	-86.604	41.157	-86.602	41.165	180	0

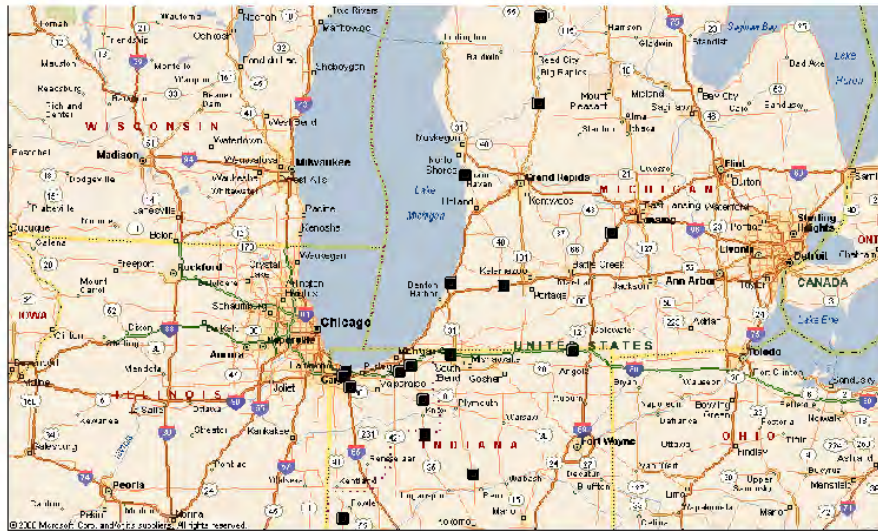

Figure A-E2. Map of the lateral acceleration offset corrections sites.

The number of sites used in the correction was determined by the desire that each vehicle traverse one or another of the sites rather regularly and frequently. Analysis of the selected sites showed that nearly 80 percent of all FOT travel time was within 1 hour of

⁴⁴ Site 0 and 1 are at the Praxair La Porte facility. Site 0 is the scale at the distribution terminal and site 1 is the private drive that connects the distribution terminal to the main highway.

⁴⁵ The scale has only one lane in total but it is used in both directions.

traversing one of these eighteen sites and 98 percent within four hours. The distribution of travel-time between locations is shown graphically in the cumulative distribution of Figure A-E3.

Surveying the sites

To measure the average cross-slope at the 18 correction sites a 1998 Ford Taurus station wagon was specially instrumented with two electronic inclinometers and two accelerometers mounted on straight piece of angle iron and secured laterally to the flat surface behind the rear seat of the vehicle⁴⁶. The accelerometers used were high-quality servo accelerometers. They were to provide the primary signals for measuring the cross slope of the site while traversing it with the vehicle. The inclinometers, while appropriate only for static measurements, were known to be very stable over long time. They were intended to provide a “zero reference” for the accelerometer signals; to provide this reference, a brief segment of data was taken with the vehicle parked immediately before each measurement. This zero-calibration process also included measuring the slope of the instrument bar with a precision (manual), pendulum inclinometer as a cross check on the electronic inclinometers.

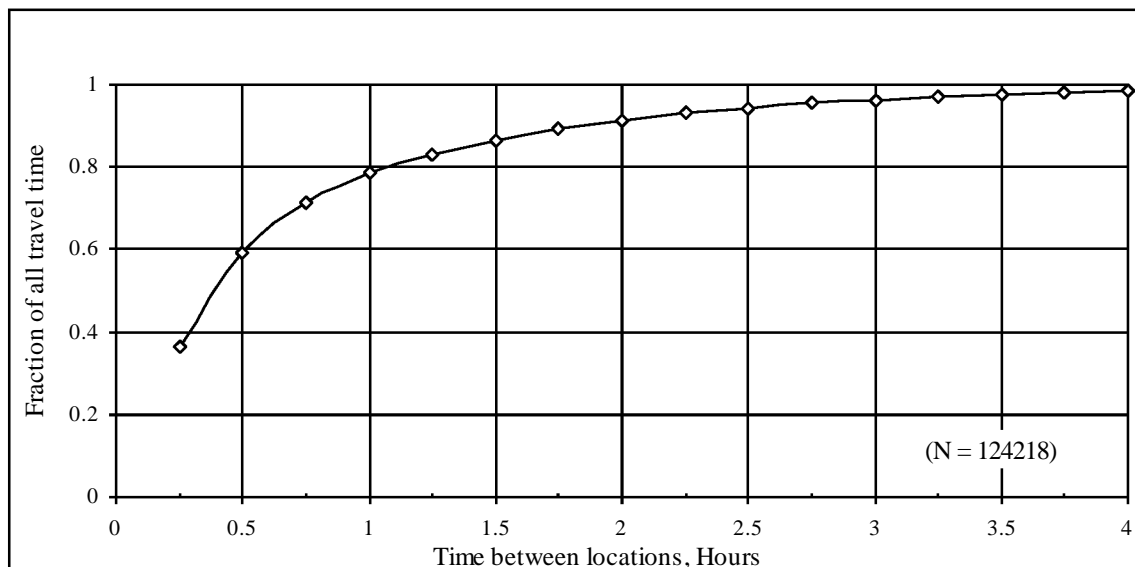

Figure A-E3. Cumulative distribution of travel time between the 18 lateral-acceleration drift-correction sites as a fraction of FOT travel time

⁴⁶ Two sets of transducers were used to provide redundancy and increase the statistical accuracy of the tests. The results from inclinometer and accelerometer transducer pairs were averaged, respectively. The following presentation and discussion of results is based upon the averaged data. Prior to installing, the transducers were calibrated and zeroed on-the-bench where a zero slope condition could be accurately established.

All eighteen sites were visited in to, 2-day road trips by an UMTRI technician. Calibration checks were conducted at UMTRI immediately prior to and following each trip as follows:

- Properly inflate all tires to the vehicle OEM specification.
- Position the vehicle on a relatively level concrete pad.
- Mark the position of all wheels on the pad.
- Measure and document the cross slope of the pad at the front and rear axles using a level and manual inclinometer.
- Collect about 30 seconds of data.
- Repeat with the process at the same location but with the direction of the vehicle reversed.
- Repeat the entire process three times.

The results of this procedure showed that the measured offset between the instruments and the road remained relatively constant at 0.0082 g throughout all of road cross slope tests. Moreover, by comparing the tests done prior to traveling to the sites with those done afterward the change in this instrument offset was determined to be less than 0.0006 g.

The test procedure used at each roadway site was as follows:

- Park the vehicle off the road at a relatively flat, convenient and safe place.
- Initialize and start the DAS.
- Initialize data recording.
- Record on the log sheet the date, site number, heading, position, and GPS-time from the DAS display.
- Take and record inclination of the instrument bar with the manual inclinometer.
- Using the right-most lane (if multiple lanes exist), drive through the site in one direction at the posted speed limit in a straight and steady manner without changing lanes.
- Turn around and drive through the site in the other direction (again in the right-most lane) at the posted speed limit and in a straight and steady manner without changing lanes
- Park the vehicle in the same location used at the outset, and terminate data recording with the DAS.
- Repeat this process two additional times, starting at the third step .
- Repeat the process one more time, but measure the center or left lane if a multilane roadway.

Following the data collection, the test files and log sheets were then loaded into a database for analysis.

Determining the reference cross slopes

The first step of the cross-slope site data processing was to calculate an offset that corrects the drift in the accelerometer transducers and includes the instrument offset. The

inclinometer transducers served as the truth device for zeroing the accelerometers and hence removing any DC drift. Inclinometers are stable transducers and do not need to be recalibrated often. The process for removing any drift was to compare the accelerometer measure to those of the inclinometer while the vehicle was parked on a relatively flat surface. The resulting *AyCorrection*, in gs, was calculated per the following equation:

$$AyCorrection = Ay - Angle - b \quad A-E1$$

where:

Ay is the average value of the accelerometer transducers in gs,
Angle is the average value of the inclinometer transducers in gs, and
b is offset between the transducers and the road in gs

The resulting correction for each of the 18 test sites is shown in Figure A-E4. The figure shows that for a given site the correction (calculated on at least three separate measures) was repeatable and consistent. The average of the standard deviation for each site is 0.0005 g.

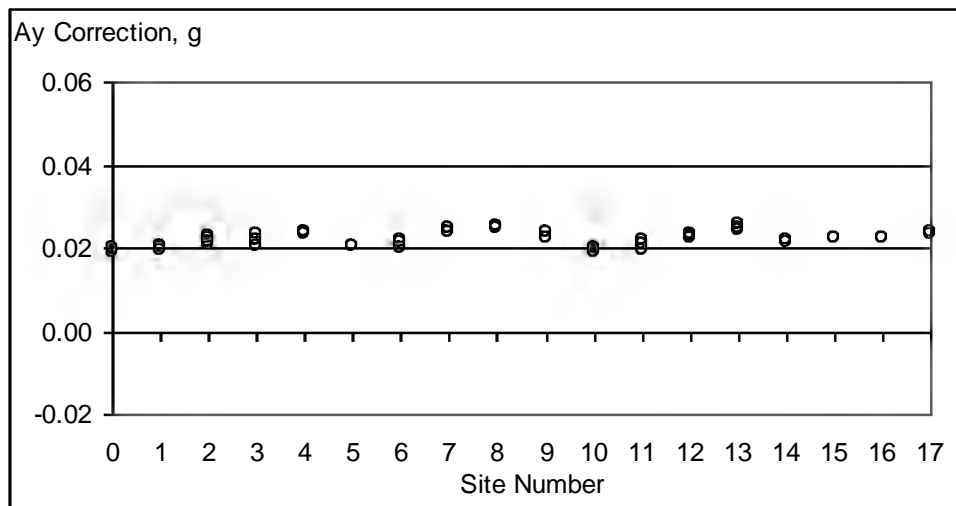

Figure A-E4. Lateral acceleration correction for transducer drift and instrument offset

Once the *AyCorrection* was calculated for each site, the data for the repeat passes through each site were analyzed. These data were first identified in the time-history record using GPS position coordinates that fit within the geographical region of the site and the heading angle was used to distinguish the direction of travel of the test vehicle. The average measured-lateral acceleration, *AyMeasured*, was calculated for each pass over each site and the results are shown in figure A-E5⁴⁷. The figure shows that the measured-lateral acceleration averages were repeatable. The average of the standard

⁴⁷ These results are for the right-most lane only of multilane highways

deviation for each site is 0.00087 g and 0.00093 g for direction 1 and direction 2, respectively.

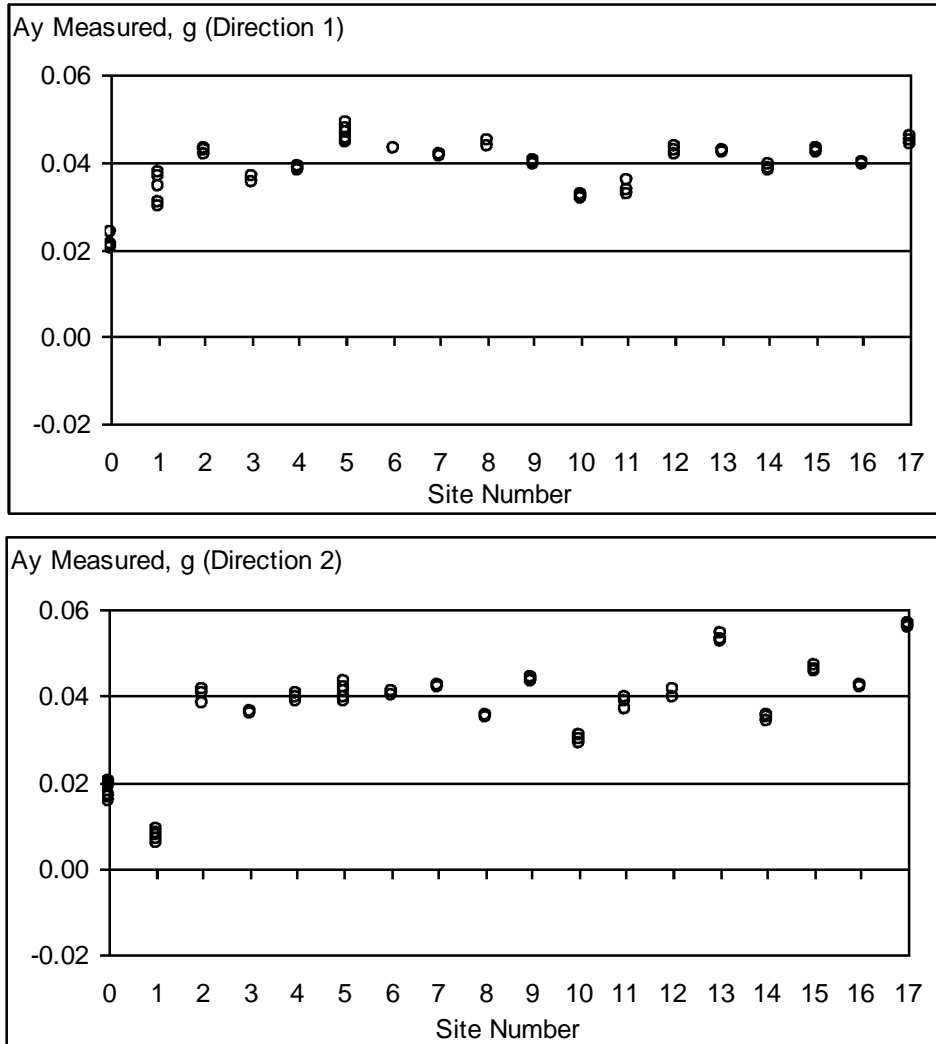

Figure A-E5. Direction 1 and direction 2 measured-lateral acceleration for each site

Next, a lateral acceleration correction due to the overall heading change was calculated and included in the offset correction. This correction is given by the following equation, which is based on an assumption of quasi-steady behavior over the time period of interest:

$$Ay_{Heading} = \left(\frac{((Speed/3.6) * (StartHeading - EndHeading) * 0.0174)}{(DeltaTime * 0.1)} \right) / g \quad A-E2$$

where:

- Speed* is the average speed for the pass in kph,
- StartHeading* is the average heading for 1.5 s at the start of the pass in degrees,
- EndHeading* is the average heading for 1.5 s at the end of the pass in degrees,

DeltaTime is the time of the pass in deci-seconds, and
g is gravity constant in m/s².

Finally, the cross slope, in gs, for each site was calculated using the following equation:

$$\text{CrossSlope} = \text{AyMeasured} - \text{AyHeading} - \text{AyCorrection} \quad \text{A-E3}$$

where:

AyMeasured is the average lateral acceleration as measured by the transducers in gs,

AyHeading is the correction due to heading change in gs, and

AyCorrection is the drift and instrument correction in gs.

Figure A-E6 shows the cross slope values for each site in direction 1 and 2 respectively. The results were repeatable. For the cross slope, the average of the standard deviation for each site is 0.00065 g and 0.00102 g for direction 1 and direction 2, respectively. The average cross-slope (and standard deviation) for all roads (excluding sites 0 and 1) is 0.018 g (0.003 g) for direction 1 and 0.019 g (0.006 g) for direction 2.

More detailed statistics for each site and direction are shown in table A-E2. The table contains the average and standard deviation of the measured cross-slope, a count of the number of passes, and the heading angle for the given direction of travel. Note: sites 0, 1, and 5 were measured on both trips with the instrumented cross-slope measurement vehicle⁴⁸, hence the larger number of counts or passes.

Table A-E2. Average cross slope statistics of each site for both direction of travel

Site No.	Direction 1				Direction 2			
	Average Cross slope, g	Stdev, g	Count	Heading, deg	Average Cross slope, g	Stdev, g	Count	Heading, deg
0	0.001	0.00026	5	88	-0.003	0.00148	5	268
1	0.013	0.00139	6	90	-0.014	0.00121	6	270
2	0.021	0.00092	3	247	0.019	0.00120	3	67
3	0.014	0.00067	3	47	0.014	0.00173	3	227
4	0.015	0.00031	3	272	0.017	0.00053	3	92
5	0.024	0.00103	6	270	0.018	0.00111	6	90
6	0.022	0.00105	3	180	0.021	0.00150	3	0
7	0.017	0.00047	3	180	0.018	0.00071	3	0
8	0.019	0.00026	3	161	0.010	0.00040	3	341
9	0.017	0.00066	3	84	0.021	0.00089	3	263
10	0.012	0.00101	3	336	0.010	0.00121	3	156
11	0.014	0.00058	3	0	0.018	0.00167	3	180
12	0.017	0.00097	3	90	0.019	0.00151	3	270
13	0.017	0.00038	3	180	0.028	0.00025	3	0
14	0.017	0.00046	3	44	0.013	0.00066	3	224

⁴⁸ To measure all 18 sites required two separate trips.

Table A-E2 continued.

Site No.	Direction 1				Direction 2			
	Average Cross slope, g	Stdev, g	Count	Heading, deg	Average Cross slope, g	Stdev, g	Count	Heading, deg
15	0.021	0.00039	3	90	0.024	0.00028	3	270
16	0.018	0.00041	3	51	0.019	0.00048	3	231
17	0.021	0.00054	3	180	0.032	0.00065	3	0

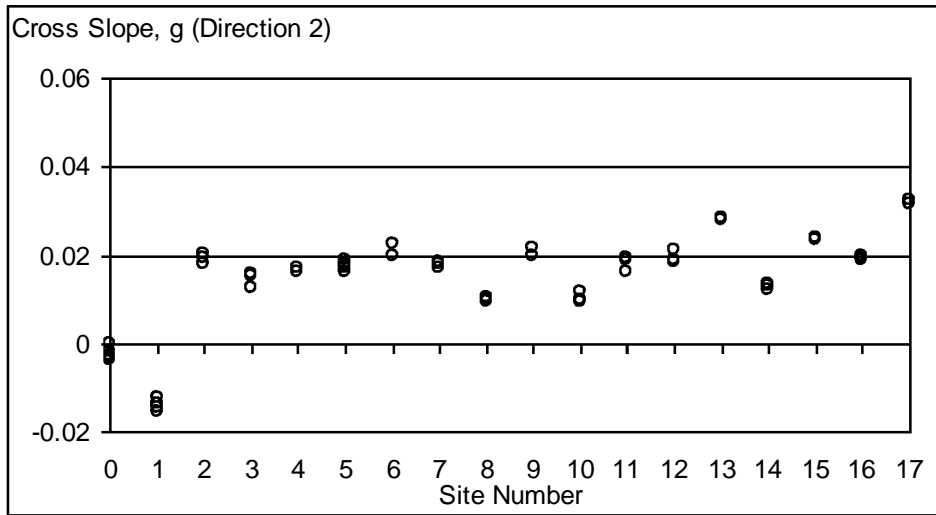
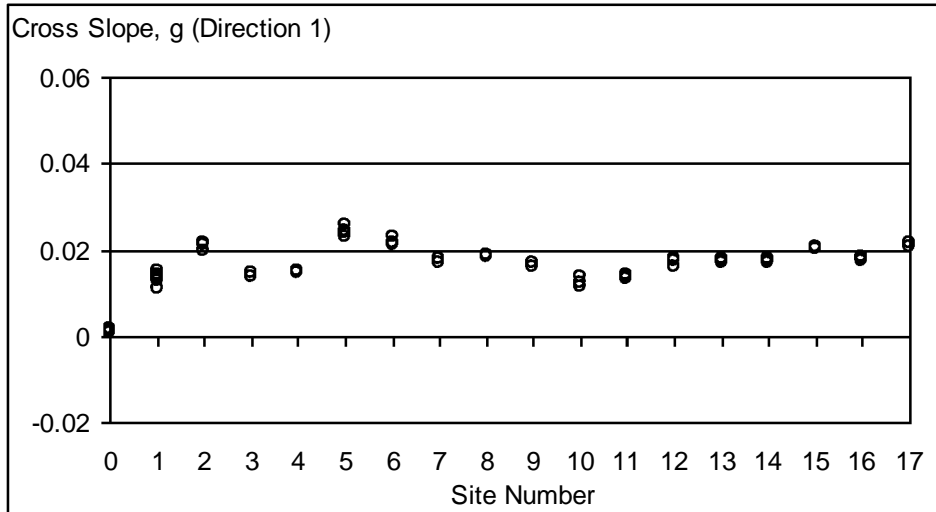

Figure A-E6. Cross slope for each site in direction 1 and 2, respectively

Correcting the FOT Lateral Acceleration Data

A number of procedures were developed to facilitate the processing and analysis of the time-history data collected in the FOT. One important routine, for the correction of the lateral acceleration measure, was a procedure to identify the time when a FOT vehicle traversed a particular segment of roadway. This procedure scanned the entire archive of GPS position coordinates to identify when the vehicles were traversing any of the 18

predetermined correction locations. For the entire FOT database, a total of 15,337 passes were identified for the 18 sites.

Having identified explicitly in the database, the subset of data for each pass, a series of statistical measures were calculated and saved for each pass. These measures included:

- average speed,
- average and standard deviation of the lateral acceleration,
- average heading angle for the pass and for the first and last 1.5 s of the pass,
- average air-spring pressure,
- minimum, maximum, average, and standard deviation of yaw-rate,
- a date/time variable that uniquely identifies the start of the pass.

The speed and yaw-rate calculations were used as a quality check of the passes. For the high speed sites any pass with an average speed below 70 kph was not considered in further calculations. Also passes that had an absolute average yaw-rate of more than 0.4 deg/s were not used in further analysis.

Following the identification and calculation of the statistical measure, an analysis of the data was done to establish the lane position for all passes over sites with multiple lanes for each direction of travel. To accomplish this, first a table of lane changes for all the FOT travel was made using the Lane Tracker™ data. (See the subsection lane changes which follows.) These data were then analyzed to determine the lane position of the vehicles when they passed through the corrections sites. It was assumed that the vehicle was in the right lane, unless the lane change data showed otherwise. The exact rules for determining which lane the vehicle was in depended in part on the location. For most locations,⁴⁹ a 60-second, pre- and post-site window was used to identify lane changes. If a lane change to the left was found in the pre-site window the pass was flagged as being in the left lane and not used to determine a lateral acceleration offset. Similarly, if a lane change to the right was found in the post-site time window the pass was not used. Of course, passes with any lane change on the reference segment were also excluded. (The yaw-rate constraint to qualify a valid straight pass also served to excluded many of the passes with lane changes on the segment.)

A lateral-acceleration correction value, called $AyOffset$, was calculated for each pass⁵⁰ and direction over the 18 correction sites. The equation used to calculate the value is given in equation A-E4 below:

⁴⁹ Site 12 was an exception and 30 second window was used. This site had a frequently used entrance ramp 1.5 km East of the site. So many of the FOT vehicles passing through this site heading West would have a lane change to the left as they entered the highway from the entrance ramp.

⁵⁰ Right-lane pass of multilane highways

$$AyOffset = AvgAy - AyHeading - CrossSlope \quad A-E4$$

where:

- AvgAy* is the average lateral acceleration for the pass, in gs
- AyHeading* is the heading correction given by equation 2 for the pass, in gs
- CrossSlope* is the measured cross-slope for the site and direction of travel, also in gs.

Lateral acceleration for all travel was then corrected by using the *AyOffset* value closest in time for the particular vehicle. The object of this correction process was the calculated variable *AySmooth*, and the resulting variable was *AySmoothCor*. That is, every smoothed, lateral-acceleration value, referred to as *AySmooth* and stored in the TwoCalc tables, was corrected using the value of *AyOffset* for the appropriate tractor and closest in time.

The final step in the correction process of lateral acceleration was to validate the correction by selecting three geographical locations within the FOT travel region and comparing the measured lateral acceleration before and after applying the offset correction. The results of this analysis are given in table A-E3 and are shown for one location in figure AE-7. The table shows the average and standard deviation values for all passes over the three sites for corrected and uncorrected lateral acceleration. The table shows a substantial reduction in the standard deviation from an average of 0.02 to 0.005 gs. This reduction is clearly shown in figure A-E7, where the corrected values has a much tighter distribution than the uncorrected values.

Table A-E3. Average and standard deviations values for all passes over the validation sites before and after the *AyOffset* correction

<i>Validation Road Name</i>	<u><i>Uncorrected Ay</i></u>		<u><i>Corrected Ay</i></u>	
	<i>Average</i>	<i>Stdev.</i>	<i>Average</i>	<i>Stdev.</i>
South-bound US-31	0.026	0.016	0.020	0.004
North-bound US-31	0.007	0.020	0.016	0.005
South-bound US196	0.023	0.019	0.019	0.004
North-bound US196	0.007	0.020	0.013	0.004
East-bound I-90	0.013	0.018	0.011	0.005
West-bound I-90	0.007	0.020	0.003	0.005

Lane changes

All FOT tractors were equipped with the Lane Tracker™ system. This is a vision-based system and measures the lateral offset from the right- and left-lane boundary markers. The camera for the system was mounted 21 cm to the passenger-side near the top of the front windshield but within the pass of the left-side windshield wiper. The offsets the system measures are from the lane boundary demarcation to the system camera. The system was active during all driving and the left- and right-offset values were recorded by the DAS at 2 Hz. The system also had a status flag that indicated the

quality of the two offset measures and gave some indication of when the system detected a lane change or lane-boundary crossing. Turn-signal activity was also monitored by the system and logged by the UMTRI DAS. Table A-E4 shows the bitwise mapping of the tracker status message.

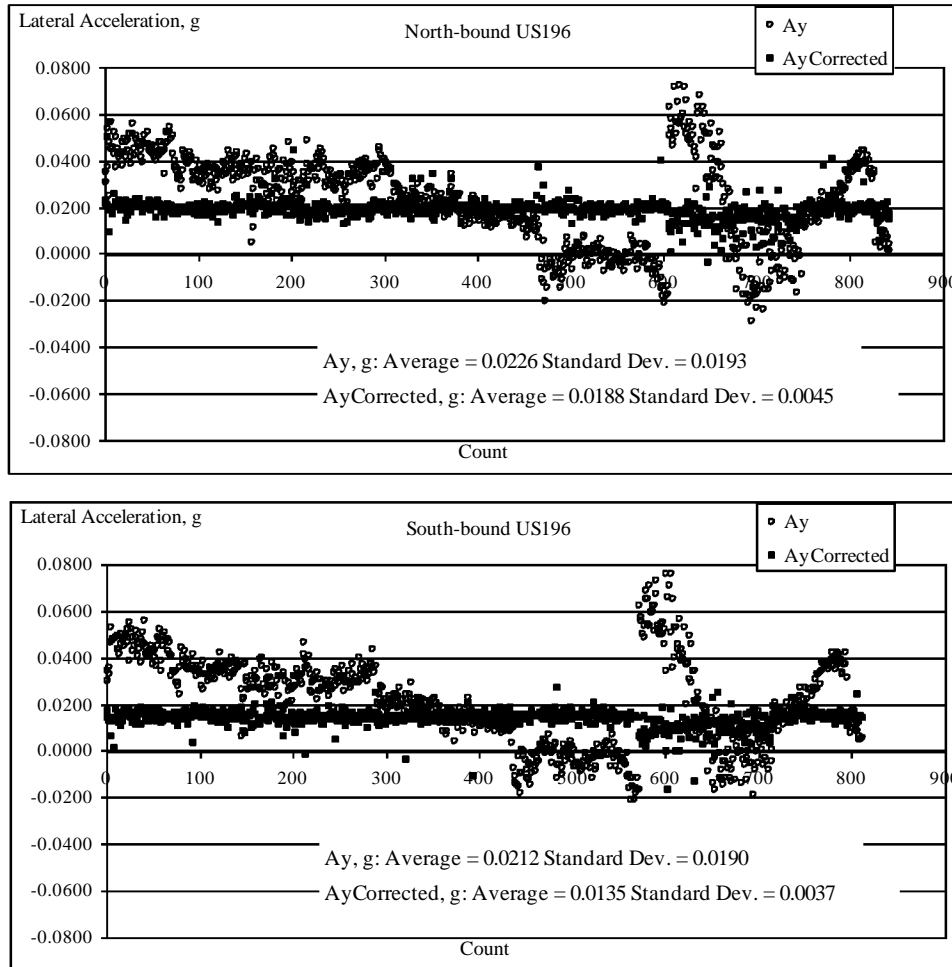

Figure A-E7. Distribution of corrected and uncorrected lateral acceleration at a validation site

Table A-E4. Lane tracker status mapping

Bit position	Value	Message
0	1	Always true
1	2	Always true
2	4	Tracking Right
3	8	Warning Right
4	16	Tracking Left
5	32	Warning Left
6	64	Disabled
7	128	Turn signal On

The characteristics of a lane change in terms of the offset measures of the Lane Tracker system are very unique. An example of a lane change to the left is shown in

figure A-E8. The figure shows both left- and right-offset values as a function of time. For the first second, the figure shows the vehicle is in the center of the lane. (Since the camera is mounted 0.21 m to right of the tractor centerline, travel in the center lane results in values of 1.52 and 1.94 m for the right-and left-offset, respectively.) The lane change begins just after one second when the two measures converge to a value of 1.7 m. As the vehicle moves laterally in the lane, from 1 to 5 seconds, the right-offset increases while the left-offset decreases. The rate of change of these measures is very close which makes sense since lane widths are for the most part constant. From 5 to 5.5 seconds the vehicle passes over the center line of the two lanes and the slope of the signals switch polarity as the lane tracker system switches to monitoring the new left-boundary line with the left-offset and the center-line with the right-offset. This is then followed by the two signals converging back to their original values as the vehicle becomes centered in the new lane.

The entire FOT data archive was searched on trip-by-trip basis to determine the location of candidate lane changes. The rules used to identify lane changes in the data set were based on the offset values and the lane tracker status message. To identify candidate lane changes the difference in the offset measures was calculated and then differentiated. When the absolute value of the differential exceeded a threshold of five a record, book-marking the tractor, trip and time, was entered into the lane-change table for further analysis. The status message was used to determine the fraction of time in a 10 s window centered on the candidate lane-change time that the lane tracker was not producing a valid tracking message (i.e., the left and right offset may be in error). If this fraction exceeded 25 percent then the candidate lane change was deleted from the table of lane changes. Candidate lane changes were also deleted if the speed during the lane change was zero or could not be determined.

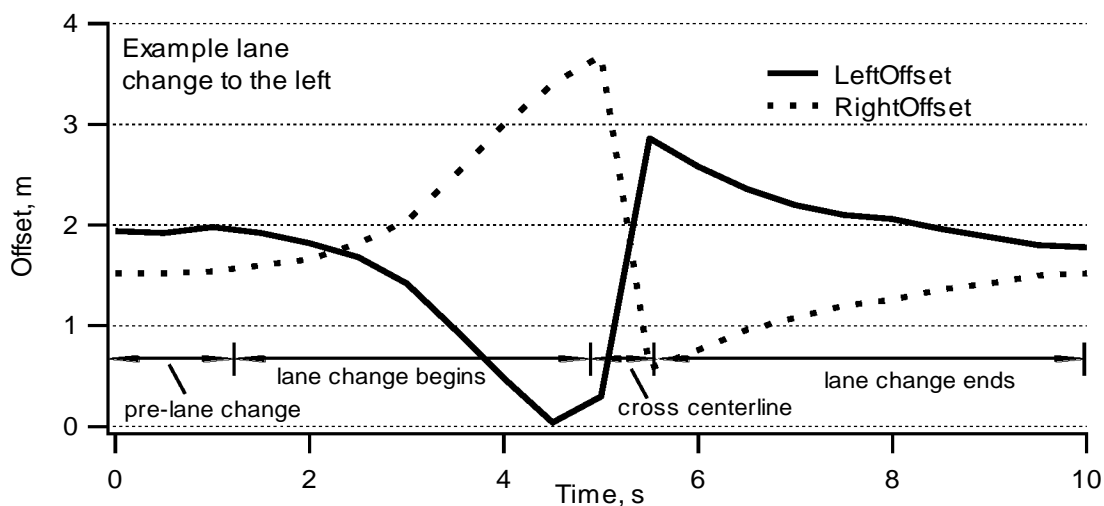

Figure A-E8. An example of the left- and right-offset values characteristic of a lane change

Appendix A-F. Delivery points

Table A-F1. Delivery Points

<i>Point</i>	<i>Dist. La Porte</i>	<i>Phs I</i>	<i>Phs II</i>	<i>Delivery Loc.</i>	<i>Point</i>	<i>Dist. La Porte</i>	<i>Phs I</i>	<i>Phs II</i>	<i>Delivery Loc.</i>
1	5	21	28	LA PORTE, IN	52	133	2	2	MORRIS, IL
2	15	3	2	MICHIGAN CITY, IN	53	135	12	6	HUNTINGTON, IN
3	15	2	2	MICHIGAN CTY, IN	54	135	15	10	LAFAYETTE, IN
4	17	16	22	KINGSBURY, IN	55	135	122	146	HOLLAND, MI
5	31	17	2	VALPARAISO, IN	56	135	69	56	HOLLAND, MI
6	31	19	8	VALPARAISO, IN	57	135	39	40	HOLLAND, MI
7	31	17	2	VALPARAISO, IN	58	135	6	4	HOLLAND, MI
8	31	2	2	VALPARAISO, IN	59	137	15	22	HOLLAND, MI
9	33	27	6	VALPARAISO, IN	60	137	0	2	ELGIN, IL
10	33	0	4	BURNS HARBOR, IN	61	137	58	60	HOLLAND, MI
11	37	156	192	SOUTH BEND, IN	62	137	417	526	HOLLAND, MI
12	37	40	20	SOUTH BEND, IN	63	137	231	38	HOLLAND, MI
13	37	116	120	SOUTH BEND, IN	64	137	31	42	HOLLAND, MI
14	37	195	252	SOUTH BEND, IN	65	137	6	10	HOLLAND, MI
15	40	6	8	SOUTH BEND, IN	66	137	44	46	HOLLAND, MI
16	55	34	0	GARY, IN	67	137	23	18	HOLLAND, MI
17	60	0	2	EAST CHICAGO, IN	68	137	2	6	HOLLAND, MI
18	60	443	428	EAST CHICAGO, IN	69	138	0	2	ELGIN, IL
19	62	16	22	ELKHART, IN	70	138	9	18	HOLLAND, MI
20	62	7	10	ELKHART, IN	71	141	0	22	HOLLAND, MI
21	63	10	10	BENTON HARBOR, MI	72	141	63	126	KOKOMO, IN
22	64	2	2	HAMMOND, IN	73	141	3	2	KOKOMO, IN
23	66	27	28	ELKHART, IN	74	141	19	16	BATTLE CREEK, MI
24	66	11	12	ELKHART, IN	75	142	8	18	HOLLAND, MI
25	66	10	20	ELKHART, IN	76	142	33	40	BATTLE CREEK, MI
26	72	0	2	DOLTON, IL	77	143	27	14	KOKOMO, IN
27	74	3	2	RIVERDALE, IL	78	143	26	18	KOKOMO, IN
28	77	103	124	GOSHEN, IN	79	143	16	34	ZEELAND, MI
29	78	0	2	CHICAGO, IL	80	143	34	34	ZEELAND, MI
30	84	45	50	BRISTOL, IN	81	143	36	72	ZEELAND, MI
31	85	28	36	WARSAW, IN	82	144	2	6	AUBURN, IN
32	87	4	4	RICHTON PARK, IL	83	146	2	2	COLDWATER, MI
33	97	0	16	THREE RIVERS, MI	84	147	12	12	SPRING LAKE, MI
34	104	5	6	FENNVILLE, MI	85	154	0	22	HAMILTON, IN
35	105	18	14	LOGANSPOURT, IN	86	154	6	6	FRANKFORT, IN
36	105	4	4	LOGANSPOURT, IN	87	157	0	2	HAMPSHIRE, IL
37	105	33	30	LOGANSPOURT, IN	88	163	71	76	GRAND RAPIDS, MI
38	110	2	4	KANKAKEE, IL	89	164	21	18	GRAND RAPIDS, MI
39	115	12	0	ALBION, IN	90	164	21	10	WOODBURN, IN
40	118	0	2	NORTH CHICAGO, IL	91	166	21	26	GRAND RAPIDS, MI
41	118	0	2	NORTH CHICAGO, IL	92	168	1	2	GRAND RAPIDS, MI
42	118	1	2	NORTH CHICAGO, IL	93	168	5	2	GRAND HAVEN, MI
43	119	1	2	WARRENVILLE, IL	94	169	14	8	JACKSON, MI
44	120	3	4	ABBOTT PARK, IL	95	170	14	16	GRAND RAPIDS, MI
45	120	0	8	BUTLER, IN	96	170	149	216	FRUITPORT, MI
46	120	0	2	WABASH, IN	97	171	23	18	WALKER, MI
47	120	1	2	ABBOTT PARK, IL	98	172	49	44	GRAND RAPIDS, MI
48	121	5	2	ELWOOD, IL	99	173	2	6	GRAND RAPIDS, MI
49	124	1	2	AURORA, IL	100	173	33	22	MUSKEGON, MI
50	125	4	0	FLORA, IN	101	176	4	6	MUSKEGON, MI
51	126	0	2	WAUKEGAN, IL	102	176	7	8	MUSKEGON, MI

<i>Point</i>	<i>Dist. La Porte</i>	<i>Phs I</i>	<i>Phs II</i>	<i>Delivery Loc.</i>
103	178	3	6	MUSKEGON, MI
104	180	16	20	MUSKEGON, MI
105	180	28	16	MUSKEGON, MI
106	182	26	30	MUSKEGON, MI
107	183	31	40	LOWELL, MI
108	184	0	4	DANVILLE, IL
109	186	3	0	OAKWOOD, IL
110	187	22	18	SPARTA, MI
111	193	5	2	BROOKFIELD, WI
112	193	0	2	BROOKFIELD, WI
113	196	9	8	EATON RAPIDS, MI
114	197	9	16	WHITEHALL, MI
115	197	26	32	WHITEHALL, MI
116	197	10	18	WHITEHALL, MI
117	200	1	4	JACKSON, MI
118	212	24	42	FREMONT, CA
119	212	4	6	INDIANAPOLIS, IN
120	212	6	6	INDIANAPOLIS, IN
121	212	5	12	FREMONT, MI
122	215	7	2	LANSING, MI
123	215	10	4	INDIANAPOLIS, IN
124	215	2	0	INDIANAPOLIS, IN
125	215	4	8	INDIANAPOLIS, IN
126	215	5	10	INDIANAPOLIS, IN
127	217	10	2	LANSING, MI
128	217	4	0	LANSING, MI
129	218	0	2	INDIANAPOLIS, IN
130	218	9	2	LANSING, MI
131	227	1	8	ADRIAN, MI
132	227	4	6	ADRIAN, MI
133	227	5	4	ADRIAN, MI
134	235	0	2	TECUMSEH, MI
135	244	29	22	TERRE HAUTE, IN
136	244	8	20	TERRE HAUTE, IN

<i>Point</i>	<i>Dist. La Porte</i>	<i>Phs I</i>	<i>Phs II</i>	<i>Delivery Loc.</i>
137	246	9	2	TUSCOLA, IL
138	248	0	2	SHEBOYGAN, WI
139	256	7	14	LUDINGTON, MI
140	263	98	90	TERRE HAUTE, IN
141	265	30	34	MARSHALL, IL
142	265	59	54	MARSHALL, IL
143	267	2	4	REED CITY, MI
144	271	0	2	S LYON, MI
145	282	0	2	WIXOM, MI
146	284	0	6	HEMLOCK, MI
147	289	0	8	HEMLOCK, MI
148	289	2	6	HEMLOCK, MI
149	289	1	8	HEMLOCK, MI
150	290	10	16	HEMLOCK, MI
151	290	5	10	HEMLOCK, MI
152	290	7	96	HEMLOCK, MI
153	290	2	14	HEMLOCK, MI
154	292	0	4	FLINT, MI
155	293	4	2	MANISTEE, MI
156	295	2	4	FLINT, MI
157	295	0	2	FLINT, MI
158	297	0	10	FLINT, MI
159	297	1	2	FLINT, MI
160	297	2	2	FLINT, MI
161	298	2	2	FLINT, MI
162	300	0	6	MIDLAND, MI
163	302	0	2	SAGINAW, MI
164	351	31	8	GRIFFITH, IN
165	376	83	128	KALKASKA, MI
166	376	0	2	KALKASKA, MI
167	412	2	0	OSCODA, MI
168	412	16	6	LEWISTON, MI
169	440	19	0	PETOSKEY, MI
170	464	12	0	ALPENA, MI

APPENDIX A-G. CURVES WITH RA&C EVENTS

Index to curves

<i>Curve Number</i>	<i>Page Number</i>
34	270
37	268
76	266
77	266
78	266
120	269
124	269
233	269
234	273
236	270
406	271
421	267
653	268
700	269
744	273
748	266
751	266
888	274
891	267
1249	267
1259	274
2233	271
2563	274
2651	271
3290	275
3464	271
4041	268
4044	268
4163	270
4165	270
4176	275
5596	272
6142	272
7917	272
8129	275
8409	276
9224	276
9717	273
15293	276
16143	277
30100	277
30201	277

Curves 751, 748

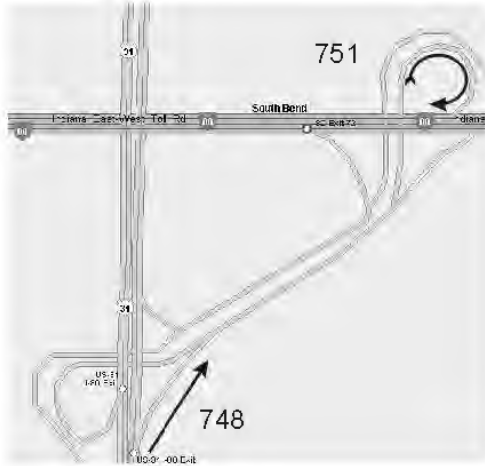

751: on-ramp from US 31 North to I-80 West near South Bend, IN
 748: off-ramp from US 31 North to I-80 East-West near South Bend, IN

Curve	751
Type	2
RoadClassStart	68
RoadClassEnd	64.4
Number of Episodes	22
Number of Alerts	40
Number of RSC Commands	8
Total Phase 2 Passes	126
Min Characteristic Speed, kph	48.1
Avg Characteristic Speed, kph	54.2
Max Characteristic Speed, kph	60.4
Min Mass, metric tons	14.1
Avg Mass, metric tons	14.5
Max Mass, metric tons	16.5
Cross-slope, degrees	-4.7
Curve	748
Type	3
RoadClassStart	68
RoadClassEnd	68
Number of Episodes	2
Number of Alerts	3
Number of RSC Commands	1
Total Phase 2 Passes	134
Min Characteristic Speed, kph	69.6
Avg Characteristic Speed, kph	69.9
Max Characteristic Speed, kph	70.1
Min Mass, metric tons	14.4
Avg Mass, metric tons	14.5
Max Mass, metric tons	14.6
Cross-slope, degrees	-3.5

Curves 76, 77, 78

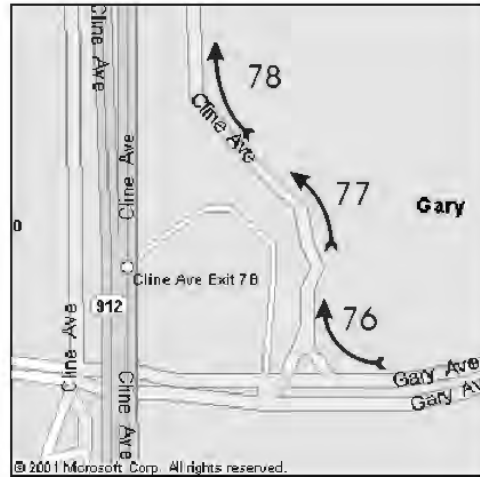

Gary Avenue West to Cline Avenue North, Gary, Indiana

Curve	76
Type	7
RoadClassStart	32
RoadClassEnd	32
Number of Episodes	10
Number of Alerts	14
Number of RSC Commands	3
Total Phase 2 Passes	156
Min Characteristic Speed, kph	29.4
Avg Characteristic Speed, kph	50.5
Max Characteristic Speed, kph	61.3
Min Mass, metric tons	14.4
Avg Mass, metric tons	15.3
Max Mass, metric tons	16.6
Cross-slope, degrees	-0.5
Curve	77
Type	9
RoadClassStart	32
RoadClassEnd	32
Number of Episodes	13
Number of Alerts	15
Number of RSC Commands	3
Total Phase 2 Passes	156
Min Characteristic Speed, kph	51.9
Avg Characteristic Speed, kph	59.3
Max Characteristic Speed, kph	66.3
Min Mass, metric tons	14
Avg Mass, metric tons	14.9
Max Mass, metric tons	18
Cross-slope, degrees	3.9
Curve	78
Type	9

RoadClassStart	32
RoadClassEnd	32
Number of Episodes	5
Number of Alerts	5
Number of RSC Commands	0
Total Phase 2 Passes	156
Min Characteristic Speed, kph	55.8
Avg Characteristic Speed, kph	59
Max Characteristic Speed, kph	65.6
Min Mass, metric tons	14.5
Avg Mass, metric tons	15.9
Max Mass, metric tons	18.1
Cross-slope, degrees	-4.2

Curve 421



US 6/35 West/North to US 35 North, south of La Porte, IN

Type	6
RoadClassStart	32
RoadClassEnd	32
Number of Episodes	11
Number of Alerts	14
Number of RSC Commands	3
Total Phase 2 Passes	59
Min Characteristic Speed, kph	39.3
Avg Characteristic Speed, kph	41.7
Max Characteristic Speed, kph	45.6
Min Mass, metric tons	14
Avg Mass, metric tons	14.7
Max Mass, metric tons	16.1
Cross-slope, degrees	-1.8

Curves 891 and 1249

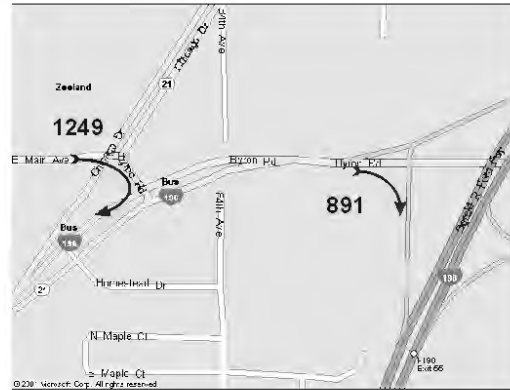

891: Byron Road E. to ramp I-196 W.
1249: Mair Ave. East to Bus. I-196 West.

Curve	891
Type	9
RoadClassStart	36
RoadClassEnd	36
Number of Episodes	11
Number of Alerts	11
Number of RSC Commands	0
Total Phase 2 Passes	104
Min Characteristic Speed, kph	22.5
Avg Characteristic Speed, kph	26.9
Max Characteristic Speed, kph	29.6
Min Mass, metric tons	14
Avg Mass, metric tons	14.4
Max Mass, metric tons	15.8
Cross-slope, degrees	0.5
Curve	1249
Type	7
RoadClassStart	Null
RoadClassEnd	Null
Number of Episodes	3
Number of Alerts	3
Number of RSC Commands	0
Total Phase 2 Passes	19
Min Characteristic Speed, kph	26.3
Avg Characteristic Speed, kph	29.4
Max Characteristic Speed, kph	31.7
Min Mass, metric tons	14.1
Avg Mass, metric tons	15.7
Max Mass, metric tons	18.6
Cross-slope, degrees	1.3

Curves 4041 and 4044



I-69 South to I-80 West, near Fremont, IN.

Curve	4041
Type	4
RoadClassStart	68
RoadClassEnd	68
Number of Episodes	2
Number of Alerts	4
Number of RSC Commands	0
Total Phase 2 Passes	17
Min Characteristic Speed, kph	49.4
Avg Characteristic Speed, kph	50.7
Max Characteristic Speed, kph	52.1
Min Mass, metric tons	14.4
Avg Mass, metric tons	16
Max Mass, metric tons	17.7
Cross-slope, degrees	-4.2
Curve	4044
Type	2
RoadClassStart	68
RoadClassEnd	68
Number of Episodes	10
Number of Alerts	15
Number of RSC Commands	4
Total Phase 2 Passes	28
Min Characteristic Speed, kph	40
Avg Characteristic Speed, kph	49.3
Max Characteristic Speed, kph	54.3
Min Mass, metric tons	13.8
Avg Mass, metric tons	17.1
Max Mass, metric tons	34
Cross-slope, degrees	-4.3

Curve 653

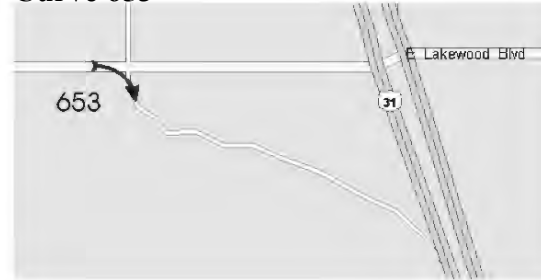

E. Lakewood Blvd. to on-ramp for US-31 South, Holland, MI.

Type	8
RoadClassStart	Null
RoadClassEnd	Null
Number of Episodes	9
Number of Alerts	9
Number of RSC Commands	0
Total Phase 2 Passes	149
Min Characteristic Speed, kph	26
Avg Characteristic Speed, kph	31.5
Max Characteristic Speed, kph	41.8
Min Mass, metric tons	14.1
Avg Mass, metric tons	15.5
Max Mass, metric tons	20.5
Cross-slope, degrees	0.2

Curve 37

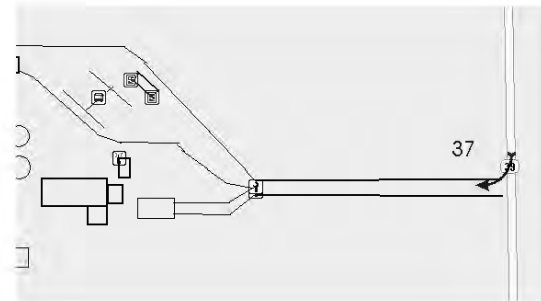

SR-39 South to Praxair Driveway, La Porte, IN

Type	14
RoadClassStart	Null
RoadClassEnd	Null
Number of Episodes	7
Number of Alerts	8
Number of RSC Commands	1
Total Phase 2 Passes	807
Min Characteristic Speed, kph	20.7
Avg Characteristic Speed, kph	25.1
Max Characteristic Speed, kph	27.8
Min Mass, metric tons	14.1
Avg Mass, metric tons	15.3
Max Mass, metric tons	17.7
Cross-slope, degrees	-0.3

Curves 120, 124 and 700

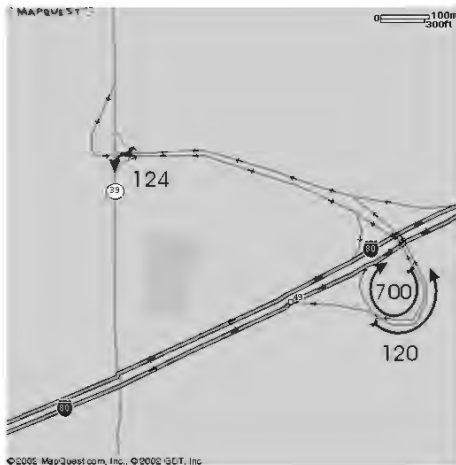

North of La Porte, IN
 120: I-80 East off-ramp.
 124: Left turn from off-ramp onto SR-39.

Curve	120
Type	5
RoadClassStart	12
RoadClassEnd	12
Number of Episodes	3
Number of Alerts	3
Number of RSC Commands	0
Total Phase 2 Passes	153
Min Characteristic Speed, kph	46.1
Avg Characteristic Speed, kph	47.9
Max Characteristic Speed, kph	51
Min Mass, metric tons	14.1
Avg Mass, metric tons	28.1
Max Mass, metric tons	35.4
Cross-slope, degrees	3.4

Curve	124
Type	8
RoadClassStart	8
RoadClassEnd	8
Number of Episodes	5
Number of Alerts	5
Number of RSC Commands	0
Total Phase 2 Passes	279
Min Characteristic Speed, kph	23.9
Avg Characteristic Speed, kph	28.1
Max Characteristic Speed, kph	31.4
Min Mass, metric tons	13.9
Avg Mass, metric tons	14.8
Max Mass, metric tons	17.3
Cross-slope, degrees	-0.8

Curve	700
Type	2
RoadClassStart	12
RoadClassEnd	12
Number of Episodes	4
Number of Alerts	4
Number of RSC Commands	0
Total Phase 2 Passes	147
Min Characteristic Speed, kph	45.5
Avg Characteristic Speed, kph	46.6
Max Characteristic Speed, kph	47.7
Min Mass, metric tons	34.4
Avg Mass, metric tons	35.1
Max Mass, metric tons	35.6
Cross-slope, degrees	-4.2

Curve 233



US-31 North to US-20 West, South Bend, IN.

Type	2
RoadClassStart	68
RoadClassEnd	64
Number of Episodes	5
Number of Alerts	7
Number of RSC Commands	1
Total Phase 2 Passes	19
Min Characteristic Speed, kph	53
Avg Characteristic Speed, kph	54.7
Max Characteristic Speed, kph	56.9
Min Mass, metric tons	14.2
Avg Mass, metric tons	14.9
Max Mass, metric tons	15.7
Cross-slope, degrees	-3.3

Number of Alerts	5
Number of RSC Commands	0
Total Phase 2 Passes	81
Min Characteristic Speed, kph	25.8
Avg Characteristic Speed, kph	27.8
Max Characteristic Speed, kph	30.5
Min Mass, metric tons	14
Avg Mass, metric tons	14.2
Max Mass, metric tons	14.4
Cross-slope, degrees	-0.8

Curves 34 and 236



US-20 to SR-39 South, Springville, IN.

Curve	34
Type	6
RoadClassStart	16
RoadClassEnd	8
Number of Episodes	2
Number of Alerts	2
Number of RSC Commands	0
Total Phase 2 Passes	51
Min Characteristic Speed, kph	24.3
Avg Characteristic Speed, kph	26.1
Max Characteristic Speed, kph	28
Min Mass, metric tons	15.5
Avg Mass, metric tons	16.1
Max Mass, metric tons	16.7
Cross-slope, degrees	-0.5
Curve	236
Type	6
RoadClassStart	8
RoadClassEnd	8
Number of Episodes	5

Curves 4163 and 4165

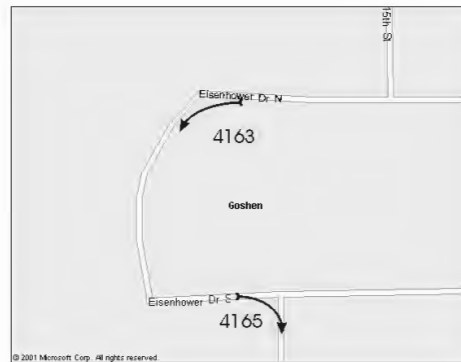

Goshen, IN

4163: Curve in Eisenhower Dr.

4165: Right turn from Eisenhower Dr. to Industrial Park Dr.

Curve	4163
Type	9
RoadClassStart	Null
RoadClassEnd	Null
Number of Episodes	5
Number of Alerts	6
Number of RSC Commands	1
Total Phase 2 Passes	49
Min Characteristic Speed, kph	35.8
Avg Characteristic Speed, kph	37.1
Max Characteristic Speed, kph	37.9
Min Mass, metric tons	14.1
Avg Mass, metric tons	15.1
Max Mass, metric tons	16.8
Cross-slope, degrees	-0.1

Curve	4165
Type	7
RoadClassStart	Null
RoadClassEnd	Null
Number of Episodes	2
Number of Alerts	2
Number of RSC Commands	0
Total Phase 2 Passes	52

Min Characteristic Speed, kph	24.5
Avg Characteristic Speed, kph	25.8
Max Characteristic Speed, kph	27
Min Mass, metric tons	15.1
Avg Mass, metric tons	16
Max Mass, metric tons	16.8
Cross-slope, degrees	0.2

Max Mass, metric tons	14.4
Cross-slope, degrees	4.3

Curves 2233 and 3464

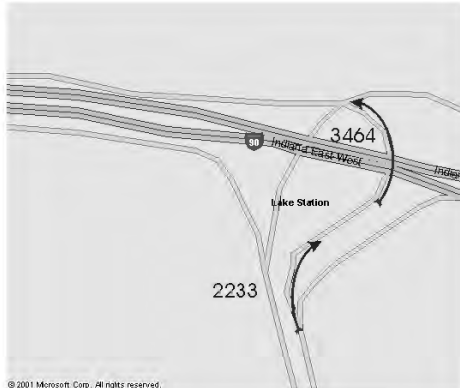

I-94 to I-90 connector ramp.

Curve	2233
Type	5
RoadClassStart	68
RoadClassEnd	68
Number of Episodes	4
Number of Alerts	5
Number of RSC Commands	0
Total Phase 2 Passes	56
Min Characteristic Speed, kph	46.2
Avg Characteristic Speed, kph	47.9
Max Characteristic Speed, kph	49
Min Mass, metric tons	14.1
Avg Mass, metric tons	15.3
Max Mass, metric tons	16.5
Cross-slope, degrees	-3.5

Curve	3464
Type	5
RoadClassStart	68
RoadClassEnd	68
Number of Episodes	2
Number of Alerts	2
Number of RSC Commands	0
Total Phase 2 Passes	56
Min Characteristic Speed, kph	45.8
Avg Characteristic Speed, kph	47.7
Max Characteristic Speed, kph	49.7
Min Mass, metric tons	14.1
Avg Mass, metric tons	14.3

Curve 406

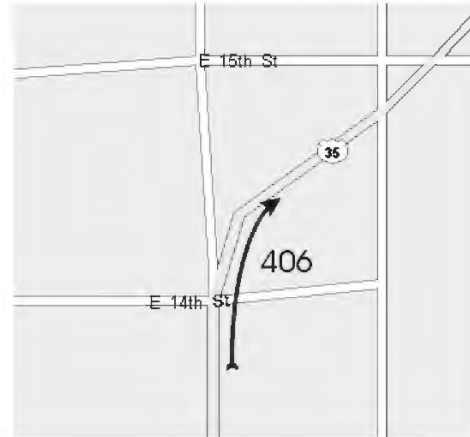

45-degree bend in US-35 North, Winamac, IN.

Type	12
RoadClassStart	16
RoadClassEnd	16
Number of Episodes	3
Number of Alerts	3
Number of RSC Commands	0
Total Phase 2 Passes	22
Min Characteristic Speed, kph	46.8
Avg Characteristic Speed, kph	49.7
Max Characteristic Speed, kph	51.4
Min Mass, metric tons	14.2
Avg Mass, metric tons	17.6
Max Mass, metric tons	22.6
Cross-slope, degrees	-2.5

Curve 2651



White Lake Drive East to on-ramp for US-31 South, Whitehall, MI.

Type	8
RoadClassStart	9.33333
RoadClassEnd	12
Number of Episodes	3
Number of Alerts	3
Number of RSC Commands	0
Total Phase 2 Passes	19
Min Characteristic Speed, kph	33.7
Avg Characteristic Speed, kph	35.9
Max Characteristic Speed, kph	37
Min Mass, metric tons	15.2
Avg Mass, metric tons	15.6
Max Mass, metric tons	16.3
Cross-slope, degrees	-0.9

Curve 5596

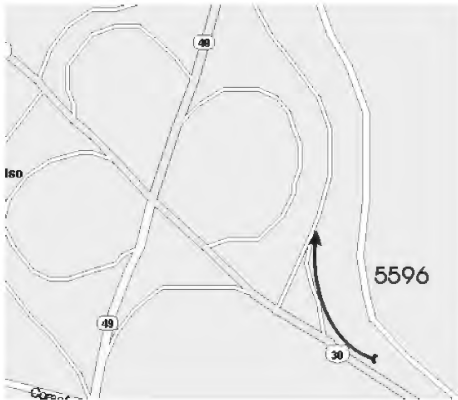

US-30 West to SR-49 North, near Valparaiso, IN.

Type	3
RoadClassStart	68
RoadClassEnd	68
Number of Episodes	3
Number of Alerts	3
Number of RSC Commands	0
Total Phase 2 Passes	9
Min Characteristic Speed, kph	58
Avg Characteristic Speed, kph	60.4
Max Characteristic Speed, kph	62.4
Min Mass, metric tons	14.5
Avg Mass, metric tons	14.7
Max Mass, metric tons	14.9
Cross-slope, degrees	-3.3

Curve 6142

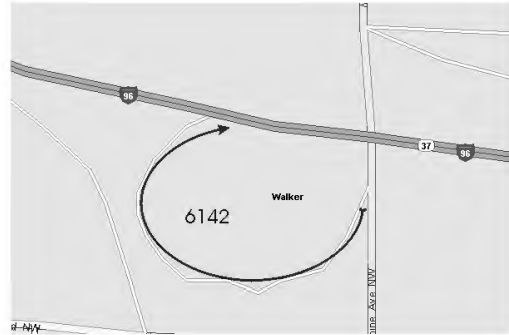

Alpine Ave. South ramp to I-96 East, Grand Rapids, MI.

Type	2
RoadClassStart	36
RoadClassEnd	36
Number of Episodes	3
Number of Alerts	3
Number of RSC Commands	0
Total Phase 2 Passes	6
Min Characteristic Speed, kph	40.1
Avg Characteristic Speed, kph	44.7
Max Characteristic Speed, kph	51
Min Mass, metric tons	27.5
Avg Mass, metric tons	31.4
Max Mass, metric tons	33.3
Cross-slope, degrees	-3.6

Curve 7917

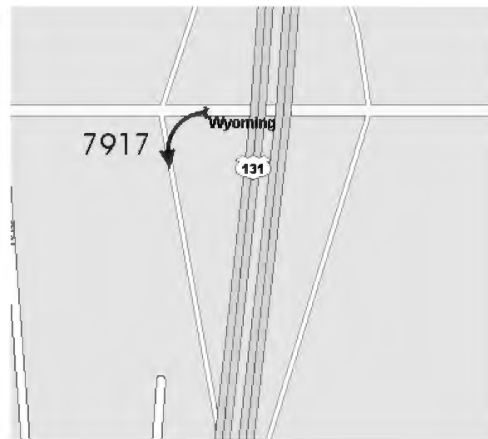

36th Street SW West to on-ramp to US-131 South, Wyoming, MI.

Type	8
RoadClassStart	12
RoadClassEnd	12
Number of Episodes	3
Number of Alerts	3
Number of RSC Commands	0
Total Phase 2 Passes	21
Min Characteristic Speed, kph	25.9
Avg Characteristic Speed, kph	28.4
Max Characteristic Speed, kph	33.4
Min Mass, metric tons	14.1
Avg Mass, metric tons	14.3
Max Mass, metric tons	14.5
Cross-slope, degrees	-0.6

Curve 234



US-20/31 North ramp to SR-2 West, South Bend, IN.

Type	11
RoadClassStart	36
RoadClassEnd	36
Number of Episodes	2
Number of Alerts	2
Number of RSC Commands	0
Total Phase 2 Passes	25
Min Characteristic Speed, kph	53.6
Avg Characteristic Speed, kph	56
Max Characteristic Speed, kph	58.3
Min Mass, metric tons	14.3
Avg Mass, metric tons	14.4
Max Mass, metric tons	14.5
Cross-slope, degrees	-4.4

Curve 9717

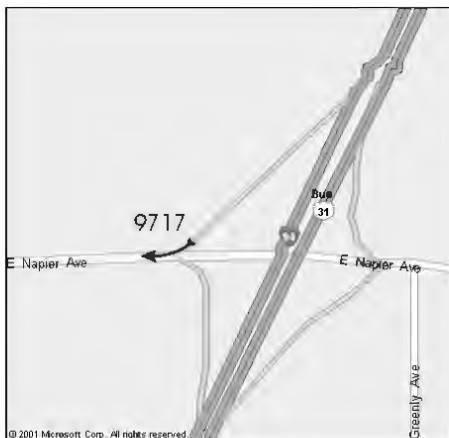

Offramp from I-94 West to East Napier Ave. West, near Benton Harbor, MI.

Type	10
RoadClassStart	45.3333
RoadClassEnd	45.3333
Number of Episodes	3
Number of Alerts	3
Number of RSC Commands	0
Total Phase 2 Passes	11
Min Characteristic Speed, kph	35.2
Avg Characteristic Speed, kph	38.3
Max Characteristic Speed, kph	42.1
Min Mass, metric tons	14.5
Avg Mass, metric tons	14.5
Max Mass, metric tons	14.6
Cross-slope, degrees	-1.3

Curve 744



Bendix Drive North to Lincoln Way West, South Bend, IN.

Type	7
RoadClassStart	8
RoadClassEnd	8
Number of Episodes	2
Number of Alerts	2
Number of RSC Commands	0
Total Phase 2 Passes	166
Min Characteristic Speed, kph	32.6
Avg Characteristic Speed, kph	33.8
Max Characteristic Speed, kph	34.9
Min Mass, metric tons	14.4
Avg Mass, metric tons	14.4
Max Mass, metric tons	14.4
Cross-slope, degrees	-1.3



Curve 1259

Off-ramp from I-94 West to La Porte Road South, New Buffalo, MI.

Type	8
RoadClassStart	8
RoadClassEnd	8
Number of Episodes	2
Number of Alerts	2
Number of RSC Commands	0
Total Phase 2 Passes	348
Min Characteristic Speed, kph	23.4
Avg Characteristic Speed, kph	23.9
Max Characteristic Speed, kph	24.4
Min Mass, metric tons	14.3
Avg Mass, metric tons	15.4
Max Mass, metric tons	16.4
Cross-slope, degrees	-2.1

Curve 888



Waverly Road South to Bus-I-196 East, Holland, MI.

Type	7
RoadClassStart	32
RoadClassEnd	32
Number of Episodes	2
Number of Alerts	2
Number of RSC Commands	0
Total Phase 2 Passes	59
Min Characteristic Speed, kph	25.7
Avg Characteristic Speed, kph	27.4
Max Characteristic Speed, kph	29.1
Min Mass, metric tons	14.4
Avg Mass, metric tons	14.9
Max Mass, metric tons	15.5
Cross-slope, degrees	0.4

Curve 2563



On-ramp to I-80 West, near Bristol, IN.

Type	1
RoadClassStart	64
RoadClassEnd	64
Number of Episodes	2
Number of Alerts	2
Number of RSC Commands	0
Total Phase 2 Passes	37
Min Characteristic Speed, kph	59.1
Avg Characteristic Speed, kph	62.3
Max Characteristic Speed, kph	65.5
Min Mass, metric tons	14.4
Avg Mass, metric tons	15.2
Max Mass, metric tons	15.9
Cross-slope, degrees	-4.1

Curve 3290

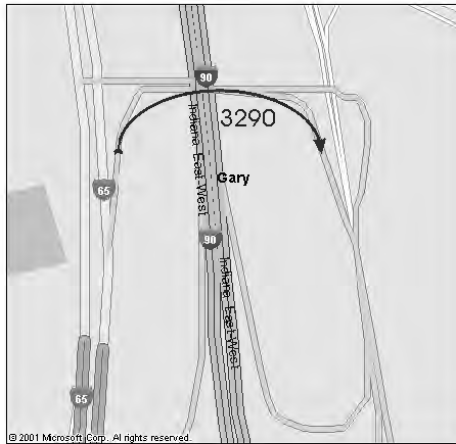

I-65 North exit ramp to I-90, Gary, IN.

Type	5
RoadClassStart	68
RoadClassEnd	68
Number of Episodes	2
Number of Alerts	2
Number of RSC Commands	0
Total Phase 2 Passes	9
Min Characteristic Speed, kph	42.6
Avg Characteristic Speed, kph	43
Max Characteristic Speed, kph	43.3
Min Mass, metric tons	14.4
Avg Mass, metric tons	14.5
Max Mass, metric tons	14.6
Cross-slope, degrees	-2.8

Curve 4176



Pike Street West to 3rd Street North, Goshen, IN.

Type	7
RoadClassStart	16
RoadClassEnd	16
Number of Episodes	2
Number of Alerts	2
Number of RSC Commands	0
Total Phase 2 Passes	12
Min Characteristic Speed, kph	28.3
Avg Characteristic Speed, kph	30.3
Max Characteristic Speed, kph	32.4
Min Mass, metric tons	14.3
Avg Mass, metric tons	14.4
Max Mass, metric tons	14.5
Cross-slope, degrees	0.2

Curve 8129

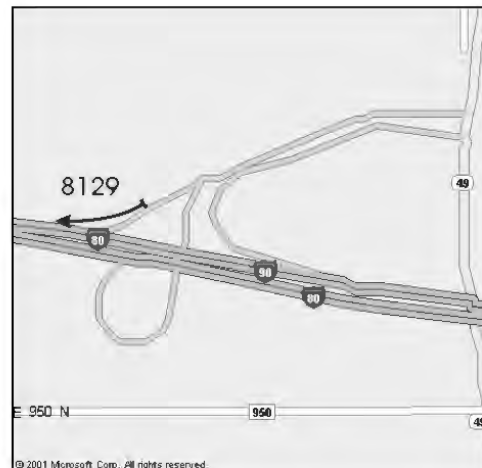

On-ramp to I-80/90 West, south of Chesterton, IN.

Type	1
RoadClassStart	68
RoadClassEnd	68
Number of Episodes	2
Number of Alerts	2
Number of RSC Commands	0
Total Phase 2 Passes	7
Min Characteristic Speed, kph	55.2
Avg Characteristic Speed, kph	57.9
Max Characteristic Speed, kph	60.5
Min Mass, metric tons	14.4
Avg Mass, metric tons	14.5
Max Mass, metric tons	14.7
Cross-slope, degrees	-2.5

Curve 9224



44th Street West to I-196 South, Grandville, MI.

Type	2
RoadClassStart	12
RoadClassEnd	12
Number of Episodes	2
Number of Alerts	3
Number of RSC Commands	0
Total Phase 2 Passes	7
Min Characteristic Speed, kph	49.4
Avg Characteristic Speed, kph	51.6
Max Characteristic Speed, kph	53.7
Min Mass, metric tons	14.4
Avg Mass, metric tons	16.1
Max Mass, metric tons	17.7
Cross-slope, degrees	-4.4

Curve 8409



Curve in Holland Street South/West, Logansport, IN.

Type	7
RoadClassStart	Null
RoadClassEnd	Null
Number of Episodes	2
Number of Alerts	2
Number of RSC Commands	0
Total Phase 2 Passes	3
Min Characteristic Speed, kph	36.7
Avg Characteristic Speed, kph	41.7
Max Characteristic Speed, kph	46.7
Min Mass, metric tons	14
Avg Mass, metric tons	14.1
Max Mass, metric tons	14.2
Cross-slope, degrees	0.5

Curve 15293



SR-25 East to I-65 North on-ramp, Lafayette, IN.

Type	8
RoadClassStart	32
RoadClassEnd	36
Number of Episodes	2
Number of Alerts	2
Number of RSC Commands	0
Total Phase 2 Passes	4
Min Characteristic Speed, kph	27
Avg Characteristic Speed, kph	29.5
Max Characteristic Speed, kph	31.9
Min Mass, metric tons	14.5
Avg Mass, metric tons	15.6
Max Mass, metric tons	16.6
Cross-slope, degrees	-0.2

Curve 16143

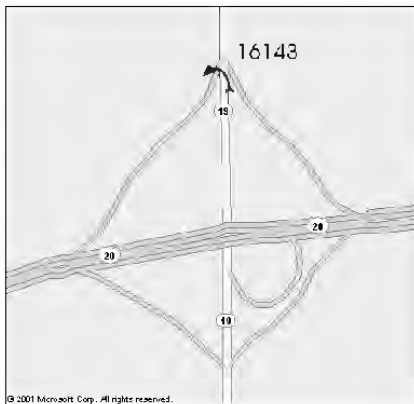

SR-19 North to on-ramp to US-20 West, south of Elkhart, IN.

Type	8
RoadClassStart	64
RoadClassEnd	64
Number of Episodes	2
Number of Alerts	2
Number of RSC Commands	0
Total Phase 2 Passes	6
Min Characteristic Speed, kph	26.3
Avg Characteristic Speed, kph	27.2
Max Characteristic Speed, kph	28.2
Min Mass, metric tons	14.3
Avg Mass, metric tons	14.4
Max Mass, metric tons	14.5
Cross-slope, degrees	-0.5

Curve 30100

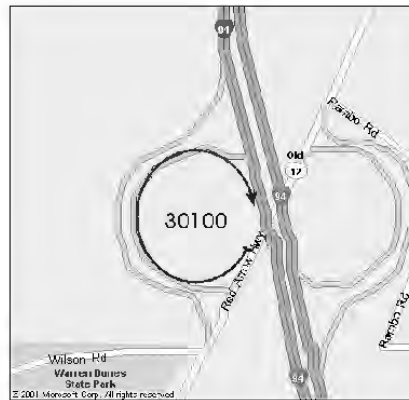

Red Arrow Highway South to I-94 West, near Bridgman, MI

Type	2
RoadClassStart	12
RoadClassEnd	12
Number of Episodes	2
Number of Alerts	2
Number of RSC Commands	0
Total Phase 2 Passes	4
Min Characteristic Speed, kph	48.8
Avg Characteristic Speed, kph	50.4
Max Characteristic Speed, kph	51.9
Min Mass, metric tons	13.9
Avg Mass, metric tons	14.7
Max Mass, metric tons	15.5
Cross-slope, degrees	-4.2

Curve 30201

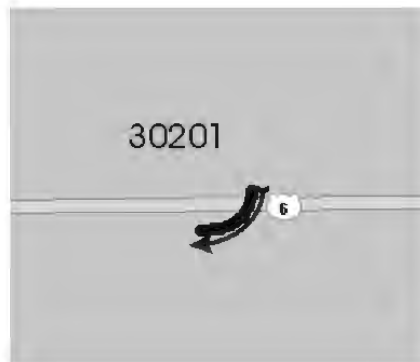

Temporary curve crossing to other side of highway for construction, US-6 West near Bremen, IN

Type	13	Min Mass, metric tons	35
RoadClassStart	16	Avg Mass, metric tons	35.3
RoadClassEnd	16	Max Mass, metric tons	35.5
Number of Episodes	2	Cross-slope, degrees	-1.5
Number of Alerts	2		
Number of RSC Commands	0		
Total Phase 2 Passes	3		
Min Characteristic Speed, kph	33.3		
Avg Characteristic Speed, kph	33.7		
Max Characteristic Speed, kph	34.1		

APPENDIX A-H. EXPOSURE BY DISTANCE

Table A-H1. Exposure by distance: all loads

<i>All Trips</i>				<i>Trips > 0.1 km</i>				<i>Trips > 0.1 km</i>			
<i>All Weather</i>				<i>All Weather</i>				<i>Good Weather</i>			
<i>All</i>				<i>All</i>				<i>All</i>			
<i>Phase 1</i>		<i>Phase 2</i>		<i>Phase 1</i>		<i>Phase 2</i>		<i>Phase 1</i>		<i>Phase 2</i>	
<i>Driver</i>	<i>Distance</i>	<i>Driver</i>	<i>Distance</i>	<i>Driver</i>	<i>Distance</i>	<i>Driver</i>	<i>Distance</i>	<i>Driver</i>	<i>Distance</i>	<i>Driver</i>	<i>Distance</i>
2019	1,538	2019	6,799	2019	1,538	2019	6,799	2019	1,464	2019	5,426
2020	20,574	2020	26,672	2020	20,574	2020	26,672	2020	17,361	2020	23,980
2021	15,321	2021	27,647	2021	15,321	2021	27,647	2021	11,837	2021	23,566
2022	19,743	2022	14,593	2022	19,742	2022	14,592	2022	17,388	2022	11,424
2023	18,840	2023	27,760	2023	18,839	2023	27,759	2023	16,946	2023	23,621
2025	19,324	2025	27,844	2025	19,324	2025	27,844	2025	14,858	2025	22,440
2026	18,657	2026	25,068	2026	18,657	2026	25,068	2026	15,161	2026	20,747
2027	18,804	2027	13,800	2027	18,804	2027	13,800	2027	15,822	2027	11,929
2028	18,426	2028	21,488	2028	18,425	2028	21,488	2028	15,787	2028	19,184
2029	16,638	2029	17,075	2029	16,637	2029	17,075	2029	14,259	2029	14,836
2030	17,566	2030	23,367	2030	17,565	2030	23,367	2030	14,214	2030	18,289
2031	26,172	2031	30,623	2031	26,172	2031	30,622	2031	21,840	2031	26,796
2032	16,462	2032	17,270	2032	16,462	2032	17,270	2032	13,123	2032	13,757
2033	14,928	2033	18,947	2033	14,927	2033	18,947	2033	12,881	2033	16,471
2034	15,543	2034	22,079	2034	15,543	2034	22,079	2034	14,153	2034	18,996
2035	17,501	2035	23,417	2035	17,500	2035	23,417	2035	14,487	2035	18,876
2036	18,027	2036		2036	18,026	2036		2036	15,052	2036	
2037	18,262	2037	4,180	2037	18,261	2037	4,180	2037	14,722	2037	3,929
2038	9,005	2038		2038	9,005	2038		2038	6,862	2038	
2039	11,306	2039		2039	11,305	2039		2039	9,126	2039	
2040	19,597	2040	8,102	2040	19,597	2040	8,102	2040	16,085	2040	7,875
2041	16,906	2041	3,567	2041	16,905	2041	3,567	2041	14,642	2041	3,449
Unknown	4,479	Unknown	31,541	Unknown	4,474	Unknown	31,537	Unknown	3,505	Unknown	26,313
Comparable	251,216	Comparable	292,311	Comparable	251,215	Comparable	292,308	Comparable	210,789	Comparable	246,669
Not comp.	122,401	Not comp.	99,530	Not comp.	122,388	Not comp.	99,522	Not comp.	100,786	Not comp.	85,233
All	373,617	All	391,842	All	373,604	All	391,831	All	311,574	All	331,902

Table A-H1 (continued). Exposure by distance: all loads

<i>Trips > 0.1 km Good Weather</i>				<i>Trips > 0.1 km Good Weather</i>			
<i>Day Phase 1</i>		<i>Night Phase 1</i>		<i>Day Phase 2</i>		<i>Night Phase 2</i>	
<i>Driver</i>	<i>Distance</i>	<i>Driver</i>	<i>Distance</i>	<i>Driver</i>	<i>Distance</i>	<i>Driver</i>	<i>Distance</i>
2019	1,417	2019	47	2019	5,328	2019	98
2020	14,714	2020	2,646	2020	21,161	2020	2,820
2021	11,348	2021	490	2021	21,190	2021	2,376
2022	14,887	2022	2,500	2022	10,190	2022	1,230
2023	16,937	2023	9	2023	23,270	2023	350
2025	9,661	2025	5,193	2025	14,702	2025	7,735
2026	11,746	2026	3,415	2026	17,577	2026	3,169
2027	12,664	2027	3,158	2027	9,939	2027	1,988
2028	14,510	2028	1,276	2028	17,768	2028	1,415
2029	5,741	2029	8,518	2029	6,674	2029	8,162
2030	5,838	2030	8,376	2030	7,542	2030	10,746
2031	12,182	2031	9,658	2031	15,981	2031	10,814
2032	4,101	2032	9,021	2032	4,631	2032	9,126
2033	3,628	2033	9,252	2033	4,342	2033	12,129
2034	9,512	2034	4,640	2034	13,787	2034	5,209
2035	5,899	2035	8,585	2035	6,778	2035	12,098
2036	9,679	2036	5,372				
2037	7,186	2037	7,536				
2038	587	2038	6,275	2037	2,253	2037	1,677
2039	2,864	2039	6,262				
2040	9,493	2040	6,591	2040	6,045	2040	1,828
2041	11,335	2041	3,307	2041	2,639	2041	807
Unknown	3,002	Unknown	477	Unknown	17,949	Unknown	8,360
Comparable	137,703	Comparable	73,101	Comparable	167,646	Comparable	79,019
Not comp.	61,230	Not comp.	39,503	Not comp.	62,102	Not comp.	23,118
All	198,933	All	112,604	All	229,748	All	102,137

Table A-H2. Exposure by distance: full loads

<i>All Trips All Weather All</i>				<i>Trips > 0.1 km All Weather All</i>				<i>Trips > 0.1 km Good Weather All</i>			
<i>Phase 1</i>		<i>Phase 2</i>		<i>Phase 1</i>		<i>Phase 2</i>		<i>Phase 1</i>		<i>Phase 2</i>	
<i>Driver</i>	<i>Distance</i>	<i>Driver</i>	<i>Distance</i>	<i>Driver</i>	<i>Distance</i>	<i>Driver</i>	<i>Distance</i>	<i>Driver</i>	<i>Distance</i>	<i>Driver</i>	<i>Distance</i>
2019	597	2019	3,542	2019	597	2019	3,384	2019	589	2019	2,642
2020	10,074	2020	13,419	2020	9,998	2020	13,322	2020	8,350	2020	11,630
2021	7,524	2021	13,814	2021	7,472	2021	13,670	2021	5,451	2021	11,362
2022	9,626	2022	7,367	2022	9,542	2022	7,285	2022	8,162	2022	5,750
2023	9,137	2023	13,622	2023	9,013	2023	13,424	2023	7,926	2023	11,346
2025	9,023	2025	14,929	2025	8,800	2025	14,577	2025	6,763	2025	11,725
2026	9,020	2026	12,551	2026	8,956	2026	12,333	2026	7,158	2026	10,902
2027	9,611	2027	6,659	2027	9,365	2027	6,653	2027	7,300	2027	5,282
2028	9,017	2028	11,962	2028	8,851	2028	11,632	2028	7,513	2028	10,345
2029	7,760	2029	8,308	2029	7,723	2029	8,033	2029	6,786	2029	6,814
2030	8,508	2030	11,684	2030	8,362	2030	11,427	2030	6,911	2030	8,930
2031	13,276	2031	14,969	2031	12,938	2031	14,916	2031	11,018	2031	12,437
2032	7,594	2032	8,460	2032	7,533	2032	8,456	2032	6,044	2032	6,724
2033	7,134	2033	9,623	2033	7,080	2033	9,541	2033	6,292	2033	8,662
2034	7,800	2034	10,394	2034	7,760	2034	10,174	2034	7,220	2034	8,760
2035	8,419	2035	11,441	2035	8,403	2035	11,249	2035	7,494	2035	9,239
2036	8,876	2036		2036	8,783	2036		2036	7,478	2036	
2037	9,626	2037		2037	9,397	2037	2,071	2037	7,859	2037	1,966
2038	4,689	2038	2,080	2038	4,626	2038		2038	3,643	2038	
2039	5,667	2039		2039	5,614	2039		2039	4,511	2039	
2040	9,172	2040	3,823	2040	8,895	2040	3,819	2040	7,642	2040	3,816
2041	7,847	2041	1,724	2041	7,619	2041	1,657	2041	6,553	2041	1,637
Unknown	1,478	Unknown	14,921	Unknown	1,461	Unknown	14,638	Unknown	1,116	Unknown	12,749
Comparable	122,433	Comparable	147,622	Comparable	120,970	Comparable	145,402	Comparable	101,972	Comparable	121,876
Not comp.	59,041	Not comp.	47,669	Not comp.	57,818	Not comp.	46,860	Not comp.	47,807	Not comp.	40,840
All	181,475	All	195,291	All	178,789	All	192,262	All	149,779	All	162,716

Table A-H2 (continued). Exposure by distance: full loads

<i>Trips over 0.1 km</i>				<i>Trips over 0.1 km</i>			
<i>Good Weather</i>				<i>Good Weather</i>			
<i>Day</i>		<i>Night</i>		<i>Day</i>		<i>Night</i>	
<i>Phase 1</i>		<i>Phase 1</i>		<i>Phase 2</i>		<i>Phase 2</i>	
<i>Driver</i>	<i>Distance</i>	<i>Driver</i>	<i>Distance</i>	<i>Driver</i>	<i>Distance</i>	<i>Driver</i>	<i>Distance</i>
2019	543	2019	46	2019	2,615	2019	96
2020	5,950	2020	2,423	2020	9,000	2020	2,697
2021	5,335	2021	32	2021	11,505	2021	
2022	7,906	2022	324	2022	5,689	2022	140
2023	8,029	2023	7	2023	11,437	2023	72
2025	2,238	2025	4,407	2025	4,115	2025	7,616
2026	6,693	2026	495	2026	9,878	2026	634
2027	4,610	2027	2,888	2027	3,303	2027	1,984
2028	7,309	2028	369	2028	10,540	2028	119
2029	1,177	2029	5,646	2029	1,028	2029	6,060
2030	1,124	2030	5,894	2030	1,716	2030	7,421
2031	2,496	2031	8,824	2031	2,656	2031	9,832
2032	1,476	2032	4,629	2032	1,974	2032	4,681
2033	308	2033	6,036	2033	970	2033	7,759
2034	6,657	2034	470	2034	8,583	2034	360
2035	5,207	2035	2,287	2035	4,952	2035	4,421
2036	7,091	2036	475	2036		2036	
2037	5,707	2037	2,214	2037	1,686	2037	288
2038	96	2038	3,456	2038		2038	
2039	586	2039	3,958	2039		2039	
2040	6,628	2040	1,158	2040	3,290	2040	531
2041	6,477	2041	270	2041	1,597	2041	103
Unknown	799	Unknown	325	Unknown	7,499	Unknown	5,414
Comparable	61,106	Comparable	41,518	Comparable	76,544	Comparable	46,399
Not comp.	33,335	Not comp.	15,115	Not comp.	27,487	Not comp.	13,830
All	94,442	All	56,633	All	104,031	All	60,229

Table A-H3. Exposure by distance: partial loads

<i>All Trips</i>				<i>Trips over 0.1 km</i>				<i>Trips over 0.1 km</i>			
<i>All Weather</i>				<i>All Weather</i>				<i>Good Weather</i>			
<i>All</i>				<i>All</i>				<i>All</i>			
<i>Phase 1</i>		<i>Phase 2</i>		<i>Phase 1</i>		<i>Phase 2</i>		<i>Phase 1</i>		<i>Phase 2</i>	
<i>Driver</i>	<i>Distance</i>	<i>Driver</i>	<i>Distance</i>	<i>Driver</i>	<i>Distance</i>	<i>Driver</i>	<i>Distance</i>	<i>Driver</i>	<i>Distance</i>	<i>Driver</i>	<i>Distance</i>
2019	170	2019	194	2019	170	2019	194	2019	170	2019	99
2020	1,181	2020	1,465	2020	1,181	2020	1,465	2020	1,014	2020	1,213
2021	2,134	2021	1,373	2021	2,134	2021	1,373	2021	1,894	2021	1,312
2022	2,244	2022	1,361	2022	2,244	2022	1,361	2022	2,058	2022	1,209
2023	1,614	2023	2,458	2023	1,614	2023	2,457	2023	1,580	2023	2,120
2025	2,987	2025	2,221	2025	2,987	2025	2,220	2025	2,536	2025	1,945
2026	1,042	2026	3,086	2026	1,042	2026	3,086	2026	1,022	2026	2,683
2027	3,351	2027	1,272	2027	3,351	2027	1,272	2027	2,880	2027	1,166
2028	1,576	2028	2,014	2028	1,576	2028	2,014	2028	1,091	2028	1,908
2029	2,848	2029	1,795	2029	2,848	2029	1,795	2029	2,320	2029	1,603
2030	2,837	2030	3,394	2030	2,837	2030	3,394	2030	2,152	2030	2,621
2031	3,276	2031	2,488	2031	3,276	2031	2,488	2031	2,624	2031	2,183
2032	1,113	2032	1,736	2032	1,113	2032	1,736	2032	842	2032	1,466
2033	2,569	2033	1,816	2033	2,569	2033	1,816	2033	1,983	2033	1,611
2034	1,995	2034	3,259	2034	1,995	2034	3,258	2034	1,761	2034	2,986
2035	1,916	2035	2,688	2035	1,916	2035	2,688	2035	1,678	2035	2,033
2036	2,283	2036		2036	2,283	2036		2036	1,687	2036	
2037	1,760	2037		2037	1,760	2037	750	2037	1,527	2037	666
2038	972	2038	750	2038	972	2038		2038	580	2038	
2039	1,138	2039		2039	1,138	2039		2039	785	2039	
2040	3,461	2040	1,525	2040	3,461	2040	1,525	2040	2,277	2040	1,431
2041	3,073	2041	103	2041	3,073	2041	103	2041	2,741	2041	103
Unknown	223	Unknown	3,308	Unknown	222	Unknown	3,308	Unknown	139	Unknown	2,751
Comparable	29,108	Comparable	27,844	Comparable	29,108	Comparable	27,844	Comparable	24,414	Comparable	24,142
Not comp.	16,654	Not comp.	10,460	Not comp.	16,652	Not comp.	10,459	Not comp.	12,925	Not comp.	8,966
All	45,763	All	38,304	All	45,761	All	38,303	All	37,338	All	33,108

Table A-H3 (continued). Exposure by distance: partial loads

<i>Trips over 0.1 km Good Weather</i>				<i>Trips over 0.1 km Good Weather</i>			
<i>Day Phase 1</i>		<i>Night Phase 1</i>		<i>Day Phase 2</i>		<i>Night Phase 2</i>	
<i>Driver</i>	<i>Distance</i>	<i>Driver</i>	<i>Distance</i>	<i>Driver</i>	<i>Distance</i>	<i>Driver</i>	<i>Distance</i>
2019	170	2019		2019	98	2019	1
2020	940	2020	73	2020	1,213	2020	0
2021	1,652	2021	242	2021	1,284	2021	29
2022	1,574	2022	483	2022	801	2022	405
2023	1,580	2023		2023	2,119	2023	1
2025	2,217	2025	319	2025	1,938	2025	4
2026	985	2026	37	2026	2,428	2026	255
2027	2,795	2027	85	2027	1,164	2027	0
2028	960	2028	131	2028	1,355	2028	552
2029	1,509	2029	811	2029	811	2029	793
2030	1,169	2030	983	2030	1,393	2030	1,228
2031	2,363	2031	261	2031	1,932	2031	251
2032	166	2032	675	2032	689	2032	776
2033	1,087	2033	896	2033	275	2033	1,336
2034	1,006	2034	755	2034	2,193	2034	793
2035	149	2035	1,529	2035	185	2035	1,848
2036	1,044	2036	642	2036		2036	
2037	681	2037	846	2037	323	2037	343
2038	48	2038	532	2038		2038	
2039	283	2039	501	2039		2039	
2040	1,071	2040	1,206	2040	1,200	2040	229
2041	1,725	2041	1,017	2041	103	2041	
Unknown	136	Unknown	3	Unknown	1,425	Unknown	1,325
Comparable	17,220	Comparable	7,192	Comparable	17,189	Comparable	6,947
Not comp.	8,089	Not comp.	4,835	Not comp.	5,739	Not comp.	3,224
All	25,310	All	12,027	All	22,928	All	10,171

Table A-H4. Exposure by distance: empty loads

<i>All Trips</i>				<i>Trips over 0.1 km</i>				<i>Trips over 0.1 km</i>			
<i>All Weather</i>				<i>All Weather</i>				<i>Good Weather</i>			
<i>All</i>				<i>All</i>				<i>All</i>			
<i>Phase 1</i>		<i>Phase 2</i>		<i>Phase 1</i>		<i>Phase 2</i>		<i>Phase 1</i>		<i>Phase 2</i>	
<i>Driver</i>	<i>Distance</i>	<i>Driver</i>	<i>Distance</i>	<i>Driver</i>	<i>Distance</i>	<i>Driver</i>	<i>Distance</i>	<i>Driver</i>	<i>Distance</i>	<i>Driver</i>	<i>Distance</i>
2019	771	2019	3,063	2019	771	2019	3,062	2019	704	2019	2,615
2020	8,935	2020	11,788	2020	8,935	2020	11,788	2020	7,607	2020	11,071
2021	5,663	2021	12,460	2021	5,663	2021	12,459	2021	4,576	2021	10,749
2022	7,874	2022	5,865	2022	7,873	2022	5,865	2022	7,100	2022	4,385
2023	8,088	2023	11,681	2023	8,088	2023	11,681	2023	7,330	2023	9,992
2025	6,838	2025	10,695	2025	6,838	2025	10,695	2025	5,286	2025	8,763
2026	8,594	2026	9,432	2026	8,594	2026	9,431	2026	6,951	2026	7,552
2027	5,841	2027	5,870	2027	5,841	2027	5,870	2027	5,444	2027	5,476
2028	7,833	2028	7,513	2028	7,833	2028	7,513	2028	7,018	2028	6,617
2029	5,259	2029	6,971	2029	5,259	2029	6,971	2029	4,530	2029	6,144
2030	6,221	2030	8,289	2030	6,220	2030	8,289	2030	5,044	2030	6,530
2031	9,620	2031	13,165	2031	9,620	2031	13,165	2031	7,896	2031	12,124
2032	7,074	2032	7,074	2032	7,074	2032	7,074	2032	5,496	2032	5,636
2033	5,157	2033	7,509	2033	5,157	2033	7,509	2033	4,547	2033	6,130
2034	5,749	2034	8,427	2034	5,748	2034	8,427	2034	5,264	2034	7,067
2035	7,166	2035	9,288	2035	7,166	2035	9,288	2035	5,313	2035	7,471
2036	6,868	2036		2036	6,868	2036		2036	5,799	2036	
2037	6,852	2037		2037	6,852	2037	1,351	2037	5,252	2037	1,290
2038	3,343	2038	1,351	2038	3,343	2038		2038	2,730	2038	
2039	4,500	2039		2039	4,500	2039		2039	3,798	2039	
2040	6,963	2040	2,754	2040	6,963	2040	2,754	2040	6,021	2040	2,623
2041	5,691	2041	1,740	2041	5,691	2041	1,740	2041	4,865	2041	1,643
Unknown	1,430	Unknown	11,727	Unknown	1,428	Unknown	11,726	Unknown	1,248	Unknown	9,233
Comparable	98,641	Comparable	118,430	Comparable	98,640	Comparable	118,429	Comparable	82,710	Comparable	100,999
Not comp.	43,692	Not comp.	38,233	Not comp.	43,686	Not comp.	38,229	Not comp.	37,107	Not comp.	32,113
All	142,333	All	156,662	All	142,327	All	156,658	All	119,817	All	133,112

Table A-H4 (continued). Exposure by distance: empty loads

<i>Trips over 0.1 km</i>				<i>Trips over 0.1 km</i>			
<i>Good Weather</i>				<i>Good Weather</i>			
<i>Day</i>		<i>Night</i>		<i>Day</i>		<i>Night</i>	
<i>Phase 1</i>		<i>Phase 1</i>		<i>Phase 2</i>		<i>Phase 2</i>	
<i>Driver</i>	<i>Distance</i>	<i>Driver</i>	<i>Distance</i>	<i>Driver</i>	<i>Distance</i>	<i>Driver</i>	<i>Distance</i>
2019	704	2019	1	2019	2,614	2019	1
2020	7,458	2020	149	2020	10,948	2020	122
2021	4,360	2021	216	2021	8,402	2021	2,347
2022	5,407	2022	1,693	2022	3,700	2022	685
2023	7,328	2023	2	2023	9,715	2023	277
2025	4,938	2025	344	2025	8,649	2025	114
2026	4,069	2026	2,883	2026	5,271	2026	2,281
2027	5,259	2027	185	2027	5,472	2027	4
2028	6,241	2028	777	2028	5,873	2028	744
2029	2,862	2029	1,669	2029	4,836	2029	1,309
2030	3,545	2030	1,499	2030	4,433	2030	2,097
2031	7,323	2031	573	2031	11,393	2031	731
2032	1,953	2032	3,542	2032	1,968	2032	3,669
2033	2,227	2033	2,320	2033	3,097	2033	3,033
2034	1,849	2034	3,416	2034	3,011	2034	4,056
2035	544	2035	4,769	2035	1,642	2035	5,829
2036	1,544	2036	4,255	2036		2036	
2037	798	2037	4,453	2037	244	2037	1,046
2038	443	2038	2,287	2038		2038	
2039	1,995	2039	1,803	2039		2039	
2040	1,794	2040	4,227	2040	1,555	2040	1,068
2041	2,845	2041	2,020	2041	939	2041	704
Unknown	1,110	Unknown	137	Unknown	7,637	Unknown	1,595
Comparable	58,993	Comparable	23,712	Comparable	75,302	Comparable	25,699
Not comp.	17,602	Not comp.	19,504	Not comp.	26,098	Not comp.	6,012
All	76,595	All	43,216	All	101,400	All	31,711

APPENDIX A-I. SUBJECTIVE DATA FORMS, SUMMARIES, AND QUESTIONNAIRES

The forms contained in this sub-appendix are organized in the chronological sequence they appeared in the field operational test. The title on the form is not always consistent with how it is referred to in this report. This was done to avoid influencing participants' answers to survey questions with survey titles that might be too suggestive of an intended use. Thus the Decision Making questionnaire was given the nondescript name, *Start of Study Driver Questionnaire*. In other cases, the title printed on the survey was lengthy and awkward, and did not convey its functional role in the FOT. They were renamed in the report to streamline referencing and to clarify their functional role. Survey titles are listed below with their printed title followed by the title, *in parenthesis*, that they were referenced by in this report.

- The Subject Consent Form. This form provides prospective participants in the study with an overview of the study and an explicit notice that such participation is voluntary.
- Start of Study Driver Questionnaire (Decision-making Questionnaire). This questionnaire was used at the start of the field test to obtain data thought to be predictive of accident involvement [8].
- Initial Self-Administered Questionnaire (The Initial Survey). This questionnaire was given immediately after drivers were introduced to the RA&C system.
- Short Interim Survey (Short Survey). Two rounds of this questionnaire were distributed. It was brief and primarily used to keep track of any difficulties that might develop among drivers using the RA&C.
- Long Periodic Survey (Long Survey). Three rounds of this survey were distributed. Answer tallies are provided for these surveys in this appendix (within the square brackets).
- RA&C Final Structured Interview (Final Structured Interview). This survey was administered at the end of the field test to obtain final driver opinions about the RA&C. Answer tallies and summaries are provided in italics alongside each question.
- RA&C Final Management Interview (Local Management Opinion Survey). This survey is a shorter version of the Final Structured Interview directed to the Praxair local fleet management. Answers are provided in italics along with each question.

SUBJECT CONSENT FORM

Field Operational Test of the Roll Stability Advisor

The purpose of this study is to evaluate a new safety system for heavy trucks. This system will be installed in six new tractors used to haul nitrogen tankers, and we will monitor how these trucks are driven over normal delivery operations throughout the year. The study is divided into three phases. At the start, the safety system will not be active and we will monitor your normal delivery activity in these vehicles for about 5 months. We would like you to drive as you normally do during this period. Next, we will describe the safety system in detail, and again request your consent to participate. The safety system will then be activated and we will continue monitoring your driving for about 4½ more months. During this time, we will also ask you to complete short (less than 10 min) questionnaires periodically to find out what you think of the system. Finally, we will compile periodic driving reports that will be reviewed with you at regular intervals by your local fleet supervisor, while we continue monitoring your driving for another 3 months.

At the end of the study, a meeting will be held to discuss your opinions and to answer any questions you may have. This meeting will be videotaped and subsequently transcribed into written form. These tapes will be stored in a secure location and your name will not be associated with your comments. Please indicate whether you are willing to be videotaped at this session

I am willing to have this meeting recorded on tape.

Signed: _____ Date: _____

Participation in this study is strictly voluntary. You can also withdraw from the study at any time for any reason without penalty by contacting John Sullivan (see address and telephone number below).

All information collected will remain confidential except as may be required by federal, state, or local law. The data recorded in the study will be analyzed in a variety of ways to assess the impact of the safety device on driving. The results of this analysis will be made public in various reports produced by the University of Michigan Transportation Research Institute and agencies of the Department of Transportation. If you have any questions about the study you can contact:

John M. Sullivan, Assistant Research Scientist
University of Michigan Transportation Research Institute
2901 Baxter Rd.
Ann Arbor, MI 48109-2150
Email: jsully@umich.edu Phone: (734) 764-8560

If you have any questions about the approval of this study, or your rights as a participant in this study, you can contact: Kate M. Keever

IRB Behavioral Sciences Committee
1040 Fleming Administration Building
Ann Arbor, MI 48109-1340
Email: keever@umich.edu Phone: (734) 936-0933

I have reviewed and I understand the material presented above. I am willing to participate in this study and I understand that my is entirely voluntary.

Date Signature

Witness Please print your name

Investigator: John Sullivan – (734)-764-856

START OF STUDY DRIVER QUESTIONNAIRE

Please provide the following information.

Driver ID: _____

Age: _____ Sex (M F)

Number of years truck driving: _____

Number of years driving tankers: _____

Please answer all of the questions below by marking the appropriate box. The boxes provided are intended to give a scale of frequency from never or very infrequently on the left, to very frequently or always on the right.

Questions	Never	Infrequently	Somewhat Infrequently	Somewhat frequently	Frequently	Always
1. Do you enjoy making decisions?						
2. Do you rely on "gut feeling" when making decisions?						
3. Do you like to consult with others?						
4. Do you stick by your decisions come what may?						
5. When you find one option that will just about do, do you leave it at that?						
6. Do you remain calm when you have to make decisions very quickly?						
7. Do you feel in control of things?						
8. How often are your decisions governed by your ideals regardless of practical difficulties?						
9. Do you make decisions without considering all of the implications?						
10. Do you change your mind about things?						
11. Do you take the safe option if there is one?						
12. Do you prefer to avoid making decisions if you can?						
13. Do you plan well ahead?						

Questions

	Never	Infrequently	Somewhat Infrequently	Somewhat frequently	Frequently	Always
14. When making decisions, do you find yourself favoring first one option, then another?						
15. Do you carry on looking for something better even if you have found a course of action that is just about OK?						
16. Do you find it difficult to think clearly when you have to decide something in a hurry?						
17. Do you make up your own mind about things regardless of what others think?						
18. Do you avoid taking advice over decisions?						
19. Do you work out all the pros and cons before making a decision?						
20. In your decision making, how often are practicalities more important than principles?						
21. Is your decision making a deliberate logical process?						

INITIAL STAGE SELF-ADMINISTERED QUESTIONNAIRE

We would like your thoughts about two systems in your truck, the roll-over advisory system and the roll-over control system.

We will keep this information completely confidential, and will not share your information with your employer. In case we need to follow-up we need to have your driver ID number.
Thanks!
 What is your driver ID number? _____

5. Have you actually driven a truck equipped with ...
 (4) Roll-over advisory system? (1) Yes [5] (2) No [8]
 Roll-over control system? (2) Yes [3] (2) No [10]
7. I expect the roll-over advisory system to:
 (4) Greatly reduce my chances of having a roll-over [3]
 (2) Somewhat reduce my chances of having a roll-over [10]
 (3) Make no difference in my chances of a roll-over [0]
8. A roll-over advisory system message saying that a curve you are taking requires a speed slower by 3 mph means that:
 (4) You should slow down immediately when the message appears [3]
 Next time you take this turn or one like it, you should go slower by 3 mph. [10]
- Do you have a home computer? (1) Yes [9] (2) No [4]
- How often do you use it yourself?
 (1) Frequently [3] (2) Occasionally [4] (3) Rarely [1] (4) Never [1]
- What is your level of expertise on the computer
 I know more about computers than most people I work with [5]
 I know less about computers than most people I work with [8]
- Have you used any other "high tech" truck control or information systems when working with other employers in the past few years?
 (1) Yes [12] (2) No [1]
- IF YES → Please name them: FleetAdvisor [11] or CADEC [1]
- In general, did you see these systems as:
 useful to you in driving your truck [7]
 creates a problem for you when driving your truck [4]
 not useful to you in driving your truck but not a problem either [2]

How strongly do you agree or disagree with the following statements?

Statements	Strongly 5	Agree 4	Agree 3	Neither Agree or Disagree 2	Disagree 1	Strongly Disagree
33. High tech systems like these really do not help the experienced driver	5 [1]	4 [2]	3 [6]	2 [3]	1 [1]	
34. I would be better off driving without these types of high tech advice and control systems	5 [1]	4 [1]	3 [5]	2 [4]	1 [2]	
37. I don't need the roll over advisory system to keep from rolling my truck	5 [1]	4 [3]	3 [5]	2 [3]	1 [1]	
40. I have a good understanding about how to use the roll over advisory system.	5 [1]	4 [9]	3 [3]	2 [0]	1 [0]	
42. I don't expect to drive any differently as a result of having the roll over advisory system in my truck than I would drive without it.	5 [0]	4 [5]	3 [3]	2 [4]	1 [0]	
I am comfortable having the roll-over advisory on my truck	5 [0]	4 [10]	3 [2]	2 [1]	1 [0]	
I am comfortable having the roll-over control on my truck	5 [1]	4 [8]	3 [2]	2 [2]	1 [0]	

- Formatted: Bullets and Numbering
- Formatted: Bullets and Numbering
- Formatted: Bullets and Numbering
- Formatted: Bullets and Numbering
- Formatted: Bullets and Numbering
- Formatted: Bullets and Numbering

Thank you for your participation!

SHORT INTERIM SURVEY

Please take a minute to complete this very short questionnaire about the **Roll Stability Advisor, the Roll Stability Control, and the Hard Brake Event Detector.**

Statements	Strongly Agree	Agree	Neither Agree or Disagree	Disagree	Strongly Disagree
	5	4	3	2	1
1. The Roll Stability Advisor is giving me useful feedback about my driving in curves and corners. N/A - system has not activated	5	4	3	2	1
2. The Roll Stability Control operates safely when it slows my truck. N/A - system has not activated	5	4	3	2	1
3. The Hard Braking Event Detector is giving me useful feedback about my use of brakes. N/A - system has not activated	5	4	3	2	1
4. I am learning things about my driving habits from the Roll Stability Advisor I had not known. N/A - system has not activated	5	4	3	2	1

About how many of the following do you remember having in the past 10 days of driving?

5. Roll Stability Advisories to go slower in a curve:	0	1	2	3	4	5	6	7	8	9	10	11 or more
6. Roll Stability Control automatically slowing your truck:	0	1	2	3	4	5	6	7	8	9	10	11 or more
7. Hard Braking Event Detector issuing an advisory:	0	1	2	3	4	5	6	7	8	9	10	11 or more

Is there anything about these systems you would like to comment on?

LONG PERIODIC DRIVER SURVEY - SEPT 19, 2001

We would like your thoughts about three systems in your truck, the Roll Stability Advisor, the Roll Stability Control, and the Hard Brake Advisor, now that they have been activated. *Thanks!*

We will keep this information confidential; we will not share this information with your employer. However we need to know who is completing surveys, and we use an ID number on the form.

Select the statement you agree with most:

1. In the coming months, I expect the Roll Stability Advisor and Control system to:
 - (1) Greatly reduce my chances of having a roll-over [1]
 - (2) Somewhat reduce my chances of having a roll-over [3]
 - (3) Reduce my chances of roll-over a little [3]
 - (4) Make no difference in my chances of a roll-over [5]

2. In general, do you see these systems as:

- (1) useful to you in driving your truck [2]
- (2) creates a problem for you when driving your truck [1]
- (3) not useful to you in driving your truck but not a problem either [7]

How strongly do you agree or disagree with the following statements? Circle a number, or **NA** if you have not seen the safety system operate.

How much do you agree or disagree with these statements?	Strongly Agree	Agree	Neither Agree or Disagree	Disagree	Strongly Disagree
	5	4	3	2	1
3. The Roll Stability Advisor provides me with information about my vehicle that I would not normally have. NA [2]	5 [4]	4 [4]	3 [4]	2 [1]	1 [0]
4. The advisory messages from the Roll Stability Advisor provide useful advice. NA [2]	5 [2]	4 [5]	3 [4]	2 [1]	1 [1]
5. The advisory messages from the Roll Stability Advisor are easy to understand. NA [1]	5 [3]	4 [9]	3 [2]	2 [0]	1 [0]
6. When an advisory message appears, it is easy to determine which maneuver caused it. NA [4]	5 [3]	4 [7]	3 [2]	2 [0]	1 [0]

7. When I get an advisory message, it is clear what I could have done differently to avoid getting a message. NA [4]	5 [2]	4 [5]	3 [3]	2 [1]	1 [0]
8. Since the new safety system was activated, I drive my vehicle more safely with regard to rollover risk. NA [1]	5 [2]	4 [2]	3 [6]	2 [4]	1 [0]
9. Since the new safety system was activated, I drive my vehicle more safely with regard to hard braking. NA [2]	5 [2]	4 [4]	3 [4]	2 [1]	1 [2]
10. Roll advisories are sometimes displayed when there is no real rollover risk. NA [3]	5 [9]	4 [0]	3 [2]	2 [0]	1 [1]
11. I think some of my maneuvers should have produced advisory messages, but none were displayed after the maneuver. NA [2]	5 [2]	4 [4]	3 [1]	2 [4]	1 [2]
12. I am surprised by some advisory messages that occur during what I think is a safe maneuver. NA [4]	5 [4]	4 [5]	3 [1]	2 [1]	1 [0]
13. Advisory messages about hard braking are helpful to me. NA [4]	5 [1]	4 [2]	3 [4]	2 [2]	1 [1]
14. The advisory messages and alarms do not interfere with my driving. NA [2]	5 [5]	4 [3]	3 [1]	2 [3]	1 [1]
15. The speed reduction recommendations are accurate. NA [3]	5 [2]	4 [4]	3 [2]	2 [3]	1 [1]
16. I have enough time to safely read the roll advisories. NA [2]	5 [4]	4 [4]	3 [3]	2 [1]	1 [1]
17. The Roll Stability Control has come on and slowed me at times I do not think it should have come on. NA [10]	5 [2]	4 [0]	3 [2]	2 [1]	1 [0]
18. The messages from the roll over advisory system are easy to read. NA [2]	5 [2]	4 [9]	3 [2]	2 [0]	1 [0]
19. The information I get from the Roll Stability Advisor about rollover danger is helpful. NA [3]	5 [3]	4 [2]	3 [5]	2 [2]	1 [0]

20. With the Roll Stability Advisor, I don't drive any differently than I would drive without it. NA[0] 5[7] 4[4] 3[3] 2[1] 1[0]
21. The Roll Stability Advisor's messages interfere with my ability to drive safely because they distract me. NA[1] 5[1] 4[2] 3[4] 2[3] 1[4]
22. High tech systems like these really do not help the experienced driver. NA[0] 5[1] 4[5] 3[4] 2[3] 1[2]
23. I would be better off driving without these types of high tech advice and control systems. NA[0] 5[0] 4[1] 3[10] 2[2] 1[2]
24. I don't need the Roll Stability Advisor to keep from rolling my truck. NA[1] 5[2] 4[2] 3[9] 2[0] 1[1]
25. I have a good understanding about how to use the Roll Stability Advisor. NA[0] 5[5] 4[1] 3[9] 2[0] 1[0]
26. The Roll Stability Control system can slow my truck safely NA[6] 5[1] 4[0] 3[5] 2[1] 1[1]

27. I am learning things about my driving habits from the Roll Stability Advisor and Control systems that I did not know. NA[2] 5[1] 4[2] 3[5] 2[3] 1[1]
28. I haven't had any difficulty learning how to use these systems. NA[3] 5[4] 4[5] 3[3] 2[0] 1[0]
29. These systems sometimes interfere with my driving responsibilities. NA[2] 5[1] 4[1] 3[8] 2[0] 1[2]
30. These systems often fail to give me an alert when I think they should. NA[2] 5[1] 4[3] 3[5] 2[1] 1[2]
31. I find that having this safety system in my truck reduces the stress and fatigue of driving. NA[0] 5[3] 4[1] 3[3] 2[4] 1[3]
32. Having this system in my truck has reduced the number of accidents or near-accident situations compared to what I would have had without it. NA[1] 5[1] 4[0] 3[5] 2[4] 1[2]

Please estimate the number of times the Roll Stability Advisor and Control was activated.

In the last 2 weeks, the Roll Stability Advisor and Control advised me about my driving about _____ times.

0[8] 5[0] 4[0] 3[2] 2[0] 1[2]

Is there anything you would like to comment on about the safety system, in general?

LONG PERIODIC DRIVER SURVEY - OCT 30, 2001

We will keep this information confidential; we will not share this information with your employer. However we need to know who is completing surveys, and we use an ID number on the form.

Select the statement you agree with most:

1. In the coming months, I expect the Roll Stability Advisor and Control system to:

- (1) Greatly reduce my chances of having a roll-over [2]
- (2) Somewhat reduce my chances of having a roll-over [2]
- (3) Reduce my chances of roll-over a little [0]
- (4) Make no difference in my chances of a roll-over [7]

2. In general, do you see these systems as:

- (1) useful to you in driving your truck [3]
- (2) creates a problem for you when driving your truck [1]
- (3) not useful to you in driving your truck but not a problem either [6]

29 How strongly do you agree or disagree with the following statements? Circle a number, or **NA** if you have not seen the safety system operate.

How much do you agree or disagree with these statements?	Strongly	Agree	Agree	Neither	Disagree	Strongly
	5	4	3	2	1	Disagree
3. The Roll Stability Advisor provides me with information about my vehicle that I would not normally have. NA [1] 5 [4] 4 [3] 3 [3] 2 [3] 1 [0]						
4. The advisory messages from the Roll Stability Advisor provide useful advice. NA [2] 5 [3] 4 [4] 3 [3] 2 [2] 1 [0]						
5. The advisory messages from the Roll Stability Advisor are easy to understand. NA [1] 5 [2] 4 [9] 3 [1] 2 [1] 1 [0]						
6. When an advisory message appears, it is easy to determine which maneuver caused it. NA [1] 5 [2] 4 [7] 3 [3] 2 [1] 1 [0]						
7. When I get an advisory message, it is clear what I could have done differently to avoid getting a message. NA [1] 5 [1] 4 [8] 3 [2] 2 [2] 1 [0]						

8. Since the new safety system was activated, I drive my vehicle more safely with regard to rollover risk. NA [0] 5 [0] 4 [3] 3 [8] 2 [1] 1 [2]
9. Since the new safety system was activated, I drive my vehicle more safely with regard to hard braking. NA [1] 5 [1] 4 [5] 3 [4] 2 [1] 1 [2]
10. Roll advisories are sometimes displayed when there is no real rollover risk. NA [1] 5 [7] 4 [2] 3 [2] 2 [2] 1 [0]
11. I think some of my maneuvers should have produced advisory messages, but none were displayed after the maneuver. NA [1] 5 [3] 4 [3] 3 [2] 2 [3] 1 [2]
12. I am surprised by some advisory messages that occur during what I think is a safe maneuver. NA [1] 5 [5] 4 [5] 3 [0] 2 [1] 1 [1]
13. Advisory messages about hard braking are helpful to me. NA [2] 5 [0] 4 [3] 3 [5] 2 [4] 1 [0]
14. The advisory messages and alarms do not interfere with my driving. NA [1] 5 [2] 4 [0] 3 [8] 2 [2] 1 [1]
15. The speed reduction recommendations are accurate. NA [1] 5 [3] 4 [2] 3 [6] 2 [1] 1 [1]
16. I have enough time to safely read the roll advisories. NA [1] 5 [3] 4 [2] 3 [3] 2 [4] 1 [1]
17. The Roll Stability Control has come on and slowed me at times I do not think it should have come on. NA [7] 5 [1] 4 [2] 3 [2] 2 [2] 1 [0]
18. The messages from the roll over advisory system are easy to read. NA [1] 5 [3] 4 [6] 3 [2] 2 [2] 1 [0]
19. The information I get from the Roll Stability Advisor about rollover danger is helpful. NA [1] 5 [2] 4 [6] 3 [5] 2 [1] 1 [0]
20. With the Roll Stability Advisor, I don't drive any differently than I would drive without it. NA [0] 5 [5] 4 [6] 3 [3] 2 [0] 1 [0]
21. The Roll Stability Advisor's messages interfere with my ability to drive safely because they distract me. NA [1] 5 [2] 4 [0] 3 [5] 2 [4] 1 [2]

22. High tech systems like these really do not help the experienced driver. NA[0] 5[3] 4[2] 3[5] 2[4] 1[0]
23. I would be better off driving without these types of high tech advice and control systems. NA[0] 5[0] 4[2] 3[8] 2[2] 1[2]
24. I don't need the Roll Stability Advisor to keep from rolling my truck. NA[0] 5[1] 4[5] 3[8] 2[0] 1[0]
25. I have a good understanding about how to use the Roll Stability Advisor. NA[1] 5[3] 4[9] 3[0] 2[1] 1[0]
26. The Roll Stability Control system can slow my truck safely NA[7] 5[0] 4[1] 3[4] 2[0] 1[1]
27. I am learning things about my driving habits from the Roll Stability Advisor and Control systems that I did not know. NA[1] 5[3] 4[3] 3[5] 2[1] 1[1]

28. I haven't had any difficulty learning how to use these systems. NA[1] 5[3] 4[7] 3[2] 2[1] 1[0]
29. These systems sometimes interfere with my driving responsibilities. NA[1] 5[1] 4[2] 3[6] 2[3] 1[1]
30. These systems often fail to give me an alert when I think they should. NA[1] 5[0] 4[7] 3[1] 2[4] 1[1]
31. I find that having this safety system in my truck reduces the stress and fatigue of driving. NA[1] 5[1] 4[0] 3[4] 2[4] 1[4]
32. Having this system in my truck has reduced the number of accidents or near-accident situations compared to what I would have had without it. NA[1] 5[0] 4[1] 3[4] 2[5] 1[3]

29

Please estimate the number of times the Roll Stability Advisor and Control was activated.

In the last 2 weeks, the Roll Stability Advisor and Control advised me about my driving about _____ times.

0[8] 5[2] 4[0] 3[0] 2[2] 1[2]

Is there anything you would like to comment on about the safety system, in general?

LONG PERIODIC DRIVER SURVEY - DEC 5, 2001

We will keep this information confidential; we will not share this information with your employer. However we need to know who is completing surveys, and we use an ID number on the form.

Select the statement you agree with most:

1. In the coming months, I expect the Roll Stability Advisor and Control system to:

- (1) Greatly reduce my chances of having a roll-over [1]
- (2) Somewhat reduce my chances of having a roll-over [1]
- (3) Reduce my chances of roll-over a little [3]
- (4) Make no difference in my chances of a roll-over [3]

2. In general, do you see these systems as:

- (1) useful to you in driving your truck [5]
- (2) creates a problem for you when driving your truck [0]
- (3) not useful to you in driving your truck but not a problem either [3]

How strongly do you agree or disagree with the following statements? Circle a number, or **NA** if you have not seen the safety system operate.

How much do you agree or disagree with these statements?	Strongly Agree	Agree	Neither Agree or Disagree	Disagree	Strongly Disagree
	5	4	3	2	1
3. The Roll Stability Advisor provides me with information about my vehicle that I would not normally have. NA [2] 5 [2] 4 [3] 3 [5] 2 [2] 1 [0]					
4. The advisory messages from the Roll Stability Advisor provide useful advice. NA [2] 5 [2] 4 [4] 3 [5] 2 [1] 1 [0]					
5. The advisory messages from the Roll Stability Advisor are easy to understand. NA [2] 5 [2] 4 [6] 3 [3] 2 [1] 1 [0]					
6. When an advisory message appears, it is easy to determine which maneuver caused it. NA [2] 5 [1] 4 [7] 3 [4] 2 [0] 1 [0]					
7. When I get an advisory message, it is clear what I could have done differently to avoid getting a message. NA [2] 5 [1] 4 [7] 3 [4] 2 [0] 1 [0]					
8. Since the new safety system was activated, I drive my vehicle more safely with regard to rollover risk.					

	NA [1]	5 [0]	4 [4]	3 [7]	2 [1]	1 [1]
9. Since the new safety system was activated, I drive my vehicle more safely with regard to hard braking. NA [0] 5 [1] 4 [4] 3 [7] 2 [2] 1 [0]						
10. Roll advisories are sometimes displayed when there is no real rollover risk. NA [2] 5 [5] 4 [3] 3 [3] 2 [1] 1 [0]						
11. I think some of my maneuvers should have produced advisory messages, but none were displayed after the maneuver. NA [2] 5 [4] 4 [3] 3 [3] 2 [1] 1 [0]						
12. I am surprised by some advisory messages that occur during what I think is a safe maneuver. NA [2] 5 [5] 4 [3] 3 [3] 2 [1] 1 [0]						
13. Advisory messages about hard braking are helpful to me. NA [3] 5 [1] 4 [2] 3 [5] 2 [2] 1 [1]						
14. The advisory messages and alarms do not interfere with my driving. NA [1] 5 [1] 4 [4] 3 [4] 2 [2] 1 [2]						
15. The speed reduction recommendations are accurate. NA [1] 5 [1] 4 [2] 3 [8] 2 [1] 1 [1]						
16. I have enough time to safely read the roll advisories. NA [2] 5 [1] 4 [7] 3 [3] 2 [1] 1 [0]						
17. The Roll Stability Control has come on and slowed me at times I do not think it should have come on. NA [5] 5 [0] 4 [4] 3 [4] 2 [1] 1 [0]						
18. The messages from the roll over advisory system are easy to read. NA [1] 5 [2] 4 [6] 3 [3] 2 [2] 1 [0]						
19. The information I get from the Roll Stability Advisor about rollover danger is helpful. NA [2] 5 [2] 4 [2] 3 [7] 2 [0] 1 [1]						
20. With the Roll Stability Advisor, I don't drive any differently than I would drive without it. NA [0] 5 [3] 4 [3] 3 [8] 2 [0] 1 [0]						
21. The Roll Stability Advisor's messages interfere with my ability to drive safely because they distract me. NA [0] 5 [1] 4 [1] 3 [7] 2 [2] 1 [3]						
22. High tech systems like these really do not help the experienced driver. NA [0] 5 [3] 4 [1] 3 [7] 2 [2] 1 [1]						
23. I would be better off driving without these types of high tech advice and control systems. NA [0] 5 [2] 4 [0] 3 [9] 2 [2] 1 [1]						

24. I don't need the Roll Stability Advisor to keep from rolling my truck. NA[0] 5[3] 4[0] 3[10] 2[0] 1[1]
25. I have a good understanding about how to use the Roll Stability Advisor. NA[0] 5[2] 4[8] 3[4] 2[0] 1[0]
26. The Roll Stability Control system can slow my truck safely NA[6] 5[0] 4[0] 3[5] 2[1] 1[1]
27. I am learning things about my driving habits from the Roll Stability Advisor and Control systems that I did not know. NA[0] 5[2] 4[2] 3[6] 2[1] 1[2]
28. I haven't had any difficulty learning how to use these systems. NA[0] 5[2] 4[6] 3[4] 2[0] 1[0]

29. These systems sometimes interfere with my driving responsibilities. NA[0] 5[1] 4[1] 3[8] 2[0] 1[3]
30. These systems often fail to give me an alert when I think they should. NA[1] 5[0] 4[3] 3[6] 2[0] 1[3]
31. I find that having this safety system in my truck reduces the stress and fatigue of driving. NA[0] 5[0] 4[1] 3[7] 2[2] 1[3]
32. Having this system in my truck has reduced the number of accidents or near-accident situations compared to what I would have had without it. NA[0] 5[0] 4[1] 3[2] 2[7] 1[3]

Please estimate the number of times the Roll Stability Advisor and Control was activated.

In the last 2 weeks, the Roll Stability Advisor and Control advised me about my driving about _____ times.

0[7] 5[0] 4[1] 3[1] 2[3] 1[2]

Is there anything you would like to comment on about the safety system, in general?

RA&C FINAL STRUCTURED INTERVIEW

Basic Ground Rules – Review with Each Driver

- Statements are confidential
- There are no right or wrong answers
- Need to keep a schedule
- Audio taping may be used, subject to permission from the driver
- Interview purpose is to learn your opinions about the on-board safety system—roll stability advisor and control.

Driver Info/Experience

1. Name: _____ .
2. Driver ID: _____ .
3. Years experience:
 - 3.1. In trucking _____ years. *Mean = 23.0 years*
 - 3.2. With tankers _____ years. *Mean = 11.5 years*
 - 3.3. With Praxair _____ years. *Mean = 9.9 years*

System Function

Roll Stability Advisor

4. While you were driving, do you recall seeing any **Roll Stability Advisor** messages? ¹

(Y) (N) 13Y, 1N

(If no, go to question 5.)

- 4.1. How many total roll advisory messages did you see over the course of the test (specify a number)? _____ advisories. *Mean = 10.4*

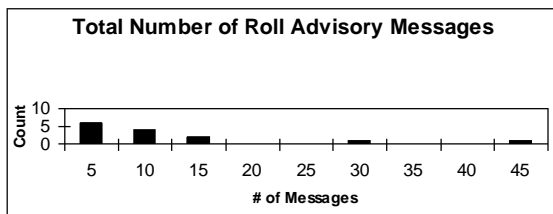

¹ (When this first question is asked, the drivers may not distinguish between the RSA, RSC, and HBED. Go to the system they are answering for, and then return to answer for the others.)

4.2. Were you able to distinguish different kinds of roll advisory messages?

(Y) (N) 5Y, 7N

If yes, ask the driver:

- only lowest
- 3 mph reduction
- always same one

4.2.1. Were some messages different from others?²

(Y) (N) 3Y, 3N

Specify: .

- Slow down 5 mph

4.2.2. How many levels of advisory did you get? _____.(number) Mode = 1

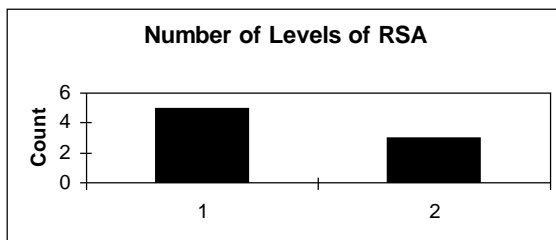

4.2.3. Do you think that is (pick one):

- (a) too many 0
- (b) just enough 2
- (c) too few 1

4.3. Did you understand the meaning of the roll advisory system messages?

(Y) (N) 12Y, 0N

(If no, skip to question 5).

4.4. What did the message say (select any the driver mentions)?

- (a) slow down now 5
- (b) slow down next time 8
- (c) specify: _____.

² (The drivers may not have the various messages sorted their minds. A RSA Level I with a different speed suggestion may be perceived as two kinds of messages. Another driver may lump all RSA and RSC into a single category with HBED in the other. It will be enlightening to learn how the drivers group the messages.)

- *Sliding*
- *3 drivers mentioned slowing down 3mph*
- *1 driver mentioned slowing down*

4.5. What did you do?

- (a) slowed down 2
- (b) nothing 8
- (c) remembered to slow down next time 3
- (d) other (*specify*) _____.

Hard Braking

5. While you were driving, do you recall seeing any of the **Hard Braking** messages?

(Y) (N) 5Y, 8N

(If answer is no, skip to question 6.)

5.1. How many total hard braking advisories did you see during the test? _____ advisories.

Mean = 4.2

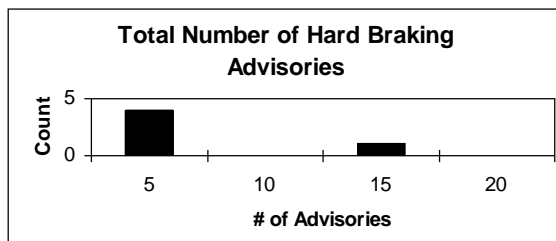

5.2. Were you able to distinguish different kinds of hard braking advisory messages?

(Y) (N) 2Y, 1N

(If answer is no, skip to question 6.)

5.2.1. How many levels of advisory did you get? _____ *Mode = 1*

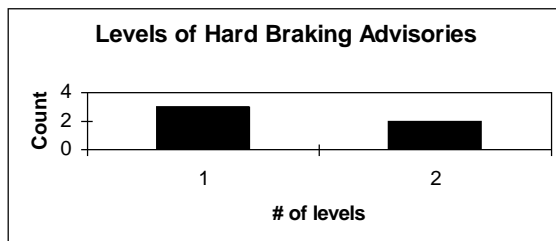

5.2.2. Do you think that is (*pick one*):

- (a) too many 0
- (b) just enough 1
- (c) too few 0

5.3. Did you understand the meaning of the hard braking messages?

(Y) (N) 2Y, 3N

(If answer is no, skip to question 6.)

5.3.1. Do you remember what any of the messages said (*please describe*)?

- *Hard braking*

5.3.2. What did you do?

- (a) eased off the brake 1
- (b) nothing 2
- (c) other (*specify*) _____ .

- *Worked not to get them*

Roll Stability Control

6. While you were driving, do you recall any **Roll Stability Control** events?

(Y) (N) 0Y, 10N

(If answer is no, skip to question 7.)

6.1. What did you notice about the behavior of your truck?

- (a) loss of power
- (b) nothing
- (c) other (*specify*) _____

6.2. Did you notice any indicators _____ (*select all that apply*) during the event?

- (a) lights
- (b) messages
- (c) warning sounds
- (d) other (*specify*) _____

(If nothing selected, skip to 6.3)

- 6.2.1. Did this *indicator* help you understand what was happening to the vehicle?
(Y) (N)
- 6.2.2. Do you think the additional *indicator* signals were necessary?
(Y) (N)
- 6.2.3. How do you think the *indicator* affected the way you operated your vehicle?
(a) distracted me
(b) helped me
(c) had no effect
- 6.3. Did this *indicator* help you understand that you were in a safety-critical maneuver?
(Y) (N)
- 6.4. Did you also see any roll *Advisory* messages when the roll stability *Control* activated.
(Y) (N)?
- 6.5. Can you explain why a roll stability control event occurred?
(a) speed-related
(b) load-related
(c) roadway characteristics
(d) don't know
(e) other (*specify*) _____ .
- 6.6. What did you do (*specify*)? _____ .

Message Salience/Visibility Under Operating Conditions

The next questions we're going to ask you are concerned with the way the advisory messages appeared to you? Note: If driver reports seeing no advisory messages, skip to Question 8.

Message Center

7. Could you distinguish the safety-related messages from other, informational messages on the message center?
(Y) (N) 12Y, 1N
8. How many of the messages do you think you saw when they appeared on the display?
(a) All 7
(b) most 2
(c) some 1
(d) few
(e) none
(f) other (*number*) 2 drivers reported 85%

8.1. Is it possible you didn't notice a message that appeared briefly?

(Y) (N) 5Y, 8N

8.2. How many do you think you missed (number)? _____ . Mode = 0



- One driver reported missing a few
- Another driver reported missing 15%
- Another driver didn't know how many he had missed

8.3. Rate the effectiveness of the message center as a means to deliver advisories.

- (a) very good 8
- (b) good 5
- (c) neither good nor bad
- (d) bad
- (e) very bad

8.4. Can you name some conditions when the messages were easier to read?

8.5. Can you name some conditions when the messages were harder to read?

	Easy	Hard
(a) Sunlight	(7)	(6)
(b) Darkness	(13)	(0)
(c) heavy traffic	(10)	(1)
(d) other	()	()

Sounds

9. Did you hear the warning sound when the messages came on?

(Y) (N) 12Y, 2N

If no, skip to Question 9.

9.1. How many levels of warning tones did you notice? _____ (number).

Mode = 1

For each level distinguished, ask driver to:

9.1.1. Rate the duration of the sounds:

	Level 1	Level 2	Level 3
(a) too short	(2)	()	()
(b) ok	(9)	(1)	()
(c) too long	(1)	()	()

Reasons cited: _____

9.1.2. Rate the loudness of the sound (note the volume of the tone does not vary but the driver might perceive it differently in each circumstance).

	Level 1	Level 2	Level 3
(a) too soft	(4)	()	()
(b) ok	(7)	()	()
(c) too loud	(1)	()	()

Reasons cited: _____

9.2. The sound was _____ in bringing my attention to the displayed messages.

- (a) Helpful 12
(b) not helpful 0

9.3. Could you distinguish the beeps from other sounds in the cab?

(Y) (N) 10Y, 2N

9.4. Did you find the sound distracting?

(Y) (N) 2Y, 10N

9.5. Were the messages themselves distracting?

(Y) (N) 1Y, 11N

Other system features

Trip/Leg logging

10. Did you use the trip/leg feature?

(Y) (N) 9Y, 5N

(If yes, go to Question 9.2)

10.1. Why (select all that apply)?

- (a) not sure about its operation
- (b) not useful to me 1
- (c) not interested in using it
- (d) too few events to bother with 4
- (e) other (specify) Too much to do with Eaton System

(Go to Question 10.)

10.2. Which events did you track?

- (a) HBED
 - (b) RSA
 - (c) other (specify) _____.
- Six drivers tracked both
 - one driver tracked only RSA
 - one driver tracked ?, to see if it worked

Acknowledge Key

11. Did you use the acknowledge key to dismiss advisory messages?

(Y) (N) 3Y, 9N

(If no, go to 10.2)

11.1. Did you try to acknowledge all messages?

(Y) (N) 1Y, 3N

(Go to Question 11.)

11.2. Why (give reason)?

- (a) inconvenient
- (b) wanted to keep eyes on road
- (c) other (specify) _____.

Validity/Trust: Acceptance/Rejection from experience

Ask driver to rate his level of agreement with the following statement:

12. I am better off driving without these types of high-tech advice and control systems.

- (a) strongly agree 1
- (b) agree 1
- (c) neither agree nor disagree 7
- (d) disagree 5
- (e) strongly disagree

13. Rate the accuracy of each of the systems.	RSA	HBED	RSC
(a) Very accurate	(2)	(1)	()
(b) Somewhat accurate	(4)	(3)	()
(c) Unable to judge accuracy	(1)	(1)	()
(d) somewhat inaccurate	(6)	(1)	()
(e) very inaccurate	()	()	()

14. Did you ever get some messages you thought were wrong?

(Y) (N) 9Y, 4N

(If yes, ask the following:)

14.1. What situations were most likely to produce wrong messages (specify)?

- Empty going around an S curve at slow speeds
- 2 drivers mentioned empty on ramps
- 3 drivers mentioned empty
- Empty making a 90 degree turn
- 2 drivers mentioned receiving a wrong message at a stop
- Gravel, slippery pavement

15. Overall the speed reduction advice seemed _____ (select one):

- (a) Very accurate 5
- (b) Somewhat accurate 4
- (c) Don't know 0
- (d) Somewhat inaccurate 2
- (e) Very inaccurate

Value/efficacy

Here we want to find out if the driver considers the roll advisor and control system a valuable safety system, and to estimate how much the driver thinks the system may have affected his driving.

Roll Stability Advisor

16. Do you think the roll stability advisor has changed your driving? In terms of safety, would you say your driving is:

- (a) Much safer
- (b) Somewhat safer 7
- (c) Not at all safer 6
- (d) Somewhat less safe
- (e) Much less safe

17. Do you drive differently now than you did 5 months ago?

(Y) (N) 7Y, 7N

If yes, answer the follow-up:

17.1. How is your driving different (specify):

- (a) _____
- (b) _____
- (c) _____

- Awareness of curves
- Better judge of curves
- Awareness of ramps – cloverleafs
- More conscious of safety condition
- More conscious of turns, aware of safety
- Curves

18. Do you drive differently in an RA&C-equipped truck than you do in other trucks?

(Y) (N) 2Y, 12N

19. Can you name special driving situations that you handle differently as a result of using the system?

(wait for driver to respond and check all that are mentioned)

- (a) High-speed maneuvers
- (b) Low-speed maneuvers
- (c) Turns 3
- (d) Exiting freeways 2

(e) Entering freeways 3

(f) Other (specify) *Two drivers mentioned ramps, anticipating braking distance, slick roads*

20. Do you think the advisories helped you learn anything about avoiding a rollover?

(Y) (N) 6Y, 6N

Specify: _____

- *Be aware of surroundings/loaded, empty*
- *Confirmed his estimate of stability*
- *Ramp transversal, valuable for inexperienced driver*
- *Avoid alarm, slowly aware*
- *Driver feels he is too cautious*
- *Conscious of turns*
- *Slower around curves*
- *Exit ramps are taken slowly, makes you realize danger on ramps*

21. Did the advisory system provide you with safety information that was not normally available?

(Y) (N) 7Y, 5N

Specify: _____

- *Learned about certain stretches, curves of road*
- *Stability info*
- *Round about way – planted doubt*
- *Alarm sounded in conditions driver didn't think were hazardous*
- *Didn't think load shifts too much*
- *Handling of vehicle*
- *Stability*

Roll Stability Control

22. Do you recall a particular incident when the roll stability Control activated?

(Y) (N) 0Y, 2N

If the answer is no, skip to Question 22.

22.1. Do you think the stability control system affected your driving?

(Y) (N)

If yes,

22.1.1. Please specify how: _____

22.2. Do you think the stability control system helped?

(Y) (N)

22.3. Do you think the stability control system made your driving safer?

(Y) (N)

22.4. Did the stability control system concern you when it activated?

(Y) (N)

If yes, specify:

22.4.1. How did it concern you?

Mental Workload

Tell driver:

Mental workload is defined as the mental demand on your limited resources.

Think back to last spring (before the RA&C was active) and rate using a scale of 0 to 100, what was your level mental workload you experienced when performing the following driving tasks. Then think of your mental workload over the past five months and indicate your mental workload using the same 0 to 100 scale. 0 means very low mental workload at all was required and 100 means there was an extremely high demand.

23. What was your workload?

	Before Activation	past five months
going around a curve on a two-lane road	_____	_____
taking an off-ramp	_____	_____
making a fast lane change	_____	_____
taking an on-ramp and merging	_____	_____
the worst condition you ordinarily face	_____	_____

Value with respect to experience

24. Select the degree of benefit or harm that the RSA might provide for each potential user:

	You	Experienced	Inexperienced
(a) Great benefit	(1)	(1)	(10)
(b) Some benefit	(8)	(9)	(3)
(c) No benefit	(5)	(4)	()
(d) Harmful	()	()	(1)

Circumstances/locations

25. Were there specific driving situations where you found the system most useful?

(Y) (N) 7Y, 5N

If yes, check situations that driver mentions, or add ones not listed:

- (a) Unfamiliar roadways
- (b) Roadway geometry 6
- (c) Roadway class
- (d) Weather conditions
- (e) Driver state (fatigue level/start or end of tour)
- (f) Other _____

- Construction zones
- Traffic

26. Were there specific driving locations where the system seemed to activate often?

(Y) (N) 8Y, 4N

If yes, ask the next 2 questions:

26.1. Did you already know these locations to be risky?

(Y) (N) 4Y, 4N

26.2. Do Praxair drivers discuss high-risk locations with each other?

(Y) (N) 6Y, 2N

27. Even when you drove a truck without the system, do you think your driving was affected by your experience in a truck with the system?

(Y) (N) 6Y, 6N

Undesirable effects

28. Can you describe anything undesirable about the RSA?

(Y) (N) 2Y, 12N

If yes, please specify: _____

- Don't want to be bothered by another beep
- Distracting

29. Did you find the advisory messages distracting?

(Y) (N) 1Y, 12N

If yes ask the following:

29.1. Specify (how, why): _____

- Only when it shouldn't have come on, slow speed (empty)
- 2 times

29.2. As the weeks went by, did the distraction:

(a) increase

(b) decrease _____/

30. Were there any messages you thought were unnecessary?

(Y) (N) 8Y, 5N

If yes, ask:

30.1. What was happening when you got an unnecessary message:

- Unloaded truck
- 90 degree turn, slow, unloaded trailer
- Dead stop, accelerating when empty
- Left turn on empty, stop
- Empty
- Empty

31. Did you ever find yourself reading advisory messages when you should have been watching the road?

(Y) (N) 4Y, 9N

32. Do you think you might come to *RELY* on this technology?

(Y) (N) 2Y, 12N

33. Do you think you might become *RELIANT* on technology in general?

(Y) (N) 9Y, 5N

Ancillary Benefit

34. What was the system's effect on your level of fatigue?

- (a) Reduced fatigue 1
- (b) Did not change fatigue 13
- (c) Increased fatigue

35. Do you think the system has changed the likelihood of crashes that are not rollovers?

(Y) (N) 3Y, 11N

36. Has this system changed your driving job?

(Y) (N) 3Y, 11N

If yes, specify how: _____

- Increased awareness

37. Do you like your job better now?

(Y) (N) 1Y, 13N

38. Would you be concerned if your advisory messages were reported back to LaPorte?

(Y) (N) 4Y, 10N

If yes, specify WHY? _____

- Could use it unfairly against drivers
- Invasion of privacy
- Unless fired – false information

39. How did the system compare to other safety systems on board?

	safety benefit	driver interference
(a) Better than most	(6)	(7)
(b) Same as most	(7)	(6)
(c) Worse than most	(1)	(1)

Training Adequacy

40. After 5 months of use, do you think the training you received was adequate?

(Y) (N) 13Y, 1N

41. Did the system behave as you expected?

(Y) (N) 8Y, 4N

42. Did you share your opinions about the system with other drivers?

(Y) (N) 12Y, 2N

42.1. Did others express positive opinions about the system?

(Y) (N) 4Y, 3N, 6Both positive and negative comments

43. Do you think you had more or less advisories than the average Praxair driver?

(More) (Less)

- 2 More
- 8 Less
- 1 Same
- 3 Don't know

44. What do you think can be done to make the system better?

Please specify:

-
- Should be more sensitive
 - Low speed-empty-unwanted warning
 - Buzz before event, then after (positive for fatigue)
 - Warn before dangerous event, not every turn goes off lane
 - Empty alerts
 - Needs driver adjusted sensitivity
 - Lengthen the beeps
 - Make warning signal different from others in truck
 - More sensitive to stability, not braking part
 - More sensitive to loaded conditions and less when empty
 - Adjust computer to know empty or loaded, take a turn faster

45. What is your final assessment?

(a) Accept 7

(b) Reject

(c) Accept with change—specify: _____

- Prenotice if crash system goes off
- Fix unloaded problem
- More sensitive to loads, less sensitive to empty
- Distinct tone
- More sensitive

- Correct sensitivity when empty
- If system can tell if empty or loaded

46. The next time a new set of tractors is purchased, which options would you choose first, second, third.... (*Rank your order of preference*): (*Average Rank is given:*)

- (a) 3.7 _____ Interior upgrade
- (b) 3.4 _____ Roll Stability Advisor
- (c) 4.2 _____ Roll Stability Control
- (d) 4.3 _____ Hard Braking Event Detector
- (e) 2.6 _____ Forward Collision Warning
- (f) 2.8 _____ Lane departure
- (g) _____ Other (*specify*)

Version modifications:

- 11/9/01 v 1.5 modified to break out tone levels in questionnaire. Added some lines for clarification of driver (for reasons why the tone was considered too short or too long).
- 11/11/01 v1.7 integrated Battelle's comments.
- 11/12/01 v1.8 corrected typos, modified some language.

RA&C FINAL MANAGEMENT INTERVIEW

1. Name: .
2. Did drivers comment on the Roll Stability Advisor and Control System?
(Y)~~X~~ (N)
If yes,
 - 2.1. What percent were Positive: *majority were positive*
Negative: *negative comments were mostly about the accuracy of the advisories*
Neither _____
 - 2.2. Did any drivers report the system was distracting?
(Y) (N) ~~xxx~~ *No...maybe one guy commented.*
 - 2.3. Did drivers comment on the accuracy of the advisories?
(Y)~~xxx~~ (N)
If yes, specify: some thought that the system wasn't accurate when it delivered alarms.
3. Did you notice any change in trip times after the RA&C was introduced?
(Y) ~~xxx~~ (N)
If yes,
 - 3.1. How did efficiency change? *Increased gas efficiency, might have been due to overspeed warnings.*
4. Do you think periodic reports on a driver's stability performance would improve the system's effectiveness?
(Y) ~~XXX~~ (N)
If yes, ask:
 - 4.1. What sort of information would you like to see in the performance report?
(x) Summary RSA Score for x-week period
(x) Incident report (details of when and where the event occurred)
Details of warning location would be helpful. Let driver know which curves on which trips produced alarms. Weekly reports would work best, but not much further delay.
 - 4.2. How frequently should the report be produced?
(x) weekly
() bi-weekly (*might be acceptable if specifics related to the incident could be supplied.*)

- monthly
- bi-monthly
- quarterly

4.3. Who should receive the performance report?

- only the driver
- only management
- both driver and management (*Definitely*)

5. Compared to the safety benefit of ABS, do you think the drivers found the RA&C:

- a greater benefit
- same benefit
- less benefit

Great benefit in raising driver's awareness of rollover hazards.

6. Compared to the degree of distraction produced by ABS systems, did drivers report the distraction from the RA&C as: *Don't know.*

- greater
- the same
- less

7. In general, what do you think of the Roll Stability Advisor? (free form comment)

The presence of the system in the truck sustained driver awareness of rollover hazards.

8. Did you find a difference in managing the fleet with the RA&C compared to managing the fleet without it?

- Yes specify _____
- No

APPENDIX A-J. RA&C DATABASE TABLES

ON-VEHICLE DATA

See tables 3-14 and 3-15 in main text

PRAXAIR DATA

CustomerLocs

Field	Data Type	Units
City	sysname	
State	sysname	
Zip	sysname	
Longitude	float	Degrees
Latitude	float	Degrees
CustID	sysname	
CustName	sysname	

Deliveries

Field	Data Type	Units
DeliveryStart	datetime	UTC
DeliveryEnd	datetime	UTC
TourStart	datetime	UTC
TourEnd	datetime	UTC
DriverID	varchar	
driverlastname	varchar	
customerTank	varchar	
Customer	varchar	
CustomerOrderNum	varchar	

DriverList

Field	Data Type	Units
DriverId	int	
UMTRIDriverId	smallint	
FirstName	varchar	
MiddleName	varchar	
LastName	varchar	
CustDriverID	int	
NonComparable	bit	
PhaseIDistance	real	km

Fills

Field	Data Type	Units
Location	varchar	
Product	varchar	
Trailer	varchar	
StartWeight	int	Lbs
EndWeight	int	Lbs
FillTime	datetime	UTC

SessionActivities

Field	Data Type	Units
SesID	int	
Time	datetime	UTC
SourceFile	char	
Activity	varchar	
LocDescription	varchar	

Sessions

Field	Data Type	Units
SesID	int	
DriverID	int	
VehicleID	int	
Trailer	varchar	
StartTime	datetime	UTC
EndTime	datetime	UTC
StartWeight	int	Lbs
EndWeight	int	Lbs
ProductVolumeFt3	int	Cubic feet Cubic feet per pound
ProductSpVolume	real	Gallons
FuelUsed	real	Gallons
DT	datetime	UTC
SesFilename	varchar	
TranFilename	varchar	
TransCount	smallint	
OverSpeeds	smallint	
OverRevs	smallint	
Idles	smallint	
RapidDecelCount	smallint	
MaxSpeed	tinyint	Mph
VehicleMileage	real	Miles
StopCount	smallint	
CustomerIDRoute	varchar	
TotalDrivingTime	smallint	Hours
TotalDistance	smallint	Miles
ECU	smallint	

Tractors

Field	Data Type	Units
VehicleID	smallint	
Tractor	tinyint	

WEATHER DATA

METAR_REPORTS

Field	Data Type	Units
Identifier	char	
DateTime	char	UTC
Observation	varchar	
Temperature	smallint	Degrees F
DewPoint	smallint	Degrees F
Windspeed	smallint	Knots
WindDir	smallint	Degrees
Visibility	real	Statute Miles
NumDateTime	datetime	UTC
BarPressure	real	Inches of Hg

Stations

Field	Data Type	Units
Identifier	char	
Name	varchar	
Latitude	real	Degrees
Longitude	real	Degrees
State	char	
Elevation	real	m

GPS MAPPING

GpsMap

Field	Data Type	Units
Tractor	tinyint	
Trip	smallint	
Link	int	
Node	int	
MapTime	int	
TimeOnLink	real	s
TimeStopped	real	s
TimeEstimate	real	s
MapError	real	
RoadClass	tinyint	
RoadName	char	

GpsShapePoints

Field	Data Type	Units
Link	int	
Point	tinyint	
Longitude	real	Degrees
Latitude	real	Degrees

TIME HISTORIES

AyTrailer

Field	Data Type	Units
Tractor	tinyint	
Trip	int	
TestTime	int	Ds
AyTrailer	real	g's
Rollover	real	g's
AyTrRolloverRatio	real	
Speed	real	Kph
SpeedHist	tinyint	
AyTrailerHist	tinyint	
RollRatioAyTrailerHist	tinyint	
AyTotal	real	g's
AyTotalHist	tinyint	
TotalMass	real	Metric Tons
RollRatioAyTotalHist	tinyint	
BadWeather	bit	
SolarZenithAngle	real	Degrees

FiveMin

Field	Data Type	Units
Tractor	tinyint	
Trip	smallint	
GPSTime	int	ds
Temperature	decimal	degrees C
Pressure	real	atmospheres
Visibility	decimal	km
Windspeed	decimal	kph
WindDir	smallint	Degrees
PrecipIntensity	smallint	
Weight	int	kg
CurrentSesDistance	real	km
TotalSesDistance	real	km
WiperIntensity	real	
AvgAirspringPressure	real	kpa
SolarZenithAngle	float	Degrees
Delay	bit	
MinSpeed	real	kph
MaxSpeed	real	kph
TotalMass	real	metric tons.
Rollover	float	g's.
DistInFiveMin	real	km
BadWeather	tinyint	

TwoCalc

Field	Data Type	Units
Tractor	tinyint	
Trip	smallint	
TestTime	int	ds
CruiseState	tinyint	
AySmooth	real	g's
Curvature	real	1/km
AySmoothCor	real	g's
Gear	tinyint	
YawRateDot	real	Degrees/sec/sec
AyDriver	real	g's
Ay465	real	g's
Speed	real	Kph
SpeedHist	tinyint	
AyDriverHist	tinyint	
AySmoothCorHist	tinyint	
Ay465Hist	tinyint	
AySmoothCorNHist	tinyint	
Ay465NHist	tinyint	
AyDriverNHist	tinyint	
CurvatureHist	tinyint	
Rollover	real	
RollRatio465Hist	tinyint	
RoadClassHist	tinyint	

PraxairCatalog

Field	Data Type	Units
Time	float	UTC
TestId	smallint	
RecordId	smallint	
Tractor	tinyint	
Trip	smallint	
RecCount	int	
Filename	varchar	
Status	tinyint	
LastChange	smalldatetime	

RSAActionLog

Field	Data Type	Units
ActionID	int	
Tractor	tinyint	
Trip	smallint	
TestId	smallint	
RecordId	smallint	
Action	smallint	
ActionTime	smalldatetime	UTC
Message	varchar	

RSACatalog

Field	Data Type	Units
Time	float	UTC
TestId	smallint	
RecordId	smallint	
Tractor	tinyint	
Trip	smallint	
RecCount	int	
Filename	varchar	
TableName	varchar	
Status	tinyint	
LastChange	smalldatetime	

BOOKKEEPING TABLES

Notes

Field	Data Type	Units
Noteld	smallint	
Valid	tinyint	
Corrected	tinyint	
ShortNote	nvarchar	
ShortNote	sysname	
FullDescription	ntext	

PraxairActionLog

Field	Data Type	Units
ActionID	int	
Tractor	tinyint	
Trip	smallint	
TestId	smallint	
RecordId	smallint	
Action	smallint	
ActionTime	smalldatetime	UTC
Message	varchar	

TrailerDates

Field	Data Type	Units
trailer	varchar	
month	int	
day	int	
year	int	

TripList

Field	Data Type	Units
Tractor	tinyint	
Trip	smallint	
Session	int	
Origin	varchar	

Destination	varchar
Driver	int
ECU	smallint
DistancePrior	real km
Trailer	varchar
Phase	tinyint

AyTrailerMax	real	g's
AyTrailerSustMax	real	g's
AyTrailerSustTimeMax	int	ds
Ay465Max	real	g's
Ay465SustMax	real	g's
Ay465SustTimeMax	int	ds
DecelMax	real	g's
DecelSustMax	real	g's
DecelSustTimeMax	int	ds
SessionDistance	real	km
PhaseDistance	real	km
TripDistance	real	km
CurveDistance	real	km
Night	tinyint	
TotalMass	real	metric tons

TripNotes

Field	Data Type	Units
Tractor	tinyint	
Trip	smallint	
Noteld	smallint	

ECU	int	
Driver	smallint	
Rollover	float	g's
CountRSC	tinyint	
MaxRSALevel	tinyint	
AyTotalMax	real	g's
AyTotalSustMax	real	g's
AyTotalSustTimeMax	int	ds
SpeedAyTotalSust	real	kph
CurveAyTotalSust	real	kph
CurveAyDriverSust	real	kph

CURVE ANALYSIS

CurvePerformance

Field	Data Type	Units
Tractor	tinyint	
Trip	smallint	
StartTime	int	ds
EndTime	int	ds
CurveNumber	int	
ParkingLot	tinyint	
MaxCurvature	real	1/km.
HeadingChange	real	degrees
TimeToBadWeather	smallint	minutes
TimeSinceBadWeather	int	ds
TimeUntilBadWeather	int	ds
CurveSustMax	real	1/km.
CurveSustTimeMax	int	ds
AyDriverMax	real	g's
AyDriverSustMax	real	g's
AyDriverSustTimeMax	int	ds
SpeedMax	real	kph
SpeedSustMax	real	kph
SpeedSustTimeMax	int	ds
SpeedInit	real	kph
SpeedAvg	real	kph
SpeedFinal	real	kph
SpeedMin	real	kph
SpeedAyDriverSust	real	kph
SpeedMaxCurvatureSust	real	kph
SpeedBrakeStart	real	kph
SpeedBrakeEnd	real	kph
BrakeOnStartTime	int	ds
BrakeOnEndTime	int	ds
BrakeOnCount	int	ds

CurveStats

Field	Data Type	Units
CurveNumber	int	
Passes	int	
CurveTime	real	ds
MaxCurvature	real	1/km
HeadingChange	real	Degrees
StartHeading	real	Degrees
EndHeading	real	Degrees
StartLongitude	float	Degrees
StartLatitude	float	Degrees
EndLongitude	float	Degrees
EndLatitude	float	Degrees
DistanceCorrection	float	km
SuperEllnGs	float	g's
RoadClass	tinyint	

CurveStatsParking

Field	Data Type	Units
CurveNumber	int	
Passes	int	
CurveTime	real	ds
MaxCurvature	real	1/km

HeadingChange	real	Degrees
StartHeading	real	Degrees
EndHeading	real	Degrees
StartLongitude	float	Degrees
StartLatitude	float	Degrees
EndLongitude	float	Degrees
EndLatitude	float	Degrees
DistanceCorrection	float	

TimeToBadWeather	smallint	minutes
MaxCurveSust	real	1/km
MaxCurveSustTime	int	ds
MaxAyDriver	real	g's
MaxAyDriverSust	real	g's
MaxAyDriverSustTime	int	ds
MaxSpeed	real	kph
MaxSpeedSust	real	kph
MaxSpeedSustTime	int	Ds
MaxAyTrailer	real	g's
MaxAyTrailerSust	real	g's
MaxAyTrailerSustTime	int	ds
SpeedInit	real	kph
SpeedAvg	real	kph
SpeedFinal	real	kph
TripDistance	real	km
Night	bit	
TotalMass	real	Metric tons
ECU	smallint	
Driver	smallint	

CurveTimes

Field	Data Type	Units
Tractor	tinyint	
Trip	smallint	
StartGpsTime	int	ds
EndGpsTime	int	ds
CurveNumber	int	
MaxCurvature	real	1/km
StartHeading	real	Degrees
EndHeading	real	Degrees
StartDistance	real	km
EndDistance	real	km
StartNOS	tinyint	
EndNOS	tinyint	
StartFix	tinyint	
EndFix	tinyint	

OTHER ANALYSES

AyOffset

Field	Data Type	Units
Tractor	tinyint	
Trip	int	
BigTime	float	
Location	int	
Direction	real	
Ay	real	
AyHeading	real	
AyRoad	real	
AyOffset	real	

CurveTimesParking

Field	Data Type	Units
Tractor	tinyint	
Trip	smallint	
StartGpsTime	int	ds
EndGpsTime	int	ds
CurveNumber	int	
MaxCurvature	real	1/km
StartHeading	real	degrees
EndHeading	real	degrees
StartDistance	real	km
EndDistance	real	km
StartNOS	tinyint	
EndNOS	tinyint	
StartFix	tinyint	
EndFix	tinyint	

BrakeEvents

Field	Data Type	Units
Tractor	tinyint	
Trip	smallint	
StartTime	int	ds
EndTime	int	ds
MaxDecel	real	g's

Precurves

Field	Data Type	Units
Tractor	tinyint	
Trip	smallint	
StartGpsTime	int	ds
EndGpsTime	int	ds
MaxCurvature	real	1/km

LaneChange

Field	Data Type	Units
Tractor	tinyint	
Trip	int	
GpsTime	int	ds
PreLeftOffset	real	
PreRightOffset	real	