

FINAL  
CONTRACT REPORT

PB2000-103425



INVESTIGATION OF THE RESISTANCE  
OF THE PILE CAPS  
AND INTEGRAL ABUTMENTS  
TO LATERAL LOADING

ROBERT L. MOKWA, P.E.,  
and  
J. MICHAEL DUNCAN, Ph.D., P.E.  
Charles E. Via, Jr. Department of Civil  
and Environmental Engineering  
Virginia Polytechnic and State University  
Blacksburg, Virginia

REPRODUCED BY:  
U.S. Department of Commerce  
National Technical Information Service  
Springfield, Virginia 22161

**NTIS**

V · I · R · G · I · N · I · A



TRANSPORTATION RESEARCH COUNCIL

---

VIRGINIA TRANSPORTATION RESEARCH COUNCIL



**Standard Title Page - Report on Federally Funded Project**

1. Report No. FHWA/VTRC 00-CR4	2. Government Accession No.	3. Recipient's Catalog No.	
4. Title and Subtitle Investigation of the Resistance of Pile Caps and Integral Abutments to Lateral Loading		5. Report Date February 2000	
		6. Performing Organization Code	
7. Author(s) Robert L. Mokwa, J. Michael Duncan		8. Performing Organization Report No. VTRC 00-CR4	
9. Performing Organization and Address  Virginia Transportation Research Council 530 Edgemont Road Charlottesville, VA 22903		10. Work Unit No. (TRAIS)	
		11. Contract or Grant No. 00050918	
12. Sponsoring Agencies' Name and Address  Virginia Department of Transportation      FHWA 1401 E. Broad Street                              400 North 8th Street, Room 750 Richmond, VA 23219                                Richmond, VA 23239		13. Type of Report and Period Covered Final – July 1998-June 1999	
		14. Sponsoring Agency Code	
15. Supplementary Notes			
16. Abstract  This research provides a means of assessing and quantifying many important aspects of pile group and pile cap behavior under lateral loads. The program of work performed in this study includes developing a full-scale field test facility, conducting approximately 30 lateral load tests on pile groups and pile caps, performing laboratory geotechnical tests on natural soils obtained from the site and on imported backfill materials, and performing analytical studies. A detailed literature review was also conducted to assess the current state of practice in the area of laterally loaded pile groups.  A method called the "group-equivalent pile" approach (abbreviated GEP) was developed for creating analytical models of pile groups and pile caps that are compatible with established approaches for analyzing single laterally loaded piles. A method for calculating pile cap resistance-deflection curves (p-y curves) was developed during this study, and has been programmed in the spreadsheet called PYCAP.  A practical, rational, and systematic procedure was developed for assessing and quantifying the lateral resistance that pile caps provide to pile groups. Comparisons between measured and calculated load-deflection responses indicate that the analytical approach developed in this study is conservative, reasonably accurate, and suitable for the use in design of pile caps and integral abutments. The results of this research are expected to improve the current state of knowledge and practice regarding pile group and pile cap behavior.			
17 Key Words integral abutment, pile cap, lateral resistance, lateral loading		18. Distribution Statement No restrictions. This document is available to the public through NTIS, Springfield, VA 22161.	
19. Security Classif. (of this report) Unclassified	20. Security Classif. (of this page) Unclassified	21. No. of Pages 66	22. Price



**FINAL CONTRACT REPORT**

**INVESTIGATION OF THE RESISTANCE OF PILE CAPS AND INTEGRAL  
ABUTMENTS TO LATERAL LOADING**

**Robert L. Mokwa, P.E., and J. Michael Duncan, Ph.D., P.E.  
Charles E. Via, Jr. Department of Civil and Environmental Engineering  
Virginia Tech  
Blacksburg, Virginia**

(The opinions, findings, and conclusions expressed in this  
report are those of the authors and not necessarily those of  
the sponsoring agency)

*Project Monitors*

Edward J. Hoppe, Virginia Transportation Research Council

Contract Research Sponsored by  
Virginia Transportation Research Council

Virginia Transportation Research Council  
(A Cooperative Organization Sponsored Jointly by the  
Virginia Department of Transportation and  
the University of Virginia)

Charlottesville, Virginia

February 2000  
VTRC 00-CR4

## NOTICE

The project that is the subject of this report was done under contract for the Virginia Department of Transportation, Virginia Transportation Research Council. The opinions and conclusions expressed or implied are those of the contractors, and, although they have been accepted as appropriate by the project monitors, they are not necessarily those of the Virginia Transportation Research Council or the Virginia Department of Transportation.

Each contract report is peer reviewed and accepted for publication by Research Council staff with expertise in related technical areas. Final editing and proofreading of the report are performed by the contractor.

PROTECTED UNDER INTERNATIONAL COPYRIGHT  
ALL RIGHTS RESERVED  
NATIONAL TECHNICAL INFORMATION SERVICE  
U.S. DEPARTMENT OF COMMERCE

Copyright 2000, Virginia Department of Transportation.

NTIS is authorized to reproduce and sell this report. Permission for further reproduction must be obtained from the copyright owner.

Reproduced from  
best available copy.



## TABLE OF CONTENTS

INTRODUCTION .....	1
PURPOSE AND SCOPE .....	1
LITERATURE REVIEW.....	2
DATA .....	2
Field Test Facility.....	2
Soil Data.....	6
METHOD OF ANALYSIS.....	9
Pile Group Effects .....	9
Overview of Analytic Approach.....	10
Single Pile Model .....	12
Background.....	12
Calculations for p-y Curves .....	12
Pile Group Model .....	17
Background.....	17
Group Pile p-y Curves.....	17
Pile-Head Rotations.....	18
Pile-Head Rotational Stiffness Calculations .....	18
Pile Cap Model .....	25
Background.....	25
Passive Earth Pressure Resistance.....	25
Three-Dimensional Effects.....	31
Pile Cap Stiffness .....	32
Pile Cap p-y Curves.....	34
Summary.....	37
Pile Caps .....	37
Integral Bridge Abutments.....	41
RESULTS.....	42
Single Piles .....	42
Pile Groups with No Cap Resistance.....	42
NE Pile Group .....	43
NW Pile Group.....	43
SE Pile Group.....	43

Passive Resistance of the Bulkhead with No Piles .....	51
Pile Groups with Cap Resistance.....	51
Pile Caps Embedded in Natural Soil .....	53
Pile Caps Backfilled with Granular Backfill.....	55
<b>DISCUSSION</b> .....	55
Summary of Design Method.....	55
<b>SUMMARY</b> .....	60
<b>CONCLUSIONS AND RECOMMENDATIONS</b> .....	62
<b>ACKNOWLEDGEMENTS</b> .....	63
<b>REFERENCES</b> .....	63

## LIST OF TABLES

Table 1	Summary of previous load tests performed to evaluate the lateral resistance of pile caps .....	3
Table 2	Soil stratigraphy at the Kentland Farms test facility.....	6
Table 3	$\phi_o$ and $\Delta\phi$ values for the backfill materials.....	9
Table 4	Initial tangent modulus values .....	9
Table 5	Skin resistance values for Kentland Farms pile groups.....	22
Table 6	$M_{ult}$ and $k_{m\theta}$ values for the Kentland Farms pile groups .....	25
Table 7	Summary of results from <i>PYCAP</i> analyses .....	39
Table 8	Parameters used to calculate pile cap p-y curves.....	41
Table 9	Corner pile adjustment factor .....	60



## LIST OF FIGURES

Figure 1	Comparison of published load versus deflection curves .....	4
Figure 2	Kentland Farms test facility.....	5
Figure 3	Summary of parameters for natural soils.....	7
Figure 4	Proposed p-multiplier design curves. ....	11
Figure 5	Soil parameters for calculating p-y curves .....	13
Figure 6	Example of p-y calculations using spreadsheet <i>PYPILE</i> .....	14
Figure 7	p-y curves for <i>LPILE Plus 3.0</i> .....	16
Figure 8	Conceptual model for estimating pile group rotational restraint.....	19
Figure 9	Details for rotational restraint calculations.....	21
Figure 10	$k_{m\theta}$ approximation .....	23
Figure 11	Log spiral approximation.....	26
Figure 12	Graphical representation of the log spiral earth pressure method .....	27
Figure 13	$\phi = 0$ passive wedge model.....	30
Figure 14	<i>PYCAP Summary</i> worksheet for bulkhead in natural soil .....	33
Figure 15	Initial tangent modulus ( $E_i$ ) for natural soil, New Castle sand, and crusher run gravel .....	35
Figure 16	<i>Elasticity</i> worksheet for the bulkhead in natural soil.....	36
Figure 17	<i>Hyperbola</i> worksheet for the bulkhead in natural soil.....	38
Figure 18	p-y curves for 0.91-m-deep pile cap in four different soils .....	40
Figure 19	Single pile load testing arrangement.....	45
Figure 20	Measured response of south pile in natural soil.....	46

Figure 21	Calculated load-deflection curves for the south pile in natural soil, using p-y curves from <i>PYSHEET</i> .....	47
Figure 22	Calculated response for the NE pile group with no cap resistance.....	48
Figure 23	Calculated response for the NW pile group with no cap resistance .....	49
Figure 24	Calculated response for the SE pile group with no cap resistance .....	50
Figure 25	Comparison of measured and calculated passive resistance for bulkhead in natural soil and gravel.....	52
Figure 26	Comparison between calculated and measured responses for pile caps in natural soil.....	54
Figure 27	Comparison between calculated and measured responses for pile caps backfilled with crusher run gravel .....	56
Figure 28	Comparison between calculated and measured responses of SE cap backfilled with New Castle sand .....	57

## ABSTRACT

Bridges and buildings are often supported on deep foundations. These foundations consist of groups of piles coupled together by concrete pile caps, or in the case of integral bridges, by integral abutments. Pile caps and abutments are often massive and deeply buried, consequently, they would be expected to provide significant resistance to lateral loads. However, practical procedures for computing the resistance of pile caps to lateral loads have not been developed, and, for this reason, cap resistance is usually ignored.

Neglecting pile cap resistance results in estimates of pile group deflections and bending moments under load that may exceed the actual deflections and bending moments by 100 % or more. Advances could be realized in the design of economical pile-supported foundations, and their behavior more accurately predicted, if the cap resistance can be accurately assessed.

This research provides a means of assessing and quantifying many important aspects of pile group and pile cap behavior under lateral loads. The program of work performed in this study includes developing a full-scale field test facility, conducting approximately 30 lateral load tests on pile groups and pile caps, performing laboratory geotechnical tests on natural soils obtained from the site and on imported backfill materials, and performing analytical studies. A detailed literature review was also conducted to assess the current state of practice in the area of laterally loaded pile groups.

A method called the "group-equivalent pile" approach (abbreviated GEP) was developed for creating analytical models of pile groups and pile caps that are compatible with established approaches for analyzing single laterally loaded piles. A method for calculating pile cap resistance-deflection curves (p-y curves) was developed during this study, and has been programmed in the spreadsheet called *PYCAP*.

A practical, rational, and systematic procedure was developed for assessing and quantifying the lateral resistance that pile caps provide to pile groups. Comparisons between measured and calculated load-deflection responses indicate that the analytical approach developed in this study is conservative, reasonably accurate, and suitable for use in design of pile caps and integral abutments. The results of this research are expected to improve the current state of knowledge and practice regarding pile group and pile cap behavior.



## **FINAL CONTRACT REPORT**

### **INVESTIGATION OF THE RESISTANCE OF PILE CAPS AND INTEGRAL ABUTMENTS TO LATERAL LOADING**

**Robert L. Mokwa, Ph.D., P.E. and J. Michael Duncan, Ph.D., P.E.  
Virginia Polytechnic Institute and State University**

#### **INTRODUCTION**

This report describes the results of research on the lateral load resistance of pile caps and integral abutments. With regards to passive resistance, integral abutments respond in the same manner as pile caps. Thus, in this report, pile supported integral abutments are considered to be a specific type or subclass of pile caps, and the two terms can be assumed interchangeable, unless noted otherwise. The capacity of pile caps to resist lateral load is often neglected in the design of pile foundations. However, the resistance of the pile cap can be as large as the resistance of the piles themselves, or even larger. There is a need for improved understanding of the factors that control the magnitude of cap resistance, and for rational design procedures to include cap resistance in the design of pile groups to resist lateral loads.

#### **PURPOSE AND SCOPE**

The purpose of this research study is to evaluate the lateral load resistance of pile caps and to develop a rational and practical approach that engineers can use in design for evaluating the lateral response of pile groups, including the pile cap resistance.

The scope and objectives of the research study are as follows:

1. Evaluate the state of knowledge with respect to the lateral load resistance of pile caps.
2. Design and construct a field test facility to perform lateral load tests on pile groups with and without caps, and on individual piles.
3. Perform field load tests to evaluate the accuracy of theoretical and analytical methods for estimating the performance of pile caps in natural soils, and pile caps embedded in compacted backfill.
4. Perform laboratory and in situ tests to evaluate the properties of the natural soils encountered at the site and the imported soils used as backfill.

5. Perform studies on the interaction between piles, pile caps, and the adjacent ground. The focus of these studies will be to develop practical procedures for including pile cap resistance in the analysis of pile groups.

## **LITERATURE REVIEW**

A comprehensive literature review was conducted as part of this research to examine the current state of knowledge regarding pile cap resistance to lateral loads. Over 350 journal articles and other publications pertaining to lateral resistance, testing, and analysis of pile caps, piles, and pile groups were collected and reviewed. Pertinent details from these studies were evaluated and, whenever possible, assimilated into tables and charts so that useful trends and similarities can readily be observed. Some of the data, such as graphs that present p-multipliers as functions of pile spacing, are utilized as design aids in subsequent sections of this report.

The review of relevant technical literature indicates there is a scarcity of published information available in the subject area of pile cap lateral resistance. Of the articles reviewed, only four papers were found that describe load tests performed to investigate the lateral resistance of pile caps. The results from these four studies, summarized in Table 1 and Figure 1, show that the lateral load resistance provided by pile caps can be very significant, and that in most cases the cap resistance is as large as the resistance provided by the piles themselves.

## **DATA**

### **Field Test Facility**

A field test facility was designed and constructed specifically for this project to perform lateral load tests on deep foundations. The test site is located at Virginia Tech's Kentland Farms, approximately 10 miles west of Blacksburg, Virginia. The site lies within the floodplain of the New River. The facility was designed to perform full-scale load tests to investigate the lateral load resistance of pile caps and to obtain data for developing the analytical approach.

Construction of the load testing apparatus and test foundations was completed in April 1998. The test foundations consist of three pile groups each with four piles. One group has a cap 0.46 meters thick and two have 0.91 meter thick caps. The facility also includes two individual test piles, and a buried concrete wall (or bulkhead) with no piles. Figure 2 shows a plan view of the test site and the layout of the test foundations. The piles are all HP10x42 steel sections. The piles beneath the southeast cap are 3 meters long, and the others are approximately 5.8 meters long. The bulkhead has no piles, and consists of a monolithic block of reinforced concrete measuring approximately 1.92 meters in length, 0.91 meters in width, and 1.07 meters in depth.

The caps and bulkhead were positioned so that the loading axes pass through their centroids. Excavations were trimmed to neat lines and grades using a small backhoe and shovels. Concrete was poured against undisturbed ground wherever possible, so that the first series of load tests could measure the resistance of the pile caps in contact with the natural ground at the site.

Lateral loads were applied to the pile caps and bulkhead using an Enerpac 1800-kN double acting hydraulic ram. The struts and connections in the load path were designed to apply maximum compressive loads of 667 kN and tensile loads of 445 kN. The tests were performed by applying compressive forces only. Details pertaining to the test facility and the instrumentation that was used during load testing can be found in the research report by Mokwa et al. (1998).

**Table 1.** Summary of previous load tests performed to evaluate the lateral resistance of pile caps.

Reference	Pile Type	Cap Size	Foundation Soils	Cap Contribution*
Beatty 1970	2 x 3 group of step-tapered mandrel driven concrete piles	4.1 m long x 4.0 m wide x 2.7 m thick (estimated)	miscellaneous fill over soft silty clay and clay	more than 50%
Kim and Singh 1974	2 x 3 group of 10BP42 steel piles	3.7 m long x 2.4 m wide x 1.2 m thick	silty and sandy clay, with $S_{uavg} \approx 96$ kPa in top 4.6 m	about 50%
Rollins et al. 1997	3 x 3 group of 0.3 m dia. steel pipe piles	2.7 m long x 2.7 m wide x 1.2 m thick	compacted sandy gravel fill over silt and clay	about 50%
Zafir and Vanderpool 1998	2 x 2 group of 0.6 m dia. drilled shafts	3.4 m diameter by 3.0 m thick	silty sand, clayey sand, and sandy clay with caliche layers	more than 50%

\* “Cap Contribution” reflects the approximate contribution of the pile cap to the lateral load resistance of the pile group.

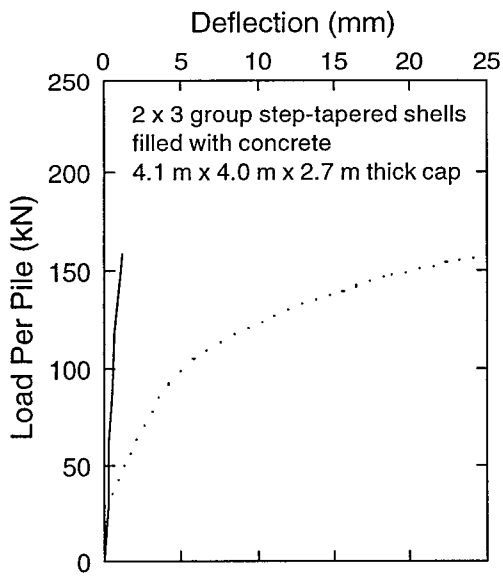

(a) Beatty, 1970.

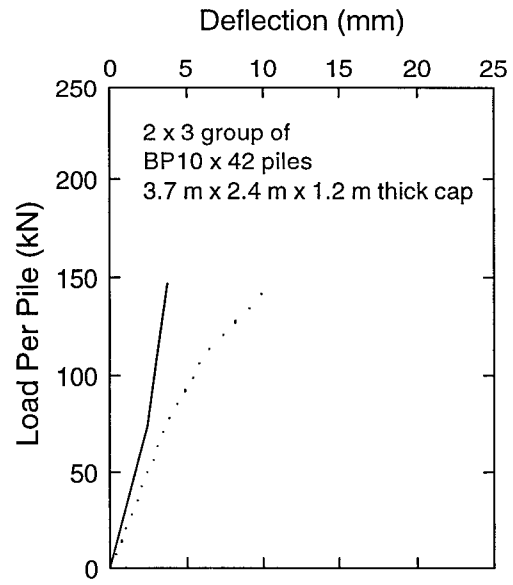

(b) Kim and Singh, 1974.

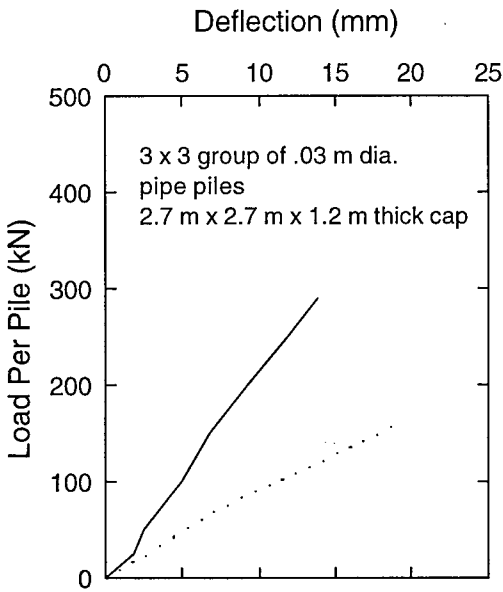

(c) Rollins et al., 1997.

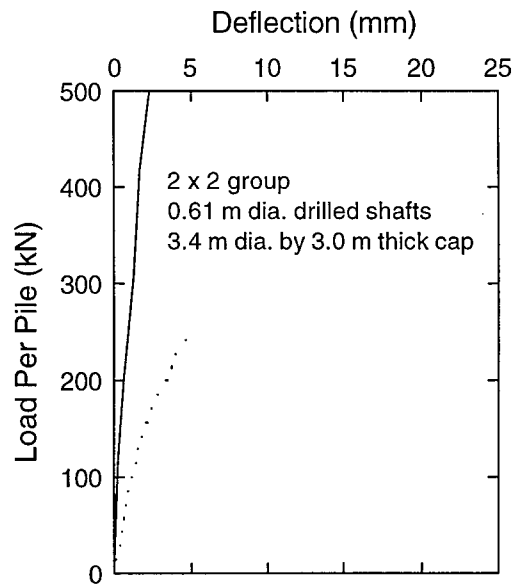

(d) Zafir and Vanderpool, 1998.

Legend for all four plots

- pile cap in contact with soil
- ..... soil resistance removed from pile cap

Figure 1. Comparison of published load versus deflection curves.



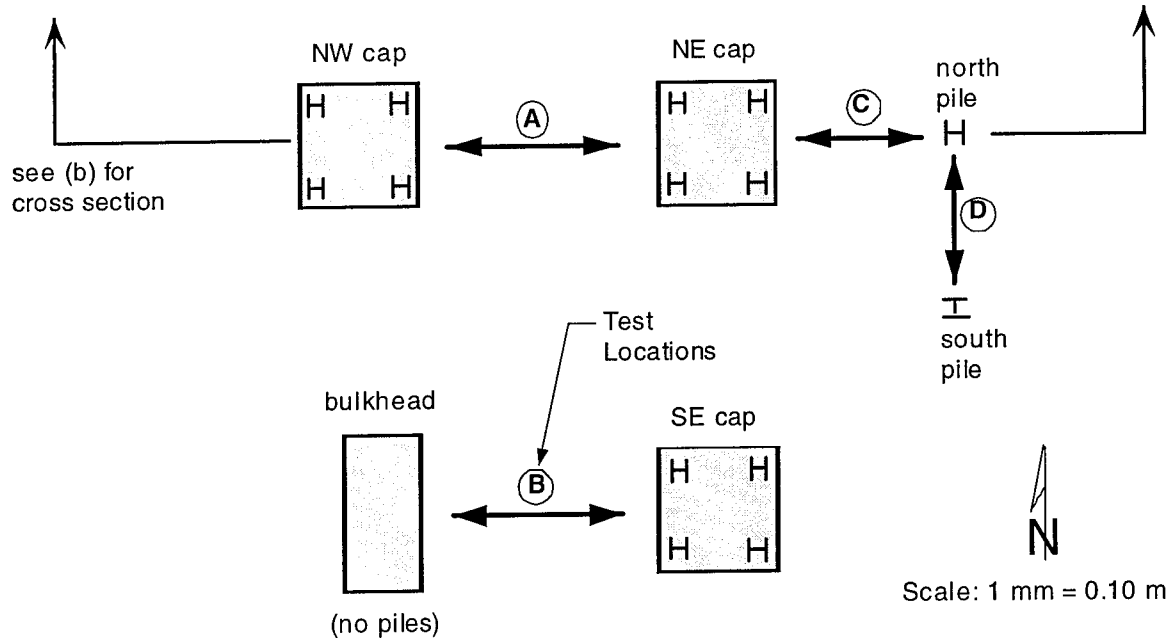

(a) Plan view of test facility.

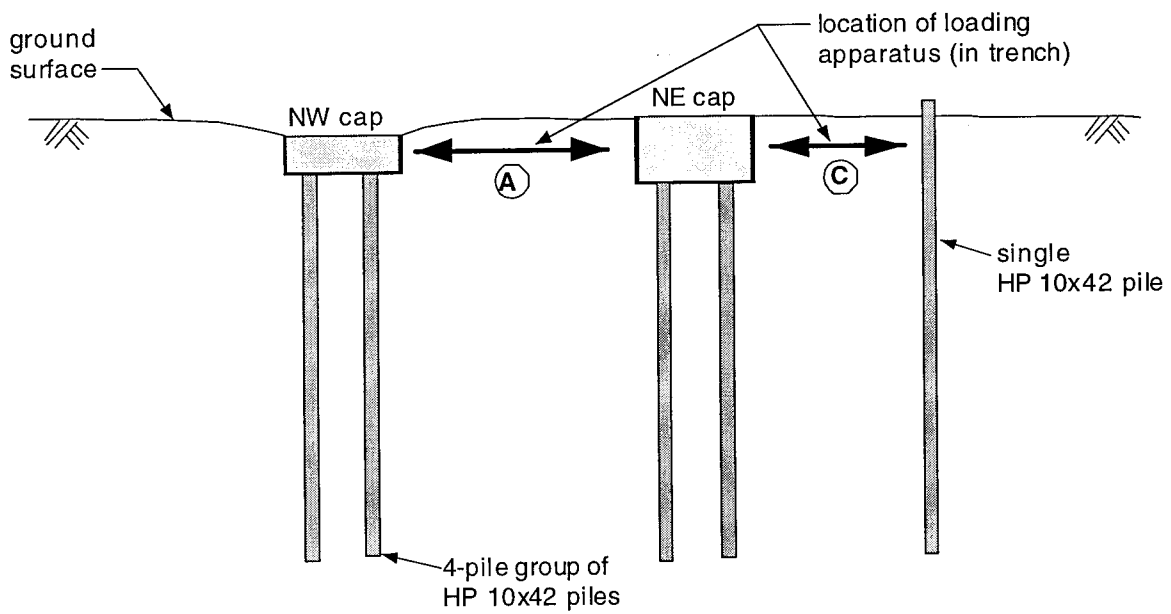

(b) Cross section through loading trenches A and C.

Figure 2. Kentland Farms field test facility.

## Soil Data

Test results for samples obtained at different depths are described according to the project benchmark, which was established at an arbitrary elevation of 30.48 meters. The actual elevation of the benchmark is unknown, but judging from the USGS Radford North quadrangle map, it is approximately 518 meters above mean sea level. The ground surface in the area of the test foundations was relatively flat. The average surface elevation, after stripping the topsoil, was 29.7 meters.

The soil conditions at the site, which covers an area about 30 meters by 15 meters, are quite uniform. The soil profile revealed by six borings and two test pits is described in Table 2.

**Table 2.** Soil stratigraphy at the Kentland Farms test facility.

Elevation (m)	Soil Description
29.7 to 28.6	Brown silty sand and sandy lean clay with fine sands and frequent small roots.
28.6 to 30.0	Dark brown, moist sandy lean clay with occasional gravel.
30.0 to 25.8	Brown moist sandy silt with lenses of silty sand.
25.8 to 24.5	Brown, moist sandy silt and silty sand.
24.5 to 23.6	Light brown sandy lean clay and sandy silt with trace of gravel.

In general, the soils at the site consist of sandy clay, sandy silt, and silty sand with thin layers of gravel. In accordance with the Unified Soil Classification System (ASTM D2487), the soils are classified as ML, CL, SC, and CL-ML. The research report by Mokwa et al. (1998) contains a description of the in situ and laboratory testing program that was conducted to evaluate the engineering properties of the natural soils. A summary of the soil parameters developed for the natural soils at the field test site are shown in Figure 3.

Two soil types were used as backfill in the lateral load tests: New Castle sand and crusher run gravel. These materials were selected because they are representative of the types of backfill materials often used for pile caps, footings, and other buried structures.

New Castle sand is a relatively clean, fine sand consisting predominantly of subangular grains of quartz. About 70 % of the sand passes the No. 40 sieve and less than 1 % passes the No. 200 sieve. The coefficient of uniformity is 2.0, the coefficient of curvature is 2.8, and the Unified Classification is SP. The specific gravity of solids, determined in general accordance with ASTM D854, is 2.65. The maximum and minimum densities determined in general accordance with ASTM D4253 and ASTM D4254 are 16.5 and 13.7 kN/m<sup>3</sup>, respectively.

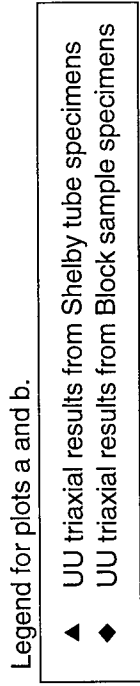
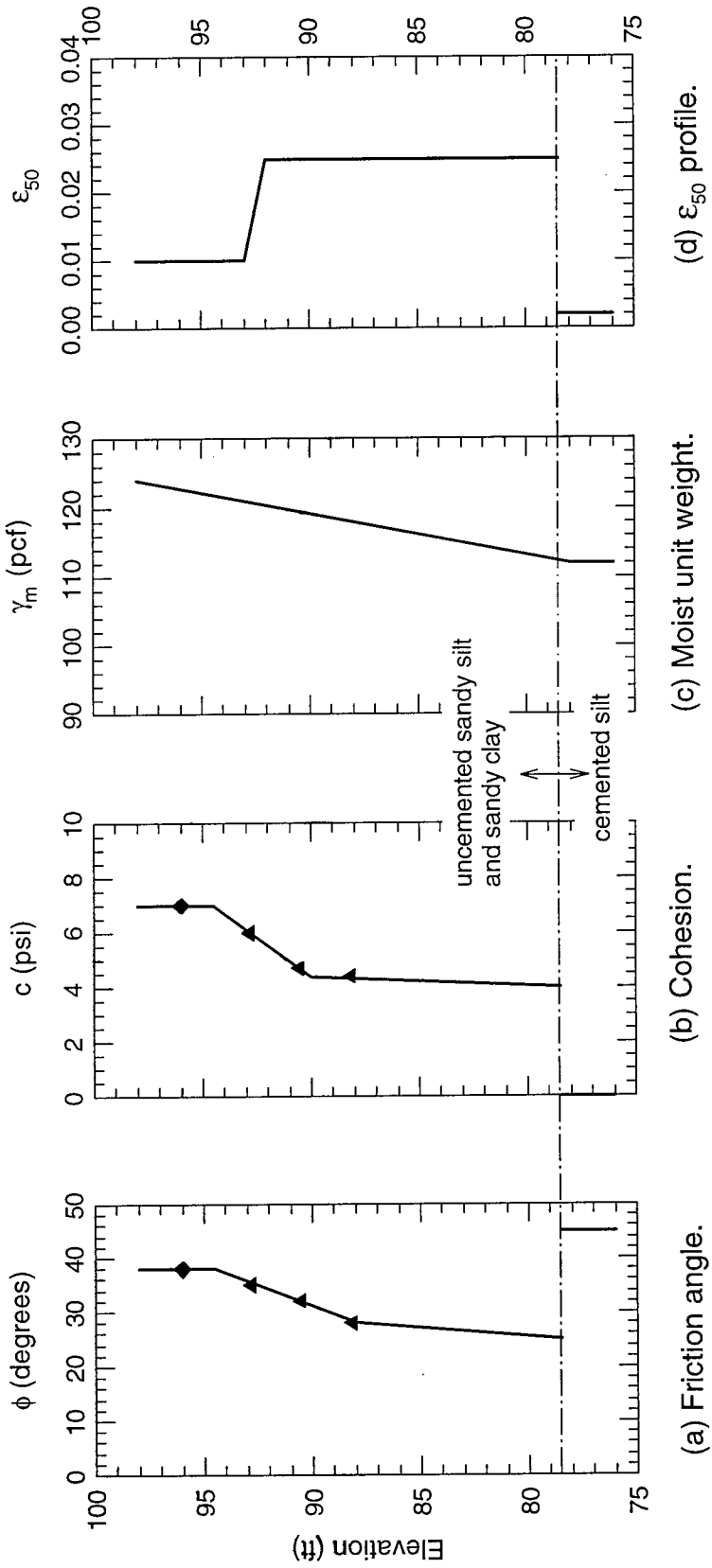

Figure 3. Summary of parameters for natural soils.

Crusher run gravel was obtained from the Sisson and Ryan Stone Quarry, located in Shawsville, Virginia. The material is produced by processing and screening quartz and limestone rock to produce a well-graded mixture containing angular to subangular grains that range in size from 19-mm gravel to silt-size particles. The gravel is produced to meet the requirements of VDOT Road and Bridge Specification Section 205, Crusher Run Aggregate. The material obtained for this project also meets the more stringent gradation requirements of VDOT Road and Bridge Specification Section 208, 21B-Subbase and Base Material. Approximately 40 to 50 % of the material passes the No. 4 sieve, 10 to 20 % passes the No. 40 sieve, and 5 to 10 % passes the No. 200 sieve. The soil passing the No. 200 sieve classifies as nonplastic silt, ML. The coefficient of uniformity is 23, the coefficient of curvature is 2.8, and the Unified Classification for the crusher run aggregate ranges between a GW-GM and a SW-SM. This material is referred to as gravel or crusher run gravel in this report.

A laboratory testing program was conducted to measure the engineering properties of the backfill soils and to provide a basis for estimating the values of the parameters that will be used to perform analyses of the full-scale lateral load tests.

Shear strength versus relative density relationships for the backfill soils were developed using the results of the CD triaxial tests, which were performed on reconstituted 71-mm-diameter specimens at low confining pressures. A suite of tests were performed at relative densities ranging from loose to very dense.

Test specimens were prepared using the method of undercompaction developed by Ladd (1978). The advantages of this procedure is that it uses the same type of compaction energy that was used in the field, and it provides a means of obtaining consistent and repeatable results, with minimal particle segregation. Specimens are prepared to a target relative density by placing soil in layers, inside a forming jacket, and compacting each layer with a small tamper. The compaction density of each layer is varied linearly from the bottom to the top, with the bottom (first) layer having the lowest density. A nearly uniform density is achieved throughout the specimen because compaction of each succeeding layer further densifies the underlying lower layers, which are compacted initially to densities below the target density.

The results were normalized using the  $\phi_o - \Delta\phi$  approach (Duncan et al. 1980) to account for curvature of the failure envelope caused by changes in the level of confining stress. Equation 1 is used to determine the friction angle,  $\phi'$ :

$$\phi' = \phi_o - \Delta\phi \log \left( \frac{\sigma'_3}{p_a} \right) \quad \text{Equation 1}$$

where  $\phi_o$  is the friction angle at 1 atmosphere confining pressure,  $\Delta\phi$  is the change in  $\phi'$  over one log cycle,  $\sigma'_3$  is the effective confining pressure, and  $p_a$  is the atmospheric pressure.

Mathematical expressions were developed for calculating  $\phi_o$  and  $\Delta\phi$  based on the relative density of the soil, which was determined from nuclear density gauge and sand cone tests that were performed on the backfill soils. Using these expressions in conjunction with the relative density

values ( $D_r$ ) measured in the field, the values of  $\phi_o$  and  $\Delta\phi$  shown in Table 3 were calculated for the backfill materials:

**Table 3.**  $\phi_o$  and  $\Delta\phi$  values for the backfill materials.

Backfill	$D_r$ (%)	$\phi_o$ (deg)	$\Delta\phi$ (deg)
compacted sand	60	40.3	7.8
uncompacted sand	10	32.1	4.5
compacted gravel	55	45.0	8.3

Effective stress friction angles were calculated for the analyses discussed in the next section using these values of  $\phi_o$  and  $\Delta\phi$ , and Equation 1. The effective cohesion is zero for the backfill soils.

Values of the initial tangent modulus,  $E_i$ , were estimated by transforming the stress-strain data using the hyperbolic formulation described by Duncan and Chang (1970). Based on these plots, the following values of  $E_i$  shown in Table 4 will be used for the natural soils at the site and the imported backfill material:

**Table 4.** Initial tangent modulus values.

Type of Soil	$E_i$ (kN/m <sup>2</sup> )
natural soil	42,750
compacted sand	66,880
uncompacted sand	34,500
compacted gravel	36,540

Additional details pertaining to the laboratory tests can be found in the research report by Mokwa et al. (1998).

## METHOD OF ANALYSIS

### Pile Group Effects

Measurements of displacements and stresses in full-scale and model pile groups indicate that piles in a group carry unequal lateral loads, depending on their location within the group and the spacing between piles. This unequal distribution of load among piles is caused by “shadowing”, which is a term used to describe the overlap of shear zones and consequent reduction of soil resistance. A popular method to account for shadowing is to incorporate p-multipliers into the p-y method of analysis. The p-multiplier values depend on pile position within the group and pile spacing.

The concept of  $p$ -multipliers (also called  $f_m$ ) were described by Brown et al. (1988) as a way of accounting for pile group effects by making adjustments to  $p$ - $y$  curves. The multipliers are empirical reduction factors that are experimentally derived from load tests on pile groups. Because they are determined experimentally, the multipliers include both elasticity and shadowing effects. This eliminates the need for a separate  $y$ -multiplier, which is found in many elasticity-based methods. The procedure follows the same approach used in the  $p$ - $y$  method of analysis, except that a multiplier, with a value less than one, is applied to the  $p$ -values of the single pile  $p$ - $y$  curve. This reduces the ultimate soil resistance and softens the shape of the  $p$ - $y$  curve.

The results from 11 experimental studies were reviewed in which  $p$ -multipliers for pile groups of different sizes and spaces were developed. In these studies, which include 29 separate tests,  $p$ -multipliers were determined through a series of back-calculations using results from instrumented pile-group and single pile load tests. Based on results from these tests, design curves were developed for estimating pile group efficiency values and  $p$ -multipliers as functions of pile arrangement and pile spacing. Figure 4 contains design curves for estimating  $p$ -multipliers for the leading row, 1<sup>st</sup> trailing row, 2<sup>nd</sup> trailing row, and 3<sup>rd</sup> and subsequent trailing rows. These design curves represent state-of-the-art values for use in analysis and design of laterally loaded pile groups, and are used in the analytical approach described in the following sections.

### **Overview of Analytic Approach**

Analyses were performed using the “group-equivalent pile” method, which was developed during the course of this research. The “group-equivalent pile” (abbreviated GEP) method makes it possible to analyze a pile group using computer programs developed for analyzing single piles, such as *LPILE Plus 3.0* (1997).

The GEP method involves the following elements:

- Step 1. A method for developing  $p$ - $y$  curves for single piles in soils with friction, soils with cohesion, and soils with both friction and cohesion.
- Step 2. A method for modeling the resistance of pile groups to lateral loading, including group effects and rotational restraint due to the cap.
- Step 3. A method for computing  $p$ - $y$  curves for pile caps in soils with friction, cohesion, or both friction and cohesion.

The development and application of the procedure are described in the following sections.

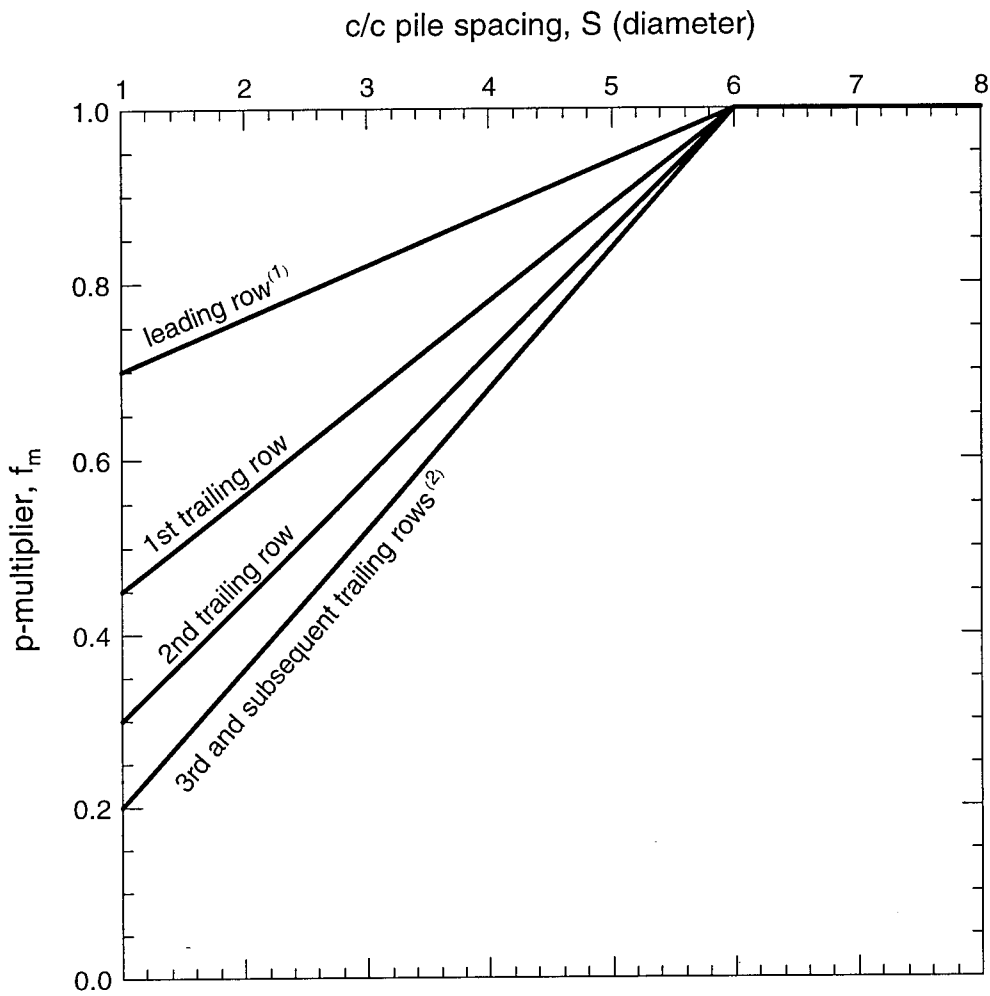

Notes:

- (1) The term row used in this chart refers to a line of piles oriented perpendicular to the direction of applied load.
- (2) Use the  $f_m$  values recommended for the 3rd trailing row for all rows beyond the third trailing row.
- (3) Bending moments and shear forces computed for the corner piles should be adjusted as follows:

<u>side by side spacing</u>	<u>corner pile factor (<math>f_{mc}</math>)</u>
3D	1.0
2D	1.2
1D	1.6

Figure 4. Proposed p-multiplier design curves.

## Single Pile Model

### Background

The laboratory tests and the field load tests performed on two HP 10 x 42 piles provide a basis for development of p-y curves for the partly saturated silty and clayey soils (natural soils) at the field test facility. The soil parameters used to develop p-y curves for the natural soils are summarized in Figure 5.

There are a number of formulations available for developing p-y curves. These are often empirically related to values of soil strength and stress-strain characteristics, which can be measured in the field or laboratory. Most of these methods use a cubic parabola to model the relationship between p and y. The general form of the cubic parabola relationship is expressed as follows:

$$p = 0.5 p_{ult} \left[ \frac{y}{(A \epsilon_{50} D)} \right]^n \quad \text{Equation 2}$$

where p is the soil resistance (kN/m);  $p_{ult}$  is the maximum value of p at large deflections (kN/m); y is the lateral deflection of a pile at a particular depth (mm); D is the diameter or width of the pile (mm);  $\epsilon_{50}$  is the strain required to mobilize 50 % of the soil strength (dimensionless); A is a parameter that controls the magnitude of deflections (dimensionless); and n is an exponent (dimensionless), which equals 0.33 for a cubic parabola.

The cubic parabola formulation was used to calculate p-y curves in this study using the procedure developed by Mokwa et al. (1997) for evaluating the lateral response of piles and drilled shafts in partially saturated soils. This p-y curve formulation was found by Mokwa et al. (1997) to be more accurate than the c- $\phi$  formulation developed by Reese (1997) for silty soils.

### Calculations for p-y Curves

The spreadsheet *PYSHEET* Mokwa et al. (1997) was developed to facilitate p-y curve calculations. *PYSHEET* has been renamed to *PYPILE*, and is included as a worksheet in the workbook named *PYCAPSI*, which is described in subsequent sections of this report. Printed output from *PYPILE* is shown in Figure 6. This spreadsheet incorporates Brinch Hansen's expressions for  $K_c$  and  $K_q$  and includes the modification factor,  $M$ , used by Helmers et al. (1997) to improve the reliability of Brinch-Hansen's (1961) theory. Equations used to calculate  $K_c$  and  $K_q$  are shown in the documentation file that accompanies *PYCAPSI*. The studies described here were performed with  $M = 0.85$  and  $A = 2.5$ , but the values of  $M$  and  $A$  can be varied in the spreadsheet if desired. The spreadsheet can be used to calculate p-y curves for piles or drilled shafts of any size in c- $\phi$  soils, and the soil properties and the pile or shaft diameter can be varied with depth. Single pile p-y curves for the piles at the Kentland Farms test facility are shown in Figure 7(a).



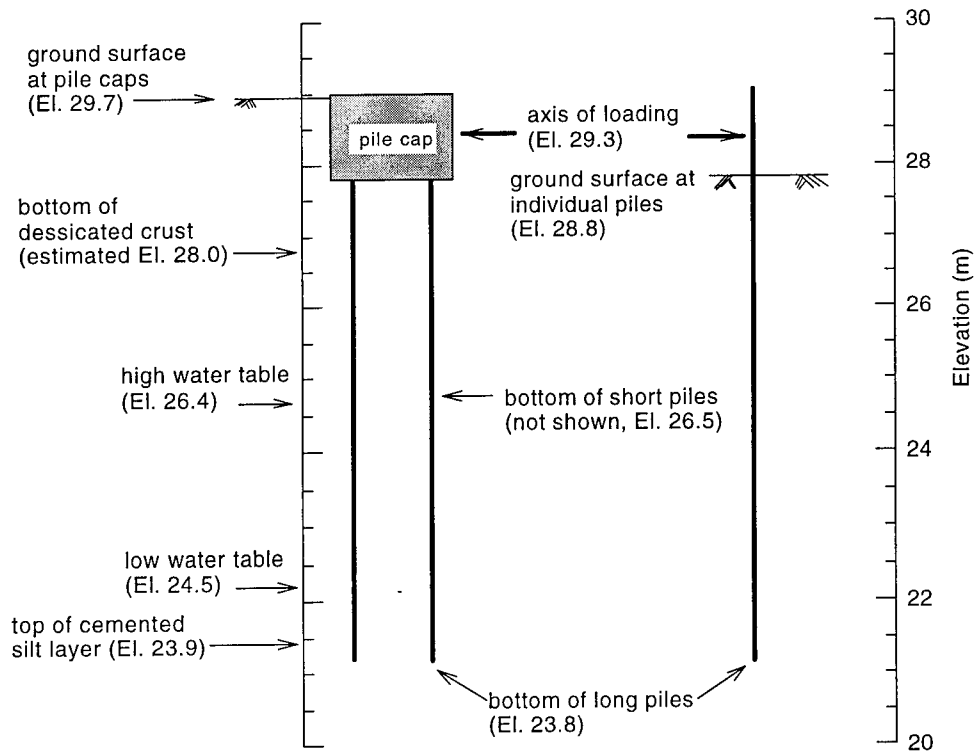

Elevation (m)	Moist unit weight, $\gamma_m$ (kN/m <sup>3</sup> )	Cohesion total stress, $c$ (kN/m <sup>2</sup> )	Friction angle total stress, $\phi$ (degrees)	Strain at 50% $\sigma_{dmax}$ $\epsilon_{50}$
29.7	19.43	48.3	38.0	0.01
29.3	19.29	48.3	38.0	0.01
28.8	19.15	48.3	38.0	0.01
28.0	18.91	41.4	35.0	0.025
26.8	18.54	34.5	28.0	0.025
26.5	18.44	29.6	27.0	0.025
24.4	17.66	27.6	25.0	0.025
24.1	17.64	0.0	45.0	0.002
23.8	17.60	0.0	45.0	0.002

Figure 5. Soil parameters for calculating p-y curves.

## PYPILE - Soil Resistance vs. Deflection (p-y) Calculation Sheet

Created by R.L. Mokwa and J.M. Duncan - June 1997

Date: 9/15/99  
 Description: NW Pile Group  
 Engineer: rlm

Slope Angle (deg), $f =$		Input (red lettering)						Calculated Values		
0								Brinch-Hansen (1961)		
Depth, x (m)	D (m)	$\gamma$ (kN/m <sup>3</sup> )	c (kN/m <sup>2</sup> )	$\phi$ (deg)	$\epsilon_{50}$	A	M	$K_c$	$K_q$	$p_{ult}$ (kN/m)
0.00	0.253	19.15	48.3	37	0.01	2.5	0.85	9.97	8.31	104
0.76	0.253	18.91	41.4	34.5	0.025	2.5	0.85	40.48	11.39	396
1.98	0.253	18.54	29.7	27	0.025	2.5	0.85	32.19	8.11	270
4.42	0.253	7.85	27.3	5	0.025	2.5	0.85	9.61	0.71	62
4.72	0.253	7.85	0	45	0.002	2.5	0.85	344.72	72.66	579
5.03	0.253	7.85	0	45	0.002	2.5	0.85	356.21	75.20	638
0.00	0	0.00	0	40	0.002	2.5	0.85	#DIV/0!	#DIV/0!	#DIV/0!
0.0	0	0.00	0	40	0.002	2.5	0.85	#DIV/0!	#DIV/0!	#DIV/0!
0.0	0	0.00	0	0	0	0	0	#DIV/0!	0.00	#DIV/0!

Definition of Parameters			
x =	depth below ground surface (ft)	$K_c =$	cohesive resistance coefficient
D =	shaft diameter [L]	$K_q =$	friction resistance coefficient
$\gamma =$	soil unit weight [F/L <sup>3</sup> ]	$p_{ult} =$	ultimate soil resistance [L-F/L <sup>2</sup> ]
c =	soil cohesion [F/L <sup>2</sup> ]	p =	soil resistance [L-F/L <sup>2</sup> ]
f =	soil friction angle (deg)	y =	shaft deflection
$\epsilon_{50} =$	strain required to mobilize 50% of the soil strength		
A =	p-y curve shape factor		
M =	ultimate lateral load reduction factor		

The p-y values calculated below (shaded cells) are formatted for cutting and pasting directly into LPILE plus 3.0 input files.

p-y values for single isolated pile				LPILE input for group pile			
multiplier = 1.0				pile p multiplier = 3.20			
Depth (mm)	$p/p_{ult}$	y (mm)	p (kN/mm)	$p/p_{ult}$	y (mm)	p (kN/mm)	
0.0	0.00	0.00	0.000	0.00	0.00	0.000	No. of data points defining p-y curve
0.1	0.05	0.010	0.010	0.05	0.033	0.033	
0.2	0.40	0.021	0.021	0.40	0.066	0.066	
0.3	1.37	0.031	0.031	1.37	0.099	0.099	
0.4	3.24	0.041	0.041	3.24	0.133	0.133	
0.5	6.33	0.052	0.052	6.33	0.166	0.166	
0.7	17.36	0.072	0.072	17.36	0.232	0.232	
0.9	36.89	0.093	0.093	36.89	0.298	0.298	
1.0	50.60	0.103	0.103	50.60	0.331	0.331	
1.0	632.50	0.104	0.104	632.50	0.331	0.331	
Depth (mm)	762.0			762.0			No. of data points defining p-y curve
0.0	0.00	0.000	0.000	0.00	0.000	0.000	
0.1	0.13	0.040	0.040	0.13	0.127	0.127	
0.2	1.01	0.079	0.079	1.01	0.253	0.253	
0.3	3.42	0.119	0.119	3.42	0.380	0.380	
0.4	8.10	0.158	0.158	8.10	0.507	0.507	
0.5	15.81	0.198	0.198	15.81	0.633	0.633	
0.7	43.39	0.277	0.277	43.39	0.886	0.886	
0.9	92.22	0.356	0.356	92.22	1.139	1.139	
1.0	126.50	0.395	0.395	126.50	1.265	1.265	
1.0	1581.25	0.396	0.396	1581.25	1.266	1.266	
Depth (mm)	1981.0			1981.0			No. of data points defining p-y curve

Figure 6. Example of p-y calculations using spreadsheet PYPILE (1 of 2).

Single pile p-y values

GEP p-y values

Depth (mm)	1981.0	10	No. of data points defining p-y curve	1981.0	10
0.0	0.00	0.000		0.00	0.000
0.1	0.13	0.027		0.13	0.086
0.2	1.01	0.054		1.01	0.173
0.3	3.42	0.081		3.42	0.259
0.4	8.10	0.108		8.10	0.345
0.5	15.81	0.135		15.81	0.431
0.7	43.39	0.189		43.39	0.604
0.9	92.22	0.243		92.22	0.776
1.0	126.50	0.269		126.50	0.862
1.0	1581.25	0.270	1581.25	0.863	
Depth (mm)	4420.0	10	No. of data points defining p-y curve	4420.0	10
0.0	0.00	0.000		0.00	0.000
0.1	0.13	0.006		0.13	0.020
0.2	1.01	0.012		1.01	0.040
0.3	3.42	0.019		3.42	0.059
0.4	8.10	0.025		8.10	0.079
0.5	15.81	0.031		15.81	0.099
0.7	43.39	0.043		43.39	0.138
0.9	92.22	0.056		92.22	0.178
1.0	126.50	0.062		126.50	0.197
1.0	1581.25	0.062	1581.25	0.197	
Depth (mm)	4724.0	10	No. of data points defining p-y curve	4724.0	10
0.0	0.00	0.000		0.00	0.000
0.1	0.01	0.058		0.01	0.186
0.2	0.08	0.116		0.08	0.371
0.3	0.27	0.174		0.27	0.557
0.4	0.65	0.232		0.65	0.742
0.5	1.27	0.290		1.27	0.927
0.7	3.47	0.405		3.47	1.297
0.9	7.38	0.521		7.38	1.668
1.0	10.12	0.579		10.12	1.853
1.0	126.50	0.579	126.50	1.854	
Depth (mm)	5029.0	10	No. of data points defining p-y curve	5029.0	10
0.0	0.00	0.000		0.00	0.000
0.1	0.01	0.064		0.01	0.205
0.2	0.08	0.128		0.08	0.409
0.3	0.27	0.192		0.27	0.613
0.4	0.65	0.255		0.65	0.817
0.5	1.27	0.319		1.27	1.022
0.7	3.47	0.447		3.47	1.430
0.9	7.38	0.574		7.38	1.838
1.0	10.12	0.638		10.12	2.042
1.0	126.50	0.638	126.50	2.043	

Figure 6-Continued. Example of p-y calculations using spreadsheet *PYPILE* (2 of 2).

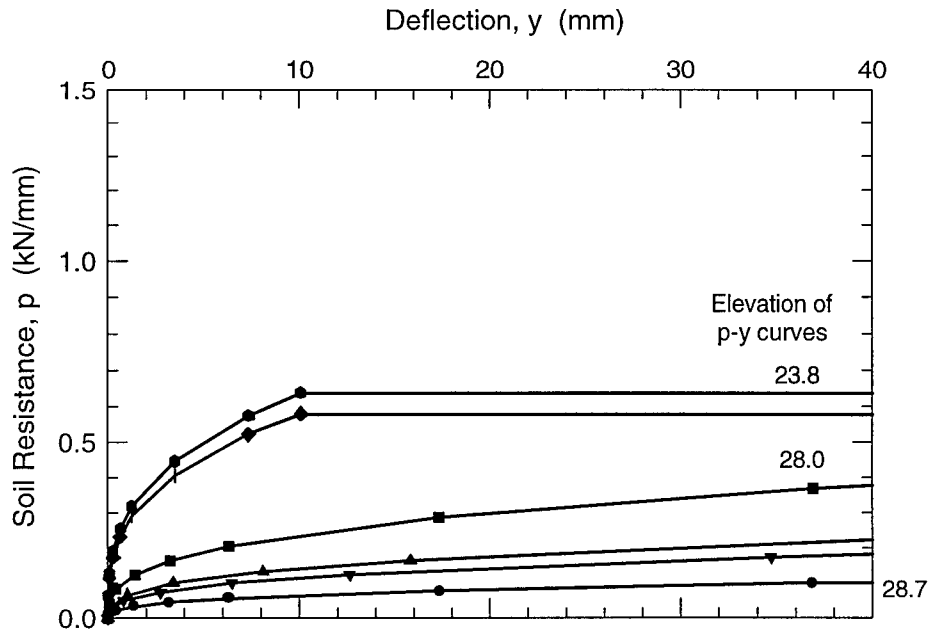

(a) Single pile p-y curves.

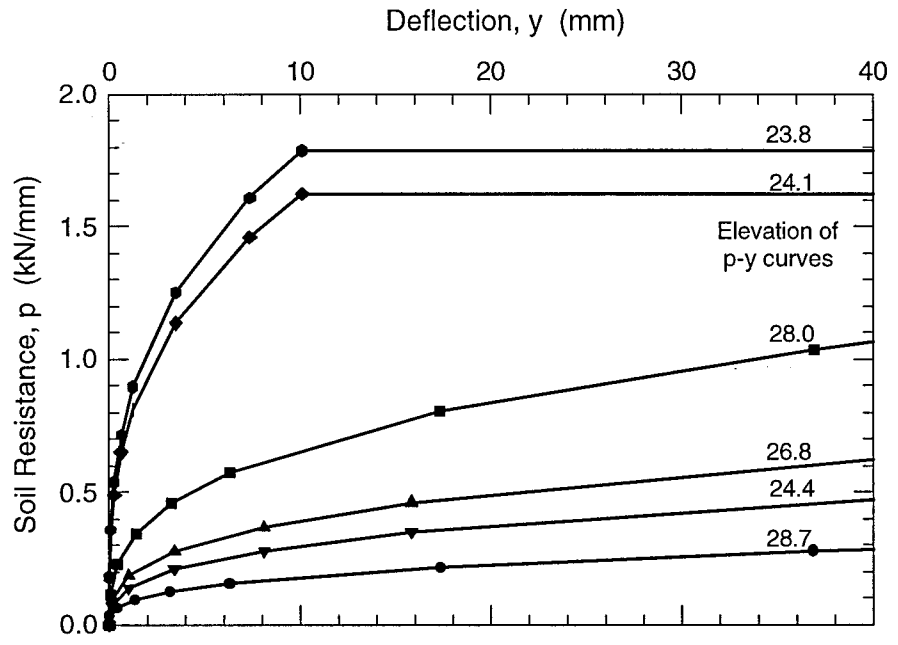

(b) Equivalent group pile p-y curves.

Figure 7. p-y curves for LPILE Plus 3.0 analyses.

## Pile Group Model

### Background

The single pile model developed in the previous section forms a part of the pile group model. The computer program *LPILE Plus 3.0* (1997) was used to analyze the pile groups at the test facility using the approach outlined below:

1. The piles in a four-pile group were modeled as a single pile with four times the moment of inertia of the actual pile, giving four times the flexural resistance of a single pile.
2. The “p” values for each pile were adjusted to account for group effects using the reduction factors shown in Figure 4.
3. The adjusted “p” values were summed to develop the combined “p” values for the group of piles.
4. The pile-head boundary condition of the “group- equivalent pile” was determined by estimating the rotational restraint provided by the pile cap.
5. The model created in steps 1 through 4 (the “group-equivalent pile” model) was analyzed using *LPILE Plus 3.0*, and the results were compared to the results of the load tests on the pile groups.

Details of these steps are described in the following pages.

### Group Pile p-y Curves

The GEP p-y curves were developed using the conditions and properties shown in Figure 5. The analytical approach for pile groups was similar to the single pile approach, except the single pile p-values were adjusted to account for the number of piles, and to account for reduced efficiencies caused by pile-soil-pile interactions. In other words:

$$p = \sum_{i=1}^N p_i f_{mi} \quad \text{Equation 3a}$$

where  $p_i$  is the p-value for the single pile,  $f_{mi}$  is the p-multiplier determined from Figure 4, and N is the number of piles in the group.

For the 4-pile groups at the Kentland Farms facility, with piles spaced equally at 4D, the p values equal:

$$p = (p \text{ single pile}) \times 3.2$$

Equation 3b

The p-y curves calculated using this method are shown in Figure 7(b). The *EXCEL* spreadsheet *PYPILE* was used to create p-y curves for the NE, NW, and SE pile groups.

### Pile-Head Rotations

Although piles in a group are restrained against rotation by a pile cap, the piles will experience a small amount of rotation during lateral loading. Rotation at the pile-head is caused primarily by: 1) deformation and possibly cracking of concrete at the pile connection to the cap, and 2) rotation of the cap and the pile group caused by vertical movement of the piles.

Flexural cracking of the concrete, in the caps at Kentland Farms, was minimized by using reinforcement in both the top and bottom faces of the cap and by providing a minimum of 5 inches of cover around the piles. Thus, for the pile groups tested in this study, pile-head rotation caused by deformation or cracking of the concrete was negligible in comparison to the rotational effects associated with vertical movement of the piles.

Rotation of the cap caused by vertical movement of the piles can be significant, depending on the vertical capacities of the piles. During lateral loading, the front of the cap tends to move downward and the back of the cap tends to move upward. The amount of rotation depends primarily on the upward movement of the trailing piles, and is a function of the skin friction that is developed on the piles.

The pile group rotational stiffness concept is illustrated in Figure 8. The magnitude of vertical displacement,  $\Delta$ , is controlled by a number of factors, including skin friction or side resistance,  $Q_s$ , end resistance,  $Q_p$ , elastic shortening or lengthening of the piles, frictional resistance at the ends of the cap, and rotational resistance developed as the leading edge of the cap “toes” into the soil. Based on the load tests performed during this study, it appears that the largest contribution to restraint is that due to the frictional resistance of the piles.

The movement required to mobilize skin friction is considerably smaller than the movement required to mobilize end resistance, and is relatively independent of the pile size and soil type (Kulhawy 1984). There is no consensus in the literature regarding the amount of movement that is required to mobilize skin friction fully. However, a range from 2.5 to 7.6 mm is usually considered to be reasonable (Davisson 1975, Gardner 1975, and Kulhawy 1984). Values at the high end of this range are most likely associated with bored piles or drilled shafts, while values at the low end of the range are more representative of driven piles. For the purpose of back calculating  $\theta_{ult}$ , the value of  $\Delta_{ult}$  was assumed equal to 2.5 mm for the piles in this study.

### Pile-Head Rotational Stiffness Calculations

The value of  $k_{m\theta}$  is defined as:

$$k_{m\theta} = \frac{M}{\theta}$$

Equation 4

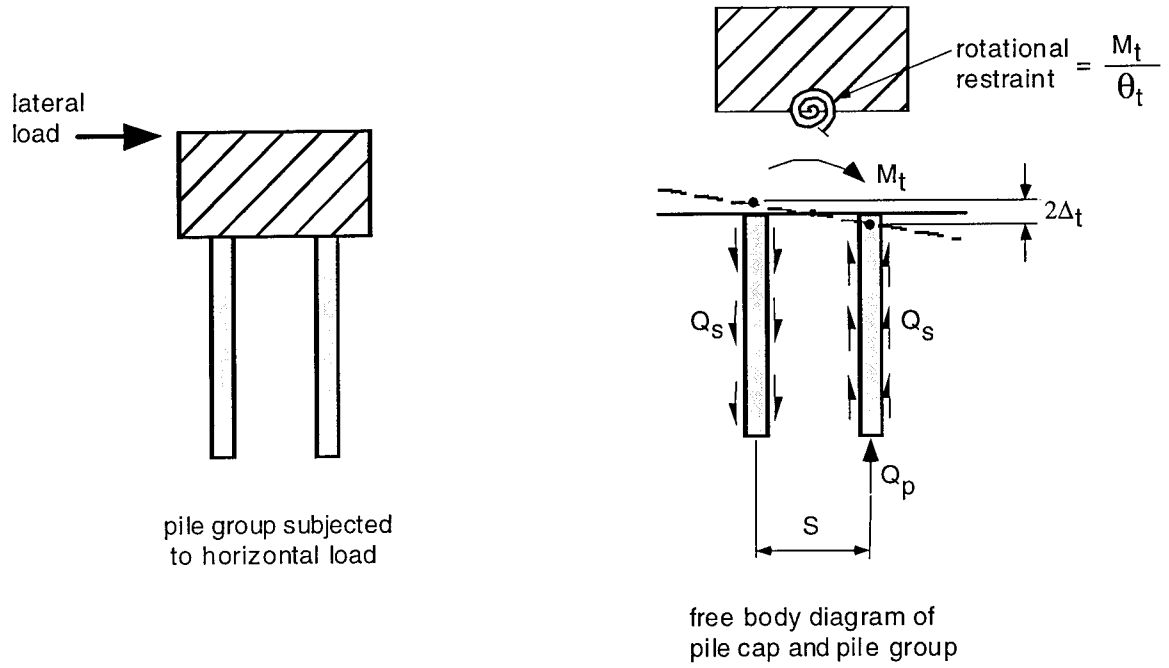

- $M_t$  = moment resisting rotation
- $\Delta_t$  = vertical displacement of pile
- $Q_s$  = pile side resistance force
- $Q_p$  = pile end resistance force
- $S$  = spacing between leading and trailing rows
- $\theta_t$  = angular rotation of cap and pile head

Figure 8. Conceptual model for estimating pile group rotational restraint.

where  $M$  is the restraining moment that resists rotation, and  $\theta$  is the angular rotation of the pile head. The value of  $k_{m\theta}$  approaches infinity for a pure fixed-head condition (zero slope), and  $k_{m\theta}$  is 0 for a pure free-head condition (zero restraining moment,  $M$ ).

Angular rotation of the pile head is assumed here to be equal to the rotation of the pile cap, which is a function of vertical pile movement. The amount of angular rotation can be determined from geometry as:

$$\theta = \tan^{-1} \frac{2\Delta_t}{S} \quad \text{Equation 5}$$

where  $S$  is the spacing between the leading and trailing rows of piles.

The ultimate value of bending moment that can be counted on to resist cap rotation,  $M_{ult}$ , is a function of the side resistance force from each pile,  $Q_{si}$ , and the moment arm,  $X_i$ , as follows:

$$M_{ult} = \sum_{i=1}^N Q_{si} X_i \quad \text{Equation 6}$$

where  $N$  is the number of piles in the group, and  $X_i$  is the moment arm, as shown in Figure 9(a).

There are a number of recognized methods for estimating  $Q_{si}$ , including rational approaches such as the  $\alpha$ -method (Tomlinson 1987),  $\beta$ -method (Esrig and Kirby 1979) and the  $\lambda$ -method (Vijayvergiya and Focht 1972). The computer program *SPILE* (1993), available from the FHWA, is useful for estimating pile skin resistance. *SPILE* uses the  $\alpha$ -method for performing total stress analyses of cohesive soils and the Nordlund (1963) method for performing effective stress analyses of noncohesive soils. In situ approaches are also available such as the SPT method developed by Meyerhof (1976) or the CPT method by Nottingham and Schmertmann (1975).

Estimates of skin resistance for the piles in this study were made using the  $\alpha$ -method (Tomlinson 1987), in which pile skin resistance,  $Q_s$ , is given by:

$$Q_s = \alpha S_u A_s \quad \text{Equation 7}$$

where  $\alpha$  is an adhesion factor that modifies the undrained shear strength,  $S_u$ , and  $A_s$  is the surface area of the pile shaft or perimeter area.  $\alpha$  values depend on the magnitude of  $S_u$ , the pile length and diameter, and the type of soil above the cohesive bearing stratum. Because the natural soil at the site is partially saturated, its shear strength consists of both cohesive ( $c$ ) and frictional ( $\phi$ ) components. An equivalent  $S_u$  value was estimated for this  $c$ - $\phi$  soil using the following expression:

$$S_u = c + \sigma_h \tan \phi \quad \text{Equation 8}$$



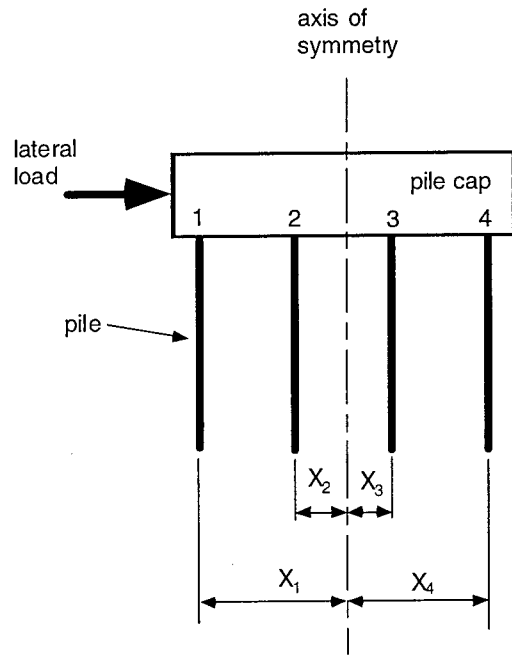

(a) Cross-section through a 4 by 4 pile group.

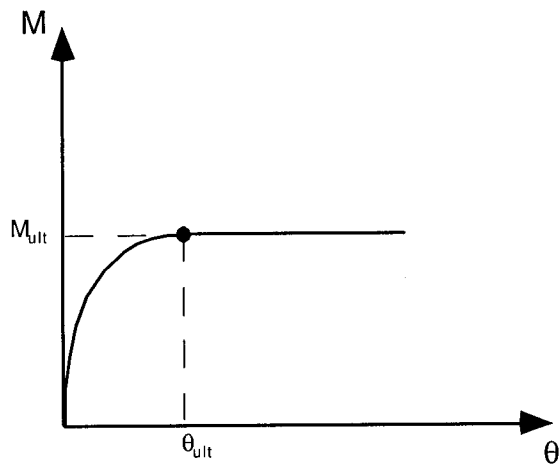

(b) Assumed relationship between  $M$  and  $\theta$ .

Figure 9. Details for rotational restraint calculations.

where  $\sigma_h$  is the horizontal stress at the depth of interest. Because the natural soil is overconsolidated and may contain residual horizontal stresses caused by pile driving, it was assumed that  $\sigma_h$  was equal to the vertical stress,  $\sigma_v$ .

Although the soils were relatively homogeneous at the Kentland Farms site,  $Q_{si}$  values varied between the three pile groups because of differences in the length of the piles in each group. Pile lengths used in the skin resistance analyses were based on the distance from the bottom of the pile cap to the pile tip. There was a 0.23 meter difference in length between the NE and NW pile groups because the NE 0.91-meter-deep cap extended 0.23 meters deeper than the NW 0.46-meter-deep cap. The piles in the SE group were only driven 3 meters. Because the SE cap was 0.91 meters deep, the piles extended only 2.1 meters below the bottom of the cap. Calculated values of  $Q_{si}$  for the piles in the three test groups are shown in Table 5.

**Table 5.** Skin resistance values for Kentland Farms pile groups.

Foundation	Pile Length (m)	$Q_{si}$ per pile (kN)
NE group	5.0	347
NW group	5.3	365
SE group	2.1	133

Skin resistance values  $Q_{si}$  shown in Table 5 were used with Equation 6 to estimate the limiting value of the restraining moment,  $M_{ult}$ . As shown in Figure 9(b), the relationship between  $M$  and  $\theta$  is expected to be nonlinear up to  $M_{ult}$ . The slope of a line drawn through any point along the  $M$ - $\theta$  distribution defines the value of  $k_{m\theta}$ . As shown in Figure 10(a), it was assumed the initial nonlinear portion of the  $M$ - $\theta$  curve could be represented by a cubic parabola. The actual shape of the curve is unknown, but a cubic parabola provides a reasonable approximation.

The relationship between  $M$  and  $\theta$  was simplified for the analyses by approximating the curve by a straight line, as shown in Figure 10(a). The corresponding value of  $k_{m\theta}$  (the slope of this line) can be computed as follows:

The cubic parabola shown in Figure 10(a) can be represented as;

$$M = M_{ult} \left( \frac{\theta}{\theta_{ult}} \right)^{0.33} \quad \text{Equation 9a}$$

rearranging terms;

$$\frac{M}{M_{ult}} = \left( \frac{\theta}{\theta_{ult}} \right)^{0.33} \quad \text{Equation 9b}$$

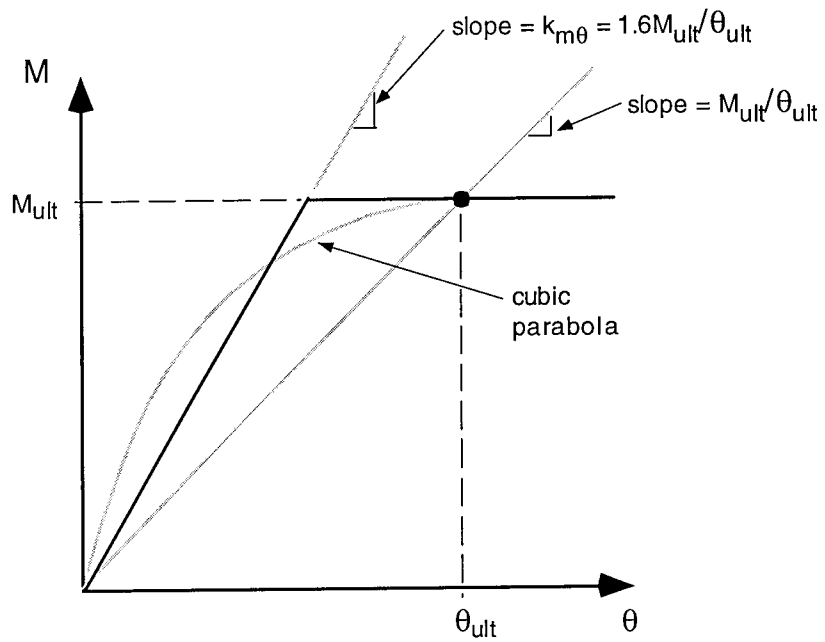

(a) Graphical illustration of  $k_{m\theta}$  approximation.

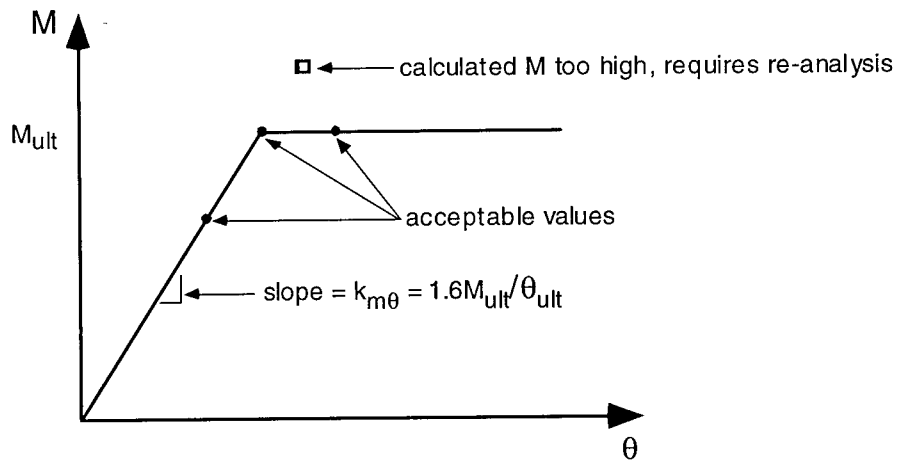

(b) Assumed  $k_{m\theta}$  distribution for analysis and design

Figure 10.  $k_{m\theta}$  approximation.

when 
$$\frac{\theta}{\theta_{ult}} = 0.5$$

$$\frac{M}{M_{ult}} = (0.5)^{0.33} = 0.79 \quad \text{Equation 9c}$$

thus,  $M = 0.79M_{ult}$  for  $\theta = 0.5\theta_{ult}$

and, consequently,

$$k_{m\theta} = \frac{M}{\theta} = \frac{0.79M_{ult}}{0.5\theta_{ult}} = 1.6 \frac{M_{ult}}{\theta_{ult}} \quad \text{Equation 9d}$$

For the purpose of these analyses, it was assumed that the rotational restraint,  $k_{m\theta}$ , is constant up to the value of  $M_{ult}$ , as shown in Figure 10(b).

Using the relationships developed above,  $k_{m\theta}$  can be determined as follows:

$$k_{m\theta} = 1.6 \frac{M_{ult}}{\theta_{ult}} = 1.6 \frac{\sum_{i=1}^N Q_{si} X_i}{\tan^{-1}\left(\frac{2\Delta_t}{S}\right)} \quad \text{Equation 10}$$

The value of  $k_{m\theta}$  can be estimated using the iterative process described below:

**Step 1.** The rotational restraint calculated from Equation 7.10 is used as the initial pile head boundary condition.

**Step 2.** The calculated value of moment at the pile-head ( $M_{pile}$ ), obtained from the *LPILE Plus 3.0* analysis, is compared to the value of  $M_{ult}$  calculated using Equation 5.

- If  $M_{piles} > M_{ult}$ , the analysis is repeated using a smaller value of  $k_{m\theta}$ . This condition is represented by the square in Figure 10(b).
- If  $M_{piles} \leq M_{ult}$ , the solution is acceptable. This condition is represented by the solid circles in Figure 10(b).

Using the approach described in this section, the values of  $M_{ult}$  and  $k_{m\theta}$  shown in Table 6 were calculated for the NE, NW, and SE pile groups.

**Table 6.**  $M_{ult}$  and  $k_{m\theta}$  values for the Kentland Farms pile groups.

Foundation	$M_{ult}$ (kN-m)	$k_{m\theta}$ (kN-m/rad)
NE group	711	227,130
NW group	739	236,170
SE group	276	88,366

## Pile Cap Model

### Background

Load tests conducted during this study indicate that pile caps provide considerable resistance to lateral loads. This section describes the procedures that were developed for estimating cap resistance using an approach that can be readily coupled with the procedures for analyzing single piles and groups of piles. The approach provides a method for computing the cap resistance derived from passive earth pressures, and models the variation of this resistance with cap deflection using hyperbolic p-y curves. As described in the following paragraphs, the hyperbolic p-y curves are defined by the ultimate passive force and the initial elastic stiffness of the embedded pile cap.

### Passive Earth Pressure Resistance

The log spiral earth pressure theory was used to estimate the passive pressure developed on pile caps. The log spiral failure surface consists of two zones: 1) the Prandtl zone, which is bounded by a logarithmic spiral, and 2) the Rankine zone, which is bounded by a plane, as shown in Figure 11(a). The shape of the log spiral surface is shown in Figure 11(b). For large values of the wall friction angle,  $\delta$ , the theory is more accurate than Rankine or Coulomb's earth pressure theories, which apply only to simple states of stress, or use plane surfaces to approximate the failure surface. The log spiral, Rankine, and Coulomb theories provide identical results when the wall friction angle,  $\delta$ , is zero. However,  $K_p$  values estimated using Coulomb's theory are non-conservative, and can be very inaccurate for  $\delta$  values greater than about  $0.4\phi$ . On the other hand, Rankine's theory does not account for wall friction, and, consequently, may greatly underestimate passive earth pressures, especially at larger values of  $\delta$ .

The wall friction angle at the front face of a pile cap will be large because of the restraint against vertical movement of the cap that is provided by the piles. For this reason, the log spiral earth pressure theory is the most appropriate theory for estimating the ultimate passive pressure developed by pile caps.

Log spiral earth pressure forces can be determined using a trial and error graphical process based on the principle that a force vector acting on the log spiral failure surface makes an angle of  $\phi$  with the tangent to the spiral, and the lines of action of the force vectors pass through the center of the spiral, as shown in Figure 12. This approach can provide accurate results for any magnitude of wall friction, and can also account for cohesion in c- $\phi$  soils. However, the graphical procedure is time-consuming, and is not adaptable to computer calculations. Caquot and Kerisel (1948) developed tables that can be used for estimating the earth pressure coefficient,  $K_p$ , based on the log spiral theory.

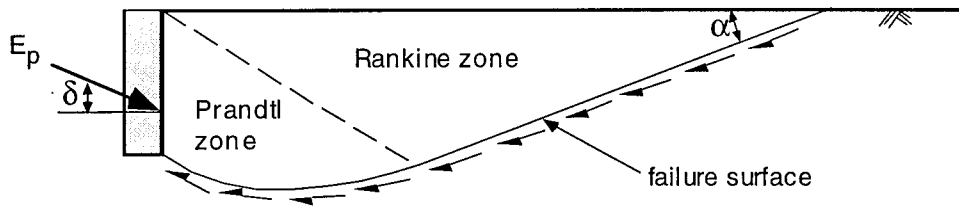

$E_p$  = passive earth pressure  
 $\delta$  = wall friction angle  
 $\alpha = 45 - \phi/2$

(a) Theoretical shape of passive failure zone.

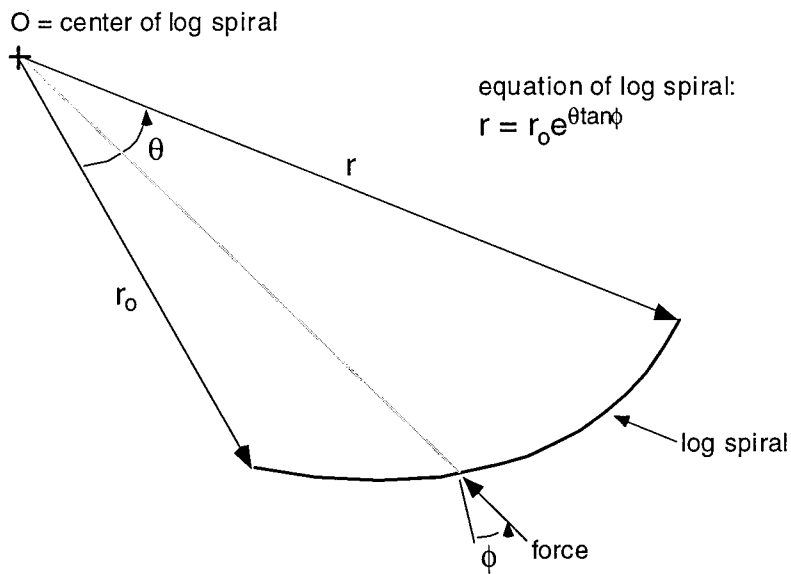

(b) Log spiral.

Figure 11. Log spiral approximation.

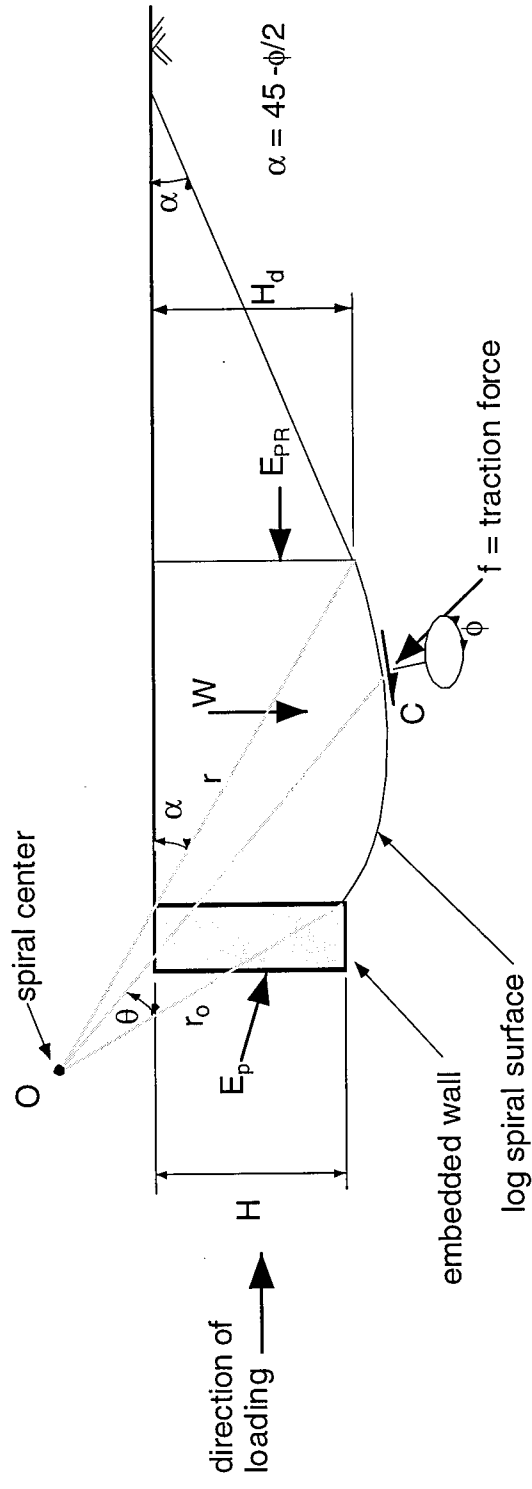

Figure 12. Graphical representation of the log spiral earth pressure method.

These tables are available in many foundation engineering text books and manuals. The disadvantages of the tables are that they cannot be used in computer programs, and that they do not account for cohesion.

An *EXCEL* spreadsheet was developed by the authors to calculate passive earth pressures using the log spiral earth pressure theory, and was extended significantly during the course of this study. In its present form, the program accounts for friction, cohesion, and surcharge components of passive pressures, and any magnitude of wall friction. The program is coded in an *EXCEL* workbook named *PYCAPSI*, which was developed for calculating p-y curves for embedded pile caps. The workbook *PYCAPSI* contains a number of different worksheets. The log spiral calculations are performed in the worksheet named *Log Spiral*. Details of the log spiral earth pressure theory, and the worksheet *Log Spiral*, are provided in documentation file included with *PYCAPSI*.

The magnitude of the interface wall friction angle and the effects of wall friction on passive earth pressures have been the focus of numerous studies including the classic retaining wall studies by Terzaghi (1932, 1934a, and 1934b), the interface tests performed on dense sands and concrete by Potyondy (1961), and the finite element studies by Clough and Duncan (1971). These studies and others indicate that wall friction is not an absolute value but depends on the amount of wall movement as well as on the soil properties and the properties of the soil/wall interface. In practice, average values of wall friction are often used based on engineering judgement and experience.  $\delta$  values used in practice most often fall within the range of about  $0.4\phi$  to  $0.8\phi$ . Recommended values of  $\delta$  for use in design can be found in geotechnical books and publications such as NAVFAC DM7.2 (1982) for various types of soils and interface materials.

The passive earth pressure force,  $E_p$ , can be expressed in terms of its three primary components: 1) soil weight and friction,  $E_{p\phi}$ , 2) soil cohesion,  $E_{pc}$ , and 3) surcharge,  $E_{pq}$ .  $E_p$ , which is in units of force per unit length, can be expressed as:

$$E_p = (E_{p\phi} + E_{pc} + E_{pq}) \quad \text{Equation 11a}$$

or, in terms of earth pressure coefficients:

$$E_p = \frac{1}{2}\gamma H^2 K_{p\phi} + 2cHK_{pc} + qHK_{pq} \quad \text{Equation 11b}$$

where the earth pressure coefficient for friction and soil weight is defined as:

$$K_{p\phi} = \frac{2E_{p\phi}}{\gamma H^2} \quad \text{Equation 11c}$$

the earth pressure coefficient for cohesion is defined as:

$$K_{pc} = \frac{E_{pc}}{2cH} \quad \text{Equation 12b}$$

and the earth pressure coefficient for surcharge is defined as:



$$K_{pq} = \frac{E_{pq}}{qH} \quad \text{Equation 12c}$$

The  $K_{p\phi}$  value determined using the log spiral method approaches the Rankine value of  $K_p$  as  $\delta$  approaches zero. For this reason, and because numerical difficulties occasionally occur when  $\delta$  is less than 2 degrees, *PYCAPSI* automatically defaults to the Rankine value of  $K_p$  when  $\delta$  is less than 2 degrees. In this case, the ultimate passive force,  $E_p$ , is expressed in terms of force per unit length as:

$$E_p = \frac{1}{2}\gamma H^2 K_p + 2cH\sqrt{K_p} + qHK_p \quad \text{Equation 13}$$

where  $K_p$  is determined from Rankine theory as:

$$K_p = \tan^2\left(45 + \frac{\phi}{2}\right) \quad \text{Equation 14}$$

The value of  $E_p$  calculated using either of the approaches described above is modified by applying a factor to account for three-dimensional effects. This factor, called  $R$ , is discussed in the next section. The 3-D passive earth pressure force,  $P_{ult}$  is thus determined from  $E_p$  as follows:

$$P_{ult} = E_p R b \quad \text{Equation 15}$$

where  $P_{ult}$  is the ultimate passive earth pressure force (force units),  $R$  is a correction factor for 3-D effects (dimensionless), and  $b$  is the width of footing or length of wall (length units).

When  $\phi = 0$ , *PYCAPSI* defaults to a different method for calculating passive earth pressure, which is called the  $\phi = 0$  sliding wedge method. The method closely follows the approach developed by Reese (1997) for modeling the failure zone in front of a laterally loaded pile. This approach assumes that the ground surface rises and translates in the direction of load. The failure wedge is represented as a plane surface, as shown in Figure 13. The semi-empirical equation used to calculate the passive earth pressure force is:

$$P_{ult} = \frac{cbH}{2} \left( 4 + \frac{\gamma H}{c} + \frac{0.25H}{b} + 2\alpha \right) \quad \text{Equation 16}$$

where  $\alpha$  is a factor that accounts for adhesion between the cohesive soil and the wall. Typical values of  $\alpha$  can be found in geotechnical books and publications such as NAVFAC DM7.2 (1982). Conservative values of  $\alpha$  should be used if there is a possibility that adhesion between the soil and wall could be lost or destroyed by water, frost action or remolding during cyclic loading.

The development of Equation 16 is described in documentation file that accompanies *PYCAPSI*. This equation is based on full-scale test results, thus it implicitly includes three-

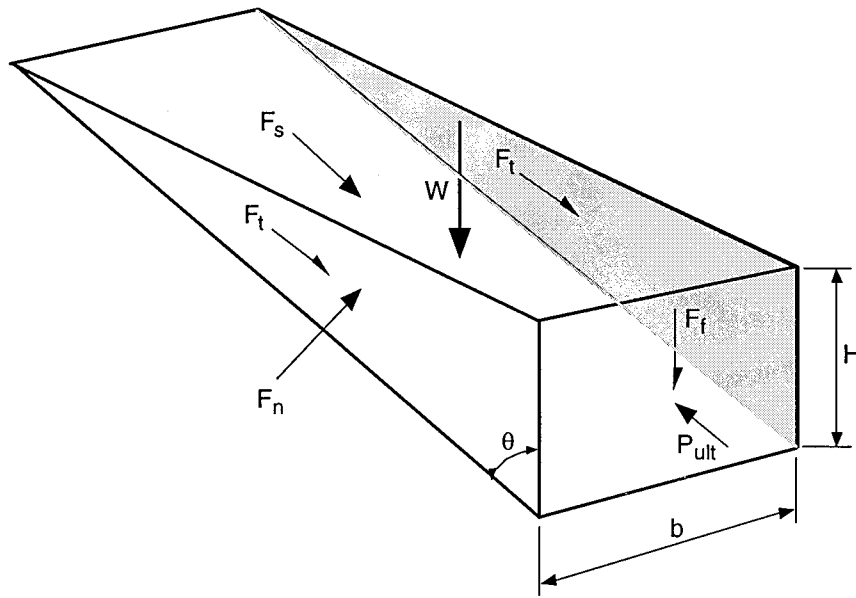

Orthogonal view of failure wedge

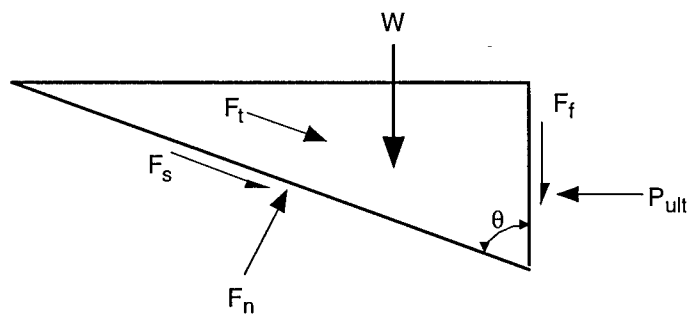

Side view of failure wedge

Figure 13.  $\phi = 0$  passive wedge model.

dimensional and shape effects and, consequently, additional modifications using the 3-D shape factor are not necessary.

The process described in the preceding paragraphs, including the generation of pile cap  $p$ - $y$  values, is automated in the program *PYCAPSI*. The next section describes the procedure used to modify two-dimensional plane strain passive earth pressures to model three-dimensional behavior.

### Three-Dimensional Effects

Load tests were performed on the bulkhead at the field test facility to study the relationship between passive pressures and deflections. Because the bulkhead had no piles, its resistance to lateral load was provided almost entirely by passive pressure. Frictional resistance on its sides and base was negligibly small. Load tests were conducted to failure for the bulkhead embedded in natural ground, and after backfilling in front of it with crusher run gravel.

Pile cap resistance to horizontal movement is a function of the passive soil resistance developed at its front face, plus any sliding resistance on the sides and bottom of the cap, less any active earth pressure force on the back face of the cap. In the case of the bulkhead at Kentland Farms, the active force and the sliding resistance are small compared to the passive resistance, and they tend to offset each other. Passive earth pressure is thus the primary source of resistance to lateral load.

Various methods were examined for calculating the ultimate resistance of the bulkhead, using soil shear strength parameters that were developed from the laboratory tests. These methods included the classical Rankine, Coulomb, and log spiral earth pressure theories; the sliding wedge formulation described by Reese and Sullivan (1980); Brinch Hansen's (1961) ultimate load theory; and Ovesen's (1964) procedure to correct for three-dimensional effects. The most accurate results for both the  $c$ - $\phi$  natural soils and the cohesionless crusher run backfill were obtained using the log spiral earth pressure theory, modified for three-dimensional shape effects using Ovesen's (1964) procedure.

Conventional earth pressure theories consider only two-dimensional conditions, which correspond to a long wall moving against the soil. In the case of a bulkhead or pile cap, larger passive pressures are possible because of three-dimensional effects. A zone within the soil, which is wider than the face of the cap, is involved in resisting movement of the cap. The ratio between three-dimensional and two-dimensional soil resistance varies with the friction angle of the soil and the depth below the ground surface. Ovesen's theory provides a means of estimating the magnitude of this three-dimensional effect.

Ovesen (1964) conducted model tests on anchor blocks embedded in granular soils, and developed an empirical method for estimating the 3-D resistance of the embedded blocks. Ovesen's expressions can be re-arranged to obtain a 3-D modifying factor (called  $R$  in this study) that can be calculated as follows:

$$R = 1 + (K_p - K_a)^{2/3} \left[ 1.1E^4 + \frac{1.6B}{1 + 5 \frac{b}{H}} + \frac{0.4(K_p - K_a)E^3 B^2}{1 + 0.05 \frac{b}{H}} \right] \quad \text{Equation 17}$$

where  $K_p$  and  $K_a$  are the passive and active earth pressure coefficients;  $b$  is the width of the cap measured horizontally in a direction normal to the applied load;  $H$  is the height of the cap;  $B$  is based

on the spacing of multiple anchor blocks ( $B = 1$  for a single pile cap); and  $E$  is based on the depth of embedment of the pile cap, defined as:

$$E = 1 - \frac{H}{z + H} \quad \text{Equation 18}$$

where  $z$  is the depth of embedment measured from the ground surface to the top of the cap.

The value of  $K_{p\phi}$  determined in *PYCAPSI* is used in place of  $K_p$  in Equation 10.  $K_a$  is determined using the Rankine earth pressure theory, which is approximately equivalent to the log spiral value because the active failure surface is very close to a plane.

The ultimate earth pressure force,  $P_{ult}$  (in units of force), can be determined by combining Equations 11 and 17 as follows:

$$P_{ult} = RE_p b = R(E_{p\phi} + E_{pc} + E_{pq})b \quad \text{Equation 19}$$

where  $R$  is Ovesen's 3-D modifying factor (dimensionless),  $E_p$  is the two-dimensional or plane strain ultimate passive force (force per length units),  $b$  is the cap width or wall length (length units),  $E_{p\phi}$  is the earth pressure component due to soil weight and friction (force per length units),  $E_{pc}$  is the earth pressure component due to cohesion (force per length units),  $E_{pq}$  is the earth pressure component due to surcharge (force per length units).

These calculations are performed in the worksheet named *Log Spiral*, which is part of the workbook *PYCAPSI*. A copy of the output generated by *PYCAPSI* is shown in Figure 14. This output was generated in the worksheet titled *Summary*, which is used for specifying soil parameters and cap dimensions, and for displaying calculated results, including pile cap p-y values. The p-y values are formatted for copying and pasting directly into *LPILE Plus 3.0* or *GROUP* data files. The *GROUP* p-y values are not shown in Figure 14. They are the same as the *LPILE Plus 3.0* values, except the p and y columns are transposed.

Ovesen's tests were performed on compacted sand with friction angles ranging from  $\phi = 32$  degrees to 41 degrees. The maximum difference in earth pressure coefficients ( $K_p - K_a$ ) was 5.7 in Ovesen's tests, and  $R$  did not exceed a value of about 2. As a conservative measure, a limit of 2.0 was placed on the value of  $R$  that is calculated in *PYCAPSI*.

### **Pile Cap Stiffness**

The initial stiffness of the pile cap response corresponds to the initial slope of the load deflection curve. This value can be approximated using elasticity theory. The approach by Douglas and Davis (1964) for estimating the horizontal displacement of a vertical rectangle in a semi-infinite homogenous elastic mass was used in this study. The slope of the calculated load versus elastic displacement curve is called  $k_{max}$ , which is defined as the initial elastic stiffness with units of force divided by length.

## Ultimate Capacity Calculation Sheet - PYCAPSI

Created by R.L. Mokwa and J.M. Duncan - August 1999

Date: 12/09/1999  
 Description: Bulkhead in natural soil  
 Engineer: RLM

### Input Values (red)

cap width,	b (m) =	1.92
cap height,	H (m) =	1.07
embedment depth,	z (m) =	0.00
surcharge,	$q_s$ (kN/m <sup>2</sup> ) =	0.0
cohesion,	c (kN/m <sup>2</sup> ) =	46.44
soil friction angle,	$\phi$ (deg.) =	37.00
wall friction,	$\delta$ (deg.) =	3.5
initial soil modulus,	$E_1$ (kN/m <sup>2</sup> ) =	42750
poisson's ratio,	$\nu$ =	0.33
soil unit weight,	$\gamma_m$ (kN/m <sup>3</sup> ) =	19.17
adhesion factor,	$\alpha$ =	0.00
failure ratio (see notes)	$R_f$ =	0.85
<b>Calculated Values (blue)</b>		
$K_a$ (Rankine) =		0.25
$K_p$ (Rankine) =		4.02
$K_p$ (Coulomb) =		4.56
$K_{p\phi}$ (Log Spiral, soil weight) =		4.66
$K_{pq}$ (Log Spiral, surcharge) =		0.00
$K_{pc}$ (Log Spiral, cohesion) =		2.11
$E_p$ (kN/m) =		260.9
Ovesen's 3-D factor, R =		1.43
$k_{max}$ , elastic stiffness (kN/mm) =		156.7
<b><math>P_{ult}</math> (kN) =</b>		<b>717.2</b>
$P_{ult}$ (kips) =		161.2

### Notes:

$E_p$  = passive earth pressure per foot of wall

$$E_p = (E_{p\phi} + E_{pq} + E_{pc}) = 0.5\gamma H^2 K_{p\phi} + qHK_{pq} + 2cHK_{pc}$$

$K_{p\phi}$ ,  $K_{pq}$ ,  $K_{pc}$  = Log spiral earth pressure coefficients

$$\text{for } \delta = 0, E_p = 0.5\gamma H^2 K_p + qHK_p + 2cH(K)^{0.5}$$

$$P_{ult} = E_p R_b \quad (\text{passive force on wall})$$

$$\text{for } \phi = 0, P_{ult} = 0.5cbH(4 + \gamma H/c + 0.25H/b + 2\alpha)$$

$R_f$  = failure ratio, suggested range = 0.80 to 0.90

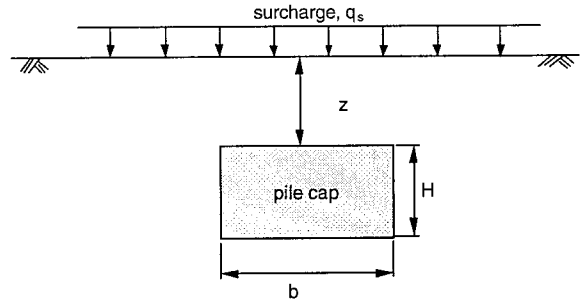

### LPILE

*p-y values for pile cap*

	y (mm)	p (kN/mm)	
Depth (in) ==>	0	10	<=== No. of data points
	0.00	0.000	definig p-y curves
	0.20	0.028	
	0.80	0.102	
	2.00	0.214	
	6.00	0.416	
	10.00	0.513	
	15.00	0.580	
	20.00	0.621	
	40.00	0.670	
	200.00	0.670	
Depth (in) ==>	1070	10	<=== No. of data points
	0.00	0.0	definig p-y curves
	0.20	0.0	
	0.80	0.1	
	2.00	0.2	
	6.00	0.4	
	10.00	0.5	
	15.00	0.6	
	20.00	0.6	
	40.00	0.7	
	0.00	0.7	

Figure 14. PYCAP Summary worksheet for bulkhead in natural soil.

The approach used to estimate  $k_{\max}$  is somewhat approximate in that it is based on the average deflection of the corners of a flexible rectangular area. This approach slightly underestimates the deflection because the deflection at the corners of a flexible area is smaller than the deflection of a rigid area, which would be a closer approximation of the bulkhead or of a pile cap. However, the difference between the average corner deflection for a flexible rectangle and the deflection of a rigid rectangle is offset by the effect of shear on the sides and bottom of the cap, which are neglected in the elastic solution. Thus, the use of an elastic solution based on a flexible loaded area is approximate, but it is believed to be sufficiently accurate for practical purposes.

The parameters needed to estimate  $k_{\max}$  include Poisson's ratio ( $\nu$ ), the initial tangent modulus of the soil ( $E_i$ ), and the dimensions and depth of the pile cap. A Poisson's ratio of 0.33 was assumed for the natural soils and a value of 0.30 was assumed for the granular backfill materials. The analysis is not sensitive to  $\nu$ , and reasonable estimates can be obtained from published correlations based on type of soil.

Estimates of the initial tangent modulus,  $E_i$ , were obtained from laboratory triaxial stress-strain curves.  $E_i$  values for the natural soils and backfill materials are shown in Figure 15. When triaxial data is unavailable, values of  $E_i$  can be estimated using published correlations available in the geotechnical literature, such as the book *Foundation Analysis and Design* (Bowles 1982).

The equations used to compute  $k_{\max}$  are given in the documentation file that is included with *PYCAPSI*. These equations and associated influence factors are programmed in the worksheet called *Elasticity*, which is part of the *PYCAPSI* workbook. Figure 16 contains an example of the *Elasticity* worksheet that was used to compute  $k_{\max}$  for the natural soils.  $k_{\max}$  calculations are performed automatically when the *Summary* worksheet is activated. It is not necessary to enter the worksheet *Elasticity* to calculate pile cap p-y values, because the required soil parameters and cap dimensions are input in the *Summary* worksheet. The results, including the calculated  $k_{\max}$  value, are also displayed in the *Summary* worksheet.

Using this approach, values of  $k_{\max}$  were computed for the bulkhead embedded in natural soil ( $k_{\max} = 156$  kN/mm) and for the bulkhead embedded in compacted gravel ( $k_{\max} = 130$  kN/mm).

### Pile Cap p-y Curves

Load-deflection curves for the pile caps and bulkhead were estimated using a hyperbolic equation of the same form as used by Duncan and Chang (1970) to represent stress-strain curves for soil. The hyperbolic load-deflection relationship is expressed as:

$$P = \frac{y}{\left( \frac{1}{k_{\max}} + R_f \frac{y}{P_{ult}} \right)} \quad \text{Equation 20}$$

where  $P$  is the load at any deflection  $y$ ,  $P_{ult}$  is the ultimate passive force,  $k_{\max}$  is the initial stiffness, and  $R_f$  is the failure ratio. The failure ratio is defined as the ratio between the actual failure force and the hyperbolic ultimate force, which is an asymptotic value that is approached as  $y$  approaches infinity.

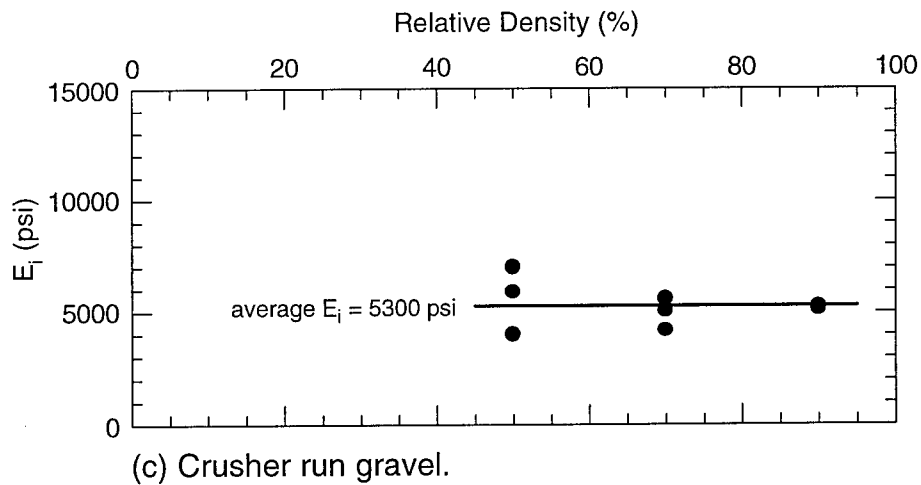
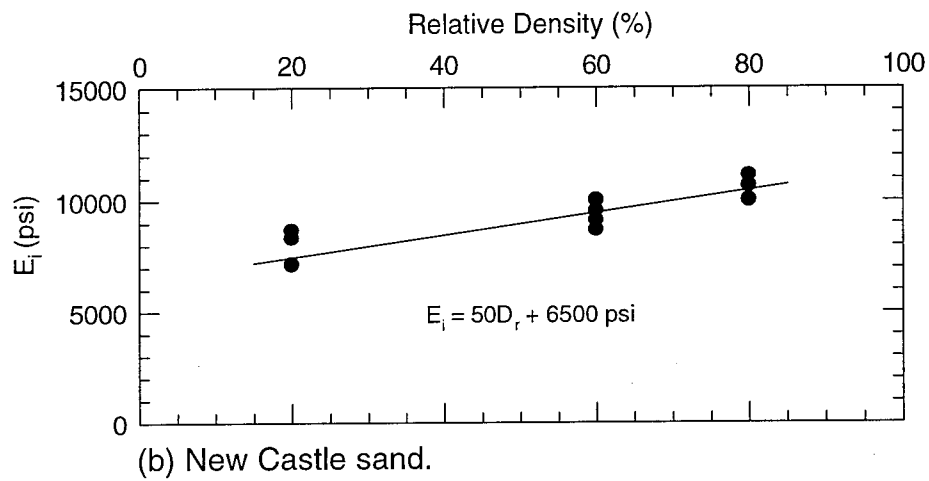
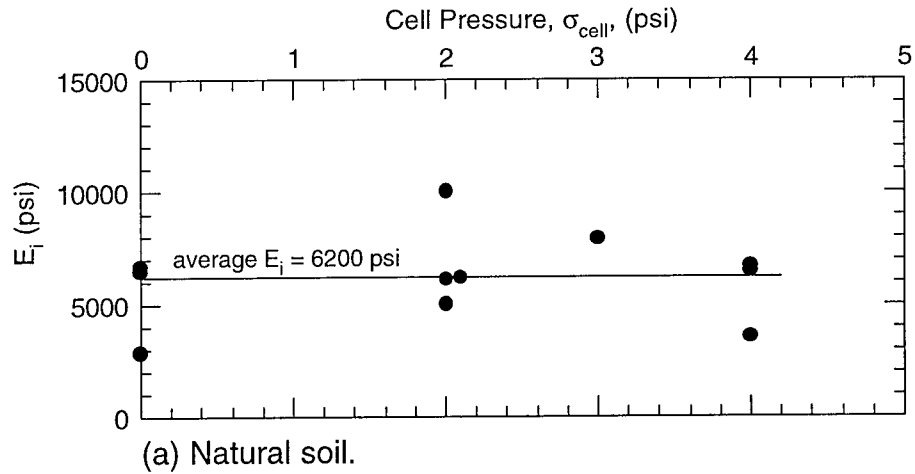

Figure 15. Initial tangent modulus ( $E_i$ ) for natural soil, New Castle sand, and crusher run gravel.

## Elasticity Solution for Horizontal Loading on a Vertical Rectangle

Created by R.L. Mokwa - August 1999

Reference: Douglas, D.J. and Davis, E.H. (1964). *Geotechnique*, Vol.14(3), p. 115-132.

**Description:** Bulkhead in natural soil

**Date:** 9/15/99

### Equations

$$y_1 = \frac{P(1+\nu)(l_1)}{16\pi HE(1-\nu)} \quad y_2 = \frac{P(1+\nu)(l_2)}{16\pi HE(1-\nu)}$$

### Input Parameters

- $y_1$  = horizontal deflection at upper corner of rectangle
- $y_2$  = horizontal deflection at lower corner of rectangle
- $P$  = applied force
- $\nu$  = Poisson's ratio
- $E_i$  = Initial tangent soil modulus
- $H$  = rectangle height
- $F_1, F_4, F_5$  = influence factors
- $c_1, c_2, d$  = dimensions defined in diagram
- $l_1 = \{ (3-4\nu)F_1 + F_4 + 4(1-2\nu)(1-\nu)F_5 \}$
- $l_2 = \{ (3-4\nu)F_1 + F_2 + 4(1-2\nu)(1-\nu)F_3 \}$

$$y_{avg} = (y_1 + y_2)/2$$

$k_{max}$  = Initial elastic stiffness

= slope of  $P$  versus  $y_{avg}$  line

$$k_{max} = P/y_{avg}$$

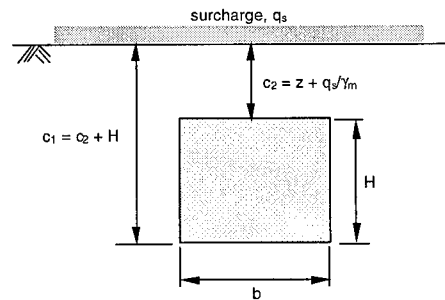

### Input from Summary Sheet

$\nu$ =	0.33
$E_i$ (kN/m <sup>2</sup> ) =	42750
$H$ (m) =	1.07
$b$ (m) =	1.92
$c_1$ (m) =	1.07
$c_2$ (m) =	0.00

### Calculated Values

$K_1 = 2c_1/b$ =	1.115
$K_2 = 2c_2/b$ =	0.000
$F_1$ =	2.566
$F_2$ =	1.476
$F_3$ =	0.625
$F_4$ =	2.566
$F_5$ =	1.705
$l_1$ =	8.430
$l_2$ =	6.356

### Results

Initial elastic stiffness,  $k_{max}$

$$k_{max} = 156678.1 \text{ kN/m}$$

$$k_{max} = 894.37 \text{ kips/inch}$$

Figure 16. *Elasticity* worksheet for the bulkhead in natural soil.



For soil stress-strain curves,  $R_f$  is always smaller than unity, and varies from 0.5 to 0.9 for most soils (Duncan et al. 1980). The value of  $R_f$  can be estimated by substituting  $P_{ult}$  for  $P$ , and by substituting the movement required to fully mobilize passive resistance,  $\Delta_{max}$  for  $y$ . Re-arranging the terms in Equation 7.21 results in the following expression for  $R_f$ :

$$R_f = 1 - \frac{P_{ult}}{\Delta_{max} k_{max}} \quad \text{Equation 21}$$

Calculations for  $R_f$  are performed in the *PYCAPSI* worksheet called *Hyperbola* using Equation 21. A copy of the *Hyperbola* worksheet is shown in Figure 17, for the bulkhead embedded in natural soil. Based on finite element and experimental studies by Clough and Duncan (1971),  $\Delta_{max}$  was assumed to equal 4 % of the wall (or cap) height for the foundations in this study. As shown in Table 7, the value of  $R_f$  calculated using Equation 21 ranged from 0.67 to 0.97 for the pile caps and bulkhead at the Kentland Farms test facility, with an average value of 0.83.

Calculated load-deflection curves can readily be converted to p-y curves by dividing the load,  $P$ , by the cap height. This approach results in a constant value of resistance versus depth. A linear variation can also be assumed, but the difference between a constant value and a linear variation is negligible. Consequently, a constant value was assumed in the analyses conducted for this study.

All the components necessary for calculating pile cap p-y values have been described in the preceding pages. Soil parameters and cap dimensions are input in the *Summary* worksheet,  $P_{ult}$  is calculated in the *Log Spiral* worksheet, and  $k_{max}$  is calculated in the *Hyperbolic* worksheet. The hyperbolic equation is solved and p-y values are calculated in the *Hyperbolic* worksheet, and the output is displayed in the *Summary* worksheet.

## Summary

### Pile Caps

Based on the approach described in this section, the computer spreadsheet named *PYCAPSI* was developed for calculating pile cap p-y curves. *PYCAPSI* includes the worksheets *Summary*, *Log Spiral*, *Hyperbola*, *Elasticity*, and *PYPILE*. (*PYPILE* is used to compute p-y curves for piles rather than caps, and works independently of the other sheets.) The cap p-y values are formatted for copying and pasting from the *Summary* worksheet directly into an *LPILE Plus3.0* or *GROUP* data input file.

The calculations performed in each spreadsheet are described in the file called *Documentation*, which is included on the diskette with *PYCAPSI*. The diskette also contains *PYCAP*, which has the same features as *PYCAPSI*, except english units are used in place of SI units.

Computed results, such as the earth pressure coefficients (Rankine, Coulomb, and log spiral), Ovesen's 3-D factor ( $R$ ),  $k_{max}$  and  $P_{ult}$  are displayed in the *Summary* worksheet. An example of p-y curves calculated for the 0.91-meter-deep cap in natural soil, compacted gravel, compacted sand, and loose sand are shown in Figure 18. The parameters used to develop the cap p-y curves for the analyses described in this report are summarized in Table 8.

# Hyperbolic Calculation Sheet

Created by R.L. Mokwa - August 1999

**Description:** Bulkhead in natural soil

**Hyperbolic equation:**  $P = y / \left( \frac{1}{k_{max}} + (yR_i / P_{ult}) \right)$   $R_i = \left( \frac{\Delta_{max}}{P_{ult}} - (1/k) \right) (P_{ult} / \Delta_{max})$

**Input values - Use "Summary" worksheet for data entry.**

$k_{max}$ (kN/mm) =	156.678	$\Delta_{max}/H =$	0.85
H (mm) =	1070.00	$\Delta_{max}$ (mm) =	909.50
$P_{ult}$ (kN) =	717.2	$R_i =$	0.85

**Calculated values using hyperbolic formulation**

Def. (mm)	Load (kN)
y	P
0	0.00
0.1	15.38
0.2	30.21
0.4	58.34
0.8	109.13
1.6	193.27
2	228.50
2.5	267.51
3	301.87
4	359.61
5	406.23
6	444.66
7	476.88
8	504.29
9	527.89
10	548.42
11	566.44
12	582.40
13	596.61
14	609.36
15	620.86
16	631.28
17	640.77
18	649.45
19	657.42
20	664.76
22	677.84
24	689.13
26	698.98
28	707.66
30	715.35
32	717.20
34	717.20
36	717.20
38	717.20
40	717.20
42	717.20
44	717.20
46	717.20
48	717.20
50	717.20
52	717.20
54	717.20

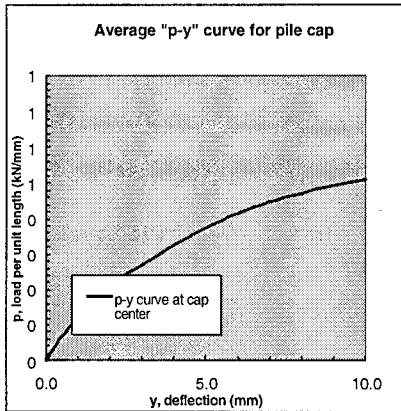
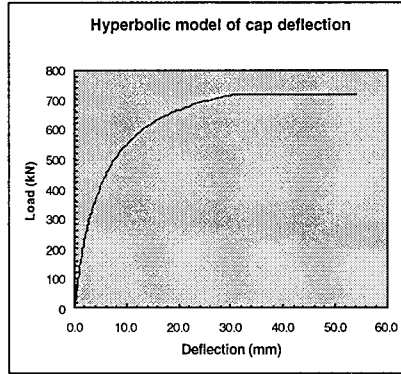

### p-y curves for pile cap

Constant Distribution

y (mm)	p (kN/mm)	p=P/H (kN/mm)
0	10	
0.00	0.000	<== depth, No. of points
0.20	0.028	
0.80	0.102	
2.00	0.214	
6.00	0.416	
10.00	0.513	
15.00	0.580	
20.00	0.621	
40.00	0.670	
200.00	0.670	
<b>1070.00</b>	<b>10</b>	<== depth, No. of points
0.00	0.000	
0.20	0.028	
0.80	0.102	
2.00	0.214	
6.00	0.416	
10.00	0.513	
15.00	0.580	
20.00	0.621	
40.00	0.670	
0.00	0.670	

Figure 17. Hyperbola worksheet for the bulkhead in natural soil.

**Table 7.** Summary of results from *PYCAP* analyses.

<b>Foundation</b>	<b>Soil around pile cap</b>	<b>Hyperbolic <math>R_f</math></b>	<b><math>K_{p\phi}</math></b>	<b><math>K_{pc}</math></b>	<b><math>K_{pq}</math></b>	<b>3-D factor <math>R</math></b>	<b><math>k_{max}</math> (kN/mm)</b>	<b><math>P_{ult}</math> (kN)</b>
Bulkhead	natural soil	0.89	4.65	2.11	0	1.43	157	712
Bulkhead	gravel backfill	0.93	10.22	0	0	1.75	132	409
NE 0.91-m cap	natural soil	0.70	12.51	4.42	0	1.91	128	1,432
NE 0.91-m cap	gravel backfill	0.82	26.46	0	0	2.00	109	712
NW 0.46-m cap	natural soil	0.67	12.71	4.41	7.66	1.87	108	658
NW 0.46-m cap	gravel backfill	0.89	26.46	0	0	1.80	71	160
SE 0.91-m cap	natural soil	0.70	12.51	4.42	0	1.91	128	1,432
SE 0.91-m cap	gravel backfill	0.82	26.46	0	0	2.00	190	712
SE 0.91-m cap	compacted sand	0.95	16.92	0	0	2.00	200	351
SE 0.91-m cap	loose sand	0.97	7.58	0	0	1.65	103	116

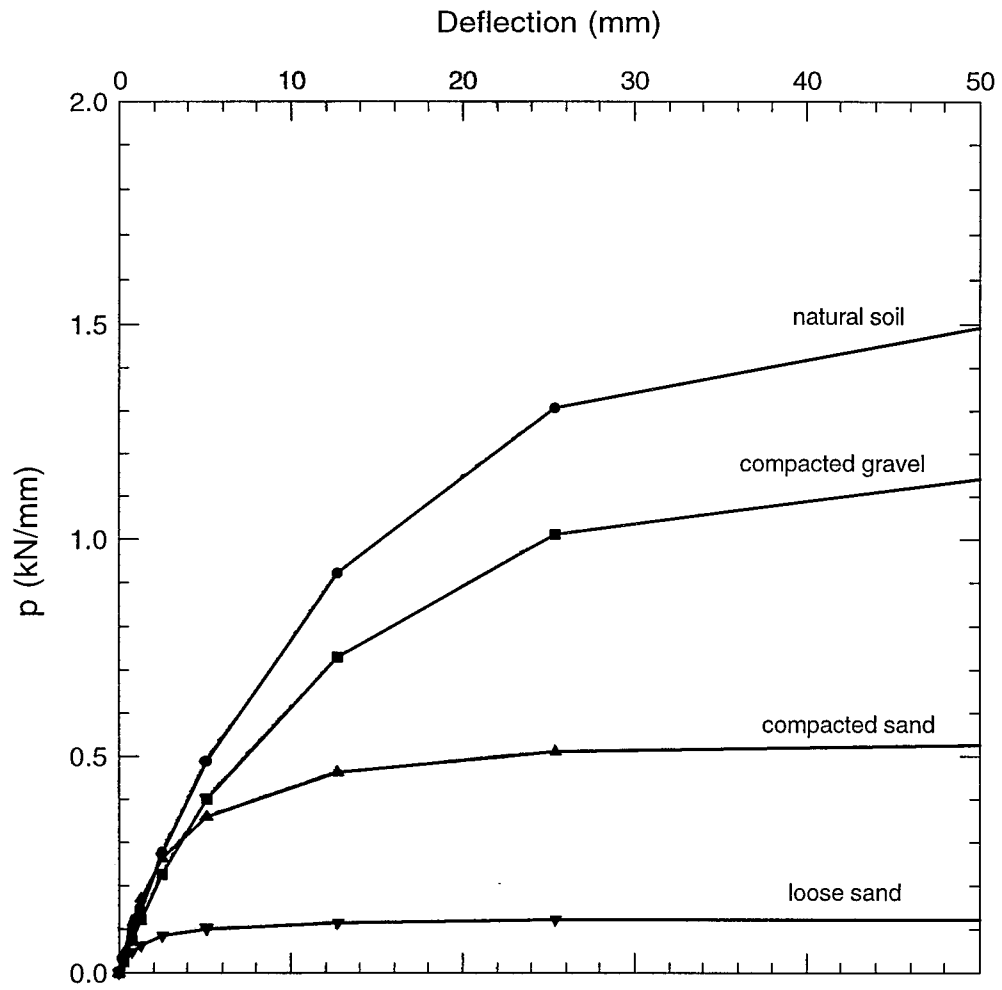

Figure 18.  $p$ - $y$  curves for 0.91-m-deep pile cap in four different soils.

The components necessary for creating soil models for pile groups and pile caps were described in the previous sections. These models, in the form of p-y curves, can be input into computer programs such as *LPILE Plus 3.0* (1997), *GROUP* (1996), or *Florida Pier* (1998) to compute the lateral response of the foundation system. *GROUP* and *Florida Pier* contain matrix structural analysis packages for computing reactions that are caused by interactions between the piles and pile cap. However, numerous problems were encountered when externally generated pile cap p-y curves were used with these programs, and it appears that they require further development and validation before they can be used with cap resistance.

**Table 8.** Parameters used to calculate pile cap p-y curves.

Parameter	Natural soil	Compacted gravel	Compacted sand	Loose sand
$\phi$ (deg)	38	50	46	37
$\delta$ (deg)	30	25	23	18.5
$c$ (kN/m <sup>2</sup> )	48	0	0	0
$\alpha$	1	0	0	0
$\gamma_m$ (kN/m <sup>3</sup> )	19.3	21.1	16.3	14.5
$E_i$ (kN/m <sup>2</sup> )	42,600	36,400	67,000	34,500
$\nu$	0.33	0.30	0.30	0.30

For this reason, the simplified method described previously was developed for use in *LPILE Plus 3.0*. This method models the pile group as a “group-equivalent pile” (GEP), with a rotationally restrained pile head boundary condition. The pile cap is modeled as an enlarged section with pile cap p-y values from *PYCAPSI*. This approach has been used to calculate the load-deflection responses of the foundations tested in this study.

### Integral Bridge Abutments

Integral bridges grow longer when temperatures rise, and they become shorter when temperatures fall. As these bridges grow longer, their abutments are pushed against the approach fills,

and the earth pressures acting on the abutments increase. The method described in the preceding paragraphs, for computing the lateral load resistance of pile caps, can be used to compute these pressures.

The spreadsheet *PYCAPSI*, with appropriate input reflecting the dimensions of the abutment and the properties of the approach fill, can be used to compute the total earth pressure load exerted on the abutment by the approach fill, corresponding to any amount of movement of the abutment toward the fill.

*PYCAPSI* does not provide information regarding the distribution of these earth pressures. Two extremes (uniform, and increasing linearly with depth from zero at the surface) have been used for analysis of pile caps, with essentially the same results. Until more is known about the distributions of these earth pressures, it seems logical to adopt the same approach for integral bridge abutments. That is, to consider two extreme distributions, uniform and triangular, and to base design on the one that produces the most severe effects in the superstructure, in combination with other loads. It would be desirable to study further the distributions of passive earth pressures on integral bridge abutments, and their effects on bridge superstructures when combined with other loads.

## RESULTS

### Single Piles

Load-deflection response curves for the north and south piles were calculated using p-y curves computed using the computer spreadsheet *PYPPILE*. Soil parameters used in the calculations were obtained from laboratory tests, which are summarized in Figure 3. Values for p-y curves were calculated using the pile model shown in Figure 5, and are plotted in Figure 7(a). The p-y values were input into *LPILE Plus 3.0* to calculate the response of single piles to lateral loading. Response curves generated by *LPILE Plus 3.0* include load versus deflection, load versus moment, and load versus shear distributions along the pile length. The load-deflection curves shown in this chapter are referenced to pile deflections at the ground surface, as shown in Figure 19.

Measured load-deflection and load-rotation response curves for the south pile are shown in Figure 20. The north pile measured load-deflection curve is not shown because it was almost identical to that of the south pile. Calculated load-deflection curves are compared to the measured response curve for the south pile in Figure 21. The calculated response curves were obtained using p-y curves from *PYPPILE* with the Mokwa et al. (1997) formulation. As shown in Figure 21(a), the pile-head restraining condition falls between a pure fixed-head (zero slope) and a pure free-head (zero moment) condition. A third response curve was calculated for a rotationally restrained pile-head by back-calculating the rotational restraint  $k_{m0}$ . As shown in Figure 21(b), a  $k_{m0}$  value of 6,215 kN-m/rad was found to provide the best match between calculated and observed load-deflection responses. This illustrates the importance of accurately quantifying the pile-head rotational stiffness.

### Pile Groups with No Cap Resistance

Load-deflection curves for the NE, NW, and SE pile groups at the Kentland Farms facility were calculated using *LPILE Plus 3.0* and the procedure described in this chapter, with the Mokwa et al. (1997) p-y curves. Calculated results were compared to the measured load-deflection curves for

the pile groups. The first comparisons did not include cap resistance. The calculated results were compared to the load tests performed after soil was removed from the sides and the front of the pile caps.

### **NE Pile Group**

The piles in the NE group extended 5.0 meters below the cap, which was 0.91 meters deep.  $p$ - $y$  values for the “group-equivalent pile” for this group were computed using *PYPILE*. Calculated load-deflection curves for assumed fixed-head and free-head boundary conditions are shown in Figure 22(a). Neither of these conditions provides a reasonable estimate of the measured behavior. At a load of 600 kN, the fixed-head case under-predicts the deflection by 67 %, while the free-head case over-predicts the deflection by over 400 %.

The results obtained using a rotationally restrained pile-head boundary condition are in better agreement with the measured deflections, as shown in Figure 22(b). The rotational restraint,  $k_{m\theta} = 227,130$  kN-m/rad, was estimated using the approach described in the previous section. In this case, at a load of 600 kN the calculated deflection was only 17 % greater than the measured deflection, a difference of only 1.01 mm.

### **NW Pile Group**

The piles in the NW group extended 5.3 meters below the cap, which was 0.46 meters deep.  $p$ - $y$  values for the equivalent NW-group-pile were computed using *PYPILE*. Calculated load-deflection curves for assumed fixed-head and free-head boundary conditions are shown in Figure 23(a). Neither of these conditions provides a reasonable estimate of the measured behavior. At a load of 600 kN, the fixed-head case under-predicts the deflection by 56 %, while the free-head case over-predicts the deflection by over 200 %.

The results obtained using a rotationally restrained pile-head boundary condition are considerably more accurate, as shown in Figure 23(b). The rotational restraint,  $k_{m\theta} = 236,170$  kN-m/rad, was estimated using the approach described in the previous section. In this case, at a load of 600 kN the calculated deflection was only 13 % less than the measured deflection, a difference of only 0.76 mm.

### **SE Pile Group**

The piles in the SE group extended 7 feet below the cap, which was 0.91 meters deep.  $p$ - $y$  values for the SE group-pile were computed using *PYPILE*. Calculated load-deflection curves for assumed fixed-head and free-head boundary conditions are shown in Figure 24(a). Neither of these conditions provides a reasonable estimate of the measured behavior. At a load of 400 kN, the fixed-head case under-predicts the deflection by 53 %, while the free-head case was extremely over-conservative, predicting failure at a load of about 178 kN.

The results obtained using a rotationally restrained pile-head boundary condition are shown in Figure 24(b). The rotational restraint,  $k_{m\theta} = 88,366$  kN-m/rad, was estimated using the approach described in the previous section. At a load of 600 kN, the calculated deflection was approximately 100 % greater than the measured deflection, a difference of about 8.63 mm. Although not as accurate as in the cases of the NE and NW pile groups, the calculations are more accurate than assuming fixed-

head or free-head conditions, and provide a conservative approximation that would be reasonable for use in design.

In summary, the method that was developed for estimating the lateral capacity of pile groups provided results that were in reasonable agreement with full-scale lateral load tests at the NE and NW pile groups. The largest difference between calculated and measured load-deflection results occurred for the SE group, which had the shortest piles. The author believes that as the pile lengths decrease, other factors begin to have greater effects on the rotational restraint of the pile head. Piles as short as 7 feet would not typically be used unless they were driven to refusal in a firm bearing strata. The short piles beneath the SE cap were not driven to refusal, and have very small axial capacities. The rotations of the cap will be controlled by the uplift capacity of the trailing piles. Consequently, the SE cap will experience larger rotations because of the small amount of skin resistance that can be developed by its shorter piles. It seems likely that the accuracy of the procedure could be improved by varying the value of  $k_{m\theta}$  to represent a nonlinear variation of  $M$  with  $\theta$ . However, this would complicate the procedure to such an extent that it would be too time-consuming for use in routine practice.



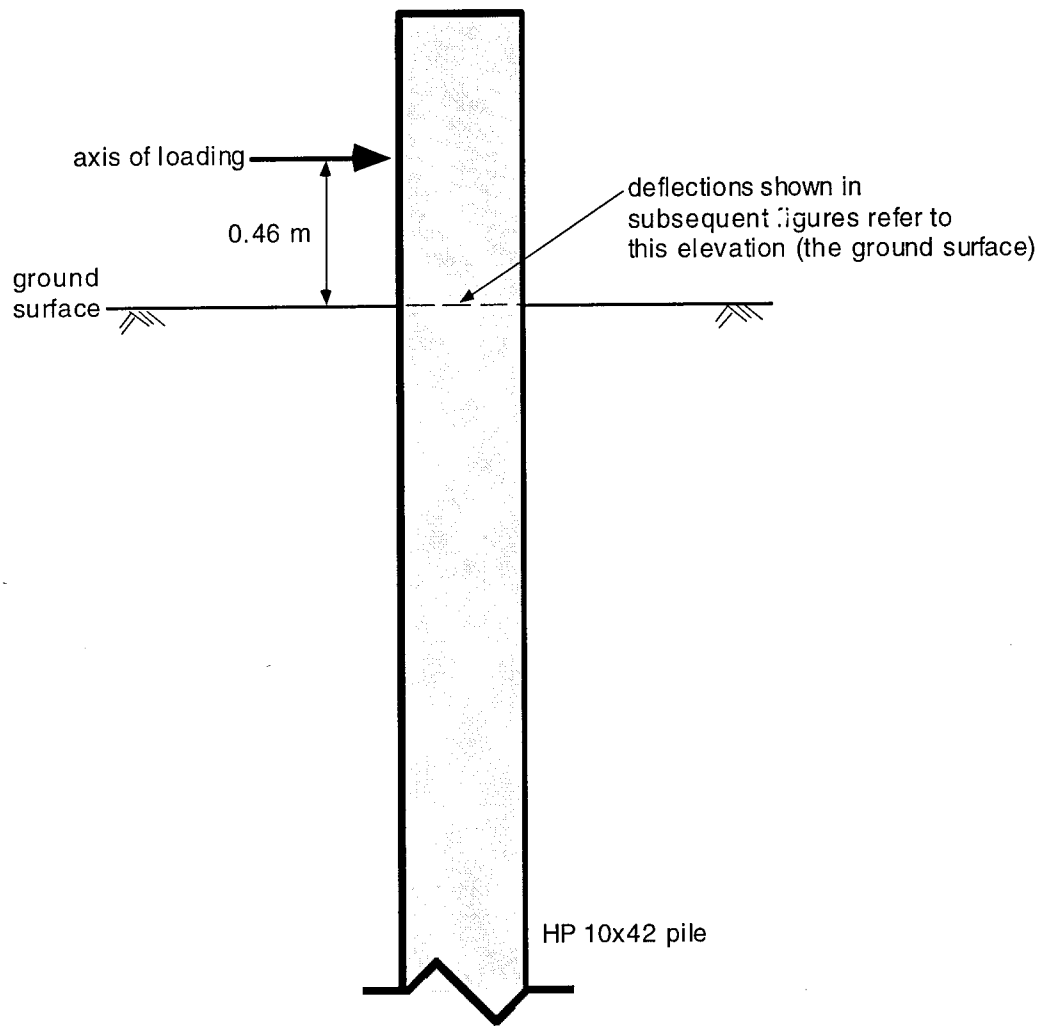
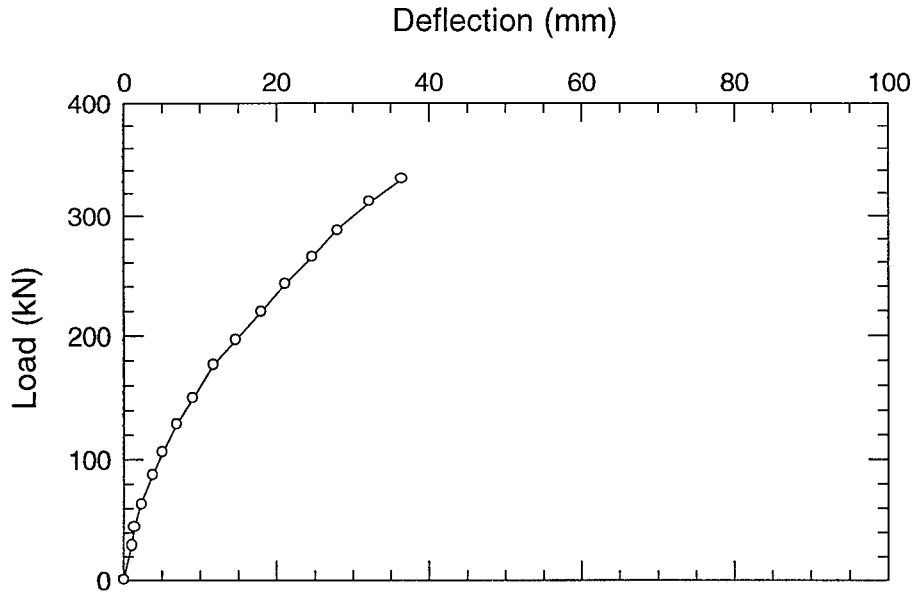
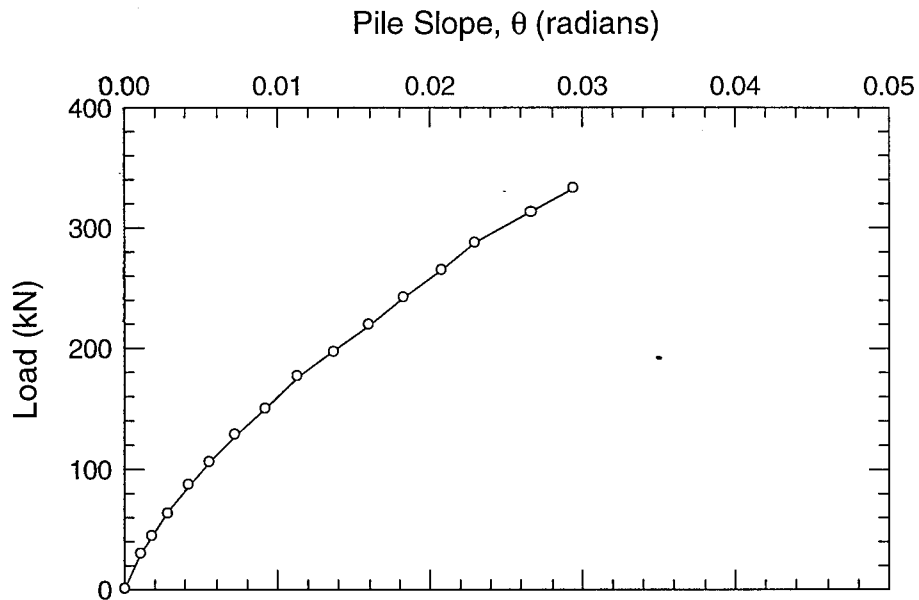

Figure 19. Single pile load testing arrangement.



(a) Measured load versus deflection response.



(b) Measured load versus pile-head rotation.

Figure 20. Measured response of south pile in natural soil.

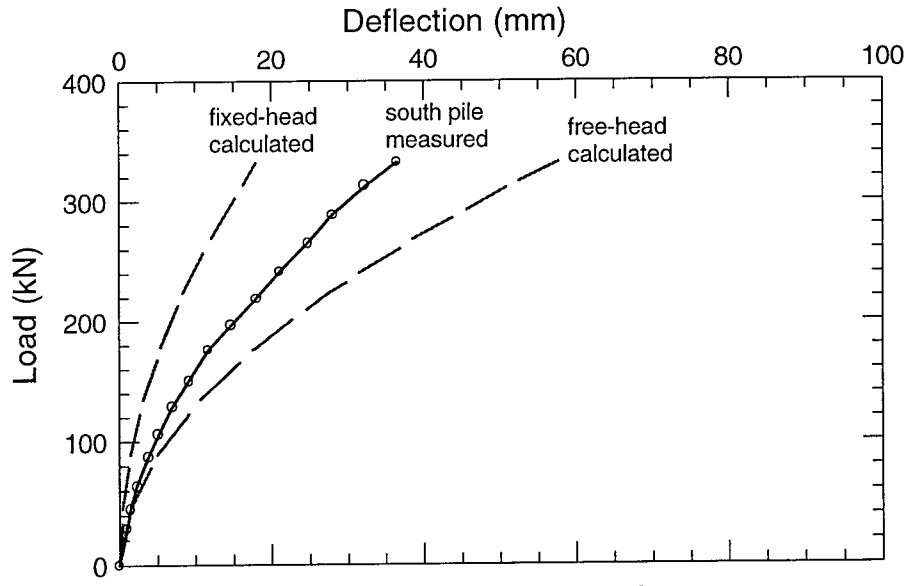

(a) Fixed-head and free-head boundary conditions.

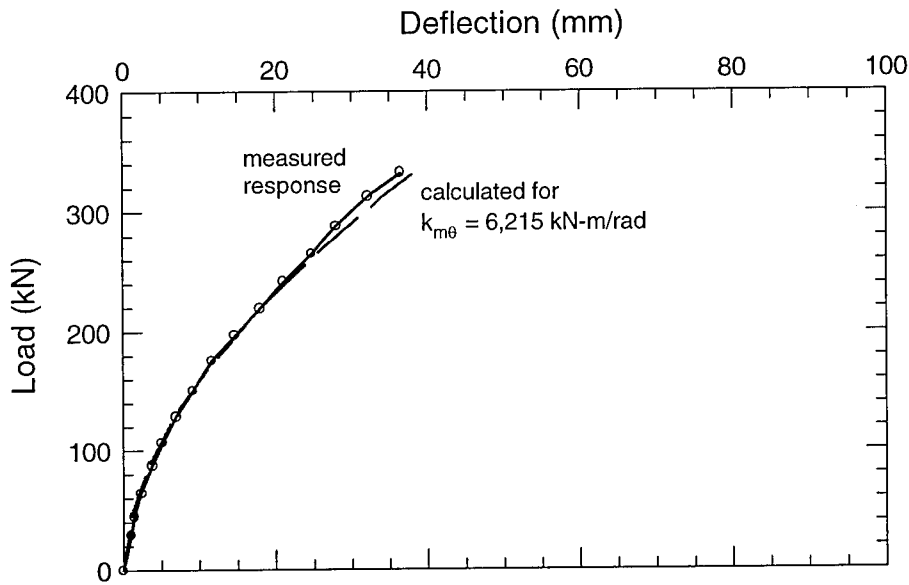

(b) Rotationally restrained pile-head boundary condition, best fit  $k_{m\theta}$  value.

Figure 21. Calculated load-deflection curves for the south pile in natural soil, using p-y curves from *PYSHEET*.

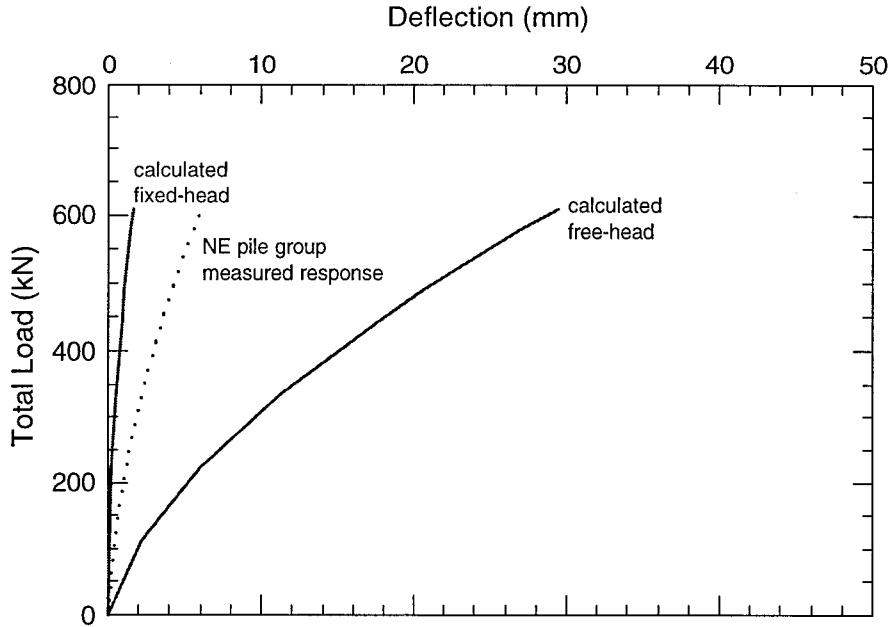

(a) Calculated response for fixed-head and free-head boundary conditions.

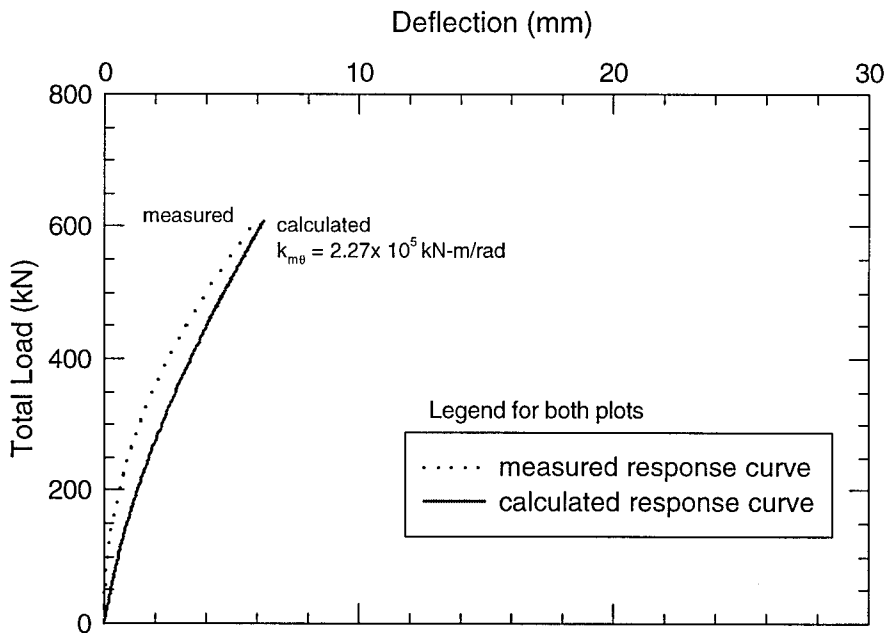

(b.) Calculated response for rotationally restrained pile head boundary condition.

Figure 22. Calculated response for the NE pile group with no cap resistance.

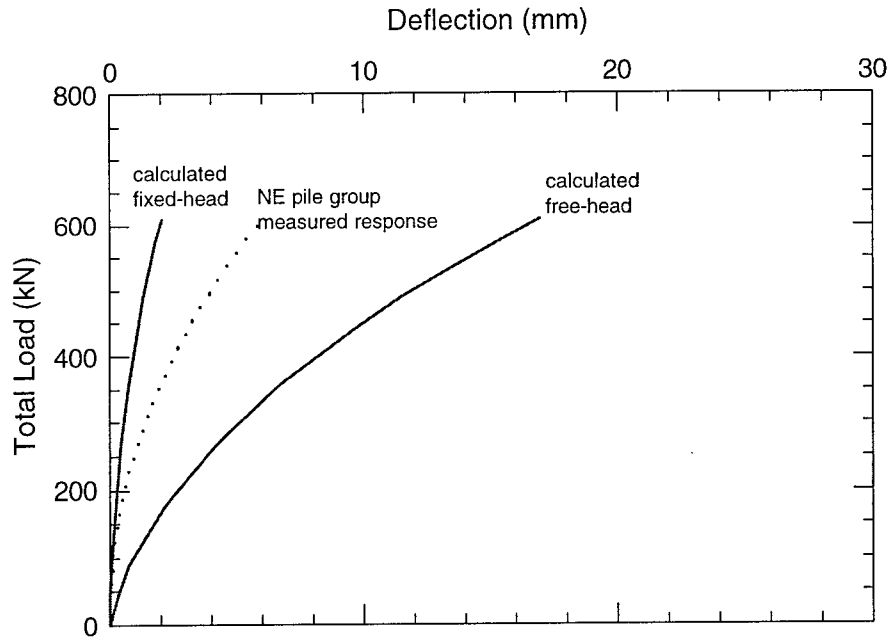

(a) Calculated response for fixed-head and free-head boundary conditions.

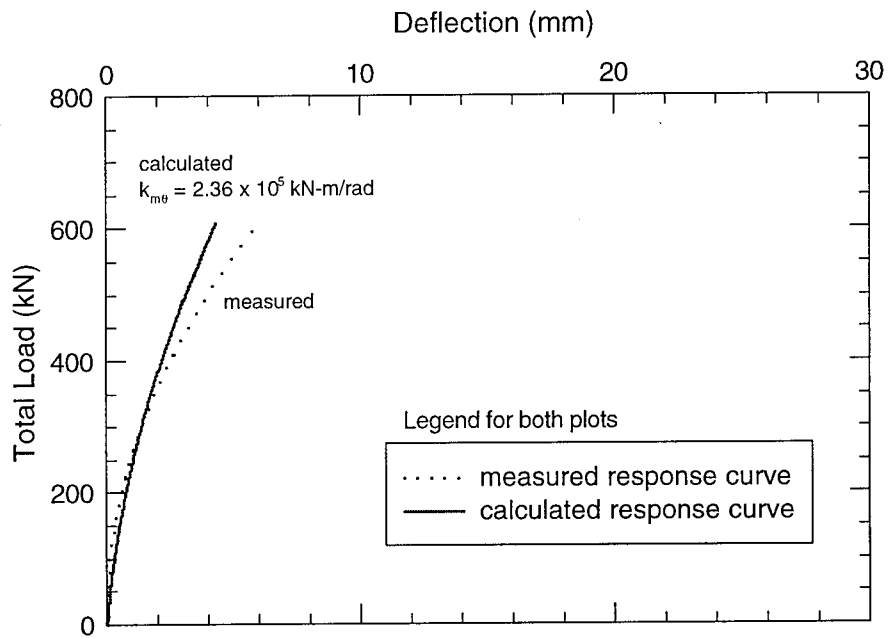

(b.) Calculated response for rotationally restrained pile head boundary condition.

Figure 23. Calculated response for the NW pile group with no cap resistance.

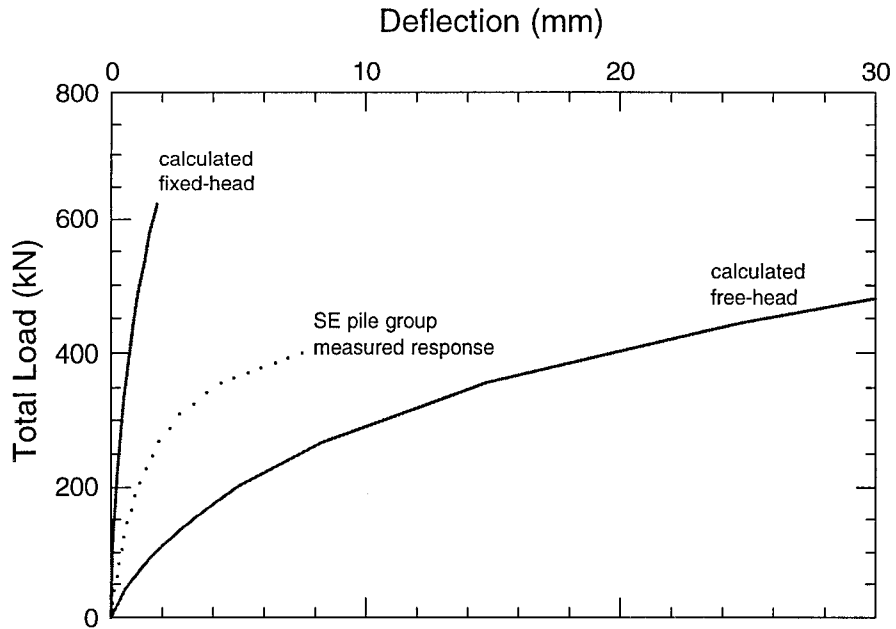

(a) Calculated response for fixed-head and free-head boundary conditions.

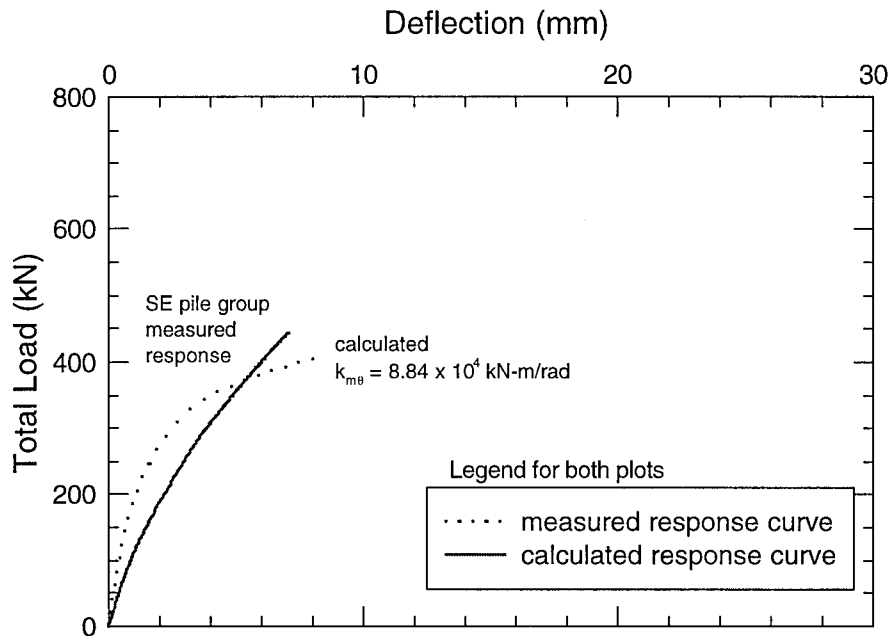

(b.) Calculated response for rotationally restrained pile head boundary condition.

Figure 24. Calculated response for the SE pile group with no cap resistance.

### Passive Resistance of the Bulkhead with No Piles

Using *PYCAPSI*, the passive resistance of the bulkhead was calculated for natural soils at the site and for crusher run gravel backfill. Estimated values of the average soil parameters at the center of the bulkhead were used in the analyses. Even though the applied load was horizontal, a small amount of wall friction developed as soil within the passive failure wedge moved upward, due to the weight of the bulkhead as it moved with the soil. The magnitude of the resulting frictional force is limited to the weight of the bulkhead, which is about 44 kN. This force corresponds to a wall friction angle,  $\delta$ , of about 3.5 degrees for the natural soils, where the computed passive force was 712 kN, and  $\delta = 6.2$  degrees for the crusher run gravel, where the computed passive force was 409 kN.

Average parameters for the natural soils were obtained from Figure 3 and consisted of  $\phi = 37$  degrees,  $c = 46.4 \text{ kN/m}^2$ , and  $\gamma_m = 19.2 \text{ kN/m}^3$ . For a wall friction angle of 3.5 degrees,  $K_{p\phi} = 4.65$ ,  $K_{pc} = 2.11$ ,  $K_{pq} = 0$ , and  $K_a = 0.25$ . Ovesen's R value was 1.43. Using these values, the calculated passive resistance,  $P_{ult}$ , was 712 kN for the bulkhead embedded in natural soil. As shown in Figure 25(a), the calculated ultimate resistance, and the calculated load versus deflection response is in good agreement with the load test results. The *PYCAPSI* output sheet for this analysis shown in Figure 14.

The measured  $\phi'$  values for the crusher run gravel is very high at low confining pressures.  $\phi'$  values as high as 53 degrees were determined at the center of the bulkhead, 0.53 meters below the ground surface. For these low confining pressures and high  $\phi'$  values, some degree of progressive failure seems inevitable as a result of the sharply peaked stress-strain curves. As an allowance for these anticipated failure effects, it was decided to use  $\phi' = 50$  degrees for the compacted crusher run gravel.

For  $\phi' = 50$  degrees,  $c = 0$ ,  $\gamma_m = 21.0 \text{ kN/m}^3$ , and a wall friction angle of 6.2 degrees (corresponding to the weight of the bulkhead):  $K_{p\phi} = 10.22$ ,  $K_{pc} = K_{pq} = 0$ , and  $K_a = 0.13$ . Ovesen's R value was 1.75. Using *PYCAPSI*, the calculated passive resistance,  $P_{ult}$ , was 409 kN for the bulkhead backfilled with crusher run gravel. As shown in Figure 25(b), the calculated ultimate resistance agrees quite well with the load test results, and is slightly conservative.

### Pile Groups with Cap Resistance

Load-deflection response curves were calculated for the 3 pile groups at the Kentland Farms load test facility. The response curves were developed for pile caps embedded in natural soil, and for pile caps backfilled with granular material (crusher run gravel or New Castle sand). The analyses were performed using the following procedure:

- Step 1. Estimate soil parameters.
- Step 2. Calculate single pile p-y curve.
- Step 3. Modify the single pile curve for group effects.

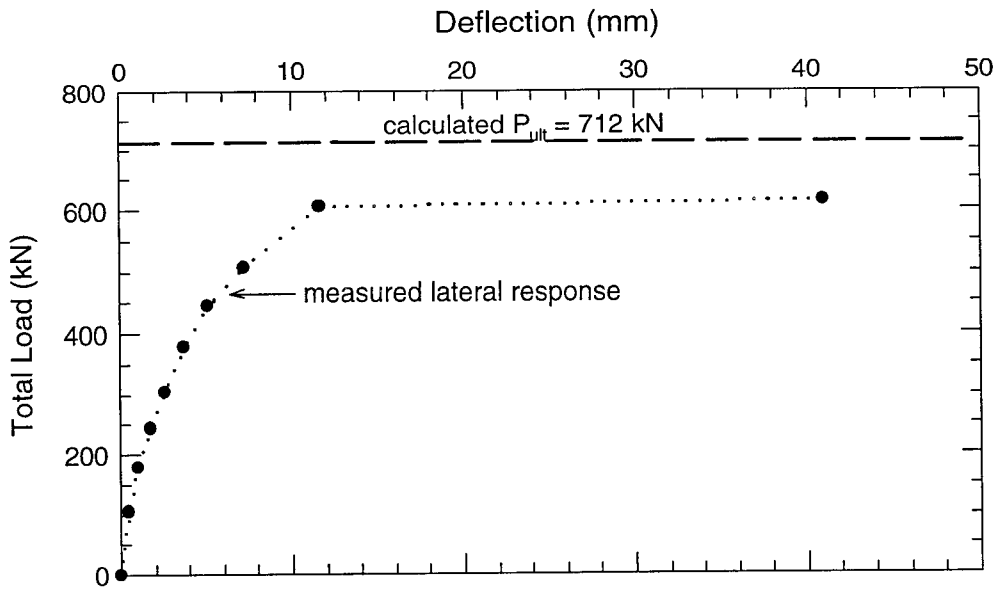

(a) Bulkhead embedded in natural soil.

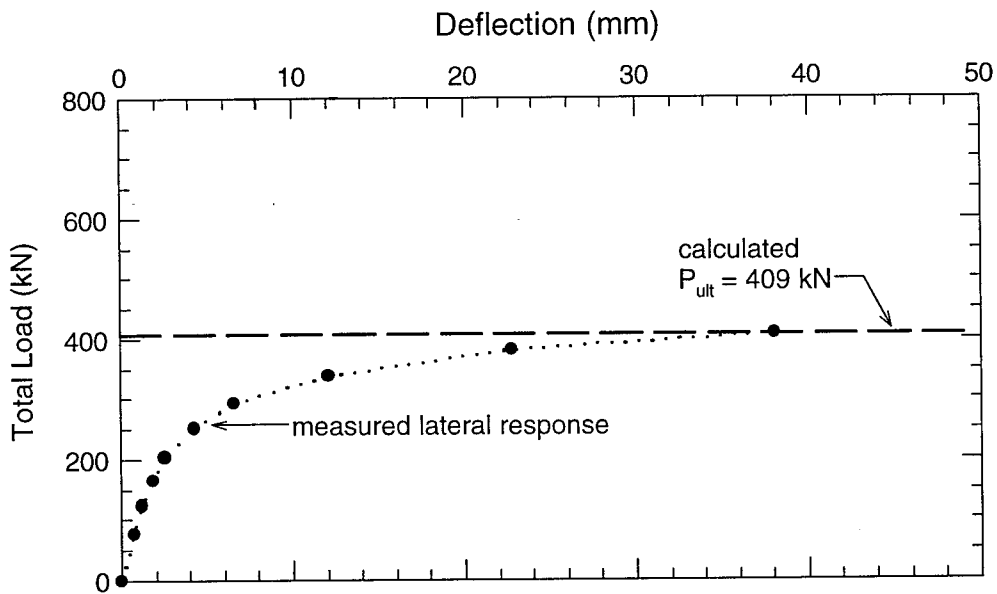

(b) Bulkhead backfilled with compacted crusher run gravel.

Figure 25. Comparison of measured and calculated passive resistance for bulkhead in natural soil and gravel.



- Step 4. Estimate the pile-head rotational restraint.
- Step 5. Determine  $P_{ult}$  for the pile cap.
- Step 6. Determine the initial cap stiffness,  $k_{max}$ .
- Step 7. Develop p-y curves for the pile cap.
- Step 8. Perform the analysis.
- Step 9. Evaluate the results.

Details of each step of the procedure are described in the Discussion Section.

Steps 2 through 7 are automated in the spreadsheet *PYCAPSI*. Step 8 can be performed using lateral analysis computer programs such as *LPILE Plus 3.0*, *GROUP*, or *Florida Pier*. The analyses conducted during this study were performed using the GEP approach with *LPILE Plus 3.0*. The input parameters that were used to calculate pile cap p-y values are summarized in Table 8.

The procedure outlined above was used to calculate load-deflection curves for the three pile groups at the Kentland Farms test facility. These curves were compared to the observed responses measured during the load tests, as described in the following paragraphs.

### **Pile Caps Embedded in Natural Soil**

Analyses were performed for the NE, NW, and SE pile groups with their caps embedded in natural soils. These caps were constructed by pouring concrete against undisturbed natural ground. Intimate, uniform contact was achieved between the cap and natural soil, thus, a relatively high value of wall friction ( $\delta = 0.8\phi$ ) was assumed. The values of soil parameters that were used in the analyses are shown in Table 8. Calculated load-deflection plots are compared to measured response curves in Figure 26. The  $k_{n0}$  values used in the analyses are shown in the plots.

As shown in the plots in Figure 26, the calculated deflections for the three groups were larger than the measured responses and are therefore somewhat conservative. The discrepancy between calculated and measured deflections indicates that the strength of the natural soil in the top 3 feet may have been underestimated. This soil was highly desiccated, making it difficult to obtain undisturbed samples, even using block sampling techniques. Consequently, the triaxial strength tests may have resulted in estimates of shear strength that are smaller than the actual in situ strengths, because of sample disturbance.

The difference between observed and calculated results could also be affected by construction-related factors that are difficult to account for in any analytical method. For example, the method of cap construction can effect the rotational stiffness of the system. The caps were constructed at this test facility by pouring concrete against carefully excavated, undisturbed trench sidewalls. Consequently, cap rotations were probably less than the calculated values. This may explain, in part, the conservative nature of the calculated response curves shown in Figure 26.

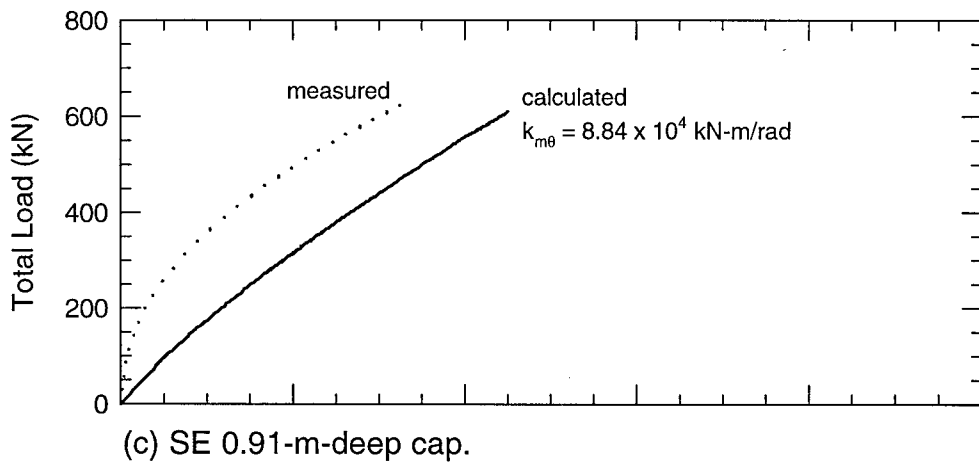
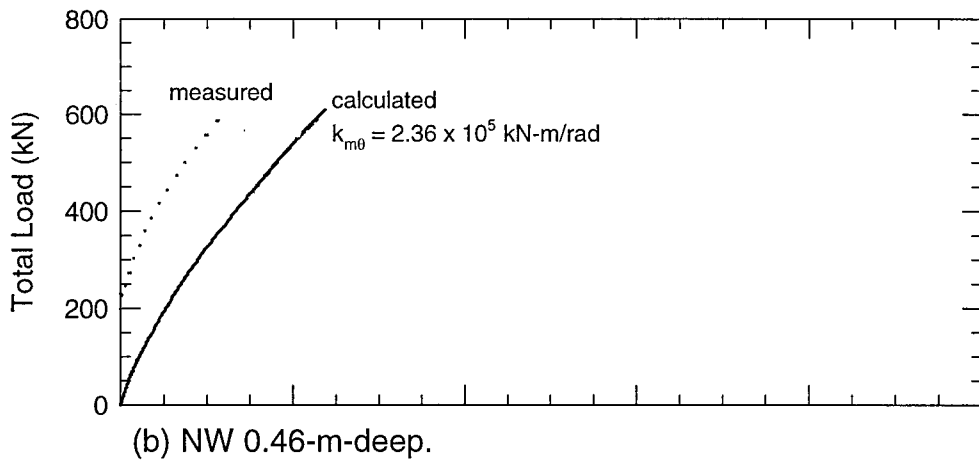
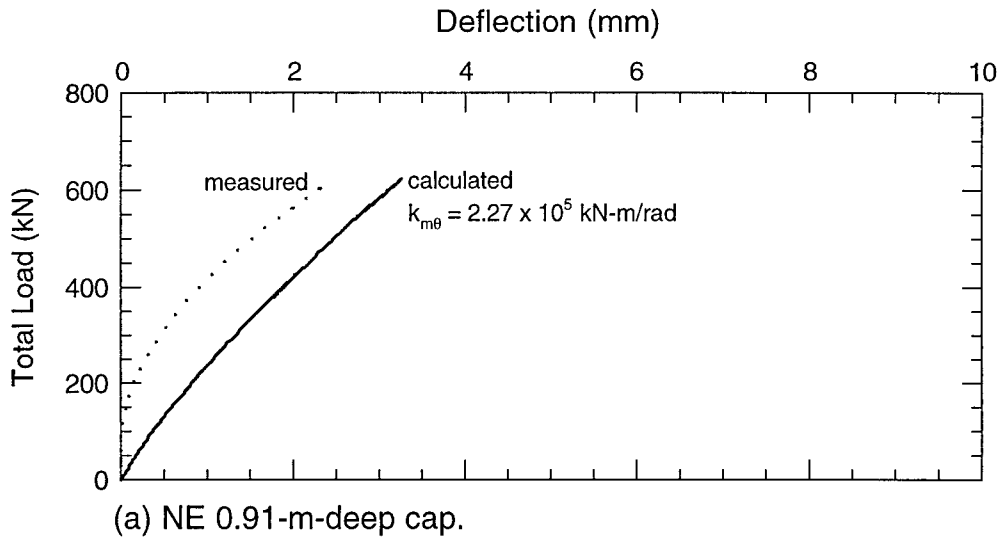

Figure 26. Comparison between calculated and measured responses for pile caps in natural soil.

## **Pile Caps Backfilled with Granular Backfill**

Load tests were performed on the NE, NW, and SE pile caps backfilled with compacted crusher run gravel. The SE cap was also tested using uncompacted and compacted New Castle sand backfill. A comprehensive laboratory program was conducted to develop soil parameters for the backfill materials, based on measured field densities. The soil parameters used in the analyses are summarized in Table 8.

The backfill was placed and compacted around the caps after the natural soil was excavated and removed. During construction, backfill along the cap face was most likely not compacted as well as the backfill in the remainder of the excavation because of difficulties in compacting immediately adjacent to the vertical concrete face. For this reason, the wall friction angle,  $\delta$ , was assumed equal to  $0.5\phi$ .

Results calculated using *PYCAPSI* are shown in Table 7. Calculated load-deflection curves are compared to measured results in Figure 27 for the pile caps backfilled with gravel, and in Figure 28 for the SE cap backfilled with sand.

As shown in Figures 27 and 28, the agreement between measured and calculated results is quite good for the pile caps in granular backfill. For the most part, the differences between calculated and observed deflections were less than 30 %. In the case of the NW cap, the calculated load-deflection curve is virtually identical to the measured response (Figure 27b). The calculated results are conservative in all cases except the SE cap backfilled with New Castle sand. In this case, the calculated deflections are greater than the observed deflections at loads below 311 kN, and the calculated deflections are less than the observed deflection at loads above 311 kN (Figure 28).

## **DISCUSSION**

### **Summary of Design Method**

The preceding sections described the details of the approach developed for analyzing laterally loaded pile groups. The approach can be summarized in a systematic design method, as described below.

#### **Step 1. Estimate soil parameters.**

The soil parameters required for the analyses are:  $\phi$ ,  $c$ ,  $\delta$ ,  $\alpha$ ,  $\nu$ ,  $E_i$ , and  $\gamma_m$ .

Undrained (total stress) values of  $\phi$  and  $c$  should be used for fine-grained soils. These values can be obtained from UU triaxial tests or estimated using correlations with in situ test results, such as those obtained from SPT, CPT or vane shear tests. Drained (effective stress) values should be used for cohesionless soils. Values of  $\phi'$  can be estimated using correlations with in situ test results, such as SPT or CPT, or by performing CD triaxial tests.  $c'$  is usually assumed equal to zero for effective

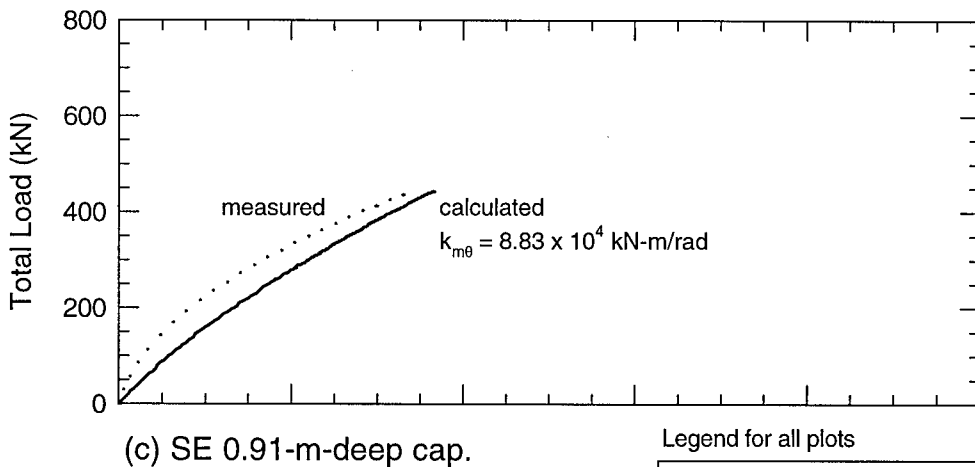
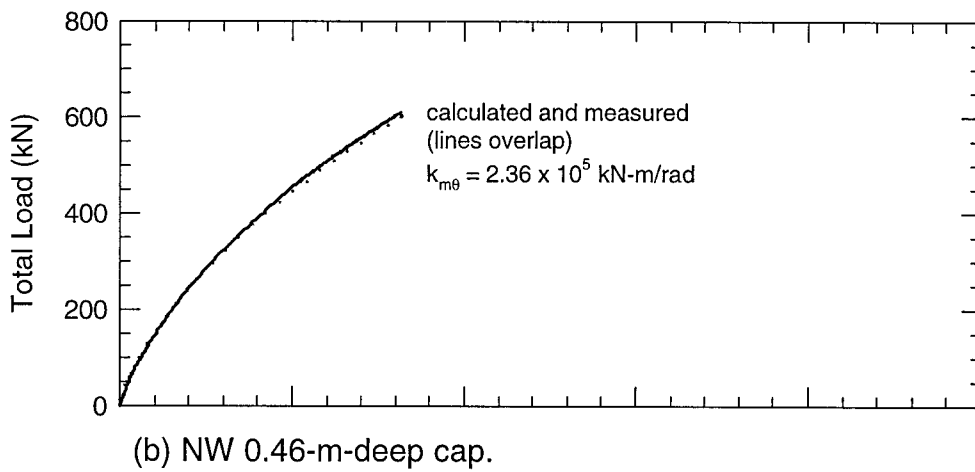
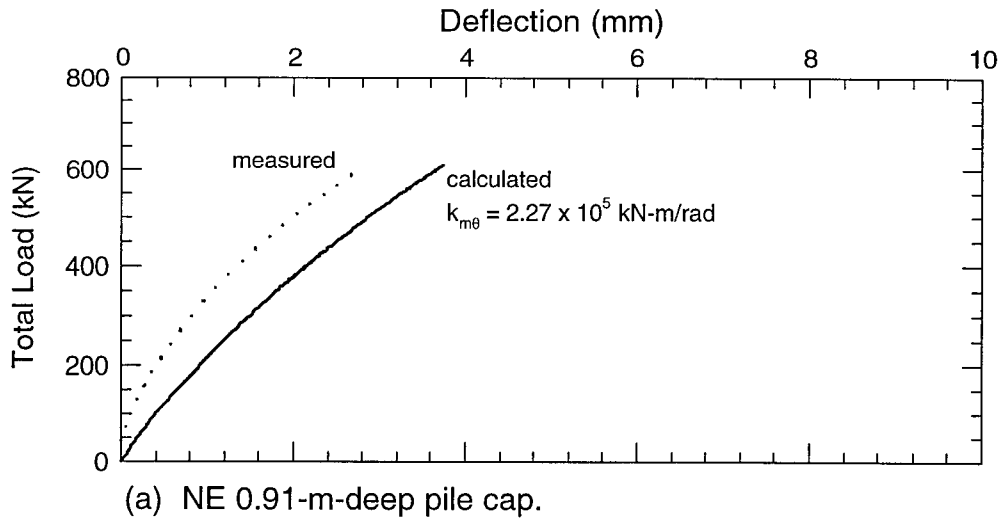

Legend for all plots

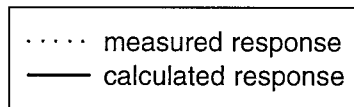
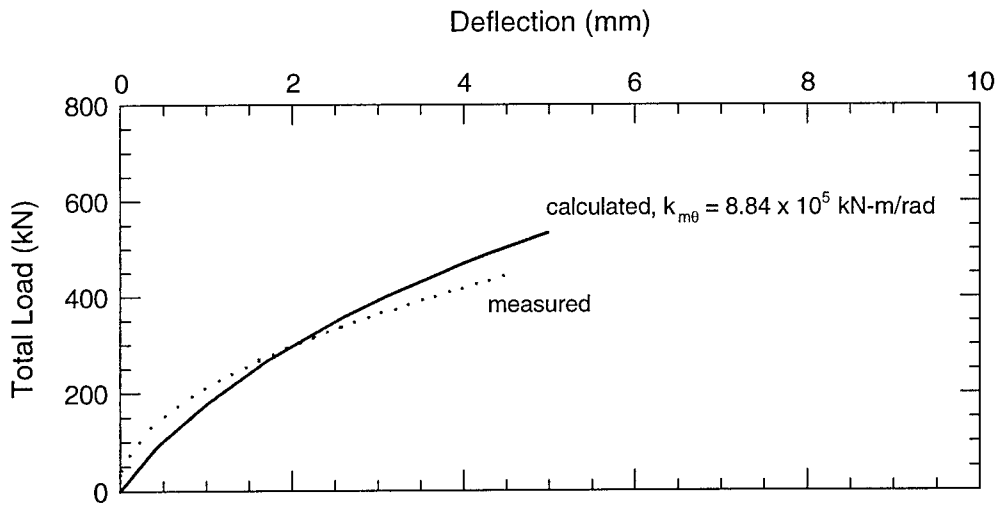
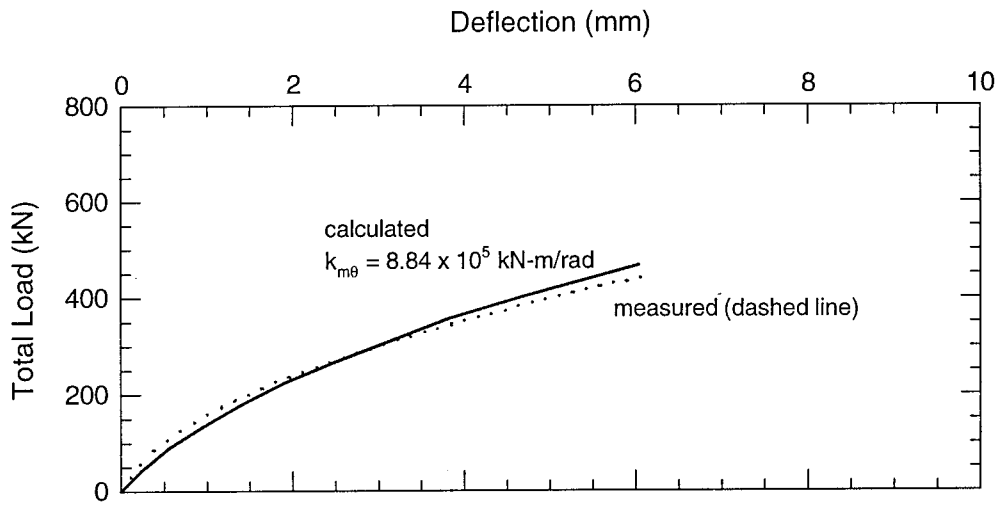

Figure 27. Comparison between calculated and measured responses for pile caps backfilled with crusher run gravel.



(a) SE cap backfilled with compacted sand.



(b) SE cap backfilled with loose sand.

Legend for both plots

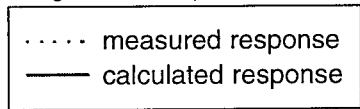

Figure 28. Comparison between calculated and measured responses of SE cap backfilled with New castle sand.

stress analyses. Correlations available in the geotechnical literature can be used to approximate  $\phi'$  if the soil type and relative density, or dry unit weight are known.

Wall friction,  $\delta$ , and the adhesion factor,  $\alpha$ , can be estimated based on type of soil and type of interface material using published values such as those found in NAVFAC DM7.2 (1982).

Poisson's ratio can be estimated from correlations based on type of soil.

Values of initial tangent modulus,  $E_i$ , can be obtained using stress-strain results from triaxial tests or estimated based on type of soil or based on SPT  $N$  values, CPT  $q_c$  values, or  $S_u$  values (see tables in *Foundation Analysis and Design*, Bowles 1982).

### **Step 2. Calculate single pile p-y curves.**

For  $c$ - $\phi$  soils, use Brinch-Hansen's ultimate theory together with the cubic parabola formulation to develop p-y curves. This is done in the spreadsheet *PYPILE*, which is a separate worksheet in *PYCAPSI*. *PYPILE* can also be used for  $c = 0$  or for  $\phi = 0$  soils, or the "default" p-y formulations in *LPILE Plus 3.0* can be used.

### **Step 3. Modify the single pile p-y curves for group effects.**

The group-equivalent pile (GEP) p-y curves are developed in *PYPILE* by multiplying the p-values by the term  $\sum_{i=1}^N f_{mi}$ . Values of  $f_m$  can be obtained from Figure 4. The GEP p-y curves can be copied and pasted from *PYPILE* directly into *LPILE Plus 3.0*.

### **Step 4. Estimate the pile-head rotational restraint, $k_{m\theta}$ .**

The rotational restraint is a function of the side resistance of the piles, the deflection required to mobilize skin friction, and the corresponding moment on the pile cap.  $k_{m\theta}$  is determined using Equation 10. The pile skin friction capacity,  $Q_{si}$ , can be calculated using rational approaches such as the  $\alpha$ -method (Tomlinson 1987),  $\beta$ -method (Esrig and Kirby 1979) and the  $\lambda$ -method (Vijayvergiya and Focht 1972). In situ approaches are also available, such as the SPT method developed by Meyerhof (1976) or the CPT method by Nottingham and Schmertmann (1975). The computer program *SPILE* (1993), available from the FHWA, is useful for computing values of  $Q_{si}$ .

### **Step 5. Determine $P_{ult}$ for the pile cap.**

The ultimate lateral load resistance of the pile cap is determined using the log spiral earth pressure theory and Ovesen's 3-D correction factor. Calculations for  $P_{ult}$  are performed using the *EXCEL* workbook named *PYCAPSI*. *PYCAPSI* contains the worksheets *Summary*, *Log Spiral*, *Hyperbola*, *Elasticity*, and *PYPILE*. Soil parameters and cap dimensions are specified in worksheet *Summary*.  $P_{ult}$  calculations are performed in worksheet *Log Spiral*. The results are displayed in the *Summary* worksheet.

### Step 6. Determine the cap stiffness, $k_{max}$ .

The initial stiffness of the pile cap is approximated using elasticity theory.  $k_{max}$  is calculated using the worksheet *Elasticity*, which is part of the *PYCAPSI* workbook. Soil parameters needed for  $k_{max}$  calculations ( $E_i$  and  $\nu$ ) and cap dimensions are specified in the *Summary* worksheet. Calculations for  $k_{max}$  are performed automatically when worksheet *Summary* is activated.

### Step 7. Develop p-y curves for the pile cap

Pile cap p-y values are developed using the hyperbolic formulation with  $P_{ult}$  and  $k_{max}$ . Parameters are specified in the *Summary* worksheet, calculations are performed in the *Hyperbolic* worksheet, and the results, p-y values, are displayed in the *Summary* worksheet. The cap p-y values can be copied and pasted from the *Summary* worksheet directly into *LPILE Plus 3.0*.

### Step 8. Perform the analysis.

The lateral response of the pile group is analyzed using *LPILE Plus 3.0*. p-y curves developed for the GEP (Step 3) and for the pile cap (Step7) are used to represent the soil resistance. The pile group is modeled as a single pile with EI equal to the sum of the EI values for all of the piles in the group. The cap is modeled by enlarging the top portion of the GEP based on the cap dimensions. A rotationally restrained pile-head boundary condition is specified using the value of  $k_{m0}$  calculated during Step6.

### Step 9. Evaluate the results.

The calculated displacements of the GEP correspond to the displacements of the actual pile group. However, to determine the shear forces (V) and moments (M) of the piles within the group, the shear forces and moments of the GEP are factored based on the pile's row multiplier,  $f_{mi}$  and the EI value for each pile. This is done as follows:

$$V_i = V_{gep} \left( \frac{f_{mi} EI_i}{\sum_{i=1}^N (f_{mi} EI_i)} \right) (f_{mc}) \quad \text{Equation 22}$$

where  $V_i$  is the shear in pile  $i$ ,  $V_{gep}$  is the total shear for the GEP,  $N$  is the number of piles,  $f_{mi}$  is the p-multiplier for the row containing the pile of interest ( $f_m$  is obtained from Figure 4),  $EI_i$  is the flexural stiffness of pile  $i$ , and  $f_{mc}$  is a multiplier for corner piles. Corner piles in the leading row carry a larger share of the load than non-corner piles. Consequently, the corner piles will have larger shear forces and bending moments. The multiplier,  $f_{mc}$ , is an adjustment factor to account for larger values of  $V_i$  and  $M_i$  in the corner piles. Based on 1g model tests by Franke (1988), the values shown in Table 9 are recommended for  $f_{mc}$ :

**Table 9.** Corner pile adjustment factor.

<b>Pile spacing measured normal to direction of load</b>	<b><math>f_{mc}</math> factor</b>
non-corner piles	1.0
$\geq 3D$	1.0
2D	1.2
1D	1.6

The moment in pile  $i$  is computed as:

$$M_i = M_{gep} \left( \frac{f_{mi} EI_i}{\sum_{i=1}^N (f_{mi} EI_i)} \right) (f_{mc}) \quad \text{Equation 23}$$

where  $M_i$  is the moment in pile  $i$  and  $M_{gep}$  is the moment computed for the GEP.

Equations 22 and 23 can be simplified using a distribution coefficient called  $D_i$ , which is defined as:

$$D_i = \left( \frac{f_{mi} EI_i}{\sum_{i=1}^N (f_{mi} EI_i)} \right) \quad \text{Equation 24}$$

Thus, the shear and moment in pile  $i$  are determined using the following equations:

$$V_i = V_{gep} D_i f_{mc} \quad \text{Equation 25a}$$

$$M_i = M_{gep} D_i f_{mc} \quad \text{Equation 25b}$$

## SUMMARY

The program of work accomplished in this study includes performing a detailed literature review on the state of knowledge of pile group and pile cap resistance to lateral loads, developing a full-scale field test facility, conducting numerous lateral load tests on pile groups and individual piles, performing laboratory tests on natural soils obtained from the site and on imported backfill materials,



and the development of an analytical method that can be used by practicing engineers for including the lateral resistance of pile caps in the design of deep foundation systems.

This report describes the analytical approach that was developed for evaluating the lateral response of pile groups with embedded caps. The approach involves creating p-y curves for single piles, pile groups, and pile caps using the computer spreadsheets *PYPILE* and *PYCAPSI*.

Single pile p-y curves are developed using Brinch Hansen's (1961) ultimate load theory for soils that possess both cohesion and friction. The approach is programmed in *PYPILE*, which can be used to calculate p-y curves for piles of any size, with soil properties that are constant or that vary with depth.

"Group-equivalent pile" (GEP) p-y curves are obtained by multiplying the "p" values of the single pile p-y curves by a modification factor that accounts for reduced capacities caused by group interaction effects, and summing the modified p-values for all the piles in the group. The p-multiplier curves developed in this study are used for this purpose. The pile group is modeled in the computer program *LPILE Plus 3.0* using the GEP p-y curves. The flexural resistance of the GEP pile is equal to the sum of the flexural resistances of all the piles in the group.

A rotationally restrained pile-head boundary condition is used in the analysis. The rotational stiffness is estimated from the axial skin friction of the piles, the deflection required to mobilize skin friction, and the corresponding moment on the pile cap.

Pile cap resistance is included in the analysis using cap p-y curves. A method of calculating cap p-y curves was developed during this study, and has been programmed in the spreadsheet *PYCAPSI*. The approach models the passive earth pressures developed in front of the cap. These passive pressures are represented by p-y curves developed from a modified hyperbolic formulation, which is defined by the ultimate passive force and the initial elastic stiffness of the embedded pile cap. The ultimate passive force is determined using the log spiral earth pressure theory in conjunction with Ovesen's (1964) three-dimensional correction factors.

The GEP approach for creating pile group and pile cap p-y curves provides a means of modeling the soil in a way that is compatible with established approaches for analyzing laterally loaded single piles. *LPILE Plus 3.0* was used to calculate load-deflection curves for the pile groups tested in this study, and for a load test described in the literature. Comparisons between measured and calculated load-deflection responses indicate that the analytical approach developed in this study is conservative, reasonably accurate, and suitable for design purposes. Deviations between calculated and measured load-deflection values fall well within the practical range that could be expected for analyses of the lateral response of pile groups. This approach represents a significant improvement over current design practices, which often completely ignore the cap resistance.

The authors believe it would be difficult to obtain more accurate estimates of pile group behavior, even with more complex analytical methods, because of the inevitable uncertainties and variations in soil conditions, unknown or uncontrollable construction factors, and the complex structural and material interactions that occur between the piles, pile cap, and soil.

The results of this research are expected to improve the current state of knowledge regarding pile group and pile cap behavior and to provide a practical, rational, and systematic approach for

assessing and quantifying the lateral resistance that pile caps provide to deep foundation systems. The authors believe that the analytical approach developed during this research is suitable for all except the largest projects, where lateral load behavior of pile groups is an extremely critical issue. For projects where the expense can be justified, the design method can be verified or improved by performing on-site full-scale load tests on groups of instrumented piles.

## CONCLUSIONS AND RECOMMENDATIONS

It is clear, from examples in the literature and from the field tests performed on pile groups at Virginia Tech's field test site that pile caps and integral abutments provide considerable resistance to lateral loads. Neglecting this resistance in design results in excessive estimates of pile group deflections and bending moments under load, and underestimates the foundation stiffness. In many situations, neglecting cap resistance introduces inaccuracies of one hundred percent or more. There is a need for rational procedures to include cap resistance in the design of pile groups to resist lateral loads. This research has made it possible to quantify many important aspects of pile group and pile cap behavior under lateral loads caused by occurrences such as wind, wave action, and bridge deck thermal expansions and contractions.

The systematic approach described in this report is recommended for calculating the lateral response of pile supported structures such as pile caps and integral bridge abutments. The approach is automated in the computer program *PYCAPSI*, and consists of the following steps:

1. Estimate the soil parameters, including  $\phi$ ,  $c$ ,  $\delta$ ,  $\alpha$ ,  $\nu$ ,  $E_s$ , and  $\gamma_m$
2. Calculate single pile p-y curves using *PYPILE*.
3. Modify the single pile p-y curves using the p-multiplier values shown in Figure 4.
4. Estimate the pile-head rotational restraint,  $k_{m\theta}$ , using Equation 10.
5. Compute the ultimate lateral load resistance of the pile cap or integral bridge abutment. The approach is based on the log spiral earth pressure theory modified for three-dimensional effects.
6. Determine the cap stiffness,  $k_{max}$  using elasticity theory.
7. Develop p-y curves for the pile cap or integral abutment. These are computed and displayed in the *Summary* worksheet of the workbook *PYCAPSI*.
8. Compute displacements, bending moments, and shear forces in the foundation using the p-y curves developed in step 7 in conjunction with finite difference computer programs such as *LPILE Plus 3.0* or *COM624*. The p-y curves developed in step 7 are expected to be suitable for use in future versions of the finite element computer program *Florida Pier* (1998).

The spreadsheet *PYCAPSI* can be used to compute the total earth pressure load exerted on integral bridge abutments, corresponding to any amount of movement of the abutment toward the fill.

It would be desirable to study further the distributions of passive earth pressure on integral bridge abutments, and their effects on bridge superstructures when combined with other loads.

### ACKNOWLEDGEMENTS

The Virginia Transportation Research Council and the Virginia Department of Transportation provided funding for this work. In addition, Mr. Mokwa's participation in this project was funded by a Charles E. Via, Jr. Fellowship from the Virginia Tech Civil and Environmental Engineering Department.

Mr. Scott Aker of Coalfield Services, Inc., Wytheville, Virginia, donated approximately \$5,000 in piles and pile driving equipment and services.

The authors would like to express their appreciation to Dr. Edward Hoppe of the Virginia Transportation Research Council for his guidance and helpful suggestions regarding this research study.

Virginia Tech graduate students Craig Benedict, Brian Metcalfe, Sami Arsoy, and Jeff McGregor provided valuable assistance during the construction and testing phases of the project. Dr. Tom Brandon assisted during the site field investigation and in developing the data acquisition system. Dr. Tom Murray reviewed the structural design drawings of the loading apparatus and pile caps. Mr. Dennis Huffman and Mr. Brett Farmer fabricated several parts of the field load test apparatus. Without the able assistance of these many people, this study would not have been possible.

### REFERENCES

- Beatty, C. I. (1970). *Lateral test on pile groups*. Foundation Facts, VI(1), 18-21.
- Bowles, J. E. (1982). *Foundation Analysis and Design*, McGraw-Hill Book Company, New York, NY.
- Brown, D. A., Morrison, C., and Reese, L. C. (1988). *Lateral load behaviour of pile group in sand*. ASCE Journal of Geotechnical Engineering, 114(11), 1261-1276.
- Caquot, A. I., and Kerisel, J. (1948). *Tables for the calculation of passive pressure, active pressure, and bearing capacity of foundations*. Libraire du Bureau des Longitudes, de L'ecole Polytechnique, Paris Gauthier-villars, Imprimeur-Editeur, 120.
- Clough, G. W., and Duncan, J. M. (1971). *Finite element analyses of retaining wall behavior*. ASCE Journal of the Soil Mechanics and Foundations Division, 97(SM12), 1657-1672.
- Davisson, M. T. (1975). *Pile load capacity*. Design Construction and Performance of Deep Foundations, San Francisco, CA, 1-49.
- Douglas, D. J., and Davis, E. H. (1964). *The movements of buried footings due to moment and horizontal load and the movement of anchor plates*. Geotechnique, 14(2), 115-132.

- Duncan, J. M., Byrne, P., Wong, K. S., and Mabry, P. (1980). *Strength, stress-strain and bulk modulus parameters for finite element analysis of stress and movements in soil masses*. UCB/GT/80-01, College of California, Berkeley, California.
- Duncan, J. M., and Chang, C. Y. (1970). *Nonlinear analysis of stress and strain in soils*. ASCE Journal of the Soil Mechanics and Foundations Division, 96(SM5), 1629-1653.
- Esrig, M. E., and Kirby, R. C. (1979). *Advances in general effective stress method for the prediction of axial capacity for driven piles in clay*. 11th Annual Offshore Technology Conference, Houston, Texas, 437-449.
- Florida Pier (1998). *User's manual for Florida Pier*. NT Version 1.27, Prepared by the Department of Civil Engineering University of Florida, Gainesville, Florida.
- Franke, E. (1988). *Group action between vertical piles under horizontal loads*, W.F. Van Impe, ed., A.A. Balkema, Rotterdam, The Netherlands, p. 83 - 93.
- Gardner, W. S. (1975). *Considerations in the design of drilled piers*. Design Construction and Performance of Deep Foundations, San Francisco, CA, 1-32.
- GROUP (1996). *A program for the analysis of a group of piles subjected to axial and lateral loading*. Version 4.0 by Lymon Reese, Shin Tower Wang, Jose A. Arrellaga, and Joe Hendrix (for ENSOFT, Inc), Austin Texas.
- Hansen, B. (1961). *The ultimate resistance of rigid piles against transversal forces*. Bulletin No. 12, Danish Geotechnical Institute, Copenhagen.
- Hoit, M. (1999). Personal communication with Marc Hoit, University of Florida, co-creator of Florida Pier computer program.
- Kim, J. B., and Singh, L. P. (1974). *Effect of pile cap - soil interaction on lateral capacity of pile groups*. Master of Science Thesis, Dept. of CE, Bucknell University, Lewisburg, PA.
- Kulhawy, F. H. (1984). *Limiting tip and side resistance*. Analysis and Design of Pile Foundations, ASCE National Convention, San Francisco, CA, 80-98.
- Ladd, R. S. (1978). *Preparing test specimens using undercompaction*. Geotechnical Testing Journal, GTJODJ, 1(1), 16 - 23.
- LPILE (1997). *A program for the analysis of piles and drilled shafts under lateral loads*. Computer program by Lymon Reese, Shin Tower Wang, Jose A. Arrellaga, and Joe Hendrix, ENSOFT, Inc.
- Meyerhof, G. G. (1976). *Bearing capacity and settlement of pile foundations*. ASCE Journal of the Geotechnical Engineering Division, 102(GT3), 196-228.

- Mokwa, R. L., Duncan, J. M., and Arsoy, S. (1998). "Report of research on resistance of pile caps and integral abutments to lateral loading." *A report of research performed under sponsorship of the Virginia Transportation Research Council*, Virginia Tech, Blacksburg, VA.
- Mokwa, R. L., Duncan, J. M., and Helmers, M. J. (1997). *Deflections and bending moments in drilled shaft sound wall foundations under working load conditions*. The Charles E. Via, Jr. Department of Civil Engineering, Virginia Tech, Blacksburg, VA.
- NAVFAC (1982). *Foundations and earth structures design manual 7.2*. Dept. of the Navy, Naval Facilities Engineering Command, Alexandria, VA.
- Nordlund, R. L. (1963). *Bearing capacity of piles in cohesionless soils*. ASCE Soil Mechanics and Foundation Journal, SM(3).
- Nottingham, L., and Schmertmann, J. (1975). *An investigation of pile capacity design procedures*. Final Report D629 to FDOT from the Dept. of Civil Engineering, Univ. of Florida, September, 159.
- Ovesen, N. K. (1964). *Anchor slabs, calculation methods and model tests*. Bulletin No. 16, The Danish Geotechnical Institute, Copenhagen.
- Potyondy, J. G. (1961). *Skin friction between various soils and construction materials*. Geotechnique, 11(1), 339-353.
- Reese, L. C., and Sullivan, W. R. (1980). *Documentation of computer program COM624*. University of Texas, Austin, TX.
- Reese, L. C., and Wang, S. T. (1997). *LPILE Plus 3.0 Technical manual of documentation of computer program*. Ensoft, Inc., Austin, Texas.
- Rollins, M., K., Weaver, T. J., and Peterson, K. T. (1997). *Statnamic lateral load testing of a full-scale fixed-head pile group*. Report, UDOT, FHWA.
- SPILE (1993). *A microcomputer program for determining ultimate vertical static pile capacity - users manual*. by, Alfredo Urzua, U.S. Dept. of Transportation, FHWA-SA-92-044, June, 43 pages.
- Terzaghi, K. (1932). *Record earth-pressure testing machine*. Engineering News Record, 109, September, 365-369.
- Terzaghi, K. (1934). *Large retaining wall tests. Part V. Pressure of glacial till*. Engineering News Record, III, 503-508.
- Terzaghi, K. (1934a). *Large retaining wall tests. Part I. Pressure of dry sand*. Engineering News Record, February, 136-140.

Terzaghi, K. (1955). *Evaluation of coefficient of subgrade reaction*. *Geotechnique*, 5(4), 297-326.

Tomlinson, M. J. (1987). *Pile Design and Construction*. Viewpoint Publication, 415 pages.

Vijayvergiya, V. N., and Focht, J. A. (1972). *A new way to predict the capacity of piles in clay*. 4th Annual Offshore Technology Conference, Houston, Texas, Vol. 2, 865-874.

Zafir, Z., and Vanderpool, W. E. (1998). *Lateral response of large diameter drilled shafts: I-15/US 95 load test program*. Proceedings of the 33rd Engineering Geology and Geotechnical Engineering Symposium, University of Nevada, Reno, 161-176.