

**EXAMINING THE EFFECTS OF MIXER TYPE AND
TEMPERATURE ON THE PROPERTIES OF ULTRA-HIGH
PERFORMANCE CONCRETE**

MBTC-3012

By

Andrew M. Tackett

&

W. Micah Hale

The contents of this report reflect the views of the author, who is responsible for the facts and accuracy of the information presented herein. This document is disseminated under the sponsorship of the Department of Transportation, University Transportation Centers Program, in the interest of information exchange. The U.S. Government assumes no liability for the contents or use thereof.

ABSTRACT

Ultra-High Performance Concrete (UHPC) is a highly advanced material that has been created as a result of many years of concrete research and development. UHPC addresses a number of concerns that plague most concrete types by taking advantage of today's latest technology in order to produce this innovative product.

Although UHPC is known for producing many beneficial qualities for concrete users, because of the unique makeup of the material, there are some areas that remain unexplored. For instance, the mixer typically specified to batch UHPC is a high shear/energy mixer (e.g. pan). Currently, little information is known as to whether a beneficial or negative impact may be experienced in concrete properties (e.g. flow, strength, MOE) when a lower shear/energy mixer (e.g. drum/ready-mix truck) is used. Another point of interest that has not been explored is the effect on fresh concrete temperature produced when the dry constituent mixing materials (also referred to as premix), such as portland cement, aggregate, silica fume, and ground quartz, are placed at some specific temperature and batched with ice as a replacement for mixing water.

Because of these two uncertainties, the goal of this thesis is to rectify such unknowns. Two studies were fashioned addressing the issues listed in the previous paragraph. Both studies documented UHPC fresh (flow and temperature) and hardened properties (modulus of elasticity and compressive strength) to gather information for analysis purposes.

The influence of ice on resultant batch temperature could not be determined for the small pan made batches. The drum mixed batches, with their larger volume of materials, proved more beneficial for analysis. Flows for both mixers were erratic over time, but were generally within the acceptable specifications; this fact was dependent upon the type of mixer used.

Two different curing procedures were used during the research period. The type of curing regimen used largely influenced UHPC hardened properties. Depending upon the type of curing method used, a stark difference in ultimate strength and MOE values could be observed.

TABLE OF CONTENTS

CHAPTER 1	INTRODUCTION.....	1
1.1	GENERAL	1
1.2	OBJECTIVES.....	1
1.3	SCOPE.....	3
CHAPTER 2	LITERATURE REVIEW.....	4
2.1	GENERAL	4
2.2	HISTORY OF EARLY CONCRETE	4
2.3	UHPC	5
2.3.1	Fibers	8
2.3.2	UHPC Types	10
2.4	MIXERS.....	16
2.4.1	Batch Mixers.....	16
2.4.2	Continuous Mixers	18
2.4.3	Differences between Batch and Continuous Mixers	18
2.5	CONCRETE MIXING	19
2.6	CONCRETE TEMPERATURE.....	21
2.6.1	Preventing High Fresh Concrete Temperatures	22
2.6.2	Effect of Concrete Temperature on Admixture Performance.....	23
2.7	CONCLUSION	24
CHAPTER 3	EXPERIMENTAL PROCEDURES AND RESEARCH PROGRAM	25
3.1	GENERAL	25
3.2	SCOPE.....	25
3.3	TEMPERATURE STUDY.....	26

3.3.1	Premix Temperature Conditions	27
3.4	MIXER STUDY.....	29
3.4.1	Hobart®/Blakeslee® Pan Mixer Information	30
3.4.2	Stone® Rotating Drum Information.....	30
3.4.3	Ready-Mix Truck Information.....	31
3.5	MATERIALS.....	31
3.5.1	Superplasticizer.....	31
3.5.2	Premix	31
3.5.3	Fibers	31
3.6	PRECISION.....	31
3.7	THERMOCOUPLE TEMPERATURE RECORDING	32
3.7.1	Fiber and Premix Resistance to Changes in Temperature.....	32
3.7.2	UHPC Heat Evolution.....	33
3.8	BATCHING METHODS.....	34
3.8.1	Full Batch Method	34
3.8.2	Half Batch Method.....	38
3.9	SAMPLING.....	40
3.10	CASTING AND CURING	41
3.11	FRESH CONCRETE TESTS	41
3.11.1	Temperature.....	41
3.11.2	Flow.....	42
3.12	HARDENED CONCRETE TESTS.....	43
3.12.1	Compressive Strength.....	43

3.12.2	Modulus of Elasticity	43
CHAPTER 4	RESULTS AND ANALYSIS	45
4.1	GENERAL	45
4.2	TEMPERATURE STUDY.....	45
4.2.1	Fresh Concrete Properties	45
4.2.2	Hardened Concrete Properties	62
4.3	MIXER STUDY.....	68
4.3.1	Mixture Homogeneity	68
4.3.2	Mixing Time	70
4.3.3	Premix Shelf Life	73
4.3.4	Hardened Concrete Properties	74
CHAPTER 5	CONCLUSIONS AND RECOMMENDATIONS.....	79
5.1	GENERAL	79
5.2	TEMPERATURE STUDY.....	79
5.2.1	Fresh Concrete Properties	79
5.2.2	Hardened Concrete Properties	81
5.3	MIXER STUDY.....	82
5.3.1	Fresh Properties.....	82
5.3.2	Mix Time.....	82
5.3.3	Hardened Concrete Properties	83
5.4	RECOMMENDATIONS.....	84
REFERENCES.....		87

LIST OF FIGURES

Figure 2.1	Typical UHPC® Cylinder Failure.....	14
Figure 2.2	Comparison of Pan and Drum Mixers.....	17
Figure 3.1	Illustration of Hobart®/Blakeslee® Mixing Motion. ³²	30
Figure 3.2	Fiber Heat Exchange Thermocouple Recording Setup.	33
Figure 3.3	Monitoring UHPC Heat Evolution.....	34
Figure 3.4	Evidence of Dry Premix Agglomerations.	36
Figure 3.5	Buchanan-Pi Girder Cast in Winnipeg.	37
Figure 3.6	Rotating Drum Trial Batch Size.....	38
Figure 3.7	Homogeneity Issue from Full Batch Method.	39
Figure 4.1	Temperature vs. Time Trends for the Pan Mixer.	46
Figure 4.2	Temperature versus Time Trends for the Rotating Drum Mixer.	47
Figure 4.3	Batch T3 Changes in Temperature over Time.....	49
Figure 4.4	Batch T3 Changes in Temperature over a 45 Minute Period.	50
Figure 4.5	Pan Mixer Temperature Analysis Using 90% Confidence Lines.	51
Figure 4.6	Non-grouped Pan Mixer Temperature Analysis.....	52
Figure 4.7	Drum Mixer Temperature Analysis Using 90% Confidence Intervals.....	53
Figure 4.8	Non-grouped Drum Mixer Temperature Analysis.	54
Figure 4.9	Fiber and Premix Resistance to Changes in Temperature.....	55
Figure 4.10	Static Flows for Pan Mixer.	58

Figure 4.11	Dynamic Flows for Pan Mixer.	59
Figure 4.12	Static Flows for Drum Mixer.	59
Figure 4.13	Dynamic Flows for Drum Mixer.	60
Figure 4.14	Changes in Static Flow versus Temperature for Pan Mixer.	61
Figure 4.15	Changes in Static Flow versus Temperature for Drum Mixer.	62
Figure 4.16	Pan and Rotating Drum Cylinder Breaks.	63
Figure 4.17	Visual Comparison between Pan and Drum Mixed Cylinders.	64
Figure 4.18	Prism Immersed in Water for Curing.	65
Figure 4.19	Unmixed Portions of Premix Material Contained on Flow Table.	69
Figure 4.20	Evidence of Unmixed Portions of Premix in Winnipeg Cast Cylinders.	69
Figure 4.21	Total Mix Time for Pan Mixed Batches.	70
Figure 4.22	Total Mix Time for Drum Mixed Batches.	71
Figure 4.23	Total Mix Time for Drum Mixed Batches with Respect to Three Volumes.	72
Figure 4.24	Premix Shelf Life.	73
Figure 4.25	Compressive Strength of Cylindrical Specimens over Time.	77

LIST OF TABLES

Table 2.1	Typical Composition of UHPC	7
Table 2.2	Chemical Makeup of Steel Fibers ⁷	12
Table 2.3	UHPC Material Characteristics ⁷	12
Table 2.4	UHPC BS 1000 Mix Proportions ¹³	15
Table 3.1	Temperature Study Mixing Matrix	27
Table 3.2	Mixer Study Mixing Matrix	29
Table 3.3	UHPC Heat Evolution Testing Regimen	34
Table 4.1	UHPC Heat Evolution Testing Regimen	48
Table 4.2	Comparison of Estimated and Observed Fresh Concrete Temperature	57
Table 4.3	Pan Cylinder MOE Results	66
Table 4.4	Drum Cylinder MOE Results	67
Table 4.5	Drum Prism MOE Results	68
Table 4.6	MOE Results from Winnipeg and U of A.....	75
Table 4.7	Compressive Strength Average for All Mixers	76

LIST OF EQUATIONS

Equation 4.1	Estimation of Fresh Concrete Temperature ³	56
Equation 4.2	Graybeal MOE Estimation.....	65

CHAPTER 1 INTRODUCTION

1.1 GENERAL

Ultra-High Performance Concrete (UHPC) is a new type of concrete that exhibits material characteristics far surpassing all other concrete types. To obtain UHPC's superb properties, caution must be made to all aspects of its formation, including mixing. Typically, the specified mixer for UHPC is a high energy/high shear mixer. For laboratories, a small shear mixer is relatively inexpensive. Laboratories usually generate small batch sizes, which may not be indicative of actual field conditions. A high shear mixer may not always be a viable option for ready-mix companies. Lower energy rotating drum mixers are primarily used in the ready-mix industry. Therefore, an investigation must be made to see if changes in UHPC properties are induced by the use of a different mixer type.

Fresh concrete temperature influences many parameters including but not limited to: set time, ultimate strength, flow/slump, and workability. Depending upon the ambient temperature condition, some method(s) may be used to regulate concrete temperature. In high temperature instances, ice can be used to abate temperature gains and aid in mixing efficiency. The effect of adding ice to normal concrete has already been documented, and resources are readily available illustrating its effect.¹ However, the makeup of UHPC is different than most ordinary concretes, in that it is denser, has an extremely low water to cementitious materials ratio (w/cm), and contains metal fibers. These changes in composition may have an unusual effect when compared to ordinary concretes. Therefore, at a minimum, research must be performed documenting the influence of ice on UHPC fresh temperature.

1.2 OBJECTIVES

To determine the effect of mixer type on UHPC, the goal of the research program was to compare the results generated between three mixer types, each of a different size. The three mixers used, with their respective capacities, are as follows: a pan mixer 19 L (20 quart), a rotating drum mixer 0.35 m³ (12.5 ft³), and an 8.3 m³ (10.8 yd³) ready-mix truck. Temperature

and flow tests were conducted to document fresh concrete properties, whereas compressive strength and modulus of elasticity tests were performed to evaluate hardened properties.

Also investigated during the research period, was the influence of ice on various premix temperatures. The term premix is to be understood as the summation of cementing and filler components, such as portland cement, sand, silica fume and ground quartz, used to produce UHPC. Items such as ice/water, fibers, or chemical additives are not considered premix materials. For a given premix temperature, the purpose was to determine how effective ice, when used as a replacement for mixing water, acts in lowering the batched concrete temperature. Multiple batches were made using premix temperature conditions ranging from 0 to 35 °C (32 to 95 °F). Emphasis was placed on fresh concrete properties for this phase of research. Newly batched concrete temperature and flow values were charted over specified time intervals to view if their characteristics change. Included within the temperature study was the use of a data acquisition system to observe the amount of heat gain/loss that occurs when a freshly batched UHPC sample remains under ambient temperature conditions for a prolonged time. Additionally, the degree of premix and fiber susceptibility to temperature change was examined; in other words, an analysis was made on how resistant either material is to transitioning from one temperature state to another. The following provides a small list of bullet points to highlight the main objectives listed in the previous paragraphs.

- For a given premix temperature, find out how effective ice is at lowering the batched concrete temperature.
- Determine how freshly batched UHPC flow and temperature characteristics change over time.
- Using a data acquisition system, document how freshly batched UHPC temperature changes when subjected to ambient temperature conditions for an extended period. Also analyze how resistant dry premix and fibers are to changes in temperature.

- Compare the results generated between three mixer types, each of a different capacity. To analyze the results, use flow and temperature for fresh concrete properties and compressive strength and modulus of elasticity for hardened properties.

1.3 SCOPE

By understanding the effect mixer type has on UHPC properties, one will be able to know the expected gains/losses that occur when using a certain type of mixer. These property changes will help industrial companies to understand if the need for a high shear mixer is truly justified.

It is a widely known fact in the concrete community that the lower the fresh concrete temperature (excluding concrete cold enough to inhibit proper hydration reactions) the better the long term strength.^{1,2} By using ice as a replacement for mixing water, the decrease in batched temperature should improve long term strengths. More importantly, this study examines the degree for which ice is effective in UHPC's fluid state. By using ice over a spectrum of premix temperatures, this research will aid the user of UHPC by illustrating how well ice can mitigate heat and possibly maintain flows.

CHAPTER 2 LITERATURE REVIEW

2.1 GENERAL

For this literature review, temperature is a point of concern. Temperature changes can influence both fresh and hardened concrete properties. In addition to temperature concerns, this literature review also examines the effect of mixer type on normal concrete. In general, not much attention is paid to mixers. However, the selection of a mixer can be crucial to businesses in terms of cost or simply time to mix. With UHPC, high shear mixers are recommended. Differences in fresh and hardened UHPC properties may be observed for changes in the type of mixer.

The two aforementioned points of interest will be further explored in the following pages by examining works from experts within the concrete field. The information provided by said experts should help in understanding the phenomena that will occur during the research period. This review will begin by providing a historical perspective on the evolution of concrete from its earliest stages to today. Next, the development, material properties, and advantages of utilizing UHPC are outlined; included within this discussion will be the research program's specific application of UHPC, UHPC. Afterwards, the categorization of mixers will be considered. As there are many mixers available for use today, each type has a different configuration and purpose. As a result, definitions will be provided denoting the attributes a mixer must possess in order to be labeled of a certain type. Finally, the importance of temperature as it relates to concrete and its additives will be explored.

2.2 HISTORY OF EARLY CONCRETE

The development of concrete dates back many centuries. In fact, one of the oldest known sections of concrete was a floor slab discovered in Yiftah El in Galilee, Israel. The slab, thought to be from around 7000 BC, was comprised of three basic ingredients: cooked lime, stone, and water. Over the next few centuries, concrete underwent small developmental changes, but through experimentation and some research, large improvements were made in 300 BC when the Romans decided to introduce volcanic ash into their current concrete production.

Using the ash mined from Pozzuoli, Italy a new mix was created that had strengths much greater than their original design.³ Furthermore, the Roman's use of a supplementary cementing material is also referred to, even today, as a pozzolan.

Within the past two centuries, much technological advancement has been made in the concrete field. With the advent of chemical additives, a producer of concrete can influence the set time, slump, and even air entrainment of a mix. For example, the use of superplasticizers (SP), which are also known as high range water reducers (HRWR), can make concrete flow and consolidate on its own. Other options, apart from the use of chemicals, are available as well. Concrete's weight can be reduced or enhanced with a change in aggregates. Lightweight aggregates may be necessary for specific applications; the use of such aggregates can reduce concrete's unit weight, making slabs and wall sections thinner. Heavyweight concrete containing steel and iron aggregates can create a unit weight in excess of 300 pounds per cubic foot. Such concrete is useful in nuclear reactor walls.⁴ Nevertheless, strength is always a concern; as the boundaries of design are being pushed continually by architects and engineers with the creation of longer span bridges and taller buildings, concrete must become stronger, more flexible, and even more durable.

2.3 UHPC

UHPC, also known in some concrete circles as UHPFRC (Ultra-High Performance Fiber-Reinforced Concrete), is a multifaceted material. Because of its complexity, many years have been invested in the development of UHPC. To begin, the development of UHPC can be traced back to about the 1930s. During this time, Eugène Freyssinet understood that if one were to apply pressure to concrete during the setting process, the effect would be to increase the material's compressive strength. Later in the 1960s, applying pressure to the concrete was used in conjunction with a curing regimen that included a heat source and a water saturated environment. Using this methodology, samples were created which had breaking strengths of 648 MPa (94,000 psi).

Today essentially two UHPC mix types exist, Densified Small Particle (DSP) and Macro Defect Free (MDF).⁵ A DSP mix contains very fine particles, a high cementitious material content, and hard aggregates for its strength. A MDF concrete is created with the aid of polymerization and polymer-modified mortars. Polymerization is, roughly speaking, the use of polymers to fill in the voids of the concrete. The problem with a MDF mix is that it is difficult to make and contains many potential problems, one being excessive creep. While both of these mixes are very strong, they are very brittle as well. The solution for increasing the material's ductility can be attributed to the use of metal fibers.⁵ Fibers not only offer increased ductility, but can also alleviate some of the reinforcing steel requirements necessary in composite sections.⁶ This fact will be explained in further detail later. MDF concrete mixtures are difficult to produce and the scope of this research doesn't involve the use of such a mix; therefore, only DSP type mixes will be discussed henceforth with any exceptions being noted.

To create a truly dense, homogeneous UHPC mixture, the grading of constituent materials must be optimized. Having a good understanding of packing ability or particle orientation is a must to create these efficient mixes. UHPC is much the same as normal concrete in that no one true mix design exists. Accordingly, it must be noted that Table 2.1 references a typical production version of UHPC. Information concerning UHPC will be discussed at greater lengths later in this review. To alert the reader, not all UHPC mixes contain quantities of ground quartz, as it is used for a filler material. According to Rossi (2001), "mechanical performance homogeneity" can be improved with the use of mineral microfibers like wollastonite² or in this case, ground quartz.

Table 2.1 Typical Composition of UHPC⁷

Material	Amount (kg/m³)	Amount (lb/yd³)	Percent by Weight	Average Diameter (µm)
Portland cement	712	1200	28.5	15
Fine sand	1020	1720	40.8	150 - 600
Silica fume	231	390	9.3	<10
Ground quartz	211	355	8.4	10
Superplasticizer	30.7	51.8	1.2	N/A
Accelerator	30	50.5	1.2	N/A
Steel fibers	156	263	6.2	200
Water	109	184	4.4	N/A

If one were to scan down the right side column of Table 2.1, one should notice that the particle sizes for the mix are extremely small. To provide the reader a better understanding of the size of particles used in a UHPC mix, a few common everyday examples of scale will be discussed. The largest particle in the mix, fine sand, has a potential diameter of up to 600 micrometers (0.024 inches). At that size, the particle is still less than half the thickness of a U.S. dime. On the other extreme, the use of silica fume serves two functions: increase compressive strength by increasing cementitious material content, and to fill in the void spaces created by the larger aggregates.⁷ With particle sizes already being used in the 10 and 15 micrometer (.0004 to .0006 inch) range, the particle size necessary to fill voids in the concrete must be extremely small. In fact, the average size of a microsilica (silica fume) particle is equal to or smaller than the average human red blood cell.

When viewing Table 2.1, it can be easily inferred that a large amount of cementitious materials (sometimes referred to as paste or cement paste) are employed. Almost 40 percent (37.8) of the total batch volume consists of silica fume and cement. This large paste content is a must for producing a very strong, high quality concrete. Another requirement to produce a strong

concrete is a low water to cementitious materials ratio (w/cm). In this mix, a very low w/cm of 0.12 is used. Typical, everyday concrete w/cm ratios range from 0.4 to 0.5; these values should help show that UHPC's low w/cm is far from the norm. One may notice that an accelerator is used in the mix. With large dosages of superplasticizer, UHPC mixes may take a while to set up. Therefore to combat this potential problem, an accelerator may be employed to help reduce the set time.

Low w/cm values generally make concrete hard to place. Since UHPC uses such a small w/cm ratio, much help is needed to make the mixture flow and consolidate. Today's high performance superplasticizers having either a polycarboxylate (PC), Napthalene Sulfonate (NS), or Melamine Sulfonate (MS) base allow the dense, highly homogeneous mixture to be poured with the concerns of segregation being lessened. The development of such admixtures is a welcomed addition. PC superplasticizers function through their flexible polymer chains. These chains wrap around the cement grains and begin to push away from one another, thus helping to increase the concrete's flow. As mentioned earlier, there are two other types of chemical admixtures available today, Napthalene Sulfonate and Melamine Sulfonate. Both of these admixtures act in a manner similar to a PC admixture.⁸

It is important to note that there is a saturation point for PC, NS, and MS admixtures. At the saturation dosage, the admixture will no longer be effective in producing beneficial results. After exceeding the saturation point with a PC admixture, a decrease in workability and an increase in mixing time should be expected. However, when the saturation dosage is met for NS and MS type admixtures, little or no noticeable change in workability should occur. In general, both MS and NS admixtures are able to achieve larger flows, but a PC admixture is more efficient, requiring lower dosages.⁸

2.3.1 Fibers

The only non liquid or granular component used in a UHPC mixture is metal fibers. While metal fibers don't necessarily serve to increase the homogeneity of a mix, their selection has an influence on the concrete at both the macro and micro levels. Typically, metal fibers are

cylindrical in shape. Each fiber resembles a steel reinforcing rod, but on a much smaller scale. Actually, metal fibers have the same characteristics that their larger scale counterparts contain. Each fiber can have hooked or straight ends and experience the same principal modes of failure such as pullout and rupture.⁹

In general, fiber content influences the ductility of UHPC. With an increase in fiber content there is an increase in ductility.⁵ However, this is merely a generalization and is not true for all cases; the ductility provided by fibers is limited to the scale of application. Rossi explains how the fibers can contribute on both the material (e.g. cylinder) and structural (e.g. beam) scale. To briefly explain his rationale for the use of both terms, fibers can help stitch tensile cracks together only if there is sufficient bond length available.⁵

Consider two rectangular shaped beams, both being of equal width and reinforcement, with one beam possessing a height greater than the other. If the placement of reinforcement was the same for both beams, and each was tested to failure, the strains in the taller beam would be greater than that of the smaller one. For a short fiber, pullout would be of great concern. Therefore, it can be said that short fibers do not perform as well as a longer fibers in large strain applications. Nevertheless this fact is dependent upon the fiber size. Either fiber length will be more than adequate for tests with cylinders⁵, but rarely are applications found that are consistent with that scale.

The diameter of most fibers is approximately 0.15 to 0.2 mm (0.006 to 0.008 in). However, when working with fibers, fiber length is usually the biggest concern. Fiber length can not only influence how effective the fiber is at holding tension cracks together, but the workability of a fresh concrete mixture as well. In general, the shorter the fiber used, the more workable the mix. As discussed earlier, using such generalities can be problematic. Nevertheless, workability of a mix is still important as well as the fiber's ability to pass through tight groups of rebar and not form a cluster.⁵ If fibers do not move freely enough to properly disperse themselves through rebar or formwork, alignment problems may occur. Graybeal used three point flexural tests with UHPC specimens containing fibers aligned perpendicular and parallel to the principle flexural tensile

forces. In his testing, the specimens with fibers aligned perpendicular to the principle flexural tensile forces experienced a more than three time reduction in strength when compared to those with fibers aligned parallel to the principle flexural tensile forces.⁷ When the fibers are properly aligned, a flexural tensile strength of 8 MPa (1160 psi) may be used.^{6,10} This is a welcomed advancement considering that the analysis of normal concrete structures proposed by the American Concrete Institute (ACI) assumes a 0 psi value for concrete tensile strength.

2.3.2 UHPC Types

By now, one should be able to realize that the selection of fibers can have a large impact on the qualities of UHPC. In fact, there are three offshoot UHPC mixes with respect to fiber usage alone. These three mix types include Compact Reinforced Composites (CRC), Reactive Powder Concrete (RPC), and Multi-Scale Fiber-Reinforced Concrete (MSFRC).⁵ These mixes may be referred to as UHPFRC. Keeping with the chronological timeline of the development of UHPC, each of these mixes are listed in order of development from oldest to newest.

2.3.2.1 CRC

Developed by Aalborg Portland in Denmark, CRC was created using a very high percentage (5 – 10) of metal fibers. The fibers, all of the same size, were 6 mm (0.24 in) long and .15 mm (0.006 in) in diameter. The high percentage of fibers increases the material's ductility on a small scale, but due to their short length, the use of these fibers for a larger scale application is difficult to justify.⁵

2.3.2.2 RPC

The use of a larger fiber was employed in the development of RPC. The new fibers were two times as long as CRC fibers, while maintaining the same diameter. The increased length caused workability issues, thereby not permitting the same percentage of fibers as that of CRC. Instead of using 5 to 10 percent fibers, RPC could only have a fiber content of 2.5%. At this level the fibers do not increase the uniaxial tensile strength of the material. However, some benefits do come as a result of the addition of longer fibers. The ductility at the structural scale is increased when compared to CRC.⁵

2.3.2.3 *MSFRC*

By learning from both CRC and RPC, the development of a multi-scale fibrous concrete was developed. MSFRC uses up to 7% fibers by volume, with 5% of fibers being short straight end and the remaining 2% long hooked end. Although this mix has been developed to work with both small and large scale applications, it is still relegated to laboratory use.⁵

2.3.2.4 *Ductal*

Ductal® is a marketed form of UHPC that was developed by the participation of three groups: Lafarge, Rhodia, and Bouygues.⁷ For the most part, Ductal is a RPC type of concrete with a few modifications being made to help increase its performance characteristics. Some of these modifications include, but are not limited to, fiber surfaces having a chemical treatment used to improve bonding within the granular mixture, and the removal of sand with the replacement of mineral microfibers⁵, e.g. ground quartz. The steel fibers used in Ductal possess an extremely high tensile strength; 2600 MPa (377 ksi) is the minimum specified strength required by Lafarge. Like RPC, all fibers are of the same size containing a length of 12.7mm (0.5 inches) and a diameter of 0.2 mm (0.008 inches). During the creation of the steel fibers, a thin layer of brass covers the fibers, but this veneer is worn away during the mixing process. In addition to iron, other chemicals are used in the production of the steel fibers.⁷ For more information regarding the chemical makeup of the steel fibers, see Table 2.2.

Although there are other versions of UHPC available with slight variances to the fiber length and microfiber content⁵, for this paper the primary makeup of UHPC is shown as Table 2.1. When mixed and cured appropriately, UHPC possesses many outstanding material characteristics. These characteristics can be very helpful to many concrete users, namely engineers and architects. An overview of the typical material properties can be located in Table 2.3 with commentary provided afterward detailing the benefits of the enhanced material characteristics.

Table 2.2 Chemical Makeup of Steel Fibers⁷

Element	Composition (percent)
Carbon	0.69 - 0.76
Silicon	0.15 - 0.30
Manganese	0.40 - 0.60
Phosphorus	≤ 0.025
Sulfur	≤ 0.025
Chromium	≤ 0.08
Aluminum	≤ 0.003

Table 2.3 UHPC Material Characteristics⁷

Material Characteristic	S.I.	U.S. Customary
Compressive strength	180 – 225 MPa	26.1 – 32.6 ksi
Modulus of elasticity	55 – 58.5 GPa	7977 – 8485 ksi
Flexural strength	40 – 50 MPa	5802 – 7252 ksi
Chloride ion diffusion	$1.9 \times 10^{-14} \text{ m}^2/\text{s}$	$2.05 \times 10^{-13} \text{ ft}^2/\text{s}$
Carbonation penetration depth	< 0.5 mm	< 0.02 in
Freeze-thaw resistance	100% RDM	100% RDM
Salt-scaling resistance	< 0.012 kg/m ²	.285lb/ft ²
Entrapped air content	2 – 4%	2 – 4%
Post-cure shrinkage	0 microstrain	0 microstrain
Creep coefficient	0.2 – 0.5	0.2 - 0.5
Density	2,440 – 2,550 kg/m ³	152.3 – 159.2 lb/ft ³

The exceptional values for compressive strength, modulus of elasticity, and flexural strength should be of no surprise to the reader since both the cementitious material and fiber content have been well documented. While not as obvious, the benefits of low permeability and high freeze-thaw resistance can be attributed to the extremely dense particle arrangement. By adding extraordinarily small particles, like those which make up silica fume, the ability for water to infiltrate, or even escape, the material is reduced.¹¹ Likewise, the durability of the material is increased. Heightened durability results in benefits for bridges, dams, and other types of applications where corrosion to reinforcing steel by the permeation of water and salts should be avoided. Further benefits can be had by engineers and architects when looking at UHPC's small levels of shrinkage and creep; in areas that require very precise architectural tolerances over time, users of this material will know that its dimensions are maintained much better than a standard concrete mix.

Another added advantage to using this product involves simply the batch preparation. Batching UHPC is convenient; a user only needs water (ice), SP, fibers, premix, and a mixer. The premix arrives to the user - with each constituent material already premeasured - contained in 36 kg (80 lb) bags for ease of use. Table 2.4 provides Lafarge's Ductal BS 1000 mix proportions for a one cubic meter and one cubic yard batch. Without the premix bags, the acquisition and weighing precision of the constituent materials would be troublesome and perhaps unnecessary.

Not all benefits of UHPC may be inferred by a simple table alone; some benefits are present that can't be necessarily quantified. For those unfamiliar with the failure of normal concrete, during failure, material is usually expelled. When using UHPC, its compressive behavior at failure is different than that of normal concrete (assuming normal concrete doesn't contain fibers). Because of adding fibers, cylinders have the failure plane somewhat held together, keeping material from rapidly being discharged.⁷ For a visual reference see Figure 2.1. If failure was to occur in large structures or even structural elements, reducing the potential of fleeing material during a catastrophic failure could help keep nearby civilians safe. Although the

visible failures between UHPC and normal concrete differ, they both exhibit a very similar stress-strain response. In fact, the old ACI 318 equations for modulus of elasticity only needed a scalar modification to, with reasonable accuracy, predict the relationship.¹²



Figure 2.1 Typical UHPC Cylinder Failure.

The addition of fibers not only contribute to concrete's tensile strength and failure characteristics, but can also add ample shear resistance in prestressed members.⁵ The level of shear resistance can be enough to justify the elimination of stirrups in certain elements.⁶ Additional benefits such as the material's self leveling and self compacting capability eliminate the need for vibration while reducing finishing requirements. Even the strain values produced in UHPC are also an improvement upon normal concrete. Compressive strains produced in non-cured and steam cured specimens are 0.0035 and 0.0041, respectively.¹² Other authors have converged upon the similar compressive strain values as well.¹⁰ While only slightly higher, the additional strain helps designers get the most from their concrete. Using a strain of 0.003, like that used for normal concrete, would limit designers from fully utilizing UHPC.

UHPC can have very respectable material benefits, but without the proper curing regimen applied to the material, it cannot reach its full potential. It is known that concrete will continue to cure and gain strength as long as heat (excluding levels high enough to be detrimental) and water are present.⁴ If concrete is cured under normal conditions, the rate of strength gain over time will decrease, meaning the ability to gain strength becomes less as time passes. As a result, some

producers of UHPC will use aggressive curing methods to rapidly “age” the concrete. One method to age the concrete consists of using steam – it supplies the two necessary quantities for curing: water and heat. Steam treatment is applied to UHPC for a period of 48 hours at 90 °C (194 °F) to obtain the material values listed in Table 2.3. The temperatures used in steam curing can cause problems with delayed ettringite formation (DEF).⁴ One may think that perhaps more heat is better. A threshold for the applied heat does exist; this temperature value depends upon factors like the w/cm and materials used (supplementary cementing materials, aggregates, w/cm). For example, the threshold is 400 °C (752 °F) for high strength concrete.⁴

Table 2.4 Ductal BS 1000 Mix Proportions¹³

Component	Batch Size		% by Weight
	m ³	ft ³	
UHPC premix	2194 kg	136.97 lb	87.4
SP	30 kg	1.87 lb	1.2
Water/Ice	130 kg	8.12 lb	5.2
Fibers	156 kg	9.74 lb	6.2

UHPC has many advantages. Although it is nice to advertise all of the positives about UHPC, problems do exist both in an immediate and deferred sense. The cost of UHPC is somewhere on the order of 1,000 U.S. dollars per cubic yard. An additional cost may be incurred strictly on the type of mixer used. When mixing UHPC, a high shear mixer is recommended. Many ready-mix companies do not possess a high shear mixer, making the desire to produce UHPC on a much larger scale less appealing. Compound this with the fact that due to the increased unit weight and viscosity of UHPC, mixers can become highly taxed, thereby requiring batch sizes to be reduced.¹⁴ Although a smooth surface is easily made with UHPC mixes, finishing work can become problematic. The “finished” surface that is produced can be extremely slick, even with tining. The time for the mix to become adequately plastic can be much longer than normal concrete as well. Finishers may be surprised to know that there will be little or no

bleed water at all with UHPC.^{11,14} Although not documented for UHPC mixes, SCC type mixes can have either one of two problems with concrete pump trucks: segregation or decreased flow and filling ability. As pumping pressure rises, so do the detrimental effects.¹⁵ Similar effects for UHPC should be expected because of the use of small aggregate and high cement paste content, but additional research is necessary. Finally with all of the added strength, section geometry can be reduced. Designers must keep in mind the ramifications of such reductions, as for many years concrete has relied on its sheer mass to reduce second order effects, e.g. buckling.

2.4 MIXERS

For today's concrete user, the selection of a mixer can accommodate any size and budget. From personal users to large scale industrial ready-mix companies, a mixer exists to suit their needs. The following section will address issues regarding concrete mixers, that is, how a mixer is classified and what advantages/disadvantages are innate to each mixer type.

The National Institute of Standards and Technology (NIST) classify concrete mixers into two distinct categories: batch mixers and continuous mixers. The former creates concrete mixes in discrete, volumetrically limited quantities. Each "batch" is produced by introducing materials as required during the mixing cycle. Mixing ceases when the desired homogeneity is obtained, and the mixer discharges its contents. From here, this series is repeated as necessary.⁹ The following paragraphs provide some additional insight into batch mixers.

2.4.1 Batch Mixers

Batch mixers can be divided into drum mixers and pan mixers. Pan mixers may also be referred to as vertical shaft mixers or turbines.¹⁶ The main consideration for the division involves the axis of rotation of each mixer. Drum mixers usually function on a horizontal or inclined axis, compared to a pan mixer's vertical axis operation. Drum mixers consist of a hollow metal drum containing blades affixed along the inside perimeter. The purpose of a drum's blades is to aide in the mixing and discharging of concrete.

A diverse arrangement of bowl, blade, and scraper configurations exist among pan mixers. The pan, mixer shaft, and scraper can each be fixed or allowed to move. Essentially, a pan mixer consists of a bowl shaped receptacle known as a pan, whose purpose is to hold the mixing materials while a single or series of blades/paddles act to mix the concrete. During this entire process a scraper, if used, traces the edge of the pan peeling off any concrete adhering to the sides of the container.⁹ Figure 2.2 juxtaposes a pan mixer on the left with a drum mixer on the right, both preparing a UHPC sample.



Figure 2.2 Comparison of Pan and Drum Mixers.

Drum mixers may be purchased in one of three types: non-tilting, tilting, and reversing. These are fairly self explanatory devices; the first type doesn't allow the drum to move out of the horizontal position, while the second allows itself to be discharged at the desired angle. The reversing drum mixer contains continuous flight blades attached to the inside perimeter of the drum in a spiral configuration. Depending on the arrangement of the blades, as the drum turns one direction, the blades keep the concrete in the bottom of the drum so it can be mixed properly. To discharge the drum, simply reverse the rotation of the mixer. The blades now act to bring the concrete to the upward end of the drum much like an auger lifts soil cuttings from a borehole. This type of setup is used largely in the ready-mix industry.¹⁶ Front discharge trucks utilize this technology to make pours easier for company drivers and placement/finish workers.

2.4.2 Continuous Mixers

A continuous mixer is defined by the American Concrete Institute (ACI) as follows: "When the output of the mixer is equivalent to the input of materials and the mixer can be operated without interruption to charge or discharge material, the mixer can be considered continuous."¹⁷ Typically, continuous mixers are constructed with a hollow cylinder placed at some angle with respect to the ground. This angle can range anywhere from 15 to 25 degrees.¹⁶ Dry materials are placed in the lower portion of the mixer and a single auger flight works the materials together, kneading the concrete and expelling it from the upper end. Liquids may be supplied by pumps, cylinders, or even air pressure. The amount of liquid used in the production of concrete should be "controlled by valves or timers and measured by flow meters."¹⁷

Depending on the circumstance, a simple modification may be necessary to adjust the mixing time. To accomplish this, one would see that as the trough (mixing tube/cylinder) is lowered, the angle created between the trough and ground is lessened, thereby making mixing time less; the opposite holds true when the trough is raised.¹⁷

2.4.3 Differences between Batch and Continuous Mixers

Time can be the main concern when it comes to selecting between a batch or continuous mixer. The speed in which a continuous mixer can produce concrete is typically much faster than a rotating drum apparatus. Wilk compared specimens produced from both rotating drum and continuous mixers. His findings concluded that the samples tested from both batch and continuous mixers exhibited little difference in ultimate strength, but in regards to time there was a five minute difference to produce batches of equal volume.¹⁸

Mixing time is not the only concern involved in the selection of a batch or continuous mixer. Batch mixers can be burdensome because of their finite nature. After every batch, the container must be fully emptied, cleaned, and started again. However, the continuous viewing ability allows the user to fully monitor the progress of the mixture, and the amount of material loss is small.

Clean up is simple for continuous mixers. As soon as the supply is met, all that remains is to clean up the equipment. Continuous mixers are also great at producing large volumes of low slump concrete, but do not fair well when it comes to air entrainment. Even with the use of air entraining admixtures, because of such expedited mixing, the results are not always desirable.¹⁹ SCC and UHPC mixes, like UHPC, require longer times to mix and therefore much more attention, making their use more appropriate for batch mixers.

2.5 CONCRETE MIXING

The evolution of concrete from its initial stage as a random assortment of granular and liquid materials to a blended, homogeneous final product occurs similarly regardless of the mixer type used. Cazacliu and Roquet, examined the development of concrete from a dry mixing phase to the end product, a fluid, workable mixture. Most of their research documented the amount of power consumption required during defined intervals within the mixing process. Their results were obtained from the use of three different mixers, each with varying volumes. Two specific high shear mixers were used: planetary and twin-shaft. Both mixers help to mix the concrete quicker than lower energy counterparts (e.g. drum). Only one twin-shaft mixer was used; it contained a volume of 0.5 m^3 (17.7 ft^3). Two planetary mixers, one of 0.33 m^3 (11.7 ft^3) and the other of 1.5 m^3 (53 ft^3), were also employed. The following bullet points provide small summaries of the authors determined “mixing-stages.” Within each mixing-stage, the required mixing power and physical characteristics of the concrete mixture are denoted. The dry mixing of constituent materials is not a “mixing-stage,” rather after the addition of liquids is the first mixing-stage initiated.²⁰ Mixing stages summarized from Cazacliu and Roquet:

- Mixing-stage 1
 - During the addition of water, a spike in amperage is observed. This energy draw eventually levels off, but jumps even higher when superplasticizers are added. The authors deem this stage as granule growth. In this stage, “granules” are created by the adherence of fine materials to the introduced liquids. Through

mixing shear, the liquid keeps the granules bound together with the excess liquid reaching the surface of the granule to quickly collect more fine materials.

- Mixing-stage 2
 - After all of the fine powder materials have been collected by the granules, the remaining liquid contained within each of the granules begins to form a surface sheen. Inconsistencies in power demand still occur which may be attributed to the differing rates of development of “wet” granules within the entire mixture. The peak value of power demand is when the “wet” granules account for most of the mixture. At this point, the authors declare the mixture a “hard paste,” demonstrating “raspberry-like shape[s].”

- Mixing-stage 3
 - After the mixture contains all “wet” granules, the process of degradation begins. Granules start breaking down as cohesion begins to decline. The overall need for amperage begins to decline as well. Even with the breaking down of all wet granules, inconsistencies of power usage still remain from relative wet and dry zones within the mixture.

- Mixing-stage 4
 - After the granules have sufficiently disbanded, additional amounts of liquid held by granules which contained more water and superplasticizer than others disperses throughout the mixture. Power demand is continually decreasing due to the homogeneity of the concrete at this time.¹⁶ The look and action of the concrete could be considered dough-like.

The authors believe that the time in which liquids are added to the mix is immaterial; they also state that this is a suggestive statement rather than fact and more research is therefore necessary.²⁰

2.6 CONCRETE TEMPERATURE

Temperature could be considered one of the most important parameters in ensuring a well performing concrete. In concrete's fresh phase, concrete temperature influences the set time, hydration rate, and slump.¹ During hot weather, the probability for problems with fresh concrete escalate as there is an increase in: water demand, slump loss, rate of setting, plastic shrinkage cracking, and the inability to control entrained air content. For hardened concrete characteristics, a high fresh concrete temperature can decrease ultimate strength (but increase early age strength⁴), durability, and surface homogeneity, while also causing increased cracking and permeability issues, thus raising the chance for reinforcing steel corrosion.¹ On the other hand, extremely cold temperatures are to be avoided as well. Compressive tests were performed on concrete that had been placed and then froze. The frozen concrete was thawed and vibrated before initial set occurred. The frozen concrete specimens had a 5% lower compressive strength compared to concrete that was not frozen.²

As mentioned previously, the amount of air entrainment within concrete is influenced by the fresh concrete temperature. The importance of air entrainment is significant. Normal concrete's ability to withstand multiple cycles of freezing and thawing is heightened as concrete contains more air.⁴ With inadequate air entrainment, expanding water will create small microcracks, which after multiple cycles of freezing and thawing, will cause durability issues. Generally stated, the more air that is used the less able permeated water can harm the concrete.⁴ The previous statement assumes that the air is distributed adequately in appropriate size air entrainment bubbles rather than large air voids. As air entrainment increases a decrease in compressive strength should be expected; however, this effect shall not be discussed here.

Yamamoto and Kobayashi affirmed some of the previously listed temperature effects found in high temperature fresh concrete. The authors noted that the amount of air entraining admixture increased with increasing concrete temperature.²¹ It was also stated that with higher temperatures come higher slump losses. To be specific, slump losses at 7 °C (45 °F) and 20 °C

(68 °F) were relatively small, but when tests were conducted at 35 °C (95 °F), slump loss was significant.²¹

During the summer months, construction projects are in full swing; the longer days and less frequent rainfall allow for more work to be accomplished. The summer months also bring high temperatures and low humidity, both unfavorable conditions for concrete users.¹ According to Mahboub and Cutshaw, the Portland Cement Association (PCA) claims that hot weather is any temperature between 24 to 38 °C (75 to 100 °F). While the PCA has defined their hot weather conditions, there is a discrepancy among the academic world to establish which temperatures are appropriate to place concrete without substantial loss of performance. Some researchers believe that a temperature range of 10 to 16 °C (50 to 60 °F) is sufficient while some others claim that a larger range of temperatures, say 4 to 40 °C (40 to 104 °F) can be employed. The range of proper concrete placement temperature may be disputed, but a compressive strength loss of 4% may be experienced for temps between 32 and 38 °C (90 and 100 °F) and up to 10% for temperatures greater than 38 °C (100 °F).²²

2.6.1 Preventing High Fresh Concrete Temperatures

Methods are available to alleviate the potential of having a high temperature fresh concrete. One method involves cooling the mixing water. Using chilled mix water can lower the concrete temperature by as much as 6 °C (10 °F). Some concrete producers even use ice as a replacement for chilled water.¹ The use of ice serves as a shearing agent; chunks of ice help break up cement agglomerations in the mixer, while simultaneously cooling down the materials and decreasing the set time.²³ Temperature differences of as much as 11 °C (20 °F) can be achieved simply by using ice.¹

Liquid nitrogen can be used as an alternative cooling method. Liquid nitrogen can be released into an already mixed concrete, cooling the temperature down very quickly.¹ One great benefit to using liquid nitrogen is that it doesn't influence the w/cm. Pure nitrogen is an extremely light element, that when released to the atmosphere, changes into its gaseous form and thereby does not stay with the concrete. The only drawback to using liquid nitrogen is the high cost.¹

A final method to lowering the temperature of concrete involves cooling the aggregates. Typically aggregates constitute the largest component of a concrete mix, and with their cooling, concrete temperatures can also be controlled. Much like the use of liquid nitrogen, the amount of money required to implement some type of aggregate cooling scheme could be significant.¹

Aside from directly cooling the fresh concrete, there are other methods that may be simpler to perform. Using smaller batch sizes can reduce heat. A set-retarder can also help lessen rapid heat gains.²²

2.6.2 Effect of Concrete Temperature on Admixture Performance

In an article published by Petit et al., the authors explain how fresh concrete temperature also plays a role in how well admixtures perform. An increase in temperature can change the level in which chemicals like SP act. To be specific, a rise in temperature will influence the effectiveness of the SP. Such an occurrence can cause inconsistencies in rheological characteristics. It was reported that rises in temperature cause an increase in material yield stress (decrease in slump – getting the material to start flowing becomes more difficult) but a decrease in plastic viscosity (the material will flow easier once in motion). The authors also determined that with an increase in w/cm, the influence of temperature on yield stress is reduced. One other interesting find is that of the micromortars (small size SCC mixture containing no large aggregate) tested, all experienced a linear increase in yield stress over temperature and time.²⁴

Similar research was performed by Jolicoeur et al. on the rheological properties of superplasticized cement pastes. With SP dosage remaining constant, the authors experienced “significant non-linear variations with temperature.”²⁵ This result is contrasted with the previously described work of Petit et al. Jolicoeur et al. used a polynaphthalene sulfonate superplasticizer (PNS) for their studies. An attempt was made to see if perhaps some correlation existed regarding the effect of temperature on slump loss with respect to time. A non-linear relationship was discovered. However, a successful relationship was made with the use of silica fume in mixes. The authors pointed out that temperature has a larger influence on silica fume mixes; at high temperatures, silica fume mixes can even reject the adsorption of PNS. To explain the

rheological irregularities in their work, the authors suggested that the odd changes in fluidity over time may be attributed to opposing effects. For example, as concrete temperature increases, cement hydration does as well. Accordingly, greater slump losses should be experienced. However, with greater temperatures come higher superplasticizer adsorption levels. With cement grains taking up more superplasticizer, this act will hinder hydration and try to keep flows more constant.²⁵

2.7 CONCLUSION

It has been demonstrated within the previous pages of this literature review that UHPC does perform in a manner far superior to normal concrete. While the benefits of UHPC over normal concrete are well received, this study is concerned with two points of interest: temperature and mixer type. Relatively little work has been produced for the effect of mixer type on UHPC. The mixing process has been extensively documented, but the effects of mixer type on concrete performance have not been thoroughly investigated. Much literature is published documenting the influence of temperature on normal concrete. However, because of stark differences between normal concrete and UHPC such as aggregate gradation, and fiber usage, it appears justifiable that research is completely necessary to identify the impact of temperature and mixer type on UHPC.

CHAPTER 3 EXPERIMENTAL PROCEDURES AND RESEARCH PROGRAM

3.1 GENERAL

The goal of the research program was to determine the effects of mixer type and initial premix temperature on the performance of UHPC. This chapter will attempt to demonstrate, in great detail, the testing methods used to obtain data and the procedures for batching, curing, and sampling the concrete.

3.2 SCOPE

Two different studies were performed. The first study involved examining the effect of initial premix temperature on UHPC properties, whereas the second study looked at the change in properties that may occur by varying the type of mixer. The following paragraphs provide a small, but more descriptive overview of the research program.

Three different mixers were used for the mixer study; each bullet point lists some key details about each mixer.

- Mixer 1 – For the first 32 batches, a Hobart 19 L (20 quart) pan mixer was used. Batch sizes were 5.7 L (0.2 ft³). For the next 9 batches, a Blakeslee 19 L (20 quart) pan mixer was employed. The Blakeslee mixer used the same batch size as the Hobart mixer. The mixing speed of each mixer was placed at the minimum setting; both mixers used similar style paddles.
- Mixer 2 – Stone® 0.35 m³ (12.5 ft³) rotating drum mixer. This mixer contained three blades spaced evenly along the interior perimeter of the drum. Batch sizes were mainly 0.11 m³ (4 ft³), and 85 L (3 ft³).
- Mixer 3 – 8.3 m³ (10.8 yd³) (estimated size) ready-mix truck (rotating drum mixer). Two batches were created with volumes of approximately 5 m³ (6.5 yd³).²⁶

Both studies only utilized two fresh concrete testing methods; a flow test taken from ASTM C 1437, Flow of Hydraulic Cement Mortar,²⁷ and a temperature test conducted in

accordance with ASTM C 1064, Temperature of Freshly Mixed Hydraulic-Cement Concrete.²⁸ For hardened concrete properties, compressive strength was performed according to ASTM C 39, Compressive Strength of Cylindrical Concrete Specimens,²⁹ and two Modulus of Elasticity tests were conducted, including ASTM C 469, Static Modulus of Elasticity and Poisson's Ratio of Concrete in Compression,³⁰ and ASTM C 215, Fundamental Transverse, Longitudinal, and Torsional Resonant Frequencies of Concrete Specimens.³¹ All tests contained some type of modification. These changes will be discussed in their respective sections.

The method used to produce UHPC at the University of Arkansas (U of A) was very simple. Basically, bags of premix were used with ice, superplasticizer, and, when appropriate, steel fibers to create a concrete mixture. The premix was placed at temperatures ranging from 0 to 35 °C (32 to 95 °F). Batching began by recording the initial temperature of the premix, followed by emptying the premix into the drum or pan and starting the mixer. After ice and SP were added, mixing continued until a final product was rendered. A representative sample of UHPC was gathered, and its fresh temperature was measured. For the temperature study, the sample material was monitored for changes in temperature and flow values over a specified period of time. In addition to fresh concrete temperature and flow tests (when applicable), the mixer study cast and cured 100 x 200 mm (4 x 8 in) cylinders and 100 x 100 x 400 mm (4 x 4 x 16 in) prisms.

3.3 TEMPERATURE STUDY

The temperature study involved mixing UHPC over a spectrum of premix temperatures. Using the pan mixer, four batches were tested for each initial premix temperature block to ensure an adequate statistical average. The same reasoning was used for the rotating drum mixer; instead of using a minimum of four batches, a value of three was chosen instead. In the ready-mix truck application, the research team could only obtain data from two trucks. Table 3.1 provides the tests, minimum number of batches, and target initial premix temperature ranges used for the temperature study.

Table 3.1 Temperature Study Mixing Matrix

Pan			Rotating Drum			Ready-Mix Truck		
Temp. (°C)	Min. Batches	Tests	Temp. (°C)	Min. Batches	Tests	Temp. (°C)	Min Batches	Tests
$x < 0$	1	T,F	$0 \leq x \leq 10$	3	T,F	N/A	2	N/A
$0 < x \leq 5$	4	T,F						
$5 < x \leq 10$	4	T,F						
$10 < x \leq 15$	4	T,F	$10 < x \leq 20$	3	T,F			
$15 < x \leq 20$	4	T,F						
$20 < x \leq 25$	4	T,F						
$25 < x \leq 30$	4	T,F	$20 < x \leq 30$	3	T,F			
$30 < x \leq 35$	4	T,F						
$x > 35$	1	T,F						

Legend: T = Temperature (ASTM C 1064), F = Flow (ASTM C 1437)

The main interests of the temperature study were to observe the changes in both fresh concrete temperature and flow. Therefore, flow and temperature were measured at 10 minute intervals for a minimum of 30 minutes after batching. The variation in flow and temperature characteristics will be analyzed in the following chapter.

3.3.1 Premix Temperature Conditions

Three methods were used to change the premix temperature from its original temperature condition to some target temperature for testing. The next three sections should describe the methods used to obtain such premix temperature conditions.

3.3.1.1 Pure Ambient Temperature

This method's purpose was to let the premix acclimate itself to an outdoor or indoor ambient temperature without an external means. The premix was placed in areas where two

conditions were met: first, the environment must have low moisture and secondly, the locale must be able to subject the premix, as close as possible, to the target temperature for a prolonged time. The two main storage areas used by the research team were the outdoor material storage shed and an indoor environmental chamber, both located at the ERC. The outdoor shed was the most desired location to stockpile materials because it is a close representation of a typical ready-mix storage environment. This method was preferred over all other premix temperature altering schemes.

3.3.1.2 *Pseudo Ambient Temperature*

To create a suitable artificial premix temperature, some modifications were made to the environment in which the premix was placed. An oven was used to heat the premix up to a temperature of 35 °C (95 °F), whereas the freezer could lower the premix temperature down to -5 °C (23 °F). The only problem with both devices is that these values were their minimums. Efforts were made to heat the premix to a temperature of less than 35° C, or cool the premix to a level above -5 °C, but both were unsuccessful.

As it can be inferred, the process of altering the premix temperature was not always easy; some ambient temperature days accommodated the target temperature well, that is to say, no heating or cooling was necessary to obtain the proper temperature. However on most days, the temperature of the premix had to be modified by a peripheral means. Premix temperatures generated by a freezer or oven were labeled as pseudo ambient temperatures, in that they are false representations of the actual ambient temperature conditions. The majority of batches were tested under pure ambient or pseudo ambient conditions. This method was used for premix only; it was not used for the metal fibers or SP. If the temperature of the premix was close to the target temperature, the premix was allowed to sit in the lab, being stirred in approximately 15 minute intervals, until it reached the target temperature.

3.3.1.3 *Pseudo Ambient Mix*

To save time, a third method was used to adjust premix temperatures. For target temperatures that were not conducive to ambient temperatures during the day of testing, pseudo

ambient mixes were made by combining determined portions of colder or hotter premix materials to a known volume of laboratory temperature premix. Using the weighted average method, two known quantities of premix would be blended together using proportions necessary to produce a mix temperature equal to that of the target temperature. The premix quantities were added together and allowed to mix for 2 minutes. Afterwards, the temperature was recorded and the premix was blended for another 2 minutes. At this point, the temperature was taken once again. If a large change in consecutive temperature measurements occurred, or there was a significant difference between both thermometers ($>3\text{ }^{\circ}\text{C}$ or $>5\text{ }^{\circ}\text{F}$) used, mixing would continue, in two minute intervals, until two consecutive temperature tests showed little to no change. Once the premix initial temperature was established, the mixing process would immediately commence by adding ice and SP. Any time in which the premix temperature was documented, multiple measurements were made to ensure accuracy.

3.4 MIXER STUDY

The mixer study incorporated three different mixers, each of varying size, to determine their level of effect on UHPC fresh (when applicable) and hardened properties. Table 3.2 illustrates the testing matrix used for the mixer study.

Table 3.2 Mixer Study Mixing Matrix

Pan			Rotating Drum			Ready-Mix Truck		
Temp. ($^{\circ}\text{C}$)	No. Batches	Tests	Temp. ($^{\circ}\text{C}$)	No. Batches	Tests	Temp. ($^{\circ}\text{C}$)	No. Batches	Tests
$0 \leq x \leq 10$	1	C, M ₁ , M ₂	$0 \leq x \leq 10$	1	F, C, M ₁ , M ₂ , T	N/A	2	C, M ₁ , M ₂
$10 < x \leq 20$	1	C, M ₁ , M ₂	$10 < x \leq 20$	1	F, C, M ₁ , M ₂ , T			
$20 < x \leq 30$	1	C, M ₁ , M ₂	$20 < x \leq 30$	1	F, C, M ₁ , M ₂ , T			
Legend: C = Compression (ASTM C 39), M ₁ = Modulus of Elasticity (ASTM C 469), M ₂ = Modulus of Elasticity (ASTM C 215)								

Although a range of initial premix temperatures did not have to be tested in this study, literature exists documenting high fresh concrete temperature's detrimental effect on ultimate

strength.¹ Therefore, to be more thorough, three batches were conducted, each at different initial premix temperatures.

3.4.1 Hobart®/Blakeslee® Pan Mixer Information

Two different brands of pan mixers were used. Both mixers were capable of batching the same size mixture, i.e. 20 quarts (19 L). For the first 32 mixes a Hobart® planetary style mixer was used. After 32 batches, the Hobart® mixer was taken back by the owner – the U of A simply borrowed the mixer. All subsequent batches were produced by the Blakeslee® mixer. Essentially, both mixers operated with a counterclockwise rotating paddle fixed to a clockwise revolving shaft as illustrated in Figure 3.1. Both mixers were set at their minimum mixing speeds. The difference between each mixer's minimum speed was considered negligible.

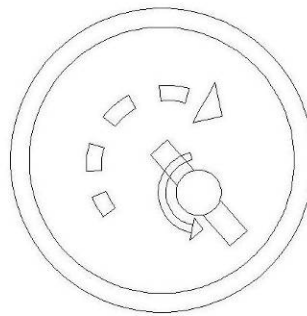

Figure 3.1 Illustration of Hobart®/Blakeslee® Mixing Motion.³²

3.4.2 Stone® Rotating Drum Information

The rotating drum mixer used by the research team was of the Stone® brand. The mixer had a listed capacity of 0.35 m³ (12.5 ft³) and contained three evenly spaced blades affixed to the inside perimeter of the drum. Mixing was conducted as horizontally as possible, but with enough vertical tilt to prevent any loss of material. The mixer did not have an adjustable speed; it is therefore assumed that the mixer produced all batches at the same rotation rate. The rotation speed calculated by the author was approximately 21.5 rotations per minute.

3.4.3 Ready-Mix Truck Information

The ready-mix truck had a drum volume of approximately 8.3 m³ (10.8 yd³), and contained the typical corkscrew fin arrangement found in most ready-mix trucks. Various mixing speeds were used for the ready-mix truck and shall be discussed in further detail later.

3.5 MATERIALS

3.5.1 Superplasticizer

A Chryso® Fluid Premia polycarboxylate base SP was used during the research program. The SP was contained in plastic 5-gallon containers and was stored in the environmental chamber at the Engineering Research Center (ERC). A benefit of storing the SP in an environmental chamber is the lessening of mixing variables - a constant temperature SP can simplify future analyses. The temperature maintained by the environmental chamber was typically in the range of 21-25°C (70-77°F). Further information involving superplasticizers can be found in Chapter 2.

3.5.2 Premix

The premix material used in the study arrived at the University of Arkansas on pallets containing 31-32 36 kg (80 lb) bags per pallet. Premix composition is documented in greater detail in Chapter 2.

3.5.3 Fibers

The fibers arrived to the University of Arkansas in cardboard boxes measuring 38.1 x 22.2 x 29.2 cm (15 x 8.75 x 11.5 in). For more steel fiber material information, see Chapter 2.

3.6 PRECISION

For the pan mixer, the weighing of SP, ice, and fibers was to the nearest gram. The premix material weight was rounded to the nearest tenth of a pound. For flow and temperature tests, values were recorded to the nearest millimeter and tenth of a degree Centigrade respectively.

The 0.11 m³ (4 ft³) and 85 L (3 ft³) Stone® rotating drum batches required much greater material weights, therefore lessening the expected precision requirements. Instead of a single gram precision for SP and ice, this time the SP and ice were weighed out to the nearest tenth of a pound. The premix precision remained the same. Flow and temperature recording precision remained the same as well.

3.7 THERMOCOUPLE TEMPERATURE RECORDING

3.7.1 Fiber and Premix Resistance to Changes in Temperature

It was proposed that the metal fibers, due to their large surface area and high heat of conductivity, act as poor heat conductors and dissipate heat very quickly when exposed to ambient temperatures for less than 30 minutes. The idea for this experiment occurred during batching. A small sample of fibers was heated up in conjunction with the premix. Before adding the fibers to the mixer, their temperature was recorded; this time the temperature of the fibers was near ambient temperature. It was then decided that a test be conducted with thermocouples to provide more research on this event. To conduct the experiment, two bowls of fibers and two bowls of premix were used. Each bowl contained 500 grams of material. Two bowl sets were made, that is, one bowl of fibers and one bowl of premix were placed as one set in a hot environment at 52°C (125°F), whereas the other bowl set was placed in a freezer at approximately -20°C (-4°F).

To record as precisely as possible the changes in fiber temperature, thermocouple wires were stored under the same conditions as the fibers. This allows for a lessening of “false” readings because the wires don’t have to acclimate themselves to the temperatures in which they are being tested. The use of a 500 gram (1.1 lb) sample was merely to create a simple, almost unit measurement of heat change. Consistency was kept in containers; the bowls which held the fibers during the thermocouple testing were the same ones used to stage fibers in the pan mixer batches. It is known that with larger masses of fibers, or differences in containers, the expected heat changes should be different. The purpose of this study was merely to better understand the heat capacity of the fibers and the premix.

The wires were placed in the center of each sample. Thermocouple data was acquired through a Measurement Computing® data logger and complimentary software used on the laptop computer viewed in Figure 3.2.



Figure 3.2 Fiber Heat Exchange Thermocouple Recording Setup.

3.7.2 UHPC Heat Evolution

To double check the manually made temperature recordings and chart the effect of adding fibers, 5.7 L (0.2 ft³) batches of UHPC were made and monitored for changes in temperature over several hours. Figure 3.3 illustrates the setup used to monitor temperature over time. The same Measurement Computing® data logger and software were used as described in the previous section. As soon as batching was complete for the pan mixer, the sample was emptied into a 5-gallon bucket and one thermocouple was placed in the center of the sample and the second thermocouple was placed approximately 38 – 51 mm (1.5 - 2 in) from an edge. Three digital readout thermometers were used to check the accuracy of the thermocouples over at least a 30 minute period. The data logger recorded one sample every ten seconds for a minimum duration of twenty hours. The temperature changes were monitored for the three cases shown in Table 3.3.

Table 3.3 UHPC Heat Evolution Testing Regimen

Batch	Premix Temperature (°C)	Ice/Water	Fibers
T1	25	Water	No
T2	26	Ice	No
T3	27	Ice	Yes



Figure 3.3 Monitoring UHPC Heat Evolution.

3.8 BATCHING METHODS

3.8.1 Full Batch Method

The hot weather mixing guidelines use ice as a replacement for mixing water; this method is recommended for ambient temperatures over 25 °C (77 °F). Since ice was used throughout the majority of the research period, the hot weather mixing procedure was selected. A summary of the mixing procedure is provided as follows with commentary on the actual mixing conditions viewed by the research team.

1. Add the entire quantity of premix to the mixer.
2. Blend the premix together for a period of 2 minutes.
3. After 2 minutes, add the entire quantity of ice plus 50% of the total quantity of SP.

4. At 10 minutes, add the remainder of SP.
5. When the mixture becomes fluid, add the steel fibers.*
6. Continue mixing until the fibers are satisfactorily dispersed.

*If used.

Before the mixing process began, the premix and SP temperatures were obtained. The actual ambient temperature, date, and time were also recorded. Once the premix contents were dumped into the drum or pan, the mixer was started and a stop watch was initiated to help keep track of mixing time. This is the datum (also referred to as time zero) for which the mixing procedure's time is kept – a new datum will be established in the beginning of the temperature and flow tests. For the first two minutes, the mixer's agitation had broken up most of the premix material. Depending upon the time of testing, a number of bags that had set on the pallet for a few months contained dry, hard premix chunks which proved difficult to break up. These chunks, or agglomerations, did not appear to be previously exposed to any type of moisture. Figure 3.4 illustrates this occurrence.

After the two minute period, the addition of ice and one-half the quantity of SP was introduced to the mixers. The ice would be added first for a time of 30 seconds to 1 minute. After the addition of ice, the SP would be added over a period of about 10 to 30 seconds. At the 10 minute barrier, the remainder of SP was added. The second addition of SP also occurred over an interval of 10 to 30 seconds. Mixing would continue until the substance had the consistency of dough. The time in which this stage was reached proved variable.

Once the mixture was uniform, the mixer was stopped and fibers were added (if used). The time between the last addition of SP and the introduction of fibers (point of mix fluidity) will be referred to as "gap time." Before the fibers were added, their temperature was recorded. If the fiber temperature was not recorded, their temperature was assumed to equal to the ambient temperature (see Section 3.7.1). The concrete was deemed ready to pour after it was either fluid, or the fibers had been given ample time to disperse themselves (typically 5 minutes).



Figure 3.4 Evidence of Dry Premix Agglomerations.

The application of this procedure on a much larger scale was performed using ready mixed trucks. Mixing began with each truck receiving large bags of premix via an overhead crane, beginning at approximately 5 A.M. Next, as the drum rotated at 6 revolutions per minute (rpm), ice followed by SP, were added to the drum over a 20 minute period. Mixing speed increased to 12 rpm for about 15 minutes to melt the ice. As soon as the ice had melted, the mixing speed was reduced back down to 6 rpm and metal fibers were added. Finally, to finish mixing, the drum was sped back up to 12 rpm for approximately 15 minutes followed by reducing the rate down to 2 rpm for 2 minutes to help release entrapped air.²⁶ Before discharging the material into the forms, Lafarge employees checked the progress of the material by climbing up on the truck and viewing the drum's contents as well as reversing the rotation of the drum and discharging a portion of material.



Figure 3.5 Buchanan-Pi Girder.

3.8.1.1 Batch Size Determination

Using the full batch method, the determination of a suitable batch size was developed for both the pan and rotating drum mixers. For the pan mixer, the starting batch size was selected as 9.4 L ($1/3 \text{ ft}^3$); this volume (approximately 50% of total capacity) taxed the mixer. The starting batch size was purely arbitrary, therefore the subsequent batch size was reduced to one-half the original batch size, or 4.7 L ($1/6 \text{ ft}^3$). Testing out the new 4.7 L batch, it was quite visible that the mixer was experiencing no stress, yet mixing continued for over an hour with the premix never “turning-over,” or becoming fluid. The next (now third) batch size was upped to 5.7 L ($1/5 \text{ ft}^3$), because it was thought that there wasn’t a sufficient amount of material to mix properly in a 4.7 L ($1/6 \text{ ft}^3$) batch. The first mix produced with a 5.7 L ($1/5 \text{ ft}^3$) batch size required about 35 minutes of mixing. It was decided that there was no need to try a larger batch size because the increase would cause a less efficient use of materials and increased stress for the pan mixer.

The selection of a batch size for the rotating drum mixer began at 57L (2 ft^3). At this volume, the batch did not mix successfully. The premix reached the granular growth stage as mentioned in Section 2.6 of the Literature Review, but the mix never became fluid. Figure 3.6 provides a picture of the final product after three hours of mixing.



Figure 3.6 Rotating Drum Trial Batch Size.

The ensuing batch size was upped to 85 L (3 ft³) and the results were successful. However, it was visually apparent that the mixer not only needed more material (it appeared that there wasn't enough kneading action), but it could easily handle a larger batch size. It was also believed that a larger batch size would provide a batch to mixer volume ratio similar to the pan mixer. Subsequently, the batch size was increased to 0.11 m³ (4 ft³). As testing continued, it was discovered that the research team did not have enough material to complete their studies with 0.11 m³ (4 ft³) batch sizes. Therefore, some additional 85 L (3 ft³) batches were conducted in place of 0.11 m³ (4 ft³) ones.

It must be documented that these observations were made early on in the rotating drum research period. Discussed later, the half-batch method clearly shows that 57 L (2 ft³) volumes can be mixed successfully. As a result, another variable must be the cause of concern for the improper mixing of the 57 L trial batch discussed earlier. This anomaly, thought to be related to the material's shelf life, will be discussed later in the Results and Analysis section (Chapter 4) of this thesis.

3.8.2 Half Batch Method

The batching procedure (3.8.1 Full Batch Method) was easy to follow and produced good results for the pan mixer. However, this wasn't always the case for the rotating drum mixer. Some of the rotating drum's batches had an undesirable homogeneity. It was thought that the

mixing procedure could be a contributing factor to the mixing problem. Another, very similar, procedure was then adopted in hopes of alleviating the homogeneity problem. Figure 3.7 illustrates the homogeneity issue; some batches contained hard, unmixed chunks of premix varying in size, most averaging the diameter of a U.S. quarter.



Figure 3.7 Homogeneity Issue from Full Batch Method.

In previous research at the University of Arkansas conducted by Dr. Edmundo Ruiz, his work with UHPC consisted of making batches sequenced in halves. Essentially, the research team followed a procedure similar to that of Dr. Ruiz. This new procedure was completed as follows:

1. “Butter” (coat) the mixer’s interior with a small amount of water.
2. Fill the mixer with $\frac{1}{2}$ total quantity of premix material.
3. Premix for 2 minutes; next, add 50% total quantity of ice and 25% total quantity of SP.
4. Mix until 10 minutes have passed and add the remaining (25% original total) SP.
5. When the mixture becomes fluid, add the second half of premix and let mix for 2 minutes.
6. Add the remainder of ice and half of the remaining SP.

7. After another 8 minutes, add the remaining portion of SP.
8. Mix until fluid.
9. Add fibers*
10. Pour¹³

*Fibers were not used for every batch. In a conversation held with a member of Lafarge, it was indicated that the fibers used with the research team's tests, do not significantly influence the flow of UHPC.²³

3.9 SAMPLING

The procedures for sampling varied for each mixer. For example, the pan mixer's batch size was only 5.7 L (0.2 ft³), falling short of the ASTM C 172, Standard Practice for Sampling Freshly Mixed Concrete minimum sample size of 28 L (1 ft³). Nevertheless, sampling from the pan mixer consisted of emptying the bowl's contents into a 5-gallon bucket for flow and temperature tests. An exception was made for molding cylinders. To maximize the use of material, cylinders were cast with material taken directly from the pan.

Two wheelbarrows were used to sample UHPC for the rotating drum mixer. The first wheelbarrow received approximately $\frac{1}{4}$ of the total batch volume (28 L or 1 ft³) then was removed. Next, the second, empty wheelbarrow was moved into place and was given approximately $\frac{1}{2}$ of the original total batch volume, or 57 L (2 ft³). Finally, the first or original wheelbarrow was rolled back into place and received the remaining mixer contents. The second wheelbarrow's contents were used for temperature and flow tests as well as molding of compressive specimens. It should be noted that for both the pan and rotating drum mixes, samples were never reused, i.e. material from flow tests was not used for making cylinders.

The ready-mix truck also received its sampling material in a wheelbarrow. The truck directed its chute at the wheelbarrow and slowly discharged its contents until a sufficient sample was received.

3.10 CASTING AND CURING

All cylinders and prisms created at the U of A were cast and cured in accordance with Lafarge's recommendations. The casting process consisted of pouring UHPC into the appropriate mold in one lift with no rodding or vibration. Each cylinder, when full of material, was taken and the bottom of the cylinder was struck forcibly against the ground 10 times. The self consolidating nature of UHPC easily filled in the cylinder molds. The cylinders, once cast, were immediately taken into an environmental chamber at the ERC. On average after 48-55 hours from the time of casting, the cylinders/prisms were demolded. The approximate 48-55 hour demold time was also considered because of the work of Graybeal (2006). In his work, Graybeal stated that UHPC cylinders demolded too early had lesser strengths than cylinders demolded between 47-55 hours after casting.⁷ After demolding, specimens were placed in an oven at 90 °C (194 °F) for a period of 48 hours, while being immersed in pans full of water. Upon removal, the cylinders were placed into an end-grinder to remove any surface irregularities and promote more consistent strength results. Cylinders and prisms cast during the ready-mix truck application in Winnipeg were cured and end-ground by Lafarge.

3.11 FRESH CONCRETE TESTS

3.11.1 Temperature

ASTM C 1064, Temperature of Freshly Mixed Hydraulic-Cement Concrete, was used as a reference for recording UHPC temperature. The temperature of the fresh concrete was recorded every 10 minutes, if possible. For most tests, this was the rule. In some cases, due to unexpected circumstances, e.g. assistance with other lab personnel, the temperature was not recorded precisely at 10 minute intervals. Readings from thermometers were not taken until temperatures had stabilized.

For the pan mixer, the aforementioned ASTM standard was difficult to meet. Immediately after sampling the mixture, a wire jig was placed inside the 5-gallon bucket to hold the thermometers in place. The wire created a semi-stable, consistent location for temperature readings. The thermometer depth varied for each batch because of the wire's non-rigid nature.

For the most part, it could be said that at least 51 cm (2 in) of cover was maintained throughout testing.

3.11.2 Flow

The tests for flow were conducted similarly to ASTM C 1437, Flow of Hydraulic Cement Mortar. A few modifications were made since the test uses a concrete mixture rather than pure mortar. The test is performed on equipment conforming to ASTM C 230, Flow Table for Use in Tests of Hydraulic Cement. A summary of the procedure used by the author to measure flow is as follows:

1. Dampen the cone and flow table surface to SSD condition.
2. Scoop an ample amount of UHPC from the sampling container.
3. Allow UHPC to flow on its own, requiring little to no help, into the cone
4. Using a strike off bar, level off the top of the cone.
5. Ensure that the flow table is clean of any debris.
6. Lift the cone for a period of approximately 5 seconds.
7. Scrape off the inside of the slump cone and place additional material, if any, into the center of the concrete puddle.
8. Allow the material to flow for 1.5 to 2 minutes.
9. Record the flow across 3-axes to the nearest millimeter.
10. Turn the handle on the flow table at approximately two revolutions per second (100 rev/min) for 10 seconds (20 total revolutions).
11. Allow the material to flow for another 1.5 to 2 minutes.
12. Record the flow across 3-axes to the nearest millimeter.

13. Discard material and prepare for future testing.

It was specified that acceptable static and dynamic flows were in the range of 200 to 230 mm (7.9 to 9.1 in) and 220 to 250 mm (8.7 to 9.8 in) respectively.³³

3.12 HARDENED CONCRETE TESTS

3.12.1 Compressive Strength

Compression testing was performed with adherence to Lafarge's specification of a loading rate of 1 MPa/sec. According to Graybeal, tests conducted at loading rates higher than ASTM C 39 have little effect on the compressive strength results of UHPC.⁷

3.12.2 Modulus of Elasticity

3.12.2.1 *ASTM C 469*

Two methods were used to determine modulus of elasticity (MOE). Cylinders were tested in accordance with ASTM C 469 standard with one exception. A 100 kip MTS machine available at the ERC could not fully produce 40% of the material's maximum compressive stress. Since the UHPC's maximum compressive stress is so high, the cylinders were loaded to 15-20% of the compressive strength. A 102 mm (4") extensometer was used to determine strain measurements for cylinders created by the drum and pan mixer. A linear variable differential transformer (LVDT) was used in place of the extensometer for the ready-mix based cylinders.

3.12.2.2 *ASTM C 215*

The method used to obtain MOE via pressure waves is ASTM C 215. Slight modifications were made to the specification. As a note, cylinders were all tested in succession followed by all of the prisms. First, an initial natural frequency test was run as a rough estimation. Depending upon the specimen, the rough estimation had to be conducted once because the natural frequencies of all subsequent specimens were close to the same value. Next, after isolating the first mode of the cylinder of prism, the test was run again placing all data recording within a much smaller spectrum. This allowed for a more efficient use of data acquisition. The natural frequency was the average of three tests and the calculation methods for unconstrained

MOE (dynamic Young's Modulus) were performed in compliance with the aforementioned ASTM specification.

CHAPTER 4 RESULTS AND ANALYSIS

4.1 GENERAL

This chapter presents a compilation of observations and data recorded from the experimental procedures described in the previous chapter. This section will proceed by documenting and analyzing data obtained from the temperature study followed by the mixer study. Great effort has been made to separate out the topics belonging to the mixer study and the temperature study. However, since variables like temperature and mix time can be related, some of the results tend to overlap. The amount of overlap becomes difficult to manage especially when examining material characteristics such as compressive strength or flow. The main focus of the temperature study is to examine two points of interest: first, document the changes in UHPC temperature over time, and second, determine the resultant temperature for a freshly batched UHPC sample given some initial premix temperature. In each study, the discussion of data and results will be done in a volumetric manner; the pan mixer will be discussed first followed by the rotating drum, and concluding with the ready-mix truck, when applicable. As a note, the Stone® rotating drum mixer will at times be referred to simply as the drum or drum mixer.

4.2 TEMPERATURE STUDY

The goal of the temperature study is to determine two pieces of information about UHPC; the first objective as mentioned in the General section (4.1) of this chapter, is to document the changes in UHPC temperature over time. The second objective is to observe the fresh concrete temperature produced after creating multiple batches of UHPC under various premix temperatures with ice as a replacement for mixing water. Fresh and hardened concrete property tests will be performed to help gather information for this study.

4.2.1 Fresh Concrete Properties

The fresh concrete properties tested in the temperature study include temperature (ASTM C 1064) and flow (ASTM C 1437). Additional information regarding these tests can be located in greater detail in Chapter 3.

4.2.1.1 Temperature

During the course of the study, it was required that a minimum of four batches be produced for each 5 °C increment of premix temperature; this places a minimum number of batches at thirty-five. Rather than meeting the minimum requirement, thirty-eight pan mixed batches were produced. Manual temperature measurements were made as described in Chapter 3. On average, four temperature measurements were made over an approximately thirty minute period. In Figure 4.1, one can view representative curves for temperature values versus time. Plotting over thirty curves on one graph appears congested and can be troublesome for most readers to interpret. Therefore, one curve was selected from each temperature group (e.g. one from 10-15 °C, one from 20-25 °C, and so on.) that best represented the group's flow behavior. To understand the graph's legend, the first description is the batch number, which represents its order out of thirty-eight mixes, and second, the value in parentheses marks the premix starting temperature.

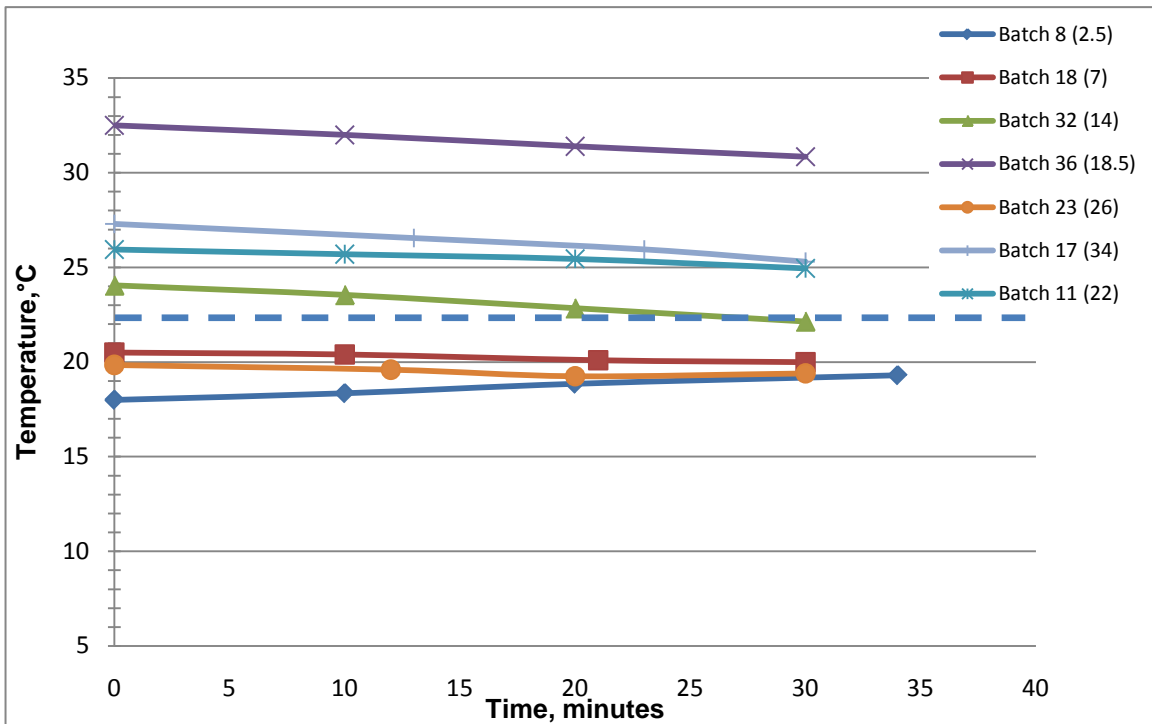

Figure 4.1 Temperature vs. Time Trends for the Pan Mixer.

Rather than honing in on each individual batch, one should observe the overall picture. It should be easily observed that the fresh concrete temperatures trend toward the horizontal

dashed line. The dashed line represents the average ambient temperature (22°C or 72 °F) experienced over months of testing. To better understand the UHPC's unusual affinity for acclimating itself to ambient temperature, an additional method was employed to chart the changes in temperature over time. The results from this method will be explored further later.

The temperature study for drum mixed batches was based on 85 L (3 ft³) and 0.11 m³ (4 ft³) volumes. Using the rotating drum mixing procedures outlined in Chapter 3, eleven batches were created. Of the eleven batches, five had a volume of 85 liters and the remaining six were of the 0.11 m³ size. Due to the much smaller number of batches created, all of the drum batches containing temperature-time tests are shown in Figure 4.2.

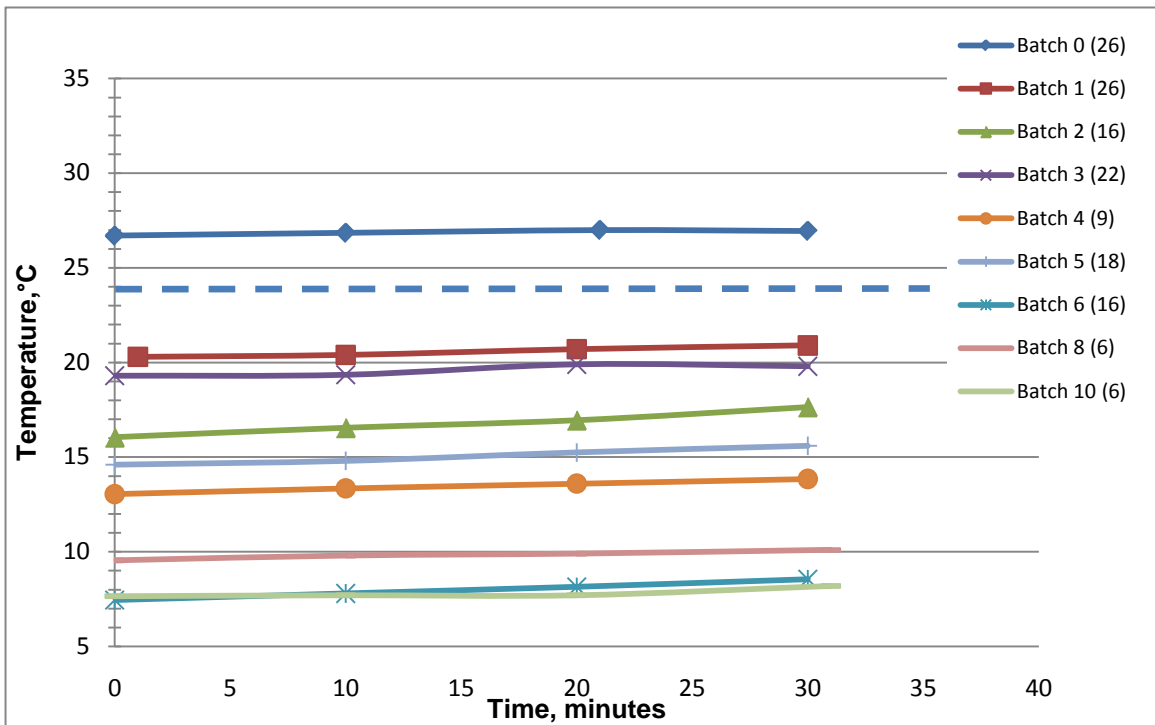

Figure 4.2 Temperature versus Time Trends for the Rotating Drum Mixer.

As it can be inferred from the graph, the rotating drum mixes exhibit a much slower movement towards the average ambient temperature (horizontal dashed line) when compared to the pan mixer. This effect makes sense; as the mass or volume of some material is increased, so does its ability to resist changes in temperature. Therefore, the effect that is viewed in Figure 4.2 is due in part to the much larger volume of materials used to create the drum mixed batches; in

fact, the rotating drum's 85 L (3 ft³) and 0.11 m³ (4 ft³) batch sizes are 15 and 20 times larger than the pan batch sizes used.

4.2.1.1.1 Temperature Measurement by Thermocouples As mentioned earlier, the pan mixer's batches tend to adjust to ambient temperature quickly; as a result, a more precise method using thermocouples (TC) and a data acquisition system was chosen to better understand this phenomenon. Three batches of UHPC were individually prepared and tested as documented in Section 3.7.2, with the specifics of each case being documented in Table 3.3. For the reader's ease, the aforementioned table is reproduced as Table 4.1.

Table 4.1 UHPC Heat Evolution Testing Regimen

Batch	Premix Temp. (°C)	Ice/Water	Fibers
T1	25	Water	No
T2	26	Ice	No
T3	27	Ice	Yes

Since the thirty-eight batches created for the temperature study contained ice and fibers, the best comparison would be to plot case T3 only, as the other cases are not pertinent to the current topic of discussion. Twenty plus hours of data were recorded for the T3 batch. The temperature-time record of this experiment is shown in Figure 4.3.

The graph clearly shows that the batch temperature trends towards the ambient temperature. However, to be consistent with the time limitation of the manual temperature recording in the previous section, all data after 45 minutes should not be considered. This will allow for a fair comparison of data generated by both acquisition methods. The first 45 minutes of temperature and time history are shown in Figure 4.4.

To help interpret both Figure 4.3 and Figure 4.4, the descriptions on the legend can be understood with some explanation. The first letter and number pair marks the batch case. In parentheses, moving from left to right, the numerical value represents the premix initial

temperature, followed by an I or W which mark whether ice or water was used; continuing on, if an F is used, it is to designate that fibers were included in the mix, and finally, the last letter is for describing the temperature condition being measured, A for ambient and U for UHPC. Some data consolidation was used to simplify both graphs - each curve is an average of two TC wires.

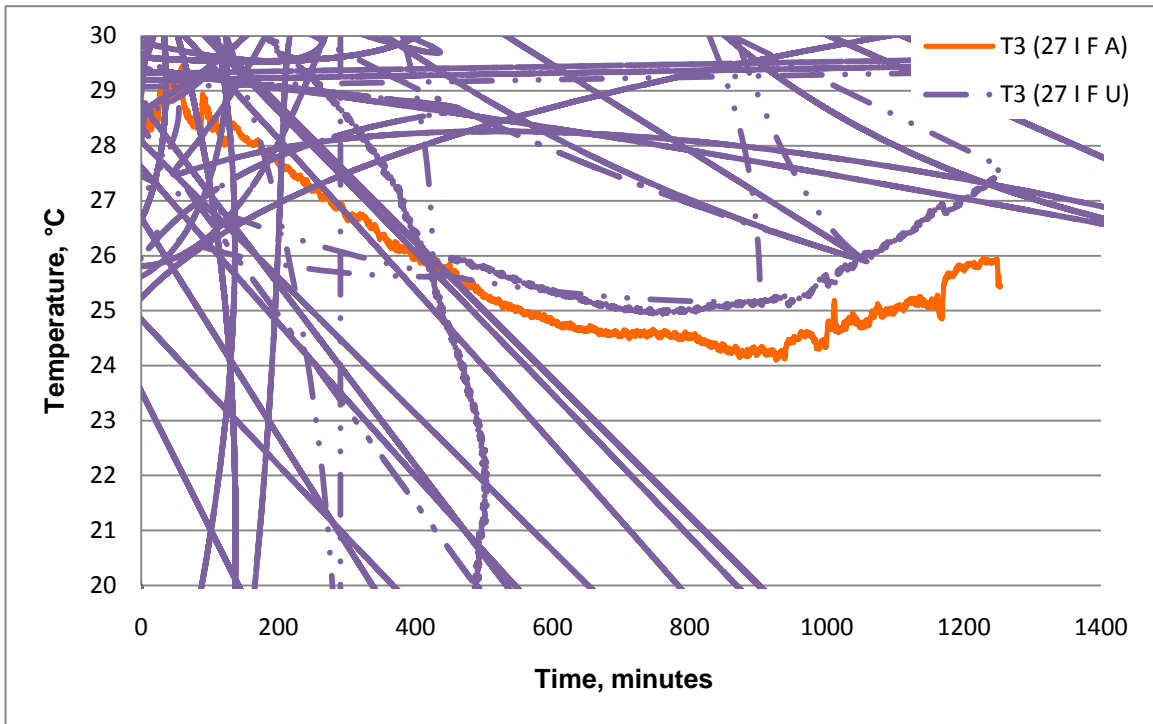

Figure 4.3 Batch T3 Changes in Temperature over Time.

Apart from the large, unexpected drop in temperature at about seven minutes, both the ambient and UHPC temperatures almost appear to be in-phase, meaning that when the ambient temperature begins to climb/fall, the UHPC temperature reacts immediately, without any lag. This finding makes the data appear questionable. The UHPC sample has mass and therefore should be somewhat resistant to immediate changes in ambient temperature. A possible explanation may be due to “cold” and “hot” spots similar to the wet and dry zones that occur in the mixing process as described in the Literature Review. Through driving factors such as convection, perhaps the thermocouple is reading material that is trying to separate itself to either a cold region or a warm region. Nevertheless, the data show that UHPC wants to acclimate itself to the ambient temperature within the first 45 minutes after mixing.

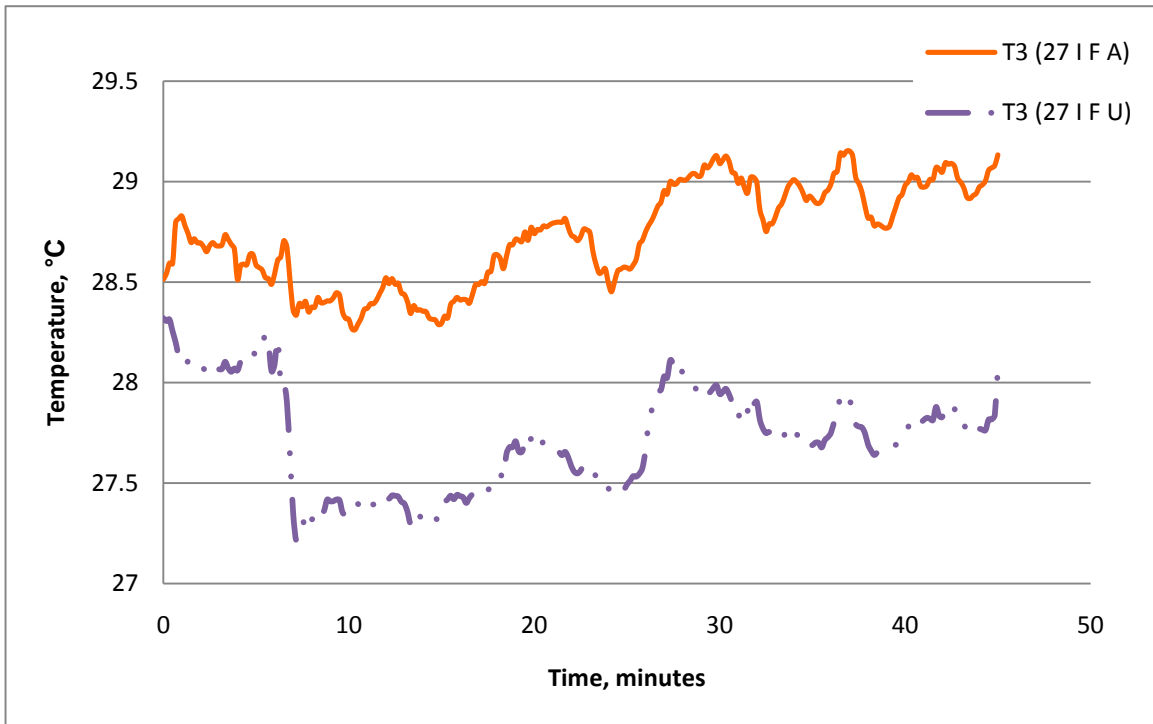

Figure 4.4 Batch T3 Changes in Temperature over a 45 Minute Period.

4.2.1.1.2 Pan Temperature Analysis It appears that UHPC is very susceptible to changes in temperature for small batches like those created in the pan mixer, but its temperature resilience does increase as the quantity of materials is raised. While this information is obvious, it serves little purpose without knowing the fresh concrete resultant temperature. If one was to understand the fresh concrete temperature, then one could pair with it the knowledge of UHPCs ability to retain heat in respect to volume. Therefore, an analysis was performed to determine if the premix, or component starting temperature used with ice, had any influence on the resulting batch temperature. If the premix temp at 30 °C (86 °F), had a large influence on the resulting batch temperature, whereas 15 °C (59 °F) did not, then this information would be useful to concrete producing companies who want to know if their use of ice is justified for the conditions given. The graph used to conduct this analysis is Figure 4.5.

To help explain the graph, the initial premix temperature groups are represented from low temperature to high temperature in 5 °C increments. For example, group 1 ranges from 0 to 5 °C, and group 2 is from 5 to 10 °C; this trend continues on up to group 7, which is the 30 to 35 °C initial premix temperature range.

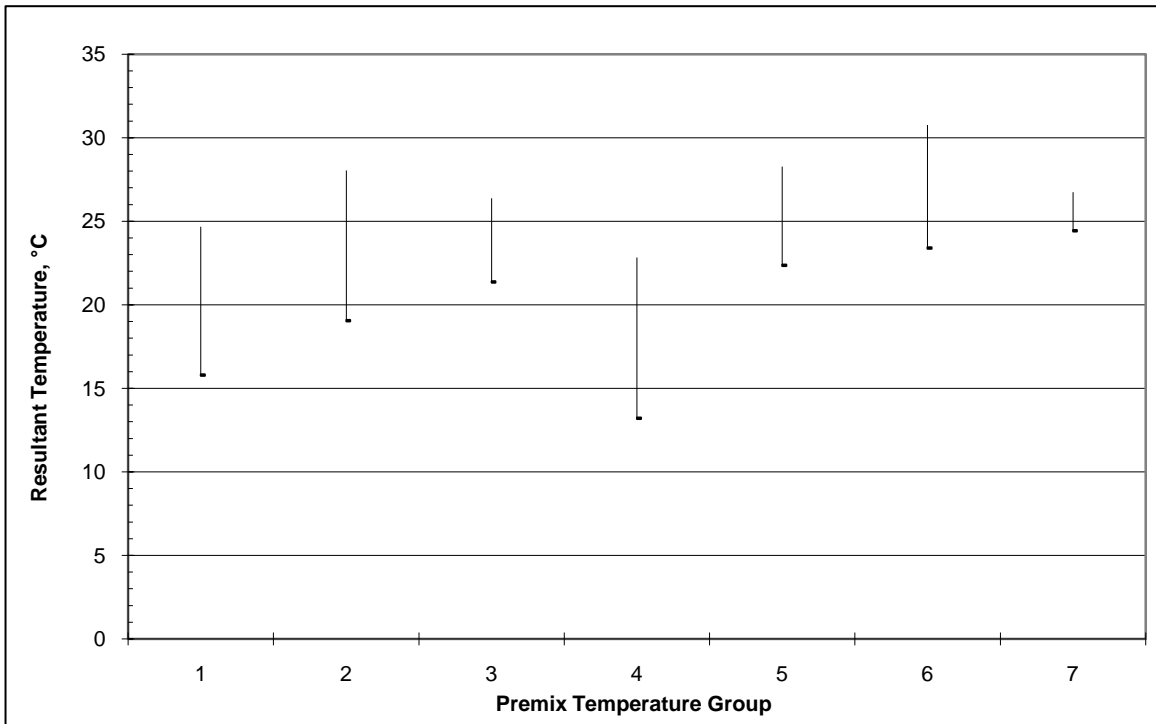

Figure 4.5 Pan Mixer Temperature Analysis Using 90% Confidence Lines.

If one was to draw a horizontal line across the page from left to right, or vice versa, they (most likely will) intersect multiple confidence interval columns. Such an instance of intersection shall henceforth be referred to as “overlap.” Overlap proves the significance of whether two or more sets of data are significantly related to one another. Relating the effect of overlap to this graph, high overlap demonstrates that the same result can be reached by a number of different initial premix temperatures, whereas low to zero overlap would indicate that each result is dependent upon the initial premix temperature. Since the amount of overlap is high for Figure 4.5, the graph clearly proves that for a given premix temperature the same resultant temperature can be arrived at by a number of other potential premix temperatures. For a quick example of overlap, look at temperature groups 3 and 6 (10 to 15 °C and 30 to 35 °C). The data prove that if one was to place premix at 12.5 or 32.5 °C, their likelihood of arriving at the same resultant temperature is very good because each group’s amount of overlap is large. However, the graph here only tells part of the story. Figure 4.6 shows the “non-grouped,” or individual batch data from the pan mixer temperature tests.

The diagonal line on Figure 4.6 is absolutely critical to interpreting the data. Since the diagonal is placed on a one-to-one slope, the use of this line aides in understanding if ice provides a beneficial effect. So, if one was to have a premix starting temperature at 5 °C, one would move up vertically from the x-axis from the 5 °C mark until they touched the diagonal. After the point of intersection was reached, one would then move horizontally across the page to the y-axis where they would get the same resultant temperature. This one-to-one relationship allows the reader to see that if a data point lies under the diagonal line, then its resultant temperature is lower than its original temperature, meaning that the ice was effective in reducing temperature over the course of mixing.

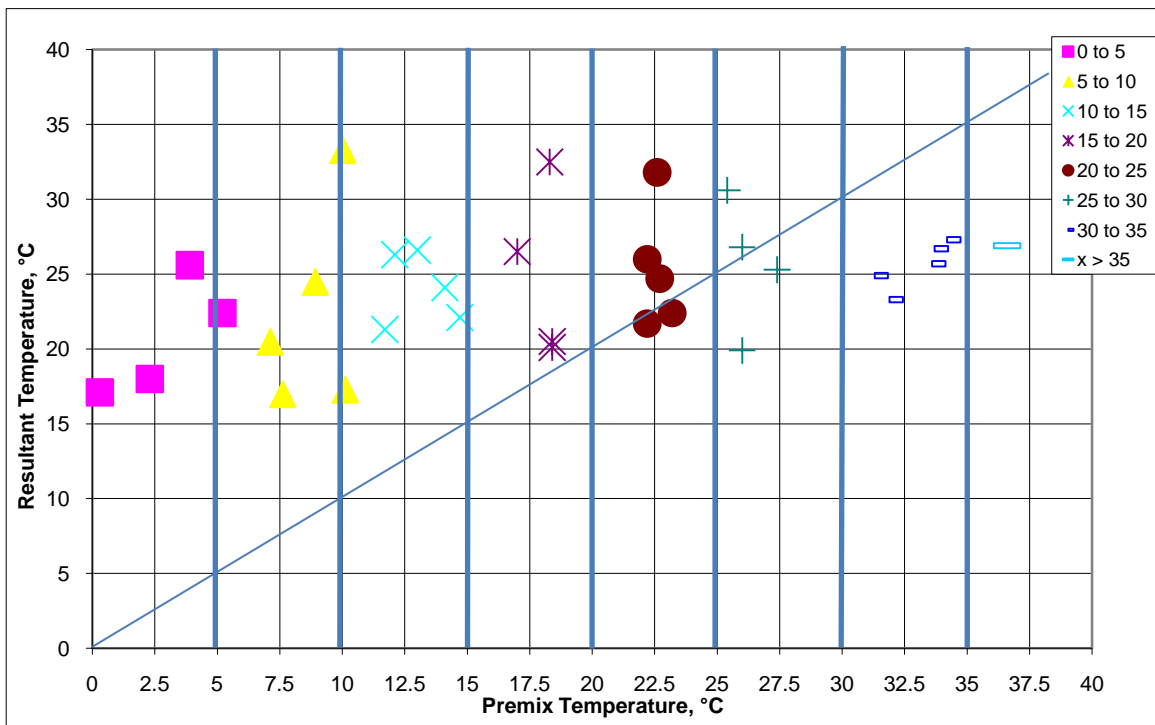

Figure 4.6 Non-grouped Pan Mixer Temperature Analysis.

Before one should draw any direct conclusions from this graph, one must understand that these results are misleading. It appears that ice is effective at the high range of premix temperatures tested. One must reconsider the amount of overlap that was proven in the previous figure before making any new conclusions. Most likely, the ambient temperature is the main factor influencing the resultant temperature. Only one reasonable conclusion can be drawn here: the pan mixer's batch size is too small, which in turn makes it very susceptible to changes in

temperature. Conversely, from earlier results the drum mixer exhibited little changes in temperature over time; it was theorized that because of the drum batches increased mass, they are more resistant to changes in temperature. If in fact the batch's ability to not succumb to ambient temperature is maintained during batching, then the comparison between premix temperature and resultant temperature should provide some helpful information.

4.2.1.1.3 Drum Temperature Analysis Using the same analysis method as derived in the previous section, Figure 4.7 illustrates the resultant temperature of each batch versus the starting, or original premix temperature. As a reminder, the temperature groups tested in the drum mixer study were in ten degree increments, not five degree increments as performed in the pan mixer tests.

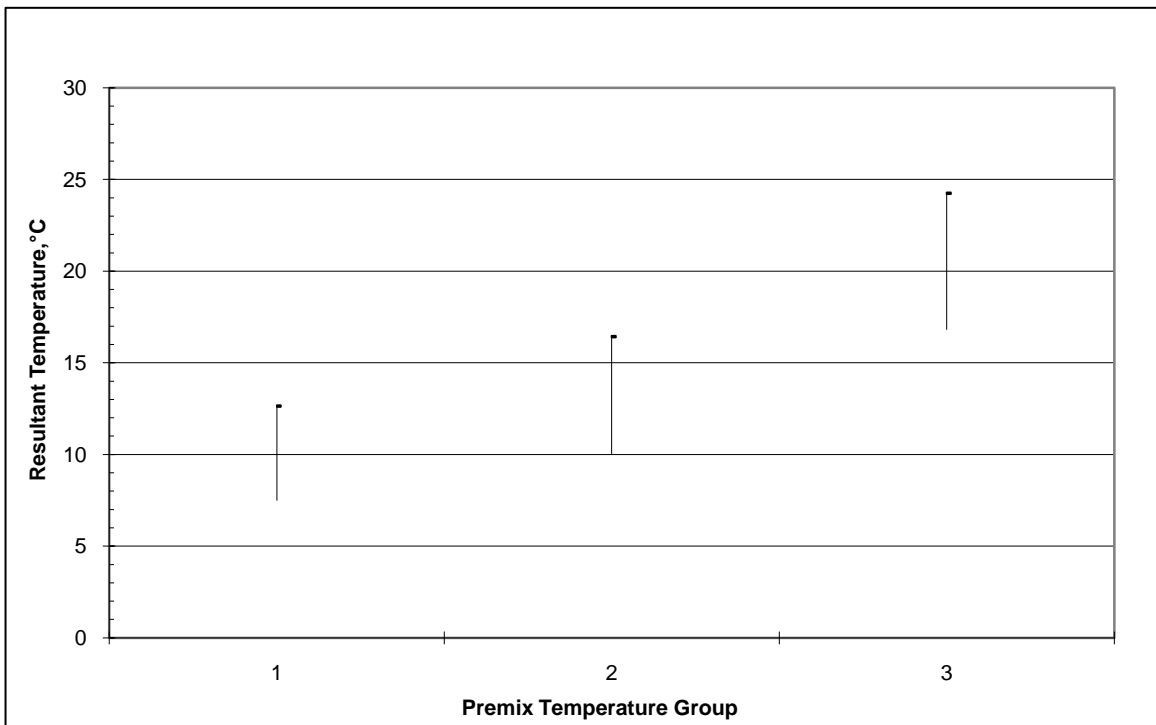

Figure 4.7 Drum Mixer Temperature Analysis Using 90% Confidence Intervals.

While there is a little overlap between the data, a definite trend has appeared. This trend may be ruled out in group 1 (0-10 °C), but further examination must be made between temperature groups 2 and 3 (10-20 and 23-30 °C respectively). One can see that premix temperature has some impact on the resultant temperature at these batch sizes. To further explore this effect, Figure 4.8 shows the individual resultant batch temperature values. Once

again the vertical lines are used to delineate the temperature groups tested. Upon examination of the figure, it appears that premix temperature is more effective in helping cool down the concrete for both 10-20 and 20-30 °C temperature groups, but since no data is present below 15 °C, it is better stated that the premix temperature is influenced at temperatures above 15 °C.

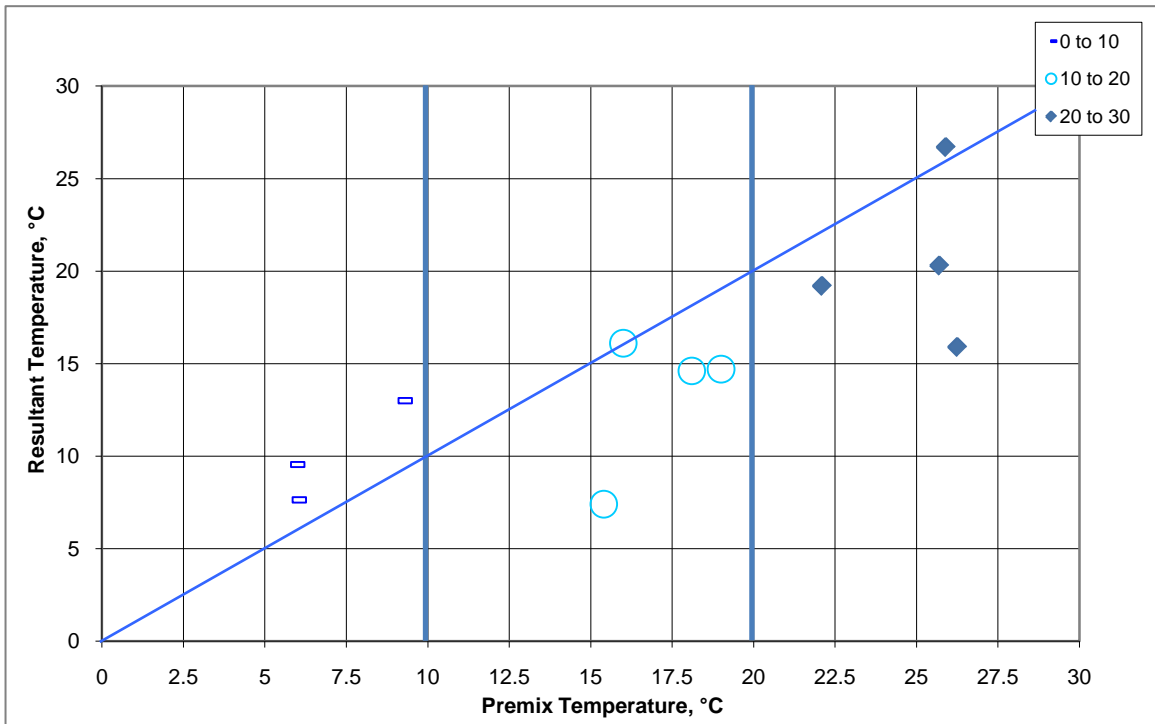

Figure 4.8 Non-grouped Drum Mixer Temperature Analysis.

It may appear odd to the observer that for temperatures below 10 °C, the effect of using ice produces a resultant temperature that is greater than the input temperature. Upon further inspection, one must understand that friction is one of the primary modes in which mixers work. Any buildup of friction creates heat, and heat over long periods of time will raise a concrete's temperature.

4.2.1.1.4 Premix and Fiber Resistance to Changes in Temperature It was mentioned in the previous section that at temperatures above 15 °C, the effect of using ice is justifiable. Using this information led to the investigation of how well the dry premix and fibers perform at maintaining their internal temperature when placed in a “hot” and “cold” environment then, when removed, allowed to acclimate themselves to the ambient temperature. The results of this study are located in Figure 4.9.

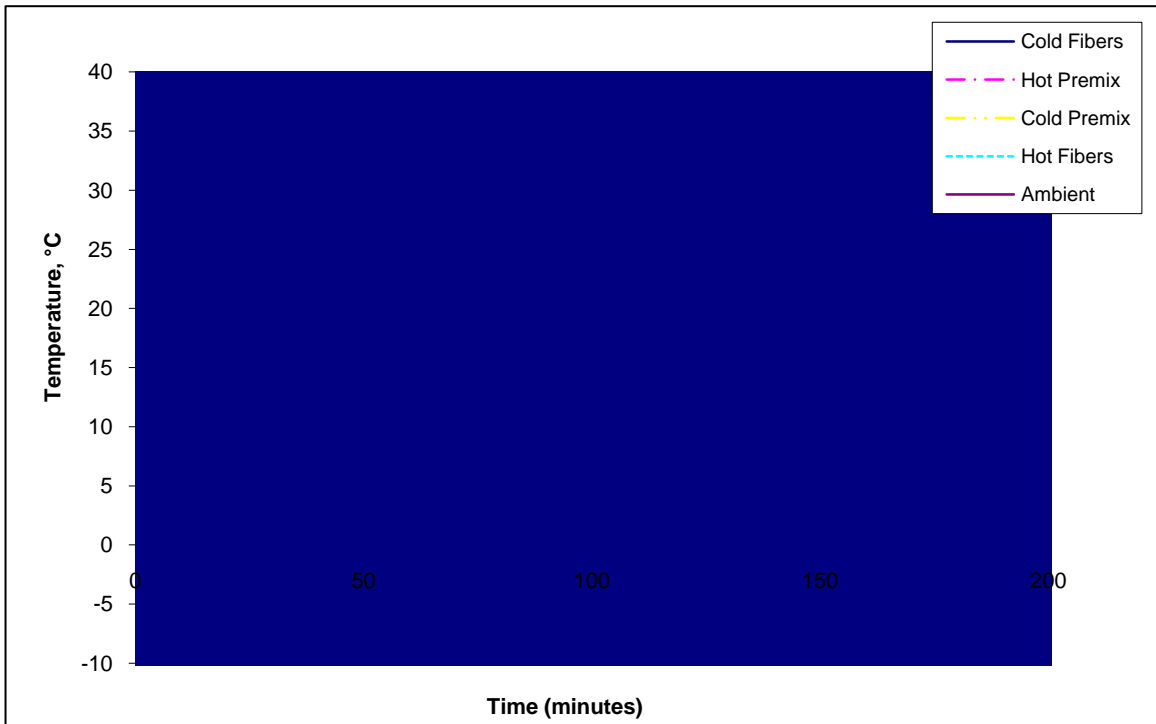

Figure 4.9 Fiber and Premix Resistance to Changes in Temperature.

This study was also done in part because of the undesirable results with the T3 batch. Essentially, this study followed the procedure described in Section 3.7.1; one of the proposed ideas from the section was that the fibers don't hold their temperature very well. It is easily distinguishable from the figure that the assumption is true. The fibers have a large surface area and are poor heat insulators, but in comparison the premix appears to hold heat well. This fact is important for ready-mix companies, because if their location has experienced consecutive days of cold/hot weather followed by an unseasonably opposite temperature day, the fibers will be very close to the ambient temperature, whereas the premix will be lagging behind, exhibiting a temperature closer to a few hours previous, maybe even to the previous day. Knowing that the premix is on a lag could help companies save money by not having to use ice. Nevertheless, it is still recommended that one determine the temperature of all mixing materials before mixing. The premix may perform better than the fibers in holding heat, but it cannot outperform larger heat capacity materials like water.

Additionally, with larger masses than the ones tested, heat will be held longer. If the scale of testing was to be increased, there would be slight differences to the curves experienced

during testing. With this new finding, one can now assert that the fibers should be considered at ambient temperature when added to a mix. This study also serves to show that temperature changes in the premix over time can be significant as well.

4.2.1.1.5 Estimating Fresh UHPC Temperature Soon after mixing began, it was evident that if an established method existed in which the research team could check, or even predict their results, then it should be referred to for this experiment. Such an equation does exist, and it can be found in the Design and Control of Concrete Mixtures³ or in this thesis as Equation 4.1.

Equation 4.1 Estimation of Fresh Concrete Temperature³

$$T(^{\circ}\text{C}) = \frac{0.22(M_p * T_p) + M_{sp} - 80 * M_i}{0.22(M_p) + M_{sp} + M_i}$$

The large letters in the equation, M and T, represent mass and temperature. The equation is referenced for metric units; in this case the mass should be in kilograms and temperature in degrees Celsius. The equation has been modified somewhat by the author. The subscripts p, sp, and i stand for premix, superplasticizer, and ice respectively. The original equation contained temperature and mass inputs for aggregate, mixing water, and internal aggregate water. The author believes that his attempt to modify this equation may be in vain; multiple changes were made to make the equation as effective as possible, but all results remained far from the observed values. With the unpredictable trend in resultant temperature, an accurate prediction may be difficult to achieve. One must keep in mind that many variables are active when using a mixer; these variables include but are not limited to: mixer time, mixer speed, initial premix temperature, ambient temperature, component temperature (superplasticizer, water/ice, and metal fibers), batch size, and mixer shear. The difficulty of quantifying all of these variables to produce an equation describing resulting concrete temperature can be extremely tedious.

The equation works off of the principle of specific heat. Specific heat is defined as the amount of energy required to change a unit volume/mass of a substance or material by a unit measurement of temperature. To put this into metric units applicable for Equation 4.1, it would be

how much energy is required (kilojoules) for a one kilogram sample of material to increase in temperature by one degree Celsius. Knowing the volume of the batches used, the component weights were inserted into the equation and values were computed for a number of temperature scenarios. A summary of the results can be viewed in Table 4.2 with the actual field values being placed in an adjacent column for comparison purposes. The pan mixer's results are not published in Table 4.2 because it has been proven earlier that the pan mixer's batch size disallows for a proper evaluation of the resultant temperature.

Table 4.2 Comparison of Estimated and Observed Fresh Concrete Temperature

Rotating Drum Mixer Temperatures, °C			
Ambient	Premix	Equation 4.1	Observed
28.9	25.9	1.3	26.7
28.3	25.7	1.2	20.3
33.9	16.0	-5.6	16.1
24.4	22.1	-1.6	19.2
21.1	9.1	-11.1	13.0
23.3	18.1	-4.6	14.6
20.0	15.4	-6.7	7.4
21.1	19.0	-4.0	14.7
21.1	5.8	-13.5	9.5
21.1	26.3	1.2	15.9
20.0	5.9	-13.5	7.6

The overall disagreement between field and estimated values provide plenty of justification that this equation is inadequate for the research team's application. Upon further examination of the equation, the specific value of portland cement (0.92 kJ/kg*°C) is very low

when compared to water’s specific heat value of 4.184 kJ/kg*°C.¹ Since UHPC mixes contain very high proportions of cementitious materials, it should make sense that the fresh concrete’s ability to retain heat is poor. This can also be affirmed by looking at Figure 4.9. An approximate 10 °C change was made in premix temperature over 25 minutes for the “cold” premix.

4.2.1.2 Flow

Flow tests were conducted on all thirty-eight pan made batches. Eleven drum based batches were made during the research period, but only nine batches were tested for changes in flow over time.

4.2.2.1.1 Static and Dynamic Flows for Pan and Drum Mixers The second fresh concrete property tested was flow. Similar to the temperature measurements made by thermometers in an earlier section, testing for flow was over an approximately 35 to 40 minute period. The static and dynamic flows over time for the pan and drum mixer batches are presented in Figures 4.10 through Figure 4.13. It should be noted that the dark horizontal lines denote the acceptable flow ranges: 200 to 230 millimeters for static flow and 230 to 250 millimeters for dynamic flow.

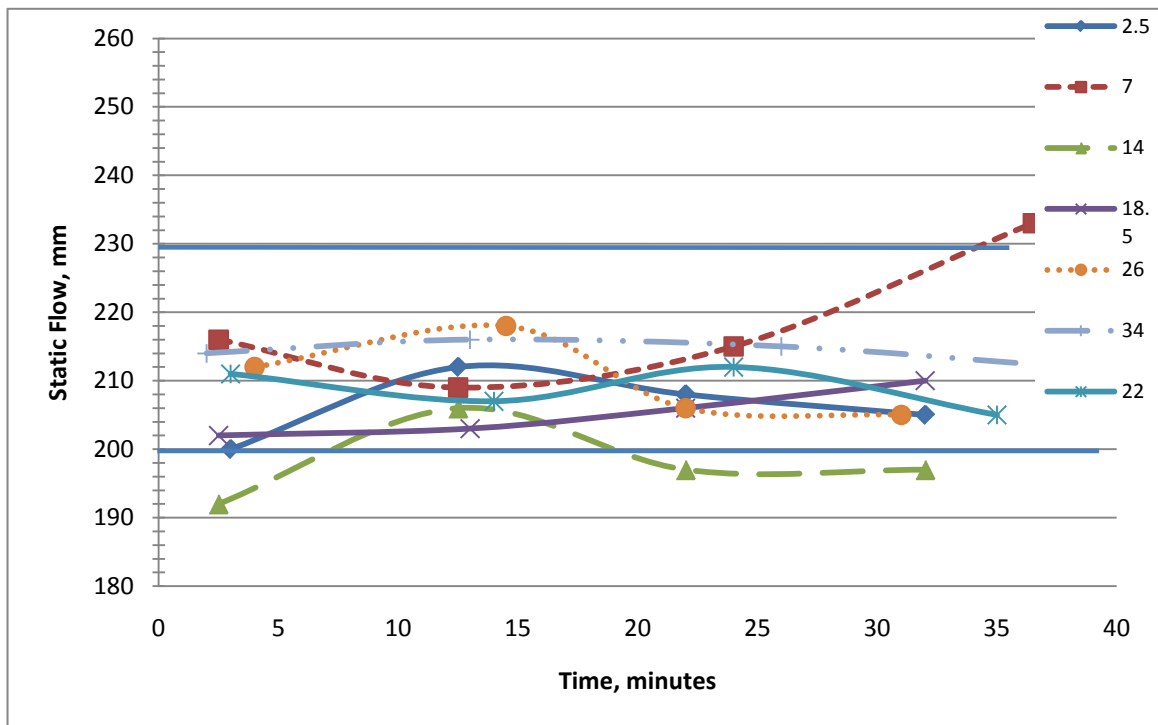

Figure 4.10 Static Flows for Pan Mixer.

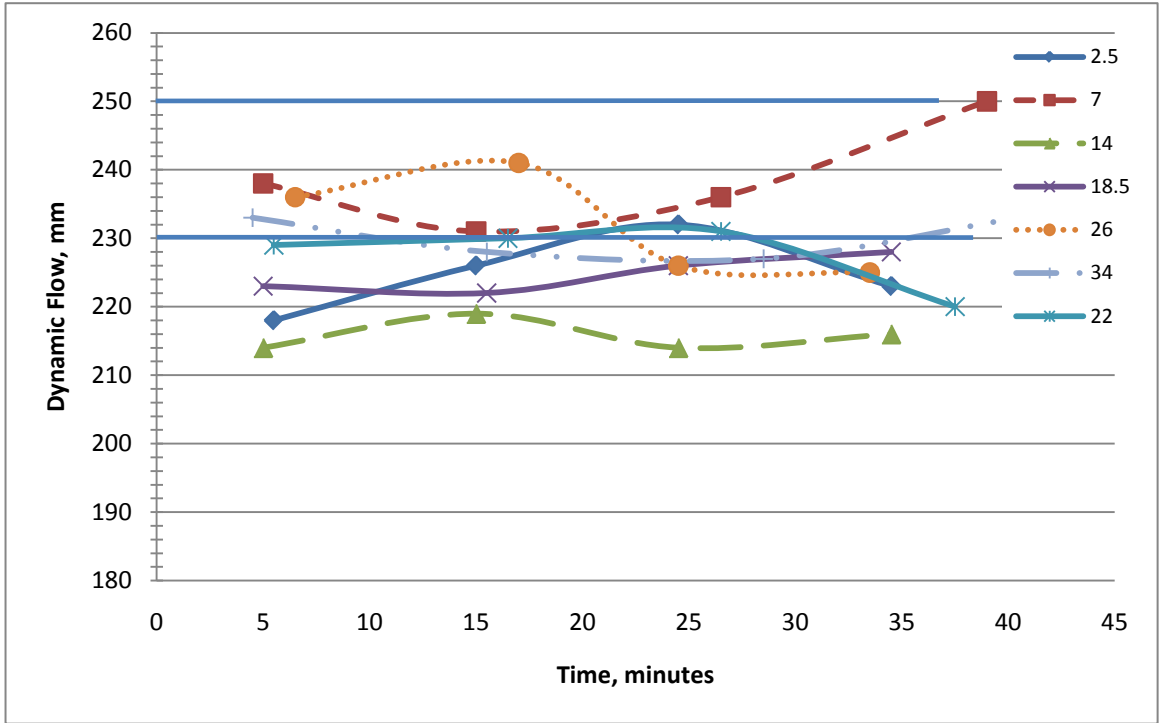

Figure 4.11 Dynamic Flows for Pan Mixer.

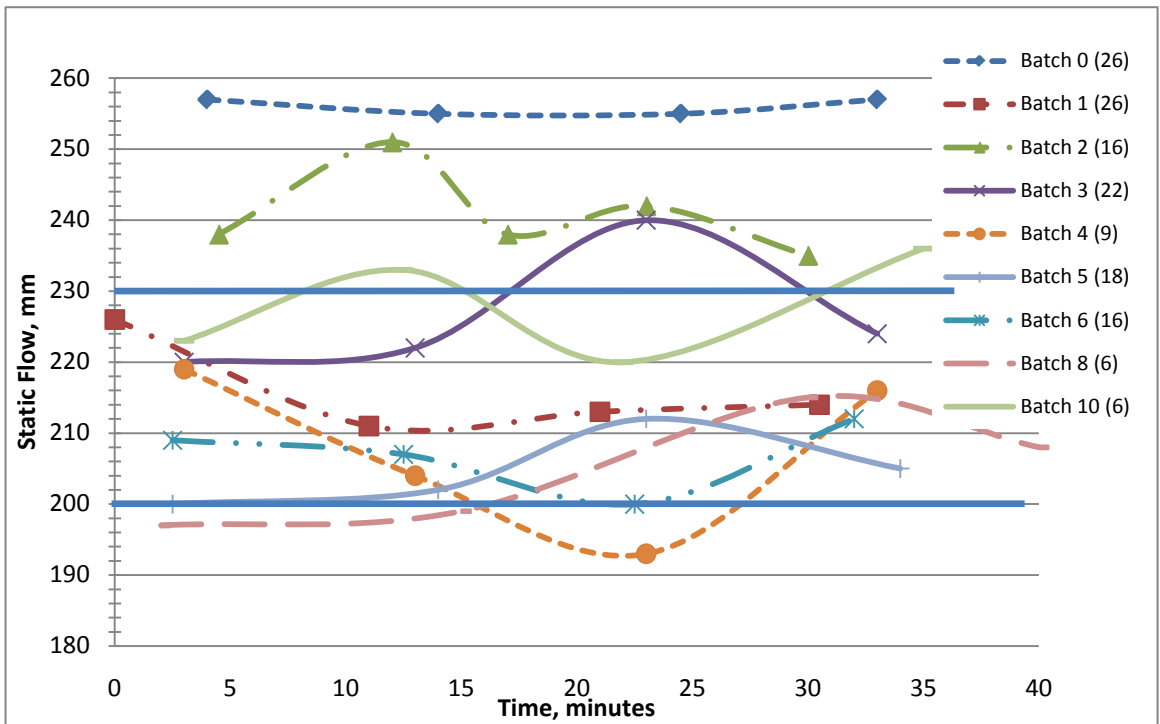

Figure 4.12 Static Flows for Drum Mixer.

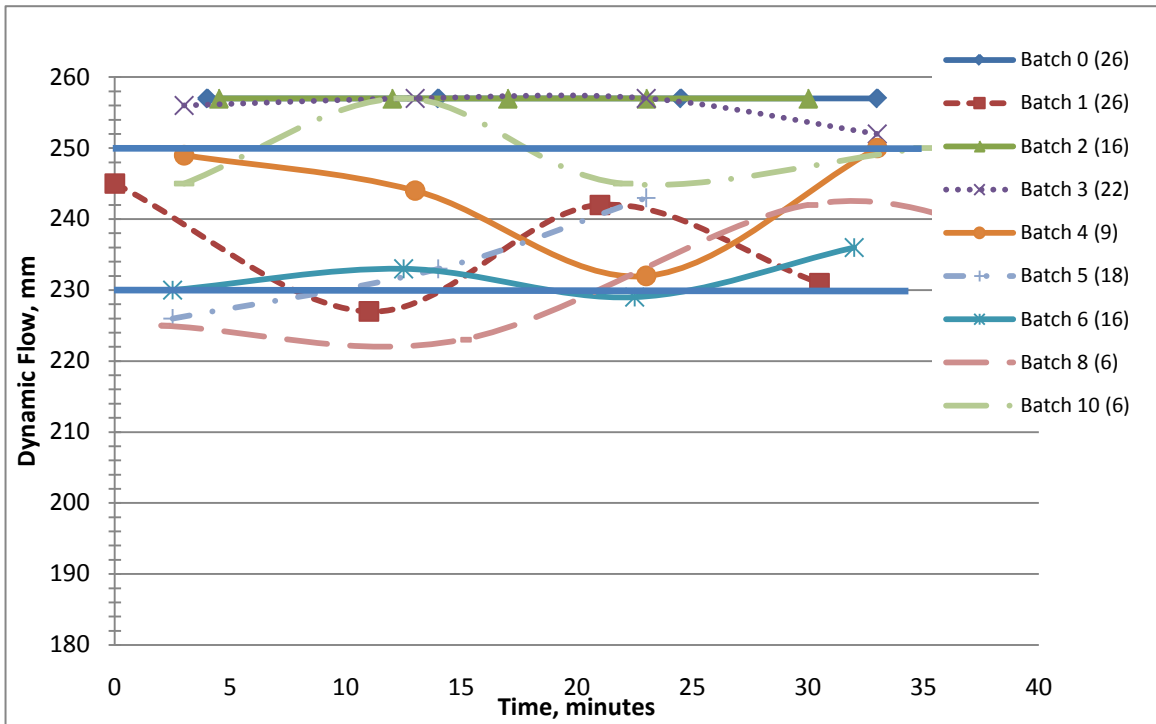

Figure 4.13 Dynamic Flows for Drum Mixer.

It is readily apparent to any observer that the flows did not exhibit any true trend. In fact, most flows were erratic, with sudden increases and decreases over time. As denoted in the Literature Review, rheological inconsistencies were also experienced by Jolicoeur.²⁵ It appears that the pan mixer is able to create good static flow values but is somewhat ineffective when dynamic flows are considered. Conversely, the drum mixer is exceedingly effective at creating good dynamic flow values, yet its mixes have far too high static flows. The changes in flow may be attributed to a number of factors, such as the level of dampness/dryness of the flow table, age of premix, and the small testing sample size. Looking further at the small test sample size, since the measurement of flow is to the nearest millimeter, a ten millimeter (0.4 inches) change in flow appears to be a drastic difference in the graphs. If a larger sample was taken, perhaps the results could be more consistent.

4.2.2.1.2 Flow versus Changes in Temperature It would be expected that any changes in flow with respect to temperature should yield an inconsistent result, because it has already been established that the flows are unpredictable in time. Nonetheless, Figure 4.14 and Figure 4.15 present the typical flows from Figures 4.10 and 4.12, now with respect to temperature. As one

can see, the results agree with the assumption; no true linear or reasonable curved trend exists which can accurately predict the changes in flow in respect to temperature. Even though the curves for both graphs are somewhat consistent in their shape, they still contain no definable trend. In every curve, there are sharp contrasts in flow over some elapsed temperature. The anomaly is that some curves exhibit decreases in flow with increases in temperature, while others illustrate the exact opposite. It appears that for the pan mixer, most data show that as temperature increases, flow decreases. However, the opposite appears to be occurring for the drum mixer. Due to the extremely opposing results, no true and consistent relationship can be gathered between flow and temperature.

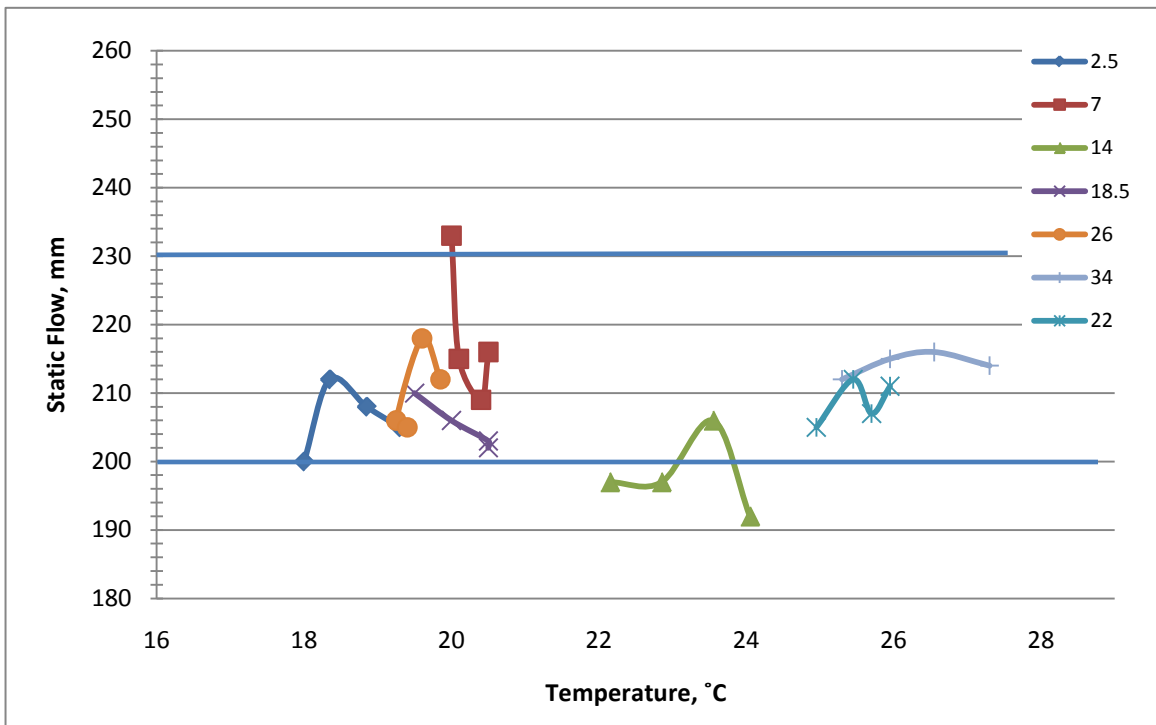

Figure 4.14 Changes in Static Flow versus Temperature for Pan Mixer.

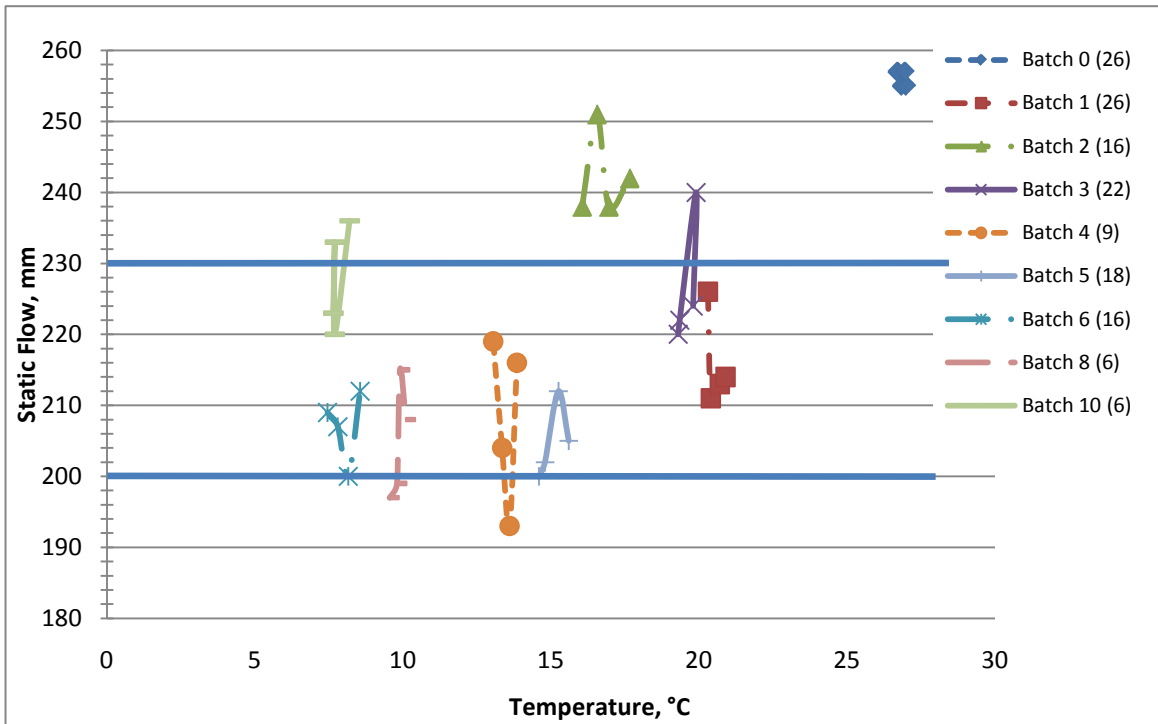

Figure 4.15 Changes in Static Flow versus Temperature for Drum Mixer.

4.2.2 Hardened Concrete Properties

The hardened concrete property tests conducted for the temperature study include compressive strength (ASTM C 39), whose results may be referred to as cylinder breaks or breaks, and modulus of elasticity (ASTM C 215, ASTM C 469). Further information on these tests may be located in Chapter 3.

4.2.2.1 Compressive Strength of Pan and Drum Cylinders

Multiple cylinders and prisms (when applicable) were cast and cured under the procedures documented in Chapter 3. The compressive strength results for the pan mixer and drum mixer are shown in Figure 4.16. On the x-axis, the temperature groups are given as whole numbers; this is to be understood as 10 °C increments starting from a temperature of 0 °C. Specifically, Group 1 is the range of from 0 to 10 °C, Group 2 is from 10 to 20 °C, and so on. The small data points represent individual breaks, but the large, singular data point depicts the group average.

Overall, the pan mixer breaks exhibited little difference in ultimate strength as temperature changed, whereas the drum mixer appeared to display a trend that as premix

temperature increases, ultimate strength increases as well. This effect is contradictory to published research on normal concrete; in fact, the opposite is generally the accepted idea. More research will definitely need to be performed to understand this effect. The author also finds it odd that the drum mixed cylinders, (see Figure 4.17 for comparison – pan cylinders on left, drum on right) which contained many voids and visual irregularities, exhibit far more consistent cylinder breaks than the normal, visually aesthetic look of the pan created cylinders.

The ultimate strength for all cylinders tested was unexpectedly low. The cylinders were cured in water for 48 hours at a temperature of 90 °C (194 °F). After the 48 hour curing time had been met, the pans, containing the cylinders and prisms and water, were placed in the environmental chamber. The cylinders were taken out of the water once the water had reached ambient temperature. The U of A does not possess a steam chamber as required by Lafarge to cure UHPC cylinders properly, so instead of curing the cylinders in a dry, zero humidity condition, the cylinders (and prisms) were immersed in pans full of water.

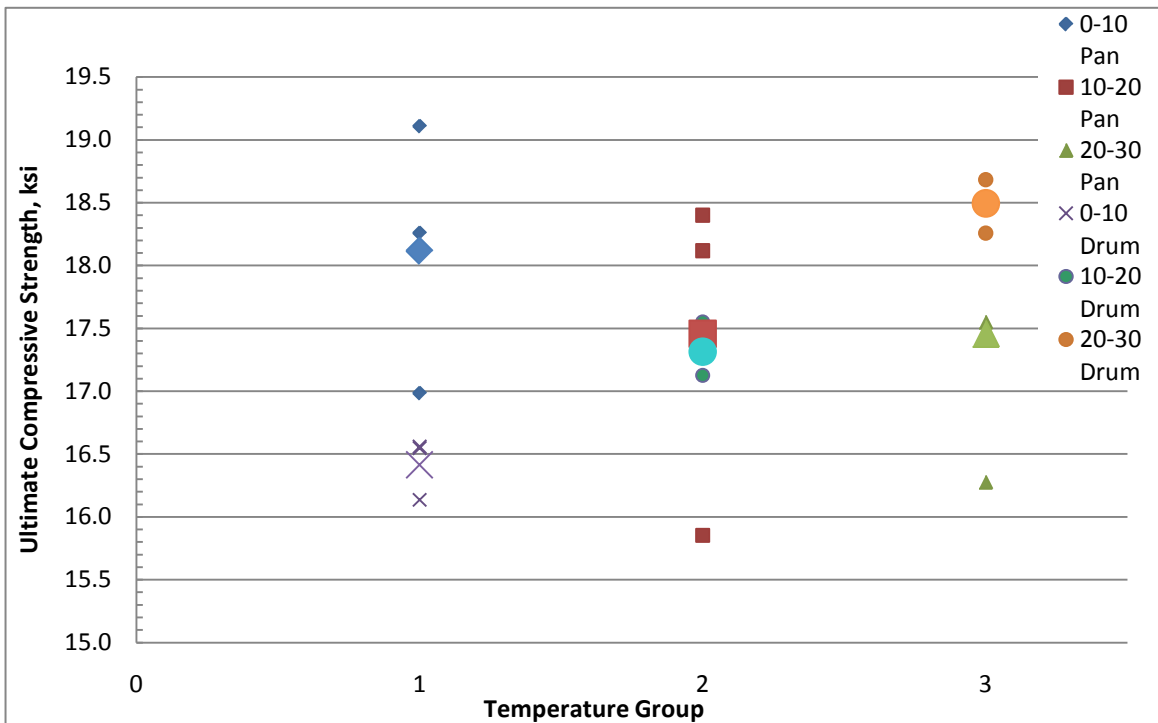

Figure 4.16 Pan and Rotating Drum Cylinder Breaks.



Figure 4.17 Visual Comparison between Pan and Drum Mixed Cylinders.

A picture is presented in Figure 4.18 partially demonstrating the curing regimen. The effect of using this method may hinder the ultimate strength of the cylinders, but since all pan and drum cylinders were cast and cured in the same conditions, the strength reducing effect can be ignored, with the values of each break still maintaining significance for analysis. Therefore, it can still be said that the drum mixed cylinders increased in strength as the premix starting temperature was increased. Both the pan and drum cylinders contained similar average ultimate strength values only in the 10 to 20 °C range. In colder temperatures, the pan mixer yields a higher strength, whereas in the upper 20 to 30 °C range the drum mixer produces a stronger concrete.

If the phenomenon of high fresh concrete temperature was purely related to concrete ultimate strength, then the pan mixer should have outperformed the drum mixer on all strength tests. Cylinders cast from the pan mixer contained a fresh concrete temperature of at least 20 °C (68 °F), whereas the hottest drum mixed cylinders were at about 16 °C (61 °F).

Flow could be referenced to strength, but perhaps only in the general sense. The flows from the drum mixer are typically better than the pan mixer, but the drum's poorly consolidated cylinders used in compressive tests tell otherwise. Since some of the compressive specimens were cast from batches that did not (or could not) perform flow tests, it is impossible to make a specific relationship on flow and strength. As a result, more research is necessary to understand the effect between the type of mixer employed and its effect on ultimate strength.



Figure 4.18 Prism Immersed in Water for Curing.

4.2.2.2 Comparison of MOE Values

The Modulus of Elasticity tests for the pan and drum cylinders were conducted in accordance with the procedures outlined in Chapter 3. Table 4.3 and Table 4.4 compare MOE values for the pan and drum cylinders based on the ASTM C 469 and ASTM C 215 specifications. All cylinders were first tested with ASTM C 215 followed by ASTM C 469. The ASTM C 469 test experiences much larger strains than ASTM C 215, thus microcracking may occur.

The results in Tables 4.3 and 4.4 are compared to the work of Graybeal.¹² In his paper, Graybeal modified an existing equation to predict MOE for UHPC, while using UHPC as his UHPC research preference. His equation, derived from the ACI 318 code with a scalar modification, is shown as Equation 4.2. As a note, the unit for ultimate compressive strength, f'_c , should be in pounds per square inch.

Equation 4.2 Graybeal MOE Estimation

$$E = 46200 \sqrt{f'_c}$$

Table 4.3 Pan Cylinder MOE Results

Cylinder	ASTM C 215 (ksi)	ASTM C 469 (ksi)	E (ksi) Graybeal
PM 0-10 (1)	5729	6600	6386
PM 0-10 (2)	5584	7000	6021
PM 0-10 (3)	6527	6450	6243
PM 10-20 (1)	6164	6700	6219
PM 10-20 (2)	5439	5850	6267
PM 10-20 (3)	6019	6300	5817
PM 20-30 (1)	4786	5750	6291
PM 20-30 (2)	4351	5950	6121
PM 20-30 (3)	3481	5650	5894

Using Graybeal's equation as the control for the MOE values, the drum mixer experienced an average percent difference of 11.6 and 13.4 for the ASTM C 215 and ASTM C 469 tests respectively. The percent differences for both methods moved in opposite directions for the pan mixer. ASTM C 469 was 6.7 percent off of Graybeal's estimate, whereas ASTM C 215 increased to a 14.9 percent difference.

Overall, the MOE results are very scattered and inconsistent, even within respective temperature groups. Modulus of Elasticity values obtained by the ASTM C 215 method are put in to question when specimens contain voids; a few of the drum mixed cylinders had small voids, which did make it troublesome to obtain a representative MOE value.

In addition to the cylinders cast, three prisms were also cast for each rotating drum temperature group. Since the prisms could not be tested in compression at the ERC, they were tested in accordance with ASTM C 215 only. Table 4.5 contains the results from this test.

Table 4.4 Drum Cylinder MOE Results

Cylinder	ASTM C 215 (ksi)	ASTM C 469 (ksi)	E (ksi) Graybeal
DM 0-10 (1)	5511	5450	5943
DM 0-10 (2)	7687	6650	5945
DM 0-10 (3)	6599	5100	5869
DM 10-20 (1)	6381	7950	6046
DM 10-20 (2)	5728	5350	6121
DM 10-20 (3)	6164	5400	6071
DM 20-30 (1)	7251	7550	6315
DM 20-30 (2)	6671	6200	6291
DM 20-30 (3)	5003	5500	6243

There is a large difference in MOE between the prisms and the cylinders created from the rotating drum mixer – not to mention Graybeal's estimates. The prisms yield far more consistent results, but the answers do not appear to rectify the large difference in MOE values. It is known that the ASTM C 215 test naturally overestimates MOE, and is sensitive to geometric irregularities. The author believes that these two facts could be the reason behind the inconsistent results.

Table 4.5 Drum Prism MOE Results

Prism	ASTM C 215 (ksi)
DM 0-10 (1P)	7832
DM 0-10 (2P)	7760
DM 0-10 (3P)	7832
DM 10-20 (1P)	8267
DM 10-20 (2P)	8050
DM 10-20 (3P)	8412
DM 20-30 (1P)	7977
DM 20-30 (2P)	7760
DM 20-30 (3P)	8267

4.3 MIXER STUDY

4.3.1 Mixture Homogeneity

The high energy/high shear mixing action provided by the pan mixer yielded consistent, homogeneous batches throughout the research period. However, batches created by the drum mixer varied; some batches contained portions of unmixed material—this fact was dependent upon the mixing method used. The half-batch method produced far less unmixed portions of premix material than the full batch method. Figure 4.19 shows a flow test which contained some of these unbroken premix “chunks.” The occurrence of unmixed portions of premix is not limited to the research team. Premix chunks were also found in the ready-mix truck samples cast in Winnipeg (see Figure 4.20).



Figure 4.19 Unmixed Portions of Premix Material Contained on Flow Table.

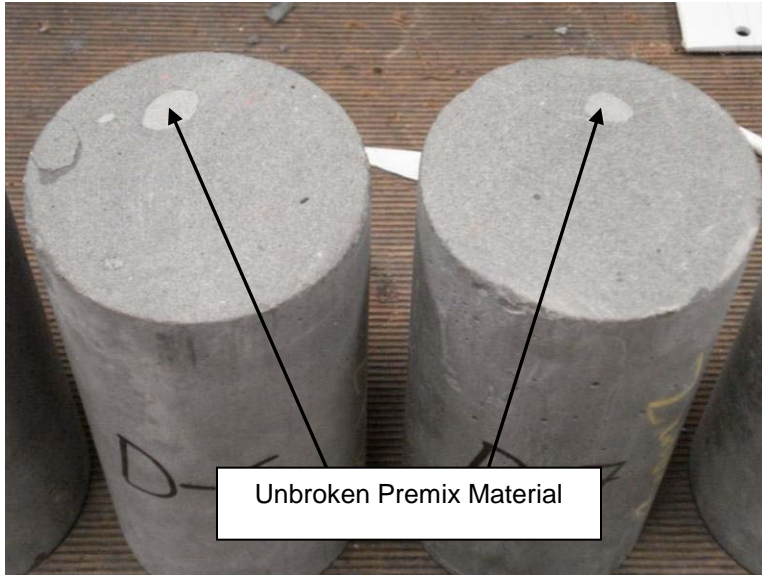

Figure 4.20 Evidence of Unmixed Portions of Premix in Winnipeg Cast Cylinders.

Both methods required nearly the same amount of mix time. Therefore, if possible, it is advised to separate batches into halves (perhaps thirds or more if needed) to mix the material as effectively as possible. Such portions of unbroken premix material can influence the flow of the final product. Additionally, if the premix material is not sufficiently broken up before the addition of any liquids, the chance for the material to fracture in the mixer appears to become less as more liquids are added.

4.3.2 Mixing Time

Mixing time is very important to a producer of concrete. If the mix design requires a long mixing time to render a good product, then one must adjust accordingly: a ready-mix company may budget in mixing on long hauls, or workers might have to start their shift earlier than normal. Because the pan mixer had consistent batch sizes, it stands to reason that its total mixing times should not vary. However, over months, it appeared to the author that the time required to mix UHPC increased. Figure 4.21 documents the total mix times in respect to the batch number.

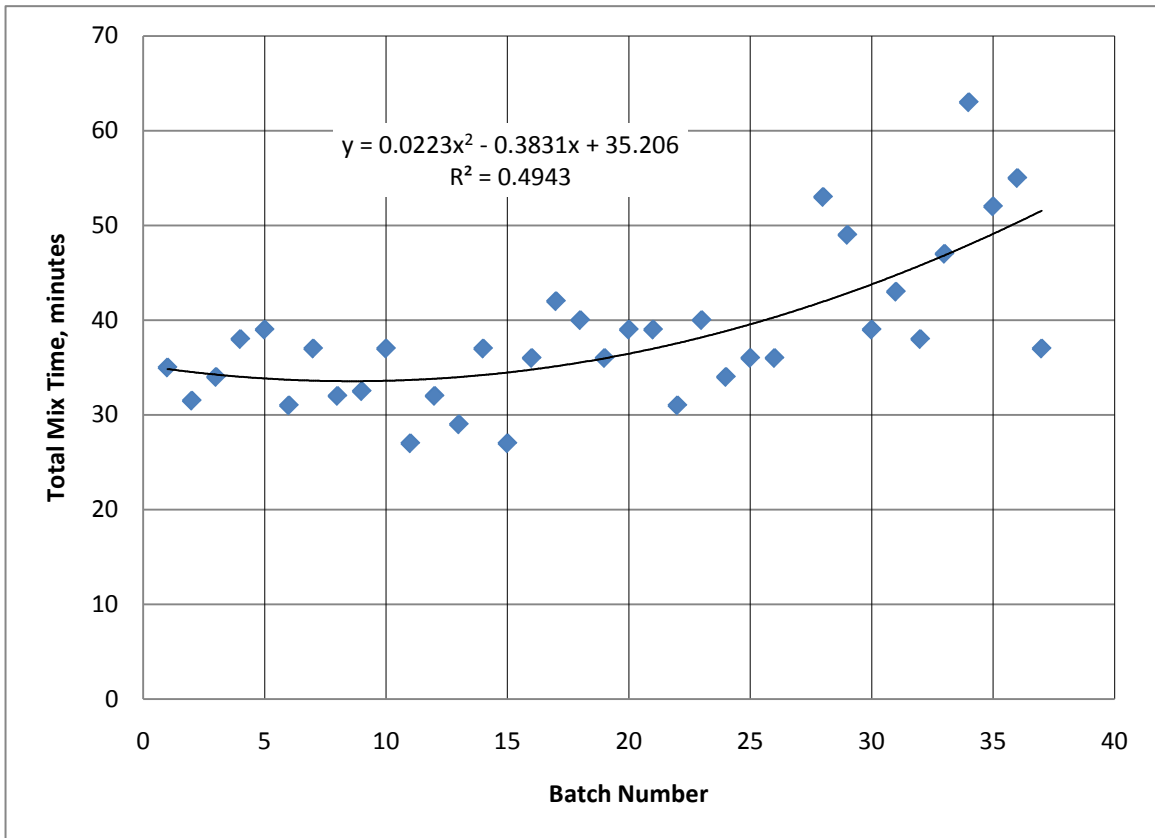

Figure 4.21 Total Mix Time for Pan Mixed Batches.

It appears that the mix times for the pan mixer vary greatly. There is a slight upward trend as the batches progress, but the R-squared value of 0.49 demonstrates that there is an insignificant amount of data to prove that mixing times increased as the days progressed during the research period. The reason for this effect may be due to other factors such as premix age and premix confining stress, which will be further explored later.

The drum mixer had a slight advantage over the pan mixer in that it had multiple batch sizes tested, which allows for two sets of data to be analyzed rather than one. Figure 4.22 provides the mix times for both 85 L (3 ft³) and 0.11 m³ (4 ft³) batches. Although it is rarely advisable to use data from two batch sizes in order to produce some conclusion about the relationship between batch size and mix time, additional data can be used by calling upon previous work performed by Edmundo Ruiz. In his work with UHPC, Ruiz used the same Stone® rotating drum mixer as the author. On average, his total mix time for a 0.26 m³ (9.35 ft³) batch was approximately 105 minutes.¹³ Figure 4.23 illustrates the average mix times from the 85 and 113 liter mixes plus the additional information from the 265 liter (9.35 ft³) mixes.

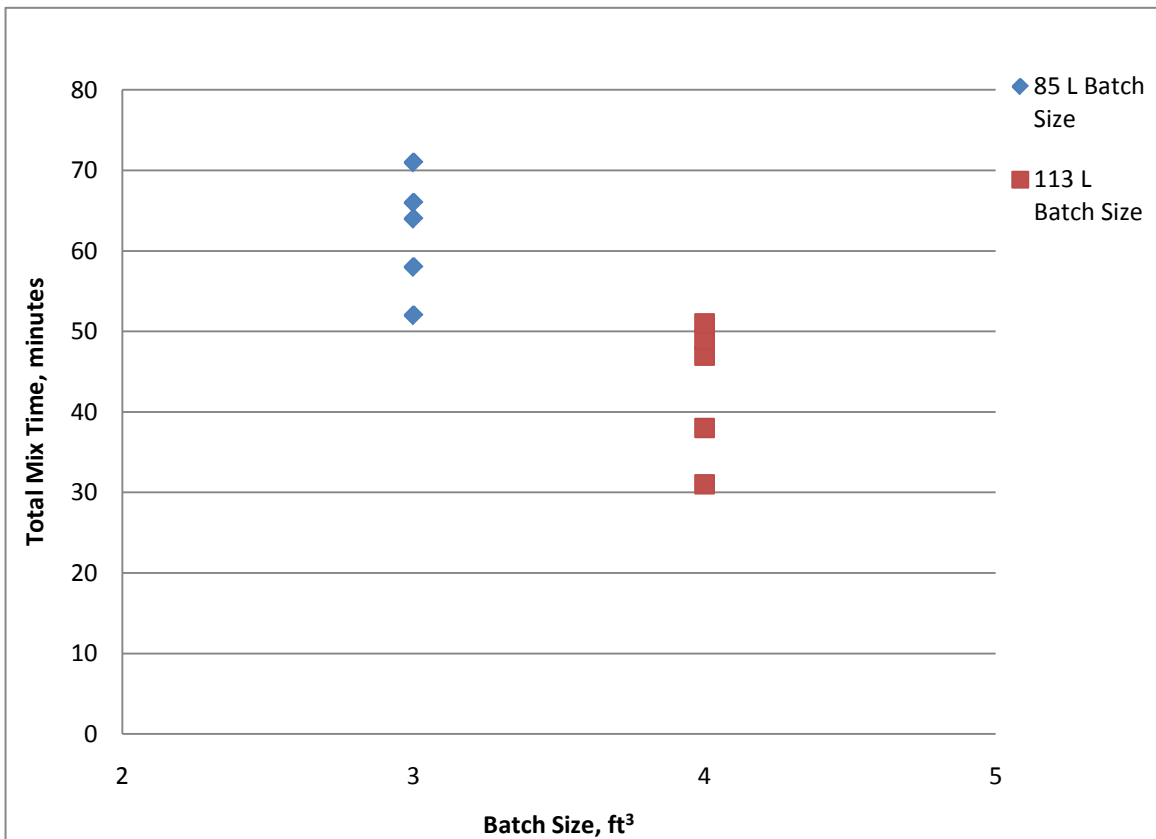

Figure 4.22 Total Mix Time for Drum Mixed Batches.

The average mix times for the 85 liter and 113 liter volumes were 62 and 43 minutes respectively. When mixing the larger 113 liter batch size, it was evident that the extra material made mixing easier. The extra material may reach a saturation point at some time; in other words, there must be a point in which mixing time no longer decreases.

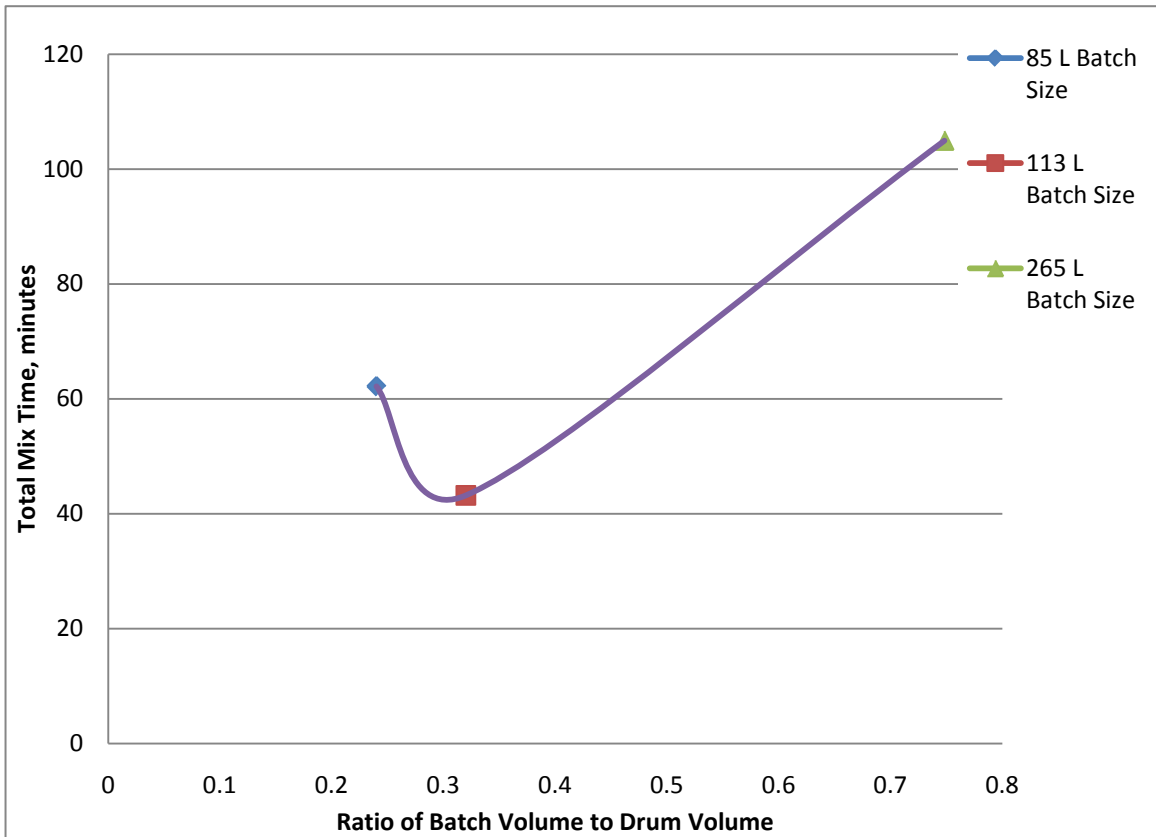

Figure 4.23 Total Mix Time for Drum Mixed Batches with Respect to Three Volumes.

Because of the large gap in mixing volumes, a true trend on batch volume to drum volume cannot be established; the work in Figure 4.23 is merely a starting point. Instead of using batch size as the x-axis, the ratio between batch volume and drum volume is used. The author finds it interesting that for a batch to drum ratio of 0.32, an average mix time of 43 minutes was experienced. This result is not far from that of the pan mixer, whose 0.3 batch to pan volume only required an average time of 38 minutes to mix.

UHPC may be sensitive to batch sizes; one must keep in mind the information described in Chapter 3 that at a batch to pan volume of 0.25, the concrete never successfully mixed. In the half-batch method, a ratio of 0.16 was used to batch 57 L (2 ft³) at a time. At a minimum, the author recommends a batch size to mixer ratio of 0.2 for a rotating drum apparatus and a ratio of 0.3 for a pan style mixer. Still, these assumptions use fresh, new premix and do not account for the increased difficulty of mixing as premix age increases.

4.3.3 Premix Shelf Life

Aside from mixture homogeneity, increases in mixing time were thought to be related to the shelf life of the premix. The research team believed that as premix age increased, the mixing time increased and homogeneity decreased. To further explore this effect, for each batch, the number of days was calculated between the date of batching and the date of receiving the premix pallet. These values were compared to the total mixing time, and the results from this comparison may be seen in Figure 4.24.

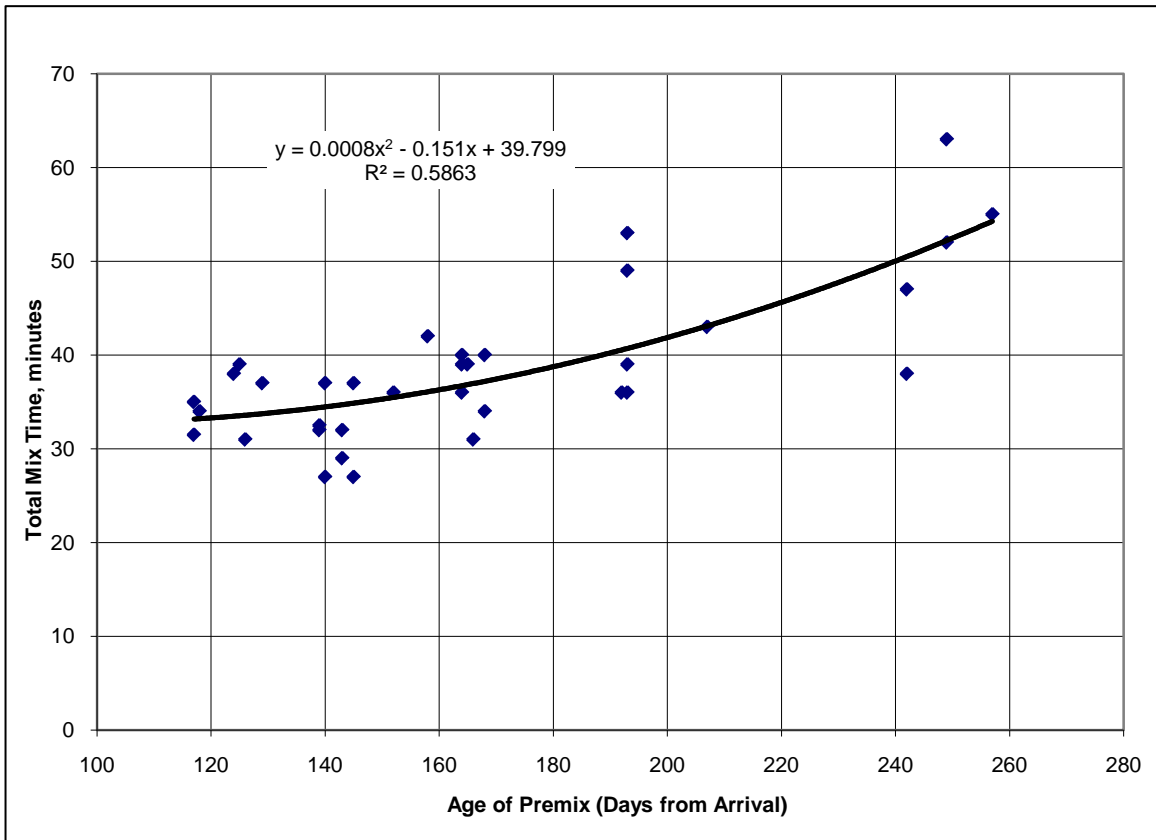

Figure 4.24 Premix Shelf Life.

This graph contains an R-squared value that is not quite sufficient enough to conclude that shelf life is the primary cause of increased mixing time. One other variable that may contribute to increases in mixing time could be the coupled effect of shelf life and bag location within the pallet. Premix bags located at the top of the pallet contain little to no chunks of material, but as one moves down the pallet, an increasing number of premix chunks – with the toughness and hardness of each one increasing - were discovered. Since the research team did

not document the location in the pallet of each bag that was involved in mixing. It is therefore difficult to determine the effect of premix confining stress on mixing time.

4.3.4 Hardened Concrete Properties

The fresh concrete property characteristics brought about by the use of a different mixer has already been well documented in the temperature study. In Section 4.2.2.1 it was demonstrated that the average of all cylinder breaks for the drum and the pan mixers was approximately the same. In fact, the difference between the two averages was on the order of about 1.5 percent. Since both mixers used the same premix temperature range for testing, it appears odd that the pan mixer's specimens do not increase in ultimate strength as premix temperature increases. This occurrence only happens for the drum mixer. Therefore, more research is necessary to determine, with greater accuracy, the hardened property benefits between mixers of high and low energy/shear.

Looking back at Figure 4.16, the differences in strength between both the pan and drum mixers are insignificant. Although the pan outperforms the drum in the lowest temperature range, the drum mixer only lags the pan mixer by approximately 10 percent. In the highest temperature range, the pan mixer underperforms; it is almost 6 percent behind the drum mixer. The true problem arises when these results are compared to the ready-mix truck case. Presented in Table 4.6 is data from cylinders and prisms constructed during the formation of Buchanan-Pi girders in Winnipeg. Again, the cylinder results are compared to Graybeal's MOE estimation equation. As a note, RMT stands for Ready Mix Truck, and P marks the use of a prism.

Table 4.6 MOE Results from Winnipeg and U of A

Prism	ASTM C 215 (ksi)	Cylinder	ASTM C 215 (ksi)	ASTM C 469 (ksi)	E (ksi) Graybeal
RMT-1P	8621	RMT-2	-	9726	-
RMT-2P	8016	RMT-3	-	9737	7992
RMT-3P	8481	RMT-4	9091	9231	7710
RMT-4P	8492	RMT-5	9097	9455	7441
RMT-5P	8207	RMT-6	9089	10306	7655
RMT-6P	7759	RMT-7	9062	9488	7644
RMT-7P	9058	RMT-8	-	-	7174
RMT-8P	8017	RMT-9	-	-	7532
RMT-9P	7972	RMT-10	9008	-	-
RMT-10P	7921	RMT-11	9047	-	-
RMT-11P	8453	-	-	-	-
RMT-12P	8195	-	-	-	-
RMT-13P	7992	-	-	-	-

In August 2008, during a Buchanan-Pi girder pouring in Winnipeg, cylinders were cast for both the author and Graybeal. In a work later prepared by Graybeal, it is stated that the average compressive strength of cylinders he tested was approximately 258 MPa (37.5 ksi).²⁶ Table 4.7 shows the comparison between average compressive strength values for the pan, drum, and both ready-mix truck sets. Even with ignoring the effects of the poor curing regimen, there are differences in values between the ultimate strengths gathered by the author and Graybeal.

Table 4.7 Compressive Strength Average for All Mixers

Pan, MPa, (ksi)	Drum, MPa, (ksi)	Ready-Mix Truck (U of A), MPa, (ksi)	Ready-Mix Truck (Graybeal), MPa, ksi
122 (17.7)	120 (17.4)	186.4 (27)	258 (37.5)

The author believes that some of the difference is contained in the loading rate. The rate, approximately 0.5 MPa/sec (73 psi/sec), was used for all cylinders tested. Lafarge specifies a load rate is 1 MPa/second.^{7,12,26} Even with this knowledge, the 28 percent difference in ultimate strength should not be experienced. Graybeal stated that his cylinders were tested approximately three to four months after they were cast. The research team at the U of A broke cylinders from a range of one month to approximately 1.4 years after casting. This contrast in strength values led the author to see if a retrogressive strength trend may develop over time. Figure 4.25 illustrates the cylinder breaks tested over time. In the figure, each point represents a singular cylinder break.

Earlier in this section it was declared that a lower energy mixer appears to produce a higher quality concrete in terms of ultimate strength (at least in the highest temperature range tested). Even though high energy/shear mixers are specified by most UHPC producers, it appears completely justifiable that a high ultimate strength (up to 258 MPa) can be produced by a low energy mixer. For one to understand this, refer back to Table 2.3 - the typical UHPC material characteristics table – and look at the increase in strength. The table should show one that the 258 MPa strength is almost 15 percent higher than the accepted norm.

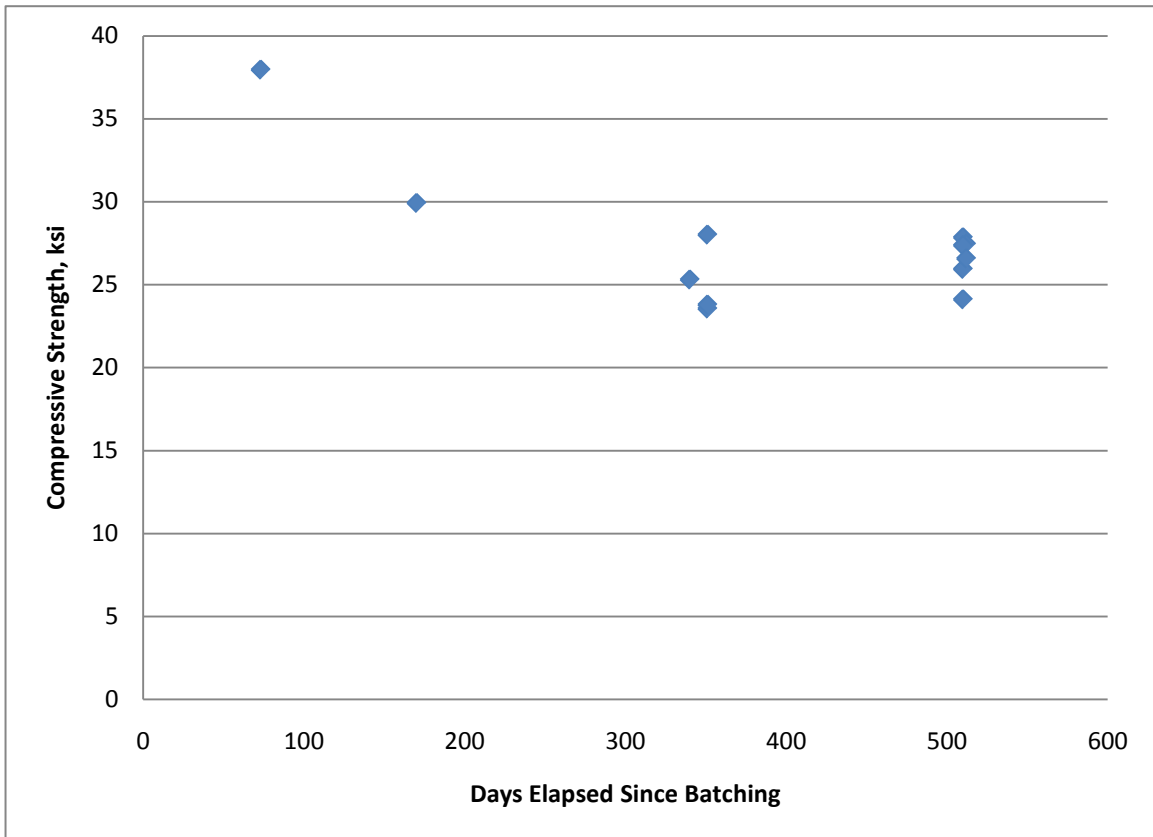

Figure 4.25 Compressive Strength of Cylindrical Specimens over Time.

It does appear that over time the strength of UHPC diminishes some but then levels off. The only problem to Figure 4.25 is that there is not enough data early in the research period to support such a trend. Less than 100 days after testing, one cylinder broke at nearly 262 MPa (38 ksi), but due to the lack of testing, it is uncertain whether other cylinders tested at that date would demonstrate the same strength. What this graph does prove, is that UHPC appears to retain its strength after one year has passed, at whatever strength that may be. Even with the production of this graph, the stark difference between the author's results and that of Graybeal remain unresolved. The author believes the effect to be produced by delayed ettringite formation (DEF).

DEF is an internal phenomenon that occurs when a sulfate rich source is used such as gypsum tainted aggregates or high sulfate cement. Ettringite is formed as one of the early strength compounds during the setting and hardening of concrete; its formation does not typically harm the concrete, however ettringite can become a problem at temperatures above 65 °C. At said temperatures, ettringite breaks down and releases sulfate ions which are absorbed into

Calcium Silica Hydrate (CSH), one of the main strength producing compounds in concrete. Later, the sulfate ions are desorbed and ettringite is reformed. The reformation of ettringite causes expansion, which leads to cracking.⁴ The increased microrcracking can causes detrimental strengths. Nevertheless, further study could be performed examining the potential strength regression of UHPC over time.

CHAPTER 5 CONCLUSIONS AND RECOMMENDATIONS

5.1 GENERAL

The research program set out to analyze the effect of temperature and mixer type on the properties of UHPC. This chapter summarizes the research and provides recommendations developed from the previous chapter.

5.2 TEMPERATURE STUDY

5.2.1 Fresh Concrete Properties

5.2.1.1 *Temperature*

The temperature study successfully demonstrated that at any initial premix temperature, ice is ineffective for small batch sizes like those made by the pan mixer. This fact was established by a number of methods. First, the fresh concrete temperature was monitored over time, where thermometers showed that the batch trends quickly towards the ambient temperature. This fact was confirmed by an experiment using a data acquisition system and thermocouples. The final effort that truly signaled that the pan batch size was ineffective was the comparison of all of the resultant batch temperatures versus the respective initial premix temperatures. Due to the high amount of overlapping confidence intervals (described in Chapter 4) between the batches tested, it was shown that for large differences in premix temperature, the same result was statistically possible.

The larger rotating drum batches proved much more profitable for results; this was first confirmed by viewing the small change in fresh concrete temperature over time. The rotating drum mixer also showed that at temperatures above 15 degrees Celsius (59 °F), the use of ice becomes effective.

An attempt was made to estimate fresh UHPC temperature based on an already developed equation from the Design and Control of Concrete Mixtures text.³ The equation was inherently unable to provide the proper estimation of temperature because of the large contrast between the makeup of normal concrete and UHPC. Nevertheless, the equation was modified,

as best as possible, to estimate fresh concrete temperature, using ice, for the drum mixed batches. The results were far from the observed values. Because the pan mixer batch size had already been established as unacceptable, the equation was not applied in that context.

As a side experiment, equal weight samples of premix and fibers were heated and cooled to selected temperatures apart from the ambient temperature. The samples were allowed to acclimate themselves to the ambient temperature over a period of time. The results from this experiment proved that the fibers are high conductors of heat, or are poor heat insulators because they quickly move their internal temperature to the ambient condition. The premix on the other hand proved more resilient to change than the fibers. This study showed that if a ready mix company experiences a trend in weather followed by an unseasonable day, the input temperature of the fibers would most likely be equal to the ambient temperature during the time of batching, whereas the premix would be lagging behind. Using this information with the knowledge of the effectiveness of ice in regards to batch size, a large producer of UHPC may know whether or not to use ice as a replacement for mixing water. It must be noted that the samples sizes used in the test were 500 grams (1.1 lb). As the amount of materials increases, the susceptibility to changes in heat becomes less. Therefore, for large quantities of premix and fibers, one must still determine each material's temperature, rather than assume based on a small sample size.

5.2.1.2 *Flow*

Generally, the flows from the pan mixer were acceptable in the static flow test, but were mostly unacceptable for the dynamic flow test. Conversely, the drum mixer produced static flows that were too high for the static flow test, but generally contained adequate (some were too high as well) flows for the dynamic flow test.

The flow pattern over time was erratic for both mixers. Changes in flows would be experienced; some flows would suddenly increase then decrease or vice versa. Typically the changes in flow were not so large that they placed the majority of the flows tested outside the accepted tolerances. An attempt was made to correlate changes in flow to changes in

temperature. Due to the nonlinearity of flow in respect to in time, combined with the changes in temperature over time, the graphs that were developed did not provide any observational significance.

5.2.2 Hardened Concrete Properties

5.2.2.1 Compressive Strength

Cylinders were tested to failure from both pan and drum mixers. The cylinders were produced over three temperature groups ranging from 0-10, 10-20, and 20-30 °C respectively. The results show that the pan mixer contains the highest breaks in the 0-10 °C range, but levels off in the next two temperature groups. Specimens from the rotating drum mixer steadily increased in strength from low to high temperature. This result is contradictory to normal concrete, where typically, the lower the concrete's initial fresh temperature the better the ultimate strength.

Prisms were also cast in drum made batches. The prisms were tested along with the drum cast cylinders for MOE. The results from the MOE testing were compared to the work of Graybeal.¹² The two methods used to obtain MOE, ASTM C 469 and ASTM C 215, proved erratic. Between cylinders cast from the same batch, there was little consistency even using the same method. Using Graybeal's equation as the control, the ASTM C 469 specification provided less average error than the ASTM C 215 specification. The reason behind the poor ASTM C 215 performance could be attributed to the geometric irregularities (bugholes/voids) in some of the cylinders. The MOE results between prisms and cylinders constructed from the same drum batch differed greatly. Each prism's MOE was far too high when viewed in respect to the ultimate strengths exhibited by the cylinders.

It cannot be stressed enough the importance of a good curing regimen. The cylinder breaks were poor, but the consistency in curing regimen allowed the author to develop the conclusions listed in the previous paragraphs.

5.3 MIXER STUDY

5.3.1 Fresh Properties

5.3.1.1 *Temperature and Flow*

The temperature study, for the most part, documented the fresh and hardened properties developed from each mixer. Therefore, the author believes there is no need to reiterate the results already discussed in previous paragraphs.

5.3.1.2 *Mixture Homogeneity*

Throughout the research period, the pan mixer provided many fluid, homogeneous mixtures. The drum mixer however did not possess the same ease in producing consistent batches. Two batching methods, known as the full batch and half-batch method, were used to mix UHPC. The half-batch method was far better at producing pan-like batches, because it contained little to no premix chunks, or unmixed portions of premix left over from batching.

5.3.2 Mix Time

The time required to mix concrete properly is vital to a producer of concrete. Extra or less time in batching has a monetary influence, which is why concrete providers like to know how long it will take to render a useable product. It was decided that the author examine why mix times varied over the research period. A slight increase in mixing time was required for the pan mixer over the research period, but there was not enough statistical significance (R^2 value of 0.49) to confirm this trend. The drum mixer on the other hand was very beneficial because of its multiple batch sizes. The 85 L (3 ft³) batches contained an average mix time of 62 minutes, whereas the 113 L (4 ft³) batch size only took 43 minutes.

Knowing that previous work had been performed on UHPC with the same mixer, the author used data from Dr. Edmundo Ruiz, on his 265 L (9.35 ft³) batches. Dr. Ruiz stated that it took approximately 105 minutes on average to batch UHPC for his application. Using this data, combined with the average times for both the 85 and 113 liter batches, a graph was created to see if a favorable batch/mixer volume existed which would provide the lowest possible mix time.

Due to the large gap between the 113 and 265 liter volumes, it was deemed that more research is necessary to fully explore the relationship of batch volume to mix time.

Increasing mixing times over the research period were thought to be the result of the premix having some unknown shelf life. It was thought that as the premix “aged”, the mix times became greater. A graph was created which plotted the total mix time versus the age of the premix at the time of batching. Once again, an undesirable R^2 value was the result. This issue, combined with confining stress (the issue believed to be the cause of the premix ‘chunks’), is thought to be the main cause of the difficult mixing manifested in longer mix times and decreases in homogeneity.

5.3.3 Hardened Concrete Properties

The results from the ready-mix truck were published in this section. In this section, the fact was reiterated that the curing regimen was performed inadequately. Nevertheless, the cylinders and prisms produced by the author were compared to the results provided by the pan and drum mixer. It was deemed that the obvious difference-because of the curing regimen-would disallow the ability to effectively compare hardened properties across the three mixer types.

It is unknown to the author why the curing regimen used for the research period produced poor strength and MOE results. The author’s curing methods proved, theoretically at least, to be sound, but this was not the case. Further research is necessary to understand the effect of the author’s curing regimen.

Finally, the results of cylinders tested from the ready-mix truck application were compared to the results of match cylinders created for Graybeal. The author’s average compressive strength of 186 MPa (27 ksi) was 28 percent lower than the 258 MPa (37.5 ksi) average compressive strength reported by Graybeal. Many of the author’s cylinders were tested late in the research period, which led to the development of a graph showing the ultimate strength of some cylinders tested over time. The main goal of the figure was to determine if UHPC

demonstrated retrogressive strengths over time. A few data points hinted to the fact that UHPC may indeed degrade in strength over time, but there just was not a sufficient amount of data to support such a trend. Delayed ettringite formation was proposed as the reason behind the disparate strength values.

5.4 RECOMMENDATIONS

This chapter has hopefully served to summarize the results obtained for both the temperature and mixer studies during the research period. This section shall now highlight all of the main points developed from each study. The following list of bullet points provides the recommendations from the temperature study:

- Batches produced by the pan mixer were too small to effectively analyze the effects of ice combined with premix temperature.
- Due to the larger batch volume required for the drum mixer, its mix was far less susceptible to changes in temperature. Those changes helped to prove that at temperatures above 15 °C, ice is effective at reducing the resultant batch temperature.
- The fibers used in UHPC are poor insulators of heat and are not resilient to changes in temperature. The premix, however, is more resistant to changes in temperature, but because of the sample size tested, its effect of holding temperature on a large scale is unknown.
- An attempt was made to estimate fresh concrete temperature from an already established equation. Using this equation proved ineffective to accurately describe fresh concrete temperature. Additional research will be necessary on batch sizes at least as large as those used in the drum mixer to develop a proper equation to predict fresh concrete temperature.
- Flows for both the pan and drum mixer were erratic, but, for the most part, stayed within the acceptable boundaries. The pan mixer produced good static flows and poor dynamic flows, whereas the drum mixer had poor static flows, but good (sometimes too much) dynamic flows.

- The attempt to relate flow to temperature was in vain. The results from the batches tested exhibited contradictory results; the results from the pan mixer show that as temperature increases, flow tends to decrease, whereas the opposite is viewed with the pan mixer. For the most part, the results are too erratic to develop any conclusion.
- The drum and pan mixer cylinders performed well in opposing temperature ranges and were very close to the same in the middle temperature region. One trend was evident after completion of the drum cylinder breaks: as temperature increased, so did the ultimate strength of the cylinders. Also, the actual strengths from both mixer types failed to get close to 200 MPa (29 ksi). Instead the results averaged approximately 121 MPa (17.5 ksi), which led the author to believe that the curing regimen was the root cause of the poor results.
- Comparisons from MOE tests conducted on prisms and cylinders created from pan and drum batches were compared to an estimation equation provided by Graybeal.¹² The results from both methods used to obtain MOE were erratic; the least error producing method was ASTM C 469.

The mixer study recommendations are as follows:

- Mixture homogeneity is not a concern for a high energy mixer. A change in batching method may be required for drum or lower energy mixers. Batches should be broken into halves, or thirds if needed, to help make sure that the premix material is sufficiently broken up.
- It was thought that since the batch size for the pan mixer was the same throughout the research period, perhaps the mixing time should also be the same. This effect was proven to be untrue; however, the reason behind this effect was believed to be a result of confining stress and shelf life. However more research is necessary to understand the increasing mix times.
- The effect of mix times on the drum mixer were helpful due to the two batch sizes tested. The two sets of data seemed to imply that as batch size increased, the total required mix

time decreased. With only two sets of data used, a third point was gathered but the new batch size did not help to further explain the trend of batch volume to total mixing time.

- It was suggested that for a rotating drum batch, a minimum batch to mixer volume of 0.2 be used, and for a pan mixed batch, a batch to mixer volume of 0.3 is recommended. However, additional research is necessary to prove this effect. Additional research is also necessary to understand the optimum batch to mixer volume in which one can have the smallest mix time possible. Supposing that the proposed research became a reality, the volumetric spectrum of testing UHPC mixes would be inherently limited, because UHPC mixes are usually held to a maximum batch volume to drum volume of 60 to 70 percent.^{14,26}
- The hardened concrete properties from the ready-mix truck were compared to the drum and pan mixer. Ultimate strengths from the author were compared to match cylinders tested by Graybeal. Graybeal's results proved much higher than those tested by the U of A research team (28 percent).
- Finally the results of ready-mix truck cylinders tested to failure were plotted over time. The data supported the notion that UHPC could experience a negative change in strength. The author believes the effect could be attributed to DEF, but much more data is necessary to verify this trend.

REFERENCES

1. ACI Committee 305. 1992. "Making Good Concrete in Hot Weather." *Concrete International*. 14 (4): 55,56.
2. Suprenant, B.A. "Freezing Concrete as a Construction Practice," *Cold Regions Science and Technology*, 11 (2): 195-197. Referenced in Concrete Q & A. *Concrete International*.
3. Kosmatka, S. H., Kerkhoff, B., et al. 2002. *Design and Control of Concrete Mixtures*. Portland Cement Association. 21, 229.
4. Mehta, P.K., and Monteiro, P.J.M. 2006. *Concrete: Structure, Properties, and Materials*. McGraw Hill. 61,65,138-144,153-154,161-162,261.
5. Rossi, P. 2001. "Ultra-High Performance Fiber-Reinforced Concretes." *Concrete International*. 23 (12): 46-52.
6. Acker, P., Baloche, C., et al. 2002. "Setra Ultra High Performance Fibre-Reinforced Concretes Interim Recommendations." Association Française de Génie Civil. 20,28,63,142.
7. Graybeal, B. A. 2006. "Material Property Characterization of Ultra-High Performance Concrete." *FHWA-HRT-06-103*. 1,3,6,44,46.
8. Nehdi, M. and Al-Martini, S. 2009. "Coupled Effects of High Temperature, Prolonged Mixing Time, and Chemical Admixtures on Rheology of Fresh Concrete." *ACI Materials Journal*. 106 (3): 235-237.
9. Tackett, A. M. 2009. "Effect of Mixer Type on the Performance of Ultra-High Performance Concrete." Proceedings, FIB Conference. Concrete 21st Century Superhero, London, England. 1-8.
10. Gowripalan, N. and Gilbert, R.I. 2000. Design Guidelines for RPC Prestressed Concrete Beams. VSL (Aust) Pty Ltd. 11,12,15.
11. Samman, T. A., Mirza, W. H., and Wafa, F. F. 1996. "Plastic Shrinkage Cracking of Normal and High-Strength Concrete: A Comparative Study." *ACI Materials Journal*. 93 (1): 37,40.
12. Graybeal, B. A. 2007. "Compressive Behavior of Ultra-High-Performance Fiber-Reinforced Concrete." *ACI Materials Journal*. 104 (2): 147-151.
13. Ruiz, Edmundo. 2007. Dissertation for the University of Arkansas.
14. Niwa, J., Uchida, Y., et al. 2006. Recommendations for Design and Construction of Ultra High Strength Fiber Reinforced Concrete Structures (Draft). Japan Society of Civil Engineers. 87.
15. Feys, D., Roussel, N., et al. 2009. Influence of Pumping on the Properties of Self-Compacting Concrete. Proceedings, FIB Conference. Concrete 21st Century Superhero, London, England. 1-8.
16. ACI Committee 304. 1985. "Guide for Measuring, Mixing, Transporting, and Placing Concrete." *ACI Journal Proceedings*. 82 (3): 245.
17. ACI Committee 304. 1991. "Guide for the Use of Volumetric-Measuring and Continuous-Mixing Concrete Equipment." *ACI Technical Documents*. 93-94.

18. Wilk, B. 1931. "A Comparison of Continuous With Batch Mixers in Plant Operation." *ACI Journal Proceedings*. 31 (11): 656,658.
19. Ferraris, C. F. 2001. "Concrete Mixing Methods and Concrete Mixers: State of the Art." *Journal of Research of the National Institute of Standards and Technology*. 106 (2) 392-394.
20. Cazacliu, B., Roquet, N. 2009. "Concrete Mixing Kinetics by Means of Power Measurement." *Journal of Cement and Concrete Research*. 39 (3): 182-193.
21. Yamamoto, Y. and Kobayashi, S. 1986. "Effect of Temperature on the Properties of Superplasticized Concrete." *ACI Journal Proceedings*. 83 (1): 80, 82-86.
22. Mahboub, K. C. and Cutshaw, Q. A. 2001. "Effects of Fresh Concrete Temperature and Mixing Time on Compressive Strength of Concrete." *ACI Materials Journal*. 98 (1): 59-61.
23. Seibert, Peter. "Effect of fibers on flow and the influence of ice in mixing." Phone conversation. July 8, 2009.
24. Petit, J.Y., Khayat, K. H., and Wirquin, E. 2008. "Methodology to Couple Time-Temperature Effects on Rheology of Mortar." 105 (4): 342,343,345,349.
25. Jolicoeur, C., Sharman, J., et al. "The Influence of Temperature on the Rheological Properties of Superplasticized Cement Pastes." *ACI Special Publication*. 173: 382,385,387,389.
26. Graybeal, B. 2009. "Structural Behavior of a 2nd Generation Ultra-High Performance Pi-Girder." *FHWA-HRT-10-026*. 11,19, 20.
27. ASTM Standard C 1437, 2007, "Flow of Hydraulic Cement Mortar," ASTM International, West Conshohocken, PA, DOI: C1437-07, www.astm.org.
28. ASTM Standard C 1064, 2005, "Temperature of Freshly Mixed Hydraulic-Cement Concrete," ASTM International, West Conshohocken, PA, DOI: C1064-05, www.astm.org.
29. ASTM Standard C 39, 2005, "Compressive Strength of Cylindrical Concrete Specimens," ASTM International, West Conshohocken, PA, DOI: C0039-05, www.astm.org.
30. ASTM Standard C 469, 2007e1, "Static Modulus of Elasticity and Poisson's Ratio of Concrete in Compression," ASTM International, West Conshohocken, PA, DOI: C0469-05E01, www.astm.org.
31. ASTM Standard C 215, 2002, "Fundamental Transverse, Longitudinal, and Torsional Resonant Frequencies of Concrete Specimens," ASTM International, West Conshohocken, PA, DOI: C0215-02, www.astm.org.
32. Image inspired by Ferraris, C.F. 2001. "Concrete Mixing Methods and Concrete Mixers: State of the Art." *Journal of Research of the National Institute of Standards and Technology*. 106 (2) 394.
33. Seibert, Peter. "Flow specifications." October 4, 2008. E-mail.