

**IMPROVED SAFETY AND EFFICIENCY
OF PROTECTED/PERMITTED RIGHT-
TURNS IN OREGON**

Final Report

PROJECT SPR 789



Oregon Department of Transportation

IMPROVED SAFETY AND EFFICIENCY OF PROTECTED/PERMITTED RIGHT-TURNS IN OREGON

Final Report

PROJECT SPR 789

by

David Hurwitz, Ph.D., Associate Professor
Hisham Jashami, Graduate Research Assistant
Kamilah Buker, Graduate Research Assistant
Oregon State University
School of Civil and Construction Engineering
101 Kearney Hall
Corvallis, OR 97331

Christopher Monsere, Ph.D., P.E., Associate Professor
Sirisha Kothuri, Ph.D., Research Associate
Andrew Kading, Graduate Research Assistant
Department of Civil and Environmental Engineering
Portland State University
PO Box 751
Portland, OR 97207

for

Oregon Department of Transportation
Research Section
555 13th Street NE
Salem OR 97301

May 2018

1. Report No. FHWA-OR-RD-18-14	2. Government Accession No.	3. Recipient's Catalog No.	
4. Title and Subtitle Improved Safety and Efficiency of Protected/Permitted Right-Turns in Oregon		5. Report Date May 2018	6. Performing Organization Code
7. Author(s) David Hurwitz, Chris Monsere, Sirisha Kothuri, Hisham Jashami, Kamilah Buker, Andrew Kading		8. Performing Organization Report No.	
9. Performing Organization Name and Address Oregon State University Portland State University Corvallis, Oregon 97331 Portland OR 97207		10. Work Unit No. (TRAIS)	11. Contract or Grant No.
12. Sponsoring Agency Name and Address Oregon Dept. of Transportation Federal Highway Admin. Research Section and 400 Seventh Street, SW 555 13 th Street NE, Suite 1 Washington, DC 20590-0003 Salem, OR 97301		13. Type of Report and Period Covered Final Report	
14. Sponsoring Agency Code		15. Supplementary Notes	
16. Abstract This research aimed to develop an understanding of the safety and operational implications of using the flashing yellow arrow (FYA) in permitted and protected/permitted right turn (PPRT) operations to maximize safety and efficiency. This report includes a review of more than 50 scientific and technical articles on the selection of right turn phasing alternatives and a review of Oregon crash data at intersections with exclusive right-turning lanes from 2011-2013. The study had three phases: 1) a web-based survey, 2) a microsimulation model, and 3) and a driving simulator study. The survey measured Oregon driver's comprehension of right-turn signal display. Analysis revealed a general misunderstanding of the required driver response for the steady red arrow signal indication, but comprehension of the FYA for right turns was high. The microsimulation model of several PPRT phasing alternatives indicated that the pedestrian volumes had the greatest effects on delays. The driving simulator experiment indicated that driver responses were relatively consistent with those observed in the web-based survey. The results suggest that Oregon transportation agencies might improve driver-yielding behavior and pedestrian safety at signalized intersections with high volumes of permissive right turns from exclusive right-turn lanes by using the FYA display in lieu of a steady circular green display.			
17. Key Words Protected/Permitted Right Turns, Safety, Human Factors, Traffic Operations, PPRT, Flashing Yellow Arrow (FYA)		18. Distribution Statement	
19. Security Classification (of this report) Unclassified	20. Security Classification (of this page) Unclassified	21. No. of Pages	22. Price

SI* (MODERN METRIC) CONVERSION FACTORS

APPROXIMATE CONVERSIONS TO SI UNITS					APPROXIMATE CONVERSIONS FROM SI UNITS				
Symbol	When You Know	Multiply By	To Find	Symbol	Symbol	When You Know	Multiply By	To Find	Symbol
<u>LENGTH</u>					<u>LENGTH</u>				
in	inches	25.4	millimeters	mm	mm	millimeters	0.039	inches	in
ft	feet	0.305	meters	m	m	meters	3.28	feet	ft
yd	yards	0.914	meters	m	m	meters	1.09	yards	yd
mi	miles	1.61	kilometers	km	km	kilometers	0.621	miles	mi
<u>AREA</u>					<u>AREA</u>				
in ²	square inches	645.2	millimeters squared	mm ²	mm ²	millimeters squared	0.0016	square inches	in ²
ft ²	square feet	0.093	meters squared	m ²	m ²	meters squared	10.764	square feet	ft ²
yd ²	square yards	0.836	meters squared	m ²	m ²	meters squared	1.196	square yards	yd ²
ac	acres	0.405	hectares	ha	ha	hectares	2.47	acres	ac
mi ²	square miles	2.59	kilometers squared	km ²	km ²	kilometers squared	0.386	square miles	mi ²
<u>VOLUME</u>					<u>VOLUME</u>				
fl oz	fluid ounces	29.57	milliliters	ml	ml	milliliters	0.034	fluid ounces	fl oz
gal	gallons	3.785	liters	L	L	liters	0.264	gallons	gal
ft ³	cubic feet	0.028	meters cubed	m ³	m ³	meters cubed	35.315	cubic feet	ft ³
yd ³	cubic yards	0.765	meters cubed	m ³	m ³	meters cubed	1.308	cubic yards	yd ³
NOTE: Volumes greater than 1000 L shall be shown in m ³ .									
<u>MASS</u>					<u>MASS</u>				
oz	ounces	28.35	grams	g	g	grams	0.035	ounces	oz
lb	pounds	0.454	kilograms	kg	kg	kilograms	2.205	pounds	lb
T	short tons (2000 lb)	0.907	megagrams	Mg	Mg	megagrams	1.102	short tons (2000 lb)	T
<u>TEMPERATURE (exact)</u>					<u>TEMPERATURE (exact)</u>				
°F	Fahrenheit	(F-32)/1.8	Celsius	°C	°C	Celsius	$\frac{1.8C+32}{2}$	Fahrenheit	°F

*SI is the symbol for the International System of Measurement

ACKNOWLEDGEMENTS

The authors thank the Oregon Department of Transportation (ODOT) and the Federal Highway Administration (FHWA) for funding this research. The Technical Advisory Committee has provided valuable input throughout the project (Craig Black-ODOT, Scott Cramer-ODOT, Julie Kentosh-ODOT, Katie Johnson-ODOT, and Bikram Raghubansh-Clackamas County). Additional students at Oregon State University helped reduce data and code the simulator environment (Kayla Fleskes, MS, Ellie Simpson, MS, Hameed Aswad Mohammed, PhD, Hagai Tapiro, Post-Doctoral researcher, and Logan Scott-Deeter, undergraduate). The project was managed expertly by Mark Joerger, ODOT Research Coordinator.

DISCLAIMER

This document is disseminated under the sponsorship of the Oregon Department of Transportation and the United States Department of Transportation in the interest of information exchange. The State of Oregon and the United States Government assume no liability of its contents or use thereof.

The contents of this report reflect the views of the author(s) who are solely responsible for the facts and accuracy of the data presented herein. The contents do not necessarily reflect the official policies of the Oregon Department of Transportation or the United States Department of Transportation.

The State of Oregon and the United States Government do not endorse products of manufacturers. Trademarks or manufacturers' names appear herein only because they are considered essential to the object of this document.

This report does not constitute a standard, specification, or regulation.

TABLE OF CONTENTS

1	INTRODUCTION.....	1
2	LITERATURE REVIEW	3
2.1	TYPES OF TURNING MOVEMENTS	3
2.2	GEOMETRY	3
2.3	PHASING	5
2.4	DISPLAY.....	8
2.5	USE OF DETECTORS IN RIGHT-TURN OPERATIONS.....	9
2.6	EFFECTS OF RESTRICTING RIGHT TURNS ON RED	10
2.7	PEDESTRIANS	10
2.8	BICYCLISTS.....	12
2.9	SAFETY	12
2.10	SUMMARY.....	13
3	ANALYSIS OF CRASH DATA	15
3.1	SUMMARY.....	19
4	SURVEY	21
4.1	DESIGN AND REFINEMENT	21
4.2	INSTRUMENT.....	21
4.3	ADMINISTRATION	22
4.4	RESPONSE RATE.....	24
4.5	DEMOGRAPHIC SUMMARY	25
4.6	RESULTS AND ANALYSIS.....	27
4.6.1	Coding.....	27
4.6.2	Open-ended Comprehension Questions.....	30
4.6.2.1	<i>Steady Circular Green Ball</i>	<i>30</i>
4.6.2.2	<i>Steady Green Arrow.....</i>	<i>31</i>
4.6.2.3	<i>Steady Circular Red.....</i>	<i>32</i>
4.6.2.4	<i>Steady Red Arrow</i>	<i>33</i>
4.6.2.5	<i>Flashing Yellow Arrow</i>	<i>34</i>
4.6.3	Multiple-Choice Comprehension Questions.....	35
4.6.3.1	<i>Steady Red Arrow Comprehension</i>	<i>35</i>
4.6.3.2	<i>Red Arrow and Circular Red Comparison</i>	<i>36</i>
4.6.3.3	<i>Flashing Yellow Arrow Comprehension.....</i>	<i>37</i>
4.6.3.4	<i>Flashing Yellow Arrow, Circular Green Comparison.....</i>	<i>38</i>
4.7	SUMMARY.....	39
5	MICROSIMULATION	41
5.1	SIMULATION MODEL BACKGROUND.....	41
5.2	TYPES OF SIMULATION MODELS	41
5.3	MODEL DEVELOPMENT.....	42
5.3.1	Site Selection	43
5.3.2	Geometry.....	43
5.3.3	Volumes	45

5.3.4	Vehicle Composition	45
5.3.5	Signal Timing.....	45
5.4	RESULTS	46
5.4.1	Base Model	46
5.4.2	Sensitivity Analysis	47
5.5	SUMMARY	48
6	DRIVING SIMULATOR EXPERIMENT	49
6.1	EXPERIMENTAL EQUIPMENT.....	49
6.1.1	Driving Simulator	49
6.1.1.1	<i>Simulator Data</i>	51
6.1.1.2	<i>Simulator Sickness</i>	52
6.1.2	Eye Tracker	52
6.2	EXPERIMENTAL DESIGN	53
6.2.1	Road and Intersection Geometry	54
6.2.2	Experimental Variables.....	55
6.2.2.1	<i>Independent Variables</i>	55
6.2.2.2	<i>Dependent Variables</i>	56
6.2.3	Factorial Design	56
6.2.4	Counterbalancing and Presentation of Driving Scenarios	57
6.3	DRIVING SIMULATOR EXPERIMENTAL PROTOCOL	59
6.3.1	Recruitment.....	59
6.3.2	Informed Consent and Compensation.....	60
6.3.3	Prescreening Survey.....	60
6.3.4	Calibration Drive	61
6.3.5	Eye-Tracking Calibration.....	62
6.3.6	Experimental Drive.....	63
6.3.7	Postdrive Survey	63
6.4	DATA REDUCTION	63
6.4.1	Eye-Tracking Data.....	63
6.4.2	Simulator Data	65
6.5	RESULTS AND ANALYSIS.....	65
6.5.1	Participants.....	66
6.5.1.1	<i>Summary Statistics</i>	66
6.5.1.2	<i>Demographics</i>	66
6.5.2	Postdrive Survey Results	67
6.5.3	Driver Decision Making	69
6.5.3.1	<i>Steady Circular Green</i>	72
6.5.3.2	<i>Steady Green Arrow</i>	72
6.5.3.3	<i>Steady Circular Red</i>	73
6.5.3.4	<i>Steady Red Arrow</i>	73
6.5.3.5	<i>Flashing Yellow Arrow with Pedestrian Walk Interval (FYAW)</i>	73
6.5.3.6	<i>Flashing Yellow Arrow with Pedestrian Clearance Interval (FYAC)</i>	74
6.5.4	Visual Attention.....	74
6.5.4.1	<i>Average Total Fixation Duration (ATFD)</i>	74
6.5.4.2	<i>Descriptive Data and Statistical Analysis</i>	74
6.5.4.3	<i>Circular Red and Red Arrow Indications</i>	75

6.5.4.4	<i>Circular Green and Flashing Yellow Arrow Indications</i>	76
6.5.4.5	<i>Flashing yellow arrow with walk interval and with clearance interval</i>	78
6.5.4.6	<i>Presence of Pedestrians</i>	80
6.6	SUMMARY	81
6.6.1	Driver Decision Making	81
6.6.2	Driver Visual Attention.....	81
7	CONCLUSIONS	83
7.1	SURVEY	83
7.2	MICROSIMULATION.....	84
7.3	DRIVING SIMULATOR.....	85
7.3.1	Driver Decision Making	85
7.3.2	Driver Visual Attention.....	85
7.4	SYNTHESIS AND DISCUSSION OF RESULTS	86
7.4.1	Indications That Require the Driver to Yield	86
7.4.2	Indications That Require Drivers to Stop	87
7.4.3	Indications That Communicate to the Driver That the Movement Is Exclusive	87
7.5	LIMITATIONS OF THE RESEARCH	88
7.6	RECOMMENDATIONS FOR PRACTICE	88
8	REFERENCES	91
APPENDIX A NHTSA DATA		
APPENDIX B SURVEY INSTRUMENT		
APPENDIX C SAMPLE OPEN ENDED RESPONSES		
APPENDIX D GRID LAYOUTS AND FIGURES OF SURVEY-SIMULATOR RESPONSES		

List of Tables

Table 2.1: Potential benefits and liabilities of right-turn lanes (FHWA 2015).....	5
Table 2.2: Typical right-turn overlap settings (FHWA 2015)	7
Table 3.1: Summary of ODOT crash data (2011–2013).....	15
Table 3.2 Severity of ODOT right-turn crashes at signalized intersections (2011–2013).....	15
Table 3.3: Comparison of proportions of crashes at intersections by collision type.....	17
Table 3.4: Comparison of proportions of crash types at intersections by cause of crash.....	18
Table 4.1: Sampling scheme for driver survey	23
Table 4.2 Demographic comparison between survey and Census respondents	26
Table 4.3: Characteristics of survey respondents	27
Table 4.4: Error Coding of Narrative.....	28
Table 4.5: Estimated values of Cohen’s kappa coefficient	30
Table 4.6: Responses to open-ended question on steady green circular ball signal indication.....	31
Table 4.7: Responses to open-ended question on steady green arrow signal indication.....	32
Table 4.8: Responses to open-ended question on steady circular red signal indication	33
Table 4.9: Responses to open-ended question on steady red arrow signal indication	34
Table 4.10: Responses to open-ended question on flashing yellow arrow signal indication	35
Table 4.11: Responses to multiple-choice question on steady red arrow signal indication	36
Table 4.12: Confidence levels for responses to multiple-choice question on steady red arrow signal indication	36
Table 4.13: Comprehension of red arrow vs. circular red signal indications.....	37
Table 4.14: Responses to multiple-choice question on flashing yellow arrow indication	38
Table 4.15: Confidence level for responses to multiple-choice question on flashing yellow arrow indication.....	38
Table 4.16: Comprehension of flashing yellow arrow vs. circular green signal indications	39
Table 5.1 Average green times from simulation.....	47
Table 5.2 Percent change in delay, by movement and phase.....	48
Table 6.1: Experimental variables and levels	57
Table 6.2: Grids and right-turning intersection layout.....	58
Table 6.3: Summary of participant population	66
Table 6.4: Participant demographics	67
Table 6.5: Postdrive survey question responses	69
Table 6.6: Error coding of narrative for the simulator experiments	70
Table 6.7: Steady circular green circular responses.....	72
Table 6.8: Steady green arrow responses.....	72
Table 6.9: Steady circular red responses	73
Table 6.10: Steady red arrow responses	73
Table 6.11: Responses to flashing yellow arrow during pedestrian walk interval.....	73
Table 6.12: Responses to flashing yellow arrow during pedestrian clearance interval.....	74
Table 6.13: Descriptive statistics for TFD by signal type, bay length, and AOI	76
Table 6.14: Tukey’s HSD multiple comparisons by signal type, bay length, and AOI	76
Table 6.15: Descriptive statistics for TFD by signal type, bay length, and AOI	77
Table 6.16: Tukey’s HSD multiple comparisons by signal type, bay length, and AOI	78
Table 6.17: Descriptive statistics for TFD by signal type, bay length and AOI	79
Table 6.18: Tukey’s HSD multiple comparisons by signal type, bay length, and AOI	80
Table 6.19: Two-sample t-test of ATFDs comparing AOIs by presence of conflicting pedestrian.....	80

List of Figures

Figure 2.1: Island geometry (ODOT)	4
Figure 2.2: General phasing with permitted phasing for right turns (USDOT 2015)	6
Figure 2.3: Phasing scheme for right-turn overlaps (USDOT 2015).....	7
Figure 2.4 Oregon Signal Head Types for Right-Turns.....	8
Figure 2.5: Example scheme for PPRT phasing (ODOT 2015).....	9
Figure 2.6: Entrance (left) and exit (right) treatments (Dixon et al. 2000)	13
Figure 4.1: Recruitment postcard for the survey	24
Figure 4.2: Geographic distribution of respondents	25
Figure 4.3: Image used for open-ended question on steady green circular ball signal indication (with RTO sign)	31
Figure 4.4: Image used for open-ended question on steady green arrow signal indication (with RTO sign)	32
Figure 4.5: Image used for open-ended question on steady circular red signal indication (with RTO sign)	33
Figure 4.6: Image used for open-ended question on steady red arrow signal indication (with RTO sign).....	34
Figure 4.7: Image used for open-ended question on flashing yellow arrow signal indication (with RTO sign)	35
Figure 4.8: Image used for question on comprehension of red arrow vs. circular red signal indications	37
Figure 4.9: Image used for question on comprehension of flashing yellow arrow vs. circular green signal indications	39
Figure 5.1: HILS data flow (Stevanovic et al. 2009).....	42
Figure 5.2: Data flow in SITL model (Stevanovic et al. 2009)	42
Figure 5.3: Site location for simulation	43
Figure 5.4: Intersection geometry.....	44
Figure 5.5: Volumes used in the simulation model	44
Figure 5.6: Phase rotation diagram for NW Cornell Rd. and NW Evergreen Pkwy.....	45
Figure 5.7: Average delays by movement	46
Figure 6.1: Operator workstation for driving simulator. Left: Designing an experiment in the Internet Scene Assembler with Javascript. Right: Researcher evaluating a newly designed environment.....	49
Figure 6.2: Simulated environment in OSU driving simulator, from the participant’s perspective inside (left) and from outside (right) the vehicle	50
Figure 6.3: Operator workstation for full-scale driving simulator. Monitors are shown displaying SimObserver (left), and the simulated environment (center) or vehicle dashboard (right) as seen in the vehicle	51
Figure 6.4: Screenshots of the six views from SimObserver. Clockwise from top left: simulated scene as projected on the screen; driver’s upper body and hands on steering wheel; acceleration and brake pedals in vehicle; entire simulator viewed from outside the vehicle; steering wheel and dashboard; and driver’s face.....	52
Figure 6.5: OSU researcher demonstrating the Mobile Eye XG Glasses (left) and Mobile Recording Unit (right)....	53
Figure 6.6: Example of signal and pedestrian head configurations in the simulator environment	53
Figure 6.7: Screenshot of a sample environment coded in the simulator	54
Figure 6.8: Screenshot of a cross-section of the right-turn roadway environment coded in the simulator.....	54
Figure 6.9: Example scenario of a participant approaching the right turn on a red arrow.....	55
Figure 6.10: Example scenario of right turns with 50- and 100-ft turning bay lengths	56
Figure 6.11: Example scenario of right turns with and without the presence of pedestrians.....	56
Figure 6.12: Example layout of Grid 1 with four right-turning (RT) scenarios – Path Start-Right-Right-Right-Through-Right-Right-Left-Left-Right-Finish	59
Figure 6.13: Layout of calibration drive.....	61
Figure 6.14: Screenshots of calibration drive in the simulation. Left: Approach to a curve near the beginning of the drive. Right: Approach to a signalized intersection, where a yellow billboard indicates a right turn	62
Figure 6.15: Eye-tracking calibration image	62
Figure 6.16: Example of a participant fixation pattern on the signal head (two AOIs)	64
Figure 6.17: Example of a participant fixation pattern on pedestrian (three AOIs).....	64
Figure 6.18: Screenshot of Data Distillery software interface (identifiable participant information was removed) ...	65
Figure 6.19: Participant comprehensions of the flashing yellow arrow (FYA) and red arrow (RA) indications	68
Figure 6.20: Screenshot of Simobserver platform	71
Figure 6.21: Boxplots of TFD disaggregated by signal type	75
Figure 6.22: Boxplots of TFD disaggregated by signal type	77
Figure 6.23: Boxplots of TFD disaggregated by signal type	79

Figure 7.1: Signal Heads for Right-Turn Operations.....90

1 INTRODUCTION

Accommodating motor vehicles that are turning (left or right) at signalized intersections requires a careful understanding of the safety and efficiency of design and operational variables. Turning vehicles are the primary collision risk for non-motorized road users. When turning movements need to be controlled directly, proper driver response to traffic control is critical. A substantial and compelling body of research has established that the flashing yellow arrow indication for permitted left turns improves driver comprehension and behavioral responses to the permissive condition (yield to other vehicles and persons in conflict with movement) and highlights the potential risks for pedestrians. Because right turns are generally permitted during the pedestrian walk and clearance indications, it is common for right-turning drivers to make yielding errors. Although traffic engineers have a good understanding of driver comprehension and response to the circular green ball or solid green arrow indications for right-turning movements, there is limited research related to use of the flashing yellow arrow indication for right-turn movements or driver comprehension of the solid red right arrow in Oregon.

The objective of this research was to develop an understanding of the safety and operational implications of using the flashing yellow arrow indication to indicate a permitted right turn. Following a comprehensive review of the literature and Oregon crash data, which identified relevant factors such as roadway geometry, traffic, and pedestrian volumes, the research focused on intersections with exclusive right-turning lanes. The research used three key efforts to accomplish these objectives:

- A web-based survey to understand the comprehension of Oregon drivers of right-turn signal display alternatives (see Chapter 4);
- A microsimulation to explore the operational performance of several protected/permitted right-turn (PPRT) phasing alternatives under varying volumes (right-turn vehicle volumes, conflicting pedestrian movements, and conflicting left-turn vehicular movements) (see Chapter 5); and
- A driving simulator experiment to examine motorist behavior in response to right-turn signal displays with two levels of both pedestrian activity and length of turning bays (Chapter 6).

This *Final Report* summarizes the research and is organized into eight chapters. Chapter 2 presents a brief literature review. Chapter 3 presents the analysis of crash data at signalized intersections in Oregon. Chapter 4 describes the survey administration and analysis of the results. Chapter 5 presents the software-in-the-loop microsimulation models. Chapter 6 describes the design of the driving simulator experiment and results of the analysis. Chapter 7 summarizes the findings of the major research tasks, synthesizes the results, and presents recommendations for the use of PPRT phasing to maximize the safety of non-motorized road users and the overall efficiency of ODOT's signalized intersections. Cited references are summarized in Chapter 8.

2 LITERATURE REVIEW

This chapter reviews the literature, including design manuals, guidance documents, and published articles, related to right-turn operations at signalized intersections. The chapter is organized by topical area and concludes with a summary. No research was found that evaluated flashing yellow arrow use in the context of protected-permissive right-turn (PPRT) operations.

2.1 TYPES OF TURNING MOVEMENTS

Right turns at a signalized intersections can be categorized as either: (1) right turns that have the right of way (ROW), or (2) right turns that must yield, to be consistent with the rules of the road (USDOT 2015). A protected right turn falls into the first category of right-turn movements: the ROW is provided, and no conflicting vehicles (or pedestrians) are allowed (USDOT 2015). A permissive right turn falls into the second category: drivers are only allowed to proceed through the intersection if there is an acceptable gap in the conflicting flow of vehicles, including bicycles, or pedestrians (USDOT 2015). A protected plus permitted turn is a combination that either begins with a protected movement and transitions into a permitted movement or vice versa. (USDOT 2015).

2.2 GEOMETRY

An protected right turn requires a dedicated right-turn lane that is used only by vehicles making right turns (USDOT 2015). Intersection approach designs must accommodate turning movements for all appropriate design vehicles. Turning radius is a key element in intersection design (ODOT 2012). Before designing the intersection, the appropriate design vehicle must be identified. The intersection radius should be selected to minimize the overall size of the intersection and the pedestrian crossing distance (ODOT 2012). For example, if most of the turning traffic comprises passenger cars, then it is not cost-effective or pedestrian-friendly to design the turning radius for large trucks (AASHTO 2011).

Through-traffic and right-turning traffic have differential speeds and can potentially cause safety issues in a shared lane configuration. Speed differentials in a shared lane can result in increased delay for through vehicles and increased likelihood of rear-end crashes (FHWA 2004). To mitigate this problem, use of an exclusive right-turn lane may be appropriate (ODOT 2012). Exclusive right-turn lanes improve safety and have the potential to improve the overall operation and efficiency of the intersection (ODOT 2012).

Right-turn lanes are generally designed to be 12-ft wide with a shoulder of 3–4 ft (ODOT 2012). When designing an exclusive right-turn lane in an urban environment, through-bike movement needs to be incorporated (ODOT 2012). Conflicts between right-turning traffic and bicyclists can be minimized by positioning the bike lane to the left of the right-turn lane, to align the bicyclist better with the through movement as the bicyclist travels downstream (ODOT 2012). The design of a bike lane between a through lane and a right-turn lane contains a conflict point where the

cyclist's path must be crossed by a right-turning vehicle further back from the intersection (ODOT 2012). To alert users to conflicting paths in this area, the bike lane is usually marked with short skip striping (ODOT 2012). As cited in the Oregon Department of Transportation (ODOT) *Traffic Signal Policy and Guidelines*, “The *Manual on Uniform Traffic Control Devices* (MUTCD) and the Federal Highway Administration (FHWA) have allowed this area to be colored green as an experimental condition to draw more attention to the conflict area” (ODOT 2012). The standard width of a bike lane located between the through and right-turn lanes is 5 ft (ODOT 2012).

Turning roadways and channelization are important aspects of intersection design (AASHTO 2011). For intersections, turning roadway widths are based on the volume and classification of turning vehicles that need to be accommodated. Most turning roadways are designed for right-turning traffic. Three types of right-turning roadways are possible at intersections: a corner triangular island design, a minimum edge-of-travel-way design, and a free-flow design utilizing a simple radius or compound radii (AASHTO 2011). The American Association of State Highway and Transportation Officials (AASHTO) defines “channelization” as the separation or regulation of “conflicting traffic movements into definite paths or travel by traffic islands or pavement markings to facilitate the orderly movements of both vehicles and pedestrians” (AASHTO 2011). Use of channelization increases the capacity and operational efficiency, reduces the crash frequency, and provides positive guidance to motorists (AASHTO 2011).

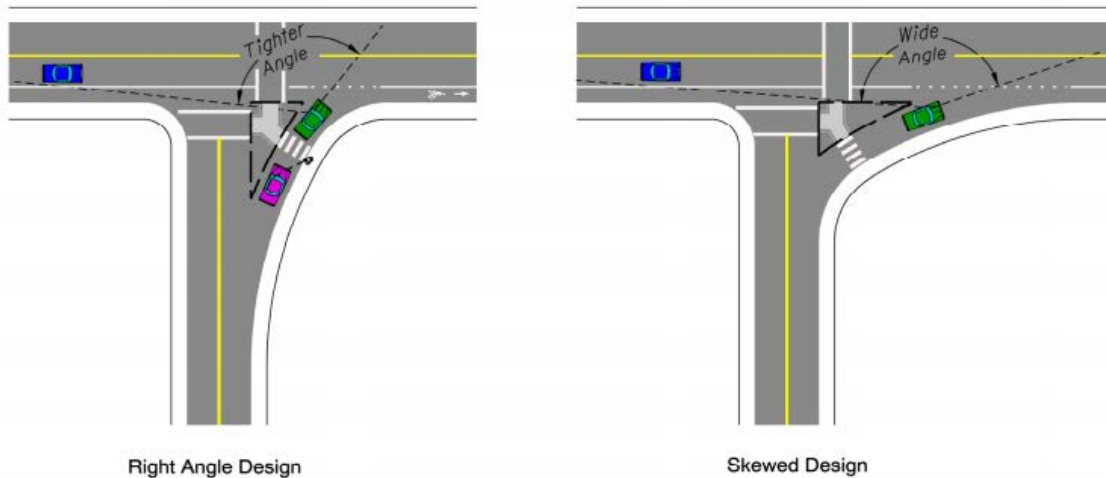

Figure 2.1: Island geometry (ODOT)

AASHTO defines an island as the area used for the control of movements performed by vehicles between traffic lanes (AASHTO 2011). Channelization islands are used to protect pedestrians, store traffic control devices, separate conflicts, control the angle of conflict, eliminate excessive pavement areas, regulate traffic, favor predominant turning movements, and protect or localize turning or crossing vehicles (AASHTO 2011). Islands can improve operations and safety by separating right-turning and through movements (FHWA 2004). Raised or painted islands can provide large turning radii to accommodate larger vehicles, thereby enabling faster turning speeds (FHWA 2004) that are good for vehicles but potentially unsafe for pedestrians. Faster turning speeds are discouraged by ODOT in the *Highway Design Manual*, and tighter angles are

encouraged instead (see Figure 2.1: Island geometry (ODOT)). Channelization has the potential to reduce the frequency of right-turn angle crashes (FHWA 2004). The Federal Highway Administration (FHWA) has tabulated the advantages and disadvantages of right-turn lanes (Table 2.1).

Table 2.1: Potential Benefits and Liabilities of Right-Turn Lanes (FHWA 2015)

CHARACTERISTIC	POTENTIAL BENEFITS	POTENTIAL LIABILITIES
Safety	Separation of right-turn vehicles from through traffic	Higher speed of right-turning vehicles increases risk to pedestrians
Operations	Higher right-turn capacity, shorter green time, less delay for following through vehicles, additional storage for approach queues	Potential for off-tracking of large vehicles
Multimodal	None identified	Longer pedestrian crossing distance, time, and exposure; may require transit stop relocation
Physical	None identified.	Large intersection footprint
Socioeconomic	None identified	Right-of-way/construction costs; access restrictions to property
Enforcement, education, and maintenance	None identified	Periodic enforcement may be needed to prevent red light violations, especially if right turns on red are prohibited

Although channelization islands provide several benefits, a study conducted in Georgia on vehicle speeds at exclusive right-turn lanes concluded that treatments with right-turn lanes and raised islands resulted in the highest frequency of crashes among several treatment options (Fitzpatrick et al. 2006), including right-turn lanes with a lane line, island, shared through lane, or shared through lane with an island. In Texas, right-turn lanes with raised islands had the second highest amount of crashes (Fitzpatrick et al. 2006). Types of crashes included rear-end right-turn crashes, right angle and merge crashes, and sideswipe crashes (Fitzpatrick et al. 2006).

2.3 PHASING

The *Traffic Signal Timing Manual* defines a traffic signal phase as “a timing process, within the signal controller, that facilitates serving one or more movements at the same time” (USDOT 2015). Furthermore, “the MUTCD defines a signal phase as the right-of-way, yellow change, and red clearance intervals in a cycle that are assigned to an independent traffic movement or combination of traffic movements” (FHWA 2008). Generally, the National Electric Manufacturers Association phase numbering system combines right-turn and through movements because they are typically permitted (USDOT 2015). Figure 2.2 shows a typical phasing scheme for an intersection with permitted right-turn movements.

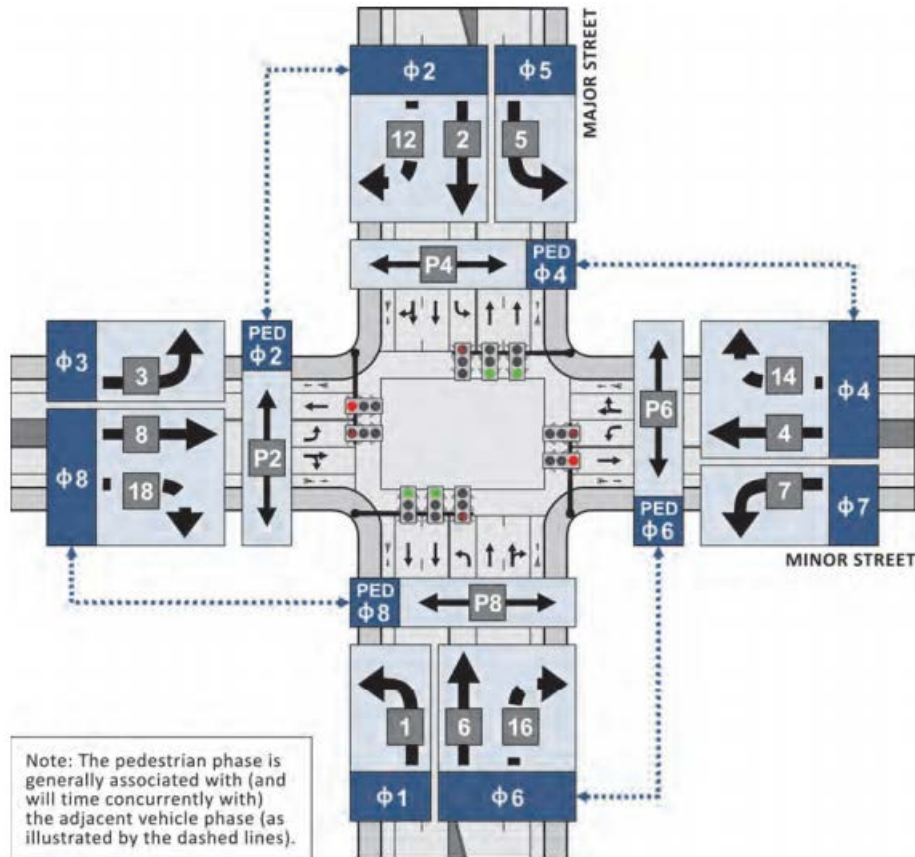

Figure 2.2: General phasing with permitted phasing for right turns (USDOT 2015)

When the right-turn movement is a protected movement, overlap timing can be used (USDOT 2015). A sample phasing scheme is shown in Figure 2.3. Overlaps are most often used for right-turn movements when exclusive right-turn lanes exist (USDOT 2015). The parent phase is typically the compatible left-turn phase for right-turn overlaps (USDOT 2015). When the conflicting pedestrian phase is active, some traffic signal controllers allow omission of the right-turn overlap (USDOT 2015). This feature is used when the pedestrian phase is associated with the vehicular through movement (USDOT 2015). Both the compatible left-turn and adjacent through movements are parent phases for the right-turn overlap modifier feature (USDOT 2015). When the conflicting pedestrian phase is assigned to a modifier phase, the right-turn overlap is excluded only when there is a pedestrian call on the adjacent movement (USDOT 2015). When there is no pedestrian modifier, the right-turn overlap must run adjacent to the through movement as a permitted movement to avoid conflicts with pedestrians (USDOT 2015). Table 2 provides a diagram for typical right-turn overlap settings.

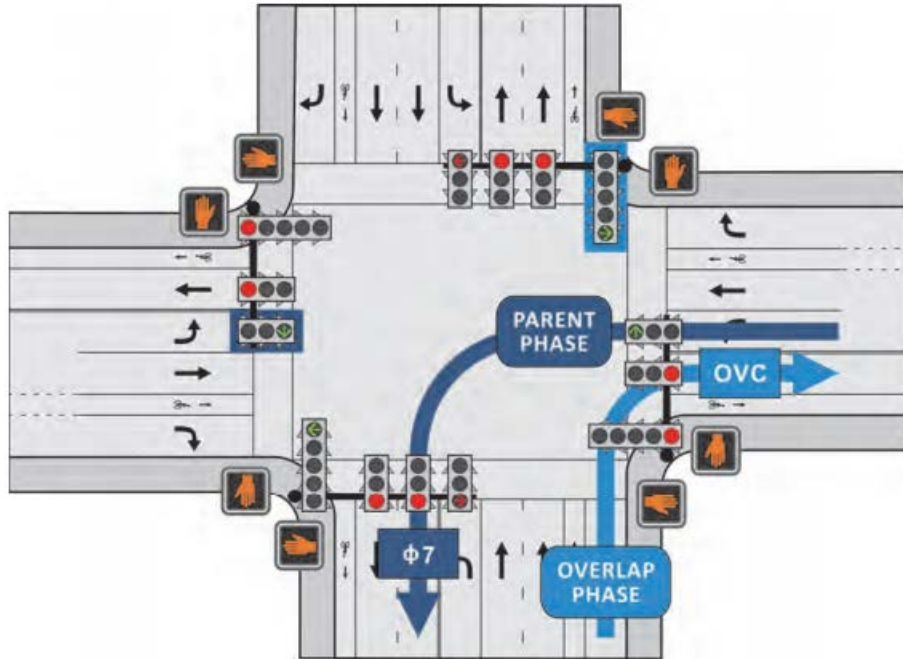

Figure 2.3: Phasing scheme for right-turn overlaps (USDOT 2015)

Table 2.2: Typical Right-Turn Overlap Settings (FHWA 2015)

MOVEMENT NUMBER	OVERLAP LETTER ¹	PARENT PHASE	PEDESTRIAN MODIFIER PHASE FOR RIGHT-TURN OVERLAP OMIT (IF AVAILABLE)
12	A	2* & 3	2P
14	B	4* & 5	4P
16	C	6* & 7	6P
18	D	8* & 1	8P

¹ Agencies may have different overlap assignments based on their preference.

* These phases should not be included as parent phases if a controller feature to omit right-turn overlap with active conflicting pedestrian phases is not available.

Furth et al. (2014) examined appropriate phasing for right turns and pedestrian/bicycle crossings under conditions of high turn volume or high speed, focusing on protected right-turn phasing. They introduced a unique “protected-yet-concurrent” phasing scheme. This scheme, which uses four rings rather than two, allows through movements to operate at a different time from the turning phase and at the same time as the parallel vehicular through phase. To illustrate the scheme and determine its likely effects on delay and street footprints, seven examples of concurrent phasing in the United States and the Netherlands were used. The study concluded that the delay and ROW requirements were minimal, and that the complexity of the phasing plans, coordination, and possibility of using re-service would affect phasing performance. Although this phasing scheme requires a right-turn lane, the authors argued that it uses time efficiently and is more efficient and economical than an exclusive pedestrian phasing scheme.

2.4 DISPLAY

Options to support right-turn signal phasing include permitted, protected-permitted, and protected displays (USDOT 2015). Right-turn signal installations and mode of operation are determined after an engineering study with consideration of factors related to capacity, congestion, and crash history (ODOT 2017). These factors include the presence of right-turn lane(s), right-turn volume and presence of conflicting crosswalk (ODOT 2017). If protected phasing is needed, then a separate overlap load switch must be provided for right-turn displays in exclusive right-turn lanes. This modification is preferred over combining the compatible left-turn signal phase with the right-turn arrow indication, as the latter tends to reduce flexibility in signal timing and effectiveness of traffic operations. Right-turn movements are permitted when an adjacent pedestrian phase is called (USDOT 2015). This permission can be signaled with a circular green indication. When no pedestrians are present, the right-turn movement is protected and can be signaled with a green arrow (USDOT 2015). The *Signal Timing Manual* states that “if a protected-only display is used with a pedestrian modifier function, the right-turn vehicular movement will be omitted when the conflicting pedestrian phase is called, and a right-turn red arrow will be displayed” (USDOT 2015).

In Oregon, a right-turn movement that is faced with a circular red, or red arrow indication is permitted to turn after coming to a complete stop unless a posted sign states otherwise. This movement is called a permissive right-turn on red (ODOT 2015). Determination of right-turn signal phasing is based on engineering studies and factors including capacity, right-turn volume, and presence of congestion and related crashes, right-turn lane(s), and conflicting cross walk(s) (ODOT 2015). The permissive right-turn mode is the most commonly used and requires no signal head. Right-turn movements operate simultaneously with corresponding through movements but must yield to conflicting pedestrian movement (ODOT 2015).

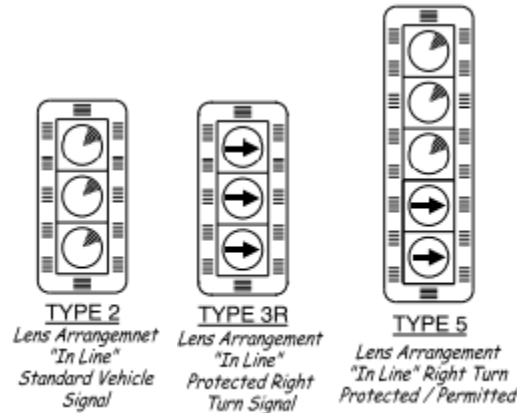

Figure 2.4 Oregon signal head types for right-turns

Figure 2.4 shows the signal types used in Oregon for right turns. Type 2 signal head is used for the permissive only movement, installed typically as a shared signal head and is applicable to the adjacent through movement also. Type 3R signal head is used for the true overlap. The not-ped feature is used if there is a conflicting crosswalk. Type 5 signal head is used for the “faux-overlap”, where the ball indications are wired to the thru phases and the arrow indications are

wired to the complimentary left-turn phase. The green ball will be active with the parent thru phase green indication and the green arrow is active only when the complimentary left-turn parent phase is green.

In the PPRT mode, the right-turn movement is protected during one part of the cycle and permissive during another (ODOT 2015). The protected portion generally occurs during the complementary left-turn phase, while the permissive portion occurs during the corresponding through-movement phase (ODOT 2015). The PPRT mode can provide operational benefits during heavy right-turn volumes (ODOT 2015). Figure 2.5 shows an example of PPRT phasing in a ring barrier diagram. The standard display NB right-turn phasing shown in Figure 2.5 is a Type 5 signal head. The arrow indications are wired to phase 1 and the circular indications are wired to phase 8.

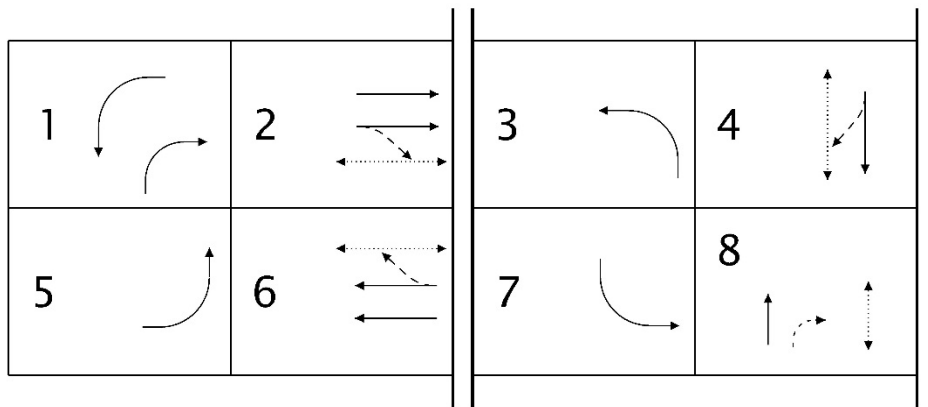

Figure 2.5: Example scheme for PPRT phasing (ODOT 2015)

Protected-only right-turns are generally used for exclusive right-turn lanes and can run concurrently with any non-conflicting vehicular or pedestrian movement (ODOT 2015). Traffic may only turn right when presented with a green arrow (ODOT 2015).

2.5 USE OF DETECTORS IN RIGHT-TURN OPERATIONS

Detectors used in right-turn lanes are sometimes designed to drop calls when permitted turns, such as right-turn-on-red (RTOR), are made and no other vehicles are present (USDOT 2015). A delay is placed on those detection zones to prevent calls from immediately being sent to the controller (USDOT 2015). These detectors are used to reduce delay by reducing calls due to RTOR and to call right-turn phases (USDOT 2015). The Traffic Signal Timing Manual defines delay as the temporary disabling of detector outputs for a phase (USDOT 2015). Delay values are determined by how long a vehicle is expected to occupy a detector before leaving it (USDOT 2015). Delay should be considered for right-lane detection when the capacity of the RTOR exceeds the right-turn volume or when a conflicting movement is on recall (USDOT 2015). However, delay may reduce the efficiency of the intersection if the RTOR capacity is limited (USDOT 2015). Typical delay settings range from 8 to 12 seconds (USDOT 2015), with larger delay values corresponding to higher cross-street volumes (USDOT 2015).

2.6 EFFECTS OF RESTRICTING RIGHT TURNS ON RED

Although developed as a fuel- and time-saving measure, RTORs can sometimes be detrimental for pedestrians (FHWA 2015a). Even though vehicle codes state that vehicles must come to a complete stop before they complete the RTOR, many drivers do not comply (FHWA 2015a). When drivers look to the right to check for approaching vehicles before they complete a turn, they tend to forget to check the crosswalk area for a crossing pedestrian. To gain more visibility, motorists tend to pull up into the crosswalk and block pedestrians from crossing (FHWA 2015a). When pedestrian volume is high, exclusive pedestrian phases and prohibition of RTORs should be considered, with signing used to inform motorists of the restriction (FHWA 2015a). The purpose of restricting RTORs is to increase pedestrian safety and reduce crash frequency at intersections (FHWA 2015a). RTORs may be prohibited specifically for operations at certain (e.g., busiest) times of the day (FHWA 2015a).

Qureshi and Han (2001) determined that delay-related procedures at signalized intersections in the *Highway Capacity Manual* (HCM) do not effectively include effects of RTORs. They developed a queueing theory based on the use of queueing accumulation polygons that included RTORs. Two general queueing accumulation polygon patterns resulted from the four classes of signal phasing. Patterns consisted of two conflicting, two nonconflicting, and alternating conflicting and nonconflicting regimes. Delay was calculated from each pattern. The authors tested model performance using field and simulated data and determined that delays predicted by the models differed from observed and HCM delays. Based on several conditions and compared to the HCM approach, the proposed models predicted reductions in delay.

2.7 PEDESTRIANS

Exclusive pedestrian intervals have the potential to reduce the number of pedestrian crashes by 50% at sites of heavy pedestrian volume and low vehicle speed (FHWA 2015b). To give pedestrians a head start when entering an intersection at a crosswalk, a leading pedestrian interval may be used (NACTO 2012), which gives pedestrians a walk signal in advance of the green light for motorists (FHWA 2015b). Motorists are more likely to see and, therefore, to yield to pedestrians. To create self-enforcing yielding to pedestrians, pedestrian safety islands can be implemented. Channelized right-turn lanes can be eliminated to slow turning speeds (NACTO 2012). Tight corner radii, curb extensions, and pedestrian safety islands all force drivers to navigate intersections more cautiously (NACTO 2012). Pedestrians frequently are assigned to a through-traffic movement, with the assumption that a vehicle or bicyclist must yield before making a right turn (FHWA 2008). This phasing scheme may be inappropriate when exclusive right-turn lanes and high right-turn traffic volumes are present. In these cases, a lagging pedestrian interval may be used, in which the pedestrian walk interval does not start until a few seconds after the through-movement phase begins. This approach allows the waiting right-turn queue to clear before the pedestrian walk indication activates (FHWA 2008).

Rao and Ni (2015) conducted a conflict analysis of two signalized intersections with different right-turn control schemes: one allowing RTORs and one with PPRTs. Trajectory information was collected at both intersections. A conflict risk assessment model was created based on the combination of collision probability and severity. “[A]ccording to signal schemes and lane function, cycle length and crosswalk were split into 16 several time and space intervals counted

as space-time cells, and pedestrian-vehicle conflict risk 17 degree of each space-time cell was calculated by risk assessment model” (Rao and Ni 2015). Conflicts between right-turn vehicles and pedestrians occurred more frequently with the RTOR scheme. Under the two signal control schemes, conflict risks for pedestrians and vehicles differed temporally, with highest risk during the pedestrian green-flash time with the RTOR scheme but during the pedestrian red time with the PPRT scheme. The study concluded that the PPRT vehicle control scheme can significantly reduce the number of conflicts between pedestrians and vehicles.

The North Carolina Department of Transportation (NCDOT) developed a method to analyze design characteristics that affect pedestrians and bicyclists when crossing signalized intersections (Steinman and Hines 2004). Key features that were studied included crossing distance, roadway space allocation, corner radius dimensions, and traffic signal characteristics as they relate to level of service. The results have the potential to be used as a diagnostic tool to assess and improve pedestrian and bicyclist safety levels.

Leden (2002) analyzed crash data from 300 intersections in Hamilton, Ontario, from 1983 through 1986. The study compared “pedestrian safety during semi-protected schemes, where left-turning vehicles face no opposing traffic but have potential conflicts with pedestrians, with pedestrian safety at normal non-channelized signalized approaches, where right-turning vehicles have potential conflicts with pedestrians.” Hourly flow for left- and right-turning vehicles were examined by four different approaches. Pedestrians encountered greater risk from left- than from right-turning vehicles. Risk and number of pedestrian accidents per pedestrian decreased with increased pedestrian flow, suggesting that increased pedestrian mode share can have a positive effect on pedestrian safety at signalized intersections.

A study on pedestrian safety found that Florida had the highest rate of pedestrian fatalities in the United States during 2008–2011 (FDOT 2015). The study was conducted to understand driver behavior and compliance at signalized intersections when using four pedestrian signs: Stop Here on Red, No Turn on Red, Turning Vehicles Yield to Pedestrians, and Right on Red Arrow after Stop (FDOT 2015). This study applied two tools to improve efficiency of data processing: the Naturalistic Driving Study (NDS) Automatic Video Processing Tool, which detects and tracks pedestrians and traffic signal indications, and the NDS Data Reduction and Analysis Tool, which reviews and analyzes NDS videos and sensors (FDOT 2015). Data were divided into two groups for analysis: the feature group (including pedestrians) and the control group (excluding pedestrians) (FDOT 2015). Drivers showed the highest rate of compliance with the No Turn on Red sign (FDOT 2015). Stop on Red, No Turn on Red, and Right on Red Arrow after Stop features increased the likelihood of compliance compared to the control group (FDOT 2015). Compared to control sites, rates of compliance for features were higher when pedestrians were present (vs. not present) at the intersection (FDOT 2015).

Pedestrian space and delay are used to measure the pedestrian’s level of service at signalized intersections. Hubbard et al. (2009) questioned whether this measure effectively reflects the negative effects that right-turning vehicles have on pedestrians. They used a binary logit model to identify factors affecting the likelihood that pedestrian safety will be compromised (i.e., the pedestrian is delayed or must alter their travel path or speed). Factors affecting pedestrian safety were the pedestrian direction of travel, right-turn volume, volume of pedestrians crossing,

whether the pedestrian arrived late, whether the pedestrian began crossing after the walk interval ended, and crosswalk characteristics.

2.8 BICYCLISTS

A recent study for ODOT was conducted to analyze right-hook (RH) crashes during the latter portion of the green phase at signalized intersections (Hurwitz, D. et al. 2015). A RH crash is an accident that occurs between a right-turning vehicle and through-moving bicycle. An extensive literature review of RH crashes was included in that document but is not repeated here. Experiments were jointly conducted by Oregon State University (OSU) and Portland State University (PSU) in the OSU Driving Simulator Lab (Jannat 2014). The study concluded that “78% of bicyclists were unaware of their stopping position with respect to stopped vehicles queued at an intersection during a red indication, and 19% of motorists reported that they would not yield to the adjacent bicyclist approaching from behind if they were detected in rear-view or side-view mirrors (Jannat 2014)”. When comparing crash and near-crash scenarios, the most common cause of failure was the driver’s failure to search actively for the bicyclist (Hurwitz, D. et al. 2015). Crash and near-crash situations were measured by time-to-collision. Several different intersection treatments (environmental factors, signage, curb radii, pavement markings, and protected intersection designs) were evaluated for their abilities to reduce the frequency and severity of RH crashes (Hurwitz, D. et al. 2015). Protected intersection designs performed well, with motorists being more likely to notice adjacent bicyclists compared to treatments that did not include this mitigation.

2.9 SAFETY

Analyzing the causes and rates of right-turn crashes at 68 right-turn approaches in Illinois, Schattler et al. (2015) sought to identify locations that could benefit from design modifications. Significantly higher crash and injury rates were correlated with approach head-turn angles greater than 140°, right-turn angles less than 45°, and intersection skew angles less than 75° (Schattler et al. 2015). The authors recommended several design modifications (still under investigation), such as decreasing the radius, removing or modifying channelized islands, adjusting the stop bar position, and providing pavement markings to separate paths for passenger cars when accommodating large trucks.

Dixon et al. (2000) analyzed right-turn approaches in Georgia, with the aim of demonstrating the limitations of certain right-turn configurations and identifying mitigation options. Finding limited research on right-turn treatments at signalized intersections, the authors divided common right-turn treatments into entrance and exit treatments (Figure 2.6). “Entrances,” used to describe the upstream, were defined as entry points and geometric features used by vehicles to perform right turns. “Exits” were defined as geometric conditions or traffic control devices where right-turning vehicles entered conflicting traffic streams. Geometric conditions and traffic control devices are dependent on each other and were evaluated together (Dixon et al. 2000). When traffic islands were used, fewer right-angle crashes were observed. Use of an exclusive turn lane correlated with an increase in the number of sideswipe crashes. In the absence of additional controls, the use of an exclusive right-turn lane on the cross street did not reduce the number of rear-end crashes. These findings could serve as a basis for further research of factors such as traffic volume, conflicts, road types, and limited right-turn treatments.

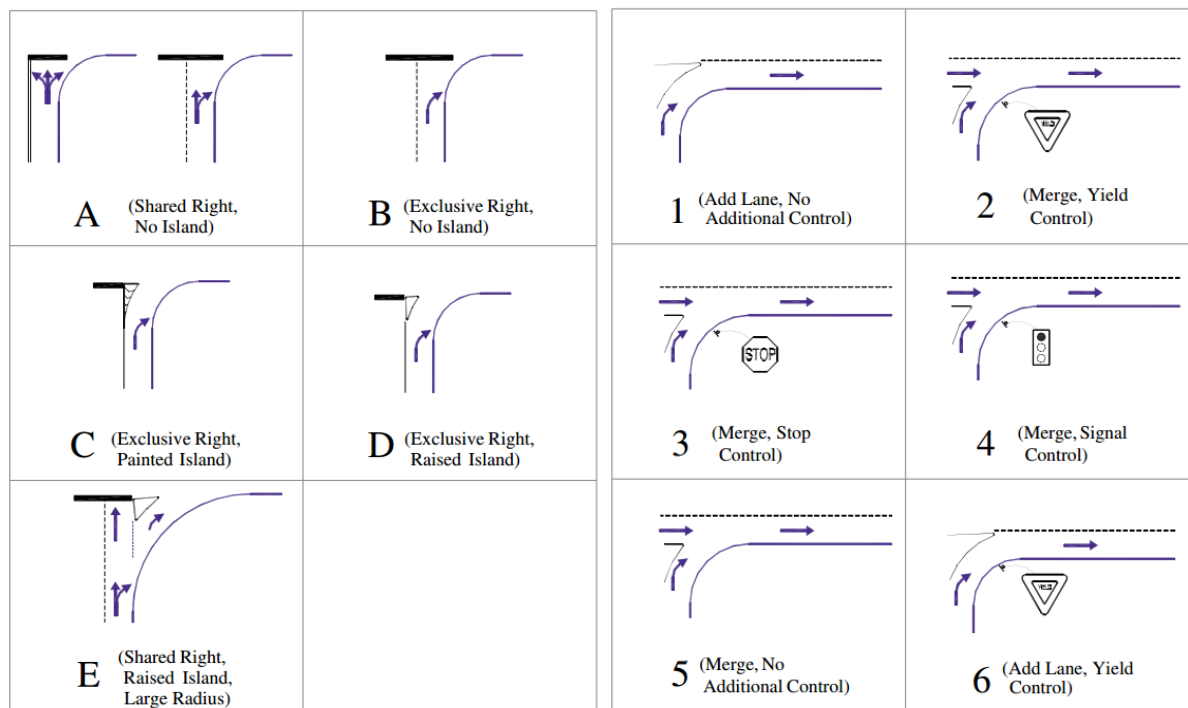

Figure 2.6: Entrance (left) and exit (right) treatments (Dixon et al. 2000)

Conflicts at signalized intersections and reductions in safety can result from improper geometric design and signal settings (Chai and Wong 2014). A study conducted at Nanyang Technological University simulated four cross-intersection scenarios using a cellular automata model (Chai and Wong 2014). Relationships between conflicts involving right-turn vehicles, traffic volume, and right-turn movement control strategies were analyzed (Chai and Wong 2014). The authors estimated traffic volume impacts, permissive right-turn vs. red-amber-green arrow, shared vs. right-turn lanes, and signal settings (Chai and Wong 2014). They concluded that prediction models can be developed on the occurrence and severity of vehicle conflicts based on different geometric layouts and control strategies (Chai and Wong 2014).

2.10 SUMMARY

The planning, design, and operation of signalized intersections are complex processes that require the balancing of safety and efficiency for all system users. Right-turn-lane geometry is an important variable affecting safety and operational efficiency. Pedestrians must be accommodated for safe operation. While the flashing yellow arrow is allowed for PPRT operations, there has been no previous research on the operational or safety implications of PPRT phasing.

3 ANALYSIS OF CRASH DATA

Right-turn crash data at signalized intersections in Oregon were reviewed for years 2011–2013 (Table 3.1). Crash records were filtered to identify all crashes that occurred at signalized intersections,¹ which accounted for 18–20% of reported crashes in 2011–2013. Crashes at signalized intersections were filtered to identify those involving a right-turning vehicle². For 2011–2013, an average of 848 crashes per year involved right-turning vehicles at signalized intersections (1.7% of all crashes, 8.8% of crashes at signalized intersections). Table 3.2 decomposes data for right-turn crashes at signalized intersections by crash severity. Nine fatal crashes, 1,146 injury crashes, and 1,389 property-damage-only crashes were associated with right-turn movements at signalized intersections in Oregon during 2011–2013.

Table 3.1: Summary of ODOT Crash Data (2011–2013)

CATEGORY	2011	2012	2013	3-YEAR AVG
Total reported crashes	49,053	49,798	49,510	49,454
Crashes at traffic signals	9,183 (18.7%)	9,690 (19.5%)	10,061 (20.3%)	9,645 (19.5%)
Right-turn crashes at traffic signals	809 (1.7%)	881 (1.8%)	854 (1.7%)	848 (1.7%)

Table 3.2 Severity of ODOT Right-Turn Crashes at Signalized Intersections (2011–2013)

CRASH SEVERITY	2011	2012	2013	3-YEAR AVG
Fatal	3 (0.4%)	3 (0.3%)	3 (0.4%)	3 (0.4%)
Injury	377 (46.6%)	423 (48.0%)	346 (40.5%)	382 (45.0%)
Property damage only	429 (53.0%)	455 (51.7%)	505 (59.1%)	463 (54.6%)
Total	809	881	854	848

The researchers sought comparable published tabulations for comparison. The National Highway Traffic Safety Administration (NHTSA) analyzed causes of crashes (Choi 2010), using data collected at crash scenes during 2005–2007. Among crashes at intersections, 52.5% occurred at intersections with at least one traffic signal, and 1.8% of vehicles at these signalized intersections were turning right before the crash (see Appendix A). The NHTSA did not find any statistically significant and critical reasons of driver error for the right-turn crashes. Reasons for differences in percentages of right-turn crash contributions in Oregon vs. nationally are likely related to differences in included crash types. No other analysis of statewide-signalized intersection data by turning movement was found in the literature.

Next, characteristics of right-turn crashes in Oregon were compared to characteristics of all other crashes at signalized intersections. Proportions of right-turn and intersection crashes were

¹ TRAF_CNTL_DEVICE_SHORT_DESC = “TRF SIGNAL

² MVMNT_SHORT_DESC = “TURN-R”

compared by a proportions test, with the null hypothesis assuming no difference based on collision type. Null (Eq. 3.1) and alternate (Eq. 3.2) hypotheses are listed below:

$$H_0: p_1 = p_2 \quad (3.1)$$

$$H_A: p_1 \neq p_2 \quad (3.2)$$

The z-value was computed by the following equations.

$$Z = \frac{(\hat{p}_1 - \hat{p}_2)}{\sqrt{\hat{p}(1-\hat{p})\left(\frac{1}{n_1} + \frac{1}{n_2}\right)}} \quad (3.3)$$

$$\hat{p}_1 = \frac{y_1}{n_1}, \hat{p}_2 = \frac{y_2}{n_2} \quad (3.4)$$

$$\hat{p} = \frac{y_1 + y_2}{n_1 + n_2} \quad (3.5)$$

Where y_1 and y_2 are the number of right-turn and intersection crashes, respectively, and n_1 and n_2 are the total number of right-turn and intersection crashes for 2011–2013. Statistically significant differences ($P \leq 0.05$; gray in Table 3.3) were found between proportions of right-turn vs. intersection crashes for all collision types except head-on and parking maneuver collisions. The turning movement difference would be expected because the right-turning crash would likely be typed as a “turning movement” (the most significant event is used to type the crash). There were small proportions of backing, sideswipe (meeting and overtaking), miscellaneous, and noncollision crashes, such that statistically significant differences are not necessarily critical. Large differences in pedestrian and fixed-object collisions may indicate a potential area for simulator studies. As expected, rear-end and angle crashes were less frequent.

Table 3.3: Comparison of Proportions of Crashes at Intersections by Collision Type

COLLISION TYPE	RIGHT-TURN CRASHES	ALL OTHER CRASHES	RIGHT-TURN %	ALL OTHER %	P
Backing	1	287	0.04%	1.07%	0.00*
Miscellaneous	4	10	0.16%	0.04%	0.01*
Pedestrian	218	625	8.57%	2.32%	0.00*
Angle	37	5,034	1.45%	18.69%	0.00*
Head-on	2	46	0.08%	0.17%	0.27
Rear-end	184	12,976	7.23%	48.18%	0.00*
Sideswipe-meeting	0	47	0.00%	0.17%	0.03*
Sideswipe-overtaking	22	465	0.86%	1.73%	0.00*
Turning movement	1,905	6,819	74.88%	25.32%	0.00*
Parking maneuver	4	17	0.16%	0.06%	0.09
Non-collision	11	37	0.43%	0.14%	0.00*
Fixed-object or other-object	156	571	6.13%	2.12%	0.00*
Total	2,544	26,934			

* Statistically significant at 95% confidence level; Bold text indicates differences where proportions were significantly higher for right-turn crashes.

Table 3.4 shows differences in crash proportions by cause of crash and results of statistical analysis (with similar table formatting applied). Statistically significant differences were observed for crashes due to not yielding ROW (to pedestrians, bicyclists, or other vehicles), passing the stop sign or red flasher, improper overtaking, following too close, making improper turns, other non-specified reasons (not improper driving), improper change of traffic lanes, driver drowsy/fatigued, disregarding traffic control device, presence of non-motorist illegally in the roadway, non-motorist clothing not visible, load shifting on a vehicle, and inattention/careless driving. Of these, the greatest differences in proportions were observed for crashes caused by following too closely, making an improper turn, and not yielding ROW.

Table 3.4: Comparison of Proportions of Crash Types at Intersections by Cause of Crash

CRASH CAUSE	RIGHT-TURN CRASHES	ALL OTHER CRASHES	RIGHT -TURN %	ALL OTHER %	P
Speed too fast for conditions	176	710	6.92%	2.64%	0.80
Did not yield right of way	885	4411	34.79%	16.38%	0.00*
Passed stop sign or red flasher	2	22	0.08%	0.08%	0.00*
Disregarded R-A-G traffic signal	227	6213	8.92%	23.07%	0.96
Drove left of center on two-way road	9	51	0.35%	0.19%	0.08
Improper overtaking	73	83	2.87%	0.31%	0.00*
Followed too closely	256	10835	10.06%	40.23%	0.00*
Made improper turn	590	816	23.19%	3.03%	0.00*
Other improper driving	77	818	3.03%	3.04%	0.98
Mechanical defect	0	11	0.00%	0.04%	0.31
Other (not improper driving)	11	40	0.43%	0.15%	0.00*
Improper change of traffic lanes	20	381	0.79%	1.41%	0.01*
Disregarded other traffic control device	22	129	0.86%	0.48%	0.01*
Wrong way on one-way roadway	7	42	0.28%	0.16%	0.16
Driver drowsy/fatigued/sleepy	2	81	0.08%	0.30%	0.04*
Nonmotorist illegally in roadway	37	111	1.45%	0.41%	0.00*
Nonmotorist clothing not visible	4	11	0.16%	0.04%	0.01*
Vehicle improperly parked	0	5	0.00%	0.02%	0.49
Defective steering mechanism	0	2	0.00%	0.01%	0.66
Inadequate or no brakes	6	58	0.24%	0.22%	0.83
Vehicle lost load or load shifted	2	1	0.08%	0.00%	0.00*
Tire failure		1	0.00%	0.00%	0.76
Phantom/non-contact vehicle	1	39	0.04%	0.14%	0.17
Inattention	34	851	1.34%	3.16%	0.00*
Driving in excess of posted speed	3	46	0.12%	0.17%	0.53
Speed racing	1	1	0.04%	0.00%	0.04*
Careless driving	42	687	1.65%	2.55%	0.01*
Reckless driving	49	405	1.93%	1.50%	0.10
(blank)	1	6	0.04%	0.02%	0.59
Total	2,544	26,934			

* Statistically significant at 95% confidence level

3.1 SUMMARY

A review of Oregon crash data for 2011–2013 revealed that 18–20% of all crashes annually occurred at signalized intersections, of which 1.7–1.8% were attributed to right-turning movement (accounting for 8.8% of all crashes at signalized intersections). Most of these crashes (54.6%) were property-damage-only crashes. Comparison of right-turn and intersection crash proportions revealed large, statistically significant, and relevant differences in angle, pedestrian, rear-end, and fixed-object crash types. Following too closely, not yielding ROW, and improper turns were crash causes with significantly different proportions between right-turn and all intersection crashes.

4 SURVEY

A survey was conducted to understand how well Oregon drivers comprehend different right-turn signal display alternatives. Open-ended and multiple-choice questions were developed to elicit each driver's understanding and self-reported response to typical traffic signal displays for controlling right turns. The survey was conducted online, with recruitment through postcards that were mailed to 9,872 addresses in Oregon. This chapter describes the development and administration of the survey and the results of the analysis.

4.1 DESIGN AND REFINEMENT

The first step in designing the survey was the development of a generic template for survey images. The research team designed the initial image template by considering a recent Florida DOT report (Boot et al. 2015). A Google Sketch Up image was used instead of a real photo, to enable explicit modification of the scene. Every effort was made to present questions neutrally, allowing respondents to provide meaningful answers reflecting their comprehension of the signal indications. Past questions on other surveys on flashing yellow arrow comprehension were used as a guide. Several rounds of review and refinement followed the internal development of the survey questions. Transportation graduate students at OSU and PSU and members of the project Technical Advisory Committee (TAC) from ODOT tested a pilot survey and provided feedback for further improvements of the format and content of the survey questions. Once the project team was satisfied with the survey design, the survey was finalized. The finalized survey, distribution methods, and record handling were reviewed and approved by the IRB of PSU (163752 IR).

4.2 INSTRUMENT

The survey consisted of 21 questions. The first section of the survey included open-ended questions, which asked respondents to report their understanding of right-turn signal display indications. Specific questions regarded comprehension of the green ball, green arrow, red ball, red arrow, and flashing yellow arrow indications. For these questions, respondents were presented a computer image of an intersection from a driver's perspective and were instructed to assume that they were turning right. The scale of the signal heads was slightly enlarged to make the displays more prominent in the image. Survey images are shown in the results and analysis section for each question. Two versions of each question were developed: one version with and one version without a Right Turn Only (RTO) sign. The survey was designed such that half of the respondents were randomly administered one version with the RTO sign and the other half were administered the version without the sign for all open-ended questions.

In the second section of the survey, respondents were given a set of multiple-choice questions. They were asked to provide their reasoning for what they perceived as either similarities or differences between the red ball and red arrow and between the green ball and flashing yellow arrow signal indications. The third and final section of the survey consisted of closed-ended

multiple-choice demographic questions on the respondent's income and education levels, driving habits, and eyesight. The entire survey instrument is included in Appendix B.

4.3 ADMINISTRATION

A survey response rate of 6–8% was assumed based on a previously conducted postcard/online design by researchers at PSU (Currans et al., 2015). To generate sufficient responses for analysis, a sample size of 10,000 respondents was selected. A sampling scheme was designed based on the proportion of the population in each county (Table 4.1). Based on this scheme, a random sample of addresses within each county was purchased through Info USA. After removing incorrect/missing addresses from the purchased address sample, there remained 9,872 households to which recruitment materials could be sent. Each household was assigned a unique ID number.

Table 4.1: Sampling Scheme for Driver Survey

REGION	COUNTY	POPULATION	POPULATION %	# OF ADDRESSES
1	Clackamas	397,385	22.46	990
	Hood River	24,245	1.37	60
	Multnomah	777,490	43.94	1937
	Washington	570,510	32.24	1421
2	Clatsop	37,750	3.03	94
	Columbia	50,390	4.04	126
	Tillamook	25,690	2.06	64
	Yamhill	103,630	8.32	258
	Polk	78,570	6.31	196
	Marion	329,770	26.47	822
	Lincoln	47,225	3.79	118
	Linn	120,860	9.70	301
	Benton	90,005	7.22	224
	Lane	362,150	29.06	902
3	Douglas	109,910	22.43	274
	Curry	22,470	4.59	56
	Coos	62,990	12.85	157
	Josephine	83,720	17.08	209
	Jackson	210,975	43.05	526
4	Wasco	26,370	8.22	66
	Sherman	1,790	0.56	4
	Gilliam	1,975	0.62	5
	Jefferson	22,445	6.99	56
	Wheeler	1,445	0.45	4
	Crook	21,085	6.57	53
	Deschutes	170,740	53.20	425
	Lake	8,010	2.50	20
	Klamath	67,110	20.91	167
5	Morrow	11,630	6.21	29
	Umatilla	79,155	42.30	197
	Union	26,625	14.23	66
	Wallowa	7,100	3.79	18
	Baker	16,425	8.78	41
	Grant	7,430	3.97	19
	Harney	7,295	3.90	18
	Malheur	31,480	16.82	78
	Oregon	4,013,845		10,000

A recruitment postcard (shown in Figure 4.1) containing pertinent information about the survey objectives and the online link was sent to each address. On the other side of the postcard, the household ID number was included, which respondents were required to enter while answering the survey. Survey responses were never linked to names of respondents answering the survey, thus ensuring confidentiality of responses. Recipients were provided with the option of providing their contact information at the end of the online survey, to be entered into a drawing for one of five \$100 Amazon.com gift cards.

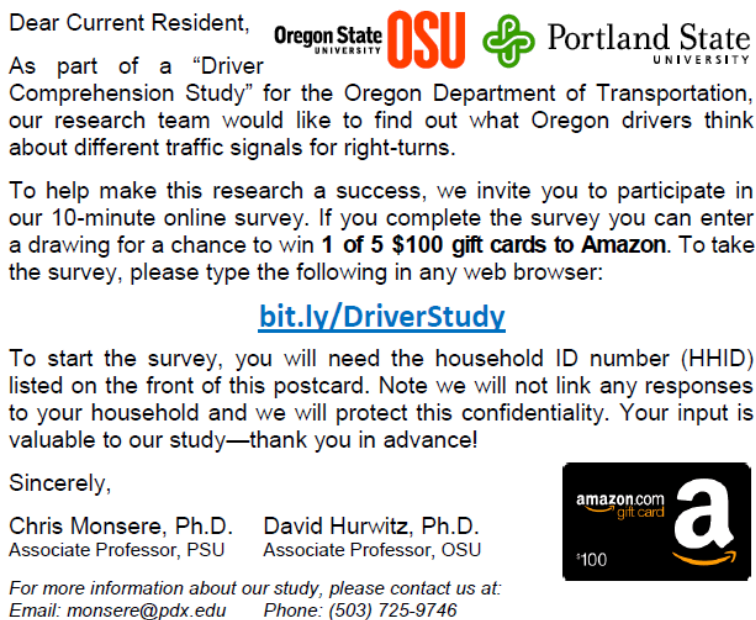

Figure 4.1: Recruitment postcard for the survey

4.4 RESPONSE RATE

Postcards were mailed to 9,872 addresses. A total of 416 respondents clicked the online link to begin the survey; however, only 399 respondents completed the survey. No postcards were returned as undeliverable. The calculated response rate was 4%. Figure 4.2 shows the geographic distribution of respondents. Responses were received from all five ODOT regions.

The lower response rate for this survey compared to previous surveys using similar methods was attributed to two reasons. First, the shortened URL that was used for the online link on the postcard was case-sensitive. Typing the online link exactly as presented on the postcard led to the correct survey (bit.ly/DriverStudy), but typing all lowercase letters (bit.ly/driverstudy) sent recipients to a paper at the University of Wisconsin on autonomous vehicles. The research team fielded calls and emails from some recipients and clarified the link; however, it is possible that some recipients typed the link in lowercase letters and did not contact the research team for clarification when the link did not work. Second, due to the project schedule, response postcards were mailed on 16 May 2016 from the FedEx processing center in California. The first postcards arrived in Oregon a week before Memorial Day weekend. Initial responses were strong, and then a drop off in response rate was observed over the holiday weekend.

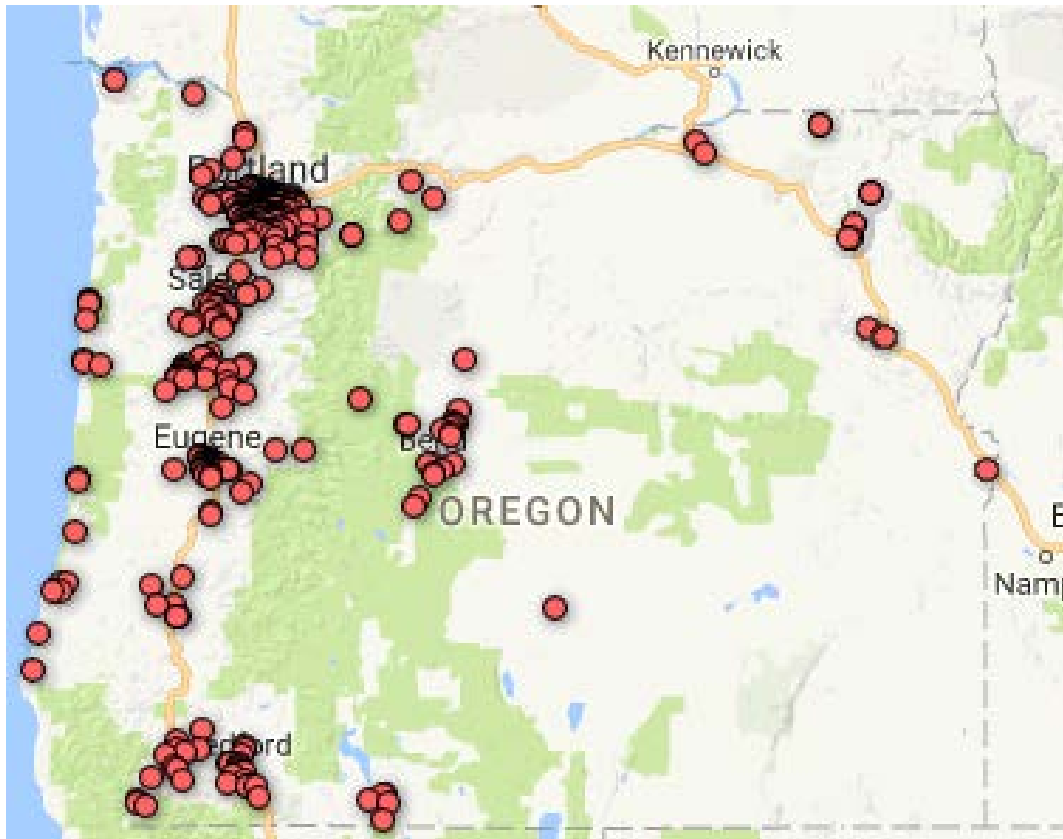

Figure 4.2: Geographic distribution of respondents

4.5 DEMOGRAPHIC SUMMARY

Of the 399 people who responded to the survey, 397 people provided some or all of the requested demographic information. Table 4.2 presents demographic information for all survey respondents, categorized by whether they received the version of the survey with or without the RTO sign (“Sign” vs. “No Sign” in tables). Percentages for Oregon from the Census Bureau are shown where available.

Older, educated white males were overrepresented as survey respondents compared to 2010 Census estimates for Oregon (US Census). Survey respondents were 61% male compared to 49% male for the total population. Survey respondents were generally older than the general population, with larger representation in the 55–64 and 65+ years categories. Survey respondents were 93% White/Caucasian (vs. 79% reported in the Census). According to the US Census American Community Survey (ACS) data, approximately 30% of Oregonians have a Bachelor’s degree or higher, compared to over 65% of respondents in the sample. The ACS reports that 89.5% of Oregon residents have a high-school education or higher, compared to 98% of sample respondents. About 71% of survey respondents reported household incomes of less than \$100,000, which compares well to the Census data of 75%. Proportions did not differ between respondents who took the survey with or without the RTO sign.

Table 4.2 Demographic Comparison between Survey and Census Respondents

CATEGORY	DEMOGRAPHIC VARIABLE	SURVEY %	SURVEY % (SIGN)	SURVEY % (NO SIGN)	CENSUS %
Gender (n = 397)	Male	60.7	59.3	62.1	49.2
	Female	39.3	40.7	37.9	50.8
Age (n = 399)	18–24	2.0	1.5	2.5	
	25–34	8.3	11.2	5.4	13.7
	35–44	15.3	16.8	13.8	13.1
	45–54	14.5	12.2	16.7	14.1
	55–64	29.3	28.6	30.0	13.3
	65+	30.6	29.6	31.5	13.8
Race (n = 375)	American Indian or Alaska Native	0.5	1.1	0.0	1.1
	Asian	2.1	1.1	3.1	3.6
	Black or African American	0.5	0.0	1.0	1.7
	Hispanic or Latino/a	2.4	3.3	1.6	11.7
	White or Caucasian	92.5	91.8	93.2	78.5
	Other	1.9	2.7	1.0	3.3
Income (n = 336)	Less than \$25,000	9.2	6.6	11.8	23.6
	\$25,000 – \$50,000	19.0	18.0	20.1	23.2
	\$50,000 – \$75,000	21.4	24.6	18.3	17.0
	\$75,000 – \$100,000	21.1	18.6	23.7	11.5
	\$100,000 – \$150,000	19.6	21.0	18.3	13.4
	\$150,000 – \$200,000	6.3	7.2	5.3	5.7
	\$200,000 or more	3.3	4.2	2.4	5.6
Education (n = 396)	No schooling completed, or < 1 year	0.0	0.0	0.0	4.1
	Nursery, kindergarten, and elementary grades (1–8)	0.0	0.0	0.0	
	High school (grades 9–12, no degree)	2.0	1.5	2.5	6.5
	High-school graduate (or equivalent)	5.8	5.7	5.9	24.5
	Some college (1–4 years, no degree)	18.7	16.5	20.8	26.6
	Associate degree (incl. occup. or academic degrees)	11.1	11.3	10.9	8.2
	Bachelor’s degree (BA, BS, AB etc.)	33.3	38.1	28.7	18.9
	Master’s degree (MA, MS, MENG, MSW, etc.)	19.4	18.0	20.8	11.2
	Professional school degree (MD, DDC, JD etc.)	4.8	6.2	3.5	
	Doctorate degree (PhD, EdD, etc.)	4.8	2.6	6.9	

Table 4.3 summarizes the driving behaviors of respondents. Respondents tended to drive multiple times in a week (97%), to be licensed for over 10 years (96%), and to hold an Oregon driver's license (98%). More than half (58%) of respondents reported that they drove more than 10,000 miles each year. A small percentage of respondents (3%) indicated that they were colorblind. Most respondents indicated that they used corrective glasses or contacts for vision (65%).

Table 4.3: Characteristics of Survey Respondents

CATEGORY	DEMOGRAPHIC VARIABLE	SURVEY %	SURVEY % (SIGN)	SURVEY % (NO SIGN)
Driving frequency	Less than 1 time per week	2.0	2.0	2.0
	1 time per week	0.8	0.5	1.0
	2 – 4 times per week	15.0	14.3	15.8
	5 – 10 times per week	32.1	33.7	30.5
	More than 10 times per week	50.1	49.5	50.7
Driver's license	1 – 2 years	0.5	0.0	1.0
	3 – 5 years	1.5	1.0	2.0
	6 – 10 years	2.3	2.6	2.0
	10+ years	95.7	96.4	95.0
Miles driven per year	Less than 5,000	14.3	12.8	15.8
	5,000 – 9,999	27.8	28.6	27.1
	10,000 – 14,999	30.3	30.1	30.5
	15,000 – 19,999	16.8	15.8	17.7
	Greater than 20,000	10.8	12.8	8.9
Oregon driver's license	Yes	97.7	97.4	98.0
	No	2.3	2.6	2.0
Color blind	Yes	2.5	3.1	2.0
	No	96.5	95.9	97.0
	Don't want to provide this information/Don't Know	1.0	1.0	1.0
Corrective glasses or contacts	Yes	65.0	65.3	65.0
	No	34.0	34.7	34.0
	Don't want to provide this information/Don't Know	1.0	0.0	1.0

4.6 RESULTS AND ANALYSIS

4.6.1 Coding

Because the survey contained open-ended questions designed to assess comprehension of various signal display indications, the responses needed to be categorized for further analysis. The

research team reviewed each open-ended response. Responses were coded as correct, partially correct, or incorrect by two reviewers independently, based on established criteria shown in Table 4.4. The same coding convention was followed for coding both the responses from the survey and the actions observed in the simulator experiments, therefore providing a basis for comparison of the results from both experiments.

Table 4.4: Error Coding of Narrative

DISPLAY INDICATION	CORRECT	PARTIALLY CORRECT	INCORRECT
Steady Circular Green	Turn right with caution after yielding to pedestrians in the crosswalk	Turn right without stopping but failed to state that they would yield to pedestrians if present in the crosswalk	Stop before turning
Steady Green Arrow	Turn right without stopping recognizing that the steady green arrow indication means a protected movement (or) Indicated that they would watch for pedestrians who may cross against the pedestrian Don't Walk signal	Check for pedestrians and turn right (or) slow down and check for pedestrians and other cross traffic but did not recognize the protected movement in either case	Stop before turning
Steady Circular Red and Steady Red Arrow	Come to a complete stop and complete the turn when they found a safe gap or remained stopped if they failed to find a gap	Stop or turn right, without providing additional details	Stop and remained stopped until the green indication
Flashing Yellow Arrow	Turn right with caution after yielding to pedestrians in crosswalk	Turn right without stopping or failed to state that they would yield to pedestrians if present in the crosswalk	Stop before turning

For the steady circular green, responses were coded as correct if the respondents indicated that they would turn right with caution after yielding to pedestrians in the crosswalk. A response was coded as incorrect, if the respondents indicated that they would stop before turning. Partially

correct codes were assigned to responses when the respondents stated that they would turn right without stopping, but failed to mention yielding to pedestrians if present, in the crosswalk. A correct response for the steady green arrow was coded when the respondent recognized that it was a protected movement and stated that they would turn right without stopping. A response was also coded as correct, if the respondent stated that they would watch for pedestrians who may jaywalk against the signal indication. A partially correct response was coded when the respondents stated that they would check for pedestrians and turn right or if they slowed down to check for pedestrians and other cross traffic, but did not give any indication that they recognized that a steady green arrow implied a protected movement. Responses were coded as incorrect, when the respondents stated that they would stop and turn right. The coding convention followed for the steady circular red and the steady red arrow indications was the same, as according to Oregon law the expected correct action for both display indications is the same for right turns. A response for these indications was coded as correct, when the respondents stated that they would come to a complete stop and complete the turn after finding a safe gap or they would stop and remained stopped, if they failed to find a suitable gap. A partially correct response was coded when the respondents stated that they would stop or turn right, without providing additional details. A response was coded as incorrect, if the respondents stated that they would stop and remained stopped until the green indication. For the flashing yellow arrow signal display indication, responses were coded as correct, if the respondents stated that they would turn right with caution after yielding to pedestrians in the crosswalk. A partially correct response was coded, when respondents stated that they would turn right without stopping or failed to state that they would yield to pedestrians if present in the crosswalk. A stated response of stopping before turning was coded as incorrect.

Interrater reliability was assessed by Cohen’s kappa coefficient κ , a statistic that measures interrater agreement for categorical items and is calculated as follows:

$$\kappa = \frac{\text{Pr}(a) - \text{Pr}(e)}{1 - \text{Pr}(e)} \quad (4-1)$$

where $\text{Pr}(a)$ represents the actual observed agreement, and $\text{Pr}(e)$ represents the chance agreement. $\text{Pr}(e)$ is calculated using the following formula:

$$\text{Pr}(e) = \frac{\left(\frac{cm^1 * rm^1}{n}\right) + \left(\frac{cm^2 * rm^2}{n}\right)}{n} \quad (4-2)$$

where cm^1 is the column 1 total, cm^2 is the column 2 total, rm^1 is the row 1 total, rm^2 represents the row 2 total, and n is the number of observations. This statistic can range between -1 and +1, where 0 represents agreement due to random chance, and 1 represents perfect agreement between the raters (McHugh 2012). Kappa statistic values of 0.61–0.80 indicate substantial agreement, and those of 0.81–1.00 indicate almost perfect agreement.

Cohen’s kappa statistic was calculated for the steady circular green, steady green arrow, steady circular red, steady red arrow, and flashing yellow arrow questions separately with and without the RTO sign. For all but one question, one independent coding trial was conducted. For the green arrow question, two coding trials were conducted. Following estimation of the kappa

statistic (trials 1 and 2), phone meetings between the research team members were conducted, and coding discrepancies were resolved. Kappa values are shown in Table 4.5.

Table 4.5: Estimated Values of Cohen’s Kappa Coefficient

CATEGORY	TRIAL 1 (SIGN)	TRIAL 1 (NO SIGN)	TRIAL 2 (SIGN)	TRIAL 2 (NO SIGN)	TRIAL 3 (SIGN)	TRIAL 3 (NO SIGN)
Green Ball	0.86	0.88	1.00	1.00		
Green Arrow	0.77	0.65	0.75	0.74	1.00	1.00
Red Ball	0.79	0.84	1.00	1.00		
Red Arrow	0.89	0.91	1.00	1.00		
Flashing Yellow Arrow	0.86	0.81	1.00	1.00		

4.6.2 Open-ended Comprehension Questions

Each respondent was asked five open-ended questions to determine their comprehension of the steady red circular ball, steady red arrow, steady green circular ball, steady green arrow, and flashing yellow arrow signal indications for right-turn movements. Respondents were presented with this wording for each of the five displays:

*Imagine that you are approaching the intersection in **the lane farthest to the right and planning to TURN RIGHT**. What action would you take based on the current signal display? Please type your response in the box below and be as descriptive as possible.*

Responses to each question were reviewed and classified as correct, partially correct, or incorrect. Coding criteria for each display are provided in each subsection. A sample of the open-ended responses is included in Appendix C. A discussion of each of these signal display indications follows.

4.6.2.1 Steady Circular Green Ball

Participants were presented the image shown in Figure 4.3 and asked to imagine that they were driving in the right lane with a steady circular green ball indication. They were prompted to describe their resulting course of action. Responses were coded as following the coding convention outlined in Table 4.4.

Results of the analysis of the responses are shown in Table 4.6. Most respondents (73%, n=398) correctly indicated that they would turn right and yield to pedestrians in the crosswalk. The remaining respondents largely indicated that they knew that they had the ROW to proceed (25%) but did not include any descriptions of yielding to pedestrians before turning so were coded partially correct. Only 2.3% stated that they would stop before turning and were coded incorrect. Groups with or without the RTO sign differed in the proportion of drivers who stated that they would yield to pedestrians (70%, n=195 with vs. 76%, n=205 without the sign). These differences were not statistically significant based on the two-proportion z test (p -value = 0.14 for correct, 0.10 for partially correct, and 0.78 for incorrect responses).

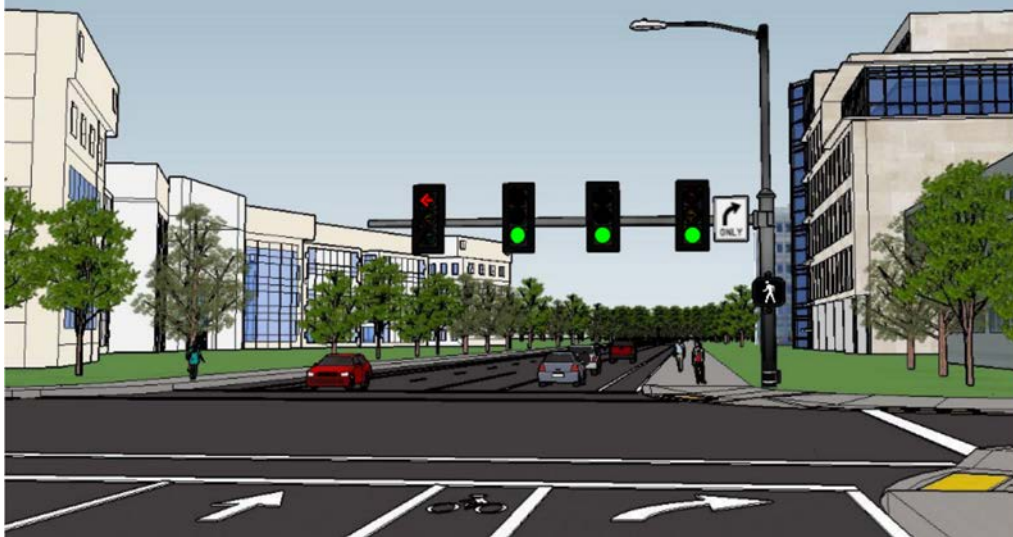

Figure 4.3: Image used for open-ended question on steady green circular ball signal indication (with RTO sign)

Table 4.6: Responses to Open-ended Question on Steady Green Circular Ball Signal Indication

RESPONSE	OVERALL (N = 398)	SIGN (N = 195)	NO SIGN (N = 203)
Correct	73.1%	69.7%	76.4%
Partially Correct	24.6%	28.2%	21.1%
Incorrect	2.3%	2.1%	2.5%

4.6.2.2 Steady Green Arrow

Respondents were presented with the image shown in Figure 4.4 and asked to describe their course of action when faced with a steady green arrow signal indication in the right-turn lane. Responses were coded following the coding convention outlined in Table 4.4.

Table 4.7 summarizes the results for this question, which was answered by 397 participants (195 with and 202 without the RTO sign). The exclusive movement communicated by the green arrow was not well understood by the respondents. Only 63% (n=397) of respondents correctly stated that the steady green arrow communicates a completely protected movement and that they did not need to yield to pedestrians and other vehicles. However, 32.7% were coded as partially incorrect because they indicated that they would check for pedestrians and turn right, or if they indicated that they would slow down and check for pedestrians and other cross traffic, but did not recognize the exclusive protected movement. This is a fail-safe comprehension response and many respondents preferred to be cautious and check for pedestrians before turning. Respondents presented with the image including the RTO sign (n=195) responded correctly at a rate 11% higher than respondents who were not presented the sign (n=202). The results were statistically significantly different in proportions of correct responses (p -value = 0.03 for correct, 0.06 for partially correct, and 0.47 for incorrect responses)..

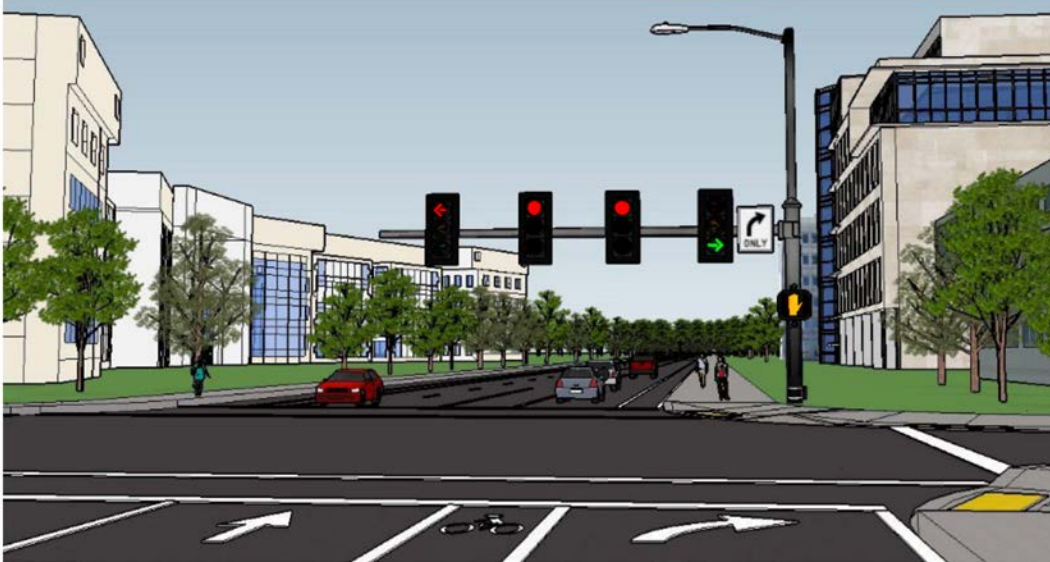

Figure 4.4: Image used for open-ended question on steady green arrow signal indication (with RTO sign)

Table 4.7: Responses to Open-ended Question on Steady Green Arrow Signal Indication

RESPONSE	OVERALL (N = 397)	SIGN (N = 195)	NO SIGN (N = 202)
Correct	63.5%	68.7%	58.4%
Partially Correct	32.7%	28.2%	37.1%
Incorrect	3.8%	3.1%	4.5%

4.6.2.3 Steady Circular Red

Participants were provided the image in Figure 4.5 and asked a question designed to assess their comprehension of the steady circular red signal indication for right-turn movement. Responses were following the coding convention outlined in Table 4.4.

Table 4.8 summarizes the findings for this question, which was answered by 398 participants (195 with and 203 without the RTO sign). The steady circular red signal indication was well understood by respondents with 83% (n=398) of respondents stating that they would come to complete stop and complete the turn when they found a safe gap, or that they would remain stopped if they failed to find a gap. An additional 7% were coded partially correct because they did not provide additional detail other than stopping. Proportions of correct, partially correct, and incorrect responses were similar between groups with (n=195) and without (n=203) the RTO sign (p -value = 0.26 for correct, 0.20 for partially correct, and 0.76 for incorrect responses).

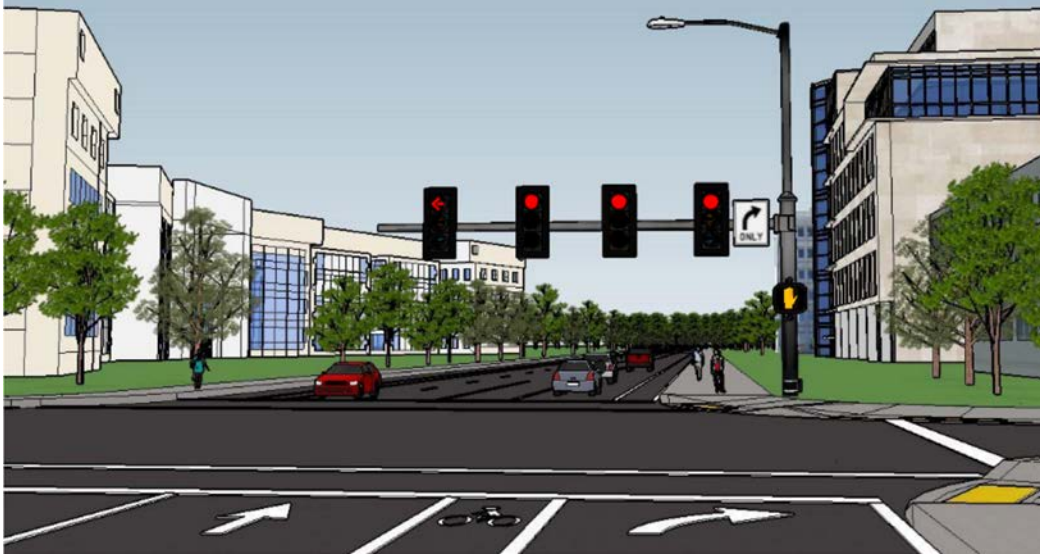

Figure 4.5: Image used for open-ended question on steady circular red signal indication (with RTO sign)

Table 4.8: Responses to Open-ended Question on Steady Circular Red Signal Indication

RESPONSE	OVERALL (N = 398)	SIGN (N = 195)	NO SIGN (N = 203)
Correct	83.2%	81.0%	85.2%
Partially Correct	7.0%	8.7%	5.4%
Incorrect	9.8%	10.3%	9.4%

4.6.2.4 Steady Red Arrow

Participants were provided the image shown in Figure 4.6 and asked a question designed to ascertain their comprehension of the steady red arrow signal indication. Responses were coded following the coding convention outlined in Table 4.4.

Table 4.9 summarizes results for this question, which was answered by 398 respondents (195 with and 202 without the RTO sign). This display had the lowest comprehension with only 52% (n=398) stating that they would come to a complete stop and would turn if an acceptable gap was available after yielding to other traffic and pedestrians or would remain stopped if they failed to find a gap (Oregon law allows RTOR after coming to a complete stop regardless of red ball or red arrow). An additional 7% were coded partially incorrect (they did not provide additional details). The remaining 41% were coded as incorrect and the most common incorrect response was the perception that drivers needed to remain stopped until the indication changed to green. The proportions of incorrect responses were statistically significant different in proportions, 34% (n=195) with and 47% (n=202) without the sign, p -value = 0.01 for correct, 0.77 for partially correct, and 0.02 for incorrect responses.

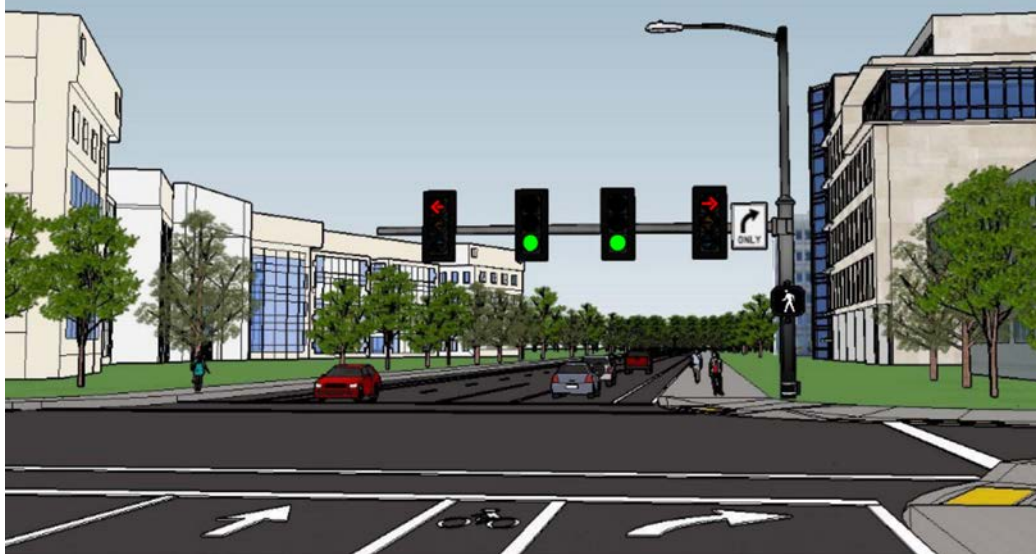

Figure 4.6: Image used for open-ended question on steady red arrow signal indication (with RTO sign)

Table 4.9: Responses to Open-ended Question on Steady Red Arrow Signal Indication

RESPONSE	OVERALL (N = 397)	SIGN (N = 195)	NO SIGN (N = 202)
Correct	52.1%	57.9%	46.5%
Partially Correct	7.3%	7.7%	6.9%
Incorrect	40.6%	34.4%	46.5%

4.6.2.5 Flashing Yellow Arrow

Respondents were presented the image shown in Figure 4.7 and asked a question designed to probe their comprehension of the flashing yellow arrow indication. Online, the yellow arrow flashed at the appropriate interval (an animated GIF image was created). Responses were coded following the coding convention outlined in **Table 4.4.**

Table 4.10 presents the results for this question, which was answered by 398 respondents (195 with and 203 without the RTO sign). Most respondents (77%, n= 398) understood the expected driver response from the FYA indication and stated that they would exhibit caution while turning and yield to pedestrians and cross traffic while coming to a stop if necessary. An additional 3.8% were coded partially incorrect because although the respondents indicated that they would make the turn with caution while yielding they did not mention stopping. The remaining 19.6% were coded incorrect stated that they would come to a complete stop before turning or would remain stopped until the signal display became green. The group provided the RTO sign had a significantly higher proportion of correct responses than the group that was not provided this sign (81% vs. 72%, p -value = 0.04). Groups with (n=195) and without (n=203) the RTO sign did not differ significantly in their proportions of partially correct (p -value = 0.22) and incorrect responses (p -value = 0.12).



Figure 4.7: Image used for open-ended question on flashing yellow arrow signal indication (with RTO sign)

Table 4.10: Responses to Open-ended Question on Flashing Yellow Arrow Signal Indication

RESPONSE	OVERALL (N = 398)	SIGN (N = 195)	NO SIGN (N = 203)
Correct	76.6%	81.0%	72.4%
Partially Correct	3.8%	2.6%	4.9%
Incorrect	19.6%	16.4%	22.7%

4.6.3 Multiple-Choice Comprehension Questions

Four sets of close-ended multiple-choice comprehension questions were posed to respondents regarding signal displays for right-turn movements. The first two sets of questions concerned participants' comprehension of the steady red arrow and flashing yellow arrow indications and their level of confidence in their responses. The third and fourth sets concerned participants' perceptions of the similarities and differences between the red arrow and circular red indications, and between the circular green and flashing yellow arrow indications, for right-turning movements. Each of these question sets is discussed further below.

4.6.3.1 Steady Red Arrow Comprehension

Respondents were presented an image of a steady red arrow with the following wording to gauge steady red arrow comprehension:

In Oregon, if you are turning right and you see the steady red right arrow display, what would be the appropriate response? How confident are you of your answer?

Three choices were presented to respondents – they can turn right cautiously without stopping, they can turn right but first must come to a complete stop and find a gap before turning (correct response), or they must stop and wait until they receive a green

indication before turning. Table 4.11 shows the results from the survey. Overall, 53% of respondents chose the correct response. The group presented the RTO sign had a higher proportion of correct responses, although differences between groups were not significant (with sign n = 196, without sign n = 203; p -value = 0.12 for correct or incorrect responses). Regardless of whether the sign was displayed, many respondents did not comprehend the correct action to be taken when faced with a steady red arrow signal indication. As shown in Table 4.12, respondents were generally very confident (56%) or confident (30%) in their responses, with no significant difference in proportions between groups with and without the RTO sign. These results, coupled with the comprehension results, show some confusion among Oregon drivers regarding the steady red arrow and the appropriate course of action.

Table 4.11: Responses to Multiple-choice Question on Steady Red Arrow Signal Indication

RESPONSE	OVERALL (N = 399)	SIGN (N = 196)	NO SIGN (N = 203)
Turn right cautiously without stopping	0%	0%	0%
Complete stop and find a gap before turning	52.6%	56.6%	48.8%
Stop and wait for a green indication before turning	47.4%	43.4%	51.2%

Table 4.12: Confidence Levels for Responses to Multiple-choice Question on Steady Red Arrow Signal Indication

CONFIDENCE LEVEL	OVERALL (N = 399)	SIGN (N = 196)	NO SIGN (N = 202)
Very confident	56.3%	56.1%	56.4%
Confident	29.9%	30.6%	29.2%
Neutral	5.0%	5.1%	5.0%
Somewhat confident	6.5%	6.6%	6.4%
Not at all confident	2.3%	1.5%	3.0%

4.6.3.2 Red Arrow and Circular Red Comparison

Respondents were asked if the red arrow and circular red signal indications for the right-turn movement were the same or different as a two-choice question. Signal display indications are shown in Figure 4.8. Respondents were asked to explain the reasoning behind their choice. Table 4.13 shows the results from the survey for this question.

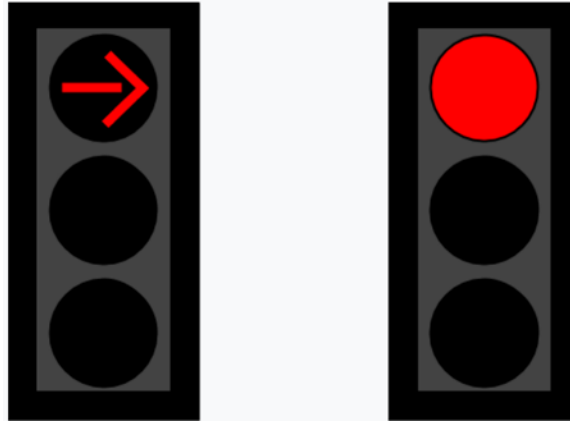

Figure 4.8: Image used for question on comprehension of red arrow vs. circular red signal indications

Table 4.13: Comprehension of Red Arrow Vs. Circular Red Signal Indications

SAMPLE	SIMILAR	DIFFERENT
Overall (n = 395)	49.6%	50.4%
Sign (n = 194)	51.5%	48.5%
No sign (n = 201)	47.8%	52.2%

Overall, 395 respondents answered this question (with sign n = 194, without sign n = 201). Half of respondents thought that the circular red and red arrow signal displays were the same, and half thought that they were different. No significant differences in comprehension or between groups with and without the RTO sign were found (p -value = 0.45 for both same and different). Among respondents who indicated that the signal displays were different, the overwhelming reasoning for the difference was the perception that with the red ball, drivers were supposed to stop and were allowed to proceed if they were able to find a gap before turning; whereas with the red arrow, they indicated that drivers needed to come to a complete stop and remain stopped until they get a green indication. Incorrect/missing responses regarding the correct course of action for the right-turn arrow display in Oregon mirrored the findings discussed earlier with the right-turn arrow open-ended question.

4.6.3.3 Flashing Yellow Arrow Comprehension

Respondents were presented with the following wording to gauge their understanding of the flashing yellow arrow indication and their confidence in their response:

In Oregon, if you are turning right and you see the flashing yellow arrow display, what would be the appropriate response? How confident are you of your answer?

Table 4.14 shows the responses obtained from the survey. Overall, 76% of respondents chose the correct response – turn cautiously right without stopping. A higher proportion of correct responses was found among respondents who were presented with the RTO sign for previous questions, but the difference in proportions was not statistically

different between groups. Stopping and waiting for a green indication before turning was the only option that yielded statistically significant differences in proportions with and without the sign (with sign n = 196, without sign n = 203; P = 0.19 for correct, 0.38 or 0.05 for incorrect responses). However, this difference was the result of the very small sample size. As shown in Table 4.15, 86% of respondents were confident or very confident in their responses, with similar confidence levels between groups with and without the RTO sign.

Table 4.14: Responses to Multiple-choice Question on Flashing Yellow Arrow Indication

RESPONSE	OVERALL (N = 399)	SIGN (N = 196)	NO SIGN (N = 203)
Turn right cautiously without stopping	75.7%	78.6%	72.9%
Complete stop and find a gap before turning	23.3%	21.4%	25.1%
Stop and wait for a green indication before turning	1.0%	0.0%	2.0%

Table 4.15: Confidence Level for Responses to Multiple-choice Question on Flashing Yellow Arrow Indication

CONFIDENCE LEVEL	OVERALL (N = 398)	SIGN (N = 195)	NO SIGN (N = 203)
Very confident	50.0%	48.5%	51.5%
Confident	35.7%	37.2%	34.2%
Neutral	5.5%	6.1%	5.0%
Somewhat confident	5.8%	4.6%	6.9%
Not at all confident	3.0%	3.1%	3.0%

4.6.3.4 Flashing Yellow Arrow, Circular Green Comparison

Respondents were asked to indicate their perceptions of similarities and/or differences between the flashing yellow arrow and the steady circular green signal indications, along with the reasoning behind their choice. A total of 395 responses were received for this question, with the results summarized in Table 4.16. An overwhelming majority of respondents (91%) indicated that the two signal displays meant different things to them as drivers, while only 9% indicated that they were the same. Examination of the open-ended responses revealed that most people associated green displays with proceeding with the movement and having ROW, but associated flashing yellow displays with the need to slow down, exercise caution, and yield if necessary. Of the respondents who indicated that the indications were the same, their reasoning was that both indications require the driver to yield to pedestrians in the crosswalk before proceeding. Among the groups with and without the RTO sign, the proportions were similarly distributed across the two categories, with most respondents stating that the flashing yellow arrow and the steady circular green signal indications were different. No statistically significant differences in proportions were observed with and without the RTO sign (with sign n = 194, without sign n = 201; p-value = 0.77 for same or different).

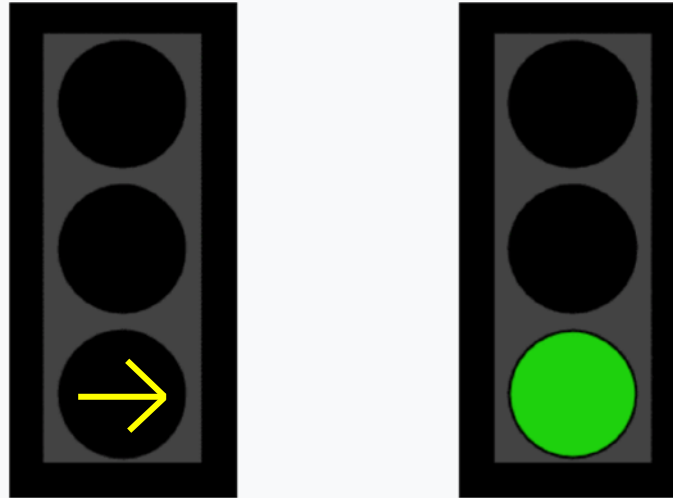

Figure 4.9: Image used for question on comprehension of flashing yellow arrow vs. circular green signal indications

Table 4.16: Comprehension of Flashing Yellow Arrow Vs. Circular Green Signal Indications

SAMPLE	SIMILAR	DIFFERENT
Overall (n = 395)	9.4%	90.6%
With sign (n = 194)	9.8%	90.2%
Without sign (n = 201)	9.0%	91.0%

4.7 SUMMARY

A survey was conducted to understand how well Oregon drivers comprehend different right-turn signal display alternatives. The survey was conducted online with recruitment through postcards that were mailed to 9,872 addresses in Oregon. The survey consisted of 21 questions. The first section of the survey included open-ended questions which asked respondents to report their understanding of green ball, green arrow, red ball, red arrow, and flashing yellow arrow indications. Respondents were presented an image of intersection and asked “*Imagine that you are approaching the intersection in the lane farthest to the right and planning to TURN RIGHT. What action would you take based on the current signal display?*”? Respondents were randomly presented with intersections with or without a “Right Turn Only (RTO)” sign placed overhead on the signal mast arm adjacent to the signal display. In the second section of the survey, respondents were given a set of multiple-choice questions to provide their reasoning for what they perceived as either similarities or differences between the red ball and red arrow and between the green ball and flashing yellow arrow signal indications. The third and final section of the survey consisted of closed-ended multiple-choice demographic questions on the respondent’s income and education levels, driving habits, and eyesight. Overall, the survey received responses from a wide geographical area of Oregon but was over-represented by older white males compared to statewide demographic estimates from Census data.

The research team reviewed each open-ended response and coded them as correct, partially correct, or incorrect by two reviewers independently, based on established criteria for each signal display. Interrater reliability was assessed by Cohen's kappa coefficient κ , a statistic that measures interrater agreement for categorical items. Initial coding revealed substantial agreement for most displays except the green arrow. After a series of iterations and discussions, all coding inconsistencies were resolved.

Overall, analysis of the of 399 completed survey open-ended responses revealed that most respondents understood the steady circular green (73% correct), steady green arrow (63% correct), steady circular red (83% correct). Even though the FYA display for right turns is uncommon in Oregon and most drivers surveyed are not likely to have encountered the display, comprehension was high (77% correct). In the multiple-choice response, 75% correctly identified the response "Turn right cautiously without stopping" as the expected response. There was a general misunderstanding of the required driver response for the steady red arrow signal indication in the open-ended responses (52% correct). These were confirmed in the follow-up multiple-choice questions, where nearly 50% of the respondents incorrectly and confidently (86%) identified the correct response to the steady red arrow to be "stop and wait for a green indication before turning".

With respect to the steady red arrow, there are a number of possible explanations for this misunderstanding. First, most drivers see red arrows for left turns, where the correct response is almost always to stop and wait for the light to turn green. Second, driver laws pertaining to the correct course of action for red arrow signal display indications also vary significantly between states (Oregon and California are completely opposite).

Interestingly, for the flashing yellow arrow and steady red arrow displays, higher proportions of correct responses were observed when the RTO sign was present versus when this sign was absent. Other than the sign clearly indicating the signal head is for right-turn movements, it provides no additional guidance about the expected response. The prior research on the flashing yellow arrow signal indication did not find significant differences in comprehension with the use of additional signage.

5 MICROSIMULATION

A signalized intersection with PPRT phasing was constructed in a microsimulation environment. The objective was to explore the operational performance of several PPRT phasing alternatives under varying volumes (right-turn vehicle volumes, conflicting pedestrian movements, and conflicting left-turn vehicular movements). The software VISSIM was used to build the simulated intersection. Within VISSIM, the ASC/3 software-in-the-loop signal controller was used for signal timing and phasing purposes. The following sections describe the simulation configuration and results.

5.1 SIMULATION MODEL BACKGROUND

Numerous tools – analytical and simulation models – have been developed for analyzing traffic. Analytical models use mathematical formulations to determine traffic states (capacity, density, speed, delay, and queuing) of small-scale facilities (Akçelik 2007). Multimodal in nature, simulation models are used to model traffic flows and interactions between modes in a transportation network. Both tools are useful in evaluating design alternatives and making decisions. Simulation models are categorized as macroscopic, mesoscopic, or microscopic. In macroscopic models, the simulation takes place on a section basis, without explicitly considering individual vehicles. Some well-known examples of macroscopic simulation models are PASSER, SYNCHRO, TRANSYT, and TRANSYT7F. Mesoscopic models are a blend of macroscopic and microscopic models. Microscopic models model the movement of individual vehicles in the traffic stream based on car-following and lane-changing models. Popular microsimulation models are PARAMICS, AIMSUN, VISSIM, SIMTRAFFIC, and CORSIM.

Microsimulation models are increasingly being used as analysis tools worldwide and offer several advantages, such as an ability to model system wide effects of alternatives and various geometric configurations. Although these models can provide detailed statistics, they often require large amounts of data, the accuracy of which affects the precision of results. Microsimulation models need to be properly calibrated and validated to yield accurate results. Some degree of user skill is required to build a representative model. Each of the physical aspects, whether hardware or software, must be created within the microsimulation model itself. These hardware/software-in-the-loop (HITL/SITL) systems are the mathematical models of the hardware/software that are used to represent the hardware/software within the simulation itself.

5.2 TYPES OF SIMULATION MODELS

Traffic flows at signalized intersections can be modeled by HITL or SITL systems. HITL systems require a simulation model on the computer which interfaces with a controller interface device and an actual traffic signal controller. The controller interface device passes the detector calls and phase status between the traffic controller and the microsimulation model. Figure 5.1 shows the data flow in a HILS system. Various simulation modeling packages, such as CORSIM, SimTraffic and VISSIM, are capable of supporting HITL applications. Major

disadvantages with HILS systems are the inability to speed up or slow down the simulation, the lack of synchronization between controllers and computer clocks, and the need for separate controller hardware for each intersection (Urbanik et al. 2006).

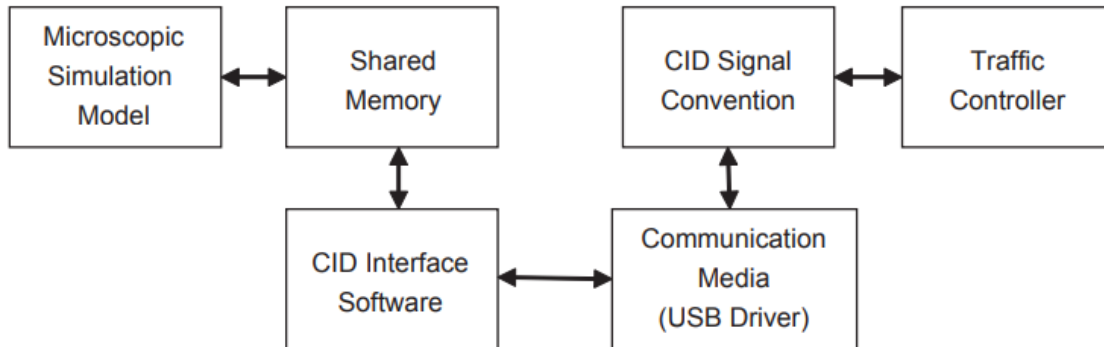

Figure 5.1: HILS data flow (Stevanovic et al. 2009)

SITL systems use a microscopic simulation model, a virtual traffic controller that runs on the same computer, and an interface that allows for communication and exchange of information between the microscopic simulation and the virtual traffic controller (Stevanovic et al. 2009). The biggest advantage of SILS is the ability to speed up or slow down the simulation. Two SITL applications have been developed – Siemens’s NextPhase, which connects to CORSIM and VISSIM, and Econolite’s ASC/3, which connects to VISSIM (Stevanovic et al. 2009). The ASC/3 virtual controller is the only commercially available SITL system. The ASC/3 virtual controller embedded in VISSIM was developed by PTV America and Econolite Control Products in cooperation with the University of Idaho. The ASC/3 virtual controller software in VISSIM is identical to the software that runs in controllers in the field. Figure 5.2 shows the data flow in a SITL model. In this study, the ASC/3 virtual traffic controller was used in VISSIM to simulate a signalized intersection with PPRT phasing.

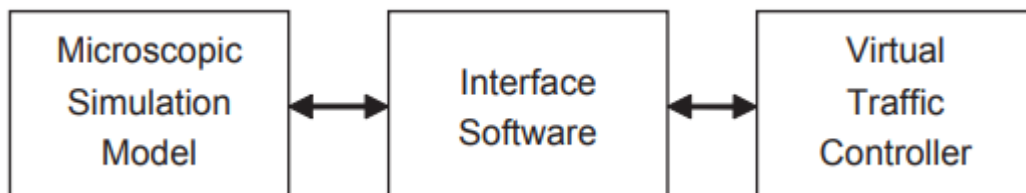

Figure 5.2: Data flow in SITL model (Stevanovic et al. 2009)

5.3 MODEL DEVELOPMENT

Steps undertaken for model development were selecting the site and gathering input data (geometry, traffic volumes, vehicle composition, and signal timing parameters). These steps are described in detail in the following sections.

5.3.1 Site Selection

Selection of the site was primarily based on discussions with TAC members, which revealed that PPRT phasing using a FYA display was present at two Oregon intersections – NW Cornell Rd. and NW Evergreen Pkwy. in Beaverton and NW 3rd St. and NW Van Buren Ave. in Corvallis, Oregon. The research team chose to simulate the intersection of NW Cornell Rd. and NW Evergreen Pkwy. in VISSIM because that location was perceived to be more transferable due to the presence of a one-way approach at the Corvallis location. Figure 5.3 shows the simulation site, which was located to the west of downtown Portland.

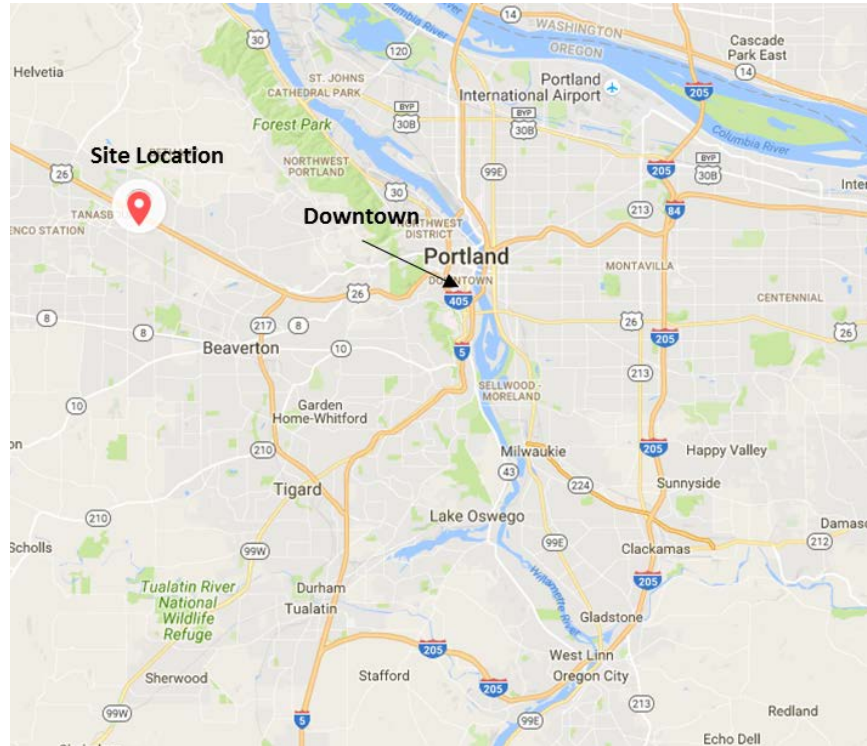

Figure 5.3: Site location for simulation

5.3.2 Geometry

At this intersection (Figure 5.4), Cornell Rd. in the eastbound (EB) direction has one through lane, one shared through/right lane, and an exclusive left-turn lane. The westbound (WB) approach has two through lanes, exclusive right- and left-turn lanes, and a bike lane to the left of the exclusive right-turn lane. The southbound (SB) approach has exclusive left- and right-turn lanes, a shared left/through lane, and a curb bike lane. The northbound (NB) approach is minor and is one lane that is shared among all movements. All of the lane lengths and widths used in the simulation model were measured by using Bing satellite images present in VISSIM.



Figure 5.4: Intersection geometry

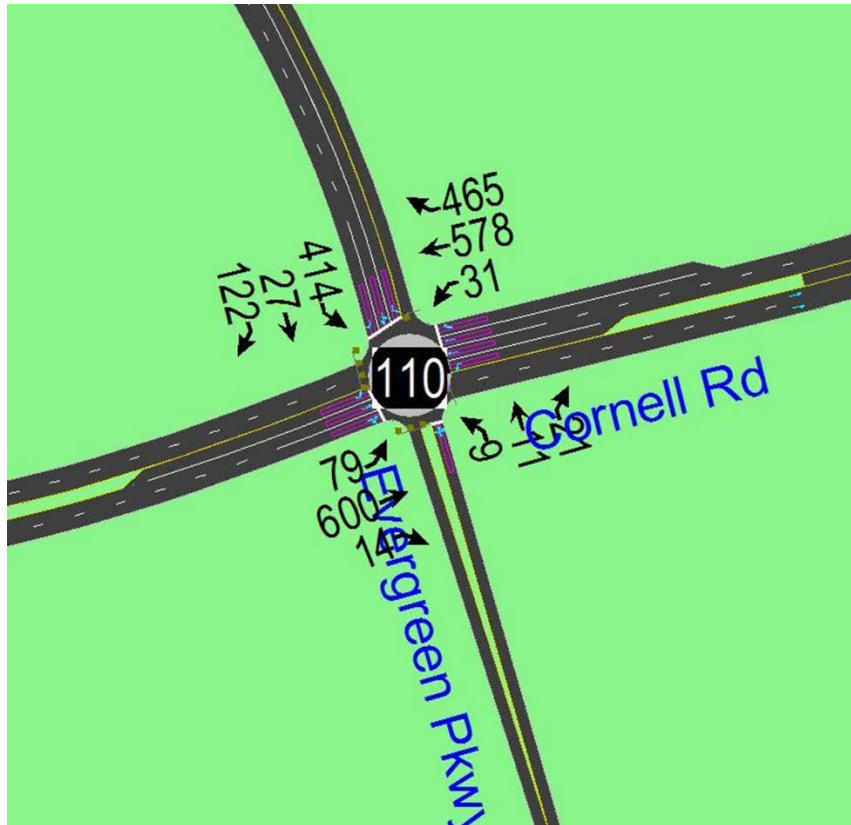

Figure 5.5: Volumes used in the simulation model

5.3.3 Volumes

Volumes used in the VISSIM simulation were provided to the research team in the form of a Synchro file by Washington County, Oregon, the agency responsible for operating the signal. The research team selected the PM peak period volume data (Figure 5.5), because turning movement counts were readily available for this period.

5.3.4 Vehicle Composition

Vehicle composition was coded as 98% passenger cars and 2% heavy vehicles, based on classification data obtained from Washington County. For passenger cars, each vehicle was assumed to be of single occupancy. Default driving behaviors within VISSIM were used for both vehicle type.

5.3.5 Signal Timing

Signal timing plans for this intersection were obtained from Washington County. This intersection operates as a 6-phase intersection, with protected/permitted left- and right-turn movements. The major street left-turn movements (phases 1 and 5) are protected/permitted with a flashing yellow arrow signal display. Additionally, PPRT phasing is enabled for phase 6 (WB to NB movement). Split phasing is present at this intersection for side street phases 4 and 8 as seen in Figure 5.6. Typically, this intersection is coordinated with cycle lengths ranging from 100 to 130 seconds, depending on the time of day. However, this intersection was operated as an isolated intersection, while retaining the same signal timing parameters (min green, max green, gap times, etc.), because the research team felt that coordination issues were not directly relevant to permitted right-turn performance.

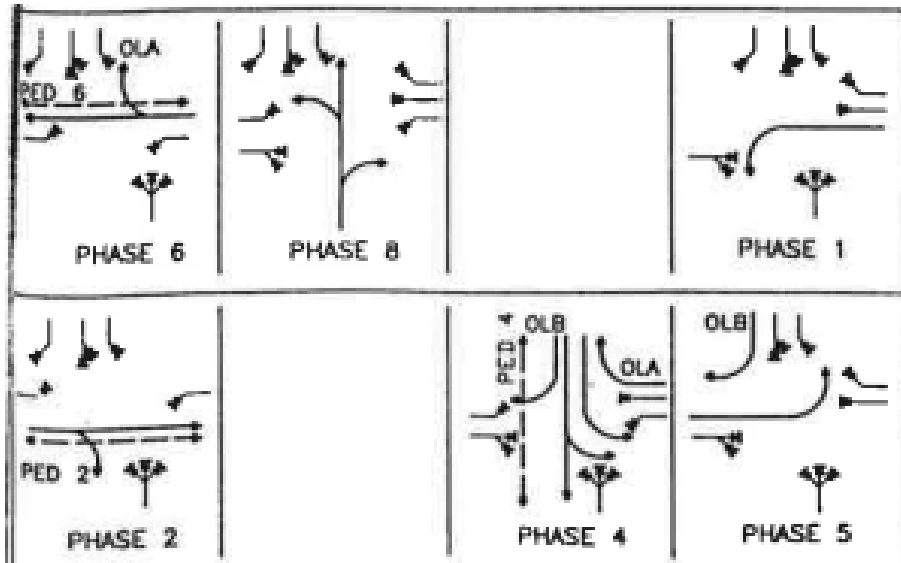

Figure 5.6: Phase rotation diagram for NW Cornell Rd. and NW Evergreen Pkwy.

For the WB right-turn movement, which has PPRT phasing, three indications are displayed. A green arrow is displayed when the non-conflicting SB left turn is active. A flashing yellow arrow is displayed when the concurrent WB green is active. If a pedestrian is present on phase 6 and a call is received by the controller, then a red arrow indication is shown for the WB right-turn movement. The research team invested substantial time in exploring how to make the flashing yellow indication work simultaneously within the ASC/3 virtual controller and VISSIM for the left- and right-turn permitted movements at this intersection. The team used VISSIM 7.0 with overlaps to allow the left- and right-turn flashing yellow arrows to function appropriately.

5.4 RESULTS

5.4.1 Base Model

Initial base model runs were conducted by using the volumes shown in Figure 5.5. Ten runs were simulated for the base model, and average delays per movement and average green times were extracted. Figure 5.7 shows the average delays per movement derived from the base case model.

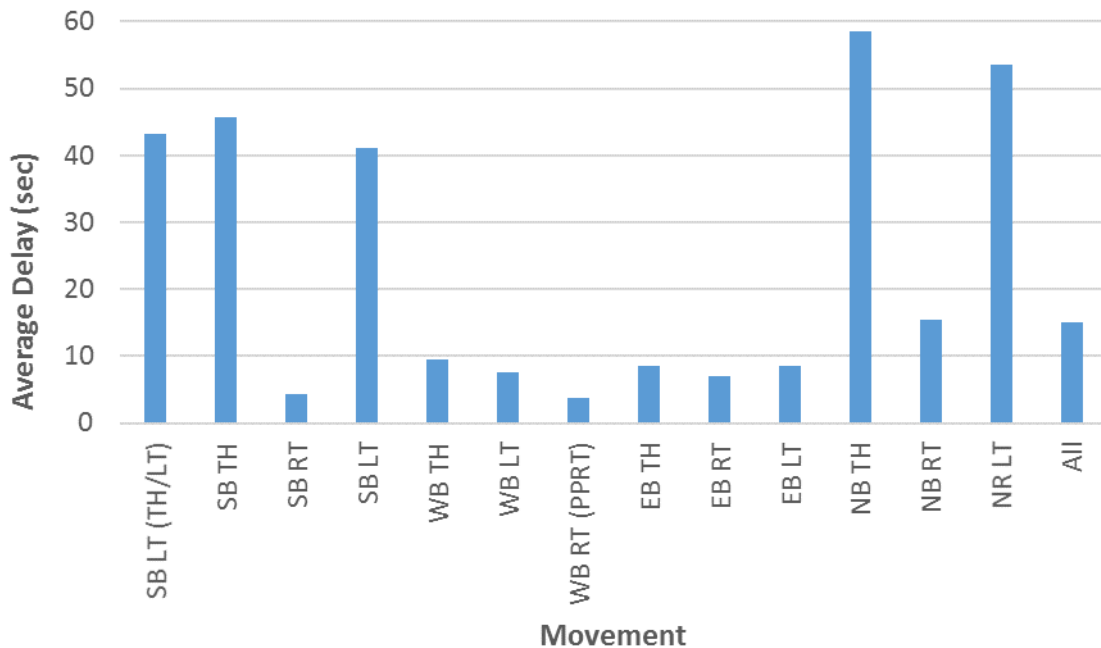

Figure 5.7: Average delays by movement

Across all movements, the average control delay was 15 seconds per vehicle. The WB right turn, which is the movement of interest, experienced average delays of less than 4 seconds. This short delay time was probably related to the low volume of pedestrians (10 per crosswalk per hour) used in the simulation. Both the WB and WB left-turn movements (which were protected/permitted) showed small delays. Longest delays (50–60 seconds) were observed for the SB movements and were probably due to the small average green time of 20 seconds (Table 5.1). As expected, major street phases 2 and 6 had the highest average green times. Walk times for pedestrian phases ranged between 5 and 7 seconds.

Table 5.1 Average Green Times From Simulation

PHASE	BASE
1	4.3
2	72.1
4	19.8
5	5.0
6	69.7
8	5.5
Ped 2	5.0
Ped 4	6.0
Ped 6	7.0

5.4.2 Sensitivity Analysis

To examine how volume affected delays, a sensitivity analysis was undertaken. Six different scenarios were tested: compared to the base case, (1) EB left-turn volumes (phase 5) were increased by 10%, (2) EB left-turn volumes (phase 5) were increased by 25%, (3) WB right-turn volumes (phase 6) were increased by 10%, (4) WB right-turn volumes (phase 6) were increased by 25%, (5) pedestrian volumes on phase 6 were increased by 5 times, and (6) pedestrian volumes on phase 6 were increased by 10 times.

Table 5.2 shows the percent difference in delays for the six scenarios, compared to the base case. For scenarios 1 and 2, increasing volumes for the EB left turn did not result in significant delay increases for any phase. Minor increases in delays were observed for the WB through phase, possibly due to the flashing yellow arrow indication. Increasing the right-turn vehicular volumes in scenarios 3 and 4 resulted in increased delays for the WB right-turn movement. Increases in pedestrian volumes in scenarios 5 and 6 had the greatest effects in terms of delay increases for both WB right and EB left turns. This result is intuitive because both of these movements conflict with pedestrian movements. Overall, delays showed little to no change with an increase in EB left- or WB right-turn volumes. The largest delays were the result of the increase in pedestrian volumes.

Table 5.2 Percent Change in Delay, by Movement and Phase

% DIFF TO BASE	10% EB LT	25% EB LT	10% WB RT	25% WB RT	50 PEDS	100 PEDS
SB LT (TH/LT)	--	--	--	--	--	--
SB TH	--	--	--	--	--	--
SB RT	--	1%	--	--	6%	13%
SB LT	--	--	--	--	--	--
WB TH	5%	4%	--	-4%	--	--
WB LT	2%	1%	11%	7%	--	--
WB RT (PPRT)	--	2%	18%	41%	49%	74%
EB TH	1%	3%	2%	--	--	--
EB RT	-12%	-2--	2%	-1%	--	--
EB LT	2%	-3%	2%	4%	5%	13%
NB TH	--	--	--	-2%	--	--
NB RT	1%	1%	-1%	-1%	--	--
NB LT	--	--	--	--	--	--
Ped 02 EB	--	--	5%	4%	--	--
Ped 02 WB	--	--	-1%	1%	--	--
Ped 04 SB	--	--	--	--	--	--
Ped 04 NB	--	--	--	--	--	--
Ped 06, WB	1--	-4%	-6%	-6%	21%	107%
Ped 06, EB	--	-6%	1%	1%	2%	79%
All	1%	1%	--	-1%	7%	27%

-- indicates no change (0%)

5.5 SUMMARY

This chapter describes the development of a microsimulation model and the resulting analyses. The objective of the microsimulation was to explore the operational performance of PPRT phasing alternatives under varying volumes (right-turn pedestrian movements and conflicting left-turn vehicular movements) to provide guidance for interpreting results from the driving simulator. A base model, based on a real-world intersection, was simulated in VISSIM. Sensitivity analysis was performed by increasing conflicting left-turn, right-turn, and pedestrian volumes in six different scenarios. As expected, results from the simulation models indicate that the pedestrian volumes had the greatest effects on delays.

6 DRIVING SIMULATOR EXPERIMENT

This chapter describes an experiment conducted in the OSU Driving Simulator Laboratory. The experiment was designed to use surrogate safety measures (driver performance and decision making) to evaluate the performance of PPRT phasing alternatives.

6.1 EXPERIMENTAL EQUIPMENT

The experimental design and established experimental protocols were selected to address the research questions of interest. This approach is grounded in accepted practice (Fisher et al. 2011) and leverages the unique research capabilities at OSU. Two primary tools were used for this experiment, the OSU driving simulator and the Applied Science Laboratories (ASL) eye-tracking system, which are described in detail in the following sections.

6.1.1 Driving Simulator

The OSU driving simulator facility consists of two primary components: a desktop development simulator and a full-scale high-fidelity motion-based simulator. Researchers first built and test drove the environment using the desktop development simulator. The multimonitor platform of the desktop development simulator (Figure 6.1), with the incorporated steering wheel and floor pedals, is used for creating, coding, and testing developed scenes. This desktop development simulator allows for quick troubleshooting during environment development.



Figure 6.1: Operator workstation for driving simulator. Left: Designing an experiment in the Internet Scene Assembler with Javascript. Right: Researcher evaluating a newly designed environment

The full-scale OSU driving simulator is a high-fidelity motion-based simulator comprising a full 2009 Ford Fusion cab mounted above an electric pitch motion system capable of rotating $\pm 4^\circ$.

The vehicle cab is mounted on the pitch motion system, with the driver's eye point located at the center of the viewing volume. The pitch motion system allows for the accurate representation of acceleration or deceleration (Swake et al. 2013). Three liquid crystals on silicon projectors with a resolution of $1,400 \times 1,050$ are used to project a front view of $180^\circ \times 40^\circ$. These front screens measure $11 \text{ ft} \times 7.5 \text{ ft}$. A digital light-processing projector is used to display a rear image for the driver's center mirror. The two side mirrors have embedded LCD displays. The update rate for projected graphics is 60 Hz. Ambient sounds around and internal sounds in the vehicle are modeled with a surround-sound system. The computer system includes a quad-core host running Realtime Technologies SimCreator Software (version 3.2) with a 60-Hz graphics update rate. The simulator software is capable of capturing and outputting accurate values for performance measures (speed, position, brake, and acceleration). Figure 6.2 shows views of the simulated environment created for this experiment from inside (left) and outside (right) the vehicle.



Figure 6.2: Simulated environment in OSU driving simulator, from the participant's perspective inside (left) and from outside (right) the vehicle

The full-scale driving simulator is controlled from the operator workstation (Figure 6.3). The full driving simulator is located in a separate room from the desktop development simulator and the full simulator operator workstation. This separation prevents participants in the vehicle from being affected by visual or audible events from researchers during the experiment.



Figure 6.3: Operator workstation for full-scale driving simulator. Monitors are shown displaying SimObserver (left), and the simulated environment (center) or vehicle dashboard (right) as seen in the vehicle

The virtual environment was developed by using Simulator software packages, including Internet Scene Assembler (ISA) (version 2.0), SimCreator, and Blender (version 2.45). The simulated test track was developed in ISA by using Java Script-based sensors that change the signal indication and display dynamic objects, such as pedestrians crossing the street towards the turning vehicle when the participant vehicle approaches.

6.1.1.1 Simulator Data

The following parameters describing the participant vehicle were recorded at roughly 60 Hz (60 times per second) throughout the duration of the experiment:

- Time – Maps changes in the speed, acceleration, and position of the participant vehicle relative to the location of the intersection;
- Instantaneous speed of participant vehicle – Identifies changes in speed when the driver approaches an intersection;
- Instantaneous position of participant vehicle – Estimates the headway and distance upstream from the stop line of the participant vehicle when approaching an intersection;
- SimObserver data – The driving simulator is equipped with five cameras positioned at various viewing angles to observe the actions of participants when approaching an intersection. Figure 6.4 shows the various camera views and screen captures that were recorded by SimObserver (version 2.02.4).



Figure 6.4: Screenshots of the six views from SimObserver. Clockwise from top left: simulated scene as projected on the screen; driver’s upper body and hands on steering wheel; acceleration and brake pedals in vehicle; entire simulator viewed from outside the vehicle; steering wheel and dashboard; and driver’s face.

6.1.1.2 Simulator Sickness

Simulator sickness is a phenomenon wherein a person exhibits symptoms similar to motion sickness due to use of a simulator (Fisher et al. 2011; Owens and Tyrrell 1999). Symptoms can include headache, nausea, dizziness, sweating, and in extreme situations, vomiting. Although there is no definitive explanation for simulator sickness, one widely accepted theory, cue conflict theory, suggests that it arises from the mismatch of visual motion cues and physical motion cues, as perceived by the vestibular system (Owens and Tyrrell 1999).

6.1.2 Eye Tracker

In conjunction with the driving simulator, an eye-tracking system was used to record where participants were looking while driving in the simulator. Eye-tracking data were collected with the ASL Mobile Eye-XG platform (Figure 6.5), which allows the user unconstrained eye and head movements. A 30-Hz sampling rate was used, with an accuracy of 0.5–1.0° (OSU Driving and Bicycle Research Lab 2011). Gaze was calculated based on the correlation between the participant’s pupil position and the reflection of three infrared lights on the eyeball. Eye movement consists of fixations and saccades. Fixations occur when the gaze is directed towards a particular location and remains still for some period of time (Green 2007; Fisher et al. 2011). Saccades occur when the eye moves between fixations. The ASL Mobile Eye-XG system records a fixation when the participant’s eyes pause in a certain position for more than 100 milliseconds. Quick movements to another position (saccades) are calculated indirectly from the dwell time

between fixations. Total dwell times are recorded by the equipment as the sum of the time of fixations and saccades consecutively recorded within an area of interest (AOI).

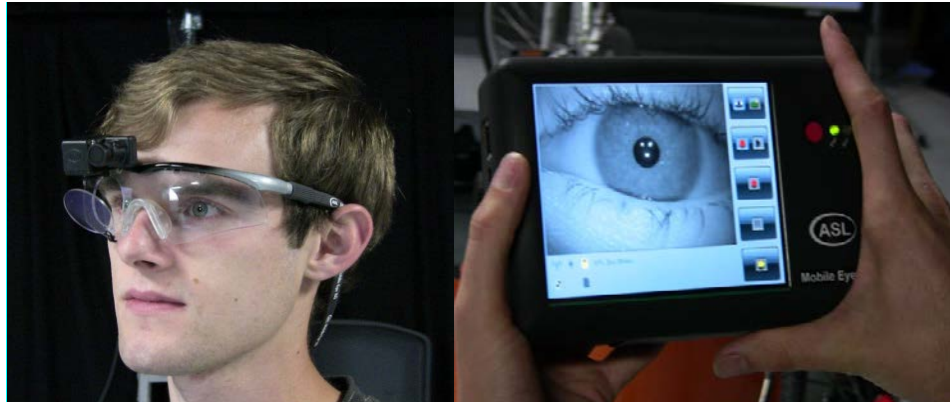

Figure 6.5: OSU researcher demonstrating the Mobile Eye XG Glasses (left) and Mobile Recording Unit (right)

6.2 EXPERIMENTAL DESIGN

To address research questions related to Oregon drivers' comprehension of different right-turn signal display alternatives, an experiment was designed by using the OSU driving simulator and the eye-tracker equipment. Two types of signal heads and five different indications were created for use in the simulator scenarios. Additionally, a pedestrian signal head indication (with either the walking person or upraised hand background) was added to each scenario. Signal heads were developed by using Blender (version 2.71). Figure 6.6 provides examples of signal heads as seen in the simulator from the perspective of an approaching driver.

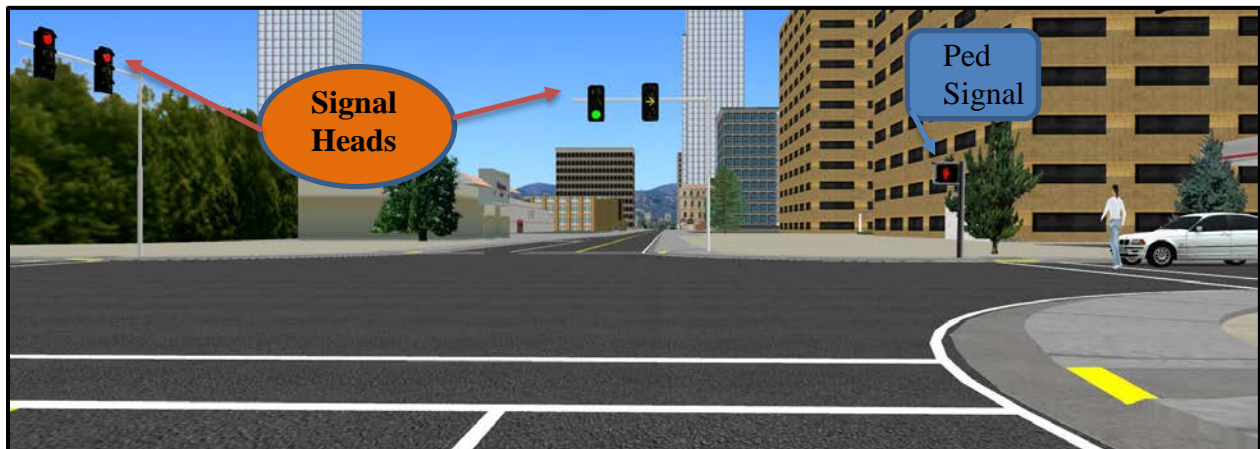

Figure 6.6: Example of signal and pedestrian head configurations in the simulator environment

6.2.1 Road and Intersection Geometry

Intersection approaches included one through lane and an exclusive right-turn lane, along with a single receiving lane for the right-turn movement. The posted speed limit was 35 mph. The roadside was light-to-medium-density commercial and industrial development, and light ambient traffic was included. The roadway cross-section consisted of two 12-ft traffic lanes in each direction with no median (Figure 6.7), while the cross-section of the roadway receiving the right-turn roadway consisted of two 10-ft traffic lanes in each direction with no median (Figure 6.8). A yellow centerline, solid white edge line, small 1-ft paved shoulder, and 6.5-ft-wide pedestrian sidewalks on both sides of the road were constantly present.



Figure 6.7: Screenshot of a sample environment coded in the simulator



Figure 6.8: Screenshot of a cross-section of the right-turn roadway environment coded in the simulator

6.2.2 Experimental Variables

6.2.2.1 Independent Variables

Three independent variables were included in the experiment: signal indication type and active display, length of the right-turn bay, and presence of pedestrians (Figures 6.9, 6.10, and 6.11). These variables were selected by the research team in collaboration with the ODOT Technical Advisory Committee (TAC) to help answer the research questions.

The first independent variable, “signal indication type,” had two and three levels for each type of signal head: circular red and circular green, and solid red arrow, solid green arrow, and flashing yellow arrow. The flashing yellow arrow had two levels: walk interval on (FYAW) and clearance interval on (FYAC). Signal displays and arrangements were as realistic as possible, and no additional signs (e.g., Right Turn Only) were present. The second independent variable, “right-turn bay length,” had two levels: 50 and 100 ft. The length of the turning bay was determined based on an examination and statistical analysis of the lengths of turning bays on 21 Oregon State highway intersections. The final independent variable, “presence of a conflicting pedestrian in the crosswalk,” had two levels: 1) no (zero) pedestrians present and 2) one conflicting pedestrian walking towards the participant’s vehicle.



Figure 6.9: Example scenario of a participant approaching the right turn on a red arrow

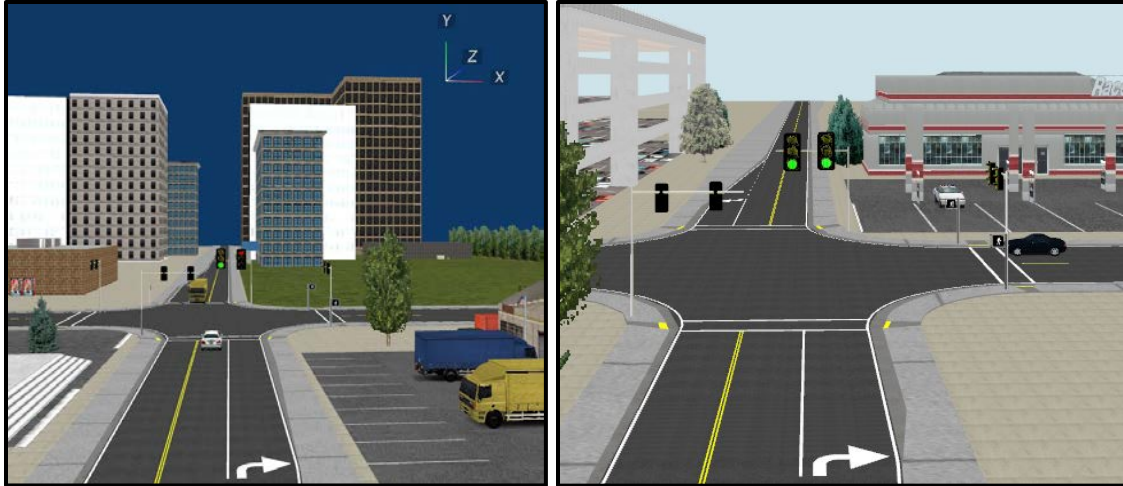

Figure 6.10: Example scenario of right turns with 50- and 100-ft turning bay lengths



Figure 6.11: Example scenario of right turns with and without the presence of pedestrians

6.2.2.2 Dependent Variables

Three primary dependent variables were observed based on the research questions and independent variables selected for this experiment. Visual attention was recorded from the eye-tracking equipment as participants glanced towards AOIs (defined later). Driver decision making was observed by driver behavior (stop, yield, or go) in response to the signal display and phasing. The speed of the participant vehicle was observed from the simulator data to determine how participants accelerate/decelerate while approaching a right-turning bay. These changes can demonstrate potentially unsafe driver behavior, such as sharp braking or crossing a lane line into conflicting traffic.

6.2.3 Factorial Design

A factorial design was chosen for this experiment to enable exploration of all three independent variables separately. The factorial design for the three variables, each with two or three levels, resulted in the inclusion of 24 scenarios, which were presented within subjects. The within-

subject design provides advantages of greater statistical power and reduced error variance associated with individual differences (Cobb 1998). However, one fundamental disadvantage of the within-subject design is the existence of “practice effects,” caused by practice, experience, and growing familiarity with procedures as participants move through the sequence of conditions. To control for practice effects, the order of the presentation of scenarios to participants needs to be randomized or counterbalanced (Girden 1992). Table 6.1 summarizes the independent variables and their associated levels in the factorial design.

Table 6.1: Experimental Variables and Levels

VARIABLE	ACRONYM	CATEGORY	LEVEL	LEVEL DESCRIPTION	
Signal Head	SHA	Nominal (categorical)	1	CR: Circular Red	
			2	CG: Circular Green	
	SHB		1	SRA: Solid Red Arrow	
			2	SGA: Solid Green Arrow	
			3	FYA: Flashing Yellow Arrow	W: Walk interval
				C: Clearance walk interval	
Geometry	G	Discrete	1	TB1: Right-turn bay length 1: 50 ft	
			2	TB2: Right-turn bay length 2: 100 ft	
Pedestrians	P	Discrete	1	No pedestrians crossing	
			2	Pedestrians crossing	

6.2.4 Counterbalancing and Presentation of Driving Scenarios

To control for the practice or carryover effect, the order of the scenarios was counterbalanced. Six different track layouts were developed and presented in random order to each participant. Randomized, partial counterbalancing was chosen due to its simplicity and flexibility in terms of statistical analysis and number of required participants. Each track had four right-turning maneuvers, and each right turn was randomly assigned one level for each of the three independent variables. To provide more variability in track presentation, the start and finish locations of these grids were varied. Right-turning scenarios were interrupted by through and left-turn movements at intersections that were not experimental scenarios to prevent participants from anticipating the motivation of the study and to reduce the risk of simulator sickness.

Table 6.2 presents the configuration layout for each of the 24 right-turn scenarios that were presented to participants, in a randomized order, across six tracks (labeled as T # in the table heading). Figures 6.9 to 6.11 show examples of individual scenarios in the simulator as presented to the drivers. Each right turn had one level for each of the three independent variables. Figure 6.12 shows an example grid layout with four right-turning scenarios (Grid 1). The “Path” in the

Figure indicates the sequence of intersections through which the participant drove. Layouts of other grids with two, three, and four right-turning scenarios are included in Appendix D.

Participants were instructed to turn right at an intersection through an automated voice command saying “Please, turn right at the next intersection.” This voice command was generated by a Java Script-based sensor placed at the right-turning intersection approach, which was triggered by the presence of the participant vehicle on the sensor. The command was set to announce twice at 400- and 200-ft in advance of the right-turn movement. For left-turn and through movements, the participant heard automated voice commands saying “Please, turn left at the next intersection” and “Please, go straight,” respectively. Finally, participants were instructed to stop the vehicle at the end of each track through an automated voice command saying “Please, stop the vehicle.”

Table 6.2: Grids and Right-turning Intersection Layout

T #	RT #	SIGNAL HEAD	BAY LENGTH (ft)	PEDESTRIAN
<i>Grid 1</i>				
6	1	FYAC	50	No pedestrian crossing
22	2	SGA	100	Pedestrian crossing
9	3	SRA	100	No pedestrian crossing
14	4	CG	50	Pedestrian crossing
<i>Grid 2</i>				
23	1	FYAW	100	Pedestrian crossing
8	2	CG	100	No pedestrian crossing
2	3	CG	50	No pedestrian crossing
18	4	FYAC	50	Pedestrian crossing
<i>Grid 3</i>				
19	1	CR	100	Pedestrian crossing
5	2	FYAW	50	No pedestrian crossing
7	3	CR	100	No pedestrian crossing
4	4	SGA	50	No pedestrian crossing
<i>Grid 4</i>				
20	1	CG	100	Pedestrian crossing
12	2	FYAC	100	No pedestrian crossing
10	3	SGA	100	No pedestrian crossing
21	4	SRA	100	Pedestrian crossing
<i>Grid 5</i>				
16	1	SGA	50	Pedestrian crossing
1	2	CR	50	No pedestrian crossing
11	3	FYAW	100	No pedestrian crossing
17	4	FYA	50	Pedestrian crossing
<i>Grid 6</i>				
3	1	SRA	50	No pedestrian crossing
13	2	CR	50	Pedestrian crossing
15	3	SRA	50	Pedestrian crossing
24	4	FYAC	100	Pedestrian crossing

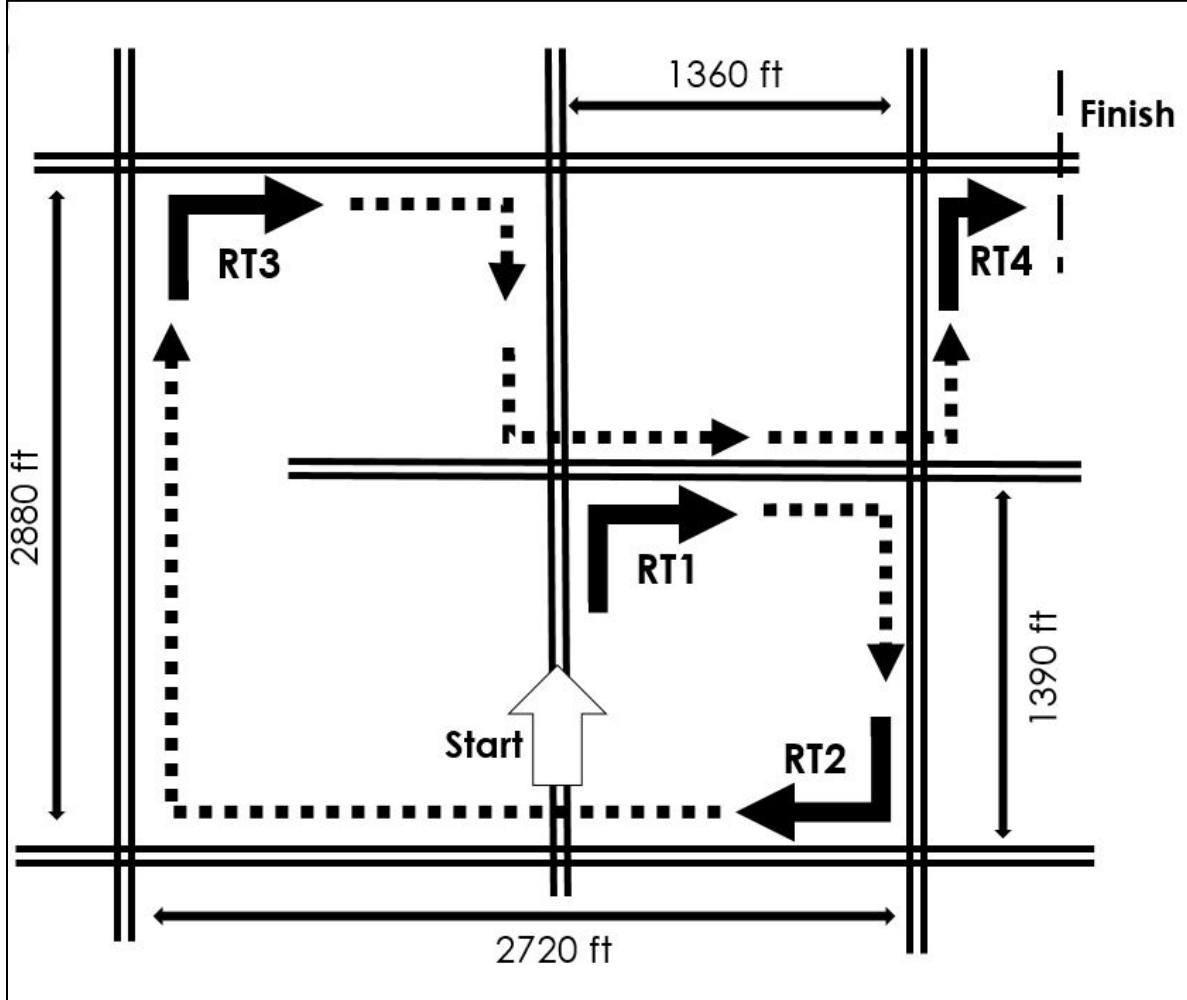

Figure 6.12: Example layout of Grid 1 with four right-turning (RT) scenarios – Path Start-Right-Right-Right-Through-Right-Right-Left-Left-Right-Finish

6.3 DRIVING SIMULATOR EXPERIMENTAL PROTOCOL

The experimental procedure was carefully designed to reduce the occurrence of simulator sickness, such as by providing long tangential sections between intersections or small breaks between driving successive grids. The entire data collection process was designed to ensure that all necessary information was recorded efficiently. This section describes the step-by-step procedures of the driving simulator study, as conducted for each individual participant.

6.3.1 Recruitment

A total of 52 individuals, primarily from the community surrounding Corvallis, Oregon, were participants in the experiment. The population of interest was licensed drivers; therefore, only licensed drivers residing in Oregon with at least 1 year of driving experience were recruited for

the experiment. Participants were required to not wear glasses (contacts were acceptable), to be physically and mentally capable of legally operating a vehicle, and to be deemed competent to provide written, informed consent. Participants were recruited through flyers posted around campus and the surrounding community and through emails sent to different campus organizations and email listservs. Older participants were specifically recruited by email using the Center for Healthy Aging Research registry (LIFE Registry), which includes people 50 years or older who reside in Oregon and wish to volunteer for research studies. Researchers did not initially screen interested participants based on gender; however, once the quota for men was reached, only women were allowed to participate. Although it was expected that many participants would be OSU students, an effort was made to incorporate participants of all ages within the specified range of 18 to 75 years. Throughout the entire study, participant data were kept under double-locked security in compliance with accepted Institutional Review Board (IRB) procedures (Study #7435). Each participant was randomly assigned a number to remove any uniquely identifiable information from the recorded data.

6.3.2 Informed Consent and Compensation

When the test participant arrived at the laboratory, they received the OSU IRB-approved informed consent document, which described the reasoning behind the study, the importance of participation, and the risks and benefits of the test for the participant. The researcher discussed the document and the overall idea of the experiment with the participant, who was invited to ask questions. The participant was informed that they could stop the experiment at any time for any reason and still receive full compensation (\$20 cash) for participating in an experimental trial. To avoid biasing the experiment, participants were not told the specific research hypotheses.

6.3.3 Prescreening Survey

Participants were administered a prescreening survey on their demographics (i.e., age, gender, ethnicity, driving experience, highest level of education, and prior experience with driving simulators) and questions in the following areas:

- *Vision* – Good vision was crucial for this experiment. Participants were asked if they used corrective glasses or contact lenses while driving. Their abilities to see the driving environment clearly and to read visual instructions (displayed on the screen) to stop driving were confirmed.
- *Simulator sickness* – Participants with previous driving simulation experience were asked about any simulator sickness that they experienced. If they had previously experienced simulator sickness, they were encouraged not to participate in the experiment.
- *Motion sickness* – Participants were surveyed about any kind of motion sickness they had experienced in the past. If an individual had a strong tendency towards any kind of motion sickness, they were encouraged not to participate in the experiment.

6.3.4 Calibration Drive

After completing the prescreening survey, participants performed a 5-minute calibration drive. The overall purpose of this drive was to acclimate participants to the mechanics of the vehicle and the virtual reality of the simulator and to determine if they were prone to simulator sickness. Once seated in the vehicle for the test drive, participants were allowed to adjust the seat, rearview mirror, and steering wheel to maximize comfort and performance while driving. They were instructed to drive and follow all traffic laws as they normally would.

According to Zhao et al. (2015), effective calibration drives introduce the participant to two primary roadway characteristics in the simulator environment: acceleration and deceleration on a stretch of roadway, and turning at intersections. Figure 6.13 shows the standard calibration drive that was developed for this experiment, which included the two elements. The environment of the calibration drive was simple and did not include any roadside development. Large yellow billboards with arrows were used to instruct the driver on which way to turn at intersections. Before the calibration drive, participants were instructed to follow the arrows on the billboards.

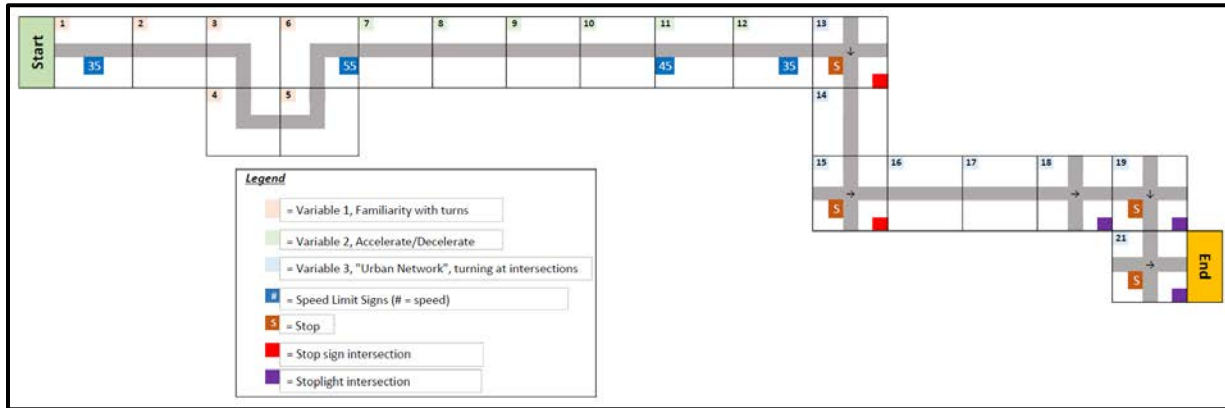

Figure 6.13: Layout of calibration drive

Figure 6.14 shows views from two locations in the calibration drive. Participants who reported experiencing simulator sickness during or after the calibration drive were not allowed to continue in the experimental drives.



Figure 6.14: Screenshots of calibration drive in the simulation. Left: Approach to a curve near the beginning of the drive. Right: Approach to a signalized intersection, where a yellow billboard indicates a right turn

6.3.5 Eye-Tracking Calibration

After the calibration drive was completed, researchers equipped participants with a head-mounted eye tracker. Participants were directed to look at different locations on a calibration image projected on the forward screen of the driving simulator (Figure 6.15). If the eye-tracking equipment was unable to perform the calibration, which depended on eye position and other physical attributes of the participant, then the experiment was not continued.

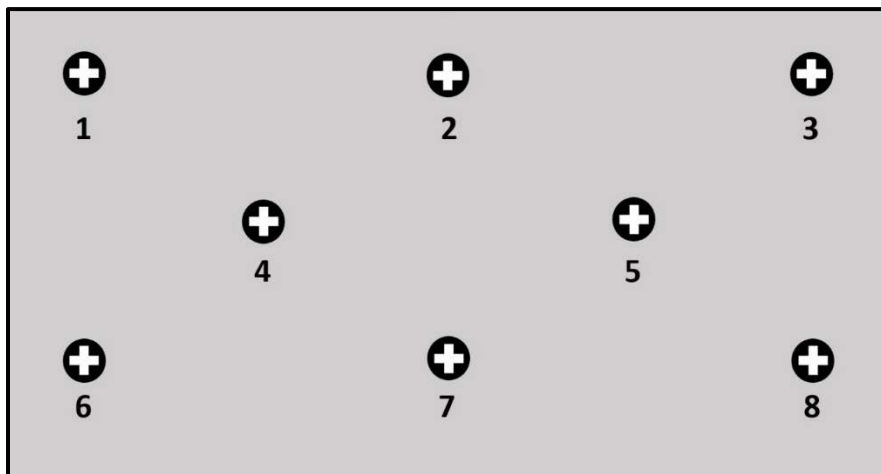

Figure 6.15: Eye-tracking calibration image

6.3.6 Experimental Drive

After the motorist's eyes were calibrated to the driving simulator screens, they were given brief instructions about the test environment and the tasks that they were required to perform. The experiment was divided into six tracks. At the completion of each experimental drive, the researcher instructed the participant to stop the vehicle and ascertained whether the participant was experiencing simulator sickness. The virtual driving course (six tracks) was designed to take 30 to 40 minutes to complete (total).

6.3.7 Postdrive Survey

As the final step of the experiment, drivers were asked to respond to several questions in a postdrive digital survey, which included questions about their previous responses to the indications, and how they interpreted each indication. The survey asked if the participant had experienced any simulator sickness during the experiment. The entire experiment, including the consent process, eye-tracker calibration, and postdrive questionnaire, lasted about 1 hour.

6.4 DATA REDUCTION

Eye-tracking and simulator data for participants were carefully reduced to extract fixations on the various AOIs. The following sections describe these processing procedures.

6.4.1 Eye-Tracking Data

After collecting participants' eye-movement data, fixation and dwell data were analyzed by AOI polygons with the *ETAnalysis* software suite. For this process, researchers watched each video segment that included a right turn at an intersection (24 per participant). These video segments were cropped to the length of time that the driver entered the turning bay (generally 6–50 seconds). Next, researchers drew AOI polygons on individual video frames in a sequence separated by intervals of approximately 5–10 frames. Once the researcher manually situated each AOI, an “anchor” was created within the software. Distance and size differences of the AOIs between these anchors were interpolated by the *ETAnalysis* software to ensure that all fixations and dwells on the AOIs (i.e., signal display, pedestrians) were captured. Researchers analyzed motorist's eye-tracking data starting from the point when the participant entered the turning bay at the intersection and continued until the participant completed the right-turn maneuver. Therefore, all of the objects of concern related to the current research questions appeared before the right-turning maneuvers were completed.

Figure 6.16 is a screenshot of the *ETAnalysis* software, presenting an example of a video that has been coded with AOIs. At this particular moment, the motorist was fixating on the traffic signal. This figure also includes heat maps (orange-yellow circular patterns) of the pedestrian traffic signal head AOI with a walk interval in the motorist's field of view.

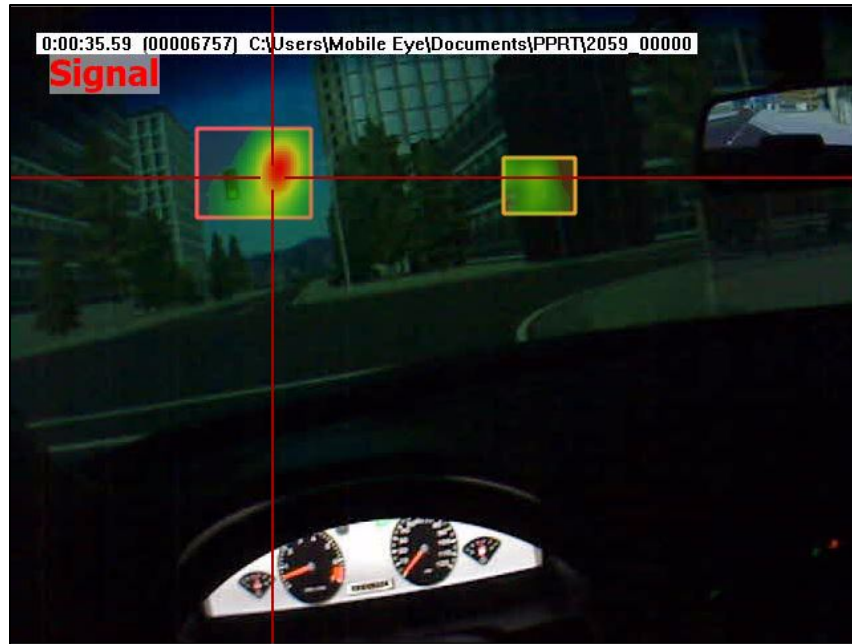

Figure 6.16: Example of a participant fixation pattern on the signal head (two AOIs)

Figure 6.17 presents an example of a participant fixating on a pedestrian in the conflicting crosswalk, with the AOI shown at the center of the figure by the blue rectangle and red crosshairs. This figure exemplifies a complex driving scenario in which the motorist, before turning right at the intersection, had to scan for all three key AOIs examined in this study (traffic signal display, pedestrian signal head, and crossing pedestrian in the conflicting crosswalk).

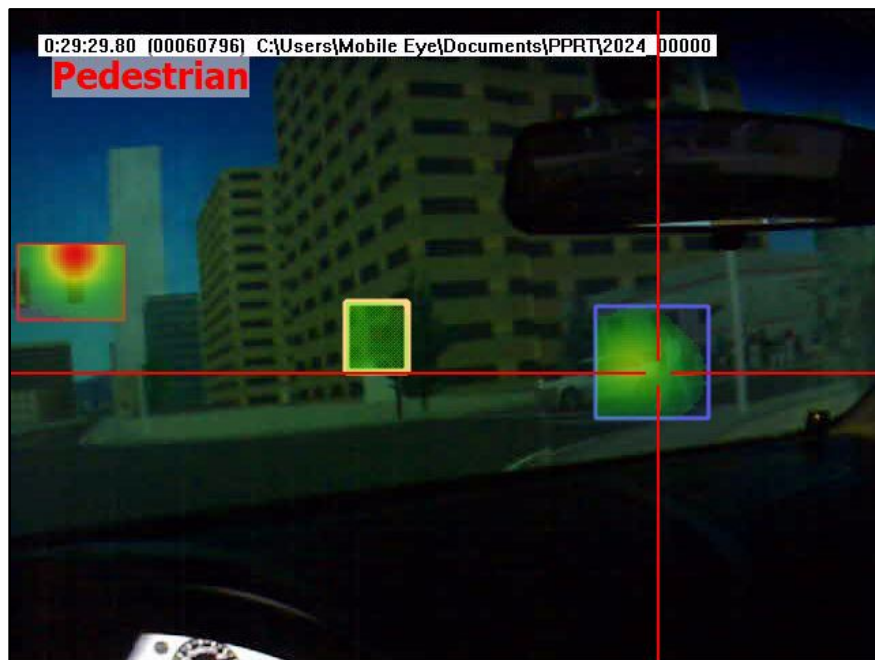

Figure 6.17: Example of a participant fixation pattern on pedestrian (three AOIs)

Once the AOIs were coded for each individual video file, output spreadsheets of all fixations and dwells for each AOI were produced by using the ETAnalysis software. Fixations and dwells outside the coded AOIs were universally defined as OUTSIDE and were not analyzed further. Researchers exported these data files and imported them into different analysis packages (e.g., Microsoft Excel and RStudio) for further analysis.

6.4.2 Simulator Data

Simulator data were collected from the driving simulator and SimObserver platform during the experiment. A complete data file was generated for each participant for each of the six experimental drives. Files, including collected video data and all output of vehicle characteristics (e.g., lateral position and velocity), were opened in the Data Distillery (version 1.34) software suite, which provided quantitative outputs (numerical and graphical) in combination with the recorded video. Figure 6.18 shows the SimObserver video output in conjunction with numerical data (right side) and graphical representations of data in columns (bottom).

In the Data Distillery program, the 24 right-turning maneuvers for each participant were located using the video data. Velocity and acceleration/deceleration data from the simulator corresponding to the maneuver were segmented from the point where the participant entered the turning bay until the right-turning maneuver was reached.

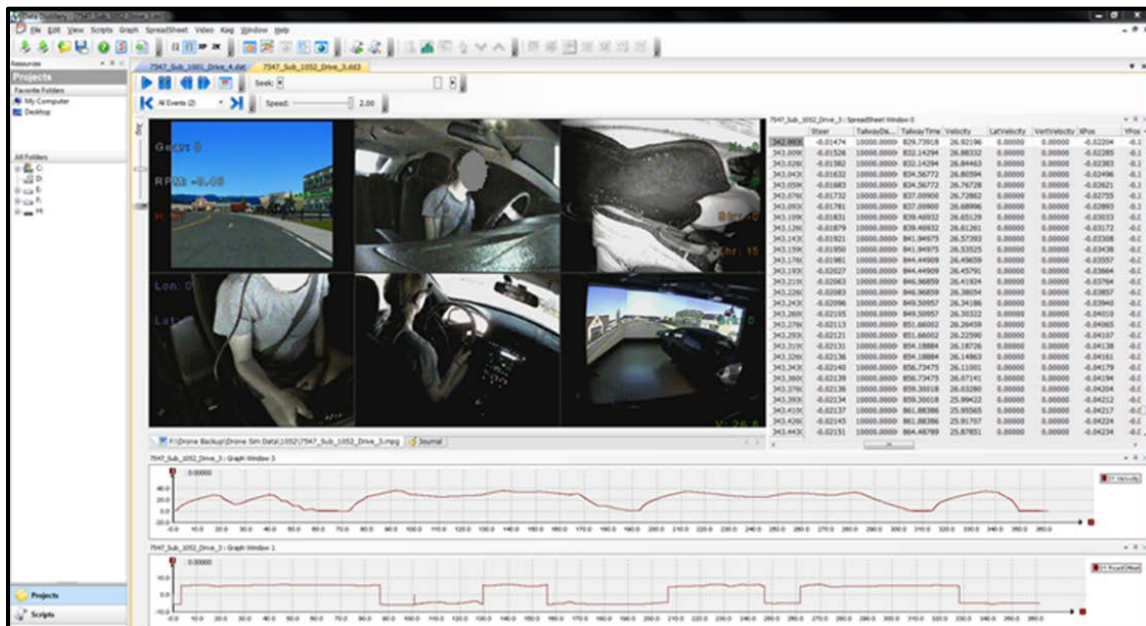

Figure 6.18: Screenshot of Data Distillery software interface (identifiable participant information was removed)

6.5 RESULTS AND ANALYSIS

This section presents the results of the simulator experiment. The first subsection describes the participant demographics. The next subsection describes the collection of driver decision-making

data from the SimObserver platform. Finally, the results from the analysis of visual attention and driver decision making are described.

6.5.1 Participants

Study participants were recruited from the community in and around Corvallis, Oregon.

6.5.1.1 Summary Statistics

The simulator study included 52 participants (27 men), ~10% (3 women, 2 men) of whom reported simulator sickness and did not complete the experiment (Table 6.3). All responses from participants who exhibited simulator sickness were excluded from the analyzed data set. Failure to calibrate the experimental equipment accurately resulted in the loss of data for one additional participant. The final analyzed sample population comprised 46 participants (M age = 30.9, SD age = 11.7) who completed the experiment and had complete simulator data including 21 women (M age = 29.3, SD age = 11.8) and 25 men (M age = 32.3, SD age = 11.7), and 43 of whom also had complete eye-tracking data.

Table 6.3: Summary of Participant Population

POPULATION	TOTAL	MEN	WOMEN
Total enrolled	52 (100%)	27 (52%)	25 (48%)
Simulator sickness (%)	5 (10%)	2 (40%)	3 (60%)
Experimental calibration issue (%)	1 (2%)	0 (0%)	1 (100%)
Final analyzed sample (%)	46 (88%)	25 (54%)	21 (46%)

6.5.1.2 Demographics

Every effort was made to recruit a representative sample of the Oregon driving public. Table 6.4 summarizes the demographic information that was recorded during the prescreening survey for the 46 participants with complete information. All participants were licensed drivers who resided in the state of Oregon (not necessarily Oregon licensed).

Table 6.4: Participant Demographics

	POSSIBLE RESPONSES	NUMBER OF PARTICIPANTS	PERCENTAGE OF PARTICIPANTS
How many years have you been licensed?	1–5 years	18	39%
	6–10 years	12	26%
	11–15 years	3	7%
	16–20 years	6	13%
	More than 20 years	7	15%
How often do you drive in a week?	1 time per week	6	13%
	2–4 times per week	9	20%
	5–10 times per week	12	26%
	More than 10 times per week	19	41%
How many miles did you drive last year?	0–5,000 miles	15	33%
	5,000–10,000 miles	12	26%
	10,000–15,000 miles	9	20%
	15,000–20,000 miles	8	17%
	More than 20,000 miles	2	4%
What corrective lenses do you wear while driving?	Glasses	0	0%
	Contacts	7	15%
	None	39	85%
Do you experience motion sickness?	Yes	6	13%
	No	40	87%

6.5.2 Postdrive Survey Results

After participants completed the driving simulator experiment, they were asked to complete a short postdrive survey. Participants were asked what the appropriate response would be if they were turning right and saw either the steady red arrow or flashing yellow arrow indication. Three choices were offered: they could turn right cautiously without stopping; they could turn right after coming to a complete stop and finding a gap; or they could stop and wait for the green before turning. Driver responses are summarized in Figure 6.19. Overall, 65% of participants demonstrated poor comprehension of the correct action when faced with a steady red arrow display, whereas 78% of participants chose the correct response to the flashing yellow arrow display.

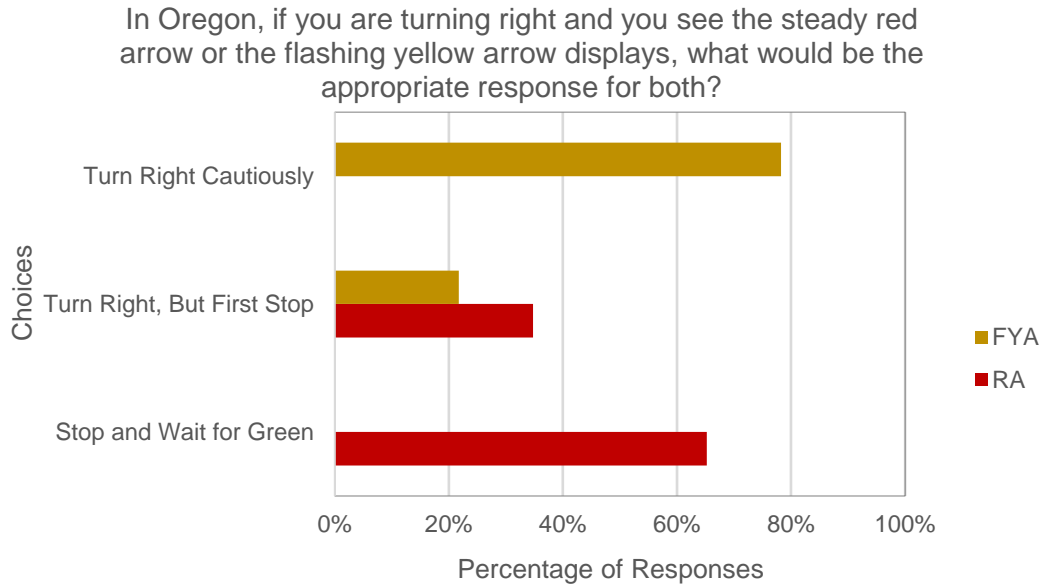

Figure 6.19: Participant comprehensions of the flashing yellow arrow (FYA) and red arrow (RA) indications

When participants were asked to indicate how confident they were in their responses, 76% of participants were very confident that they must stop and wait until they received a green indication before turning when presented a steady red right-turn arrow. However, their confidence level was confident to very confident that they could turn right cautiously without stopping on the flashing yellow arrow display while turning right.

One of the independent variables explored in this experiment was whether participants saw any differences between the circular red and red arrow indications and between the circular green and flashing yellow arrow indications. Participants were asked in the postdrive survey to identify whether or not they perceived these indications as the same while turning right in Oregon. Responses to these questions (Table 6.5) showed that 61% of participant thought the circular red and the steady red arrow indications meant different things, whereas 39% of participants thought that they had the same meaning. Most participants (80%) indicated that the circular green and flashing yellow arrow indications had different meanings.

Table 6.5: Postdrive Survey Question Responses

QUESTION	OPTIONS	RESPONSES	PERCENTAGE
As a driver in Oregon, do the steady circular red ball and the steady red arrow for the right-turning maneuver mean the same to you?	Yes	18	39%
	No	28	61%
As a driver in Oregon, do the flashing yellow arrow and the steady circular green ball for the right-turning maneuver mean the same to you?	Yes	9	20%
	No	37	80%

6.5.3 Driver Decision Making

Video data provide information on participant behavior that can facilitate interpretation of quantitative data. Decisions in response to each signal display were extracted from the SimObserver data. Data were carefully reviewed and classified into three categories: Correct, Partially correct, and Incorrect/Missing, based on established criteria shown in Table 6.6. The much of the coding convention for the actions observed in the simulator experiment followed the coding criteria of survey (Table 4.4).

Table 6.6: Error Coding of Narrative for the Simulator Experiments

DISPLAY INDICATION	CORRECT	PARTIALLY CORRECT	INCORRECT
Steady Circular Green	Turn right with caution after yielding to pedestrians (if present) in the crosswalk	Turn right without checking for pedestrians even though the walk indication was displayed (or) not checking before turning but stopping once they saw a pedestrian	Stop before turning (vehicle speed < 1 mph) to check for pedestrians (or) A crash with pedestrian
Steady Green Arrow	Turn right without stopping, recognizing that the SGA indicates a protected right-turn movement	Check for pedestrians and turn right (or) slow down and check for pedestrians and other cross traffic but did not recognize the protected movement in either case	Stop before turning (vehicle speed < 1 mph) to check for pedestrians
Steady Circular Red and Steady Red Arrow	Come to a complete stop (vehicle speed < 1 mph) and complete the turn when they find a safe gap	Turn right without coming to a complete stop (vehicle speed > 1 mph)	Stop and remain stopped until the green indication
Flashing Yellow Arrow	Turn right with caution after yielding to pedestrians (if present) in crosswalk	Turn right without caution (vehicle speed > 15 mph) (or) not yielding when necessary	Stop before turning (vehicle speed < 1 mph) to check for pedestrians (or) remain stopped until the green indication

For the steady circular green (SCG), to be coded as correct, participants must turn right after yielding to pedestrians (if present) in the crosswalk. Partially correct actions resulted from drivers turning right without checking for pedestrians even though the walk indication was displayed, or not checking before turning but stopping once they saw a pedestrian. Incorrect

actions resulted from either drivers coming to a complete stop (vehicle speed < 1 mph) to check for pedestrians, or a crash with a pedestrian. Driver responses were coded as correct if they turned right without stopping, recognizing that the steady green arrow (SGA) indicates a protected right-turn movement. A response was coded partially incorrect if drivers slowed down or checked for pedestrians and other conflicting movements before turning. The incorrect action resulted from drivers coming to a complete stop (vehicle speed < 1 mph) while checking for pedestrians. The coding convention followed for the steady circular red (SCR) and the steady red arrow (SRS) indications was the same, as according to Oregon law the expected correct action for both display indications is the same for right turns. Responses were classified as correct if participants came to a complete stop (vehicle speed < 1 mph) and completed the turn when a safe gap was selected. Partially correct actions resulted from drivers making the right turn without coming to a complete stop. Responses were coded as incorrect if participants came to a complete stop and waited for a green indication. For the flashing yellow arrow (FYA), driver responses were coded as correct if they exhibited caution while turning and yielded to pedestrians when present, stopping when necessary. Partially correct actions resulted from drivers not turning right with caution (vehicle speed > 15 mph) or not yielding when necessary. Responses were coded as incorrect if drivers came to a complete stop (vehicle speed < 1 mph) before turning, or if they remained stopped until the signal display became green.

For example, one participant stopped in response to the red arrow, rejected an acceptable gap, and waited for the green arrow indication before performing a right turn (Figure 6.20). This participant incorrectly interpreted the red arrow indication. After completing the experimental drives, the participant remarked to the researcher that they thought the right-turn red arrow display was as restrictive as it is for left turns.

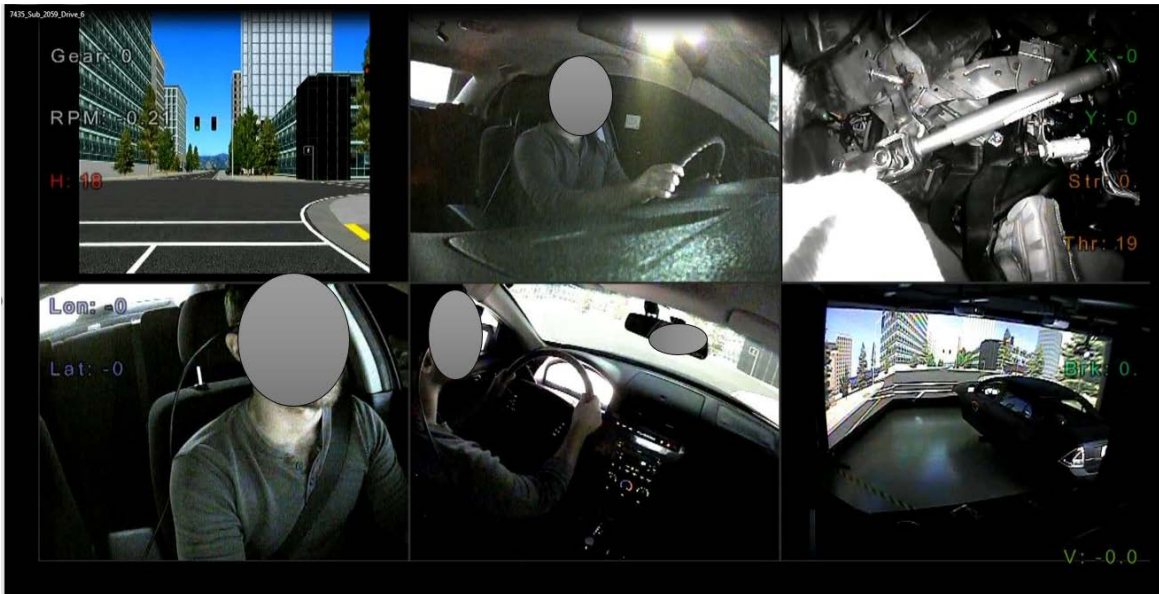

Figure 6.20: Screenshot of Simobserver platform

6.5.3.1 Steady Circular Green

Responses were coded following the convention outlined in Table 6.6. Nine crashes or near-miss crashes were observed during 96 right turns in the 50- and 100-ft right-turn bays in the presence of pedestrians. Table 6.7 summarizes results for participants' comprehension of the steady circular green indication.

The circular green indication was evaluated in the simulator in scenarios with turning bay lengths of 50 and 100 ft, with or without a pedestrian present. Proportions of correct actions ranged from 67% (50-ft bay with pedestrian) to 76% (100-ft bay without pedestrian), partially correct actions ranged from 11% (100-ft bay without pedestrian) to 33% (50-ft bay with pedestrian), and incorrect actions ranged from 0% (50- or 100-ft bay with pedestrian) to 13% (100-ft bay without pedestrian). In general, the steady circular green indication was well understood, and all incorrect driver actions resulted in fail-safe driver responses.

Table 6.7: Steady Circular Green Circular Responses

RESPONSE	50 - NO PED	50 - PED	100 - NO PED	100 - PED
Incorrect	6.5%	6.5%	13.0%	13.0%
Partially Correct	19.6%	26.1%	10.9%	13.1%
Correct	73.9%	67.4%	76.1%	73.9%

6.5.3.2 Steady Green Arrow

Responses were coded following the convention outlined in Table 6.6. Table 6.8 summarizes participants' responses to the steady green arrow indication.

Table 6.8: Steady Green Arrow Responses

RESPONSE	50 - NO PED	50 - PED	100 - NO PED
Incorrect	0.0%	2.2%	0.0%
Partially Correct	2.2%	13.0%	15.2%
Correct	97.8%	84.8%	84.8%

High proportions (85%-98%) of correct actions were observed among simulator participants responding to the steady green arrow indication in the 50-ft turning bay with and without a pedestrian and in the 100-ft turning bay without a pedestrian. Due to a programming error, the results from the 100-ft turning bay scenario with pedestrians are not reported. Responses deemed as partially correct varied between 2% and 15%. Low levels of incorrect responses were observed (0%-2%). These results indicate that the steady green arrow indication was well understood by driving simulator participants.

6.5.3.3 Steady Circular Red

Responses were coded following the convention outlined in Table 6.6. Table 6.9 summarizes participants' responses to the steady circular red indication.

Table 6.9: Steady Circular Red Responses

RESPONSE	50 - NO PED	50 - PED	100 - NO PED	100 - PED
Incorrect	30.4%	28.3%	26.1%	30.4%
Partially Correct	6.5%	21.7%	21.7%	6.5%
Correct	63.0%	50.0%	52.2%	63.0%

Proportions of correct actions to the steady circular red indication ranged from 50% (50-ft bay without pedestrian) to 63% (50-ft bay without pedestrian, 100-ft bay with pedestrian), partially correct actions ranged from 7% to 22%, and incorrect actions ranged from 26% to 30%. Proportions of incorrect actions were higher for this indication than for the steady circular green indication. These errors resulted in fail-safe responses; although they may result in efficiency losses, they are not expected to reduce safety.

6.5.3.4 Steady Red Arrow

Responses were coded following the convention outlined in Table 6.6. Table 6.10 summarizes responses to this indication.

Table 6.10: Steady Red Arrow Responses

RESPONSE	50 - NO PED	50 - PED	100 - NO PED	100 - PED
Incorrect	69.6%	67.4%	65.2%	67.1%
Partially Correct	6.5%	2.2%	8.7%	0.0%
Correct	23.9%	30.4%	26.1%	32.6%

Drivers exhibited low levels of correct responses (24%-33%) to the steady red arrow indication due to their tendency to stop and wait for a steady green indication before proceeding. These actions are considered fail-safe responses and they affect efficiency more directly than safety. The proportions between the different tested scenarios were similar.

6.5.3.5 Flashing Yellow Arrow with Pedestrian Walk Interval (FYAW)

Responses were coded following the convention outlined in Table 6.6. Table 6.11 summarizes responses to the flashing yellow arrow during the pedestrian walk interval.

Table 6.11: Responses to Flashing Yellow Arrow during Pedestrian Walk Interval

RESPONSE	50 - NO PED	50 - PED	100 - NO PED	100 - PED
Incorrect	15.2%	0.0%	10.9%	0.0%
Partially Correct	0.0%	2.2%	0.0%	2.2%
Correct	84.8%	97.8%	89.1%	97.8%

High levels of correct responses (85% to 98%) were observed with the flashing yellow arrow indication. Incorrect actions were primarily observed with the 50- and 100-ft turning bay scenarios with no pedestrian present (11% and 15%). The high proportion of correct responses indicates that the flashing yellow arrow indication is well understood by Oregon drivers.

6.5.3.6 Flashing Yellow Arrow with Pedestrian Clearance Interval (FYAC)

The same coding as was used with FYAW was used to identify drivers’ responses to the flashing yellow arrow during the pedestrian clearance interval. High levels of comprehension of the FWAC were observed (89%-98%). Incorrect actions were observed for the 50- and 100-ft turning bay scenarios when no pedestrian was present. Thus, using a flashing yellow arrow during the pedestrian clearance interval resulted in drivers correctly responding in most situations. Table 6.12 summarizes participants’ comprehension of this indication.

Table 6.12: Responses to Flashing Yellow Arrow during Pedestrian Clearance Interval

RESPONSE	50 - NO PED	50 - PED	100 - NO PED	100 - PED
Incorrect	6.5%	0.0%	4.4%	0.0%
Partially Correct	0.0%	2.2%	0.0%	10.9%
Correct	93.5%	97.8%	95.6%	89.1%

6.5.4 Visual Attention

Visual attention data were gathered and reduced from the ASL Mobile Eye XG for the 43 participants with complete eye-tracking data. This section organizes eye-tracking results by the three independent variables: signal indication type and active display, right-turn bay length, and presence of pedestrians. Data were analyzed in R Studio version 1.0.153 and SAS 9.4.

6.5.4.1 Average Total Fixation Duration (ATFD)

The total fixation duration (TFD) within a prescribed AOI was used to measure motorists’ visual attention on different targets. For each right-turning maneuver, the number and duration (in seconds) of participants’ fixations on AOIs were recorded, with a TFD of 0 seconds indicating that the participant did not look at the target. The ATFD was calculated by averaging all participants’ total fixations on an AOI.

6.5.4.2 Descriptive Data and Statistical Analysis

The type of signal display, turning bay length, and presence of a pedestrian in the conflicting crosswalk may influence motorists’ visual attention while turning right. Therefore, these factors were included as independent variables. Although other factors (e.g., motorists’ experience level, age, pedestrian conspicuity) may also influence motorists’ visual search task at an intersection, those factors are outside the scope of this study. The first independent variable, “type of signal indication,” had six levels: 1) circular green, 2) circular red, 3) green arrow, 4) red arrow, 5) flashing yellow arrow with walk interval on (FYAW), and 6) flashing yellow arrow with clearance interval on (FYAC). The second independent variable, “turning bay length,” had two levels: 1) 50 ft

and 2) 100 ft. The last independent variable, “presence of a conflicting pedestrian in the crosswalk,” had two levels: 1) no pedestrian and 2) one pedestrian walking towards the participant in the conflicting crosswalk. One of the primary dependent variables of this experiment was the visual attention of motorists during the right-turn maneuver. Fixation data for different AOIs were statistically analyzed by using SAS (version 9.4).

Each participant completed 24 right-turning maneuvers and received all possible combinations of independent variables (6×2×2). Therefore, repeated measure analysis of variance (ANOVA) was used to statistically determine if there were any differences in the variances between levels with respect to display type, AOI, or bay length. Pairwise comparisons of estimated marginal means TFDs were calculated with Tukey’s Honest Significant Difference (HSD) test. In the following subsections, the TFD is used as a performance metric to compare the visual distribution potential between levels of signal indications.

6.5.4.3 Circular Red and Red Arrow Indications

Participants’ responses while turning right at intersections operating the MUTCD standard circular red signal configuration were compared to responses at intersections with the steady red arrow display. The TFD was calculated for each participant during each right-turning maneuver. Right turns were sorted by signal indication type, turning bay length, and AOI (signal and pedestrian signal). Data were visualized as boxplots of TFD disaggregated by three independent variables. Figure 6.21 shows TFD values for AOIs at intersections with no pedestrians, 50- and 100-ft turning bay lengths, and circular red and red arrow indications. Median TFDs ranged from 0.10 to 3.91 seconds. The highest median TFD occurred with the red arrow indication in the 50-ft bay while fixating on the signal head. The lowest median TFD occurred with the circular red indication in the 50-ft bay while fixating on the pedestrian signal head.

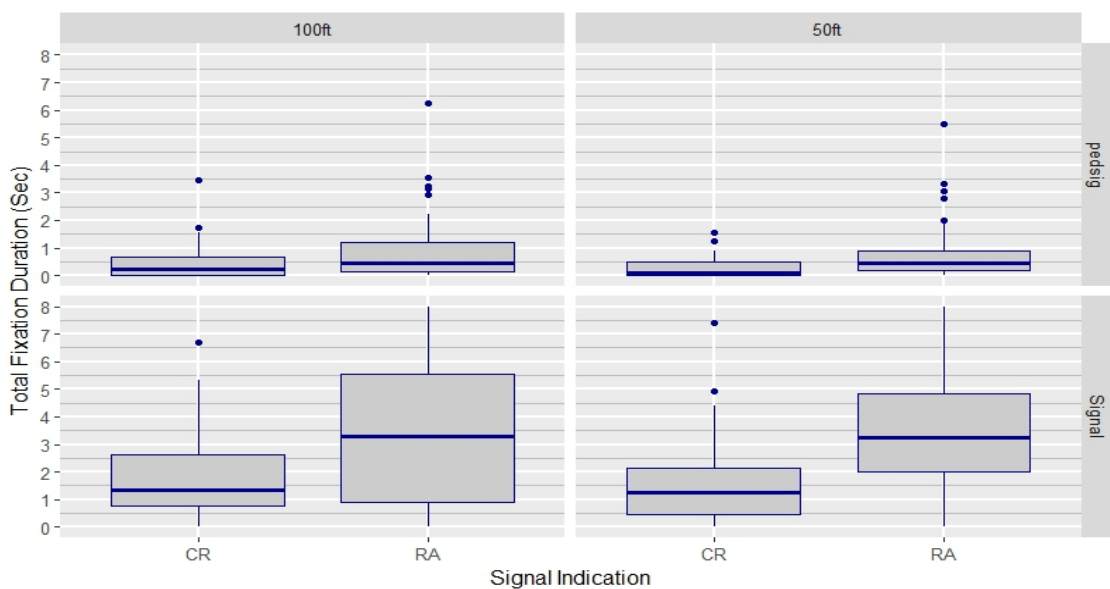

Figure 6.21: Boxplots of TFD disaggregated by signal type

Table 6.13 contains descriptive statistics for TFDs for each independent variable. Repeated-measures ANOVA, used to determine whether mean TFD was affected by the three factors (signal type, bay length, and AOI), revealed a significant effect of the listed variables on the mean TFD ($F(7, 343) = 29.40, p < 0.001$).

Table 6.13: Descriptive Statistics for TFD by Signal Type, Bay Length, and AOI

AOI		SIGNAL				PEDSIG			
SIGNAL TYPE		CR		RA		CR		RA	
BAY LENGTH		100ft	50ft	100ft	50ft	100ft	50ft	100ft	50ft
DESCRIPTIVE STATISTICS	MEDIAN	1.51	1.26	3.60	3.91	0.23	0.10	0.43	0.47
	MEAN	1.93	1.60	3.85	4.98	0.44	0.28	0.92	0.81
	STD DEV	1.78	1.49	3.24	3.82	0.67	0.37	1.28	1.10

Tukey’s HSD post hoc pairwise comparison was performed to understand differences between group means. Results at the 95% confidence level (Table 6.14) showed a significant difference between mean TFDs for interactions with the circular red, 50-ft bay, and signal AOI ($M = 1.60, SD = 1.49$) compared to interactions with the red arrow, 50-ft bay, and signal AOI ($M = 4.98, SD = 3.82$). A significant difference between mean TFDs was found for interactions with the circular red, 100-ft bay, and signal AOI ($M = 1.93, SD = 1.78$) compared to interactions with the red arrow, 100-ft bay, and signal AOI ($M = 3.85, SD = 3.24$). No significant difference between mean TFDs was observed when the AOI was changed for the same combination of the other two factors.

Table 6.14: Tukey’s HSD Multiple Comparisons by Signal Type, Bay Length, and AOI

COMPARISON	MEAN DIFFERENCE	P	95% CI	
			LOWER	UPPER
CR:50:Signal vs. RA:50:Signal	3.37	<0.001	2.02	4.73
CR:50:PedSig vs. RA:50:PedSig	0.53	N.S.	-0.81	1.89
CR:100:Signal vs. RA:100:Signal	1.92	<0.001	0.56	3.27
CR:100:PedSig vs. RA:100:PedSig	0.48	N.S.	-0.87	1.83

6.5.4.4 Circular Green and Flashing Yellow Arrow Indications

Participants’ responses while turning right at all intersections operating the circular green indication were compared to responses at intersections operating a flashing yellow arrow indication. The TFD was measured for each participant during each right-turning maneuver, and right turns were sorted by signal indication type, turning bay length, and AOI (signal and pedestrian signal). Data were visualized as boxplots of TFD disaggregated by three independent variables. Figure 6.22 shows TFD values for AOIs at intersections with no pedestrians, 50- and 100-ft turning bay lengths, and circular green

and flashing yellow arrow indications. Median TFDs ranged from 0.10 to 1.54 seconds. The flashing yellow arrow indication in the 100-ft bay while fixating on the signal head had the highest median TFD, and the circular green indication in the 50-ft bay while fixating on the pedestrian signal head had the lowest median TFD.

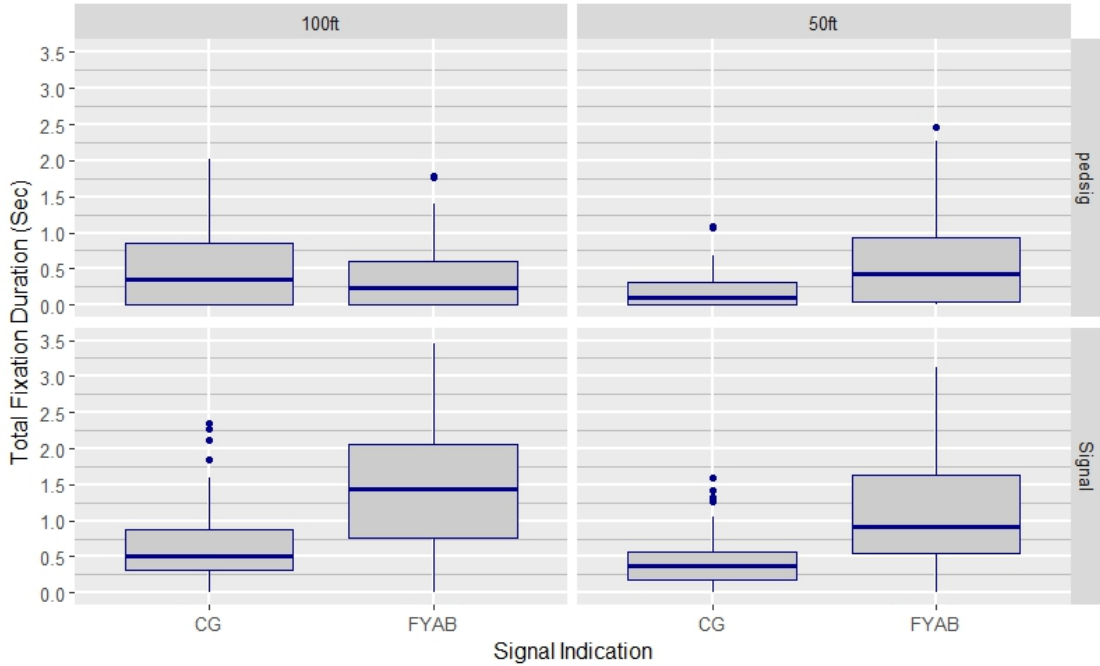

Figure 6.22: Boxplots of TFD disaggregated by signal type

Table 6.15 contains descriptive statistics for the TFDs of participants for each independent variable. Repeated-measures ANOVA revealed a significant effect of the independent variables on the TFD ($F(7, 343) = 22.37, p < 0.001$).

Table 6.15: Descriptive Statistics for TFD by Signal Type, Bay Length, and AOI

AOI		SIGNAL				PEDSIG			
SIGNAL TYPE		CG		FYAC		CG		FYAC	
BAY LENGTH		100ft	50ft	100ft	50ft	100ft	50ft	100ft	50ft
DESCRIPTIVE STATISTICS	MEDIAN	0.50	0.37	1.54	0.91	0.36	0.10	0.23	0.43
	MEAN	0.69	0.47	1.70	1.11	0.48	0.21	0.42	0.63
	STD DEV	0.61	0.42	1.13	0.82	0.49	0.28	0.52	0.65

Results of Tukey's HSD post hoc pairwise test at the 95% confidence level (Table 6.16) showed a significant difference between the mean TFDs for interactions with the circular green, 50-ft bay, and signal AOI ($M = 0.47, SD = 0.42$) compared to interactions with the flashing yellow arrow, 50-ft bay, and signal AOI ($M = 1.11, SD = 0.82$). There was a significant difference between the mean TFDs for interactions with the circular green,

100-ft bay, and signal AOI ($M = 0.69$, $SD = 0.61$) compared to interactions with the flashing yellow arrow, 100-ft bay, and signal AOI ($M = 1.11$, $SD = 0.82$), but no significant difference between mean TFDs when the pedestrian signal head AOI was accounted at the 100-ft bay ($M = 0.48$, $SD = 0.49$) and 50-ft bay ($M = 0.42$, $SD = 0.52$).

Table 6.16: Tukey’s HSD multiple comparisons by signal type, bay length, and AOI

COMPARISON	MEAN DIFFERENCE	P	95% CI	
			LOWER	UPPER
CG:50:Signal vs. FYA:50:Signal	0.63	<0.001	0.20	1.07
CG:50:PedSig vs. FYA:50:PedSig	0.41	0.07	-0.02	0.85
CG:100:Signal vs. FYA:100:Signal	1.02	<0.001	0.58	1.45
CG:100:PedSig vs. FYA:100:PedSig	-0.06	N.S.	-0.49	0.37

6.5.4.5 Flashing yellow arrow with walk interval and with clearance interval

Participants’ responses while turning right at all intersections operating the flashing yellow arrow indication were compared between those with the walk interval or clearance interval signal configuration (FYAW vs. FYAC). The TFD was calculated for each participant during each right-turning maneuver, and right turns were sorted by signal indication type, turning bay length, and AOI (signal and pedestrian signal). Data were visualized as boxplots of TFD disaggregated by three independent variables. Figure 6.23 shows the TFD values for AOIs at intersections with no pedestrians, 50- and 100-ft turning bay lengths, and FYAW and FYAC signal indications. Median TFDs ranged from 0.13 to 1.70 seconds. The scenario of FYAW, 50-ft bay length, and signal head AOI had the highest median TFD, whereas the scenario of FYAW, either turning bay length, and pedestrian signal head AOI had the lowest median TFD.

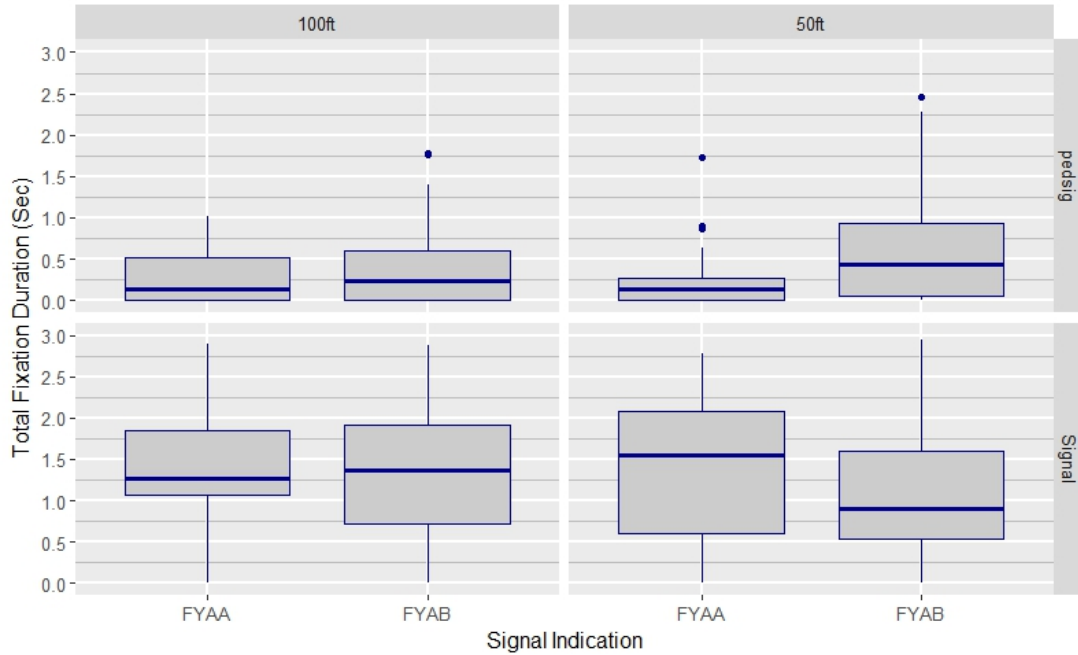

Figure 6.23: Boxplots of TFD disaggregated by signal type

Table 6.17 contains descriptive statistics for the TFDs of participants for each independent variable. Repeated-measures ANOVA revealed a significant effect of the independent variables on the mean TFD ($F(7, 343) = 29.72, p < 0.001$).

Table 6.17: Descriptive Statistics for TFD by Signal Type, Bay Length and AOI

AOI		SIGNAL				PEDSIG			
SIGNAL TYPE		FYAW		FYAC		FYAW		FYAC	
BAY LENGTH		100ft	50ft	100ft	50ft	100ft	50ft	100ft	50ft
DESCRIPTIVE STATISTICS	MEDIAN	1.29	1.70	1.54	0.91	0.13	0.13	0.23	0.43
	MEAN	1.47	1.66	1.70	1.11	0.27	0.22	0.42	0.63
	STD DEV	0.75	1.06	1.13	0.82	0.32	0.33	0.52	0.65

Tukey's HSD post hoc pairwise comparison at the 95% confidence level (Table 6.18) showed a significant difference between mean TFDs of the interaction with the FYAW, 50-ft bay, and signal AOI ($M = 1.66, SD = 1.06$) compared to the interaction with the FYAC, 50-ft bay, and signal AOI ($M = 1.11, SD = 0.82$), but no significant difference between mean TFDs of other factor combinations.

Table 6.18: Tukey’s HSD multiple comparisons by signal type, bay length, and AOI

COMPARISON	MEAN DIFFERENCE	P	95% CI	
			LOWER	UPPER
FYAW:50:Signal vs. FYAC:50:Signal	-0.54	0.01	-1.04	-0.05
FYAW:50:PedSig vs. FYAC:50:PedSig	0.40	N.S.	-0.08	-0.90
FYAW:100:Signal vs. FYAC:100:Signal	0.23	N.S.	-0.26	0.73
FYAW:100:PedSig vs. FYAC:100:PedSig	0.14	N.S.	-0.34	0.64

6.5.4.6 Presence of Pedestrians

The effect of the presence of a pedestrian in the conflicting crosswalk on the TFD of the right-turning motorists on an AOI was analyzed in the driving environment. Two-sample, two-sided Student’s or Welch’s (when variances were not equal) t-tests for five signal displays regardless of turning bay length were conducted to determine whether the ATFDs on specific AOIs varied with the presence of pedestrians (Table 6.19). The only two statistically significant differences were found in the ATFD of the AOI (signal) when the red arrow or FYAW indication was active in the presence of a pedestrian. Motorists spent less time fixating on the red arrow signal head when a conflicting pedestrian was present in the crosswalk compared to when no pedestrian was present. However, they spent more time fixating on the flashing yellow arrow signal when a conflicting pedestrian was present in the crosswalk as compared to when no pedestrian was present.

Table 6.19: Two-sample T-test of ATFDs Comparing AOIs by Presence of Conflicting Pedestrian

AOI	ATFD (seconds)		Welch's t-test
	PED	NO PED	PED vs. NO PED
	SIGNAL CONFIGURATION		P-VALUE
CG			
Signal	0.55	0.58	N.S.
Ped Signal	0.36	0.34	N.S.
CR			
Signal	1.90	1.76	N.S.
Ped Signal	0.38	0.35	N.S.
RA			
Signal	2.8	4.4	<0.001
Ped Signal	0.72	0.86	N.S.
FYAW			
Signal	2.08	1.56	<0.001
Ped Signal	0.34	0.24	0.10
FYAC			
Signal	1.51	1.40	N.S.
Ped Signal	0.43	0.52	N.S.

6.6 SUMMARY

A driving simulator experiment was conducted to examine motorist behavior in response to right-turn signal displays (circular green, circular red, red arrow, green arrow, FYAW, and FYAC) with two levels of pedestrian activity (with and without the presence of a pedestrian) and length of exclusive right-turning bays (50 and 100 ft). Fifty-two participants participated in the simulator study and 46 completed the task. Motorists' decision-making and visual attention were evaluated during 24 right-turn maneuvers at signalized intersections.

6.6.1 Driver Decision Making

Analysis of driver decision making revealed that most participants understood the steady circular green, steady green arrow, steady circular red, and flashing yellow arrow signal indications. These findings were consistent in both turning bays (50 and 100 ft), regardless of whether a pedestrian was present. The steady red arrow indication resulted in the most variable driver response, which could be attributed to the fact that red arrows for right turns are uncommon. In Oregon, steady red arrows are most commonly used for left-turn movements, where the correct response is almost always to stop and remain stopped until a green indication is displayed. Driver laws pertaining to the correct response to a steady red arrow indication vary between states.

Alternatively, more than 85% of drivers responded correctly to the flashing yellow arrow indication, which indicates that the flashing yellow arrow indication for right turns is well understood by Oregon drivers. The proportion of incorrect actions (15%) was observed in scenarios without pedestrians. This finding suggests that the flashing yellow arrow indication for permitted right turns improved driver comprehension and behavioral responses to the permissive right-turn condition and, at a minimum, did not increase pedestrian risk while crossing in proximity to right-turning vehicles.

In total, six crashes or near-miss crashes were observed during 46 right turns in the 100-ft exclusive right-turn bays in the presence of a pedestrian in the conflicting crosswalk, and three crashes or near-miss crashes were observed in the 50-ft exclusive right-turn bay. This finding indicates that traveling at higher speeds in the longer exclusive right-turning bays contributes to increased pedestrian risk.

6.6.2 Driver Visual Attention

The visual attention of drivers was measured via their TFDs on different AOIs. Results of repeated-measures ANOVA revealed statistically significant two-way interactions between the combined effects of signal type (circular red vs. red arrow, circular green vs. red arrow) and AOI on driver TFDs ($p < 0.001$).

Regardless of the length of the turning bay, right-turning drivers had longer mean TFDs on the signal head when presented with a red arrow display than when they were presented with a circular red display ($p < 0.001$, Tukey's HSD). The increased duration of visual attention on the red arrow indication, when considered in conjunction with the lower correct response rate observed in driver decision making, supports the connection between visual attention and cognition while driving (e.g., drivers looked at the red arrow indication longer because they were

unsure of what the correct response was, and many responded incorrectly). Similarly, regardless of the length of the turning bay, right-turning drivers had significantly longer mean TFDs on the signal head when presented with the flashing yellow arrow than when presented with the circular green indication ($p < 0.001$). Most drivers responded correctly to both signals, but fixated longer on the flashing yellow arrow signal head. The longer duration of fixation, when considered with the search for an acceptable gap, indicates a more robust visual search task. This finding supports the theory that drivers demonstrate safer actions in response to the flashing yellow arrow than they do to the circular green (Rietgraf and Schattler 2013).

No statistically significant differences were identified for the mean TFDs on the pedestrian signal heads for the walk or walk clearance indications ($p > 0.05$). There was, however, a statistically significant interaction of the mean TFDs between the FYAW (walk interval on) and FYAC (walk clearance interval) and the AOIs ($p < 0.01$). Multiple comparison results showed that drivers spent more time fixating on the pedestrian signal when the clearance interval ran concurrently with the flashing yellow arrow.

Finally, the presence of a pedestrian had a statistically significant effect on the ATFDs of the signal AOIs ($p < 0.001$) when the red arrow or the flashing yellow arrow indication was active. When a conflicting pedestrian was crossing the intersection in the motorist's forward vision, they fixated nearly 50% less on the signal head when the red arrow was active, whereas the opposite was true when the flashing yellow arrow indication was active.

7 CONCLUSIONS

The objective of this research was to develop an understanding of the safety and operational implications of using the flashing yellow arrow to indicate a permitted right turn. To accomplish these objectives, the research team followed a robust research plan. First, a comprehensive review of the scientific and technical articles was performed. The review found that right-turn-lane geometry is an important variable, and that pedestrians must be accommodated for safe operation of permissive right turns. The review identified technical guidance related to right-turn overlap phasing, a common application of PPRT. While the flashing yellow arrow is allowed for PPRT operations in the MUTCD, the review found no previous published research on the operational or safety implications of PPRT phasing using the flashing yellow arrow display.

Right-turn crashes at signalized intersections were analyzed by using reported Oregon crash data from 2011–2013. In Oregon, 18% to 20% of all crashes reported annually occurred at signalized intersections (9,600 crashes per year), with around 9% (850 per year) of these crashes involving right turns. Approximately 3% of crashes were fatal (3 crashes per year) and 45% involved injury (380 per year; the remaining 55% were property-damage-only). Proportions of crashes caused by following too closely, not yielding ROW, and improper turning were significantly different between right-turn and all intersection crashes.

Following these tasks, the research team designed, conducted, and analyzed three primary research tasks:

1. A web-based survey to understand Oregon driver's comprehension of right-turn signal display alternatives;
2. A microsimulation to explore the operational performance of several PPRT phasing alternatives under varying volumes (right turn vehicle volumes, conflicting pedestrian movements, and conflicting left turn vehicular movements); and
3. A driving simulator experiment to examine motorist behavior in response to right-turn signal displays with two levels of pedestrian activity and length of exclusive right-turning bays.

The following sections summarize the results of these tasks and are followed by a discussion of limitations, a synthesis of the three experiments, and recommendations for practice.

7.1 SURVEY

A survey was conducted to understand how well Oregon drivers comprehend different right-turn signal display alternatives. The survey was conducted online with recruitment through postcards that were mailed to 9,872 addresses in Oregon. The survey consisted of 21 questions. The first section of the survey included open-ended questions which asked respondents to report their understanding of green ball, green arrow, red ball, red arrow, and flashing yellow arrow

indications. Respondents were presented an image of an intersection and asked “*Imagine that you are approaching the intersection in the lane farthest to the right and planning to TURN RIGHT. What action would you take based on the current signal display?*”? Respondents were randomly presented intersection images with or without a “Right Turn Only (RTO)” sign placed overhead on the signal mast arm adjacent to the signal display. In the second section of the survey, respondents were given a set of multiple-choice questions to provide their reasoning for what they perceived as either similarities or differences between the steady red ball and steady red arrow and between the steady green ball and flashing yellow arrow signal indications. The third and final section of the survey consisted of closed-ended multiple-choice demographic questions on the respondent’s income and education levels, driving habits, and eyesight. Overall, the survey received responses from a wide geographical area of Oregon but was over-represented by older white males compared to statewide demographic estimates from Census data.

The research team reviewed each open-ended response. Two reviewers independently coded the responses as correct, partially correct, or incorrect, based on established criteria for each signal display. Interrater reliability was assessed by Cohen’s kappa coefficient κ , a statistic that measures interrater agreement for categorical items. Initial coding revealed substantial agreement for most displays except the green arrow. After a series of iterations and discussions, all coding inconsistencies were resolved.

Analysis of the of 399 completed open-ended survey responses revealed that most respondents understood the steady circular green (73% correct), steady green arrow (63% correct), and steady circular red (83% correct) indications. Even though the flashing yellow arrow display for right turns is currently uncommon in Oregon, and most drivers surveyed are not likely to have encountered the display, comprehension was high (77% correct). In the multiple-choice response, 75% correctly identified the response “Turn right cautiously without stopping” as the expected response. There was a general misunderstanding of the required driver response for the steady red arrow signal indication in the open-ended responses (52% correct). This confusion was confirmed in the follow-up multiple-choice questions, where nearly 50% of respondents incorrectly and confidently (86%) identified the correct response to the steady red arrow to be “stop and wait for a green indication before turning”.

7.2 MICROSIMULATION

A three-leg signalized intersection that currently uses PPRT phasing was constructed in a microsimulation environment. The objective was to explore the operational performance of several PPRT phasing alternatives under varying volumes (right-turn vehicle volumes, conflicting pedestrian movements, and conflicting left-turn vehicular movements). The software VISSIM was used to build the simulated intersection. Within VISSIM, the ASC/3 software-in-the-loop signal controller was used for signal timing and phasing purposes.

To examine how volume affected delay, a sensitivity analysis was undertaken. Six different scenarios were tested: compared to the base case, (1) EB left-turn volumes (phase 5) were increased by 10%, (2) EB left-turn volumes (phase 5) were increased by 25%, (3) WB right-turn volumes (phase 6) were increased by 10%, (4) WB right-turn volumes (phase 6) were increased by 25%, (5) pedestrian volumes on phase 6 were increased by 5 times, and (6) pedestrian volumes on phase 6 were increased by 10 times. Overall, delays showed little to no change with

an increase in EB left- or WB right-turn volumes. As expected, results from the simulation models indicate that the pedestrian volumes had the greatest effects on delays.

7.3 DRIVING SIMULATOR

The experiment was conducted in the OSU full-scale high-fidelity driving simulator. A randomized partially counterbalanced factorial experimental design was used to evaluate the effects of three independent variables – right-turning signal indication, exclusive right-turning bay length, and presence of a pedestrian in the conflicting crosswalk – on driver behavior during right-turn maneuvers. The simulator study involved 52 participants (27 men), with ~10% (3 women and 2 men) reporting simulator sickness and not completing the experiment. The final analyzed sample population comprised 46 participants who completed the experiment and had complete simulator data, 43 of whom also had complete eye-tracking data.

7.3.1 Driver Decision Making

The steady red arrow indication resulted in the most variable driver response. This result could be attributed to the fact that steady red arrows for right turns are uncommon. In Oregon, steady red arrows are typically used for left-turn movements, where the correct response is almost always to stop and remain stopped until a green indication is displayed. Laws pertaining to the correct driver response to a steady red arrow indication vary between states. On the other hand, more than 85% of drivers responded correctly to the flashing yellow arrow indication, which indicates that this indication for right turns is well understood by Oregon drivers. The 15% of incorrect responses were observed in scenarios without pedestrians. This finding suggests that the flashing yellow arrow indication improves driver comprehension and behavioral responses to the permissive right-turn condition and, at a minimum, does not increase pedestrian risk while crossing in proximity to right-turning vehicles.

7.3.2 Driver Visual Attention

Mean TFD on the signal head was significantly higher when drivers were presented with a red arrow display than with a circular red display, regardless of the length of the exclusive turning bay ($p < 0.001$). The increased duration of visual attention on the red arrow indication, when considered in conjunction with the lower correct response rate observed in the driver decision making, supports the connection between visual attention and cognition while driving (e.g., drivers looked at the red arrow indication longer because they were unsure of what the correct response was, and many responded incorrectly). Similarly, the mean TFD on the signal head was significantly higher when drivers were turning right on the flashing yellow arrow display than when they were turning right on a circular green, regardless of the length of the turning bay ($p < 0.001$). Although most drivers responded correctly to both signals, drivers fixated on the flashing yellow arrow signal head longer. The longer duration, when considered in the context of the search for an acceptable gap, indicates a more robust visual search task. This finding supports the theory that drivers demonstrate safer actions in response to the flashing yellow arrow when compared to the circular green (Rietgraf and Schattler 2013).

7.4 SYNTHESIS AND DISCUSSION OF RESULTS

Experimental results from the online survey of drivers and the observed behaviors in the driving simulator experiment can be combined to enhance the evidence provided by each experiment independently. The survey included a broad geographical and demographic participation of Oregon drivers, while the simulator population was diverse in demographics (although local to Corvallis, Oregon). Taken together, these experiments provide a good cross-section of Oregon drivers. Broadly, the research explored the driver response to right-turn signal indications that: 1) require the driver to yield to conflicting pedestrians and vehicles (steady circular green and flashing yellow arrow indications), 2) require the driver to stop and to find a gap in conflicting pedestrian and vehicle flow before turning (steady circular red and steady red arrow indications), and 3) are implemented in such a way that vehicle movement is exclusive (steady green arrow). The synthesis of these observations is presented below.

7.4.1 Indications That Require the Driver to Yield

Steady Circular Green – Results from the survey and driving simulator experiments were consistent, with 73% of open-ended responses to the survey being coded as correct compared to 67%-74% of observed behaviors in the simulator scenarios. Partially correct responses resulted from respondents failing to state in the survey (25% of the sample) or to demonstrate in the simulator (by near misses with pedestrians; 10%-19% of right turns) that they would yield to pedestrians.

Flashing Yellow Arrow – Results from the survey and the driving simulator experiments were consistent, with high rates of correct responses in both. In the survey, ~77% of responses were coded as correct. In the driving simulator, the correct behavior was observed in 84%-95% of cases. In general, the flashing yellow arrow indication is well understood with very few or no incorrect responses from either the survey or observations in simulator participants. Incorrect responses, when participants stated or were observed to stop before turning or to remain stopped until the green indication, were infrequent in the survey (0%-20%). Although it may affect efficiency, this incorrect response is considered a fail-safe action that does not adversely affect safety. Simulator participants were exposed to the flashing yellow arrow indication with both the Pedestrian Walk and Pedestrian Don't Walk signals active for the conflicting crosswalk. Analysis of the visual attention and response data detected no difference between the displays. Results from the simulator experiment suggest that displaying the flashing yellow arrow during either the pedestrian walk or clearance phase was well understood by simulator participants.

Oregon drivers well comprehend the flashing yellow arrow indication for permissive right turns. When comparing the visual attention between displays, the mean TFD on the signal head was significantly higher when drivers were turning right on the flashing yellow arrow display as compared to the circular green in both turning bays ($p < 0.001$). Overall, the results of this research suggest that the expected driver response to the permissive requirement of right turns is better communicated with the flashing yellow arrow than with the circular green indication.

7.4.2 Indications That Require Drivers to Stop

Steady Circular Red – Results from the survey and simulator experiment were generally consistent, but not as consistent as the responses that required yielding. Whereas 83% of responses were coded as correct in the survey, between 50% and 63% of observed behaviors were coded as correct in the simulator. A higher proportion of incorrect actions were observed for the simulator experiment than for the survey (26%-30% vs. 10%). A response was classified as incorrect if the participant stopped and waited for the green indication or if they did not perform a complete stop before turning. It is possible that drivers who were shown the steady red arrow scenario before the steady circular red indication were influenced to think that a green arrow would be displayed after the circular red, increasing the rate of stopping and waiting in the simulator. These errors resulted in generally fail-safe responses and are not expected to affect safety negatively.

Steady Red Arrow – Results from the survey and the simulator were consistent. It is clear from both experiments that there is large misunderstanding of the steady red arrow indication. In the survey, only 52% of participant's responses were coded as correct. Observed driver behavior in the simulator was even lower, with only 23% to 33% of right-turning cases being coded as correct. Most drivers (65%-70%) in the simulator came to a complete stop and waited for the green indication before turning, even when gaps were present.

Use of two signal displays that have the same legal interpretation in Oregon for right turns is a source of confusion for drivers. In the survey, respondents were asked if the circular red and red arrow indications have the same meaning, and approximately 50% agreed (and 50% did not). In the simulator, many drivers responded by stopping and remaining stopped when presented with a steady right-turn red arrow. While this result is a fail-safe response, it increases delay, especially if the preferred response is to turn right on red if gaps are available. Presently, the only option to stop right-turning traffic completely is a "No Turn on Red" sign. Use of a supplemental sign in conjunction with a signal indication requires additional driver search and information processing efforts, which can lead to errors in compliance and pedestrian yielding decisions. Recommendations are provided below to consider changing this practice.

7.4.3 Indications That Communicate to the Driver That the Movement Is Exclusive

The correct driver response (as coded in this survey and simulator experiment) requires that drivers acknowledge that the indication provides for the exclusive movement of the right turn³. One can argue that it is prudent to acknowledge the possibility of pedestrian conflict (even if not allowed operationally). However, only 64% of survey responses were coded as correct. A higher proportion of participants in the simulator experiment took correct actions in response to this indication (85%-98%). Higher proportions of partially correct responses were observed in the survey than in the simulator. Partially correct responses resulted from survey respondents stating that they would check for a pedestrian and turn right or slow down and check for a pedestrian

³ MUTCD defines the appropriate driver response to the steady green arrow as identical to that of the circular green: proceed after yielding to conflicting vehicles and pedestrians. However, it also forbids use of the arrow with any conflicting movement; so, in practice, motor vehicles are always provided an exclusive movement with this display.

and/or cross traffic. In general, this indication was well understood by survey and simulator participants.

7.5 LIMITATIONS OF THE RESEARCH

This research provides valuable insights on PPRT phasing alternatives at signalized intersections. For the online survey, the distribution of respondents was biased towards white men and an older population compared to most recent Census distributions. Additionally, a larger proportion of respondents were from southern Oregon and are closer to California, where steady red arrow laws require drivers to stop and remain stopped until the green indication. This fact could have influenced the large proportion of incorrect responses that were observed. Washington laws are identical to those in Oregon. The sample also largely consisted of drivers who were not color blind, and who were mostly licensed in Oregon.

There were a few limitations associated with the microsimulation experiment that was conducted in this study. The simulated intersection was treated as an isolated intersection, when in reality it operates as a part of a coordinated system, due to the complexity of gathering data inputs for the entire corridor. Therefore, the impacts of coordinated signal timing on PPRT phasing were not evaluated. Additionally, only the peak period impacts were evaluated, as the volumes were only available for that period. Lastly, pedestrian volumes were not available and, hence, had to be assumed. However, a sensitivity analysis was performed with varying pedestrian volumes to understand the effects of higher and lower pedestrian volumes on the PPRT movement.

Although the within-subject design of the driving simulator provides the potential for increased statistical power, a potential limitation is fatigue effects, which can cause a participant's performance to degrade over the course of the experiment as they become tired or bored. The order of the scenarios was partially randomized, drive times were minimized, and breaks were introduced between drives to limit the influence of fatigue effects. Additionally, the resource and time constraints of the project limited the number and levels of variables that could be evaluated. Additional work is recommended to address the limitations of this study and to consider the potential effects of right-turn crash mitigation strategies from this research.

7.6 RECOMMENDATIONS FOR PRACTICE

Based on the findings of this research, the following recommendations are made for the Oregon DOT to consider:

- 1) Add language in the applicable ODOT documents, policies and manuals to require the use of the FYA in for protected permissive right turn operations and allow use of FYA for permissive right turn operations.
 - The experiment demonstrated high driver comprehension of the yielding response required by the flashing yellow arrow indication for permitted right turns. The good comprehension likely is related to Oregon driver's familiarity with the flashing yellow arrow displays for left turns. The experiment provides support for operating FYA in permissive or protected-permissive mode for right-turn operation with a dedicated right-turn lane and a signal head for pedestrians. This operation is likely

most useful when right-turn conflicts with pedestrians are high but there may be benefit to wider applications. Evidence from the simulator experiment clearly suggests that the flashing yellow arrow indication encourages better driver response while turning right and would be preferred over the circular green display for permissive operation, particularly in the presence of pedestrian movements. Responses to survey items on the flashing yellow arrow indication demonstrated good comprehension about the requirement to yield to pedestrians during right turns. Also, a higher proportion of partially correct responses were observed for the circular green display which indicated a failure to mention “pedestrians” as compared to the flashing yellow arrow indication. Given the improved driver comprehension of the flashing yellow arrow indication, there would be benefits to pedestrians with better driver yielding and awareness of conflicting pedestrians.

Due to better yielding and driver behavior, Oregon transportation agencies could potentially improve pedestrian safety at signalized intersections with high volumes of permissive right turns from exclusive right-turn lanes by using the FYA display in lieu of a STEADY CIRCULAR GREEN display. This type of operation is currently in use at NW 3rd St and NW Van Buren Ave in Corvallis, OR with two one-way streets.

Additional research is needed to give clear guidance on the use of PPRT phasing vs. protected only right turn phasing that excludes the pedestrian walk and clearance interval as well as use of the PPRT FYA during the pedestrian walk and clearance interval.

Options include:

- Displaying the FYA only during the clearance interval and DO NOT WALK (steady red arrow display during the walk interval; currently implemented at NW 3rd St and NW Van Buren Ave in Corvallis, OR)
- Displaying the FYA only during the DO NOT WALK (steady red arrow display through the walk and clearance interval; currently implemented at NW Evergreen Pkwy and NW Cornell Rd in Washington County, OR).
- Displaying the STEADY GREEN ARROW only during the DO NOT WALK (steady red arrow display through the walk and clearance interval; provided by protected only right turn phasing that excludes the pedestrian walk and clearance interval).
- Displaying the FYA during the pedestrian walk, clearance interval, and DO NOT WALK

When PPRT FYA is restricted during the pedestrian walk and clearance interval (option 2), it is functionally the same as a protected only right turn (option 3). However, Option 2 can be used in situations where option 3 is not allowed, such as where there is an opposing FYA for the left-turns with a single receiving lane (MUTCD section 4D.05 item F1 of Paragraph 3). It can also help with managing the transition during the clearance interval.

1) Add language in the applicable ODOT documents, policies and manuals to recommend the use of R10-17a sign at locations using the STEADY RED ARROW.

- In Oregon, for the right turn, current driver laws (ORS 811.360) treat the circular red and steady red arrow the same and allow right turns after stopping. From both the survey and the driving simulator experiment, it is clear that there is significant confusion about the expected driver response to the steady red arrow. Because many drivers assume that the expected response is to remain stopped there is an increase in vehicle delay that results from this confusion. Absent any change to ORS 811.360, the use of the R10-17a sign is recommended. The current MUTCD states that:

“Where turns on red are permitted and the signal indication is a steady RED ARROW, the RIGHT (LEFT) ON RED ARROW AFTER STOP (R10-17a) sign should be installed adjacent to the RED ARROW signal indication.”

Use of the R10-17a sign could clear any confusion for the drivers and improve right-turn efficiency at intersections.

2) Add two new signal head types in the applicable ODOT documents, policies and manuals: Replace the TYPE5 signal head with a TYPE3RCF signal head for PPRT operations and add a TYPE 3RF signal head for permissive right turn operations as shown in Figure 7.1.

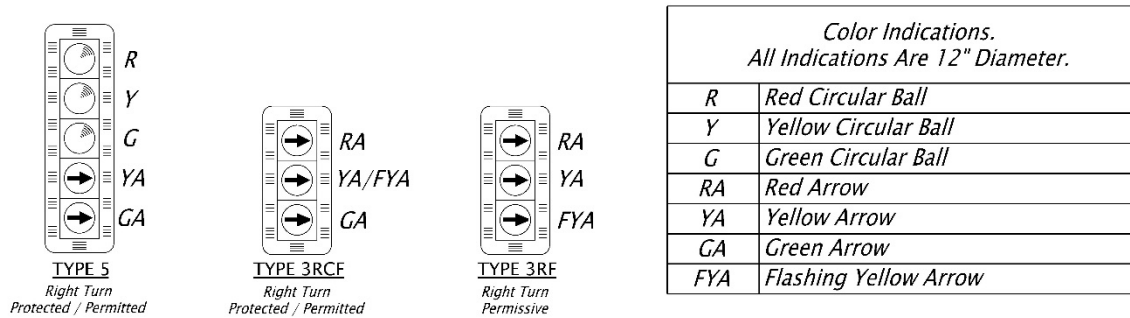

Figure 7.1: Signal Heads for Right-Turn Operations

Current ODOT guidelines allow the use of a 3-section head with center flash for PPLT operations with the approval of the region traffic engineer and the location inventory by the state traffic operations engineer, but a similar signal head type is not described in the traffic signal design manual for PPRT operations. Currently, the TYPE3RCF is in use in Washington County for the PPRT operation and therefore updating the guidance documents will bring the policy in line with practice

8 REFERENCES

- Akcelik, R. *Microsimulation and Analytical Models for Traffic Engineering*. Presentation presented at ARRB-AUSTROADS Microsimulation Forum in Australia, Sept 19-20, 2007. Retrieved from [http://www.sidrasolutions.com/Documents/Akcelik_ARRBMicrosimulationForum\(Sep07\).pdf](http://www.sidrasolutions.com/Documents/Akcelik_ARRBMicrosimulationForum(Sep07).pdf)
- Boot, W., Charness, N., Roque, N., Barajas, K., Dirghalli, J., & Mitchum, A. (2015). *The Flashing Right Turn Signal with Pedestrian Indication: Human Factors Studies to Understand the Potential of a New Signal to Increase Awareness of and Attention to Crossing Pedestrians* (Final ed., p. 0-45, Rep. No. BDV30-977-13). Tallahassee, FL: Florida Department of Transportation. Retrieved from http://www.fdot.gov/research/Completed_Proj/Summary_TE/FDOT-BDV30-977-13-rpt.pdf .
- Chai, C., & Wong, Y. (2014). Micro-simulation of vehicle conflicts involving right-turn vehicles at signalized intersections based on cellular automata. *Accident Analysis & Prevention*, 63, 94-103. doi:10.1016/j.aap.2013.10.023
- Choi, E. (2010). *Crash factors in intersection-related crashes: An on-scene perspective* (p. 0-37, Publication No. DOT HS 811 366). Washington, D.C.: U.S. Dept. of Transportation, National Highway Traffic Safety Administration. Retrieved from <https://crashstats.nhtsa.dot.gov/Api/Public/ViewPublication/811366> .
- Cobb, G. W. (1998). *Introduction to design and analysis of experiments*. Emeryville, CA: Key College Publishing.
- Currans, K., Gehrke, S., & Clifton, K. (2015). Visualizing Neighborhoods in Transportation Surveys: Testing Respondent Perceptions of Housing, Accessibility, and Transportation Characteristics. In *Transportation Research Board 94th Annual Meeting*. Washington, D.C.: Transportation Research Board.
- Dewar, Robert, and Paul Olson. *Human Factors in Traffic Safety*. Lawyers & Judges Publishing Company, 2007.
- Dixon, K., Hibbard, J., & Nyman, H. (2000). Right-turn treatment for signalized intersections. In *Urban Street Symposium: Conference proceedings: Dallas, Texas, June 28-30, 1999* (pp. 1-11). Washington, D.C.: Transportation Research Board, National Research Council.
- Federal Highway Administration. (2015, November 9). Signs and Signals: Right Turn on Red Restrictions. Retrieved from <https://safety.fhwa.dot.gov/saferjourney1/library/countermeasures/44.htm>

- Federal Highway Administration. (2015, November 9). Signs and Signals: Upgrade/Modify Pedestrian Signal Timing. Retrieved from <https://safety.fhwa.dot.gov/saferjourney1/library/countermeasures/41.htm>
- Federal Highway Administration, & U. S. Department Of Transportation. (2008). *Traffic signal timing manual*. CreateSpace Independent Publishing Platform.
- Fisher, D., Pollatsek, A., & Horrey, W. (2011). Eye Behaviors: How Driving Simulators can expand their Role in Science and Engineering. *Handbook of Driving Simulation for Engineering, Medicine, and Psychology*. doi:10.1201/b10836-19
- Fisher, D. L. (2011). *Handbook of driving simulation for engineering, medicine, and psychology* (1st ed.). Boca Raton: CRC Press.
- Fisher, D., Pollatsek, A., & Horrey, W. (2011). Eye Behaviors: How Driving Simulators can expand their Role in Science and Engineering. *Handbook of Driving Simulation for Engineering, Medicine, and Psychology*. doi:10.1201/b10836-19
- Fitzpatrick, K., Schneider, W., & Park, E. (2006). Operation and Safety of Right-Turn Lane Designs. *Transportation Research Record: Journal of the Transportation Research Board*, 1961(1), 55-64. doi:10.3141/1961-07
- Furth, P., Koonce, P., Miao, Y., Peng, F., & Littman, M. (2014). Mitigating Right-Turn Conflict with Protected Yet Concurrent Phasing for Cycle Track and Pedestrian Crossings. *Transportation Research Record: Journal of the Transportation Research Board*, 2438, 81-88. doi:10.3141/2438-09
- Girden, E. R. (1992). *ANOVA: Repeated Measures*. Thousand Oaks, CA: Sage Publications.
- Green, P. Where Do Drivers Look While Driving (and for How Long)? In *Human Factors in Traffic Safety*, 2nd edition (R. E. Dewar, R. Olson, eds.), Lawyers & Judges Publishing, Tucson, 2007, pp. 57–82.
- Hassan, S. (n.d.). *Right Turns on Red Arrow by State Does your state allow it ?* Lecture presented at 2016 TRB – Annual Meeting, Washington, D.C.
- Highway Design Manual*. Oregon Dept. of Transportation, 2012, www.oregon.gov/ODOT/Engineering/Documents_RoadwayEng/HDM_00-Full-Report.pdf
- Houten, R., Retting, R., Farmer, C., & Houten, J. (2000). Field Evaluation of a Leading Pedestrian Interval Signal Phase at Three Urban Intersections. *Transportation Research Record: Journal of the Transportation Research Board*, 1734, 86-92. doi:10.3141/1734-13
- Hubbard, S. M., Bullock, D. M., & Mannering, F. L. (2009). Right Turns on Green and Pedestrian Level of Service: Statistical Assessment. *Journal of Transportation Engineering*, 135(4), 153-159. doi:10.1061/(asce)0733-947x(2009)135:4(153)

- Hurwitz, D., Jannat, M., Warner, J., Monsere, C., & Razmpa, A. (2015, July 8). *Towards Effective Design Treatment For Right Turns at Intersections with Bicycle Traffic*. (Publication No. SPR 767). Retrieved http://www.oregon.gov/ODOT/Programs/ResearchDocuments/SPR767_FinalReport_070815.pdf
- Leden, Lars. "Pedestrian Risk Decrease with Pedestrian Flow. A Case Study Based on Data from Signalized Intersections in Hamilton, Ontario." *Accident Analysis & Prevention*, vol. 34, no. 4, 2002, pp. 457–464., doi:10.1016/s0001-4575(01)00043-4.
- Lin, P., Kourtellis, A., Wang, Z., & Guo, R. (2015, October). *Understanding Interactions between Drivers and Pedestrian Features at Signalized Intersections* (Publication No. BDV25 TWO 977-16). Retrieved http://www.fdot.gov/research/Completed_Proj/Summary_OP/FDOT-BDV25-977-16-rpt.pdf.
- National Association of City Transportation Officials. *NACTO Urban Street Design Guide: Overview*. Island Press, 2012.
- Oregon State University. (2012, October 30). Driving and Bicycling Simulator. Retrieved November 26, 2017, from <http://cce.oregonstate.edu/driving-and-bicycling-simulator>
- Oregon State University. (2012, November 15). Driving and Bicycling Simulator Research. Retrieved May 30, 2013, from <http://cce.oregonstate.edu/driving-and-bicycling-simulator-research>
- Owens, D. A., & Tyrrell, R. A. (1999). Effects of luminance, blur, and age on nighttime visual guidance: A test of the selective degradation hypothesis. *Journal of Experimental Psychology: Applied*, 5(2), 115-128. doi:10.1037//1076-898x.5.2.115
- Qureshi, M., & Han, L. (2001). Delay Model for Right-Turn Lanes at Signalized Intersections with Uniform Arrivals and Right Turns on Red. *Transportation Research Record: Journal of the Transportation Research Board*, 1776, 143-150. doi:10.3141/1776-19
- Rao, M., & Ni, Y. (2016). *Pedestrian-vehicle Conflict Risk Analysis in Different Right-turn Signal Schemes at Intersection* (Publication No. 16-5263). Retrieved from <https://trid.trb.org/view/1393943>.
- Rodegerdts, L. A., Nevers, B., Robinson, B., Ringert, J., Koonce, P., Bansen, J., . . . Courage, K. (2004). *Signalized Intersections: Informational Guide* (p. 0-369, Publication No. FHWA-HRT-04-091). McLean, VA: Federal Highway Administration. Retrieved from <https://www.fhwa.dot.gov/publications/research/safety/04091/04091.pdf>.
- Rietgraf, A., & Schattler, K. (2013). Behavior of Left-Turning Drivers During Permissive Interval of Protected-Permissive Operation. *Transportation Research Record: Journal of the Transportation Research Board*, 2384, 35-44. doi:10.3141/2384-05

- Schattler, K. L., Marc, B., Travis, W., & Robert, F. (2015). *Areawide Analysis of Right Turn Crashes at Intersections with Channelized Islands* (p. 0-17, Tech. No. 47). Vancouver, Canada.
- Steinma, N., & Hines, D. (2004). Methodology to Assess Design Features for Pedestrian and Bicyclist Crossings at Signalized Intersections. *Transportation Research Record: Journal of the Transportation Research Board*, 1878, 42-50. doi:10.3141/1878-06
- Schattler, K. L., Marc, B., Travis, W., & Robert, F. (2015). *Areawide Analysis of Right Turn Crashes at Intersections with Channelized Islands* (p. 0-17, Tech. No. 47). Vancouver, Canada.
- Stevanovic, A., Abdel-Rahim, A., Zlatkovic, M., & Amin, E. (2009). Microscopic Modeling of Traffic Signal Operations. *Transportation Research Record: Journal of the Transportation Research Board*, 2128, 143-151. doi:10.3141/2128-15
- Swake, J., M. Jannat, M. Islam, and D. Hurwitz. *Driver Response to Phase Termination at Signalized Intersections: Are Driving Simulator Results Valid?* Presented at the 7th International Driving Symposium on Human Factors in Driving Assessment, Training, and Vehicle Design, Bolton Landing, NY, 2013.
- U.S. Census Bureau. (n.d.). American Community Survey (ACS). Retrieved from <https://www.census.gov/programs-surveys/acs/> .
- U.S. Census Bureau. (n.d.). U.S. Census Bureau QuickFacts: UNITED STATES. Retrieved from <https://www.census.gov/quickfacts/fact/table/US/PST045217> .
- Urbanik, T. (2015). *Signal timing manual* (03-103). Washington, D.C.: Transportation Research Board. doi:10.17226/22097
- Zhao, J., Yun, M., Zhang, H. M., & Yang, X. (2015). Driving simulator evaluation of drivers' response to intersections with dynamic use of exit-lanes for left-turn. *Accident Analysis & Prevention*, 81, 107-119. doi:10.1016/j.aap.2015.04.028

APPENDIX A - NHTSA DATA

Table 5. Driver-attributed critical reasons by traffic control device and critical pre-crash event										
Traffic Control Device	CRITREASON	Z-values			Observed frequency			Expected frequency		
		Turn left	Cross over	Turn right	Turn left	Cross over	Turn right	Turn left	Cross over	Turn right
Traffic Signal	Inadequate Surveillance	6	-62	-20	110,785	51,116	2,076	108,923	67,223	3,232
	Internal Distraction	-82	144*	37	4,092	21,780	1,160	13,740	8,480	408
	Inattention	-66	109*	-16	2,371	12,996	0	8,362	5,161	248
	External Distraction	12*	-1	-12	5,974	3,063	0	5,090	3,142	151
	False Assumption of Other's Action	151*	-73	-10	42,327	4,542	375	20,681	12,764	614
	Illegal Maneuver	-89	167*	41	4,388	25,830	1,339	15,471	9,548	459
	Misjudgment of Gap or Other's Speed	12*	-89	28	14,856	181	957	13,415	8,279	398
	Too Fast for Conditions or Aggressive Driving	-42	84*	2	187	4,340	79	2,123	1,310	63
	Turned With Obstructed View	29*	-108	-17	22,684	0	165	18,747	11,570	556
	Performance Error	-21	9	6	735	1,251	88	1,574	971	47
	Critical Non-Performance Error	-6	92*	-8	1,875	4,676	0	2,147	1,325	64
Stop Sign	Inadequate Surveillance	39*	37*	-39	51,385	59,007	1,102	43,336	50,614	3,400
	Internal Distraction	-64	5	-19	709	6,792	35	5,467	6,385	429
	Inattention	-45	45*	-16	760	6,720	0	3,327	3,886	261
	External Distraction	-45	26*	-13	0	3,614	0	2,025	2,365	159
	False Assumption of Other's Action	-49	-50	127*	3,819	4,691	3,882	8,228	9,610	646
	Illegal Maneuver	-35	36*	2	3,437	10,226	518	6,156	7,189	483
	Misjudgment of Gap or Other's Speed	39*	-8	-20	8,186	5,640	0	5,337	6,234	419
	Too Fast for Conditions or Aggressive Driving	-29	-11	-8	0	641	0	845	986	66
	Turned With Obstructed View	84*	-91	9	14,675	210	800	7,459	8,711	585
	Performance Error	3	-22	25	689	130	227	626	731	49
	Critical Non-Performance Error	-29	-30	-8	0	38	0	854	998	67
None	Inadequate Surveillance	10*	9	-33	53,639	4,254	874	51,274	3,729	2,507
	Internal Distraction	-17	70	10	5,106	1,993	497	6,468	470	316
	Inattention	-18	-17	-14	2,812	0	0	3,936	286	192
	External Distraction	12*	-13	-11	2,969	0	0	2,396	174	117
	False Assumption of Other's Action	-64	-24	-7	3,451	58	317	9,735	708	476
	Illegal Maneuver	-78	13	-3	595	836	308	7,283	530	356
	Misjudgment of Gap or Other's Speed	63*	-19	-18	11,287	58	0	6,315	459	309
	Too Fast for Conditions or Aggressive Driving	-23	-9	134	285	0	983	999	73	49
	Turned With Obstructed View	97*	-25	28	17,974	0	1,019	8,825	642	432
	Performance Error	5	-7	134	866	0	843	741	54	36
	Critical Non-Performance Error	-32	-9	-7	0	0	0	1,011	73	49

Note: * statistically significant

Data Source: NMVCCS 2005-2007

APPENDIX B - SURVEY INSTRUMENT

SURVEY INSTRUMENT

This online survey is being conducted by Portland State University and Oregon State University as part of a research project for the Oregon Department of Transportation. This survey should only take you about 10 minutes or less to complete. Your involvement in this study is completely voluntary, and you may choose not to participate or stop your participation at any point without consequence.

This survey consists of a series of questions asking about your interpretation of the signal display indications for right-turn movements. We will protect the confidentiality of your individual responses. The information you provide will only be used for the purposes of this study. The findings from this study are intended to help inform decision tools and policy needs. If published, the results will be presented in summary form only.

By clicking below and completing this online survey, you acknowledge that you:

- **are at least 18 years of age;**
- **have a valid driver's license from a U.S. state; and**
- **agree to participate in the Driver Comprehension Survey.**

After the survey, you will have the option to be directed to another survey to enter your name into a drawing for a chance to win a \$100 gift card to Amazon. The contact information you provide will not be linked to your survey responses.

If you have any concerns, injury, or problems about your participation in our Driver Comprehension Study or your rights as a research subject, please contact the Human Subjects Research Review Committee, Office of Research and Strategic Partnerships, Post Office Box 751, Portland State University, (877) 480-4400. If you have any questions about the Driver Comprehension Study, please feel free to call us at (503)725-9746 or email us at monsere@pdx.edu.

Thank you,

Dr. Chris Monsere, co-PI
Department of Civil and Environmental Engineering
Portland State University

Dr. David Hurwitz, co-PI
School of Civil and Construction Engineering
Oregon State University

Please begin this survey by entering the **HOUSEHOLD ID NUMBER** provided on the postcard we sent you:
We only need this information to track the number of responses in each county to calculate a response rate. We will not associate your household address with your responses.

What is your AGE?

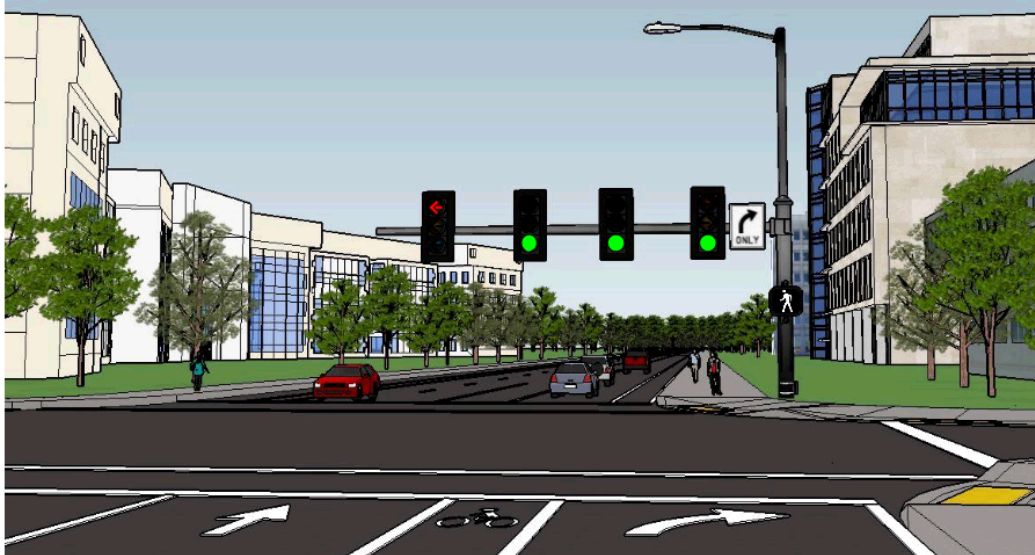

Imagine that you are approaching the intersection in **the lane farthest to the right and planning to TURN RIGHT.**

What action would you take based on the current signal display?

Please type your response in the box below and be as descriptive as possible

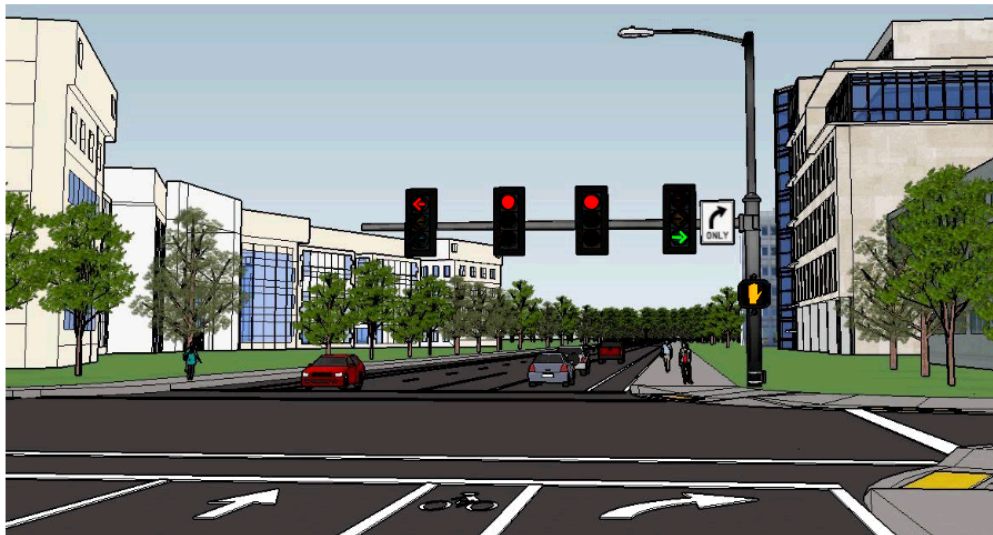

Imagine that you are approaching the intersection in **the lane farthest to the right and planning to TURN RIGHT.**

What action would you take based on the current signal display?

Please type your response in the box below and be as descriptive as possible

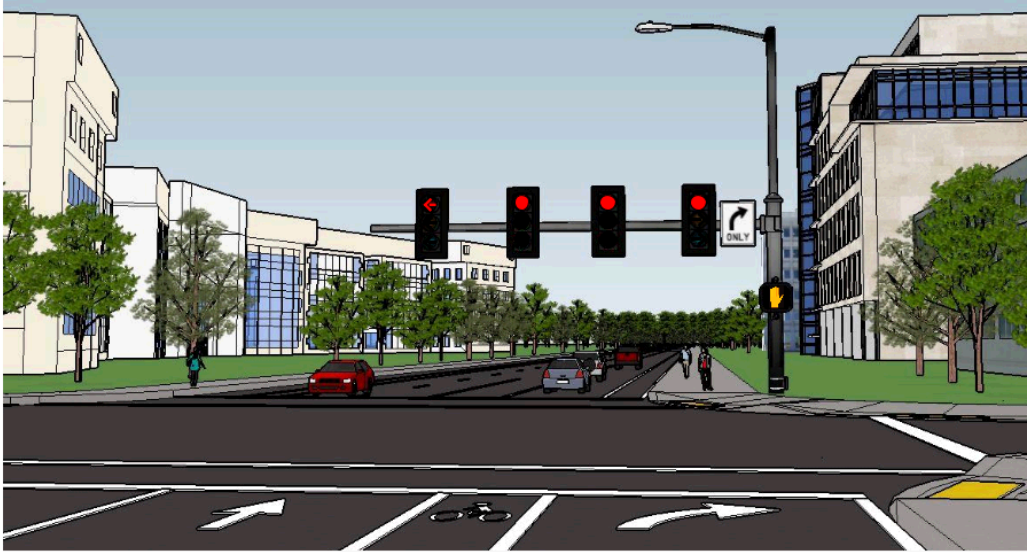

Imagine that you are approaching the intersection in **the lane farthest to the right and planning to TURN RIGHT.**

What action would you take based on the current signal display?

Please type your response in the box below and be as descriptive as possible

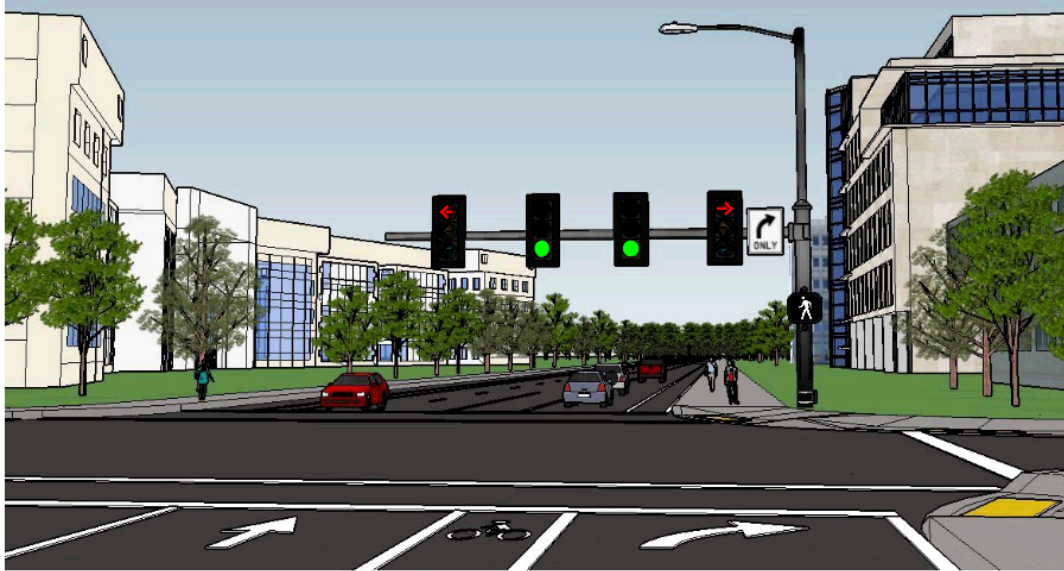

Imagine that you are approaching the intersection in **the lane farthest to the right and planning to TURN RIGHT.**

What action would you take based on the current signal display?

Please type your response in the box below and be as descriptive as possible

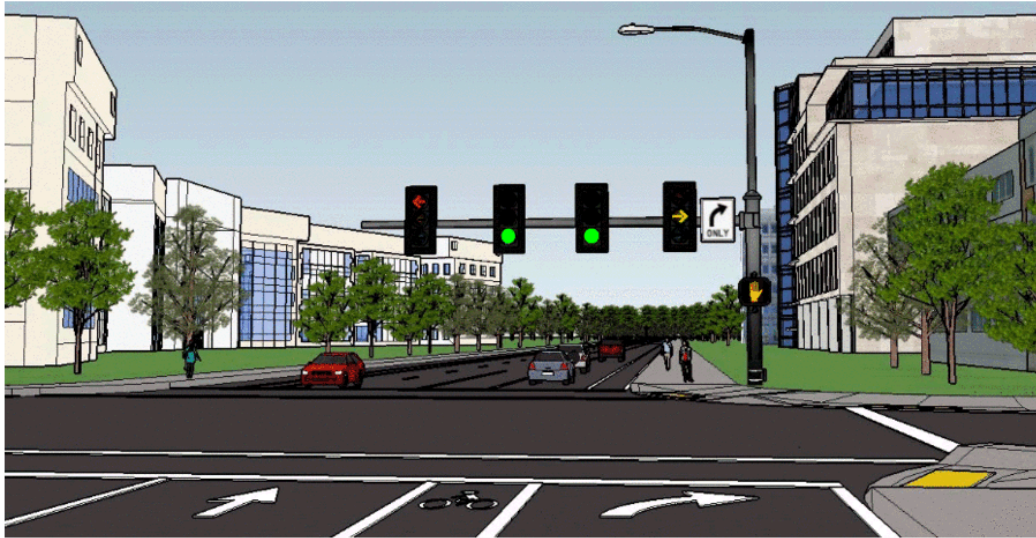

Imagine that you are approaching the intersection in **the lane farthest to the right and planning to TURN RIGHT.**

What action would you take based on the current signal display?

Please type your response in the box below and be as descriptive as possible

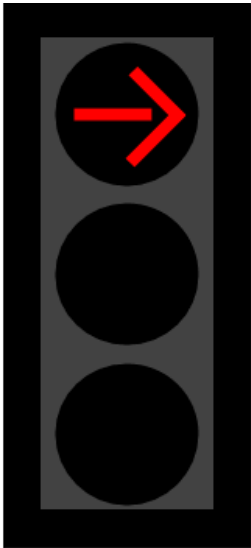

In Oregon, if you are turning right and you see the steady red right arrow display, what would be the appropriate response?

- I can turn right without stopping
- I can turn right, but must come to a complete stop and find a gap before turning.
- I must stop and wait until I receive a green indication before turning.

How confident are you of your answer?

- Very Confident
- Confident
- Neutral
- Somewhat Confident
- Not at all Confident

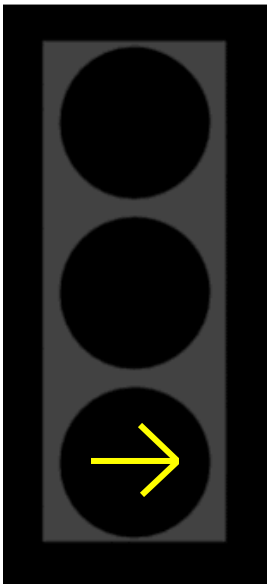

In Oregon, if you are turning right and you see the flashing yellow arrow display, what would be the appropriate response?

- I can turn right without stopping
- I can turn right, but must come to a complete stop and find a gap before turning.
- I must stop and wait until I receive a green indication before turning.

How confident are you of your answer?

- Very Confident
- Confident
- Neutral
- Somewhat Confident
- Not at all Confident

For the next two questions, imagine you are turning right as in the previous scenarios.

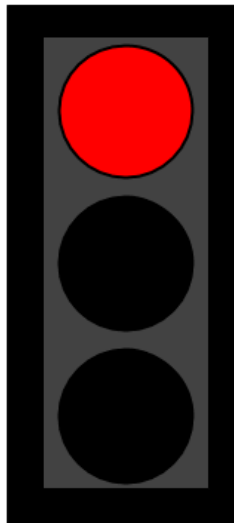
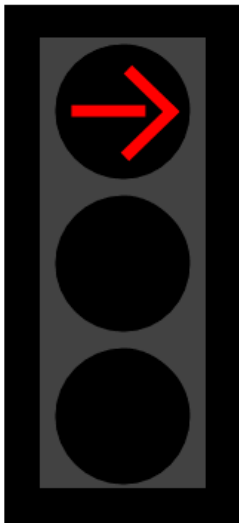

Consider the two displays: 1) steady red arrow 2) steady circular red ball. As a driver, do these mean the same thing to you?

- Yes – They mean the same to me
- No –They mean different things

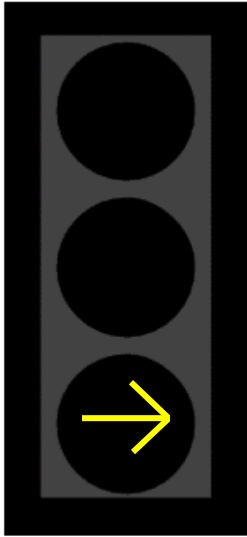

Consider the two displays: 1) steady red arrow 2) steady circular red ball. As a driver, do these mean the same thing to you?

- Yes – They mean the same to me
- No –They mean different things

We will now ask 11 short questions about you. Your responses will help us in our analysis of the prior responses.

How often do you DRIVE in a week?

- 1 time per week
- 2 – 4 times per week
- 5 – 10 times per week
- More than 10 times per week

How LONG have you had your driver's license?

- 1 – 2 years
- 3 – 5 years
- 6 – 10 years
- More than 10 years

On average, how many MILES do you drive per year?

- Less than 5,000
- 5,000 – 9,999
- 10,000 – 14,999
- 15,000 – 19,999
- 20,000 or more

Is your driver's license issued by the State of Oregon?

- Yes
- No

If NO please select which U.S. state your drivers license was issued from.

If you selected OTHER, please type the name of the country or place where your drivers license was issued from.

What GENDER do you most identify with?

- Male
- Female
- Other

Are you COLOR BLIND?

- Yes
- No
- Prefer not to say/Don't know

Do you currently wear CORRECTIVE GLASSES or contacts?

- Yes
- No
- Prefer not to say/Don't know

Which race do you consider yourself?

- American Indian or Alaska Native
- Asian
- Black or African American
- Hispanic or Latino/a
- White or Caucasian
- Other
- I prefer not to provide this information

What is your annual HOUSEHOLD INCOME?

- Less than \$25,000
- @5,000 to less than \$50,000
- \$50,000 to less than \$75,000
- \$75,000 to less than \$100,000
- \$100,000 to less than \$200,000
- \$200,000 or more
- I prefer not to provide this information

What is the highest LEVEL OF EDUCATION you have completed?

- No schooling completed, or less than 1 year
- Nursery, kindergarten, and elementary grades (grades 1-8)
- High school (grades 9-12), no degree
- High school graduate (or equivalent)
- Some college (1-4 years, no degree)
- Associate degree (including occupational or academic degrees)
- Bachelor's degree (BA, BS, AB, etc)
- Masters's degree (MA, MS, MENG, MSW, etc)

- Professional school degree (MD, DDC, JD, etc)
- Doctorate degree (PhD, EdD, etc)
- I prefer not to respond

Thank you for completing our online survey. We appreciate your time and value your input.

Please click "Continue" below if you would like to be entered into a drawing to win a \$100 Amazon gift card! The contact information you provide for the drawing entry will not be linked to the survey entry you completed in any way.

APPENDIX C - SAMPLE OPEN-ENDED RESPONSES

Sample Open Ended Responses

GREEN CIRCULAR

Correct

- “Check for pedestrians (particularly those using the crosswalk on the right) and, if safe, proceed to turn right.”
- “Yield to bikes and pedestrian, if any, then turn right.”

Incorrect/partially correct

- “turn right without stopping”
- “I’d turn right without hesitation”

GREEN ARROW

Correct

- “Turn right without stopping”
- “reduce speed and make a right turn into nearest lane to right hand side. no requirement to stop or yield.”

Incorrect/partially correct

- “Check for possible pedestrian traffic, make sure intersection has no cross traffic and proceed when safe.”
- “Look for pedestrians and turn right”

RED CIRCULAR

Correct

- “I would stop. Clear intersection, look left, right, left. Clear crosswalk for pedestrians, check mirrors. If it is safe to do so, I will proceed with making a right turn”
- “I would stop at the intersection. I would then consider whether cross traffic volume and pedestrian traffic volume might make it possible for me to make the right turn on red. Otherwise, I would wait for a green light to turn right.”

Incorrect/partially correct

- “Use right signal and stop at the line”.
- “Stop. Wait for green light in my lane. Red light looks to be specific to my lane”.

RED ARROW

Correct

- “Turn signal on, check blind spot, move to right side of lane, slow down, check for cross traffic and pedestrians as approach the corner, and stop at the corner. Verify traffic and pedestrians are clear, then make the turn”
- “Stop. Look for pedestrians then cross traffic and proceed if clear”.

Incorrect/partially correct

- stay stopped, and do not turn right as long as right-turn arrow is red
- Remain in far right lane. Stop behind the crosswalk. Turn right after the light changes.

FLASHING YELLOW ARROW

Correct

- “Turn signal on indicating a right turn. Light is flashing yellow so I can continue with caution for any turning automobiles or bikes. Pedestrians should not be crossing because of the Don't Walk sign, but I would continue to monitor crosswalk for the unexpected pedestrian walking on a Don't Walk signal. Proceed around turn and down street if safe to proceed.”
- “proceed with caution.”

Incorrect/partially correct

- “I would stop and wait to turn when it was clear to do so.”
- “Stop, then proceed to turn right if all is clear (no pedestrians preparing to cross, no cars coming from the left or turning into that lane from across the street).”

**APPENDIX D - GRID LAYOUTS AND
FIGURES OF SURVEY-SIMULATOR RESPONSES**

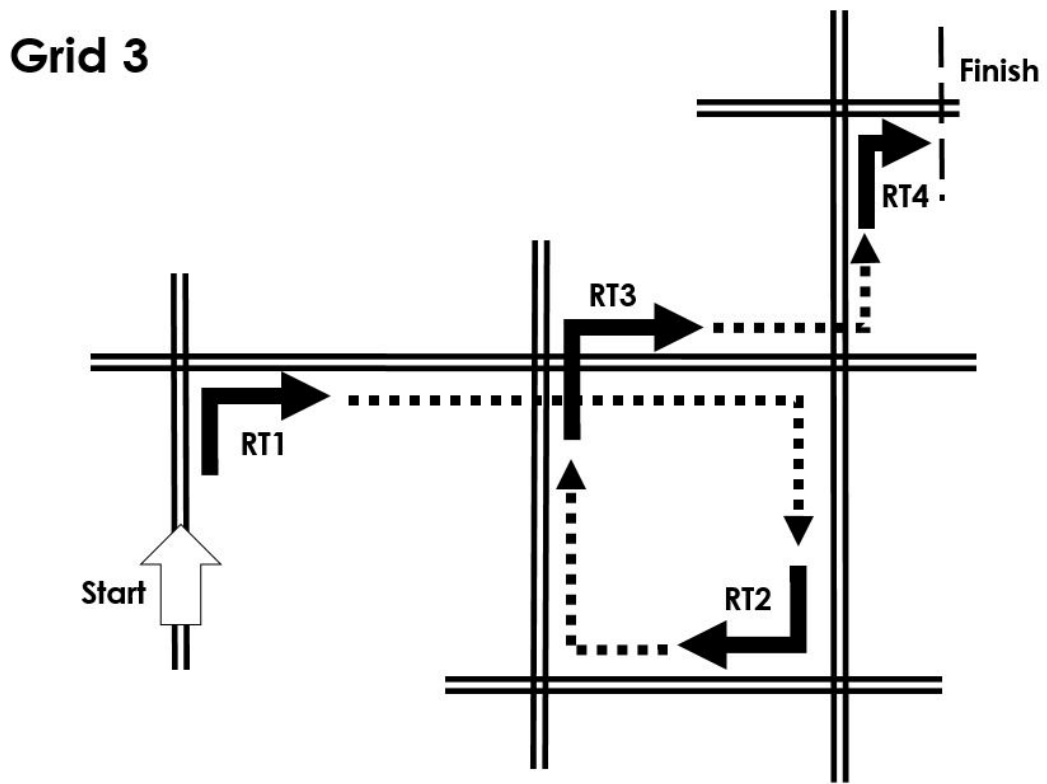
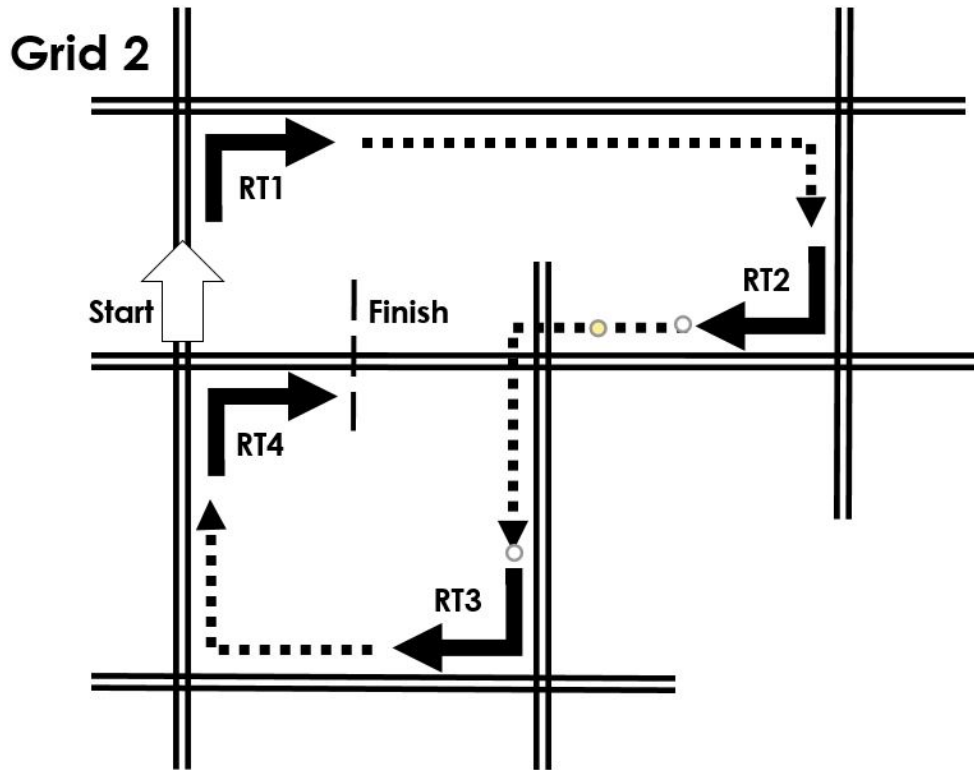

Grid 4

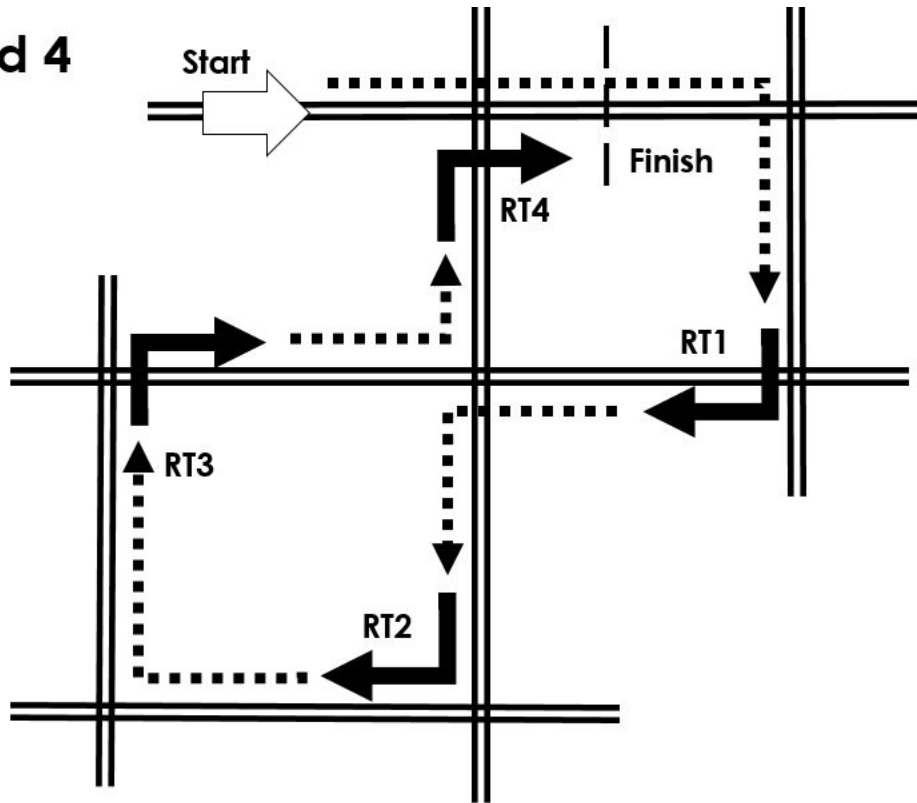

Grid 5

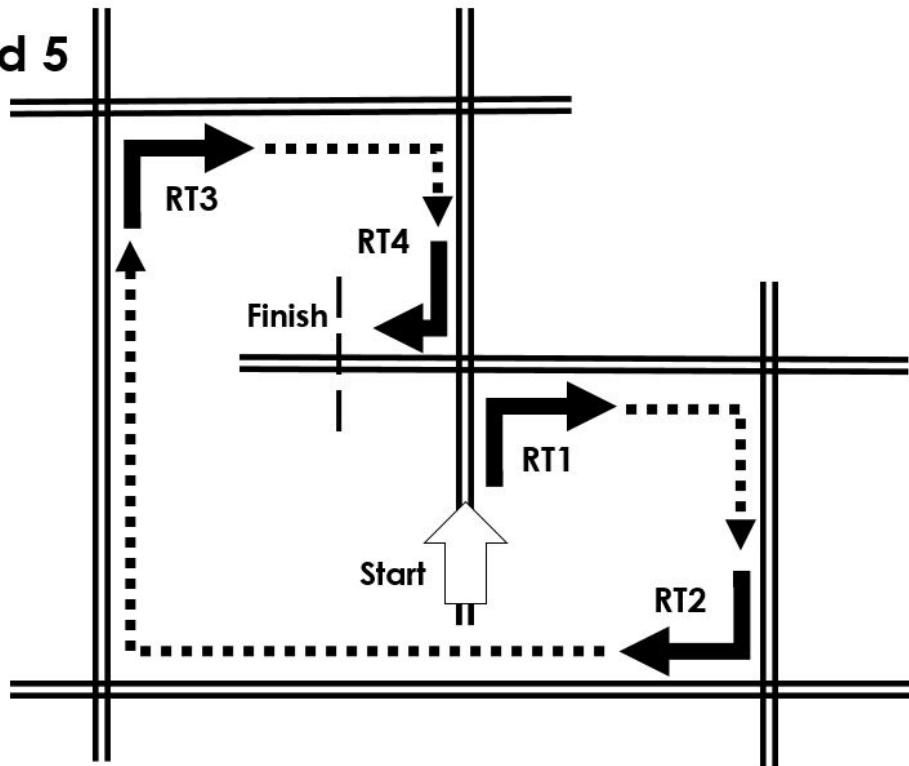

Grid 6

