

Effects of Wheel-Load Spatial Repeatability on Road Damage: A Literature Review



PB99-107435

PUBLICATION NO. FHWA-RD-97-036

SEPTEMBER 1998

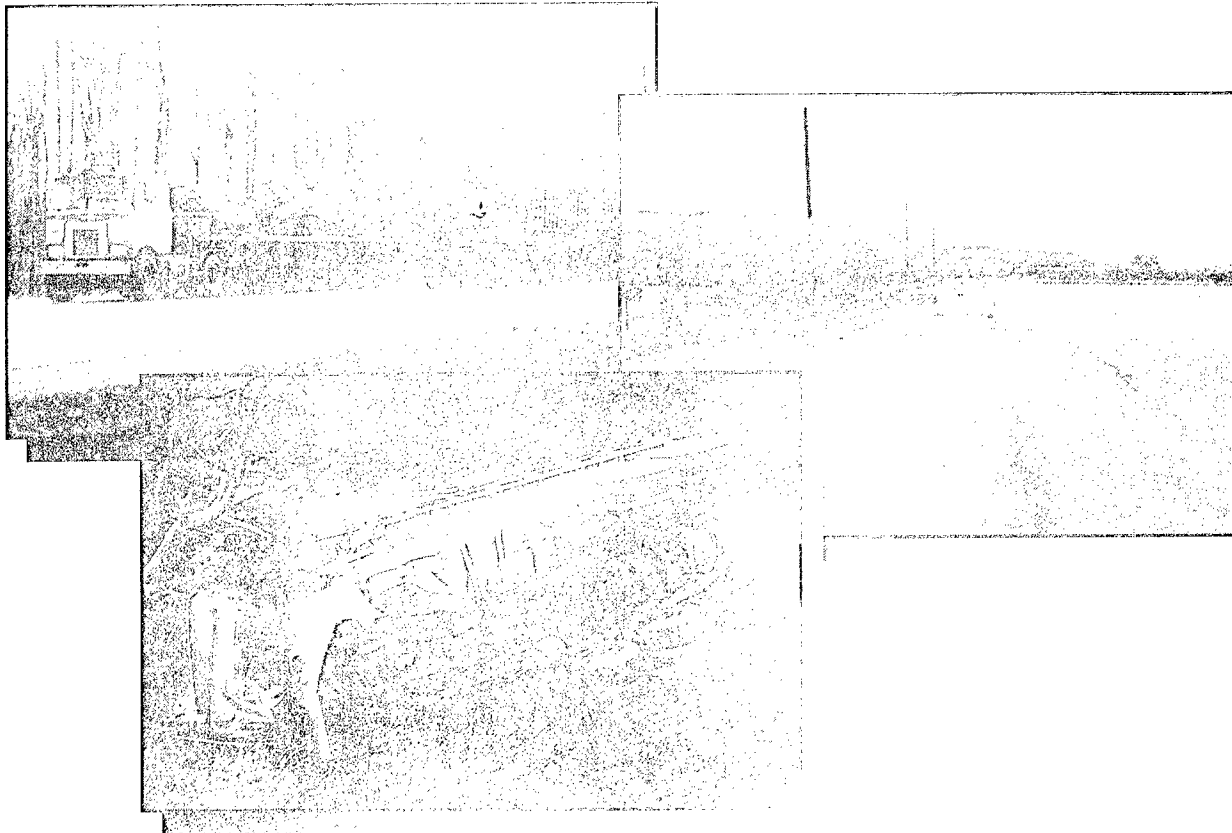

U.S. Department of Transportation
Federal Highway Administration

Research and Development
Turner-Fairbank Highway Research Center
6300 Georgetown Pike
McLean, VA 22101-2296

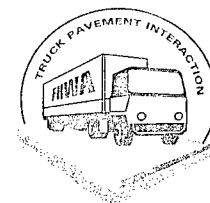

REPRODUCED BY:
U.S. Department of Commerce
National Technical Information Service
Springfield, Virginia 22161

NTIS

FOREWORD

This report reviews the available literature on the effects of spatial repeatability of dynamic wheel loads on pavement damage produced by heavy road vehicles due to different types of suspension systems and the use of wide-base single versus dual tires.

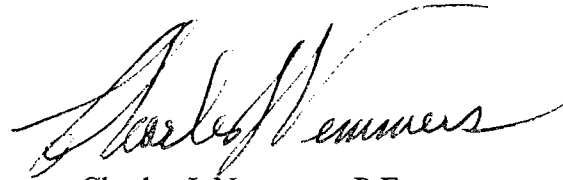
A handwritten signature in black ink, reading "Charles J. Nemmers". The signature is fluid and cursive, with a long horizontal stroke at the end.

Charles J. Nemmers, P.E.
Director, Office of Engineering
Research and Development

NOTICE

This document is disseminated under the sponsorship of the Department of Transportation in the interest of information exchange. The United States Government assumes no liability for its contents or use thereof. This report does not constitute a standard, specification, or regulation.

The United States Government does not endorse products or manufacturers. Trade and manufacturers' names appear in this report only because they are considered essential to the object of the document.

1. Report No. FHWA-RD-97-036	2  PB99-107435	3. Recipient's Catalog No.	
4. Title and Subtitle EFFECTS OF WHEEL-LOAD SPATIAL REPEATABILITY ON ROAD DAMAGE: A LITERATURE REVIEW		5. Report Date September 1998	
7. Author(s) Nezih Mrad, Moustafa El-Gindy, and William Kenis		6. Performing Organization Code 8. Performing Organization Report No. CSTT-HWV-CTR-022	
9. Performing Organization Name and Address National Research Council of Canada Centre for Surface Transportation Technology U-89 Alert Rd., Uplands Ottawa, Ontario, Canada K1A 0R6		10. Work Unit No. (TRAIS) 3C4A	
12. Sponsoring Agency Name and Address Office of Engineering Research and Development Federal Highway Administration 6300 Georgetown Pike McLean, Virginia 22101-2296		11. Contract or Grant No. DTFH61-96-Z-00022	
15. Supplementary Notes Contracting Officer's Technical Representative (COTR): Bill Kenis, HNR-30		13. Type of Report and Period Covered 10/01/96 - 10/01/97	
16. Abstract Concerns about growing governmental budgetary deficits and the awareness of the economic advantages associated with a safe and well-maintained road infrastructure are two of the main reasons for devoting attention to better understanding the problem of pavement wear caused by heavy road vehicles. The objective of this report is to conduct a review of the present and previously developed work devoted to the study of vehicle/road interaction. In particular, two of the most pressing questions that are to be answered in the area of heavy vehicle-generated road damage deal with the spatial repeatability of dynamic wheel loads produced by heavy road vehicles due to different types of suspension systems and the use of wide-base dual tires. The outcome of this review, which is a part of the Federal Highway Administration (FHWA) Truck Pavement Interaction research program on truck size and weight, plays a determining role in assessing heavy truck suspension systems, tire configurations, and their contribution to pavement damage.		14. Sponsoring Agency Code	
17. Key Words Spatial repeatability, truck dynamics, pavement damage.	18. Distribution Statement No restrictions. This document is available to the public through the National Technical Information Service, Springfield, Virginia 22161.		
19. Security Classif. (of this report) Unclassified	20. Security Classif. (of this page) Unclassified	21. No. of Pages 50	22. Price

SI* (MODERN METRIC) CONVERSION FACTORS

APPROXIMATE CONVERSIONS FROM SI UNITS

Symbol	When You Know	Multiply By	To Find	Symbol	When You Know	Multiply By	To Find	Symbol
LENGTH								
in	inches	25.4	millimeters	mm	millimeters	0.039	inches	in
ft	feet	0.305	meters	m	meters	3.28	feet	ft
yd	yards	0.914	meters	m	kilometers	1.09	yards	yd
mi	miles	1.61	kilometers	km		0.621	miles	mi
AREA								
in ²	square inches	645.2	square millimeters	mm ²	square millimeters	0.0016	square inches	in ²
ft ²	square feet	0.093	square meters	m ²	square meters	10.764	square feet	ft ²
yd ²	square yards	0.836	square meters	m ²	square meters	1.195	square yards	yd ²
ac	acres	0.405	hectares	ha	hectares	2.47	acres	ac
mi ²	square miles	2.59	square kilometers	km ²	square kilometers	0.386	square miles	mi ²
VOLUME								
fl oz	fluid ounces	29.57	milliliters	mL	milliliters	0.034	fluid ounces	fl oz
gal	gallons	3.785	liters	L	liters	0.264	gallons	gal
ft ³	cubic feet	0.028	cubic meters	m ³	cubic meters	35.71	cubic feet	ft ³
yd ³	cubic yards	0.765	cubic meters	m ³	cubic meters	1.307	cubic yards	yd ³
NOTE: Volumes greater than 1000 l shall be shown in m ³								
MASS								
oz	ounces	28.35	grams	g	grams	0.035	ounces	oz
lb	pounds	0.454	kilograms	kg	kilograms	2.202	pounds	lb
T	short tons (2000 lb)	0.907	megagrams (or "metric ton")	Mg (or "t")	megagrams (or "metric ton")	1.103	short tons (2000 lb)	T
TEMPERATURE (exact)								
°F	Fahrenheit temperature	5(F-32)/9 or (F-32)/1.8	Celsius temperature	°C	Celsius temperature	1.8C + 32	Fahrenheit temperature	°F
ILLUMINATION								
fc	foot-candles	10.76	lux	lx	lux	0.0929	foot-candles	fc
fl	foot-Lamberts	3.426	candela/m ²	cd/m ²	candela/m ²	0.2919	foot-Lamberts	fl
FORCE and PRESSURE or STRESS								
lbf	poundforce	4.45	newtons	N	newtons	0.225	poundforce	lbf
lbf/in ²	poundforce per square inch	6.89	kilopascals	kPa	kilopascals	0.145	poundforce per square inch	lbf/in ²

* SI is the symbol for the International System of Units. Appropriate rounding should be made to comply with Section 4 of ASTM E380. (Revised September 1993)

TABLE OF CONTENTS

INTRODUCTION	1
SPATIAL REPEATABILITY	2
Measure of Road Loadings.....	4
Measure of Spatial Repeatability.....	5
Mean Separation of Wheel Force Peaks.....	5
Correlation Coefficient.....	5
Spatial Repeatability Index	6
EFFECTS OF SUSPENSION VARIATION ON ROAD DAMAGE.....	7
Effects of Suspension Characteristics on Dynamic Tire Forces.....	9
Spatial Repeatability of Dynamic Tire Forces.....	19
EFFECTS OF TIRE FACTORS ON ROAD DAMAGE	31
CONCLUSIONS.....	38
RECOMMENDATIONS	39
REFERENCES	41

LIST OF FIGURES

1.	Measured wheel-load variations on the axles of a tandem leaf-spring suspension plotted as a function of distance for three runs over the same section of test track at 32 km/h	3
2.	Measured values of SRI on a test track for articulated and rigid vehicles with different types of suspension systems.....	7
3.	Correlation coefficient versus phase distance for frequencies of 3 and 15 Hz and a speed of 22 m/s and correlation coefficient threshold.....	8
4.	Phase-shifted dynamic tire force history.....	8
5.	Reduction of dynamic wheel loads in the tractor drive axle due to reduction of static wheel loads by introduction of an air-suspension lift axle	10
6.	Reduction of dynamic wheel loads in the trailer axle due to reduction of static wheel loads by introduction of an air-suspension lift axle.....	10
7.	Tractor drive walking-beam suspension (Hendrickson RTE 440 - extended leaf tandem)	11
8.	Trailer drive walking-beam suspension (Chalmers 754-44-LW)	11
9.	Air suspension trailer lift axle (Neway AR95-14).....	11
10.	Typical suspensions used on heavy trucks.....	12
11.	Effects of variation of trailer suspension type, vehicle speed, and road roughness on the dynamic wheel forces of the tractor.....	13
12.	Effects of variation of trailer suspension type, vehicle speed, and road roughness on the dynamic wheel forces of the trailer	13
13.	Maximum impact factors for air and steel suspensions for all axles of a tridem tractor-semitrailer.....	14
14.	Two-axle semi-trailer dynamic load coefficients measured on a medium section of the TRL track	16
15.	Drive axle dynamic load coefficients measured on a medium section of the TRL track	16
16.	Three-axle semi-trailer dynamic load coefficients measured on a medium section of the TRL track	16
17.	Drive axle dynamic pavement wear factors measured on a rough section of the TRL track.....	17
18.	Dynamic loads for one wheel of a semi-trailer on a rough section of the TRL track	20
19.	Cumulative impact factor for heavy vehicle wheels on a trunk road.....	21
20.	Impact factors for heavy vehicle wheels on a TRL road site (Abington site).....	21
21.	Impact factors for second axle of a two-axle rigid laboratory test vehicle traveling on a smooth RN10 highway at approximately 45 km/h	22
22.	Impact factors for second axle of a two-axle rigid laboratory test vehicle traveling on a smooth RN10 highway at approximately 58 km/h	22
23.	Mean impact factors for type 5 vehicles	23
24.	Vehicle-type silhouettes.....	23
25.	Impact factors for the first axle of type 5 vehicles on a specific day (s = steel suspension, a = air suspension)	23

26.	Mean impact factors for type 5 vehicles from total traffic flow	24
27.	Impact factors for different types of vehicles - Types 1 through 9.....	24
28.	Correlation coefficients for specific wheels in repeated runs	26
29.	Correlation coefficients for specific wheels in runs conducted at different speeds	27
30.	Typical PSD for air-spring suspension	28
31.	Typical PSD for walking-beam suspension.....	28
32.	Correlation coefficients for specific wheels from similar and different tractor suspensions	29
33.	Correlation coefficients between wheel loads of lead and trailing axles of tandem-axle groups.....	29
34.	Correlation coefficients between tractor and trailer wheel loads in repeated runs.....	30
35.	Comparison of load versus deflection data and vertical stiffness (K) for dual tires and wide-base single tires	33
36.	Load versus deflection for conventional tire under different pressures.....	33
37.	Load versus deflection for wide-base tire under different pressures	33
38.	Rigid pavement stress functions of conventional single, dual, and wide-base tires.....	34
39.	Flexible pavement strain functions of conventional single, dual, and wide-base tires.....	34
40.	Rutting functions of conventional single, dual, and wide-base tires	34
41.	Rigid pavement fatigue damage versus inflation pressure for dual and wide-base tires.....	35
42.	Flexible pavement fatigue damage versus inflation pressure for dual and wide-base tires	35
43.	Rut depth versus inflation pressure for dual and wide-base tires	35
44.	Measured peak deflection profiles under dual and wide-base tires on a road section	36
45.	Speed effect on average vertical compressive strain at the top of a thick section of road under dual and wide-base tires	36
46.	Effect of dual and wide-base tire loads on footprint area	37
47.	Average locked wheel stopping distances on wet pavement, loaded and unloaded trailer	37

LIST OF TABLES

1.	Potential reduction in dynamic pavement wear at 90 km/h on a medium roughness TRL test track	15
2.	DLCs for different types of suspension systems of the NRC truck traveling on a test track with an RCR of 5.2 and a vehicle speed of 80 km/h	18
3.	DLCs for tractor suspensions	19
4.	Pavement wear increases resulting from the use of a steel-spring walking-beam suspension versus an air-spring suspension	25
5.	Tire types and physical characteristics	31

INTRODUCTION

A road develops permanent deformation (ruts) or fatigue damage (cracks) because of the stress and strain induced in its structure by surface loading and climatic changes. A vehicle's static and dynamic wheel loads (DWLs)¹ contributing to surface loading have a great impact on pavement distress and premature road failure. These failures constitute a substantial financial burden on society at large in maintaining a good road infrastructure. It is estimated that the United Kingdom's annual expenditure on road maintenance is approximately £2.6 billion (equivalent to US\$1.6 billion), of which £1.2 billion (equivalent to US\$738 million) is spent on resurfacing and patching (these costs do not reflect the time lost in traffic delays). Of the £1.2 billion, approximately half can be attributed directly to heavy road vehicles, and much of the remainder can be attributed to the weather (Potter *et al.*, 1995). In contrast, the U.S. Government spends an estimated US\$9 billion on road damage maintenance caused by heavy vehicles (Cebon, 1993). Dynamic tire forces generated by the vibration of these moving road-damaging heavy vehicles excited by road surface roughness are heavily influenced by vehicle speed, road roughness, vehicle design, and characteristics (particularly, its suspension system, tire configuration, and loading conditions). A comprehensive study in this area and an analysis of the effects of heavy vehicle characteristics on pavement response and performance are presented by Gillespie *et al.* (1993). The heavy vehicle characteristics of interest in their study included gross vehicle weight, axle load, axle configuration, suspension properties, tire type, tire pressure, tire contact pressure area, tire configuration, and operating conditions.

There have been two main approaches to estimating the road-damaging effects of dynamic tire forces. Some researchers believe that dynamic tire forces form a stochastic process, i.e., forces are randomly applied to each point along a given stretch of a road so that each point incurs forces statistically similar to other points along the same road and, therefore, induce uniformly distributed road damage (Eisenmann, 1975). Other researchers (Hahn, 1985; Addis *et al.*, 1986; Woodrooffe *et al.*, 1988; Gyenes and Mitchell, 1992) believe that there is considerable evidence showing that for a given speed, the dynamic wheel-load time histories generated by a particular heavy vehicle are concentrated and repeated at specific locations along the road for subsequent test runs. This phenomenon is termed "spatial repeatability" (Cole and Cebon, 1992; Collop *et al.*, 1994). It is assumed that an increase of approximately 20 to 30 percent of road damage is induced if the former type of road loading is considered (O'Connell *et al.*, 1986; Mitchell and Gyenes, 1989); whereas, in the latter approach, some locations along the road may be expected to incur approximately four times more damage than the average, according to the fourth power law (Cebon, 1985).

Throughout the literature, some researchers, such as Gyenes *et al.* (1992) and Gyenes and Mitchell (1992), reported that a closely repeated spatial distribution of dynamic wheel loadings (high correlation of dynamic tire forces) exists for a vehicle traveling over a selected road section at a particular speed. Since a large portion of heavy vehicles

¹ Also known as Dynamic Tire Forces.

possess similar geometry and dynamic characteristics and tend to travel at similar highway speeds, as suggested by Hahn (1985), spatial repeatability of road loadings is expected in normal traffic flow. However, for a particular class of heavy vehicles that tend to have the same mass distribution and geometry (which is government-regulated), different suspension systems, as well as tire type and configuration, could alter the magnitude of the dynamic wheel loads, which, in turn, have a direct impact on the pavement's condition and performance. For instance, based on an experimental study performed by Woodrooffe *et al.* (1986), it was shown that for a vehicle speed of 80 km/h and a ride comfort rating (RCR)² of 5.2, an increase of 23 percent in the dynamic load coefficient (DLC)³ exists if a rubber suspension walking beam is used compared to an airbag suspension system.

Therefore, in order to enhance the overall efficiency of highway/vehicle systems, reduce the amount of vehicle-generated road damage and maintenance cost, and ultimately assist manufacturers and regulators in developing and promoting "road-friendly" subsystems, two of the most pressing questions in the area of heavy vehicle-generated road damage need to be answered. These deal with the induced road damage associated with the spatial correlation of dynamic wheel loads produced by heavy road vehicles due to different types of suspension systems and due to the use of wide-base single versus dual tires.

SPATIAL REPEATABILITY

As stated in the previous section and in addition to the environmentally induced pavement damage, wheel forces generated by vibration of a moving vehicle excited by pavement surface roughness are considered to be of great importance in pavement wear evaluation and assessment. A portion of the pavement wear caused by wheel forces is attributed to their average values. This is known as static load. The remainder is attributed to their dynamic components, known as dynamic wheel loads. It is argued by some researchers that these dynamic wheel loads are randomly distributed along a given stretch of road. However, despite being a "stochastic" process, there is considerable evidence (Moran *et al.*, 1995; Gyenes and Mitchell, 1992; Collop *et al.*, 1994) showing that for a given speed, the wheel-load time histories generated by a particular heavy vehicle are spatially repeatable or strongly correlated in the spatial domain for successive runs over a given stretch of road. Figure 1, from Addis *et al.* (1986), illustrates this effect and shows the measured wheel-load variations on the axles of a tandem leaf-spring suspension when driven at 32 km/h over the same section of test track three times. This degree of high correlation for dynamic loads under normal traffic conditions has important implications for road wear. If dynamic loadings exhibit perfect correlation, the

² RCR = Ride Comfort Rating related to road response:

8 < RCR < 10	for excellent road
6 < RCR < 8	for good road
4 < RCR < 6	for fair road
2 < RCR < 4	for poor road
RCR < 2	for very poor road

³ DLC = Standard Deviation of Wheel Load/Nominal Static Wheel Load.

road wear (as stated by Gyenes and Mitchell (1992)) would increase, according to the fourth power rule, by about 13 percent to 38 percent for corresponding dynamic wheel-load coefficients⁴ of about 0.15 to 0.25 (corresponding to common impact factors⁵ of 1.3 to 1.5). Whereas, if dynamic loadings exhibit very low correlation, the load histories form a stochastic process and the road wear, as stated by Eisenmann (1975), would increase as the variance of the dynamic loads increases.

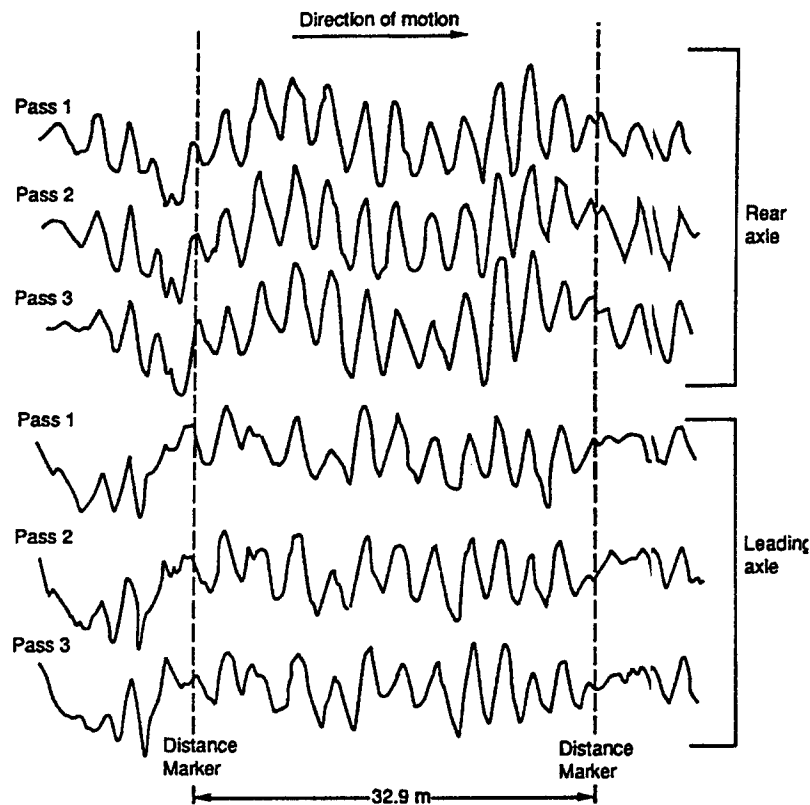

Figure 1. Measured wheel-load variations on the axles of a tandem leaf-spring suspension plotted as a function of distance for three runs over the same section of test track at 32 km/h (Addis *et al.*, 1986).⁶

⁴ DLC = Root Mean Square of Dynamic Load/Static Load.

⁵ Dynamic Impact Factor (IF) = Peak Dynamic Wheel Force/Static Axle Load.

⁶ As seen in Figure 1, the same locations along the 32.9-m stretch of road incur the maximum loads on each run.

Due to the significant implications of spatial repeatability on road damage by heavy vehicles, several methodologies for measuring the spatial repeatability of dynamic loads have been identified and utilized in studying the vehicle/pavement characteristics. The mathematical framework of the spatial repeatability of dynamic wheel loads generated by heavy vehicles is presented by Cole and Cebon (1992) and Collop *et al.* (1994) and is briefly outlined in the following subsections.

Measure of Road Loadings

To enable the effects of all axles of the vehicle to be considered, the total force at a particular point on the road – known as aggregate tire force – can be written as the sum of the dynamic forces applied to each point on the road by all axles of the vehicle:

$$F_k = \sum_{j=1}^{N_a} P_{jk} \quad k = 1, 2, \dots, N_s \quad (1)$$

where,

- F_k = aggregate force at point k along the path of the wheel
- P_{jk} = applied force at point k by tire j
- N_a = number of axles on the vehicle
- N_s = number of points along the assessed road

A disadvantage associated with this road loading measurement technique is that the aggregate force methodology does not reflect the mechanisms of road damage or the sensitivity of road materials to stress/strain levels. In addition, it does not distinguish between the peaks and troughs of the force histories (repeatability of peak loads is most important in measuring road damage). These disadvantages can be overcome by summing the measured dynamic tire forces applied to each point along the road after raising them individually to the power n . This is known as the weighed aggregate force model (Cebon, 1987) and can be expressed mathematically as:

$$F_k^n = \sum_{j=1}^{N_a} P_{jk}^n \quad k = 1, 2, \dots, N_s \quad (2)$$

where n is chosen to represent the type of road damage being considered.⁷ For flexible pavements, a value of n equal to 4 is suitable for fatigue damage (Kinder and Lay, 1988); whereas an n value of 1 is more suitable for permanent deformation (Gillespie *et al.*, 1993). If n is set to 4, then equation (2) represents the aggregate fourth-power force model referred to in the earlier section.

⁷ Generally, the road damage factor n is between 4 and 8 (the argument of what value should be assigned to n is still open for debate).

Measure of Spatial Repeatability

A suitable measure of spatial repeatability should indicate the degree of correlation between two dynamic wheel-load signals. Two signals are known to have a high correlation or repeatability if the peaks of their spatial history occur close together along the same stretch of road. However, these signals are known to possess low correlation or repeatability if the peaks of one signal occur near the troughs of the other signal. Three methods were identified as measurements of the spatial repeatability of dynamic wheel loads. These are the correlation coefficient (Cole, 1990; Collop *et al.*, 1994), mean separation of tire force peaks and accumulated damage (Cole and Cebon, 1992), and spatial repeatability index (Collop *et al.*, 1996). For the sake of completeness and clarity, some of these techniques are briefly presented. However, the reader is strongly encouraged to consult the appropriate references for a more descriptive explanation of these methods.

Mean Separation of Wheel Force Peaks

This technique utilizes the mean separation of aggregate tire forces from a reference load history as a measure of spatial repeatability. This mean separation can be determined by identifying, in both the reference aggregate tire force history and a second load history, the positions of peaks greater than, say, the 95th percentile level. Each peak of the tire load history is identified and then compared to its respective peak value of the reference load history. The distance between the peaks is then calculated. These distances are then averaged to determine the mean separation of all peaks. Thus, a high degree of correlation would be identified by a small value of the mean separation (Cole and Cebon, 1992).

Correlation Coefficient

In this approach, a statistical property known as the correlation coefficient ρ is used to determine a quantitative measure of spatial repeatability. The correlation coefficient is defined by:

$$\rho = \frac{E\{[f(t) - \mu_f][g(t) - \mu_g]\}}{\sigma_f \sigma_g} \quad (3)$$

where μ_f , μ_g and σ_f , σ_g are the means and standard deviations of two signals $f(t)$ and $g(t)$, respectively, and $E\{.\}$ is the expectation operator. The values of ρ range between +1 and -1. A value of +1 indicates that the two signals representing the dynamic wheel loads along the path of the tire in consecutive runs are highly correlated (in phase). This further states that the peaks and troughs of each signal occur at the same locations. A value of -1 indicates a low correlation (anti-phase) and the peaks of one wave correspond to the troughs of the other. Cole (1990) determined that correlation coefficients higher than

0.707 indicate high correlation of the dynamic loads; whereas correlation coefficients smaller than 0.707 indicate low dynamic loads correlation.

Spatial Repeatability Index

The Spatial Repeatability Index (SRI) is defined as the correlation coefficient for an aggregate tire force history, $g(t)$, compared with a reference aggregate force history, $f(t)$. For the purpose of examining the properties of the spatial repeatability index and the spatial correlation coefficient, the two aggregate force histories are assumed to be two sine waves of frequency ω as follows (Cole, 1990):

$$f(t) = \sin(\omega t) \tag{4-a}$$

$$g(t) = \sin(\omega t + \phi) \tag{4-b}$$

where the phase difference ϕ between the two aggregate force histories represents the phase shift. Thus, this index can be defined as follows (Collop *et al.*, 1994), where the time, $t = x/V$, equals the ratio of the vehicle's traveled distance divided by its speed and dx represents the displacement differential:

$$\text{SRI} = \frac{\omega}{2\pi V} \frac{\int_0^{2\pi V/\omega} [f(t) - \mu_f][g(t) - \mu_g] dx}{\sigma_f \sigma_g} \tag{5}$$

As illustrated in Figure 2, there is no distinct relationship between the values of SRI and vehicle speed for different groups of vehicles. Consequently, to obtain information regarding the distribution of spatial repeatability within the same vehicle fleet, a suitable parameter, known as spatial distribution number (SDN), is identified and introduced by Collop *et al.* (1996). This parameter characterizes the degree of spatial repeatability exhibited by the vehicle fleet. For example, $\text{SDN}=0$ would correspond to perfect repeatability, whereas $\text{SDN}=\infty$ would correspond to situations where the loads are randomly applied in space with each point receiving statistically similar levels of loading. Further analysis of this spatial repeatability methodology can be found in Collop *et al.* (1996).

Generally, as noted by Cole (1990), a correlation factor of 0.707 is a reasonable threshold of spatial repeatability. This threshold corresponds to one-eighth of a cycle phase difference ($\phi = 45^\circ$) when the load signals are assumed to be $f(t)$ and $g(t)$. Figure 3 shows the correlation coefficient, including the threshold, related to the phase difference in terms of spatial location along the road for frequencies of 3 and 15 Hz and a vehicle speed of 80 km/h; whereas Figure 4 illustrates the tire force history along a section of road as a function of distance and phase shift (Collop *et al.*, 1996).

EFFECTS OF SUSPENSION VARIATION ON ROAD DAMAGE

It has already been well established by both pavement and vehicle engineers that road damage is induced by climatic and environmental changes, tire configuration, and characteristics, as well as vehicle type, weight, speed, and configuration (Woodrooffe, 1995; Gillespie and Karamihas, 1993; Cole and Cebon, 1992; Cebon, 1989; Woodrooffe and LeBlanc, 1986; Cebon, 1985; Sweatman, 1983). Environmentally induced road damage is briefly presented by Gillespie *et al.* (1993) and is beyond the scope of this study.

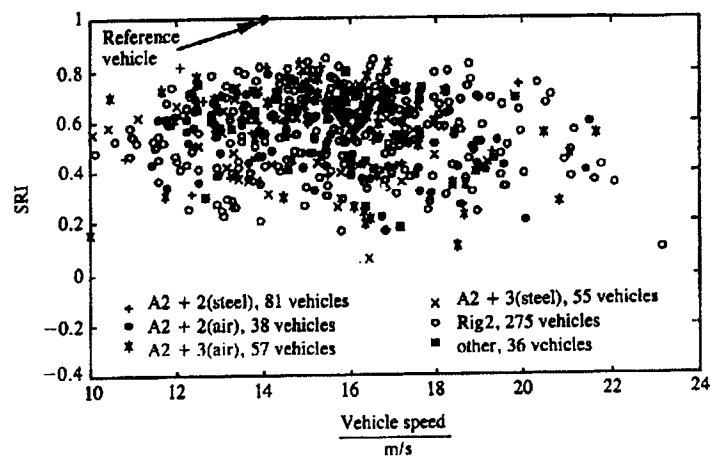

Figure 2. Measured values of SRI on a test track for articulated and rigid vehicles with different types of suspension systems (Collop *et al.*, 1996).⁸

⁸ The vehicles identified in Figure 2 are classified according to class and type of suspension on the trailer. For instance, the designation A₂+2 (steel) refers to all four-axle articulated vehicles with tandem steel-sprung trailer suspensions and Rig 2 refers to two-axle rigid lorries with any suspension. These measurements were performed during tests in mixed traffic on a section of the A34 trunk road in Oxfordshire, England.

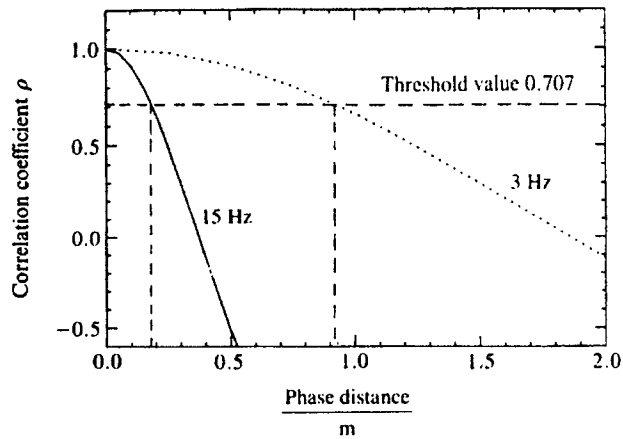

Figure 3. Correlation coefficient versus phase distance for frequencies of 3 and 15 Hz and a speed of 22 m/s and correlation coefficient threshold (Cole, 1990).⁹

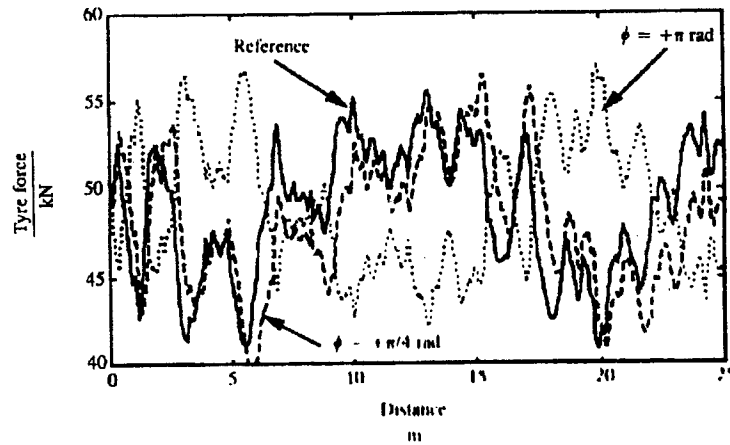

Figure 4. Phase-shifted dynamic tire force history (Collop *et al.*, 1996).¹⁰

⁹ For the frequency of 15 Hz, the threshold corresponds to a 0.18-m phase distance (about the length of a tire contact patch or small pothole). One may note that the fleet of heavy vehicles was tested on a Transport and Road Research Laboratory (TRRL) test track and a validated vehicle simulation model was used for subsequent results in the presentation by Cole and Cebon (1992).

¹⁰ One may observe that a change of phase $\phi = 45^\circ$ correspond to the reasonable threshold set by Cole (1990).

The effects of tire characteristics and configuration on the health of the pavement are discussed in the effects of tire factors on road damage section. It is well established that the bouncing of heavy vehicles causes pavement-damage-inducing dynamic loads that are typically 10 percent to 30 percent of static loads, depending on the vehicle's type and characteristics, in particular, the suspension systems and road roughness. Reduction of static wheel loads, which can be achieved by the reduction of vehicle weight and/or the increase of number of axles, could reduce the pavement damage inflicted by these static loads. Woodrooffe and LeBlanc (1986) showed that adding an air-lift suspension axle to a tandem-axle suspension in the National Research Council (NRC) Canadian truck resulted in a 16 percent decrease of the tractor static wheel loads and a 22 percent reduction of the trailer static wheel loads. In addition, they illustrated, as shown in Figures 5 through 9, that reduction of the static wheel loads does not necessarily translate into a proportional decrease in dynamic wheel loads. Furthermore, they stated that, in general, the percentage decrease in dynamic wheel loading is less than the percentage decrease in static loading.

For a selected road roughness, vehicle speed, and configuration, the large variation in dynamic wheel forces can be attributed to the significant variation in suspension type and characteristics (Sweatman, 1983). Indeed, in view of all the road loading factors examined in their experimental study, Woodrooffe and LeBlanc (1986) clearly determined that dynamic wheel loading emerges as the most dominant suspension performance factor. Hence, a significant reduction in dynamic pavement wheel loadings can be enhanced through the design and the use of the "road-friendlier" suspension systems.

Effects of Suspension Characteristics on Dynamic Tire Forces

Throughout the years, several suspension systems and configurations were examined for their efficiency and "road-friendliness" on pavements. Typical suspension systems that are commonly used for heavy vehicles are shown in Figure 10. In addition to these suspension systems, several others, such as airbag suspensions, were evaluated as alternative friendlier suspension systems. Sweatman (1983) has set the stage for studying dynamic wheel loads in axle group suspensions of heavy vehicles. His investigation examined trailer four-spring tandem, six-spring triaxle short-arm-rocker, and air suspensions and tractor drive axle walking-beam, single-point, and torsion bar suspensions. He observed that the dynamic forces are affected by vehicle speed, road roughness, and tire pressure. In particular, he determined that an increase in tire pressure, vehicle velocity, and/or road roughness increases the dynamic wheel loadings. Moreover, Woodrooffe and LeBlanc (1986) have conducted a controlled experimental program on the effects of suspension variations on the dynamic wheel loads of a heavy articulated highway vehicle (NRC truck). Their study has focused on the investigation of the suspension parameters, such as suspension type, axle spread, and axle load as a function of road roughness and vehicle speed. Laboratory and field tests confirmed the strong

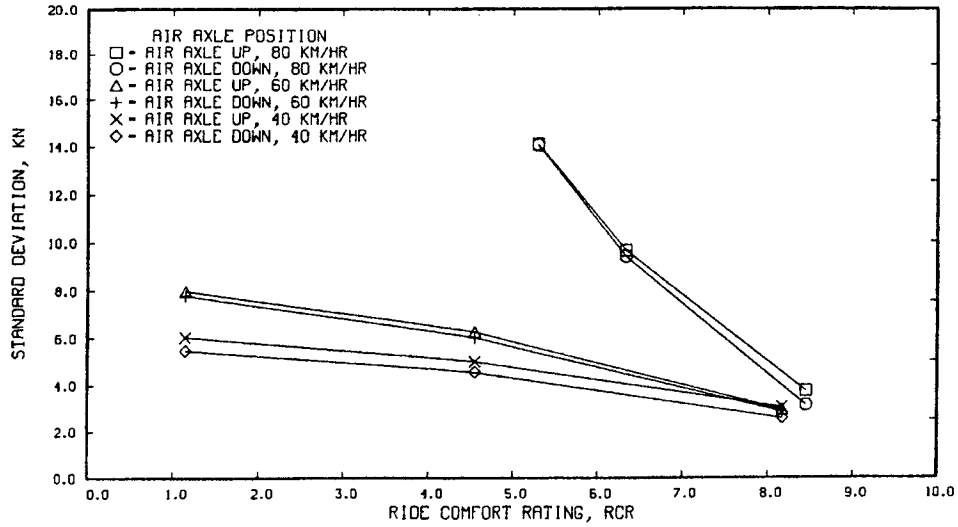

Figure 5. Reduction of dynamic wheel loads in the tractor drive axle due to reduction of static wheel loads by introduction of an air-suspension lift axle (Woodroffe *et al.*, 1986).¹¹

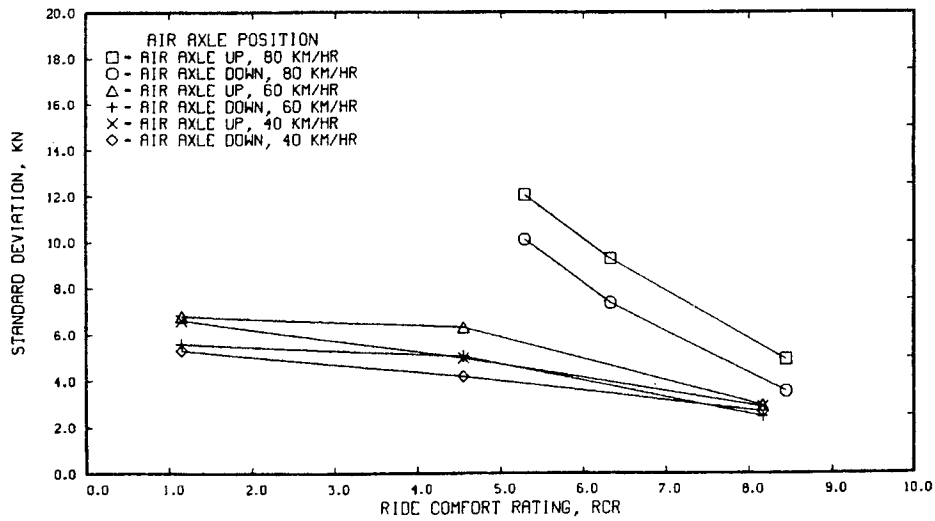

Figure 6. Reduction of dynamic wheel loads in the trailer axle due to reduction of static wheel loads by introduction of an air-suspension lift axle (Woodroffe *et al.*, 1986).

¹¹ Further information on the National Research Council truck instrumentation and configuration can be found in Woodroffe *et al.* (1986) and LeBlanc *et al.* (1992). Furthermore, one may observe that the tractor drive suspension is a walking-beam steel-leaf spring suspension (shown in Figure 7) and the trailer suspension is a tandem-axle multi-leaf spring (four-spring) suspension with tandem-axle spacing of 1.27 m.

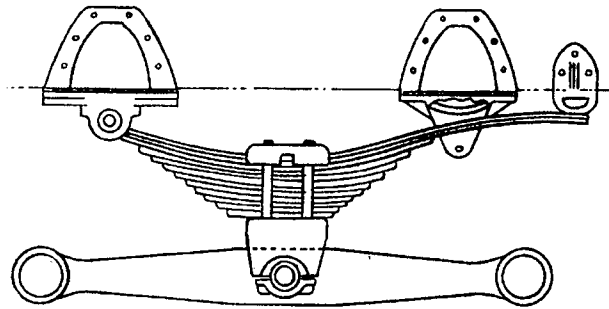

Figure 7. Tractor drive walking-beam suspension (Hendrickson RTE 440 - extended leaf tandem).

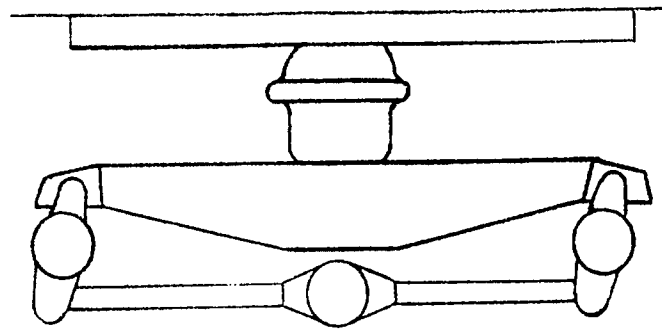

Figure 8. Trailer drive walking-beam suspension (Chalmers 754-44-LW).

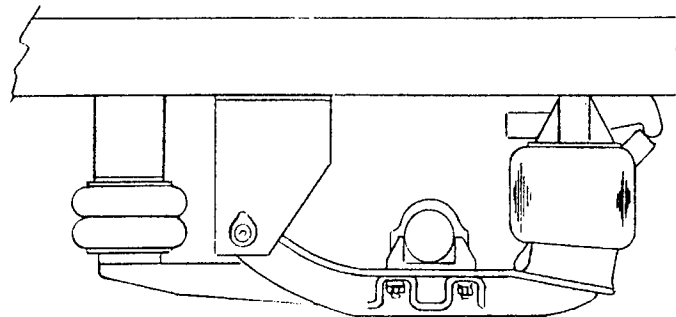
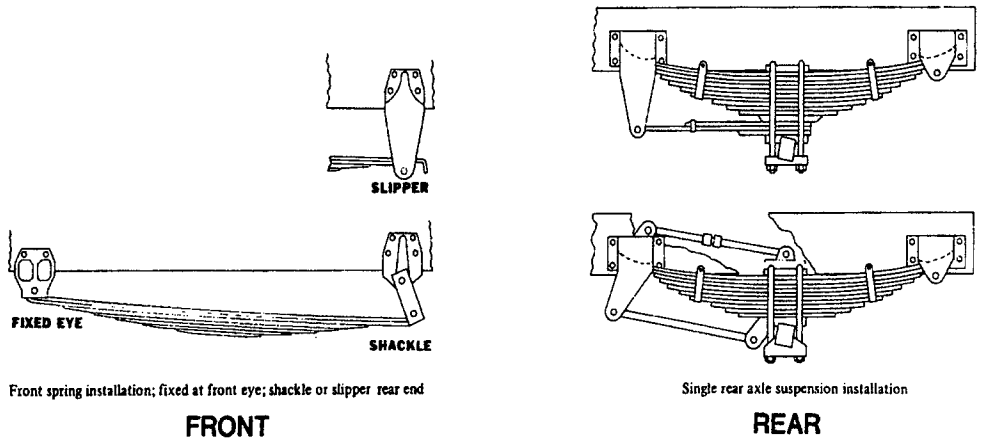
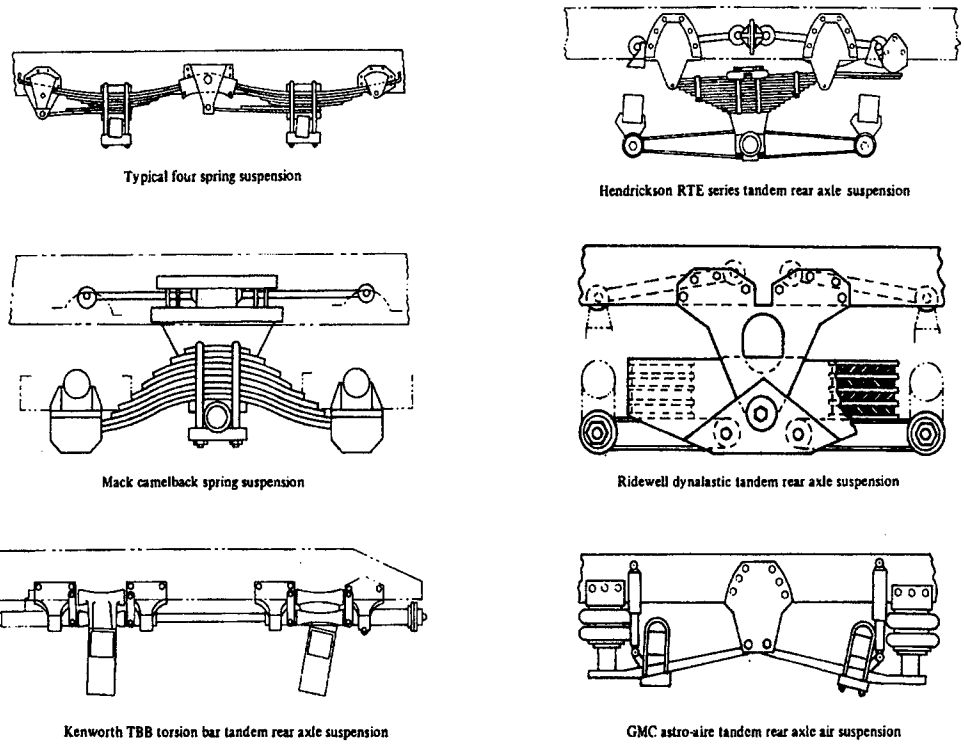

Figure 9. Air suspension trailer lift axle (Neway AR95-14).



TYPICAL SINGLE AXLE SUSPENSIONS



TYPICAL REAR TANDEM AXLE SUSPENSIONS

Figure 10. Typical suspensions used on heavy trucks (Gillespie, 1985).

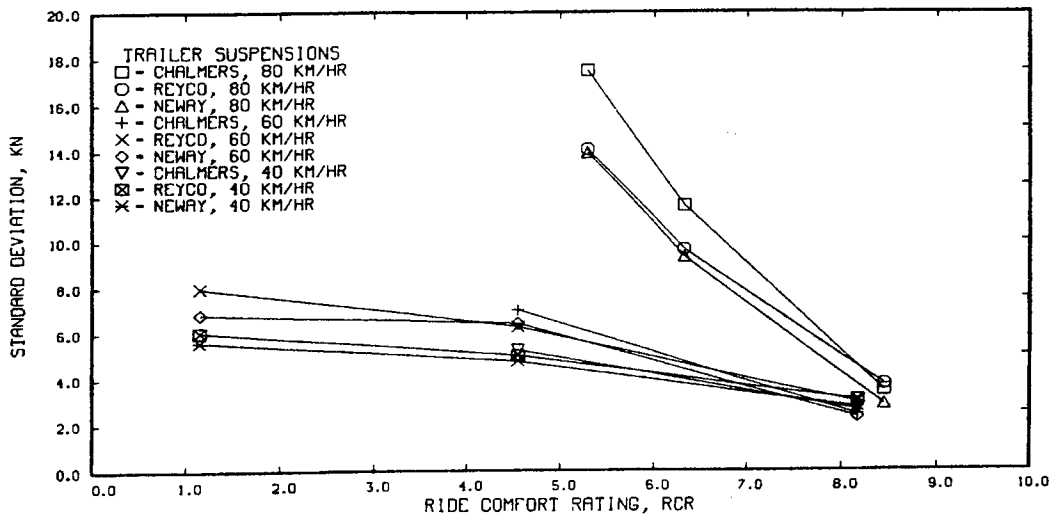

Figure 11. Effects of variation of trailer suspension type, vehicle speed, and road roughness on the dynamic wheel forces of the tractor (Woodrooffe *et al.*, 1986).¹²

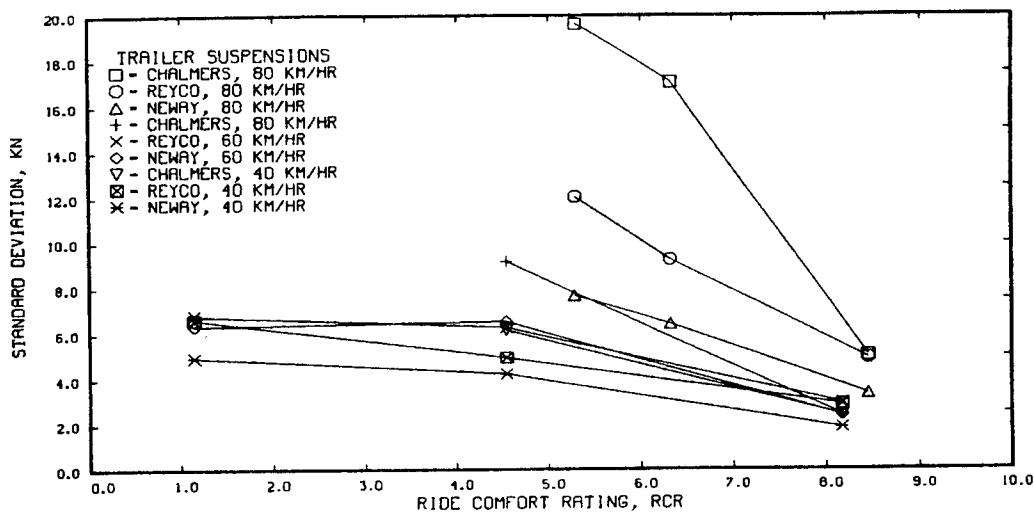

Figure 12. Effects of variation of trailer suspension type, vehicle speed, and road roughness on the dynamic wheel forces of the trailer (Woodrooffe *et al.*, 1986).

¹² The tractor drive suspension is a walking-beam steel-leaf spring suspension (Figure 7).

The trailer suspensions are:

- Chalmers - rubber with restrictor walking-beam suspension.
- Reyco - tandem-axle multi-leaf spring (four-spring) suspension.
- Neway - airbag tandem-axle suspension.

The experiment was performed for a nominal trailer axle spread of 1.3 m with the lift axle up.

dependence of dynamic wheel loads on the vehicle speed as demonstrated by Sweatman (1983). In particular, it was determined that the wheel forces increased exponentially with an increase of vehicle speed and road roughness (Figures 5 through 9, 11, and 12). Furthermore, as the road roughness decreased (RCR increased), it was observed that these dynamic loads converge to significantly smaller values independently of the suspension system and vehicle speed. In addition and as illustrated by Figures 5 through 9, 11, and 12, the airbag suspensions are found to provide lower dynamic loadings for both the tractor and trailer assembly (particularly at higher speeds) when compared with the walking-beam and tandem-axle multi-leaf spring suspensions. These findings are in agreement with Sweatman's (1983) experimental results. Additional study on a tractor-semitrailer that confirmed these findings was presented by O'Connor *et al.* (1996). As illustrated in Figure 13, there is no significant difference in the impact factor between the two types of suspensions for the tractor axles; however, the steel tridem axles exhibited, on the average, an 11 percent higher maximum impact factor than air suspensions.

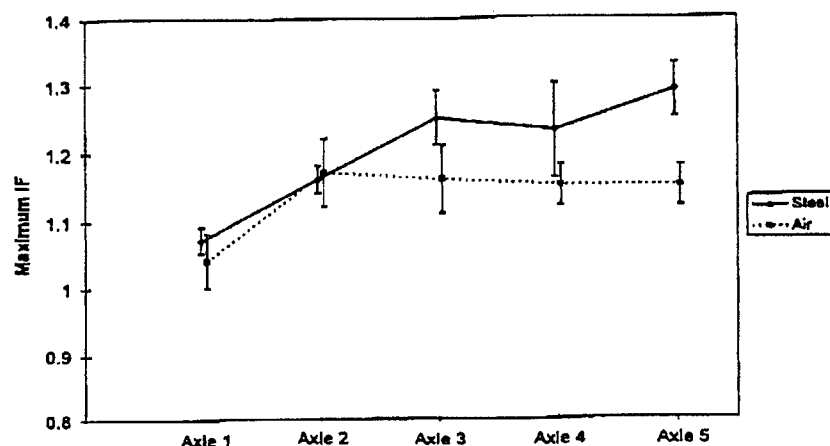

Figure 13. Maximum impact factors (IF) for air and steel suspensions for all axles of a tridem tractor-semitrailer (O'Connor *et al.*, 1996).

The study further supported the argument that increased dynamic wheel loads are obtained at higher vehicle speeds. Moreover, a similar study conducted by Streit *et al.* (1995) confirmed some of the above results. This study investigated the effects of vehicle and road characteristics on the magnitude of dynamic pavement loading. The characteristics examined included suspension type, tire type, tire inflation pressure, vehicle speed, axle static load, and road roughness. As expected, it was determined that road roughness and vehicle speed have the strongest effect on dynamic wheel loads; whereas the wheel static load has a relatively lesser effect on the DLC. Furthermore, this study¹³ has determined that air suspensions are less friendlier than steel suspensions for DLCs larger than 0.15. It is commonly believed that adequately damped suspensions

¹³ In the study, a rigid Navstar International S series, flatbed single-axle truck model 1957, assembled in 1980, is utilized. The front suspension is a constant-rate leaf-spring assembly, whereas the rear axle is configured either as a progressive leaf-spring assembly or an air suspension with tapered leaf spring. For further basic geometry and weight characteristics for this truck, refer to Streit *et al.* (1995).

meeting very specific damping ratio and bouncing frequency criteria (OECD, 1992) have lesser dynamics than leaf-spring suspensions. Apparently the air suspension used in this case does not meet these required criteria.

Experimental studies conducted by Gyenes *et al.* (1992) at the Transport Research Laboratory (TRL) illustrated the strong dependence of the DLC on the vehicle speed. Figures 14 through 16 show the results of the dependence of the DLC on the vehicle speed as well as on the type of suspensions for drive axles and two- and three-axle semi-trailers on a medium roughness section of the TRL track; whereas Figure 17 demonstrates the pavement wear induced by different suspensions at different speeds for both drive and trailer axles. The air suspensions used by these authors are conventional with trailing arms, whereas the rubber spring suspensions use a beam to link the axles (walking beam). It is obvious that different suspensions provide large differences for the DLC values, with air suspensions providing the lowest values in most of the cases with respect to steel and rubber suspensions. Generally and as illustrated by Table 1, there is a substantial wear savings when air suspensions are used instead of steel and rubber suspensions, particularly at high speeds. However, as shown in Figure 14, one should be careful in making such a general statement without identifying the suspension type and characteristics, application, and vehicle speed.

Table 1. Potential reduction in dynamic pavement wear at 90 km/h on a medium roughness TRL test track (Gyenes *et al.*, 1992).

Axle/Suspension	Dynamic pavement wear factor $\cong 1 + 6 (\text{DLC})^2$	Wear saving, air instead of steel or rubber (%)
2-axle rigid, drive, multi-leaf steel	1.10	6
Tractor drive, steel leaf	1.07	3
Tractor drive, air or improved steel	1.04	
Trailer 2-axle bogie, steel leaf	1.25	15
Trailer 2-axle bogie, rubber/walking beam	1.19	11
Trailer 2-axle bogie, air	1.06	
Trailer 3-axle bogie, steel leaf	1.14	9
Trailer 3-axle bogie, air	1.04	

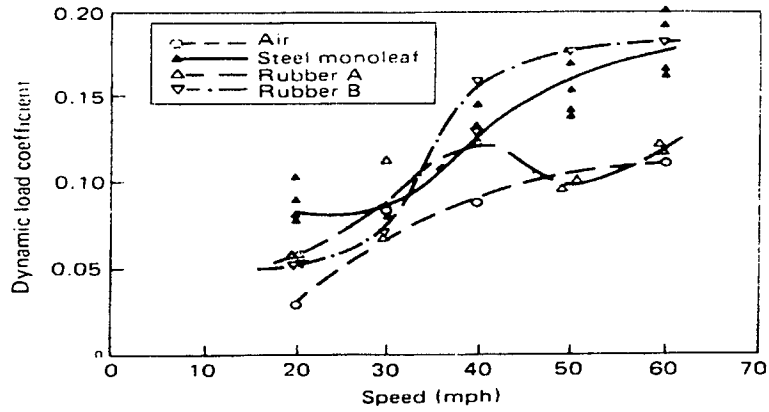

1 mi/h = 1.61 km/h

Figure 14. Two-axle semi-trailer dynamic load coefficients measured on a medium section of the TRL track (Gyenes *et al.*, 1992).

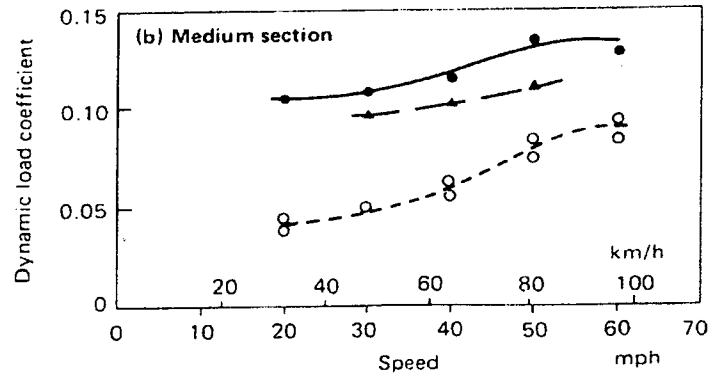

1 mi/h = 1.61 km/h

Figure 15. Drive axle dynamic load coefficients measured on a medium section of the TRL track (Gyenes *et al.*, 1992).

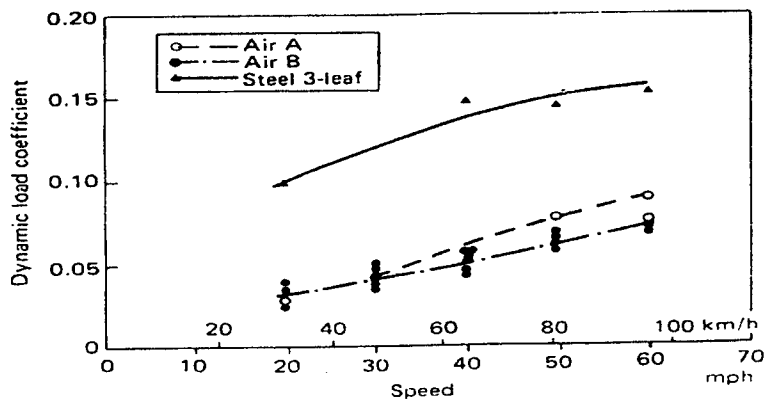

1 mi/h = 1.61 km/h

Figure 16. Three-axle semi-trailer dynamic load coefficients measured on a medium section of the TRL track (Gyenes *et al.*, 1992).

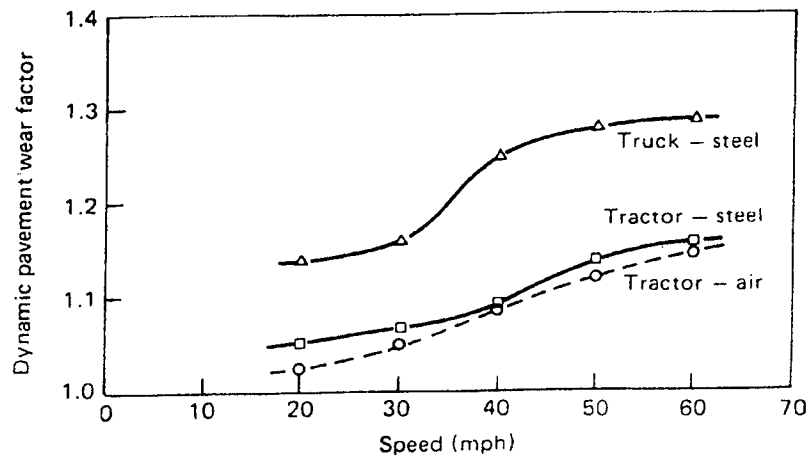

1 mi/h = 1.61 km/h

(a)

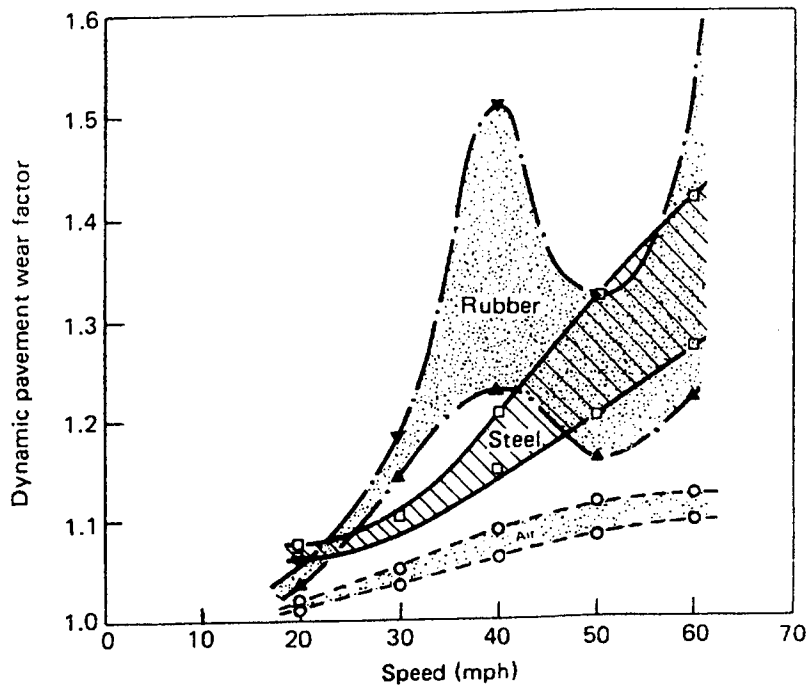

1 mi/h = 1.61 km/h

(b)

Figure 17. Drive axle dynamic pavement wear factors measured on a rough section of the TRL track (Gyenes *et al.*, 1992).

Woodrooffe *et al.*'s (1986) investigation further examined the effects of a trailer suspension spread on the dynamic wheel loads. It was observed that the loads associated with the variations of trailer axle spread are generally small (in terms of DLC they are less than 3 percent), with the exception of the four spring suspensions in which the axle spread is found to be a function of road roughness. It is believed that the up to 8 percent change in DLC is due to the variation of the kinematics (mechanical dependency) of tandem suspensions. The modest axle spread sensitivity of the air suspensions is due to their mechanical independency. This study went further in analyzing and determining the dynamic wheel loads as a function of the number of axles in a suspension group. It was determined that the addition of a third axle (air-lift suspension) to a tandem axle suspension group reduced the static wheel loads by 16 percent for the tractor and 22 percent for the trailer. From their conservative point of view, they stated that this reduction of dynamic wheel loads generally can be expected to be proportional to the reduction of static wheel loads, depending on the suspension systems, road roughness, and vehicle speed. It was stated that, in some cases, the percentage decrease in dynamic wheel load can be very near the percentage decrease in static wheel load.

In addition to demonstrating that all examined suspensions show convergence to low dynamic activities on smooth roads, even at higher speeds, researchers in this field reported that on moderated roads, the dynamic characteristics of the suspensions vary widely, depending on the suspension type examined. However, there is a clear order of suspension preference in terms of dynamic wheel loading and reduction of road damage. According to Woodrooffe and LeBlanc (1986), if arranged from lowest to highest dynamic loading, the following order could occur:

- 1 - Air suspension.
- 2 - Four-spring suspension.
- 3 - Walking-beam suspension.

This could further be illustrated by examining dynamic wheel-load coefficients in Tables 2 and 3.

Table 2. DLCs for different types of suspension systems of the NRC truck traveling on a test track with an RCR of 5.2 and a vehicle speed of 80 km/h (Woodrooffe *et al.*, 1986).

Suspension Type	Dynamic Load Coefficient (%)
Airbag	16
Four Spring (Leaf Spring)	24
Leaf-Spring Walking Beam	28
Rubber-Spring Walking Beam	39

Table 3. DLCs for tractor suspensions (LeBlanc *et al.*, 1995).

Road Roughness (IRI) ¹⁴	Air Spring (DLC)	Steel-Spring Walking Beam (DLC)
1.1 (smooth)	0.03	0.09
3.5 (average)	0.08	0.26
4.7 (rough)	0.11	0.37

Based on these findings and other factors such as sensitivity of the suspensions to static load equalization, load transfer due to braking and pitching, and the suspension contribution to vehicle stability and control, one may be tempted to restrict the use of a particular suspension system through regulatory means. However, further important considerations in selecting these suspension systems, such as spatial repeatability of the dynamic wheel loads, should be investigated.

Spatial Repeatability of Dynamic Tire Forces

Experimental research has been conducted to investigate spatial repeatability of dynamic pavement loads caused by heavy goods vehicles under different test conditions. Gyenes and Mitchell (1992) have observed that under one wheel of a steel-sprung semi-trailer traveling on a rough section of a TRL track, a relatively high degree of repeatability of the dynamic wheel loading is experienced (Figure 18) during two different runs in a period of more than a year. Similarly, their preliminary results (Figure 19) on the cumulative impact factor for heavy vehicle wheels on a road showed that the pattern of load concentration points did not change greatly in time for two-wheel tracks of about 100 axles. These preliminary results regarding the persistence of the spatial repeatability of the impact factor over time have been confirmed by the British experiment as reported by Jacob (1995) in Figure 20. Further experimental investigation of spatial repeatability performed by O'Connor *et al.* (1996),¹⁵ illustrated that strong evidence of spatial repeatability exists, particularly at lower speeds. It is clear from Figures 21 and 22 that there exists a spatial repeatability trend with a 10 to 15 percent difference in amplitude of the impact factor at some sensor locations for the second axle of a laboratory test vehicle. In addition, it was observed that at lower speeds, the impact factor spatial history produced a more cyclical pattern.

Contrary to the findings of Gyenes and Mitchell (1992) as well as Jacob (1995), O'Connor *et al.* (1996) determined (Figure 23) that the pattern of the mean impact¹⁶ factor for gross vehicle weights¹⁷ of type 5 vehicles (Figure 24) shows some general trend for spatial repeatability, especially beyond 10 m (these authors have not commented on

¹⁴ IRI = International Roughness Index.

¹⁵ The experiments were performed at the French site, RN10 highway, at LaVerriere (Yvelines) on a smooth pavement.

¹⁶ Impact Factor = Weigh-in-motion (WIM) Weight /Static Weight. The mean impact factor for axles is the mean for all axles of all vehicles of the impact factor.

¹⁷ The gross vehicle weight impact factor is the ratio of the sum (for all axles of the vehicle) of the axle WIM weights to the statically weighed gross vehicle weight.

the cause of lower repeatability experienced at distances up to 10 m). However, for axle 1 of a type 5 vehicle, a high variation of this impact pattern was experienced, leading to a reduction of the spatial repeatability. O'Connor *et al.* (1996) further determined that for a particular vehicle fleet having the same characteristics and traveling over the same road at the same speed, the variation in the impact factors appears to be almost random (Figure 25). These impact factor spatial histories, for a particular population of vehicles of one type, are influenced by the small variations of vehicle speed, vehicle dynamic characteristics, and dimensions. Such characteristic variations include some differences of axle spacing and suspension parameters (damping, dry friction, inertia, etc.).

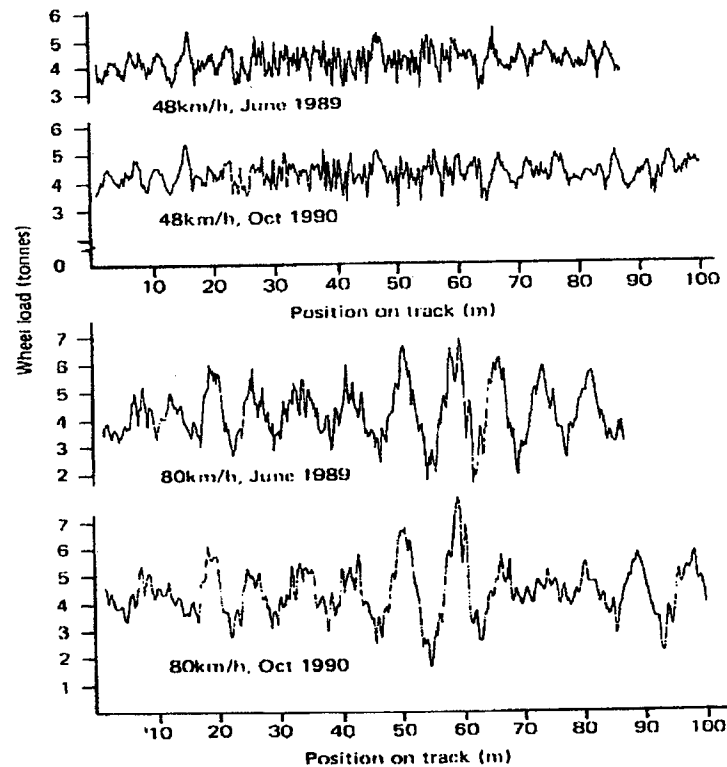

Figure 18. Dynamic loads for one wheel of a semi-trailer on a rough section of the TRL track (Gyenes and Mitchell, 1992).

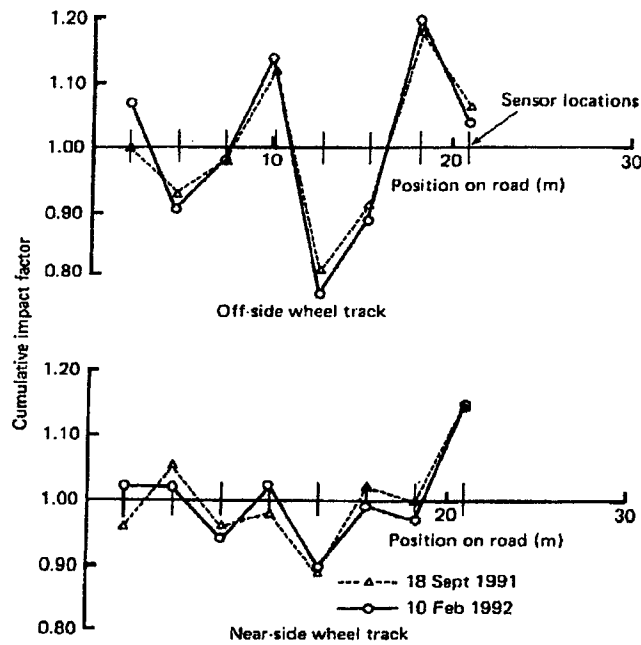

Figure 19. Cumulative impact factor for heavy vehicle wheels on a trunk road (Gyenes and Mitchell, 1992).

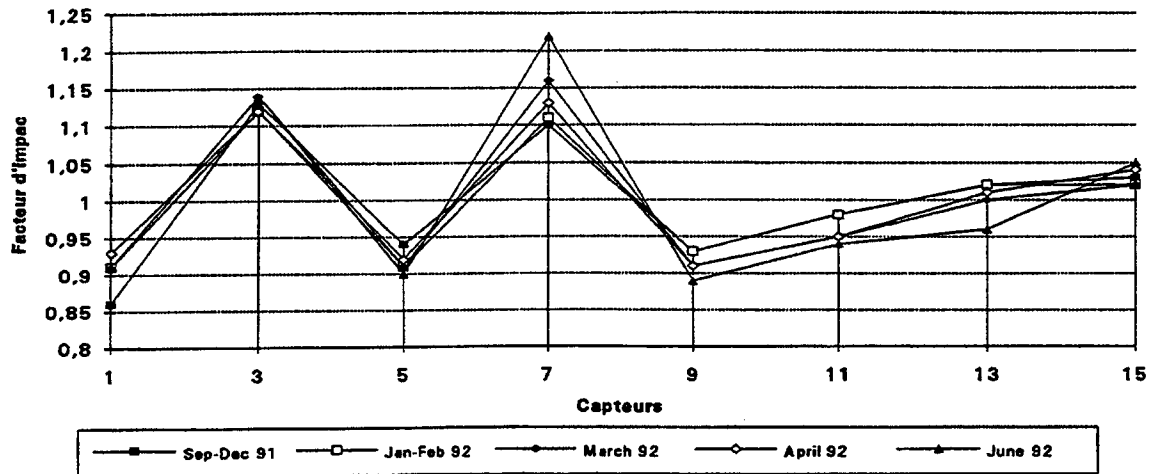

Figure 20. Impact factors for heavy vehicle wheels on a TRL road site (Abington site) (Jacob, 1995).

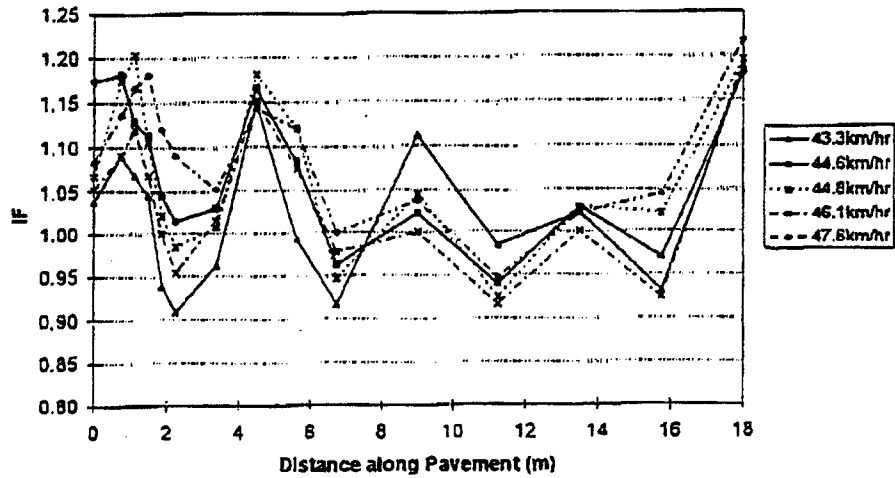

Figure 21. Impact factors for second axle of a two-axle rigid laboratory test vehicle traveling on a smooth RN10 highway at approximately 45 km/h (O'Connor *et al.*, 1996).

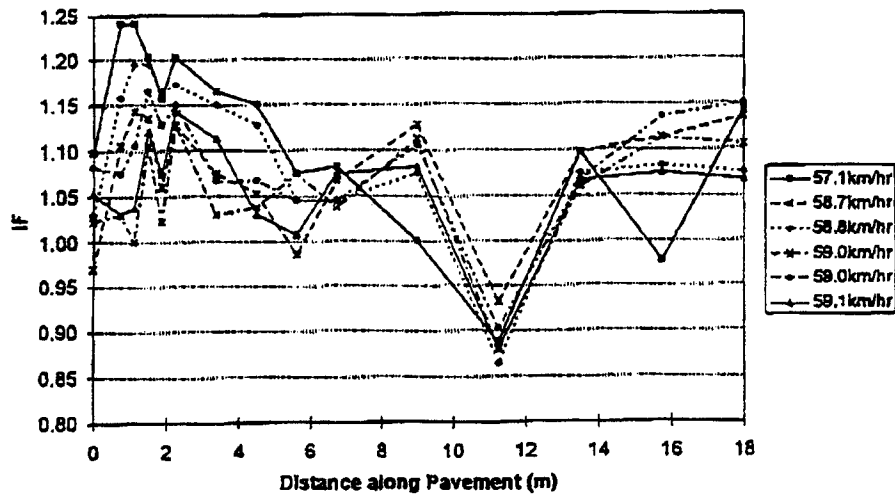

Figure 22. Impact factors for second axle of a two-axle rigid laboratory test vehicle traveling on a smooth RN10 highway at approximately 58 km/h (O'Connor *et al.*, 1996).

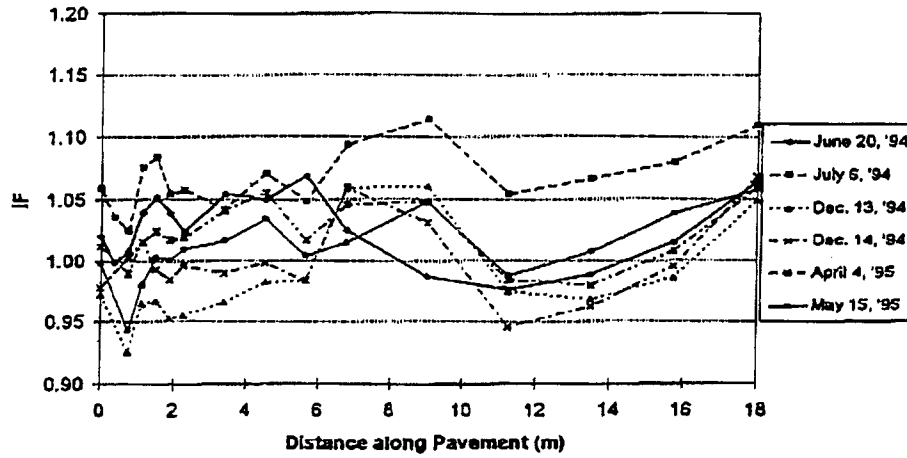

Figure 23. Mean impact factors for type 5 vehicles (O'Connor *et al.*, 1996).

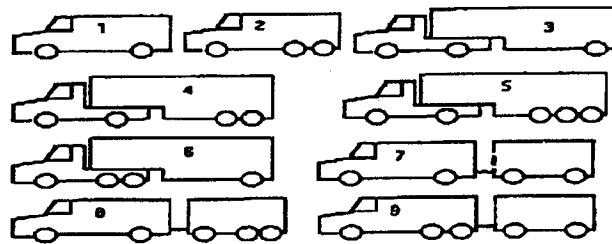

Figure 24. Vehicle-type silhouettes (O'Connor *et al.*, 1996).

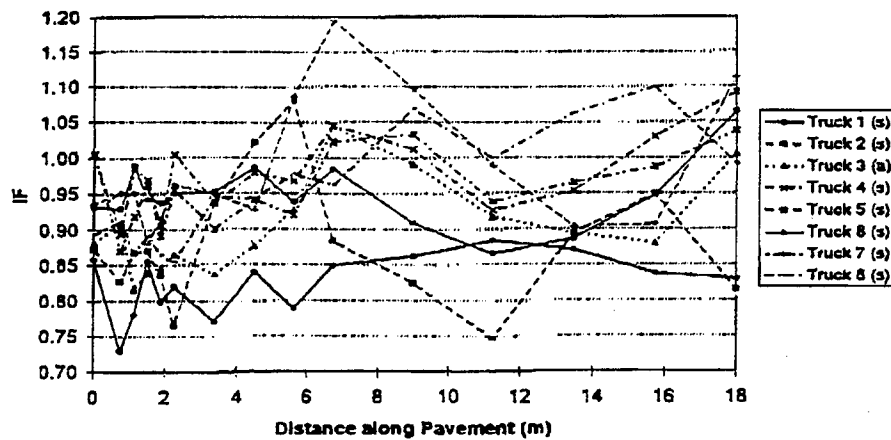

Figure 25. Impact factors for the first axle of type 5 vehicles on a specific day (s = steel suspension, a = air suspension) (O'Connor *et al.*, 1996).

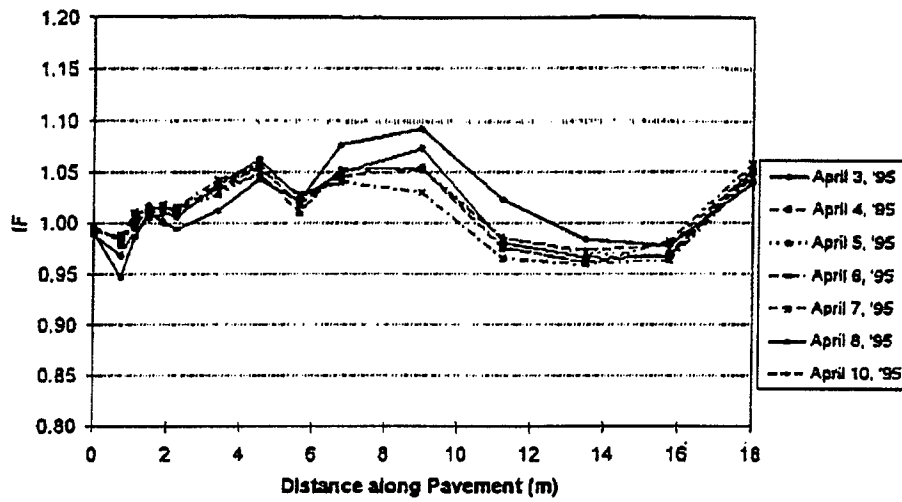

Figure 26. Mean impact factors for type 5 vehicles from total traffic flow (O'Connor *et al.*, 1996).

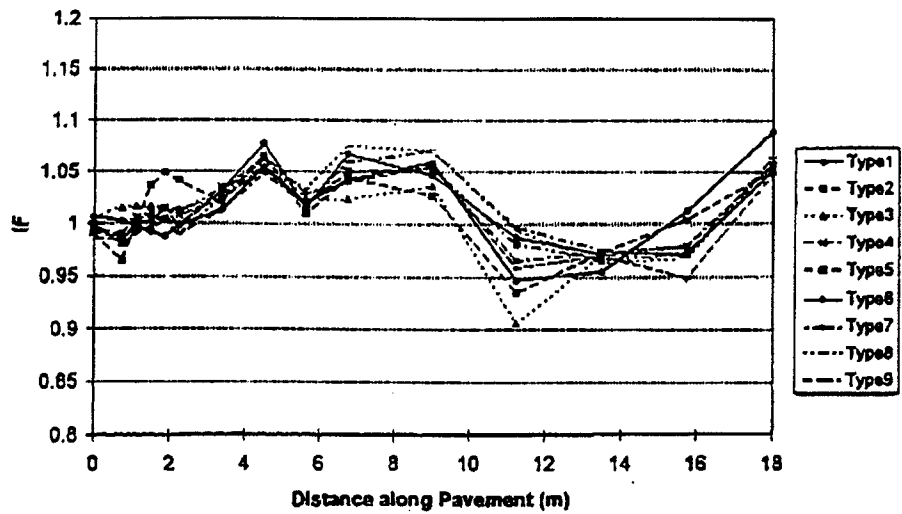

Figure 27. Impact factors for different types of vehicles - Types 1 through 9 (O'Connor *et al.*, 1996).

Finally, O'Connor *et al.* (1996) concluded their study by introducing the phenomenon called “Statistical Spatial Repeatability.” This is a convergence of the mean impact factors pattern when the number of individual records increases to a critical pattern number. As shown in Figure 26, it is clear that a pattern of strong spatial repeatability becomes evident for a significant amount of data collected for 1107 type 5 trucks. For small sample sizes of vehicles, the “vehicle effect” due to the dimensions and dynamic parameters strongly influences the impact factor and the effect of the pavement is suppressed. However, when the sample size increases, the different influences of many individual vehicles compensate and the pavement effect becomes more dominant. Hence, spatial repeatability is shown clearly only for vehicle types for which a large amount of data is available. Indeed, as illustrated by Figure 27, if a large quantity of data was collected for all vehicle types, a similar impact factor pattern could be expected for full traffic flow of different vehicle types. Hence, it appears that vehicle type had little significance on the pattern of the impact factor for a large quantity of data.

Due to the importance of the spatial repeatability of dynamic wheel forces on the pavement damage illustrated in Table 4, LeBlanc and Woodrooffe (1995) have conducted an experimental study on NRC research tractor-trailers (developed for spatial repeatability experiments) for different types of suspension systems and configurations – in particular, air-spring suspensions and steel-spring walking-beam suspensions. This table is based on the measured DLCs and on the assumption that the fourth power law holds. Their experimental research revealed that for the same vehicle configuration, speed, wheel load, and road section, spatial correlation increased with road roughness for air-spring suspensions, but decreased marginally with road roughness for walking-beam suspensions (Figure 28). They have indicated that the possible low spatial repeatability on smooth roads compared to average and rough roads for air-suspension systems can be attributed to the non-repeatable wheel imbalance that is known to be independent of the road roughness.

Table 4. Pavement wear increases resulting from the use of a steel-spring walking-beam suspension versus an air-spring suspension.

Road Roughness (IRI)	Percentage Increase in Pavement Wear	
	Weakly Correlated Wheel Loads	Strongly Correlated Wheel Loads
Smooth	4%	43%
Average	37%	150%
Rough	75%	245%

Furthermore, a study of the effects of speed on these types of suspension for specific wheels in different runs was conducted by the same authors. Figure 29 illustrates the high sensitivity of spatial repeatability to vehicle speed, in particular, for the walking-beam suspensions. It was stated that the high sensitivity was due to the narrow frequency bands of the wheel loads of the walking-beam suspensions when compared to the air-spring suspensions (Figures 30 and 31). This, in fact, leads to the observation that two

vehicles with significantly different wheel-load Power Spectral Densities (PSDs) may exhibit very low spatial repeatability if they are operated at the same speed, but relatively high levels of repeatability if they are operated at different speeds.

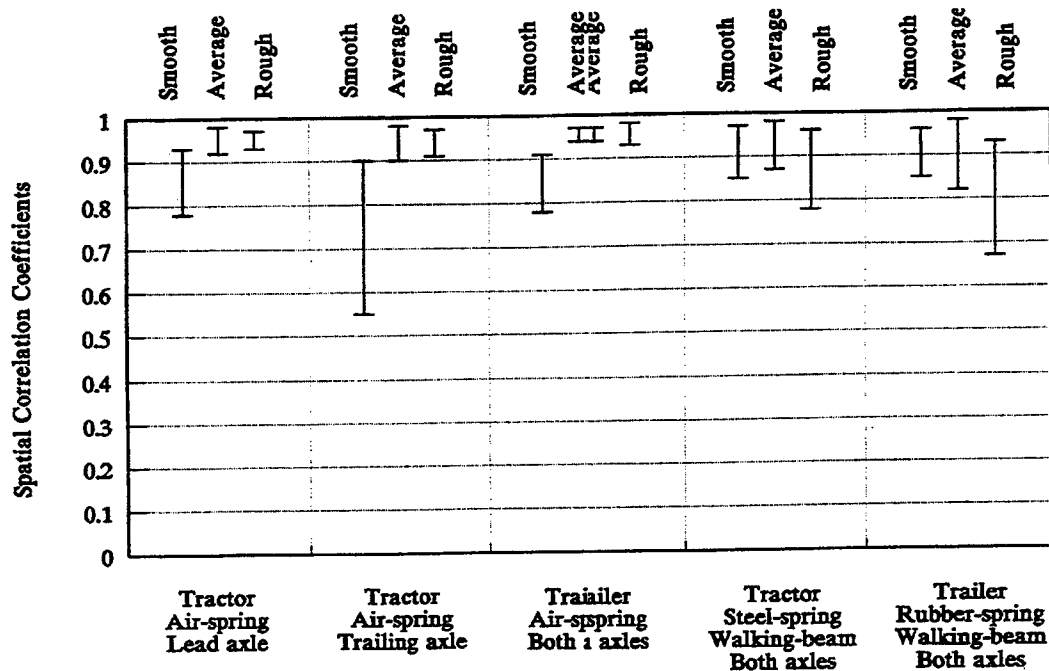

Figure 28. Correlation coefficients for specific wheels in repeated runs (LeBlanc and Woodroffe, 1995).

Their investigation went further by examining the effects of suspension type on the spatial correlation (Figure 32). Examination of the results of Figures 29 and 32 reveals that, for a walking-beam suspension, changing the vehicle speed by 10 km/h can reduce the spatial repeatability by a greater amount than that caused by replacing the walking-beam suspension with an air suspension. For instance, a 10-km/h increase in speed would reduce the spatial correlation by about 40 percent to a low level of 0.1; whereas replacing the tractor walking-beam suspension by an air-spring suspension would reduce the spatial correlation by about 35 percent to a higher level of 0.5 (as illustrated by these figures).

They concluded the study by investigating the spatial correlation within tandem-axle groups and between tractor and trailer suspension types. Again, the high sensitivity to vehicle speed for the walking-beam suspension between wheel loads of lead and trailing axles of tandem-axle groups is demonstrated in Figure 33. They have reported that the principal reason for this high sensitivity is that the lead and trailing axle motions are independent from one another for the air-spring suspensions, but are dependent for the walking-beam suspensions. Furthermore, these authors have conducted experiments studying the spatial correlation between tractor and trailer suspension groups during repeated runs. As shown in Figure 34, a higher correlation was determined when air-

spring suspensions were used for both tractor and trailer configurations. The reason for the higher correlation was not investigated by these authors.

Finally, and as part of the DIVINE project, preliminary results presented by Jacob (1995) analyzing the spatial repeatability of axle impact forces on pavement versus road and vehicle characteristics indicated that for the same load configuration and speed, a good wheel spatial repeatability exists. However, as the speed varies, this repeatability is lost. In addition, impact factors along the pavement varied from 20 to 40 percent for steel and from 10 to 40 percent for air suspensions where the steel-to-air-suspension impact factor ratio varied from 1 (for 3 tons (1.36 tonnes)) to 2 (for 3 to 8 tonnes). This author further observed that the impact factors increased (slowly) with the speed (same load) and decreased with static loads. These results, as indicated by the author, are not conclusive due to the incomplete study presented.

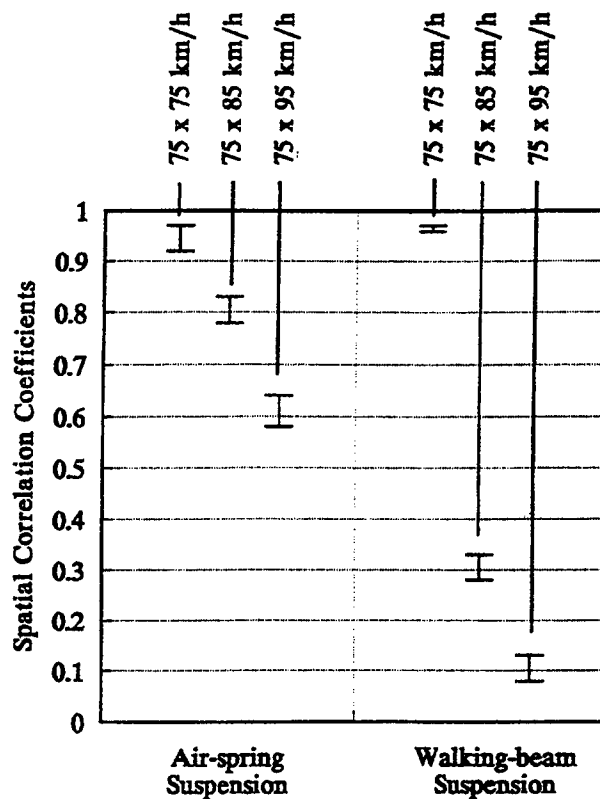

Figure 29. Correlation coefficients for specific wheels in runs conducted at different speeds (LeBlanc and Woodrooffe, 1995).

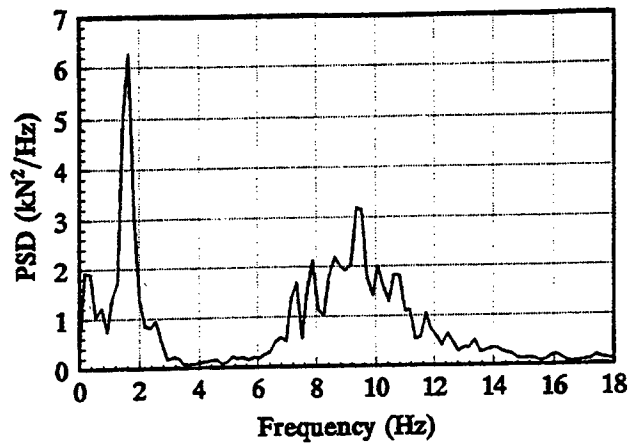

Figure 30. Typical PSD for air-spring suspension (LeBlanc and Woodrooffe, 1995).

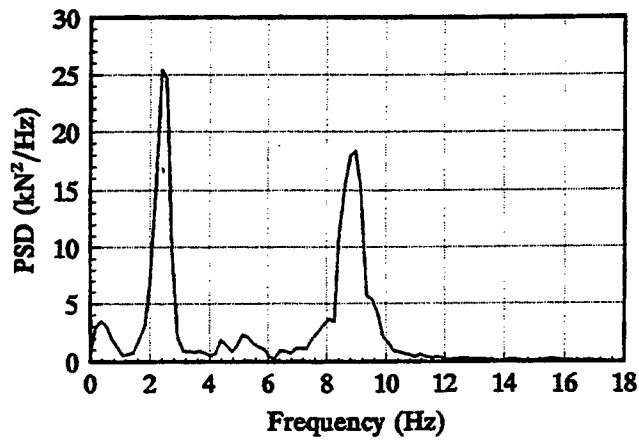

Figure 31. Typical PSD for walking-beam suspension (LeBlanc and Woodrooffe, 1995).

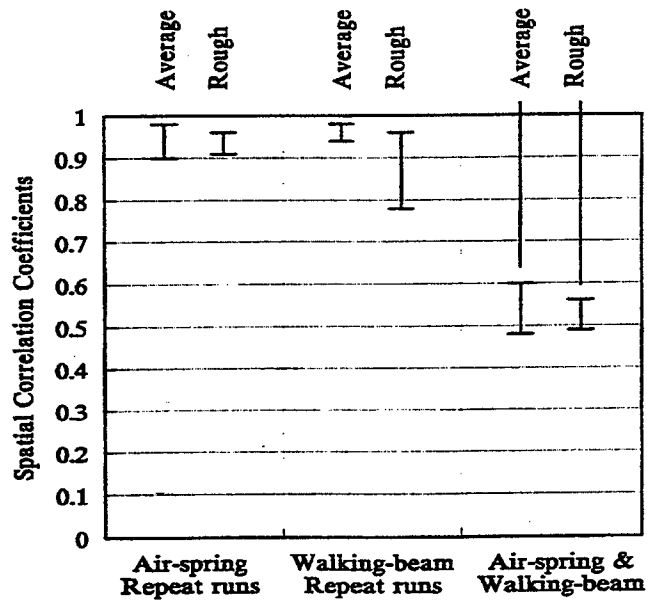

Figure 32. Correlation coefficients for specific wheels from similar and different tractor suspensions (LeBlanc and Woodrooffe, 1995).

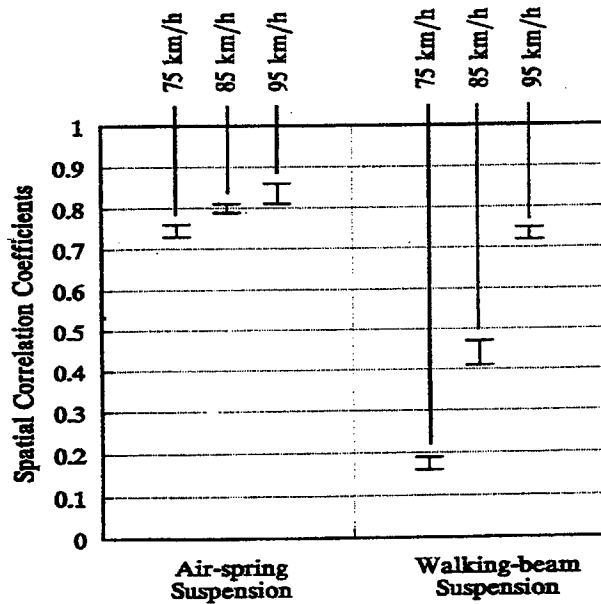

Figure 33. Correlation coefficients between wheel loads of lead and trailing axles of tandem-axle groups (LeBlanc and Woodrooffe, 1995).

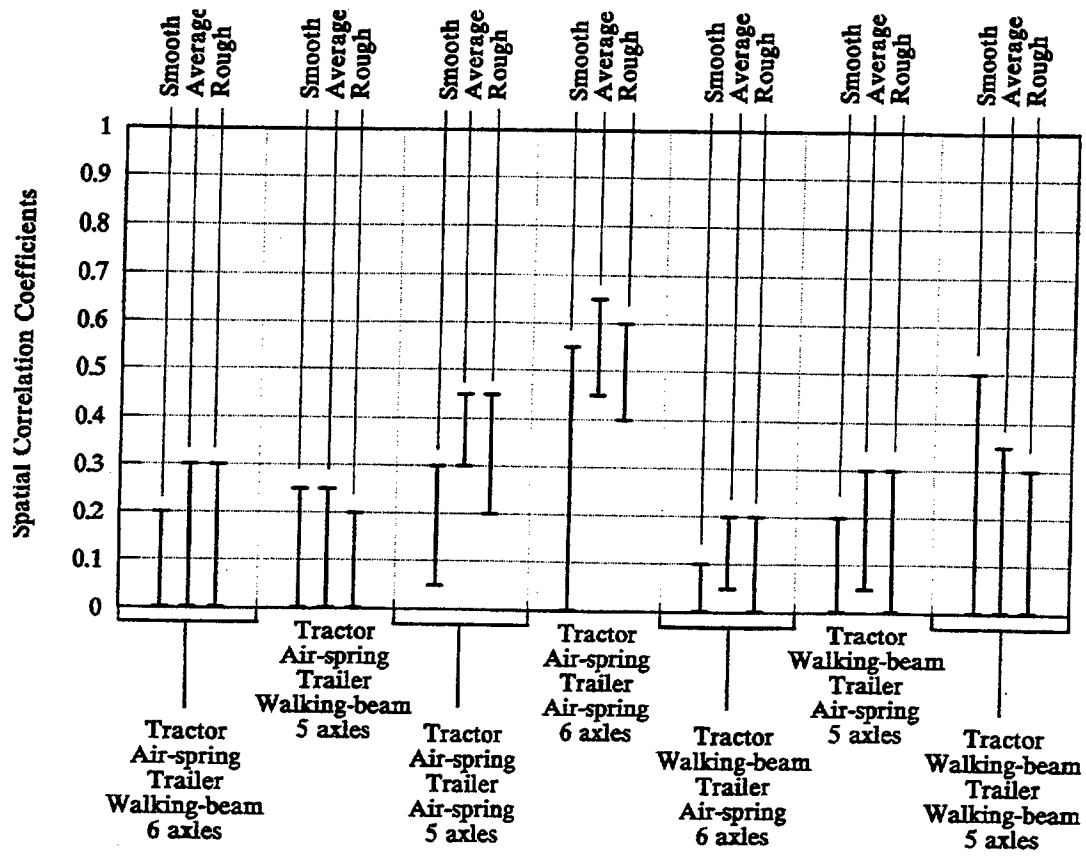

Figure 34. Correlation coefficients between tractor and trailer wheel loads in repeated runs (LeBlanc and Woodrooffe, 1995).

EFFECTS OF TIRE FACTORS ON ROAD DAMAGE

Since the early 1930s, pneumatic tires, which are designed for use by passenger cars and light trucks, have been increasingly used in heavy road vehicles. However, the concerns regarding limited natural resources, safety and economic constraints, and different tire types and mounting configurations for heavy vehicle applications are being investigated. It is well known that in addition to the variation of vehicle characteristics contributing to road damage, tire type, inflation pressure, footprint contact pressure area, stiffness, and mounting configuration are also known to inversely affect road condition and performance (Akram and Scullion, 1992). For instance, it was determined by Huhtala *et al.* (1992) that an increase of 20 percent of inflation pressure for a conventional tire (Table 5) would increase the aggressiveness of these tires by a factor of 1.1 to 1.4 times.

Table 5. Tire types and physical characteristics (Gillespie *et al.*, 1993).

Name	Tire Size (and Equivalent)	Nominal Tread Width Range ¹⁸ (in)	Axle Load Capacity (kips)		Assumed Contact Dimensions (in)	
			Single	Dual	Width	Length
Conventional	11R22.5 10.00-20 11R24.5 295/75R22.5	7-9	12	20	8	9 (single) 8 (dual)
Low profile	215/75R17.5 245/75R19.5	6.5-8	NA	17	7	7
Wide-base single	15R22.5 385/65R22.5	10-12	16	NA	11	11
Wide-base single	18R22.5 445/65R22.5	13-15	20	NA	14	12

1 in = 25.4 mm

1 kip = 6897 kPa

The wide-base tires that are commonly used on heavy trucks only for short-haul services in the United States are being investigated as a replacement for the existing single- and dual-tire configurations for the long-haul services. The wide-base tires are known to provide several benefits over conventional tires (single and dual tires). Some of these benefits include: the improved roll stability due to the allowed larger distance between the spring suspensions in tanker applications that lower the center of gravity; the softer ride due to the 40 percent reduction of the tire vertical stiffness (Figure 35); and the 5.3-kN total weight reduction for an 18-wheeler converted to a 10-wheeler with aluminum wheels. Furthermore, proponents claim that using these wide-base single tires on tractors and trailers improves fuel consumption, ride comfort, handling and maneuverability, braking (also reduces tire cost and increases payload), and ease of wheel and tire mounting (Giles, 1979). Figures 36 and 37 illustrate the increased load capacity as well

¹⁸ Observed range from a random sample of tires.

as the advantages of increased tire pressure and load capacity for a conventional tire and a wide-base tire. Despite these advantages, the trucking industry in the United States is reluctant to adapt wide-base single tires for the long-haul applications due to the road damage associated with their application (Tielking, 1995).

Several road tests and experiments investigating the effects of tire type and configuration on pavement damage were conducted (Huhtala *et al.*, 1992; Streit *et al.*, 1995). These investigations revealed that single tires induce more damage to pavement than dual or super-single tires (Figures 38 through 40). However, super-single tires were found to cause more road damage than dual tires (Figures 41 through 44). Furthermore, it is indicated by Huhtala *et al.* (1992) that wide-base tires are more aggressive than dual tires by a factor of 1.2 to 1.9 if they were compared to the most common dual tires. Additional study by the same authors indicated that within the same class of wide-base tires, the aggressiveness may vary by a factor of up to 1.6 due to the change in the contact pressure area, with less aggressiveness occurring with wider tires.

In their experimental study, Akram and Scullion (1992) illustrated that the pavement life is not only affected by the tire type, but also by the vehicle speed. Figure 45 illustrates the speed dependence of the vertical compressive strain at the top of a thick sub-grade under dual and wide-base single tires. For the same loading conditions and an increase in speed, the predicted strain on the surface of a designated sub-grade decreased more for dual tires than for wide-base single tires; that is, wide-base tires are 2 to 4.8 times more damaging for a thin and a thick selected sub-grade slab. However, in the same figure, it is illustrated that the measured pavement deflections under both dual tires and wide-base single tires decreased with an increase in speed, thus inducing less damage.

Furthermore, due to the decrease of footprint cross area of wide-base single tires (Figure 46), which is about 12 percent less than that of a dual tire set, less frictional force is applied during braking. This increases the stopping distance, particularly at high speeds, as shown by Figure 47. As suggested by Akram and Scullion (1992), this increase in stopping distance can be eliminated by changing the tire tread components.

Even though research has been conducted identifying the potential and detrimental effects of replacing single and dual tires by wide-base super-single tires, not much research has surfaced supporting the advantages of wide-base tires. Published estimates of fuel savings range from 5 to 9 percent when 16 conventional radial tires are replaced by 8 wide radial tires (Tielking, 1995). In addition, the advantages associated with improved ride comfort may come at the expense of negative vertical stability. Furthermore, no study has found that wide-base tires are less safe than dual tires. At least one safety advantage increases the driver's awareness of tire failure.

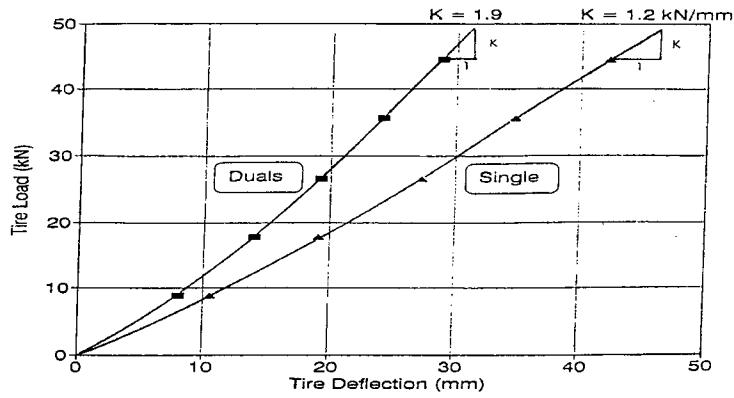

Figure 35. Comparison of load versus deflection data and vertical stiffness (K) for dual tires and wide-base single tires (Tielking, 1995).

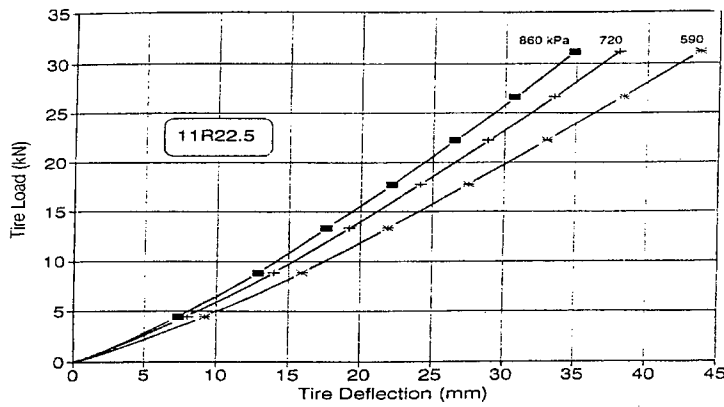

Figure 36. Load versus deflection for conventional tire under different pressures (Tielking, 1995).

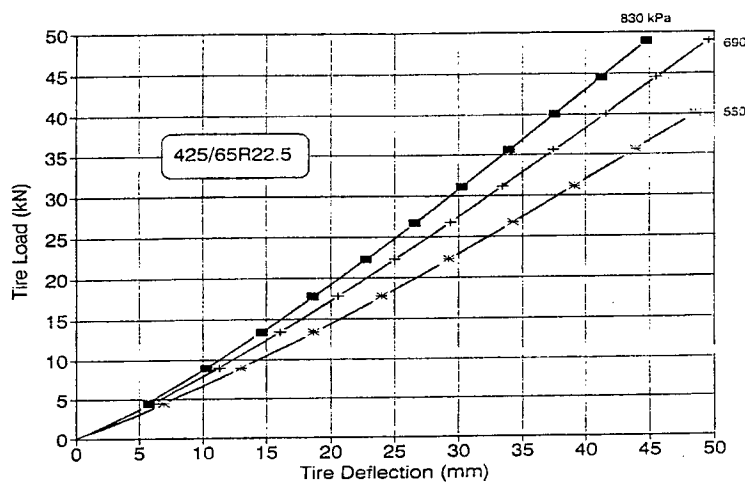
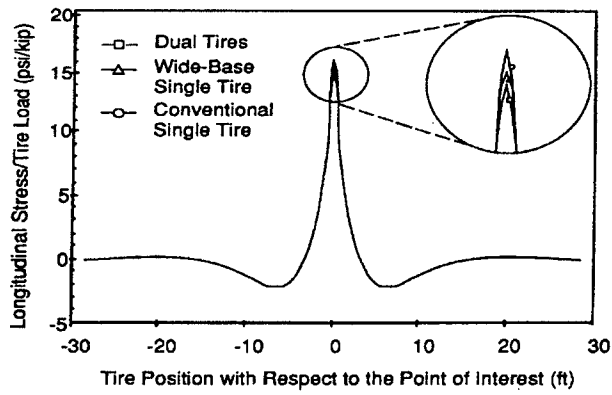
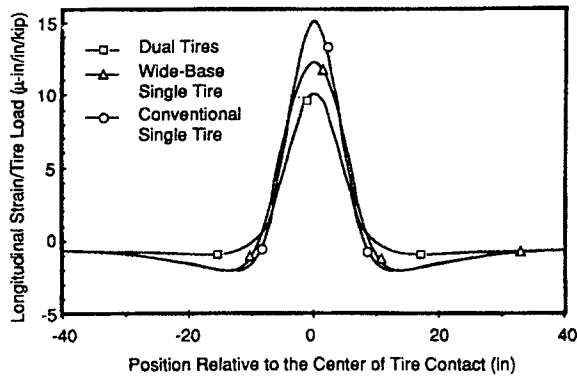

Figure 37. Load versus deflection for wide-base tire under different pressures (Tielking, 1995).



1 ft = 0.305 m
 1 psi = 6.897 kPa
 1 kip = 6897 kPa

Figure 38. Rigid pavement stress functions of conventional single, dual, and wide-base tires (Gillespie *et al.*, 1993).



1 in = 25.4 mm
 1 kip = 6897 kPa

Figure 39. Flexible pavement strain functions of conventional single, dual, and wide-base tires (Gillespie *et al.*, 1993).

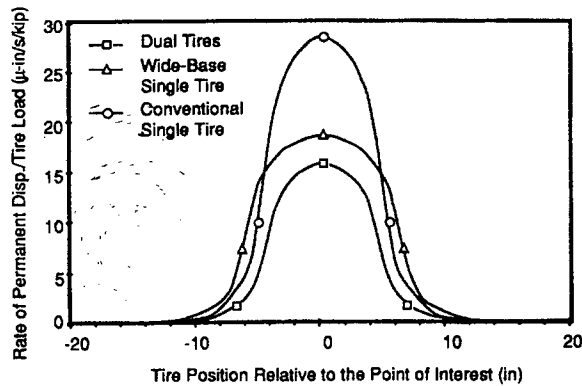

1 in = 25.4 mm
 1 kip = 6897 kPa

Figure 40. Rutting functions of conventional single, dual, and wide-base tires (Gillespie *et al.*, 1993).

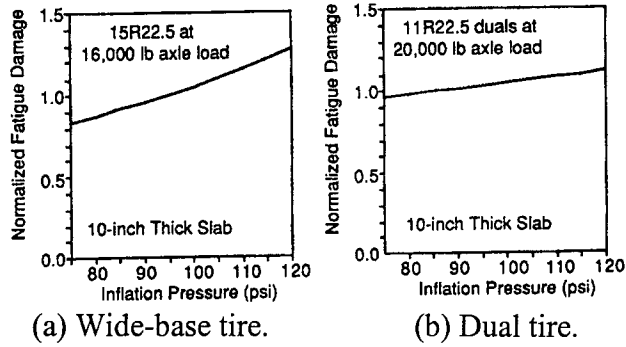

1 in = 25.4 mm
 1 lb = 0.454 kg
 1 psi = 6.897 kPa

Figure 41. Rigid pavement fatigue damage versus inflation pressure for dual and wide-base tires (Gillespie *et al.*, 1993).

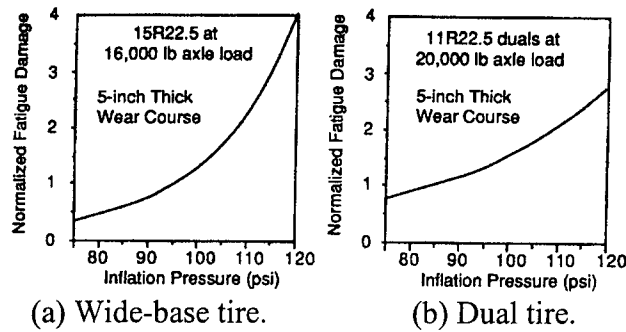

1 in = 25.4 mm
 1 lb = 0.454 kg
 1 psi = 6.897 kPa

Figure 42. Flexible pavement fatigue damage versus inflation pressure for dual and wide-base tires (Gillespie *et al.*, 1993).

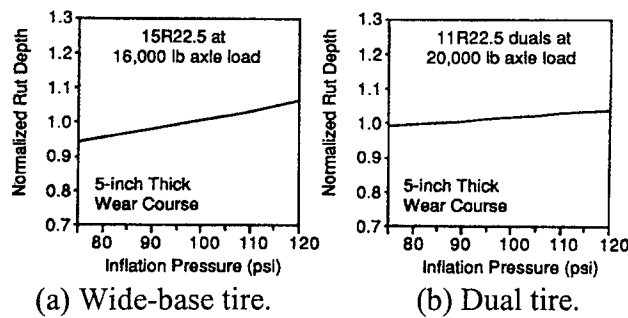

1 in = 25.4 mm
 1 lb = 0.454 kg
 1 psi = 6.897 kPa

Figure 43. Rut depth versus inflation pressure for dual and wide-base tires (Gillespie *et al.*, 1993).

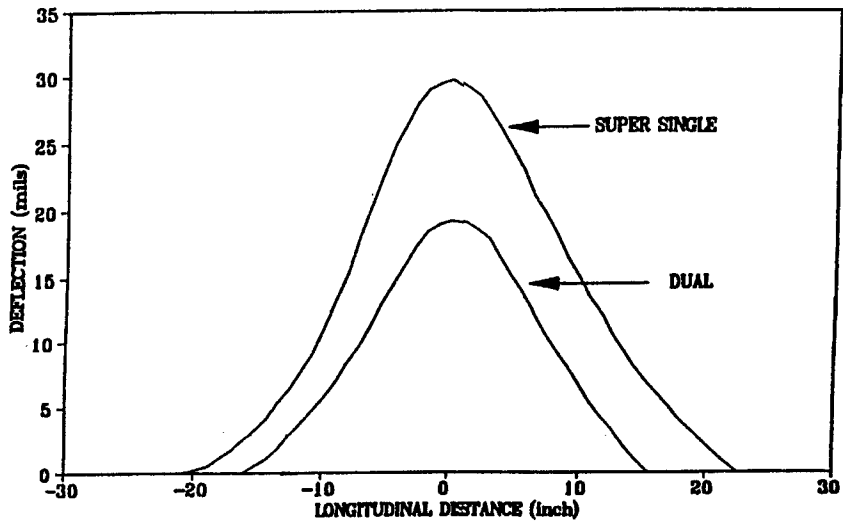

1 in = 25.4 mm

1 mil = 0.001 in = 0.0254 mm

Figure 44. Measured peak deflection profiles under dual and wide-base tires on a road section (Akram *et al.*, 1992).

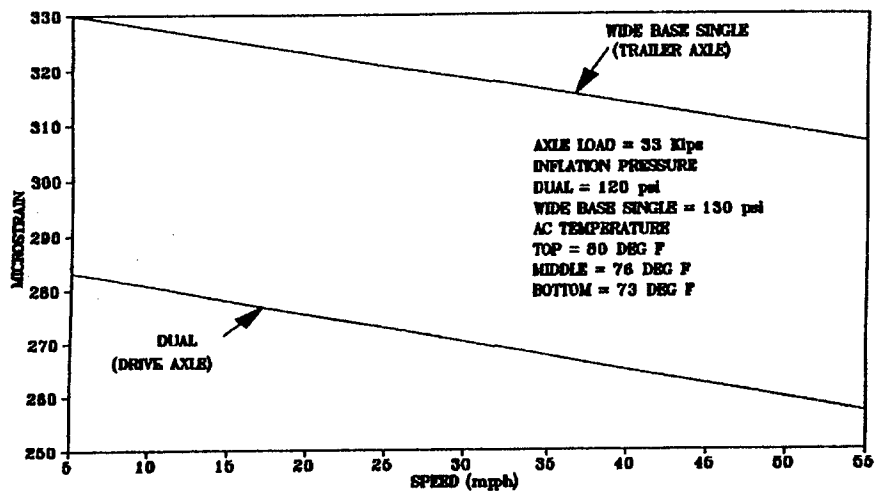

1 mi/h = 1.61 km/h

1 kip = 6897 kPa

1 psi = 6.897 kPa

$^{\circ}\text{C} = (^{\circ}\text{F} - 32) / 1.8$

Figure 45. Speed effect on average vertical compressive strain at the top of a thick section of road under dual and wide-base tires (Akram *et al.*, 1992).

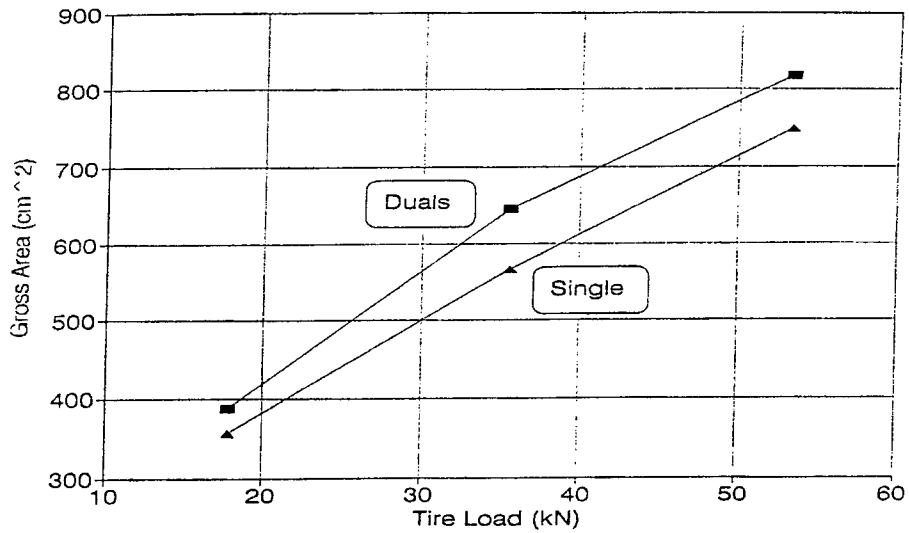

Figure 46. Effect of dual and wide-base tire loads on footprint area (Tielking, 1995).

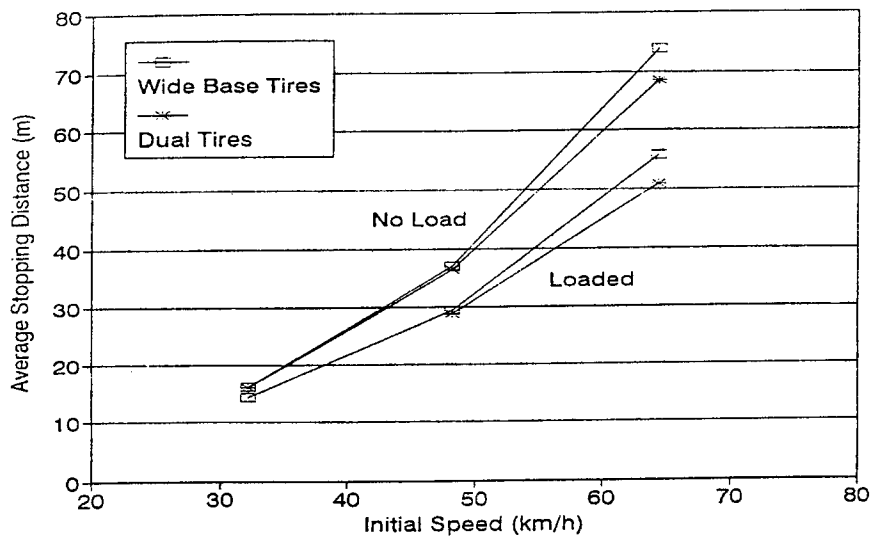

Figure 47. Average locked wheel stopping distances on wet pavement, loaded and unloaded trailer (Tielking, 1995).

CONCLUSIONS

This extensive literature survey has focused on the study of spatial repeatability of dynamic wheel loads and its effect on pavement damage. Several research programs were conducted to identify the effects of the environment, vehicle design, characteristics, and operating conditions on the pavement damage. Among these studies, suspension type and characteristics, as well as tire type and configuration, are identified as major contributors to pavement deterioration. Within these two groups, an examination of the dynamic wheel forces, their patterns, and their impact on the pavement damage as they propagate along the roads is performed.

Concluding observations and remarks identifying the relationship between spatial repeatability of dynamic wheel forces, suspension type, and road damage are reported as follows:

- Dynamic tire forces, which are highly dependent on vehicle speed, configuration, suspension type, road roughness, tire type, and configuration, are either randomly distributed or spatially repeated along the path of a vehicle.
- The considerable research conducted in this area illustrated trends of spatial repeatability (high correlation) of these dynamic wheel loads. If dynamic wheel forces exhibit high correlation ($\rho \geq 0.707$), the road wear would increase according to the fourth power rule, inducing four times more road damage than the average value); however, if a low correlation ($\rho < 0.707$) is exhibited, the road wear would increase as the variance of the dynamic loads.
- Excessive road wear could be reduced by using “road-friendlier” suspensions. Generally speaking, *adequately damped* air-spring (road-friendlier) suspensions (meeting specific damping ratio and bouncing frequency criteria) outperformed steel and rubber suspensions in delivering lower DLCs, particularly at higher speeds and on rougher roads (the DLC’s ratio of rubber and/or steel suspensions to air suspensions is at about three). Hence, air-spring suspensions can be suitable for providing lower dynamic loads if they are properly designed.
- Air suspensions have been shown to provide higher spatial correlation at conditions providing lower DLC (that is, at lower speeds and lower road roughness).
- On rougher roads and for a specified speed, air suspensions exhibited higher spatial repeatability (correlation) of dynamic wheel loading that induces about 170 percent higher pavement wear than weakly correlated wheel loads.
- For the same road roughness and same wheels at repeated vehicle runs, as speed increases, the spatial correlation decreases for steel suspensions at a higher rate than air suspensions (i.e., an average of 0.1 spatial correlation coefficient was determined at 95 km/h for a walking-beam suspension as compared to 0.6 for an air-spring

suspension). This behavior would be reversed for both suspensions if measurements were made for wheels of the lead and trailing axles of a tandem-axles group, i.e., as speed increases, spatial repeatability increases for both types of suspension. It was further observed that for the same wheels, an increase in speed would reduce the correlation of wheel loads more than replacing a walking-beam suspension by an air suspension.

As stated in the report, even though there is a 0.24 reduction of the DLC and a 60 percent reduction of pavement damage between the walking beam and air suspensions, several other factors that influence these percentages need to be considered (i.e., tire type and inflation pressure, wheel-base filtering, suspension cross-coupling). More importantly, the results presented in this report are accumulated from research conducted on several distinct vehicles on different roads with suspension systems possessing similar characteristics and parameters. As presented previously, the small variations in the vehicle and suspension characteristics may lead to a random DLC history.

Moreover, despite their stated benefits, it was clear that super-single tires caused 2 to 4.8 times more damage than the commonly used conventional dual tires. Dual tires have been shown to decrease strain on the pavement. Hence, at higher speeds, these tires would lower pavement damage. This phenomenon conflicts with the conclusions stated above, that is, the desire for vehicle operation at lower speeds.

The dilemma that faces the pavement engineer and the vehicle engineer, without any consistent experimental evaluation, is whether to adopt air suspensions as “road-friendlier” suspensions. Certainly, one would want to provide the operation of normal traffic on smoother roads at lower speeds. However, at lower speeds, which provide lower dynamic loadings, the spatial correlation is high for the same wheels and the strain on the pavement is larger for wide-base tires. As illustrated earlier, keeping the vehicle fleets at a lower number may reduce the spatial correlation (as shown by O’Connor *et al.* (1996), spatial repeatability is only experienced in a vehicle fleet for which a large quantity of data is available).

RECOMMENDATIONS

As illustrated in the previous discussion, there is no clear evidence supporting the reduction of pavement damage while using air-suspension systems. It is clear that these suspension systems provide lower DLCs (lower pavement damage); however, at times, there is high spatial correlation of the dynamic wheel loads. This may induce more damage than conventional suspension systems with low wheel force correlation. Therefore, it is recommended that consistent studies conforming with a set of testing criteria should be conducted on vehicles exhibiting similar dynamic characteristics with identical suspension systems:

- Identify the class of vehicles and their characteristics (size, weight, suspension type, tire type, and configuration, etc.).

- Establish testing and performance criteria based on the already established research.
- Identify the main vehicle components contributing to the pavement damage.
- For these components, determine the DLCs and the correlation coefficient for all vehicle axles.
- Based on the findings, determine the “road-friendly” vehicle components (suspensions and tires), optimum operating conditions, and the existence of spatial repeatability for the selected class of vehicle.

REFERENCES

Addis, R. R.; Holiday, A. R.; and Mitchell, C. G. B., 1986, "Dynamic Loading of Road Pavements," *Proceedings of International Symposium on Heavy Vehicle Weights and Dimensions*, Kelowna, British Columbia, Canada, pp. 55-68.

Akram, T. and Scullion, T., 1992, *Estimating Damage Effects of Dual vs. Wide-Base Single Tires With Multidepth Deflectometers*, Texas Transportation Institute, College Station, Research Report 1184-1.

Cebon, D., 1985, *An Investigation of the Dynamic Interaction Between Wheeled Vehicles and Road Surfaces*, Ph.D. Dissertation, University of Cambridge, U.K.

Cebon, D., 1987, "Assessment of the Dynamic Wheel Forces Generated by Heavy Road Vehicles," *Proceedings of ARRB/FORS Symposium on Heavy Vehicle Suspension Characteristics*, Canberra, Australia, pp. 143-162.

Cebon, D., 1989, "Vehicle-Generated Road Damage: A Review," *Vehicle System Dynamics*, Vol. 18, No. 1-3, pp. 107-150.

Cebon, D., 1993, "Interaction Between Heavy Vehicles and Roads," The Thirty-Ninth L. Ray Buckendale Lecture, SAE SP-951.

Cole, D. J., 1990, *Measurement and Analysis of Dynamic Tyre Forces Generated by Lorries*, Ph.D. dissertation, Department of Engineering, University of Cambridge, U.K.

Cole, D. J. and Cebon, D., 1992, "Spatial Repeatability of Dynamic Tyre Forces Generated by Heavy Vehicles," *Proceedings of the Institution of Mechanical Engineers, Part D: Journal of Automobile Engineering*, Vol. 206, No. 1, pp. 17-27.

Collop, A. C.; Cebon, D.; and Cole, D. J., 1996, "Effects of Spatial Repeatability on Long-Term Flexible Pavement Performance," *Proceedings of the Institution of Mechanical Engineers, Part C: Journal of Automobile Engineering*, Vol. 210, pp. 97-110.

Collop, A. C.; Potter, T. E. C.; Cebon, D.; Cole, D. J., 1994, "Investigation of Spatial Repeatability Using a Tire Force Measuring Mat," *Transportation Research Board*, Washington, D.C. 20418, No. 1448, pp. 1-7.

Eisenmann, J., 1975, "Dynamic Wheel Load Fluctuations: Road Stress," *Strasse und Autobahn*, No. 4, pp. 127-128, Köln, Germany.

Giles, W. L., 1979, "Expanded Applications for Wide-Base Radial Truck Tires," *SAE Truck and Bus Meeting*, Fort Wayne, Indiana, Society of Automotive Engineers.

Gillespie, T. D., 1985, *Heavy Truck Ride*, The University of Michigan, Transportation Research Institute, SP-607, SAE: The Engineering Resource for Advancing Mobility, The Thirty-First L. Ray Buckendale Lecture.

Gillespie, T. D. and Karamihas, S. M., 1993, "Characterizing the Road-Damaging Dynamics of Truck Tandem Suspensions," *SAE International Truck and Bus Meeting and Exposition, Detroit, Michigan, SAE Technical Paper No. 932994. Also included in Proceedings No. SP-1002* (Published by the Society of Automotive Engineers, Inc., Warrendale, Pennsylvania).

Gillespie, T. D.; Karamihas, S. M.; Sayers, M. W.; Nasim, M. A.; Hansen, W.; Ehsan, N.; and Cebon, D., 1993, *Effects of Heavy-Vehicle Characteristics on Pavement Response and Performance*, National Cooperative Highway Research Program, Report 353, Transportation Research Board, National Research Council, National Academy Press, Washington, D.C.

Gyenes, L. and Mitchell, C. G. B., 1992, "The Spatial Repeatability of Dynamic Pavement Loads Caused by Heavy Goods Vehicles," *Heavy Vehicles and Roads: Technology, Safety, and Policy. Proceedings of the Third International Symposium on Heavy Vehicle Weights and Dimensions*, Queen's College, Cambridge, U.K., pp. 95-101.

Gyenes, L.; Mitchell, C. G. B.; and Phillips, S. D., 1992, "Dynamic Pavement Loads and Tests of Road-Friendliness for Heavy Vehicle Suspensions," Transport Research Laboratory, SAE Paper 922464, International Truck and Bus Meeting and Exposition, Toledo, Ohio.

Hahn, W. D., 1985, "Effects of Commercial Vehicle Design on Road Stress: Vehicle Research Results." Institut Fur Krufftfahrwesen, Uniyersitat Hannover, Germany (Translated by TRRL as WP/V&ED/87/38).

Huhtala, M.; Pihlajamaki, J.; and Miettinen, V., 1992, "The Effect of Wide-Based Tyres on Pavements," *Heavy Vehicles and Roads: Technology, Safety, and Policy. Proceedings of the Third International Symposium on Heavy Vehicle Weights and Dimensions*, pp. 211-217.

Jacob, B., "Spatial Repeatability of Impact Forces on a Pavement and Multi-Sensor WIM - Research Element 5 of the OECD IR6 DIVINE Project," 1995, Road Transport Technology, *Proceedings of the Fourth International Symposium on Heavy Vehicle Weights and Dimensions*, Vol. 4, pp. 273-279.

Kinder, D. F. and Lay, M. G., 1988, *Review of the Fourth Power Law*, Internal Report AIR000-248, Australian Road Research Board.

LeBlanc, P. A. and Woodrooffe, J., 1995, "Spatial Correlation of Dynamic Wheel Loads," *Road Transport Technology, Proceedings of the Fourth International Symposium on Heavy Vehicle Weights and Dimensions*, Vol. 4, pp. 281-290.

LeBlanc, P. A.; Woodrooffe, J.; and Papagiannakis, A. T., 1992, "A Comparison of the Accuracy of Two Types of Instrumentation for Measuring Vertical Wheel Load," *Heavy Vehicles and Roads: Technology, Safety, and Policy*, Thomas Telford, London, U.K.

Mitchell, C. G. B. and Gyenes, L., 1989, "Dynamic Pavement Loads Measurement for a Variety of Truck Suspensions," *Proceedings, 2nd International Conference on Heavy Vehicle Weights and Dimensions*, Kelowna, British Columbia, Canada.

Moran, T.; Sullivan, M.; Mahoney, J.; and Chatti, K., 1995, "A Demonstration of the Theory of Spatial Repeatability," *Proceedings of the Forth International Symposium on Heavy Vehicle Weights and Dimensions, Road Transport Technology - 4*, University of Michigan Transportation Research Institute, Ann Arbor, pp. 291-300.

Morris, J. R., 1987, *Effects of Heavy Vehicle Characteristics on Pavement Response: Phase 1*, prepared for NCHRP project 1-25, Transportation Research Board.

O'Connell, S.; Abbo, E.; and Hedrick, K., 1986, "Analyses of Moving Dynamic Loads on Highway Pavements, Part I: Vehicle Response," *Proceedings, International Symposium on Heavy Vehicle Weights and Dimensions*, Kelowna, British Columbia, Canada.

O'Connor, T.; O'Brian, E. J.; and Jacob, B., 1996, "An Experimental Investigation of Spatial Repeatability," *EF/Vehicle-Infrastructure IV/San Diego*, California, pp. 1-17.

OECD, 1992, *Dynamic Loading of Pavements*, Road Transport Research, ISBN 92-64-13762-9, p. 105.

Potter, T. E. C.; Cebon, D.; and Cole, D. J., 1995, "An Investigation of Road Damage Due to Measured Dynamic Tyre Forces," *Proceedings of the Institution of Mechanical Engineers, Part D-Journal of Automobile Engineering*, Vol. 209, No. 1, pp. 9-24.

Streit, D. A.; Kulakowski, B. T.; and Wollyung, R. J., 1995, *Dynamic Vehicle Forces on Pavements*, Draft Report, The Pennsylvania Transportation Institute, Federal Highway Administration Contract No. DTFH61-90-C-00084.

Sweatman, P. F., 1983, *A Study of Dynamic Wheel Forces in Axle Group Suspensions of Heavy Vehicles*, Australian Road Research Board, Special Report No. 27.

Tielking, J. T., 1995, "Wide-Base Radial Truck Tyres: Properties and Performance," *Heavy Vehicle Systems, International Journal of Vehicle Design*, Vol. 2, No. 3/4, pp. 187-207.

Woodrooffe, J., 1995, "Heavy Truck Suspension Damper Performance for Improved Road Friendliness and Ride Quality," *SAE International Truck and Bus Meeting and Exposition*, Winston-Salem, North Carolina, SAE Technical Paper No. 952636. Also

included in Proceedings No. SP-1128. Published by Society of Automotive Engineers, Inc., Warrendale, Pennsylvania.

Woodrooffe, J. H. F. and LeBlanc, P. A., 1986, "The Influence of Suspension Variations on Dynamic Wheel Loads of Heavy Vehicles," *SAE Truck and Bus Meeting and Exposition*, King of Prussia, Pennsylvania, SAE Technical Paper No. 861973. Published by Society of Automotive Engineers, Inc., Warrendale, Pennsylvania.

Woodrooffe, J. H. F.; LeBlanc, P. A.; and LePiane, K. R., 1986, *Effects of Suspension Variations on the Dynamic Wheel Loads of a Heavy Articulated Highway Vehicle: Rig Development, Experimental Program and Findings*, Technical Report, Vehicle Weights and Dimensions Study, Vol. 11.

Woodrooffe, J. H. F.; LeBlanc, P. A.; and Papagiannakis, A. T., 1988, "Suspension Dynamics - Experimental Findings and Regulatory Implications," *SAE Conference on Vehicle/Pavement Interaction. SP765, SAE Trans. 881847*, Indianapolis, Indiana, Society of Automotive Engineers.