

# Developing Representative Michigan Truck Configurations for Bridge Load Rating

MDOT ORBP Reference Number: OR14-023

## FINAL REPORT

February 28, 2018

### **Prepared For:**

Michigan Department of Transportation  
Research Administration  
8885 Ricks Rd.  
P.O. Box 30049  
Lansing MI 48909

### **Prepared By:**

Wayne State University  
5050 Anthony Wayne Drive  
Detroit, MI 48202

### **Authors:**

Christopher D. Eamon  
Sasan Siavashi



# Developing Representative Michigan Truck Configurations for Bridge Load Rating

MDOT ORBP Reference Number: OR14-023

## FINAL REPORT

February 28, 2018

### **Prepared For:**

Michigan Department of Transportation  
Research Administration  
8885 Ricks Rd.  
P.O. Box 30049  
Lansing MI 48909

### **Prepared By:**

Wayne State University  
5050 Anthony Wayne Drive  
Detroit, MI 48202

### **Authors:**

Christopher D. Eamon  
Sasan Siavashi



## TECHNICAL REPORT DOCUMENTATION PAGE

<b>1. Report No.</b> SPR -1640	<b>2. Government Accession No.</b> N/A	<b>3. Recipient's Catalog No.</b>	
<b>4. Title and Subtitle</b> Developing Representative Michigan Truck Configurations for Bridge Load Rating		<b>5. Report Date</b> 2/28/2018	
		<b>6. Performing Organization Code</b> N/A	
<b>7. Author(s)</b> Christopher D. Eamon and Sasan Siavashi		<b>8. Performing Organization Report No.</b> N/A	
<b>9. Performing Organization Name and Address</b> Wayne State University 5057 Woodward, Suite 13001 Detroit, MI 48202		<b>10. Work Unit No.</b> N/A	
		<b>11. Contract or Grant No.</b> Contract 2016-0070 Z2	
<b>12. Sponsoring Agency Name and Address</b> Michigan Department of Transportation (MDOT) Research Administration 8885 Ricks Road P.O. Box 33049 Lansing, Michigan 48909		<b>13. Type of Report and Period Covered</b> Final Report, 3/1/2016 to 2/28/2018	
		<b>14. Sponsoring Agency Code</b> N/A	
<b>15. Supplementary Notes</b> Conducted in cooperation with the U.S. Department of Transportation, Federal Highway Administration. MDOT research reports are available at <a href="http://www.michigan.gov/mdotresearch">www.michigan.gov/mdotresearch</a> .			
<b>16. Abstract</b> The objective of this study is to recommend a rating process representative of Michigan load effects for legal and extended permit vehicles. For this study, high fidelity WIM data from 20 Michigan sites were analyzed. Using vehicle weight and configuration filtering criteria developed for the project, the WIM data were filtered to capture Michigan legal and extended permit truck traffic. From this data, load effects were generated for bridge spans from 20 to 200 ft, considering simple and continuous moments and shears, as well as single lane and two lane effects. Load effects were then projected to 5 years for rating and used in a reliability-based analysis to determine the rating live load effects needed to meet minimum and target reliability levels for LRFR and LFR rating procedures. Bridge beam types considered for the analysis were steel, prestressed concrete, reinforced concrete, spread box, and side-by-side box. A rating process was recommended to best meet the required reliability level.			
<b>17. Key Words</b> Bridges, WIM, Load Rating, Live Load, Reliability		<b>18. Distribution Statement</b> No restrictions. This document is also available to the public through the Michigan Department of Transportation.	
<b>19. Security Classif. (of this report)</b> Unclassified	<b>20. Security Classif. (of this page)</b> Unclassified	<b>21. No. of Pages</b> 370	<b>22. Price</b> N/A

## **DISCLAIMER**

*This publication is disseminated in the interest of information exchange. The Michigan Department of Transportation (hereinafter referred to as MDOT) expressly disclaims any liability, of any kind, or for any reason, that might otherwise arise out of any use of this publication or the information or data provided in the publication. MDOT further disclaims any responsibility for typographical errors or accuracy of the information provided or contained within this information. MDOT makes no warranties or representations whatsoever regarding the quality, content, completeness, suitability, adequacy, sequence, accuracy or timeliness of the information and data provided, or that the contents represent standards, specifications, or regulations.*

**TABLE OF CONTENTS**

LIST OF TABLES ..... 7

LIST OF FIGURES ..... 8

EXECUTIVE SUMMARY ..... 9

CHAPTER 1: INTRODUCTION ..... 10

    Statement Of The Problem ..... 10

    Objectives Of The Study ..... 11

    Summary of Research Tasks ..... 11

CHAPTER 2: LITERATURE REVIEW ..... 12

    Models Developed for AASHTO Standards ..... 12

    MDOT Reports and Standards ..... 13

    NCHRP Reports and Related Research..... 15

    Collecting and Analyzing WIM Data..... 20

    Additional Load Model Development for Bridge Design and Rating ..... 21

CHAPTER 3: SUMMARY OF DOCUMENTS DESCRIBING LEGAL AND EXTENDED PERMIT VEHICLES..... 25

    Review Documents..... 25

    Michigan Vehicle Code and Related Documents..... 25

    Code of Federal Regulations Part 658..... 31

    Fixing America’s Surface Transportation Act (FAST) (P.L. 114-94) (2015)..... 35

    Federal Size Regulations for Commercial Motor Vehicles (US DOT FHWA 2004).... 36

    Intermodal Surface Transportation Efficiency Act of 1991 (ISTEA “Freeze”)..... 40

    Potential Conflicts Between The MVC and Federal Requirements..... 41

    Enforcement of Vehicle Regulations..... 43

    Expected Vehicle Configurations..... 44

    Michigan Truck Registration Data ..... 49

    Extended Permit Hauler Survey ..... 50

CHAPTER 4: SUMMARY OF MDOT PERMITTING PROCESS ..... 52

    Definitions ..... 52

    Permitting Process for Single Trip Permits ..... 53

Permitting Process for Extended Permits .....	54
CHAPTER 5: SUMMARY OF WEIGH-IN-MOTION DATA ANALYSIS .....	55
Introduction .....	55
Data Collection .....	55
Vehicle Load Effects .....	60
CHAPTER 6: DETERMINATION OF REQUIRED RATING LOAD EFFECTS .....	67
Process Summary .....	67
Bridge Structures Considered .....	73
Data Projection .....	75
CHAPTER 7: RESULTS .....	82
CHAPTER 8: RECOMMENDED RATING PROCESS .....	87
Simplified Rating Approach .....	87
Assessment of Rating Factor using Required Load Effect (RLE) Tables .....	88
Exact Rating Assessment Using Structure-Specific Reliability Analysis .....	89
Posting Vehicles .....	95
REFERENCES .....	100
APPENDIX A. FEDERAL BRIDGE FORMULA TABLE .....	105
APPENDIX B. FEDERALLY DESIGNATED ROUTES IN MICHIGAN .....	107
APPENDIX C. SUMMARY OF MICHIGAN STATE POLICE INTERVIEW .....	110
APPENDIX D. SUMMARY OF INTERVIEW WITH MTA .....	112
APPENDIX E. EXTENDED PERMIT HAULER SURVEY .....	114
APPENDIX F. DATA FOR LEGAL AND EXTENDED PERMIT (LEP) VEHICLES .....	116
APPENDIX G. SUMMARY OF VEHICLE LOAD EFFECTS .....	122
APPENDIX H. CUMULATIVE DISTRIBUTION FUNCTIONS OF TOP 5% OF LOAD EFFECTS .....	153
APPENDIX I. PROJECTION RESULTS .....	179
APPENDIX J. REQUIRED LIVE LOAD EFFECTS .....	220
APPENDIX K. REQUIRED LOAD FACTORS .....	267



APPENDIX L. EXISTING RATING RELIABILITY INDICES .....	319
APPENDIX M. NOMINAL DEAD LOADS USED IN RELIABILITY ANALYSIS.....	366

## LIST OF TABLES

Table 3. 1 Limits for Permit Loads.....	30
Table 3. 2 Grandfathered ST Lengths.....	32
Table 3. 3 Specialized Equipment Length Limits.....	33
Table 3. 4. Specialized Equipment Length Limits.....	40
Table 3. 5. Length and Weight Limitations of Vehicles Under ISTEAA.....	41
Table 3. 6. Freightliner Trucks.....	45
Table 3. 7. International Trucks.....	45
Table 3. 8. Peterbilt Trucks.....	45
Table 3. 9. Western Star Trucks.....	46
Table 3. 10. Utility Trailers.....	46
Table 3. 11. Wabash Trailers.....	47
Table 3. 12. Stoughton Trailers.....	47
Table 3. 13. Fontaine Trailers.....	47
Table 3. 14. XL Specialized Trailers.....	48
Table 3. 15. Rogers Trailers.....	49
Table 3. 16. Trucks Registered in Michigan by GVW.....	49
Table 3. 17. Registered Farm, Milk, and Log Trucks in Michigan.....	50
Table 3. 18. Typical Michigan Trucks.....	51
Table 5. 1. WIM Sites.....	52
Table 5. 2. Small Vehicles Filtering Criteria.....	58
Table 5. 3. Filtering Criteria.....	58
Table 5. 4. Legal/Extended Permit Filtering Criteria.....	59
Table 5. 5. Vehicle Statistics for LEP Vehicles.....	59
Table 6. 1. Statistical Parameters for DF.....	71
Table 6. 2. Random Variable Statistics.....	72
Table 7. 1. Governing MDOT Trucks.....	83
Table 7. 2. LRFR Load Factors Greater Than 1.0.....	84
Table 7. 3. LFR Load Factors Greater Than 1.35.....	85
Table 7. 4. LFR Load Factors Greater Than 1.30.....	86
Table 8. 1. Reliability Indices For a 60' Span Bridge Posted for Simple Moment (2-lane effects) with Exact Assessment of Rating Factor.....	97
Table 8. 2. Reliability Indices For a 60' Span Bridge Posted for Simple Moment (2-lane effects) with Existing Assessment of Rating Factor, LRFR.....	98
Table 8. 3. Reliability Indices For a 60' Span Bridge Posted for Simple Moment (2-lane effects) with Existing Assessment of Rating Factor, LFR.....	99

## LIST OF FIGURES

Figure 3. 1. Automobile and Boat Transporter Combinations.....	38
Figure 3. 2. B-Train Semitrailer-Semitrailer Combination.....	38
Figure 3. 3. Beverage Semitrailer (and Tractor).....	38
Figure 3. 4. Maxi-cube Vehicle.....	38
Figure 3. 5. Saddlemount with Fullmount Combination.....	38
Figure 3. 6. Dromedary Deck or Plate.....	39
Figure 3. 7. Truck Tractor-Semitrailer Combination.....	39
Figure 3. 8. Truck Tractor-Semitrailer-Trailer Combination.....	40
Figure 3. 9. Truck Configurations.....	44
Figure 3. 10. XL Specialized Semitrailers.....	49
Figure 5. 1. WIM Sites With ADTT $\geq 5000$ .....	56
Figure 5. 2. WIM Sites With ADTT $\sim 3500$ .....	56
Figure 5. 3. WIM Sites With ADTT $\sim 1500$ .....	57
Figure 5. 4. WIM Sites With ADTT $\sim 400$ .....	57
Figure 5. 5. Simple Span Moments, Single LEP Vehicles.....	62
Figure 5. 6. Simple Span Shears, Single LEP Vehicles.....	62
Figure 5. 7. Continuous Span Moments, Single LEP Vehicles.....	63
Figure 5. 8. Continuous Span Shears, Single LEP Vehicles.....	63
Figure 5. 9. Maximum Single, Following, and Side-by-side Simple Span Moments.....	64
Figure 5. 10. Maximum Single, Following, and Side-by-side Simple Span Shears.....	64
Figure 5. 11. Maximum Single, Following, and Side-by-side Continuous Span Moments.....	65
Figure 5. 12. Maximum Single, Following, and Side-by-side Continuous Span Shears.....	65
Figure 5. 13. Examples of 7-9 Axle LEP Truck Configurations That Govern Load Effects.....	66
Figure 5. 14. Examples of 11-Axle LEP Truck Configurations That Govern Load Effects.....	66
Figure 6. 1. CDFs of Top 350 Simple Span, Single Lane Moments for Spans From 20 – 200 ft. .....	77
Figure 6. 2. CDFs of Top 1% of Simple Span, Single Lane Moments for Spans From 20 – 200 ft. .....	77
Figure 6. 3. CDFs of Top 5% of Simple Span, Single Lane Moments for Spans From 20 – 200 ft. .....	78
Figure 6. 4. Projected Mean Maximum Simple Span, Single Lane Moment for Different $n$ Values. .....	78
Figure 6. 5. Projected Mean Maximum Simple Span, Single Lane Shear for Different $n$ Values.....	79
Figure 6. 6. Projected Mean Maximum Continuous Span, Single Lane Moment for Different $n$ Values.....	79
Figure 6. 7. Projected Mean Maximum Continuous Span, Single Lane Shear as a function of span and number of data $n$ used for data fit.....	80

## EXECUTIVE SUMMARY

Truck configurations that are used for MDOT bridge rating are meant to represent the load effects caused by actual vehicles. However, these models were developed decades ago and may no longer closely resemble modern truck configurations. Of particular concern are the load effects caused by extended permit vehicles, which are not known with certainty. If the idealized vehicles that are used for bridge rating do not well-represent actual traffic loads, bridges may be rated inaccurately. This may lead to traffic restrictions that are not necessary, as well as potentially allowing traffic on structures that should be restricted. The objective of this study is to recommend a rating process representative of Michigan load effects for legal and extended permit vehicles, such that accurate bridge rating is ensured.

Information was first gathered from MDOT, the trucking industry, law enforcement, as well as other state and federal sources to clarify the definition of legal and extended permit vehicles, the permitting process, and how traffic restrictions are enforced. Next, high fidelity weigh-in-motion (WIM) data from 20 Michigan sites were analyzed. Using vehicle weight and configuration filtering criteria developed for the project, the WIM data were filtered to capture Michigan legal and extended permit truck traffic. From this data, load effects were generated for bridge spans from 20 to 200 ft, considering simple and continuous moments and shears, as well as single lane and two lane effects.

Using an extreme type I extrapolation method, load effects were then projected to 5 years for rating and used in a reliability-based analysis to determine the rating live load effects for legal and extended permit vehicles needed to meet a minimum reliability index of 1.5 for any bridge girder with an minimum average index of 2.5, safety levels used in the development of the AASHTO Manual for Bridge Evaluation. Bridge beam types considered for the analysis were steel, prestressed concrete, reinforced concrete, spread box, and side-by-side box. Results were computed for two rating procedures; load factor rating (LFR), used for older bridges designed by the AASHTO Standard Specifications, and Load and Resistance Factor Rating (LRFR), used for more recent bridges designed by AASHTO Load and Resistance Factor Design (LRFD) Specifications. In general, it was found that the required load effects varied significantly from one structure to the next, with most structures rated conservatively using LFR and all structures rated conservatively using LRFR. For LRFR, it was found that simple span side by side box beam bridges spanning 20' required highest load factors, while for LFR, side by side box beam structures as well as bridges of various types with 4' girder spacing required highest load factors.

It was further determined that no rating vehicle model could well-match the required rating load effects across all spans and load effects without having significant conservatism in some cases. However, a simple, conservative rating procedure was recommended to ensure that all structures would meet a minimum reliability level of 1.5. A more precise method was also developed to minimize conservatism in the rating process but allow the required safety level to be realized for all structures.

## **CHAPTER 1: INTRODUCTION**

### **Statement of The Problem**

Over the last several decades, the configuration of trucks traveling over Michigan bridges, as well as federally required bridge load rating procedures, have undergone significant changes. In 1974, the Federal Highway Act legally established Bridge Formula B, limiting gross vehicle weight (GVW) to 80 kips, depending on number of axles and spacing. However, states with legal vehicles that exceeded the Bridge Formula limits were allowed to keep their legal vehicle configurations that were currently in use. In Michigan, many of these grandfathered legal vehicles were established years earlier, where the maximum GVW could approach 164 kips, depending on configuration (MDOT 2013). These vehicle configurations still remain in the current set of 28 legal vehicles that MDOT must consider for load rating. However, recent weigh-in-motion (WIM) data analysis has shown that few of these vehicle configurations still exist on the roads today (Eamon et al. 2014), resulting in a significant mismatch between vehicles used for rating and those that actually load Michigan bridges.

Moreover, various changes in rating requirements developed in the last decade. Prior to 2003, bridges were rated based on the Manual for Condition Evaluation of Bridges (based on Load Factor Rating, LFR), modeled after the Load Factor Design (LFD)-based Standard design specifications. However, following the release of the 1994 AASHTO Load and Resistance Factor Design (LRFD) design specifications, the LFR Condition Evaluation (rating) manual was replaced with the Manual for Condition Evaluation and Load and Resistance Factor Rating (LRFR) of Highway Bridges in 2003. Significant revisions to the rating process occurred in 2008, when the earlier manual was replaced with the Manual for Bridge Evaluation (MBE), and then again in 2011 another revision incorporating additional significant changes was released (Sivakumar and Ghosn 2011). Moreover, in 2010, FHWA required that structures designed by LRFD were to be rated with the LRFR procedure in the MBE rather than the LFR manual. These changes have caused significant complications in the load rating procedure for MDOT (Curtis and Till 2008).

Considering the changes in vehicle configurations as well as rating procedures, recent MDOT research (Eamon et al. 2014) determined that significant inconsistencies in bridge reliability exist under the current rating process. These inconsistencies lead to the undesirable situation where some structures are under or over-rated with regard to actual traffic loads. This results in some structures not meeting target safety levels, while traffic is unnecessarily restricted on others. Moreover, the current use of 28 vehicles for legal load rating and 20 vehicles for routine permit rating is cumbersome and inefficient. The development of optimal legal vehicle configurations for accurate and efficient load rating, that best represents actual Michigan vehicles and load effects, is the focus of this study.

## **Objectives of The Study**

The goal of this study is to address the problem above. The research objectives are to:

1. Determine and clarify the legal load and permit requirements and processes in accordance with the Michigan Vehicle Code, MDOT's Transport Permits Unit, and other relevant MDOT units.
2. Collect and analyze weigh-in-motion (WIM) and other relevant vehicle data, as needed to characterize and quantify Michigan truck traffic and corresponding load effects, particularly for legal vehicles.
3. Compare WIM and other data analysis to the Michigan Vehicle Code and the 28 Michigan-legal trucks considered by MDOT. Identify and characterize discrepancies for both truck configurations and load effects.
4. Develop recommendations for optimal Michigan legal and extended permit truck configurations for efficient and accurate load rating that considers both LFR and LRFR methods.

## **Summary of Research Tasks**

This research is composed of the following tasks:

Task 1. State-of-the-art literature review

Task 2. Clarify, integrate, and document MDOT permitting procedures

Task 3. Gather information from Michigan law enforcement and the trucking industry to clarify current practice, future trends, and needs

Task 4. Collect and analyze WIM data

Task 5. Determine actual truck configurations operating in Michigan

Task 6. Identify differences between actual vehicles and Michigan legal vehicles

Task 7. Develop optimal load rating methods for LFR and LRFR

Task 8. Prepare project deliverables

## **CHAPTER 2: LITERATURE REVIEW**

The literature review represents a summary of standards, research, and best practices related to the development of vehicle configurations for bridge load rating. The review included a broad search of technical engineering journals, conference proceedings, standards, and handbooks. In addition, technical reports relevant to the topic such as those published by The Michigan Department of Transportation (MDOT), The Federal Highway Administration (FHWA), The National Cooperative Highway Research Program (NCHRP), and other state Departments of Transportation (DOTs) were reviewed. The review focused on identifying methods for WIM data filtering, checking, sorting, and analysis; procedures that are used in practice to identify legal and permit vehicles; results of existing data analysis of Michigan loads; and methods for developing idealized truck load models.

### **Models Developed for AASHTO Standards**

Due to the limited amount of traffic data available at the time, the AASHTO LRFD Bridge Design Specifications (2010) load model was developed from a 2-week sample of truck weights measured in Ontario in 1975. Moreover, several assumptions were made to allow extrapolation of the data to the 75-year expected mean maximum load used to calibrate the design load. Many of these assumptions concerned multiple presence, or more than one vehicle on the span at once. For multiple presence of side-by-side trucks in adjacent lanes, it was assumed that every 1 in 15 trucks was side-by-side with any other truck. It was also assumed that 1 in 30 side-by-side truck events occur with fully correlated (i.e. identical) truck weights. These assumptions resulted in a model which stipulates that for every 1 in 450 heavy truck crossings, it is side-by-side with an equally heavy truck. Simulations from this model determined that the case of two side-by-side, fully-correlated trucks governed maximum load effect. The governing trucks were each 85% of the maximum 75-year single lane truck, which was equivalent to 1.0-1.2 times the equivalent HL-93 load, depending on bridge span. This maximum governing load was assumed normally distributed with coefficient of variation from 0.14 to 0.18, depending on span length. In addition to vehicular live load, the statistics for other random variables (RVs) necessary for reliability assessment were established for the AASHTO LRFD Code development. These include bridge component dead loads and girder moment and shear resistances. These RVs, as well as the corresponding reliability models and associated limit states, have been identified and quantified for steel, concrete, and prestressed concrete bridge girders in NCHRP 368 (Nowak 1999), and were used for the calibration of the LRFD code. Using these statistics for reliability assessment led to the development of the HL-93 load, with a live load factor of 1.75 (without impact) and associated multi-lane and ADTT adjustment factors, to meet the minimum target reliability level for LRFD design of  $\beta=3.5$ . Bridges with spans greater than 200 ft were not considered.

The Manual for Bridge Evaluation (MBE) was published by AASHTO in 2008, replacing the 1998 Manual for Condition Evaluation of Bridges (based on Load Factor Rating, LFR) and the 2003 Manual for Condition Evaluation and Load and Resistance Factor Rating (LRFR) of Highway Bridges. In the original publication of the MBE, for  $AADT \geq 5000$ , the LRFD truck traffic model with side-by-side probability of 1 in 15 for heavy trucks was maintained for consistency, although this was known to be an extremely conservative value (Ghosn 2008; Sivakumar et al. 2007). It was also taken as 1 in 100 for an ADTT of 1000, and as 1 in 1000 for an ADTT of 100. The LRFD traffic load assumptions resulted in a mean maximum load event of two side-by-side 120 kip trucks for a 2-year return period or two side-by-side 130 kip trucks for

a 5-year return period, assuming AASHTO Type 3S2 equivalent truck configurations. This governing live load was assumed to be lognormally distributed with a coefficient of variation of 0.18. To maintain the target evaluation reliability levels of  $\beta=3.5$  for inventory ratings and  $\beta=2.5$  for operating ratings using LRFR with this model, the resulting legal load factor was 1.8 for truck weights up to 100 kips (for ADTT  $\geq 5000$ ). To maintain the target reliability for permit trucks, the live load factor was linearly interpolated between 1.8 and 1.3 for truck gross vehicle weights (GVWs) between 100 and 150 kips.

The MBE was revised in 2011 (Sivakumar and Ghosn 2011) using WIM data from six states (New York, Mississippi, Indiana, Florida, California, and Texas). Four vehicle scenarios on a bridge were considered: a permit vehicle alone; two routine permit vehicles side-by-side; a routine permit vehicle alongside a random vehicle; and a special permit vehicle alongside a random vehicle. Based on a 5-year return period, the revisions recalibrated the LRFR live load factors to result in a target reliability level of  $\beta=2.5$  for permit loads, with a minimum level of  $\beta=1.5$ . Using the LRFR rating procedures, permit live load factors varied from 1.4 to 1.15 using two-lane load distribution factors, depending on ADTT and the load effect (gross vehicle weight divided by truck axle length).

### **MDOT Reports and Standards**

What constitutes a legal vehicle is specified in the Michigan Vehicle Code: Public Act 300 of 1949 (and amendments), Chapter VI (Size, Weight, and Load) (MVC). Primarily, provisions given in Sections 257.716-722 are most relevant to this project. The MVC falls within the general limitations provided for vehicles by various federal laws. These include the *Code of Federal Regulations, Title 23, Chapter I, Subchapter G, Part 658* (CFR) (FHWA 2015); the *Fixing America's Surface Transportation (FAST) Act* size and weight provisions (CFR 2015); *Federal Size Regulations for Commercial Motor Vehicles* (FSR) (FHWA 2004); and the *Intermodal Surface Transportation Efficiency Act of 1991* (ISTEA "Freeze"). MDOT summarizes Michigan legal vehicle provisions in Document T-1 "Maximum Legal Truck Loadings and Dimensions". Additional MDOT documents T-2 "Information on the Movement of Oversize or Overweight Vehicles and Loads," and T-3 "Information on the Movement of Mobile Homes and Building Modules" similarly summarize permit requirements for haulers. The current load rating procedure used by MDOT is summarized in the Bridge Analysis Guide (MDOT 2005, with 2009 Interim Update), as are the current legal vehicles used for rating. The wider permitting process used by MDOT was recently summarized briefly in RC-1589, *Review and Revision of Overload Permit Classification* (Mlynarski et al. 2013). Currently, MDOT uses 28 vehicles for legal load rating and 20 vehicles for overload rating. Each overload vehicle has three weight classes, A, B, and C, where A has the heaviest axle loads and C the lightest. Bridges that can carry the moments and shears caused by all Class A vehicles are classified as "Overload Class A" bridges; bridges that can carry all Class B but not all Class A loads are classified as "Overload Class B" bridges, and so-on, while a bridge is classified as "Overload Class D" if it cannot pass all "Overload Class C" level loads (MDOT 2005). Permits are restricted from crossing Overload Class D bridges. Bridges that cannot carry all legal loads are accordingly posted, while if the load effect of a permit vehicle exceeds that associated with the corresponding bridge classification, it is prohibited from travelling over that structure without additional adjustment.



MDOT released several research reports that involve load model development from weigh-in-motion (WIM) data. WIM data is collected from sites where sensor systems are embedded in the roadway surface. When a vehicle crosses the sensors, high-fidelity systems can determine the number of vehicle axles, axle weight, and vehicle speed. Once the data are filtered to remove spurious readings, a detailed record of the actual vehicle configurations passing over specific roadway locations can be developed. These configurations can then be used in place of a hypothetical design or rating vehicle to determine the expected load effects caused by actual traffic. Reports that made use of WIM data include RC-1413, *Investigation of the Adequacy of Current Bridge Design Loads in the State of Michigan* (Van de Lindt and Fu 2002), which estimates the reliability of MDOT bridges using Michigan WIM data; RC-1466, *LRFD Load Calibration for State of Michigan Trunkline Bridges* (Fu and Van de Lindt 2006), which calibrated the live load factor for design using LRFD based on WIM data; and R-1511, *Recommendations for Michigan Specific Load and Resistance Factor Design Loads and Load and Resistance Factor Rating Procedures* (Curtis and Till 2008), which developed modified load and rating models for LRFD/LRFR based on NCHRP 454 (Moses 2001) and earlier reports.

From the information in these reports, best summarized in R-1511, MDOT determined that if structures were designed per LRFD HL-93 loading and rated utilizing LRFR with the load factors per the AASHTO Manual for Bridge Evaluation (MBE), many bridges could have insufficient rating factors for some Michigan legal loads and permit loads (which were previously allowed using the load factors and procedures in the MBE). Under the LFR approach, bridges are assumed to have an MDOT overload vehicle only, with no multiple presence of similar heavy trucks in adjacent lanes. Using the LRFR approach in the MBE, multiple presence is assumed, which subjects the overload vehicles to the multi-lane girder distribution factors (GDFs) and load factors associated with legal-heavy vehicles, typically causing lower bridge ratings under the LRFR approach.

As a result, MDOT modified both the design and the rating process to better correspond to Michigan loads. Although these modifications were based on a relatively small data set (approximately 46,000 vehicles) collected from WIM data in the Metro Detroit area, they were adopted to avoid the restrictive results of LRFD/LRFR on Michigan traffic. The modifications involved changing LRFR load factors for legal and overload vehicles, which resulted in the LRFR-modified (LRFR-mod) provisions, which present a series of adjusted load factors to be used for bridge evaluation. However, the LRFR-mod rating factors were based on limited, generic (although from Michigan) multiple presence data, where a multiple presence probability of 1/30 was used to develop the LRFR-mod load factor for  $ADTT \geq 5000$ . This adjustment did not completely address the problem of new bridges being under-rated for traffic loads that were previously allowed, so MDOT additionally changed the base LRFD design load to the HL-93-modified (HL-93-mod) load, which considers an additional single 60 kip axle load, as well as an increased load factor of 1.2 over the LRFD loads. With these modifications in rating and design, the ratios of Michigan legal loads and overload moments to design moments were returned to values less than 1.0 for spans less than 200 ft (longer spans were not investigated). Here it should be noted that prior to HL-93-mod, when using Load Factor Design, MDOT was designing trunkline bridges to HS-25 load effects to account for overload requirements.

In RC-1601, *Side-By-Side Probability for Bridge Design and Analysis* (Eamon et al. 2014), MDOT again considered refinement of design and rating factors based on WIM data. In this

study, high fidelity WIM data from 20 Michigan sites were analyzed and load effects were generated for bridge spans from 20 to 400 ft, considering simple and continuous moments and shears, as well as single lane and two lane effects. Bridge structures considered for the calibration included steel, prestressed concrete, reinforced concrete, spread box beam, side-by-side box beam, and special long span structures. The calibration considered design; legal load rating; routine permit load rating; and special permit rating. It was found that the set of vehicles used for rating is notably different from the current traffic profile in Michigan found from WIM data, and continued use of these idealized vehicles leaves significant inconsistencies in bridge reliability index. The differences between the Michigan vehicles used for load rating and actual vehicles found from WIM data were also noted by Green et al. (2005), where from a survey of over 1000 logging trucks, it was concluded that very few of these trucks could be fit to the standard rating vehicle configurations. Later, Eamon et al. (2014; 2015) proposed several levels of recommendations for load factors, with different trade-offs with respect to ease of use and consistency in reliability index. One of these was the use of the HL-93 design load, which was found to provide more consistent results than HL-93-mod. Using HL-93 and imposing a minimum average reliability index of 3.5 for all structures and a minimum reliability index of 3.0 for any structure resulted in live load factors of 2.5 for moment and 3.2 for shear for spans up to 200 ft; and for spans from 300-400 ft in length, a live load factor of 2.2 for moment, 3.0 for steel structures in shear, and 3.8 for PC structures in shear. The above system produced an average reliability index of 4.2 for spans up to 200 ft and, average reliability index of 3.8 for longer spans, where no individual girder has reliability index less than 3.0. Due to the complex nature of the inconsistency of the results, it was recommended that to achieve the most consistent level of reliability across all structures, a reliability based design optimization (RBDO) procedure be conducted to guide design load model development in future work. This process was previously used to optimize the design of bridges and other structures (Thompson et al. 2006; Behnam and Eamon 2013; Eamon and Rais-Rohani 2009; Rais-Rohani et al. 2005; 2010). MDOT similarly concluded that additional analysis was needed before implementing new load factors.

### **NCHRP Reports and Related Research**

At a national level, various NCHRP reports have investigated development of rating vehicle configurations. This work includes NCHRP 108, *Bridge Weight-Limit Posting Practice* (Imbsen 1984); NCHRP 143, *Uniformity Efforts in Oversize/Overweight Permits* (Humphrey 1988); and NCHRP 359, *Bridge Rating Practices and Policies for Overweight Vehicles* (Fu and Fu 2006), which summarize bridge evaluation and rating practices. These studies found that a large variability exists in procedures throughout the US. NCHRP Report 368, *Calibration of LRFD Bridge Design Code* (Nowak 1999) describes the development of the LRFD load model discussed above, while NCHRP Reports 454, *Calibration of Load Factors for LRFR Bridge Evaluation* (Moses 2001) and 20-07(285), *Recalibration of LRFR Live Load Factors in the AASHTO Manual for Bridge Evaluation* (Sivakumar and Ghosn 2011) describe the development of the LRFR load models. In NCHRP 454, it was found that characterizing the multiple presence (multiple trucks crossing the bridge simultaneously) probability for load modeling is difficult, as multiple presence is affected by traffic volume, speed, road grade, weather, traffic obstacles, truck grouping, as well as other parameters. Moreover, load effects from multiple presence are strongly interlinked with truck headway distance, defined as the distance between trucks, which is also a function of various road and traffic conditions. The LRFR live load factor is given in

NCHRP Report 454 as a function of gross vehicle weight and expected maximum total weight of the rating vehicles and alongside vehicles.

In an effort to refine load models for special hauling vehicles, NCHRP 575, *Legal Truck Loads and AASHTO Legal Loads For Posting* (Sivakumar et al. 2007) developed a multiple presence model with additional complexity. Different multiple presence statistics were calculated for variations in bridge span as well as adjacent lane truck headway distances, where headway distance separations up to a maximum of 60 ft were considered to indicate multiple presence, depending on bridge span (headway distances greater than 60 ft were no longer considered to be a side-by-side event). Moreover, side-by-side presence was taken as a function of truck headway distance in adjacent lanes within the same direction of travel and bridge span. It was found that, depending on span and vehicle configuration, significant load effect from multiple presence could occur within headway distances of 10 to 60 ft. More precisely, it was found that for spans less than 100 ft, headway distance under 40 ft produced significant side-by-side multiple presence moments, while for longer spans, headway distances up to 60 ft should be considered. Using this model, multiple presence was calculated from WIM data from 18 states, including Michigan (on US-23) and Ohio (on I-75). It was found that multiple presence probabilities ranged from 1.4- 3.35%. These are much lower multiple presence probabilities than assumed in LRFD and LRFR, with the maximum side-by-side probabilities of 3.35% occurring at a three-lane site with ADTT > 5,000 and 1.37% for a two-lane site with ADTT > 2,500.

NCHRP 683, *Protocols for Collecting and Using Traffic Data in Bridge Design* (Sivakumar et al. 2011) further developed the multiple presence model, considering various traffic configuration possibilities, including multiple side-by-side trucks in adjacent lanes, and developed multiple presence statistics from WIM data for different ADTT and bridge spans. It was suggested that multiple presence loads could be generated by developing single-lane truck weight probability densities, then combining the multi-lane effects by convolution, as suggested by Croce and Salvatore (Croce and Salvatore 2001), as well as Monte Carlo Simulation (MCS), while maximum load effects for longer time periods were estimated by statistical extrapolation. Note that MCS is a traditional technique often used for probabilistic simulation when actual field test or experimental results are unavailable. It involves generating random values for uncertain parameters in the model (random variables), based on their available statistical parameters, such as the mean, standard deviation, and assumed probability density function. These simulated values are then inserted within the model and the model is evaluated. Many such simulations are conducted to generate a large set of artificial model results. Limitations of the Croce and Salvatore model include an assumption that the GVW distribution is identical in adjacent lanes and that there is no correlation between truck weights. For the development of statistical load models used for reliability analysis, the upper tail of the distribution, where the heaviest vehicles are described, is most critical. However, it was noted that WIM data is particularly subject to various collection errors in this region, due to vehicle dynamics, tire configurations, and other factors.

NCHRP 683 further developed a general framework for data filtering, much of which is based on the FHWA Traffic Monitoring Guide (2001). Four main subtasks are described: data filtering; review of eliminated data for verification; implementation of QC checks; and assessing the statistical adequacy of the data.

The purpose of the data filtering step is to flag collected results that appear to be unreliable or that may indicate an unrealistic vehicle. For example, axle weights and spacings that are unreasonably small or large; unreasonably high or low speeds (low-speed trucks are difficult to separate); and discrepancies in GVW and sum of axle weights. NCHRP 683, as well as other research efforts (O'Brien and Enright 2011; Pelphrey and Higgins 2006; Tabatabai et al. 2009), provide similar recommendations for a filtering process. The data recommended for flagging generally include: speeds below 10 or above 100 mph; truck length above 120 ft (or as appropriate for the expected local truck configurations); total number of axles less than 3 or greater than 13 (or as appropriate); first axle spacing less than 5 ft; any axle spacing less than 3.4 ft; sum of axle spacing greater than total truck length; individual axle greater than 70 kips (or as appropriate); steer axle greater than 25 kips or less than 6 kips; any axle less than 2 kips; GVW less than 12 kips or greater than 280 kips; sum of the axle weights is different from GVW beyond 5-10%.

For the data review step, a sample of the data eliminated is inspected and reviewed, and compared to expected truck configurations to ensure that the filtering procedure is working properly and realistic trucks are not unintentionally eliminated. If available, it is recommended that historical permit or nearby weigh station data also be used to verify that the collected WIM data are reasonable.

Multiple QC checks are then used to verify data accuracy. In general, these checks include comparing truck percentages by type and GVWs found in the WIM data to historical values or manual counts, and comparing measured axle weights and configurations to reasonably expected values. The first check is to compare vehicle type percentages to expected values at the site, if available. The following checks are suggested by NCHRP 683 for the common 5-axle (Class 9 or 3S2) semi-trailer truck data collected: compare the number and proportion of trucks over 100 kips to expected values; compare the mean drive axle weight to the mean values found in NCHRP Report 495 (Fu et al. 2003); compute the mean value for steering axle weight, which is typically between 9 kips and 11 kips; and check mean spacing between drive tandem axles, and compare to expected values. Finally, a histogram of GVW can be developed. The usual distribution is bi-modal, with one peak corresponding to an unloaded vehicle and the second for a loaded vehicle. These peaks can be compared to expected values (typically 30 kips unloaded and 72 - 80 kips loaded).

Assessing the statistical adequacy of the data involves inspection of the confidence interval of the upper tail of WIM data. Because only a small sample of the entire truck population is collected from WIM data, using this limited data to model the entire population is associated with uncertainty. The uncertainty associated with the upper tail (heaviest) of the truck weights is of particular concern. This uncertainty is statistically quantifiable with confidence interval evaluation (Ang and Tang 2007). NCHRP 683 recommends that the 95% confidence interval of the upper 5% of truck weights from the WIM data is considered. That is, what range of uncertainty is associated with critical distribution parameters such as mean value and standard deviation, to a 95% level of confidence. Here, the distribution type that best-fits the upper 5% of the WIM data, per standard goodness-of-fit tests, such as Kolmogorov-Smirnov, Chi-square, or Anderson Darling (Ang and Tang 2007), is determined. Then, the appropriate confidence interval is constructed for mean value and standard deviation. Thus, the range of values representing uncertainty in the mean and standard deviation can be quantified to a 95%

confidence level. An unacceptably wide confidence interval indicates that an inadequate number of data were collected. In this case, additional data collection from these sites is recommended, or to remove the affected sites from the project database.

In NCHRP 683, several different truck placement possibilities that may cause variations in load effect were considered. Here, multiple presence statistics were generated for two “side-by-side” trucks, defined as two trucks in adjacent lanes overlapping by one-half of a truck length or more; two “staggered” trucks, defined as two trucks with an overlap less than one-half of a truck length but a gap between them of less than the bridge span; and for “multiple” trucks, where more than one truck side-by-side appears in both lanes.

Convolution was also suggested as a method to generate multiple presence effects, as described in NCHRP 683 and elsewhere (Croce and Salvatore 2001). Here, the single-lane load effect histograms are numerically integrated with the convolution equation, which provides the probability density function (PDF) of two events (i.e. two trucks side-by-side), ( $f_{xs}$ ), which is given by:  $f_{xs}(X_s) = \int_{-\infty}^{+\infty} f_{x2}(X_s - x_1)f_{x1}(x_1)dx_1$ , where  $f_{x1}$  and  $f_{x2}$  are the PDFs of truck load effects  $x_1$ ,  $x_2$  for lanes 1 and 2. Then, from the resulting PDF, the needed statistical parameters describing two-lane load effects can be directly calculated. However, it was found by (O’Brien and Enright 2011) that since the convolution process assumes independence between truck weights in each lane, which is not necessarily correct, it can lead to misrepresentation of maximum load effects.

NCHRP 495, *Effect of Truck Weight on Bridge Network Costs* (Fu et al. 2003) describes a process to evaluate the effect of changing allowable truck weights on the cost of maintaining highway bridges, due to the increased damage caused by increased truck loads. In order to estimate the damage on bridge structures, a process to obtain truck weight and frequency distributions was developed, considering the data obtained from state weight stations.

Dealing with multiple presence poses particular difficulties for rating. For legal and routine permit loads, most spans will have the possibility of multiple presence, which must be accounted for. The definition of multiple presence itself is not straightforward, as even holding various other factors such as ADTT and site location constant, the load effect caused by multiple presence varies greatly depending on truck headway distance in adjacent lanes, in the same lane, bridge span length, and truck weight correlations as well. Some approaches ignore these complexities and model multiple presence by placing two trucks exactly side-by-side on the analysis bridge. This provides an associated occurrence probability, such as in every 15 or 30 heavy truck passages, potentially based on WIM data (Moses 2001; AASHTO 2003). These multiple presence probabilities are directly calculated from the WIM data for various scenarios such as a ‘side-by-side’, ‘staggered’, or ‘multiple’ truck, for various span lengths. In this model, the precise definitions (truck headway distances and overlaps considered) used to characterize multiple presence statistics are determined based on those required to produce a significant increase in load effect over that of a single lane truck load, such as suggested by NCHRP 575 (Sivakumar et al. 2007) and others (Fu and You 2009; O’Brien and Enright 2011). Fu and You (2009) used this approach and considered multiple presence to occur if an adjacent truck increased the single-lane truck moment by 20% or more. Based on an analysis of WIM data from New York, they found multiple presence probabilities from 0.4 - 3.5%, as a function of ADTT

and bridge span. However, this approach generally will not produce the most accurate multiple presence load effects, as typically, all relevant load information simply cannot be captured using this method, as significant variations in load effect are neglected (Sivakumar et al. 2011; O'Brien and Enright 2011).

Another approach is to directly determine multiple-lane load effects from MCS of different traffic configurations statistically quantified from the WIM data, as suggested in (O'Brien and Enright 2011; Kwon et al. 2010). This approach is potentially most accurate, but is also most difficult to use and generalize to multiple locations, as a value for multiple presence probability is not directly calculated. This approach also requires a high-resolution timestamp in the WIM data of at least 1/100 second to properly capture the needed traffic patterns. For this simulation model, various truck parameters available from the WIM data are modeled as random variables (RVs), such as truck weights, speeds, and inter-vehicle gaps within and between lanes. These RVs are characterized by fitting the parameters to best-fit analytical probability distributions. In addition to the individual RV parameters, their inter-relationships are also statistically characterized, which is done from high resolution WIM data by developing the correlation matrix between the RVs for linear relationships, or empirical copulas for more complex non-linear relationships (O'Brien and Enright 2011; Tabatabai et al. 2009).

Croce and Salvatore (2001) presented a more general theoretical stochastic traffic model to account for vehicular interactions. Their proposed model was based on a modified equilibrium renewal process of vehicle arrivals on a bridge, and formulates the problem of traffic actions in terms of the general theory of stochastic processes. An analytical expression for the cumulative distribution functions (CDFs) of the maximum load effect over a given time interval was developed under general assumptions. The resulting CDFs allowed studying multilane traffic effects, as well as the combined effects of traffic and other load actions, while accounting for arbitrary variations in traffic flow.

Later, O'Brien and Caprani (2005) studied 2-lane bridges up to 165 ft in length with opposing traffic for events involving more than two trucks simultaneously on the bridge. They statistically modeled vehicle headway distances measured from five days of WIM data collected from the two outermost lanes of a motorway near Auxerre, France. In the simulations, it was found that critical traffic load events are strongly dependent on the assumptions used for the headway distance (the time or distance between the front axle of a leading truck and the front axle of a following vehicle) and gap (the time or distance between the rear axle of the front truck and the front axle of the following truck) between successive trucks. Specifically, it was determined that mean load effect could be altered by 20% to 30% for reasonable gap choices. Headway distances were found to be a function of traffic flow, where headways of less than 1.5 seconds were insensitive to flow and could be fit well to quadratically increasing cumulative distribution functions, while headways from 1.5 to 4.0 seconds were strongly influenced by flow. Inter-truck headway is influenced by truck driver behavior as well as the number of cars between trucks. They also determined that medium and long span bridge loads are strongly influenced by traffic congestion, where the gaps between vehicles become small and there is no significant dynamic interaction. For short span bridges, however, free-flowing traffic involving a small number of vehicles with dynamic interaction becomes more critical.

One of the most recent and sophisticated multiple presence models is given by O'Brien and Enright (O'Brien and Enright 2011), who carefully studied WIM data from European sites and found subtle but important correlations between vehicle weights, speeds and headway distances. They found that neglecting these correlations, as in previous efforts, could lead to errors close to 10% in maximum load effect. To properly model the multiple presence effect on a two-lane bridge, it was proposed that the truck traffic model includes three headway, or gap, distributions: in-lane gaps for each lane, as well as an inter-lane gap. Moreover, inter-relationships exist between gap distance, vehicle weights, and speeds. To determine maximum lifetime load effect statistics from this model, a smoothed bootstrap simulation approach was used, which re-samples traffic scenarios based on the WIM data and uses kernel functions to introduce additional variation. A bootstrapping method attempts to better estimate population statistics (such as mean maximum and variance of the mean) by taking multiple samples from the original data sample available (i.e. 'resampling'). Statistics from these various bootstrap samples can be computed to refine the statistical characterization of the population of concern. A kernel function is a 'reduced' form of a probability density function where parameters that are not functions of the random variable are removed. O'Brien and Enright concluded that the model produced a better fit to the data than those neglecting the multi-lane correlations.

### **Collecting and Analyzing WIM Data**

Various agencies have focused on the use of local WIM data to refine bridge rating models. These include the Texas, Missouri, Oregon, New York, and Wisconsin DOTs (Lee and Souny-Slitine 1998; Kwon et al. 2010; Pelphery et al. 2006; Ghosn et al. 2011; Taatabai et al. 2009). The Texas Department of Transportation (TxDOT) developed a procedure to determine equivalent single axle loads (ESALs) from WIM-collected traffic volume and classification data (Lee, C.E. and Souny-Slitine 1998). The system was also used to monitor weekly and monthly data trends, such as the proportion of various vehicle classes and lane use. The system analyzed traffic data on-site by the WIM system computer and used an Excel spreadsheet for vehicle classification and calculation of ESALs. The method used traffic volume and vehicle class data rather than axle load data directly, but found that the cumulative ESALs at a site depend on the traffic volume and axle loads.

As suggested earlier, a significant complication that arises when using WIM data is that it generally contains a substantial number of erroneous records, requiring data filtering for accuracy. Various researchers have proposed WIM data management approaches, including Raz et al. (2004) and Monsere et al. (2008), and Sivakumar et al. 2011, as discussed above. Raz et al. (2004) proposed a data mining approach for automatically detecting anomalies in WIM data. The procedure was useful for automatically detecting unlikely and erroneously classified vehicles, and could identify hardware or software problems in WIM systems. Monsere et al. (2008) studied methods for collecting, sorting, filtering, and archiving WIM data to permit development of long-term continuous records of high quality. The study used the WIM data archive to monitor WIM sensor health, develop loads for asphalt design and models for bridge rating and deck design. In addition, freight movement was monitored to develop volume, weight, safety, and time demands on highways. Data were analyzed and filtered to handle anomalous results. Axle load spectra and time of occurrence models were developed, and Monte Carlo techniques were used to generate load histories for pavement damage estimates. Moreover, side-by-side vehicular events were quantified using the precise time stamps available in the WIM data. The long term

record was used to extrapolate the best possible statistical tail for single lane loading cases on bridges.

Pelphery et al. (2008) described a series of suggestions for collecting and analyzing WIM data that includes filtering, sorting, quality control, as well as how to use the data in a load factor calibration process. The data were cleaned and filtered to remove records with formatting mistakes, spurious data, and other errors identified by the following criteria: a record does not follow the general format pattern; GVW less than 2 kips or greater than 280 kips; GVW differs from the sum of axle weights by more than 7%; an individual axle is greater than 50 kips; the speed is less than 10 mph or greater than 99 mph; truck length is greater than 200 ft; the sum of the axle spacing lengths are less than 7 ft or greater than the truck length; the first axle spacing is less than 5 ft or any axle spacing is less than 3.4 ft; and the number of axles is greater than 13. Note the similarities to these recommendations and those made by NCHRP 683. A conventional and modified sorting method for the WIM data were then developed and compared. The conventional method sorts vehicles based on their GVW, axle group weights, and truck length. This method accounts for the axle weights and spacing in assigning each vehicle to an appropriate weight table. The method tends to assign more vehicles to higher weight tables than the modified sort. The modified methods sort vehicles based only on their GVW and rear-to-steer axle length, and it does not account for axle groupings. This method assigns more vehicles to lower weight tables than the conventional sort. However, it produces higher coefficients of variation and hence higher live load factors, resulting in a more conservative method overall than the conventional method. In the study, the conventional sort method was used to calculate live load factors, because this was believed to better represent the traffic regulatory and enforcement procedures used. Additionally, only the top 20% of the truck weight data from each category was considered, as projected from the upper tail of the weight histogram.

As different load rating processes are used for legal and permit loads, the associated vehicle pools are best considered separately for accuracy. Unfortunately, this separation is often difficult, as recognized by various sources (Enright et al. 2015; Eamon et al. 2014; Sivakumar et al. 2011). Due to this difficulty, many researchers (Nowak 1993; Bailey & Bez 1999; Enright & O'Brien 2013; etc.) make no distinction between permit and standard trucks. Some more recent research efforts attempted to develop methods to separate the vehicle pools, such as by GVW (Enright and Obrien 2010), number of axles (Sivakumar et al. 2011), and axle spacing configuration (Enright et al. 2015).

### **Additional Load Model Development for Bridge Design and Rating**

Early work includes that by Ghosn and Moses (1986), who, as a precursor to Nowak (1999) used reliability analysis with data from large scale field measurements of actual truck loadings and bridge responses. The data were used to project maximum expected live loads in the lifetime of the structure and to calculate a safety index. A target safety index was extracted from these values and a new design procedure was proposed to achieve this target index to provide uniform reliability for the spans considered. The target safety index was derived from average AASHTO performance, and it was suggested that the approach could be extended to allow rating of existing bridges where load conditions were monitored by WIM systems.



Ghosn (2000) considered a reliability-based procedure to determine the optimal allowable loads on highway bridges considering static and dynamic effects and the effect of increasing the legal load limit on bridge safety. The procedure used to select the most appropriate allowable truck weight was developed as follows: choose suitable safety criteria; select an acceptable reliability level; choose a range of typical bridges (designed with different code criteria, span lengths, configurations, material types, and capacity levels); statistically describe the safety margins of these typical bridges (including the likelihood of overloads and simultaneous truck occurrence); calibrate a new allowable truck load; check the effect of the proposed truck loads on the existing network of bridges, and verify that the number of bridge deficiencies under the new regulation will be acceptable in terms of the additional costs required to maintain the existing bridge network. In this process, the maximum permissible live load moment would be determined by trial and error to satisfy the target safety index for all of the bridge types considered. The allowable truck loads that would produce the permissible live load envelope is then to be determined.

Rather than relying upon WIM, Fu and Hag-Elsafi (2000) suggested that live load model development could be based on records of granted overload permits. They presented a method to develop live load models based on the permit data, developed associated models for assessing reliability, and proposed permit-load factors for overload checking.

Miao and Chan (2002) developed a new approach for load model for short span bridges to obtain extreme daily moments and shears in simply supported bridges and compared the results to the traditional normal probability paper approach used to form the AASHTO LRFD load model. The method involved the following steps: calculate extreme daily bending moments and shear forces based on the WIM data; analyze the data statistically for load model parameters (axle weights, gross vehicle weights and axle spacing); divide the traffic into two types: loose and dense traffic status; use the Equivalent Base Length for modeling bridge live load models. In the procedure, MCS was used to simulate the complex interactions of random parameters governing truck loads. Axle spacings were divided into internal and tandem spacings. It was found that axle spacing was best modeled with a lognormal distribution, while axle weights as well as GVW best followed an inverse normal distribution. For lower traffic densities, where a single vehicle model can be used to represent load effects, the maximum value of axle weight and GVW for bridge design was found to follow an Extreme Type I distribution, while a Weibull distribution was found to better model more dense traffic, when multiple vehicles are on the span.

Ghosn et al. (2008) describes how site-specific truck weight and traffic data collected using WIM data can be used to obtain estimates of the maximum live load for a 75-year design life for new bridges as well as the two year return period for capacity evaluation of an existing bridge. It was determined that data from the upper tails of WIM data histograms from several sites match normal probability distributions, a finding allowing the application of extreme value theory to obtain the statistics of maximum load effect. Extreme value theory is a technique that can be used to extrapolate statistics of a small data pool to those describing a larger pool containing more extreme events; for example, the use of a year of traffic data to estimate maximum load effects over 75 years. It was also found that average bridge reliability varies considerably from state to state, and that the reliability levels associated with two-lane load effects, as designed/rated, are significantly higher than the one-lane load effects. This occurs because of the lower number of side-by-side events, as well as the lower load effect produced by two-lane

events when compared to the conservative multiple presence model used to calibrate the AASHTO LRFD Code. The conservativeness of the LRFD multiple presence assumptions are demonstrated by Ghosn (2008), who considered load data found in California, and determined that the LRFD load factor would require a reduction from 1.75 to 1.2 for the two-lanes loaded case to maintain a consistent reliability level with the one-lane loaded case.

O'Brien et al. (2010) predicted lifetime maximum truck load by using MCS to simulate traffic representative of measured vehicle data for a given bridge. Such parameters as GVW, number of axles, axle spacing, distribution of GVW between axles, and inter-vehicle spacing were included as parameters in the model. The study used WIM systems at two European sites and considered three different methods of modeling GVW, based on histograms of the weight data: parametric fitting, which produced a moderately good fit for most of the GVW range, but significantly underestimated the probabilities in the critical upper tail; nonparametric fitting, which produced a reasonable fit for the range of commonly observed GVWs, but presented problems in the upper region of the histogram where observations are few and there are gaps with no measured data, and GVWs heavier than the maximum measured value cannot be simulated; and semi-parametric fitting, which had the best accuracy in the critical tail region, and was the ultimately recommended approach.

For development of the Eurocode traffic live load model, load effects were estimated by extrapolating from WIM data as well as MCS. However, each lane was simulated independently (Bruls et al. 1996; O'Connor et al. 2001), limiting the multiple presence model accuracy, similar to the NCHRP 683 model.

In addition to his work on the LRFD Code calibration, Nowak (Nowak et al. 2010) recently considered load models for long-span bridges, and developed a corresponding traffic simulation model for this case. It was found that the maximum load scenario is a traffic jam in which trucks tend to line up in one lane. He noted, however, that trucks are usually separated by lighter vehicles, and in this typical situation, a single overloaded truck did not have a significant effect on total load effect.

Ghosn et al. (2011), used the simplified adjustment procedure suggested in the MBE to develop a load and resistance factor rating method for permit and legal loading for New York State DOT from WIM data. Oregon DOT calibrated live load factors used for design from WIM data (Pelphery et al. 2006), and Wisconsin DOT statistically modeled maximum load effects from WIM data by fitting multi-modal distributions to axle loads and spacings, then using MCS with empirical copulas to model the axle load and spacing relationships (Taatabai et al. 2009).

Missouri DOT recently completed a recalibration of load factors for bridge design and rating, based on local WIM data (Kwon et al. 2010). Assumptions in the traffic model were that: minimum headway distance is 0.5 s; the time between trucks could be modeled with a shifted exponential distribution; and that 70% of trucks were in the right lane. Maximum load effects were then assumed to follow a Gumbel distribution, and extreme value theory was used for projection to the design maximum load. Similar to previous methods used to characterize multiple presence, the loads in adjacent traffic lanes were treated as independent.

Zhao and Tabatabai (2012) evaluated the effectiveness of the standard permit vehicle (Wis-SPV) used for bridge design and rating in Wisconsin, and proposed a 5-axle single-unit rating truck to supplement the existing evaluation vehicle.

These latest research efforts noted above relied heavily upon WIM data for model development. However, some work has been done to refine bridge evaluation procedures based on permit data alone (Fu and Hag-Elsafi 2000; Fu and Moses 1991; Fu and Hag-Elsafi 1996). Similarly, Chang et al (2015) recently verified the applicability of bridge rating vehicles to evaluate a superload using finite element modeling.

## **CHAPTER 3: SUMMARY OF DOCUMENTS DESCRIBING LEGAL AND EXTENDED PERMIT VEHICLES**

### **Review Documents**

To establish rules to identify legal and permit vehicles, the following documents and regulations were reviewed and summarized:

1. *Michigan Vehicle Code*, Act 300 of 1949, with amendments as of June 6, 2016 (MVC).
2. *Maximum Legal Truck Loadings and Dimensions (T-1)* (MDOT 2016).
3. *Information on the Movement of Oversize or Overweight Vehicles and Loads*, Document T-2 (MDOT 2014).
4. *Information on the Movement of Mobile Homes and Building Modules (T-3)* (MDOT 2004).
5. *Truck Driver's Guidebook* (MCTS 2015) (TDG).
6. *Code of Federal Regulations, Title 23, Chapter I, Subchapter G, Part 658: Truck Size and Weight, Routine Designations – Length, Width, and Weight Limitations* (FHWA 2015).
7. *Fixing America's Surface Transportation Act (FAST) P.L. 114-94 (2015)*.
8. *Federal Size Regulations for Commercial Motor Vehicles (FHWA 2004)*.
9. *Intermodal Surface Transportation Efficiency Act of 1991 (ISTEA "Freeze")*.

In addition, an interview with Michigan State Police (MSP) personnel was conducted to understand how vehicle load limits are actually enforced. In general, this summary is limited to characteristics which influence vehicle load effects that can be used for analysis and which may allow identification of vehicles from high-fidelity Michigan WIM stations; it does not represent a summary of all vehicle characteristics (for example, height and width restrictions are not included).

### **Michigan Vehicle Code and Related Documents**

The following represents a summary of what constitutes a legal vehicle according to the Michigan Vehicle Code (Act 300 of 1949, with amendments as of June 6, 2016) (MVC). This summary is limited to characteristics which may allow identification of legal vehicles based on what is currently collected from high-fidelity Michigan WIM stations; it does not represent a summary of all legal vehicle characteristics (for example, height and width restrictions are not included, characteristics which are not identifiable from WIM data), and thus it is not a thorough summary of state vehicular law. All rules are summarized as briefly as possible and put in algorithm form to facilitate later programming for WIM data analysis.

In addition to the MVC, four other related documents were reviewed: *Maximum Legal Truck Loadings and Dimensions (T-1)*; *Information on the Movement of Oversize or Overweight Vehicles and Loads (T-2)*; *Information on the Movement of Mobile Homes and Building Modules (T-3)* (MDOT 2016; 2014; 2004); and the *Truck Driver's Guidebook* (MCTS 2015) (TDG). These documents were consulted to confirm and clarify interpretation of MVC rules. Discrepancies that were found are noted below.

In the review, most rules are identified by a rule number (for example “(2)”). These rule numbers are not necessarily sequential, but refer to the specific MVC number for that rule. There are three main sections of the MVC from which all relevant rules were obtained: 257.627 (speed limitations); 257.719 (length limitations); and 257.722 (weight limitations).

## **Parameter Definitions**

The following symbols are used in this document:

### Vehicle Types (common):

TT = truck-tractor

TTS = truck-tractor with semi-trailer

TTT = truck-tractor with trailer

C = any combination of TT, TTS, TTT

T = truck (single vehicle; no trailer or semitrailer)

TW = truck with trailer or semitrailer

### Vehicle Characteristics

GVW = gross vehicle weight (kips)

W = gross weight of a group of 2 or more consecutive axles to the nearest 500 pounds

V = speed (mph)

S = axle spacing (ft)

P = axle load (kips)

S<sub>T</sub> = spacing from a tandem axle to any other axle (ft)

P<sub>T</sub> = a single tandem axle weight (kips)

N = number of total axles of vehicle

N<sub>g</sub> = number of axles in a group of consideration

S<sub>TT</sub> = spacing between two consecutive tandems (last to first axles) (ft)

L = overall length (ft)

L<sub>g</sub> = distance between the extreme axles in the group (ft)

## **Speed Rules**

Legal vehicle speeds are summarized in Section 257.627.

- (6) For C with GVW  $\geq$  10k:
  - V  $\leq$  55\*
  - V  $\leq$  35 for seasonal reduced loading (see below).
- (6) For T, C, school bus: V  $\leq$  60 if posted V = 70.

\*For a modified agriculture vehicle, V  $\leq$  45.

## Length Rules

Legal vehicle lengths are summarized in Sections 257.719 and 257.719a.

### Section 257.719

Rule (2) is referred to as the normal length maximum. In general, this corresponds to rules listed for non-designated highways in T-1.

- (2a) For T:  $L \leq 40'$ .

T-1 specifies that this applies to all vehicles that are not covered elsewhere, and does not specify type of highway; TDG specifies that this applies for all highways, implying not just non-designated highways.

- (2a) For bus, motor home:  $L \leq 45'$ .

This limitation does not appear in T1-T3 or TDG.

- (2b) For articulated bus:  $L \leq 65'$ .
- (2c) For T, TW, C transporting boats or vehicles:  $L \leq 65'$ .
- (2c) For T, TW, C transporting boats from manufacturer:  $L \leq 75'$ .
- (2c) For stinger-steered combination vehicle:  $L \leq 75'$ .

TDG specifies that for stinger-steered combinations used *to transport vehicles*:  $L \leq 75'$ .

T1 states that a stinger-steered combination may have  $L \leq 80'$  (matches FAST requirements).

- (2d) For a semitrailer:  $L \leq 50'$ .
- (2e,f) For TW, C:  $L \leq 59'$ .
- (2g) For dump trucks C:  $L \leq 65'$ ; for accompanying semitrailers or trailers:  $L \leq 28.5'$ .
- (2h) For multiple vehicles utilizing 1 tow bar or 3 saddle mounts:  $L \leq 55'$ .
- (2i) For a recreational vehicle and trailer:  $L \leq 75'$ .

Note: special exceptions for log haulers appear in (2a) and (3b), allowing for over-length vehicles. However, rule (9) states that these added provisions "do not apply unless 23 USC 127(d) is amended to allow crib vehicles carrying logs to be loaded as described in this section." Such an amendment could not be identified, and therefore these rules are not included here.

Rule (3) refers to designated highways.

- (3a) For TTS:  $L \leq \infty$  if semitrailer:  $L \leq 53'$  (for a single semitrailer).
- (3a) For semitrailers: If  $L > 50'$ ,  $37' \leq L \leq 41'$  from kingpin to center of rear axle assembly.
- (3b) For TW:  $L \leq 65'$ .
- (3b) For TW transporting sawn logs:  $L \leq 70'$ .

For crib vehicle with semitrailer/trailer transporting sawn logs:  $L \leq 75'$  & GVW  $\leq 164k$ .

- (3c,d) For TTS, TTT:  $L \leq \infty$  If:  
For each semitrailer:  $L \leq 28.5'$  (for two trailers or semitrailers); or  
For overall length of semitrailers/trailers:  $L \leq 58'$ .
- (3e) For multiple vehicles with 1 tow bar or 3 saddle mounts:  $L \leq 97'$ .
- (3f) For TT and lowboy semitrailer:  $L \leq \infty$  If:  
For semitrailer:  $L \leq 59'$  and  $L \leq 55'$  from kingpin to rear axle.
- (4) For TW, TTS to transport vehicles:  $L \leq 79'$ .

TDG specifies that this rule only applies if the tractor is also designed to transport vehicles; if only the semitrailer transports vehicles, then the truck falls under rule (3).

- (5a) For T: a maximum of 1 trailer or semitrailer is allowed\*  
For TT: a maximum of 2 semitrailers or trailers are allowed  
  
\*Farm tractor: up to 2 trailers;  
\*Garbage truck: up to 4 trailers if during daylight,  $L \leq 55'$ , and  $V \leq 15$ .
- (5b) For any vehicle:  $N \leq 11$ .

#### Section 257.719a

- (1) For mobile home:  
Without tractor (single vehicle):  $L \leq 45'$ .  
With tractor:  $L \leq 60'$ .
- (8) For a mobile home:  $S \geq 34''$ .

Note: a provision is given within MVC (not detailed here) limiting lowboy semitrailers greater than 59' to no more than 4 axles.

#### **Weight Rules**

Legal GVWs are summarized in Section 257.722.

Rule (1) is referred to as the normal loading maximum.

- (1a) For  $S \geq 9'$ ,  $P \leq 18k$ .
- (1b) For  $3.5' \leq S < 9'$ ,  $P \leq 13k$ .
- (1c) For  $S < 3.5'$ ,  $P \leq 9k$ .

For designated highways:

- (2) For  $S_T \geq 9'$ ,  $P_T \leq 16k$ .
- (3) 1 tandem can have  $P_T = 16k$  if all other tandems have  $P_T \leq 13k$  and  $S_T \geq 9'$ .
- (3) For TTS: If  $N \leq 5$ , allowed 2 consecutive tandems with  $P_T = 16k$  and  $S_T \geq 9'$ .

T-1 lists rule (2) under the ‘normal loading’ heading, for vehicles exceeding 80k GVW.

For designated highways and  $GVW \leq 80\text{ k}$ :

- (12a)  $P \leq 20\text{ k}$
- (12b)  $\sum P_T \leq 34\text{ k}$
- (12c) For any group of 2 or more consecutive axles:  $W \leq 500[(L_g * N_g / (N_g - 1)) + 12N_g + 36]^*$

\*Exception: For each of 2 consecutive sets of tandems,  $\sum P_T \leq 34\text{ k}$  if  $S_{TT} > 36'$ .

Note that the above formula, the Federal Bridge Formula, is rarely directly used by haulers and law enforcement to assess vehicles, but tabular results are used. Such a table is provided in Appendix A.

A tandem is defined here as: 2 axles with:  $3.33' \leq S_T < 8'$ .

T-1 lists rule (12a) under the ‘normal loading’ heading. It also defines (12b) and the (12c) exception ( $\sum P_T \leq 34\text{ k}$ ) as a 17k limit for each tandem axle.

For special designated highways\*:

- (4) For TTS: If  $N \leq 5$  and  $GVW \leq 80\text{ k}$ , allowed 2 consecutive tandems with  $P_T \leq 17\text{ k}$ ,  $S_{TT} > 36'$ , and  $S_T > 9'$ . This rule does not apply during reduced seasonal loading.

A tandem is defined here as either: 2 axles with:  $3.33' \leq S_T < 8'$  or  $3.5' \leq S_T < 9'$ . Most broadly, this would result in:  $3.33' \leq S_T < 9'$ . The TDG defines a tandem as  $3.5' \leq S_T < 9'$ .

\*Rule (4) is specifically for vehicles delivering agricultural products “between the national truck network or special designated highways and any other highway.”

T-1 references this rule under the ‘normal loading’ heading.

Exception for agricultural and timber hauling vehicles:

- (13) The axle loading maximums under subsections (1), (2), (3), and (4) are increased by 10% for vehicles transporting agricultural commodities or raw timber (but GVW restrictions are unaltered). Not applicable when seasonal weight restrictions are in effect.

Seasonal Weight Reductions:

- (6) Seasonal weight reductions do not apply to public utility vehicles.
- (8) During March, April, and May, maximum axle load allowable on concrete is reduced by 25%, and reduced by 35% for all other types of roads.

Exceptions:



- vehicles hauling agricultural commodities or public utility vehicles on a local agency road.
- vehicles delivering propane fuel if the tank is filled to not more than 50% of its capacity.

T-1 states that vehicles within 5 miles of a special designated highway are subjected to the reduced axle loads (when seasonal reductions apply).

**MDOT Document T-2: Information on The Movement of Oversize or Overweight Vehicles and Loads**

Permits are not issued under various circumstances:

1. For loads that could be reduced to legal loads by distributing the load to multiple vehicles.
2. For overweight vehicles during the spring weight restriction period (except in a public emergency), nor for vehicles with more than 11 axles.
3. For travel beyond daylight hours or on weekends. Moreover, permits are not issued for movement from 12:00 noon on the day preceding and continuing unit daylight of the first day after the following holidays: New Year’s Day; Memorial Day; Independence Day; Labor Day; Thanksgiving Day; Christmas Day.
4. Single trip permits for vehicles exceeding 150’ in length.

Permits are given within the limitations in Table 3.1 (where L = overall length and P = axle weight). Unless otherwise noted, all axle loads for single trip or extended permits must fall within legal limits.

Table 3.2. Grandfathered ST Lengths.

Table 3. 1 Limits for Permit Loads.

Transportation Load	Restrictions for Type of Permit	
	Single Trip	Extended
Construction equipment	L ≤ 150’	L ≤ 85’ P ≤ 24 k <sup>1</sup> GVW ≤ 150 k
Farm equipment <sup>2</sup>	L ≤ 150’	L ≤ 80’
Mobile homes, building modules, modular home frames, etc.	L ≤ 105’ L ≤ 80’ for body length	L ≤ 95’
Poles, Pipes, and similar (over length only)	L ≤ 150’	L ≤ 85’ <sup>3</sup> No overweight loads.
Hydraulic boat lift trailer	Not issued	L ≤ 85’
Boats, prefabricated items, structural steel, trusses, empty tanks, etc.	L ≤ 150’	L ≤ 85’
Logging trailer	Not issued	Truck: L ≤ 42’ Trailer: L ≤ 75’ Limited to 11 axles

		No overweight loads.
Pavement marking	Not issued	$L \leq 40'$
Raw forest product	Not issued	$L \leq 85'$ $GVW \leq 90 \text{ k}$
Snow	$L \leq 40'$	$L \leq 40'$ Cannot be overweight or travel on interstates.
Wreckers	Permits issued for disabled vehicles	Permits issued for disabled vehicles
Milk	Not issued	$L \leq 59'$ Overweight only issued during spring weight restrictions.

- 1 Axle limit does not apply to empty to self-propelled scrapers, rubber-tired loaders or dozers, or 2 axle mobile cranes.
- 2 Permit is not required if equipment is driven or towed no less than minimum posted speed.
- 3 Work vehicles for public utilities may have  $L \leq 150'$  within the service area of the utility company.

### **Code of Federal Regulations Part 658**

This review specifically concerns the Code of Federal Regulations, Title 23 (Highways), Chapter I (FHWA, DOT), Subchapter G (Engineering and Traffic Operations), Part 658: Truck Size and Weight, Routine Designations – Length, Width, and Weight Limitations (CFR) (FHWA 2015).

The CFR primarily concerns limiting the ability of a State to restrict certain vehicle configurations and dimensions. Two sections within the CFR are related to weight and length limitations: 658.13 and 658.19. In this summary, most provisions are identified by a rule number or letter (for example “(2)”). These letters and numbers are not necessarily sequential, but refer to the specific CFR letter/number for that rule.

### **Abbreviations**

GVW = gross vehicle weight (kips)  
L = overall length (ft)  
TTS = truck-tractor with semi-trailer  
ST = semitrailer  
TTST = truck-tractor with semi-trailer and trailer  
Tr = trailer  
P = axle load (kips)  
 $P_T$  = a single tandem axle weight (kips)  
 $S_T$  = spacing from a tandem axle to any other axle (ft)

STAA = Surface Transportation Assistance Act of 1982  
LCV = Long Commercial Vehicle

## Length Provisions

Length provisions are summarized in Section 658.13.

(a) Length provisions apply only to two vehicle combinations: 1) truck tractors with a semitrailer, and; 2) truck tractors with semitrailers and trailers. Additionally, length provisions apply only to the National Network (NN) or when vehicles are in transit between NN highways and terminals or service locations (the NN includes the Interstate System, with some routes potentially excluded; see Appendix B for more detail).

(b) The following limits are not allowed to be imposed by a State:

- (1)  $L < 48'$  for a ST in a TTS combination.
- (2)  $L < 28'$  for a ST or Tr in a TTST combination.
- (3)  $L < \infty$  for entire TTS or TTST commercial vehicle.
- (4) Prohibition of the TTST combination if a commercial vehicle.
- (5) Prohibition of a ST or Tr which has  $L = 28.5'$  when in a TTST combination if the Tr or ST was in legal and actual operation on December 1, 1982 and the TTST had  $L \leq 65'$ .

(c) State maximum length limits for ST in a TTS combination and ST and Tr in a TTST combination are as follows:

- (1) States cannot prohibit Tr or ST dimensions that were in actual and lawful use on December 1, 1982. Grandfathered lengths for a few states are shown in Table 3.2 (Appendix B of Part 658):

Table 3. 2 Grandfathered ST Lengths.

State	Length (ft)
Michigan	48
Indiana <sup>1</sup>	48.5
Illinois	53
Wisconsin <sup>1</sup>	48

<sup>1</sup>See CFR 858.13 (g) for more detail.

- (2) If on December 1, 1982, State length limitations on a ST were given in terms of the distance from the kingpin to rearmost axle or end of the ST, then any ST that complies with that limitation is allowed.

(d) Buses on the NN cannot be restricted to have  $L < 45'$ .

(e) States cannot impose limits for specialized equipment exceeding those given in Table 3.3.

Table 3. 3 Specialized Equipment Length Limits.

Vehicle	Length Limitation
Automobile and boat transporter <sup>1</sup>	$L^2 \leq 65'$
Stinger-steered automobile and boat transporter	$L^2 \leq 75'$
Truck-trailer boat transporters	$L \leq 65'$
Drive-away saddle-mount vehicle transporter	$97' \leq L \leq 97'$ <sup>3</sup>
Truck-tractor semitrailer-semitrailer	$L^4 \leq 28$ or $28 \frac{1}{2}$ $L \leq \infty$ if $L^4 \leq 28$ or $28 \frac{1}{2}$ if grandfathered
B-train Combination <sup>5</sup>	$L \leq 48'$ or grandfathered length when no semitrailer is mounted to the B-train hitch
Beverage Semitrailer	$L \leq \infty$ <sup>7</sup> $L \leq 28'$ for centerline of the kingpin to the rear of the semitrailer (exclusive of rear-mounted devices)
Maxi-Cube Vehicle	$L \leq 65'$ including the space between the cargo boxes $L^6 \leq 60'$ $L \leq 34'$ for cargo (excluding drawbar/ hitching device)
Munitions carrier with dromedary	$L \leq 75'$

Note that L refers to the total overall length of the item considered.

- 1 Those with a fifth-wheel located on tractor frame over rear axle(s), including “low boys”.
- 2 All length provisions regarding automobile transporters are exclusive of front and rear cargo overhang.
- 3 Length of any semitrailer.
- 4 No State shall impose an overall length of less or more than 97 feet
- 5 The B-train assembly is excluded from the measurement of trailer length when used between the first and second trailer of a truck-tractor semitrailer-semitrailer combination vehicle.
- 6 Distance from the front of the first to the rear of the second cargo box, including the space between the cargo boxes.
- 7 When operating in a truck tractor-beverage semitrailer or truck tractor-beverage semitrailer-beverage trailer combination on the NN.

(g) States cannot impose  $L < 46'$  from the kingpin to the center of the rear axle on trailers or semitrailers used to transport vehicles for motorsport competitions.

### Weight Provisions

Weight provisions are summarized in Section 658.17. They apply to vehicles on the National System of Interstate and Defense Highways and to reasonable access routes.

(b; e)  $GVW \leq \min(80k, \text{Federal Bridge Formula})$

For use of the Bridge Formula, axle spacing distance is to be rounded down if it exceeds the nearest foot by less than 6”. If the distance exceeds the nearest foot by  $\geq 6''$ , a State may decide whether to round up or down to the nearest foot.

See 12c + exception, MVC Summary, for Bridge Formula.

(c)  $P \leq 20k$

Single axle weight (P) in CFR is defined as the total weight of all axles within 3.33' (40") or closer (Section 658.5).

(d)  $\sum P_T \leq 34k$

Tandem axle weight ( $\sum P_T$ ) is defined as the total axle weight by two or more consecutive axles with spacing  $3.33' < S_T \leq 8'$  (Section 658.5).

(f) States may not limit steering axles less than: min (20k, axle rating from manufacturer).

States also may not impose weight restrictions more severe than rules b, c, d, e, above.

(g) Scale tolerance is to be included in the weight restrictions; 2-3% is suggested, up to a maximum of 5%.

(h) States may issue special permits for over-weight vehicles for non-divisible vehicles or loads.

A non-divisible load is defined as that which cannot be dismantled in 8 hours. Refer to the FHWA FAQ for additional detail.

(i) the limits in sections (b-d) don't apply to legal weights authorized under State law on July 1, 1956, and requirements for axle groups do not apply to vehicles under State axle group rules grandfathered on January 4, 1975.

(n) Vehicles utilizing auxiliary power or idle reduction technology to promote reduction of fuel use and emissions may be allowed up to an additional 400 pounds in gross, axle, tandem or Bridge Formula weight limits. Note that Title 23, U.S.C. Sec. 127 allows this weight to be increased up to 550 pounds.

It also notes that states that have enforced from October 6, 1992 to November 30, 2005, a single axle weight limitation of  $20k \leq P \leq 24k$  may not enforce a single axle weight limit of  $P < 24k$  (section k).

### **Michigan Exceptions**

Appendix C in CFR Part 658 applies to trucks over 80k on the Interstate System, and to trucks on the National Network over the Surface Transportation Assistance Act of 1982 (STAA) length limits. State-by-State exceptions are given; only the Michigan provisions are summarized here.

Allowed Michigan exceptions:

- A long combination vehicle (LCV) of TT + two trailing units, where total  $L \leq 58'$  for the cargo-carrying units, and  $GVW \leq 164 k$  (see MVC weight rules 3b,c,d).

- Rules 1a, 1b, 1c, 3, 8 in MVC Weight Rules and 3c,d and 5b in Length Rules Summary.
- GVW, depending on single axle and axle group weight limits.
- Truck with trailer weight restrictions are governed by the MVC, as it is not a LCV and its weight is not subject to ISTEA freeze.
- Truck with trailer may have  $L \leq 70'$  if carrying logs (see MVC weight rule 3b).
- Permits for divisible loads of more than 80 kips must conform to either Federal or grandfathered requirements.

Appendix B in this report provides the National Network Federally Designated Routes in Michigan, as specified in CFR Part 658. Note that the MDOT “Michigan Truck Operators Map” (2016) also provides National Network Routes as well as Special Designated Highways.

### **Fixing America’s Surface Transportation Act (FAST) (P.L. 114-94) (2015)**

The FAST Act imposes several modifications on CFR Part 658 and revises the maximum State limits for certain vehicles.

#### **Section A**

Section A notes that Section 127 of Title 23 of the United States Code establishes weight limitations for vehicles operating on the Interstate System, and summarizes these limits (see “Weight Provisions” in the CFR summary, above).

#### **Section C**

Section C provides a description of truck size and weight provisions for particular vehicles within several subsections, as given below.

*Milk Products (Section 1409).* Permits may be issued by States for milk vehicles (now considered non-divisible) exceeding 80 k or the Federal Bridge Formula. Note that CFR 650 Subpart C requires load rating and posting (if necessary) of bridges for unrestricted routine permit loads.

*Interstate Weight (Section 1410).* Several modifications to CFR are provided, as follows:

- a. CFR weight limitations do not apply to a covered heavy-duty tow and recovery vehicle.
- b. For emergency vehicles, States are not allowed to impose laws more restricting than the following:  $P < 24$  k for a steering axle;  $P < 33.5$  k for a drive axle;  $\sum P_T <$

62 k for tandem axles;  $\sum P_T < 52$  k on tandem rear drive steering axles; and GVW  $< 86$  k.

- c. Vehicles powered primarily by natural gas may exceed any vehicle weight limit (up to a GVW of 82 k) to account for any additional weight of the natural gas fuel system.

Automobile Transporters (Section 5520). States cannot impose a limit less than  $L \leq 80'$  on a stinger-steered automobile transporter, with a front overhang of less than 4' and a rear overhang of less than 6'. Note that the previous limitations were  $L \leq 75'$ , including a 3' front and 4' rear overhang.

Commercial Delivery of Light- and Medium-Duty Trailers (Section 5523). States cannot impose a limit less than  $L \leq 82'$  on a towaway trailer transportation combination (TTTC). The TTTC consists of a trailer transporter and two trailers or semitrailers with  $GVW \leq 26$  k and in which the trailers or semitrailers carry no cargo. States will need to establish guidelines for rating and posting for these vehicles.

## **Section D**

This section provides terms and definitions. Single and tandem axle weights are defined as in the CFR (see section (d) of CFR, above).

### **Federal Size Regulations for Commercial Motor Vehicles (US DOT FHWA 2004)**

This document summarizes CFR length rules and provides definitions of vehicle types.

#### **Definitions**

Truck tractor. The non-cargo-carrying power unit used with a semitrailer.

Truck. A truck that carries cargo on the same chassis as the power unit and cab.

Straight truck. A straight truck is a truck alone; it has no trailer or semitrailer.

Automobile and boat transporter combination. A vehicle combination transporting assembled highway vehicles, including truck camper units (Figure 3.1).

B-Train combination. A truck tractor-semitrailer-semitrailer combination where the two trailing units are connected by a fifth wheel attached to a frame under the first semitrailer that extends beyond the rear of that semitrailer (the "B-train" hitch) (Figure 3.2).

Beverage semitrailer. A drop frame, side access semitrailer for beverage delivery. The upper coupler plate may extend beyond the front of the semitrailer, but not beyond a semicircle whose radius is from the kingpin to the front corner of the semitrailer (Figure 3.3).

Maxi cube vehicle. A combination vehicle consisting of a straight truck and a trailing unit, both of which carry cargo. The truck's cargo box may be loaded or unloaded through the trailing semitrailer or trailer (Figure 3.4).

Saddlemount combination. A truck tractor towing other vehicles. The front axle of each towed vehicle is mounted on top of the frame of the vehicle in front. A fullmount is a vehicle mounted entirely on the frame of the first or last vehicle in the combination (Figure 3.5).

Dromedary. A box or plate mounted behind the cab and forward of the fifth wheel on the frame of the power unit of a truck tractor-semitrailer combination to carry freight (Figure 3.6).

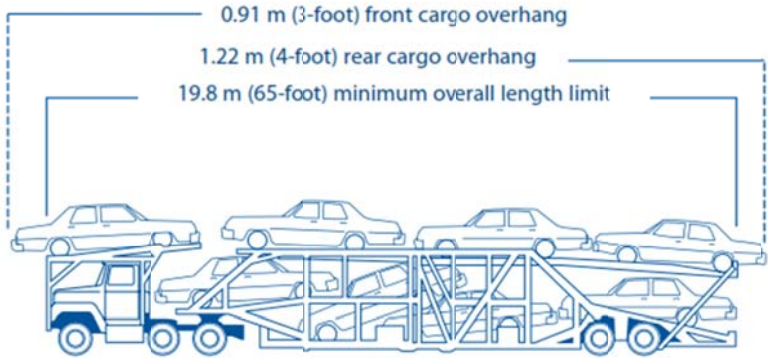

(a) Conventional Automobile Transporter Combination.

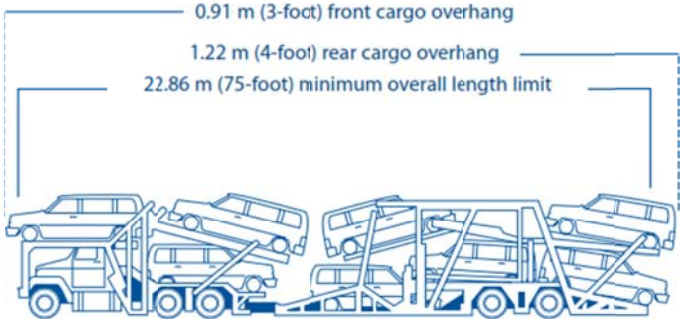

(b) Stringer-steered Auto Transporter Combination.

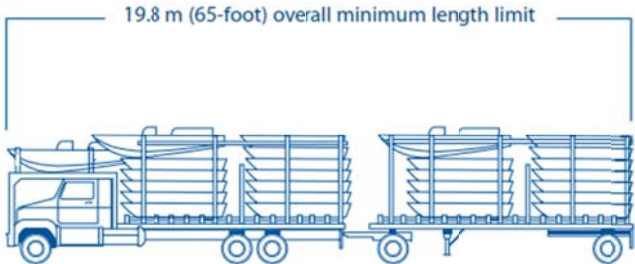

(c) Straight Truck Towing a Trailer Transporting Boats.

Figure 3. 1. Automobile and Boat Transporter Combinations.



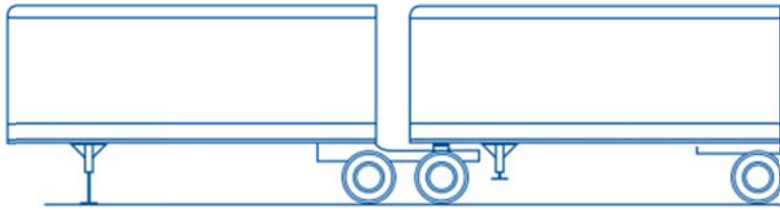

Figure 3. 2. B-Train Semitrailer-Semitrailer Combination.

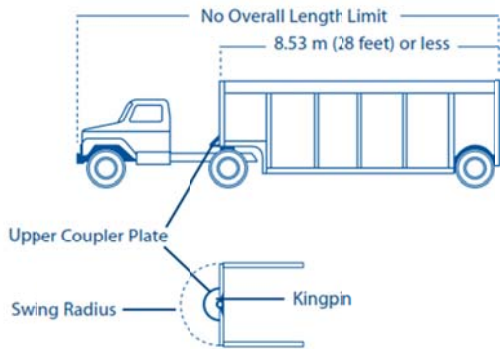

Figure 3. 3. Beverage Semitrailer (and Tractor).

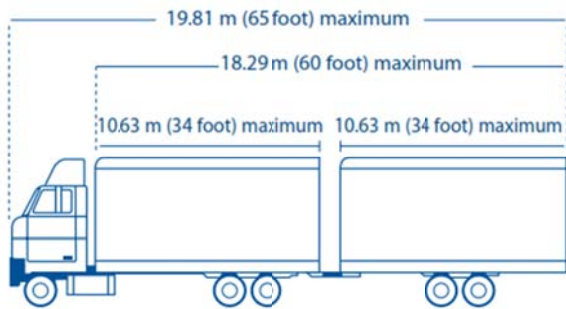

Figure 3. 4. Maxi-cube Vehicle.



Figure 3. 5. Saddlemount with Fullmount Combination.

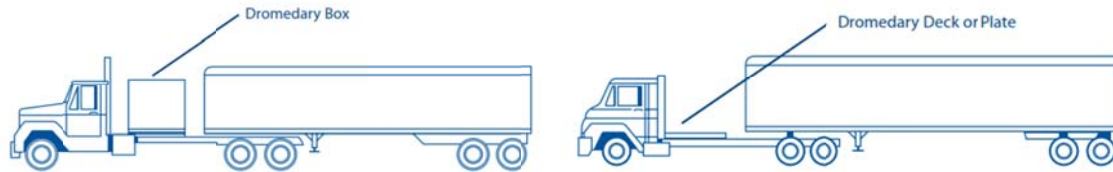

Figure 3. 6. Dromedary Deck or Plate.

### Truck (T) Regulations

A straight truck is not subject to Federal regulations.

For a truck towing a trailer or semitrailer,  $L \leq 65'$  for its cargo-carrying units (see discussion of ISTEA “Freeze,” below).

Other Federal regulations apply to specialized combination vehicles composed of trucks; see below.

### Truck Tractor with Semitrailer (TTS) Regulations

For a TTS on the NN or reasonable access routes,  $L \leq \infty$ .

For ST,  $L \leq 48'$  or the grandfathered limit ( see Table 1, above).

See Figure 3.7.

### Truck Tractor with Semitrailer and Trailer (TTST) Regulations

For a TTST on the NN or reasonable access routes,  $L \leq 65$ .

$L \leq 28'$  for the Tr or ST.

$L \leq 28.5'$  for the Tr or ST on vehicles that were in use on December 1, 1982.

See Figure 3.8.

The maximum overall length of the cargo-carrying units for twin trailer combinations when one trailer has  $L > 28.5'$  is determined by ISTEA (see below).

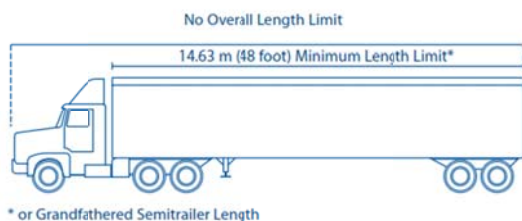

Figure 3. 7. Truck Tractor-Semitrailer Combination.

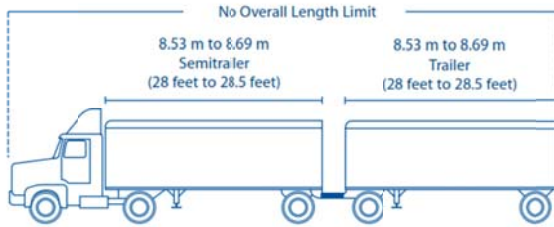

Figure 3. 8. Truck Tractor-Semitrailer-Trailer Combination.

### Bus Regulations

For a bus on the NN or reasonable access routes,  $L \leq 45'$ .

### Specialized Equipment Regulations

Length limits are given in Table 3.4.

Table 3. 4. Specialized Equipment Length Limits.

Vehicle	Length Limitation
Automobile and boat transporter <sup>1</sup>	$L \leq 65'$
Stinger-steered automobile and boat transporter <sup>2</sup>	$L \leq 75'$
Straight truck transporting boats	$L \leq 65'$
B-train Combination	$L \leq 65'$ $L \leq 48'$ or grandfather length when no semitrailer is attached to the B-train hitch
Beverage Semitrailer	$L \leq \infty$ $L \leq 28'$ for trailer + length of the extended upper coupler plate
Maxi-Cube Vehicles	$L \leq 65'$ $L \leq 60'$ for cargo carrying unit(s) $L \leq 34'$ for cargo (excluding drawbar/ hitching device)
Saddlemount and Saddlemount with fullmount combination	Allowed to pull at least 3 other vehicles $L \leq 75'$ on NN and reasonable access routes
Dromedary	$L \leq 75'$ on NN and reasonable access routes

Note that L refers to the total overall length of the item considered.

8 Those with a fifth-wheel hitch located on the tractor frame over the drive axle or axles.

9 Those with fifth-wheel hitch located on a drop frame positioned below and behind the rear tractor axle.

### Intermodal Surface Transportation Efficiency Act of 1991 (ISTEA “Freeze”).

This summary is taken from *Federal Size Regulations for Commercial Vehicles* and associated *FAQ*.

ISTEA imposed two vehicle configuration “freezes”:

1. A limitation on the maximum weight of long combination vehicles (LCVs) consisting of a truck tractor and two or more trailer or semitrailers on the Interstate System.
2. A limitation on the overall length of the cargo carrying units of combination vehicles on the National Network with two or more units, when one or both exceeds 28.5’.

These maximum weights and lengths are those that were in actual and legal operation in a State on June 1, 1991. Limits are given for selected States in Table 3.5. Note that length is measured from the foremost load carrying structure of the first unit to the rearmost load carrying structure of the last unit, including the hitch or hitches between the units, but excluding the upper coupler on a beverage semitrailer.

Table 3. 5. Length and Weight Limitations of Vehicles Under ISTEA.

State	Truck tractor and 2 trailing units		Truck tractor and 3 trailing units		Other <sup>1</sup>	
	Length (ft) <sup>2</sup>	Weight (k)	Length (ft)	Weight (k)	Length (ft)	Weight (k)
Michigan	58	164	Not allowed	Not allowed	63	Not allowed
Indiana	106	127.4	104.5	127.4	58	Not allowed
Illinois	Not allowed	Not allowed	Not allowed	Not allowed	Not allowed	Not allowed
Wisconsin	Not allowed	Not allowed	Not allowed	Not allowed	Not allowed	Not allowed

- 1 Other vehicles may include a truck towing one trailer, or a semitrailer and trailer, an automobile/boat transporter, or a saddle-mount combination. Refer to CFR for more information.
- 2 Maximum cargo-carrying length from the front of first cargo unit to the rear of the last cargo unit. This distance does not include length exclusive devices which have been approved by the Secretary of Transportation or a State.

### Grandfather rights

Grandfather rights arise from 23 U.S.C. 127(a) and allow State weight limits to exceed Federal weight limits on the Interstate System. Under the first grandfather right, states may allow vehicles of higher axle or GVW limits if such weights were permitted on July 1, 1956. Under the second grandfather right, states may allow vehicles that exceed Bridge Formula or axle weight limits linked to axle spacing requirements if such weights were permitted on January 4, 1975. For Michigan, the date for all grandfather rights given above is May 1, 1982.

### **Potential Conflicts Between The MVC and Federal Requirements**

Potential conflicts between the MVC and the FAST Act and CFR 658 have been found; these are summarized below.

### **Fast Act Provisions**

This information is found within Section C of the FAST Act. States are required to rate and post bridges to account for vehicles within these requirements.

*1. Milk Products (Section 1409).* Permits may be issued by States for milk vehicles (now considered non-divisible) exceeding 80 k or the Federal Bridge Formula. Note that CFR 650

Subpart C requires load rating and posting (if necessary) of bridges for unrestricted routine permit loads.

Note that it does not require that permits are issued, but may be issued if desired by the State. MI currently allows extended permits for milk trucks (limited to 59' length), but overweight loads are only allowed during spring weight restrictions. Single trip permits are not issued. No conflict is apparent with the current MI permit rules.

2. Interstate Weight (Section 1410). Several modifications to CFR are provided, as follows:

- a. CFR weight limitations do not apply to a covered heavy-duty tow and recovery vehicle (this towing vehicle has a GVW no less than the vehicle it tows). However, there do not appear to be requirements for states to modify their current policies with regard to these vehicles. Currently, T-2 issues permits for disabled vehicles to be towed. No conflict is apparent with the current permit rules.
- b. For emergency vehicles (to respond to fires and other hazards), States are not allowed to impose laws more restricting than the following:  $P < 24$  k for a steering axle;  $P < 33.5$  k for a drive axle;  $\sum P_T < 62$  k for tandem axles;  $\sum P_T < 52$  k on tandem rear drive steering axles; and  $GVW < 86$  k. Currently, the MVC and State Police does not impose any weight restrictions on emergency vehicles when responding to an emergency (although T2 indicates that permits are issued for emergency vehicles during an emergency). Therefore, no conflict is apparent with the current rules.
- c. Vehicles powered primarily by natural gas may exceed any vehicle weight limit (up to a GVW of 82 k) imposed under the CFR, to account for any additional weight of the natural gas fuel system; up to 2 k of additional load can be applied to any axle. However, this does not require that states allow this additional load. The MVC does not mention this additional weight. Therefore, there appears to be no conflict with the current MI vehicle rules.

3. Automobile Transporters (Section 5520). States cannot impose a limit of  $L \leq 80'$  on a stinger-steered automobile transporter, with a front overhang of less than 4' and a rear overhang of less than 6'. Note that the previous limitations were  $L \leq 75'$ , including a 3' front and 4' rear overhang. The MVC specifies limits of  $L \leq 75'$  with 3' front and 4' rear extension. However, T1 matches the longer FAST length limitations.

4. Commercial Delivery of Light- and Medium-Duty Trailers (Section 5523). States cannot impose a limit of  $L \leq 82'$  on a towaway trailer transportation combination (TTTC). The TTTC consists of a trailer transporter and two trailers or semitrailers with  $GVW \leq 26$  k and in which the trailers or semitrailers carry no cargo. The MVC and T1 do not explicitly address this vehicle.

## **CFR Part 658 Provisions**

1. Motorsport Vehicle Transporters. In the CFR, the maximum length restriction from the kingpin to rear axle of a trailer/semitrailer transporting vehicles for motorsports competitions is 46'. The MVC (rule 3a) list that for semitrailers, if overall length > 50', then  $37' \leq L \leq 41'$  from the kingpin to center of the rear axle assembly.

2. Beverage semitrailers. No length restriction is allowed when a beverage semitrailer is in a truck tractor-semitrailer or truck tractor-semitrailer-trailer combination. Also, the maximum restriction is  $L \leq 28'$  from the kingpin to the rear axle. The MVC has the following length restrictions for semitrailers (but does not mention a beverage semitrailer):  $L \leq 53'$  for semitrailer (3a); and  $L \leq 65'$  for truck tractor-trailer or TT-semitrailer (3b).

3. Munitions carrier with dromedary. These vehicles (a truck with semitrailer) have a maximum length restriction of 75'. However, the MVC (3b) specifies  $L < 65'$  for a truck with a semitrailer.

4. Additional vehicle weight. Vehicles may be allowed a 0.55 k increase in the Bridge Formula / 80k limit if fuel use reduction technologies are used. The increase allowance does not appear to be required, however. MVC provides no discussion of this.

## **Enforcement of Vehicle Regulations**

To understand how Michigan State Police (MSP) identify illegal vehicles, common overweight vehicle configurations and related enforcement issues, an interview was conducted in September 2016 with MSP personnel. The results are summarized in Appendix C.

In general, suspect illegal vehicles are stopped by MSP either by real-time examination of WIM data, when available, or by the officer's experience in observing characteristics of overweight vehicles. Some of these characteristics include the presence of a large load on the truck; excessive tire deformation; hot tires; and trucks that appear to have operating difficulties.

Vehicle dimensions are measured with a tape measure or roller wheel. Wheel weights can be measured with a portable scale with 25 kip capacity, or a large platform scale available at weigh stations that can weigh cumulative axle weights as the truck moves over the platform. For platform weighing, moving vehicles often increase scale weight readings, and the allowable weight is increased slightly. For example, the legal limit of 34 kips for two tandem axles is increased to 36 kips during platform weight checking. Tire pressure can be determined with a pressure gauge or from tire width and axle weight measurements. A common occurrence is that a vehicle is within GVW limitations, but an axle(s) exceeds its weight limits, indicating that the load is not properly distributed. Records of specific illegal vehicle configurations are not recorded, only the resulting ticket fine. Implements of husbandry, if not loaded on a trailer, and salt trucks have no GVW or axle weight restrictions.

## Expected Vehicle Configurations

To better understand some of the expected extended permit vehicle configurations in Michigan, a review of currently available vehicle information provided by several major truck and trailer manufacturers was conducted. The review focused on heavy duty vehicles and high capacity trailers, including specialized vehicle options. Additionally, a Michigan Trucking Association representative was interviewed, available truck registration data were reviewed, and a survey was submitted to selected haulers in Michigan requesting information on extended permit submittals.

### **Typical Truck and Truck-Tractors available from Manufacturers**

The heavy duty trucks produced by Freightliner, International, Peterbilt, and Western Star are summarized. The manufacturers surveyed provide vehicles in a single rear axle, tandem, tridem, or twin steer arrangement, as shown in Figure 3.9. In general, precise information is not available because these vehicles are typically made specifically to suit the needs of customers, and axle load capacity will vary depending on the type of axle and suspension placed on the vehicle. Therefore, a range of axle weights and wheelbase dimensions is given. In the tables below, N/S means the information was not provided, GCW refers to the possible Gross Combination Weight, and N/A means not applicable for that case. Weight is given in kips.

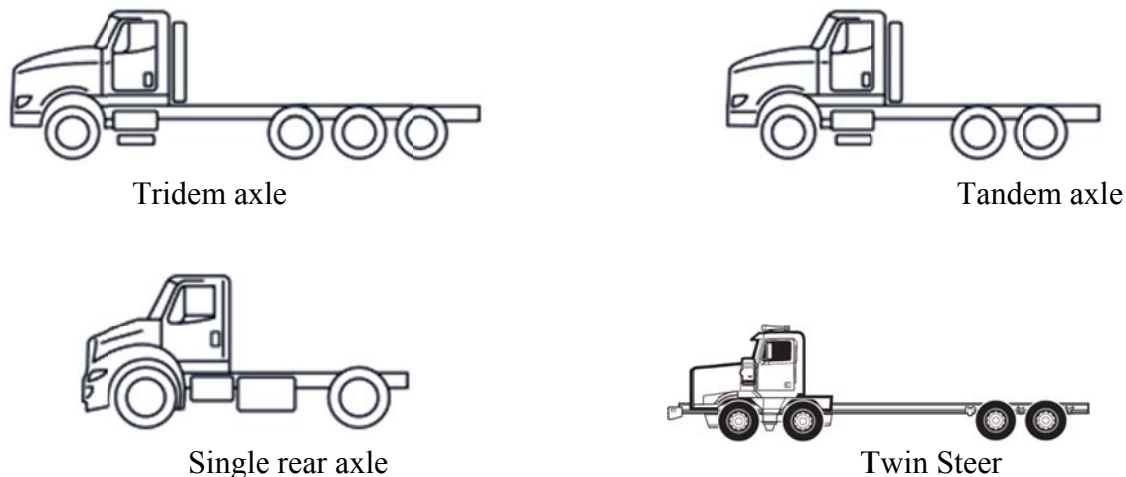

Figure 3. 9. Truck Configurations.

### Freightliner

Four types of heavy trucks are available from Freightliner, as presented in Table 3.6. These include trucks for general highway use (122 SD and M2 112), and for “severe duty” (114 SD and 108 SD). However, each truck model can be configured into specialized vehicles as well. For example, Truck 122 SD can be used as a general hauler, or configured as a mobile crane, a logging or towing vehicle, or a dump truck; Truck M2 112 can be configured as a crane; Truck 114 SD as a towing vehicle, a dump truck, or other construction vehicle; and Truck 108 SD as a

crane, dump truck, or other construction vehicle. Other possible configurations exist as well. Axle spacing is not available.

Table 3. 6. Freightliner Trucks.

Truck Model	Steer axle	Single rear axle	Tandem axles	Tridem axles	GVW	GCW
122 SD	12 – 22	23 – 26	40 – 70	69	92	210
M2 112	≤ 16	≤ 30	≤ 46	N/A	≤ 62	N/S
114 SD	≤ 22	≤ 38	≤ 58	≤ 69	≤ 91	N/S
108 SD	≤ 20	≤ 38	≤ 46	N/A	≤ 79	N/S

### International

Two heavy duty (Paystar and HX Series) and three severe duty (9900i; Prostar; Lonestar) trucks are presented in Table 3.7. The Paystar truck can also be configured as a heavy hauler, a crane, or a construction vehicle; the HX Series as a crane, construction vehicle, or concrete mixer; the 9900i a long haul or construction vehicle; the Prostar as a long haul or tanker; and the Lonestar as a long haul vehicle. Other configurations are possible as well.

Table 3. 7. International Trucks.

Truck Model	Steer axle	Single rear axle	Tandem axles	Tridem axles	GVW	GCW	Wheelbase
Paystar	12–22	N/A	40–70	53	52.3–80	80–150	14.5-21.8’
HX Series	12–22	N/A	40–70	53	52–92	N/S	N/S
9900i	12–14	N/A	40–46	N/A	52–60	90–140	17–20’
Prostar	12–14	23	40–46	N/A	32–60	≤ 140	11.7-21’
Lonestar	12.3-14.6	N/A	40–46	N/A	52.3-60.6	90-140	17-22.3’

### Peterbilt

Peterbilt provides four truck types, including those for highway use (587), and vocational (i.e. specialized work) use (389, 367, and 348), as shown in Table 3.8. Model 389 can be configured as a dump truck or logging vehicle, while Model 367 can be used as a dump truck, logging vehicle, or general construction vehicle. Axle spacing was not provided.

Table 3. 8. Peterbilt Trucks.

Truck Model	Steer axle	Single rear axle	Tandem axles	Tridem axles	GVW	GCW
389	12 – 20	21 – 30	40 – 52	66 – 69	N/S	N/S
367	12 – 22	21 – 30	40 – 70	66 – 69	N/S	N/S
348	12 – 20	21 – 30	40 – 46	N/A	33 – 66	N/S
587	21 – 26	21 – 23	40 – 46	N/A	N/S	N/S



## Western Star

Western Star presents trucks for highway and vocational use (4700 and 4800), vocational and off-road use (6900), and a general vehicle that can be used for highway, vocational, or off-road use (4900), as shown in Table 3.9. The 4700 can also be used as a construction, towing, or bulk hauling vehicle; the 4800 for construction, logging, towing, or bulk hauling; the 6900 for construction, logging, towing, or heavy hauling; and the 4900 for any of the uses above.

Table 3. 9. Western Star Trucks.

Truck Model	Steer axle(s)	Single rear axle	Tandem axles	Tridem axles	GVW	GCW	Wheelbase
4700	12 – 23	23 – 26	40 – 46	N/A	N/S	N/S	≤ 25'
4800*	40	N/A	40 – 52	69	N/S	N/S	≤ 37.3'
6900	20 – 28	N/A	46 – 70	69 – 105	N/S	N/S	≤ 40.5'
6900*	44	N/A	70 – 110	69	N/S	N/S	≤ 40.5'
4900*	40 – 44	N/A	46 - 70	69	N/S	N/S	≤ 37.3'

\* Twin Steer Model

## **Trailers**

Heavy duty truck trailers offered from Utility, Wabash, Stoughton, and Fontaine trailer manufacturing companies are summarized, as well as specialized trailers from XL Specialized and Rogers. Note that special use recommendations (e.g. that load should be evenly distributed on the trailer) are not provided in the tables. Length refers to overall length unless otherwise noted.

### Utility Trailers

Trailers produced by Utility are shown in Table 3.10. The Utility trailer is a semi-trailer designed to be pulled by a semi-tractor/truck. The semi-trailer is not to be used in conjunction with a straight truck.

Table 3. 10. Utility Trailers.

Trailer Model	Use	Length	Capacity	No. of axles
4000D-X	Dry van	53'	65 k GVW	2
3000 R	Refrigerated van	53'	65 k GVW	2
Tautliner	Van+Flatbed	53'	55 k payload	2
4000 S	Flatbed	≤ 53'	80 k payload	2

### Wabash Trailers

Wabash trailers are shown in Table 3.11.

Table 3. 11. Wabash Trailers.

Trailer Model	Use	Length	Capacity	No. of axles*
DuraPlate XD-35	Dry van	53'	68 k GVW	2
ArcticLite	Refridge. van	53'	68 k GVW	2
Steel Flatbed	Platform	28' - 53'	≤ 125 k	2
Steel Dropdeck	Platform	28' - 53'	≤ 94 kips	2
Coil Hauler	Platform	48'	90 k payload	2
Aluminum Flatbed	Platform	28' to 53'	≤ 140 kips	2
Alum. Dropdeck	Platform	48' to 53'	≤ 105 kips	2

\* Only XD-35 is limited to 2 axles maximum.

### Stoughton Trailers

Stoughton produces dry van trailers. Available types are presented in Table 3.12.

Table 3. 12. Stoughton Trailers.

Trailer Model	Length	Capacity
Extra wide	53'	55 k payload
Grain trailer	40'	70 k GVW
Container	53'	67.2 k GVW
Open top	53'	25 k per axle; 55 k payload
Furniture van	53'	20 k per axle; 55 k payload

### Fontaine Trailers

Fontaine produces a variety of commercial, platform, heavy haul, and military trailers. A selection of heavy duty trailers are presented in Table 3.13.

Table 3. 13. Fontaine Trailers.

Trailer Model	Use	Length	Payload Capacity	No. of axles
LXTN40	heavy haul	29-50' deck	80 k 25 k per axle	2-3
80 class	construction	28-30' deck	160 k	6
Xcalibur XTD*	heavy haul	53'-72'	80 k	3
45H-MXP**	heavy haul	29'-50'	90 k	2-4
Infinity TX dropdeck	Platform	53'	80 k	2-3
55H-FLD	heavy haul	51' 25' deck	110 k 25 k per axle	3-4

\* Extendable dropdeck; \*\* Extendable deck

## XL Specialized Semitrailers

XL Specialized manufactures heavy haul and specialized semitrailers for construction, commercial, agriculture, wind energy, oil and gas, and custom transportation uses. Some heavy-duty trailers are presented in Table 3.14. Figure 3.10 illustrates some of these semitrailers.

Table 3. 14. XL Specialized Trailers.

Semitrailer Model	Use	Length	Overall Capacity	No. of axles*
XL 70-HDG	Agriculture	53'	70 k	2+1
XL 110-MFG	Agriculture	48'	110 k	3+1
XL 120-HDG	Construction	53'	120 k	3+1
XL 110-HFG	Construction	51'	110 k	3+1
XL 100-HFG	oil and gas	51'	100 k	3+1
XL blademate	wind energy	53'; opens to 184'	90 k	3+1

\* an extra axle that can be used when needed and flipped up or removed when not needed.

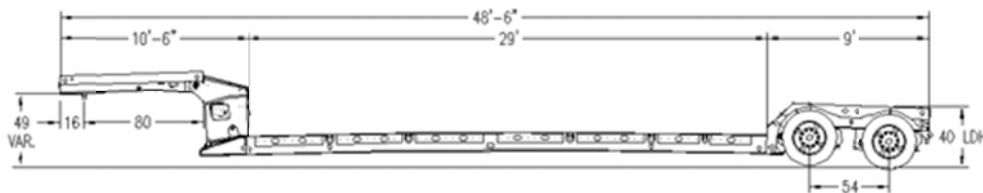

(a) XL 70-HDG

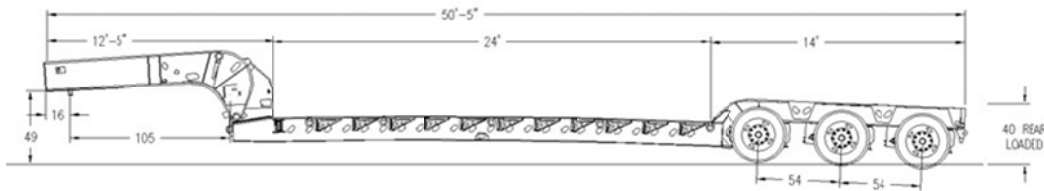

(b) XL 120-HDG

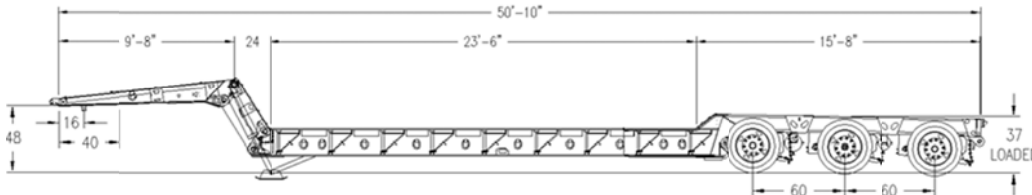

(c) XL 100-HFG Pipeline Special

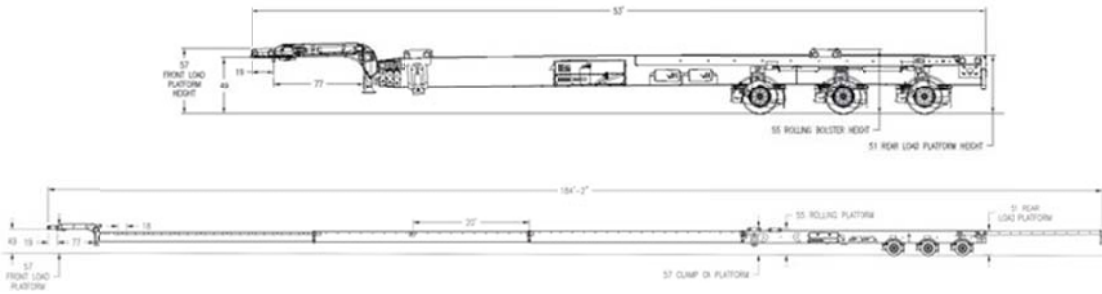

(d) XL Blademate

Figure 3. 10. XL Specialized Semitrailers.

### Rogers Trailers

Rogers produces specialized trailers for construction and mining. Some heavy-duty trailers are presented in Table 3.14.

Table 3. 15. Rogers Trailers.

Trailer Model	Use	Length	Capacity	No. of axles
SP100DS	construction	28' deck	200 k	3+1
Sp1101B	heavy hauling	85'	220 k	4+2
Sp88pl	hauling mining equipment	50'	176 k	4
FG100L	loaded by crane	35' deck	200 k	5

### Michigan Truck Registration Data

The information below was summarized from *Michigan's Truck-Weight Law and Truck-User Fees* (MDOT Intermodal Policy Division, 2012). In December 2012, according to the Secretary of State, 79,865 trucks, excluding farm and log trucks, were registered by weight in Michigan, as shown in Table 3.15. This does not include approximately 31,600 Michigan-based power units registered with the International Registration Plan. Since trucks frequently carry less than their elected gross weight, the operating weight cannot be determined from this data.

According to the Michigan Trucking Association (See Appendix D), five axle trucks (with trailer lengths of 48' and 53') are the most common type. In addition, twins (a truck-tractor having two 28.5' trailers) are common. Currently, 5 axle trucks on interstate highways are preferred, as such configurations work best with the Bridge Formula. The MTA predicts heavier trucks in the future. For example, the MTA expects that the current 80 kip federal limit will be increased to 95 kips for interstate highways. If this occurs, an increased number of 6-axle trucks are expected.

Table 3. 16. Trucks Registered in Michigan by GVW.

Elected Gross Weight	Number	Percentage
0 to 24 k	38,071	47.7
24k to 26k	8,079	10.1
26k to 28k	1,812	2.3
28k to 32k	4,668	5.8
32k to 36k	3,309	4.1
36k to 42k	1,756	2.2
42k to 48k	2,765	3.5
48k to 54k	5,384	6.7
54k to 60k	1,278	1.6
60k to 66k	1,020	1.3
66k to 72k	2,612	3.3
72k to 80k	2,756	3.4
80k to 90k	924	1.2
90k to 100k	778	1.0
100k to 115k	710	0.9
115k to 130k	737	0.9
130k to 145k	587	0.7
145k to 160k	2,328	2.9
160k to 164k	321	0.4
Total	79,895	100

### **Farm, Milk, and Log trucks**

In 2012, there were 46,946 farm, milk, and log trucks in Michigan, as shown in Table 3.16. Weight data are not available.

Table 3. 17. Registered Farm, Milk, and Log Trucks in Michigan.

Truck Class	Number	Percentage
Farm Trucks	38,342	81.7
“Special” farm trucks	6,120	13.0
Milk-hauling trucks	150	0.3
Log trucks	2,334	5.0
Total	46,946	100

Typical Trucks registered in Michigan are given in Table 3.17.

### **Extended Permit Hauler Survey**

A survey was submitted to a selection of Michigan haulers in order to obtain data on typical extended permit vehicle configurations. The survey and its results are given in Appendix E.

Table 3. 18. Typical Michigan Trucks.

Vehicle	GVW	Axle weight
Most-common truck	< 26 k	not available
Medium truck	32 k	< 18 k / axle
Standard semi-trailer	73 k on 5 axles	Four 16 k axles
Standard Interstate semi-trailer	80k on 5 axles	Four 17 k axles
MI multi-axle truck	150k on 11 axles	Eight 13k axles + two 16k axles
MI multi-axle single trailer	150 k on 11 axles	Eight 13k axles + two 16k axles
MI 8-axle log truck	125k	Five 18k axles, three 13k axles

## CHAPTER 4: SUMMARY OF MDOT PERMITTING PROCESS

### Definitions

The information in this chapter is based on interviews of MDOT staff as well as information obtained from MDOT research reports. The process used to grant single-trip and extended permits is discussed.

Single Trip Permit. A permit issued for one-time travel to carry a specific load on a specific route. For this permit, the vehicle configuration (axle spacing and weights) is known. Vehicle and load limitations are given in MDOT document T-2. This is similar to the definition of a “special permit” in the AASHTO Manual for Bridge Evaluation.

Extended Permit. A permit issued annually for any vehicle or load that the hauler indicates will meet the limitations given in MDOT document T-2. The exact load and configuration of a combined vehicle (e.g. tractor and trailer combination) is not necessarily known, nor is the route that the vehicle may take. An extended permit is treated as a legal load with regard to access on roadways. Also called “annual” or “routine” permits.

Superload. A vehicle/load exceeding 16’ in width, 15’ in height, and/or 150’ in length (see MDOT form 2465). Note that weight is not associated with a superload. A superload is a special form of a single trip permit; i.e. it is valid for one-time travel on a specific route only.

Vehicle Class. Twenty rating vehicle configurations used to represent permit vehicles are divided into three weight classes: A, B, and C. Class A vehicles have the highest axle weights, while class B and C represent reduced axle weights. These vehicles are given in Appendix C (Table 8.1) of MDOT Research Report R-1511.

Bridge Class. Most bridges can be grouped into one of 4 classes, A, B, C, or D. Class A bridges can support the load effects for all 20 rating vehicles (discussed above) at their Class A axle weights. Class B bridges cannot support all Class A vehicles, but can support load effects produced by all Class B (and lower) vehicles, and so-on. Class D bridges cannot support all Class C load effects. Bridge class is determined in the rating process. If the rating factor is greater than 1.0 for all 20 vehicles in Class A, the bridge is designated as Class A. If all rating factors are not greater than 1.0, the bridge is rated for Class B vehicles; if all Class B rating factors are not greater than 1.0, then the bridge is rated for Class C vehicles. Finally, if all Class C vehicle rating factors are not greater than 1.0, the bridge is designated Class D. For bridge rating, capacity is usually determined using normal LRFR methods for LRFD-designed bridges and LFR for LFD-designed bridges, although in some cases, LRFR has been used to rate a LFD-designed structure. Currently, only LFR is used for permit analysis, although suggested LRFR rating factors are given in R-1511.

Class S Bridge. A bridge built between 1965 and 1972 that was designed using H15-44 criteria. Vehicles that produce moments below those of Class B or C (depending on bridge capacity) and have axle loads less than 38 kips are allowed to pass Class S bridges.

Class R Bridge. A bridge with beam spacing greater than 10' or a truss bridge. For this bridge, vehicles with axle length (i.e. vehicle width) greater than 8' are not eligible for load effect reduction, unlike on other bridges.

### **Permitting Process for Single Trip Permits**

1. The hauler provides vehicle, load, and route information on-line through the MiTRIP application process. Required vehicle information includes (but is not limited to): height, width, axle weights, axle spacing, GVW, number of tires per axle, and tire width. Required route information includes the date of travel, origin, destination, and the specific route of travel. However, the data provided by the hauler may not be accurate.
2. Once hauler input information is received, Transportation Permits Unit (TPU) staff check if tire pressure, weight, and length are within the limits provided in T-2 for a Single-Trip Permit. Although detailed limitations are summarized in the previous chapter, general limitations can be summarized as follows: axle weights up to 24 k, tire loads up to 700 lb/in of tire width, and GVW up to 150 k.
3. The vehicle is then analyzed using Bentley *Superload* software. Vehicle load effects are calculated on simple spans ranging from 15' to 160' at 5' increments using the impact factor taken from the AASHTO Standard Specifications (LFD) to determine maximum moments and shears.
4. Within *Superload*, the maximum moments and shears caused by the vehicle are automatically compared to the maximums allowed for the bridges (i.e. maximum allowed load effects for the bridge classes of the bridges on the route) found on the vehicle route. Bridge class load effect limits are given in Tables 22 and 23 of MDOT Research Report RC-1589. These limits were found by determining the maximum moments and shears on simple spans generated from Trucks 1-20 for that bridge length and class. Whether a bridge is R or S Class is also checked. For bridges other than R, if the hauler's axle width is greater than 8', axle loads are reduced by the following factor:  $\text{Axle weight} / ((\text{axle spacing} + 8) / 16)$ , where axle spacing is in feet.
5. If the hauler's vehicle moment and shear effects are less than the limits for the bridge class along the route chosen, the permit is issued. Permits are initially denied for load effects exceeding the limits for the bridge class along the route chosen. No overweight permits are issued for Class D bridges (exceptions: Mackinac Bridge, International Bridge, and Blue Water Bridge).
6. Loads which cannot be approved by TPU are typically returned to the hauler for redistribution of the load or re-routing. The hauler may request a more detailed load capacity analysis to determine if such an analysis would allow the vehicle to pass. The BMLR conducts the load capacity analysis, whereby each bridge on the route is analyzed



more precisely using *AASHTOWare Bridge Rating* software. If, according the refined analysis, the vehicle can pass over all bridges on the route, then the permit is issued.

### **Permitting Process for Extended Permits**

1. The hauler provides vehicle and load information on-line through the MiTRIP application process, as per Step 1 of the Single-Trip Permitting procedure, above.
2. Once hauler input information is received, Transportation Permits Unit (TPU) staff check if tire pressure, weight, and length are within the limits provided in T-2 for an Extended Permit.
3. If the vehicle information provided is within the limits for an Extended Permit, the permit is granted. Note that route information is not considered. Here the vehicle is treated as a legal load with regard to roadway and bridge passage throughout the State. The current assumption is that the load effects generated by an Extended Permit vehicle fall within the legal load envelope. Due to the ability of haulers to combine different permit vehicles into new combinations, the exact resulting vehicle weight and configuration are unknown. For example, multiple single vehicles may have individual permits, but these may be linked together resulting in new combinations that have not been explicitly considered previously.

## CHAPTER 5: SUMMARY OF WEIGH-IN-MOTION DATA ANALYSIS

### Introduction

MDOT collects weigh-in-motion (WIM) data for various reasons. FHWA requires that states provide monthly traffic reports; WIM data facilitates these counts. These data are also used by MDOT for traffic planning, pavement and bridge design, as well as by law enforcement to aid identification of illegal vehicles. A discussion of WIM data collection procedures is presented in the Traffic Monitoring Guide (2013). MDOT is currently upgrading its WIM collection systems, with elevated cameras and expanded availability of real-time traffic data.

A periodic calibration process is used to verify that WIM equipment is properly recording data. In general, a class 9 vehicle (70 k) is passed over each WIM station in each lane at three different speeds; 6 passes at 55 mph, 9 passes at 60 mph, and 6 passes at 65 mph. The WIM equipment is then calibrated such that it accurately records the axle weights and spacings of the test vehicle.

### Data Collection

Of the 41 MDOT Weigh-in-Motion (WIM) sites available with high-speed data (at least 100 Hz) collection necessary to accurately record vehicle configurations and positioning, a selection of 20 representative sites throughout the State were chosen in four general average daily truck traffic (ADTT) categories, as shown in Table 5.1 and Figures 5.1-5.4. These sites were recommended for use in MDOT Research Report RC-1601 and were re-reviewed by members of the Research Advisory Panel, including Michigan State Police and WIM data collection engineers, for suitability and data collection accuracy in this study.

These stations are generally on major routes (State and Interstate roadways) with relatively large traffic volumes.

Table 5. 1. WIM Sites.

Site	Location	ADTT	Site	Location	ADTT
High ADTT ( $\geq 5000$ )			Mid ADTT ( $\sim 3500$ )		
9209	I-275	8529	5059	I-196	3376
7029	I-94	9479	6369	I-69	3870
8869	I-69	5983	6469	I-94	3966
9189	I-275	7313	5289	US-31	2903
7269	I-69	7050	5099	I-96	3245
8839	I-94	10041	Low ADTT ( $\sim 1500$ )		
7169	I-94	8091	4049	I-75	907
7219	I-94	9265	6429	I-75	1732
7159	I-94	14161	8029	US-127	1995
9699	I-75	16516	Very Low ADTT ( $\sim 400$ )		
			1199	M-95 (UP)	361
			2029	US-2 (UP)	491

The WIM data used were collected for 34 months from February 2014 to January 2017 (excluding April and May 2014, which were unavailable). Out of the 159,513,070 total vehicles represented by all high-speed WIM sites in this period of time, the 20 sites selected contained 101,417,034 vehicles (63.6% of the total available).

Each WIM station employs an automatic filtering system that removes the majority of non-critical traffic from the database. These lightweight vehicles include motorcycles, cars, and light trucks (vehicle classes 1-3). These vehicles are summarized in Table 5.2, below.



Figure 5. 1. WIM Sites With ADTT  $\geq$ 5000.



Figure 5. 2. WIM Sites With ADTT  $\sim$ 3500.

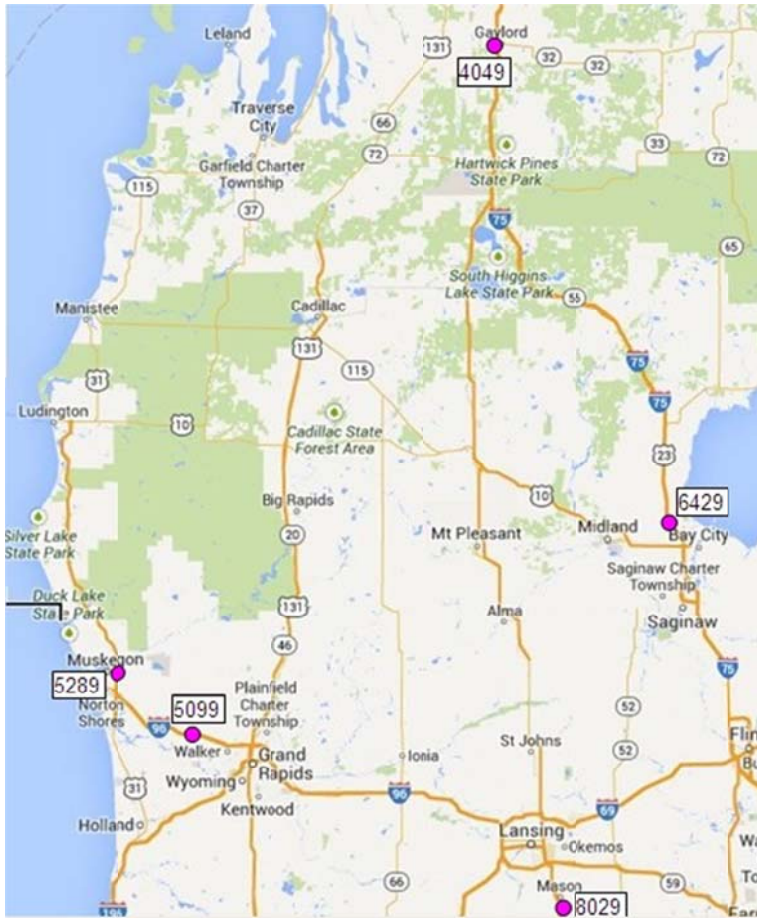

Figure 5. 3. WIM Sites With ADTT ~1500.

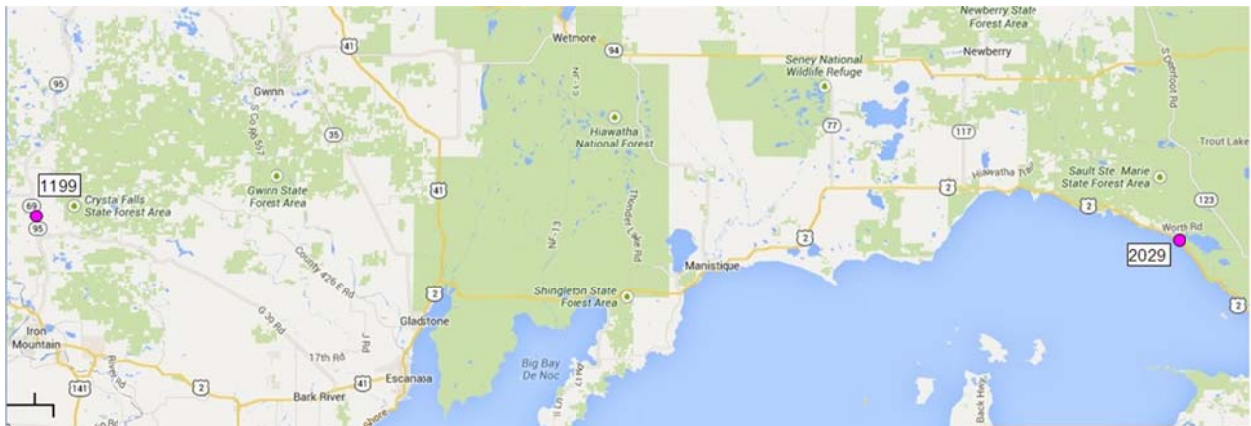

Figure 5. 4. WIM Sites With ADTT ~400.



Table 5. 2. Small Vehicles Filtering Criteria.

Class	Vehicle	Axles	Axle Spacing (ft)				Weight (k)
			1st	2nd	3rd	4th	
1	Motorcycle	2	0.1-6				0.1-3
2	Car	2	6-10.1				1-8
3	Truck	2	10.1-16				1-9
2	Car, 1-Axle Trailer	3	6-10.1	6-30			1-12
3	Truck, 1-Axle Trailer	3	10.1-16	6-30			1-15
2	Car, 2-Axle Trailer	4	6-10.1	6-30	1-12		1-12
3	Truck, 2-Axle Trailer	4	10.1-16	6-30	1-12		1-15
3	Truck, 3-Axle Trailer	5	10.1-16	6-30	1-12	1-12	1-15

Additional data filtering criteria were employed to eliminate unrealistic vehicles from the database. These criteria are given in Table 5.3, and are essentially those found in RC-1601, and modified slightly based on Research Advisory Panel recommendations. Additional criteria used to categorize a vehicle as legal or extended permit (LEP) are given in Table 5.4.

Overall, 11,849,377 (11.7%) of the results from the 20 selected sites were removed due to data filtering. From the remaining 89,567,657 vehicle records, 88,943,172 ( 99.3%) fall into legal and extended permit categories. LEP vehicle statistics (after filtering) are given in Table 5.5. In the table, percentiles are given independently for each parameter considered and do not necessarily represent the same vehicle. Note that a 5% tolerance is given to classify these vehicles, in terms of axle weight, axle spacing, and gross vehicle weight (GVW).

Table 5. 3. Filtering Criteria.

Criteria Type	Criteria for Elimination
Vehicle Class	Class 1-3 (automatic elimination)
Gross Vehicle Weight	GVW < 12 kips (no upper limit) GVW differs from axle weight sum by more than 10%
Axle Weight	First Axle > 25 kips or < 6 kips Any axle > 40 kips or < 2 kips
Vehicle Length	Length < 5 ft Length > 200 ft
Axle Spacing	First axle spacing < 5 ft Any axle spacing < 3 ft
Speed	Speed < 20 or > 100 MPH for GVW vehicles < 200 kips Speed < 20 or > 85 MPH for GVW vehicles > 200 kips
Number of Axles	Number of axles < 2 or > 13*

\* The WIM equipment does not store axle weight and configuration data beyond 13 axles.

Table 5. 4. Legal/Extended Permit Filtering Criteria.

Vehicle Type	Criteria
Legal, GVW > 80 kips	For axles spaced $\geq 9$ ft, axles $\leq 18$ kips
	For axles spaced from 3.5 – 9 ft, axles $\leq 13$ kips
	For axles spaced < 3.5 ft, axles $\leq 9$ kips
Legal, GVW < 80 kips	Any individual axle $\leq 20$ kips
	Sum of tandem axles $\leq 34$ kips
Extended Permit (Construction)	Length $\leq 85$ ft
	Any axle $\leq 24$ kips
	GVW $\leq 150$ kips

Table 5. 5. Vehicle Statistics for LEP Vehicles.

	No. Axles	Vehicle Length (ft)	GVW (kips)
Mean	5	54.0	51.8
Median	5	58.7	46.9
Mode	5	60.4	32.4
Minimum	2	5.0	12.0
Maximum	11	89.2	157.5
80%	5	61.6	71.2
85%	5	62.2	74.3
90%	6	63.2	77.6
95%	9	65.7	88.3
98%	11	69.8	130.6
99%	11	74.0	141.8
99.9%	11	80.3	155.3

For LEP vehicles, frequency histograms are given in Appendix F for GVW, length, number of axles, for all LEP vehicles and the top 20% and top 5% of LEP vehicles, as well as vehicle statistics for each year and the percentage of LEP vehicles recorded from each WIM site.

To confirm the reasonableness of the WIM data, several checks were implemented as recommended in NCHRP 683. Among these, the following numerical comparisons for 5-axle (Class 9 or 3S2) semi-trailer truck data were considered.

Drive tandem axle spacing. The mean distance between the drive axles is compared to a standard value of 4.3 ft (Fu et al. 2003). The computed mean value among all sites is 5.1 ft, while the median and mode are both 4.3 ft. Although the mean value found is about 1 ft longer than the 2003 NCHRP value, since most vehicles have the expected value of 4.3 ft, the results appear reasonable. Also note that Michigan WIM data collected in 2011-2012 (RC 1601) found mean

values from 4.5-4.9 ft, depending on location. This appears to indicate a trend of more modern vehicles having greater axle spacing.

Drive axle weight. The mean drive (2nd) axle weight is compared to the mean values found in NCHRP Report 505, which was taken as a maximum of 13 kips. The mean drive axle found from all sites was 11 kips with a median of 10.6 kips. The mean drive axle weight found in RC 1601 was 11.4 kips.

Steering axle weight. The typical range for steering axle weight was reported to be 9 - 11 kips (NCHRP 683). The mean steering axle found was 10.8 kips, with a median of 10.6 kips and mode of 11.0 kips. These values match those found in RC 1601.

GVW histogram. The histogram is expected to have a bimodal shape with peaks near 30 and 72-80 kips, representing unloaded and loaded trucks (NCHRP 683). The site histograms were found to have a similar bimodal shape with nearly identical expected peaks of 32 and 73 kips.

### **Vehicle Load Effects**

Vehicle load effects were calculated for span lengths of 20-200 ft in increments of 20 ft. Considered effects were maximum simple span moments and shears, and maximum continuous span positive or negative moments and shears. Continuous load effects are calculated assuming a structure continuous for moment over a center support with two equal length spans, each equal to the length of the single span structure. In this case, center support shears and negative moment values are reported. Load effects were calculated by incrementing vehicle configurations recorded from the WIM data across the considered span lengths and recording maximum load effect values. Due to the large volume of data considered, to maintain computational feasibility, the speeds of multiple presence vehicles were taken to be identical, such that their positions relative to one another do not change over the span length.

Overall results are given in Figures 5.5-5.12 below, where figures present load effect values per span and corresponding vehicle percentiles in increments between 80 and 99.9% for the load effect in question. Figures 5.9-5.12 compare single vehicle load effects to following and two lane load effects. Additional information is given in Appendix G, while Appendix H provides cumulative distribution functions (CDFs) of single vehicle load effects. In general, little variation was found between load effects among different years.

The following labels are used for the figures and tables in this chapter and in Appendix G:

*Max MDOT* = maximum load effect caused by any of the (unfactored) 28 MDOT legal trucks.

*Max Single* = maximum load effect caused by a single vehicle

*Max Single+Following* = greatest of maximum load effect caused by a single vehicle or multiple (“following”) vehicles in a single lane.

*Max Two-Lane* = maximum load effect caused by vehicles in adjacent lanes. The value reported represents the entire two lane load effect on the bridge.

*Ratio (Max/MDOT)* = ratio of the maximum load effect recorded to the *Max MDOT* value.

*Governing Truck No.* = the MDOT truck number associated with *Max MDOT*.

*#Vehicles > Governing* = the number of recorded load effects greater than *Max MDOT*.

$\%Vehicles > Governing = \#Vehicles > Governing / \text{total vehicles.}$

As shown in the figures, recorded maximum vehicle load effects exceed those generated by unfactored MDOT legal vehicles for all load effects, for almost all spans. Exceptions are continuous span moments for spans greater than 160 ft and continuous span shears for spans greater than 80 ft.

For single vehicles, a clear trend is present where highest ratios of maximum recorded load effect to MDOT load effect occur for the shortest spans. Simple moments and shears have similar maximum/MDOT ratios from about 1.7-1.04, as a function of span, whereas continuous moments and shears also have similar ratios, from 1.3-0.98 as a function of span. Generally, more vehicles exceed MDOT load effects for shorter spans as well. The highest proportion of vehicle load effects exceeding MDOT load effects are 29% of simple moments and 14% of simple shear at 20 ft span; 2.3% of continuous moments at 60 ft span, and 0.6% of continuous shears at 20' span.

In most cases of simple span load effects, the maximum two lane load effect exceeded the maximum following load effect, which in turn exceeded the single vehicle load effect (note that the two lane load effect represents the total load effect in both lanes). For continuous span moments, however, the following load effect exceeded the two lane effect for spans 80 ft and larger. This is likely due to the more-widely spaced following vehicle configurations that maximize negative moments but do not generate maximum positive moments. Interestingly, two lane continuous shears and following shears generate very close maximum load effects for longer spans. As shown in Appendix G (see summary Tables G.29-G.32), although the maximum load effects for two lane and following vehicles may be significantly higher than for single vehicles, for moments and shears, no significant difference among single and following occurs throughout the large majority of the vehicle sample, even up to the 99.9 percentile. Two lane moments and shears are significantly greater than single vehicle effects throughout the majority of the vehicle sample considered, and, as following effects, generally increase as span length increases.

For comparison, the frequency of vehicle side-by-side occurrence was analyzed using a portion of the WIM data. Defining side-by-side (sbs) as any vehicle overlap, it was found that any two LEP vehicles approximately have a 0.92% frequency of sbs; vehicle with GVW > 80 kips has a 0.24% sbs frequency with any other vehicle; and any two vehicles with GVW > 80 kips have a 0.019% sbs frequency. These values are within the range of results reported in RC-1601.

A sample of LEP vehicles generating the largest load effects found from the WIM data are given in Figures 5.13 and 5.14. As shown these governing vehicles typically have from 7-11 axles.



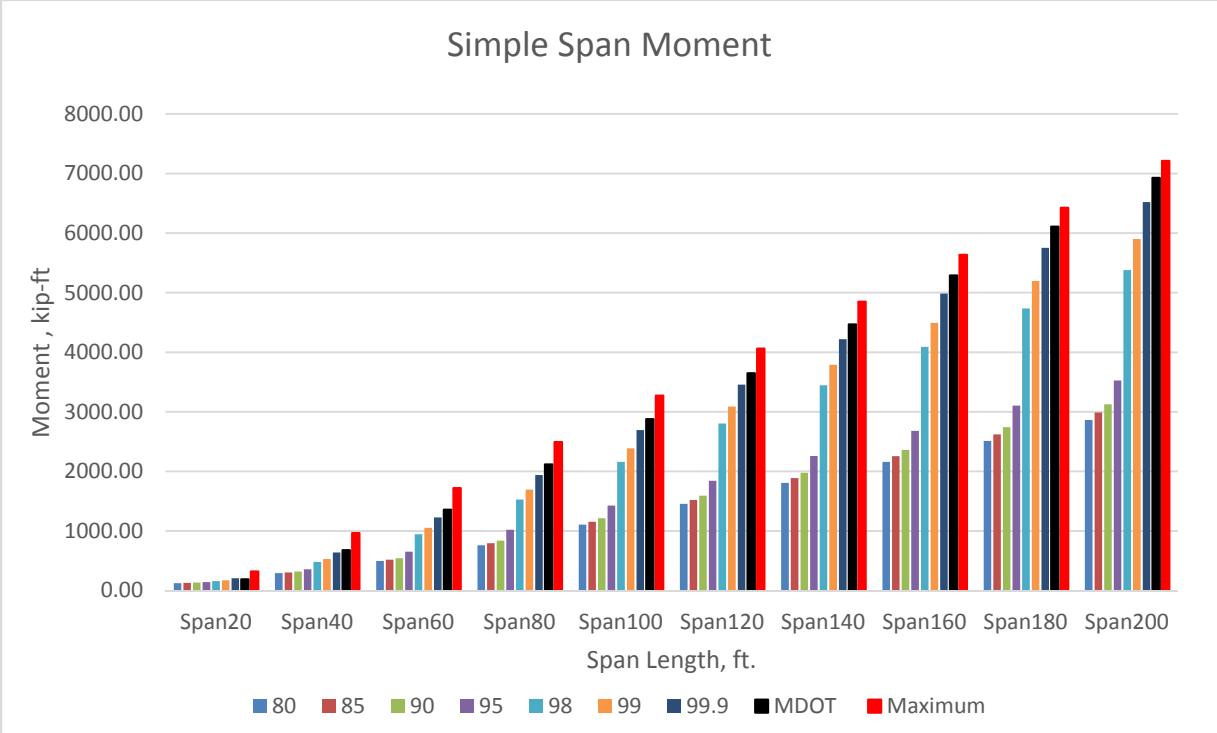

Figure 5. 5. Simple Span Moments, Single LEP Vehicles.

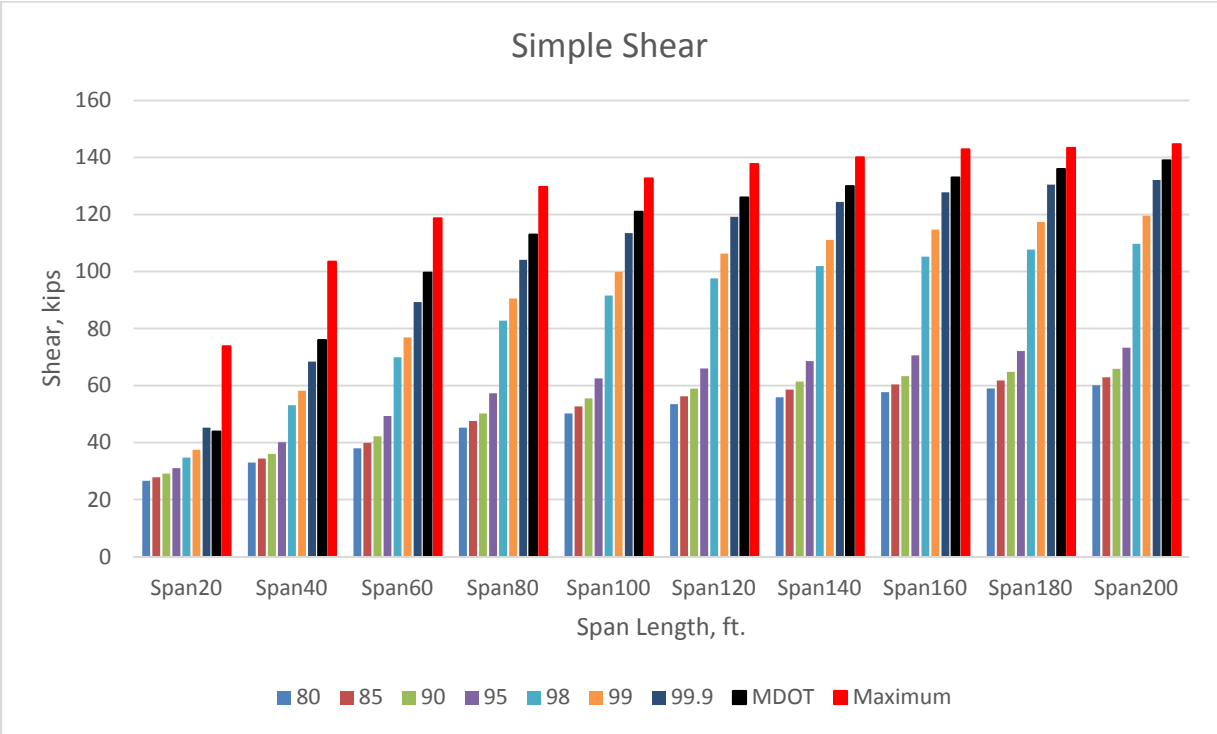

Figure 5. 6. Simple Span Shears, Single LEP Vehicles.

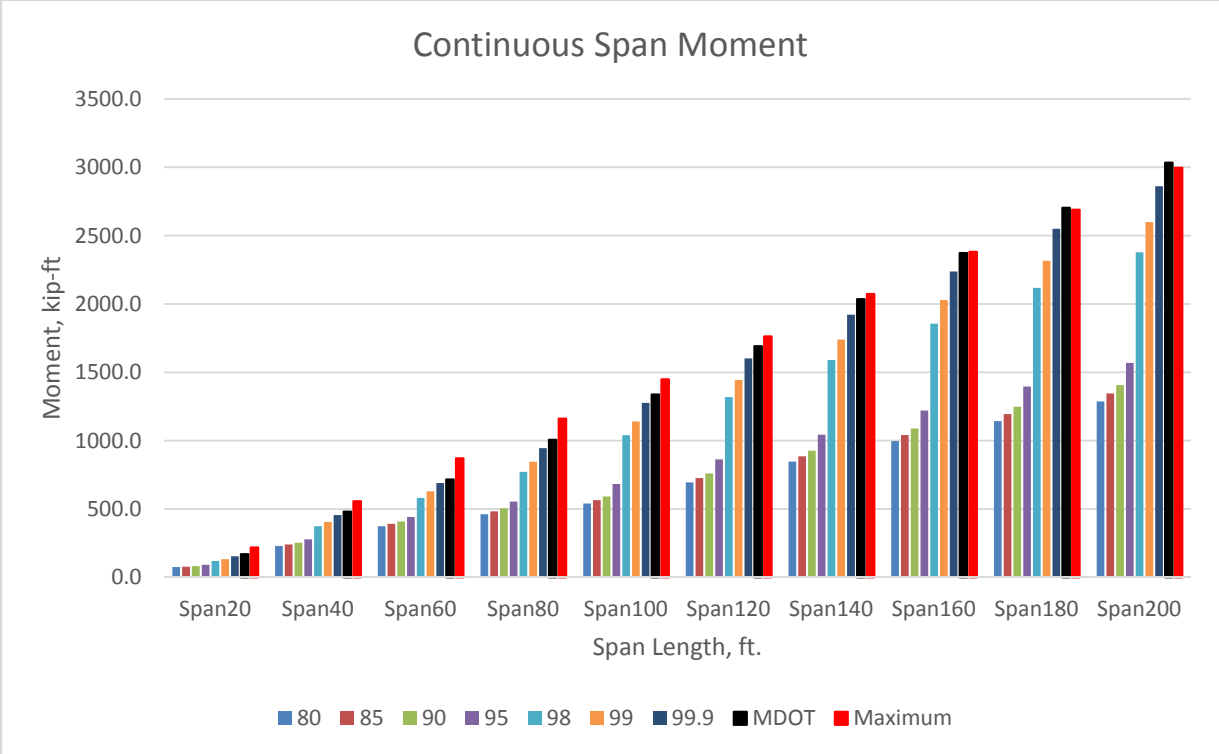

Figure 5. 7. Continuous Span Moments, Single LEP Vehicles.

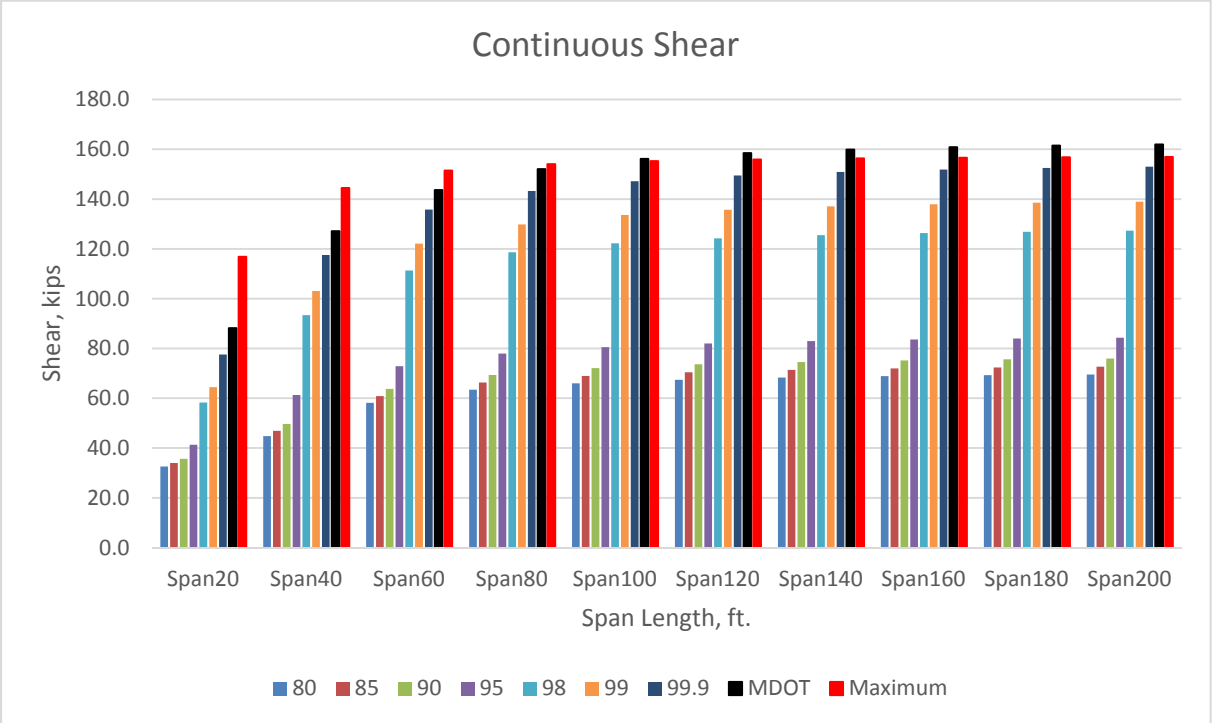

Figure 5. 8. Continuous Span Shears, Single LEP Vehicles.

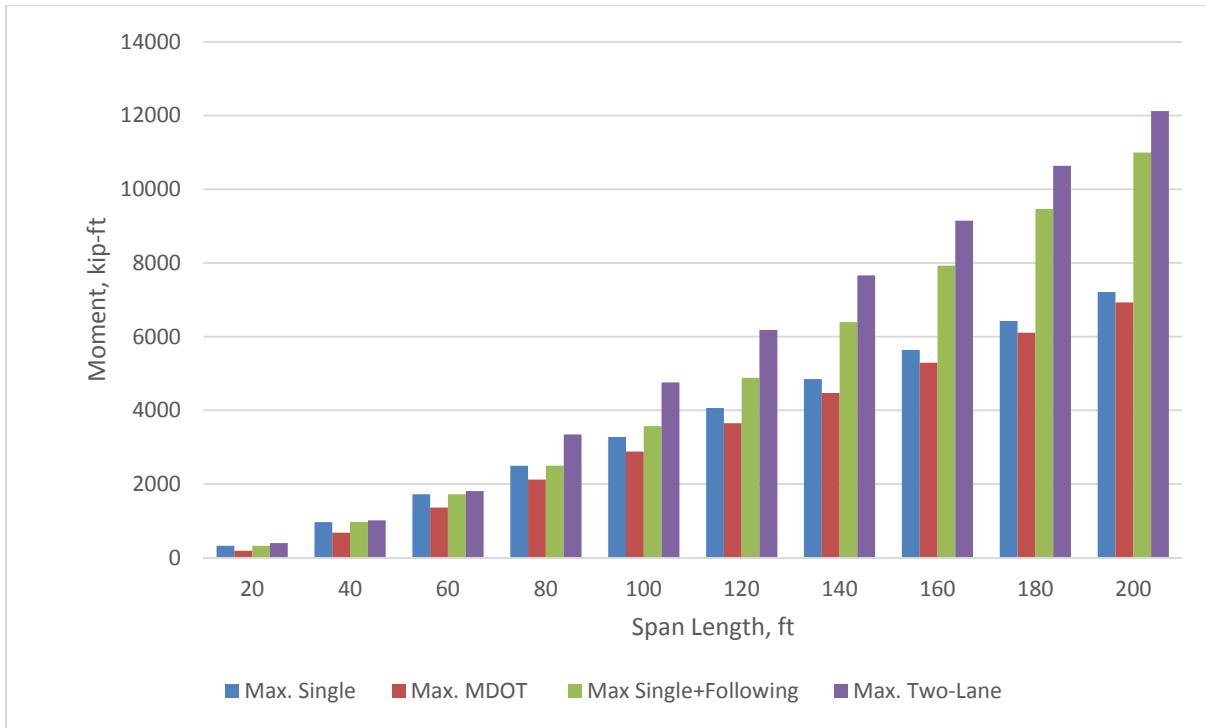

Figure 5. 9. Maximum Single, Following, and Side-by-side Simple Span Moments.

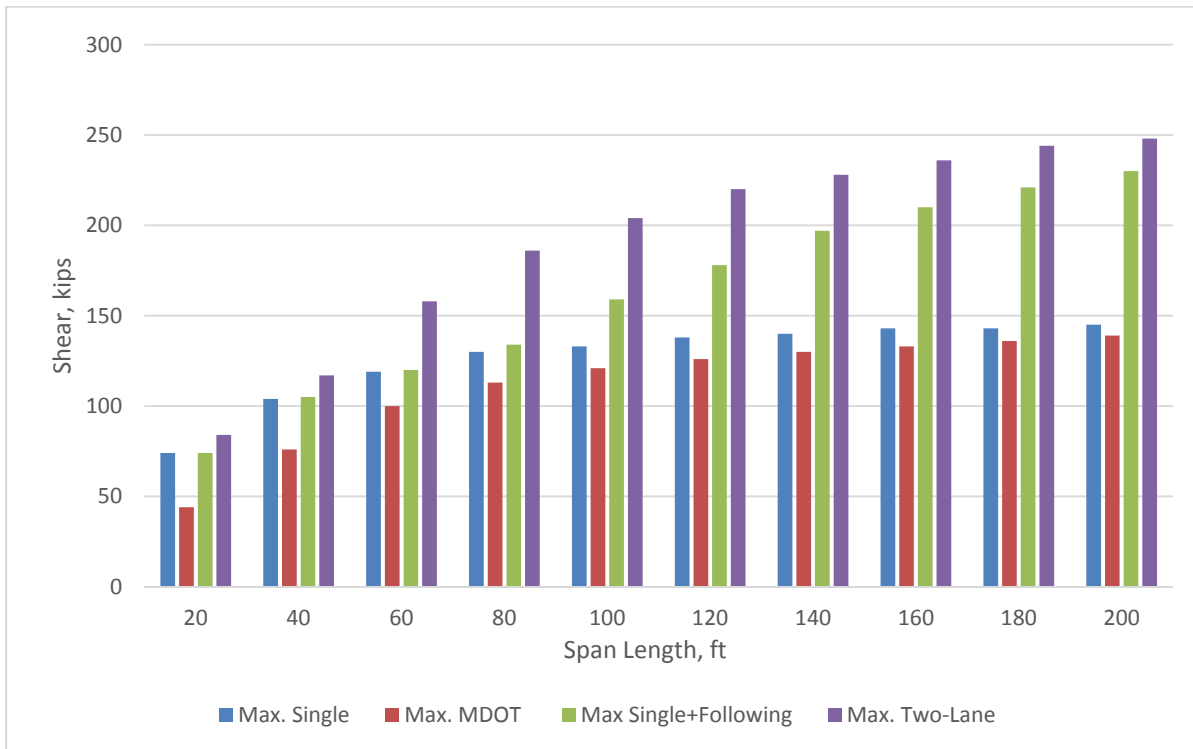

Figure 5. 10. Maximum Single, Following, and Side-by-side Simple Span Shears.

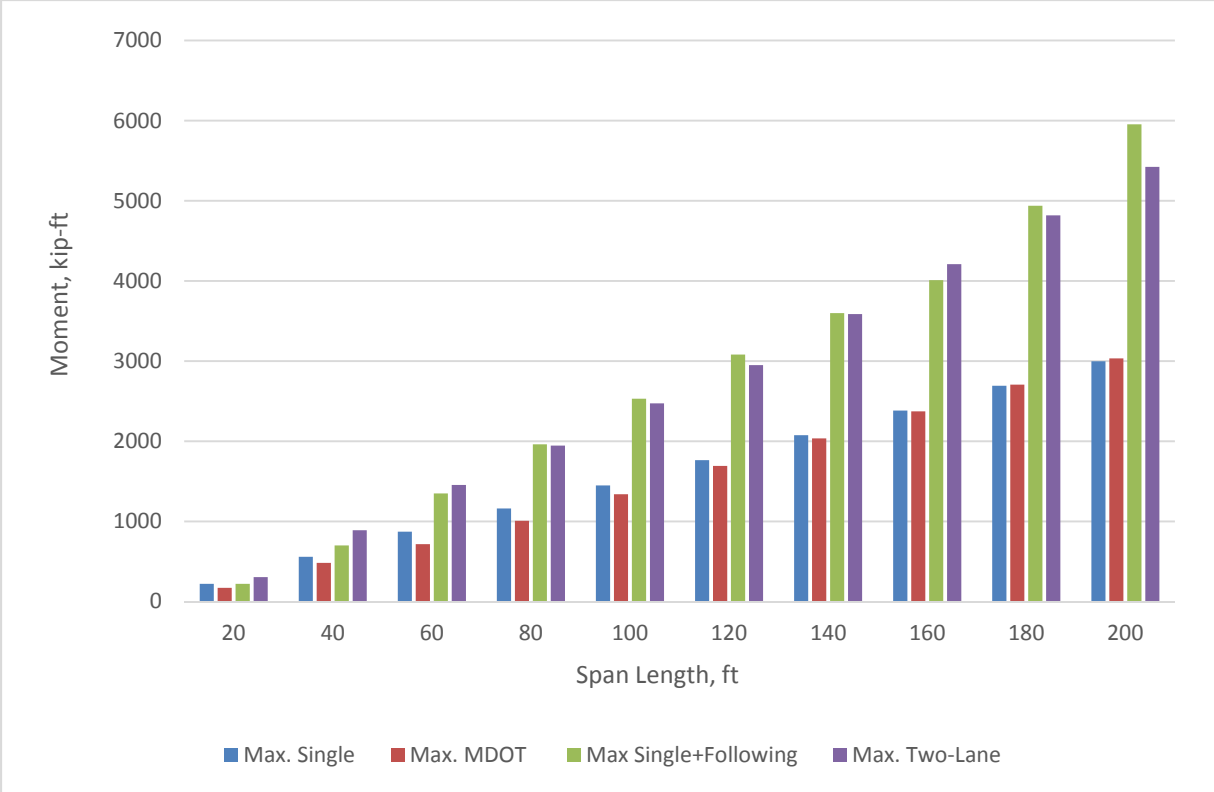

Figure 5. 11. Maximum Single, Following, and Side-by-side Continuous Span Moments.

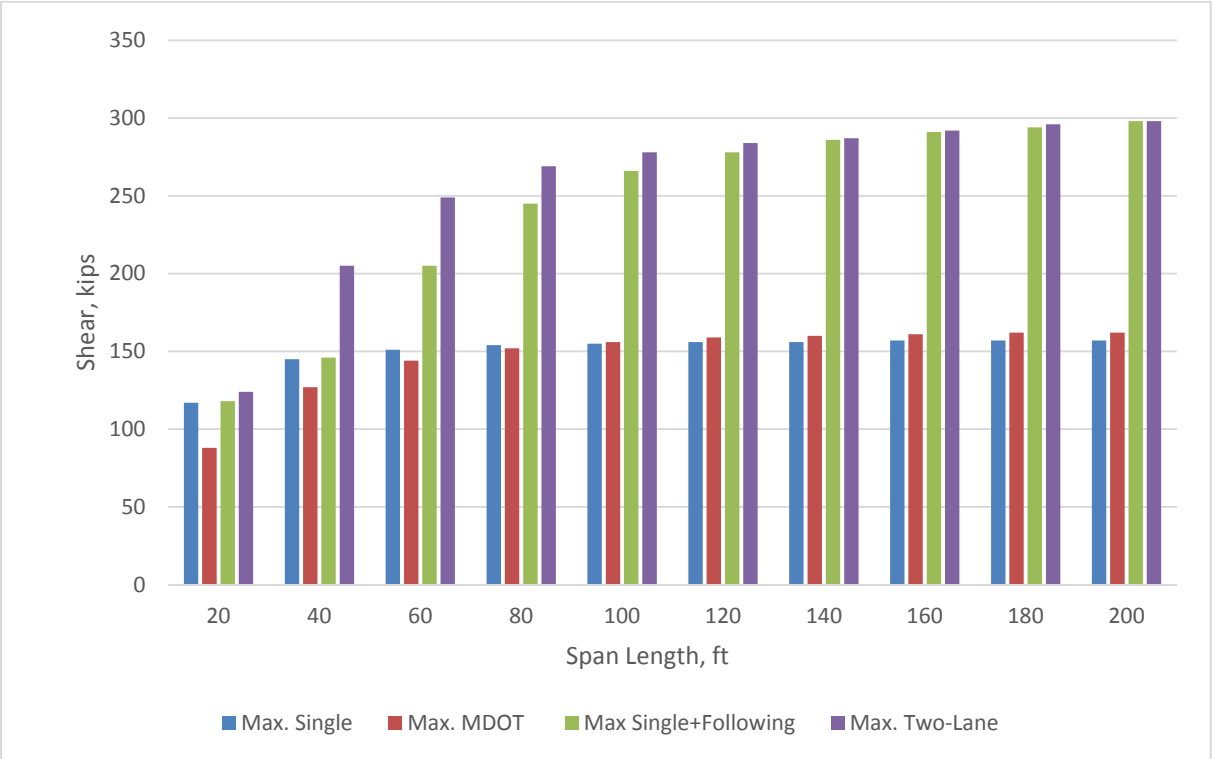

Figure 5. 12. Maximum Single, Following, and Side-by-side Continuous Span Shears.

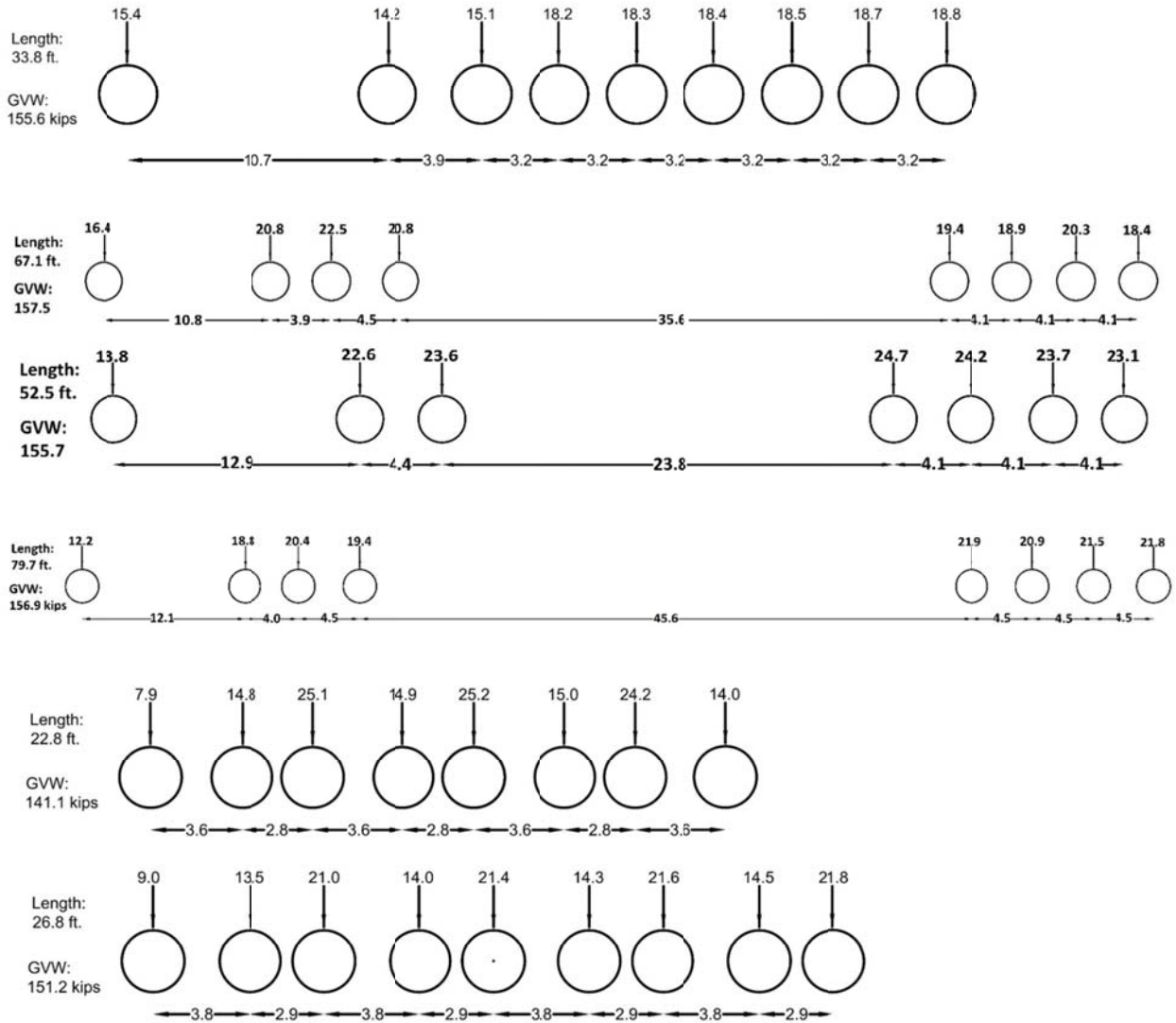

Figure 5. 13. Examples of 7-9 Axle LEP Truck Configurations That Govern Load Effects.

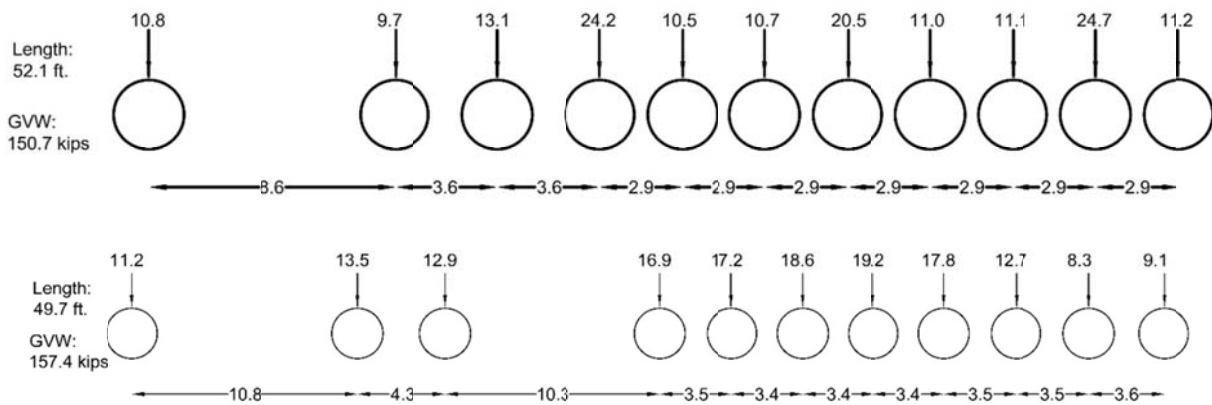

Figure 5. 14. Examples of 11-Axle LEP Truck Configurations That Govern Load Effects.

## CHAPTER 6: DETERMINATION OF REQUIRED RATING LOAD EFFECTS

### Process Summary

Required load effects to rate bridges for legal and extended permit (LEP) vehicles are determined such that bridge girders meet minimum and target reliability levels specified in the MBE calibration. To be consistent with the current LRFR procedure, this study follows the general framework established in NCHRP Reports 683 (use of WIM data in design calibration) and 20-07(285) (LRFR Calibration). This research only concerns the Strength I limit state, where it is assumed that extended permit vehicles are included along with legal vehicles within the legal load rating framework. Strength I refers to strength-based limit states that involve the normal use of the bridge. Maximum load effects are based on a 5-year return period. The Strength I rating calibration will use the data pool of WIM LEP vehicles, as described in Chapter 5. Here it is assumed that illegal vehicles are not accounted for in the Strength I framework, but will be considered in a future Strength II rating calibration effort. For the Strength I rating calibration, a target reliability index for rating is specified as 2.5, with a minimum limit of 1.5 for any specific bridge girder case. A rating factor of 1.0 implies that if a bridge is designed to the legal load (rather than the design load), the reliability index for the structure will match the target (rating) level. Practically, the analysis is done by determining the hypothetical nominal capacity of the bridge as a function of a required live load effect in place of the design load, along with the corresponding AASHTO (LRFR or LFR, as appropriate) rating procedure. Once nominal capacity is determined (as a function of the unknown required live load), the rating factor is set at 1.0 and the load effect is adjusted such that the required reliability level is met. The procedure is as follows:

#### **1-Lane Load Effects**

1. A selection of representative WIM sites is used to develop load effects. Individual site data must be kept separate, such that site-to-site variation in the results can be computed. However, mean results from the pool of sites are used to generate load effect statistics. This process is described in the *Data Projection* section below. The ten highest ADTT sites given in Table 5.1 were used for this procedure.
2. For each site, the vehicle load effects (moments and shears) are determined, as described in Chapter 5, above, where actual following vehicle load effects are included.
3. A data projection technique based on an Extreme Type I distribution fit, as described below, is used to estimate the mean and the coefficient of variation (COV, or  $V$ ) of the maximum load effect,  $\bar{L}_{\max}$  and  $V_{\max}$ , respectively, at 5 years.
4.  $\bar{L}_{\max}$  is determined as a load effect on a selection of hypothetical bridge girders. First, a selection of typical bridges is compiled such that dead load effects and girder distribution factors (DF)s can be calculated. The selection of bridges used for rating in this study is given near the end of this Chapter.

$\bar{L}_{\max}$  for 1-lane moment on a girder ( $\bar{L}_{\max 1M}$ ) is given by:

$$\bar{L}_{\max 1M} = \bar{L}_{\max} * IM * DF_1/1.2 \quad (6.1)$$

where

$DF_1$  = the 1-lane DF, as given in AASHTO LRFD. Note that it is divided by 1.2 to remove the multiple presence factor, which is directly accounted for in  $\bar{L}_{\max}$ .

For most steel, prestressed concrete, and reinforced concrete girder bridges supporting a concrete deck, the AASHTO LRFD 1-lane DF for moment is taken as:

$$DF_1 = 0.06 + \left(\frac{S}{14}\right)^{0.4} \left(\frac{S}{L}\right)^{0.3} \left(\frac{K_g}{12Lt_s^3}\right)^{0.1} \quad (6.2)$$

where  $K_g = n(I + Ae_g^2)$ ;  $A$  is the beam cross-sectional area;  $e$  is the distance between the centroids of the beam and deck;  $I$  is for the beam; and  $n$  is the modular ratio of the beam and deck.

For most girder bridges, the AASHTO LRFD 1-lane DF for shear is taken as:

$$DF_1 = 0.36 + \left(\frac{S}{25}\right) \quad (6.3)$$

Expressions in AASHTO LRFD for the other types of structures considered (for example, spread and side-by-side box beam bridges), or those with geometric parameters outside of the range of that specified for the above equations are similarly used when appropriate.

$IM$  = the impact factor, taken as a mean value of 1.13 for one lane loaded with heavy vehicles, as used in the MBE calibration (Sivakumar et al. 2011).

5. Continue to step 6 below.

## 2-Lane Load Effects

1. A selection of representative WIM sites is used to develop load effects. Individual site data must be kept separate, such that site-to-site variation in the results can be computed. However, mean results from the pool of sites are used to generate load effect statistics. The same sites considered for the 1-lane effects are considered for 2-lane load effects.

2. For each site, the 2-lane vehicle load effects (moments and shears) are determined, as described in Chapter 5, above, where actual following vehicle load effects are included in each

lane. Here, a complication arises in that there is no DF equation in AASHTO that allows for side-by-side vehicles of different weights and configurations. An analysis technique such as FEA or grillage modeling would be ideal in this case. However, the time involved to construct detailed numerical models for each of the many different bridge configurations considered is not feasible. Therefore, an approximate method is used, as suggested by Moses (2001) and implemented by Sivakumar et al. (2011a,b). Here, the total 2-lane moment effect ( $M_{12}$ ) is given by:

$$M_{12} = M_1 * DF_1 + M_2(DF_2 - DF_1) \quad (6.4)$$

where

$M_1$  = the moment due to the vehicle(s) in lane 1.

$DF_1$  = the AASHTO LRFD single lane DF (after dividing out the 1.2 multiple presence factor).

$M_2$  = the moment due to the vehicle(s) in lane 2 (while in the recorded spatial position on the span relative to the lane 1 vehicle(s); see Chapter 5).

$DF_2$  = the AASHTO LRFD 2-lane DF, which for most steel, prestressed concrete, and reinforced concrete girder bridges supporting a concrete deck, is given as:

$$DF_2 = 0.075 + \left(\frac{S}{9.5}\right)^{0.6} \left(\frac{S}{L}\right)^{0.2} \left(\frac{K_g}{12Lt_s^3}\right)^{0.1} \quad (6.5)$$

For shear, the same process is followed above using equation 6.4, but 1 and 2-lane moment DFs are replaced with shear DFs. For example, for most steel, prestressed concrete, and reinforced concrete girder bridges supporting a concrete deck, the 2-lane shear DF is given as:

$$DF_2 = 0.2 + \left(\frac{S}{12}\right) - \left(\frac{S}{35}\right)^{2.0} \quad (6.6)$$

This is done for each of the 2-lane load effects from the site considered.

3. The same data projection technique used for 1-lane load effects is also used for 2-lane effects. The projection is used to estimate the mean and COV of the maximum load effect,  $\bar{L}_{\max}$  and  $V_{\max}$ , respectively, at 5 years, from the data set of the 2-lane load effects found in step 2, above.

4.  $\bar{L}_{\max}$  is determined as a load effect on the selection of hypothetical bridge girders. The same structures used for the 1-lane load effects are used here as well.  $\bar{L}_{\max}$  for 2-lane moments on a girder ( $\bar{L}_{\max 2M}$ ) is given by:



$$\bar{L}_{\max 2M} = \bar{L}_{\max} * IM \quad (6.7)$$

Here, the DF is already embedded in the data, in Steps 2 and 3. IM is taken as a mean value of 1.10 for two lanes loaded with heavy traffic, as used in the MBE calibration (Sivakumar et al. 2011).

5. Continue to step 6 below.

**For Both 1 and 2-Lane Load Effects (separately):**

6. Quantify live load uncertainty. There are various uncertainties that must be accounted for in the live load model. These are as follows:

a) Uncertainty in the future data projection ( $V_{proj}$ ). This is  $V_{\max}$ , as found from the projection technique, as in Step 3 above (determined as  $V_{proj} = V_{\max} = \sigma_{L_{\max}} / \bar{L}_{\max}$ , where  $\sigma_{L_{\max}}$  and  $\bar{L}_{\max}$  are found from the projection; see below).

b) Uncertainty in mean maximum load effects among different sites ( $V_{site}$ ). Here,  $V_{site}$  can be computed directly as the COV of  $\bar{L}_{\max}$  values found from the different sites, for 1- and 2 lane load effects, for the particular load effect case considered. Note that different values in  $V_{site}$  will occur depending on bridge span and configuration.

c) Uncertainty in  $\bar{L}_{\max}$  based on the WIM data at a particular site ( $V_{data}$ ). There is no direct way to assess this uncertainty. However, Sivakumar et al. (2011) suggests that it be estimated based on a standard deviation taken equal to the value of data at the 95% upper and lower confidence intervals (assessed by using a proportion confidence interval based on an estimated 50-interval CDF), where it is assumed that these values fall within 1.96 standard deviations of the mean. Thus, the standard deviation to use for  $V_{data}$ ,  $\sigma_{V_{data}}$ , is given by:

$$\sigma_{V_{data}} = |(d_{95}) - \bar{x}| / 1.96 \quad (6.8)$$

where

$(d_{95})$  = the upper 95% upper or lower confidence interval value for  $\bar{L}_{\max}$ .

$\bar{x}$  = the mean; i.e.  $\bar{L}_{\max}$ .

COV ( $V_{data}$ ) can then be computed as usual (i.e. =  $\sigma_{V_{data}} / \bar{x}$ ).  $V_{data}$  is reported to be approximately 2% for 1-lane effects and 3% for 2-lane effects, for 1 year of WIM data (Sivakumar 2011). Based on the analysis of WIM data in RC-1601, it was found that  $V_{data}$  was below 2% for all cases investigated. Therefore, the 2% and 3% values above are conservatively used. As reported in RC-1601, total COV of live load is dominated by other sources of variation, and it was found that altering  $V_{data}$  from 0-3% has no significant effect on the total live load COV.

d) Uncertainty in impact factor ( $V_{IM}$ ).  $V_{IM}$  is taken as 9% for 1-lane effects and 5.5% for 2-lane effects (Sivakumar et al. 2011).

e) Uncertainty in load distribution ( $V_{DF}$ ). Based on a series of field tests comparing measured load distribution effects to the AASHTO LRFD DF formula,  $V_{DF}$  is given in Table 6.1 below (Sivakumar et al. 2011). Bias factor  $\lambda$  refers to the mean value divided by the AASHTO LRFD value.

Table 6. 1. Statistical Parameters for DF.

Bridge Type		Moment		Shear	
		1 Lane	2 Lane	1 Lane	2 Lane
Composite	$\lambda$	0.78	0.90	0.72	0.82
Steel	COV	0.11	0.14	0.14	0.18
Reinforced	$\lambda$	0.79	0.93	0.76	0.88
Concrete	COV	0.16	0.15	0.12	0.18
Prestressed	$\lambda$	0.78	0.90	0.77	0.88
Concrete	COV	0.12	0.13	0.11	0.16

For each of the case combinations above (i.e. for a particular WIM data site, bridge configuration, and 1 or 2-lane load effect), the final COV of mean maximum load effect,  $V_{max L}$ , is then determined. For a product function of random variables such as eq. 6.1 or 6.7 (and assuming the uncertainties from the data projection, site, and data are similarly represented in product form), it can be shown that if RVs are uncorrelated and COV is not too large, the COV of the function can be reasonably determined by ignoring the second order relationships as:

$$V_{max L} = (V_{proj}^2 + V_{site}^2 + V_{data}^2 + V_{IM}^2 + V_{DF}^2)^{1/2} \quad (6.9)$$

7. Reliability for the selection of bridges is then calculated. The general limit state function is:

$$g = R - (D_p + D_s + D_w) - LL \quad (6.10)$$

Random variables considered are girder resistance ( $R$ ), dead load from prefabricated ( $D_p$ ), site-cast ( $D_s$ ), and wearing surface ( $D_w$ ) components, and vehicular live load ( $LL$ ). Statistics are taken from Nowak (1999) to be consistent with the AASHTO LRFD and MBE calibrations, and are given in Table 6.2.

Although it is not precisely correct, in previous AASHTO design and rating calibrations, for reliability analysis, girder resistance is taken as a lognormal random variable while the sum of load effects is assumed normal.

Mean  $R$  is calculated from  $\bar{R} = R_n \lambda_r$ .  $R_n$  is written as a function of the unknown nominal live load effect and live load factor needed such that reliability requirements are met with the appropriate AASHTO code rating procedure when the rating factor is set to 1.0.

Table 6. 2. Random Variable Statistics.

Random Variable		Bias Factor	COV
Resistance RVs		R	
Prestressed Concrete, Moment		1.05	0.075
Prestressed Concrete, Shear		1.15	0.14
Reinforced Concrete, Moment		1.14	0.13
Reinforced Concrete, Shear*		1.20	0.155
Steel, Moment		1.12	0.10
Steel, Shear		1.14	0.105
Load RVs			
Vehicle Live Load	LL	from $L_{max}$ ; see above	
DL, Prefabricated	D <sub>p</sub>	1.03	0.08
DL, Site-Cast	D <sub>s</sub>	1.05	0.10
DL, Wearing Surface	D <sub>w</sub>	mean 3.5''	0.25

\*Assumes shear stirrups present

For LRFR calibration,  $R_n$  is determined by:

$$R_n = (1/\phi)(1.25DC + 1.5DW + \gamma_L (DF_2)(nominal\ live\ load\ effect + IM)) \quad (6.11)$$

where

$\gamma_L$  = live load factor, to be determined in conjunction with the nominal live load effect

DC = component dead load.

DW = wearing surface dead load.

IM = impact factor, taken as 1.33 times the nominal vehicle design load (design truck or axle, but not lane load).

DF<sub>2</sub> = AASHTO 2-lane girder distribution factor, as given in Section 4 of the AASHTO LRFD Code.

$\phi$  = resistance factor, specific to the material and failure mode, as specified in AASHTO LRFD. For steel members,  $\phi=1.0$  for moment and shear effects; for prestressed concrete members (assuming tension controlled),  $\phi=1.0$  for moment and 0.9 for shear effects; for reinforced concrete structures (not considered in design, but only for rating), assuming tension controlled,  $\phi=0.9$  for moment and shear effects).

For LRFR legal load rating, for simple spans (less than 200'), only the truck is considered for load effects, but for continuous spans, negative moments and shears at interior supports are determined from 2 legal trucks spaced 30' apart, then multiplied by 0.75. Then, a 0.2 kip/ft load is added. In some short span cases (spans 20' considering moment and 20' and 40' for shear), it was found that a single vehicle produced a larger load effect

than two vehicles with the lane load. In these cases, the maximum load effect of either was case used.

For LFR calibration,  $R_n$  is determined by:

$$R_n = (1/\phi)(1.3D + \gamma_L (DF_{2s})(1/2)(\text{nominal live load effect} + I)) \quad (6.12)$$

where

$\gamma_L$  = live load factor, to be determined in conjunction with the nominal live load effect.

$DF_{2s}$  = two lane distribution factor specified in the AASHTO Standard (i.e. S/5.5 for most steel and prestressed concrete girder bridges applications, and S/6.0 for most reinforced concrete (T-beam) girder bridges, where S = girder spacing).

Appropriate expressions given in AASHTO Standard are used for the other cases considered in this report.

I = AASHTO Standard impact factor, taken as  $(50/(L+125))$ ,  $\leq 0.30$ .

$\phi$  = resistance factor, which is the same as the corresponding LRFD resistance factor for all considered structures, except for reinforced concrete members in shear, where  $\phi = 0.85$ .

For LFR legal load rating, for all spans simple and continuous (less than 200'), a single truck is used to determine load effects.

Due to the large number of reliability calculations required, the reliability analysis is conducted with the closed form, simplified First Order, Second Moment (FOSM) procedure, such that the required LF can be solved for directly. This method assumes all RVs are normal, which is conservative when resistance is lognormal, as assumed for bridge member resistance. To account for this, an adjustment factor representing the ratio of (exact  $\beta$  / FOSM  $\beta$ ) was applied such that the reliability index computed by FOSM better approximates the exact value, as determined by direct Monte Carlo Simulation (MCS). These adjustment factors are given in RC-1601 and are: 1.04 when the desired  $\beta=2.5$ , and 1.0 when the desired  $\beta=1.5$ .

8. The nominal load effect and live load factor  $\gamma_L$  are adjusted to achieve reliability results closest to the target  $\beta$  for rating of 2.5, with a minimum  $\beta$  of 1.5. In the MBE, the load factor was chosen such that the average of all cases considered met the target index of 2.5, and all cases met the minimum value of 1.5. This is the process used here.

### **Bridge Structures Considered**

The following bridge characteristics were used for analysis:

### 1. Girder Type:

- a. Prestressed concrete I-girders (PC).
- b. Steel girders (CS).
- c. Reinforced concrete girders (RC).
- d. Prestressed concrete box beams, spaced (BS).
- e. Prestressed concrete box beams, side-by-side (BT).

### 2. Span Type:

- a. Simple Span.
- b. Two-Span continuous (both spans of equal length).

### 3. Span Lengths (ft):

- a. 20-200 at increments of 20 for all girders except RC, which is limited to 100.

### 4. Girder Spacing (as applicable, ft):

- a. 4-12 at increments of 2.
- b. For side-by-side box beams, two widths (36", 48") are used.

### 5. Load Effects:

- a. Simple moments (Ms)
- b. Continuous (negative) moments (Mc).
- c. Continuous positive moments (Mcp).
- d. Simple shears (Vs).
- e. Continuous shears (Vc).

Bridges are assumed to support a reinforced concrete deck and have a wearing surface and additional typical non-structural items relevant for dead load calculation. The dead load of these components is based on values used in the AASHTO LRFD calibration as well as NCHRP reports 683 and 285. Dead load effects used in this study are given in Appendix M. Note reinforced concrete bridges have no significant prefabricated dead load component.

For girder distribution for moment, the term  $\left(\frac{K_g}{12L_t^3}\right)^{0.1}$  in eq. 6.5 was found to have a minor effect on results for typical ranges of girder stiffness, and is taken as 1.0 as per the AASHTO LRFD and MBE calibrations. For box beam bridges, a selection of beam configurations was considered (as shown in the MDOT Bridge Analysis Guide), in order to determine stiffness for moment and shear distribution to the beams. In general, a range of depths from 17" – 60" with widths from 36-48" were considered. However, it was found that moment distribution was not particularly sensitive to depth and any reasonable beam selection would produce similar results.

## Data Projection

The load effects calculated from the WIM data (see Chapter 5) were based on truck traffic collected over a 34 month period. For rating, however, load effects are to be based on a 5 year period, respectively. Thus, a data projection method is used to estimate load effect statistics for longer periods of time. This projection does not account for any possible changes in vehicle weights nor uncertainties in potential future vehicles. Rather, the projection only estimates what maximum load effect statistics would be found for the desired return period by probabilistically extrapolating from the existing number of load effects calculated from the available WIM data pool.

If the tail end of the data is reasonably normally distributed, it can be shown that an Extreme Type I distribution can be used to extrapolate to future extreme load events with the following procedure (Ang and Tang 2007):

1. The cumulative distribution function (CDF;  $F_x(x)$ ) of the load effects  $i$ :  $F_x(x) = (i/1+n)$ , is developed, where  $n$  is the number of data used to fit the trend line and  $x$  is the load effect. Here, the data are a set of the highest moments or shears calculated from the WIM data.
2. The inverse standard normal CDF of each computed CDF value is taken:  $(F_x(x))$ :  $\Phi^{-1}(F_x(x))$ .
3. The upper tail of the CDF values, representing the greatest load effects, are plotted as a function of load effect  $x$ . As the data are plotted on a normal probability axis, a generally linear trend indicates that the data approach a normal distribution. If the trend is reasonably linear, then a linear regression line is constructed that best fits this data. The slope ( $m$ ) and intercept ( $n_o$ ) of the line are determined.
5. It can be shown that the mean value of the best-fit normal distribution is given as:  $\bar{x} = -n_o/m$  with standard deviation  $\sigma = ((1 - n_o)/m) - \bar{x}$ .
6. Load effect statistics are extrapolated to longer periods of time by first computing  $N$ , the number of expected events in the extrapolated return period. It can be calculated as  $N = nw*(Y/tw)$ , where  $Y$  is the length of the new return period (5 years);  $nw$  is the number of events in the WIM data (in step 1) that were collected, and  $tw$  is the number of years of WIM data considered for which the  $nw$  data were collected.
7. The load effect statistics (mean maximum and standard deviation) for the new return period can be computed as follows:

$$\bar{L}_{\max} = \mu_N + \frac{0.5772157}{\alpha_N} \quad (6.13)$$

$$\sigma_{L_{\max}} = \frac{\pi}{\sqrt{6}\alpha_N} \quad (6.14)$$

where

$$\mu_N = \bar{x} + \sigma \left( \sqrt{2 \ln(N)} - \frac{\ln(\ln(N)) + \ln(4\pi)}{2\sqrt{2 \ln(N)}} \right) \quad (6.15)$$

$$\alpha_N = \frac{\sqrt{2 \ln(N)}}{\sigma} \quad (6.16)$$

## Projection Results

Per step 3 above, the upper tail of the load effect data are used to determine maximum load statistics. For the projection, the load effects from the ten WIM sites with the largest ADTT values were used; these sites were associated with the largest load effects. However, little guidance is available in the technical literature as to how much of the data ( $n$ ) is to be considered within the upper tail used for projection. Although NCHRP 683 as well as RC-1601 used the upper 5% of the data, it was found that for the data considered in this study, this amount of data often results in a significant nonlinear trend and would thus be poorly represented by the projection technique. It was determined that a much smaller proportion of the tail is needed to for a strong linear fit. For single-lane load effects, this was taken as the greatest 350 load effects for each case. For two-lane load effects, this was typically taken as 250, but in some cases 50, depending on the span and load effect, to generate the best fits. Values for the number of data ( $n$ ) used in the extrapolation line fit for 2-lane load effects are given in Tables I.10-I.13 in Appendix I. As shown in the figures, goodness of fit appears very good in nearly all cases. Tables I.1 and I.10-I.13 also present  $R^2$  values to quantify goodness of fit. As shown, most are very close to 1.0, indicating an excellent linear fit. An example illustrating how  $n$  effects the goodness of fit is given in Figures 6.1-6.3 below, where it can be seen that the best fits are achieved with a low value for  $n$  (350). As shown in Figures 6.4-6.7, results are relatively insensitive to changes in  $n$ . Note that the number of data used to fit the projection line ( $n$ ) is not the number of data used ( $N$ ) in Equations 6.15 and 6.16 to determine maximum load effect statistics, which is not an arbitrary value but a function of the number of WIM data collected. The value of  $N$  is estimated by taking a weighted average of ADTT among the 10 sites considered in the projection, based on the number of load effects ( $ne_i$ ) recorded for each site  $i$ :

$ADTT_{ave} = \frac{\sum_{i=1}^{10} ADTT_i \times ne_i}{N_{34}}$ , where  $N_{34}$  is the total number of data for a given load effect collected at all 10 sites over the time period (34 months) available.  $ADTT_{ave}$  values were 8009 for single and following events and 149 for side-by-side events. Values of  $N$  are then determined by:  $N = ADTT_{ave} \times 365 \text{ days} \times 5 \text{ years}$ . Final  $N$  values were approximately  $1.46 \times 10^7$  for single and following events and 272,000 for side-by-side events. Note that to record possible two lane load effects, a side-by-side event was conservatively defined as occurring when two adjacent lane vehicles have closest axles separated no more than half of the longest bridge span length considered (or, within 100 ft). Vehicles separated by up to 200 ft were considered for possible following load effects. Based on the resulting  $ADTT_{ave}$  values for one lane (single and following) and two lane events, this results in a frequency of a side-by-side event of approximately 1.9%. This can be compared to a side-by-side frequency of about half that (0.9%)

which was found by defining side-by-side more strictly as vehicle overlap, as discussed in Chapter 5.

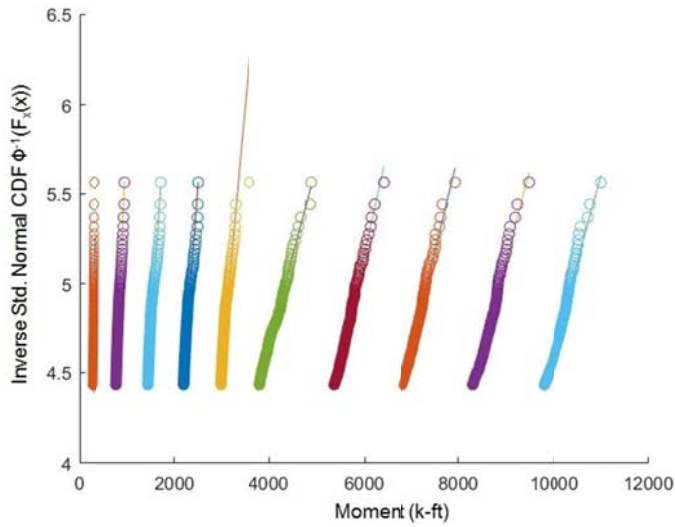

Figure 6. 1. CDFs of Top 350 Simple Span, Single Lane Moments for Spans From 20 – 200 ft.

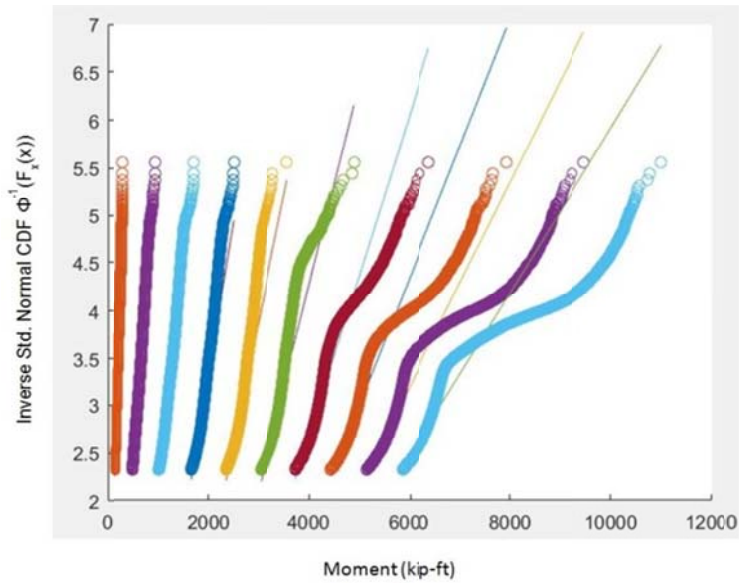

Figure 6. 2. CDFs of Top 1% of Simple Span, Single Lane Moments for Spans From 20 – 200 ft.



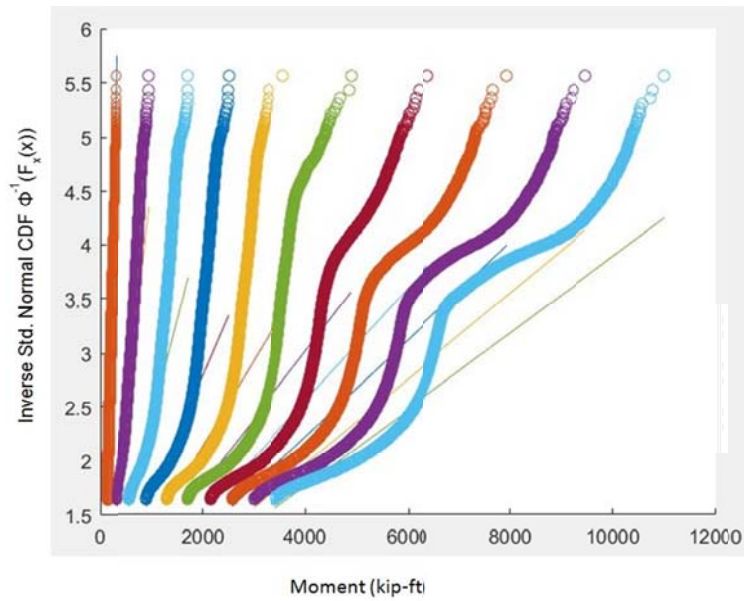

Figure 6.3. CDFs of Top 5% of Simple Span, Single Lane Moments for Spans From 20 – 200 ft.

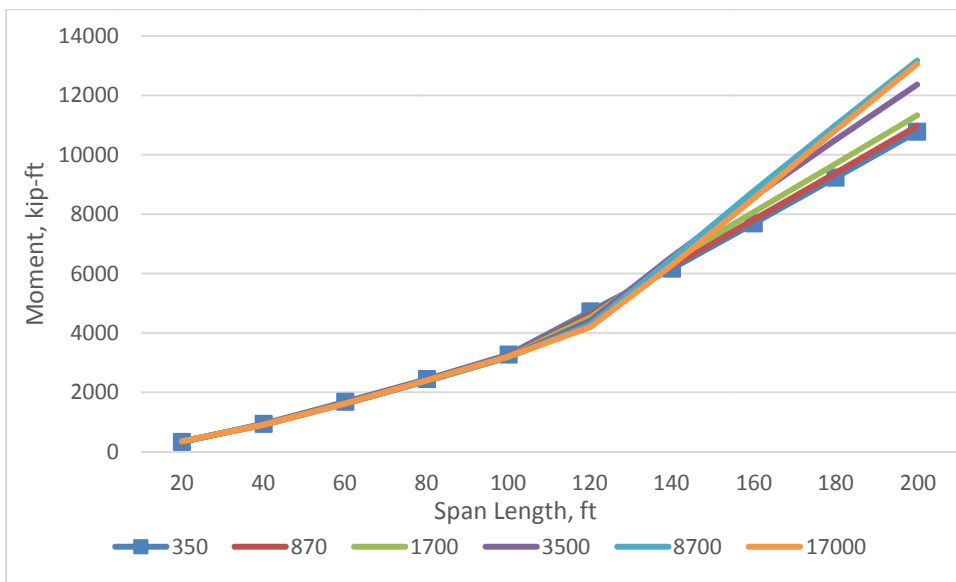

Figure 6.4. Projected Mean Maximum Simple Span, Single Lane Moment for Different  $n$  Values.

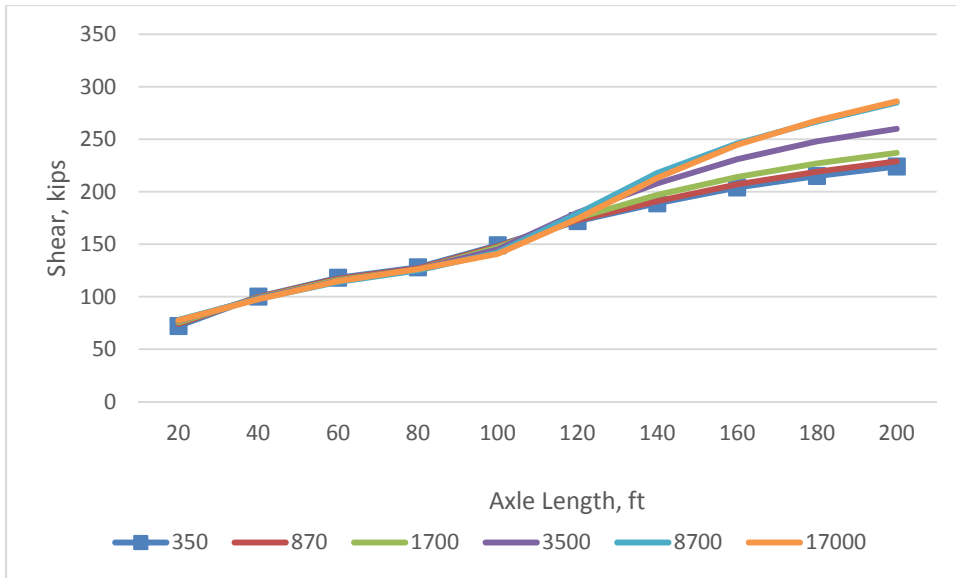

Figure 6. 5. Projected Mean Maximum Simple Span, Single Lane Shear for Different  $n$  Values.

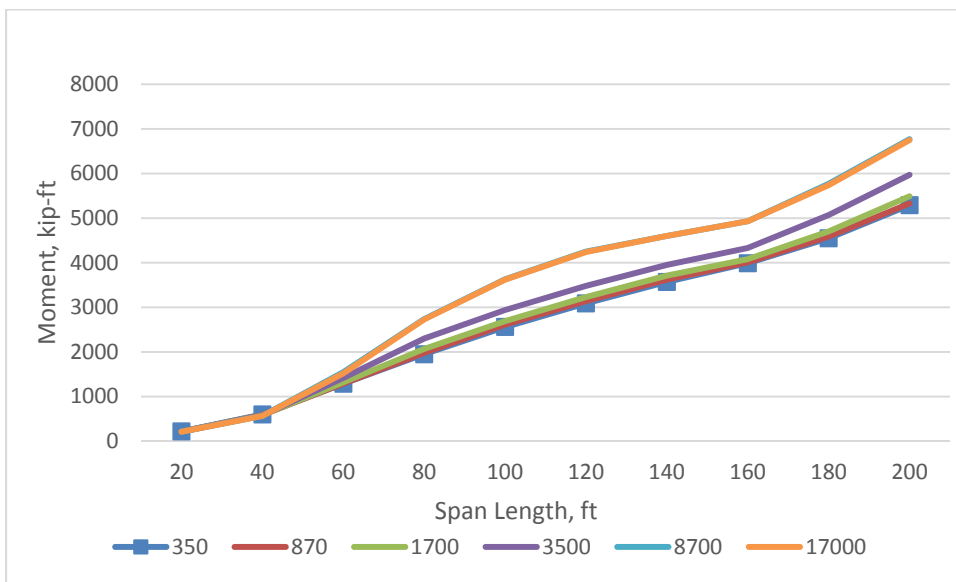

Figure 6. 6. Projected Mean Maximum Continuous Span, Single Lane Moment for Different  $n$  Values.

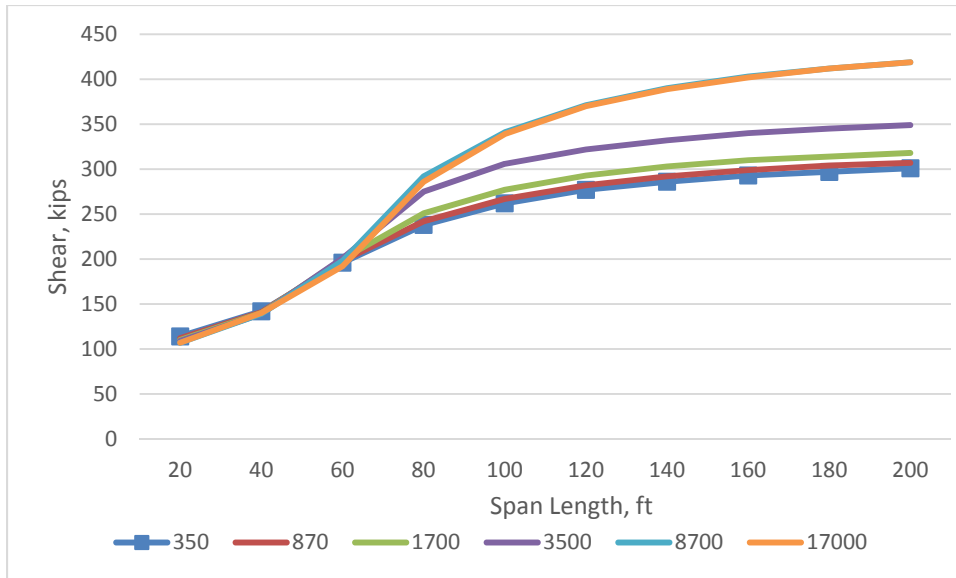

Figure 6. 7. Projected Mean Maximum Continuous Span, Single Lane Shear as a function of span and number of data  $n$  used for data fit.

All projections are given in Appendix I, where Figures I.1-I.4 describe one-lane results and I.5-I.44 refer to two-lane results. For the two-lane results, multiple projection lines are given for each span and load effect. These 3-4 multiple lines represent different fractional weights of the second lane vehicle used in conjunction with the full weight of the first lane vehicle. This is to generate load effects for bridges with different load distribution factors. Note that results for continuous positive moments are not shown, but were found to be nearly identical to positive simple moments, but with load effects reduced by a factor of approximately 0.80.

Consider Equation 6.4 used to distribute the total live load effect to a girder:

$$M_{12} = M_1 * DF_1 + M_2(DF_2 - DF_1) \quad (6.4)$$

In this format, load effects for the two lanes must be separated. However, because two-lane effects are determined considering the position of each vehicle in adjacent lanes relative to one-another, the total load effect must be combined together before projected to develop maximum load effect statistics. That is, simply taking the maximum load effect in each lane separately and adding these effects, without accounting for vehicle relative position, would significantly increase the two-lane load effect beyond what is actually present. Therefore, the load effects in adjacent lanes cannot be treated independently. Before these load effects are combined prior to projection, the fraction of load effect that a vehicle in each lane contributes to a single girder must be accounted for. This fraction is bridge-dependent, as it is governed by  $DF_1$  and  $DF_2$ . To account for this in the projection, Equation 6.4 can be rewritten as:

$$M_{12} = M_1 * DF_1 + M_2 * (kDF_1) = DF_1(M_1 + kM_2) \quad (6.17)$$

where  $k = (DF_2 - DF_1)/DF_1$

Representative k factors for all bridges considered in this study have been computed using values for  $DF_1$  and  $DF_2$  as described with Equation 6.4, above. These values are given in Tables I.5. and I.6. in Appendix I. A range of 3-4 k factors for each span length was then selected that would envelope these values. These k factors were used to adjust the second-lane vehicle load effect prior to combining the two-lane load effects for projection. The k factors used in the projections are given in Tables I.7 and I.8 in Appendix I. For bridges with k values between the range of k values chosen, linear interpolation was used to determine load effects. These linear interpolation expressions are given in Table I.9, where  $y$  is the resulting mean maximum (mLmax) load effect value and  $x$  is the actual k value for the structure. The  $R^2$  values corresponding to the expressions in Table I.9 are given in Tables I.10-I.13. As shown by the generally high  $R^2$  values in the table, linear interpolation was found to provide a good estimation of the load effect for structures with intermediate k values.

Final results of the projection are given in Table I.1 for single-lane load effects and Tables I.2-I.4 for two-lane effects.

In the tables, the following labels are used:

Effect: refers to the load effect; either simple moment (Ms), simple shear (Vs), continuous moment (Mc), or continuous shear (Vc). Note that separate values for  $M_{cp}$  are not given. However, mLmax values for  $M_{cp}$  are nearly identical to those for Ms, multiplied by the factor 0.80 ( $M_{cp} = 0.80M_s$ ).  $V_{proj}$  and  $V_{site}$  values for  $M_{cp}$  are practically identical for those of Ms.

Span: bridge span (ft).

mLmax:  $\bar{L}_{max}$ , found from the data projection. Note that the data used for  $\bar{L}_{max}$  projection represents a single pool of data combined from all 10 sites.

Vproj: COV of  $\bar{L}_{max}$ ; i.e.  $\sigma_{L_{max}} / \bar{L}_{max}$ .

Vsite: COV of  $\bar{L}_{max}$  determined from each of the 10 different sites. This value was determined by projecting the load effects from each of the sites separately, then computing the COV of the load effect.

R<sup>2</sup>: coefficient of determination ( $R^2$ ), used to measure the goodness of fit. A value of 1.0 indicates a perfect linear fit.

## CHAPTER 7: RESULTS

Based on the process described in Chapter 6, the effective live load effect (the nominal live load while applying a live load factor of 1.0) required to meet the minimum reliability index of 1.5 for each case was calculated. Results are presented in Tables J.1 and J.2 in Appendix J. In the tables, the following notation is used:

Lane refers to the method in which load effects were calculated; either single-lane load effects that include following vehicles (“fol”) or two-lane load effects. Two-lane load effect cases are designated with a three character code, two numbers and a letter. The numbers refer to the girder spacing considered (e.g. “08” indicates an 8 ft girder spacing). The letter refers to the type of girder, which affects distribution factor and therefore the k factor and ultimately the load effect. “G” represents a girder bridge that either has steel, prestressed concrete, or reinforced concrete girders, while “B” represents a spread box beam, and a “T” represents a side-by-side box beam. For side-by-side box beam results, the numbers preceding “T” represent the box width considered; either 36 in or 48 in.

Effect refers to the type of load effect considered; either simple span moment (Ms), continuous moment (Mc), continuous simple span shear (Vs), or continuous shear (Vc).

Span refers to the bridge span (ft).

Type indicates the specific girder bridge type considered, which affects the k factor. This entry is composed of two letters and two numbers. The letters are either “CS” for steel, “PC” for prestressed concrete, “BS” for spread box beam, and “BT” for side-by-side box beams. The two following numbers refer to the girder spacing (ft).

RLE is the required live load effect necessary to meet a reliability index of 1.5. Due to the variation in RLE from one structure to the next, imposing load factors such that the minimum required index of 1.5 is met by all structures will provide an average reliability greater than the 2.5 average target. Therefore, RLE is only provided for  $\beta=1.5$ . Note that the RLE is based on an  $R_n$  value that includes DF but did not include IM (i.e.  $R_n$  is artificially low). That is, to determine required load factors for a particular nominal rating truck load effect, RLE would be further reduced by the factor  $1/(1+IM)$  for LRFR, applied on the truck portion of load only, or  $(1/I)$  for LFR. Alternatively, the value for RLE can be left unchanged, and the nominal truck load effect increased by the impact factor when comparing to the RLE. In other words, the required load factor can be computed as:  $LF_{req} = RLE / [(1 + IM)(nominal\ vehicle\ load\ effect)]$ . Note that, in the case of LRFR, when shears or negative moments over continuous supports are considered, since IM is not applied to the uniform load, the “nominal vehicle effect” would represent the load effect resulting from either: (a single truck x (1 + IM)), or (two trucks x 0.75 x (1 + IM) + the uniform load of 0.2 k/ft), and the required load factor can then be computed as:  $LF_{req} = RLE / (nominal\ vehicle\ load\ effect)$ .

If RLE is directly used to determine a rating factor in place of the vehicular live load, IM (or I) would not be included but DF would be included in load assessment. This is further discussed in Chapter 8.

To visualize the RLE, required load factors were calculated based on the “governing” MDOT legal truck (1-28) for the given span length. The trucks that were used (where “governing” was based on the nominal, single truck load effect) are shown in Table 7.1. Note that the load effects given in Table 7.1 are not the final load effects used in the rating process, but are used only to illustrate potential required load factors.

Table 7. 1. Governing MDOT Trucks.

Simple Moment			Simple Shear		Continuous Moment		Continuous Shear	
Span	Truck	Ms	Truck	Vs	Truck	Mc	Truck	Vc
20	14	189	16	44	14	170	14	88
40	14	680	17	76	18	482	17	127
60	17	1360	17	100	22	716	25	144
80	17	2120	17	113	17	1008	25	152
100	17	2880	18	121	25	1339	25	156
120	25	3650	18	126	25	1692	25	159
140	25	4470	18	130	25	2036	25	160
160	25	5290	18	133	25	2373	25	161
180	25	6110	25	136	25	2705	25	162
200	25	6930	25	139	25	3034	25	162

Continuous Moment, Positive		
Span	Truck	Mcp
20	17	157
40	16	538
60	17	1069
80	16	1706
100	16	2331
120	16	2960
140	16	3592
160	16	4226
180	25	4897
200	25	5575

Using the truck and nominal load effect given in Table 7.1 as a rating vehicle within the LRFR or LFR procedures, the required load factor is calculated to meet a reliability index of 1.5 for each structure. Results are given in Appendix K. For all structures except side-by-side box beams, values are listed left to right by bridge geometry in the pattern shown in Appendix J Table J.1 (i.e. the first result is for a 20’ span, 4’ girder spacing bridge; the second result is for a 20’ span, 6’ girder spacing bridge; the 6<sup>th</sup> result is for a 40’ span, 4’ spacing bridge, and the last result is for a 200’ span, 12’ spacing bridge).

As shown, most load factors are less than 1.0 for LRFR and less than 1.3 for LFR, with some exceptions. The cases with highest load factors required are given in Table 7.2 for LRFR and Table 7.3 for LFR. For LRFR, cases where load factors exceed 1.0 are for simple, 20 ft span moments and shears; all except for two cases are for side-by-side box beams. For LFR, all load factors that exceed 1.35 are for shears and moments for bridges with 4 ft girder spacing and shears for side-by-side box beams. Table 7.4 presents cases for LFR with required load factors beyond 1.30. Note that, if it is assumed that prestressed concrete (PC), spaced box beams (BS), and side-by-side box beams (BT) are rated assuming that continuous beams act as simple spans, then the cases Vc, Mc and Mcp do not apply to these girders; this would remove a number of cases from Tables 7.3 and 7.4.

As shown in Appendix K, note that for some long span structures, the dead load effect dominates to such an extent that the required load factor is approximately zero. This is because the degree of uncertainty in the load effect has a significant impact on reliability index, where a lower degree of uncertainty (i.e. lower COV) results in greater reliability. Generally, the mean dead load effect used in the reliability analysis has significantly less uncertainty than the live load effect, where COV is from 8-10% for the majority of the dead load effect ( see Table 6.2), where COV of the live load effect has an average of 23% (and varies from 15-36%, depending on the bridge case and load effect), once all of the contributing uncertainties discussed in Chapter 6 are accounted for; see Eq. 6.9). As the bridge structures considered increase in length, the proportion of dead load to live load increases, and thus reliability index increases. Correspondingly, using a lower live load effect in the rating process will cause reliability index to decrease, and using no live load at all would generally produce a very low (or even negative, in some cases) reliability index. However, at a certain length, which varies depending on the bridge type and load effect considered, the increase in reliability index caused by the increased dead load to live load ratio becomes sufficiently high such using a live load of zero in the rating process will produce a net reliability index of 1.5. Practically, this means that for these structures, the dead load factor (1.3 for LFR; 1.25 and 1.5 for LRFR) is sufficiently high to account for the projected live load effect as well.

Appendix L presents reliability indices of girders rated using current load factors (1.3 for LFR and those given in MDOT Report R-1511 for LRFR) applied to the governing MDOT vehicle. As expected, nearly all reliability indices are significantly higher than 1.5, indicating a very conservative rating approach for most structures.

Table 7. 2. LRFR Load Factors Greater Than 1.0.

Lane	Effect	Span	Type	LF
04G	Vs	20	CS04	1.01
04B	Ms	20	BS04	1.01
fol	Vs	20	BT36	1.03
fol	Ms	20	BT36	1.11
fol	Ms	20	BT48	1.07
36T	Ms	20	BT36	1.10
36T	Vs	20	BT36	1.06
48T	Ms	20	BT48	1.06

Table 7. 3. LFR Load Factors Greater Than 1.35.

Lane	Effect	Span	Type	LF
fol	Vs	20	CS04	1.39
fol	Vc	80	CS04	1.48
fol	Vc	100	CS04	1.62
fol	Vc	120	CS04	1.68
fol	Vc	140	CS04	1.69
fol	Vc	160	CS04	1.67
fol	Vc	180	CS04	1.64
fol	Vc	200	CS04	1.62
04G	Ms	20	CS04	1.40
04G	Vs	20	CS04	1.47
fol	Vc	120	PC04	1.36
04G	Ms	20	PC04	1.39
04G	Ms	20	RC04	1.40
04G	Vs	20	RC04	1.41
04B	Ms	20	BS04	1.39
fol	Vs	20	BT36	1.71
fol	Vc	20	BT36	1.43
fol	Vc	80	BT36	1.47
fol	Vc	100	BT36	1.54
fol	Vc	120	BT36	1.49
fol	Vc	140	BT36	1.40
36T	Vs	20	BT36	1.77
36T	Vc	20	BT36	1.40
48T	Vs	20	BT48	1.40



Table 7. 4. LFR Load Factors Greater Than 1.30.

Lane	Effect	Span	Type	LF
fol	Ms	20	CS04	1.31
fol	Vs	20	CS04	1.39
fol	Vs	160	CS04	1.30
fol	Vs	180	CS04	1.32
fol	Vs	200	CS04	1.32
fol	Vc	80	CS04	1.48
fol	Vc	100	CS04	1.62
fol	Vc	120	CS04	1.68
fol	Vc	140	CS04	1.69
fol	Vc	160	CS04	1.67
fol	Vc	180	CS04	1.64
fol	Vc	200	CS04	1.62
04G	Ms	20	CS04	1.40
04G	Vs	20	CS04	1.47
fol	Ms	20	PC04	1.32
fol	Vc	100	PC04	1.36
fol	Vc	120	PC04	1.36
fol	Vc	140	PC04	1.34
fol	Vc	160	PC04	1.31
04G	Ms	20	PC04	1.39
04G	Vs	20	PC04	1.34
fol	Ms	20	RC04	1.31
04G	Ms	20	RC04	1.40
04G	Vs	20	RC04	1.41
fol	Ms	20	BS04	1.33
fol	Vc	100	BS04	1.33
fol	Vc	120	BS04	1.33
04B	Ms	20	BS04	1.39
fol	Vs	20	BT36	1.71
fol	Vc	20	BT36	1.43
fol	Vc	80	BT36	1.47
fol	Vc	100	BT36	1.54
fol	Vc	120	BT36	1.49
fol	Vc	140	BT36	1.40
fol	Vs	20	BT48	1.33
36T	Vs	20	BT36	1.77
36T	Vc	20	BT36	1.40
48T	Vs	20	BT48	1.40
04G	Mcp	20	CS04	1.33
04G	Mcp	20	RC04	1.32

## CHAPTER 8: RECOMMENDED RATING PROCESS

### Simplified Rating Approach

As indicated in Table 7.2, for LRFR, the existing MDOT rating system meets minimum reliability levels in all cases provided no less than a load factor of 1.11 is applied to the governing rating vehicle; the current minimum load factor for extended permit vehicles is specified as 1.15 in the MBE. As discussed in Chapter 6, the standard LFR or LRFR procedure was used to assess required rating factors, but using the MDOT trucks rather than the AASTHO rating trucks. That is, the load factors were computed for the single MDOT truck that produced the greatest moment or shear effect for the span considered (or, in the case of LRFR for continuous spans, two reduced weight trucks separated by 30' and the rating lane load), using a two lane distribution factor.

As shown in the Figures in Appendix K and the Tables in Appendix L, however, using the existing system results in grossly conservative results for many cases, potentially resulting in premature posting for the majority of structures, for both LRFR and LFR. Note that the load factors are assumed to be calculated using existing code procedures for legal vehicles (i.e. DF is computed for the two lanes loaded case).

Based on these results, if the existing levels of significant conservatism in rating is not a concern, a simple method to ensure that the minimum reliability level of 1.5 is met for all cases considered is as follows:

- 1) For LRFR, apply a load factor of 1.11 in all cases. Alternatively, a load factor of 1.05 can be used in all cases except for side-by-side box beams with spans less than 40', where a load factor of 1.11 can be used (per Table 7.2).
- 2) For LFR, the existing load factor of 1.3 can be used for all cases except for those listed in Table 7.3. Note that all cases listed in Table 7.3 have 4' girder spacing, or are side-by-side box beams. In lieu of referencing the specific load factors required for each case in Table 7.3, a simple and conservative approach is to use a load factor of 1.77 for moments and shears for girder spacing cases less than 6' and for side-by-side box beams. Alternatively, for these cases, for girder spacings between 4' - 6', linear interpolation between the load factors of 1.3 (at 6' spacing) to 1.77 (at 4' spacing) is also reasonable.

The existing rating vehicle that is known to govern for the span considered can be used with the load factors suggested in items 1) and 2) above.

Unfortunately, no rating vehicle model will be able to well-match the required rating load effects across all spans and load effects without having significant conservatism in some cases. This is due to a variety of factors, including the inability of single rating vehicles to replicate the complex pattern of load effects caused by multiple presence; that the mean maximum load used for reliability assessment is not a function of a single maximum vehicle event, but by a statistical averaging of many hundreds of load effects; the varying uncertainties in load and resistance for different bridge geometries and material types; and the difference between the girder distribution

factors used for design and rating and “actual” load distribution (taken as the LRFD factors, modified by the bias factors given in Table 6.1).

As such, producing a different set of rating vehicles than those currently in use will produce minimal benefit. An exception is the development of a more complex notional model that varies with span and load effect, but that may bear little resemblance to actual vehicles. The Research Advisory Panel deemed this approach undesirable. A more accurate, alternate assessment of rating factor that eliminates the conservatism in the method discussed above is given in the next sections.

### **Assessment of Rating Factor using Required Load Effect (RLE) Tables**

To eliminate the generally conservative estimation of rating factor from using the load model, and possibly avoiding the need for a more refined analysis for a structure with rating factor (RF) < 1, the load model can be bypassed and the rating factor associated with  $\beta=1.5$  can be more precisely calculated as shown below.

For LRFR, RF is calculated as:

$$RF = \frac{\phi R_n - 1.25DC - 1.5DW}{\gamma_{LL}(LL + IM)} \quad (8.1)$$

In Appendix J, the required load effect values (RLE) are given for  $R_n$  that includes DF but did not include IM. That is, DF must be similarly included in load assessment but IM not included. Also note that the RLE was computed while  $R_n$  was reduced by  $\phi$ . Therefore, it should not be further reduced with  $\phi$  when rating (i.e. when prestressed concrete shears and reinforced concrete shears and moments are considered). Practically, RF can be assessed using Table J.1 values as follows:

$$RF = \frac{R_n - 1.25DC - 1.5DW}{(RLE)(DF)} \quad (8.2)$$

where RLE is the required load effect taken from Table J.1. This can be implemented computationally with any load configuration that would generate a maximum load effect value equal to the required RLE. For example, considering rating for moment and arbitrarily using a single point load moving across a simple span, the load value required for the point load is:  $RLE*(4/L)$ , where L is the bridge span. In such an analysis, the RLE value must be matched without adjustment; i.e. no additional factors (such as IM) would be applied.

Similarly, for LFR, RF is given by:

$$RF = \frac{\phi R_n - 1.3D}{\gamma(LL)(1 + I)(DF)} \quad (8.3)$$

This would be assessed using the RLE values found from Table J.2 as:

$$RF = \frac{R_n - 1.3D}{(RLE)(DF)} \quad (8.4)$$

Note that here (for LFR only), DF is to be reduced by an additional factor of 1/2 to convert from axle to wheel loads.

As shown in Tables J.1 and J.2, RLE values are given for span increments of 20 ft and girder spacing increments of 2 ft. The relationship between RLE and span and girder spacing is only mildly nonlinear, and linear interpolation is recommended for generation of RLE values for intermediate cases.

### Caution

The Simplified approach as well as the RLE Tables approach is based on assumed typical dead load effects, as summarized in Appendix M. In general, if the considered structure has significantly lower dead load effects for prefabricated ( $D_p$ ) or site cast ( $D_s$ ) components than given in Appendix M, or if it has a significantly greater dead load effect for wearing surface ( $D_w$ ), then it is possible that the structure will be rated unconservatively using these methods.

### **Exact Rating Assessment Using Structure-Specific Reliability Analysis**

Assessment of rating factor using the RLE tables discussed above produces exact results for the specific bridges considered. Assumed dead loads are given in Tables M.1-M.5 in Appendix M, and are primarily based on the dead load assumptions used to calibrate the AASHTO LRFD code. Because different uncertainties are associated with live load and dead load components, assumptions with regard to dead loads will affect the reliability analysis and thus the RLE. In general, using greater nominal dead loads in the initial design than shown in Appendix M will increase reliability (and thus lower RLE). Additionally, to a small extent for LRFR but to a significant extent for LFR, the live load distribution factor used will also affect the analysis. For LFR, distribution factors within the 2002 Standard Specifications were assumed to be used for initial design. Discrepancies between the LRFD factors (used to proportion the mean live load in the reliability analysis) and LFR factors (used to determine nominal girder resistance for LFR) will also affect results.

Therefore, to achieve the most accurate assessment of rating factor, the nominal dead load components and distribution factors for a specific structure under consideration can be used, and the RLE of that specific structure reassessed.

### **Example Rating Process**

As an example, consider an interior beam on Bridge 75031-C01 in the MDOT inventory. This bridge is a reinforced concrete structure that simply spans 22' and has beam spacing of 5'-3" (5.25'). The nominal resistance is given as 386 kip-ft, while the nominal dead load is given as 1.42 kips/ft (maximum dead load moment = 85.9 kip-ft), which includes a 10" asphalt wearing

surface of 144 PCF. The operating rating will be assessed, using the greatest load effect generated from either normal, designated, or special designated rating vehicles. The governing rating truck load is 228 kip-ft for a 22' span (Truck 17).

For LFR,

$DF = (1/2)(S/6) = 0.5(5.25/6) = 0.438$ ;  $I = \max(50/(125+L), 0.30) = 0.30$ ;  $\phi = 0.9$  for RC moment (2002 Standard Specifications).

With the current MDOT rating procedure, rating factor is computed as:

$$RF = \frac{\phi R_n - 1.3D}{\gamma(LL)(1+I)(DF)} = \frac{(0.9)(386) - 1.3(85.9)}{1.3(228)(1+0.3)(0.438)} = 1.40$$

For LRFR,

$$DF = 0.075 + \left(\frac{S}{9.5}\right)^{0.6} \left(\frac{S}{L}\right)^{0.2} \left(\frac{K_g}{12Lt_s^3}\right)^{0.1} = 0.075 + \left(\frac{5.25}{9.5}\right)^{0.6} \left(\frac{5.25}{22}\right)^{0.2} (1.0) = 0.601$$

(For purposes of this example, it is assumed that the term  $\left(\frac{K_g}{12Lt_s^3}\right)^{0.1} = 1.0$ ).

$IM = LL(0.33)$ ;  $\phi = 0.9$  for RC moment;  $DW = [(10/12)(0.144)(5.25)](22)^2 / 8 = 38.1$  k-ft;  $DC = 85.9 - 38.1 = 47.8$ .

Assuming an annual permit with  $ADTT > 5000$  with  $GVW/AL > 3.0$  (Truck 17),  $\gamma_{LL} = 1.30$  according to the MBE or  $\gamma_{LL} = 1.21$  according to the MDOT Bridge Analysis Guide. Using the latter,

$$RF = \frac{\phi R_n - 1.25DC - 1.5DW}{\gamma_{LL}(LL + IM)} = \frac{0.9(386) - 1.25(47.8) - 1.5(38.1)}{(1.21)(228 \times 0.601 \times 11.33)} = 1.05$$

### **Simplified Rating Approach**

For LFR,

The girder spacing is  $< 6'$ ; this falls under one of the exception cases listed in Section 8.1 (item 2). Interpolating for load factor, between 1.3 at 6' spacing and 1.77 at 4' spacing,  $\gamma = 1.48$ . Therefore,

$$RF = \frac{\phi R_n - 1.3D}{\gamma(LL)(1+I)(DF)} = \frac{(0.9)(386) - 1.3(85.9)}{1.48(228)(1+0.3)(0.438)} = 1.23$$

For LRFR,

Since the example case does not represent a case in Table 7.2, a load factor of 1.05 may be applied.

$$RF = \frac{\phi R_n - 1.25DC - 1.5DW}{\gamma_{LL}(LL + IM)} = \frac{0.9(386) - 1.25(47.8) - 1.5(38.1)}{(1.05)(228 \times 0.601 \times 11.33)} = 1.20$$

### Use of RLE Tables

From Tables J.1 and J.2, RLE for single lane (fol) and two-lane (0xG) load effects can be obtained for simple moments (Ms) for reinforced concrete girders spanning 20' and 40':

Lane	Effect	Span	Type	RLE, LFR	RLE, LRFR
fol	Ms	20	RC04	323	214
fol	Ms	20	RC06	269	202
fol	Ms	40	RC04	707	533
fol	Ms	40	RC06	583	500
04G	Ms	20	RC04	343	227
06G	Ms	20	RC06	290	217
04G	Ms	40	RC04	671	506
06G	Ms	40	RC06	561	482

Taking the maximum of either 1-lane or 2-lane effects for each case:

Span	Type	RLE, LFR	RLE, LRFR
20	RC04	343	227
20	RC06	290	217
40	RC04	707	533
40	RC06	583	500

For LFR,

Interpolating these maximum values for 5.25' girder spacing results in RLE = 309 for 20' span and 629 for 40' span, for a final interpolated RLE at 22' span = 341.

From Eq. 8.4:

$$RF = \frac{R_n - 1.3D}{(RLE)(DF)} = \frac{386 - 1.3(85.9)}{(341)(0.438)} = 1.84$$

For LRFR,

Interpolating these values for 5.25' girder spacing results in RLE = 221 for 20' span and 512 for 40' span, for a final interpolated RLE at 22' span = 250.

From Eq. 8.2:

$$RF = \frac{R_n - 1.25DC - 1.5DW}{(RLE)(DF)} = \frac{386 - 1.25(47.8) - 1.5(38.1)}{(250)(0.601)} = 1.79$$

### **Exact Assessment**

The most precise rating assessment can be made with direct reliability analysis of the particular structure considered. This can be simply done in spreadsheet form.

For LFR,

In the accompanying spreadsheet, first identify the corresponding bridge type and load effect case in the “Rn Calculation LFR” Sheet, and choose a span and girder spacing. The exact girder spacing and span length does not matter, as these values will be manually input corresponding to the specific structure considered. For example, take row 422 for use in this example, “Ms-20-RC04”. What is important to match is the specific load effect (Ms) and bridge type (RC) considered; any row with the labels “Ms” and “RC” could similarly be used.

Within row 422, in column D (“Dw”), input an appropriate nominal value representing that used for design of the girder. As it is unlikely that a 10” wearing surface was initially used for design, in this example, a 2” wearing surface is assumed. The resulting moment on the girder is:  $[(2/12)(0.144)(5.25)](22)^2 / 8 = 7.62$  k-ft. Since no information is available concerning precast components (Dp), assume Dp = 0 and the remaining recorded dead load is site cast (Ds). Thus, input 0 in column E (“Dp”) and 47.8 (see above) in column F (“Ds”).

The existing moment due to the 10” wearing surface is 38.1 k-ft (see above); insert this value into column G “mDw”. Note that the default value for mean Dw (mDw) in the spreadsheet is that used for the LRFD calibration; i.e. 3.5”, regardless of the actual design value (this is because it was found that actual wearing surface thickness is 3.5” on average, and it bears little relationship to the design value). If there is significant discrepancy between the design and existing values for site cast and precast components, then the nominal values for design can be inserted to columns F and E, while the existing values for Dp and Ds can be input into columns H (mDp) and I (mDs), respectively. However, if this is done, then the existing value of Dp should be increased by the bias factor of 1.03, while the existing value of Ds should be increased by the bias factor of 1.05.

Next, find the corresponding row within the section “Mean Rn Calculation/phi” within the same sheet, which starts at Row 817. The corresponding row within this section to that used above, “Ms-20-RC04”, is row 1422. In column G, input the distribution factor (not including the factor of ½) that is to be used to generate Rn. Assuming that the 2002 Standard Specifications are considered,  $DF = 5.25/6 = 0.875$ .

Within the Sheet “STR I LFR Rating”, find the corresponding one lane load effect row “fol-Ms-20-RC04”, which is row 822. In column E, insert the live load distribution factor to be used for analysis. When both single lane as well as two lane load effects are considered, a single lane DF must be used. This is because the two lane mean maximum load effects were already proportioned to correspond to a single lane event (see Eq. 6.24). Here, the assumed more accurate LRF factors are recommended.

For one lane load effects,

$$DF = 0.06 + \left(\frac{S}{14}\right)^{0.4} \left(\frac{S}{L}\right)^{0.3} \left(\frac{K_g}{12Lt_s^3}\right)^{0.1} = 0.06 + \left(\frac{5.25}{14}\right)^{0.4} \left(\frac{5.25}{22}\right)^{0.3} (1.0)^{0.1} = 0.50$$

The last term  $(K_g/12Lt_s^3)$  may be calculated more precisely, if desired.

The multiple presence factor of 1.2 must be removed:  $DF_1 = DF/1.2 = 0.50/1.2 = 0.416$ .

This value is inserted into cell E822. It must also be inserted into the corresponding two lane load effect row, “04G-Ms-20-RC04”, row 922 (cell E922).

Note that this DF is further modified by a bias factor given in column F to better correspond to field test data, as used in the MBE calibration (see Table 6.1, above). The final DF value used in the reliability analysis to proportion live load to the girder is calculated in column G.

The final values to alter in the spreadsheet are the mean maximum live load statistics. These can be linearly interpolated from bounding values, which can be read from Tables I.1-I.4 Appendix I, or taken directly from the spreadsheet. Note that the values in the spreadsheet are available with a greater number of significant digits than those given in the tables, but using either source will not have a significant effect on results.

For single lane effects:

Lane	Effect	Span	Type	mLmax	Vproj	Vsite
fol	Ms	20	RC	327	0.026	0.088
fol	Ms	40	RC	939	0.038	0.095

The above labels correspond to those shown in the spreadsheet. To read these values from the Tables in Appendix I, see the first and second rows of the leftmost top block of Table I.1; one-



lane statistics (“fol”) are not dependent on bridge type, so the “Type” label does not appear in the table.

The interpolated values for a 22’ span are mLmax = 388, Vproj = 0.027, and Vsite = 0.089. These values are inserted into columns H, I, and J of row 822, respectively.

The resulting RLE (column AJ) = 393.

For two lane effects:

Lane	Effect	Span	Type	mLmax	Vproj	Vsite
04G	Ms	20	RC04	305	0.055	0.090
06G	Ms	20	RC06	308	0.055	0.090
04G	Ms	40	RC04	796	0.040	0.090
06G	Ms	40	RC06	805	0.040	0.090

Interpolating these values for 5.25’ girder spacing results in a mLmax of 307 for 20’ span and 802 for 40’ span, for final interpolated values at 22’ span of mLmax = 357, Vproj = 0.054, and Vsite = 0.090.

The resulting RLE = 409 (column AJ), which governs. The main reason that the RLE is significantly higher here than when using the RLE tables is the large wearing surface load; as noted earlier, the RLE tables assume that a 3.5” thick wearing surface is on the bridge.

$$RF = \frac{R_n - 1.3D}{(RLE)(DF)} = \frac{386 - 1.3(85.9)}{(409)(0.438)} = 1.53$$

For LRFR,

Repeat the same process used for LFR, but access the sheets “Rn Calculation LRFR” and “STR I LRFR Rating.” Row and column locations for the LRFR sheets are identical to those in LFR.

The only value different from that in LFR is for DF on Sheet “Rn Calculation LRFR” (cell G1422), which is taken as 0.601 (see above).

The resulting RLEs for one and two lane effects are 288 and 299, respectively. Taking the maximum RLE of 299:

$$RF = \frac{R_n - 1.25DC - 1.5DW}{(RLE)(DF)} = \frac{386 - 1.25(47.8) - 1.5(38.1)}{(299)(0.601)} = 1.50$$

## Summary of Results

Comparing the results of the different rating processes produces the following rating factors:

Method	Expected accuracy	RF result: LFR	RF result: LRFR
Existing MDOT	worst	1.40	1.05
Simplified	better	1.23	1.20
RLE Tables	even better	1.84	1.79
Exact	exact	1.53	1.50

The presumption is that as the expected accuracy of a method increases, its calculated RF should move closer to the ‘exact’ values of 1.53 and 1.50. For most structures, this trend is expected to occur. However, this will not be true for every structure. For example, the degree of conservatism (or unconservatism, in some cases for LFR) varies significantly using the existing system; for a particular structure, the existing approach may be coincidentally more or less conservative (and thus closer to the exact result) than the Simplified or RLE Tables approaches.

The only difference between the RLE Tables method and an exact assessment is that an assumption was made as to the proportion of dead load to live load for a structure when using the RLE Tables (all of the assumed dead load effect values are given in Appendix M). The further apart the dead load / live load proportion is between that assumed and that on a particular structure rated, the less accurate the RLE Tables method will be.

This is what happened for the structure used in the above example. The RLE Tables method overestimated the rating factor because the assumed wearing surface thickness used to develop the RLE tables is 2.25”, while it is actually given as 10” for the structure considered. Because the wearing surface has a COV of 0.25 (much larger than the COV of 0.10 for the deck and girder dead load), and makes up a larger portion of the dead load effect than assumed, this added a significant amount of uncertainty to the dead load value, which lowers reliability, and thus rating factor, to about 1.5 (exact) as compared to the value of approximately 1.8 computed from the RLE Tables method.

### **Posting Vehicles**

A rigorous analysis of the posting process requires a computationally-intensive approach. The recommended procedure for this analysis is as follows.

1) There are two potential sources of error to consider; error within the rating procedure and error within the posting procedure. Error within the rating procedure was addressed in sections above. To accurately understand error only within the posting procedure, error within the rating procedure must be eliminated. To eliminate rating procedure error, a base rating load effect must be used that produces a rating factor of 1.0 under no traffic restriction (i.e. the RLE). Using existing rating vehicles, this can be done practically by determining the load factor required on the rating vehicle used such that  $RF=1.0$  when reliability index = 1.5, as done in previous sections of this report. This calibrating load factor (which will vary from one bridge case to another) will be used in subsequent calculations.

2) To examine the effect of imposing a given traffic restriction (for example, a 40 or 60 ton posting), the corresponding  $R_n$  that would have caused the given posting must be determined. Following the current rating process, this is done by reducing the rating vehicle load effect to

that corresponding to the traffic restriction (i.e. the rating vehicle tonnage is reduced to the posted tonnage by proportionally reducing the load effect). The value of  $R_n$  needed to set the rating factor equal to 1.0 is then determined, while imposing the load factor found from step 1 above. This is the  $R_n$  value corresponding to the given posting in the current rating process, while any error in the rating process was eliminated by using the calibrating load factor. 3) New live load statistics corresponding to the traffic restriction must be determined. Assuming that the posting is exactly followed (i.e. discounting illegal crossings), WIM data entries that exceed the given posting are eliminated. The load effects and live load random variable statistics of the remaining vehicle pool are then recomputed. This is the computationally-intensive portion of the analysis.

4) Using the  $R_n$  value determined in Step 2 along with the new live load statistics from Step 3, reliability is assessed. If reliability index is less than 1.5, then the posting did not sufficiently restrict traffic; if reliability index is greater than 1.5, then the posting was overly restrictive.

Given the computational effort required in Step 3, a complete assessment of all load effects for all span lengths is beyond the scope of this report. However, an example case was considered for evaluation. This case was that for two-lane simple moments on a 60 ft span. Once proportioned to girders, two-lane and single lane load effects are similar in most cases. However, two-lane load effects were specifically considered because the number of two-lane events is significantly smaller (from 1-2 orders of magnitude) than single lane events, reducing the computational effort needed for evaluation.

Results are given in Table 8.1 for steel (CS), prestressed concrete (PC), reinforced concrete (RC), spread box (BS), and side-by-side box beam (BT) girders with girder spacing from 4-12 ft. In the table, reliability indices are given for no traffic restriction ( $\beta=1.50$ ), for a 60 ton restriction, and for a 40 ton restriction, calculated using the procedure described above. For a 60 ton restriction, for both LRFR and LFR, a slight drop in reliability index for nearly all cases considered (average  $\beta = 1.41$  for LRFR; average  $\beta = 1.33$  for LFR) is evident, where LRFR values range from 1.33-1.73 and LFR values range from 1.07-1.53. These values are fairly close to the desired minimum of 1.5, and are not particularly concerning; it was determined that raising  $R_n$  from 0-2% (1% on average for LRFR; 2% on average for LFR) over that which initiated the posting would cause reliability indices to increase again to 1.5.

For a 40 ton restriction, however, results are more significant, where reliability indices are significantly below the minimum required in some cases, ranging from 0.57 – 1.32 for LRFR (0.83 on average) and from 0.56 – 1.15 for LFR (0.81 on average). It was determined that raising  $R_n$  from 5-14% (9% on average for both LRFR and LFR) over that which initiated the posting would cause reliability indices to increase to 1.5.

If the current MDOT rating process is used without adjustment, although some exceptions exist, as discussed in Chapter 7, for most cases, a significant amount of conservatism exists when rating factor is calculated, causing most structures to be potentially posted prematurely. This is also the case for the example considered for the posting vehicle analysis (i.e. 60 ft span, simple moment). Keeping this existing conservatism in bridge rating (in step 2 of the analysis process above, using an existing load factor of 1.3 in LFR and 1.15 in LRFR in place of the calibrating

load factor), the posting vehicle analysis was reconsidered, with results given in Tables 8.2 and 8.3. As shown, regardless of the traffic restriction imposed, reliability indices are significantly greater than 1.5. For reference, the level of conservatism inherent in the rating process associated with these high values of reliability is also given, in terms of the ratio of the provided load effect to the required load effect (“Provided Load / RLE”); this is essentially the ratio of the load factor of 1.3 (LFR) or 1.15 (LRFR) used in the rating analysis to that required to produce  $\beta=1.5$  when the rating factor is 1.0, without traffic restriction.

The results given in Tables 8.2 and 8.3 should be considered with caution, as these apply only to the specific case considered (60 ft span, simple moment, two-lane effects). Moreover, for cases that are less conservative in rating, reliability indices are likely to be lower than those shown in Tables 8.2 and 8.3. The unconservative cases shown in Chapter 7 would be particularly troublesome, with reliability indices likely less than those in Table 8.1, if the existing rating process is used as-is.

Table 8. 1. Reliability Indices For a 60’ Span Bridge Posted for Simple Moment (2-lane effects) with Exact Assessment of Rating Factor.

Exact	LRFR			LFR		
	Restriction			Restriction		
Bridge	None	60 Ton	40 Ton	None	60 Ton	40 Ton
CS04	1.50	1.34	0.57	1.50	1.35	0.59
CS06	1.50	1.34	0.60	1.50	1.35	0.62
CS08	1.50	1.34	0.63	1.50	1.35	0.64
CS10	1.50	1.35	0.67	1.50	1.36	0.68
CS12	1.50	1.36	0.71	1.50	1.37	0.73
PC04	1.50	1.37	0.68	1.50	1.40	0.76
PC06	1.50	1.35	0.61	1.50	1.37	0.67
PC08	1.50	1.33	0.57	1.50	1.35	0.62
PC10	1.50	1.33	0.57	1.50	1.35	0.61
PC12	1.50	1.33	0.58	1.50	1.34	0.61
RC04	1.50	1.73	1.32	1.50	1.53	1.20
RC06	1.50	1.58	1.23	1.50	1.49	1.19
RC08	1.50	1.48	1.14	1.50	1.46	1.14
RC10	1.50	1.44	1.13	1.50	1.44	1.15
RC12	1.50	1.43	1.13	1.50	1.43	1.15
BS04	1.50	1.42	0.90	1.50	1.36	0.92
BS06	1.50	1.39	0.81	1.50	1.24	0.75
BS08	1.50	1.37	0.75	1.50	1.15	0.63
BS10	1.50	1.36	0.74	1.50	1.10	0.58
BS12	1.50	1.36	0.74	1.50	1.07	0.56
BT36	1.50	1.47	1.13	1.50	1.22	1.03
BT48	1.50	1.47	1.13	1.50	1.22	1.03

As shown in the Tables, whether the initial rating process is conservative nor not, reliability level drops as a greater vehicle restriction is required to be imposed. This occurs because the mean maximum vehicle load effect found from the WIM data and load projection does not directly

correspond to the decrease in rating vehicle load effect. In particular, decreasing the rating vehicle load effect by a given amount, and eliminating corresponding vehicles by GVW from the vehicle pool, does not result in an equivalent decrease in mean maximum load effect. For example, in the example case considered, rating vehicle 17 governs load effects (GVW 151.4 k). Reducing this vehicle to 60 tons GVW results in a reduction of approximately 20% of GVW. However, restricting the WIM data to vehicles no greater than 60 tons results in an average decrease in mean maximum live load effect among the different girders considered of about 15%. Similarly, restricting vehicle 17 to 40 tons GVW represents a 47% reduction in GVW. However, this corresponds to an average decrease in mean maximum load effect of only approximately 24% when vehicles greater than 40 tons are removed from the WIM data. The reason for this discrepancy is because single rating vehicles cannot well-replicate the actual complex pattern of live load caused by vehicles in multiple lanes (as well as following vehicles in a single lane). In general, maximum two-lane load effects are caused not by rare, extremely heavy vehicles, but rather by combinations of more common lower-weight vehicles. Many of these vehicle combinations that affect the load projection may fall below the traffic restrictions imposed in posting.

Table 8. 2. Reliability Indices For a 60' Span Bridge Posted for Simple Moment (2-lane effects) with Existing Assessment of Rating Factor, LRF.

Existing Bridge	Provided Load / RLE	LRF		
		Restriction		
		None	60 Ton	40 Ton
CS04	2.07	4.19	3.84	2.74
CS06	2.11	4.20	3.85	2.76
CS08	2.14	4.21	3.85	2.78
CS10	2.18	4.19	3.83	2.79
CS12	2.22	4.17	3.81	2.79
PC04	2.13	4.52	4.10	2.88
PC06	2.12	4.61	4.16	2.90
PC08	2.11	4.66	4.21	2.91
PC10	2.12	4.67	4.21	2.91
PC12	2.13	4.67	4.20	2.91
RC04	2.60	3.60	3.37	2.70
RC06	2.69	3.60	3.36	2.71
RC08	2.68	3.64	3.40	2.73
RC10	2.74	3.63	3.39	2.74
RC12	2.80	3.63	3.39	2.74
BS04	2.40	4.51	4.08	2.99
BS06	2.37	4.65	4.20	3.04
BS08	2.36	4.73	4.26	3.06
BS10	2.36	4.75	4.27	3.06
BS12	2.37	4.74	4.26	3.05
BT36	2.59	4.13	3.74	2.84
BT48	2.69	4.23	3.83	2.92

Table 8. 3. Reliability Indices For a 60' Span Bridge Posted for Simple Moment (2-lane effects) with Existing Assessment of Rating Factor, LFR.

Existing Bridge	Provided Load / RLE	LRFR		
		Restriction		
		None	60 Ton	40 Ton
CS04	1.95	3.94	3.61	2.54
CS06	2.26	4.44	4.08	2.99
CS08	2.50	4.75	4.38	3.29
CS10	2.71	4.94	4.56	3.48
CS12	2.90	5.07	4.69	3.62
PC04	2.06	4.29	3.90	2.76
PC06	2.31	4.94	4.49	3.22
PC08	2.50	5.39	4.91	3.56
PC10	2.67	5.69	5.18	3.80
PC12	2.82	5.90	5.38	3.98
RC04	2.31	3.28	3.07	2.46
RC06	2.73	3.58	3.35	2.72
RC08	2.93	3.80	3.56	2.89
RC10	3.21	3.94	3.68	3.02
RC12	3.15	3.84	3.59	2.94
BS04	2.25	4.12	3.75	2.77
BS06	2.77	5.19	4.72	3.52
BS08	2.69	5.22	4.73	3.50
BS10	3.45	6.31	5.76	4.41
BS12	3.14	5.88	5.34	4.02
BT36	3.63	5.06	4.61	3.61
BT48	3.69	5.09	4.64	3.63

Unfortunately, there is no way to accurately determine what additional vehicle restriction is necessary to produce desired levels of reliability without conducting the analysis discussed in the steps above for a wider range of cases. However, based on the single case (60 ft span, two lane, simple moment) examined above, a possible interim approach to consider may be as follows.

Based on the additional needed increase in  $R_n$  discussed above, for cases when rating is assessed with the 'exact' method, or when rating is assessed using the current rating process for a case that is not considerably conservative, if a 60 ton restriction is computed to be required,  $R_n$  for the girder should be further reduced by 1% for LRFR and 2% for LFR, then the required posting recomputed. If a 40 ton restriction is required, then girder  $R_n$  should be further reduced by approximately 10% for both LRFR and LFR, and the required posting recomputed. The accuracy of this suggestion is unverified, however.

## REFERENCES

- AASHTO LRFD Bridge Design Specifications, 5<sup>st</sup> ed. American Association of State Highway and Transportation Officials, Washington, D.C., 2010.
- AASHTO Manual for Bridge Evaluation, 2<sup>nd</sup> ed. American Association of State Highway and Transportation Officials, Washington, D.C., 2011.
- AASHTO Manual for Condition Evaluation and Load and Resistance Factor Rating (LRFR) of Highway Bridges, American Association of State Highway and Transportation Officials, Washington, D.C., 2003.
- AASHTO Manual for Condition Evaluation of Bridges, American Association of State Highway and Transportation Officials, Washington, D.C., 1998.
- AASHTO Standard Specifications for Highway Bridges, American Association of State Highway and Transportation Officials, Washington, D.C., 2002.
- Bailey, S. and Bez, R. "Site specific probability distribution of extreme traffic action effects." Probabilistic engineering mechanics, Vol 14, No. 1, 1999.
- Behnam, B. and Eamon, C. "Reliability-based design optimization of concrete flexural members reinforced with ductile FRP bars." Construction and Building Materials, Vol. 47, 2013.
- Bruls A, Croce P, Sanpaolesi L, Sedlacek O. ENV1991 - Part 3: traffic loads on bridges; calibration of load models for road bridges. In: Proceedings of IABSE colloquium, Delft, The Netherlands: IABSE-AIPC-IVBH; pp. 439-53, 1996.
- Chang, B., Bourland, M., Couch, T., Zou, H., and Jung, T. "Evaluation of Texas Superheavy-Load Criteria for Bridges." ASCE Journal of Performance of Constructed Facilities, Vol. 29, No. 4, 2015.
- Croce, P. and Salvatore, W. "Stochastic model for multilane traffic effects on bridges." ASCE Journal of Bridge Engineering, Vol. 6, No.2, pp. 136-143, 2001.
- Curtis, R. and Till, R. "Recommendations for Michigan Specific Load and Resistance Factor Design Loads and Load and Resistance Factor Rating Procedures." MOOT Research Report R-1511, April 2008.
- Data Collection Guide for SPS WIM Sites, 1<sup>st</sup> ed. Federal Highway Administration, Turner-Fairbank Highway Research Center Pavement Performance Division, Virginia, 2001.
- Dawe P. Research perspectives: traffic loading on highway bridges. London: Thomas Telford, 2003.
- Eamon, C., Kamjoo, V., and Shinki, K. "Design Live Load Factor Calibration for Michigan Highway Bridges." ASCE Journal of Bridge Engineering (accepted for publication 2015)
- Eamon, C., Kamjoo, V., and Shinki, K. "Side-by-side Probability for Bridge Design and Analysis." MDOT Research Report RC-1601, 2014.
- Eamon, C. and Rais-Rohani, M. "Integrated reliability and sizing optimization of a large composite structure." Marine Structures, Vol. 22, No. 2, 2009.
- Eamon, C., Wu, H.C., Makkawy, A., and Siavashi, S. "Design and construction guidelines for strengthening bridges using fiber reinforced polymers (FRP)." MDOT Research Report RC-1614, 2014.
- ECI. Eurocode 1: actions on structures. Part 2: Traffic loads on bridges. Brussels: European Standard EN 1991-2:2003: European Committee for Standardization, TC250, 2003.
- EliceGUI, M., Stefanowicz, T., and Severns, D. "Loads and Load Factors." NDOT Structures Manual, Chapter 12, Nevada Department of Transportation, 2008.

- Elkins, L., and Higgins, Ch. "Development of Truck Axle Spectra from Oregon Weight-in-Motion Data for use in Pavement Design and Analysis." FHWA, Report no. OR-RD-08-06, Oregon Department of Transportation and Federal Highway Administration, 2008.
- Enright B. and O'Brien, E. "Management Strategies for Special Permit Vehicles for Bridge Loading." Transport Research Arena Europe, Brussels, 2010.
- Enright, B. and O'Brien, E. "Monte Carlo simulation of extreme traffic loading on short and medium span bridges". Structure and Infrastructure Engineering, Vol 9, No. 12, 2013.
- Enright, B., Obrien, E., and Leahy, C. "Identifying and Modelling Permit Trucks for Bridge Loading." Proceedings of the ICE – Bridge Engineering, 2015.
- Federal Highway Administration. Code of Federal Regulations, Title 23 (Highways), Chapter I (FHWA, DOT), Subchapter G (Engineering and Traffic Operations), Part 658: Truck Size and Weight, Routine Designations – Length, Width, and Weight Limitations, 2015.
- Federal Highway Administration. Federal Size Regulations for Commercial Motor Vehicles (2004).
- Fixing America's Surface Transportation Act (FAST) P.L. 114-94 (2015).
- Folwell, M. and Stephens, Jerry. "System for Processing and Analyzing WIM and AVC Data." FHWA, Report no. MT-97/8117-3, Montana Department of Transportation 1997.
- Fu, G., and Fu, C. "Bridge Rating Practices and Policies for Overweight Vehicles." NCHRP Report 359. Washington, D.C., Transportation Research Board, 2006.
- Fu, G. and Hag-Elsafi, O. "Vehicular Overloads: Load Model, Bridge Safety, and Permit Checking." ASCE Journal of Bridge Engineering, Vol. 5, No.1, pp. 49-57, 2000.
- Fu, G., Feng, J., Dekelbab, W., Moses, F., Cohen, H., Meliz, D., and Thompson, P. "Effect of Truck Weight on Bridge Network Costs." NCHRP Report 495. Washington, D.C., Transportation Research Board, 2003.
- Fu, G. and Moses, F. "Overload Permit Checking Based on Structural Reliability." Transportation Research Record 1290, 1991.
- Fu, O. and Van de Lindt. "LRFD Load Calibration for State of Michigan Trunkline Bridges." MDOT Research Report RC-1466, August, 2006.
- Fu, O. and You, J. "Truck Loads and Bridge Capacity Evaluation in China." ASCE Journal of Bridge Engineering, Vol. 14, No.5, pp. 327-335, 2009.
- Ghosn, M. "Development of Truck Weight Regulations Using Bridge Reliability Model." ASCE Journal of Bridge Engineering, Vol. 5, No.4, pp. 293-303, 2008.
- Ghosn, M. and Moses, F. "Reliability Calibration of Bridge Design Code." Journal of Structural Engineering, Vol. 112, no. 4, 1986.
- Ghosn, M., Sivakumar, B., and Miao, F. "Load and Resistance Factor Rating (LRFR) in NYS, Volume II, Final Report." NYSDOT Report C-06-13., 2011.
- Ghosn, M., Sivakumar, B., and Moses, F. "Modeling maximum live load effects on highway bridges." Proceedings from the First International Symposium on Live-Cycle Civil Engineering, Varenna, Italy, June, pp. 335-341, 2008.
- Ghosn, M., Sivakumar, B., and Moses, F. "Using weigh-in-motion data for modeling maximum live load effects on highway bridges." Proceedings of the Fifth International IABMAS Conference, Philadelphia, USA, July, 2010.
- Gindy, M., and Nassif, H.H. "Multiple presence statistics for bridge live load base on weigh-in-motion data." Transportation research board 86<sup>th</sup> annual meeting, Washington, D.C., 2006.
- Green, C., Sproule, W., and McNinch, T. "Michigan Log Truck Study II, Final Report." MDOT,



- 2005.
- Humphrey, T.F. "Uniformity Efforts in Oversize/Overweight Permits." NCHRP Report 143. Washington, D.C., Transportation Research Board, 1988.
- Imbsen, R.A. "Bridge Weight-Limit Posting Practice." NCHRP Report 108. Washington, D.C., Transportation Research Board, 1984.
- Intermodal Surface Transportation Efficiency Act of 1991, 1991.
- Lawson, D., Hing, C., and Carota, J. "Bridge Load Rating of a Super Load using AASHTO LRFR." ASCE Structures Congress, 2013.
- Kwon, O-S, Kim, E., Orton, S, Salim, H., and Hazlett, T. "Calibration of the Live Load Factor in LRFD Design Guidelines", MODOT Report ORI1-003, Sept. 2010.
- Lee, C.E. and Garnet, J.E. "Collection and Analysis of Augmented Weight-in-Motion Data." Center for Transportation Research Bureau of Engineering Research, the University of Texas at Austin, Report no. 987-8, 1996.
- Lee, C.E. and Souny-Slitine, N. "Final Research Findings on Traffic-Load Forecasting Using Weight-in-Motion Data." Center for Transportation Research Bureau of Engineering Research, the University of Texas at Austin, Report no. 987-7, 1998.
- Lu, Q., Harvey, J., Le, J., Quinley, R., Redo, D., and Avis, J. "Truck Traffic Analysis using Weigh-In-Motion (WIM) Data in California." University of California, Berkeley Institute of Transportation Studies, Pavement Research Center, 2002.
- Michigan Center for Truck Safety (MCTS). Truck Driver's Guidebook, 16<sup>th</sup> Ed. 2015.
- MDOT Bridge Analysis Guide, 2005 Ed, with 2009 Interim Update, Parts 1 and 2. MDOT Construction and Technology Support Area, 2009.
- MDOT. Maximum Legal Truck Loadings and Dimensions, T-1. MDOT, 2016.
- MDOT. Information on the Movement of Mobile Homes and Building Modules, T-3. Transport Permits Unit, 2004.
- MDOT. Information on the Movement of Oversize or Overweight Vehicles and Loads, T-2, 2014.
- Michigan Center for Truck Safety, *Truck Driver's Guidebook, 16<sup>th</sup> ed.*, Lansing, MI (2015).
- Michigan Vehicle Code: Public Act 300 of 1949 (and amendments), Legislative Council, State of Michigan 2015.
- Mlynarski, M., Spangler, B., and Rogers, H. "Review and Revision of Overload Permit Classification." MDOT Research Report RC-1589, 2013.
- Miao, T.J. and Chan. T.H.T. "Bridge live load models from WIM data." Engineering Structures, Vol. 24, No. 8, pp. 1071-1084. 2002.
- Monsere, L., Higgins, Ch. and Nichols, A. "Application of WIM Data for Improved Modeling, Design, and Rating." Oregon Transportation Research and Education Consortium, Oregon Department of Transportation, 2011.
- Moses, F. "Calibration of load factors for LRFR bridge evaluation." NCHRP Report no. 454, Washington, D.C., Transportation Research Board, 2001.
- Moses, F. and Ghosn, M. "Instrumentation for Weighing Trucks-In-Motion for Highway Bridge Loads." Final Report, FHWA/OH-83-001 to Ohio DOT, Case Western Reserve University, August, 1983.
- Nowak, A.S. "Calibration of LRFD Bridge Design Code." NCHRP 368, Washington, D.C., Transportation Research Board, 1999.
- Nowak, A.S. "Calibration of LRFD Bridge Code." Journal of Structural Engineering. Vol. 121, No. 8, pp. 1245-1251, 1995.

- Nowak, A.S. "Live load model for highway bridges." *Structural Safety*, Vol. 13, pp. 53-66, 1993.
- Nowak, A.S., Lutomirska, M., and Sheikh Ibrahim, F.I. "The development of live load factors for long span bridges." *Bridge Structures*, Vol. 6, No. 1, pp. 73-79, 2010.
- O'Brien, E.J. and Caprani, C. "Headway modeling for traffic load assessment of short to medium span bridges." *The Structural Engineer*, Vol. 83, No. 16, pp. 33-36, 2005.
- O'Brien, E.J. and Enright, B. "Modeling same-direction two-lane traffic for bridge loading." *Structural Safety*, No. 33, pp. 296-304, 2011.
- O'Brien, E.J. Enright, B., and Getacollew, A. "Importance of the Tail in Truck Weight Modeling for Bridge Assessment." *ASCE Journal of Bridge Engineering*, Vol. 15, No.2, pp. 210-213, 2010.
- O'Connor A, Jacob B, O'Brien EJ, Prat M. Report of current studies performed on normal load model of ECI Part 2. Traffic loads on bridges. *Rev Francaise de Genie Civ.* Vol. 5, No.4, pp. 411-33, 2001.
- Park, A., Lim, J., Chon, C. and Kim, D. "A Practical Overweight Permit Analysis System in Seoul." *Proceedings, Bridge Maintenance, Safety, Management, Resilience and Sustainability*, London, 2012.
- Pelphrey, J., Higgins, CH., Sivakumar, B., Groff, R.L., Hartman, B.H., Charbonneau, J.P., Rooper, J.W., and Johnson, B.V. "State-Specific LRFR Live Load Factors Using Weigh-in-Motion Data." *ASCE Journal of Bridge Engineering*, Vol. 13, no. 4, pp. 339-350, 2008.
- Pelphrey, J. and Higgins, C. "Calibration of LRFR Live Load Factors Using Weigh-In-Motion Data, Interim Report SPR 635, June, 2006.
- Qu, T., Lee, C.E. and Huang, L. "Traffic -Load Forecasting Using Weight-in-Motion Data." *Center for Transportation Research Bureau of Engineering Research, the University of Texas at Austin, Report no. TX-99/987-6, 1997.*
- Raz, O., Buchheit, R., Shaw, M., Koopman, P., and Faloutsos, Ch. "Detecting Semantic Anomalies in Truck Weigh-In-Motion Traffic Data Using Data Mining." *American Society of Civil Engineers, Journal of Computing in Civil Engineering*, ISSN : 0887-3801, 2004.
- Rais-Rohani, M., Eamon, C., and Keesecker, A. "Structural analysis and sizing optimization of a composite advanced sail design concept." *Marine Technology*, Vol. 42, No. 2, 2005.
- Rais-Rohani, M., Solanki, K., Acar, E., and Eamon, C. "Shape and sizing optimization of automotive structures with deterministic and probabilistic design constraints." *International Journal of Vehicle Design*, Vol. 54, No. 4, 2010.
- Siavashi, S., Makkway, A., Eamon, C. and Wu, H. C. "Long Term Degradation of FRP Bond in Harsh Climate," *SAMPE Conference Proceedings*. Seattle, WA, May, 2017.
- Sivakumar, B. "LRFR Limit States, Reliability Indices & Load Factors." *Load & Resistance Factor Rating of Highway Bridge, Session 4, FHWA LRFR Seminar, HNTB Corp., 2008.*
- Sivakumar, B. and Ghosn, M. "Recalibration of LRFR Live Load Factors in the AASHTO Manual for Bridge Evaluation." *NCHRP Project 20-07, Task 285, 2011.*
- Sivakumar, B., Moses, F., Fu, G., and Ghosn, M. "Legal truck loads and AASHTO legal loads or posting." *NCHRP Report 575, 2007.*
- Sivakumar, B., Ghosn, M., and Moses, F. "Protocols for collecting and using traffic data in bridge design." *NCHRP Report 683, Washington, D.C., Transportation Research Board, 2011.*

- Tabatabai, H., Zhao, J., and Lee, C-W. "Statistical Analysis of Heavy Truck Loads Using Wisconsin Weigh-In-Motion Data." WDOT Project CFIRE 01-02, September 2009.
- Thompson, M., Eamon, C. and Rais-Rohani, M. "Reliability-based optimization of fiber-reinforced polymer composite bridge deck panels." *Journal of Structural Engineering*, Vol. 132, No. 12, 2006.
- Traffic Monitoring Guide. FWHA-PL-Ot-021. U.S. Department of Transportation Federal Highway Administration, Office of Highway Policy Information, May 1, 2001.
- Van de Lindt, J. and Fu, G. "Investigation of the Adequacy of Current Bridge Design Loads in the State of Michigan." MDOT Research Report RC-1413, July 2002.
- Zhao, J. and Tabatabai, H. "Evaluation of a Permit Vehicle Model Using Weigh-in-Motion Trucks Records." *ASCE Journal of Bridge Engineering*, Vol. 17, No. 2, 2012.

# APPENDIX A. FEDERAL BRIDGE FORMULA TABLE

Tabular values for the Federal Bridge Formula are presented in Figure A.1.

Distance in feet (L) between the extremes of any group of 2 or more consecutive axles		Maximum load in pounds carried on any group of 2 or more consecutive axles							
L	N=	2 AXLES	3 AXLES	4 AXLES	5 AXLES	6 AXLES	7 AXLES	8 AXLES	9 AXLES
Tandem Axle Weight	4.....	34,000	.....	.....	.....	.....	.....	.....	.....
	5.....	34,000	.....	.....	.....	.....	.....	.....	.....
	6.....	34,000	.....	.....	.....	.....	.....	.....	.....
	7.....	34,000	.....	.....	.....	.....	.....	.....	.....
	8.....	34,000	34,000	.....	.....	.....	.....	.....	.....
	More than 8/less than 9	38,000	42,000	.....	.....	.....	.....	.....	.....
	9.....	39,000	42,500	.....	.....	.....	.....	.....	.....
	10.....	40,000	43,500	.....	.....	.....	.....	.....	.....
	11.....	.....	44,000	.....	.....	.....	.....	.....	.....
	12.....	.....	45,000	50,000	.....	.....	.....	.....	.....
	13.....	.....	45,500	50,500	.....	.....	.....	.....	.....
	14.....	.....	46,500	51,500	.....	.....	.....	.....	.....
	15.....	.....	47,000	52,000	.....	.....	.....	.....	.....
	16.....	.....	48,000	52,500	58,000	.....	.....	.....	.....
	17.....	.....	48,500	53,500	58,500	.....	.....	.....	.....
	18.....	.....	49,500	54,000	59,000	.....	.....	.....	.....
	19.....	.....	50,000	54,500	60,000	.....	.....	.....	.....
20.....	.....	51,000	55,500	60,500	66,000	.....	.....	.....	
21.....	.....	51,500	56,000	61,000	66,500	.....	.....	.....	
22.....	.....	52,500	56,500	61,500	67,000	.....	.....	.....	
23.....	.....	53,000	57,500	62,500	68,000	.....	.....	.....	
24.....	.....	54,000	58,000	63,000	68,500	74,000	.....	.....	
25.....	.....	54,500	58,500	63,500	69,000	74,500	.....	.....	
26.....	.....	55,500	59,500	64,000	69,500	75,000	.....	.....	
27.....	.....	56,000	60,000	65,000	70,000	75,500	.....	.....	
28.....	.....	57,000	60,500	65,500	71,000	76,500	82,000	.....	
29.....	.....	57,500	61,500	66,000	71,500	77,000	82,500	.....	
30.....	.....	58,500	62,000	66,500	72,000	77,500	83,000	.....	
31.....	.....	59,000	62,500	67,500	72,500	78,000	83,500	.....	
32.....	.....	.....	60,000	63,500	68,000	73,000	78,500	84,500	90,000
33.....	.....	.....	64,000	68,000	72,000	77,500	82,500	88,500	94,000
34.....	.....	.....	64,500	69,000	73,000	78,000	83,500	89,500	95,000
35.....	.....	.....	65,500	70,000	74,000	79,000	84,500	90,500	96,000
36.....	.....	.....	66,000	70,500	75,000	80,000	85,000	91,000	96,500
37.....	.....	Exception	66,500	71,000	76,000	81,000	86,000	92,000	97,000
38.....	.....	.....	67,500	71,500	77,000	82,000	87,500	93,000	98,000
39.....	.....	.....	68,000	72,000	77,500	82,500	88,500	94,000	99,000
40.....	.....	.....	68,500	73,000	78,000	83,500	89,500	95,000	100,000
41.....	.....	.....	69,500	73,500	78,500	84,000	90,000	96,000	101,000
42.....	.....	.....	70,000	74,000	79,000	84,500	90,500	96,500	101,500
43.....	.....	.....	70,500	75,000	80,000	85,000	91,000	97,000	102,000
44.....	.....	.....	71,500	75,500	80,500	85,500	91,500	97,500	102,500
45.....	.....	.....	72,000	76,000	81,000	86,000	92,000	98,000	103,000
46.....	.....	.....	72,500	76,500	81,500	87,000	92,500	98,500	103,500
47.....	.....	.....	73,500	77,500	82,000	87,500	93,000	99,000	104,000
48.....	.....	.....	74,000	78,000	83,000	88,000	93,500	99,500	104,500
49.....	.....	.....	74,500	78,500	83,500	88,500	94,000	100,000	105,000
50.....	.....	.....	75,500	79,000	84,000	89,000	94,500	100,500	105,500
51.....	.....	.....	76,000	80,000	84,500	89,500	95,000	101,000	106,000
52.....	.....	.....	76,500	80,500	85,000	90,000	95,500	101,500	106,500
53.....	.....	.....	77,500	81,000	86,000	91,000	96,500	102,000	107,000
54.....	.....	.....	78,000	81,500	86,500	91,500	97,000	102,500	107,500
55.....	.....	.....	78,500	82,500	87,000	92,000	97,500	103,000	108,000
56.....	.....	Interstate Gross Weight Limit	79,500	83,000	87,500	92,500	98,000	103,500	108,500
57.....	.....	.....	80,000	83,500	88,000	93,000	98,500	104,000	109,000
58.....	.....	.....	.....	84,000	89,000	94,000	99,000	104,500	109,500
59.....	.....	.....	.....	85,000	89,500	94,500	99,500	105,000	110,000
60.....	.....	.....	.....	85,500	90,000	95,000	100,500	105,500	110,500

Figure A.1. Federal Bridge Formula Table (from Vehicle Sizes and Weights Handbook , J.J. Keller & Associates, Inc., 2015).

To illustrate use of the table, assume the following axle weights for a 5 axle truck: steering axle 10.5 k; tandem drive axles 32.4 k; tandem trailer axles 33.2 k; GVW 76.1 k. Axle spacings are: 1-5: 51'; 1-3: 20'; 2-5: 35'. First check axles 1-5. For  $L=51$  and  $N=5$ , maximum load=80 k. Since the truck GVW=76 k, ok. Second, check axles 1-3 (steer and drive axles). For  $L = 20$  and  $N=3$ , maximum load = 51 k. Since axles 1-3 weigh  $10.5+32.4= 42.9$  k, ok. Finally, check axles 2-5. For  $L=35$  and  $N=4$ , maximum load = 65 k. Since axles 2-5 weigh  $32.4+33.2 = 65.6$  k, the limit is exceeded.

## APPENDIX B. FEDERALLY DESIGNATED ROUTES IN MICHIGAN

Route	From	To
I-75 Conn	US 24BR Pontiac	I-75.
US 2	WI State Line Ironwood	WI State Line S. of Crystal Falls.
US 2	WI State Line Iron Mountain	I-75 St. Ignace.
US 8	US 2 Norway	WI State Line.
US 10	Ludington	I-75 Bay City.
US 12	IN State Line	I-94 W. Jct. Ypsilanti.
US 23	OH State Line	I-75 Mackinaw City.
US 24	OH State Line	MI 15 Waterford.
US 24BR	US 24 S. of Pontiac	MI 1 Pontiac.
US 27	IN State Line	I-75 S. of Grayling.
US 31	IN State Line	I-75 Mackinaw City.
US 33	IN State Line	US 12 Niles.
US 41	WI State Line	Houghton.
US 45	WI State Line	MI 26 Rockland.
US 127	OH State Line	I-69/US 27 N. of Lansing.
US 131	IN State Line	US 31 Petoskey.
US 141	WI State Line S. of Crystal Falls	US 41/MI 28.
US 223	US 23	US 12/127 Somerset.
MI 10	I-375 Detroit	Orchard Lake Road.
MI 13	I-69 Lennon	I-75 Saginaw (via MI 81).
MI 13	I-75 Kawkawlin (via I-75 Conn.)	US 23 Standish.
MI 14	I-94 Ann Arbor	I-96/275 Plymouth.
MI 15	US 24 Clarkston	MI 25 Bay City.
MI 18	US 10	MI 61 Gladwin.
MI 20	US 31 New Era	MI 37 White Cloud.
MI 20	US 27 Mt. Pleasant	US 10 Midland.
MI 21	I-96 near Grand Rapids	I-69 Flint.
MI 24	I-75 Auburn Hills (via I-75 Conn.)	I-69 Lapeer.
MI 24	MI 46	MI 81 Caro.
MI 26	US 45 Rockland	MI 38.
MI 27	I-75	US 23 Cheboygan.
MI 28	US 2 Wakefield	I-75.
MI 32	Hillman	Alpena.
MI 33	Mio	Fairview.
MI 35	US 2/41 Escanaba	US 2/41 Gladstone.

MI 36	US 127 Mason	Dansville.
MI 37	MI 55	US 31/MI 72 Traverse City.
MI 37	I-96 Grand Rapids	MI 46 Kent City.
MI 38	US 45 Ontonagon	US 41 Baraga.
MI 39	I-75 Lincoln Park	MI 10 Southfield.
MI 40	MI 89 Allegan	US 31BR/I-196BL Holland.
MI 43	MI 37 Hastings	US 127 Lansing.
MI 46	US 131 Howard City	MI 25 Port Sanilac.
MI 47	I-675 Saginaw (via MI 58)	US 10.
MI 50	MI 43/66 Woodbury	MI 99 Eaton Rapids.
MI 50	US 127 S. Jet	I-75 Monroe.
MI 51	US 12 Niles	I-94.
MI 52	OH State Line	US 12 Clinton.
MI 52	I-96 Webberville	MI 46 W. of Saginaw.
MI 53	MI 3 Detroit	MI 25 Port Austin.
MI 55	US 31 Manistee	I-75.
MI 55	MI 65	US 23 Tawas City.
MI 57	US 131 N. of Rockford	US 27.
MI 57	MI 52 Chesaning	I-75 Clio.
MI 59	US 24 BR Pontiac	I-94.
MI 60	MI 62 Cassopolis	I-69/US 27.
MI 61	MI 115	US 27 Harrison.
MI 61	MI 18 Gladwin	US 23 Standish.
MI 63	US 31 Scottdale	I-196.
MI 65	US 23 Omer	MI 55.
MI 65	MI 72 Curran	MI 32.
MI 65	Posen	US 23 N. of Posen.
MI 66	IN State Line	US 12 Sturgis.
MI 66	Battle Creek	MI 78.
MI 66	MI 43/50 Woodbury	MI 46 Edmore.
MI 67	US 41 Trenary	MI 94 Chatham.
MI 68	US 31/131 Petoskey	US 23 Rogers City.
MI 69	US 2/141 Crystal Falls	MI 95 Sagola.
MI 72	US 31/MI 37 Traverse City	US 23 Harrisville.
MI 77	US 2	MI 28 Seney.
MI 78	MI 66	I-69 Olivet.
MI 81	MI 24 Caro	MI 53.
MI 82	MI 37 S. Jct. Newago	US 131.
MI 83	Frankenmuth	I-75.

MI 84	I-75	MI 25 Bay City.
MI 89	MI 40 Allegan	US 131.
MI 94	US 41	MI 28 Munising.
MI 95	US 2 Iron Mountain	US 41/MI 28.
MI 104	US 31 Grand Haven	I-96.
MI 115	US 27	MI 22 Frankfort.
MI 117	US 2 Engadine	MI 28.
MI 123	I-75 N. of St. Ignace	MI 28.
MI 142	MI 25 Bay Port	MI 53.
MI 205	IN State Line	US 12 W. of Union.



## APPENDIX C. SUMMARY OF MICHIGAN STATE POLICE INTERVIEW

### Q1. What are the criteria used to stop a suspected overweight vehicle?

A vehicle is stopped either by examination of WIM data (see Q4) or by the officer's experience in observing characteristics of overweight vehicles. Some of these characteristics include the presence of a large load on the truck; excessive tire deformation; hot tires; and trucks that appear to have operating difficulties.

### Q2. How is the actual truck configuration (size and weight) determined?

Dimensions are measured with a tape measure or roller wheel. Wheel weights can be measured with a portable scale with 25 kip capacity (see Figure 1), or a large platform scale available at weigh stations that can weigh cumulative axle weights as the truck moves over the platform. For platform weighing, moving vehicles often increase scale weight readings, and the allowable weight is increased slightly. For example, the legal limit of 34 kips for two tandem axles is increased to 36 kips during platform weight checking. Tire pressure can be determined with a pressure gauge or from tire width and axle weight measurements



Figure C.1. Portable Scale.

### Q3. Are data available providing the weight and truck configurations found?

Only ticket fines are recorded, not configurations or weight. A common occurrence is that a vehicle is within GVW limitations, but an axle(s) exceeds its weight limits; i.e. the load is not properly distributed.

### Q4. How is WIM data used for enforcement?

Officers located near WIM stations may monitor passing vehicles in their police car. The data available are axle weight, axle spacing and GVW. The officer is notified of potential overweight axles.

**Q5. What types of permit are available?**

Two types of permits are available: a single permit and an extended (annual) permit.

**Q6. If a vehicle has a permit, is it allowed to move through all routes?**

Permits are issued for a specific route only. If an officer stops a permit vehicle, all permit information is verified including date, GVW, axle spacing, and route. Vehicles travelling off-route, over-speed, or otherwise exceed permit limitations are treated as an illegal vehicle and the permit is terminated. Appropriate enforcement rules are applied to each type of route (e.g. special designated; designated; etc).

**Q7. Is it a common occurrence that permit vehicles exceed the limitations of their permit?**

No, the majority of trucks have the same weight and axle spacing as it appears on the permit.

**Q8. What criteria are used to determine permit vehicle weight and axle spacing limitations?**

MSP follow the *Size and Weight Guide* (internal MSP document) which specifies limitations for different types of vehicles.

**Q9. What rules apply to vehicles that have the ability to raise axles?**

Drivers are allowed to lift axles if no limits are exceeded.

**Q10. Do you have any recommendations for bridge posting or how to consider the effects of side-by-side vehicles?**

None.

**Q11. Are there vehicles which are always allowed?**

Implements of husbandry if not loaded on a trailer, and salt trucks.

## APPENDIX D. SUMMARY OF INTERVIEW WITH MTA

To gather information on Michigan truck configurations, an interview was conducted in September, 2016 with the Michigan Trucking Association Executive Director. Questions and answers are as follows.

### Q1. What are the extreme vehicle configurations available (i.e. causing the greatest load effects)?

Unknown; this information might be obtained from MDOT and the State Police.

### Q2. What are common current vehicle configurations and trends for future vehicles, with particular consideration to heavy vehicles?

Five axle trucks (with trailer lengths of 48' and 53') are the most common type. In addition, twins (a truck-tractor having two 28.5' trailers) are common. Currently, 5 axle trucks on interstate highways are preferred, as such configurations work best with the Bridge Formula.

Heavier trucks are expected in the future. For example, it is predicted that the current 80 kip federal limit will be increased to 95 kips for interstate highways. If this occurs, an increased number of 6-axle trucks are expected (Figure D.1).

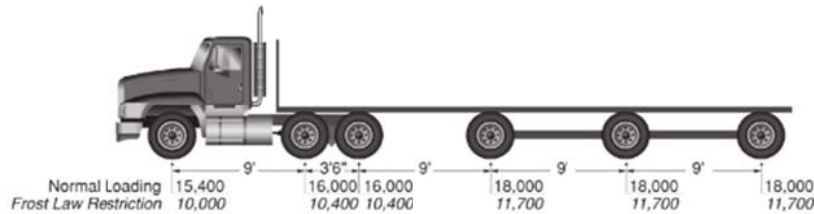

(a) MDOT Truck No. 6.

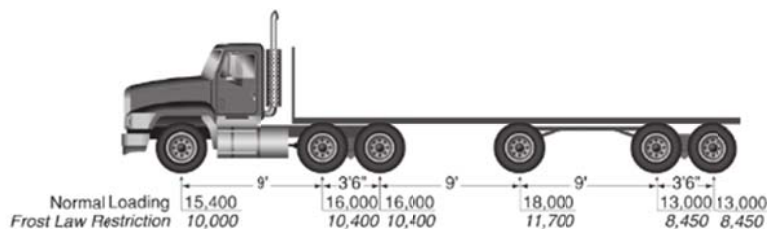

(b) MDOT Truck No. 8.

Figure D.1. Common Six-Axle Truck Configurations (from Truck Driver's GuideBook, MCTS, 2015).

A small percentage of existing vehicles (about 1% of trucks; approximately 600-700 vehicles) have 11 axles. It is not expected that this weight limitation will be reduced in the future nor that the axle configuration will change. These trucks are for specialized business interests such as

farming and construction. The maximum GVW for these trucks is 164 kips, although most are under 154 GVW. Although legal in Michigan, these vehicles require permits to go through neighboring states such as Wisconsin, Ohio, and Indiana. The most common configurations are shown in Figure D.2.

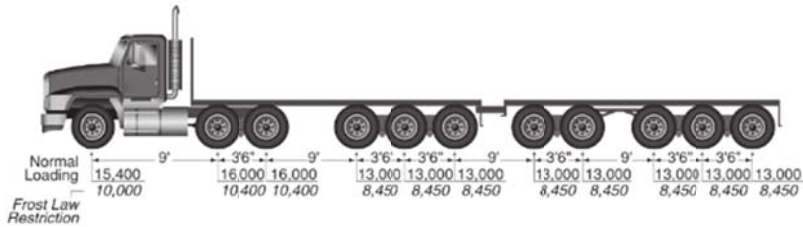

(a) MDOT Truck No. 21.

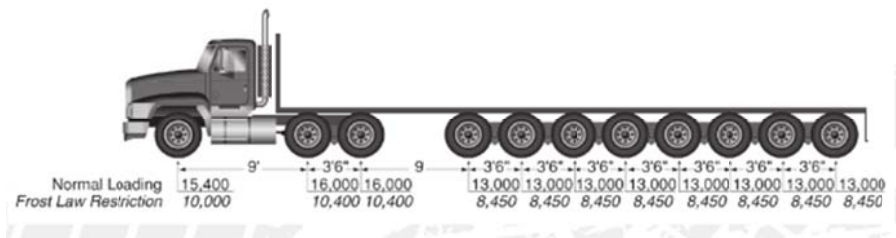

(b) MDOT Truck No. 17.

Figure D.2. Common Eleven-Axle Truck Configurations (from Truck Driver’s GuideBook, MCTS, 2015).

**Q3. Do you have concerns or recommendations for how bridges are posted?**

No particular concerns. However, it is recommended that MDOT also post maximum axle weights for Spring restrictions. Note that when applying for a permit, the carrier is responsible to make sure that his vehicle can pass over the bridges on the route. This will be verified by MDOT before the permit is issued.

## APPENDIX E. EXTENDED PERMIT HAULER SURVEY

### Survey

The following survey was submitted to a selection of haulers:

1. Have you ever applied for an extended permit for construction vehicles and if so, how often do you typically drive these vehicles in Michigan?
2. What are the axle weights and axle spacing of the heaviest extended permit vehicle(s) (including cargo) that you operate in Michigan? Please provide configuration diagram, if possible.
3. Do you anticipate any changes to these vehicles (configurations, weights, time, frequency of operation) in the next ten years? Please describe.

### Responses

#### Question 1 Responses

As far as how often we move these loads it varies greatly depending on job schedule and progress.

Yes. Drive time with the loads vary upon work load. ( Three times a week.)

#### Question 2 Responses

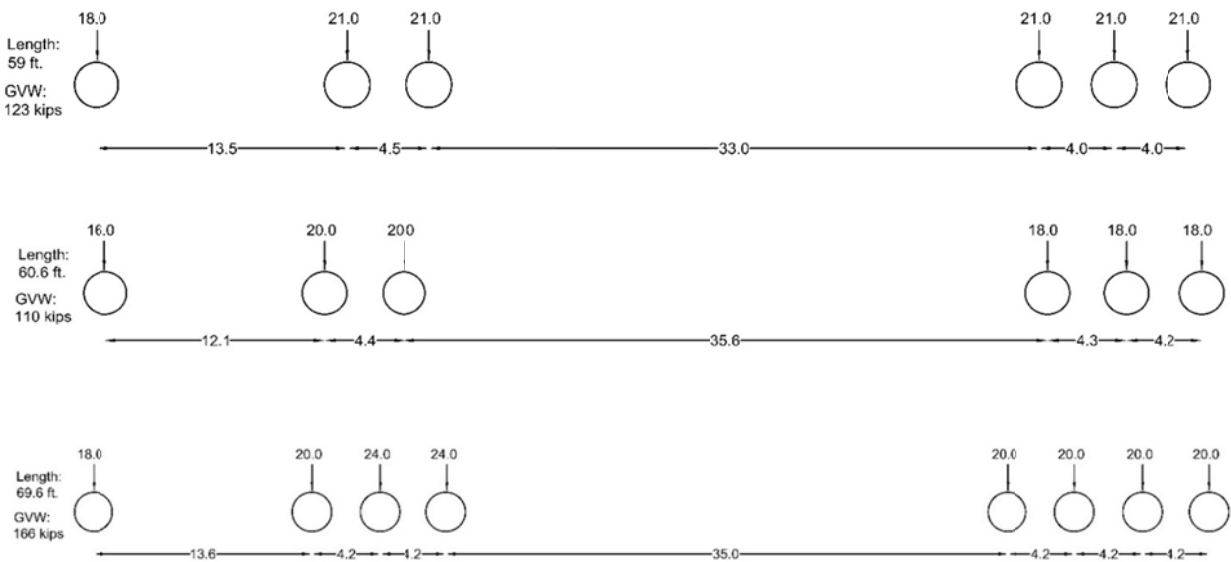

### Question 3 Responses

Yes, we update equipment yearly so weights and configurations change.

We have much heavier loads but they require Single trip permits from MDOT.

## APPENDIX F. DATA FOR LEGAL AND EXTENDED PERMIT (LEP) VEHICLES

Table F.1. Percentage of LEP Vehicles Recorded By WIM Site.

WIM Site	Percentage	WIM Site	Percentage
1199	0.4	7159	11.9
2029	0.4	7169	6.8
4049	0.8	7219	7.8
5059	2.8	7269	5.9
5099	2.7	8029	1.7
5289	2.4	8839	8.4
6369	3.2	8869	5.0
6429	1.5	9189	6.1
6469	3.3	9209	7.1
7029	7.9	9699	13.8
		Total	100

Table F.2. Yearly Statistics for Legal and Extended Permit Vehicles.

Year:	2014			2015			2016		
No. Vehicles	23,886,714			30,480,144			34,576,315		
	No. Axles	Length (ft)	GVW (kips)	No. Axles	Length (ft)	GVW (kips)	No. Axles	Length (ft)	GVW (kips)
Mean	5	54.1	52.1	5	54.3	51.1	5	54.0	51.1
Median	5	58.3	47.2	5	58.9	46.2	5	59.0	46.3
Mode	5	60.2	32.6	5	60.6	31.6	5	60.6	33.0
Minimum	2	5.0	12.0	2	5.0	12.0	2	5.0	12.0
Maximum	11	89.2	157.5	11	90.0	157.5	11	90.0	157.5
80%	5	61.1	70.7	5	61.7	70.7	5	61.8	71.0
85%	5	61.7	73.6	5	62.3	73.9	5	62.4	74.4
90%	6	62.8	76.8	6	63.3	77.0	6	63.3	77.9
95%	9	65.3	90.1	8	66.0	86.6	8	65.9	84.4
98%	11	69.7	131.4	11	70.1	129.0	11	69.8	127.3
99%	11	73.6	142.5	11	74.3	140.4	11	74.1	140.0
99.9%	11	80.1	155.2	11	80.8	154.8	11	80.7	155.3

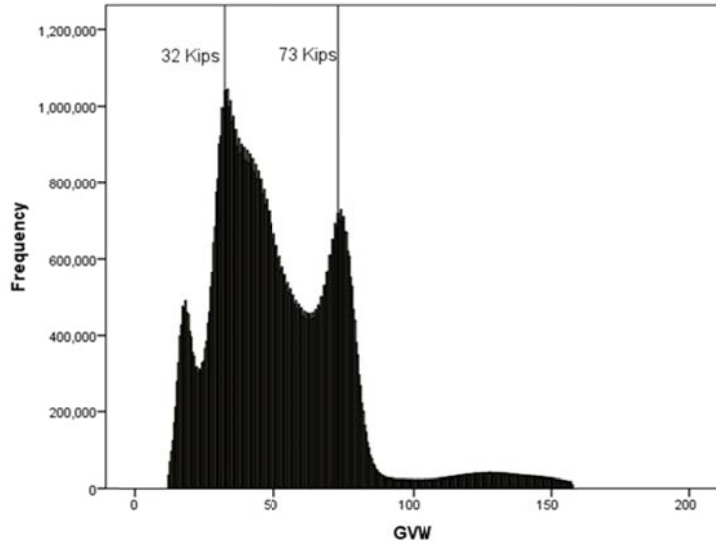

Figure F.1. All LEP GWV (kips) Frequency Histogram.

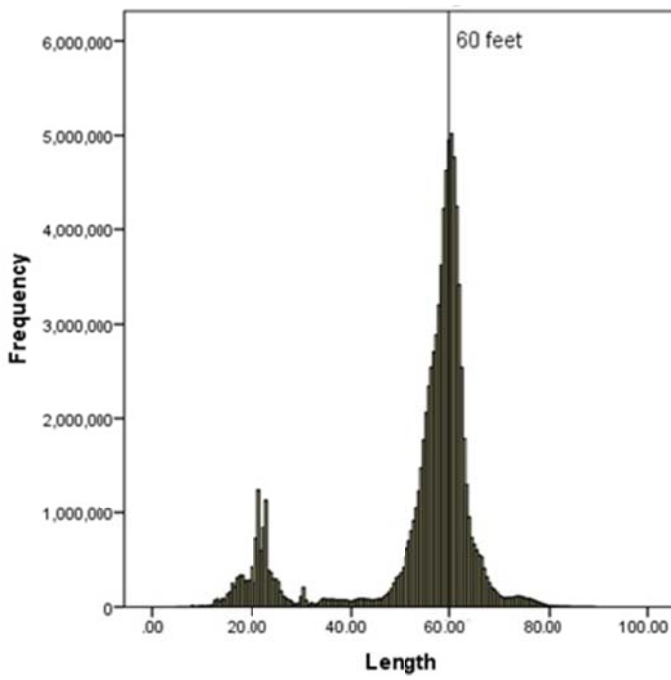

Figure F.2. All LEP Vehicle Length Frequency Histogram.



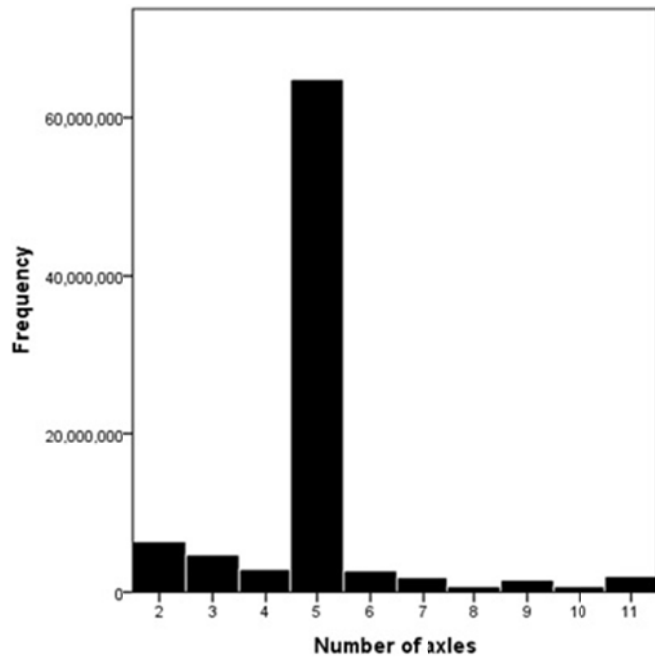

Figure F.3. All LEP Number of Axles Frequency Histogram.

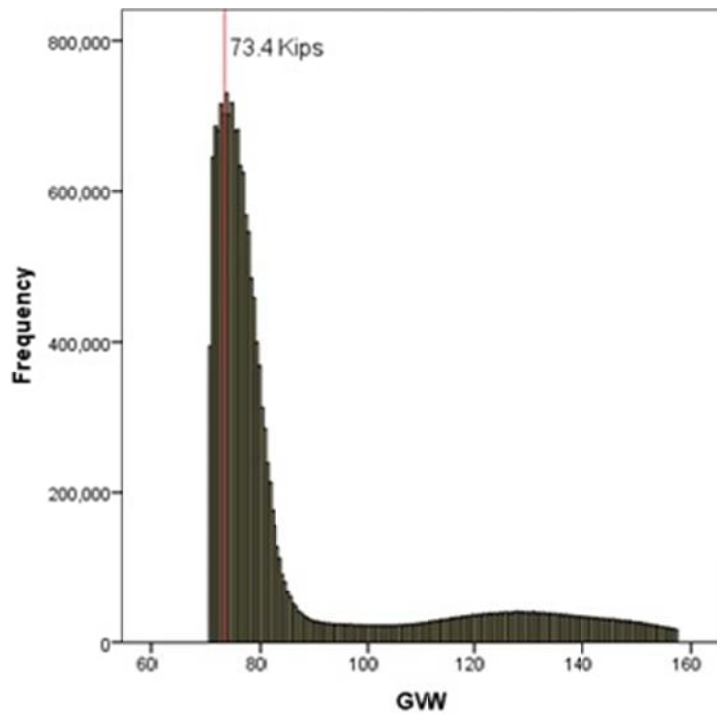

Figure F.4. Top 20% LEP GWV (kips) Frequency Histogram.

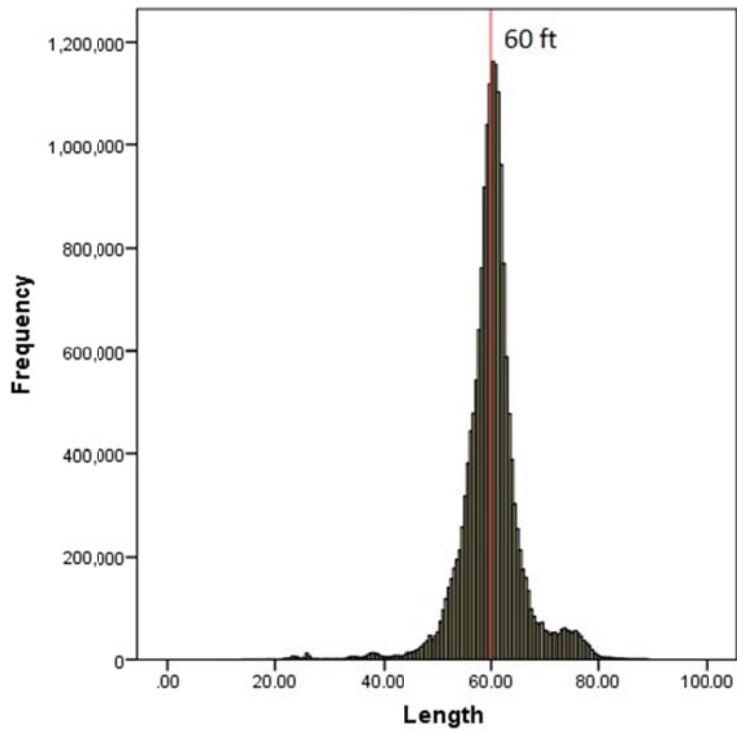

Figure F.5. Top 20% LEP Vehicle Length (ft) Frequency Histogram.

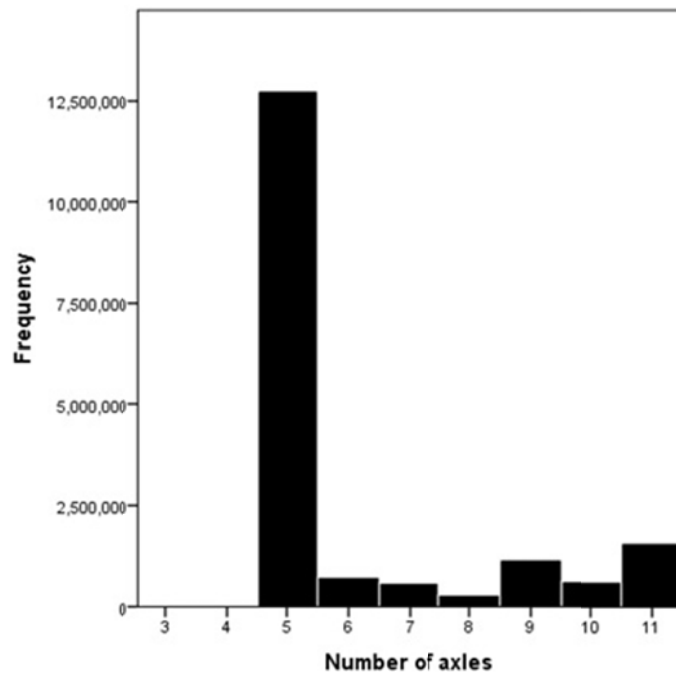

Figure F.6. Top 20% LEP Vehicle Number of Axles Frequency Histogram.

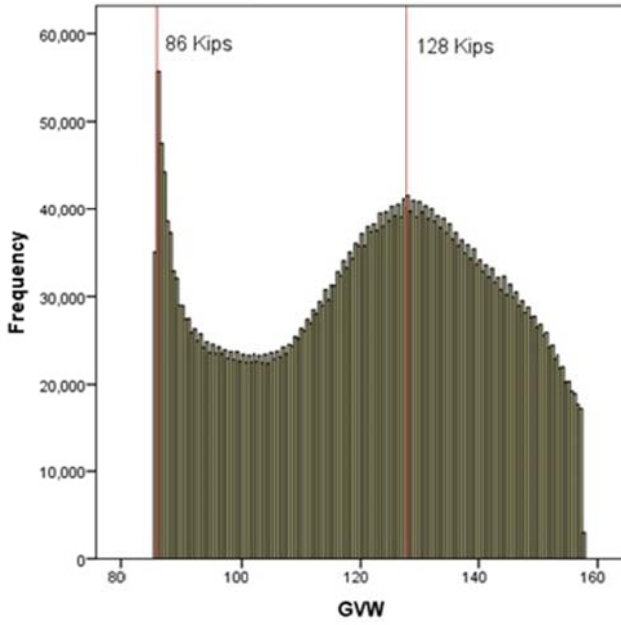

Figure F.7. Top 5% LEP GWV (kips) Frequency Histogram.

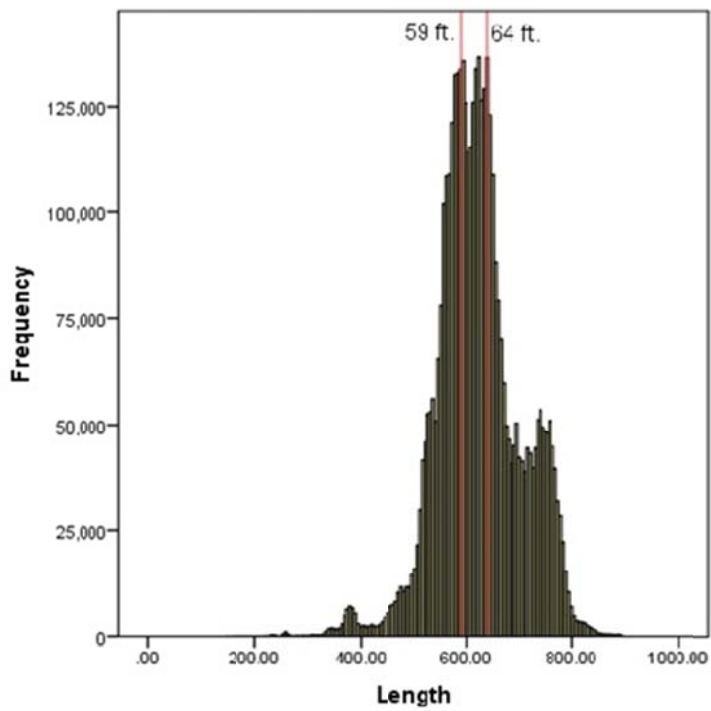

Figure F.8. Top 5% LEP Vehicle Length (ft) Frequency Histogram.

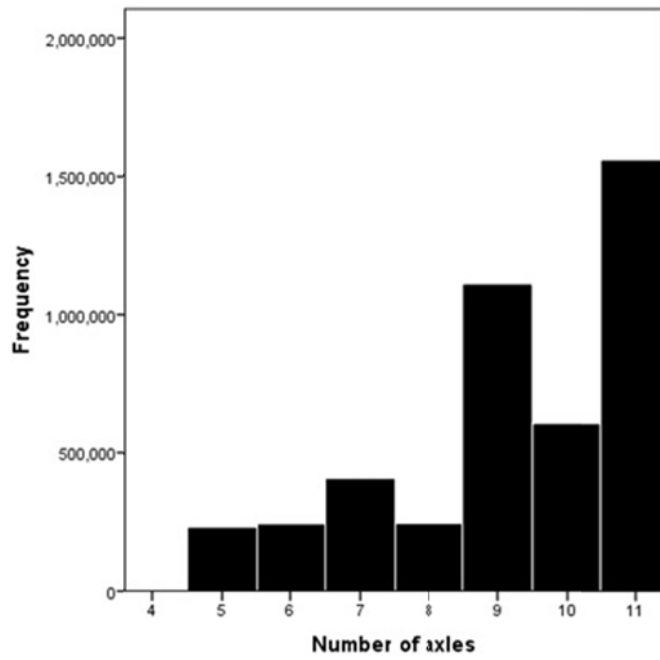

Figure F.9. Top 5% LEP Vehicle Number of Axles Frequency Histogram.

## APPENDIX G. SUMMARY OF VEHICLE LOAD EFFECTS

Table G.1. 2014 Simple Span Moments, Single LEP Vehicles.

	Span (ft) (moment in kip-ft)									
	20	40	60	80	100	120	140	160	180	200
Mean	89	220	388	592	846	1102	1359	1616	1874	2132
Median	82	203	355	532	764	998	1233	1468	1702	1937
Mode	53	108	183	271	324	446	522	621	717	794
Maximum	323	873	1570	2330	3112	3894	4676	5457	6240	7024
80%	123	292	495	761	1107	1455	1805	2156	2507	2858
85%	128	303	515	794	1153	1516	1880	2244	2610	2975
90%	134	317	539	836	1208	1585	1963	2342	2722	3102
95%	142	356	647	1011	1407	1812	2222	2635	3049	3464
98%	159	486	953	1538	2168	2809	3450	4092	4734	5376
99%	172	534	1062	1708	2401	3102	3805	4508	5211	5914
99.9%	209	642	1233	1946	2701	3461	4224	4989	5756	6524
Max MDOT	189	680	1360	2120	2880	3650	4470	5290	6110	6930

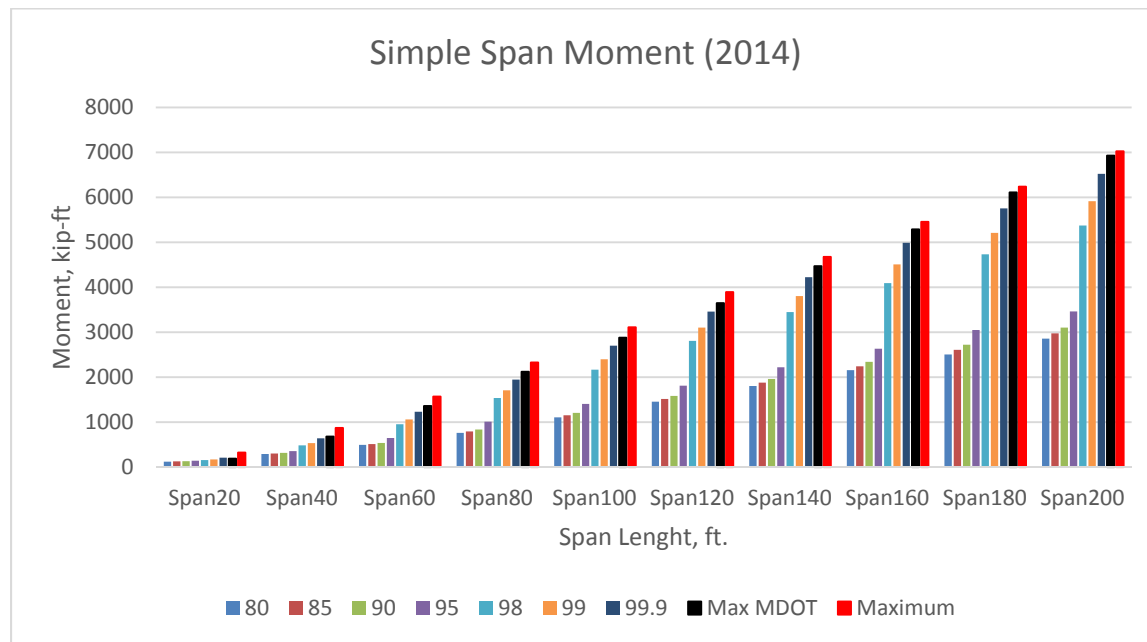

Figure G.1. 2014 Simple Span Moments, Single LEP Vehicles.

Table G.2. 2014 Simple Span Shears, Single LEP Vehicles.

	Span (ft) (shear in kips)									
	20	40	60	80	100	120	140	160	180	200
Mean	20	26	30	34	37	40	41	43	44	45
Median	18	24	27	30	33	36	37	38	39	40
Mode	11	13	14	15	15.8 <sup>a</sup>	15	16	16	16	16
Maximum	74	96	113	123	129	134	137	139	142	143
80%	27	34	39	46	51	54	57	58	60	61
85%	28	35	41	49	54	57	59	61	62	64
90%	30	37	43	51	56	60	62	64	65	66
95%	32	43	54	62	68	72	74	76	78	79
98%	36	56	73	86	95	101	106	109	111	113
99%	39	61	80	94	103	109	114	118	120	123
99.9%	47	70	91	106	115	121	126	129	132	134
Max MDOT	44	76	100	113	121	126	130	133	136	139

<sup>a</sup> Multiple modes exist; the smallest is shown.

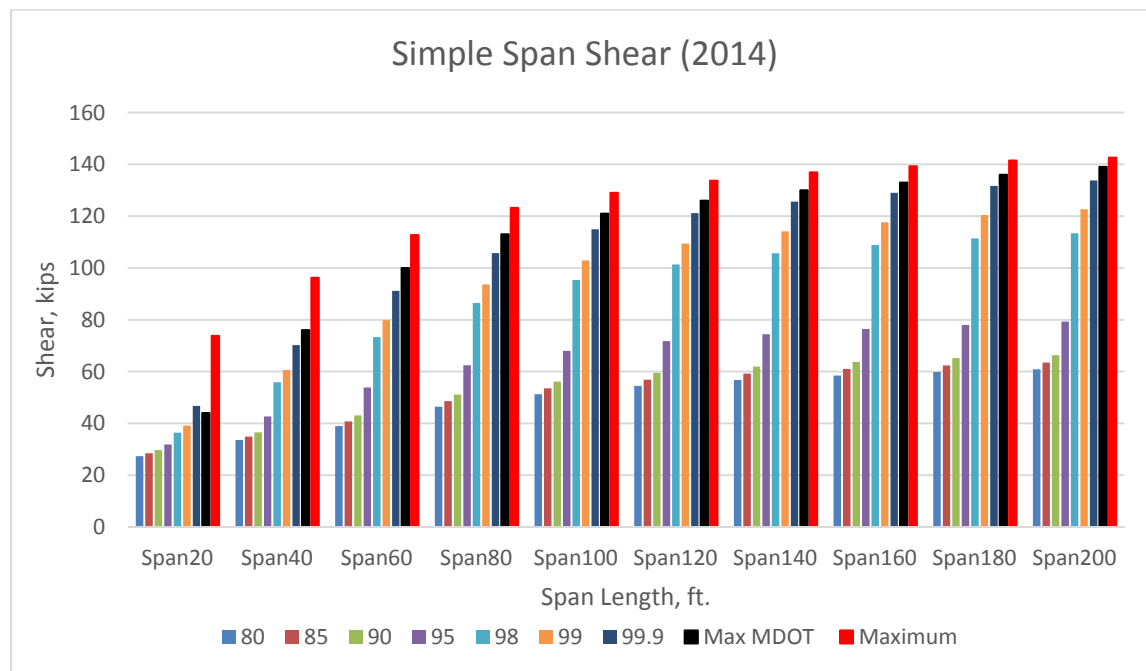

Figure G.2. 2014 Simple Span Shears, Single LEP Vehicles.

Table G.3. 2015 Simple Span Moments, Single LEP Vehicles.

	Span (ft) (moment in kip-ft)									
	20	40	60	80	100	120	140	160	180	200
Mean	88	217	384	583	833	1086	1340	1595	1849	2103
Median	80	198	348	519	746	976	1206	1436	1667	1897
Mode	56	108	470	245	349	446	479	602	689	776
Maximum	317	953	1707	2486	3266	4045	4825	5605	6384	7165
80%	123	291	496	757	1103	1452	1803	2154	2506	2856
85%	128	304	516	790	1151	1515	1882	2249	2616	2982
90%	133	318	541	833	1208	1586	1967	2350	2731	3113
95%	142	359	661	1036	1449	1870	2295	2721	3149	3577
98%	158	480	941	1523	2153	2795	3438	4082	4727	5371
99%	170	527	1046	1687	2374	3074	3774	4475	5175	5876
99.9%	206	635	1222	1927	2677	3435	4196	4959	5724	6491
Max MDOT	189	680	1360	2120	2880	3650	4470	5290	6110	6930

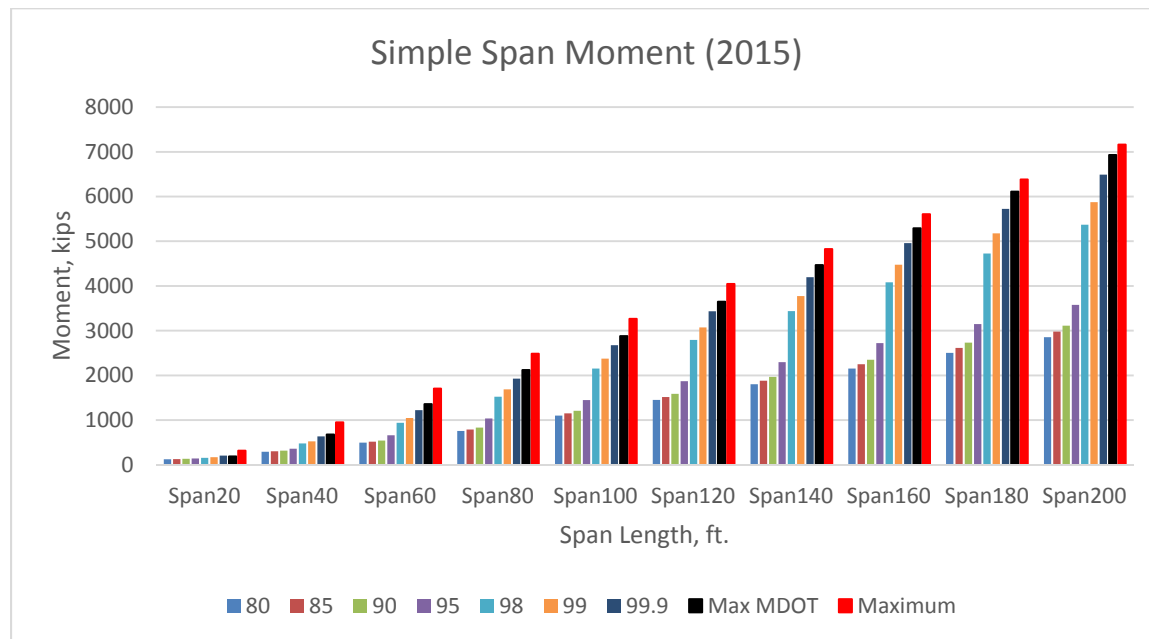

Figure G.3. 2015 Simple Span Moments, Single LEP Vehicles.

Table G.4. 2015 Simple Span Shears, Single LEP Vehicles.

	Span (ft) (shear in kips)									
	20	40	60	80	100	120	140	160	180	200
Mean	19	23	28	33	36	38	40	41	42	43
Median	17	21	25	30	33	35	37	38	39	39
Mode	10	15	18	14	14	15	15	15	16	16
Maximum	72	98	112	121	126	129	131	133	135	138
80%	26	29	37	43	47	51	53	56	57	58
85%	27	31	39	45	49	53	56	58	60	61
90%	29	32	41	47	52	55	58	60	62	63
95%	31	38	47	53	58	61	64	66	68	70
98%	34	50	66	78	85	90	94	97	100	102
99%	37	56	73	85	93	99	103	107	110	112
99.9%	4	66	83	96	105	111	116	120	123	125
Max MDOT	44	76	100	113	121	126	130	133	136	139

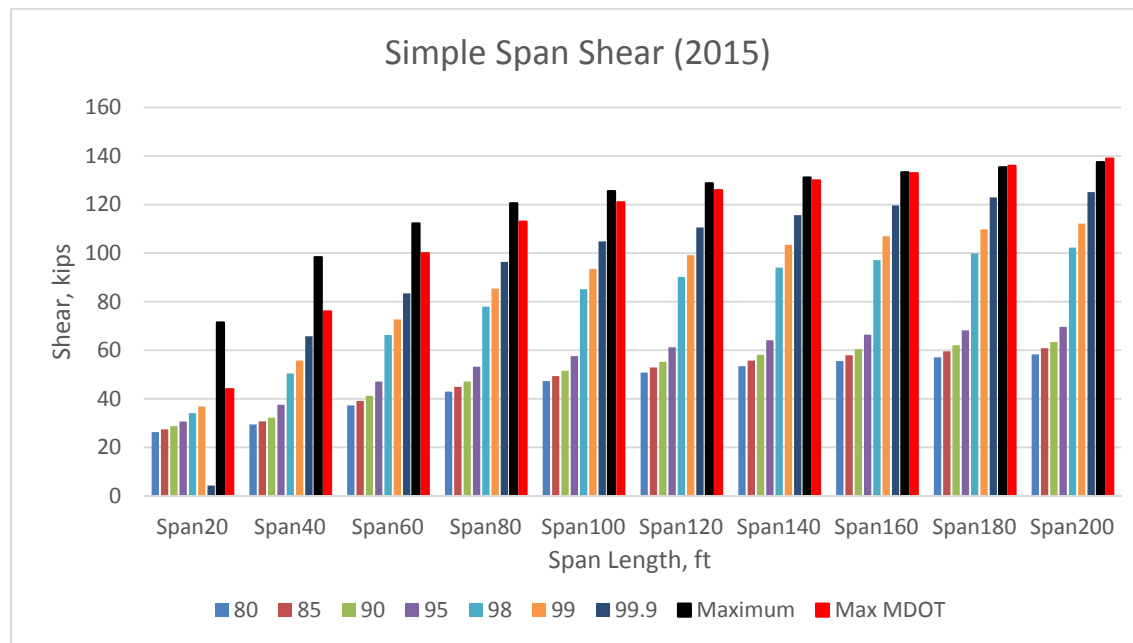

Figure G.4. 2015 Simple Span Shears, Single LEP Vehicles.



Table G.5. 2016 Simple Span Moments, Single LEP Vehicles.

	Span (ft) (moment in kip-ft)									
	20	40	60	80	100	120	140	160	180	200
Mean	88	217	383	581	831	1083	1337	1592	1846	2100
Median	80	198	348	520	747	977	1208	1439	1669	1900
Mode	56	107	453	245	365	464	479	588	673	759
Maximum	316	965	1721	2496	3275	4064	4851	5639	6426	7213
80%	122	292	497	758	1105	1454	1806	2160	2511	2862
85%	128	305	519	794	1157	1523	1892	2263	2631	2999
90%	134	319	544	837	1216	1598	1984	2371	2756	3140
95%	142	350	618	968	1367	1775	2188	2603	3019	3435
98%	156	471	923	1497	2119	2753	3388	4023	4659	5295
99%	168	522	1038	1673	2358	3055	3754	4452	5150	5849
99.9%	206	636	1222	1934	2693	3460	4227	4995	5764	6533
Max MDOT	189	680	1360	2120	2880	3650	4470	5290	6110	6930

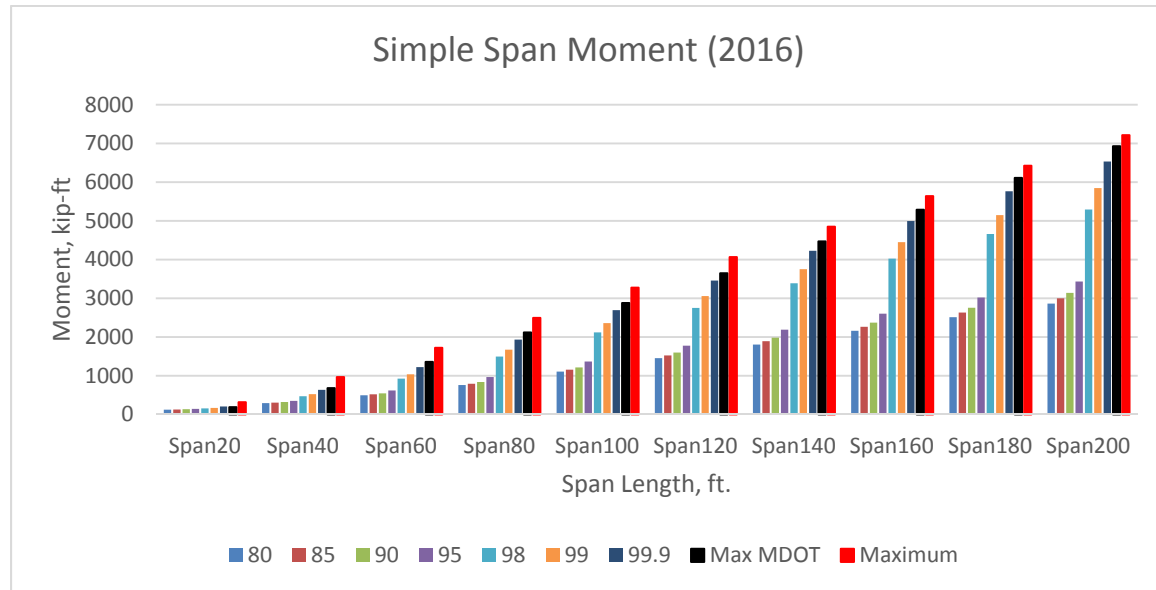

Figure G.5. 2016 Simple Span Moments, Single LEP Vehicles.

Table G.6. 2016 Simple Span Shears, Single LEP Vehicles.

	Span (ft) (shear in kips)									
	20	40	60	80	100	120	140	160	180	200
Mean	19	25	29	33	36	38	40	41	42	43
Median	17	23	26	29	32	34	35	37	38	38
Mode	10	14	15	16	16	15	17	16	16	16
Maximum	70	101	118	130	133	138	140	143	143	145
80%	26	33	38	45	50	53	56	57	59	60
85%	27	34	39	47	52	56	58	60	62	63
90%	29	36	42	50	55	59	61	63	65	66
95%	31	39	47	56	61	65	67	69	71	72
98%	34	51	68	81	90	96	100	103	106	108
99%	36	57	75	89	98	105	110	113	116	118
99.9%	44	67	88	103	113	118	124	128	130	132
Max MDOT	44	76	100	113	121	126	130	133	136	139

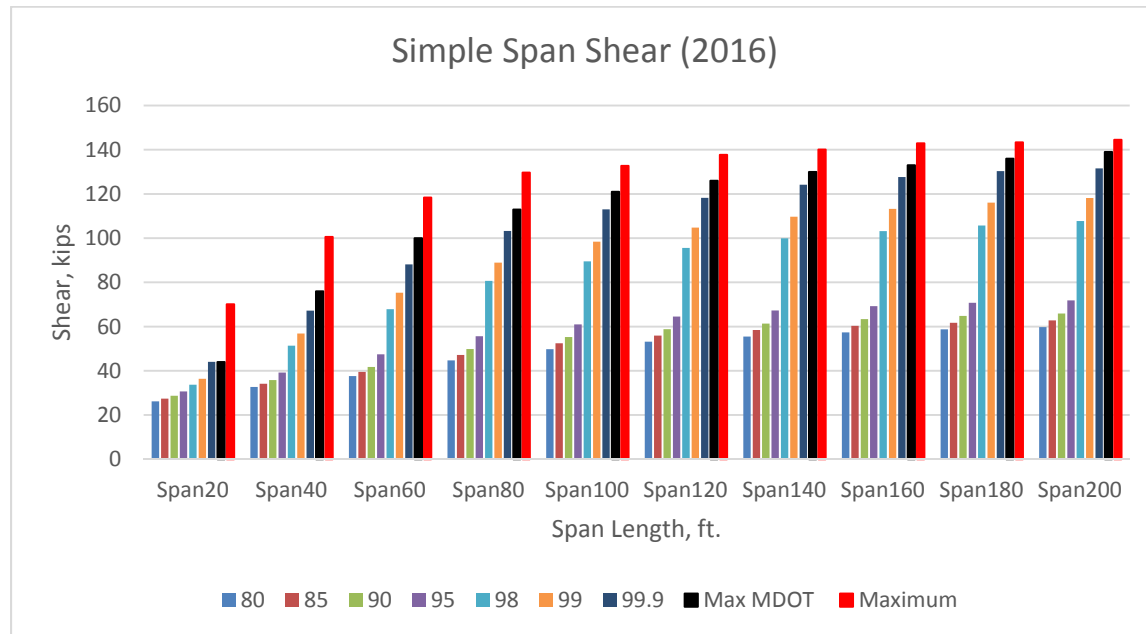

Figure G.6. 2016 Simple Span Shears, Single LEP Vehicles.

Table G.7. 2014 Continuous Span Moments, Single LEP Vehicles.

	Span (ft) (moment in kip-ft)									
	20	40	60	80	100	120	140	160	180	200
Mean	-59	-165	-268	-340	-410	-520	-631	-739	-846	-951
Median	-55	-149	-247	-312	-369	-468	-569	-667	-764	-860
Mode	-29	-61	-87	-114	-158	-188	-231	-263	-300	-334
Maximum	-220	-558	-871	-1161	-1400	-1721	-2037	-2350	-2661	-2970
80%	-75	-231	-374	-460	-540	-695	-848	-996	-1142	-1286
85%	-78	-241	-390	-479	-563	-724	-883	-1038	-1190	-1340
90%	-82	-253	-406	-500	-589	-757	-922	-1083	-1242	-1398
95%	-95	-285	-445	-566	-738	-927	-1115	-1300	-1482	-1663
98%	-124	-382	-590	-789	-1063	-1345	-1621	-1891	-2158	-2422
99%	-136	-410	-633	-857	-1159	-1465	-1763	-2056	-2344	-2631
99.9%	-156	-458	-689	-950	-1280	-1605	-1924	-2240	-2553	-2864
Max MDOT	-170	-482	-716	-1008	-1339	-1692	-2036	-2373	-2705	-3034

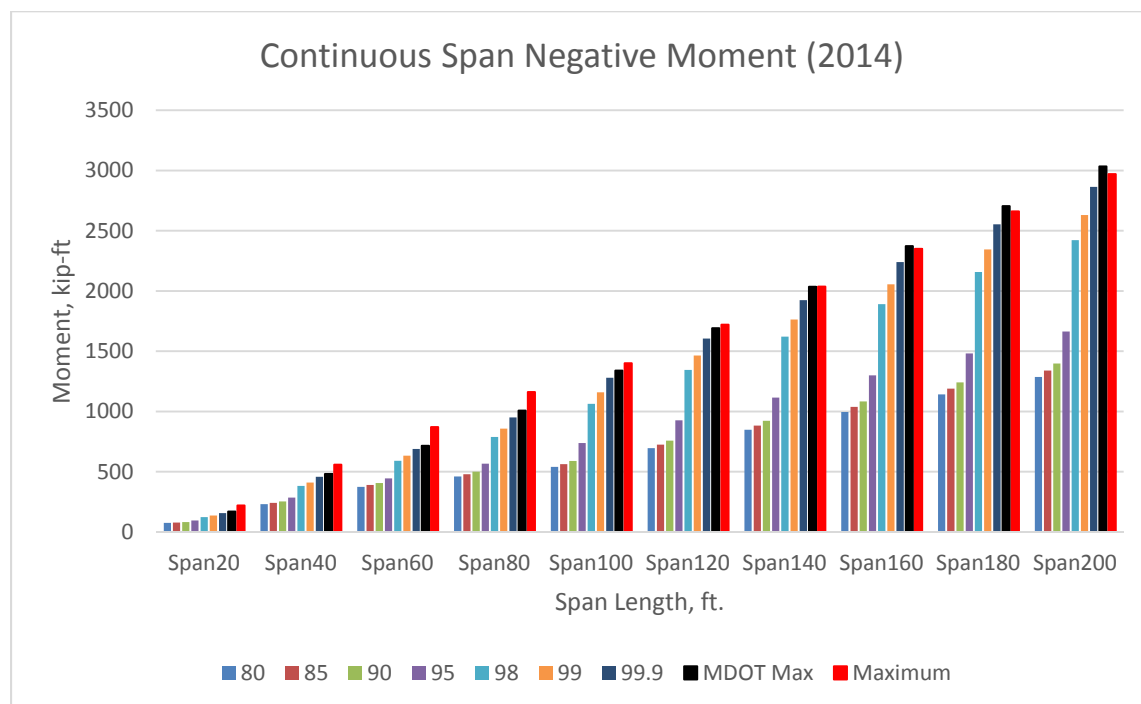

Figure G.7. 2014 Continuous Span Moments, Single LEP Vehicles.

Table G.8. 2014 Continuous Span Shears, Single LEP Vehicles.

	Span (ft) (shear in kips)									
	20	40	60	80	100	120	140	160	180	200
Mean	25	35	44	47	49	50	50	51	51	51
Median	23	31	39	42	44	45	46	46	46	46
Mode	32	17	17	18	17	16	15	16	16	17
Maximum	110	138	147	151	154	155	155	156	156	156
80%	33	45	58	63	66	67	68	69	69	69
85%	34	47	61	66	69	70	71	72	72	72
90%	36	50	64	69	72	73	74	75	75	75
95%	44	67	78	83	85	87	88	88	89	89
98%	60	96	114	121	124	126	128	129	129	130
99%	66	105	124	132	135	137	139	140	140	141
99.9%	78	118	136	143	147	150	151	152	153	153
Max MDOT	88	127	144	152	156	159	160	161	162	162

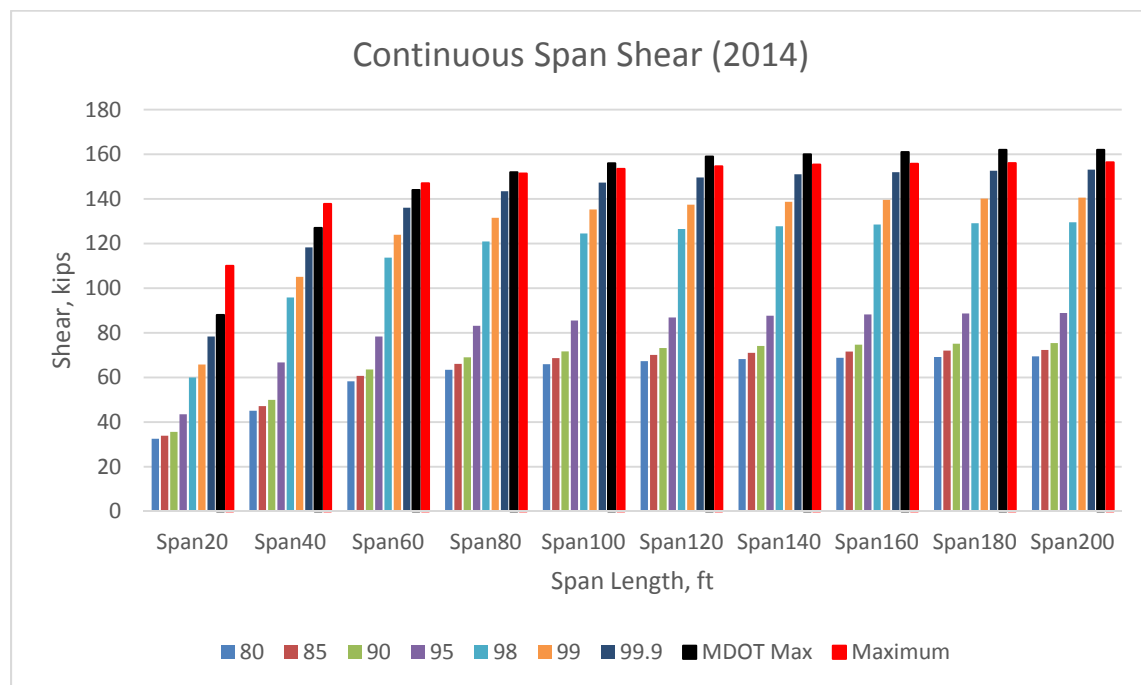

Figure G.8. 2014 Continuous Span Shears, Single LEP Vehicles.

Table G.9. 2015 Continuous Span Moments, Single LEP Vehicles.

	Span (ft) (moment in kip-ft)									
	20	40	60	80	100	120	140	160	180	200
Mean	-59	-161	-264	-336	-403	-510	-619	-725	-830	-934
Median	-55	-145	-242	-307	-363	-458	-557	-653	-748	-842
Mode	-28	-60.2 <sup>a</sup>	-84.4 <sup>a</sup>	-120	-156	-178	-224	-259	-308	-309.3 <sup>a</sup>
Maximum	-216	-550	-870	-1142	-1436	-1747	-2055	-2361	-2665	-2969
80%	-75	-229	-375	-462	-540	-693	-846	-995	-1141	-1285
85%	-78	-240	-392	-483	-563	-724	-884	-1039	-1192	-1343
90%	-82	-252	-408	-504	-589	-757	-923	-1085	-1244	-1401
95%	-92	-279	-442	-556	-695	-877	-1058	-1237	-1413	-1588
98%	-120	-374	-582	-771	-1037	-1316	-1587	-1854	-2116	-2376
99%	-133	-404	-627	-842	-1136	-1438	-1733	-2022	-2307	-2589
99.9%	-154	-454	-689	-940	-1268	-1592	-1911	-2227	-2541	-2851
Max MDOT	-170	-482	-716	-1008	-1339	-1692	-2036	-2373	-2705	-3034

<sup>a</sup> Multiple modes exist; the smallest is shown.

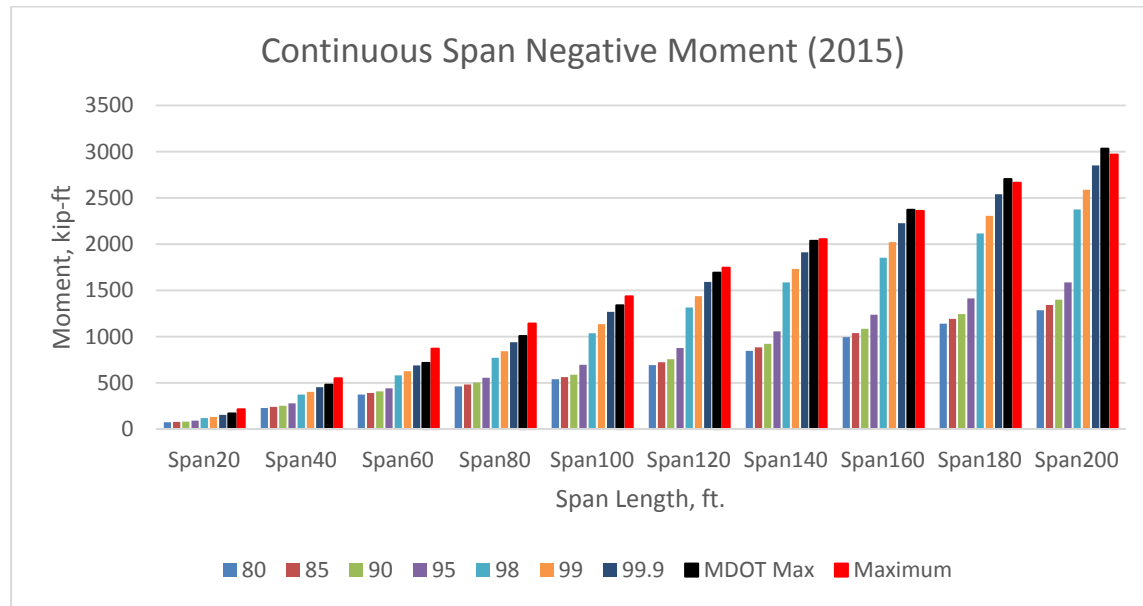

Figure G.9. 2015 Continuous Span Moments, Single LEP Vehicles.

Table G.10. 2015 Continuous Span Shears, Single LEP Vehicles.

	Span (ft) (shear in kips)									
	20	40	60	80	100	120	140	160	180	200
Mean	25	34	43	46	48	49	49	50	50	50
Median	23	30	38	42	43	44	45	45	45	45
Mode	32	16	17	17	17	16	16.1 <sup>a</sup>	16	16	17
Maximum	116	143	150	153	154	154	155	156	156	156
80%	33	45	58	63	66	67	68	69	69	69
85%	34	47	61	66	69	70	71	72	72	73
90%	36	49	63	69	72	73	74	75	75	76
95%	42	62	74	79	82	83	84	85	85	85
98%	58	93	111	118	122	124	125	126	127	127
99%	64	103	122	129	133	135	137	137	138	138
99.9%	77	117	135	143	147	149	150	151	152	153
Max MDOT	88	127	144	152	156	159	160	161	162	162

<sup>a</sup> Multiple modes exist; the smallest is shown.

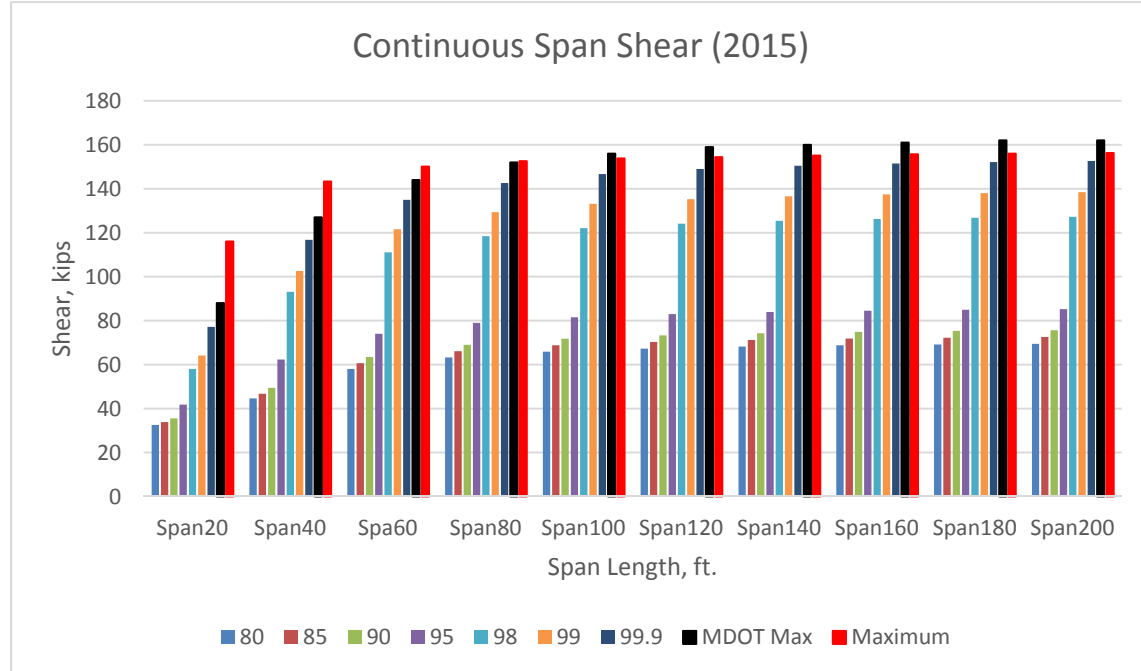

Figure G.10. 2015 Continuous Span Shears, Single LEP Vehicles.

Table G.11. 2016 Continuous Span Moments, Single LEP Vehicles.

	Span (ft) (moment in kip-ft)									
	20	40	60	80	100	120	140	160	180	200
Mean	-59	-161	-265	-336	-402	-509	-618	-725	-830	-933
Median	-55	-145	-243	-308	-364	-458	-558	-655	-750	-844
Mode	-29	-59	-83	-118	-153	-202	-224	-253	-305	-304
Maximum	-220	-549	-870	-1134	-1449	-1763	-2074	-2383	-2691	-2997
80%	-76	-229	-376	-464	-542	-695	-849	-998	-1145	-1290
85%	-79	-242	-394	-487	-568	-729	-890	-1047	-1201	-1353
90%	-83	-254	-413	-510	-595	-764	-932	-1096	-1257	-1416
95%	-90	-276	-442	-551	-660	-840	-1019	-1195	-1368	-1540
98%	-118	-369	-575	-761	-1024	-1299	-1567	-1830	-2089	-2345
99%	-132	-403	-627	-839	-1131	-1432	-1727	-2015	-2299	-2581
99.9%	-154	-458	-692	-946	-1279	-1607	-1927	-2243	-2556	-2866
Max MDOT	-170	-482	-716	-1008	-1339	-1692	-2036	-2373	-2705	-3034

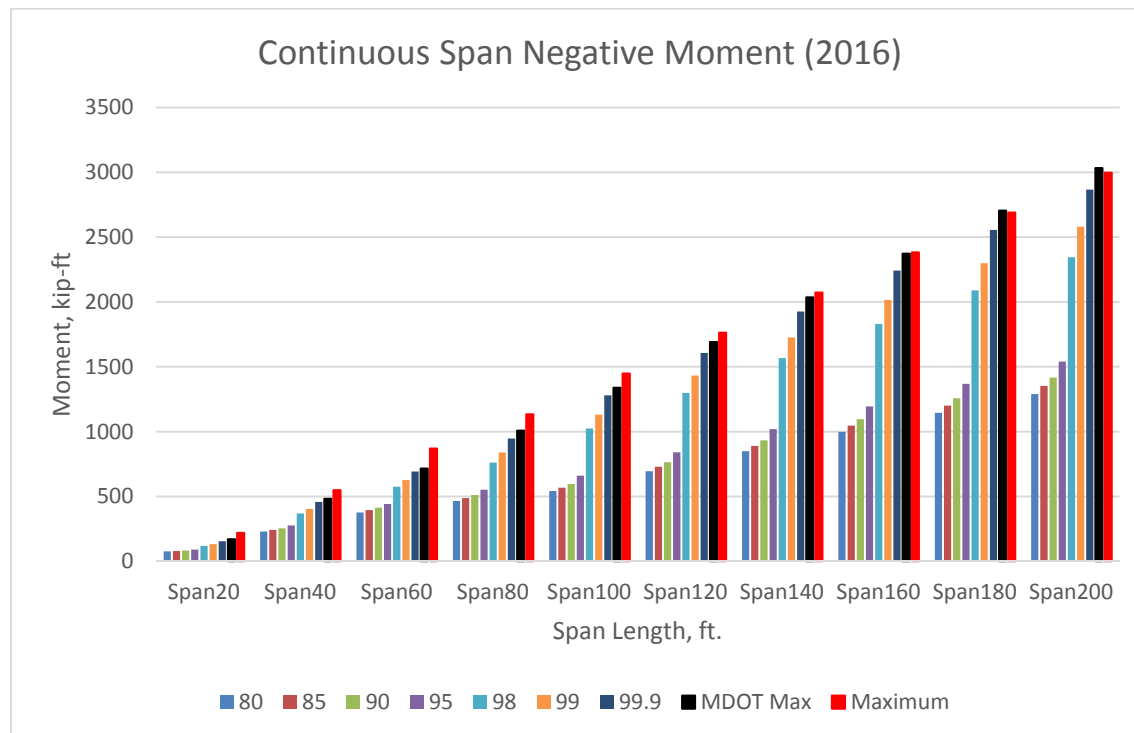

Figure G.11. 2016 Continuous Span Moments, Single LEP Vehicles.

Table G.12. 2016 Continuous Span Shears, Single LEP Vehicles.

	Span (ft) (shear in kips)									
	20	40	60	80	100	120	140	160	180	200
Mean	25	34	43	46	48	49	49	50	50	50
Median	23	30	38	42	43	44	45	45	45	46
Mode	34	16	17	17	17	17	17	17	17	17
Maximum	117	145	151	154	155	156	156	157	157	157
80%	33	45	58	64	66	68	68	69	69	70
85%	34	47	61	67	69	71	72	72	73	73
90%	36	50	64	70	73	74	75	76	76	77
95%	40	58	71	76	79	81	82	82	83	83
98%	57	92	110	117	121	123	124	125	125	126
99%	64	102	121	129	133	135	136	137	138	138
99.9%	77	118	136	144	147	150	151	152	153	153
Max MDOT	88	127	144	152	156	159	160	161	162	162

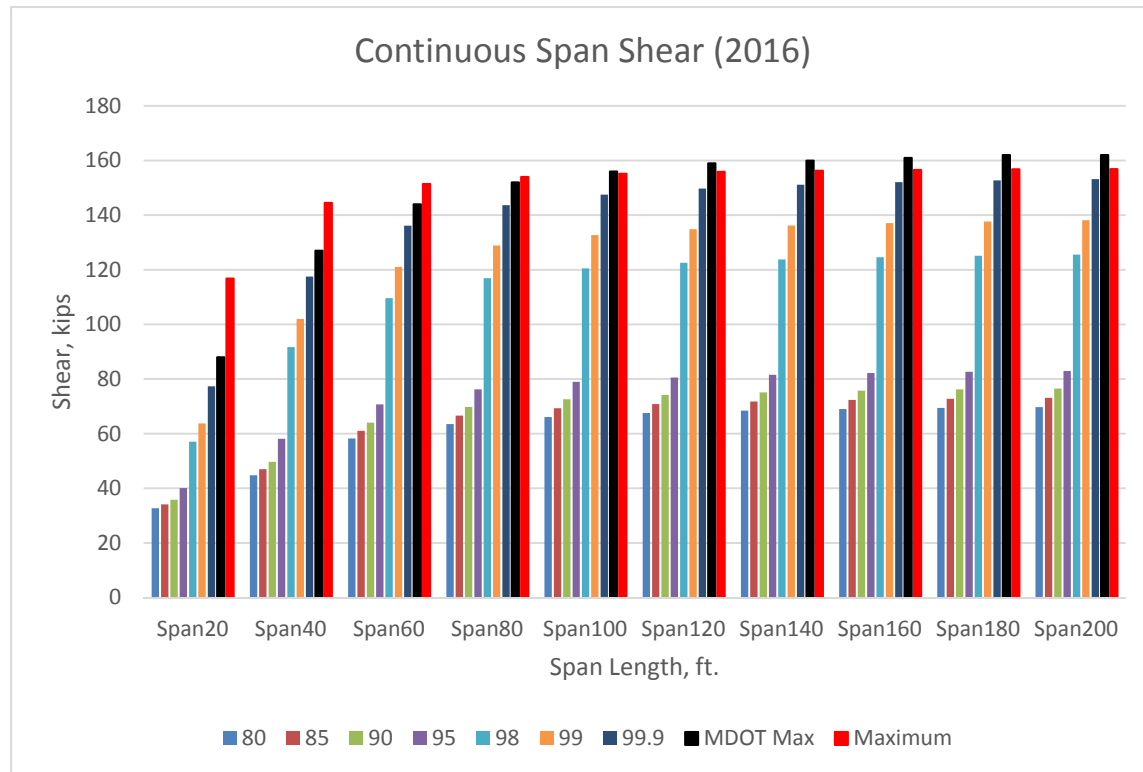

Figure G.12. 2016 Continuous Span Shears, Single LEP Vehicles.



Table G.13. Simple Span Moments, Single LEP Vehicles.

	Span (ft) (moment in kip-ft)									
	20	40	60	80	100	120	140	160	180	200
Mean	88	218	386	586	838	1092	1348	1604	1860	2116
Median	81	200	350	524	752	984	1216	1448	1680	1912
Mode	56	107	453	245	341	446	479	588	673	759
Minimum	28	56	84	111	146	181	225	287	351	414
Maximum	323	965	1721	2496	3275	4064	4851	5639	6426	7213
80%	123	292	496	759	1106	1455	1806	2159	2510	2862
85%	128	304	517	793	1155	1520	1887	2255	2622	2989
90%	134	319	543	837	1213	1593	1976	2359	2742	3125
95%	142	357	651	1021	1427	1841	2260	2681	3103	3526
98%	158	482	945	1529	2160	2803	3447	4091	4736	5381
99%	170	529	1052	1696	2386	3088	3791	4494	5197	5900
99.9%	208	639	1228	1938	2693	3456	4220	4986	5753	6522
Max MDOT	189	680	1360	2120	2880	3650	4470	5290	6110	6930
Ratio (Max / MDOT)	1.71	1.42	1.27	1.18	1.14	1.11	1.09	1.07	1.05	1.04
Governing Truck No.	14	14	17	17	17	25	25	25	25	25
# Vehicles >Governing	256560	28462	7215	3348	3914	4049	1622	586	219	62
% Vehicles >Governing	0.288	0.032	0.008	0.004	0.004	0.005	0.002	0.001	0.000	0.000

Table G.14. Simple Span Shears, Single LEP Vehicles.

	Span (ft) (shear in kips)									
	20	40	60	80	100	120	140	160	180	200
Mean	19	25	29	33	36	38	40	42	43	43
Median	18	23	26	29	32	34	36	37	38	39
Mode	10	14	15	16	16	15	15	16	16	16
Minimum	5	5	5	5	6	7	7	8	8	8
Maximum	74	104	119	130	133	138	140	143	143	145
80%	27	33	38	45	50	54	56	58	59	60
85%	28	34	40	48	53	56	59	60	62	63
90%	29	36	42	50	55	59	61	63	65	66
95%	31	40	49	57	62	66	69	71	72	73
98%	35	53	70	83	92	98	102	105	108	110
99%	38	58	77	91	100	106	111	115	117	120
99.9%	45	68	89	104	113	119	124	128	130	132
Max MDOT	44	76	100	113	121	126	130	133	136	139
Ratio (Max / MDOT)	1.68	1.36	1.19	1.15	1.10	1.09	1.08	1.07	1.05	1.04
Governing Truck No.	16	17	17	17	18	18	18	18	25	25
# Vehicles >Governing	124080	9721	2986	2801	3006	3204	4064	4319	2530	704
% Vehicles >Governing	0.140	0.011	0.003	0.003	0.003	0.004	0.005	0.005	0.003	0.001

Table G.15. Continuous Span Moments, Single LEP Vehicles.

	Span (ft) (moment in kip-ft)									
	20	40	60	80	100	120	140	160	180	200
Mean	-59	-162	-265	-337	-404	-512	-622	-729	-834	-938
Median	-55	-146	-244	-309	-365	-461	-560	-658	-753	-848
Mode	-28	-59	-82	-120	-153	-178	-224	-259	-305	-304
Minimum	-11	-24	-51	-73	-92	-110	-130	-149	-175	-195
Maximum	-220	-558	-871	-1161	-1449	-1763	-2074	-2383	-2691	-2997
80%	-75	-230	-375	-462	-541	-694	-847	-996	-1143	-1287
85%	-79	-241	-392	-483	-565	-726	-886	-1042	-1195	-1345
90%	-82	-253	-410	-506	-592	-760	-926	-1089	-1249	-1406
95%	-92	-279	-442	-554	-684	-864	-1043	-1221	-1395	-1569
98%	-120	-374	-582	-772	-1040	-1318	-1590	-1856	-2118	-2378
99%	-133	-405	-629	-845	-1141	-1444	-1740	-2030	-2316	-2599
99.9%	-155	-457	-690	-946	-1276	-1602	-1921	-2237	-2550	-2861
Max MDOT	-170	-482	-716	-1008	-1339	-1692	-2036	-2373	-2705	-3034
Ratio (Max / MDOT)	1.29	1.16	1.22	1.15	1.08	1.04	1.02	1.00	0.99	0.99
Governing Truck No.	14	18	22	17	25	25	25	25	25	25
# Vehicles >Governing	5019	13810	20412	19887	3866	177	8	1	0	0
% Vehicles >Governing	0.006	0.016	0.023	0.022	0.004	0.000	0.000	0.000	0.000	0.000

Table G.16. Continuous Span Shears, Single LEP Vehicles.

	Span (ft) (shear in kips)									
	20	40	60	80	100	120	140	160	180	200
Mean	25	35	43	46	48	49	50	50	50	51
Median	23	30	39	42	44	44	45	45	46	46
Mode	32	16	17	17	17	17	16	16	17	17
Minimum	6	6	7	8	10	10	11	11	11	11
Maximum	117	145	151	154	155	156	156	157	157	157
80%	33	45	58	63	66	67	68	69	69	70
85%	34	47	61	66	69	70	71	72	72	73
90%	36	50	64	69	72	74	75	75	76	76
95%	41	61	73	78	81	82	83	84	84	84
98%	58	93	111	119	122	124	126	126	127	127
99%	65	103	122	130	134	136	137	138	139	139
99.9%	78	118	136	143	147	150	151	152	153	153
Max MDOT	88	127	144	152	156	159	160	161	162	162
Ratio (Max / MDOT)	1.33	1.14	1.05	1.01	0.99	0.98	0.98	0.97	0.97	0.97
Governing Truck No.	14	17	25	25	25	25	25	25	25	25
# Vehicles >Governing	4981	2241	373	3	0	0	0	0	0	0
% Vehicles >Governing	0.006	0.003	0.000	0.000	0.0	0.0	0.0	0.0	0.0	0.0

Table G.17. Simple Span Moments, Single+Following LEP Vehicles.

	Span (ft) (moment in kip-ft)									
	20	40	60	80	100	120	140	160	180	200
Mean	88	218	386	586	838	1089	1351	1610	1870	2129
Median	82	202	353	528	760	996	1237	1475	1712	1950
Mode	56	109	182	258	373	430	524	613	675	794
Minimum	28	56	84	111	146	181	225	287	351	414
80%	123	291	494	756	1102	1451	1809	2163	2517	2872
85%	128	303	515	793	1155	1513	1885	2255	2624	2994
90%	134	319	543	837	1213	1593	1970	2356	2741	3127
95%	142	357	651	1021	1427	1841	2260	2681	3103	3526
98%	158	482	945	1529	2160	2803	3447	4091	4736	5381
99%	170	529	1052	1696	2386	3088	3791	4494	5197	5900
99.90%	208	639	1228	1931	2688	3453	4230	5007	5787	6568
Maximum	323	969	1722	2500	3571	4885	6394	7928	9465	11000

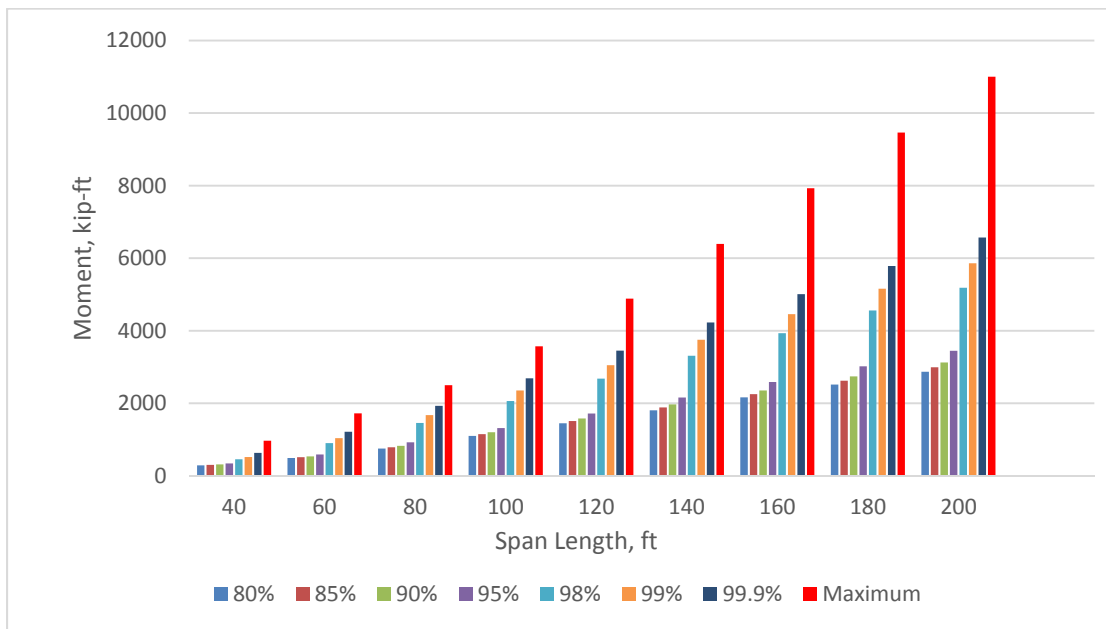

Figure G.13. Simple Span Moments, Single+Following LEP Vehicles.

Table G.18. Simple Span Shears, Single+Following LEP Vehicles.

	Span (ft) (shear in kips)									
	20	40	60	80	100	120	140	160	180	200
Mean	19	25	29	33	36	39	41	42	43	44
Median	18	24	27	30	33	35	37	38	39	40
Mode	11	14	15	15	16	16	17	16	16	16
Minimum	5	5	5	5	6	7	7	8	8	8
80%	27	33	38	46	51	54	56	58	60	61
85%	28	35	40	48	53	57	59	61	62	63
90%	29	36	42	50	56	59	62	64	65	66
95%	31	40	49	57	62	66	69	71	72	73
98%	35	53	70	83	92	98	102	105	108	110
99%	38	58	77	91	100	106	111	115	117	120
99.90%	45	68	89	104	114	120	125	129	132	134
Maximum	74	105	120	134	159	178	197	210	221	230

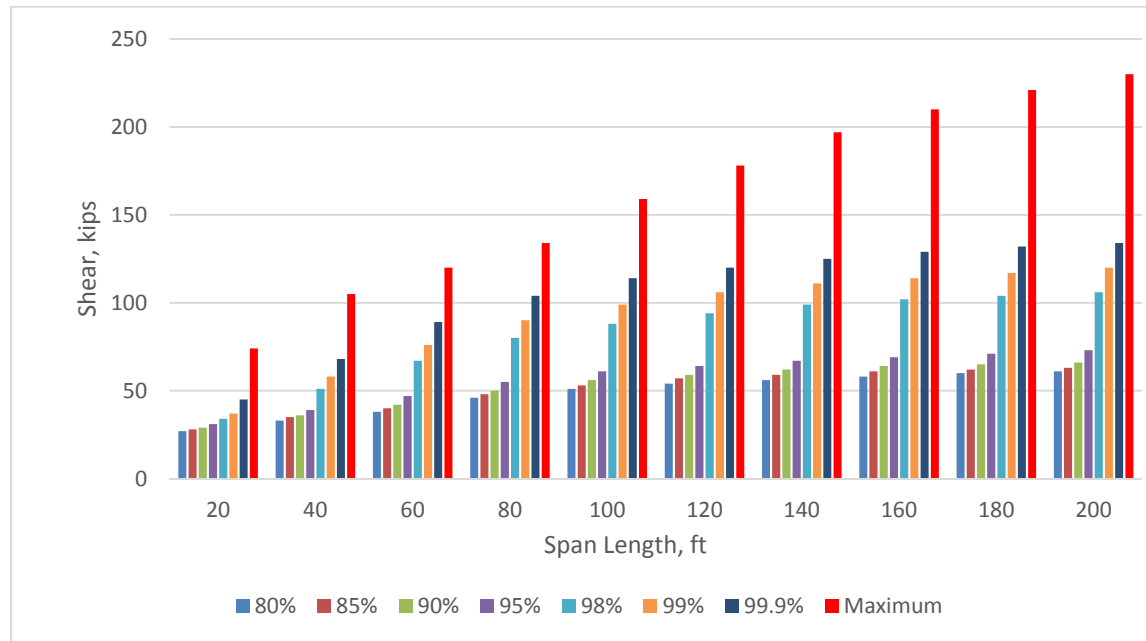

Figure G.14. Simple Span Shears, Single+Following LEP Vehicles.

Table G.19. Continuous Span Moments, Single+Following LEP Vehicles.

	Span (ft) (moment in kip-ft)									
	20	40	60	80	100	120	140	160	180	200
Mean	-59	-162	-268	-341	-408	-517	-627	-735	-841	-947
Median	-56	-149	-249	-315	-372	-470	-572	-671	-769	-866
Mode	-28	-59	-82	-120	-153	-202	-224	-259	-308	-304
Minimum	-11	-24	-51	-73	-92	-110	-130	-149	-175	-195
80%	-75	-229	-375	-464	-543	-697	-850	-1000	-1146	-1292
85%	-79	-241	-392	-484	-566	-727	-887	-1042	-1195	-1347
90%	-82	-253	-408	-506	-593	-760	-926	-1088	-1248	-1406
95%	-92	-279	-442	-554	-684	-864	-1043	-1221	-1395	-1569
98%	-120	-374	-582	-772	-1040	-1318	-1590	-1856	-2118	-2378
99%	-133	-405	-629	-843	-1137	-1444	-1740	-2030	-2316	-2599
99.90%	-155	-457	-695	-962	-1295	-1622	-1943	-2258	-2571	-2884
Maximum	-220	-700	-1349	-1962	-2531	-3080	-3597	-4009	-4938	-5953

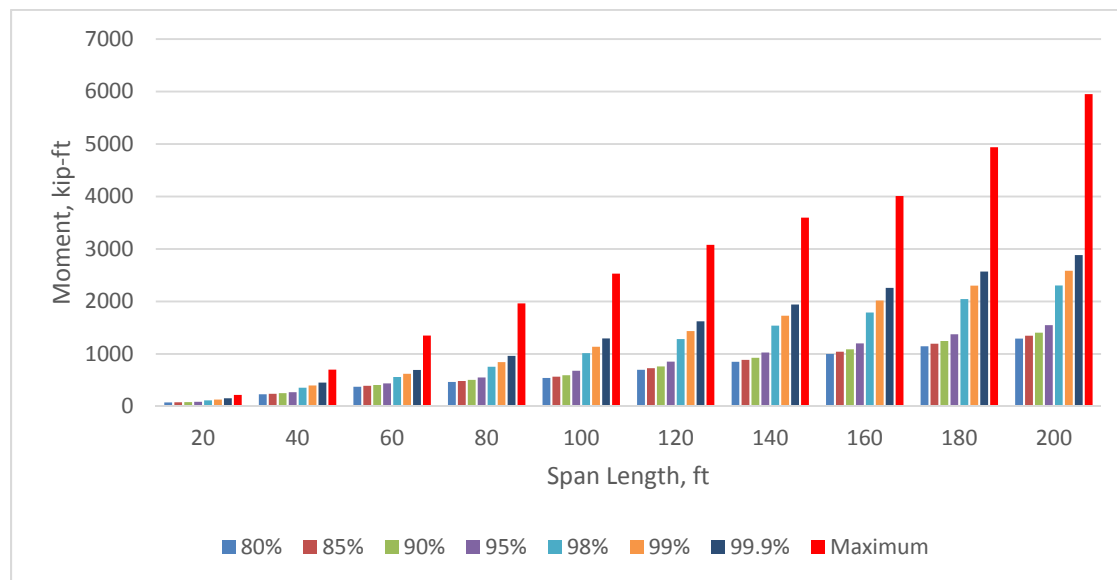

Figure G.15. Continuous Span Moments, Single+Following LEP Vehicles.

Table G.20. Continuous Span Shears, Single+Following LEP Vehicles.

	Span (ft) (shear in kips)									
	20	40	60	80	100	120	140	160	180	200
Mean	25	35	43	47	49	50	50	51	51	51
Median	23	31	39	43	44	45	46	46	47	47
Mode	32	16	17	17	17	17	16	17	17	17
Minimum	6	6	7	8	10	10	11	11	11	11
80%	33	45	58	64	66	68	69	69	70	70
85%	34	47	61	66	69	71	71	72	73	73
90%	36	50	64	69	72	74	75	75	76	76
95%	41	61	73	78	81	82	83	84	84	84
98%	58	94	112	120	122	125	127	128	128	128
99%	65	103	122	130	134	136	137	138	139	139
99.90%	78	118	136	144	148	151	152	153	154	155
Maximum	118	146	205	245	266	278	286	291	294	298

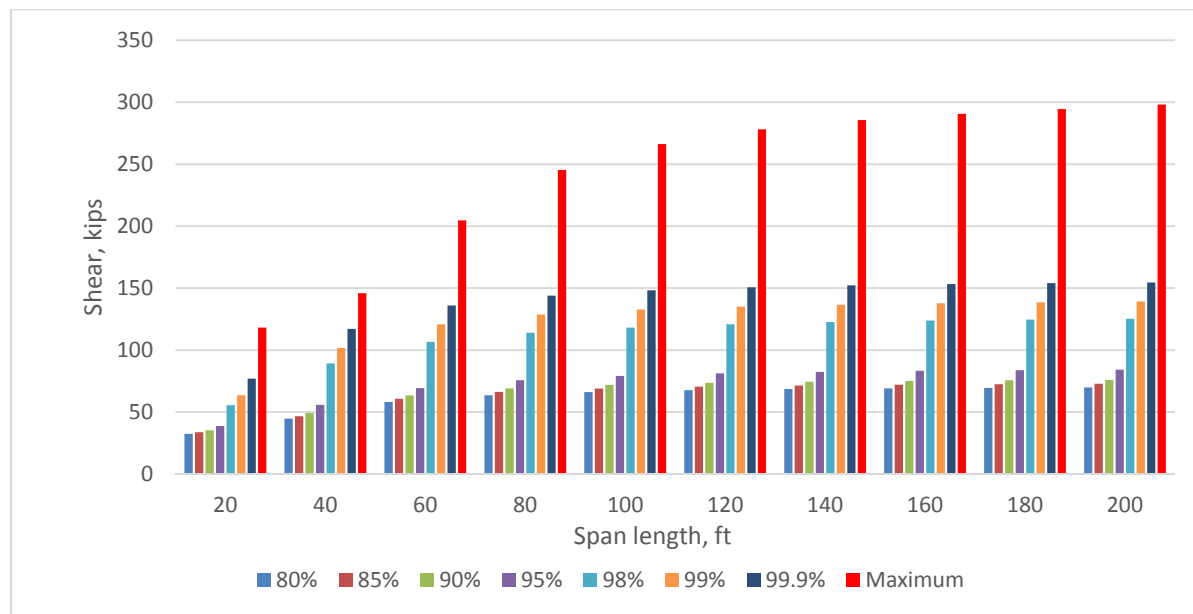

Figure G.16. Continuous Span Shears, Single+Following LEP Vehicles.

Table G.21. Simple Span Moments, Two Lane LEP Vehicles.

	Span (ft) (moment in kip-ft)									
	20	40	60	80	100	120	140	160	180	200
Mean	95	233	413	651	980	1529	2251	2750	3248	3746
Median	89	215	377	588	899	1450	2181	2661	3140	3619
80%	128	305	522	815	1225	1964	2726	3334	3945	4556
85%	134	320	549	868	1314	2096	2874	3521	4170	4820
90%	143	346	609	993	1496	2288	3099	3793	4497	5205
95%	163	421	789	1299	1893	2714	3761	4568	5373	6181
98%	191	504	993	1605	2319	3259	4373	5294	6229	7166
99%	211	550	1092	1763	2532	3545	4640	5617	6615	7621
100%	253	688	1298	2082	3104	4260	5512	6698	7923	9167
Maximum	398	1015	1809	3348	4756	6183	7664	9150	10636	12121

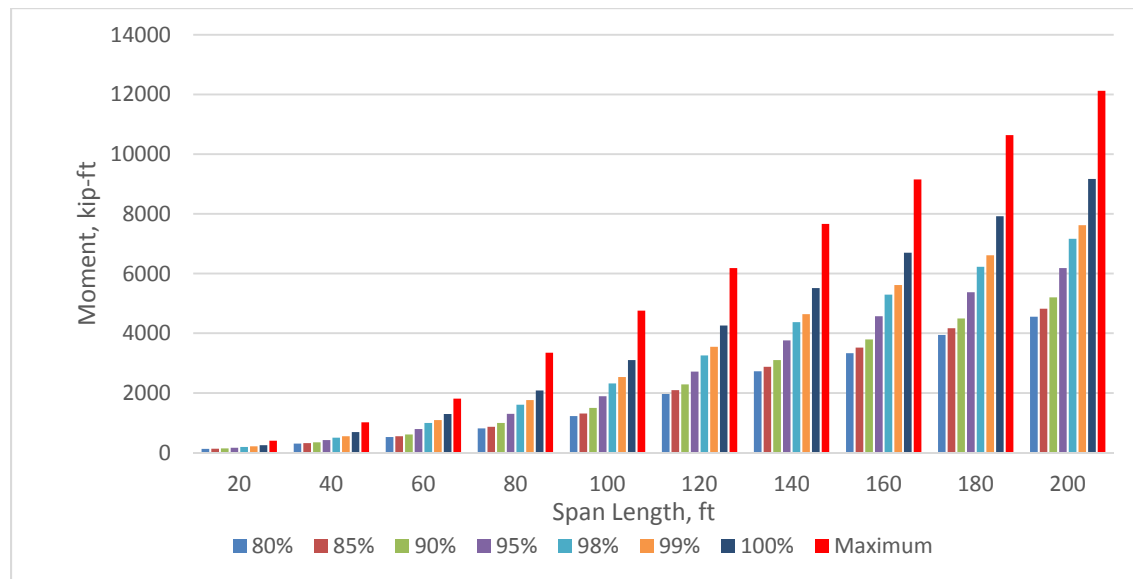

Figure G.17. Simple Span Moments, Side-by-side LEP Vehicles.

Table G.22. Simple Span Shear, Two Lane LEP Vehicles.

	Span (ft) (shear in kips)									
	20	40	60	80	100	120	140	160	180	200
Mean	24	30	35	40	44	47	49	51	52	53
Median	23	29	33	38	42	44	46	48	49	50
80%	32	39	47	54	59	63	66	68	70	72
85%	34	42	50	58	64	68	71	74	77	79
90%	37	45	55	63	70	75	79	82	85	87
95%	40	52	65	75	83	88	93	97	100	103
98%	44	61	79	92	101	108	114	118	121	124
99%	47	67	86	100	110	117	123	127	131	134
99.9%	56	80	101	116	126	135	144	152	158	163
Maximum	84	117	158	186	204	220	228	236	244	248

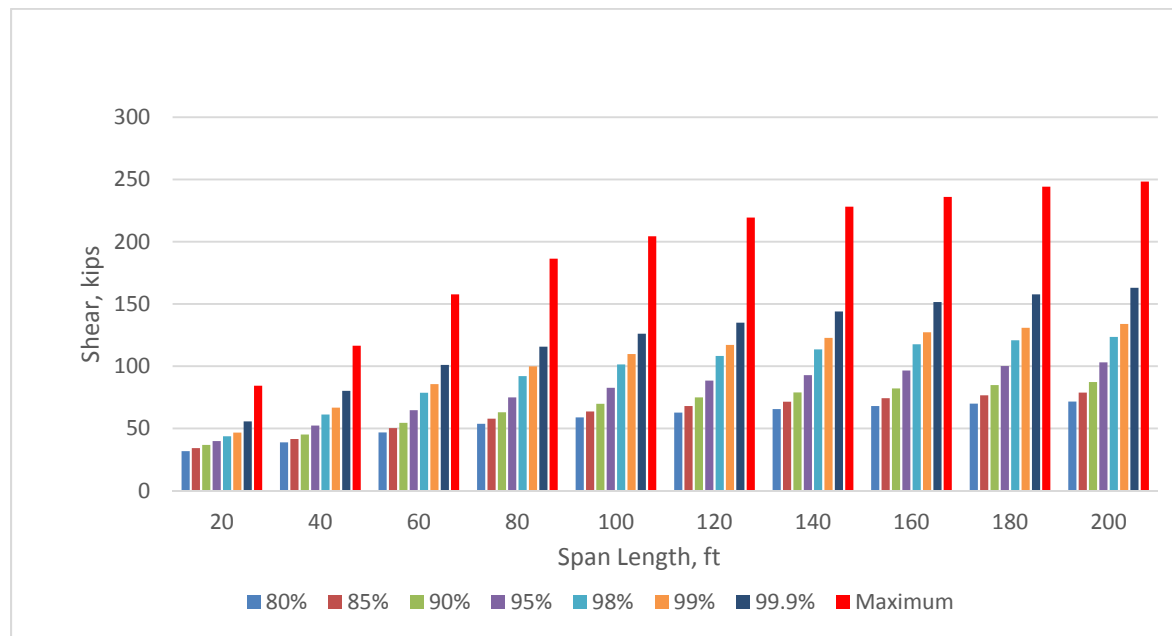

Figure G.18. Simple Span Shears, Two Lane LEP Vehicles.



Table G.19. Continuous Span Moments, Two Lane LEP Vehicles.

	Span (ft) (moment in kip-ft)									
	20	40	60	80	100	120	140	160	180	200
Mean	-71	-187	-319	-423	-525	-647	-775	-906	-1045	-1183
Median	-67	-178	-302	-394	-480	-596	-717	-840	-965	-1089
80%	-92	-254	-435	-582	-728	-879	-1051	-1230	-1430	-1629
85%	-100	-270	-479	-644	-808	-979	-1168	-1364	-1587	-1810
90%	-110	-292	-526	-708	-900	-1091	-1294	-1507	-1759	-2009
95%	-125	-333	-587	-803	-1049	-1282	-1507	-1754	-2049	-2341
98%	-142	-404	-662	-921	-1222	-1529	-1833	-2136	-2451	-2770
99%	-152	-436	-725	-1027	-1365	-1705	-2037	-2369	-2733	-3108
99.9%	-181	-504	-882	-1296	-1704	-2104	-2485	-2889	-3359	-3841
Maximum	-305	-890	-1455	-1945	-2472	-2949	-3586	-4208	-4818	-5422

a. Multiple modes exist. The smallest value is shown

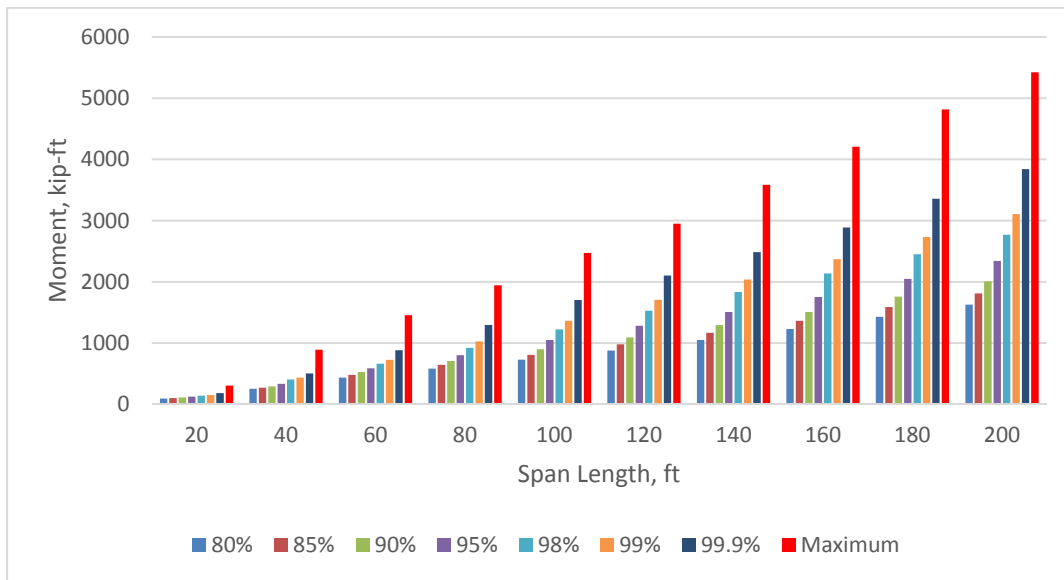

Figure G.23. Continuous Span Moments, Two Lane LEP Vehicles.

Table G.24. Continuous Span Shears, Two Lane LEP Vehicles.

	Span (ft) (shear in kips)									
	20	40	60	80	100	120	140	160	180	200
Mean	31	43	54	60	63	65	66	67	67	67
Median	30	40	50	55	58	59	60	61	61	61
80%	41	55	70	79	85	88	90	91	92	93
85%	44	60	76	87	93	97	100	101	102	103
90%	48	66	84	96	103	108	110	112	114	114
95%	55	83	100	112	120	125	128	131	132	133
98%	65	103	125	136	143	147	149	151	152	153
99.0%	71	112	136	149	159	165	169	171	173	175
99.9%	87	130	161	182	196	204	210	213	216	218
Maximum	124	205	249	269	278	284	287	292	296	298

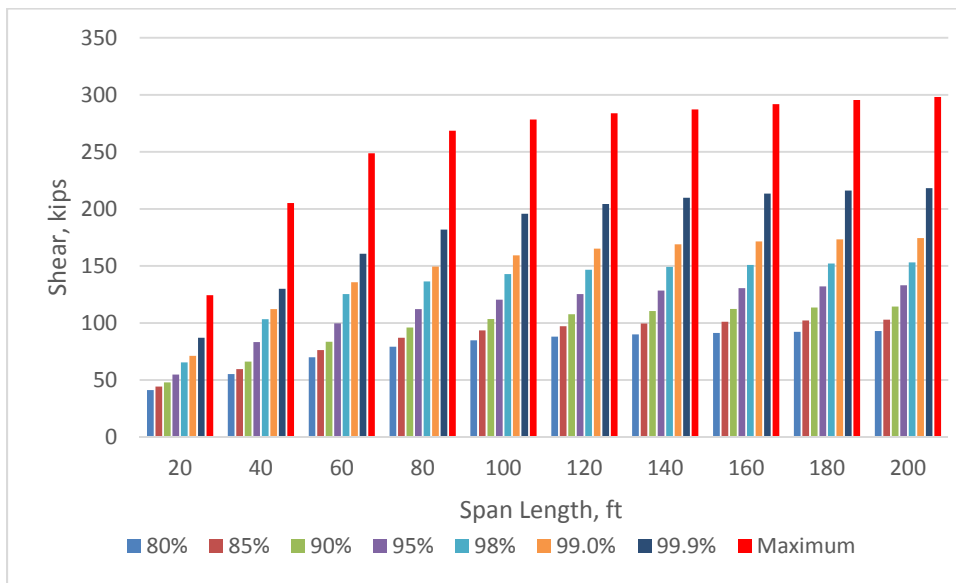

Figure G.20. Continuous Span Shears, Two Lane LEP Vehicles.

Table G.25. Simple Span Moments, Single + Following / Single LEP Vehicles.

	Span (ft) (Ratio)									
	20	40	60	80	100	120	140	160	180	200
Mean	1.00	1.00	1.00	1.00	1.00	1.00	1.00	1.00	1.01	1.01
Median	1.01	1.01	1.01	1.01	1.01	1.01	1.02	1.02	1.02	1.02
80%	1.00	1.00	1.00	1.00	1.00	1.00	1.00	1.00	1.00	1.00
85%	1.00	1.00	1.00	1.00	1.00	1.00	1.00	1.00	1.00	1.00
90%	1.00	1.00	1.00	1.00	1.00	1.00	1.00	1.00	1.00	1.00
95%	1.00	1.00	1.00	1.00	1.00	1.00	1.00	1.00	1.00	1.00
98%	1.00	1.00	1.00	1.00	1.00	1.00	1.00	1.00	1.00	1.00
99%	1.00	1.00	1.00	1.00	1.00	1.00	1.00	1.00	1.00	1.00
99.90%	1.00	1.00	1.00	1.00	1.00	1.00	1.00	1.00	1.01	1.01
Maximum	1.00	1.00	1.00	1.00	1.09	1.20	1.32	1.41	1.47	1.53

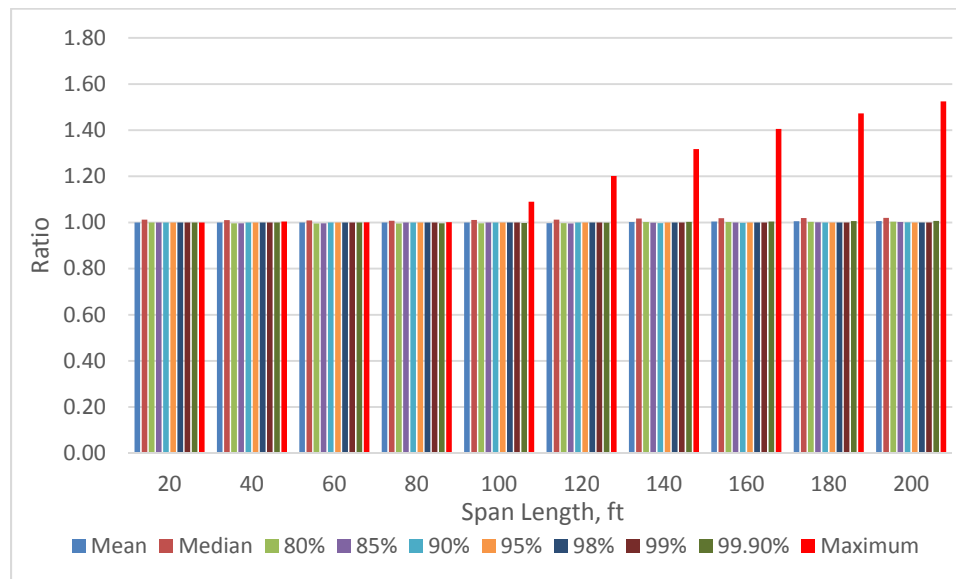

Figure G.21. Simple Span Moments, Single + Following / Single LEP Vehicles.

Table G.26. Simple Span Moments, Two Lane / Single LEP Vehicles.

	Span (ft) (Ratio)									
	20	40	60	80	100	120	140	160	180	200
Mean	1.08	1.07	1.07	1.11	1.17	1.40	1.67	1.71	1.75	1.77
Median	1.10	1.08	1.08	1.12	1.20	1.47	1.79	1.84	1.87	1.89
80%	1.04	1.04	1.05	1.07	1.11	1.35	1.51	1.54	1.57	1.59
85%	1.05	1.05	1.06	1.09	1.14	1.38	1.52	1.56	1.59	1.61
90%	1.07	1.08	1.12	1.19	1.23	1.44	1.57	1.61	1.64	1.67
95%	1.15	1.18	1.21	1.27	1.33	1.47	1.66	1.70	1.73	1.75
98%	1.21	1.05	1.05	1.05	1.07	1.16	1.27	1.29	1.32	1.33
99%	1.24	1.04	1.04	1.04	1.06	1.15	1.22	1.25	1.27	1.29
99.9%	1.22	1.08	1.06	1.07	1.15	1.23	1.31	1.34	1.38	1.41
Maximum	1.23	1.05	1.05	1.34	1.45	1.52	1.58	1.62	1.66	1.68

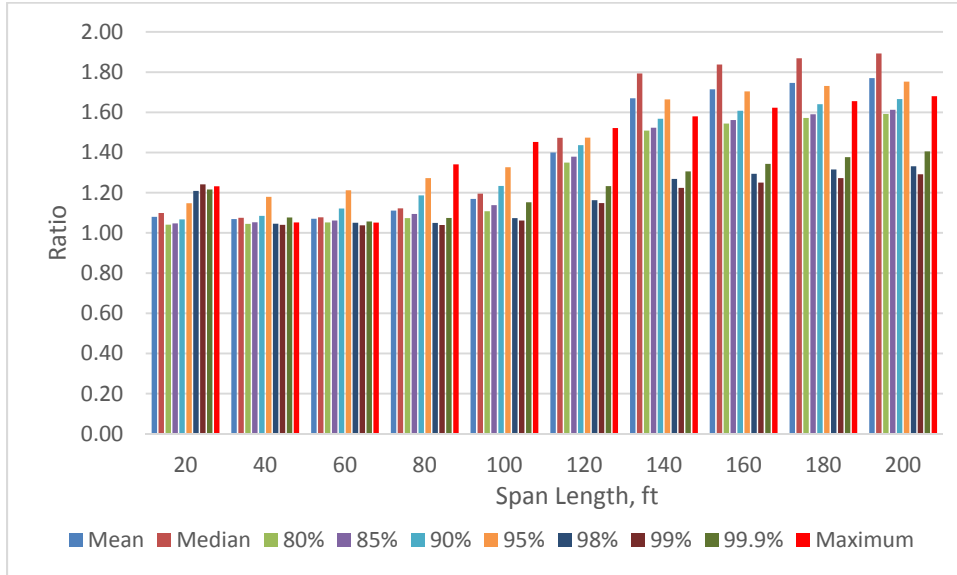

Figure G.22. Simple Span Moments, Two Lane / Single LEP Vehicles.

Table G.27. Simple Span Shears, Single + Following / Single LEP Vehicles.

	Span (ft) (Ratio)									
	20	40	60	80	100	120	140	160	180	200
Mean	1.00	1.00	1.00	1.00	1.00	1.03	1.03	1.00	1.00	1.02
Median	1.00	1.04	1.04	1.03	1.03	1.03	1.03	1.03	1.03	1.03
80%	1.00	1.00	1.00	1.02	1.02	1.00	1.00	1.00	1.02	1.02
85%	1.00	1.03	1.00	1.00	1.00	1.02	1.00	1.02	1.00	1.00
90%	1.00	1.00	1.00	1.00	1.02	1.00	1.02	1.02	1.00	1.00
95%	1.00	1.00	1.00	1.00	1.00	1.00	1.00	1.00	1.00	1.00
98%	1.00	1.00	1.00	1.00	1.00	1.00	1.00	1.00	1.00	1.00
99%	1.00	1.00	1.00	1.00	1.00	1.00	1.00	1.00	1.00	1.00
99.90%	1.00	1.00	1.00	1.00	1.01	1.01	1.01	1.01	1.02	1.02
Maximum	1.00	1.01	1.01	1.03	1.20	1.29	1.41	1.47	1.55	1.59

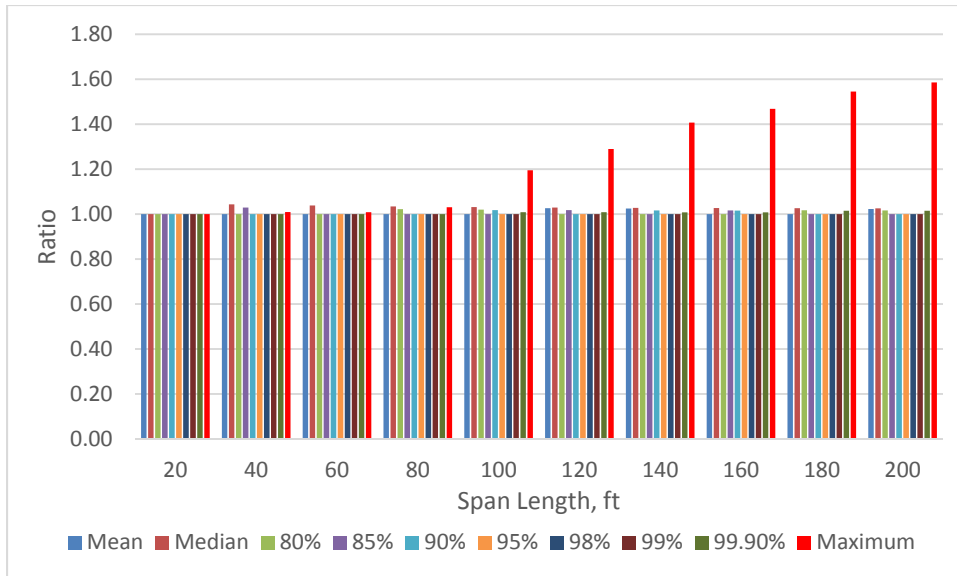

Figure G.23. Simple Span Shears, Single + Following / Single LEP Vehicles.

Table G.28. Simple Span Shears, Two Lane / Single LEP Vehicles.

	Span (ft) (Ratio)									
	20	40	60	80	100	120	140	160	180	200
Mean	1.26	1.20	1.21	1.21	1.22	1.24	1.23	1.21	1.21	1.23
Median	1.28	1.26	1.27	1.31	1.31	1.29	1.28	1.30	1.29	1.28
80%	1.19	1.18	1.24	1.20	1.18	1.17	1.18	1.17	1.19	1.20
85%	1.21	1.24	1.25	1.21	1.21	1.21	1.20	1.23	1.24	1.25
90%	1.28	1.25	1.31	1.26	1.27	1.27	1.30	1.30	1.31	1.32
95%	1.29	1.30	1.33	1.32	1.34	1.33	1.35	1.37	1.39	1.41
98%	1.26	1.15	1.13	1.11	1.10	1.10	1.12	1.12	1.12	1.13
99%	1.24	1.16	1.12	1.10	1.10	1.10	1.11	1.10	1.12	1.12
99.90%	1.24	1.18	1.13	1.12	1.12	1.13	1.16	1.19	1.22	1.23
Maximum	1.14	1.13	1.33	1.43	1.53	1.59	1.63	1.65	1.71	1.71

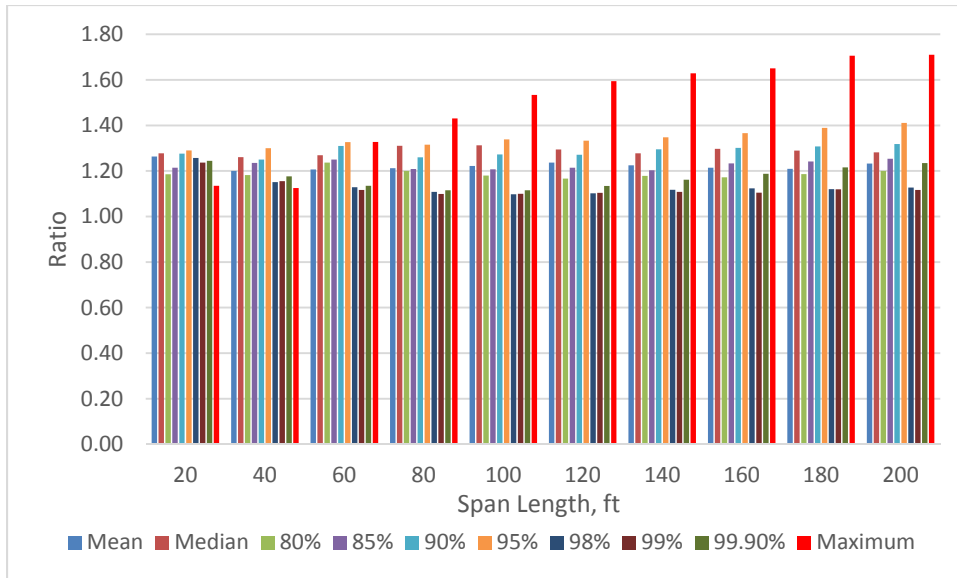

Figure G.24. Simple Span Shears, Two Lane / Single LEP Vehicles.

Table G.29. Continuous Span Moments, Single + Following / Single LEP Vehicles.

	Span (ft) (Ratio)									
	20	40	60	80	100	120	140	160	180	200
Mean	1.00	1.00	1.01	1.01	1.01	1.01	1.01	1.01	1.01	1.01
Median	1.02	1.02	1.02	1.02	1.02	1.02	1.02	1.02	1.02	1.02
80%	1.00	1.00	1.00	1.00	1.00	1.00	1.00	1.00	1.00	1.00
85%	1.00	1.00	1.00	1.00	1.00	1.00	1.00	1.00	1.00	1.00
90%	1.00	1.00	1.00	1.00	1.00	1.00	1.00	1.00	1.00	1.00
95%	1.00	1.00	1.00	1.00	1.00	1.00	1.00	1.00	1.00	1.00
98%	1.00	1.00	1.00	1.00	1.00	1.00	1.00	1.00	1.00	1.00
99%	1.00	1.00	1.00	1.00	1.00	1.00	1.00	1.00	1.00	1.00
99.90%	1.00	1.00	1.01	1.02	1.01	1.01	1.01	1.01	1.01	1.01
Maximum	1.00	1.25	1.55	1.69	1.75	1.75	1.73	1.68	1.84	1.99

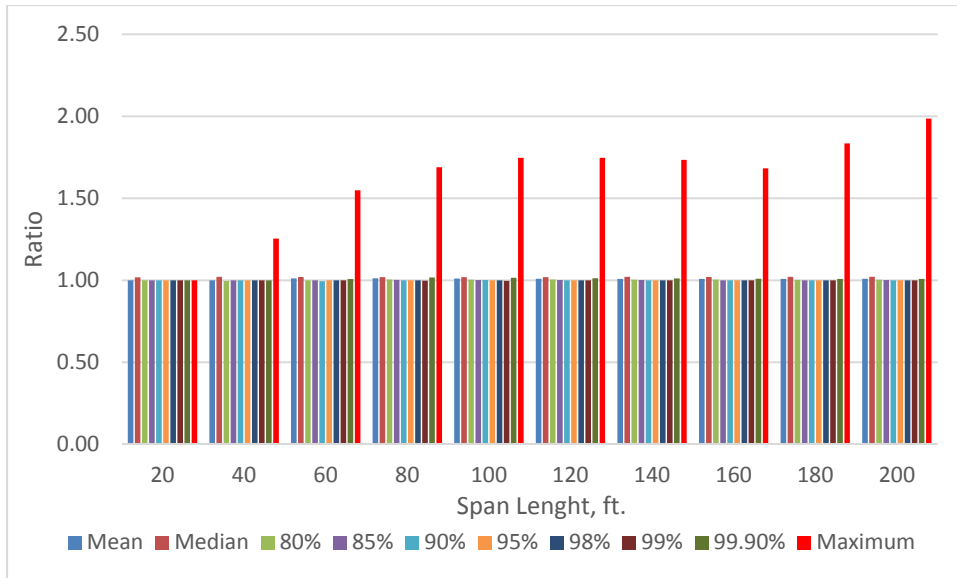

Figure G.25. Continuous Span Moments, Single + Following / Single LEP Vehicles.

Table G.30. Continuous Span Moments, Two Lane / Single LEP Vehicles.

	Span (ft) (Ratio)									
	20	40	60	80	100	120	140	160	180	200
Mean	1.20	1.15	1.20	1.26	1.30	1.26	1.25	1.24	1.25	1.26
Median	1.22	1.22	1.24	1.28	1.32	1.29	1.28	1.28	1.28	1.28
80%	1.23	1.10	1.16	1.26	1.35	1.27	1.24	1.23	1.25	1.27
85%	1.27	1.12	1.22	1.33	1.43	1.35	1.32	1.31	1.33	1.35
90%	1.34	1.15	1.28	1.40	1.52	1.44	1.40	1.38	1.41	1.43
95%	1.36	1.19	1.33	1.45	1.53	1.48	1.44	1.44	1.47	1.49
98%	1.18	1.08	1.14	1.19	1.18	1.16	1.15	1.15	1.16	1.16
99%	1.14	1.08	1.15	1.22	1.20	1.18	1.17	1.17	1.18	1.20
99.90%	1.17	1.10	1.28	1.37	1.34	1.31	1.29	1.29	1.32	1.34
Maximum	1.39	1.59	1.67	1.68	1.71	1.67	1.73	1.77	1.79	1.81

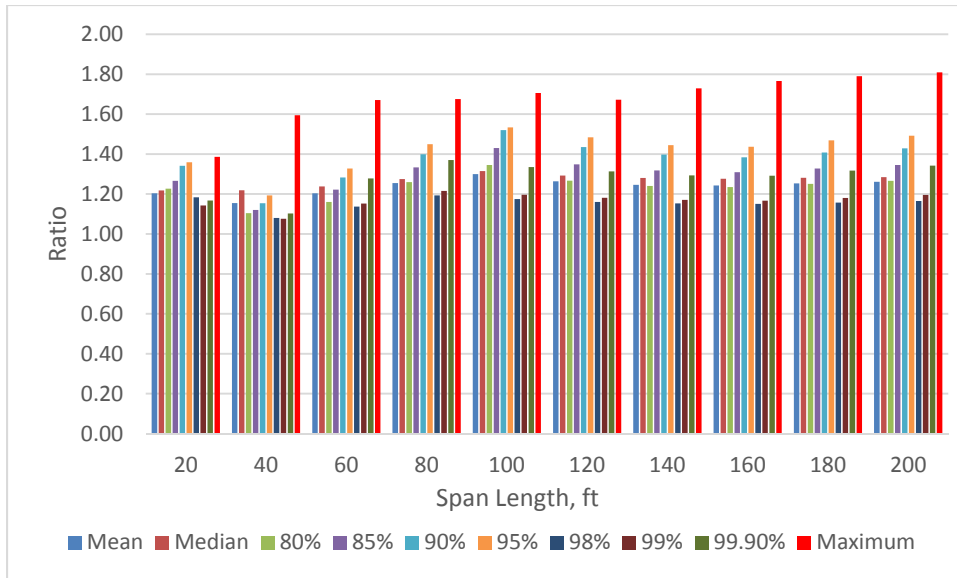

Figure G.26. Continuous Span Moments, Two Lane / Single LEP Vehicles.

Table G.31. Continuous Span Shears, Single + Following / Single LEP Vehicles.

	Span (ft) (Ratio)									
	20	40	60	80	100	120	140	160	180	200
Mean	1.00	1.00	1.00	1.02	1.02	1.02	1.00	1.02	1.02	1.00
Median	1.00	1.03	1.00	1.02	1.00	1.02	1.02	1.02	1.02	1.02
80%	1.00	1.00	1.00	1.02	1.00	1.01	1.01	1.00	1.01	1.00
85%	1.00	1.00	1.00	1.00	1.00	1.01	1.00	1.00	1.01	1.00
90%	1.00	1.00	1.00	1.00	1.00	1.00	1.00	1.00	1.00	1.00
95%	1.00	1.00	1.00	1.00	1.00	1.00	1.00	1.00	1.00	1.00
98%	1.00	1.01	1.01	1.01	1.00	1.01	1.01	1.02	1.01	1.01
99.00%	1.00	1.00	1.00	1.00	1.00	1.00	1.00	1.00	1.00	1.00
99.90%	1.00	1.00	1.00	1.01	1.01	1.01	1.01	1.01	1.01	1.01
Maximum	1.01	1.01	1.36	1.59	1.72	1.78	1.83	1.85	1.87	1.90



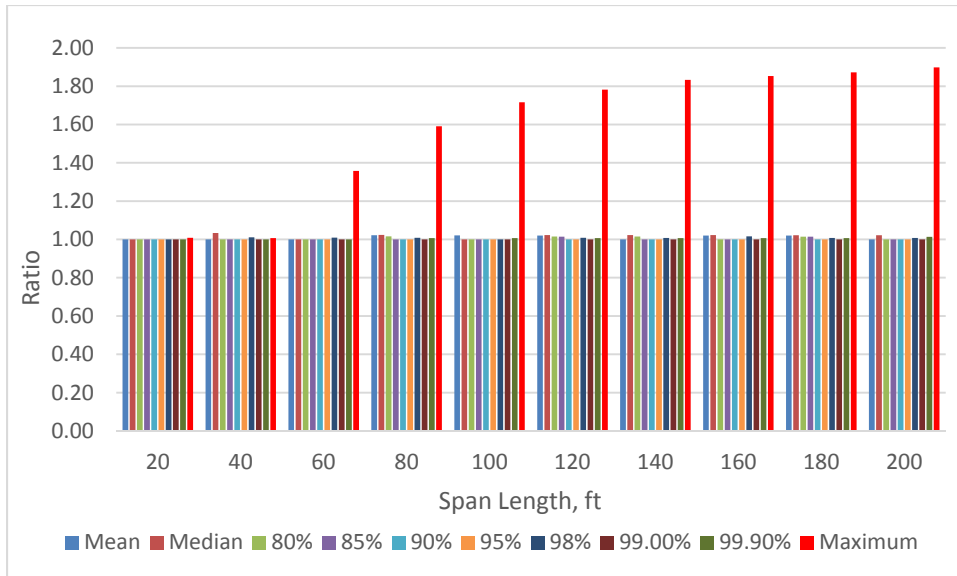

Figure G.27. Continuous Span Shears, Single + Following / Single LEP Vehicles.

Table G.32. Continuous Span Shears, Two Lane / Single LEP Vehicles.

	Span (ft) (Ratio)									
	20	40	60	80	100	120	140	160	180	200
Mean	1.24	1.23	1.26	1.30	1.31	1.33	1.32	1.34	1.34	1.31
Median	1.30	1.33	1.28	1.31	1.32	1.34	1.33	1.36	1.33	1.33
80%	1.24	1.22	1.21	1.25	1.29	1.31	1.32	1.32	1.33	1.33
85%	1.29	1.28	1.25	1.32	1.35	1.39	1.41	1.40	1.42	1.41
90%	1.33	1.32	1.31	1.39	1.43	1.46	1.47	1.49	1.50	1.50
95%	1.34	1.36	1.37	1.44	1.48	1.52	1.54	1.56	1.57	1.58
98%	1.12	1.11	1.13	1.14	1.17	1.19	1.18	1.20	1.20	1.20
99.00%	1.09	1.09	1.11	1.15	1.19	1.21	1.23	1.24	1.24	1.26
99.90%	1.12	1.10	1.18	1.27	1.33	1.36	1.39	1.40	1.41	1.42
Maximum	1.06	1.41	1.65	1.75	1.79	1.82	1.84	1.86	1.89	1.90

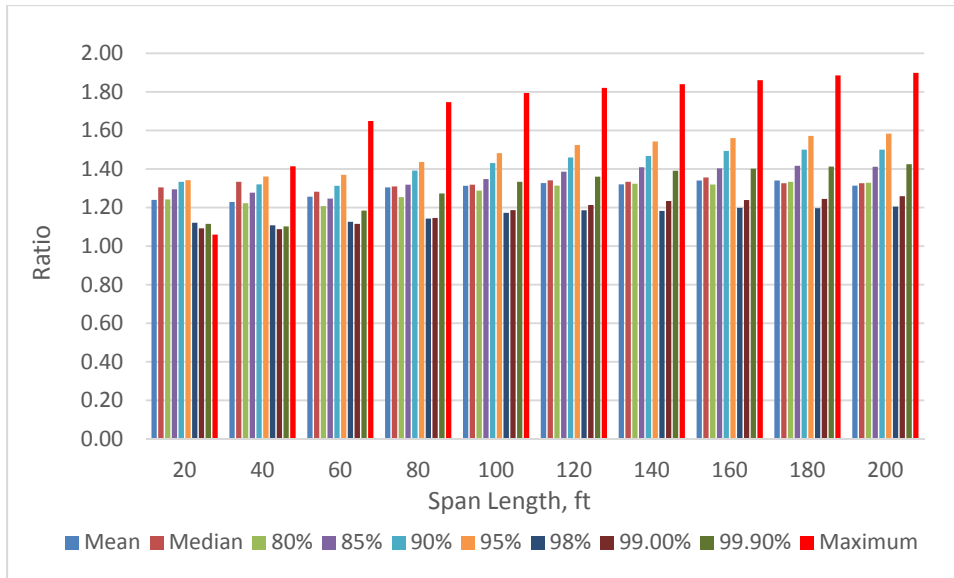

Figure G.28. Continuous Span Shears, Two Lane / Single LEP Vehicles.

Table G.33. Maximum Simple Span Moments.

	Span (ft) (moment in kip-ft)									
	20	40	60	80	100	120	140	160	180	200
Max. Single	323	965	1721	2496	3275	4064	4851	5639	6426	7213
Max. MDOT	189	680	1360	2120	2880	3650	4470	5290	6110	6930
Max Single+Following	323	969	1722	2500	3571	4885	6394	7928	9465	11000
Max. Two-Lane	398	1015	1809	3348	4756	6183	7664	9150	10636	12121

Table G.34. Maximum Simple Span Shears.

	Span (ft) (shear in kips)									
	20	40	60	80	100	120	140	160	180	200
Max. Single	74	104	119	130	133	138	140	143	143	145
Max. MDOT	44	76	100	113	121	126	130	133	136	139
Max Single+Following	74	105	120	134	159	178	197	210	221	230
Max. Two-Lane	84	117	158	186	204	220	228	236	244	248

Table G.35. Maximum Continuous Span Moments.

	Span (ft) (moment in kip-ft)									
	20	40	60	80	100	120	140	160	180	200
Max. Single	-220	-558	-871	-1161	-1449	-1763	-2074	-2383	-2691	-2997
Max. MDOT	-170	-482	-716	-1008	-1339	-1692	-2036	-2373	-2705	-3034
Max Single+Following	-220	-700	-1349	-1962	-2531	-3080	-3597	-4009	-4938	-5953
Max. Two-Lane	-305	-890	-1455	-1945	-2472	-2949	-3586	-4208	-4818	-5422

Table G.36. Maximum Continuous Span Shears.

	Span (ft) (shear in kips)									
	20	40	60	80	100	120	140	160	180	200
Max. Single	117	145	151	154	155	156	156	157	157	157
Max. MDOT	88	127	144	152	156	159	160	161	162	162
Max Single+Following	118	146	205	245	266	278	286	291	294	298
Max. Two-Lane	124	205	249	269	278	284	287	292	296	298

**APPENDIX H. CUMULATIVE DISTRIBUTION FUNCTIONS OF TOP 5% OF LOAD EFFECTS**

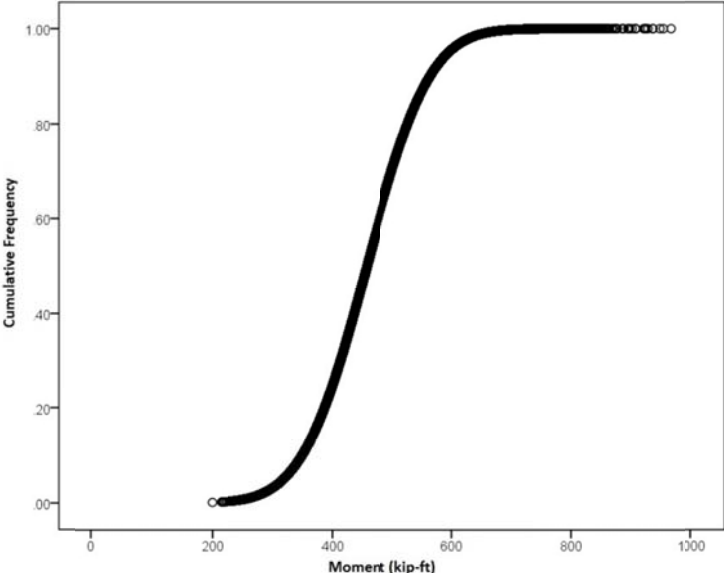

Figure H.1. CDF of Top 5% of Simple 20 ft Span Moments, Single LEP Vehicles.

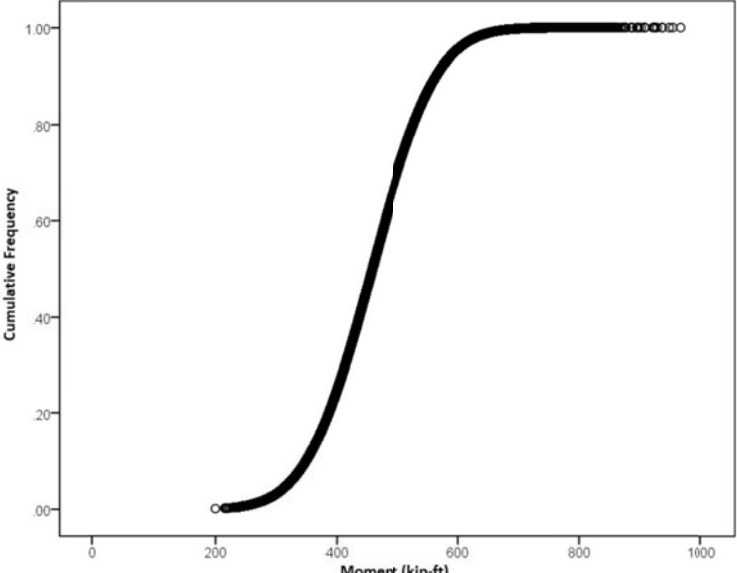

Figure H.2. CDF of Top 5% of Simple 40 ft Span Moments, Single LEP Vehicles.

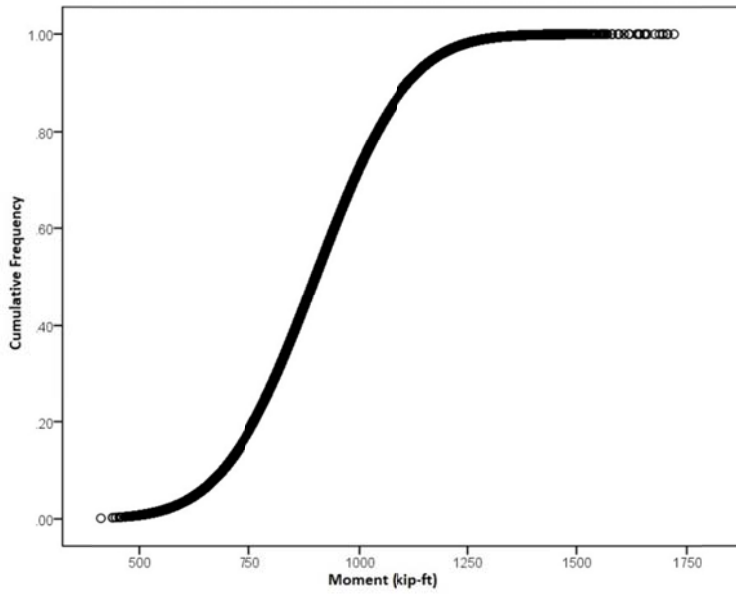

Figure H.3. CDF of Top 5% of Simple 60 ft Span Moments, Single LEP Vehicles.

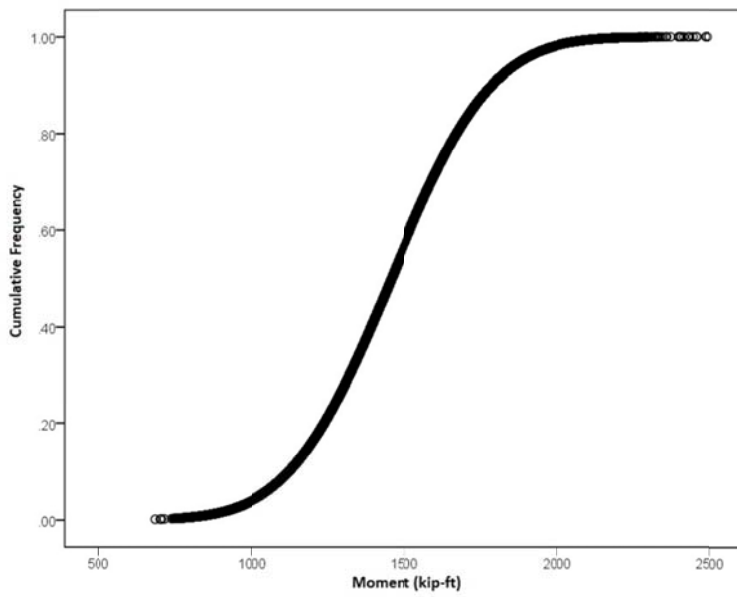

Figure H.4. CDF of Top 5% of Simple 80 ft Span Moments, Single LEP Vehicles.

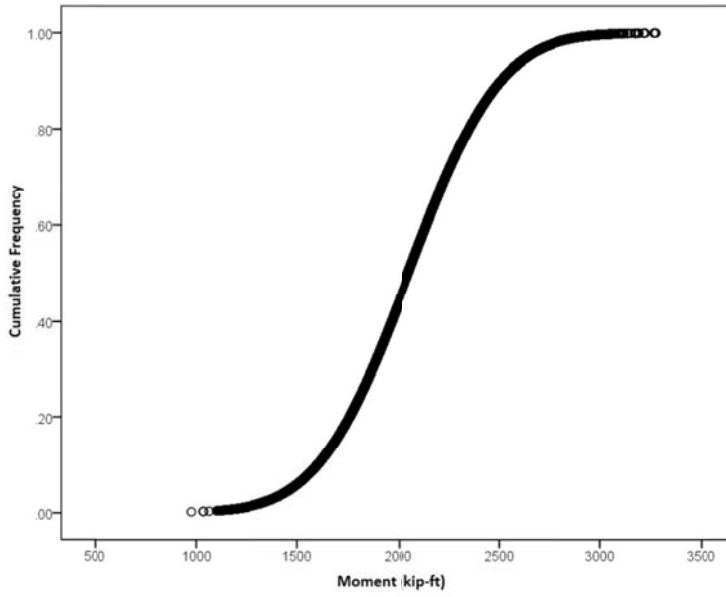

Figure H.5. CDF of Top 5% of Simple 100 ft Span Moments, Single LEP Vehicles.

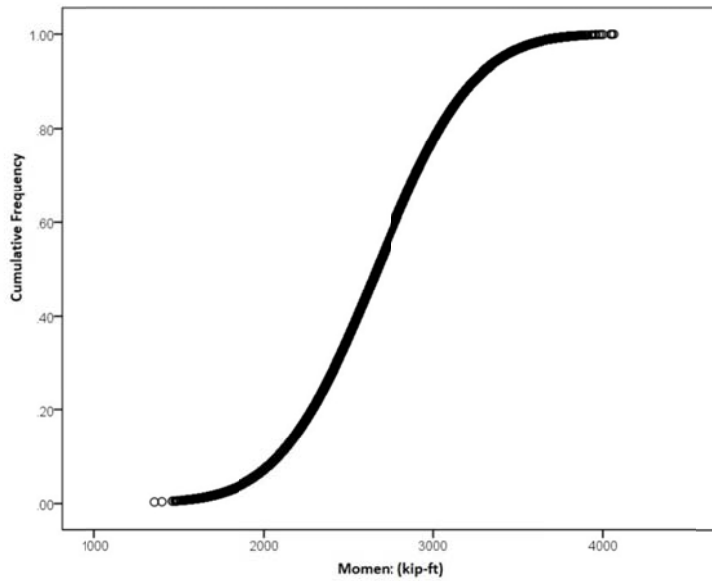

Figure H.6. CDF of Top 5% of Simple 120 ft Span Moments, Single LEP Vehicles.

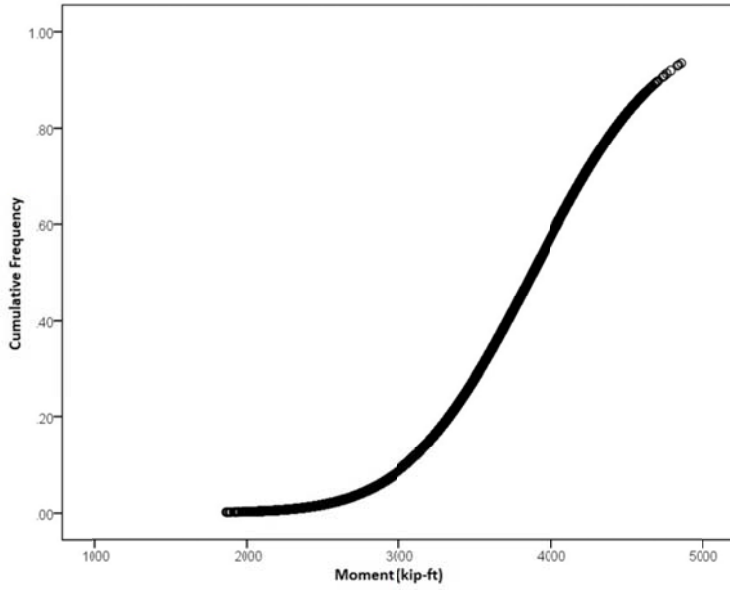

Figure H.7. CDF of Top 5% of Simple 140 ft Span Moments, Single LEP Vehicles.

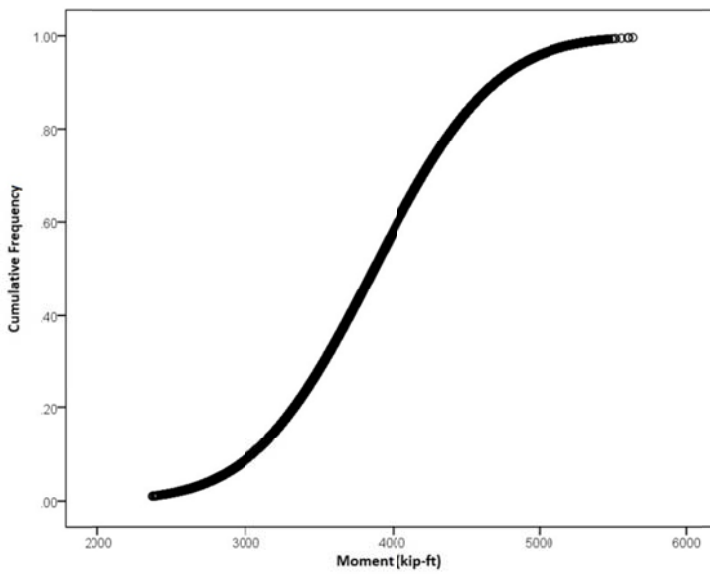

Figure H.8. CDF of Top 5% of Simple 160 ft Span Moments, Single LEP Vehicles.

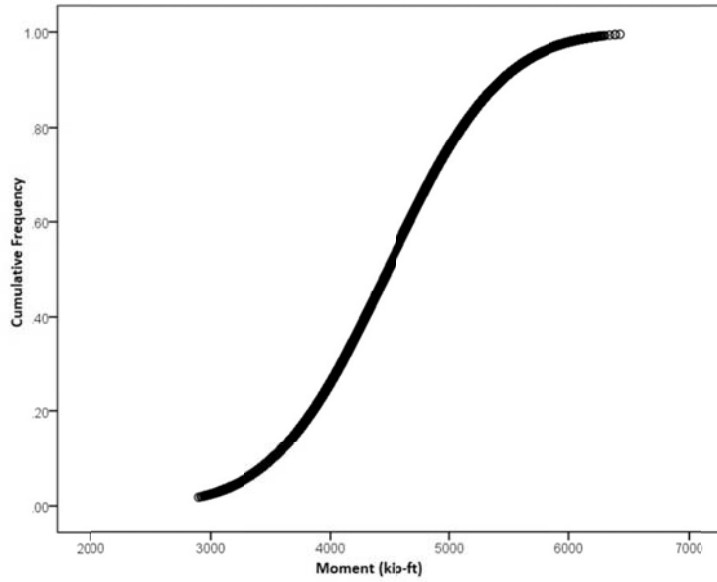

Figure H.9. CDF of Top 5% of Simple 180 ft Span Moments, Single LEP Vehicles.

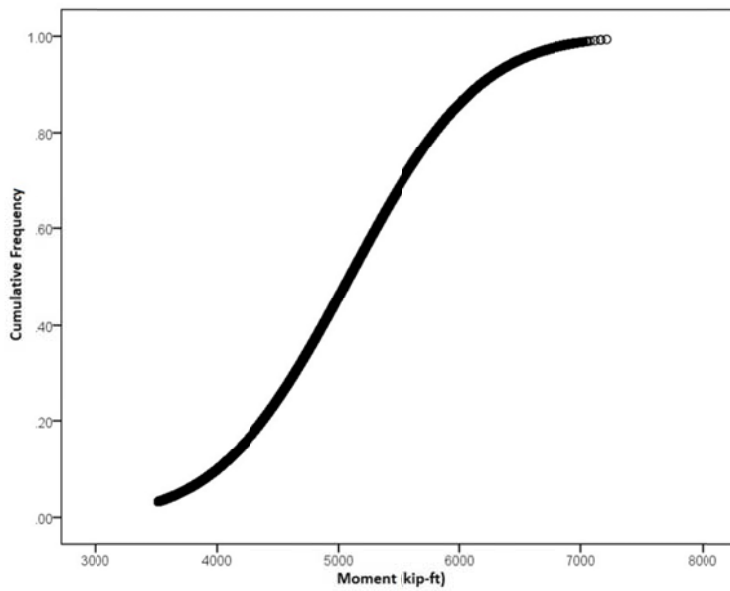

Figure H.10. CDF of Top 5% of Simple 200 ft Span Moments, Single LEP Vehicles.



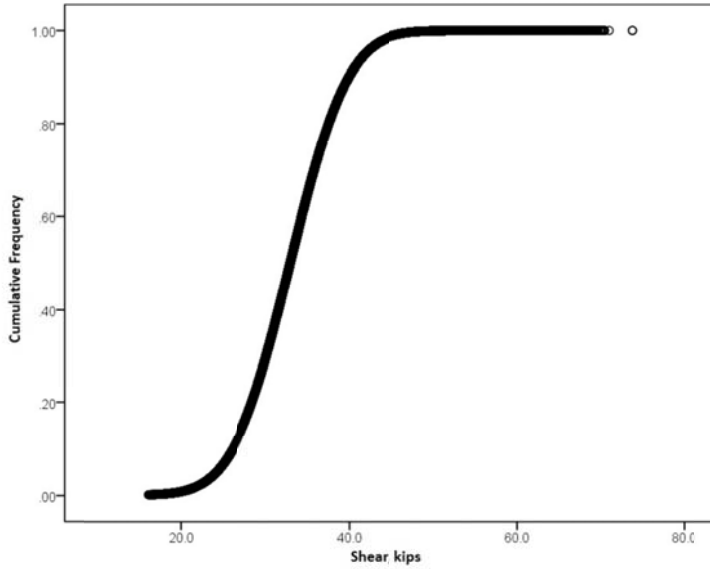

Figure H.11. CDF of Top 5% of Simple 20 ft Span Shears, Single LEP Vehicles.

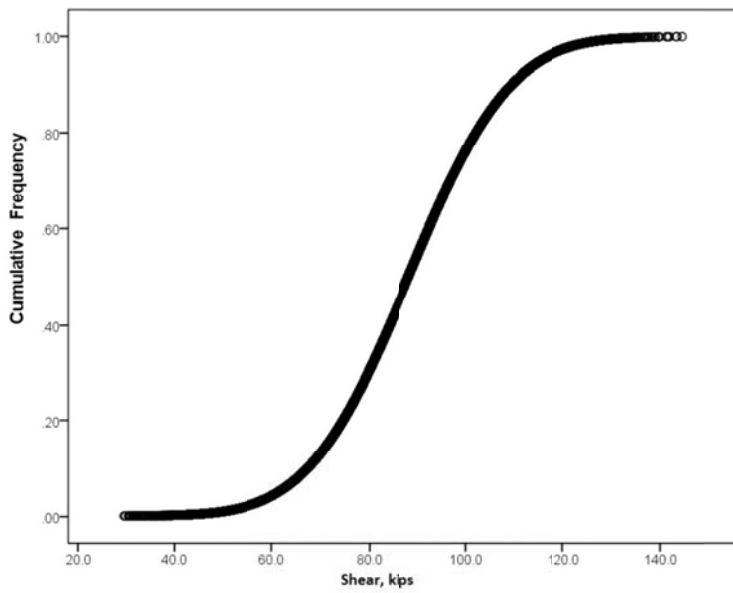

Figure H.12. CDF of Top 5% of Simple 40 ft Span Shears, Single LEP Vehicles.

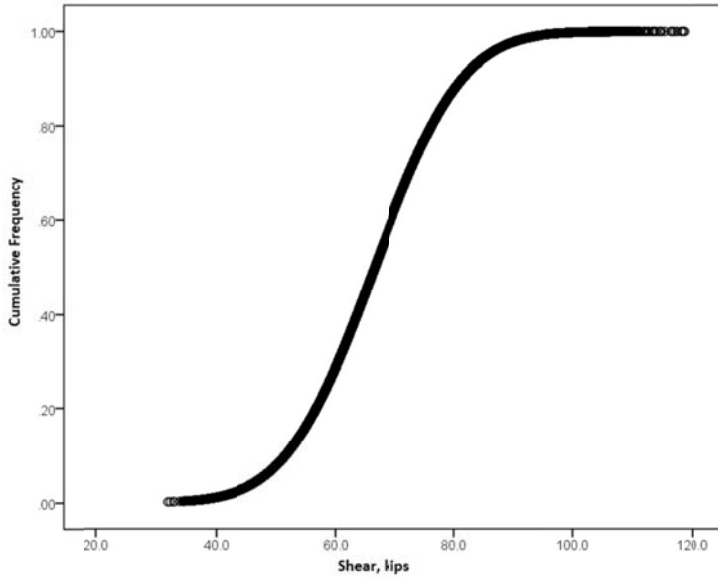

Figure H.13. CDF of Top 5% of Simple 60 ft Span Shears, Single LEP Vehicles.

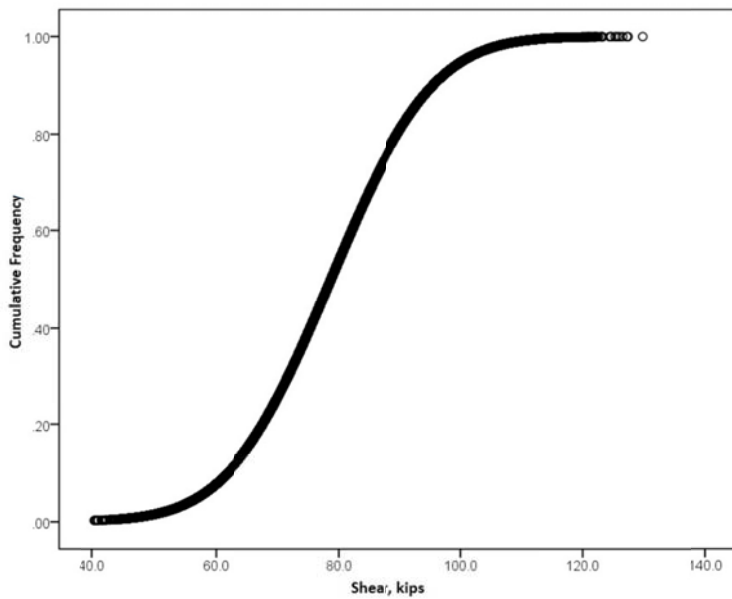

Figure H.14. CDF of Top 5% of Simple 80 ft Span Shears, Single LEP Vehicles.

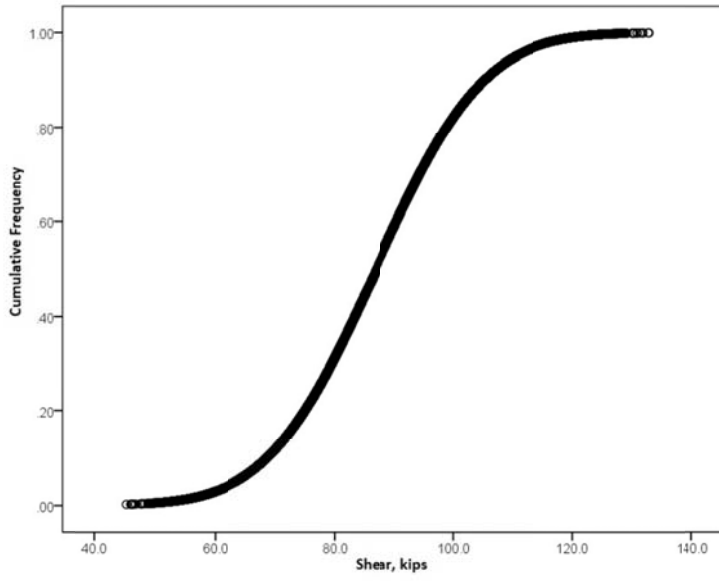

Figure H.15. CDF of Top 5% of Simple 100 ft Span Shears, Single LEP Vehicles.

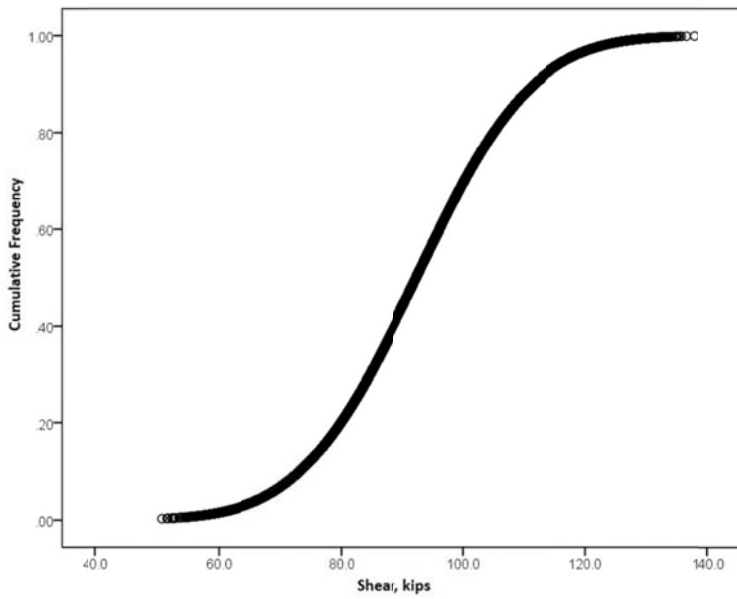

Figure H.16. CDF of Top 5% of Simple 120 ft Span Shears, Single LEP Vehicles.

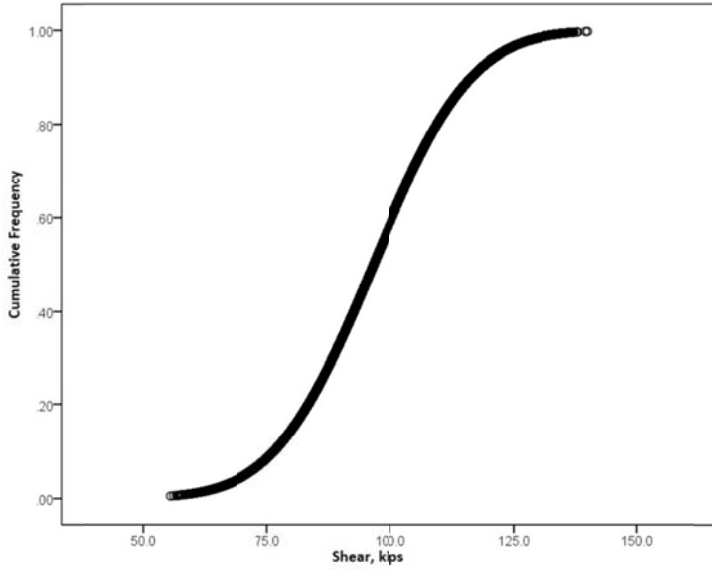

Figure H.17. CDF of Top 5% of Simple 140 ft Span Shears, Single LEP Vehicles.

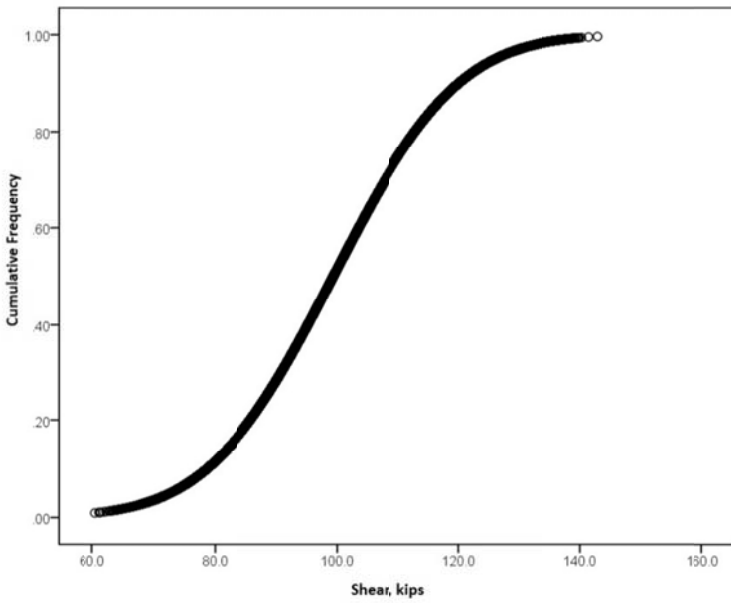

Figure H.18. CDF of Top 5% of Simple 160 ft Span Shears, Single LEP Vehicles.

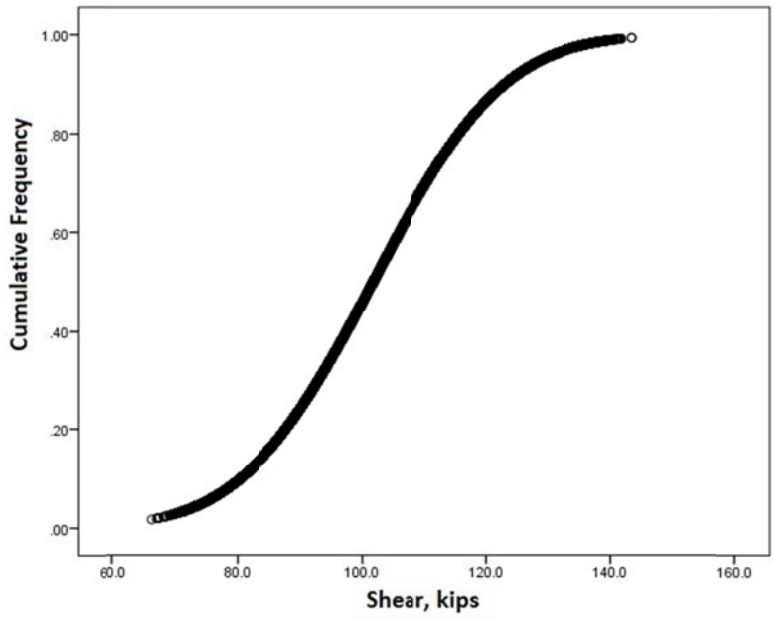

Figure H.19. CDF of Top 5% of Simple 180 ft Span Shears, Single LEP Vehicles.

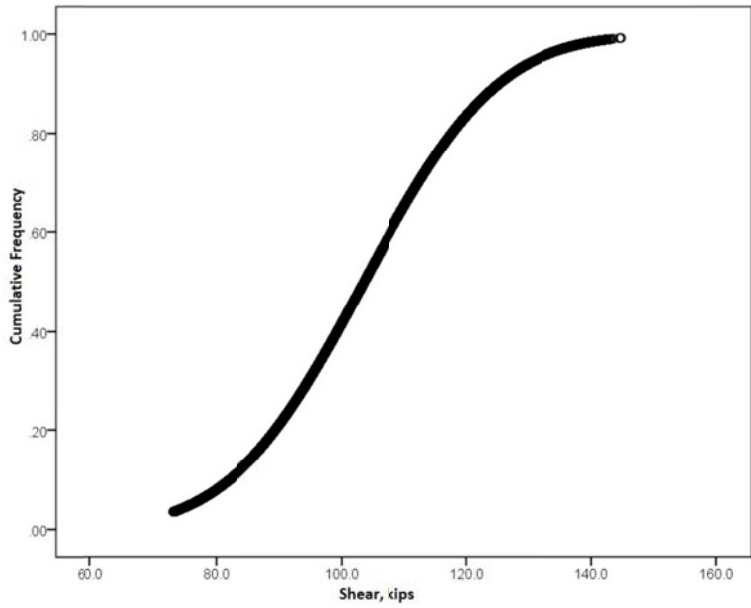

Figure H.20. CDF of Top 5% of Simple 200 ft Span Shears, Single LEP Vehicles.

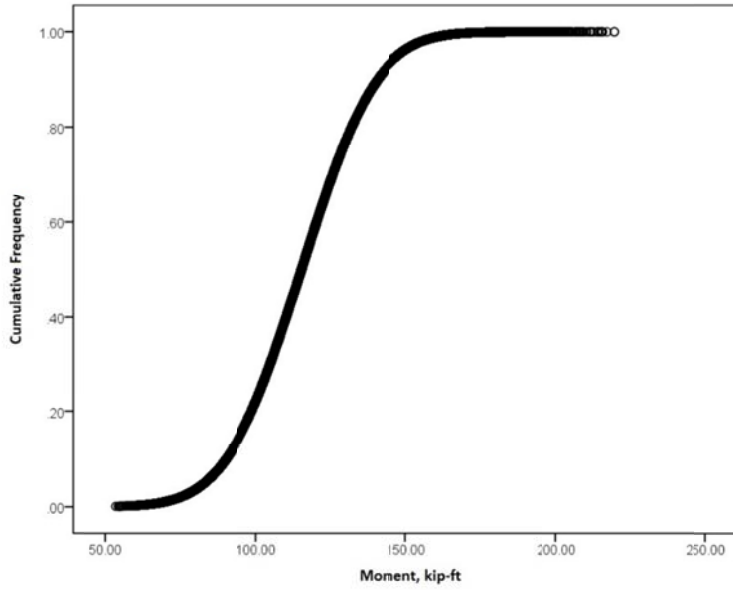

Figure H.21. CDF of Top 5% of Continuous 20 ft Span Moments, Single LEP Vehicles.

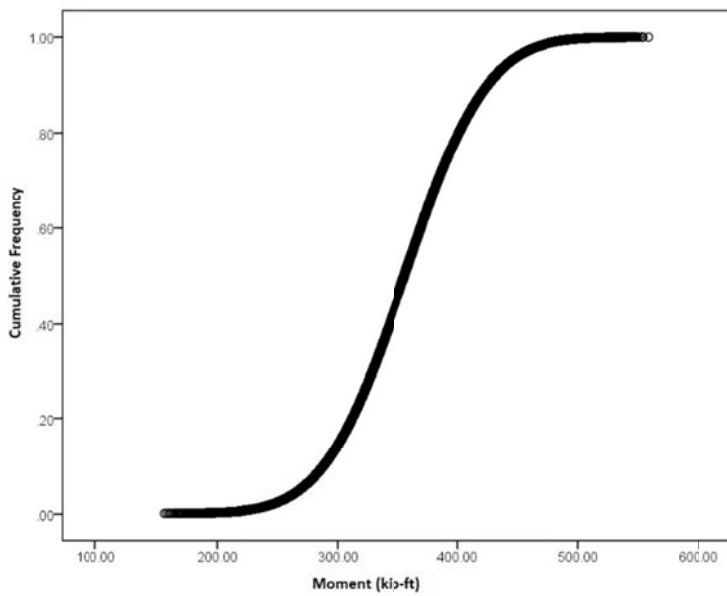

Figure H.22. CDF of Top 5% of Continuous 40 ft Span Moments, Single LEP Vehicles.

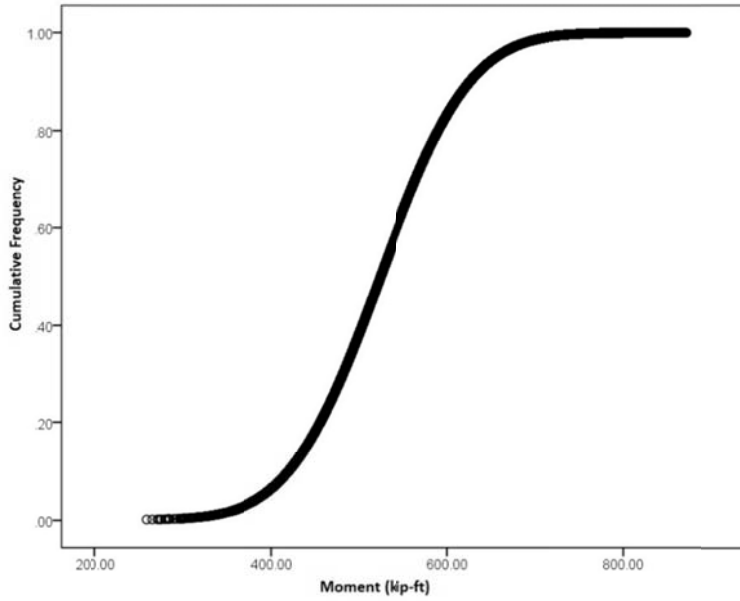

Figure H.23. CDF of Top 5% of Continuous 60 ft Span Moments, Single LEP Vehicles.

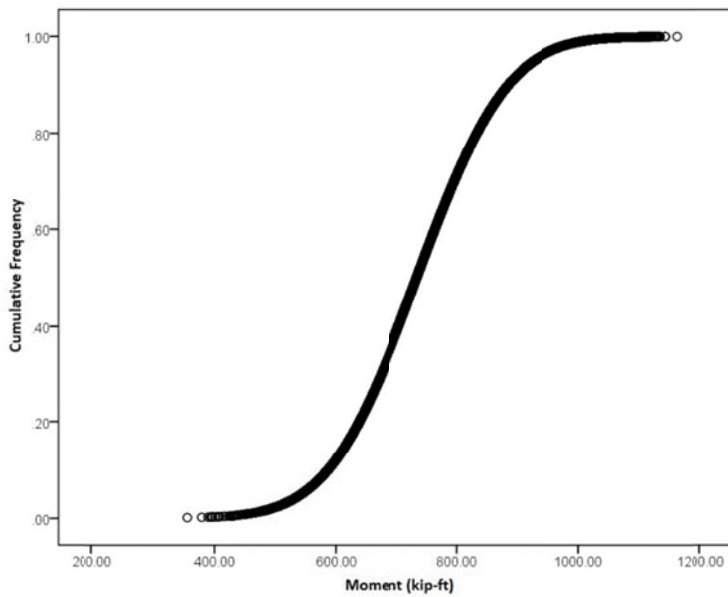

Figure H.24. CDF of Top 5% of Continuous 80 ft Span Moments, Single LEP Vehicles.

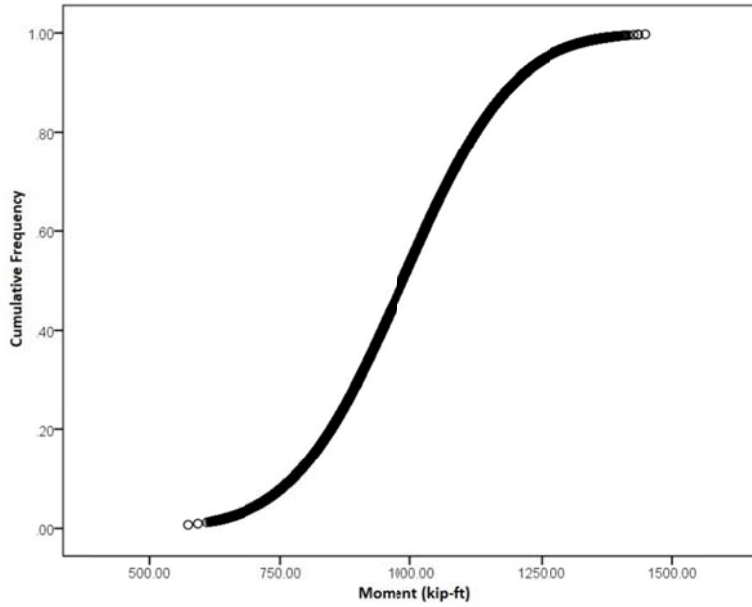

Figure H.25. CDF of Top 5% of Continuous 100 ft Span Moments, Single LEP Vehicles.

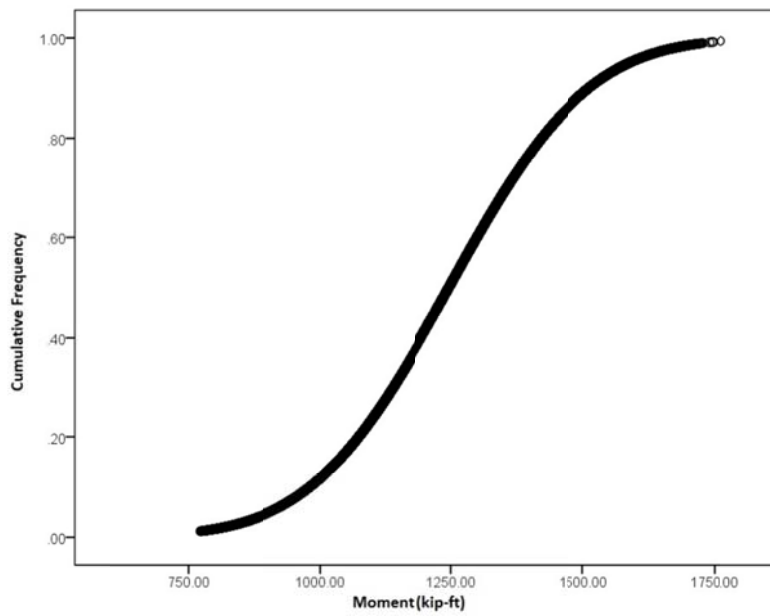

Figure H.26. CDF of Top 5% of Continuous 120 ft Span Moments, Single LEP Vehicles.



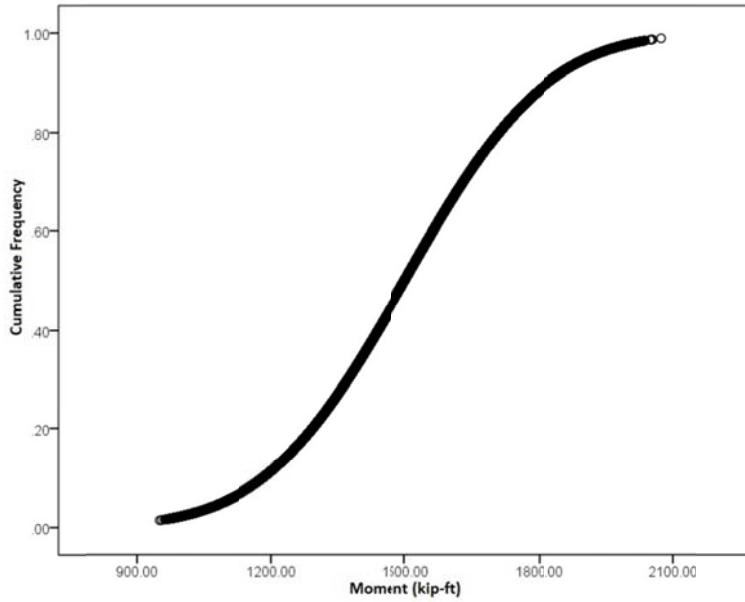

Figure H.27. CDF of Top 5% of Continuous 140 ft Span Moments, Single LEP Vehicles.

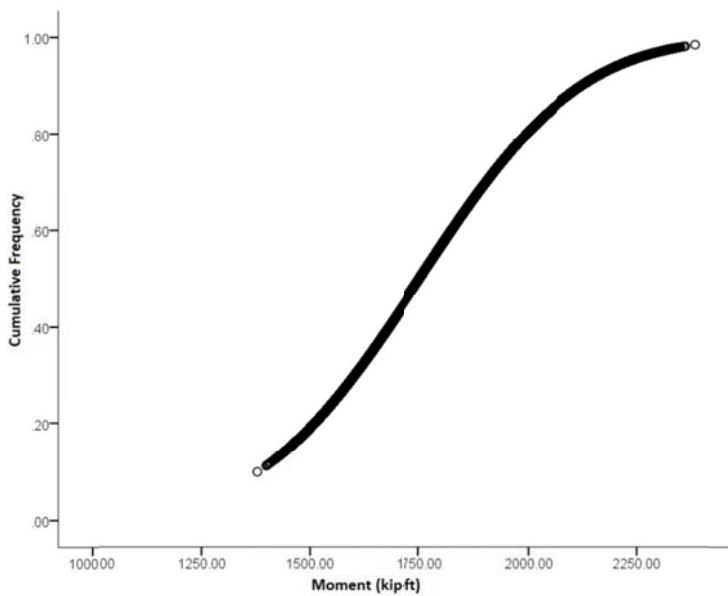

Figure H.28. CDF of Top 5% of Continuous 160 ft Span Moments, Single LEP Vehicles.

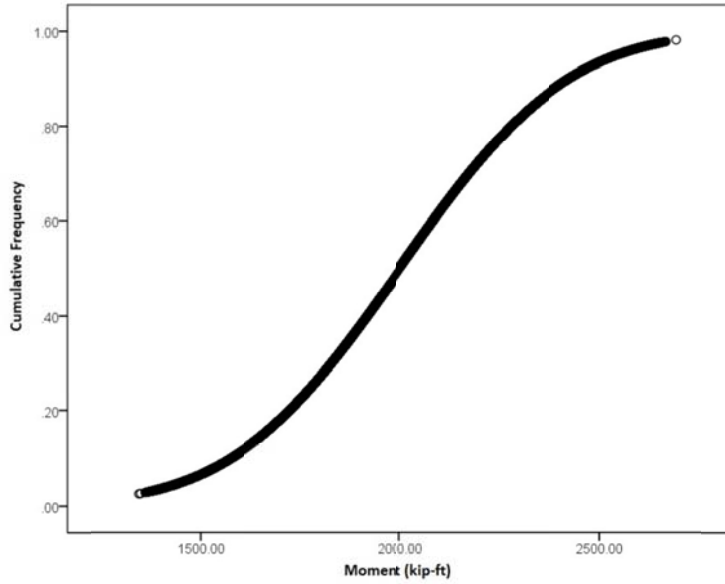

Figure H.29. CDF of Top 5% of Continuous 180 ft Span Moments, Single LEP Vehicles.

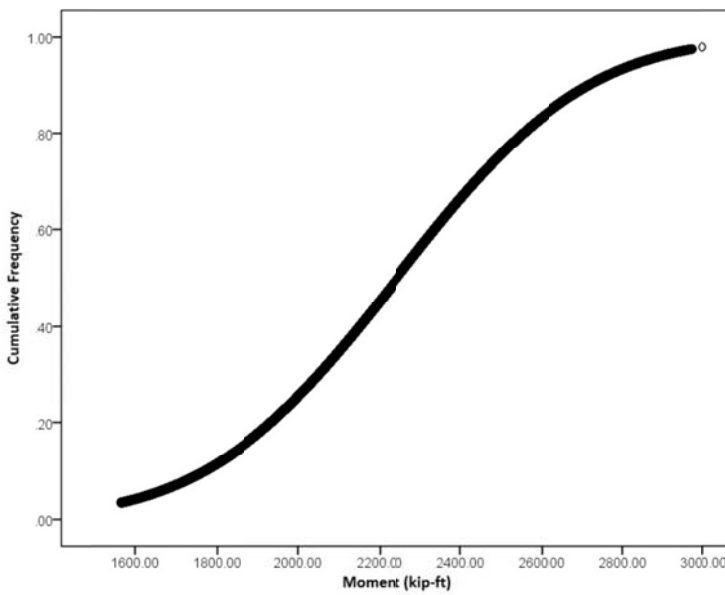

Figure H.30. CDF of Top 5% of Continuous 200 ft Span Moments, Single LEP Vehicles.

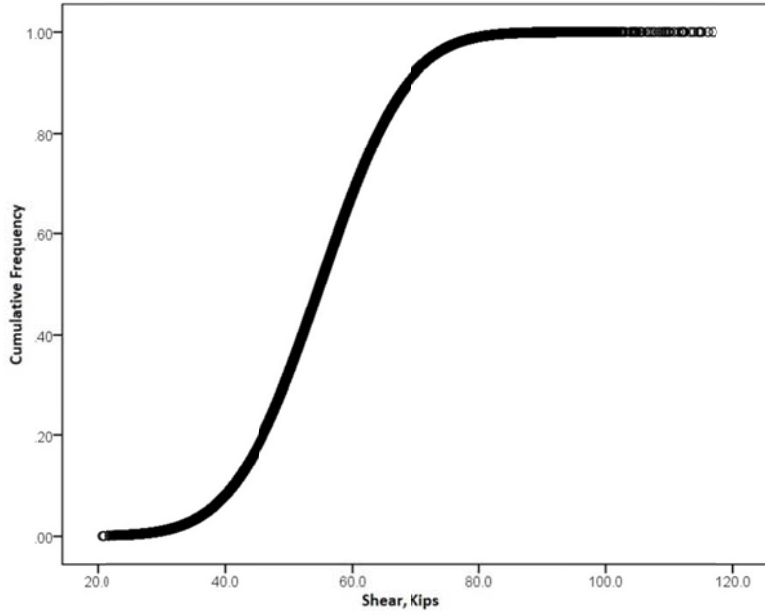

Figure H.31. CDF of Top 5% of Continuous 20 ft Span Shears, Single LEP Vehicles.

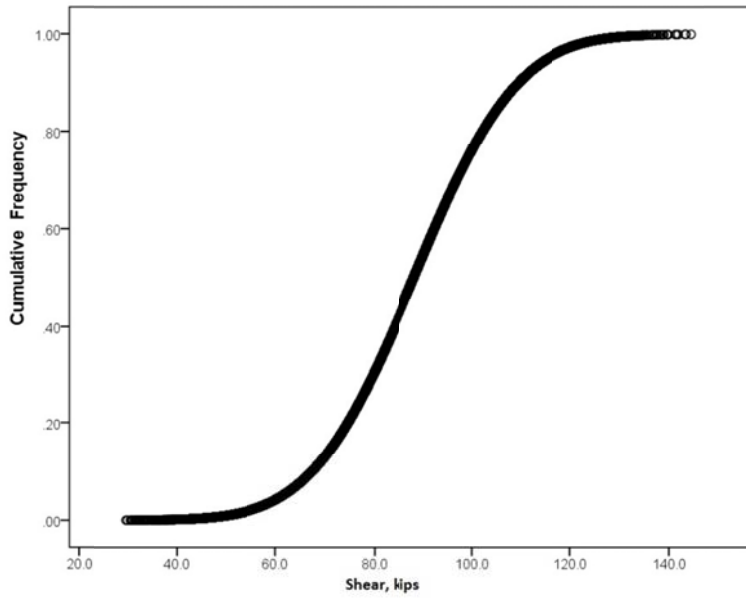

Figure H.32. CDF of Top 5% of Continuous 40 ft Span Shears, Single LEP Vehicles.

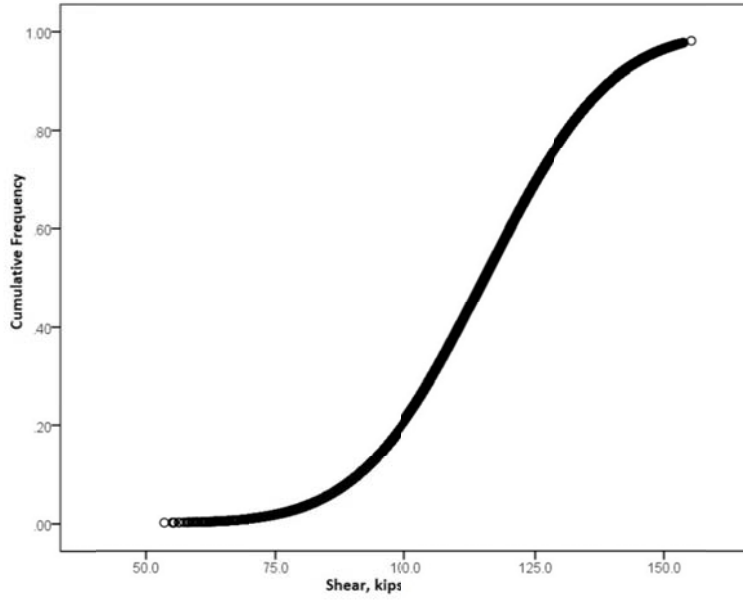

Figure H.33. CDF of Top 5% of Continuous 60 ft Span Shears, Single LEP Vehicles.

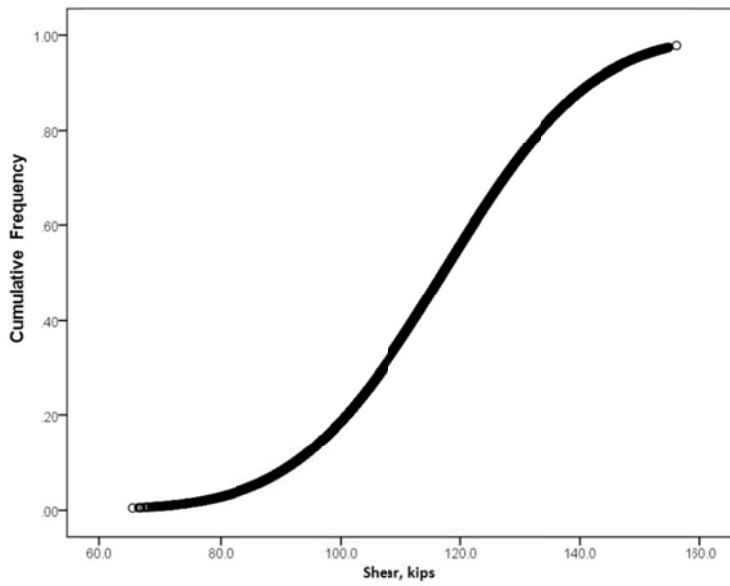

Figure H.34. CDF of Top 5% of Continuous 80 ft Span Shears, Single LEP Vehicles.

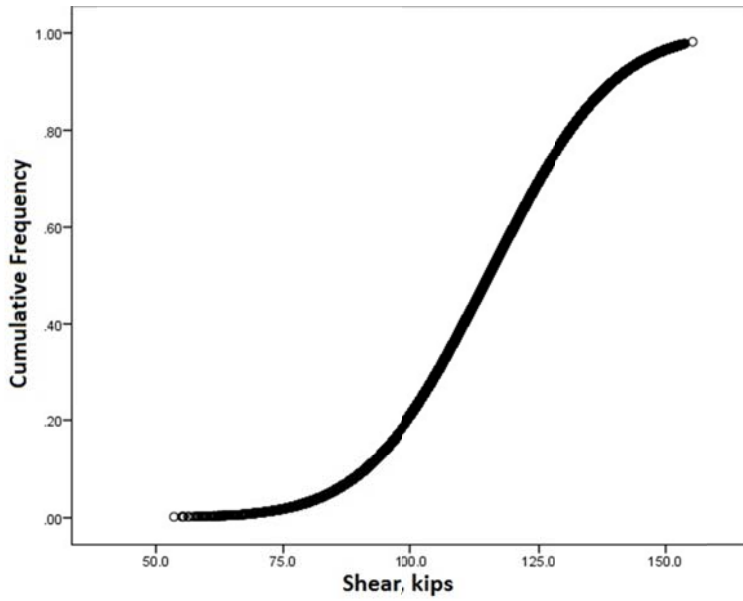

Figure H.35. CDF of Top 5% of Continuous 100 ft Span Shears, Single LEP Vehicles.

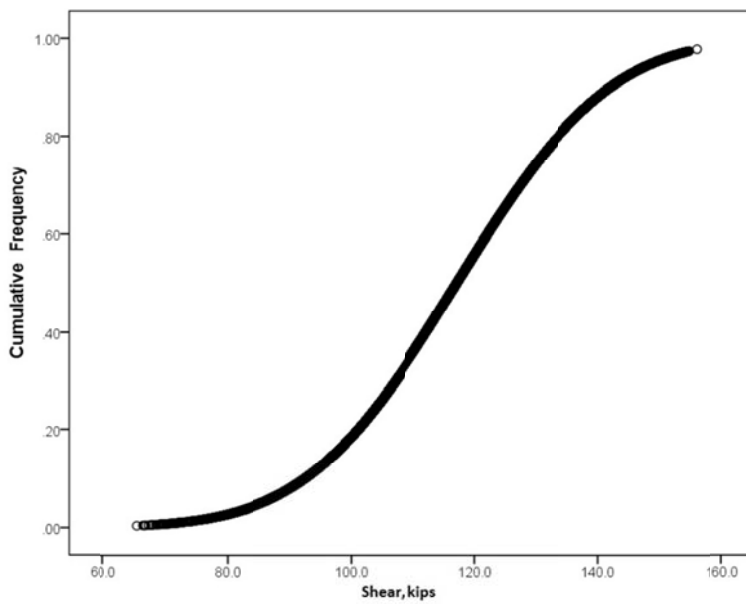

Figure H.36. CDF of Top 5% of Continuous 120 ft Span Shears, Single LEP Vehicles.

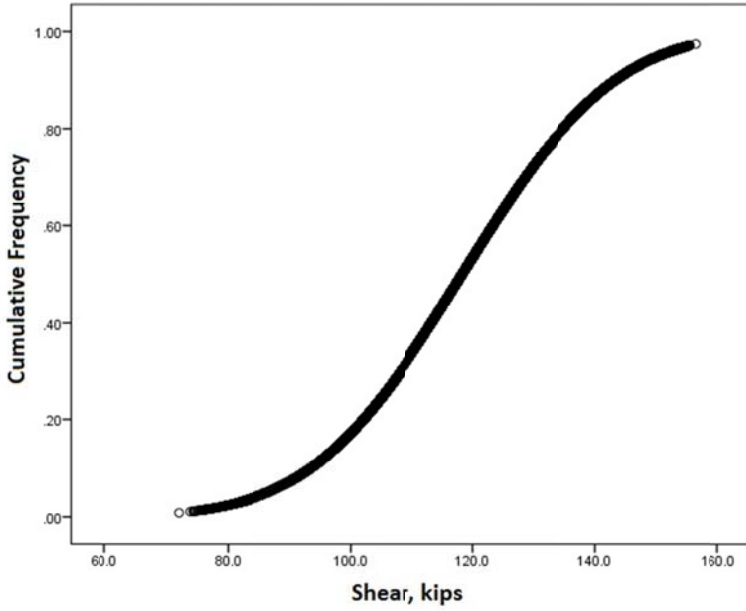

Figure H.37. CDF of Top 5% of Continuous 140 ft Span Shears, Single LEP Vehicles.

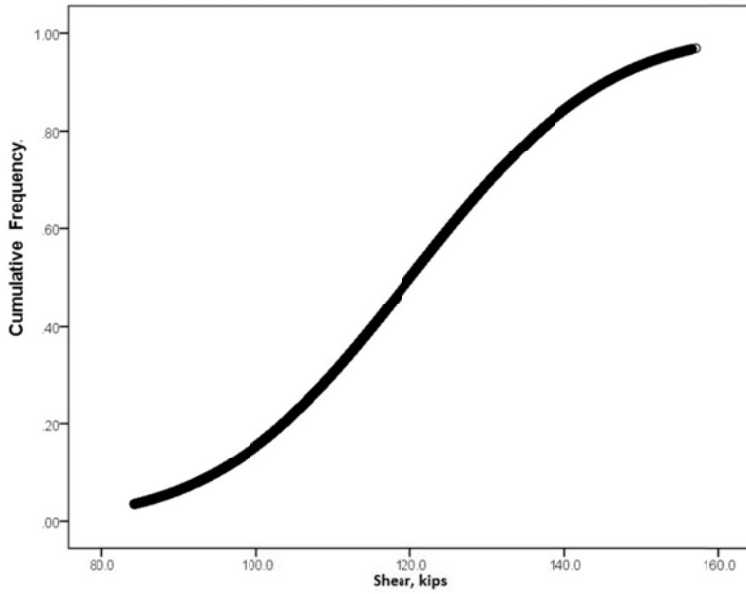

Figure H.38. CDF of Top 5% of Continuous 160 ft Span Shears, Single LEP Vehicles.

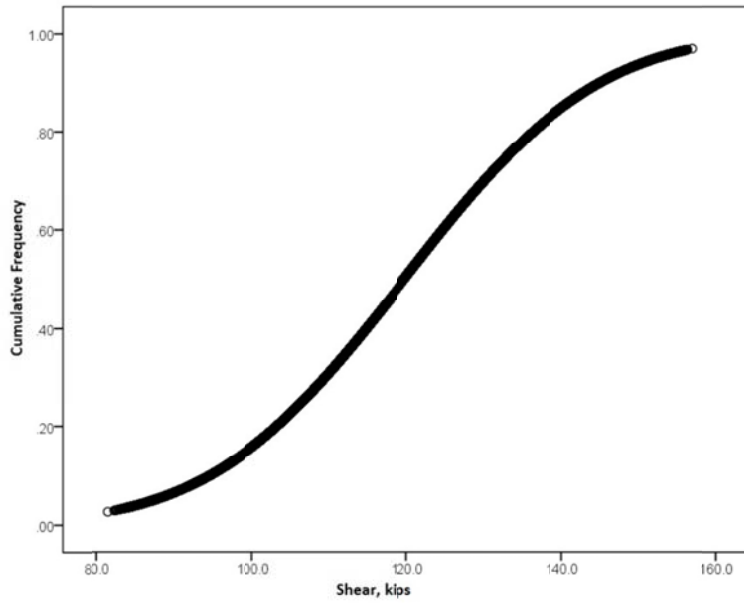

Figure H.39. CDF of Top 5% of Continuous 180 ft Span Shears, Single LEP Vehicles.

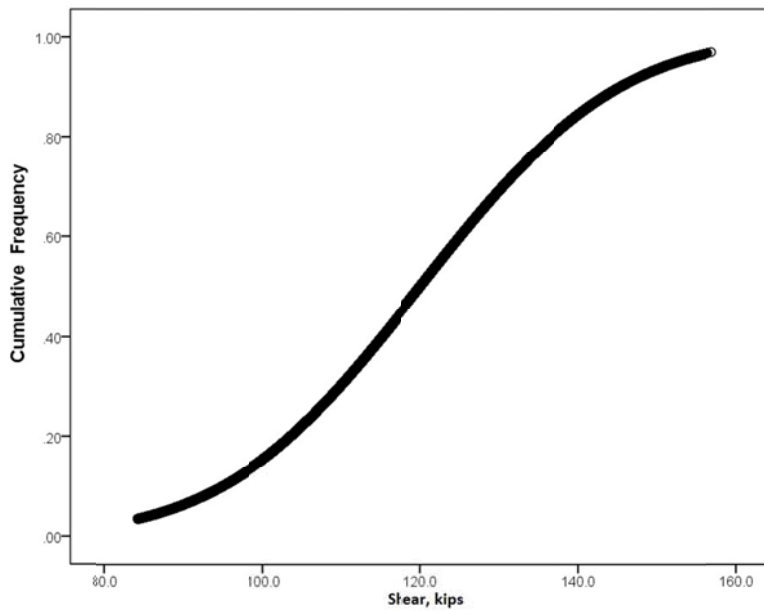

Figure H.40. CDF of Top 5% of Continuous 200 ft Span Shears, Single LEP Vehicles.

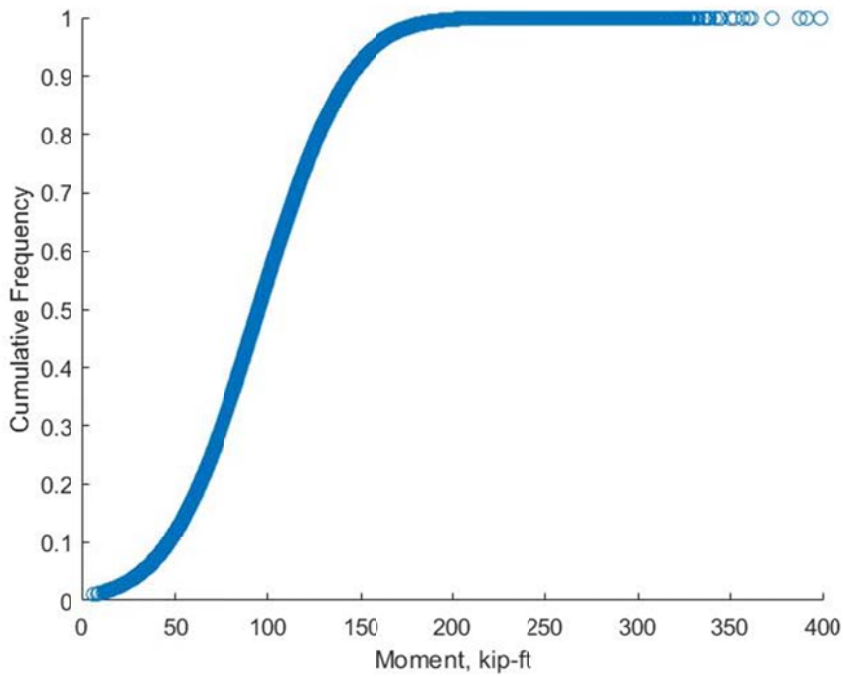

Figure H.41. CDF of Simple 20 ft Span Moments, Two Lane LEP Vehicles.

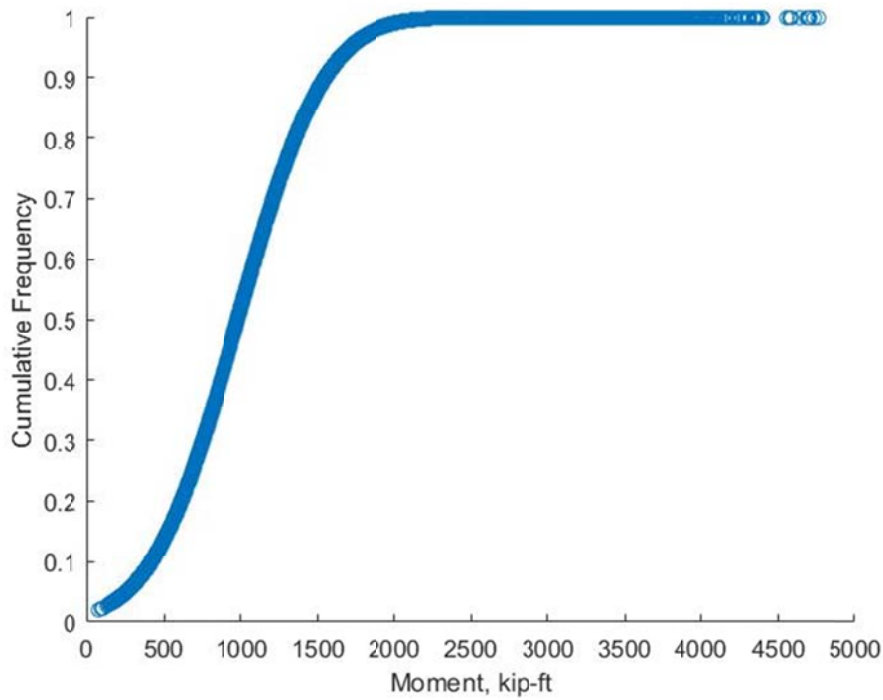

Figure H.42. CDF of Simple 100 ft Span Moments, Two Lane LEP Vehicles.



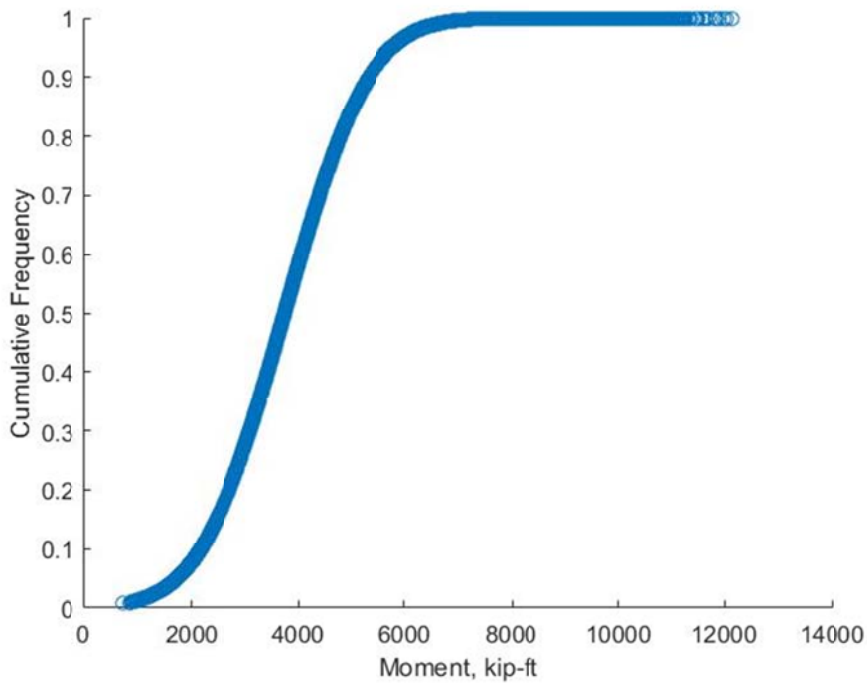

Figure H.43. CDF of Simple 200 ft Span Moments, Two Lane LEP Vehicles.

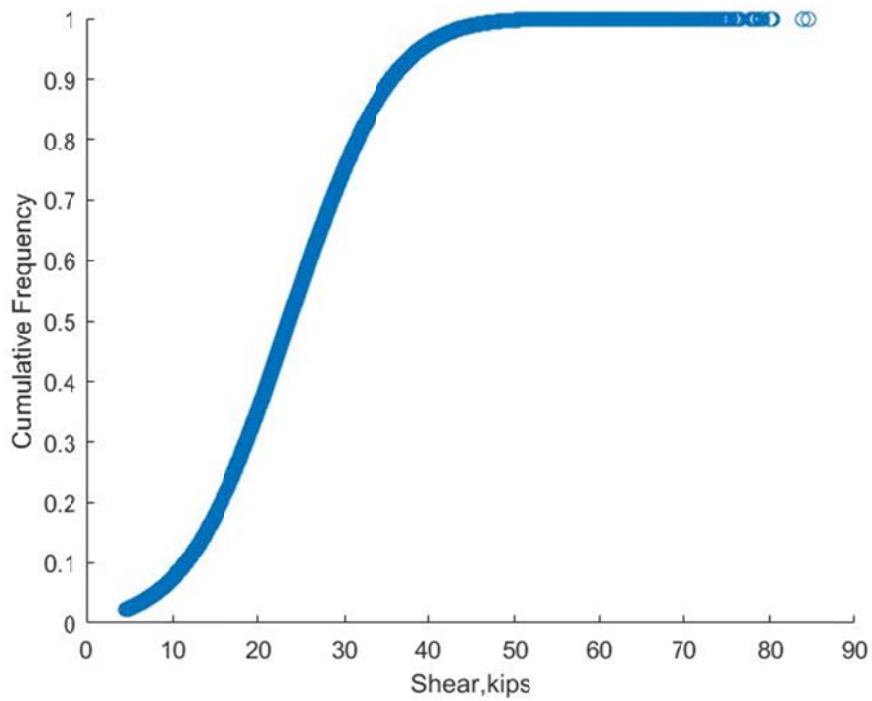

Figure H.44. CDF of Simple 20 ft Span Shears, Two Lane LEP Vehicles.

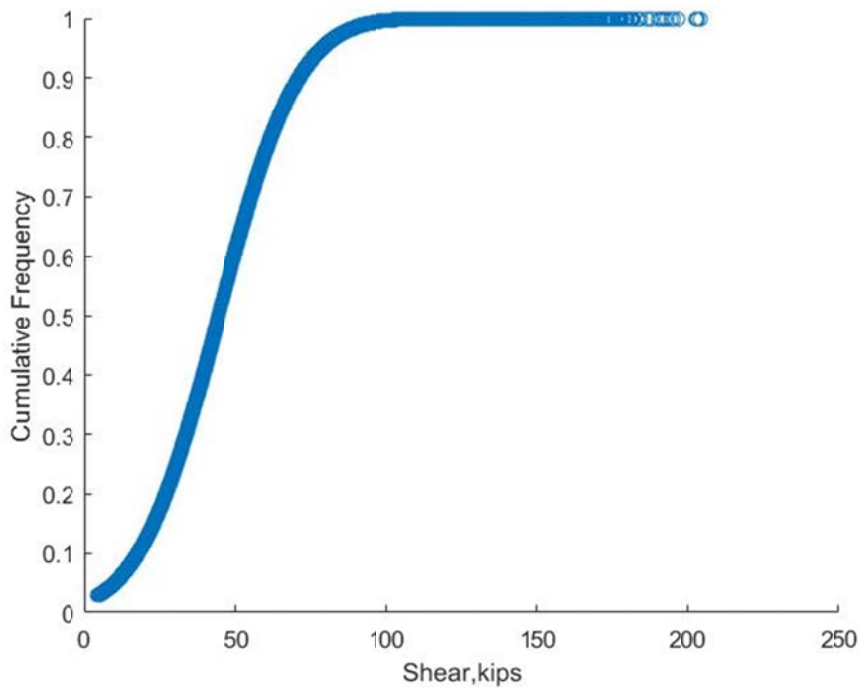

Figure H.45. CDF of Simple 100 ft Span Shears, Two Lane LEP Vehicles.

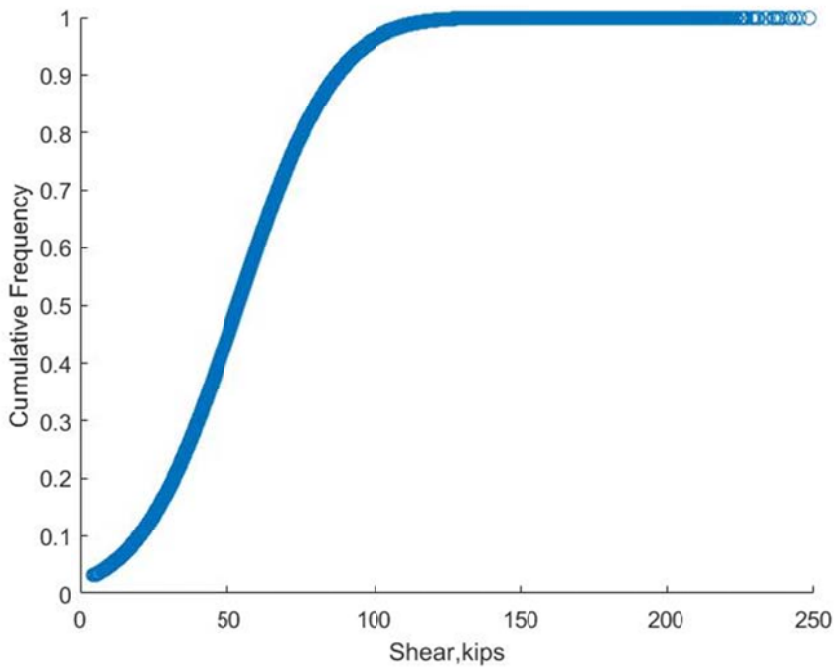

Figure H.46. CDF of Simple 200 ft Span Shears, Two Lane LEP Vehicles.

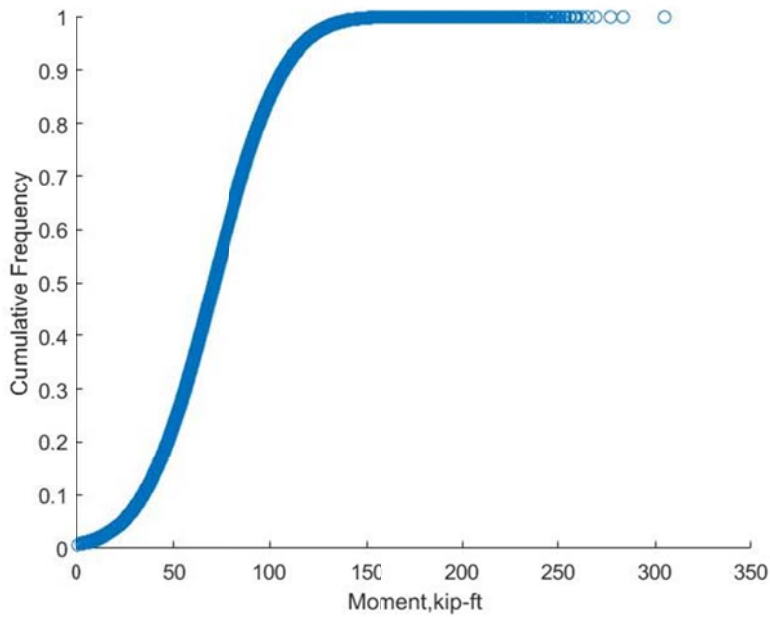

Figure H.47. CDF of Continuous 20 ft Span Moments, Two Lane LEP Vehicles.

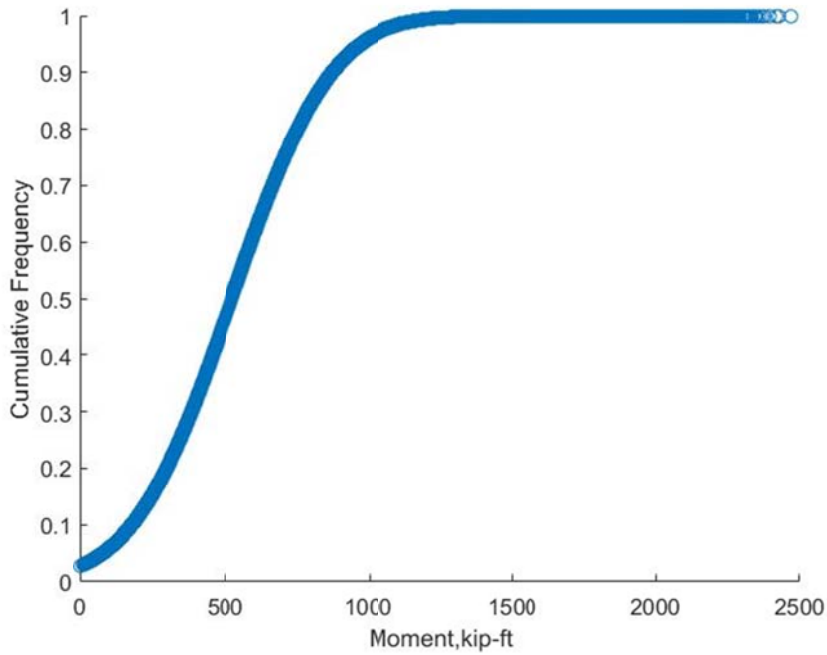

Figure H.48. CDF of Continuous 100 ft Span Moments, Two Lane LEP Vehicles.

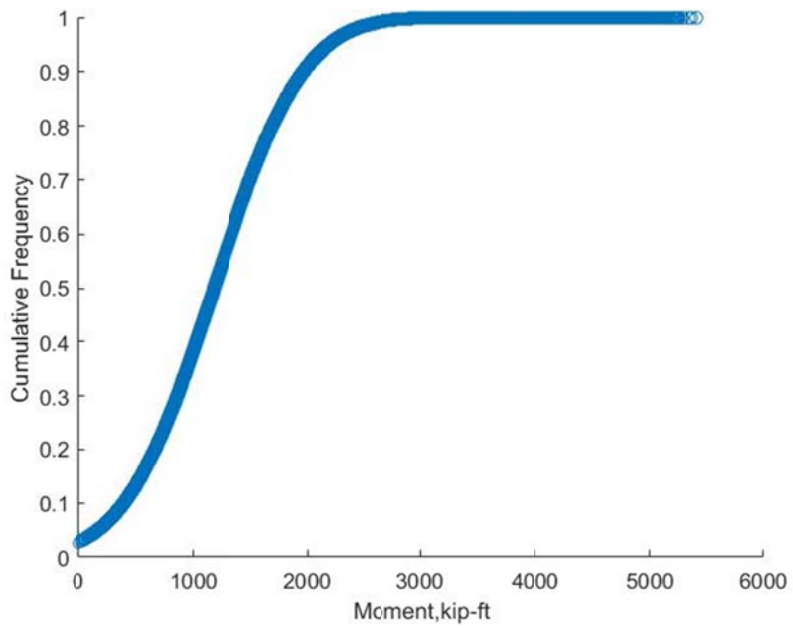

Figure H.49. CDF of Continuous 200 ft Span Moments, Two Lane LEP Vehicles.

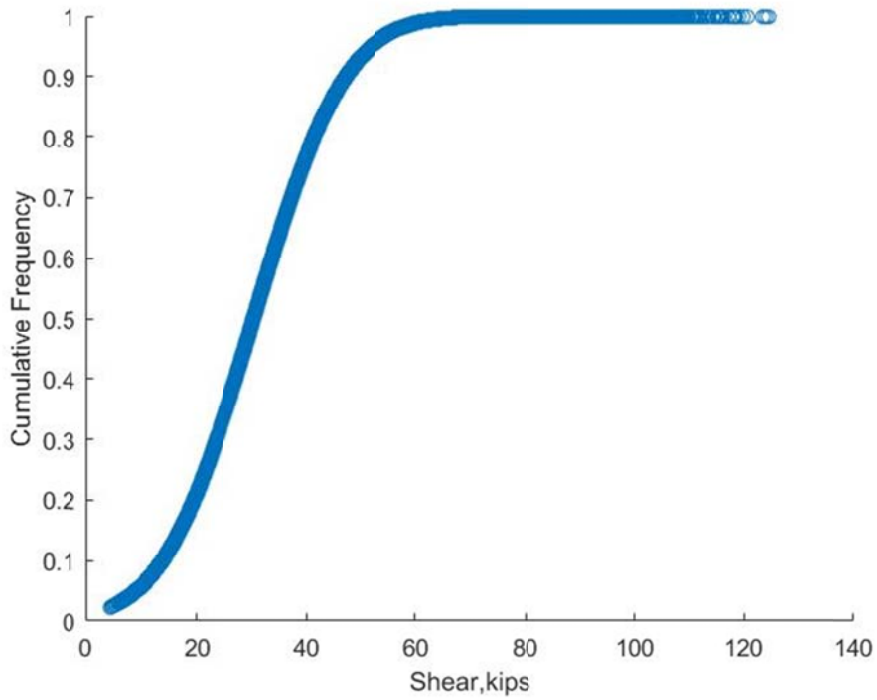

Figure H.50. CDF of Continuous 20 ft Span Shears, Two Lane LEP Vehicles.

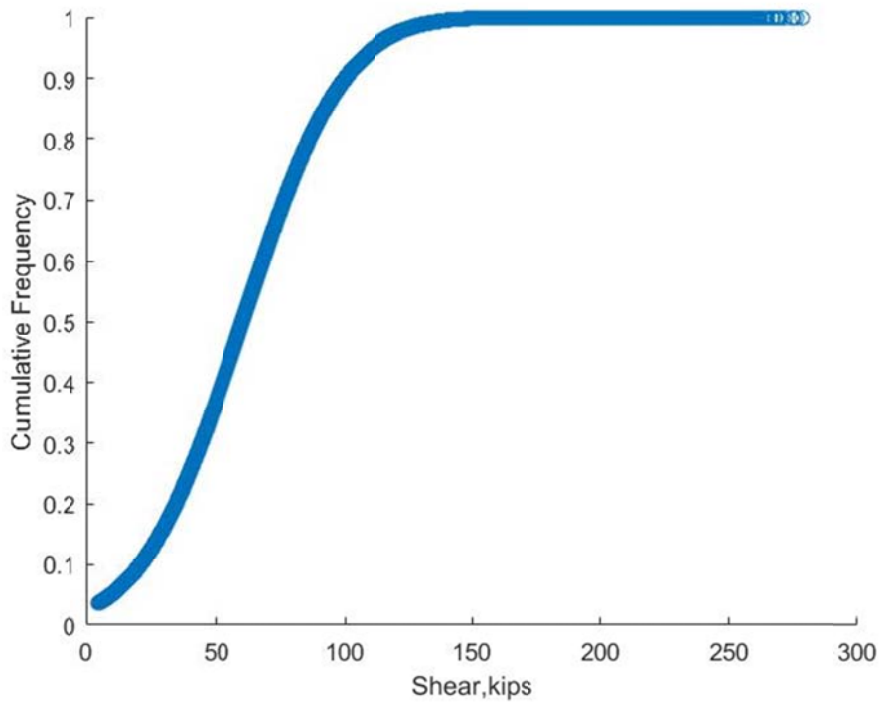

Figure H.51. CDF of Continuous 100 ft Span Shears, Two Lane LEP Vehicles.

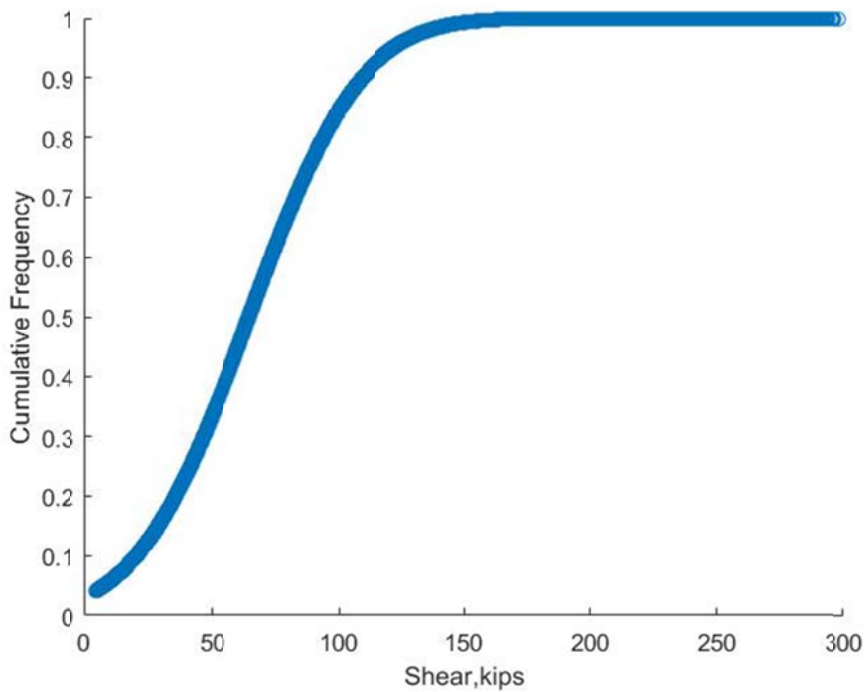

Figure H.52. CDF of Continuous 200 ft Span Shears, Two Lane LEP Vehicles.

## APPENDIX I. PROJECTION RESULTS

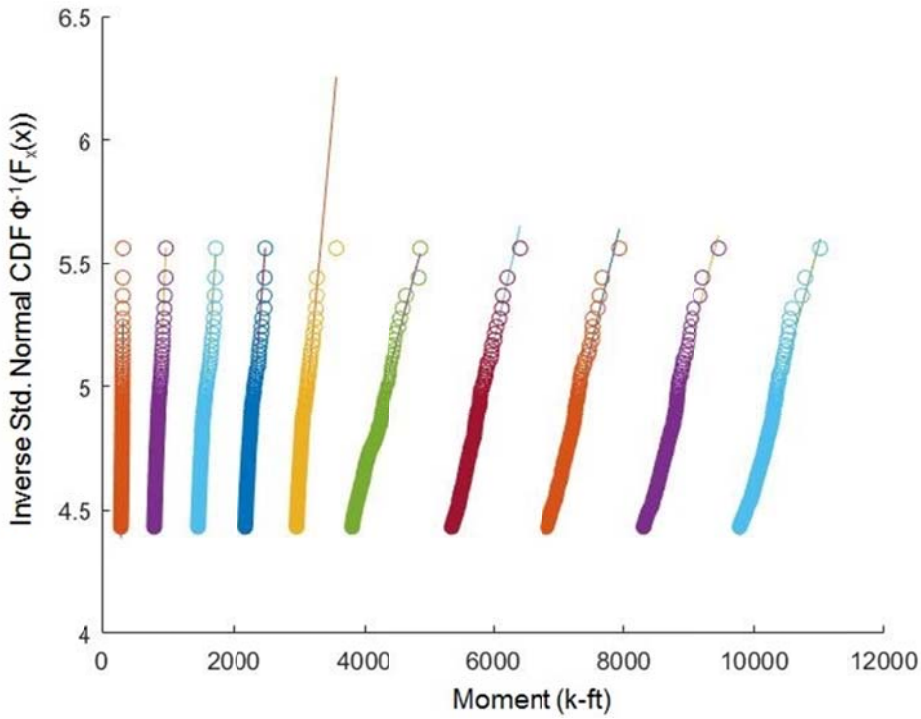

Figure I.1. Load Projections for One Lane Simple Moment, 20'-200' Spans.

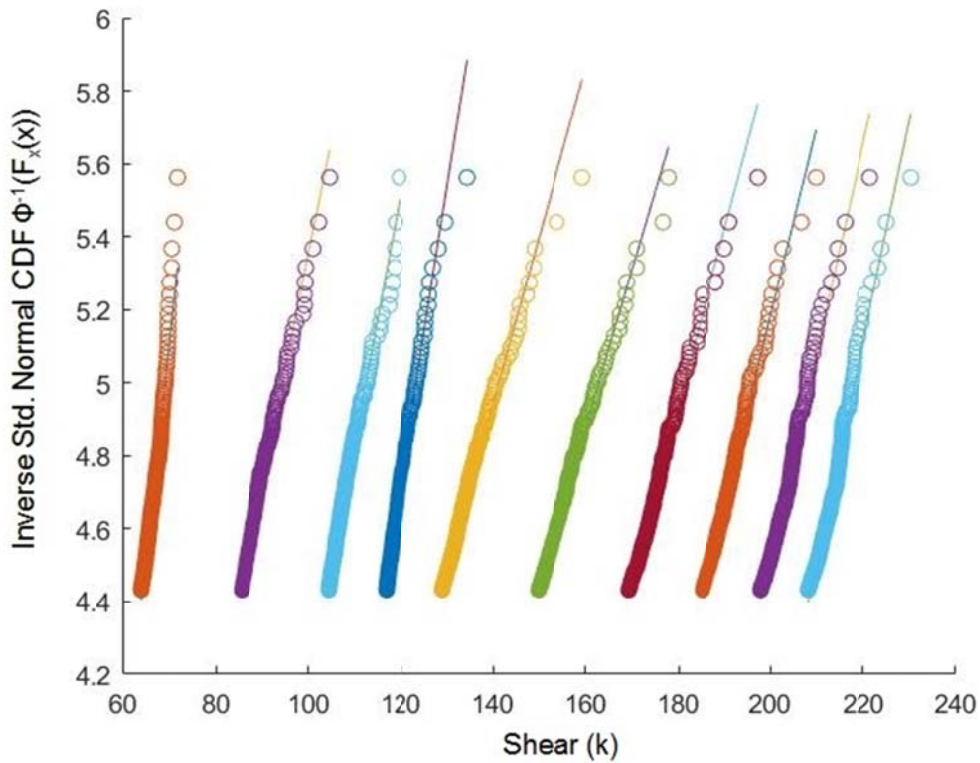

Figure I.2. Load Projections for One Lane Simple Shear, 20'-200' Spans.

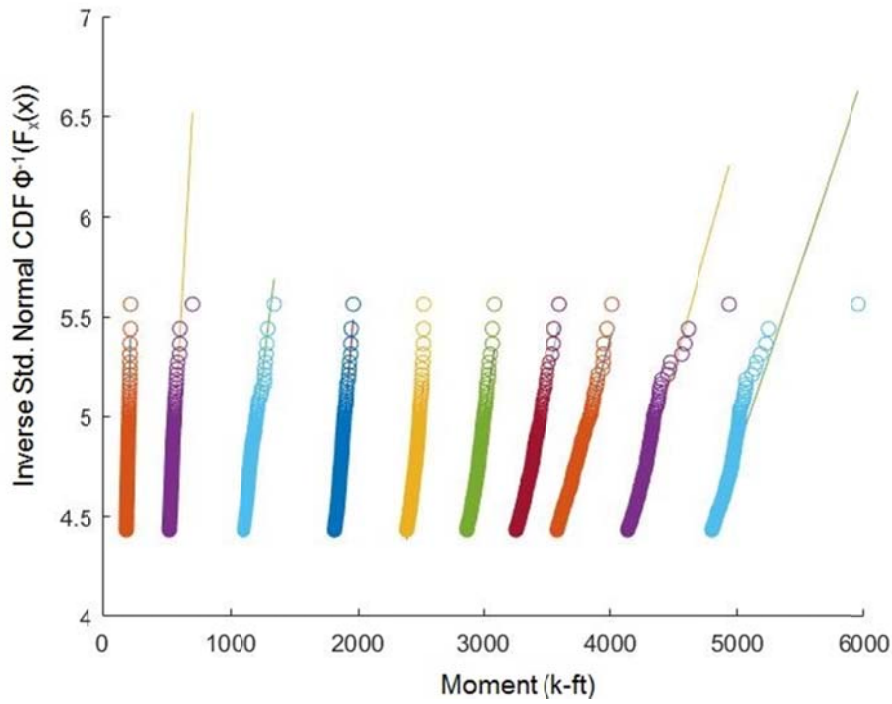

Figure I.3. Load Projections for One Lane Continuous Moment, 20'-200' Spans.

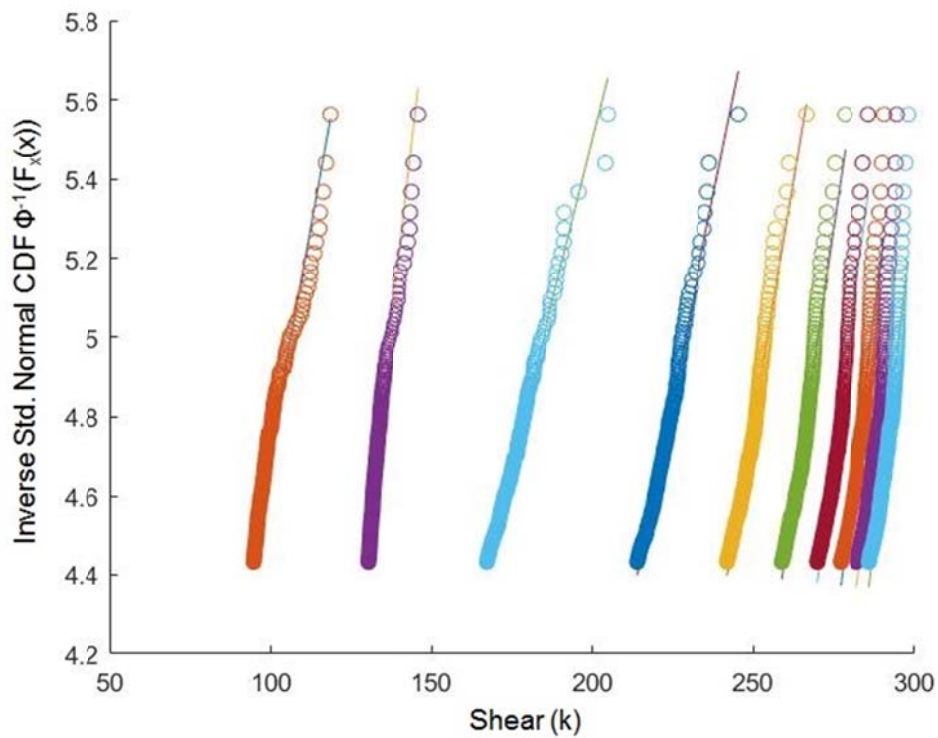

Figure I.4. Load Projections for One Lane Continuous Shear, 20'-200' Spans.

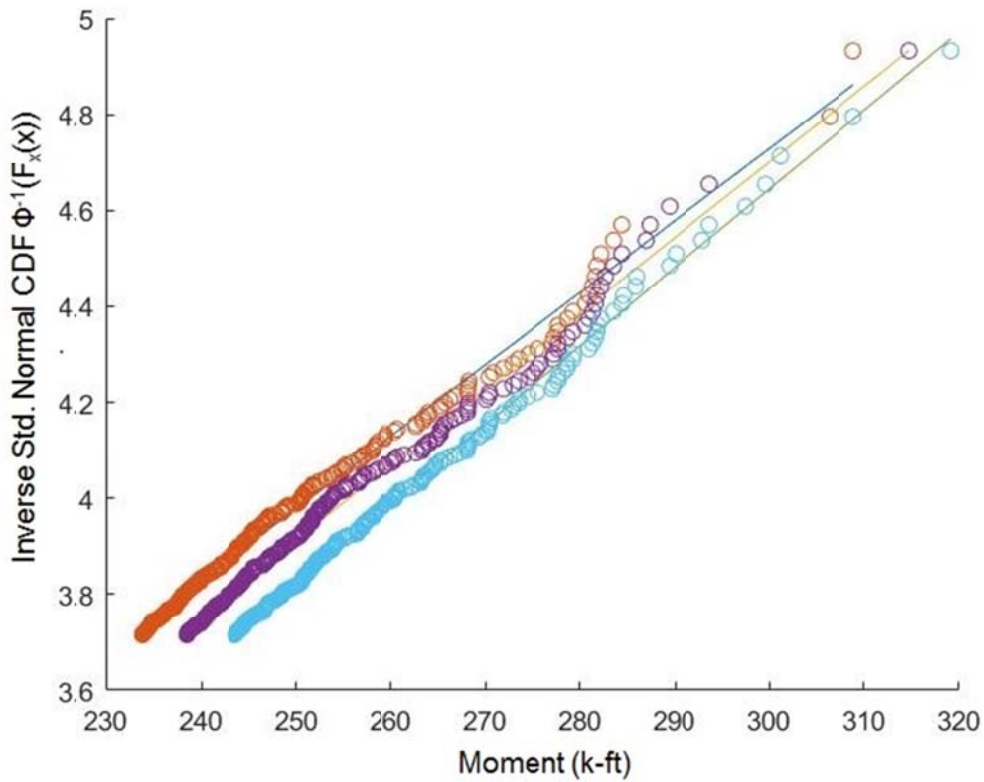

Figure I.5. Load Projections for Two Lane Simple Moment, 20' Span.

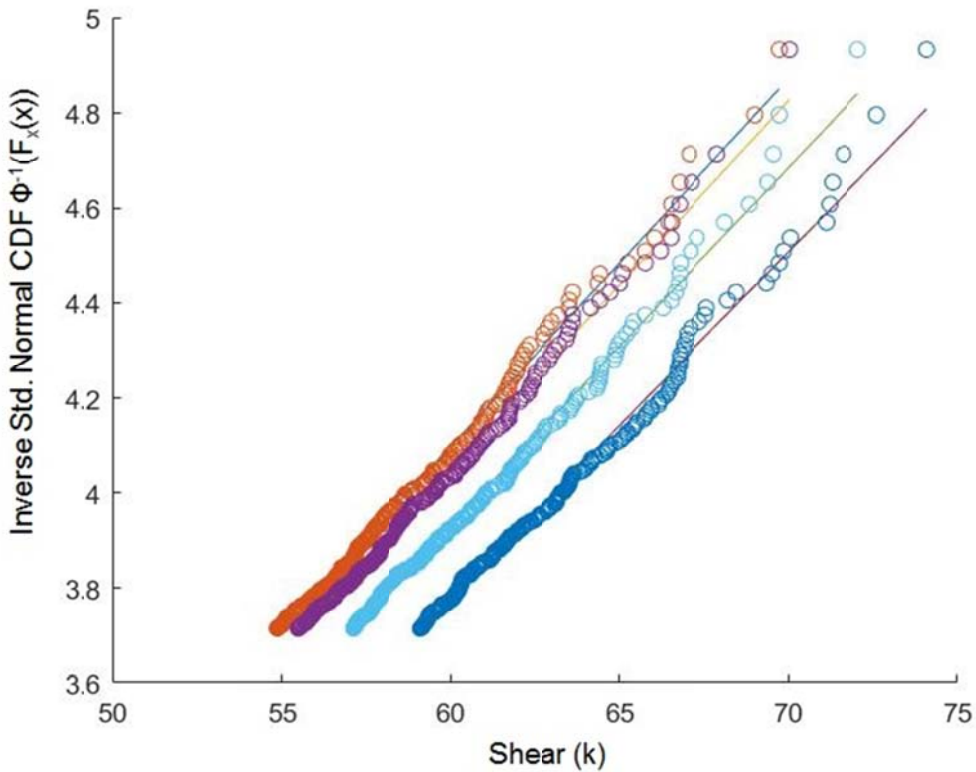

Figure I.6. Load Projections for Two Lane Simple Shear, 20' Span.



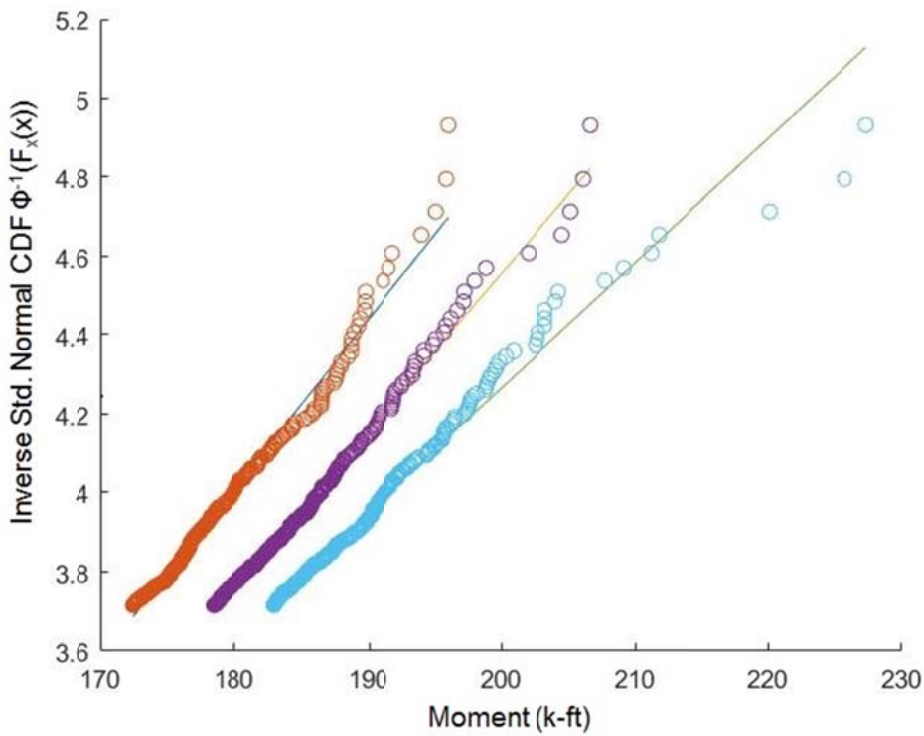

Figure I.7. Load Projections for Two Lane Continuous Moment, 20' Span.

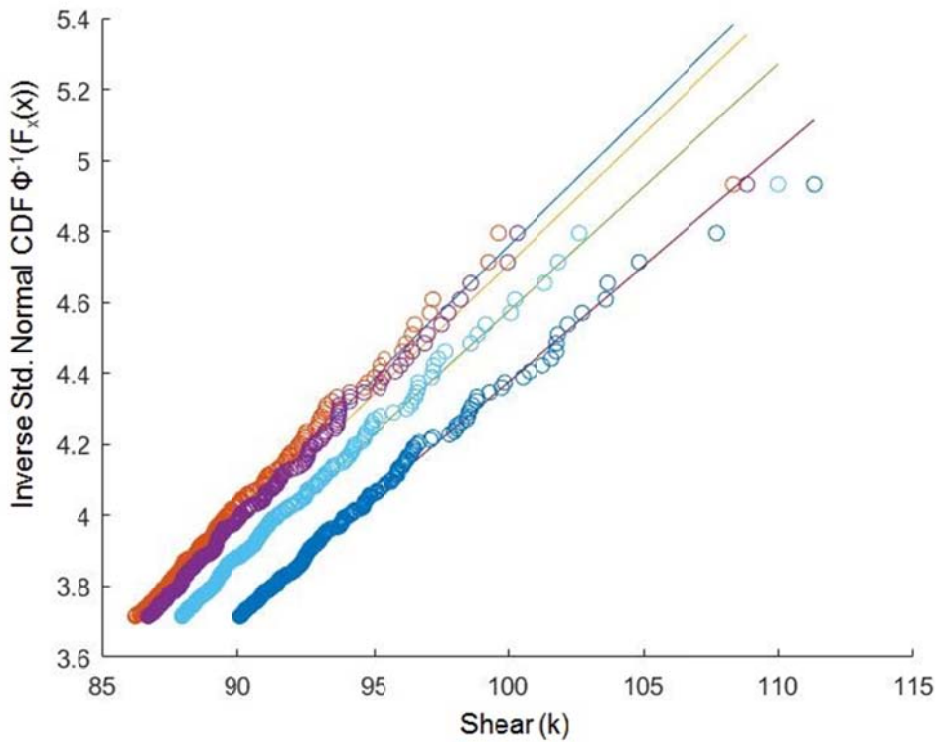

Figure I.8. Load Projections for Two Lane Continuous Shear, 20' Span.

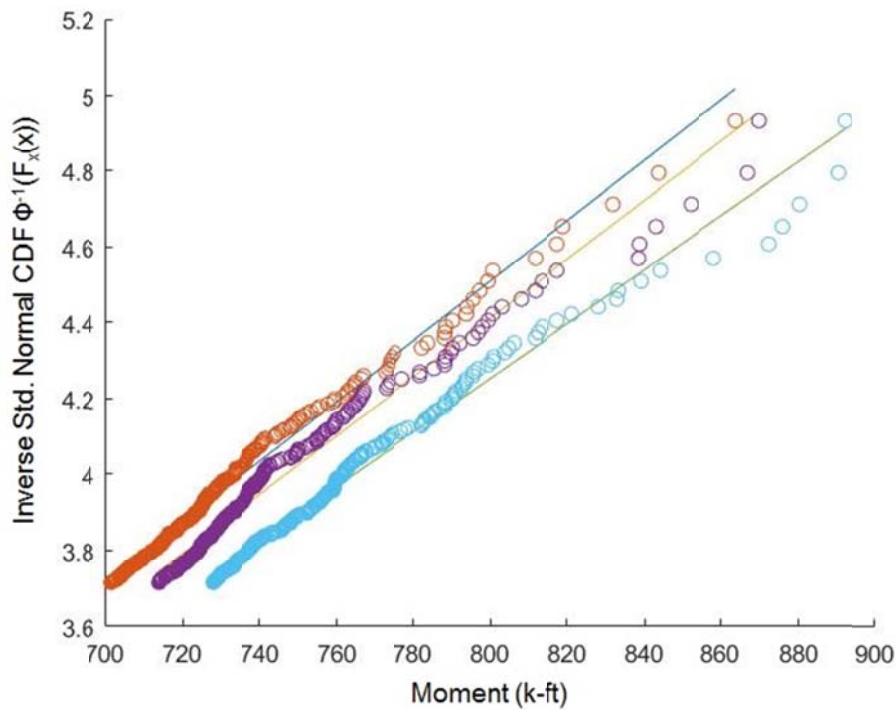

Figure I.9. Load Projections for Two Lane Simple Moment, 40' Span.

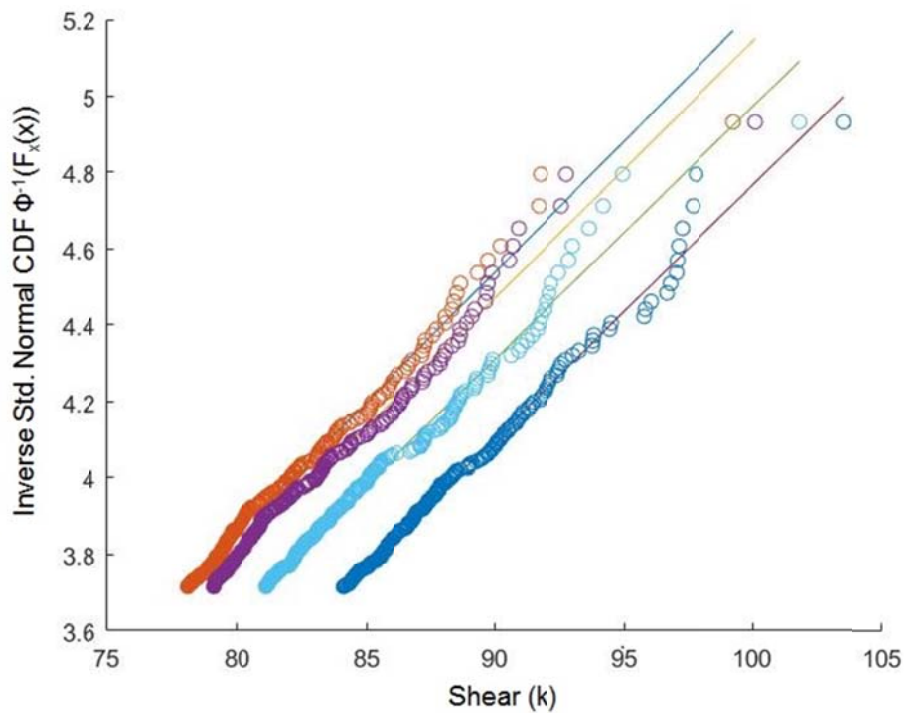

Figure I.10. Load Projections for Two Lane Simple Shear, 40' Span.

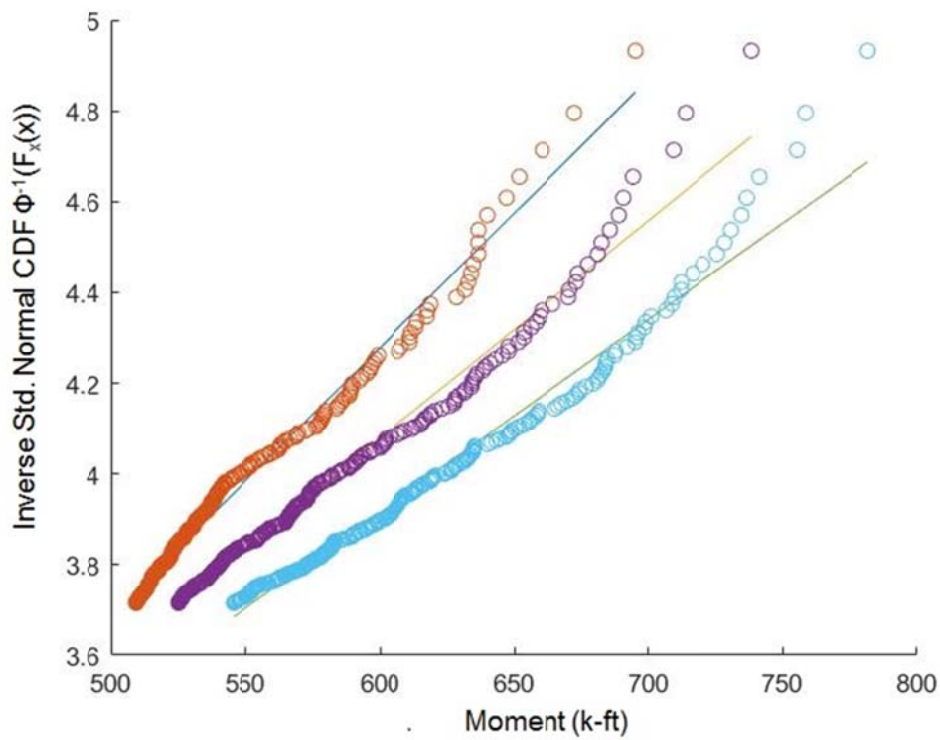

Figure I.11. Load Projections for Two Lane Continuous Moment, 40' Span.

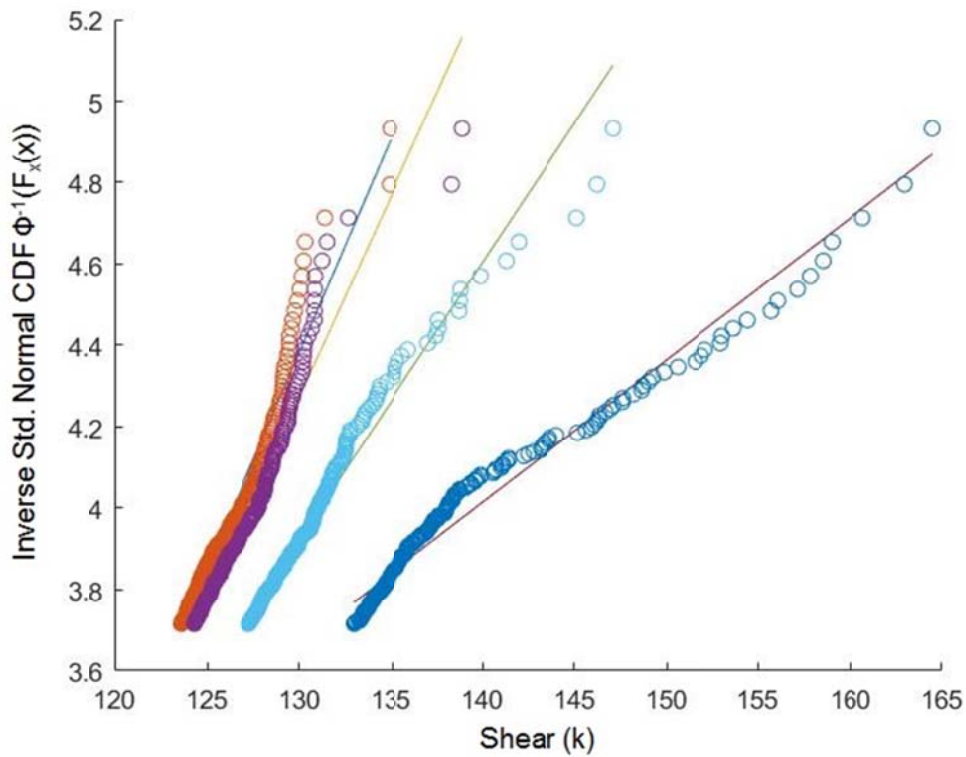

Figure I.12.a. Load Projections for Two Lane Continuous Shear, 40' Span, n=250.

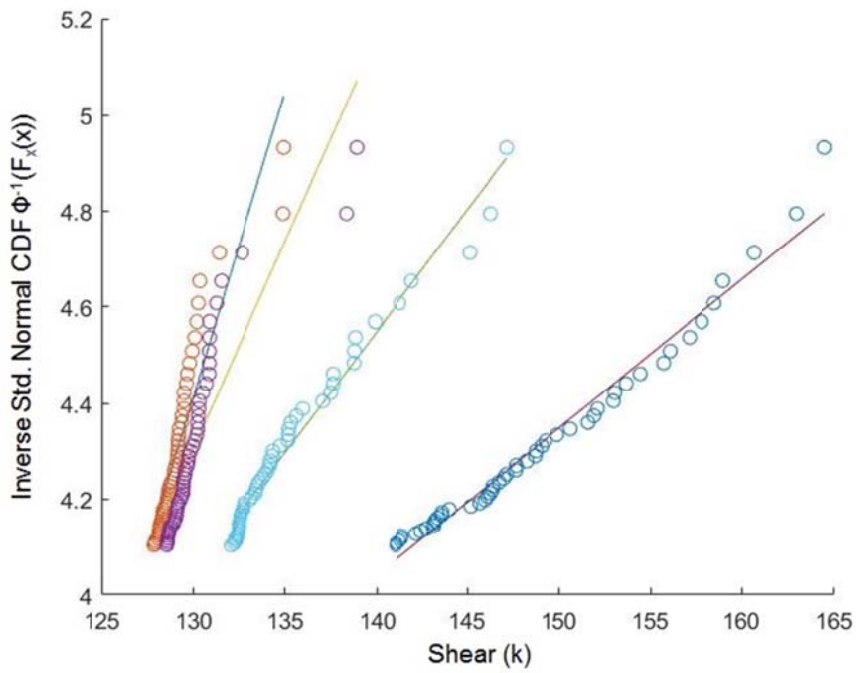

Figure I.12.b. Load Projections for Two Lane Continuous Shear, 40' Span, n=50.

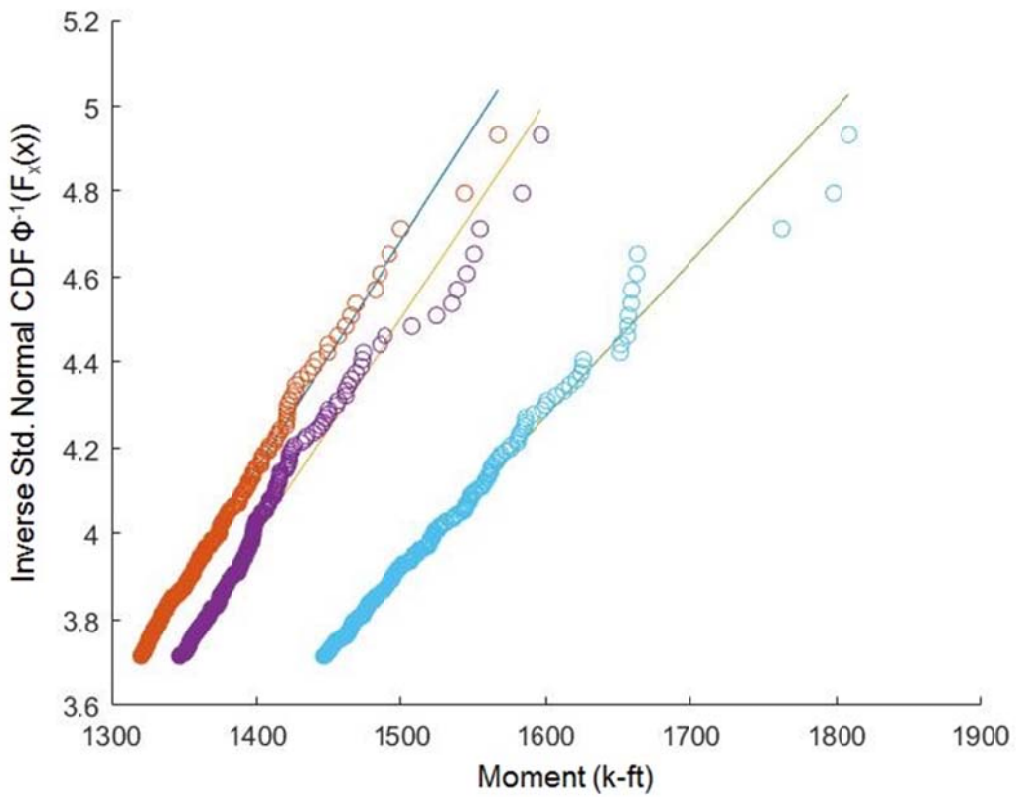

Figure I.13. Load Projections for Two Lane Simple Moment, 60' Span.

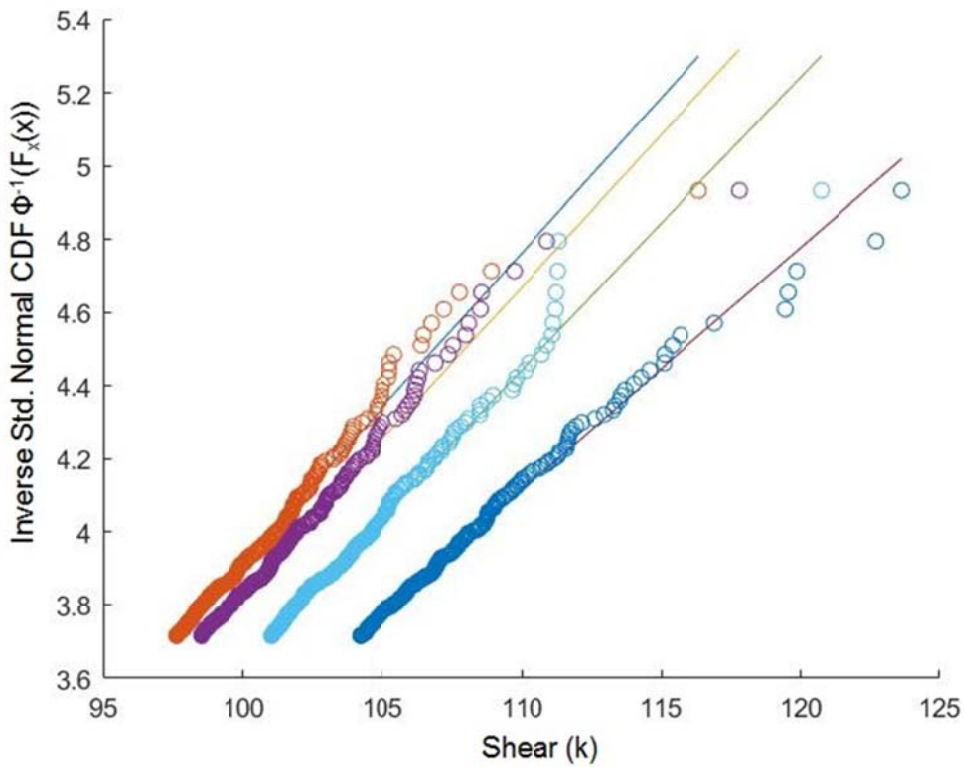

Figure I.14. Load Projections for Two Lane Simple Shear, 60' Span.

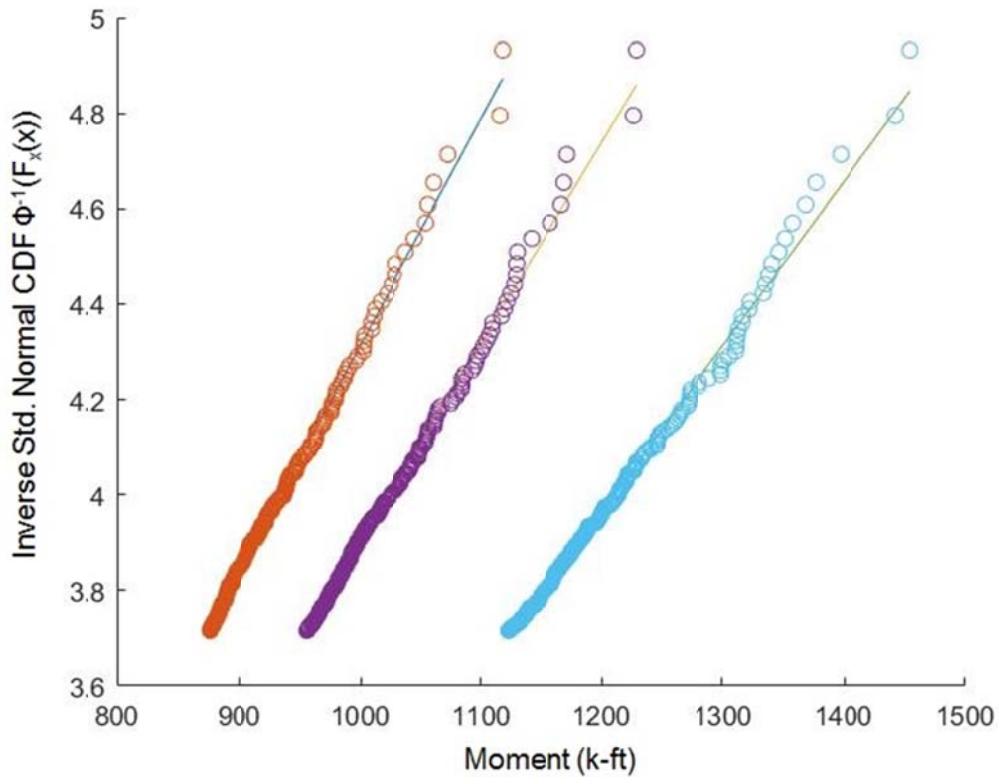

Figure I.15. Load Projections for Two Lane Continuous Moment, 60' Span.

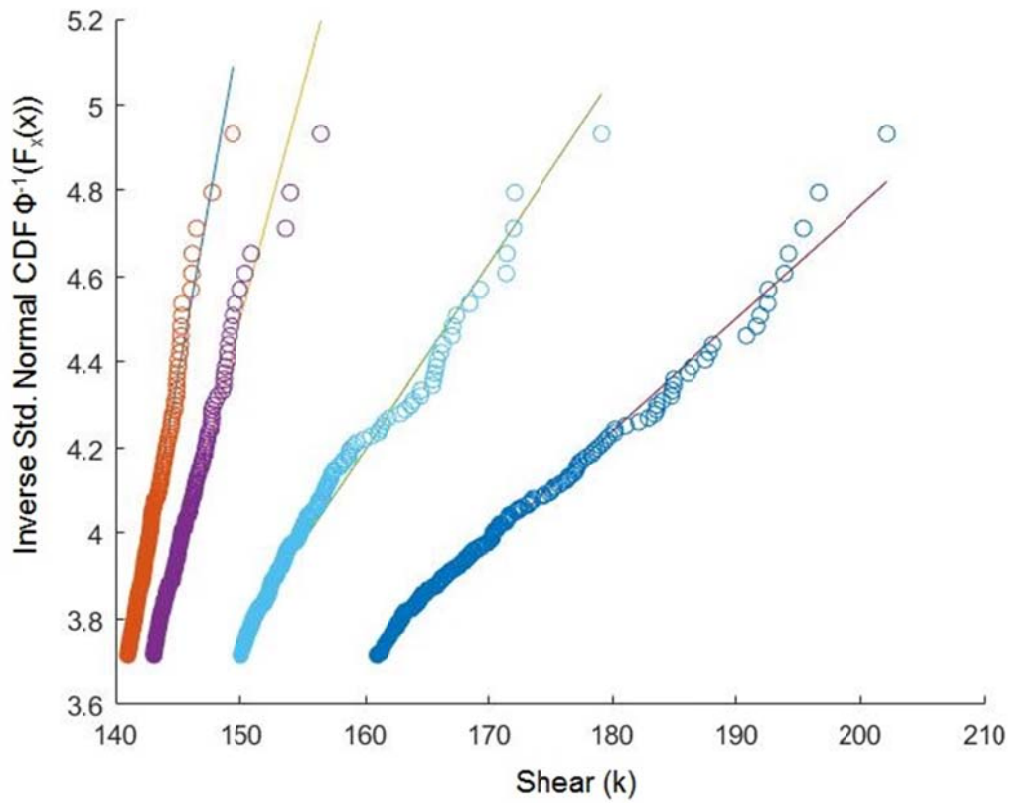

Figure I.16. Load Projections for Two Lane Continuous Shear, 60' Span.

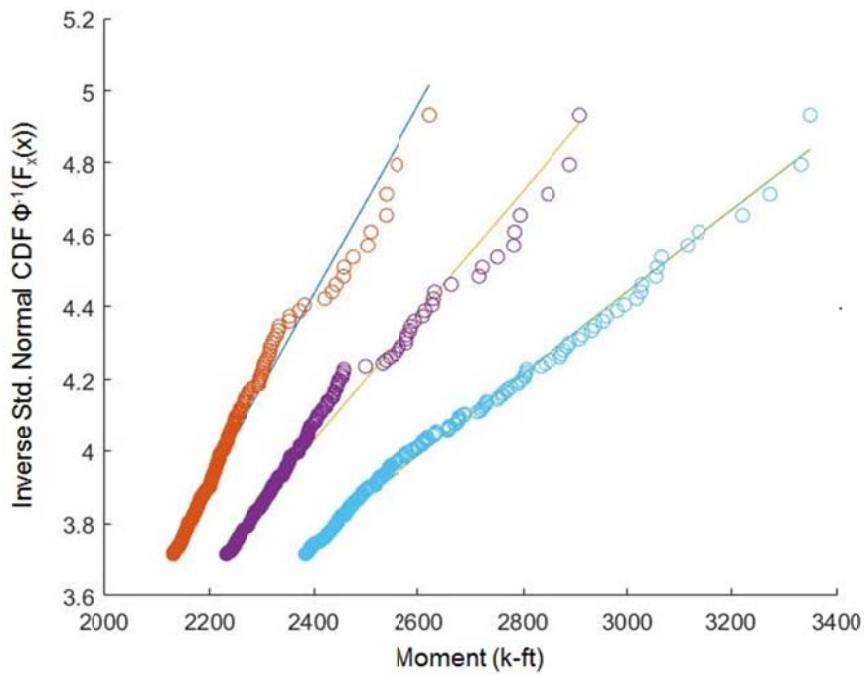

Figure I.17. Load Projections for Two Lane Simple Moment, 80' Span.

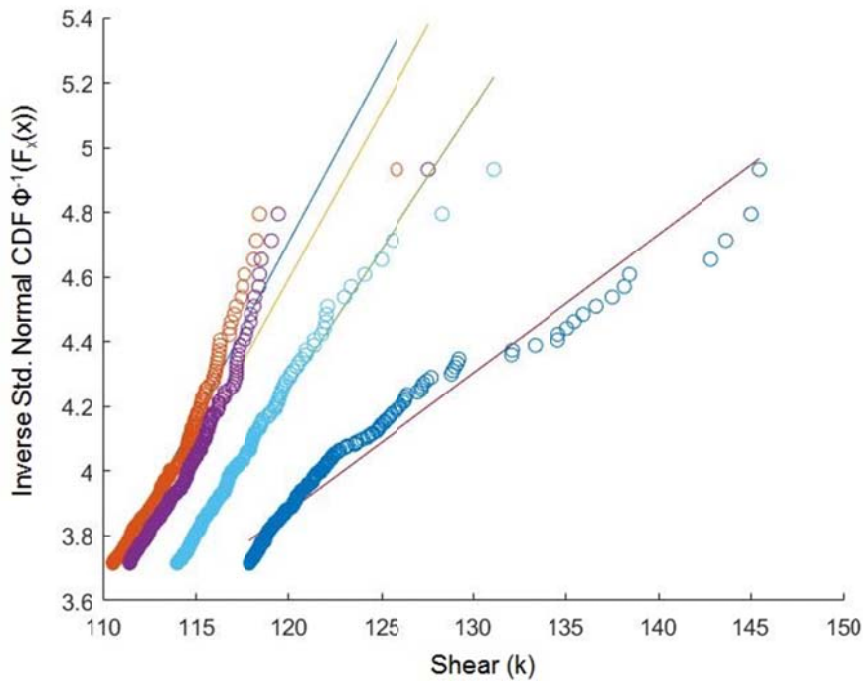

Figure I.18. Load Projections for Two Lane Simple Shear, 80' Span.

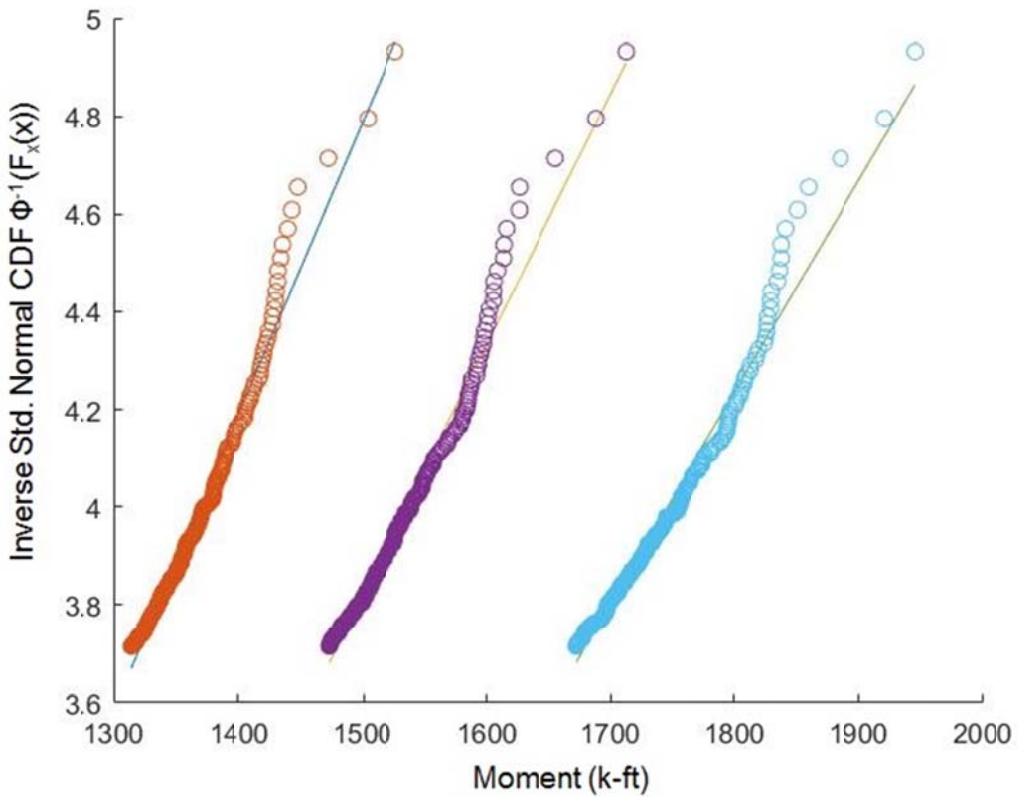

Figure I.19. Load Projections for Two Lane Continuous Moment, 80' Span.



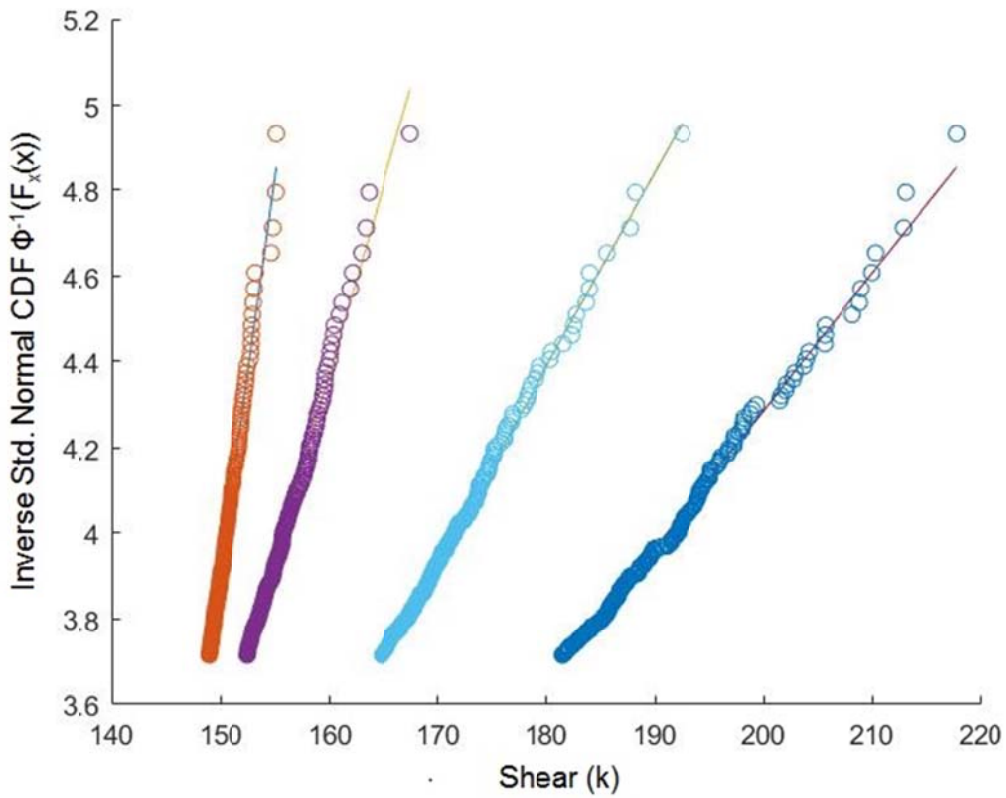

Figure I.20. Load Projections for Two Lane Continuous Shear, 80' Span.

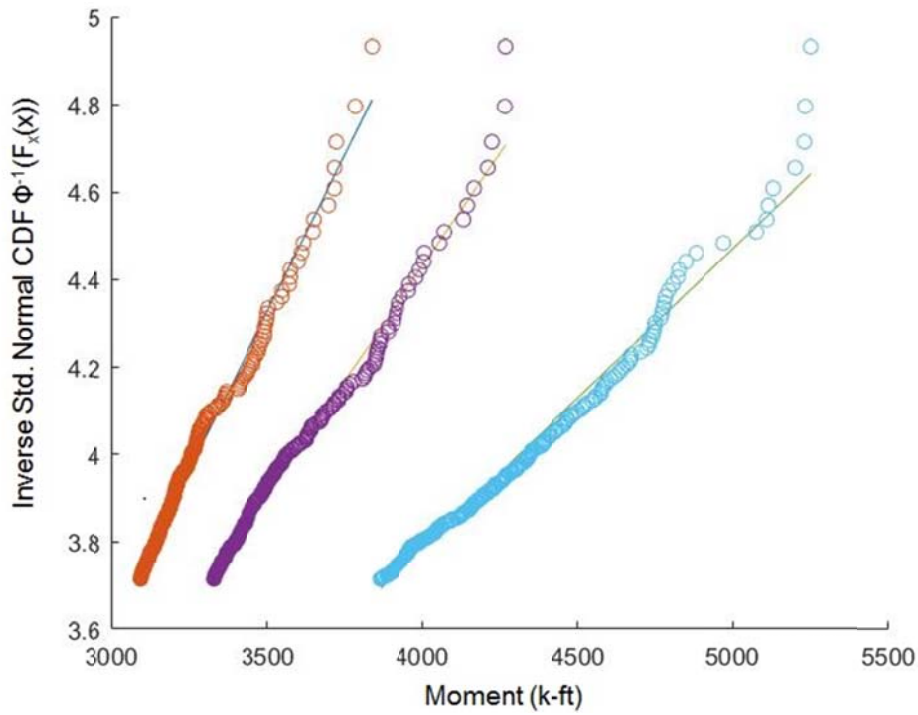

Figure I.21. Load Projections for Two Lane Simple Moment, 100' Span.



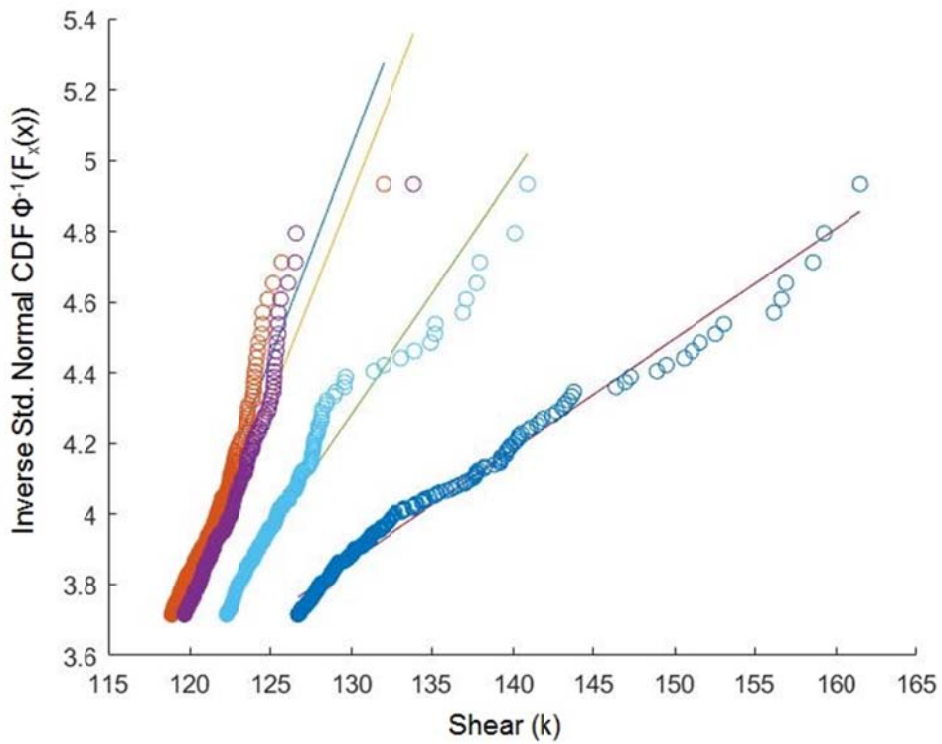

Figure I.22. Load Projections for Two Lane Simple Shear, 100' Span.

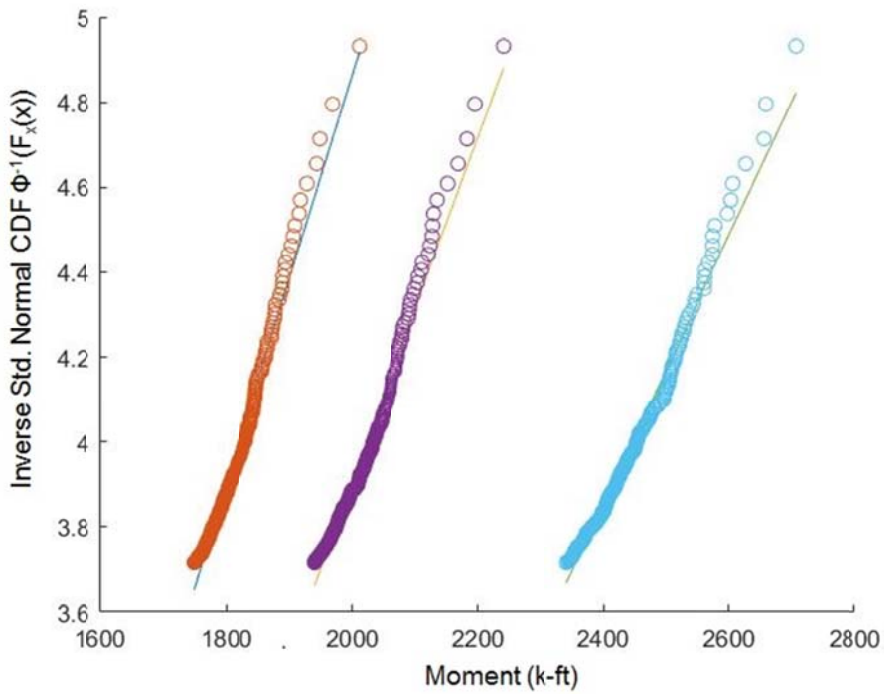

Figure I.23. Load Projections for Two Lane Continuous Moment, 100' Span.

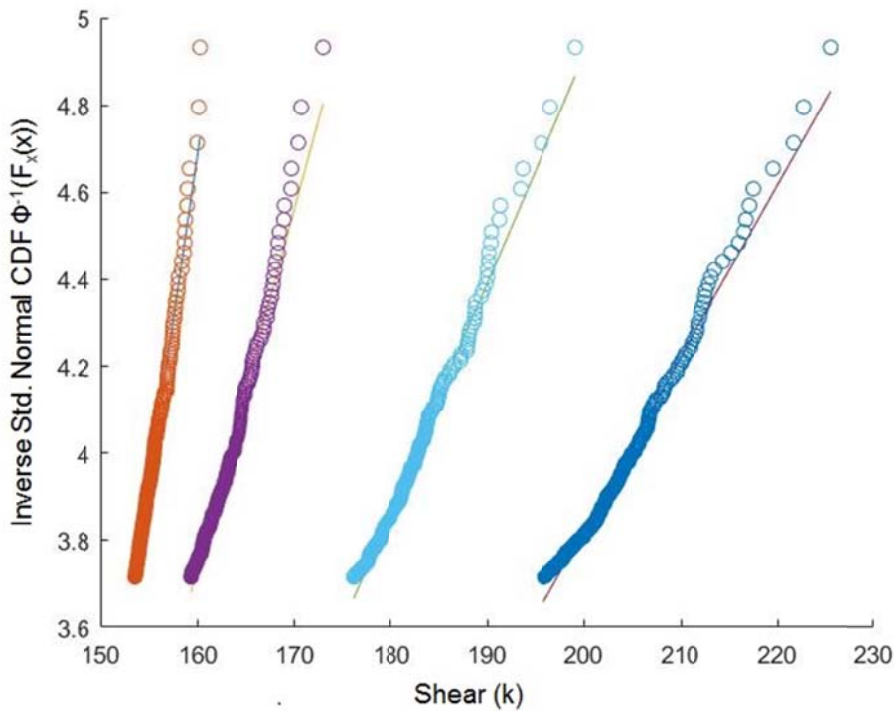

Figure I.24. Load Projections for Two Lane Continuous Shear, 100' Span.

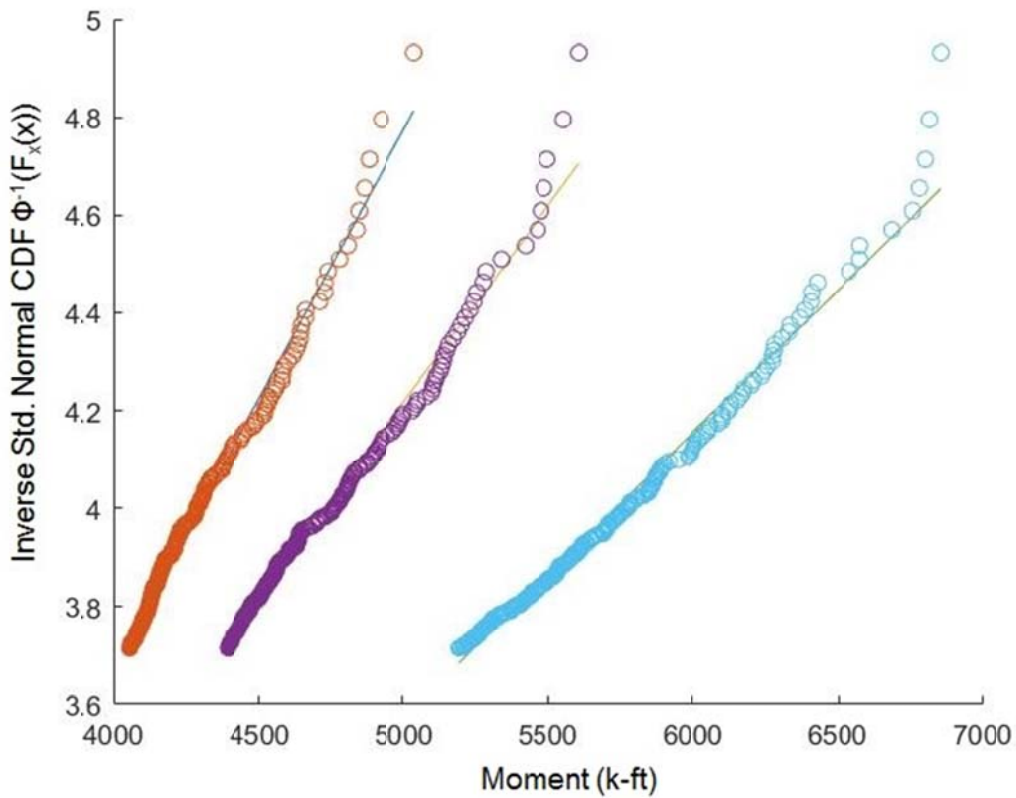

Figure I.25. Load Projections for Two Lane Simple Moment, 120' Span.

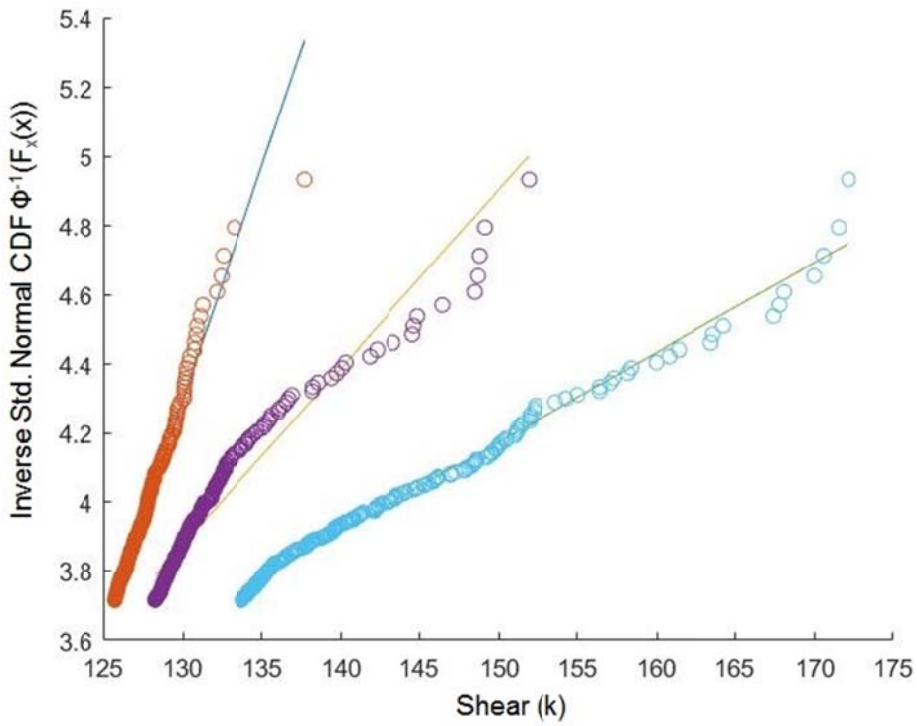

Figure I.26. Load Projections for Two Lane Simple Shear, 120' Span.

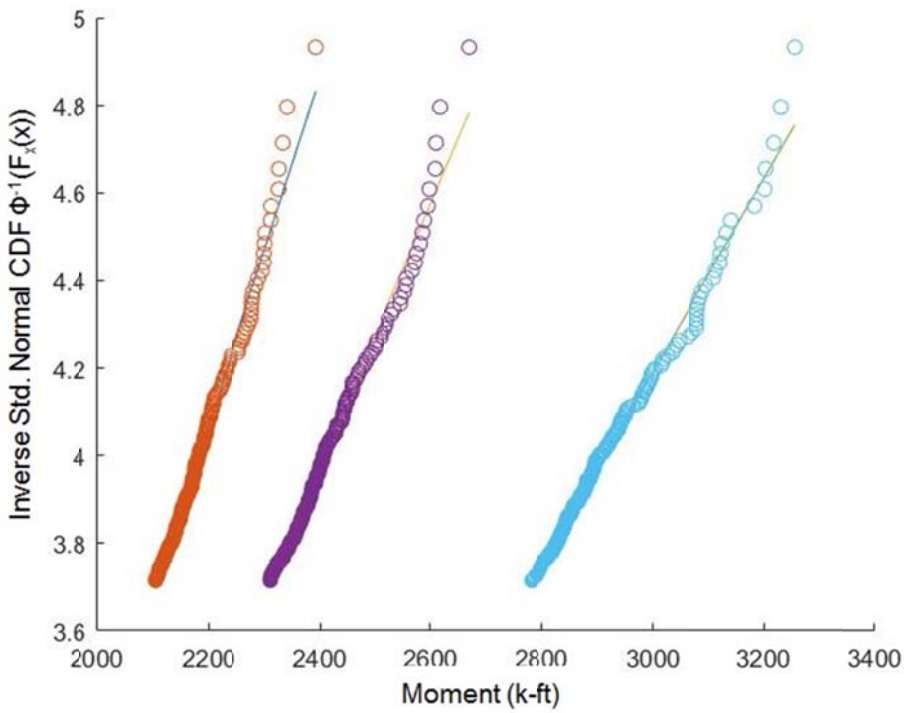

Figure I.27. Load Projections for Two Lane Continuous Moment, 120' Span.

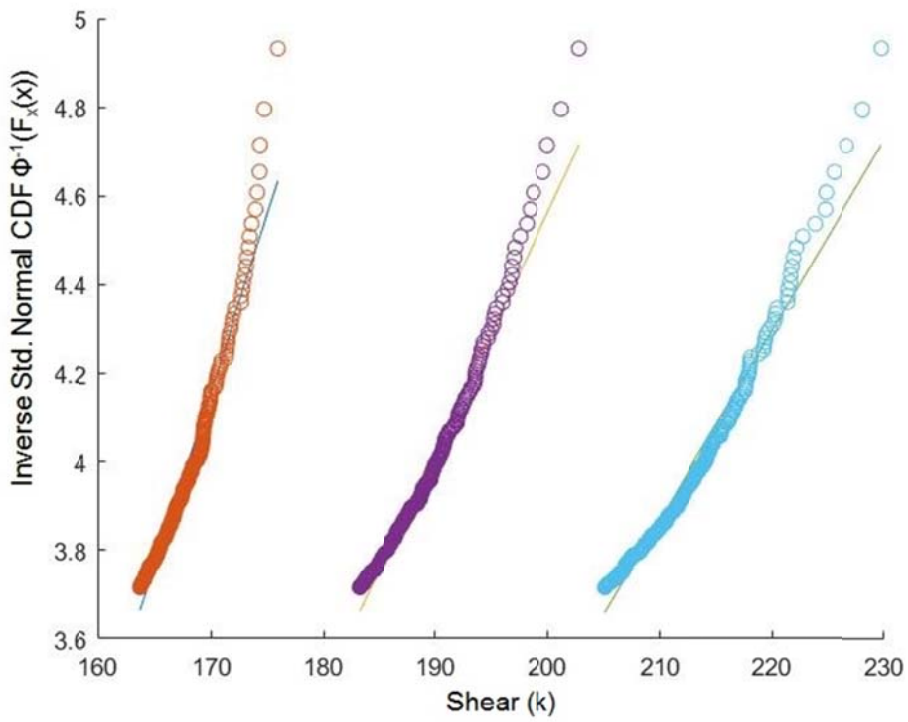

Figure I.28. Load Projections for Two Lane Continuous Shear, 120' Span.

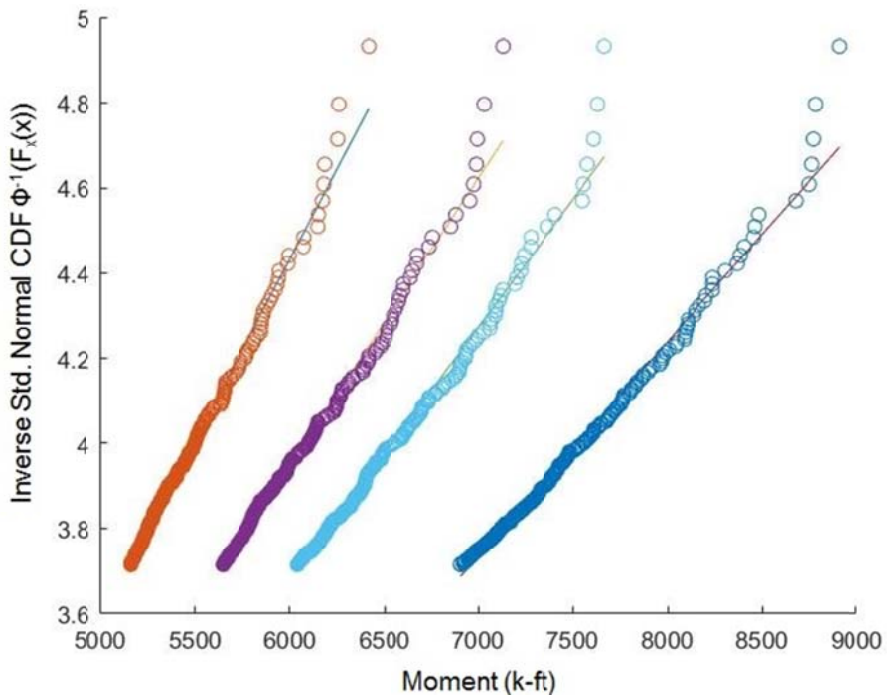

Figure I.29. Load Projections for Two Lane Simple Moment, 140' Span.

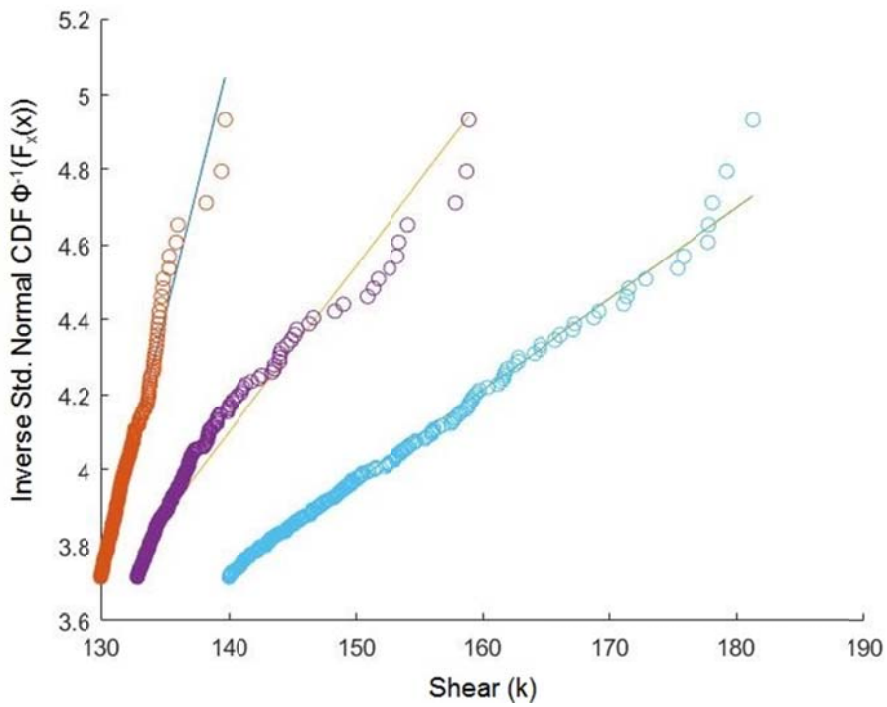

Figure I.30. Load Projections for Two Lane Simple Shear, 140' Span.

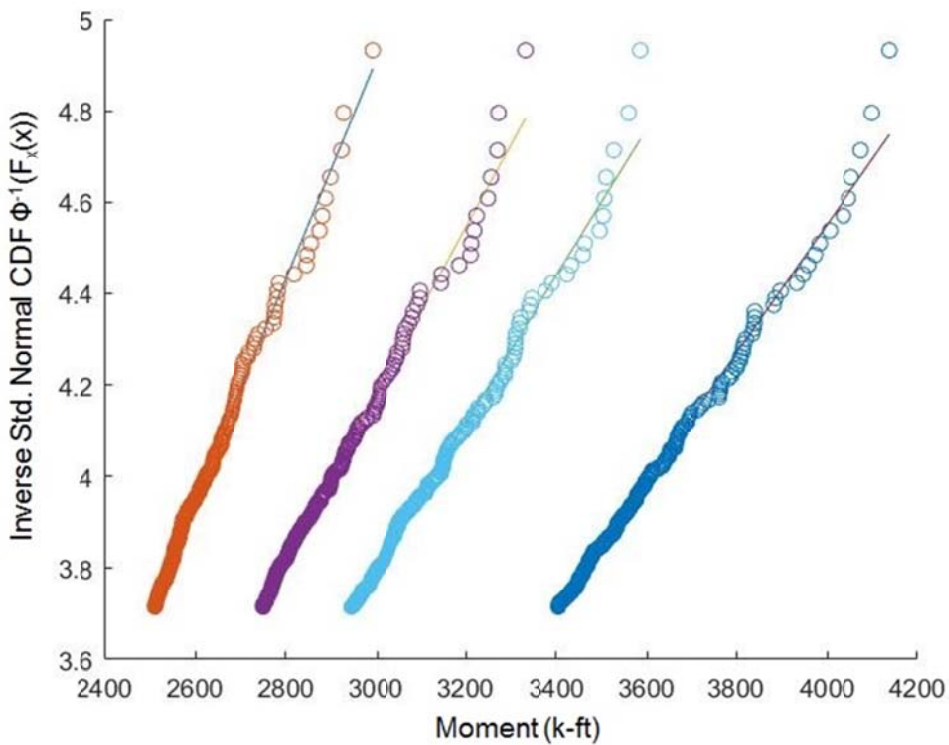

Figure I.31. Load Projections for Two Lane Continuous Moment, 140' Span.

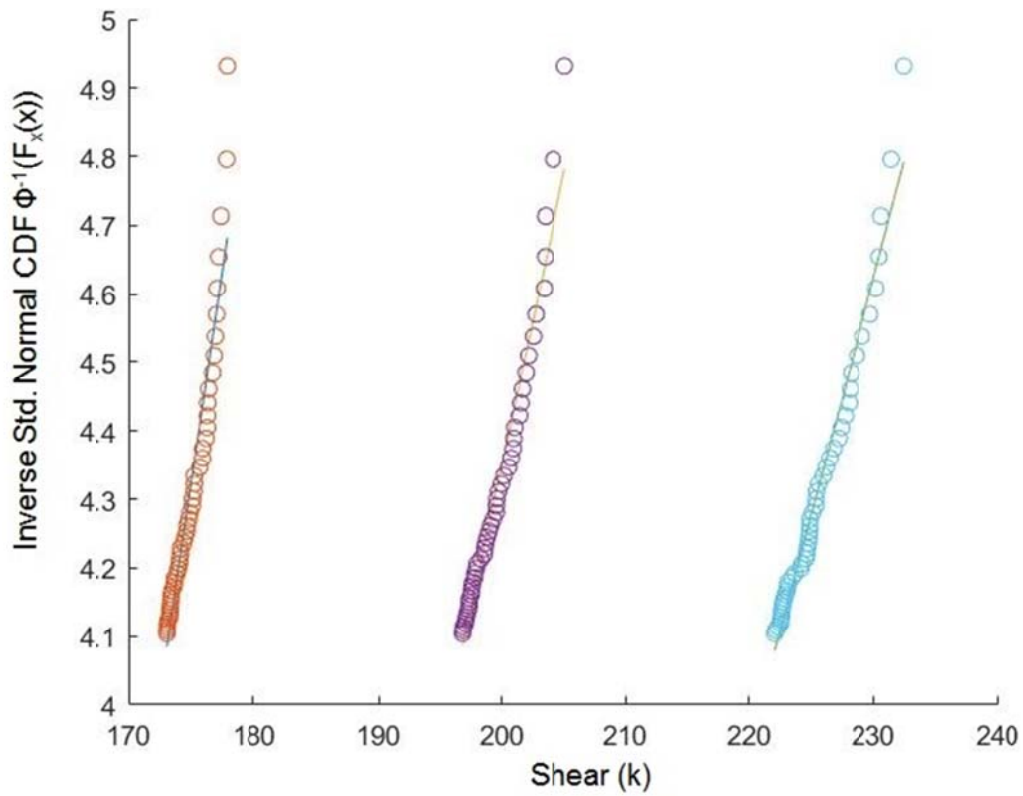

Figure I.32. Load Projections for Two Lane Continuous Shear, 140' Span.

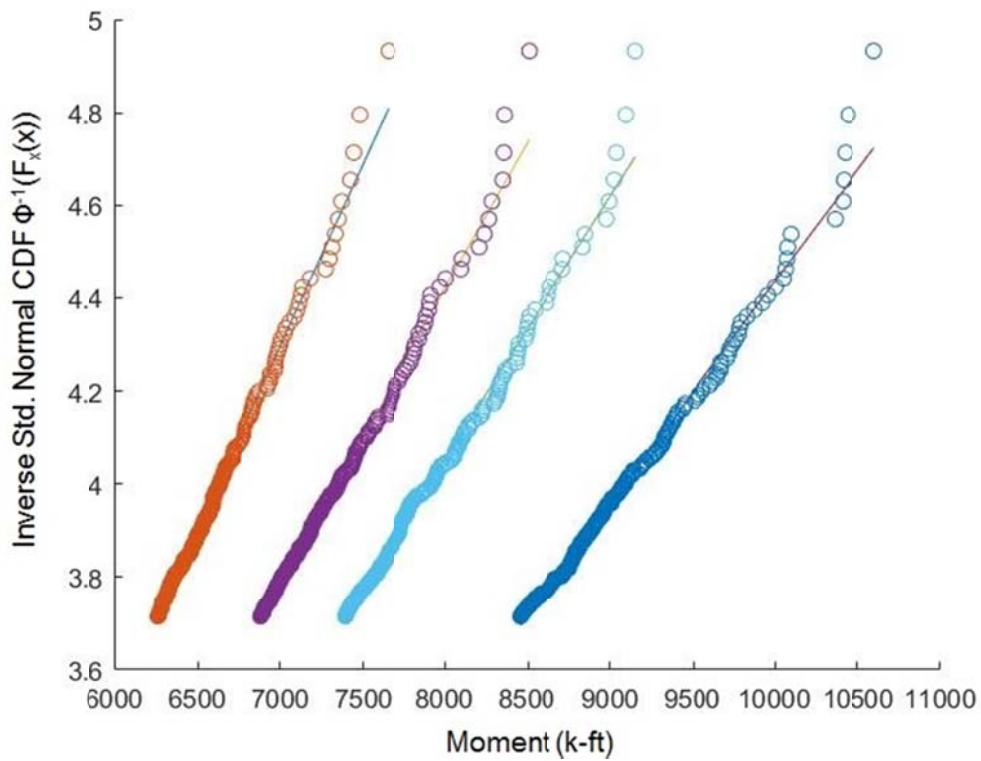

Figure I.33. Load Projections for Two Lane Simple Moment, 160' Span.

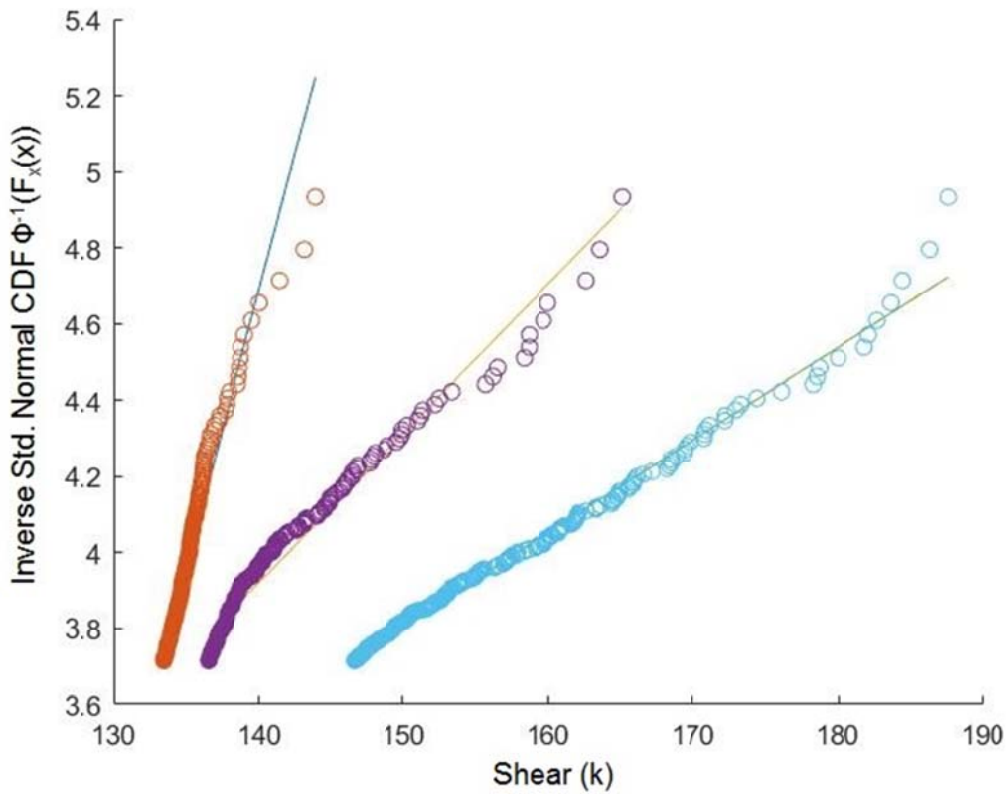

Figure I.34. Load Projections for Two Lane Simple Shear, 160' Span.

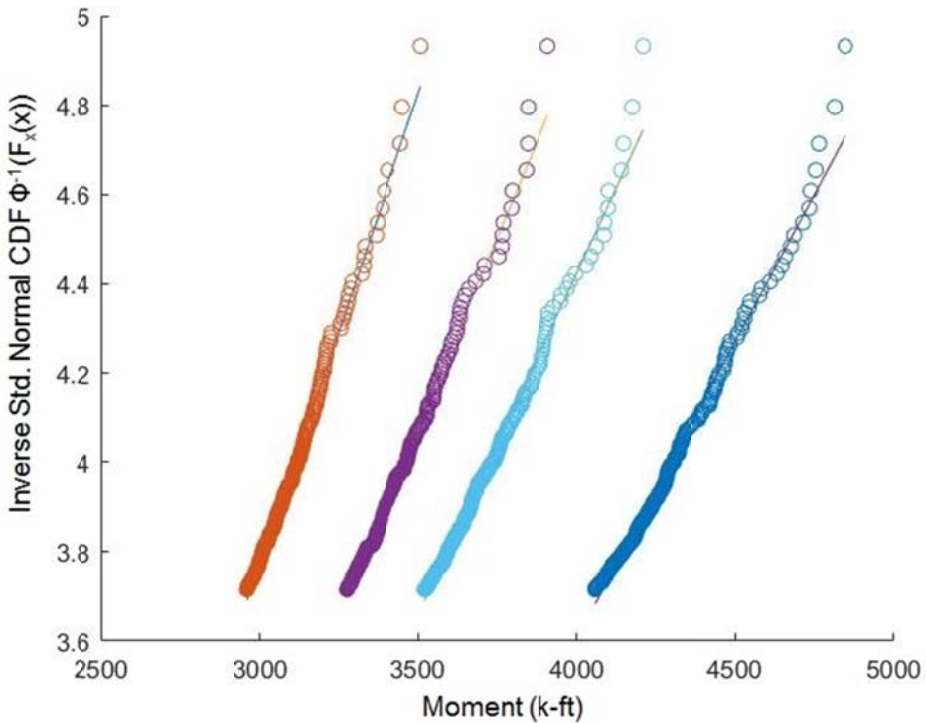

Figure I.35. Load Projections for Two Lane Continuous Moment, 160' Span.



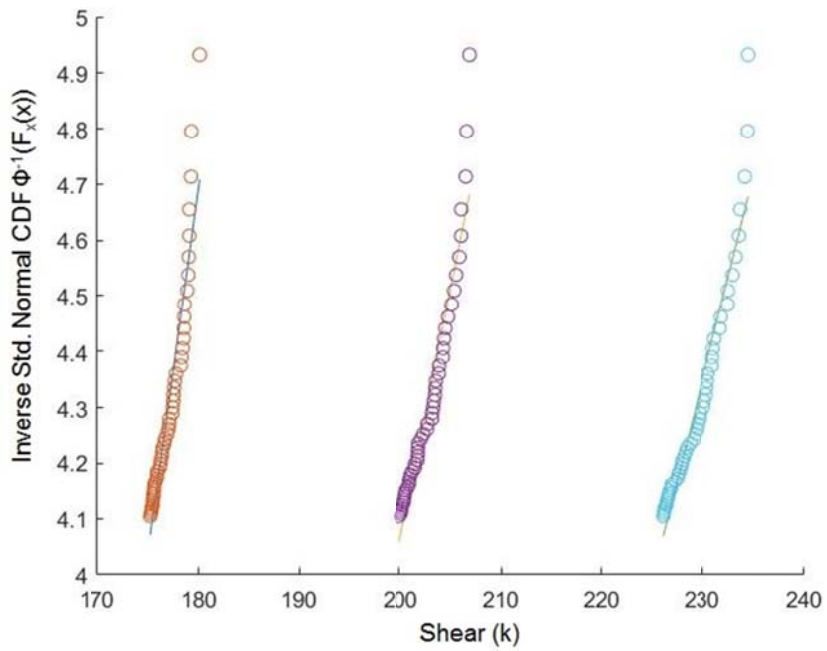

Figure I.36. Load Projections for Two Lane Continuous Shear, 160' Span.

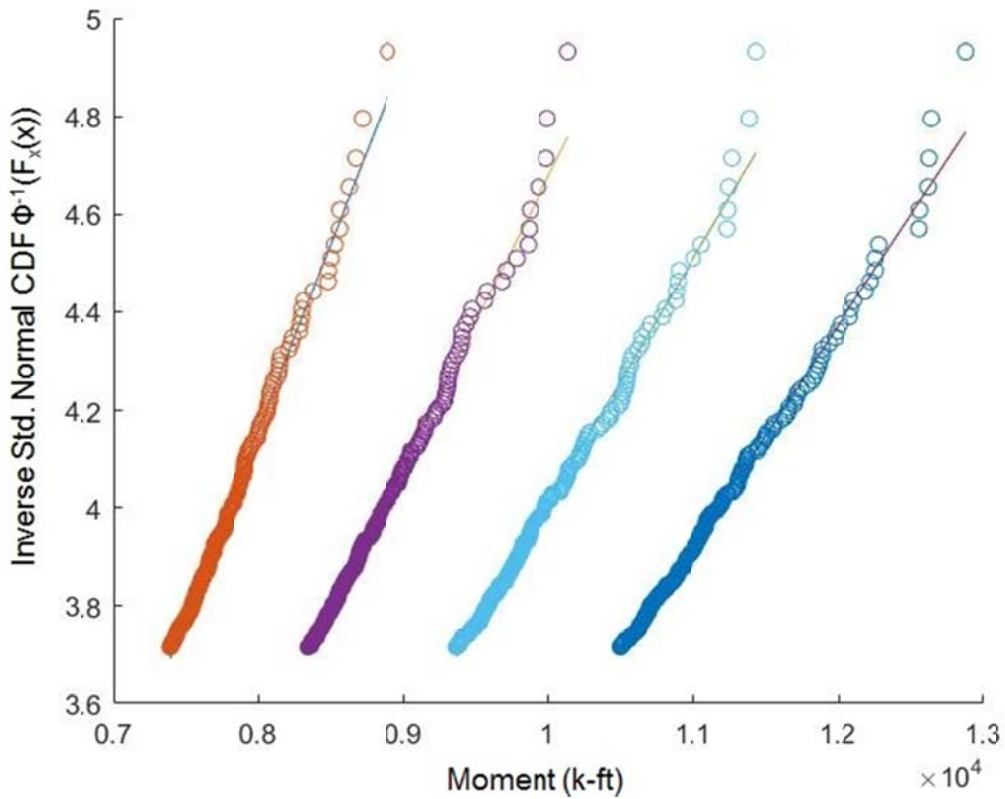

Figure I.37. Load Projections for Two Lane Simple Moment, 180' Span.



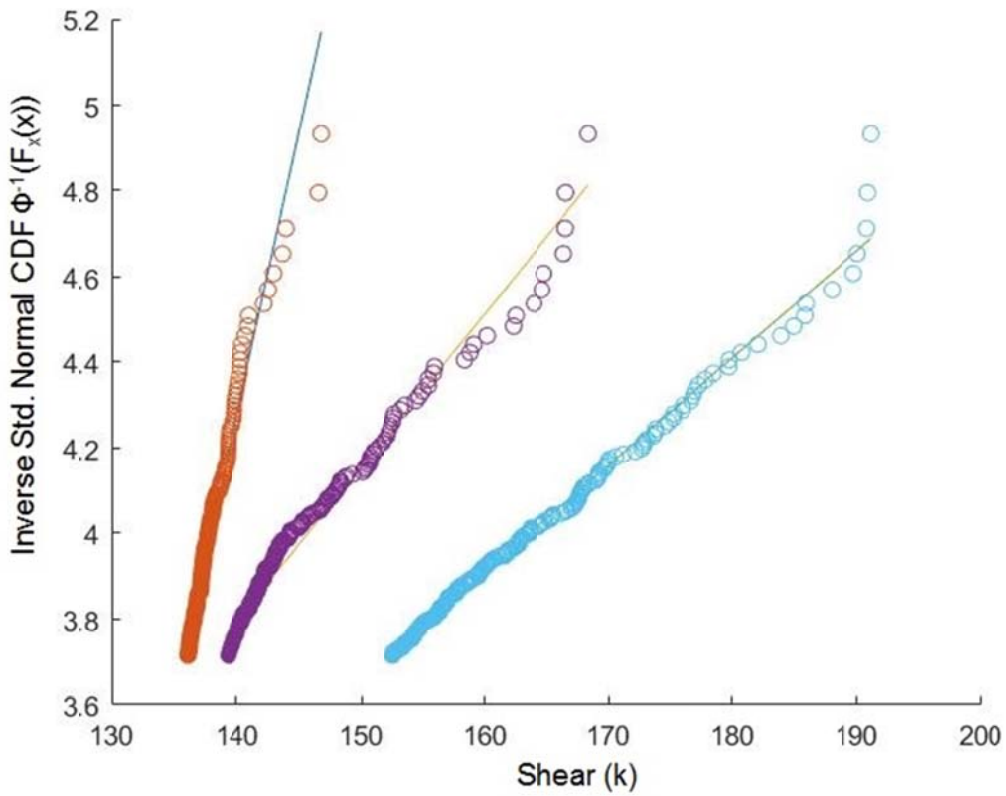

Figure I.38. Load Projections for Two Lane Simple Shear, 180' Span.

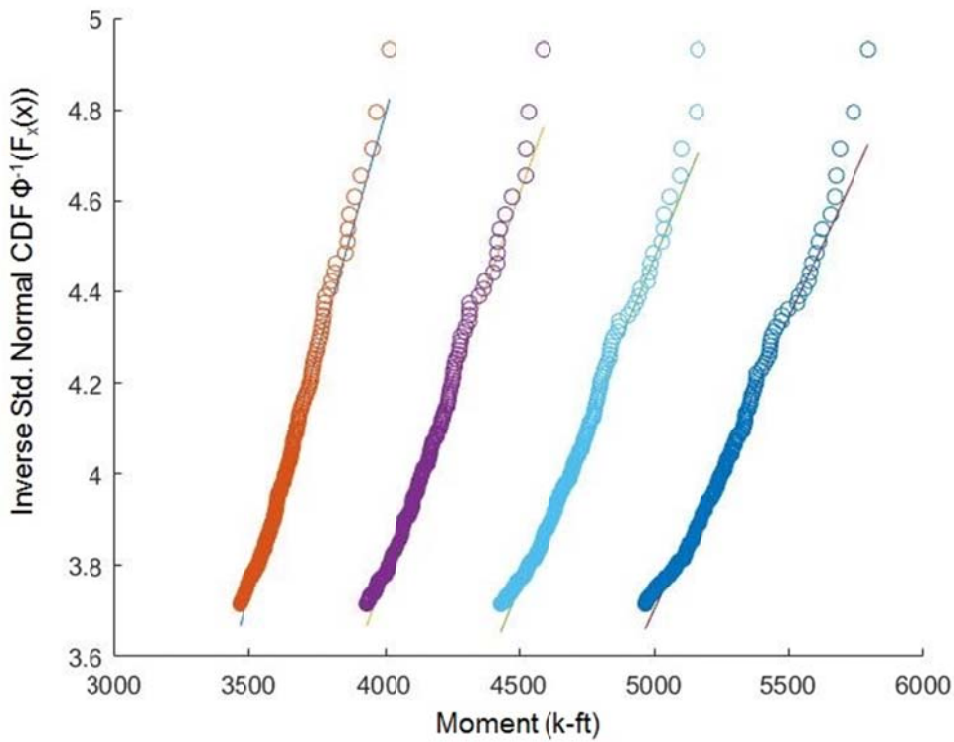

Figure I.39. Load Projections for Two Lane Continuous Moment, 180' Span.

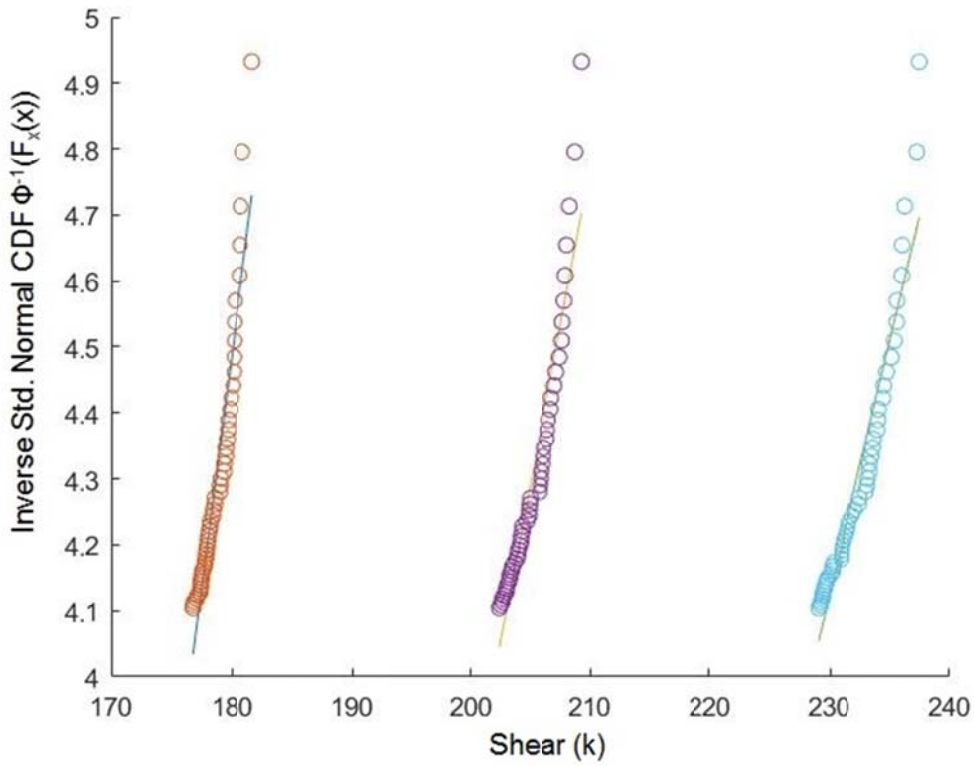

Figure I.40. Load Projections for Two Lane Continuous Shear, 180' Span.

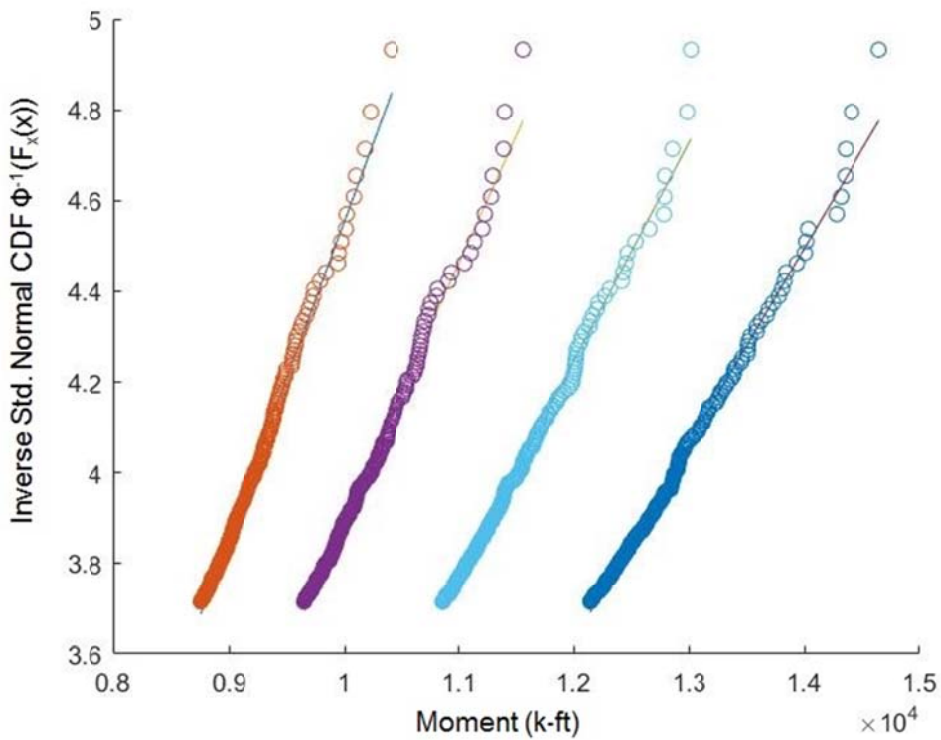

Figure I.41. Load Projections for Two Lane Simple Moment, 200' Span.

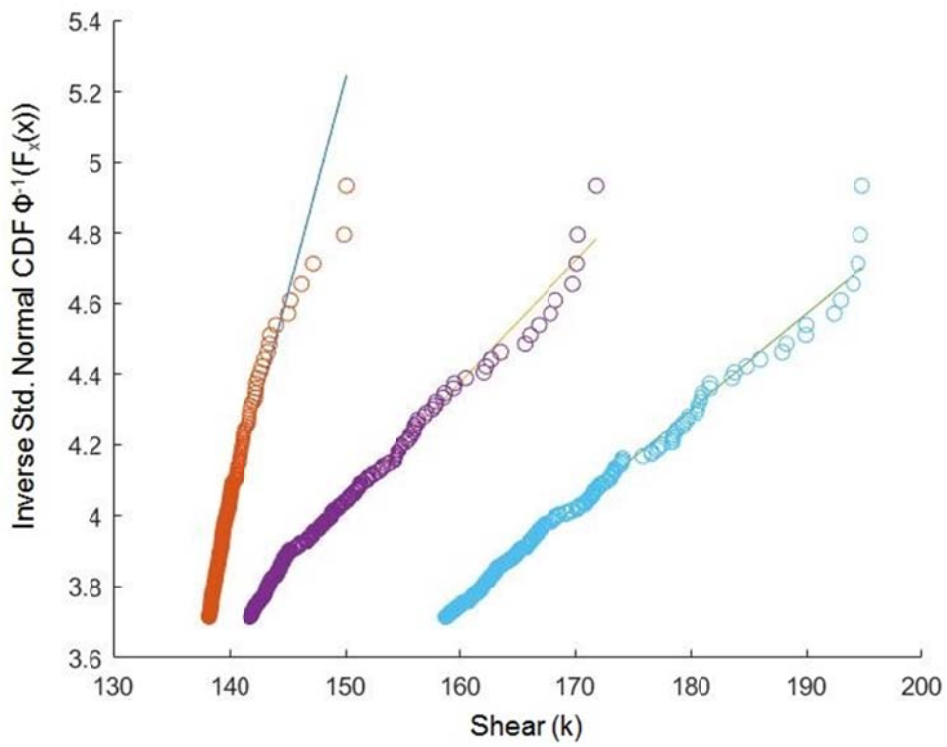

Figure I.42. Load Projections for Two Lane Simple Shear, 200' Span.

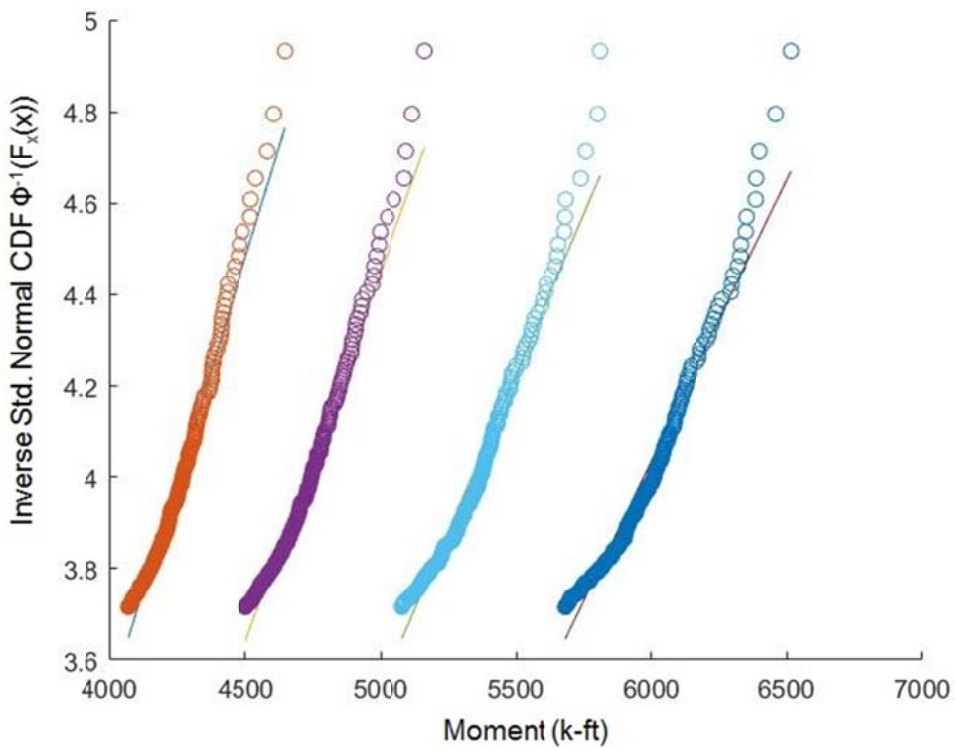

Figure I.43. Load Projections for Two Lane Continuous Moment, 200' Span.

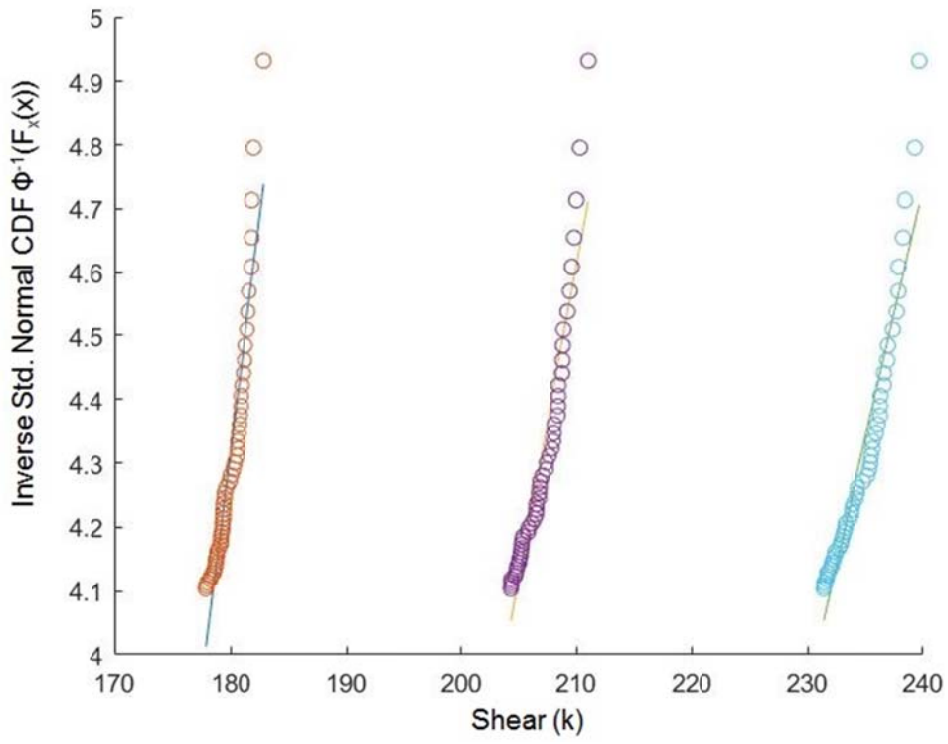

Figure I.44. Load Projections for Two Lane Continuous Shear, 200' Span.

Table I.1. One Lane Load Effect Projection Statistics.

Effect	Span	mLmax	Vproj	Vsite	R^2
Ms	20	327	0.03	0.09	0.95
Ms	40	939	0.04	0.10	0.97
Ms	60	1681	0.03	0.09	0.93
Ms	80	2448	0.03	0.07	0.95
Ms	100	3272	0.02	0.06	0.91
Ms	120	4725	0.05	0.06	0.99
Ms	140	6166	0.03	0.09	1.00
Ms	160	7694	0.03	0.16	0.99
Ms	180	9236	0.02	0.20	0.98
Ms	200	10779	0.02	0.22	0.98

Effect	Span	mLmax	Vproj	Vsite	R^2
Vs	20	72	0.03	0.09	0.97
Vs	40	100	0.04	0.09	0.99
Vs	60	118	0.03	0.09	0.99
Vs	80	128	0.02	0.08	0.99
Vs	100	149	0.03	0.06	0.99
Vs	120	172	0.03	0.11	0.99
Vs	140	189	0.02	0.18	0.99
Vs	160	204	0.02	0.22	0.99
Vs	180	215	0.02	0.24	0.99
Vs	200	224	0.02	0.25	0.98

Effect	Span	mLmax	Vproj	Vsite	R^2
Mc	20	219	0.04	0.05	1.00
Mc	40	600	0.03	0.04	0.88
Mc	60	1288	0.03	0.27	0.99
Mc	80	1948	0.02	0.31	0.99
Mc	100	2565	0.02	0.26	0.96
Mc	120	3090	0.02	0.24	0.97
Mc	140	3568	0.02	0.22	0.99
Mc	160	3992	0.02	0.21	0.99
Mc	180	4552	0.02	0.22	0.93
Mc	200	5293	0.02	0.23	0.84

Effect	Span	mLmax	Vproj	Vsite	R^2
Vc	20	114	0.04	0.13	0.96
Vc	40	142	0.02	0.13	0.95
Vc	60	196	0.04	0.09	0.99
Vc	80	238	0.02	0.23	0.98
Vc	100	262	0.02	0.26	0.97
Vc	120	277	0.02	0.25	0.96
Vc	140	286	0.01	0.24	0.95
Vc	160	293	0.01	0.24	0.94
Vc	180	297	0.01	0.23	0.93
Vc	200	301	0.01	0.23	0.93

Effect	Span	Bridge	mLmax	Vproj	Vsite
Mcp	20	CS04	262	0.03	0.09
Mcp	40	CS04	751	0.04	0.10
Mcp	60	CS04	1345	0.03	0.09
Mcp	80	CS04	1958	0.03	0.07
Mcp	100	CS04	2618	0.02	0.06
Mcp	120	CS04	3780	0.05	0.06
Mcp	140	CS04	4933	0.03	0.09
Mcp	160	CS04	6155	0.03	0.16
Mcp	180	CS04	7389	0.02	0.20
Mcp	200	CS04	8623	0.02	0.22

Table I.2. Two Lane Load Effect Projection Statistics for CS, PC, RC.

Effect	Span	Bridge	mLmax	Vproj	Vsite
Ms	20	CS-PC-RC04	305	0.06	0.09
Ms	20	CS-PC-RC06	308	0.05	0.09
Ms	20	CS-PC-RC08	310	0.05	0.09
Ms	20	CS-PC-RC10	312	0.05	0.09
Ms	20	CS-PC-RC12	313	0.05	0.09
Ms	40	CS-PC-RC04	796	0.04	0.09
Ms	40	CS-PC-RC06	805	0.04	0.09
Ms	40	CS-PC-RC08	813	0.04	0.09
Ms	40	CS-PC-RC10	819	0.04	0.09
Ms	40	CS-PC-RC12	825	0.04	0.09
Ms	60	CS-PC-RC04	1461	0.03	0.08
Ms	60	CS-PC-RC06	1487	0.03	0.08
Ms	60	CS-PC-RC08	1508	0.03	0.08
Ms	60	CS-PC-RC10	1525	0.03	0.08
Ms	60	CS-PC-RC12	1539	0.04	0.08
Ms	80	CS-PC-RC04	2478	0.04	0.12
Ms	80	CS-PC-RC06	2567	0.05	0.12
Ms	80	CS-PC-RC08	2636	0.05	0.12
Ms	80	CS-PC-RC10	2692	0.05	0.12
Ms	80	CS-PC-RC12	2740	0.05	0.12
Ms	100	CS-PC-RC04	3669	0.05	0.14
Ms	100	CS-PC-RC06	3823	0.05	0.14
Ms	100	CS-PC-RC08	3942	0.05	0.14
Ms	100	CS-PC-RC10	4038	0.06	0.14
Ms	100	CS-PC-RC12	4121	0.06	0.14
Ms	120	CS-PC04	4899	0.05	0.14
Ms	120	CS-PC06	5102	0.05	0.14
Ms	120	CS-PC08	5258	0.05	0.14
Ms	120	CS-PC10	5386	0.06	0.14
Ms	120	CS-PC12	5494	0.06	0.14
Ms	140	CS-PC04	6144	0.05	0.13
Ms	140	CS-PC06	6396	0.05	0.13
Ms	140	CS-PC08	6591	0.05	0.13
Ms	140	CS-PC10	6749	0.05	0.13
Ms	140	CS-PC12	6883	0.05	0.13
Ms	160	CS-PC04	7398	0.05	0.13
Ms	160	CS-PC06	7700	0.05	0.13
Ms	160	CS-PC08	7933	0.05	0.13

Ms	160	CS-PC10	8122	0.05	0.13
Ms	160	CS-PC12	8282	0.05	0.13
Ms	180	CS-PC04	8666	0.04	0.13
Ms	180	CS-PC06	9026	0.04	0.13
Ms	180	CS-PC08	9304	0.04	0.13
Ms	180	CS-PC10	9529	0.04	0.13
Ms	180	CS-PC12	9719	0.04	0.13
Ms	200	CS-PC04	10102	0.04	0.13
Ms	200	CS-PC06	10496	0.04	0.13
Ms	200	CS-PC08	10798	0.04	0.13
Ms	200	CS-PC10	11044	0.04	0.13
Ms	200	CS-PC12	11252	0.04	0.13
Vs	20	CS-PC-RC04	67	0.05	0.10
Vs	20	CS-PC-RC06	68	0.05	0.10
Vs	20	CS-PC-RC08	69	0.05	0.10
Vs	20	CS-PC-RC10	70	0.05	0.10
Vs	20	CS-PC-RC12	70	0.05	0.10
Vs	40	CS-PC-RC04	92	0.04	0.09
Vs	40	CS-PC-RC06	94	0.04	0.09
Vs	40	CS-PC-RC08	95	0.04	0.09
Vs	40	CS-PC-RC10	96	0.04	0.09
Vs	40	CS-PC-RC12	96	0.04	0.09
Vs	60	CS-PC-RC04	109	0.03	0.11
Vs	60	CS-PC-RC06	112	0.03	0.11
Vs	60	CS-PC-RC08	114	0.03	0.11
Vs	60	CS-PC-RC10	115	0.03	0.11
Vs	60	CS-PC-RC12	115	0.03	0.11
Vs	80	CS-PC-RC04	121	0.02	0.13
Vs	80	CS-PC-RC06	126	0.03	0.13
Vs	80	CS-PC-RC08	129	0.03	0.13
Vs	80	CS-PC-RC10	131	0.04	0.13
Vs	80	CS-PC-RC12	133	0.04	0.13
Vs	100	CS-PC-RC04	128	0.02	0.14
Vs	100	CS-PC-RC06	136	0.03	0.14
Vs	100	CS-PC-RC08	141	0.04	0.14
Vs	100	CS-PC-RC10	145	0.04	0.14
Vs	100	CS-PC-RC12	147	0.05	0.14
Vs	120	CS-PC04	130	0.01	0.14
Vs	120	CS-PC06	142	0.03	0.14
Vs	120	CS-PC08	150	0.04	0.14
Vs	120	CS-PC10	156	0.05	0.14

Vs	120	CS-PC12	160	0.05	0.14
Vs	140	CS-PC04	135	0.01	0.14
Vs	140	CS-PC06	148	0.03	0.14
Vs	140	CS-PC08	158	0.04	0.14
Vs	140	CS-PC10	164	0.05	0.14
Vs	140	CS-PC12	168	0.05	0.14
Vs	160	CS-PC04	138	0.01	0.14
Vs	160	CS-PC06	153	0.03	0.14
Vs	160	CS-PC08	163	0.04	0.14
Vs	160	CS-PC10	170	0.05	0.14
Vs	160	CS-PC12	175	0.05	0.14
Vs	180	CS-PC04	141	0.01	0.15
Vs	180	CS-PC06	157	0.03	0.15
Vs	180	CS-PC08	168	0.04	0.15
Vs	180	CS-PC10	175	0.05	0.15
Vs	180	CS-PC12	180	0.05	0.15
Vs	200	CS-PC04	144	0.02	0.15
Vs	200	CS-PC06	161	0.03	0.15
Vs	200	CS-PC08	172	0.04	0.15
Vs	200	CS-PC10	179	0.05	0.15
Vs	200	CS-PC12	184	0.05	0.15
Mc	20	CS-PC-RC04	203	0.03	0.09
Mc	20	CS-PC-RC06	205	0.03	0.09
Mc	20	CS-PC-RC08	206	0.04	0.09
Mc	20	CS-PC-RC10	207	0.04	0.09
Mc	20	CS-PC-RC12	208	0.04	0.09
Mc	40	CS-PC-RC04	619	0.07	0.18
Mc	40	CS-PC-RC06	647	0.07	0.18
Mc	40	CS-PC-RC08	669	0.08	0.18
Mc	40	CS-PC-RC10	686	0.08	0.18
Mc	40	CS-PC-RC12	702	0.08	0.18
Mc	60	CS-PC-RC04	1046	0.05	0.16
Mc	60	CS-PC-RC06	1087	0.05	0.16
Mc	60	CS-PC-RC08	1118	0.05	0.16
Mc	60	CS-PC-RC10	1144	0.05	0.16
Mc	60	CS-PC-RC12	1166	0.05	0.16
Mc	80	CS-PC-RC04	1487	0.03	0.15
Mc	80	CS-PC-RC06	1542	0.03	0.15
Mc	80	CS-PC-RC08	1584	0.03	0.15
Mc	80	CS-PC-RC10	1618	0.03	0.15
Mc	80	CS-PC-RC12	1648	0.03	0.15



Mc	100	CS-PC-RC04	1940	0.03	0.14
Mc	100	CS-PC-RC06	2011	0.03	0.14
Mc	100	CS-PC-RC08	2066	0.03	0.14
Mc	100	CS-PC-RC10	2111	0.03	0.14
Mc	100	CS-PC-RC12	2148	0.03	0.14
Mc	120	CS-PC04	2356	0.03	0.12
Mc	120	CS-PC06	2447	0.03	0.12
Mc	120	CS-PC08	2517	0.03	0.12
Mc	120	CS-PC10	2573	0.03	0.12
Mc	120	CS-PC12	2622	0.03	0.12
Mc	140	CS-PC04	2847	0.04	0.12
Mc	140	CS-PC06	2963	0.04	0.12
Mc	140	CS-PC08	3053	0.04	0.12
Mc	140	CS-PC10	3127	0.04	0.12
Mc	140	CS-PC12	3189	0.04	0.12
Mc	160	CS-PC04	3402	0.04	0.13
Mc	160	CS-PC06	3541	0.04	0.13
Mc	160	CS-PC08	3649	0.04	0.13
Mc	160	CS-PC10	3736	0.04	0.13
Mc	160	CS-PC12	3809	0.04	0.13
Mc	180	CS-PC04	3943	0.03	0.14
Mc	180	CS-PC06	4107	0.03	0.14
Mc	180	CS-PC08	4233	0.03	0.14
Mc	180	CS-PC10	4335	0.03	0.14
Mc	180	CS-PC12	4421	0.03	0.14
Mc	200	CS-PC04	4597	0.03	0.14
Mc	200	CS-PC06	4774	0.03	0.14
Mc	200	CS-PC08	4910	0.03	0.14
Mc	200	CS-PC10	5021	0.03	0.14
Mc	200	CS-PC12	5114	0.03	0.14
Vc	20	CS-PC-RC04	98	0.04	0.17
Vc	20	CS-PC-RC06	100	0.04	0.17
Vc	20	CS-PC-RC08	101	0.04	0.17
Vc	20	CS-PC-RC10	102	0.04	0.17
Vc	20	CS-PC-RC12	102	0.04	0.17
Vc	40	CS-PC-RC04	134	0.02	0.23
Vc	40	CS-PC-RC06	141	0.03	0.23
Vc	40	CS-PC-RC08	146	0.03	0.23
Vc	40	CS-PC-RC10	149	0.04	0.23
Vc	40	CS-PC-RC12	151	0.04	0.23
Vc	60	CS-PC-RC04	153	0.02	0.24

Vc	60	CS-PC-RC06	166	0.03	0.24
Vc	60	CS-PC-RC08	175	0.04	0.24
Vc	60	CS-PC-RC10	182	0.04	0.24
Vc	60	CS-PC-RC12	186	0.05	0.24
Vc	80	CS-PC-RC04	163	0.02	0.24
Vc	80	CS-PC-RC06	179	0.03	0.24
Vc	80	CS-PC-RC08	190	0.03	0.24
Vc	80	CS-PC-RC10	197	0.03	0.24
Vc	80	CS-PC-RC12	202	0.04	0.24
Vc	100	CS-PC-RC04	171	0.02	0.22
Vc	100	CS-PC-RC06	187	0.03	0.22
Vc	100	CS-PC-RC08	199	0.03	0.22
Vc	100	CS-PC-RC10	207	0.03	0.22
Vc	100	CS-PC-RC12	212	0.03	0.22
Vc	120	CS-PC04	175	0.02	0.21
Vc	120	CS-PC06	193	0.02	0.21
Vc	120	CS-PC08	206	0.02	0.21
Vc	120	CS-PC10	214	0.03	0.21
Vc	120	CS-PC12	220	0.03	0.21
Vc	140	CS-PC04	179	0.02	0.21
Vc	140	CS-PC06	198	0.02	0.21
Vc	140	CS-PC08	210	0.02	0.21
Vc	140	CS-PC10	219	0.03	0.21
Vc	140	CS-PC12	225	0.03	0.21
Vc	160	CS-PC04	181	0.02	0.20
Vc	160	CS-PC06	200	0.02	0.20
Vc	160	CS-PC08	214	0.02	0.20
Vc	160	CS-PC10	223	0.03	0.20
Vc	160	CS-PC12	229	0.03	0.20
Vc	180	CS-PC04	183	0.02	0.19
Vc	180	CS-PC06	203	0.02	0.19
Vc	180	CS-PC08	217	0.02	0.19
Vc	180	CS-PC10	226	0.03	0.19
Vc	180	CS-PC12	232	0.03	0.19
Vc	200	CS-PC04	184	0.02	0.19
Vc	200	CS-PC06	204	0.02	0.19
Vc	200	CS-PC08	218	0.02	0.19
Vc	200	CS-PC10	228	0.03	0.19
Vc	200	CS-PC12	234	0.03	0.19

Table I.2a. Two Lane Positive Moment Projection Statistics for CS, PC, RC.

Effect	Span	Bridge	mLmax	Vproj	Vsite
Mcp	20	CS-PC-RC04	244	0.06	0.09
Mcp	20	CS-PC-RC 06	246	0.05	0.09
Mcp	20	CS-PC-RC 08	248	0.05	0.09
Mcp	20	CS-PC-RC 10	249	0.05	0.09
Mcp	20	CS-PC-RC 12	251	0.05	0.09
Mcp	40	CS-PC-RC04	636	0.04	0.09
Mcp	40	CS-PC-RC 06	644	0.04	0.09
Mcp	40	CS-PC-RC 08	651	0.04	0.09
Mcp	40	CS-PC-RC 10	656	0.04	0.09
Mcp	40	CS-PC-RC 12	660	0.04	0.09
Mcp	60	CS-PC-RC04	1169	0.03	0.08
Mcp	60	CS-PC-RC 06	1190	0.03	0.08
Mcp	60	CS-PC-RC 08	1206	0.03	0.08
Mcp	60	CS-PC-RC 10	1220	0.03	0.08
Mcp	60	CS-PC-RC 12	1231	0.04	0.08
Mcp	80	CS-PC-RC04	1983	0.04	0.12
Mcp	80	CS-PC-RC 06	2054	0.05	0.12
Mcp	80	CS-PC-RC 08	2109	0.05	0.12
Mcp	80	CS-PC-RC 10	2154	0.05	0.12
Mcp	80	CS-PC-RC 12	2192	0.05	0.12
Mcp	100	CS-PC-RC04	2935	0.05	0.14
Mcp	100	CS-PC-RC 06	3058	0.05	0.14
Mcp	100	CS-PC-RC 08	3153	0.05	0.14
Mcp	100	CS-PC-RC 10	3231	0.06	0.14
Mcp	100	CS-PC-RC 12	3296	0.06	0.14
Mcp	120	CS-PC04	3919	0.05	0.14
Mcp	120	CS-PC06	4082	0.05	0.14
Mcp	120	CS-PC08	4207	0.05	0.14
Mcp	120	CS-PC10	4309	0.06	0.14
Mcp	120	CS-PC12	4395	0.06	0.14
Mcp	140	CS-PC04	4915	0.05	0.13
Mcp	140	CS-PC06	5117	0.05	0.13
Mcp	140	CS-PC08	5273	0.05	0.13
Mcp	140	CS-PC10	5399	0.05	0.13
Mcp	140	CS-PC12	5507	0.05	0.13
Mcp	160	CS-PC04	5918	0.05	0.13
Mcp	160	CS-PC06	6160	0.05	0.13
Mcp	160	CS-PC08	6346	0.05	0.13
Mcp	160	CS-PC10	6498	0.05	0.13
Mcp	160	CS-PC12	6626	0.05	0.13
Mcp	180	CS-PC04	6932	0.04	0.13
Mcp	180	CS-PC06	7221	0.04	0.13

Mcp	180	CS-PC08	7443	0.04	0.13
Mcp	180	CS-PC10	7623	0.04	0.13
Mcp	180	CS-PC12	7776	0.04	0.13
Mcp	200	CS-PC04	8082	0.04	0.13
Mcp	200	CS-PC06	8397	0.04	0.13
Mcp	200	CS-PC08	8639	0.04	0.13
Mcp	200	CS-PC10	8835	0.04	0.13
Mcp	200	CS-PC12	9001	0.04	0.13

Table I.3. Two Lane Load Effect Projection Statistics for BS.

Effect	Span	Type	mLmax	Vproj	Vsite
Ms	20	BS04	303	0.06	0.09
Ms	20	BS06	307	0.05	0.09
Ms	20	BS08	310	0.05	0.09
Ms	20	BS10	313	0.05	0.09
Ms	20	BS12	315	0.05	0.09
Ms	40	BS04	822	0.04	0.09
Ms	40	BS06	838	0.04	0.09
Ms	40	BS08	850	0.04	0.09
Ms	40	BS10	859	0.04	0.09
Ms	40	BS12	867	0.04	0.09
Ms	60	BS04	1560	0.04	0.08
Ms	60	BS06	1603	0.04	0.08
Ms	60	BS08	1634	0.04	0.08
Ms	60	BS10	1660	0.04	0.08
Ms	60	BS12	1681	0.04	0.08
Ms	80	BS04	2836	0.06	0.12
Ms	80	BS06	2977	0.07	0.12
Ms	80	BS08	3082	0.07	0.12
Ms	80	BS10	3166	0.07	0.12
Ms	80	BS12	3236	0.08	0.12
Ms	100	BS04	4407	0.07	0.14
Ms	100	BS06	4652	0.07	0.14
Ms	100	BS08	4834	0.07	0.14
Ms	100	BS10	4980	0.07	0.14
Ms	100	BS12	5102	0.07	0.14
Ms	120	BS04	5890	0.07	0.14
Ms	120	BS06	6210	0.07	0.14
Ms	120	BS08	6447	0.07	0.14
Ms	120	BS10	6637	0.07	0.14

Ms	120	BS12	6797	0.07	0.14
Ms	140	BS04	7565	0.06	0.13
Ms	140	BS06	7969	0.06	0.13
Ms	140	BS08	8268	0.06	0.13
Ms	140	BS10	8507	0.06	0.13
Ms	140	BS12	8708	0.06	0.13
Ms	160	BS04	9294	0.05	0.13
Ms	160	BS06	9781	0.05	0.13
Ms	160	BS08	10142	0.05	0.13
Ms	160	BS10	10431	0.05	0.13
Ms	160	BS12	10674	0.05	0.13
Ms	180	BS04	10823	0.05	0.13
Ms	180	BS06	11392	0.05	0.13
Ms	180	BS08	11815	0.05	0.13
Ms	180	BS10	12153	0.05	0.13
Ms	180	BS12	12436	0.05	0.13
Ms	200	BS04	12654	0.04	0.13
Ms	200	BS06	13281	0.04	0.13
Ms	200	BS08	13745	0.04	0.13
Ms	200	BS10	14116	0.04	0.13
Ms	200	BS12	14428	0.04	0.13
Vs	20	BS04	68	0.05	0.10
Vs	20	BS06	69	0.05	0.10
Vs	20	BS08	70	0.05	0.10
Vs	20	BS10	70	0.05	0.10
Vs	20	BS12	71	0.05	0.10
Vs	40	BS04	93	0.04	0.09
Vs	40	BS06	94	0.04	0.09
Vs	40	BS08	95	0.04	0.09
Vs	40	BS10	96	0.04	0.09
Vs	40	BS12	97	0.04	0.09
Vs	60	BS04	111	0.03	0.11
Vs	60	BS06	112	0.03	0.11
Vs	60	BS08	114	0.03	0.11
Vs	60	BS10	115	0.03	0.11
Vs	60	BS12	116	0.03	0.11
Vs	80	BS04	123	0.02	0.13
Vs	80	BS06	127	0.03	0.13
Vs	80	BS08	130	0.03	0.13
Vs	80	BS10	132	0.04	0.13
Vs	80	BS12	134	0.04	0.13

Vs	100	BS04	132	0.03	0.14
Vs	100	BS06	138	0.03	0.14
Vs	100	BS08	142	0.04	0.14
Vs	100	BS10	146	0.04	0.14
Vs	100	BS12	149	0.05	0.14
<hr/>					
Vs	120	BS04	136	0.02	0.14
Vs	120	BS06	146	0.03	0.14
Vs	120	BS08	152	0.04	0.14
Vs	120	BS10	158	0.05	0.14
Vs	120	BS12	163	0.06	0.14
<hr/>					
Vs	140	BS04	141	0.02	0.14
Vs	140	BS06	152	0.04	0.14
Vs	140	BS08	160	0.04	0.14
Vs	140	BS10	166	0.05	0.14
Vs	140	BS12	172	0.06	0.14
<hr/>					
Vs	160	BS04	145	0.02	0.14
Vs	160	BS06	157	0.04	0.14
Vs	160	BS08	166	0.04	0.14
Vs	160	BS10	173	0.05	0.14
Vs	160	BS12	179	0.06	0.14
<hr/>					
Vs	180	BS04	149	0.02	0.15
Vs	180	BS06	161	0.04	0.15
Vs	180	BS08	170	0.04	0.15
Vs	180	BS10	178	0.05	0.15
Vs	180	BS12	184	0.06	0.15
<hr/>					
Vs	200	BS04	153	0.02	0.15
Vs	200	BS06	165	0.03	0.15
Vs	200	BS08	174	0.04	0.15
Vs	200	BS10	182	0.05	0.15
Vs	200	BS12	188	0.05	0.15
<hr/>					
Mc	20	BS04	202	0.03	0.09
Mc	20	BS06	205	0.03	0.09
Mc	20	BS08	207	0.03	0.09
Mc	20	BS10	208	0.04	0.09
Mc	20	BS12	209	0.04	0.09
<hr/>					
Mc	40	BS04	694	0.08	0.18
Mc	40	BS06	739	0.08	0.18
Mc	40	BS08	772	0.08	0.18
Mc	40	BS10	799	0.08	0.18
Mc	40	BS12	821	0.08	0.18
<hr/>					
Mc	60	BS04	1197	0.05	0.16

Mc	60	BS06	1262	0.05	0.16
Mc	60	BS08	1311	0.05	0.16
Mc	60	BS10	1350	0.05	0.16
Mc	60	BS12	1382	0.05	0.16
Mc	80	BS04	1706	0.03	0.15
Mc	80	BS06	1793	0.03	0.15
Mc	80	BS08	1857	0.03	0.15
Mc	80	BS10	1908	0.03	0.15
Mc	80	BS12	1951	0.03	0.15
Mc	100	BS04	2280	0.04	0.14
Mc	100	BS06	2394	0.04	0.14
Mc	100	BS08	2478	0.04	0.14
Mc	100	BS10	2545	0.04	0.14
Mc	100	BS12	2601	0.04	0.14
Mc	120	BS04	2798	0.04	0.12
Mc	120	BS06	2941	0.04	0.12
Mc	120	BS08	3047	0.04	0.12
Mc	120	BS10	3132	0.04	0.12
Mc	120	BS12	3203	0.04	0.12
Mc	140	BS04	3504	0.05	0.12
Mc	140	BS06	3690	0.05	0.12
Mc	140	BS08	3828	0.05	0.12
Mc	140	BS10	3939	0.05	0.12
Mc	140	BS12	4032	0.05	0.12
Mc	160	BS04	4276	0.04	0.13
Mc	160	BS06	4500	0.04	0.13
Mc	160	BS08	4666	0.04	0.13
Mc	160	BS10	4799	0.04	0.13
Mc	160	BS12	4911	0.04	0.13
Mc	180	BS04	4921	0.04	0.14
Mc	180	BS06	5180	0.04	0.14
Mc	180	BS08	5371	0.04	0.14
Mc	180	BS10	5524	0.04	0.14
Mc	180	BS12	5653	0.04	0.14
Mc	200	BS04	5746	0.03	0.14
Mc	200	BS06	6028	0.03	0.14
Mc	200	BS08	6237	0.03	0.14
Mc	200	BS10	6404	0.03	0.14
Mc	200	BS12	6545	0.03	0.14
Vc	20	BS04	99	0.04	0.17
Vc	20	BS06	100	0.04	0.17

Vc	20	BS08	101	0.04	0.17
Vc	20	BS10	102	0.04	0.17
Vc	20	BS12	102	0.04	0.17
Vc	40	BS04	138	0.02	0.23
Vc	40	BS06	143	0.03	0.23
Vc	40	BS08	147	0.04	0.23
Vc	40	BS10	150	0.04	0.23
Vc	40	BS12	153	0.04	0.23
Vc	60	BS04	160	0.02	0.24
Vc	60	BS06	170	0.03	0.24
Vc	60	BS08	178	0.04	0.24
Vc	60	BS10	184	0.04	0.24
Vc	60	BS12	189	0.05	0.24
Vc	80	BS04	171	0.02	0.24
Vc	80	BS06	183	0.03	0.24
Vc	80	BS08	192	0.03	0.24
Vc	80	BS10	200	0.04	0.24
Vc	80	BS12	206	0.04	0.24
Vc	100	BS04	179	0.02	0.22
Vc	100	BS06	192	0.03	0.22
Vc	100	BS08	202	0.03	0.22
Vc	100	BS10	210	0.03	0.22
Vc	100	BS12	217	0.03	0.22
Vc	120	BS04	184	0.02	0.21
Vc	120	BS06	198	0.02	0.21
Vc	120	BS08	208	0.02	0.21
Vc	120	BS10	217	0.03	0.21
Vc	120	BS12	225	0.03	0.21
Vc	140	BS04	188	0.02	0.21
Vc	140	BS06	202	0.02	0.21
Vc	140	BS08	213	0.02	0.21
Vc	140	BS10	222	0.03	0.21
Vc	140	BS12	230	0.03	0.21
Vc	160	BS04	191	0.02	0.20
Vc	160	BS06	206	0.02	0.20
Vc	160	BS08	217	0.02	0.20
Vc	160	BS10	226	0.03	0.20
Vc	160	BS12	234	0.03	0.20
Vc	180	BS04	193	0.02	0.19
Vc	180	BS06	208	0.02	0.19
Vc	180	BS08	220	0.02	0.19



Vc	180	BS10	229	0.03	0.19
Vc	180	BS12	237	0.03	0.19
Vc	200	BS04	194	0.02	0.19
Vc	200	BS06	210	0.02	0.19
Vc	200	BS08	222	0.02	0.19
Vc	200	BS10	231	0.03	0.19
Vc	200	BS12	240	0.03	0.19

Table I.4. Two Lane Load Effect Projection Statistics for BT.

Effect	Span	Bridge	mLmax	Vproj	Vsite
Ms	20	BT36-48	290	0.06	0.09
Ms	40	BT36-48	782	0.04	0.09
Ms	60	BT36-48	1489	0.03	0.08
Ms	80	BT36-48	2729	0.05	0.12
Ms	100	BT36-48	4318	0.06	0.14
Ms	120	BT36-48	5990	0.07	0.14
Ms	140	BT36-48	7752	0.06	0.13
Ms	160	BT36-48	9584	0.05	0.13
Ms	180	BT36-48	11550	0.05	0.13
Ms	200	BT36-48	12304	0.04	0.13
Vs	20	BT36-48	66	0.05	0.10
Vs	40	BT36-48	90	0.04	0.09
Vs	60	BT36-48	108	0.03	0.11
Vs	80	BT36-48	118	0.02	0.13
Vs	100	BT36-48	125	0.02	0.14
Vs	120	BT36-48	126	0.01	0.14
Vs	140	BT36-48	130	0.01	0.14
Vs	160	BT36-48	134	0.01	0.14
Vs	180	BT36-48	138	0.01	0.15
Vs	200	BT36-48	142	0.01	0.15
Mc	20	BT36-48	194	0.03	0.09
Mc	40	BT36-48	580	0.07	0.18
Mc	60	BT36-48	1088	0.05	0.16
Mc	80	BT36-48	1641	0.03	0.15
Mc	100	BT36-48	2239	0.03	0.14
Mc	120	BT36-48	2843	0.03	0.12
Mc	140	BT36-48	3590	0.05	0.12
Mc	160	BT36-48	4409	0.04	0.13
Mc	180	BT36-48	5251	0.04	0.14
Mc	200	BT36-48	5588	0.03	0.14
Vc	20	BT36-48	97	0.04	0.17
Vc	40	BT36-48	129	0.02	0.23

Vc	60	BT36-48	144	0.02	0.24
Vc	80	BT36-48	155	0.01	0.24
Vc	100	BT36-48	163	0.01	0.22
Vc	120	BT36-48	168	0.02	0.21
Vc	140	BT36-48	173	0.02	0.21
Vc	160	BT36-48	176	0.02	0.20
Vc	180	BT36-48	179	0.02	0.19
Vc	200	BT36-48	181	0.02	0.19

Table I.5. k Values for CS, PC, RC, BS Moments and BS Shears.

Span (ft)	Spacing (ft)	k, Moment	k, Moment	k, Shear
		CS, PC, RC	BS	BS
20	4	0.40	0.37	0.27
20	6	0.45	0.44	0.38
20	8	0.49	0.49	0.46
20	10	0.52	0.54	0.53
20	12	0.54	0.57	0.58
40	4	0.49	0.63	0.27
40	6	0.54	0.71	0.38
40	8	0.58	0.78	0.46
40	10	0.61	0.83	0.53
40	12	0.64	0.87	0.58
60	4	0.54	0.75	0.27
60	6	0.59	0.84	0.38
60	8	0.64	0.91	0.46
60	10	0.67	0.96	0.53
60	12	0.70	1.00	0.58
80	4	0.57	0.81	0.27
80	6	0.63	0.91	0.38
80	8	0.68	0.98	0.46
80	10	0.72	1.03	0.53
80	12	0.75	1.08	0.58
100	4	0.60	0.90	0.27
100	6	0.66	0.99	0.38
100	8	0.71	1.07	0.46
100	10	0.75	1.13	0.53
100	12	0.78	1.18	0.58
120	4	0.62	0.93	0.27
120	6	0.69	1.03	0.38
120	8	0.74	1.11	0.46
120	10	0.78	1.17	0.53
120	12	0.81	1.22	0.58
140	4	0.64	1.01	0.27
140	6	0.71	1.11	0.38
140	8	0.76	1.19	0.46
140	10	0.80	1.25	0.53
140	12	0.83	1.31	0.58

160	4	0.66	1.08	0.27
160	6	0.72	1.19	0.38
160	8	0.78	1.27	0.46
160	10	0.82	1.33	0.53
160	12	0.85	1.38	0.58
180	4	0.67	1.08	0.27
180	6	0.74	1.19	0.38
180	8	0.79	1.27	0.46
180	10	0.84	1.33	0.53
180	12	0.87	1.39	0.58
200	4	0.68	1.14	0.27
200	6	0.75	1.25	0.38
200	8	0.81	1.33	0.46
200	10	0.85	1.40	0.53
200	12	0.89	1.45	0.58

Table I.6. k Values for CS, PC, RC Shears and BT Moments and Shears.

	Spacing (ft)	k, Shear
		CS, PC, RC
	4	0.20
FOR	6	0.34
ALL	8	0.44
SPANS	10	0.50
	12	0.55

Span (ft)	Width (in)	k, Moment	k, Shear
		BT	BT
20	36	0.15	0.05
40	36	0.41	0.09
60	36	0.60	0.11
80	36	0.74	0.12
100	36	0.86	0.14
120	36	0.96	0.15
140	36	1.06	0.16
160	36	1.14	0.16
180	36	1.22	0.17
200	36	1.07	0.18
20	48	0.16	0.16
40	48	0.43	0.20
60	48	0.62	0.23
80	48	0.77	0.24
100	48	0.89	0.26
120	48	0.99	0.27
140	48	1.09	0.28
160	48	1.17	0.29
180	48	1.25	0.30
200	48	1.17	0.30

Table I.7. k Values Used for Two Lane Load Effects, Moment.

Span	k1	k2	k3	k4
20	0.15	0.40	0.55	-
40	0.55	0.65	0.75	-
60	0.55	0.70	1.00	-
80	0.55	0.75	1.00	-
100	0.60	0.80	1.20	-
120	0.60	0.80	1.20	-
140	0.65	0.85	1.00	1.30
160	0.65	0.85	1.00	1.30
180	0.65	0.90	1.15	1.40
200	0.70	0.90	1.15	1.40

Table I.8. k Values Used for Two Lane Load Effects, Shear.

Span	k1	k2	k3	k4
20	0.10	0.20	0.40	0.60
40	0.10	0.20	0.40	0.60
60	0.10	0.20	0.40	0.60
80	0.10	0.20	0.40	0.60
100	0.10	0.20	0.40	0.60
120	0.20	0.40	0.60	-
140	0.20	0.40	0.60	-
160	0.20	0.40	0.60	-
180	0.20	0.40	0.60	-
200	0.20	0.40	0.60	-

Table I.9. Load Projection Mean Maximum Interpolation Equations for Two Lane Effects.

Simple Moment			Continuous Moment		
Span	Equation	R <sup>2</sup>	Span	Equation	R <sup>2</sup>
20	$y = 60.158x + 280.61$	0.92	20	$y = 36.381x + 188.63$	0.95
40	$y = 187.5x + 704.29$	0.96	40	$y = 530x + 360.83$	1.00
60	$y = 471.74x + 1207.4$	0.97	60	$y = 718.86x + 660.06$	1.00
80	$y = 1499.8x + 1619.4$	1.00	80	$y = 919.36x + 960.59$	1.00
100	$y = 2492.9x + 2172.9$	1.00	100	$y = 1150x + 1250$	1.00
120	$y = 3185.7x + 2915.7$	1.00	120	$y = 1421.4x + 1471.4$	1.00
140	$y = 3861.2x + 3667.3$	1.00	140	$y = 1784.4x + 1702.3$	1.00
160	$y = 4511.1x + 4431.9$	1.00	160	$y = 2077.8x + 2036.1$	1.00
180	$y = 5268x + 5127.8$	1.00	180	$y = 2388x + 2339.8$	1.00
200	$y = 5640x + 6244$	1.00	200	$y = 2540x + 2859$	1.00

Simple Shear			Continuous Shear		
Span	Equation	R <sup>2</sup>	Span	Equation	R <sup>2</sup>
20	$y = 9.661x + 65.11$	0.99	20	$y = 10.458x + 96.376$	0.97
40	$y = 13.237x + 89.173$	0.99	40	$y = 47.966x + 124.66$	0.92
60	$y = 17.966x + 105.66$	0.97	60	$y = 95.085x + 133.85$	0.98
80	$y = 35.254x + 113.54$	0.89	80	$y = 111.02x + 141.17$	1.00
100	$y = 53.559x + 117.59$	0.93	100	$y = 120.34x + 146.39$	1.00
120	$y = 85x + 113.33$	0.97	120	$y = 130x + 148.67$	1.00
140	$y = 97.5x + 115$	0.98	140	$y = 132.5x + 152.33$	1.00
160	$y = 107.5x + 116.33$	0.99	160	$y = 140x + 152.67$	1.00
180	$y = 112.5x + 118.67$	1.00	180	$y = 142.5x + 154.33$	1.00
200	$y = 115x + 121.33$	1.00	200	$y = 145x + 155$	1.00

Table I.10. Load Projection R-Square Values for Two Lane, Simple Moment.

Span	n	k1	k2	k3	k4
20	250	0.99	0.99	0.99	-
40	50	0.99	1.00	0.99	-
60	250	0.98	0.98	0.99	-
80	250	0.98	0.98	0.99	-
100	250	0.99	0.99	0.98	-
120	250	0.99	0.99	0.98	-
140	250	0.99	1.00	0.99	0.99
160	250	0.99	0.99	0.99	0.99
180	250	1.00	0.99	0.99	0.99
200	250	0.99	0.98	0.98	0.97

Table I.11. Load Projection R-Square Values for Two Lane, Simple Shear.

Span	n	k1	k2	K3	k4
20	250	1.00	1.00	0.99	0.99
40	50	0.99	0.99	0.99	0.99
60	250	0.98	0.98	0.98	0.99
80	250	0.96	0.95	0.99	0.94
100	250	0.96	0.95	0.95	0.98
120	50	0.98	0.93	0.99	-
140	50	0.98	0.95	0.99	-
160	50	0.95	0.97	0.99	-
180	50	0.96	0.98	0.99	-
200	250	0.9	0.99	0.99	-

Table I.12. Load projection R-Square Values for Two Lane, Continuous Moment.

Span	n	k1	k2	K3	k4
20	250	0.99	0.99	0.97	-
40	50	0.99	0.98	0.99	-
60	250	1.00	1.00	1.00	-
80	250	0.98	0.98	0.98	-
100	250	0.98	0.98	0.98	-
120	250	0.99	0.99	0.99	-
140	250	0.99	0.99	0.99	0.99
160	250	0.99	0.99	0.99	1.00
180	250	0.99	0.98	0.98	0.98
200	250	1.0	0.97	0.96	0.96

Table I.13. Load Projection R-Square Values for Two Lane, Continuous Shear.

Span	n	k1	k2	K3	k4
20	250	0.98	0.98	0.99	0.99
40	50	0.96*	0.95*	0.97	0.97
60	250	0.99	0.98	0.98	0.99
80	250	0.99	0.99	1.00	1.00
100	250	0.99	0.98	0.99	0.98
120	50	0.96	1.00	1.00	-
140	50	0.91	0.96	0.97	-
160	50	0.90	0.92	0.92	-
180	50	0.90	0.91	0.91	-
200	50	0.90	0.90	0.91	-

\* n=250

## APPENDIX J. REQUIRED LIVE LOAD EFFECTS

**Table J.1. LRFR Required Load Effects.**

### Single Lane Load Effects, Steel Girders

Lane	Effect	Span	Bridge	RLE	Lane	Effect	Span	Bridge	RLE
fol	Ms	20	CS04	232	fol	Mc	20	CS04	150
fol	Ms	20	CS06	224	fol	Mc	20	CS06	145
fol	Ms	20	CS08	218	fol	Mc	20	CS08	142
fol	Ms	20	CS10	213	fol	Mc	20	CS10	138
fol	Ms	20	CS12	209	fol	Mc	20	CS12	135
fol	Ms	40	CS04	613	fol	Mc	40	CS04	371
fol	Ms	40	CS06	591	fol	Mc	40	CS06	359
fol	Ms	40	CS08	575	fol	Mc	40	CS08	349
fol	Ms	40	CS10	560	fol	Mc	40	CS10	340
fol	Ms	40	CS12	547	fol	Mc	40	CS12	331
fol	Ms	60	CS04	1031	fol	Mc	60	CS04	859
fol	Ms	60	CS06	991	fol	Mc	60	CS06	825
fol	Ms	60	CS08	961	fol	Mc	60	CS08	797
fol	Ms	60	CS10	933	fol	Mc	60	CS10	771
fol	Ms	60	CS12	908	fol	Mc	60	CS12	747
fol	Ms	80	CS04	1389	fol	Mc	80	CS04	1237
fol	Ms	80	CS06	1339	fol	Mc	80	CS06	1188
fol	Ms	80	CS08	1299	fol	Mc	80	CS08	1149
fol	Ms	80	CS10	1264	fol	Mc	80	CS10	1113
fol	Ms	80	CS12	1227	fol	Mc	80	CS12	1075
fol	Ms	100	CS04	1705	fol	Mc	100	CS04	1412
fol	Ms	100	CS06	1657	fol	Mc	100	CS06	1372
fol	Ms	100	CS08	1625	fol	Mc	100	CS08	1346
fol	Ms	100	CS10	1584	fol	Mc	100	CS10	1308
fol	Ms	100	CS12	1539	fol	Mc	100	CS12	1264
fol	Ms	120	CS04	2404	fol	Mc	120	CS04	1536
fol	Ms	120	CS06	2315	fol	Mc	120	CS06	1478
fol	Ms	120	CS08	2273	fol	Mc	120	CS08	1460
fol	Ms	120	CS10	2218	fol	Mc	120	CS10	1422
fol	Ms	120	CS12	2151	fol	Mc	120	CS12	1367
fol	Ms	140	CS04	2995	fol	Mc	140	CS04	1525
fol	Ms	140	CS06	2885	fol	Mc	140	CS06	1473
fol	Ms	140	CS08	2825	fol	Mc	140	CS08	1455
fol	Ms	140	CS10	2754	fol	Mc	140	CS10	1417
fol	Ms	140	CS12	2660	fol	Mc	140	CS12	1349
fol	Ms	160	CS04	3621	fol	Mc	160	CS04	1408
fol	Ms	160	CS06	3485	fol	Mc	160	CS06	1367
fol	Ms	160	CS08	3417	fol	Mc	160	CS08	1366

fol	Ms	160	CS10	3331	fol	Mc	160	CS10	1334
fol	Ms	160	CS12	3205	fol	Mc	160	CS12	1254
fol	Ms	180	CS04	4139	fol	Mc	180	CS04	1295
fol	Ms	180	CS06	3983	fol	Mc	180	CS06	1264
fol	Ms	180	CS08	3914	fol	Mc	180	CS08	1283
fol	Ms	180	CS10	3818	fol	Mc	180	CS10	1258
fol	Ms	180	CS12	3657	fol	Mc	180	CS12	1160
fol	Ms	200	CS04	4532	fol	Mc	200	CS04	1210
fol	Ms	200	CS06	4380	fol	Mc	200	CS06	1206
fol	Ms	200	CS08	4284	fol	Mc	200	CS08	1213
fol	Ms	200	CS10	4149	fol	Mc	200	CS10	1165
fol	Ms	200	CS12	3941	fol	Mc	200	CS12	1031
fol	Vs	20	CS04	56	fol	Vc	20	CS04	92
fol	Vs	20	CS06	50	fol	Vc	20	CS06	82
fol	Vs	20	CS08	46	fol	Vc	20	CS08	76
fol	Vs	20	CS10	44	fol	Vc	20	CS10	72
fol	Vs	20	CS12	42	fol	Vc	20	CS12	70
fol	Vs	40	CS04	76	fol	Vc	40	CS04	112
fol	Vs	40	CS06	67	fol	Vc	40	CS06	99
fol	Vs	40	CS08	63	fol	Vc	40	CS08	92
fol	Vs	40	CS10	59	fol	Vc	40	CS10	88
fol	Vs	40	CS12	57	fol	Vc	40	CS12	85
fol	Vs	60	CS04	88	fol	Vc	60	CS04	151
fol	Vs	60	CS06	78	fol	Vc	60	CS06	134
fol	Vs	60	CS08	72	fol	Vc	60	CS08	124
fol	Vs	60	CS10	68	fol	Vc	60	CS10	118
fol	Vs	60	CS12	66	fol	Vc	60	CS12	114
fol	Vs	80	CS04	92	fol	Vc	80	CS04	197
fol	Vs	80	CS06	82	fol	Vc	80	CS06	175
fol	Vs	80	CS08	76	fol	Vc	80	CS08	162
fol	Vs	80	CS10	72	fol	Vc	80	CS10	154
fol	Vs	80	CS12	69	fol	Vc	80	CS12	149
fol	Vs	100	CS04	104	fol	Vc	100	CS04	217
fol	Vs	100	CS06	92	fol	Vc	100	CS06	193
fol	Vs	100	CS08	86	fol	Vc	100	CS08	180
fol	Vs	100	CS10	82	fol	Vc	100	CS10	171
fol	Vs	100	CS12	79	fol	Vc	100	CS12	165
fol	Vs	120	CS04	121	fol	Vc	120	CS04	226
fol	Vs	120	CS06	107	fol	Vc	120	CS06	200
fol	Vs	120	CS08	99	fol	Vc	120	CS08	186
fol	Vs	120	CS10	94	fol	Vc	120	CS10	177
fol	Vs	120	CS12	91	fol	Vc	120	CS12	170
fol	Vs	140	CS04	135	fol	Vc	140	CS04	227
fol	Vs	140	CS06	119	fol	Vc	140	CS06	201



fol	Vs	140	CS08	110	fol	Vc	140	CS08	186
fol	Vs	140	CS10	105	fol	Vc	140	CS10	177
fol	Vs	140	CS12	100	fol	Vc	140	CS12	170
fol	Vs	160	CS04	146	fol	Vc	160	CS04	226
fol	Vs	160	CS06	128	fol	Vc	160	CS06	199
fol	Vs	160	CS08	119	fol	Vc	160	CS08	185
fol	Vs	160	CS10	113	fol	Vc	160	CS10	175
fol	Vs	160	CS12	108	fol	Vc	160	CS12	168
fol	Vs	180	CS04	151	fol	Vc	180	CS04	221
fol	Vs	180	CS06	133	fol	Vc	180	CS06	195
fol	Vs	180	CS08	123	fol	Vc	180	CS08	181
fol	Vs	180	CS10	116	fol	Vc	180	CS10	172
fol	Vs	180	CS12	111	fol	Vc	180	CS12	164
fol	Vs	200	CS04	154	fol	Vc	200	CS04	218
fol	Vs	200	CS06	135	fol	Vc	200	CS06	192
fol	Vs	200	CS08	125	fol	Vc	200	CS08	177
fol	Vs	200	CS10	118	fol	Vc	200	CS10	168
fol	Vs	200	CS12	111	fol	Vc	200	CS12	160

Lane	Effect	Span	Bridge	RLE
fol	Mcp	20	CS04	184
fol	Mcp	20	CS06	177
fol	Mcp	20	CS08	173
fol	Mcp	20	CS10	169
fol	Mcp	20	CS12	165
fol	Mcp	40	CS04	483
fol	Mcp	40	CS06	466
fol	Mcp	40	CS08	453
fol	Mcp	40	CS10	441
fol	Mcp	40	CS12	430
fol	Mcp	60	CS04	807
fol	Mcp	60	CS06	777
fol	Mcp	60	CS08	752
fol	Mcp	60	CS10	730
fol	Mcp	60	CS12	709
fol	Mcp	80	CS04	1078
fol	Mcp	80	CS06	1041
fol	Mcp	80	CS08	1010
fol	Mcp	80	CS10	982
fol	Mcp	80	CS12	951
fol	Mcp	100	CS04	1303
fol	Mcp	100	CS06	1271
fol	Mcp	100	CS08	1251
fol	Mcp	100	CS10	1220

fol	Mcp	100	CS12	1182
fol	Mcp	120	CS04	1831
fol	Mcp	120	CS06	1765
fol	Mcp	120	CS08	1740
fol	Mcp	120	CS10	1699
fol	Mcp	120	CS12	1643
fol	Mcp	140	CS04	2252
fol	Mcp	140	CS06	2174
fol	Mcp	140	CS08	2136
fol	Mcp	140	CS10	2083
fol	Mcp	140	CS12	2004
fol	Mcp	160	CS04	2675
fol	Mcp	160	CS06	2580
fol	Mcp	160	CS08	2541
fol	Mcp	160	CS10	2479
fol	Mcp	160	CS12	2373
fol	Mcp	180	CS04	2994
fol	Mcp	180	CS06	2889
fol	Mcp	180	CS08	2855
fol	Mcp	180	CS10	2788
fol	Mcp	180	CS12	2653
fol	Mcp	200	CS04	3201
fol	Mcp	200	CS06	3108
fol	Mcp	200	CS08	3054
fol	Mcp	200	CS10	2954
fol	Mcp	200	CS12	2776

### Two Lane Load Effects, Steel Girders

Lane	Effect	Span	Bridge	RLE	Lane	Effect	Span	Bridge	RLE
04G	Ms	20	CS04	247	04G	Mc	20	CS04	161
06G	Ms	20	CS06	241	06G	Mc	20	CS06	156
08G	Ms	20	CS08	236	08G	Mc	20	CS08	154
10G	Ms	20	CS10	232	10G	Mc	20	CS10	151
12G	Ms	20	CS12	228	12G	Mc	20	CS12	148
04G	Ms	40	CS04	584	04G	Mc	40	CS04	472
06G	Ms	40	CS06	571	06G	Mc	40	CS06	477
08G	Ms	40	CS08	561	08G	Mc	40	CS08	482
10G	Ms	40	CS10	551	10G	Mc	40	CS10	482
12G	Ms	40	CS12	542	12G	Mc	40	CS12	481
04G	Ms	60	CS04	1005	04G	Mc	60	CS04	724
06G	Ms	60	CS06	986	06G	Mc	60	CS06	727
08G	Ms	60	CS08	970	08G	Mc	60	CS08	726
10G	Ms	60	CS10	954	10G	Mc	60	CS10	721
12G	Ms	60	CS12	938	12G	Mc	60	CS12	715

04G	Ms	80	CS04	1649	04G	Mc	80	CS04	930
06G	Ms	80	CS06	1653	06G	Mc	80	CS06	936
08G	Ms	80	CS08	1652	08G	Mc	80	CS08	936
10G	Ms	80	CS10	1645	10G	Mc	80	CS10	932
12G	Ms	80	CS12	1631	12G	Mc	80	CS12	920
04G	Ms	100	CS04	2329	04G	Mc	100	CS04	1069
06G	Ms	100	CS06	2363	06G	Mc	100	CS06	1094
08G	Ms	100	CS08	2392	08G	Mc	100	CS08	1115
10G	Ms	100	CS10	2395	10G	Mc	100	CS10	1115
12G	Ms	100	CS12	2383	12G	Mc	100	CS12	1102
04G	Ms	120	CS04	2991	04G	Mc	120	CS04	1173
06G	Ms	120	CS06	3016	06G	Mc	120	CS06	1193
08G	Ms	120	CS08	3057	08G	Mc	120	CS08	1230
10G	Ms	120	CS10	3063	10G	Mc	120	CS10	1236
12G	Ms	120	CS12	3043	12G	Mc	120	CS12	1219
04G	Ms	140	CS04	3524	04G	Mc	140	CS04	1239
06G	Ms	140	CS06	3560	06G	Mc	140	CS06	1278
08G	Ms	140	CS08	3606	08G	Mc	140	CS08	1324
10G	Ms	140	CS10	3614	10G	Mc	140	CS10	1336
12G	Ms	140	CS12	3581	12G	Mc	140	CS12	1309
04G	Ms	160	CS04	3968	04G	Mc	160	CS04	1260
06G	Ms	160	CS06	4018	06G	Mc	160	CS06	1315
08G	Ms	160	CS08	4084	08G	Mc	160	CS08	1383
10G	Ms	160	CS10	4100	10G	Mc	160	CS10	1405
12G	Ms	160	CS12	4055	12G	Mc	160	CS12	1368
04G	Ms	180	CS04	4312	04G	Mc	180	CS04	1174
06G	Ms	180	CS06	4387	06G	Mc	180	CS06	1253
08G	Ms	180	CS08	4482	08G	Mc	180	CS08	1349
10G	Ms	180	CS10	4512	10G	Mc	180	CS10	1384
12G	Ms	180	CS12	4455	12G	Mc	180	CS12	1335
04G	Ms	200	CS04	4680	04G	Mc	200	CS04	1073
06G	Ms	200	CS06	4780	06G	Mc	200	CS06	1186
08G	Ms	200	CS08	4862	08G	Mc	200	CS08	1277
10G	Ms	200	CS10	4866	10G	Mc	200	CS10	1293
12G	Ms	200	CS12	4771	12G	Mc	200	CS12	1212
04G	Vs	20	CS04	59	04G	Vc	20	CS04	91
06G	Vs	20	CS06	54	06G	Vc	20	CS06	83
08G	Vs	20	CS08	51	08G	Vc	20	CS08	78
10G	Vs	20	CS10	49	10G	Vc	20	CS10	74
12G	Vs	20	CS12	47	12G	Vc	20	CS12	72
04G	Vs	40	CS04	79	04G	Vc	40	CS04	128
06G	Vs	40	CS06	72	06G	Vc	40	CS06	120
08G	Vs	40	CS08	67	08G	Vc	40	CS08	115
10G	Vs	40	CS10	65	10G	Vc	40	CS10	112
12G	Vs	40	CS12	63	12G	Vc	40	CS12	110

04G	Vs	60	CS04	93	04G	Vc	60	CS04	144
06G	Vs	60	CS06	84	06G	Vc	60	CS06	140
08G	Vs	60	CS08	79	08G	Vc	60	CS08	137
10G	Vs	60	CS10	76	10G	Vc	60	CS10	135
12G	Vs	60	CS12	74	12G	Vc	60	CS12	134
04G	Vs	80	CS04	101	04G	Vc	80	CS04	151
06G	Vs	80	CS06	93	06G	Vc	80	CS06	147
08G	Vs	80	CS08	89	08G	Vc	80	CS08	145
10G	Vs	80	CS10	86	10G	Vc	80	CS10	144
12G	Vs	80	CS12	84	12G	Vc	80	CS12	142
04G	Vs	100	CS04	104	04G	Vc	100	CS04	150
06G	Vs	100	CS06	98	06G	Vc	100	CS06	148
08G	Vs	100	CS08	95	08G	Vc	100	CS08	147
10G	Vs	100	CS10	93	10G	Vc	100	CS10	146
12G	Vs	100	CS12	91	12G	Vc	100	CS12	144
04G	Vs	120	CS04	102	04G	Vc	120	CS04	149
06G	Vs	120	CS06	100	06G	Vc	120	CS06	147
08G	Vs	120	CS08	99	08G	Vc	120	CS08	147
10G	Vs	120	CS10	98	10G	Vc	120	CS10	146
12G	Vs	120	CS12	97	12G	Vc	120	CS12	145
04G	Vs	140	CS04	102	04G	Vc	140	CS04	148
06G	Vs	140	CS06	100	06G	Vc	140	CS06	146
08G	Vs	140	CS08	100	08G	Vc	140	CS08	146
10G	Vs	140	CS10	100	10G	Vc	140	CS10	145
12G	Vs	140	CS12	98	12G	Vc	140	CS12	143
04G	Vs	160	CS04	100	04G	Vc	160	CS04	143
06G	Vs	160	CS06	99	06G	Vc	160	CS06	142
08G	Vs	160	CS08	100	08G	Vc	160	CS08	143
10G	Vs	160	CS10	100	10G	Vc	160	CS10	142
12G	Vs	160	CS12	99	12G	Vc	160	CS12	141
04G	Vs	180	CS04	97	04G	Vc	180	CS04	138
06G	Vs	180	CS06	98	06G	Vc	180	CS06	138
08G	Vs	180	CS08	99	08G	Vc	180	CS08	138
10G	Vs	180	CS10	99	10G	Vc	180	CS10	138
12G	Vs	180	CS12	98	12G	Vc	180	CS12	137
04G	Vs	200	CS04	95	04G	Vc	200	CS04	133
06G	Vs	200	CS06	95	06G	Vc	200	CS06	134
08G	Vs	200	CS08	96	08G	Vc	200	CS08	134
10G	Vs	200	CS10	96	10G	Vc	200	CS10	134
12G	Vs	200	CS12	95	12G	Vc	200	CS12	132

Lane	Effect	Span	Bridge	RLE
04G	Mcp	20	CS04	196
06G	Mcp	20	CS06	191
08G	Mcp	20	CS08	187
10G	Mcp	20	CS10	184
12G	Mcp	20	CS12	181
04G	Mcp	40	CS04	460
06G	Mcp	40	CS06	450
08G	Mcp	40	CS08	441
10G	Mcp	40	CS10	433
12G	Mcp	40	CS12	426
04G	Mcp	60	CS04	787
06G	Mcp	60	CS06	772
08G	Mcp	60	CS08	759
10G	Mcp	60	CS10	746
12G	Mcp	60	CS12	732
04G	Mcp	80	CS04	1281
06G	Mcp	80	CS06	1286
08G	Mcp	80	CS08	1286
10G	Mcp	80	CS10	1280
12G	Mcp	80	CS12	1268
04G	Mcp	100	CS04	1790
06G	Mcp	100	CS06	1823
08G	Mcp	100	CS08	1851
10G	Mcp	100	CS10	1854
12G	Mcp	100	CS12	1843
04G	Mcp	120	CS04	2286
06G	Mcp	120	CS06	2311
08G	Mcp	120	CS08	2352
10G	Mcp	120	CS10	2359
12G	Mcp	120	CS12	2340
04G	Mcp	140	CS04	2664
06G	Mcp	140	CS06	2701
08G	Mcp	140	CS08	2746
10G	Mcp	140	CS10	2755
12G	Mcp	140	CS12	2725
04G	Mcp	160	CS04	2952
06G	Mcp	160	CS06	3004
08G	Mcp	160	CS08	3071
10G	Mcp	160	CS10	3088
12G	Mcp	160	CS12	3046
04G	Mcp	180	CS04	3143
06G	Mcp	180	CS06	3220
08G	Mcp	180	CS08	3316

10G	Mcp	180	CS10	3348
12G	Mcp	180	CS12	3294
04G	Mcp	200	CS04	3338
06G	Mcp	200	CS06	3443
08G	Mcp	200	CS08	3528
10G	Mcp	200	CS10	3537
12G	Mcp	200	CS12	3448

### Single Lane Load Effects, PC Girders

Lane	Effect	Span	Bridge	RLE	Lane	Effect	Span	Bridge	RLE
fol	Ms	20	PC04	236	fol	Mc	20	PC04	151
fol	Ms	20	PC06	230	fol	Mc	20	PC06	148
fol	Ms	20	PC08	226	fol	Mc	20	PC08	145
fol	Ms	20	PC10	222	fol	Mc	20	PC10	143
fol	Ms	20	PC12	218	fol	Mc	20	PC12	141
fol	Ms	40	PC04	614	fol	Mc	40	PC04	363
fol	Ms	40	PC06	601	fol	Mc	40	PC06	358
fol	Ms	40	PC08	591	fol	Mc	40	PC08	354
fol	Ms	40	PC10	580	fol	Mc	40	PC10	349
fol	Ms	40	PC12	571	fol	Mc	40	PC12	344
fol	Ms	60	PC04	1018	fol	Mc	60	PC04	840
fol	Ms	60	PC06	1001	fol	Mc	60	PC06	830
fol	Ms	60	PC08	988	fol	Mc	60	PC08	821
fol	Ms	60	PC10	971	fol	Mc	60	PC10	807
fol	Ms	60	PC12	955	fol	Mc	60	PC12	794
fol	Ms	80	PC04	1313	fol	Mc	80	PC04	1147
fol	Ms	80	PC06	1311	fol	Mc	80	PC06	1155
fol	Ms	80	PC08	1305	fol	Mc	80	PC08	1155
fol	Ms	80	PC10	1291	fol	Mc	80	PC10	1143
fol	Ms	80	PC12	1276	fol	Mc	80	PC12	1128
fol	Ms	100	PC04	1539	fol	Mc	100	PC04	1224
fol	Ms	100	PC06	1568	fol	Mc	100	PC06	1269
fol	Ms	100	PC08	1582	fol	Mc	100	PC08	1295
fol	Ms	100	PC10	1577	fol	Mc	100	PC10	1295
fol	Ms	100	PC12	1566	fol	Mc	100	PC12	1288
fol	Ms	120	PC04	2147	fol	Mc	120	PC04	1246
fol	Ms	120	PC06	2195	fol	Mc	120	PC06	1330
fol	Ms	120	PC08	2221	fol	Mc	120	PC08	1382
fol	Ms	120	PC10	2216	fol	Mc	120	PC10	1396
fol	Ms	120	PC12	2202	fol	Mc	120	PC12	1398
fol	Ms	140	PC04	2703	fol	Mc	140	PC04	1194
fol	Ms	140	PC06	2777	fol	Mc	140	PC06	1325
fol	Ms	140	PC08	2817	fol	Mc	140	PC08	1407
fol	Ms	140	PC10	2818	fol	Mc	140	PC10	1441

fol	Ms	140	PC12	2804	fol	Mc	140	PC12	1455
fol	Ms	160	PC04	3311	fol	Mc	160	PC04	1055
fol	Ms	160	PC06	3425	fol	Mc	160	PC06	1248
fol	Ms	160	PC08	3488	fol	Mc	160	PC08	1371
fol	Ms	160	PC10	3495	fol	Mc	160	PC10	1430
fol	Ms	160	PC12	3480	fol	Mc	160	PC12	1459
fol	Ms	180	PC04	3848	fol	Mc	180	PC04	950
fol	Ms	180	PC06	4012	fol	Mc	180	PC06	1214
fol	Ms	180	PC08	4107	fol	Mc	180	PC08	1385
fol	Ms	180	PC10	4125	fol	Mc	180	PC10	1470
fol	Ms	180	PC12	4114	fol	Mc	180	PC12	1517
fol	Ms	200	PC04	4261	fol	Mc	200	PC04	874
fol	Ms	200	PC06	4491	fol	Mc	200	PC06	1220
fol	Ms	200	PC08	4633	fol	Mc	200	PC08	1451
fol	Ms	200	PC10	4665	fol	Mc	200	PC10	1562
fol	Ms	200	PC12	4662	fol	Mc	200	PC12	1629
fol	Vs	20	PC04	51	fol	Vc	20	PC04	86
fol	Vs	20	PC06	46	fol	Vc	20	PC06	77
fol	Vs	20	PC08	43	fol	Vc	20	PC08	72
fol	Vs	20	PC10	41	fol	Vc	20	PC10	68
fol	Vs	20	PC12	39	fol	Vc	20	PC12	66
fol	Vs	40	PC04	68	fol	Vc	40	PC04	102
fol	Vs	40	PC06	60	fol	Vc	40	PC06	91
fol	Vs	40	PC08	56	fol	Vc	40	PC08	85
fol	Vs	40	PC10	54	fol	Vc	40	PC10	81
fol	Vs	40	PC12	52	fol	Vc	40	PC12	79
fol	Vs	60	PC04	76	fol	Vc	60	PC04	137
fol	Vs	60	PC06	68	fol	Vc	60	PC06	123
fol	Vs	60	PC08	64	fol	Vc	60	PC08	115
fol	Vs	60	PC10	61	fol	Vc	60	PC10	109
fol	Vs	60	PC12	59	fol	Vc	60	PC12	106
fol	Vs	80	PC04	75	fol	Vc	80	PC04	174
fol	Vs	80	PC06	67	fol	Vc	80	PC06	156
fol	Vs	80	PC08	63	fol	Vc	80	PC08	146
fol	Vs	80	PC10	61	fol	Vc	80	PC10	139
fol	Vs	80	PC12	59	fol	Vc	80	PC12	135
fol	Vs	100	PC04	80	fol	Vc	100	PC04	185
fol	Vs	100	PC06	73	fol	Vc	100	PC06	167
fol	Vs	100	PC08	69	fol	Vc	100	PC08	157
fol	Vs	100	PC10	66	fol	Vc	100	PC10	150
fol	Vs	100	PC12	64	fol	Vc	100	PC12	145
fol	Vs	120	PC04	91	fol	Vc	120	PC04	189
fol	Vs	120	PC06	83	fol	Vc	120	PC06	170
fol	Vs	120	PC08	79	fol	Vc	120	PC08	160

fol	Vs	120	PC10	75	fol	Vc	120	PC10	153
fol	Vs	120	PC12	73	fol	Vc	120	PC12	149
fol	Vs	140	PC04	100	fol	Vc	140	PC04	186
fol	Vs	140	PC06	92	fol	Vc	140	PC06	169
fol	Vs	140	PC08	87	fol	Vc	140	PC08	159
fol	Vs	140	PC10	84	fol	Vc	140	PC10	152
fol	Vs	140	PC12	81	fol	Vc	140	PC12	148
fol	Vs	160	PC04	107	fol	Vc	160	PC04	183
fol	Vs	160	PC06	98	fol	Vc	160	PC06	165
fol	Vs	160	PC08	93	fol	Vc	160	PC08	156
fol	Vs	160	PC10	90	fol	Vc	160	PC10	150
fol	Vs	160	PC12	87	fol	Vc	160	PC12	145
fol	Vs	180	PC04	110	fol	Vc	180	PC04	177
fol	Vs	180	PC06	100	fol	Vc	180	PC06	160
fol	Vs	180	PC08	96	fol	Vc	180	PC08	152
fol	Vs	180	PC10	92	fol	Vc	180	PC10	146
fol	Vs	180	PC12	90	fol	Vc	180	PC12	142
fol	Vs	200	PC04	109	fol	Vc	200	PC04	170
fol	Vs	200	PC06	100	fol	Vc	200	PC06	155
fol	Vs	200	PC08	96	fol	Vc	200	PC08	148
fol	Vs	200	PC10	93	fol	Vc	200	PC10	142
fol	Vs	200	PC12	90	fol	Vc	200	PC12	138

### Two Lane Load Effects, PC Girders

Lane	Effect	Span	Bridge	RLE	Lane	Effect	Span	Bridge	RLE
04G	Ms	20	PC04	248	04G	Mc	20	PC04	159
06G	Ms	20	PC06	245	06G	Mc	20	PC06	157
08G	Ms	20	PC08	242	08G	Mc	20	PC08	156
10G	Ms	20	PC10	238	10G	Mc	20	PC10	154
12G	Ms	20	PC12	236	12G	Mc	20	PC12	152
04G	Ms	40	PC04	577	04G	Mc	40	PC04	462
06G	Ms	40	PC06	573	06G	Mc	40	PC06	478
08G	Ms	40	PC08	569	08G	Mc	40	PC08	490
10G	Ms	40	PC10	564	10G	Mc	40	PC10	496
12G	Ms	40	PC12	558	12G	Mc	40	PC12	499
04G	Ms	60	PC04	979	04G	Mc	60	PC04	693
06G	Ms	60	PC06	983	06G	Mc	60	PC06	720
08G	Ms	60	PC08	985	08G	Mc	60	PC08	737
10G	Ms	60	PC10	981	10G	Mc	60	PC10	745
12G	Ms	60	PC12	975	12G	Mc	60	PC12	749
04G	Ms	80	PC04	1562	04G	Mc	80	PC04	831
06G	Ms	80	PC06	1619	06G	Mc	80	PC06	886
08G	Ms	80	PC08	1656	08G	Mc	80	PC08	922
10G	Ms	80	PC10	1674	10G	Mc	80	PC10	940



12G	Ms	80	PC12	1683	12G	Mc	80	PC12	951
04G	Ms	100	PC04	2148	04G	Mc	100	PC04	878
06G	Ms	100	PC06	2271	06G	Mc	100	PC06	980
08G	Ms	100	PC08	2354	08G	Mc	100	PC08	1047
10G	Ms	100	PC10	2397	10G	Mc	100	PC10	1083
12G	Ms	100	PC12	2426	12G	Mc	100	PC12	1107
04G	Ms	120	PC04	2710	04G	Mc	120	PC04	882
06G	Ms	120	PC06	2886	06G	Mc	120	PC06	1034
08G	Ms	120	PC08	3004	08G	Mc	120	PC08	1137
10G	Ms	120	PC10	3067	10G	Mc	120	PC10	1193
12G	Ms	120	PC12	3107	12G	Mc	120	PC12	1231
04G	Ms	140	PC04	3206	04G	Mc	140	PC04	904
06G	Ms	140	PC06	3440	06G	Mc	140	PC06	1118
08G	Ms	140	PC08	3594	08G	Mc	140	PC08	1261
10G	Ms	140	PC10	3680	10G	Mc	140	PC10	1344
12G	Ms	140	PC12	3734	12G	Mc	140	PC12	1399
04G	Ms	160	PC04	3634	04G	Mc	160	PC04	902
06G	Ms	160	PC06	3938	06G	Mc	160	PC06	1186
08G	Ms	160	PC08	4140	08G	Mc	160	PC08	1377
10G	Ms	160	PC10	4254	10G	Mc	160	PC10	1489
12G	Ms	160	PC12	4325	12G	Mc	160	PC12	1562
04G	Ms	180	PC04	3995	04G	Mc	180	PC04	823
06G	Ms	180	PC06	4386	06G	Mc	180	PC06	1192
08G	Ms	180	PC08	4646	08G	Mc	180	PC08	1440
10G	Ms	180	PC10	4794	10G	Mc	180	PC10	1585
12G	Ms	180	PC12	4888	12G	Mc	180	PC12	1682
04G	Ms	200	PC04	4380	04G	Mc	200	PC04	730
06G	Ms	200	PC06	4853	06G	Mc	200	PC06	1188
08G	Ms	200	PC08	5172	08G	Mc	200	PC08	1500
10G	Ms	200	PC10	5344	10G	Mc	200	PC10	1676
12G	Ms	200	PC12	5457	12G	Mc	200	PC12	1796
04G	Vs	20	PC04	54	04G	Vc	20	PC04	86
06G	Vs	20	PC06	50	06G	Vc	20	PC06	78
08G	Vs	20	PC08	47	08G	Vc	20	PC08	73
10G	Vs	20	PC10	45	10G	Vc	20	PC10	70
12G	Vs	20	PC12	44	12G	Vc	20	PC12	69
04G	Vs	40	PC04	71	04G	Vc	40	PC04	117
06G	Vs	40	PC06	65	06G	Vc	40	PC06	110
08G	Vs	40	PC08	61	08G	Vc	40	PC08	107
10G	Vs	40	PC10	59	10G	Vc	40	PC10	104
12G	Vs	40	PC12	57	12G	Vc	40	PC12	103
04G	Vs	60	PC04	81	04G	Vc	60	PC04	130
06G	Vs	60	PC06	75	06G	Vc	60	PC06	128
08G	Vs	60	PC08	71	08G	Vc	60	PC08	127

10G	Vs	60	PC10	68	10G	Vc	60	PC10	125
12G	Vs	60	PC12	67	12G	Vc	60	PC12	125
04G	Vs	80	PC04	82	04G	Vc	80	PC04	129
06G	Vs	80	PC06	78	06G	Vc	80	PC06	129
08G	Vs	80	PC08	76	08G	Vc	80	PC08	130
10G	Vs	80	PC10	74	10G	Vc	80	PC10	130
12G	Vs	80	PC12	73	12G	Vc	80	PC12	129
04G	Vs	100	PC04	78	04G	Vc	100	PC04	122
06G	Vs	100	PC06	77	06G	Vc	100	PC06	124
08G	Vs	100	PC08	77	08G	Vc	100	PC08	126
10G	Vs	100	PC10	76	10G	Vc	100	PC10	127
12G	Vs	100	PC12	76	12G	Vc	100	PC12	127
04G	Vs	120	PC04	72	04G	Vc	120	PC04	116
06G	Vs	120	PC06	76	06G	Vc	120	PC06	120
08G	Vs	120	PC08	78	08G	Vc	120	PC08	124
10G	Vs	120	PC10	79	10G	Vc	120	PC10	125
12G	Vs	120	PC12	79	12G	Vc	120	PC12	125
04G	Vs	140	PC04	69	04G	Vc	140	PC04	112
06G	Vs	140	PC06	74	06G	Vc	140	PC06	118
08G	Vs	140	PC08	78	08G	Vc	140	PC08	121
10G	Vs	140	PC10	79	10G	Vc	140	PC10	123
12G	Vs	140	PC12	80	12G	Vc	140	PC12	123
04G	Vs	160	PC04	64	04G	Vc	160	PC04	105
06G	Vs	160	PC06	71	06G	Vc	160	PC06	112
08G	Vs	160	PC08	76	08G	Vc	160	PC08	117
10G	Vs	160	PC10	78	10G	Vc	160	PC10	119
12G	Vs	160	PC12	79	12G	Vc	160	PC12	120
04G	Vs	180	PC04	60	04G	Vc	180	PC04	98
06G	Vs	180	PC06	68	06G	Vc	180	PC06	106
08G	Vs	180	PC08	74	08G	Vc	180	PC08	112
10G	Vs	180	PC10	77	10G	Vc	180	PC10	114
12G	Vs	180	PC12	78	12G	Vc	180	PC12	115
04G	Vs	200	PC04	54	04G	Vc	200	PC04	91
06G	Vs	200	PC06	64	06G	Vc	200	PC06	100
08G	Vs	200	PC08	70	08G	Vc	200	PC08	107
10G	Vs	200	PC10	73	10G	Vc	200	PC10	110
12G	Vs	200	PC12	75	12G	Vc	200	PC12	111

### Single Lane Load Effects, RC Girders

Lane	Effect	Span	Bridge	RLE	Lane	Effect	Span	Bridge	RLE
fol	Ms	20	RC04	214	fol	Mc	20	RC04	136
fol	Ms	20	RC06	202	fol	Mc	20	RC06	128
fol	Ms	20	RC08	198	fol	Mc	20	RC08	126

fol	Ms	20	RC10	193	fol	Mc	20	RC10	122
fol	Ms	20	RC12	189	fol	Mc	20	RC12	119
fol	Ms	40	RC04	533	fol	Mc	40	RC04	305
fol	Ms	40	RC06	500	fol	Mc	40	RC06	282
fol	Ms	40	RC08	492	fol	Mc	40	RC08	280
fol	Ms	40	RC10	475	fol	Mc	40	RC10	268
fol	Ms	40	RC12	462	fol	Mc	40	RC12	259
fol	Ms	60	RC04	820	fol	Mc	60	RC04	633
fol	Ms	60	RC06	774	fol	Mc	60	RC06	591
fol	Ms	60	RC08	763	fol	Mc	60	RC08	586
fol	Ms	60	RC10	734	fol	Mc	60	RC10	559
fol	Ms	60	RC12	709	fol	Mc	60	RC12	537
fol	Ms	80	RC04	987	fol	Mc	80	RC04	788
fol	Ms	80	RC06	943	fol	Mc	80	RC06	750
fol	Ms	80	RC08	935	fol	Mc	80	RC08	747
fol	Ms	80	RC10	893	fol	Mc	80	RC10	707
fol	Ms	80	RC12	855	fol	Mc	80	RC12	671
fol	Ms	100	RC04	1043	fol	Mc	100	RC04	714
fol	Ms	100	RC06	1021	fol	Mc	100	RC06	704
fol	Ms	100	RC08	1014	fol	Mc	100	RC08	706
fol	Ms	100	RC10	963	fol	Mc	100	RC10	660
fol	Ms	100	RC12	907	fol	Mc	100	RC12	608
fol	Vs	20	RC04	52	fol	Vc	20	RC04	85
fol	Vs	20	RC06	45	fol	Vc	20	RC06	75
fol	Vs	20	RC08	42	fol	Vc	20	RC08	70
fol	Vs	20	RC10	40	fol	Vc	20	RC10	67
fol	Vs	20	RC12	38	fol	Vc	20	RC12	64
fol	Vs	40	RC04	68	fol	Vc	40	RC04	101
fol	Vs	40	RC06	59	fol	Vc	40	RC06	89
fol	Vs	40	RC08	55	fol	Vc	40	RC08	83
fol	Vs	40	RC10	52	fol	Vc	40	RC10	78
fol	Vs	40	RC12	50	fol	Vc	40	RC12	75
fol	Vs	60	RC04	75	fol	Vc	60	RC04	134
fol	Vs	60	RC06	65	fol	Vc	60	RC06	118
fol	Vs	60	RC08	61	fol	Vc	60	RC08	110
fol	Vs	60	RC10	57	fol	Vc	60	RC10	104
fol	Vs	60	RC12	54	fol	Vc	60	RC12	100
fol	Vs	80	RC04	75	fol	Vc	80	RC04	170
fol	Vs	80	RC06	65	fol	Vc	80	RC06	149
fol	Vs	80	RC08	60	fol	Vc	80	RC08	139
fol	Vs	80	RC10	56	fol	Vc	80	RC10	131
fol	Vs	80	RC12	54	fol	Vc	80	RC12	126
fol	Vs	100	RC04	82	fol	Vc	100	RC04	183
fol	Vs	100	RC06	71	fol	Vc	100	RC06	161
fol	Vs	100	RC08	66	fol	Vc	100	RC08	150

fol	Vs	100	RC10	62
fol	Vs	100	RC12	58

fol	Vc	100	RC10	141
fol	Vc	100	RC12	135

Lane	Effect	Span	Bridge	RLE
fol	Mcp	20	RC04	168
fol	Mcp	20	RC06	158
fol	Mcp	20	RC08	155
fol	Mcp	20	RC10	150
fol	Mcp	20	RC12	147
fol	Mcp	40	RC04	409
fol	Mcp	40	RC06	381
fol	Mcp	40	RC08	376
fol	Mcp	40	RC10	362
fol	Mcp	40	RC12	351
fol	Mcp	60	RC04	610
fol	Mcp	60	RC06	572
fol	Mcp	60	RC08	567
fol	Mcp	60	RC10	542
fol	Mcp	60	RC12	522
fol	Mcp	80	RC04	696
fol	Mcp	80	RC06	663
fol	Mcp	80	RC08	663
fol	Mcp	80	RC10	627
fol	Mcp	80	RC12	595
fol	Mcp	100	RC04	668
fol	Mcp	100	RC06	660
fol	Mcp	100	RC08	663
fol	Mcp	100	RC10	621
fol	Mcp	100	RC12	572

### Two Lane Load Effects, RC Girders

Lane	Effect	Span	Bridge	RLE
04G	Ms	20	RC04	227
06G	Ms	20	RC06	217
08G	Ms	20	RC08	215
10G	Ms	20	RC10	210
12G	Ms	20	RC12	207
04G	Ms	40	RC04	506
06G	Ms	40	RC06	482
08G	Ms	40	RC08	480
10G	Ms	40	RC10	468
12G	Ms	40	RC12	459
04G	Ms	60	RC04	801
06G	Ms	60	RC06	773
04G	Mc	20	RC04	156
06G	Mc	20	RC06	148
08G	Mc	20	RC08	146
10G	Mc	20	RC10	143
12G	Mc	20	RC12	140
04G	Mc	40	RC04	425
06G	Mc	40	RC06	419
08G	Mc	40	RC08	431
10G	Mc	40	RC10	429
12G	Mc	40	RC12	428
04G	Mc	60	RC04	578
06G	Mc	60	RC06	571

08G	Ms	60	RC08	777	08G	Mc	60	RC08	588
10G	Ms	60	RC10	758	10G	Mc	60	RC10	581
12G	Ms	60	RC12	743	12G	Mc	60	RC12	575
04G	Ms	80	RC04	1227	04G	Mc	80	RC04	621
06G	Ms	80	RC06	1234	06G	Mc	80	RC06	629
08G	Ms	80	RC08	1263	08G	Mc	80	RC08	658
10G	Ms	80	RC10	1249	10G	Mc	80	RC10	646
12G	Ms	80	RC12	1234	12G	Mc	80	RC12	632
04G	Ms	100	RC04	1611	04G	Mc	100	RC04	535
06G	Ms	100	RC06	1669	06G	Mc	100	RC06	579
08G	Ms	100	RC08	1721	08G	Mc	100	RC08	620
10G	Ms	100	RC10	1712	10G	Mc	100	RC10	607
12G	Ms	100	RC12	1690	12G	Mc	100	RC12	582
04G	Vs	20	RC04	56	04G	Vc	20	RC04	87
06G	Vs	20	RC06	50	06G	Vc	20	RC06	77
08G	Vs	20	RC08	47	08G	Vc	20	RC08	73
10G	Vs	20	RC10	45	10G	Vc	20	RC10	70
12G	Vs	20	RC12	44	12G	Vc	20	RC12	68
04G	Vs	40	RC04	72	04G	Vc	40	RC04	118
06G	Vs	40	RC06	64	06G	Vc	40	RC06	109
08G	Vs	40	RC08	61	08G	Vc	40	RC08	105
10G	Vs	40	RC10	58	10G	Vc	40	RC10	102
12G	Vs	40	RC12	56	12G	Vc	40	RC12	100
04G	Vs	60	RC04	82	04G	Vc	60	RC04	129
06G	Vs	60	RC06	73	06G	Vc	60	RC06	124
08G	Vs	60	RC08	69	08G	Vc	60	RC08	123
10G	Vs	60	RC10	66	10G	Vc	60	RC10	121
12G	Vs	60	RC12	63	12G	Vc	60	RC12	119
04G	Vs	80	RC04	84	04G	Vc	80	RC04	129
06G	Vs	80	RC06	77	06G	Vc	80	RC06	126
08G	Vs	80	RC08	74	08G	Vc	80	RC08	126
10G	Vs	80	RC10	71	10G	Vc	80	RC10	124
12G	Vs	80	RC12	69	12G	Vc	80	RC12	123
04G	Vs	100	RC04	82	04G	Vc	100	RC04	124
06G	Vs	100	RC06	78	06G	Vc	100	RC06	123
08G	Vs	100	RC08	76	08G	Vc	100	RC08	123
10G	Vs	100	RC10	73	10G	Vc	100	RC10	122
12G	Vs	100	RC12	71	12G	Vc	100	RC12	120

Lane	Effect	Span	Bridge	RLE
04G	Mcp	20	RC04	178
06G	Mcp	20	RC06	170
08G	Mcp	20	RC08	168
10G	Mcp	20	RC10	164
12G	Mcp	20	RC12	161

04G	Mcp	40	RC04	388
06G	Mcp	40	RC06	367
08G	Mcp	40	RC08	367
10G	Mcp	40	RC10	357
12G	Mcp	40	RC12	349
04G	Mcp	60	RC04	596
06G	Mcp	60	RC06	573
08G	Mcp	60	RC08	579
10G	Mcp	60	RC10	563
12G	Mcp	60	RC12	549
04G	Mcp	80	RC04	886
06G	Mcp	80	RC06	893
08G	Mcp	80	RC08	922
10G	Mcp	80	RC10	909
12G	Mcp	80	RC12	895
04G	Mcp	100	RC04	1115
06G	Mcp	100	RC06	1170
08G	Mcp	100	RC08	1219
10G	Mcp	100	RC10	1211
12G	Mcp	100	RC12	1189

### Single Lane Load Effects, Spread Box Beams (BS)

Lane	Effect	Span	Bridge	RLE	Lane	Effect	Span	Bridge	RLE
fol	Ms	20	BS04	243	fol	Mc	20	BS04	155
fol	Ms	20	BS06	232	fol	Mc	20	BS06	149
fol	Ms	20	BS08	225	fol	Mc	20	BS08	145
fol	Ms	20	BS10	219	fol	Mc	20	BS10	141
fol	Ms	20	BS12	214	fol	Mc	20	BS12	138
fol	Ms	40	BS04	542	fol	Mc	40	BS04	316
fol	Ms	40	BS06	525	fol	Mc	40	BS06	310
fol	Ms	40	BS08	513	fol	Mc	40	BS08	305
fol	Ms	40	BS10	501	fol	Mc	40	BS10	300
fol	Ms	40	BS12	490	fol	Mc	40	BS12	294
fol	Ms	60	BS04	831	fol	Mc	60	BS04	666
fol	Ms	60	BS06	817	fol	Mc	60	BS06	662
fol	Ms	60	BS08	806	fol	Mc	60	BS08	656
fol	Ms	60	BS10	791	fol	Mc	60	BS10	644
fol	Ms	60	BS12	776	fol	Mc	60	BS12	632
fol	Ms	80	BS04	1064	fol	Mc	80	BS04	905
fol	Ms	80	BS06	1065	fol	Mc	80	BS06	916
fol	Ms	80	BS08	1060	fol	Mc	80	BS08	918
fol	Ms	80	BS10	1047	fol	Mc	80	BS10	908
fol	Ms	80	BS12	1032	fol	Mc	80	BS12	894
fol	Ms	100	BS04	1237	fol	Mc	100	BS04	961
fol	Ms	100	BS06	1263	fol	Mc	100	BS06	1003

fol	Ms	100	BS08	1274	fol	Mc	100	BS08	1025
fol	Ms	100	BS10	1266	fol	Mc	100	BS10	1023
fol	Ms	100	BS12	1254	fol	Mc	100	BS12	1015
fol	Ms	120	BS04	1682	fol	Mc	120	BS04	922
fol	Ms	120	BS06	1734	fol	Mc	120	BS06	1013
fol	Ms	120	BS08	1760	fol	Mc	120	BS08	1065
fol	Ms	120	BS10	1754	fol	Mc	120	BS10	1079
fol	Ms	120	BS12	1741	fol	Mc	120	BS12	1081
fol	Ms	140	BS04	1939	fol	Mc	140	BS04	713
fol	Ms	140	BS06	2043	fol	Mc	140	BS06	877
fol	Ms	140	BS08	2099	fol	Mc	140	BS08	974
fol	Ms	140	BS10	2108	fol	Mc	140	BS10	1016
fol	Ms	140	BS12	2101	fol	Mc	140	BS12	1035
fol	Ms	160	BS04	2166	fol	Mc	160	BS04	402
fol	Ms	160	BS06	2343	fol	Mc	160	BS06	660
fol	Ms	160	BS08	2441	fol	Mc	160	BS08	815
fol	Ms	160	BS10	2469	fol	Mc	160	BS10	891
fol	Ms	160	BS12	2470	fol	Mc	160	BS12	932
fol	Ms	180	BS04	2426	fol	Mc	180	BS04	158
fol	Ms	180	BS06	2686	fol	Mc	180	BS06	518
fol	Ms	180	BS08	2831	fol	Mc	180	BS08	735
fol	Ms	180	BS10	2881	fol	Mc	180	BS10	846
fol	Ms	180	BS12	2893	fol	Mc	180	BS12	909
fol	Ms	200	BS04	2366	fol	Mc	200	BS04	0
fol	Ms	200	BS06	2751	fol	Mc	200	BS06	275
fol	Ms	200	BS08	2975	fol	Mc	200	BS08	580
fol	Ms	200	BS10	3058	fol	Mc	200	BS10	733
fol	Ms	200	BS12	3094	fol	Mc	200	BS12	827
fol	Vs	20	BS04	48	fol	Vc	20	BS04	81
fol	Vs	20	BS06	45	fol	Vc	20	BS06	75
fol	Vs	20	BS08	42	fol	Vc	20	BS08	71
fol	Vs	20	BS10	40	fol	Vc	20	BS10	68
fol	Vs	20	BS12	39	fol	Vc	20	BS12	65
fol	Vs	40	BS04	61	fol	Vc	40	BS04	94
fol	Vs	40	BS06	58	fol	Vc	40	BS06	88
fol	Vs	40	BS08	55	fol	Vc	40	BS08	83
fol	Vs	40	BS10	53	fol	Vc	40	BS10	80
fol	Vs	40	BS12	50	fol	Vc	40	BS12	77
fol	Vs	60	BS04	67	fol	Vc	60	BS04	124
fol	Vs	60	BS06	63	fol	Vc	60	BS06	116
fol	Vs	60	BS08	61	fol	Vc	60	BS08	111
fol	Vs	60	BS10	58	fol	Vc	60	BS10	106
fol	Vs	60	BS12	56	fol	Vc	60	BS12	102
fol	Vs	80	BS04	66	fol	Vc	80	BS04	158

fol	Vs	80	BS06	63	fol	Vc	80	BS06	149
fol	Vs	80	BS08	61	fol	Vc	80	BS08	142
fol	Vs	80	BS10	59	fol	Vc	80	BS10	136
fol	Vs	80	BS12	57	fol	Vc	80	BS12	131
fol	Vs	100	BS04	73	fol	Vc	100	BS04	172
fol	Vs	100	BS06	71	fol	Vc	100	BS06	162
fol	Vs	100	BS08	69	fol	Vc	100	BS08	155
fol	Vs	100	BS10	66	fol	Vc	100	BS10	149
fol	Vs	100	BS12	64	fol	Vc	100	BS12	143
fol	Vs	120	BS04	82	fol	Vc	120	BS04	173
fol	Vs	120	BS06	80	fol	Vc	120	BS06	165
fol	Vs	120	BS08	78	fol	Vc	120	BS08	158
fol	Vs	120	BS10	75	fol	Vc	120	BS10	152
fol	Vs	120	BS12	73	fol	Vc	120	BS12	146
fol	Vs	140	BS04	86	fol	Vc	140	BS04	166
fol	Vs	140	BS06	86	fol	Vc	140	BS06	160
fol	Vs	140	BS08	84	fol	Vc	140	BS08	155
fol	Vs	140	BS10	82	fol	Vc	140	BS10	149
fol	Vs	140	BS12	79	fol	Vc	140	BS12	143
fol	Vs	160	BS04	88	fol	Vc	160	BS04	159
fol	Vs	160	BS06	89	fol	Vc	160	BS06	154
fol	Vs	160	BS08	88	fol	Vc	160	BS08	150
fol	Vs	160	BS10	86	fol	Vc	160	BS10	145
fol	Vs	160	BS12	83	fol	Vc	160	BS12	140
fol	Vs	180	BS04	87	fol	Vc	180	BS04	150
fol	Vs	180	BS06	90	fol	Vc	180	BS06	148
fol	Vs	180	BS08	90	fol	Vc	180	BS08	145
fol	Vs	180	BS10	88	fol	Vc	180	BS10	140
fol	Vs	180	BS12	85	fol	Vc	180	BS12	135
fol	Vs	200	BS04	81	fol	Vc	200	BS04	139
fol	Vs	200	BS06	86	fol	Vc	200	BS06	139
fol	Vs	200	BS08	87	fol	Vc	200	BS08	138
fol	Vs	200	BS10	86	fol	Vc	200	BS10	134
fol	Vs	200	BS12	83	fol	Vc	200	BS12	130

### Two Lane Load Effects, Spread Box Beams (BS)

Lane	Effect	Span	Bridge	RLE	Lane	Effect	Span	Bridge	RLE
04B	Ms	20	BS04	253	04B	Mc	20	BS04	163
06B	Ms	20	BS06	246	06B	Mc	20	BS06	159
08B	Ms	20	BS08	241	08B	Mc	20	BS08	156
10B	Ms	20	BS10	236	10B	Mc	20	BS10	153
12B	Ms	20	BS12	232	12B	Mc	20	BS12	150
04B	Ms	40	BS04	528	04B	Mc	40	BS04	463



06B	Ms	40	BS06	523	06B	Mc	40	BS06	484
08B	Ms	40	BS08	518	08B	Mc	40	BS08	497
10B	Ms	40	BS10	512	10B	Mc	40	BS10	504
12B	Ms	40	BS12	506	12B	Mc	40	BS12	508
04B	Ms	60	BS04	865	04B	Mc	60	BS04	652
06B	Ms	60	BS06	877	06B	Mc	60	BS06	690
08B	Ms	60	BS08	883	08B	Mc	60	BS08	714
10B	Ms	60	BS10	881	10B	Mc	60	BS10	725
12B	Ms	60	BS12	877	12B	Mc	60	BS12	731
04B	Ms	80	BS04	1513	04B	Mc	80	BS04	789
06B	Ms	80	BS06	1584	06B	Mc	80	BS06	856
08B	Ms	80	BS08	1628	08B	Mc	80	BS08	898
10B	Ms	80	BS10	1649	10B	Mc	80	BS10	919
12B	Ms	80	BS12	1661	12B	Mc	80	BS12	931
04B	Ms	100	BS04	2213	04B	Mc	100	BS04	887
06B	Ms	100	BS06	2343	06B	Mc	100	BS06	995
08B	Ms	100	BS08	2425	08B	Mc	100	BS08	1063
10B	Ms	100	BS10	2464	10B	Mc	100	BS10	1097
12B	Ms	100	BS12	2488	12B	Mc	100	BS12	1118
04B	Ms	120	BS04	2756	04B	Mc	120	BS04	885
06B	Ms	120	BS06	2949	06B	Mc	120	BS06	1053
08B	Ms	120	BS08	3070	08B	Mc	120	BS08	1160
10B	Ms	120	BS10	3130	10B	Mc	120	BS10	1215
12B	Ms	120	BS12	3165	12B	Mc	120	BS12	1251
04B	Ms	140	BS04	3159	04B	Mc	140	BS04	851
06B	Ms	140	BS06	3433	06B	Mc	140	BS06	1104
08B	Ms	140	BS08	3602	08B	Mc	140	BS08	1262
10B	Ms	140	BS10	3693	10B	Mc	140	BS10	1351
12B	Ms	140	BS12	3746	12B	Mc	140	BS12	1407
04B	Ms	160	BS04	3470	04B	Mc	160	BS04	751
06B	Ms	160	BS06	3845	06B	Mc	160	BS06	1104
08B	Ms	160	BS08	4076	08B	Mc	160	BS08	1324
10B	Ms	160	BS10	4201	10B	Mc	160	BS10	1448
12B	Ms	160	BS12	4278	12B	Mc	160	BS12	1528
04B	Ms	180	BS04	3746	04B	Mc	180	BS04	581
06B	Ms	180	BS06	4240	06B	Mc	180	BS06	1049
08B	Ms	180	BS08	4545	08B	Mc	180	BS08	1340
10B	Ms	180	BS10	4713	10B	Mc	180	BS10	1506
12B	Ms	180	BS12	4818	12B	Mc	180	BS12	1613
04B	Ms	200	BS04	3839	04B	Mc	200	BS04	265
06B	Ms	200	BS06	4467	06B	Mc	200	BS06	873
08B	Ms	200	BS08	4858	08B	Mc	200	BS08	1254
10B	Ms	200	BS10	5065	10B	Mc	200	BS10	1463
12B	Ms	200	BS12	5201	12B	Mc	200	BS12	1603
04B	Vs	20	BS04	52	04B	Vc	20	BS04	81

06B	Vs	20	BS06	49	06B	Vc	20	BS06	76
08B	Vs	20	BS08	47	08B	Vc	20	BS08	73
10B	Vs	20	BS10	45	10B	Vc	20	BS10	70
12B	Vs	20	BS12	44	12B	Vc	20	BS12	68
04B	Vs	40	BS04	65	04B	Vc	40	BS04	111
06B	Vs	40	BS06	62	06B	Vc	40	BS06	108
08B	Vs	40	BS08	60	08B	Vc	40	BS08	105
10B	Vs	40	BS10	58	10B	Vc	40	BS10	103
12B	Vs	40	BS12	56	12B	Vc	40	BS12	101
04B	Vs	60	BS04	72	04B	Vc	60	BS04	122
06B	Vs	60	BS06	70	06B	Vc	60	BS06	123
08B	Vs	60	BS08	68	08B	Vc	60	BS08	124
10B	Vs	60	BS10	66	10B	Vc	60	BS10	123
12B	Vs	60	BS12	64	12B	Vc	60	BS12	123
04B	Vs	80	BS04	75	04B	Vc	80	BS04	123
06B	Vs	80	BS06	75	06B	Vc	80	BS06	127
08B	Vs	80	BS08	74	08B	Vc	80	BS08	128
10B	Vs	80	BS10	73	10B	Vc	80	BS10	129
12B	Vs	80	BS12	71	12B	Vc	80	BS12	128
04B	Vs	100	BS04	75	04B	Vc	100	BS04	119
06B	Vs	100	BS06	77	06B	Vc	100	BS06	125
08B	Vs	100	BS08	78	08B	Vc	100	BS08	127
10B	Vs	100	BS10	77	10B	Vc	100	BS10	128
12B	Vs	100	BS12	77	12B	Vc	100	BS12	128
04B	Vs	120	BS04	69	04B	Vc	120	BS04	113
06B	Vs	120	BS06	75	06B	Vc	120	BS06	120
08B	Vs	120	BS08	79	08B	Vc	120	BS08	125
10B	Vs	120	BS10	80	10B	Vc	120	BS10	126
12B	Vs	120	BS12	81	12B	Vc	120	BS12	127
04B	Vs	140	BS04	62	04B	Vc	140	BS04	105
06B	Vs	140	BS06	72	06B	Vc	140	BS06	115
08B	Vs	140	BS08	77	08B	Vc	140	BS08	120
10B	Vs	140	BS10	79	10B	Vc	140	BS10	122
12B	Vs	140	BS12	80	12B	Vc	140	BS12	123
04B	Vs	160	BS04	55	04B	Vc	160	BS04	95
06B	Vs	160	BS06	67	06B	Vc	160	BS06	107
08B	Vs	160	BS08	74	08B	Vc	160	BS08	114
10B	Vs	160	BS10	77	10B	Vc	160	BS10	117
12B	Vs	160	BS12	78	12B	Vc	160	BS12	118
04B	Vs	180	BS04	48	04B	Vc	180	BS04	85
06B	Vs	180	BS06	62	06B	Vc	180	BS06	100
08B	Vs	180	BS08	70	08B	Vc	180	BS08	108
10B	Vs	180	BS10	74	10B	Vc	180	BS10	112
12B	Vs	180	BS12	76	12B	Vc	180	BS12	114

04B	Vs	200	BS04	38	04B	Vc	200	BS04	73
06B	Vs	200	BS06	55	06B	Vc	200	BS06	91
08B	Vs	200	BS08	64	08B	Vc	200	BS08	100
10B	Vs	200	BS10	69	10B	Vc	200	BS10	105
12B	Vs	200	BS12	71	12B	Vc	200	BS12	107

### Single Lane Load Effects, Side-By-Side Box Beam (BT), 36" Wide Box

Lane	Effect	Span	Bridge	RLE	Lane	Effect	Span	Bridge	RLE
fol	Ms	20	BT36	280	fol	Mc	20	BT36	177
fol	Ms	40	BT36	598	fol	Mc	40	BT36	334
fol	Ms	60	BT36	826	fol	Mc	60	BT36	633
fol	Ms	80	BT36	927	fol	Mc	80	BT36	740
fol	Ms	100	BT36	970	fol	Mc	100	BT36	674
fol	Ms	120	BT36	1196	fol	Mc	120	BT36	420
fol	Ms	140	BT36	1180	fol	Mc	140	BT36	9
fol	Ms	160	BT36	1094	fol	Mc	160	BT36	0
fol	Ms	180	BT36	795	fol	Mc	180	BT36	0
fol	Ms	200	BT36	884	fol	Mc	200	BT36	0
fol	Vs	20	BT36	60	fol	Vc	20	BT36	100
fol	Vs	40	BT36	75	fol	Vc	40	BT36	113
fol	Vs	60	BT36	79	fol	Vc	60	BT36	146
fol	Vs	80	BT36	77	fol	Vc	80	BT36	183
fol	Vs	100	BT36	85	fol	Vc	100	BT36	196
fol	Vs	120	BT36	93	fol	Vc	120	BT36	194
fol	Vs	140	BT36	97	fol	Vc	140	BT36	186
fol	Vs	160	BT36	99	fol	Vc	160	BT36	176
fol	Vs	180	BT36	95	fol	Vc	180	BT36	163
fol	Vs	200	BT36	90	fol	Vc	200	BT36	152

### Two Lane Load Effects, Side-By-Side Box Beam (BT), 36" Wide Box

Lane	Effect	Span	Bridge	RLE	Lane	Effect	Span	Bridge	RLE
36T	Ms	20	BT36	208	36T	Mc	20	BT36	177
36T	Ms	40	BT36	405	36T	Mc	40	BT36	396
36T	Ms	60	BT36	603	36T	Mc	60	BT36	545
36T	Ms	80	BT36	974	36T	Mc	80	BT36	603
36T	Ms	100	BT36	1385	36T	Mc	100	BT36	593
36T	Ms	120	BT36	1654	36T	Mc	120	BT36	426
36T	Ms	140	BT36	1804	36T	Mc	140	BT36	194
36T	Ms	160	BT36	1845	36T	Mc	160	BT36	0
36T	Ms	180	BT36	1770	36T	Mc	180	BT36	0
36T	Ms	200	BT36	1644	36T	Mc	200	BT36	0
36T	Vs	20	BT36	47	36T	Vc	20	BT36	98
36T	Vs	40	BT36	57	36T	Vc	40	BT36	124
36T	Vs	60	BT36	63	36T	Vc	60	BT36	128

36T	Vs	80	BT36	62	36T	Vc	80	BT36	126
36T	Vs	100	BT36	60	36T	Vc	100	BT36	121
36T	Vs	120	BT36	52	36T	Vc	120	BT36	113
36T	Vs	140	BT36	46	36T	Vc	140	BT36	104
36T	Vs	160	BT36	39	36T	Vc	160	BT36	92
36T	Vs	180	BT36	32	36T	Vc	180	BT36	80
36T	Vs	200	BT36	24	36T	Vc	200	BT36	68

### Single Lane Load Effects, Side-By-Side Box Beam (BT), 48" Wide Box

Lane	Effect	Span	Bridge	RLE	Lane	Effect	Span	Bridge	RLE
fol	Ms	20	BT48	268	fol	Mc	20	BT48	169
fol	Ms	40	BT48	572	fol	Mc	40	BT48	320
fol	Ms	60	BT48	789	fol	Mc	60	BT48	603
fol	Ms	80	BT48	883	fol	Mc	80	BT48	702
fol	Ms	100	BT48	919	fol	Mc	100	BT48	634
fol	Ms	120	BT48	1128	fol	Mc	120	BT48	383
fol	Ms	140	BT48	1104	fol	Mc	140	BT48	0
fol	Ms	160	BT48	1008	fol	Mc	160	BT48	0
fol	Ms	180	BT48	706	fol	Mc	180	BT48	0
fol	Ms	200	BT48	598	fol	Mc	200	BT48	0
fol	Vs	20	BT48	53	fol	Vc	20	BT48	89
fol	Vs	40	BT48	65	fol	Vc	40	BT48	99
fol	Vs	60	BT48	67	fol	Vc	60	BT48	127
fol	Vs	80	BT48	63	fol	Vc	80	BT48	157
fol	Vs	100	BT48	68	fol	Vc	100	BT48	167
fol	Vs	120	BT48	72	fol	Vc	120	BT48	163
fol	Vs	140	BT48	74	fol	Vc	140	BT48	152
fol	Vs	160	BT48	72	fol	Vc	160	BT48	140
fol	Vs	180	BT48	65	fol	Vc	180	BT48	126
fol	Vs	200	BT48	57	fol	Vc	200	BT48	112

### Two Lane Load Effects, Side-By-Side Box Beam (BT), 48" Wide Box

Lane	Effect	Span	Bridge	RLE	Lane	Effect	Span	Bridge	RLE
48T	Ms	20	BT48	267	48T	Mc	20	BT48	170
48T	Ms	40	BT48	519	48T	Mc	40	BT48	388
48T	Ms	60	BT48	774	48T	Mc	60	BT48	531
48T	Ms	80	BT48	1260	48T	Mc	80	BT48	586
48T	Ms	100	BT48	1795	48T	Mc	100	BT48	574
48T	Ms	120	BT48	2141	48T	Mc	120	BT48	411
48T	Ms	140	BT48	2334	48T	Mc	140	BT48	184
48T	Ms	160	BT48	2384	48T	Mc	160	BT48	0
48T	Ms	180	BT48	2284	48T	Mc	180	BT48	0
48T	Ms	200	BT48	2077	48T	Mc	200	BT48	0
48T	Vs	20	BT48	56	48T	Vc	20	BT48	89
48T	Vs	40	BT48	68	48T	Vc	40	BT48	114

48T	Vs	60	BT48	72	48T	Vc	60	BT48	121
48T	Vs	80	BT48	72	48T	Vc	80	BT48	118
48T	Vs	100	BT48	69	48T	Vc	100	BT48	113
48T	Vs	120	BT48	60	48T	Vc	120	BT48	103
48T	Vs	140	BT48	51	48T	Vc	140	BT48	93
48T	Vs	160	BT48	41	48T	Vc	160	BT48	80
48T	Vs	180	BT48	29	48T	Vc	180	BT48	66
48T	Vs	200	BT48	17	48T	Vc	200	BT48	52

**Table J.2. LFR Required Load Effects.**

**Single Lane Load Effects, Steel Girders**

Lane	Effect	Span	Bridge	RLE	Lane	Effect	Span	Bridge	RLE
fol	Ms	20	CS04	322	fol	Mc	20	CS04	208
fol	Ms	20	CS06	275	fol	Mc	20	CS06	178
fol	Ms	20	CS08	247	fol	Mc	20	CS08	160
fol	Ms	20	CS10	228	fol	Mc	20	CS10	147
fol	Ms	20	CS12	213	fol	Mc	20	CS12	137
fol	Ms	40	CS04	755	fol	Mc	40	CS04	455
fol	Ms	40	CS06	641	fol	Mc	40	CS06	388
fol	Ms	40	CS08	574	fol	Mc	40	CS08	347
fol	Ms	40	CS10	526	fol	Mc	40	CS10	318
fol	Ms	40	CS12	488	fol	Mc	40	CS12	295
fol	Ms	60	CS04	1182	fol	Mc	60	CS04	984
fol	Ms	60	CS06	998	fol	Mc	60	CS06	829
fol	Ms	60	CS08	889	fol	Mc	60	CS08	736
fol	Ms	60	CS10	810	fol	Mc	60	CS10	668
fol	Ms	60	CS12	749	fol	Mc	60	CS12	615
fol	Ms	80	CS04	1506	fol	Mc	80	CS04	1337
fol	Ms	80	CS06	1273	fol	Mc	80	CS06	1128
fol	Ms	80	CS08	1134	fol	Mc	80	CS08	1002
fol	Ms	80	CS10	1035	fol	Mc	80	CS10	910
fol	Ms	80	CS12	954	fol	Mc	80	CS12	834
fol	Ms	100	CS04	1754	fol	Mc	100	CS04	1441
fol	Ms	100	CS06	1497	fol	Mc	100	CS06	1232
fol	Ms	100	CS08	1352	fol	Mc	100	CS08	1115
fol	Ms	100	CS10	1237	fol	Mc	100	CS10	1017
fol	Ms	100	CS12	1140	fol	Mc	100	CS12	931
fol	Ms	120	CS04	2393	fol	Mc	120	CS04	1494
fol	Ms	120	CS06	2016	fol	Mc	120	CS06	1261

fol	Ms	120	CS08	1823	fol	Mc	120	CS08	1152
fol	Ms	120	CS10	1669	fol	Mc	120	CS10	1054
fol	Ms	120	CS12	1533	fol	Mc	120	CS12	958
fol	Ms	140	CS04	2873	fol	Mc	140	CS04	1387
fol	Ms	140	CS06	2420	fol	Mc	140	CS06	1180
fol	Ms	140	CS08	2180	fol	Mc	140	CS08	1080
fol	Ms	140	CS10	1993	fol	Mc	140	CS10	988
fol	Ms	140	CS12	1821	fol	Mc	140	CS12	885
fol	Ms	160	CS04	3348	fol	Mc	160	CS04	1159
fol	Ms	160	CS06	2818	fol	Mc	160	CS06	998
fol	Ms	160	CS08	2543	fol	Mc	160	CS08	935
fol	Ms	160	CS10	2326	fol	Mc	160	CS10	860
fol	Ms	160	CS12	2113	fol	Mc	160	CS12	754
fol	Ms	180	CS04	3682	fol	Mc	180	CS04	920
fol	Ms	180	CS06	3099	fol	Mc	180	CS06	809
fol	Ms	180	CS08	2807	fol	Mc	180	CS08	786
fol	Ms	180	CS10	2569	fol	Mc	180	CS10	729
fol	Ms	180	CS12	2321	fol	Mc	180	CS12	617
fol	Ms	200	CS04	3869	fol	Mc	200	CS04	696
fol	Ms	200	CS06	3278	fol	Mc	200	CS06	651
fol	Ms	200	CS08	2953	fol	Mc	200	CS08	636
fol	Ms	200	CS10	2677	fol	Mc	200	CS10	570
fol	Ms	200	CS12	2387	fol	Mc	200	CS12	439
fol	Vs	20	CS04	79	fol	Vc	20	CS04	131
fol	Vs	20	CS06	61	fol	Vc	20	CS06	100
fol	Vs	20	CS08	52	fol	Vc	20	CS08	85
fol	Vs	20	CS10	46	fol	Vc	20	CS10	76
fol	Vs	20	CS12	42	fol	Vc	20	CS12	69
fol	Vs	40	CS04	108	fol	Vc	40	CS04	160
fol	Vs	40	CS06	83	fol	Vc	40	CS06	122
fol	Vs	40	CS08	70	fol	Vc	40	CS08	103
fol	Vs	40	CS10	62	fol	Vc	40	CS10	92
fol	Vs	40	CS12	57	fol	Vc	40	CS12	84
fol	Vs	60	CS04	125	fol	Vc	60	CS04	215
fol	Vs	60	CS06	95	fol	Vc	60	CS06	164
fol	Vs	60	CS08	80	fol	Vc	60	CS08	139
fol	Vs	60	CS10	71	fol	Vc	60	CS10	123
fol	Vs	60	CS12	65	fol	Vc	60	CS12	113
fol	Vs	80	CS04	131	fol	Vc	80	CS04	280
fol	Vs	80	CS06	99	fol	Vc	80	CS06	214
fol	Vs	80	CS08	84	fol	Vc	80	CS08	181

fol	Vs	80	CS10	74	fol	Vc	80	CS10	161
fol	Vs	80	CS12	67	fol	Vc	80	CS12	147
fol	Vs	100	CS04	147	fol	Vc	100	CS04	309
fol	Vs	100	CS06	112	fol	Vc	100	CS06	236
fol	Vs	100	CS08	95	fol	Vc	100	CS08	200
fol	Vs	100	CS10	84	fol	Vc	100	CS10	178
fol	Vs	100	CS12	77	fol	Vc	100	CS12	162
fol	Vs	120	CS04	170	fol	Vc	120	CS04	321
fol	Vs	120	CS06	129	fol	Vc	120	CS06	244
fol	Vs	120	CS08	110	fol	Vc	120	CS08	207
fol	Vs	120	CS10	97	fol	Vc	120	CS10	184
fol	Vs	120	CS12	88	fol	Vc	120	CS12	168
fol	Vs	140	CS04	189	fol	Vc	140	CS04	320
fol	Vs	140	CS06	143	fol	Vc	140	CS06	243
fol	Vs	140	CS08	121	fol	Vc	140	CS08	206
fol	Vs	140	CS10	107	fol	Vc	140	CS10	183
fol	Vs	140	CS12	97	fol	Vc	140	CS12	166
fol	Vs	160	CS04	203	fol	Vc	160	CS04	317
fol	Vs	160	CS06	153	fol	Vc	160	CS06	240
fol	Vs	160	CS08	130	fol	Vc	160	CS08	203
fol	Vs	160	CS10	115	fol	Vc	160	CS10	180
fol	Vs	160	CS12	104	fol	Vc	160	CS12	164
fol	Vs	180	CS04	209	fol	Vc	180	CS04	309
fol	Vs	180	CS06	157	fol	Vc	180	CS06	234
fol	Vs	180	CS08	133	fol	Vc	180	CS08	198
fol	Vs	180	CS10	118	fol	Vc	180	CS10	176
fol	Vs	180	CS12	106	fol	Vc	180	CS12	159
fol	Vs	200	CS04	211	fol	Vc	200	CS04	302
fol	Vs	200	CS06	159	fol	Vc	200	CS06	229
fol	Vs	200	CS08	134	fol	Vc	200	CS08	193
fol	Vs	200	CS10	118	fol	Vc	200	CS10	171
fol	Vs	200	CS12	106	fol	Vc	200	CS12	154

Lane	Effect	Span	Bridge	RLE
fol	Mcp	20	CS04	255
fol	Mcp	20	CS06	218
fol	Mcp	20	CS08	196
fol	Mcp	20	CS10	180
fol	Mcp	20	CS12	168
fol	Mcp	40	CS04	593

fol	Mcp	40	CS06	504
fol	Mcp	40	CS08	451
fol	Mcp	40	CS10	413
fol	Mcp	40	CS12	383
<hr/>				
fol	Mcp	60	CS04	923
fol	Mcp	60	CS06	780
fol	Mcp	60	CS08	694
fol	Mcp	60	CS10	632
fol	Mcp	60	CS12	583
<hr/>				
fol	Mcp	80	CS04	1162
fol	Mcp	80	CS06	985
fol	Mcp	80	CS08	878
fol	Mcp	80	CS10	801
fol	Mcp	80	CS12	736
<hr/>				
fol	Mcp	100	CS04	1325
fol	Mcp	100	CS06	1138
fol	Mcp	100	CS08	1034
fol	Mcp	100	CS10	946
fol	Mcp	100	CS12	869
<hr/>				
fol	Mcp	120	CS04	1799
fol	Mcp	120	CS06	1520
fol	Mcp	120	CS08	1383
fol	Mcp	120	CS10	1268
fol	Mcp	120	CS12	1161
<hr/>				
fol	Mcp	140	CS04	2122
fol	Mcp	140	CS06	1795
fol	Mcp	140	CS08	1627
fol	Mcp	140	CS10	1489
fol	Mcp	140	CS12	1352
<hr/>				
fol	Mcp	160	CS04	2412
fol	Mcp	160	CS06	2040
fol	Mcp	160	CS08	1857
fol	Mcp	160	CS10	1700
fol	Mcp	160	CS12	1534
<hr/>				
fol	Mcp	180	CS04	2570
fol	Mcp	180	CS06	2177
fol	Mcp	180	CS08	1994
fol	Mcp	180	CS10	1829
fol	Mcp	180	CS12	1636
<hr/>				
fol	Mcp	200	CS04	2597
fol	Mcp	200	CS06	2225



fol	Mcp	200	CS08	2024
fol	Mcp	200	CS10	1833
fol	Mcp	200	CS12	1607

### Two Lane Load Effects, Steel Girders

Lane	Effect	Span	Bridge	RLE	Lane	Effect	Span	Bridge	RLE
04G	Ms	20	CS04	343	04G	Mc	20	CS04	222
06G	Ms	20	CS06	296	06G	Mc	20	CS06	192
08G	Ms	20	CS08	268	08G	Mc	20	CS08	174
10G	Ms	20	CS10	248	10G	Mc	20	CS10	161
12G	Ms	20	CS12	233	12G	Mc	20	CS12	151
04G	Ms	40	CS04	719	04G	Mc	40	CS04	580
06G	Ms	40	CS06	619	06G	Mc	40	CS06	517
08G	Ms	40	CS08	560	08G	Mc	40	CS08	480
10G	Ms	40	CS10	517	10G	Mc	40	CS10	452
12G	Ms	40	CS12	484	12G	Mc	40	CS12	430
04G	Ms	60	CS04	1152	04G	Mc	60	CS04	827
06G	Ms	60	CS06	993	06G	Mc	60	CS06	730
08G	Ms	60	CS08	897	08G	Mc	60	CS08	670
10G	Ms	60	CS10	828	10G	Mc	60	CS10	625
12G	Ms	60	CS12	774	12G	Mc	60	CS12	588
04G	Ms	80	CS04	1793	04G	Mc	80	CS04	998
06G	Ms	80	CS06	1577	06G	Mc	80	CS06	884
08G	Ms	80	CS08	1446	08G	Mc	80	CS08	813
10G	Ms	80	CS10	1352	10G	Mc	80	CS10	760
12G	Ms	80	CS12	1274	12G	Mc	80	CS12	712
04G	Ms	100	CS04	2419	04G	Mc	100	CS04	1076
06G	Ms	100	CS06	2154	06G	Mc	100	CS06	973
08G	Ms	100	CS08	2005	08G	Mc	100	CS08	918
10G	Ms	100	CS10	1884	10G	Mc	100	CS10	862
12G	Ms	100	CS12	1780	12G	Mc	100	CS12	808
04G	Ms	120	CS04	3001	04G	Mc	120	CS04	1118
06G	Ms	120	CS06	2648	06G	Mc	120	CS06	1004
08G	Ms	120	CS08	2469	08G	Mc	120	CS08	962
10G	Ms	120	CS10	2322	10G	Mc	120	CS10	910
12G	Ms	120	CS12	2188	12G	Mc	120	CS12	849
04G	Ms	140	CS04	3407	04G	Mc	140	CS04	1098
06G	Ms	140	CS06	3013	06G	Mc	140	CS06	1008
08G	Ms	140	CS08	2806	08G	Mc	140	CS08	975
10G	Ms	140	CS10	2639	10G	Mc	140	CS10	927

12G	Ms	140	CS12	2478	12G	Mc	140	CS12	857
04G	Ms	160	CS04	3691	04G	Mc	160	CS04	1012
06G	Ms	160	CS06	3276	06G	Mc	160	CS06	954
08G	Ms	160	CS08	3066	08G	Mc	160	CS08	948
10G	Ms	160	CS10	2890	10G	Mc	160	CS10	911
12G	Ms	160	CS12	2706	12G	Mc	160	CS12	833
04G	Ms	180	CS04	3850	04G	Mc	180	CS04	803
06G	Ms	180	CS06	3439	06G	Mc	180	CS06	799
08G	Ms	180	CS08	3244	08G	Mc	180	CS08	836
10G	Ms	180	CS10	3069	10G	Mc	180	CS10	820
12G	Ms	180	CS12	2865	12G	Mc	180	CS12	736
04G	Ms	200	CS04	4010	04G	Mc	200	CS04	565
06G	Ms	200	CS06	3609	06G	Mc	200	CS06	634
08G	Ms	200	CS08	3389	08G	Mc	200	CS08	684
10G	Ms	200	CS10	3182	10G	Mc	200	CS10	661
12G	Ms	200	CS12	2943	12G	Mc	200	CS12	560
04G	Vs	20	CS04	84	04G	Vc	20	CS04	130
06G	Vs	20	CS06	66	06G	Vc	20	CS06	101
08G	Vs	20	CS08	57	08G	Vc	20	CS08	87
10G	Vs	20	CS10	51	10G	Vc	20	CS10	78
12G	Vs	20	CS12	47	12G	Vc	20	CS12	72
04G	Vs	40	CS04	113	04G	Vc	40	CS04	182
06G	Vs	40	CS06	88	06G	Vc	40	CS06	147
08G	Vs	40	CS08	75	08G	Vc	40	CS08	128
10G	Vs	40	CS10	68	10G	Vc	40	CS10	117
12G	Vs	40	CS12	62	12G	Vc	40	CS12	109
04G	Vs	60	CS04	132	04G	Vc	60	CS04	206
06G	Vs	60	CS06	103	06G	Vc	60	CS06	171
08G	Vs	60	CS08	88	08G	Vc	60	CS08	153
10G	Vs	60	CS10	79	10G	Vc	60	CS10	141
12G	Vs	60	CS12	73	12G	Vc	60	CS12	132
04G	Vs	80	CS04	143	04G	Vc	80	CS04	214
06G	Vs	80	CS06	114	06G	Vc	80	CS06	180
08G	Vs	80	CS08	99	08G	Vc	80	CS08	162
10G	Vs	80	CS10	89	10G	Vc	80	CS10	150
12G	Vs	80	CS12	82	12G	Vc	80	CS12	140
04G	Vs	100	CS04	146	04G	Vc	100	CS04	212
06G	Vs	100	CS06	119	06G	Vc	100	CS06	180
08G	Vs	100	CS08	105	08G	Vc	100	CS08	163
10G	Vs	100	CS10	96	10G	Vc	100	CS10	151
12G	Vs	100	CS12	89	12G	Vc	100	CS12	142

04G	Vs	120	CS04	143	04G	Vc	120	CS04	211
06G	Vs	120	CS06	120	06G	Vc	120	CS06	179
08G	Vs	120	CS08	109	08G	Vc	120	CS08	163
10G	Vs	120	CS10	101	10G	Vc	120	CS10	152
12G	Vs	120	CS12	95	12G	Vc	120	CS12	142
04G	Vs	140	CS04	141	04G	Vc	140	CS04	208
06G	Vs	140	CS06	120	06G	Vc	140	CS06	177
08G	Vs	140	CS08	110	08G	Vc	140	CS08	161
10G	Vs	140	CS10	102	10G	Vc	140	CS10	150
12G	Vs	140	CS12	95	12G	Vc	140	CS12	140
04G	Vs	160	CS04	137	04G	Vc	160	CS04	199
06G	Vs	160	CS06	118	06G	Vc	160	CS06	171
08G	Vs	160	CS08	108	08G	Vc	160	CS08	156
10G	Vs	160	CS10	102	10G	Vc	160	CS10	146
12G	Vs	160	CS12	95	12G	Vc	160	CS12	137
04G	Vs	180	CS04	132	04G	Vc	180	CS04	190
06G	Vs	180	CS06	114	06G	Vc	180	CS06	164
08G	Vs	180	CS08	106	08G	Vc	180	CS08	151
10G	Vs	180	CS10	100	10G	Vc	180	CS10	141
12G	Vs	180	CS12	93	12G	Vc	180	CS12	132
04G	Vs	200	CS04	126	04G	Vc	200	CS04	182
06G	Vs	200	CS06	110	06G	Vc	200	CS06	157
08G	Vs	200	CS08	102	08G	Vc	200	CS08	145
10G	Vs	200	CS10	96	10G	Vc	200	CS10	135
12G	Vs	200	CS12	89	12G	Vc	200	CS12	126

Lane	Effect	Span	Bridge	RLE
04G	Mcp	20	CS04	271
06G	Mcp	20	CS06	234
08G	Mcp	20	CS08	212
10G	Mcp	20	CS10	196
12G	Mcp	20	CS12	184
04G	Mcp	40	CS04	565
06G	Mcp	40	CS06	487
08G	Mcp	40	CS08	440
10G	Mcp	40	CS10	406
12G	Mcp	40	CS12	380
04G	Mcp	60	CS04	899
06G	Mcp	60	CS06	776
08G	Mcp	60	CS08	701

10G	Mcp	60	CS10	647
12G	Mcp	60	CS12	603
04G	Mcp	80	CS04	1387
06G	Mcp	80	CS06	1222
08G	Mcp	80	CS08	1123
10G	Mcp	80	CS10	1049
12G	Mcp	80	CS12	986
04G	Mcp	100	CS04	1845
06G	Mcp	100	CS06	1652
08G	Mcp	100	CS08	1544
10G	Mcp	100	CS10	1453
12G	Mcp	100	CS12	1371
04G	Mcp	120	CS04	2271
06G	Mcp	120	CS06	2012
08G	Mcp	120	CS08	1887
10G	Mcp	120	CS10	1778
12G	Mcp	120	CS12	1672
04G	Mcp	140	CS04	2538
06G	Mcp	140	CS06	2258
08G	Mcp	140	CS08	2116
10G	Mcp	140	CS10	1994
12G	Mcp	140	CS12	1867
04G	Mcp	160	CS04	2686
06G	Mcp	160	CS06	2405
08G	Mcp	160	CS08	2272
10G	Mcp	160	CS10	2148
12G	Mcp	160	CS12	2003
04G	Mcp	180	CS04	2715
06G	Mcp	180	CS06	2456
08G	Mcp	180	CS08	2347
10G	Mcp	180	CS10	2232
12G	Mcp	180	CS12	2072
04G	Mcp	200	CS04	2728
06G	Mcp	200	CS06	2502
08G	Mcp	200	CS08	2383
10G	Mcp	200	CS10	2245
12G	Mcp	200	CS12	2057

## Single Lane Load Effects, PC Girders

Lane	Effect	Span	Bridge	RLE	Lane	Effect	Span	Bridge	RLE
fol	Ms	20	PC04	236	fol	Mc	20	PC04	151
fol	Ms	20	PC06	230	fol	Mc	20	PC06	148
fol	Ms	20	PC08	226	fol	Mc	20	PC08	145
fol	Ms	20	PC10	222	fol	Mc	20	PC10	143
fol	Ms	20	PC12	218	fol	Mc	20	PC12	141
fol	Ms	40	PC04	614	fol	Mc	40	PC04	363
fol	Ms	40	PC06	601	fol	Mc	40	PC06	358
fol	Ms	40	PC08	591	fol	Mc	40	PC08	354
fol	Ms	40	PC10	580	fol	Mc	40	PC10	349
fol	Ms	40	PC12	571	fol	Mc	40	PC12	344
fol	Ms	60	PC04	1018	fol	Mc	60	PC04	840
fol	Ms	60	PC06	1001	fol	Mc	60	PC06	830
fol	Ms	60	PC08	988	fol	Mc	60	PC08	821
fol	Ms	60	PC10	971	fol	Mc	60	PC10	807
fol	Ms	60	PC12	955	fol	Mc	60	PC12	794
fol	Ms	80	PC04	1313	fol	Mc	80	PC04	1147
fol	Ms	80	PC06	1311	fol	Mc	80	PC06	1155
fol	Ms	80	PC08	1305	fol	Mc	80	PC08	1155
fol	Ms	80	PC10	1291	fol	Mc	80	PC10	1143
fol	Ms	80	PC12	1276	fol	Mc	80	PC12	1128
fol	Ms	100	PC04	1539	fol	Mc	100	PC04	1224
fol	Ms	100	PC06	1568	fol	Mc	100	PC06	1269
fol	Ms	100	PC08	1582	fol	Mc	100	PC08	1295
fol	Ms	100	PC10	1577	fol	Mc	100	PC10	1295
fol	Ms	100	PC12	1566	fol	Mc	100	PC12	1288
fol	Ms	120	PC04	2147	fol	Mc	120	PC04	1246
fol	Ms	120	PC06	2195	fol	Mc	120	PC06	1330
fol	Ms	120	PC08	2221	fol	Mc	120	PC08	1382
fol	Ms	120	PC10	2216	fol	Mc	120	PC10	1396
fol	Ms	120	PC12	2202	fol	Mc	120	PC12	1398
fol	Ms	140	PC04	2703	fol	Mc	140	PC04	1194
fol	Ms	140	PC06	2777	fol	Mc	140	PC06	1325
fol	Ms	140	PC08	2817	fol	Mc	140	PC08	1407
fol	Ms	140	PC10	2818	fol	Mc	140	PC10	1441
fol	Ms	140	PC12	2804	fol	Mc	140	PC12	1455
fol	Ms	160	PC04	3311	fol	Mc	160	PC04	1055
fol	Ms	160	PC06	3425	fol	Mc	160	PC06	1248
fol	Ms	160	PC08	3488	fol	Mc	160	PC08	1371
fol	Ms	160	PC10	3495	fol	Mc	160	PC10	1430
fol	Ms	160	PC12	3480	fol	Mc	160	PC12	1459
fol	Ms	180	PC04	3848	fol	Mc	180	PC04	950
fol	Ms	180	PC06	4012	fol	Mc	180	PC06	1214

fol	Ms	180	PC08	4107	fol	Mc	180	PC08	1385
fol	Ms	180	PC10	4125	fol	Mc	180	PC10	1470
fol	Ms	180	PC12	4114	fol	Mc	180	PC12	1517
fol	Ms	200	PC04	4261	fol	Mc	200	PC04	874
fol	Ms	200	PC06	4491	fol	Mc	200	PC06	1220
fol	Ms	200	PC08	4633	fol	Mc	200	PC08	1451
fol	Ms	200	PC10	4665	fol	Mc	200	PC10	1562
fol	Ms	200	PC12	4662	fol	Mc	200	PC12	1629
fol	Vs	20	PC04	51	fol	Vc	20	PC04	86
fol	Vs	20	PC06	46	fol	Vc	20	PC06	77
fol	Vs	20	PC08	43	fol	Vc	20	PC08	72
fol	Vs	20	PC10	41	fol	Vc	20	PC10	68
fol	Vs	20	PC12	39	fol	Vc	20	PC12	66
fol	Vs	40	PC04	68	fol	Vc	40	PC04	102
fol	Vs	40	PC06	60	fol	Vc	40	PC06	91
fol	Vs	40	PC08	56	fol	Vc	40	PC08	85
fol	Vs	40	PC10	54	fol	Vc	40	PC10	81
fol	Vs	40	PC12	52	fol	Vc	40	PC12	79
fol	Vs	60	PC04	76	fol	Vc	60	PC04	137
fol	Vs	60	PC06	68	fol	Vc	60	PC06	123
fol	Vs	60	PC08	64	fol	Vc	60	PC08	115
fol	Vs	60	PC10	61	fol	Vc	60	PC10	109
fol	Vs	60	PC12	59	fol	Vc	60	PC12	106
fol	Vs	80	PC04	75	fol	Vc	80	PC04	174
fol	Vs	80	PC06	67	fol	Vc	80	PC06	156
fol	Vs	80	PC08	63	fol	Vc	80	PC08	146
fol	Vs	80	PC10	61	fol	Vc	80	PC10	139
fol	Vs	80	PC12	59	fol	Vc	80	PC12	135
fol	Vs	100	PC04	80	fol	Vc	100	PC04	185
fol	Vs	100	PC06	73	fol	Vc	100	PC06	167
fol	Vs	100	PC08	69	fol	Vc	100	PC08	157
fol	Vs	100	PC10	66	fol	Vc	100	PC10	150
fol	Vs	100	PC12	64	fol	Vc	100	PC12	145
fol	Vs	120	PC04	91	fol	Vc	120	PC04	189
fol	Vs	120	PC06	83	fol	Vc	120	PC06	170
fol	Vs	120	PC08	79	fol	Vc	120	PC08	160
fol	Vs	120	PC10	75	fol	Vc	120	PC10	153
fol	Vs	120	PC12	73	fol	Vc	120	PC12	149
fol	Vs	140	PC04	100	fol	Vc	140	PC04	186
fol	Vs	140	PC06	92	fol	Vc	140	PC06	169
fol	Vs	140	PC08	87	fol	Vc	140	PC08	159
fol	Vs	140	PC10	84	fol	Vc	140	PC10	152
fol	Vs	140	PC12	81	fol	Vc	140	PC12	148
fol	Vs	160	PC04	107	fol	Vc	160	PC04	183

fol	Vs	160	PC06	98	fol	Vc	160	PC06	165
fol	Vs	160	PC08	93	fol	Vc	160	PC08	156
fol	Vs	160	PC10	90	fol	Vc	160	PC10	150
fol	Vs	160	PC12	87	fol	Vc	160	PC12	145
fol	Vs	180	PC04	110	fol	Vc	180	PC04	177
fol	Vs	180	PC06	100	fol	Vc	180	PC06	160
fol	Vs	180	PC08	96	fol	Vc	180	PC08	152
fol	Vs	180	PC10	92	fol	Vc	180	PC10	146
fol	Vs	180	PC12	90	fol	Vc	180	PC12	142
fol	Vs	200	PC04	109	fol	Vc	200	PC04	170
fol	Vs	200	PC06	100	fol	Vc	200	PC06	155
fol	Vs	200	PC08	96	fol	Vc	200	PC08	148
fol	Vs	200	PC10	93	fol	Vc	200	PC10	142
fol	Vs	200	PC12	90	fol	Vc	200	PC12	138

### Two Lane Load Effects, PC Girders

Lane	Effect	Span	Bridge	RLE	Lane	Effect	Span	Bridge	RLE
04G	Ms	20	PC04	341	04G	Mc	20	PC04	217
06G	Ms	20	PC06	298	06G	Mc	20	PC06	191
08G	Ms	20	PC08	272	08G	Mc	20	PC08	175
10G	Ms	20	PC10	253	10G	Mc	20	PC10	163
12G	Ms	20	PC12	239	12G	Mc	20	PC12	154
04G	Ms	40	PC04	696	04G	Mc	40	PC04	554
06G	Ms	40	PC06	612	06G	Mc	40	PC06	509
08G	Ms	40	PC08	561	08G	Mc	40	PC08	482
10G	Ms	40	PC10	524	10G	Mc	40	PC10	460
12G	Ms	40	PC12	495	12G	Mc	40	PC12	442
04G	Ms	60	PC04	1091	04G	Mc	60	PC04	760
06G	Ms	60	PC06	971	06G	Mc	60	PC06	703
08G	Ms	60	PC08	898	08G	Mc	60	PC08	667
10G	Ms	60	PC10	842	10G	Mc	60	PC10	636
12G	Ms	60	PC12	798	12G	Mc	60	PC12	610
04G	Ms	80	PC04	1627	04G	Mc	80	PC04	818
06G	Ms	80	PC06	1499	06G	Mc	80	PC06	790
08G	Ms	80	PC08	1419	08G	Mc	80	PC08	769
10G	Ms	80	PC10	1352	10G	Mc	80	PC10	743
12G	Ms	80	PC12	1296	12G	Mc	80	PC12	718
04G	Ms	100	PC04	2096	04G	Mc	100	PC04	742
06G	Ms	100	PC06	1985	06G	Mc	100	PC06	783
08G	Ms	100	PC08	1911	08G	Mc	100	PC08	799

10G	Ms	100	PC10	1839	10G	Mc	100	PC10	790
12G	Ms	100	PC12	1775	12G	Mc	100	PC12	774
04G	Ms	120	PC04	2518	04G	Mc	120	PC04	625
06G	Ms	120	PC06	2413	06G	Mc	120	PC06	743
08G	Ms	120	PC08	2339	08G	Mc	120	PC08	800
10G	Ms	120	PC10	2258	10G	Mc	120	PC10	810
12G	Ms	120	PC12	2184	12G	Mc	120	PC12	806
04G	Ms	140	PC04	2844	04G	Mc	140	PC04	519
06G	Ms	140	PC06	2762	06G	Mc	140	PC06	723
08G	Ms	140	PC08	2696	08G	Mc	140	PC08	824
10G	Ms	140	PC10	2614	10G	Mc	140	PC10	858
12G	Ms	140	PC12	2533	12G	Mc	140	PC12	866
04G	Ms	160	PC04	3070	04G	Mc	160	PC04	367
06G	Ms	160	PC06	3038	06G	Mc	160	PC06	674
08G	Ms	160	PC08	2996	08G	Mc	160	PC08	829
10G	Ms	160	PC10	2919	10G	Mc	160	PC10	890
12G	Ms	160	PC12	2838	12G	Mc	160	PC12	912
04G	Ms	180	PC04	3204	04G	Mc	180	PC04	124
06G	Ms	180	PC06	3250	06G	Mc	180	PC06	560
08G	Ms	180	PC08	3247	08G	Mc	180	PC08	783
10G	Ms	180	PC10	3185	10G	Mc	180	PC10	878
12G	Ms	180	PC12	3108	12G	Mc	180	PC12	921
04G	Ms	200	PC04	3329	04G	Mc	200	PC04	0
06G	Ms	200	PC06	3454	06G	Mc	200	PC06	421
08G	Ms	200	PC08	3494	08G	Mc	200	PC08	725
10G	Ms	200	PC10	3439	10G	Mc	200	PC10	851
12G	Ms	200	PC12	3366	12G	Mc	200	PC12	916
04G	Vs	20	PC04	77	04G	Vc	20	PC04	121
06G	Vs	20	PC06	60	06G	Vc	20	PC06	95
08G	Vs	20	PC08	52	08G	Vc	20	PC08	82
10G	Vs	20	PC10	47	10G	Vc	20	PC10	73
12G	Vs	20	PC12	44	12G	Vc	20	PC12	68
04G	Vs	40	PC04	99	04G	Vc	40	PC04	166
06G	Vs	40	PC06	78	06G	Vc	40	PC06	135
08G	Vs	40	PC08	68	08G	Vc	40	PC08	119
10G	Vs	40	PC10	61	10G	Vc	40	PC10	109
12G	Vs	40	PC12	56	12G	Vc	40	PC12	101
04G	Vs	60	PC04	113	04G	Vc	60	PC04	183
06G	Vs	60	PC06	90	06G	Vc	60	PC06	155
08G	Vs	60	PC08	78	08G	Vc	60	PC08	140
10G	Vs	60	PC10	71	10G	Vc	60	PC10	130



12G	Vs	60	PC12	65	12G	Vc	60	PC12	123
04G	Vs	80	PC04	113	04G	Vc	80	PC04	180
06G	Vs	80	PC06	93	06G	Vc	80	PC06	156
08G	Vs	80	PC08	83	08G	Vc	80	PC08	143
10G	Vs	80	PC10	76	10G	Vc	80	PC10	134
12G	Vs	80	PC12	71	12G	Vc	80	PC12	126
04G	Vs	100	PC04	104	04G	Vc	100	PC04	166
06G	Vs	100	PC06	90	06G	Vc	100	PC06	148
08G	Vs	100	PC08	83	08G	Vc	100	PC08	137
10G	Vs	100	PC10	77	10G	Vc	100	PC10	130
12G	Vs	100	PC12	73	12G	Vc	100	PC12	123
04G	Vs	120	PC04	94	04G	Vc	120	PC04	157
06G	Vs	120	PC06	87	06G	Vc	120	PC06	142
08G	Vs	120	PC08	83	08G	Vc	120	PC08	134
10G	Vs	120	PC10	79	10G	Vc	120	PC10	127
12G	Vs	120	PC12	75	12G	Vc	120	PC12	121
04G	Vs	140	PC04	87	04G	Vc	140	PC04	149
06G	Vs	140	PC06	84	06G	Vc	140	PC06	137
08G	Vs	140	PC08	82	08G	Vc	140	PC08	130
10G	Vs	140	PC10	79	10G	Vc	140	PC10	124
12G	Vs	140	PC12	76	12G	Vc	140	PC12	118
04G	Vs	160	PC04	79	04G	Vc	160	PC04	137
06G	Vs	160	PC06	79	06G	Vc	160	PC06	129
08G	Vs	160	PC08	79	08G	Vc	160	PC08	124
10G	Vs	160	PC10	77	10G	Vc	160	PC10	119
12G	Vs	160	PC12	74	12G	Vc	160	PC12	114
04G	Vs	180	PC04	71	04G	Vc	180	PC04	126
06G	Vs	180	PC06	74	06G	Vc	180	PC06	121
08G	Vs	180	PC08	75	08G	Vc	180	PC08	118
10G	Vs	180	PC10	74	10G	Vc	180	PC10	114
12G	Vs	180	PC12	72	12G	Vc	180	PC12	110
04G	Vs	200	PC04	61	04G	Vc	200	PC04	113
06G	Vs	200	PC06	67	06G	Vc	200	PC06	112
08G	Vs	200	PC08	71	08G	Vc	200	PC08	111
10G	Vs	200	PC10	70	10G	Vc	200	PC10	108
12G	Vs	200	PC12	69	12G	Vc	200	PC12	104

### Single Lane Load Effects, RC Girders

Lane	Effect	Span	Bridge	RLE	Lane	Effect	Span	Bridge	RLE
fol	Ms	20	RC04	323	fol	Mc	20	RC04	205

fol	Ms	20	RC06	269	fol	Mc	20	RC06	169
fol	Ms	20	RC08	245	fol	Mc	20	RC08	155
fol	Ms	20	RC10	224	fol	Mc	20	RC10	140
fol	Ms	20	RC12	228	fol	Mc	20	RC12	143
fol	Ms	40	RC04	707	fol	Mc	40	RC04	400
fol	Ms	40	RC06	583	fol	Mc	40	RC06	324
fol	Ms	40	RC08	531	fol	Mc	40	RC08	298
fol	Ms	40	RC10	481	fol	Mc	40	RC10	268
fol	Ms	40	RC12	486	fol	Mc	40	RC12	269
fol	Ms	60	RC04	996	fol	Mc	60	RC04	759
fol	Ms	60	RC06	823	fol	Mc	60	RC06	621
fol	Ms	60	RC08	753	fol	Mc	60	RC08	573
fol	Ms	60	RC10	677	fol	Mc	60	RC10	511
fol	Ms	60	RC12	679	fol	Mc	60	RC12	508
fol	Ms	80	RC04	1098	fol	Mc	80	RC04	858
fol	Ms	80	RC06	922	fol	Mc	80	RC06	718
fol	Ms	80	RC08	851	fol	Mc	80	RC08	669
fol	Ms	80	RC10	758	fol	Mc	80	RC10	589
fol	Ms	80	RC12	751	fol	Mc	80	RC12	577
fol	Ms	100	RC04	1037	fol	Mc	100	RC04	654
fol	Ms	100	RC06	904	fol	Mc	100	RC06	583
fol	Ms	100	RC08	841	fol	Mc	100	RC08	554
fol	Ms	100	RC10	743	fol	Mc	100	RC10	480
fol	Ms	100	RC12	719	fol	Mc	100	RC12	449
fol	Vs	20	RC04	74	fol	Vc	20	RC04	124
fol	Vs	20	RC06	55	fol	Vc	20	RC06	93
fol	Vs	20	RC08	47	fol	Vc	20	RC08	79
fol	Vs	20	RC10	41	fol	Vc	20	RC10	70
fol	Vs	20	RC12	41	fol	Vc	20	RC12	70
fol	Vs	40	RC04	95	fol	Vc	40	RC04	144
fol	Vs	40	RC06	69	fol	Vc	40	RC06	107
fol	Vs	40	RC08	59	fol	Vc	40	RC08	91
fol	Vs	40	RC10	51	fol	Vc	40	RC10	80
fol	Vs	40	RC12	51	fol	Vc	40	RC12	79
fol	Vs	60	RC04	101	fol	Vc	60	RC04	188
fol	Vs	60	RC06	74	fol	Vc	60	RC06	140
fol	Vs	60	RC08	63	fol	Vc	60	RC08	120
fol	Vs	60	RC10	54	fol	Vc	60	RC10	105
fol	Vs	60	RC12	53	fol	Vc	60	RC12	104
fol	Vs	80	RC04	95	fol	Vc	80	RC04	235
fol	Vs	80	RC06	69	fol	Vc	80	RC06	176

fol	Vs	80	RC08	59
fol	Vs	80	RC10	50
fol	Vs	80	RC12	48
fol	Vs	100	RC04	98
fol	Vs	100	RC06	72
fol	Vs	100	RC08	61
fol	Vs	100	RC10	52
fol	Vs	100	RC12	49

fol	Vc	80	RC08	150
fol	Vc	80	RC10	131
fol	Vc	80	RC12	129
fol	Vc	100	RC04	247
fol	Vc	100	RC06	186
fol	Vc	100	RC08	157
fol	Vc	100	RC10	137
fol	Vc	100	RC12	135

Lane	Effect	Span	Bridge	RLE
fol	Mcp	20	RC04	253
fol	Mcp	20	RC06	210
fol	Mcp	20	RC08	191
fol	Mcp	20	RC10	174
fol	Mcp	20	RC12	177
fol	Mcp	40	RC04	540
fol	Mcp	40	RC06	441
fol	Mcp	40	RC08	404
fol	Mcp	40	RC10	364
fol	Mcp	40	RC12	367
fol	Mcp	60	RC04	731
fol	Mcp	60	RC06	600
fol	Mcp	60	RC08	553
fol	Mcp	60	RC10	494
fol	Mcp	60	RC12	493
fol	Mcp	80	RC04	747
fol	Mcp	80	RC06	627
fol	Mcp	80	RC08	587
fol	Mcp	80	RC10	517
fol	Mcp	80	RC12	506
fol	Mcp	100	RC04	601
fol	Mcp	100	RC06	538
fol	Mcp	100	RC08	514
fol	Mcp	100	RC10	445
fol	Mcp	100	RC12	416

## Two Lane Load Effects, RC Girders

Lane	Effect	Span	Bridge	RLE	Lane	Effect	Span	Bridge	RLE
04G	Ms	20	RC04	343	04G	Mc	20	RC04	219
06G	Ms	20	RC06	290	06G	Mc	20	RC06	182
08G	Ms	20	RC08	265	08G	Mc	20	RC08	168
10G	Ms	20	RC10	244	10G	Mc	20	RC10	154
12G	Ms	20	RC12	250	12G	Mc	20	RC12	157
04G	Ms	40	RC04	671	04G	Mc	40	RC04	520
06G	Ms	40	RC06	561	06G	Mc	40	RC06	449
08G	Ms	40	RC08	517	08G	Mc	40	RC08	429
10G	Ms	40	RC10	473	10G	Mc	40	RC10	400
12G	Ms	40	RC12	482	12G	Mc	40	RC12	415
04G	Ms	60	RC04	971	04G	Mc	60	RC04	629
06G	Ms	60	RC06	823	06G	Mc	60	RC06	544
08G	Ms	60	RC08	767	08G	Mc	60	RC08	525
10G	Ms	60	RC10	700	10G	Mc	60	RC10	484
12G	Ms	60	RC12	712	12G	Mc	60	RC12	497
04G	Ms	80	RC04	1387	04G	Mc	80	RC04	578
06G	Ms	80	RC06	1229	06G	Mc	80	RC06	522
08G	Ms	80	RC08	1169	08G	Mc	80	RC08	519
10G	Ms	80	RC10	1081	10G	Mc	80	RC10	475
12G	Ms	80	RC12	1108	12G	Mc	80	RC12	479
04G	Ms	100	RC04	1696	04G	Mc	100	RC04	350
06G	Ms	100	RC06	1562	06G	Mc	100	RC06	373
08G	Ms	100	RC08	1498	08G	Mc	100	RC08	398
10G	Ms	100	RC10	1396	10G	Mc	100	RC10	362
12G	Ms	100	RC12	1426	12G	Mc	100	RC12	352
04G	Vs	20	RC04	81	04G	Vc	20	RC04	126
06G	Vs	20	RC06	61	06G	Vc	20	RC06	96
08G	Vs	20	RC08	53	08G	Vc	20	RC08	83
10G	Vs	20	RC10	47	10G	Vc	20	RC10	73
12G	Vs	20	RC12	47	12G	Vc	20	RC12	74
04G	Vs	40	RC04	101	04G	Vc	40	RC04	168
06G	Vs	40	RC06	76	06G	Vc	40	RC06	133
08G	Vs	40	RC08	66	08G	Vc	40	RC08	117
10G	Vs	40	RC10	58	10G	Vc	40	RC10	106
12G	Vs	40	RC12	58	12G	Vc	40	RC12	107
04G	Vs	60	RC04	110	04G	Vc	60	RC04	180
06G	Vs	60	RC06	83	06G	Vc	60	RC06	148
08G	Vs	60	RC08	72	08G	Vc	60	RC08	134

10G	Vs	60	RC10	63	10G	Vc	60	RC10	123
12G	Vs	60	RC12	63	12G	Vc	60	RC12	125
04G	Vs	80	RC04	108	04G	Vc	80	RC04	175
06G	Vs	80	RC06	84	06G	Vc	80	RC06	147
08G	Vs	80	RC08	74	08G	Vc	80	RC08	135
10G	Vs	80	RC10	66	10G	Vc	80	RC10	123
12G	Vs	80	RC12	65	12G	Vc	80	RC12	125
04G	Vs	100	RC04	98	04G	Vc	100	RC04	161
06G	Vs	100	RC06	80	06G	Vc	100	RC06	137
08G	Vs	100	RC08	72	08G	Vc	100	RC08	127
10G	Vs	100	RC10	64	10G	Vc	100	RC10	116
12G	Vs	100	RC12	63	12G	Vc	100	RC12	118

Lane	Effect	Span	Bridge	RLE
04G	Mcp	20	RC04	269
06G	Mcp	20	RC06	226
08G	Mcp	20	RC08	207
10G	Mcp	20	RC10	190
12G	Mcp	20	RC12	195
04G	Mcp	40	RC04	512
06G	Mcp	40	RC06	425
08G	Mcp	40	RC08	394
10G	Mcp	40	RC10	359
12G	Mcp	40	RC12	364
04G	Mcp	60	RC04	713
06G	Mcp	60	RC06	601
08G	Mcp	60	RC08	565
10G	Mcp	60	RC10	514
12G	Mcp	60	RC12	520
04G	Mcp	80	RC04	976
06G	Mcp	80	RC06	869
08G	Mcp	80	RC08	838
10G	Mcp	80	RC10	772
12G	Mcp	80	RC12	788
04G	Mcp	100	RC04	1120
06G	Mcp	100	RC06	1056
08G	Mcp	100	RC08	1032
10G	Mcp	100	RC10	959
12G	Mcp	100	RC12	973

### Single Lane Load Effects, Spread Box Beams (BS)

Lane	Effect	Span	Bridge	RLE	Lane	Effect	Span	Bridge	RLE
fol	Ms	20	BS04	326	fol	Mc	20	BS04	207
fol	Ms	20	BS06	220	fol	Mc	20	BS06	140
fol	Ms	20	BS08	205	fol	Mc	20	BS08	131
fol	Ms	20	BS10	154	fol	Mc	20	BS10	99
fol	Ms	20	BS12	159	fol	Mc	20	BS12	102
fol	Ms	40	BS04	663	fol	Mc	40	BS04	377
fol	Ms	40	BS06	494	fol	Mc	40	BS06	286
fol	Ms	40	BS08	483	fol	Mc	40	BS08	283
fol	Ms	40	BS10	367	fol	Mc	40	BS10	217
fol	Ms	40	BS12	390	fol	Mc	40	BS12	232
fol	Ms	60	BS04	955	fol	Mc	60	BS04	753
fol	Ms	60	BS06	753	fol	Mc	60	BS06	602
fol	Ms	60	BS08	759	fol	Mc	60	BS08	613
fol	Ms	60	BS10	582	fol	Mc	60	BS10	471
fol	Ms	60	BS12	630	fol	Mc	60	BS12	510
fol	Ms	80	BS04	1157	fol	Mc	80	BS04	965
fol	Ms	80	BS06	955	fol	Mc	80	BS06	812
fol	Ms	80	BS08	988	fol	Mc	80	BS08	848
fol	Ms	80	BS10	766	fol	Mc	80	BS10	659
fol	Ms	80	BS12	840	fol	Mc	80	BS12	723
fol	Ms	100	BS04	1238	fol	Mc	100	BS04	917
fol	Ms	100	BS06	1073	fol	Mc	100	BS06	828
fol	Ms	100	BS08	1141	fol	Mc	100	BS08	900
fol	Ms	100	BS10	894	fol	Mc	100	BS10	710
fol	Ms	100	BS12	991	fol	Mc	100	BS12	790
fol	Ms	120	BS04	1619	fol	Mc	120	BS04	746
fol	Ms	120	BS06	1442	fol	Mc	120	BS06	764
fol	Ms	120	BS08	1556	fol	Mc	120	BS08	883
fol	Ms	120	BS10	1226	fol	Mc	120	BS10	715
fol	Ms	120	BS12	1369	fol	Mc	120	BS12	810
fol	Ms	140	BS04	1696	fol	Mc	140	BS04	334
fol	Ms	140	BS06	1592	fol	Mc	140	BS06	526
fol	Ms	140	BS08	1762	fol	Mc	140	BS08	698
fol	Ms	140	BS10	1407	fol	Mc	140	BS10	600
fol	Ms	140	BS12	1586	fol	Mc	140	BS12	703
fol	Ms	160	BS04	1702	fol	Mc	160	BS04	0
fol	Ms	160	BS06	1704	fol	Mc	160	BS06	204
fol	Ms	160	BS08	1944	fol	Mc	160	BS08	441

fol	Ms	160	BS10	1574	fol	Mc	160	BS10	433
fol	Ms	160	BS12	1790	fol	Mc	160	BS12	540
fol	Ms	180	BS04	1765	fol	Mc	180	BS04	0
fol	Ms	180	BS06	1885	fol	Mc	180	BS06	0
fol	Ms	180	BS08	2210	fol	Mc	180	BS08	258
fol	Ms	180	BS10	1810	fol	Mc	180	BS10	328
fol	Ms	180	BS12	2076	fol	Mc	180	BS12	450
fol	Ms	200	BS04	1374	fol	Mc	200	BS04	0
fol	Ms	200	BS06	1727	fol	Mc	200	BS06	0
fol	Ms	200	BS08	2157	fol	Mc	200	BS08	0
fol	Ms	200	BS10	1805	fol	Mc	200	BS10	144
fol	Ms	200	BS12	2102	fol	Mc	200	BS12	277
fol	Vs	20	BS04	68	fol	Vc	20	BS04	114
fol	Vs	20	BS06	45	fol	Vc	20	BS06	77
fol	Vs	20	BS08	42	fol	Vc	20	BS08	71
fol	Vs	20	BS10	32	fol	Vc	20	BS10	53
fol	Vs	20	BS12	33	fol	Vc	20	BS12	55
fol	Vs	40	BS04	88	fol	Vc	40	BS04	136
fol	Vs	40	BS06	65	fol	Vc	40	BS06	100
fol	Vs	40	BS08	63	fol	Vc	40	BS08	97
fol	Vs	40	BS10	48	fol	Vc	40	BS10	73
fol	Vs	40	BS12	51	fol	Vc	40	BS12	77
fol	Vs	60	BS04	96	fol	Vc	60	BS04	181
fol	Vs	60	BS06	75	fol	Vc	60	BS06	139
fol	Vs	60	BS08	75	fol	Vc	60	BS08	137
fol	Vs	60	BS10	57	fol	Vc	60	BS10	104
fol	Vs	60	BS12	61	fol	Vc	60	BS12	112
fol	Vs	80	BS04	94	fol	Vc	80	BS04	235
fol	Vs	80	BS06	76	fol	Vc	80	BS06	184
fol	Vs	80	BS08	78	fol	Vc	80	BS08	184
fol	Vs	80	BS10	60	fol	Vc	80	BS10	140
fol	Vs	80	BS12	65	fol	Vc	80	BS12	152
fol	Vs	100	BS04	103	fol	Vc	100	BS04	253
fol	Vs	100	BS06	85	fol	Vc	100	BS06	202
fol	Vs	100	BS08	88	fol	Vc	100	BS08	204
fol	Vs	100	BS10	68	fol	Vc	100	BS10	155
fol	Vs	100	BS12	74	fol	Vc	100	BS12	169
fol	Vs	120	BS04	115	fol	Vc	120	BS04	255
fol	Vs	120	BS06	97	fol	Vc	120	BS06	207
fol	Vs	120	BS08	102	fol	Vc	120	BS08	211
fol	Vs	120	BS10	78	fol	Vc	120	BS10	161

fol	Vs	120	BS12	86	fol	Vc	120	BS12	176
fol	Vs	140	BS04	118	fol	Vc	140	BS04	240
fol	Vs	140	BS06	102	fol	Vc	140	BS06	198
fol	Vs	140	BS08	108	fol	Vc	140	BS08	204
fol	Vs	140	BS10	84	fol	Vc	140	BS10	157
fol	Vs	140	BS12	93	fol	Vc	140	BS12	172
fol	Vs	160	BS04	117	fol	Vc	160	BS04	223
fol	Vs	160	BS06	105	fol	Vc	160	BS06	189
fol	Vs	160	BS08	113	fol	Vc	160	BS08	196
fol	Vs	160	BS10	88	fol	Vc	160	BS10	151
fol	Vs	160	BS12	97	fol	Vc	160	BS12	167
fol	Vs	180	BS04	114	fol	Vc	180	BS04	210
fol	Vs	180	BS06	105	fol	Vc	180	BS06	181
fol	Vs	180	BS08	115	fol	Vc	180	BS08	191
fol	Vs	180	BS10	90	fol	Vc	180	BS10	148
fol	Vs	180	BS12	100	fol	Vc	180	BS12	164
fol	Vs	200	BS04	101	fol	Vc	200	BS04	188
fol	Vs	200	BS06	98	fol	Vc	200	BS06	167
fol	Vs	200	BS08	110	fol	Vc	200	BS08	179
fol	Vs	200	BS10	87	fol	Vc	200	BS10	139
fol	Vs	200	BS12	97	fol	Vc	200	BS12	155

### Two Lane Load Effects, Spread Box Beams (BS)

Lane	Effect	Span	Bridge	RLE	Lane	Effect	Span	Bridge	RLE
04B	Ms	20	BS04	341	04B	Mc	20	BS04	218
06B	Ms	20	BS06	233	06B	Mc	20	BS06	149
08B	Ms	20	BS08	219	08B	Mc	20	BS08	141
10B	Ms	20	BS10	166	10B	Mc	20	BS10	107
12B	Ms	20	BS12	173	12B	Mc	20	BS12	111
04B	Ms	40	BS04	646	04B	Mc	40	BS04	564
06B	Ms	40	BS06	492	06B	Mc	40	BS06	454
08B	Ms	40	BS08	488	08B	Mc	40	BS08	468
10B	Ms	40	BS10	376	10B	Mc	40	BS10	369
12B	Ms	40	BS12	404	12B	Mc	40	BS12	405
04B	Ms	60	BS04	997	04B	Mc	60	BS04	735
06B	Ms	60	BS06	810	06B	Mc	60	BS06	629
08B	Ms	60	BS08	834	08B	Mc	60	BS08	669
10B	Ms	60	BS10	651	10B	Mc	60	BS10	532
12B	Ms	60	BS12	714	12B	Mc	60	BS12	593
04B	Ms	80	BS04	1697	04B	Mc	80	BS04	826



06B	Ms	80	BS06	1457	06B	Mc	80	BS06	754
08B	Ms	80	BS08	1548	08B	Mc	80	BS08	828
10B	Ms	80	BS10	1230	10B	Mc	80	BS10	668
12B	Ms	80	BS12	1377	12B	Mc	80	BS12	754
04B	Ms	100	BS04	2372	04B	Mc	100	BS04	831
06B	Ms	100	BS06	2092	06B	Mc	100	BS06	820
08B	Ms	100	BS08	2256	08B	Mc	100	BS08	936
10B	Ms	100	BS10	1801	10B	Mc	100	BS10	766
12B	Ms	100	BS12	2032	12B	Mc	100	BS12	877
04B	Ms	120	BS04	2852	04B	Mc	120	BS04	704
06B	Ms	120	BS06	2584	06B	Mc	120	BS06	802
08B	Ms	120	BS08	2826	08B	Mc	120	BS08	974
10B	Ms	120	BS10	2268	10B	Mc	120	BS10	818
12B	Ms	120	BS12	2576	12B	Mc	120	BS12	954
04B	Ms	140	BS04	3051	04B	Mc	140	BS04	488
06B	Ms	140	BS06	2862	06B	Mc	140	BS06	733
08B	Ms	140	BS08	3184	08B	Mc	140	BS08	971
10B	Ms	140	BS10	2579	10B	Mc	140	BS10	847
12B	Ms	140	BS12	2950	12B	Mc	140	BS12	1011
04B	Ms	160	BS04	3109	04B	Mc	160	BS04	176
06B	Ms	160	BS06	3044	06B	Mc	160	BS06	599
08B	Ms	160	BS08	3457	08B	Mc	160	BS08	911
10B	Ms	160	BS10	2826	10B	Mc	160	BS10	836
12B	Ms	160	BS12	3258	12B	Mc	160	BS12	1024
04B	Ms	180	BS04	3191	04B	Mc	180	BS04	0
06B	Ms	180	BS06	3278	06B	Mc	180	BS06	418
08B	Ms	180	BS08	3807	08B	Mc	180	BS08	821
10B	Ms	180	BS10	3145	10B	Mc	180	BS10	809
12B	Ms	180	BS12	3654	12B	Mc	180	BS12	1026
04B	Ms	200	BS04	2928	04B	Mc	200	BS04	0
06B	Ms	200	BS06	3234	06B	Mc	200	BS06	79
08B	Ms	200	BS08	3877	08B	Mc	200	BS08	585
10B	Ms	200	BS10	3238	10B	Mc	200	BS10	666
12B	Ms	200	BS12	3797	12B	Mc	200	BS12	902
04B	Vs	20	BS04	73	04B	Vc	20	BS04	115
06B	Vs	20	BS06	50	06B	Vc	20	BS06	78
08B	Vs	20	BS08	47	08B	Vc	20	BS08	73
10B	Vs	20	BS10	36	10B	Vc	20	BS10	55
12B	Vs	20	BS12	37	12B	Vc	20	BS12	57
04B	Vs	40	BS04	93	04B	Vc	40	BS04	160
06B	Vs	40	BS06	70	06B	Vc	40	BS06	123

08B	Vs	40	BS08	69	08B	Vc	40	BS08	123
10B	Vs	40	BS10	53	10B	Vc	40	BS10	95
12B	Vs	40	BS12	57	12B	Vc	40	BS12	103
04B	Vs	60	BS04	104	04B	Vc	60	BS04	179
06B	Vs	60	BS06	82	06B	Vc	60	BS06	148
08B	Vs	60	BS08	84	08B	Vc	60	BS08	154
10B	Vs	60	BS10	64	10B	Vc	60	BS10	122
12B	Vs	60	BS12	70	12B	Vc	60	BS12	135
04B	Vs	80	BS04	108	04B	Vc	80	BS04	182
06B	Vs	80	BS06	91	06B	Vc	80	BS06	156
08B	Vs	80	BS08	95	08B	Vc	80	BS08	166
10B	Vs	80	BS10	74	10B	Vc	80	BS10	132
12B	Vs	80	BS12	82	12B	Vc	80	BS12	149
04B	Vs	100	BS04	105	04B	Vc	100	BS04	173
06B	Vs	100	BS06	93	06B	Vc	100	BS06	154
08B	Vs	100	BS08	100	08B	Vc	100	BS08	166
10B	Vs	100	BS10	79	10B	Vc	100	BS10	133
12B	Vs	100	BS12	89	12B	Vc	100	BS12	151
04B	Vs	120	BS04	96	04B	Vc	120	BS04	163
06B	Vs	120	BS06	91	06B	Vc	120	BS06	150
08B	Vs	120	BS08	103	08B	Vc	120	BS08	165
10B	Vs	120	BS10	84	10B	Vc	120	BS10	133
12B	Vs	120	BS12	96	12B	Vc	120	BS12	152
04B	Vs	140	BS04	82	04B	Vc	140	BS04	146
06B	Vs	140	BS06	84	06B	Vc	140	BS06	140
08B	Vs	140	BS08	98	08B	Vc	140	BS08	157
10B	Vs	140	BS10	81	10B	Vc	140	BS10	128
12B	Vs	140	BS12	94	12B	Vc	140	BS12	147
04B	Vs	160	BS04	67	04B	Vc	160	BS04	127
06B	Vs	160	BS06	76	06B	Vc	160	BS06	128
08B	Vs	160	BS08	92	08B	Vc	160	BS08	147
10B	Vs	160	BS10	78	10B	Vc	160	BS10	121
12B	Vs	160	BS12	91	12B	Vc	160	BS12	140
04B	Vs	180	BS04	54	04B	Vc	180	BS04	111
06B	Vs	180	BS06	69	06B	Vc	180	BS06	119
08B	Vs	180	BS08	88	08B	Vc	180	BS08	140
10B	Vs	180	BS10	75	10B	Vc	180	BS10	117
12B	Vs	180	BS12	89	12B	Vc	180	BS12	136
04B	Vs	200	BS04	35	04B	Vc	200	BS04	89
06B	Vs	200	BS06	57	06B	Vc	200	BS06	104
08B	Vs	200	BS08	78	08B	Vc	200	BS08	127

10B	Vs	200	BS10	68	10B	Vc	200	BS10	108
12B	Vs	200	BS12	82	12B	Vc	200	BS12	127

**Single Lane Load Effects, Side-By-Side Box Beam (BT), 36' Wide Box**

Lane	Effect	Span	Bridge	RLE	Lane	Effect	Span	Bridge	RLE
fol	Ms	20	BT36	284	fol	Mc	20	BT36	177
fol	Ms	40	BT36	512	fol	Mc	40	BT36	275
fol	Ms	60	BT36	639	fol	Mc	60	BT36	473
fol	Ms	80	BT36	631	fol	Mc	80	BT36	476
fol	Ms	100	BT36	558	fol	Mc	100	BT36	320
fol	Ms	120	BT36	588	fol	Mc	120	BT36	0
fol	Ms	140	BT36	390	fol	Mc	140	BT36	0
fol	Ms	160	BT36	108	fol	Mc	160	BT36	0
fol	Ms	180	BT36	0	fol	Mc	180	BT36	0
fol	Ms	200	BT36	0	fol	Mc	200	BT36	0
fol	Vs	20	BT36	98	fol	Vc	20	BT36	164
fol	Vs	40	BT36	112	fol	Vc	40	BT36	171
fol	Vs	60	BT36	120	fol	Vc	60	BT36	224
fol	Vs	80	BT36	114	fol	Vc	80	BT36	277
fol	Vs	100	BT36	122	fol	Vc	100	BT36	293
fol	Vs	120	BT36	130	fol	Vc	120	BT36	286
fol	Vs	140	BT36	133	fol	Vc	140	BT36	267
fol	Vs	160	BT36	131	fol	Vc	160	BT36	246
fol	Vs	180	BT36	120	fol	Vc	180	BT36	222
fol	Vs	200	BT36	110	fol	Vc	200	BT36	203

**Two Lane Load Effects, Side-By-Side Box Beam (BT), 36' Wide Box**

Lane	Effect	Span	Bridge	RLE	Lane	Effect	Span	Bridge	RLE
36T	Ms	20	BT36	281	36T	Mc	20	BT36	178
36T	Ms	40	BT36	459	36T	Mc	40	BT36	331
36T	Ms	60	BT36	618	36T	Mc	60	BT36	398
36T	Ms	80	BT36	936	36T	Mc	80	BT36	363
36T	Ms	100	BT36	1258	36T	Mc	100	BT36	255
36T	Ms	120	BT36	1372	36T	Mc	120	BT36	0
36T	Ms	140	BT36	1321	36T	Mc	140	BT36	0
36T	Ms	160	BT36	1124	36T	Mc	160	BT36	0
36T	Ms	180	BT36	765	36T	Mc	180	BT36	0
36T	Ms	200	BT36	370	36T	Mc	200	BT36	0
36T	Vs	20	BT36	101	36T	Vc	20	BT36	160

36T	Vs	40	BT36	114	36T	Vc	40	BT36	187
36T	Vs	60	BT36	126	36T	Vc	60	BT36	196
36T	Vs	80	BT36	123	36T	Vc	80	BT36	189
36T	Vs	100	BT36	115	36T	Vc	100	BT36	179
36T	Vs	120	BT36	95	36T	Vc	120	BT36	161
36T	Vs	140	BT36	78	36T	Vc	140	BT36	143
36T	Vs	160	BT36	60	36T	Vc	160	BT36	121
36T	Vs	180	BT36	41	36T	Vc	180	BT36	98
36T	Vs	200	BT36	24	36T	Vc	200	BT36	78

### Single Lane Load Effects, Side-By-Side Box Beam (BT), 48" Wide Box

Lane	Effect	Span	Bridge	RLE	Lane	Effect	Span	Bridge	RLE
fol	Ms	20	BT48	278	fol	Mc	20	BT48	174
fol	Ms	40	BT48	501	fol	Mc	40	BT48	269
fol	Ms	60	BT48	622	fol	Mc	60	BT48	459
fol	Ms	80	BT48	611	fol	Mc	80	BT48	458
fol	Ms	100	BT48	533	fol	Mc	100	BT48	299
fol	Ms	120	BT48	555	fol	Mc	120	BT48	0
fol	Ms	140	BT48	351	fol	Mc	140	BT48	0
fol	Ms	160	BT48	61	fol	Mc	160	BT48	0
fol	Ms	180	BT48	0	fol	Mc	180	BT48	0
fol	Ms	200	BT48	0	fol	Mc	200	BT48	0
fol	Vs	20	BT48	76	fol	Vc	20	BT48	129
fol	Vs	40	BT48	85	fol	Vc	40	BT48	132
fol	Vs	60	BT48	85	fol	Vc	60	BT48	165
fol	Vs	80	BT48	77	fol	Vc	80	BT48	203
fol	Vs	100	BT48	81	fol	Vc	100	BT48	212
fol	Vs	120	BT48	83	fol	Vc	120	BT48	201
fol	Vs	140	BT48	81	fol	Vc	140	BT48	183
fol	Vs	160	BT48	75	fol	Vc	160	BT48	163
fol	Vs	180	BT48	61	fol	Vc	180	BT48	139
fol	Vs	200	BT48	48	fol	Vc	200	BT48	119

### Two Lane Load Effects, Side-By-Side Box Beam (BT), 48" Wide Box

Lane	Effect	Span	Bridge	RLE	Lane	Effect	Span	Bridge	RLE
48T	Ms	20	BT48	276	48T	Mc	20	BT48	175
48T	Ms	40	BT48	452	48T	Mc	40	BT48	331
48T	Ms	60	BT48	609	48T	Mc	60	BT48	396
48T	Ms	80	BT48	930	48T	Mc	80	BT48	359

48T	Ms	100	BT48	1252	48T	Mc	100	BT48	251
48T	Ms	120	BT48	1364	48T	Mc	120	BT48	0
48T	Ms	140	BT48	1310	48T	Mc	140	BT48	0
48T	Ms	160	BT48	1111	48T	Mc	160	BT48	0
48T	Ms	180	BT48	751	48T	Mc	180	BT48	0
48T	Ms	200	BT48	299	48T	Mc	200	BT48	0
<hr/>					<hr/>				
48T	Vs	20	BT48	80	48T	Vc	20	BT48	127
48T	Vs	40	BT48	89	48T	Vc	40	BT48	152
48T	Vs	60	BT48	92	48T	Vc	60	BT48	157
48T	Vs	80	BT48	89	48T	Vc	80	BT48	151
48T	Vs	100	BT48	82	48T	Vc	100	BT48	141
48T	Vs	120	BT48	67	48T	Vc	120	BT48	124
48T	Vs	140	BT48	51	48T	Vc	140	BT48	106
48T	Vs	160	BT48	35	48T	Vc	160	BT48	85
48T	Vs	180	BT48	15	48T	Vc	180	BT48	63
48T	Vs	200	BT48	0	48T	Vc	200	BT48	42
<hr/>					<hr/>				

## APPENDIX K. REQUIRED LOAD FACTORS

### Load Factors for LRFR

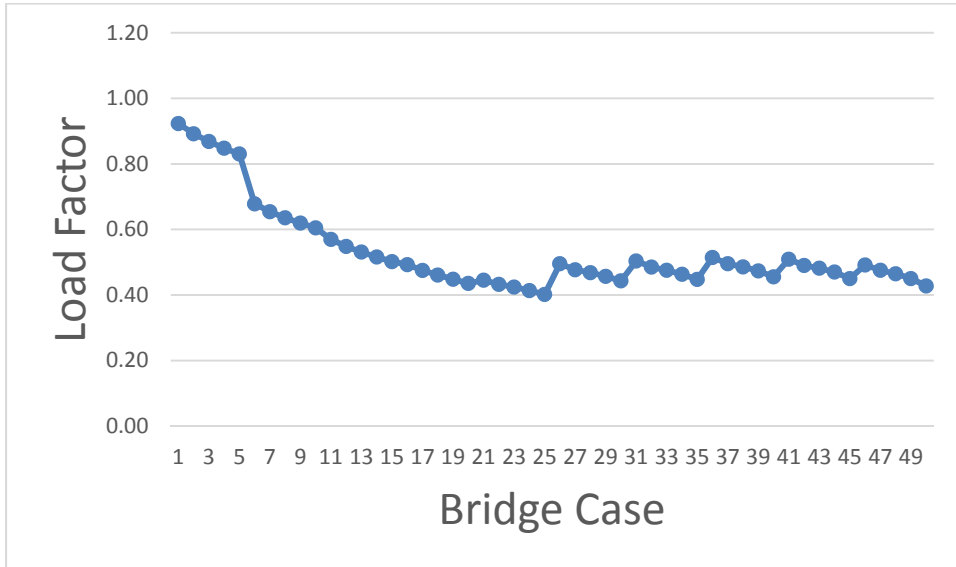

Figure K.1.1. Required Load Factors for Steel, Simple Moment, One Lane.

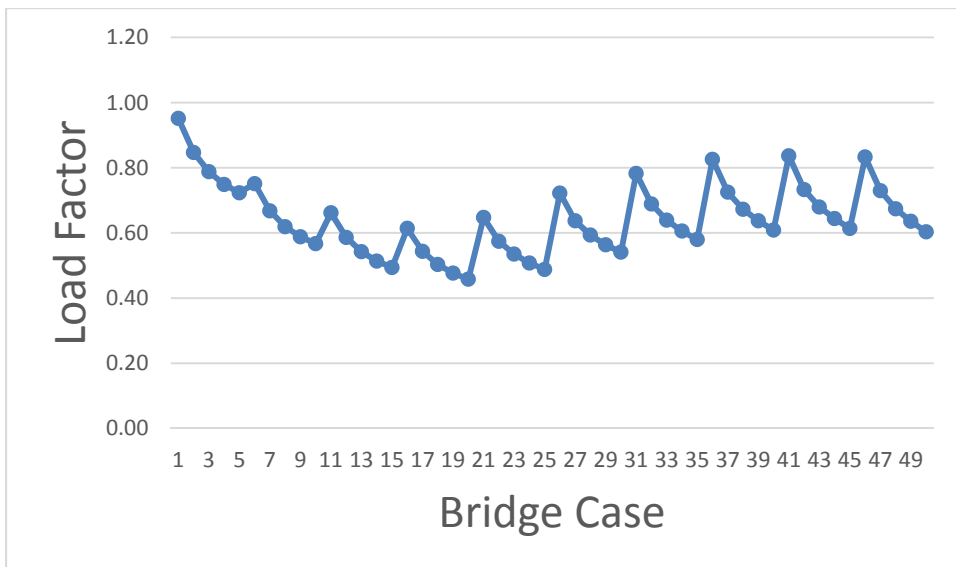

Figure K.1.2. Required Load Factors for Steel, Simple Shear, One Lane.

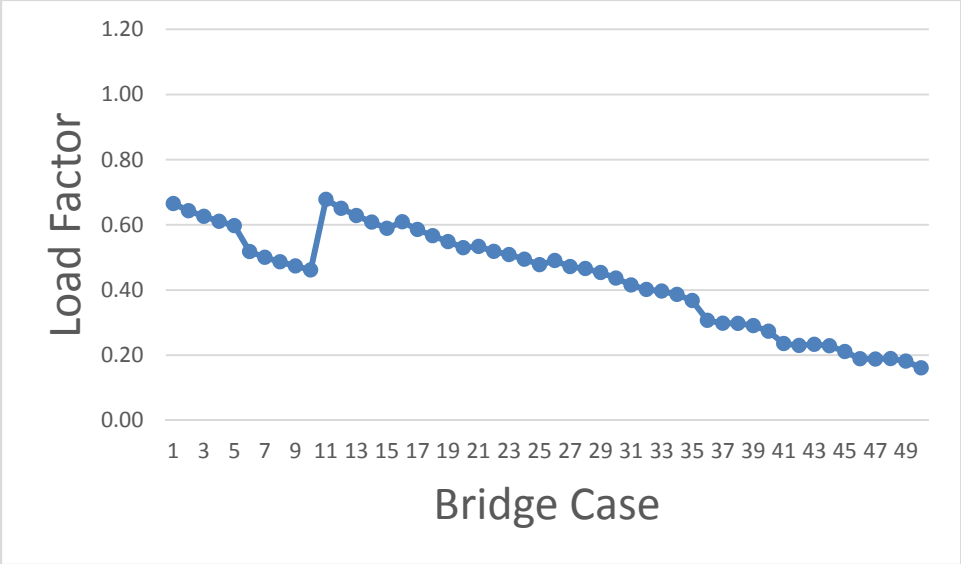

Figure K.1.3.1. Required Load Factors for Steel, Continuous Negative Moment, One Lane.

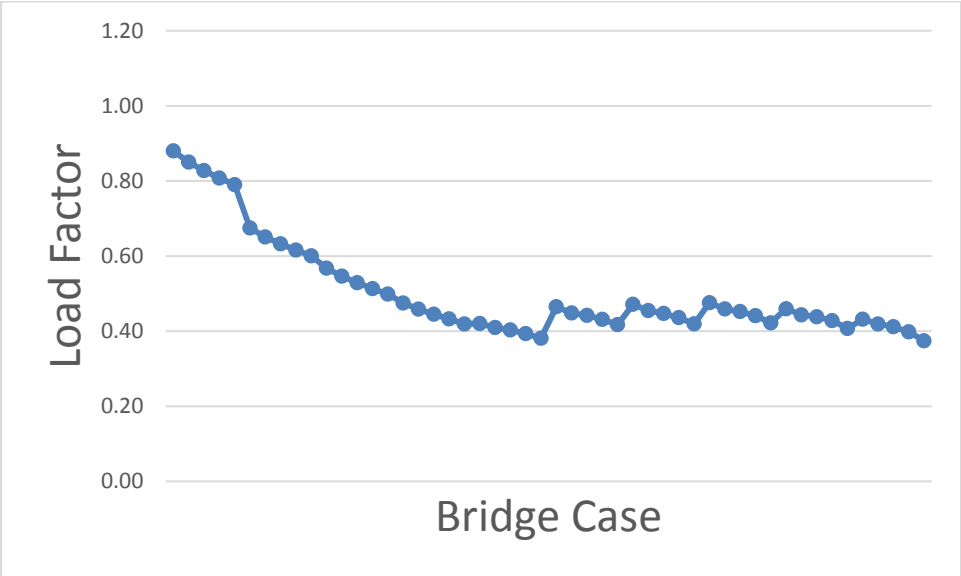

Figure K.1.3.2. Required Load Factors for Steel, Continuous Positive Moment, One Lane.

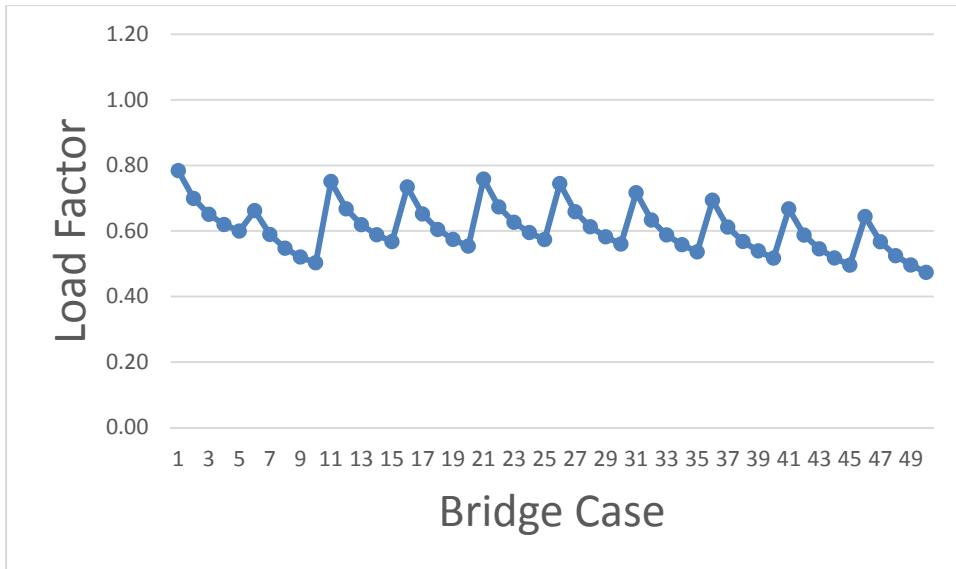

Figure K.1.4. Required Load Factors for Steel, Continuous Shear, One Lane.

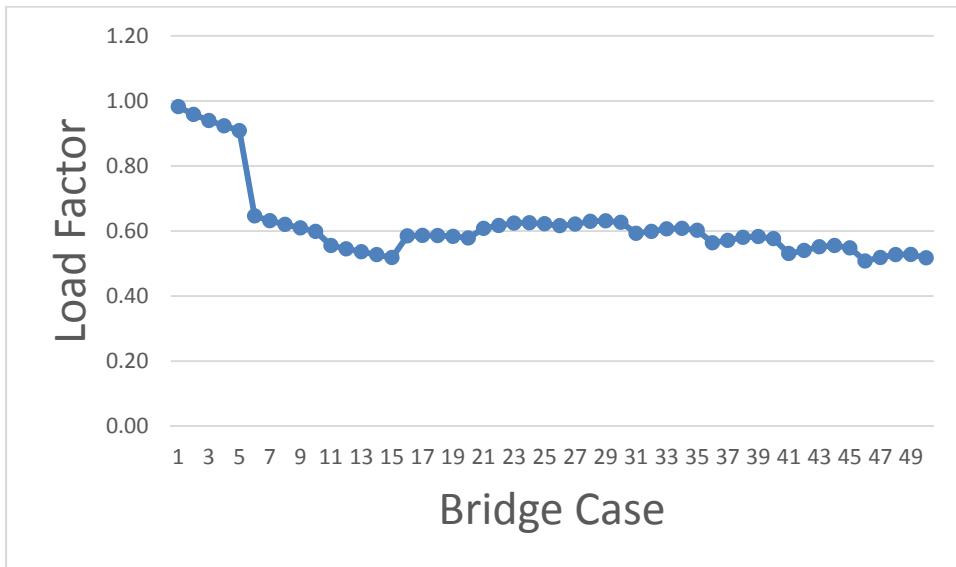

Figure K.1.5. Required Load Factors for Steel, Simple Moment, Two Lane.



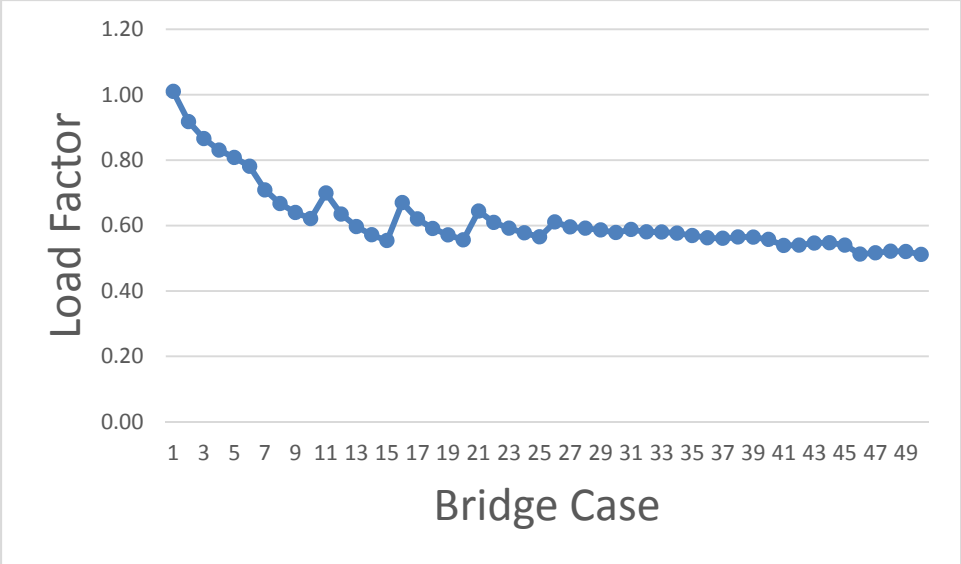

Figure K.1.6. Required Load Factors for Steel, Simple Shear, Two Lane.

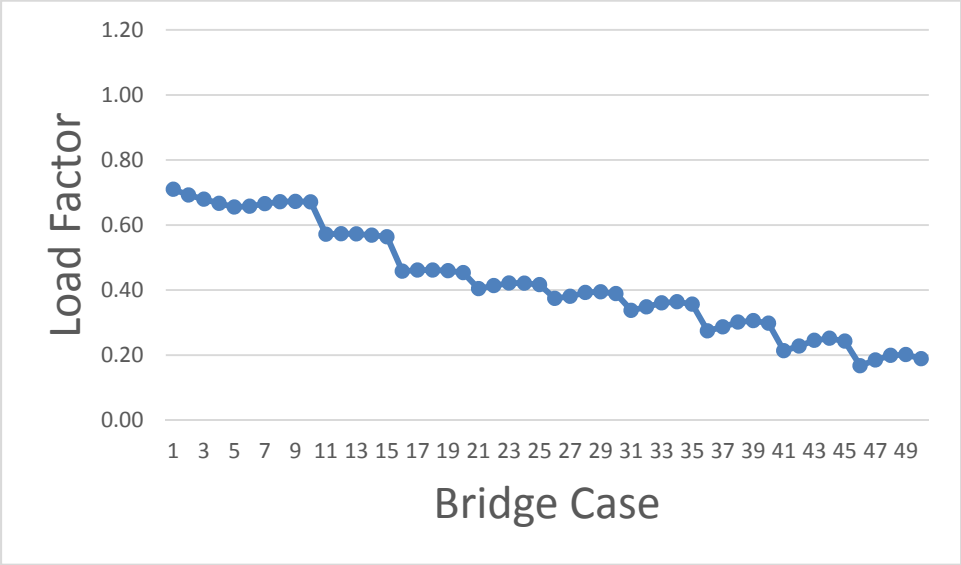

Figure K.1.7.1. Required Load Factors for Steel, Continuous Negative Moment, Two Lane.

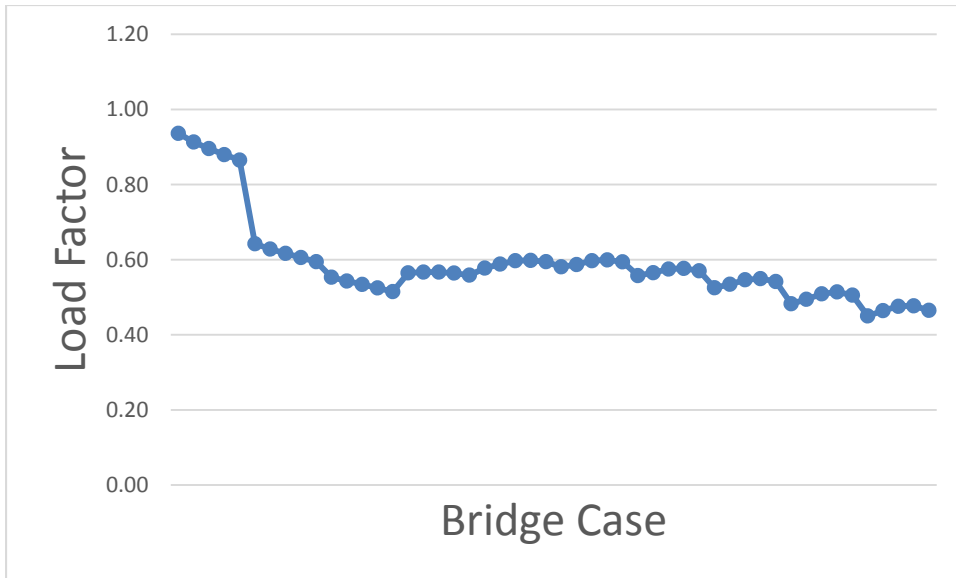

Figure K.1.7.2. Required Load Factors for Steel, Continuous Positive Moment, Two Lane.

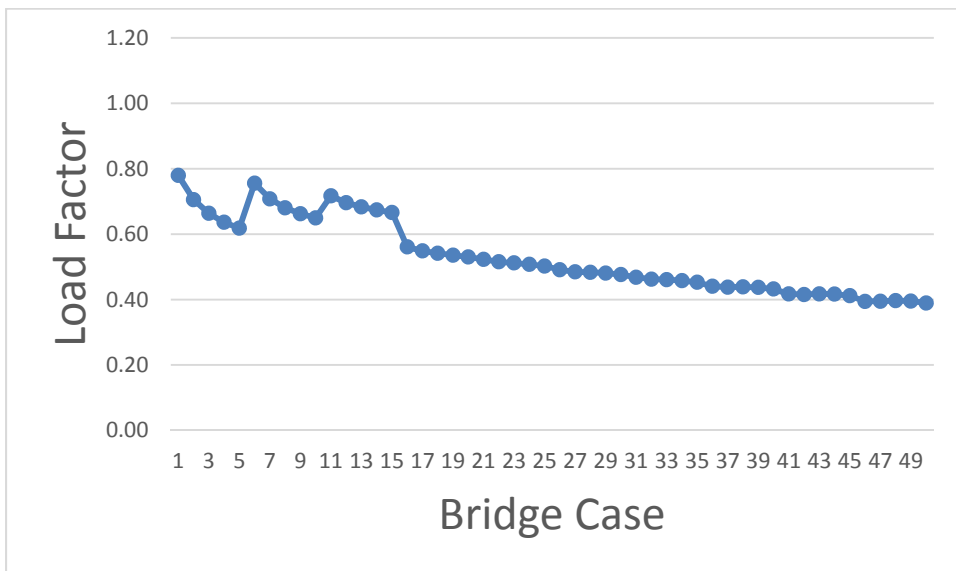

Figure K.1.8. Required Load Factors for Steel, Continuous Shear, Two Lane.

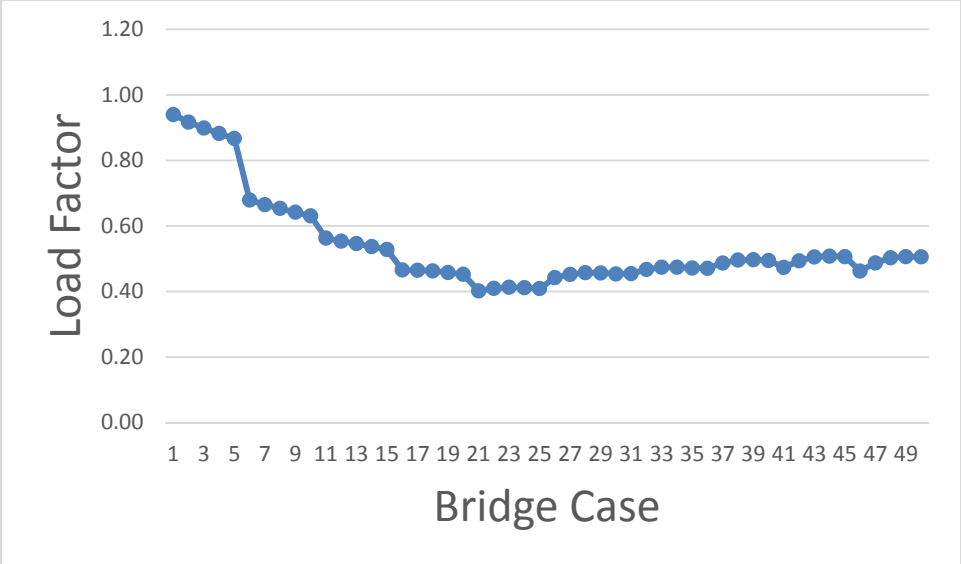

Figure K.1.9. Required Load Factors for PC, Simple Moment, One Lane.

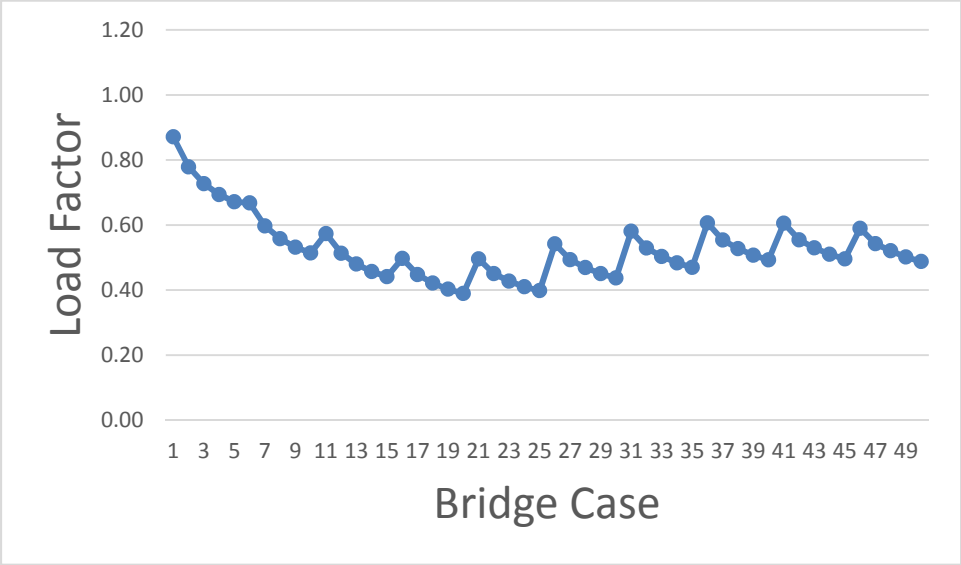

Figure K.1.10. Required Load Factors for PC, Simple Shear, One Lane.

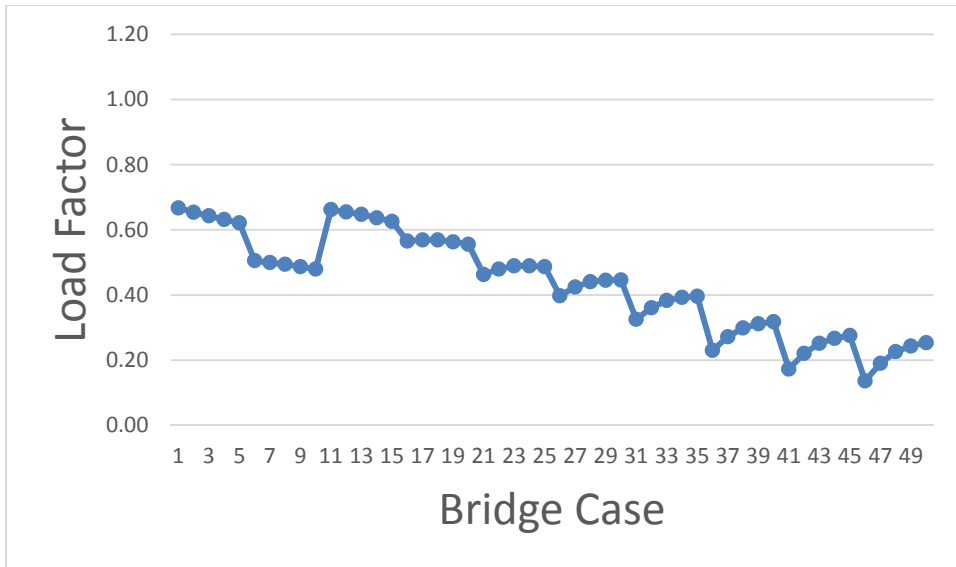

Figure K.1.11. Required Load Factors for PC, Continuous Negative Moment, One Lane.

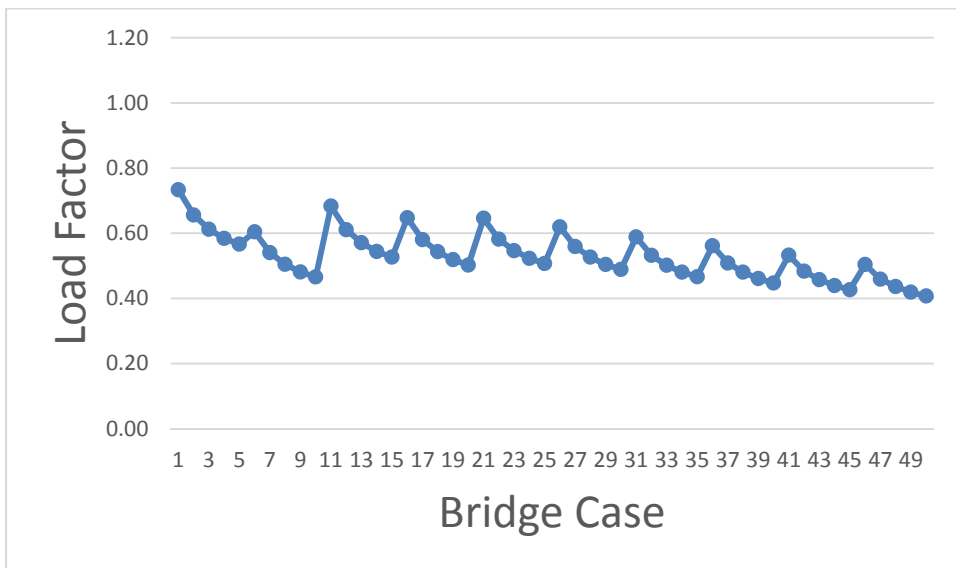

Figure K.1.12. Required Load Factors for PC, Continuous Shear, One Lane.

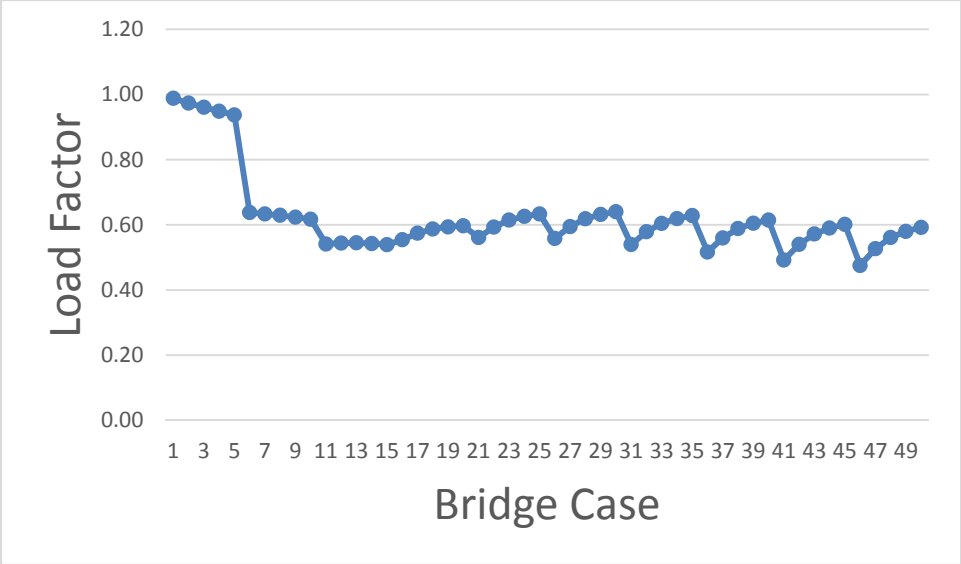

Figure K.1.13. Required Load Factors for PC, Simple Moment, Two Lane.

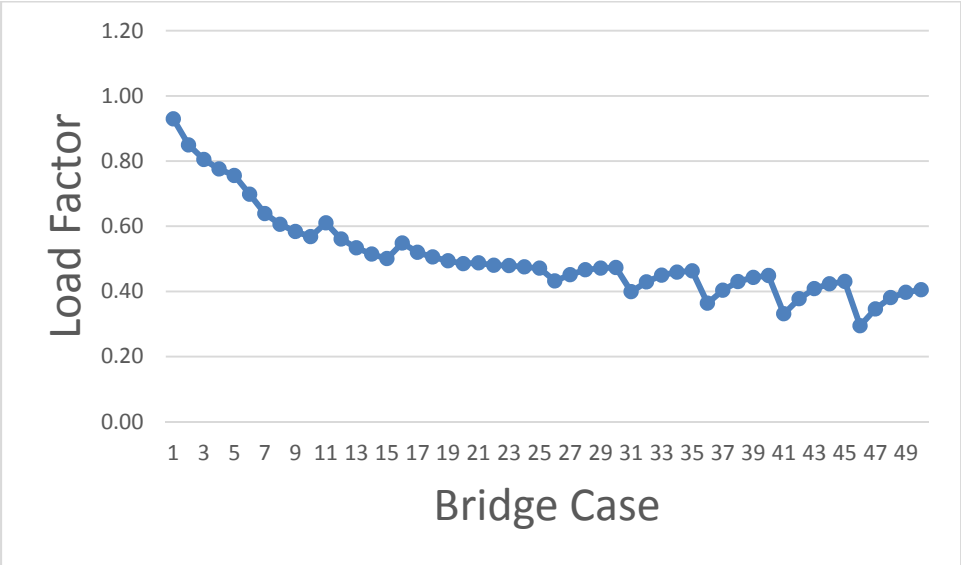

Figure K.1.14. Required Load Factors for PC, Simple Shear, Two Lane.

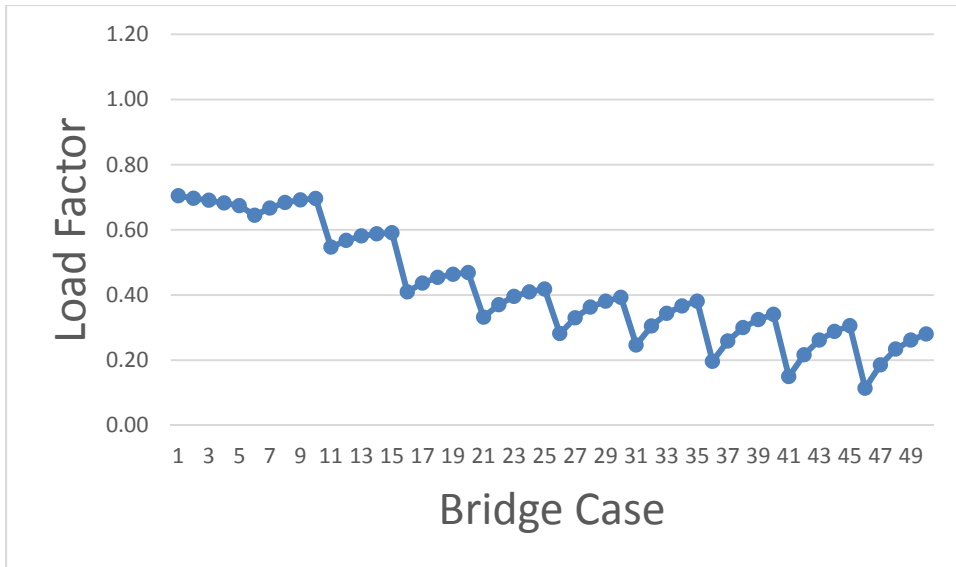

Figure K.1.15. Required Load Factors for PC, Continuous Negative Moment, Two Lane.

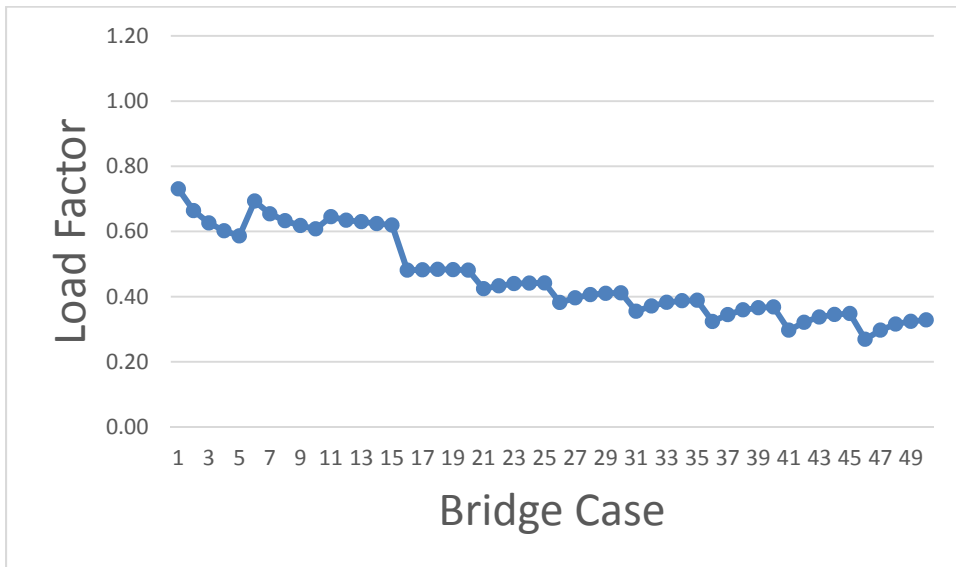

Figure K.1.16. Required Load Factors for PC, Continuous Shear, Two Lane.

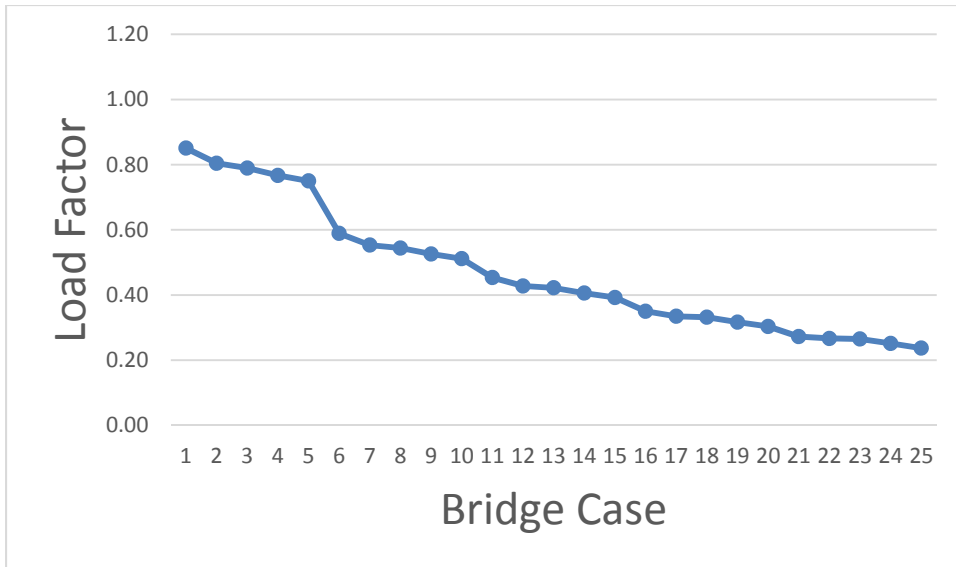

Figure K.1.17. Required Load Factors for RC, Simple Moment, One Lane.

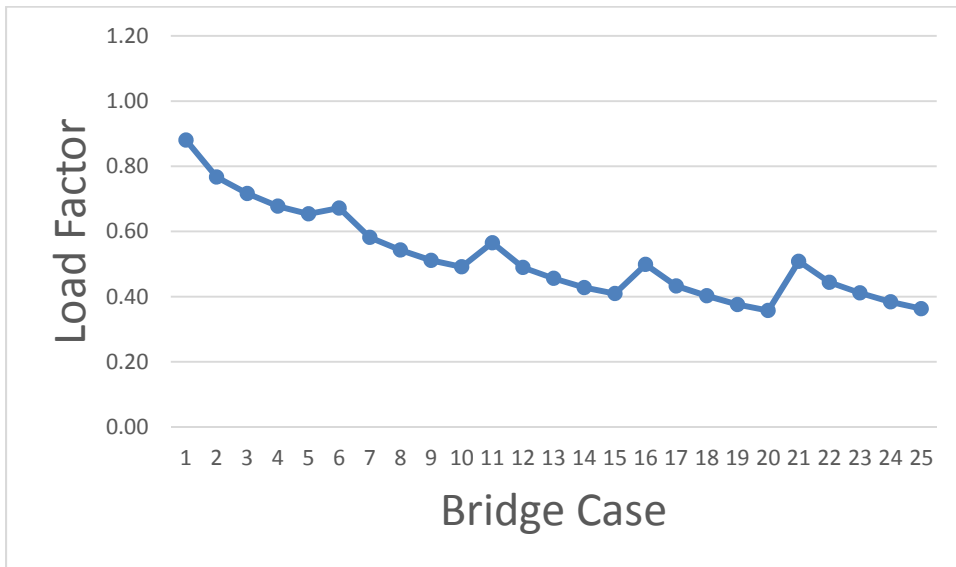

Figure K.1.18. Required Load Factors for RC, Simple Shear, One Lane.

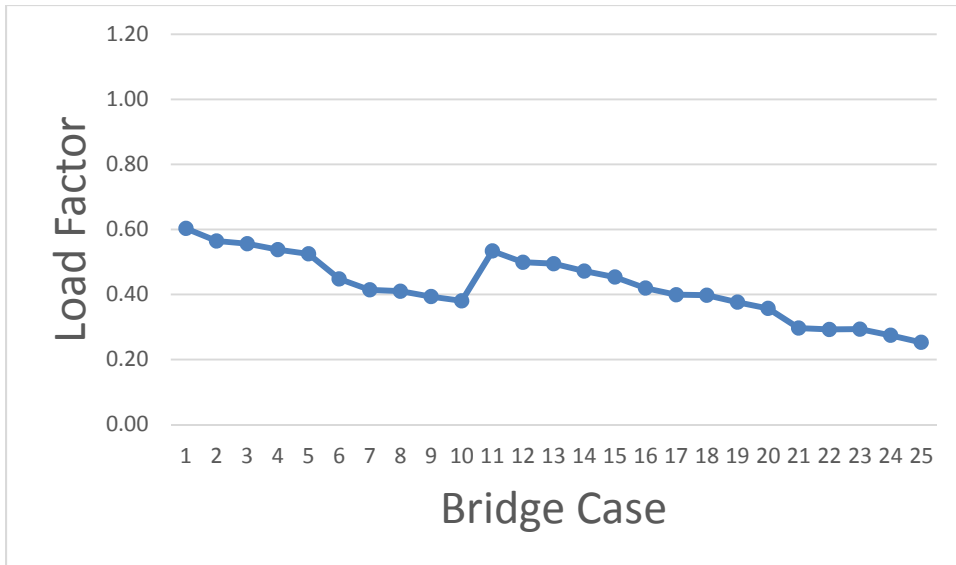

Figure K.1.19.1. Required Load Factors for RC, Continuous Negative Moment, One Lane.

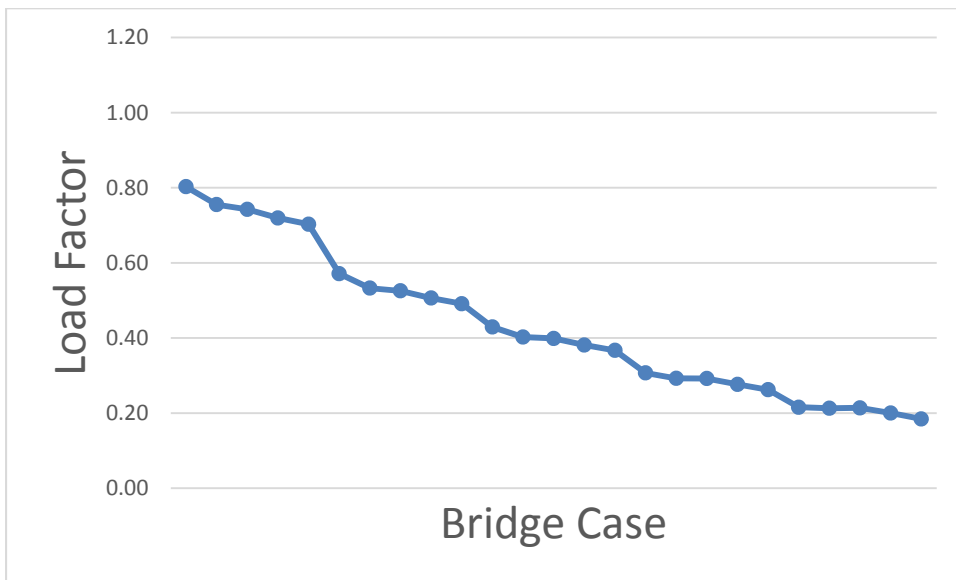

Figure K.1.19.2. Required Load Factors for RC, Continuous Positive Moment, One Lane.



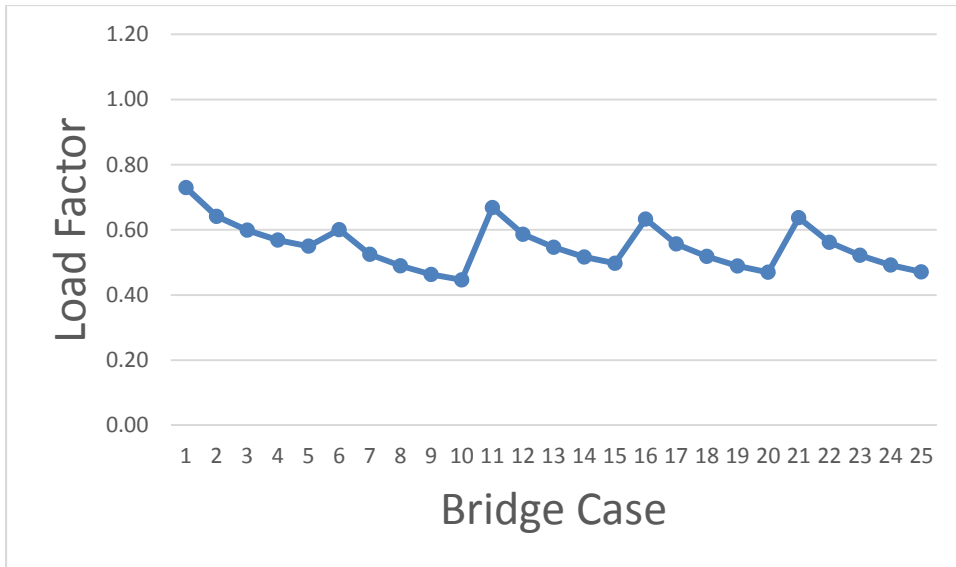

Figure K.1.20. Required Load Factors for RC, Continuous Shear, One Lane.

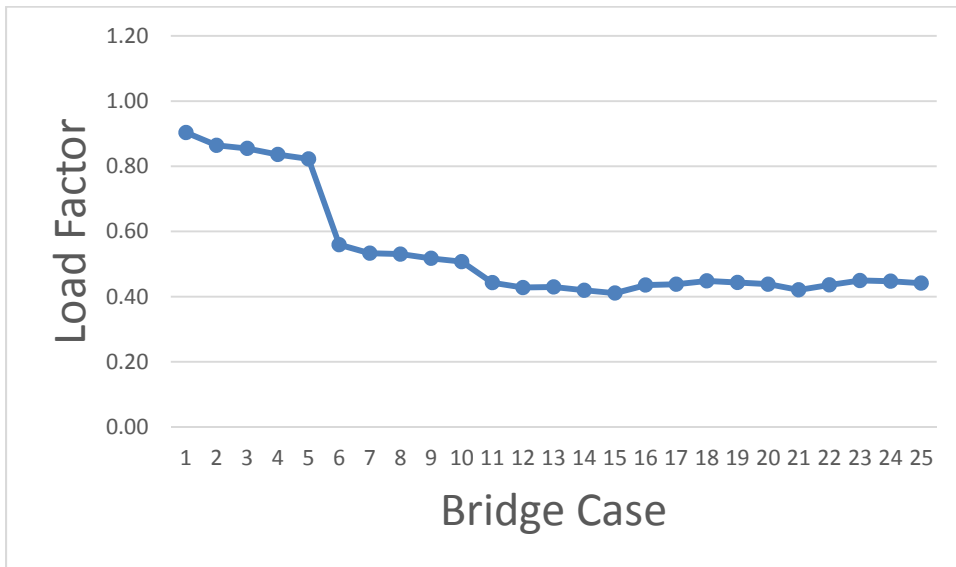

Figure K.1.21. Required Load Factors for RC, Simple Moment, Two Lane.

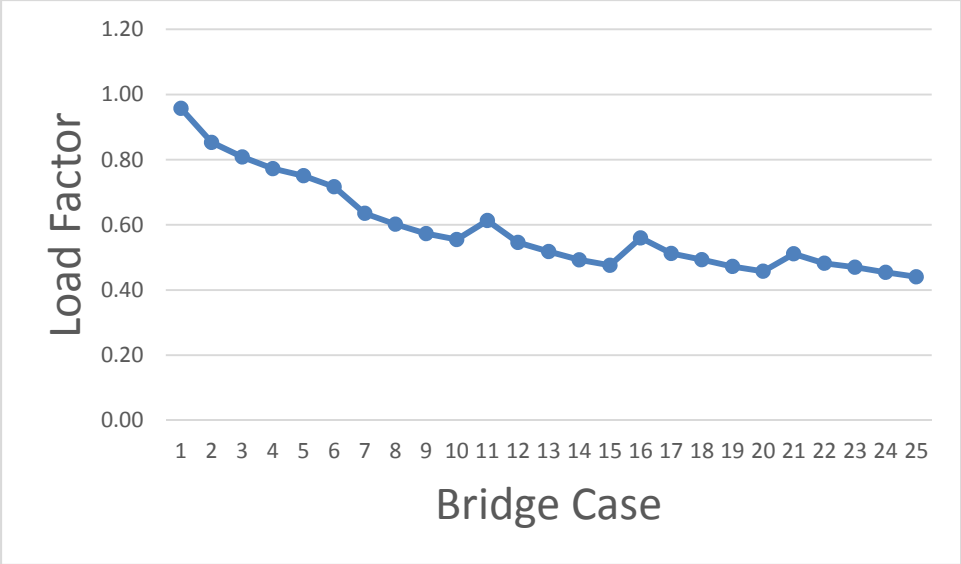

Figure K.1.22. Required Load Factors for RC, Simple Shear, Two Lane.

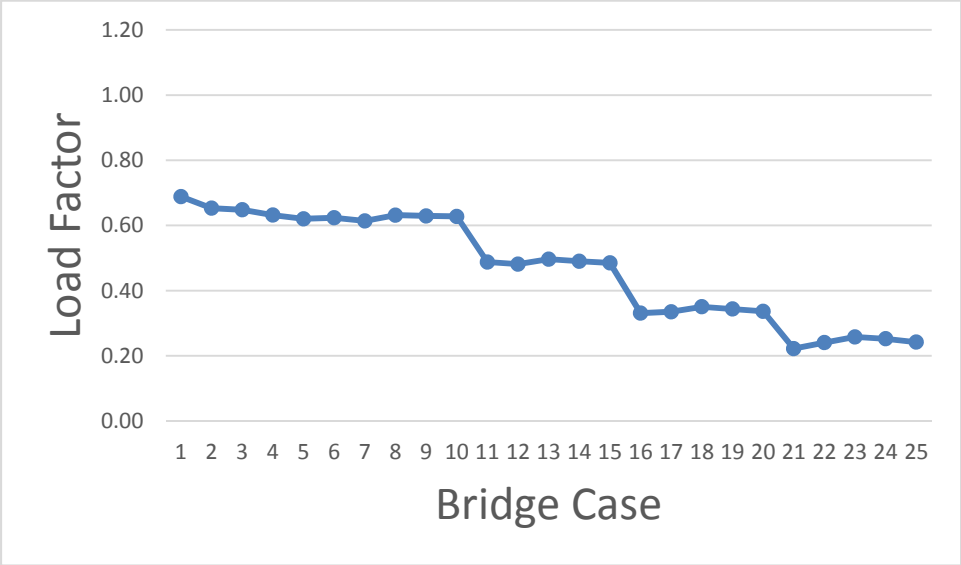

Figure K.1.23.1. Required Load Factors for RC, Continuous Negative Moment, Two Lane.

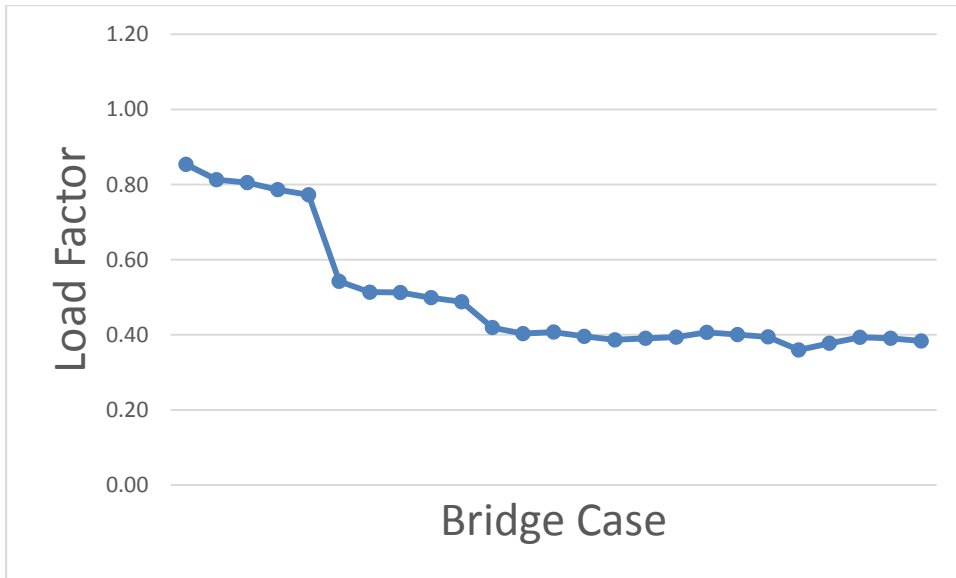

Figure K.1.23.2. Required Load Factors for RC, Continuous Positive Moment, Two Lane.

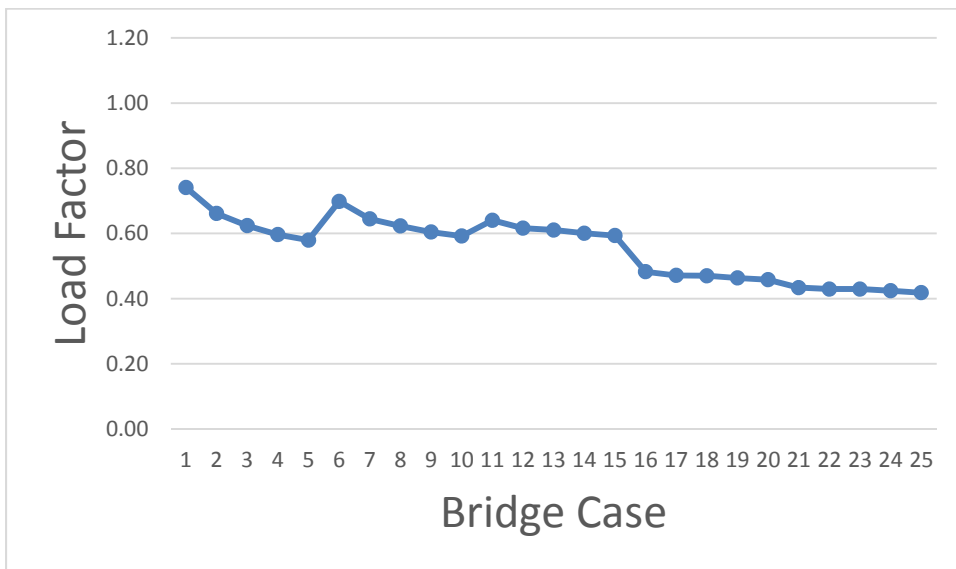

Figure K.1.24. Required Load Factors for RC, Continuous Shear, Two Lane.

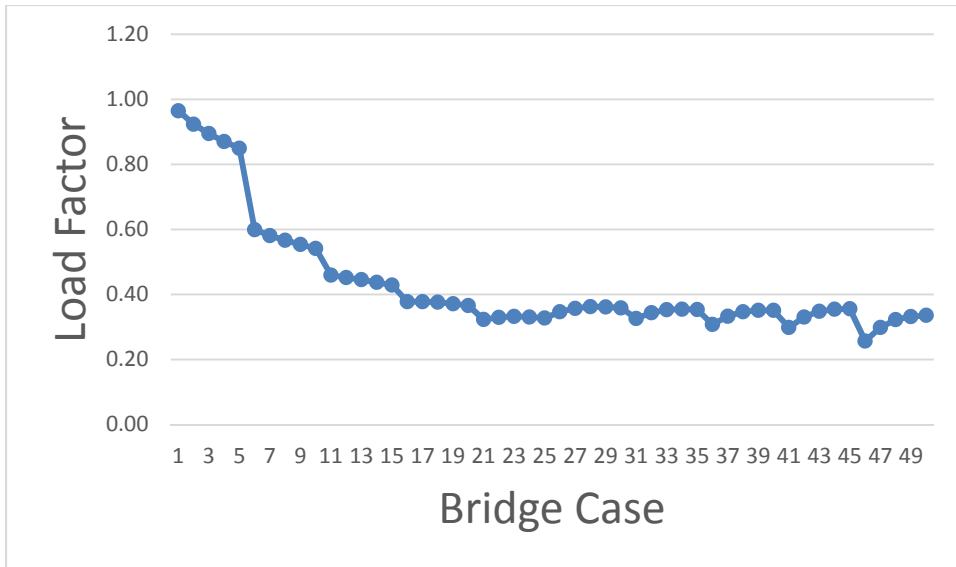

Figure K.1.25. Required Load Factors for Spread Box, Simple Moment, One Lane.

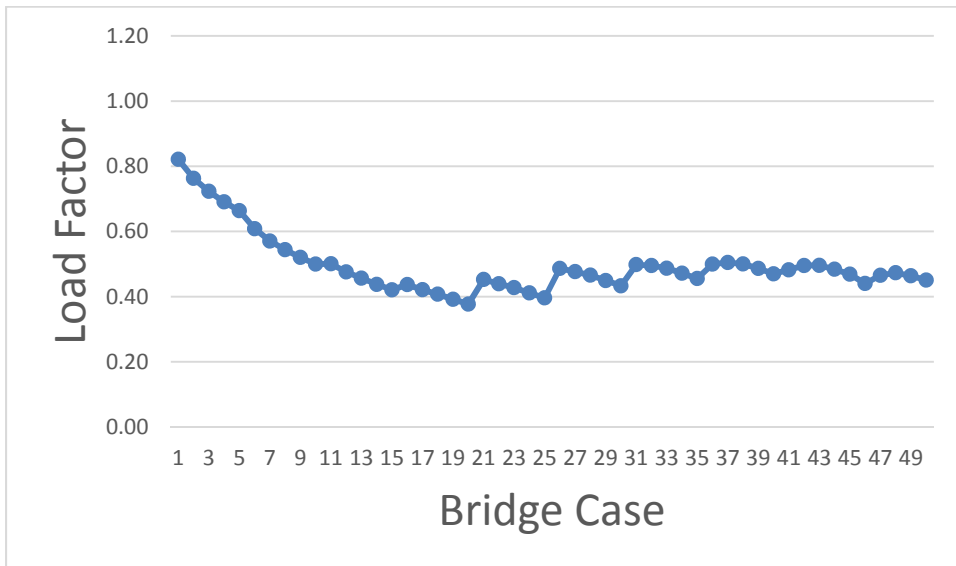

Figure K.1.26. Required Load Factors for Spread Box, Simple Shear, One Lane.

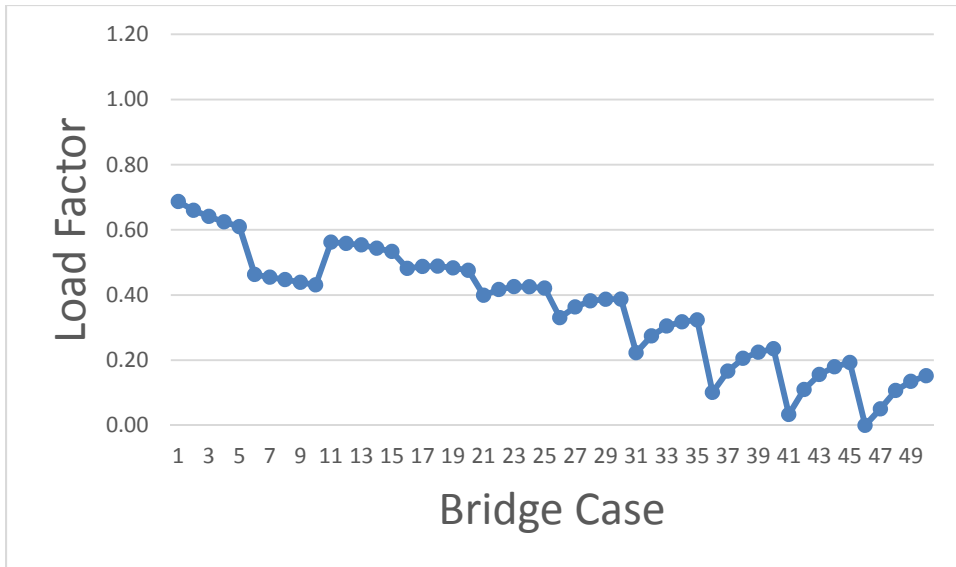

Figure K.1.27. Required Load Factors for Spread Box, Continuous Negative Moment, One Lane.

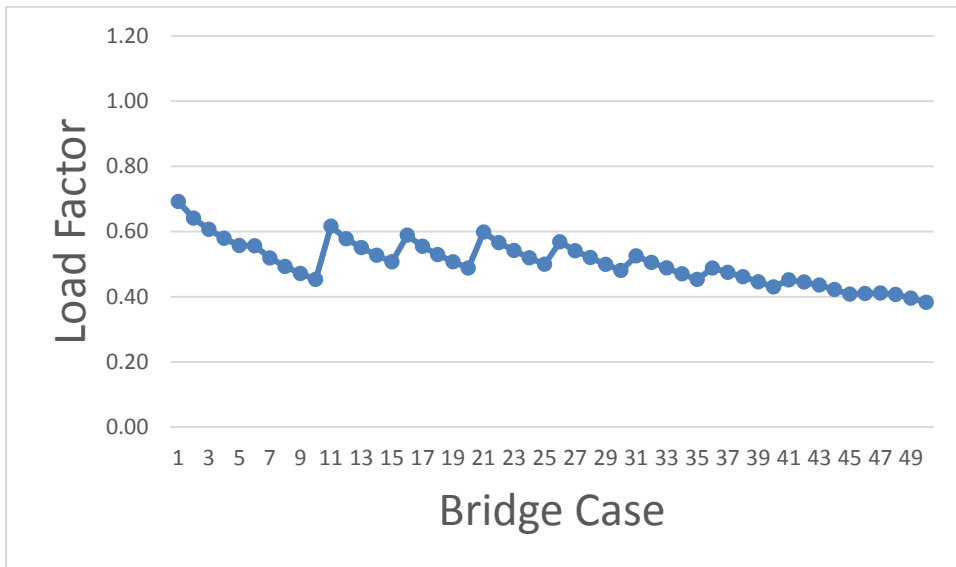

Figure K.1.28. Required Load Factors for Spread Box, Continuous Shear, One Lane.

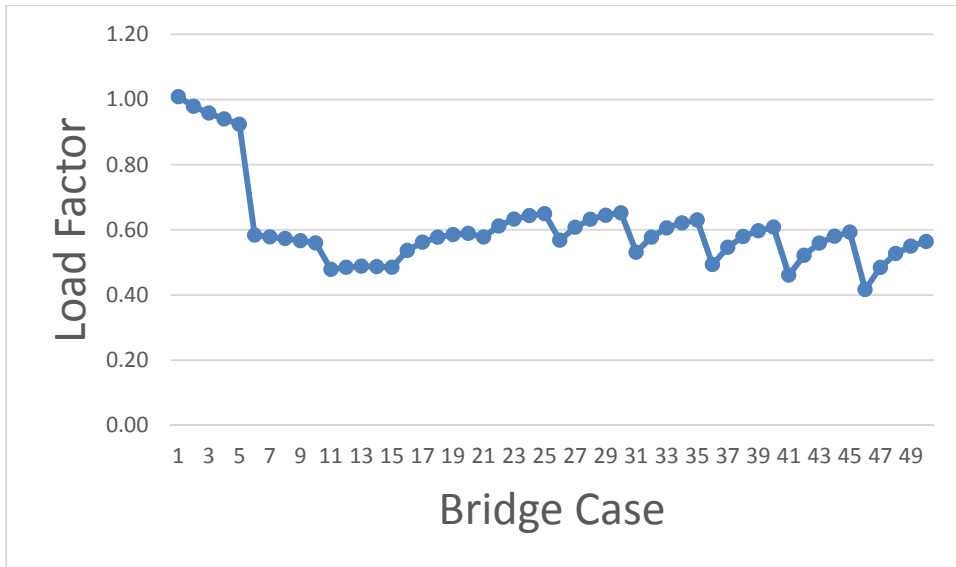

Figure K.1.29. Required Load Factors for Spread Box, Simple Moment, Two Lane.

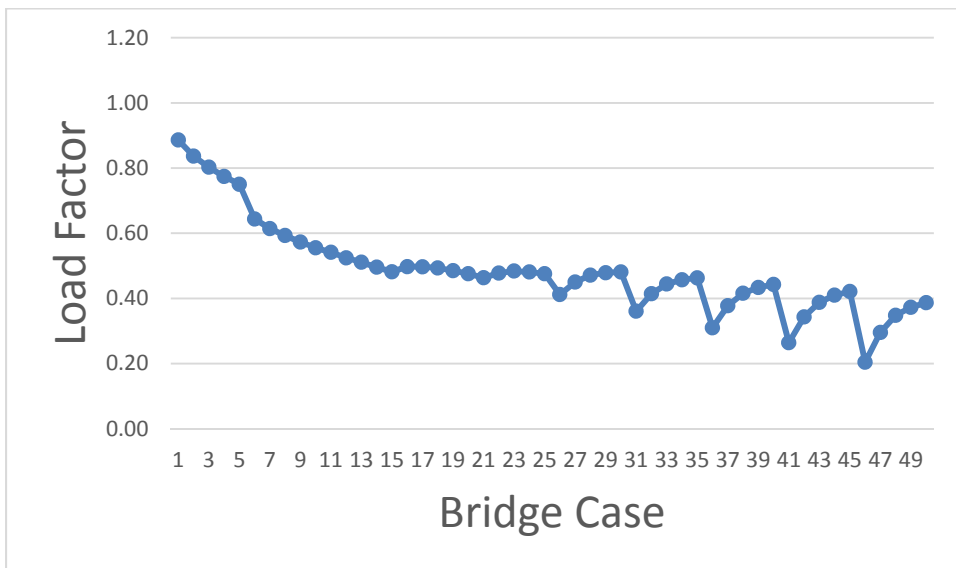

Figure K.1.30. Required Load Factors for Spread Box, Simple Shear, Two Lane.

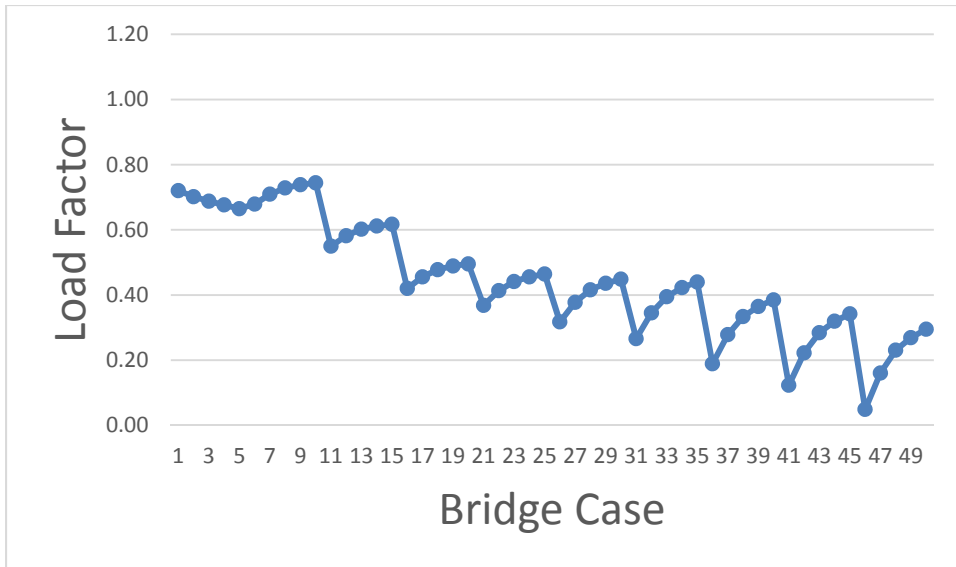

Figure K.1.31. Required Load Factors for Spread Box, Continuous Negative Moment, Two Lane.

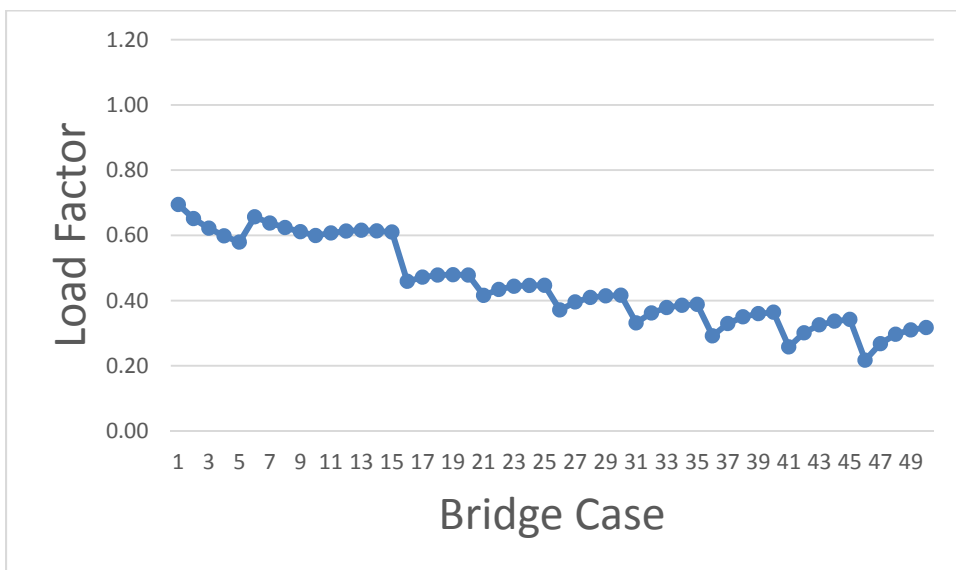

Figure K.1.32. Required Load Factors for Spread Box, Continuous Shear, Two Lane.

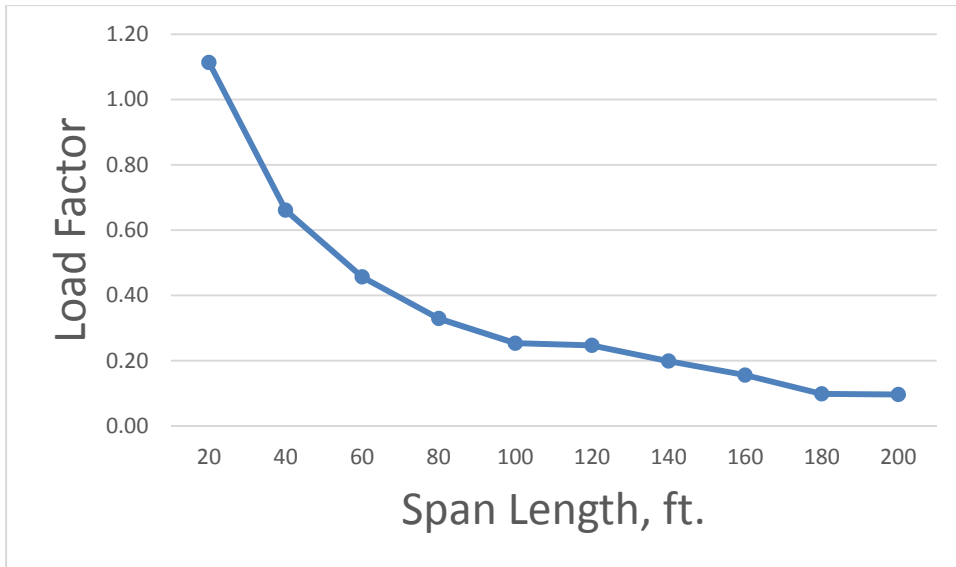

Figure K.1.33. Required Load Factors for 36" SBS Box, Simple Moment, One Lane.

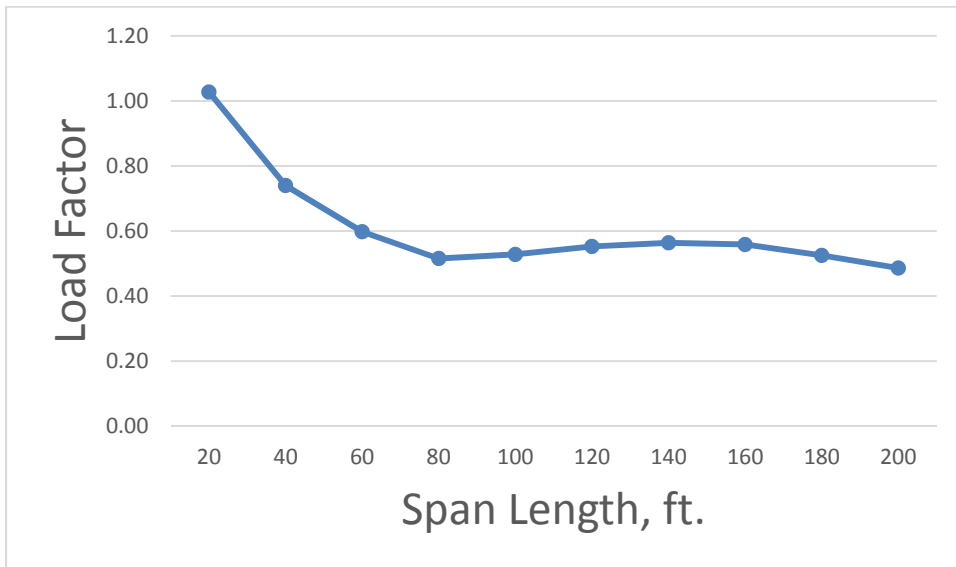

Figure K.1.34. Required Load Factors for 36" SBS Box, Simple Shear, One Lane.



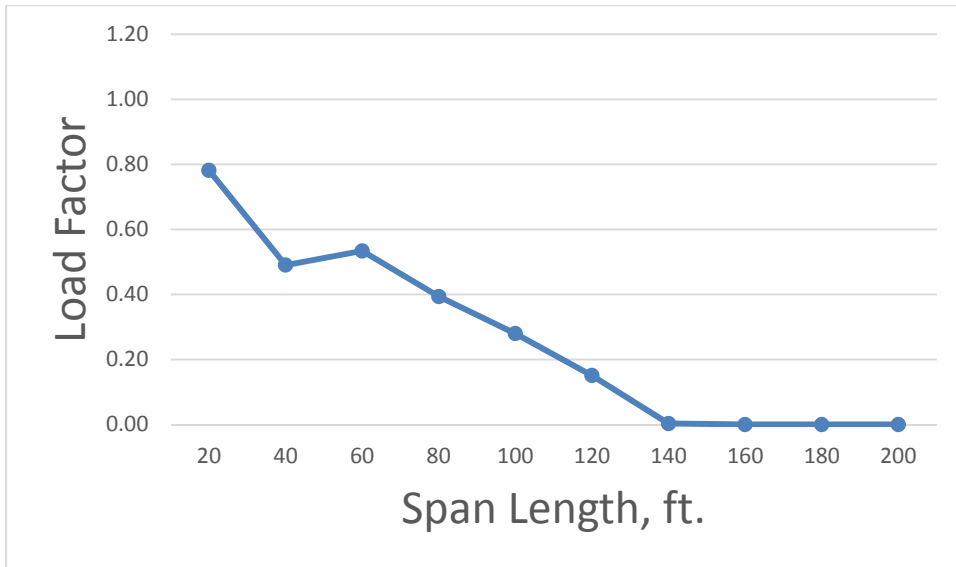

Figure K.1.35. Required Load Factors for 36" SBS Box, Continuous Negative Moment, One Lane.

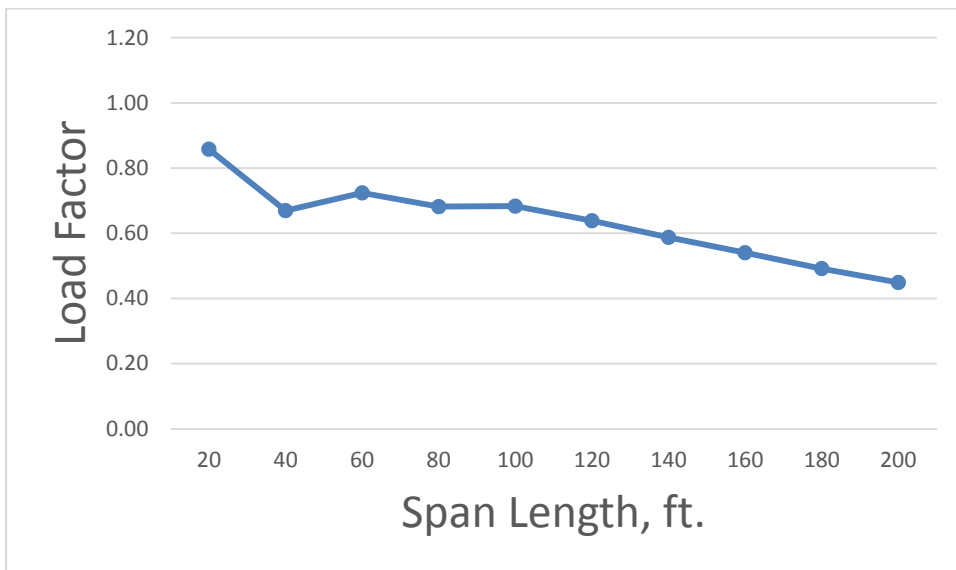

Figure K.1.36. Required Load Factors for 36" SBS Box, Continuous Shear, One Lane.

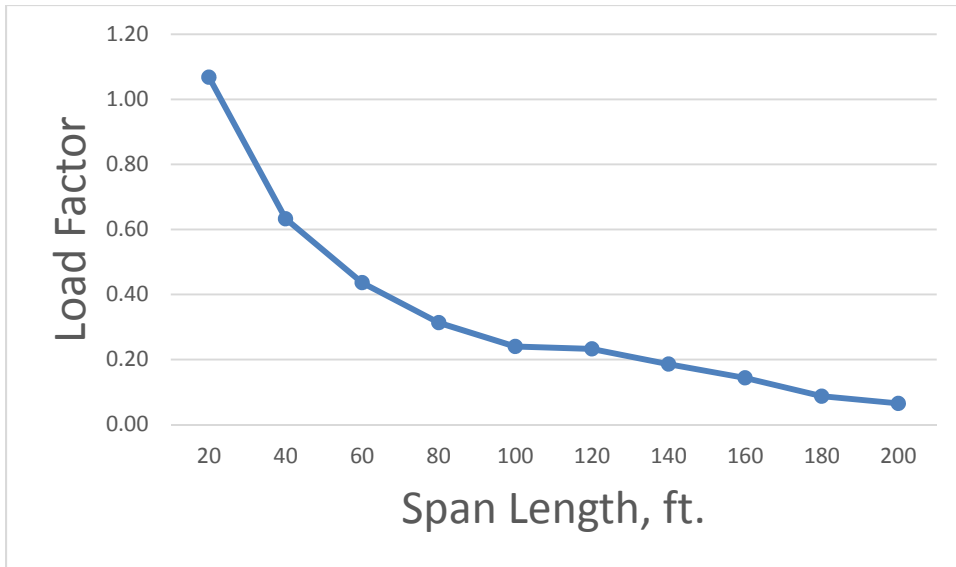

Figure K.1.37. Required Load Factors for 48” SBS Box, Simple Moment, One Lane.

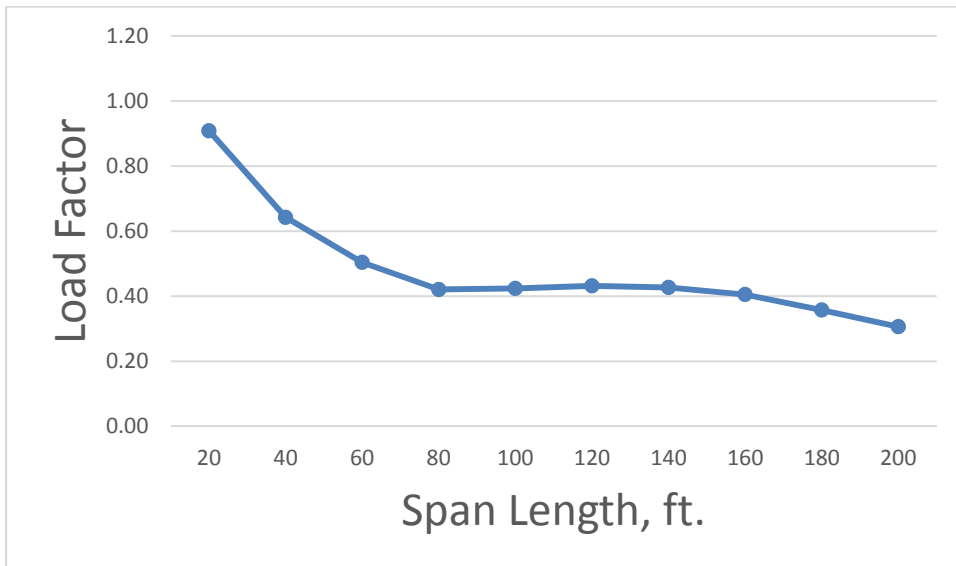

Figure K.1.38. Required Load Factors for 48” SBS Box, Simple Shear, One Lane.

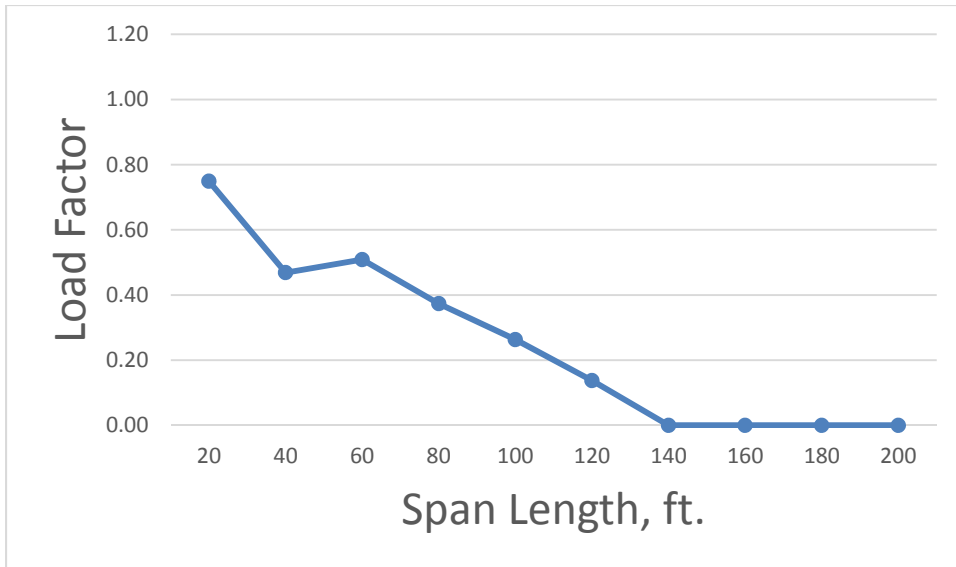

Figure K.1.39. Required Load Factors for 48” SBS Box, Continuous Negative Moment, One Lane.

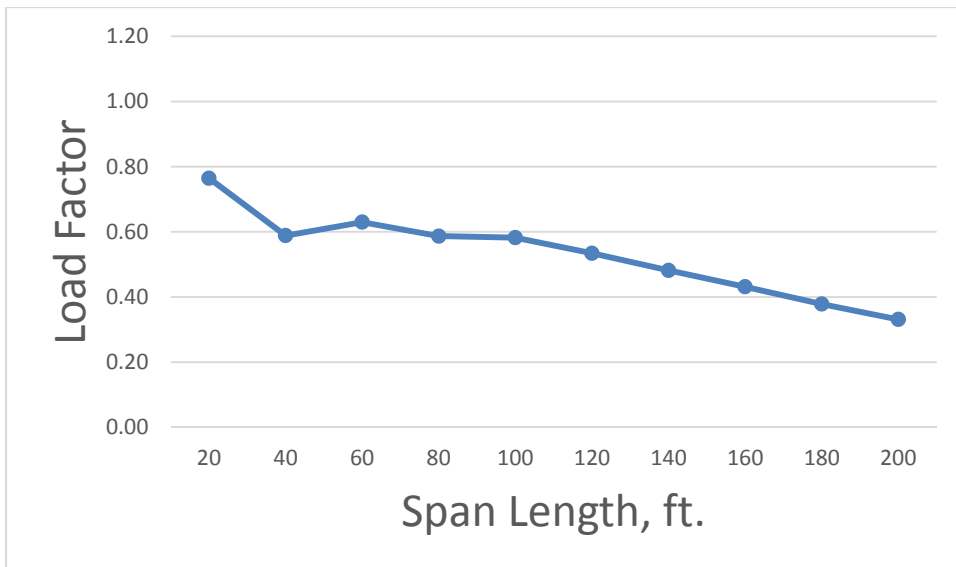

Figure K.1.40. Required Load Factors for 48” SBS Box, Continuous Shear, One Lane.

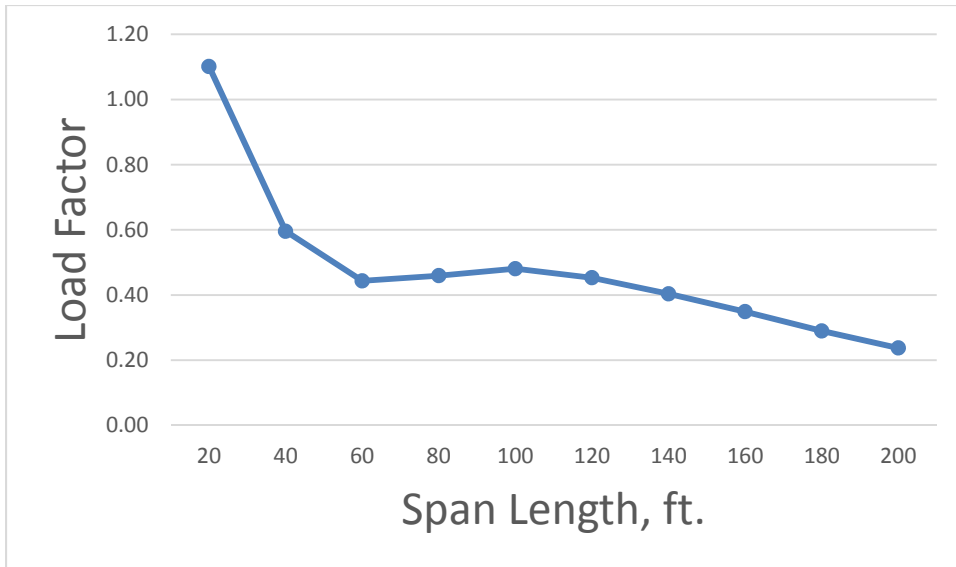

Figure K.1.41. Required Load Factors for 36" SBS Box, Simple Moment, Two Lane.

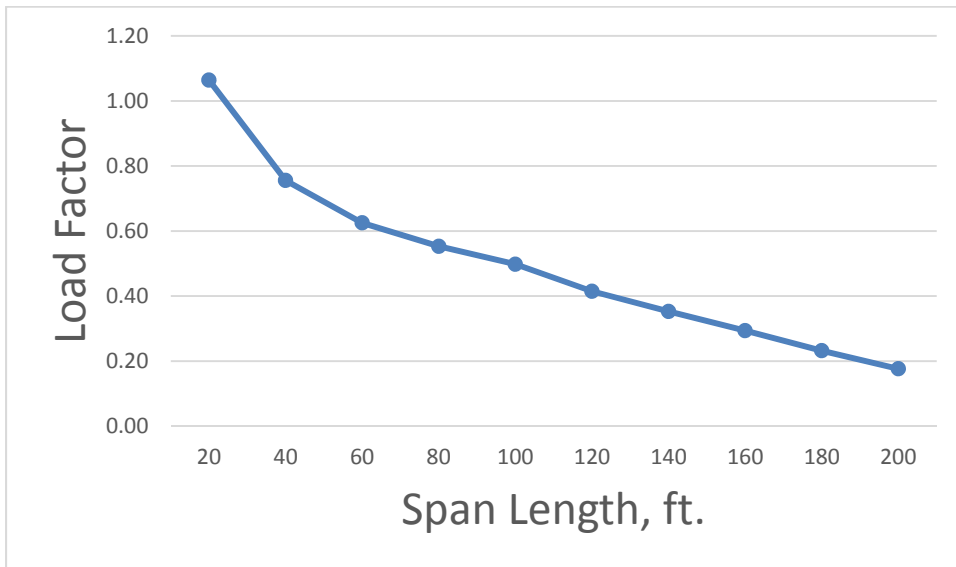

Figure K.1.42. Required Load Factors for 36" SBS Box, Simple Shear, Two Lane.

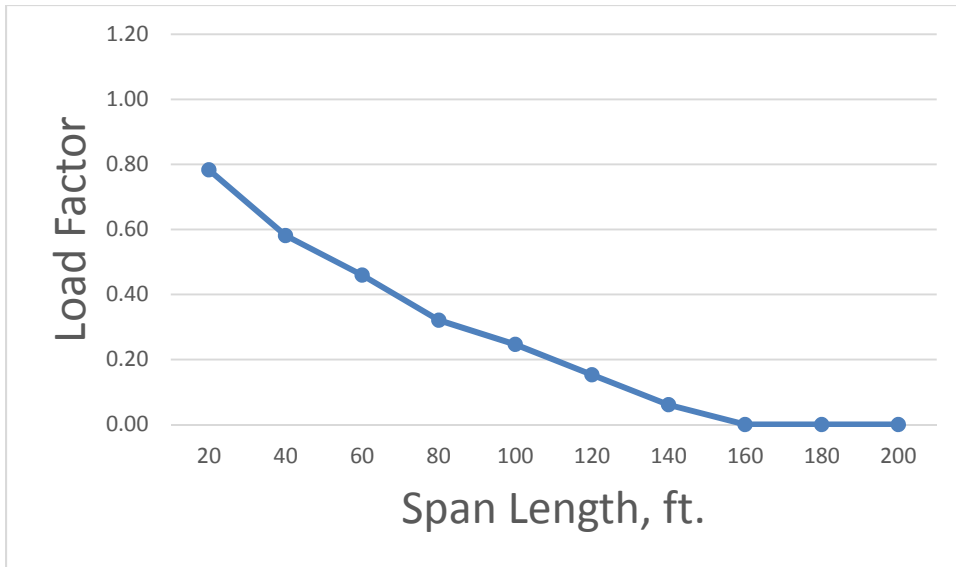

Figure K.1.43. Required Load Factors for 36" SBS Box, Continuous Negative Moment, Two Lane.

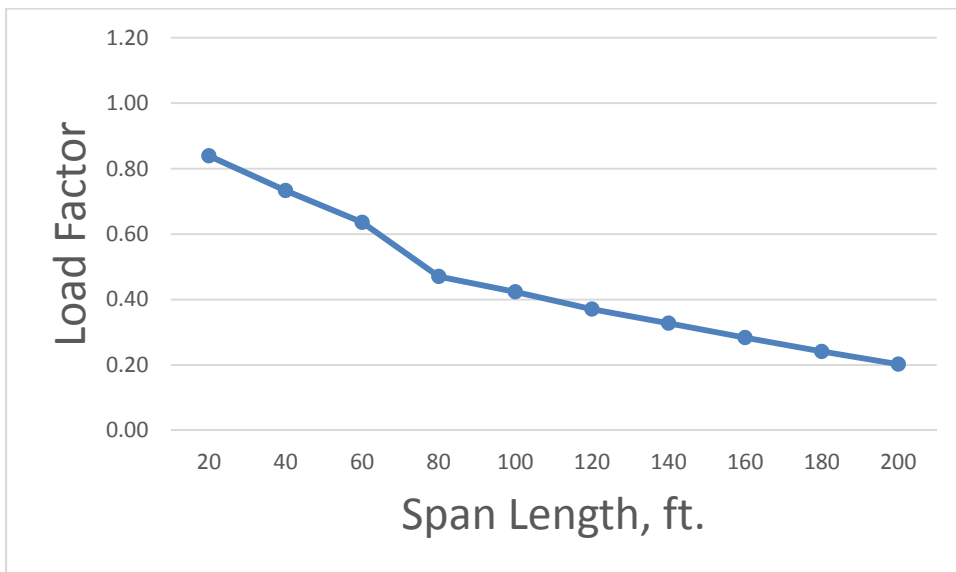

Figure K.1.44. Required Load Factors for 36" SBS Box, Continuous Shear, Two Lane.

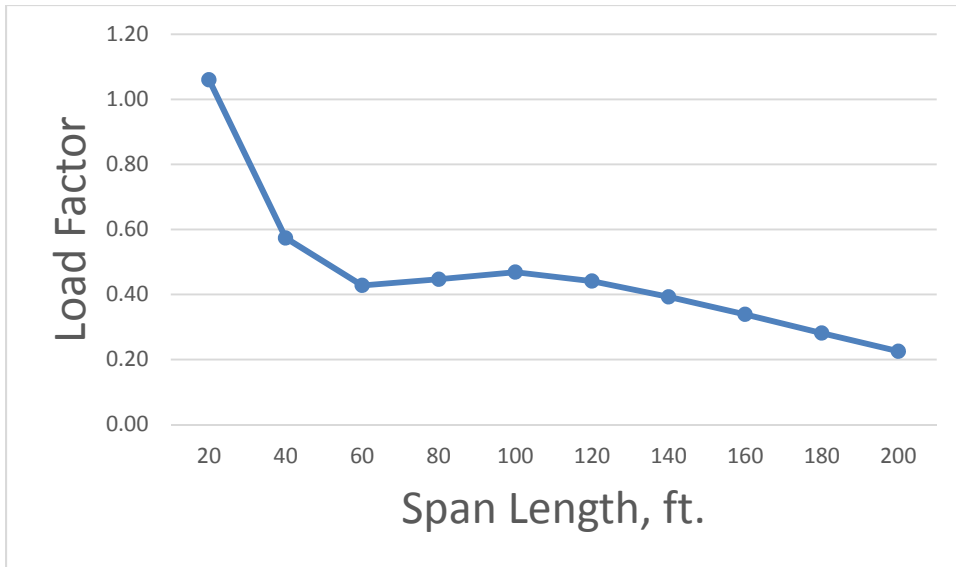

Figure K.1.45. Required Load Factors for 48" SBS Box, Simple Moment, Two Lane.

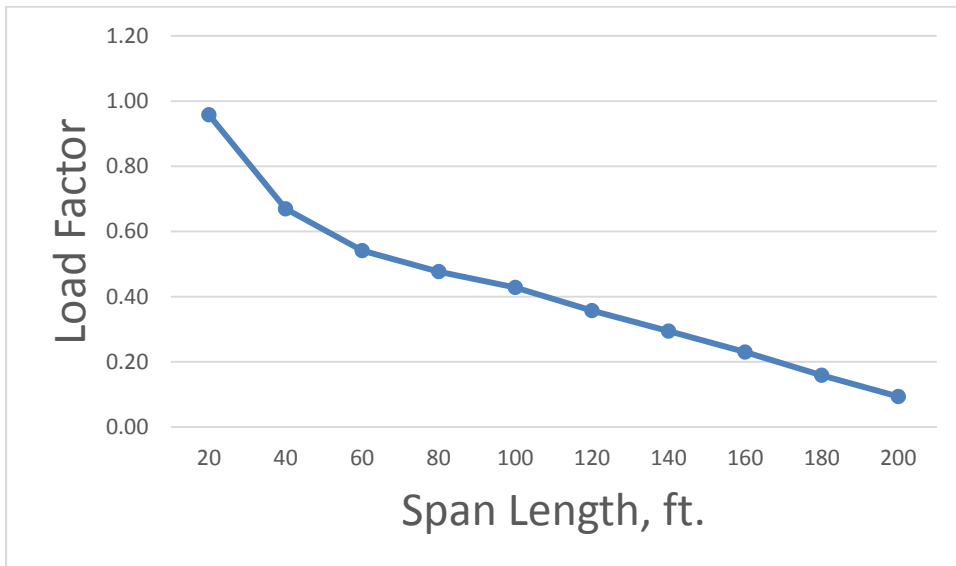

Figure K.1.46. Required Load Factors for 48" SBS Box, Simple Shear, Two Lane.

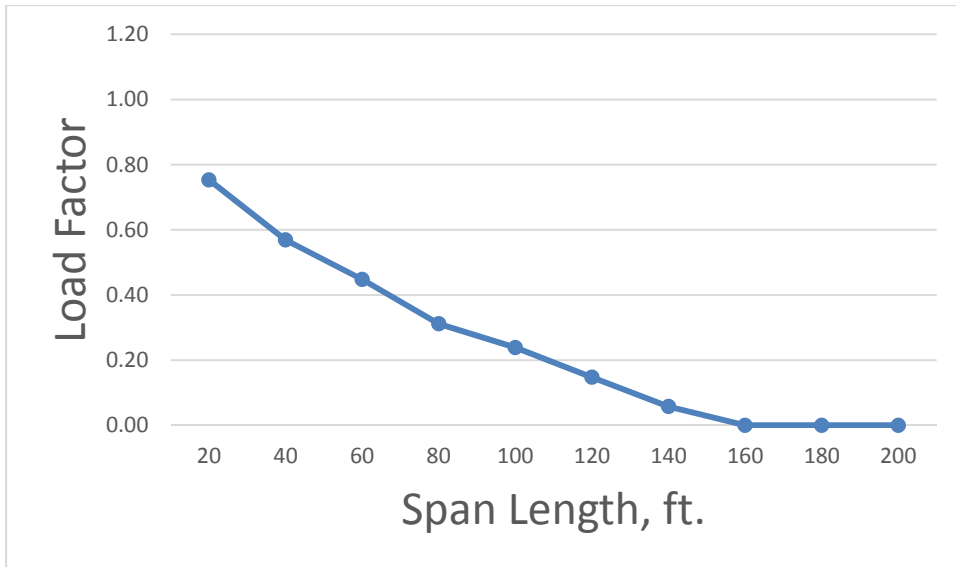

Figure K.1.47. Required Load Factors for 48” SBS Box, Continuous Negative Moment, Two Lane.

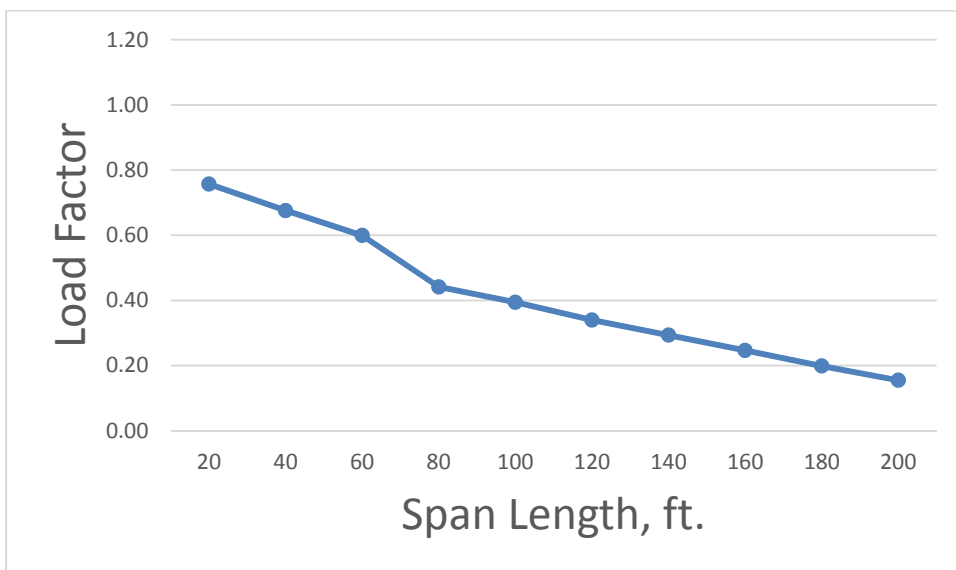

Figure K.1.48. Required Load Factors for 48” SBS Box, Continuous Shear, Two Lane.

### Load Factors For LFR

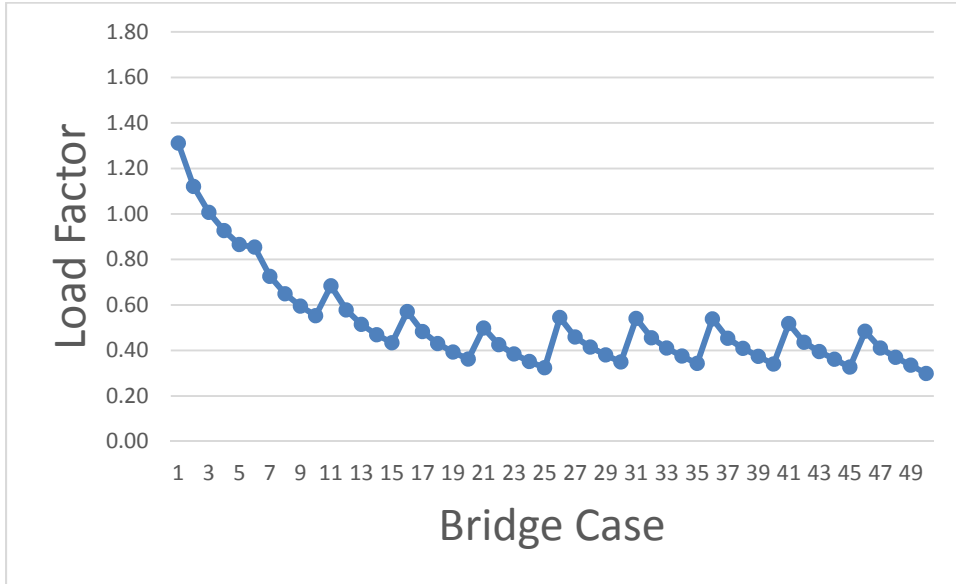

Figure K.2.1. Required Load Factors for Steel, Simple Moment, One Lane.

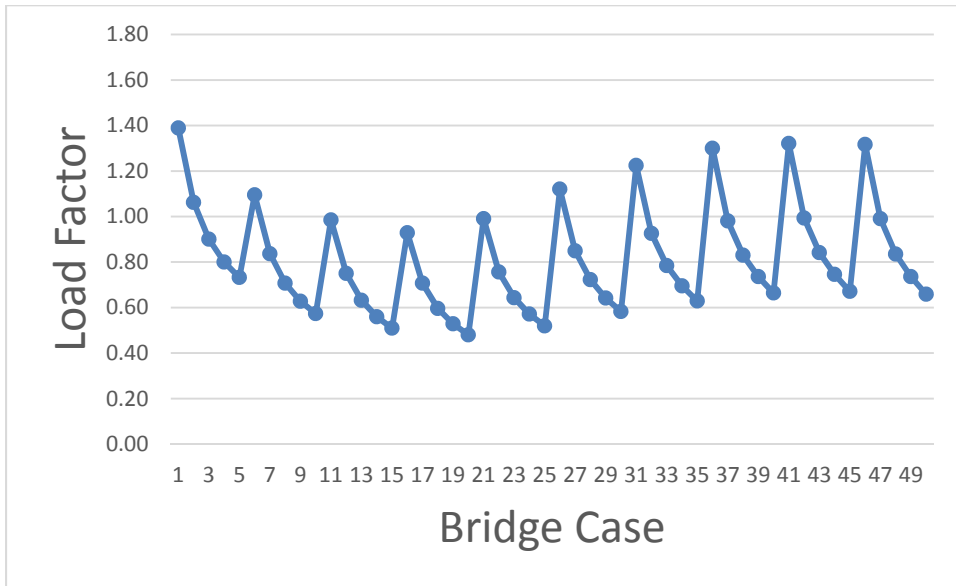

Figure K.2.2. Required Load Factors for Steel, Simple Shear, One Lane.



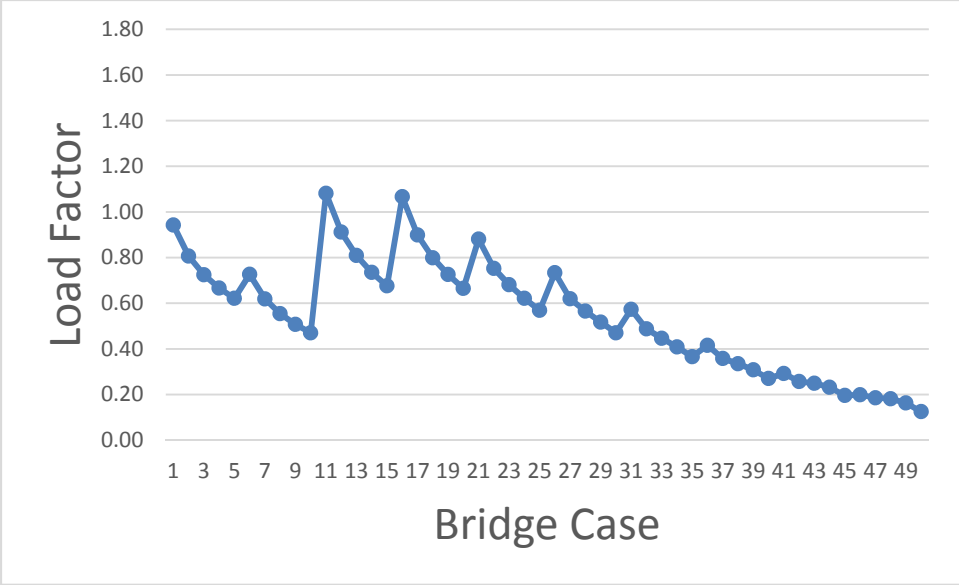

Figure K.2.3.1. Required Load Factors for Steel, Continuous Negative Moment, One Lane.

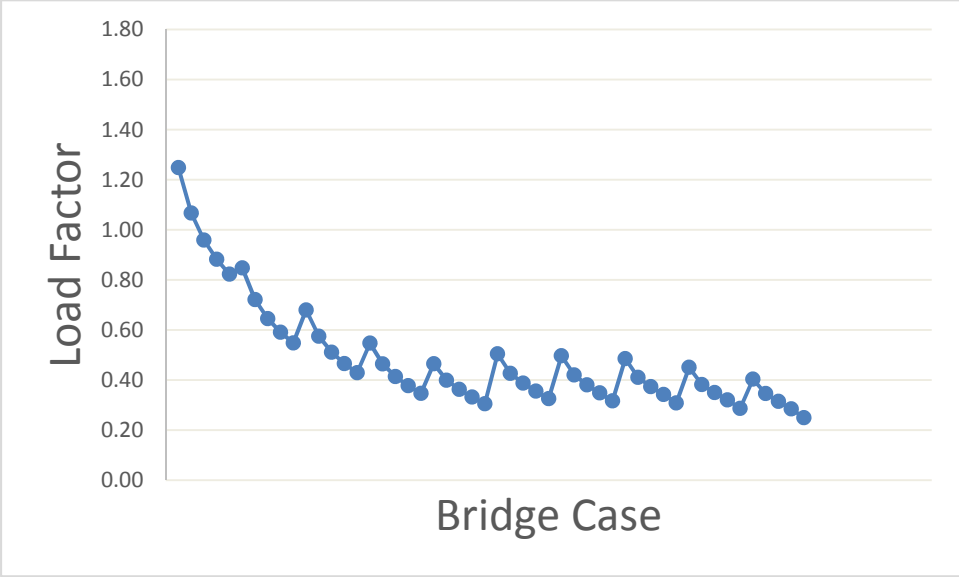

Figure K.2.3.2. Required Load Factors for Steel, Continuous Positive Moment, One Lane.

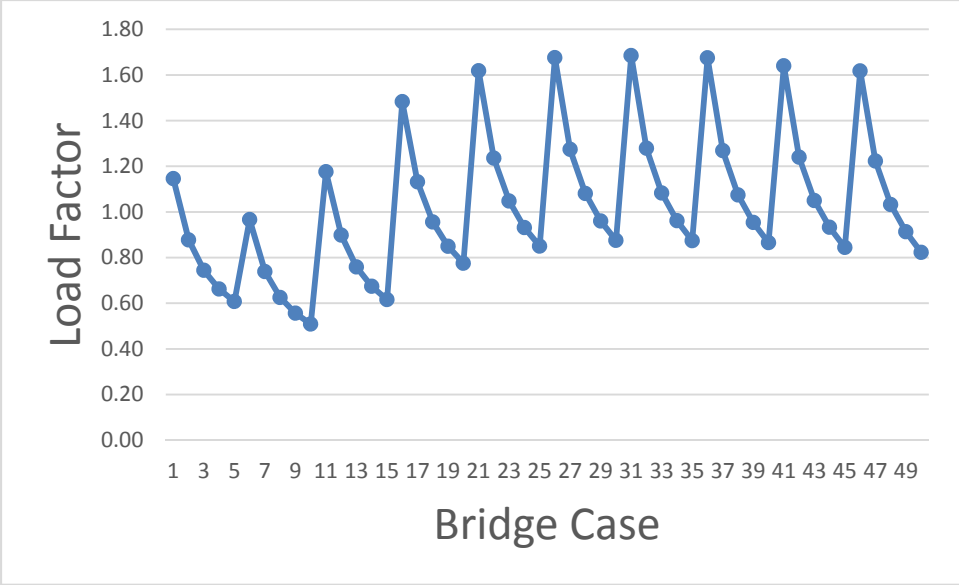

Figure K.2.4. Required Load Factors for Steel, Continuous Shear, One Lane.

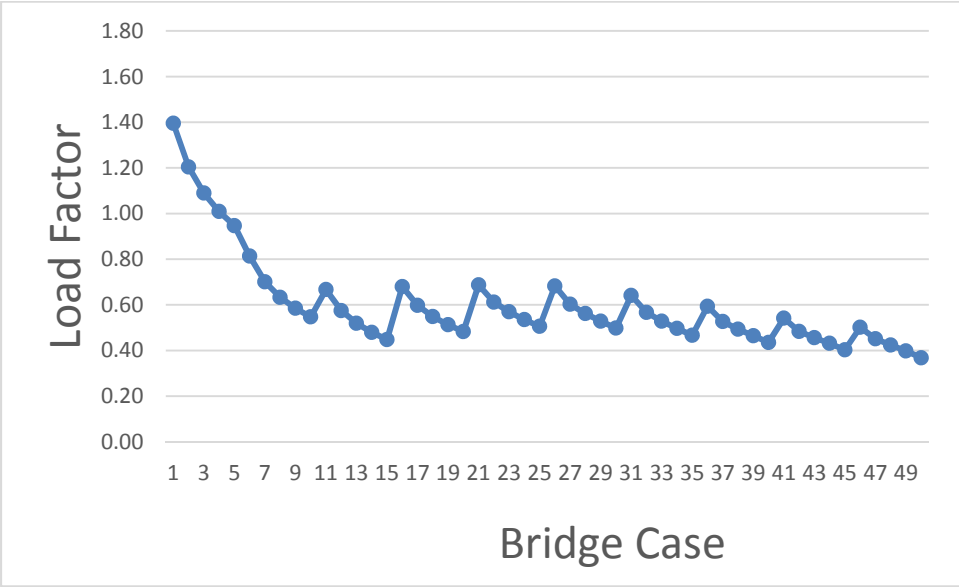

Figure K.2.5. Required Load Factors for Steel, Simple Moment, Two Lane.

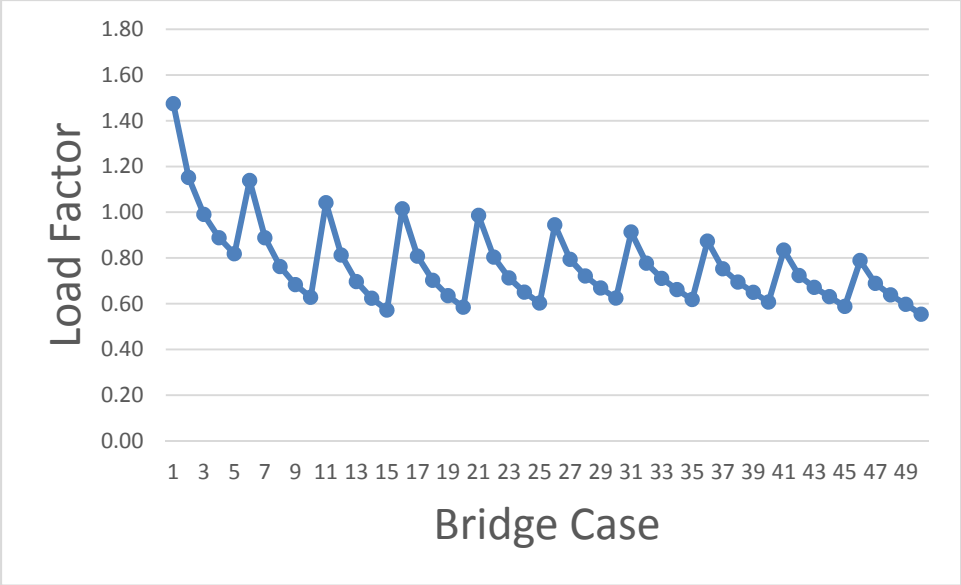

Figure K.2.6. Required Load Factors for Steel, Simple Shear, Two Lane.

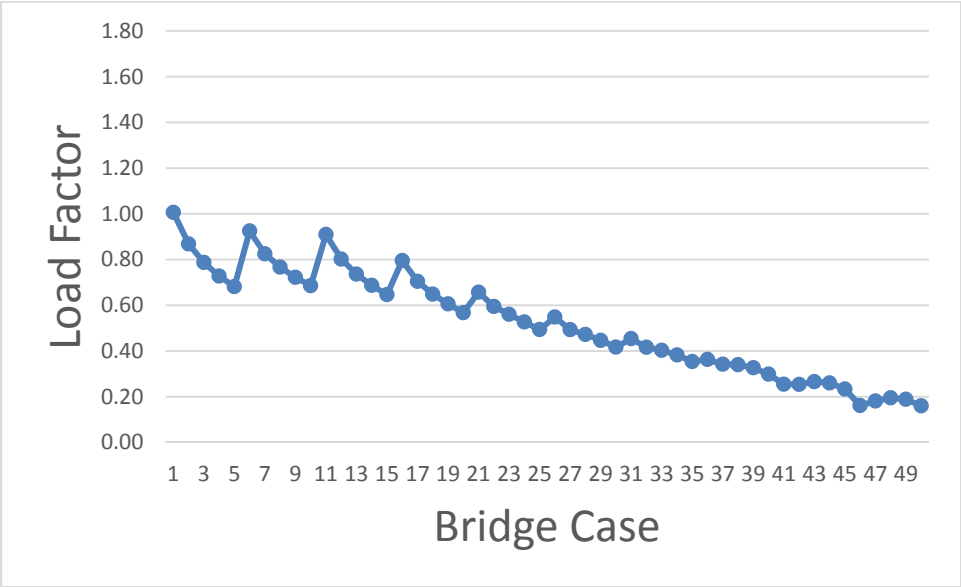

Figure K.2.7.1. Required Load Factors for Steel, Continuous Negative Moment, Two Lane.

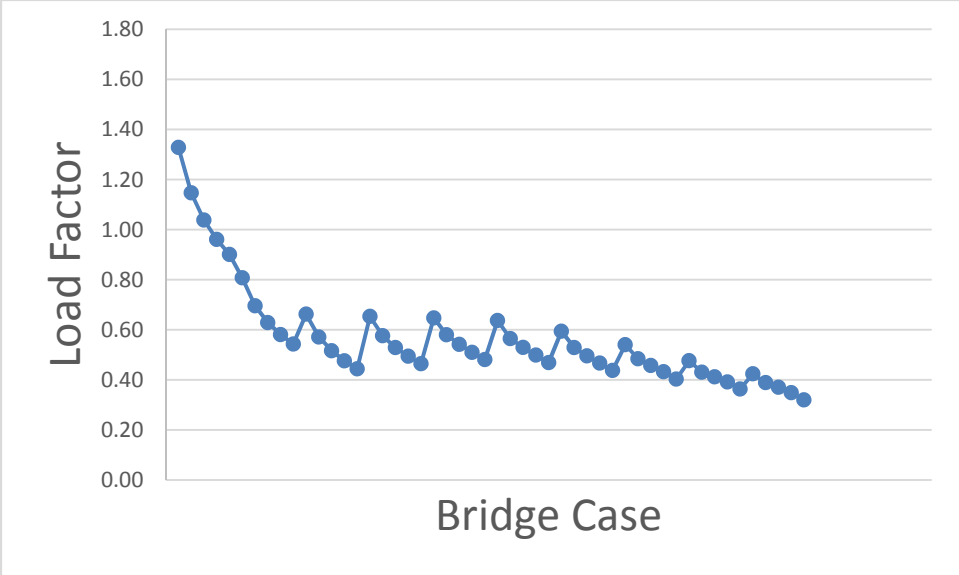

Figure K.2.7.2. Required Load Factors for Steel, Continuous Positive Moment, Two Lane.

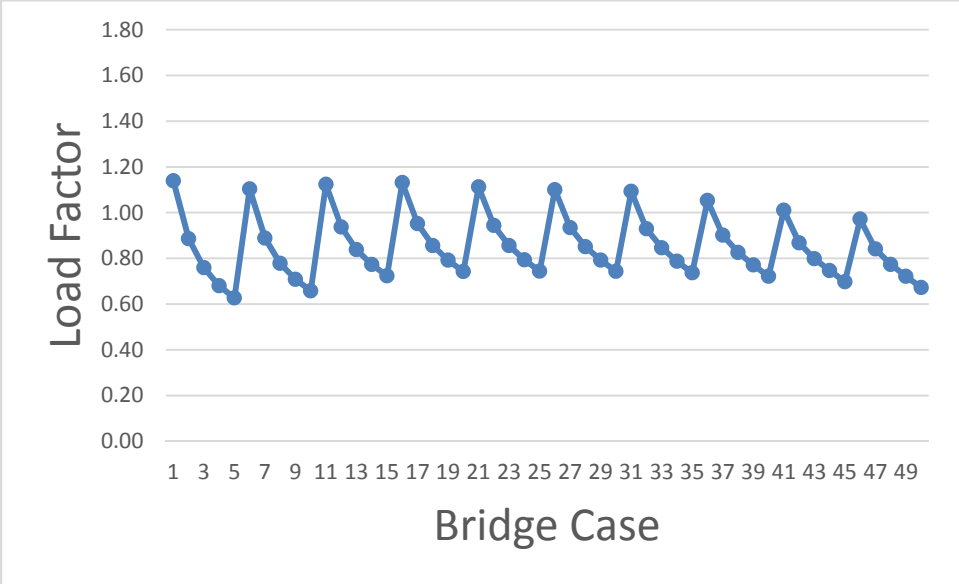

Figure K.2.8. Required Load Factors for Steel, Continuous Shear, Two Lane.

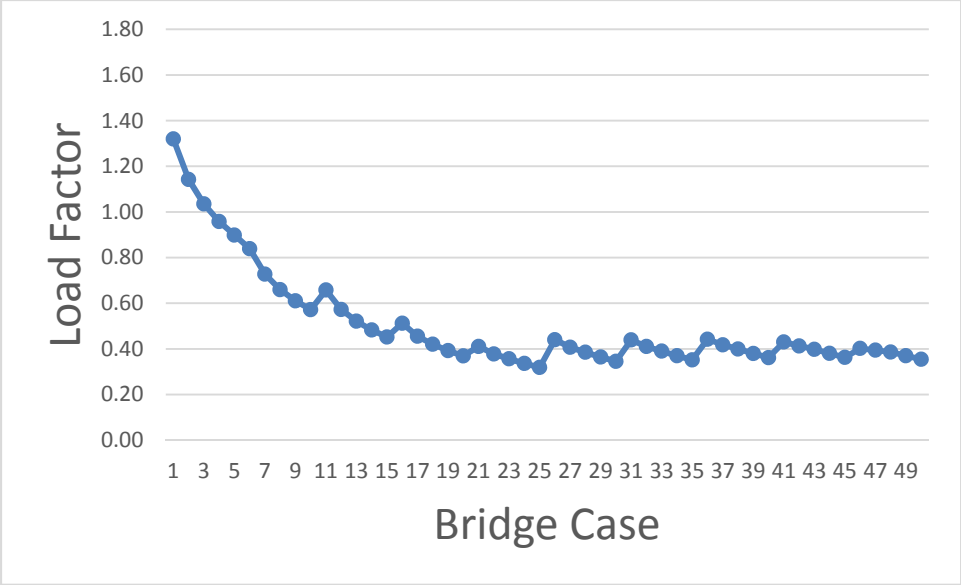

Figure K.2.9. Required Load Factors for PC, Simple Moment, One Lane.

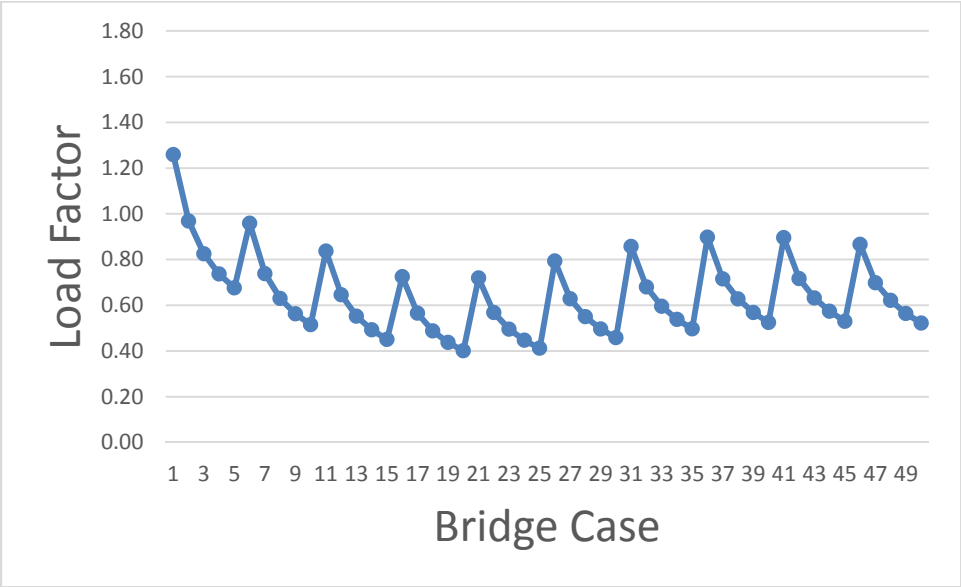

Figure K.2.10. Required Load Factors for PC, Simple Shear, One Lane.

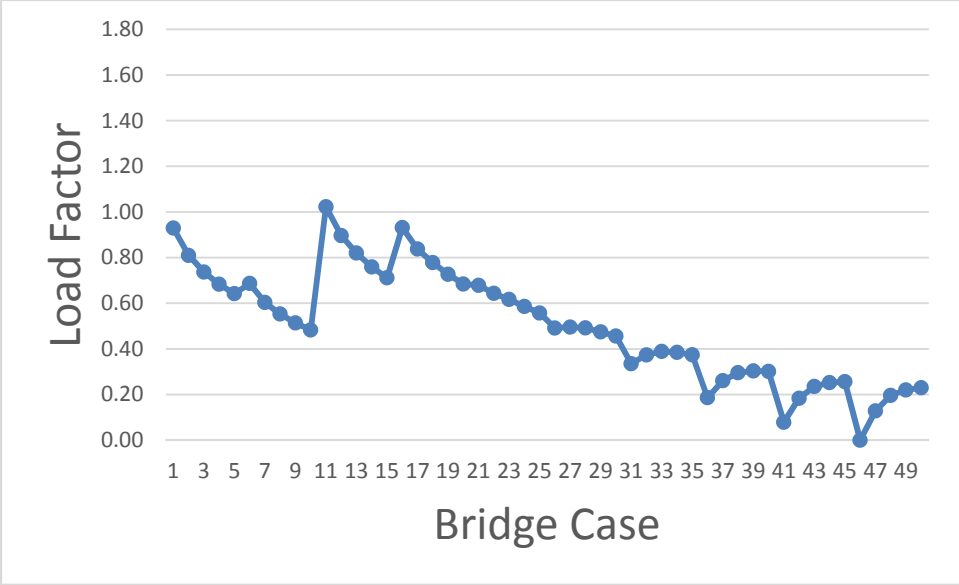

Figure K.2.11. Required Load Factors for PC, Continuous Negative Moment, One Lane.

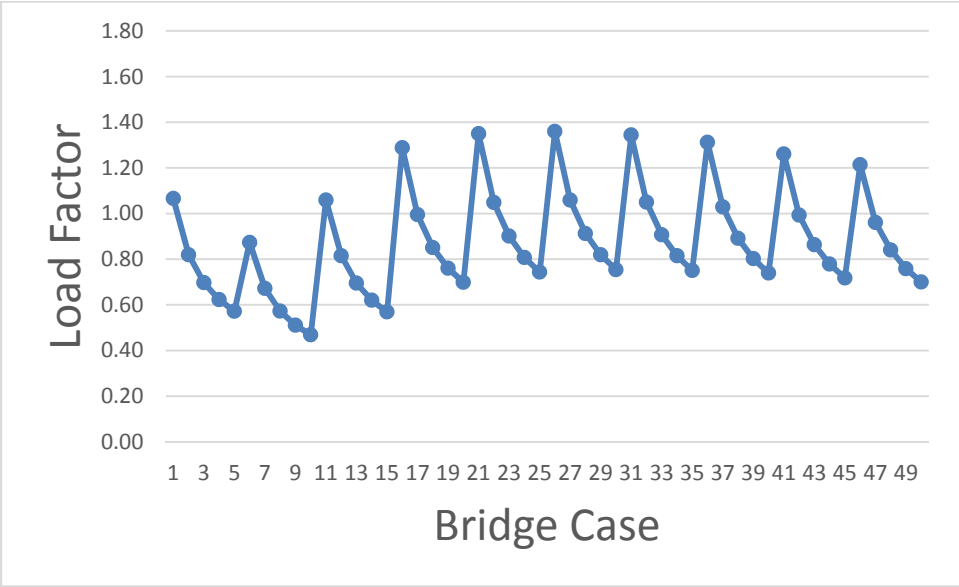

Figure K.2.12. Required Load Factors for PC, Continuous Shear, One Lane.

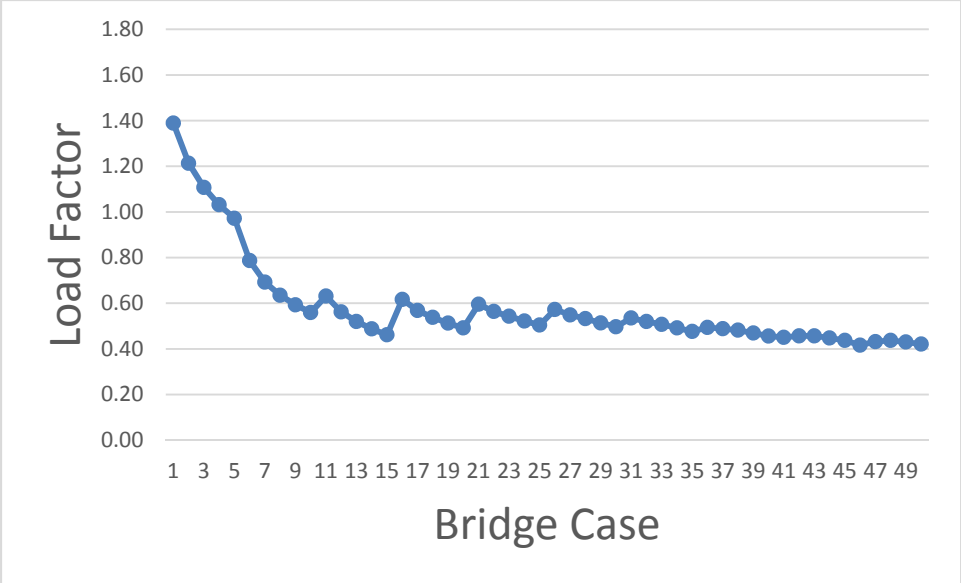

Figure K.2.13. Required Load Factors for PC, Simple Moment, Two Lane.

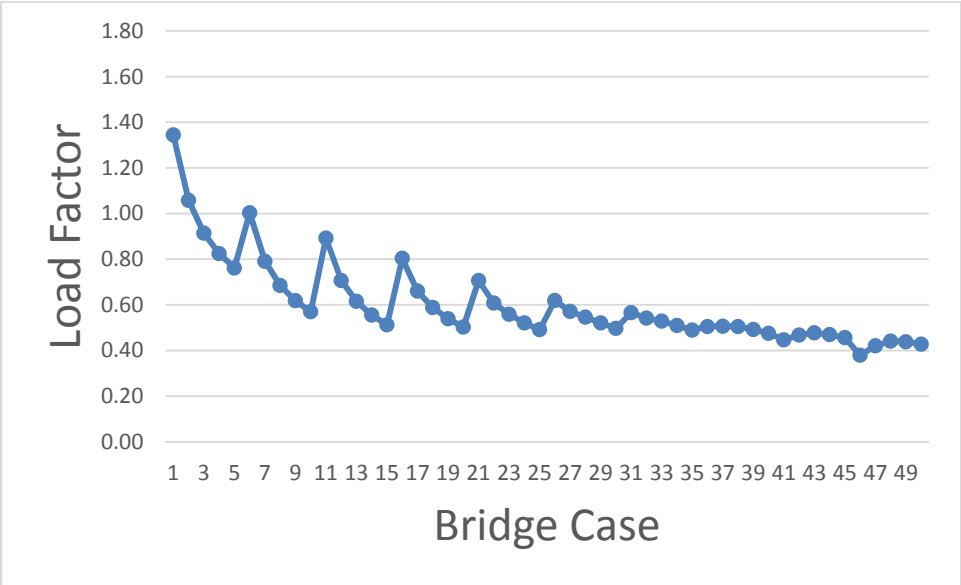

Figure K.2.14. Required Load Factors for PC, Simple Shear, Two Lane.

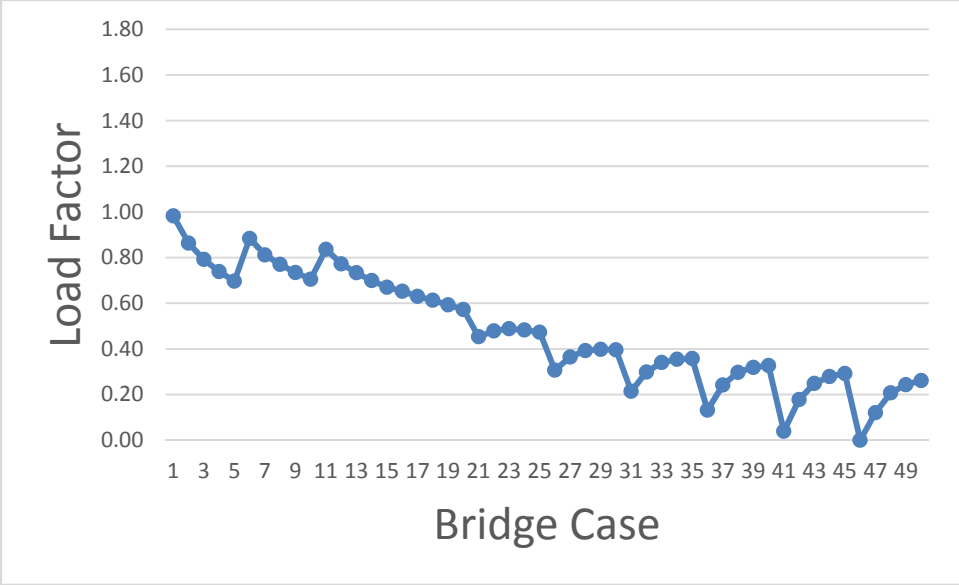

Figure K.2.15. Required Load Factors for PC, Continuous Negative Moment, Two Lane.

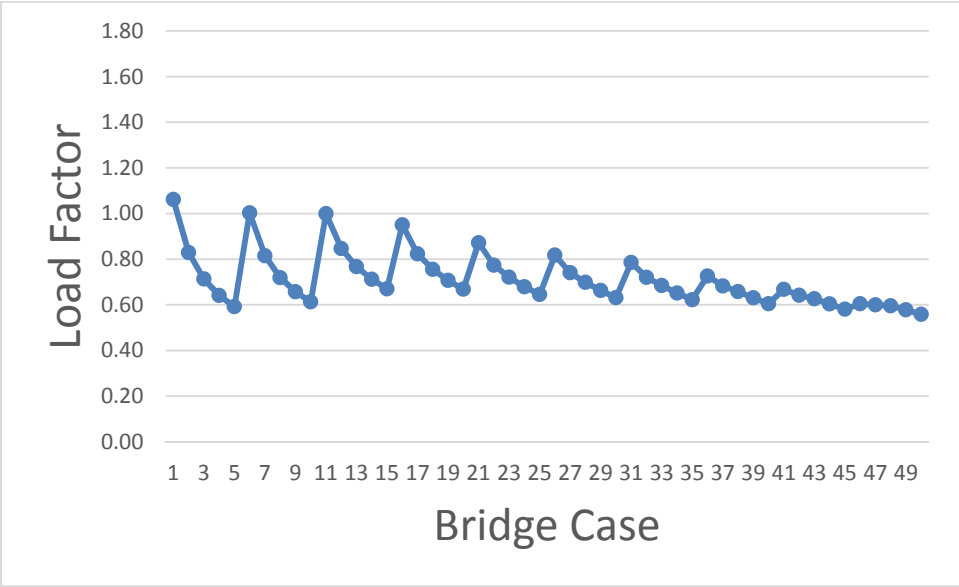

Figure K.2.16. Required Load Factors for PC, Continuous Shear, Two Lane.



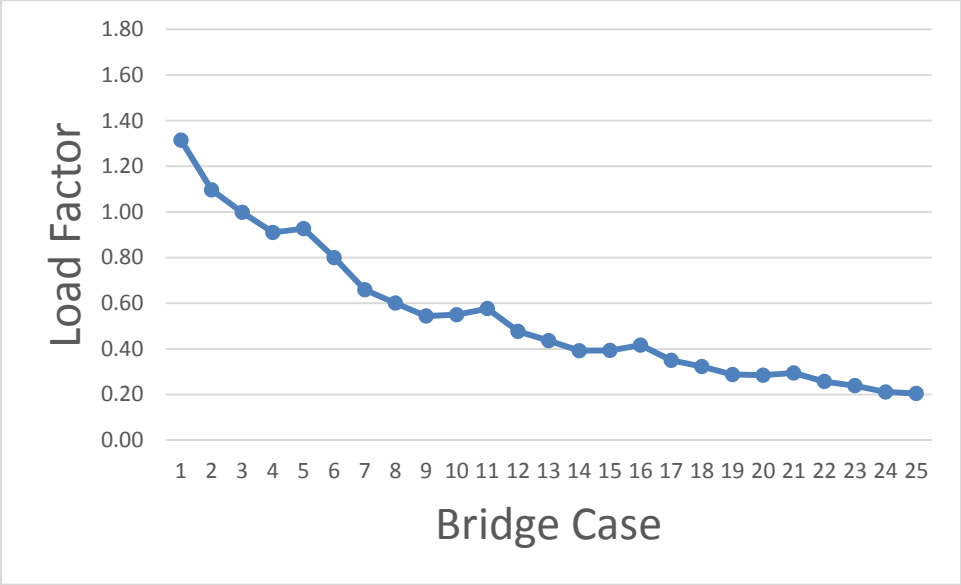

Figure K.2.17. Required Load Factors for RC, Simple Moment, One Lane.

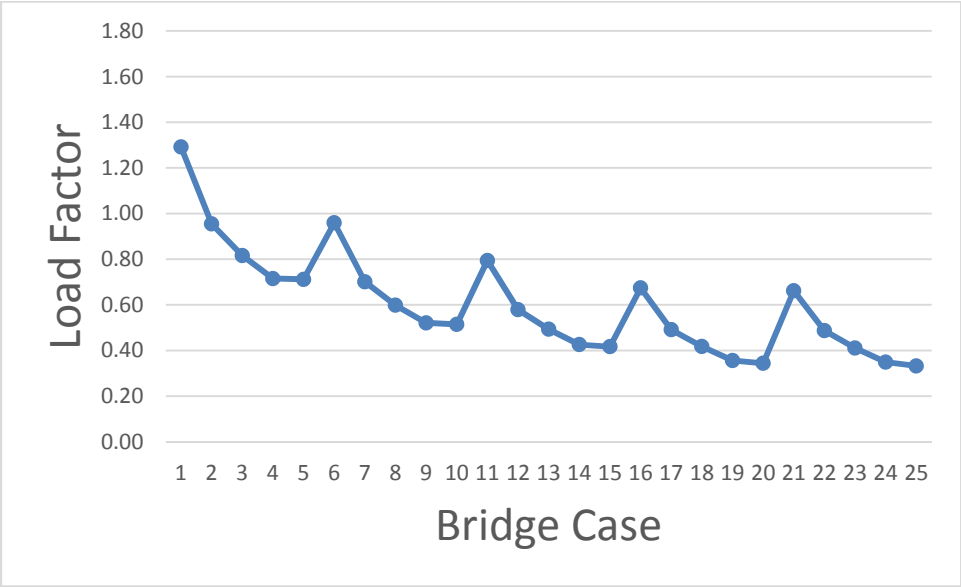

Figure K.2.18. Required Load Factors for RC, Simple Shear, One Lane.

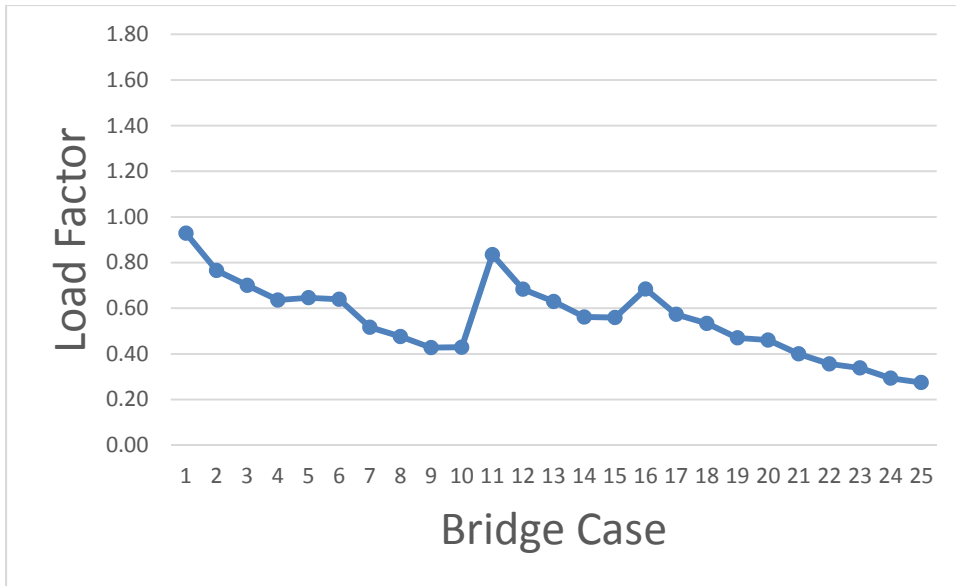

Figure K.2.19.1. Required Load Factors for RC, Continuous Negative Moment, One Lane.

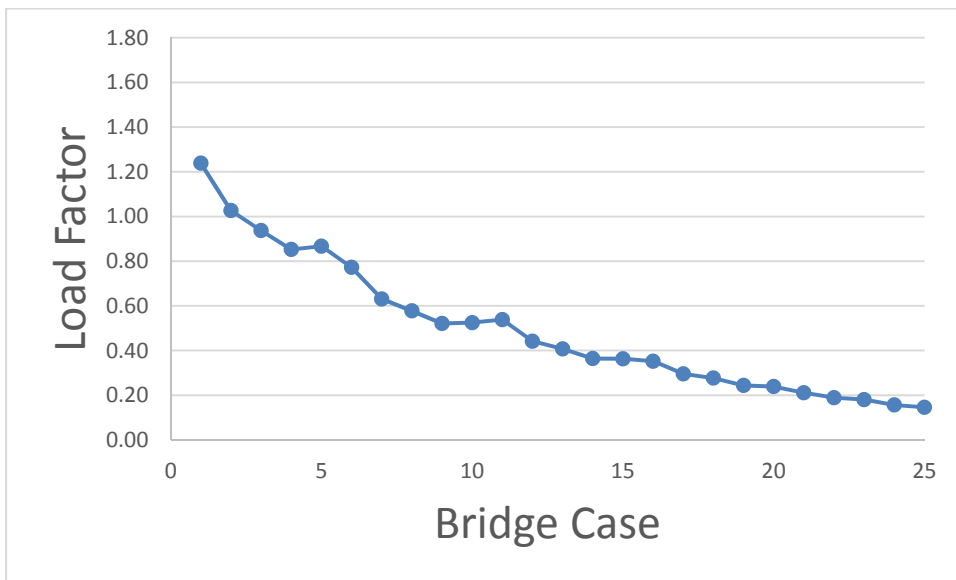

Figure K.2.19.2. Required Load Factors for RC, Continuous Positive Moment, One Lane.

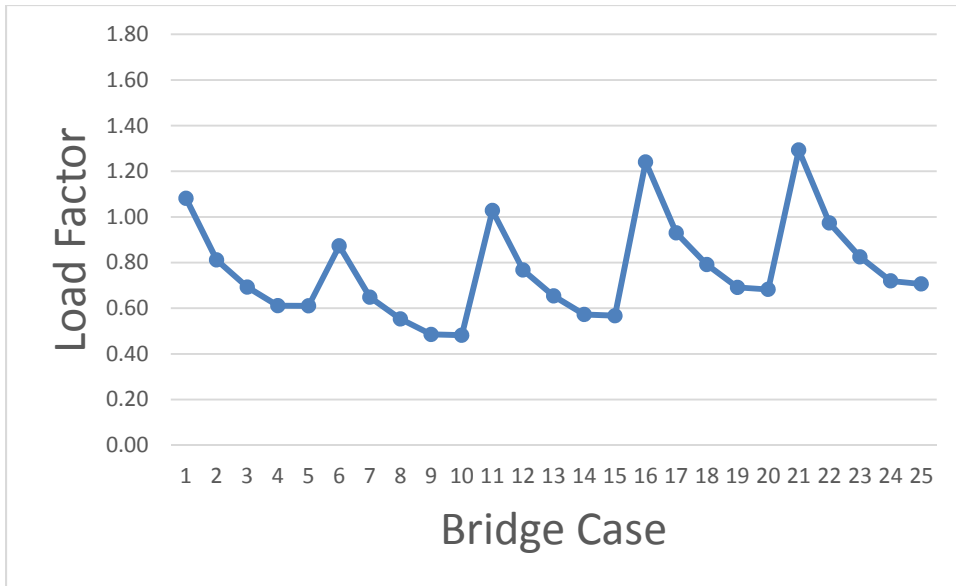

Figure K.2.20. Required Load Factors for RC, Continuous Shear, One Lane.

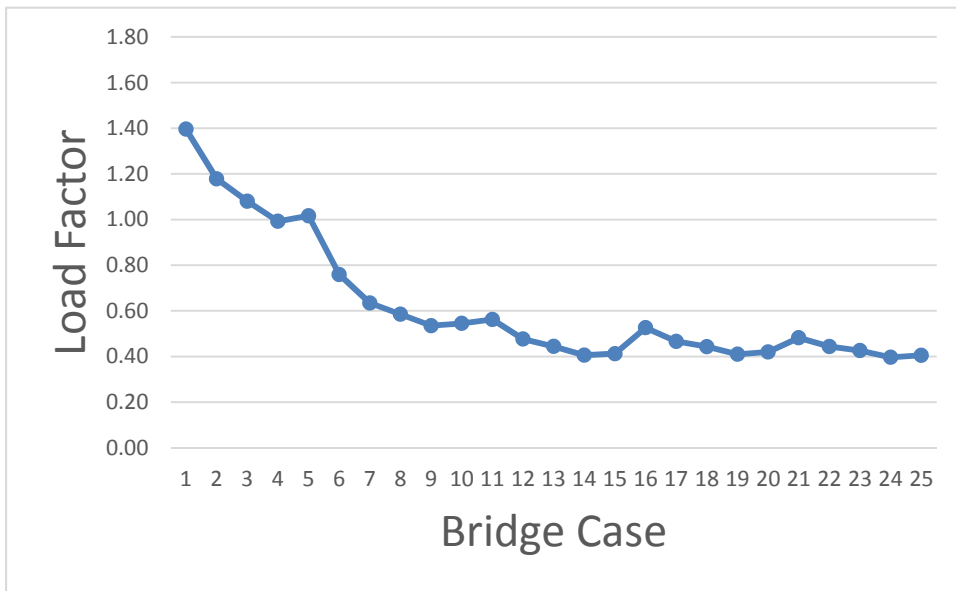

Figure K.2.21. Required Load Factors for RC, Simple Moment, Two Lane.

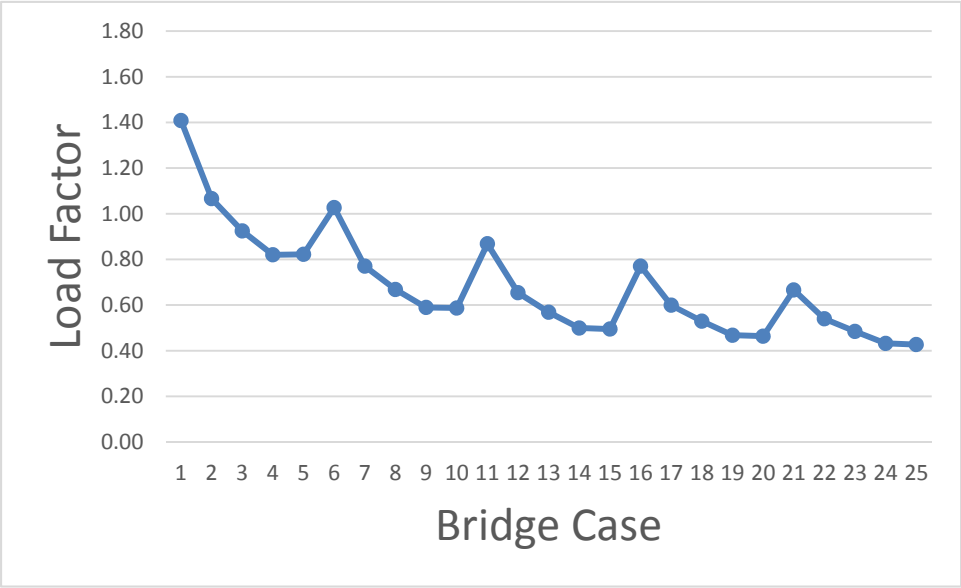

Figure K.1.22. Required Load Factors for RC, Simple Shear, Two Lane.

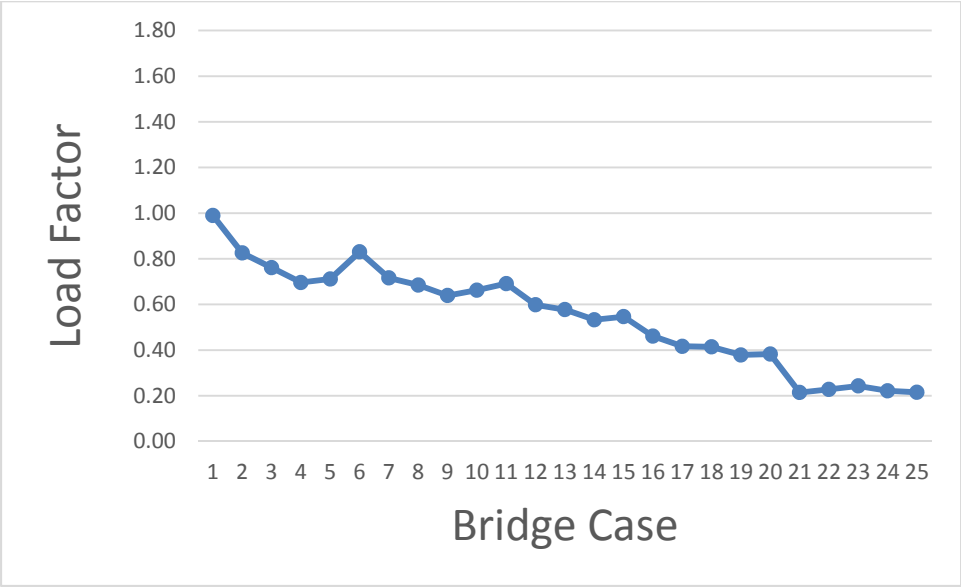

Figure K.2.23.1. Required Load Factors for RC, Continuous Negative Moment, Two Lane.

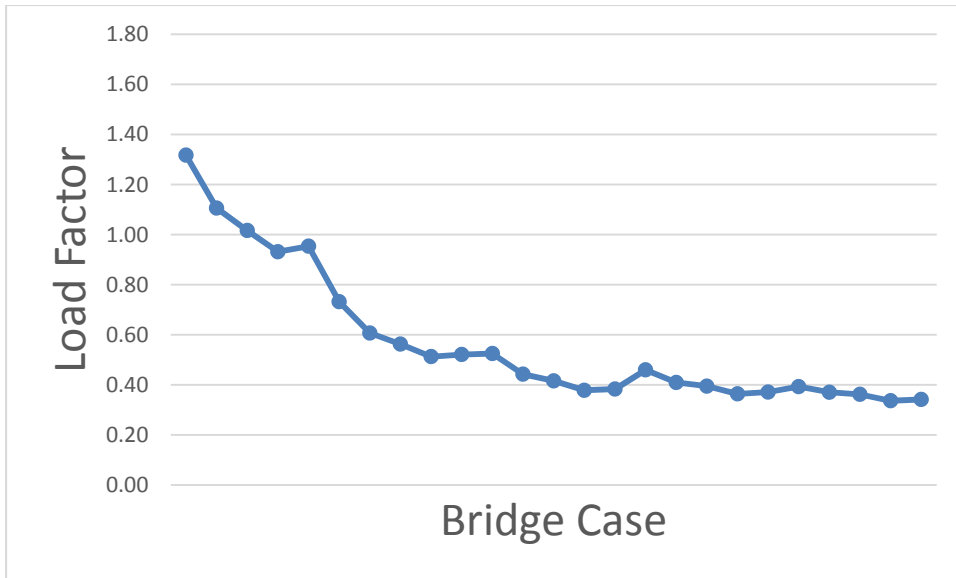

Figure K.2.23.2. Required Load Factors for RC, Continuous Positive Moment, Two Lane.

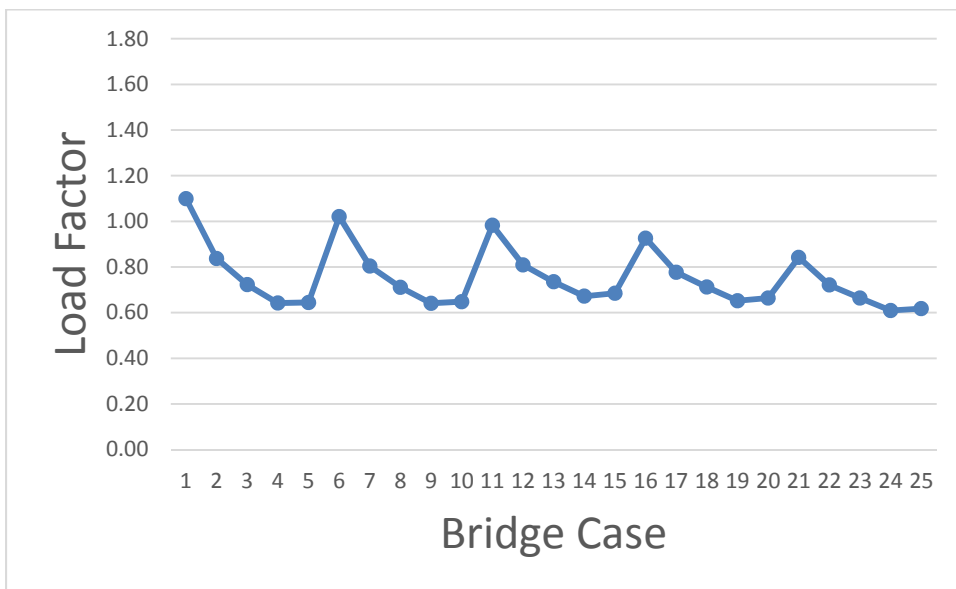

Figure K.2.24. Required Load Factors for RC, Continuous Shear, Two Lane.

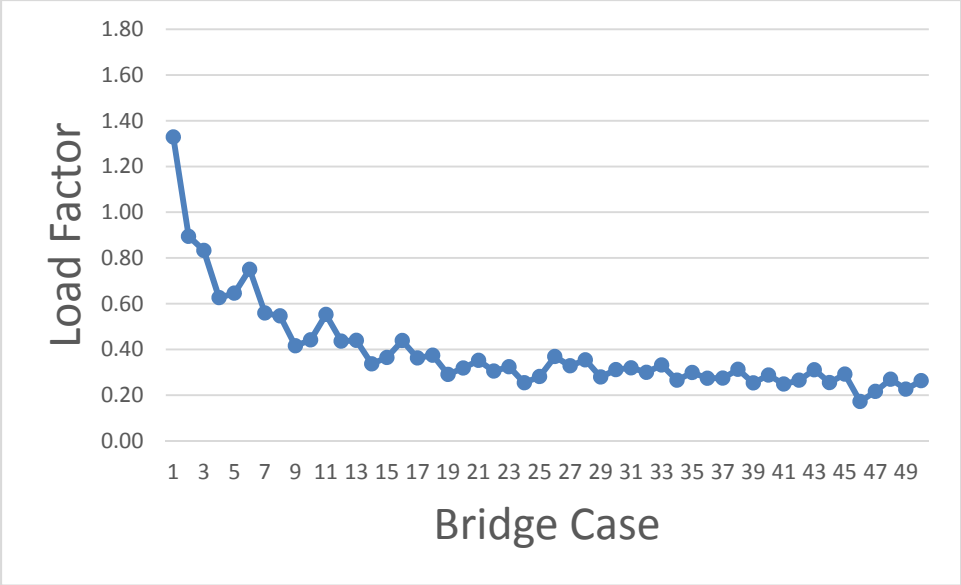

Figure K.2.25. Required Load Factors for Spread Box, Simple Moment, One Lane.

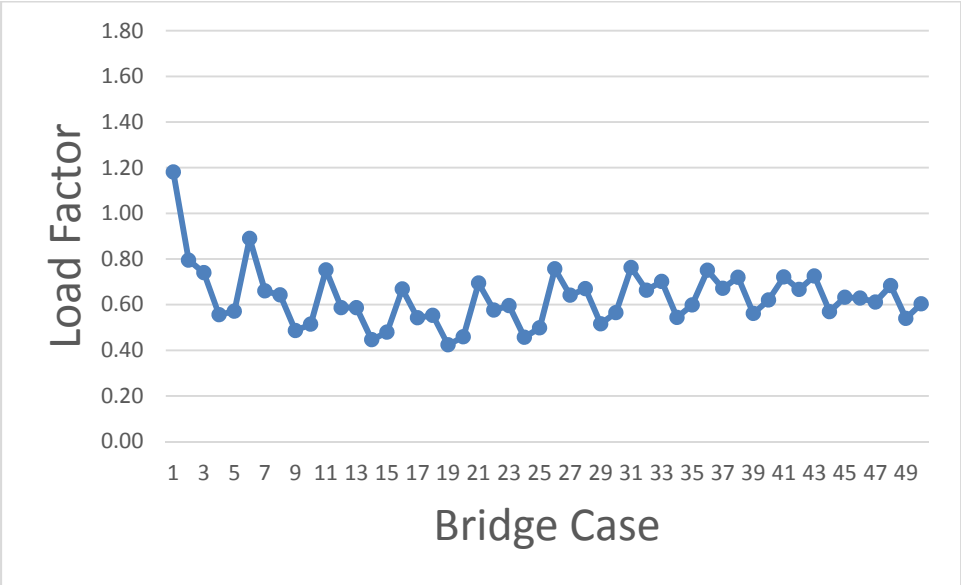

Figure K.2.26. Required Load Factors for Spread Box, Simple Shear, One Lane.

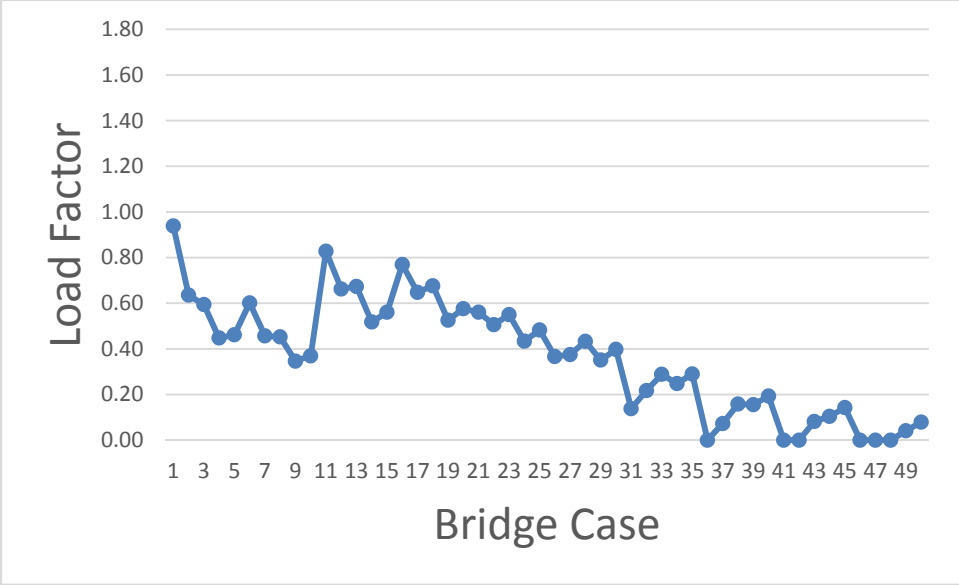

Figure K.2.27. Required Load Factors for Spread Box, Continuous Negative Moment, One Lane.

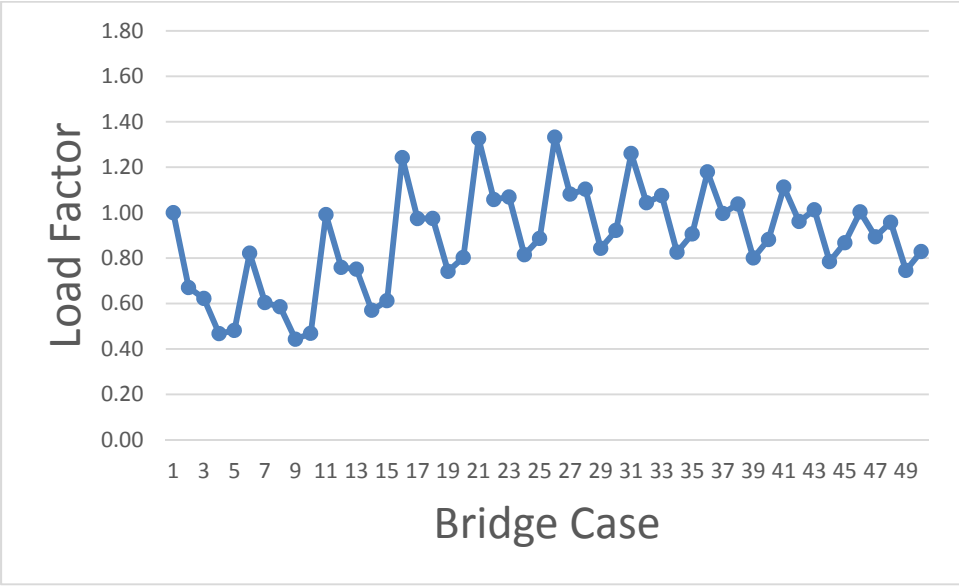

Figure K.2.28. Required Load Factors for Spread Box, Continuous Shear, One Lane.

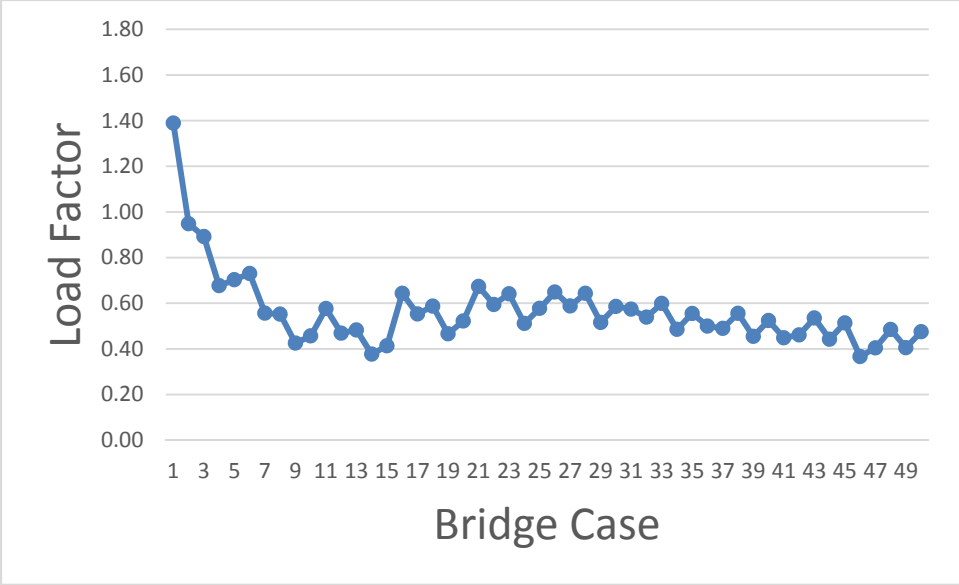

Figure K.2.29. Required Load Factors for Spread Box, Simple Moment, Two Lane.

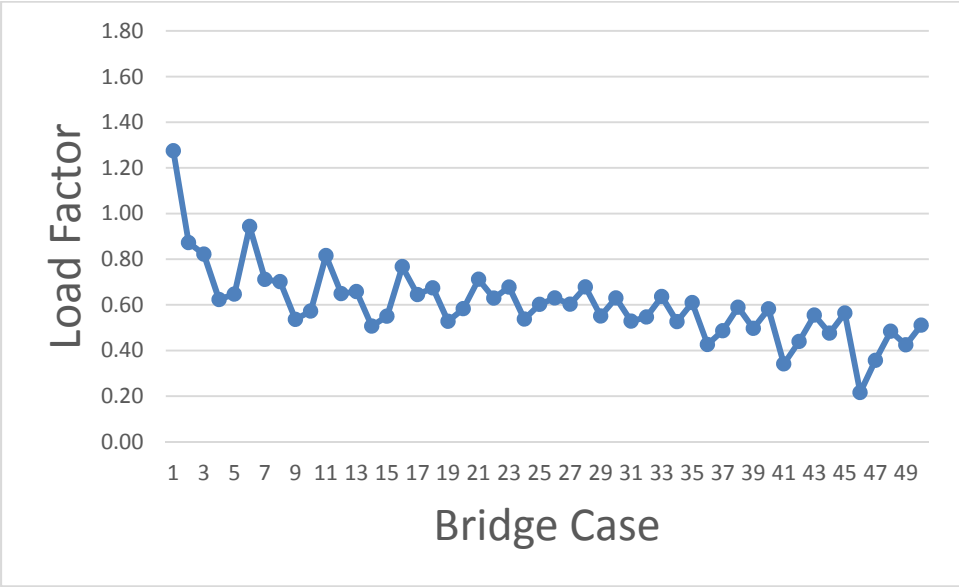

Figure K.2.30. Required Load Factors for Spread Box, Simple Shear, Two Lane.



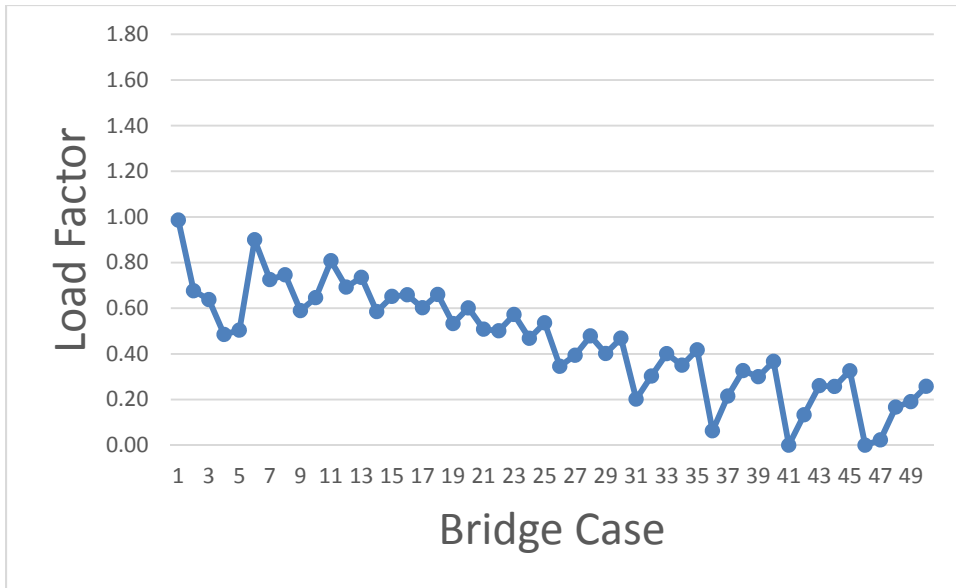

Figure K.2.31. Required Load Factors for Spread Box, Continuous Negative Moment, Two Lane.

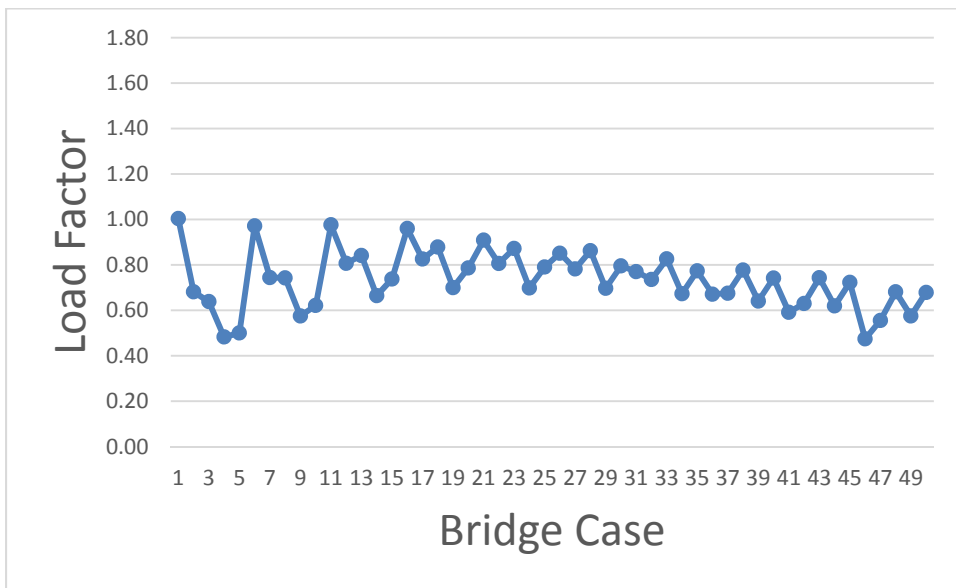

Figure K.2.32. Required Load Factors for Spread Box, Continuous Shear, Two Lane.

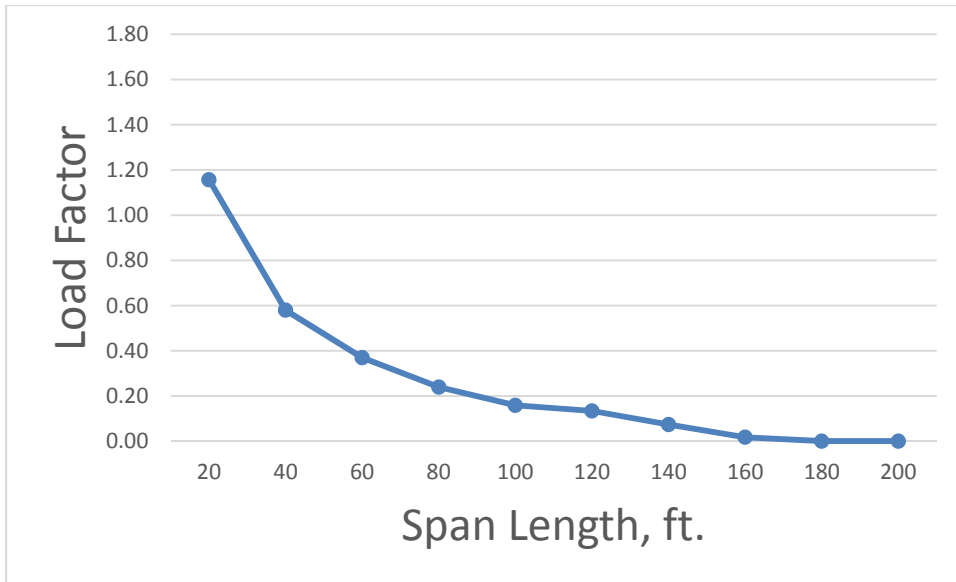

Figure K.2.33. Required Load Factors for 36" SBS Box, Simple Moment, One Lane.

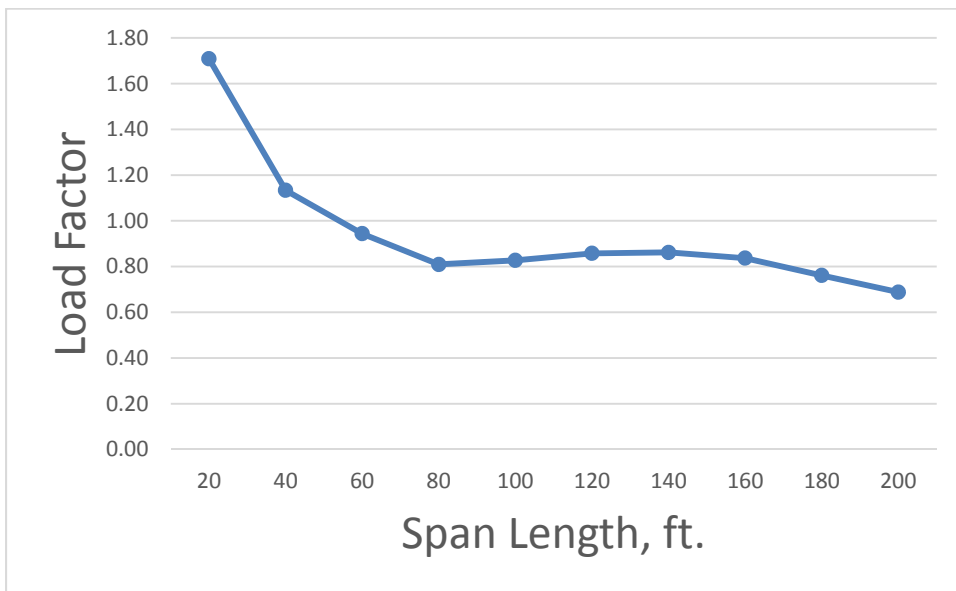

Figure K.2.34. Required Load Factors for 36" SBS Box, Simple Shear, One Lane.

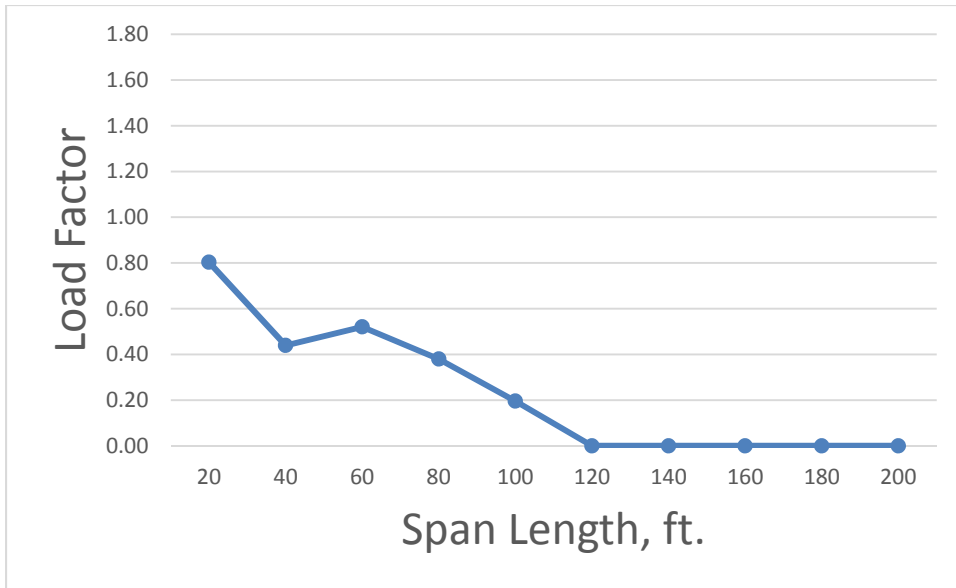

Figure K.2.35. Required Load Factors for 36" SBS Box, Continuous Negative Moment, One Lane.

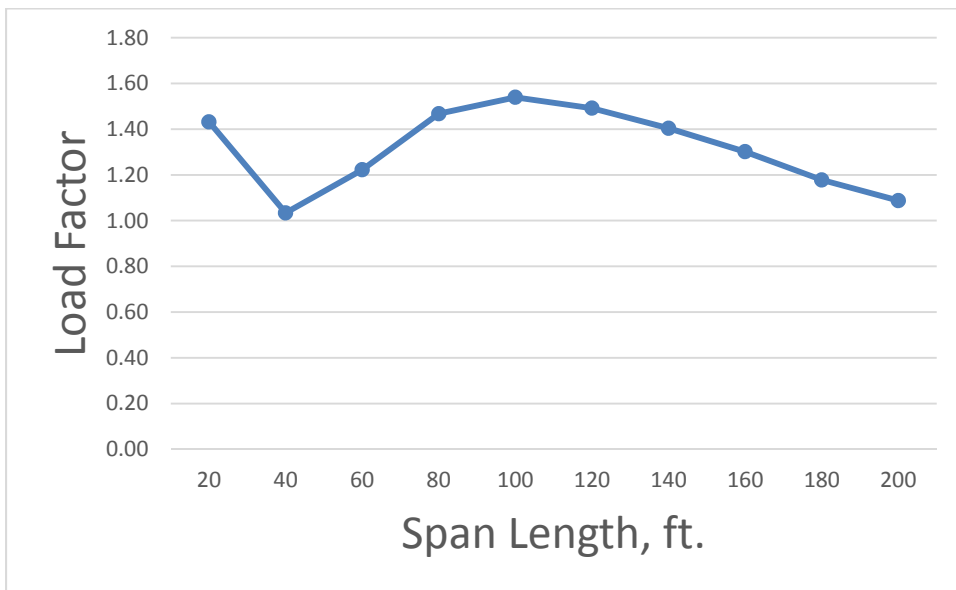

Figure K.2.36. Required Load Factors for 36" SBS Box, Continuous Shear, One Lane.

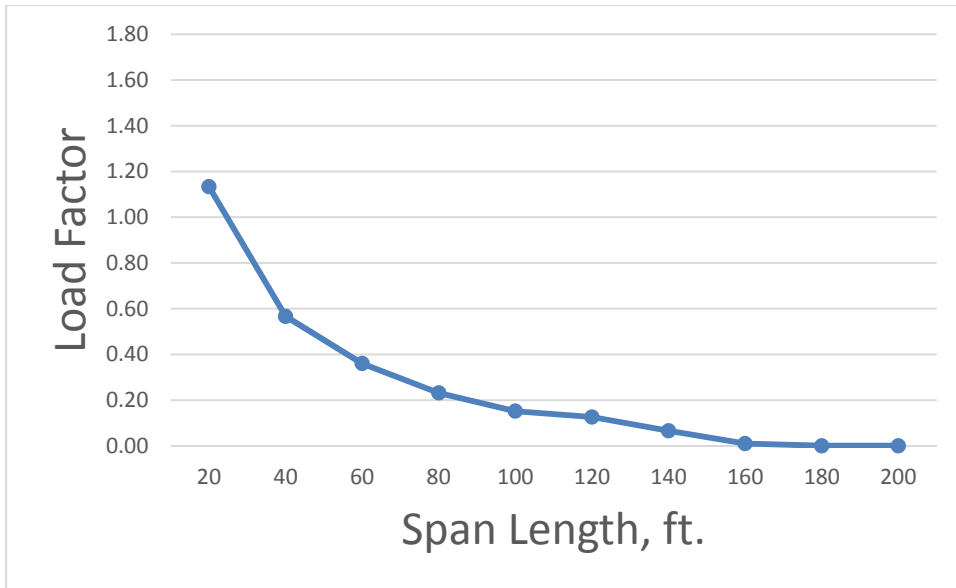

Figure K.2.37. Required Load Factors for 48” SBS Box, Simple Moment, One Lane.

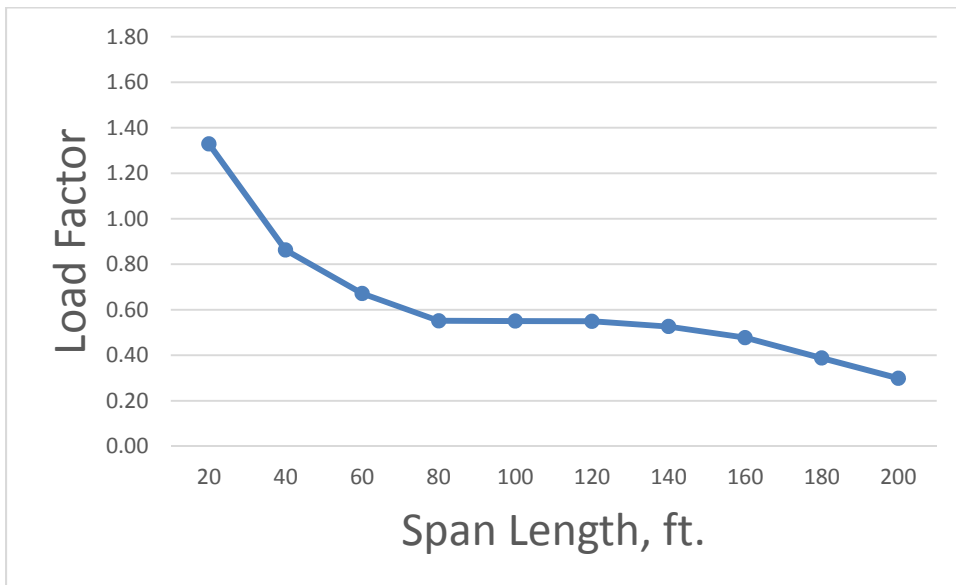

Figure K.2.38. Required Load Factors for 48” SBS Box, Simple Shear, One Lane.

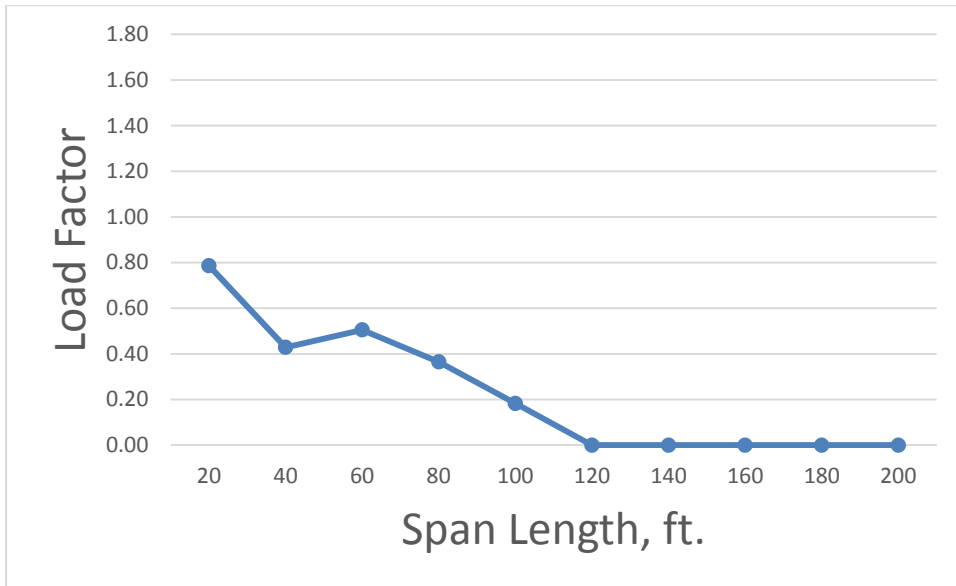

Figure K.2.39. Required Load Factors for 48” SBS Box, Continuous Negative Moment, One Lane.

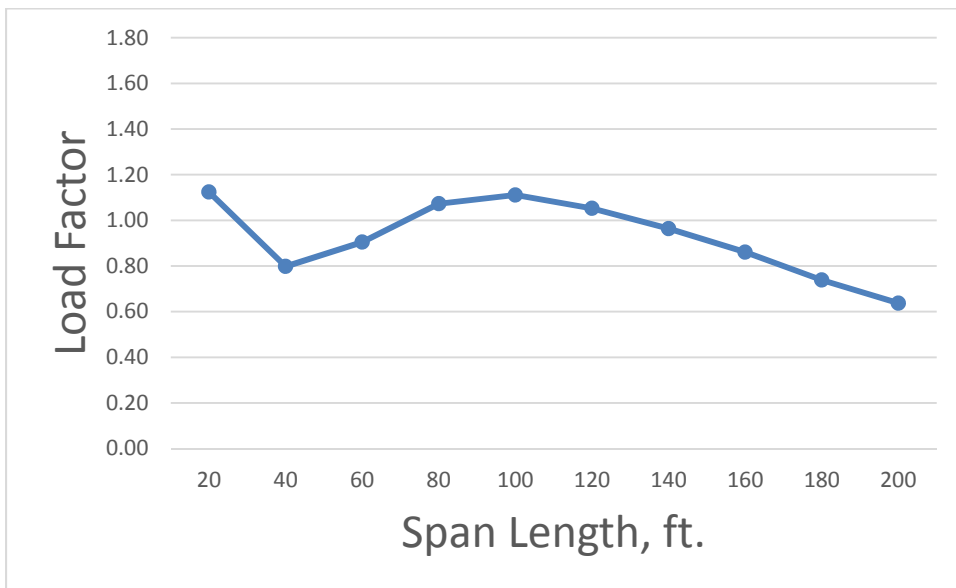

Figure K.2.40. Required Load Factors for 48” SBS Box, Continuous Shear, One Lane.

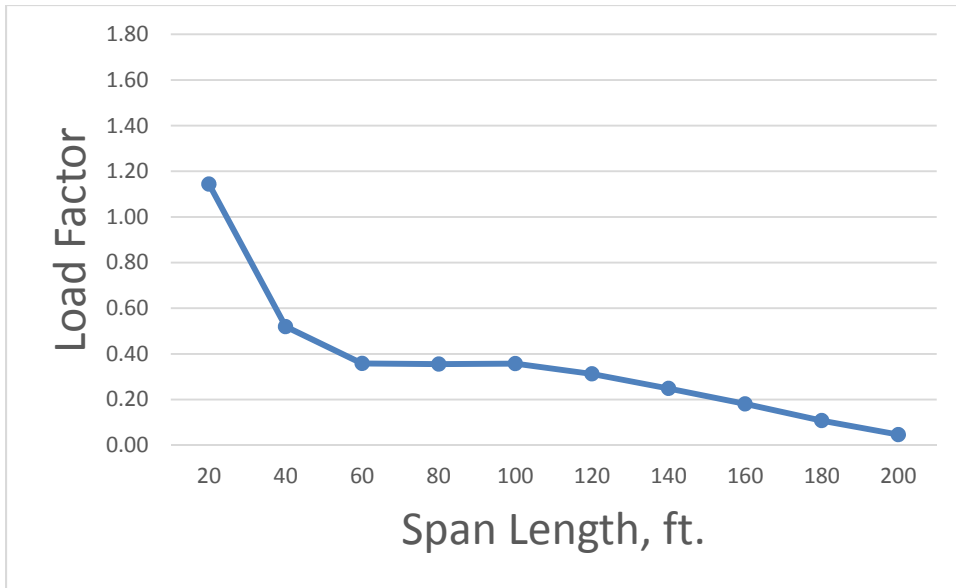

Figure K.2.41. Required Load Factors for 36" SBS Box, Simple Moment, Two Lane.

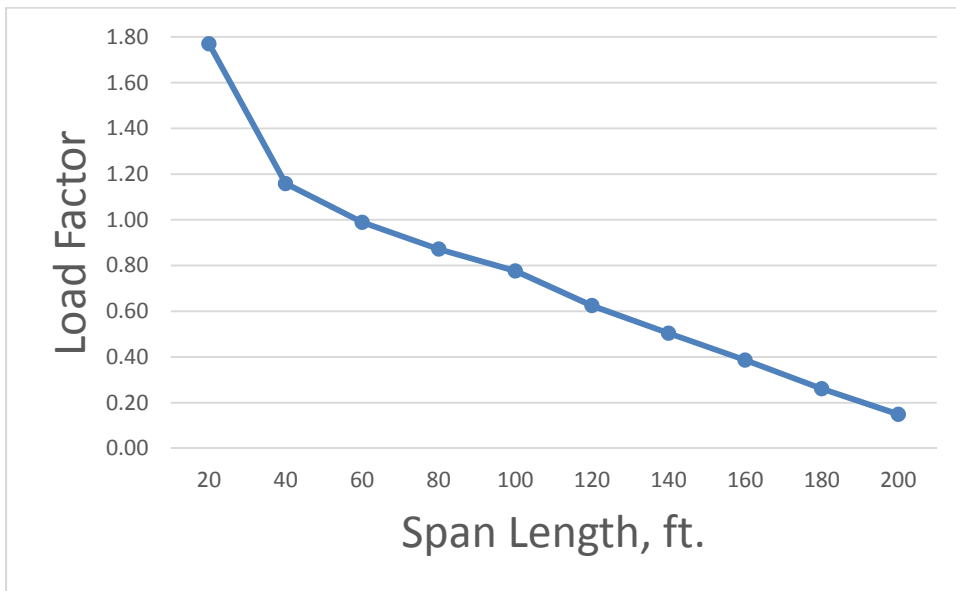

Figure K.2.42. Required Load Factors for 36" SBS Box, Simple Shear, Two Lane.

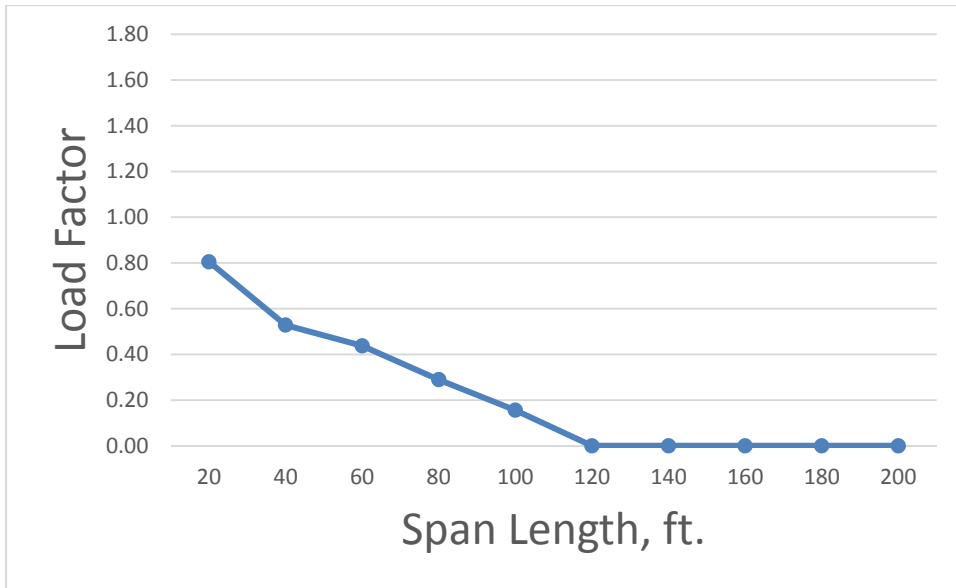

Figure K.2.43. Required Load Factors for 36" SBS Box, Continuous Negative Moment, Two Lane.

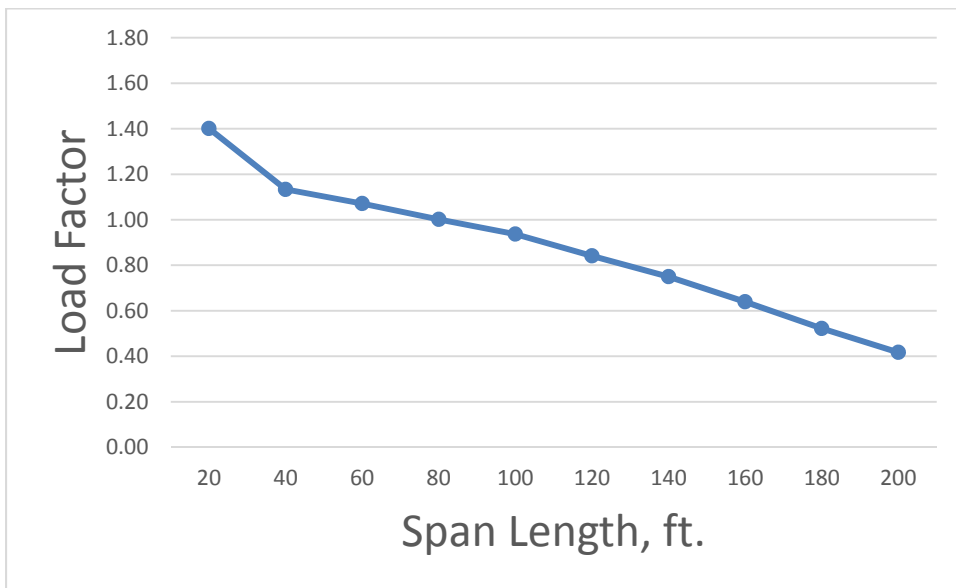

Figure K.2.44. Required Load Factors for 36" SBS Box, Continuous Shear, Two Lane.

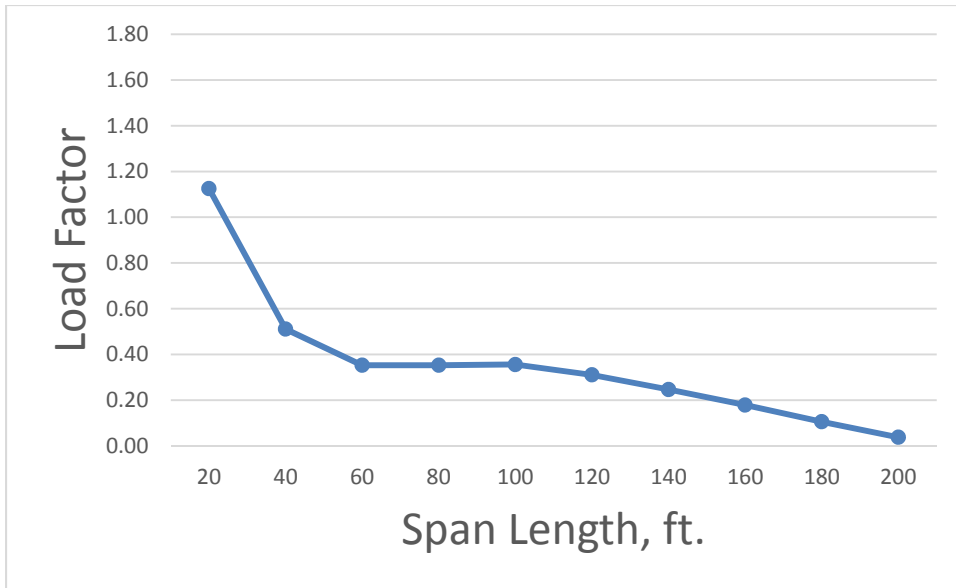

Figure K.2.45. Required Load Factors for 48" SBS Box, Simple Moment, Two Lane.

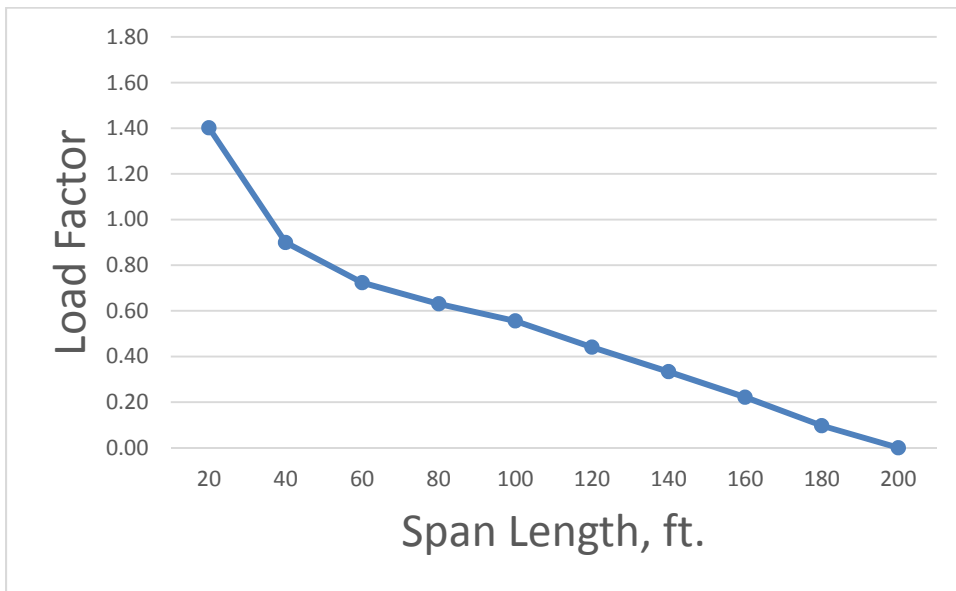

Figure K.2.46. Required Load Factors for 48" SBS Box, Simple Shear, Two Lane.



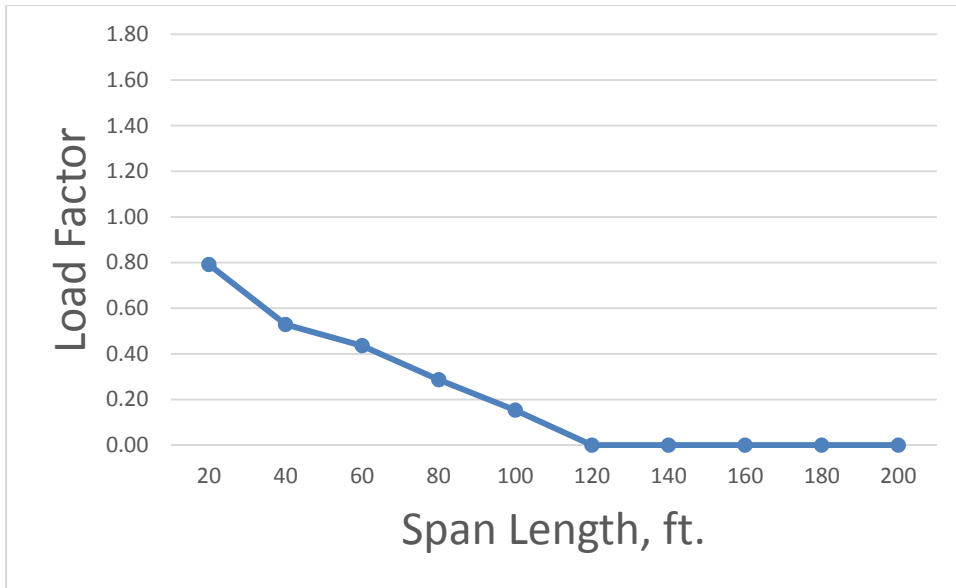

Figure K.2.47. Required Load Factors for 48” SBS Box, Continuous Negative Moment, Two Lane.

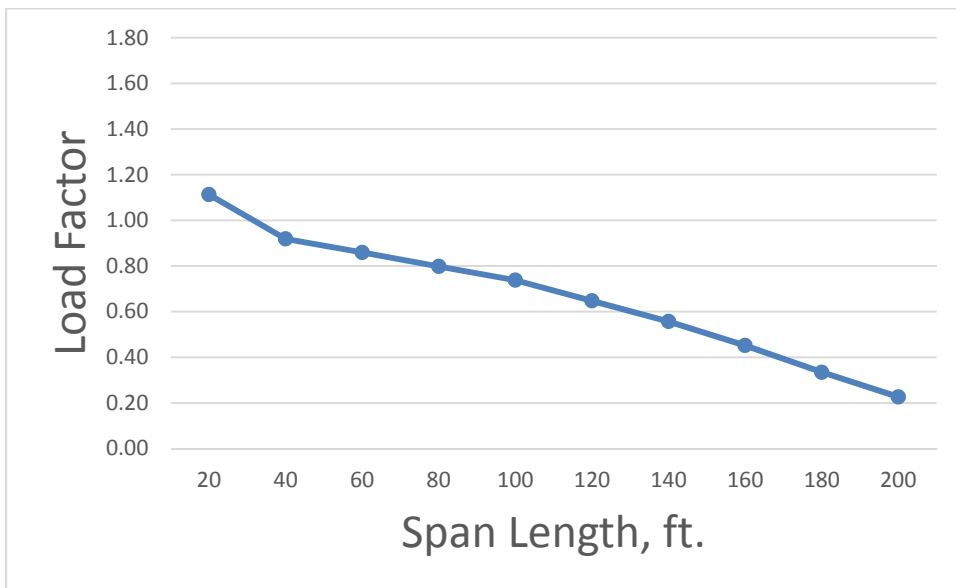

Figure K.2.48. Required Load Factors for 48” SBS Box, Continuous Shear, Two Lane.

## APPENDIX L. EXISTING RATING RELIABILITY INDICES

### Existing LRFR Indices

#### Single Lane Load Effects, Steel Girders

Lane	Effect	Span	Bridge	Beta	Lane	Effect	Span	Bridge	Beta
fol	Ms	20	CS04	3.13	fol	Mc	20	CS04	4.43
fol	Ms	20	CS06	3.28	fol	Mc	20	CS06	4.52
fol	Ms	20	CS08	3.38	fol	Mc	20	CS08	4.59
fol	Ms	20	CS10	3.46	fol	Mc	20	CS10	4.63
fol	Ms	20	CS12	3.52	fol	Mc	20	CS12	4.65
fol	Ms	40	CS04	4.22	fol	Mc	40	CS04	4.56
fol	Ms	40	CS06	4.32	fol	Mc	40	CS06	4.61
fol	Ms	40	CS08	4.39	fol	Mc	40	CS08	4.64
fol	Ms	40	CS10	4.43	fol	Mc	40	CS10	4.64
fol	Ms	40	CS12	4.45	fol	Mc	40	CS12	4.63
fol	Ms	60	CS04	4.31	fol	Mc	60	CS04	3.20
fol	Ms	60	CS06	4.38	fol	Mc	60	CS06	3.29
fol	Ms	60	CS08	4.42	fol	Mc	60	CS08	3.35
fol	Ms	60	CS10	4.43	fol	Mc	60	CS10	3.39
fol	Ms	60	CS12	4.43	fol	Mc	60	CS12	3.42
fol	Ms	80	CS04	4.44	fol	Mc	80	CS04	3.38
fol	Ms	80	CS06	4.48	fol	Mc	80	CS06	3.45
fol	Ms	80	CS08	4.51	fol	Mc	80	CS08	3.50
fol	Ms	80	CS10	4.51	fol	Mc	80	CS10	3.53
fol	Ms	80	CS12	4.48	fol	Mc	80	CS12	3.54
fol	Ms	100	CS04	4.30	fol	Mc	100	CS04	3.29
fol	Ms	100	CS06	4.35	fol	Mc	100	CS06	3.34
fol	Ms	100	CS08	4.38	fol	Mc	100	CS08	3.38
fol	Ms	100	CS10	4.37	fol	Mc	100	CS10	3.39
fol	Ms	100	CS12	4.34	fol	Mc	100	CS12	3.39
fol	Ms	120	CS04	3.76	fol	Mc	120	CS04	3.21
fol	Ms	120	CS06	3.80	fol	Mc	120	CS06	3.23
fol	Ms	120	CS08	3.84	fol	Mc	120	CS08	3.26
fol	Ms	120	CS10	3.84	fol	Mc	120	CS10	3.26
fol	Ms	120	CS12	3.82	fol	Mc	120	CS12	3.24
fol	Ms	140	CS04	3.51	fol	Mc	140	CS04	3.17
fol	Ms	140	CS06	3.54	fol	Mc	140	CS06	3.18
fol	Ms	140	CS08	3.57	fol	Mc	140	CS08	3.19
fol	Ms	140	CS10	3.58	fol	Mc	140	CS10	3.18
fol	Ms	140	CS12	3.56	fol	Mc	140	CS12	3.16
fol	Ms	160	CS04	3.24	fol	Mc	160	CS04	3.27
fol	Ms	160	CS06	3.28	fol	Mc	160	CS06	3.27
fol	Ms	160	CS08	3.31	fol	Mc	160	CS08	3.27

fol	Ms	160	CS10	3.32	fol	Mc	160	CS10	3.25
fol	Ms	160	CS12	3.31	fol	Mc	160	CS12	3.22
fol	Ms	180	CS04	3.06	fol	Mc	180	CS04	3.24
fol	Ms	180	CS06	3.10	fol	Mc	180	CS06	3.24
fol	Ms	180	CS08	3.13	fol	Mc	180	CS08	3.24
fol	Ms	180	CS10	3.14	fol	Mc	180	CS10	3.23
fol	Ms	180	CS12	3.14	fol	Mc	180	CS12	3.19
fol	Ms	200	CS04	2.95	fol	Mc	200	CS04	3.17
fol	Ms	200	CS06	2.98	fol	Mc	200	CS06	3.17
fol	Ms	200	CS08	3.01	fol	Mc	200	CS08	3.17
fol	Ms	200	CS10	3.02	fol	Mc	200	CS10	3.15
fol	Ms	200	CS12	3.02	fol	Mc	200	CS12	3.12
fol	Vs	20	CS04	2.83	fol	Vc	20	CS04	3.85
fol	Vs	20	CS06	3.30	fol	Vc	20	CS06	4.32
fol	Vs	20	CS08	3.58	fol	Vc	20	CS08	4.60
fol	Vs	20	CS10	3.75	fol	Vc	20	CS10	4.76
fol	Vs	20	CS12	3.84	fol	Vc	20	CS12	4.86
fol	Vs	40	CS04	3.51	fol	Vc	40	CS04	4.13
fol	Vs	40	CS06	3.92	fol	Vc	40	CS06	4.55
fol	Vs	40	CS08	4.15	fol	Vc	40	CS08	4.79
fol	Vs	40	CS10	4.27	fol	Vc	40	CS10	4.93
fol	Vs	40	CS12	4.34	fol	Vc	40	CS12	5.00
fol	Vs	60	CS04	3.90	fol	Vc	60	CS04	3.41
fol	Vs	60	CS06	4.25	fol	Vc	60	CS06	3.86
fol	Vs	60	CS08	4.44	fol	Vc	60	CS08	4.11
fol	Vs	60	CS10	4.53	fol	Vc	60	CS10	4.25
fol	Vs	60	CS12	4.57	fol	Vc	60	CS12	4.33
fol	Vs	80	CS04	3.98	fol	Vc	80	CS04	3.28
fol	Vs	80	CS06	4.29	fol	Vc	80	CS06	3.71
fol	Vs	80	CS08	4.45	fol	Vc	80	CS08	3.96
fol	Vs	80	CS10	4.53	fol	Vc	80	CS10	4.11
fol	Vs	80	CS12	4.55	fol	Vc	80	CS12	4.20
fol	Vs	100	CS04	3.61	fol	Vc	100	CS04	3.04
fol	Vs	100	CS06	3.92	fol	Vc	100	CS06	3.45
fol	Vs	100	CS08	4.09	fol	Vc	100	CS08	3.70
fol	Vs	100	CS10	4.17	fol	Vc	100	CS10	3.85
fol	Vs	100	CS12	4.20	fol	Vc	100	CS12	3.94
fol	Vs	120	CS04	3.17	fol	Vc	120	CS04	3.07
fol	Vs	120	CS06	3.48	fol	Vc	120	CS06	3.46
fol	Vs	120	CS08	3.66	fol	Vc	120	CS08	3.70
fol	Vs	120	CS10	3.75	fol	Vc	120	CS10	3.84
fol	Vs	120	CS12	3.79	fol	Vc	120	CS12	3.92
fol	Vs	140	CS04	2.79	fol	Vc	140	CS04	3.14
fol	Vs	140	CS06	3.10	fol	Vc	140	CS06	3.52

fol	Vs	140	CS08	3.28	fol	Vc	140	CS08	3.74
fol	Vs	140	CS10	3.38	fol	Vc	140	CS10	3.87
fol	Vs	140	CS12	3.42	fol	Vc	140	CS12	3.93
fol	Vs	160	CS04	2.53	fol	Vc	160	CS04	3.17
fol	Vs	160	CS06	2.84	fol	Vc	160	CS06	3.53
fol	Vs	160	CS08	3.01	fol	Vc	160	CS08	3.73
fol	Vs	160	CS10	3.11	fol	Vc	160	CS10	3.85
fol	Vs	160	CS12	3.16	fol	Vc	160	CS12	3.91
fol	Vs	180	CS04	2.33	fol	Vc	180	CS04	3.21
fol	Vs	180	CS06	2.62	fol	Vc	180	CS06	3.53
fol	Vs	180	CS08	2.78	fol	Vc	180	CS08	3.72
fol	Vs	180	CS10	2.88	fol	Vc	180	CS10	3.83
fol	Vs	180	CS12	2.93	fol	Vc	180	CS12	3.88
fol	Vs	200	CS04	2.28	fol	Vc	200	CS04	3.22
fol	Vs	200	CS06	2.55	fol	Vc	200	CS06	3.52
fol	Vs	200	CS08	2.71	fol	Vc	200	CS08	3.70
fol	Vs	200	CS10	2.80	fol	Vc	200	CS10	3.80
fol	Vs	200	CS12	2.85	fol	Vc	200	CS12	3.84

Lane	Effect	Span	Bridge	Beta
fol	Mcp	20	CS04	3.28
fol	Mcp	20	CS06	3.41
fol	Mcp	20	CS08	3.50
fol	Mcp	20	CS10	3.57
fol	Mcp	20	CS12	3.62
fol	Mcp	40	CS04	4.07
fol	Mcp	40	CS06	4.16
fol	Mcp	40	CS08	4.22
fol	Mcp	40	CS10	4.25
fol	Mcp	40	CS12	4.25
fol	Mcp	60	CS04	4.10
fol	Mcp	60	CS06	4.15
fol	Mcp	60	CS08	4.19
fol	Mcp	60	CS10	4.19
fol	Mcp	60	CS12	4.17
fol	Mcp	80	CS04	4.26
fol	Mcp	80	CS06	4.29
fol	Mcp	80	CS08	4.30
fol	Mcp	80	CS10	4.29
fol	Mcp	80	CS12	4.26
fol	Mcp	100	CS04	4.12
fol	Mcp	100	CS06	4.15
fol	Mcp	100	CS08	4.17
fol	Mcp	100	CS10	4.15
fol	Mcp	100	CS12	4.12

fol	Mcp	120	CS04	3.62
fol	Mcp	120	CS06	3.64
fol	Mcp	120	CS08	3.67
fol	Mcp	120	CS10	3.66
fol	Mcp	120	CS12	3.63
fol	Mcp	140	CS04	3.36
fol	Mcp	140	CS06	3.38
fol	Mcp	140	CS08	3.40
fol	Mcp	140	CS10	3.40
fol	Mcp	140	CS12	3.37
fol	Mcp	160	CS04	3.11
fol	Mcp	160	CS06	3.14
fol	Mcp	160	CS08	3.16
fol	Mcp	160	CS10	3.16
fol	Mcp	160	CS12	3.15
fol	Mcp	180	CS04	2.96
fol	Mcp	180	CS06	2.99
fol	Mcp	180	CS08	3.01
fol	Mcp	180	CS10	3.01
fol	Mcp	180	CS12	3.00
fol	Mcp	200	CS04	2.87
fol	Mcp	200	CS06	2.89
fol	Mcp	200	CS08	2.91
fol	Mcp	200	CS10	2.91
fol	Mcp	200	CS12	2.90

### Two Lane Load Effects, Steel Girders

Lane	Effect	Span	Bridge	Beta	Lane	Effect	Span	Bridge	Beta
04G	Ms	20	CS04	2.82	04G	Mc	20	CS04	4.13
06G	Ms	20	CS06	2.93	06G	Mc	20	CS06	4.20
08G	Ms	20	CS08	3.01	08G	Mc	20	CS08	4.25
10G	Ms	20	CS10	3.07	10G	Mc	20	CS10	4.28
12G	Ms	20	CS12	3.11	12G	Mc	20	CS12	4.29
04G	Ms	40	CS04	4.37	04G	Mc	40	CS04	3.67
06G	Ms	40	CS06	4.42	06G	Mc	40	CS06	3.62
08G	Ms	40	CS08	4.45	08G	Mc	40	CS08	3.56
10G	Ms	40	CS10	4.46	10G	Mc	40	CS10	3.52
12G	Ms	40	CS12	4.46	12G	Mc	40	CS12	3.49
04G	Ms	60	CS04	4.38	04G	Mc	60	CS04	3.78
06G	Ms	60	CS06	4.39	06G	Mc	60	CS06	3.73
08G	Ms	60	CS08	4.39	08G	Mc	60	CS08	3.70
10G	Ms	60	CS10	4.37	10G	Mc	60	CS10	3.65
12G	Ms	60	CS12	4.35	12G	Mc	60	CS12	3.61

04G	Ms	80	CS04	3.96	04G	Mc	80	CS04	4.13
06G	Ms	80	CS06	3.92	06G	Mc	80	CS06	4.08
08G	Ms	80	CS08	3.90	08G	Mc	80	CS08	4.05
10G	Ms	80	CS10	3.86	10G	Mc	80	CS10	4.00
12G	Ms	80	CS12	3.82	12G	Mc	80	CS12	3.94
04G	Ms	100	CS04	3.58	04G	Mc	100	CS04	3.81
06G	Ms	100	CS06	3.54	06G	Mc	100	CS06	3.77
08G	Ms	100	CS08	3.52	08G	Mc	100	CS08	3.75
10G	Ms	100	CS10	3.48	10G	Mc	100	CS10	3.70
12G	Ms	100	CS12	3.44	12G	Mc	100	CS12	3.65
04G	Ms	120	CS04	3.27	04G	Mc	120	CS04	3.59
06G	Ms	120	CS06	3.22	06G	Mc	120	CS06	3.54
08G	Ms	120	CS08	3.20	08G	Mc	120	CS08	3.51
10G	Ms	120	CS10	3.17	10G	Mc	120	CS10	3.46
12G	Ms	120	CS12	3.14	12G	Mc	120	CS12	3.41
04G	Ms	140	CS04	3.18	04G	Mc	140	CS04	3.38
06G	Ms	140	CS06	3.15	06G	Mc	140	CS06	3.33
08G	Ms	140	CS08	3.12	08G	Mc	140	CS08	3.30
10G	Ms	140	CS10	3.09	10G	Mc	140	CS10	3.25
12G	Ms	140	CS12	3.06	12G	Mc	140	CS12	3.20
04G	Ms	160	CS04	3.10	04G	Mc	160	CS04	3.36
06G	Ms	160	CS06	3.07	06G	Mc	160	CS06	3.31
08G	Ms	160	CS08	3.04	08G	Mc	160	CS08	3.28
10G	Ms	160	CS10	3.01	10G	Mc	160	CS10	3.23
12G	Ms	160	CS12	2.98	12G	Mc	160	CS12	3.18
04G	Ms	180	CS04	3.03	04G	Mc	180	CS04	3.30
06G	Ms	180	CS06	2.99	06G	Mc	180	CS06	3.26
08G	Ms	180	CS08	2.97	08G	Mc	180	CS08	3.23
10G	Ms	180	CS10	2.94	10G	Mc	180	CS10	3.19
12G	Ms	180	CS12	2.91	12G	Mc	180	CS12	3.14
04G	Ms	200	CS04	2.94	04G	Mc	200	CS04	3.22
06G	Ms	200	CS06	2.91	06G	Mc	200	CS06	3.18
08G	Ms	200	CS08	2.89	08G	Mc	200	CS08	3.16
10G	Ms	200	CS10	2.86	10G	Mc	200	CS10	3.12
12G	Ms	200	CS12	2.84	12G	Mc	200	CS12	3.08
04G	Vs	20	CS04	2.52	04G	Vc	20	CS04	3.76
06G	Vs	20	CS06	2.91	06G	Vc	20	CS06	4.17
08G	Vs	20	CS08	3.15	08G	Vc	20	CS08	4.41
10G	Vs	20	CS10	3.29	10G	Vc	20	CS10	4.55
12G	Vs	20	CS12	3.37	12G	Vc	20	CS12	4.63
04G	Vs	40	CS04	3.31	04G	Vc	40	CS04	3.39
06G	Vs	40	CS06	3.65	06G	Vc	40	CS06	3.63
08G	Vs	40	CS08	3.85	08G	Vc	40	CS08	3.78
10G	Vs	40	CS10	3.96	10G	Vc	40	CS10	3.86

12G	Vs	40	CS12	4.01	12G	Vc	40	CS12	3.91
04G	Vs	60	CS04	3.64	04G	Vc	60	CS04	3.35
06G	Vs	60	CS06	3.93	06G	Vc	60	CS06	3.44
08G	Vs	60	CS08	4.10	08G	Vc	60	CS08	3.49
10G	Vs	60	CS10	4.18	10G	Vc	60	CS10	3.52
12G	Vs	60	CS12	4.21	12G	Vc	60	CS12	3.53
04G	Vs	80	CS04	3.63	04G	Vc	80	CS04	4.20
06G	Vs	80	CS06	3.84	06G	Vc	80	CS06	4.26
08G	Vs	80	CS08	3.95	08G	Vc	80	CS08	4.28
10G	Vs	80	CS10	4.00	10G	Vc	80	CS10	4.29
12G	Vs	80	CS12	4.02	12G	Vc	80	CS12	4.28
04G	Vs	100	CS04	3.54	04G	Vc	100	CS04	4.31
06G	Vs	100	CS06	3.68	06G	Vc	100	CS06	4.34
08G	Vs	100	CS08	3.76	08G	Vc	100	CS08	4.37
10G	Vs	100	CS10	3.79	10G	Vc	100	CS10	4.37
12G	Vs	100	CS12	3.79	12G	Vc	100	CS12	4.36
04G	Vs	120	CS04	3.57	04G	Vc	120	CS04	4.41
06G	Vs	120	CS06	3.60	06G	Vc	120	CS06	4.42
08G	Vs	120	CS08	3.61	08G	Vc	120	CS08	4.43
10G	Vs	120	CS10	3.61	10G	Vc	120	CS10	4.42
12G	Vs	120	CS12	3.59	12G	Vc	120	CS12	4.40
04G	Vs	140	CS04	3.51	04G	Vc	140	CS04	4.39
06G	Vs	140	CS06	3.51	06G	Vc	140	CS06	4.40
08G	Vs	140	CS08	3.50	08G	Vc	140	CS08	4.41
10G	Vs	140	CS10	3.49	10G	Vc	140	CS10	4.39
12G	Vs	140	CS12	3.46	12G	Vc	140	CS12	4.37
04G	Vs	160	CS04	3.44	04G	Vc	160	CS04	4.38
06G	Vs	160	CS06	3.42	06G	Vc	160	CS06	4.37
08G	Vs	160	CS08	3.41	08G	Vc	160	CS08	4.37
10G	Vs	160	CS10	3.38	10G	Vc	160	CS10	4.36
12G	Vs	160	CS12	3.36	12G	Vc	160	CS12	4.33
04G	Vs	180	CS04	3.27	04G	Vc	180	CS04	4.34
06G	Vs	180	CS06	3.25	06G	Vc	180	CS06	4.33
08G	Vs	180	CS08	3.23	08G	Vc	180	CS08	4.33
10G	Vs	180	CS10	3.21	10G	Vc	180	CS10	4.31
12G	Vs	180	CS12	3.18	12G	Vc	180	CS12	4.27
04G	Vs	200	CS04	3.22	04G	Vc	200	CS04	4.28
06G	Vs	200	CS06	3.20	06G	Vc	200	CS06	4.27
08G	Vs	200	CS08	3.19	08G	Vc	200	CS08	4.27
10G	Vs	200	CS10	3.16	10G	Vc	200	CS10	4.24
12G	Vs	200	CS12	3.14	12G	Vc	200	CS12	4.20

Lane	Effect	Span	Bridge	Beta
04G	Mcp	20	CS04	2.98
06G	Mcp	20	CS06	3.08
08G	Mcp	20	CS08	3.15
10G	Mcp	20	CS10	3.20
12G	Mcp	20	CS12	3.24
04G	Mcp	40	CS04	4.21
06G	Mcp	40	CS06	4.25
08G	Mcp	40	CS08	4.28
10G	Mcp	40	CS10	4.28
12G	Mcp	40	CS12	4.27
04G	Mcp	60	CS04	4.16
06G	Mcp	60	CS06	4.16
08G	Mcp	60	CS08	4.16
10G	Mcp	60	CS10	4.13
12G	Mcp	60	CS12	4.10
04G	Mcp	80	CS04	3.84
06G	Mcp	80	CS06	3.80
08G	Mcp	80	CS08	3.77
10G	Mcp	80	CS10	3.73
12G	Mcp	80	CS12	3.69
04G	Mcp	100	CS04	3.50
06G	Mcp	100	CS06	3.46
08G	Mcp	100	CS08	3.43
10G	Mcp	100	CS10	3.39
12G	Mcp	100	CS12	3.35
04G	Mcp	120	CS04	3.20
06G	Mcp	120	CS06	3.16
08G	Mcp	120	CS08	3.13
10G	Mcp	120	CS10	3.10
12G	Mcp	120	CS12	3.06
04G	Mcp	140	CS04	3.09
06G	Mcp	140	CS06	3.05
08G	Mcp	140	CS08	3.02
10G	Mcp	140	CS10	2.99
12G	Mcp	140	CS12	2.95
04G	Mcp	160	CS04	2.99
06G	Mcp	160	CS06	2.95
08G	Mcp	160	CS08	2.93
10G	Mcp	160	CS10	2.90
12G	Mcp	160	CS12	2.87
04G	Mcp	180	CS04	2.93
06G	Mcp	180	CS06	2.89
08G	Mcp	180	CS08	2.86
10G	Mcp	180	CS10	2.83



12G	Mcp	180	CS12	2.80
04G	Mcp	200	CS04	2.85
06G	Mcp	200	CS06	2.82
08G	Mcp	200	CS08	2.80
10G	Mcp	200	CS10	2.77
12G	Mcp	200	CS12	2.74

### Single Lane Load Effects, PC Girders

Lane	Effect	Span	Bridge	Beta	Lane	Effect	Span	Bridge	Beta
fol	Ms	20	PC04	3.19	fol	Mc	20	PC04	4.75
fol	Ms	20	PC06	3.35	fol	Mc	20	PC06	4.92
fol	Ms	20	PC08	3.48	fol	Mc	20	PC08	5.05
fol	Ms	20	PC10	3.58	fol	Mc	20	PC10	5.13
fol	Ms	20	PC12	3.66	fol	Mc	20	PC12	5.18
fol	Ms	40	PC04	4.49	fol	Mc	40	PC04	4.88
fol	Ms	40	PC06	4.65	fol	Mc	40	PC06	5.03
fol	Ms	40	PC08	4.77	fol	Mc	40	PC08	5.14
fol	Ms	40	PC10	4.85	fol	Mc	40	PC10	5.18
fol	Ms	40	PC12	4.90	fol	Mc	40	PC12	5.20
fol	Ms	60	PC04	4.59	fol	Mc	60	PC04	3.29
fol	Ms	60	PC06	4.74	fol	Mc	60	PC06	3.39
fol	Ms	60	PC08	4.85	fol	Mc	60	PC08	3.46
fol	Ms	60	PC10	4.90	fol	Mc	60	PC10	3.51
fol	Ms	60	PC12	4.93	fol	Mc	60	PC12	3.55
fol	Ms	80	PC04	4.64	fol	Mc	80	PC04	3.47
fol	Ms	80	PC06	4.81	fol	Mc	80	PC06	3.57
fol	Ms	80	PC08	4.93	fol	Mc	80	PC08	3.64
fol	Ms	80	PC10	4.98	fol	Mc	80	PC10	3.69
fol	Ms	80	PC12	5.00	fol	Mc	80	PC12	3.71
fol	Ms	100	PC04	4.39	fol	Mc	100	PC04	3.34
fol	Ms	100	PC06	4.58	fol	Mc	100	PC06	3.44
fol	Ms	100	PC08	4.71	fol	Mc	100	PC08	3.51
fol	Ms	100	PC10	4.76	fol	Mc	100	PC10	3.54
fol	Ms	100	PC12	4.78	fol	Mc	100	PC12	3.56
fol	Ms	120	PC04	3.80	fol	Mc	120	PC04	3.23
fol	Ms	120	PC06	3.96	fol	Mc	120	PC06	3.32
fol	Ms	120	PC08	4.06	fol	Mc	120	PC08	3.38
fol	Ms	120	PC10	4.11	fol	Mc	120	PC10	3.40
fol	Ms	120	PC12	4.12	fol	Mc	120	PC12	3.40
fol	Ms	140	PC04	3.56	fol	Mc	140	PC04	3.18
fol	Ms	140	PC06	3.69	fol	Mc	140	PC06	3.27
fol	Ms	140	PC08	3.78	fol	Mc	140	PC08	3.31
fol	Ms	140	PC10	3.82	fol	Mc	140	PC10	3.33
fol	Ms	140	PC12	3.83	fol	Mc	140	PC12	3.32

fol	Ms	160	PC04	3.30	fol	Mc	160	PC04	3.29
fol	Ms	160	PC06	3.41	fol	Mc	160	PC06	3.37
fol	Ms	160	PC08	3.48	fol	Mc	160	PC08	3.42
fol	Ms	160	PC10	3.51	fol	Mc	160	PC10	3.43
fol	Ms	160	PC12	3.53	fol	Mc	160	PC12	3.42
fol	Ms	180	PC04	3.12	fol	Mc	180	PC04	3.28
fol	Ms	180	PC06	3.21	fol	Mc	180	PC06	3.36
fol	Ms	180	PC08	3.27	fol	Mc	180	PC08	3.41
fol	Ms	180	PC10	3.30	fol	Mc	180	PC10	3.42
fol	Ms	180	PC12	3.31	fol	Mc	180	PC12	3.40
fol	Ms	200	PC04	3.00	fol	Mc	200	PC04	3.21
fol	Ms	200	PC06	3.08	fol	Mc	200	PC06	3.29
fol	Ms	200	PC08	3.14	fol	Mc	200	PC08	3.33
fol	Ms	200	PC10	3.16	fol	Mc	200	PC10	3.34
fol	Ms	200	PC12	3.17	fol	Mc	200	PC12	3.32
fol	Vs	20	PC04	2.69	fol	Vc	20	PC04	3.43
fol	Vs	20	PC06	3.01	fol	Vc	20	PC06	3.74
fol	Vs	20	PC08	3.20	fol	Vc	20	PC08	3.93
fol	Vs	20	PC10	3.31	fol	Vc	20	PC10	4.04
fol	Vs	20	PC12	3.37	fol	Vc	20	PC12	4.10
fol	Vs	40	PC04	3.11	fol	Vc	40	PC04	3.57
fol	Vs	40	PC06	3.38	fol	Vc	40	PC06	3.85
fol	Vs	40	PC08	3.54	fol	Vc	40	PC08	4.01
fol	Vs	40	PC10	3.62	fol	Vc	40	PC10	4.10
fol	Vs	40	PC12	3.67	fol	Vc	40	PC12	4.15
fol	Vs	60	PC04	3.33	fol	Vc	60	PC04	3.08
fol	Vs	60	PC06	3.56	fol	Vc	60	PC06	3.37
fol	Vs	60	PC08	3.70	fol	Vc	60	PC08	3.54
fol	Vs	60	PC10	3.78	fol	Vc	60	PC10	3.64
fol	Vs	60	PC12	3.81	fol	Vc	60	PC12	3.69
fol	Vs	80	PC04	3.32	fol	Vc	80	PC04	3.05
fol	Vs	80	PC06	3.53	fol	Vc	80	PC06	3.33
fol	Vs	80	PC08	3.66	fol	Vc	80	PC08	3.50
fol	Vs	80	PC10	3.73	fol	Vc	80	PC10	3.60
fol	Vs	80	PC12	3.76	fol	Vc	80	PC12	3.66
fol	Vs	100	PC04	3.07	fol	Vc	100	PC04	2.90
fol	Vs	100	PC06	3.27	fol	Vc	100	PC06	3.16
fol	Vs	100	PC08	3.40	fol	Vc	100	PC08	3.32
fol	Vs	100	PC10	3.47	fol	Vc	100	PC10	3.42
fol	Vs	100	PC12	3.50	fol	Vc	100	PC12	3.48
fol	Vs	120	PC04	2.84	fol	Vc	120	PC04	2.90
fol	Vs	120	PC06	3.03	fol	Vc	120	PC06	3.15
fol	Vs	120	PC08	3.15	fol	Vc	120	PC08	3.31
fol	Vs	120	PC10	3.22	fol	Vc	120	PC10	3.40

fol	Vs	120	PC12	3.26	fol	Vc	120	PC12	3.46
fol	Vs	140	PC04	2.65	fol	Vc	140	PC04	2.93
fol	Vs	140	PC06	2.84	fol	Vc	140	PC06	3.17
fol	Vs	140	PC08	2.95	fol	Vc	140	PC08	3.31
fol	Vs	140	PC10	3.02	fol	Vc	140	PC10	3.40
fol	Vs	140	PC12	3.06	fol	Vc	140	PC12	3.45
fol	Vs	160	PC04	2.52	fol	Vc	160	PC04	2.93
fol	Vs	160	PC06	2.69	fol	Vc	160	PC06	3.16
fol	Vs	160	PC08	2.80	fol	Vc	160	PC08	3.30
fol	Vs	160	PC10	2.87	fol	Vc	160	PC10	3.38
fol	Vs	160	PC12	2.90	fol	Vc	160	PC12	3.43
fol	Vs	180	PC04	2.39	fol	Vc	180	PC04	2.94
fol	Vs	180	PC06	2.55	fol	Vc	180	PC06	3.15
fol	Vs	180	PC08	2.66	fol	Vc	180	PC08	3.28
fol	Vs	180	PC10	2.72	fol	Vc	180	PC10	3.36
fol	Vs	180	PC12	2.75	fol	Vc	180	PC12	3.41
fol	Vs	200	PC04	2.36	fol	Vc	200	PC04	2.93
fol	Vs	200	PC06	2.51	fol	Vc	200	PC06	3.14
fol	Vs	200	PC08	2.61	fol	Vc	200	PC08	3.26
fol	Vs	200	PC10	2.66	fol	Vc	200	PC10	3.34
fol	Vs	200	PC12	2.70	fol	Vc	200	PC12	3.38

### Two Lane Load Effects, PC Girders

Lane	Effect	Span	Bridge	Beta	Lane	Effect	Span	Bridge	Beta
04G	Ms	20	PC04	2.93	04G	Mc	20	PC04	4.48
06G	Ms	20	PC06	3.04	06G	Mc	20	PC06	4.61
08G	Ms	20	PC08	3.12	08G	Mc	20	PC08	4.69
10G	Ms	20	PC10	3.19	10G	Mc	20	PC10	4.74
12G	Ms	20	PC12	3.25	12G	Mc	20	PC12	4.78
04G	Ms	40	PC04	4.76	04G	Mc	40	PC04	3.87
06G	Ms	40	PC06	4.88	06G	Mc	40	PC06	3.82
08G	Ms	40	PC08	4.96	08G	Mc	40	PC08	3.76
10G	Ms	40	PC10	5.00	10G	Mc	40	PC10	3.72
12G	Ms	40	PC12	5.02	12G	Mc	40	PC12	3.68
04G	Ms	60	PC04	4.75	04G	Mc	60	PC04	3.99
06G	Ms	60	PC06	4.84	06G	Mc	60	PC06	3.98
08G	Ms	60	PC08	4.90	08G	Mc	60	PC08	3.97
10G	Ms	60	PC10	4.91	10G	Mc	60	PC10	3.93
12G	Ms	60	PC12	4.90	12G	Mc	60	PC12	3.90
04G	Ms	80	PC04	4.17	04G	Mc	80	PC04	4.17
06G	Ms	80	PC06	4.20	06G	Mc	80	PC06	4.22
08G	Ms	80	PC08	4.21	08G	Mc	80	PC08	4.24
10G	Ms	80	PC10	4.19	10G	Mc	80	PC10	4.22

12G	Ms	80	PC12	4.17	12G	Mc	80	PC12	4.19
04G	Ms	100	PC04	3.70	04G	Mc	100	PC04	3.84
06G	Ms	100	PC06	3.72	06G	Mc	100	PC06	3.91
08G	Ms	100	PC08	3.72	08G	Mc	100	PC08	3.95
10G	Ms	100	PC10	3.70	10G	Mc	100	PC10	3.94
12G	Ms	100	PC12	3.67	12G	Mc	100	PC12	3.91
04G	Ms	120	PC04	3.36	04G	Mc	120	PC04	3.58
06G	Ms	120	PC06	3.37	06G	Mc	120	PC06	3.65
08G	Ms	120	PC08	3.36	08G	Mc	120	PC08	3.68
10G	Ms	120	PC10	3.34	10G	Mc	120	PC10	3.66
12G	Ms	120	PC12	3.31	12G	Mc	120	PC12	3.63
04G	Ms	140	PC04	3.27	04G	Mc	140	PC04	3.39
06G	Ms	140	PC06	3.28	06G	Mc	140	PC06	3.44
08G	Ms	140	PC08	3.28	08G	Mc	140	PC08	3.45
10G	Ms	140	PC10	3.26	10G	Mc	140	PC10	3.43
12G	Ms	140	PC12	3.23	12G	Mc	140	PC12	3.40
04G	Ms	160	PC04	3.18	04G	Mc	160	PC04	3.37
06G	Ms	160	PC06	3.20	06G	Mc	160	PC06	3.43
08G	Ms	160	PC08	3.19	08G	Mc	160	PC08	3.45
10G	Ms	160	PC10	3.17	10G	Mc	160	PC10	3.43
12G	Ms	160	PC12	3.14	12G	Mc	160	PC12	3.39
04G	Ms	180	PC04	3.11	04G	Mc	180	PC04	3.34
06G	Ms	180	PC06	3.12	06G	Mc	180	PC06	3.39
08G	Ms	180	PC08	3.11	08G	Mc	180	PC08	3.41
10G	Ms	180	PC10	3.09	10G	Mc	180	PC10	3.39
12G	Ms	180	PC12	3.06	12G	Mc	180	PC12	3.35
04G	Ms	200	PC04	3.01	04G	Mc	200	PC04	3.26
06G	Ms	200	PC06	3.02	06G	Mc	200	PC06	3.32
08G	Ms	200	PC08	3.02	08G	Mc	200	PC08	3.34
10G	Ms	200	PC10	3.00	10G	Mc	200	PC10	3.32
12G	Ms	200	PC12	2.97	12G	Mc	200	PC12	3.28
04G	Vs	20	PC04	2.49	04G	Vc	20	PC04	3.39
06G	Vs	20	PC06	2.75	06G	Vc	20	PC06	3.66
08G	Vs	20	PC08	2.91	08G	Vc	20	PC08	3.83
10G	Vs	20	PC10	3.01	10G	Vc	20	PC10	3.92
12G	Vs	20	PC12	3.07	12G	Vc	20	PC12	3.98
04G	Vs	40	PC04	3.00	04G	Vc	40	PC04	3.14
06G	Vs	40	PC06	3.22	06G	Vc	40	PC06	3.31
08G	Vs	40	PC08	3.36	08G	Vc	40	PC08	3.41
10G	Vs	40	PC10	3.43	10G	Vc	40	PC10	3.47
12G	Vs	40	PC12	3.47	12G	Vc	40	PC12	3.50
04G	Vs	60	PC04	3.20	04G	Vc	60	PC04	3.11
06G	Vs	60	PC06	3.39	06G	Vc	60	PC06	3.17
08G	Vs	60	PC08	3.51	08G	Vc	60	PC08	3.21

10G	Vs	60	PC10	3.57	10G	Vc	60	PC10	3.23
12G	Vs	60	PC12	3.60	12G	Vc	60	PC12	3.24
04G	Vs	80	PC04	3.16	04G	Vc	80	PC04	3.62
06G	Vs	80	PC06	3.30	06G	Vc	80	PC06	3.68
08G	Vs	80	PC08	3.39	08G	Vc	80	PC08	3.71
10G	Vs	80	PC10	3.43	10G	Vc	80	PC10	3.72
12G	Vs	80	PC12	3.46	12G	Vc	80	PC12	3.72
04G	Vs	100	PC04	3.07	04G	Vc	100	PC04	3.61
06G	Vs	100	PC06	3.17	06G	Vc	100	PC06	3.67
08G	Vs	100	PC08	3.24	08G	Vc	100	PC08	3.71
10G	Vs	100	PC10	3.27	10G	Vc	100	PC10	3.72
12G	Vs	100	PC12	3.29	12G	Vc	100	PC12	3.72
04G	Vs	120	PC04	3.06	04G	Vc	120	PC04	3.63
06G	Vs	120	PC06	3.11	06G	Vc	120	PC06	3.68
08G	Vs	120	PC08	3.14	08G	Vc	120	PC08	3.72
10G	Vs	120	PC10	3.15	10G	Vc	120	PC10	3.73
12G	Vs	120	PC12	3.15	12G	Vc	120	PC12	3.73
04G	Vs	140	PC04	3.02	04G	Vc	140	PC04	3.61
06G	Vs	140	PC06	3.05	06G	Vc	140	PC06	3.66
08G	Vs	140	PC08	3.07	08G	Vc	140	PC08	3.70
10G	Vs	140	PC10	3.08	10G	Vc	140	PC10	3.71
12G	Vs	140	PC12	3.08	12G	Vc	140	PC12	3.71
04G	Vs	160	PC04	2.97	04G	Vc	160	PC04	3.58
06G	Vs	160	PC06	3.00	06G	Vc	160	PC06	3.63
08G	Vs	160	PC08	3.01	08G	Vc	160	PC08	3.67
10G	Vs	160	PC10	3.01	10G	Vc	160	PC10	3.68
12G	Vs	160	PC12	3.01	12G	Vc	160	PC12	3.68
04G	Vs	180	PC04	2.88	04G	Vc	180	PC04	3.54
06G	Vs	180	PC06	2.90	06G	Vc	180	PC06	3.60
08G	Vs	180	PC08	2.91	08G	Vc	180	PC08	3.63
10G	Vs	180	PC10	2.91	10G	Vc	180	PC10	3.64
12G	Vs	180	PC12	2.90	12G	Vc	180	PC12	3.64
04G	Vs	200	PC04	2.85	04G	Vc	200	PC04	3.51
06G	Vs	200	PC06	2.87	06G	Vc	200	PC06	3.56
08G	Vs	200	PC08	2.88	08G	Vc	200	PC08	3.60
10G	Vs	200	PC10	2.88	10G	Vc	200	PC10	3.61
12G	Vs	200	PC12	2.87	12G	Vc	200	PC12	3.60

### Single Lane Load Effects, RC Girders

Lane	Effect	Span	Bridge	Beta	Lane	Effect	Span	Bridge	Beta
fol	Ms	20	RC04	2.98	fol	Mc	20	RC04	3.87
fol	Ms	20	RC06	3.08	fol	Mc	20	RC06	3.88

fol	Ms	20	RC08	3.16	fol	Mc	20	RC08	3.96
fol	Ms	20	RC10	3.21	fol	Mc	20	RC10	3.98
fol	Ms	20	RC12	3.26	fol	Mc	20	RC12	4.00
fol	Ms	40	RC04	3.71	fol	Mc	40	RC04	3.75
fol	Ms	40	RC06	3.74	fol	Mc	40	RC06	3.74
fol	Ms	40	RC08	3.81	fol	Mc	40	RC08	3.81
fol	Ms	40	RC10	3.83	fol	Mc	40	RC10	3.81
fol	Ms	40	RC12	3.85	fol	Mc	40	RC12	3.81
fol	Ms	60	RC04	3.67	fol	Mc	60	RC04	2.94
fol	Ms	60	RC06	3.70	fol	Mc	60	RC06	2.99
fol	Ms	60	RC08	3.77	fol	Mc	60	RC08	3.05
fol	Ms	60	RC10	3.78	fol	Mc	60	RC10	3.07
fol	Ms	60	RC12	3.79	fol	Mc	60	RC12	3.09
fol	Ms	80	RC04	3.65	fol	Mc	80	RC04	3.01
fol	Ms	80	RC06	3.69	fol	Mc	80	RC06	3.06
fol	Ms	80	RC08	3.75	fol	Mc	80	RC08	3.10
fol	Ms	80	RC10	3.75	fol	Mc	80	RC10	3.12
fol	Ms	80	RC12	3.75	fol	Mc	80	RC12	3.13
fol	Ms	100	RC04	3.51	fol	Mc	100	RC04	2.86
fol	Ms	100	RC06	3.56	fol	Mc	100	RC06	2.90
fol	Ms	100	RC08	3.61	fol	Mc	100	RC08	2.94
fol	Ms	100	RC10	3.61	fol	Mc	100	RC10	2.95
fol	Ms	100	RC12	3.61	fol	Mc	100	RC12	2.95
fol	Vs	20	RC04	2.65	fol	Vc	20	RC04	3.34
fol	Vs	20	RC06	2.93	fol	Vc	20	RC06	3.59
fol	Vs	20	RC08	3.10	fol	Vc	20	RC08	3.76
fol	Vs	20	RC10	3.19	fol	Vc	20	RC10	3.84
fol	Vs	20	RC12	3.24	fol	Vc	20	RC12	3.89
fol	Vs	40	RC04	3.03	fol	Vc	40	RC04	3.45
fol	Vs	40	RC06	3.23	fol	Vc	40	RC06	3.65
fol	Vs	40	RC08	3.37	fol	Vc	40	RC08	3.80
fol	Vs	40	RC10	3.43	fol	Vc	40	RC10	3.86
fol	Vs	40	RC12	3.46	fol	Vc	40	RC12	3.90
fol	Vs	60	RC04	3.19	fol	Vc	60	RC04	2.98
fol	Vs	60	RC06	3.36	fol	Vc	60	RC06	3.21
fol	Vs	60	RC08	3.47	fol	Vc	60	RC08	3.36
fol	Vs	60	RC10	3.52	fol	Vc	60	RC10	3.43
fol	Vs	60	RC12	3.54	fol	Vc	60	RC12	3.47
fol	Vs	80	RC04	3.17	fol	Vc	80	RC04	2.98
fol	Vs	80	RC06	3.32	fol	Vc	80	RC06	3.21
fol	Vs	80	RC08	3.42	fol	Vc	80	RC08	3.36
fol	Vs	80	RC10	3.46	fol	Vc	80	RC10	3.43
fol	Vs	80	RC12	3.47	fol	Vc	80	RC12	3.47
fol	Vs	100	RC04	2.94	fol	Vc	100	RC04	2.83
fol	Vs	100	RC06	3.10	fol	Vc	100	RC06	3.06

fol	Vs	100	RC08	3.19	fol	Vc	100	RC08	3.20
fol	Vs	100	RC10	3.23	fol	Vc	100	RC10	3.27
fol	Vs	100	RC12	3.24	fol	Vc	100	RC12	3.31

Lane	Effect	Span	Bridge	Beta
fol	Mcp	20	RC04	3.09
fol	Mcp	20	RC06	3.17
fol	Mcp	20	RC08	3.24
fol	Mcp	20	RC10	3.29
fol	Mcp	20	RC12	3.32
fol	Mcp	40	RC04	3.60
fol	Mcp	40	RC06	3.62
fol	Mcp	40	RC08	3.68
fol	Mcp	40	RC10	3.70
fol	Mcp	40	RC12	3.71
fol	Mcp	60	RC04	3.52
fol	Mcp	60	RC06	3.54
fol	Mcp	60	RC08	3.60
fol	Mcp	60	RC10	3.60
fol	Mcp	60	RC12	3.61
fol	Mcp	80	RC04	3.52
fol	Mcp	80	RC06	3.55
fol	Mcp	80	RC08	3.61
fol	Mcp	80	RC10	3.60
fol	Mcp	80	RC12	3.60
fol	Mcp	100	RC04	3.37
fol	Mcp	100	RC06	3.42
fol	Mcp	100	RC08	3.47
fol	Mcp	100	RC10	3.47
fol	Mcp	100	RC12	3.45

Lane	Effect	Span	Bridge	Beta
04G	Ms	20	RC04	2.81
06G	Ms	20	RC06	2.89
08G	Ms	20	RC08	2.94
10G	Ms	20	RC10	2.99
12G	Ms	20	RC12	3.02
04G	Ms	40	RC04	3.83
06G	Ms	40	RC06	3.82
08G	Ms	40	RC08	3.87
10G	Ms	40	RC10	3.88
12G	Ms	40	RC12	3.88
04G	Mc	20	RC04	3.56
06G	Mc	20	RC06	3.58
08G	Mc	20	RC08	3.63
10G	Mc	20	RC10	3.65
12G	Mc	20	RC12	3.67
04G	Mc	40	RC04	3.14
06G	Mc	40	RC06	3.09
08G	Mc	40	RC08	3.07
10G	Mc	40	RC10	3.04
12G	Mc	40	RC12	3.02

**Two Lane Load Effects, RC Girders**

04G	Ms	60	RC04	3.72	04G	Mc	60	RC04	3.11
06G	Ms	60	RC06	3.72	06G	Mc	60	RC06	3.08
08G	Ms	60	RC08	3.76	08G	Mc	60	RC08	3.08
10G	Ms	60	RC10	3.75	10G	Mc	60	RC10	3.07
12G	Ms	60	RC12	3.74	12G	Mc	60	RC12	3.05
04G	Ms	80	RC04	3.42	04G	Mc	80	RC04	3.25
06G	Ms	80	RC06	3.41	06G	Mc	80	RC06	3.24
08G	Ms	80	RC08	3.43	08G	Mc	80	RC08	3.25
10G	Ms	80	RC10	3.41	10G	Mc	80	RC10	3.23
12G	Ms	80	RC12	3.39	12G	Mc	80	RC12	3.21
04G	Ms	100	RC04	3.16	04G	Mc	100	RC04	3.01
06G	Ms	100	RC06	3.16	06G	Mc	100	RC06	3.01
08G	Ms	100	RC08	3.17	08G	Mc	100	RC08	3.02
10G	Ms	100	RC10	3.15	10G	Mc	100	RC10	3.01
12G	Ms	100	RC12	3.13	12G	Mc	100	RC12	2.99
04G	Vs	20	RC04	2.39	04G	Vc	20	RC04	3.25
06G	Vs	20	RC06	2.65	06G	Vc	20	RC06	3.48
08G	Vs	20	RC08	2.80	08G	Vc	20	RC08	3.63
10G	Vs	20	RC10	2.88	10G	Vc	20	RC10	3.71
12G	Vs	20	RC12	2.93	12G	Vc	20	RC12	3.75
04G	Vs	40	RC04	2.87	04G	Vc	40	RC04	3.03
06G	Vs	40	RC06	3.06	06G	Vc	40	RC06	3.18
08G	Vs	40	RC08	3.18	08G	Vc	40	RC08	3.27
10G	Vs	40	RC10	3.23	10G	Vc	40	RC10	3.31
12G	Vs	40	RC12	3.27	12G	Vc	40	RC12	3.34
04G	Vs	60	RC04	3.04	04G	Vc	60	RC04	2.99
06G	Vs	60	RC06	3.18	06G	Vc	60	RC06	3.04
08G	Vs	60	RC08	3.29	08G	Vc	60	RC08	3.08
10G	Vs	60	RC10	3.33	10G	Vc	60	RC10	3.09
12G	Vs	60	RC12	3.35	12G	Vc	60	RC12	3.09
04G	Vs	80	RC04	3.00	04G	Vc	80	RC04	3.44
06G	Vs	80	RC06	3.11	06G	Vc	80	RC06	3.47
08G	Vs	80	RC08	3.18	08G	Vc	80	RC08	3.50
10G	Vs	80	RC10	3.20	10G	Vc	80	RC10	3.50
12G	Vs	80	RC12	3.21	12G	Vc	80	RC12	3.49
04G	Vs	100	RC04	2.92	04G	Vc	100	RC04	3.43
06G	Vs	100	RC06	2.99	06G	Vc	100	RC06	3.46
08G	Vs	100	RC08	3.04	08G	Vc	100	RC08	3.48
10G	Vs	100	RC10	3.06	10G	Vc	100	RC10	3.48
12G	Vs	100	RC12	3.06	12G	Vc	100	RC12	3.47

Lane	Effect	Span	Bridge	Beta
04G	Mcp	20	RC04	2.93
06G	Mcp	20	RC06	2.99



Ss08G	Mcp	20	RC08	3.04
10G	Mcp	20	RC10	3.08
12G	Mcp	20	RC12	3.11
04G	Mcp	40	RC04	3.70
06G	Mcp	40	RC06	3.69
08G	Mcp	40	RC08	3.74
10G	Mcp	40	RC10	3.74
12G	Mcp	40	RC12	3.74
04G	Mcp	60	RC04	3.56
06G	Mcp	60	RC06	3.55
08G	Mcp	60	RC08	3.59
10G	Mcp	60	RC10	3.57
12G	Mcp	60	RC12	3.56
04G	Mcp	80	RC04	3.32
06G	Mcp	80	RC06	3.31
08G	Mcp	80	RC08	3.32
10G	Mcp	80	RC10	3.30
12G	Mcp	80	RC12	3.29
04G	Mcp	100	RC04	3.08
06G	Mcp	100	RC06	3.09
08G	Mcp	100	RC08	3.09
10G	Mcp	100	RC10	3.07
12G	Mcp	100	RC12	3.05

### Single Lane Load Effects, Spread Box Beams (BS)

Lane	Effect	Span	Bridge	Beta	Lane	Effect	Span	Bridge	Beta
fol	Ms	20	BS04	3.06	fol	Mc	20	BS04	4.63
fol	Ms	20	BS06	3.31	fol	Mc	20	BS06	4.88
fol	Ms	20	BS08	3.49	fol	Mc	20	BS08	5.04
fol	Ms	20	BS10	3.63	fol	Mc	20	BS10	5.14
fol	Ms	20	BS12	3.74	fol	Mc	20	BS12	5.21
fol	Ms	40	BS04	4.76	fol	Mc	40	BS04	4.76
fol	Ms	40	BS06	4.99	fol	Mc	40	BS06	4.97
fol	Ms	40	BS08	5.15	fol	Mc	40	BS08	5.10
fol	Ms	40	BS10	5.24	fol	Mc	40	BS10	5.15
fol	Ms	40	BS12	5.28	fol	Mc	40	BS12	5.16
fol	Ms	60	BS04	4.79	fol	Mc	60	BS04	3.41
fol	Ms	60	BS06	5.02	fol	Mc	60	BS06	3.56
fol	Ms	60	BS08	5.17	fol	Mc	60	BS08	3.65
fol	Ms	60	BS10	5.23	fol	Mc	60	BS10	3.71
fol	Ms	60	BS12	5.25	fol	Mc	60	BS12	3.74
fol	Ms	80	BS04	4.83	fol	Mc	80	BS04	3.55
fol	Ms	80	BS06	5.06	fol	Mc	80	BS06	3.68

fol	Ms	80	BS08	5.20	fol	Mc	80	BS08	3.77
fol	Ms	80	BS10	5.25	fol	Mc	80	BS10	3.82
fol	Ms	80	BS12	5.26	fol	Mc	80	BS12	3.84
fol	Ms	100	BS04	4.68	fol	Mc	100	BS04	3.39
fol	Ms	100	BS06	4.90	fol	Mc	100	BS06	3.51
fol	Ms	100	BS08	5.03	fol	Mc	100	BS08	3.58
fol	Ms	100	BS10	5.06	fol	Mc	100	BS10	3.61
fol	Ms	100	BS12	5.06	fol	Mc	100	BS12	3.61
fol	Ms	120	BS04	4.09	fol	Mc	120	BS04	3.20
fol	Ms	120	BS06	4.28	fol	Mc	120	BS06	3.30
fol	Ms	120	BS08	4.40	fol	Mc	120	BS08	3.36
fol	Ms	120	BS10	4.44	fol	Mc	120	BS10	3.37
fol	Ms	120	BS12	4.44	fol	Mc	120	BS12	3.36
fol	Ms	140	BS04	3.82	fol	Mc	140	BS04	3.09
fol	Ms	140	BS06	4.00	fol	Mc	140	BS06	3.18
fol	Ms	140	BS08	4.11	fol	Mc	140	BS08	3.22
fol	Ms	140	BS10	4.14	fol	Mc	140	BS10	3.22
fol	Ms	140	BS12	4.14	fol	Mc	140	BS12	3.21
fol	Ms	160	BS04	3.57	fol	Mc	160	BS04	3.14
fol	Ms	160	BS06	3.73	fol	Mc	160	BS06	3.23
fol	Ms	160	BS08	3.83	fol	Mc	160	BS08	3.27
fol	Ms	160	BS10	3.86	fol	Mc	160	BS10	3.27
fol	Ms	160	BS12	3.86	fol	Mc	160	BS12	3.25
fol	Ms	180	BS04	3.38	fol	Mc	180	BS04	3.09
fol	Ms	180	BS06	3.52	fol	Mc	180	BS06	3.18
fol	Ms	180	BS08	3.61	fol	Mc	180	BS08	3.23
fol	Ms	180	BS10	3.64	fol	Mc	180	BS10	3.23
fol	Ms	180	BS12	3.64	fol	Mc	180	BS12	3.21
fol	Ms	200	BS04	3.25	fol	Mc	200	BS04	3.01
fol	Ms	200	BS06	3.38	fol	Mc	200	BS06	3.10
fol	Ms	200	BS08	3.46	fol	Mc	200	BS08	3.14
fol	Ms	200	BS10	3.49	fol	Mc	200	BS10	3.14
fol	Ms	200	BS12	3.49	fol	Mc	200	BS12	3.12
fol	Vs	20	BS04	2.86	fol	Vc	20	BS04	3.59
fol	Vs	20	BS06	3.09	fol	Vc	20	BS06	3.83
fol	Vs	20	BS08	3.25	fol	Vc	20	BS08	3.99
fol	Vs	20	BS10	3.37	fol	Vc	20	BS10	4.10
fol	Vs	20	BS12	3.46	fol	Vc	20	BS12	4.18
fol	Vs	40	BS04	3.21	fol	Vc	40	BS04	3.67
fol	Vs	40	BS06	3.41	fol	Vc	40	BS06	3.88
fol	Vs	40	BS08	3.55	fol	Vc	40	BS08	4.03
fol	Vs	40	BS10	3.65	fol	Vc	40	BS10	4.13
fol	Vs	40	BS12	3.71	fol	Vc	40	BS12	4.20
fol	Vs	60	BS04	3.36	fol	Vc	60	BS04	3.18

fol	Vs	60	BS06	3.55	fol	Vc	60	BS06	3.40
fol	Vs	60	BS08	3.68	fol	Vc	60	BS08	3.55
fol	Vs	60	BS10	3.76	fol	Vc	60	BS10	3.65
fol	Vs	60	BS12	3.82	fol	Vc	60	BS12	3.73
fol	Vs	80	BS04	3.35	fol	Vc	80	BS04	3.17
fol	Vs	80	BS06	3.53	fol	Vc	80	BS06	3.38
fol	Vs	80	BS08	3.65	fol	Vc	80	BS08	3.53
fol	Vs	80	BS10	3.73	fol	Vc	80	BS10	3.63
fol	Vs	80	BS12	3.78	fol	Vc	80	BS12	3.71
fol	Vs	100	BS04	3.14	fol	Vc	100	BS04	3.02
fol	Vs	100	BS06	3.31	fol	Vc	100	BS06	3.22
fol	Vs	100	BS08	3.42	fol	Vc	100	BS08	3.36
fol	Vs	100	BS10	3.50	fol	Vc	100	BS10	3.46
fol	Vs	100	BS12	3.55	fol	Vc	100	BS12	3.54
fol	Vs	120	BS04	2.90	fol	Vc	120	BS04	3.02
fol	Vs	120	BS06	3.06	fol	Vc	120	BS06	3.20
fol	Vs	120	BS08	3.17	fol	Vc	120	BS08	3.34
fol	Vs	120	BS10	3.25	fol	Vc	120	BS10	3.44
fol	Vs	120	BS12	3.30	fol	Vc	120	BS12	3.51
fol	Vs	140	BS04	2.72	fol	Vc	140	BS04	3.02
fol	Vs	140	BS06	2.86	fol	Vc	140	BS06	3.20
fol	Vs	140	BS08	2.96	fol	Vc	140	BS08	3.33
fol	Vs	140	BS10	3.03	fol	Vc	140	BS10	3.42
fol	Vs	140	BS12	3.09	fol	Vc	140	BS12	3.49
fol	Vs	160	BS04	2.60	fol	Vc	160	BS04	3.01
fol	Vs	160	BS06	2.72	fol	Vc	160	BS06	3.18
fol	Vs	160	BS08	2.81	fol	Vc	160	BS08	3.30
fol	Vs	160	BS10	2.87	fol	Vc	160	BS10	3.39
fol	Vs	160	BS12	2.93	fol	Vc	160	BS12	3.45
fol	Vs	180	BS04	2.48	fol	Vc	180	BS04	3.00
fol	Vs	180	BS06	2.59	fol	Vc	180	BS06	3.16
fol	Vs	180	BS08	2.67	fol	Vc	180	BS08	3.28
fol	Vs	180	BS10	2.73	fol	Vc	180	BS10	3.37
fol	Vs	180	BS12	2.78	fol	Vc	180	BS12	3.43
fol	Vs	200	BS04	2.45	fol	Vc	200	BS04	2.98
fol	Vs	200	BS06	2.55	fol	Vc	200	BS06	3.13
fol	Vs	200	BS08	2.62	fol	Vc	200	BS08	3.25
fol	Vs	200	BS10	2.68	fol	Vc	200	BS10	3.33
fol	Vs	200	BS12	2.72	fol	Vc	200	BS12	3.39

### Two Lane Load Effects, Spread Box Beams (BS)

Lane	Effect	Span	Bridge	Beta	Lane	Effect	Span	Bridge	Beta
04B	Ms	20	BS04	2.83	04B	Mc	20	BS04	4.39

06B	Ms	20	BS06	3.01	06B	Mc	20	BS06	4.57
08B	Ms	20	BS08	3.14	08B	Mc	20	BS08	4.70
10B	Ms	20	BS10	3.23	10B	Mc	20	BS10	4.75
12B	Ms	20	BS12	3.31	12B	Mc	20	BS12	4.80
04B	Ms	40	BS04	4.87	04B	Mc	40	BS04	3.50
06B	Ms	40	BS06	5.03	06B	Mc	40	BS06	3.44
08B	Ms	40	BS08	5.14	08B	Mc	40	BS08	3.39
10B	Ms	40	BS10	5.18	10B	Mc	40	BS10	3.35
12B	Ms	40	BS12	5.20	12B	Mc	40	BS12	3.31
04B	Ms	60	BS04	4.72	04B	Mc	60	BS04	3.58
06B	Ms	60	BS06	4.86	06B	Mc	60	BS06	3.59
08B	Ms	60	BS08	4.95	08B	Mc	60	BS08	3.58
10B	Ms	60	BS10	4.97	10B	Mc	60	BS10	3.55
12B	Ms	60	BS12	4.96	12B	Mc	60	BS12	3.51
04B	Ms	80	BS04	4.06	04B	Mc	80	BS04	3.90
06B	Ms	80	BS06	4.11	06B	Mc	80	BS06	3.96
08B	Ms	80	BS08	4.12	08B	Mc	80	BS08	3.98
10B	Ms	80	BS10	4.10	10B	Mc	80	BS10	3.96
12B	Ms	80	BS12	4.06	12B	Mc	80	BS12	3.92
04B	Ms	100	BS04	3.61	04B	Mc	100	BS04	3.55
06B	Ms	100	BS06	3.62	06B	Mc	100	BS06	3.60
08B	Ms	100	BS08	3.61	08B	Mc	100	BS08	3.61
10B	Ms	100	BS10	3.58	10B	Mc	100	BS10	3.58
12B	Ms	100	BS12	3.55	12B	Mc	100	BS12	3.54
04B	Ms	120	BS04	3.28	04B	Mc	120	BS04	3.27
06B	Ms	120	BS06	3.29	06B	Mc	120	BS06	3.31
08B	Ms	120	BS08	3.28	08B	Mc	120	BS08	3.32
10B	Ms	120	BS10	3.25	10B	Mc	120	BS10	3.28
12B	Ms	120	BS12	3.22	12B	Mc	120	BS12	3.24
04B	Ms	140	BS04	3.19	04B	Mc	140	BS04	3.03
06B	Ms	140	BS06	3.20	06B	Mc	140	BS06	3.05
08B	Ms	140	BS08	3.20	08B	Mc	140	BS08	3.05
10B	Ms	140	BS10	3.17	10B	Mc	140	BS10	3.02
12B	Ms	140	BS12	3.14	12B	Mc	140	BS12	2.97
04B	Ms	160	BS04	3.10	04B	Mc	160	BS04	3.01
06B	Ms	160	BS06	3.12	06B	Mc	160	BS06	3.04
08B	Ms	160	BS08	3.12	08B	Mc	160	BS08	3.03
10B	Ms	160	BS10	3.09	10B	Mc	160	BS10	3.00
12B	Ms	160	BS12	3.06	12B	Mc	160	BS12	2.96
04B	Ms	180	BS04	3.02	04B	Mc	180	BS04	2.97
06B	Ms	180	BS06	3.04	06B	Mc	180	BS06	3.00
08B	Ms	180	BS08	3.04	08B	Mc	180	BS08	3.01
10B	Ms	180	BS10	3.02	10B	Mc	180	BS10	2.98
12B	Ms	180	BS12	2.99	12B	Mc	180	BS12	2.94
04B	Ms	200	BS04	2.94	04B	Mc	200	BS04	2.90

06B	Ms	200	BS06	2.97	06B	Mc	200	BS06	2.94
08B	Ms	200	BS08	2.98	08B	Mc	200	BS08	2.95
10B	Ms	200	BS10	2.95	10B	Mc	200	BS10	2.92
12B	Ms	200	BS12	2.93	12B	Mc	200	BS12	2.89
04B	Vs	20	BS04	2.63	04B	Vc	20	BS04	3.53
06B	Vs	20	BS06	2.82	06B	Vc	20	BS06	3.73
08B	Vs	20	BS08	2.95	08B	Vc	20	BS08	3.87
10B	Vs	20	BS10	3.05	10B	Vc	20	BS10	3.97
12B	Vs	20	BS12	3.13	12B	Vc	20	BS12	4.05
04B	Vs	40	BS04	3.09	04B	Vc	40	BS04	3.22
06B	Vs	40	BS06	3.26	06B	Vc	40	BS06	3.34
08B	Vs	40	BS08	3.37	08B	Vc	40	BS08	3.43
10B	Vs	40	BS10	3.45	10B	Vc	40	BS10	3.49
12B	Vs	40	BS12	3.51	12B	Vc	40	BS12	3.53
04B	Vs	60	BS04	3.23	04B	Vc	60	BS04	3.12
06B	Vs	60	BS06	3.39	06B	Vc	60	BS06	3.17
08B	Vs	60	BS08	3.50	08B	Vc	60	BS08	3.21
10B	Vs	60	BS10	3.56	10B	Vc	60	BS10	3.23
12B	Vs	60	BS12	3.61	12B	Vc	60	BS12	3.24
04B	Vs	80	BS04	3.18	04B	Vc	80	BS04	3.60
06B	Vs	80	BS06	3.30	06B	Vc	80	BS06	3.66
08B	Vs	80	BS08	3.39	08B	Vc	80	BS08	3.70
10B	Vs	80	BS10	3.44	10B	Vc	80	BS10	3.72
12B	Vs	80	BS12	3.47	12B	Vc	80	BS12	3.73
04B	Vs	100	BS04	3.09	04B	Vc	100	BS04	3.61
06B	Vs	100	BS06	3.19	06B	Vc	100	BS06	3.67
08B	Vs	100	BS08	3.25	08B	Vc	100	BS08	3.71
10B	Vs	100	BS10	3.29	10B	Vc	100	BS10	3.73
12B	Vs	100	BS12	3.31	12B	Vc	100	BS12	3.74
04B	Vs	120	BS04	3.05	04B	Vc	120	BS04	3.61
06B	Vs	120	BS06	3.11	06B	Vc	120	BS06	3.68
08B	Vs	120	BS08	3.14	08B	Vc	120	BS08	3.72
10B	Vs	120	BS10	3.16	10B	Vc	120	BS10	3.74
12B	Vs	120	BS12	3.16	12B	Vc	120	BS12	3.74
04B	Vs	140	BS04	2.98	04B	Vc	140	BS04	3.55
06B	Vs	140	BS06	3.03	06B	Vc	140	BS06	3.63
08B	Vs	140	BS08	3.06	08B	Vc	140	BS08	3.68
10B	Vs	140	BS10	3.07	10B	Vc	140	BS10	3.70
12B	Vs	140	BS12	3.07	12B	Vc	140	BS12	3.70
04B	Vs	160	BS04	2.92	04B	Vc	160	BS04	3.50
06B	Vs	160	BS06	2.96	06B	Vc	160	BS06	3.58
08B	Vs	160	BS08	2.99	08B	Vc	160	BS08	3.63
10B	Vs	160	BS10	2.99	10B	Vc	160	BS10	3.65
12B	Vs	160	BS12	2.99	12B	Vc	160	BS12	3.66

04B	Vs	180	BS04	2.83	04B	Vc	180	BS04	3.45
06B	Vs	180	BS06	2.87	06B	Vc	180	BS06	3.54
08B	Vs	180	BS08	2.88	08B	Vc	180	BS08	3.59
10B	Vs	180	BS10	2.89	10B	Vc	180	BS10	3.61
12B	Vs	180	BS12	2.89	12B	Vc	180	BS12	3.62
04B	Vs	200	BS04	2.79	04B	Vc	200	BS04	3.39
06B	Vs	200	BS06	2.83	06B	Vc	200	BS06	3.48
08B	Vs	200	BS08	2.85	08B	Vc	200	BS08	3.54
10B	Vs	200	BS10	2.85	10B	Vc	200	BS10	3.56
12B	Vs	200	BS12	2.85	12B	Vc	200	BS12	3.57

### Single Lane Load Effects, Side-By-Side Box Beam (BT), 36" Wide Box

Lane	Effect	Span	Bridge	Beta	Lane	Effect	Span	Bridge	Beta
fol	Ms	20	BT36	2.26	fol	Mc	20	BT36	3.79
fol	Ms	40	BT36	3.99	fol	Mc	40	BT36	4.11
fol	Ms	60	BT36	4.21	fol	Mc	60	BT36	3.14
fol	Ms	80	BT36	4.29	fol	Mc	80	BT36	3.32
fol	Ms	100	BT36	4.16	fol	Mc	100	BT36	3.18
fol	Ms	120	BT36	3.66	fol	Mc	120	BT36	3.01
fol	Ms	140	BT36	3.48	fol	Mc	140	BT36	2.90
fol	Ms	160	BT36	3.30	fol	Mc	160	BT36	2.92
fol	Ms	180	BT36	3.16	fol	Mc	180	BT36	2.88
fol	Ms	200	BT36	3.00	fol	Mc	200	BT36	2.80
fol	Vs	20	BT36	2.24	fol	Vc	20	BT36	2.99
fol	Vs	40	BT36	2.84	fol	Vc	40	BT36	3.28
fol	Vs	60	BT36	3.13	fol	Vc	60	BT36	2.85
fol	Vs	80	BT36	3.17	fol	Vc	80	BT36	2.88
fol	Vs	100	BT36	2.97	fol	Vc	100	BT36	2.77
fol	Vs	120	BT36	2.75	fol	Vc	120	BT36	2.80
fol	Vs	140	BT36	2.58	fol	Vc	140	BT36	2.84
fol	Vs	160	BT36	2.48	fol	Vc	160	BT36	2.86
fol	Vs	180	BT36	2.38	fol	Vc	180	BT36	2.86
fol	Vs	200	BT36	2.36	fol	Vc	200	BT36	2.86

### Two Lane Load Effects, Side-By-Side Box Beam (BT), 36" Wide Box

Lane	Effect	Span	Bridge	Beta	Lane	Effect	Span	Bridge	Beta
36T	Ms	20	BT36	2.31	36T	Mc	20	BT36	3.76
36T	Ms	40	BT36	4.37	36T	Mc	40	BT36	3.61
36T	Ms	60	BT36	4.30	36T	Mc	60	BT36	3.44
36T	Ms	80	BT36	3.82	36T	Mc	80	BT36	3.59
36T	Ms	100	BT36	3.45	36T	Mc	100	BT36	3.28
36T	Ms	120	BT36	3.14	36T	Mc	120	BT36	3.03

36T	Ms	140	BT36	3.03	36T	Mc	140	BT36	2.84
36T	Ms	160	BT36	2.94	36T	Mc	160	BT36	2.81
36T	Ms	180	BT36	2.85	36T	Mc	180	BT36	2.77
36T	Ms	200	BT36	2.80	36T	Mc	200	BT36	2.73
36T	Vs	20	BT36	2.11	36T	Vc	20	BT36	3.01
36T	Vs	40	BT36	2.77	36T	Vc	40	BT36	2.96
36T	Vs	60	BT36	3.03	36T	Vc	60	BT36	3.05
36T	Vs	80	BT36	3.05	36T	Vc	80	BT36	3.57
36T	Vs	100	BT36	3.01	36T	Vc	100	BT36	3.58
36T	Vs	120	BT36	3.02	36T	Vc	120	BT36	3.59
36T	Vs	140	BT36	2.97	36T	Vc	140	BT36	3.53
36T	Vs	160	BT36	2.92	36T	Vc	160	BT36	3.49
36T	Vs	180	BT36	2.82	36T	Vc	180	BT36	3.43
36T	Vs	200	BT36	2.79	36T	Vc	200	BT36	3.37

### Single Lane Load Effects, Side-By-Side Box Beam (BT), 48" Wide Box

Lane	Effect	Span	Bridge	Beta	Lane	Effect	Span	Bridge	Beta
fol	Ms	20	BT48	2.45	fol	Mc	20	BT48	3.98
fol	Ms	40	BT48	4.15	fol	Mc	40	BT48	4.24
fol	Ms	60	BT48	4.33	fol	Mc	60	BT48	3.24
fol	Ms	80	BT48	4.39	fol	Mc	80	BT48	3.41
fol	Ms	100	BT48	4.24	fol	Mc	100	BT48	3.24
fol	Ms	120	BT48	3.74	fol	Mc	120	BT48	3.06
fol	Ms	140	BT48	3.54	fol	Mc	140	BT48	2.94
fol	Ms	160	BT48	3.36	fol	Mc	160	BT48	2.96
fol	Ms	180	BT48	3.21	fol	Mc	180	BT48	2.91
fol	Ms	200	BT48	3.06	fol	Mc	200	BT48	2.83
fol	Vs	20	BT48	2.57	fol	Vc	20	BT48	3.30
fol	Vs	40	BT48	3.06	fol	Vc	40	BT48	3.51
fol	Vs	60	BT48	3.26	fol	Vc	60	BT48	3.08
fol	Vs	80	BT48	3.26	fol	Vc	80	BT48	3.10
fol	Vs	100	BT48	3.07	fol	Vc	100	BT48	2.98
fol	Vs	120	BT48	2.86	fol	Vc	120	BT48	2.99
fol	Vs	140	BT48	2.71	fol	Vc	140	BT48	3.00
fol	Vs	160	BT48	2.60	fol	Vc	160	BT48	2.99
fol	Vs	180	BT48	2.51	fol	Vc	180	BT48	2.97
fol	Vs	200	BT48	2.48	fol	Vc	200	BT48	2.95

### Two Lane Load Effects, Side-By-Side Box Beam (BT), 48" Wide Box

Lane	Effect	Span	Bridge	Beta	Lane	Effect	Span	Bridge	Beta
48T	Ms	20	BT48	2.50	48T	Mc	20	BT48	3.93
48T	Ms	40	BT48	4.50	48T	Mc	40	BT48	3.69
48T	Ms	60	BT48	4.41	48T	Mc	60	BT48	3.51
48T	Ms	80	BT48	3.90	48T	Mc	80	BT48	3.65
48T	Ms	100	BT48	3.52	48T	Mc	100	BT48	3.33
48T	Ms	120	BT48	3.20	48T	Mc	120	BT48	3.06
48T	Ms	140	BT48	3.08	48T	Mc	140	BT48	2.87
48T	Ms	160	BT48	2.98	48T	Mc	160	BT48	2.84
48T	Ms	180	BT48	2.89	48T	Mc	180	BT48	2.79
48T	Ms	200	BT48	2.83	48T	Mc	200	BT48	2.75
48T	Vs	20	BT48	2.40	48T	Vc	20	BT48	3.28
48T	Vs	40	BT48	2.97	48T	Vc	40	BT48	3.12
48T	Vs	60	BT48	3.15	48T	Vc	60	BT48	3.09
48T	Vs	80	BT48	3.11	48T	Vc	80	BT48	3.55
48T	Vs	100	BT48	3.04	48T	Vc	100	BT48	3.55
48T	Vs	120	BT48	2.99	48T	Vc	120	BT48	3.53
48T	Vs	140	BT48	2.93	48T	Vc	140	BT48	3.47
48T	Vs	160	BT48	2.87	48T	Vc	160	BT48	3.41
48T	Vs	180	BT48	2.78	48T	Vc	180	BT48	3.34
48T	Vs	200	BT48	2.75	48T	Vc	200	BT48	3.29

### Existing LFR Indices

#### Single Lane Load Effects, Steel Girders

Lane	Effect	Span	Bridge	Beta	Lane	Effect	Span	Bridge	Beta
fol	Ms	20	CS04	1.46	fol	Mc	20	CS04	2.89
fol	Ms	20	CS06	2.18	fol	Mc	20	CS06	3.54
fol	Ms	20	CS08	2.66	fol	Mc	20	CS08	3.95
fol	Ms	20	CS10	3.02	fol	Mc	20	CS10	4.24
fol	Ms	20	CS12	3.30	fol	Mc	20	CS12	4.45
fol	Ms	40	CS04	3.22	fol	Mc	40	CS04	3.59
fol	Ms	40	CS06	3.86	fol	Mc	40	CS06	4.12
fol	Ms	40	CS08	4.27	fol	Mc	40	CS08	4.45
fol	Ms	40	CS10	4.55	fol	Mc	40	CS10	4.67
fol	Ms	40	CS12	4.75	fol	Mc	40	CS12	4.81
fol	Ms	60	CS04	3.87	fol	Mc	60	CS04	2.02
fol	Ms	60	CS06	4.43	fol	Mc	60	CS06	2.52
fol	Ms	60	CS08	4.77	fol	Mc	60	CS08	2.86
fol	Ms	60	CS10	4.99	fol	Mc	60	CS10	3.11
fol	Ms	60	CS12	5.14	fol	Mc	60	CS12	3.30
fol	Ms	80	CS04	4.14	fol	Mc	80	CS04	1.97
fol	Ms	80	CS06	4.63	fol	Mc	80	CS06	2.40



fol	Ms	80	CS08	4.93	fol	Mc	80	CS08	2.69
fol	Ms	80	CS10	5.12	fol	Mc	80	CS10	2.91
fol	Ms	80	CS12	5.24	fol	Mc	80	CS12	3.07
fol	Ms	100	CS04	4.11	fol	Mc	100	CS04	2.28
fol	Ms	100	CS06	4.56	fol	Mc	100	CS06	2.63
fol	Ms	100	CS08	4.85	fol	Mc	100	CS08	2.88
fol	Ms	100	CS10	5.03	fol	Mc	100	CS10	3.06
fol	Ms	100	CS12	5.13	fol	Mc	100	CS12	3.19
fol	Ms	120	CS04	3.75	fol	Mc	120	CS04	2.49
fol	Ms	120	CS06	4.18	fol	Mc	120	CS06	2.80
fol	Ms	120	CS08	4.48	fol	Mc	120	CS08	3.01
fol	Ms	120	CS10	4.66	fol	Mc	120	CS10	3.16
fol	Ms	120	CS12	4.77	fol	Mc	120	CS12	3.27
fol	Ms	140	CS04	3.54	fol	Mc	140	CS04	2.63
fol	Ms	140	CS06	3.95	fol	Mc	140	CS06	2.89
fol	Ms	140	CS08	4.23	fol	Mc	140	CS08	3.07
fol	Ms	140	CS10	4.40	fol	Mc	140	CS10	3.19
fol	Ms	140	CS12	4.51	fol	Mc	140	CS12	3.27
fol	Ms	160	CS04	3.31	fol	Mc	160	CS04	2.71
fol	Ms	160	CS06	3.70	fol	Mc	160	CS06	2.93
fol	Ms	160	CS08	3.97	fol	Mc	160	CS08	3.08
fol	Ms	160	CS10	4.14	fol	Mc	160	CS10	3.17
fol	Ms	160	CS12	4.24	fol	Mc	160	CS12	3.24
fol	Ms	180	CS04	3.17	fol	Mc	180	CS04	2.70
fol	Ms	180	CS06	3.53	fol	Mc	180	CS06	2.89
fol	Ms	180	CS08	3.78	fol	Mc	180	CS08	3.02
fol	Ms	180	CS10	3.94	fol	Mc	180	CS10	3.10
fol	Ms	180	CS12	4.04	fol	Mc	180	CS12	3.16
fol	Ms	200	CS04	3.08	fol	Mc	200	CS04	2.66
fol	Ms	200	CS06	3.41	fol	Mc	200	CS06	2.82
fol	Ms	200	CS08	3.64	fol	Mc	200	CS08	2.93
fol	Ms	200	CS10	3.79	fol	Mc	200	CS10	3.01
fol	Ms	200	CS12	3.89	fol	Mc	200	CS12	3.06
fol	Vs	20	CS04	1.21	fol	Vc	20	CS04	2.07
fol	Vs	20	CS06	2.37	fol	Vc	20	CS06	3.27
fol	Vs	20	CS08	3.07	fol	Vc	20	CS08	3.99
fol	Vs	20	CS10	3.53	fol	Vc	20	CS10	4.45
fol	Vs	20	CS12	3.85	fol	Vc	20	CS12	4.77
fol	Vs	40	CS04	2.21	fol	Vc	40	CS04	2.79
fol	Vs	40	CS06	3.29	fol	Vc	40	CS06	3.91
fol	Vs	40	CS08	3.90	fol	Vc	40	CS08	4.55

fol	Vs	40	CS10	4.29	fol	Vc	40	CS10	4.94
fol	Vs	40	CS12	4.55	fol	Vc	40	CS12	5.21
fol	Vs	60	CS04	2.58	fol	Vc	60	CS04	1.93
fol	Vs	60	CS06	3.57	fol	Vc	60	CS06	3.07
fol	Vs	60	CS08	4.13	fol	Vc	60	CS08	3.74
fol	Vs	60	CS10	4.47	fol	Vc	60	CS10	4.16
fol	Vs	60	CS12	4.69	fol	Vc	60	CS12	4.44
fol	Vs	80	CS04	2.70	fol	Vc	80	CS04	1.04
fol	Vs	80	CS06	3.59	fol	Vc	80	CS06	2.00
fol	Vs	80	CS08	4.10	fol	Vc	80	CS08	2.61
fol	Vs	80	CS10	4.40	fol	Vc	80	CS10	3.04
fol	Vs	80	CS12	4.60	fol	Vc	80	CS12	3.34
fol	Vs	100	CS04	2.39	fol	Vc	100	CS04	0.82
fol	Vs	100	CS06	3.23	fol	Vc	100	CS06	1.66
fol	Vs	100	CS08	3.72	fol	Vc	100	CS08	2.22
fol	Vs	100	CS10	4.03	fol	Vc	100	CS10	2.61
fol	Vs	100	CS12	4.23	fol	Vc	100	CS12	2.91
fol	Vs	120	CS04	1.96	fol	Vc	120	CS04	0.74
fol	Vs	120	CS06	2.78	fol	Vc	120	CS06	1.56
fol	Vs	120	CS08	3.26	fol	Vc	120	CS08	2.09
fol	Vs	120	CS10	3.57	fol	Vc	120	CS10	2.46
fol	Vs	120	CS12	3.78	fol	Vc	120	CS12	2.75
fol	Vs	140	CS04	1.66	fol	Vc	140	CS04	0.76
fol	Vs	140	CS06	2.42	fol	Vc	140	CS06	1.55
fol	Vs	140	CS08	2.87	fol	Vc	140	CS08	2.05
fol	Vs	140	CS10	3.17	fol	Vc	140	CS10	2.40
fol	Vs	140	CS12	3.38	fol	Vc	140	CS12	2.67
fol	Vs	160	CS04	1.50	fol	Vc	160	CS04	0.82
fol	Vs	160	CS06	2.19	fol	Vc	160	CS06	1.57
fol	Vs	160	CS08	2.61	fol	Vc	160	CS08	2.04
fol	Vs	160	CS10	2.90	fol	Vc	160	CS10	2.37
fol	Vs	160	CS12	3.10	fol	Vc	160	CS12	2.62
fol	Vs	180	CS04	1.46	fol	Vc	180	CS04	0.92
fol	Vs	180	CS06	2.10	fol	Vc	180	CS06	1.62
fol	Vs	180	CS08	2.49	fol	Vc	180	CS08	2.06
fol	Vs	180	CS10	2.76	fol	Vc	180	CS10	2.37
fol	Vs	180	CS12	2.95	fol	Vc	180	CS12	2.60
fol	Vs	200	CS04	1.47	fol	Vc	200	CS04	0.99
fol	Vs	200	CS06	2.06	fol	Vc	200	CS06	1.65
fol	Vs	200	CS08	2.43	fol	Vc	200	CS08	2.06
fol	Vs	200	CS10	2.68	fol	Vc	200	CS10	2.35

fol Vs 200 CS12 2.86

fol Vc 200 CS12 2.57

Lane	Effect	Span	Bridge	Beta
fol	Mcp	20	CS04	1.68
fol	Mcp	20	CS06	2.36
fol	Mcp	20	CS08	2.82
fol	Mcp	20	CS10	3.15
fol	Mcp	20	CS12	3.41
fol	Mcp	40	CS04	3.13
fol	Mcp	40	CS06	3.72
fol	Mcp	40	CS08	4.10
fol	Mcp	40	CS10	4.36
fol	Mcp	40	CS12	4.54
fol	Mcp	60	CS04	3.69
fol	Mcp	60	CS06	4.20
fol	Mcp	60	CS08	4.53
fol	Mcp	60	CS10	4.73
fol	Mcp	60	CS12	4.86
fol	Mcp	80	CS04	3.99
fol	Mcp	80	CS06	4.43
fol	Mcp	80	CS08	4.71
fol	Mcp	80	CS10	4.88
fol	Mcp	80	CS12	4.98
fol	Mcp	100	CS04	3.95
fol	Mcp	100	CS06	4.35
fol	Mcp	100	CS08	4.62
fol	Mcp	100	CS10	4.77
fol	Mcp	100	CS12	4.87
fol	Mcp	120	CS04	3.62
fol	Mcp	120	CS06	4.00
fol	Mcp	120	CS08	4.27
fol	Mcp	120	CS10	4.42
fol	Mcp	120	CS12	4.52
fol	Mcp	140	CS04	3.41
fol	Mcp	140	CS06	3.76
fol	Mcp	140	CS08	4.00
fol	Mcp	140	CS10	4.16
fol	Mcp	140	CS12	4.25
fol	Mcp	160	CS04	3.20
fol	Mcp	160	CS06	3.53
fol	Mcp	160	CS08	3.76

fol	Mcp	160	CS10	3.90
fol	Mcp	160	CS12	3.99
fol	Mcp	180	CS04	3.07
fol	Mcp	180	CS06	3.38
fol	Mcp	180	CS08	3.59
fol	Mcp	180	CS10	3.73
fol	Mcp	180	CS12	3.82
fol	Mcp	200	CS04	3.00
fol	Mcp	200	CS06	3.28
fol	Mcp	200	CS08	3.48
fol	Mcp	200	CS10	3.60
fol	Mcp	200	CS12	3.68

### Two Lane Load Effects, Steel Girders

Lane	Effect	Span	Bridge	Beta	Lane	Effect	Span	Bridge	Beta
04G	Ms	20	CS04	1.19	04G	Mc	20	CS04	2.58
06G	Ms	20	CS06	1.84	06G	Mc	20	CS06	3.20
08G	Ms	20	CS08	2.29	08G	Mc	20	CS08	3.60
10G	Ms	20	CS10	2.63	10G	Mc	20	CS10	3.88
12G	Ms	20	CS12	2.89	12G	Mc	20	CS12	4.10
04G	Ms	40	CS04	3.39	04G	Mc	40	CS04	2.68
06G	Ms	40	CS06	3.97	06G	Mc	40	CS06	3.10
08G	Ms	40	CS08	4.33	08G	Mc	40	CS08	3.36
10G	Ms	40	CS10	4.58	10G	Mc	40	CS10	3.55
12G	Ms	40	CS12	4.76	12G	Mc	40	CS12	3.70
04G	Ms	60	CS04	3.94	04G	Mc	60	CS04	2.56
06G	Ms	60	CS06	4.44	06G	Mc	60	CS06	2.94
08G	Ms	60	CS08	4.75	08G	Mc	60	CS08	3.20
10G	Ms	60	CS10	4.94	10G	Mc	60	CS10	3.37
12G	Ms	60	CS12	5.07	12G	Mc	60	CS12	3.49
04G	Ms	80	CS04	3.65	04G	Mc	80	CS04	2.69
06G	Ms	80	CS06	4.08	06G	Mc	80	CS06	3.01
08G	Ms	80	CS08	4.35	08G	Mc	80	CS08	3.23
10G	Ms	80	CS10	4.53	10G	Mc	80	CS10	3.37
12G	Ms	80	CS12	4.65	12G	Mc	80	CS12	3.47
04G	Ms	100	CS04	3.37	04G	Mc	100	CS04	2.80
06G	Ms	100	CS06	3.77	06G	Mc	100	CS06	3.07
08G	Ms	100	CS08	4.03	08G	Mc	100	CS08	3.25
10G	Ms	100	CS10	4.20	10G	Mc	100	CS10	3.36

12G	Ms	100	CS12	4.32	12G	Mc	100	CS12	3.45
04G	Ms	120	CS04	3.25	04G	Mc	120	CS04	2.88
06G	Ms	120	CS06	3.63	06G	Mc	120	CS06	3.11
08G	Ms	120	CS08	3.88	08G	Mc	120	CS08	3.27
10G	Ms	120	CS10	4.04	10G	Mc	120	CS10	3.37
12G	Ms	120	CS12	4.15	12G	Mc	120	CS12	3.43
04G	Ms	140	CS04	3.22	04G	Mc	140	CS04	2.85
06G	Ms	140	CS06	3.57	06G	Mc	140	CS06	3.05
08G	Ms	140	CS08	3.80	08G	Mc	140	CS08	3.18
10G	Ms	140	CS10	3.95	10G	Mc	140	CS10	3.26
12G	Ms	140	CS12	4.05	12G	Mc	140	CS12	3.32
04G	Ms	160	CS04	3.18	04G	Mc	160	CS04	2.80
06G	Ms	160	CS06	3.50	06G	Mc	160	CS06	2.96
08G	Ms	160	CS08	3.72	08G	Mc	160	CS08	3.08
10G	Ms	160	CS10	3.86	10G	Mc	160	CS10	3.15
12G	Ms	160	CS12	3.95	12G	Mc	160	CS12	3.20
04G	Ms	180	CS04	3.14	04G	Mc	180	CS04	2.76
06G	Ms	180	CS06	3.43	06G	Mc	180	CS06	2.90
08G	Ms	180	CS08	3.63	08G	Mc	180	CS08	3.00
10G	Ms	180	CS10	3.76	10G	Mc	180	CS10	3.07
12G	Ms	180	CS12	3.85	12G	Mc	180	CS12	3.11
04G	Ms	200	CS04	3.07	04G	Mc	200	CS04	2.71
06G	Ms	200	CS06	3.35	06G	Mc	200	CS06	2.83
08G	Ms	200	CS08	3.53	08G	Mc	200	CS08	2.92
10G	Ms	200	CS10	3.66	10G	Mc	200	CS10	2.98
12G	Ms	200	CS12	3.73	12G	Mc	200	CS12	3.02
04G	Vs	20	CS04	0.99	04G	Vc	20	CS04	2.05
06G	Vs	20	CS06	2.00	06G	Vc	20	CS06	3.13
08G	Vs	20	CS08	2.64	08G	Vc	20	CS08	3.80
10G	Vs	20	CS10	3.07	10G	Vc	20	CS10	4.23
12G	Vs	20	CS12	3.38	12G	Vc	20	CS12	4.54
04G	Vs	40	CS04	2.03	04G	Vc	40	CS04	2.13
06G	Vs	40	CS06	3.02	06G	Vc	40	CS06	2.99
08G	Vs	40	CS08	3.60	08G	Vc	40	CS08	3.52
10G	Vs	40	CS10	3.98	10G	Vc	40	CS10	3.88
12G	Vs	40	CS12	4.23	12G	Vc	40	CS12	4.14
04G	Vs	60	CS04	2.34	04G	Vc	60	CS04	2.03
06G	Vs	60	CS06	3.25	06G	Vc	60	CS06	2.71
08G	Vs	60	CS08	3.78	08G	Vc	60	CS08	3.13
10G	Vs	60	CS10	4.12	10G	Vc	60	CS10	3.42
12G	Vs	60	CS12	4.34	12G	Vc	60	CS12	3.65

04G	Vs	80	CS04	2.35	04G	Vc	80	CS04	1.97
06G	Vs	80	CS06	3.13	06G	Vc	80	CS06	2.58
08G	Vs	80	CS08	3.58	08G	Vc	80	CS08	2.97
10G	Vs	80	CS10	3.88	10G	Vc	80	CS10	3.23
12G	Vs	80	CS12	4.08	12G	Vc	80	CS12	3.44
04G	Vs	100	CS04	2.35	04G	Vc	100	CS04	2.00
06G	Vs	100	CS06	3.00	06G	Vc	100	CS06	2.55
08G	Vs	100	CS08	3.38	08G	Vc	100	CS08	2.90
10G	Vs	100	CS10	3.64	10G	Vc	100	CS10	3.15
12G	Vs	100	CS12	3.82	12G	Vc	100	CS12	3.35
04G	Vs	120	CS04	2.41	04G	Vc	120	CS04	2.01
06G	Vs	120	CS06	2.91	06G	Vc	120	CS06	2.52
08G	Vs	120	CS08	3.22	08G	Vc	120	CS08	2.84
10G	Vs	120	CS10	3.42	10G	Vc	120	CS10	3.07
12G	Vs	120	CS12	3.58	12G	Vc	120	CS12	3.25
04G	Vs	140	CS04	2.41	04G	Vc	140	CS04	1.99
06G	Vs	140	CS06	2.84	06G	Vc	140	CS06	2.46
08G	Vs	140	CS08	3.10	08G	Vc	140	CS08	2.75
10G	Vs	140	CS10	3.29	10G	Vc	140	CS10	2.97
12G	Vs	140	CS12	3.42	12G	Vc	140	CS12	3.14
04G	Vs	160	CS04	2.41	04G	Vc	160	CS04	2.04
06G	Vs	160	CS06	2.78	06G	Vc	160	CS06	2.46
08G	Vs	160	CS08	3.01	08G	Vc	160	CS08	2.72
10G	Vs	160	CS10	3.18	10G	Vc	160	CS10	2.92
12G	Vs	160	CS12	3.30	12G	Vc	160	CS12	3.07
04G	Vs	180	CS04	2.41	04G	Vc	180	CS04	2.09
06G	Vs	180	CS06	2.74	06G	Vc	180	CS06	2.47
08G	Vs	180	CS08	2.94	08G	Vc	180	CS08	2.71
10G	Vs	180	CS10	3.09	10G	Vc	180	CS10	2.88
12G	Vs	180	CS12	3.20	12G	Vc	180	CS12	3.03
04G	Vs	200	CS04	2.41	04G	Vc	200	CS04	2.11
06G	Vs	200	CS06	2.71	06G	Vc	200	CS06	2.46
08G	Vs	200	CS08	2.91	08G	Vc	200	CS08	2.67
10G	Vs	200	CS10	3.04	10G	Vc	200	CS10	2.83
12G	Vs	200	CS12	3.14	12G	Vc	200	CS12	2.96

Lane	Effect	Span	Bridge	Beta
04G	Mcp	20	CS04	1.41

06G	Mcp	20	CS06	2.04
08G	Mcp	20	CS08	2.46
10G	Mcp	20	CS10	2.78
12G	Mcp	20	CS12	3.03
<hr/>				
04G	Mcp	40	CS04	3.28
06G	Mcp	40	CS06	3.82
08G	Mcp	40	CS08	4.17
10G	Mcp	40	CS10	4.40
12G	Mcp	40	CS12	4.56
<hr/>				
04G	Mcp	60	CS04	3.76
06G	Mcp	60	CS06	4.22
08G	Mcp	60	CS08	4.50
10G	Mcp	60	CS10	4.68
12G	Mcp	60	CS12	4.80
<hr/>				
04G	Mcp	80	CS04	3.56
06G	Mcp	80	CS06	3.95
08G	Mcp	80	CS08	4.20
10G	Mcp	80	CS10	4.36
12G	Mcp	80	CS12	4.47
<hr/>				
04G	Mcp	100	CS04	3.32
06G	Mcp	100	CS06	3.68
08G	Mcp	100	CS08	3.91
10G	Mcp	100	CS10	4.06
12G	Mcp	100	CS12	4.17
<hr/>				
04G	Mcp	120	CS04	3.20
06G	Mcp	120	CS06	3.53
08G	Mcp	120	CS08	3.76
10G	Mcp	120	CS10	3.90
12G	Mcp	120	CS12	4.00
<hr/>				
04G	Mcp	140	CS04	3.14
06G	Mcp	140	CS06	3.44
08G	Mcp	140	CS08	3.64
10G	Mcp	140	CS10	3.78
12G	Mcp	140	CS12	3.86
<hr/>				
04G	Mcp	160	CS04	3.08
06G	Mcp	160	CS06	3.35
08G	Mcp	160	CS08	3.54
10G	Mcp	160	CS10	3.66
12G	Mcp	160	CS12	3.74
<hr/>				
04G	Mcp	180	CS04	3.04
06G	Mcp	180	CS06	3.29

08G	Mcp	180	CS08	3.46
10G	Mcp	180	CS10	3.57
12G	Mcp	180	CS12	3.64
04G	Mcp	200	CS04	2.99
06G	Mcp	200	CS06	3.22
08G	Mcp	200	CS08	3.38
10G	Mcp	200	CS10	3.48
12G	Mcp	200	CS12	3.55

**Single Lane Load Effects, PC Girders**

Lane	Effect	Span	Bridge	Beta	Lane	Effect	Span	Bridge	Beta
fol	Ms	20	PC04	1.43	fol	Mc	20	PC04	3.01
fol	Ms	20	PC06	2.14	fol	Mc	20	PC06	3.74
fol	Ms	20	PC08	2.66	fol	Mc	20	PC08	4.26
fol	Ms	20	PC10	3.07	fol	Mc	20	PC10	4.65
fol	Ms	20	PC12	3.40	fol	Mc	20	PC12	4.94
fol	Ms	40	PC04	3.38	fol	Mc	40	PC04	3.82
fol	Ms	40	PC06	4.12	fol	Mc	40	PC06	4.47
fol	Ms	40	PC08	4.65	fol	Mc	40	PC08	4.93
fol	Ms	40	PC10	5.03	fol	Mc	40	PC10	5.24
fol	Ms	40	PC12	5.32	fol	Mc	40	PC12	5.47
fol	Ms	60	PC04	4.13	fol	Mc	60	PC04	2.15
fol	Ms	60	PC06	4.85	fol	Mc	60	PC06	2.60
fol	Ms	60	PC08	5.34	fol	Mc	60	PC08	2.94
fol	Ms	60	PC10	5.68	fol	Mc	60	PC10	3.21
fol	Ms	60	PC12	5.93	fol	Mc	60	PC12	3.43
fol	Ms	80	PC04	4.38	fol	Mc	80	PC04	2.19
fol	Ms	80	PC06	5.05	fol	Mc	80	PC06	2.53
fol	Ms	80	PC08	5.52	fol	Mc	80	PC08	2.79
fol	Ms	80	PC10	5.82	fol	Mc	80	PC10	3.01
fol	Ms	80	PC12	6.05	fol	Mc	80	PC12	3.19
fol	Ms	100	PC04	4.27	fol	Mc	100	PC04	2.51
fol	Ms	100	PC06	4.90	fol	Mc	100	PC06	2.81
fol	Ms	100	PC08	5.34	fol	Mc	100	PC08	3.04
fol	Ms	100	PC10	5.63	fol	Mc	100	PC10	3.23
fol	Ms	100	PC12	5.84	fol	Mc	100	PC12	3.38
fol	Ms	120	PC04	3.89	fol	Mc	120	PC04	2.70
fol	Ms	120	PC06	4.47	fol	Mc	120	PC06	2.98
fol	Ms	120	PC08	4.89	fol	Mc	120	PC08	3.19
fol	Ms	120	PC10	5.16	fol	Mc	120	PC10	3.35



fol	Ms	120	PC12	5.37	fol	Mc	120	PC12	3.48
fol	Ms	140	PC04	3.69	fol	Mc	140	PC04	2.81
fol	Ms	140	PC06	4.23	fol	Mc	140	PC06	3.06
fol	Ms	140	PC08	4.62	fol	Mc	140	PC08	3.26
fol	Ms	140	PC10	4.88	fol	Mc	140	PC10	3.40
fol	Ms	140	PC12	5.08	fol	Mc	140	PC12	3.51
fol	Ms	160	PC04	3.47	fol	Mc	160	PC04	2.86
fol	Ms	160	PC06	3.95	fol	Mc	160	PC06	3.09
fol	Ms	160	PC08	4.31	fol	Mc	160	PC08	3.26
fol	Ms	160	PC10	4.56	fol	Mc	160	PC10	3.39
fol	Ms	160	PC12	4.75	fol	Mc	160	PC12	3.48
fol	Ms	180	PC04	3.32	fol	Mc	180	PC04	2.84
fol	Ms	180	PC06	3.76	fol	Mc	180	PC06	3.04
fol	Ms	180	PC08	4.09	fol	Mc	180	PC08	3.20
fol	Ms	180	PC10	4.33	fol	Mc	180	PC10	3.30
fol	Ms	180	PC12	4.51	fol	Mc	180	PC12	3.38
fol	Ms	200	PC04	3.23	fol	Mc	200	PC04	2.79
fol	Ms	200	PC06	3.63	fol	Mc	200	PC06	2.96
fol	Ms	200	PC08	3.94	fol	Mc	200	PC08	3.10
fol	Ms	200	PC10	4.17	fol	Mc	200	PC10	3.19
fol	Ms	200	PC12	4.33	fol	Mc	200	PC12	3.26
fol	Vs	20	PC04	1.60	fol	Vc	20	PC04	2.18
fol	Vs	20	PC06	2.40	fol	Vc	20	PC06	3.04
fol	Vs	20	PC08	2.87	fol	Vc	20	PC08	3.53
fol	Vs	20	PC10	3.17	fol	Vc	20	PC10	3.84
fol	Vs	20	PC12	3.39	fol	Vc	20	PC12	4.05
fol	Vs	40	PC04	2.32	fol	Vc	40	PC04	2.70
fol	Vs	40	PC06	2.99	fol	Vc	40	PC06	3.44
fol	Vs	40	PC08	3.39	fol	Vc	40	PC08	3.86
fol	Vs	40	PC10	3.64	fol	Vc	40	PC10	4.12
fol	Vs	40	PC12	3.82	fol	Vc	40	PC12	4.29
fol	Vs	60	PC04	2.55	fol	Vc	60	PC04	2.11
fol	Vs	60	PC06	3.16	fol	Vc	60	PC06	2.86
fol	Vs	60	PC08	3.52	fol	Vc	60	PC08	3.30
fol	Vs	60	PC10	3.75	fol	Vc	60	PC10	3.58
fol	Vs	60	PC12	3.90	fol	Vc	60	PC12	3.77
fol	Vs	80	PC04	2.62	fol	Vc	80	PC04	1.52
fol	Vs	80	PC06	3.14	fol	Vc	80	PC06	2.18
fol	Vs	80	PC08	3.46	fol	Vc	80	PC08	2.60
fol	Vs	80	PC10	3.66	fol	Vc	80	PC10	2.89
fol	Vs	80	PC12	3.80	fol	Vc	80	PC12	3.10

fol	Vs	100	PC04	2.45	fol	Vc	100	PC04	1.42
fol	Vs	100	PC06	2.91	fol	Vc	100	PC06	1.98
fol	Vs	100	PC08	3.20	fol	Vc	100	PC08	2.35
fol	Vs	100	PC10	3.40	fol	Vc	100	PC10	2.61
fol	Vs	100	PC12	3.54	fol	Vc	100	PC12	2.81
fol	Vs	120	PC04	2.24	fol	Vc	120	PC04	1.41
fol	Vs	120	PC06	2.66	fol	Vc	120	PC06	1.92
fol	Vs	120	PC08	2.94	fol	Vc	120	PC08	2.26
fol	Vs	120	PC10	3.13	fol	Vc	120	PC10	2.50
fol	Vs	120	PC12	3.27	fol	Vc	120	PC12	2.69
fol	Vs	140	PC04	2.07	fol	Vc	140	PC04	1.44
fol	Vs	140	PC06	2.47	fol	Vc	140	PC06	1.91
fol	Vs	140	PC08	2.73	fol	Vc	140	PC08	2.22
fol	Vs	140	PC10	2.91	fol	Vc	140	PC10	2.45
fol	Vs	140	PC12	3.05	fol	Vc	140	PC12	2.62
fol	Vs	160	PC04	1.97	fol	Vc	160	PC04	1.48
fol	Vs	160	PC06	2.33	fol	Vc	160	PC06	1.91
fol	Vs	160	PC08	2.57	fol	Vc	160	PC08	2.20
fol	Vs	160	PC10	2.75	fol	Vc	160	PC10	2.41
fol	Vs	160	PC12	2.88	fol	Vc	160	PC12	2.57
fol	Vs	180	PC04	1.93	fol	Vc	180	PC04	1.55
fol	Vs	180	PC06	2.26	fol	Vc	180	PC06	1.94
fol	Vs	180	PC08	2.49	fol	Vc	180	PC08	2.20
fol	Vs	180	PC10	2.65	fol	Vc	180	PC10	2.40
fol	Vs	180	PC12	2.78	fol	Vc	180	PC12	2.54
fol	Vs	200	PC04	1.93	fol	Vc	200	PC04	1.59
fol	Vs	200	PC06	2.23	fol	Vc	200	PC06	1.95
fol	Vs	200	PC08	2.44	fol	Vc	200	PC08	2.19
fol	Vs	200	PC10	2.59	fol	Vc	200	PC10	2.37
fol	Vs	200	PC12	2.71	fol	Vc	200	PC12	2.51

### Two Lane Load Effects, PC Girders

Lane	Effect	Span	Bridge	Beta	Lane	Effect	Span	Bridge	Beta
04G	Ms	20	PC04	1.19	04G	Mc	20	PC04	2.75
06G	Ms	20	PC06	1.84	06G	Mc	20	PC06	3.43
08G	Ms	20	PC08	2.31	08G	Mc	20	PC08	3.90
10G	Ms	20	PC10	2.69	10G	Mc	20	PC10	4.26
12G	Ms	20	PC12	3.00	12G	Mc	20	PC12	4.54
04G	Ms	40	PC04	3.65	04G	Mc	40	PC04	2.85

06G	Ms	40	PC06	4.35	06G	Mc	40	PC06	3.27
08G	Ms	40	PC08	4.83	08G	Mc	40	PC08	3.56
10G	Ms	40	PC10	5.17	10G	Mc	40	PC10	3.78
12G	Ms	40	PC12	5.43	12G	Mc	40	PC12	3.96
04G	Ms	60	PC04	4.29	04G	Mc	60	PC04	2.76
06G	Ms	60	PC06	4.94	06G	Mc	60	PC06	3.14
08G	Ms	60	PC08	5.39	08G	Mc	60	PC08	3.41
10G	Ms	60	PC10	5.69	10G	Mc	60	PC10	3.61
12G	Ms	60	PC12	5.90	12G	Mc	60	PC12	3.77
04G	Ms	80	PC04	3.91	04G	Mc	80	PC04	2.91
06G	Ms	80	PC06	4.44	06G	Mc	80	PC06	3.23
08G	Ms	80	PC08	4.82	08G	Mc	80	PC08	3.46
10G	Ms	80	PC10	5.08	10G	Mc	80	PC10	3.63
12G	Ms	80	PC12	5.27	12G	Mc	80	PC12	3.76
04G	Ms	100	PC04	3.58	04G	Mc	100	PC04	2.99
06G	Ms	100	PC06	4.05	06G	Mc	100	PC06	3.26
08G	Ms	100	PC08	4.38	08G	Mc	100	PC08	3.47
10G	Ms	100	PC10	4.62	10G	Mc	100	PC10	3.62
12G	Ms	100	PC12	4.80	12G	Mc	100	PC12	3.73
04G	Ms	120	PC04	3.45	04G	Mc	120	PC04	3.05
06G	Ms	120	PC06	3.88	06G	Mc	120	PC06	3.30
08G	Ms	120	PC08	4.20	08G	Mc	120	PC08	3.49
10G	Ms	120	PC10	4.42	10G	Mc	120	PC10	3.62
12G	Ms	120	PC12	4.59	12G	Mc	120	PC12	3.71
04G	Ms	140	PC04	3.41	04G	Mc	140	PC04	3.01
06G	Ms	140	PC06	3.83	06G	Mc	140	PC06	3.23
08G	Ms	140	PC08	4.13	08G	Mc	140	PC08	3.39
10G	Ms	140	PC10	4.34	10G	Mc	140	PC10	3.51
12G	Ms	140	PC12	4.50	12G	Mc	140	PC12	3.58
04G	Ms	160	PC04	3.36	04G	Mc	160	PC04	2.95
06G	Ms	160	PC06	3.75	06G	Mc	160	PC06	3.14
08G	Ms	160	PC08	4.04	08G	Mc	160	PC08	3.28
10G	Ms	160	PC10	4.25	10G	Mc	160	PC10	3.38
12G	Ms	160	PC12	4.40	12G	Mc	160	PC12	3.45
04G	Ms	180	PC04	3.31	04G	Mc	180	PC04	2.90
06G	Ms	180	PC06	3.68	06G	Mc	180	PC06	3.07
08G	Ms	180	PC08	3.96	08G	Mc	180	PC08	3.19
10G	Ms	180	PC10	4.15	10G	Mc	180	PC10	3.28
12G	Ms	180	PC12	4.29	12G	Mc	180	PC12	3.33
04G	Ms	200	PC04	3.24	04G	Mc	200	PC04	2.84
06G	Ms	200	PC06	3.59	06G	Mc	200	PC06	2.99

08G	Ms	200	PC08	3.85	08G	Mc	200	PC08	3.10
10G	Ms	200	PC10	4.03	10G	Mc	200	PC10	3.17
12G	Ms	200	PC12	4.17	12G	Mc	200	PC12	3.22
04G	Vs	20	PC04	1.40	04G	Vc	20	PC04	2.16
06G	Vs	20	PC06	2.13	06G	Vc	20	PC06	2.95
08G	Vs	20	PC08	2.57	08G	Vc	20	PC08	3.42
10G	Vs	20	PC10	2.87	10G	Vc	20	PC10	3.72
12G	Vs	20	PC12	3.08	12G	Vc	20	PC12	3.92
04G	Vs	40	PC04	2.19	04G	Vc	40	PC04	2.25
06G	Vs	40	PC06	2.83	06G	Vc	40	PC06	2.87
08G	Vs	40	PC08	3.21	08G	Vc	40	PC08	3.24
10G	Vs	40	PC10	3.45	10G	Vc	40	PC10	3.49
12G	Vs	40	PC12	3.63	12G	Vc	40	PC12	3.67
04G	Vs	60	PC04	2.41	04G	Vc	60	PC04	2.20
06G	Vs	60	PC06	2.98	06G	Vc	60	PC06	2.67
08G	Vs	60	PC08	3.32	08G	Vc	60	PC08	2.96
10G	Vs	60	PC10	3.54	10G	Vc	60	PC10	3.17
12G	Vs	60	PC12	3.69	12G	Vc	60	PC12	3.32
04G	Vs	80	PC04	2.44	04G	Vc	80	PC04	2.21
06G	Vs	80	PC06	2.89	06G	Vc	80	PC06	2.60
08G	Vs	80	PC08	3.18	08G	Vc	80	PC08	2.84
10G	Vs	80	PC10	3.37	10G	Vc	80	PC10	3.02
12G	Vs	80	PC12	3.50	12G	Vc	80	PC12	3.17
04G	Vs	100	PC04	2.45	04G	Vc	100	PC04	2.26
06G	Vs	100	PC06	2.81	06G	Vc	100	PC06	2.58
08G	Vs	100	PC08	3.04	08G	Vc	100	PC08	2.79
10G	Vs	100	PC10	3.20	10G	Vc	100	PC10	2.95
12G	Vs	100	PC12	3.32	12G	Vc	100	PC12	3.08
04G	Vs	120	PC04	2.49	04G	Vc	120	PC04	2.28
06G	Vs	120	PC06	2.75	06G	Vc	120	PC06	2.55
08G	Vs	120	PC08	2.93	08G	Vc	120	PC08	2.74
10G	Vs	120	PC10	3.06	10G	Vc	120	PC10	2.88
12G	Vs	120	PC12	3.16	12G	Vc	120	PC12	3.00
04G	Vs	140	PC04	2.47	04G	Vc	140	PC04	2.25
06G	Vs	140	PC06	2.70	06G	Vc	140	PC06	2.50
08G	Vs	140	PC08	2.86	08G	Vc	140	PC08	2.67
10G	Vs	140	PC10	2.97	10G	Vc	140	PC10	2.81
12G	Vs	140	PC12	3.06	12G	Vc	140	PC12	2.91
04G	Vs	160	PC04	2.46	04G	Vc	160	PC04	2.27
06G	Vs	160	PC06	2.66	06G	Vc	160	PC06	2.49
08G	Vs	160	PC08	2.80	08G	Vc	160	PC08	2.64

10G	Vs	160	PC10	2.90	10G	Vc	160	PC10	2.76
12G	Vs	160	PC12	2.98	12G	Vc	160	PC12	2.86
04G	Vs	180	PC04	2.45	04G	Vc	180	PC04	2.28
06G	Vs	180	PC06	2.62	06G	Vc	180	PC06	2.48
08G	Vs	180	PC08	2.75	08G	Vc	180	PC08	2.62
10G	Vs	180	PC10	2.84	10G	Vc	180	PC10	2.73
12G	Vs	180	PC12	2.92	12G	Vc	180	PC12	2.82
04G	Vs	200	PC04	2.45	04G	Vc	200	PC04	2.29
06G	Vs	200	PC06	2.61	06G	Vc	200	PC06	2.46
08G	Vs	200	PC08	2.72	08G	Vc	200	PC08	2.59
10G	Vs	200	PC10	2.81	10G	Vc	200	PC10	2.69
12G	Vs	200	PC12	2.88	12G	Vc	200	PC12	2.77

### Single Lane Load Effects, RC Girders

Lane	Effect	Span	Bridge	Beta	Lane	Effect	Span	Bridge	Beta
fol	Ms	20	RC04	1.46	fol	Mc	20	RC04	2.54
fol	Ms	20	RC06	2.05	fol	Mc	20	RC06	3.00
fol	Ms	20	RC08	2.36	fol	Mc	20	RC08	3.28
fol	Ms	20	RC10	2.64	fol	Mc	20	RC10	3.49
fol	Ms	20	RC12	2.56	fol	Mc	20	RC12	3.41
fol	Ms	40	RC04	2.82	fol	Mc	40	RC04	3.06
fol	Ms	40	RC06	3.23	fol	Mc	40	RC06	3.37
fol	Ms	40	RC08	3.51	fol	Mc	40	RC08	3.61
fol	Ms	40	RC10	3.70	fol	Mc	40	RC10	3.76
fol	Ms	40	RC12	3.63	fol	Mc	40	RC12	3.68
fol	Ms	60	RC04	3.22	fol	Mc	60	RC04	2.22
fol	Ms	60	RC06	3.56	fol	Mc	60	RC06	2.53
fol	Ms	60	RC08	3.81	fol	Mc	60	RC08	2.72
fol	Ms	60	RC10	3.96	fol	Mc	60	RC10	2.88
fol	Ms	60	RC12	3.88	fol	Mc	60	RC12	2.83
fol	Ms	80	RC04	3.34	fol	Mc	80	RC04	2.24
fol	Ms	80	RC06	3.64	fol	Mc	80	RC06	2.48
fol	Ms	80	RC08	3.86	fol	Mc	80	RC08	2.63
fol	Ms	80	RC10	3.99	fol	Mc	80	RC10	2.77
fol	Ms	80	RC12	3.91	fol	Mc	80	RC12	2.72
fol	Ms	100	RC04	3.28	fol	Mc	100	RC04	2.40
fol	Ms	100	RC06	3.56	fol	Mc	100	RC06	2.58
fol	Ms	100	RC08	3.76	fol	Mc	100	RC08	2.71
fol	Ms	100	RC10	3.88	fol	Mc	100	RC10	2.82
fol	Ms	100	RC12	3.80	fol	Mc	100	RC12	2.78

fol	Vs	20	RC04	1.52	fol	Vc	20	RC04	2.11
fol	Vs	20	RC06	2.35	fol	Vc	20	RC06	2.92
fol	Vs	20	RC08	2.77	fol	Vc	20	RC08	3.35
fol	Vs	20	RC10	3.05	fol	Vc	20	RC10	3.62
fol	Vs	20	RC12	3.02	fol	Vc	20	RC12	3.60
fol	Vs	40	RC04	2.27	fol	Vc	40	RC04	2.62
fol	Vs	40	RC06	2.90	fol	Vc	40	RC06	3.27
fol	Vs	40	RC08	3.23	fol	Vc	40	RC08	3.63
fol	Vs	40	RC10	3.44	fol	Vc	40	RC10	3.85
fol	Vs	40	RC12	3.41	fol	Vc	40	RC12	3.82
fol	Vs	60	RC04	2.52	fol	Vc	60	RC04	2.12
fol	Vs	60	RC06	3.04	fol	Vc	60	RC06	2.78
fol	Vs	60	RC08	3.33	fol	Vc	60	RC08	3.14
fol	Vs	60	RC10	3.51	fol	Vc	60	RC10	3.38
fol	Vs	60	RC12	3.47	fol	Vc	60	RC12	3.35
fol	Vs	80	RC04	2.59	fol	Vc	80	RC04	1.60
fol	Vs	80	RC06	3.02	fol	Vc	80	RC06	2.23
fol	Vs	80	RC08	3.28	fol	Vc	80	RC08	2.58
fol	Vs	80	RC10	3.44	fol	Vc	80	RC10	2.84
fol	Vs	80	RC12	3.40	fol	Vc	80	RC12	2.82
fol	Vs	100	RC04	2.44	fol	Vc	100	RC04	1.51
fol	Vs	100	RC06	2.83	fol	Vc	100	RC06	2.06
fol	Vs	100	RC08	3.07	fol	Vc	100	RC08	2.38
fol	Vs	100	RC10	3.22	fol	Vc	100	RC10	2.62
fol	Vs	100	RC12	3.19	fol	Vc	100	RC12	2.61

Lane	Effect	Span	Bridge	Beta
fol	Mcp	20	RC04	1.65
fol	Mcp	20	RC06	2.20
fol	Mcp	20	RC08	2.50
fol	Mcp	20	RC10	2.75
fol	Mcp	20	RC12	2.68
fol	Mcp	40	RC04	2.77
fol	Mcp	40	RC06	3.15
fol	Mcp	40	RC08	3.40
fol	Mcp	40	RC10	3.58
fol	Mcp	40	RC12	3.51
fol	Mcp	60	RC04	3.11
fol	Mcp	60	RC06	3.42
fol	Mcp	60	RC08	3.64
fol	Mcp	60	RC10	3.78

fol	Mcp	60	RC12	3.71
fol	Mcp	80	RC04	3.24
fol	Mcp	80	RC06	3.51
fol	Mcp	80	RC08	3.71
fol	Mcp	80	RC10	3.83
fol	Mcp	80	RC12	3.75
fol	Mcp	100	RC04	3.19
fol	Mcp	100	RC06	3.44
fol	Mcp	100	RC08	3.61
fol	Mcp	100	RC10	3.72
fol	Mcp	100	RC12	3.64

### Two Lane Load Effects, RC Girders

Lane	Effect	Span	Bridge	Beta	Lane	Effect	Span	Bridge	Beta
04G	Ms	20	RC04	1.25	04G	Mc	20	RC04	2.36
06G	Ms	20	RC06	1.82	06G	Mc	20	RC06	2.82
08G	Ms	20	RC08	2.12	08G	Mc	20	RC08	3.09
10G	Ms	20	RC10	2.39	10G	Mc	20	RC10	3.30
12G	Ms	20	RC12	2.30	12G	Mc	20	RC12	3.21
04G	Ms	40	RC04	2.95	04G	Mc	40	RC04	2.54
06G	Ms	40	RC06	3.32	06G	Mc	40	RC06	2.83
08G	Ms	40	RC08	3.58	08G	Mc	40	RC08	2.99
10G	Ms	40	RC10	3.75	10G	Mc	40	RC10	3.13
12G	Ms	40	RC12	3.66	12G	Mc	40	RC12	3.01
04G	Ms	60	RC04	3.28	04G	Mc	60	RC04	2.50
06G	Ms	60	RC06	3.58	06G	Mc	60	RC06	2.72
08G	Ms	60	RC08	3.80	08G	Mc	60	RC08	2.87
10G	Ms	60	RC10	3.94	10G	Mc	60	RC10	2.98
12G	Ms	60	RC12	3.84	12G	Mc	60	RC12	2.89
04G	Ms	80	RC04	3.09	04G	Mc	80	RC04	2.57
06G	Ms	80	RC06	3.36	06G	Mc	80	RC06	2.75
08G	Ms	80	RC08	3.54	08G	Mc	80	RC08	2.87
10G	Ms	80	RC10	3.66	10G	Mc	80	RC10	2.96
12G	Ms	80	RC12	3.57	12G	Mc	80	RC12	2.89
04G	Ms	100	RC04	2.93	04G	Mc	100	RC04	2.61
06G	Ms	100	RC06	3.17	06G	Mc	100	RC06	2.76
08G	Ms	100	RC08	3.33	08G	Mc	100	RC08	2.86
10G	Ms	100	RC10	3.44	10G	Mc	100	RC10	2.94
12G	Ms	100	RC12	3.35	12G	Mc	100	RC12	2.87

04G	Vs	20	RC04	1.26	04G	Vc	20	RC04	2.03
06G	Vs	20	RC06	2.05	06G	Vc	20	RC06	2.79
08G	Vs	20	RC08	2.44	08G	Vc	20	RC08	3.20
10G	Vs	20	RC10	2.73	10G	Vc	20	RC10	3.47
12G	Vs	20	RC12	2.70	12G	Vc	20	RC12	3.44
04G	Vs	40	RC04	2.10	04G	Vc	40	RC04	2.16
06G	Vs	40	RC06	2.71	06G	Vc	40	RC06	2.75
08G	Vs	40	RC08	3.03	08G	Vc	40	RC08	3.07
10G	Vs	40	RC10	3.25	10G	Vc	40	RC10	3.29
12G	Vs	40	RC12	3.21	12G	Vc	40	RC12	3.24
04G	Vs	60	RC04	2.35	04G	Vc	60	RC04	2.17
06G	Vs	60	RC06	2.85	06G	Vc	60	RC06	2.60
08G	Vs	60	RC08	3.13	08G	Vc	60	RC08	2.84
10G	Vs	60	RC10	3.31	10G	Vc	60	RC10	3.03
12G	Vs	60	RC12	3.27	12G	Vc	60	RC12	2.96
04G	Vs	80	RC04	2.40	04G	Vc	80	RC04	2.19
06G	Vs	80	RC06	2.79	06G	Vc	80	RC06	2.55
08G	Vs	80	RC08	3.02	08G	Vc	80	RC08	2.75
10G	Vs	80	RC10	3.18	10G	Vc	80	RC10	2.91
12G	Vs	80	RC12	3.13	12G	Vc	80	RC12	2.85
04G	Vs	100	RC04	2.42	04G	Vc	100	RC04	2.23
06G	Vs	100	RC06	2.73	06G	Vc	100	RC06	2.53
08G	Vs	100	RC08	2.92	08G	Vc	100	RC08	2.71
10G	Vs	100	RC10	3.05	10G	Vc	100	RC10	2.85
12G	Vs	100	RC12	3.00	12G	Vc	100	RC12	2.79

Lane	Effect	Span	Bridge	Beta
04G	Mcp	20	RC04	1.46
06G	Mcp	20	RC06	2.00
08G	Mcp	20	RC08	2.27
10G	Mcp	20	RC10	2.52
12G	Mcp	20	RC12	2.43
04G	Mcp	40	RC04	2.89
06G	Mcp	40	RC06	3.23
08G	Mcp	40	RC08	3.46
10G	Mcp	40	RC10	3.62
12G	Mcp	40	RC12	3.53
04G	Mcp	60	RC04	3.16
06G	Mcp	60	RC06	3.43
08G	Mcp	60	RC08	3.63
10G	Mcp	60	RC10	3.75



12G	Mcp	60	RC12	3.66
04G	Mcp	80	RC04	3.03
06G	Mcp	80	RC06	3.27
08G	Mcp	80	RC08	3.44
10G	Mcp	80	RC10	3.55
12G	Mcp	80	RC12	3.45
04G	Mcp	100	RC04	2.89
06G	Mcp	100	RC06	3.10
08G	Mcp	100	RC08	3.24
10G	Mcp	100	RC10	3.34
12G	Mcp	100	RC12	3.26

### Single Lane Load Effects, Spread Box Beams (BS)

Lane	Effect	Span	Bridge	Beta	Lane	Effect	Span	Bridge	Beta
fol	Ms	20	BS04	1.40	fol	Mc	20	BS04	2.98
fol	Ms	20	BS06	3.43	fol	Mc	20	BS06	4.99
fol	Ms	20	BS08	3.83	fol	Mc	20	BS08	5.37
fol	Ms	20	BS10	5.40	fol	Mc	20	BS10	6.75
fol	Ms	20	BS12	5.19	fol	Mc	20	BS12	6.54
fol	Ms	40	BS04	3.64	fol	Mc	40	BS04	3.92
fol	Ms	40	BS06	5.07	fol	Mc	40	BS06	5.16
fol	Ms	40	BS08	5.23	fol	Mc	40	BS08	5.30
fol	Ms	40	BS10	6.50	fol	Mc	40	BS10	6.40
fol	Ms	40	BS12	6.15	fol	Mc	40	BS12	6.05
fol	Ms	60	BS04	4.20	fol	Mc	60	BS04	2.49
fol	Ms	60	BS06	5.34	fol	Mc	60	BS06	3.24
fol	Ms	60	BS08	5.43	fol	Mc	60	BS08	3.27
fol	Ms	60	BS10	6.54	fol	Mc	60	BS10	4.18
fol	Ms	60	BS12	6.15	fol	Mc	60	BS12	3.86
fol	Ms	80	BS04	4.31	fol	Mc	80	BS04	2.40
fol	Ms	80	BS06	5.29	fol	Mc	80	BS06	2.94
fol	Ms	80	BS08	5.34	fol	Mc	80	BS08	2.91
fol	Ms	80	BS10	6.35	fol	Mc	80	BS10	3.67
fol	Ms	80	BS12	5.95	fol	Mc	80	BS12	3.37
fol	Ms	100	BS04	4.29	fol	Mc	100	BS04	2.64
fol	Ms	100	BS06	5.14	fol	Mc	100	BS06	3.10
fol	Ms	100	BS08	5.17	fol	Mc	100	BS08	3.05
fol	Ms	100	BS10	6.09	fol	Mc	100	BS10	3.71
fol	Ms	100	BS12	5.69	fol	Mc	100	BS12	3.41

fol	Ms	120	BS04	3.88	fol	Mc	120	BS04	2.76
fol	Ms	120	BS06	4.63	fol	Mc	120	BS06	3.14
fol	Ms	120	BS08	4.64	fol	Mc	120	BS08	3.09
fol	Ms	120	BS10	5.52	fol	Mc	120	BS10	3.66
fol	Ms	120	BS12	5.12	fol	Mc	120	BS12	3.37
fol	Ms	140	BS04	3.72	fol	Mc	140	BS04	2.87
fol	Ms	140	BS06	4.39	fol	Mc	140	BS06	3.19
fol	Ms	140	BS08	4.38	fol	Mc	140	BS08	3.14
fol	Ms	140	BS10	5.20	fol	Mc	140	BS10	3.63
fol	Ms	140	BS12	4.82	fol	Mc	140	BS12	3.36
fol	Ms	160	BS04	3.55	fol	Mc	160	BS04	2.91
fol	Ms	160	BS06	4.15	fol	Mc	160	BS06	3.19
fol	Ms	160	BS08	4.13	fol	Mc	160	BS08	3.13
fol	Ms	160	BS10	4.89	fol	Mc	160	BS10	3.56
fol	Ms	160	BS12	4.53	fol	Mc	160	BS12	3.30
fol	Ms	180	BS04	3.36	fol	Mc	180	BS04	2.85
fol	Ms	180	BS06	3.89	fol	Mc	180	BS06	3.09
fol	Ms	180	BS08	3.86	fol	Mc	180	BS08	3.03
fol	Ms	180	BS10	4.57	fol	Mc	180	BS10	3.40
fol	Ms	180	BS12	4.23	fol	Mc	180	BS12	3.17
fol	Ms	200	BS04	3.29	fol	Mc	200	BS04	2.82
fol	Ms	200	BS06	3.77	fol	Mc	200	BS06	3.02
fol	Ms	200	BS08	3.74	fol	Mc	200	BS08	2.96
fol	Ms	200	BS10	4.39	fol	Mc	200	BS10	3.29
fol	Ms	200	BS12	4.07	fol	Mc	200	BS12	3.07
fol	Vs	20	BS04	1.79	fol	Vc	20	BS04	2.39
fol	Vs	20	BS06	3.00	fol	Vc	20	BS06	3.67
fol	Vs	20	BS08	3.22	fol	Vc	20	BS08	3.89
fol	Vs	20	BS10	3.98	fol	Vc	20	BS10	4.61
fol	Vs	20	BS12	3.89	fol	Vc	20	BS12	4.52
fol	Vs	40	BS04	2.42	fol	Vc	40	BS04	2.79
fol	Vs	40	BS06	3.21	fol	Vc	40	BS06	3.66
fol	Vs	40	BS08	3.30	fol	Vc	40	BS08	3.76
fol	Vs	40	BS10	3.96	fol	Vc	40	BS10	4.43
fol	Vs	40	BS12	3.80	fol	Vc	40	BS12	4.27
fol	Vs	60	BS04	2.59	fol	Vc	60	BS04	2.21
fol	Vs	60	BS06	3.20	fol	Vc	60	BS06	2.96
fol	Vs	60	BS08	3.25	fol	Vc	60	BS08	3.01
fol	Vs	60	BS10	3.85	fol	Vc	60	BS10	3.72
fol	Vs	60	BS12	3.67	fol	Vc	60	BS12	3.52
fol	Vs	80	BS04	2.60	fol	Vc	80	BS04	1.60

fol	Vs	80	BS06	3.11	fol	Vc	80	BS06	2.21
fol	Vs	80	BS08	3.13	fol	Vc	80	BS08	2.22
fol	Vs	80	BS10	3.68	fol	Vc	80	BS10	2.93
fol	Vs	80	BS12	3.49	fol	Vc	80	BS12	2.72
fol	Vs	100	BS04	2.43	fol	Vc	100	BS04	1.46
fol	Vs	100	BS06	2.87	fol	Vc	100	BS06	1.96
fol	Vs	100	BS08	2.88	fol	Vc	100	BS08	1.95
fol	Vs	100	BS10	3.40	fol	Vc	100	BS10	2.61
fol	Vs	100	BS12	3.21	fol	Vc	100	BS12	2.39
fol	Vs	120	BS04	2.22	fol	Vc	120	BS04	1.46
fol	Vs	120	BS06	2.60	fol	Vc	120	BS06	1.87
fol	Vs	120	BS08	2.58	fol	Vc	120	BS08	1.84
fol	Vs	120	BS10	3.08	fol	Vc	120	BS10	2.45
fol	Vs	120	BS12	2.89	fol	Vc	120	BS12	2.24
fol	Vs	140	BS04	2.12	fol	Vc	140	BS04	1.55
fol	Vs	140	BS06	2.43	fol	Vc	140	BS06	1.90
fol	Vs	140	BS08	2.40	fol	Vc	140	BS08	1.86
fol	Vs	140	BS10	2.86	fol	Vc	140	BS10	2.40
fol	Vs	140	BS12	2.68	fol	Vc	140	BS12	2.20
fol	Vs	160	BS04	2.06	fol	Vc	160	BS04	1.63
fol	Vs	160	BS06	2.32	fol	Vc	160	BS06	1.93
fol	Vs	160	BS08	2.28	fol	Vc	160	BS08	1.88
fol	Vs	160	BS10	2.71	fol	Vc	160	BS10	2.38
fol	Vs	160	BS12	2.53	fol	Vc	160	BS12	2.19
fol	Vs	180	BS04	2.03	fol	Vc	180	BS04	1.69
fol	Vs	180	BS06	2.24	fol	Vc	180	BS06	1.94
fol	Vs	180	BS08	2.20	fol	Vc	180	BS08	1.88
fol	Vs	180	BS10	2.59	fol	Vc	180	BS10	2.33
fol	Vs	180	BS12	2.42	fol	Vc	180	BS12	2.15
fol	Vs	200	BS04	2.05	fol	Vc	200	BS04	1.77
fol	Vs	200	BS06	2.23	fol	Vc	200	BS06	1.98
fol	Vs	200	BS08	2.19	fol	Vc	200	BS08	1.92
fol	Vs	200	BS10	2.54	fol	Vc	200	BS10	2.32
fol	Vs	200	BS12	2.39	fol	Vc	200	BS12	2.15

### Two Lane Load Effects, Spread Box Beams (BS)

Lane	Effect	Span	Bridge	Beta	Lane	Effect	Span	Bridge	Beta
------	--------	------	--------	------	------	--------	------	--------	------

04B	Ms	20	BS04	1.19	04B	Mc	20	BS04	2.75
06B	Ms	20	BS06	3.13	06B	Mc	20	BS06	4.69
08B	Ms	20	BS08	3.48	08B	Mc	20	BS08	5.02
10B	Ms	20	BS10	5.02	10B	Mc	20	BS10	6.40
12B	Ms	20	BS12	4.78	12B	Mc	20	BS12	6.16
04B	Ms	40	BS04	3.75	04B	Mc	40	BS04	2.68
06B	Ms	40	BS06	5.11	06B	Mc	40	BS06	3.63
08B	Ms	40	BS08	5.22	08B	Mc	40	BS08	3.59
10B	Ms	40	BS10	6.45	10B	Mc	40	BS10	4.66
12B	Ms	40	BS12	6.08	12B	Mc	40	BS12	4.24
04B	Ms	60	BS04	4.12	04B	Mc	60	BS04	2.62
06B	Ms	60	BS06	5.19	06B	Mc	60	BS06	3.26
08B	Ms	60	BS08	5.22	08B	Mc	60	BS08	3.17
10B	Ms	60	BS10	6.31	10B	Mc	60	BS10	4.04
12B	Ms	60	BS12	5.88	12B	Mc	60	BS12	3.64
04B	Ms	80	BS04	3.53	04B	Mc	80	BS04	2.69
06B	Ms	80	BS06	4.35	06B	Mc	80	BS06	3.18
08B	Ms	80	BS08	4.26	08B	Mc	80	BS08	3.08
10B	Ms	80	BS10	5.28	10B	Mc	80	BS10	3.80
12B	Ms	80	BS12	4.80	12B	Mc	80	BS12	3.43
04B	Ms	100	BS04	3.21	04B	Mc	100	BS04	2.78
06B	Ms	100	BS06	3.88	06B	Mc	100	BS06	3.18
08B	Ms	100	BS08	3.76	08B	Mc	100	BS08	3.07
10B	Ms	100	BS10	4.70	10B	Mc	100	BS10	3.69
12B	Ms	100	BS12	4.23	12B	Mc	100	BS12	3.34
04B	Ms	120	BS04	3.07	04B	Mc	120	BS04	2.82
06B	Ms	120	BS06	3.65	06B	Mc	120	BS06	3.15
08B	Ms	120	BS08	3.52	08B	Mc	120	BS08	3.05
10B	Ms	120	BS10	4.39	10B	Mc	120	BS10	3.58
12B	Ms	120	BS12	3.93	12B	Mc	120	BS12	3.26
04B	Ms	140	BS04	3.08	04B	Mc	140	BS04	2.80
06B	Ms	140	BS06	3.61	06B	Mc	140	BS06	3.07
08B	Ms	140	BS08	3.48	08B	Mc	140	BS08	2.96
10B	Ms	140	BS10	4.28	10B	Mc	140	BS10	3.43
12B	Ms	140	BS12	3.85	12B	Mc	140	BS12	3.13
04B	Ms	160	BS04	3.07	04B	Mc	160	BS04	2.77
06B	Ms	160	BS06	3.55	06B	Mc	160	BS06	2.99
08B	Ms	160	BS08	3.43	08B	Mc	160	BS08	2.89
10B	Ms	160	BS10	4.17	10B	Mc	160	BS10	3.30
12B	Ms	160	BS12	3.75	12B	Mc	160	BS12	3.02
04B	Ms	180	BS04	3.00	04B	Mc	180	BS04	2.73

06B	Ms	180	BS06	3.42	06B	Mc	180	BS06	2.91
08B	Ms	180	BS08	3.30	08B	Mc	180	BS08	2.80
10B	Ms	180	BS10	3.99	10B	Mc	180	BS10	3.16
12B	Ms	180	BS12	3.59	12B	Mc	180	BS12	2.90
04B	Ms	200	BS04	2.99	04B	Mc	200	BS04	2.71
06B	Ms	200	BS06	3.37	06B	Mc	200	BS06	2.86
08B	Ms	200	BS08	3.26	08B	Mc	200	BS08	2.76
10B	Ms	200	BS10	3.89	10B	Mc	200	BS10	3.08
12B	Ms	200	BS12	3.53	12B	Mc	200	BS12	2.84
04B	Vs	20	BS04	1.56	04B	Vc	20	BS04	2.34
06B	Vs	20	BS06	2.73	06B	Vc	20	BS06	3.57
08B	Vs	20	BS08	2.92	08B	Vc	20	BS08	3.77
10B	Vs	20	BS10	3.71	10B	Vc	20	BS10	4.51
12B	Vs	20	BS12	3.59	12B	Vc	20	BS12	4.41
04B	Vs	40	BS04	2.28	04B	Vc	40	BS04	2.30
06B	Vs	40	BS06	3.04	06B	Vc	40	BS06	3.10
08B	Vs	40	BS08	3.11	08B	Vc	40	BS08	3.13
10B	Vs	40	BS10	3.78	10B	Vc	40	BS10	3.84
12B	Vs	40	BS12	3.60	12B	Vc	40	BS12	3.62
04B	Vs	60	BS04	2.44	04B	Vc	60	BS04	2.18
06B	Vs	60	BS06	3.03	06B	Vc	60	BS06	2.73
08B	Vs	60	BS08	3.05	08B	Vc	60	BS08	2.66
10B	Vs	60	BS10	3.65	10B	Vc	60	BS10	3.31
12B	Vs	60	BS12	3.45	12B	Vc	60	BS12	3.02
04B	Vs	80	BS04	2.41	04B	Vc	80	BS04	2.13
06B	Vs	80	BS06	2.86	06B	Vc	80	BS06	2.55
08B	Vs	80	BS08	2.83	08B	Vc	80	BS08	2.44
10B	Vs	80	BS10	3.38	10B	Vc	80	BS10	3.03
12B	Vs	80	BS12	3.16	12B	Vc	80	BS12	2.74
04B	Vs	100	BS04	2.39	04B	Vc	100	BS04	2.15
06B	Vs	100	BS06	2.75	06B	Vc	100	BS06	2.49
08B	Vs	100	BS08	2.68	08B	Vc	100	BS08	2.37
10B	Vs	100	BS10	3.18	10B	Vc	100	BS10	2.92
12B	Vs	100	BS12	2.95	12B	Vc	100	BS12	2.63
04B	Vs	120	BS04	2.39	04B	Vc	120	BS04	2.17
06B	Vs	120	BS06	2.65	06B	Vc	120	BS06	2.44
08B	Vs	120	BS08	2.55	08B	Vc	120	BS08	2.31
10B	Vs	120	BS10	2.99	10B	Vc	120	BS10	2.80
12B	Vs	120	BS12	2.75	12B	Vc	120	BS12	2.52
04B	Vs	140	BS04	2.40	04B	Vc	140	BS04	2.19
06B	Vs	140	BS06	2.61	06B	Vc	140	BS06	2.42

08B	Vs	140	BS08	2.51	08B	Vc	140	BS08	2.28
10B	Vs	140	BS10	2.90	10B	Vc	140	BS10	2.73
12B	Vs	140	BS12	2.66	12B	Vc	140	BS12	2.46
04B	Vs	160	BS04	2.41	04B	Vc	160	BS04	2.24
06B	Vs	160	BS06	2.58	06B	Vc	160	BS06	2.42
08B	Vs	160	BS08	2.47	08B	Vc	160	BS08	2.29
10B	Vs	160	BS10	2.83	10B	Vc	160	BS10	2.69
12B	Vs	160	BS12	2.60	12B	Vc	160	BS12	2.44
04B	Vs	180	BS04	2.39	04B	Vc	180	BS04	2.24
06B	Vs	180	BS06	2.53	06B	Vc	180	BS06	2.39
08B	Vs	180	BS08	2.43	08B	Vc	180	BS08	2.26
10B	Vs	180	BS10	2.75	10B	Vc	180	BS10	2.63
12B	Vs	180	BS12	2.53	12B	Vc	180	BS12	2.39
04B	Vs	200	BS04	2.41	04B	Vc	200	BS04	2.27
06B	Vs	200	BS06	2.53	06B	Vc	200	BS06	2.40
08B	Vs	200	BS08	2.43	08B	Vc	200	BS08	2.27
10B	Vs	200	BS10	2.72	10B	Vc	200	BS10	2.60
12B	Vs	200	BS12	2.52	12B	Vc	200	BS12	2.38

### Single Lane Load Effects, Side-By-Side Box Beam (BT), 36" Wide Box

Lane	Effect	Span	Bridge	Beta	Lane	Effect	Span	Bridge	Beta
fol	Ms	20	BT36	2.03	fol	Mc	20	BT36	3.58
fol	Ms	40	BT36	4.40	fol	Mc	40	BT36	4.59
fol	Ms	60	BT36	4.97	fol	Mc	60	BT36	3.28
fol	Ms	80	BT36	5.03	fol	Mc	80	BT36	3.17
fol	Ms	100	BT36	4.88	fol	Mc	100	BT36	3.27
fol	Ms	120	BT36	4.47	fol	Mc	120	BT36	3.29
fol	Ms	140	BT36	4.26	fol	Mc	140	BT36	3.26
fol	Ms	160	BT36	4.04	fol	Mc	160	BT36	3.21
fol	Ms	180	BT36	3.87	fol	Mc	180	BT36	3.14
fol	Ms	200	BT36	3.64	fol	Mc	200	BT36	3.02
fol	Vs	20	BT36	0.60	fol	Vc	20	BT36	1.15
fol	Vs	40	BT36	1.86	fol	Vc	40	BT36	2.19
fol	Vs	60	BT36	2.20	fol	Vc	60	BT36	1.67
fol	Vs	80	BT36	2.34	fol	Vc	80	BT36	1.22
fol	Vs	100	BT36	2.22	fol	Vc	100	BT36	1.15
fol	Vs	120	BT36	2.08	fol	Vc	120	BT36	1.25
fol	Vs	140	BT36	1.99	fol	Vc	140	BT36	1.38
fol	Vs	160	BT36	1.96	fol	Vc	160	BT36	1.50

fol	Vs	180	BT36	1.97	fol	Vc	180	BT36	1.62
fol	Vs	200	BT36	1.98	fol	Vc	200	BT36	1.68

**Two Lane Load Effects, Side-By-Side Box Beam (BT), 36” Wide Box**

Lane	Effect	Span	Bridge	Beta	Lane	Effect	Span	Bridge	Beta
36T	Ms	20	BT36	2.09	36T	Mc	20	BT36	3.54
36T	Ms	40	BT36	4.77	36T	Mc	40	BT36	4.08
36T	Ms	60	BT36	5.06	36T	Mc	60	BT36	3.59
36T	Ms	80	BT36	4.57	36T	Mc	80	BT36	3.44
36T	Ms	100	BT36	4.20	36T	Mc	100	BT36	3.37
36T	Ms	120	BT36	3.97	36T	Mc	120	BT36	3.31
36T	Ms	140	BT36	3.82	36T	Mc	140	BT36	3.20
36T	Ms	160	BT36	3.70	36T	Mc	160	BT36	3.10
36T	Ms	180	BT36	3.58	36T	Mc	180	BT36	3.03
36T	Ms	200	BT36	3.45	36T	Mc	200	BT36	2.95
36T	Vs	20	BT36	0.52	36T	Vc	20	BT36	1.25
36T	Vs	40	BT36	1.80	36T	Vc	40	BT36	1.89
36T	Vs	60	BT36	2.10	36T	Vc	60	BT36	1.97
36T	Vs	80	BT36	2.22	36T	Vc	80	BT36	2.05
36T	Vs	100	BT36	2.28	36T	Vc	100	BT36	2.10
36T	Vs	120	BT36	2.38	36T	Vc	120	BT36	2.17
36T	Vs	140	BT36	2.41	36T	Vc	140	BT36	2.21
36T	Vs	160	BT36	2.43	36T	Vc	160	BT36	2.26
36T	Vs	180	BT36	2.44	36T	Vc	180	BT36	2.29
36T	Vs	200	BT36	2.43	36T	Vc	200	BT36	2.30

**Single Lane Load Effects, Side-By-Side Box Beam (BT), 48” Wide Box**

Lane	Effect	Span	Bridge	Beta	Lane	Effect	Span	Bridge	Beta
fol	Ms	20	BT48	2.12	fol	Mc	20	BT48	3.66
fol	Ms	40	BT48	4.47	fol	Mc	40	BT48	4.63
fol	Ms	60	BT48	5.01	fol	Mc	60	BT48	3.32
fol	Ms	80	BT48	5.06	fol	Mc	80	BT48	3.21
fol	Ms	100	BT48	4.91	fol	Mc	100	BT48	3.29
fol	Ms	120	BT48	4.49	fol	Mc	120	BT48	3.31
fol	Ms	140	BT48	4.27	fol	Mc	140	BT48	3.27
fol	Ms	160	BT48	4.06	fol	Mc	160	BT48	3.22
fol	Ms	180	BT48	3.89	fol	Mc	180	BT48	3.15
fol	Ms	200	BT48	3.69	fol	Mc	200	BT48	3.04

fol	Vs	20	BT48	1.43	fol	Vc	20	BT48	2.00
fol	Vs	40	BT48	2.48	fol	Vc	40	BT48	2.86
fol	Vs	60	BT48	2.76	fol	Vc	60	BT48	2.41
fol	Vs	80	BT48	2.80	fol	Vc	80	BT48	1.92
fol	Vs	100	BT48	2.65	fol	Vc	100	BT48	1.80
fol	Vs	120	BT48	2.50	fol	Vc	120	BT48	1.85
fol	Vs	140	BT48	2.39	fol	Vc	140	BT48	1.92
fol	Vs	160	BT48	2.33	fol	Vc	160	BT48	1.99
fol	Vs	180	BT48	2.32	fol	Vc	180	BT48	2.06
fol	Vs	200	BT48	2.30	fol	Vc	200	BT48	2.09

**Two Lane Load Effects, Side-By-Side Box Beam (BT), 48” Wide Box**

Lane	Effect	Span	Bridge	Beta	Lane	Effect	Span	Bridge	Beta
48T	Ms	20	BT48	2.16	48T	Mc	20	BT48	3.61
48T	Ms	40	BT48	4.82	48T	Mc	40	BT48	4.08
48T	Ms	60	BT48	5.09	48T	Mc	60	BT48	3.59
48T	Ms	80	BT48	4.58	48T	Mc	80	BT48	3.45
48T	Ms	100	BT48	4.21	48T	Mc	100	BT48	3.38
48T	Ms	120	BT48	3.98	48T	Mc	120	BT48	3.31
48T	Ms	140	BT48	3.83	48T	Mc	140	BT48	3.20
48T	Ms	160	BT48	3.71	48T	Mc	160	BT48	3.11
48T	Ms	180	BT48	3.59	48T	Mc	180	BT48	3.03
48T	Ms	200	BT48	3.47	48T	Mc	200	BT48	2.96
48T	Vs	20	BT48	1.27	48T	Vc	20	BT48	2.01
48T	Vs	40	BT48	2.38	48T	Vc	40	BT48	2.44
48T	Vs	60	BT48	2.63	48T	Vc	60	BT48	2.45
48T	Vs	80	BT48	2.64	48T	Vc	80	BT48	2.45
48T	Vs	100	BT48	2.63	48T	Vc	100	BT48	2.45
48T	Vs	120	BT48	2.63	48T	Vc	120	BT48	2.47
48T	Vs	140	BT48	2.62	48T	Vc	140	BT48	2.47
48T	Vs	160	BT48	2.60	48T	Vc	160	BT48	2.48
48T	Vs	180	BT48	2.59	48T	Vc	180	BT48	2.49
48T	Vs	200	BT48	2.57	48T	Vc	200	BT48	2.48



## APPENDIX M. NOMINAL DEAD LOADS USED IN RELIABILITY ANALYSIS

Table M.1. Steel Girder Dead Loads.

Span	Bridge	Nominal Moment (k-ft)			Nominal Shear (k)		
		Dw	Dp	Ds	Dw	Dp	Ds
20	CS04	5.4	2.8	27.3	1.1	0.7	5.5
20	CS06	8.1	3.0	37.3	1.6	0.8	7.5
20	CS08	10.8	4.0	46.3	2.2	0.8	9.3
20	CS10	13.5	4.6	57.9	2.7	1.2	11.6
20	CS12	16.2	5.4	71.0	3.2	1.4	14.2
40	CS04	21.6	14.0	109.0	2.2	1.4	10.9
40	CS06	32.4	15.0	149.0	3.2	1.5	14.9
40	CS08	43.3	20.0	185.0	4.3	2.0	18.5
40	CS10	54.1	23.0	231.0	5.4	2.3	23.1
40	CS12	64.9	27.0	284.0	6.5	2.7	28.4
60	CS04	48.7	39.0	245.0	3.2	2.6	16.3
60	CS06	73.0	48.0	335.0	4.9	3.2	22.3
60	CS08	97.3	70.0	414.0	6.5	4.7	27.6
60	CS10	121.7	84.0	521.0	8.1	5.6	34.7
60	CS12	146.0	103.0	639.0	9.7	6.9	42.6
80	CS04	86.5	128.0	436.0	4.3	6.4	21.8
80	CS06	129.8	148.8	596.0	6.5	7.4	29.8
80	CS08	173.0	186.0	740.0	8.6	9.3	37.0
80	CS10	216.3	208.3	925.6	10.8	10.4	46.3
80	CS12	259.5	245.8	1136.0	13.0	12.3	56.8
100	CS04	135.2	329.0	681.0	5.4	13.2	27.2
100	CS06	202.8	361.0	931.0	8.1	14.4	37.2
100	CS08	270.3	386.0	1150.0	10.8	15.4	46.0
100	CS10	337.9	407.0	1447.0	13.5	16.3	57.9
100	CS12	405.5	458.0	1775.0	16.2	18.3	71.0
120	CS04	194.6	502.0	981.0	6.5	16.7	32.7
120	CS06	292.0	607.0	1341.0	9.7	20.2	44.7
120	CS08	389.3	650.0	1656.0	13.0	21.7	55.2
120	CS10	486.6	681.0	2083.0	16.2	22.7	69.4
120	CS12	583.9	773.0	2556.0	19.4	25.8	85.2
140	CS04	264.9	842.6	1335.3	7.6	24.1	38.2
140	CS06	397.4	1015.2	1825.3	11.3	29.0	52.2
140	CS08	529.9	1128.0	2266.3	15.1	32.2	64.8
140	CS10	662.3	1218.2	2834.7	18.9	34.8	81.0
140	CS12	794.8	1401.0	3479.0	22.7	40.0	99.4
160	CS04	346.0	1337.9	1744.0	8.6	33.4	43.6
160	CS06	519.0	1611.9	2384.0	13.0	40.3	59.6
160	CS08	692.1	1791.0	2960.0	17.3	44.8	74.0

160	CS10	865.1	1934.3	3702.4	21.6	48.4	92.6
160	CS12	1038.1	2224.4	4544.0	25.9	55.6	113.6
180	CS04	437.9	1993.0	2207.3	9.7	44.3	49.1
180	CS06	656.9	2401.2	3017.3	14.6	53.4	67.1
180	CS08	875.9	2668.0	3746.3	19.4	59.3	83.3
180	CS10	1094.9	2881.4	4685.9	24.3	64.0	104.1
180	CS12	1313.8	3313.7	5751.0	29.2	73.6	127.8
200	CS04	540.7	2780.0	2725.0	10.8	55.6	54.5
200	CS06	811.0	3303.0	3725.0	16.2	66.1	74.5
200	CS08	1081.3	3790.0	4600.0	21.6	75.8	92.0
200	CS10	1351.7	4190.0	5788.0	27.0	83.8	115.8
200	CS12	1622.0	4875.0	7100.0	32.4	97.5	142.0

Table M.2. Prestressed Concrete Girder Dead Loads.

Span	Bridge	Nominal Moment (k-ft)			Nominal Shear (k)		
		Dw	Dp	Ds	Dw	Dp	Ds
20	PC04	5.4	29.0	27.3	1.1	5.8	5.5
20	PC06	8.1	29.0	37.3	1.6	5.8	7.5
20	PC08	10.8	29.0	46.3	2.2	5.8	9.3
20	PC10	13.5	29.0	57.9	2.7	5.8	11.6
20	PC12	16.2	29.0	71.0	3.2	5.8	14.2
40	PC04	21.6	116.0	109.0	2.2	11.6	10.9
40	PC06	32.4	116.0	149.0	3.2	11.6	14.9
40	PC08	43.3	116.0	185.0	4.3	11.6	18.5
40	PC10	54.1	116.0	231.0	5.4	11.6	23.1
40	PC12	64.9	116.0	284.0	6.5	11.6	28.4
60	PC04	48.7	262.0	245.0	3.2	17.5	16.3
60	PC06	73.0	262.0	335.0	4.9	17.5	22.3
60	PC08	97.3	262.0	414.0	6.5	17.5	27.6
60	PC10	121.7	262.0	521.0	8.1	17.5	34.7
60	PC12	146.0	262.0	639.0	9.7	17.5	42.6
80	PC04	86.5	640.0	436.0	4.3	32.0	21.8
80	PC06	129.8	640.0	596.0	6.5	32.0	29.8
80	PC08	173.0	640.0	740.0	8.6	32.0	37.0
80	PC10	216.3	640.0	925.6	10.8	32.0	46.3
80	PC12	259.5	640.0	1136.0	13.0	32.0	56.8
100	PC04	135.2	1275.0	681.0	5.4	51.0	27.2
100	PC06	202.8	1275.0	931.0	8.1	51.0	37.2
100	PC08	270.3	1275.0	1150.0	10.8	51.0	46.0
100	PC10	337.9	1275.0	1447.0	13.5	51.0	57.9
100	PC12	405.5	1275.0	1775.0	16.2	51.0	71.0
120	PC04	194.6	1899.0	981.0	6.5	63.3	32.7
120	PC06	292.0	1899.0	1341.0	9.7	63.3	44.7

120	PC08	389.3	1899.0	1656.0	13.0	63.3	55.2
120	PC10	486.6	1899.0	2083.0	16.2	63.3	69.4
120	PC12	583.9	1899.0	2556.0	19.4	63.3	85.2
140	PC04	264.9	2597.0	1335.3	7.6	74.2	38.2
140	PC06	397.4	2597.0	1825.3	11.3	74.2	52.2
140	PC08	529.9	2597.0	2266.3	15.1	74.2	64.8
140	PC10	662.3	2597.0	2834.7	18.9	74.2	81.0
140	PC12	794.8	2597.0	3479.0	22.7	74.2	99.4
160	PC04	346.0	3456.0	1744.0	8.6	86.4	43.6
160	PC06	519.0	3456.0	2384.0	13.0	86.4	59.6
160	PC08	692.1	3456.0	2960.0	17.3	86.4	74.0
160	PC10	865.1	3456.0	3702.4	21.6	86.4	92.6
160	PC12	1038.1	3456.0	4544.0	25.9	86.4	113.6
180	PC04	437.9	4455.0	2207.3	9.7	99.0	49.1
180	PC06	656.9	4455.0	3017.3	14.6	99.0	67.1
180	PC08	875.9	4455.0	3746.3	19.4	99.0	83.3
180	PC10	1094.9	4455.0	4685.9	24.3	99.0	104.1
180	PC12	1313.8	4455.0	5751.0	29.2	99.0	127.8
200	PC04	540.7	5650.0	2725.0	10.8	113.0	54.5
200	PC06	811.0	5650.0	3725.0	16.2	113.0	74.5
200	PC08	1081.3	5650.0	4600.0	21.6	113.0	92.0
200	PC10	1351.7	5650.0	5788.0	27.0	113.0	115.8
200	PC12	1622.0	5650.0	7100.0	32.4	113.0	142.0

Table M.3. Reinforced Concrete Girder Dead Loads.

Span	Bridge	Nominal Moment (k-ft)			Nominal Shear (k)		
		Dw	Dp	Ds	Dw	Dp	Ds
20	RC04	5.4	0	33.5	1.1	0	6.7
20	RC06	8.1	0	55	1.6	0	11.0
20	RC08	10.8	0	61.5	2.2	0	12.3
20	RC10	13.5	0	77.5	2.7	0	15.5
20	RC12	16.2	0	91.5	3.2	0	18.3
40	RC04	21.6	0	168	2.2	0	16.8
40	RC06	32.4	0	250	3.2	0	25.0
40	RC08	43.3	0	284	4.3	0	28.4
40	RC10	54.1	0	350	5.4	0	35.0
40	RC12	64.9	0	414	6.5	0	41.4
60	RC04	48.7	0	460	3.2	0	30.7
60	RC06	73.0	0	630	4.9	0	42.0
60	RC08	97.3	0	720	6.5	0	48.0
60	RC10	121.7	0	878	8.1	0	58.5
60	RC12	146.0	0	1035	9.7	0	69.0
80	RC04	86.5	0	960	4.3	0	48.0

80	RC06	129.8	0	1240	6.5	0	62.0
80	RC08	173.0	0	1424	8.6	0	71.2
80	RC10	216.3	0	1720	10.8	0	86.0
80	RC12	259.5	0	2024	13.0	0	101.2
100	RC04	135.2	0	1712.5	5.4	0	68.5
100	RC06	202.8	0	2125	8.1	0	85.0
100	RC08	270.3	0	2462.5	10.8	0	98.5
100	RC10	337.9	0	2937.5	13.5	0	117.5
100	RC12	405.5	0	3462.5	16.2	0	138.5

Table M.4. Spread Box Beam Dead Loads.

Span	Bridge	Nominal Moment (k-ft)			Nominal Shear (k)		
		Dw	Dp	Ds	Dw	Dp	Ds
20	BS04	5.4	23.0	27.3	1.1	4.6	5.5
20	BS06	8.1	23.0	37.3	1.6	4.6	7.5
20	BS08	10.8	23.0	46.3	2.2	4.6	9.3
20	BS10	13.5	23.0	57.9	2.7	4.6	11.6
20	BS12	16.2	23.0	71.0	3.2	4.6	14.2
40	BS04	21.6	120.0	109.0	2.2	11.7	10.9
40	BS06	32.4	120.0	149.0	3.2	11.7	14.9
40	BS08	43.3	120.0	185.0	4.3	11.7	18.5
40	BS10	54.1	120.0	231.0	5.4	11.7	23.1
40	BS12	64.9	120.0	284.0	6.5	11.7	28.4
60	BS04	48.7	320.0	245.0	3.2	21.0	16.3
60	BS06	73.0	320.0	335.0	4.9	21.0	22.3
60	BS08	97.3	320.0	414.0	6.5	21.0	27.6
60	BS10	121.7	320.0	521.0	8.1	21.0	34.7
60	BS12	146.0	320.0	639.0	9.7	21.0	42.6
80	BS04	86.5	624.0	436.0	4.3	31.0	21.8
80	BS06	129.8	624.0	596.0	6.5	31.0	29.8
80	BS08	173.0	624.0	740.0	8.6	31.0	37.0
80	BS10	216.3	624.0	925.6	10.8	31.0	46.3
80	BS12	259.5	624.0	1136.0	13.0	31.0	56.8
100	BS04	135.2	1000.0	681.0	5.4	40.0	27.2
100	BS06	202.8	1000.0	931.0	8.1	40.0	37.2
100	BS08	270.3	1000.0	1150.0	10.8	40.0	46.0
100	BS10	337.9	1000.0	1447.0	13.5	40.0	57.9
100	BS12	405.5	1000.0	1775.0	16.2	40.0	71.0
120	BS04	194.6	1566.0	981.0	6.5	52.0	32.7
120	BS06	292.0	1566.0	1341.0	9.7	52.0	44.7
120	BS08	389.3	1566.0	1656.0	13.0	52.0	55.2
120	BS10	486.6	1566.0	2083.0	16.2	52.0	69.4
120	BS12	583.9	1566.0	2556.0	19.4	52.0	85.2

140	BS04	264.9	2303.0	1335.3	7.6	66.0	38.2
140	BS06	397.4	2303.0	1825.3	11.3	66.0	52.2
140	BS08	529.9	2303.0	2266.3	15.1	66.0	64.8
140	BS10	662.3	2303.0	2834.7	18.9	66.0	81.0
140	BS12	794.8	2303.0	3479.0	22.7	66.0	99.4
160	BS04	346.0	3200.0	1744.0	8.6	80.0	43.6
160	BS06	519.0	3200.0	2384.0	13.0	80.0	59.6
160	BS08	692.1	3200.0	2960.0	17.3	80.0	74.0
160	BS10	865.1	3200.0	3702.4	21.6	80.0	92.6
160	BS12	1038.1	3200.0	4544.0	25.9	80.0	113.6
180	BS04	437.9	4334.0	2207.3	9.7	96.0	49.1
180	BS06	656.9	4334.0	3017.3	14.6	96.0	67.1
180	BS08	875.9	4334.0	3746.3	19.4	96.0	83.3
180	BS10	1094.9	4334.0	4685.9	24.3	96.0	104.1
180	BS12	1313.8	4334.0	5751.0	29.2	96.0	127.8
200	BS04	540.7	5700.0	2725.0	10.8	114.0	54.5
200	BS06	811.0	5700.0	3725.0	16.2	114.0	74.5
200	BS08	1081.3	5700.0	4600.0	21.6	114.0	92.0
200	BS10	1351.7	5700.0	5788.0	27.0	114.0	115.8
200	BS12	1622.0	5700.0	7100.0	32.4	114.0	142.0

Table M.5. Side-by-Side Box Beam Dead Loads.

Span	Bridge	Nominal Moment (k-ft)			Nominal Shear (k)		
		Dw	Dp	Ds	Dw	Dp	Ds
20	BT36	4.1	23.0	20.4	0.8	4.5	4.1
40	BT36	16.3	120.0	81.8	1.6	12.0	8.2
60	BT36	36.6	320.0	183.8	2.4	21.0	12.3
80	BT36	65.0	624.0	327.0	3.3	31.0	16.4
100	BT36	101.6	1000.0	510.8	4.1	40.0	20.4
120	BT36	146.3	1566.0	735.8	4.9	52.0	24.5
140	BT36	199.1	2303.0	1001.4	5.7	66.0	28.6
160	BT36	260.0	3200.0	1308.0	6.5	80.0	32.7
180	BT36	329.1	4334.0	1655.4	7.3	96.0	36.8
200	BT36	406.3	5700.0	2043.8	8.1	114.0	40.9
20	BT48	5.4	30.7	27.3	1.1	6.1	5.5
40	BT48	21.7	160.0	109.0	2.2	16.0	10.9
60	BT48	48.8	426.7	245.0	3.3	28.4	16.3
80	BT48	86.7	832.0	436.0	4.3	41.6	21.8
100	BT48	135.4	1333.3	681.0	5.4	53.3	27.2
120	BT48	195.0	2088.0	981.0	6.5	69.6	32.7
140	BT48	265.4	3070.7	1335.3	7.6	87.7	38.2
160	BT48	346.7	4266.7	1744.0	8.7	106.7	43.6
180	BT48	438.8	5778.7	2207.3	9.8	128.4	49.1
200	BT48	541.7	7600.0	2725.0	10.8	152.0	54.5