

National Positioning, Navigation, and Timing Architecture Study

Final Report



September 2008

FOREWORD

This document summarizes the results of the National Positioning, Navigation, and Timing Architecture Study conducted from May 2006 to August 2007.

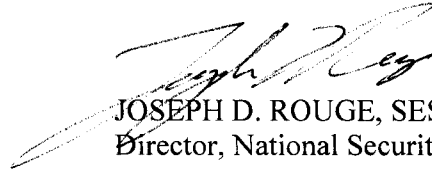
A handwritten signature in black ink, appearing to read "Joseph D. Rouge". The signature is fluid and cursive, with a large initial "J" and "R".

JOSEPH D. ROUGE, SES
Director, National Security Space Office

TABLE OF CONTENTS

LIST OF FIGURES	vi
LIST OF TABLES.....	viii
1 EXECUTIVE SUMMARY	1
1.1 Background.....	1
1.2 Scope.....	1
1.3 Process	1
1.4 Vision.....	2
1.5 Strategy	3
1.6 Architectural Vectors.....	3
1.6.1 Multiple Phenomenologies	3
1.6.2 Interchangeable Solutions.....	3
1.6.3 Synergy of PNT with Communications.....	4
1.6.4 Cooperative Organizational Structures.....	4
1.7 Architecture Recommendations.....	4
1.8 Conclusion	5
2 INTRODUCTION	6
2.1 Background.....	6
2.1.1 Utility	6
2.1.2 Architectural Need.....	8
2.1.3 Related Efforts	8
2.2 Guidance and Direction	10
2.3 Participants.....	11
2.4 Methodology.....	12
2.4.1 Data Gathering.....	12
2.4.2 Concept Development.....	12
2.4.2.1 Architectural Trade Space.....	13
2.4.2.1.1 Trade Axes.....	13
2.4.2.1.2 Architectural Concepts.....	13
2.4.2.2 Representative Architectures	13
2.4.2.3 Hybrid Architectures.....	14
2.4.3 Development of Recommendations.....	14

3	DATA COLLECTION	15
3.1	Future Environment Assessment	15
3.1.1	Approach.....	15
3.1.2	Environmental Trends and Stressors in the Future Environment	16
3.2	Projected Requirements / Needs / Users.....	17
3.3	Risk Management	20
3.4	Current and Evolved Baselines.....	20
3.5	Capability Gaps.....	24
3.6	Technology Assessment.....	26
3.7	Cost Information	28
3.7.1	Purpose and Scope of Cost Effort.....	28
3.7.2	Methodology	29
3.7.3	Cost Data Collection	30
3.7.4	Cost Assessment Results.....	30
3.8	Industry Information	30
3.8.1	Engagement Approach.....	30
3.8.2	Industry Perspective.....	31
4	CONCEPT DEVELOPMENT AND ASSESSMENT.....	33
4.1	Architectural Trade Space Development	33
4.1.1	Architectural Trade Axes	33
4.1.2	Architectural Concepts.....	35
4.1.3	Evaluation Criteria	40
4.1.3.1	Interoperability.....	40
4.1.3.2	Uniformity.....	41
4.1.3.3	Adaptability.....	41
4.1.3.4	Robustness	41
4.1.3.5	Sustainability.....	42
4.2	Architecture Design and Assessment.....	42
4.2.1	Representative Architectures	43
4.2.1.1	Development	44
4.2.1.1.1	RA0 – Evolved Baseline.....	45
4.2.1.1.2	RA1 – Dependent Terrestrial	47
4.2.1.1.3	RA2A – Heavy Space	49

4.2.1.1.4	RA3 was merged into RA2.....	50
4.2.1.1.5	RA4 – Network-Aided GPS.....	51
4.2.1.1.6	RA5 – Sensor-Aided PNT	52
4.2.1.1.7	RA6 – Autonomy	55
4.2.1.2	Evaluation	58
4.2.1.2.1	RA0 – Evolved Baseline.....	59
4.2.1.2.2	RA1 – Dependent Terrestrial.....	59
4.2.1.2.3	RA2A – Heavy Space.....	60
4.2.1.2.4	RA4 – Network-Aided GPS.....	61
4.2.1.2.5	RA5 – Sensor-Aided PNT	62
4.2.1.2.6	RA6 – Autonomy	62
4.2.2	Hybrid Architectures.....	63
4.2.2.1	Design	63
4.2.2.1.1	Hybrid 0 – Evolved Baseline	65
4.2.2.1.2	Hybrid A – Greatest Common Denominator	67
4.2.2.1.3	Hybrid B – Network-Centric Greatest Common Denominator	71
4.2.2.1.4	Hybrid C – Lowest Acceptable Common Denominator.....	73
4.2.2.2	Assessment.....	77
4.2.2.2.1	Hybrid 0 – Evolved Baseline	80
4.2.2.2.2	Hybrid A – Greatest Common Denominator	81
4.2.2.2.3	Hybrid B – Network-Centric Greatest Common Denominator	83
4.2.2.2.4	Hybrid C – Lowest Acceptable Common Denominator.....	84
4.3	Development of Findings and Recommendations	85
5	RECOMMENDED ARCHITECTURE.....	86
5.1	A Vision for US Leadership in Global PNT.....	87
5.2	The Greater Common Denominator Strategy & Supporting Recommendations	87
5.3	The Multiple Phenomenologies Vector & Supporting Recommendations.....	89
5.4	The Interchangeable Solutions Vector & Supporting Recommendations	90
5.5	The Synergy of PNT & Communications Vector & Supporting Recommendations.....	92
5.6	The Cooperative Organizational Structures Vector & Supporting Recommendations.....	92
5.7	“Should-Be” Architecture.....	93
5.8	Next Steps	96
Appendix A	– Decision Memo.....	97
Appendix B	– Terms of Reference	98

Appendix C	– Authors and Participating Individuals	104
Appendix D	– Joint Capabilities Document Summary	112
Appendix E	– PNT Needs Source Documents	114
Appendix F	– Risk Summary	115
Appendix G	– Evolved Baseline Data Package	126
Appendix H	– Gap Charts.....	165
Appendix I	– Cost Data	172
Appendix J	– Definitions	180
Appendix K	– Abbreviations and Acronyms	191

LIST OF FIGURES

Figure 1-1 "As-Is", Evolved Baseline, and "Should-Be" Architectures	1
Figure 1-2 PNT Architecture Guiding Principles	2
Figure 2-1 PNT Applications Permeate Society	7
Figure 2-2 Related PNT Efforts	8
Figure 2-3 Architecture Study Participants.....	11
Figure 2-4 PNT Architecture Cumulative Process	12
Figure 3-1 PNT User Perspectives (2025).....	18
Figure 3-2 PNT Functional Reference Model	19
Figure 3-3 "As-Is", Evolved Baseline, and "Should-Be" Architectures	21
Figure 3-4 "As-Is" PNT Architecture Graphic (2007)	22
Figure 3-5 PNT Evolved Baseline Graphic (2025).....	23
Figure 3-6 Sample Gap Chart	25
Figure 3-7 Root Causes of the PNT Gaps and Shortfalls Identified in the Study	27
Figure 4-1 Architectural Trade Space for the PNT Architecture.....	35
Figure 4-2 Mapping of PNT Concepts into the Architectural Trade Space	40
Figure 4-3 From Representative Architectures to Recommendations.....	42
Figure 4-4 Analysis Framework	43
Figure 4-5 RA Analysis	44
Figure 4-6 Representative Architectures within the PNT Trade Space.....	45
Figure 4-7 Theme of Representative Architecture 0, Evolved Baseline	46
Figure 4-8 Theme of Representative Architecture 1, Dependent Terrestrial.....	47
Figure 4-9 Representative Architecture 1, Dependent Terrestrial.....	48
Figure 4-10 Theme of Representative Architecture 2A, Heavy Space.....	49
Figure 4-11 Representative Architecture 2A, Heavy Space	50
Figure 4-12 Theme of Representative Architecture 4, Network-Aided GPS	51
Figure 4-13 Representative Architecture 4, Network-Aided GPS.....	52
Figure 4-14 Theme of Representative Architecture 5, Sensor-Aided PNT	53
Figure 4-15 Representative Architecture 5, Sensor-Aided PNT	54
Figure 4-16 Theme of Representative Architecture 6, Autonomy	56
Figure 4-17 Representative Architecture 6, Autonomy	57

Figure 4-18 Scoring Scale and Coloring Scheme	58
Figure 4-19 RA0 Scoring.....	59
Figure 4-20 RA1 Scoring.....	60
Figure 4-21 RA2A Scoring.....	61
Figure 4-22 RA4 Scoring.....	61
Figure 4-23 RA5 Scoring.....	62
Figure 4-24 RA6 Scoring.....	63
Figure 4-25 Hybrid 0, Evolved Baseline	66
Figure 4-26 Hybrid A, Greatest Common Denominator	68
Figure 4-27 Hybrid B, Network-Centric Greatest Common Denominator	73
Figure 4-28 Hybrid C, Lowest Acceptable Common Denominator	75
Figure 4-29 Hybrid Architecture Assessment Emphasis	77
Figure 4-30 Example IFUE Diagram.....	78
Figure 4-31 Hybrid 0 Assessment Job Aid	80
Figure 4-32 Hybrid A Assessment Job Aid	81
Figure 4-33 Hybrid B Assessment Job Aid	83
Figure 4-34 Hybrid C Assessment Job Aid	84
Figure 5-1 PNT Architecture Vision, Strategy, and Vectors	86
Figure 5-2 "Should-Be" PNT Architecture Graphic (2025), System-Centric View.....	94
Figure 5-3 "Should-Be" PNT Architecture (2025), User-Centric View.....	96

LIST OF TABLES

Table 3-1 List of PNT Systems in Scope (2007-2025).....	24
Table 3-2 Scope of Programs in “As-Is” Cost Baseline	29
Table 3-3 Scope of Programs in Expanded Cost Baseline	30
Table 3-4 Participating Industry Organizations	31
Table 4-1 Candidate Trade Axes	34
Table 4-2 ADT Concept Descriptions	40
Table 4-3 Guide to Hybrid A IFUE Diagram (Figure 4-30).....	79
Table 4-4 Example IFUE Explanation of MPEJE Use Case (Figure 4-30).....	79

1 EXECUTIVE SUMMARY

1.1 Background

The Assistant Secretary of Defense for Networks and Information Integration (ASD/NII) and the Under Secretary of Transportation for Policy (UST/P) sponsored a National Positioning, Navigation, and Timing (PNT) Architecture Study to “provide more effective and efficient PNT capabilities focused on the 2025 timeframe and an evolutionary path for government-provided systems and services.” ASD/NII and UST/P co-sponsored the study in response to multiple Department of Defense (DoD) and Civil Agency recommendations to develop a comprehensive National PNT Architecture as a framework for developing future PNT capabilities and supporting infrastructure.

1.2 Scope

The PNT architecture is national in scope and includes DoD, the intelligence community, as well as civil, commercial, and international users and systems supporting global U.S. interests. This includes terrestrial- and space-based PNT data providers, autonomous sources of PNT data, complementary communications and data networks as sources of PNT data, terrestrial- and space-based users, research and development efforts, and US Government organizations involved with providing, coordinating, or implementing PNT data.

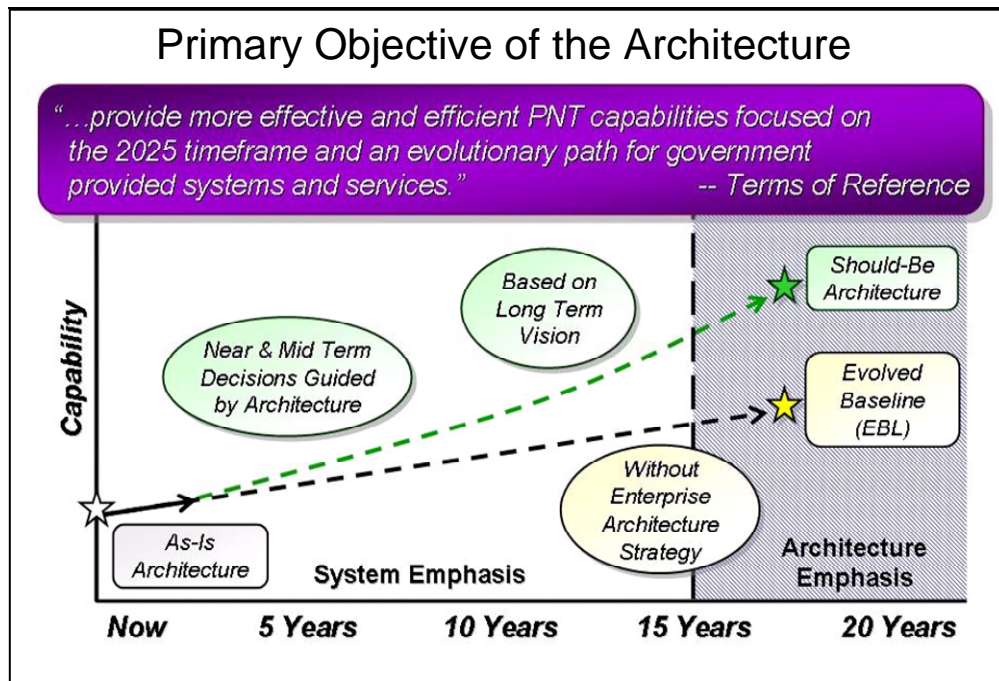

Figure 1-1 "As-Is", Evolved Baseline, and "Should-Be" Architectures

1.3 Process

Many DoD and Civil Agencies provided manpower for the Architecture Development Team (ADT) that executed a structured process to identify and describe three PNT architectures (Figure 1-1):

- an “As-Is” Architecture describing the current mostly *ad hoc* mix of capabilities
- an Evolved Baseline (EBL) depicting future capabilities based on current planning and programming documents, and on expected supporting technological advances. The ADT determined that the EBL would not meet all future PNT capability needs.
- The ADT constructed the “Should-Be” Architecture to address the projected capability gaps representing future capabilities based on a long-term vision that more completely satisfies future needs.

The path to achieving the “Should-Be” Architecture is described by the National PNT Architecture’s Guiding Principles (Figure 1-2), representing an overarching Vision of the US role in PNT, an architectural Strategy to fulfill that Vision, and four Vectors which support the Strategy. The ADT recommended nineteen specific initiatives to support executing the Strategy to implement the Architecture’s Vectors.

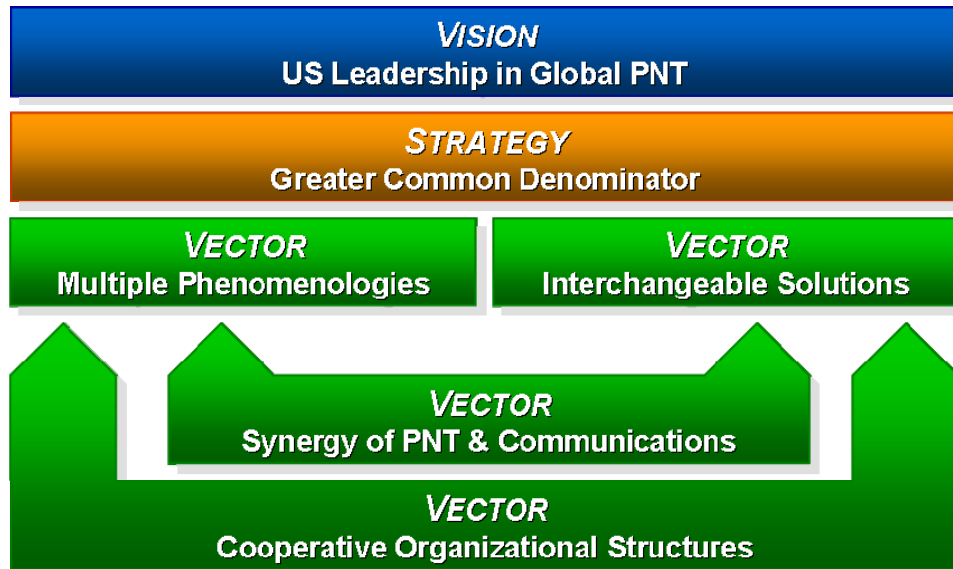

Figure 1-2 PNT Architecture Guiding Principles

1.4 Vision

The National PNT Architecture’s vision is for the United States to maintain leadership in global PNT by efficiently developing and fielding effective PNT capabilities that are available worldwide. The US can achieve this vision by implementing the following practices:

- Developing and adhering to stable policies, building credibility both domestically and internationally, thus enabling the commercial sector to innovate and advance PNT through competitive practices
- Providing PNT capabilities in a coordinated manner, sharing information, and presenting a unified view of National objectives by promoting inter-agency cooperation across the full scope of PNT activities

- Maximizing the practical use of military, civil, commercial and foreign systems and technologies, and leading the effort to integrate all available signals to achieve assured higher-performing PNT solutions
- Judiciously developing and applying comprehensive standards and best practices, while encouraging others to adopt or align with US capabilities

1.5 Strategy

The National PNT Architecture seeks to fulfill its vision using a Greater Common Denominator strategy to effectively provide standard solutions that meet the majority of users' needs. The study found that a large number of PNT users have a set of needs in **common** with each other that can be more efficiently satisfied by standard solutions than by numerous customized systems without losing effectiveness. External sources of PNT information such as the Global Positioning System (GPS) make a broad range of capabilities globally available to meet the needs of the **greatest** number of users. Therefore, a vital element of the strategy is to leverage US Global Navigation Satellite System (GNSS) modernization, which provides significantly more capability on a global scale to an unlimited number of users. The strategy also focuses the architecture on wide adoption of low-burden (*e.g.* size, weight, power, and cost) autonomous features to overcome physical and electromagnetic interference. In addition, the strategy accommodates specialized solutions where it is either inefficient or inappropriate to provide the required capability using a standard solution. Lastly, the US must continue to balance the need for a national security advantage with the advantages inherent in providing greater common capabilities, in accordance with National policies.

1.6 Architectural Vectors

1.6.1 Multiple Phenomenologies

The National PNT Architecture promotes the use of multiple phenomenologies to ensure robust availability and to address gaps in the ability to operate in physically and electromagnetically impeded environments. Multiple phenomenologies refer to diverse physical phenomena such as multiple radiofrequencies and inertial sensors as well as diverse sources and data paths using those physical phenomena (*e.g.* multiple radio frequencies) to provide interchangeable solutions to the user. The Multiple Phenomenology Vector includes issues related to standards, criteria of use (especially when incorporating foreign data sources), and mixing ground-, air-, space-based and internal data sources for a single solution.

1.6.2 Interchangeable Solutions

The National PNT Architecture promotes the flexibility to provide timely, accurate, and reliable PNT solutions that meet user needs regardless of the data sources available. This includes the ability to combine signals from multiple data sources into a single solution, as well as the ability to provide a solution from System B when System A is not available. This vector includes the US taking a leadership role in international forums as part of the effort to establish clear, reasonable standards to enable efficient, effective exploitation of diverse PNT data sources.

1.6.3 Synergy of PNT with Communications

Data communications networks currently support PNT capabilities by carrying PNT aiding and augmentation data, GIS data, etc. The National PNT Architecture leverages users' increasing connectivity to more capable communications networks to use those networks as sources of PNT, not merely as data channels for PNT aiding and augmentation data. This vector promotes the fusion of PNT features with new and evolving communications capabilities (*e.g.*, cellular telephones), which will enable increased PNT robustness by offering services outside of traditional radionavigation spectrum. Further detailed assessments regarding specific solutions are needed to provide recommended implementation guidance.

1.6.4 Cooperative Organizational Structures

The National PNT Architecture requires interagency coordination and cooperation to ensure the necessary levels of information sharing across the PNT Enterprise. This vector includes establishing coordination processes to ensure effective operations, efficient acquisition (for both data source equipment and user equipment), and relevant science and technology application development. This vector also incorporates an enterprise-level PNT modeling and simulation capability to benefit, for example, mission planning and user equipment decisions. In addition, this capability would support subsequent architecture development efforts.

1.7 Architecture Recommendations

The Architecture Development Team identified a set of nineteen recommended actions to support implementing the strategy and vectors leading to the "Should-Be" Architecture as documented in Architecture Guidance Memo dated 16 June 2008:

GREATER COMMON DENOMINATOR STRATEGY

1. Maintain GPS as a cornerstone of the National PNT Architecture
2. Monitor PNT signals to verify service levels, observe environmental effects, detect anomalies, and identify signal interference for near real-time dissemination
3. As GPS modernization or other methods demonstrate new operational capabilities, agencies should transition or divest US GNSS augmentation assets that are unnecessarily redundant to their requirements
4. Continue to investigate methods to provide high-accuracy-with-integrity solutions for safety-of-life applications
5. Develop a National approach to protect the military PNT advantage

MULTIPLE PHENOMENOLOGY VECTOR

6. Encourage appropriate development and employment of equipment that integrates information from diverse sources and information paths
7. Assess the potential for the use of foreign PNT systems for safety-of-life applications and critical infrastructure users and, as appropriate, develop clear standards and criteria for their use

8. Continue military PNT Exclusive Use Policy while studying development of capabilities to enable military use of other signals
9. Promote standards for PNT pseudolites and beacons to facilitate interchangeability and avoid interference
10. Study evolution of space-based and terrestrial PNT capabilities to support diversity in PNT sources and information paths
11. Ensure critical infrastructure precise time and time interval users have access to and take advantage of multiple available sources

INTERCHANGEABLE SOLUTIONS VECTOR

12. Use participation in international PNT-related activities to promote the interchangeability of PNT sources while assuring compatibility
13. Evolve standards, calibration techniques, and reference frames to support future accuracy and integrity needs
14. Identify and develop common standards that meet users' needs for PNT information exchange, assurance, and protection
15. Establish common standards that meet users' needs for the depiction of position information for local and regional operations

SYNERGY OF PNT AND COMMUNICATIONS VECTOR

16. Identify and evaluate methods, standards, and potential capabilities for fusion of PNT with communications

COOPERATIVE ORGANIZATIONAL STRUCTURES VECTOR

17. Develop a National PNT coordination process
18. Identify and leverage Centers of Excellence for PNT phenomenology and applications
19. Define, develop, sustain, and manage a PNT modeling and simulation core analytical framework

1.8 Conclusion

The National PNT Architecture encompasses ground-, air-, space-based and internal PNT data sources to efficiently provide effective PNT solutions to DoD and US Civil users around the world and in space. It also identifies the importance of supporting infrastructure necessary to implement and maintain future PNT services for US users world-wide. The architecture addresses capability gaps projected to exist in the 2025 timeframe, and articulates recommended initiatives to close those gaps (or mitigate their effects). Implementing the National PNT Architecture recommendations and transition to the Should-Be Architecture will maximize PNT services to DoD and US Civil users.

2 INTRODUCTION

2.1 Background

PNT touches almost every aspect of American life today. It is essential for defense and civilian applications ranging from the DoD's joint network-centric and precision operations to the transportation and telecommunications sectors – improving efficiency, increasing safety, and making America more productive. However, the extent of dependence on systems like GPS, or possible alternative PNT systems, is not explicitly understood. Further, there is no existing architecture available to guide investment decisions on implementing either PNT services or capabilities. Absence of a coordinated PNT architecture may result in operational risks, uncoordinated research efforts, lack of clear developmental paths, potentially wasteful procurements, inefficient deployment of PNT resources, and possible impacts to architectures or other systems depending on PNT utility.

This report documents an interagency effort to develop a National PNT Enterprise Architecture. Operating under a terms of reference signed by the ASD/NII and UST/P, the team considered alternative future mixes of global (space- and non-space-based) and regional PNT solutions, backup systems, PNT augmentations, and autonomous PNT capabilities, and made recommendations to put the US on a path to achieving a future “Should-Be” National PNT Architecture. The scope included DoD, intelligence community, civil, commercial, and international PNT users and systems supporting global US interests. Goals included addressing priorities identified in the PNT Joint Capabilities Document and informing future decisions of US Government PNT executive committees: the DoD PNT Executive Committee (EXCOM), the Civil PosNav EXCOM, and National Space-Based PNT EXCOM.

2.1.1 Utility

Within the DoD, precise PNT capabilities are fundamental to nearly all joint concepts (i.e., Joint Operational Concepts, Joint Functional Concepts, and Joint Integrating Concepts), including Major Combat Operations, Homeland Security, Battlespace Awareness, Force Application, Global Strike, and Command and Control (C2). Precise PNT is critical to achieving the tenets of the DoD's Future Joint Vision, and is exemplified by use of precision guided munitions (PGMs), handheld battlefield navigation units, and time/frequency-dependent network-centric operations. The Joint Capabilities Document (JCD) for Positioning, Navigation and Timing, 26 September 2006, identified PNT capabilities required by the joint warfighter to ensure PNT availability in any environment or under any condition (see Appendix D for summary). These needed capabilities are the basis for future PNT solution developments across Doctrine, Organization, Training, Material, Logistics, Personnel, or Facilities (DOTMLPF). For example, timing capabilities synchronize C2 systems and Intelligence, Surveillance, and Reconnaissance (ISR) systems. Positioning and navigation capabilities support the knowledge needed to achieve Battlespace Awareness, and the effects needed to accomplish tasks under Major Combat Operations and Homeland Security.

The use of PNT also is very extensive in the civil community. PNT capabilities are utilized for every mode of transportation, including stringent safety-of-life applications such as civil aviation navigation and surveillance, maritime harbor entrance and approach, search and rescue, positive train control, and intelligent transportation systems.

The commercial sector has found a variety of innovative ways to leverage precise PNT, including power grid management and precision farming to maximize crop yields and optimize fertilizer application. Location-based services and recreational use of PNT are exploding and there are numerous applications of PNT for scientific exploration and environmental monitoring. Precise timing is critical for communication systems and network security. As illustrated in Figure 2-1, PNT now permeates almost all sectors of US society, spanning military and civil applications.

<p style="text-align: center;">Aviation</p> <ul style="list-style-type: none"> Flight Management / Navigation Systems Component of IFF Mode S & Automatic Dependent Surveillance - Broadcast <ul style="list-style-type: none"> Fuel Management Optimization 	<p style="text-align: center;">Maritime</p> <ul style="list-style-type: none"> Harbor Entrance & Approach Inland Waterway Navigation Guidance & Control Systems Fleet Tracking / Reporting Salvage Operations 	<p style="text-align: center;">Land Warfare</p> <ul style="list-style-type: none"> Desert Operations Urban Warfare Maneuver Coordination Mine Clearing & Explosive Ordnance Disposal 
<p style="text-align: center;">Space</p> <ul style="list-style-type: none"> Launch Vehicle Tracking Satellite Positioning Attitude Determination Surveillance Accuracy <ul style="list-style-type: none"> Ballistic Missile Defense Targeting / Control 	<p style="text-align: center;">Weapons & Targeting</p> <ul style="list-style-type: none"> Terrain Guidance Target Location Systems Precision Guided Munitions Precision Artillery Cruise Missiles 	<p style="text-align: center;">Land Transportation</p> <ul style="list-style-type: none"> Intelligent Transportation System Positive Train Control Inter-modal Fleet Tracking Real-time Vehicle Routing Just-in-Time Inventory Management 
<p style="text-align: center;">Survey & Mapping</p> <ul style="list-style-type: none"> Multiple Sensor Correlation Dynamic Surveying Datum Management <ul style="list-style-type: none"> Geospatial Information Systems Integration 	<p style="text-align: center;">Special Operations</p> <ul style="list-style-type: none"> Land, Air, Sea Navigation Underwater Navigation Covert Day / Night Rendezvous Precise Timing Clandestine Insertion 	<p style="text-align: center;">Communications & Networks</p> <ul style="list-style-type: none"> Secure Communications Synchronization Cellular Integration Paging / Locating Network Synchronization C4I/JTIDS Systems E911 
<p style="text-align: center;">Energy</p> <ul style="list-style-type: none"> Power Grid Management Sea Floor Exploitation <ul style="list-style-type: none"> Resource Exploration <ul style="list-style-type: none"> Oil / Gas Drilling Nuclear Waste Management 	<p style="text-align: center;">Search & Rescue</p> <ul style="list-style-type: none"> Combat Survivor / Evader Locator Emergency Locator Beacons 	<p style="text-align: center;">Recreation</p> <ul style="list-style-type: none"> Hiking Fishing Boating Biking Hot Air Ballooning Trip Planning 
<p style="text-align: center;">Environment</p> <ul style="list-style-type: none"> Tide / Current Measures BLM Tract Management Oil Spill Containment <ul style="list-style-type: none"> Hazardous Waste Remediation Resources Management 	<p style="text-align: center;">Agriculture</p> <ul style="list-style-type: none"> Field Maintenance Planting, Fertilization, and Harvesting Optimization Open Range Livestock Tracking Improved Crop Dusting Efficiency 	<p style="text-align: center;">Public Health & Safety</p> <ul style="list-style-type: none"> Firefighting Coordination Emergency Vehicle Tracking / Reporting Earthquake Prediction Accident Location Notification Stolen Vehicle Location 

Figure 2-1 PNT Applications Permeate Society

2.1.2 Architectural Need

Over the last several years, various organizations have noted the need for an architecture to guide the implementation of PNT capabilities. In October 2005, a Defense Science Board Task Force reported on The Future of the Global Positioning System. The task force noted that a “comprehensive National Strategy has been lacking” and there “has not been a systematically constructed and commonly accepted architecture to foster consensus among the various agencies responsible for implementation of GPS and its components and complements.” They recommended that DoD “sponsor and lead an interagency effort to develop a comprehensive national PNT architecture to guide future investment and implementation decisions regarding GPS and complementary systems and technologies.” In addition, as early as 2002, the need for an architecture was identified as an issue through the National Security Space Program Assessment – a space community assessment process facilitated by the National Security Space Office (NSSO). A key recommendation from this process was the “... development of a comprehensive PNT architecture that addresses the core issues of position and timing standards, GPS dependency, and a need to focus PNT S&T and R&D” (Science and Technology and Research and Development). Most recently, United States Strategic Command (USSTRATCOM) conducted a PNT Capabilities Assessment leading to a Joint Requirements Oversight Council (JROC)-approved JCD. The JCD noted that “PNT users need a comprehensive architecture that captures the current and future operational systems and technical requirements of PNT capabilities.” The above efforts as well as the related efforts below had implications for a PNT Architecture.

2.1.3 Related Efforts

A wide range of related efforts were considered that were being pursued concurrently by other organizations. These are reflected in Figure 2-2 and briefly outlined below.

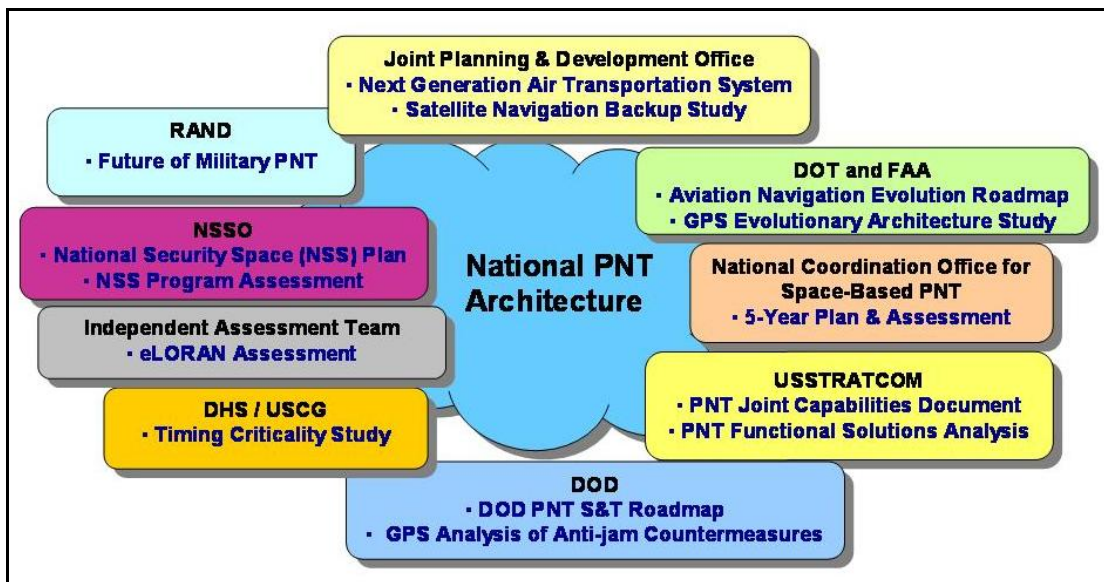

Figure 2-2 Related PNT Efforts

- **DoD PNT Science and Technology Roadmap** – The Deputy Under Secretary of Defense for Science and Technology (DUSD(S&T)) directed the development of a

PNT S&T Roadmap. The roadmap provides guidance for a coordinated program to improve the PNT capabilities to support and enable DoD's emerging PNT needs and net-centric operations. The 2008 version is currently in coordination.

- **USSTRATCOM PNT Joint Capabilities Document and Functional Solutions Analysis (FSA)** – The PNT JCD (25 Sep 06) summarized PNT capability gaps requiring solutions in the 2006-2025 timeframe. An FSA is the third step of the Department of Defense Joint Capabilities Integration and Development System process. United States Strategic Command is the sponsor of the PNT FSA, with support from the Services, Combatant Commands, and oversight by the Net-Centric Functional Capabilities Board. This FSA provides recommendations for solutions to gaps identified in the PNT JCD and is currently under JROC review.
- **Aviation Navigation Evolution Roadmap** – The roadmap is the Federal Aviation Administration (FAA) approach to addressing the needs of “performance-based” operations. Completed in 2006 and updated in March 2008, this roadmap outlines plans to deploy/maintain specific navigation systems.
- **GPS Evolutionary Architecture Study (GEAS) Panel** – The FAA-sponsored a study, done in conjunction with Stanford University, to evaluate future architecture options for Wide Area Augmentation System (WAAS)/GPS to provide robust LPV-200¹ service worldwide. The final report is under review.
- **Next Generation Air Transportation System (NextGen)** – The Joint Planning & Development Office was chartered by Congress to develop NextGen, an enterprise architecture that provides the holistic structure to manage the transformation of the National Air Transportation System. The transformation requires new policies to create the right relationships and behaviors, modernization of infrastructure to reduce cost and set the stage for a new level of performance, and R&D to create new functionality and capability that takes advantage of a modernized infrastructure by 2025.
- **The Future of Military PNT** – The RAND Corporation was chartered by the US Air Force (USAF) to conduct a study to determine how the USAF can meet the national security PNT needs of the future. The study included detailed analysis of user needs through a review of documented needs and identified new or additional needs by analyzing joint mission documentation and success parameters and interviewing mission area experts and warfighters. The final report is in coordination.
- **GPS Analysis of Anti-jam Countermeasures** – The Office of the Assistant Secretary of Defense for Networks and Information Integration (OASD/NII) chartered a study by the Decision Support Center to assess trade-offs between space-based and user equipment (UE) anti-jam capabilities and to conduct a cost analysis of implementing UE oriented anti-jam improvements.

¹ LPV-200 – lateral precision with vertical guidance, with a 200 foot minimum decision height

- **Independent Assessment Team Review of eLORAN** – A team of experts was chartered by the Under Secretary of Transportation for Policy to review and assess continuing need for the current US LORAN infrastructure. Results were presented to the DOT and the Department of Homeland Security (DHS) Pos/Nav Executive Committees in March 07.
- **Satellite Navigation (SATNAV) Backup Study** – Conducted by the NGATS Institute by an ITT-led team and completed in September 2007, this effort developed a set of potential backup Area Navigation solutions for NextGen that meet specified navigation requirements, accommodate “Voice of the Customer” (especially users) needs, and are cost effective.
- **Department of Homeland Security Timing Criticality Study** – Currently, DHS (with Volpe Center support) is assessing the consequences of GPS timing/frequency service outages or disruptions in critical uses (safety of life, security, economic/commerce). The effort will determine the viability (performance, cost, etc.) of using precision timing/frequency alternatives to back up GPS (alternatives: atomic clocks, eLORAN, WWV/WWVB²).
- **National Space-Based PNT Coordination Office Five-Year Plan and Assessment** – The Five-Year Plan provides a comprehensive roadmap for space-based PNT activities across the federal government in support of the goals and objectives of the US Space-Based PNT Policy of 2004. Signed on 5 Oct 07, this document is updated annually in conjunction with a yearly assessment.
- **National Security Space Program Assessment (NSSPA) and Plan (NSSP)** – The NSSPA and NSSP are cross-community products done for the DoD Executive Agent for Space in accordance with DoDD 5101.2, 3 Jun 03. The NSSPA reports on the consistency of the implementation of space programs with respect to policy, strategy, planning and programming guidance, and architectural decisions. The NSSP is intended to steer the space community to align the National Security Space (NSS) capabilities, investment planning, and national policies and strategies. The NSSPA was completed in December 2007, with NSSP publication anticipated in March 2008.

2.2 Guidance and Direction

Community efforts to pursue development of a PNT Architecture began in early 2006. These efforts are reflected in three “tasking” documents. The first document was a memo (23 Jan 06) from ASD/NII to the Deputy Secretary of Defense that indicated that NSSO would develop an architecture to address interagency PNT requirements, written in preparation for a National Space-Based PNT EXCOM meeting. The second document contained the official actions from the EXCOM meeting (26 Jan 06) that tasked the National Space-Based PNT Coordination Office (NCO) to initiate an architecture effort with NSSO as part of the NCO’s five-year planning process. The third document was a Department of Transportation (DOT) memo (14 Mar 06) reflecting the decision by the

² See Appendix J – Definitions

Under Secretary of Transportation for Policy to have the Research and Innovative Technology Administration (RITA) lead the architecture on behalf of DOT for the civil community. The NSSO drafted and coordinated a terms of reference (TOR) based on these three documents that was signed by ASD/NII and UST/P (the study co-sponsors) on 11 Jul 06. A copy of the signed TOR is included in Appendix B.

The TOR captured the planned approach to develop a National PNT Architecture to “help guide future PNT system-of-systems investment and implementation decisions.” The stated objective was “... to provide more effective and efficient PNT capabilities focused on the 2025 timeframe and an evolutionary path for government-provided PNT systems and services.” The choice of 2025 was far enough in the future to allow flexibility in the development of alternate architectures while permitting sufficient time to address needed, more near-term programmatic and budgeting requirements to achieve this long-term goal.

2.3 Participants

As part of describing the planned approach to developing the architecture, the TOR outlined the responsibilities of participants at three levels: working, review, and decision-making. The working level was the Architecture Development Team (ADT), composed of action officers across the PNT community within the Federal Government. The ADT was assembled to assist in gathering data, conducting analyses, and coordinating analyses and recommendations. Next, a Review and Validation (R&V) Team composed of O-6/GS-15 level representatives from organizations participating on the ADT was assigned to periodically review ADT status, findings, and direction. Finally, a Decision Coordination Group (DCG) with membership at the senior officer/executive level (O-7/8/SES) served as the senior review and approval team for products intended for presentation to the study co-sponsors. Figure 2-3 below highlights the breadth of interagency involvement. Appendix D contains a list of the participating individuals.

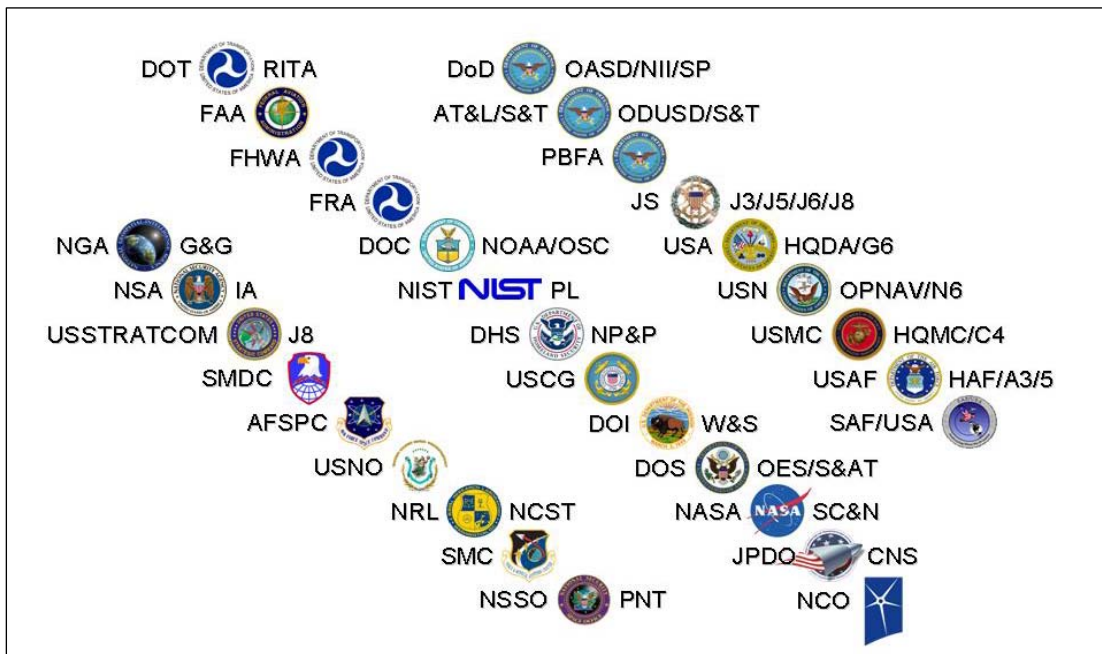

Figure 2-3 Architecture Study Participants

2.4 Methodology

The PNT Architecture study followed an approach derived from the standard NSSO architecture development methodology, as described in the NSSO Architecting Guide and illustrated in Figure 2-4. The methodology completes the architecture using information derived from basic systems engineering functions: Data Gathering, Concept Development, and Analysis and Assessment, with significant community involvement and participation throughout the process to identify solutions for enterprise architecture problems.

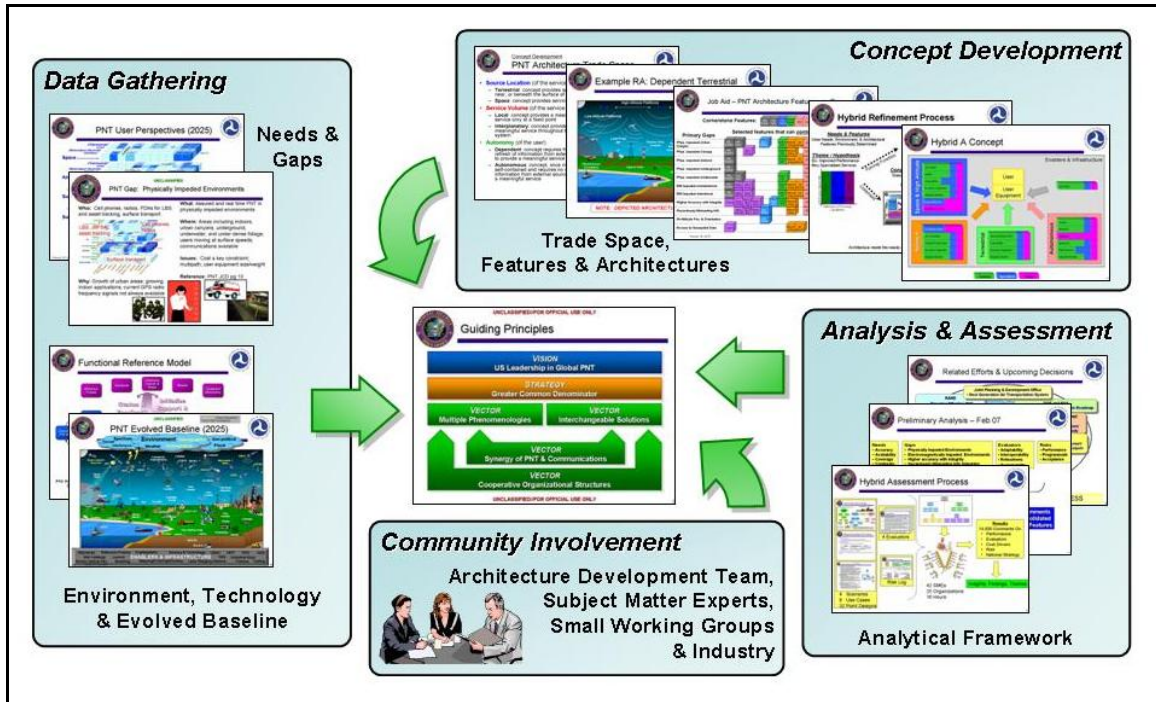

Figure 2-4 PNT Architecture Cumulative Process

2.4.1 Data Gathering

“Data Gathering” collects information relevant to task of developing an architecture for a far-future timeframe. This information includes projections on the future environment in which the architecture will operate; current requirements and projected future needs; current technology assessments; current baseline systems, capabilities, and their projected future state if no new architecture is developed; cost basis information needed for architectural cost projections; currently identified capability gaps; and information from the public sector, including proprietary information provided by private industry.

2.4.2 Concept Development

“Concept Development” is conducted in three steps. The first step is to identify and characterize the architectural trade space; the second step is to develop and evaluate representative architectures (RAs) to gain insight into different areas of the trade space; and the third step is to develop and assess hybrid architectures that span the trade space to gain further insight and knowledge prior to developing recommendations for the enterprise architecture. The analysis and assessment of the trade space, RAs, and hybrid

architectures is interleaved within the concept development process, and is addressed within the discussion of concept development.

2.4.2.1 Architectural Trade Space

The ADT developed descriptive trade axes to define the architectural trade space and differentiate architectural concepts. The ADT evaluated its architectural concepts against the axes and placed the concepts within the trade space according to their characteristics as defined by the trade axes. This approach helped the ADT ensure it had considered combinations of various “outside the box” approaches and that it had considered possible solutions in all the “corners” of the architectural trade space.

2.4.2.1.1 Trade Axes

Descriptive trade axes differentiate various approaches to meeting architectural needs and describe the differences between them. The trade axes used in this study were “descriptors” that described the types of solutions being considered rather than “evaluators,” such as cost and performance, that are commonly used in systems engineering to evaluate and compare interactions between solutions.

2.4.2.1.2 Architectural Concepts

Architectural concepts are general descriptions of material and non-material solutions meeting PNT-related needs. They may be, but are not necessarily, linked to specific needs or existing implementation solutions, since these needs and solutions have not been identified for the 2025 timeframe; however, they must be relatable to the architectural trade axes.

2.4.2.2 Representative Architectures

The ADT developed and evaluated RAs to characterize and gain insight into the strengths, weaknesses, and architectural features associated with different areas of the architectural trade space. This helped ensure the ADT did not rush to an apparently obvious solution without considering the full range of available options, and the implications of using solutions from different areas of the trade space. The ability of an RA to meet potential needs was not as important in the early stages of architectural development as increasing the team’s understanding of why an architectural elements would meet (or did not meet) those needs or why architectural elements inhibited (or enabled) other architectural elements in meeting those needs.

Each RA focuses on a particular area of the trade space, which largely restricts the solutions included in each RA and which forces an explicit understanding of associated strengths and weaknesses associated with that trade space region. The ADT then selected elements associated with the RA’s trade space “corner” or “edge” to be included in the RA. This approach results in extreme solutions that allows the team to identify more easily the strengths and weaknesses associated with different architectural approaches.

2.4.2.3 Hybrid Architectures

Hybrid architectures each focus on a different general approach, or theme, to meeting national PNT needs; they differ from the RAs in that hybrids are intended to effectively and efficiently satisfy user needs and overcome capability gaps, in contrast with the RAs which were focused on characterizing the PNT trade space. The design of each hybrid is informed by the RA assessment and is intended to meet customer needs through the integration of concepts and technologies that span the trade space, and which can incorporate PNT capabilities outside the assigned vector if no reasonable or rational solutions exist within the vector itself.

2.4.3 Development of Recommendations

The ADT developed the final recommendations, vectors, strategy, and vision based on the insights gained from the team's evaluation of the aspects, features, and perceived strengths and shortfalls of the hybrid architectures, rather than trying to pick a "winner" from among the hybrid architectures. The NSSO core team reviewed the hybrid assessments for findings, grouped these findings into a large number of potential recommendations, then presented the proposed findings and recommendations to the entire ADT. These proposed findings and recommendations were used as a starting point to examine the large number of potential recommendations.

The ADT ultimately validated and achieved consensus on nineteen recommendations, organized into four main architectural vectors, a strategy, and an overarching architectural vision. The Review & Validation Team reviewed the ADT's recommendations and achieved consensus on the ADT products after making additional changes; the Decision Coordination Group reviewed the R&V Team's recommendation and also reached consensus after making some further changes.

3 DATA COLLECTION

The purpose of data collection is to develop an appreciation of the required functions, objectives, and trade space drivers of the study area before beginning Concept Development or alternative architectures. The ADT engaged the military, civil, commercial, and national security communities to update previous knowledge and to gather new information on requirements, capabilities, and available technology. The team also extrapolated the future national security environment, estimated the threat and user needs in this environment, and evaluated the extent to which the evolved baseline could sufficiently exploit technology opportunities while addressing these needs. To accomplish this, the ADT divided into four sub-teams corresponding to the task areas of future environment, user needs, technology, and evolved baseline.

3.1 Future Environment Assessment

Architecture development efforts must focus on the user-defined environment of tomorrow, rather than solving today's problems, to provide context for the overall effort. Future environment work limits the scope of the architecture trade space by attempting to determine what future trends are more likely to happen, thereby allowing the ADT to better focus their efforts.

3.1.1 Approach

Given time and resource constraints, it is prohibitive to design an architecture for all possible future states. The challenge is to describe the future using a few carefully selected trends, yet still cover the most important and stressing possibilities.

Previous NSSO architecture efforts noted that much of the researched “future environment” data painted similar pictures of the future, but then had certain descriptive vectors that pushed the environment in unique ways. These earlier architecture efforts noted that encapsulating the majority of future environment data could be accomplished by describing a set of *core assumptions* (the similar picture) and using the descriptive *trends*, or *stressors*, to push or “stress” that core.

To establish the core assumptions, the team assembled, reviewed, and discussed a wide range of future environment related documents. Some examples of these included Service vision and DoD transformation documents. One particularly useful work, published through the United States Joint Forces Command, was *The Joint Operational Environment – The World Through 2020 and Beyond*. This cross-community work was intended as a framework for considering the future and determining the impact on operations—much the same as architecture future environment assessment. The assumptions resulting from the team deliberations are:

- The United States will remain a global political, economic, and military superpower.
- The global impact of increasingly lethal non-state actors in addition to the competing capabilities and interests of peer and near-peer states will continue to stress US diplomatic, information, military, and economic strengths.

- The information domain will affect future warfare and economic development just as decisively as the industrial age altered these two areas more than 100 years ago.
- Commercial imperatives will increasingly direct the nature of research and development and control the dissemination of key technologies.
- Cultures and economic enterprises throughout the world will become increasingly dependent on technology development, innovation, and integration.
- The world's population will grow substantially, especially in urban areas. Significant growth in the developing and economically poor countries will increase the likelihood of operating in an urban environment.

3.1.2 Environmental Trends and Stressors in the Future Environment

Given the “core” assumptions described above, the team turned to outlining what they saw as potential trends and stressors that could impact the future of PNT. Trends were viewed as more specific expected future direction, while stressors were seen as more general impact areas.

Trends

- PNT will be integrated into defense, intelligence, and civilian applications to a much greater extent than it is today.
- Solutions will be needed for delivery of capability in the typically challenged environments, for example, inside buildings and in urban canyons.
- Increased activity in the radiofrequency (RF) spectrum will drive development of more autonomous PNT capabilities to deliver assured PNT.
- Changes in population sizes, wealth, densities, and locations will drive a greater call for PNT capabilities in general, and specifically within urban environments.
- Threats to PNT (denial, spoofing, cyber, etc.) will become more sophisticated, raising the importance of information integrity for all users.

Stressors

- **World Politics** – Attempts by governments to dictate specific systems within their area of influence or for their military forces. Military exclusivity may not be practical to maintain, forcing the US to treat PNT as “air on the battlefield.”
- **Economic Forces** – Typified by, but not limited to, the effect of commercial sector applications and the introduction of competing PNT systems. Global commercial interests could overshadow military interests and could challenge the US market leadership position in PNT devices.
- **Technological Advances** – The continued progression towards micro electro-mechanical systems (MEMS), chip-scale atomic clocks (CSACs), and nanotechnology. Miniaturization along these lines may offer “game-changing” opportunities to improve user equipment capabilities.

The primary purpose of the future environment work was to provide context for the concept development portion of the architecting process. The potential trends and stressors above helped the ADT frame the environment that the proposed National PNT Architecture will have to support.

3.2 Projected Requirements / Needs / Users

While documented and validated requirements are of great utility during an architecture effort, the 2025 timeframe for the effort drove the consideration of projected needs, not only those needs which had already become validated requirements, when determining the focus of the architecture. A Needs Team was formed to collect and consolidate both current, validated requirements and projected future needs from throughout the PNT user community. It quickly became apparent that there are many user communities with common needs as well as a number of users with specialized and specific needs. Simultaneously satisfying all of these needs, for all users, in all environments would be extremely difficult and costly. For example, some users need very high (sub-centimeter) accuracy; many need to operate indoors; others need to operate in highly dynamic conditions, *e.g.*, military aircraft. However, not all of the requirements need to be met for all users, making the solution of these needs more tractable. For example, few or no users need centimeter accuracy indoors under high dynamics. A framework was developed to depict user needs and environments (Figure 3-1); it also helps map capability gaps to specific user community segments. Note that the “*” in some cubes indicates that the color on the chart for that user group accounts to some extent for indirect users as well (one ISR platform making use of PNT might support a large number of users). Note also that the size of the groups is indicated not to show one application or user group is necessarily more important than another, but to understand the relative scope of the user group; for example whether there are any users in that situation or how many users a solution may need to satisfy. It provided a framework in which to analyze the user community and better understand who is affected by each capability gap. The contents of this chart are further documented as an annex to the Evolved Baseline Description Document that is contained within Appendix G of this report.

The Needs Team developed a spreadsheet (Appendix E) to catalog the complex collection of needs identified to support the many user groups. It also chose to focus its efforts on those needs projected to not be met by the Evolved Baseline, as well as the most promising opportunities for improvements and efficiencies. These gaps and opportunities formed the basis for the development, assessment, and evaluation of potential architectures, and they are discussed in Section 3.5.

The team also developed a PNT Functional Reference Model, shown in Figure 3-2, in order to better understand the functions which the components of an architecture must collectively perform. The model highlights the functions which must be provided by any PNT Architecture to include providing position, timing, and orientation information, augmenting some of that information, as well as reception of that information by the user to determine position, time, and/or orientation. It also involves a number of initialization, support, sustainment, status and feedback functions. In the model, navigation is depicted as a user function, derived from positioning, timing, and orientation information received over a period of time.

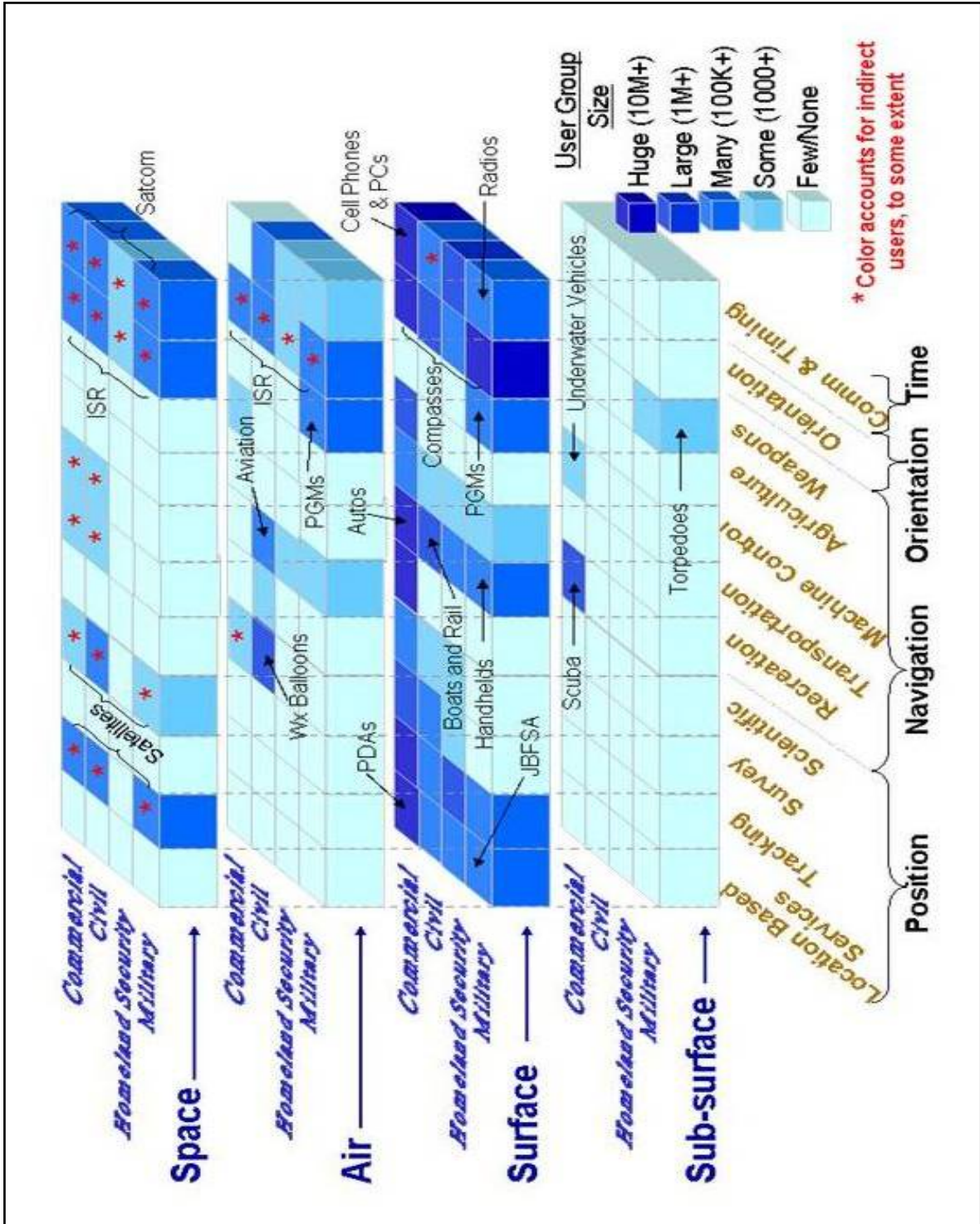

Figure 3-1 PNT User Perspectives (2025)

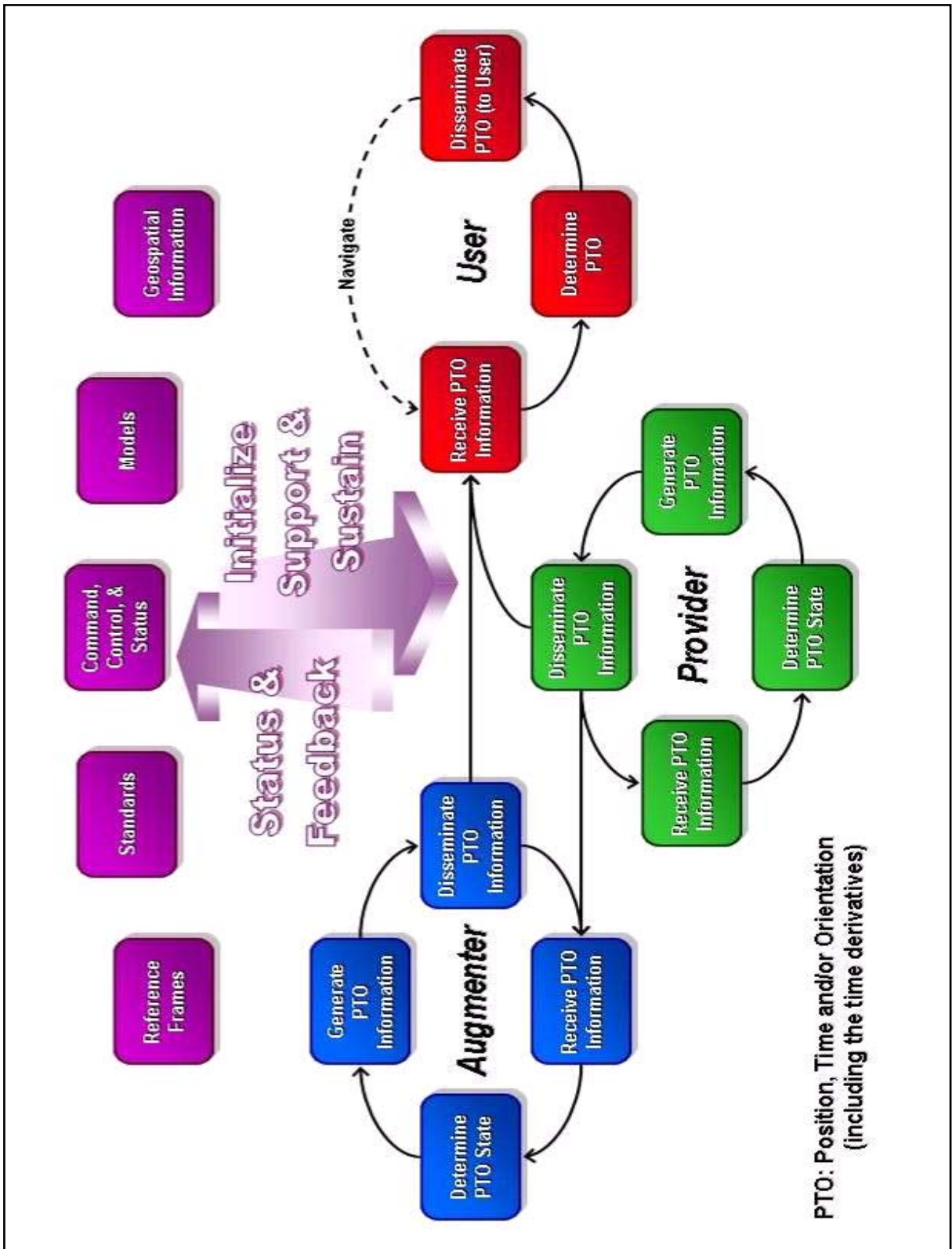

Figure 3-2 PNT Functional Reference Model

3.3 Risk Management

The PNT architecture development effort included a Risk Management process designed to provide a proper balance between risk and opportunity, avoid potential unacceptable risks where appropriate, and take a proactive and well-planned role in anticipating and responding to risks as they occur. Risks were identified and a preliminary analysis was performed during the development of the Representative Architectures. As features from the Representative Architectures were incorporated into the Hybrid Architectures, the identification and analysis steps were updated, resulting in development of a risk likelihood (probability) template for each hybrid architecture.

The use of this Risk Management process during the development of the PNT Architecture had three primary objectives. First, inclusion of risk in the assessment framework ensured that the concepts and courses of action with extreme risk were generally avoided and/or filtered out of the various architectures as those risks were identified. Alternatively, the individual hybrid architectures were designed to eliminate or mitigate such risks. Second, risks which remained in the "Should-Be" Architecture were considered when developing the recommendations, in many cases including focused research, development, or assessment designed to mitigate such risks, vice immediate implementation of a high risk feature. Third, the risks are documented in the final report, and should be considered for further mitigation during follow-on activities such as transition and implementation planning. For a more detailed description of the process used and its results, see Appendix F. A discussion of the risks identified by the ADT for each RA is also discussed in Appendix H.

3.4 Current and Evolved Baselines

An Evolved Baseline Team was formed to describe the baseline architecture. As Figure 3-3 indicates, the team identified an "As-Is" Architecture which described the mix of systems that exists today. The team also identified a PNT Evolved Baseline Architecture which described the systems expected to be operational in 2025 if the current path is followed without the benefit of an enterprise architecture strategy. The goal of the architecture effort was to develop a "Should-Be" Architecture which would effectively and efficiently provide improved capability in the 2025 timeframe.

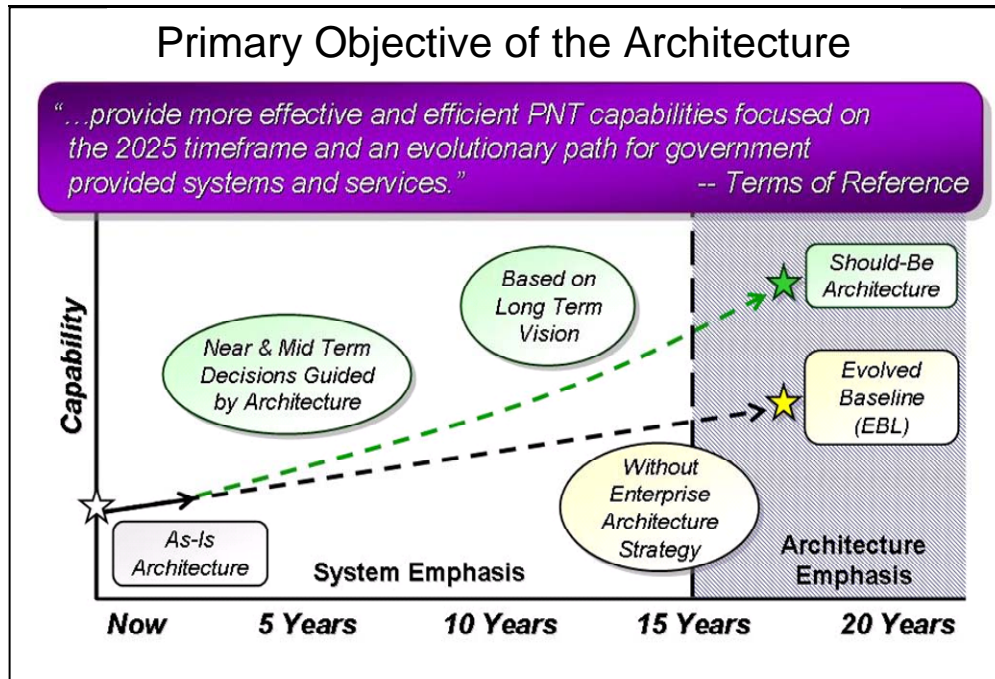

Figure 3-3 “As-Is”, Evolved Baseline, and “Should-Be” Architectures

The “As-Is” PNT architecture consists of an *ad hoc* mix of external and autonomous PNT providers as well as PNT augmentations. These systems provide PNT to a wide array of space, air, land, and maritime users, both civil and military. PNT service today relies upon a large number of PNT enabling capabilities and infrastructures in an environment which includes spectrum, weather, fiscal and geo-political challenges. Further, this architecture is characterized by widespread use of GPS, and a large number of systems that augment GPS, where each augmentation is optimized for different user groups. The US Department of Defense, US Department of Transportation, other US Government civil agencies, and commercial companies each provide PNT service to their respective users. Figure 3-4 depicts the “As-Is” PNT Architecture.

The Evolved Baseline in 2025 will contain many similar systems that will have evolved since 2007 as well as some new systems, especially a variety of international global navigation satellite systems, regional navigation satellite systems, and augmentations. The yellow text in Figure 3-5 highlights the new systems. The environment in which these systems will operate has evolved as well. Demographically, there will be a significant growth in the number of users demanding PNT services, many of them in urban environs. The user growth patterns will drive a need for increased capacity in the supporting infrastructure(s). Technologically, improved systems such as CSACs and MEMS INSS will be available, and network connectivity will be widespread.

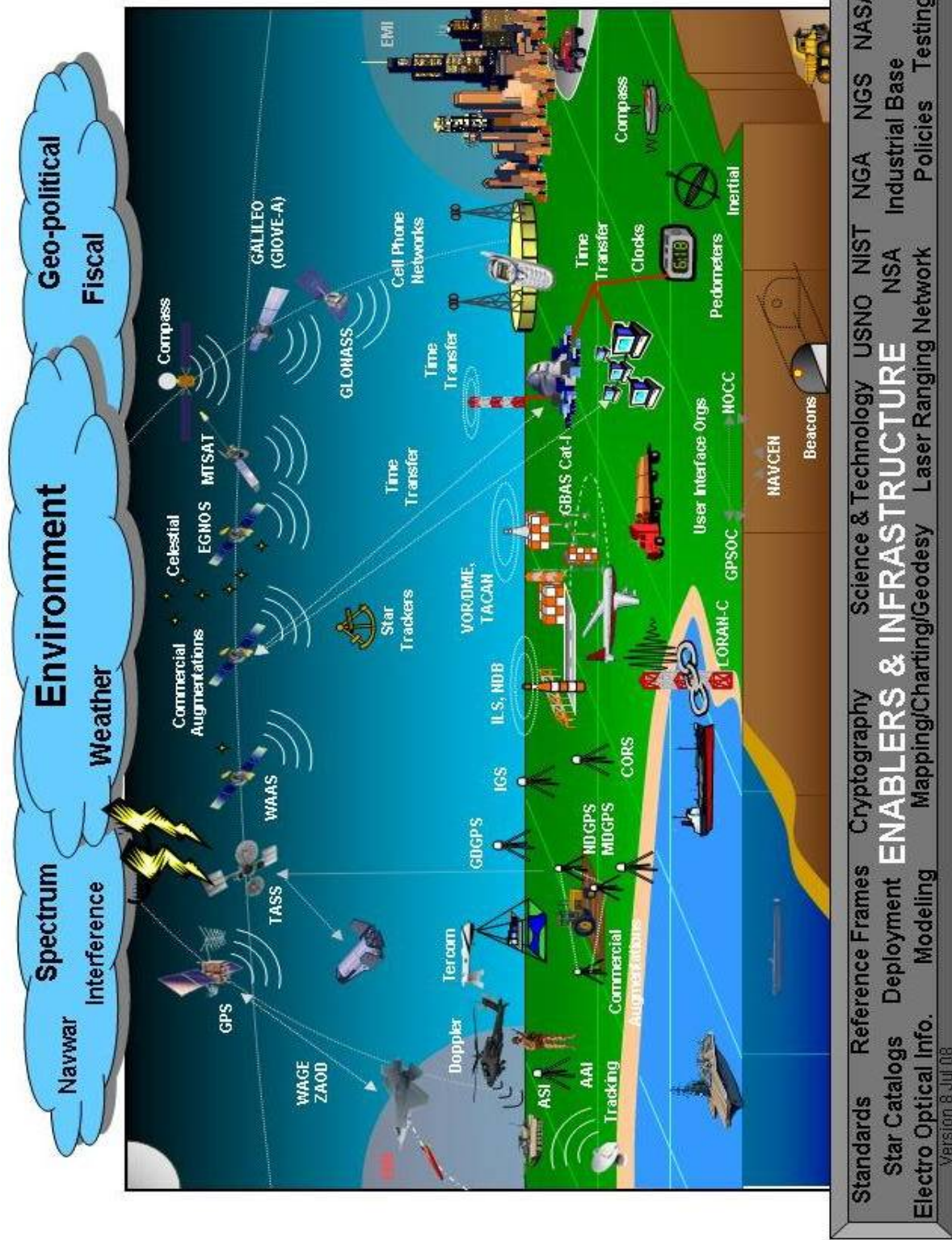

Figure 3-4 “As-Is” PNT Architecture Graphic (2007)

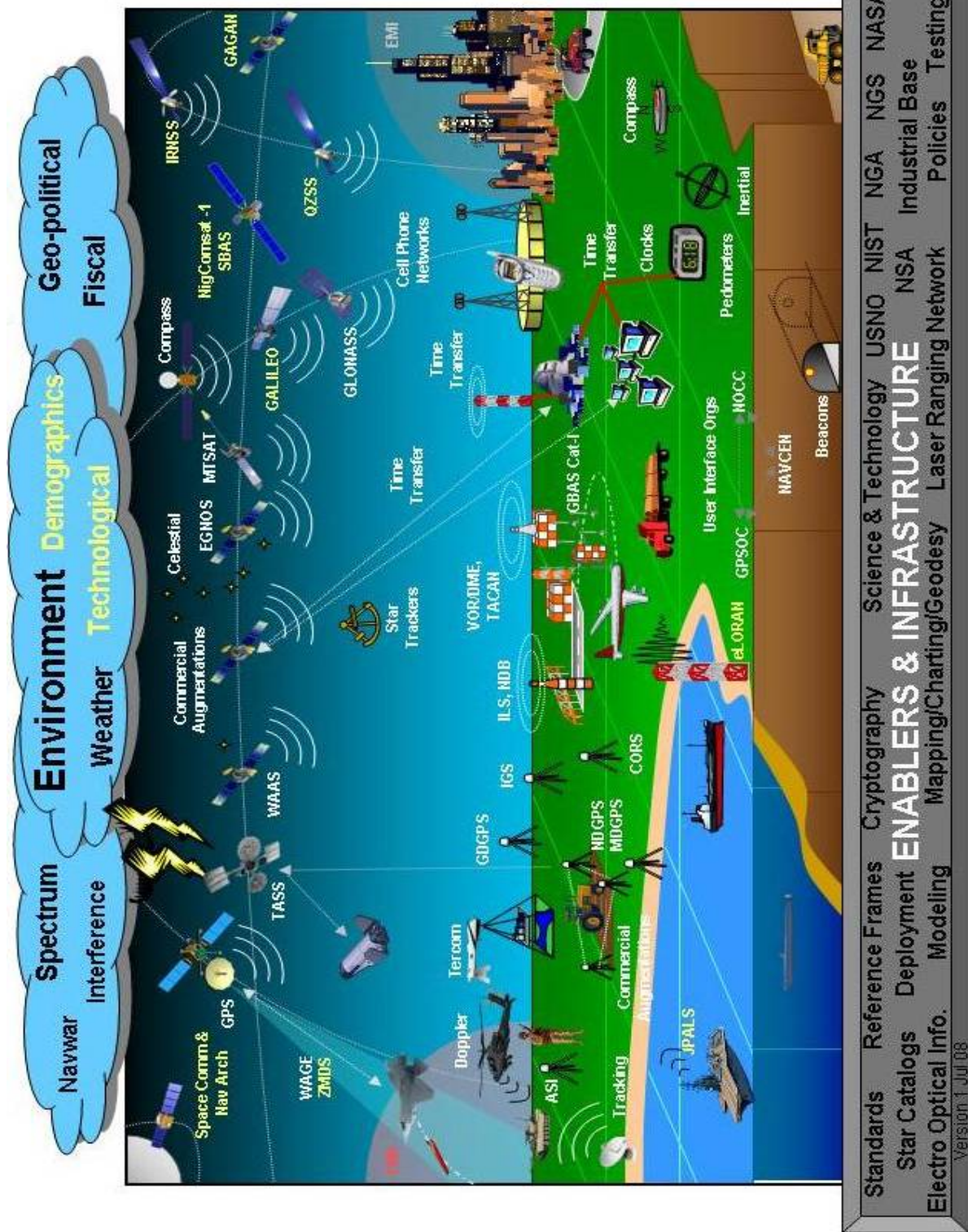

Figure 3-5 PNT Evolved Baseline Graphic (2025)

A list of the systems documented as being included in the “As-Is” and Evolved Baseline Architectures is contained in Table 3-1. A more complete description of the Evolved Baseline is contained in Appendix G.

List of PNT Systems “In Scope”		
<p>Space-Based PNT Providers</p> <ul style="list-style-type: none"> • GPS • GLONASS (Russia) • Compass (China) • GALILEO (EU) • QZSS (Japan) • IRNSS (India) • Space Comm and Nav Arch <p>Ground-Based PNT Providers</p> <ul style="list-style-type: none"> • LORAN-C and eLORAN • VOR/DME, TACAN • ILS, NDB • Tracking • Cell Network PNT <p>Autonomous PNT Providers</p> <ul style="list-style-type: none"> • Inertial Navigation Systems • Compass • Clocks • Celestial Navigation • Star Trackers • Time Transfer • Terrain Contour Matching • Doppler • Pedometers 	<p>Space-Based PNT Augmentations</p> <ul style="list-style-type: none"> • WAAS • TASS • Commercial Augmentations • MTSAT (Japan) • EGNOS (EU) • GAGAN (India) • NigComsat-1 SBAS <p>Ground-Based PNT Augmentations</p> <ul style="list-style-type: none"> • NDGPS, MDGPS • Commercial Augmentations • GBAS Cat-I • SDB Accuracy Spt Infrastr. • AAI (U-2 DGPS) • JPALS <p>Network-Based PNT Aug.</p> <ul style="list-style-type: none"> • GDGPS • CORS • IGS • Zero Age of Data (ZAOD) • Zero Age Message and Data Service (ZMDS) 	<p>Environment</p> <ul style="list-style-type: none"> • Spectrum (Navwar; Interference) • Weather • Fiscal • Geo-political • Demographics • Technological <p>Enablers and Infrastructure</p> <ul style="list-style-type: none"> • Timing Standards • Reference Frames • Other Standards • Star Catalogs • Deployment • Modeling • Mapping/Charting/Geodesy • Electro Optical Information • Cryptography • Laser Ranging Networks • Science and Technology • User Interface Orgs (GPSOC, Navcen, NOCC) • Policies • Testing • Industrial Base • USNO • NIST • NGA • NGS • NSA

Table 3-1 List of PNT Systems in Scope (2007-2025)

3.5 Capability Gaps

The architecture effort was able to accommodate the huge scope of National PNT (many systems, applications, users, etc.) by focusing the architecture on efficiently meeting current capabilities while also addressing projected gaps in capability. The 26 Sep 2006 PNT JCD identified a number of validated gaps in capability which are projected to exist in the 2025 timeframe even if the PNT Evolved Baseline comes to be. The team started with these DoD-centric gaps, and added and modified them based on the Federal Radionavigation Plan and various civil documents to address the entire PNT Enterprise. All of the DoD gaps had some parallel civil community need.

The team identified the following gaps as being of primary concern:

1. Assured and real-time PNT in physically impeded environments
2. Assured and real-time PNT in electromagnetically impeded environments, to include operations during spoofing, jamming and unintentional interference
3. Higher accuracy with integrity needed (especially for future highway and rail applications)

4. Timely notification (as short as 1 second in some situations) when PNT information is degraded or misleading, especially for safety-of-life applications or to avoid collateral damage
5. High-altitude/space position and orientation, to include real-time high-accuracy position and orientation (<10 milliarcseconds) information
6. User access to timely geospatial information for successful navigation
7. PNT modeling capabilities in impeded conditions to determine impacts, more timely modeling capabilities, and a capability to predict impacts in urban environments

The effort also identified two key opportunities:

1. An opportunity for improved collaboration/consolidation of PNT services
2. An opportunity to enable new applications/uses based on increased performance (to include accuracy, coverage, integrity, etc.)

The team employed the User Perspectives depicted in Figure 3-1 to identify users and their circumstances that would likely be affected by specific capability gaps. The results are documented in a series of Gap Charts contained in Appendix H. As an example, the gap chart in Figure 3-6 is used to document the users most affected by a gap in the ability to operate in a physically impeded environment.

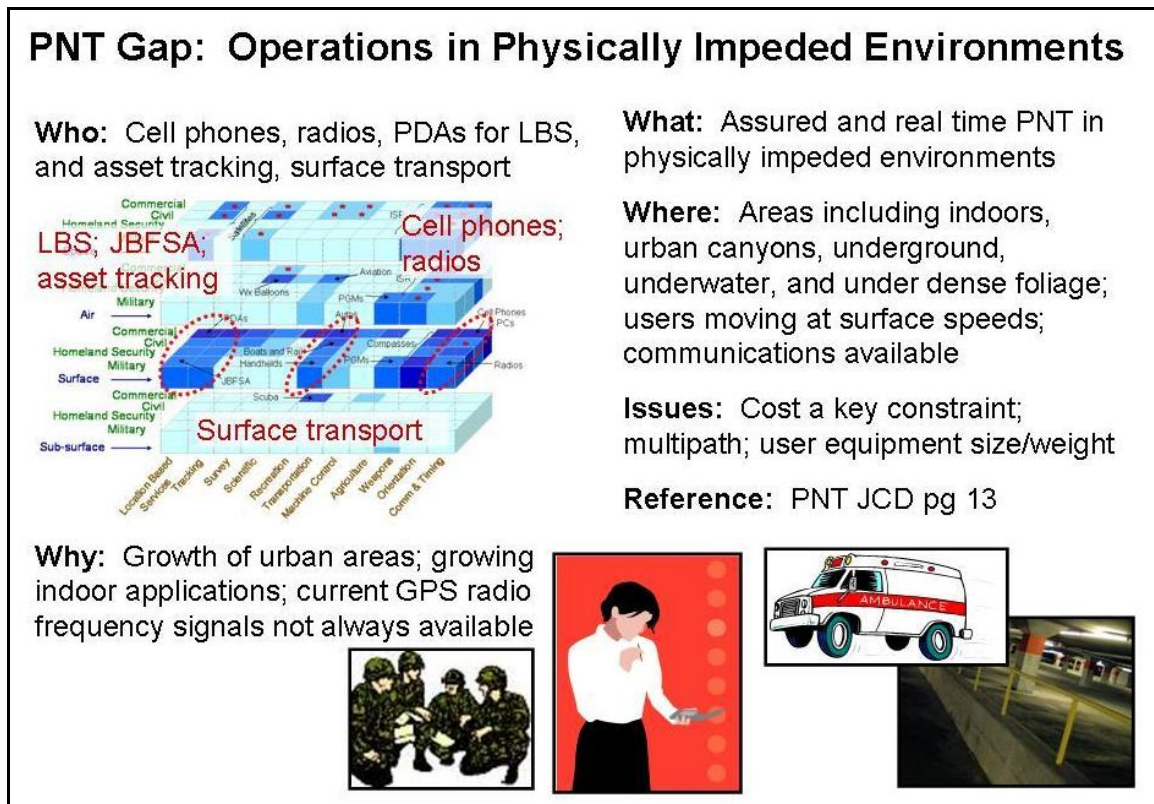

Figure 3-6 Sample Gap Chart

The need for the PNT Architecture to satisfy these gaps had a considerable impact on the solutions which were explored during the development of representative architectures, hybrid architectures, and the proposed “Should-Be” Architecture. The need to provide PNT in impeded environments including urban canyons, indoors, underground or underwater and in the face of interference and jamming drove consideration of solutions integrating RF signals such as GPS with autonomous capabilities such as inertial systems and clocks, since RF signals alone would not be expected to function in situations of the worst impedances. The need to provide high accuracy with integrity of the order of 10cm for some intelligent transportation system functions drove consideration of real-time tracking of the carrier phase of the GPS signal, such as High Accuracy Nationwide Differential GPS (HA-NDGPS), and GPS trilateration solutions. The ADT also considered beacons to provide frequent high-accuracy updates to inertial systems, and autonomous sensor systems to provide high-accuracy relative positioning. The need for improved user access to geospatial information was one reason for considering networked solutions in the architectures. Closer examination of the orientation gap identified in the PNT JCD focused attention on the orientation needs of high-altitude and space users, as well as high-accuracy positioning needs. The Orientation Functional Solutions Analysis refined understanding of the gap by indicating plans to close the current orientation gap for terrestrial users.

3.6 Technology Assessment

The ADT’s technology assessment team identified potential new technologies for further consideration later in the architecture development process. Technologies were generally accepted if they were currently at Technology Readiness Level 3, which was defined as:

“Active research and development is initiated. This includes analytical studies and laboratory studies to physically validate analytical predictions of separate elements of the technology. Examples include components that are not yet integrated or representative.”³

Many of the identified technologies focused on the ability of autonomous PNT capabilities for high accuracy and precision for location, orientation, timing, and frequency control absent RF-based PNT capabilities. This was because the current US PNT architecture is fundamentally based on the use of RF aids: GPS, TACAN, VOR/DME, etc., whose signals show the evolution of RF navigation systems, such as Gee and LORAN, first developed during World War II.

Aircraft radionavigation aids developed over the course of the 20th century have led to a significant change in PNT infrastructure by shifting the burden of PNT from individual users onto centrally-provided radionavigation products and services. The burden has shifted so significantly by the early 21st century that radionavigation has widely supplanted traditional solar observations, stellar observations, and map-and-compass orienteering as a means of precision navigation while vastly improving PNT accuracy and

³ *Defense Acquisition Guidebook*. U.S. Department of Defense: 2006.

precision. Furthermore, most of the gaps and shortfalls identified in Section 3.5 and shown in Figure 3-7 are due to environmentally-related attenuation or multipath effects in the power levels and frequencies used by these radionavigation systems.

Physically Impeded	Urban Canyon	RF Absorption, Multipath	RF
	Canopy	RF Absorption	
	Indoors	RF Absorption, Multipath	
	Underground	RF Absorption, Multipath	
	Underwater	RF Absorption	
EMI	Unintentional	Low-Power RF	
	Intentional	Low-Power RF	
High Accuracy with Integrity		RF Absorption & Multipath; Tolerances	
Notification of Harmful & Misleading Information		Reliable Recognition and Notification	
High Altitude and Space Positioning and Orientation		References & Sensors	
Access to GIS		C ⁴ I	

Figure 3-7 Root Causes of the PNT Gaps and Shortfalls Identified in the Study

The reason for the recent emergence of these shortfalls is that PNT customers are demanding the convenience, accuracy, and precision available through RF-based PNT capabilities in areas where physics constrains GPS and other signals in the ~1-2 GHz range; for example, these frequencies have difficulty penetrating underneath dense foliage and inside buildings as they are readily absorbed by water or reflected by building materials. There are two general types of technologically-based solutions to these problems:

- 1) Develop autonomous capabilities to increase customer independence from RF-based PNT aids and sources while maintaining the performance and convenience of RF-based capabilities
- 2) Make the RF capabilities upon which the architecture depends more robust so that they penetrate areas where current RF-based capabilities are inhibited.

The difficulties in developing a purely technological solution to implement the second approach resulted in greater emphasis within the team on the development of technological applications to support autonomous solutions. The team identified the following types of general technologically-based solutions and approaches:

- Improvements to global navigation satellite systems
- Improvements to networked regional radionavigation systems
- Adaptation of existing technologies to new applications

- Alternatives to global radionavigation solutions
 - Inertial navigation systems (INSs)
 - Timing sources
 - Local radionavigation systems
 - Local augmentation for global and networked regional radionavigation systems
- Adaptation of existing technologies to new applications
- Interface (physical, data, etc.) implementation
- Component miniaturization
- Adaptation of existing technologies
- Standards and information management
- Computation and storage capabilities

During PNT concept development, the ADT considered the capabilities of these technologies, as well as broader ramifications of their widespread use in overcoming the gaps and shortfalls identified in Section 3.5.

3.7 Cost Information

3.7.1 Purpose and Scope of Cost Effort

The goal of the cost effort was a fiscally informed architecture, so cost data was needed to make the ADT aware of the potential costs and cost drivers in the options being considered by the PNT Architecture team; however, the scope of the architecture effort, including government- and commercially-provided domestic and foreign systems shown previously in Table 3-1, far exceeded the scope of the cost effort, which focused primarily on costs to the US Government. This is because US PNT budget decisions are not generally affected by the amounts paid by commercial and foreign entities to develop their own capabilities, even though these entities' PNT capabilities are important considerations within the PNT architecture.

US Government costs due to foreign and commercial systems are within the scope of the cost effort when the US must ensure the additional capabilities and/or data sources provided by these systems can be reliably employed for US military or safety-of-life civil operations. Providing signal monitoring and disseminating warnings of degraded or misleading information are examples of services for which the US Government would bear the cost when incorporating non-US signals into the US PNT architecture.

As an addition to the primary scope described above, the cost impact of the architecture to non-US Government users is of interest, and may be examined to the extent possible and practical. However, this will require further definition of future user equipment than the recommendations currently capture, particularly with respect to the "Multiple Phenomenologies" and "Interchangeable Solutions" vectors. Other questions concerning non-US Government costs, such as the economic impact of PNT or commercial mass-

manufacturability of CSACs, may also be examined to the extent possible/practical. However, the purpose of such “secondary scope” activities would be to supplement recommendations as they are refined, and would not be intended to guide budgetary decisions.

3.7.2 Methodology

Cost data is developed in three stages. The first stage is the development of the “As-Is Cost Baseline”, which requires knowledge and understanding of the *actual* cost of systems already built and in use (see Table 3-2) to provide a starting reference point for the projection of future architectural costs. The second stage is the development of the “Expanded Cost Baseline,” which includes the *estimated* costs of US Government programs under study and/or planned for the near/mid future (see Table 3-3) in addition to the “As-Is Cost Baseline”. The last stage is the development of estimates of the difference in cost between the programs of the “Expanded Cost Baseline” and the concepts recommended in the “Should-Be” Architecture, based upon expected changes and enhancements to existing technologies and capabilities, and known costs.

Cost data collection is imperative to the success of the cost effort given the comparative approach to architecture development. Existing programs’ costs and technical parameters (cost drivers) must be understood, as must existing estimates, studies, and analyses for near/mid-term programs. Both serve as a basis for predicting future costs and cost drivers. Cooperation, including data sharing, by ADT members and architecture participants’ financial management and cost estimating groups is essential.

<p>DoD</p> <ul style="list-style-type: none"> – USAF <ul style="list-style-type: none"> • GPS space seg • OCS ground seg – Military GPS User Equipment – Accuracy Support Infrastructure (ASI) <p>NGA</p> <ul style="list-style-type: none"> • GPS MSs <p>DoT</p> <ul style="list-style-type: none"> – FAA <ul style="list-style-type: none"> • WAAS space seg • WAAS ground seg • WAAS UE integration and certification – FHWA, FRA, RITA <ul style="list-style-type: none"> • NDGPS <p>DoC</p> <ul style="list-style-type: none"> – NOAA / NGS <ul style="list-style-type: none"> • CORS <p>DHS (USCG)</p> <ul style="list-style-type: none"> • MDGPS (part of NDGPS network) • LORAN-C 	<p>NASA / JPL</p> <ul style="list-style-type: none"> – GDGPS – IGS – TASS <p>Joint DoD and FAA Ground-Based Providers</p> <ul style="list-style-type: none"> – VOR/DME/VORTAC/TACAN Stations – ILS and NDBs – UE integration and certification <p>Other Costs</p> <ul style="list-style-type: none"> – Science & Technology and Research & Development <ul style="list-style-type: none"> • NIST and their ops • USNO et al • Inertial Navigation Systems (INSs) – Standards and Policies Development – PNT Infrastructure <ul style="list-style-type: none"> • Networks • Zero Age of Data • User Interface Organizations – GIS – Cryptography – Govt. Subsidies
--	--

Table 3-2 Scope of Programs in “As-Is” Cost Baseline

<p>DoD</p> <ul style="list-style-type: none"> - Next-Gen GPS space and ground systems and Military GPS User Equipment - Joint Precision Approach and Landing System (JPALS) <p>FAA</p> <ul style="list-style-type: none"> - LAAS <p>FHWA</p> <ul style="list-style-type: none"> - ITS <p>RITA</p> <ul style="list-style-type: none"> - ITS JPO <p>DHS (USCG)</p> <ul style="list-style-type: none"> - eLORAN 	<p>NASA</p> <ul style="list-style-type: none"> - SCA <p>FHWA, NGS, USCG</p> <ul style="list-style-type: none"> - HA-NDGPS <p>Other Costs</p> <ul style="list-style-type: none"> - Star Catalog Update - Pseudolites - Chip Scale Atomic and Other Clocks - MEMS-INSs - Talon Namath ZAOD effort
---	---

Table 3-3 Scope of Programs in Expanded Cost Baseline

3.7.3 Cost Data Collection

Calls for cost data in June 2006, May 2007, and July 2007 yielded meager results, although good support was received from FAA. Some unclassified data was gathered via Internet searches; however, the officially transmitted and substantiated data that is essential to robust, defensible, traceable cost analysis was not supplied to the NSSO. Appendix I contains a detailed inventory of the cost data collected thus far, with data sources identified, as well as remaining data needs by program and organization.

3.7.4 Cost Assessment Results

The cost estimation effort collected subject matter expert input on cost drivers with respect to the hybrid architectures and their use cases, and used this information to help shape the architecture strategy, vectors and recommendations. However, the cost estimation effort was deferred because of lack of system detail in an Enterprise level Architecture and because government organizations did not provide the needed cost information.

3.8 Industry Information

The DCG reinforced the need for the ADT to engage industry as part of the data collection effort. Commercial industry was viewed as a driving force in the area of innovation – more so than the government sector. The paragraphs below outline the engagement approach and provide a summary of industry’s perspective on PNT topics.

3.8.1 Engagement Approach

NSSO issued a Request for Information (RFI) from commercial sources jointly with DOT’s Research and Innovative Technology Administration. The organizations listed in Table 3-4 presented their needs, observations, and perspectives on PNT to members of the ADT. The discussions were insightful with a number of the organizations offering proprietary information.

On-Grid	NavCom Tech	Honeywell
Analytical Graphics Incorporated	Advanced Navigation & Positioning Corporation	Boeing Navigation & Communication Systems
Oak Ridge National Labs	OmniStar	Booz Allen Hamilton
Boeing Commercial Aircraft	Advanced Research Corporation	International LORAN Association
Lockheed Martin IS&S	SiRF	Rockwell Collins
Jet Propulsion Lab	AeroAstro	AFRL – AFIT ANT
Boeing Phantom Works	NAVSYS Corp	Penn State ARL
Raytheon	Viasat	A-B-Sea Research

Table 3-4 Participating Industry Organizations

3.8.2 Industry Perspective

Two of the top themes from industry representatives were the need for stable, long-term policies and enforcement of established international agreements. In their view, these influence several things;

- Foster expansive technological and economic growth
- Preserve US system utility (*e.g.*, spectrum management)
- Preserve US industry competitiveness (*e.g.*, GNSS user equipment development)
- Positively influence the actions of other nations through stable policies

Industry also offered a view on the division of responsibilities between the government and commercial sectors.

- The government develops, operates, and sustains the PNT infrastructure as well as military and civil services; the commercial sector adds value for customer applications
- The government is reluctant to furnish services beyond its own needs, however sound investment by the government may yield a beneficial economic return
- Thoughts on the level to which government should provide PNT services ranged widely among the industry participants , and depends on an organization’s business model:
 - Government should only provide the infrastructure and base capabilities; the commercial sector will provide improvements as supported by the market
 - Government should provide as much as is economically feasible; the commercial sector will always find a way to improve and therefore profit
- Government sanctioned standardization is critical to the efficient proliferation of local and regional systems (*e.g.*, Real-Time Networks (RTNs))
- Interoperability of regional systems is no substitute for a global solution (*e.g.*, commercial airlines’ adoption of GNSS-based solutions)

Looking to the future, company representatives offered their thoughts on what lies ahead. These included:

- Disruptive technologies [ones that cause significant changes] are on the horizon (*e.g.*, CSACs, highly accurate optical clocks, low-cost MEMS inertial measurement units (IMUs), and extremely precise interferometric INSs) with the potential to significantly affect the future PNT Architecture.
- GPS will no longer be the only navigation satellite system; the US will have to strive for continued pre-eminence
- DoD may plan to only be dependent upon US systems, but should maintain awareness of other foreign or civil PNT services because they might help address stated military capability gaps
- Civil uses will tend towards hybrid GNSS solutions and incorporate supporting services to make PNT available everywhere

As part of the dialogue, Industry was asked “what they desired” from the US Government and the architecture. Two of the top recommendations included accelerating GPS modernization and supporting global PNT solutions. The first would result in a greater number of available signals and improved signal structures for commercial companies to leverage, while the second supports operations and sales in the international environment.

4 CONCEPT DEVELOPMENT AND ASSESSMENT

The Concept Development and Assessment phases followed the Data Gathering phase in the creation of the PNT Architecture, and comprised two major activities: the development of the architectural trade space, and the synthesis, development, and assessment of RAs and hybrid architectures used to gain insight into different areas and aspects of that trade space.

4.1 Architectural Trade Space Development

Team members established an architectural trade space containing the full range of potential PNT approaches for consideration by the ADT, and then developed many concepts to explore the full range of potential solutions within the trade space. The ADT used established NSSO processes to ensure the consideration of “outside the box” material and non-material solutions, since concepts that might seem extreme or outlandish in 2005 could easily be commonplace in 2025.

4.1.1 Architectural Trade Axes

The ADT developed a number of candidate trade axes to describe the range of architectural solutions, rather than to evaluate the performance of architectural elements. The ADT identified common themes apparent in the candidate trade axes, as shown in Table 4-1, and used the themes as a starting point for the identification of the final architectural trade axes and the characterization of their ranges of potential solutions.

Theme	Candidate Axis	Range of Potential Solutions
Independence	Solution Source	Autonomous vs. Collaborative vs. Dependent
	Source Independence	Autonomous vs. Networked
	Implementation	External vs. Internal
	Availability	External vs. Internal
	PNT Sources	Internal vs. External Ground vs. Space
Control/Cost	Cost Burden	Government Provider vs. User
	Control	US Government-owned vs. Regulated vs. Uncontrolled
	US Government Role	Regulated vs. Non-regulated
	Capability Burden	Infrastructure vs. End User
Standardization	Service	Unique vs. Special vs. General
	National Security	Exclusive vs. Non-exclusive
	Asset Usage (control)	Dedicated vs. Shared
	Standardization	Unique vs. Common
	Objective	National Security vs. Commerce
	Data Network	PNT-specific vs. Shared
	Data Processing	Distributed (local) vs. Centralized
Coverage	Coverage/Availability	Local vs. Regional vs. Global vs. Universal
	Service Area	Local vs. Regional vs. Global
	Coverage	Global vs. Regional

Theme	Candidate Axis	Range of Potential Solutions
	PNT Networks	Local vs. Global
	Complexity	High vs. Medium/Mix vs. Low
Information Assurance (IA)	IA Approach	Quality vs. Quantity
	Information Integrity	Off-board vs. Onboard
	Security	Secure vs. Open
	Access	Open vs. Restricted
	Trust	Assured (restricted source) vs. Use any source
Refresh Rate	Customer Resynchronization Rate	Near-real-time vs. Regulated vs. "Never"
	Resynchronization Mechanism	RF vs. Mix vs. Hardline
	Resynchronization Source	One vs. Several vs. Many
	Source	RF vs. Non-RF

Table 4-1 Candidate Trade Axes

The ADT evaluated and discussed the candidate trade axes and reached consensus on three final axes that combined elements of several candidate axes, with the end of each axis describing an “extreme” solution set along that axis.

1. Autonomy:
 - Dependent: the concept requires frequent refresh of information from one or more external sources to provide a meaningful service
 - Autonomous: the concept, once initialized, requires no refresh of information from external sources to provide a meaningful service
2. Service Volume
 - Local: the concept provides a meaningful service only at a fixed point
 - Interplanetary: the concept provides a meaningful service throughout the solar system
3. Source Location
 - Terrestrial: the concept provides service from, near, or beneath the surface of the earth
 - Space: the concept provides service from space

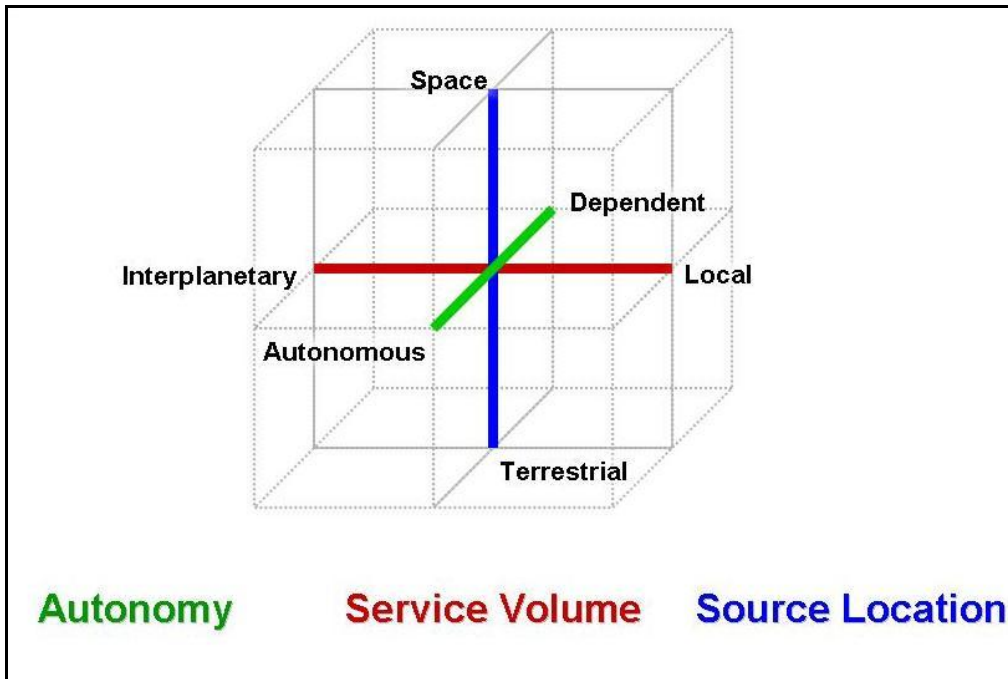

Figure 4-1 Architectural Trade Space for the PNT Architecture

4.1.2 Architectural Concepts

The ADT developed 50 PNT concepts to populate the trade space. These concepts were associated with different areas of the architectural trade space and used as the foundation for the development of RAs, as shown in Table 4-2.

ID	Concept	Description
1	GPS/Galileo	Widespread civil and military use of dual-capable GPS/Galileo receivers, where the military uses GPS as a “gold standard” to ensure security, and all make use of fault detection/isolation algorithms enabled by abundant satellites in view
2	GPS/INS/Clock	Widespread use of INSSs and clocks for semi-autonomous operations, reinitialized whenever GPS signals are available and making use of chip-scale atomic clocks
3	PNT source backup	Provide shipboard alternate PNT source capability; Navigation Sensor System Interface can be modified to provide PNT backup source
4	Optimum satellite constellations for 2025	Evaluate geosynchronous (GEO), Medium Earth Orbit (MEO), and Low Earth Orbit (LEO), as well as combinations of these orbit types, for use by global navigation satellite systems
5	Improve GPS constellation communications capability	Transmit navigation message from GEO satellites and from streaming wireless Internet servers

ID	Concept	Description
6	Monitor GPS disruptions	This concept includes a central command center, real-time geospatial information system (GIS) display of local and regional outages, and in-place mitigation plans
7	Generalized constellation improvements	Add laser retroreflectors to all satellites to improve tracking and orbit determination capabilities
8	Space-based with backup and integrity	Space-based multi-source basis (GPS, Galileo, Space-Based Augmentation Systems (SBAS)) with ground-based backup for basic capabilities and integrated integrity modeling
9	Integrated inertial navigation	Incorporate improved INS in navigation systems
10	Star tracker	Incorporate improved star trackers in navigation systems
11	Celestial reference frame	Provide positions of celestial objects commensurate with star tracker accuracy
12	Optical clocks	Use atomic transitions at optical frequencies to provide improved time and frequency measurement
13	Accurate calibration of time dissemination systems	Real-time calibration of devices used to disseminate accurate time
14	Cross-links on GNSS	Elements of GNSS connected via laser cross-links
15	Timing on communications satellites	Incorporate precise time dissemination capability on planned communications satellites, including atomic clocks and appropriate mathematical algorithms to incorporate environmental effects, propagation delays, and relativity
16	Optical fiber time transfer	Establish timing facilities that transmit timing coordination data through fiber-optic communication
17	Space navigation with GNSS	Design future GNSS with the ability to enable space navigation
18	Bathymetry	Develop bathymetric databases to provide more accurate underwater navigation
19	National PNT management	Develop a national acquisition structure to manage procurement of PNT systems
20	Lunar directional beacon	GPS-like beacon on lunar near-side
21	Lunar omni-directional beacon	GPS-like pseudolites on Lunar/Mars surface
22	Lunar/Mars communication and navigation satellites	Communication satellites in orbit around Mars and the Moon with PNT payloads (and users with software-defined radios)
23	Radionavigation using amplitude modulation (AM) signals	AM-only system works like a kinematic differential GPS system

ID	Concept	Description
24	Stereo video imaging	Two forward-facing cameras and two aft-facing cameras track fixed objects
25	Assisted GPS (AGPS)	Predicts GPS satellite vehicle signals, Doppler shift, and pseudo-random noise sequence phase. Sensitivity assistance is achieved by data bit modulation removal and increased integration, resulting in an improvement of 3-4 dB
26	Global Locate	GPS capabilities are integrated into cell phone networks, to include massively parallel hardware correlators in the network infrastructure, with dwell times increased by 30-40 dB and assisted GPS using data provided by a separate wireless link
27	Distributed PNT	Integrates navigation sensors (GPS, INS, fathometers, gyrocompass, EM-log) prediction data
28	High-altitude GNSS pseudolites	Stable, high-altitude GNSS pseudolites (altitude ~70,000 ft)
29	Differential GNSS (DGNSS) ground-based augmentation system	Worldwide differential GNSS augmentation in a GDGPS-like implementation, but with integrity for terrestrial users as well. This would be achieved by a confederation of existing/planned capabilities
30	Differential GNSS space-based augmentation system	Worldwide differential GNSS augmentation in a GDGPS/TASS-like implementation, but with integrity for terrestrial users as well. This would be achieved by a confederation of existing/planned capabilities
31	Single DGNSS SBAS	A single service which could provide centimeter-level accuracy in near-real-time, as well as providing post-processing data for millimeter-level accuracy data reduction, as well as providing integrity information in real-time over local RF networks
32	Terrestrial RF Precise Time and Time Interval (PTTI) Transfer	Nationwide-Worldwide precise time transfer via terrestrial RF network with 10μsec accuracy. Think WWVB (currently 100μsec accuracy given path delay correction) with order-of-magnitude accuracy increase and additional antennae
33	Multi-satellite system Receiver Autonomous Integrity Monitoring (RAIM)	Autonomously provides integrity via the use and monitoring of multiple, independent, highly-available navigation systems
34	Network Interference Detection and Geolocation	Worldwide GNSS and SBAS interference detection via communications-enabled UE status reporting and centralized monitoring

ID	Concept	Description
35	National Modeling and Simulation Effort	Intelligence, Defense, Civil, Industry, and Academia solutions enabling the Positioning, Navigation, Timing, and Orientation domain to be modeled and simulated. A standards-based framework would be the backbone of the tool, which would include system-specific algorithmic components plugged into the framework that would provide varying and documented degrees of fidelity and validation.
36	Civil/Private cooperative DGNSS reference station network	Civil-seeded DGNSS network with standardized data access protocols and reference station accuracy validation. The civil agency provides critical infrastructure with the opportunity for private enterprise to participate where value is created.
37	Civil/Private cooperative RTN reference station network	Civil-seeded RTN with standardized data access protocols and reference station accuracy validation. The civil agency provides dense critical infrastructure to meet increased accuracy needs in high population-density areas, with the opportunity for private enterprise to participate where value is created
38	Network-aided GNSS	Widespread use of GNSS augmented via communications networks (for example, cell phone network). Where GPS is available, use cell phone (or other military communications) to provide information to aid acquisition of GPS signals and improve accuracy. Where GPS is not available, use network for coarse PNT. Network could also provide additional value-added location-based services
39	Relative Navigation	Users determine PNT through relative navigation broadcasts to and from other users. Relative navigation tied to inertial reference frame through GPS and star tracker users by some users. Develop high accuracy, day/night use star trackers, and update star catalog (Joint Milliarsecond Pathfinder Survey mission (J-MAPS)).
40	GPS/LORAN	Widespread use of dual-capable GPS/LORAN receivers where robust PNT is required. Field complete e-LORAN, especially in Alaska, and encourage development of (relatively) small, low-cost, dual-capable receivers while exploring lower cost ownership options for O&M of LORAN infrastructure.

ID	Concept	Description
41	Improved GPS user equipment	Widespread use of improved user equipment to include anti-jam antennas and electronics in a variety of form factors and price ranges as well as high sensitivity for improved outdoor operations. Military equipment would include low-performance nulling antennas for selected low-end users, and high performance beam steering antennas for high-end users. All equipment would include high-sensitivity capability and an ability to integrate the received signal for longer periods to aid acquisition when needed. Civil equipment would add dual or triple frequency capability to overcome unintentional interference.
42	Improved interference detection	Relatively simple interference detection capabilities fielded at all GPS and augmentation monitor stations, as well as selected high-value trusted users (airfields, aircraft carriers, command and control aircraft, military headquarters) along with (interference resistant) communications connectivity to report GPs interference or jamming to central processing nodes. Coordinated civil-military, multi-security level interference database, managed by real-time operations centers to provide user situational awareness and facilitate response to shut down interference sources with the goal of reducing the level of interference/jamming to which users will be subjected.
43	Wide Area Augmentation System Integrity on GPS III	WAAS monitor stations provide GPS integrity messages for dissemination by GPS III, vice existing WAAS space segment. GPS III high-capacity crosslinks ensure timeliness. Explore inclusion of other worldwide monitor stations (Galileo, Quasi Zenith Satellite System (QZSS), GLONASS, etc.) with appropriate sanity checks
44	Image-aided inertial navigation systems	Users requiring moderate accuracy and high robustness use the fusion of data from MEMS, INs, CSACs, pedometers, wheel-counters, and image-aiding for navigation. Reference AFRL Industry Days presentation.
45	Exploiting Signals of Opportunity	Receiver to capture and use Signals of Opportunity (SOO) to provide a navigation solution without a dedicated transmitting antenna.
46	Universal PNT system	Integrated receiver using INS, GNSS, clock, celestial, and SOO inputs
47	Personal PNT	Integrated receiver using INS, GNSS, CSAC, SOO using MEMS or nanotechnology implementation that is personally portable (<i>e.g.</i> , wristwatch-sized)
48	Integrated communications and GNSS	System employing both the communications systems and GNSS to provide robust PNT

ID	Concept	Description
49	Gravimetric Navigation	Use precision gravity mapping and sensing to determine position with respect to the Earth
50	Satellite Laser Tracking	Use of satellite laser retroreflectors and ground-based laser tracking to improve satellite orbital models, including those of the Global Positioning System (GPS)

Table 4-2 ADT Concept Descriptions

The ADT assessed the concepts and mapped them to the trade space to ensure that the entire trade space was addressed, as illustrated in Figure 4-2.

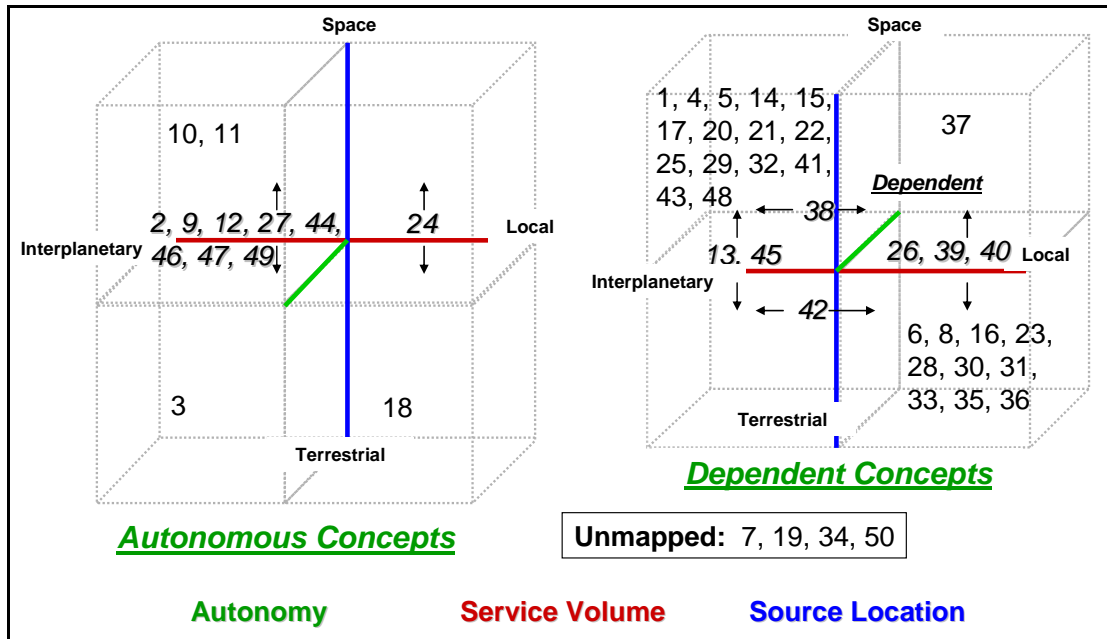

Figure 4-2 Mapping of PNT Concepts into the Architectural Trade Space

4.1.3 Evaluation Criteria

The ADT defined and developed five main criteria to evaluate concepts as they were to be implemented in the representative and hybrid architectures: Interoperability, Uniformity, Adaptability, Robustness, and Sustainability; Uniformity was subsumed by Interoperability prior to the ADT concept evaluation. Each representative architecture was evaluated regarding the degree to which it exhibited each characteristic; however, the key weight in the study was not the scoring level but the participants' discussion (captured in on-line format) on why certain representative and hybrid architectures were ranked as they were.

4.1.3.1 Interoperability

Interoperability is defined as the ability of systems, units, or organizations to provide services to and accept services from other systems, units, or organizations as required to support the mission(s). There are five levels of interoperability:

- Level 1:** Stovepiped operations, disparate sensors/electronics using disparate signals/sources

- Level 2:** Ad-hoc operations, short-term coalitions, regional focus
- Level 3:** Coordinated operations, multifunctional electronics, similar signal protocols
- Level 4:** Routine joint operations, recommended standards and practices
- Level 5:** Seamless operations, universal electronics or common signals

4.1.3.2 Uniformity

Uniformity is defined as the ability to present information/data in a consistent manner that is transparent to the user over a large region/nation/world/planet. There are five levels:

- Level 1:** Disparate references, standards, etc. (proprietary- access limited)
- Level 2:** Limited acceptance of uniformity mechanisms (multiple alternatives, no consistent 'rules of use')
- Level 3:** Moderate acceptance of uniformity mechanisms (common reference models, different environmental models, etc.)
- Level 4:** Widespread use of uniformity mechanisms (well defined 'rules of use')
- Level 5:** Common reference models, environmental models, algorithms, presentation models, protocols, standards (timing, datum, grid)

4.1.3.3 Adaptability

Adaptability is the ease of modifying architecture elements in response to change without having to change the underlying architecture, where change may include changing missions, contingencies, user requirements and capabilities, policy, hostile activity, technology, threats, and world environment. There are five levels:

- Level 1:** Requires large architectural changes and/or takes a long time
- Level 2:** Requires multiple architectural component changes (highly coupled, interdependent, extensive testing)
- Level 3:** Ability to change something within the maintenance/ development cycle
- Level 4:** Modular components (plug and play), networked
- Level 5:** Rapid change, with limited impact to the underlying architecture

4.1.3.4 Robustness

Robustness is the ability of the PNT architecture to deliver a continuous PNT solution in any condition (hostile action, environmental, system internal failures) over a given time period. The five levels of robustness are:

- Level 1:** There is no redundancy if the primary capability is lost
- Level 2:** Results in intermittent, unpredictable performance
- Level 3:** Rapid but predictable degradation
- Level 4:** Graceful long-term degradation
- Level 5:** PNT solution any time any where, redundancy, architecture not susceptible to hostile action and/or environmental conditions

4.1.3.5 Sustainability

Sustainability is the ability to maintain the necessary level and duration of operational activities. Sustainability is a function of providing for and maintaining the levels of ready forces, materiel and consumables necessary to support mission efforts (Joint Pub 1-02). The five levels of sustainability are:

- Level 1:** Onerous – Requires lengthy planning, continuous attention, large capital investments by service providers, extensive procurement and implementation efforts
- Level 2:** Difficult – Requires planning and attention, significant investment, careful implementation
- Level 3:** Moderate – Requires some planning and attention, investment and implementation responsibilities shared among providers and users
- Level 4:** Uncomplicated – Requires little planning or continuing investment, implementation issues limited
- Level 5:** Simple – Self-sustaining, self-financing, no implementation issues\

4.2 Architecture Design and Assessment

Architecture Design and Assessment focused on developing and assessing alternative architectural approaches. The ADT used the results of the trade space evaluation to create seven representative architectures (RAs) that explored aspects of trade space, where each RA was an intentional and significant departure from the EBL. The ADT evaluated the RAs and developed hybrid architectures integrating concepts to meet future needs, overcome capability gaps, and support political, economic, and military strategies in a risk- and cost-informed manner. The hybrid architecture assessment shaped the final recommendations (see Figure 4-3).

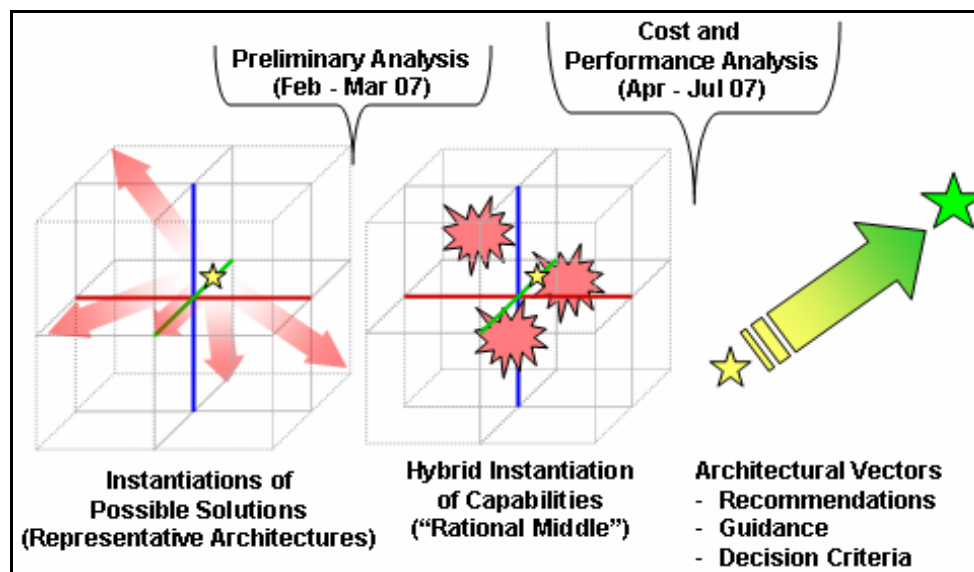

Figure 4-3 From Representative Architectures to Recommendations

The ADT developed and used the analysis framework shown in Figure 4-4 when it found no quantitative analysis tools existed for enterprise-level architecture assessments, and

used a network of laptop computers to capture evaluation scores and narrative responses. In addition, the ADT leveraged previous and ongoing related studies and analyses. However, when using these related efforts for an enterprise-level assessment the team had to factor in the typically more tightly scoped results.

For example, the PNT Joint Capabilities Document and its supporting analysis provided significant insight into DoD capabilities, needs, and potential solutions. The 2005 Civil PNT Analysis of Alternatives, produced for the Interagency GPS Executive Board, and various interagency documents such as the Federal Radionavigation Plan provided similar information for the civil community. The Federal Aviation Administration's GEAS provided needed insight into the role of various alternatives in providing accuracy with high integrity, especially for aviation applications. The draft National Space-based PNT Five-Year Plan provided program status and plans for many PNT systems, as well as program budget data. The PNT Architecture Development Team, in general, and the NSSO facilitators specifically, assimilated this data for use in the architecture process. As described earlier, numerous studies by other agencies were underway during this timeframe. The PNT Architecture process was used to enhance shared situational awareness and leverage these ongoing efforts through the use of informational status update briefings and by taking advantage of overlapping membership.

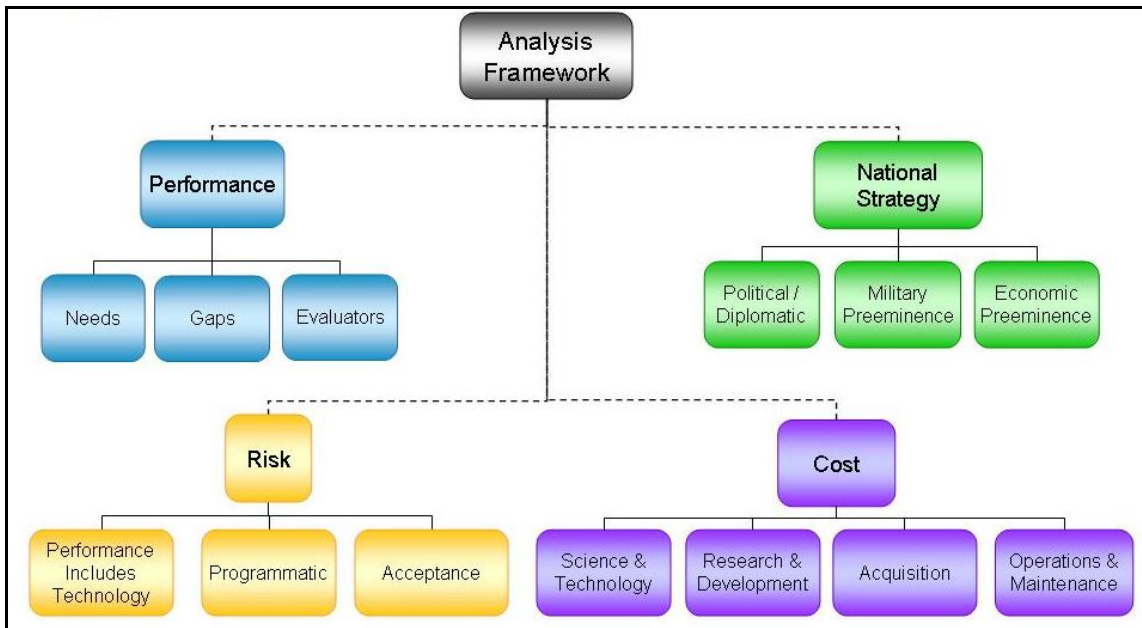

Figure 4-4 Analysis Framework

4.2.1 Representative Architectures

The ADT developed and evaluated the RAs with the primary objective of obtaining insights, finding trends, and identifying key features that could be used to develop the “rational middle” hybrid architectures. The ADT considered the expected ability of each RA to meet user needs, satisfy identified gaps, and address the evaluators shown in Figure 4-5. Subject matter expert (SME) perspectives on the risks associated with the RAs were collected; however, the costs of the RAs were not assessed due to a lack of

supporting cost data for meaningful cost analysis (see Section 3.7) and because the RAs were not intended to be actionable architectures.

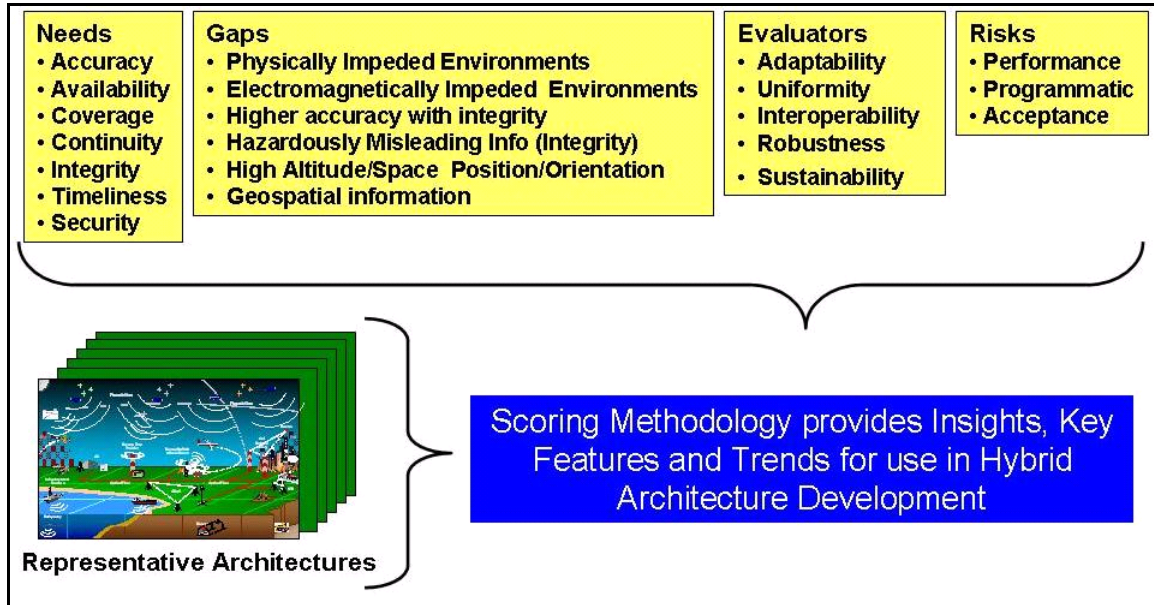

Figure 4-5 RA Analysis

The following questions exemplify those asked during the RA evaluation effort, in which the ADT asked SMEs to evaluate performance-related gaps from their perspectives as SMEs, and to answer a set of similar questions on organizational needs from the perspective of SMEs’ parent organizations.

- How well does the RA meet the users’ needs in a physically impeded environment? This includes urban canyons, under canopy (i.e., trees), indoors, underground, and underwater.
 - Rating Scale
 - Exceeds user needs (highly effective)
 - Meets user needs (very effective)
 - Meets most user needs (moderately effective)
 - Meets some user needs (somewhat effective)
 - Does not meet user needs (not effective)
- What are your rationale and associated assumptions?
- What features contribute to addressing the gap?
- Are there any issues and/or concerns?

4.2.1.1 Development

The ADT developed seven RAs, plus an RA representing the EBL, to ensure sufficient examination of the full trade space identified during the Concept Development Phase, which was defined by the following major architectural trade axes:

- Service Volume (ranging from “interplanetary” to “local”)

- Autonomy (ranging from “autonomous” to “dependent”)
- Source Location (ranging from “terrestrial” to “space”)

The ADT examined the trade space corners to establish what the extremes had to offer and elected to develop RAs to explore the following trade space corners and edges, as illustrated in Figure 4-6:

0. Evolved Baseline
1. Dependent / Terrestrial
2. Space / Interplanetary / Dependent, emphasizing GNSS
3. Space / Interplanetary / Dependent, emphasizing GNSS and celestial navigation
4. Terrestrial / Local / Dependent, emphasizing network-aiding of GPS
5. Interplanetary / Autonomous, emphasizing autonomous sensors and aiding sources
6. Autonomy
7. Interplanetary / Autonomous, emphasizing clocks and inertial navigation systems

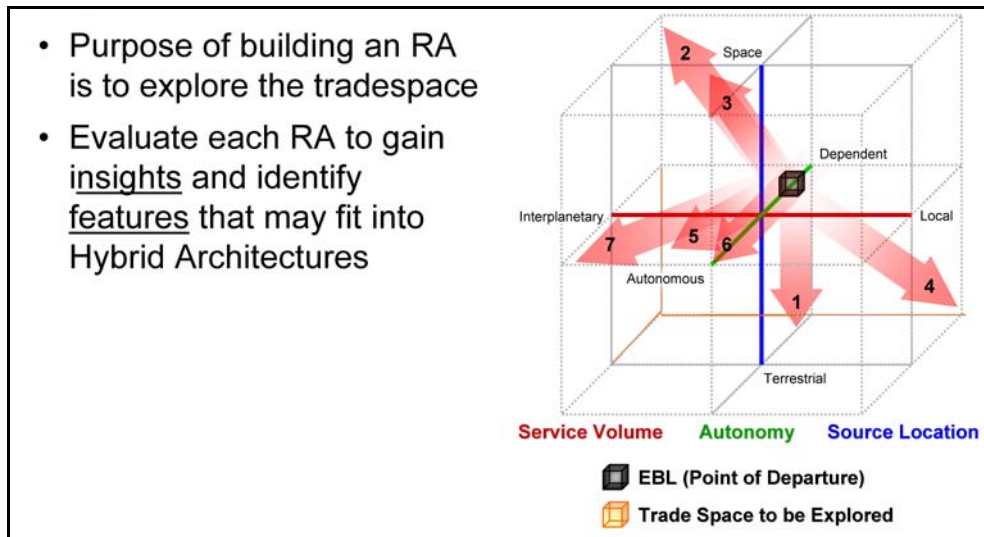

Figure 4-6 Representative Architectures within the PNT Trade Space

The ADT adjusted and consolidated the RAs to conserve analytic resources while still ensuring adequate exploration of the trade space extremes. RA3 was merged into RA2, and RA 7 was eliminated as being overly redundant with RA5 and RA6. The resultant RAs are individually described below:

4.2.1.1.1 RA0 – Evolved Baseline

4.2.1.1.1.1 Overview, Composition, and Direction

The EBL includes the systems which are expected to be operational in 2025 if the current path is followed without the benefit of an enterprise architecture strategy. While the EBL

included systems which individually spanned the trade space, when combined it was assessed that the EBL was predominantly a dependent architecture. The EBL is further described in Section 3.4 as well as Appendix G.

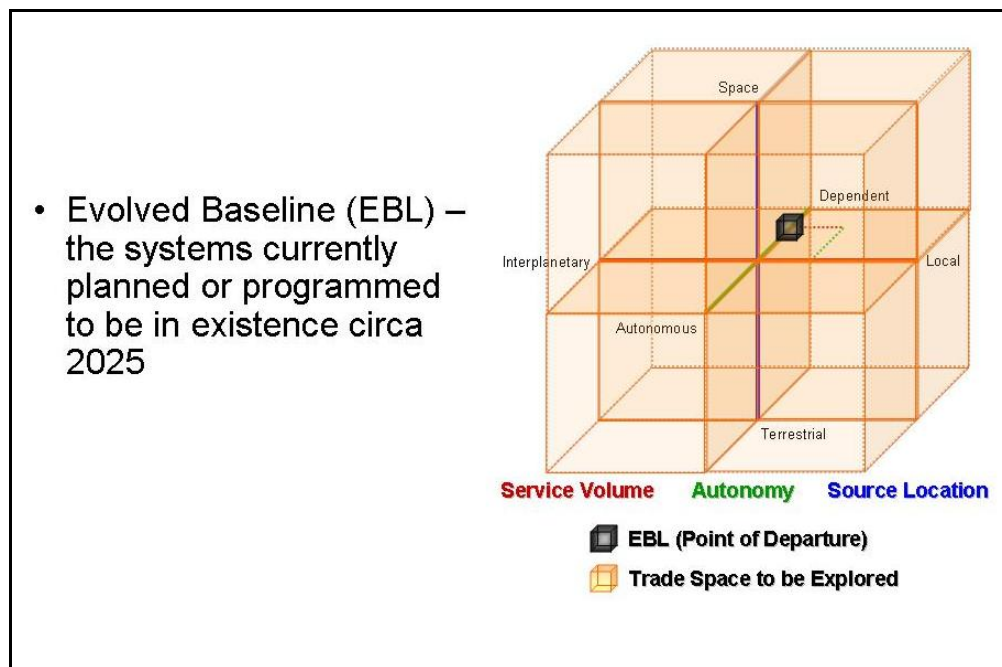

Figure 4-7 Theme of Representative Architecture 0, Evolved Baseline

4.2.1.1.1.2 Insights and Analytical Expectations

Preliminary analysis of RA0 indicated that, by definition, the EBL would fall short of satisfying projected user needs in the areas of the primary gaps which were defined in Section 3.2. However, also by definition, the EBL was expected to do a good job of sustaining current capabilities, except in the area of orientation, where current star catalog accuracy is known to be degrading over time. It was also important to note that a number of the systems contained in the EBL have improvements planned which would make some contribution to covering some portion of these gaps.

The planned GPS III spot beam, as well as L1C, L2C, L5 and M-code pilot (dataless) channels which allow longer integration times, would help in physically and electromagnetically impeded operations (or “ops”). Use of combined GNSS would improve Dilution of Precision (DOP), and hence accuracy, for users presently planning to use this capability, and use of clocks/INSs by some users would allow coasting through short outages. GPS III and its crosslinks reduce age of data, improving accuracy for users requiring high accuracy with integrity. The capability gap with respect to notification of degraded or misleading information would be reduced by use of combined GNSS constellations with fault detection algorithms by some users, improvements from GPS III integrity, and fielding of the Joint Precision Approach and Landing System (JPALS) for military users. The EBL provides for use of star trackers and the star catalog for orientation needs, however with star catalog accuracy degrading, the EBL is expected to be unable to sustain current performance in this area. NASA’s Space Communication and Navigation Architecture (SCA) contained in the EBL would be key to meeting many

space needs. Infrastructure within the EBL provides users with some geospatial information.

With regard to the evaluator areas, GPS provides a common core for many users by aiding interoperability, and many standards exist for use of various PNT systems within an applications area. The EBL is rich with choices as a base for adaptation; however, the wide diversity of systems used also increases the complexity of total solutions.

Robustness is provided through the graceful degradation of GNSS and the many backup choices including autonomous concepts (INS, clock, compass, etc.) available. The large number of diverse systems to sustain increases the complexity and cost of sustainment, yet the overlap reduces sustainment risk or the impact from sustainment problems in one system.

4.2.1.1.2 RA1 – Dependent Terrestrial

4.2.1.1.2.1 Overview, Composition, and Direction

RA1 focused on the use of terrestrial-based systems as the primary means of satisfying user needs. As reflected in Figure 4-8, this RA moved towards the dependent-terrestrial side of the trade space to explore options with a reduced dependence on space-based PNT. In this context, terrestrial includes airborne solutions such as aerial pseudolites and high-altitude airships. However, in a push towards the dependent-terrestrial part of the trade space, this RA did not include the use of autonomous solutions.

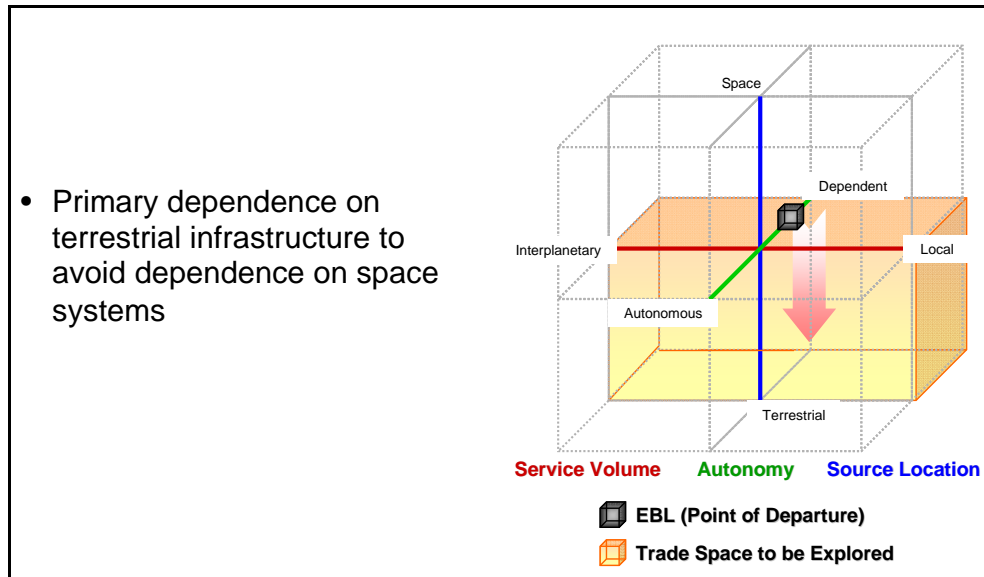

Figure 4-8 Theme of Representative Architecture 1, Dependent Terrestrial

This RA drew on the concepts offered by the ADT for this part of the trade space. Keeping with the dependent theme reflected in Figure 4-8, examples of primary sources included high- and low-altitude platforms serving as “GNSS-like” pseudolites combined with low and medium frequency “LORAN-like” systems. This architecture proposed use of radiofrequency PTTI for low precision/accuracy timing users, while advancing optical fiber time transfer for high precision/accuracy needs. Other concepts considered included

pursuit of civil/private cooperative RTN reference station networks, leveraging cell-phone networks, and exploiting signals of opportunity.

The ADT made a number of assumptions in constructing this RA. Some of the key assumptions include high-altitude, airship-based platforms will be economically feasible to operate at high altitudes for extended periods of time, a combination of terrestrial technologies will successfully meet high-accuracy terrestrial requirements, and that the US Government will facilitate growth of public/private partnerships to provide RTN coverage. Other assumptions include achievable development of affordable combined receivers and the successful application differential techniques similar to those currently in use by Ground-Based Augmentation Systems (GBAS).

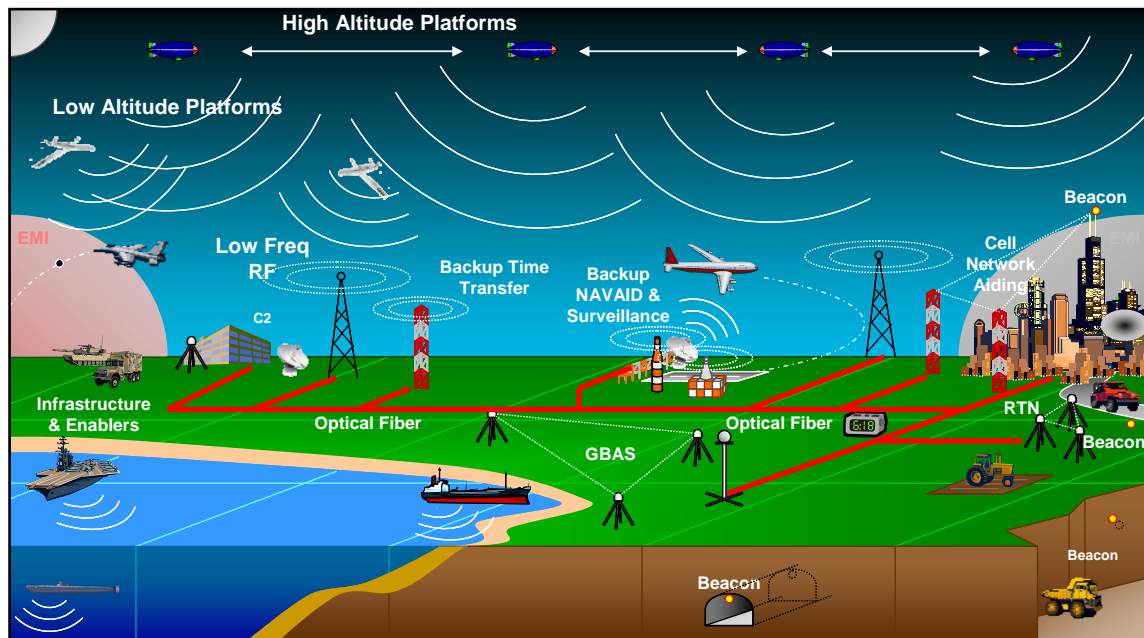

Figure 4-9 Representative Architecture 1, Dependent Terrestrial

4.2.1.1.2.2 Insights and Analytical Expectations

This RA replaces the global, precise PNT capability provided today by GNSS with a mix of terrestrial PNT sources. Going down this path promises a number of performance, programmatic, and acceptance challenges. Some performance concerns are based on challenges associated with the endurance and positioning of high-altitude platforms (airships and unmanned aerial vehicles (UAVs)). Lack of autonomy in this area of the tradespace may exacerbate performance losses during periods of electronic interference (natural or man-made), that could be easily mitigated with inertial sensing devices.

This RA has many technical unknowns so programmatic costs could be very high. There would also be significant transition costs associated with moving away from the current space-based infrastructure, including wide-ranging impact to user equipment costs and the likely need for more real estate to support the increased ground-based infrastructure. This is a major shift from the EBL and likely to be unpalatable for many, both here and abroad. Finally, this approach puts the ability to operate seamlessly worldwide at risk, reducing the potential for a global solution for many users.

4.2.1.1.3 RA2A – Heavy Space

4.2.1.1.3.1 Overview, Composition, and Direction

Representative Architecture 2A (RA2A) was an extensive modification to the EBL with increased emphasis on combined GNSS constellations and widespread reductions to dependent terrestrial infrastructure and autonomous systems.

During Concept Development, this architecture evolved from a less extreme version (RA2) which added additional space-based concepts to the EBL. RA2A further added some space-based concepts initially identified in RA3 (consideration of a GPS signal on E6 and a US regional constellation). In addition, significant reductions to the non-space-based components of the EBL were made. This more extreme version of the architecture was chosen, not because it was felt it would provide superior performance, but to explore a more extreme portion of the tradespace and determine what could and could not be accomplished with a space-based architecture.

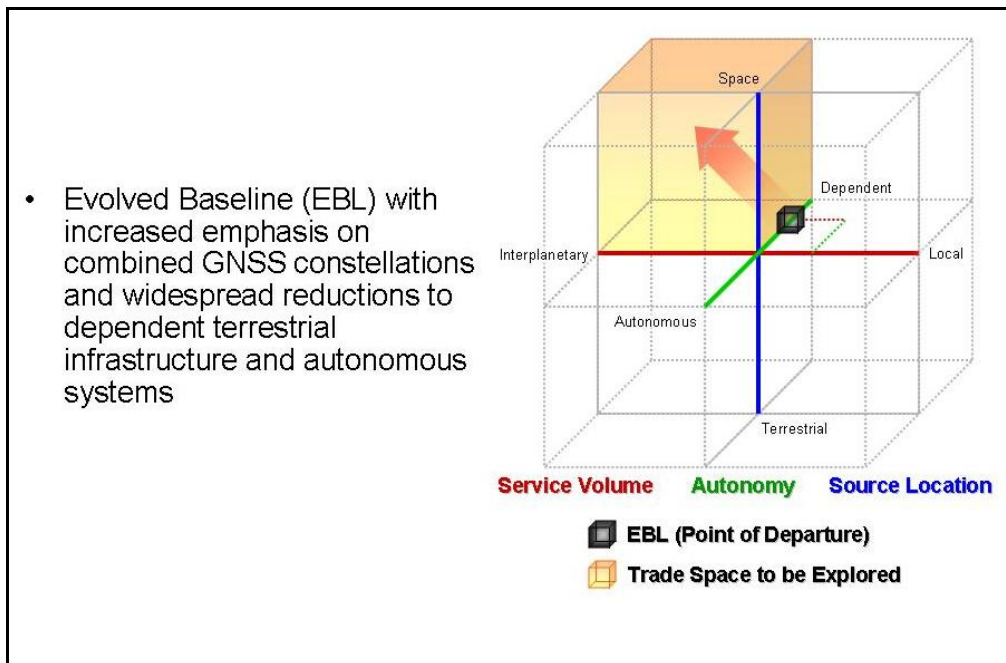

Figure 4-10 Theme of Representative Architecture 2A, Heavy Space

Figure 4-11 highlights the concepts which were added or received increased emphasis, and those parts of the EBL which were deleted from consideration. The changes included widespread use of combined GNSS constellations, receivers able to receive interoperable signals in at least L1C and L5 bands, and the addition of a signal at E6 to allow trilateration. Improved integrity and security were enabled by fault detection/isolation algorithms and the large numbers of satellites in view, as well as cross-system sanity checks. It included a 30 space vehicle (SV) GPS constellation with crosslinks and spot beam initial operating capability (IOC = 18 SVs) by 2025. GPS SVs included higher power signals for improved operations in an impeded environment (+10dB earth coverage on M-code; +10 dB on L1C civil signals). Spot beam capable satellites also included an ability to flex all navigation power to M-code spot, allowing the military to use a small subset of the overall constellation to provide one to four very high-power spot beams in theater. RA2A

included an improved SCA which added two more lunar satellites, surface pseudolites, and an improved deep space network. It further included a LEO augmentation constellation to aid acquisition and improve accuracy by enabling RTK-like (real-time kinematic) tracking of signal phase, as well as a US regional navigation satellite system, like QZSS, to improve DOP in urban canyons. The general approach was to add everything which could potentially help performance from space, while stripping out almost all ground-based or autonomous systems, in order to understand the strengths and weakness of an all-space solution.

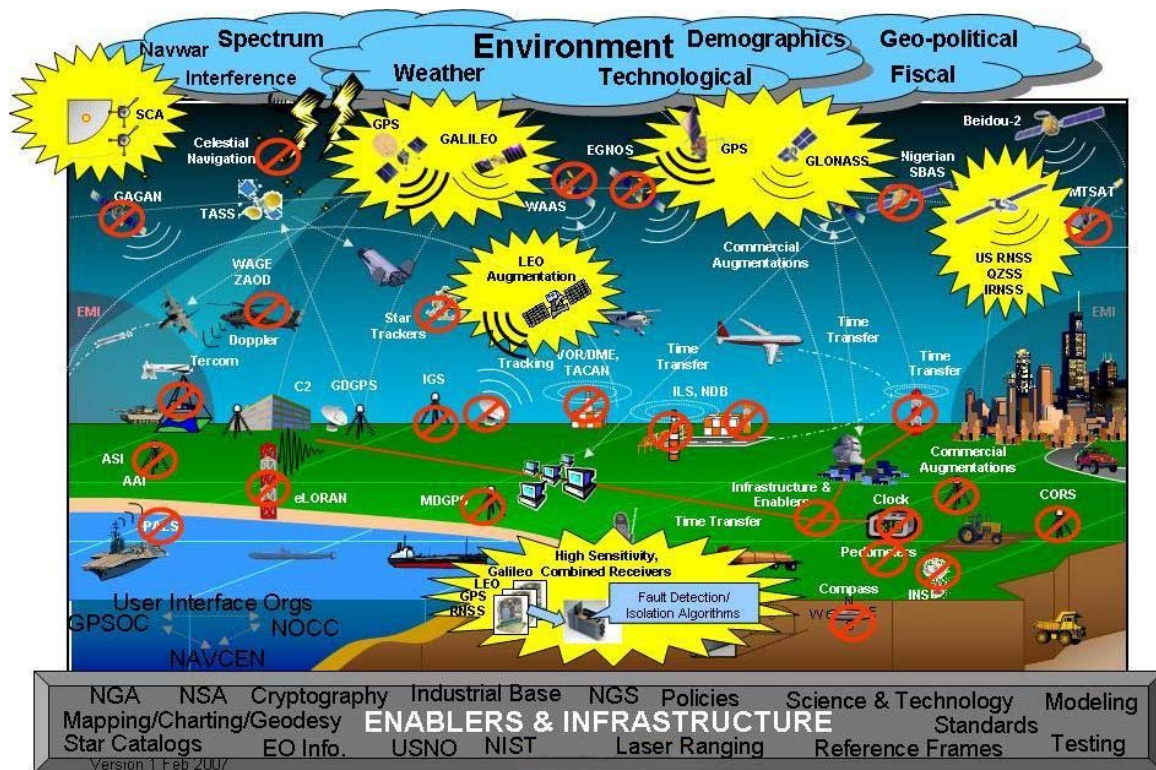

Figure 4-11 Representative Architecture 2A, Heavy Space

4.2.1.1.3.2 Insights and Analytical Expectations

Preliminary analysis of RA2A indicated that this architecture was potentially flawed by the lack of mechanisms to coast through the smallest outages, given the removal of all clocks, compasses and inertial systems contained in the Evolved Baseline. Higher power GPS signals and use of foreign GNSS, regional systems, and a LEO augmentation constellation provide numerous potential signals, but lack of networked positioning systems such as cell phone networks were expected to impact operations indoors. The numerous GNSS signals were expected to provide significant integrity through fault detection algorithms. Lack of celestial navigation capabilities was expected to limit orientation accuracy for the most demanding users. Overall, the expectation was that the lack of autonomous systems would hurt performance in physically impeded environments, and that the emphasis on space-based solutions would help interoperability (many using the same systems), while hurting adaptability (systems hardware in space).

4.2.1.1.4 RA3 was merged into RA2

4.2.1.1.5 RA4 – Network-Aided GPS

4.2.1.1.5.1 Overview, Composition, and Direction

RA4 was a modification to the Evolved Baseline with additional emphasis on the use of network aiding of GPS. It included all the current components of the EBL, while adding or making more widespread use of a number of networked systems. HA-NDGPS was added to provide a core accuracy improvement through RTK GPS. This network would be augmented by local RTK networks supported, facilitated, and enabled by, but not funded by, the Federal Government's On-Grid Initiative through standards, cost benefit analyses, and incentives. Other countries' differential GPS networks would be encouraged to upgrade to HA-NDGPS. This RA assumed the fielding of similar, but deployable, military networks for out-of-band transfer of PNT information. Widespread use of eLORAN to provide backup PNT was included since it was complementary to the architecture's capabilities and to explore this difference of the tradespace compared to, for example, RA2A, Heavy Space. Cell phone networks are used to disseminate updates and aid acquisition, as well as provide tertiary PNT. A key technology investment would be in low-cost GPS/eLORAN/networked receivers. The RA considered possible deletion of one or more GPS augmentation systems and possible deletion/reduction of one or more ground-based navigation aids (replaced with eLORAN as backup), however it was assessed with the full complement of EBL systems.

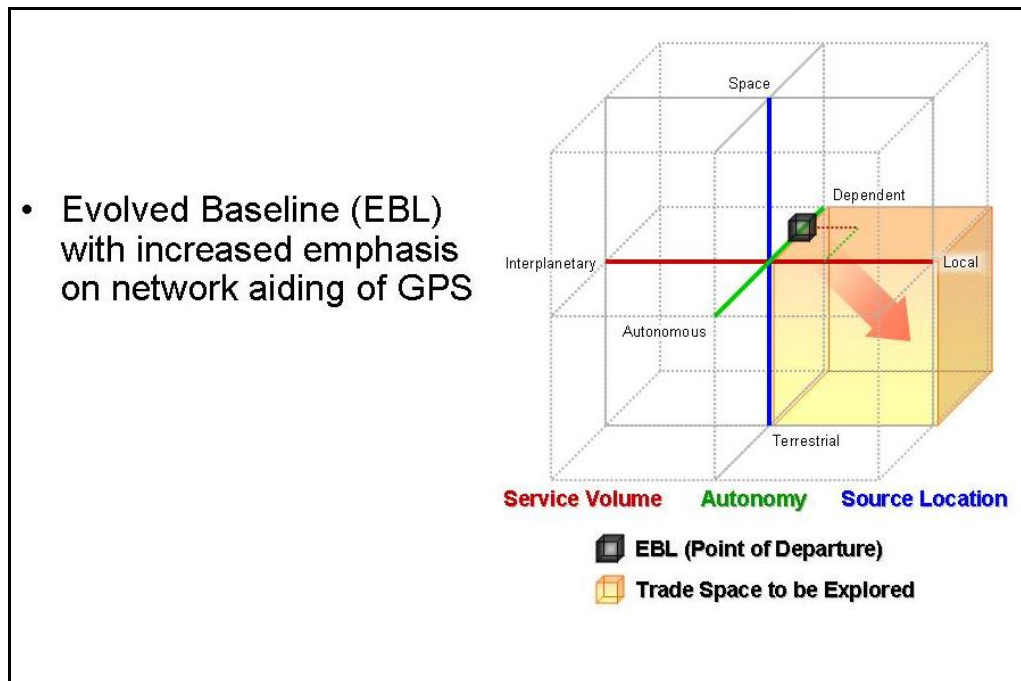

Figure 4-12 Theme of Representative Architecture 4, Network-Aided GPS

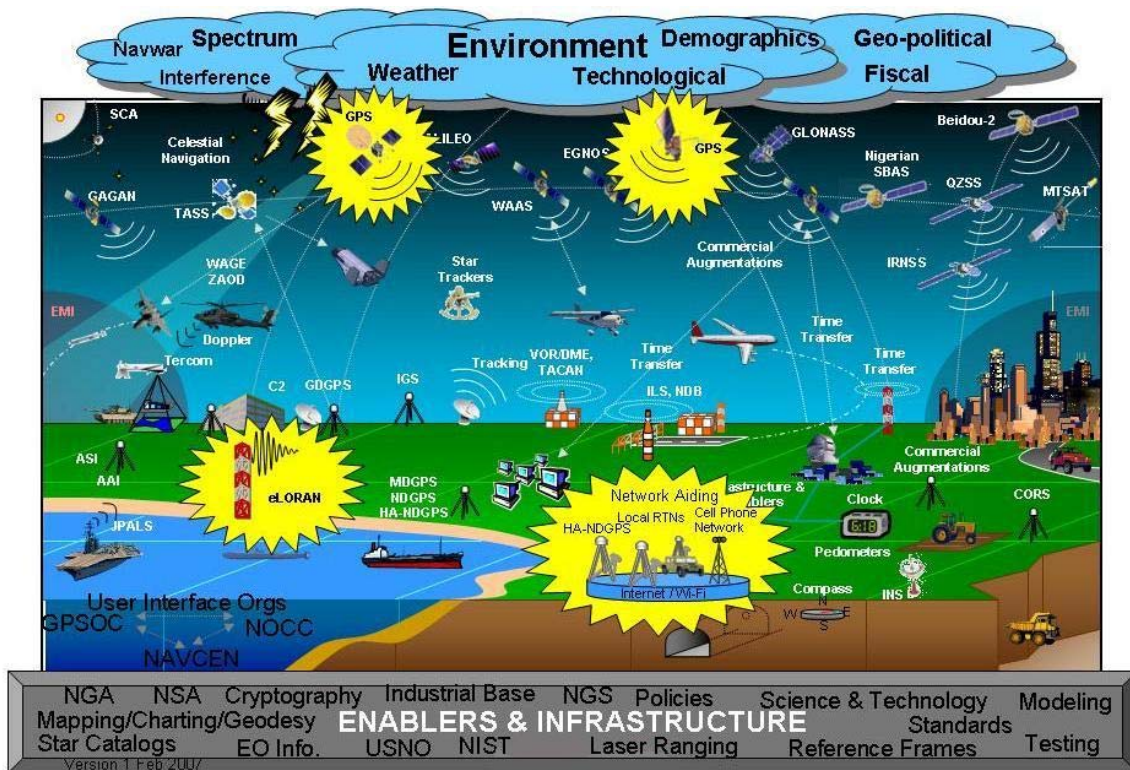

Figure 4-13 Representative Architecture 4, Network-Aided GPS

4.2.1.1.5.2 Insights and Analytical Expectations

Preliminary analysis of RA4 indicated that multiple network aiding concepts and wide use of INSs/clocks to coast through outages would help in both physically and electromagnetically impeded environments. Cell phone coarse positioning would help in urban canyons and indoors. Widespread use of eLORAN would help against interference. High accuracy with integrity users would make use of HA-NDGPS and RTNs to provide real-time kinematic tracking of the GPS phase, while use of INSs/clocks would enable these users to coast through short outages. Warning of degraded or misleading information would be provided by EBL methods, augmented by integrity messages provided through the network. EBL capabilities for star tracking and celestial navigation remain unchanged (with the accuracy of the star catalog degrading). Widespread networked communications would be used to distribute geospatial data. Widespread network accessibility would facilitate some kinds of adaptability. eLORAN and cell networks provide backup capability for robustness, as do overlaps in RTN coverage. However, the large number of RTNs owned by multiple organizations would complicate sustainability, as would complicated user equipment able to connect to GPS, eLORAN, and networks.

4.2.1.1.6 RA5 – Sensor-Aided PNT

4.2.1.1.6.1 Overview, Composition, and Direction

RA5 focused on the widespread adoption of autonomous sensors and individual aiding sources as a primary means of satisfying PNT needs on an interplanetary scale. A variety

of dependent aiding sources were also introduced given the necessity to initialize and reinitialize various autonomous sources on a periodic basis. However, the architecture aimed to minimize the number of distinct types, if not the amount, of such dependent sources. As a result, the dependent sources were principally limited to highly standardized local-terrestrial devices in addition to a global-space component.

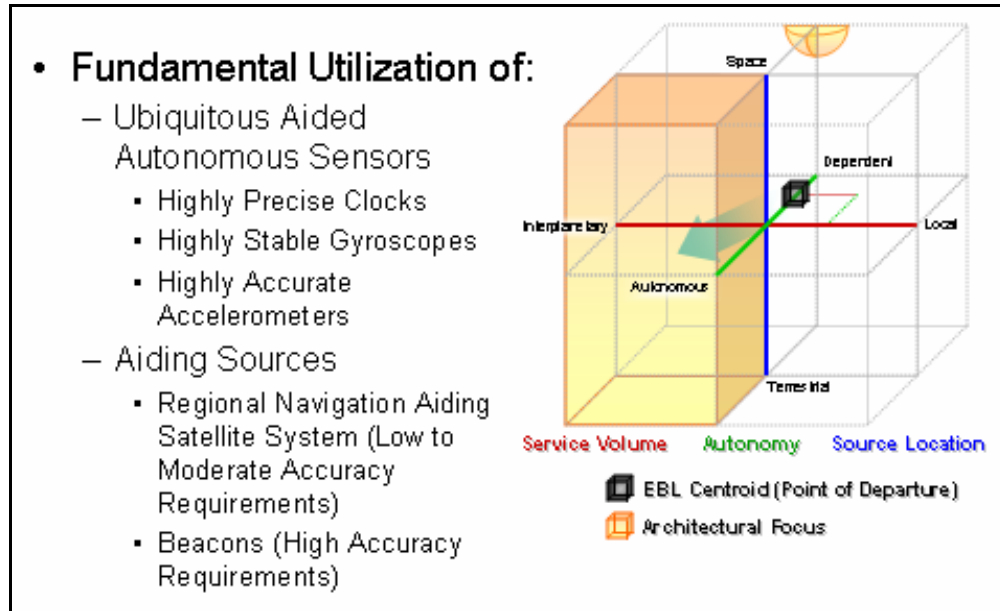

Figure 4-14 Theme of Representative Architecture 5, Sensor-Aided PNT

RA5 aimed to provide users with independence through the widespread use of autonomous sources and aiding services. Existing and planned systems already aligned with the thrust of this architecture were highlighted for early adoption. For example, highly stable inertial sensors (*e.g.*, gyroscopes and accelerometers), highly stable clocks, celestial navigation, barometric altimetry, bathymetry, and compasses (magnetic and gravimetric) were emphasized. Additional unplanned autonomous systems were targeted for increased research and development. For example, alternative celestial navigation techniques utilizing infrared, pulsars and quasars, in addition to the associated high-accuracy mapping missions were explored. Technology investments in autonomous capabilities were also considered. For example, highly stable miniaturized INSs, highly stable clocks and oscillators, and highly accurate miniaturized star trackers were assessed.

However, autonomous capabilities and aiding systems are obviously insufficient as they require periodic initialization. As a result, various dependent capabilities were explored within the architecture. For example widespread adoption of beacons was envisioned for use within roadways, runways, harbors, natural canyons, cities and urban canyons, commercial quarries and pits, tunnels and caves, commercial mines, precision survey, agriculture fields, and indoors. Additional efforts would be required to develop unplanned dependent systems, such as the Regional Navigation Aiding Satellite System (RNASS). The RNASS maintains two sub-constellations of four satellites each, and provides rolling coverage to terrestrial users once every three hours. These two sources constitute the primary means by which autonomous sources are reinitialized via

dependent means. As the tight integration of autonomous capabilities and aiding sources dominates the architecture, significant technology investments are envisioned for high-performance, cost-reasonable user equipment which integrates and fuses information to achieve autonomy for periods of up to nine hours.

In contrast to the many investments in autonomous technologies and systems, many existing and planned systems would be retired as they counter the architectural theme. For example, radionavigation satellite systems (*e.g.*, GPS, GLONASS, Beidou, Galileo, IRNSS, and QZSS⁴) in addition to their space and ground-based augmentations (*e.g.*, WAAS, EGNOS, MSAS, GDGPS, and Nigerian SBAS, LAAS, MDGPS, NDGPS, HA-NDGPS, CORS, IGS, and RTNs⁴) would be decommissioned. Likewise, ground-based positioning, surveillance and navigation aids such as LORAN, RADAR, NDB, VOR, DME, TACAN, and ILS⁴ would be removed from service. Similarly, image and terrain recognition navigation techniques like DSMAC and TERCOM⁴ would be retired. Lastly, terrestrial RF time transfer and positioning systems such as WWV would be deactivated.

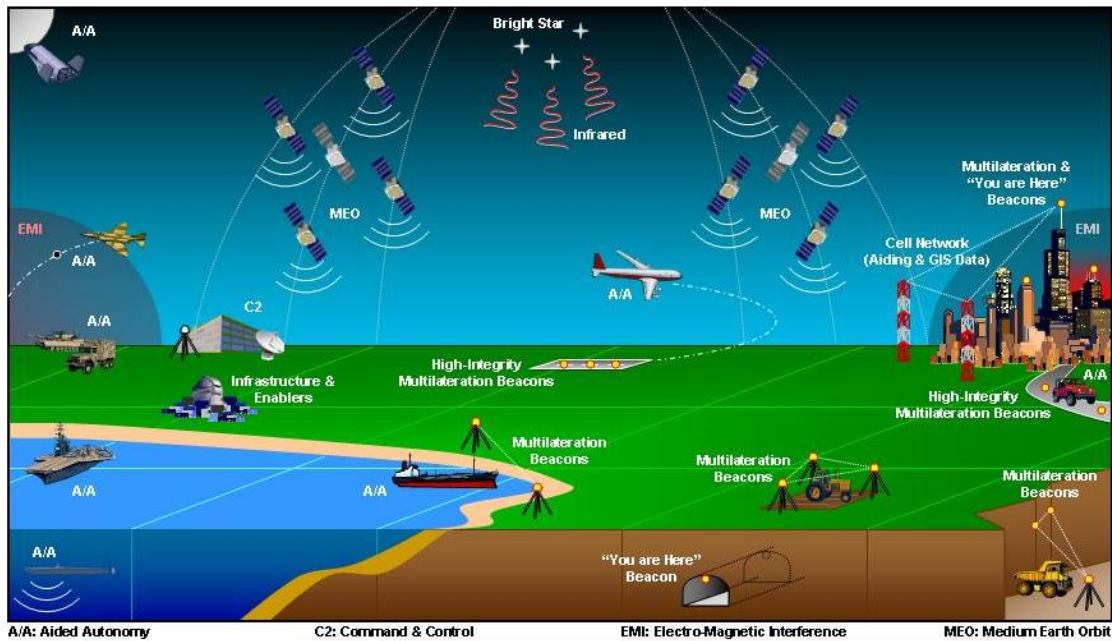

Figure 4-15 Representative Architecture 5, Sensor-Aided PNT

4.2.1.1.6.2 Insights and Analytical Expectations

The architecture centrally depends upon widely available and highly-capable inertial sensor technology to provide six to nine hours of acceptable performance. While current low-burden clock technologies appear promising, a significantly positive evolution of IMU technology would be required. Current expectations for low-burden IMUs, while

⁴ See Appendix K – Acronyms and Abbreviations – for the full names of the programs listed in acronym form here

promising, fall short of the needs of this architecture. The assessment of this architecture will depend significantly on expectations for IMU technologies in the target timeframe.

Secondly, the architecture is principally invested in beacon technology. High- and low-technology beacons providing multilateration as well as simple “you-are-here” positioning and timing services are a key consideration. Of primary concern is the massive scale on which beacons would have to be installed. At best, the argument for success lies in the relative simplicity and inexpensiveness of beacon technology, brought about by mass market demand. To illustrate, “you-are-here” beacon technology could provide a return on investment to real-estate proprietors through provision of valued service to PNT users. For example, beacons which enable location based services, and the direct and indirect fee-for-service markets they represent, could be a path to large-scale installation and thus PNT service viability.

Ultimately, this architecture is expected to struggle providing acceptable services to more demanding users (*e.g.*, scientific, survey, and transportation). Additionally, the architecture is expected to fall short in overcoming some projected capabilities gaps, such as providing higher accuracy with integrity as well as sustaining lengthy operations in impeded environments where little or less dense infrastructure exists. Finally, significant challenges are expected in accepting such a wholesale departure from the EBL, especially in the area of user equipage given potential incurred increased costs, at least in the short-run.

4.2.1.1.7 RA6 – Autonomy

4.2.1.1.7.1 Overview, Composition, and Direction

RA6 attempted to bridge the gap between the EBL and customer needs by providing customers with better capabilities and better communications connectivity, rather than relying on shared PNT-only services. The main reasons for this approach were that the existing PNT infrastructure cannot always reach customers in need and PNT needs are continually evolving as customer operating areas and performance needs change.

The general inability to reach remote customers covers several current PNT gaps, including access to terrestrial data networks to exchange or receive PNT information; access to open- or closed-loop RF transmission of PNT information (*e.g.*, GPS); natural and artificial limitations on real-time RF transmission; and the high cost of extending shared PNT capabilities to support niche customers.

The ability to adapt or rapidly develop new shared PNT capabilities to meet the majority of customer areas and needs across the entire range of US Government and commercial customers is a daunting challenge. RA6 focused on allowing individual customers to tailor a set of infrastructure-provided tools to provide their own solutions when beyond the reach of the PNT infrastructure, or when the infrastructure is unable to meet needs for greater precision, accuracy, reliability, etc.

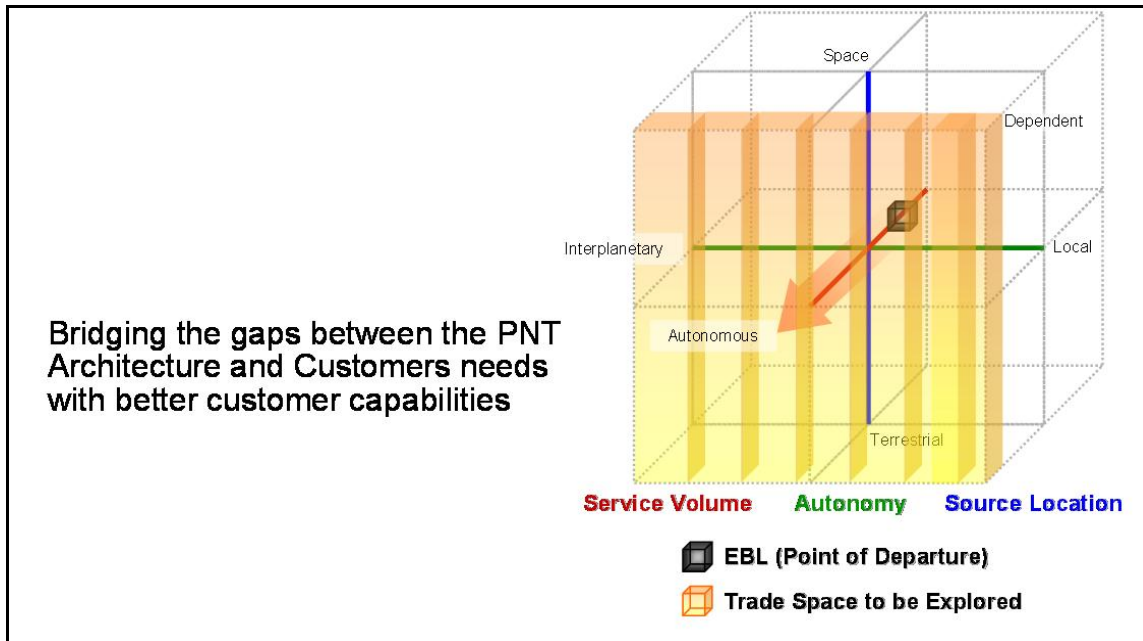

Figure 4-16 Theme of Representative Architecture 6, Autonomy

The main features of RA6 that supported greater user autonomy were:

- Use of the “meter stick,” a theoretical, tailorable construct that carried the appropriate autonomous sensors, reference data, and communications interfaces and that would allow a customer to meet its PNT needs through direct sensing of the environment with comparison to reference points
- Establishment and maintenance of more robust PNT reference standards
- Less frequent but more robust re-initialization of PNT information, including the projection of reference standards to the field and the ability to meet needs while refreshing PNT reference data at longer intervals
- More robust customer capability, including slower decay in PNT accuracy and precision after the re-initialization of PNT information, the ability of customers to maintain mission success while being independent of PNT support infrastructure for longer periods of time, and the availability of “autonomous” PNT capabilities in lieu of service provided by central or shared PNT resources

The key assumptions were that customers could use novel operating concepts and combine multiple PNT solutions to meet most PNT needs, and that users had other, non-PNT resources available to accomplish their objectives in spite of shortfalls in the capabilities provided by a centralized PNT infrastructure. For example, alternatives to precision GPS-guided munitions might include larger bombs to overcome the larger Circular Error Probable, or the use of alternative guidance mechanisms.

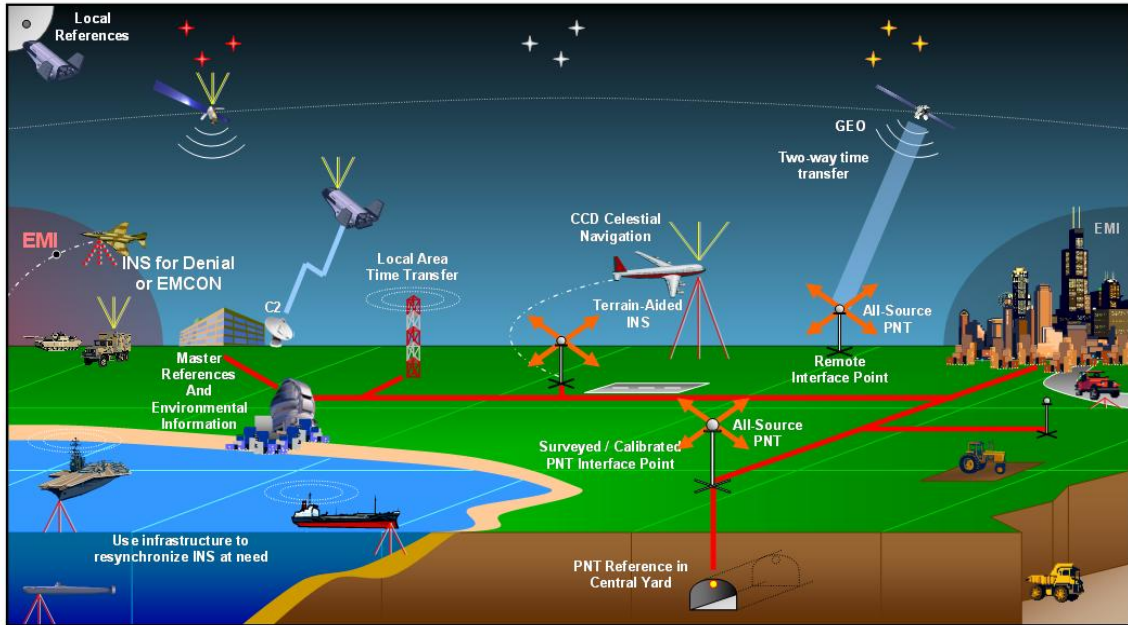

Figure 4-17 Representative Architecture 6, Autonomy

The team identified performance and programmatic risks with this approach, including whether customer communities would even accept this approach. Performance risks included long-term INS stability and drift, the availability of worldwide Level 5 DTED (Digital Terrain Elevation Data) through RADAR and high-precision celestial surveys, interference from multiple active emitters, and the burden on the user from hosting requisite autonomous capabilities and computation. Programmatic risks included the risks of developing and deploying sensors and computational user equipment, and the risk in developing new satellites needed to update GIS reference databases. Acceptance risks were identified because of the shift to the freedom (and burden) of being more responsible for meeting their own PNT needs.

4.2.1.1.7.2 Insights and Analytical Expectations

Historically, autonomous PNT products and services have been provided independently by measuring the elevation of the sun, stars, and moon above the horizon, and comparing the measurements to a limited GIS infrastructure: in antiquity, GIS consisted of maps, astronomical references, and verbal lore; in the 17th century, maps were supplemented with a standard time reference correlated with astronomical observations made at the Royal Greenwich Observatory (now the Royal Observatory, Greenwich). Through World War II, long-range aircraft had a crew member, the “navigator,” whose sole responsibility was to determine the aircraft’s location in flight by observing stars in daylight and correlating the observations with local time (on a wristwatch) and GIS data in tabular form.

Aircraft radionavigation aids developed over the course of the 20th century have led to a significant change in PNT infrastructure by shifting the PNT burden of PNT from individual users onto centrally-provided radionavigation products and services. The burden has shifted so significantly by the early 21st century that radionavigation has

widely supplanted traditional solar and stellar observations, and map- and-compass orienteering as a means of precision navigation while vastly improving PNT accuracy and precision.

RA6 explored the limits and implications of trying to force PNT customers to be as autonomous as possible – in essence, shifting the burden of providing PNT capabilities back to the customers. The expectation was that forcing customers to use autonomous capabilities would increase the burden of providing on users to the point where it has been since historical times, but with the proviso that the desirable attributes of radionavigation, such as increased accuracy and precision, would be retained. This approach would likely be unpopular among those who have become accustomed to bearing minimal costs for PNT while becoming ever more dependent on radionavigation capabilities, but popular with those who wish to extend those capabilities into areas where physics precludes or inhibits support from current-generation PNT products and services.

4.2.1.2 Evaluation

The ADT evaluated the RAs with regard to their ability to address the gaps and shortfalls identified in Section 3.6, and the degree to which they reflected the architectural features of Interoperability (to include Uniformity), Adaptability, Robustness, and Sustainability as defined in Section 4.1.3. The evaluation of the RAs was made on five-point ordinal scales, as shown in Figure 4-18.

The RAs were evaluated numerically, not to determine an absolute quantitative rating on the value of that representative architecture, but rather to provide insight and to identify key features and trends for use in hybrid development. The scores provided tip-offs as to places to look among the thousands of comments received in order to determine which features worked well and why, and which features had problems, and why. This insight aided the development of improved hybrid architectures better able to meet users’ needs.

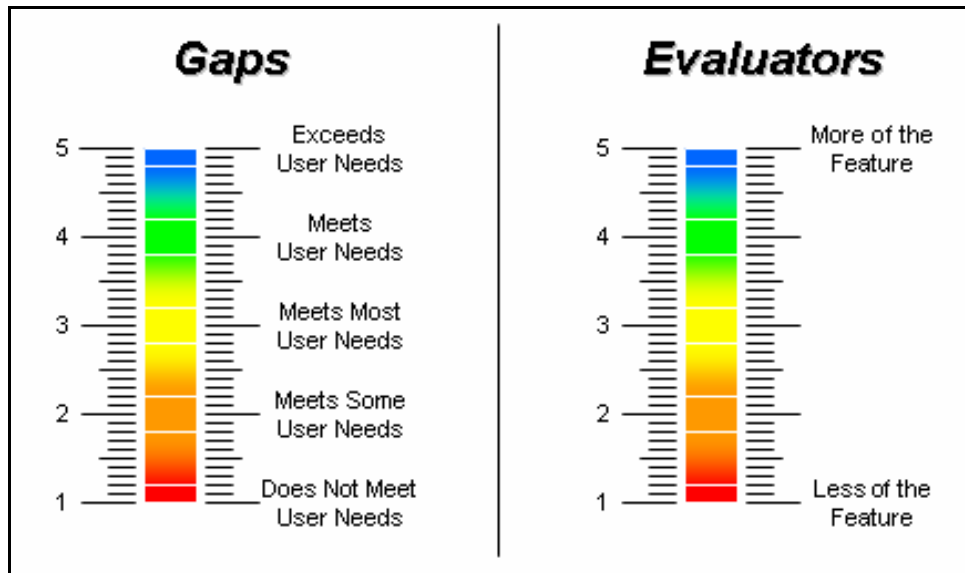

Figure 4-18 Scoring Scale and Coloring Scheme

4.2.1.2.1 RA0 – Evolved Baseline

Due to limited meeting time, the ADT did not score RA0 against the gaps, since by definition they were expected to fall short. RA0 scored moderately in most of the evaluators, but scored the highest of the RAs in robustness, due to the large number of potential solutions and combinations of multiple phenomenologies used or planned for use by users in applications where such robustness was most needed.

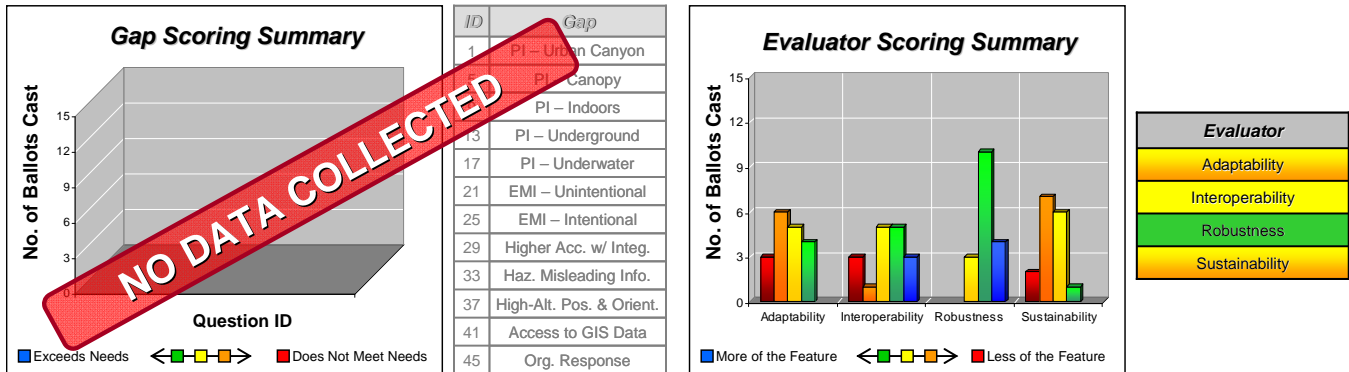

Figure 4-19 RA0 Scoring

4.2.1.2.2 RA1 – Dependent Terrestrial

The scores for RA 1 are shown below in Figure 4-20. The team felt a networked approach using diverse signals (cell, RF, etc.) will help address capability gaps due to physically and electromagnetically impeded environments. Similarly, low frequency and higher power signals may reduce these gaps as well, but won't completely eliminate them. This was especially true for the physically impeded environment under water. Also with respect to higher power, the potential downside of creating self-interference must be considered. Additionally, the low rating for high-altitude positioning and orientation results from removal of space-based sources and the likelihood that significantly more ground infrastructure would be needed to meet PNT needs for a user in space. Finally, using high-altitude platforms (HAPs), pseudolites, or other terrestrial sources was not viewed as sufficient for high-accuracy positioning needs (ITS, etc.), but would potentially meet the needs of high-accuracy timing users. HAPs and pseudolites in general were not seen as practical for a global PNT solution. However, they could serve as a gap-filler or transitional solution, especially for an impeded environment, yet deployability is cited as a key concern.

With respect to the evaluators, the team saw positive aspects in adaptability and robustness. A key feature noted under adaptability was that terrestrial-based systems permit more rapid updates or upgrades to address changes in needs or the environment. However, there may be a need for a greater number of systems for required coverage resulting in more individual systems that need to be updated or upgraded to provide the new capability. Hence, the ease of changing the underlying supporting infrastructure for terrestrial-based systems must be also considered. In the area of robustness, use of low frequency and higher power signals was viewed positively. However, some members expressed concern that a very robust commercial/civil system could impact military force protection measures, effectively making PNT hard to deny to an adversary. The team also

noted that robustness can't effectively be achieved through RF alone and this approach would need UE capable of leveraging the new signals.

The weaker evaluators for this RA were interoperability and sustainability. The team didn't think that implementing high-accuracy terrestrial-based systems globally was feasible and the resulting regional nature would complicate interoperability. Two other items noted as potentially complicating interoperability were that there may be difficulty justifying implementation in low user-density areas (cost utility) and that the implementation burden will shift to regions or countries, so resources might not be available to implement equally everywhere. In the area of sustainability, the unknowns with respect to HAP maintenance requirements caused significant skepticism that a high-altitude network was feasible. Also, many felt there would be a deployability burden for DoD to transport HAPs and supporting equipment to an area of operations.

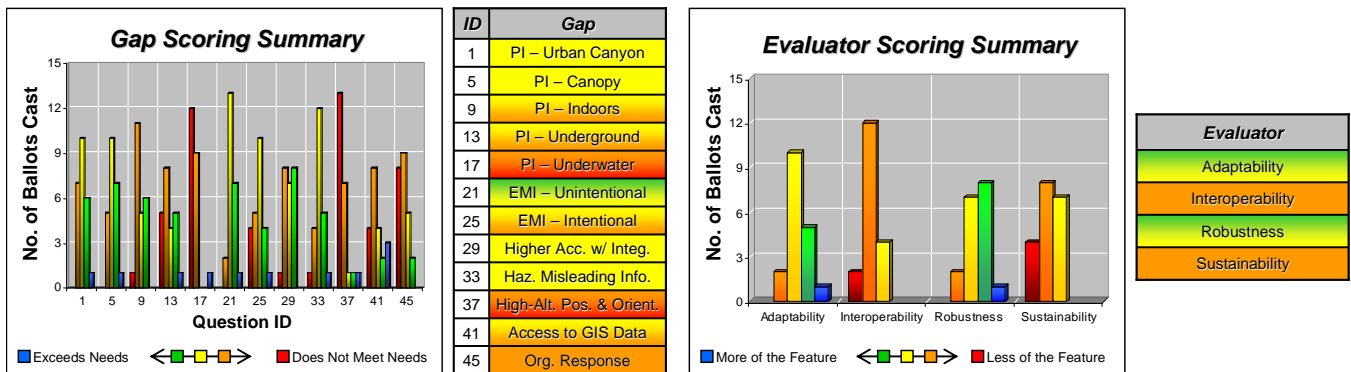

Figure 4-20 RA1 Scoring

4.2.1.2.3 RA2A – Heavy Space

RA2A-specific insights from the assessment by the team's experts included many points regarding the strengths and weaknesses of combined GNSS constellations. They help in urban canyons and under canopy, as do higher power and regional systems. GNSS with augmentations can provide higher accuracy and integrity. GNSS signals are not received underground or underwater, and work poorly indoors. A key weakness was the need for integration with inertial systems and clocks to allow coasting through outages. Use of non-DoD GNSS systems raised security concerns for military use.

The multiple signal sources, signal diversity, increased signal strength, LEO augmentation, and spot beam available in this architecture all helped with overcoming electromagnetically impeded environments, but some raise the noise floor, and all are still fairly low power. The team felt they needed a backup based on an alternate phenomenology. The team was concerned that the LEO augmentation solution was likely to be more expensive and a greater risk to meeting Intelligent Transportation System (ITS) needs than a real-time network or use of GPS E6 for trilateration with a wide area network solution.

In general, space systems can contribute to global interoperability, but tend not to be adaptable. Software reprogramming was identified as a key way to help adaptability of space-based solutions.

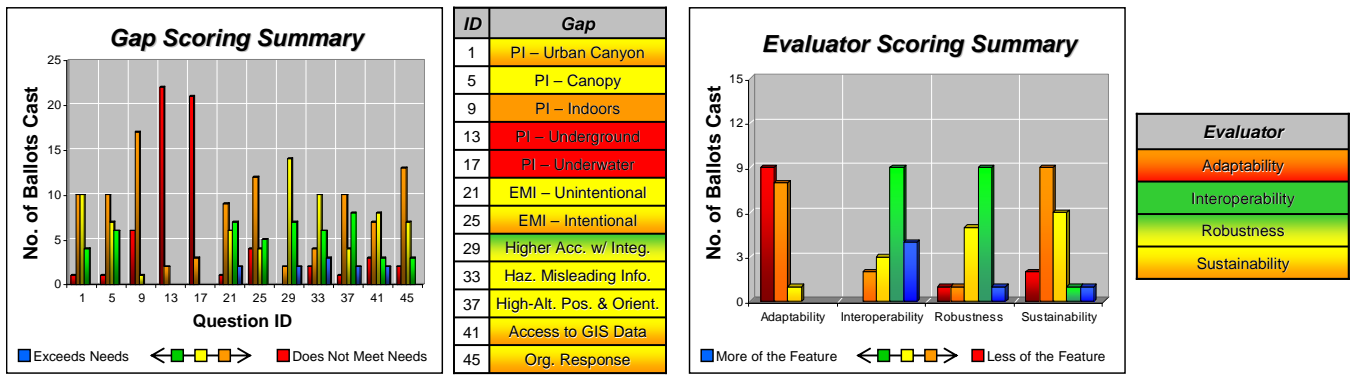

Figure 4-21 RA2A Scoring

4.2.1.2.4 RA4 – Network-Aided GPS

RA4A scored higher than any other RA in the organizational response in its overall acceptability to each organization (3.4 on a scale of 1-5 compared to 2.0 to 2.4 for the other RAs). However, analysis of the comments made during the scoring revealed that this score was primarily because the RA built on the entire planned Evolved Baseline as a foundation, rather than any universal superiority of networked solutions in general. The included networked solutions certainly contributed to covering the gaps, but the strength of this solution came from the combination of networks with the EBL (including GNSS and autonomous solutions), not from networks alone.

Network aiding of GNSS helps provide high accuracy with integrity and helps disseminate GIS data. It works in urban canyons, but not underground or underwater since there are no GNSS signals to aid. It is expected to work poorly indoors or under canopy. Cell network PNT will work as far indoors as cell phones (good match for E911), however accuracy is degraded and cell networks are not available everywhere. Any system which does work in a physically impeded environment is likely to suffer reduced accuracy due to multi-path effects. The team was concerned that proliferation of network transmissions could result in unintentional interference. They recommended consideration of network-enabled relative navigation (example: Link-16). eLORAN was identified as a potential aviation or timing backup, but would not meet high-precision positioning needs. Networked solutions were identified as aiding interoperability and adaptability, and the team felt that network-aided architectures could be robust.

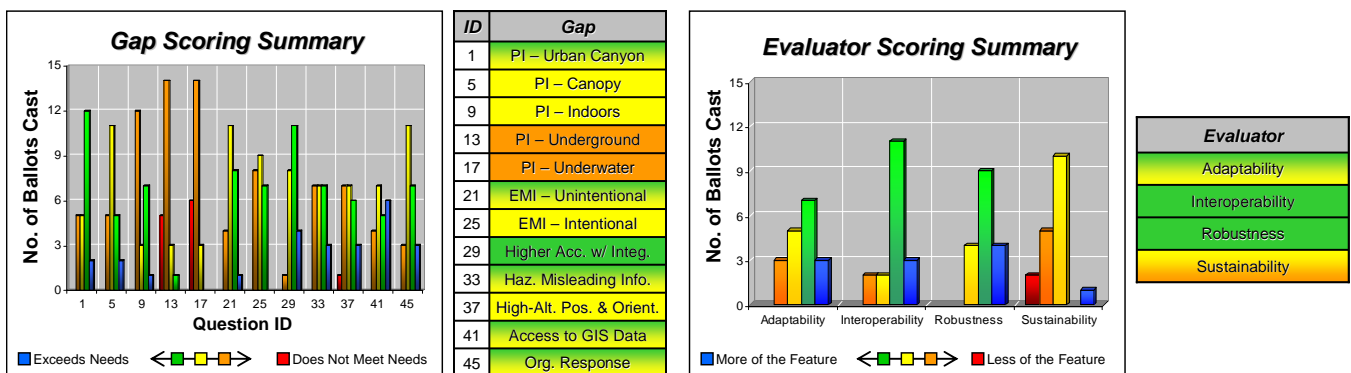

Figure 4-22 RA4 Scoring

4.2.1.2.5 RA5 – Sensor-Aided PNT

This architecture performed best by partially overcoming impeded operations gaps. The assessment clearly evidenced that the autonomous capabilities and local aiding sources supported this position. This architecture fell short in meeting the higher accuracy with integrity gap; however the autonomous features and aiding sources were seen as a principle benefit whereas the dependent technologies and their inability to effectively refresh the autonomous devices were viewed as the primary issue. The notification of hazardously misleading information was viewed negatively given the lack of supported methodologies or the need for numerical redundancies to assure integrity; a significant impact on user burden. Additionally, this architecture did little to resolve the need for high-altitude positioning and approached access to GIS data as primarily a communications issue. Lastly, and perhaps most interestingly, while the architecture was rated among the highest of all RAs, it was rated among the worst in organizational acceptance. This is largely attributed to the fundamental shift in PNT which would be required to plan, implement, and transition to such a significantly autonomous architecture.

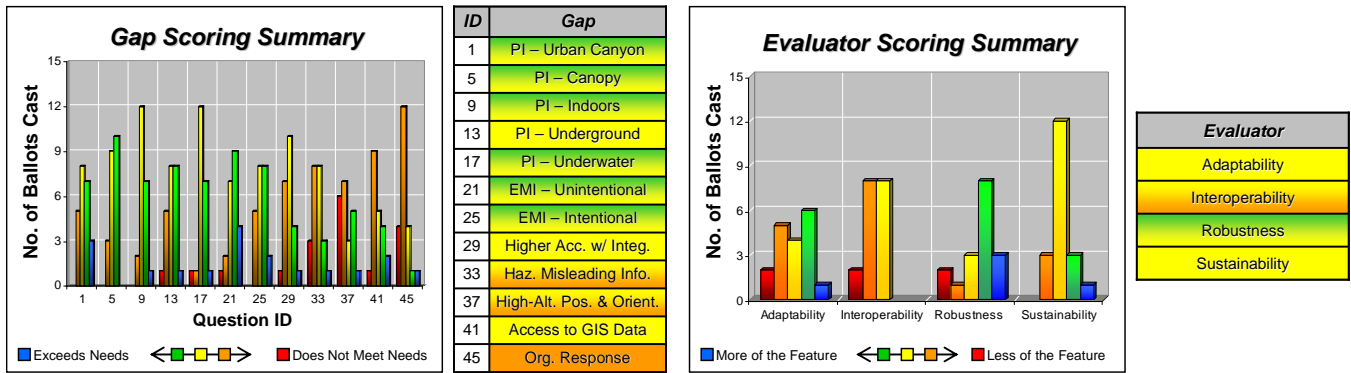

Figure 4-23 RA5 Scoring

4.2.1.2.6 RA6 – Autonomy

The assessment of RA 6 indicated the “autonomy” concept was limited by several factors, including:

1. There is no miracle sensor, though a small, cheap atomic clock could provide significant benefits. The team could not foresee one autonomous PNT sensor that would overcome all potential shortfalls, *e.g.*, an inertial navigation system that, once initialized, could provide sufficiently accurate and precise PNT measurements for periods of time that would be significant from the perspective of national security operations. Suites of PNT sensors and computation to integrate their results could provide a fairly complete picture, but these could impose substantial burdens on disadvantaged customers.
2. User burden is important. The user burden that would result when individuals were forced to provide weight, power, and storage for autonomous PNT sensors and the computation required to correlate different sensor inputs into an integrated and highly reliable PNT picture. For example, Marine Corps representatives pointed out infantrymen already carry 80 lbs. of equipment as a standard load, and

it would be difficult for them to carry new PNT sensor and computation suites and still carry out their missions.

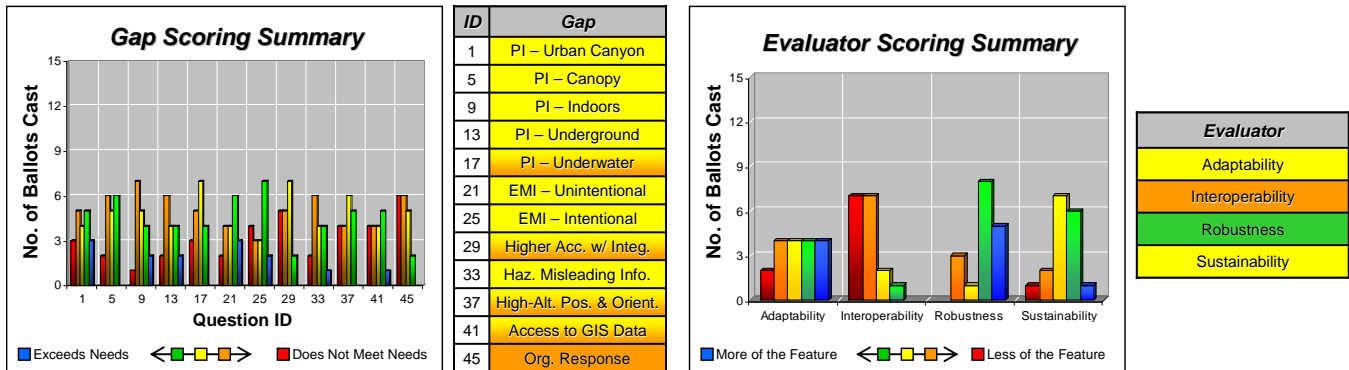

Figure 4-24 RA6 Scoring

4.2.2 Hybrid Architectures

Having investigated fundamental trades central to PNT, a set of hybrid architectures were subsequently developed to effectively and efficiently satisfy user needs and overcome capability gaps. Unlike RAs, hybrid architectures were not artificially restricted to specific regions of the trade space. Rather, each hybrid represented a rational and informed integration of concepts and technologies which spanned the trade space. Ultimately, the ADT developed three hybrid architectures. Once again, the EBL was maintained as a reference against which to compare the hybrid architectures.

4.2.2.1 Design

The ADT developed three hybrid architectures based on the observations and insights gained in the development and assessment of the RAs. The composition of each hybrid was drawn from a common set of architectural components, or “building blocks,” identified as a result of the RA assessment. The ADT identified architectural “cornerstones” that would be part of all the hybrids, and a number of “features” that could be included in each, within the restrictions of the overall theme of each hybrid. The EBL was used as a reference against which to compare the ADT-developed hybrid architectures.

The assessment of the RAs highlighted the value of solutions which integrated longer range, dependent systems such as GNSS with autonomous systems such as on board inertial and clock systems, as well as the utility of networks in helping to provide PNT. Therefore, all three hybrid architectures included a mix of dependent, autonomous and networked solutions.

The building blocks treated as “cornerstones” to be included in each hybrid were:

- Enablers
 - EBL enablers
 - GIS data
- A US Global Navigation Satellite System
- Ground-based PNT capabilities

- Autonomous capabilities
 - Inertial measurement units and navigation systems
 - Precision clocks
 - Celestial navigation
- Capabilities with unspecified implementations
 - Accuracy augmentation
 - Integrity augmentation
- Networks

The architectural features from which the designer(s) could choose included:

- New collection, organizational, and availability mechanisms for GIS data
- Greater redundancy for greater robustness
- General improvements in RF-based navigation aids
 - More broadcast power
 - Reduced age of data
 - Signal diversity
 - Communications links for navigation augmentation information
- Space-based or high-altitude elements
 - More navigation satellites
 - Use of higher radiofrequencies
 - Foreign/Commercial GNSS
 - High-altitude platforms
 - Moon/Mars Navigation Satellite System
- Ground-based PNT
 - Low/Extremely Low Frequency radionavigation services
- Network-focused elements
 - Military communications networks, including MILSATCOM
 - Civil communications networks, including relay satellites
 - Commercial/Private communications networks, including satellite communications (SATCOM), terrestrial fiber-optic networks, and cell phone networks
 - Networks to aid primary GNSS PNT sources
- Autonomous elements
 - Vastly improved Inertial Navigation Systems (INS)
 - Vastly improved clocks
 - Multilateration and “here” beacons
 - Multi-sensor integration
 - Multi-source multilateration
 - Signals of Opportunity

- Sensing of objects and topographic features
- Celestial navigation
- More frequent calibration

The ADT selected the broad theme of a “common denominator” for the national PNT architecture, and based all hybrids on variants of this theme. The ADT selected four hybrid architectures (including the EBL) to explore potential advantages and issues with different levels of commonality:

- The Evolved Baseline (“Hybrid 0”)
- Greatest Common Denominator (“Hybrid A”) which called for more commonly available capabilities with relatively low burden placed on PNT customers
- Network-Centric Greatest Common Denominator (“Hybrid B”) which called for commonly available capabilities and stressed use of networks for PNT
- Lowest Acceptable Common Denominator (“Hybrid C”) which called for less commonly available capabilities with relatively greater burden placed on PNT customers

4.2.2.1.1 Hybrid 0 – Evolved Baseline

4.2.2.1.1.1 Overview, Composition, and Direction

The Evolved Baseline documents the architecture the team thought will exist in 2025 if the US remains on its current vector, without a national PNT enterprise architecture. The EBL is described in Section 3.4 as well as Appendix G. The current *de facto* PNT architecture consists of an ad-hoc mix of external and autonomous PNT providers as well as PNT augmentations. These systems provide PNT to a wide array of space, air, land, and maritime users, both civil and military. PNT is supported by a large number of PNT enabling capabilities and infrastructure, and must be provided in an environment which includes spectrum, weather, fiscal and geo-political challenges. The current “As-Is” PNT Architecture is characterized by widespread use of GPS, and a large number of systems that augment GPS. Each augmentation has been optimized for a different user group(s). An abstract view of the categories of systems contained in the EBL is contained in Figure 4-25.

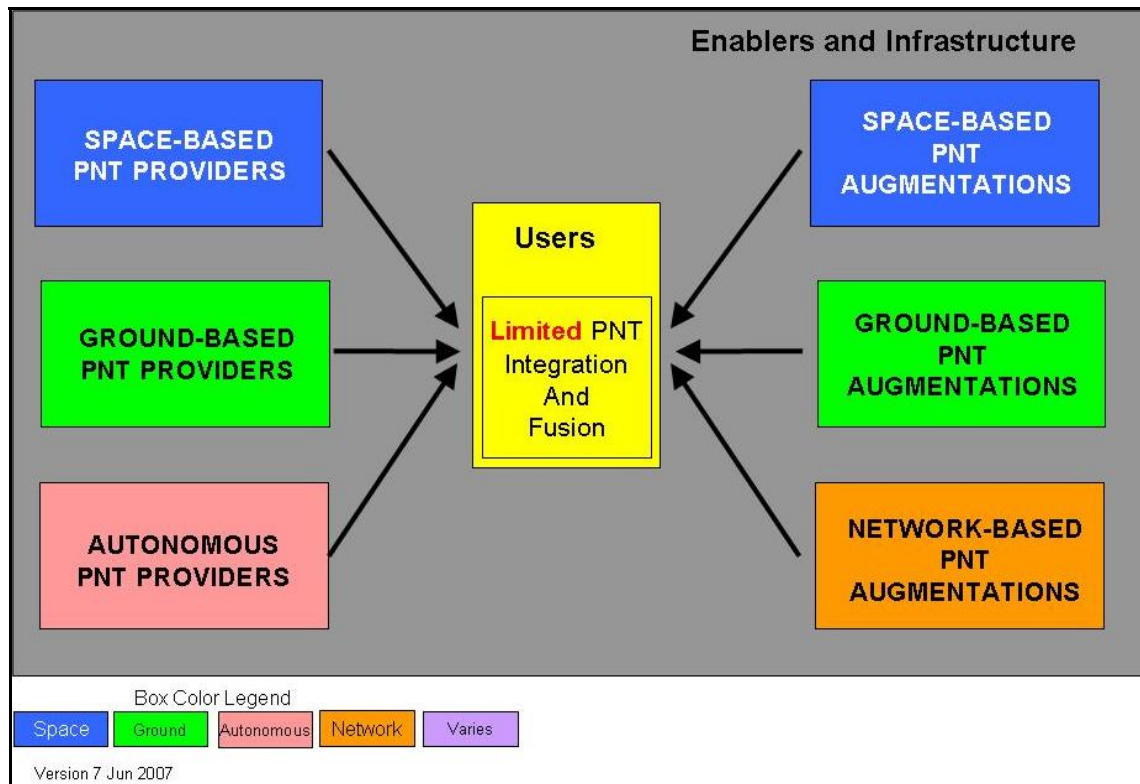

Figure 4-25 Hybrid 0, Evolved Baseline

4.2.2.1.1.2 Insights and Analytical Expectations

By definition, Hybrid 0 was expected to fail to adequately meet the primary PNT gaps, since the gaps were selected to describe the key areas where the EBL was expected to fail to meet expected needs. However, some features in the EBL contribute positively, if insufficiently individually, towards capabilities described by the gaps.

Modernized US GNSS, including L1C and L5 codes and an ability to use longer integration times with modernized codes, helps in impeded environments.

US GNSS coupled with inertial systems provides core PNT capability for many users, allowing them to coast through short outages. Simple multi-sensor integration (wheel counters, steering wheel rotation sensors) can further improve coasting through outages.

For military applications, GPS III spot beam, M-code, longer integration times, tight coupling, coasting on INS and nulling antennas all help overcome impedances.

Augmentation systems and receiver RAIM fault detection/isolation algorithms, especially when used in conjunction with combined GNSS receivers, provide some level of integrity.

Cell phone PNT provides a robust backup capability, although with degraded accuracy. ILS provides CAT II/III precision approach for selected users at selected airports. ILS, VOR/DME/TACAN/NDB provide independent backup for aviation users.

With respect to timing for network synchronization, US GNSS provides primary timing dissemination to a common standard. Atomic clocks (Cesium, Rubidium) provide robust

backups, but are only fielded selectively. Fiber optic land lines and two-way satellite time and frequency transfer provide highly accurate time where available.

For space users, specialized receivers able to receive GNSS side lobes are key to operations above LEO. Earth-based tracking networks determine orbits beyond the Earth-Moon L1 point. Lunar communication and navigation satellites provide navigation signals in lunar orbit and on the lunar surface. Star trackers and the star catalog provide high- accuracy orientation, although degraded accuracy compared to 2007. RADAR and LIDAR provide high-accuracy relative positioning for proximity operations. For space surface users (Moon, Mars), use of MEMS IMUs allows coasting between sparse data updates from lunar satellites, but may result in significantly degraded accuracy between lunar satellite passes. Multi-sensor integration of optical data is key for accurate surface autonomous operations.

The space-based providers in the EBL are critical to interoperability by tying disparate specialized and autonomous solutions to a common reference frame and time. The EBL's adaptability is limited by long fielding times of space-based systems (especially with 'launch for sustainment' strategy), and long timelines to integrate new user equipment throughout the user community. The diverse EBL architecture offers a rich field from which to choose solutions for new applications, but complicates adjustment of the entire architecture to a change – a “survival of the fittest” environment. With respect to robustness, many users are not planning to take advantage of the robust solutions made possible by integrating GNSS with autonomous solutions and ground-based PNT providers as backups. Finally, the proliferation of varied specialized solutions (augmentations, ground-based backups) makes sustainment complex and limits opportunities for cross-utilization.

4.2.2.1.2 Hybrid A – Greatest Common Denominator

4.2.2.1.2.1 Overview, Composition, and Direction

Hybrid A was chartered to provide common solutions for many users, integrate solutions horizontally across domains, and generally strive for the greatest common denominator by emphasizing dependent, long-range service broadcasts direct to users. To fulfill this vision, the architecture stressed highly common dependent as well as autonomous solutions, a small set of specialized capabilities, a broad spectrum of user equipment in accordance with user means, and the judicious use of foreign systems.

Hybrid Architecture A principally focused on providing of highly-common dependent solutions. As a result, long-range dependent solutions and global services were emphasized. While uniform global services were preferred capabilities, compatible and/or interoperable regional services were incorporated as well. Highly-common autonomous solutions were an architectural cornerstone; more specifically, autonomous solutions which could be produced and utilized on a massive scale to meet the “common” criteria set for Hybrid A.

While striving for a high degree of commonality, the development team acknowledged that some needs are special, and that they will require specialized solutions. At the same time, the architecture was chartered to minimize the number of special “silver bullet” solutions, and thus minimized their usage.

Another foundation of the architecture focused on the user being afforded the opportunity to equip such that some or all available sources are utilized. As a result, a broad spectrum of user equipment would be available for manufacture and consumption.

Lastly, the architecture explored the significant use of foreign systems in private, commercial, civil, and military applications. In doing so, the architecture prudently required monitoring, characterization, and notification of degraded or misleading information as well as commensurate user equipment action and user notification of foreign systems in use. In the absence of sufficient autonomous user equipment integrity monitoring, characterization and notification capabilities, or the inability to communicate with an external monitoring, characterizing, and notifying source, the user equipment could or would revert to a US-only operating mode in some or all situations.

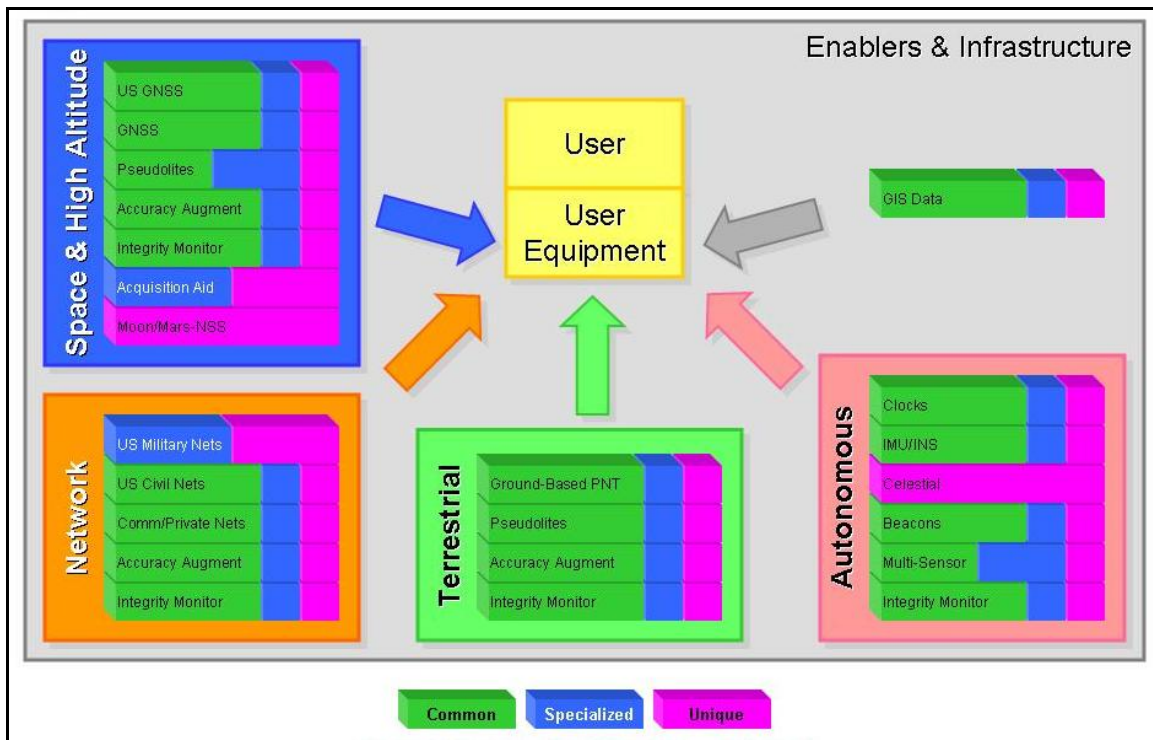

Figure 4-26 Hybrid A, Greatest Common Denominator

4.2.2.1.2.2 Assumptions

Several technological, enabling, and policy assumptions were made supporting these architectural tenets:

Technology

- Space Systems
 - The US and EU are major GNSS providers with long-term commitments to and investment in the mission
 - Russia and China are contemplated to be major GNSS providers while Japan and India are major Regional (RNSS) providers
 - The US GNSS has established modernized signals, constellation cross-links, and inherent integrity on a global scale

- Terrestrial Systems
 - The US has committed to developing, operating, and maintaining a terrestrial RF system supporting CONUS, Alaska, and Hawaii through 2025
 - Europe, Asia, the Pacific Rim, and the Middle East maintain compatible terrestrial RF systems
- Autonomous Systems
 - Mass markets have made CSACs and MEMS IMUs widely available and cost-reasonable (*e.g.*, markets of billions per year)
 - Mass markets have made “you-are-here” beacon technology widely available and cost-reasonable
- User Equipment
 - Multi-source fusion and/or integration algorithms, RAIM, and fault detection and exclusion routines are standard features
- Networks
 - High-bandwidth connectivity is common for all users, fixed and mobile, high-end through low-end

Infrastructure and Enablers

- Internationally acknowledged/accepted reference frames, surfaces, models, datums, and grids are capable of supporting the level of accuracy technologically possible within this architecture (*e.g.*, solar, geodetic, geoid, gravity, etc)
- The PTTI infrastructure keeps technological and operational pace with an exponential demand for communications bandwidth
- A refreshed star catalog exists
- Just enough standards exist to foster compatibility within the “you-are-here” beacon market
- High Resolution Terrain Information (HRTI) for both natural and manmade surfaces (*e.g.*, mountains as well as buildings)
- GIS data exists with incredible detail (*e.g.*, structural floor plans and descriptive detail)

Policy

- Foreign providers of navigation satellite systems, major terrestrial RF services, and their augmentations are at least compatible with US offerings
- US policy and its practical application accounts for military use of foreign systems.

4.2.2.1.2.3 Insights and Analytical Expectations

Hybrid A was expected to rate well with respect to the evaluators, interoperability, adaptability, robustness, and sustainability. Interoperability was a fundamental necessity of the architecture, and thus the focus of significant political, economic, and military

effort. Increased emphasis on a more centralized body chartered to provide and actively champion a vision for PNT would be required. This body would continuously track enterprise-wide needs and implementation while enforcing or modifying the vision in accordance with future needs and potential solutions. With respect to adaptability, a significant emphasis was placed on user equipment integration and/or fusion of myriad inputs (i.e. much more so than the EBL). Such integration and fusion would be facilitated by functionally-flexible receivers (*e.g.*, software defined). On a massive scale this approach allows modification of existing systems as well as introduction of new systems. Robustness was delivered through an “Availability-in-Depth” strategy, to ensure service by integrating widely applicable features spanning the solution-space (i.e. dependent to autonomous providers and augmenters), phenomenologies, and transmission mediums. Lastly, the architecture would achieve sustainability through a high degree of ubiquitous and interrelated solutions, enabling and requiring a more complex yet focused management paradigm than the EBL. Major system enhancements or decommissionings would hold greater consequences, but would be somewhat mitigated by the “Availability-in-Depth” strategy.

Hybrid A has included cost drivers in the areas of S&T and R&D, acquisition and procurement, integration, O&M, and disposal. Developing a cost-efficient production method for massive adoption of CSAC and MEMS IMU technologies would require investments in S&T and R&D phases, but is seen as a significant benefit. Developing a cost-efficient production method for massive adoption of beacons would potentially reduce the PNT-related costs via integration with other features (*e.g.*, communications functionality). Acquisition and procurement costs are impacted by acquiring and sustaining an established global LEO constellation for the purposes of aiding GNSS acquisition (nominally 77 satellites with 10-year life expectancies via a quintuple-manifest launch strategy). Additionally, significant investment would be required to sustain a 33-satellite US GNSS constellation to increase availability for high-visibility-needs users. Utilization of one or more foreign GNSS offers the potential for significant benefits relative to US costs also. Lastly, O&M and decommissioning costs benefit from fewer specialized and unique solutions. This is achieved through greater reliance upon ubiquitous dependent services (*e.g.*, GNSS) and mass-produced autonomous elements (*e.g.*, CSACs and MEMS IMUs) such that there are fewer if more consequential systems to operate and maintain.

National strategy expectations are illustrated along political, military, and economic lines. International leadership would be attained through an integrated enterprise as the US may cede preeminence if beneficial features of foreign systems and services are not integrated in US solutions. Preeminence is a function of at least two factors: developing, fielding and maintaining systems and services which offer a distinct advantage, and integrating and employing systems and services in an advantageous manner. Military use of foreign systems is allowed while ensuring that the US is neither reliant nor dependent on such services; however, military operations would not always be independent either. US commitment to reasonable, prudent, and conditional military use of foreign systems could significantly benefit military PNT solutions. Conditional use would require monitoring, characterization, and notification of degraded or misleading information with commensurate user equipment action and user notification. In the absence of sufficient autonomous user equipment integrity monitoring, characterization and notification

capabilities, or the inability to communicate with an external monitoring, characterizing, and notifying source, the user equipment could or would revert to a US-only operating mode in some or all situations. Additionally, economic benefits from significant new markets could result from this architecture given potential applications like Location-Based Services (LBS), resulting from low-burden timekeeping and inertial technologies.

4.2.2.1.3 Hybrid B – Network-Centric Greatest Common Denominator

4.2.2.1.3.1 Overview, Composition, and Direction

Hybrid B was a variation on the Greater Common Denominator approach that leveraged communications networks of all types to improve PNT capabilities by allowing greater cooperation and coordination between PNT architecture elements. The ADT considered using this network-centric approach within the context of Hybrid C, but felt the necessary “net-centricity” infrastructure would be more consistent with a “greatest” common denominator approach of Hybrid A. Hybrid B was initially envisioned as a “cell phone network-centric” approach, where cell phone networks would augment EBL capabilities, but it evolved into a design where robust RF and optical communications capabilities were mobilized to provide direct PNT measurement and to support PNT-related customer activities. Since RF spectrum is an extremely valuable and scarce commodity, Hybrid B emphasized dual-use of current communications frequencies to perform PNT-related functions and carry PNT-related information.

4.2.2.1.3.2 Assumptions

Hybrid B made the following assumptions regarding communications capabilities in the 2025 timeframe:

- Digital communications will be ubiquitous, to include personal RF communications devices, such as cell phones and Personal Digital Assistants; commercial television and radio systems; fiber-optic internet and landline communication in the home; and satellite RF communications service
- Military communications will still follow the current “narrowband, wideband, protected” paradigm, and will emphasize increasing data rates, but will still not be able to meet demand; however, tactical communications networks will be developed that can overcome impeded environments
- Commercial satellite communications will continue to make up shortfalls in meeting demands for military communications, with services available in retail markets for personal, private use
- Reporting, privacy, and constitutional issues raised by combining PNT and two-way communications will be resolved, and “Blue Force Tracking” capabilities will extend to homeland security applications, first responders, etc.

The Hybrid B approach embodied five general assumptions in addition to the specific assumptions regarding communications capabilities:

1. It assumed an ability to leverage existing, planned, and future fiber-optic and RF communications networks to provide primary PNT determination, such as

ranging, multilateration, and time synchronization, as well as enabling the exchange of information to augment primary PNT capabilities.

2. It assumed the overall operating philosophy of a “thin-client” network, where the network bears the burden of ensuring robustness and incentivizing user behavior on the assumption that most users have some communications connectivity at all times, but some users will need to be independent of the network from time to time. This approach allows better service to PNT customers by improving the monitoring and exclusivity features, while at the same time taking advantage of inherent, minimally burdensome customer capabilities in computation, local data integration, and data fusion.
3. In meeting specific needs in a dynamic situation, the Hybrid B approach would leverage several “good enough” solutions rather than devise a single “heroic” solution, and choose them in the following preference order:
 - a. Leverage a PNT data source and communications paths that already exist
 - b. Leverage an existing PNT source and develop a new communications path
 - c. Develop a new PNT source but leverage an existing communications path
 - d. Develop a new PNT source and a new communications path
4. Safety-of-life applications would require at least government regulation if not ownership of the assets involved in public transportation and airspace control.
5. In general, the Hybrid B approach would leverage several “good enough” applications rather than try to devise a single, “heroic” solution.

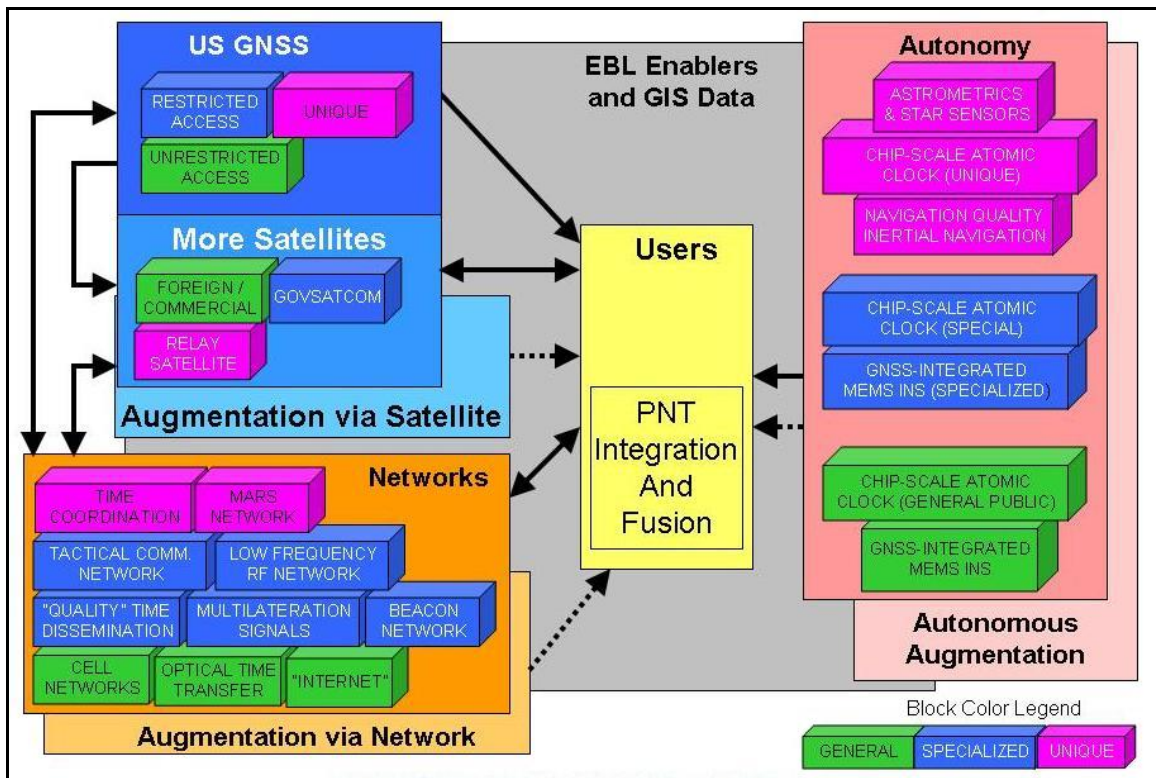

Figure 4-27 Hybrid B, Network-Centric Greatest Common Denominator

4.2.2.1.3.3 Insights and Analytical Expectations

In general, any user with ready access to communications capabilities was expected to do well, given the assumed ability to leverage any and all communications capabilities to provide at least augmentation of other primary PNT sources if not primary PNT determination.

This approach was expected to allow significant improvements in PNT coverage in built-up areas including major cities and areas where low-frequency communications services (with better ability to penetrate structural materials) would be readily available or which could be developed and deployed by implementing changes to local building codes as part of a campaign to improve public safety and improve PNT capabilities for First Responders. This approach would also work well over broad rural or remote areas of the United States where low-frequency commercial radio signals (*e.g.*, commercial AM, FM, and satellite) would be both available and ubiquitous in the 2025 timeframe. It would also allow improvements in areas where the US military had provided communications capability either through military or commercial SATCOM or by developing tactical RF communications networks.

The users expected to do least-well under this approach were those who could not communicate due to lack of supporting communications infrastructure, or who would not due to performance considerations. In those, fully autonomous capabilities would be needed that could bridge the times when communications capabilities, and not just PNT capabilities, were either unavailable or otherwise could not be used.

The least expensive applications would be those that could leverage existing PNT and communications capabilities; the most expensive would be those (such as expeditions to the Moon and Mars) that would have to develop and deploy their entire communications and PNT infrastructure with no ability to leverage existing infrastructure.

4.2.2.1.4 Hybrid C – Lowest Acceptable Common Denominator

4.2.2.1.4.1 Overview, Composition, and Direction

Hybrid C emphasizes specialized solutions and vertical integration especially through greater use of integrated autonomous solutions tailored for each user group. The assessment of the representative architectures had shown that a purely autonomous architecture would be unable to meet all user needs, have challenges providing globally interoperable solutions, and have difficulties re-initializing such autonomous solutions after drift. The group, therefore, felt that some basic core of capability from space-based, terrestrial, and networked dependent systems would be required for Hybrid C to meet user needs at an acceptable level. The team then changed the title of the Hybrid C architecture from ‘lowest common denominator’ to ‘lowest acceptable common denominator’ to reflect this approach. The architecture relies on the integration of US GNSS with autonomous inertial navigation and clock systems for this core “lowest acceptable common denominator” capability. Widespread network connectivity provides PNT aiding information to improve this core capability. It is further improved by connection to a network of specialized augmentation systems tailored to each user

community, but leveraging capabilities developed for other user communities where appropriate. Demanding specialized and unique needs are met with further augmentation by multi-sensor integrated solutions, use of high-accuracy star trackers, and/or a variety of beacon systems. Further specialized needs and robustness are provided by a number of ground-based PNT providers. All of these systems are supported by enabling features based on modifications to Evolved Baseline capabilities.

4.2.2.1.4.2 Description and Rationale of Key Features

A US GNSS such as GPS provides a common core capability to most users, including moderately high accuracy and availability in unimpeded environments, periodic re-initialization for autonomous systems, and a common position and timing reference frame that enables interoperability. Planned modernization of GPS capabilities key to this hybrid include widespread use of the new L2C, L5, and L1C signals when available to improve accuracy and robustness, as well as use by the military of the new M-code to aid security and operations in impeded environments.

Widespread integration of INS and clock capabilities provides coasting through outages in impeded environments. Solutions may be tailored to specific groups of users, though continuous technological development will shift individual technologies from specialized toward widespread common application over time.

Multiple specialized augmentation systems tailored to each user community provide aiding information such as differential corrections, updated clock and ephemeris corrections, integrity messages, updated model parameters, and geospatial information to improve performance and situational awareness. This information is provided either through direct broadcasts and/or through a network. The network also provides user time synchronization. The augmentation systems are networked together, so that each user community can leverage capabilities of the other augmentations where appropriate.

Multi-sensor integration of sensors such as LIDAR, RADAR, SONAR, and imaging provides relative positioning for the most demanding positioning applications, such as the high accuracy with integrity requirements for some ITS needs.

In challenging environments, or for unique applications, positioning is widely augmented through the use of various beacons, pseudolites, and/or Radio Frequency Identification (RFID) tags. This would include urban canyons, indoor areas, and underground areas such as tunnels and mines.

The goal is to emphasize specialized and unique solutions that best meet each user's needs, such as the use of improved star trackers and an updated star catalog to support high altitude/space orientation users, and the use of specialized ground-based PNT providers for aviation, maritime, land, and space users.

An abstract view of the categories of systems contained in Hybrid C is contained in Figure 4-28.

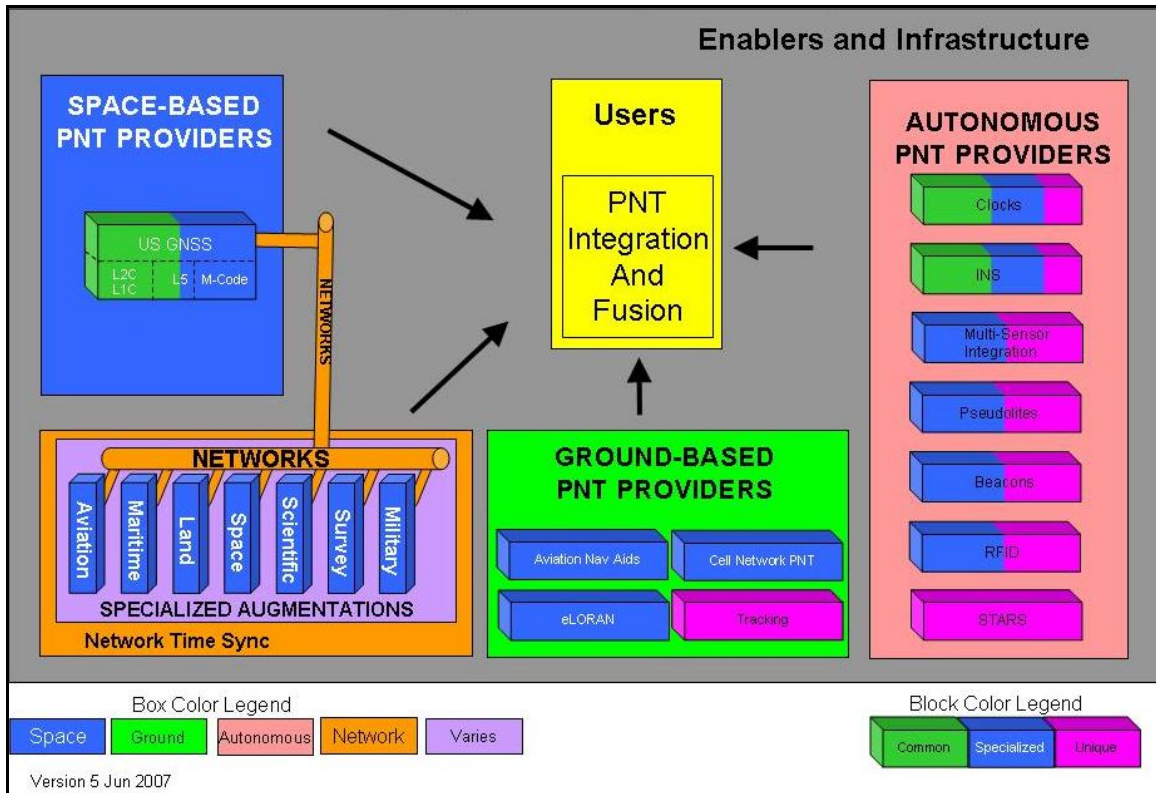

Figure 4-28 Hybrid C, Lowest Acceptable Common Denominator

4.2.2.1.4.3 Insights and Analytical Expectations

Discussions during the development of Hybrid C provided expectations going into the hybrid assessment phase of how some of the features included in the hybrid would contribute to the architecture's overall performance. Use of US GNSS coupled with INSs/clocks provides a core PNT capability for most users. The strength of Hybrid C was expected to come from the integration of specialized solutions to a common core of GNSS and autonomous capabilities in order to individually address user needs.

With respect to covering key gaps, modernization to civil L1C and L5 codes, somewhat longer integration times for some users, and ultra-tight integration between GNSS and INS/clock all help in impeded environments. Cell and WiFi networks also provide robust backup PNT with degraded accuracy in impeded environments.

For many military users, GPS III spot beam, M-code, somewhat longer integration times, tight coupling, and coasting on clock/INS as well as controlled reception pattern antenna (CRPA) antenna and multi-sensor integration all help overcome impedances.

For the toughest urban locations, Hybrid C uses beacons and pseudolites to improve availability. Dedicated short-range communication beacons provide communications to/from infrastructure and land vehicles, supplemented by cell service. An RFID in cell phones could provide nearby precise relative location for E911 applications.

For users needing the highest relative accuracy, it is provided by multi-sensor integration. For intelligent transportation users, RADAR provides collision avoidance warnings and

magnetic sensors are used to sense lane departures. Aviation uses multi-sensor integration (RADAR or Optical) for collision avoidance on the ramp.

In-vehicle RAIM algorithms are used to compare data from multiple sources for fault detection/isolation, improving integrity. INSS/clocks provide additional signals for short periods where fewer than six SVs are in view. Specialized augmentations provide further integrity through monitoring and warning, though this provided unnecessary duplication with fault detection algorithms. ILS provides CAT II/III precision approach for selected users at selected airports, and ILS, VOR/DME/TACAN/NDB provide independent backup for aviation users.

In order to address increased needs for geospatial data, Hybrid C leverages existing cell, WiFi, and other communications links to provide this geospatial data to the user.

With respect to timing, US GNSS provides primary timing dissemination to a common standard. Atomic clocks (Cesium, Rubidium) provide robust backup for the networks of which they are a part. Fiber optic land lines and two-way satellite time and frequency transfer provide highly accurate time where available. A ground-based PNT solution such as eLORAN provides an additional backup choice with low user cost.

For space users, specialized receivers able to receive GNSS side lobes are key to operations above low earth orbit. Earth-based tracking networks determine orbits beyond the Earth-Moon L1 point. Lunar communications and navigation satellites provide navigation signals in lunar orbit and on the lunar surface. Improved star trackers and an updated star catalog provide high-accuracy orientation. RADAR and LIDAR provide high-accuracy relative positioning for proximity operations. For space surface users (Moon, Mars), MEMS IMUs/clocks allow coasting between sparse data updates from lunar satellites and pseudolites. Multi-sensor integration of optical data is key for accurate surface autonomous operations.

In Hybrid C, the GNSS is critical to interoperability by tying disparate specialized and autonomous solutions to a common reference frame and time. The development and advocacy of standards for augmentations (within each community), cell networks, ground-based PNT providers, pseudolites and beacons are also critical in order to encourage global interoperability. Like the EBL, the Hybrid C architecture of specialized systems offers a rich field from which to choose solutions for new applications, but complicates adjustment of the entire architecture to a change – a “survival of the fittest” environment. GNSS crosslinks and reprogrammability (in satellites and user equipment) help implement changes more quickly. US GNSS, integrated with autonomous solutions, and backed up by ground-based PNT providers as appropriate, can provide robust solutions. GPS Modernization (M-code, spot beam, crosslinks) and development of low-cost CSACs, MEMS INS, and sensor-aided inertial technologies are key enablers of robustness. The proliferation of varied specialized solutions (*e.g.*, augmentations, ground-based backups, pseudolites, beacons) in the hybrid makes sustainment complex. However, sensor-aided inertial systems ease sustainability (compared to terrain matching sensors) since they don’t require a database of their surroundings for comparison.

4.2.2.2 Assessment

The assessment of the hybrid architectures was based on the framework outlined in Figure 4-4, but the team assessed the hybrid architectures in the context of scenarios and use cases to better focus participants on specific instances. The scenarios and their subordinate use cases included:

- Future Urban Setting
 - Wireless Communications / E911 Rescue
 - Surface Transportation – Intelligent Transportation System
 - Aviation – Next Generation Super Density Operations
- Major Combat Operations
 - Military Precision Engagement in Jamming Environment
 - Dismounted Military Application in an Urban Environment
- Global War on Terror
 - Clandestine Operations Involving Special Operations Forces
 - Timing and Frequency for Global, High-Capacity Network Operations
- Space
 - Mars Mission

The different elements of the hybrid architecture assessment combined to evaluate the performance, national strategy, cost, and risk associated with each hybrid approach, as shown in Figure 4-29, where the size of the check marks displayed indicates the level of emphasis for each of the framework areas. For example, the use cases provided the basis for assessing the ability to meet gaps and needs, while the design constraints and assumptions of the hybrid architectures themselves provided the basis for assessing implications to national strategy.

	Performance			National Strategy			Cost			Risk		
	Gaps	Needs	Evals	Policy	Military	Eco	S&T	R&D	O&M	Perf.	Strat.	Cost
Use Cases												
				[Only Cost Drivers]								
Scenarios												
Hybrid												

Figure 4-29 Hybrid Architecture Assessment Emphasis

The ADT reviewed each hybrid architecture with regard to how the hybrids addressed each use case or scenario. Each hybrid used an Integrating, Fusing User Equipment (IFUE) construct to represent user equipment needed to receive, integrate, and fuse different sources and types of PNT information. For example, Figure 4-30 illustrates an IFUE diagram for Military Precision Engagement in a Jamming Environment (MPEJE), specifically, an unmanned combat air vehicle delivering a PGM. A detailed explanation of the numbered elements in Figure 4-30 is shown in Table 3-1, with an explanation of the underlying architecture strategy in Table 4-4. Note the lightning bolts in Figure 4-30 represent interference.

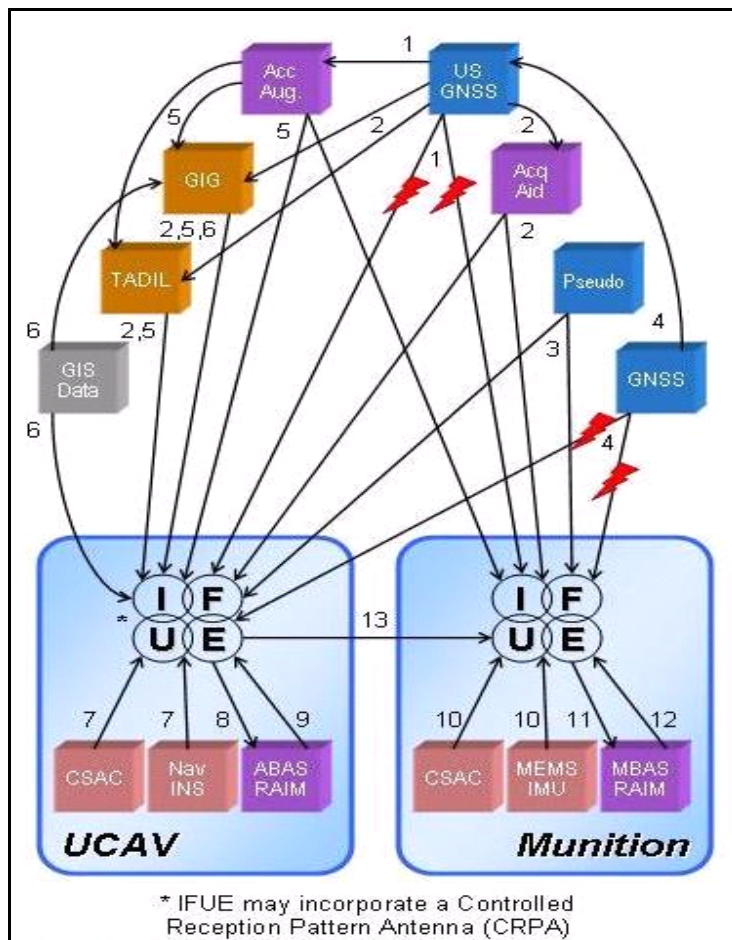

Figure 4-30 Example IFUE Diagram

<ol style="list-style-type: none"> 1. In some situations, IFUE & Accuracy Augmentations continuously receives US GNSS signals (e.g. before intentional jamming forces receiver to lose lock) <ul style="list-style-type: none"> - Typically 8+ sources in view, less so in challenging terrain (e.g. mountains) - Greater power, reduced code rates, codeless channels, as well as clock & inertial coupling enable lower RSS tracking - US GNSS monitors non-US GNSS integrity & distributes notification of DMI 2. In some situations, IFUE receives signals and US GNSS aiding data <ul style="list-style-type: none"> - Dedicated LEO constellation offers 1 or 2 sources in view - MILSATCOM offers 1 or 2 sources in view - Network distribution methods (e.g. GIG) - Provide US GNSS and GNSS clock & ephemeris information to aid in reacquisition - Ranging signal for use as an additional source in solution 3. IFUE regularly receives theater deployed US airborne GNSS-like Pseudolite signals <ul style="list-style-type: none"> - Typically 4+ sources in view, more so when used in conjunction w/ US GNSS and monitored non-US GNSS - Airborne pseudolites deployed in advance of forces - Pulse modulation 4. In some situations, IFUE continuously receives non-US GNSS signals (e.g. before intentional jamming forces receiver to lose lock) <ul style="list-style-type: none"> - Typically 16+ sources in view, less so in challenging terrain (e.g. mountains) - Greater power, reduced code rates, codeless channels, as well as clock & inertial coupling enable lower RSS tracking 5. IFUE periodically receive Accuracy Augmentation data via direct or indirect communications channels <ul style="list-style-type: none"> - Distributed via various mediums (e.g. direct RF, GIG, TADIL) 6. IFUE continuously assesses and discriminately integrates GIS data <ul style="list-style-type: none"> - Information available within IFUE via non-real time feed (e.g. periodic media-load) or real-time network pull/push (e.g. GIG) 7. IFUE continuously integrates on CSAC & Navigation-grade INS 8. IFUE continuously provides US GNSS signals, GNSS signals, periodic augmentation & integrity data, as well as aircraft-based CSAC & INS information to the RAIM engine 9. IFUE continuously receives aircraft-based RAIM-computed protection levels 10. IFUE continuously integrates on CSAC & MEMS IMU 11. IFUE continuously provides US GNSS signals, GNSS signals, periodic augmentation & integrity data, as well as aircraft-based CSAC & INS information to the RAIM engine 12. IFUE continuously receives aircraft-based RAIM-computed protection levels 13. UAV relays PNT information to the munition <ul style="list-style-type: none"> - Relevant PNT source information (e.g. US GNSS ephemeris, Pseudolite position, GNSS ephemeris & integrity information)

Table 4-3 Guide to Hybrid A IFUE Diagram (Figure 4-30)

Most Relevant Features for Addressing Gaps	Observations
<ul style="list-style-type: none"> ■ ■ – US GNSS & Accuracy Augmentations <ul style="list-style-type: none"> • Multiple & improved signal structures, reduced data rates and/or pilot channels, & inherent integrity • More power • Monitors US & non-US GNSS clock, ephemeris, & signal integrity & disseminates information ■ ■ – Non-US GNSS & Accuracy Augmentations <ul style="list-style-type: none"> • Additional visibility, therefore greater availability • Multiple & improved signal structures, reduced data rates and/or pilot channels ■ ■ – Pseudolites <ul style="list-style-type: none"> • Additional visibility, therefore greater availability • Higher power signals ■ ■ – Networks <ul style="list-style-type: none"> • Aiding, augmentation, integrity & GIS data channel ■ ■ – CSACs, Nav-Grade INS, MEMS IMU, CRPA & RAIM <ul style="list-style-type: none"> • Coasting through signal outages • Performance enhancer via coupling (e.g. reduced acquisition time, interference margin, anti-spoof via detection and exclusion) • Identification of DMI • Controlled reception patter antenna 	<ul style="list-style-type: none"> - A stressing need is to examine the reasonable and prudent use of foreign systems in US military solutions <ul style="list-style-type: none"> • Should the US commit to conditional military use of foreign systems • Conditional use would require monitoring, characterization and notification of degraded or misleading information with commensurate user equipment action and user notification • In the absence of sufficient autonomous user equipment integrity monitoring, characterization and notification capabilities and/or the inability to communicate with an external monitoring, characterizing, and notifying source, the user equipment could/should revert to a US-only operating mode in some/all situations • Which situations constitute acceptable and unacceptable risk given a design which satisfies the prior "conditions", for example: <ul style="list-style-type: none"> - A UCAV with remote human pilot - An autonomous UCAV with some PNT-aware logic - A munition, which once released, cannot be recalled
<ul style="list-style-type: none"> ■ EM Impeded / Intentional ■ Notification of DMI ■ High Accuracy w/ Integrity 	

Table 4-4 Example IFUE Explanation of MPEJE Use Case (Figure 4-30)

In order to organize the review the assessment of each hybrid, job aid charts were developed to help highlight where the subject matter experts felt a hybrid was either a positive or negative contribution to meeting a gap in a use case, or where there was disagreement. Gray areas indicate use-case/gap combinations that were not assessed. The job aid for each hybrid is shown in the subsequent respective hybrid evaluation write-ups.

4.2.2.2.1 Hybrid 0 – Evolved Baseline

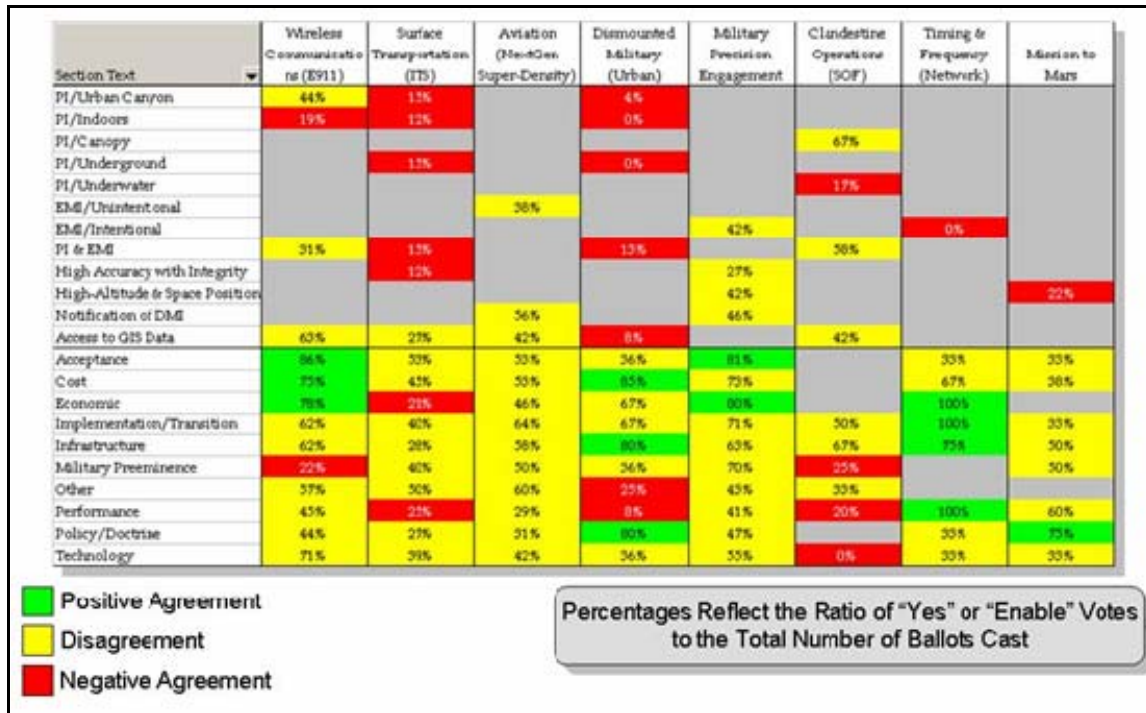

Figure 4-31 Hybrid 0 Assessment Job Aid

With respect to the capability gaps, the assessment of Hybrid 0 resulted in many insights and findings which informed the development of the “Should Be” Architecture. These findings included the importance and limitations of space-based PNT systems in meeting the capability gaps. For example, higher power M-code, INS integration, and advanced anti-jam antennas were all seen as important steps to addressing PNT availability in the face of electromagnetic interference. Similarly, increased power from a spot beam on US GNSS helps but is not enough to overcome physically impeded environments. The use of a 60+ SV combined GNSS constellation and eLORAN was able to meet some accuracy needs, but was insufficient to provide needed continuity for intelligent transportation needs without the addition of beacons. The special operations use case highlighted how many tough technical problems can be overcome with some basic changes to concepts of operations. Finally, the assessment of the Evolved Baseline re-emphasized that the current star catalog is degrading in its ability to support highly accuracy orientation users.

With respect to the evaluators, the assessment of Hybrid 0 highlighted the importance of global solutions and standards in providing interoperability, yet these same global solutions may impede adaptability and by themselves lack robustness. The assessment indicated that the GPS-centric architecture added a certain common thread of interoperability. However, in order for space-based systems and their augmentations to be

used globally, they need to be monitored globally, and the results of this monitoring should be provided in a feedback loop to users. In a similar vein, global use of augmentations requires international coordination in appropriate international bodies. Interoperability is further enabled by a standardized/common approach to transmission of localized geospatial data referenced to WGS-84. The assessment identified that standards can be limiting, and that GNSS services tend not to be readily adaptable. It also recognized, however, that it is hard to find any global solution that is readily adaptable. Finally, it suggested a need for more autonomous solutions in order to achieve robustness.

With respect to strategy, the assessment highlighted economic impacts when primary service is lost under an EBL approach, for example the January 2007 San Diego interference outage impacting timing users. A team member raised the point that national critical infrastructure is be protected per US policy. Others indicated that the PNT architecture shouldn't have to solve the geospatial data, weather, Joint Blue Force Situational Awareness, Red Force Situational Awareness, mission planning, targeting, and battle damage assessment missions. We should instead harness/leverage parallel information and push/pull technologies from the commercial side – the military version of location based services.

From a cost driver perspective, the team found that inertia is always a problem. Once users adopt a technology, it is very hard to transition to a new technology, unless cost/schedule of transition is too attractive to ignore.

4.2.2.2.2 Hybrid A – Greatest Common Denominator

Section Text	Wireless Communications (E911)	Surface Transportation (ITS)	Aviation (NextGen Super-Density)	Dismounted Military (Urban)	Military Precision Engagement	Clandestine Operations (SOF)	Timing & Frequency (Network)	Mission to Mars
PI/Urban Canyon	100%	69%		92%				
PI/Indoors	88%	62%		84%				
PI/Canopy						83%		
PI/Underground		69%		44%				
PI/Underwater						50%		
EMI/Unintentional			83%					
EMI/Intentional					88%		71%	
PI & EMI	100%	69%		84%		58%		
High Accuracy with Integrity		42%			73%			
High-Altitude & Space Position					50%			67%
Notification of DMI			88%		84%			
Access to GIS Data	100%	81%	87%	75%		83%		
Acceptance	69%	30%	65%	83%	75%	100%	100%	40%
Cost	36%	14%	63%	28%	28%	50%	60%	14%
Economic	78%	33%	100%	42%	64%	33%	67%	100%
Implementation/Transition	67%	43%	59%	31%	33%	50%	100%	17%
Infrastructure	42%	25%	72%	41%	33%	33%	100%	33%
Military Preeminence	33%	40%	64%	93%	94%	100%		75%
Other	75%	33%	63%	14%	88%			
Performance	82%	47%	100%	88%	71%	86%	100%	40%
Policy/Doctrine	64%	45%	47%	60%	29%	40%	100%	17%
Technology	69%	74%	89%	88%	73%	75%	80%	57%

■ Positive Agreement
■ Disagreement
■ Negative Agreement

Percentages Reflect the Ratio of “Yes” or “Enable” Votes to the Total Number of Ballots Cast

Figure 4-32 Hybrid A Assessment Job Aid

Hybrid A rated highly for overall performance in physically impeded environments, electromagnetically impeded environments and for access to integrity information as well as GIS data. More specifically, the use of international systems such as foreign GNSS', offered PNT solutions to users in visibility-challenged environments (*e.g.*, urban canyons and similar natural terrain). The network components and integrated autonomous features of the architecture also provided beneficial solutions to users indoors and underground. Similarly, these features also benefited users experiencing electromagnetic interference. Long term interference and significant intentional interference was overcome by the hybrid's low-frequency and high-power service providers. The use of widely available and expected networks also offered users beneficial access to integrity information as well as GIS data. Overall, Hybrid A was rated well in the areas of performance and enabling technologies due to the integration of multiple phenomenologies, diversity within phenomenologies, and taking advantage of network solutions reasonably expected in the 2025 timeframe. This layering of solutions presents a "rich" palate of PNT sources from which a solution may be formed, offering "Availability-in-Depth" and some non-insignificant degree of robustness.

Hybrid A presents significant opportunities and challenges for national strategy. The architecture was rated well for military preeminence due to performance. Similarly, the hybrid was viewed as a technology and economic enabler given the significant transition to greater PNT services for a vast array of users on a worldwide scale. This transition represents significant markets for new services as well as future generations of user equipment and thus presents tremendous opportunities for US industry. However, the transition to using foreign systems and integrating multiple phenomenologies providing greater services to a larger, more common segment of the user base enables more accurate, precise, and highly available solutions to users worldwide. Such an approach enables not only the US, but foreign governments and private users alike. The US' ability to maintain a strategic advantage over our military adversaries and economic competitors enters a new era where Navwar concepts and export controls may require more advanced military concepts while testing the US Government's ability to appropriately minimize regulation on PNT technologies and thereby enable US industry to compete with international service providers and equipment manufacturers.

Hybrid A also represented a highly-common PNT enterprise which would require a concerted effort to plan, acquire, transition to, operate, and maintain. Significant benefits could be realized in operating fewer types of systems which meet significantly more users' needs; however, the impact of failures would be magnified given the greater reliance on more consequential systems.

The hybrid also evoked serious concerns regarding the use of foreign systems and services in light of becoming part of common solutions. Military uses as well as safety-of-life users would require clear direction regarding the use of foreign systems with respect to requirements for monitoring, characterization of integrity, communications channels over which to receive integrity notifications, and the mechanisms by which to revert to approved services, ostensibly those operated by the US Government, to ensure safe operations.

Hybrid A represented both significant costs as well as economic opportunities to the US. The architecture would be challenged by the effort required to implement and transition to the

envisioned end state. The infrastructure was seen as needing considerable change, both in the area of new infrastructure, as well as the transition to a more streamlined operations. Conversely, the architecture represents significant markets for new services as well as future generations of user equipment and thus presents tremendous opportunities for US industry. Again, the US Government’s ability to appropriately minimize regulation on PNT technologies and thereby enable US industry to compete with international service providers and equipment manufacturers is a key factor.

4.2.2.2.3 Hybrid B – Network-Centric Greatest Common Denominator

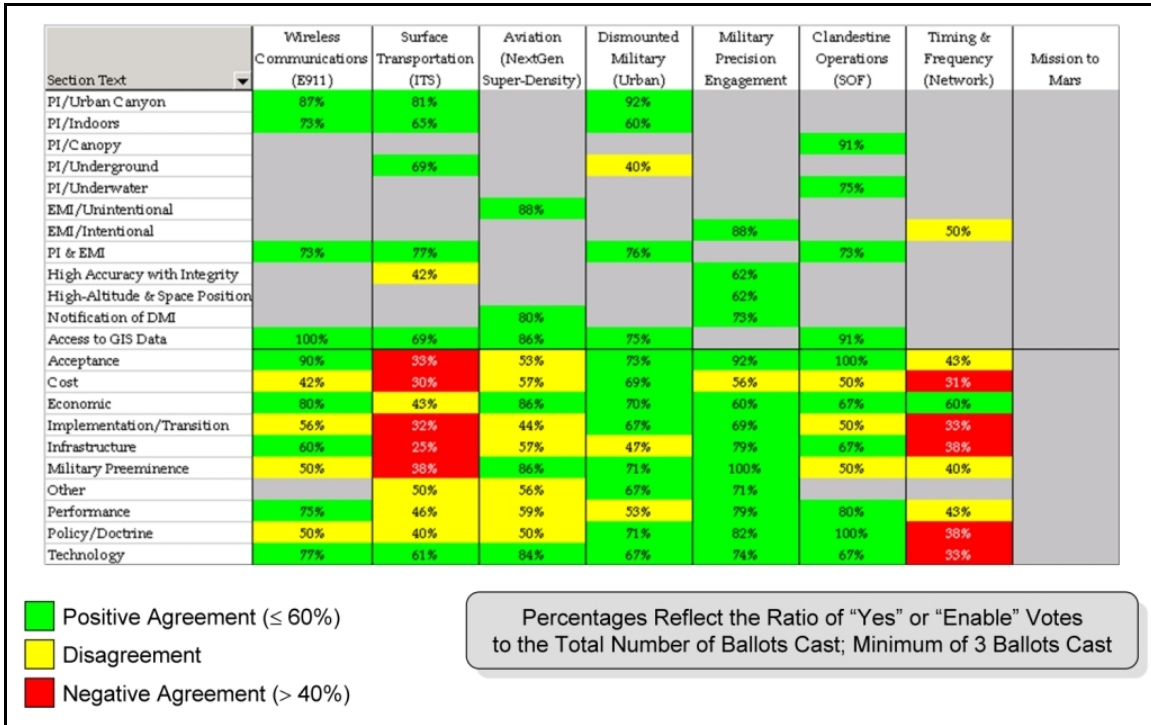

Figure 4-33 Hybrid B Assessment Job Aid

There was general agreement that the Hybrid B approach would meet performance needs when dealing with physical and electromagnetic interference test cases (e.g., urban canyons, under canopy, and under water), with general agreement that it would enable PNT capabilities indoors, in domestic underground facilities, e.g., subways, and in the face of intentional and unintentional EMI, as well as enabling access to GIS data. The most difficult areas for Hybrid B were in areas requiring high degrees of accuracy with integrity, e.g., ITS, and areas where no PNT infrastructure currently exists, e.g., missions to the Moon and Mars, and underground areas outside the United States.

Outside of performance issues and setting aside the extremely difficult ITS needs and extraplanetary missions, most of the assessment team felt that it was at least arguable that the Hybrid B approach could be undertaken with a manageable level of risk, and that it could reasonably be expected to win acceptance from the PNT user community, have a positive economic benefit, and support a policy of retaining military pre-eminence, with specific concerns voiced regarding specific use cases with the specific implementation chosen for Hybrid B.

Overall, the team’s assessment was this approach would or could meet most of the needs with acceptable architectural investment and risk management by the 2025 timeframe, but that some specific cases would need to be addressed on an individual basis, with heavier emphasis on autonomous or other approaches in areas where the PNT network infrastructure was unavailable or incapable of supporting future PNT needs.

4.2.2.2.4 Hybrid C – Lowest Acceptable Common Denominator

Section Text	Wireless Communications (E911)	Surface Transportation (ITS)	Aviation (NextGen Super-Density)	Dismounted Military (Urban)	Military Precision Engagement	Clandestine Operations (SOF)	Timing & Frequency (Network)	Mission to Mars
PI/Urban Canyon	87%	77%		48%				
PI/Indoors	80%	62%		52%				
PI/Canopy						100%		
PI/Underground		65%		36%				
PI/Underwater						91%		
EMI/Unintentional			70%					
EMI/Intentional					69%		83%	
PI & EMI	73%	62%		67%		91%		
High Accuracy with Integrity		62%			69%			
High-Altitude & Space Position					58%			89%
Notification of DMI			83%		73%			
Access to GIS Data	80%	85%	35%	74%		91%		
Acceptance	60%	44%	56%	64%	100%	100%	67%	33%
Cost	36%	26%	50%	81%	67%	50%	50%	17%
Economic	50%	50%	38%	78%	70%	33%	100%	33%
Implementation/Transition	38%	35%	71%	85%	71%	71%	100%	40%
Infrastructure	64%	26%	88%	75%	92%	60%		67%
Military Preeminence	67%	25%	67%	50%	87%	100%		67%
Other		50%	57%	67%	57%			
Performance	71%	50%	33%	50%	75%	83%	100%	40%
Policy/Doctrine	27%	27%	53%	86%	62%	67%	100%	75%
Technology	75%	60%	68%	71%	76%	89%	60%	57%

■ Positive Agreement (>75%)

■ Disagreement

■ Negative Agreement (>75%)

Percentages Reflect the Ratio of “Yes” or “Enable” Votes to the Total Number of Ballots Cast; Minimum of 3 Ballots Cast

Figure 4-34 Hybrid C Assessment Job Aid

Many features of the Hybrid C architecture contributed to addressing the capability gaps. Autonomous capabilities such as CSACs, MEMS IMUs, and sensor-aided inertial systems aided GNSS signal acquisition/lock and allowed coasting during signal outages. There was some concern with adversary access to these technologies; however, such access may be unavoidable. The GPS III spot beam integrated with an IMU and CSAC helped against impedances – sufficient for canopy but insufficient deep indoors or underground. Similarly, spot beam, nulling antennas, multi-sensor integration and coupling with INS/clock were valuable in mitigating electromagnetic interference, especially for military users. However, such an integrated solution only allowed coasting for a short time before accuracy degraded. Many in the team felt that wider use of autonomous components such as sensor-aided inertial or zero velocity updates could have improved performance during such long outages for some user groups.

The team felt that Hybrid C suffered in multiple use cases by not taking advantage of foreign GNSS and selected use of pseudolites to improve availability and enable receiver fault detection/isolation. They also expressed concern that GPS III full capabilities (spot beam, crosslinks, and integrity) may never be deployed, significantly impacting the overall performance of the architecture.

Receiver fault detection algorithms, improved GPS III integrity, and integration with INS/clock all helped improve system integrity. The team felt that inertial navigation systems should generally include gravity compensation to improve accuracy. It also felt that an updated star catalog and improved star trackers were the key to meeting orientation requirements.

A key point with respect to the evaluators was that while diverse solutions provide robustness, numerous signals could result in conflicts that are not resolvable with high accuracy and integrity. With respect to the strategy assessment, the team felt that in general the use of military autonomous systems assists military preeminence, and reliance on nonsecure augmentations reduces the military advantage.

A key cost driver identified was the fact that infrastructure and user equipage to support intelligent transportation system applications was likely large. Further, “where-in-lane” solutions for collision avoidance and lane departure warnings may not be practical by 2025.

4.3 Development of Findings and Recommendations

The NSSO ADT core team developed the initial set of findings and recommendations based on insights gained from over 14,000 assessment team's inputs on the hybrid architectures, as well as the team's scoring of the hybrid architectures in the various scenarios and use cases (see Section 4.2.2.2). The team focused on the comments associated with the higher scoring areas to help frame the major aspects of the "Should-Be" Architecture recommendations.

The NSSO core team presented its proposed findings and recommendations to the entire ADT, which used the NSSO recommendations as a starting point to examine a large number of potential recommendations before ultimately validating and achieving consensus on nineteen recommendations, organized into four main architectural vectors, a strategy, and an overarching architectural vision. The Review & Validation Team reviewed the ADT's recommendations and achieved consensus on the ADT products after making additional changes; the Decision Coordination Group reviewed the R&V Team's recommendation and also reached consensus after making some further changes. See Section 2.3 for a description of the R&V Team and the DCG.

5 RECOMMENDED ARCHITECTURE

The National PNT Architecture provides the architectural vision for US leadership in global PNT by promoting a “Greater Common Denominator” strategy, where the core needs of many users are efficiently met through externally-provided, commonly-available solutions, rather than by numerous, individually-customized systems. The architecture also calls for the wide adoption of low-burden (e.g., size, weight, power, and cost) autonomous features to overcome physical and electromagnetic impedances that are not easily overcome by RF-based or other common solutions. Managing the relationship between common and autonomous solutions will require continual evaluation of new material and non-material solutions and balancing the need for a military advantage with the benefits of providing greater common capabilities.

The vision and strategy are supported by four vectors, which together support the complete guiding principles of the National PNT Architecture:

1. Multiple Phenomenologies – Use multiple phenomenologies to the maximum extent practical to ensure robust availability
2. Interchangeable Solutions – Strive for interchangeable solutions to enhance efficiency and exploit source diversity
3. Synergy of PNT and Communications – Pursue fusion of PNT with new and evolving communications capabilities
4. Cooperative Organizational Structures – Promote interagency coordination and cooperation to ensure the necessary levels of information sharing

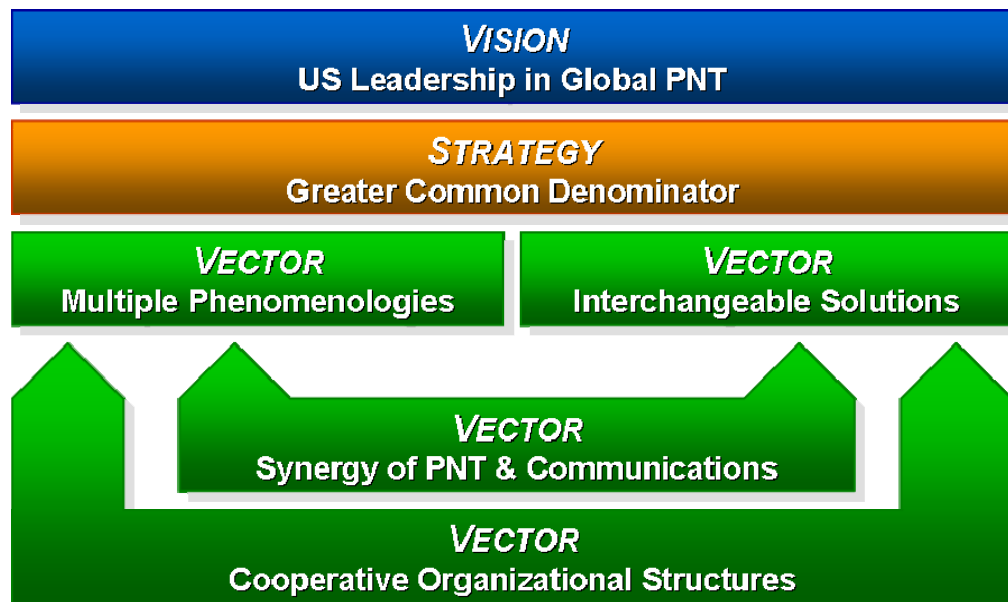

Figure 5-1 PNT Architecture Vision, Strategy, and Vectors

5.1 A Vision for US Leadership in Global PNT

US Leadership in Global PNT

The National PNT Architecture’s vision is for “US Leadership in Global PNT,” based on the policy foundation set by the National Space-Based PNT Policy (NSPD-39). The US can lead by efficiently developing and fielding PNT capabilities and avoiding unnecessarily redundant government services as determined by the responsible government agencies to meet their requirements. Additionally, the US should issue and adhere to stable policies, building credibility both domestically and internationally, enabling the commercial sector to innovate and advance PNT through competitive practices. Furthermore, US government agencies should provide PNT capabilities in a coordinated manner, share information, and present a more unified view of US objectives by promoting inter-agency cooperation across the full scope of PNT. Also, the US should maximize the practical use of military, civil, commercial and foreign systems and technologies, leading the integration of available signals to achieve assured, higher-performing PNT solutions. Lastly, the US should judiciously develop and apply standards and best practices, encouraging others to adopt or align with US capabilities.

5.2 The Greater Common Denominator Strategy & Supporting Recommendations

The US can Best Achieve Efficiency and Effectiveness through a Greater Common Denominator Approach

The National PNT Architecture seeks to fulfill the architectural vision by promoting a “Greater Common Denominator” strategy. In this architecture, users are predominantly dependent upon external sources of PNT information where “greater” capabilities meet the needs of a larger, more “common” segment of the user base. In that vein, US GNSS modernization is vital to providing significantly more capability on a global scale to an unlimited number of users. GPS is already implementing a modernization strategy by offering multiple frequencies for all users, thereby removing the ionosphere as a significant source of error. When new operational capabilities are demonstrated, combined with the removal of selective availability, the need for some external augmentation systems should be reduced. However, other augmentations may still be needed to provide certain types of services, additional ranging sources, or to serve specialized users. In addition to users being dependent on external sources, the architecture is also centrally focused on wide adoption of low-burden (e.g. size, weight, power and cost) autonomous features to overcome physical and electromagnetic impedances. The Architecture also acknowledges that specialized solutions will continue to exist where it is either inefficient or inappropriate to provide the required capability more commonly, to ensure robustness for certain applications, or to meet agency regulatory responsibilities. Lastly, the US must continue to balance the need for a national security advantage in light of providing greater capabilities at a common level.

1 Maintain GPS as a Cornerstone of the National PNT Architecture

Modernized GPS is a cornerstone of the National PNT Architecture as it increases performance for users on a global scale. Additional frequencies and spectral separation, more robust signal structures, real-time networking, and anti-jam enhancements raise the current floor capability and promote US systems and leadership. To that end, establishing an “expected” schedule for modernized capabilities would better facilitate planning by defense, civil, and commercial organizations.

2 Monitor PNT Signals to Verify Service Levels, Observe Environmental Effects, Detect Anomalies, and Identify Signal Interference for Near Real-Time Dissemination

The US should monitor signals it intends to use, defining and refining benchmarks, thereby becoming a source for absolute and comparative performance data. Monitoring also serves to detect environmental effects, anomalies, and interference with US systems and prepares the US for use of foreign services. Some key risks are mitigated when systems are monitored, their integrity is characterized, and users and their equipment are empowered with that information in a timely manner. A monitoring needs assessment will include both military and civil assessment of signals and services to be monitored including foreign and domestic government signals/services.

3 As GPS Modernization or other Methods Demonstrate New Operational Capabilities, Agencies should Transition or Divest US GNSS Augmentation Assets that are Unnecessarily Redundant to their Requirements

Given significant investments in modernizing GPS to provide greater capability to a common segment of the user base, an opportunity to divest or transition US GNSS augmentation assets that become unnecessarily redundant may present itself. However, time phasing of any transition or divestment decision as well as availability of user equipment will be critical factors in user acceptance. With respect to positional accuracy, multiple frequencies for civil users enables receivers to remove ionospheric delay locally, in real-time. Of the systems which remain, there is potential to optimize use of the reference stations and processing facilities for functions such as the PNT signal monitoring discussed above.

4 Continue to Investigate Methods to Provide High-Accuracy-with-Integrity Solutions for Safety-of-Life Applications

One of PNT’s stressing future gaps is providing High Accuracy with Integrity for Safety-of-Life applications. In the realm of several decimeter accuracies, the US should establish the level of integrity required by specific operations and the capability that can be assured with current solutions while investigating the necessary infrastructure changes and reference frame updates to support ten centimeter accuracy with integrity. The community

also needs to research improved and alternative absolute and relative navigation techniques and the best methods to ensure seamless navigation.

5 Develop a National Approach to Protect Military PNT Advantage

The nation must also protect a military PNT advantage in light of the Greater Common Denominator strategy. The availability of multi-phenomenology technologies to potential adversaries increases the complexity of PNT denial. Military advantage may likely go to those who equip fastest and have doctrine and training to efficiently exploit those capabilities. Therefore, the US should review PNT capability export controls for autonomous systems and integration technologies given the proposed diverse sources and paths approach.

5.3 The Multiple Phenomenologies Vector & Supporting Recommendations

1 Use Multiple Phenomenologies to the Maximum Extent Practical to Ensure Robust Availability

The National PNT Architecture promotes the use of multiple phenomenologies to ensure robust availability and address gaps in the ability to operate in physically and electromagnetically impeded environments. “Multiple phenomenologies” refers to diverse phenomena such as radio frequencies and inertial sensors as well as diverse sources and data paths using those physical phenomena (e.g. multiple radio frequencies).

6 Encourage Appropriate Development and Employment of Equipment that Integrates Information from Diverse Sources and Information Paths

User equipment should integrate diverse sources and information paths which provide a more robust solution than their single phenomenology counterparts. For example, inertial and autonomous timekeeping systems allow for coasting through service outages from dependent systems and aid in reacquisition. Additionally, sensor aiding compensates for drift and can provide high relative accuracy.

7 Assess the Potential for the Use of Foreign PNT Systems for Safety-of-Life Applications and Critical Infrastructure Users and, as Appropriate, Develop Clear Standards and Criteria for their Use

The use of foreign PNT systems may enhance solution accuracy and availability and provide robustness to some system outages or vulnerabilities. Wide usage of combined multi-system PNT receivers in the commercial market is expected as developers and users will utilize all systems that offer added value. As such, the US should work through standards organizations to identify clear criteria for usage of and service compatibility with foreign systems. US solutions should still be promoted as a first choice, but the nation should plan to remove US obstacles to use of compatible foreign PNT systems.

8

Continue Military PNT “Exclusive Use” Policy while Studying Development of Capabilities to Enable Military Use of other Signals

The US should maintain policies that ensure military forces are not critically dependent upon foreign systems while maintaining and developing capabilities to deny the hostile use of PNT. However, the use of foreign PNT systems and signals of opportunity may increase PNT solution accuracy and availability, and provide a contingency capability. The US should initiate a thorough study regarding conditions to enable DoD use of US civil and foreign PNT sources, to include considering impacts and costs to user equipment, signal monitoring and alert capabilities, and robust integrity and information assurance algorithms.

9

Promote Standards for PNT Pseudolites and Beacons to Facilitate Interchangeability and Avoid Interference

Pseudolites and beacons can provide location-based PNT services where GNSS signals are impeded; however, the potential for wide usage creates compatibility, interoperability, and spectrum noise challenges. Standards should be promoted to facilitate integration of any pseudolite and beacon with other RF-based PNT solutions. Furthermore, user communities should explore the appropriate balance between pseudolites, beacons, and autonomous technologies.

10

Study Evolution of Space-Based and Terrestrial PNT Capabilities to Support Diversity in PNT Sources and Information Paths

Current systems and their future plans need to be revisited in light of the multiple phenomenology vectors. For example, space-based PNT is a cornerstone of the PNT architecture, but should not be bound by the current GPS construct as technology evolves. Additionally, some terrestrial systems have limited applicability to different modes of transportation or do not fit with perceived needs for 2025. As the vectors and recommendations begin to impact PNT, subsequent analytical efforts should be undertaken to review and revise the National PNT Architecture.

11

Ensure Critical Infrastructure Precise Time and Time Interval Users have Access to and take Advantage of Multiple Available Sources

The US should ensure critical infrastructure precise time and time interval users have access to and can take advantage of multiple available sources. Near-term policy options should be explored to encourage robust solutions. In addition to meeting current needs, future PTTI requirements for critical infrastructure elements should be identified and continued development of PTTI solutions should be fostered.

5.4 The Interchangeable Solutions Vector & Supporting Recommendations

2

Strive for Interchangeable Solutions to Enhance Efficiency and Exploit Source Diversity

The National PNT Architecture promotes the interchangeability of solutions to enhance efficiency and exploit source diversity. Interchangeable solutions have a degree of compatibility and interoperability that allows the combination of diverse sources to obtain a superior PNT solution.

12 Use Participation in International PNT-Related Activities to Promote the Interchangeability of PNT Sources while Assuring Compatibility

The US should refine PNT-related policy goals and objectives to include interchangeability and leverage capabilities in global forums as foreign PNT systems are influenced by US involvement and leadership. Furthermore, service interchangeability can widen markets for US PNT products in the global marketplace.

13 Evolve Standards, Calibration Techniques, and Reference Frames to Support Future Accuracy and Integrity Needs

Standards are fundamental to ensuring interchangeability. Anticipated future measurement accuracy needs will be more demanding than they are today. Reference frames must be an order of magnitude better than required measurement accuracy, and thus major improvements to reference frame definitions will be needed to support centimeter-level absolute accuracies. The US should determine the accuracy of standards, calibration techniques, and reference frames needed to support projected real-time absolute positioning accuracy and integrity needs. Areas for exploration include earth-fixed and celestial reference frames, earth orientation, grids, timing, frequency, physical models, and data transfer.

14 Identify and Develop Common Standards that Meet Users' Needs for PNT Information Exchange, Assurance and Protection

Using information from multiple and diverse phenomenologies may likely produce chaotic, non-assured, and insecure data without standardized information interfaces. Information must be protected against unauthorized use, abuse, and exploitation. Users need convenient access to multiple data sources via diverse paths and all relevant PNT-related information to make informed decisions. The US should review whether current frameworks are sufficient in these areas or develop relevant appropriate standards.

15 Establish Common Standards that Meet Users' Needs for the Depiction of Position Information for Local and Regional Operations

Different coordinate systems exist within and between civil and military communities, and errors can be introduced when converting between coordinate systems. Using different coordinate system grids to define locations can impact interoperability and compromise safety. The US should reemphasize directives to use Military Grid Reference Systems (MGRS) and the civil equivalent, US National Grid (USNG); enforce existing National Spatial Data Infrastructure guidance on use of USNG; and amend CJCSI 3900-01C, Position Reference Procedures, to require use of MGRS (or USNG as documented) when grid coordinates are needed for local or regional tactical ground operations. In addition to the MGRS grid coordinates, geodetic coordinates may also be provided for interface with

other systems requiring them. Tactics, techniques, and procedures should also be reviewed to ensure appropriate use of grid and geodetic coordinates for specific applications and interoperability between them.

5.5 The Synergy of PNT & Communications Vector & Supporting Recommendations

3

Pursue, where Appropriate, Fusion of PNT with New and Evolving Communications Capabilities

The National PNT Architecture leverages users' increasing connectivity to communications networks for use as sources of PNT, not merely as data channels for PNT aiding and augmentation data. This Vector promotes the fusion of PNT features with new and evolving communications capabilities, resulting in increased robustness by offering services outside of traditional radionavigation spectrum.

16

Identify and Evaluate Methods, Standards and Potential Capabilities for Fusion of PNT with Communications

Data communications networks currently support PNT capabilities by carrying PNT aiding and augmentation data, GIS data, etc.; however, opportunities exist to exploit the synergy between RF-based PNT and communications by leveraging communications capabilities to provide PNT capabilities directly. This is consistent with the multi-phenomenology vector of employing diverse sources and information paths, and would increase PNT robustness by offering services outside of traditional radionavigation spectrum. Leadership and initiative is needed to avoid stove-piped solutions, and detailed assessments regarding specific solutions are needed, so the US should establish a community of experts to pursue synergies between communications and PNT. Initially, the US should study the lessons learned from existing PNT/Communications fusion efforts, such as cellular and WiFi networks, iGPS, tactical radio networks, E911, the Air Force Satellite Control Network, and NASA's SCA to help determine what provides the best options for both systems and their users.

5.6 The Cooperative Organizational Structures Vector & Supporting Recommendations

4

Promote Interagency Coordination & Cooperation to Ensure the Necessary levels of Information Sharing

The National PNT Architecture promotes a coordination process, building on existing organizations, where appropriate, to facilitate cooperation and information sharing.

17

Develop a National PNT Coordination Process

Significant benefits would result from a long-term national PNT coordination process extending beyond space-based PNT, in terms of understanding national PNT needs, synergies, and implications of decisions on the national architecture. The US should

identify and organize the nation's expertise to perform a National PNT Coordination Process. The process could address PNT needs analysis, program assessments, and cost estimation; advise and encourage S&T and R&D on key PNT-related technologies; and perhaps provide system engineering and integration support to PNT program offices, providers, and customers.

18

Identify and Leverage Centers of Excellence for PNT Phenomenology and Applications

As part of the National PNT Coordination Process, Phenomenology and Application Centers of Excellence could focus the national effort on S&T, ensuring sufficient breadth and depth with efficient use of national resources. Additionally, they could offer UE program offices knowledgeable resources regarding the performance and cost of alternative technologies.

19

Define, Develop, Sustain, and Manage a PNT Modeling and Simulation Core Analytical Framework

The US is lacking an enterprise-level PNT modeling and simulation capability. The existing capability gap will only grow with an enterprise evolving toward the use of multiple phenomenologies and interchangeable sources. Future enterprise-level architecture and user equipment decisions will benefit from analytical support. Under the auspices of the National PNT Coordination Function, the US should develop a core analytical framework and initial capability to be made available to the community.

5.7 “Should-Be” Architecture

The “Should-Be” Architecture illustrates the future state of PNT based on the Guiding Principles and supporting recommendations. PNT services will continue to be provided by space, terrestrial, and autonomous sources; however, they are provided and used in accordance with the architectural vectors.

- User equipment will integrate dependent and autonomous sources to enhance solution robustness.
- Sources of PNT information will be more interchangeable, offering greater service availability.
- Leveraging PNT-enabled communications capabilities will increase robustness by offering services outside of traditional radionavigation spectrum.
- Interagency cooperation supports these Vectors by coordinating the national effort.
 - Traceability to common reference frame and time scale
 - Centers of expertise sharing technological knowledge
 - Streamlined performance monitoring and feedback channels

Adoption of the PNT Architecture Guiding Principles and supporting recommendations would provide a path towards a future state illustrated by the “Should-Be” PNT Architecture contained in Figure 5-2. The “Should-Be” Architecture will meet more user needs, and meet them more efficiently, than the Evolved Architecture.

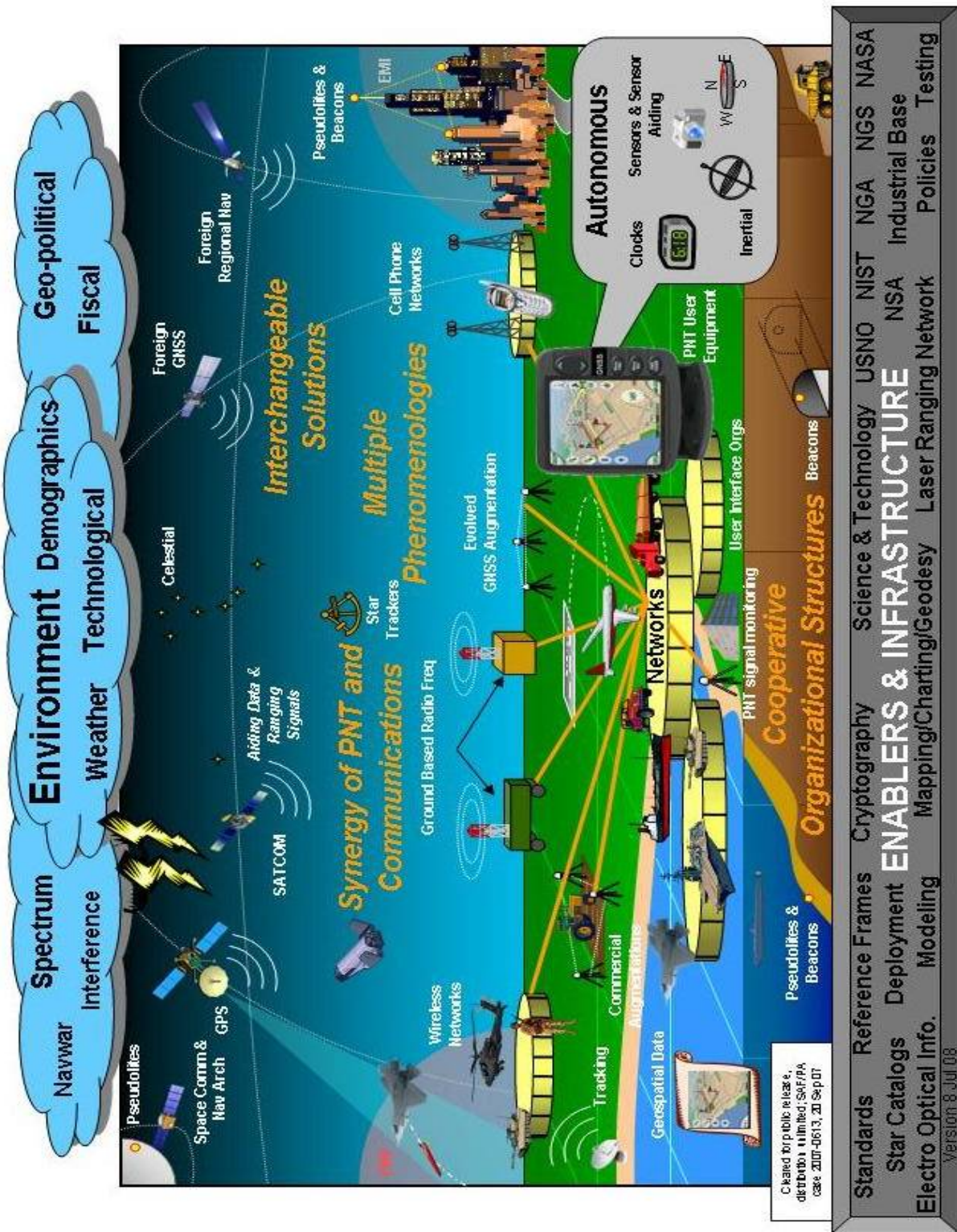

Figure 5-2 "Should-Be" PNT Architecture Graphic (2025), System-Centric View

As in the Evolved Baseline, GPS remains a cornerstone of the “Should-Be” PNT Architecture. Planned modernization of GPS (multiple frequencies, improved accuracy and integrity, new user equipment with fault detection algorithms) enables the transition or divestment of some PNT augmentations, resulting in an evolved GNSS augmentation capability. Higher power spot beams on GPS III and modernized GPS M-code user equipment offer improved anti-jam capabilities in electromagnetically impeded environments, while multiple civil signals mitigate the effects of unintentional interference. Multiple civil frequencies also improve accuracy by removing most ionospheric error during normal ionospheric conditions, but do not eliminate the effect of ionospheric scintillation when it occurs.

The “Interchangeable Solutions” vector facilitates more widespread use of other PNT solutions in integrated PNT receivers, such as use of foreign GNSS and regional navigation systems to improve availability, integrity, and robustness.

The “Multiple Phenomenologies” vector encourages widespread use of integrated PNT user equipment which combines such phenomenologies as GNSS and ground-based RF systems with autonomous solutions such as inertial systems, user clocks, and sensor-aiding. Such integrated solutions address user capability gaps and offer the potential ability to operate in physically impeded environments such as urban canyons and indoors.

The use of multiple phenomenologies and interchangeable solutions, as well as the pursuit of improved accuracy, drives a need for a number of reference frames, standards development, and coordination activities between various PNT providers. The celestial reference frame in particular is currently degrading in accuracy. Therefore, improved celestial navigation and an updated star catalog will enable sustained and improved orientation capabilities.

The “Synergy of PNT and Communications” vector will increase the use of communications networks to provide and augment robust PNT capabilities, taking advantage of the wider connectivity users will have in the future. Further study is necessary to determine specific implementations for developing solutions such as aiding and ranging signals through communications satellites, relative ranging through communications networks such as currently done by many cell phone and WiFi systems, and relative navigation between PNT users.

The “Cooperative Organizational Structures” vector recognizes this architecture as national in scope. Therefore, interagency cooperation between US PNT organizations is critical to successfully integrating space and non-space solutions. Enterprise-wide cooperation will also be necessary to ensure foreign PNT sources can be appropriately used in capability solutions.

A large number of enabling and infrastructure capabilities form the foundation for the “Should-Be” PNT Architecture, as it did for the Evolved Baseline. However, these enabling capabilities will need to evolve to encompass the larger scope of the PNT enterprise in order to facilitate the solutions required to address the capability gaps; especially solutions based on integrated, multiple-phenomenology approaches.

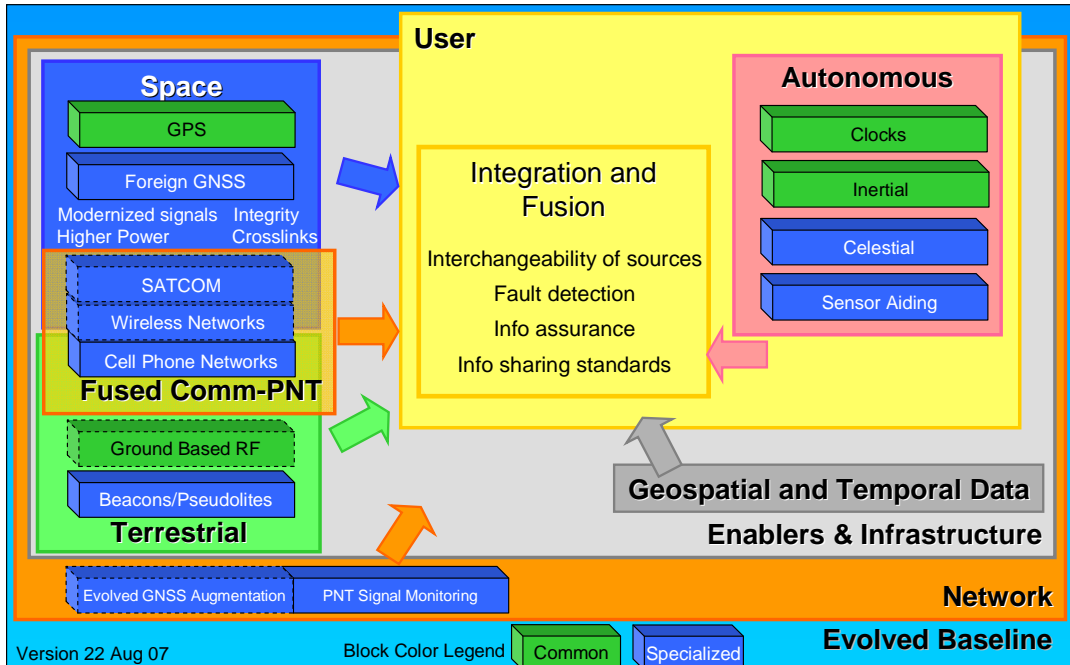

Figure 5-3 “Should-Be” PNT Architecture (2025), User-Centric View

In addition to a system-centric view of the “Should-Be” Architecture shown in Figure 5-2, the ADT developed a user-centric view, captured in Figure 5-3. Within the user’s equipment, algorithms which integrate and fuse PNT information from interchangeable solutions and multiple phenomenologies will increase service availability and solution robustness. Leveraging PNT-enabled communications capabilities will enable services outside of traditional radionavigation spectrum. Cooperative organizational structures will be key in developing and applying standards for information sharing, supporting interchangeable solutions

5.8 Next Steps

The NSSO will facilitate the development of a PNT Architecture Transition Plan by an Architecture Transition Team (ATT) composed of representatives from PNT stakeholder organizations. The Transition Plan will identify specific tasks, products, and schedules to begin implementation of the PNT Architecture. The Transition Plan will be reviewed and approved by the DCG, and will be published as part of an Architecture Implementation Memorandum.

APPENDIX A – DECISION MEMO

Below is a copy of the Architecture Guidance Memorandum issued by the Architecture Co-Sponsors.

June 16, 2008

MEMORANDUM FOR DISTRIBUTION

SUBJECT: National Positioning, Navigation, and Timing Architecture Guidance Memorandum

An interagency team led by the Office of the Assistant Secretary of Defense for Networks and Information Integration and the Department of Transportation's Research and Innovative Technology Administration recently concluded a National Positioning, Navigation, and Timing (PNT) Architecture Study. The study's vision, strategy, vectors and recommendations are at Attachment 2.

As co-sponsors of this study, and in accordance with its Terms of Reference, we approve the vision, strategy, vectors and recommendations included in Attachment 2 and direct the start of transition planning. The PNT Architecture Transition Team (Attachment 3), facilitated by the National Security Space Office, will develop a National PNT Architecture Transition Plan defining the time-phased, fiscally-informed roadmap to guide implementation. A National PNT Architecture Transition Planning progress report will be available by June 30, 2008.

Questions on this action should be directed to Captain Milton Abner, USN (571-432-1433, NSSO.PNT@osd.mil).

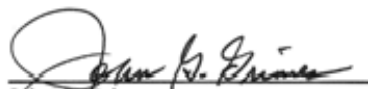

John G. Grimes
Assistant Secretary of Defense for
Networks and Information Integration

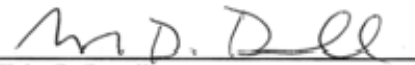

Tyler D. Duvall
Acting Under Secretary of Transportation
For Policy

Attachments

1. Distribution
2. Approved PNT Architecture Vision, Strategy, Vectors and Recommendations
3. Transition Planning Roles and Responsibilities

APPENDIX B – TERMS OF REFERENCE

UNCLASSIFIED

NATIONAL POSITIONING, NAVIGATION AND TIMING ARCHITECTURE TERMS OF REFERENCE

1. Purpose

This Terms of Reference (TOR) documents a planned approach to develop a National Positioning, Navigation and Timing (PNT) Architecture to help guide future PNT system-of-systems investment and implementation decisions. The objective is to provide more effective and efficient PNT capabilities focused on the 2025 timeframe and an evolutionary path for government-provided PNT systems and services. The choice of 2025 is a point far enough in the future to allow flexibility in the development of alternate architectures while permitting sufficient time to address needed, more near term, programmatic and budgeting requirements to achieve this “long term” goal.

This effort will document the current national PNT architecture and evaluate alternative future mixes of global (space and non space-based) and regional PNT solutions, backup systems, PNT augmentations, and autonomous PNT capabilities to address priorities identified in the DoD PNT Joint Capabilities Document (JCD) and civil equivalent documents. It will support future decisions of bodies such as the DoD PNT and Civil Pos/Nav Executive Committees, as well as the National Space-Based PNT Executive Committee (EXCOM).

2. Background

U.S. Space-Based PNT Policy states that the U.S. must continue to improve and maintain the Global Positioning System (GPS), augmentations to GPS, and back-up capabilities to meet growing national, homeland, and economic security requirements. PNT touches almost every aspect of American life today. It is essential for defense and civilian applications ranging from the Department of Defense’s Joint network centric and precision operations to the transportation and telecommunications sectors—improving efficiency, increasing safety, and making America more productive. However, the extent of dependence on systems like GPS, or possible alternate systems for PNT, is not explicitly understood. Nor is implementation of PNT services guided by an architecture that enables contributions of component parts of the national PNT enterprise to be evaluated within the context of the overall system for investment decisions related to system sustainment or improvement. Absence of a coordinated PNT architecture may result in operational risks, uncoordinated research efforts, lack of clear developmental paths, potentially wasteful procurements, inefficient deployment of PNT resources, and possible impacts to architectures or other systems depending on PNT.

3. Authority

The National Security Space Office (NSSO) under the DoD Executive Agent for Space was tasked in a 21 Mar 2005 memo from the acting Secretary of the AF and Director of the NRO to develop architectures for national security space (NSS)¹ and to lead the collaborative efforts of the NSS community to:

¹National Security Space is defined as the combined space activities of the DoD and National Intelligence Community (IC) as well as those of the civil and commercial sectors that impact U.S. national security.

UNCLASSIFIED

1

UNCLASSIFIED

“Develop and coordinate for community consideration using appropriate processes: NSS strategies, concepts, plans, architectures for mid-to-long-term, enterprise engineering activities, transition strategies, and functional area integration efforts.”

Request for architecture support came from both the Assistant Secretary of Defense for Networks and Information Integration (ASD(NII)) and the National Space-Based PNT EXCOM.

- ASD(NII) requested the NSSO conduct a PNT architecture study to develop a National PNT Architecture to help guide DoD decisions, as well as national resource allocation in the development of future PNT systems.
- U.S. Space-Based PNT Policy directs the National Space-Based PNT EXCOM to develop a Five-Year National Space-Based PNT Plan. The National Space-Based PNT EXCOM Charter, signed by the Secretaries of Defense and Transportation, indicates that the Five-Year Plan will include architectures. The National Space-Based PNT EXCOM directed the National Space-Based PNT Coordination Office (NPCO) to initiate an effort with the NSSO to develop an overall U.S. space-based PNT architecture as part of this process (Action Item, 26 Jan 06).

The architecture development effort will also support Joint and related Civil PNT efforts.

- Joint Requirements Oversight Council (JROC) Memo 171-05 highlighted USSTRATCOM’s PNT JCD as the basis for future PNT to meet warfighter needs. This architecture effort will define the “as is” architecture and provide an analytic basis for a Functional Solution Analysis (FSA) to address gaps identified in the PNT JCD.
- The U.S. Department of Transportation (DOT) Research and Innovative Technology Administration (RITA) was tasked by the Under Secretary (U/S) of Transportation for Policy to lead the National PNT Architecture effort on behalf of the civil community. RITA, which includes the Volpe National Transportation Systems Center, will coordinate Architecture products through the Office of the Secretary of Transportation (OST) Policy staff for policy oversight and guidance.

4. Objectives

The PNT Architecture will:

- Define a future PNT system-of-systems architecture achievable through evolution and investment by the 2025 timeframe to include a definition of critical interrelationships between component systems as well as backup systems.
- Serve as the DoD PNT architecture to guide DoD decisions on future PNT system-of-systems for providing worldwide PNT capability.
- Serve as key input to future Five-Year National Space-Based PNT Plans and provide a basis for future Federal Radionavigation Plan (FRP) development.
- Provide an analytic basis for a FSA in response to gaps identified in USSTRATCOM’s PNT JCD. To address gaps identified by the PNT JCD, while concurrently meeting civil requirements for reliable PNT services, it is important for the architecture to address capabilities that are cost-effective, even in physically and electromagnetically challenged environments.
- Guide development of the DoD PNT Science & Technology (S&T) Roadmap to balance needs of known requirements (demand pull) with the need to maintain a

UNCLASSIFIED

capabilities- and effects-based S&T program that satisfies anticipated or unforeseen long-term PNT user needs (technology push).

- Serve as a basis for making informed recommendations on DoD, civil, commercial, and international PNT program plans, requirements, budgets, schedules, international partnerships, S&T investments, and policies.
- Serve as a framework against which new requirements or capabilities can be systematically evaluated.
- Inform follow-on efforts to transition from the existing ad hoc architecture, through the funded extended baseline architecture, to an envisioned 2025 architecture.
- Be refined and evolved by a repeatable process that in turn will support inputs to the annual budget process. This process will enable integration of changes to evolving threats, requirements, technologies, and resources into future planning activities and the evolving PNT architecture.

5. Scope

This effort will document the current national PNT architecture and evaluate alternative future mixes of global (space and non space-based) and regional PNT solutions, backup systems, PNT augmentations and autonomous PNT capabilities to address priorities identified in the PNT Joint Capabilities Document, and to inform future decisions of the DoD and National Space-Based PNT EXCOM regarding National PNT Services.

The architecture will be national in scope, and will include DoD, intelligence community (IC), civil, commercial, and international users and systems supporting global U.S. interests. The effort will address the value users obtain from the systems, and how those users are supported by the systems. In order to evaluate end-to-end capabilities, the architecture must also take into account integration of PNT hardware and software into specific end user devices and applications.

Sovereign PNT legal responsibilities and liabilities will be considered in development of any proposed global U.S. services. The effort must accommodate relevant U.S. commitments in international agreements².

The U.S. PNT system-of-systems should provide uninterrupted service anywhere in the world and in space to at least geosynchronous altitude and provide robust protection against interference. It is therefore important that architecture development be influenced by Navigation Warfare (Navwar)³ electronic protection, electronic support, infrastructure protection, and information assurance requirements, and to a lesser degree, by electronic attack (EA) and EA associated electronic support needs (EA will be considered in greater detail by an NSSO Space Control Architecture). The architecture should also be cognizant of safety-of-life navigation, homeland security, and commercial needs for protection of PNT capability and reduction of

² An example is the commitment in Article 11 of the 2004 Agreement on GPS-Galileo Cooperation that the "Parties agree to use [a] common baseline modulation for the Galileo Open Service and the future GPS III civil signal ..."

³ **Navwar Terms** – *Electronic Protection*: the ability of our forces to effectively use GPS information in the conduct of military operations, this is accomplished by overcoming the effects of hostile jamming on GPS receivers; *Electronic Support*: involves several tasks—detecting hostile jamming targeting our forces, characterizing and locating the interference source, and negating or destroying if required; *Electronic Attack*: the ability to effectively deny adversary forces access to and use of satellite navigation information against our forces.

UNCLASSIFIED

vulnerability to intentional and unintentional disruption. Current use and alternatives for future use of foreign operated PNT services will be examined for means to protect U.S. interests.

While the PNT architecture effort can consider concepts that are neither in existence nor planned, emphasis should be on initiatives that will improve one or more areas of the evolved baseline. While GPS is one of many PNT systems within the scope of the study, the focus of the PNT Architecture is not on developing new, alternate GPS architectures.

The architecture concepts must be fiscally informed and cost estimates should be produced to support comparing architecture alternatives and programming for recommended architecture components. To ensure the most cost effective solutions for the USG, support affordability determinations, and to inform cost allocation decisions, cost must always be considered during the evaluation and selection of concepts.

The architecture effort will describe projected long term resources and efforts required to transition and sustain the selected architecture into the future. Included in the architecture are S&T efforts, supporting infrastructure, key models and standards.

To keep the effort manageable and within available resources, the effort will leverage existing studies and analysis tools (in particular those with a quantitative basis), and select only those areas for intensive study that show promise for improvement and efficiency enhancements, and are most likely to close capability gaps.

It is understood that certain pre-decisional budget data and cost estimates, data which are not normally shared between Departments, will need to be provided to NSSO and the ADT to document and evaluate alternative architectures. The NSSO has processes in place to protect the security and proprietary nature of such data.

6. Roles and Responsibilities

A PNT Architecture **Decision Coordination Group (DCG)** will guide the architecture development and act as sponsors. The DCG will be hosted by NSSO with membership at the senior officer/executive level (O-7/8/SES) from OASD(NII), RITA, Joint Staff, Services, NPCO, FAA, USSTRATCOM, and other stakeholder Departments and Agencies as appropriate. The DCG will periodically review architecture efforts and will forward the final coordinated Architecture Development Team (ADT) products to the OASD(NII), U/S of Transportation for Policy, and Joint Requirements Oversight Council (JROC) for review and approval. After acceptance by ASD(NII) and U/S of Transportation for Policy the final product will be forwarded to the National Space-Based PNT EXCOM for consideration. Any changes in scope or content of the products will be authorized by the D/NSSO after discussion with the DCG or the undersigned, as appropriate. Dissenting views within the DCG will be addressed to resolution or acknowledged in the final report where and when appropriate. Understanding that timing of findings may be critical in Departmental and U.S. government-wide decision making, the DCG may provide coordinated interim findings (e.g., assisting the NPCO in developing the National PNT Five-Year Plan).

A **Review and Validation (R&V) Team** will periodically review ADT status, findings, and direction. The R&V Team will be composed of O-6/GS-15 level representatives from organizations participating on the ADT. Meetings will be hosted by the NSSO/PNT Division Chief.

UNCLASSIFIED

4

UNCLASSIFIED

A **PNT Architecture Development Team** will assist in gathering data, conduct analyses, and coordinate analyses and recommendations. The NSSO PNT Division Chief will lead the team with action officer level participation from organizations across the PNT community within the Federal Government. Participants will need to provide a reach-back capability for data, analyses, and impact descriptions as the effort proceeds. To maximize efficiency, subject matter experts will draft portions of architecture work at their respective work locations and their products will be submitted to the ADT for integration. ADT sub-groups may be formed as needed to investigate specific systems within the architecture, PNT technologies that complement space-based PNT systems, or specific user communities with unique PNT requirements or approaches necessary to achieving its requirements.

Members of the **NSSO PNT Division**, augmented as appropriate by designated representatives from various stakeholder organizations, will coordinate development, consolidate data, conduct or oversee analysis, develop and evaluate concepts and recommendations, and document the overall effort. The PNT Division Chief will lead this group. At the conclusion of the architecture development activity, NSSO PNT will lead a smaller team consisting of representatives from each organization to implement the recommended architecture, construct the final presentation and document the plan to implement the recommendations. Although not intended to participate as members of aforementioned working groups, industry input will be solicited on an "as-needed basis" to provide insight into technologies and opportunities to meet user needs.

Participant organizations will provide support as needed, per respective Department, Agency or DCG direction.

- The NSSO will supply personnel, facilities, and resources to lead and integrate the effort, and will make up the core of the ADT.
- All Departments represented on the National Space-Based PNT EXCOM will provide representatives designated by agency DCG members to participate in the R&V Team, on the ADT, or to provide assistance to the ADT.
- Significant participation and coordination efforts will be required from DOT to represent the civil community in development of a PNT Architecture that meets civil and commercial requirements. RITA has been designated by the Under Secretary of Transportation for Policy to lead the national PNT Architecture effort for the civil community. RITA will provide assistance and expertise as part of the ADT.
- Significant participation and coordination from the NPCO will be required for this national effort to ensure inputs from and participation by all agencies of the U.S. government with PNT missions and responsibilities.
- To respond to the PNT JCD, and for the architecture to serve as an analytic basis for a corresponding FSA, active consultation will be maintained with the FSA sponsor, OASD(NII), USSTRATCOM and Joint Staff J-8 personnel.
- Assistance of the Services, National Geospatial-Intelligence Agency (NGA), and the GPS Joint Program Office (JPO) will be required to obtain GPS-related data, and possibly in conducting limited performance analysis related to variations in alternate GPS architectures. This same assistance will be required from program offices of each GPS augmentation systems.

UNCLASSIFIED

5

UNCLASSIFIED

- Similarly, data and analysis support from non-space based PNT providers and developers will be required to ensure appropriate alternatives and augmentations are considered.
- Combatant Commander and Service Component input will be solicited through the R&V Team and ADT to ensure the architecture is acceptable from a warfighter's perspective.
- Participant organizations will provide data from previous PNT associated analyses to support anticipated assessments required to complete the architecture. Examples of data required include threat and technology assessments, cost estimates, and analyses of alternatives. NSSO will limit the scope and frequency of such data/study requests wherever possible and will keep the Decision Coordination Group (DCG) apprised of the status of all data requests.

7. Security and Classification

The architecture effort will operate at multiple security levels. Activities and meetings will normally be held at the Secret level, but will be conducted with the understanding that National level architecture documentation, roadmap, and final report will be produced at the unclassified level, and cleared for unlimited public distribution. Some subset of the participants, and a small portion of discussion and analysis, will take place at the TS/SCI level to account for user needs protected at that level. The need for a TS/SCI appendix to the final report is yet to be determined. All members of the PNT ADT will need at least a Secret clearance; however, occasional access to personnel without security clearances may be needed to address select issues.

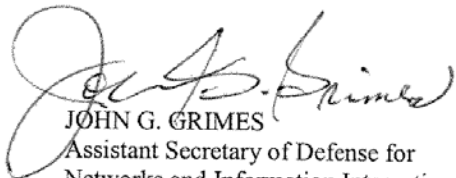
JOHN G. GRIMES
Assistant Secretary of Defense for
Networks and Information Integration

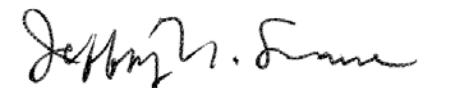
JEFFREY N. SHANE
Under Secretary of Transportation for Policy

APPENDIX C – AUTHORS AND PARTICIPATING INDIVIDUALS

Primary Report Authors:

Name	Title	Service	Organization
Abner, Milton	CAPT	USN	NSSO/PNT Division Chief
Anton, John		CTR	NSSO/PNT (Scitor)
David, Mike		CTR	NSSO/PNT (Overlook)
Dickerman, Ronald		CTR	NSSO/PNT (SRA International)
Husted, Patrick	Lt Col	USAF	NSSO/PNT
Ken Kepchar		GOVT	FAA
Popejoy, Paul		CTR	NSSO/PNT (Aerospace)
Schoonenberg, David		CTR	NSSO/PNT (SAIC)
Vicario, Jeff	LCDR	USN	NSSO/PNT
Wentworth, James		CTR	NSSO/AE
Watkiss, Eric	CDR	USN	NSSO/PNT
Zappi, Mary		CTR	NSSO/PNT (Tecolote)

This Final Report was reviewed by representatives of the OSD/NII and DOT/RITA Study Co-Sponsors prior to signature.

Participants:

Name	Title	Service	Organization
Abbley, William		CTR	SMC/GPSW (Aerospace)
Adde, Barbara		GOVT	NASA
Alexander, Dexter	LTC	USA	SMDC
Alexander, Ken		GOVT	FAA Rep to NCO
Allen, Leonard		GOVT	FRA
Anderson, Jon	Lt Col	USAF	SAF/USAL (DC Cell)
Andrade, Richard		CTR	HQMC/C4/Strategic Planning (CS) Div
Andrews, Chuck		CTR	Joint Navigation Warfare Center
Armor, James	Maj Gen	USAF	NSSO
Arnold, Jim		GOVT	FHWA

Name	Title	Service	Organization
Aymar, Edward		CTR	HQDA/CIO/G6
Barr, Dale		GOVT	DHS/NPPD
Bartone, Chris		CTR	Ohio University
Bayless, Steven		GOVT	DOT-OST
Beard, Ron		GOVT	NRL (Code 8150)
Benson, Donald		CTR	SMC/GPSW (MITRE)
Berstis, Knute		GOVT	NOAA/NGS
Betz, John		CTR	MITRE
Blizard, Matthew	CAPT	USCG	USCG/Comm NAVCEN
Bollwerk, Bill		GOVT	US Naval Observatory
Bonniksen, Christine		CTR	OASD/NII Space Programs
Borden, Andrew		CTR	SMC/GPSW (BAH)
Braibanti, Ralph		GOVT	State OES/Space & AT
Brennan, Shawn	Lt Col	USAF	NSSO/PNT
Brewer, Mike	Col	USAF	OASD/NII Space Programs
Brodsky, Beryl		CTR	NASA (Overlook)
Broussard, Robert		CTR	AFSPC/A5 (Aerospace)
Buchanan, Jennifer		CTR	NSSO/PNT (SRA International)
Byram, Joe		CTR	SPAWAR PMW-170 (Overlook)
Cabala, John	Lt Col	USAF	FAA/DoD Liaison
Camp, Richard		GOVT	PM, DISA Timing & Sync Program
Carroll, James (Jim)	Dr.	GOVT	DOT/Volpe Center
Casswell, Rebecca		GOVT	USCG
Castaldo, Rick		GOVT	FAA
Chadwell, Riley		GOVT	USSTRATCOM/J35
Chartier, Christopher		GOVT	NII/Joint C4ISR Decision Spt Center
Clary, Milt		CTR	AF/A5RM
Clore, Raymond		GOVT	State OES/Space & AT
Coon, James (Mike)	Lt Col	USAF	ACC, Systems Support Div
Corcoran, Joseph		GOVT	OPNAV N6F1
Cosby, John		CTR	NSSO/AE
Cotter, Daniel		GOVT	DHS

Name	Title	Service	Organization
Crane, Robert		GOVT	DHS Rep to NCO
Crews, Mark	Col	USAF	SMC/GPSW
Cross, Lyle	Col	USMC	HQMC/C4/Strategic Planning (CS) Div
Cryderman, Jay	Capt	USAF	SMC/GPSW
Dalberg, James	CAPT	USN	NSSO/PNT Division Chief
Dall, Mark		GOVT	NSA/I121
Daniels, Charlie	Maj	USAF	NCO
Deagan, William	Maj	USA	USSTRATCOM/J8
DeCleene, Bruce		GOVT	FAA
Deloache, Tim		CTR	HQMC/C4/Strategic Planning (CS) Div
Denton, Mark		GOVT	HQMC/C4/Strategic Planning (CS) Div
Dixon, David	LCDR	USCG	USCG Office of Navigation
Doherty, James		CTR	IDA
Donley, Richard	Lt Col	USAF	AF/A5RS
Dorland, Bryan	Dr.	GOVT	US Naval Observatory
Dritt, Dan	Maj	USAF	ACC/A8SS
Dubay, Curt	CAPT	USCG	DHS PNT
Emilian , John		CTR	NSSO/PNT (MITRE)
Enge, Per	Dr.		Stanford University
Evans, David		CTR	NSSO (Aerospace)
Fearheller, Scott		GOVT	NASIC
Fiedler, Steve		USAF	NSSO (AFRL Liaison)
Fleming, Cal		GOVT	ACC/A8SN
Fong, Frank		CTR	Tecolote (Cost Support to NSSO)
Frost, Curtis	Col	USAF	USSTRATCOM/J8
Gaume, Ralph	Dr.	GOVT	US Naval Observatory
Genter, Wayne	Dr.	CTR	ITT-AES
George, Kelly	CAPT	USMC	USMC/PP&O/PLI
Gidney, Jim		CTR	SMC/GPSW (Aerospace)
Gifford, Al		GOVT	NASA
Glascoe, William	Maj	USAFR	NSSO/AE
Gottschalk, Steve	Maj	USAF	USSTRATCOM/J88(S)

Name	Title	Service	Organization
Grantham, Scott		CTR	OASD/NII Space Programs
Hagemeier, Hal		GOVT	NSSO
Hardis, Jonathan	Dr.	GOVT	NIST
Hare, Mike		CTR	SMC/GPSW
Harmon, Norah		CTR	Joint Staff/J-8
Harrington, Patrick	Lt Col	USAF	SAF/USAL
Harris, Arthur	CDR	GOVT	NSSO/AE
Hart, George		GOVT	PM Navigation
Haug, Brian	Maj	USAF	AF/A3SS
Hegarty, Chris	Dr.	CTR	FAA (MITRE)
Henry, Sean		CTR	NSSO/AE
Hessey, Jay		CTR	PEO C4I&Space PMW 170
Hodgkiss, William	Col	USAF	SAF/USAL
Holland, John	Dr.	CTR	NSSO (MITRE)
Hosken, Ed		CTR	DNI CIO EA
Hothem, Larry		GOVT	DOI/USGS
Houghton, Rob			FAA - Cost Support
Hunter, Pete		CTR	OPNAV N6
Hyatt, Kent		CTR	OASD/NII (Overlook)
Ingegneri, Robert	Lt Col	USAF	AF/A3O
John, Richard		GOVT	DOT/RITA/Volpe Center
Kaplan, Marshall		CTR	NSSO
Keeler, Nelson (Ned)		GOVT	DOT/RITA/Volpe Center
Kent, James	Lt Col	USAF	Joint Staff/J-8
Kim, Jason		GOVT	DOC
King, Rick	LTC	USA	Joint Staff/J6C
Kneller, Ed	CDR	USN	NSSO/PNT
Kondas, Mike		CTR	NSSO
Lavrakas, John		CTR	Advanced Research Corp
Layton, Bill		CTR	DISA (BAH)
Leveson, Irv		CTR	DOC
Levine, Judah		GOVT	NIST

Name	Title	Service	Organization
Lindsay, Edward		CTR	HQMC/C4/Strategic Planning (CS) Div
Lorge, Frank		GOVT	FAA Tech Center
Luber, David	Capt	USMC	HQMC/PP&O/PLI
Maguire, Jack	Lt Col	USAFR	NSSO/PNT
Manney, John	Lt Col	USAF	AFSPC/A5NN
Manning, Dennis		GOVT	NGA - GPS Div
Markin, Kelly		CTR	MITRE
Mason, Brian	Dr.	GOVT	US Naval Observatory
Mason, Richard		CTR	RAND
Mathur, Navin		CTR	TAC/AMTI (Supporting FAA)
Mazur, Jonathan		CTR	NSSO/PNT (SAIC)
McCarthy, Dennis	Dr.	GOVT	US Naval Observatory
McCartney, Scott	CDR	USCG	USCG
McConnell, Kelly	Capt	USMC	HQMC/PP&O/PLI
McGuirk, Jolene	Capt	USAFR	NSSO/PNT
McNeff, Jules		CTR	OASD/NII (Overlook)
Merkle, Peter (Jay)		GOVT	FAA
Meyer, Howard		CTR	OUSD (AT&L) (BAH)
Meyer, Steaven	Capt	USAF	SMC/GPSW
Meyers, Timothy		CTR	OASD/NII & Army CERDEC (Overlook)
Miles, Calvin		GOVT	FAA ATO-W
Miller, James		GOVT	NASA
Miller, Mike	Dr.	GOVT	Eglin AFB Munitions Dir
Mitchell, Brian		GOVT	RDECOM/CERDEC/C2D
Montgomery, Kirk	LT	USCG	USCG
Myers, Amanda	Maj	USAF	USSTRATCOM/J8
Nadel, Miriam		CTR	OSD/NII (Aerospace)
Nagle, Tom		GOVT	SMC/GPSW (DOT Liaison)
Narins, Mitch		GOVT	FAA
Nelson, Jeff	LtCol	USMC	HQMC/C4/Strategic Planning (CS) Div
Nichols, Steve		CTR	JPDO (BAH)
O'Brian, Tom		GOVT	NIST

Name	Title	Service	Organization
Occhi, Tony		CTR	SMC/GPSW
Ogorzalek, Matthew		GOVT	US Army SMDC
O'Laughlin, Daniel		CTR	FAA
Olsen, David		GOVT	FAA/ATO-P
Olson, Paul		GOVT	RDECOM/CERDEC/C2D
O'Rear, Dan		GOVT	FAA
Oria, A.J.	Dr.	CTR	NASA (Overlook)
Palermo, Joseph		CTR	JPDO AATS IPT
Pelletier-Costa, Kimberly		CTR	SAF/USA (Aerospace)
Peterson, Eric		GOVT	DOT/RITA
Pettus, William		GOVT	CERDEC
Pickett, Justin	LTC	USA	USSTRATCOM/J8
Pierce, Jessica		CTR	HQDA/G-3/5/7
Potter, Terry		GOVT	HQDA/CIO/G6
Powers, Ed		GOVT	US Naval Observatory
Pruitt, Gary		CTR	ARINC (Advanced Technology Programs)
Racine, Ron	Maj	USMC	HQMC
Radice, Jim			USCG/NAVCEN
Raquet, John	Dr.	GOVT	AFRL/AFIT
Reaser, Rick	Col	USAF	SMC/GPSW
Rivera, Jose		CTR	NSSO/AE (Aerospace)
Rizvi, Abbas		GOVT	FAA
Rollo, Randy		GOVT	SPAWAR
Rush, John		GOVT	NASA
Russo, Anthony	Col	USAF	NCO
Sapp, Joe		CTR	AF/A5RS (Scitor)
Schaefer, Daniel		CTR	ITT-AES
Schilling, Charles	CDR	USN	US Naval Observatory
Schlechte, Gene		GOVT	USCG Nav Center
Schmidt, Lara	Dr.	CTR	RAND
Senior, Ken	Dr.	GOVT	NRL

Name	Title	Service	Organization
Shankland, Paul	CDR	USN	US Naval Observatory
Sharrett, Patrick		CTR	AFPSC/A3FS
Shaw, Brian		GOVT	NSSO/PDA
Shaw, Michael		GOVT	NCO
Shepherd, Dwight	CAPT	USN	OPNAV
Shinn, John		CTR	USSTRATCOM/J844
Shirasago, Dale		CTR	OASD/NII (DSC)
Singer, Richard	Dr.	GOVT	ODUSD (S&T)
Skalski, Henry (Hank)		GOVT	DOT/AFSPC/OST
Smith, George		GOVT	NSSO/PNT Division Chief
Smith, Patrick	Col	USAF	SAF/USAL
Staats, Nancy	Lt Col	USAF	AFSPC/A3FS
Staso, Michael		CTR	NSSO (MITRE)
Stear , Ed	Dr.	CTR	IDA/GPS-IRT
Stear, David		CTR	SAF/USAL
Stephens, Vincent		GOVT	USSTRATCOM/J844
Stephenson, Bruce	Lt Col	USAFR	NSSO/PNT
Stevenson, William	Lt Col	USAF	USSTRATCOM/J84
Swider, Ray		GOVT	OASD/NII
Temple, Park	Dr.	CTR	NRO/DDSE (Aerospace)
Tettelbach, Frederick	CAPT	USN	US Naval Observatory
Thompson, Chuck		CTR	NCO/DHS (SAIC)
Toler, Maria		CTR	SMC/GPSW (BAH)
Trinkle, Gary		CTR	HQDA/G-3/5/7 (DAMO-SSS)
Tsang, Phil		CTR	NSSO/AE
Turner, David		CTR	NCO
Uecker, Tim	Lt Col	USAF	AF/A5RI
Van Dyke, Karen		GOVT	DOT/RITA/Volpe Ctr
Vaughn, Dave		CTR	Joint Staff/J-6 (SAIC)
Walding, Jay		GOVT	DASD/FP/Space Policy
Walker, Maureen		GOVT	NCO
Walls, Kenny		CTR	USSTRATCOM/J8

Name	Title	Service	Organization
Ward, Kenneth		GOVT	FAA ATO-W
Warren, Steve	CAPT	USN	US Naval Observatory
Wassink, John	Col	USMC	HQMC/PP&O/PL
Watkiss, Eric	CDR	USN	NSSO/PNT
Weate, Andrew	LTC	USA	Space and Missile Defense Division
White, Jonathan	CAPT	USN	US Naval Observatory
White, Rebecca		GOVT	SMDC, Concepts & Architecture Div
Wiley, Barbara		GOVT	NGA
Winters, Steven	Col	USMC	AFSPC/A3FS
Winton, Daniel		CTR	MILSATCOM (MCSW)
Wolf, James	Col	GOVT	AFSPC/A5N
Wong, Alice		GOVT	State OES/Space & AT
Yeronick, Sean		CTR	AF/A5RE
Zebal, Ken		CTR	AFSPC/A3FS
Zillic, David		CTR	HQDA/CIO/G6

APPENDIX D – JOINT CAPABILITIES DOCUMENT SUMMARY

The JCD for PNT establishes the PNT capabilities required by the DoD, Combatant Commanders and their components, and service organizations to accomplish their Unified Command Plans or nationally directed missions. The following definitions describe the elements of PNT:

- Positioning – the ability to accurately and precisely determine one’s location and orientation two dimensionally (or three dimensionally when required) referenced to a standard geodetic system (WGS-84, height above ellipsoid or other vertical datum as directed in CJCSI 3900.01B), anywhere within the battlespace, and within user-defined timeliness parameters.
- Navigation – the ability to determine current and desired position (relative or absolute) and, referencing geospatial information and products to characterize the environment and conditions, apply corrections to course, orientation and speed to attain a desired position anywhere within the battlespace, within user-defined timeliness parameters.
- Timing – the ability to acquire and maintain accurate and precise time from a standard such as Coordinated Universal Time (UTC) anywhere within the battlespace, and within user-defined timeliness parameters. Timing includes time transfer.

Complementing PNT capabilities work in unison to ensure users receive Position, Velocity, and Time (PVT) information at needed accuracy and reliability. PNT and PVT are often used interchangeably, though they have different meanings. PNT is a joint capability, with three constituent capabilities (Positioning, Navigation, and Timing). PVT is information produced by a PNT capability. The core capability needed by the joint user is 100% availability of PNT.

A PNT Functional Area Analysis (FAA) identifies attributes used to characterize PNT capabilities:

1. Availability – reliable access to PNT data and information services for authorized users,
2. Accuracy – the degree of conformance between the estimated or measured navigation, positioning, or timing output parameter of a platform at a given time and its true navigation, positioning, or timing output parameter,
3. Precision – the degree of mutual agreement among a series of individual measurements,
4. Integrity – the ability of a PNT service to notify a user of degraded or misleading information,
5. Security – the ability to ensure the acquired or received PNT information is from a true source, and
6. Timeliness – a user-defined standard defining the time elapsed from the awareness of need for PNT data to the user’s PNT solution.

The PNT Functional Area Analysis identified six conditions in which PNT users operate:

1. Surface – the area where PNT operations may occur on the earth surface,
2. Sub-surface – the area where PNT operations may occur below the earth’s surface to include caves and underwater (sea, oceans, lakes),
3. Below MEO – the area from the earth’s surface to just inside MEO (22,000 km altitude),
4. MEO and above – the area beginning at 22,000 km from the earth’s surface into outer space (including highly elliptical orbits),
5. Impeded – constrained or restricted access to RF, sound, light, and other information transmission media by the physical (natural or man-made) environment (for example, “urban canyons”, triple canopy jungle, inside buildings, or in the presence of EMI), and
6. Unimpeded – unconstrained or unrestricted access to RF energy, sound, light and other information transmission media considering nominal terrain interference and transmitter and receiver mask angles.

The PNT JCD identified the following capability gaps:

1. Assured PNT in any environment or condition
 - a. Secure and Reliable PNT capabilities protected from interference and spoofing
 - b. Consistent PNT in changing environments
 - c. PNT in subsurface conditions
 - d. Access to Geospatial information (Availability, Accuracy, Security, Timeliness)
2. Notification of degraded or misleading PNT (Integrity)
3. Determine position and orientation for high-altitude users (Accuracy)
4. Determine orientation for joint users (Accuracy, Timeliness)
5. Model effects of impedances due to conditions or environment (Availability)

The PNT JCD also identified non-material issues that encumber the ability of the Service and DoD to provide assured PNT to joint users. Doctrinal issues:

1. RF PNT capabilities are not well synchronized with emerging PNT capability development, such as miniaturized atomic clocks, improved INSs, and non-GPS RF solutions
2. No overarching PNT architecture for the DoD or the United States
3. The operational and mission context of Navwar are oriented towards RF PNT capabilities

A lack of understanding of how orientation relates to PNT results in disparate efforts to develop orientation capabilities.

APPENDIX E – PNT NEEDS SOURCE DOCUMENTS

The PNT Architecture Needs Team assessed the following source documents in order to summarize PNT needs:

- Joint Capabilities Document for Positioning, Navigation and Timing, USSTRATCOM, 26 Sept 2006, (S/NF)
- PNT Joint Capabilities Document Vignette Spreadsheets, USSTRATCOM, 2006, (FOUO)
- 2005 Federal Radionavigation Plan, DoD DHS and DOT (U)
- Homeland Security Institute, GPS Timing Criticality Follow-on Study
- Radionavigation Systems: A Capabilities Investment Strategy, Radionavigation Systems Task Force, DOT, (Jan 2004)
- Space Communication Architecture Working Group (SCAWG) NASA Space Communication and Navigation Architecture Recommendations for 2005-2030 (p.64), 15 May 06 (U)
- "GPS Timing in Electric Power Systems", Kenneth Martin, Bonneville Power Administration, 42nd CGSIC Timing Subcommittee (U)
- USNO Timing Requirements Brief to NSSO, Dennis McCarthy, USNO (FOUO)

APPENDIX F – RISK SUMMARY⁵

The objective of Risk Management is to provide a proper balance between risk and opportunity. It seeks to understand and avoid the potential cost, schedule, and performance/technical risks to an endeavor, and to take a proactive and well-planned role in anticipating them and responding to them if they occur. The Risk Management process used during the development of the National PNT Architecture, shown in Figure 1, provides an organized, systematic decision-making methodology to effectively deal with uncertainty in accomplishing program and/or organizational objectives.

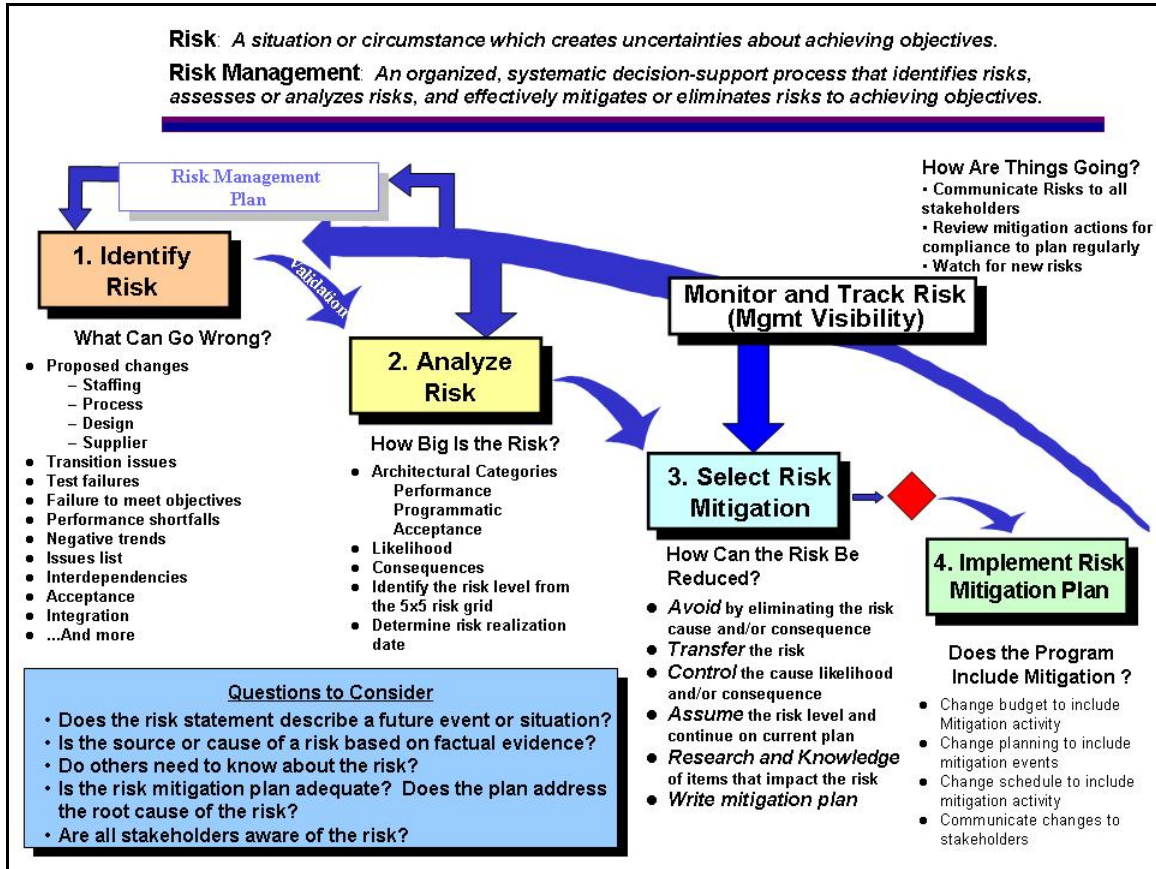

Figure 1 Risk Management Process

Step 1 – Risk Identification

Risk is defined as a future event or situation with a realistic probability (between 0% and 100%) of occurrence and an unfavorable consequence or impact to the successful accomplishment of well-defined goals if it occurs.

⁵ Primary Section Author – Mr. Kenneth Kepchar, FAA/CSEP CISSP

Risk identification is a systematic effort to uncover possible events or conditions that, if they occur, may hinder achievement of program or organization objectives. This step was covered during the ADT development of the representative architectures. As the characteristics and features of each representative architecture were explored, any accompanying risks were identified. A risk log was developed and the risks were categorized.

A Risk Management process classifies each risk according to the root cause of the risk event, traditionally in the categories of technical, schedule, and cost. However, for the purposes of supporting the development of an architecture, it is more useful to view the root cause in terms of one of the following three categories: (1) performance of the capabilities captured in the architecture, (2) programmatics of implementing the recommendations, or (3) external forces such as stakeholder acceptance that influence the realization of the architectural components. To aid in a subsequent risk analysis, each ADT member was asked to identify aspects of performance, programmatics, and acceptance that were potentially driving the risk identified. These “aspects” are identified in the tables discussed below.

The performance category deals with the characteristics and features of the architecture itself: It considers performance benefits offered by inclusion of a capability in the architecture, as well as the performance uncertainties introduced as a result. Also considered are technical capabilities, integration issues, technologies involved along with their maturity levels, and operational considerations, as shown in the table below.

Technology	TE
Integration	IN
Technical Capabilities	Tx
Hardware	TH
Software	TS
Sci/Eng Algorithms	TA
Operational Problems	OP

Table 1 – Performance Risk Factors

Implementing portions of the architecture imposes a set of uncertainties, usually driven by programmatic efforts to turn architectural concepts into operational systems or capabilities. More traditional categories of implementation/transition, schedule, and cost provide useful insight into the risks associated with this phase of the endeavor, as shown in the table below.

Cost	PC
Schedule	PS
Implementation/Transition	PI

Table 2 – Programmatic Risk Factors

Acceptance captures those conditions and forces external to the architecture that influence the extent to which concepts become part of the operational US PNT infrastructure. This category considers the impacts on the stakeholder and the user, within political, international, social, market, and policy contexts, as shown in the table below.

Stakeholder Participation	AS
User	AU
Policy	AP
International	AI
Ownership	AO
Economic/Social	AE
Military Pre-eminence	AM

Table 3 – Acceptance Risk Factors

Step 2 – Risk Analysis

The second step in the process shown in Figure 1 above is to perform an assessment of each risk to determine its relative impact on the overall architectural effort. A preliminary analysis was performed by the ADT members on the identified risks to ensure a degree of consistency among the relative assessment ratings across the ADT. Detailed analysis of the individual risks was deferred until the Transition Planning Phase. The preliminary analysis performed is described below.

Risk analysis (or risk assessment) provides insight into the significance of identified risks by assessing their likelihood and the consequence to the endeavor should the risk event occur. A risk likelihood (probability) template (shown in Figure 2 below) was developed for each hybrid architecture. Risks were mapped into a risk grid to determine the individual risk level (red indicates high, yellow for medium, and green indicates low). A second template was subsequently used to evaluate the consequence or impact for each risk, should it materialize (Figure 3). The likelihood and consequence, though tied to the same risk event, were considered to be independent of one another.

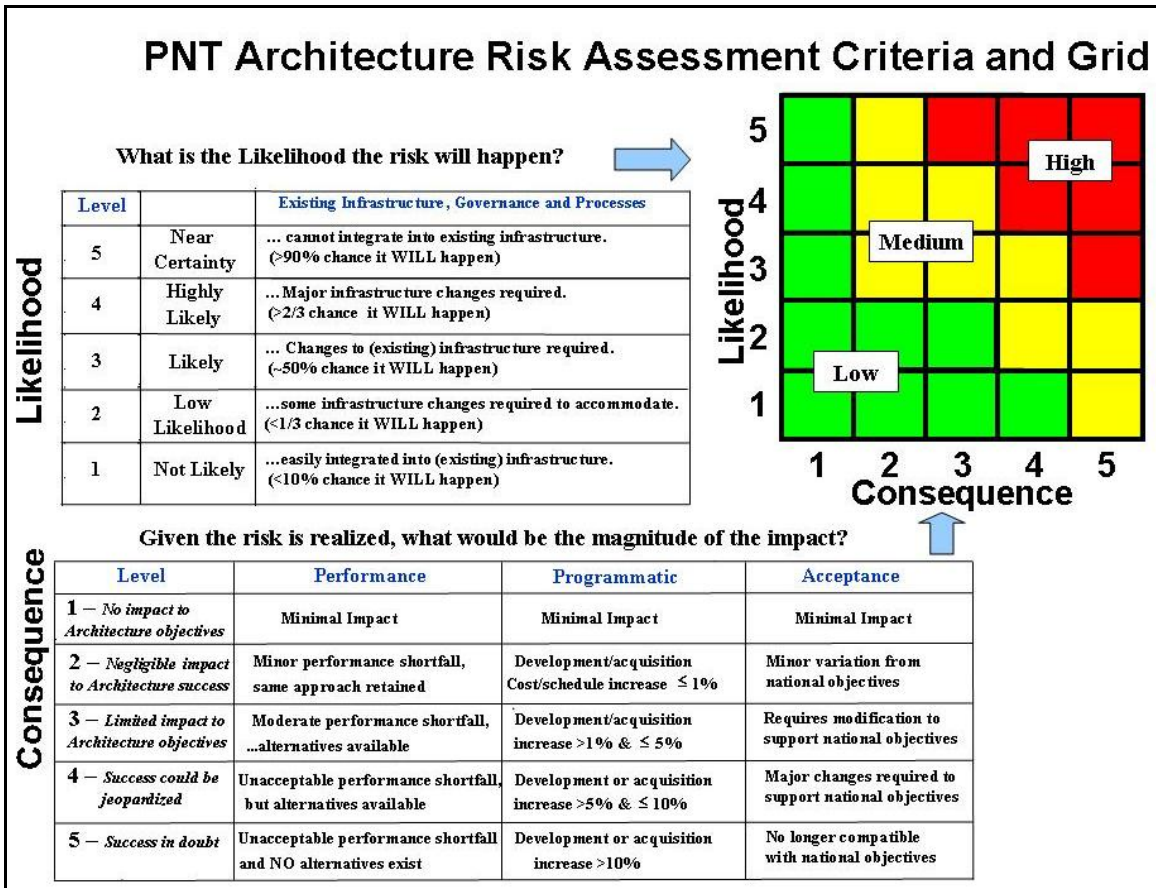

Figure 2 Risk Likelihood Template

Input was collected from ADT members over the course of several sessions. Participants were requested to relate the areas of uncertainty to the gaps that served as the basis for the representative architectures. To help capture this data, the risk data gathering template shown in Figure 3 was developed. Next, this data was compiled into a risk register and summarized. The summarized risks helped drive “Should Be” recommendations, which in turn helped mitigate the risks identified.

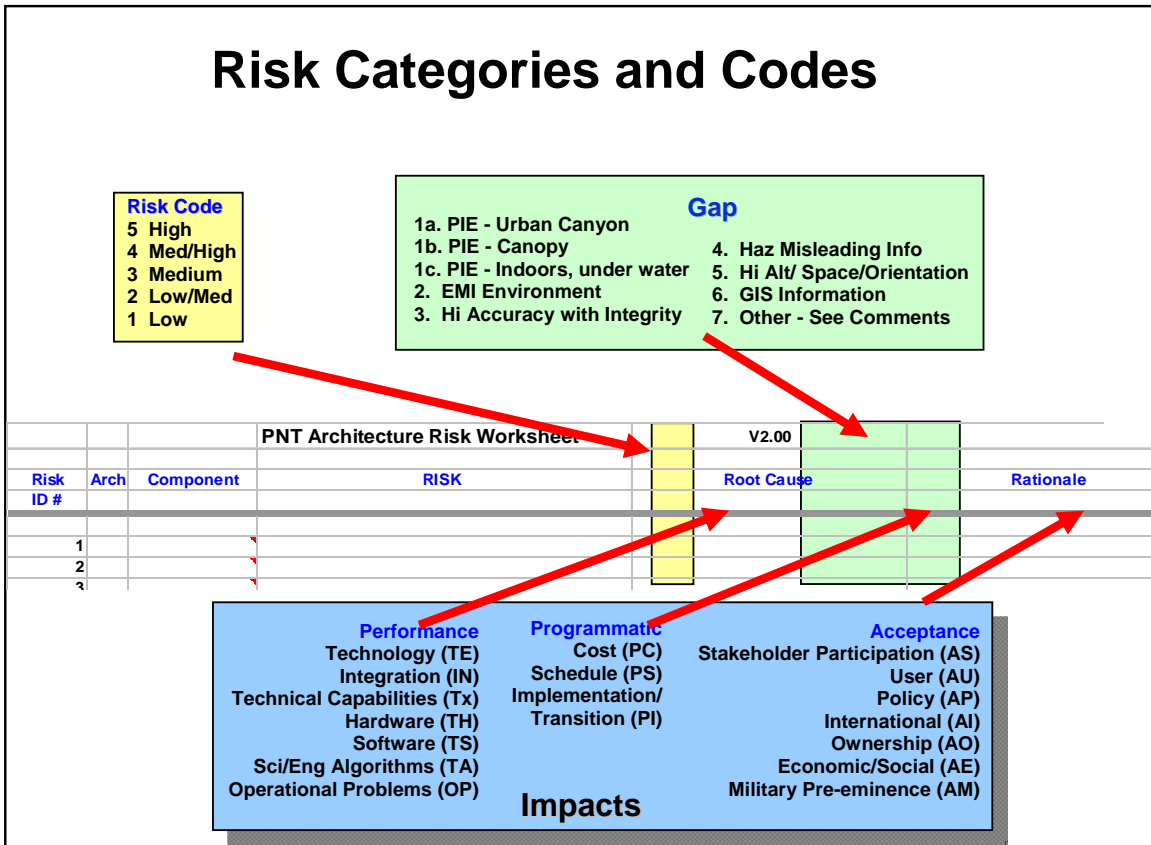

Figure 3 Risk Data Gathering Template

Detailed analysis of the individual risks was deferred until the Transition Planning Phase, when each of the risks identified will be grouped with the architectural recommendation(s) that the risk has the most bearing on. The focus of risk analysis during the Transition and Implementation phases will shift to identifying recommendation interdependency risks and appropriate mitigations or decision points for each.

Steps 3 and 4 – Risk Mitigation

The transition plan for each architecture recommendation will address the risks involved and the mitigations recommended for the transition to implementation. The objective of risk mitigation or risk reduction efforts is to implement appropriate and cost-effective mitigation plans to reduce or eliminate the risks. In Figure 1, a red diamond symbolizes the decision point where the mitigation plans are accepted, modified, or rejected. In the architectural process, this occurs as the transition plans are decided upon and developed for each architectural recommendation. Implementation of the mitigation plans occurs as part of the implementation of the recommendations themselves.

Results

The risks identified by the ADT were grouped by Performance, Programmatic, and Acceptance area; each category is subsequently summarized. The risk likelihood templates created by the ADT for each of the four hybrid architectures are provided at the end of this appendix.

Performance – The risks identified by the ADT support findings in the following areas:

Star charts and reference Frames upgrades (Enablers)

- Degrading celestial charts inhibit accurate orientation and positioning for high altitude and space users
- ITS needs reference frames, models, datum, etc. compatible with required positioning performance, and an affordable means to map the road system to create the GIS database

MEMS IMU (INS) Research & Development (Technology)

- Lack of progress in IMU development degrades the ability for autonomous PNT when GNSS is not available

CSAC Research & Development (Technology)

- Performance, power, size, clock stability are yet to be consistently achieved in one package to allow this technology to be considered as a viable approach to autonomous operation
- Optical Time Transfer (sub-femtosecond (10^{-15}) accuracy of optical atomic clocks) has yet to be demonstrated over long-haul distances. This can inhibit network synchronization performance.

Network information security

- If PNT is based on a network solution, the vulnerability of the network to information system security threats can result in the loss of PNT integrity and availability

Use of Comm. Networks for PNT

- If communications networks are used to convey PNT as well as communications, there may be insufficient bandwidth available on the link with the resultant degradation/loss of both services

Network integration and interoperability

- Cost and acceptance roadblocks for the user regarding reliance on multiple networks for reliable PNT services
- Multiple networks that the user interfaces with may not share the same PNT information

Multi-sensor integration

- If data from multiple sensors and various sources are not effectively integrated in the UE then accuracy, availability and robustness of the PNT solution will suffer

Beacon Standardization

- If beacons, pseudolites, and RFIDs are not standardized, at least within user groups, then interoperability and extent of coverage suffers

GNSS performance aiding thru augmentation systems

- If user high accuracy and integrity demands exceed planned GNSS capabilities, then specialized augmentation systems will be required to achieve the required performance levels

GPS III Performance levels

- Spot beam development may not support including this capability on the payload to support military needs

Non-US GNSS performance and dependability

- If required performance levels depend on foreign GNSS assets, then signal integration and performance levels must be assured to prevent loss or degradation of service
- Integration of multiple GNSS (especially foreign) puts an added workload on the operators of GPS in trying to coordinate the timing and navigation solution between different systems

Programmatic – The risks identified by the ADT support findings in the following areas:

US Government leadership and organizational structures

- The jurisdictional responsibilities of multiple Congressional Committees for the funding of PNT programs across multiple Departments open the possibility of uneven and/or delayed infrastructure implementation
- Dispersion of responsibilities among numerous departments and government agencies coupled with perceived lack of authority to enforce US policy for those elements of this National PNT architecture that represent PNT services provided or regulated by the US Government will impede the synergistic effects envisioned by this effort

Beacons

- Extensive infrastructure required to be developed and built to provide alternate PNT services via terrestrial pseudolites

Network (cell) availability and integration

- If standards are not in place, users cannot depend on having compatible cell networks resulting in loss of service
- Present cell coverage exists primarily where there is a dense population. If the architecture is to rely on delivery of PNT information over networks not designed for PNT purposes, sufficient coverage must be ensured.

Network information security

- DoD experience with the GIG and the development of information assurance efforts shows that information system security implementation is far more complex than planned for multiple networks being integrated

UE integration

- If Modernized GPS User Equipment is not developed and fielded on schedule, then military will not obtain benefits from GPS modernization including improved robustness in impeded environments

R&D transition into production and the market

- US Government needs to develop the ability to complete successful R&D and transition that technology to production and field use in a timely and efficient way

Acceptance – The risks identified by the ADT support findings in the following areas:

US leadership

- If the US loses leadership in international forums such as ICAO and therefore must follow standards developed by other countries, then the US is at risk of losing economic and military pre-eminence

International acceptance and collaboration

- Failure to coordinate with other GNSS providers (European Union, Russia, China, etc.) may result in loss of US control in international use of GNSS
- If the PNT solutions selected for use by the US are not accepted and fielded worldwide, especially with respect to specialized PNT augmentations, the PNT architecture will not provide a global solution

Policy

- If beacons are to be extensively used for PNT services, then policy is required to mandate standards (building codes, etc.) to avoid inconsistent infrastructure implementation and integration
- Non-US GNSS usage vs. dependency
- Ownership and concomitant liability issues

Summary risk charts for each representative architecture as identified by the ADT

The template shown in Figure 2 above was used to summarize the ADT's findings on the various representative architectures; the findings are presented in the following charts. Colors indicate risk level (red for high, yellow for medium, and green for low). In each of the subsequent figures, pink highlighting indicates items assessed by the ADT at a 5-5 risk level.

Risk Matrix – Hybrid A A

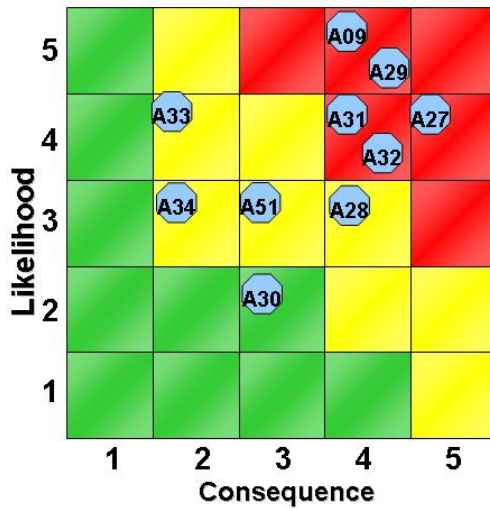

- (A09) Military adoption of eLORAN
- (A27) Chip Scale Atomic Clock
- (A28) MEMS IMU
- (A51) Military Use of Foreign Sources
- (A30) Pseudolites
- (A31) Beacon Development
- (A32) Intelligent Transportation System Stability
- (A33) Global LEO GNSS Acquisition Aid
- (A34) 33 Satellite US GNSS Constellation
- (A29) Foreign PNT Integration

Risk Matrix – Hybrid B B

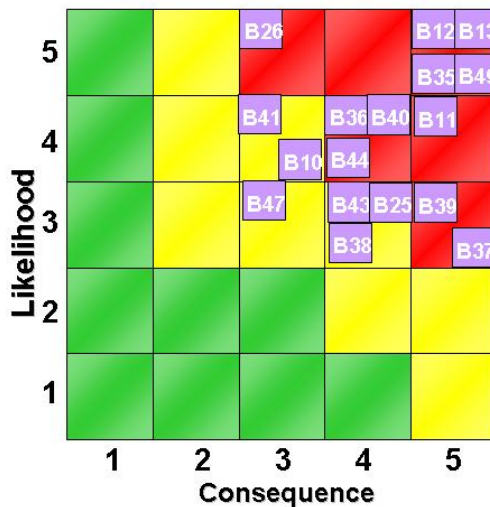

- (B26) eLORAN Acceptance
- (B11/39) Beacon Network Coverage
- (B12) Cell Network Global Interoperability
- (B13/36) Cell Network Coverage
- (B47) Political will
- (B35) HA NDGPS (ITS Application)
- (B38/41) Network Interoperability
- (B43) SatComm Network application
- (B10) MEMS/INS
- (B40) MultiLat Network Accuracy
- (B25) Network based Integrity
- (B37) Network Protection
- (B49) Network Integration
- (B44) Space based networks

Risk Matrix –Hybrid C

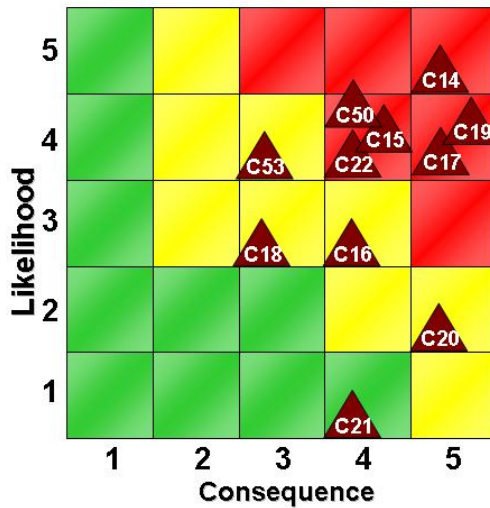

- (C20) Industrial Base
- (C21) Multi-sensor Integration
- (C18) Aviation Augmentation Accuracy
- (C22) Beacon Standards
- (C15) CSAC Development
- (C50) UE Multisensor Integration
- (C53) Ground Infrastructure Integration
- (C16) International standards
- (C17) Star Tracker Development
- (C14) UE Integration Algorithms
- (C19) Modernized military UE

Risk Matrix – Common Theme (Recommendation Implications)

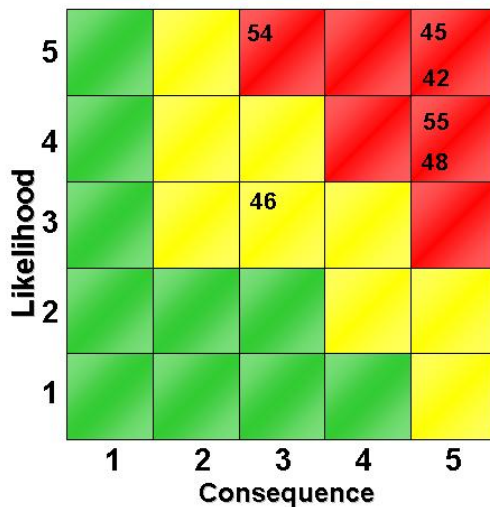

- (46) IMU Development
- (54) LF Augmentation
- (45) US GNSS Leadership
- (48) US GPS Acquisition
- (42) High Accuracy with Integrity
- (55) US Policy concerning foreign GNSS use

Risk Matrix - EBL

E

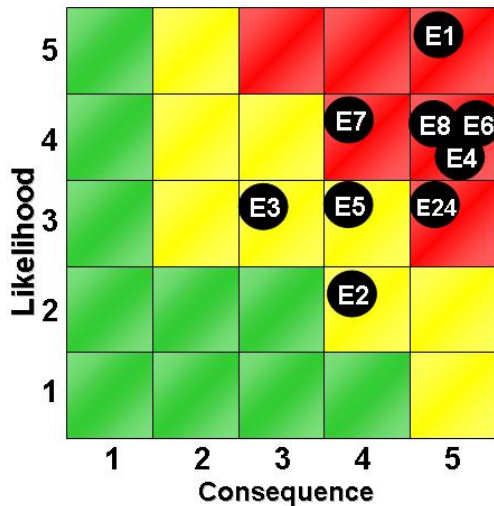

- (E3) Aviation Augmentation Accuracy (*Same as C18*)
- (E7) INS Accuracy
- (E5) eLORAN & NDGPS Sustainment
- (E8) Reference Frame Maintenance
- (E1) UE Integration Algorithms (*Same as C14*)
- (E4) Modernized military UE (*Same as C19*)
- (E6) GPS III Acquisition
- (E2) International standards (*Same as C16*)
- (E24) CSAC Development

Conclusion

The use of this Risk Management process during the development of the PNT Architecture had three primary objectives. First, inclusion of risk in the assessment framework ensured that the concepts and courses of action with extreme risk were generally avoided and/or filtered out of the various architectures as those risks were identified, or the architectures were designed to eliminate or mitigate such risks. Second, risks which remained in the "Should-Be" Architecture were considered when developing the recommendations, in many cases including focused research, development, or assessment designed to mitigate such risks, vice immediate implementation of a high-risk feature. Third, the risks are documented in the final report, and should be considered for further mitigation during follow-on activities such as transition and implementation planning.

APPENDIX G – EVOLVED BASELINE DATA PACKAGE

Evolved Baseline Package: The EBL data package as developed by the architecture effort consists of:

- National PNT Architecture Evolved Baseline Description (MS Word)
- Draft PNT Overview graphic, Enterprise View and Systems List (MS PowerPoint)
- PNT Architecture Consolidated Data Sheets (MS Excel)
- PNT Enterprise database (MS Access)
- PNT Architecture User Perspectives graphics (MS PowerPoint)
- PNT References (a file folder structure containing various reference documents)

National PNT Architecture Evolved Baseline: The current *de facto* PNT Architecture consists of an *ad hoc* mix of external and autonomous PNT providers as well as PNT augmentations. These systems provide PNT to a wide array of space, air, land, and maritime users, both civil and military. PNT is supported by a large number of PNT enabling capabilities and infrastructure, and must be provided in an environment which includes spectrum, weather, fiscal, and geo-political challenges. The current “As-Is” PNT Architecture is characterized by widespread use of GPS, and a large number of systems that augment GPS. Each augmentation has been optimized for a different user group or groups. There are also a large number of non-space based systems that provide navigation services. A challenge in evolution from this baseline is that it will require, among other things, user communities that support the case for the evolution and availability of user equipment and operational procedures and information to achieve the evolution. The absence or deficiency of any of these factors will adversely impact the provision and use of PNT services. Most funding for external PNT providers is provided by the US Government to the US Air Force and to a lesser extent by the US Department of Transportation and other civil government agencies. However, there are a number of commercial GPS augmentations that operate on a for-profit basis.

Components of the PNT Architecture:

External PNT Providers. Systems or combinations of systems which provide users with PNT (or orientation) data from an independent source external to the user, compared to either a relative point or reference frame.

Autonomous PNT Providers. Systems or combinations of systems which provide users with PNT (or orientation) data from an independent source without frequent reliance on external data, compared to either a relative point or reference frame. Most such systems do, however, require initialization from an external source, and/or comparison to externally developed reference information (star catalog, map).

PNT Augmentation. Space and/or ground-based systems that provide users of positioning, navigation, and timing signals with additional information that enables users to obtain enhanced performance when compared to the un-augmented signals alone. This additional information may include differential corrections, corrections or updates to

clock and ephemeris information, additional ranging signals, or other aids to signal acquisition, accuracy, availability, and/or integrity.

PNT Environment. Characteristics or attributes of the physical or virtual environment that may or may not influence the operation and performance of the PNT Architecture.

PNT Enablers and Infrastructure. Capabilities and organizations that provide key support to PNT providers and augmentations, but that do not directly provide a PNT capability themselves.

PNT Users. The community of persons and organizations that use PNT systems in any application to determine their position, time, orientation, and/or use that information to navigate. Includes military, homeland security, civil, and commercial users in space, in the air, on the surface of the earth (land or water, indoor or outdoor) and subsurface (underwater, underground).

Brief descriptions of PNT systems in the Evolved Baseline:

The ***Global Positioning System*** (GPS) consists of a nominal 24 satellite constellation and its associated control segment and user equipment. It provides the core of PNT capabilities for many users worldwide.

GLONASS is a multi-use, space-based radionavigation system run by Roscosmos (Russia's space agency) and Russia's Ministry of Defense to meet civilian consumer, government agency, and military needs. The system is in the process of repopulating its constellation, with 15 satellites on orbit. GLONASS plans to have 11 operational satellites by the end of 2007 and 24 operational satellites by the end of 2010.

Beidou-1 or the Beidou Navigation Test System (BNTS) as announced to the open press by the Chinese government is the Chinese satellite navigation system designed to provide positioning, fleet-management, and precision-time dissemination to Chinese military and civil users. It consists of three satellites deployed in geostationary orbit over China. Beidou-1 supports two types of satellite navigation capabilities: Radio Determination Satellite Service (RDSS) and Satellite-Based Augmentation System (SBAS). The RDSS capability is operational, and the status of the SBAS is unknown. Beidou-1 provides limited coverage and only supports users in and around China.

The Beidou-1 geostationary (GEO) constellation was merged in with a planned medium Earth orbit (MEO) constellation previously called Beidou-2, and called ***Compass*** when the first MEO satellite was launched on 13 Apr 07. Compass will likely consist of approximately 2-5 GEO satellites and up to 30 MEO satellites placed in up to six orbital planes.

GALILEO is a multi-use, space-based radionavigation system in development through a joint initiative shared by the European Commission and European Space Agency (ESA), to meet civilian consumer and government agency needs. It provides highly accurate time and 3-dimensional position and velocity information to users worldwide. The system is currently in its design phase, with two demonstration satellites (GIOVE-A,B) on orbit, and plans full operational capability in 2013. A full constellation will consist of 30 satellites as well as ground infrastructure to control the satellites.

The *Quasi Zenith Satellite System (QZSS)* is a multi-use, space-based regional radionavigation system in development by the government of Japan. It is essentially a GPS augmentation system at MEO. The system is currently in its research phase, soon to enter development and testing. The space segment will consist of three satellites with the first satellite to be launched for testing purposes in 2009.

The *Indian Regional Navigation Satellite System (IRNSS)* is a regional satellite navigation system being developed by the India Space Research Organization (ISRO) along with India's Defense Research Development Organization (DRDO) in concert with its GPS regional augmentation system. The IRNSS will consist of 4 GEO satellites and 4 non-GEO satellites.

The *Space Communications and Navigation Architecture (SCA)* is being designed to provide the necessary communication and navigation services for NASA space Exploration and Science missions out to the 2030 time frame. The architecture will feature clustered networking services at the Earth, Moon, and Mars that are connected to Earth via long-haul links. The architecture will also provide radiometric tracking services available to all spacecraft and support time distribution that is related to a common time reference.

LORAN is a stand-alone, hyperbolic radionavigation system that provides horizontal coverage throughout the 48 conterminous states, their coastal areas, and most of Alaska south of the Brooks Range. It supports positioning, navigation, and timing services for air, land, and marine users. The LORAN-C system has undergone a modernization program to include solid state transmitters in the Continental US (CONUS), triple cesium clocks and modern time and frequency equipment, etc. This system is now referred to as *Modernized LORAN*. Completion of all modernization activities (mainly the five remaining Alaskan stations - work at Kodiak has already been completed), and the availability of eLORAN receivers will result in *Enhanced LORAN (eLORAN)*, which can be briefly described as an internationally standardized position, navigation, and time multi-modal service. It will be the latest evolution of the low-frequency long-range (LORAN) radionavigation system. eLORAN will meet the accuracy, availability, integrity, and continuity performance requirements for aviation non-precision approach, maritime harbor entrance and approach, land mobile, and precise time and frequency applications. eLORAN will be an independent, dissimilar complement to GNSS that allows diverse user communities to retain their safety, security, environmental, and economic benefits when GNSS services are disrupted.

VOR/DME, and its military counterpart, *TACAN*, provide aviation users with bearing and distance-measuring navigation services for en route through nonprecision approach phases of flight.

The *Instrument Landing System (ILS)* is the predominant system supporting precision approaches in the US. With the advent of GPS-based precision approach systems, the role of Category I ILS will be reduced. ILS will continue to provide precision approach service at major terminals.

Aeronautical Nondirectional Beacons (NDBs) serve as nonprecision approach aids at some airports. They are also used as compass locators, generally collocated with the outer marker of an ILS, and are used as en route navigation aids.

Some *cell* phone *networks* provide *PNT* through the ability to transfer time via phone communications and do coarse positioning through triangulation among signals received from multiple cell phone towers.

Both the DoD and NASA make use of a network of *Earth-based tracking* antennas to determine the position of various objects, especially those in space.

Many users make use of autonomous PNT sources, either stand-alone or integrated with other systems, to obtain PNT capabilities. These include highly accurate inertial navigation systems in high-end platforms and lower cost accelerometers integrated into automobiles. Similarly, highly accurate atomic clocks provide stand-alone timing, and less accurate clocks are often used for timing, with their drifts corrected by being integrated with GPS. Terrain Contour Matching (TERCOM) systems are used in navigation by matching local terrain to that of a known database, especially in guidance for some cruise missiles. Doppler ranging systems provide velocity information useful in navigation, that are often integrated with GPS and/or INS systems. Finally, many users rely on a compass, perhaps in conjunction with a map, as a primary or backup navigation means.

Celestial navigation involves use of optical devices, compared against a known star catalog, to determine position and orientation/attitude. It is often used by land, maritime, and air users for navigation. Similarly, *star trackers* are sensors used by spacecraft requiring high pointing accuracy to determine their orientation.

A variety of means are used for *time transfer*, to synchronize clocks at two geographically separated locations. These include two-way time transfer and common view time transfer of, for example, communications satellites. The military in particular makes use of data links to synchronize timing of communications cryptography by ‘passing a Mickey’ between two users, such as between Airborne Warning and Control System (AWACS) and fighter aircraft.

Pedometers and similar devices such as odometers and wheel counters measure distance traveled as an aid in determining position. They are widely used in some applications in the civil community.

The GPS is augmented by a number of other global and regional systems. The *Wide Area Augmentation System (WAAS)*, an SBAS operated by the FAA, is optimized to provide improved accuracy and integrity to aviation users. WAAS consists of (nominally) 2 satellites in GEO orbit, 2 WAAS Master Stations, 3 Uplink Stations, and 25 reference stations. It supports aircraft navigation during departure, en route, arrival, and approach operations. WAAS is also used to support FAA safety, capacity, and efficiency initiatives and is also used in many other civil applications. The *Multifunctional Transport Satellite (MTSAT)* and *European Geostationary Navigation Overlay Service (EGNOS)* are similar space-based augmentation systems operated by Japan and the European Union, respectively.

The *TDRSS Augmentation Service for Satellites (TASS)* disseminates the Global Differential GPS (GDGPS) real-time differential correction message to Earth satellites to enable precise autonomous orbit determination, science processing, and the planning of operations in Earth orbit (see figure below). The TASS signal is transmitted on S-band

from NASA's TDRSS satellites and also provides a ranging signal synchronized with GPS. The TDRSS system consists of in-orbit telecommunications satellites stationed at GEO and associated ground stations located at White Sands, New Mexico and Guam. Its function is to provide Space Network tracking; provide data, voice and video services to NASA scientific satellites, the Shuttle, International Space Station, and to other NASA customers; and to provide user navigational data needed to locate the orbit and position of NASA user satellites.

A number of *commercial GPS augmentations* exist, such as Fugro's OmniSTAR, John Deere's StarFire, Global Locate, and Qualcomm's SnapTrack. Some of these provide differential corrections; some improve a receiver's capability to provide positioning output (Snap Track); others tie in to NASA GDGPS to transmit more accurate ephemeris. Depending on the system, augmentation information is disseminated through either space-based or ground-based transmitters.

GPS and GEO Augmented Navigation (GAGAN) is a planned Indian satellite-based regional GPS augmentation system, sponsored by the Indian Union Ministry of Civil Aviation with active support from the Indian Space Research Organization (ISRO). The payload was under fabrication as of May 2005. First launch is planned for 2008 on the GSAT-4 satellite. It is intended as a low-cost satellite navigation system, which would have seven geostationary satellites, always visible and covering the region. (Ref: Indigenous satellite navigation system on the anvil, M. Somasekhar, Hyderabad, May 10, 2005).

The planned *NigComsat-1 SBAS* is a WAAS-like augmentation that consists of two L-band navigation transponders on the Chinese DFH-4 satellite. Launch date was planned for 2006-2007 but is now TBD. Nigeria Communications Satellite Corp. plans to lease the SBAS transponder to a TBD GNSS provider; however, no plans have yet been made for the ground infrastructure to support its SBAS capabilities.

The *Maritime Differential GPS (MDGPS)* is sponsored by the US Coast Guard, and provides increased accuracy and integrity of the GPS using land-based reference stations that transmit correction messages primarily for maritime users. The MDGPS partners with sites operated by the Army Corp of Engineers to provide coastal coverage of CONUS, the Great Lakes, Puerto Rico, and portions of Alaska, Hawaii, and the Mississippi River Basin. MDGPS includes 2 control centers, 48 remote broadcast sites, and similar sites located in 40 countries worldwide. Further improvements to accuracy and the development of 1 to 2 second time-to-alarm integrity are anticipated. Additional information may be obtained from the NAVCEN website: <http://www.navcen.uscg.gov>.

The *Nationwide Differential GPS (NDGPS)* is an expansion of the Coast Guard's MDGPS to provide increased accuracy and integrity of the GPS using land-based reference stations that transmit correction messages, primarily in CONUS, for inland users (authorized by Public Law 105-66 section 346). NDGPS utilizes the MDGPS control centers, and is comprised of 38 operational sites. The High Accuracy NDGPS (HA-NDGPS) system is currently under development in order to enhance the performance of NDGPS. Two HA-NDGPS reference stations are currently operational and providing 10 to 15 cm accuracy throughout the coverage area. However, FY07 Federal Railroad Administration (FRA)/DOT budget submission zeroed funding for the

NDPGS program. Follow-on discussions revealed that the FRA is unwilling to continue support of NDGPS in its portfolio of programs. Without DOT or other government agency funding, the Coast Guard cannot continue its involvement in electronic aids to navigation systems serving exclusive inland purposes. DOT's Research and Innovative Technology Administration (RITA) agreed to fund O&M to sustain NDGPS through FY08, so NDGPS remains a part of the EBL at this time. Additional information may be obtained from the NAVCEN website: <http://www.navcen.uscg.gov>.

The **Ground-Based Augmentation System (GBAS) Cat-1** is a GPS augmentation system deployed in Australia and in beta testing in Germany, Spain, and the US to support aviation Category I precision approach. GPS GBAS provide local area corrections, integrity, and flight path information to aircraft in the terminal area for high accuracy operations.

The **Joint Precision Approach and Landing System (JPALS)** will provide GPS- / INS-based precision instrument approach guidance for DoD aircraft.

The **Global Differential GPS (GDGPS)** is a global, seamless, and very high accuracy GPS augmentation system developed by Caltech's Jet Propulsion Laboratory (JPL) to support real-time positioning, timing, and environmental monitoring for NASA's science missions. GDGPS also provides advanced real-time GPS performance monitoring in support of GPS operations at the US Air Force, and a host of other real-time products and services. The network consists of 70 dual-frequency GPS reference stations that have been operational since 2000. Additional information may be obtained from the GDGPS website: <http://www.gdgps.net>.

The **National Continuously Operating Reference Stations (CORS)** is a GPS augmentation system managed by NOAA that archives and distributes GPS data from more than 650 stations worldwide for precision positioning and atmospheric modeling applications. CORS data is both broadcast directly as well as over the internet. Historically, CORS served post-processing users of GPS, but is being modernized to support real-time users.

International GNSS Service (IGS). The International GNSS Service, formerly International GPS Service, is recognized as an international scientific service, and it advocates an open data and equal access policy. NASA contributions to the IGS include day-to-day management and coordination by the IGS Central Bureau, management of NASA's global GPS network that contributes to the IGS Network, an Analysis Center (one of eight) for GPS orbits, clocks, and reference frame products, and an IGS Global Data Center where full access to data and products is provided. Over 10 years, IGS has expanded to a coordinated network of more than 350 GPS monitoring stations from 200 contributing organizations in 80 countries. Other contributing US agencies and organizations include, among others, the National Oceanic and Atmospheric Administration/National Geodetic Survey, the US Naval Observatory (USNO), National Geospatial-Intelligence Agency (NGA), and the National Science Foundation. The IGS mission is to provide the highest quality data and products as the standard for GNSS in support of Earth science research, multidisciplinary applications, and education, as well as to facilitate other applications benefiting society. Approximately 100 IGS stations

report with a latency of one hour. This data, and other information, may be obtained from the IGS website at: <http://igscb.jpl.nasa.gov>.

Concepts relevant to the EBL:

The PNT Architecture must operate in the **environment of the future**. Environmental issues include growing challenges in the electromagnetic spectrum both from unintentional interference as well as (primarily for military systems) friendly and hostile navigation warfare (Navwar). Navigation warfare includes the need for electronic protection against jamming, spoofing, and interference. It also includes electronic attack capabilities to deny the hostile use of any space-based positioning, navigation, and timing services, without unduly disrupting civil and commercial access to civil positioning, navigation, and timing services outside an area of military operations, or for homeland security purposes. Finally, Navwar includes electronic support - the ability to detect, locate, and characterize hostile jamming or interference affecting friendly users. Relevant electronic support efforts include NGA's GPS Jammer Location System (JLOC) and DHS's PNT Interference Detection and Mitigation Plan.

Other environmental challenges include those caused by weather (poor visibility, ionospheric scintillation, etc.) and geography as well as fiscal and geo-political challenges. A growing world population will add demographic challenges, increasing PNT demand and the need to support higher capacity in PNT user systems. The growing and changing technological environment presents both challenges and opportunities if the PNT architecture is designed to take advantage of them.

PNT services are **enabled by supporting capabilities** to include reference frames, timing standards, and other standards. Data and data transfer standards, for example, enable data sharing and transfer through the adoption of standards determined by the appropriate agency. Other enabling capabilities include star catalogs; deployment; modeling; mapping, charting, and geodesy; electro-optical information; cryptography; laser ranging networks; and science and technology.

PNT services are further **supported by infrastructure** from a variety of organizations to include policies, testing, and the industrial base. This infrastructure includes both physical infrastructure and non-physical support capabilities. USNO serves as the official time source for the DoD and GPS. The National Institute of Science and Technology (NIST) maintains the frequency and time interval standards for the US civil community. NGA exploits and analyzes imagery and geospatial information to describe, assess, and visually depict (such as in maps) physical features and geographically referenced activities on the Earth in support of national security objectives. NOAA's National Geodetic Survey (NGS) defines and manages the National Spatial Reference System (NSRS), a national coordinate system that provides the foundation for transportation and communication, mapping and charting, and a multitude of scientific and engineering applications. The National Security Agency provides GPS cryptographic keys. The National Aeronautics and Space Administration conducts research and development in the area of monitoring the earth and space environment (geodesy, ionospheric monitoring, space weather, etc.), receivers for precise positioning of science users in space, and space-qualified clocks.

PNT infrastructure also includes three primary organizations that serve as interfaces to the PNT user community. The GPS Operations Center (GPSOC) supports DoD users. The FAA's National Operations Control Center (NOCC) serves as the user interface with the civil aviation community, while the US Coast Guard's Navigation Center (NAVCEN) provides this function for the rest of the civil community.

PNT Enterprise View

The PNT Enterprise View documents key connectivity and information flow between systems contained in the “As Is” PNT Architecture baseline. It provides insight into the operation and dependencies of the system-of-systems PNT Enterprise, and will form a valuable reference when exploring conceptual excursions to the baseline. This chapter of the PNT Architecture EBL description document serves as a summary companion to a data set contained in a Microsoft Access database and a pictorial view (plot - entitled with “Enterprise View”). A list of definitions follows on page 137.

History: Revision 1 of the PNT Enterprise View was a starting point for future efforts to evaluate and model the PNT domain, as well as providing a jumping-off point for architectural studies and efforts. The physical depiction of Rev 1, The PNT Enterprise View or “Wall” resides in the Da Vinci Conference Room at NSSO’s Waples Mill facility. The observer of the “Wall” will note that it is *mostly* constructed to read from top-down; left-to-right, just as one would read a book. Most notably, as one reads the “Wall – Revision1” from left to right, one will notice that Enablers, Providers, Augmenters, and Users are sequential/linear. Also, directionality of the linkages was implied by convention (Top/Left – Input; Bottom/Right – Output).

Requirements for Revision 2: Revision 2 of the “PNT Enterprise View” is a grand departure from Revision 1; namely, the book format was not levied as a requirement. Furthermore, it was suggested that everything be laid out with straight line connectors in PowerPoint. It was quickly realized that this approach has tremendous merit, as the entire domain could be visualized, connected, and easily accommodate changes. The challenge was to piece the puzzle together (while being limited to two dimensions) with minimum lines crossing over boxes and obscuring the “view.” Directionality in Revision 2 is depicted by arrows. Although other tools can represent the data better and make it easier to put together, PowerPoint was chosen for its widespread availability.

Specific requirements:

- Connectors use arrows for directionality vs. top/left (input – Revision 1) and bottom/right (output – Revision 1)
- Connectors are either a source or a sink; but never both
- Can have multiple sources or sinks
- Connectors remain attached to the boxes when moved or resized
- Straight connectors where possible
- Bend connectors where necessary

Discussion of Plot:

To reiterate, Revision 2 is not structured in a book format, and is more unconstrained. Generally, the Enablers are situated in the bottom left of the view. Augmenters are positioned at the top with most of the Providers on the right side. Exceptions are the huge

User group and GPS Provider which are more centrally located along a diagonal. The “Wall” was constructed this way to ease viewing and traceability.

Unlike Revision 1 where directionality was depicted by convention, Revision 2 uses arrows. Example follows (using box color, line color, and directionality):

WAAS (an Augmenter - brown) provides Status (green) information to POCC (an Enabler - blue).

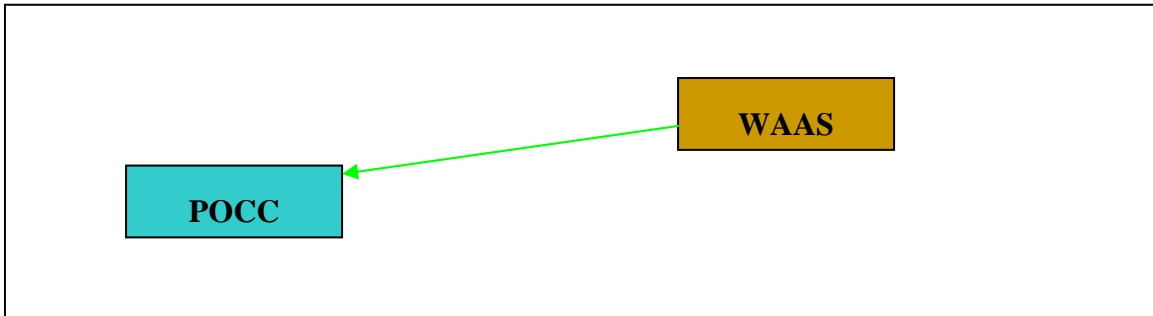

The legend for the box colors (four: Enablers, Augmenters, Providers, and Users) and line colors (four: Status, PTO, C2, and Support) are located on the plot in the lower right corner.

One may also notice that there are circular activities depicted in Revision 2, for example, NAVCEN and NOCC (below). Each one provides “Status” to the other. What can not be depicted at this time is the logical order or sequence of data. In other words, the answer to the question, “What’s on the line, when?” is not answered at this time.

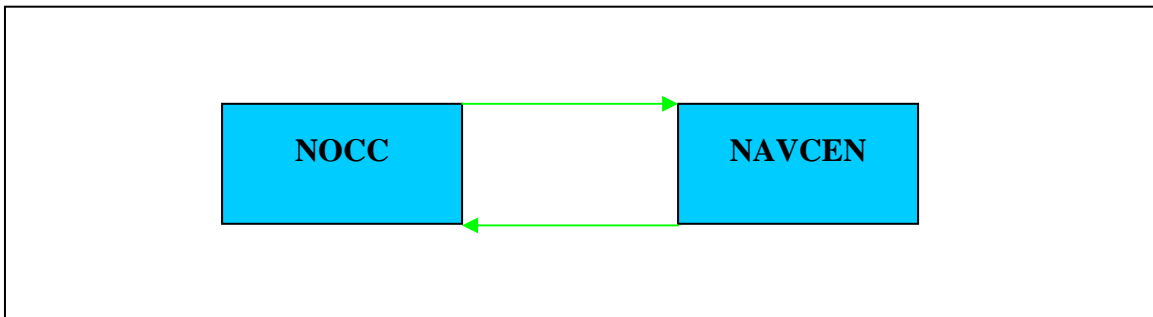

Discussion of Data Set:

The data set provided by the PNT Architecture Division was used to wire the “Wall.” The Access database is useful for sorting, organizing, and importing the data into other tools and data formats. Sample of sheet provided:

Interfaces				
Source	Sink	Type	Title	Standard
USNO	GPS	Support	Clock Parameters	ICD-GPS-202

Interfaces				
Source	Sink	Type	Title	Standard
GPS	GPSOC	Status	Military User Support Data	
JSpOC	GPS	C2	S-T-O	ICD-GPS-215
GPSOC	NOCC	Status	User Support Data	
WAAS	NOCC	Status	Operator Interface	
WAAS	POCC	Status	Operator Interface	
IERS	WAAS	Support	Earth Orientation Parameters	
GPS	WAAS	PTO	GPS Civil Signals	ICD-GPS-200
GPS	User	PTO	GPS Signals	ICD-GPS-200/203/700/703

The complete lists of changes (for Revision 2) were:

- Change GPS-to-NOCC to GPSOC-to-NOCC.
- Add GDGPS-to-GPSOC (Status)
- Add CMOC-to-AFSCN (RFI & Collision Avoidance Data)
- Change JSpOC-to-GPS (Status) to GPS-to-JSpOC (Status)
- Add JSpOC-to-GPSOC (Course of Action (COA) Tasking)
- Add GPSOC-to-JSpOC (COA Impact Analysis)
- Add GPSOC-to-User (Status)
- Add NOCC-to-User (GPS & WAAS Status)
- Add USNO-to-LORAN-C (Master Time)

Recommendations for Future Revisions:

May want to consider breaking out the “User” into more detail or having an appendix view which can be at a higher level of classification. Currently “User” has 29 separate inputs.

Graphics may enhance the presentation.

Since this is tool-limited to PowerPoint currently, a recommendation was made to add animation to the slide, i.e. bring out the boxes and lines sequentially. An alternative would be to build a slideshow with multiple iterations (such as 25 slides in slide show). For meeting the requirements of Revision 2, none of these options are desirable.

A question for consideration is, “are there enough different lines?” The red line depicting Position, Timing, and Orientation information comes to mind.

Definitions:

System Key (The Boxes)

Provider: Systems which provide users with position, timing, and/or orientation

Augmenter: Systems which augment Providers via external means (*e.g.* differential corrections, additional ranging signals, increased accuracy, integrity monitoring)

User: The community of persons and organizations that directly use PNT systems in any application to determine their position, time, orientation, and/or use that information to navigate

Enabler: Capabilities and organizations **that provide key support to** Providers, Augmenters, and/or Users, but do not provide a direct PNT capability themselves

Interface Key (The Lines)

PTO: Position, Time, and/or Orientation

C2: Command & Control

Status: Reporting of Operational Information

Support: Information necessary to the completion of the receiving system’s mission

Evaluation of user needs and system-of-systems performance of the Evolved Baseline:

Evaluation of needed PNT services as well as system-of-systems architecture performance should be conducted from the perspective of the user, since needs and performance vary widely depending on the user’s domain, sector, and application. For the purpose of this architecture effort, user domains have been categorized as Space, Air, Surface (land and water, indoors and outdoors), or Subsurface (underwater, underground). User sectors have been categorized as Military, Homeland Security, Civil, and Commercial. Eleven applications, or user groups, together define the various applications to which PNT services can be put to use.

Descriptions of Domains:

Space: The area where PNT operations can occur above the Earth’s atmosphere, within and beyond Earth orbit

Air: The area where PNT operations can occur above the surface of the earth and below orbital altitudes

Surface: The area where PNT operations can occur on the Earth’s surface (land and water) to include inside of man-made structures on the surface of the earth. Indoor use is included as part of surface operations since many surface users make use of the same PNT devices when they transition from outdoor to indoor use

Subsurface: The area where PNT operations can occur below the Earth's surface to include in caves and underwater

Description of Sectors:

Military: US and allied armed forces and intelligence community that apply PNT capabilities in support of national and homeland defense missions under their respective Departments or Ministries of Defense

Homeland Security: US and allied government users in support of homeland security missions, including law enforcement, first responders, and the US Coast Guard. Does not include commercial users that are part of critical infrastructure who use purely commercial products. May include authorized use of secure equipment.

Civil: Use of PNT services by civil government agencies, or in otherwise commercial applications heavily regulated by the federal government, such as air or harbor navigation

Commercial: Use of PNT services by individuals and companies in the pursuit of individual goals or profit, where use is not heavily regulated by the federal government

Descriptions of Applications:

Applications fall into the general categories of position, navigation, orientation, and time, and within those general categories are a number of more specific applications.

Location-Based Services: Use of PNT to enable location-based services that exploit knowledge about where an information device user is located. Examples included location-targeted advertising or allowing a user to find the nearest business of a particular type. May involve use indoors and in urban environments. Includes applications which fuse various information (navigation, tracking, location of underlying infrastructure) to create a picture of the environment or battlespace, such as military joint blue force situational awareness use and civil/commercial geospatial information systems.

Tracking: Use of PNT services to track and manage the position of assets, people, and animals. Includes fleet management; dispatch of emergency vehicles; and tracking of high-value cargo, children, parolees, and tagged animals for scientific studies. Also includes orbit determination for space vehicles when such determination is done off-board. A key component is the need to communicate tracking information to some central base for consolidation, processing, and management. However, the fused use of position information of various types to present a picture of the environment or battlespace is covered under location-based services.

Survey: Use of PNT services for surveying the locations of points on or near the earth for purposes to include establishing legal boundaries, support of engineering and construction projects, and conducting mine warfare. Typically involves a need for very high accuracy, but in a low dynamic or static environment, and which often permits post-processing to determine positions.

Scientific: Use of PNT services in support of scientific research. Often requires extremely high accuracy, but often allows post-processing of data.

Recreation: Use of PNT services during a wide variety of recreational activities, including fishing, boating, golfing, hiking, hunting, scuba diving, and geocaching. User equipment may be handheld or integrated into various vehicles. Normally does not involve safety of life use, but in some cases it may affect safety (aid in planning decompression schedules during scuba diving, personal avalanche transponders). Relatively low cost is usually a constraint.

Transportation: Use of PNT services to support the movement of people or goods from one location to another. User equipment may be handheld or integrated into the vehicle. Most land surface applications need to operate in an urban environment. Surface applications are a relatively low dynamic environment. Air applications may be a high dynamic environment. International interoperability is important for many users.

Machine control: Use of PNT services for automated or aided control of machines, such as construction or mining equipment. Precision agriculture is covered in a separate category, as is control or aiding of transportation systems.

Agriculture: Use of PNT services in agriculture to precisely plant, till, and apply fertilizer and insecticides to help farmers increase quantity and quality of crops while decreasing operating costs

Weapons: Use of PNT services to guide, or aid in the guidance of, weapons

Orientation: Use of PNT services to determine the navigational pointing of an object referenced to the appropriate surrounding environment, either two dimensionally (heading or bearing) or three dimensionally (pitch, roll, and yaw) (also known as attitude).

Timing: Use of PNT services for timing, time transfer, synchronization, and communications. Includes synchronization of communications, computer networks, automated teller machines, and power grids, as well as providing time of day information. Many users are static. Many applications support critical infrastructure (banking, power, etc.). Includes use in cell phones for E-911. May involve use indoors and in urban environments.

Annex A: User Perspective Supporting Data

Location-Based Services

Space – Don't project significant numbers of space LBS users in any sector, so all scored as few/none

- Military -
- Homeland Security -
- Civil -
- Commercial -

Air – Users of LBS in air would primarily be same devices as used on surface, so included there. Air specific users scored as few/none for all sectors.

- Military -
- Homeland Security -
- Civil -
- Commercial -

Surface

- Military – Score as Many, 100k+, assuming that most current users of PNT will need some form of LBS such as a JBFSA system, but that expense and acquisition challenges will preclude these being issues individually to every member of US military.
- Homeland Security – Scored as Many, 100k+, under same assumption as for military, using either JBFSA or LBS type systems.
- Civil – Scored as Many, 100K+, under same assumption as for military, applied to civil personnel, using primarily LBS type systems.
- Commercial – Key form factors for location based services are handheld PDAs, cell phones, notebook PCs etc.

(FOUO quantitative data deleted from unclassified version)

Note probably great overlap with cell phone timing users. Handheld or PC-based asset tracking GIS a significant application included here, but no details identified. One specific example – buddie tracking, ref:

<http://www.smh.com.au/news/Technology/New-service-tells-buddies-locations-on-a-cell-phone/2006/11/14/1163266537262.html>

Subsurface – Scored as Few/none for all sectors since no significant number of specific underwater or underground LBS users. Note that indoor use is included under surface domain.

- Military -
- Homeland Security -

- Civil -
- Commercial -

Tracking

Space – Space tracking includes use by satellites for orbit determination using off-board means. Real time navigation with on-board capabilities tracked under ‘transportation’. Though total numbers of satellites in military, civil, and commercial sectors numbers in low hundreds, these are portrayed as ‘100K+ many’ since they indirectly impact so many users through communications and ISR missions

- Military – Scored as Many due to impact
- Homeland Security – Few-None since no DHS owned satellites
- Civil – Scored as Many due to impact
- Commercial – Scored as Many due to impact

Air – Scored as few-none since PNT use by aircraft is primarily used for transportation vice tracking, and surveillance tracking systems (radars) are outside scope of architecture effort.

- Military – Few-None
- Homeland Security – Few-None
- Civil – Few-None
- Commercial – Few-None

Surface – Scored primarily for vehicle fleet management applications; there is however the potential for this application to expand significantly from widespread use of asset tracking logistics/pallet tracking and use indoors (smart PNT-capable RFID tags etc).

- Military – Scored as Many (100K+). While most military PNT systems used primarily for transportation or communications, so relatively few fleet tracking systems, scored as Many for likely pallet tracking applications not yet fully defined.
- Homeland Security – Scored as Large (1M+). Wide use of PNT systems in tracking fleets of emergency vehicles (estimate 100k+). Note however that this may duplicate count many vehicles also counted in transportation category. Also include here tracking of prison parolees and felony sex offenders who wear GPS ankle bracelets to track their location. The state of Florida currently spends \$10 per day per offender, or about \$3,650 a year, for active monitoring. Reference: <http://www.salon.com/news/feature/2006/12/19/offenders/index1.html> According to a 2001 report issued by the American Correctional Association regarding 1999 statistics, 22,192 people were under electronic monitoring for either probation or parole. With more than six million people in the nation's correctional system, states continue to look for alternative methods. Reference: <http://www.locationintelligence.net/articles/272.html> Use this rationale to score overall as Large, 1M+

- Civil – Scored as Many (100K+) for various civil agency fleet tracking use. Approximately 64000 public buses in US Ref: <http://www.apta.com/research/stats/bus/bussum.cfm>. Includes rail use for train control (also counted under Navigation). In 2000, the entire United States railroad system encompassed 660 railroads, 220,000 miles of track, 20,000 freight locomotives, 8,800 passenger locomotives/coaches, 1,300,000 freight cars, and 265,000 employees. (PNT usually track trains/locomotives, not cars; might track cars for logistics in future Ref: <http://www.fra.dot.gov/downloads/Research/rdv0202.pdf> State of Wisconsin uses 729 snowplows Ref: <http://www.dot.wisconsin.gov/travel/road/frequentlyaskedquestions.htm>
- Commercial – Scored as Huge (10M+) since 4 million receivers shipped in 2005 Ref: ABI Research, 2005. Would include commercial buses (motor coaches) – 3900 in US & Canada as of 2006 Ref: <http://www.buses.org/press%5Froom/Industry%5FFacts/>

Subsurface – Few/none. No widespread use underwater or underground.

- Military –
- Homeland Security -
- Civil -
- Commercial -

Survey

Space – space system orbit determination scored under tracking, so no space ‘survey’ applications

- Military – None
- Homeland Security – None
- Civil – None
- Commercial – None

Air – Survey not normally done from air. ISR applications are scored under ‘orientation’.

- Military – None
- Homeland Security – None
- Civil – None
- Commercial – None

Surface

- Military – 93 Army survey receivers ref: Army UE Roadmap Army UE Piv2(031704).xls

- Homeland Security – Scored as Some (1000+) since survey is a widespread task in disaster recovery operations; however, no detailed information on group size available.
- Civil – Civil survey population likely to be a significant fraction of the size of the commercial survey market since civil government heavily involved in surveying.
- Commercial – The Council of European Geodetic Surveyors (CLGE) and Geomter Europas (GE) published a Market Report (Schuster et al., 2003) which quantified the surveying market in 23 Countries in Europe at 24.4B per annum and estimated that over 520,000 professional geodetic surveyors were employed in this market. Ref:
<http://www.dit.ie/DIT/built/spatial/spatial/PDFs/TheFutureoftheSurveyingProfession.pdf> (amplifying quantitative FOUO data deleted from unclassified version)

Subsurface – Underground, underwater, or indoor survey market is small or non-existent. Geographic information system applications are covered under location based services vice here.

- Military -
- Homeland Security -
- Civil -
- Commercial -

Scientific

Space

- Military – Scored as Some 1000+ since very few military scientific satellites, and indirectly benefit a fairly small number of military researchers.
- Homeland Security – Scored as Few/None under rationale that most scientific use not in support of homeland security
- Civil – Civil space use scored as Many 100k+ since assume most space science use is by civil space community. While total number of satellites using PNT is small, results of effort used by a large number of scientists indirectly, and benefits most of population as indirect beneficiaries of scientists indirect use.
- Commercial – Scored as Some under rationale that most scientific use not commercial, especially in space, but some since a few satellites controlled by academia

Air – Total amount of science work done in air is small compared to surface use; most that is done would be by weather community or commercial community (if treat academic use as commercial)

- Military – Few/None
- Homeland Security – Few/None

- Civil – Score as Large to include PNT use by weather (Wx) balloons. Approximately 800,000 Wx balloon launches a year worldwide. All would include some means of determining altitude and tracking location Ref: <http://www.islandnet.com/~see/weather/almanac/arc2005/alm05jul.htm>
- Commercial – Scored as Some, 1000+ for academic scientific work in air, and some indirect users.

Surface – Surface scientific applications dominated by commercial (academic) users of PNT data, such as geophysicists studying earthquake prediction.

- Military – Relatively small number of military scientists directly using PNT data for science purposed – scored as few/none.
- Homeland Security – Scored as some 1000+ for indirect users of PNT data for disaster prediction
- Civil – Scored as some 1000+ for indirect users of PNT data for disaster prediction and other science efforts within federal government
- Commercial – Scored as Many 100k+ based on estimate of number of scientists making use of precision PNT data for things like earthquake prediction. Based on: 41000 scientists attending American Geophysical Union (AGU) 2005 Joint Assembly; 11000 geophysicists at 2005 AGU annual meeting; estimated 130,000 lives saved by successful prediction, a day or more in advance, of an earthquake in China in 1970's, in which a city of 1M was evacuated. Further data: 760000 data sets provided by User Friendly CORS utility website in 2006.

Subsurface – Scored as few/none since most scientific activities requiring PNT not done underwater or underground.

- Military -
- Homeland Security -
- Civil -
- Commercial -

Recreation

Space – Currently few-none recreational users in space.

- Military -
- Homeland Security -
- Civil -
- Commercial -

Air – Most recreational users in air are captured under transportation users. So scored as few-none. Exception – for improved discrimination, recreational gliders scored under recreation vice transportation.

- Military -

- Homeland Security -
- Civil – Scored as “Some 1000+” since some 16,000 glider pilots in US are members of the Soaring Society of America in 2006; ref: <http://www.ssa.org/society/whatisthessa.asp>
- Commercial -

Surface – Military, homeland security, and civil users are by definition not involved in recreation while on the job.

- Military -
- Homeland Security -
- Civil -
- Commercial – Includes hikers, geocachers, etc. Scored as Huge since 20M GPS receivers shipped worldwide in 2005. Ref ABI Research.

Subsurface – Few identified large recreational applications of PNT underwater or underground. To the extent there are, most are included in surface commercial numbers above. Key exception is recreational scuba divers.

- Military -
- Homeland Security -
- Civil -
- Commercial – Score as Large 1M+ for 6M recreational scuba divers in world, per A-B-Sea Research at 9 Nov 06 Industry Days, 1.5-2M users in US; currently use compasses and water pressure sensors for depth, but in future could use other PNT means (underwater GPS pseudolites, inertial navigation systems etc.).

Transportation

Space – Off-board orbit determination accounted for under ‘tracking’ vice transportation, though growing use of real time on-board PNT systems for orbit determination scored under transportation

- Military – Few/No users
- Homeland Security – No users
- Civil – Score as ‘Some 1000+’ with an * to capture growing tendency to use PNT services in a real time mode on-board. Current users include space shuttle
- Commercial – Score as ‘Some 1000+’ with an * to capture growing tendency to use PNT services in a real time mode on-board.

Air

- Military – 21000 military aircraft – approx 5700 AF, 5200 Navy, 10000 Army. While many are clearly ‘transportation’ users, all military aviation use in support of navigation counted here for simplicity. Reference GPS UE roadmap, 2001

- Homeland Security – Thousands of aircraft, counting police helos etc. Ref: Ken Ward, FAA indicates public use aircraft for federal DHS, FBI, US Marshals Service (USMS), and state and local police maybe a thousand; counting air ambulance commercial operations supporting security/emergency response add some more.
- Civil – Total global commercial aviation market projected at 37000 aircraft in 2020; these don't necessarily have any particular navigation system; General aviation fleet projected to grow from 214,591 units in 2005 to some 252,775 in 2017. ref: <http://www.boeing.com/commercial/cmo/> and <http://www.airportbusiness.com/publication/article.jsp?pubId=1&id=5982> In 2005, 533 million passengers enplaned at the 35 large hub airports. The are currently operating near capacity, yet projected to increase by 60 percent to 760 million passenger enplanements by the year 2020 Ref: FAA's Navigation Evolution Roadmap, 30 Oct 06 draft. Confirming data from Honeywell at 7 Nov 06 Industry Days—8000 commercial major airliners, 30000 business jets, 200000 general aviation planes. Also, Ken Ward, FAA indicated 2004 total US general aviation and Air Taxi fleet was 219,400 aircraft.
- Commercial – While aviation market is normally described as 'commercial' and 'general', both these user groups are captured here under 'civil' vice 'commercial' since the air transportation industry is heavily regulated and monitored, even in real-time.

Surface

- Military – ~208k handhelds planned by Army as of 2020 Ref: Army UE Roadmap Army UE Piv2(031704).xls
- Homeland Security – estimate in 100K's since 47,000 Ford Crown Victorias sold as police cars in 2005, one of the most popular models for that purpose
- Civil – ABI research 2005 study indicated 3.5M receivers shipped in 2004 for marine use; most would be primarily for transportation. World merchant fleet (1000+ tons) was 800,000 in 2004. Reference: http://www.marad.dot.gov/Marad_Statistics/Country-MFW-7-04.pdf Over 1M large scale fishing vessels. Ref: <http://www.emagazine.com/view/?197> Smaller boats are captured in recreational application. Commercial boating use captured here since fairly heavily regulated and monitored, especially near harbors. Includes rail use for train control (also counted under Tracking). In 2000, the entire United States railroad system encompassed 660 railroads, 220,000 miles of track, 20,000 freight locomotives, 8,800 passenger locomotives/coaches, 1,300,000 freight cars, and 265,000 employees. Ref: <http://www.fra.dot.gov/downloads/Research/rdv0202.pdf>
Also includes civil land vehicles such as city buses and snow plows. Approximately 64000 public buses in US Ref: <http://www.apta.com/research/stats/bus/bussum.cfm>
State of Wisconsin uses 729 snowplows Ref: <http://www.dot.wisconsin.gov/travel/road/frequentlyaskedquestions.htm>

- Commercial – 10M+ receivers in automobiles. 7M receivers shipped in 2005. Note approx 200M automobiles in US in 2000 based on census figures on number of households and average number of cars per household. Ref ABI Research 2005 and census figures.

Subsurface

- Military – Coded as few/none though does include <100 US Navy submarines. Also used by allies.
- Homeland Security – very small numbers
- Civil – very small numbers
- Commercial – very small numbers

Machine control

Space – Total space users for machine control small, since use for tracking and transportation covered separately. Does include use for robotic positioning for space construction and other relative positioning applications such as use to determine position of a robotic arm, very short range radars and ranging systems etc.

- Military -
- Homeland Security -
- Civil – Scored as “Some 1000+” with an * based on recommendation of Mr. Oria, supporting NASA, to account for projected growth in space use of relative PNT for construction, manipulation, or other interactions between multiple space machines (use of a robotic arm etc).
- Commercial – Scored as Some, 1000+ with an * for same rationale as Civil.

Air – Total air users for machine control small, since use for transportation or orientation (ISR) covered separately

- Military -
- Homeland Security -
- Civil -
- Commercial -

Surface

- Military – Includes military robots in urban environments. Scored as Some.
- Homeland Security – Includes police robots in urban environments. Scored as Some.
- Civil – Includes robots in urban environments. Scored as Some, though numbers unknown.
- Commercial – Includes use by construction and mining equipment; agricultural use covered separately. Trimble indicates over 300,000 machines sold in 5 year

period prior to 2002 that could potentially fit in this category. Ref:
<http://apps.shareholder.com/sec/viewerContent.aspx?companyid=TRMB&docid=1795644>

Subsurface

- Military – Includes small numbers of military robots in underwater or underground environments. Scored as Few/None.
- Homeland Security – Includes small numbers of police robots in underwater or underground environments. Scored as Few/None.
- Civil – Includes small numbers of robots in underwater or underground environments. Scored as Few/None.
- Commercial – Includes robots in underwater or underground environments. Scored as Some (1000+), though numbers unknown. Examples include autonomous underwater vehicles or remotely operated underwater vehicles. All such vehicles tracked in this category, though the vehicle may actually be used in support of another application such as LBS, tracking, survey, scientific, or agriculture. References: <http://en.wikipedia.org/wiki/ROV> and <http://www.gavia.is/products/applications.html> Sales for the Gavia seem to be in the 1-10 at a time range, so appears likely that total of all such vehicles is above 1000 but below 100,000. Would also include positioning of underground vehicles (underground mining vehicles etc); however, most of these vehicles appear to be simple transporters with little need for PNT; therefore numbers of vehicles needing PNT seem unlikely to raise the score here up to 100,000.

Agriculture

Currently and projected out through 2025, primary agricultural users of PNT are commercial surface users. Some commercial air users for spraying. All others are few-none.

Space

- Military -
- Homeland Security -
- Civil -
- Commercial -

Air

- Military -
- Homeland Security -
- Civil -
- Commercial – Score as Some (1000+) Includes PNT devices used to support aerial spraying – crop dusting, spraying of pesticides etc. in manned or unmanned aircraft and helicopters Reference:

http://www.trimble.com/aggps_trimflight3.shtml and <http://www.yamaha-motor.co.jp/global/industrial/sky/lineup/index.html> Would seem unlikely that there would be 100,000 of these, however, Yamaha site indicates 1600 registered agricultural helicopters and 8000 registered operators in Japan in 2002, so easily 1000+ worldwide.

Surface

- Military -
- Homeland Security -
- Civil -
- Commercial – Use in precision farming to guide large agricultural machines (combines etc), perhaps in future smaller tractors as well. Scored as Large, 1M+ users based on 2004 data indicating 1M+ harvest units in 6 large agriculturally producing nations, and about 8M tractors in those nations. Ref: CS Market Research: Brazil, Precision Agricultural Equipment Aug 2004 at http://www.buyusainfo.net/docs/x_1228091.pdf

(amplifying quantitative data deleted from unclassified version)

Subsurface

- Military -
- Homeland Security -
- Civil -
- Commercial -

Weapons

(Whole section deleted from unclassified versions as potentially FOUO; key source was GPS UE Roadmaps.)

Orientation

Space – Space ISR, earth sensing and other sensor use of PNT tracked as orientation users, though some overlap with ‘space tracking’ and real-time ‘transportation’ users. Scored as ‘Many 100K+’ to account for indirect use of space ISR products.

- Military – Many, to account for indirect use by significant fraction of US military
- Homeland Security – No DHS satellites, but scored as Some to account for DHS use of ISR products.
- Civil – Many, to account for indirect use of civil satellites, though counting only a fraction of the indirect beneficiaries of space weather data etc.
- Commercial – many, to account for indirect use of commercial remote sensing satellites.

Air – Airborne ISR, earth sensing and other sensor use of PNT tracked as orientation users, though some overlap with ‘transportation’ users.

- Military – Scored as ‘Many 100K+’ to account for indirect use of airborne ISR products
- Homeland Security – Scored as ‘Some 1K+’ to account for indirect use of airborne ISR products
- Civil – Scored as ‘Many 100K+’ to account for indirect use of airborne ISR products
- Commercial – Scored as ‘Many 100K+’ to account for indirect use of airborne ISR products

Surface – Surface orientation use of PNT would seem likely dominated by use of a compass, since use of GPS not widespread for this application (or such use is combined with transportation and tracked there). However, compasses are commonly installed in many automobiles, most medium to large boats, and carried by many hikers.

- Military – Score as Huge, 10M+ - Assume at least one compass carried by each soldier, numbers of US users greater than 1M, world users greater than 10M. For GPS users, primarily used in artillery and other indirect fire applications. Army UE roadmap indicates approx 9000 indirect fire receivers, ref: Army UE Roadmap Army UE Piv2(031704).xls
- Homeland Security – Score as many, 100K+, comparable to number of transportation users, such as in police cars (or carried by police officers)
- Civil – Based on data for number of large boats/ships, this seems likely to be millions of compasses, at minimum
- Commercial – Based on some fraction of automobiles worldwide, as well as large commercial market for handheld compasses, score this as Huge, 10M+

Subsurface – No obvious dedicated subsurface or indoor use. Use of compasses likely to be for dual subsurface/surface use, with emphasis on surface use. Therefore, all sectors scored as few/none.

- Military – Military submarines have inertial navigation systems, however total numbers are small.
- Homeland Security -
- Civil -
- Commercial -

Communications and Timing

Space – Includes timing for use in communications; overall number of space users small, but impact is larger since supports a large number of ground users

- Military -

- Homeland Security – Homeland security users in general don't operate their own satellites, but scored as 'some' to account for DHS use of satellite communications.
- Civil -
- Commercial -

Air – Primarily timing users for communications in airplanes; duplicates in many cases transportation users. General and commercial aviation users scored as civil users since aviation industry is heavily regulated. See transportation category for market size.

- Military -
- Homeland Security -
- Civil – Note that timing for communications use is growing with passenger internet and voice services which make commercial (civil for these purposes) aircraft their own SATCOM earth station and internet service provider. See Connexion by Boeing.
- Commercial -

Surface – Primary applications are radios and networked computers

- Military – Scored as Many 100k+. Approx 46k JTRS radios planned, replaced with 58k m-code capable JTRS radios, 10k Combat Survivor Evader Locator (CSEL) radios; ref: Army UE Roadmap Army UE Piv2(031704).xls. Also includes networked laptop computers such as an estimated 275000 Panasonic Toughbook military laptops at use in Middle East by US military. Ref: <http://www.slate.com/id/2080546/>
- Homeland Security – Assume approx 1M homeland security radios using PNT for timing in 2025 since approx 800,000 full time police officers in US ref: <http://www.ojp.usdoj.gov/bjs/lawenf.htm> Would also include an estimated 100k+ laptop computers in police cars, using PNT for network connectivity. See transportation for further data.
- Civil – Score as Many 100k+ based on estimate of number of civil PCs hooked to network. Would also include “Some (1000+)” use of radios since most civil government outdoors users of radios would be captured under Homeland Security above as first responders. Also includes TBD numbers of civil government users outdoors for land use planning, agriculture, infrastructure and similar non-first responder applications.
- Commercial – Scored as ‘Huge (10M+)’, and perhaps deserving of its own larger category, since cell phone users of PNT exceed 100M. 59M cell phones using GPS shipped worldwide in 2005 Ref: ABI Research. Qualcomm indicates it itself has shipped over 100M GPS cell phones total. Also includes some 208M PCs shipped worldwide in 2005—all would use PNT directly or indirectly to synchronize network. Note approx 218 million cell phones in US as of 2005, per CIA factbook. Ref:

http://news.com.com/PC+market+surged+in+2005,+will+settle+in+2006/2100-1003_3-6028454.html

Subsurface – Subsurface applications of PNT for timing would include systems designed primarily for surface work that are counted there. Other uses would be few/none.

- Military -
- Homeland Security -
- Civil -
- Commercial -

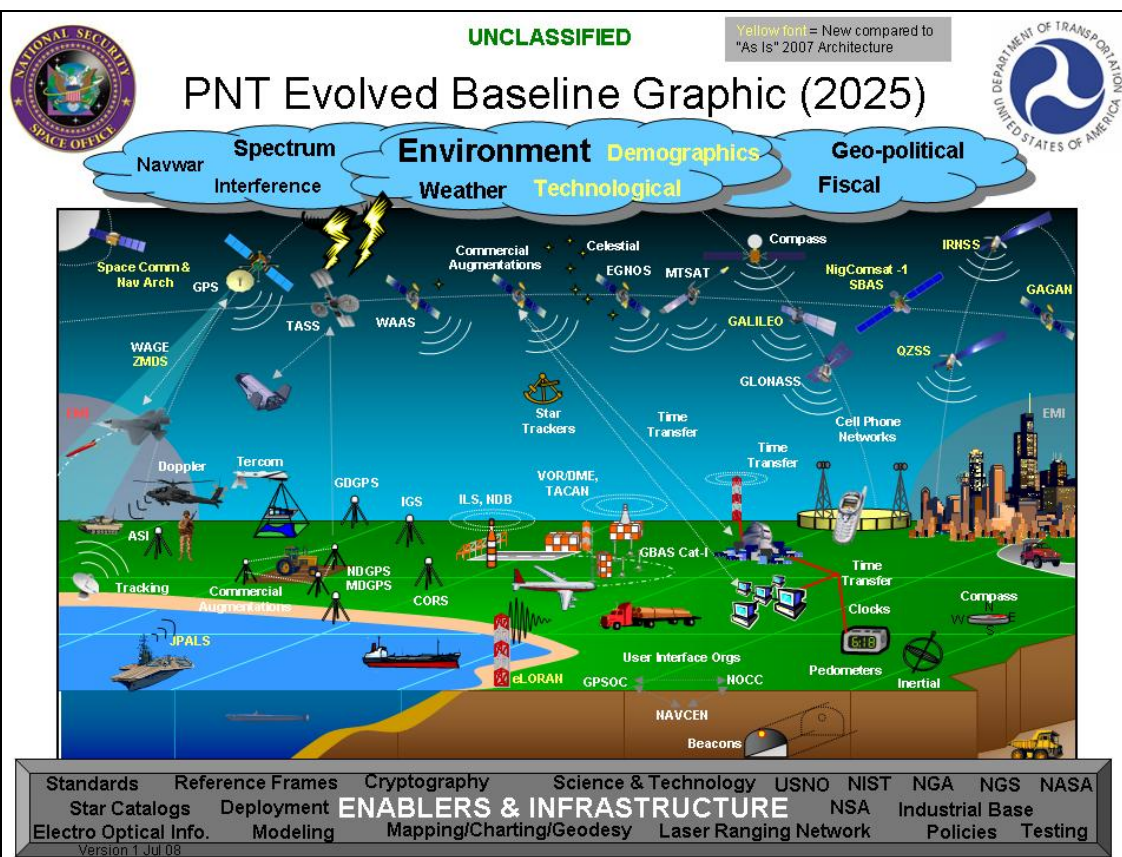
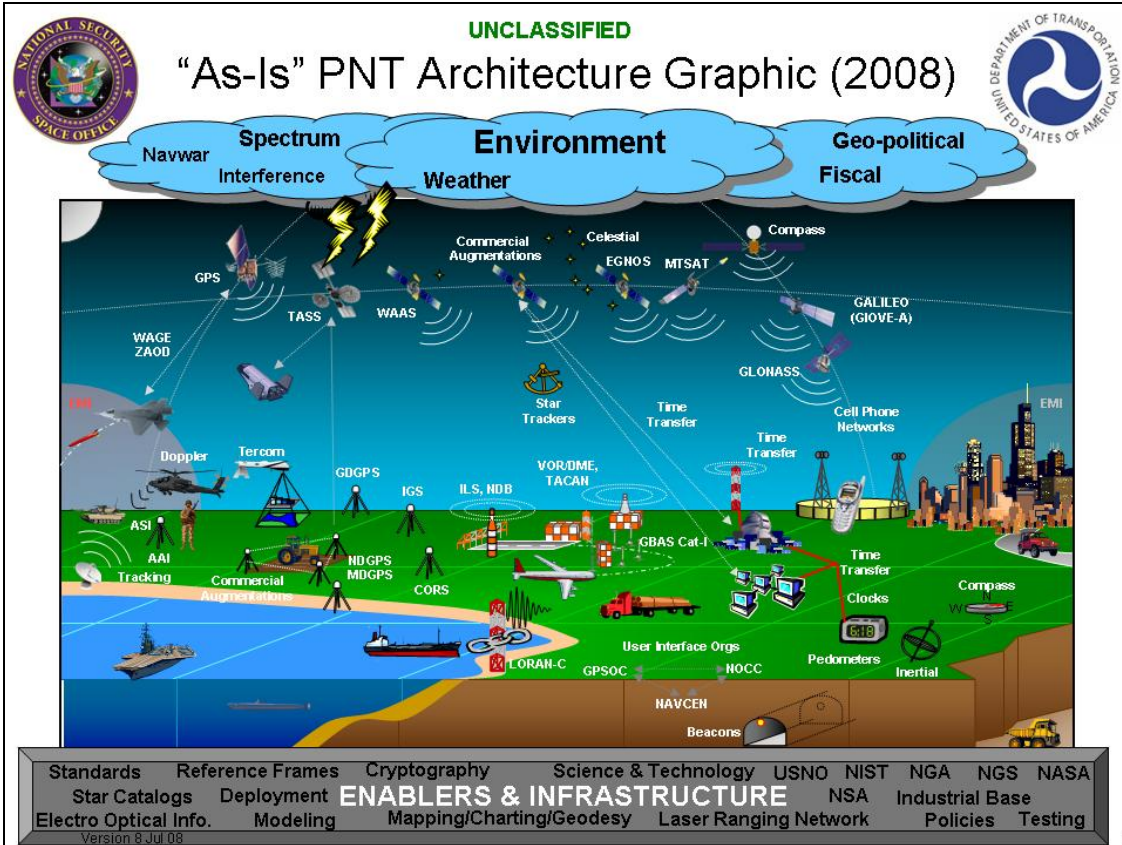



UNCLASSIFIED

Draft Evolved Baseline (2025)

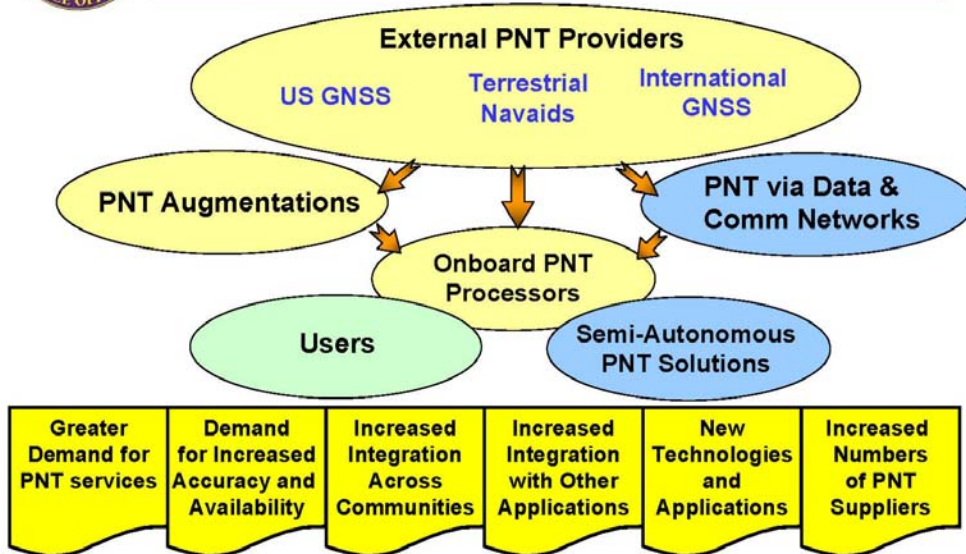

Version 1 Feb 2007

3



UNCLASSIFIED

A Draft PNT Architecture Construct

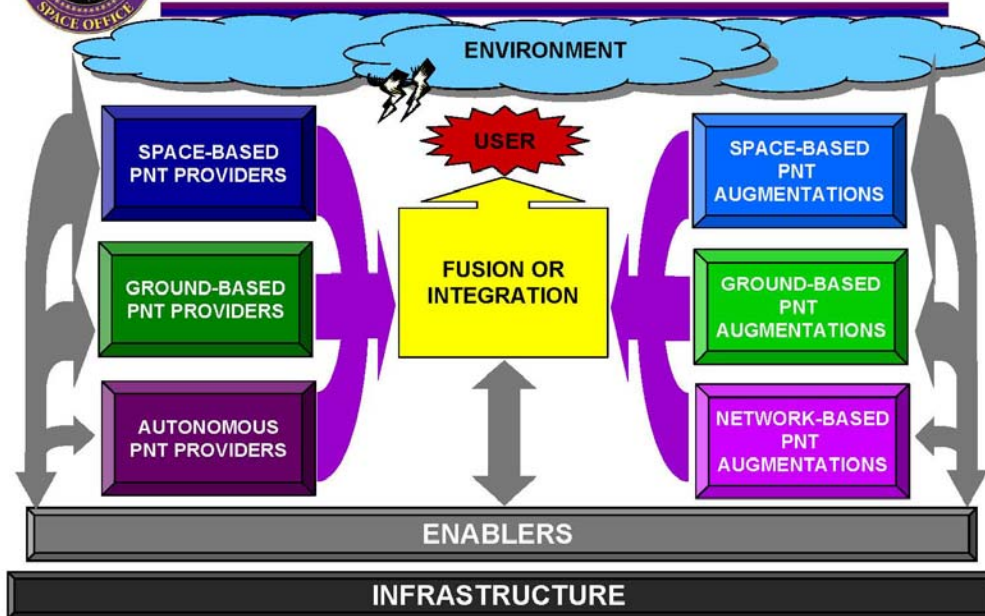



UNCLASSIFIED

List of PNT Systems “In Scope”

Space-Based PNT Providers

- GPS
- GLONASS (Russia)
- Compass (China)
- GALILEO (EU)
- QZSS (Japan)
- IRNSS (India)
- Space Comm and Nav Arch

Ground-Based PNT Providers

- LORAN-C and eLORAN
- VOR/DME, TACAN
- ILS, NDB
- Tracking
- Cell Network PNT

Autonomous PNT Providers

- Inertial Navigation Systems
- Compass
- Clocks
- Celestial Navigation
- Star Trackers
- Time Transfer
- Terrain Contour Matching
- Doppler
- Pedometers

Space-Based PNT Augmentations

- WAAS
- TASS
- Commercial Augmentations
- MTSAT (Japan)
- EGNOS (EU)
- GAGAN (India)
- NigComsat-1 SBAS

Ground-Based PNT Augmentations

- NDGPS, MDGPS
- Commercial Augmentations
- GBAS Cat-I
- SDB Accuracy Spt Infrastr.
- AAI (U-2 DGPS)
- JPALS

Network-Based PNT Aug.

- GDGPS
- CORS
- IGS
- Zero Age of Data (ZAOD)
- Zero Age Message and Data Service (ZMDS)

Environment

- Spectrum (Navwar; Interference)
- Weather
- Fiscal
- Geo-political
- Demographics
- Technological

Enablers

- Timing Standards
- Reference Frames
- Other Standards
- Star Catalogs
- Deployment
- Modeling
- Mapping/Charting/Geodesy
- Electro Optical Information
- Cryptography
- Laser Ranging Networks
- Science and Technology

Infrastructure

- USNO
- NIST
- NGA
- NGS
- NSA
- NASA
- User Interface Orgs (GPSOC, Navcen, NOCC)
- Policies
- Testing
- Industrial Base

5



UNCLASSIFIED

Space Based PNT Providers



2007

- GPS
 - L1 C/A (29 SVs)
 - L1 P(Y) (29 SVs)
 - L2 P(Y) (29SVs)
 - L2C (1 SV codeless)
- GLONASS (Russia)
- Compass (China)
- GALILEO (GIOVE-A)(EU)

Add:

2011

- GPS
 - L2C (15 SVs)
 - M-Code Earth (15 SVs)
 - L5 (7 SVs)
- GALILEO (EU)
- QZSS (Japan)
- IRNSS (India)(1+ SVs)
- Space Communications and Navigation Architecture (SCA)

Add:

2025

- GPS
 - L5 (30 SVs?)
 - L1C (30 SVs?)
 - M-Code Spot (20 SVs?)
- IRNSS (India)(8 SVs)

6



UNCLASSIFIED

Ground Based PNT Providers



2007

2011

2025

- LORAN-C
- VOR/DME, TACAN
- ILS
- NDB
- Tracking
- Cell Network PNT

Replace:

Add:

- LORAN-C with eLORAN

7



UNCLASSIFIED

Autonomous PNT Providers



2007

2011

2025

- Inertial Navigation Systems
- Compass
- Clocks
- Celestial Navigation
- Star Trackers
- Time Transfer
- Terrain Contour Matching (TERCOM)
- Doppler
- Pedometers

Add:

Add:

8



UNCLASSIFIED

Space based PNT Augmentations



2007

2011

2025

- | | | |
|---|---|-------------|
| <ul style="list-style-type: none"> • WAAS • TASS • Commercial Augmentations • MTSAT (Japan) • EGNOS (EU) | <p>Add:</p> <ul style="list-style-type: none"> • GAGAN (India) • NigComsat-1 SBAS | <p>Add:</p> |
|---|---|-------------|



UNCLASSIFIED

Ground based PNT Augmentations



2007

2011

2025

- | | | |
|--|-------------|---|
| <ul style="list-style-type: none"> • NDGPS • MDGPS • Commercial Augmentations • GBAS Cat-I • Small Diameter Bomb Accuracy Support Infrastructure (ASI) (AF) • AAI (U-2 DGPS) | <p>Add:</p> | <p>Add:</p> <ul style="list-style-type: none"> • JPALS <p>Remove:</p> <ul style="list-style-type: none"> • AAI (U-2 DGPS) |
|--|-------------|---|

Note: Systems which broadcast from ground based transmitters but also provide augmentation through networks are listed on next slide, "Network Based PNT Augmentations"



UNCLASSIFIED

Network based PNT Augmentations



2007

2011

2025

- | | | |
|---|--|------|
| <ul style="list-style-type: none"> • GDGPS • CORS • IGS • Zero Age of Data (ZAOD) <ul style="list-style-type: none"> - Nav Msg Replacement (ZNAV) | Replace ZAOD with: <ul style="list-style-type: none"> • Zero Age Message and Data Service (ZMDS) <ul style="list-style-type: none"> - Includes addition of Zero Age Differential GPS (ZDGPS) capability | Add: |
|---|--|------|

11



UNCLASSIFIED

Environment



2007

2011

2025

- | | | |
|--|--|------|
| <ul style="list-style-type: none"> • Spectrum <ul style="list-style-type: none"> - Navwar - Interference • Weather • Fiscal • Geo-Political | Add: <ul style="list-style-type: none"> • Demographics • Technological | Add: |
|--|--|------|

12



UNCLASSIFIED

Enablers

ENABLERS

2007

2011

2025

- Timing Standards
- Reference Frames
- Other Standards
- Star Catalogs
- Deployment
- Modeling
- Mapping/Charting/Geodesy
- Electro Optical Info
- Cryptography
- Laser Ranging Networks
- Science & Technology

Add:

Add:

13



UNCLASSIFIED

Infrastructure

INFRASTRUCTURE

2007

2011

2025

- USNO
- NIST
- NGA
- NGS
- NSA
- NASA
- User Interface Orgs
(GPSOC, Navcen,
NOCC)
- Policies
- Testing
- Industrial Base

Add:

Add:

14



UNCLASSIFIED

Space-Based PNT Providers Roadmap

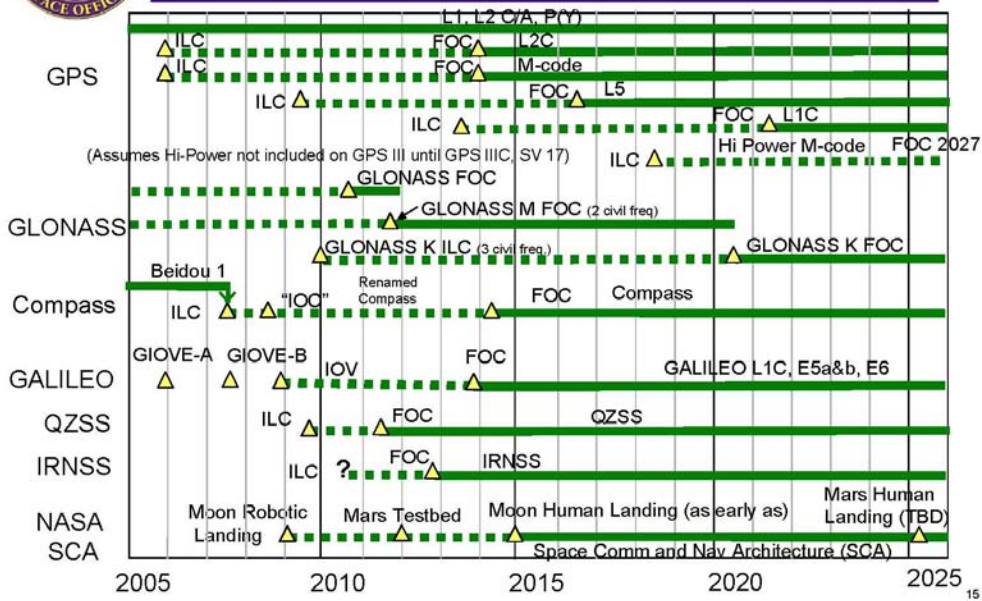

UNCLASSIFIED

Ground-Based PNT Providers Roadmap

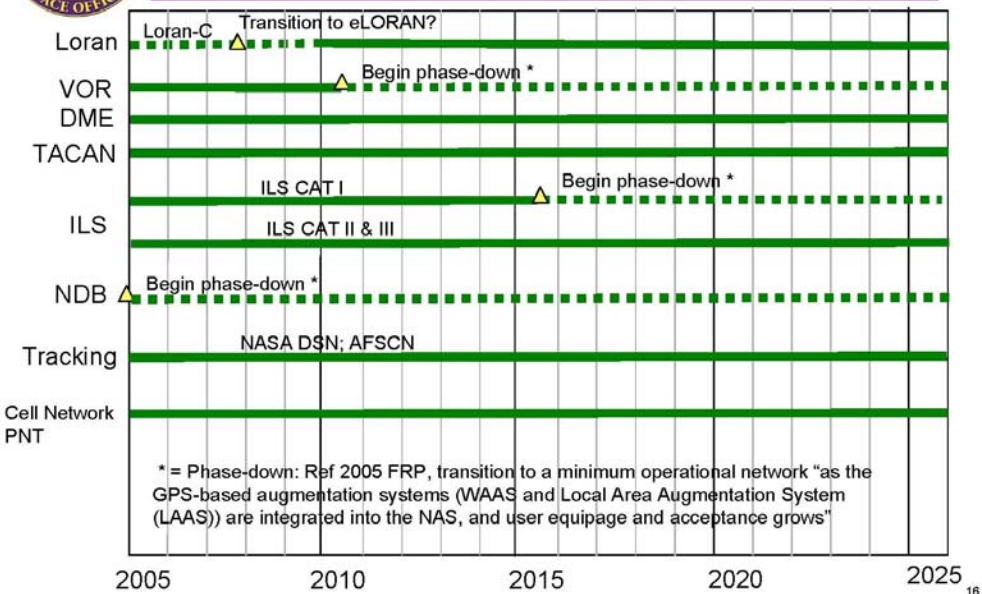



UNCLASSIFIED

Autonomous PNT Providers Roadmap

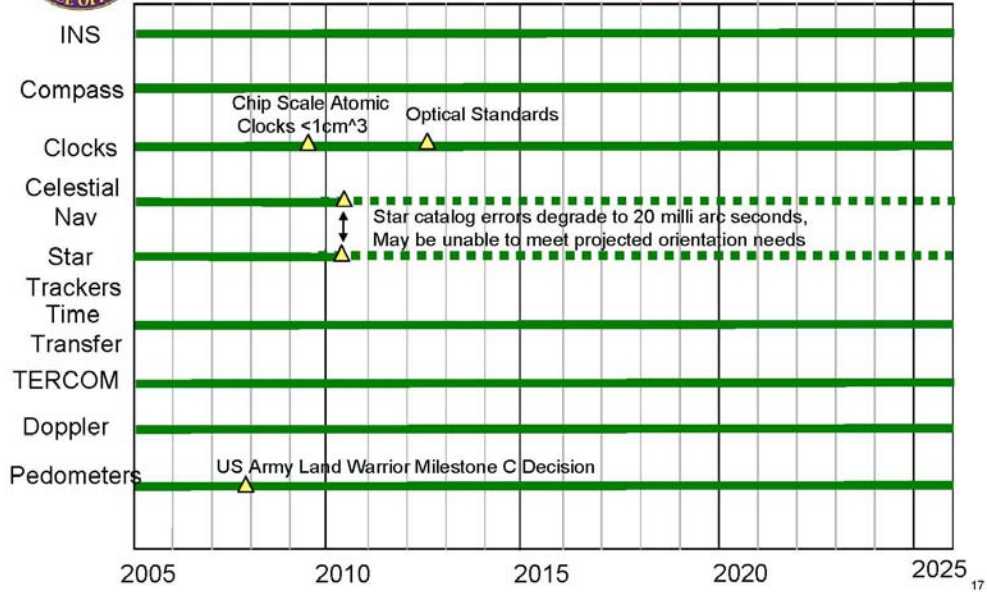

UNCLASSIFIED

Space-Based PNT Augmentations Roadmap

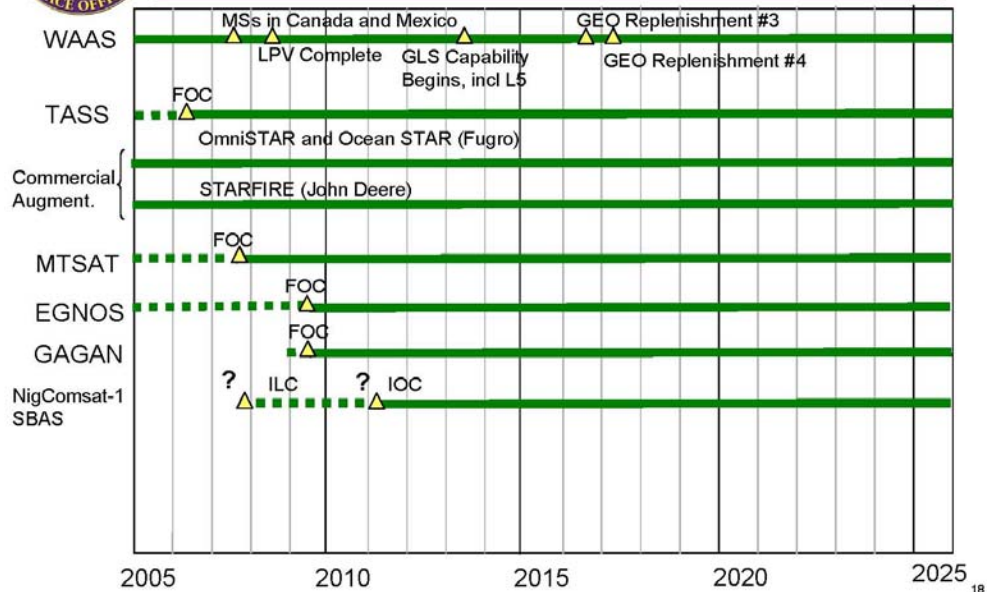

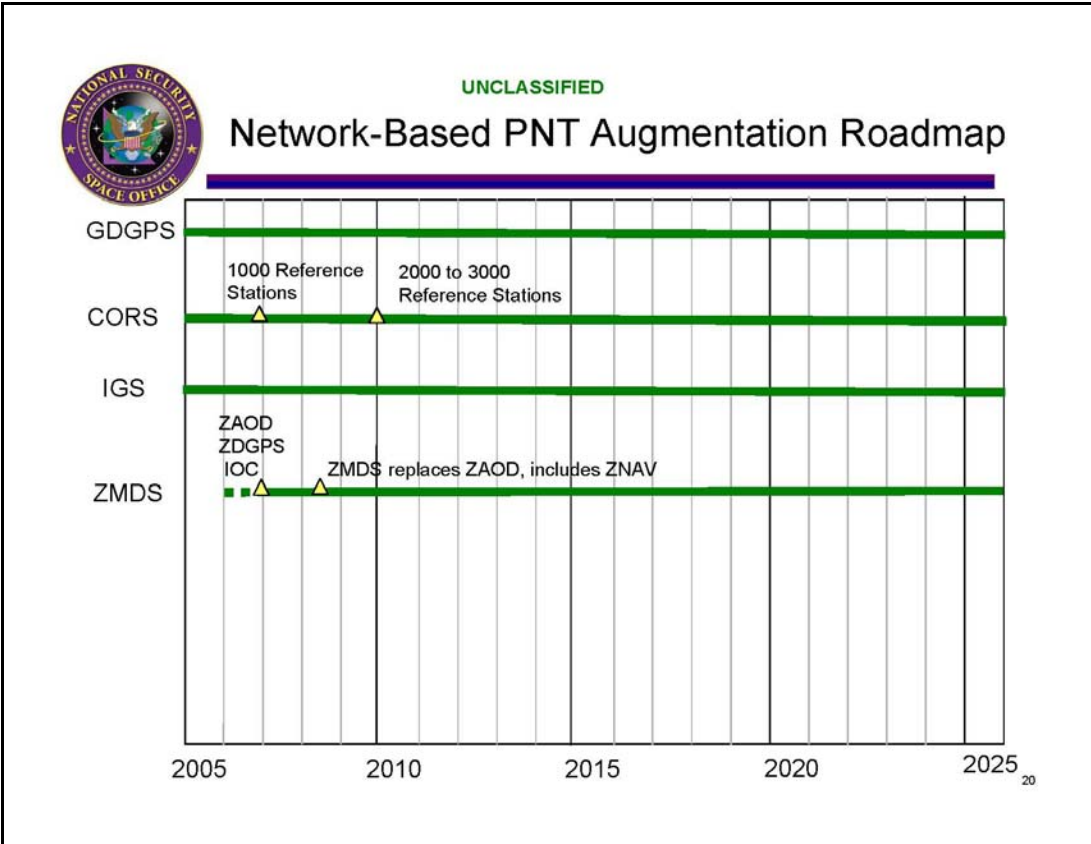
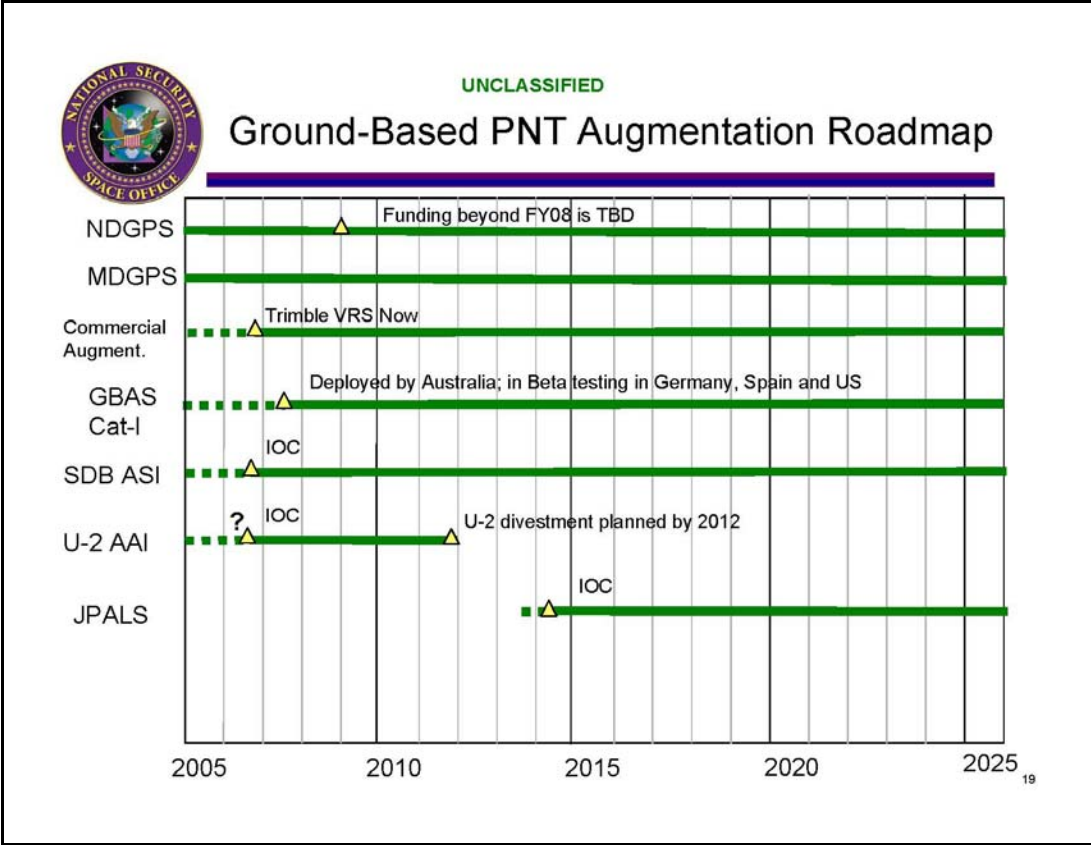



UNCLASSIFIED

PNT User Perspectives (2025)

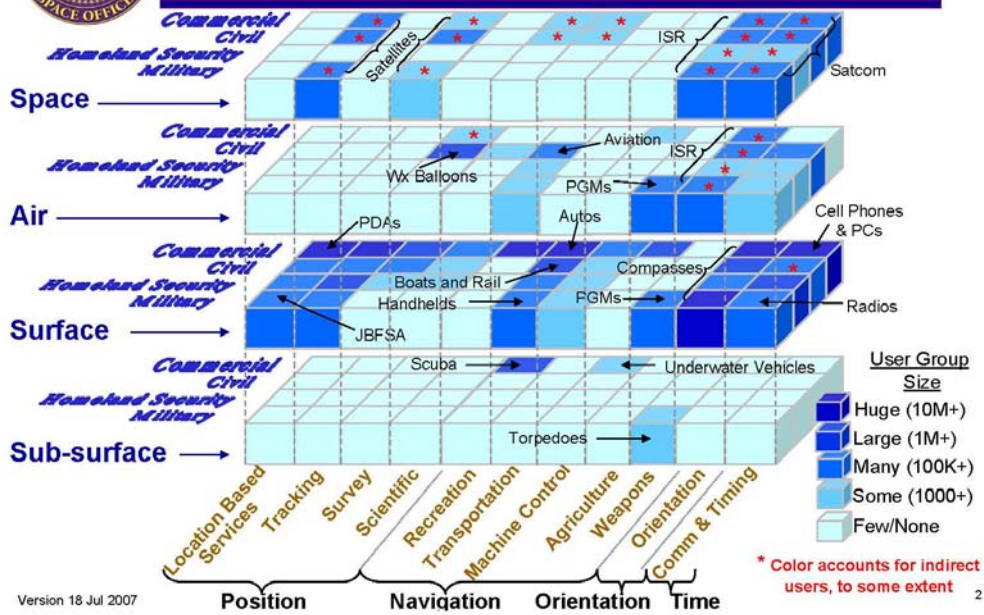

UNCLASSIFIED

PNT User Perspectives

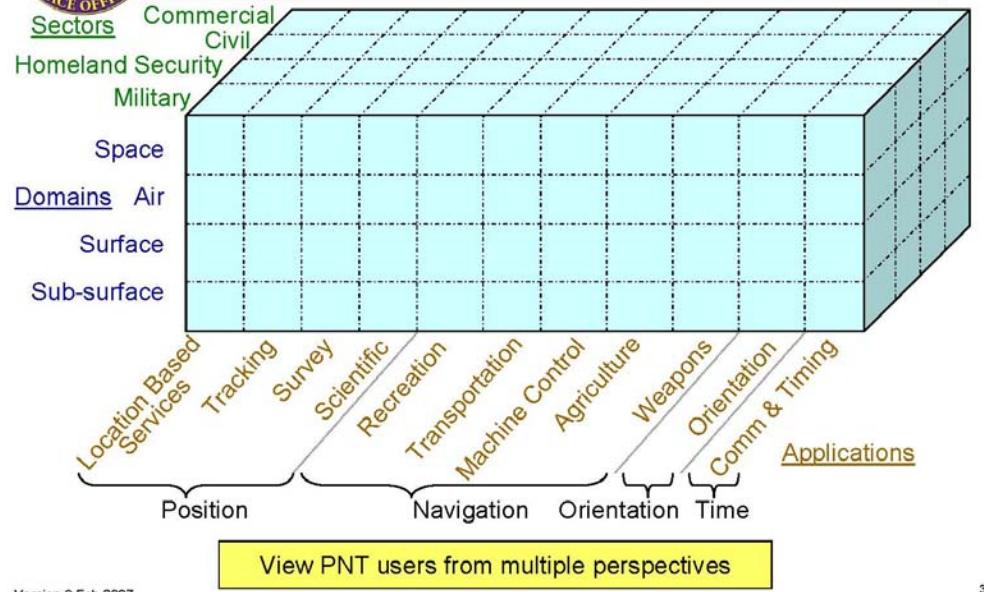



UNCLASSIFIED

Example: Civil Surface Navigation

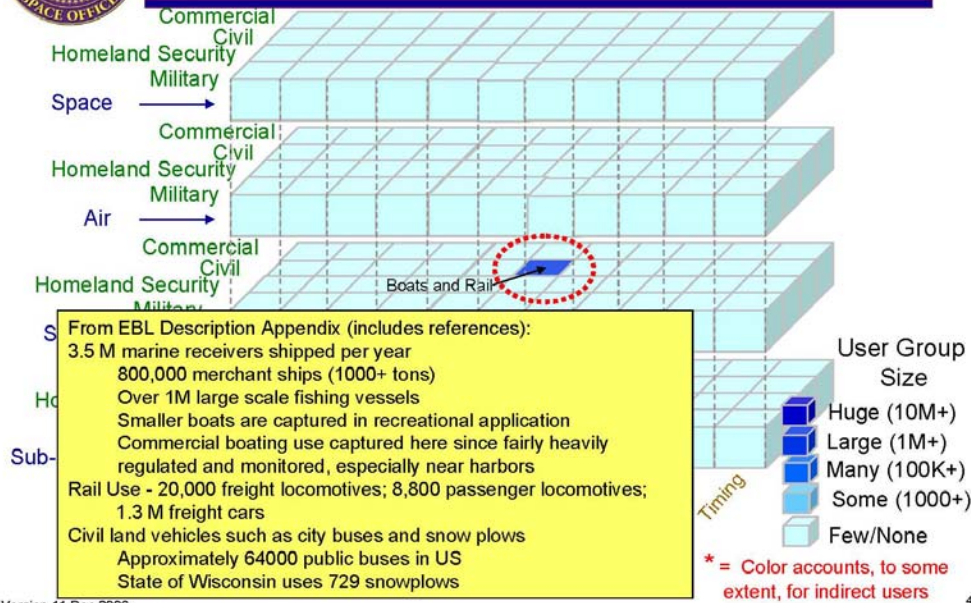

Version 11 Dec 2006

4

APPENDIX H – GAP CHARTS

The Architecture Development Team identified several future capability needs (2025) that the Evolved Baseline would not be able to meet. Those capability gaps were derived from the 26 Sep 06 JROC-approved Joint Capabilities Document with modifications and additions from parallel civil community documents. The gaps can be classified as follows:

- Inability to meet PNT needs in physically impeded environments
- Inability to meet PNT needs in electronically impeded environments
- Inability to consistently provide higher accuracy with integrity where and when needed
- Inability to provide notification of degraded or misleading information where and when needed
- Inability to provide high altitude/space position and orientation services
- Inability to provide access to improved GIS data regarding intended path of travel
- Insufficient modeling capability

The following corresponding charts describe the conditions, rationale, user(s) and issues related to the identified capability gaps.

Primary PNT Gaps

- **Gaps primarily from 26 Sep 06 JROC-approved PNT JCD, but with additions / modifications from parallel civil community documents**
 - Operations in Physically Impeded Environments
 - Operations in Electromagnetically Impeded Environments
 - Higher accuracy with integrity
 - Notification of Degraded or Misleading Information (Integrity)
 - High Altitude/Space Position and Orientation
 - Geospatial information - access to improved GIS data (regarding intended path of travel)
 - Insufficient modeling capability

PNT Gap: Operations in Physically Impeded Environments

Who: Cell phones, radios, PDAs for LBS, and asset tracking

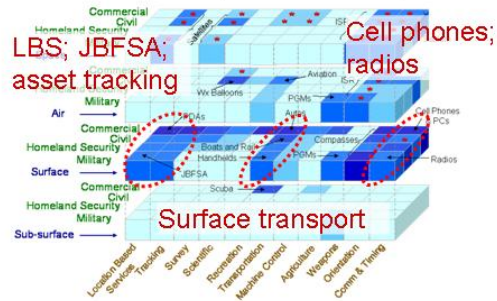

What: Assured and real time PNT in physically impeded environments

Where: Areas including indoors, urban canyons, underground, underwater, and under dense foliage; users moving at surface speeds; communications available

Issues: Cost a key constraint; multipath; user equipment size/weight

Reference: PNT JCD pg 13

Why: Growth of urban areas; growing indoor applications; current GPS radio frequency signals not always available



2

PNT Gap: Operations in Electromagnetically Impeded Environments

Who: Military users during combat operations; civil users in safety of life and urban applications facing interference

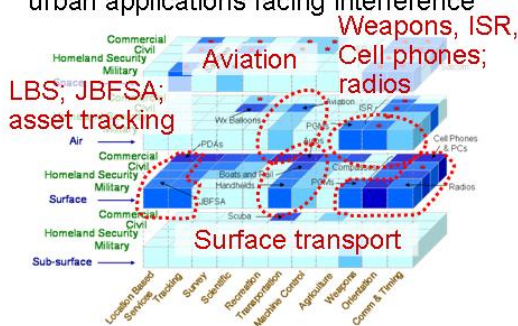

What: Assured and real time PNT in electromagnetically impeded environments, to include operations during spoofing, jamming and unintentional interference

Where: All military operations, but especially in proximity to enemy jammers; interference for civil users more likely in urban areas; low to high dynamics

Issues: Cost a common constraint; Multi frequency use (e.g. L1 & L5) can increase or decrease vulnerability; user equipment size/weight
What is threat/need indoors?

Reference: PNT JCD pg 13

Why: Growing jamming threat; interference more common



3

PNT Gap: Higher accuracy with integrity

Who: Future automobiles; railroads

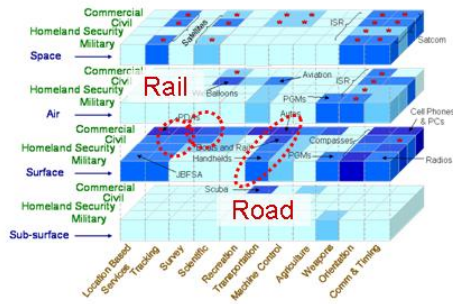

Why: Growing population requires increased road and rail capacity; allows more cars/trains to safely fit on the same highways/tracks; increased efficiency/profits; improve safety

What: Advanced driver assistance (road departure and lane change collision avoidance) systems need 10cm accuracy; railroads need 1m accuracy for positive train control and 10cm accuracy for rail survey and test; advisory systems affecting safety of life drive integrity requirements

Where: On roads/rail at surface speeds; includes urban canyons, under canopy, in tunnels and valleys

Reference: 2006 FRP pg 4-6 & 4-7; PNT JCD pg 16



4

PNT Gap: Notification of Degraded or Misleading Information (Integrity)

Who: Air and surface transportation; weapons

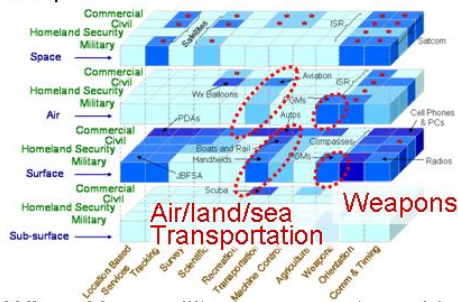

Why: Many military users not provided with timely notification of degraded or misleading information; civil community seeks lower cost integrity for safety of life applications; PNT dependence makes spoofing more attractive

What: Timely notification (as short as 1 sec in some situations) when PNT information is degraded or misleading, especially for safety of life applications or to avoid collateral damage

Where: Transportation routes including roads, harbors, and airport approaches; military operations especially with high jamming/spoofing threat

Issues: Integrity requirements for JBFSA and intelligent highway use; sufficient availability of integrity

Reference: PNT JCD pg 13-14



5

PNT Gap: High Altitude/Space Position and Orientation

Who: Support to “space situational awareness, intelligence collection, and other missions”; NASA missions

What: Real time high accuracy position and orientation (<10 milliarseconds) information. Example: 3cm (relative) formation flying

Where: Space (Keplerian orbits) and at high altitude (medium dynamics)

Issues: No funding to update star catalog; GPS signal availability at GEO and beyond; need for additional radiometric sources beyond Earth orbit (cislunar space, and beyond)

Reference: PNT JCD pg 14 & 17; NASA Space Communication (and Navigation) Architecture

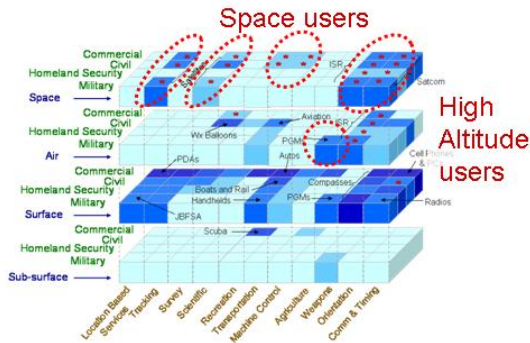

Why: Current star catalog degrading; growing scientific uses – formation flying; navigation in environments with sparse radiometric signals

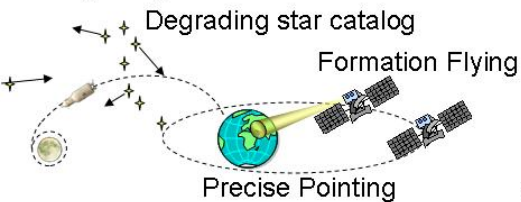

6

PNT Gap: Geospatial Information

Who: Air, surface and subsurface navigation users

What: Users require access to timely geospatial information for successful navigation

Where: On, near, or under the surface of the earth

Issues: What information is needed? How should it be produced? How should it be disseminated? How should it be processed, fused, and displayed?

Reference: PNT JCD pg 9, 13 & 23

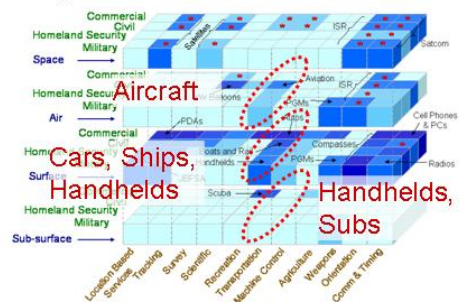

Why: Robust geospatial information facilitates use of navigation information and provides the user with the knowledge of the environment along the intended path of travel.

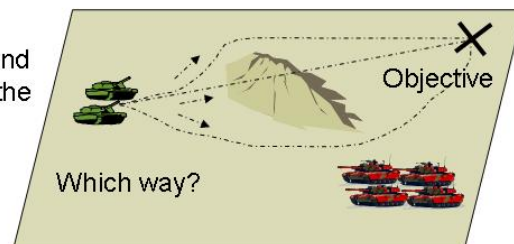

7

PNT Gap: Insufficient Modeling Capability

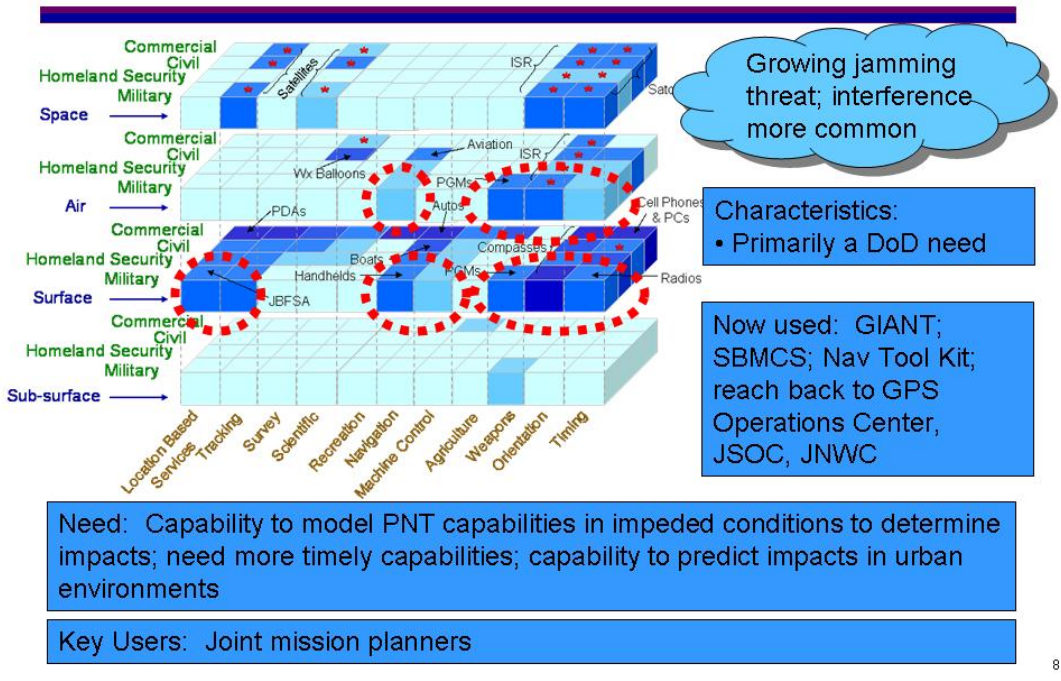

The Team also anticipates opportunities to improve PNT service performance during the course of implementing the “Should-Be” Architecture, even though the improvements may not be tied to specific needs. Areas with high potential for improvement include collaborations on ground- and space-based augmentations for GNSS, and new applications based on increased system performance levels. For example, increased participation in collaborative activities may find additional roles for LORAN, and efforts to improve GPS performance may result in lower ground costs for CAT II/III Precision Approach making that capability more widely available.

PNT Opportunities

- Improved collaboration/consolidation of PNT Services, e.g.:
 - Mix of ground- and space-based GNSS augmentations
 - Role of LORAN
- New applications/uses based on increased performance (to include accuracy, coverage, integrity, etc.), e.g.:
 - Reduced cost/wider availability of CAT II/III Precision approach
 - Backup timing
 - Synergy of navigation and communications

9

PNT Opportunity: Improved Collaboration or Consolidation of PNT Services

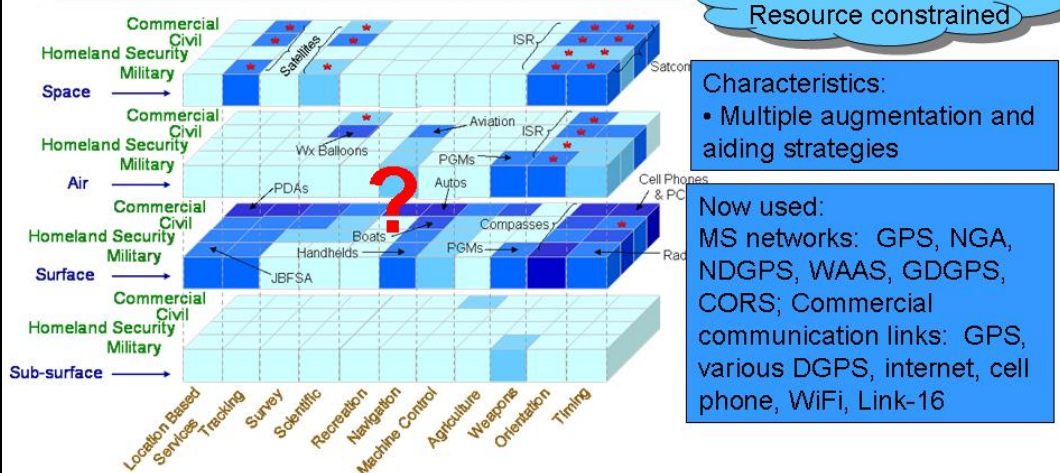

Growing needs;
Resource constrained

Characteristics:
• Multiple augmentation and aiding strategies

Now used:
MS networks: GPS, NGA, NDGPS, WAAS, GDGPS, CORS; Commercial communication links: GPS, various DGPS, internet, cell phone, WiFi, Link-16

Need: Meet growing needs robustly and efficiently. What is appropriate mix of augmentations? What is role of NDGPS? LORAN?

Key Users: TBD

10

PNT Opportunity: New applications/uses based on increased performance

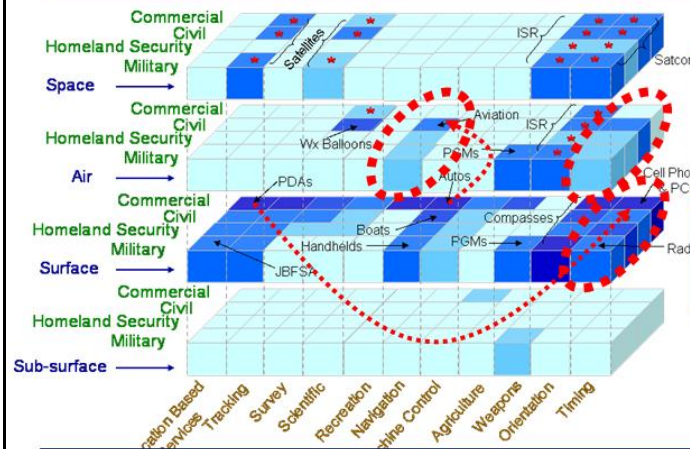

Growing needs;
Resource constrained

- Characteristics:
- Diverse user groups
 - Diverse, tailored solutions
 - Sometimes, more is better

Now used:
All systems in PNT Evolved Baseline

Need: Meet growing needs robustly and efficiently. Can solutions used by one group be applied more widely? Can a combination of solutions meet previously unsatisfied needs? Can solutions to previous gaps meet other needs as well?
Example: ITS solution apply to Cat II/III Approach?

Key Users: TBD – Aviation navigation? Backup timing?

APPENDIX I – COST DATA

The following charts are included to accomplish the following:

- Detail the types of data requested to support the cost estimating effort (slide 1)
- Present the timeline of data requests (slides 1 and 3)
- Associate the data needed by program with organizations (slides 4-11)
- Provide an inventory of the data collected to date (slides 4-12)
- Provide an inventory of the data still needed (slides 4-11)
- Illustrate other non-program areas of cost (slides 12-14)

Cost Requirements & Wish List (Presented to ADT on May 24, 2007)

1. Define legacy system
 - Identify phase-out plan
2. Define follow-on system
 - Identify start/stop dates
3. New technologies planned
4. Assumptions for changes based on evolving/projected threats
 - ★ Modified systems are NEW systems!
5. Actual costs
6. Completed estimates
7. Schedules
 - Date (year) current program is expected to reach end of life
 - Date next program is to be phased in and its life expectancy
8. For items to be estimated, size (weight, lines of code) and quantity are essential
 - Other technical information is often required depending upon the item and the estimating model (power, bandwidth)
 - Descriptions of changes from one block or generation to the next and the impacted hardware and software (HW/SW) are required
 - ★ Budgets are helpful, but are not the answer!

Initial Data Request Yielded Little Response

FAA cost analyst provided Infrastructure & Installation and O&M Rough Order of Magnitude (ROM) cost data for:

- VOR
- DME
- NDB
- ILS
- LAAS (estimate)

- WAAS – provided segment-level 20-year life cycle cost estimate

- Some of the data conflicts with data from other sources obtained later
- Lower-level hardware data desired, but unavailable

SAF/USAL, USSTRATCOM, and GPS Wing coordinated to provide GPS budget and schedule data

- Five-year budget data not helpful considering the magnitude and duration of the program

Follow-up Data Request Emails sent to ADT Members July 20, 2007

GPS space, launch, ground, UE: Sent to SAF/USAL

No response received

JPALS: Sent to SAF/USAL

No response received

GPS Monitoring: Sent to NGA

No response received

CORS: Sent to NOAA

Info sufficient to construct estimate for current build plan received in email reply

LORAN & MDGPS: Sent to USCG

- Original email request sent June 20, 2007 subsequent to NAVCEN visit
- No response received to either email data request

HA-NDGPS: Sent to FHWA, DoT

Received "Program Plan" document and actual costs for existing experimental sites in response

TASS, SCA, IGS, GDGPS: Sent to NASA

Received "NASA Space Communication and Navigation Architecture Recommendations 2005-2030" document in response

DoD – GPS Data Inventory and Needs

GPS, OCX, and MUE

Have:

- Budget data (06-12) for space and control segments combined (from several sources, some conflicting)
- Budget data (06-12) for MUE
- GPS Wing's launch schedule as of July 2007
- Technical data sufficient to create NSSO space segment estimate for GPS-III A

Lacking:

- Realistic GPS III launch schedule
 - Necessary for phasing estimate and coordinating dependent programs' schedules
- GPS launch and control segment cost estimates (SMC, GPS Wing, AFCAA) for pass-thru
- OCX-specific data (technical, cost, schedule) for estimating use
- MUE-specific data (technical, quantity, cost, schedule) for estimating use
- Military receiver integration costs for aircraft, ships, and vehicles not known, to include cost of standards development, certification, and testing

4

DoD – Other Data Inventory and Needs

Have:

JPALS

- Budget data (06-11)

JMAPS

- Program-level ROM provided by program office program manager – no insight into what ROM represents (scope, fidelity, type of cost)

JTRS

- Program-level ROM and quantity located online
- Not in scope as of May 2007, but technology employed in this program is of interest to the architecture

Lacking:

JPALS

- No specific data (technical, quantity, cost, or schedule) for estimating use

JMAPS

- No technical details to construct ROM crosscheck
- No schedule or launch vehicle information

JTRS

- Definition as to how this program, or software reprogrammable receiver technology, may fit into the architecture

5

NGA Data Inventory and Needs

GPS Monitoring Costs; GIS Contributions; Grids, Reference Frames, and Standards Development Costs

No data provided

Lacking:

- **NGA budget data (classified)**
- **GPS monitoring costs (actuals) - would apply to baseline as well as serve as an analogy for costing the monitoring of foreign systems**
- **Specific technical data for estimating monitoring stations**
- **Cost insight to standards development, grids, and GIS/cartographic PNT uses**

Note:

NIST also contributes to the development of standards

6

FAA Data Inventory and Needs

WAAS – Have:

- **FAA provided 20-year life cycle draft estimate – rounded high-level WBS element costs may be used in analogy estimates for this and similar efforts (e.g. comm lease)**
- **Budget data (07-11)**

Ground-Based Navigation Aids

Have:

- **JPDO provided a copy of the NGATS Satellite Navigation Back-up Study, which contained ROM costs of DMEs**
- **FAA provided ROM costs of infrastructure & installation and annual O&M**
Conflicts with DME costs provided in NGATS Sat Nav Back-up Study
- **FAA provided draft estimate information for LAAS infrastructure & installation and O&M**
- **FAA provided ROM for decommissioning of VORs and DMEs**
- **FAA provided federal quantities of ILS, DME, VOR, NDB, and TACAN**

Lacking:

- **Segregated HW, SW, and installation costs for use in costing system expansion and in developing estimating models**
- **Recapitalization information (HW purchased and upgrade descriptions)**
- **Cost estimate of annual savings due to reduction to minimum operating network**

7

(add to “Lacking” above) Aviation GNSS user equipment including schedules/characteristics/cost and quantities

Other DoT Data Inventory and Needs

Have:

NDGPS (inland) / HA-NDGPS

- Outdated 2007 President's Budget for NDGPS
- NDGPS site location (quantity) data available online
- Cost data for existing experimental HA-NDGPS sites provided by Jim Arnold via email
- "HA-NDGPS Program Plan – Draft 09/30/2005" by James Arnold, FHWA – contains technical data

Intelligent Transportation System (ITS)

- Extensive hardware cost database available online – many programs and applications – not all apply to PNT
- "Working Paper: National Costs of the Metropolitan ITS Infrastructure: Updated with 2005 Deployment Data – July 2006" by MitreTek Systems available online

Positive Train Control (not in architecture cost scope)

- "Quantification of the Business Benefits of Positive Train Control"
Prepared for the Federal Railroad Administration by Zeta-Tech Associates
Revised March 15, 2004 – contains cost data and economic benefit study
- Although out of scope, but above document contains applicable insight

Lacking:

- Future of NDGPS / HA-NDGPS – program definition and decision
- For ITS, NSSO focus should be on what the USG would federally provide and be accountable for – this must be defined as related to PNT Architecture

8

USCG Data Inventory and Needs

MDGPS

Have:

- USCG budget data for MDGPS and NAVCEN (07-12) with O&M and recapitalization costs separately identified
- Site location (quantity) data available online

Lacking:

- Technical descriptions of the hardware for use in developing analogous systems estimating models
- Segregated HW, SW, and installation costs for use in costing system expansion and developing estimating models
- Recapitalization information (HW purchase/upgrade descriptions)

LORAN-C and eLORAN

Have:

- Site location data (quantity) for LORAN-C available online
- Loran IAT's PNT EXCOM 20 Mar 07 briefing contains ROMs for annual O&M, maintenance backlog, upgrade to eLORAN, and new transmitters
- JPDO's Satellite Navigation Back-up Study also contains O&M estimates consistent with the IAT projections

This data was sufficient for constructing a draft estimate

Lacking:

- Segregated HW, SW, and installation costs for LORAN-C for use in developing estimating models

9

NOAA/NGS Data Inventory and Needs

CORS

Have:

- NGS budget data (07-12)
- Site quantity data by Govt. agency or other owner available online
- Annual O&M including recap and cost of new site construction ROMs provided via email from NOAA official

This data was sufficient for constructing a draft estimate

Lacking:

- Segregated HW and installation costs **for use in developing estimating models**
- Greater insight into recapitalization (HW purchase/upgrade descriptions)

10

NASA Data Inventory and Needs

Programs:

- TASS
- SCA
- IGS
- GDGPS

Have:

- Budget data (07-12) at NASA level (not broken out by program)
- "NASA Space Communication and Navigation Architecture Recommendations 2005-2030" document

Lacking:

- TASS actuals
- Program estimates
- Program-specific data (technical, cost, or schedule) for estimating use
- Multiple program sponsors for IGS and GDGPS – what are NASA's responsibilities?

11

S&T / R&D Data Inventory and Needs by Organization

NIST

- Have budget data (07-12) for Timing R&D
- Sufficient to carry forward as a pass-thru in estimate ... **however:**
 1. Chip scale atomic clock funding should be separately examined, and future cost projections for this technology should be separately analyzed, considering its importance in the architecture
 2. NSSO should identify NIST's cost contribution towards standards development

USNO

- Have budget data (07-12) for OM&N and Procurement
- Sufficient to carry forward as a pass-thru in estimate ... **however**, lacking detail as to what this is buying

National Labs, DARPA, Other Federally Funded Research

- Cost and scope of their PNT contributions is unclear
- MEMS-IMU funding should be separately examined, and future cost projections for this technology should be separately analyzed, considering its importance in the architecture
- See also "Investment Priorities" on slide 14 of this briefing

12

Other Data Inventory and Needs by Topic

PNT Infrastructure

- Networks
- User Interface Organizations
 - Five-year budget data available for USCG facilities
 - Five-year budget data available for NCO and NCO/PNT Support
 - Headcounts and labor rates needed to estimate expansion of coordination function, to include application / phenomenology champions

Multiple Phenomenologies and Interchangeable Solutions

- Budgetary recommendation to "Further develop civil and military user equipment program plans to enable or leverage multiple phenomenologies" is difficult to assign a dollar figure to
- Cost projections for next generation civil and military user equipment that employ these recommendations require greater definition

Pseudolites and Beacons

- Greater definition of utilization, to include quantity, required for cost purposes

Talon Namath Zero Age of Data effort

- No data collected for this program

Comm-PNT Fusion Recommendation

- Entails several AoAs – request others in the community participate
- Budgetary recommendation to "Fund detailed assessment of the viability of specific solutions" is difficult to assign a dollar figure to

13

Investment Priorities (Presented to DCG on August 14, 2007)

Specific items of interest

- Clocks (optical, space qualified atomic, chip scale atomic)
- Low-burden inertial measurement units
- Sensor-aided inertial navigation systems
- Star trackers and gyros
- Horizontal integration algorithms
- Integrity for high-accuracy solutions
- Advanced integrity and information assurance algorithms
- Reference frames and standards to support tighter accuracies
- Software defined receivers
- Anti-jam technologies

APPENDIX J – DEFINITIONS

Adaptability – the ease of modifying architecture elements in response to change without having to change the underlying architecture, where change may include changing missions, contingencies, user requirements and capabilities, policy, hostile activity, technology, threats, and world environment

Beacons – While generically meaning a device which emits a signal used for navigation, the PNT Architecture uses the word ‘beacon’ to refer to a device which emits a short-range signal indicating the location of the beacon. A user receiving the beacon signal would therefore take the beacon location as an approximation of the user’s location. The architecture uses ‘pseudolite’ to refer to a device which emits signals allowing a user to determine the range or bearing to the device and hence triangulate the user’s location.

Celestial Navigation – Celestial navigation is the process by which one determines their position using celestial objects such as the moon, planets, and stars with respect to the horizon, and by referring to tables contained in nautical or air almanacs. The USNO, in cooperation with H.M. Nautical Almanac Office of the United Kingdom, publishes The Nautical Almanac and The US Air Almanac. The Maritime Safety Information Center maintained by NGA also provides information for use in celestial navigation. The reader is also referred to the Astronomical Almanac Online Glossary, produced by the Astronomical Applications Department of the USNO, available at <http://asa.usno.navy.mil/SecM/Glossary.html>.

Clocks (Timekeeping Methods) – The reader is referred to the National Institute of Standards and Technology (NIST) glossary of time and frequency terms, available online at <http://tf.nist.gov/timefreq/general/enc-index.htm>.

CORS – NGS coordinates two networks of continuously operating reference stations (CORS): the National CORS network and the Cooperative CORS network. Each CORS site provides GPS carrier phase and code range measurements in support of three-dimensional positioning activities throughout the United States and its territories. CORS data is applied to position points at which GPS data have been collected. The CORS system enables positioning accuracies that approach a few centimeters relative to the National Spatial Reference System (NSRS), both horizontally and vertically.⁶

DGPS – Differential Global Positioning Systems are radionavigation systems that receive satellite-generated positioning information from GPS. DGPS calculates real-time corrections to that information based on the known geographic position of the reference stations, and then transmits those corrections over select radio beacon transmitters to users located in the transmitter’s coverage area.

DME – Distance Measuring Equipment (airborne and ground) is used to measure, in nautical miles, the slant range distance of an aircraft from the DME navigational aid. DME is usually frequency paired with other navigational aids, such as a VOR.

⁶ <http://www.ngs.noaa.gov/CORS/cors-data.html>

DSMAC – Digital Scene Matching Area Correlation is a terminal guidance system used by the Tomahawk cruise missile. A camera in the nose is activated once the missile is near its target, and the view from the camera is compared constantly to a set of 'correct' images of the target stored in the missile. When the scene matches, the missile refines its heading to place itself in the center of the 'stored' scene.

Earth-Moon L1 Point – a Lagrangian point on a line between the Earth and Moon; a Lagrangian point is defined as: one of five special points in the plane of two massive bodies orbiting one another (such as Sun and Earth, or Earth and Moon), where a third body of negligible mass (such as a satellite) can remain in equilibrium, keeping the same position relative to the other two.

EGNOS – The European Geostationary Navigation Overlay Service (EGNOS) augments the two military satellite navigation systems now operating, the US GPS and Russian GLONASS systems, and makes them suitable for safety critical applications such as flying aircraft or navigating ships through narrow channels. Consisting of three geostationary satellites and a network of ground stations, EGNOS achieves its aim by transmitting a signal containing information on the reliability and accuracy of the positioning signals sent out by GPS and GLONASS. It allows users in Europe and beyond to determine their position to within 2m.

EM-log – a Linux kernel module that makes it easy to access the most recent (and only the most recent) output from a process

GAGAN – For satellite-based navigation in India, two core constellations (GPS and GLONASS) are available. The position accuracies achievable with these core constellations require augmentation to meet the precision approach and landing requirements of Civil Aviation. The Indian SBAS named GAGAN (GPS And Geo Augmented Navigation) System will be implemented jointly by the Indian Space Research Organization and the Airports Authority of India, and consist of a GEO navigation payload, eight reference stations, and a mission control center.

GDGPS – NASA's Global Differential GPS System is a complete, highly accurate, and robust real-time GPS monitoring and augmentation system. Employing a large ground network of real-time reference receivers, innovative network architecture, and real-time data processing software, the GDGPS System provides decimeter (10 cm) positioning accuracy and sub-nanosecond time transfer accuracy anywhere in the world, on the ground, in the air, and in space, independent of local infrastructure.⁷

GLONASS – The Global Orbiting Navigation Satellite System is a Soviet space-based navigation system comparable to the American GPS system (defined below). The operational system contains 21 satellites in 3 orbital planes, with 3 on-orbit spares. GLONASS provides 100 meter accuracy with its C/A (deliberately degraded) signals and 10-20 meter accuracy with its P (military) signals.

⁷ <http://www.gdgps.net/>

Gold Standard – A PNT service with high security and information assurance features in which a user can place a large degree of trust. The architecture team described the GPS Precision Positioning Service relying on P(Y) code, and in the future M-code, as gold standards to which the positions determined from other services could be compared.

GPS – The Global Positioning System is a US space-based radionavigation system that provides reliable positioning, navigation, and timing services on a continuous worldwide basis, freely available to all. GPS provides accurate location and time information for an unlimited number of people in all weather, day and night, anywhere in the world.

The GPS is made up of three parts: satellites orbiting the Earth; control and monitoring stations on Earth; and the GPS receivers owned by users. GPS satellites broadcast signals from space that are picked up and identified by GPS receivers. Each GPS receiver then provides three-dimensional location (latitude, longitude, and altitude) plus the time.

GPS has become a mainstay of transportation systems worldwide, providing navigation for aviation, ground, and maritime operations. Disaster relief and emergency services depend upon GPS for location and timing capabilities in their life-saving missions. Everyday activities such as banking, mobile phone operations, and even the control of power grids, are facilitated by the accurate timing provided by GPS. Farmers, surveyors, geologists and countless others perform their work more efficiently, safely, economically, and accurately using the free and open GPS signals.

Greater Common Denominator –A large number of PNT users have a set of needs in common with each other that can be more efficiently satisfied by common solutions than by numerous customized systems without losing effectiveness. In this architecture, external sources of PNT information (such as GPS) make a broad range of capabilities globally available to meet the needs of the greatest segment of the user base. The architecture also acknowledges that specialized solutions will continue to exist where it is either inefficient or inappropriate to provide the required capability more commonly.

Gyroscope – a spinning mass mounted within a gimbal system; in absence of friction and unbalance, the spinning mass would remain stationary in inertial space and ideally act as a portable reference direction.

HA-NDGPS – The High Accuracy-Nationwide Differential Global Positioning System program provides the capability to broadcast corrections to GPS over long ranges to achieve a better than 10 cm (95 %) accuracy throughout the coverage area. HA-NDGPS is currently undergoing a research and development phase. The signal is available for test purposes from Hagerstown, MD and Hawk Run, PA. Application of this technology will provide advanced safety features for transportation, including lane departure warning, intersection collision warnings, and railroad track defect alerts. It also could be used for economic enhancements such as precision container tracking and automated highway lane striping.⁸

⁸ <http://www.tfhr.gov/its/ndgps/handgps/03039.htm>

iGPS – Iridium GPS is an initiative the US Government is studying that uses the Iridium communication satellite system to augment GPS signals to provide more robust anti-jam and interference protection, improved operations in restrictive environments, enhanced availability, and extremely high accuracy.

IGS – The International GNSS Service is a voluntary federation of more than 200 worldwide agencies that pool resources and permanent GPS and GLONASS station data to generate precise GPS and GLONASS products. Currently the IGS includes two GNSS, GPS and the Russian GLONASS, and intends to incorporate future GNSS.

The IGS supports Earth science research, multidisciplinary applications, and education. The IGS collects, archives, and distributes GNSS observation data sets of sufficient accuracy to meet the objectives of a wide range of scientific and engineering applications and studies. These data sets are used to generate the following products: GPS and GLONASS satellite ephemerides, Earth rotation parameters, IGS tracking station coordinates and velocities, GPS satellite and IGS tracking station clock information, Zenith tropospheric path delay estimates, and global ionospheric maps.

ILS – The Instrument Landing System is a ground based precision approach system that provides course and vertical guidance to landing aircraft. The Instrument Landing System is the predominant system supporting precision approaches in the US. With the advent of GPS-based precision approach systems, the role of Category I ILS will be reduced. ILS will continue to provide precision approach service at major terminals.

Inertial Measurement Unit – Also known as inertial sensors, IMUs, such as accelerometers and gyroscopes, are widely used in many applications in the aerospace, military, automotive, and marine industries. In the aerospace industry, these devices are used in the basic flight stabilization of aircraft and rockets as well as in navigation. Military applications include the same usages in air to air missiles, air to ground missiles, ground to air missiles, ground to ground missiles, barrage rounds and hypersonic projectiles. Automotive applications include vehicle stability systems and rollover prevention systems. Naval and marine applications include ship stabilization and navigation.

Inertial Navigation System – An inertial navigation system is a type of dead-reckoning navigational system, used on aircraft and other vehicles, which is based on the measurement of accelerations. Accelerations are measured by devices such as gyroscopes, stabilized with respect to inertial space. Navigational information such as vehicle velocity, orientation, and position is determined from these measurements by computers or other instrumentation.

Interchangeability – This term generically means “a trait that allows two things to be put or used in the place of each other”. Interchangeability applied to the PNT architecture is a characteristic that allows accurate, timely and reliable PNT solutions that meet user needs to be formed from a mix of data sources, e.g., one GPS satellite, one Galileo satellite, one LORAN signal, and a clock could be used to produce a four-dimensional PNT solution. It also includes the ability to provide a solution from System B when System A is not available.

Interoperability – the ability of systems, units, or organizations to provide services to and accept services from other systems, units, or organizations as required to support the mission(s)

IRNSS – The Indian Regional Navigational Satellite System is an independent regional satellite navigation system developed by the Indian government to reduce the nation's dependence on the GPS system operated by the US Department of Defense. The seven-satellite constellation would be a stand-alone system and is independent of an Indian project to enhance GPS signals in the region, as well as India's plans to join GLONASS and Galileo. In a May 9, 2006 announcement, the Cabinet Office the said the system "will provide an independent, indigenously developed constellation of satellites to provide satellite-based position, navigation and timing service for critical national applications."⁹

ITS – The Intelligent Transportation System encompass a broad range of wireless and wire line communications-based information and electronics technologies. When integrated into the transportation system's infrastructure, and in vehicles themselves, these technologies relieve congestion, improve safety and mobility, and enhance productivity through the use of advanced communications technologies. The Federal ITS program supports the overall advancement of ITS through investments in major initiatives, exploratory studies, and a deployment support program. Increasingly, the Federal investments are directed at targets of opportunity – major initiatives – that have the potential for significant payoff in improving safety, mobility and productivity.

JBFS – Developing Joint Blue Force Situational Awareness became a top priority for the military in 2003. As of January 2006, 11 disconnected tracking systems, ranging from commercial to US military to foreign-developed systems, have been integrated into a comprehensive Joint/Coalition Blue Force Situational Awareness capability. This capability presents an integrated picture of friendly-force position, status, and intent across the battlespace to commanders and users at strategic, operational and tactical levels. Once completed, the Blue Force Situational Awareness system will provide integrated, unified identification, location, intent, and status information about all allied or "blue" forces to the system's users. Helping alleviate the risk of friendly fire and increasing integrated, interoperable, friendly-force tracking among a number of forces is the number one priority of JBFS.

J-MAPS – The Joint Milli-Arcsecond Pathfinder Survey is a proposed program to update the star catalog and demonstrate an improved star tracker

JPALS – JPALS is an all-weather, all-mission, all-user landing system based on local area differential GPS. JPALS works with GPS to provide accurate, reliable, landing guidance for fixed and rotary wing aircraft during all weather conditions. It features a high GPS anti-jam protection to assure mission continuity in a hostile environment. JPALS equipment supports fixed-base, tactical, and shipboard applications. It is compatible with civil and military GPS signals. The JPALS system is being developed to

⁹ http://www.space.com/spacenews/archive06/India_052206.html

meet the Defense Department's need for an anti-jam, secure, all-weather Category I/II/III aircraft landing system that will be fully interoperable with planned civil systems utilizing the same technology.¹⁰

JTRS – The Joint Tactical Radio System is a transformational DoD-wide initiative to develop a family of revolutionary software-programmable tactical radios that will provide the warfighter with voice, data, and video communications, as well as interoperability across the joint battlespace. Current radio systems lack interoperability across the spectrum and have insufficient bandwidth to meet present and future communications challenges. The solution for interoperability is an all service radio and a new wideband networked waveform with the ability to provide mobile networked-connectivity across the battlespace while providing compatibility with the current waveforms in use by the DoD today.

LAAS – The Local Area Augmentation System is a ground-based satellite navigation augmentation system being developed by the FAA. LAAS uses signals from GPS to develop an extremely accurate navigation signal, and the GPS-corrected navigation signal is broadcast from a LAAS VHF data broadcast transmitter at or near the airport (approximately a 20-30 mile radius). LAAS can provide Category I precision landing to all runway ends with one system while eliminating most ILS critical areas. The eventual goal for LAAS is Category II/III service.¹¹

LBS – Location-based services are wireless “mobile content” services that provide location-specific information to mobile users moving from location to location. The service provider obtains the mobile user’s location from a GPS chip built into the phone, or by using radiolocation and trilateration of the closest cell-phone towers (for phones without GPS features). Examples of application include: requesting the nearest business or service, such as an ATM or restaurant; receiving alerts, such as notification of a sale on gas or warning of a traffic jam; and proximity-based actuation (automatic toll payment).

LORAN – LOng RANge Navigation, USCG – LORAN-C, the version of LORAN currently in use, is a stand-alone, hyperbolic radionavigation system developed to provide military users with a radionavigation capability with greater coverage and accuracy than its predecessor (LORAN-A). It was subsequently selected as the radionavigation system for civil marine use in the US coastal areas. LORAN-C provides horizontal coverage throughout the 48 conterminous states, their coastal areas, and most of Alaska south of the Brooks Range. It is approved by the FAA as a supplemental system in the NAS for the en route and terminal phases of flight and by the USCG as a means of maritime navigation in the coastal confluence zone. It is also available for use as either a primary or back-up precise frequency source to support precise timing applications. The Department of Defense has determined that LORAN is no longer needed as a positioning,

¹⁰ <http://www.raytheon.com/products/jpals/>

¹¹ http://www.faa.gov/about/office_org/headquarters_offices/ato/service_units/techops/navservices/gnss/faq/laas/

navigation, or timing aid for military users. Studies are currently ongoing regarding the implementation of Enhanced LORAN (eLORAN).¹²

MDGPS – (See also the definitions for DGPS above and NDGPS below). Maritime Differential GPS refers to the US Coast Guard's portion of NDGPS, which consists largely of coastal sites.

MEMS-IMU – Micro-Electro-Mechanical Systems (MEMS) Inertial Measurement Units (IMUs) consist of miniature devices that combine electrical and mechanical inertial sensing components. Typical of such devices are accelerometers containing miniature proof masses and sensing electronics and gyroscopic devices based on the coriolis effect using vibrating forks. As inertial sensors shrink in size and cost, the number of applications increases exponentially. As the accuracy and stability of these miniature, low-cost devices increases, higher performance systems are being introduced into lower cost items and consumer goods such as automobiles, thereby enhancing safety and functionality.

MSAS – The Japanese MTSAT Satellite-based Augmentation System (MSAS) will supply the Asia-Pacific region with capabilities similar to the US FAA's Wide Area Augmentation System (WAAS). MSAS and WAAS will be interoperable and are compliant with the International Civil Aviation Organization's Standards and Recommended Practices for satellite-based augmentation systems. The MSAS will improve the accuracy, integrity, continuity and availability of GPS satellite signals throughout the Japanese Flight Information Region by relaying augmentation information to user aircraft via Japan's Multi-functional Transport Satellite (MTSAT) geostationary satellites. The system consists of a network of Ground Monitor Stations in Japan, Monitor and Ranging Stations outside of Japan, Master Control Stations in Japan with satellite uplinks, and MTSAT geostationary satellites.

MTSAT – MTSAT is a dual mission satellite for the Japanese Ministry of Land, Infrastructure, and Transport and the Japan Meteorological Agency, performing an air traffic control and navigation function as well as a meteorological function. MTSAT-1R launched on February 26, 2005 and is operational at 140° East. MTSAT-2 launched on February 18, 2006 and is on station at 145° East. (See also MSAS definition above.)

NDGPS – Public Law 105-66 section 346 authorized the improvement and expansion of the USCG's MDGPS system into a Nationwide DGPS system. Several Federal agencies, states, and scientific organizations cooperate in the provision of NDGPS services. NDGPS uses a medium frequency broadcast optimized for surface applications. The broadcast has been demonstrated to be sufficiently robust to work throughout mountain ranges and other obstructions. NDGPS improves the accuracy, availability, and integrity of the GPS by constantly monitoring and broadcasting corrections to the GPS service using a network of reference stations of known location, meeting the needs of many more

¹² 2005 Federal Radionavigation Plan, available at <http://www.navcen.uscg.gov/pubs/frp2005/2005%20FRP%20WEB.pdf>

transportation users, and enabling such applications such as Positive Train Control and precision agriculture. (See also the definitions of DGPS and MDGPS above.)

NextGen –The 2025 Next Generation Air Transportation System vision calls for a system-wide transformation leading to a new set of capabilities that will allow the system to respond to future needs of the Nation’s air transportation. The list includes communication and physical infrastructure, the acceleration of automation and procedural changes based on 4-dimensional trajectory analyses to substantially increase capacity with safety and efficiency of the National Airspace System, and dynamic reconfiguration of airspace to be scalable to geographic and temporal demand. The Interagency Joint Planning and Development Office (JPDO) is developing the vision for NextGen and defining the research required to achieve that vision.

Precision Approach – An instrument approach procedure, based on a lateral path and a vertical glide path, that meets specific requirements established for vertical navigation performance and airport infrastructure.¹³

Pseudolites – In satellite-based precise positioning, the dominant factors are the number and geometric distribution of the satellites tracked by the receivers. In the case of global navigation satellite systems like GPS, four visible satellites are the minimum requirement for precise three-dimensional positioning. In general, the more satellites that are tracked, the more reliable the positioning solutions are. However, in some situations, such as in downtown urban canyons, engineering construction sites, and in deep open-cut pits and mines, the number of visible satellites may not be sufficient. In the worst situations, such as in underground tunnels and inside buildings, the satellite signals may be completely absent. Such problems with existing GNSS systems can be addressed by the inclusion of additional ranging signals transmitted from ground-based "pseudo-satellites" (pseudolites). Pseudolites can be used for a wide range of positioning and navigation applications, either as a substantial augmentation tool of space-borne systems, or as an independent system for indoor positioning applications. (See also definition for beacons, above.)

QZSS – The Quasi-Zenith Satellite System is a constellation consisting of three HEO satellites orbiting in different highly inclined orbital planes with geosynchronous period. QZSS is designed to overcome the physical impedances of terrain and urban areas to provide stable satellite mobile communications and navigation/positioning services from a high elevation angle. Utilization of the Quasi-zenith orbit has been shown to provide: (1) a GPS complement to broadcast positioning signal which is compatible and interoperable with GPS to enhance accuracy and availability, (2) a GPS augmentation to broadcast correction data (DGPS), and (3) to provide Broadcast and Communication services for mobile users in the specified region. The QZSS program is a united effort of the Japanese government and industry.

¹³ 2005 Federal Radionavigation Plan, available at <http://www.navcen.uscg.gov/pubs/frp2005/2005%20FRP%20WEB.pdf>

RAIM – Receiver autonomous integrity monitoring is a technology developed to assess the integrity of GPS signals in a GPS receiver system. It is of special importance in safety-critical GPS applications. RAIM detects faults with redundant GPS pseudorange measurements. That is, when more satellites are available than needed to produce a position fix, the extra pseudoranges should all be consistent with the computed position. An outlier may indicate a fault of the associated satellite or another signal integrity problem (*e.g.*, ionospheric dispersion). Traditional RAIM uses Fault Detection only; however, newer GPS receivers incorporate Fault Detection and Exclusion which enables them to continue to operate in the presence of a GPS failure. Because RAIM operates autonomously, it requires redundant pseudorange measurements. To obtain a 3D position solution, at least 4 measurements are required. To detect a fault, at least 5 measurements are required, and to isolate and exclude a fault, at least 6 measurements are required. This will work where interference has not caused complete loss of signal, and has only badly affected a small number of satellite signals.

Risk – a future event or situation with a realistic probability (between 0% and 100%) of occurrence and an unfavorable consequence or impact to the successful accomplishment of well-defined goals if it occurs.

Robustness – the ability of the PNT architecture to deliver a continuous PNT solution in any condition (hostile action, environmental, system internal failures) over a given time period.

RTK – Real-time kinematics is a process where GPS signal corrections are transmitted in real time from a reference receiver at a known location to one or more remote rover receivers. Using the code phase of GPS signals, as well as the carrier phase, which delivers the most accurate GPS information, RTK provides differential corrections to produce the most precise GPS positioning. The use of an RTK-capable GPS system can compensate for atmospheric delay, orbital errors, and other variables in GPS geometry, increasing positioning accuracy up to within a centimeter. Used by engineers, topographers, surveyors, and other professionals, RTK is a technique employed in applications where precision is paramount. RTK is used not only as a precision positioning instrument, but also as a core for navigation systems or automatic machine guidance in applications such as civil engineering and dredging.

Star Tracker (and Star Catalog) – Star trackers are cameras that recognize star patterns and thereby reveal the direction in which they are pointed. For complex missions, entire starfield databases (star catalogs) are used to identify orientation.

Sustainability – the ability to maintain the necessary level and duration of operational activities. Sustainability is a function of providing for and maintaining the levels of ready forces, materiel and consumables necessary to support mission efforts (Joint Pub 1-02).

TACAN – The Tactical Air Navigation System is the military counterpart of VOR/DME. It is an airborne, ground- or ship-based radionavigation system that combines the bearing capability of VOR and the distance-measuring function of DME. The azimuth service of TACAN primarily serves military users whereas the DME serves both military and civil users. The DoD requirement and use of land-based TACAN will continue until aircraft are properly integrated with GPS, and GPS-PPS is approved for all appropriate operations in national and international controlled airspace.

TADIL – The Tactical Data Information Links Program applies to all bit oriented message formats used in support of joint and combined operations for Joint Interoperability of Tactical Command and Control Systems (JINTACCS). The TADIL Program facilitates information exchange between the United States and Allied commands. TADIL is a Joint Chiefs of Staff approved standardized communication link suitable for transmission of machine-readable, digital information. The United States Navy uses the NATO designation, Link-16, when referring to TADIL.

Talon Namath – Precision GPS Ephemeris Distribution System; zero age of data program. “Talon NAMATH ensures the most up-to-date GPS data possible is provided directly to the cockpits of aircraft carrying out attacks against enemy targets. When employed with the Air Force's newest precision weapon, the small diameter bomb, this capability makes strikes more precise, and therefore more effective, while at the same time limiting collateral damage.”¹⁴

TASS – NASA service providing Earth satellites with precise GPS differential corrections and other ancillary information enabling decimeter-level orbit determination accuracy, and nanosecond time-transfer accuracy, onboard, in real-time. The TDRSS Augmentation Service for Satellites (TASS) broadcasts its message on the S-band multiple access channel of NASA's Tracking and Data Relay Satellite System (TDRSS). The GPS differential corrections are provided by the NASA JPL Global Differential GPS (GDGPS) System. This system provides real-time estimates of the GPS satellite states, as well as many other real-time products such as differential corrections, global ionospheric maps, and integrity monitoring. The estimated real time GPS orbit and clock states provided by the GDGPS system are accurate to better than 20 cm 3D RMS, and have been demonstrated to support sub-decimeter real time positioning and orbit determination for a variety of terrestrial, airborne, and space-borne applications.

In addition to the GPS differential corrections, TASS will provide real-time Earth orientation and solar flux information that enable precise onboard knowledge of the Earth-fixed position of the spacecraft, and precise orbit prediction and planning capabilities. TASS will also provide 5 seconds alarms for GPS integrity failures based on the unique GPS integrity monitoring service of the GDGPS System.

Trilaning – obtaining a PNT fix using three different frequencies

Uniformity – The ability to present information/data in a consistent manner that is transparent to the user over a large region/nation/world/planet

VOR – VOR, short for VHF Omni-directional Radio Range, is a very high frequency radio navigational aid, which provides suitably equipped aircraft with a continuous indication of bearing to and from the VOR station. VOR stations are often co-located with civil DMEs (VOR/DME) or military TACANs (VORTAC), allowing for a one-station position fix.

¹⁴ Lt. Gen. Frank G. Klotz, Vice Commander, Air Force Space Command – Speech to National Defense Industrial Association West Coast Dinner, Beverly Hills Hilton, Los Angeles, Calif., Feb. 3, 2007

VORTAC – VORTACs are navigational facilities consisting of two components, VOR and TACAN, which provide three services: VOR azimuth, TACAN azimuth, and TACAN slant range. The DME function (slant range) provided by the TACAN component is available for civil use, while the azimuth guidance is available only to military users. VORTACs also enable military aircraft to operate in the NAS. (See TACAN, VOR, and DME definitions above.)

WAAS – The Wide Area Augmentation System (WAAS) is a system of space systems and ground stations used in a differential GPS application, giving enhanced position accuracy. It was developed primarily for aeronautical navigation and precision approaches by the FAA and the DOT. “GPS alone does not meet the FAA's navigation requirements for accuracy, integrity, and availability. WAAS corrects for GPS signal errors caused by ionospheric disturbances, timing, and satellite orbit errors, and it provides vital integrity information regarding the health of each GPS satellite.”¹⁵

WAGE ZAOD – See http://earth-info.nga.mil/GandG/sathtml/ION2003_yinger.pdf for a thorough description of Wide Area GPS Enhancements / Zero Age of Data

WiFi – Wireless local area networks

WWV – NIST radio station WWV in Fort Collins, CO broadcasts time and frequency information worldwide 24 hours per day, 7 days per week. The broadcast information includes time announcements, standard time intervals, standard frequencies, UT1 time corrections, a BCD time code, geophysical alerts, marine storm warnings, and Global Positioning System (GPS) status reports.¹⁶

WWVB – NIST radio station WWVB is located on the same site as WWV. Broadcasts are used throughout North America to synchronize consumer electronic products like wall clocks, clock radios, and wristwatches. In addition, WWVB is used for high-level applications such as network time synchronization and frequency calibrations.

ZMDS – The Zero Age Message and Data Service is a GPS-aiding service provided by Air Force Space Command via SIPRNET which supplies updated clock and ephemeris data

¹⁵ <http://www8.garmin.com/aboutGPS/waas.html>

¹⁶ <http://tf.nist.gov/stations/wwv.html>

APPENDIX K – ABBREVIATIONS AND ACRONYMS

A/A	Aided Autonomy
AAI	a differential GPS program supporting U-2 aircraft
ADS-B	Automatic Dependent Surveillance-Broadcast
ADT	Architecture Development Team
AFB	Air Force Base
AFCAA	Air Force Cost Analysis Agency
AFIT	Air Force Institute of Technology
AFRL	Air Force Research Laboratory
AFSCN	Air Force Satellite Control Network
AGU	American Geophysical Union
AM	Amplitude Modulation
ANT	Advanced Navigation Technology Center (at AFIT)
AoA	Analysis of Alternatives
ARL	Applied Research Laboratory (at Penn State)
ASD/NII	Assistant Secretary of Defense for Networks and Information Integration
ASI	Accuracy Support Infrastructure
ATT	Architecture Transition Team
AWACS	Airborne Warning and Control System
BNTS	Beidou Navigation Test System
C2	Command and Control
C4I	Command, Control, Communications, Computing and Intelligence
CAOC	Combined Air Operation Centers
CCD	Charged Coupled Device
CGSIC	Civil Global Positioning System Service Interface Committee
CJCSI	Chairman of the Joint Chiefs of Staff Instruction
CLGE	Council of European Geodetic Surveyors
cm	centimeter

CMOC	Cheyenne Mountain Operations Center
COA	Course of Action
comm	communications
CONUS	Continental US
CORS	Continuously Operating Reference Stations
CRPA	Controlled Reception Pattern Antenna
CSAC	Chip-Scale Atomic Clocks
CSEL	Combat Survivor Evader Locator
DARPA	Defense Advanced Research Projects Agency
dB	decibel
DCG	Decision Coordination Group
DGNSS	Differential GNSS
DGPS	Differential GPS
DHS	Department of Homeland Security
DME	Distance-Measuring Equipment
DMI	Degraded / Misleading Information
DoC	Department of Commerce
DoD	Department of Defense
DOP	Dilution of Precision
DOT	Department of Transportation
DOTMLPF	Doctrine, Organization, Training, Material, Logistics, Personnel, or Facilities
DRDO	Defense Research Development Organization
DSMAC	Digital Scene Matching Area Correlation
DTED	Digital Terrain Elevation Data
DUSD(S&T)	Deputy Under Secretary of Defense for Science and Technology
EBL	Evolved Baseline
EGNOS	European Geostationary Navigation Overlay Service
eLORAN	Enhanced LORAN
EM	Electromagnetic

EMCON	Emissions Control
EMI	Electromagnetic Interference
EO	Electro-Optical
ESA	European Space Agency
EXCOM	National PNT Executive Committee
FAA	Functional Area Analysis
FAA	Federal Aviation Administration
FBI	Federal Bureau of Investigation
FHWA	Federal Highway Administration
FOC	Final Operational Capability
FOUO	For Official Use Only
FRA	Federal Rail Administration
FRP	Federal Radionavigation Plan
FSA	Functional Solutions Analysis
GAGAN	GPS and GEO Augmented Navigation (Indian SBAS)
GBAS	Ground-Based Augmentation System
GDGPS	Global Differential GPS
GE	Geomter Europas
GEAS	GNSS Evolutionary Architecture Study
GEO	Geosynchronous Orbit
GHz	Gigahertz
GIANT	GPS Interference And Navigation Tool
GIG	Global Information Grid
GIS	Geospatial Information Systems
GLONASS	Global Navigation Satellite System (Russian positioning system)
GNSS	Global Navigation Satellite System
GPS	Global Positioning System
GPSOC	GPS Operations Center, Schriever AFB, CO
GS	General Schedule (<i>e.g.</i> , GS-15)

HA-NDGPS	High Accuracy Nationwide Differential GPS
HAP	High-Altitude Platform
HW	Hardware
IA	Information Assurance
IAT	Independent Assessment Team
ICD	Interface Control Document
IERS	International Earth Rotation and reference systems Service
IFF	Identification Friend or Foe
IFUE	Integrating, Fusing User Equipment
iGPS	Iridium GPS
IGS	International GNSS Service
ILS	Instrument Landing System
IMU	Inertial Measurement Unit
INS	Inertial Navigation System
IOC	Initial Operating Capability
ION	Institute of Navigation
IRNSS	Indian Regional Navigational Satellite System
IS&S	(Lockheed Martin) Integrated Systems and Solutions
ISR	Intelligence, Surveillance, and Reconnaissance
ISRO	India Space Research Organization
ITAR	International Traffic in Arms Regulations
ITS	Intelligent Transportation System
JBFSA	Joint Blue Force Situational Awareness
JCD	Joint Capabilities Document
JLOC	GPS Jammer Location System
J-MAPS	Joint Milli-Arcsecond Pathfinder Survey
JNWC	Joint Navigation Warfare Center
JPALS	Joint Precision Approach and Landing System
JPDO	Joint Planning and Development Office

JPL	Jet Propulsion Laboratory
JPO	Joint Program Office
JROC	Joint Requirements Oversight Council
JSOC	Joint Special Operations Command
JSpOC	Joint Space Operations Center
JTIDS	Joint Tactical Information Distribution System
JTRS	Joint Tactical Radio System
LAAS	Local Area Augmentation System
LBS	Location-Based Services
lbs.	Pounds
LEO	Low Earth Orbit
LIDAR	Light Detection and Ranging
LORAN	Long Range Navigation
MCS	(GPS) Master Control Station
MDGPS	Maritime Differential GPS
MEMS	Micro Electro-Mechanical Systems
MEO	Medium Earth Orbit
MGRS	Military Grid Reference Systems
MILSATCOM	Military Satellite Communications
MS	Monitoring Station
MSAS	MTSAT Satellite-based Augmentation System
MTSAT	Multifunctional Transportation Satellite (Japanese SBAS)
MUE	Military User Equipment
NASA	National Aeronautics and Space Administration
NAVCEN	USCG's Navigation Center, Alexandria, VA
Navwar	Navigation Warfare
NCO	National Space-Based PNT Coordination Office
NDB	Non-Directional Beacon
NDGPS	Nationwide Differential GPS

NGA	National Geospatial-Intelligence Agency
NGATS	Next Generation Air Transportation System
NGS	National Geodetic Survey
NigComSat	Nigerian Communication Satellite
NIST	National Institute of Standards and Technology
NOAA	National Oceanic and Atmospheric Administration
NOCC	FAA's National Operations Control Center, Herndon, VA
NRO	National Reconnaissance Office
NSA	National Security Agency
NSRS	National Spatial Reference System
NSS	National Security Space
NSSO	National Security Space Office
NSSP	National Security Space Plan
NSSPA	National Security Space Program Assessment
O&M	Operations and Maintenance
OASD/NII	Office of the Assistant Secretary of Defense for Networks and Information Integration
OCS	Existing GPS Operational Control Segment
OCX	Future GPS III Operational Control Segment
PC	Personal Computer
PDA	Personal Digital Assistant
PGM	Precision Guided Munitions
PI	Physically Impeded
PNT	Positioning, Navigation, and Timing
POCC	Pacific Operations Control Center (WAAS)
PTO	Position, Timing, and Orientation
PTTI	Precise Time and Time Interval
PVT	Position, Velocity, and Time
QZSS	Quasi-Zenith Satellite System (Japanese positioning system)
R&D	Research and Development

R&V	Review and Validation
RA	Representative Architecture
RADAR	Radio Detection and Ranging
RAIM	Receiver Autonomous Integrity Monitoring
RDSS	Radio Determination Satellite System
RF	Radiofrequency
RFI	Request For Information
RFID	Radiofrequency Identification
RITA	Research and Innovative Technology Administration
RNASS	Regional Navigation Aiding Satellite System
RNSS	Regional Navigation Satellite System
ROM	Rough Order of Magnitude
RSS	Received Signal Strength
RTK	Real-Time Kinematics
RTN	Real-Time Network
S&T	Science and Technology
SAF/USAL	Directorate of Air Force Space Acquisition / Space Support and Force Application
SATCOM	Satellite Communications
SATNAV	Satellite Navigation
SBAS	Space-Based Augmentation System
SBMCS	Space Battle Management Command Systems
SCA	Space Communication and Navigation Architecture (NASA)
SES	Senior Executive Service
SMC	Space and Missile Systems Center
SME	Subject Matter Expert
SONAR	Sound Navigation and Ranging
SOO	Signal(s) of Opportunity
SV	Space Vehicle
SW	Software

TACAN	Tactical Air Navigation
TADIL	Tactical Data Information Links
TASS	TDRSS Augmentation Service for Satellites
TBD	To Be Determined
TDRSS	Tracking and Data Relay Satellite System
TERCOM	Terrain Contour Matching
TOR	Terms of Reference
UAV	Unmanned Aerial Vehicle
UCAV	Unmanned Combat Aerial Vehicle
UE	User Equipment
US	United States
USAF	United States Air Force
USCG	United States Coast Guard
USMS	US Marshals Service
USNG	United States National Grid
USNO	United States Naval Observatory
USSTRATCOM	United States Strategic Command
UST/P	Under Secretary of Transportation for Policy
UTC	Coordinated Universal Time
VOR	VHF Omni-Directional Radio-Range
VORTAC	a combined VOR and TACAN station
WAAS	Wide Area Augmentation System
WAGE	Wide Area GPS Enhancement
WBS	Work Breakdown Structure
WGS-84	World Geodetic System 1984
WWV/WWVB	NIST Radio Stations – see also Definitions Appendix
W _x	Weather
ZAOD	Zero Age of Data
ZDGPS	ZAOD-based Differential GPS

ZMDS	Zero Age Message and Data Service
ZNAV	ZAOD-based Navigation message