

Transportation
Kentucky Transportation Center Research
Report

University of Kentucky

Year 2018

Utilization of Light Detection and
Ranging for Quality Control and Quality
Assurance of Pavement Grades

Brad W. Rister* Levi McIntosh[†] Gabriel B. Dadi[‡]
Ruigang Yang** Eileen Grady^{††}

*University of Kentucky, brad.rister@uky.edu

[†]University of Kentucky, lmcintosh@uky.edu

[‡]University of Kentucky, gabe.dadi@uky.edu

**University of Kentucky, r.yang@uky.edu

^{††}University of Kentucky, eileen.grady@uky.edu

This paper is posted at UKnowledge.

https://uknowledge.uky.edu/ktc_researchreports/1589



Utilization of Light Detection and Ranging for Quality Control and Quality Assurance of Pavement Grades

Kentucky Transportation Center Research Report – KTC-18-01/SPR15-496-1F

DOI: <https://doi.org/10.13023/KTC.RR.2018.01>



The Kentucky Transportation Center is committed to a policy of providing equal opportunities for all persons in recruitment, appointment, promotion, payment, training, and other employment and education practices without regard for economic or social status and will not discriminate on the basis of race, color, ethnic origin, national origin, creed, religion, political belief, sex, sexual orientation, marital status, or age.

Kentucky Transportation Center
College of Engineering, University of Kentucky Lexington, Kentucky

in cooperation with
Kentucky Transportation Cabinet
Commonwealth of Kentucky

© 2018 University of Kentucky, Kentucky Transportation Center
Information may not be used, reproduced, or republished without KTC's written consent.

Research Report
KTC-18-01/SPR15-496-1F

**Utilization of Light Detection and Ranging for Quality Control and Quality Assurance of
Pavement Grades**

Brad Rister, P.E.
Program Manager

Levi McIntosh
Engineering Technician

Gabriel Dadi, Ph.D., P.E.
Assistant Professor of Civil Engineering

Ruigang Yang, Ph.D.
Professor of Computer Science

and

Eileen Grady
Research Scientist

Kentucky Transportation Center
College of Engineering
University of Kentucky
Lexington, Kentucky

In Cooperation With
Kentucky Transportation Cabinet
Commonwealth of Kentucky

The contents of this report reflect the views of the authors, who are responsible for the facts and accuracy of the data presented herein. The contents do not necessarily reflect the official views or policies of the University of Kentucky, the Kentucky Transportation Center, the Kentucky Transportation Cabinet, the United States Department of Transportation, or the Federal Highway Administration. This report does not constitute a standard, specification, or regulation. The inclusion of manufacturer names or trade names is for identification purposes and should not be considered an endorsement.

February 2018

1. Report No. KTC-18-01/SPR15-496-1F	2. Government Accession No.	3. Recipient's Catalog No	
4. Title and Subtitle Utilization of Light Detection and Ranging for Quality Control and Quality Assurance of Pavement Grades		5. Report Date February 2018	
		6. Performing Organization Code	
7. Author(s): Brad Rister, Levi McIntosh, Gabriel Dadi, Ruigang Yang, Eileen Grady		8. Performing Organization Report No. KTC-18-01/SPR15-496-1F	
9. Performing Organization Name and Address Kentucky Transportation Center College of Engineering University of Kentucky Lexington, KY 40506-0281		10. Work Unit No. (TRAIS)	
		11. Contract or Grant No. SPR 15-496	
12. Sponsoring Agency Name and Address Kentucky Transportation Cabinet State Office Building Frankfort, KY 40622		13. Type of Report and Period Covered	
		14. Sponsoring Agency Code	
15. Supplementary Notes Prepared in cooperation with the Kentucky Transportation Cabinet			
16. Abstract Light Detection and Ranging (Lidar) technology is a useful tool that can assist transportation agencies during the design, construction, and maintenance phases of transportation projects. To demonstrate the utility of Lidar, this report discusses how Lidar data can be used while performing quality control and quality assurance (QC/QA) of pavement grades along road segments where safety concerns have been identified (e.g., increased crash rates due to water ponding on the roadway). Researchers modeled surface runoff using Lidar data for several roadways that had experienced significant crash increases during wet-weather events. Based on this modeling, the Kentucky Transportation Cabinet (KYTC) undertook corrective maintenance to eliminate the points of concerns. Applying Lidar on transportation projects holds much promise, but there are several challenges related to its accuracy that transportation agencies must be cognizant of before deploying it routinely or using it to replace conventional surveying techniques.			
17. Key Words Lidar, quality control, quality assurance, 3D highway modeling, hydroplaning		18. Distribution Statement Unlimited with approval of the Kentucky Transportation Cabinet	
19. Security Classification (report) Unclassified	20. Security Classification (this page) Unclassified	21. No. of Pages 19	19. Security Classification (report)

Table of Contents

Introduction.....	1
Methodology.....	1
Mobile LiDAR Data Collection and Processing.....	1
Project Selection	3
Discussion—Analysis and Results	3
I-471 Kenton County, Kentucky.....	3
I-75 Boone County, Kentucky	7
US-641 Calloway County, Kentucky	9
I-75 Grant County, Kentucky	11
I-65 Edmonson County, Kentucky	12
Challenges in The Collection and Processing of Mobile Lidar Data.....	14
Solar Storms.....	14
Not All Lidar Data Are Created Equal	16
Summary and Conclusions	17
References.....	18

List of Figures

Figure 1 Lynx V200 mobile mapping system from Teledyne Optech	1
Figure 2 Mobile LiDAR diagram.....	2
Figure 3 Accident locations overlaid on the mobile LiDAR point cloud	4
Figure 4 Triangulated LiDAR data representing a surface DTM	5
Figure 5 Water flow analysis depicting water flow paths.....	6
Figure 6 Water flows along barrier wall and returns to roadway surface.....	6
Figure 7 Simulated flow analysis compared to field flow analysis	7
Figure 8 Water flow paths on I-75, Kenton County, Kentucky.....	8
Figure 9 Incipient hydroplaning speed versus water film thickness	9
Figure 10 US-641 Calloway County project site.....	10
Figure 11 US 641 simulated flow paths.....	11
Figure 12 I-75 accident locations with simulated flow paths	12
Figure 13 Contour lines derived using "Quick Terrain Modeler".....	13
Figure 14 As-built surface (blue) compared to design surface (red)	14
Figure 15 Solar storm.....	15
Figure 16 Effect of G4 solar storm on mobile Lidar data.....	16
Figure 17 Comparison of survey grade and planning grade DTMs.....	17

List of Tables

Table 1 Freeway Traffic Flow Reductions.....	8
---	---

Introduction

Light Detection and Ranging (LiDAR) technology is a useful tool that can assist transportation agencies during the design, construction, and maintenance phases of transportation projects. Its resourcefulness can be applied to many facets of a highway-related project. To demonstrate some of LiDAR's resourcefulness, this report will discuss utilizing mobile LiDAR technology for quality control/quality assurance (QC/QA) of pavement grades that may be causing safety concerns. Additionally, this report will discuss some challenges that may emerge when collecting and processing mobile LiDAR data. This last discussion is designed to help others avoid pitfalls when performing similar types of work.

Methodology

Mobile LiDAR Data Collection and Processing

Equipment (Hardware)

This study utilized a survey grade Lynx V200 mobile mapping system manufactured by Teledyne Optech. The Lynx V200 can collect 200,000 survey grade LiDAR data points-per-second using two spinning lasers (Figure 1). Each LiDAR data point has four attributes: x, y, z, and intensity value. The x, y, and z values define the collected data point's geospatial position (i.e., longitude, latitude, and elevation). The intensity value is a numeric value assigned to a LiDAR data point that signifies the scanned object's ability to absorb and/or reflect the laser energy.



Figure 1 Lynx V200 mobile mapping system from Teledyne Optech

The Lynx V200, as well as most mobile LiDAR units on the market today, consists of two infrared laser scanners, an inertial measurement unit (IMU), a distance measurement device (DMI), a Global Positioning System (GPS), and a data collection unit (Figure 2). Figure 2 also depicts cameras, which are optional on most mobile LiDAR systems. They can be used to colorize a point cloud with RGB values.

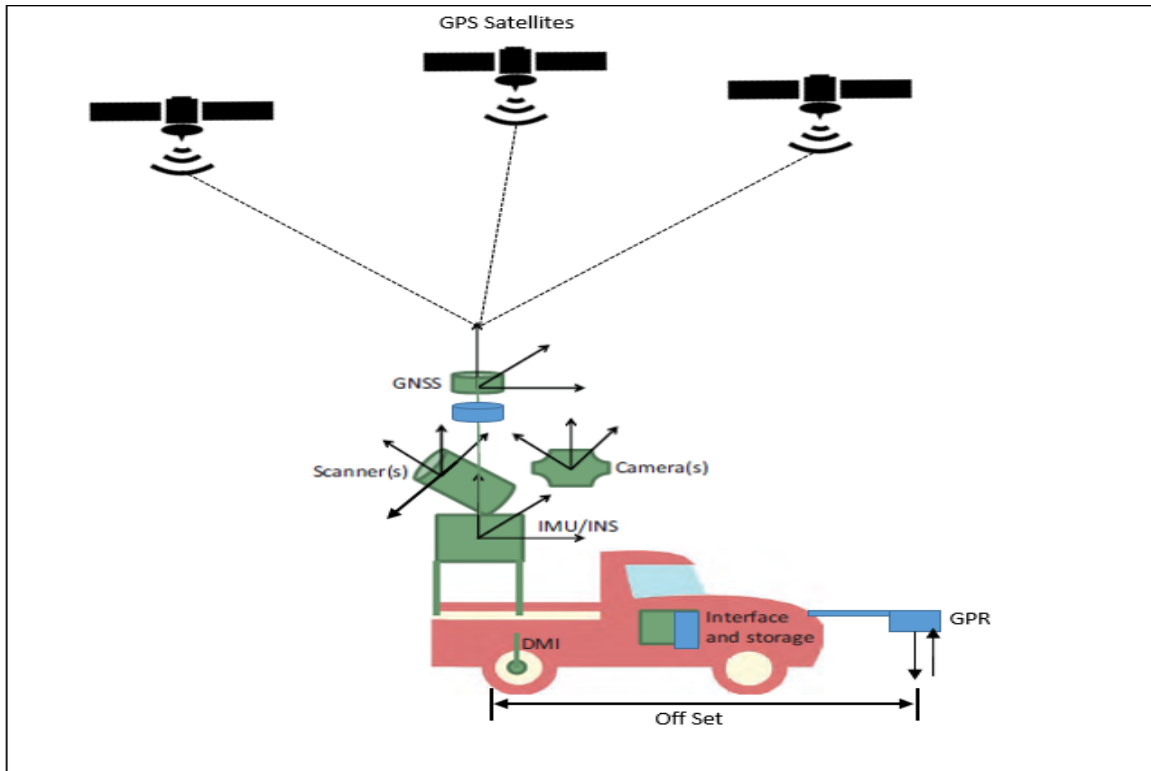

Figure 2 Mobile LiDAR diagram

Data Collection Guidance

Mobile LiDAR data collection discussed in this report was undertaken in accordance with both manufacturer recommendations and guidelines outlined in NCHRP Report 748 (1). Note — the intent of this report is not to advise on the collection of mobile LiDAR data; it is to review how LiDAR data can be used to solve transportation-related issues. Readers wanting to learn more about the specifics of mobile LiDAR data collection should consult the web-based tool, “Guidelines for the Use of Mobile LiDAR in Transportation Applications”, funded by NCHRP 15-44 (2). This web-based tool provides an interactive learning environment that introduces users to the guidelines for mobile LiDAR data collection found in NCHRP report 748. Both NCHRP 748 and 15-44 can assist individuals in understanding the mechanics of mobile LiDAR data collection.

Software for Data Processing

In addition to the Lynx V200 hardware, multiple software solutions were utilized to process the collected LiDAR data for these studies. Software programs from Bentley Microstation, Certainty 3D (TopoDOT), and Applied Imagery (Quick Terrain Modeler) were used to process LiDAR data. The discussion section covers software solutions in greater detail.

Project Selection

Projects were selected based on suspected deficiencies with the existing pavement grade and/or discrepancies within the existing project data that could be clarified using mobile LiDAR. The following list contains the projects examined for each study.

- I-471, Kenton Co. KY
- I-75, Boone Co. KY
- US-641, Calloway Co. KY
- I-75, Grant Co. KY
- I-65, Edmonson Co. KY

Discussion—Analysis and Results

This discussion focuses on mobile LiDAR's ability to collect thousands of relatively accurate survey points at highway speeds, and how transportation officials have used processed data to improve their decision making. AASHTO has observed that more quality data can translate into better results and solutions for highway projects (3).

According to the United States Department of Transportation (USDOT) approximately 5,760,000 vehicle crashes occur in the United States each year, and approximately 1,259,000 (22%) are wet-weather related (4). In 1984 transportation research engineers reported that it only takes 0.25 inches of water on a pavement surface on average tires traveling at 45 mph to cause hydroplaning (5). The five projects discussed below pertain to roadway sections that have exhibited high incidence rates for wet-weather accidents. These sites were evaluated with mobile LiDAR to determine if any problematic grade issues could be identified, and their location.

I-471 Kenton County, Kentucky

In 2014 Kentucky Transportation officials noticed that the number of wet-weather crashes had increased along a 1,000-foot stretch of roadway on I-471 in Kenton County, Kentucky. The roadway section contained both a vertical and horizontal curve. It was also presumed that the surface runoff water was not draining away from the driving lanes per the design.

Therefore, mobile LiDAR data were collected and analyzed for this area to better understand surface-water drainage patterns. For visualization purposes, the approximate locations of the 19 accidents recorded by attending police officers shortly after each occurrence are overlaid on the LiDAR point cloud (Figure 3).

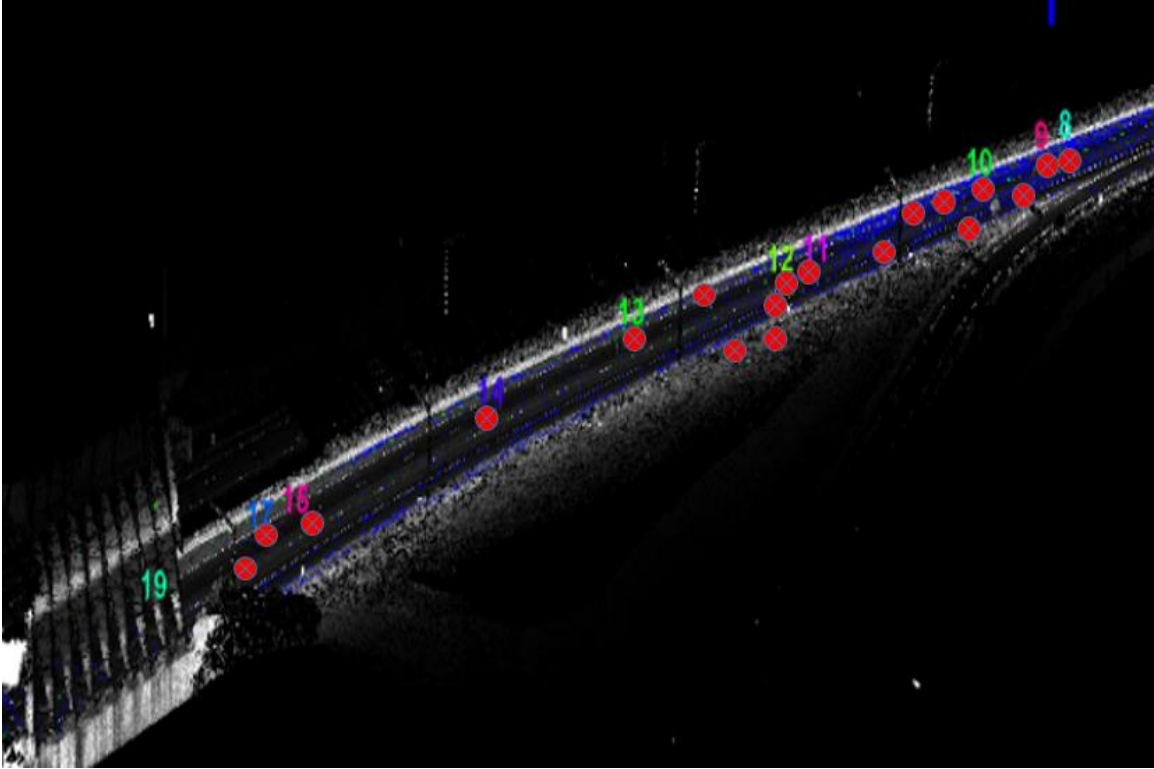

Figure 3 Accident locations overlaid on the mobile LiDAR point cloud

To identify inadequate pavement surface drainage areas on this 1,000-foot stretch of roadway, the LiDAR point cloud was first converted into a digital terrain model (DTM). As standard practice, a DTM is created by triangulating survey points into a surface model. Figure 4 is an example of a triangulated point cloud converted into a surface model. This DTM, as well as others mentioned throughout this report, was created using TopoDOT from Certainty 3D. TopoDOT is a program that converts raw LiDAR point clouds in LAS format into DTMs. After generating the DTM, simulated surface-water flow paths were mapped using Bentley’s MicroStation “downstream trace and/or trickle command.”

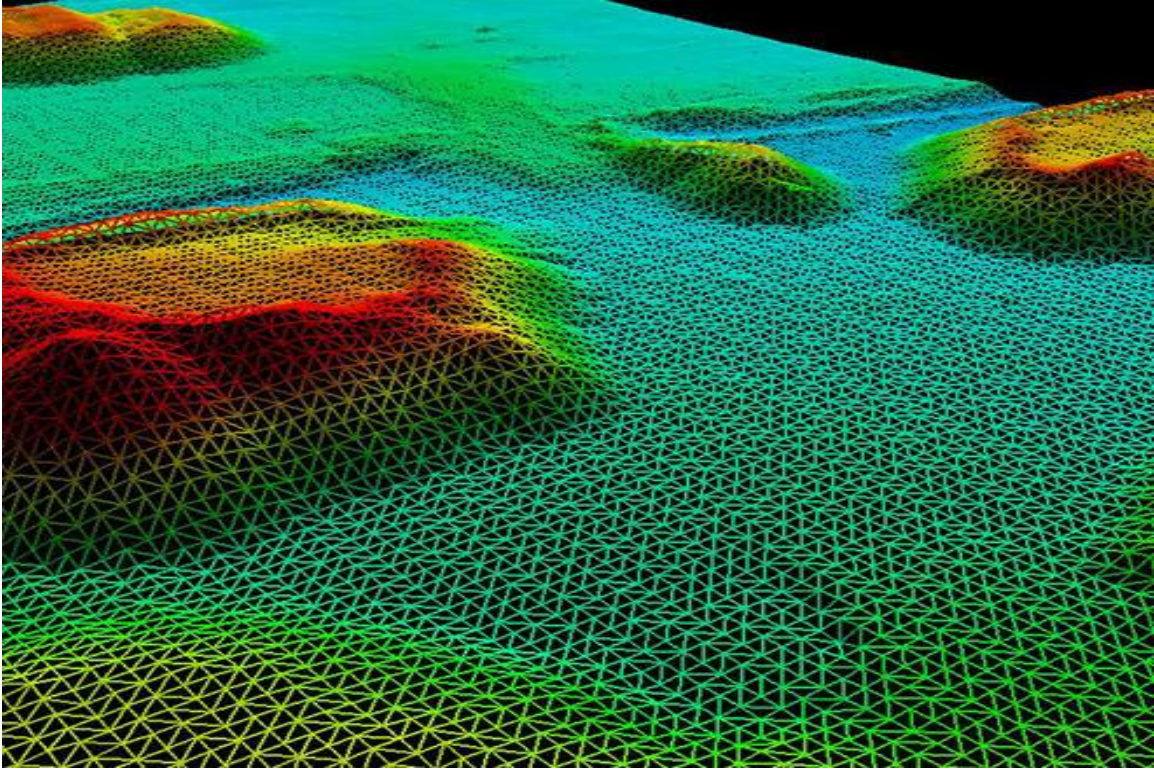

Figure 4 Triangulated LiDAR data representing a surface DTM

In Figure 5 the surface water can be seen channeling downstream against the inside barrier wall to a point of concern. At approximately 625 feet downgrade against the barrier wall, the water appears to drain back onto the roadway surface (Figure 6). This indicates a low spot and/or sag in the crown-line of the pavement on the high-side of the super-elevated section.



Figure 5 Water flow analysis depicting water flow paths



Figure 6 Water flows along barrier wall and returns to roadway surface

To confirm the simulated LiDAR results, a 25-gallon water tank was emptied on the shoulder of the roadway to recreate the surface-water flow paths. Figure 7 compares the actual surface water flow paths to the simulated water flow paths derived from the LiDAR dataset. The simulated results mirrored the field observations.



Figure 7 Simulated flow analysis compared to field flow analysis

Once the problematic surface-water flow paths were better understood, Cabinet officials deployed a pavement grinding machine to the project location. They used the grinding machine to lower the elevation of the pavement surface adjacent to the sagged location. This let the surface-water flow remain within the gutter line next to the barrier wall away from the driving lane. Since the pavement elevation was lowered, no wet-weather accidents have been recorded at this location.

I-75 Boone County, Kentucky

A 1,500-foot long section of roadway on I-75 in Boone County had also seen an increase in wet-weather related crashes. Similar to the I-471 section discussed above, GPS points from accident locations were plotted against the mobile LiDAR data set. After analyzing the LiDAR dataset utilizing the trickle command, it appeared that the surface runoff water drains back onto the left driving lane from the inside shoulder and runs downgrade within the travel lane for approximately 250 feet (Figure 8).



Figure 8 Water flow paths on I-75, Kenton County, Kentucky

Given the speed limit on this section of roadway is 70 mph, it is presumed the surface runoff on the roadway will cause vehicles to hydroplane in this area—thus resulting in potential accidents. As Table 1 shows, the average reduction of freeway speeds during precipitation events varies from 3% to 16% (6). Therefore, using the maximum average speed reduction in rain events of 16%, and assuming a travel speed of 70 mph, a vehicle normally traveling the posted speed limit would reduce its speed to 58.8 mph (93.34 km/hr.) during rainfall. Figure 9 indicates that a vehicle traveling 58.8 mph could possibly hydroplane with as little as 2 mm (5/64 inch) of water on the roadway surface (6).

Table 1 Freeway Traffic Flow Reductions

Freeway Traffic Flow Reductions				
Weather Conditions	Average Speed	Free-Flow Speed	Volume	Capacity
Light Rain/Snow	3%-13%	2%-13%	5%-10%	4%-11%
Heavy Rain	3%-16%	6%-17%	14%	10%-30%
Heavy Snow	5%-40%	5%-64%	30%-44%	12%-27%
Low Visibility	10%-12%			12%

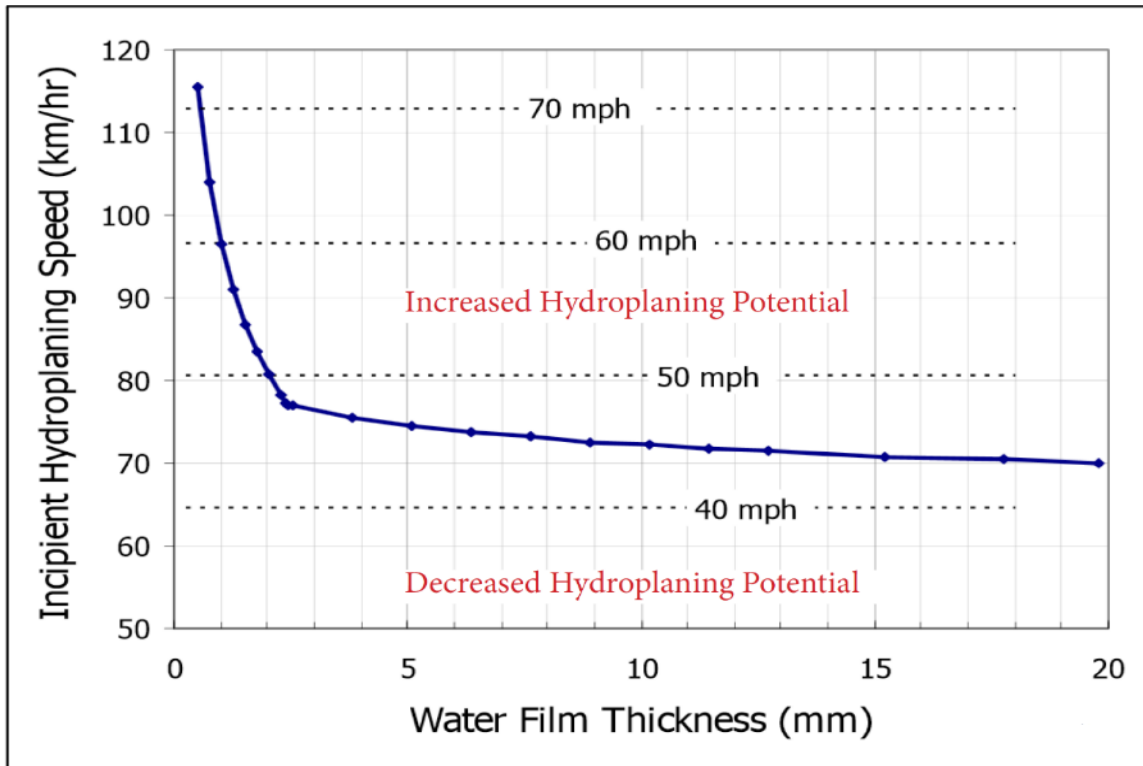

Figure 9 Incipient hydroplaning speed versus water film thickness

To reduce the number of wet-weather accidents on this stretch of roadway caused by surface-water runoff, transportation officials corrected the grade issues using a grinding machine. Since the grade was corrected, no apparent wet-weather accidents have occurred at this location, and the surface water appears to drain normally across the super-elevated section.

US-641 Calloway County, Kentucky

US-641 in Calloway County, Kentucky is another location that exhibited a high number of crashes during rainfall events (7). This location is a two-lane road that does not have the same shoulder configuration as the roads described above (Figure 10).



Figure 10 US-641 Calloway County project site

For this segment, the water trickle tool was used to evaluate drainage patterns (Figure 11). Simulated results indicated that water channels within wheel-paths of the pavement—indicative of pavement rutting. Given that cars may travel this stretch of roadway at speeds over 45 mph during wet-weather events, it is possible that the accumulated water within the wheel paths, combined with increased driving speeds, may have contributed to the crashes at this location. To ameliorate crash risk, transportation officials repaired this section of roadway once the water channeling within the wheel paths was understood (7).

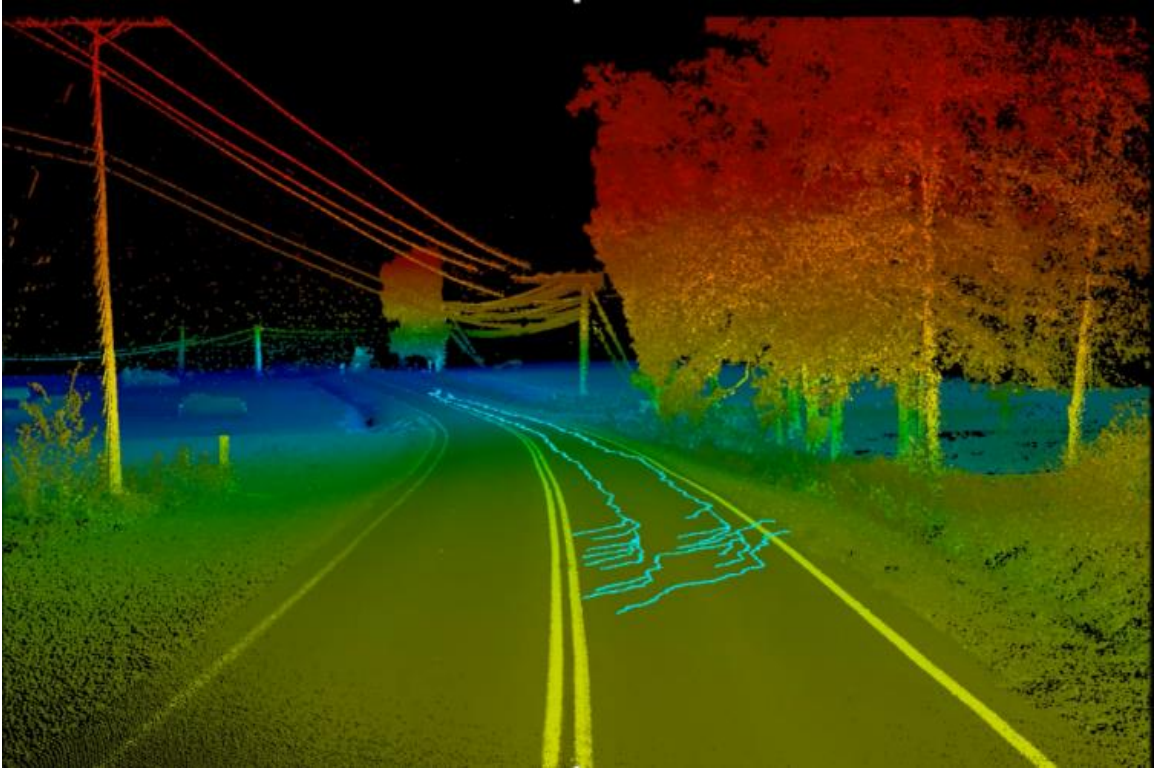

Figure 11 US 641 simulated flow paths

I-75 Grant County, Kentucky

I-75 in Grant County Kentucky experienced 37 wet-weather crashes, all along a short section of roadway. These accidents were recorded by Kentucky State Police in the spring of 2016. The approximate accident locations are denoted by the colored pins overlaid on the mobile LiDAR dataset (Figure 12).

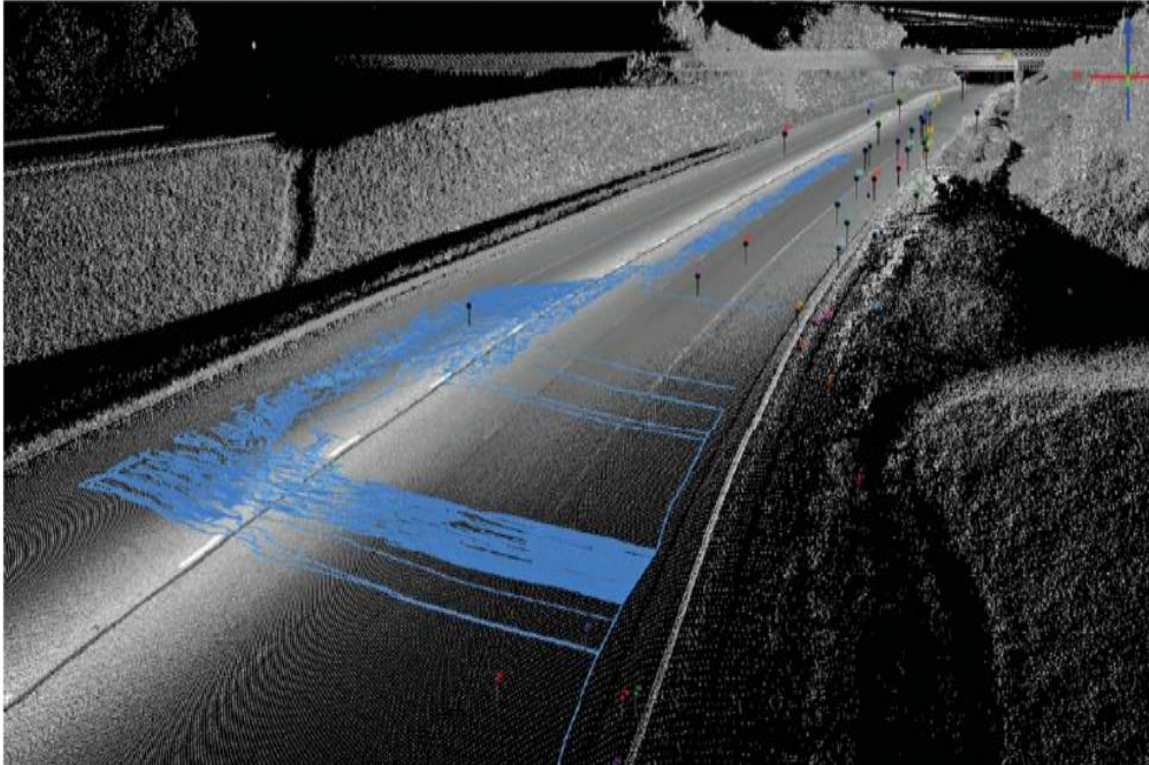

Figure 12 I-75 accident locations with simulated flow paths

Transportation officials made several attempts to monitor this location during heavy rainfall. However, no discernable pavement grade deficiencies that would have resulted in improper water drainage were recognized during these site visits. Modeling surface water flow paths using the trickle command revealed that a problematic grade issue produced improper water drainage (Figure 12). The grade issue was under repair at the time this report was written.

I-65 Edmonson County, Kentucky

The last project associated with this discussion was conducted during the construction phase of an interstate widening project on I-65 in Edmonson County, Kentucky. After the final asphalt surface was placed at the confluence of both a vertical and horizontal curve, several accidents occurred during wet-weather events.

Instead of processing the LiDAR data using the water trickle feature, a different water flow analysis method was used. The surface-water flow was analyzed using Applied Imagery’s “Quick Terrain Modeler” contour feature (Figure 13). As shown in Figure 13, contour lines depict where the surface water flows, but the pavement grade transition between the vertical and horizontal curve appears flat, as denoted by the jagged contour line. If water is draining downgrade, this jagged contour line indicates it will slow and pool in this area.

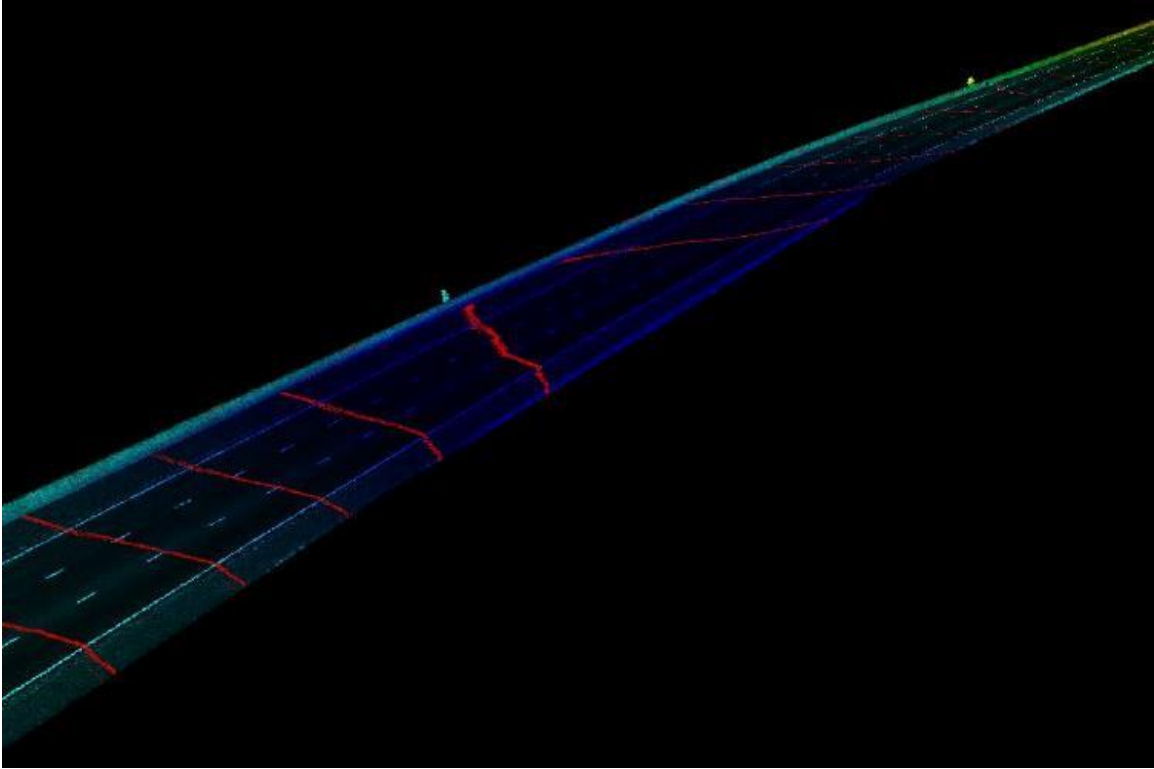

Figure 13 Contour lines derived using "Quick Terrain Modeler"

To understand how the flattened section compares to the intended design grade, Figure 14 compares the design cross section in red to the approximate as-built grade (imaged in blue). It appears that the as-built grade was above the design grade, thus trapping water. Once the contractor was notified of the improper grade issue, they milled the surface to obtain the correct cross slope.

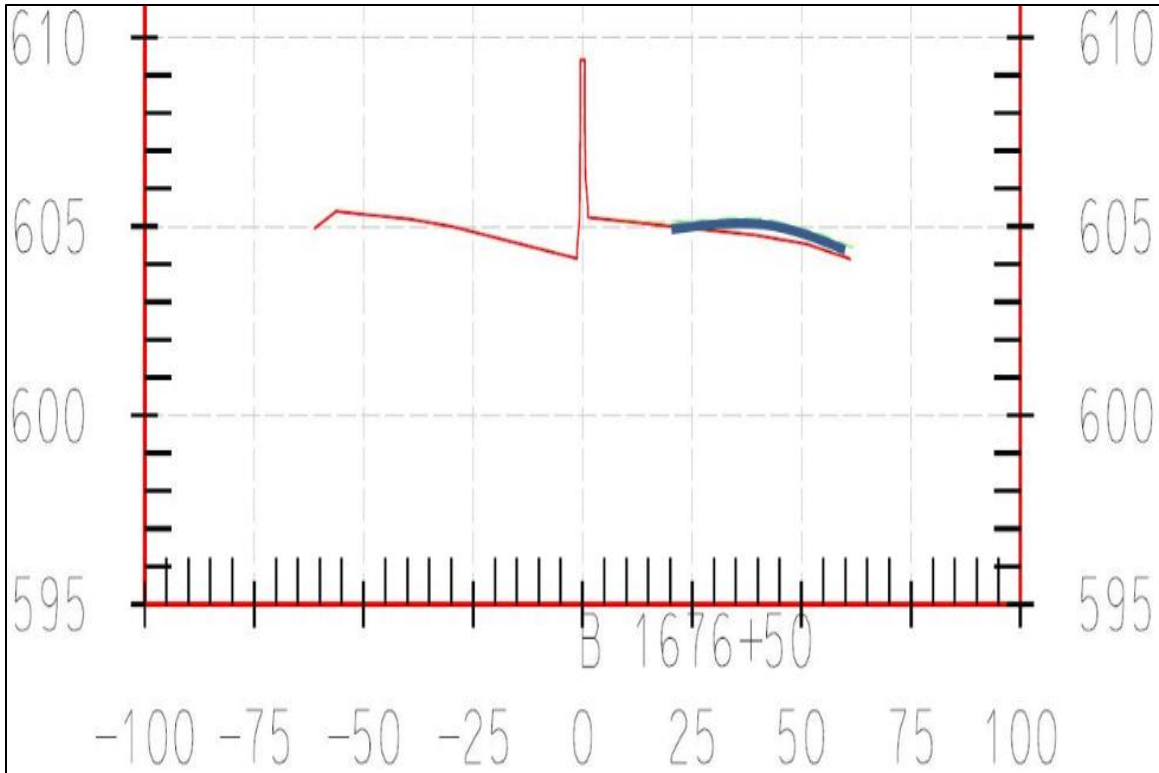

Figure 14 As-built surface (blue) compared to design surface (red)—x-y axis dimensions in feet

Challenges in The Collection and Processing of Mobile Lidar Data

Although mobile LiDAR technology is quickly advancing and becoming more common within highway design, maintenance, and construction, a few challenges discovered throughout this research study are worth mentioning.

Solar Storms

Researchers advise that space weather, otherwise known as solar storms, can reach the Earth's Ionosphere within eight minutes (Figure 15) (8). With little warning, these geomagnetic storms can disrupt GPS satellite communication.

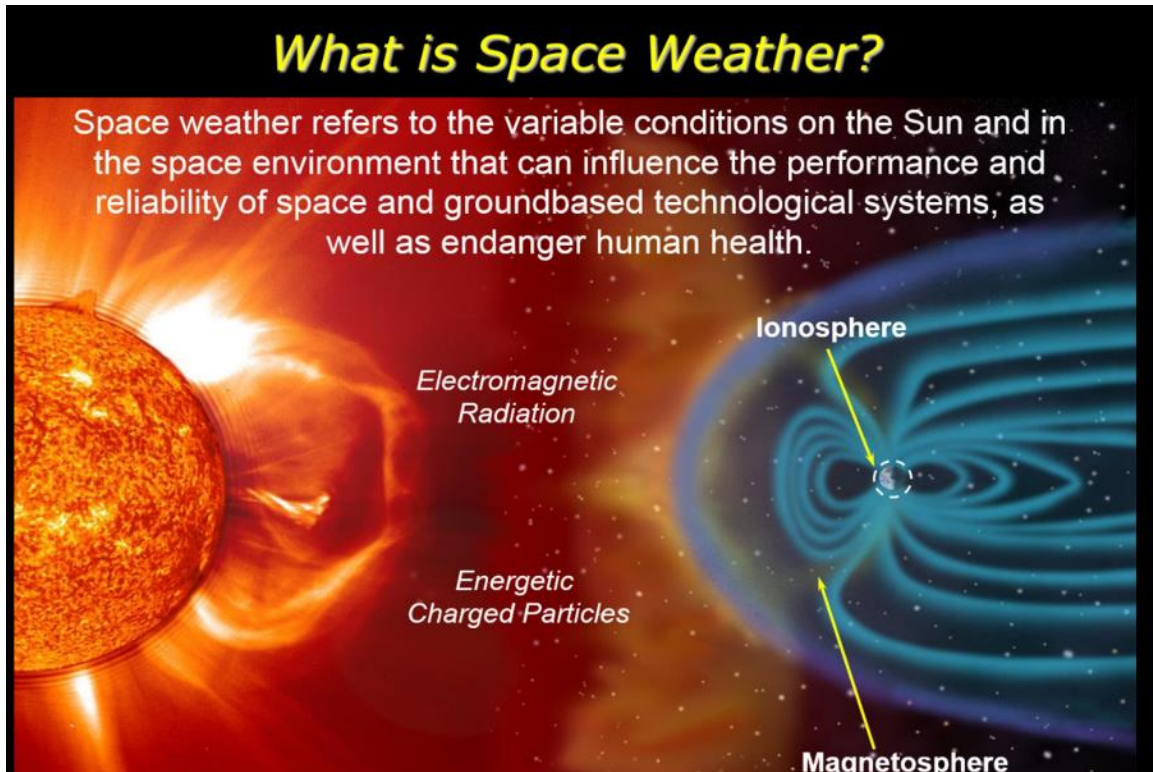

Figure 15 Solar storm (Source: NOAA)

As reported in the March 17, 2015 Washington Post, a G4 solar storm occurred on March 16, 2015 that disrupted radio communications of many of the world’s GPS satellites. Unfortunately, one of the LiDAR scans needed for this study was conducted unknowingly during this solar event. Figure 16 displays the solar storm’s impact on collected LiDAR data. Compare the centerline striping of the data collected during the solar storm (top photo) to the recollected data (bottom photo). It is apparent that data collected during the solar storm is not properly aligned. Despite numerous attempts to realign the LiDAR dataset using differential correction, the dataset could not be geospatially corrected. Therefore, the data had to be recollected.

According to the National Aeronautics and Space Administration (NASA) (8), predicting solar storms is extremely difficult. Solar storms may render a mobile LiDAR collection period useless. Practitioners must be wary of this risk. If surprise solar storms disrupt data collection, remobilizing a mobile LiDAR unit may prove financially problematic.



Figure 16 Effect of G4 solar storm on mobile Lidar data

Not All Lidar Data Are Created Equal

During this study it became apparent that there may be some confusion within the industry that all LiDAR data is the same. Figure 17 contains DTMs created from two datasets collected with different LiDAR technologies. One collected using planning grade Lidar (denoted in blue) and one with survey grade LiDAR (denoted in red). As seen in Figure 17, the triangulation of the DTMs does not overlap for the paved surface. Therefore, caution should be exercised when using LiDAR data to not overstate the accuracy to avoid a situation where that expectation does not align with the data that were actually collected.

Additionally, there is consensus among some individuals within the transportation community that LiDAR technology should replace traditional surveying. However, it should be noted that the geospatial accuracy of LiDAR data cannot be improved beyond the geospatial accuracy of the survey control it is tied into. For example, if the LiDAR data are tied to a survey control that is six inches off, then the LiDAR point cloud should also be assumed to be off by six inches or more. Using LiDAR data for design purposes elevates the importance of having more accurate survey control data from a project's outset--inferring LiDAR is a complimentary technology to traditional surveying practices when geospatial accuracy is of a concern. However, if LiDAR data are used in a relative context (where LiDAR technology appears to have its greatest accuracy and precision), the need for a highly accurate geospatially control survey is a moot point.

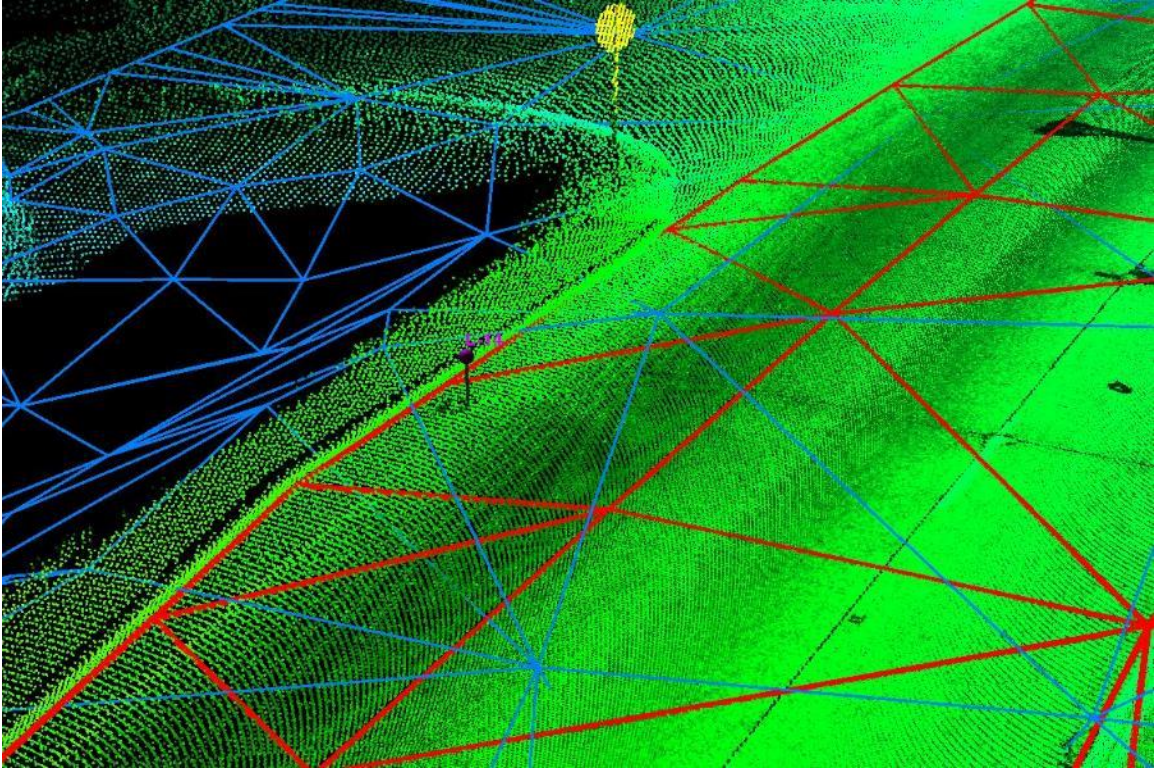

Figure 17 Comparison of survey grade and planning grade DTMs

Summary and Conclusions

This report has highlighted the opportunities of utilizing mobile LiDAR technology to assist transportation officials in making more informed engineering decisions. Processed survey grade mobile LiDAR data appear to identify where problematic grade issues are located on some of Kentucky's road network. Collecting thousands of highly accurate survey data points with mobile LiDAR to understand surface water flow characteristics is a better option than collecting data by conventional means, as normal traffic remains undisrupted and workers are kept safe during the process.

References

1. Olsen, M.J., G.V. Roe, C. Glennie, F. Persi, M. Reedy, D. Hurwitz, K. Williams, H. Tuss, A. Squellati, and M. Knodler. *NCHRP Report 748: Guidelines for the Use of Mobile LiDAR in Transportation Applications*. Transportation Research Board, Washington, D.C., 2013.
2. Olsen, M., G. Roe, C. Glennie, F. Persi, M. Reedy, D. Hurwitz, K. Williams, H. Tuss, M. Knodler, A. Squellati, M. O'Banion, M. Hales, and A. Bolander. *Guidelines for the Use of Mobile LiDAR in Transportation*. NCHRP Project 15-44, Washington, D.C. <http://learnmobilelidar.com>. Accessed Feb. 17, 2015.
3. Council, F.M., D.W. Harwood, I.B. Potts, D.J. Torbic, J.L. Graham, J.M. Hutton, B.H. Delucia, R.C. Peck, and T.R. Neuman. *NCHRP Report 500, Volume 21: Guidance for Implementaion of the AASHTO Strategic Highway Safety Plan*. Washington, D.C., 2008.
4. Transportation Safety Facts. Research Note DOT HS 812 318. NHTSA, U.S. Department of Transportation, 2016.
5. Ivey, D.L., L.I. Griffin III, T.M. Newton, R.L. Lytton, and K.C. Hankins. Predicting wet weather accidents. *Accident Analysis & Prevention*, Vol. 13, No. 2, 1981, p. 89. [https://doi.org/10.1016/0001-4575\(81\)90022-1](https://doi.org/10.1016/0001-4575(81)90022-1).
6. Huebner, R.S., J.R. Reed, and J.J. Henry. Criteria for Predicting Hydroplaning Potential. *Journal of Transportation Engineering*, Vol.112, Issue 5, 1986, p. 553. [https://doi-org.ezproxy.uky.edu/10.1061/\(ASCE\)0733-947X\(1986\)112:5\(549\)](https://doi-org.ezproxy.uky.edu/10.1061/(ASCE)0733-947X(1986)112:5(549)).
7. Rister, B., R. Yang, L. McIntosh, and G.B. Dadi. Life Saving LiDAR. *LiDAR News*, Vol. 5, No. 2, 2015, p. 50.
8. Garner, R., and B. Dunbar. *Solar Storm and Space Weather-Frequently Asked Questions*. National Aeronautics and Space Administration. https://www.nasa.gov/mission_pages/sunearth/spaceweather/index.html#q13. Accessed Feb. 17, 2015.