

93-14

CRREL REPORT



# Notes on Antarctic Aviation

Malcolm Mellor

August 1993



### ***Abstract***

Antarctic aviation has been evolving for the best part of a century, with regular air operations developing over the past three or four decades. Antarctica is the last continent where aviation still depends almost entirely on expeditionary airfields and "bush flying," but change seems imminent. This report describes the history of aviation in Antarctica, the types and characteristics of existing and proposed airfield facilities, and the characteristics of aircraft suitable for Antarctic use. It now seems possible for Antarctic aviation to become an extension of mainstream international aviation. The basic requirement is a well-distributed network of hard-surface airfields that can be used safely by conventional aircraft, together with good international collaboration. The technical capabilities already exist.

*Cover: Douglas R4D Que Sera Sera, which made the first South Pole landing on 31 October 1956. (Smithsonian Institution photo no. 40071.)*

The contents of this report are not to be used for advertising or commercial purposes. Citation of brand names does not constitute an official endorsement or approval of the use of such commercial products.

For conversion of SI metric units to U.S./British customary units of measurement consult ASTM Standard E380-89a, *Standard Practice for Use of the International System of Units*, published by the American Society for Testing and Materials, 1916 Race St., Philadelphia, Pa. 19103.

CRREL Report 93-14

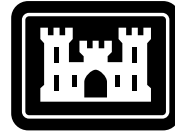

**US Army Corps  
of Engineers**

Cold Regions Research &  
Engineering Laboratory

# Notes on Antarctic Aviation

Malcolm Mellor

August 1993

## **PREFACE**

This report was prepared by Dr. Malcolm Mellor, Experimental Engineering Division, U.S. Army Cold Regions Research and Engineering Laboratory, just prior to his death in August 1991. We hope that final efforts to assemble and edit this lengthy and detailed document have not overlooked or created problems normally caught by his keen editorial eye.

This report started as a much shorter note and grew, primarily because of Malcolm's long involvement in trafficability and transportation research in polar regions. His early interest in gliders, his experience as a pilot and a designer of snow and ice runways, and his decades of use of specialized aircraft for polar operations account for his enthusiasm in preparing this work. The commentary and perceptions found throughout the text, as well as the many photographs taken by Malcolm, some during his early involvement with the Australian Antarctic program, all reflect his first-hand experience and knowledge.

Malcolm is shown here at the controls of a Soviet Ilyushin Il-18D used by the Soviet Antarctic Expedition.

This report was prepared as part of CRREL's research and engineering efforts in support of the National Science Foundation's Antarctic Program.



# CONTENTS

	Page
Preface .....	ii
Abbreviations .....	viii
Introduction .....	1
Brief history of Antarctic aviation .....	1
Early history .....	1
WW II to the IGY .....	6
Post-IGY .....	8
Evolution of equipment and facilities .....	21
Aircraft .....	21
Facilities for takeoff and landing .....	23
Navigation and radio communication .....	28
Aviation weather services .....	30
Flights to and from Antarctica .....	32
Departure points .....	32
Ports of entry in Antarctica .....	34
Aircraft in current use .....	37
Types of Antarctic airfields .....	37
Open-field landings on snow .....	41
Groomed skiways on deep snow .....	41
Runways on deep snowfields .....	46
Compacted snow on hard ice .....	58
Runways on snow-free glacier ice .....	62
Runways on first-year sea ice .....	65
Runways on multi-year sea ice .....	67
Frozen lakes .....	67
Conventional rock-fill runways .....	70
Rock fill over glacier ice .....	71
Manufactured landing mats .....	72
Bearing capacity, rutting resistance and surface roughness .....	73
Bearing capacity .....	73
Rutting resistance .....	73
Surface roughness .....	73
Runway dimensions .....	74
Runway length .....	74
Runway width .....	75
Examples of Antarctic airfields .....	76
Groomed skiways on deep snow .....	76
Runways on deep snowfields .....	79
Compacted snow runways on hard ice .....	81
Runways on snow-free glacier ice .....	82
Runways on first-year sea ice .....	98
Runways on multi-year sea ice .....	102
Runways on lake ice .....	102
Conventional rock-fill runways .....	103
Aircraft for Antarctic operations .....	114
Flights to and from Antarctica .....	114
Flights within Antarctica .....	119
Air drops .....	120
Aircraft characteristics for Antarctic work .....	121
Helicopters .....	123
Maintenance and service life .....	128

Fuel supplies .....	129
Pilot experience .....	129
Environmental and safety considerations .....	129
Facilities .....	129
Operations .....	130
Conclusion .....	130
Selected bibliography .....	131
Appendix A: Runways maintained by the U.S. Antarctic Program .....	133
Appendix B: Ground-to-air and air-to-ground visual signals for use in emergencies .....	145
Abstract .....	147

## ILLUSTRATIONS

### Figure

1. Summary of historic events in Antarctic aviation .....	2
2. Location of stations and airfields in Antarctica .....	3
3. Ford 4T trimotor used by the Byrd Antarctic Expedition .....	4
4. Lockheed Vega .....	4
5. Curtiss–Wright T-32 biplane used by the second Byrd Antarctic Expedition .....	5
6. Kellett autogyro used by the second Byrd Antarctic Expedition .....	5
7. Northrop 2B Gamma .....	6
8. Staggerwing Beechcraft 17 .....	6
9. ANARE Auster on the pack ice north of Mawson .....	7
10. USN ski–wheel Douglas R4D-8 at McMurdo .....	8
11. Lisunov Li-2 on skis near Mirny .....	9
12. USN Douglas R5D at McMurdo .....	9
13. Antarctic Airways DC-4 .....	10
14. USN ski–wheel Lockheed P2V-7 Neptune .....	10
15. USN Lockheed Super Constellation on the sea ice at McMurdo .....	11
16. USAF Douglas C-124 Globemaster II on the sea ice at McMurdo .....	11
17. ANARE ski–wheel DHC-2 Beaver over Mawson .....	12
18. USN ski–wheel DHC-3 Otter at McMurdo .....	12
19. Ilyushin Il-12D at Vostok .....	13
20. Ilyushin Il-14 at Molodezhnaya .....	14
21. Lockheed C-130 Hercules on the sea ice at McMurdo .....	14
22. One of the first “ski-Hercs” .....	15
23. Lockheed LC-130R Hercules with ski–wheels .....	15
24. USAF Lockheed C-141 StarLifter .....	16
25. Ilyushin Il-18D of the Soviet Antarctic Expedition .....	17
26. Ilyushin Il-76TD taking off from the compacted-snow runway at Molodezhnaya .....	18
27. Ilyushin Il-76TD on the compacted snow runway at Molodezhnaya .....	19
28. Front view of the Ilyushin Il-76TD at Molodezhnaya .....	19
29. Antonov An-74 of the Soviet Antarctic Expedition .....	20
30. Lockheed C-5 Galaxy of MAC on the sea ice at McMurdo .....	20
31. Lockheed C-5 Galaxy disgorging cargo through the hinged nose at McMurdo .....	21
32. Ski–wheel DHC-6 Twin Otter of Kenn Borek Air at the South Pole .....	22
33. Ski–wheel Dornier 228-100 of the German Antarctic Expedition at South Pole Station .....	22

34. Maximum takeoff weights for a range of modern aircraft, and comparison with aircraft that are of historic significance in Antarctic aviation .....	24
35. Simple skis .....	25
36. Dornier 228 outfitted for Antarctic service .....	25
37. Ski-wheel modification of the C-130 landing gear .....	25
38. Oversize tires on a DHC-6 Twin Otter .....	26
39. Float planes used in Antarctica .....	26
40. Wheels of the C-130 .....	28
41. Wheels of the Ilyushin Il-18D .....	28
42. Wheels of the Antonov An-74 .....	29
43. Daylight markers installed on major U.S. Antarctic runways and skiways .....	30
44. Arrangement of radar targets set out as approach aids at Williams Field and South Pole skiways .....	31
45. Expeditionary Approach Lighting System, as installed on the primary runways at McMurdo .....	32
46. Automatic weather station at the Pegasus site .....	32
47. Location of Antarctica relative to surrounding land masses. ....	34
48. Airport at Christchurch, New Zealand, an advance base for the USAP .....	35
49. Types of snowplanes .....	41
50. Simple drag for grooming skiway surfaces .....	45
51. Heavy anchor chain pulled by a pair of tractors, which is useful for grooming the surface of a skiway or snow runway .....	45
52. Groomed surface on the South Pole skiway .....	46
53. Grooming chains used at South Pole Station and Williams Field .....	46
54. Small articulated drag for grooming snow roads and skiways .....	47
55. Rotary snowplows .....	48
56. U.S. Navy pulverizing mixer towed by small bulldozer .....	49
57. Compaction rollers. ....	50
58. C-130 test cart on the 1990 snow runway near Casey .....	52
59. Deep ruts made by a heavily ballasted wheel roller after a first pass through moist snow at the 1990 Casey runway site .....	52
60. Imprint made in the snow runway by C-130 wheels on the Casey test cart .....	53
61. Swiss rammsonde for measuring vertical profiles of snow strength. ....	54
62. Russian penetrometer for measuring vertical profiles of strength in snow pavements .....	55
63. Nomograph for estimating the required surface strength on snow runways .....	56
64. Strength requirements for supporting C-130 and C-141 aircraft on compacted snow pavements .....	56
65. Snow strength requirements for supporting Il-18D and Il-76TD aircraft on the Molodezhnaya compacted snow runway .....	57
66. Caterpillar LGP-D8 bulldozer used for scraping hard snow from the surface of glacier ice in airfield construction experiments .....	58
67. Windrows at the McMurdo Pegasus site .....	59
68. Foremost Delta Three towing a simple drag .....	60
69. Demountable snow blowers attached to Caterpillar 950 wheel loaders .....	60
70. Modification of a grader blade for planing ice .....	61
71. Runways at the old Outer Williams Field, an airfield on coastal glacier ice that was used from 1966-67 to 1970-71 .....	63
72. Smooth blue ice near the North Masson Range, south of Mawson .....	64
73. Blue ice at a cold, dry ablation area (Mill Glacier) .....	64
74. Runway on annual sea ice, McMurdo Sound .....	66
75. Growth and decay of annual sea ice in Antarctica .....	66

76. Landing curves for the sea-ice runway at McMurdo .....	68
77. Parking curves for the sea-ice runway at McMurdo .....	69
78. Runways on multi-year sea ice .....	70
79. Conventional gravel runway at Marsh, on King George Island .....	71
80. Gravel roads built on glacier ice in Greenland .....	72
81. Military specifications for the roughness limits of runways .....	74
82. General planning guide for runway length at airports used by aircraft having maximum takeoff weights exceeding 60,000 lb .....	75
83. Approximate probability of undershoot or overrun for large aircraft .....	75
84. Williams Field skiways and traffic patterns .....	76
85. South Pole skiway and traffic patterns .....	77
86. Snow runway at Molodezhnaya, as seen from the flight deck of the Il-18D .....	78
87. Location of the McMurdo Pegasus runway .....	80
88. Accumulation-ablation transition zone on the Ross Ice Shelf near McMurdo Station .....	81
89. Layout of the Pegasus experimental runway .....	82
90. View of the Pegasus experimental runway, approaching from the north end .....	82
91. Surface conditions at the Pegasus site .....	83
92. Location of the runways at the Patriot Hills icefield .....	84
93. Blue-ice airfield at Patriot Hills .....	85
94. Location of the runway on the Mill Glacier just upstream of Plunket Point .....	86
95. Low approach to Mill Glacier .....	87
96. Contour plan of the Mill Glacier icefield .....	88
97. Location of the Mount Howe icefield .....	89
98. Mount Howe icefield, looking south .....	90
99. Location of the icefield at Mount Lechner .....	91
100. Location of the icefield at Rosser Ridge .....	92
101. Location of possible blue-ice airfield on Reedy Glacier .....	93
102. Blue-ice flow bands on the Reedy Glacier .....	94
103. Blue ice south of Mawson .....	95
104. Potential blue-ice airfield site southwest of Mawson .....	96
105. Location of the suggested blue-ice runway near the Norwegian Troll Station .....	97
106. Low-angle oblique photograph of the runway location near Troll Station .....	97
107. Location of potential airfield at Union Glacier .....	98
108. Possible blue-ice airfield on Union Glacier. ....	99
109. Locations of the runways that have been laid out on annual sea ice at McMurdo in recent years .....	100
110. Thickness of the McMurdo sea-ice runway in recent years .....	101
111. Typical layout for the seasonal runway on annual sea ice at McMurdo .....	101
112. Smooth, multi-year sea ice on the coast of Bunger Hills, near Edgeworth David summer station .....	102
113. Southern part of Beaver Lake, looking south-southwest across Radok Lake and more or less into the prevailing wind .....	103
114. Runway surface at Marsh .....	104
115. Approach to runway 11, Teniente Rodolfo Marsh Base, King George Island .....	104
116. Marambio runway on Seymour Island .....	105
117. Runway surface at Marambio .....	106



118. Runway at Dumont d'Urville during construction .....	106
119. Plan of the runway at Rothera .....	107
120. Location of Marble Point runway site. ....	108
121. Marble Point runway site, looking west towards the Wilson Piedmont Glacier .....	108
122. Site plan for a proposed runway at Marble Point .....	109
123. Representative surface material at the south end of the Marble Point runway site .....	110
124. Potential runway site in the Joubin Islands near Palmer Station .....	110
125. Deception Island .....	111
126. Runway site on volcanic ash, immediately north of Penfold Point and Whalers Bay, Deception Island .....	112
127. Unprepared runway on Deception Island .....	113
128. Turbojet and turbofan transport aircraft with general characteristics suitable for flights to and from Antarctica .....	120
129. Aircraft with characteristics that are appropriate for Antarctic internal operations .....	122
130. Great-circle distances between Antarctic airfields .....	124
131. Helicopters in Antarctic use .....	125

## **TABLES**

### Table

1. Potential Antarctic departure points .....	33
2. Antarctic airfields .....	36
3. Airfield options for Antarctica .....	38
4. Approximate take-off and landing distances for selected aircraft .....	114
5. Speeds, wing loadings and tire pressures for selected aircraft .....	117

## ABBREVIATIONS

ACN	Aircraft classification number
ADF	Automatic direction finder
ANARE	Australian National Antarctic Research Expeditions
ANI	Adventure Network International
ASR	Airport surveillance radar
AWS	Automatic weather station
BAS	British Antarctic Survey
BGLE	British Graham Land Expedition
CATSA	Cooperative Air Transport System for Antarctica
CAVU	Ceiling and visibility unlimited
CBR	California Bearing Ratio
COSPAS	Soviet equivalent of SARSAT
CRREL	Cold Regions Research and Engineering Laboratory
DFA	Arctic-grade diesel fuel
DH	DeHaviland
DME	Distance-measuring equipment
DOD	Department of Defense (U.S.A.)
EPIRB	Emergency position-indicating radio beacon
FAA	Federal Aviation Administration (U.S.A.) (also Fuerza Aérea Argentina)
FACH	Fuerza Aérea de Chile
FIDS	Falkland Islands Dependencies Survey (antecedent of British Antarctic Survey)
FLIP	Flight Information Publication
GPS	Global Positioning System
HF	High frequency
IAS	Indicated airspeed
IFR	Instrument Flight Rules
IGY	International Geophysical Year (1957)
INS	Inertial navigation system
JATO	Jet- (rocket-) assisted takeoff
LAPE	Low-altitude parachute extraction
LCN	Load classification number (old term for ACN)
MAC	Military Airlift Command (USAF) (also used as an abbreviation for McMurdo, as in MAC Center).
MF	Medium frequency
MLG	Main landing gear
MTW	Maximum takeoff weight
NCEL	Naval Civil Engineering Laboratory
NDB	Nondirectional beacon
NSF	National Science Foundation (U.S.A.)
NYANG	New York Air National Guard
O&M	Operation and maintenance
P&W	Pratt and Whitney
PAR	Precision approach radar
PBY	Patrol Bomber—Consolidated (Y was code letter for Consolidated Aircraft Co.)
PSP	Perforated steel panels
PSR	Point of safe return (euphemistic replacement for PNR—point of no return)
RAAF	Royal Australian Air Force
RAF	Royal Air Force
RDF	Radio direction finder
RNZAF	Royal New Zealand Air Force

SAE	Soviet Antarctic Expedition
SAR	Search and rescue
SARSAT	Search and rescue satellite-aided tracking
SCAR	Scientific Committee for Antarctic Research
SIPRE	Snow, Ice and Permafrost Research Establishment
STOL	Short takeoff and landing
TACAN	Tactical air navigation system (bearing plus distance to station)
TAG	Tactical Air Group
UHF	Ultra high frequency
USAF	U.S. Air Force
USAP	U.S. Antarctic Program
USCG	U.S. Coast Guard
USN	U.S. Navy
VASI	Visual approach slope indicator
VFR	Visual flight rules
VHF	Very high frequency
VOR	Very high frequency omnidirectional range
VORTAC	VOR azimuth plus TACAN azimuth and DME
VTO	Vertical takeoff
WW II	World War II

BLANK

# Notes on Antarctic Aviation

MALCOLM MELLOR

## INTRODUCTION

Antarctic aviation has been evolving for the best part of a century, but regular air operations developed only in the past three or four decades (Fig. 1). Although the concept of a Cooperative Air Transport System for Antarctica (CATSA) was developed by SCAR in 1976, international collaboration remained minimal, with a few exceptions such as the U.S.–New Zealand transport agreement and the availability of the Chilean runway at Marsh (Fig. 2). Antarctica is the last continent where aviation still depends almost entirely on expeditionary airfields and “bush flying,” but change seems imminent. In air safety, for example, there is a move towards international collaboration and coordination under the Antarctic Treaty.

The aeroplane in Antarctica is now simply a tool for getting the job done efficiently. In a national research program, its primary function is to maximize research productivity by getting people and equipment into the air and into the field, by reducing travel time for highly qualified professionals, and by expediting and safeguarding logistics and operations. Implicit in this function is a requirement for safety, cost-effectiveness and environmental protection.

It is now technically feasible to establish a well-distributed system of hard-surface airfields, making Antarctica accessible to a much wider range of conventional aircraft and providing links between stations. Some of these airfields can be developed at very low cost and with minimal environmental disturbance, thus opening up air transport possibilities for smaller and less-affluent expeditions and also for nongovernment groups. Some political, regulatory and legal impediments exist, but the growth of Antarctic flying by both government and nongovernment entities seems inevitable. It may therefore be useful to review past trends, to assess the current situation, and to consider what might

happen in the future, with or without appropriate planning.

## BRIEF HISTORY OF ANTARCTIC AVIATION

### Early history

The first person “offdeck” in Antarctica was Captain Scott, who went up to 800 ft (244 m) in a tethered British Army balloon in 1902 (followed immediately by Shackleton in a second ascent). They had gas for only one inflation. In contrast to the Arctic situation, this never developed into flights by free balloons or dirigibles and thus was a technological dead-end, to the dismay of airship buffs, who still entertain hopes. The Scott ascent was an early illustration of the fact that a balloon can’t sit out in the wind and the gas can’t be put back in the bottle.

True Antarctic aviation was born in Australia. In 1911, Douglas Mawson acquired a 60-hp Vickers R.E.P.\* monoplane. Like most machines of its time, it had wheels and skis (skids), and it could be converted to an aero-sledge by removing the wings. Carrying its pilot, Lt. H.E. Watkins of the British Army, and passenger Frank Wild, it crashed on the Adelaide race course before going to Antarctica. The repaired fuselage went south and was used as an aero-sledge at Cape Denison. It was not until November 1928 that another Australian, Hubert Wilkins, with American pilot Ben Eielson, made the first Antarctic flight, using an American Lockheed Vega for a wheel takeoff from a 2400-ft (730-m) beach runway on Deception Island.†

---

\* R.E.P.—designed by Robert Esnault-Pelterie (French)

† Some published accounts are confusing. Floats, used briefly in an early hop, were not used seriously until the following year. In 1928 two Vegas got airborne on wheels, one with a heavy fuel load that allowed it to make a 1300-mile flight.

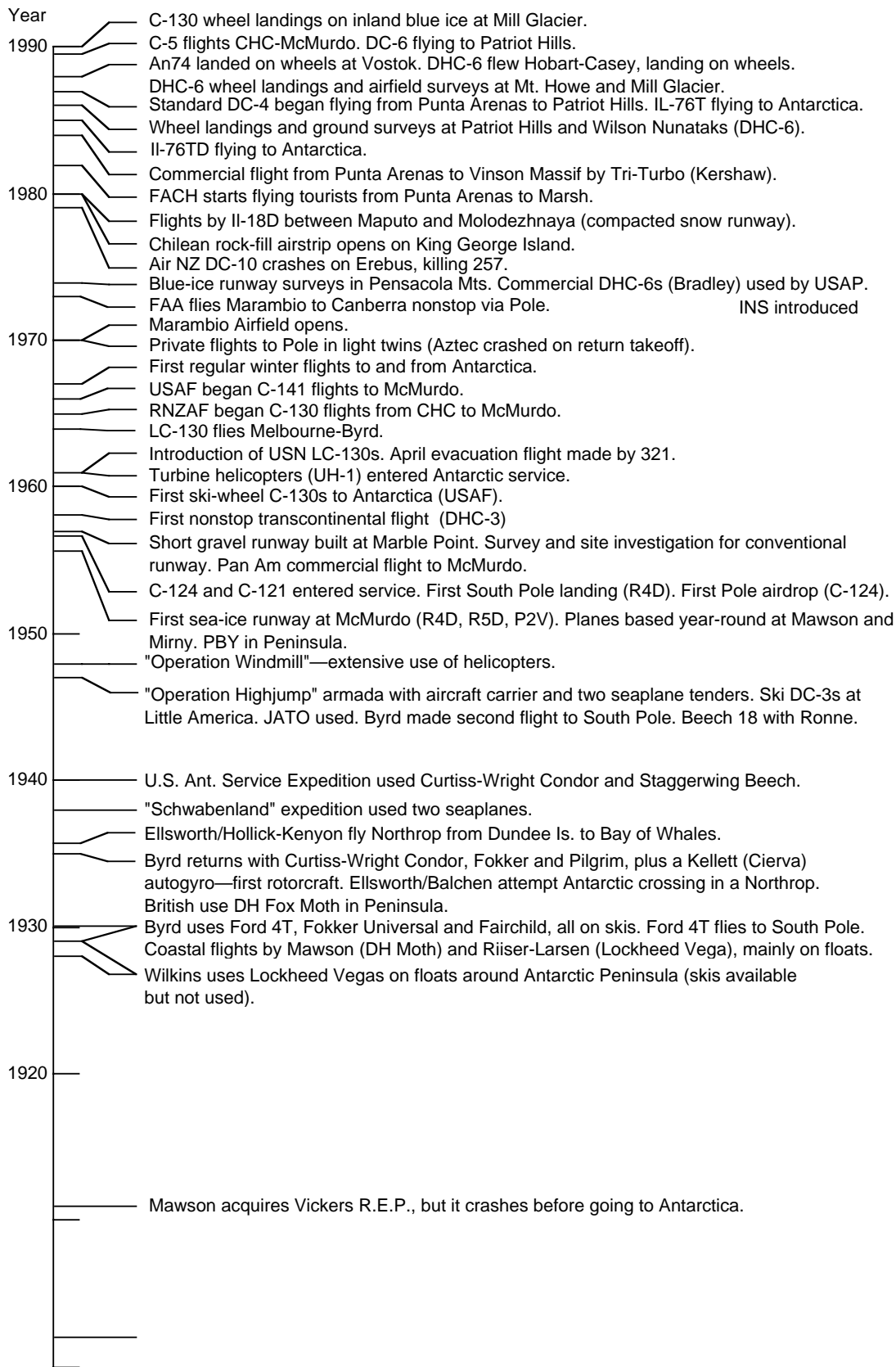

Figure 1. Summary of historic events in Antarctic aviation.

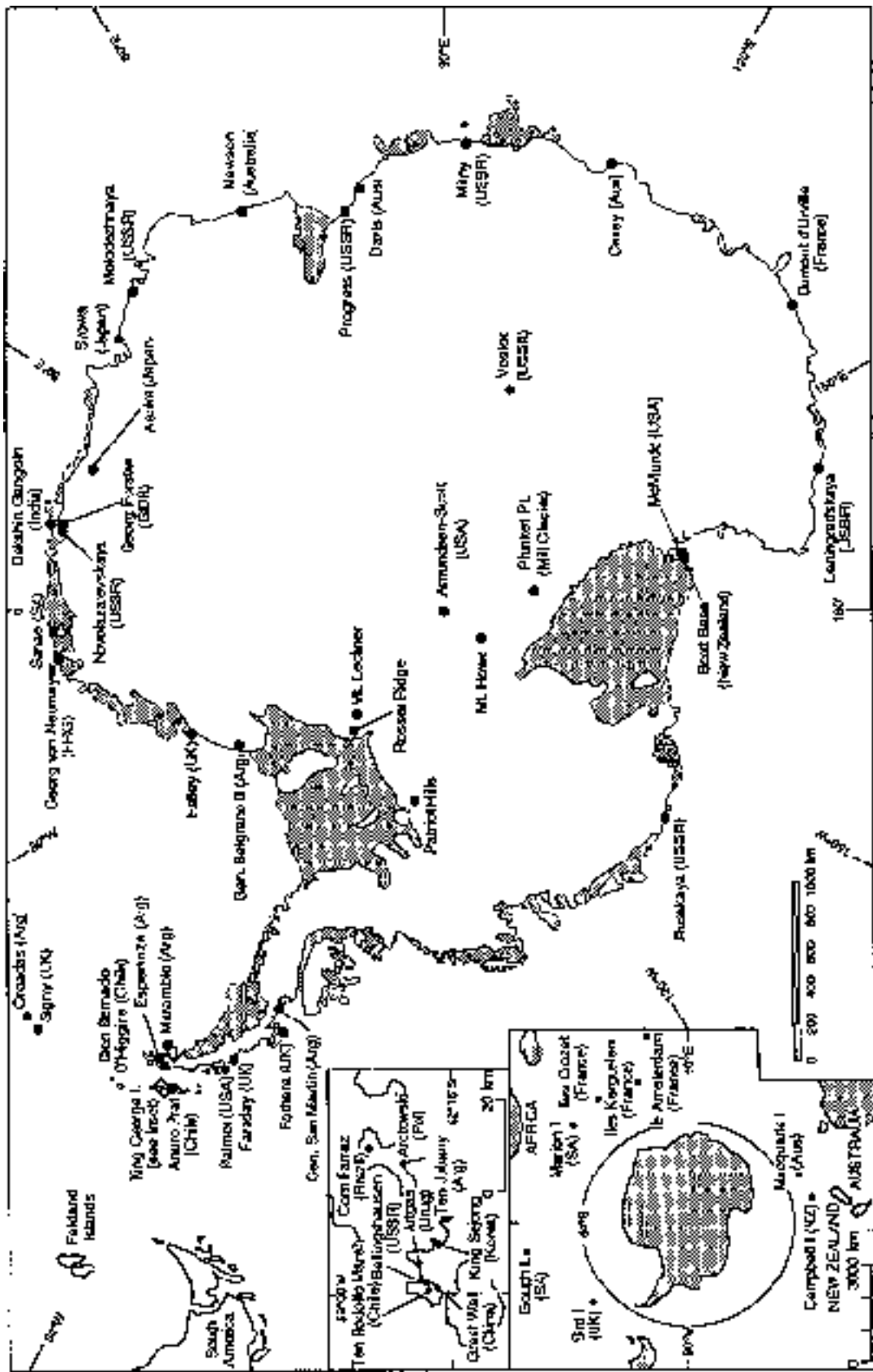

Figure 2. Location of stations and airfields in Antarctica.



*Figure 3. Ford 4T trimotor used by the Byrd Antarctic Expedition. (Smithsonian Institution photo no. 03914.)*

The serious use of aircraft on the mainland of “real Antarctica” began in 1929 when Richard E. Byrd used a Ford 4T trimotor (Fig. 3), a Fokker Universal and a Fairchild, all on skis, for exploration, survey and support of field research. The most striking accomplishment was a flight over the South Pole on 28–29 November 1929. At the same time, flights were being made around the coast of East Antarctica by Mawson’s expedition (DH Gypsy Moth) and Riiser-Larsen (Lockheed Vega) (Fig. 4). Byrd continued to dominate the aviation scene,

going back to Little America in 1934 with a twin-engine Curtiss–Wright Condor T-32 biplane (Fig. 5), a Fokker F-14 and a Fairchild Pilgrim, plus a Kellett (Cierva) autogyro (Fig. 6). In the same year, Lincoln Ellsworth and Bernt Balchen failed in their attempt to cross Antarctica in a ski Northrop Gamma, and the British Graham Land Expedition operated a DH Fox Moth on floats in the Antarctic Peninsula. In late 1935, Lincoln Ellsworth (American) and Herbert Hollick-Kenyon (English-Canadian) succeeded in crossing Antarctica in a Northrop

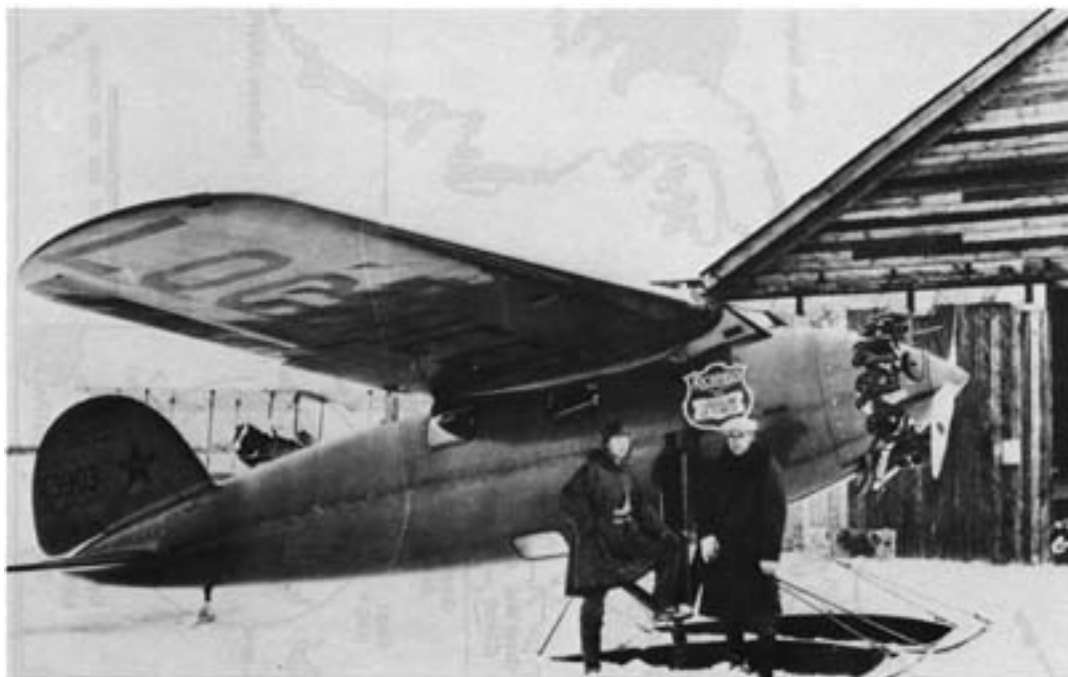

*Figure 4. Lockheed Vega. (Smithsonian Institution photo no. 15615.)*





*Figure 5. Curtiss-Wright T-32 biplane used by the second Byrd Antarctic Expedition. (Smithsonian Institution photo no. 03902.)*



*Figure 6. Kellett autogyro used by the second Byrd Antarctic Expedition. (Smithsonian Institution photo no. 03936.)*



Figure 7. Northrop 2B Gamma. (Smithsonian Institution photo no. 8275.)

2B Gamma (one 600-hp P&W Wasp), going from Dundee Island to Bay of Whales (2100 miles) in 14 days, with four landings en route (Fig. 7). After landing 25 miles short of their destination, Ellsworth and Hollick-Kenyon walked to the abandoned Little America station and were located by an RAAF DH Gypsy Moth operating from Discovery II. Ellsworth returned to Antarctica in 1938-39 with a Northrop Delta and a small Aeronca. In the mid-thirties, small floatplanes operating from ships of the Lars Christensen expeditions made excellent coastal air surveys in Enderby Land and Queen Maud Land.

#### WW II to the IGY

After a long period dominated by private enterprise, the heavy hand of government fell on Antarctic expeditions in 1938. Germany sent the “Schwabenland,” with its two Dornier Wal flying boats, as a national expedition, and the U.S. government countered in 1939 by forming its first

“Antarctic department” and sending another expedition directed by Byrd, whose previous trips had little, if any, connection with the navy.

The U.S. Antarctic Service Expedition flew two Curtiss-Wright Condors (modified AT-32s designated R4C-1 by the U.S. Navy) and a Staggerwing Beechcraft (Model 17) in Antarctica in 1940 (Fig. 8), and the expedition ship carried a twin-engine seaplane. Squabbling over territorial claims continued during WW II, and in 1944 Britain established the Falkland Islands Dependencies Survey (FIDS), which flew an Auster Autocrat in the Peninsula around 1947.

After WW II, government-controlled expeditions gradually became the norm. From 1946 to 1948, the Finn Ronne expedition, which flew a Beechcraft 18 (C-45) in the Peninsula, operated along traditional lines, but in 1947 the U.S. “Operation Highjump” sent an armada of ships, including an aircraft carrier and two seaplane tenders, producing a large amount of air photo coverage. Ski-wheel DC-3s



Figure 8. Staggerwing Beechcraft 17. (Smithsonian Institution photo no. 06919.)



*Figure 9. ANARE Auster (AOP Series, Mark 6, 145 hp DH Gypsy Major 7) on the pack ice north of Mawson. A descendant of the U.S. Taylorcraft, this model had a nominal MTW of 1990 lb (900 kg) and an actual Antarctic MTW of 2200–2400 lb (1000–1100 kg). The Antarctic variant had nonstandard oleo legs. Two of these aircraft joined the RAF as VX126 and VX127. They flew with the Norwegian–British–Swedish expedition in 1950 before transferring to the RAAF Antarctic Flight as A11-200 and A11-201 for the establishment of Mawson (1954). A11-200 was pushed overboard from Kista Dan during a storm in March 1954. After a rest with the Royal Victorian Aero Club, A11-201 rejoined the RAAF for residence at Mawson (1956–1958). It made a final trip south on floats aboard Magga Dan in 1959 for the Wilkes takeover. (Photo by M. Mellor, August 1957.)*

were flown off the carrier using JATO and were based temporarily at Little America. One of them carried Byrd on his second flight over the South Pole. Highjump also had a JA-1 Norseman. Altogether, Highjump had 19 fixed-wing aircraft and 7 helicopters. The following year another naval operation, named “Windmill,” made serious use of helicopters for the first time around the coasts of Antarctica.

The era of limited-duration expeditions ended with the Norwegian–British–Swedish expedition to Queen Maud Land (1949–1952). They operated two Auster-VI aircraft (Fig. 9) of the Royal Air Force in 1950, a single-engine C-5 and a KZ III (both Norwegian built) in 1951, and a Swedish Air Force Beechcraft 18R and Saab Safir in 1952. All six aircraft were carried to and from Antarctica aboard the expedition’s small ship *Norsel*.

In the early fifties, plans for an International Geophysical Year (1957) were hatched, and the resulting multinational invasion of Antarctica began in 1954. As things turned out, the IGY initiated

the permanent occupation of “real Antarctica” (as distinct from the Peninsula).

The IGY gave a great boost to Antarctic aviation, and by 1956 McMurdo had a sea ice runway accommodating R4D (DC-3), R5D (DC-4) and P2V (Nep-tune) aircraft with ski-wheels and, shortly after, C-121 (Constellation) and C-124 (Globemaster) transports with conventional wheel landing gear. McMurdo had its first fatal crash (a C-121) in October 1956. At Mirny the Soviet expedition had an Il-12, two Li-2s (essentially DC-3s), an An-2 and two Mi-4 helicopters. The Australian base at Mawson had a hangar housing an Auster and a DHC-2 Beaver (later two Beavers), which flew year-round. In October 1956 a ski-wheel R4D landed at the South Pole, where air drops by standard wheel-gear C-124s had begun. Perhaps the most remarkable advance was the carrying of passengers and priority freight from New Zealand to Antarctica by air in the C-124 and C-121. In the Peninsula, FIDS used a chartered PBY-5 Canso (Catalina) twin-engine amphibian from 1955 to 1957 for air photog-



*Figure 10. USN ski-wheel Douglas R4D-8 at McMurdo. A derivative of the original DC-3 (C-47) (first flown in December 1935), the R4D-8, or C-117D (MTW 31,000 lb, two 1500-hp Wright Cyclones), was the military version of the 1949 Super DC-3, or DC-3S. Standard R4Ds first entered Antarctica with Operation Highjump in 1946-47 (which abandoned six of them on the ice); they first operated for the modern USAP in 1956, and one, Que Sera Sera, made the first South Pole landing on 31 October 1956. Two R4Ds crashed in late 1959, one in November 1961, two in November 1962, two in 1964-65 and three in 1965-66. One was dropped and destroyed in 1968, the year the DC-3 retired. The landing gear was a weakness in Antarctic flying, and in 1966 they were restricted to landings on prepared runways or smooth snow. The Australians took a DC-3 to Mawson in 1960, but it was destroyed later in the year by fierce winds at the Rumdoodle runway. Altogether, over 10,000 DC-3s were built in the U.S., with more made in the U.S.S.R. as the Lisunov Li-2. (Photo by M. Mellor, October 1961.)*

raphy; this long-range machine had the capability of flying useful loads to Antarctica (Fig. 10–19).

As the IGY ran its course, through 1957 and into 1958, high-quality trimetragon photography was acquired for much of Antarctica, permitting detailed and accurate mapping, and field research was greatly facilitated by air support. In 1958 the first nonstop transpolar crossing of Antarctica (1430 miles) was made by a British single-engine DHC-3 Otter flying from Southice to McMurdo.

### **Post-IGY**

After the IGY the most significant milestone for the USAP was the introduction into Antarctica of the ski-wheel C-130 Hercules (now designated LC-130). In 1960 the USAF flew modified A-models (designated “D”) in Antarctica, and the following year the U.S. Navy Antarctic squadron (VXE-6) got

its own modified B-models (first called “BL,” then “F”).\* This made it possible to construct and maintain major inland stations entirely by air. “New Byrd” station was built this way in 1961-62, then the second Pole station (1970–1974). A number of smaller stations and field camps were built and maintained using the LC-130, including Siple station, 1240 nautical miles (2300 km) away from its parent base at McMurdo (Fig. 20–23).

Flights between Christchurch and McMurdo were expanded in the mid-sixties. Flights by standard C-130s of 40 Squadron, RNZAF, started in 1965, and standard USAF C-141s began making October and

---

\*In the early sixties the U.S. military services adopted a common system for designation of aircraft. Previously each service had its own letter-number designations.



*Figure 11. Lisunov Li-2 on skis (no mainwheels) near Mirny. In 1939 the U.S.S.R. began to build the Douglas DC-3 under license, first using the designation PS-84 and later redesignating the aircraft Li-2 (apparently for B.P. Lisunov, who seems to have added a window aft of the pilot's side window). Widely used in WWII, it was powered by two Shvetsov 1000-hp radials. The DC-3 and the Li-2 were the last of the big tail-draggers in Antarctica. (Photo by Charles Swithinbank, 19 January 1964.)*



*Figure 12. USN Douglas R5D (DC-4 Skymaster, or C-54) at McMurdo. The USAF also flew C-54s to McMurdo until about 1963. These aircraft operated on standard wheels between Christchurch and McMurdo. The DC-4 (prototype first flown in June 1938, production model first flown in February 1942) had an MTW of 73,000 lb, with four 1450-hp P&W radials. Altogether 1242 were built. (Photo by M. Mellor, November 1962.)*



*Figure 13. Antarctic Airways DC-4. Some 31 years after the DC-4 began flying to McMurdo, and almost 50 years after the first flight of its prototype, the same type of aircraft opened commercial service to Antarctica. A DC-4 of Antarctic Airways (ANI/Borek) flew between Punta Arenas and Patriot Hills, carrying climbers and tourists. (Photo by Charles Swithinbank, 22 November 1987.)*



*Figure 14. USN ski-wheel Lockheed P2V-7 Neptune. Introduced to Antarctica in 1956, the P2V long-range patrol bomber was used for aerial mapping photography and geophysical research. Derived from the original P2 (first flown in 1945), this Navy version eventually had two 3500-hp Wright piston engines and two 3800-lbf Westinghouse J34 turbojets, with an MTW of 80,000 lb. Two crashed in Antarctica (McMurdo, October 1956, and Wilkes, November 1961), and two assigned to Antarctic service crashed outside (one in Venezuela in February 1956 and one in California in August 1958). (Photo by M. Mellor, October 1961.)*



*Figure 15. USN Lockheed Super Constellation (C-121J or R7V) on the sea ice at McMurdo. The Super Constellation (first flown in October 1950) was a derivative of the original C-69 Constellation (first flown in January 1943). It had an MTW of 156,000 lb and four 3400-hp Wright turbo-compound radials. It carried passengers between Christchurch and McMurdo in backward-facing seats, with enough room to change clothes in mid-journey. The cruise speed was 280 knots. The C-121 was the last piston-engine aircraft used by the USAP, being phased out at the end of 1970. An EC-121 (WV-2) magnetometer aircraft landed short and was destroyed at McMurdo in October 1960. In October 1970, C-121J Pegasus crashed while landing below minimums on the glacier-ice runway at Outer Williams Field. (Photo by M. Mellor, October 1961.)*



*Figure 16. USAF Douglas C-124 Globemaster II on the sea ice at McMurdo. The C-124 (first flown in November 1949) had an MTW of 194,500 lb and four 3800-hp P&W (Ford) radials; 446 were built. It had nose doors with ramps and a rear hatch with an elevator, and it could accommodate double-decker loading. The C-124 began flights to Antarctica on 20 October 1956, and State of Oregon made the first South Pole cargo drop on 26 October 1956; 760 tons of materials were delivered by C-124s for construction of the original South Pole Station. The ride from Christchurch, New Zealand, to McMurdo was noisy and slow, with a 200-knot cruising speed. A 124 was badly damaged in a nosewheel landing at McMurdo in October 1956, and another landed short and was destroyed in November 1956. One crashed near Hallett in October 1958. The 124 was retired from Antarctic service about 1965. (Photo by M. Mellor, November 1962.)*



*Figure 17. ANARE ski-wheel DHC-2 Beaver over Mawson (A95-202 from A95-201). The standard Beaver had an MTW of 5100 lb (2300 kg), but these operated at 5600 lb (2540 kg). The engine was a 450-hp P&W radial. A95-201 was at Mawson from 1956 to 1958; it returned in January 1959 and was destroyed by a 96-knot blizzard (along with A95-203) at the Gwamm runway in December 1959 (after being ground-flown for two hours). A95-202 stayed at Mawson from 1956 to 1959; it returned in February 1960 (via Davis) and was destroyed by a blizzard at the Rumdoodle runway in December 1960. (Photo by M. Mellor, September 1957.)*



*Figure 18. USN ski-wheel DHC-3 Otter (U-1A) at McMurdo. The STOL Otter was an all-tin replacement for the Noorduyn (CCF) Norseman (C-46A), a Canadian bush-flying classic. The Otter (first flown in December 1951, MTW 8000 lb, 600-hp P&W radial) was used in quantity by the USAP. For 1955-56, VX-6 (no "E" in those days) had four Otters, three of which were destroyed. For 1956-57 there were 10 Otters, and only one was lost (to wind at Little America). Two were lost in 1958-59, one in a low departure turn (or possibly stall) at Marble Point. Their role in the USAP was gradually taken over by helicopters, and they were retired from the USAP in 1966. (Photo by M. Mellor, October 1961.)*





*a. Simple skis (with low-friction plastic bases).*



*b. Piston-engine takeoff run, with the nose high and apparently no flaps. Attachment of skis to the main gear can just be made out.*

*Figure 19. Ilyushin Il-12D at Vostok, 11,500 ft (3,490 m) above sea level. The Il-12 (first flown in 1944, MTW 38,000 lb, two 1775-hp radials) was designed to replace the Li-2 while still using the same runways. (Photos by Charles Swithinbank, 5 February 1964.)*



*Figure 20. Ilyushin Il-14 at Molodezhnaya. The Il-14 (first flown in 1953, MTW 38,000 lb, two 1900-hp Shvetsov radials) was developed from the Il-12. Il-14s, mostly with skis, were the backbone of Soviet air operations in Antarctica for many years. Their use has now been discontinued (the one shown has been pensioned off), for the time being leaving the SAE without aircraft capable of landing at Vostok and other places in the interior. (Photo by M. Mellor, 15 November 1990.)*



*Figure 21. Lockheed C-130 Hercules on the sea ice at McMurdo. The standard C-130, on wheels only, first flew to Antarctica in late 1959. Currently a Hercules of 40 Squadron, RNZAF (illustrated), maintains a passenger and freight service between Christchurch and McMurdo from October to early December. There are also occasional Hercules flights to McMurdo by the Italian Air Force and the RAAF (36 Squadron). In the Peninsula, flights to Marsh and Marambio are made by the USAF, FACH, FAA and the Brazilian Air Force. The C-130 Hercules (prototype first flown in August 1954, production model first flown in April 1955) has gone through many stages of development. The C-130H has four 4500-hp Allison turboprops, an MTW of 175,000 lb and a 300-knot cruising speed. Passenger amenities have remained at cattle-truck standards for over three decades. (Photo by M. Mellor, November 1990.)*



*Figure 22. One of the first “ski-Hercs,” which were modified A-models, designated C-130D. The first test version flew in 1957, and tests were completed in 1958; the machine was in service in Greenland by 1959 and in Antarctica by 1960. Twelve airframes were modified for the USAF in the original contract. Five of them are apparently in dead storage at Davis–Monthan AFB. It is reported that 487 was sold to Honduras and crashed in the jungle. Number 489 may have been sold to Honduras as a replacement. The author saw one, without engines, at Lima in 1988, carrying the markings of Fuerza Aerea del Peru and tail number 399. (Photo by M. Mellor, 1960.)*



*Figure 23. Lockheed LC-130R Hercules with ski-wheels (XD 01, or Buno 160741). Four of these machines, plus two of the older LC-130F, make up the USAP fleet of six ski-wheel transports. The aircraft are owned by NSF and operated by the USN (VXE-6). The 109th TAG, NYANG, has four LC-130Hs of more recent vintage. The LC-130 is used in Antarctica to supply inland stations and support field parties. (Photo by M. Mellor, 3 November 1990.)*



a. Introduced to Antarctic service in late 1966, the C-141 carries passengers and freight between Christchurch and McMurdo in October and early November. The original C-141A (first flown in December 1963) often “cubed out” below maximum allowable load, and all were eventually lengthened by 280 in. to C-141B standards. The MTW is 323,100 lb. It has four P&W turbofans, each delivering 20,250 lbf of thrust. The cruising speed is 430 knots, giving a relatively fast trip of about 5.3 hours to McMurdo. (Photo by M. Mellor, 16 November 1988.)



b. The C-141 has a rear cargo ramp which can also be used for air-drops at up to 200 knots. Trimmed 2° nose-up, single loads up to 35,000 lb can be dropped at speeds between 130 and 180 knots, depending on the aircraft weight. It can make deliveries to South Pole Station, with maximum platform dimensions 9.2 × 16 × 5 ft (the available load space is 8.3 × 14 × 5 ft). The high wing has anhedral, limiting the wing-tip clearance over snowbanks and on rough surfaces. At MTW the wing-tip clearance is 8.75 ft (11.2 ft empty), the outboard nacelle clearance is 3.75 ft (4.42 ft empty) and the clearance for the VHF antenna under the low fuselage is only 8.3 in. The MLG has two pairs of wheels in tandem on each side (eight total). The nose gear has a pair of wheels. The inflation pressure for the MLG is typically 180–210 lbf/in.<sup>2</sup> (Photo by M. Mellor, 18 October 1990.)

Figure 24. USAF Lockheed C-141 StarLifter.

November cargo deliveries in 1966. Winter flying remained rare, but in 1967 an annual August fly-in to McMurdo by LC-130s began (Fig. 24).

In 1964 an LC-130 flew direct to Antarctica from Melbourne, Australia, landing at Byrd after weather conditions closed both South Pole Station and McMurdo (3840 nautical miles in 15.65 hours).

Soviet flights to Antarctica were made in the sixties by an Ilyushin Il-18D, routed through Australia, New Zealand and McMurdo.

For about two decades, from the mid-sixties to the mid-eighties, there was comparatively little progress in Antarctic aviation. Earlier innovations settled into routine, turbine helicopters replaced piston-engine equipment, the USAP acquired four R-model LC-130s (converted C-130Hs), and there was an increase in the number of Antarctic expeditions with some aviation capability. A very large turboprop transport, the C-133, flew to McMurdo in 1970. Two private flights were made to the South Pole in January 1970; one aircraft, Max Conrad's Piper Aztec, crashed on the return takeoff. Commercial DHC-6 aircraft began work, and one landed

at South Pole Station about 1974. There was a major advance in navigation in 1973, when INS was introduced. A remarkable long-distance flight was made in 1973, when an Argentine Air Force (FAA) Hercules went nonstop from Marambio to Canberra, via the South Pole, in 17 hours, 32 minutes. Non-stop commercial sightseeing flights were run from Australia and New Zealand, but these ended after 257 people were killed when an Air New Zealand DC-10 hit Mount Erebus. However, tourist flights to the Peninsula started to develop in the early eighties. In 1982, FACH began flying tourists from Punta Arenas to King George Island by C-130, and in 1984 the late Giles Kershaw flew fare-paying passengers as far as Vinson Massif in the Tri-Turbo.

Significant changes began to develop in the mid-eighties. After more than a decade of development effort, Soviet engineers brought compacted snow runways to a limited-season operational state in 1980, and in February 1980, the Il-18D (Fig. 25) began direct flights between Maputo (Mozambique) and Molodezhnaya. This was followed in early 1986 with flights by a larger aircraft, a specially



*Figure 25. Ilyushin Il-18D of the Soviet Antarctic Expedition (MTW 141,000 lb; four 4250-hp Ivchenko turboprops). Chartered from Aeroflot and flown by an Aeroflot crew, the Il-18D carries passengers and light cargo between Maputo (Mozambique) and Molodezhnaya. This machine (SSSR 74267) has an extended tail cone (like the anti-submarine version) for magnetic and gravity surveys in Antarctica; it was used originally by Mr. Kosygin when he was Prime Minister. With a cheerful flight deck, quiet cabin, comfortable seats and two stewards, it is an aircraft of choice for the Antarctic frequent flyer. Contrary to popular legend, it seems unlikely that the Il-18 (first flown in July 1957) was copied from the smaller Lockheed Electra (first flown in December 1957), which was a flop until its 1979 rebirth as the P-3 Orion. Both were probably inspired by the larger Bristol Britannia (first flown in August 1952), the last aeroplane to provide real transatlantic comfort. (Photo by M. Mellor, 15 November 1990.)*



*Figure 26. Ilyushin Il-76TD taking off from the compacted-snow runway at Molodezhnaya. Similar in configuration and performance to the C-141, the Il-76T (MTW 375,000 lb, four Soloviev turboprops, first flown in March 1971) is well adapted for operation from substandard airfields. Compared with the C-141, it has twice as many mainwheels, bigger tires and much lower inflation pressures. (Photo courtesy of Vladislav Piguzov, November 1990.)*

modified Il-76TD (Fig. 26–28). A snow–ice runway was also built at Novolazarevskaya. In 1988 an An-74 (Fig. 29) landed on wheels on a compacted snow runway at Vostok. The first winter flight from South Africa was made in August 1991, when the Il-76TD evacuated 172 people from a ship that was trapped in the ice.

By the mid-eighties, private enterprise and non-government aviation activity had taken root again (commercial shipping never did disappear from the scene). Using the runway at Marsh as a stepping stone, commercial Twin Otters (DHC-6) were operating as far south as the Ellsworth Mountains. In 1987 and 1988, tourists were carried to Patriot Hills in a DC-4, which landed on blue ice with standard wheels (Fig. 13). Early in 1988 the first commercial tourists went to the South Pole, transferring from the DC-4 to Twin Otters at Patriot Hills. In 1989 the DC-4 was replaced by a DC-6. The Twin Otters continued to ferry tourists, climbers and adventurers, also supporting (off-camera) a number of adventurous exploits filmed for television. Much of this activity was organized by Adventure Network International (ANI), using Kenn Borek Air for the flying. Both are Canadian corpo-

rations. In 1988 a privately owned Australian DHC-6 (Smith and Kershaw) flew from Hobart to Casey, landing on wheels. It then flew extensively for ANARE around East Antarctica, crossed Antarctica to Cape Evans, and dropped in twice at South Pole Station before departing for Chile. The USAP was an early user of commercial aircraft. Starting about 1974, Twin Otters from Canada (initially Bradley, then Borek) worked under contract, providing support for science and, in 1988–89, airfield development studies at Mount Howe and Mill Glacier.

The use of commercial helicopters, pioneered by Australia, was common by the end of the eighties. Greenpeace made regular visits to Antarctica in the late eighties, using small helicopters for short sorties.

In the USAP a desire to use large conventional aircraft over a long operating season revived interest in runway technology, taking into consideration potential sites on all types of ice, snow and rock. In 1989, a very large transport, the Lockheed C-5B Galaxy, made two flights from Christchurch to McMurdo, and there was a repeat with three flights in October 1990 (Fig. 30, 31). Wheel landings were made by LC-130s on inland blue ice, and an

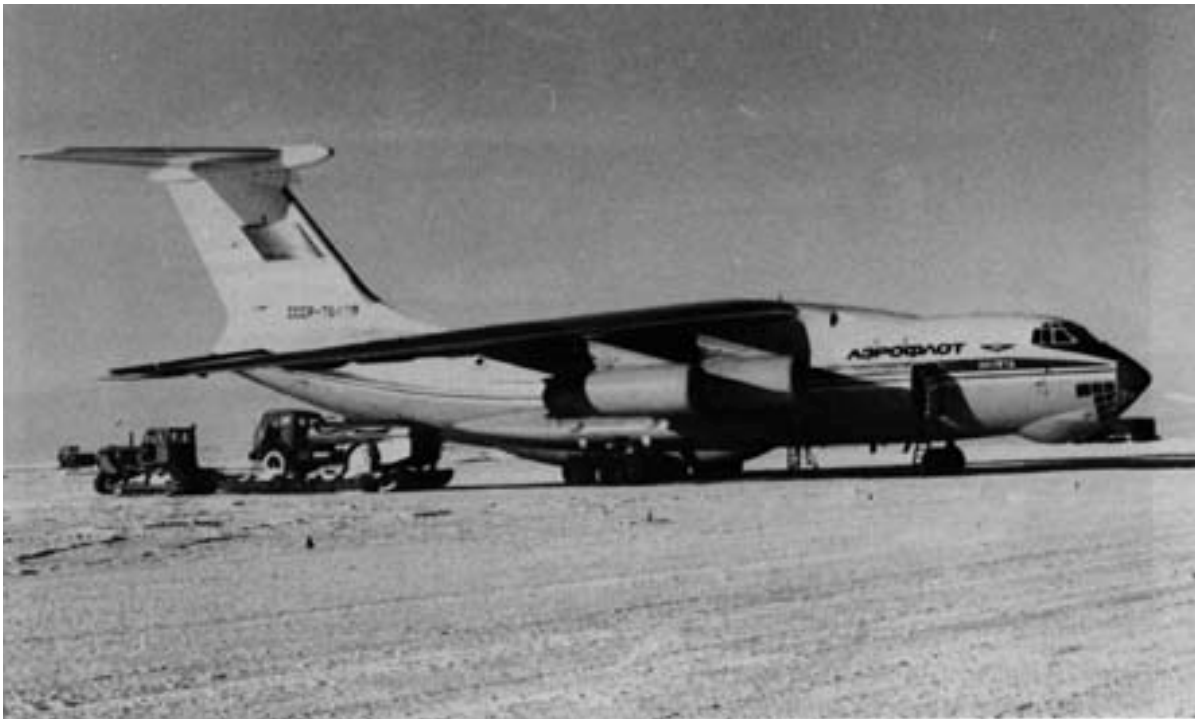

*Figure 27. Ilyushin Il-76TD on the compacted snow runway at Molodezhnaya. The MTW of the Il-76TD is 30% higher than that of the C-141B, but the overall length is about 10% less. The MLG has two units in tandem on each side. Each of these units has four wheels on a single axle, giving a total of 16 wheels for the MLG. The nose gear consists of two pairs of wheels, one on each side of the oleo leg (four wheels total). The tire pressure can be varied in flight between 36 and 73 lbf/in.<sup>2</sup> (2.5–5 bar). (Photograph by Vladimir Nazarov, November 1990.)*



*Figure 28. Front view of the Ilyushin Il-76TD at Molodezhnaya. Like the C-141 the wing has anhedral. The wing tip clearance is greater than that of the C-141—about 15.6 ft (4.74 m) unloaded. The aeroplane is powered by four Soloviev turbofans, each rated at 26,500 lbf of thrust (30% more than the C-141). The width of the mainwheel assembly can be seen on the starboard side (the MLG and nose gear have twice as many wheels as the C-141). This particular aircraft has been modified for Antarctic service with passenger seating, soundproofing, galley and in-flight working area. (Photograph by Vladimir Nazarov, November 1990.)*



*Figure 29. Antonov An-74 (MTW 76,000 lb; two Lotarev turbofans) of the Soviet Antarctic Expedition. The An-74 was developed from the An-72 (first flown in December 1977), specifically for polar operations (according to a Soviet colleague, “it is an An-72 painted red”). SSSR-72003 made the first wheel landing and takeoff on compacted snow in the high interior of Antarctica, at Vostok in November 1988. This white-knuckle feat has not been repeated so far. The aeroplane made ruts 20–30 cm deep and finally got off on the third try. (Photo by M. Mellor, 27 November 1988.)*



*Figure 30. Lockheed C-5 Galaxy of MAC on the sea ice at McMurdo. At an MTW of 840,000 lb, very thick ice (> 8 ft) is needed if the aeroplane parks for any length of time. The aircraft currently operates to McMurdo only in early October, when the sea ice is near its maximum thickness and is still very cold. The C-5 (first flown in June 1968) got off to a shaky start but came into its own after 1981, when new wings were retrofitted to the original C-5A; deliveries of the C-5B started in 1986. The MLG has two triangular units, each with six wheels, on each side, for a total of 24 wheels. The nose unit has four wheels. The C-5 is driven by four GE turbofans, each developing 43,000 lbf of thrust. The cruising speed is 450 knots, making this the fastest aeroplane in current Antarctic service, as well as the largest. (Photo by photographer’s mate Oirk Meenen, USN, 3 October 1990.)*





*Figure 31. Lockheed C-5 Galaxy disgorging cargo through the hinged nose (19 ft wide by 13.5 ft high) at McMurdo. There is also a tail ramp (19 ft wide by 12.9 ft high), which can be used for airdrops. The maximum payload is just over 130 tons (118 tonne). The swept wings have 5.5° anhedral. After landing on ice that is almost 8 ft thick, the aircraft is unloaded, refueled and sent back north without delay. Even so, there is measurable deflection of the sea ice during unloading (several inches, or around 0.1 m). In recent years the C-5 has delivered UH-1N helicopters and a DHC-6 Twin Otter for early-season operations. (Photo by photographer's mate Oirk Meenen, USN, 3 October 1990.)*

experimental wheel runway on glacier ice was built near McMurdo. The LC-130 remains the basic workhorse, providing support within Antarctica and also a capability for all-season air access to the continent (a midwinter medical evacuation was executed in June 1991).

France moved decisively in recent years, and a paved rock-fill runway is now nearing completion at Dumont d'Urville, offering a new route from Hobart to Antarctica. BAS has built a rock-fill runway at Rothera, with the intention of opening a new access route from the Falklands.

Australia experimented with snow runway construction near Casey in 1983-84, and in 1989-90 an attempt to build an operational runway came close to completion. Flights from Hobart with conventional C-130s are envisaged.

If current activity is any guide, Antarctic aviation has plenty of history still in the making.

## **EVOLUTION OF EQUIPMENT AND FACILITIES**

### **Aircraft**

Fixed-wing aircraft have to function both as flying machines and surface vehicles. In the early days of flying, the aeroplane was adapted to the operat-

ing environment by fitting it with wheels, floats or skis. These were often interchangeable options for the same machine. With small, slow aeroplanes, drag was not an overriding concern, so that wheels, floats or skis could be left to dangle in the breeze. Hybrid landing gear, such as ski-wheels or amphibious floats, could be improvised at modest cost, permitting takeoff and landing to be made in two distinctly different environments.

Prior to WW II, all Antarctic flying depended on adaptation of the machine to the environment. Wheels could be used on smooth, snow-free sea ice or on smooth beaches. Floats and flying-boat hulls could be used on open water that was not too rough. Skis were used on smooth snow and ice. Skis were not expensive: steam-bend some ash, add a couple of bungee cords, and use a coal shovel for the tail ski.

After WW II, most of the newer multi-engine aircraft had retractable gear; cruising speeds were higher than for the old aircraft, stall speeds tended to be higher, and takeoff distances had increased. Ski-wheels could still be fitted and partially retracted, but relatively costly engineering was called for. Long oleo legs were ill-suited for resisting ski-drag and sideloads. As transport aircraft became larger and faster, ski drag, both in the air and on the snow, became more serious, and the cost of ski-



*Figure 32. Ski-wheel DHC-6 Twin Otter of Kenn Borek Air at the South Pole. The Twin Otter (first flown in May 1965; MTW 12,500 lb; two 652-hp P&W turboprops) has been used in Antarctica by a number of countries for a variety of purposes, from logistics and field support to mapping photography and aerogeophysical work. Landing gear options include standard wheels, oversize “tundra tires,” hydraulic ski-wheels, fixed “penetration skis” and simple skis without wheels. In 1988-89 C-FKBG and C-FSJB (shown) operated from South Pole Station for reconnaissance, test landings and surveys at blue-ice sites in the Transantarctic Mountains. (Photo by M. Mellor, 22 January 1989.)*



*Figure 33. Ski-wheel Dornier 228-100 of the German Antarctic Expedition at South Pole Station. The Dornier 228 (first flown in March 1981; MTW 12,600 lb; two 715-hp Garrett turboprops) serves similar purposes to those of the Twin Otter; it is faster (maximum cruising speed of 231 knots at 10,000 ft, 199 knots at sea level), but it needs a bit more room for taking off and landing. (Photo by W. Tobiasson, January 1990.)*

wheel modification became high, especially if the development cost had to be recovered from just a few aircraft. The C-130 was the largest aircraft to be fitted with retractable ski-wheels. The original ski installation was first test-flown in 1957 and completed in 1958; twelve modified aircraft were delivered to the USAF in the first order. In its present form the C-130 ski-wheel modification is not a simple retrofit but rather a major modification of the gear and airframe (Fig. 32-42).

For aircraft bigger and faster than the C-130, ski modification seems unattractive and probably prohibitively expensive. Ski modification of the C-141 has been proposed and rejected a number of times. Hydraulic ski-wheels on large aircraft represent an additional source of maintenance problems. Modification is still feasible for aircraft around 6 tonne gross, but the cost can be very high when the market for modified aircraft is very small.

The Soviet Antarctic program never had ski-wheel modifications of modern aircraft. Following early use of the Li-2 and Il-12 on skis, most of the multi-engine ski flying was done by the Il-14. However, this old aircraft has now been retired from service.

#### **Facilities for takeoff and landing**

The alternative to modifying the aircraft to suit the environment is the converse: modifying the environment to suit the aircraft. The latter has been the worldwide solution since the days of grass fields and flying boats, and it seems inevitable that Antarctica will follow the trend.

In the early days of Antarctic aviation, wheel undercarriages were practical only for snow-free first-year sea ice in springtime or for smooth beaches of sand or fine gravel. They were used only rarely. Most of the coastal flying was done on floats, using smooth stretches of water in protected inlets or in the pack ice. In a few cases around the time of WW II, seaplanes were launched from ships by catapult. For inland flights, skis were the only practical landing gear. Although it is possible to land and take off from soft snow on floats or on a flying-boat hull (it has been done in Greenland with PBY Catalina and Grumman amphibians), it is not safe or practical, particularly on hard, wind-sculptured snow (the gear is unsprung). Floats and skis were readily interchangeable (ANARE used float and ski-wheel switches up to the late fifties).

Since the IGY, most aircraft operating within Antarctica have had ski-wheels, and since 1947 JATO has been available for some military aircraft to assist takeoffs at high latitudes, with heavy loads

or in “draggy” snow. However, in the windy parts of Antarctica, the hardness and roughness of the snow surface has remained a problem, even for large machines like the LC-130. In some areas of East Antarctica the sastrugi are too big to permit safe takeoff by any fixed-wing aircraft (with the possible exception of an STOL plane in a brisk wind), and injudicious choices of open-field landing areas have damaged or destroyed a number of aircraft. Over the years the combination of rough snow and JATO has proved particularly nasty. However, the mounting brackets for JATO bottles on the C-130 have now been strengthened, which solved the problem for this aircraft. To avoid damage and to reduce wear and tear on the aeroplane, snow surfaces used for ski landings are groomed with some kind of drag or snowplane.

Most conventional aircraft flying to Antarctica from New Zealand have landed on first-year sea ice or smoothed multi-year ice, a case of finding an environment that is suited to wheeled aircraft. The only required modification of the environment, snow plowing, can be regarded as minor, provided someone else is doing the plowing. The operating season for annual sea ice is limited and sometimes unpredictable—from midwinter to Christmas at the most. There have been various attempts to provide wheel runways by milling the bumps off perennial sea ice and ablating glacier ice, but for reasons given later, these runways did not come into regular use over the long term.

In the late fifties and early sixties, the U.S. made strenuous efforts to develop compacted snow runways for wheeled aircraft, both in Greenland and in Antarctica. The results were not quite good enough for practical application, but by 1980 Soviet engineers achieved limited success at Molodezhnaya and elsewhere, landing heavy aircraft early in the season and late in the season (avoiding the December-January warm period).

A conventional rock-fill runway at Marble Point was proposed in 1956, and a short gravel runway was built in 1957. Detailed site investigations were made in 1957 and later years, an environmental impact statement was prepared in 1979 and updated in 1984-85, and further site studies were made in 1988-89. However, a major runway has not yet been built at that location. The first major conventional runway, Marambio, was built on Seymour Island by Argentina about 1970. A second conventional runway, Marsh, on King George Island, was opened by Chile in 1980. France is currently engaged in a heroic project at Dumont d'Urville, constructing a rock-fill runway by linking small

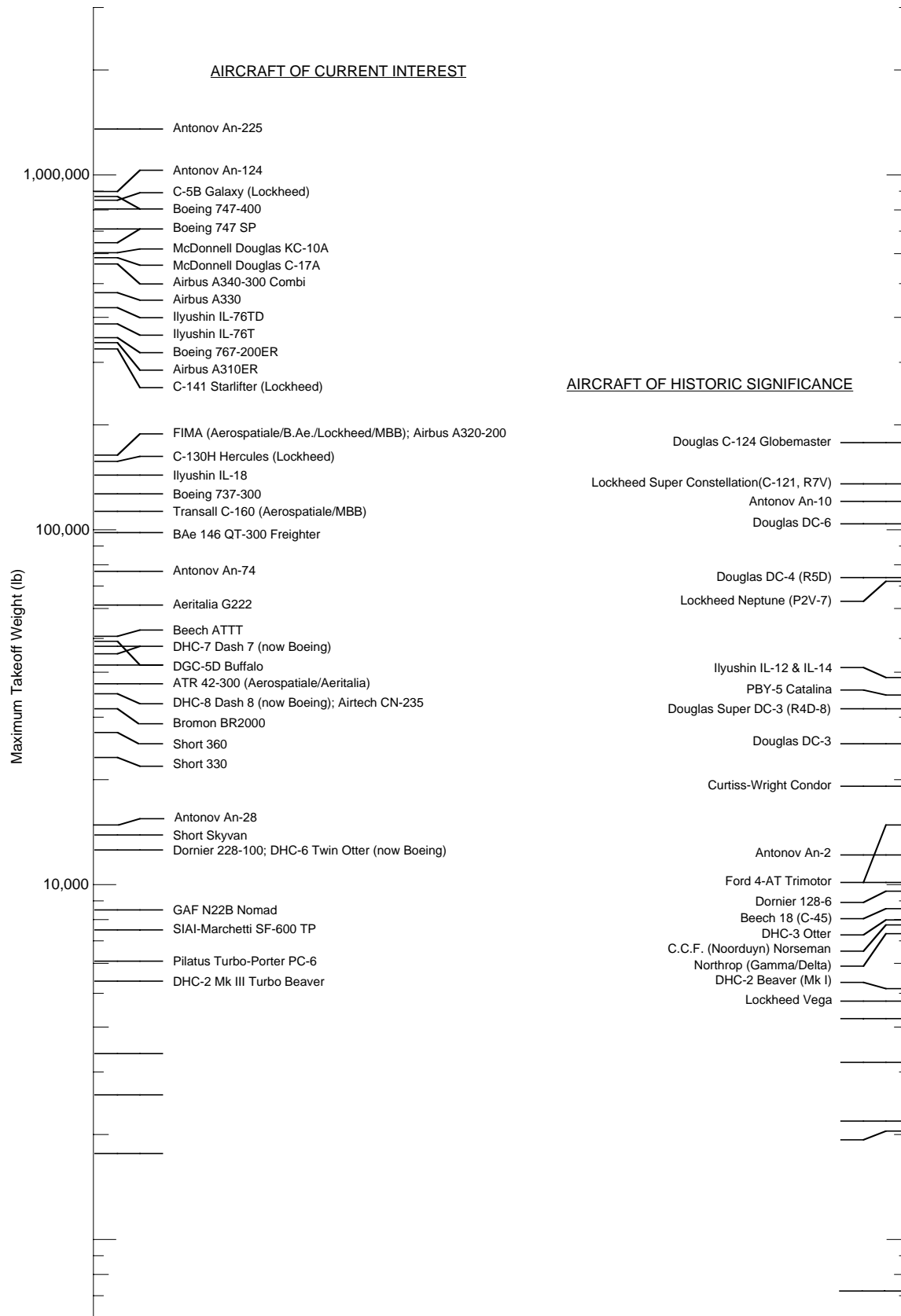

Figure 34. Maximum takeoff weights for a range of modern aircraft, and comparison with aircraft that are of historic significance in Antarctic aviation.



Figure 35. Simple skis, which save weight and drag and are satisfactory for small aircraft operating only on snow and ice. The Angry Ant had skis, ski-wheels and floats. It had a shotgun-cartridge starter, could run on mogas and could fly backwards in a strong katabatic wind. (Photo by M. Mellor, August 1957.)



Figure 36. Dornier 228 outfitted for Antarctic service. In normal service it has retractable gear, but for Antarctic service the gear remains extended, with retractable skis over the wheels. A sleek molded fairing, reminiscent of a racing bobsled, minimizes aerodynamic drag. (Photo by photographer's mate Craig Peterson, USN, December 1990.)

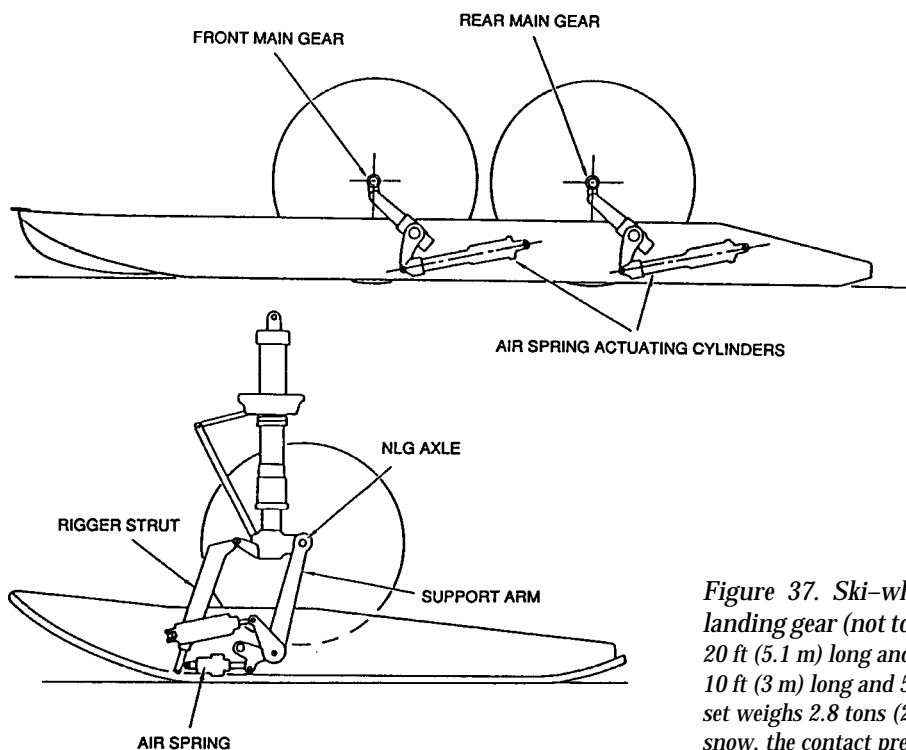

Figure 37. Ski-wheel modification of the C-130 landing gear (not to common scale). The main skis are 20 ft (5.1 m) long and 5.5 ft (1.7 m) wide. The nose ski is 10 ft (3 m) long and 5.5 ft (1.7 m) wide. The complete ski set weighs 2.8 tons (2.5 tonne). With full bearing in soft snow, the contact pressure is about 4 lbf/in.<sup>2</sup> (28 kPa).

coastal islands. Britain is also building a new rock-fill runway at Rothera. A site for a rock-fill runway was located in the Joubin Islands, near Palmer, in 1988, and there are sites for conventional runways at Vestfold Hills and Bunger Hills.

In 1973-74 there was a systematic search for inland ablation areas, termed "blue-ice" areas, that could be used as airfields. Two places were found in the Pensacola Mountains, but they were never used. A similar search was made in the Ellsworth

Mountains in 1986. Two sites were surveyed and one of them, Patriot Hills, was brought into use for conventional aircraft in 1987. Since then, this natural airfield has been used by conventional DC-4 and DC-6 aircraft. In 1988-89 the USAP reconnoitered blue-ice airfield sites in the Transantarctic Mountains, and two were surveyed. At one of these places, on Mill Glacier near Plunket Point, wheel landings were made by LC-130s in 1990. The other, at Mount Howe, has not yet been used by large



*Figure 38. Oversize tires on a DHC-6 Twin Otter (in Greenland, not Antarctica). (Photo by M. Mellor, August 1989.)*



*a. Auster being swung aboard Thala Dan by the ship's boom. (Photo by M. Mellor, February 1958.)*

*Figure 39. Float planes used in Antarctica. Small aircraft, say up to 12,500 lb MTW, can be fitted with floats fairly easily, permitting summer coastal operations almost anywhere around Antarctica. Because of the likelihood of strong winds, open moorings are not safe. Seaplanes need to be lifted aboard ship or beached on a dolly (amphibious floats add weight and complication, without significant benefits in Antarctica). Spray icing is not much of a problem in summer, but precautions against corrosion have to be taken, as for all saltwater floatplanes.*



*b. DHC-2 Beaver being lifted aboard Kista Dan. (Photo by M. Mellor, January 1957.)*



*c. DHC-3 Otter on floats (in Labrador). (Photo by M. Mellor, August 1984.)*



*d. DHC-6 Twin Otter on floats (in Labrador). (Photo by M. Mellor, August 1984.)*

*Figure 39 (cont'd).*



*Figure 40. Wheels of the C-130. The four main wheels (56 × 20.0) are usually inflated to 96 lbf/in.<sup>2</sup> for operation at high takeoff weight (e.g. 155,000 lb). This gives a normal tire deflection of 32%. For operation from unpaved airstrips, the inflation pressure can be reduced until the maximum permissible deflection of 39% is reached, at which stage the tire contact area has increased to 28% above normal. At high takeoff weight (e.g. 155,00 lb) the lowest permissible inflation pressure is 75 lbf/in.<sup>2</sup> With a gross weight of 100,000 lb, the inflation pressure can be reduced to 45 lbf/in.<sup>2</sup> The nose gear (39 × 13) inflation pressure stays the same at 60 lbf/in.<sup>2</sup> (Photo by M. Mellor, December 1988.)*



*Figure 41. Wheels of the Ilyushin Il-18D. The eight 3-ft-diameter main wheels (930 × 305 mm) carry about the same gross weight as the four larger main wheels of the C-130. The standard inflation pressure is 114 lbf/in.<sup>2</sup> (85 lbf/in.<sup>2</sup> in the 700- × 250-mm nosewheels). In principle, side-by-side wheels are preferable to wheels in tandem on a snow runway, since multiple passes of a wheel over soil or snow tend to cause progressive damage and rutting. (Photo by photographer's mate Craig Peterson, USN, November 1990.)*

aircraft (at least eight wheel landings have been made by DHC-6s). These inland blue-ice areas are quite remarkable in that the unmodified natural environment permits all-season operation of unmodified conventional aircraft.

Additional airfield sites have been identified. They include areas of ice-free rock suitable for conventional runways, inland blue-ice areas, protected stretches of smooth perennial sea ice, and coastal ablation areas where snow can be compacted over hard sublayers. Compaction of cold, dry snow in the high interior is technically feasible for selected aircraft, but it may be a few years before the required investment is made. The present indications are that a well-distributed system of runways for conventional aircraft can be established in the near future at relatively little cost.

### **Navigation and radio communication**

In the early days of Antarctic aviation, navigation depended essentially on traditional nautical techniques. For a long time the procedure remained basically dead reckoning and pilotage, using simple instruments (magnetic and gyro compasses, air-speed indicator, chronometer and drift sight), with periodic astronomical checks (bubble sextant and sun compass). With much of the flying limited to clear weather, "eyeball navigation" could be used; on a day with CAVU, visibility is phenomenal in the clear air of Antarctica. Simple RDF, and later ADF, was used for homing on signals transmitted from a base station or an expedition ship.

After the IGY, traditional methods were supplemented by use of the navigation radar to locate





*Figure 42. Wheels of the Antonov An-74. The four main wheels (1050 × 400) carry about half the weight of a C-130. It is understood that the tires have a standard inflation pressure of 114 lbf/in.<sup>2</sup>, which can be reduced to as low as 71 lbf/in.<sup>2</sup> It is estimated that a snow runway can support this aircraft if the snow density reaches or exceeds 0.58 Mg/m<sup>3</sup>. When the first wheel landing was made at Vostok, the snow runway was said to be not much over 0.45 Mg/m<sup>3</sup>, and the aircraft dug ruts 20–30 cm (8–12 in.) deep, making takeoff a desperate affair. (Photo by M. Mellor, 27 November 1988.)*

islands, coastal features and icecap features (notably crevasse fields, which paint characteristic shapes on the screen). Navigation charts improved as Antarctic mapping progressed. Systems such as Loran and Omega were not available, and pressure field navigation remained a dubious procedure in the absence of reliable weather charts. Nondirectional radio beacons (NDBs) were installed at some places for homing and directional checks.

The most dramatic advance was the introduction of INS (inertial navigation system), which gives precise position, distance, speed, track, heading and course deviation. Radar fixes and celestial position lines are still plotted as a matter of prudence on military aircraft, but the INS gives virtually everything a navigator could wish for. GPS (global positioning system) is coming into use in Antarctica as the constellation of available “Block II” satellites increases. Eventually there will be 21 active satellites, with three spares in orbit. In the air navigation mode, GPS gives position, bearing, distance, track, ground speed, estimated time to destination or waypoint, and course deviation. This capability is available with compact equipment at low cost. Integration of U.S. and Russian navigation satellites offers further improvements, and even without restricted DOD “P-code,” high-accu-

racy fixes can be achieved by differential techniques, using a base station and a moving receiver. GPS will replace the older electronic navigation systems, i.e. Transit (Sat/Nav), Loran C, Omega, Decca, some of which did not extend to Antarctica.

Polar grid navigation is used routinely for flights south of 60°S latitude, using appropriate chart projections and overlays. U.S. aircraft operating between New Zealand and McMurdo use specially prepared strip navigation maps.

Landing aids are few and far between in Antarctica. Runways and skiways at U.S. stations have standard daylight runway markers—originally black panels set at 1000-ft (305-m) intervals and marked to indicate the distance remaining. There are also “low-visibility” markers at the approach ends of the primary runways. The McMurdo primary runways have the U.S. Navy Expeditionary Approach Lighting System, which consists of ten rows of approach lights and five sequenced strobe lights. A Portable Runway Lighting System is also installed, with white lights at 500-ft (152-m) intervals. McMurdo and South Pole Station have airport surveillance radar (ASR), precision approach radar (PAR), TACAN and NDB. Approaches can also be made using the internal navigation radar; reflective panels or steel fuel drums make good targets,

but the equipment can also pick up plywood markers (Fig. 43–45).

U.S. runways in Antarctica are designated by grid heading. Grid heading is true heading minus west longitude or plus east longitude. It is understood that the orientations of Russian Antarctic runways are given as true directions. Some runways in the Peninsula follow the usual magnetic heading convention.

Radio communication evolved gradually, paced by developments in the world at large. WW II brought the most rapid development of radio equipment. The IGY increased the number of stations with the potential to communicate with aircraft. One of the special problems of Antarctica is “precipitation static” induced either by ice particles blowing across a ground antenna or by an aircraft flying through, or near, airborne ice particles. The problem is bad for MF/HF but less severe for VHF and UHF, so that it is no longer a major problem. However, another special Antarctic problem is still unsolved. Periodic solar flares disturb the ionosphere, particularly in zones girdling the magnetic

pole, causing “radio blackouts” that, for safety reasons, can bring long-range air operations to a halt.

Emergency location transmitters, or EPIRBs, can now be received by satellites in near-polar orbit, activating the COSPAS-SARSAT location and notification systems.

### Aviation weather services

Until the IGY, Antarctic aviators had very little weather information. The IGY provided a ring of stations around the coasts of Antarctica, with a few inland stations, and also an international arrangement for sharing weather observations (there was an “Antarctic Weather Central” during the IGY). There are now a few more stations, but the distribution is hopelessly inadequate for the preparation of detailed weather maps covering an entire continent. Because uncertain forecasts have to err on the side of caution, valuable flying time is lost to

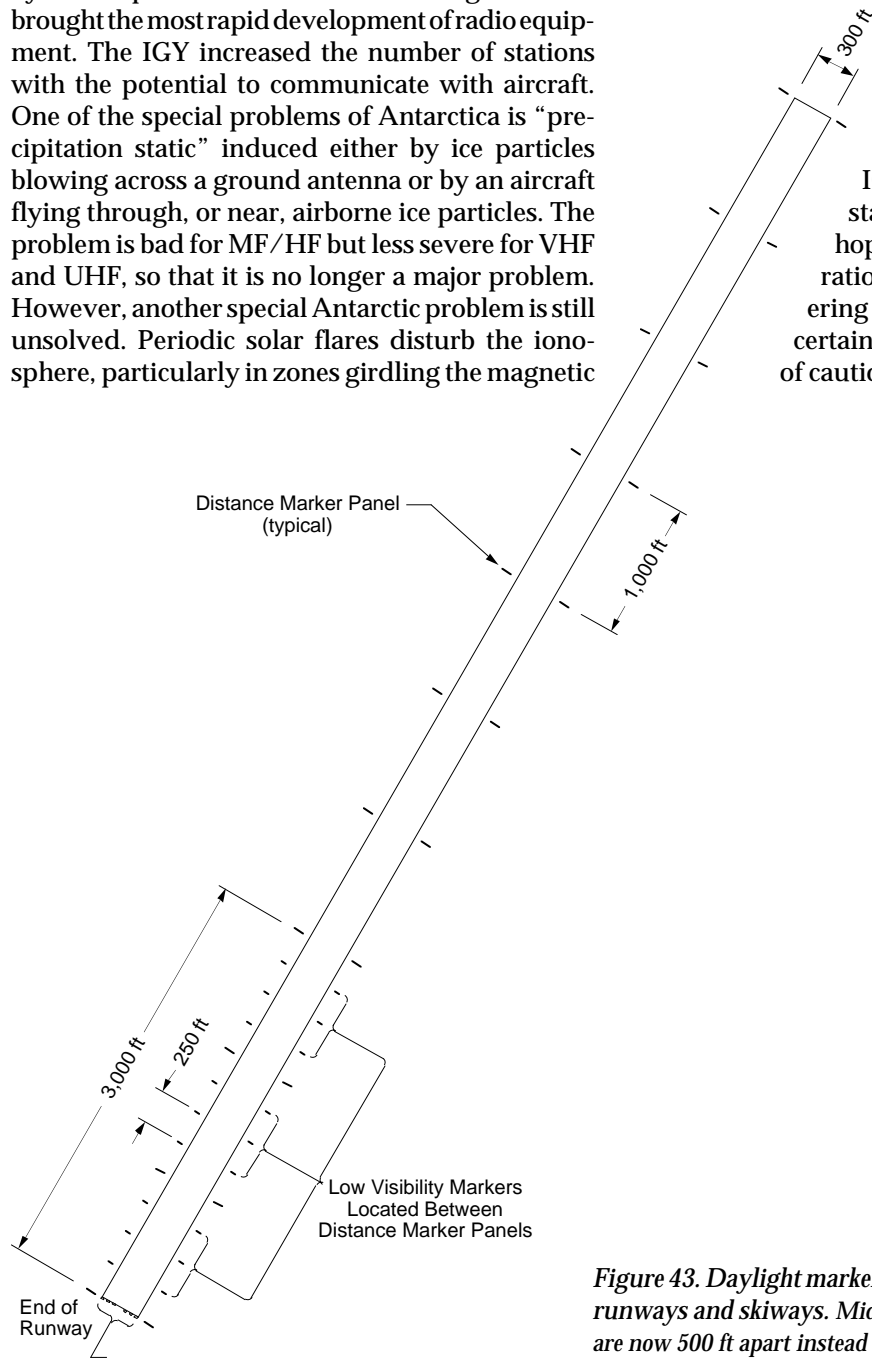
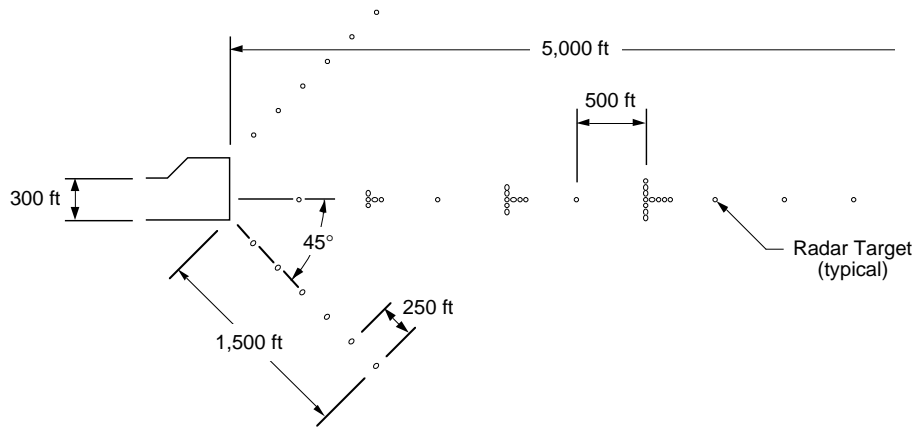
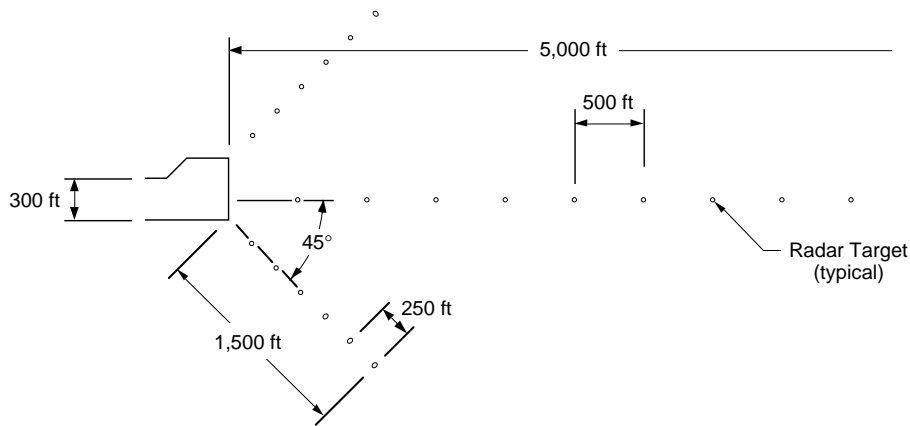

Figure 43. Daylight markers installed on major U.S. Antarctic runways and skiways. Midsection markers at South Pole Station are now 500 ft apart instead of 1000 ft. Closely spaced mesh panels have been added at Williams Field.



a. Williams Field.



b. South Pole Station.

*Figure 44. Arrangement of radar targets set out as approach aids at Williams Field and South Pole skiways. Originally these targets were empty fuel drums. Now buried, the drums have been replaced by reflective mesh markers at Williams Field. As yet there is no replacement at South Pole, but the wreck of LC-130 XD317, about one mile off the end of the skiway, makes a good approach marker for 02.*

predicted bad weather that never develops. However, unmanned automatic weather stations, first tried after the IGY, now perform and transmit quite reliably. As the network of installations expands, weather maps and terminal forecasts should improve. Perhaps the most important single piece of data is surface pressure, although temperature serves almost as well at inland sites. AWS installations (Fig. 46) are currently concentrated around the Peninsula and in the sector between 170°W and 120°E.

Weather satellites with real-time downlinks direct to Antarctic stations are now an enormous help, giving information on cloud cover, cloud temperature, movement of systems, estimates of

upper winds and, in some circumstances, surface winds.

The weather forecasting services of Australia, New Zealand, Chile, Argentina and South Africa receive some data from Antarctica and the sub-Antarctic islands and try to extend their standard synoptic charts as far south as possible by international agreement. With the widespread availability of satellite communication and facsimile services, Antarctic weather charts can be integrated with those for the outside world. Ship reports and transmissions from data buoys in the southern ocean are helpful.

The U.S. Navy maintains Antarctic weather offices in Christchurch and at McMurdo. South Pole

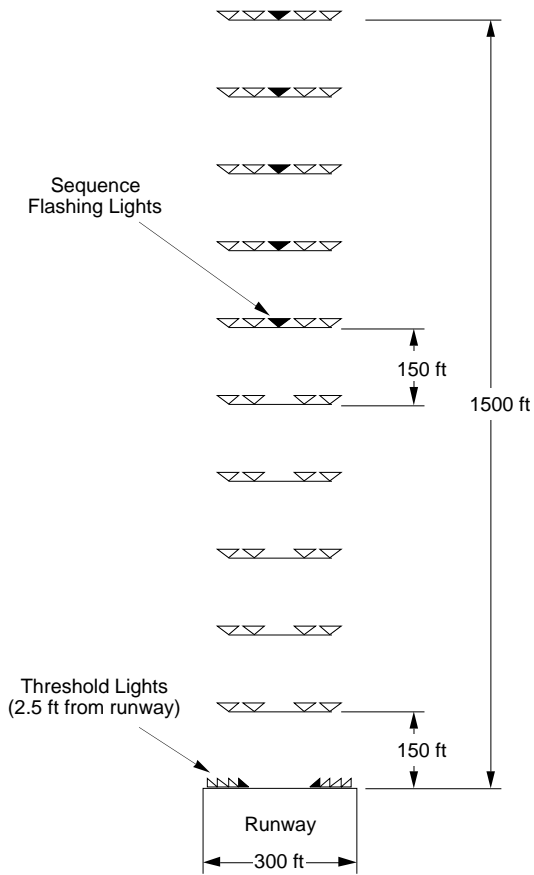

Figure 45. Expeditionary Approach Lighting System, as installed on the primary runways at McMurdo.

Station has good observing facilities but no forecasters.

Future progress in forecasting probably depends on more observing stations and on a better understanding of the dynamics of the Antarctic atmosphere.

## FLIGHTS TO AND FROM ANTARCTICA

### Departure points

For practical purposes, all flights to Antarctica must depart from a country in the southern hemisphere or from a far-south island (Fig. 47). Given the need to marshal passengers and freight and to service equipment, northern hemisphere countries need a "forward base" in a far-south host country.

The southern extremities of Africa, Australia, New Zealand and South America are obvious departure points (Table 1). South America extends farther south than any other major land mass, while the Antarctic Peninsula, at much the same longitude, extends farther north than any other part of Antarctica. The shortest air routes are thus such legs as Punta Arenas to Marsh (660 nautical miles), Ushuaia to Marambio (also 660 nautical miles) or Falkland Islands to Marsh (648 nautical miles). However, terminal weather in the Peninsula can be very unfavorable. The least favorable

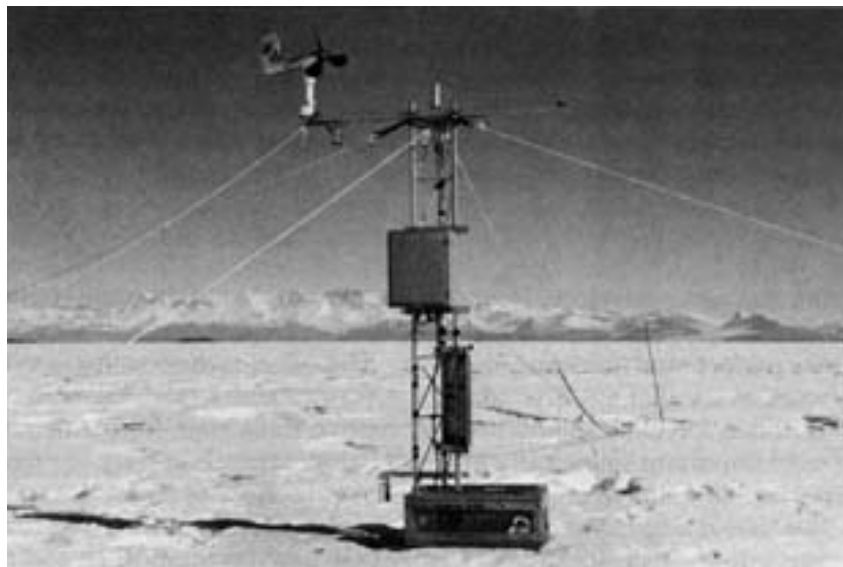

Figure 46. Automatic weather station at the Pegasus site. The basic AWS measures barometric pressure, air temperature, relative humidity, wind speed and wind direction at a height that is initially 3 m. Newer versions may include an extra temperature measurement at 0.5 m and snow temperatures 1 and 3 m below the surface. A new AWS at the south end of the Pegasus runway measures ice temperatures at depths of 0, 0.5, 0.10, 0.20, 0.40, 0.80 and 1.6 m. (Photo by M. Mellor, 23 January 1990.)

**Table 1. Potential Antarctic departure points (arranged in order of decreasing latitude).**

Departure point	Approximate coordinates	Longest runway ft (m)	Route possibilities*	Approximate great circle distances	
				Nautical miles	km
Ushuaia, Argentina	54° 28.8' S	5,299	USH—Marambio	660	1,223
	68° 10.8' W	(1,615)	USH—Patriot Hills	1,570	2,909
Punta Arenas, Chile	53° 00' S	9,153	PUQ—Marsh	660	1,223
	70° 51' W	(2,790)	PUQ—Patriot Hills	1,647	3,052
Mount Pleasant, Falkland Islands	51° 49.4' S	8,497	MPN—Marsh	648	1,201
	58° 26.6' W	(2,590)	MPN—Rothera	1,018	1,886
			MPN—Patriot Hills	1,796	3,328
Rio Gallegos, Argentina	51° 37' S	11,647	RGL—Marambio	857	1,588
	69° 19' W	(3,550)	RGL—Patriot Hills	1,753	3,248
Invercargill, New Zealand	46° 25' S 168° 19' E	5,597 (1,706)	IVC—McMurdo	1,887	3,497
Dunedin, New Zealand	45° 46' S	5,610	DUD—McMurdo	1,927	3,571
	170° 12' E	(1,710)			
Christchurch, New Zealand	43° 29' S	10,790	CHC—McMurdo	2,067	3,830
	172° 32' E	(3,289)	CHC—Dumont d'Urville	1,743	3,230
Hobart (Tas.), Australia	42° 50' S	7,386	HBA—Casey	1,846	3,421
	147° 31' E	(2,251)	HBA—Dumont d'Urville	1,440	2,668
Melbourne (Tullamarine), Australia	37° 40' S	12,000	MEL—Casey	2,078	3,850
	144° 51' E	(3,657)	MEL—Dumont d'Urville	1,744	3,232
Cape Town, South Africa	33° 33' S	10,502	CPT—Molodezhnaya	2,240	4,151
	18° 13.2 E	(3,201)	CPT—Mawson	2,552	4,729
Perth (WA), Australia	31° 56' S	11,300	PER—Casey	2,070	3,836
	115° 58' E	(3,444)	PER—Davis	2,553	4,731
			PER—Mawson	2,814	5,215
Maputo (formerly Lourenço Marques), Mozambique	25°55' S 32° 34' E	11,910 (3,630)	MPM—Molodezhnaya	2,573	4,768

\*Standard airport codes are used for commercial airports. In the USAP, Christchurch is ZCH, McMurdo is ZCM, South Pole is NPX, Byrd is NBY and Mill Glacier (Plunket Point) is MGZ.

land mass in terms of distance is southern Africa; Maputo to Molodezhnaya is 2573 nautical miles, with Cape Town to Molodezhnaya a bit shorter at 2240 nautical miles.

New Zealand was the first place to be used for regular flights to Antarctica, and Christchurch (Fig. 48) still handles the bulk of the traffic. Christchurch to McMurdo is quite a long flight (2067 nautical miles); Invercargill is a bit closer (1887 nautical miles), but it has a shorter runway and less favorable weather. Christchurch to Dumont d'Urville is a shorter trip at 1743 nautical miles.

Australia is probably the best departure place for East Antarctica. Hobart is the closest airport, 1440 nautical miles from Dumont d'Urville and 1846 nautical miles from Casey. Melbourne (Tullamarine) is further away but has a longer runway; the distances from Dumont d'Urville and Casey are 1744 and 2078 nautical miles, respectively. Perth is not ideally situated, being quite far north, but Perth–Casey is only the same distance as Christchurch–McMurdo (or Melbourne–Casey).

The big gap south of the Indian Ocean can be narrowed by airfields on sub-Antarctic islands.



Figure 47. Location of Antarctica relative to surrounding land masses.

Runways are technically feasible for Marion Island (South Africa) and Iles Kerguelen (France).

#### Ports of entry in Antarctica

Aviation seems to have been an afterthought in the siting of many major Antarctic bases (Fig. 2). In the Peninsula, Marambio and Marsh were clearly well chosen from an aviation standpoint, and the attraction of efficient air service is evidenced by the profusion of stations that have grown up on King George Island. By contrast, Palmer is poorly situated for access by air, either from the outside or from McMurdo. A long skiway or conventional runway or both can be built nearby, but the sites are logistically unattractive. McMurdo Station is on a site chosen by Scott as a far-south seaport. It is still a good seaport but not at all favorable for airport construction.

There are now only two conventional runways offering all-season access, both of them (Marsh and Marambio) at the tip of the Peninsula (Table 2). There will soon be two more rock-fill runways, Rothera (also on the Peninsula) and Dumont d'Urville. However, both of these are short strips, 3000 ft (915 m) and 3600 ft (1100 m) long, respectively.

Apart from McMurdo the runway built by Chile near Teniente Rodolfo Marsh base is the nearest thing to an Antarctic international airport, handling military and civil aircraft of various nationalities on a regular basis. It is a gravel strip, 4300 ft (1300 m) long, with runway lights, VASI, VOR/DME and NDB. The field elevation is 135 ft (41 m), and the approaches are unobstructed. The field has firefighting equipment, bulk Jet A1, a maintenance hangar and meteorological services.

AIRPORT DIAGRAM

AFD-3339

CHRISTCHURCH INTL (NZCH)  
CHRISTCHURCH, NEW ZEALAND

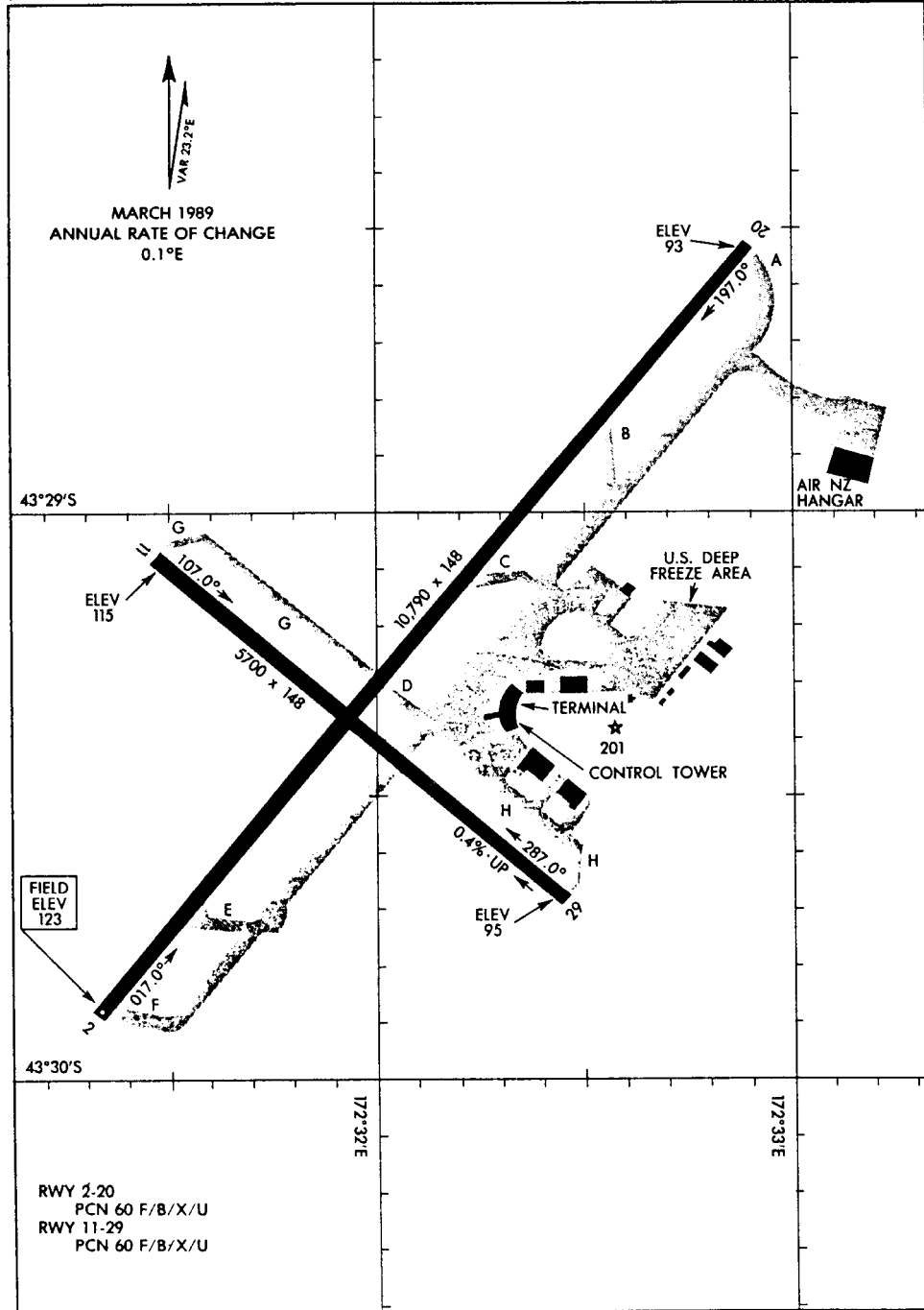

AIRPORT DIAGRAM

WGS DATUM

CHRISTCHURCH, NEW ZEALAND  
CHRISTCHURCH INTL (NZCH)

Figure 48. Airport at Christchurch, New Zealand; an advance base for the USAP. Christchurch International (Harewood) has a long runway and generally good weather. It is within reasonable range of McMurdo and Dumont d'Urville. There are commercial facilities for servicing aircraft, and the USAP maintains a hangar and facilities for its aircraft. A large Antarctic Center adjacent to the airport opened in 1990. Among numerous other functions, it houses the USAP passenger terminal and clothing distribution center.

**Table 2. Antarctic airfields. These runways ( $\geq 1$  km) now exist or are under construction.**

<i>Location</i>	<i>Type of runway</i>	<i>Coordinates (approx.)</i>	<i>Approx. field elevation</i>	<i>Longest runway</i>
Marambio	gravel	64° 14' S 56° 36' W	≈ 650 ft ≈ 200 m	4,134 ft 1,260 m
Marsh	gravel	62° 11' S 58° 57' W	135 ft 41 m	4,282 ft 1,305 m
Rothera	gravel	67° 34' S 68° 07' W	near sea level	3,000 ft 915 m
Dumont d'Urville	asphalt paving over gravel	66° 40' S 140° 01' E	≈ 16 ft ≈ 5 m	3,600 ft 1,100 m
McMurdo	(A) annual sea ice	77° 52' S 167° 08' E	(A) sea level	(A) 10,000 ft 3,000 m
	(B) groomed snow skiway		(B) 139 ft(?) 42 m (?)	(B) 10,000 ft 3,000 m
	(C) experimental, snow over glacier ice		(C) 20 ft 6 m	(C) 12,000 ft 3,660 m
Molodezhnaya	compacted snow	67° 40' S 45° 50' E	810 ft 247 m	9,200 ft 2,800 m
Casey	snow compacted over ice	66° 17' S 110° 42' E	≈ 860 ft ≈ 260 m	8,000 ft 2,440 m
Patriot Hills	natural blue ice	80° 19' S	2,500 ft(?)	11,200 ft
		81° 16' W	750 m (?)	3,410 m
Novolazarevskaya	compacted snow over ice	70° 46' S 11° 50' E		9,060 ft 2,760 m
South Pole	groomed snow skiway	90° 00' S — —	9,300 ft 2,835 m	14,000 ft 4,270 m
Vostok	compacted snow	78° 28' S 106° 48' E	12,800 ft 3,900 m	9,840 ft 3,000 m
Mill Glacier	natural blue ice	85° 06' S 167° 15' E	5,900 ft 1,800 m	≈ 24,000 ft ≈ 7,300 m
Mount Howe	natural blue ice	87° 20' S 149° 50' W	7,900 ft 2,400 m	≈ 22,600 ft ≈ 6,900 m
Rosser Ridge	natural blue ice	82° 46' S 53° 40' W	2,600 ft 800 m	≈ 7,900 ft ≈ 2,400 m
Mt. Lechner	natural blue ice	83° 15' S 51° 14' W	4,600 ft 1,400 m	≈ 9,800 ft ≈ 3,000 m

McMurdo carries most of the air traffic into Antarctica. It has a skiway (Williams Field) that can be opened for use by ski-wheel LC-130s at almost any time of year, provided there is suitable weather. Regular winter flights are made in August. Williams Field, which also has a crosswind skiway, cannot be used by conventional aircraft. A runway for wheeled aircraft is prepared on first-year sea ice each year in September. Flights in by conventional

transports (C-130, C-141 and, recently, C-5) are made in October and November, and the runway closes because of summer deterioration in mid-December. Normal operations by the heaviest aircraft cease in mid-November. An experimental wheel runway was being developed nearby on the Ross Ice Shelf in 1989-90 and 1990-91. McMurdo has PAR/ASR and TACAN and a full-time weather forecasting service. Flight-following service is provided by Auckland Radio north of 60°S and by MAC Center (in McMurdo) south of 60°S. Bulk fuel (previously JP-4, soon to be all JP-8) is delivered annually by a tanker, being distributed from large storage tanks to the various runways by expedient pipelines. Emergency services are available during air operations, with a trained crash crew and firefighting equipment on relatively fast tracked vehicles. There is a significant maintenance capability, but major scheduled maintenance is carried out in Christchurch. There is no emergency alternate for McMurdo in Antarctica; when the weather deteriorates, incoming flights return to New Zealand.

Molodezhnaya is the Russian port of entry, having a 9200-ft (2800-m) wheel runway of compacted snow 20 km east of the main station. The runway is maintained year-round but closed from mid-December until 1 February because the snow becomes too soft. The normal operating season is September to early December and early February until mid-March. The strip has been used successfully by Il-18D and Il-76TD aircraft. Russian transports tend to be well adapted for soft-field and rough-field operation. The Il-76, comparable in size and configuration to the C-141

(the 76TD is 30% heavier than the 141 at MTW), has MLG inflation pressures varying from 36 to 73 lbf/in.<sup>2</sup> (2.5 to 5 bar), whereas the C-141 MLG, with half as many wheels, has a normal inflation pressure of 180 lbf/in.<sup>2</sup> (12.4 bar) or more. The Il-18 has an inflation pressure of 114 lbf/in.<sup>2</sup> (7.9 bar), about the same as the C-5. Molodezhnaya has simple landing aids, weather forecasts, emergency services and fuel.



The alternate for Molodezhnaya is Novolazarevskaya, which has a 9100-ft (2760-m) runway of compacted snow and bare glacier ice. It is not regarded as a good runway.

An 8000-ft (2440-m) experimental wheel runway was prepared near Casey in 1989-90. It was built in a coastal ablation area that apparently has exposed blue ice, meltwater ice ("superimposed ice") and snow containing ice lenses. The intention was to fly standard C-130s from Hobart, probably early and late in the summer season. If it operates, the field is expected to have TACAN, a limited supply of Jet A1 and some firefighting equipment.

The only port of entry that is not on the coast is Patriot Hills, located in the Ellsworth Mountains, 1647 nautical miles from Punta Arenas, 1570 nautical miles from Ushuaia and 1796 nautical miles from the Falklands. This is a natural blue-ice area, with up to 11,200 ft (3,410 m) available for wheeled aircraft in the normal crosswind direction and 5800 ft (1770 m) in a direction close to the prevailing wind. Wheeled aircraft using the field have included a DC-4 and a DC-6. Summer camps have been maintained by Adventure Network International (ANI), but there is no permanent year-round settlement at the site. As far as is known, the field has no facilities, and fuel has to be flown in.

#### **Aircraft in current use**

On the most heavily traveled route, Christchurch to McMurdo, most of the scheduled flights are made by C-130s, either standard C-130s of 40 Squadron, RNZAF, or LC-130s owned by NSF and operated by VXE-6, USN. In recent years the NSF fleet of LC-130s (F and R models) has been supplemented for part of the season by newer LC-130H aircraft of the 109th TAG, New York Air National Guard (NYANG). The standard "Kiwi Hercs" operate in October, November and early December, when the sea ice runway is in service (12 flights in 1989, 14 in 1990). The LC-130s operate the route when only the skiway is available at McMurdo. Whenever possible, the LC-130 makes wheel take-offs from the sea ice runway, as this permits it to lift about 8000 lb (3600 kg) of extra cargo and fuel. Standard C-130s from 36 Squadron, RAAF, and from the Italian Air Force occasionally fly to McMurdo (five RAAF and three Italian flights in 1989; four Italian flights in 1990). For the C-130 the flight duration for the 2060-nautical-mile trip to or from McMurdo is typically just over eight hours, depending on winds (the theoretical "no-wind" time is 7 hours, 50 minutes).

In October and early November there are scheduled flights by C-141s between Christchurch and

McMurdo (18 in 1990; the number has been as high as 27 in a single season). These are standard wheeled aircraft from the USAF Military Airlift Command (MAC) that land on the sea ice runway. The C-141 can carry heavier and longer payloads than the C-130, and it is faster (430-knot long-range cruise), typically making the journey in about 5.3 hours. The aircraft flies down, refuels and returns to Christchurch the same day. By reducing the payload the C-141 can fly to McMurdo and, if the weather there is below minimums, return to Christchurch without landing ("PSR overhead").

Two trips to McMurdo were made by the C-5, the largest U.S. military transport, in October 1989, and three flights were made in early October 1990.

Standard C-130s may be used by Australia between Hobart and Casey, and by France between Hobart and Dumont d'Urville. The original choice for the run to Dumont d'Urville was the Transall C-160, but this was changed, apparently on the basis of cost considerations (being a short-range aeroplane, it is not an ideal choice for trans-ocean flights).

Soviet flights between Maputo and Molodezhnaya were made first with the Il-18D, then also with the Il-76TD. The D denotes long-range capability ("dal'nii"), a useful attribute on a flight of 2570 nautical miles with no real alternate. The aircraft are owned and operated by Aeroflot, through a charter arrangement with the Ministry of Civil Aviation.

In the Peninsula, standard C-130s are used by the Argentine and Chilean air forces for flights to Seymour Island (Marambio) and King George Island (Marsh). The USAF has flown C-130s from Punta Arenas to Marsh and taken the C-5 as far as Punta Arenas. ANI has flown from Punta Arenas to Marsh and Patriot Hills with a DC-4 and, more recently, a DC-6. These old piston-engine aircraft are not chosen for their technical attributes but because they are inexpensive. The British Antarctic Survey (BAS) has acquired a DHC-7 (Dash 7), which is to have ski-wheel modification, both for internal flights and for passenger and cargo flights between the Falklands and Rothera (with skis, the gear will not be retractable). Over the last 20 years or so, ski-wheel DHC-6s and other ski-wheel expedition aircraft have been ferried with long-range tanks and light payloads between South America and the Peninsula. In October 1990 a DHC-6 was carried to McMurdo in the C-5. German Dornier 228s are also ferried to Antarctica via the Peninsula.

#### **TYPES OF ANTARCTIC AIRFIELDS**

The following notes are summarized in Table 3.

**Table 3. Airfield options for Antarctica.  
Part A: Construction and maintenance.**

<i>Type of airfield</i>	<i>Site characteristics</i>	<i>Construction method</i>	<i>Maintenance</i>	<i>Examples</i>	<i>Environmental impact of construction and maintenance</i>
Unprepared open field.	Any deep and level snowfield or snow cover, provided roughness is not extreme.	None required.	None.	Throughout Antarctica.	None.
Groomed skiways.	Any deep and level snowfield or snow cover.	Grading, dragging, chaining to smooth the surface. Compaction in soft-snow areas. Runway markers.	Periodic repeats of initial procedures—at least annually.	Full-time summer operation, regular maintenance: Williams Field (10,000 ft), South Pole (14,000 ft). Irregular operation, occasional maintenance: Palmer (5,000 ft), Byrd (10,000), Neumayer (3,300 ft), Rothera, Fossil Bluff, Arturo Prat, Carvajal.	Insignificant at temporary skiways if all markers and materials removed. Potential for irretrievable liquid spills at permanent skiways. All visible evidence soon disappears.
Compacted snow runways (deep snow).	Deep perennial snowfield that is level and has low accumulation rate. Summer temperature approaching 0°C desirable.	Summer compaction at sites where snow becomes cohesive without suffering excessive ablation. No fully acceptable methods for construction on cold, dry snow.	Conversion of annual accumulation to hard pavement.	Molodezhnaya (9,200 ft)	Compaction process per se is innocuous. Potential for irretrievable liquid spills. All visible evidence soon disappears.
Compacted snow on hard ice.	Transition zone between accumulation and ablation areas (crevasse-free). Snow cover on sea ice.	Depending on site conditions: (a) Bulldozing to plane ice surface and mix snow. (b) Spreading snow uniformly. (c) Compacting and grading. (d) Surface grooming.	Annual re-grading. Periodic surface grooming.	Novolazarevskaya (9,100 ft) Pegasus Site, McMurdo (12,000 ft, experimental). Casey (8,000 ft, experimental).	Solids remain at, or near, surface. Liquids mix with surface snow layer. Melt pits can form. Cleanup relatively easy. Accumulation or ablation restores cleaned site to original condition.
Snow-free glacier ice (blue ice).	Smooth, level areas of net ablation, usually kept free of snow by cold local winds.	None required at the best sites. Minor planing to remove scattered bumps at some sites.	None required at ideal sites. Annual removal of scattered snow patches at some sites.	Patriot Hills (11,200 ft), Mill Glacier (24,000 ft), Mt. Howe (22,600 ft) (to be developed). Mt. Lechner (9,800 ft), Rosser Ridge (7,900 ft). Potential sites near Mawson (16,000 ft), near Mt. Cresswell, and in the Fimbulheimen and Sør-Rondane Mts. (10,000 ft).	All solids remain on surface. Non-volatile liquid contaminants disperse but remain on surface. Melt pits can be formed. All disturbance and contamination easy to clean up. Evaporation then restores site to pristine condition.
First-year sea ice.	Undisturbed, land-fast annual sea ice.	Snow plowing. Grading and grooming of thin snow cover desirable.	Periodic snow removal. Frequent ice thickness measurements for safety checks.	McMurdo (10,000)—early Oct to mid-Dec. Syowa (3,300 ft)—operated Jan. only.	All evidence of site occupation removed by ice breakup. Solid materials and wastes left on the ice undergo uncontrolled “dumping at sea.” Cleanup inhibited by hasty evacuation at end of season. Site usually evacuated before seals appear.

**Table 3 (cont'd)  
Part A. (cont'd).**

<i>Type of airfield</i>	<i>Site characteristics</i>	<i>Construction method</i>	<i>Maintenance</i>	<i>Examples</i>	<i>Environmental impact of construction and maintenance</i>
Multi-year sea ice.	Land-fast sea ice that is more than one year old (thick, low salinity, relatively rough surface).	Planing to smooth the surface. Snow plowing.	Snow plowing. Annual planing.	None in current use. Past use at McMurdo. Potential site at Bunger Hills.	Soilds and non-volatile liquids remain on surface. Efficient cleanup is feasible. Possible disturbance of seal activity.
Conventional rock-fill runway (paved or unpaved).	Level or gently-rolling ice-free terrain with unobstructed approaches. <i>or</i> Closely-spaced coastal skerries.	Ripping, scraping, drill-and-blast, rock crushing, screening, dumping, grading, paving, drainage.	Minor snow plowing. Maintenance of drainage ditches.	Marsh (4,240 ft). Marambio (4,000 ft). Under construction at Dumont d'Urville (3,600 ft) and Rothera (3,000 ft). Site available for 10,000 ft runway at Marble Point. Potential sites near Palmer (Joubin Islands, 7,350 ft), at Vestfold Hills (10,000 ft) and Bunger Hills (10,000 ft).	Permanent alteration of local landscape and minor alteration of surface drainage. Waste removal necessary but easy. Possible minor effect on bird habitats. Coastal construction unlikely to have adverse long-term effects on seals or penguins.
Rock fill over glacier ice.	Almost stagnant glacier ice with low ablation rate, level surface, and nearby source of rock fill. Alternatively, flat-lying moraine on glacier ice.	Scraping, hauling, dumping, grading. Lateral drainage.	Pothole filling, re-grading, restoration of shoulders. Re-cutting of lateral drainage channels.	None in use or proposed.	Alteration of local landscape—could last for decades after abandonment. Waste removal necessary. Liquid spills could be irretrievable.
Manufactured landing mats.	Flat, level site with low inherent bearing strength (deep snow).	Grading to close tolerances. Hand assembly of panels.	Recovery and re-installation to accommodate snow accumulation.	None in use or proposed.	Runway has no significant permanent impact if all imported materials are eventually removed. Potential for irretrievable liquid spills.

**Part B. Operational considerations.**

<i>Type of airfield</i>	<i>Operational limitations</i>	<i>Merits</i>	<i>Disadvantages</i>	<i>Appropriate aircraft</i>
Unprepared open field.	Special aircraft required. Landings should not be made on very rough snow.	Zero site costs. Wide-spread availability.	Special aircraft needed—very high cost for large aircraft. Can be hazardous.	Robust and relatively slow aircraft with skis. STOL aircraft. Tactical transports.
Groomed skiways.	Special aircraft required. Reduction of takeoff weight when snow is “draggy.”	Low site costs. Wide-spread availability of sites.	Special aircraft needed—very high cost for large aircraft. Takeoff performance reduced.	Ski planes.
Compacted snow runways (deep snow).	Probably limited to aircraft with fairly low tire pressures and low ACN/LCN. At “warm” sites, may not be useable in mid-summer.	Reasonable availability of suitable terrain. Moderate cost at favorable sites.	Borderline technology with little safety factor for bearing strength. Probably not available for all-season operation.	Aircraft with soft, large-diameter tires on wide-spaced multi-wheel assemblies.

**Table 3 (cont'd). Airfield options for Antarctica.  
Part B (cont'd). Operational considerations.**

<i>Type of airfield</i>	<i>Operational limitations</i>	<i>Merits</i>	<i>Disadvantages</i>	<i>Appropriate aircraft</i>
Compacted snow on hard ice.	At "warm" sites, may have to close for wheel traffic in mid-summer.	Low initial cost, low maintenance cost. Very high bearing strength.	Strict discipline needed to avoid dirtying the surface.	Most types of aircraft with tire pressures less than about 200 lbf/in. <sup>2</sup> (< 14 bar).
Snow-free glacier ice (blue ice).	Crosswinds and/or turbulence at some sites.	Negligible cost for development and maintenance of runways.	Windy locations. Dirt or stains on surface cannot be tolerated.	Most types of transport aircraft.
First-year sea ice.	Weight limits set by ice thickness and temperature. Short operating season—late winter to early summer. Long-term parking not available for very heavy aircraft.	Low cost for preparation and maintenance. Widespread availability. Very smooth.	Limited season—cannot be used in mid-summer and autumn. Investment is lost every year. All facilities must be portable.	Any aircraft, provided ice thickness is sufficient. Limit of max. wt. proportional to ice thickness squared. For extremely heavy aircraft (C-5, An-124), no first-year ice thick enough for long-term parking.
Multi-year sea ice.	Shutdown during ablation season. (Might be possible to alleviate or eliminate this problem.)	Stronger, more stable and longer lasting than first-year sea ice. Moderate cost.	Special equipment required for planing. Snowplow berms can accumulate to unacceptable size. Summer shutdown likely.	Any aircraft, provided surface is smoothed and ice thickness is sufficient. Max. allowable wt. proportional to ice thickness squared.
Conventional rock-fill runway (paved or unpaved).	No special limitations for a runway of adequate length and width.	Permanent investment. Safety, familiarity. All-season availability. Permanent facilities and landing aids.	High initial cost. Strong justification needed. Not many sites near existing bases.	Any aircraft if runway is paved and of sufficient length and width. Loose gravel disqualifies some aircraft or necessitates gravel deflectors.
Rock fill over glacier ice.	No special limitations for a runway of adequate length and width.	Similar to conventional runway.	High initial cost. Ill-suited for siting facilities. Not many suitable sites in useful locations.	Any aircraft suitable for operation from gravel.
Manufactured landing mats.	Not known.		Very expensive. Not permanent.	Depends on subgrade strength and shear connection between mat and subgrade (flexure, flexural waves, and "carpet rippling").

*Environmental impact on operations:*

All occupied sites contribute minor air pollution. Air operations give intermittent minor air pollution. Airborne pollutants put trace contaminants into deposited snow, permanently in areas of net accumulation. Possibility of liquid spills from aircraft, ground equipment and fuel storage. Containment and cleanup straightforward on impermeable surfaces but almost impossible after seepage into deep snow or deep, unsaturated gravels/tills/rock fills. Possibility of disturbing birds and mammals at some sites.

### Open-field landings on snow

Ski aircraft can land on unprepared snow surfaces, either the deep snow of the icecap and ice shelves or the snow cover on sea ice. Snow accumulation in Antarctica is usually insufficient for safe ski operations on ice-free rock areas. Wide, flat expanses of snow with unobstructed approaches are typical, so that the two main considerations are the hardness, or bearing capacity, of the snow and the roughness of the surface.

The hardness of the surface snow depends mainly on the density, the temperature and the length of time since the last major snowfall. Density is the most important factor. In windy areas, snowdrifting produces high surface density, typically up to about  $0.4 \text{ Mg/m}^3$  (sometimes up to  $0.45 \text{ Mg/m}^3$ ), which is more than enough to support any aircraft ski without sinkage, but too low for safe operation on wheels. In very calm conditions the density of new snow in a “warm” region can be as low as  $0.1 \text{ Mg/m}^3$ , which will not support any ski without deep sinkage. The typical density range for much of Antarctica gives ample support for skis. In those places where sinkage does occur, the aircraft or a ground vehicle may have to “track out” a takeoff path.

Long-wavelength surface roughness ( $> 100 \text{ m}$ ) is of no great concern to ski aircraft if the amplitude is fairly small. The problem is with the short-wavelength sastrugi and the more widely spaced whaleback dunes. The height and steepness of sastrugi correlates directly with surface windspeed, which in turn is influenced by topography (strong winds are often katabatic, i.e. downslope gravity winds). Whaleback dunes seem to be controlled more by the major storms that bring fresh precipitation. Tolerable limits for surface roughness are still a matter for judgment, although in 1977 Lockheed strongly advocated development of a system for measuring and

analyzing surface roughness on Antarctic snowfields, and CRREL has now developed techniques for roughness analysis. Judgments about surface roughness have often been faulty, sometimes with serious consequences. Pilots who would balk at a few little bumps on a wheel runway will happily crash their skis onto iron-hard sastrugi, which look innocuous from the air. Some instruction on the interrelationship of topography, surface winds and sastrugi would be useful for Antarctic pilots and for the people who assign their missions. Relatively smooth snow can often be found within a few miles of a very rough area, so it seems a pity to wreck an aeroplane by landing at arbitrarily chosen coordinates.

In the USAP, there are weight restrictions for open-field landings (118,000 lb, or 53,500 kg, for the LC-130).

### Groomed skiways on deep snow

Whenever ski aircraft land at a place that is already occupied by a ground party, it is worth preparing and marking a skiway.

Permanent skiways at major bases, such as South Pole Station and Williams Field, have all the attributes of standard runways except for high bearing capacity. Major skiways have standard runway markers and landing aids. Since preparation and maintenance is relatively easy, dimensions can be generous—  $300 \times 10,000 \text{ ft}$  ( $91 \times 3,050 \text{ m}$ ) at Williams Field and  $250 \times 14,000 \text{ ft}$  ( $76 \times 4,270 \text{ m}$ ) at South Pole Station. There is no systematic compaction of the snow, but the surface is made as flat as possible. With good maintenance, takeoff and landing can be very smooth. With poor maintenance and hard snow, landing can feel like a controlled crash.

One maintenance tool is the snowplane, which is really a grader with a long “wheelbase” (Fig. 49). Snowplanes are adapted from the grading planes



a. One of the original post-IGY U.S. Navy 40-ft snowplanes. (Photo by M. Mellor, 1961.)

Figure 49. Types of snowplanes.



*b. Forty-ft (12-m) snowplane working at Williams Field. The machines are operated manually, like simple graders, with on-board hydraulic power to actuate the blade. (Photo by M. Mellor, 1987.)*



*c. Eighty-ft (24-m) snowplane for subduing long-wave bumps. The long “wheelbase” gives inherent stability for fine leveling. The long trusses of this machine were plagued by structural failures in the early years. Some operator skill is required to avoid “bouncing” when the speed is too high or the bite is too deep. (Photo by M. Mellor, November 1990.)*

*Figure 49 (cont'd). Types of snowplanes.*

that are used outside the polar regions for leveling irrigation areas. Skis replace the wheels of the original machine. Snowplanes used by the USAP over the last 35 years have mostly been 40 ft (12 m) long, with one or two 80 ft (24 m) long. The latest snowplanes have a 60-ft (18-m) “wheelbase” with a moldboard that is 14 ft (4.27 m) wide; this has an

automatic height adjustment through a sensing ski and mechanical linkage, but a hydraulic control has been added to permit remote adjustment by the tractor driver. The snowplanes are inherently effective in removing bumps that have wavelengths less than their “wheelbase” lengths, and they can be hand-operated to remove more widely spaced



*d. "Automatic" snowplane, on which the cutting depth of the moldboard is adjusted through mechanical linkages by relative vertical motion in the skis. The blade height is adjusted hydraulically by the tractor driver, so that only one operator is required. More sophisticated automatic levelers were developed by CRREL (Abele 1990), but they were heavy, expensive and perhaps a bit too complicated for reliable operation in polar service. (Photo by M. Mellor, November 1990.)*



*e. Ski-mounted grading plane used at the Molodezhnaya snow runway. The device operates with a fixed blade setting. The skis are the type used on An-2 aircraft. (Photo by M. Mellor, 15 November 1990.)*

*Figure 49 (cont'd).*



*f. Ski-mounted towed grader used by the Soviet Antarctic Expedition. (Photo by M. Mellor, 15 November 1990.)*

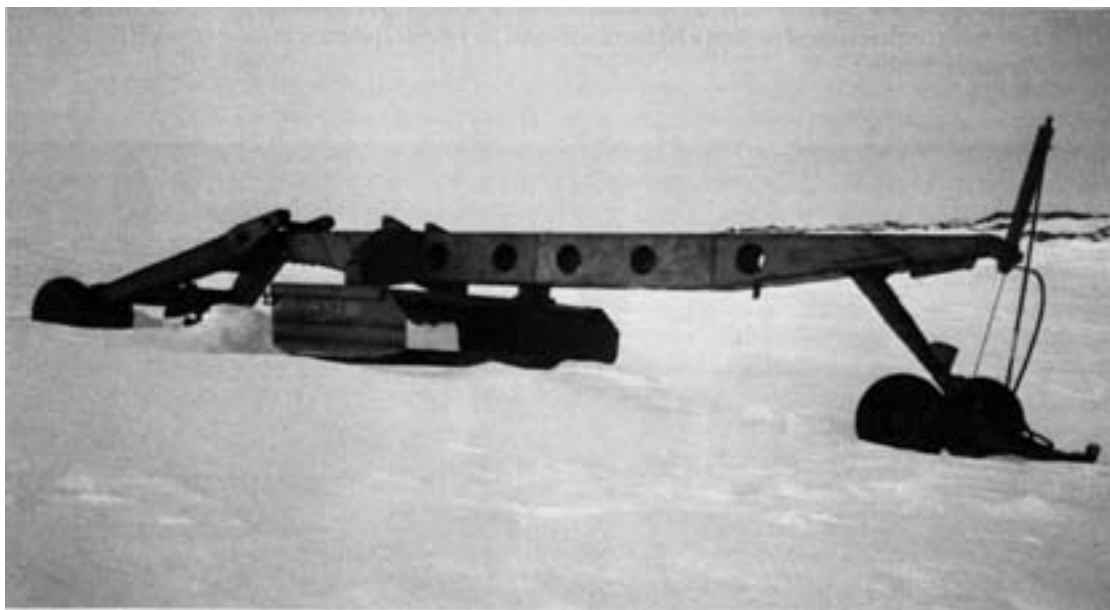

*g. Towed scoop-bucket scraper used by the Soviet Antarctic Expedition. (Photo by M. Mellor, 16 November 1990.)*

*Figure 49 (cont'd). Types of snowplanes.*

bumps. The most critical wavelength for an LC-130 is about 50 ft (15 m).

A large snowplane used by the Soviet Antarctic Expedition has its 13.8-ft (4.2-m) moldboard mounted on a heavy rectangular steel frame, which itself is carried on board aircraft skis with a “wheel-base” of 36 ft (11 m).

Some smoothing can be achieved with a towed steel drag (Fig. 50). A simple drag can be made by welding either a steel frame or a single I-beam between improvised skis. More elaborate drags, with articulation and adjustable moldboard heights, are available. A drag knocks the high points off small bumps and distributes the snow forward and





*Figure 50. Simple drag for grooming skiway surfaces. The main item is a steel I-beam with improvised end skis. It is followed here by a pipe drag. (Photo by M. Mellor, November 1988.)*

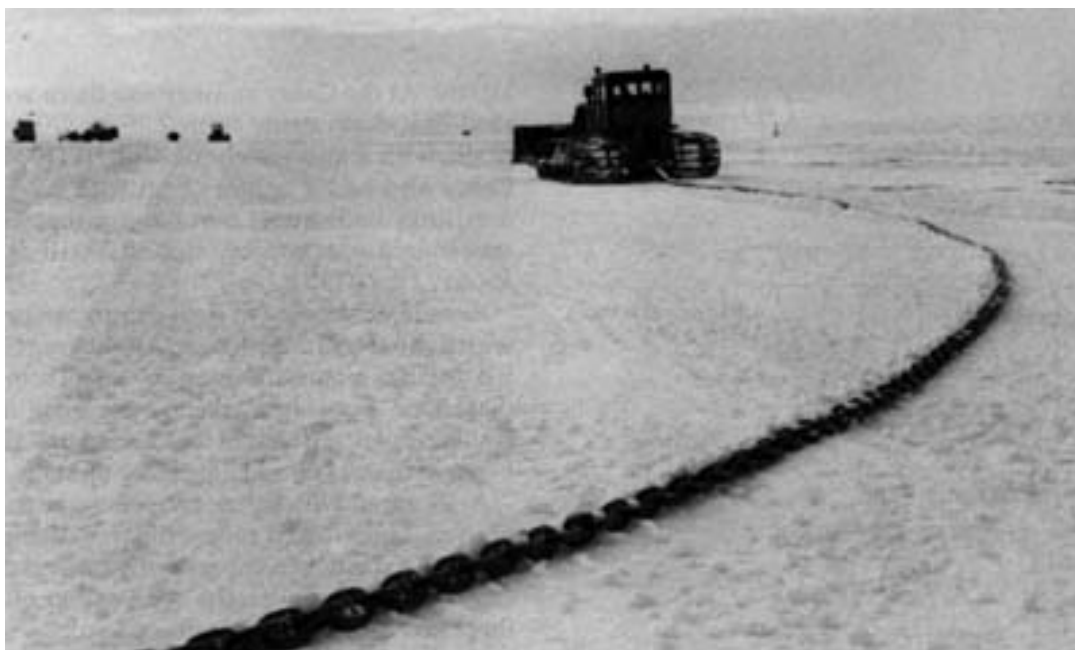

*Figure 51. Heavy anchor chain pulled by a pair of tractors, which is useful for grooming the surface of a skiway or snow runway. Several passes are needed to produce a good finish. (Photo by M. Mellor, February 1990.)*

sideways, but it does not deal with long-wavelength bumps.

A length of heavy anchor chain is effective for final grooming of the snow surface (Fig. 51). Two tractors run along opposite edges of the skiway, towing a chain whose length is greater than the skiway width, so that it trails in a horizontal cat-

enary. As the chain drags along, it breaks up snow clumps, scuffs the surface and puts a fine level finish on the skiway (Fig. 52). Debris tends to transport towards the center of the catenary, but it spills across the chain. The effect can be varied by changing the “sag” of the catenary, i.e., by moving the towing tractors closer together. The chain used



Figure 52. Groomed surface on the South Pole skiway. Planing and chaining makes a lot of difference to the skiway. In November 1988 it was rough, and aircraft took a heavy beating. In recent years the condition has generally been good. (Photo by Wayne Tobiasson, 24 January 1989.)

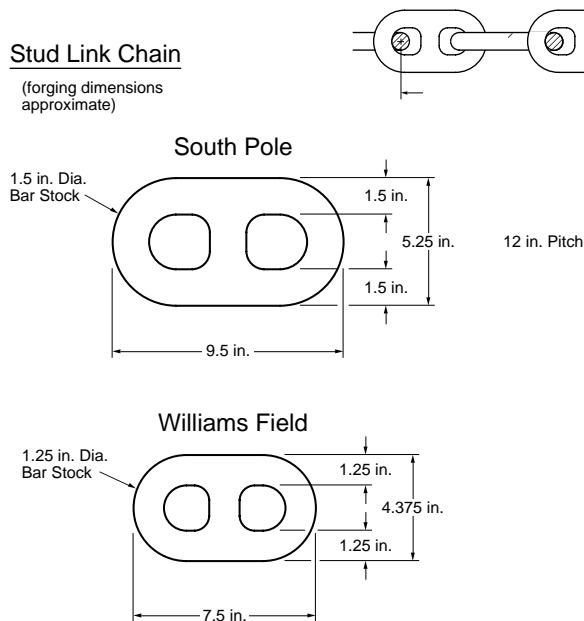

Figure 53. Grooming chains used at South Pole Station and Williams Field.

at South Pole Station (Fig. 53) has 9.5-in. (241-mm) stud-links made from 1.5-in. (38-mm) bar stock and weighing about 24 lb/ft (36 kg/m). The chain used at Williams Field, which seems too light for the job, has 7.5-in. (190-mm) stud-links made from 1.25-in. (32-mm) bar stock and weighing about 16 lb/ft (23

kg/m). At the Casey runway site there was a big stud-link chain made from 2.75-in. (70-mm) bar stock, with a unit weight of 67 lb/ft (100 kg/m). Casey also had a lighter chain with 8.7-in. (220-mm) links made from 1.6-in. (40-mm) bar stock; the unit weight was probably around 2000 lb/shot, i.e. about 22 lb/ft (33 kg/m).

Expedient skiways at field camps are prepared with lightweight vehicles and a light drag (Fig. 54). It is usually a matter of any improvement being better than none. Runway markers, even small flags on bamboo poles, are helpful for locating the skiway in overcast conditions and light blowing snow.

At locations with soft snow, some compaction is needed. Light towed rollers of large diameter are suitable. Expedient compaction by tracked vehicles can be used, and even the compaction of two or three taxi runs by an aircraft is useful.

### Runways on deep snowfields

Most of the Antarctic Ice Sheet, including the ice shelves, is accumulation area. The snow is “semi-infinite,” i.e. the snow depth is very great. It develops only small gradients of density with depth as the snow is slowly buried and transformed to impermeable ice.

### Compaction

In the late fifties and early sixties, major R&D efforts were undertaken in Greenland and Antarc-



*Figure 54. Small articulated drag for grooming snow roads and skiways. (Photo by M. Mellor, January 1991.)*

tica in an attempt to make wheel runways on cold, dry snowfields. The idea was to build a thick pavement of high-density dry snow, allowing it to “age-harden” like concrete. The latter process, technically known as sintering, depends on the progressive formation of intergranular bonds, mainly by temperature-dependent vapor diffusion.

Conventional compaction methods were thought to be fairly ineffective in cohesionless cold snow, so density was increased initially by rotary milling. One method was to comminute the natural snow with a rotary snowplow, using a special back-casting chute to redeposit the particles (Fig. 55). When uniform, equidimensional particles (like clean beach sand) are shaken into their tightest “close-packing” state, the porosity is about 40%, which for snow translates to a bulk density of about  $0.55 \text{ Mg/m}^3$ . This was the practical upper limit of density for milled snow. Comminution by a rotary plow gives small grain size and angularity, in effect making the particles surface-active and amenable to sintering. Sintering is a thermally activated rate process whose temperature dependence can be described by the Arrhenius equation.

An alternative method for processing snow depended on the use of rotary tillers (pulvimixers), which mixed and churned the snow to higher density (Fig. 56). Low-pressure compaction, typi-

cally by bulldozer tracks or by light rollers, was applied to the surface of the milled-snow pavement, but the effective depth of this process is quite small and the density of cold, dry snow cannot be increased much above  $0.55 \text{ Mg/m}^3$  without fracturing or deforming the constituent grains, which requires high pressures (above the limit of typical compaction equipment) and lateral confinement of the snow (to avoid “punching”). Devices for introducing heat or water or both were built, but they were unsuccessful, since it is difficult to make liquid water diffuse uniformly in snow.

The final outcome of the work (reviewed by Abele 1990) was an ability to build runways that had just enough bearing capacity at low air temperatures but no safety factor to accommodate either the inevitable weak spots that result from imperfect quality control or the reduction of strength with high air temperature or strong solar radiation.

In retrospect, it seems that this research may have been too abstract, seeking a way to create a runway from cold, virgin snow at any arbitrarily designated point within a matter of weeks. From an engineering standpoint, it is more realistic to seek favorable construction sites within a broadly designated area, to undertake construction at favorable times of year, and to allow sufficient time for the job. This was the Soviet approach. In the vicin-



*a. Peter snow miller adapted for runway processing on the Greenland Ice Cap. With the rotor running at high speed and the machine traveling slowly, the snow is milled to fine grain size. The grains deposit with relatively high initial density, and intergranular bonds form by vapor diffusion as very fine particles and sharp corners evaporate. (USA SIPRE photo.)*

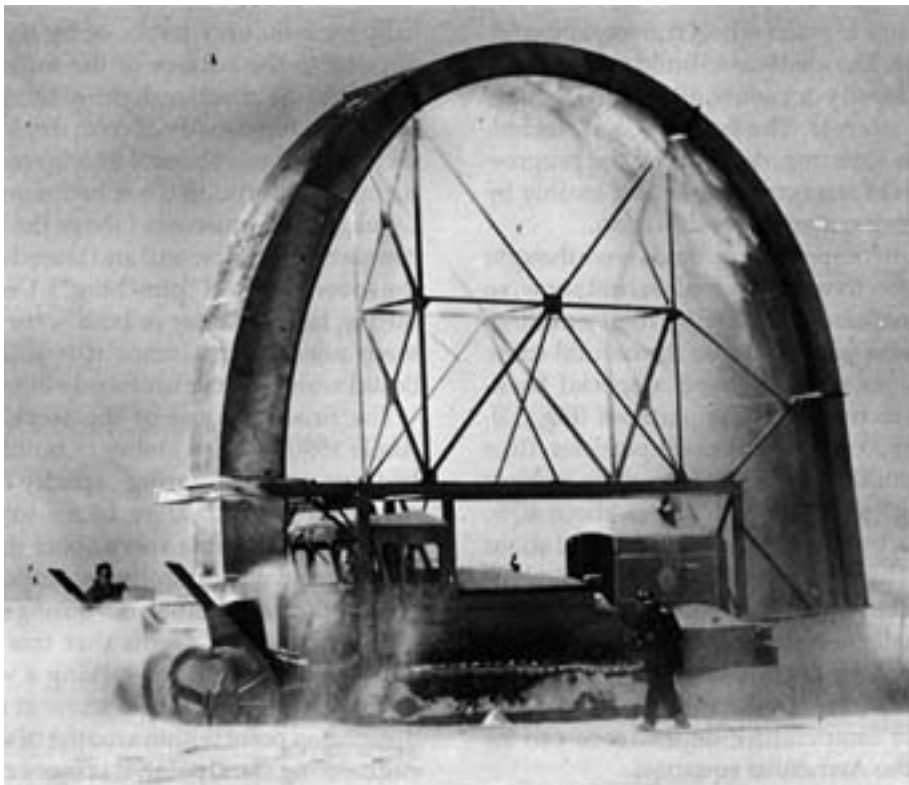

*b. Snowblast fitted with a large back-casting chute (USA SIPRE photo.)*

*Figure 55. Rotary snowplows.*



Figure 56. U.S. Navy (NCEL) pulverizing mixer towed by small bulldozer. This was experimental construction on the Ross Ice Shelf between McMurdo Station and White Island. (Photo by M. Mellor, 1961.)

ity of Molodezhnaya, snow conditions were assessed, primarily as a function of surface elevation, so as to build in an area that had a moderate accumulation rate ( $< 0.5$  m/yr) and was warm enough to give the snow some moisture and cohesion in summer but not so warm that ablation destroys the snow pavement. The present runway is the second of its type. The site is about twice as far from Molodezhnaya as the first runway was.

Having selected a favorable site, Russian engineers first level the surface, then mix and pulverize the snow with disc harrows (referred to as rippers). To prepare a strong foundation, the first snow compaction takes place in December and January when the snow is moist. In the early stages of compaction it is preferable to use rollers with fairly soft tires and light ballast (Fig. 57). For the first runway the roller weighed 9–11 tons (8–10 tonne) and the initial tire pressure was 29 lbf/in.<sup>2</sup> (0.2 MPa). For the second runway the rollers were initially ballasted to 11–17 tons (10–15 tonne), with a tire pressure of 58–87 lbf/in.<sup>2</sup> (0.4–0.6 MPa).

The second stage of construction proceeds through the winter, from February to November. After every snowfall or episode of snowdrifting, the snow is first distributed and leveled by grading and then compacted by rollers. The third stage is carried out during the following summer (December–January), when moist snow is compacted by rollers into a strong pavement. For the third stage of construction, rollers are ballasted to 28–44 tons (25–40 tonne), with a tire pressure of 87 lbf/in.<sup>2</sup> (0.6 MPa). This annual cycle of operations is sustained throughout the life of the runway, producing a runway structure of ever-increasing thickness. The

annual accumulation rate at the present site is believed to be about 1 ft/yr (0.3 m/yr). At present, there are three compaction rollers ballasted to 19 tons (17.2 tonne) each, and one is ballasted to 33 tons (30 tonne), all with tire pressures of 87 lbf/in.<sup>2</sup> (0.6 MPa). Each rolling operation is both preceded and followed by grading.

One of the most important items of equipment is the test cart, or proof roller, which can be used both for verification and final compaction. A rectangular steel frame, with a load deck for ballast, is mounted on a complete set of Ilyushin Il-18 mainwheels. These are inflated to a pressure of 116–130 lbf/in.<sup>2</sup> (0.8–0.9 MPa), which is a bit above standard inflation pressure for the aircraft (114 lbf/in.<sup>2</sup>, or 0.79 MPa). The cart is ballasted to 71 tons (64 tonne), the maximum takeoff weight of the Il-18D. Although the runway is used also by the larger and heavier Ilyushin Il-76TD (MTW 209 tons, or 190 tonne), the smaller aircraft has the controlling requirements, provided that the pavement is thick enough. The Il-76TD has 16 mainwheels, each 51 in. (1.3 m) in diameter, with an inflation pressure of 36–73 lbf/in.<sup>2</sup> (0.25–0.5 MPa).

Experimental construction of a snow runway was carried out in 1983–84 on the Law Dome, near the Australian Casey Station. The site, called Lanyon Junction, is at an altitude of about 1500 ft (470 m), just inside the zone where there is positive net accumulation every year. The average accumulation rate is about 10 g/cm<sup>2</sup>, or 10 cm of water equivalent. New drift snow at the site has a density of about 0.42 Mg/m<sup>3</sup>. After summer melt, the snow with ice lenses has an average density of 0.48 Mg/m<sup>3</sup>. There is very little ice movement ( $< 10$  m/yr), and



*a. Towed compaction roller used at Molodezhnaya. These pneumatic-tire rollers are ballasted with concrete, some to 17.2 tonne and one to 30 tonne. Each pulls a simple drag. (Photo by M. Mellor, 15 November 1990.)*



*b. Small U.S. compaction roller (a 13-wheel roller with one pair of wheels missing in this photo). Both roller and wheels are believed to be too small for efficient compaction of runway pavements. The wheels of the Delta vehicle make excellent rollers for the snow surface, but they are too lightly loaded to achieve deep compaction. (Photo by M. Mellor, November 1990.)*

*Figure 57. Compaction rollers.*



*c. Sheepfoot roller, which puts high pressure on its teeth, penetrating the snow and achieving compaction at some depth below the surface. It destroys the surface layer in the process. (Photo by M. Mellor, January 1991.)*

*Figure 57(cont'd).*

the average surface slope is about 1.5%. The procedure adopted for the 1983-84 work was broadly similar to the Soviet technique, i.e. rolling and grading. The equipment included two wheel rollers (38 and 20 tonne). Grading was done with a motor grader (with a blade width of 14 ft, or 4.27 m). The main towing vehicle was a Caterpillar D7 with a bulldozer blade. There was also a Schmidt rotary snowplow, which allowed for evaluation of the dry-processing methods developed from U.S. research. The average daily temperatures were  $-3^{\circ}\text{C}$  in December and  $-1^{\circ}\text{C}$  in January, with regular excursions above the freezing point in both months, plus solar radiation to heat the snow surface. With free moisture in the snow, rolling produced densities of  $0.7\text{ Mg/m}^3$ . Tests indicated that the compacted snow was strong enough to support a C-130.

In 1989-90 there was an abortive attempt to build and operate a compacted-snow runway just east of the research site known as S1, i.e. between S1 and the 1983-84 Lanyon Junction site, and some 5 miles (8 km) due east of Casey Station. The site elevation there is about 1000 ft (300 m), and there is both exposed ice and perennial snow cover in the vicinity. The exposed ice, on which a runway for a Twin Otter was prepared in 1988, has been described as "blue ice," i.e. glacier ice formed by snow accumu-

lation. However, it is probably "superimposed ice," formed by meltwater percolating down to an impermeable boundary and refreezing. This material has relatively large and irregular bubbles, which give fairly low density ( $\approx 0.8\text{ Mg/m}^3$ ) and a color that is more grayish than blue. The perennial snow at the site has ice lenses of varying thickness.

The construction procedure was again rolling and grading. There were two multi-wheel rollers (35 and 18 tonne). There was a motor grader and D7G and D5 crawler tractors, plus 977L and 950B loaders. There was also a test cart, or proof roller, that consisted of a load deck carried on a complete set of C-130 mainwheels inflated to  $100\text{ lbf/in.}^2$  (Fig. 58). With its full load of concrete blocks it weighed just over 77 tons (70 tonne). The intention was to build a 10,000-ft runway, but due to equipment problems this was shortened to 8,000 ft.

The runway had an alignment of 09T/27T and a centerline slope approaching 3%. Because of a late start, rollers were used at full ballast and high tire pressure right from the start (instead of compacting progressively by gradually increasing ballast and tire pressure). The rollers had to be towed, the big one by the D7G, and rolling produced deep ruts, up to 0.5 m deep, and a somewhat chaotic appearance on the first pass (Fig. 59). Subsequent



*Figure 58. C-130 test cart on the 1990 snow runway near Casey. (Photo by Bob Sheers, Australian Antarctic Division, February 1990.)*



*Figure 59. Deep ruts made by a heavily ballasted wheel roller after a first pass through moist snow at the 1990 Casey runway site. (Photo by Bob Sheers, Australian Antarctic Division, January 1990.)*

passes gradually improved the surface until, after three or four coverages, the rollers could propel themselves, producing a good surface. The smaller roller (18 tonne) was considered too light for the job, and its wheels were too small. Grading was done by a Caterpillar 14G, which was considered to

be very well suited for the job. It was fitted with wide tires and traction chains, and the blade had a scarifying edge. Laser guidance was not used on this project, but it was felt that it would have been beneficial.

The steep slope (3%) gave a significant variation





*Figure 60. Imprint made in the snow runway by C-130 wheels on the Casey test cart. (Photo by Bob Sheers, Australian Antarctic Division, February 1990.)*

of snow conditions over the length of the runway. At the low end the natural snow had thick ice lenses, with relatively strong sublayers. At the high end the annual net accumulation was greater, the ice layers were thin and widely spaced, and the sublayers were weak. The required compaction effort was greater at the high end, and the last thousand-foot section was dubbed the “horror section.” Nevertheless, one conclusion was that the entire runway should be shifted slightly east (i.e. uphill) to get more stable ground conditions.

When the fully ballasted test cart was towed over the runway, those sections that had received the full compaction treatment showed only light tire prints (Fig. 60). On partially prepared areas there was some sinkage, up to 4.5 in. (10–12 cm) in places.

Construction terminated after heavy snowfall in early February. The project was under-staffed and under-equipped for concurrent work on snow removal and construction, making it almost impossible to meet the schedule for a test flight in late February.

If reliable wheel runways are to be built on deep snow in the cold interior, special tricks will be needed. Soviet efforts to make a wheel runway at Vostok have been maintained over a long period, but, although one wheel landing has been made by the An-74, there is not yet a reliable pavement. “High-tech” approaches are technically possible

but probably not attractive at this stage in terms of cost and logistics. For example, we designed a high-pressure compaction machine that squeezes snow into slabs with a density of  $0.65 \text{ Mg/m}^3$ . Straightforward application of established compaction methods may not be capable of producing enough bearing capacity for typical western transport aircraft to operate safely. However, in areas with very low accumulation rates (e.g. the South Pole) it may be possible to build up a pavement over a long period by repeatedly compacting the surface with a special roller (a towed roller with variable ballast and variable tire inflation pressure). The key might be a procedure that keeps the vertical displacement small relative to the roller footprint during each successive pass. Deep sinkage shears cold snow and makes it behave like dry beach sand. By limiting the sinkage, the main deformation occurs in snow that is confined laterally and thus subject to triaxial compression.

For areas with relatively high accumulation rates, compacted snow runways do not seem to be a good idea, since it is necessary to convert the annual accumulation into pavement every year, with the best time for construction coinciding with the peak of the operational season.

Conventional runways have a hard pavement, either a stiff slab of concrete or a compliant (“flexible”) layer of asphaltic “black top.” This pavement

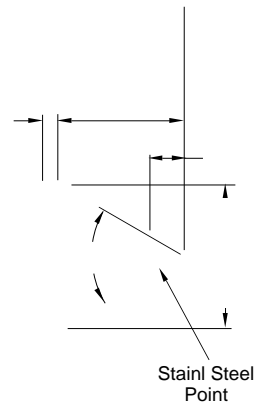
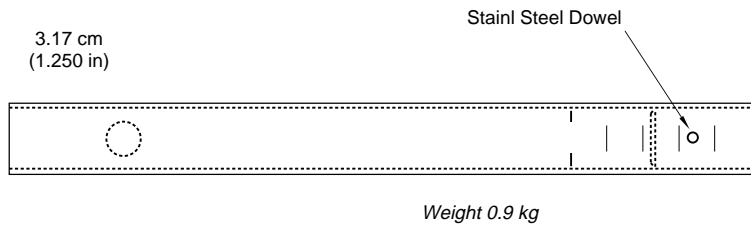
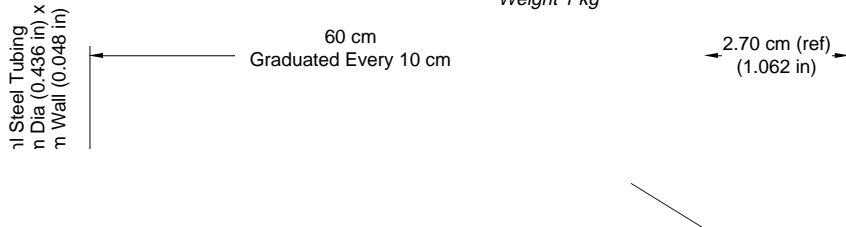
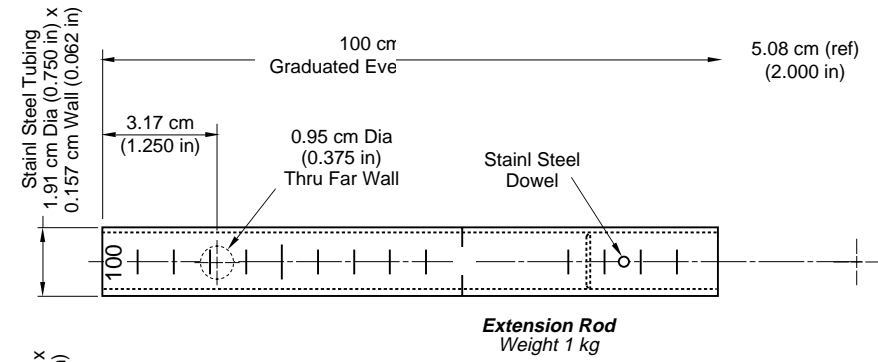

**Ramsonde Penetrometer**

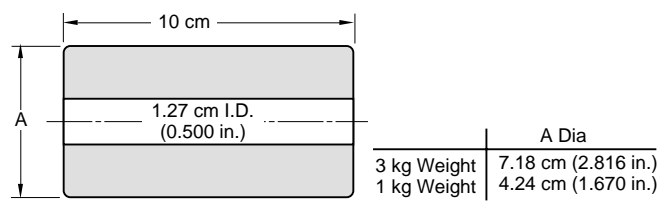

Figure 61. Swiss ramsonde for measuring vertical profiles of snow strength. Readings are often described erroneously as “ram number,” with no units. It actually measures the energy (kgf-cm) to drive a unit distance (cm), giving a result in units of force (kgf). However, since this is applied to the cross-sectional area of the cone, the measurement is actually one of specific energy (energy per unit volume) for penetration. Specific energy correlates directly with compressive strength. The device does not give useful readings until the cone is fully embedded in the snow.

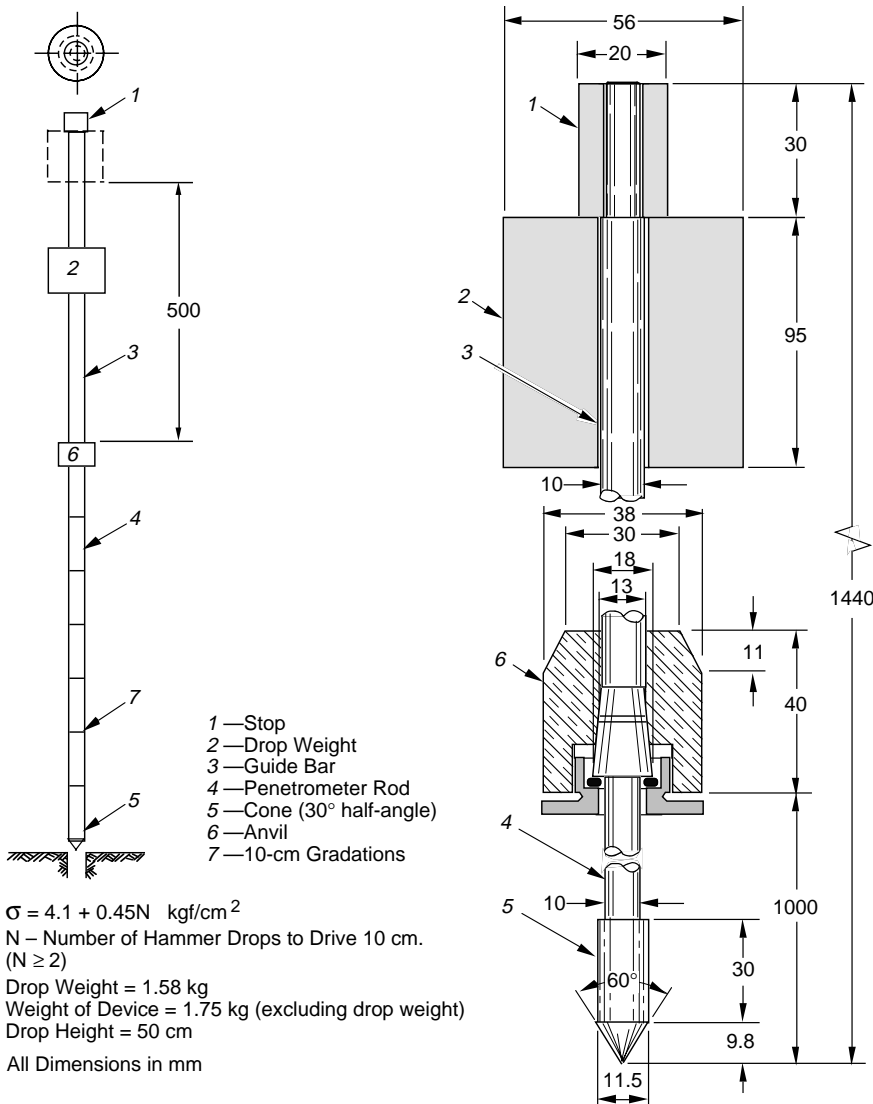

Figure 62. Russian penetrometer for measuring vertical profiles of strength in snow pavements. Measurements made by this device can be compared directly with the criteria in Figure 65. (Drawing provided by Arctic and Antarctic Research Institute, Leningrad, May 1991.)

rests on a compliant foundation, usually natural soil overlain with gravel or crushed stone or both. Conventional design methods are not directly applicable to runways consisting of compacted snow overlying natural snow, although attempts to apply conventional design have been made by Russell-Head and Budd (1989). The usual approach for a snow runway is to specify strength as a function of depth, assuming that failure will occur by punching rather than flexure. Strength, or penetration resistance, can be measured and expressed in various ways, e.g. as uniaxial compressive strength, California Bearing Ratio (CBR) or resistance to cone penetration. Of these, cone penetration is the simplest and most practical measuring method for routine purposes. U.S. and Australian engineers use the Swiss rammsonde in either standard or

modified form (Fig. 61). Russian engineers use a miniature version of a similar device (Fig. 62). A graduated rod with a conical point is driven vertically into the snow by repeatedly dropping a cylindrical weight down a guide rod from a fixed height (like a pile-driving hammer). The energy to drive through a unit vertical distance is either used directly as a “ram number,” or it is converted to equivalent uniaxial compressive strength by an empirical equation.

The required snow strength decreases with depth below the snow surface. In the surface layer, where rutting has to be resisted, it is determined largely by the aircraft tire pressure, the wheel load and the number of wheels running one behind the other (i.e. in the same rut). The required thickness of this high-strength surface layer is proportional to the

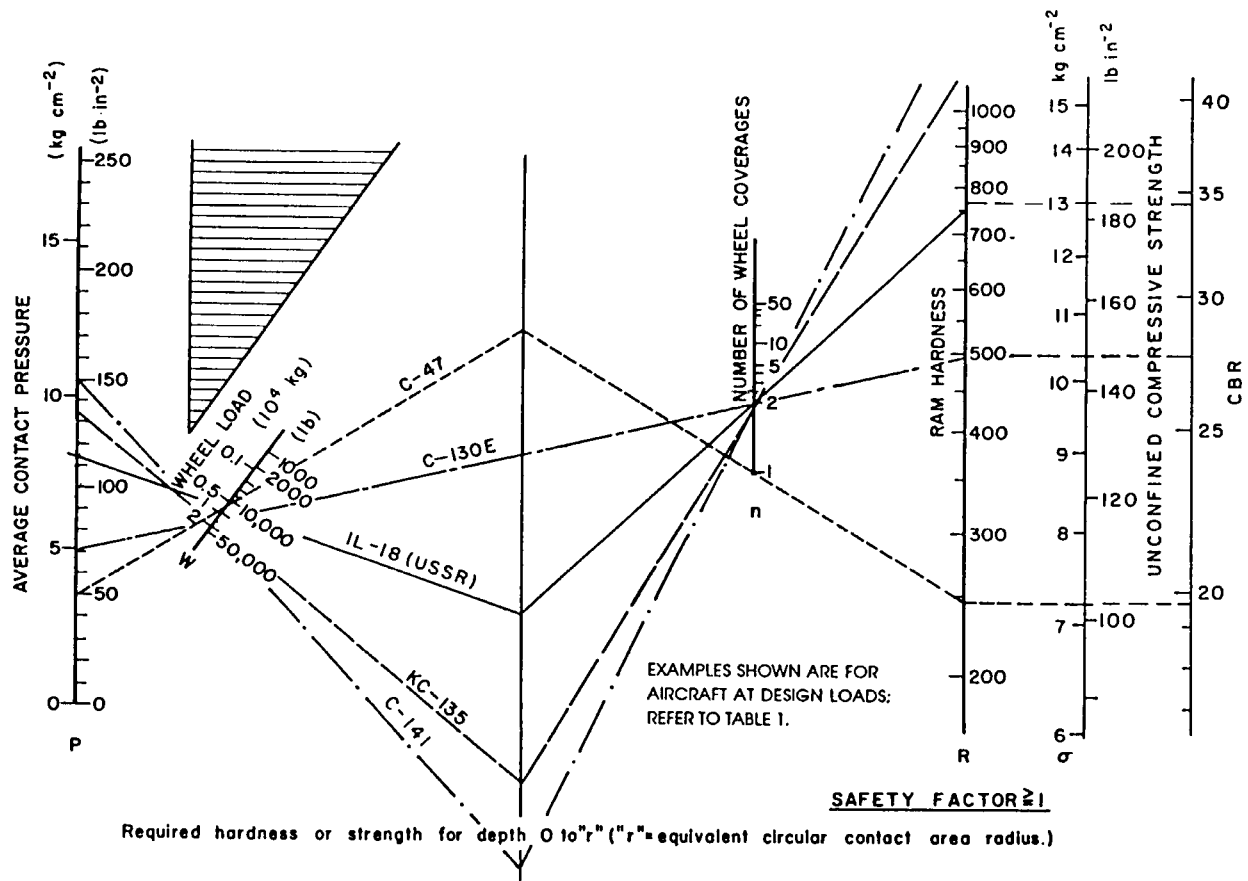

Figure 63. Nomograph for estimating the required surface strength on snow runways. The nomograph was developed from empirical correlations between rammsonde resistance (dependent variable) and an independent variable expressed as tire pressure, wheel load and number of wheels that run one behind the other. The derivation of the nomograph probably should be re-examined. (Derivation given by Abele et al. 1966; this version taken from Abele 1990.)

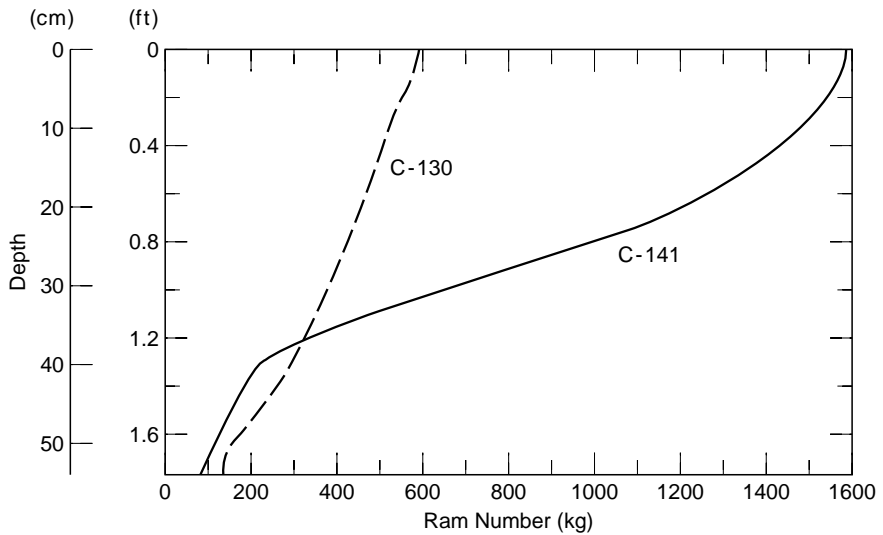

Figure 64. Strength requirements for supporting C-130 and C-141 aircraft on compacted snow pavements. The discontinuity in the C-130 curve near the surface is brought about by considerations of footprint size. The knee in the C-141 curve sets a limit to the dropoff in strength requirement as given by Boussinesq theory. (After Lee et al. 1989.)

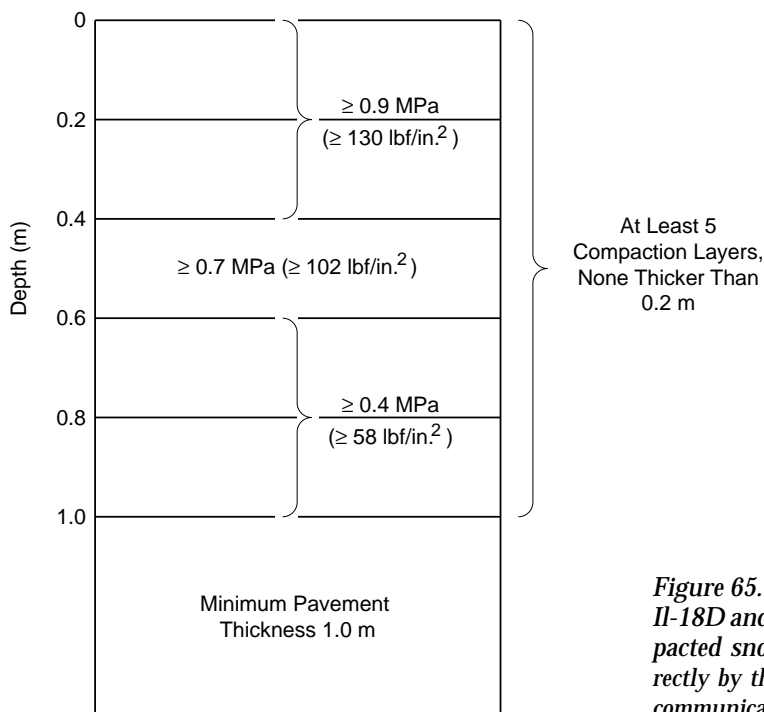

Figure 65. Snow strength requirements for supporting Il-18D and Il-76TD aircraft on the Molodezhnaya compacted snow runway. Strength values are measured directly by the penetrometer shown in Figure 62. (Personal communication, Valery M. Bragin, November 1990.)

size of the tire footprint; for transport aircraft it is typically about 1 ft, or 0.3 m. Figure 63 is a nomograph of the U.S. criteria for the surface strength requirements of snow pavements. The reduction of required strength with increasing depth is calculated theoretically, typically starting from the Boussinesq theory for vertical loads on the surface of an elastic solid. Figure 64 gives existing U.S. criteria, expressed in terms of ram number, for support of the C-130 and the C-141. Figure 65 gives Russian criteria for the Il-18D, expressed in terms of compressive strength but actually measured as cone penetration resistance, using the device shown in Figure 62.

When the nomograph of Figure 63 is used to estimate the surface strength required for the Il-18D (in lbf/in.<sup>2</sup> or kgf/cm<sup>2</sup>), it gives a value 43% higher than the value accepted and validated by Russian engineers (Fig. 65). This large discrepancy may arise partly from lack of comparability between U.S. and Russian testing methods, a question that will be resolved by joint SAE/USAP studies.

### Melting

The most common piece of advice from sidewalk supervisors is: "Pour water on the snow and make an ice runway." The same thought also occurred to engineers. The variants that have been considered include:

- Addition of water to the snow by surface spraying or by rotary mixing;
- Injection of steam, either directly on or in a rotary mix;
- Flame heating of the surface or of a mix;
- Surface flooding with thick water layers; and
- Paving with a water-snow slurry.

There are two major difficulties: the energy (fuel) needed to melt snow is enormous, and water does not diffuse uniformly in snow to make a homogeneous mixture.

To melt snow, it first has to be warmed from its original temperature to the melting point. Latent heat then has to be supplied to induce the phase change from ice to water. This basic energy requirement for melting a unit mass or unit volume of snow is easy to calculate. The sensible heat for warming is the mass (i.e. density  $\times$  volume) multiplied by the temperature change and the specific heat of ice (2.12 J/g $\cdot$ °C). The latent heat for melting is the mass (density  $\times$  volume) multiplied by the latent heat of ice (334 J/g). The most likely source of energy in Antarctica is diesel fuel; DFA has a specific energy of about 4.53 J/g (when burned with the right amount of oxygen). If a diesel-fired melting system could operate at 100% thermal efficiency, the volume ratio for water produced to fuel burned (gallon/gallon or liter/liter) would be 117 for snow that is already at 0°C and 98 for snow that

starts at  $-30^{\circ}\text{C}$ . The corresponding theoretical mass ratios are 136 and 114. However, typical melting systems are nowhere near 100% efficient, and it is unrealistic to assume more than 50% efficiency, which cuts the above ratios in half, and the actual overall efficiencies could be considerably lower than 50%. Analysis of a carefully designed water well for South Pole Station gives a mass conversion ratio of 30–35 or a volume conversion ratio of 26–30.

The maximum amount of water that can be diffused and retained uniformly by capillarity is about 3% by volume. With greater concentrations the water seeps down under gravity, concentrating in vertical “pipes” and then spreading laterally again when layers of low permeability are encountered. The depth of snow that needs to be treated is comparable to the footprint width of the aircraft tire, say around 0.3 m, or 1 ft. The area that has to be treated is very large, e.g.  $2 \times 10^6 \text{ ft}^2$ , or  $1.86 \times 10^5 \text{ m}^2$ , for a 200-  $\times$  10,000-ft runway. If the snow has been compacted to  $0.56 \text{ Mg/m}^3$ , 3% water is added, and the mass conversion ratio is 30, the required amount of fuel is almost 10,000 gal. To this has to be added the fuel for the vehicle that applies the water and for any mixing machine that might be involved. Assuming that the water freezes as a uniform dispersion, the final density after one treatment is still only  $0.59 \text{ Mg/m}^3$ , which is not enough for safe

operation of a typical large aircraft. At least one more treatment, without mechanical disturbance, would be needed.

Fuel demands for surface flooding are much higher. If the flooding is in successive 4-in. layers, the water required for a single lift on a 200-  $\times$  10,000-ft runway turns out to be  $5 \times 10^6$  gallons. With a mass conversion ratio of 30 or volume conversion ratio of 26, the fuel required to produce this water is 192,000 gallons. For two lifts, giving an 8-in. pavement, the fuel required is 384,000 gallons. This assumes that water can actually be retained on the surface to permit flooding.

During the 1950s, the U.S. Army developed machines that combined open-flame burners with rotary tillers. The developer went through five successive stages of equipment evolution. The devices were not successful, and the fuel consumption of the complete rig was heavy—the equivalent of nearly 28,000 gallons for two passes over a 200-  $\times$  10,000-ft runway. A Soviet device that fed hot air to a rototiller shroud was said to have much lower fuel consumption, but as far as is known, it was never used for serious runway construction.

#### **Compacted snow on hard ice**

At a transition between areas of net accumulation and net ablation, snow lies on top of hard ice, either “blue” glacier ice or “gray” superimposed



*Figure 66. Caterpillar LGP-D8 bulldozer used for scraping hard snow from the surface of glacier ice in airfield construction experiments. This ancient machine was built in 1956, but for planing ice surfaces it is better than modern machines because of its long tracks. The ground contact length is 160 in., or 4.1 m. (Photo by M. Mellor, January 1991.)*

ice. The latter type of ice is formed by downward percolation and refreezing of summer meltwater. This snow cover may be patchy and seasonally varying, but it can be spread fairly uniformly by machines and then compacted against the hard substrate. The primary, and essential, purpose of the snow cover is to protect the ice from solar radiation. A secondary function is to smooth over the roughness of the ice surface when no planing equipment is available.

An experimental runway was built at such a site on the Ross Ice Shelf near McMurdo station (the Pegasus site). Starting in the summer of 1989-90, large, long-track bulldozers cut down to hard ice, mixing and windrowing the snow, and planing the ice surface (Fig. 66). Snow from the windrows was then spread with a motor grader and graded with snowplanes (Fig. 67). The following spring, winter snow accumulation (4-14 in., or 0.1-0.36 m) was excavated, mixed, redistributed and densified by a large bulldozer whose blades were supported at a fixed height by adjustable "skates." Excavation was carried out with the skates set to give a 3-in. (76-mm) lift. After excavating the full width of the runway, the resulting windrows were spread initially by setting the bulldozer blades to a 6-in. (152-mm) lift. After the surface was worked with a

chain, it was graded by 60-ft and 80-ft snowplanes (the former was unsuccessful initially because its improvised skis cut deep gouges in the surface). Grading was followed by dragging and rolling, using Delta Two and Delta Three vehicles with "smooth" (as opposed to cleated) tires as expedient rollers (Fig. 68). Efficient compaction of the 6-in. (15-cm) snow pavement could not be achieved, since no rollers were available.

Being unable to compact the 6-in.-thick snow pavement on the experimental runway, in February 1991 the engineers tried to improvise equipment that would permit execution of the original construction plan. The basic idea behind this original plan was to remove the natural snow cover with blowers, plane the hard ice surface perfectly flat, and then replace the reflective snow cover progressively in very thin layers, as needed, again using snow blowers (Fig. 69). The blade of an old road grader was modified, turning the machine into a very efficient ice planer (Fig. 70). In 1991-92 a new laser-controlled grader, together with a powerful snow blower, was used to construct a second experimental runway by ice-planing and compaction of snow in very thin layers. The original Pegasus runway was compacted using a new rubber-tire roller that can be ballasted to 50 tons (45 tonne).



*Figure 67. Windrows at the McMurdo Pegasus site. To prepare the snow-on-ice runway, the ice surface was scraped by heavy, long-track bulldozers and the well-mixed snow from the windrows was respread, compacted and graded. (Photo by M. Mellor, January 1990.)*



*Figure 68. Foremost Delta Three towing a simple drag. Big, smooth-rib tires (as opposed to aggressive cleated tires) on a large vehicle are useful for gentle compaction. (Photo by M. Mellor, February 1990.)*



*a. Single-stage, all-mechanical Blanchet with axial rotation. This unit concentrates a very heavy load on the front of the tractor when it is in the raised position.*

*Figure 69. Demountable snow blowers attached to Caterpillar 950 wheel loaders. (Photos by M. Mellor, February 1991.)*





*b. Two-stage, hydraulic-drive Snowblast with transverse-rotation auger and axial-rotation impeller. This unit distributes the load, but there is an unavoidable power loss in the hydraulic drive.*



*a. Teeth are cut into the replaceable edge with a torch.*



*b. The blade is tilted forward to give at least 12° of relief angle beneath the tooth (even though this reduces the rake angle of the leading edge). With the blade angled to plow chips to one side, the cutting action is oblique rather than orthogonal; this reduces the kerf width and the kerf spacing. With the tooth geometry shown in these photos, there is a stub of uncut rib between the kerfs at full blade penetration. (Photos by M. Mellor, 4 February 1991.)*

*Figure 70 (cont'd). Modification of a grader blade for planing ice.*

The site for the runway at Casey seems comparable to the Pegasus site, although the Casey runway would pass through zones of bare ice (blue ice with a veneer of superimposed ice), heavily ablated snow over hard ice, and deep snow with ice lenses and ice crusts.

The runway at Novolazarevskaya is apparently of mixed construction, with part of the surface bare blue ice and part of the surface compacted snow over hard ice. It is not known to us how the bare ice resists summer melting.

In principle the snow cover on annual sea ice and multi-year sea ice can be compacted and graded. For first-year sea ice the advantage is extension of the operating season by protecting the ice from radiation and evaporation (which increases the surface salinity). For multi-year ice that is not too rough, snow compaction and grading is an alternative to surface-planing with rotary ice chippers.

Snow-ice transition areas at cold inland locations may be suitable for this type of construction, even though the snow is cohesionless after disaggregation.

Any runway site of this type should be free from crevasses, and the snow pavement might have to be reworked periodically to eliminate depth hoar.

#### **Runways on snow-free glacier ice**

Aircraft can land on snow-free glacier ice if there are:

- No crevasses;
- No surface obstacles (ice hummocks, melt streams, ablation pits, rocks, etc.);
- No serious approach or climbout obstructions; and
- No steep gradients.

Although it is quite difficult to find places where there are long stretches (> 3 km) of ice that meet these conditions, such places do exist.

Bare glacier ice that occurs at low elevation or low latitude (i.e. in “warm” places) is not likely to be suitable for an all-season airfield because it is hard to avoid melt pools, subsurface melt cavities and subsequent ice blisters. However, there are places where the tendency for strong ablation is moderated by special local conditions, notably per-



*Figure 71. Runways at the old Outer Williams Field, an airfield on coastal glacier ice that was used from 1966-67 to 1970-71. (U.S. Navy photo, XAM-80148-10-67, by Jackie W. Richards.)*

sistent cold winds blowing from the colder interior. From 1966-67 to 1970-71 there was a runway on blue ice near McMurdo (Outer Williams Field) (Fig. 71). Rotary ice chippers were used to plane the ice, at the same time covering it with reflective white fragments (snow was also spread to reflect solar radiation). Repeated chipping eventually depressed the runway below its surroundings, allowing meltwater to invade and pond at the peak of the ablation season.

The prime sites for airfields on glacier ice are the inland “blue-ice” areas where net ablation is the result of strong and persistent local winds, often on the lee side of a ridge (Fig. 72). Two such sites in the Pensacola Mountains were surveyed as potential airfields in 1974. Another two sites, in the Ellsworth Mountains, were surveyed in 1986. One of them, at Patriot Hills, came into use for conventional wheeled aircraft in 1987. Two more sites, in the Transantarctic Mountains, were surveyed in 1988-89. One of them, on the Mill Glacier near Plunket Point, got its first wheel landings by large aircraft in January 1990 (Fig. 73). The other, at Mount Howe, only 160

nautical miles from the South Pole, was scheduled for development work in 1990-91. In a recent air photo study (Swithinbank 1991), about 70 potential sites for blue-ice airfields were identified.

An ideal blue-ice site has a long stretch of completely snow-free ice, say 5–7 km long, oriented with its long axis parallel to the prevailing wind. The approaches are unobstructed. It is on thick ice, with gradients less than 1% (for land-based glacier ice, thickness and surface slope are inversely proportional because of the relative constancy of bed shear stress). It has a cusped surface, with regularly spaced pits about the size of a salad side-dish (giving good braking and directional control). The ice ablates slowly by direct evaporation, with very little chance of melting as long as it remains clean.

However, ideal sites may be rare. Many icefields seem to have the long direction more or less perpendicular to the prevailing wind direction, with a mountain ridge upwind of the icefield.

A blue-ice site that is acceptable but less than ideal may have a prevailing crosswind on the longest runway, or periodic bursts of turbulence (“bul



*Figure 72. Smooth blue ice near the North Masson Range, south of Mawson. The Rumdoodle skiway–runway was in this vicinity. The proposed blue-ice airfield is about 4 miles (6.5 km) west of this area. (Photo by M. Mellor, 1957.)*



*a. LC-130 parked on the blue-ice runway, with the Plunket Point moraine and the Beardmore Glacier in the background.*

*Figure 73. Blue ice at a cold, dry ablation area (Mill Glacier). (Photos by M. Mellor, 26 January 1990.)*



*b. Scale of the cupped surface, which provides good braking and directional control. The ice evaporates at a rate of 4 in./yr (10 cm/yr).*

*Figure 73 (cont'd).*

lets”) caused by vortex-shedding from a nearby mountain ridge. It may have a bumpy surface caused by scattered snow patches that induce preferential ablation (evaporation) of the ice. The latter problem is curable by initial preparation (planing) and annual maintenance (getting rid of the snow patches by plowing or brushing). Ice planing can probably be done by a modified grader (Fig. 70), avoiding the need for development of expensive special-purpose equipment.

Since blue-ice sites are usually close to ridges or mountains that project from the icecap, facilities for the airfield can be constructed on rock.

Operating experience on blue-ice airfields is still very limited, and over the long term, wind could turn out to be a problem at such sites. Protecting parked aircraft is a major concern, and ordinary tie-down arrangements may not be enough. Australia had five parked aircraft destroyed by wind (three DHC-3s, one DC-3 and one Pilatus Porter) in three separate storms at Gwamm (2 nautical miles south of Mawson) and Rumdoodle (10 nautical miles south of Mawson). If operations extend to marginally suitable weather, turbulence or wind shear could endanger landings.

#### **Runways on first-year sea ice**

Undisturbed first-year sea ice provides a hard surface that is perfectly level and very smooth (Fig. 74). However, the bearing strength of sea ice is limited, and thick annual sea ice does not last very long into the summer.

The only stable sea ice is “fast ice,” i.e. coastal sea ice anchored by indentations of the coastline and by islands. The ice that forms farther out tends to drift under the influence of ocean currents and wind shear. Because new ice can be broken up by storms, even fast ice cannot be considered stable until midwinter. The ice thickness increases with time at a steadily decreasing rate over the winter, reaching its maximum in spring or early summer and thereafter decreasing again. Summer conditions weaken the ice and produce surface melt pools. Eventually ocean swells break the decayed ice, and local winds disperse it. Taking into account the winter darkness, the useful season for safe operation of large aircraft from first-year sea ice at far-south locations in “real Antarctica” is roughly late September to early or mid-December. The season is longer for small aircraft and for emergency operations, and operation as early as August is



Figure 74. Runway on annual sea ice, McMurdo Sound. White Island is on the left and Black Island is on the right. (Photo by M. Mellor, November 1987.)

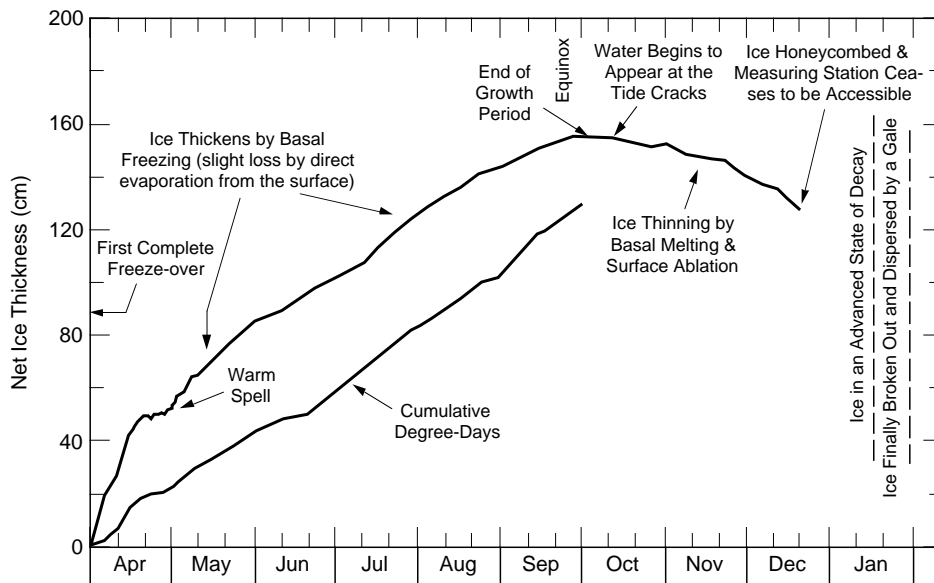

Figure 75. Growth and decay of annual sea ice in Antarctica. This record was for Mawson ( $67^{\circ}37'S$ ,  $62^{\circ}52'E$ ) in 1957. (Measurements for ANARE by M. Mellor, 1957.)

feasible along more northerly coastlines where there is a reasonable duration of daylight.

The rate of ice growth depends on the rate at which heat can be conducted through the ice sheet, from the “warm” seawater to the cold air. The temperature gradient, which controls the freezing

rate, depends on the temperature difference between sea and air, and on the ice thickness. The ice becomes a better insulator as it thickens; snow cover increases the insulation and slows the growth. Ice thickness correlates with the sum of the “freezing degree-days” after freeze-up (Fig. 75). For this

purpose, the freezing point of seawater, say  $-1.9^{\circ}\text{C}$ , is subtracted from the day's negative mean temperature to get the "freezing degree-days" for each day (e.g. on a day with a mean temperature of  $-17.7^{\circ}\text{C}$ , that day contributes 15.8 freezing degree-days). The correlation can be improved by taking account of local snow cover and wind (solar radiation is not a big variable during the Antarctic winter).

The main concern with first-year sea ice is bearing strength, which is determined mainly by ice thickness. Theoretically the maximum allowable "point" load is proportional to the ice thickness squared. For aircraft the main concern is gross weight; the geometry of the landing gear is significant but of secondary importance on thick ice, and tire pressure is almost irrelevant. The ice fails by flexure, forming a large bowl-shaped depression with radial and circumferential cracks; punch-through at the center of the disturbance is the final stage of collapse. Strength analyses for collapse under short-duration loads are based on the theory for deflection of an elastic plate on an elastic foundation, with an appropriate failure criterion (crack initiation). For static loads (e.g. parking) the analysis has to include visco-elastic (creep) effects and a safe limit for deflection. For heavy aircraft, deflections are monitored by survey methods. For a moving load, interaction of the flexural wave in the ice with the water gives a critical velocity. From a scientific standpoint, the traditional approach to bearing capacity is flawed; rate processes are not dealt with realistically, and strain probably provides a better failure criterion than stress. However, operational experience combined with imperfect theory provides adequate practical guidance (Fig. 76, 77).

At far-south locations where first-year ice gets over 2 m thick, very large aircraft can land safely in early spring. Heavily loaded large aircraft cannot park indefinitely in one place, since the ice deflects by creep, allowing water to invade the surface. On ice that is about 2.4 m thick, short-term deflection under a C-5 can be around 0.1 m (several inches).

Large snowplow berms alongside a wide runway can also deflect and crack the ice as the season advances; they can also aggravate snowdrifting problems. Fixed facilities should be distributed so as to spread the load. Refueling tanks (or bladders) could be the heaviest items. To act independently they should be separated from each other by at least the "characteristic length" for the ice (about 20 times the thickness for thick ice).

A thin snow cover should be maintained on a sea ice runway. It gives pilots braking and directional

control, it blocks evaporation, and probably most important, it reflects solar radiation in springtime. Littering and staining the ice surface has bad consequences in late November and early December, when solar radiation is strong.

### **Runways on multi-year sea ice**

Sea ice that has survived one or more summers is known variously as multi-year ice, perennial sea ice or bay ice. Its salinity is very low because the original brine cells become interconnected at "high" temperatures, allowing gravity drainage to the ocean and infiltration of fresh meltwater from the surface. The surface loses its original smoothness because of melt pools, melt channels and refrozen wet snow (including drifts).

Multi-year sea ice can become very thick, say up to 10 m. Having little salinity, it is inherently strong. Thus, bearing strength and creep resistance are usually more than adequate, even for heavy aircraft. Since this ice owes its existence to a protected location, it is very stable. It provides a good platform at all seasons, although surface melt can mar the surface in midsummer.

Long life, high strength, good stability and all-season availability make multi-year sea ice attractive as a platform for runways. However, initial construction may be troublesome, calling for special ice-chipping machines to plane the surface flat. Snow plowing for early season operations can create long-term problems by accumulating large berms that generate snow drifting and remain throughout the summer. The useful life of a runway on old ice can be terminated by the progressive growth of the snowplow berms. There are, however, some places where the net annual snow accumulation on old ice is close to zero.

Runways on old sea ice were used at McMurdo for a number of years (Fig. 78). Snowplow berms eventually grew to a height of 20 ft (6 m) or more, cracking the ice and prompting evacuation of two successive sites. There is, however, snow-free, multi-year sea ice suitable for an airfield at Bunger Hills, approximately  $66^{\circ}14' \text{ S}$ ,  $100^{\circ}35' \text{ E}$ .

### **Frozen lakes**

In some parts of Antarctica there are frozen lakes, providing surfaces that are flat, hard and often smooth. There are two broad types of lakes. One type occurs in ice-free terrain, at places like Vestfold Hills and Bunger Hills on the coast of East Antarctica, and the Dry Valleys near McMurdo Sound. The other type forms on glacier ice, or between glacier ice and ice-free rock.

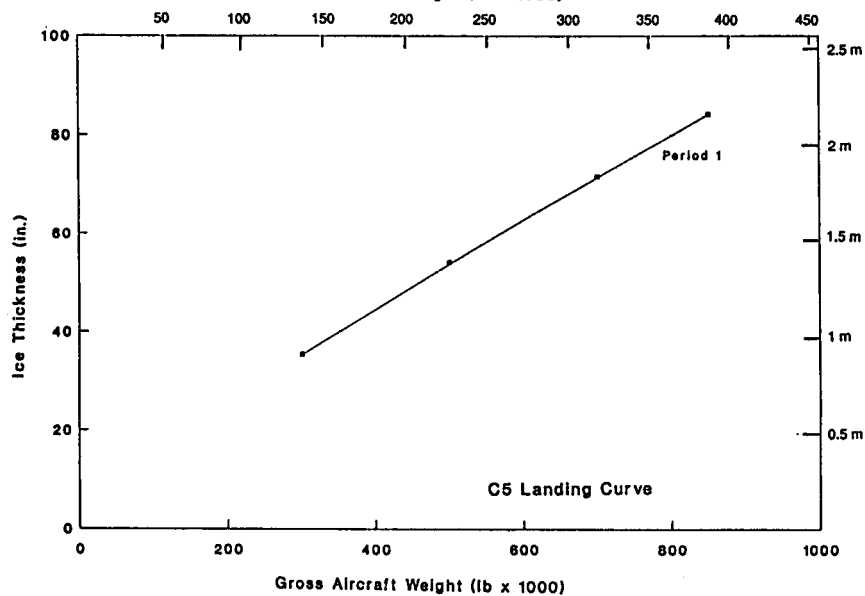
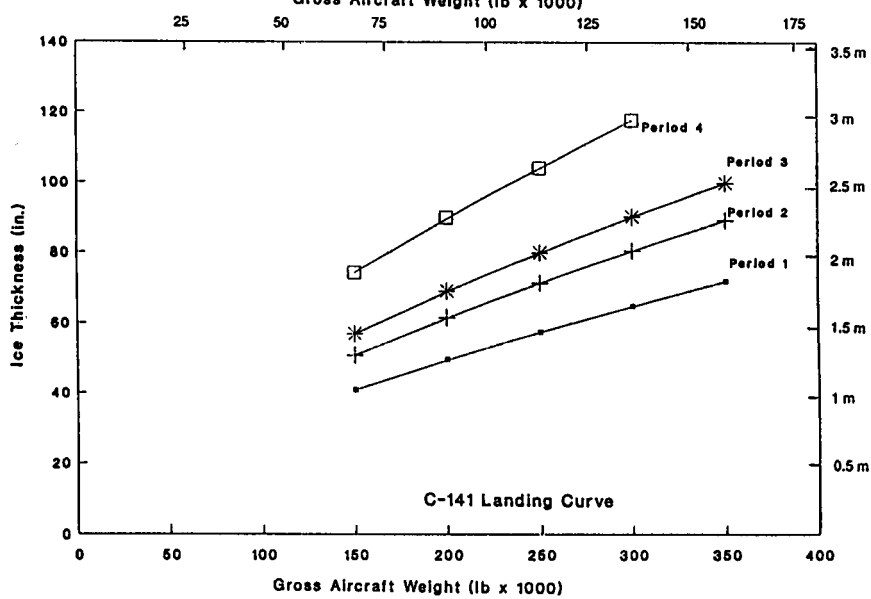
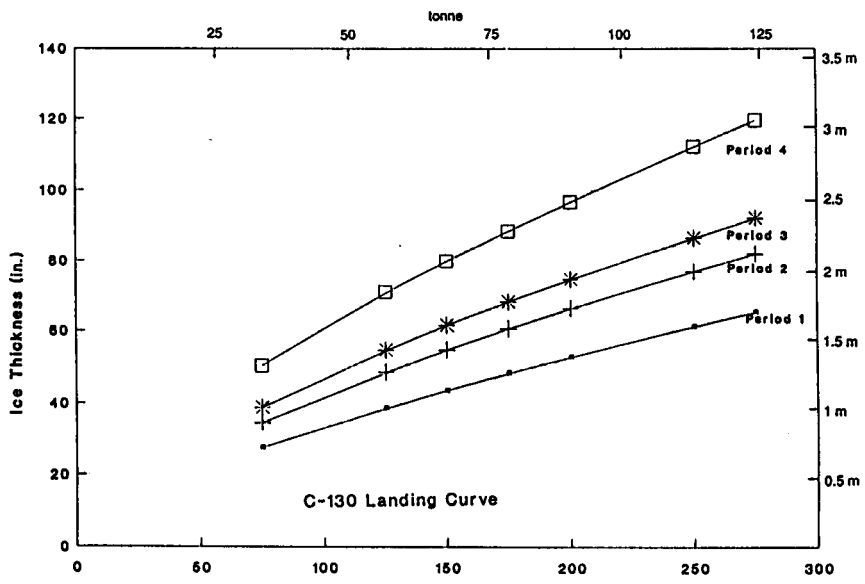

Figure 76. Landing curves for the sea-ice runway at McMurdo. The periods are: (1) mid-October to late November, (2) late November to mid-December, (3) mid-December to late December, and (4) late December to the end of January. (After Barthelemy 1990.)



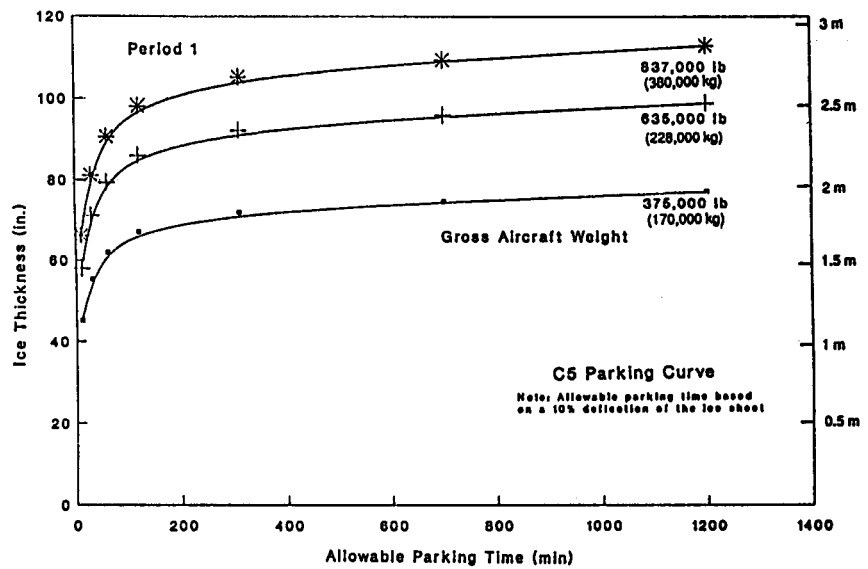
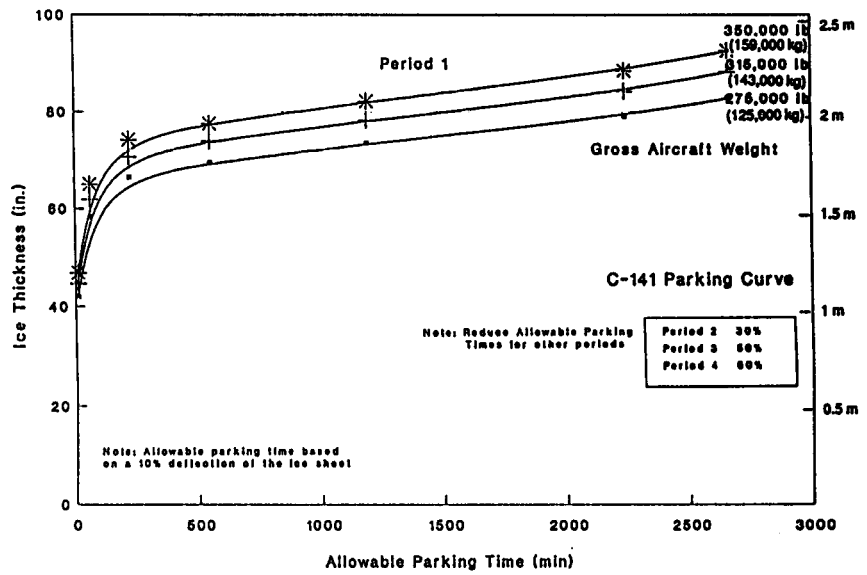
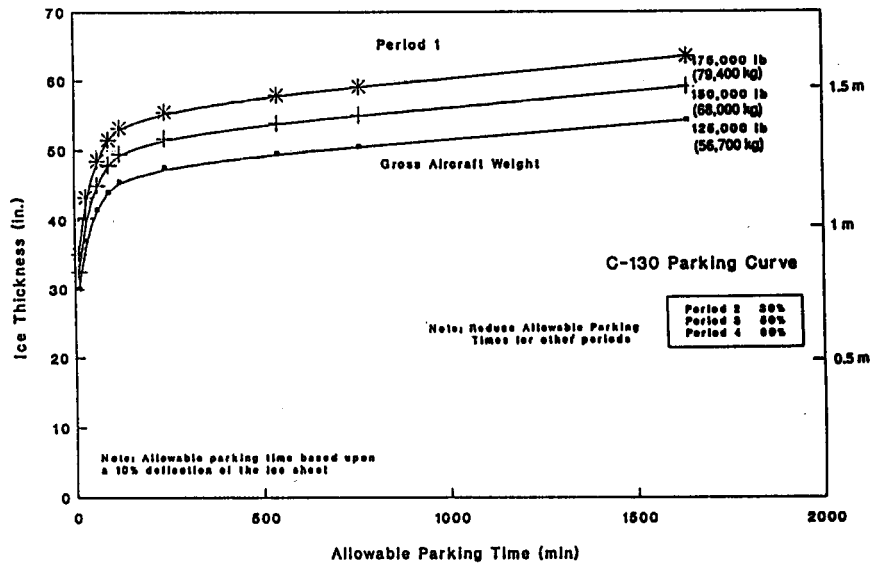
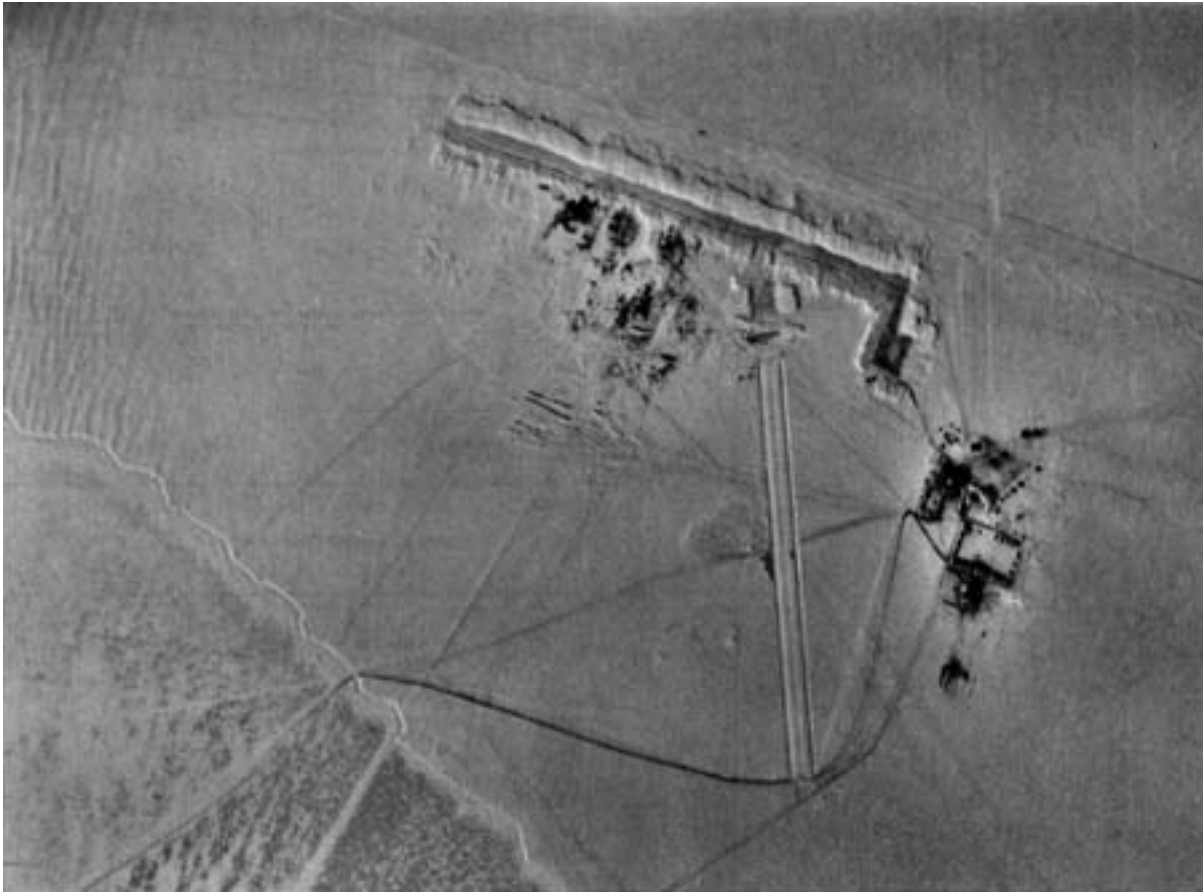

Figure 77. Parking curves for the sea-ice runway at McMurdo. The periods are: (1) mid-October to late November, (2) late November to mid-December, (3) mid-December to late December, and (4) late December to the end of January. (After Barthelemy 1990.)



*Figure 78. Runways on multi-year sea ice (first-year sea ice at lower left). Note the large snowplow berms and snowdrifts alongside the old runway. This stretch of ice broke out and went to sea about one month after the photo was taken. (USN/VX6 photo, TMA 1561, F62 23 January 1965.)*

Land-locked lakes in ice-free terrain can vary considerably in salinity and thermal regime, with consequent variations in ice thickness and duration of ice cover. However, they can provide runways for heavy transport aircraft early in the summer season. The Soviet Antarctic Expedition has landed an Ilyushin Il-18 on lake ice at Bunger Hills.

Lakes on glacier ice typically form downslope of areas that experience heavy summer melting, usually ice-free hills at low altitudes. Meltwater gathers into surface drainage channels and flows into the lake area, flooding the surface (which may move slowly) and later refreezing. The first Byrd expedition lost an aircraft (a Fokker Universal) to extreme winds at a frozen lake in the Rockefeller Mountains in March 1929. Small Australian aircraft have operated on Beaver Lake, an unusual type of lake that formed where the Amery Ice Shelf meets the Prince Charles Mountains (see detailed description later).

### **Conventional rock-fill runways**

Conventional permanent runways, with paving over graded rock fill or gravel, are clearly the most desirable for aircraft operators and pilots (Fig. 79). Over the long term they are a much better investment than temporary airfields that have to be rebuilt and abandoned at frequent intervals. The essential requirement for a conventional airport is a suitable site on ice-free rock, or a chain of small islands that are separated by narrow, shallow channels.

Sites for conventional runways are often thought to be extremely rare in Antarctica, but this perception is not really true. There are actually many sites that could be developed as conventional airports, but they are not all close to existing Antarctic stations or the coast.

Another misconception is that construction is very difficult in Antarctica, the problems of permafrost construction in the Arctic being adduced in



*Figure 79. Conventional gravel runway at Marsh, on King George Island. (Photo by M. Mellor, 18 December 1988.)*

support of this view. The reality is that Antarctica has little fine-grained, frost-susceptible soil; the most common surficial material is either bare rock or coarse glacial till that consists largely of cobbles, gravel-size particles and coarse sand. Virtually all sites at low elevation have an active layer, but it is shallow at far-south locations. In short, permafrost construction methods may be required, but the natural conditions are quite favorable. On exposed bedrock, construction is completely conventional.

The main obstacles to conventional construction are not technical. One major problem is reluctance to move the logistic center for an Antarctic program from an existing base to a place that has an airfield site, even though there may be large economic benefits over the long term. Another hurdle is arranging financing for construction, although this is little different in principle and magnitude from the building of an expedition ship or the purchase of one or two large aircraft. In recent times, a new and formidable hurdle has appeared in the form of environmentalist opposition. In light of past performance, environmental concern is quite legitimate, and it is appropriate to develop environmental impact studies in a broad context, weighing benefits and drawbacks on both local and continental scales.

Appropriate construction planning can reduce overall cost, logistic disruption and environmental

disturbance. Low-intensity activity spread over a relatively long period is likely to be more advantageous than a short-duration blitzkrieg by a large outside work force.

#### **Rock fill over glacier ice**

It is technically feasible to construct a runway by placing rock fill or gravel over almost-stagnant glacier ice. Active moraines on glaciers provide a natural illustration of the concept. With sufficient thickness of fill, the underlying ice is protected against ablation and a stable pavement can be produced. The snag is that the adjacent ice continues to ablate, probably at an accelerated rate because the fill stains the nearby ice surfaces. Eventually the runway becomes elevated above its surroundings, the shoulders become unstable, and the runway erodes along its edges.

Gravel roads were built on glacier ice in Greenland, where conditions are less favorable for the purpose than in much of Antarctica. They deteriorated quite rapidly (Fig. 80).

This type of construction could be worth considering if there are sites where natural moraines could be modified to create a runway. For example, there is a large area of flat-lying moraine alongside Mount Howe; were it not for approach obstructions and local turbulence, a rock-fill runway could be built on this site.



*Figure 80. Gravel roads built on glacier ice in Greenland. The road to the right is newly built. The one to the left has deteriorated due to ablation of the adjacent bare ice. The mean annual temperature here is  $-11^{\circ}\text{C}$ , and the thaw index is 270–360  $^{\circ}\text{C}$  degree-days, causing the ice to suffer net ablation of about 8 ft/yr (2.4 m/yr). The optimum depth of gravel fill was 3 ft (0.9 m), with 2.5 ft (0.76 m) of coarse material and 0.5 ft (0.15 m) of fine gravel capping. (U.S. Army photo by SP5 W.J. Davis, 1961.)*

### **Manufactured landing mats**

The use of military landing mats in Antarctica is often suggested by people who are unfamiliar with landing mats and Antarctica.

The first requirement for deployment of a mat system is a site for laying it. The site must then be leveled to close tolerances (0.25 in. over 12 ft, or 7 mm over 4 m). Given this requirement, there seems little point in considering mats for sites on rock or ice, which already have more than adequate bearing strength. The natural place to use mats is on deep snow.

Airfield landing mats are more substantial than the old PSP of WW II. The U.S. AM-2 system has hollow aluminum panels, 1.5 in. (38 mm) thick. Panels weigh about 6 lb/ft<sup>2</sup>, or 6.3 lb/ft<sup>2</sup> when

packaged for shipment; for a 10,000- × 200-ft runway, the shipping weight, including fasteners, is 6400 tons (5800 tonne). The estimated cost in 1988 was about \$17/ft<sup>2</sup>, or about \$34 million for enough to cover a 10,000- × 200-ft runway. The mat systems for making expedient roads (MO-MAT) are light but not significantly less expensive (about \$28 million for 10,000 × 200 ft). By itself, MO-MAT is not strong enough for heavy aircraft.

It would be very expensive to acquire matting, ship it to a remote location, and then assemble it. Once in place, there is the additional problem of how to keep it on the surface in an area with net snow accumulation. In short, mat systems do not look attractive.

## **BEARING CAPACITY, RUTTING RESISTANCE AND SURFACE ROUGHNESS**

Any runway, whether on ice, snow or rock, has to be:

- Strong enough to support the aircraft that use it;
- Hard enough to avoid the formation of wheel ruts; and
- Smooth enough to avoid damage to the aircraft and distress to the pilot.

### **Bearing capacity**

The bearing capacity of a runway is determined by the flexural strength of the pavement slab and by the penetration resistance of the underlying subgrade material. The most critical factor in the design and operation of a runway is the weight of the aircraft and the way that weight is transferred to the surface of the runway. In general, the upper limit for an aircraft would be characterized by its maximum ramp weight, which can exceed the maximum gross takeoff weight. In typical Antarctic operations it might be rare for an aircraft to be loaded to that upper limit. Most of the weight is carried by the main landing gear (MLG); the nose-wheels typically carry no more than 5–8% of the total load. If the main wheels are close together (relative to the pavement thickness), the patterns of deflection they produce overlap, and in the limit the MLG approximates the behavior of a “point load.” If the main wheels or main-wheel clusters are far apart (again relative to pavement thickness), then they tend to produce independent patterns of deflection, thus easing the tendency to break through.

The severity of pavement loading for any aircraft can be characterized by the ACN, the Aircraft Classification Number. Taking into account the aircraft weight and the geometry of the gear, the ACN is calculated for rigid pavements and flexible pavements using, in each case, four different values of subgrade strength. For any given aircraft, the ACN increases with weight raised to a power slightly greater than unity. For any given weight, the ACN tends to decrease as the size of the aircraft increases. In short, the required bearing strength increases with the weight of the aircraft using the runway, but things can be made easier by using aircraft that distribute the weight over a large area.

To proof-test the bearing capacity of a runway without actually committing an aircraft, a ballast cart can be used. This has a set of aircraft main

wheels at the correct spacing, with ballast equal to the loaded weight of the aircraft.

### **Rutting resistance**

On conventional runways the surface is usually hard enough to resist rutting, even by tires that have very high inflation pressure. The same can be said for well-built conventional runways in Antarctica and also for runways where the surface is hard ice at subfreezing temperatures. However, if the runway is surfaced with snow, then low tire pressures are needed to avoid rutting. There is no systematic guidance on allowable pressures, but one would probably expect trouble on snow with pressures above about 100 lbf/in.<sup>2</sup>, or 7 bar.

Inflation pressure alone does not give the complete story, especially for a thin snow layer on a hard substrate or for snow in which the density (i.e. strength) increases rapidly with depth. Under such conditions the bigger the footprint of the tire, the better the performance. Where the footprint width is much larger than the thickness of a finite snow layer, the snow is under triaxial compression; the tire tends to compact the snow instead of punching through it. In “deep” snow the depth of the stress bulb is proportional to the footprint width; bigger tires mobilize the strength of deeper layers.

The footprint area is estimated by dividing the wheel load by the tire pressure. It is assumed to be elliptical in shape, with the minor axis (perpendicular to the travel direction) 60% of the length of the major axis. The footprint width is estimated as  $0.874 \times (\text{contact area})^{1/2}$ . As with bearing capacity the rutting resistance can be proof-tested with a load cart that is fitted with aircraft landing gear.

### **Surface roughness**

On unprepared and substandard runways, surface roughness may be a problem. An isolated bump can induce a shock load. Continuous and irregular unevenness can excite vibrations. At risk are the gear and airframe, sensitive avionics or instruments, the pilot’s peace-of-mind and (of less consequence) passenger comfort.

There are no agreed standards for assessing roughness and setting safe limits. Roughness has been characterized in terms of:

- Vertical accelerations imposed on a given aircraft (or major components of the airframe);
- Subjective judgments by pilots; and
- Measurements of surface profiles on runways.

For Antarctic runways, CRREL has measured

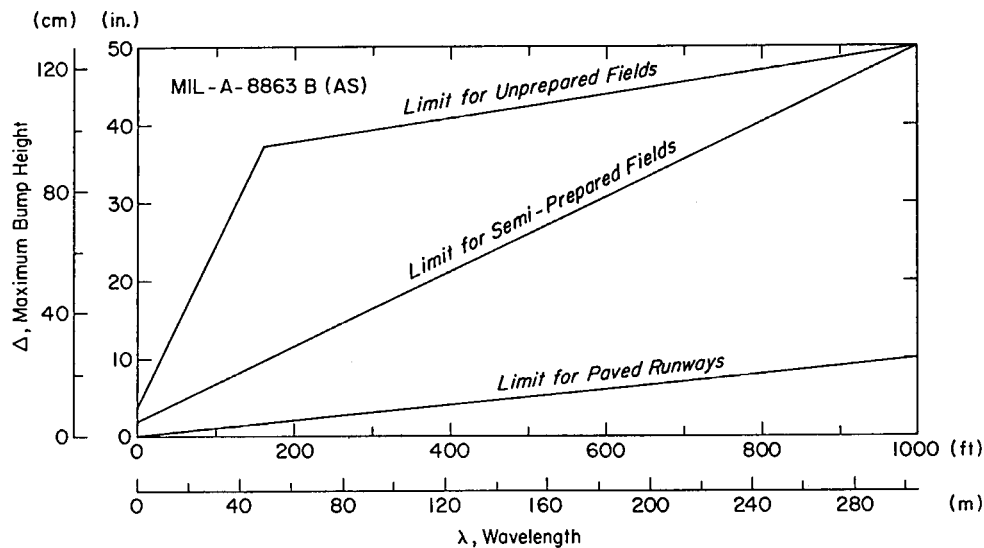

Figure 81. Military specifications for the roughness limits of runways. (From MIL-A-8863B(AS), 6 May 1987.)

sample profiles by conventional surveying and analyzed the measurements so as to obtain plots of bump height vs wavelength. From the amplitude and wavelength, it is easy to obtain vertical accelerations for given horizontal speeds. Two types of analysis have been tried so far. One uses Fourier analysis to characterize recurring bumps; by averaging, it tends to underestimate the severity of a single bad bump in the profile. The alternative is a “two-point maximum bump height” analysis, which identifies the bad bumps and tends to exaggerate the roughness problem (the worst bumps may be nonrecurring). The difficulty is to establish safe limits for roughness described this way.

Roughness or vibration limits for specific aircraft do not seem to be readily available, either from manuals or from manufacturers, although there has been research into operation from bomb-damaged runways, and the FAA is apparently developing criteria for specific aircraft. The U.S. has a military specification, MIL-A-8863B, which gives limiting envelopes of “cosine” bump height vs wavelength for paved runways, semi-prepared fields and unprepared fields (Fig. 81). This has been adopted by CRREL for assessing Antarctic runways. On the surfaces studied so far, the main problem seems to be with wavelengths ranging from the footprint length to about 30 m (100 ft). Wavelengths greater than 60 m (200 ft) do not seem to be very troublesome.

A subjective assessment of roughness can be made by high-speed taxi tests, or at remote sites, by touch-and-go landings.

## RUNWAY DIMENSIONS

### Runway length

Up to now, Antarctic runways have been expedient runways, with the length often restricted by natural site limitations or local capabilities for construction and maintenance. For the future the aim should probably be to develop some major airfields that meet or exceed the length criteria for conventional airfields handling heavy aircraft.

In temperate regions, runway length is determined by:

- The performance characteristics of the aircraft that will use the field regularly;
- The aircraft operating weights, or haul distances;
- The field elevation;
- The maximum expected temperatures;
- The surface condition on the runway; and
- The surface gradient on the runway.

Appropriate design manuals exist in both civil and military agencies (see, for example, FAA Advisory Circular 150/5325-4A, 1990).

For aircraft that have a maximum takeoff weight exceeding 60,000 lb (27,200 kg), general guidance for temperate regions is provided by Figure 82, which gives required runway length as a function of haul distance, with field elevation as a parameter. In Antarctica the requirements can be reduced somewhat in accordance with the low prevailing air temperatures.

The runway should have safety area extensions at both ends to accommodate undershoot. For air-

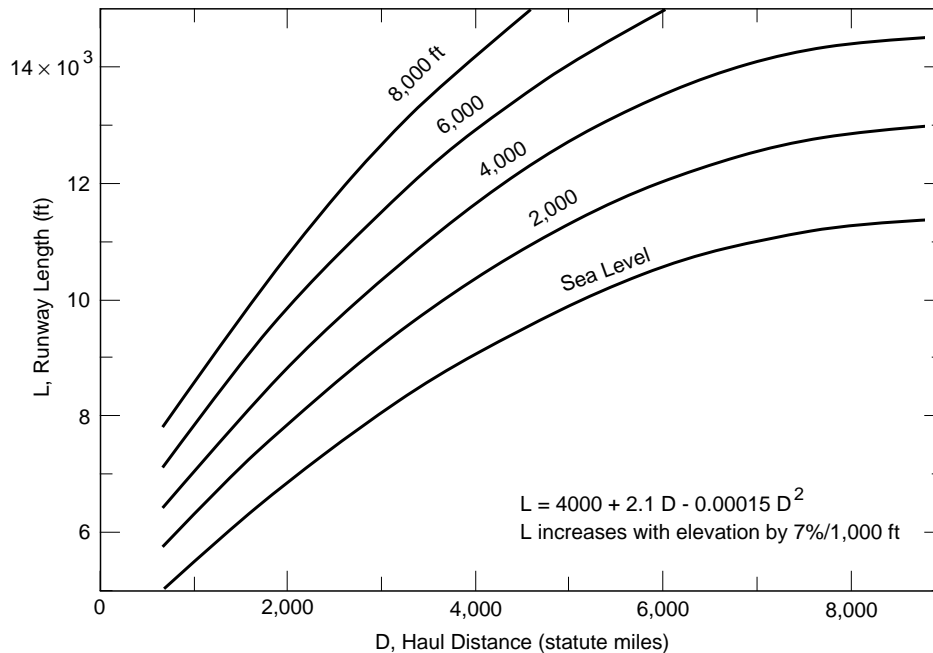

Figure 82. General planning guide for runway length at airports used by aircraft having maximum takeoff weights exceeding 60,000 lb (27,200 kg). (After FAA, AC 150/5325-4A, 1990.)

craft in approach categories C and D (approach speed 121–141 and 141–166 knots, respectively), the safety area extensions beyond the runway ends are, by FAA standards, 1000 ft (300 m) long. Figure 83 indicates the probability of undershoot and overrun for large transport aircraft.

Unconventional runways in Antarctica can meet or exceed the length requirements for large transport aircraft. The existing, and projected, conventional runways in Antarctica are substandard in terms of length.

### Runway width

On a conventional airfield the structural pavement is flanked by runway shoulders that have less bearing capacity. The shoulders provide insurance against veering, but they also retain and support the subsoil along the edges of the runway. Beyond the shoulders are clear strips designated as runway safety area. These strips are free from obstacles, flat, level, drained and firm enough to support emergency vehicles and, in emergencies, aircraft.

The requirements for runway width depend on the design group and the approach category for the largest and fastest aircraft that are intended to use the runway. The design group is determined by

wing span. The largest aircraft, such as the C-5 Galaxy, are in group VI (214–262 ft, or 65–80 m). Aircraft such as the C-130 Hercules, the C-141 Starlifter or the Ilyushin Il-76 are in group IV (118–171 ft, or 36–52 m). The approach category is defined on the basis of landing-configuration stall speed multiplied by 1.3, i.e. approach speed. Most of the large transports that are of interest for Antarctic use would fall into category C (121–141 knots) or possibly category B (91–121 knots).

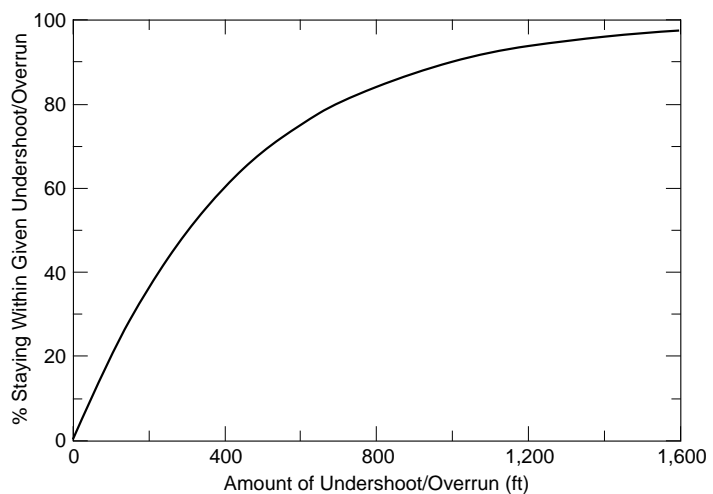

Figure 83. Approximate probability of undershoot or overrun for large aircraft. (After FAA, AC 150/5300-13, Appendix 8.)

For design group IV and approach category C/D, the required runway width is 150 ft, or 45 m, and the required shoulder width is 25 ft, or 7.5 m, giving a total width of 200 ft, or 60 m. For any design group in approach category C/D, the required total width for the runway safety area (enclosing the runway) is 500 ft, or 150 m.

In Antarctica, unconventional runways are not likely to have different construction methods for the runway and the shoulders, and the safety area may also have a surface quite similar to the runway itself. The U.S. Navy maintains a plowed width of 350 ft (107 m) on the McMurdo sea ice runway for C-5 operations; the previous width was 300 ft (91 m). At the Williams Field skiway, both “runways” are now 200 ft (61 m) wide (previously 300 ft, or 91

m). At South Pole Station the width of the skiway is 250 ft (76 m).

The required prepared width for the C-130 is 200 ft (61 m). For the C-141 it is 250 ft (76 m), and for the C-5 it is 350 ft (107 m).

The conventional runways in Antarctica are much narrower, about 100 ft (30 m) at Marsh, Marambio and Dumont d’Urville, and 150 ft (45 m) at Rothera.

## EXAMPLES OF ANTARCTIC AIRFIELDS

### Groomed skiways on deep snow

Skiways can be used only by ski-equipped aircraft, but a prepared skiway offers a smooth surface, reasonable bearing capacity (and reduced drag), runway markers and orientation into the prevailing wind.

#### McMurdo

The Williams Field skiway (Fig. 84) is located on the Ross Ice Shelf, about 7 miles (11 km) almost due

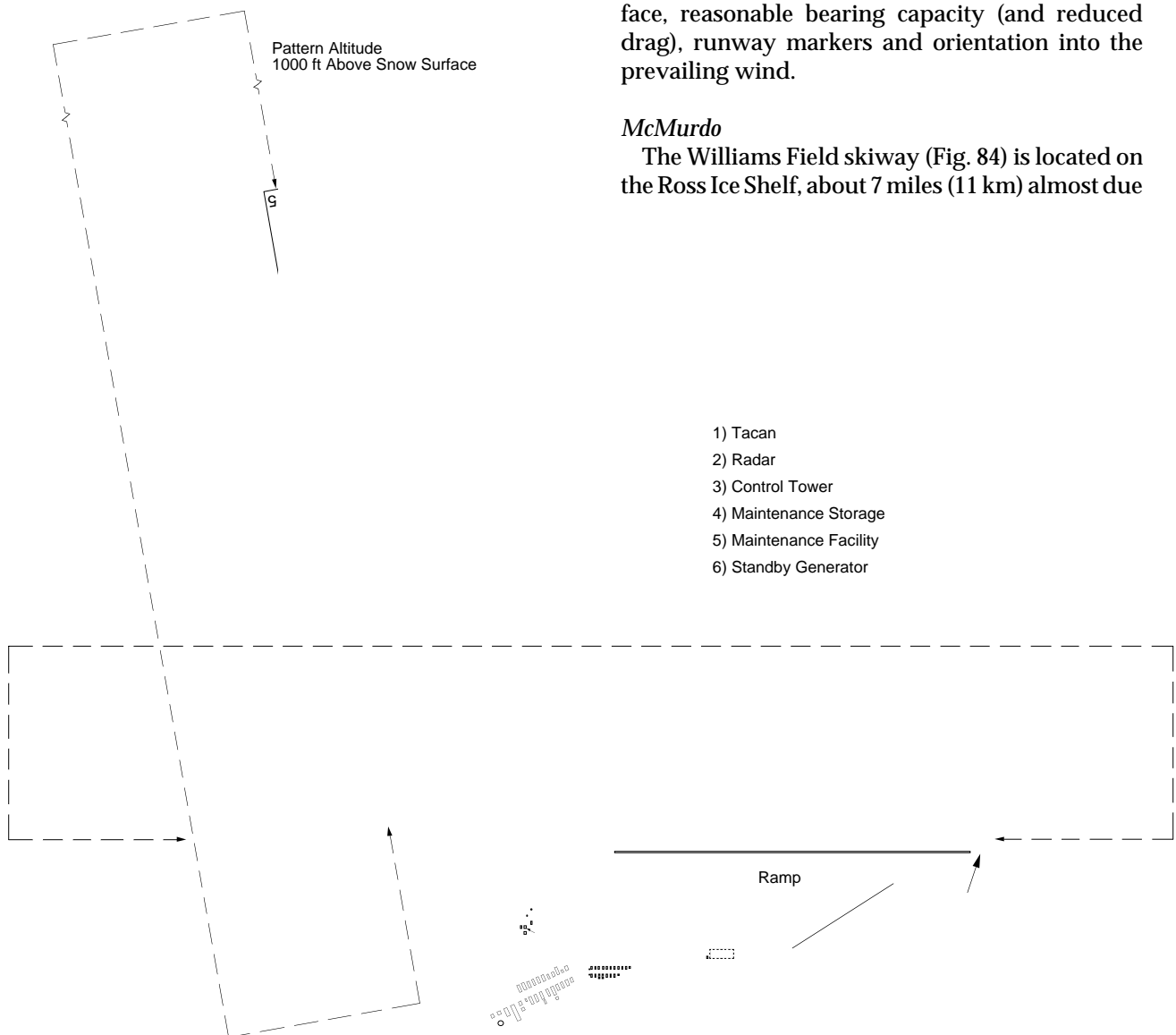

Figure 84. Williams Field skiways and traffic patterns (1990-91).



east (true) of McMurdo Station. It is in an area of net accumulation (about 2 ft, or 0.6 m, of snow per year). The primary “runway,” 07G/25G, is 10,000 × 200 ft (3,000 × 90 m). The crosswind “runway,” 15G/33G, is 8,000 × 200 ft (2,400 × 90 m). (Until 1990-91 the runway width was 300 ft.) The approximate position is 77°52' S, 167°08' E. The field elevation is given variously as 109 or 139 ft (33 or 42 m), both questionable figures in view of the likely thickness of the floating ice shelf. It has PAR, ASR, IFF, TACAN, UHF NDB and a tower. There is a large area of obstruction-free snow off the departure end of 25G for emergency whiteout landings (approach to 25G and cross TACAN, maintaining 300 ft to 2 DME on outbound radial between 260G and 330G, then land). The field has a large camp housing up to 180 people and providing facilities for maintenance, fueling and emergency services. The “runways” are maintained by dragging, compacting, grading (planing) and chaining. The runways have daylight distance marker panels at 1000-ft (305-m) spacing, with low-visibility daylight markers at the threshold, and at 250-ft (76-m) intervals for the first 3000 ft (914 m) of the approach end. Radar targets of reflective mesh have recently been added along the edges of the runway. The primary “runway” has approach lights, including strobes, and white runway lights at 500-ft (152-m) intervals. Blue taxiway lights define the ramp and its approaches. Patterns of reflective mesh panels, replacing an earlier array of steel fuel drums, provide radar targets at the approach end of the skiway.

#### South Pole Station

The South Pole Station skiway (Fig. 85) is located near the geographical south pole at an accepted elevation of 9301 ft, or 2835 m (mean pressure is 20.12 in. Hg). The snow is cold and dry, and the snow accumulation rate is low (about 0.6–1.0 ft/yr, or 0.18–0.3 m/yr). The “runway,” 02G/20G, or 20° off the Greenwich Meridian, is 14,000 × 250 ft (4,270 × 76 m). The field has PAR, ASR, TACAN and UHF NDB. The skiway is maintained by dragging, grading (planing) and chaining. Maintenance vehicles and aircraft provide some compaction. The skiway has daylight markers similar to those at Williams Field, and there is a pattern of steel fuel drums providing radar targets at the approach end (out to 5000 ft, or 1520 m). There is no lighting.

#### Byrd Surface Camp

The Byrd skiway is located at approximately 80°S, 120°W, with a field elevation of 5230 ft (1594 m). The snow is cold and dry, and the snow accu-

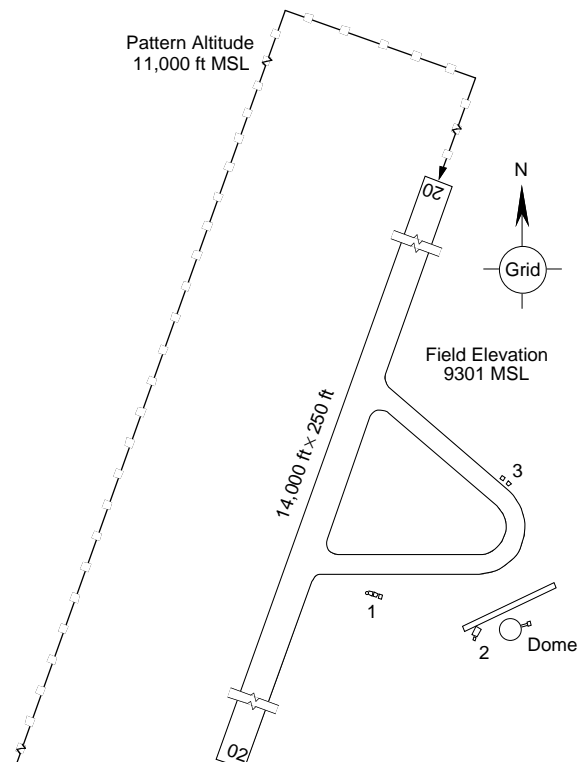

Figure 85. South Pole skiway and traffic patterns.

mulation rate is about 1.3 ft/yr (0.4 m/yr). The skiway, 08G/26G, is 10,000 × 250 ft (3,000 × 76 m).\* When the camp is occupied, the field has TACAN and UHF NDB. The skiway has daylight markers similar to those at the other U.S. skiways, but there is no lighting.

#### Palmer

Palmer has a marked but ungroomed 5000-ft skiway (06M/24M, variation 16.5°E) close to the station (southwest threshold about 1 km from the station). The field elevation ranges from about 400 to 550 ft (120 to 170 m), with the slope uphill from southwest to northeast at an average gradient of 3%. This necessitates landing uphill and taking off downhill. The snow can be too soft for safe operation between late December and early March. Landings can also be made more or less at right angles to the standard skiway, on a 2500-ft (760-m) skiway running 01/19M and crossing the crest of a ridge

\*The airport-facility directory in the DOD FLIP for 1990 gives 14,000 × 300 ft on 07/25G.

(land uphill, cross the crest, and hope to stop before the downslope gets too steep).\*

A Palmer skiway for LC-130 aircraft was surveyed in 1969, but as far as is known, it was never used. This strip starts about 2.7 miles (4.3 km) from the station, at an elevation of 1575 ft (480 m). It runs uphill from southwest to northeast at a slope of about 3.5%. A length of 3600 ft (1100 m) was surveyed, but it was felt that the strip could be extended to the northeast to give up to 9000 ft (2700 m). The snow accumulation rate in this area is very high (up to 12 ft/yr, or 3.7 m/yr).

Palmer has an NDB.

#### *Damoy*

Some 13 nautical miles east-southeast of Palmer, BAS Twin Otters use an unmaintained skiway at

---

\* This is the only Palmer runway listed in the FLIP directory.

Damoy Point, just across the Neumayer Channel on Wiencke Island. The location is 64°49'S, 63°30'W, and the field elevation is about 150 ft (46 m). The marked skiway, 05/23 magnetic, is about 3500 ft (1067 m) long. The strip slopes, so that landings are normally made uphill on 05, with takeoffs made downhill on 23. Melting can render the skiway unusable from December to March. The normal period of use is October–November.

#### *Molodezhnaya*

Molodezhnaya has two ski runways in addition to the wheel runway. They are situated 4 km south-east of the station (i.e. much closer than the wheel runway), and they have been used in recent years by Il-14, An-28 and An-2 aircraft on skis. One skiway is 8200 × 260 ft (2500 × 80 m), with an orientation of 140°–320° true and a longitudinal slope of 1° (1.7%). The elevation ranges from 886 to 1017 ft (270



*a. Turning from left base onto final. Coastal rock outcrops lie between the aircraft and the runway. The parking apron is to the left of the approach end of the runway.*



*b. Established on final for 14. The runway slopes down with a 1.1% gradient into a shallow cross-valley, with ice slopes rising beyond. The camp at Vecherniaia Hill is in the left screen.*

**Figure 86.** Snow runway at Molodezhnaya, as seen from the flight deck of the Il-18D. (Photos by M. Mellor, 15 November 1990.)



*c. Approaching the threshold. The parking apron and vehicles are in the left screen.*



*d. Starting flareout. The apparent furrows on the runway are stripes left by the skis of the grader.*

*Figure 86 (cont'd).*

to 310 m). The other skiway is 7550 × 260 ft (2300 × 80 m), with an orientation of 100°–280° true. The longitudinal slope is 1° (1.7%), and the cross-slope is 1.5° (2.6%). The mean elevation is 886 ft (270 m).

#### *Mirnyi*

The skiway at Mirnyi is 3940 × 200 ft (1200 × 60 m), with an orientation of 115°–295° true. It is 1.5 km southeast of the station at an elevation of 115 ft (35 m).

#### *Vostok*

The runway at Vostok is still only suitable for ski aircraft. It is 9840 × 260 ft (3000 × 80 m), with an orientation of 35°–215° true. The field elevation is 12,800 ft (3,900 m).

### **Runways on deep snowfields**

#### *Molodezhnaya*

Molodezhnaya (67°40'S, 45°51'E) has a skiway close to the station, plus a wheel runway for heavy

aircraft some 12 miles (20 km) east of the station at an elevation of 810 ft (247 m). The location is known as Vecherniaia (Evening) Hill. The construction methods were described earlier. The snow runway for wheeled aircraft is 9,200 × 200 ft (2800 × 60 m), with lateral safety strips 66 ft (20 m) wide along both edges and safety-area extensions of 260 ft (80 m) at both ends (Fig. 86). The orientation is 14T/32T, with the normal landing direction 140° true. In this direction the runway slopes downhill at an average gradient of 1.1%. It descends into a shallow valley, the far side of which has ice slopes that present a low climbout obstruction after takeoff on 14. There is a parking area of compacted snow extending northeast from the approach end of the runway. Aircraft park with their wheels on hard, portable mats. The normal operating season begins in October, but the runway closes in late November to avoid use during the summer melt period. It reopens the second week of February and can then operate into March. There is no lighting.

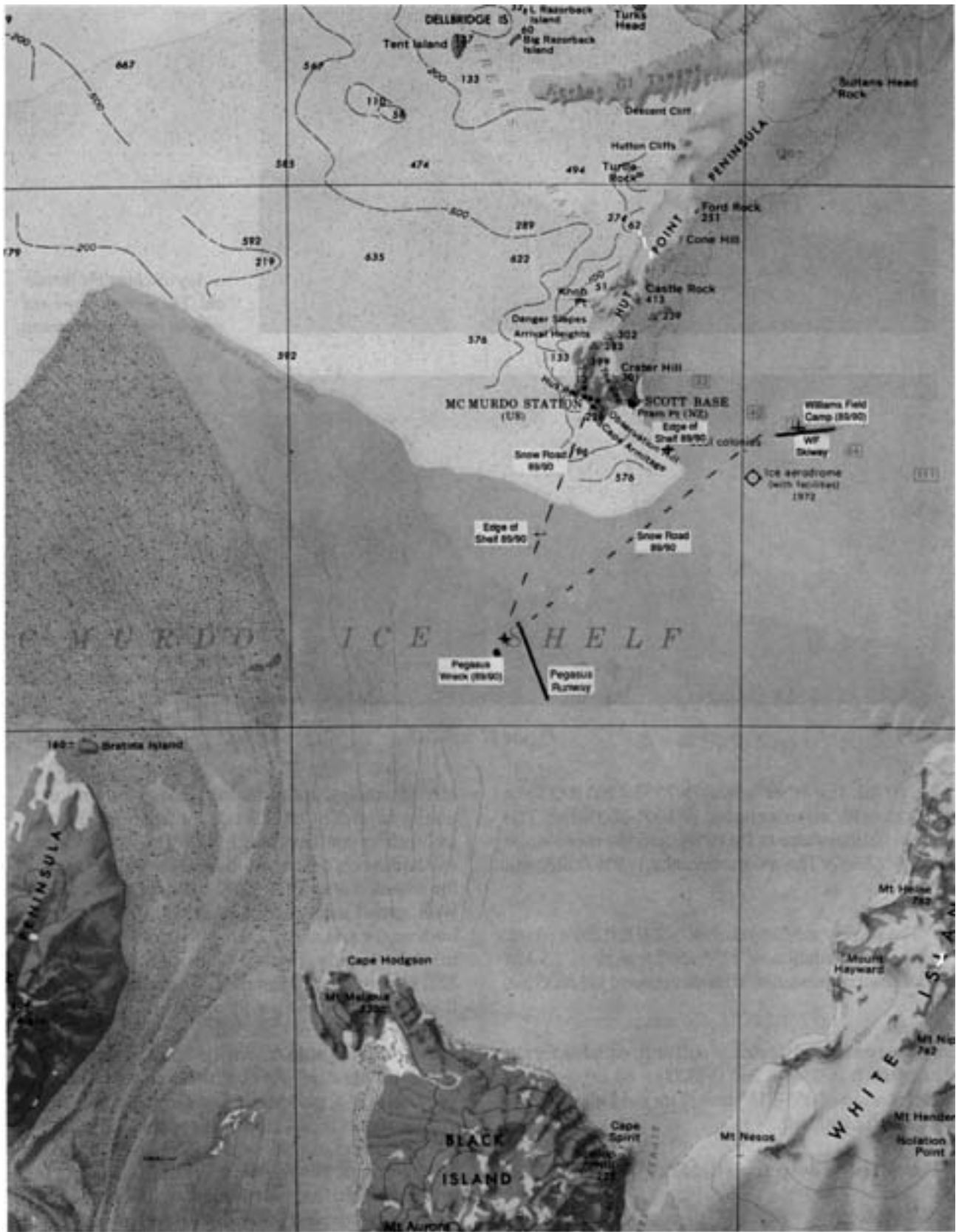

Figure 87. Location of the McMurdo Pegasus runway.

### Vostok

The runway at Vostok, which so far has been used almost solely as a skiway, is immediately southeast of the station (150 m) at an elevation of 12,800 ft (3,900 m). It is 9800 × 260 ft (3000 × 80 m), with an orientation of 035–215° true. An An-74 has landed on wheels at Vostok, but the subsequent takeoff was a bit of an adventure. The runway is not yet adequate for large wheeled aircraft. The snow density is currently about 0.45 Mg/m<sup>3</sup>; the An-74 needs about 0.58 Mg/m<sup>3</sup>. The accumulation rate is only about 5 cm of water per year, or about 15 cm of uncompacted snow.

Experimental construction near Casey, carried out in 1983–84 and 1989–90, confirmed the technical feasibility of compacted snow runways in that area (see the earlier description for details). The 1990 experimental runway lay 5 miles (8 km) due east of Casey at an elevation of 1000 ft (300 m). The runway was 8000 ft (2440 m) long, with an orientation of 09T/27T and a longitudinal slope of almost 3%. The location is 66°17'S, 110°42'E. If an airfield goes into operation here, A1 jet fuel can be delivered from Casey, which receives its supplies by ship. The field will initially have TACAN, NDB and some firefighting equipment.

### Other sites

Compaction of deep snow was considered for McMurdo and South Pole Station. For the types of aircraft that were to operate, and with the technology available, it was not deemed feasible to make reliable hard-surface runways. However, by exploiting the existing South Pole Station skiway, which has been groomed repeatedly for many years, and by using special compaction procedures over an extended period, it might be possible to make a wheel runway for certain types of aircraft (small aircraft, Russian transports, C-130s with reduced tire pressure).

Another possible site for a compacted snow runway is just south of the Larsemann Hills, about 6 km from Progress Base.

In general, runways on deep snow have the best chance of succeeding where the accumu-

lation rate is low and where there are moderately high midsummer temperatures.

### Compacted snow runways on hard ice

This is a relatively new idea, and the only known examples are both untested experimental runways.

The Pegasus\* experimental runway is located on the Ross Ice Shelf some 8 miles (13 km) south-southwest of McMurdo station (Fig. 87). It parallels the snow–ice transition, where the net snow accumulation (to the east) changes to net ablation of exposed glacier ice (to the west) (Fig. 88). The experimental runway, approximately 15T/33T, or 14G/32G, was built as 13,000 × 300 ft (3,960 × 91 m), but approximately 1500 ft (460 m) at the south end can be discarded. The surface slope is negligible. It is currently marked by two lines of flags, set 335 ft

\* Pegasus site is named for a wrecked aircraft that lies nearby at the old Outer Williams Field. Pegasus is a C-121J Super Constellation that crashed while landing below minimums in October 1970.



*Figure 88. Accumulation–ablation transition zone on the Ross Ice Shelf near McMurdo Station. In the background are White Island (left) and Black Island (right). The old Outer Williams Field can be seen in this 1970 photo, which was taken from 9000 ft (2700 m). The Pegasus runway is just inside the snow cover, to the left of Outer Williams Field in this photo. (USN/USGS photo, TMA 2264, frame 0246, 31 January 1970.)*

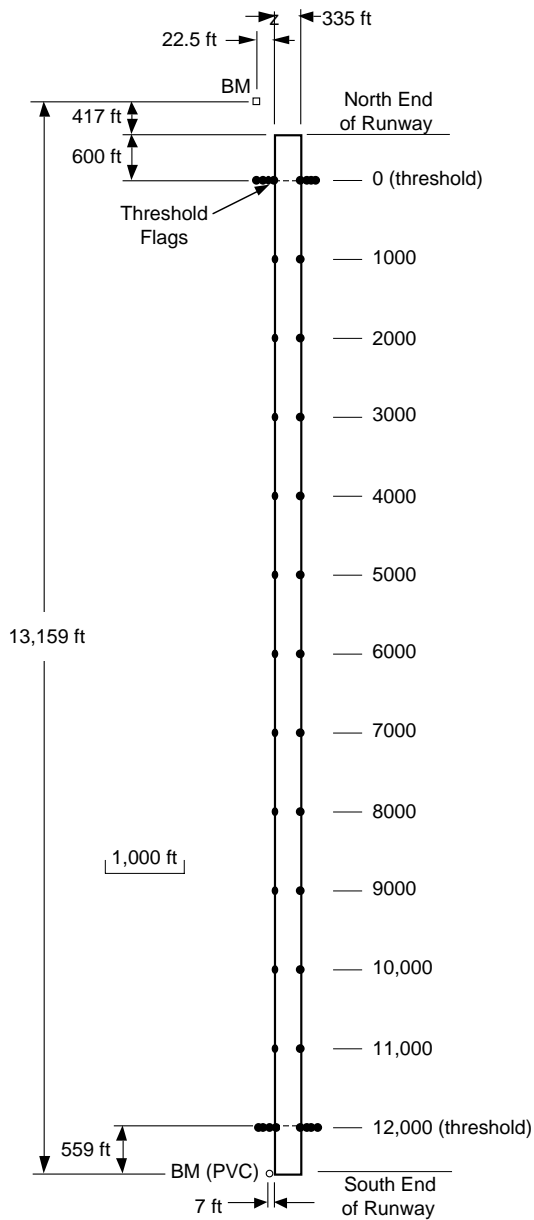

Figure 89. Layout of the Pegasus experimental runway.



Figure 90. View of the Pegasus experimental runway, approaching from the north end. The horizon in the left half of the screen is the southwest end of White Island. On the right side of the screen is the eastern shoulder of Black Island, with Minna Bluff in the far distance. (Photo by M. Mellor, 29 January 1991.)

(102 m) apart. The location of the north (approach) end of the runway is  $77^{\circ}57'S$ ,  $166^{\circ}30'E$  and the field elevation is 29 ft (9 m) (Fig. 89, 90).

There are no facilities at the experimental runway, but limited services can be provided from Williams Field over a 10-mile (16-km) compacted snow road.

If it is denuded of snow cover in midsummer (Fig. 91), the runway develops subsurface melt cavities. In winter, strong winds blow from the direction of Black Island.

### Runways on snow-free glacier ice

The first major runway on bare (blue) glacier ice was Outer Williams Field (Fig. 71, 88). It was located on the Ross Ice Shelf about one mile west of the present Pegasus site. It operated from the 1966-67 season until early 1971. Being on bare ice in an area of net ablation near sea level, it was plagued by serious summer melt problems, notably the formation of subsurface melt cavities. To combat solar radiation, a rotary ice chipper was used periodically to create a reflective surface layer of loose ice fragments. This gradually lowered the surface elevation of the runway, and when it was abandoned in 1971, maintenance reports indicated that invasion of surface meltwater from the surroundings virtually turned it into a canal. For all-season operation, only those blue-ice areas that are free from significant summer melt are worth considering.

### Patriot Hills

This airfield is an unprepared expanse ( $2 \times 8$  km) of blue ice located alongside an isolated ridge in the Heritage Range of the Ellsworth Mountains at  $80^{\circ}19'S$ ,  $81^{\circ}16'W$  (Fig. 92, 93). The exact field elevation is not known to us, but it is perhaps about 3000 ft (900 m), or possibly as low as 2500 ft (750 m). The



*a. Snow and bare ice near the Pegasus site, which varies over the course of the year and from year to year. The ice is glacier ice, and it is not perfectly smooth like first-year sea ice.*



*b. Ice blister. When subsurface melt cavities re-freeze in the autumn, the water expands and pushes up the surface to form an ice blister, which has radial cracks. An area that has significant numbers of ice blisters is unsuitable for runway construction. Even if there is enough snow cover to form a protective reflection layer, it is difficult to plane the blistered surface perfectly flat. (Photo by M. Mellor, 3 December 1989.)*

*Figure 91. Surface conditions at the Pegasus site.*

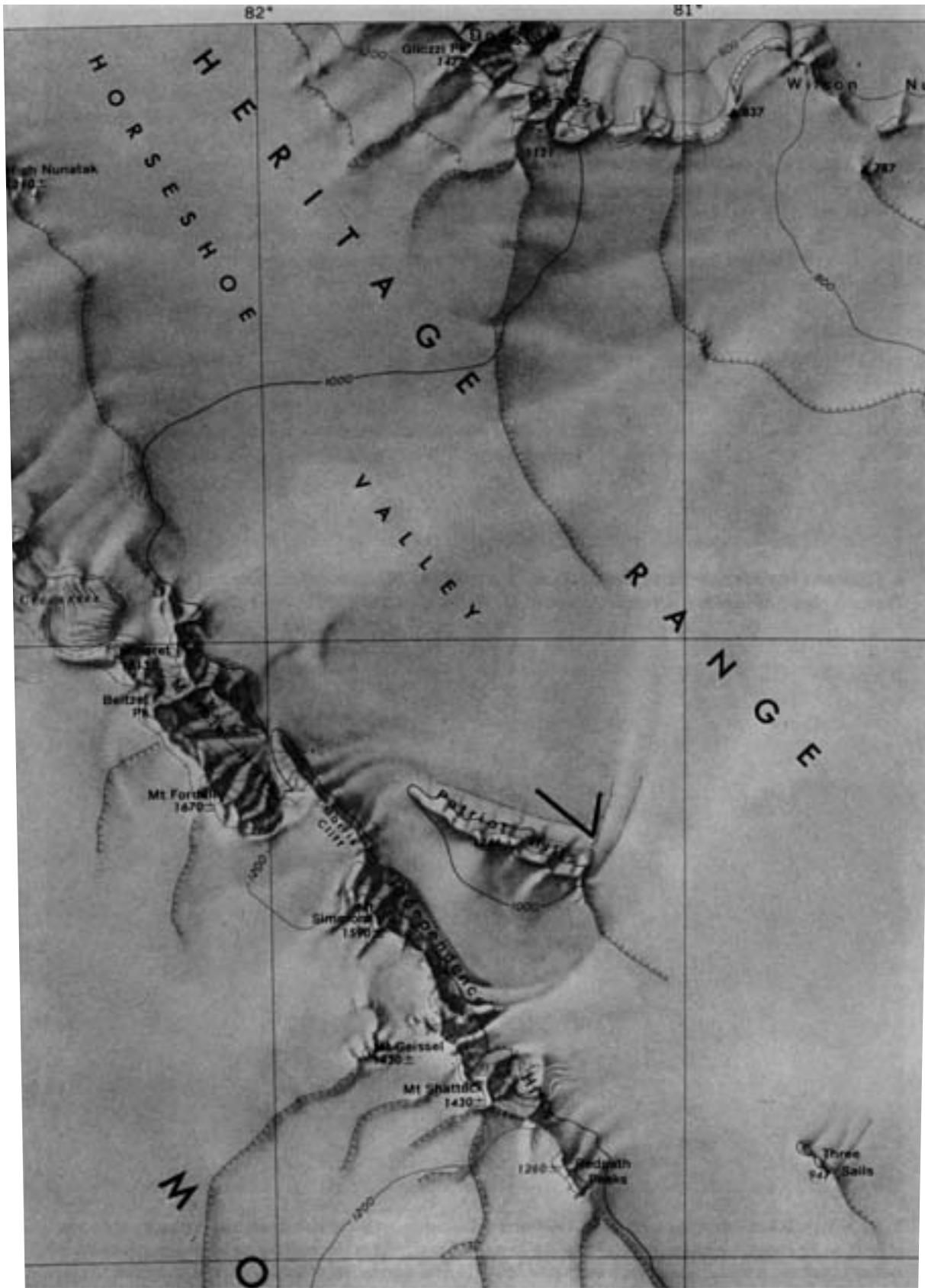

Figure 92. Location of the runways at the Patriot Hills icefield.





*Figure 93. Blue-ice airfield at Patriot Hills (lower left). (USN/USGS photo, TMA 897 F33 047.)*





*Figure 95. Low approach to Mill Glacier. For present purposes the threshold can be taken as about 3000 ft (~1000 m) beyond the Plunket Point medial moraine. The landing is normally directly into the wind, with an uphill slope averaging 1.4%. (Photo by M. Mellor, 30 November 1989.)*

prevailing wind blows from 206° true, putting the field on the lee side of the ridge. The ice has ridges, or rolls, running out at right angles from the ridge. The long runway is 11,200 ft (3,414 m) and is normally crosswind, with an orientation of 13T/31T, or 05G/23G. The overall gradient is less than 1%. Shorter runways running more or less into the wind (towards the ridge) can be used, with an orientation of about 01T/19T, or 11G/29G. The runway length is about 5800 ft (1770 m), with an overall gradient just above 1%. An approach over the ridge necessitates a minimum approach slope of about 4°. Temporary camp facilities are erected as needed on the nearby moraine.

#### *Mill Glacier near Plunket Point*

This airfield is a stretch of unprepared blue ice near the left bank of the Mill Glacier, just upstream from Plunket Point at 85°06'S, 167°15'E (Fig. 94). The field elevation is about 5900 ft (1800 m). The smooth and almost-level ice is about 23,000 ft (7 km) long and its width varies from 3300 ft (1 km) at the northern end to 330 ft (100 m) at the extreme southern end. The prevailing wind in summer seems to blow from 160° true, i.e. directly down-glacier. The long runway is almost 24,000 ft (7.3 km), with an average gradient of 1.4%. The orientation of the long runway is 16T/34T, or 15G/33G, and it is aligned with the prevailing summer wind. There are no approach obstructions at either end (Fig. 95). Crosswind runways are available, two

lines having been surveyed. Of these, the long crosswind line is 9200 ft (2.8 km) long, with an orientation of 07T/25T, or 06G/24G. The short (STOL) crosswind line is 2150 ft (655 m) long, with an orientation of 07T/25T, or 06G/24G.

Daylight markers for part of the long runway were installed in December 1990. A refuge hut and some fuel were set up on the moraine or the ice-free rock alongside the field. A contour plan has been prepared (Fig. 96).

#### *Mount Howe*

This airfield has been used in an unprepared state for wheel landings by Twin Otters (at least eight so far). For large aircraft, some minor planing of the surface is desirable to remove bumps formed where the ice has been covered by patches of snow. (No further bumps will form if the runway is cleared of snow patches about once a year.)

The Mount Howe icefield is located at 87°20'S, 149°50'W, at an elevation of about 7900 ft (2400 m) (Fig. 97). It is 160 nautical miles (296 km) from the South Pole. The prevailing wind in summer seems to blow from 120° true, putting the airfield in the lee of the mountain ridge (Fig. 98). The blue-ice area is about 30,000 ft (9 km) long in the direction north-northeast-south-southwest. The longest runway that is virtually free from obstructions at both ends is 22,600 ft (6.9 km) long, with an overall gradient of less than 1%. The orientation of this runway is 03T/21T, or 06G/24G, giving it a 90° crosswind.

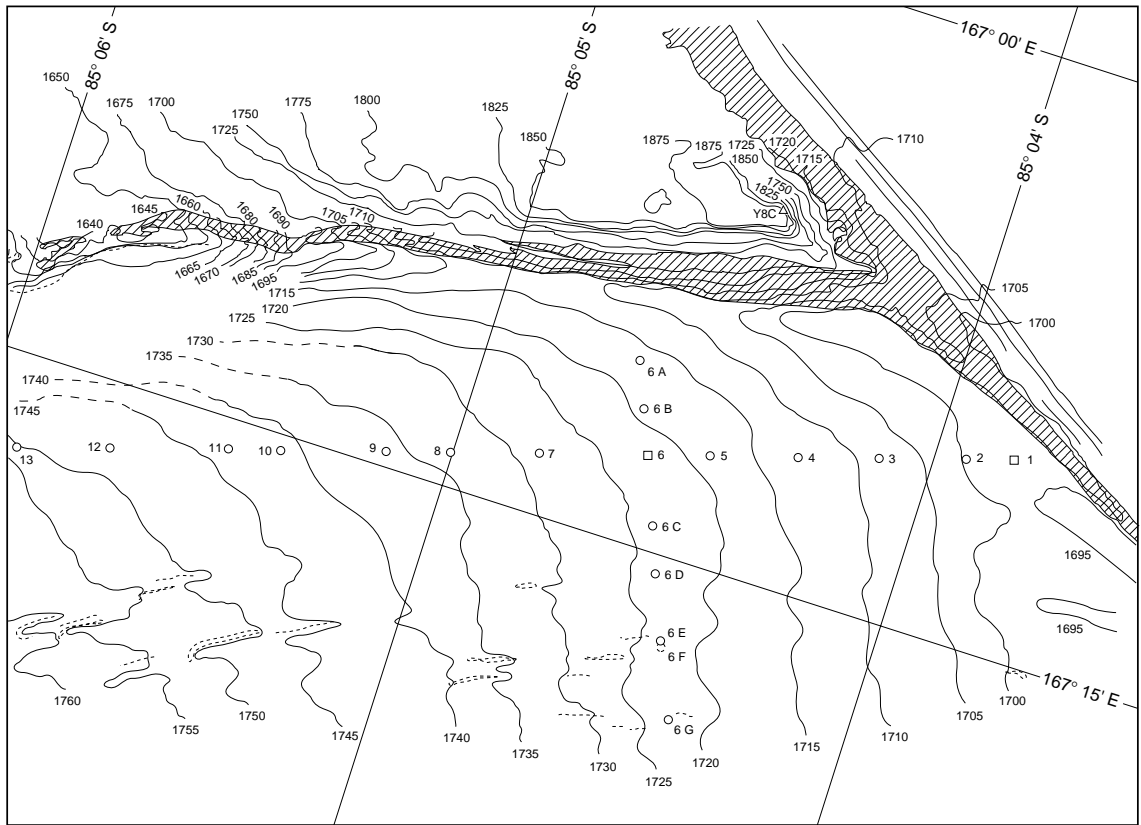
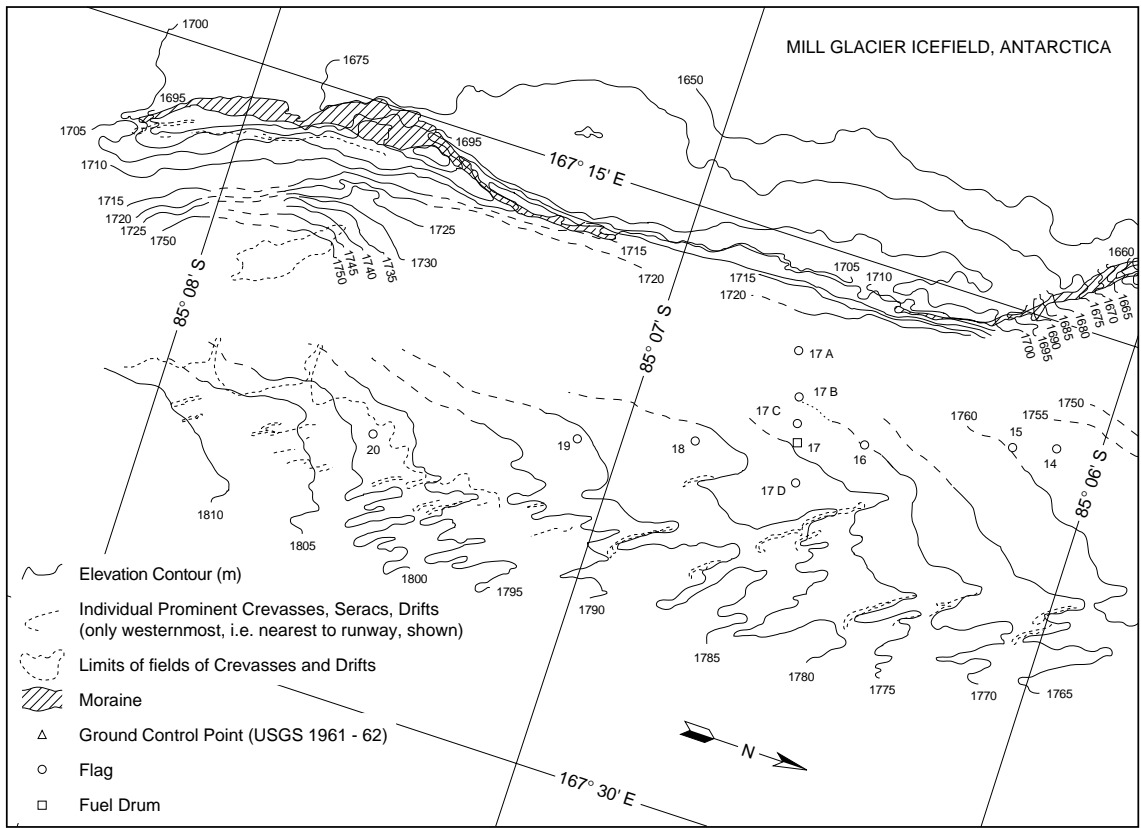

Figure 96. Contour plan of the Mill Glacier icefield. (Contours from air photographs by Henry Brecher; ground markers and leveling profiles by Charles Swinbank.)

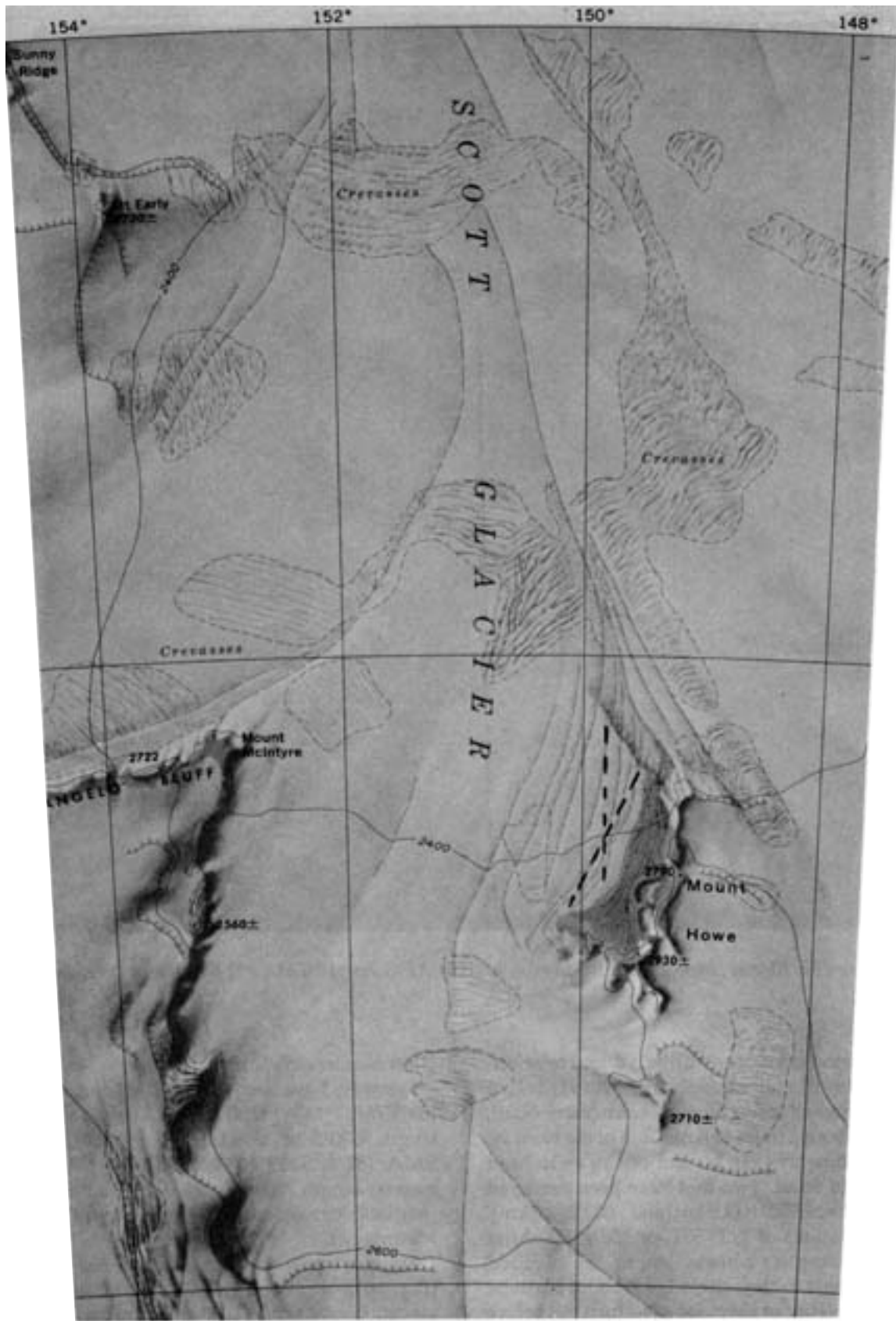

Figure 97. Location of the Mount Howe icefield.



Figure 98. Mount Howe icefield, looking south. (USN/USGS photo, TMA 891 F33 106, 9 December 1961.)

The crosswind component can be reduced by selecting a runway of similar length oriented 18T/36T, or 03G/21G, and accepting a minor obstruction (~500 ft, or 150 m) about 2 miles (3 km) south of the runway.

Shorter runways can be laid out so as to head directly into wind. Two that have been surveyed have lengths of 8700 ft (2.6 km) and 7600 ft (2.3 km), with orientations of 12T/30T, or 15G/33G. After using the complete runway length, the required climbout angle to clear the ridge is about 5° (there is actually plenty of room for a left turn out before reaching the ridge).

#### *Other blue-ice airfield sites*

Runways have been surveyed at Mount Lechner (83°15'S, 51°14'W; 4600 ft or 1400 m a.s.l.; runway length 9800 ft or 3000 m) (Fig. 99) and at Rosser Ridge (82°46'S, 53°40'W; 2600 ft or 800 m a.s.l.; runway length 7900 ft or 2400 m) (Fig. 100). There may be better airfield sites in this area (Pensacola Mountains).

There is a promising area on the Reedy Glacier (Fig. 101), at about 85°45'S, 133°00'W, with an elevation of 4000 ft (1200 m). Landing would be along glacier flow bands (Fig. 102), approximately



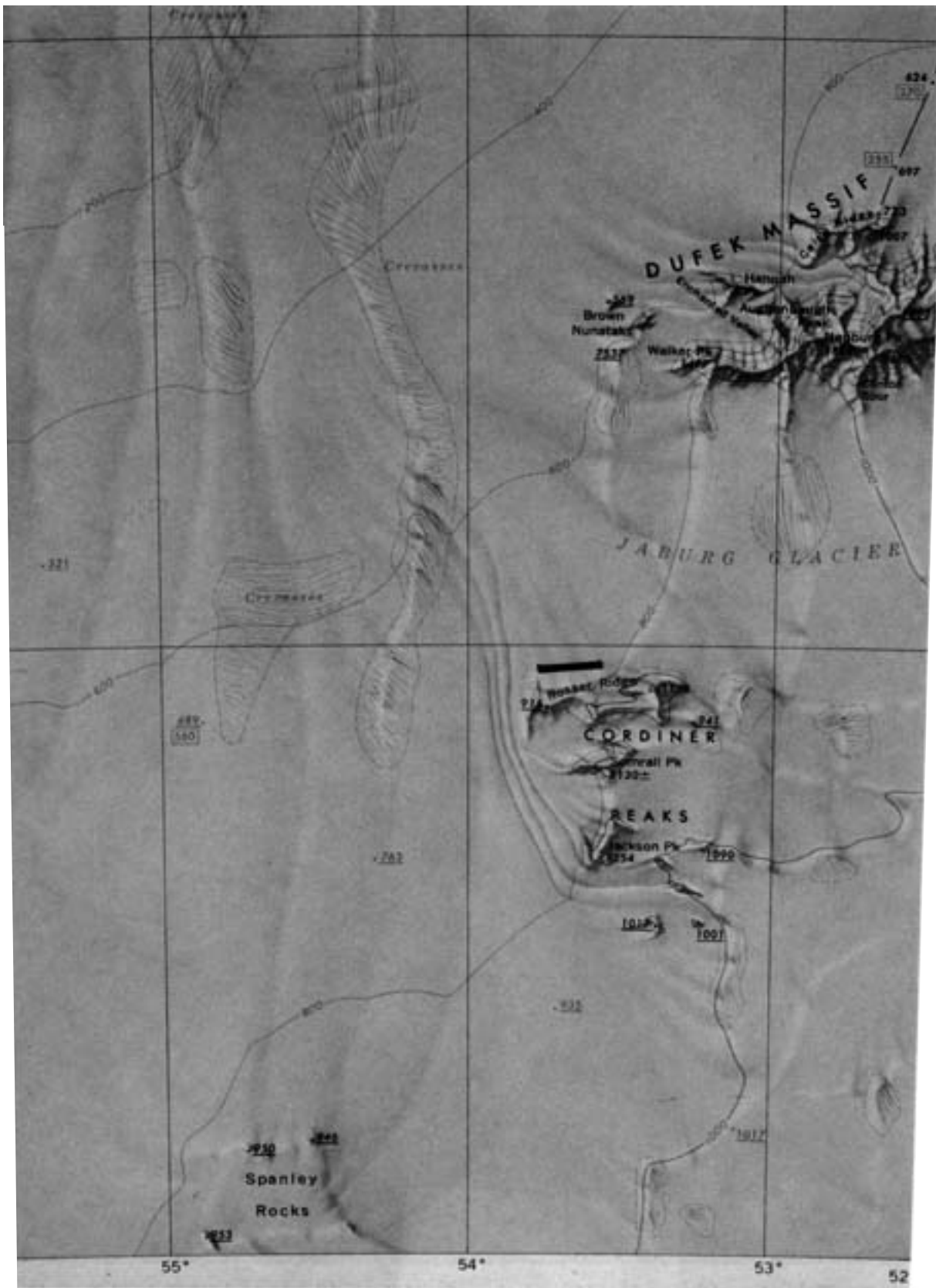

Figure 100. Location of the icefield at Rosser Ridge. See Mellor and Swithinbank (1989) for photographs.



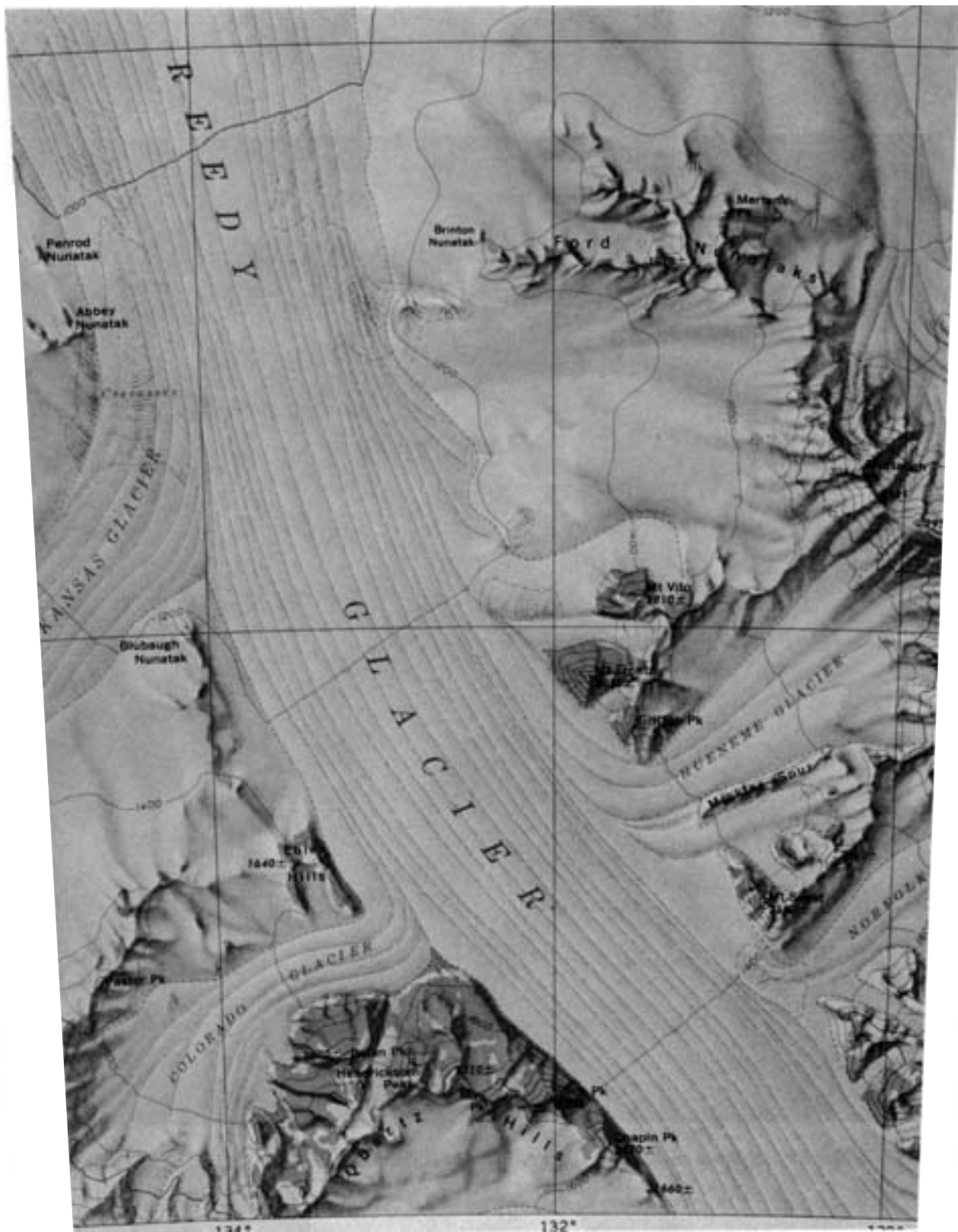

Figure 101. Location of possible blue-ice airfield on Reedy Glacier. The runway might be near the 1200-m contour at approximately 85°45'S, 133°E.



*Figure 102. Blue-ice flow bands on the Reedy Glacier. (Photo by USN for USGS, TMA 1201, L327, 31 October 1963.)*



*Figure 103. Blue ice south of Mawson. The potential airfield site is midway between the northern tips of the Masson Range (nearest ridge) and the northern tip of the David Range (more distant ridge). (Film ANT 76R, frame 9056R, 17 November 1959; see Budd and Russell-Head 1990.)*

335°–155° true, with the prevailing wind from 155° true. The surface slope is less than 1%.

There is a blue-ice site near Mawson, located at about 67°50'S, 62°30'E, with an elevation around 1600 ft (500 m) (Fig. 103, 104). The available area is perhaps about 16,000 ft (4,900 m) long, but surface gradients are up to 3%. A long runway can be aligned with the direction of strong winds (150° true), which do occur in this area; an early December storm destroyed a Beaver and a DC-3 at the nearby Rumdoodle airstrip in 1960.

There is a potential site in the Prince Charles Mountains near Mount Creswell at 72°45'S, 64°15'E. The elevation might be about 1500 m (5000 ft). The

unprepared surface has been used by small aircraft on wheels, but the patchy snow cover might have to be dispersed before use by large aircraft.

Other blue-ice sites exist in Dronning Maud Land (Orvin Mountains, Wohlthat Mountains). To the south of Novolazarevskaya there are possible sites longer than 3 km (10,000 ft) in the Fimbulheimen Mountains at about 72°S, 8°E. There are also possibilities for runways longer than 3 km (10,000 ft) in the Sør Rondane Mountains at about 72°S, 25°E.

The Norwegian Troll Station (72°01'S, 2°32'E; 1290 m elevation) is close to a blue-ice runway site. The proposed runway location is between the points 71°56'40"S, 2°39'00"E and 71°58'40"S, 2°45'

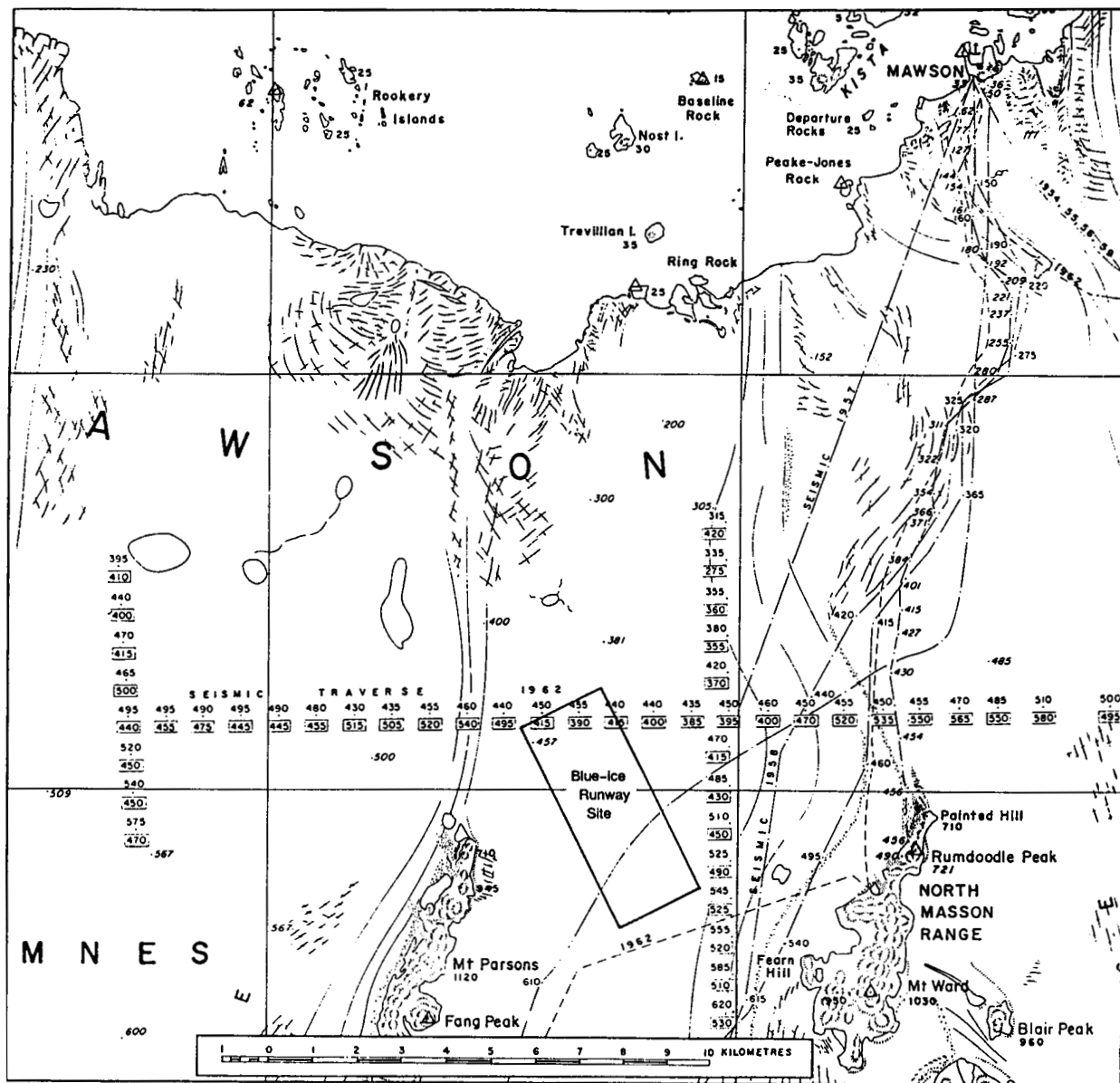

Figure 104. Potential blue-ice airfield site southwest of Mawson (From Budd and Russell-Head 1990.)

30"E.\* The direction is 135°–315° true, and the usable length is about 5 km (16,400 ft). The area had exposed blue ice in 1985 but a thin snow cover in 1990. Immediately southwest of the runway there is rock debris on the ice and a small nunatak emerges (Fig. 105, 106). The southeast end of the runway appears to be obstructed by a rock ridge (part of the Jutulsessen).

There is a possible alternative to Patriot Hills at Union Glacier.† The runway would be on snow-free blue ice, probably near mid-stream at about 79°47'S, 83°19'W, with an elevation of about 2500 ft (780 m) (Fig. 107, 108). The available length (without preparation) might be about 10,000 ft (3,000 m). The gradient may be about 1%.

\* Personal communication with Trond Eiken and Olav Orheim.

† Personal communication, Henry Perk, Kenn Borek Air.



*Figure 105. Location of the suggested blue-ice runway near the Norwegian Troll Station. (SPOT image with an overlay courtesy of Trond Eiken and Olav Orheim.)*

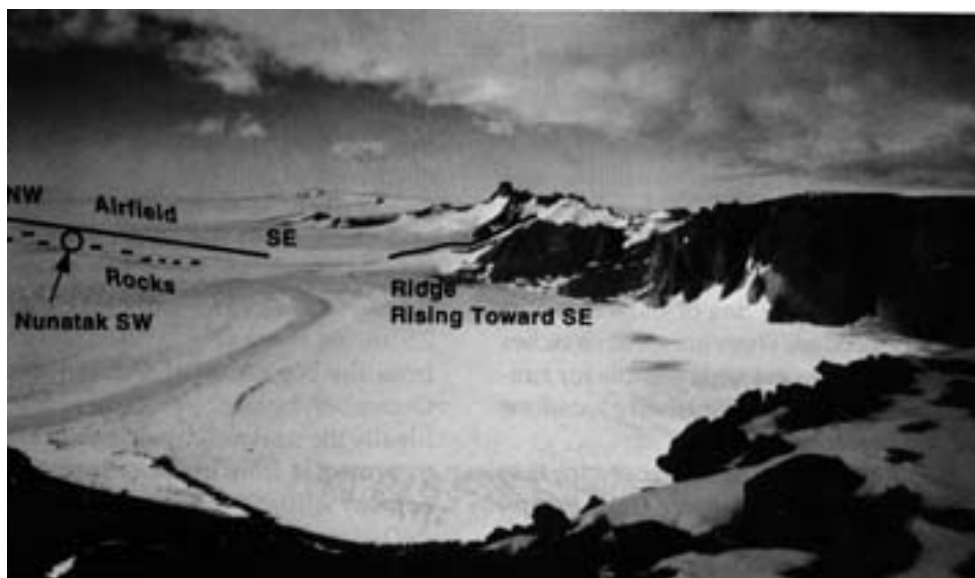

*Figure 106. Low-angle oblique photograph of the runway location near Troll Station. (Photo by Bjorn Lytskjold, Norwegian Polar Research Institute.)*



*Figure 107. Location of potential airfield at Union Glacier.*

### **Runways on first-year sea ice**

Land-fast annual sea ice is widely available, and in some windy areas it remains snow free, offering natural airfields for small wheeled aircraft. For large aircraft, stable locations and very thick ice are requirements, and snow plowing or snow compaction are likely to be needed. There are some stretches of coast where conditions are unfavorable for runways on annual sea ice, and at northerly locations the ice is too thin for large aircraft.

The only major airfield on first-year sea ice is at McMurdo. A runway is prepared by plowing snow from the annual sea ice near McMurdo station each year in late September. The preferred location is an embayment south (true) of Cape Armitage, having the runway directly aligned with skiway 07G/25G at Williams Field. However, if the ice is rough at

this location, the runway may be to the west or northwest of Hut Point, in which case the orientation is likely to be north-northwest-south-southeast. For 1990-91 the runway was 14G/32G. Runway locations are shown in Figure 109. The ice thickness in October and November is 7-8 ft (2.1-2.5 m) or more (Fig. 110). The runway operates from the beginning of October until about 12-15 December, by which time there is surface melting. Ideally the runway should retain a thin snow cover to protect it from evaporation and radiation. The runway is 10,000 × 350 ft (3,000 × 107 m), with 450-ft- (137-m-) wide turnaround areas at the ends (Fig. 111). The runway was formerly 300 ft (91 m) wide, but for C-5 operations the required runway width is 350 ft (107 m). Two taxiways lead into a large plowed area, which provides aircraft parking, tran

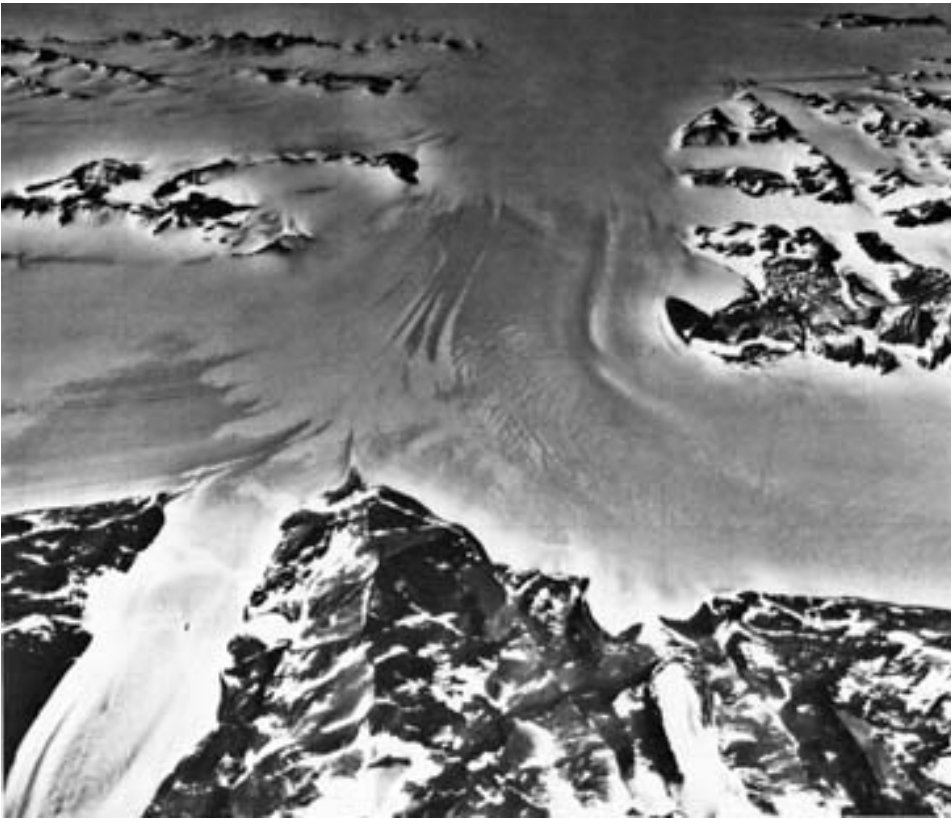

*a. USGS photo TMA  
1496, F31, 196, 14  
December 1964.*



*b. USGS photo TMA  
1714, F33, 104, 6  
January 1966.*

*Figure 108. Possible blue-ice airfield on Union Glacier.*

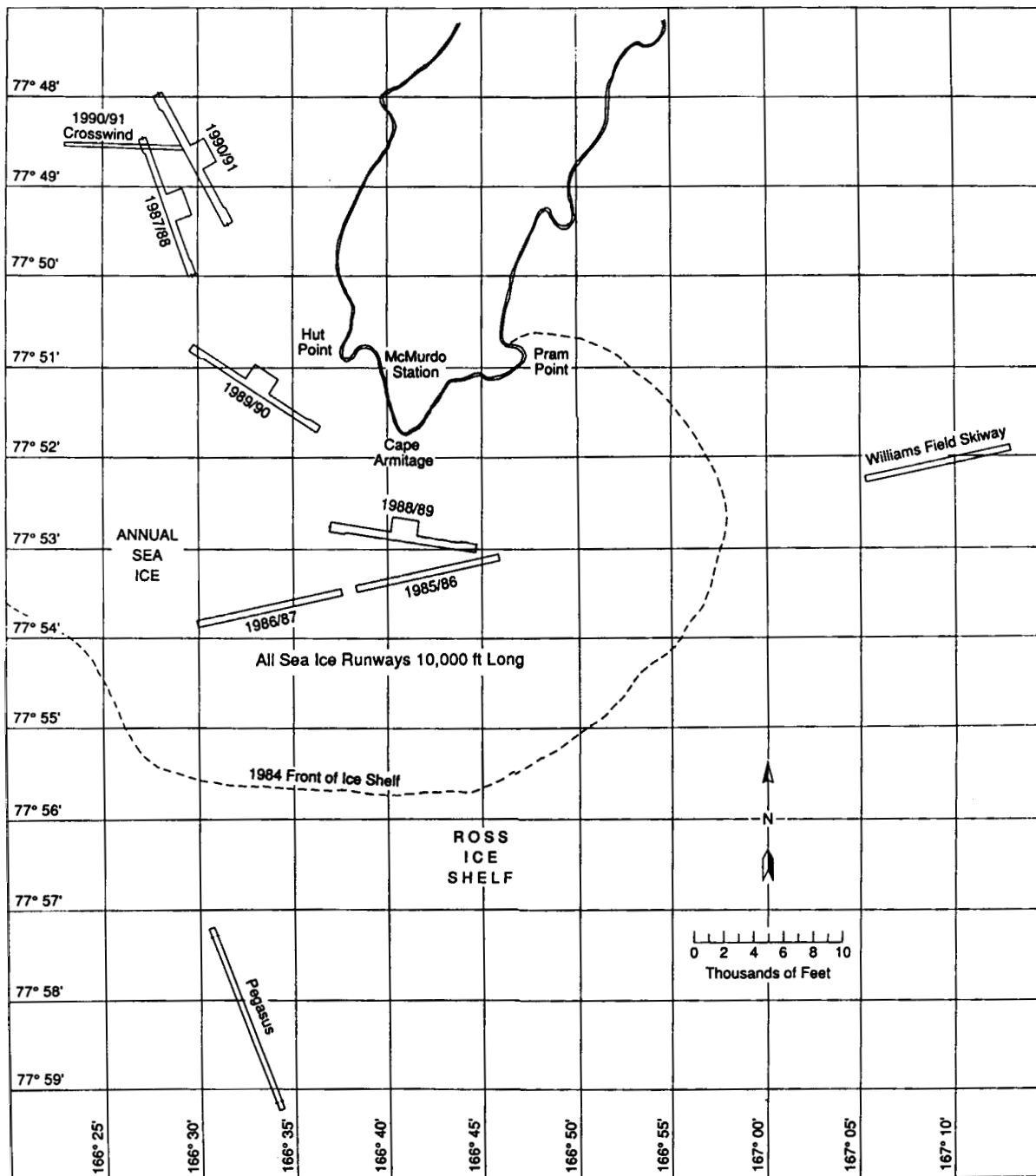

Figure 109. Locations of the runways that have been laid out on annual sea ice at McMurdo in recent years. The Williams Field skiway and the Pegasus runway are also shown.

sient parking, fuel pits, a cargo yard and the camp. The camp buildings are on heavy cargo sleds; when the field is evacuated in December, they are moved to Williams Field. The sea ice runway has PAR, ASR, TACAN and a control tower. Weather minimums are 300 ft and 3/4 mile. As of 1990-91 the fuel will be JP-8. When in operation the sea ice runway has crash crews and firefighting equipment on

appropriate vehicles. The runway has daylight markers as described for Williams Field, with marker flags to define taxiways and aprons. The runway also has approach lights and runway lights, as described for Williams Field. The ice bearing capacity for landing and parking various types of aircraft is determined by the USN Civil Engineering Laboratory (Fig. 76, 77).



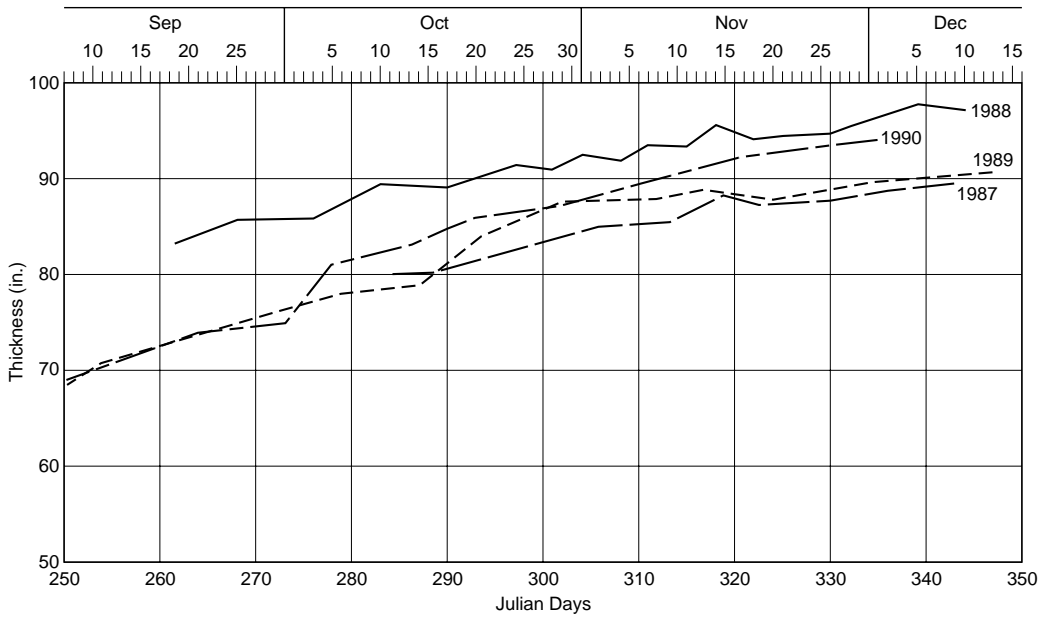

Figure 110. Thickness of the McMurdo sea-ice runway in recent years. Growth usually continues until just after mid-December. The thickness then decreases quite rapidly for a month or so, with a total loss of 3–5 ft (1–1.5 m) in thickness. Without icebreaker intervention, breakout occurs about the end of January. (Data from NSFA.)

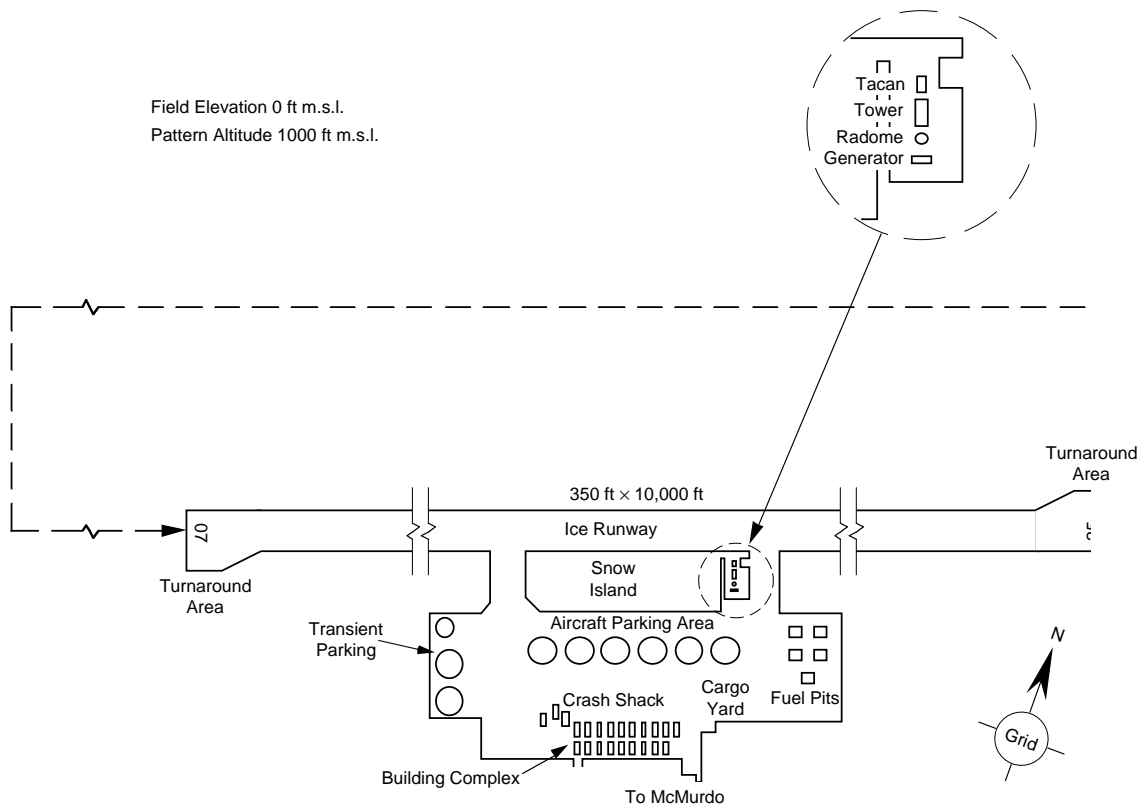

Figure 111. Typical layout for the seasonal runway on annual sea ice at McMurdo (1990 rearrangement). The runways are designated by grid heading, a practice that just about reverses north and south at McMurdo.



Figure 112. Smooth, multi-year sea ice on the coast of Bunger Hills, near Edgeworth David summer station (circled). (Film CASC 8962, frame 65, January/March 1986; see Budd and Russell-Head 1990.)

### Runways on multi-year sea ice

From 1956 until early 1962 the McMurdo runways were on multi-year sea ice (“bay ice”). By 1961-62 the snow plow berms were 20 ft (6 m) high, and they extended 150–200 ft (45–60 m) to each side of the runway, depressing and cracking the ice, which broke up and went to sea in February 1962. A new runway was built on multi-year ice in October 1962, 3 nautical miles (5.6 km) south-southwest of Cape Armitage. The natural snow cover was 4–5 ft (1.2–1.5 m) deep, and there were pressure rolls up to 2 ft (0.6 m) high. Snow was plowed off, pressure rolls were leveled by a rotary ice chipper, and low spots were flooded with sea water. By 1964-65 the snowplow berms were 30 ft (9 m) high, depressing and cracking the ice, which broke up in February 1965. Since then, the ice runway has been on first-year ice.

At Bunger Hills, near the Australian summer station called Edgeworth David (66°15'S, 100°37'E), there is a smooth, snow-free area of landlocked multi-year sea ice that is at least 2 m (6.6 ft) thick and long enough to give a 10,000 ft (3 km) runway aligned with the local strong wind direction (Fig. 112). The surrounding hills and islands reach a height of about 50 m (165 ft). The surface does not appear to deteriorate significantly during the summer melt period.

### Runways on lake ice

Some Antarctic lakes are ruled out by approach obstructions. A lake may be in a bowl-shaped depression, or it may be close to hills or rock ridges. No details of Russian operations on lake ice are currently available.

The only known site with the potential to handle



*Figure 113. Southern part of Beaver Lake, looking south-southwest across Radok Lake and more or less into the prevailing wind. The best ice for wheeled aircraft may be the dark patch on the left. (Photo by M. Mellor, September 1957.)*

large aircraft is Beaver Lake, which is located at about 70°48'S, 68°15'E, some 30 km south-southwest of Soyuz Station. The surface elevation is close to sea level. It is in a deep embayment of the Prince Charles Mountains, abutted on the north side by floating glacier ice from the Amery Ice Shelf system (Fig. 113). It appears to receive meltwater from adjacent hills to the south and west, from overflow out of Radok Lake, and from the glacier ice to the north. The lake ice is about 3 m thick; it rises and falls with the tide, having a range of about 0.3 m. The east–west width is up to about 7 miles (11 km) and the north–south length is up to about 9 km (5 miles). The smoothest ice does not extend over the full area of the lake. An open-water moat forms between the rock and the lake ice in summer. In the moat, freshwater seems to float on seawater. Ground parties have not noticed any significant layer of meltwater on top of the lake ice in summer. There is, however, strong surface ablation, and the lake ice probably maintains its thickness by basal freezing. The prevailing wind appears to be from 210° true, giving an unobstructed approach from the

north and climbout to the south over rising terrain. A recent Australian map of Beaver Lake, at 1:100,000 scale, gives a conventional topographic map on one side of the sheet and a satellite image map on the reverse side.

#### **Conventional rock-fill runways**

The following locations are airfields that are currently in use or nearing completion or would provide suitable sites.

##### *Teniente Rodolfo Marsh*

The gravel runway (Fig. 114) on King George Island (62°11'S, 58°57'W) is 4282 × 98 ft (1305 × 30 m) long at an elevation of 135 ft (41 m). The orientation is 11M/29M, and the magnetic variation is about 12° east. The runway has lights and VASI. There are no significant approach obstructions (Fig. 115). The field has VOR/DME and NDB, with HF and VHF communications. There is firefighting equipment at the runway; weather services and medical facilities are available at the nearby base. There is a hangar and bulk Jet A1. The weather is often bad.



*Figure 114. Runway surface at Marsh (rollout end of 11). The base is down the hill beyond the end of the runway. The hangar is to the right of the Twin Otter, and the ramp is behind the photographer's right shoulder. (Photo by M. Mellor, 18 December 1988.)*



*Figure 115. Approach to runway 11 (108 M) at Teniente Rodolfo Marsh Base, King George Island. (Photo by Capt. Steve Fackler, USAF, 18 December 1988.)*

#### *Base Marambio*

The Marambio runway (64°14'S, 56°36'W) was built on top of a meseta on Seymour Island as a 4100- × 115-ft (1260- × 35-m) gravel strip (Fig. 116, 117). The field elevation is 760 ft (230 m), and the orientation is 06/24 M. An extended runway was designed with an orientation 20° off that of the original runway to give better alignment with the prevailing wind. The new runway (04/22 M) overlaps the old one at the southwest end, where it is 40% complete, but construction is currently suspended. When completed, the new runway will be

7200 × 150 ft (2200 × 45 m). Marambio has VOR and NDB. The weather is often bad, with the cloud base commonly near, or below, the field elevation.

#### *Dumont d'Urville*

The runway at Dumont d'Urville (66°40'S, 140°01'E) is scheduled for completion in October 1992. It consists of a rock-fill causeway that links three islands, each of which has been cut and filled (Fig. 118). The runway is 3600 × 98 ft (1100 × 30 m), approximately 16 ft (5 m) above sea level. It will have asphalt paving laid over gravel. The orienta

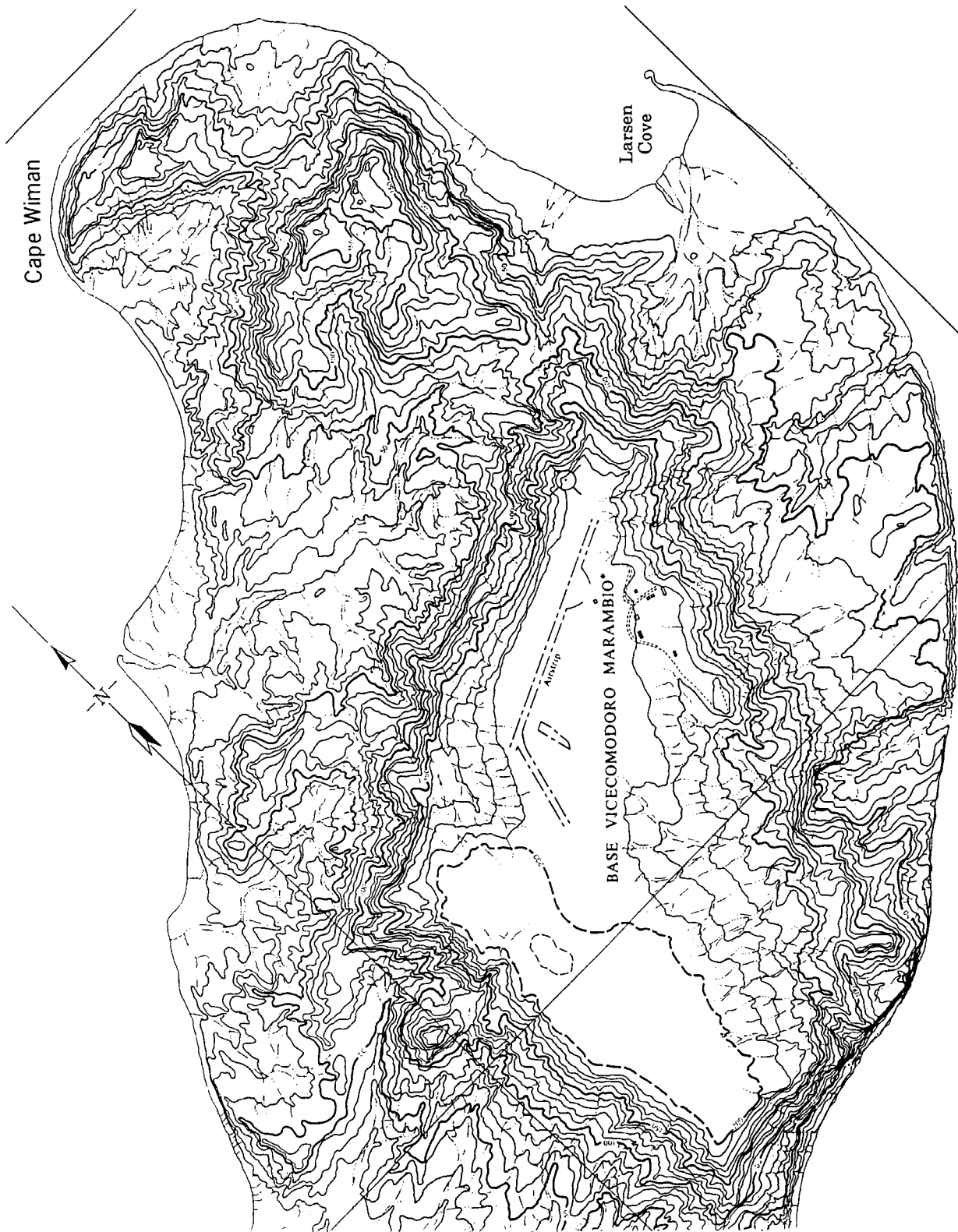

Figure 116. Marambio runway on Seymour Island. The existing runway is 06/24M. The re-aligned and extended runway will be 04/22 M, with the southwest end overlapping the west-southwest end of the existing runway.



*Figure 117. Runway surface at Marambio. (Photo courtesy of Arturo Corté.)*



*Figure 118. Runway at Dumont d'Urville during construction (1990). This view is from the seaward (northwest) end. At this stage of construction, Ile Cuvier and Ile du Lion had been leveled and the pass between them had been filled. The islands at the southeast end (Iles Buffon) were still awaiting leveling when this photo was taken. The ice in the background is the tongue of the Glacier de l'Astrolabe. (Photo courtesy of Michel Engler, Expéditions Polaires Françaises.)*

tion is approximately 135T/315T (close to the wind direction), probably favoring landing towards the southeast and takeoff towards the northwest (towards, and away from, the tongue of the Glacier de l'Astrolabe). The approach from the sea (from the northwest) is unobstructed. The field is expected to have limited facilities, a parking apron and a hangar for a Twin Otter (inside dimensions  $22.7 \times 20.5$  m). There is a turnaround at the southeast end.

The project involved the blasting of islands up to

31 m high, with rock benches up to 26 m high. The passes that had to be filled were up to 200 m wide and up to 27 m deep. The total length of fill in the passes is 475 m.

#### *Rothera*

The Rothera runway ( $67^{\circ}34'S$ ,  $68^{\circ}07'W$ ) is built on a narrow isthmus between Rothera Point and the Wormald Ice Piedmont (Fig. 119). There are short rock-fill extensions into the sea at both ends.

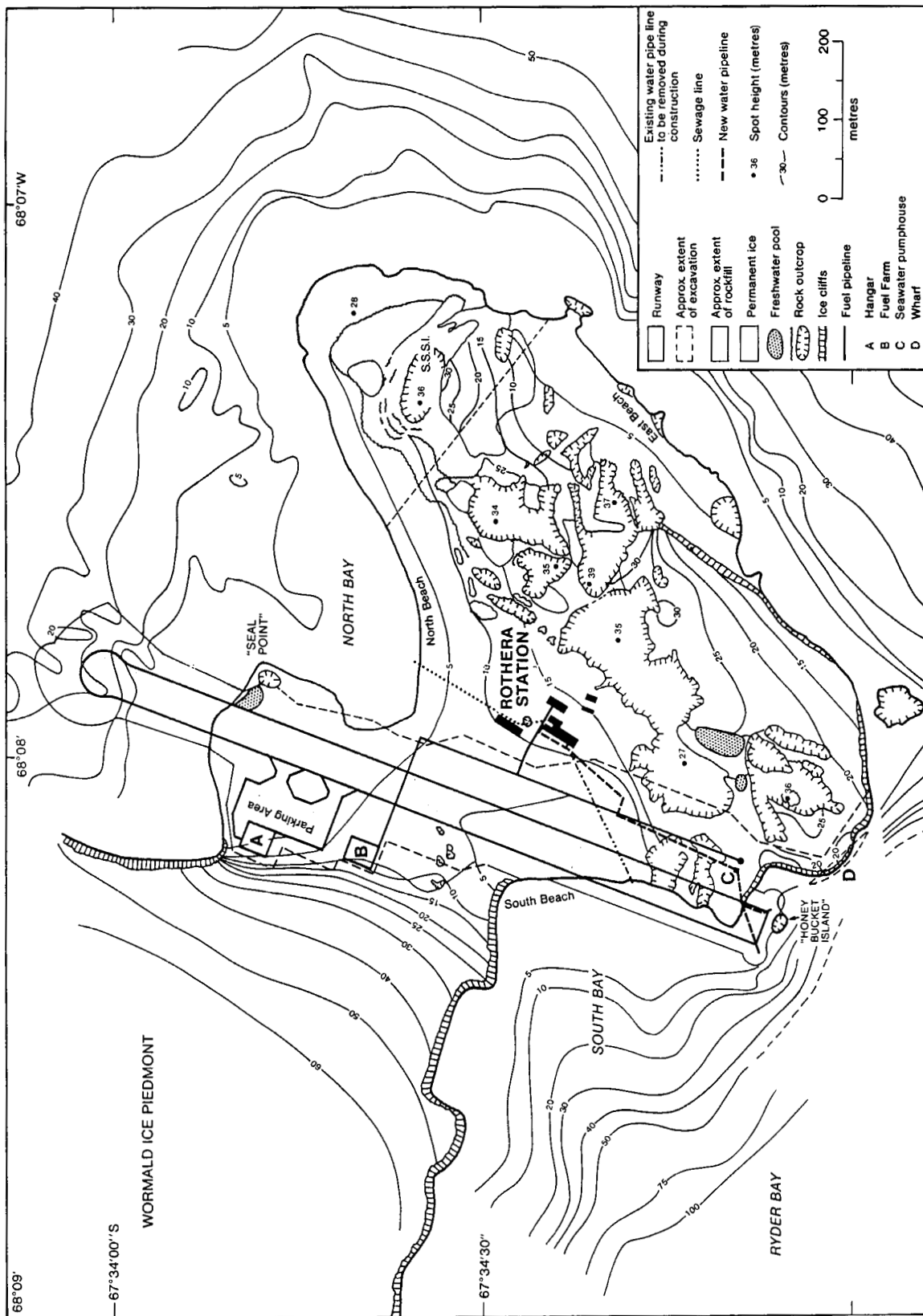

Figure 119. Plan of the runway at Rothera. (From the BAS final comprehensive Environmental Evaluation, 1989.)

The runway is 3000 × 150 ft (915 × 45 m), aligned 02T/20T. The prevailing wind is from the north. There is a 390- × 165-ft (120- × 50-m) parking area, a 115- × 108-ft (35- × 33-m) hangar and a tank farm that will have Jet A1.

#### Marble Point

Marble Point (77°28'S, 163°45'E) is probably the best Antarctic runway site investigated so far (Fig. 120, 121). Situated on the mainland, with ship access, the terrain is favorable for a 10,000-ft (3-km) runway, with 6000 ft (1800 m) of that distance easy construction (Fig. 122). The site has excellent construction material (Fig. 123) and little wildlife. Detailed engineering studies and environmental assessments have been made.

#### Vestfold Hills

Site surveys were made here by Australian engineers in 1977. Two sites for runways on rock and gravel exist a few kilometers to the east and northeast of Davis Station (68°35'S, 77°58'E). The sites are broad valleys in an ice-free area that has low relief. A runway up to 8000 ft (2.4 km) long could be built, and extension up to 10,000 ft (3 km) would be possible by placing fill in the shallow coastal water.

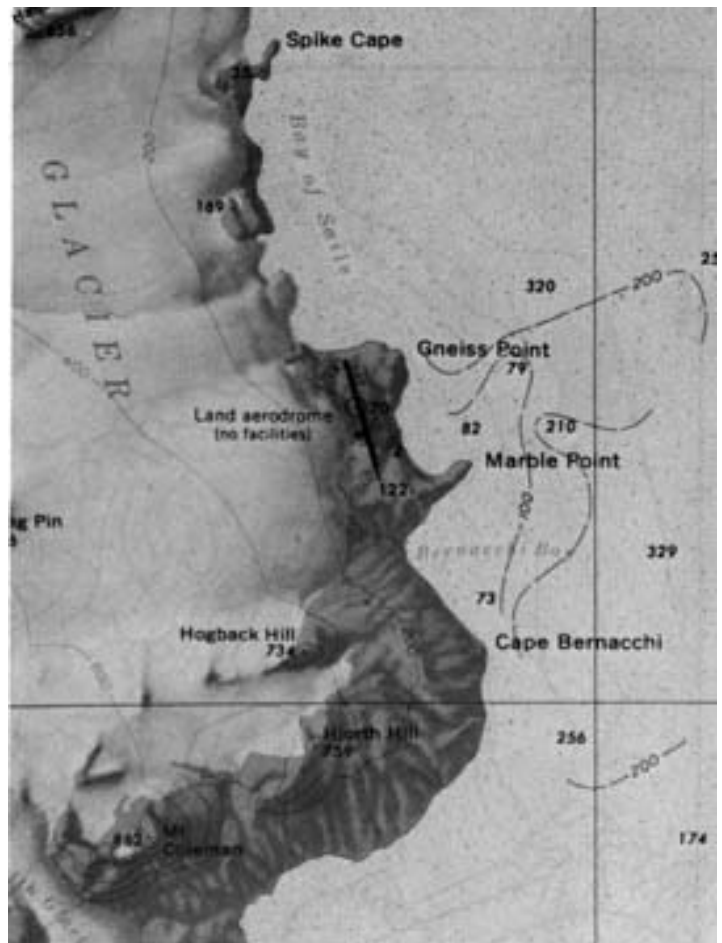

Figure 120. Location of Marble Point runway site.



Figure 121. Marble Point runway site, looking west towards the Wilson Piedmont Glacier. The north end of the runway would be out of the view to the right; the south end would be opposite. The Polar Sea is pumping helicopter fuel ashore in the first direct delivery to the Marble Point outpost. (Photo by M. Mellor, 18 January 1989.)







Figure 123. Representative surface material at the south end of the Marble Point runway site. (Photo by M. Mellor, 18 January 1989.)

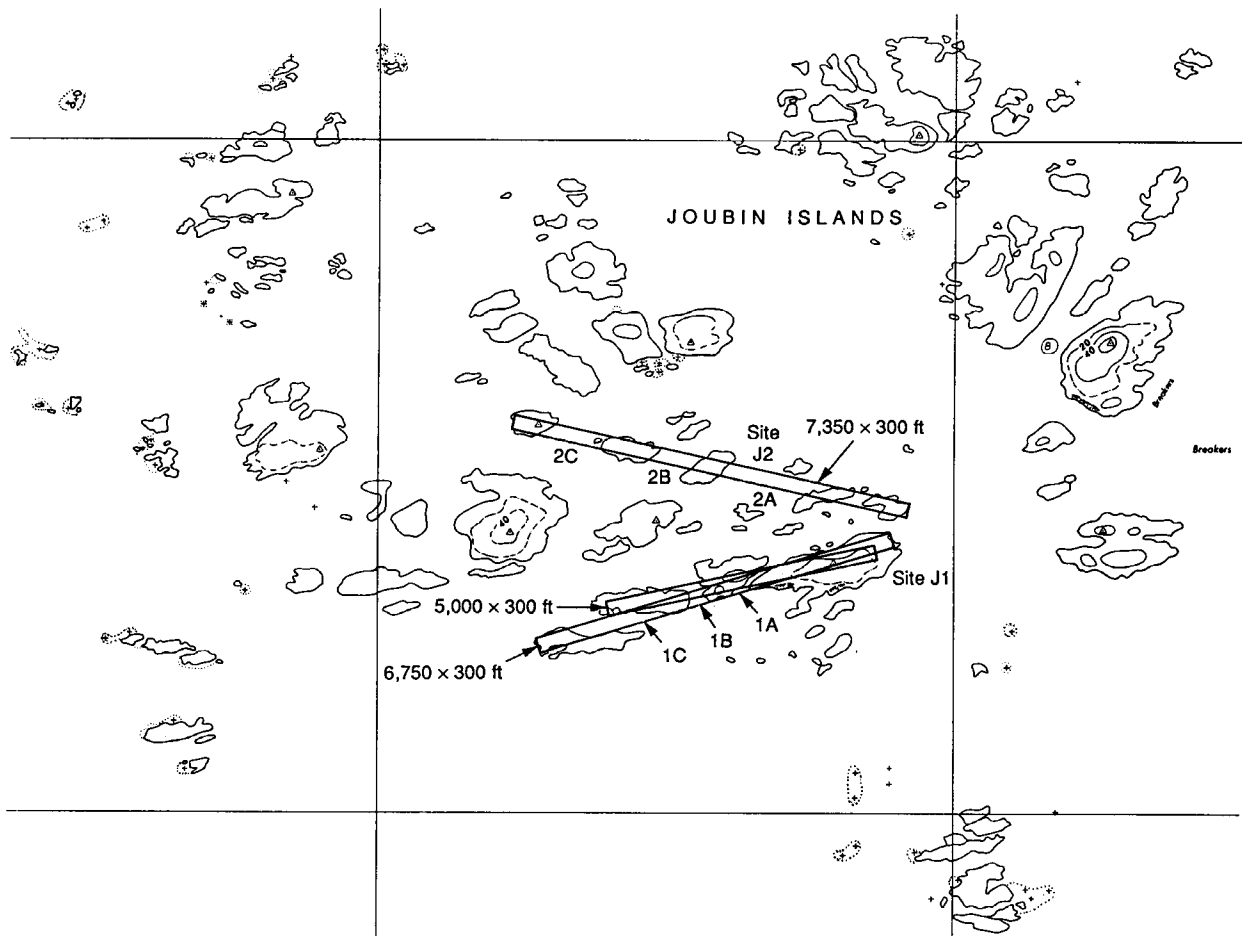

Figure 124. Potential runway site in the Joubin Islands near Palmer Station. Water depths in the passes are: 1A: 4.5 m; 1B: 11.5 m; 1C: 11 m; 2A: 6.5–8.7 m; 2B: 7.5 m; 2C: 7–11 m. At Site J1 the large island at the east end reaches a height of about 25 m; its neighbor to the west has a couple of peaks that reach about 20 m, while the other two islands are lower than 20 m. At Site J2 all the islands are low-lying.

The depth of cut required would not exceed a few meters. The area is considered to be environmentally sensitive, and full assessments would be essential.

### Bunger Hills

There is a possible runway site about 5 km north-east of Dobrowolski, at about 66°14'S, 100°50'E. A 10,000-ft (3-km) runway might be possible, but there is no access to the site by ship.

### Palmer

A runway could be built in the Joubin Islands, about 9 nautical miles (17 km) out to sea from Palmer Station (Fig. 124). Small islands would be leveled and linked by placing fill in the narrow channels between them. The easiest task would be a 5000-ft (1.5-km) runway linking three islands. By changing the alignment slightly and extending to a fourth island, the runway could be 6750 ft (2 km); this would probably be the best investment. Using another group of five low-lying islands, a 7350-ft (2.2-km) runway could be built, but the passes between the islands are quite wide and there is not much space for parking. There are no signs of nesting areas for seabirds or penguins, and the only vegetation is lichens. The islands are bare granite rock, with no significant pockets of fine-grained soil.

### Deception Island

Deception Island (62°57'S, 60°39'W) is a small horseshoe-shaped volcanic island (Fig. 125). It en-

closes a bay, Port Foster, which has its entrance at the southeast corner of the island. The overall diameter of the island is about 7.5 nautical miles. Britain, Chile and Argentina have had bases on Deception Island.

In 1928, Wilkins used a 2500-ft (760-m) runway on the east side of Port Foster for the first flight in Antarctica (Fig. 126). This runway was later covered by more volcanic ash from the 1967 and 1969 eruptions. The ash now provides a landing area (about 2000 ft, or 600 m) for relatively small aircraft with low-pressure tires (Fig. 127). This runway could be extended by installing drainage culverts and then filling and grading the ash deposit. The bearing strength could be improved by compacting the ash and perhaps by mixing in additives. A Twin Otter pilot who has used the existing expedient runway estimates that the usable length could be increased to 4000–5000 ft (1200–1500 m).<sup>\*</sup> The orientation would be approximately 15T/33T.

STOL aircraft can approach from either the harbor entrance or the ridge on the north side of the island (about 500 ft, or 150 m, at the lowest point). For large aircraft there would probably be a one-way approach from the north.

<sup>\*</sup> Personal communication, Henry Perk, Kenn Borek Air.

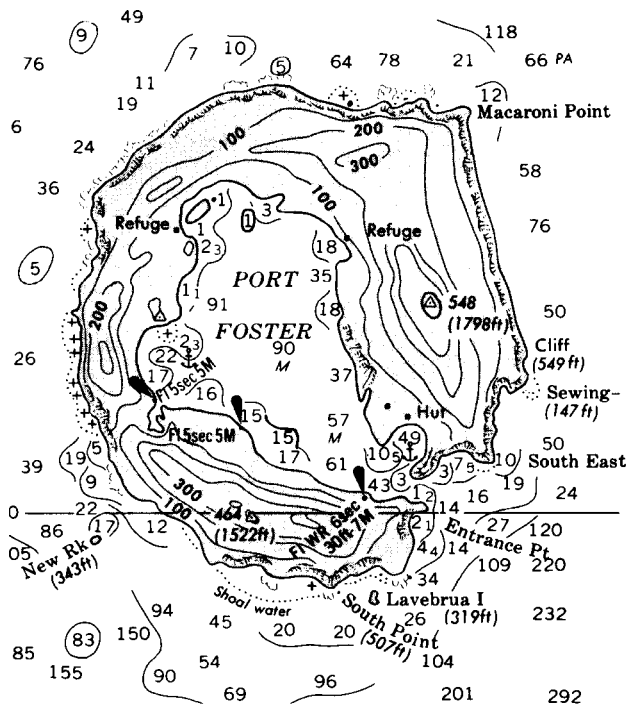

Figure 125. Deception Island.

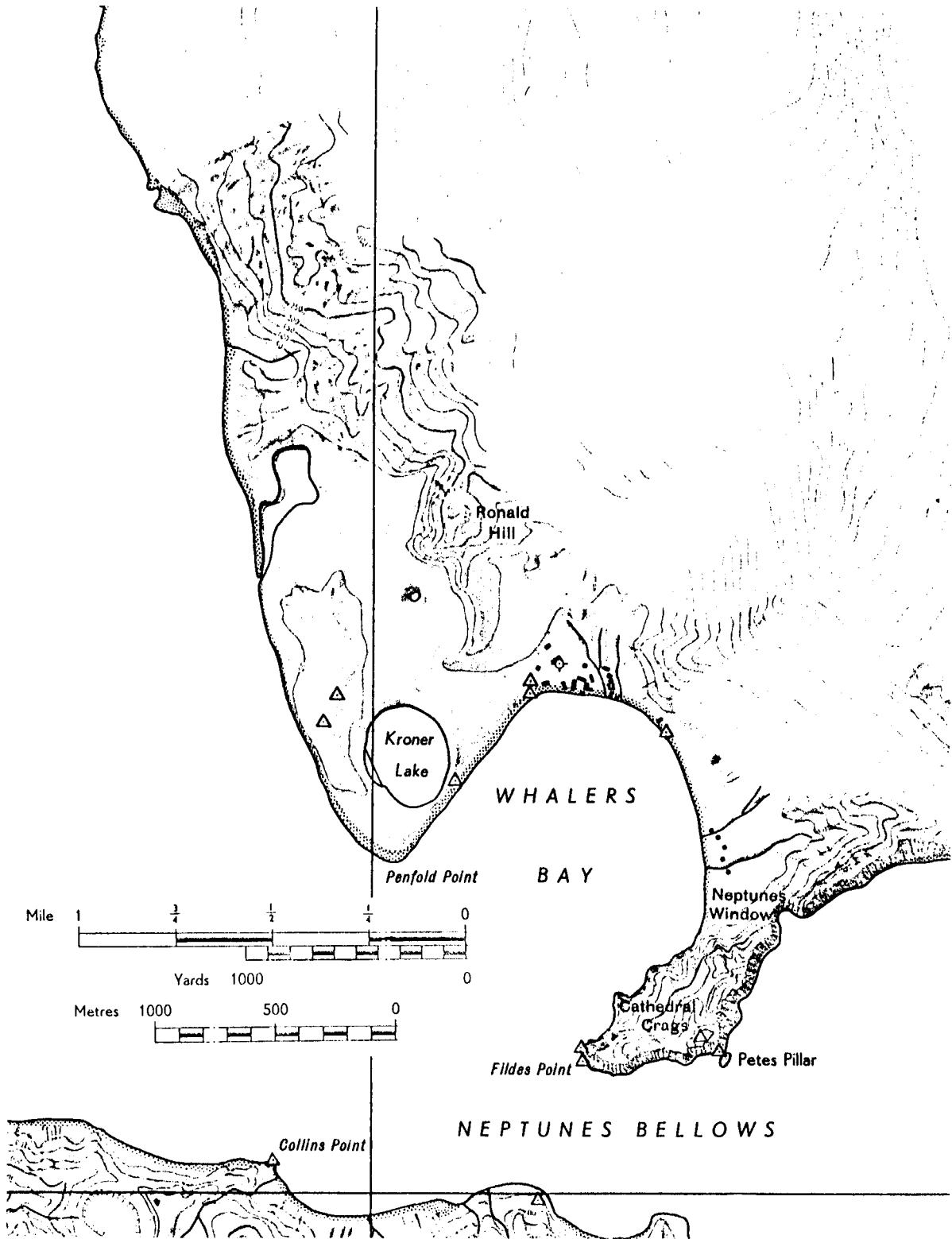

Figure 126. Runway site on volcanic ash, immediately north of Penfold Point and Whalers Bay, Deception Island.

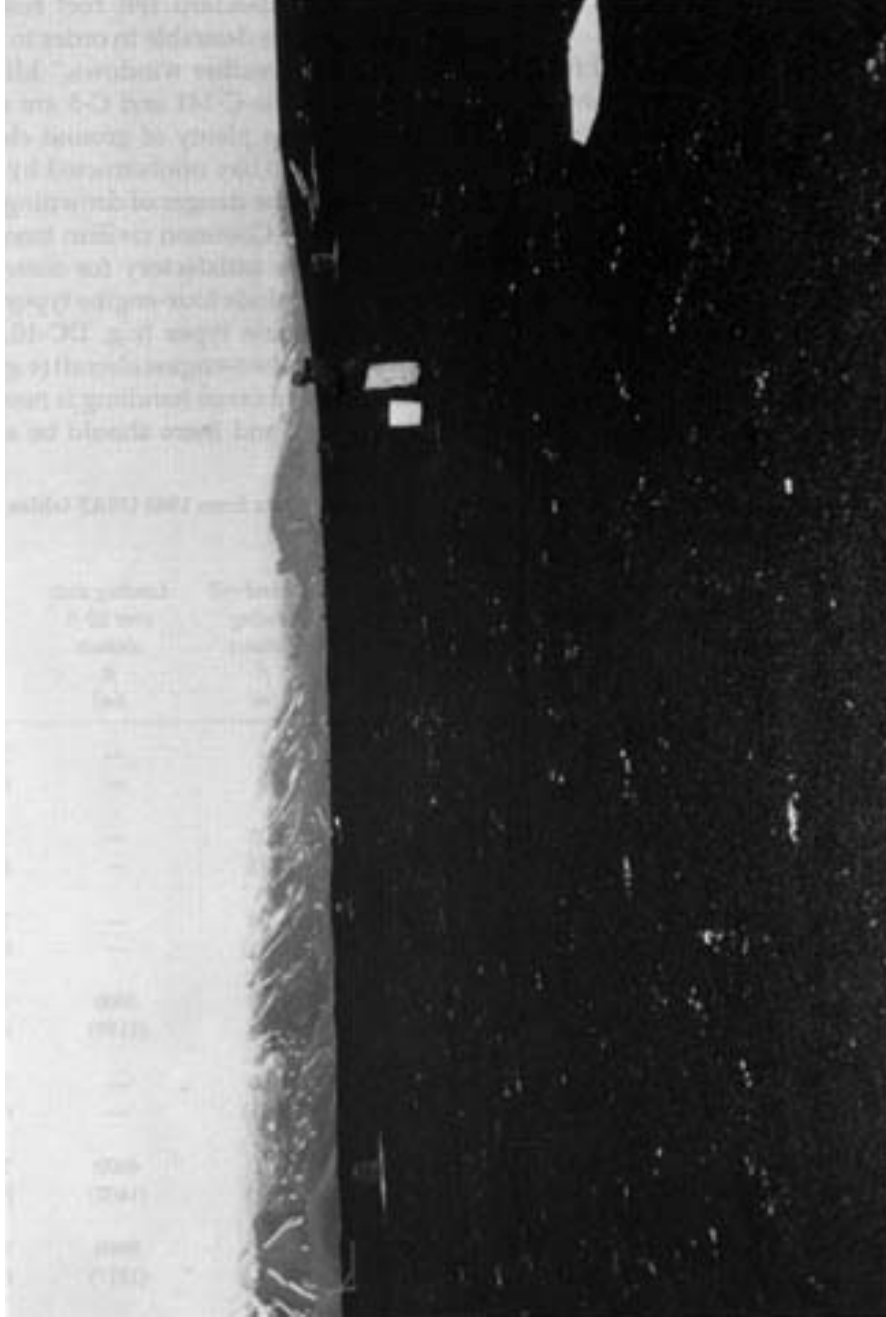

Figure 127. Unprepared runway on Deception Island. The camera faces along the runway centerline ( $320^\circ$  true). (Photo by Charles Swithinbank, 8 March 1975.)

## AIRCRAFT FOR ANTARCTIC OPERATIONS

Tables 4 and 5 summarize the characteristics of a range of aircraft types that are of potential interest in Antarctic aviation.

### Flights to and from Antarctica

The selection of aircraft for flights to and from Antarctica is strongly influenced by the runway and facilities at the port of entry and by the length of the route. Three broad flight categories can be considered:

- Long trans-ocean flights to and from well-developed Antarctic airports;
- Medium-range flights to and from short or substandard Antarctic runways with limited facilities; and
- Long trans-ocean flights to and from expedient runways that are rough or soft.

For flights of the first category, exemplified by Christchurch to McMurdo in springtime, any conventional trans-oceanic transports, civilian or military, should be satisfactory as long as they have adequate useful range, with the ability to reach an alternate or to return to the point of departure, arriving with standard IFR fuel reserves. High cruising speed is desirable in order to take advantage of brief “weather windows.” Military transports such as the C-141 and C-5 are suitable; the high wing gives plenty of ground clearance and leaves the cargo bay unobstructed by a mainspar (but increases the danger of drowning passengers after ditching). Common civilian trans-ocean aircraft should be satisfactory for many purposes. These might include four-engine types (e.g. 747, A-340), three-engine types (e.g. DC-10, MD-11, L-1011) or certain two-engine aircraft (e.g. 767, A-300, A-310). Efficient cargo handling is needed (pallets or containers), and there should be a reasonable

**Table 4. Approximate take-off and landing distances for selected aircraft. (Data from 1988 USAF tables [AFESC] and from Jane’s “All the World’s Aircraft” [various editions up to 1990/91].)**

Aircraft	A Max. T-O gross wt. lb (kg)	B Basic mission T-O gross wt. lb (kg)	Ground-roll T-O distance ft (m)	T-O distance over 50-ft obstacle ft (m)	Ground-roll landing distance ft (m)	Landing dist. over 50-ft obstacle ft (m)	Note
Antonov An-225	1,323,000 (600,000)	— —	— —	— —	— —	— —	T-O distances for weight A
Antonov An-124	892,870 (405,000)	— —	9850 (3000)	— —	2625 (800)	— —	T-O distances for weight A
Boeing 747-400	850,000 (385,490)	— —	— —	10,450 (3185)	6250 (1905)	— —	T-O distances for weight A
C-5B	840,000 (381,000)	769,000 (349,000)	7200 (2194)	8600 (2621)	2420 (738)	3900 (1189)	T-O distances for weight B
Boeing 747-SP	700,000 (317,460)	— —	— —	7950 (2423)	5400 (1646)	— —	T-O distances for weight A
KC-10A	590,000 (268,000)	590,000 (268,000)	10,400 (3170)	13,600 (4145)	2700 (823)	4600 (1402)	T-O distances for weight B
DC-10-30	580,000 (263,000)	— —	— —	11,750 (3581)	— —	5960 (1817)	T-O distances for weight A
Ilyushin Il-96	476,000 (216,000)	— —	8530 (2600)	— —	8530 (1980)	— —	
Ilyushin Il-86	419,000-459,000 (190,000–208,000)	— —	7550–8530 (2300–2600)	— —	7550–8530 (2300–2600)	— —	T-O distances for weight A
Ilyushin Il-76TD	418,900 (190,000)	— —	— —	— —	— —	— —	

**Table 4 (cont'd).**

<i>Aircraft</i>	<i>A</i> <i>Max. T-O gross</i> <i>wt.</i> <i>lb</i> <i>(kg)</i>	<i>B</i> <i>Basic mission T-O</i> <i>gross wt.</i> <i>lb</i> <i>(kg)</i>	<i>Ground-roll</i> <i>T-O distance</i> <i>ft</i> <i>(m)</i>	<i>T-O distance</i> <i>over 50-ft</i> <i>obstacle</i> <i>ft</i> <i>(m)</i>	<i>Ground-roll</i> <i>landing</i> <i>distance</i> <i>ft</i> <i>(m)</i>	<i>Landing dist.</i> <i>over 50-ft</i> <i>obstacle</i> <i>ft</i> <i>(m)</i>	<i>Note</i>
Boeing 767-300ER	400,000 (181,400)	— —	9500 (2895)	— —	— —	— —	T-O distances for weight A
Ilyushin Il-76T	374,790 (170,000)	— —	2790 (850)	— —	(1475) (450)	— —	T-O distances for weight A
Airbus A-300-600	363,800 (165,000)	— —	7600/7800 (2300/2400)	— —	5000 (1536)	— —	T-O distances for weight A
Boeing 767-200ER	351,000 (159,180)	— —	8400 (2560)	— —	— —	— —	T-O distances for weight A
Airbus A-310-300	330,700 (150,000)	— —	7900 (2400)	— —	4900 (1500)	— —	T-O distances for weight A
C-141B	323,100 (146,500)	270,000 (122,400)	3400 (1036)	4050 (1234)	1925 (587)	3600 (1097)	T-O distances for weight B
Boeing 767-200	315,000 (142,860)	— —	6500 (1980)	— —	— —	— —	T-O distances for weight A
Boeing 757-200	250,000	—	—	7580	4600	—	T-O distances for weight A
Boeing 757-200PF	(113,380)	—	—	(2310)	(1400)	—	
C-130H	175,000 (79,400)	155,000 (70,300)	3600 (1097)	5000 (1524)	2200 (671)	3880 (1183)	T-O distances for weight B
Ilyushin Il-18D	141,100 (64,000)	— —	4265 (1300)	— —	2790 (850)	— —	T-O distances for weight A
Boeing 737-200	125,000 (56,690)	115,500 (52,380)	— —	6800 (2073)	— —	4400 (1341)	T-O distances for weight B
DC-9-30	121,000 (54,875)	— —	— —	6850 (2088)	— —	4880 (1487)	T-O distances for weight
Transall C-160	112,435 (51,000)	— —	2346 (715)	— —	1800 (550)	2850 (869)	T-O distances for weight A
BAe 146-300	97,500 (44,225)	— —	4950 (1509)	— —	— —	4030 (1228)	T-O distances for weight A
Antonov An-74	76,000 (34,500)	— —	3050 (930)	— —	1526/1378 (465/420)	— —	T-O distances for weight A
Aeritalia G 222	61,730 (28,000)	— —	2170 (662)	3280 (1000)	1790 (545)	2540 (775)	T-O distances or weight A
DHC-7 Dash-7 (Series 150)	47,000 (21,320)	— —	2600 (792)	— —	3145 (959)	— —	T-O distances for weight A

**Table 4 (cont'd). Approximate take-off and landing distances for selected aircraft. (Data from 1988 USAF tables [AFESC] and from Jane's "All the World's Aircraft" [various editions up to 1990/91].)**

<i>Aircraft</i>	<i>A</i> <i>Max. T-O gross</i> <i>wt.</i> <i>lb</i> <i>(kg)</i>	<i>B</i> <i>Basic mission T-O</i> <i>gross wt.</i> <i>lb</i> <i>(kg)</i>	<i>Ground-roll</i> <i>T-O distance</i> <i>ft</i> <i>(m)</i>	<i>T-O distance</i> <i>over 50-ft</i> <i>obstacle</i> <i>ft</i> <i>(m)</i>	<i>Ground-roll</i> <i>landing</i> <i>distance</i> <i>ft</i> <i>(m)</i>	<i>Landing dist.</i> <i>over 50-ft</i> <i>obstacle</i> <i>ft</i> <i>(m)</i>	<i>Note</i>
DHC-7 Dash 7 (Series 100)	44,000 (19,960)	— —	2260 (689)	— —	1950 (595)	— —	T-O distances for weight A
DHC-8 Dash 8 (Series 300)	41,100 (18,640)	— —	3680 (1120)	— —	3680 (1120)	— —	T-O distances for weight A
ATR42	36,820 (16,700)	— —	3580 (1090)	— —	3380 (1030)	— —	T-O distances for weight A
DHC-8 Dash 8 (Series 100)	34,500 (15,650)	— —	3150 (960)	— —	2980 (908)	— —	T-O distances for weight A
Airtech (CASA/IPTN) CN-235	33,290 (15,100)	— —	1820 (554)	— —	— —	1920 (585)	T-O distances for weight A
Airtech (CASA/IPTN) CN-235M	33,290 (15,100)	— —	1820 (554)	2400 (732)	940 (286) (reversal)	2530 (772)	T-O distances for weight A
Bromon <sup>1</sup> BR2000 (civilian)	31,500 (14,290)	— —	2700 (823)	— —	1800 (550) (no reverse)	— —	T-O distances for weight A
Bromon <sup>1</sup> BR2000 (military)	31,500 (14,290)	— —	1800 (550)	— —	1800 (550) (no reverse)	— —	T-O distances for weight A
Short 330	22,900 (10,390)	— —	3420 (1042)	— —	3600 (1100)	— —	T-O distances or weight A
Antonov An-28	14,300 (6,500)	— —	853 (260)	— —	558 (170)	1035 (315)	T-O distances for weight A
Sukhoi S-80 <sup>2</sup>	13,900 (6,300)	— —	1725 (525)	— —	3235 (985)	— —	T-O distance for weight A
Dornier 228-100	12,566 (5,700)	— —	1350 (411)	1850 (564)	— —	1970 (600)	T-O distances for weight A
DHC-6 (300)	12,500 (5,670)	— —	700/860 (213/262)	1200/1500 (366/457)	515/950 (157/290)	1050/1940 (320/591)	T-O distances for weight A
Pilatus PC-6	6,173 (2,800)	— —	— (197)	646 —	— (127)	417 —	T-O distances for weight A

<sup>1</sup> Development currently halted by financial problems.

<sup>2</sup> First flight scheduled for 1992.



**Table 5. Speeds, wing loadings and tire pressures for selected aircraft. (Where approach or stall values are missing, an estimate is based on approach/stall  $\approx$  1.3. Mach no. cruise speeds are converted for ISA at 10,000 m. Two entries for the tire pressure of a given aircraft denote operational options or optional sets of tires and rims.)**

<i>Aircraft</i>	<i>Max. T-O wt. lb. (kg)</i>	<i>Approx. cruise speed (normal or economy) (knot)</i>	<i>Approx. approach speed (knot)</i>	<i>Approx. min. stall speed or landing speed (max. ldg. wt) (knot)</i>	<i>Max. wing loading (kg/m<sup>2</sup>)</i>	<i>Typical MLG tire pressure lbf/in.<sup>2</sup> (bar)</i>
Antonov An-225	1,323,000 (600,000)	378–458				
Antonov An-124	892,870 (405,000)	432–459	124–140		645	
Boeing 747-400	850,000 (385,500)		154			210 (14.5)
C-5B	840,000 (380,950)	450	135	104	659	111 (7.7)
Boeing 747 SP	700,000 (317,500)		140		621	183 (12.6)
KC-10A	590,000 (267,600)	476	151		728	200/155 (13.8/10.7)
C-17A	580,000 (263,000)	447	115			138 (9.5)
Ilyushin Il-96	476,000 (216,000)	459–486	140		552	169 (11.7)
Ilyushin Il-86	419,000–459,000 (190,000–208,000)	486–512	130–141		594–650	
Ilyushin Il-76T	374,800 (170,000)	405–432	119		567	variable 37–73 (2.5–5)
Ilyushin Il-76TD	418,900 (190,000)				633	
Airbus A-300-600	363,800 (165,000)	484	135		635	180 (12.4)
Airbus A-310 -300	330,700 (150,000)	465	135		685	163 or 129 (11.2) (8.9)
C-141B	323,100 (146,500)	430	129	104	630	180 (12.4)
Boeing 767	315,000 (142,900)	465	136		504	183 (12.6)
KC-135E	301,600 (136,800)		139			155 (10.7)

**Table 5 (cont'd). Speeds, wing loadings and tire pressures for selected aircraft. (Where approach or stall values are missing, an estimate is based on approach/stall  $\approx$  1.3. Mach no. cruise speeds are converted for ISA at 10,000 m. Two entries for the tire pressure of a given aircraft denote operational options or optional sets of tires and rims.)**

<i>Aircraft</i>	<i>Max. T-O wt. lb. (kg)</i>	<i>Approx. cruise speed (normal or economy) (knot)</i>	<i>Approx. approach speed (knot)</i>	<i>Approx. min. stall speed or landing speed (max. ldg. wt) (knot)</i>	<i>Max. wing loading (kg/m<sup>2</sup>)</i>	<i>Typical MLG tire pressure lbf/in.<sup>2</sup> (bar)</i>
Boeing 707 -120B	258,000 (117,000)		145			138 (9.5)
Boeing 757 -200	250,000 (113,400)	465	132		539	
C-130H	175,000 (79,400)	300	129-137	100	435	96 (6.6)
Ilyushin Il-18D	141,100 (64,000)	337	103			114 (7.9)
Boeing 737 -200	125,000 (56,700)		137	576		148 (10.2)
Transall C-160	112,435 (51,000)		124	95	319	55 (3.8)
BAe 146	97,500 (44,225)	383	121	92	572	122 (8.4)
Antonov An-74	76,000 (34,500)	297	97			
Aeritalia G 222	61,700 (28,000)	237	109	84	342	
DHC-7	44,000 (19,960)		83		250	107 or 70 (7.4) (4.8)
ATR 42	36,820 (16,700)	243		81/74	306	104 or 73 (7.2) (5)
DHC-8	34,500 (15,650)		90	72	288	115 m or 65 (7.9) (4.5)
Airtech CN-235	33,290 (15,100)			84	256	81 or 50 (5.6) (3.5)
Bromon <sup>1</sup> BR 2000	31,500 (14,288)	210		70	249	52 (3.6)
Short 330	22,900 (10,400)	160	96	73	247	79 (5.4)
Antonov An-28	14,300 (6,500)	181	76	70	164	51 (3.5)
Sukhoi <sup>2</sup> S-80	13,900	243				

**Table 5 (cont'd).**

<i>Aircraft</i>	<i>Max. T-O wt. lb. (kg)</i>	<i>Approx. cruise speed (normal or economy) (knot)</i>	<i>Approx. approach speed (knot)</i>	<i>Approx. min. stall speed or landing speed (max. ldg. wt) (knot)</i>	<i>Max. wing loading (kg/m<sup>2</sup>)</i>	<i>Typical MLG tire pressure lbf/in.<sup>2</sup> (bar)</i>
Dornier 228-100	12,566 (5,700)			63	178	—
DHC-6	12,500 (5,670)	135	75	58	145	38 (2.6)
Agusta (SIAI- Marchetti) SF-600 TP	7,500 (3,400)	155		59	142	42 (2.9)
Pilatus PC-6	6,200 (2,800)	115	57 (?)	52	93	32 or 12.8 (2.2) (0.88)

<sup>1</sup> Development currently halted by financial problems.

<sup>2</sup> First flight scheduled for 1992.

level of comfort for passengers (seats, lighting, toilets, controlled temperature and tolerable levels of noise and vibration). Intermittent use of heavy aircraft is attractive for intensive resupply operations and peak traffic periods. Smaller aircraft may be more economical for frequent “milk-run” services.

For medium-range flights to and from short or substandard Antarctic runways with limited facilities, the aircraft can be smaller, but it has to be capable of safe over-ocean journeys, with appropriate range and engine-out performance. In addition, it has to be capable of landing and taking off on short runways. The runway at Dumont d’Urville, which will be 1100 m (3600 ft) long and 30 m (100 ft) wide, is an example of a strip that is not really adequate for large aircraft. The ground-roll landing distances for the C-130H and the C-141B are 2200 ft (670 m) and 1925 ft (587 m), respectively. The ground-roll takeoff distances for the same aircraft at “basic mission take-off gross weight” are 3600 ft (1100 m) and 3400 ft (1036 m). The strip at Rothera will be shorter, 3000 ft, or 915 m, and for that airport prudence dictates the use of an aircraft with short-field performance. The current choice is the Dash 7, a four-engine STOL aircraft which, for Series 100, has a required landing field length of 1950 ft (595 m) and a take-off field length of 2260 ft (689 m).

For long trans-ocean flights to and from expedient runways that are rough or soft, the aircraft requires both long range and robust, high-flotation

landing gear. For Maputo–Molodezhnaya, for example, the ideal aircraft is big and fast, with a landing gear that has large-diameter tires with low inflation pressure (to avoid rutting on the surface of the snow runway) and a low ACN to avoid general collapse of the snow pavements. In general, Russian heavy transports meet these criteria far better than their Western counterparts, presumably accepting a penalty in the size and weight of the landing gear that has to be stowed and carried. However, the long-term workhorse on the Maputo–Molodezhnaya route has been the Il-18D, an old low-wing passenger aircraft that looks less than ideal but has given sterling service.

Some aircraft characteristics that seem appropriate for flights to and from Antarctica are illustrated in Figure 128.

### **Flights within Antarctica**

Apart from coastal seaplane operations, most fixed-wing flights within Antarctica have depended on ski, or ski-wheel, landing gear. In effect, the aircraft are expected to be capable of taking off and landing almost anywhere. Aircraft modified in this way have been selected for a variety of reasons, not all of which relate to technical suitability for the job. The most common operating arrangement has been ownership and operation by the Antarctic agency, as distinct from commercial charter or some military equivalent.

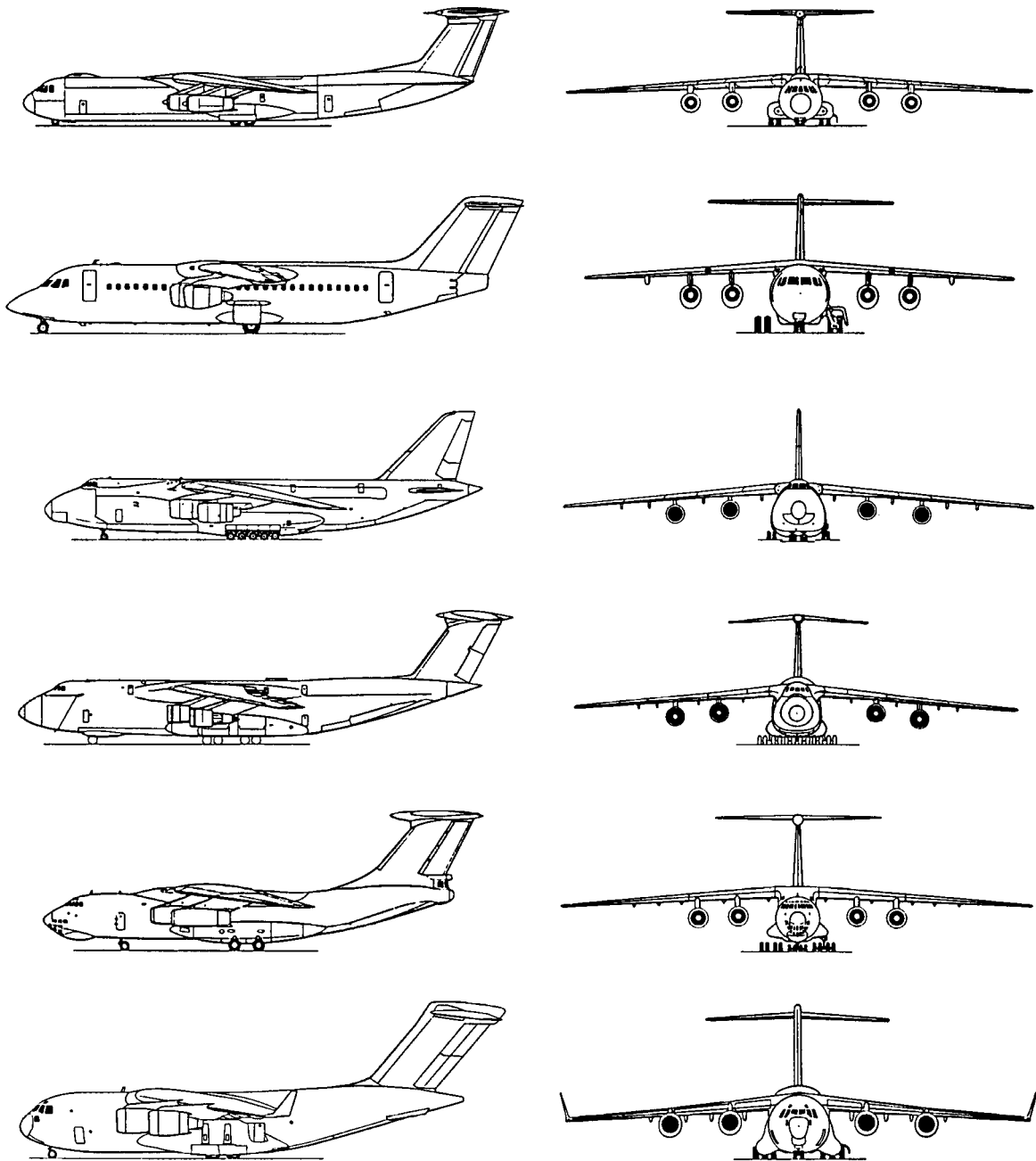

*Figure 128. Turbojet and turboprop transport aircraft with general characteristics suitable for flights to and from Antarctica (not to common scale).*

In 1988 there was a significant break with tradition when a standard Antonov An-74 made major flights within Antarctica, taking off and landing on wheels. At the same time, U.S. efforts to find inland landing fields for wheeled aircraft were stepped up. There is now a real possibility of using unmodified wheeled aircraft in support of both research and logistic operations. This could reduce the need for Antarctic agencies to run their own air forces.

### **Air drops**

Air-drop operations have been used at various times to supply U.S. inland stations, starting in 1956, when C-124 aircraft delivered everything needed for the first South Pole station. Air drop is still an option for delivering a wide range of materials, from mail to construction supplies, to sites that have no hard-surface runway.

The main air-drop techniques are:

- Free drop;
- High-velocity air drop;
- Low-velocity air drop; and
- Low-altitude parachute extraction.

Free drop is just a matter of releasing packages, bundles or objects that are unlikely to sustain significant damage on impact with the ground. In Antarctica the typical snow surface provides some shock absorption, allowing robust packages that do not reach a high terminal velocity to land without being destroyed. Small packages can be pushed from a side door in the aircraft, while large bundles are released from a tail ramp. The old Soviet aircraft, the Il-12 and Il-14, had bomb doors for dropping small objects (including specially designed fuel drums) through the cabin floor. The chance of cargo damage is minimized by flying low and slow (the classic recipe for disaster).

Some items can be dropped at high vertical velocity on energy-absorbing platforms, using only a relatively small parachute to stabilize the load so that the energy-dissipating cushion hits first. Small loads (75–150 lb) are stabilized with a 68-in.-diameter pilot parachute. For bigger loads there are 12-ft- and 26-ft high-velocity cargo parachutes. Cargo extraction parachutes can be repacked as high-velocity cargo parachutes (15 and 22 ft) using special packing procedures.

In a low-velocity air drop the aircraft (C-130 or C-141 in U.S. operations) usually flies relatively high (1200–1500 ft), and the descent of the load is slowed by conventional parachutes. The load is rigged on a special platform by trained personnel, with parachutes attached to the load by slings. Under the platform there are layers of energy-dissipating cushion material, typically multiple layers of crushable honeycomb, which is supplied to the riggers in 3-in.-thick sheets, 8 × 3 ft and 8 × 2 ft. Relatively small loads, say up to 500 lb, can be pushed from side doors (the maximum size for the C-130 is 4 × 2.5 × 5.5 ft). For delivery of large loads through a tail door, the load is usually pulled out by a cargo extraction parachute rigged to an extraction line, although a “stick” of containers may have an extraction chute only on the first container out (the release is completed by pull-up into a 6° climb). Typical U.S. cargo (recovery) parachutes, used in clusters of up to eight parachutes, are 100 ft in diameter, but a smaller one, 64 ft in diameter, is used for some purposes. Typical extraction parachutes for low-velocity air drops have diameters from 15 to 28 ft.

In a low-altitude parachute extraction (LAPE) delivery, the aircraft flies very low (wheels 5–10 ft

above the surface), and parachutes are used only to yank the load out of the cargo bay. The load is rigged on a special platform, with the extraction parachutes attached to the load. Energy-dissipating honeycomb pads are attached below the cargo platform, with multiple layers glued together. Platforms are supplied in lengths up to 32 ft. Extraction parachutes for LAPE are of the ring-slot design, in diameters from 28 to 60 ft, with 15-ft cargo extraction parachutes serving as drogue parachutes. The C-130 flies over the drop target at 120 knot IAS, 5–10 ft above ground; when the drogue parachute is released, the load leaves the aircraft after 3 seconds and about 600 ft of horizontal travel. Cargo touchdown is about 700 ft from the activation point, and there is a ground slide of 100–200 ft.

Cargo platforms for large loads are 9 ft wide. Platform lengths are 8, 12, 16, 20, 24, 28 and 32 ft. Load height, measured from the bottom of the platform, is usually limited to 100 in. for the C-130 and C-141. The maximum rigged weight for single platform loads is 25,000 lb for older C-130s and 42,000 lb for newer C-130s. For the C-141 the normal maximum weight for a single platform is 38,500, with emergency increase up to 42,000 lb under special approval.

Fuel is dropped in platform loads made up with 500-gal. collapsible fabric drums (seal drums), 55-gal. steel drums or 5-gal. fuel cans. Bulk fuel delivery by air drop is not really feasible.

Air drops deliver a lot of unwanted packaging materials (platforms, honeycomb, plywood, parachutes, slings, straps) that have to be removed from the site under current environmental protection policies.

#### **Aircraft characteristics for Antarctic work**

Irrespective of whether an aircraft is to be used on wheels or skis, there are certain characteristics that bear on its fitness for work from substandard Antarctic runways. While every operating group will have its own preferences, the following are suggested as desirable characteristics (Fig. 129):

- General configuration: High wing; high engines; tee-tail or high tail; low belly; spacious flat-floor fuselage; large doors (tail ramp, side hatch, swing nose).
- Engines: Multi-engine; gas turbine (free turbine turboprop; turbojet or turbofan).
- Landing gear: Wide stance; short legs; low ACN/LCN; large tires; soft tires; multi-wheel, multi-unit assemblies; large wheel-well fairings (for big wheels or ski retract).

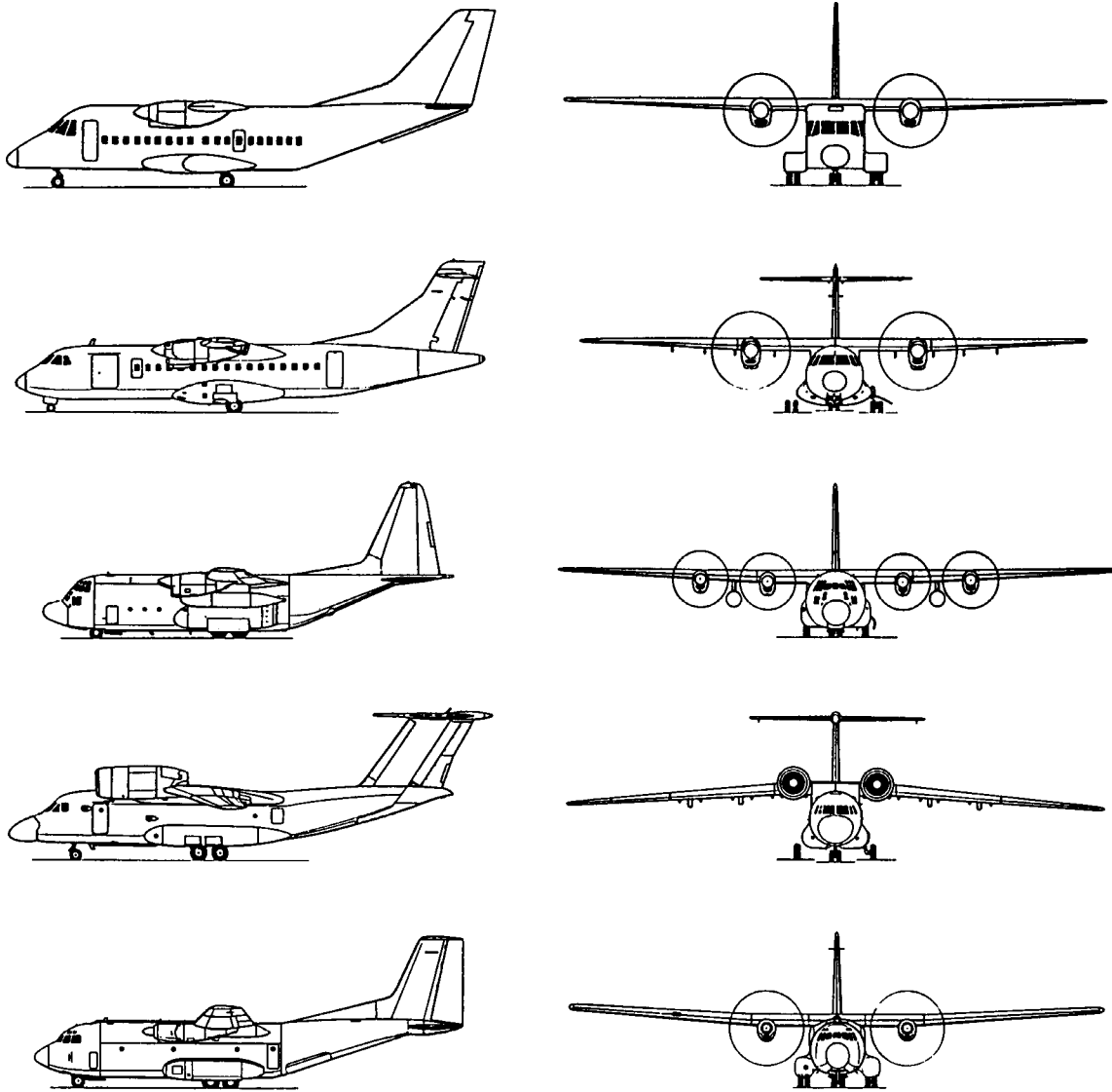

Figure 129. Aircraft with characteristics that are appropriate for Antarctic internal operations (not to common scale).

- Speeds: Reasonable cruise speed; slow approach; low stall and landing speed.
- Robustness: Strong airframe, tolerant to vibrations; reliable engines and fuel system; rough-field landing gear; good hydraulics; instruments, avionics and electrical systems resistant to vibration.
- Maintainability: Easy access to problem areas and parts that need frequent changes; spares inventories based on failure probability; easy troubleshooting; access to additional spares at reasonable speed and cost.

Another consideration is appropriate size. To carry materials and equipment for a major con-

struction project or to carry fuel and supplies to a large station, large aircraft are needed. By contrast, many science projects are served most efficiently by small aircraft. Ideally an Antarctic agency needs a mix of aircraft types. The ideal mix can vary seasonally and from year to year. These ideals are not likely to be fully attainable by direct fleet ownership.

For the past three decades the largest aircraft capable of operating freely within Antarctica has been the ski-wheel Lockheed Hercules. The most widely used small twin has been the DeHavilland (Canada) Twin Otter.

The payload and the fuel load, when added to the

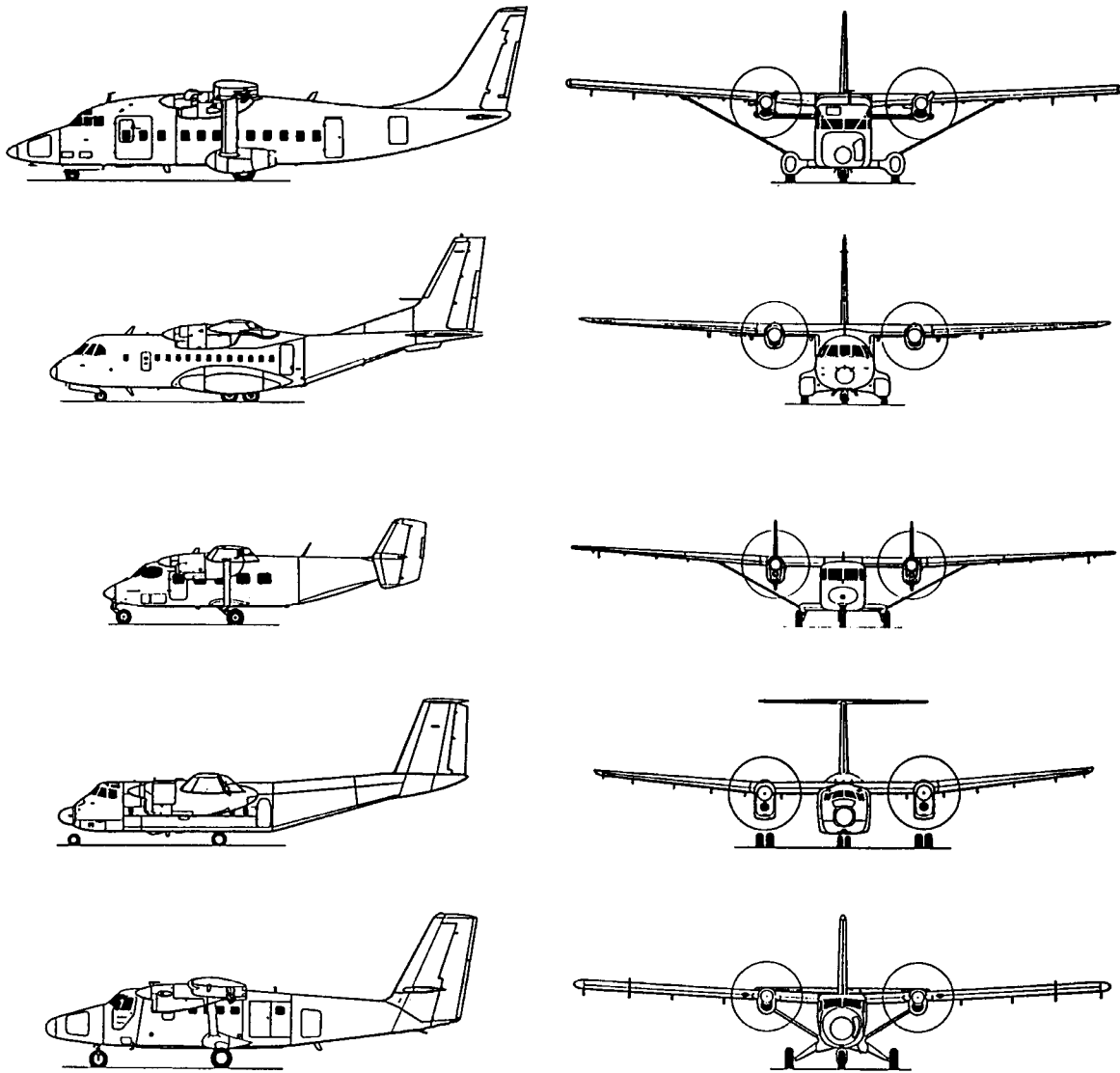

Figure 129 (cont'd).

empty weight, make up the gross load of the aircraft. Empty weight and maximum takeoff weight are approximately proportional. For aircraft with an MTW of approximately 35,000 lb (16,000 kg), the empty weight is about 63% of the MTW. For aircraft around 100,000 lb (45,000 kg), the ratio is about 56%. For the heaviest aircraft, around 850,000 lb (385,000 kg), the ratio is about 45%. Within certain limits, there can be a tradeoff between payload and fuel load, depending on the required range. For short-range lifts by typical aircraft, the payload can reach about 37% of the MTW. Long-range versions of similar aircraft may have a payload as low as 13% of the MTW. There are, of course, special

extreme-range aircraft with long, high-aspect-ratio wings that carry virtually all fuel and no payload. Normal aircraft can be made to carry "all fuel and no payload" by fitting fuselage tanks. Long-range transports with standard tanks have service ranges up to about 6,500 nautical miles (12,000 km) and ferry ranges up to about 8,000 nautical miles (15,000 km). Great circle distances between Antarctic airfields are given in Figure 130.

### Helicopters

Helicopters play an important part in Antarctic aviation, particularly in coastal and ship-based operations and in mountain flying (Fig. 131). There

	Marambio	Marsh	Rothera	Dumont d'Urville	McMurdo	Molodezhnaya	Casey	Patriot Hills	Novolazarevskaya	South Pole	Vostok	Mill Glacier	Mount Howe	Rosser Ridge	Mt. Lechner
Marambio															
Marsh	137														
Rothera	345	398													
Dumont d'Urville	2913	3024	2659												
McMurdo	2128	2231	1855	818											
Molodezhnaya	2227	2362	2235	1982	1822										
Casey	2950	3077	2769	696	1178	1454									
Patriot Hills	1045	1150	791	1874	1084	1750	1995								
Novolazarevskaya	1527	1658	1592	2289	1839	737	1946	1314							
South Pole	1546	1668	1346	1400	728	1340	1423	581	1153						
Vostok	2217	2344	2036	900	710	1165	734	1270	1389	692					
Mill Glacier	1769	1883	1531	1146	434	1513	1283	741	1426	294	603				
Mount Howe	1563	1678	1332	1354	621	1495	1457	543	1306	160	745	208			
Rosser Ridge	1113	1237	932	1824	1093	1472	1844	281	1048	433	1110	683	478		
Mt. Lechner	1143	1268	965	1799	1075	1444	1812	306	1033	405	1078	661	457	33	

	Molodezhnaya	Nautical Miles
Mawson	387	
Larsemann Hills	667	
Davis	733	
Bunger Hills	1251	
Casey	1451	
Dumont d'Urville	1982	
McMurdo	1819	
Amundsen-Scott	1340	
Vostok	1164	
Mawson	/	
Larsemann Hills	/	
Davis	/	
Bunger Hills	/	
Casey	/	
Dumont d'Urville	/	
McMurdo	/	
Amundsen-Scott	/	
Dumont d'Urville	234	
McMurdo	700	
Amundsen-Scott	813	
Dumont d'Urville	1422	
McMurdo	1400	
Amundsen-Scott	729	
Dumont d'Urville	900	
McMurdo	706	
Amundsen-Scott	692	

Figure 130. Great circle distances (nautical miles) between Antarctic airfields.





a. Piston-engine Sikorsky S-58, or H-34. Replacement of piston-engine helicopters with turbine machines greatly improved operational capabilities, e.g. in lifting field parties to high-altitude sites. Westland built a turbine version of the S-58 in the United Kingdom as the Wessex, and Sikorsky developed a turbine version as the S-58T.



b. Bell 212 (UH-1N) helicopter. The 212 is a twin-engine machine that evolved from the single-engine 204, or UH-1. (Photo by M. Mellor, November 1990.)

Figure 131. Helicopters in Antarctic use.



*c. Sikorsky S-62 (HH-52A) helicopter, which operated from U.S. Coast Guard icebreakers in Antarctica. (Photo by M. Mellor, January 1989.)*



*d. Bell 206 (Jet Ranger) on floats. Although much less powerful than the 212, it can handle a wide range of science support tasks. (Photo by M. Mellor, August 1984.)*

*Figure 131 (cont'd). Helicopters in Antarctic use.*



*e. Aerospatiale AS350 Ecureuil, or Squirrel. This is the helicopter currently favored for Antarctic operations by Australian and New Zealand contractors. It has a bit more power and lift (and higher fuel consumption) than the 206. (Photo by M. Mellor, October 1990.)*



*f. Aerospatiale SA366G Dauphin, or HH65A Dolphin. Dolphins are carried by USCG icebreakers in Antarctica. (Photo by M. Mellor, 29 January 1991.)*

*Figure 131 (cont'd).*



*g. Mil Mi-8 of the Soviet Antarctic Expedition at Halley. Up to now, this is the biggest helicopter that has been used regularly in Antarctica. It has twin 1700-hp turboshafts. The MTW for VTO is 12,000 kg (26,500 lb). (Photo by Charles Swithinbank, January 1984.)*

are many problems to be coped with, but an Antarctic helicopter operation is not radically different from well-established operations in far-north lands, such as northern Canada, Alaska and northern Siberia. One significant difference is the degree of self-sufficiency that is needed in maintenance, since Antarctica is far from spares and backup services. Provision of landing sites is not a significant consideration, but tie-downs, wind-shelters and covered maintenance facilities are needed for fixed-base operations. In some parts of Antarctica, strong winds make flight operations hazardous, and parked helicopters can be damaged or destroyed by wind.

The U.S. has always employed military helicopters, starting from Operation Windmill in 1948, which was a Navy operation. For a time, land-based helicopters were operated by the Army. Currently the Navy operates UH-1N (Bell 212) twin-turbine helicopters, while the Coast Guard flies the twin-turbine HH65A Dolphin (Aérospatiale SA366G Dauphin) from visiting icebreakers. By contrast, Australia has always chartered commercial helicopters. Starting in 1958 with small piston-engine helicopters (first the Hiller 12C, then the Bell 47G-2), there was a switch to turbine helicopters in 1966 (first the Fairchild-Hiller FH1100, then Hughes 500, later Bell 206 and Alouette 3, and currently Aérospatiale AS350 Ecureuil, or Squirrel). In recent years, companies from New Zealand and Germany

have operated Squirrel helicopters in Antarctica. The biggest helicopters to have operated in Antarctica so far are the Soviet Mil Mi-8; with a maximum takeoff weight of about 26,000 lb (11,800 kg) and two 1700-shp turboshafts, these machines have about double the weight and power of the Bell 212. They are used for unloading ships and for science support around Soyuz and Druzhnaya 4.

Military helicopters typically operate with a crew of three. Civilian helicopters are typically operated by a single pilot for VFR and with a crew of two for IFR.

#### **Maintenance and service life**

High maintenance standards are required for all aircraft, and Antarctica is not the place to let standards slip. The outdoor environment is not conducive to high-quality work, and hangars or expedient shelters should be provided if major maintenance is to be scheduled for Antarctica. If a hangar cannot be provided, as is likely to be the case for large aircraft, major scheduled maintenance should be done outside Antarctica at properly equipped facilities. Aircraft that have heavy maintenance demands, either from age or inherent deficiencies, are not really suitable for Antarctic service.

In the early years of aviation, the service life of any aircraft design was short, since progress in design and manufacturing was rapid. The DC-3 changed that, staying in "respectable" service for 30 years or so. The

Hercules has been in service for 37 years, and there is no end in sight. There is now a widely held view that airframes have eternal life, provided the specified inspections and renovations are carried out. This view probably should be treated with caution in Antarctica, where aircraft tend to have a hard life (though possibly less damaging than in tropical service).

### **Fuel supplies**

Bulk aviation fuel has to be delivered to Antarctica by ships, which discharge to primary storage depots that are on the coast. Secondary distribution within Antarctica is difficult, since there are no well-established overland freight routes or long-distance pipelines, and air delivery of fuel is highly inefficient.

In principle, fuel depots at inland airfields could best be supplied by tractor trains, but the technology for Antarctic ground transport has languished over the past three decades.

Integrated transport systems, combining sea, land and air modes of travel, are essential for efficient operation, and new developments in land vehicles and overland routes are overdue.

Fuel storage and fuel distribution systems are potential sources of pollution and deserve careful design to guard against spillage. Site selection for tank farms is important. Pipelines should be designed to accommodate local conditions (e.g. permafrost active layer, ice shelf strains, sea ice displacements). The vulnerability of neoprene bladders should be taken into account.

Fuel delivery, fuel storage, fuel quality and refueling services are matters that could benefit from international agreement and collaboration. Given the small total quantity of aviation fuel used in Antarctica, an "international tanker" seems a useful idea. Strategically located coastal refueling stations could reduce wasteful air delivery of fuel to advance bases.

In the future, hydrogen appears attractive as an aircraft fuel for inland operations. During summer there is abundant solar radiation, which can be amplified by the high albedo of snow surfaces. Ample space is available for collectors, and the efficiency of photovoltaic systems increases at low ambient temperatures. Given the projected fall in prices for photovoltaic panels, it may become feasible to use solar energy to produce hydrogen by electrolysis at remote sites in the interior of Antarctica.

### **Pilot experience**

For Antarctic operations that involve primitive airfields, expedient runways and unprepared land-

ing areas, long and varied pilot experience is valuable. In addition to normal flying skills, general experience and familiarity with "arctic" aviation, it is useful for a pilot to have first-hand knowledge of Antarctic geography, glaciology, weather, special hazards and typical user tasks. Long experience is not easy to develop. U.S. Navy pilots assigned to the USAP are limited to three consecutive tours of summer duty. Civilian pilots working directly for other national Antarctic programs commonly elect to leave Antarctic flying after two or three seasons because of the disruption to normal life that is caused by long periods in an isolated region (pay scales are also a factor). However, there are some who, enjoying the lifestyle and the challenges of Antarctic aviation, choose to work in Antarctica over a long period. For example, Kenn Borek Air now has a cadre of very experienced pilots (some quite old, others still young) who have flown over much of Antarctica in support of all types of activities. The 109th Tactical Air Group of the New York Air National Guard, which flies LC-130s in both Greenland and Antarctica, enables pilots to develop and maintain high levels of skill in polar operations over long periods.

Progressive development of air routes and ground facilities will eventually ease the special demands on pilots, but during the development phase, experience remains the key to a combination of safety and innovation.

## **ENVIRONMENTAL AND SAFETY CONSIDERATIONS**

All airports and aircraft operations have some degree of environmental impact, as noted in Table 3. However, runways are a necessity for modern Antarctic research, which is generally considered to be making a positive contribution to worldwide environmental protection. The goal should therefore be to minimize the environmental impact of Antarctic aviation on the continent as a whole. It may well be that air transport is less detrimental than ship offloads and overland freight transport.

### **Facilities**

One way to limit environmental impact is to avoid unproductive duplication of facilities. At McMurdo, for example, it seems possible that a single semi-permanent runway at the Pegasus site could replace both the Williams Field skiway and the seasonal sea ice runway. The present facilities absorb heavy annual maintenance efforts, fighting

the net snow accumulation at Williams Field and repeatedly building and losing the sea ice runway. A facility on more-or-less permanent ice, where accumulation and ablation are approximately in balance, should require less maintenance and a smaller establishment than the present airfield camps (up to 180 people at Williams Field).

Another way to avoid unnecessary duplication of facilities is to have joint-use airfields, where two or more nations combine their resources and operations.

At first sight, permanent conventional airfields on rock may seem environmentally undesirable, as they alter the local landscape. However, a conventional all-season runway is a permanent investment, and it is much easier to maintain than runways on snow or ice. Well-developed measures and regulations for environmental protection, covering everything from fuel storage to sewage disposal, are directly applicable, giving much less chance of error by inexperienced personnel. By contrast, airfields on snow and ice have to be operated by people with specialized knowledge and experience.

Good sites on blue ice are attractive because they require no runway construction and only minimal disturbance of the environment. With intelligent and disciplined operation, high standards of tidiness can be maintained, and occasional accidents can be dealt with efficiently. Given proper cleanup measures, a blue-ice site could be vacated without leaving any permanent scars.

Runway sites in accumulation areas soon regain a pristine appearance after the sites are vacated. However, major fuel spills at such sites are difficult, if not impossible, to clean up.

### **Operations**

Aircraft operations cause some pollution of the air and the snow, although the amount is minuscule compared with other continents. Trace amounts of combustion products are troublesome mainly to the science programs that deal with air chemistry and ice chemistry. As a token gesture, operators probably ought to favor fuel-efficient aircraft of appropriate size for the job (when Antarctic fuel costs are assessed realistically, this tends to take care of itself). More practically, operating procedures should minimize wasteful fuel-staging flights in which the fuel delivered is more than an order of magnitude smaller than the fuel used to get it there.

Small modifications in operating procedure might be adopted in the interest of environmental protec-

tion. For example, surface contamination by fuel drained on engine shutdown could perhaps be avoided, crew and ground staff should certainly be instructed not to discard *any* litter, and taxiing with an open tail ramp (litter source) could be discontinued. The direct benefits might be slight, but good attitudes would be formed.

Safety is a major concern in modern Antarctic operations, and aircraft make a major contribution by facilitating rapid medical evacuations, both within Antarctica and to the outside world. To exploit this capability fully, all-season operation throughout the continent is needed, without undue reliance on highly specialized aircraft. For the long term, all Antarctic operators, even those without aircraft, ought to consider the establishment of an all-season wheel runway that can be used in emergencies. In the past, medical emergencies have placed an unfair burden on the few operators that have long-range ski-wheel aircraft.

Air operations obviously should be conducted in such a way that safety is not degraded. This implies a need for:

- Appropriate, well-maintained and well-operated aircraft;
- Good, well-maintained runways;
- A selection of emergency alternates;
- The best landing aids and radios that can be provided;
- Good emergency services;
- Good weather services;
- Experienced, well-trained aircrews; and
- Efficient search-and-rescue arrangements.

### **CONCLUSION**

After a long period characterized by heroic improvisation, it now seems possible for Antarctic aviation to become an extension of mainstream international aviation. The basic requirement is a well-distributed network of hard-surface airfields that can be used safely by conventional aircraft, together with good international collaboration. Relieved of the necessity for ownership of specialized aircraft, any national Antarctic program can improve efficiency and safety by making a fairly modest investment in a hard-surface runway. For nations that already have significant air operations, the ability to utilize a variety of conventional aircraft on demand should lead to increased efficiency and lower costs. The technical capabilities for bringing these things about already exist.

## SELECTED BIBLIOGRAPHY

- Abele, G., R.O. Ramseier and A.F. Wuori** (1966) Design criteria for snow runways. *The Engineering Journal*, Engineering Institute of Canada. (Also USA Cold Regions Research and Engineering Laboratory, Technical Report 212, 1968.)
- Abele, G.** (1990) Snow roads and runways. USA Cold Regions Research and Engineering Laboratory, Monograph 90-3.
- Barthelemy, J.L.** (1990) Thirty-five years of sea-ice runway operation—McMurdo Station, Antarctica. *IAHR Ice Symposium, Espoo, Finland*.
- Budd, W.F. and D.S. Russell-Head** (1990) Runway sites for heavy wheeled aircraft in East Antarctica. Meteorology Dept., University of Melbourne, for USA Cold Regions Research and Engineering Laboratory, Hanover, N.H., 95 p.
- CATSA/SCAR** (1977) A cooperative air transport system for Antarctica (CATSA). *Annex to SCAR Bulletin 56*, VIX SCAR (Oct 1976), Scientific Committee on Antarctic Research.
- Federal Aviation Administration** (1989) Airport design. Advisory Circular AC 150/5300-13, U.S. Dept. of Transportation, 278 p.
- Federal Aviation Administration** (1990) Runway length requirements for airport design. Advisory Circular AC 150/5325-4A, U.S. Dept. of Transportation, 118 p.
- Holliway, R.** (1988) Aircraft characteristics for airfield pavement design and evaluation. Air Force Engineering and Services Center, Tyndall AFB, Florida.
- Lee, S.M., W.M. Haas, R.L. Brown and A.F. Wuori** (1989) Improving snow roads and airstrips in Antarctica. USA Cold Regions Research and Engineering Laboratory, Special Report 89-22.
- Mellor, M.** (1988) Hard-surface runways in Antarctica. USA Cold Regions Research and Engineering Laboratory, Special Report 88-13.
- Mellor, M. and C. Swithinbank** (1989) Airfields on Antarctic glacier ice. USA Cold Regions Research and Engineering Laboratory, CRREL Report 89-21.
- Naval Support Force Antarctica** (1990) Air operations manual. COMNAVSUPFORANTARCTICA Instruction 3710.2L, U.S. Navy.
- Russell-Head, D.S. and W.F. Budd** (1989) Compacted-snow runways: Guidelines for their design and construction in Antarctica. USA Cold Regions Research and Engineering Laboratory, Special Report 89-10.
- Swithinbank, C.** (1989) Ice runways near the South Pole. USA Cold Regions Research and Engineering Laboratory, Special Report 89-19.
- Swithinbank, C.** (1991) Potential airfield sites in Antarctica for wheeled aircraft. USA Cold Regions Research and Engineering Laboratory, Special Report 91-24.
- Taylor, J.W.R.** (Ed.) (various editions up to 1989-90) *Jane's All the World's Aircraft*. Jane's Defense Data, Jane's Information Group Ltd.

BLANK



**APPENDIX A: RUNWAYS MAINTAINED BY THE U.S. ANTARCTIC PROGRAM.**

Examples of approach plates from the 1990-91 season. Use is authorized only for aircraft approved by the USAP.

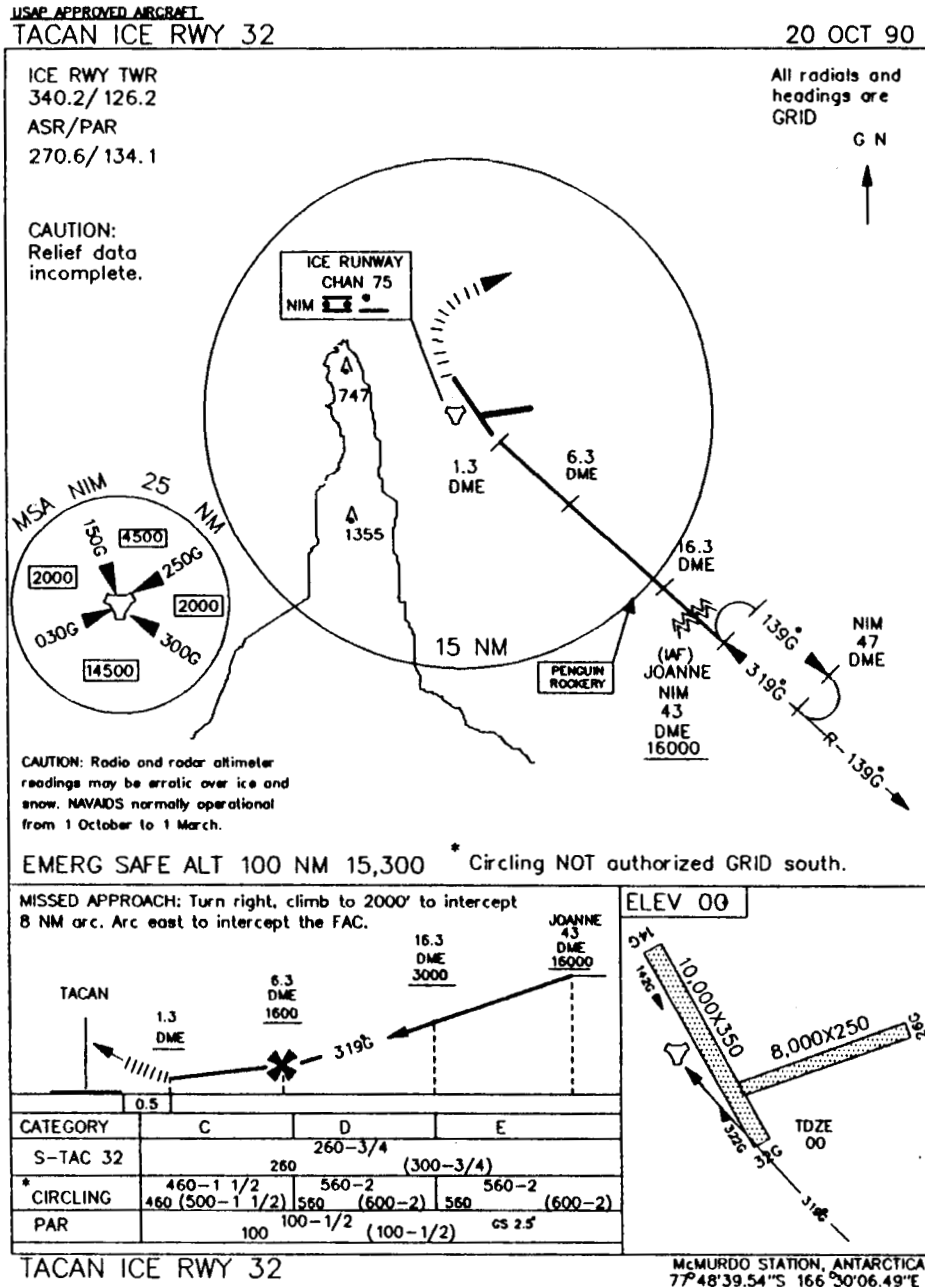

a. Approach to Ice Runway 32.

Figure A1. McMurdo Station.

USAP APPROVED AIRCRAFT

# ICE ONE DEPARTURE

24 SEP 90

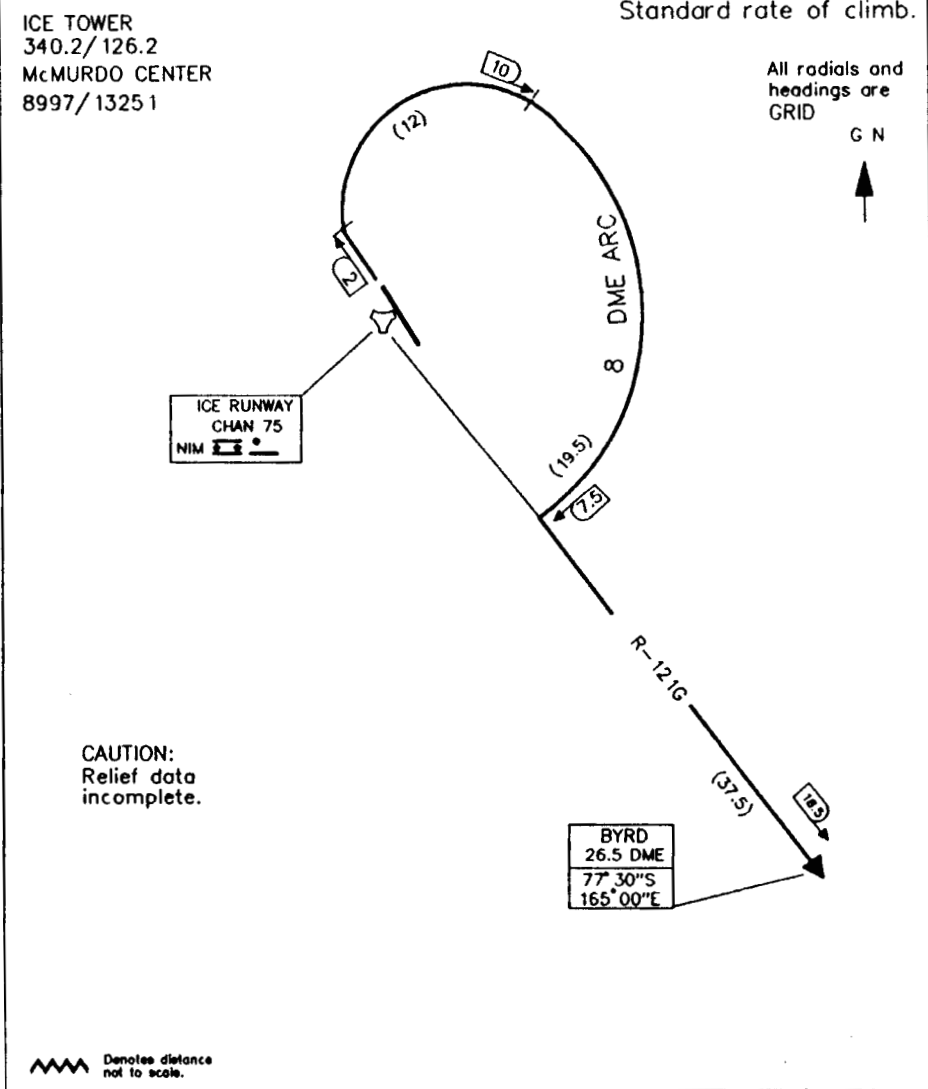

## DEPARTURE ROUTE DESCRIPTION

TAKE-OFF ICE RWY 32:  
Leaving 400', turn right to intercept NIM 8 DME arc. Arc east to the R-121G, then via assigned routing.

ICE ONE DEPARTURE

ICE RUNWAY, ANTARCTICA  
77°48'39.54"S 166°30'06.49"E

*b. Departure from Ice Runway 32.*

*Figure A1 (cont'd). McMurdo Station.*

USAP APPROVED AIRCRAFT  
**TACAN ICE RWY 26G**

31 OCT 90

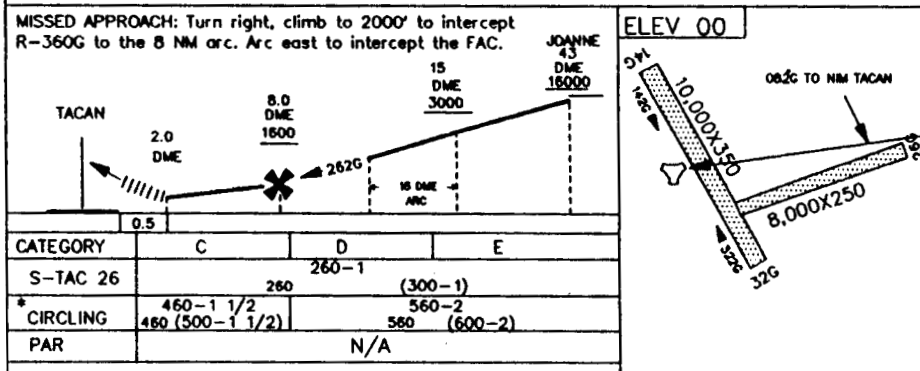
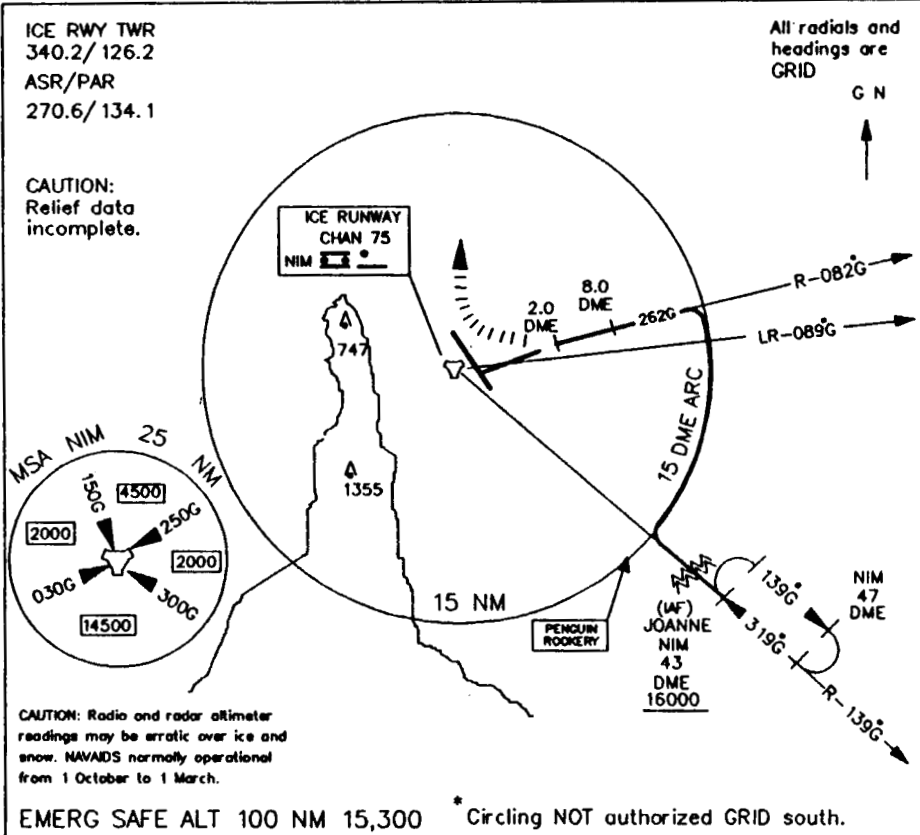

TACAN ICE RWY 26G

McMURDO STATION, ANTARCTICA  
 77°48'39.54"S 166°30'06.49"E

c. Approach to Ice Runway 26G.

Figure A1. (cont'd).



USAP APPROVED AIRCRAFT

### PEGASUS-ONE DEPARTURE

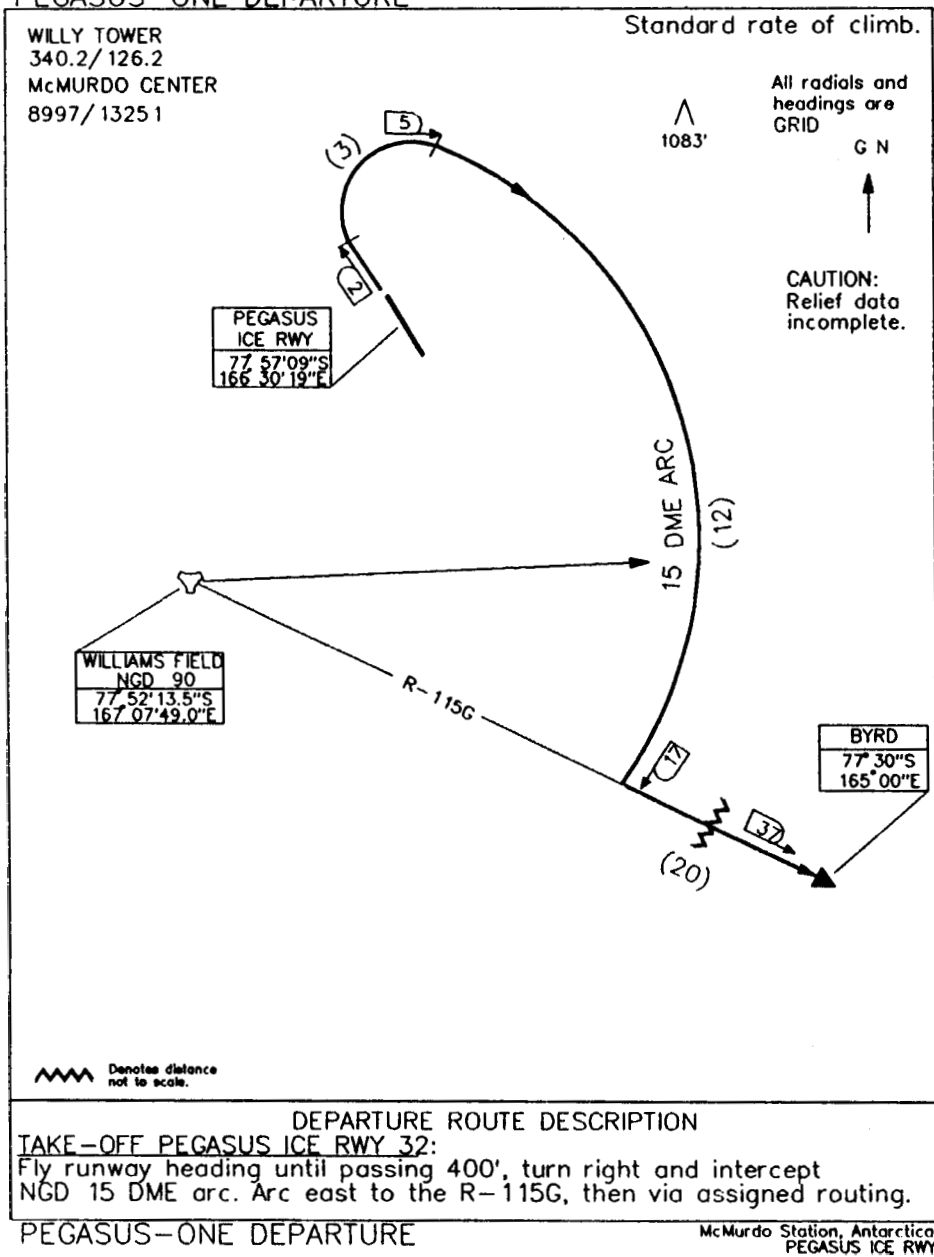

e. Departure from Pegasus Ice Runway 32G.

Figure A1. (cont'd).

TACAN SKIWAY 25G

10 AUG 90

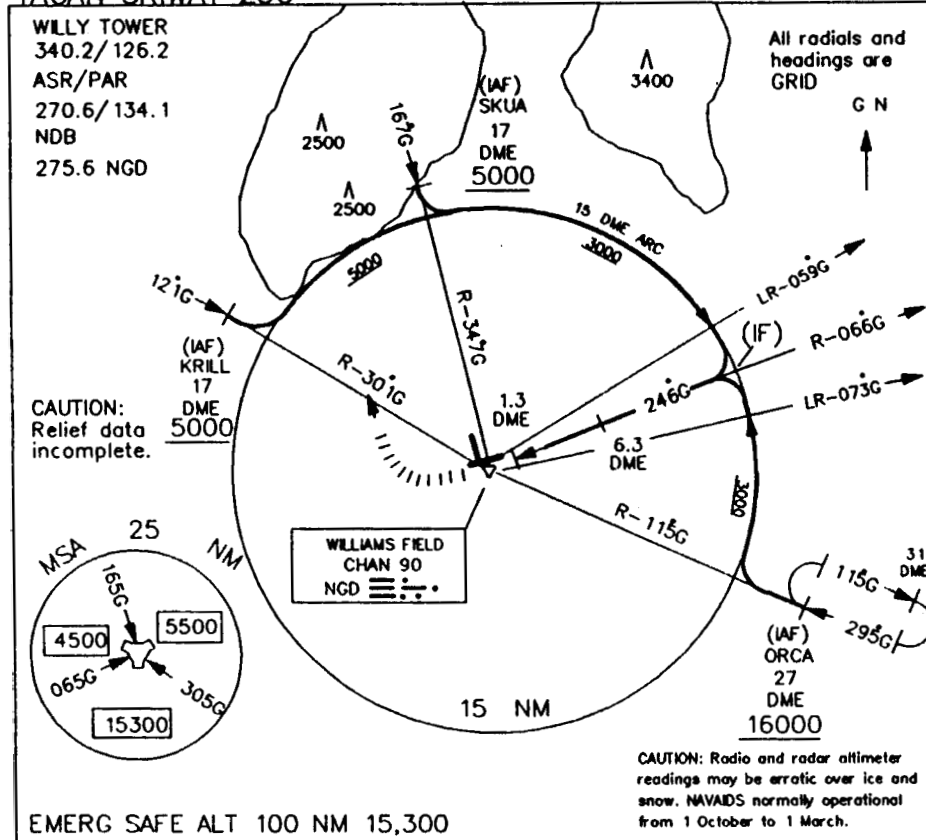

EMERG SAFE ALT 100 NM 15,300

CAUTION: Radio and radar altimeter readings may be erratic over ice and snow. NAVADS normally operational from 1 October to 1 March.

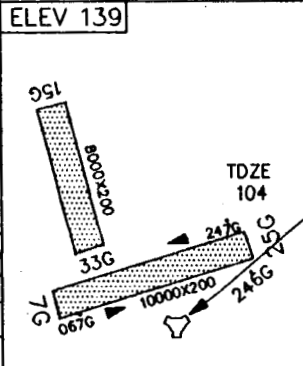
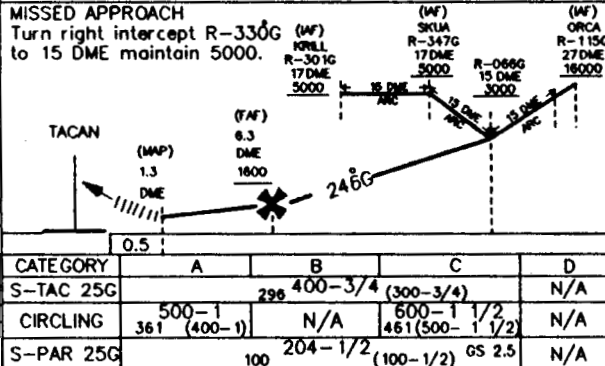

TACAN SKIWAY 25G

WILLIAMS FIELD, ANTARCTICA  
77° 52' 13.50" S 167° 07' 49.00" E

a. Approach to Skiway 25G.

Figure A2. Williams Field.

SKI-EQUIPPED USAP APPROVED AIRCRAFT  
TACAN SKIWAY 7G

10 AUG 90

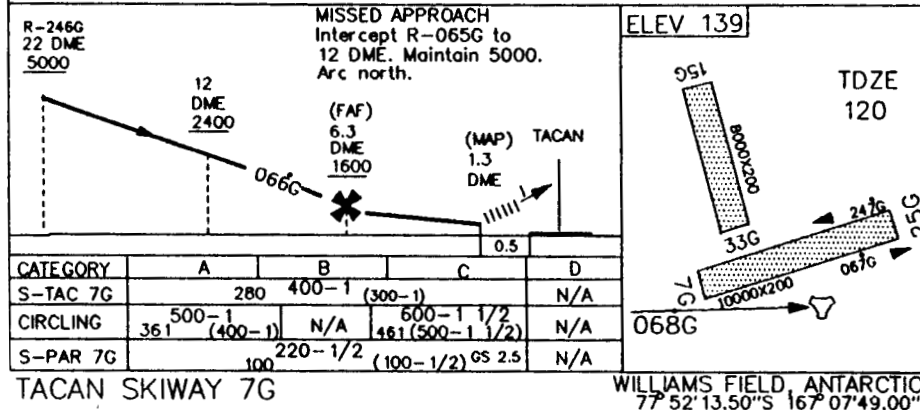
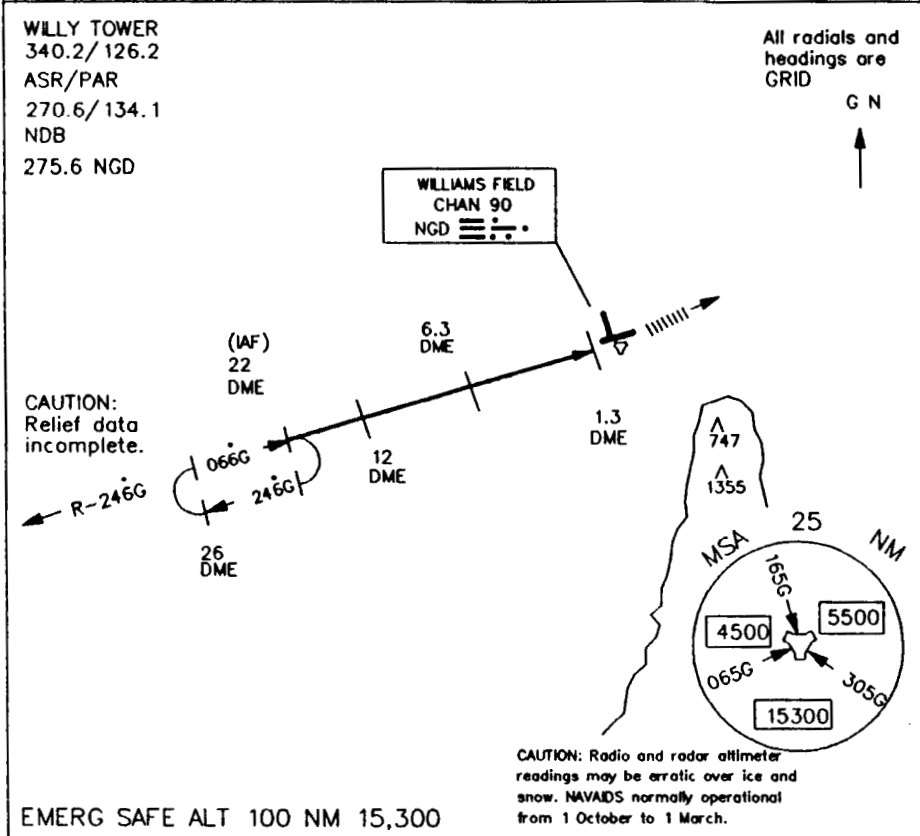

b. Approach to Skiway 7G.

Figure A2. (cont'd).

TACAN SKIWAY 15G

WILLY TOWER  
340.2/126.2  
ASR/PAR  
270.6/134.1  
NDB  
275.6 NGD

All radials and headings are GRID



CAUTION:  
Relief data  
incomplete.

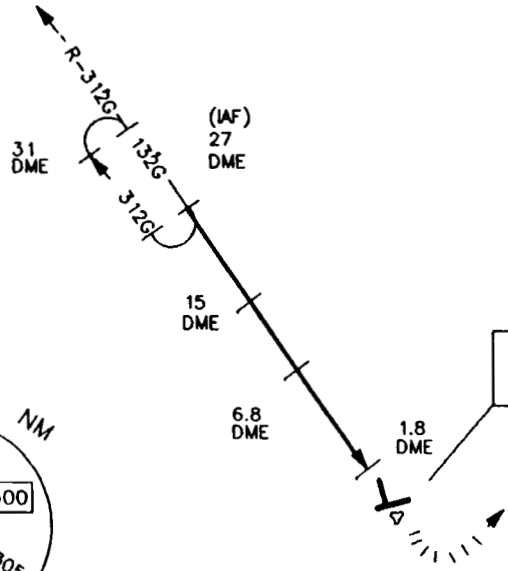
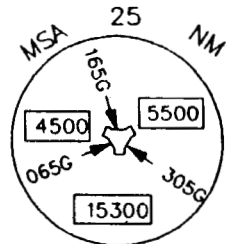

WILLIAMS FIELD  
CHAN 90  
NGD

CAUTION: Radio and radar altimeter readings may be erratic over ice and snow. NAVAIDS normally operational from 1 October to 1 March.

EMERG SAFE ALT 100 NM 15,300

R-312G  
27 DME  
5000

MISSED APPROACH  
Turn left intercept R-065G  
to 12 DME maintain 5000.  
Arc north.

ELEV 139

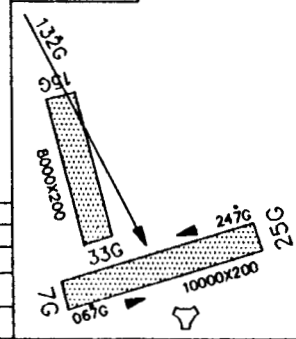
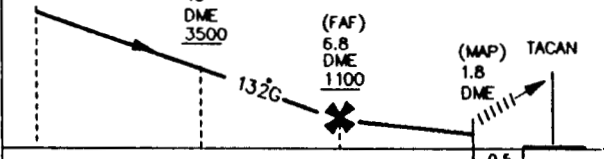

CATEGORY	A	B	C	D
S-TAC 15G	290	400-1	(300-1)	N/A
CIRCLING	N/A	N/A	N/A	N/A
S-PAR 15G	N/A	N/A	N/A	N/A

TACAN SKIWAY 15G

WILLIAMS FIELD, ANTARCTICA  
77°52'13.50"S 167°07'49.00"E

c. Approach to Skiway 15G.

Figure A2 (cont'd). Williams Field.



SKI-EQUIPPED USAP APPROVED AIRCRAFT

TACAN SKIWAY 25G

WHITEOUT LANDING PROCEDURE

31 OCT 90

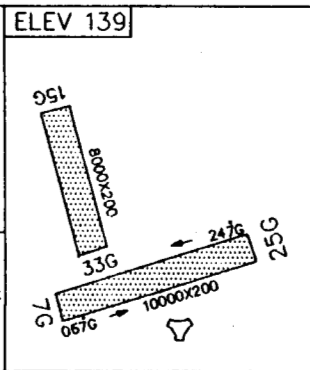
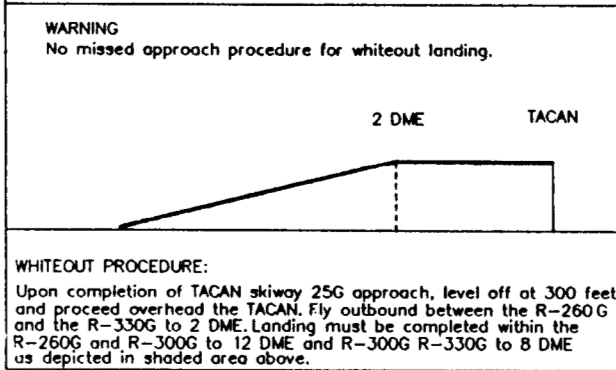
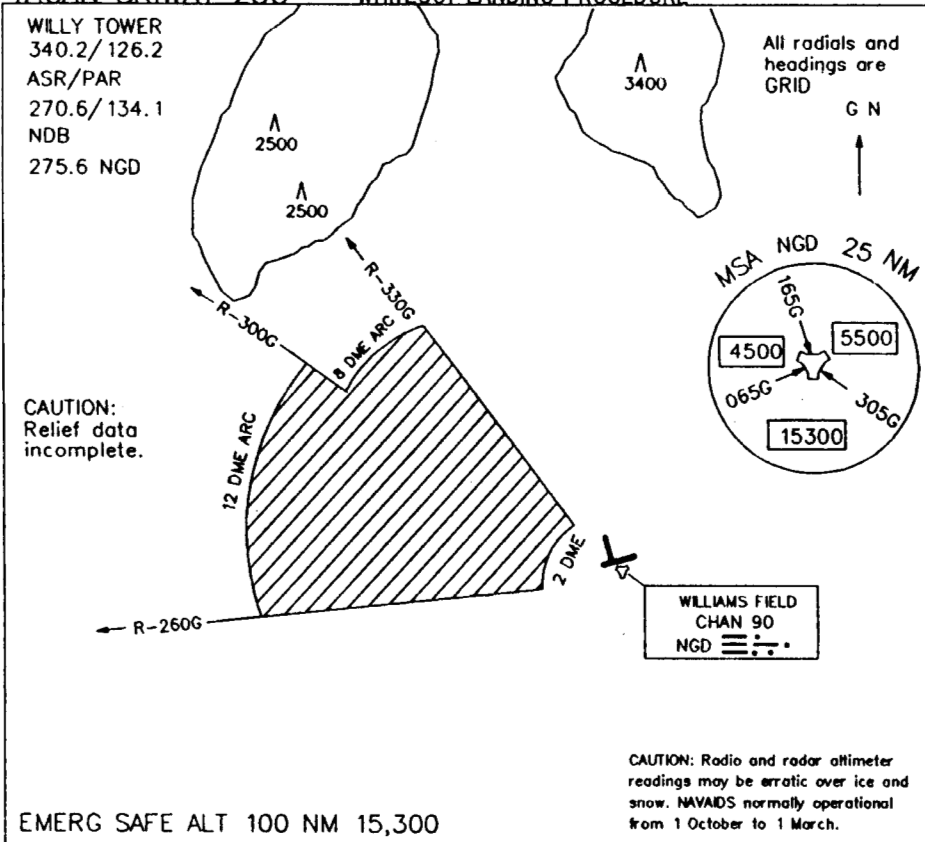

TACAN SKIWAY 25G  
WHITEOUT LANDING PROCEDURE

WILLIAMS FIELD, ANTARCTICA  
77° 52' 13.50" S 167° 07' 49.00" E

d. Whiteout landing procedure for Skiway 25G.

Figure A2. (cont'd).

SKI-EQUIPPED USAP APPROVED AIRCRAFT  
**TACAN SKIWAY 26G**

14 AUG 90

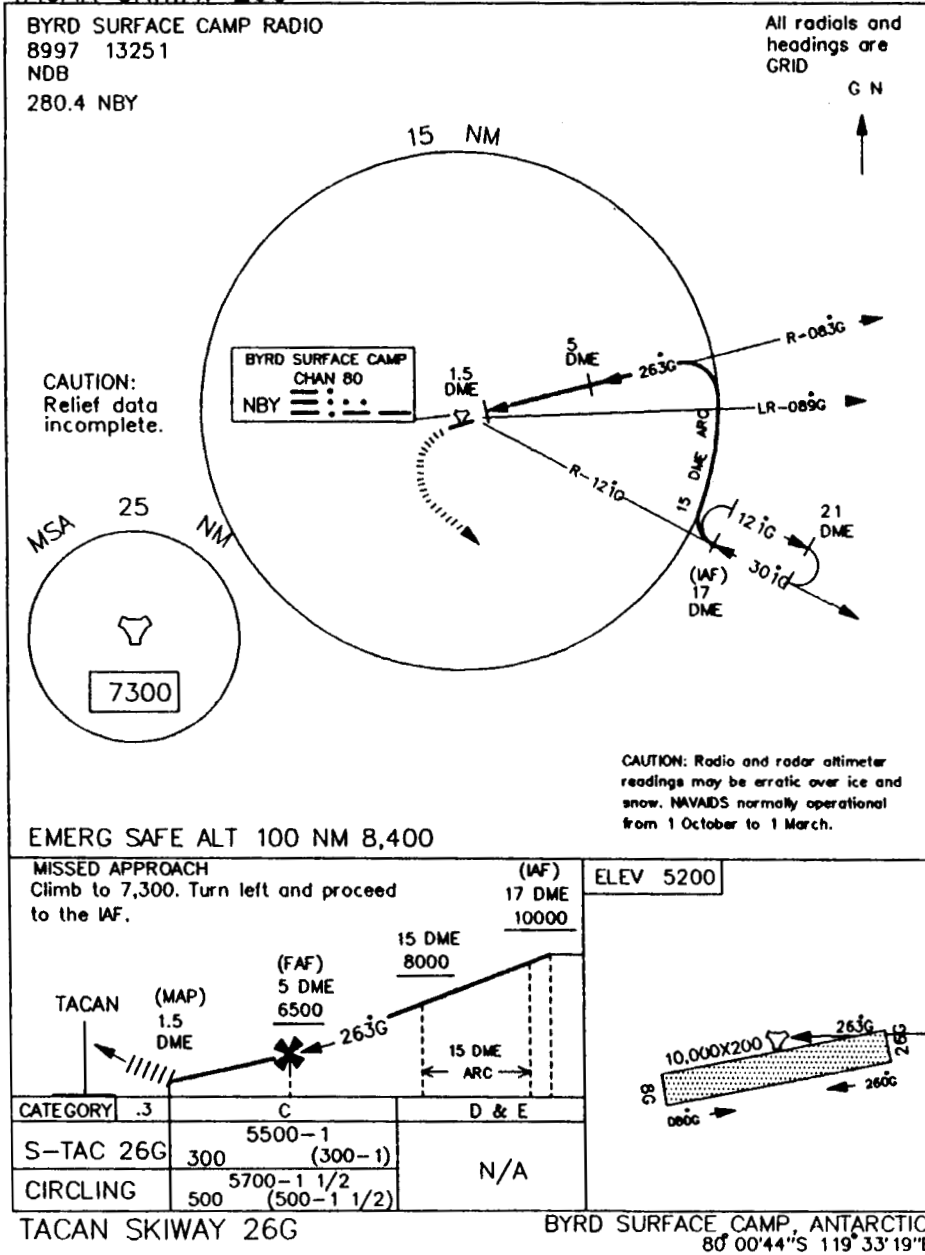
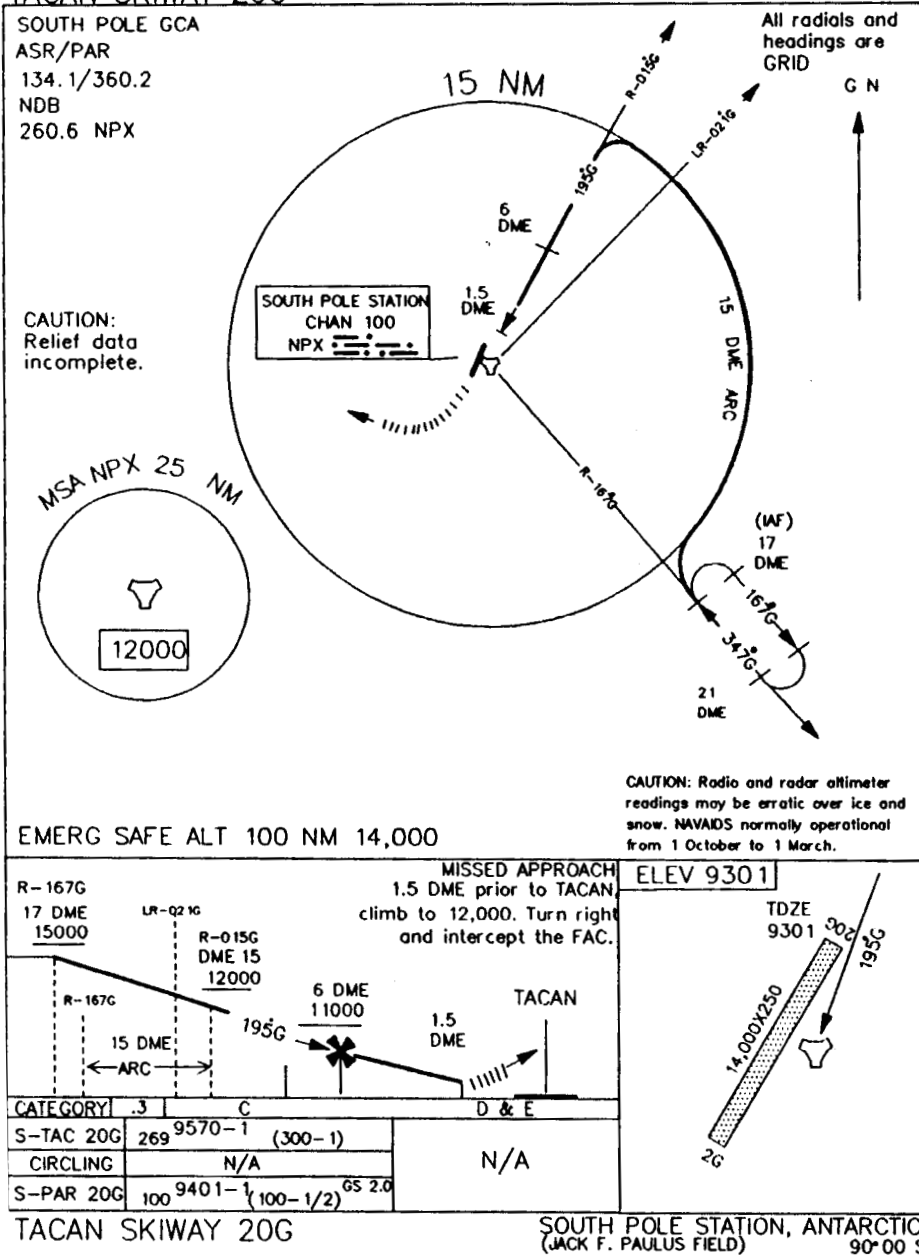

Figure A3. Byrd Surface Camp.

SKI-EQUIPPED USAP APPROVED AIRCRAFT  
**TACAN SKIWAY 20G**

1 NOV 90



a. Approach to Skiway 20G.

Figure A4. South Pole Station.

SKI-EQUIPPED USAP APPROVED AIRCRAFT

**TACAN SKIWAY 2G**

1 NOV 90

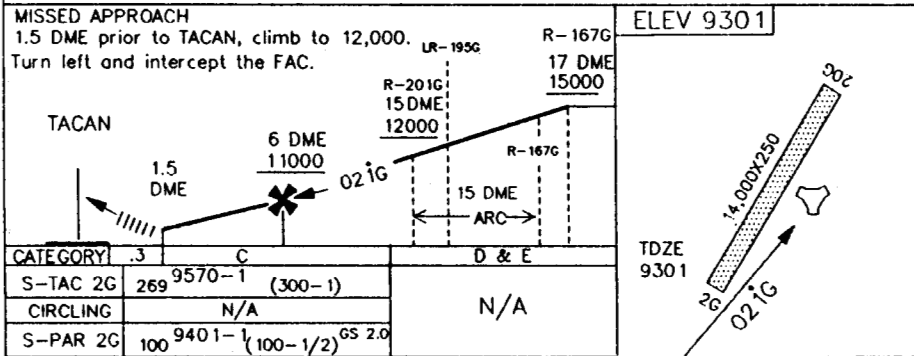
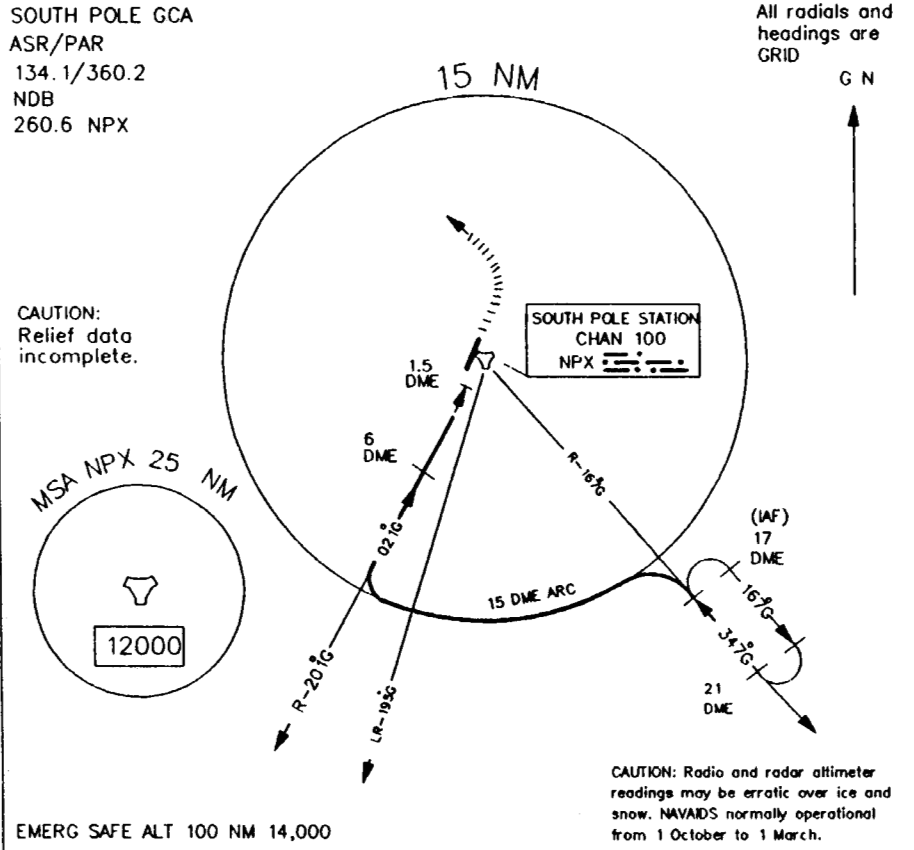

TACAN SKIWAY 2G SOUTH POLE STATION, ANTARCTICA  
(JACK F. PAULUS FIELD) 90°00 S

b. Approach to Skiway 2G.

Figure A4. (cont'd) South Pole Station.

**APPENDIX B: GROUND-TO-AIR AND AIR-TO-GROUND  
VISUAL SIGNALS FOR USE IN EMERGENCIES**

*Ground-to-air* signals can be formed with any available materials, or they can be stamped out in the snow.

- Require doctor—serious injuries ..... |
- Require medical supplies ..... | |
- Require medical assistance ..... ☒
- Unable to proceed ..... ✕
- Require food and water ..... F
- Require map and compass ..... □
- Require signal lamp with battery and radio ..... |
- Indicate direction to proceed ..... K
- Am proceeding in this direction ..... ↑
- Will attempt takeoff ..... ▷
- Airplane/vehicle seriously damaged ..... □
- Probably safe to land here ..... △
- Require assistance ..... L
- All well ..... L L
- Require mechanic ..... W

- No ..... N
- Yes ..... Y
- Not understood ..... J L
- Operation completed ..... L L L
- We have found all personnel ..... + +
- We are not able to continue.  
Returning to base ..... X X
- Have divided into groups, each proceeding  
in direction indicated ..... 
- Information received that aircraft/party  
is in this direction ..... → →
- Nothing found. Will continue to search ..... N N

The *air-to-ground* signals are as follows:

- Understand ..... Rock wings
- Do not understand ..... 360° turn to right over party
- Proceed in this direction ... Pass over party while rocking wings, proceed for one minute on heading desired, then return and execute same maneuver two more times.

# REPORT DOCUMENTATION PAGE

Form Approved  
OMB No. 0704-0188

Public reporting burden for this collection of information is estimated to average 1 hour per response, including the time for reviewing instructions, searching existing data sources, gathering and maintaining the data needed, and completing and reviewing the collection of information. Send comments regarding this burden estimate or any other aspect of this collection of information, including suggestion for reducing this burden, to Washington Headquarters Services, Directorate for Information Operations and Reports, 1215 Jefferson Davis Highway, Suite 1204, Arlington, VA 22202-4302, and to the Office of Management and Budget, Paperwork Reduction Project (0704-0188), Washington, DC 20503.

1. AGENCY USE ONLY (Leave blank)		2. REPORT DATE <b>August 1993</b>		3. REPORT TYPE AND DATES COVERED	
4. TITLE AND SUBTITLE  <b>Notes on Antarctic Aviation</b>				5. FUNDING NUMBERS	
6. AUTHORS  <b>Malcolm Mellor</b>					
7. PERFORMING ORGANIZATION NAME(S) AND ADDRESS(ES)  <b>U.S. Army Cold Regions Research and Engineering Laboratory 72 Lyme Road Hanover, New Hampshire 03755-1290</b>				8. PERFORMING ORGANIZATION REPORT NUMBER  <b>CRREL Report 93-14</b>	
9. SPONSORING/MONITORING AGENCY NAME(S) AND ADDRESS(ES)  <b>U.S. Army Cold Regions Research and Engineering Laboratory 72 Lyme Road Hanover, NH 03755</b>				10. SPONSORING/MONITORING AGENCY REPORT NUMBER  <b>National Science Foundation 1800 G Street, NW Washington, D.C. 20550</b>	
11. SUPPLEMENTARY NOTES					
12a. DISTRIBUTION/AVAILABILITY STATEMENT  <b>Approved for public release; distribution is unlimited.</b>  <b>Available from NTIS, Springfield, Virginia 22161</b>				12b. DISTRIBUTION CODE	
13. ABSTRACT ( <i>Maximum 200 words</i> )  <b>Antarctic aviation has been evolving for the best part of a century, with regular air operations developing over the past three or four decades. Antarctica is the last continent where aviation still depends almost entirely on expeditionary airfields and "bush flying," but change seems imminent. This report describes the history of aviation in Antarctica, the types and characteristics of existing and proposed airfield facilities, and the characteristics of aircraft suitable for Antarctic use. It now seems possible for Antarctic aviation to become an extension of mainstream international aviation. The basic requirement is a well-distributed network of hard-surface airfields that can be used safely by conventional aircraft, together with good international collaboration. The technical capabilities already exist.</b>					
14. SUBJECT TERMS  <b>Aircraft Airfields</b>				15. NUMBER OF PAGES <b>156</b>	
<b>Antarctica Aviation</b>				16. PRICE CODE	
<b>Aviation history Runways</b>					
17. SECURITY CLASSIFICATION OF REPORT <b>UNCLASSIFIED</b>	18. SECURITY CLASSIFICATION OF THIS PAGE <b>UNCLASSIFIED</b>	19. SECURITY CLASSIFICATION OF ABSTRACT <b>UNCLASSIFIED</b>	20. LIMITATION OF ABSTRACT  <b>UL</b>		