



TEXAS DEPARTMENT OF TRANSPORTATION

AUTOMATED AND
CONNECTED VEHICLE
(AV/CV) TEST BED TO
IMPROVE TRANSIT, BICYCLE,
AND PEDESTRIAN SAFETY

CONCEPT OF OPERATIONS PLAN

**AUTOMATED AND CONNECTED VEHICLE (AV/CV) TEST BED TO
IMPROVE TRANSIT, BICYCLE, AND PEDESTRIAN SAFETY**

CONCEPT OF OPERATIONS PLAN

Project Manager – Wade Odell, RTI
Research Supervisor – Katherine F. Turnbull, TTI

Product 0-6875-P1
Project 0-6875
Project Title: Autonomous and Connected Vehicle Test Bed to Improve Transit, Bicycle, and
Pedestrian Safety

Performed in cooperation with the
Texas Department of Transportation
and the
Federal Highway Administration

Published: February 2017

TEXAS A&M TRANSPORTATION INSTITUTE
College Station, Texas 77843-3135

TABLE OF CONTENTS

	Page
List of Figures	vi
List of Tables	vii
Chapter I – Introduction	1
Purpose of Concept of Operations Plan	1
Organization of ConOps Plan	2
Chapter II – Test Bed Vision, Goals, and Candidate Applications	3
Overarching Test Bed Vision and Goals	3
Near-Term Candidate Applications	3
Mid-Term Candidate Applications	5
Long-Term Candidate Applications	5
Chapter III – Test Beds	7
Riverside Campus Test Bed.....	7
TAMU Campus.....	9
Transit Agency and Community Test Beds	10
Chapter IV – Near-Term Candidate Application Operational Scenarios	13
Candidate Application 1 – Smart Buses: Vehicle-Based Collision-Warning System.....	13
Candidate Application 2 – Smart Buses: Collision Avoidance with Fixed Objects and Hazards	18
Candidate Application 3 – Smart Intersections: Collision Avoidance with Intersection-Based Warning Systems	21
Candidate Application 4 – Smart Bicycles: Sensors on Bicycles.....	23
Candidate Application 5 – Smart Pedestrians: Smartphone Applications (Apps).....	29
Candidate Application 6 – Smart Bike Rack: Automated Alerts for Bus Operators.....	33
Chapter V – Assessments and Evaluations	39
Preliminary Assessment of Vehicle-Based Collision Warning System	39
Quantitative Accuracy Assessment	39
Qualitative Assessment.....	47
Summary of Findings Based on the Preliminary Assessment	49
Chapter VI – Implementation Plan	51
Test Bed Schedule of Activities.....	51
Implementation Partners	53

LIST OF FIGURES

Figure 1. ConOps Plan Overview.....	1
Figure 2. Test Bed Functions.....	7
Figure 3. TAMUS Riverside Campus.....	8
Figure 4. Cardboard Pedestrians Used in Research at the Riverside Campus.....	9
Figure 5. TAMU Campus.....	10
Figure 6. Texas Public Transit Systems.....	11
Figure 7. Mobileye Shield+ Design for TAMU Bus #120.....	15
Figure 8. Example Placements of the Three Pedestrian Warning Indicators.....	16
Figure 9. Map of the Bonfire Route on the TAMU Campus.....	17
Figure 10. Delta Mobile Systems AR20 Smart Sensor System Detection Area.....	19
Figure 11. High-Level System Architecture for Smart Intersections Application.....	22
Figure 12. Possible Ways to Communicate Warning Messages to Bicyclists: Brabus E- bike with Bike Dashboard and Smartphone Mount.....	25
Figure 13. Possible Ways to Communicate Warning Messages to Bicyclists: SmartHalo Simplified Dashboard Paired with Smartphone.....	26
Figure 14. Possible Ways to Communicate Warning Messages to Bicyclists: COBI Integrated System for Connected Bicycles.....	26
Figure 15. Possible Ways to Determine Bicyclist Location and Projected Path.....	27
Figure 16. TNO Smart Bike with Multiple Features.....	28
Figure 17. Smartphone-Based Warning Messages Used in Honda’s V2P Demonstration.....	31
Figure 18. Bicycle Rack (Three-Bike Capacity) in Use by Capital Metropolitan Transportation Authority Buses in Austin, Texas.....	34
Figure 19. Bus Rider Deploying Bike Rack in Austin, Texas.....	35
Figure 20. Bike Rack Deployed Indicator in a Gillig Bus.....	36
Figure 21. Screen Capture of Mobileye Vision Zero Map with Hotspots.....	40
Figure 22. Screen Capture of Event Report from Rosco/Mobileye Telematics Website.....	41
Figure 23. Screen Capture of Rosco/Mobileye Shield+ Video Player.....	42
Figure 24. Screen Capture of TAMU Transportation Services Video Player.....	43
Figure 25. Mapped Locations of Frequently Occurring Pedestrian Collision Warnings.....	45
Figure 26. Distribution of Warnings by Hour of the Day.....	46
Figure 27. Interview Questions for TAMU Bus Drivers.....	48
Figure 28. Major Activities to Implement Test Bed Candidate Applications.....	51

LIST OF TABLES

Table 1. Proximity of Bus and Pedestrian or Cyclist.....	44
Table 2. Bus Trajectory and Proximity of Pedestrian or Bicyclist.....	44
Table 3. Roads Where Collision Warnings Occurred.....	45
Table 4. Number of Yellow Detections by Location.....	47
Table 5. Anticipated Schedule of Test Bed Activities.....	52

CHAPTER I – INTRODUCTION

PURPOSE OF CONCEPT OF OPERATIONS PLAN

This document presents the Concept of Operations (ConOps) Plan for the Automated and Connected Vehicle (AV/CV) Test Bed to Improve Transit, Bicycle, and Pedestrian Safety. As illustrated in Figure 1, the plan presents the overarching vision and goals for the test bed and the test bed locations and functions. It describes the goals, objectives, and operational scenarios for the near-term candidate applications focusing on warning-based systems for bus drivers, bicyclists, and pedestrians. The candidate applications address smart buses, smart intersections, smart bicycles, smart pedestrians, and smart bike racks. The ConOps Plan also includes an assessment and evaluation component and an implementation plan.



Source: Texas A&M Transportation Institute (TTI).

Figure 1. ConOps Plan Overview.

The ConOps Plan provides the foundation for the development of the AV/CV Test Bed to Improve Transit, Bicycle, and Pedestrian Safety. The plan is a high-level resource for the development of engineering requirements for the near-term candidate applications. It is an early and important step in the engineering process. The plan will be used by the Texas Department of Transportation (TxDOT), TTI researchers, and public and private sector partners in designing, developing, testing, piloting, and demonstrating the near-term candidate applications.

The ConOps Plan describes the basic why, who, what, where, when, and how for each of the six candidate applications. The why is presented first as it defines the issues being addressed and the goals and objectives of the candidate applications:

- Why – highlights the issues the application will address and includes the goals and objectives for the application.
- Who – describes the roles and responsibilities of the stakeholders.
- What – outlines the system components and high-level system architecture.
- Where – identifies the location of design and testing activities, pilots, and demonstrations.
- When – presents the general timing of activities.
- How – identifies possible partners and collaboration opportunities.

ORGANIZATION OF CONOPS PLAN

This ConOps Plan includes five sections following this introduction. Chapter II presents the Test Bed to Improve Transit, Bicycle, and Pedestrian Safety overarching vision, goals, and near-term, mid-term, and long-term candidate applications. Chapter III describes the test bed locations and anticipated uses. The test beds include The Texas A&M University System (TAMUS) Riverside Campus in Bryan, the Texas A&M University (TAMU) campus in College Station, and transit systems in rural, small urban, and large metropolitan areas throughout the state. Chapter IV presents the goals, objectives, and operational scenarios for each of the six near-term candidate applications. The why, who, what, where, when, and how of each candidate application are described as part of the operational scenario. Chapter V outlines the approach for assessing and evaluating the candidate applications, using the pilot of a TAMU bus equipped with a collision-avoidance system as an example. Chapter VI contains the implementation plan for the test bed.

CHAPTER II – TEST BED VISION, GOALS, AND CANDIDATE APPLICATIONS

This chapter presents the overarching vision and goals for the AV/CV Test Bed to Improve Transit, Bicycle, and Pedestrian Safety. The near-term, mid-term, and long-term candidate applications are also highlighted. The near-term candidate applications—smart buses, smart intersections, smart bicycles, smart pedestrians, and smart bike racks—focus on a warning-based system for bus drivers, bicyclists, and pedestrians. The mid-term candidate applications center on an automated vehicle response to warnings. Autonomous transit vehicles represent the long-term application. The ConOps Plan for the near-term candidate applications, including the goals and objectives, operational scenarios, and user perspectives are presented in Chapter IV. The mid-term and long-term candidate applications are provided as examples of future test bed research and deployment.

OVERARCHING TEST BED VISION AND GOALS

The overarching vision is to establish a test bed to research, develop, test, pilot, and deploy AV/CV technologies to improve transit, bicyclist, and pedestrian safety. The test bed consists of several facilities in different operating environments, including the TAMUS Riverside Campus, the TAMU campus, and transit systems in rural, small urban, and large metropolitan areas throughout the state. The vision will be realized with the participation of TxDOT, TTI, TAMU, and numerous public and private sector partners:

- Overarching Goal 1 – Reduce crashes involving transit vehicles, bicyclists, and pedestrians.
- Overarching Goal 2 – Leverage public and private resources to conduct the test bed activities.
- Overarching Goal 3 – Provide objective and unbiased assessments of technologies and techniques.
- Overarching Goal 4 – Provide transferable lessons learned to other prospective deployers in Texas and the nation.

NEAR-TERM CANDIDATE APPLICATIONS

The near-term candidate applications focus on collision avoidance with straight running and turning buses, bicyclists, and pedestrians using warning-based applications. The smart buses, smart intersections, smart bicycles, smart pedestrians, and smart bike racks use different approaches to reducing crashes. The applications focus on different user groups and transit operator responsibilities. The applications should not be considered mutually exclusive. Working together, multiple applications could greatly improve transit, bicyclist, and pedestrian safety in different environments and settings.

- **Candidate Application 1 – Smart Buses: Vehicle-Based Collision-Warning System.** The first candidate application focuses on avoiding crashes involving buses, bicyclists, and pedestrians through the use of collision-warning systems on buses. These warning systems may use cameras, sensors, and other technologies to detect bicyclists and pedestrians close to transit vehicles and alert the bus driver of their presence.
- **Candidate Application 2 – Smart Buses: Collision Avoidance with Fixed Objects and Hazards.** The second candidate application addresses reducing bus collisions with fixed objects and hazards through the use of cameras, sensors, infrared, radar, light detection and ranging (Lidar), dedicated short-range communication (DSRC), and other technologies to detect fixed objects and hazards in the path of a transit vehicle and alert the driver of their presence.
- **Candidate Application 3 – Smart Intersections: Collision Avoidance with Intersection-Based Warning Systems.** The third candidate application focuses on avoiding crashes involving buses, bicyclists, and pedestrians at signalized intersections through the use of on-vehicle technologies automatically communicating with visual and/or audible technologies at the signal. This application may use cameras, sensors, infrared, DSRC, and other technologies to communicate the presence of a turning bus to the traffic signal and activate a visual or audio warning to bicyclists and pedestrians.
- **Candidate Application 4 – Smart Bicycles: Sensors on Bicycles.** The fourth candidate application focuses on providing warnings to bicyclists about vehicles, including buses, in close proximity and imminent bicycle-vehicle crashes. Bicycles would be equipped with sensors and other technologies to detect vehicles in the path of the bicycle or approaching the bicycle. Collision-prediction algorithms will be developed and included in the bicycle technology to warn bicyclists through tactile or haptic feedback means in the seat and handle bars and/or through sounds. The sounds could also be used to alert the driver of the approaching vehicle.
- **Candidate Application 5 – Smart Pedestrians: Smartphone Applications (Apps).** The fifth candidate application uses a smartphone app to warn pedestrians of approaching buses and other vehicles. Path prediction algorithms will be developed and used to warn pedestrians of approaching buses.
- **Candidate Application 6 – Smart Bike Rack: Automated Alerts for Bus Operators.** The sixth candidate application addresses improving the safe operation of bike racks on buses. Technologies and techniques focus on enhancing the safety of bicyclists using front-mounted bike racks. Possible technologies and approaches include sensors, cameras, infrared, and networked wireless communication devices on buses and bicycles.

MID-TERM CANDIDATE APPLICATIONS

The mid-term candidate applications build on the near-term vehicle-based collision-warning systems by adding automated vehicle braking on transit buses. These applications will take advantage of automated collision-avoidance/braking systems currently available in some personal vehicles. Other systems combine the object detection system with the lane departure warning to cause the vehicle to actively resist moving out of the lane or help direct the vehicle back into the lane to avoid a crash through light braking or minor steering adjustments.

LONG-TERM CANDIDATE APPLICATIONS

The long-term candidate application focuses on a longer term view of eliminating bus, bicycle, and pedestrian crashes through the deployment of autonomous transit vehicles. This application will leverage the full range of trusted communication technologies among vehicles, infrastructure, and travelers that are reflected in vehicle-to-vehicle, vehicle-to-infrastructure, vehicle-to-pedestrian (V2P), and vehicle to everything applications. It will build on the current pilots and tests of autonomous transit vehicles underway in Europe, China, and the United States.

CHAPTER III – TEST BEDS

The AV/CV Test Bed to Improve Transit, Bicycle, and Pedestrian Safety consists of several facilities in different operating environments, including the TAMUS Riverside Campus, the TAMU campus, and transit systems in rural, small urban, and metropolitan areas throughout the state. This chapter summarizes the characteristics and anticipated use of these test beds.

Figure 2 illustrates the anticipated functions of the different test beds. Research, experimentation, and preliminary testing will occur at the TAMUS Riverside Campus. Demonstrations, pilots, and field tests will occur on the TAMU campus. Large-scale demonstrations, deployment, and integration with other transit and transportation systems will occur at transit agencies throughout the state. Assessments and evaluations will accompany the activities at each test bed.

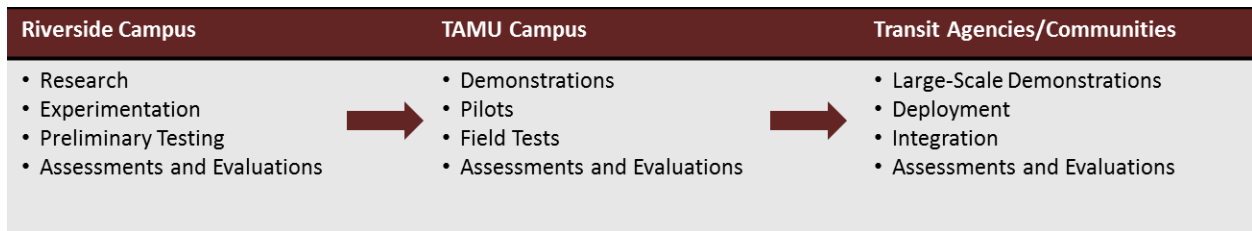

Source: TTI.

Figure 2. Test Bed Functions.

RIVERSIDE CAMPUS TEST BED

The TAMUS Riverside Campus is a 2,000-acre facility, located approximately 15 miles from the TAMU campus. As illustrated in Figure 3, the former U.S. Air Force Base includes four inactive runways, one active runway, and a large out-of-service concrete apron. This facility has low- and high-speed testing capacity and can serve multiple testing purposes simultaneously. In addition, the Riverside Campus has numerous paved secondary roads positioned in a grid-type arrangement, which could be used for further testing of candidate applications.

The Riverside Campus is currently used simultaneously by multiple divisions within TTI and by other TAMUS organizations. For example, the TTI Roadside Safety and Physical Security Division uses portions of the Riverside facility for low- and high-speed full-scale roadside safety and physical security crash tests. With an average of 60 to 100 full-scale crash tests each year, multiple test installations are under construction at any given time. Human factors and safety studies are also conducted at the Riverside Campus. The runways are used for studies to examine driver performance in response to vehicle-based or infrastructure-based technologies.



(a) Aerial View



(b) Map

Source: TTI and TAMU.

Figure 3. TAMUS Riverside Campus.

The Riverside Campus Test Bed will be used for research, experimentation, and preliminary testing of the potential technologies and approaches for the candidate transit, bicyclist, and pedestrian applications. For example, design, prototyping, and testing of the Smart Bicycle application will occur at the Riverside Campus. Figure 4 illustrates related research conducted at Riverside using cardboard pedestrians. The research was part of a closed-course study sponsored by the Federal Highway Administration (FHWA) examining the use of rectangular rapid-flashing beacons. The ability of drivers to see the cardboard pedestrians

depending on the brightness, flash patterns, and location of low-emitting diodes on the signs was tested.



Source: TTI.

Figure 4. Cardboard Pedestrians Used in Research at the Riverside Campus.

TAMU CAMPUS

The TAMU campus in College Station is the second test bed for improving transit, bicyclist, and pedestrian safety. Figure 5 shows the major buildings, streets, and landmarks on the TAMU campus. The main area of the campus is approximately 800 acres. The larger extended campus includes Easterwood Airport and additional veterinary and agricultural areas.

The TAMU campus Test Bed will be used for pilots, demonstrations, and field testing. The pilot of the Mobileye Shield+™ collision-avoidance system described in Chapter V provides an example of the use of the TAMU campus Test Bed. Assessments and evaluations will be conducted on these pilots, demonstrations, and field tests, in coordination with TAMU.

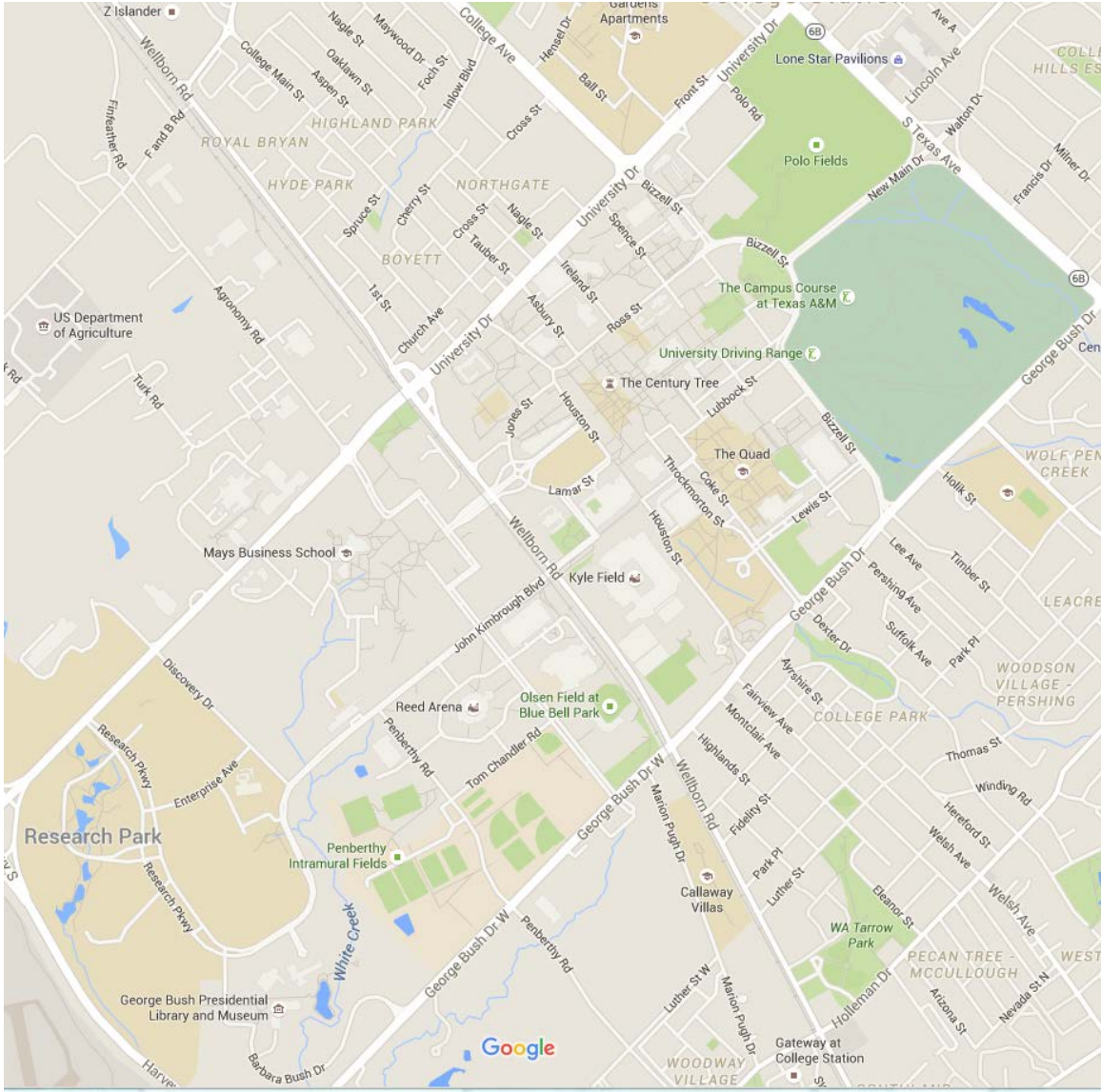

Source: Google.

Figure 5. TAMU Campus.

TRANSIT AGENCY AND COMMUNITY TEST BEDS

Transit agencies in rural, small urban, and metropolitan areas throughout the state represent the third type of test bed. As illustrated in Figure 6, there are 75 public transit systems in Texas—8 metropolitan transit authorities serving the large urban areas of the state, 30 transit districts in smaller cities, and 37 rural transit districts. Representatives from some of these transit systems have been actively involved in the AV/CV Test Bed to Improve Transit, Bicycle, and Pedestrian Safety project and have expressed interest in participating in future activities.

The transit agency and community test beds will focus on large-scale demonstrations, deployment, and integration with other transit system elements. Assessments and evaluations will be conducted on these activities, which will be conducted in partnership with the transit agencies, communities, metropolitan planning organizations, and other groups.

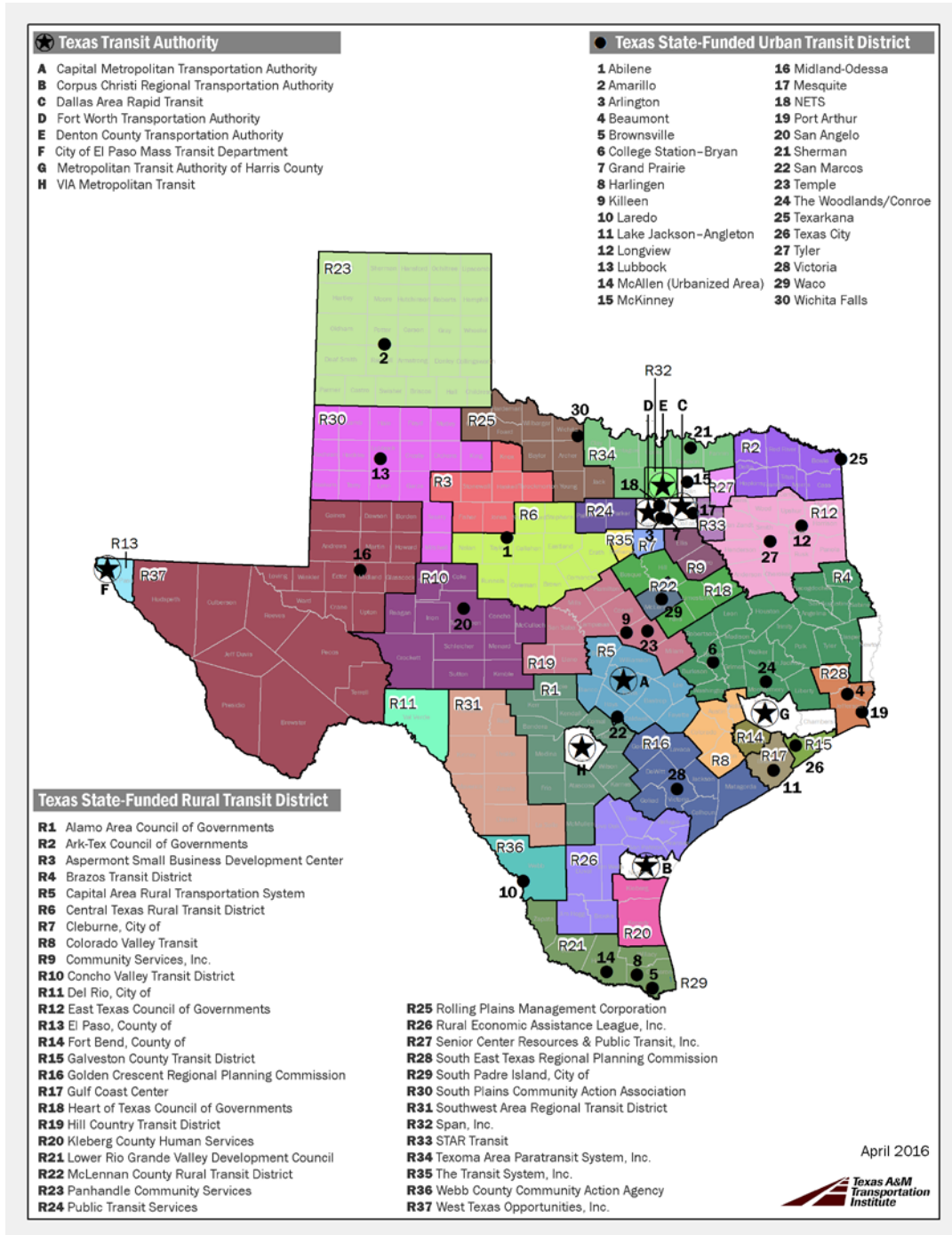

Source: TTI.

Figure 6. Texas Public Transit Systems.

CHAPTER IV – NEAR-TERM CANDIDATE APPLICATION OPERATIONAL SCENARIOS

CANDIDATE APPLICATION 1 – SMART BUSES: VEHICLE-BASED COLLISION-WARNING SYSTEM

Why

The first candidate application focuses on avoiding crashes involving buses, bicyclists, and pedestrians through the use of collision-warning systems on buses. These warning systems may use cameras, sensors, and other technologies to detect bicyclists and pedestrians close to transit vehicles and alert the driver of their presence.

Following are the goals and objectives for this candidate application:

- Goal 1.1 – Reduce crashes involving transit vehicles, bicyclists, and pedestrians.
 - Objective 1.1.1 – Reduce the number of crashes.
 - Objective 1.1.2 – Reduce the severity of crashes and personal injury and property damage.
- Goal 1.2 – Develop cost-effective approaches that require minimum alterations to bus designs and use available technologies.
 - Objective 1.2.1 – Pilot test available vehicle-based collision-avoidance systems on the TAMU campus and with transit agencies throughout the state.
 - Objective 1.2.2 – Assess the use of different technologies from both a quantitative and qualitative standpoint.
 - Objective 1.2.3 – Identify enhancements to available technologies and systems based on the result of the pilot assessments and work with companies to implement these enhancements.

Who

Transit agencies operating fixed-route and paratransit services have the major responsibility with this application. The collision-avoidance technology is located on the transit vehicle, alerting the driver to pedestrians and bicyclists near the vehicle and possible collisions. The driver is responsible for taking action. The transit agency is also responsible for the ongoing maintenance and operation of the system. School districts operating bus services for students may also be interested in this application.

What

The bus-based collision-warning system uses cameras, sensors, and other technologies on the vehicle to detect bicyclists and pedestrians in close proximity to the bus. Warnings are provided to the bus driver when bicyclists or pedestrians are within certain ranges. Commercially available bus-based collision-warning systems have recently been introduced on the market.

As part of this project, TTI was able to partner with TxDOT, TAMU Transportation Services, and the private firms, Mobileye and Rosco, to conduct a pilot of the Mobileye Shield+™ collision-warning system on one TAMU bus. The pilot was used to inform this ConOps Plan. The elements of the system are described here as an example of the technology that may be used in the candidate application. The Delta Mobile System's AR20 Smart Sensor System, which Capital Metro in Austin is evaluating, represents another collision-warning technology.

The Mobileye/Rosco Shield+™ warning system was installed on TAMU bus #120. Figure 7 illustrates the location of the on-bus system elements. These components included the cameras/intelligent vision sensors, the front center master camera added for this pilot, and three pedestrian displays. The four cameras are mounted on the right and left side at the front and rear of the bus.

The multivision sensor system identifies a variety of potential dangers—vehicles, bicyclists, and pedestrians. It includes algorithms to track the distance and speeds of these objects, which are continuously measured to calculate the risk of a collision.

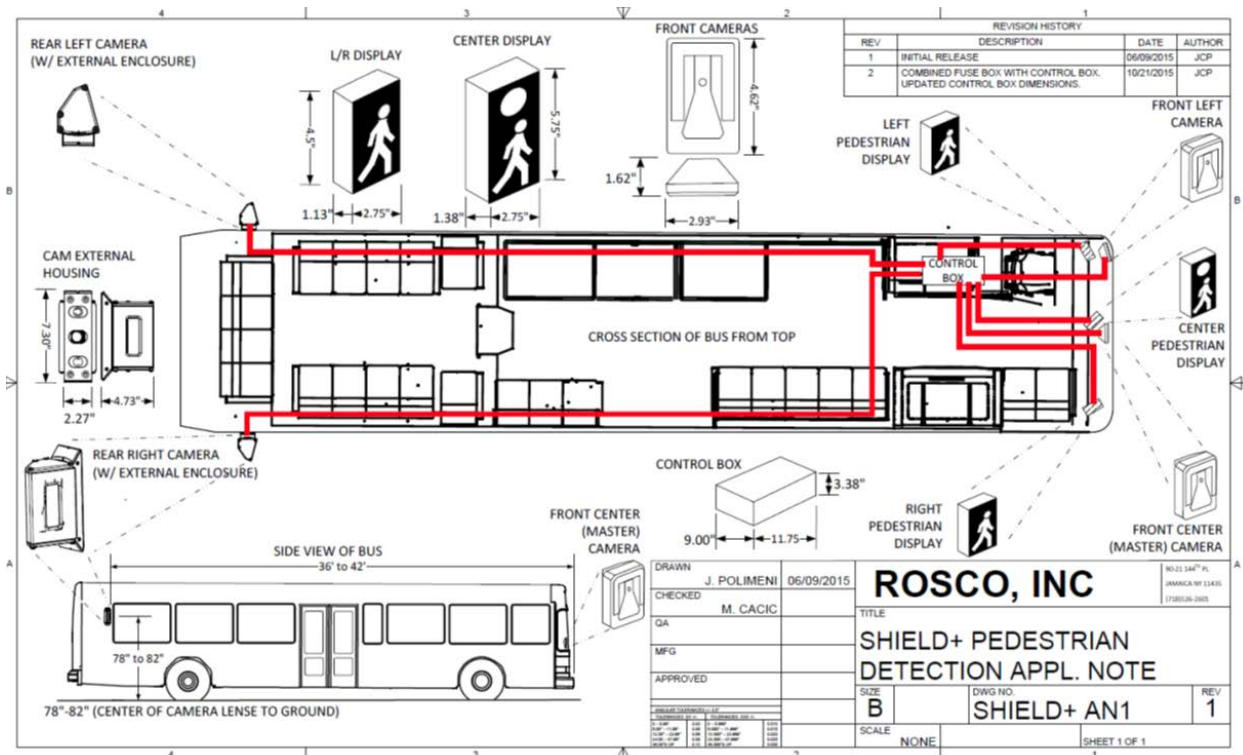

Source: Rosco, Inc.

Figure 7. Mobileye Shield+ Design for TAMU Bus #120.

As illustrated in Figure 8, the system includes displays located to the right, center, and left of the driver. The displays provide two types of warnings. A yellow light is illuminated when a bicyclist or pedestrian is detected near the right, center, or left of the bus. The yellow light indicates that the driver should exercise additional caution until confirming that the danger of a collision has passed. A flashing red light is illuminated with a beeping sound when a collision with a bicyclist or pedestrian is predicted, alerting the driver to stop in order to avoid a crash. The Mobileye/Rosco Shield+™ also includes additional “EyeWatch” features. These features include lane departure warning (LDW), speed limit indicator (SLI), headway monitoring (HM), headway monitoring warning (HMW), and forward collision warning (FCW). All these features, except for the LDW, were included on the TAMU bus.

PEDESTRIAN AND CYCLE SIDE-SENSING



The Collision Avoidance System for commercial vehicles includes three (3) display modules that alert the driver, visually and audibly, when the bus is in motion, and a pedestrian and/or cyclist is in one of the danger zones around the bus.

Source: Mobileye/Rosco.

Figure 8. Example Placements of the Three Pedestrian Warning Indicators.

Where

The Mobileye Shield+ system was installed on one TAMU bus that was assigned to the Bonfire Route, which is illustrated in Figure 9. The Bonfire Route traverses several crowded areas on the TAMU campus, including Joe Routt transitway by the Memorial Student Center, Lubbock Street/Commons area, and Ross Street shared bike and bus lanes, with buses routinely operating in close proximity to pedestrians and bicyclists. Bonfire Route also traverses University Dr./Stotzer Parkway from Asbury to Olsen Blvd., which includes several high-traffic pedestrian crossings. The assessment conducted on the pilot is described in Chapter V.

Additional pilots of other technologies will be undertaken on the TAMU campus and with transit agencies in diverse operating environments. For example, evaluating a possible pilot of the AR20 Smart Sensor System will be explored in cooperation with Capital Metro in Austin.

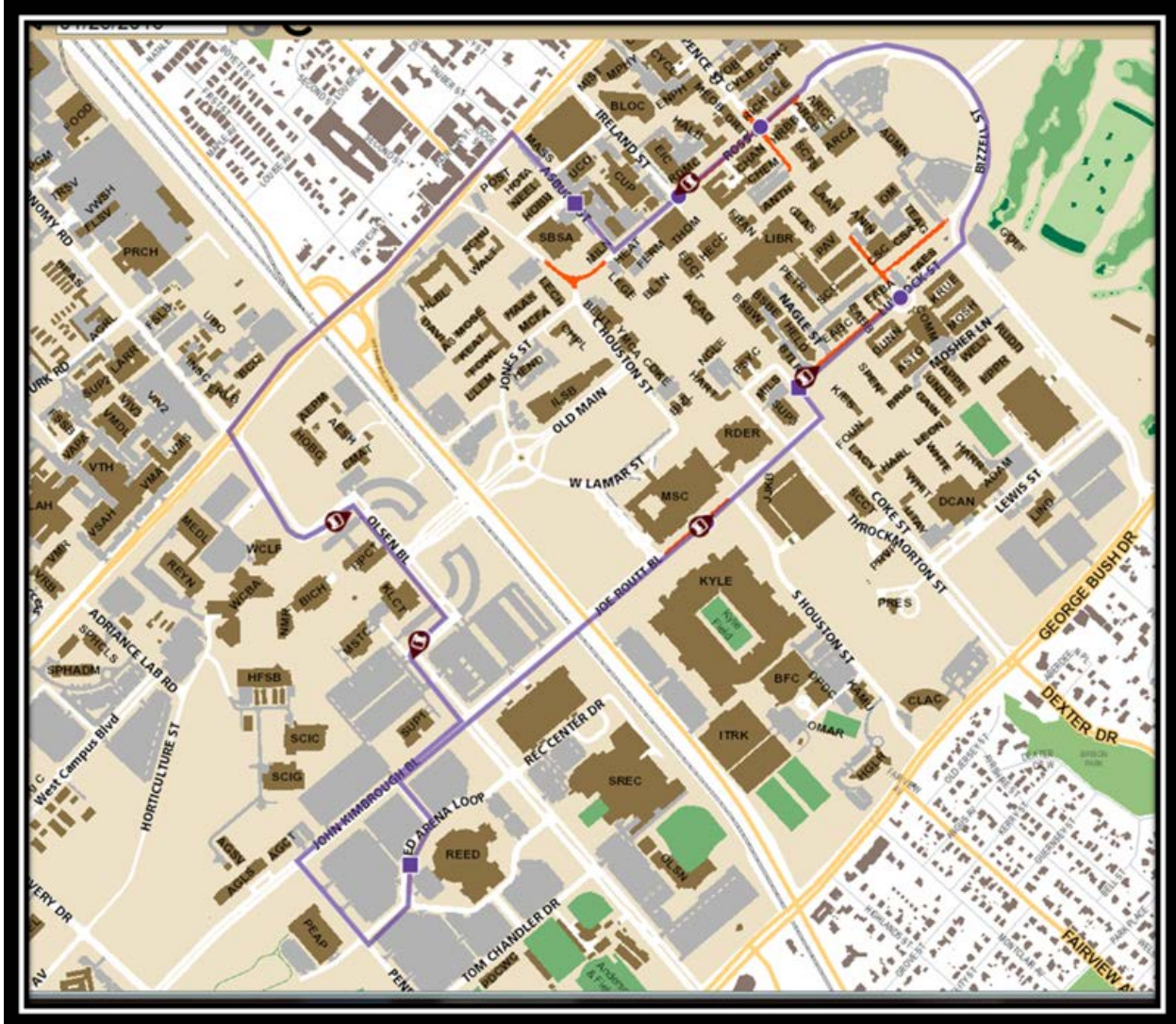

Source: TAMU.

Figure 9. Map of the Bonfire Route on the TAMU Campus.

When

An initial pilot and assessment of the Mobileye Shield+™ collision-avoidance system were conducted as part of developing this ConOps Plan. Additional pilots and assessments will be conducted during the first year of the test bed. It is anticipated that the AR20 Smart Sensor System will be piloted on the TAMU campus and/or with Capital Metro in Austin. Other technologies will also be examined and tested.

How

The ongoing piloting of vehicle-based collision-avoidance systems will be conducted in partnership with TxDOT, TTI, TAMU, transit agencies, and technology companies. These

partnerships will build on the collaboration established with the Mobileye/Rosco pilot. School districts may also participate in the pilots.

CANDIDATE APPLICATION 2 – SMART BUSES: COLLISION AVOIDANCE WITH FIXED OBJECTS AND HAZARDS

Why

The second candidate application addresses reducing bus collisions with fixed objects and hazards using cameras, sensors, infrared, radar, Lidar, DSRC, and other technologies to detect fixed objects and hazards in the path of a transit vehicle and alert the driver of their presence.

Transit vehicle collisions with fixed objects are a concern for many transit agencies in Texas. The property damage cost for collisions with fixed objects can be high. Buses collide with construction barriers, high curbs, awnings and overhead signs, utility poles, signs, trash cans, mailboxes, fire hydrants, and tree branches. Buses may stray out of the lane of travel and collide with parked cars or adjacent embankments. Collisions with fixed objects also occur with paratransit vehicles, which are typically small buses and vans, as drivers are required to maneuver in tight spaces and may be required to drive in reverse to position the vehicle before moving forward.

Following are the goals and objectives for this candidate application:

- Goal 2.1 – Reduce crashes involving transit vehicles and fixed objects and hazards.
 - Objective 2.1.1 – Reduce the number of crashes.
 - Objective 2.1.2 – Reduce the amount of property damage when a crash occurs.
- Goal 2.2 – Develop cost-effective approaches that require minimum alternatives to bus designs and use available technologies.
 - Objective 2.2.1 – Evaluate various types of sensors, such as cameras, radar, and Lidar to detect when a transit vehicle is getting too close to a fixed object.
 - Objective 2.2.2 – Evaluate cameras and ultrasonic warning devices to reduce crashes when operating in reverse.
 - Objective 2.2.3 – Evaluate night vision assist technologies to produce an enhanced view of the road ahead to reduce crashes with fixed objects that may be hard to detect at night.

Who

The application to address bus collisions with fixed objects and hazards will involve the transit agency operating fixed route and paratransit service. This application will build on

lessons learned in the previous application for a bus-based collision-warning system to detect bicyclists and pedestrians in close proximity to the bus. School districts operating bus services for students may also be interested in this application.

What

Object detection systems use various types of cameras, ultrasonic, radar, and Lidar to detect when a transit vehicle is close to a fixed object and then warn the driver. Some systems brake automatically if the driver does not respond to the warning. Figure 10 illustrates the Delta Mobile Systems AR20 Smart Sensor Systems.

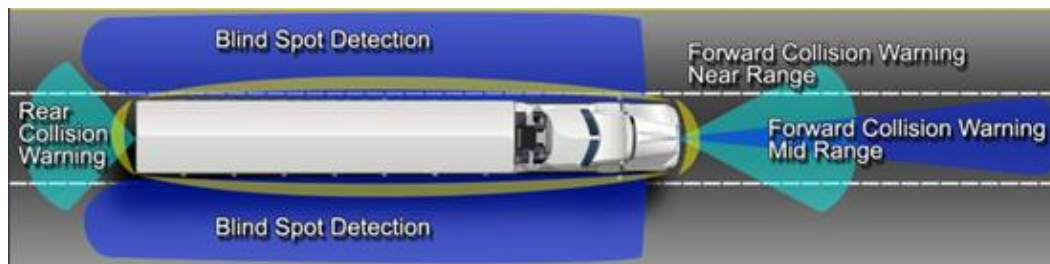

Source: Delta Mobile Systems.

Figure 10. Delta Mobile Systems AR20 Smart Sensor System Detection Area.

The following techniques will be considered for use in this application:

- Lidar technology uses light beams to detect nearby objects through a reflected signal. The system's detection range is generally 6–100 feet. Lidar performance is diminished by weather conditions, such as fog, however. Most systems issue a warning to the driver and precharge the brakes to maximize their effect if the driver brakes.
- Similar to Lidar, radar systems can detect objects to a range of approximately 500 feet and are not hampered by weather conditions. However, radar systems have a higher cost of implementation and may have poor detection abilities in the medium range of 100–200 feet.
- Ultrasonic-based systems emit high-frequency signals to a distance of 12 feet. The system can detect distinct echoes that can be used to calculate distance and relative speed. Ultrasonic-based systems are similar to the back-up sensors available on personal automobiles and typically work in combination with cameras. These systems are relatively inexpensive to implement. Ultrasonic-based systems can detect objects with a solid, reflective surface and are not intended for use to detect pedestrians.
- Night vision assists use infrared imaging to produce an enhanced vision of the road ahead. Some systems provide an audible or visual alert if a there is an object detected ahead.

These systems alert the driver if the vehicle is in danger of striking an object. Some systems use audible or visual warnings using DSRC, while other systems use haptic warnings such as steering wheel or seat vibration. The evaluation of different technologies will include testing which type of driver warning is more effective under what conditions. If the near-term vehicle based collision warning systems are effective, there are additional opportunities for mid-term candidate applications.

Some systems can cause the vehicle to brake automatically if the driver does not respond. An autobrake system may not always prevent a crash, but may reduce vehicle speed, reducing the severity of the crash. Some systems combine the object detecting system with the lane departure warning system to cause the vehicle to actively resist moving out of the lane or help direct the vehicle back into the lane (to avoid the crash with a fixed object) through light braking or minor steering adjustments.

Where

The initial system design, development, and prototyping will occur at the TAMUS Riverside Campus. A pilot will be conducted on the TAMU campus, with a larger demonstration project suggested for implementation in cooperation with Capital Metro in Austin.

When

The smart bus collision avoidance with fixed objects application will be initiated during the first year of the test bed. Building on the experience with the Mobileye Shield+™ pilot and available technologies, including the AR20, the design and prototyping will take six months. The pilot on the TAMU campus will then be initiated, with the pilot involving Capital Metro occurring in the second year.

How

The smart bus collision avoidance with fixed objects application will be designed, developed, and tested through a partnership with TxDOT, TTI, TAMU, one or more technology companies, and one or more public transit agencies in Texas. The Mobileye/Rosco Shield+™ warning system is a possible private sector partner, as TTI is currently working with them on other applications. Another possible technology is the AR20 Smart Sensor System by Delta Mobile Systems, which uses radar-based sensing technology. The AR20 is being examined by Capital Metro for possible use.

CANDIDATE APPLICATION 3 – SMART INTERSECTIONS: COLLISION AVOIDANCE WITH INTERSECTION-BASED WARNING SYSTEMS

Why

The third candidate application focuses on avoiding crashes involving buses, bicyclists, and pedestrians at signalized intersections through the use of smart buses automatically communicating with smart traffic signals to provide visual and audio warnings to bicyclists and pedestrians. Signalized intersections with high volumes of pedestrians and bicyclists crossing the street and buses making left and right hand turns are key targets for reducing crashes and improving safety.

Following are the goals and objectives for this candidate application:

- Goal 3.1 – Reduce crashes involving transit vehicles turning at intersections and bicyclists and pedestrians crossing the street.
 - Objective 3.1.1 – Design and develop a prototype smart intersection at the TAMUS Riverside Campus.
 - Objective 3.1.2 – Conduct a pilot of the smart intersection on the TAMU campus.
 - Objective 3.1.3 – Assess the pilot and make enhancements to the system as needed.
 - Objective 3.1.4 – Conduct a demonstration of the smart intersection in one urban area.
- Goals 3.2 – Develop a cost-effective smart intersection application that takes advantage of existing technologies and systems.
 - Objective 3.2.1 – Use existing traffic signal systems and communication technologies in developing the Smart Intersections application.
 - Objective 3.2.2 – Select the demonstration location based on interest and available supporting technologies.

Who

The Smart Intersections application involves the transit agency and the entity responsible for operating the traffic signal system, which is typically the city, county, or state transportation agency. Some transit and transportation agencies have signal priority systems in place, allowing a bus to receive special treatment at a signal by adjusting the Signal Phase and Timing, such as extending the green phase or shortening the red phase.

What

Figure 11 illustrates a simplified systems architecture for the Smart Intersections application.

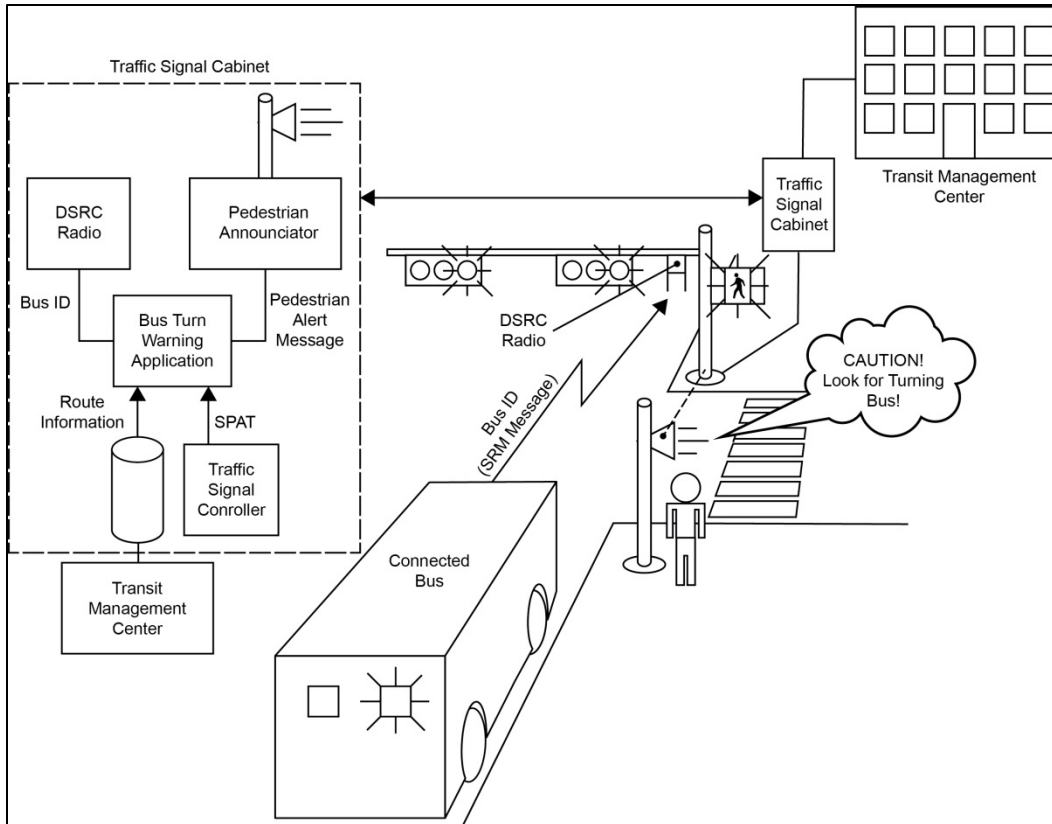

Source: TTI.

Figure 11. High-Level System Architecture for Smart Intersections Application.

The basic elements of the system are outlined in the following:

- The smart bus sends a Signal Request Message (SRM) via DSRC to the DSRC radio, which is connected to the traffic signal control cabinet. The traffic signal control cabinet is connected electronically to the transit management center.
- The bus identification (ID) is communicated to the traffic signal cabinet through the SRM, which is the SAE J 2735 DSRC message set for use by vehicles requesting priority service at a traffic signal.
- The traffic signal cabinet is linked electronically to the transit management center, which provides daily information on the buses assigned to specific routes. The system also contains route information including if the bus route (and the bus) turns right or left at the intersection.
- The system automatically compares the bus ID with the route information for the assigned bus. If the system determines that the approaching bus is turning left or right across an active pedestrian phase, a verbal and/or visual warning alert is broadcast. The verbal alert would be provided through a link to the Accessible Pedestrian Signal if available or an announcement system installed for the project.

The verbal alert could be “Caution! Look for turning bus” or a related message. The visual warning could be accomplished by automatic communications with pedestrian lights or signing that meet the *Manual of Uniform Traffic Control Devices* requirements.

Where

The initial system design, development, and prototyping will occur at the TAMUS Riverside Campus. A pilot will be conducted on the TAMU campus. A larger demonstration project will be implemented in one of the urban areas of the state with existing bus and traffic signal technologies.

When

The Smart Intersections application will be initiated during the first year of the test bed. It is anticipated that the design and prototyping will take eight months, with a pilot on the TAMU campus occurring at the end of the first year. The assessment of the pilot will be conducted during the second year, with the demonstration also initiated during the second year.

How

The Smart Intersections candidate application will be designed, developed, and tested through a partnership with TxDOT, TTI, a signal system company, and TAMU. Econolite is a possible private sector partner, as TTI is currently working with them on other opportunities.

CANDIDATE APPLICATION 4 – SMART BICYCLES: SENSORS ON BICYCLES

Why

The fourth candidate application focuses on providing warning messages to bicyclists about close proximity or imminent crashes with other road users, including buses, other motorized vehicles, other bicyclists, and pedestrians. In this application, the bicyclist and/or the bicycle are equipped with sensors or other communications technologies capable of detecting the presence and travel path of other road users in their vicinity. Path prediction algorithms are used to estimate close proximity and imminent collisions with other road users, and warning messages are provided to the bicyclist through visual, audio, or haptic (i.e., vibratory) means. If these other road users have two-way communication capability, a similar warning message is sent from the bicyclist to the other road users about the bicyclist’s presence and path.

Following are the goals and objectives for this candidate application:

- Goal 4.1 – Reduce crashes involving bicyclists and other road users.
 - Objective 4.1.1 – Design and develop a prototype smart bicycle application at the TAMUS Riverside Campus.

- Objective 4.1.2 – Conduct a pilot of the smart bicycle application on the TAMU campus.
- Objective 4.1.3 – Assess the pilot and make adjustments to the system as needed.
- Objective 4.1.4 – Use a variety of technology transfer methods to disseminate information on the smart bicycle application.
- Goal 4.2 – Develop a cost-effective smart bicycle application that takes advantage of existing technologies and systems.
 - Objective 4.2.1 – Explore opportunities with private companies providing needed components.
 - Objective 4.2.2 – Use available technology for the prototype.

Who

The primary user of this application is a bicyclist, who would benefit by having more information about other road users that are in close proximity or an imminent collision threat. Upon receiving a warning message, the bicyclist could then respond to avoid the conflict or collision threat.

If the bicyclist in this application has instantaneous communication with other road users, then these road users would also benefit by knowing the projected path of the bicyclist. For example, large trucks or buses could know the position and projected path of a bicyclist riding in their blind spot in an adjacent parallel bicycle lane. That is, the bicyclist could be broadcasting his/her position to any other road user who is capable of hearing the broadcast.

What

The core functional requirements for a smart bicycle are:

- Detect other road users in close proximity and determine their projected paths.
- Provide a warning message to the bicyclist.
- Provide the bicyclist's location and projected path to other road users.

The first functional requirement is the ability to detect other road users in close proximity and determine their projected path. This detection and path projection capability could be provided in at least two different ways:

- Bicycle-Mounted Sensor(s) – In this scenario, one or more sensors are mounted on the bicycle that can detect other road users in all other directions. Alternatively, the sensors could be mounted on the bicyclist, such as the helmet, to provide better line of sight for those sensors that may require it.

- **Communication Capability with Other Road Users** – In this scenario, other road users with a specialized communication capability are broadcasting their current location and projected path at all times. Similarly, bicyclists with similar communication capability can hear these other road users broadcasting their position and projected paths once they are within range of the broadcast. This is the basic concept envisioned in the U.S. Department of Transportation’s (USDOT’s) Connected Vehicles Program, and there are DSRC technologies that exist and could be used to meet this functional requirement. The primary hurdle at this time is widespread deployment DSRC-capable equipment among consumer vehicles and other road users.

The second functional requirement is the ability to provide a warning message to the bicyclist about close proximity or imminent collision threat with other road users. The warning message can be provided in several ways (e.g., visual, auditory, haptic/vibratory) and through several different types of devices (e.g., smartphone, handlebar-mounted dashboard gauge, vibrating handlebar grips, seat, or pedals). Figures 12, 13, and 14 show several existing technologies for providing warning messages to bicyclists.



Source: <https://www.electricbike.com/brabus/>.

Figure 12. Possible Ways to Communicate Warning Messages to Bicyclists: Brabus E-bike with Bike Dashboard and Smartphone Mount.



Source: <https://www.smarthalo.bike/>.

Figure 13. Possible Ways to Communicate Warning Messages to Bicyclists: SmartHalo Simplified Dashboard Paired with Smartphone.



Source: <http://cobi.bike/>.

Figure 14. Possible Ways to Communicate Warning Messages to Bicyclists: COBI Integrated System for Connected Bicycles.

The design of the warning message system should take into account that bicyclists are extreme multitaskers during most of their travel:

- Their bodies are balanced over two skinny rotating wheels.
- Their legs are typically in an up-and-down pedaling motion.

- Both of their arms and hands are needed for balance and steering control.
- Their eyes are scanning for possible collision threats in all directions, including backward glances for passing traffic, as well as downward for potholes and pavement seams that could severely disrupt their forward motion.

The third functional requirement is the ability to provide the bicyclist's location and projected path to other road users. This capability could be used to assist these other road users in avoiding a conflict or imminent crash with the bicyclist. The most likely implementation of this requirement is to have the bicycle broadcast a signal that could be communicated and heard by other road users with similar communications capabilities (e.g., DSRC). The location and projected path of the bicyclist could be determined by bicycle-mounted sensors or by a smartphone carried by the bicyclist. Figure 15 provides an example of possible bicycle-mounted sensors.

Bicycle Frame-Mounted Speed Sensor
(based on wheel revolutions)



Source: Wahoo Fitness (<http://www.wahoofitness.com>).

Handlebar-Mounted Speed Sensor
(based on global positioning system [GPS])



Source: Garmin (<http://www.garmin.com>).

Figure 15. Possible Ways to Determine Bicyclist Location and Projected Path.

The creation of a smart bicycle requires the integration of several different technological elements to create a seamless user experience. There are several different technologies and applications that already exist, but they have yet to be assembled and distributed commercially.

In October 2015, the USDOT issued a request for proposals (RFP) in their Small Business Innovation Research Program for a *Connected Bicycle* that is capable of broadcasting a Basic Safety Message for Bicycles through DSRC. The RFP also indicated that the Connected Bicycle should interface with a bicycle-mounted sensor (capable of measuring bicycle location and speed) and a smartphone carried by a bicyclist. No awards under this RFP have been made public at this time. The design and development of a prototype smart bicycle will monitor the status of any awards under this program.

As illustrated in Figure 16, the Dutch research organization TNO (in English, Netherlands Organization for Applied Scientific Research) has developed a smart bicycle that includes radar-based sensors, a handlebar-mounted warning system, haptic handlebar grips and seat, and an on-board data processing unit. The smart bike prototype weighs about 55 pounds and is expected to cost between \$2,000 and \$4,000 (<http://www.fastcoexist.com/3040096/this-bike-warns-you-if-a-car-is-about-to-hit-you>).

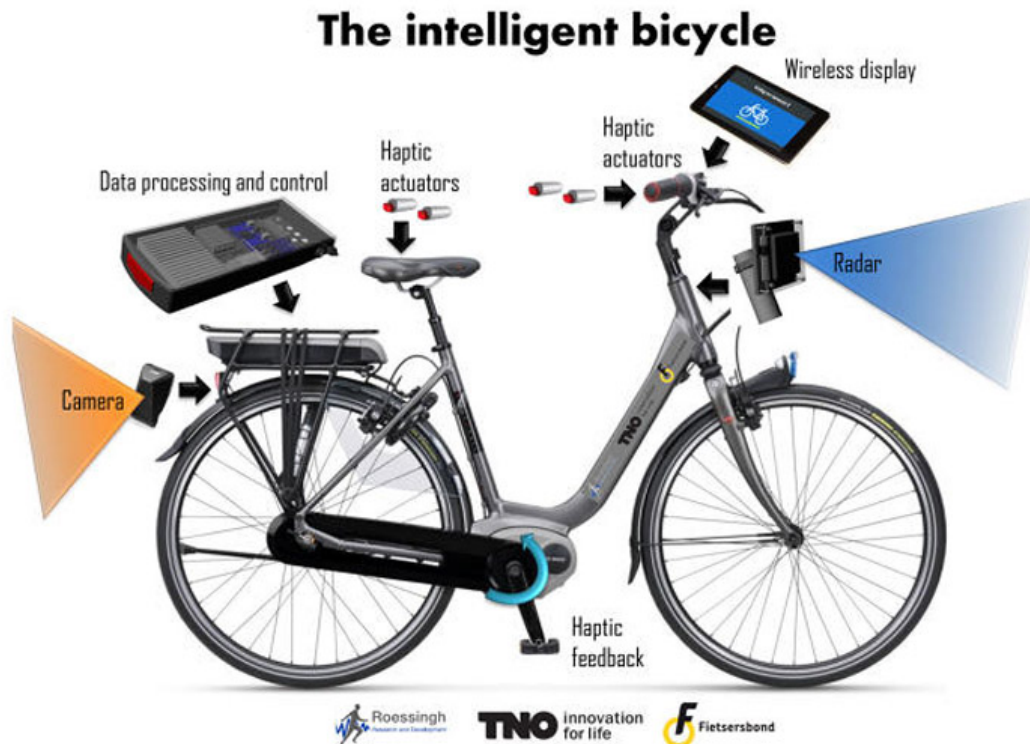

Source: <https://www.smarthalo.bike/>.

Figure 16. TNO Smart Bike with Multiple Features.

Where

The smart bicycle should be capable of meeting these functional requirements in a wide range of operating environments: crowded city streets with fast-moving car, truck, and bus traffic and hundreds of nearby pedestrians; off-road shared use paths that are frequented by many types of non-motorized users, including users with various physical or visual disabilities, other inexperienced bicyclists, and even small children; and finally, for rural highways that are used by long-distance recreational cyclists.

Current information indicates that the majority of bicycle-involved crashes in urban areas tend to occur at intersections and driveways, where turning motor vehicle traffic conflicts with straight-ahead bicyclist travel. However, bicycle-involved crashes in rural areas tend to occur away from intersections. Regardless of the location, though, smart bicycles must be capable of assessing imminent collision threats from all directions.

The initial design, development, and prototyping of the smart bicycle application will occur at the TAMUS Riverside Campus. A pilot will be conducted on the TAMU campus.

When

The smart bicycle application will be initiated during the first year of the test bed. It is anticipated that the design prototyping will take a year. The pilot on the TAMU campus will be conducted during the second year. The assessment of the pilot would also occur during the second year, with modifications made to the application based on the assessment.

How

The smart bicycle application will be designed, developed, and tested in partnership with one or more technology companies. The pilot will be conducted in cooperation with TAMU and bicycle organizations in the Bryan-College Station area.

CANDIDATE APPLICATION 5 – SMART PEDESTRIANS: SMARTPHONE APPLICATIONS (APPS)

Why

The fifth candidate application focuses on providing warning messages to pedestrians about close proximity or imminent crashes with other road users, including buses and other motorized vehicles and bicyclists. In this application, pedestrians are equipped with sensors or other communications technologies capable of detecting the presence and travel paths of other road users in their vicinity. Path prediction algorithms are used to estimate close proximity and imminent collisions with other road users, and warning messages are provided to the pedestrian through a smartphone app or other available technology. If these other road users have two-way communication capability, a similar warning message is sent from the pedestrian to the other road users.

Following are the goals and objectives for the candidate application:

- Goal 5.1 – Reduce crashes involving pedestrians and other road users.
 - Objective 5.1.1 – Reduce the number of crashes involving pedestrians and buses.
 - Objective 5.1.2 – Reduce the severity of crashes involving pedestrians and buses.
- Goal 5.2 – Examine issues associated with a smartphone app and identify design features of a prototype app.

- Objective 5.2.1 – Conduct human factors research examining issues associated with alert frequency and type, pedestrian user limitations and distractions, and compatibility with user modes.
- Objective 5.2.2 – Identify design features of a prototype smart pedestrian smartphone app, using the Destination Aggieland app as a possible platform.

Who

The primary user of this application is a pedestrian, who could benefit by having more information about other road users that are in close proximity or an imminent collision threat. Upon receiving a warning message, in some cases the pedestrian could quickly respond to avoid the conflict or collision threat.

If the pedestrian in this application has instantaneous communication with other road users, then these road users could greatly benefit by knowing the projected path of the pedestrian. For example, buses, other transit vehicles, and trucks could know the position and projected path of a pedestrian who is about to cross the road in a crosswalk or at an intersection. Operationally, the pedestrian could be broadcasting his/her position to any other road user who is capable of hearing the broadcast.

What

The core functional requirements for a smart pedestrian app are:

- Detect other road users in close proximity and determine their projected paths.
- Provide a warning message to the pedestrian.
- Provide the pedestrian's location and projected path to other road users.

The first functional requirement is the ability to detect other road users in close proximity and determine their projected path. With pedestrians, the use of supplemental sensors and instrumentation is very limited. The most powerful sensor being carried by most pedestrians in 2016 is their smartphone. Therefore, the smart pedestrian app relies on pedestrians' smartphones to communicate with other road users about their positions and projected paths.

DSRC technology is currently viewed as the basis for this V2P communication. The University of Michigan is planning to test DSRC-equipped smartphones carried by pedestrians as part of their M-City initiative (<http://www.mtc.umich.edu/test-facility>). In 2013, Honda and Qualcomm demonstrated a V2P smartphone app that relied on a DSRC- and GPS-enabled smartphone.

University of Missouri researchers have proposed other communications alternatives to DSRC. For example, the inventors of WiFi-Honk (<http://spectrum.ieee.org/cars-that-think/transportation/safety/wifihonk-smartphone-app-for-drivers-and-pedestrians-gets-you-out-of-the-way>) have proposed using readily available WiFi on a smartphone as an alternative to

DSRC. Their proposed system could operate without requiring DSRC chips in all new smartphones.

The second functional requirement is the ability to provide a warning message to the pedestrian about close proximity or an imminent collision threat with other road users. The most logical means to provide this warning message is via the smartphone app. The type and nature of the message could vary depending upon the current use pattern of the phone. If the phone is currently active, then visual alert may be ideal. If the phone has been inactive and is perhaps stored in the user's pocket or carried bag, then an audible alert could be most effective. Human factors testing could also be used to help with message content. For example, should the expected direction or nature (e.g., car, bicyclist) of the threat be provided? Figure 17 shows simple smartphone alerts used in Honda's V2P demonstration project.

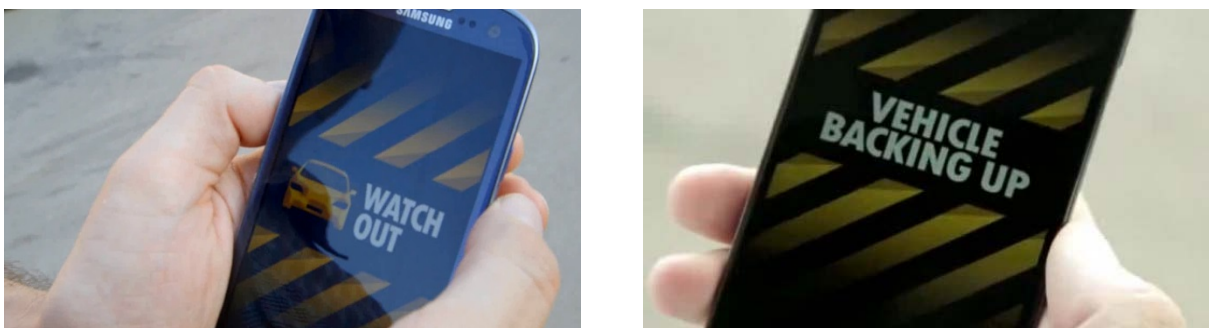

Source: Honda.

Figure 17. Smartphone-Based Warning Messages Used in Honda's V2P Demonstration.

The third functional requirement is the ability to provide the pedestrian's location and projected path to other road users. This capability could be used to assist these other road users in avoiding a conflict or imminent crash with the pedestrian. The most likely implementation of this requirement is to have the pedestrian broadcast a signal that could be communicated and heard by other road users with similar communications capabilities (e.g., DSRC). The location and projected path of the pedestrian could be determined by the smartphone app using GPS and inertial sensors on the smartphone.

What

The technical feasibility of a V2P smartphone app has been demonstrated by Honda and Qualcomm. In fact, this cooperative demonstration won a "Best of ITS" award from ITS America in June 2015. However, it is still unknown if/when smartphone manufacturers will include the DSRC radio in consumer smartphones and how quickly the consumer uptake could be for a premium feature such as this.

There are also numerous human factors questions that arise when considering a smartphone as the warning system for pedestrians. For example, what type of warning is provided for pedestrians whose smartphone is not in their hands? Would a loud audible alert

coming from a pedestrian's pants pocket or backpack be an appropriate warning for a threat that could be coming from any direction? Even if a threat warning is received by a pedestrian, does he/she have enough reaction and response time to move out of the path of a fast-moving motor vehicle? It could be that the greatest value of a pedestrian smartphone app is notifying other road users of that pedestrian's location and projected path.

An FHWA-funded study of V2P systems¹ had similar findings and questions:

- Several V2P smartphone apps have been developed in research and development, but no system is commercially available.
- Those V2P applications that require two-way, high-speed communication (i.e., DSRC) are likely to be the most effective, but also require significant market penetration to be effective.
- There are several human factors issues related to user interface that still require significant additional research. These include topics related to alert frequency and type, pedestrian user limitations, distraction, personalization, integration with existing systems, and compatibility between user modes.

Where

As with the smart bicycle candidate application, the smart pedestrian app should be capable of meeting the functional requirements in a wide range of operating environments. Pedestrians are not bound to fixed travel paths as with motor vehicles and are therefore capable of being nearly anywhere in or away from the roadway environment.

To illustrate the wide range of location scenarios, this pedestrian smartphone app may be useful on an unlit rural highway where no paved shoulder exists and the pedestrian either walks in the motor vehicle travel lane or just outside the travel lane on an unpaved shoulder. The smartphone app could also be used in busy, crowded parking lots by a pedestrian in a motorized wheelchair who has limited visibility around the parked cars. The smartphone app could also be used in shared space environments (e.g., pedestrian plaza or campus environment) where bicyclists and other non-motorized users are required to navigate blind corners or busy sidewalks.

The initial smart pedestrian human factors research will be conducted at the TAMUS Riverside Campus. It will focus on alert frequency and type, pedestrian limitations and distractions, integrating with existing systems, and capability between user methods. The basic elements of a possible smartphone app will be identified in partnership with TAMU Transportation Services as part of the Destination Aggieland app. Developing a prototype app

¹ *Vehicle to Pedestrian (V2P) Technology Scan, Needs Assessment, and Research Implementation Plan: Task 5 V2P Research Implementation Plan*, FHWA Office of Safety, May 19, 2015.

would occur when the needed DSRC is readily available on smartphones or some other technology is in place.

When

The smart pedestrian application will be initiated during the first year of the test bed. The human factors research will be undertaken first. Depending on the results, the basic elements of a prototype smartphone app will be developed in the second year.

How

The smart pedestrian application human factors research and the identification of basic elements of a smartphone app will occur at the TAMUS Riverside Campus and at TTI research facilities on the TAMU campus. The examination of a smartphone app will be conducted in partnership with TAMU Transportation Services, using the existing Destination Aggeland app as a possible platform.

CANDIDATE APPLICATION 6 – SMART BIKE RACK: AUTOMATED ALERTS FOR BUS OPERATORS

Why

The sixth candidate application addresses improving the safe operation of front-mounted bike racks on buses. Many communities in Texas are pursuing integrating bicycles and transit to promote alternative modes of transportation, increase transit ridership, improve public health, and reduce traffic congestion. Improving the safety of riders loading and unloading bicycles is important for increasing use of multiple travel modes. Ensuring that bus drivers are able to safely operate buses with bike racks is also important.

Following are the goals and objectives for this candidate application:

- Goal 6.1 – Reduce the risk of accidents involving riders loading and unloading bicycles from front-mounted bike racks.
 - Objective 6.1.1 – Design and develop a smart bike rack prototype at the TAMUS Riverside Campus.
 - Objective 6.1.2 – Pilot the smart bike rack in one or two urban areas.
 - Objective 6.1.3 – Assess and evaluate the pilots and make enhancements to the system as needed.
 - Objective 6.1.4 – Use a variety of technology transfer methods to disseminate information on the smart bike rack.

- Goal 6.2 – Develop a cost-effective smart bike rack that takes advantage of existing technologies and systems.
 - Objective 6.2.1 – Use existing technologies in designing and prototyping the smart bike rack.
 - Objective 6.2.2 – Select pilots based on interest from local stakeholders, including transit agencies, bicycles groups, and private sector partners.

Who

Transit agencies have the primary responsibility for the smart bike rack application. Transit systems will be responsible for implementing and maintaining the smart bike rack application on their buses. The participation of bus manufacturing and bike rack companies in the development and testing of the smart bike rack application will be pursued. The involvement of bicycle groups and bus riders who use bike racks is another key element of the pilot.

What

Many transit agencies provide bicycle racks on the buses. Bike racks typically carry two or three bicycles on a first come, first served, basis. Figure 18 illustrates a bicycle rack that holds three bicycles. Safety issues may arise with the use of front-mounted bike racks in some situations. Bikes need to be loaded and unloaded quickly from the bus by bicyclists without causing delays to the bus. Racks can be folded up against the front of the bus when not in use. When bicyclists load their bikes, they pull the rack down so that it is parallel to the ground and secure the bike on the rack with a spring-loaded hook before boarding the bus. Figure 19 shows a bus rider deploying a front-mounted bike rack. Visibility of the rider loading and unloading a bicycle may be a concern for bus drivers. Additionally, if an empty rack is left down, the driver may not realize that he or she has limited front clearance.



Source: TTI.

Figure 18. Bicycle Rack (Three-Bike Capacity) in Use by Capital Metropolitan Transportation Authority Buses in Austin, Texas.



Source: TTI.

Figure 19. Bus Rider Deploying Bike Rack in Austin, Texas.

Racks holding three bicycles extend the bus overhang distance, increasing the swept area of the bus. The additional space may interfere with headlamps and turn signals on certain types of buses. Also, the three-bike racks provide less space between the closest bicycle and the bus, which may cause interference with the windshield wipers and visibility. To maximize the driver's vision, most transit agencies have policies concerning attachments on bicycles positioned on bike racks. For example, child seats and baskets, as well as items that may fly off or flap around, are typically not allowed.

To address these concerns, some transit agencies, including Santa Monica Big Blue Bus and Central Florida Regional Transportation Authority (LYNX), have installed bike rack deployed indicator lights on the dashboard that alerts the bus driver when the bike rack is down. Figure 20 illustrates the LYNX system. The indicator light is illuminated while the rack is in the down position. After the rack is returned to the upright position, the indicator lamp turns off. The light is on the panel at eye level in the figure. However, on the newer Gillig buses, the light is on the panel above the transit operator's head. Locating extra mirrors on the bus that allow the drivers to see the bike rack and riders loading and unloading bicycles are also in use by many transit systems.



Source: Douglas Robinson, LYNX.

Figure 20. Bike Rack Deployed Indicator in a Gillig Bus.

The candidate application builds on these existing systems through the use of sensors and cameras. One approach will develop and test the use of sensors retrofitted on existing bus bike racks. The system will include pressure sensors located in the wheel wells connected to a display visible to the driver. The display will be illuminated when a bicycle is present on the rack. A second approach will use a small camera focused on the bike rack in the driver's blind spot. The driver will be able to monitor the display from the camera at a bus stop to check for passengers using the bike rack. A third approach will use sensors on bicycles, which will be detected by readers on the bus, with an alert sent to the driver when a bike is being placed on a rack, stationary on a rack, or being removed from a rack. A final approach might include a link to bus riders smart fare card with a bicycle user chip.

Where

The initial smart bike rack system design, development, and prototyping will occur at the TAMUS Riverside Campus. A pilot will be conducted in partnership with a transit agency in the state and local bicycle groups, with Capital Metro in Austin and Sun Metro in El Paso as possible candidates.

When

The smart bike rack application will be initiated during the first year of the test bed. It is anticipated that the design and prototyping will take eight months, with the pilot and assessment following into the second year.

How

The design, testing, and piloting of the smart bike rack will be conducted in partnership with TxDOT, TTI, technology companies, transit agencies, and bus and bike rack manufacturing companies.

CHAPTER V – ASSESSMENTS AND EVALUATIONS

Conducting assessments and evaluations of the candidate application tests, pilots, and demonstrations is an important component of the AV/CV Test Bed to Improve Transit, Bicycle, and Pedestrian Safety. These assessments will include both quantitative and qualitative components. The quantitative analysis will focus on the capabilities, accuracy, and functionality of the technologies and the applications. The qualitative analysis will focus on the users' and operators' perspective of the application.

As described previously in Chapter IV, the Mobileye Shield+ collision avoidance system was installed on TAMU bus number 120 in December 2015. The Mobile Shield+ system installed on the TAMU bus also included the Mobileye EyeWatch SLI, HM, HMW, and FCW. Training was provided to TAMU bus drivers operating bus number 120 in January before the beginning of the spring semester. The bus began regular service on January 19, the first day of the spring semester.

PRELIMINARY ASSESSMENT OF VEHICLE-BASED COLLISION WARNING SYSTEM

The preliminary assessment of the Mobileye Shield+ pilot provides an example of the scope and scale of the analysis that will be conducted as part of the test bed. The objectives for the assessment of Mobileye Shield + on the TAMU campus included:

- Evaluate the accuracy of the collision warning system to detect and report a near collision.
- Gather information from drivers to assess the value of the collision warning system.
- Identify limitations and possible enhancements for future assessment.
- Design appropriate evaluations of the vehicle-based collision warning system for a ConOps in Phase II.

The preliminary assessment of the Mobileye Shield+ system focused on a quantitative analysis of system accuracy in detecting pedestrians and bicyclists in close proximity to the bus and qualitative feedback from bus drivers who were exposed to the system during the pilot test. The results of these preliminary assessments are presented in this chapter to help guide future test bed evaluations.

QUANTITATIVE ACCURACY ASSESSMENT

This part of the analysis examined the accuracy of the Mobileye Shield+ collision alerts as compared to actual on-the-street conditions. That is, for every time the Shield+ system issued a collision alert, was a pedestrian or bicyclist in close proximity to the bus such that a collision could possibly occur?

The primary measure for system accuracy is the false alarm rate, defined as:

$$\text{False Alarm Rate (\%)} = \left[\frac{\text{Total number of "false alerts"}}{\text{Total number of alerts}} \right].$$

A *false alert* occurs when the Shield+ system provides a collision alert (which occurs when the time to collision between the bus and pedestrian/bicyclist is less than 1.5 seconds) and that condition has not been met. In the pilot test, it was not possible to calculate a time to collision with the video. As a result, a close proximity was defined to mean that the bus passes near a pedestrian or bicyclist where the trajectories could result in a collision. Video of the bus travel path was collected independently of the Shield+ system and was used to evaluate all Shield+ system alerts. These benchmark values from independently collected video was considered ground truth and was compared to the Shield+ system’s event log from a telematics website report to determine when and if a false alert occurred.

As a part of this pilot, Mobileye, and its partner and systems integrator Rosco Vision Systems, provided TTI with access to a telematics website where data for specific events can be plotted on a map, as captured in Figure 21, and specific system event and alert data could be downloaded into a spreadsheet-based report with user-selected fields. Figure 22 shows an example of an available report. The sample report captures information at the time of alert: event time, heading, speed, warning type (Status Name), latitude, and longitude.

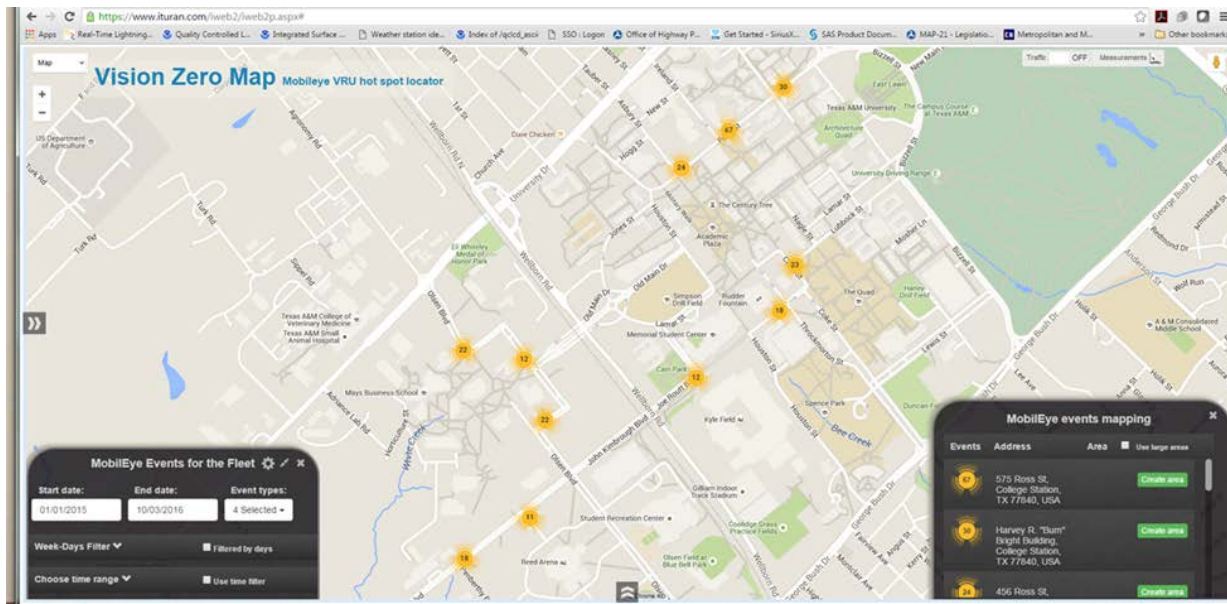

Source: TTI and Mobileye.

Figure 21. Screen Capture of Mobileye Vision Zero Map with Hotspots.

The screenshot shows the ITURAN MessageReport interface. At the top, it displays 'MessageReport' for 'Customer: ROSCO USA' and 'User: Texas A M'. Below this, it indicates 'Report Name: -' and 'Number of selected vehicles: 1'. The 'Time Period' is set to '19/01/2016 00:00:00 - 28/02/2016 23:59:28' with 'Total Records: 41'. The main data is presented in a table with the following columns: Loc Time, Vehicle name, Heading, Distance in Miles, Mileage, Address, Speed, Status Name, Latitude, and Longitude. The table contains 41 rows of data, each representing a location fix for a Texas A&M Bus #120.

Loc Time	Vehicle name	Heading	Distance in Miles	Mileage	Address	Speed	Status Name	Latitude	Longitude
19/01/2016 18:23:11	Texas A&M Bus #120	NE	81.23	109.42	Coke St. College Station, TX 77840, USA	7	PCW-RR	30.614336	-96.338731
19/01/2016 18:41:39	Texas A&M Bus #120	NW	84.02	112.21	730 Olsen Blvd. College Station, TX 77845, USA	9	PCW-LR	30.606465	-96.346835
20/01/2016 13:27:08	Texas A&M Bus #120	-	146.68	174.87	456 Ross St. College Station, TX 77840, USA	-	PCW-LR	30.617173	-96.342213
21/01/2016 08:44:57	Texas A&M Bus #120	N	215.74	243.93	400 Joe Routh Blvd. College Station, TX 77840, USA	6	PCW-RR	30.61355	-96.338316
21/01/2016 10:57:31	Texas A&M Bus #120	SW	230.89	259.08	Asbury St. College Station, TX 77840, USA	5	PCW-RR	30.61692	-96.342406
21/01/2016 13:26:09	Texas A&M Bus #120	-	248.52	276.72	456 Ross St. College Station, TX 77840, USA	-	PCW-LR	30.61701	-96.342198
21/01/2016 14:46:31	Texas A&M Bus #120	N	258.09	296.28	Coke St. College Station, TX 77840, USA	4	PCW-LR	30.614191	-96.338723
25/01/2016 09:58:15	Texas A&M Bus #120	SW	323.79	351.99	456 Ross St. College Station, TX 77840, USA	4	PCW-LR	30.616993	-96.342236
25/01/2016 17:16:22	Texas A&M Bus #120	NE	375.64	403.84	Coke St. College Station, TX 77840, USA	7	PCW-RR	30.614161	-96.33845
26/01/2016 17:13:08	Texas A&M Bus #120	E	433.4	461.59	233 Houston St. College Station, TX 77840, USA	9	PCW-LR	30.6164	-96.343553
27/01/2016 10:16:47	Texas A&M Bus #120	N	485.62	513.82	Coke St. College Station, TX 77840, USA	5	PCW-LR	30.6142	-96.338651
27/01/2016 15:48:50	Texas A&M Bus #120	NE	524.37	552.57	Coke St. College Station, TX 77840, USA	4	PCW-RR	30.614241	-96.338651
01/02/2016 09:56:12	Texas A&M Bus #120	NW	688.44	716.63	Asbury St. College Station, TX 77840, USA	6	PCW-LR	30.616943	-96.342516
01/02/2016 12:16:45	Texas A&M Bus #120	E	706.02	733.21	Coke St. College Station, TX 77840, USA	5	PCW-LR	30.614293	-96.338663
02/02/2016 08:53:29	Texas A&M Bus #120	NW	779.36	807.55	Asbury St. College Station, TX 77840, USA	9	PCW-LR	30.617068	-96.34253
02/02/2016 11:55:33	Texas A&M Bus #120	NW	800.59	828.79	Asbury St. College Station, TX 77840, USA	6	PCW-LR	30.617038	-96.342401
02/02/2016 16:56:28	Texas A&M Bus #120	NW	835.74	863.94	Ross St. College Station, TX 77840, USA	7	PCW-LR	30.616826	-96.342535
03/02/2016 12:08:34	Texas A&M Bus #120	N	903.8	932	John Kimbrough Blvd. College Station, TX 77840, USA	7	PCW-RR	30.6072	-96.347496

Source: TTI and Mobileye.

Figure 22. Screen Capture of Event Report from Rosco/Mobileye Telematics Website.

When evaluating the Mobileye Shield+ system alerts, TTI researchers used the following two video recording systems:

- Rosco Dual-Vision XC system (Figure 23) – This system was temporarily installed for the pilot. The video cameras were mounted on the bus front windshield and recorded the forward-facing view out the bus windshield and the rear-facing view of the bus interior.
- Texas A&M Transportation Services (Figure 24) – This system is permanently installed and is the primary operating video system for TAMU Transportation Services. This system includes eight unique camera views.

The combination of these two video systems provided a full view of what was happening around the bus.



Source: TTI and Rosco/Mobileye.

Figure 23. Screen Capture of Rosco/Mobileye Shield+ Video Player.



Source: TTI and TAMU Transportation Services.

Figure 24. Screen Capture of TAMU Transportation Services Video Player.

The Mobileye Shield+ system accurately detected pedestrians and bicyclists in close proximity to the bus during the study period. The telematics website reports showed the bus accumulated 41 Pedestrian Collision Warning (PCW) incidents during the 27 days included in the assessment. The telematics website report provided a detailed record for the Left Rear (PCW-LR) and the Right Rear (PCW-RR) Sensor PCWs. The telematics website did not report data for two other possible collision warnings sensors, Forward (ME-PCW) and Left Forward (PCW-LF). While collision warnings were observed being generated from the Forward and Left Front sensors, these warnings were not included in the telematics website report. The assessment obtained useable and viewable video on 37 of the 41 events. Video review showed there was a pedestrian, bicyclist, or motorcyclist in proximity to the bus for each of the 37 warnings resulting in a 0 percent false alarm rate.

$$\text{False Alarm Rate (\%)} = \left[\frac{\text{Total number of "false alerts"}}{\text{Total number of alerts}} \right] = \frac{0}{37} = 0\%$$

While the False Alarm Rate was 0 percent, there needed to be some context applied to the warnings and the inability for TTI to replicate a time to collision. Proximity was determined from the video using the best estimate of the minimum distance between the bus and the

pedestrian or cyclist. Frequently the bus would be operating in routine conditions and a warning would go off for a person walking on the sidewalk who happened to be on a trajectory that instantaneously intersected with the bus’s trajectory. In these 37 cases, there never appears to be an abrupt, reactive, or corrective type maneuver made by a driver as a result of the situation that caused the warning, indicating that the warnings were provided in an appropriate yellow, rather than the red zone. Table 1 shows a summary of the number of warnings by proximity.

Table 1. Proximity of Bus and Pedestrian or Cyclist.

Proximity	# of Warnings
0-5 Feet	10
5-10 Feet	14
10-15 Feet	8
15-20 Feet	2
Grand Total	37

Source: TTI.

While the warnings were dependent on the projected trajectory of the bus, the projected trajectory of the pedestrian, and the calculated time to collision, there were different ranges when the warning was activated depending on where and how quickly a person or cyclist was moving. Table 2 tabulates the relationship between left and right turns and the proximity of the reason for the warning along with which sensor, left rear (PCW-LR) or right rear (PCW-RR), that indicated the warning. As expected along this route, the pedestrians made up a majority of the collision warnings.

Table 2. Bus Trajectory and Proximity of Pedestrian or Bicyclist.

Proximity	Left Turn			Right Turn			Grand Total
	PCW-LR	PCW-RR	Total	PCW-LR	PCW-RR	Total	
0-5 Feet							
Bicycle	0	0	0	0	2	2	2
Pedestrian	1	0	1	1	6	7	8
5-10 Feet							
Bicycle	0	0	0	2	0	2	2
Motorcycle	1	0	1	0	0		1
Pedestrian	0	0	0	12	2	14	14
10-15 Feet							
Bicycle	0	0	0	2	1	3	3
Pedestrian	2	0	2	2	0	2	4
Skateboard	1	0	1	0	0	0	1
15-20 Feet							
Motorcycle	1	0	1	0	0	0	1
Pedestrian	0	0	0	1	0	1	1
Grand Total	6	0	6	20	11	31	37

Source: TTI.

A majority, 20 of 37, of the warnings were from the left rear sensor on right hand turns. Many of these warnings appear to be triggered during what would be considered routine turns where there are pedestrians walking on a narrow sidewalk near a building and the bus swings into the lane nearest the pedestrians to complete the turn. In a similar manner, the rear right sensor on right hand turns would often pick up pedestrians walking on the sidewalk as the bus completed its right hand turn with the front approaching the curb as the bus rolled out straight ahead and continued on the route. Table 3 presents the roads where these warnings occur most frequently. Figure 25 displays the top three roadways on a map and reinforces the notion that most warnings occur in areas with heavy pedestrian traffic. As illustrated in Table 3 and Figure 25, the highest number of warnings was recorded on Coke Street, which is a heavily traveled pedestrian and bus route.

Table 3. Roads Where Collision Warnings Occurred.

Roadway	Left Turn			Right Turn			Grand Total
	PCW-LR	PCW-RR	Total	PCW-LR	PCW-RR	Total	
Coke Street	1	0	1	6	5	11	12
Asbury Street	0	0	0	7	1	8	8
Ross Street	0	0	0	5	1	6	6
Olsen Boulevard	2	0	2	2	0	2	4
University Drive	2	0	2	0	0	0	2
John Kimbrough Blvd	0	0	0	0	2	2	2
Houston Street	1	0	1	0	0	0	1
Joe Routt Blvd	0	0	0	0	1	1	1
Lubbock Street	0	0	0	0	1	1	1
Grand Total	6	0	6	20	11	31	37

Source: TTI.

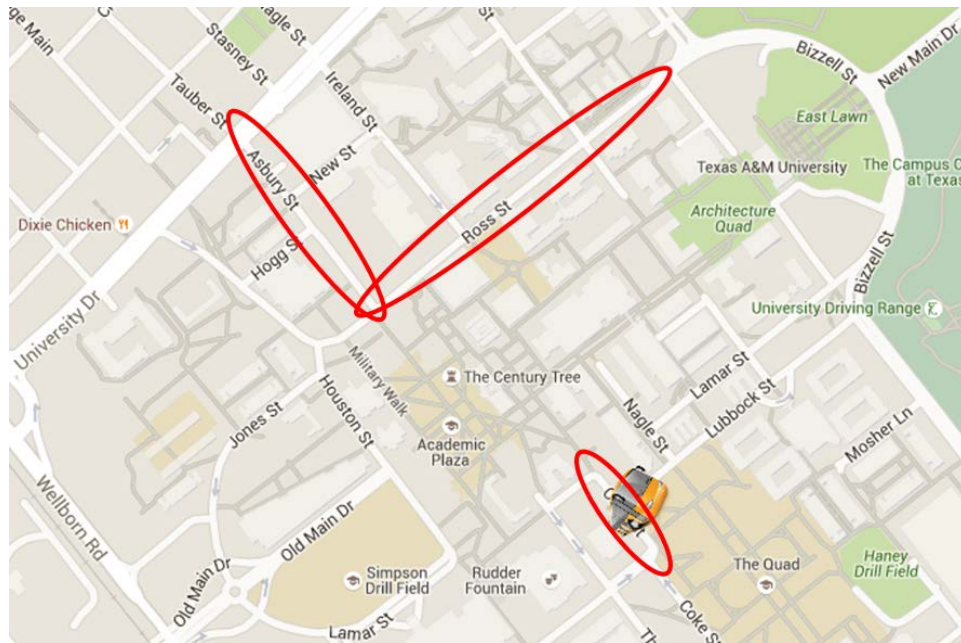

Source: TTI.

Figure 25. Mapped Locations of Frequently Occurring Pedestrian Collision Warnings.

During the pilot, the bus was typically in operation on the route from 7:00 a.m. to 8:00 p.m. Figure 26 shows that the distribution of events was fairly level throughout the daylight hours of 7:00 a.m. to 5:00 p.m. The Mobileye Shield+ system is not advertised to work in the dark; however, in well-lit areas the sensors may be able pick up pedestrians. This was not the case during the pilot as the latest recorded warning occurred was about 10 minutes before sunset, and the bus was on the route after sunrise so there were no warnings recorded pre-dawn.

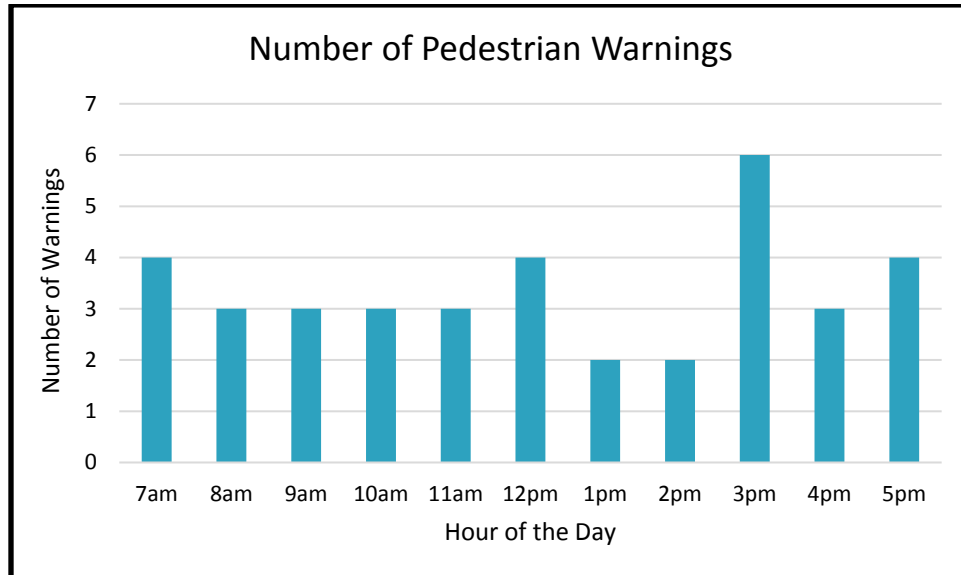

Source: TTI.

Figure 26. Distribution of Warnings by Hour of the Day.

As previously mentioned, the forward sensor PCWs were observed during the study period; however, precise time, date, and quantity information were not readily available from the telematics website report to allow video retrieval, and therefore, were not included as a part of the systematic video review portion of the study. The telematics data have been subsequently made available for these front sensor PCWs and will be studied in the future. A partial, randomly selected review of some forward facing video showed there was typically an individual in front of the bus or the geometry of the road allowed individuals to be detected who were on the sidewalk during a long left turn when the Forward PCW audio warning sounded. Subsequent to the study period, adjustments were made to the system algorithm to reduce sensitivity for individuals on the sidewalk even when facing them. A review of the system performance in the period after the study is being considered.

While not an assessment measure, the amount of yellow detection events that were displayed during the pilot was examined. Over the 27 days the bus operated, there were approximately 13,500 yellow detection events. Table 4 displays the frequency and sensor location on the bus that resulted in yellow detection lights.

Table 4. Number of Yellow Detections by Location.

Sensor Location	Number of Detections
Front	10,112
Front Left	4
Left Rear	1,131
Right Rear	2,273
Total	13,520

Source: TTI.

QUALITATIVE ASSESSMENT

To obtain qualitative feedback on the system, TTI researchers interviewed the TAMU bus drivers participating in the pilot from January 18 to February 29, a period of approximately six weeks. All drivers operating the bus received training on use of the system. The interview questions, provided in Figure 27, focused on the drivers' opinions about the effectiveness of the Shield+ collision-warning system. The names of the bus drivers were not recorded during the interviews to ensure privacy and open and honest feedback.

BUS DRIVER INTERVIEW QUESTIONS

1. Please rate your overall bus driving experience as either: High, Medium, or Low
2. How long have you been driving Texas A&M buses?
3. Prior to Texas A&M, did you have bus driving experience with other transit agencies?
4. If so, how long was this experience with other transit agencies?
5. Before this month, how often did you drive on the Bonfire Route? Very frequent (at least once a week)? Somewhat frequent (several times per month)? Or not that frequent (one or fewer times per month)?
6. Have you ever driven another vehicle that has a collision warning system like this bus? (some newer luxury car models have a pedestrian collision warning system)
7. What are your overall impressions of this collision warning system? (open-ended, more specific later)
8. Overall, how effective do you think the collision warning system is at identifying potential collisions in which pedestrians and bicyclists are in very close proximity to a moving bus?
9. In your opinion, were the warnings provided by this system accurate? That is, was there a possible collision when the visual warning was provided? Was there an imminent collision when the audible warning was provided?
10. In your opinion, was the system more likely to provide a warning when a warning was not warranted (i.e., false alarm), or was the system more likely to miss providing a warning when a collision was possible?
11. In your opinion, were the visual indicators on the warning system effective? Do you think they can be improved? If so, how could they be improved?
12. In your opinion, were the audible indicators on the warning system effective? Do you think they can be improved? If so, how could they be improved?
13. In your opinion, are there other improvements that could be made to the collision warning system? If so, please describe these improvements.
14. Is there anything else that you'd like to share with us regarding the effectiveness of this experimental collision warning system?

Source: TTI.

Figure 27. Interview Questions for TAMU Bus Drivers.

TTI researchers interviewed nine TAMU bus drivers who had driven the bus equipped with the Shield+ warning system. The level of exposure varied among drivers based on their assigned work shifts, but all drivers had at least a few shifts driving the Shield+ pilot bus. All nine drivers were considered to have sufficient exposure to the Shield+ warning system to offer informed driver feedback.

The following general themes emerged from the driver interviews:

- Comments on the EyeWatch elements of the Shield+ system (the headway, speeding, and forward collision monitoring) were very positive and more numerous than expected. Drivers liked these functions, especially the headway feature.
 - “Very effective and helpful on University Drive with speed and time to collision.”
- The general opinion voiced by the drivers was that the system worked and was usually helpful; however, a few drivers questioned the value of the system when they could see everything the system was seeing.
 - “Helpful.”

- “Audio indicators are effective... annoying, which is a good thing.”
- “Overall not worth it, after a few days I started to ignore it.”
- “It works...in front it never warned me of something I hadn’t already seen. In back, it helped bring an awareness to what was going on.”
- “I really liked it, helped with being a more consistent driver.”
- Drivers indicated that a system like this is most needed at nighttime, when human vision is much more challenged in low light.
 - “It would be great if it worked at night or in low light.”
- Drivers noted that the system was more likely to detect a pedestrian than miss the detection.
 - “Went off when it should.”
 - “It didn’t miss anyone.”
- Drivers voiced mixed opinions on whether or not alerts would give enough time for driver to react.
 - “Effective, however it may catch things a little late.”
 - “Pedestrian display seemed a little delayed, driver saw something and then it would display.”
 - “Warned with time to react.”
- Nearly all the drivers mentioned Ross Street and the Trigon/Main Campus stops as areas where they got the most pedestrian indications.

SUMMARY OF FINDINGS BASED ON THE PRELIMINARY ASSESSMENT

The preliminary assessment of the Mobileye Shield+ found the vehicle-based collision-warning system accurately detected pedestrians and bicyclists in close proximity to the bus during the 27-day study period. The assessment obtained useable and viewable video on 37 of the 41 events. Video review showed there was a 0 percent false alarm rate. The general opinion voiced by the drivers was that the system worked and was usually helpful. Drivers voiced mixed opinion on whether or not alerts would give enough time for driver to react. Drivers also stated the need for a similar system that would work at night.

The preliminary assessment of the Mobileye Shield+ system informed the appropriate evaluations for vehicle-based collision warning systems for the ConOps Plan. Through a partnership with TxDOT, TAMU, one or more technology companies, and one or more public transit agencies in Texas, TTI researchers anticipate evaluating additional technologies and other

possible collision warnings, including technologies that will work at night. Additional pilots and assessments will be conducted during the first year of the ConOps Plan for the test bed.

CHAPTER VI – IMPLEMENTATION PLAN

This chapter presents the implementation plan for the AV/CV Test Bed to Improve Transit, Bicycle, and Pedestrian Safety. It consolidates the when and how contained in the near-term candidate application operational scenarios described in Chapter IV. The anticipated schedule of activities is presented first. The partners assisting with the implementation of the test bed activities are highlighted second.

TEST BED SCHEDULE OF ACTIVITIES

As illustrated in Figure 28, the major test bed activities focus on designing and prototyping the candidate applications, conducting tests and pilots, and pursuing larger demonstrations. The two ongoing activities are conducting assessments and evaluations and sharing information and technology transfer. The results of the assessments and evaluations will feedback into the design and prototyping activities. Table 5 presents the anticipated schedule for these activities.

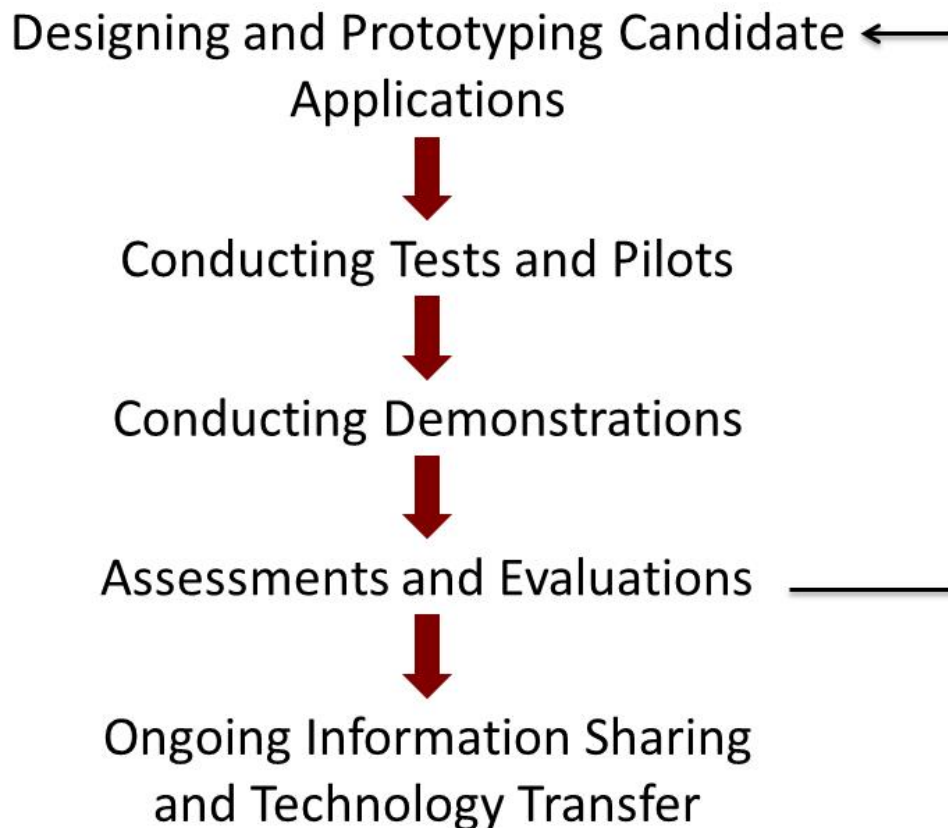

Source: TTI.

Figure 28. Major Activities to Implement Test Bed Candidate Applications.

Table 5. Anticipated Schedule of Test Bed Activities.

Activity	Year 1				Year 2			
	Q1	Q2	Q3	Q4	Q1	Q2	Q3	Q4
Design/Prototype								
Test and Pilots								
Demonstrations								
Assessments/Evaluations								
Information Sharing and Technology Transfer								

As presented in Table 5, the design and prototyping activities will occur over the first year, with some completed during the second and third quarters. The tests and pilots will be conducted during the second half of year one and the first half of year two. The larger demonstration projects will occur in the second year. The assessments and evaluations will be initiated with the start of the first tests and pilots. The information sharing and technology transfer activities will occur throughout the two-year time frame. The following activities are anticipated to be conducted on the candidate applications over the next two years:

- Execute and evaluate additional pilots with different types of on-bus collision-warning systems and identify enhancements, including examining systems for reducing bus crashes with fixed objects and hazards on TAMU buses and in selected transit systems.
- Design, develop, and pilot the Smart Intersections application, which focuses on avoiding crashes involving buses, bicyclists, and pedestrians at signalized intersections through the use of smart buses automatically communicating with smart traffic signals to provide visual and audio warnings to bicyclists and pedestrians on the TAMUS Riverside Campus and the TAMU campus.
- Analyze the availability of sensors and other communications technologies needed for the design and development of a smart bicycle prototype. The technologies should be capable of detecting the presence and travel path of other road users in the vicinity of a bicyclist.
- Conduct human factors research on the smart pedestrian smartphone application focusing on alert type and frequency, pedestrian limitations and distractions, and communication device preferences.

- Design, develop, and pilot a smart bike rack system focusing on adding sensors to existing front-mounted bike racks and adding cameras to the front of buses to alert bus drivers to passengers loading and unloading bicycles. The design and development will occur at the TAMUS Riverside Campus, and the pilots are anticipated to occur at Capital Metro in Austin and Sun Metro in El Paso.

IMPLEMENTATION PARTNERS

As stressed throughout this ConOps Plan, the success of the test bed will depend on partnerships among public sector agencies and partnerships with the private sector. Implementation of the ConOps Plan will build on the partnerships established during the first phase of the project. The key partners—TxDOT, TTI, TAMU, transit agencies, and private sector businesses—are highlighted in the following:

- TxDOT – The department will continue its leadership on the project by funding the second phase and TxDOT personnel will continue to provide overall guidance to the research team, reviewing key milestones, and participating in outreach and partnership activities.
- TTI – TTI researchers will lead the design and prototype development activities, and arrange for and assist with the test, pilots, and demonstrations. TTI will be responsible for conducting the assessments and evaluations. TTI personnel will work with public and private sector partners on these activities. TTI researchers will also conduct ongoing information sharing and technology transfer activities.
- TAMU – TAMU Transportation Services will continue to be a key partner in the design, development, and piloting of candidate applications. The pilot of the collision avoidance system on one TAMU bus provides an indication of the important role TAMU played in this project. It is anticipated that additional pilots will be conducted on TAMU buses, as well as at cross walks and intersections on campus.
- Transit Agencies – Transit agencies in the state will take the lead in testing, piloting, and demonstrating the candidate applications. Based on interest expressed during the first phase of the project, it is anticipated that TAMU Transportation Services, Brazos Transit, Houston METRO, Capital Metro in Austin, and Sun Metro in El Paso will participate in the tests, pilots, and demonstrations. Other transit systems may also assist in testing some of the candidate applications.
- Private Sector Businesses – Technology companies, bus and bike rack manufacturers, and other businesses will also be key participants in the implementation of the candidate applications. The partnership with Mobileye and Rosco to pilot the Shield+ collision-avoidance system on one TAMU bus during the first phase of the project

provides an example of possible approaches that will be used to implement the test bed candidate applications.