

1. Report No. FHWA/TX-17/0-6875-1		2. Government Accession No.		3. Recipient's Catalog No.	
4. Title and Subtitle AUTOMATED AND CONNECTED VEHICLE (AV/CV) TEST BED TO IMPROVE TRANSIT, BICYCLE, AND PEDESTRIAN SAFETY: TECHNICAL REPORT				5. Report Date Published: February 2017	
				6. Performing Organization Code	
7. Author(s) Katherine F. Turnbull, Linda Cherrington, Zach Elgart, Johanna Zmud, Trey Baker, Joan Hudson, and Jason Wagner				8. Performing Organization Report No. Report 0-6875-1	
9. Performing Organization Name and Address Texas A&M Transportation Institute College Station, Texas 77843-3135				10. Work Unit No. (TRAIS)	
				11. Contract or Grant No. Project 0-6875	
12. Sponsoring Agency Name and Address Texas Department of Transportation Research and Technology Implementation Office 125 E. 11 <sup>th</sup> Street Austin, Texas 78701-2483				13. Type of Report and Period Covered Technical Report: April 2015–April 2016	
				14. Sponsoring Agency Code	
15. Supplementary Notes Project performed in cooperation with the Texas Department of Transportation and the Federal Highway Administration. Project Title: Automated and Connected Vehicle (AV/CV) Test Bed To Improve Transit, Bicycle, And Pedestrian Safety URL: <a href="http://tti.tamu.edu/documents/0-6875-1.pdf">http://tti.tamu.edu/documents/0-6875-1.pdf</a>					
16. Abstract Crashes involving transit vehicles, bicyclists, and pedestrians are a concern in Texas, especially in urban areas. This research explored the potential of automated and connected vehicle (AV/CV) technology to reduce or eliminate these crashes. The project objectives focused on identifying safety concerns related to the interaction of transit vehicles, bicyclists, and pedestrians, and targeting AV/CV technologies to mitigate or eliminate those concerns. Concept applications were identified, along with public and private sector partners. A Concept of Operations Plan for designing, testing, piloting, demonstrating, and deploying candidate applications through an AV/CV Test Bed to Improve Transit, Bicycle, and Pedestrian Safety was developed.  To accomplish these objectives, the research team conducted 25 meetings and 4 workshops with diverse stakeholder groups to gain insight into safety issues and concerns. The research team also reviewed AV/CV case studies of related technologies and examined federal, state, and local legislation and policies related to AV/CV, bicyclists, and pedestrians. A pilot of a collision-avoidance system was conducted on one Texas A&M University bus. Near-term applications using AV/CV technologies to improve safety were developed and roundtable forums were held with stakeholders and technology firms to review the approaches and to identify possible partnerships.					
17. Key Words Autonomous Vehicles, Connected Vehicles, Public Transit, Buses, Bicycles, Pedestrians			18. Distribution Statement No restrictions. This document is available to the public through NTIS: National Technical Information Service Alexandria, Virginia <a href="http://www.ntis.gov">http://www.ntis.gov</a>		
19. Security Classif. (of this report) Unclassified		20. Security Classif. (of this page) Unclassified		21. No. of Pages 132	22. Price



**AUTOMATED AND CONNECTED VEHICLE (AV/CV) TEST BED TO  
IMPROVE TRANSIT, BICYCLE, AND PEDESTRIAN SAFETY:  
TECHNICAL REPORT**

by

Katherine F. Turnbull  
Executive Associate Director

Linda Cherrington  
Research Scientist

Zach Elgart  
Associate Transportation Researcher

Johanna Zmud  
Senior Research Scientist

Trey Baker  
Associate Research Scientist

Joan Hudson  
Associate Research Engineer

and

Jason Wagner  
Associate Transportation Researcher

Texas A&M Transportation Institute

Report 0-6875-1

Project 0-6875

Project Title: Automated and Connected Vehicle (AV/CV) Test Bed to Improve Transit, Bicycle,  
and Pedestrian Safety

Performed in cooperation with the  
Texas Department of Transportation  
and the  
Federal Highway Administration

Published: February 2017

TEXAS A&M TRANSPORTATION INSTITUTE  
College Station, Texas 77843-3135



## **DISCLAIMER**

This research was performed in cooperation with the Texas Department of Transportation (TxDOT) and the Federal Highway Administration (FHWA). The contents of this report reflect the views of the authors, who are responsible for the facts and the accuracy of the data presented herein. The contents do not necessarily reflect the official view or policies of the FHWA or TxDOT. This report does not constitute a standard, specification, or regulation.

The United States Government and the State of Texas do not endorse products or manufacturers. Trade or manufacturers' names appear herein solely because they are considered essential to the object this report.

## **ACKNOWLEDGMENTS**

This project was conducted in cooperation with TxDOT and FHWA. Wade Odell of TxDOT served as the project manager. Darla Walton and Teri Kaplan, TxDOT, served on the project team. Bonnie Duke and Gary Lobaugh, TTI, provided word processing and editing review on this document, respectively. The assistance and contributions of all these individuals is acknowledged and greatly appreciated.

# TABLE OF CONTENTS

	Page
<b>List of Figures</b> .....	<b>ix</b>
<b>List of Tables</b> .....	<b>x</b>
<b>Chapter 1: Introduction</b> .....	<b>1</b>
Background and Project Objectives.....	1
Organization of This Report .....	1
<b>Chapter 2: Case Studies, Current Research, and Demonstration Projects</b> .....	<b>3</b>
Case Study – Pedestrian Warning Systems .....	3
Case Study – CycleEye®: Side-Sensing Collision-Avoidance Technology for Transit Vehicles .....	7
Case Study – Driver Assist System for Shoulder Running Buses .....	10
Case Study – Transit Safety Retrofit Package – Michigan Safety Pilot Deployment .....	13
Case Study – CityMobil2 Automated Road Transport System Demonstrations.....	18
Case Study – Connected Intersections and Mobile Apps in New York City .....	26
Current Research and Demonstration Projects .....	29
<b>Chapter 3: Stakeholder and User Group Meetings, Workshops, and Roundtable     Forums</b> .....	<b>31</b>
Stakeholder Meetings .....	31
Stakeholder and User Group Workshops.....	39
Roundtable Forums.....	44
<b>Chapter 4: Review of Regulatory Environment</b> .....	<b>49</b>
Federal Laws and REgulations .....	49
State and Local Laws and Regulations .....	55
<b>Chapter 5: Enabling AV/CV Technologies and Mapping to Concept Applications</b> .....	<b>61</b>
Investigate Enabling AV/CV Technologies .....	61
Mapping Technologies to Concept Applications for Near-Term Testing .....	63
<b>Chapter 6: Concept of Operations Plan</b> .....	<b>69</b>
Purpose of Concept of Operations Plan.....	69
Test Bed Vision, Goals, and Candidate Applications.....	70
Test Beds.....	73
Near-Term Candidate Application Operational Scenarios .....	78
Assessments and Evaluations .....	101
Implementation Plan .....	112
<b>References</b> .....	<b>115</b>





## LIST OF FIGURES

	<b>Page</b>
Figure 1. CycleEye® on a First West of England Bus in Bristol, UK. ....	9
Figure 2. View of the DAS. ....	11
Figure 3. View through the HUD. ....	12
Figure 4. University of Michigan Bus with Samsung Galaxy Tablet. ....	15
Figure 5. PCW Driver Alerts. ....	16
Figure 6. VTRW Driver Alerts. ....	16
Figure 7. Oristano Vehicle. ....	23
Figure 8. La Rochelle Demonstration. ....	24
Figure 9. La Rochelle Vehicle and Bicycles. ....	25
Figure 10. Stakeholder Meeting Flyer. ....	31
Figure 11. Electronic Workshop Invitation. ....	39
Figure 12. Stakeholder Workshop Agenda. ....	41
Figure 13. Electronic Invitation to Roundtable Forum in College Station. ....	47
Figure 14. ConOps Plan Overview. ....	69
Figure 15. Test Bed Functions. ....	73
Figure 16. TAMUS Riverside Campus. ....	74
Figure 17. Cardboard Pedestrians Used in Research at the Riverside Campus. ....	75
Figure 18. TAMU Campus. ....	76
Figure 19. Texas Public Transit Systems. ....	77
Figure 20. Mobileye Shield+ Design for TAMU Bus #120. ....	79
Figure 21. Example Placements of the Three Pedestrian Warning Indicators. ....	80
Figure 22. Map of the Bonfire Route on the TAMU Campus. ....	81
Figure 23. Delta Mobile Systems AR20 Smart Sensor System Detection Area. ....	83
Figure 24. High-Level System Architecture for Smart Intersections Application. ....	86
Figure 25. Possible Ways to Communicate Warning Messages to Bicyclists: Brabus E- bike with Bike Dashboard and Smartphone Mount. ....	89
Figure 26. Possible Ways to Communicate Warning Messages to Bicyclists: SmartHalo Simplified Dashboard Paired with Smartphone. ....	90
Figure 27. Possible Ways to Communicate Warning Messages to Bicyclists: COBI Integrated System for Connected Bicycles. ....	90
Figure 28. Possible Ways to Determine Bicyclist Location and Projected Path. ....	91
Figure 29. TNO Smart Bike with Multiple Features. ....	92
Figure 30. Smartphone-Based Warning Messages Used in Honda’s V2P Demonstration. ....	95
Figure 31. Bicycle Rack (Three-Bike Capacity) in Use by Capital Metropolitan Transportation Authority Buses in Austin, Texas. ....	98
Figure 32. Bus Rider Deploying Bike Rack in Austin, Texas. ....	99
Figure 33. Bike Rack Deployed Indicator in a Gillig Bus. ....	100
Figure 34. Screen Capture of Mobileye Vision Zero Map with Hotspots. ....	103
Figure 35. Screen Capture of Event Report from Rosco/Mobileye Telematics Website. ....	103
Figure 36. Screen Capture of Rosco/Mobileye Shield+ Video Player. ....	104
Figure 37. Screen Capture of TAMU Transportation Services Video Player. ....	105
Figure 38. Mapped Locations of Frequently Occurring Pedestrian Collision Warnings. ....	107
Figure 39. Distribution of Warnings by Hour of the Day. ....	108
Figure 40. Interview Questions for TAMU Bus Drivers. ....	110
Figure 41. Major Activities to Implement Test Bed Candidate Applications. ....	112

## LIST OF TABLES

	<b>Page</b>
Table 1. Meetings with Transit Stakeholders. ....	32
Table 2. Meetings with Bicycle and Pedestrian Stakeholders. ....	35
Table 3. Meetings with City, MPO, and Special District Stakeholders. ....	36
Table 4. Meetings with State and Federal Agencies. ....	38
Table 5. Stakeholder Workshops – Date, Location, and Attendance. ....	40
Table 6. Roundtable Forums – Dates, Locations, and Attendees. ....	45
Table 7. Potentially Relevant Sections of the FMCSA Regulations. ....	51
Table 8. Potentially Relevant Sections of the FMVSS Standards. ....	52
Table 9. Relevant Texas Transportation Code Elements. ....	56
Table 10. Possible Technologies for Near-Term Applications. ....	61
Table 11. Mapping of Technologies to Candidate Applications. ....	64
Table 12. Candidate Applications Ranked by Key Factors. ....	66
Table 13. Collision Avoidance with Turning Buses Applications. ....	67
Table 14. Proximity of Bus and Pedestrian or Cyclist. ....	106
Table 15. Bus Trajectory and Proximity of Pedestrian or Bicyclist. ....	106
Table 16. Roads Where Collision Warnings Occurred. ....	107
Table 17. Number of Yellow Detections by Location. ....	109
Table 18. Anticipated Schedule of Test Bed Activities. ....	113
<b>List of Figures. ....</b>	<b>ix</b>
<b>List of Tables. ....</b>	<b>x</b>
<b>Chapter 1: Introduction. ....</b>	<b>1</b>
Background and Project Objectives. ....	1
Organization of This Report. ....	1
<b>Chapter 2: Case Studies, Current Research, and Demonstration Projects. ....</b>	<b>3</b>
Case Study – Pedestrian Warning Systems. ....	3
Background. ....	3
Project Description. ....	4
Perceived Demonstration Project Benefits. ....	5
Perceived Demonstration Project Limitations. ....	6
Lessons Learned. ....	6
Case Study – CycleEye®: Side-Sensing Collision-Avoidance Technology for Transit Vehicles. ....	7
Background. ....	7
Project Description. ....	7
Perceived Project Benefits. ....	9
Perceived Project Limitations. ....	9
Lessons Learned. ....	10
Case Study – Driver Assist System for Shoulder Running Buses. ....	10
Background. ....	10
Project Description. ....	10
Perceived Project Benefits. ....	12
Perceived Project Limitations. ....	13
Lessons Learned. ....	13

Case Study – Transit Safety Retrofit Package – Michigan Safety Pilot Deployment .....	13
Background .....	13
Project Description.....	14
Project Benefits .....	17
Perceived Limitations .....	17
Lessons Learned.....	17
Case Study – CityMobil2 Automated Road Transport System Demonstrations.....	18
Background .....	18
Lessons Learned from CityMobil .....	20
CityMobil2 Projects .....	21
Oristano Demonstration .....	22
Perceived Benefits .....	23
Perceived Limitations .....	23
La Rochelle Demonstration .....	24
Perceived Limitations .....	25
Lessons Learned.....	26
Case Study – Connected Intersections and Mobile Apps in New York City .....	26
Background .....	26
Project Description.....	27
Perceived Project Benefits .....	27
Perceived Project Limitations .....	28
Lessons Learned.....	28
Current Research and Demonstration Projects .....	29
<b>Chapter 3: Stakeholder and User Group Meetings, Workshops, and Roundtable</b>	
<b>Forums .....</b>	<b>31</b>
Stakeholder Meetings .....	31
Stakeholder and User Group Workshops.....	39
Safety Issues.....	41
Opportunities to Improve Safety through AV/CV Technology.....	42
Possible Concerns with Technology Applications .....	43
Research Needs .....	44
Roundtable Forums.....	44
<b>Chapter 4: Review of Regulatory Environment .....</b>	<b>49</b>
Federal Laws and REgulations .....	49
Federal Motor Carrier Safety Administration.....	49
Federal Motor Vehicle Safety Standards .....	50
Buy America Regulations under the Federal Transit Administration.....	50
Altoona Bus Testing Requirements under the Federal Transit Administration.....	52
Federal Transit Administration Public Transportation Safety Program and State Safety Oversight.....	53
Federal Guidance on Connected Vehicle.....	54
State and Local Laws and Regulations .....	55
Texas Motor Vehicle Laws and Regulations .....	55
Texas State Bicycle and Pedestrian Laws and Regulations.....	58
Texas Local Motor Vehicle, Bicycle, Pedestrian Laws, and Regulations .....	58
<b>Chapter 5: Enabling AV/CV Technologies and Mapping to Concept Applications .....</b>	<b>61</b>
Investigate Enabling AV/CV Technologies .....	61
Mapping Technologies to Concept Applications for Near-Term Testing .....	63
<b>Chapter 6: Concept of Operations Plan .....</b>	<b>69</b>

Purpose of Concept of Operations Plan .....	69
Test Bed Vision, Goals, and Candidate Applications.....	70
Overarching Test Bed Vision and Goals.....	70
Near-Term Candidate Applications .....	71
Mid-Term Candidate Applications .....	72
Long-Term Candidate Applications .....	72
Test Beds.....	73
Riverside Campus Test Bed.....	73
TAMU Campus.....	75
Transit Agency and Community Test Beds .....	76
Near-Term Candidate Application Operational Scenarios .....	78
Candidate Application 1 – Smart Buses: Vehicle-Based Collision-Warning System .....	78
Candidate Application 2 – Smart Buses: Collision Avoidance with Fixed Objects and Hazards.....	82
Candidate Application 3 – Smart Intersections: Collision Avoidance with Intersection-Based Warning Systems .....	85
Candidate Application 4 – Smart Bicycles: Sensors on Bicycles.....	87
Candidate Application 5 – Smart Pedestrians: Smartphone Applications (Apps).....	93
Candidate Application 6 – Smart Bike Rack: Automated Alerts for Bus Operators .....	97
Assessments and Evaluations .....	101
Preliminary Assessment of Vehicle-Based Collision Warning System.....	101
Quantitative Accuracy Assessment.....	102
Qualitative Assessment.....	109
Summary of Findings Based on the Preliminary Assessment .....	111
Implementation Plan .....	112
Test Bed Schedule of Activities.....	112
Implementation Partners .....	114
<b>References.....</b>	<b>115</b>

# **CHAPTER 1: INTRODUCTION**

## **BACKGROUND AND PROJECT OBJECTIVES**

Crashes involving transit vehicles, bicyclists, and pedestrians are a concern in Texas, especially in urban areas. This research explored the potential of automated and connected vehicle (AV/CV) technology to reduce or eliminate these crashes. The project objectives focused on identifying safety concerns related to the interaction of transit vehicles, bicyclists, and pedestrians, and targeting AV/CV technologies to mitigate or eliminate those concerns. Concept applications were identified, along with public and private sector partners. A Concept of Operations (ConOps) Plan for designing, testing, piloting, demonstrating, and deploying candidate applications through an AV/CV Test Bed to Improve Transit, Bicycle, and Pedestrian Safety was developed.

To accomplish these objectives, the research team conducted 25 meetings and 4 workshops with diverse stakeholder groups to gain insight into safety issues and concerns, as well as ideas on possible technologies to address these problems. The research team also reviewed AV/CV case studies of related technologies and examined federal, state, and local legislation and policies related to AV/CV, bicyclists, and pedestrians. A pilot of a camera and sensor-based collision-avoidance system was conducted on one Texas A&M University (TAMU) bus. The pilot was monitored and the results were used to assist in developing the ConOps plan. Near-term applications using AV/CV technologies to improve safety were developed and roundtable forums were held with stakeholders and technology firms to review the approaches and to identify possible partnerships.

The ConOps Plan includes the overall vision and goals for the AV/CV Test Bed to Improve Transit, Bicycle, and Pedestrian Safety. It describes the operational scenarios—the who, what, why, where, when, and how—for the near-term candidate applications. These applications focus on smart buses, smart intersections, smart bicycles, smart bicyclists and pedestrians, and smart bike racks on buses.

## **ORGANIZATION OF THIS REPORT**

This report is divided into five chapters following the introduction. Chapter 2 summarizes the case studies, research, and demonstration projects examined as part of the literature review. Chapter 3 reviews the meetings, workshops, and roundtable forums conducted to gain insight from diverse stakeholder groups and technology companies. Chapter 4 discusses the federal, state, and local regulatory environment related to AV/CV technologies, public transportation vehicle specifications, and use of the roadways by bicyclists and pedestrians. Chapter 5 maps possible enabling AV/CV technologies to the concept applications. Chapter 6 contains the ConOps Plan for the AV/CV Test Bed to Improve Transit, Bicycle, and Pedestrian Safety.



## **CHAPTER 2: CASE STUDIES, CURRENT RESEARCH, AND DEMONSTRATION PROJECTS**

Six case studies were examined in the initial research documented in Technical Memorandum 1 submitted to the Texas Department of Transportation (TxDOT) on June 30, 2015. As presented in this chapter, the case studies highlighted different transit, bicycle, and pedestrian AV/CV applications. The case studies include two examples focusing on reducing conflicts between turning buses and bicycles and pedestrians, one example of technology to assist with bus lane keeping, one example of a transit safety retrofit project, one example of automated transit systems, and one example of smartphone applications (apps) to enhance pedestrian safety at signalized intersections. The case studies were updated in preparing this final report based on the availability of new information. In addition, the chapter summarizes examples of related research projects underway at universities throughout the country, as well as pilot and demonstration projects.

The case studies follow a common format. The background to the case study is presented first, followed by a description of the project. Available information on the perceived project benefits and limitations, as well as lessons learned, is summarized.

### **CASE STUDY – PEDESTRIAN WARNING SYSTEMS**

#### **Background**

According to the Transit Cooperative Research Program, 60 percent of collisions involving a pedestrian and transit vehicle occur when a transit vehicle is making a turn at an intersection (1). These incidents may occur for any number of reasons, from the driver's line of sight being obscured to pedestrian distraction when entering a crosswalk. Emerging AV/CV technologies are enabling automated safety functions that could reduce these types of conflicts. Some applications involve sensing equipment on the exterior of a bus that notifies the bus driver of the presence of other vehicles, bicyclists, and pedestrians to avoid potential incidents. Complementary systems monitor the activity of the transit vehicle and provide warnings to bicyclists and pedestrians, allowing those in the area of the bus to avoid potential incidents.

This case study presents information on bus-based pedestrian warning systems being tested in different metropolitan areas. The Greater Cleveland Regional Transit Authority (RTA) was one of the first transit systems in the country to use a pedestrian warning system. Following two bus-pedestrian fatalities over a two-year period, RTA experimented with several different pedestrian warning strategies, including advising bus drivers to blow the vehicle's horn when turning, and connecting the bus turn signals to the standard backup alarm, resulting in a loud beep emitting from the vehicle when the turn signal was activated.

RTA obtained federal funding in 2015 to install turn detection sensors in the steering column of approximately 400 buses, accounting for approximately 83 percent of the fleet. The sensors activate speakers on the outside of the bus when a turn radius in excess of 45 degrees was detected. This system was found to reduce pedestrian incidents with turning transit vehicles, and RTA has continued to install the warning devices on their fleet vehicles (2).

Other municipal transit agencies have also implemented similar systems. In 2010, the Washington Metropolitan Area Transit Authority pilot tested a pedestrian alert system with 10 buses in the Washington, D.C., metropolitan area (3). In 2011, the Massachusetts Bay Transportation Authority (MBTA) began testing the Safe Turn Alert System from Protran, which provides turn warnings to pedestrians. The MBTA expanded the use of these devices to a total of 10 buses in 2014 (4). In early 2015, the Southeastern Pennsylvania Transportation Authority launched a 12-vehicle pilot program of the Safe Turn Alert System. The Maryland Transit Administration is also pilot testing the Safe Turn Alert and the Clever Devices Turn Warning System Solution in 10 buses in the Baltimore area (5, 6).

The Federal Transit Administration (FTA) has sponsored recent demonstrations of these technologies. One demonstration was conducted by TriMet in Portland, Oregon, in association with Applied Engineering Management Corporation and Portland State University. Information on the TriMet demonstration is summarized next.

## **Project Description**

The overall goal of the TriMet project is to determine whether current on-board devices are effective in increasing pedestrian awareness around buses, especially as distracted walking is becoming a more serious safety concern. The project is intended to meet the following objectives (7):

- Demonstrate the ability of various commercially available turn warning systems to provide timely warning to pedestrians and bicyclists that a bus is turning or pulling into/away from a bus stop.
- Determine the effectiveness of the turn warning systems at intersections and bus stops.
- Determine the benefit-cost ratio associated with the turn warning systems.
- Define the environmental parameters under which advance warning should be provided to pedestrians and bicyclists at intersections and at bus stops.
- Assess the effectiveness of an innovative warning sign at one intersection.

TriMet began testing three on-board warning devices in March 2014. Each device was installed on 15 buses for a total deployment of 45 buses covering five different routes within the city. The demonstration was operational for seven months. The following devices were used in the pilot (8, 9):



- The Protran Technology Safe Turn Alert™ utilizes audible and visible warnings, which are emitted when the steering wheel is turned a minimum of 45 degrees. The audible warning outside of the bus states “pedestrians, bus is turning,” while the visual warning takes the form of light-emitting diodes (LED) strobe lights that flash on the side of the bus. The volume on the audible warning is automatically adjusted based on the ambient noise level, meaning that warnings are quieter during the evening and at night.
- The Clever Devices Turn Warning System utilizes a sensor inside the steering column and emits an audible warning outside of the vehicle when the steering wheel is turned at least 45 degrees. The alert notifies those in the direction of the turn that “caution, bus is turning.” The volume on this warning is automatically adjusted based on the time of day or night, and whether the vehicle is operating in a quiet zone.
- The third safety application used a DINEX™ STAR LED headlight with Pedestrian Crossing Alert. This application calculated the bus’s speed and steering wheel angle in order to dynamically adjust the headlight by activating additional super bright LED lights inside the headlight in the direction of travel. Later in the pilot, an audible crossing alert, in the form of a beeping sound, was emitted whenever the bus turn signal was engaged.

These three in-vehicle safety applications were supplemented at a busy downtown Portland intersection with blank-out signs that would show “BUS” whenever a bus was waiting to turn at an instrumented intersection, thus supplying pedestrians with an additional visual warning. The BUS warnings were displayed at both ends of one crosswalk.

### **Perceived Demonstration Project Benefits**

The final draft report on the TriMet demonstration provides a comprehensive summary of the project and the evaluation results. The evaluation included assessments of the technologies, examinations of crash data, and feedback from bus drivers, other TriMet personnel, bicyclists, and pedestrians. Surveys, focus groups, and interviews were used to obtain input from these groups (9).

A majority of pedestrians surveyed for the TriMet demonstration indicated that the systems were effective in providing an alert on transit vehicle movements and in improving pedestrian safety. Most respondents also agreed that the system should be installed on additional buses. Many bus drivers suggested that the turn warning systems were only somewhat effective at improving safety, however. They further suggested that certain improvements to the programming and customization of the systems could enhance operations. Approximately half of the drivers surveyed for the evaluation indicated that the potential safety benefits outweighed the drawbacks, but nearly half did not agree with the prospect of a wider implementation. Drivers in the TriMet demonstration also reported that the LED cornering headlights provided better visibility than the regular headlights (9).

The results of the TriMet demonstration showed that the systems tested have the potential to improve pedestrian safety, but the cost effectiveness of these systems is still a question. However, the evaluation conducted a basic cost-benefit analysis and found that, under all scenarios, the benefits of the warning systems outweighed the costs. Benefit-to-cost ratios ranged from 4.6:1 to 106.6:1 (9).

### **Perceived Demonstration Project Limitations**

One possible limitation is the cost of the warning systems. For example, it was estimated that if MTA deployed the warning devices tested as part of its 10-vehicle pilot to the entire MTA fleet, it would cost approximately \$1,500 to \$2,500 per vehicle (5). Officials with MBTA in Boston reported that ProTran's bid in response to the agency's procurement request was the lowest at \$94,000 for 10 devices (4).

In addition to funding challenges, there appears to be potential limitations with the technologies. TriMet identified some limitations and challenges with the warning systems tested. First, getting the volume on the audible warnings to an appropriate volume was a challenge throughout the test. Drivers and residents complained that the volume was initially too high, but when adjustments were made, drivers reported that the volume was often too low to be effective. The evaluation team also noted issues with the calibration of the steering wheel sensors and subsequent deployment of the exterior turn warning. In some cases, the sensitivity was too high, which resulted in turn warnings being issued too early. Many of these concerns were addressed through ongoing adjustments to the in-vehicle devices, but false warnings were still an ongoing problem. Concerns were also expressed by transit riders and drivers that, regardless of the initial benefits of the warnings, they might eventually blend into the background noise and reduce in long-term effectiveness. Additionally, TriMet operators suggested that the warning systems may be more effective with pedestrians than with bicyclists (7, 9).

### **Lessons Learned**

The TriMet evaluation did not find a preference among drivers for the spoken message versus the beeping warnings. The beeps were considered by some to be more universal and therefore more effective at getting pedestrian's attention. However, others found the beeps to be "too loud, harsh, irritating, and potentially distracting." The evaluation team recommended that future systems attempt to incorporate both a spoken warning and a sound/warning tone (7, 9).

The evaluation also noted that bus operators believed the turn warning systems were important, but perhaps more so at bus stops rather than at intersections. The evaluation team recommended that future installations be carefully evaluated to determine the optimal locations and to reduce the potential for noise complaints from nearby residencies (7, 9).

## **CASE STUDY – CYCLEEYE®: SIDE-SENSING COLLISION-AVOIDANCE TECHNOLOGY FOR TRANSIT VEHICLES**

### **Background**

CycleEye® is a cyclist sensor alert system developed by United Kingdom (UK)-based Fusion Processing to address the blind spot situation associated with transit buses. The technology directly alerts bus drivers when pedestrians and bicyclists are moving close to their vehicles. It addresses concerns associated with a bus driver not seeing a bicyclist or pedestrian because they were located in the blind zone—the area around the vehicle that cannot be directly observed by the driver while operating the vehicle due to limited field of view of the mirrors.

CycleEye® was tested by Transport for London (TfL) in summer 2014. TfL conducted the six-week test on two routes selected as part of a campaign to improve road safety. The two routes were selected due to a high number of bicyclists and pedestrians (10). In June 2013, the London mayor and TfL published a plan to reduce the number of people killed or seriously injured in London by 40 percent by 2020 and to prioritize safety of the most vulnerable groups—pedestrians, bicyclists, and motorcyclists—that comprise 80 percent of serious and fatal collisions. Among other technology solutions, collision-avoidance technology was prioritized for implementation. CycleEye® was selected for the TfL test because, in a preliminary test in London, the system achieved a 98 percent success rate in identifying bicyclists (11).

### **Project Description**

Collision-avoidance technologies for reducing transit bus side collisions provide information on the presence of objects near the vehicle, their proximity, and for some technologies, the differences in the relative speeds of the bus and the detected object. Collision-avoidance systems typically rely on at least one of four underlying technologies (12):

- Lidar-based systems transmit a light beam to the area surrounding the vehicle and then detect the presence of nearby objects through the reflected signal. In addition to direction, Lidar systems can determine an object's distance and relative speed. During times of fog, heavy rain, or heavy snow, the system can become inoperable, however. Lidar sensors typically have a high cost of implementation.
- Radar-based systems use Frequency Modulated Continuous Wave radar to reliably detect moving or stationary targets. They are not adversely affected by poor weather conditions but do suffer from low angular resolution, poor detection at medium range, and generally inferior resolution to Lidar. As with Lidar, radar sensors have a high cost of implementation.
- Ultrasonic-based sensors are reliable and inexpensive. They are similar to the back-up sensors being installed on many passenger vehicles. The sensors emit an ultrasonic signal and detect an object when a recognizable echo is reflected from it. The system can

measure the detected object's distance and relative speed from the echo. Possible drawbacks include a limited detection range; objects beyond a small area around the vehicle cannot be detected, and they are only capable of providing a recognizable echo from solid objects with reflective surfaces, such as metal. As a result, they are not good for detecting soft objects, such as pedestrians wearing clothing.

- Camera systems use a pixel-based recognition algorithm to identify objects. The use of pixel-based recognition can distinguish pedestrians from other objects, a form of detection that is not possible with Lidar, radar, or ultrasonic-based systems. While most cameras systems have a relatively low cost of implementation, they rely on ideal lighting conditions for detection so they do not function well in adverse weather, direct sunlight, and evening conditions.

The other technology that was tested by TfL in 2014 was Cycle Safety Shield. It alerts the driver visibly and audibly when a bicyclist, pedestrian, or motorcyclist is close. Safety Shield issues two warnings—a flash if the bus operator is getting too close to a pedestrian or a driver and a harsh beep if a collision is imminent. It is a product of Safety Shield Systems. This system relies on software connected to sensors and video cameras, the same technology first developed by the Israeli company Mobileye that can be used in self-driving cars. Safety Shield also tested radars, but found too many faults, according to the founder (13).

Rosco Vision Systems has collaborated with Mobileye to integrate Mobileye's collision-avoidance system with pedestrian and bicycle sensing for bus applications. The Rosco Mobileye Shield+™ collision-avoidance system is being piloted in a few transit systems in the United States and Canada. A pilot of the Shield+ system on one TAMU bus was conducted as part of this project. The pilot is discussed in Chapter 6. The technology uses an intelligent vision sensor similar to a bionic eye to identify other vehicles, bicyclists, and pedestrians. It measures distance and relative speeds of these objects to calculate the risk of a collision. When collision is imminent, visual and audible alerts warn the bus driver (14).

A third technology that was not selected for the TfL trial was a radio frequency identification (RFID) system designed by Cycle Alert. This technology is similar to putting a super-charged smartcard on bikes and buses that talk to each other, with a dashboard device warning the driver when the cyclist is in their blind spot. It was felt that it would be infeasible to expect that RFID devices would be installed on all London bikes. Additionally, it was thought the system could even make roads more dangerous for bicyclists by giving a false sense of security and making drivers over-reliant on a system only used by a minority of bicyclists (13).

CycleEye® uses radar and camera technology. As Figure 1 illustrates, the unit is located on the outside of a bus on the driver's left hand side. It identifies whether an object along the side of the vehicle is a bicyclist and gives the driver an audio alert, typically cyclist left (15). The system was different from others on the market because of a detection algorithm that enabled the device to differentiate between a bicyclist and other objects on the side of the road such as lampposts, railings, and other vehicles. This smart device derives its intelligence from its programming, which is engineered to ignore other objects in the area such as railings, cars, or bollards. It ensures that these objects are not mistaken for bicycles, reducing the possibility of a false alarm.



Source: (16).

**Figure 1. CycleEye® on a First West of England Bus in Bristol, UK.**

### **Perceived Project Benefits**

CycleEye® trials were also conducted in Bristol, UK, while the TfL trial was occurring. The technology was installed on three buses operated by First West of England. A report from TfL on the evaluations of both projects has not yet been released. According to information available on the Internet, the CycleEye® technology appeared to have been well-received in the London and Bristol trials (11). The unit was operated during all times of the day and night and in all types of weather. The audible-only system also appears to reduce cognitive overload on the bus driver, allowing them to respond faster to potentially critical situations. Based on the trials, the Bristol City Council decided to install CycleEye® on additional buses (16).

### **Perceived Project Limitations**

The cost of the system represents one possible limitation (17). Other potential concerns are the system reliability, ongoing maintenance costs, and operators' acceptance. Fusion Technology personnel indicated in January 2014 before the test that costs were not yet fixed, but are forecast not to exceed 1 percent of the vehicle cost. Additionally, it is not clear how the units would survive bus washes, salt spray, and generally harsh weather (18).

## **Lessons Learned**

Testing the reliability of technologies appears to be one of the lessons learned from these projects. Considering bus driver work load also appeared to be important to ensure that bus operators are not overloaded with too many things to check and too many alerts to interpret. The results also indicate that the technologies have additional applications. For example, the city of Bristol was one of four cities selected by Innovate UK for pilot tests of autonomous vehicles (18).

## **CASE STUDY – DRIVER ASSIST SYSTEM FOR SHOULDER RUNNING BUSES**

### **Background**

One of the projects funded through the Minnesota Urban Partnership Agreement (UPA) sponsored by the United States Department of Transportation (USDOT) was the Minnesota Valley Transit Authority's (MVTA's) Driver Assist System (DAS) for buses operating on roadway shoulders. Buses are allowed to operate on the shoulders of designed freeway and roadway segments in the Minneapolis-St. Paul metropolitan area when travel speeds in the general purpose freeway lanes drop below 35 mph. The buses are allowed to travel at speeds up to 35 mph on the shoulders.

The UPA project included the development and use of a driver training simulator, equipping 10 buses with the DAS technology, and operating the buses in regular service along Cedar Avenue (Trunk Highway 77) and the Crosstown Highway (Trunk Highway 62). The main goal of the project was to enhance driver confidence in using the roadway shoulder, especially during inclement weather. Other project goals included reducing bus travel times, increasing travel time reliability and safety, and improving customer satisfaction.

The DAS project was evaluated by FTA (19) and as part of the National UPA Evaluation sponsored by the USDOT (20). Although the DAS project did not focus specifically on bus, bicycle, and pedestrian interaction, it is included as a case study because transit representatives expressed interest in AV/CV applications for lane-keeping buses during the meetings conducted as part of this project. The technologies employed in the DAS project, the experienced gained with the operation of the 10 DAS equipped buses, and the expansion of the system to additional buses in the MVTA fleet is relevant to this research project.

### **Project Description**

The DAS technologies provide feedback to MVTA bus drivers three ways—visual, tactical, and haptic. As illustrated in Figure 2, a heads-up display (HUD) and a virtual mirror provide visual feedback to bus drivers. As illustrated in Figure 3, the HUD digitally displays the boundaries of the roadway shoulder. It alerts the driver to obstacles in the path of the bus. The virtual mirror

highlights vehicles in the general purpose lane to the left of the shoulder, which helps bus drivers merge from the shoulder into the adjacent general purpose lane.

Tactical feedback to the bus driver is used to help keep the bus centered on the shoulder. If a driver veers too far to the right or to the left while operating on the shoulder, they receive tactical feedback by vibrators located on both sides of the seat cushion. The left side of the seat vibrates if a bus is veering too far to the left and the right side vibrates if the bus veering too far to the right.

Haptic steering is also used to assist the driver to operate the bus in the center of the shoulder. A motor attached to the steering column applies torque to the appropriate side of the steering wheel if a bus drifts too far to the right or left. The torque is intended to be suggestive only, as the torque strength is below a driver's control threshold.

The feedback warnings are provided in three stages. First, the HUD display turns red if the bus is 6 inches from the edge of the shoulder. Second, the seat warning is activated if a bus is within 3 inches of the edge of the shoulder. Finally, the steering motor/steering column torque is implemented if a bus is on the edge of a shoulder.



Source: (19).

**Figure 2. View of the DAS.**

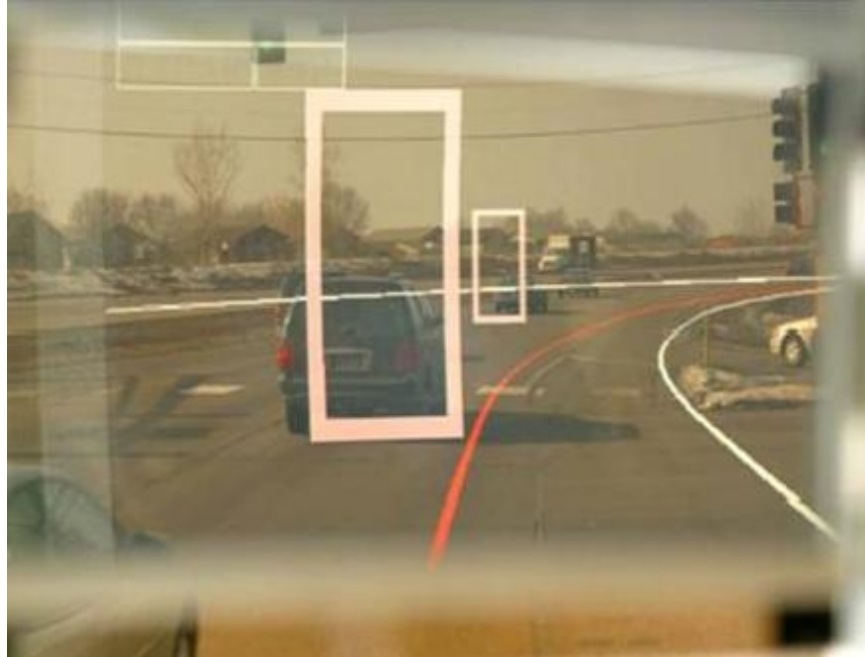

Source: (19).

**Figure 3. View through the HUD.**

### **Perceived Project Benefits**

The DAS was implemented on 10 MVTA buses in October 2010. The FTA and National UPA evaluations examined the DAS operations. The FTA evaluation of the DAS was conducted by the National Bus Rapid Transit Institute at the Center for Urban Transportation Research (CUTR). It focused on assessing the six broad areas of bus driver satisfaction, customer satisfaction, efficiency/productivity, technical performance, maintenance, and safety. The evaluation used a with and without approach. Performance data were collected from the same bus operators with the DAS set to passive mode for a 20-day period and then to an active mode for a 35-day period. The evaluation also included an examination of MVTA bus accident data, DAS maintenance records, an on-board survey of riders, and surveys and focus groups with MVTA drivers trained to use the DAS.

The results showed a 10 percent overall increase in the use of the shoulder by buses equipped with the DAS. Two of the six bus drivers increased their use of the shoulders with the DAS, four operators used the shoulder slightly less, and one driver used the shoulder significantly less. The average speed operating in the shoulder lane increased with the use of the DAS. The maximum operating speed in the shoulders for buses is 35 mph. The average speed without the DAS was close to 31 mph. The average speed with the DAS increased to 34 mph, with all six bus drivers recording faster travel speeds with the DAS. The analysis was not able to document overall changes in travel times and on-time performance even with the slight increase in speeds using the DAS (19).



The FTA-sponsored evaluation of the DAS also included obtaining feedback from MVTA bus operators on use of the system, which was intended to provide them with aids when driving on the shoulder, including reducing their stress levels. The 25 drivers who had completed DAS training and were operating DAS-equipped buses completed a survey. Two focus groups, consisting of eight drivers each, were also conducted.

In the survey, 88 percent of the bus operators strongly agreed or agreed that the DAS was easy to use and 64 percent strongly agreed or agreed that the DAS made driving on the shoulder less stressful. Thus, it appears the DAS was successful in reducing operators' stress levels when driving on the shoulder. A total of 84 percent of the operators strongly agreed or agreed that the driver simulator helped them better understand the DAS and 100 percent strongly agreed or agreed that the amount of training on the simulator and on-the-road was sufficient (19).

The survey responses and the focus group discussions indicated that the bus operators found the vibrating seat component the most beneficial. The steering wheel feedback and the HUD were rated lower, with 48 percent of the operators strongly disagreeing or disagreeing that the steering wheel feedback was helpful and 40 percent strongly disagreed or disagreed that the HUD was helpful. In the focus groups, some operators noted they did not like even the mild torque on the steering wheel and some operators commented that the HUD was distracting (19).

### **Perceived Project Limitations**

No major issues or limitations were identified as part of the evaluations. Overall, the results indicated that the technology worked well and the system was used by the MVTA operators. The use of the driver simulator to introduce bus operators to the DAS and to provide training appeared to be an important element the project.

### **Lessons Learned**

The DAS continues to be used by MVTA, with the DAS-equipped buses operating on the Metro Red Line, the first bus rapid transit line in the metropolitan area. Opened in June 2013, the Metro Red Line operates along Highway 77 and Cedar Avenue from the Mall of America to the Apple Valley Transit Station. In February 2015, MVTA was selected by FTA for federal funding to equip an additional 12 buses with the DAS.

## **CASE STUDY – TRANSIT SAFETY RETROFIT PACKAGE – MICHIGAN SAFETY PILOT DEPLOYMENT**

### **Background**

Transit applications were tested as part of the Michigan Safety Pilot Model Deployment funded by USDOT. The Safety Pilot Model Deployment in Ann Arbor includes approximately 3,000 volunteer passenger vehicles, trucks, and transit vehicles as well as infrastructure-based

technologies that enable vehicle-to-infrastructure (V2I) and vehicle-to-vehicle (V2V) applications. The overall objective of the model deployment was to determine the effectiveness of these technologies in reducing crashes. The transit safety applications tested included warning systems that alerted the bus driver of imminent crashes, the presence of pedestrians in a crosswalk, and the presence of vehicles and bicyclists in blind spots. The system provides warnings to the bus operator, who is then responsible for controlling the vehicle to avoid a crash.

## **Project Description**

The Transit Safety Retrofit Package (TRP) was developed by Battelle and tested on three University of Michigan buses. Five collision avoidance applications were tested. The TRP was activated on February 1, 2013, and typically operated over a period of 12 hours a day for eight months on the three buses. Battelle collected data on the demonstration, which was analyzed by the Volpe National Transportation Systems Center (21, 22). Following this initial deployment, data were analyzed, and the system was refined based on initial lessons learned. The refined system was redeployed for four weeks from February to March 2014.

The overall goal of the TRP was to reduce crashes and other collisions. Objectives of the TRP were to design and develop safety applications for transit buses that can communicate using V2V- and V2I-connected vehicle technologies for enhanced transit and pedestrian safety and determine if dedicated short range communications (DSRC) technologies could be combined with on-board safety applications to provide bus drivers with real time alerts regarding potential and imminent crashes (21).

The TRP system used several technologies. The three transit vehicles were equipped with an on-board unit (OBU) that contained a DSRC radio that received safety messages on the 5.9 GHz DSRC spectrum from DSRC equipment located in participating passenger vehicles and on various roadside installations. As illustrated in Figure 4, bus drivers received warnings through a Samsung Galaxy tablet, which obtained information from the OBU through a connection with the vehicular Control-Area Network bus, a standard component on most vehicles. The system also used information from the global positioning system (GPS) to signal the OBU that the vehicle was in an area where infrastructure-based technologies had been deployed. Additionally, the system relied on microwave-based Crosswalk Motion Sensors to detect the presence of pedestrians in crosswalks.



Source: (22).

**Figure 4. University of Michigan Bus with Samsung Galaxy Tablet.**

All of these technology components were combined to provide the five transit safety applications described next:

- **Forward Collision Warning (FCW).** This V2V safety application focused on preventing or mitigating forward moving rear-end collisions by warning bus drivers when there was a risk of collision. This application required that both vehicles be similarly equipped with the requisite DSRC components. FCW systems were originally tested as part of the larger Michigan Safety Pilot.
- **Emergency Electronic Brake Lights (EEBL).** This V2V application warned bus drivers when a hard-braking event occurs ahead of the bus in their lane of travel or in an adjacent lane. EEBL requires the equipping of multiple vehicles with similar DSRC equipment. The warning can be transmitted even if there are several vehicles between the bus initiating the hard braking event and the bus receiving the warning. These types of applications are viewed as being particularly useful when a bus driver's line of sight is obstructed or visibility is low due to poor weather conditions. EEBL systems were originally tested as part of the larger Michigan Safety Pilot.
- **Curve Speed Warning.** This V2I application warned bus drivers when they approached or entered a curve at a speed that was too high to allow for safe navigation. Vehicles must be equipped with the appropriate DSRC technology for this application and roadway sections for which safety warnings might be needed must have similar communications equipment installed. Curve Speed Warning systems were originally tested as part of the larger Michigan Safety Pilot.

- Pedestrian in Signalized Crosswalk Warning (PCW).** This V2I application warned the bus driver if there were pedestrians in the intended path of the bus during right or left turns. This application used two means of detecting pedestrians and notifying the driver. When a pedestrian activated a crosswalk button, the bus driver was provided an informational/cautionary indicator (Figure 5, left). The system also provided an imminent warning (Figure 5, right) based on a microwave motion sensor that detected the presence of pedestrians in the crosswalk. The PCW application was deployed at an intersection in Ann Arbor, which was equipped with some of the requisite communications hardware and was on a well-traveled bus route with significant pedestrian traffic. This particular application was developed and tested specifically as part of the TRP assessment.



Source: (22).

**Figure 5. PCW Driver Alerts.**

- Vehicle Turning Right in Front of Bus Warning (VTRW).** This V2V application warned a bus driver if vehicles were attempting to go around the bus and make a right turn as the bus departed a bus stop. This application required other vehicles, including the bus, be equipped with the requisite DSRC equipment and provided the bus driver with an informational/cautionary indicator and an imminent warning alert. The informational/cautionary indicator (Figure 6, left) was given when a vehicle moved from behind to beside the bus, while the imminent warning (Figure 6, right) is given when the other vehicle showed its intent to turn in front of the bus. The VTRW was deployed at 17 bus stops around the University of Michigan campus in Ann Arbor. This application was developed and tested specifically as part of the TRP assessment.



Source: (22).

**Figure 6. VTRW Driver Alerts.**

## **Project Benefits**

The evaluation indicated that the PCW application appeared to have improved safety for pedestrians by providing bus drivers with warnings when pedestrians were in, or were about to enter, a nearby crosswalk. The system prevented collisions whenever a transit vehicle is making a turn at an intersection that features a crosswalk. The VTRW is believed to improve safety for both vehicle passengers and transit passengers by warning the bus driver when a vehicle is navigating through a potential blind zone, which is expected to reduce collisions in the event that the bus changes lanes (22).

The evaluation concluded that the TRP in-vehicle software was effective at providing alerts to transit drivers and found that bus drivers were accepting of the system. The DSRC radio components also performed well, and none of the problems identified in the pilot could be attributed to the communications components (22).

## **Perceived Limitations**

The data collected were limited by the placement of the required V2I infrastructure, and it is anticipated that the benefits from a wider deployment of the PCW and VTRW applications may ultimately depend on the performance of the components and the coverage of the infrastructure. The evaluation indicated that there was a high rate of false alerts for the PCW application due to the limitations of the GPS and the pedestrian detector devices that were deployed. With a typical lane width of 3.35 meters, accuracy within about 1.675 meters was required; a level of accuracy that could not be provided by the components used in the test. The evaluation concluded that a reliance on GPS to activate the safety systems accurately could only be achieved with more precise technology, such as differential GPS (22).

The evaluation also concluded that the Doppler microwave-based crosswalk detectors in the PCW application were insufficient, as they were unable to adequately discern pedestrians and slow moving vehicles. The use of a “more discerning technology, such as high-speed imaging” was suggested (22).

## **Lessons Learned**

At this time, there are no plans for a broader deployment of the systems tested in Ann Arbor. The TRP is still being refined and require further testing. However, the evaluation made several technology related conclusions from the TRP that are informative for future testing efforts. A general conclusion that can be drawn from this project is that the enabling sensing technologies for transit, bicycle, and pedestrian safety applications are continually evolving and ongoing monitoring of these changes is important.

The evaluation concluded that location accuracy “is a critical need for TRP safety applications” and found that the TRP system tested in Ann Arbor suffered from poor accuracy in terms of

vehicle location. Accurate location data were particularly necessary in the PCW application because that information was used to inform the in-vehicle components that it was in-range of a PCW-enabled crosswalk and to begin receiving data from the infrastructure-based technologies. The evaluation noted that future generations of the TRP will rely on “improved GPS accuracy and a fusing of location information from different sensor types” (22).

As noted previously, the pedestrian detection sensors deployed for the TRP functioned well but did suffer from failures in the differentiation of vehicles and pedestrians. The evaluation noted that there are emerging technologies that may enable better pedestrian detection. The evaluation noted that passive and active infrared sensing technologies are already being used for some in-vehicle pedestrian warning systems and that advanced microwave-radar, video image processing, and combinations of these technologies should be considered to improve detection systems. The evaluation identified the following systems as being of interest for future testing (22):

- Autoscope is a product offered by Econolite that utilizes Machine Vision Processor sensors and is applicable in bicycle and pedestrian detection applications.
- FLIR System’s C-Walk product, which uses an integrated video camera and sensors, is capable of detecting pedestrians with a Video Graphics Array resolution at 25 frames/second.
- MigmaWalktime uses a high-resolution infrared LED stereo camera and on-board pedestrian detection algorithms.
- GridSmart is a device that uses a single, high-resolution, fisheye camera and tracking algorithms to identify and track vehicles and pedestrians.

The evaluation team also noted that cellular Bluetooth or WiFi technologies could be used to track pedestrian movement. However, the evaluation team concluded that this approach is limited in that only pedestrians possessing a Bluetooth- or WiFi-equipped cell phone would be detected (22).

## **CASE STUDY – CITYMOBIL2 AUTOMATED ROAD TRANSPORT SYSTEM DEMONSTRATIONS**

### **Background**

Automated Road Transport Systems (ARTS) are fully automated public transport vehicles controlled by a centralized fleet management system that also controls the vehicles’ interaction with the infrastructure and with other road users (23). ARTS vehicles are not autonomous; they operate under the constant management by a supervising vehicle management system under the controlled by a human operator (24). ARTS are designed as urban transport services and have as a fundamental goal the safeguarding of ARTS users and road users in the surrounding environment, including pedestrian and cyclists.

In Europe, ARTS demonstrations are being implemented under the CityMobil2 project, a European Commission (EC)-funded project that serves as a pilot platform for on-road tests in European urban environments. Five cities were selected as demonstration sites. Three large scale pilots have occurred in La Rochelle and the West Lausanne region of France, and in Milan, Italy. The large scale pilots were in operation for approximately six months with six vehicles. Small-scale pilots were in Oristano, Sardinia, and Vantaa, Finland (25). The small-scale pilots used three or four vehicles and operated for about four months. The pilots operated sequentially, with each city by turn, taking on more technical requirements and responsibilities. Two showcase sites were also selected. A showcase consisted of a two-to-three day exhibition during which visitors could become familiar with ARTS and the supporting technology.

Near-term goals of the CityMobil2 projects were to learn how the autonomous vehicles can safely interact with other road users and to develop the technical specifications and communications architecture for ARTS. Longer-term goals were to study the socioeconomic impacts of automating mobility and to help the Eurozone develop a legal framework for certifying ARTS.

CityMobil2 began in September 2012 and ends in 2016 (25). It has 45 partners, including system suppliers, city authorities (and local partners), the research community, and associations/networking organizations. The project is coordinated by the University of Rome. Twelve partners represent cities/regions (i.e., Trikala, Reggio Calabria, Leon, Saint Soulpis, Sophia Antipolis, Vantaa, Brussels, La Rochelle, San Sebastian, CERN, Milan, Oristano), while five more represent manufacturers of automated vehicles and system suppliers (i.e., YAMAHA, Robosoft, 2GetThere, Induct, Movemile). The remaining partners are research organizations and associations.

CityMobil2 demonstrations were funded under the European Union Framework Programme for Research and Innovation, Horizon 2020, at approximately \$10.7 million. Partner organizations provided the remaining funds—some \$6 million (26).

CityMobil2 was based on lessons learned from CityMobil (2006–2011), a major research project also funded by the EC. CityMobil was aimed at developing and demonstrating concepts for advanced road vehicles and new tools for managing urban transport toward the long-term goals of achieving more rational use of motorized traffic with less congestion and pollution, safer driving, a higher quality of living, and an enhanced integration with spatial development (27, 28). The following three large-scale and one small-scale demonstrations were conducted as part of CityMobil:

- At Heathrow Airport in London, a personal rapid transit system was designed and developed to connect a car park with the new Terminal 5 to demonstrate the practicality of personal rapid transit. The service consisted of four-seater battery-electric vehicles that

navigated automatically and autonomously along a 3.8 kilometer fixed guideway. The system has been operating for car park users since 2011.

- In Rome, a system operating small 20-seat automated vehicles was designed to collect people from various stops within a car park and bring them to the entrance of a new Rome exhibition building. For political and economic reasons, the system was never implemented.
- In Castellón, Spain, an autonomous-guided bus system was developed to connect the university with the city center and the seaside. It forms part of a transportation plan that will eventually connect several cities. The system uses electrical trolley buses with optical guidance systems that circulate on segregated road infrastructure. It has been in operation since 2008.
- In La Rochelle, a three-month temporary demonstration was held with two fully-automated vehicles operating along an 8 meter route between the quay in the historic town center and the university. Only one vehicle operated at a time, with a driver onboard to monitor the system. Each vehicle was equipped with two 180-degree laser scanners for localization and obstacle detection. Five stations were equipped with a touchscreen that riders could use to summon the vehicle via an IPv6 communications network that allowed a vehicle management system to transmit the users request to the vehicle.

### **Lessons Learned from CityMobil**

The CityMobil projects indicated that the important barriers to ARTS were not technological. The most important barrier was safety, and more specifically, the absence of generally accepted certification guidelines that could convince local authorities and operators that the systems were safe. One of the results of CityMobil was a risk assessment procedure that was organized into the following eight steps (24, 26):

1. Project approach: Define a preliminary design of the demonstration and then with the local safety authority(ies), adapt it to the local legal framework, and agree on responsibilities of all parties.
2. Preliminary hazard risks: With the local safety authority(ies), define the use cases and identify all possible threats within the use case to safe operation of the vehicle (such as cars, pedestrians, cyclists, animals, infrastructure) and determine mitigation measures. The demonstration design should be modified until agreement has been reached with the local safety authority that all risks have been mitigated.
3. Failure Mode, Effects, and Criticality Analysis (FMECA) and system design: After the ARTS is designed, its system engineering needs to pass a FMECA, which will demonstrate that even in case of subsystem failure, the ARTS will react according to the risk mitigation measures.



4. Verification of system safety/functionality: Field tests of the system are conducted to ensure it meets the engineering design requirements.
5. Operational description: Operational requirements are addressed, such as weather conditions, hours of operation, and lighting conditions. Testing is conducted to guarantee that that the system is safe under all potential operating conditions.
6. Verification of operational preparation: Operations manuals are produced. These include manuals for operators, their training program, the ARTS maintenance schedule, and other elements.
7. Approval design/operational safety cases: Operational safety cases are defined and tests to demonstrate safe operation are devised together with the local safety authority(ies).
8. Operational testing: Final tests are conducted prior to final approval of the local safety authority(ies) that the ARTS is ready for public use.

One additional element that has not yet been considered as of yet in the risk assessment (certification) procedure for any of the CityMobil2 sites is the likelihood of an adverse event occurring.<sup>1</sup> The question is still open as to whether a very unsafe but highly unlikely event needs to be mitigated in the ARTS system design and/or engineering.

### **CityMobil2 Projects**

CityMobil2 is being implemented in two phases. In the first phase (now complete), each of 12 partner cities/sites undertook a study to determine the potential for implementing an automated transport system and prepared a proposal for selection as a demonstration site. In Phase 2, the following selected cities are implementing pilot demonstrations:

- Large-scale demonstrations.
  - La Rochelle, France: December 2014–April 2015.
  - Milan, Italy: May–October 2015, during 2015 Expo.
  - West Lausanne, France: April–June 2015.
- Small-scale demonstrations.
  - Orisano, Sardinia: July–September 2014.
  - Vantaa, Finland: Summer 2015.

---

<sup>1</sup> Alessandrini, A. Personal communication via email on May 8, 2015.

More sites may be progressively selected to host CityMobil2 demonstrations in 2016. Additionally during the first phase, five vehicle manufacturing partners worked together to define common minimal technical specifications to make the pilot systems interoperable. At the end of the first phase, two of the five manufacturers were selected to provide six vehicles each. The two manufacturers were:

- Robosoft, a French firm established in 1985 by researchers from the French Institute for Research in Computer Science for advance robotic solutions.
- EasyMile SAS, a company formed in June 2014 by the joint venture of two leading transport automation companies, Robosoft Technology PTE Ltd and Driveplanet SAS.

CityMobil2 has an ex-post evaluation component to assess the impact and cost-benefit of implementing ARTS systems in urban areas. A total of 61 indicators have been selected to assess the impact of a project, including user acceptance, quality of service, system performance, safety, energy consumption, pollutant emission, and financial and economic costs and benefits (29). Not all indicators will be used in the each pilot site, but there are core indicators that will be measured across sites. Data are to be collected through interviews and questionnaires, automatic logs of vehicle operation and traffic/road conditions, and personal reports from ARTS manufacturers, ARTS operators, and city partners.

### **Oristano Demonstration**

The Oristano demonstration occurred over 36 days in the small Sardinian village of Torre Grande with two automated vehicles from Robosoft, following the implementation of the risk assessment procedure described earlier (25). Oristano, a nearby town, provided infrastructure and logistic support, the regional public transport operator managed the operation of the service (e.g., installed the stops and shelters and provided the on-board operators), and transport consultancy, Mlab, coordinated the demonstration (29). During the demonstration, approximately 1,600 persons were transported making 3,000 trips.

As illustrated in Figure 7, the vehicles were conventional electric minibuses converted into automatic vehicles. These vehicles operated among bicycles, pedestrians, and other service vehicles on a seven-stop, one-mile route along the seafront promenade (30). At the ends of the promenade, the vehicles turned around and traveled back in the opposite direction. The environment was simple yet demanding due to the pedestrian traffic, which was quite heavy in the evenings. No barriers or painted lines were used between the ARTS vehicles and pedestrians and bicyclists. Each bus was overseen by an experienced bus driver at all times because Italian law requires that a human be on board. Operators had a console by which they could override the automation and manually control the vehicle. The operator also provided assistance and information to the passengers and collected usage data. For legal and insurance reasons, all passengers had to register as testers before boarding. The ARTS was offered free of charge. As a risk mitigation measure, the vehicle's maximum speed was reduced from the planned 15 to

20 km/h to less than 10 km/h due to the large number of pedestrians that were on the road at peak times and technical issues that had to do with sensor range.



Source: (29).

**Figure 7. Oristano Vehicle.**

### **Perceived Benefits**

No accidents or system faults occurred during the demonstration. There were some early instances of stunting actions (i.e., testing the capacity of the ARTS vehicles to stop by older children and teenagers jumping in front of the vehicle in motion). But these quickly subsided as the novelty of the ARTS diminished.

In automated mode, the vehicles were guided by a differential GPS. In addition, the vehicles had three levels of obstacle detection and safety devices: two laser scanners on the front of the vehicles that could detect obstacles within a range of about 30 meters; an array of ultra-sound detectors on the front and the sides of the vehicles, that could recognize obstacles close to the vehicles or not directly in its trajectory; and a manual mechanical device that forced an emergency stop if everything else failed (30). The vehicles reacted differently according to the position and distance of obstacles, by slowing down or braking to a full stop.

### **Perceived Limitations**

The major shortcoming proved to be the limited quality of the GPS signal, which was the primary technology used to guide the vehicle (29). The problems were caused by the presence of pine trees with vast canopies that blocked the signal from satellites. GPS reception was spotty, and drivers had to manually override the vehicle to keep it from continually braking to a full stop as it lost the GPS signal. Another problem was that the sensors often reported non-existing obstacles, causing sudden stopping of the vehicle that was unsafe and uncomfortable for passengers. Because of this problem, the vehicles often had to be driven manually.

## La Rochelle Demonstration

La Rochelle was selected as a CityMobil2 large-scale demonstration site in part because of its previous experience with a CityMobil project. The CityMobil2 demonstration in La Rochelle was conducted from December 2014 to April 2015 (31). Figure 8 illustrates the location of the demonstration. However, prior to this start, the La Rochelle implementers had to engage in a year-long, continuous communication with the French State authorities to obtain permission to operate driverless vehicles temporarily on the prescribed route because there was no legal framework in France to allow such vehicles to circulate. In addition, extensive public awareness activities were conducted before implementation. Outreach was conducted with numerous stakeholders (e.g., residents, the police, shopkeepers, bike associations) and among school children, including workshops at 10 schools. A special edition of “Le Petit Quotidien” (i.e., national newspaper) focused on La Rochelle’s CityMobil2 demonstration. Additionally, the risk analysis procedure was implemented, and eight use cases were identified (i.e., straight path, curved path, crossing street with stop, crossing street with light, arriving at a station, leaving a station, entering single lane, and exiting single lane). Risk mitigation strategies were devised for all use cases and thoroughly tested.

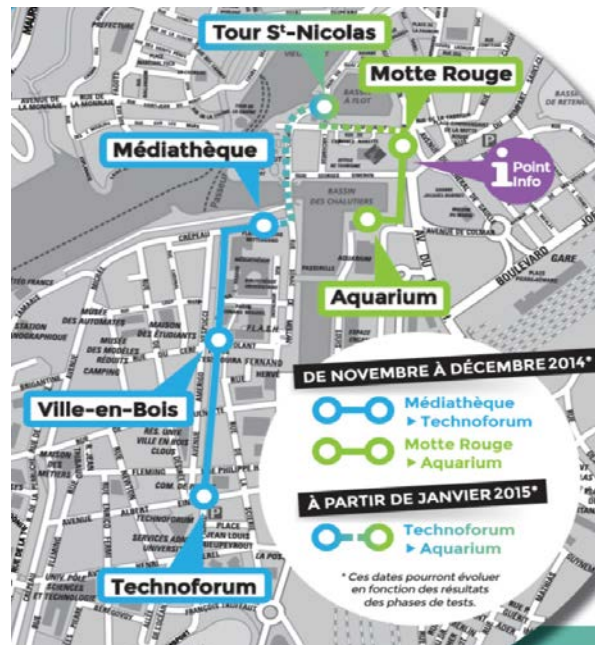

Source: (32).

**Figure 8. La Rochelle Demonstration.**

The demonstration was implemented in a stepwise manner. Beginning in December 2014, the automated vehicles provided by Robosoft operated on an initial segment linking the Aquarium with the Tourism office. The vehicles, virtually the same as in Oristano, are conventional electric minibuses, with room for 12 people, converted to be fully automated. In late January, an additional segment was added along with three new vehicles. Both segments were joined to

create the full demonstration route from mid-February to late April 2015 with six Robosoft vehicles.

As illustrated in Figure 9, the La Rochelle demonstration route was situated at the city center, and bicyclists and pedestrians shared the road with the fully automated vehicles. The vehicles operated on-demand. While the maximum speed of the automated vehicles is 45 km/h, they were limited to 7 to 10 km/h in the pilot. The whole circuit was about 1 km long, with five transit stops from where the vehicles could be boarded. These stops were installed only on one side of the road, forcing the vehicles to change lanes to dock at the station's platform.

The demonstration necessitated infrastructure changes (32). New road signs were erected that communicated that test vehicles were operating on the road. The route had six crossings with regular traffic, in which the priority was given to the ARTS vehicles through newly installed prioritized traffic signals. In addition, on-street parking was removed. To guarantee safety, an operator was present at all times in the vehicle to supervise certain vehicle's maneuvers and to assist the public.



Source: (31).

**Figure 9. La Rochelle Vehicle and Bicycles.**

The vehicles were fitted with GPS for the routes and sensors that detected obstacles on the route. Each stop consisted of a wooden platform that allowed the users to access a stopped vehicle with a touch screen that provided information and an interface to call vehicles, and a 3G communication device connected to the touch screen computer. The communications antenna was connected to the communications device and placed on a pole next to the booth.

### **Perceived Limitations**

There were no perceived limitations to the vehicle technology, the risk mitigation strategies, or the demonstration overall. There was one accident recorded. A bicyclist was texting while riding and did not see a red light. The automated vehicle did see him and did stop, with a bell activated

to warn the bicyclist. The bicyclist continued to text while riding, however, and hit the stopped vehicle. The collision happened at slow speed, and there were no injuries.<sup>1</sup>

## **Lessons Learned**

A risk assessment procedure was developed to certify that ARTS would be safe for all road users. Following the procedure, significant work was performed for risk assessment for both the Oristano and La Rochelle demonstrations. Both technological and infrastructural counter measures were implemented to ensure and enforce safety.

## **CASE STUDY – CONNECTED INTERSECTIONS AND MOBILE APPS IN NEW YORK CITY**

### **Background**

This case study focuses on vehicle-to-pedestrian (V2P) and infrastructure-to-everything applications developed for potential use in New York City that rely on an increasingly prevalent personal communications technology—Bluetooth enabled smartphones. New York City Mayor Bill de Blasio has focused on implementing a plan to improve safety on New York City streets. The roll out for Vision Zero included the development of an Action Plan outlining policy initiatives for city departments aimed at using every tool at its disposal to improve safety on city streets and eventually end traffic deaths and injuries on those streets. The plan aims to bring together government, advocacy, and private sector actors with full engagement of the public to carry out its objectives (33).

Vision Zero directs various city agencies to initiate a broad range of actions. The city’s department of transportation is directed to implement safety engineering improvements at 50 intersections and corridors. Many of these changes will take the form of traditional safety improvements, such as better lane markings, adding crosswalks, creating bike lanes, eliminating unsafe turn movements, better signal timing, and adding safety islands. However, the Vision Zero plan recognizes the value of finding new and innovative solutions, and directs the transportation department to survey national and international best practices to expand potential strategies. The plan also directs the city to work with private sector entities in the development, evaluation, and implementation of these new and innovative approaches.

To that end, AT&T launched the Connected Intersections challenge in June 2014 with the goal of using “smartphone technology and wireless networks to make pedestrians, cyclists and motorists more aware of their surroundings and alert them to potential dangers” (34). The program took the form of a three-month technology challenge where applications developers competed to create smartphone apps and wearable solutions to augment and enhance the public’s awareness of their immediate surroundings and reduce distractions. Winners would be awarded a cash prize from a pool of \$50,000. The Assistant Commissioner for Education and Outreach at New York City’s Department of Transportation served as an expert panel judge for the challenge.

## **Project Description**

In conjunction with the Connected Intersections challenge, AT&T issued a paper on how mobile technologies could be deployed in safety applications. The paper referenced several studies in recent years that have found that the distracted pedestrians, particularly those that engaged with a mobile device for activities such as texting, are less attentive to traffic and more likely to be injured (35).

In October 2014, the winners of the Connected Intersections challenge were announced, and one of the two grand prize winners was a mobile phone application aimed at increasing the awareness of pedestrians who might be using their phones while walking (36). The application uses Bluetooth technology to send messages from crosswalk signs to smartphones near the intersections that are running the application. Pedestrians would receive a visual warning in the form of an orange safety hand that would appear temporarily on their phone when they are waiting to cross and do not have the right of way. The safety hand would resemble the orange hand images that appear on crosswalk lights and are often accompanied by the warning “Do Not Walk.” Users of the app would have to have a Bluetooth-enabled phone, download the app, and be running it near an equipped intersection to benefit from it. It is not known what form the Bluetooth transmitter connected to the intersection’s traffic control devices would take.

## **Perceived Project Benefits**

The Vision Zero Action plan notes that while traffic incidents occur for all modes, the deadly toll is highest for pedestrians, who account for 56 percent of all New York City traffic fatalities. Children and seniors are identified as being especially vulnerable, with people over the age of 65 making up 12 percent of the city’s population but 33 percent of pedestrian fatalities. The plan further notes that the leading cause of death in the city for children under the age of 14 is being struck by a vehicle.

Further analysis of city data showed that that driver error in terms of inattention, speeding, and failure to yield were the main cause in 53 percent of pedestrian fatalities. In these cases, pedestrians were identified as following the law (crossing with a traffic signal, crossing in the crosswalk at an un-signalized intersection, or were not in the roadway.) The remaining 47 percent of pedestrian fatalities were attributed to pedestrian error, crossing midblock, or crossing against the traffic signal were the main contributing factors (33). According to the Transit Cooperative Research Program, 60 percent of collisions involving a pedestrian and transit vehicle occur when the transit vehicle is making a turn at an intersection (1). These incidents may occur for any number of reasons, from the driver’s line of sight being obscured to pedestrian distraction when entering a crosswalk. As such, safety applications that increase pedestrian awareness at intersections have the potential to significantly impact safety.

The TUG application could help to address pedestrian distraction by providing a visual warning on a mobile phone that the pedestrian does not have the right of way and should not proceed into the intersection. Mobile phone-based safety apps are particularly interesting in this context because, as noted previously, pedestrians who are actively engaged with their phone (such as when sending text messages) are more likely to engage in unsafe walking behavior, such as entering an intersection when they do not have right of way.

### **Perceived Project Limitations**

There are currently no plans for the wider deployment of the Bluetooth equipment that might enable use of the TUG app. For such a deployment to be effective, equipment would have to be installed at a significant number of intersections, such as those with the highest likelihood of pedestrian-vehicle incidents and particularly those intersections where pedestrians are more likely to be distracted by a mobile phone. There are currently no estimates available for the cost of this development. Furthermore, for the system to appreciably impact pedestrian safety, a large number of New York City pedestrians would need to not only have a Bluetooth-enabled phone but would also have to download and use the app.

### **Lessons Learned**

There are currently no plans in place to develop the necessary infrastructure, in the form of crosswalk based Bluetooth devices, in New York City that would support the wider deployment of the TUG application as a pedestrian safety measure. As such, there is no indication as to how well the system would work. However, the development of this app is informative in that it shows that the private sector is capable of responding to local government safety initiatives with new and innovative solutions. This case also shows that there is a potential market for the development of safety-based smartphone apps. Smartphone adoption by the general public continues to increase, and safety applications that leverage the popularity of these devices have the potential to realize significant safety benefits. In a paper produced for the AT&T Connected Intersections challenge, researchers identified the following smartphone-based technologies with the potential to increase safety for pedestrians (35):

- Applications that rely on camera technologies to increase visibility for the mobile phone user (such as by providing a view of the area ahead of them).
- Velocity-detectors that detect when a vehicle is in motion and subsequently silence alerts from incoming texts.
- Applications and wearable devices that deploy Natural User Interface principles that offer fewer distractions and do not interfere with walking activities when negotiating an intersection.



- Sensor-based technologies that warn pedestrians of oncoming traffic.
- Apps that enable better communication between pedestrian-based mobile devices and vehicles.

## CURRENT RESEARCH AND DEMONSTRATION PROJECTS

Other research studies and demonstration projects were identified during the literature review. A few examples of these activities are highlighted in this section. New research projects, pilots, and demonstration projects have been initiated since this literature review was completed. Examples of new projects include those underway by Honda, other automotive vehicle manufacturers, and university research groups:

- **Novel Collision Avoidance System for Bicycles.** Researchers at the University of Minnesota Roadway Safety Institute developed and tested a sensor-based system for bicycles that predict imminent bicycle-motor vehicle crashes and sound a horn to alert the motorists of the bicycle's presence. The system is designed to address two common types of crashes involving bicycles and motor vehicles—rear-end collisions when a vehicle is approaching a bicycle from behind and collisions involving bicycles and motor vehicles at intersections. The system also uses sonar, laser sonars, and a collision-prediction algorithm. The algorithm was initially tested in simulation studies. A bicycle equipped with sensors, electronics, and a small computer was tested in operation on the University of Minnesota campus. Preliminary results indicate that the bicycle sensor system can accurately estimate vehicle position and orientation for the two scenarios (37).
- **Pedestrian and Bicyclists Notification Systems.** A research study underway at the University of Iowa (UI), Safety Research Using Simulation (SAFER-SIM) is examining a smartphone notification system for distracted pedestrians. Using the UI's Hank Virtual Environments Lab, researchers are developing and testing a smartphone countdown warning system that notifies pedestrians who are texting on their cell phones as they are approaching an intersection. A number "8" surrounded by a bright red square appears on a cell phone as an individual is approximately eight seconds from an intersection. The system continues to count down, notify the individuals of the time before they can safely cross the street. Research on bicycle warning systems is also under development and testing at the SAFER-SIM (38).
- **Advanced Bicycle Detection.** Kimley-Horn and the City of Austin have teamed to develop and test a smartphone app that notifies a traffic signal of an approaching bicycle. While the app is focused on enhancing the flow of bicycle traffic, it also enhances the safety of bicyclists. The app has been tested on streets in Austin (39).
- **Fort Bragg Automated Shuttles.** The Applied Robotics for Installations and Base Operations is a public-private partnership focused on demonstrating driverless technology applications in the United States Army. A test involving two automated

shuttles, the size of large golf carts, was scheduled to begin in July 2015 at the base. The electric vehicles include cameras, sensors, lasers, Lidar, and GPS. The vehicles will transport soldiers between the Warrior Training Battalion barracks and Woman Army Medical Center, a distance of approximately one-third of a mile. Vehicle mapping and navigation data have been compiled, along with vehicle testing. For the first year, an operator will be in the vehicles to ensure safe operation (40). Other tests are also being conducted at Stanford University and West Point (41). A demonstration of the EasyMile shared driverless vehicle shuttle at the GoMentum Station and Bishop Ranch in Northern California was announced in October 2015. It is anticipated that this test will be initiated in 2016 (42).

- **Evaluation of Camera-Based Systems to Reduce Transit Bus Side Collisions.** Investigators with CUTR at the University of South Florida conducted this study (43) for the Florida Department of Transportation. The study examined characteristics of transit bus accidents, causes for the accidents, blind zone analyses, driving tests with and without cameras, and driver satisfaction surveys. Many conclusions were reached primarily that camera-based systems provide drivers an image that is simpler to process and requires less time than sensor-based systems. Additionally, a recommendation was made that further study is required to obtain technical specifications and settings for uniformity among transit agencies.
- **Geofencing for Fleet and Freight Management.** Investigators with CETE de Lyon in France published a paper on geofencing (44). The research involved developing a technique that allows a notification to a mobile phone when the device is within a given proximity of a mapped object or location.

## CHAPTER 3: STAKEHOLDER AND USER GROUP MEETINGS, WORKSHOPS, AND ROUNDTABLE FORUMS

### STAKEHOLDER MEETINGS

TTI researchers conducted 25 meetings with different transit, bicycle, and pedestrian stakeholders and user groups. The purpose of these meetings was to gather information on current conflicts among transit vehicles, bicyclists, and pedestrians and possible AV/CV applications to address these concerns. The meetings—which included email exchanges, telephone conference calls, and in-person meetings—were scheduled by members of the research team. Information on the project, including the flyer highlighting the study objectives and activities presented in Figure 10, was provided to the individuals prior to the meetings. Table 1 through Table 4 highlight the stakeholder and user groups meetings conducted by research team members. The key points from the different stakeholder and user groups are summarized in this section.

### Automated and Connected Vehicle (AV/CV) Test Bed to Improve Transit, Bicycle, and Pedestrian Safety

**Background**

As part of a research project sponsored by the Texas Department of Transportation (TxDOT), the Texas A&M Transportation Institute (TTI) is examining automated and connected vehicle (AV/CV) applications to improve transit, bicycle, and pedestrian safety. Data from transit agencies in metropolitan areas in Texas indicate safety concerns involving buses and pedestrians, and buses and bicyclists. This research project is exploring the potential of AV/CV to reduce or eliminate these concerns. The research project includes conducting meetings and workshops with key stakeholder groups, examining federal and state regulations associated with AV/CV deployment, documenting case studies from the U.S. and Europe, and investigating potential AV/CV technologies. The key outcome of these activities is the identification of near-term AV/CV applications to improve transit, bicycle, and pedestrian safety to move forward into a Concept of Operations (ConOps) document. The first phase of the project will be completed in August 2015. Work on the ConOps plan will begin in September 2015 and will be completed by April 2016.

**Topics for Stakeholder Groups**

- Issues and concerns associated with transit, bicycle, and pedestrian safety.
- Approaches being used to address these issues.
- Suggestions on current AV/CV technologies focusing on transit, bicycle, and pedestrian safety or potential applications of AV/CV technologies.
- Interest in future involvement in AV/CV test bed and pilot projects to improve transit, bicycle, and pedestrian safety.

**Researchers:**

<b>Dr. Katherine F. Turnbull</b> Principal Investigator Phone: (979) 845-6005 Email: k-turnbull@tamu.edu	<b>Linda Cherrington</b> Co-Investigator Phone: (713) 613-9240 Email: l-cherrington@tamu.edu
<b>Shawn Turner</b> Co-Investigator Phone: (979) 845-8829 Email: shawn-turner@tamu.edu	<b>Zachary Elgart</b> Co-Investigator Phone: (713) 613-9241 Email: z-elgart@tti.tamu.edu



Source: TTI.

**Figure 10. Stakeholder Meeting Flyer.**

**Table 1. Meetings with Transit Stakeholders.**

<i>Agency/Date</i>	<i>Attendees</i>
Texas A&M Transportation Services, May 20, 2015	Madeline Dillard, Assistant Director for Transit Ron Steedly, Alternative Transportation Manager Mark Matus, Assistant Manager, Transit Justin Tippy, Assistant Manager, Transit
Brazos Transit District, May 22, 2015	John McBeth, President/CEO Margie Lucas, Executive Vice President Wendy Weedon, Director of Marketing and Quality Assurance
Metropolitan Transit Authority of Harris County (Houston METRO), June 11, 2015	Tim Kelly, Executive Vice President Andy Skabowski, Chief Operating Officer Douglas Peck, Maintenance Support Director Sean Cagan, Chief Safety Officer Henry Debato, Manager of Bus Safety Bridgette Towns, Director of Capital Project Management Lauren Cochran, Director of Contract Operations Michael Andrade, METROLift Director
Capital Metropolitan Transportation Authority (Capital Metro), June 12, 2015	Donna Simmons, Vice President, Administration and Risk Management Compliance Officer Dottie Watkins, Vice President, Bus and Paratransit Operations Andrew Murphy, Vehicle Business Manager James Hoskins, Safety
Dallas Area Rapid Transit (DART), June 18, 2015	David Leininger, Chief Financial Officer Todd Plesko, Vice President of Planning and Development Rob Smith, Assistant Vice President for Service Planning and Development, Tim Newby, Vice President of Transportation Rocky Rogers, Assistance Vice President for Technical Services Brian Peck, Transportation Jeremy Lott, Project Manager
Capital Area Rural Transit Systems (CARTS)	Dave March, General Manager Lyle Nelson, Chief Operations Officer Pearl Jackson, Deputy General Manager
Hill Country Transit District, June 23, 2015	Robert Ator, Director of Urban Operations

Members of the research team were able to meet with representatives from the metropolitan transit authorities (MTAs) in Austin, Dallas, and Houston. Meetings with representatives associated with three rural transit systems and one university-based system were also held. A number of similar issues and concerns were voiced by representatives from the different agencies and some unique perspectives relating to local situations. As could be expected, given traffic congestion in the more urban areas of the state, MTA representatives expressed more concerns with transit, bicycle, and pedestrian interactions.

Transit representatives identified the following types of collisions and potential conflict situations involving transit vehicles, bicycles, pedestrians, and fixed objects:

- Bus collisions – other vehicles hitting a transit bus.
  - Sideswipes, including mirrors.
  - Rear-end collisions.
  - Vehicles making right and left turns into a bus.
- Bus collisions – bus hitting fixed objects.
  - Operators hitting fixed objectives, especially on the right.
  - Buses turning, bus not positioned correctly, especially for right turns.
  - Buses back-up, typically in bus facility parking lot.
- Bus-to-bicycle/pedestrian.
  - Passenger leaving bus – conflict with passing bicycle, bus moves before passenger is clear.
  - Pedestrian/bicycle veering into oncoming bus.
  - Passenger standing at bicycle rack/removing bicycle.
  - Left and right turning buses.
  - Increased risk with quieter vehicles (engine in the back) and electric vehicles, pedestrians cannot hear the bus and not aware of risk.
- LRT and rail collisions.
  - Vehicle turning into train.
  - Vehicle turning in front of train.
- LRT and rail to pedestrian.
  - Pedestrian standing too close to the platform edge (driver honks now, but it can be a problem in quiet zones).
  - Bicyclists making turns in front of light rail vehicles.
- Distracted pedestrians during special events and activities, including football game days at TAMU, downtown events in urban areas, and other special activities.
- Bicycles and pedestrians using transit-only facilities, such as the trolley pathway in The Woodlands and bus-only lanes in urban areas.

Transit representatives also identified a number of potential opportunities to address these concerns with AV/CV, intelligent transportation systems (ITS), and other related technologies. The following include examples of possible AV/CV technologies and applications suggested during the meetings with transit representatives from the various agencies:

- Sensors, cameras, and auditory alerts to detect and warn pedestrians and bicyclists of turning buses.
- Sensors, cameras, and visual/auditory alerts to warn bus operators of pedestrians and bicyclists.
- Sensors, cameras, and visual/auditory alerts for lane keeping buses.
- Smartphone apps to warn bicyclists and pedestrians of turning/approaching buses.
- Fully automated and autonomous buses for longer distances, circulators, and first and last mile service.

Transit agency representatives voiced some concerns with the potential use of AV/CV technologies and applications. Examples of these concerns included the readiness, reliability, and accuracy of various AV/CV technologies and procurement and maintenance costs. Other possible concerns included operator's complacency with autonomous features, liability issues, insurance costs, and drive acceptance.

Transit agency representatives identified the following research topics as beneficial to help advance the introduction and deployment of transit, bicycle, and pedestrian AV/CV applications:

- Human factors research on the AV/CV messages that are most effective for transit operators, and how the operators respond to messages over time.
- Human factors research on pedestrian/bicyclists reaction to AV/CV messages that are most effective and when the messages should be provided.
- Research on the reliability of automated vehicle features, including required maintenance, what happens when maintenance is deferred, and what is needed at different times of the day and in different weather conditions.
- Research on equity concerns, as the most vulnerable individuals do not have access to smartphones.
- Research on insurance costs – would they be lower with AV/CV technology?
- Research on liability issues – what is the transit agency's liability if technology is available but not deployed?

As presented in Table 2, researchers had the opportunity to obtain information from four different bicycle and pedestrian groups. Individuals from these groups indicated that conflicts between bicycles/pedestrians and motor vehicles, including buses, were concerns.

Representatives from the different groups identified the following concerns, possible AV/CV applications, and potential research topics.

**Table 2. Meetings with Bicycle and Pedestrian Stakeholders.**

<i>Agency/Date</i>	<i>Attendees</i>
TxDOT Pedestrian and Bicycle Coordinator, June 12, 2015	Teri Kaplan, Bike-Pedestrian Coordinator
America Walks, May 20, 2015	Scott Bricker, Director
Association for Pedestrian and Bicycle Professionals, May 20, 2015	Kit Keller, Executive Director Debra Goeks, Member Services/Webinar Program Manager
Federal Highway Administration (FHWA) Pedestrian and Bicycle Information Center (University of North Carolina), May 20, 2015	Charlie Zegeer, University of North Carolina Laura Sandt, University of North Carolina
Texas State University, June 23, 2015	Billy Fields, Assistant Professor of Political Science

Bicycle and pedestrian stakeholders identified the following types of potential conflict situations involving bicycles, pedestrians, transit vehicles, and other motorists:

- Limited space for bikes on shared use roadways results in safety risks for bicyclists.
- Lack of common design standards results in a variety of different and sometimes conflicting roadway markings and operating rules for bicyclists.
- Accessibility suffers without a bike network that accommodates all levels of riders.
- In general, road users (including motorists, bicyclists) do not know or do not follow rules of the road for bicyclists.
- In many instances, transit and bikes share the lane at bus stops and other areas, leading to issues about shared space and bike/transit conflict.
- Distracted pedestrians are a safety concern for bicyclists and motorists.
- Blind spots—which may include bus driver blind spots (cannot see other vehicles or bicyclist or pedestrians) and built environment blind spot (cannot see what is around the corner)—are concerns for bicyclists.
- High vehicle speeds on some roadways and highways add additional risks for bicyclists.

Representatives of bicycle and pedestrian groups identified the following possible approaches to address these issues:

- There are an increasing number of designated bike lanes, which improve safety.
- A set of design standards with widely accepted rules of the road would be beneficial.
- Various public service initiatives (“Be kind to bicyclists”).

- More training and public information is needed for all user groups.
- Consider expanded use of sideguards, which are sometimes installed on large vehicles, including buses, to protect cyclists and pedestrians.

In general, representatives of bicycle and pedestrian groups were not familiar with technologies that could assist to resolve identified safety concerns. Suggestions included technology that could communicate information about rules of the road and warnings when a potentially unsafe situation occurs. It was also suggested that vehicle automation could possibly be used to enforce physical distance between bicyclists and passing motorists. The following suggestions were also made during the meeting:

- Improve wayfinding in busy activity centers and congested corridors to assist bicyclists and pedestrians in avoiding conflict locations and dangerous situations.
- Examine using vehicle automation to enforce cyclist passing laws.
- Continue to explore safety warning – something that beeps when a vehicle is too close (within 3 ft) to bicycles and pedestrians.
- Bicycle and pedestrian stakeholders stated additional research is needed to understand how motorists and bicyclists/pedestrians will respond to connected messages. They suggested that there are many distractions already, and research is needed in actual operating environments to understand if AV/CV technology can be effective.

As noted in Table 3, researchers conducted meetings with representatives from two metropolitan planning organizations (MPOs), three cities, one township, and one special district. As noted, many common issues related to transit, bicycle, and pedestrian conflicts, possible approaches for addressing these concerns, and potential research topics emerged from the meetings.

**Table 3. Meetings with City, MPO, and Special District Stakeholders.**

<i>Agency/Date</i>	<i>Attendees</i>
City of College Station, May 22, 2015	Troy Rother, Traffic Engineer James Robertson, Assistant Traffic Engineer
Capital Area Metropolitan Planning Organization (CAMPO), May 29, 2015	Julie Mazur, CAMPO Commute Solutions
Houston Energy Corridor, June 9, 2015	Clark Martinson, General Manager
Houston-Galveston Area Council (H-GAC), June 8, 2015	Shelley Whitworth, Transportation Program Manager
The Woodlands Township, June 8, 2015	Chris LaRue, Transit Program Manager
City of San Antonio, June 15, 2015	Timothy Mulry, Sustainable Transportation Manager
City of Austin, June 22, 2015	Annick Beaudet, Manager Strategic Planning Division
City of Dallas, July 1, 2015	Ashley Haire, Bicycle Transportation Engineer



City, MPO, and special district representatives identified the following safety concerns:

- Bicycle and pedestrian safety is a broad concern that includes many facets and issues, including infrastructure issues (roadways, bicycle lanes, sidewalks, intersection design, etc.), connectivity, and problems with design and rules of the road throughout the network.
- Right turns in front of bikes and pedestrians are a common concern, which may be the result of poor visibility at intersections and other issues.
- Limited space for bikes on shared use roadways results in sideswipes and rear end collisions.
- Vision Zero (a concept that targets zero pedestrian fatalities) is a goal for many communities. Increasing bicycle ridership seems to have resulted in more incidents reported. Safety could increase as more people report incidents.
- Distracted pedestrians are a growing concern.
- Enforcement and education regarding bicycle and pedestrian safety is an ongoing challenge. Stakeholders indicated they struggle to develop effective programs and maintain consistency with enforcement. They also noted that increasing transit availability mixed with ongoing multimodal planning efforts could lead to higher number of conflicts because of wider assortment of mode choices—if the ratio of bicyclists and pedestrians increases accidents will be more likely.
- Problems with connectivity (both for bicyclists and pedestrians) create dangerous situations/interactions for users.

Stakeholders also identified concerns related to AV/CV implementation:

- Transit operators may become complacent and begin to forget safety responsibilities and/or warnings after AV/CV technology is implemented.
- AV/CV technology may fail and cause additional safety risks.

City, MPO, and special district representatives identified opportunities related to the implementation of AV/CV technology:

- Speed limitation—enforce restricted speed through connectivity and automation.
- Congestion reduction—automated vehicles can reduce human error and therefore increase throughput.
- Beyond safety, automation and connectivity have the potential to improve user experience/interaction.

Similar to other stakeholders, city, MPO, and special district representatives identified topics for future research related to AV/CV technology implementation:

- How will people adapt to the use of AV/CV technology? Will people adopt or ignore the warnings?
- How can infrastructure be incorporated into the connected system?
- How does automation work in very dense bicyclists/pedestrian environments? Will false positives compromise positive outcomes?
- Can AV/CV technology be used to improve education/knowledge of roadway users about rules of the road?

As noted in Table 4, researchers obtained input from representatives with the NPS San Antonio Missions National Historic Park, the Texas State Independent Living Council, and the USDOT. The topics covered in these meeting are:

- Need for connectivity—not possible to encourage options for walking/riding bicycle if there are not continuous sidewalks and/or bike paths.
- In a park environment, additional stakeholders are the national environment and wildlife groups.
- Seek ways AV/CV technology can make the visitor experience easier (parking congestion, etc.).
- Remember all pedestrians and transit users, including individuals with disabilities, especially those using mobility devices such as wheelchairs.
- Consider the different USDOT efforts underway and build on current activities, including efforts underway at Turner-Fairbanks. As a follow-up, recent reports and information were provided.
- Safety is a major goal for the USDOT and AV/CV is a major focus.

**Table 4. Meetings with State and Federal Agencies.**

<i>Agency/Date</i>	<i>Attendees</i>
National Parks Service, San Antonio Missions National Historic Park, June 22, 2015	Krista Sherwood, River, Trails, and Conservation Assistant
Texas State Independent Living Council, June, 9 2015	Kellé Martin, Project Specialist
United States Department of Transportation, June 25, 2015	Ellen Partridge, Office of the Assistant Secretary for Research Elwin Rodriguez, FTA Phil Weiser, National Highway Traffic Safety Administration Gabe Rousseau, Office of Safety Karen Timpone, Office of Safety Bob Sheehan, ITS-Joint Programs Office Alex Kaiser, Volpe National Transportation Center

## STAKEHOLDER AND USER GROUP WORKSHOPS

Four workshops were conducted to obtain additional information and insights from key stakeholders and user groups on concerns related to transit, bicycle, and pedestrian interactions and possible AV/CV applications to address these issues. Figure 11 presents an example of the electronic invitation used to invite participants. The workshops were held at the TTI Offices in Austin, Houston, and Arlington, and at the Sun Metro Office in El Paso. Table 5 presents the location, data, and attendance for the workshops. The Arlington Workshop was rescheduled due to weather concerns with Tropical Storm Bill. Figure 12 presents the agenda used at the Austin Workshop. Similar agendas were used at the Houston, Arlington, and El Paso workshops.

***You Are Invited***

**Workshop on Automated and Connected Vehicle (AV/CV) Test Bed to Improve Transit, Bicycle, and Pedestrian Safety**

**Workshop Details**     *Date: Friday June 12, 2015*     *Location (click for map):*  
*Time: 9 AM - 11:30 AM*     Texas A&M Transportation Institute (TTI) - Austin  
505 East Huntland Drive, Suite 490 Austin, Texas 78752  
*To Register Click Here*     Phone: 512-487-0946

**Background**

As part of a research project sponsored by the Texas Department of Transportation (TxDOT), the Texas A&M Transportation Institute (TTI) is examining automated and connected vehicle (AV/CV) applications to improve transit, bicycle, and pedestrian safety. Data from transit agencies in metropolitan areas in Texas indicate safety concerns involving buses and pedestrians, and buses and bicyclists. This research project is exploring the potential of AV/CV to reduce or eliminate these concerns. The research project includes conducting meetings and workshops with key stakeholder groups, examining federal and state regulations associated with AV/CV deployment, documenting case studies from the U.S. and Europe, and investigating potential AV/CV technologies. The key outcome of these activities is the identification of near-term AV/CV applications to improve transit, bicycle, and pedestrian safety to move forward into a Concept of Operations (ConOps) document. The first phase of the project will be completed in August 2015. Work on the ConOps plan will begin in September 2015 and will be completed by April 2016.

**Workshop Topics**

*Your participation in a workshop to discuss the following topics will enhance the research project and transportation in Texas*

- Issues and concerns associated with transit, bicycle, and pedestrian safety.
- Approaches being used to address these issues.
- Suggestions on current AV/CV technologies focusing on transit, bicycle, and pedestrian safety or potential applications of AV/CV technologies.
- Interest in future involvement in AV/CV test bed and pilot projects to improve transit, bicycle, and pedestrian safety.

**Contact Information**

Zachary Elgart Associate Transportation Researcher, Workshop Coordinator Phone: (713) 613-9241 Email: z-elgart@tti.tamu.edu	Katie Turnbull Executive Associate Director, Principal Investigator Phone: (979) 845-6005 Email: k-turnbull@tamu.edu
---	--



Source: TTI.

**Figure 11. Electronic Workshop Invitation.**

**Table 5. Stakeholder Workshops – Date, Location, and Attendance.**

<i>Location/ Date</i>	<i>Attendees</i>
Austin TTI Office, Friday, June 12, 2015	Ashby Johnson, Executive Director, CAMPO Darla Walton, TxDOT Public Transportation Division, East Region, Bryan Wade Odell, TxDOT Research and Technology Implementation Office, Austin Jeff Arndt, CEO, VIA Metropolitan Transit, San Antonio Teri Kaplan, TxDOT Bike-Pedestrian Coordinator, Austin Andrew Murphy, Capital Metro, Vehicle Business Manager, Austin James Hoskins, Capital Metro, Safety, Austin Lisa Weston, CAMPO, Long Range Planning, Austin Elliott McFadden, B-Cycle, Bike Austin Board, Austin
	TTI – Katie Turnbull, Shawn Turner, Linda Cherrington, Zachary Elgart, Trey Baker, Jason Wagner, Joan Hudson, Reza Farzaneh, James Cardenas
Houston TTI Office, Friday, June 19, 2015	Shelley Whitworth, Houston-Galveston Area Council Lauren Cochran, Metropolitan Transit Authority of Harris County Art Jackson, Metropolitan Transit Authority of Harris County Ron McElhose, Port Arthur Transit Thomas Thompson, South East Texas Hike & Bike Coalition Luke Abraham, South East Texas Hike & Bike Coalition Garlin Wynn, TxDOT Wade Odell, TxDOT Kelly Rector, The Energy Corridor District
	TTI – Katie Turnbull, Shawn Turner, Linda Cherrington, Zach Elgart
Arlington TTI Office Wednesday, June 24, 2015	Garry Brandenburg, Fort Worth Transportation Authority Inmon Wiley, Fort Worth Transportation Authority Matt McCarty, TxDOT Fort Worth Rick Cortez, TxDOT Dallas Olive MacGorman, TxDOT RTI (intern) Isaac Aguilar, TxDOT RTI (intern) Wade Odell, TxDOT RTI Jeremy Lott, Dallas Area Rapid Transit Gregory Masota, NCTCOG Perry Eggleston, University of Texas Arlington
	TTI – John Overman, Linda Cherrington, Rajat Rajbhandari, Zach Elgart
El Paso Sun Metro Office Friday, August 7, 2015	Jay Banasiak - Director, Sun Metro Kevin Bunce – Assistant Director of Maintenance, Sun Metro Kyle Ibarra - RTS Program Manager, Sun Metro Paul Guercio - Safety and Security Manager, Sun Metro Johnny Balcazar - Assistant Safety Manager, Sun Metro Ismael Segovia - TOD Project Manager, Sun Metro (cyclist) Lonnie Tapscott - Website coordinator, Sun Metro (cyclist) Arturo Arce - Graphic Designer, Sun Metro (cyclist) Claudia Ortega - Environmental Specialist, TxDOT El Paso District Antonio "Tony" Santana – Designer, TxDOT El Paso District Gus Sanchez, TxDOT El Paso District Scott White - Policy Director, VeloPaso   Board Member, El Paso Bicycle Club Victor Cordero - VeloPaso Pat Bastidas – Director, Please Be Kind to Cyclists   Program Manager, Drive Kind Ride Kind Kalina Sanchez – Press and Social Media, Please Be Kind to Cyclists Xavier Banales - CEO, Project Amistad Bob Geyer, Transportation Manager, El Paso County
	TTI – Alfredo Sanchez, Swopnil Samont, David Galicia, Katie Turnbull, Linda Cherrington, Zachary Elgart

**Texas Department of Transportation  
Research Project 0-6875  
Automated Vehicle/Connected Vehicle (AV/CV) Test Bed  
To Improve Transit, Bicycle, and Pedestrian Safety  
Stakeholder Workshop  
June 12, 2015, 9:00 a.m.–11:30 a.m.  
Texas A&M Transportation Institute Office  
505 E. Huntland Dr., Austin, TX  
Agenda**

1. Welcome and Introductions
2. Research Project Overview
3. Stakeholder Workshop Objectives
4. Transit, Bicycle, and Pedestrian Interaction
5. Possible AV/CV Technologies to Address Concerns
6. Next Steps and Future Collaboration

Source: TTI.

**Figure 12. Stakeholder Workshop Agenda.**

The major topics discussed by participants at the four stakeholder workshops are summarized in this section. The workshops included stakeholders representing transit agencies, local governments, MPOs, bicycle user groups, universities, and special districts. The workshop summary is organized by the four themes—safety issues; opportunities to improve safety with technology; possible concerns with technology safety; and research needs.

**Safety Issues**

The following are safety issues discussed by the stakeholders:

- Safety concerns are highest at intersections, bus stops, park-and-ride facilities, and other related locations.
- Bicycle use is growing, especially around some of the campuses in small urban and metropolitan areas. The use of bike racks on buses is increasing with this growth in bicyclists.
- Bicyclists removing their bikes from a bike rack mounted on the front of a bus or in a luggage storage area on an over-the-road bus can be safety concerns.

- Bike racks on buses are often full; there is a need for more bike rack capacity. Options are needed to accommodate more bicycles on buses safely.
- Bike racks on the back of a bus would make it harder for the bus driver to see someone loading or unloading their bike, creating more safety concerns. Would bike share programs help by reducing the need to bring your own bike?
- Bicyclists and pedestrians sharing bus-only facilities can be a safety concern.
- Distracted bicyclists and pedestrians create safety risks for themselves, transit, and other vehicles in all regions.
- Bus operators are challenged by blind spots during turning movements and when passing bicycles.
- Bicycles and pedestrians are often unaware of their responsibilities and rights as they pertain to both shared and dedicated facilities, leading to risky interactions and unpredictable behavior.
- Inadequate/limited infrastructure for bicycles and pedestrians can diminish accessibility and can result in risky interactions between modes.
- Shared bicycle and bus lanes are challenging for buses to navigate safely.
- Litter and debris in bike lanes and curb lanes are safety concerns for bicyclists.
- Some states have safe distance passing laws; when road conditions allow, the safe distance is at least 3 ft for passenger vehicles and light trucks, and 6 ft for commercial motor vehicles and trucks passing a bicycle.
- A number of cities in Texas—including Austin, El Paso, Houston, and San Antonio—have Safe Passing/Vulnerable Road User ordinances that address safe passing distances.
- Outreach and education is needed to all stakeholder groups. Information can also be incorporated into bus driver training programs.

### **Opportunities to Improve Safety through AV/CV Technology**

The following are opportunities to improve safety through AV/CV technology discussed by the stakeholders:

- Consider applications of the bus turning notifications in different environments.
- Consider AV/CV technologies to address concerns with bike rack use and bike storage.
- Consider autonomous buses for specific applications.
- Consider smartphone apps for warning and collision avoidance.

- As more cities in Texas and the United States accommodate bicycles and pedestrians and plan for multimodal accessibility, diverse modal interactions will become more common and could benefit from AV/CV technology.
- Transit is the controllable variable in transit/bicycle/pedestrian interactions, so consider a focus on transit-specific AV/CV technology.
- A system that could assist operators by maintaining constant speed and making necessary adjustments in response to challenging/risky conditions would be beneficial.
- Haptic feedback could be a compromise between audio (annoying to passengers and passersby) and visual (possibly distracting to operator) notifications if properly incorporated into transit operator training.
- Improving safety for individuals with special needs should be a major focus of AV/CV technology.
- Infrastructure that provides accessibility for all modes could reduce risk to bicycles and pedestrians.
- Beyond safety, AV/CV technology can be used to engage facility users, provide wayfinding and interpretation information, and gather user data and feedback.
- Fully autonomous vehicles represent an opportunity to reduce congestion.

### **Possible Concerns with Technology Applications**

The following are concerns with technology applications discussed by the stakeholders:

- Transit operators may be distracted by AV/CV technology, resulting in increased risk.
- Connected users (bicycles and pedestrians) may become distracted by safety warnings.
- Connected user technologies may not improve safety because they depend on users both installing and initializing the app.
- Autonomous vehicles may suffer from tech failures and people that choose to abuse the safety features (i.e., stepping in front of a vehicle because they know it will stop).
- Maintenance related to all levels of technology integration could become costly and challenging.
- “Unintelligent” automated safety devices are not specific enough (i.e., always signaling a turn despite lack of pedestrians) and are not installed in a beneficial manner (i.e., bus light up signs are placed too high and are too small).
- AV/CV technology must be capable of identifying pedestrians using wheelchairs and children.

- AV/CV technology must be fully functional in darkness and poor weather.
- There may be equity concerns with population groups that do not own smartphones.

## **Research Needs**

The following research needs were identified by the stakeholders:

- Human factor research for transit operators focusing on how vehicle operators will react to increased notification and feedback, and examine if distraction is a realistic concern.
- Examine how transit operator training protocols can incorporate AV/CV technology.
- Examine how existing technologies react to dense urban environments. For example, will large quantities of pedestrians overwhelm such systems or will a congested roadway lead to constant warnings?
- Examine standardized AV/CV technology and AV/CV testing to ensure replicability and predictable outcomes post real-world implementation.
- Continue to examine tests and demonstrations to assess changes in incident rates as a result of existing AV/CV technology.
- Examine the insurance/risk management implications of AV/CV technology.
- Examine AV/CV technology regulations and public policies.
- Examine the design of infrastructure to accommodate (or potentially, remove the need for) AV/CV technology.
- Examine cost and maintenance concerns for transit operators.
- Examine liability and legal issues associated with possible crashes with AV/CV systems.
- Examine possible equity concerns with different AV/CV applications.

## **ROUNDTABLE FORUMS**

Four roundtable forums were held as part of this project. The roundtable forums brought together representatives from the public and private sectors to discuss opportunities to collaborate on research, tests, pilots, and demonstrations related to the test bed to improve transit, bicycle, and pedestrian safety. Table 6 lists the dates, locations, and attendees at the roundtable forums.



**Table 6. Roundtable Forums – Dates, Locations, and Attendees.**

<i>Location/Date</i>	<i>Attendees</i>
TTI Austin Office, Austin, Friday, May 15, 2015	David Agnew, Continental Automotive Doug Feicht, Denali Group Robert Heller, Southwest Research Institute Jason JonMichael, HNTB Corp. Scott McBroom, Denali Group Dave Miller, Siemens Mobility J. D. Stanley, Cisco Darby Swank, Telvent Jim Templeton, Deloitte Ken Vaughn, Trevilon Justin Word, Central Texas Regional Mobility Authority TTI – Johanna Zmud and Katie Turnbull
TTI State Headquarters Research Building, College Station, TX, Tuesday, March 8, 2016	Wade Odell, TxDOT Errick Thompson, City of Dallas Andrew Murphy, Capital Metropolitan Transportation Authority Darla Walton, TxDOT-PTN James Hoskins, Capital Metropolitan Transportation Authority Elizabeth Bruchez, Brazos Transit District Mike Cacic, Rosco Vision Systems Gary Cox, North East Independent School District John Hendrickson, Waco Transit/Texas Transit Association Richard Steinhaus, Rosco Vision Systems David Ellice, Mobileye Tom Leach, Mobileye Dana Albers, Mobileye Barrett Ochoa, TAMU Transportation Services Peter Lange, TAMU Transportation Services Lauren Cochran, Houston METRO (via Skype) TTI – Zachary Elgart, Katie Turnbull, Linda Cherrington, Shawn Turner, Pete Koeneman, Joan Hudson, David Sparks, Ed Seymour, Justin Malnar, Tim Lomax
Conference Calls February 17, 2016 New Flyer of America Inc.  March 24, 2016 Proterra	David Warren, Director of Sustainable Transportation Thomas Small, Director of New Product Development Joseph R. Gibson, Vice President National Sales TTI – Katie Turnbull and Linda Cherrington  Ryan Popple, President and Chief Executive Officer TTI – Linda Cherrington

The first roundtable forum was held early in the project. The May 15, 2015, roundtable forum was held in the Austin TTI Office in conjunction with a meeting on another research project. Representatives from public agencies, technology companies, and consulting firms provided input on current projects, technology applications, and possible pilots. Technologies noted for enhancing transit, bicycle, and pedestrian safety included motion sensors, back-up and front-mounted cameras, infrared, DSRC, and smartphone apps. Information from this roundtable

forum was used to map technologies to near-term concept applications, which is discussed in Chapter 5.

The second roundtable forum was held in College Station on March 8, 2016. Figure 13 presents the electronic invitation to this roundtable forum, which provided an update on the project and a review of the near-term candidate applications. It also included a presentation on the pilot of the Rosco/Mobileye Shield+™ collision-avoidance system on one TAMU bus and a tour on the bus of the Bonfire Route on the TAMU campus. Participants included representatives from TxDOT, transit agencies, school districts, cities, TAMU, Rosco, Mobileye, and other groups.

After the tour, participants discussed elements of the collision-avoidance system, additional applications of the data generated by the system, and other technology applications. The near-term candidate applications were discussed, along with possible tests and pilots. Information from this roundtable forum was used in the development of the ConOps plan contained in Chapter 6.

The final two Roundtable Forums were conducted by conference calls with representatives from bus manufacturing companies. One call was held with representatives from New Flyer of America, Inc. The second call was held with a representative of Proterra. The purpose of these conference calls was to obtain perspectives from bus manufacturing company representatives on possible AV/CV applications, the speed of integration with other bus developments, and the potential for autonomous buses in the future. Information from these calls was used in developing the ConOps plan in Chapter 6.

# *You Are Invited*

## Roundtable Forum Automated and Connected Vehicle (AV/CV) Test Bed to Improve Transit, Bicycle, and Pedestrian Safety

**Details** Date: Tuesday March 8, 2016  
Time: 10am - 2pm

**Location** Texas A&M Transportation Institute (TTI) – College  
Station State Headquarters and Research Building,  
Room 144

2935 Research Parkway, College Stations, TX, 77845

[To Register Click Here](#)

Registration is free and must be  
completed by March 3, 2015

### Background

As part of a research project sponsored by the Texas Department of Transportation (TxDOT), the Texas A&M Transportation Institute (TTI) is examining automated and connected vehicle (AV/CV) applications to improve transit, bicycle, and pedestrian safety.

Building on the meetings and workshops held in 2015, the Roundtable Forum will provide an update on the project, including the applications and technologies being examined. A pilot project is underway on the Texas A&M University (TAMU) Campus, with one TAMU bus equipped the Mobileye Shield+ collision avoidance system. The bus is in daily operation on one of the campus routes. Roundtable Forum participants will have the opportunity to ride the bus and see the system in operation. Participants will also have the opportunity to discuss additional applications of different AV/CV technologies and provide input into the test bed Concept of Operations (ConOps) plan.

**Free parking and lunch will be provided.**

### Roundtable Forum Agenda

- > 10:00 AM Welcome and Introductions
- > 10:15 AM Project Update and ConOps Plan
- > 11:00 AM Tour of the Mobileye Shield+ Pilot
- > 12:15 PM Lunch with Interactive Discussion
- > 1:00 PM Questions/Answers on Pilot
- > 1:30 PM Discussion of Future Activities/Wrap Up



### Contact Information

Zachary Elgart  
Associate Transportation Researcher, Roundtable Forum Coordinator  
Phone: (713) 613-9241 Cell: (737) 932-1481 Email: z-elgart@tti.tamu.edu

Katie Turnbull  
Executive Associate Director, Principal Investigator  
Phone: (979) 845-6005 Email: k-turnbull@tamu.edu



Figure 13. Electronic Invitation to Roundtable Forum in College Station.



## **CHAPTER 4: REVIEW OF REGULATORY ENVIRONMENT**

This chapter reviews federal and state regulations related to the near-term candidate applications focusing on warning-based systems for bus operators, bicyclists, and pedestrians. As discussed in the ConOps plan in Chapter 6, the candidate applications address smart buses, smart intersections, smart bicycles, smart pedestrians, and smart bike racks. For clarification and consistency, definitions for connected vehicle, automated vehicle, and autonomous vehicle are:

- Connected vehicle—a vehicle capable of safe, interoperable networked wireless communications between other vehicles, the infrastructure, and passengers’ personal communications devices to enable crash prevention and safety, mobility, and environmental benefits.
- Automated vehicle—a vehicle in which at least some aspects of a safety-critical control function occur without direct input from the driver, such as steering, acceleration, or braking. This function may respond to communications from within or external to the vehicle.
- Autonomous vehicle—an automated vehicle that only uses vehicle sensors (as opposed to communications systems as in CVs) to control the safety-critical control functions.

The candidate applications fall under the category of connected vehicle technology. For this reason, the regulations pertaining to automated and autonomous vehicle operations are not included in this review.

### **FEDERAL LAWS AND REGULATIONS**

The research team reviewed federal laws and regulations associated with the following agencies and topics:

- The Federal Motor Carrier Safety Administration (FMCSA).
- The Federal Motor Vehicle Safety Standards (FMVSS).
- The Buy America Requirements under the FTA.
- The Altoona Bus Testing requirements under FTA.
- FTA Notices of Proposal Rule Making on the Public Transportation Safety Program and the State Safety Oversight requirements.
- Pending regulations and standards for CV systems.

#### **Federal Motor Carrier Safety Administration**

The research team reviewed the FMCSA regulations, under 49 Code of Federal Regulations (CFR) Parts 300-399, and identified the following three sections that relate to this project (45):

- Section 392: Driving Commercial Vehicles.
- Section 393: Parts and Accessories Necessary for Safe Operation.
- Section 396: Inspection, Repair, and Maintenance.

Table 7 presents a brief summary of the regulations in these sections.

### **Federal Motor Vehicle Safety Standards**

Researchers reviewed the FMVSS (46) to identify pertinent standards that could affect the development of the AV/CV transit, bicycle, and pedestrian safety test bed. Table 8 presents potentially relevant sections of the FMVSS. The sections address topics related to brakes and braking systems; mirrors, lamps, and reflective devices; and accelerator control systems.

Exemptions from the FMVSS are governed under Part 555, which are issued in the case of “substantial economic hardship to a manufacturer, the facilitation of the development of new motor vehicle safety or low-emissions engine features, or the existence of an equivalent overall level of motor vehicle safety” (46).

### **Buy America Regulations under the Federal Transit Administration**

The Buy America Requirements under FTA are a series of regulations that place restrictions on the source of materials and end products used in transit rolling stock, including buses, light rail vehicles, commuter rail vehicles, and heavy rail vehicles (47). The regulations restrict the use of federal funds for procuring transit vehicles, as well as transit vehicle parts and components, unless the vehicle is composed of at least 60 percent, by cost, of American-made parts and assembled domestically. Small purchases may be eligible for a General Public Interest Waiver for Buy America. The Fixing America’s Surface Transportation (FAST) Act defines a small purchase as \$150,000 or less. Given the candidate applications, researchers assume that these requirements are not relevant or will be eligible under the small purchase waiver.

**Table 7. Potentially Relevant Sections of the FMCSA Regulations.**

Section	Title	Text or Summary	Potential Relevance
<b>Driving Commercial Vehicles</b>	<a href="#">392.62</a> : Safe Operation, Buses	Buses cannot be driven unless they meet certain requirements (e.g., “unrestricted freedom of movement to the driver and his proper operation of the bus”)	Any modifications cannot violate these requirements; the driver cannot have movements restricted
	<a href="#">392.82</a> : Using a Handheld Mobile Telephone	Drivers cannot use handheld mobile telephones	Any modifications cannot require a driver to use a handheld mobile telephone
<b>Parts and Accessories Necessary for Safe Operation</b>	<a href="#">393.3</a> : Additional Equipment Requirements	Additional equipment that decreases safety is prohibited, but other equipment—as long as it does not reduce safety—is not prohibited	Any modifications cannot decrease safety; other equipment is not necessarily banned
	<a href="#">393.9</a> : Lamps	Lamps must be operated at all times and cannot be obscured by other equipment or material	Any modifications cannot obscure lamps, or render them inoperable
	<a href="#">393.19</a> : Hazard Warning Signals	“The hazard warning signal operating unit on each commercial motor vehicle shall operate independently of the ignition or equivalent switch, and when activated, cause all turn signals required by § 393.11 to flash simultaneously”	Any modifications must leave the hazard warning signals capable of operation independent of the ignition switch
	<a href="#">393.28</a> : Wiring Systems	“Electrical wiring shall be installed and maintained to conform to SAE J1292”	Any modifications to the wiring systems must conform to these standards
	<a href="#">393.30</a> : Battery Installation	This section provides, in specific detail, the exact way a battery must be installed	Any modifications that involve the battery must not violate these requirements
	<a href="#">393.40</a> : Brake Systems	This section provides, in specific detail, the exact ways brakes of differing varieties must operate	Any modifications that involve the brakes must not violate these requirements
	<a href="#">393.51</a> : Warning Signals	Buses must be equipped with warning signals that inform the driver when a brake system fails and must meet certain requirements	Any modifications that involve the brakes must not violate these requirements
	<a href="#">393.52</a> : Brake Performance	Describes the manner in which braking systems must perform	Any modifications that involve the brakes must not violate these requirements
	<a href="#">393.80</a> : Rear-Vision Mirrors	Describes the requirements on where mirrors can be placed, the number of mirrors required, and other related information	Any modifications that involves rear-vision mirrors must not violate these requirements
	<a href="#">393.201</a> : Frames	Describes the requirements for frames; parts and accessories cannot be welded to the frame or chassis	Any modifications cannot be welded to the vehicle’s frame
	<a href="#">393.209</a> : Steering Wheel Systems	Describes the requirements and standards for steering wheels and associated components	Modifications cannot violate these requirements
<a href="#">396.3</a> : Inspection, Repair and Maintenance	Establishes requirements for inspecting, repairing, and maintaining commercial vehicles	Requirements include “parts and accessories which may affect safety of operation” including modifications	

Source: TTI, based on FMCSA regulations in 49 CFR Part 300-399.

**Table 8. Potentially Relevant Sections of the FMVSS Standards.**

Section and Title	Summary or Text
Standard No. 108: Lamps, Reflective Devices, and Associated Equipment	This standard specifies requirements for original and replacement lamps, reflective devices, and associated equipment. Its purpose is to reduce traffic crashes and deaths and injuries resulting from traffic crashes, by providing adequate illumination of the roadway, and by enhancing the conspicuity of motor vehicles on the public roads so that their presence is perceived and their signals understood, both in daylight and in darkness or other conditions of reduced visibility.
Standard No. 111: Rearview Mirrors	This standard specifies requirements for the performance and location of inside and outside rearview mirrors. Its purpose is to reduce the number of deaths and injuries that occur when the driver of a motor vehicle does not have a clear and reasonably unobstructed view to the rear.
Standard No. 131: School Bus Pedestrian Safety Devices	This standard establishes requirements for devices that can be installed on school buses to improve the safety of pedestrians in the vicinity of stopped school buses. Its purpose is to reduce deaths and injuries by minimizing the likelihood of vehicles passing a stopped school bus and striking pedestrians in the vicinity of the bus.
Part 555: Temporary Exemptions from Motor Vehicle Safety Standards	This regulation provides a means by which manufacturers of motor vehicles may obtain temporary exemptions from specific safety standards on the grounds of substantial economic hardship, facilitation of the development of new motor vehicle safety or low-emission engine features, or existence of an equivalent overall level of motor vehicle safety.

Source: TTI, based on the FMVSS.

### **Altoona Bus Testing Requirements under the Federal Transit Administration**

Any bus that is purchased or leased using financial assistance from FTA is subject to testing under the Altoona Bus Testing Program (48, 49). Further, if a bus has undergone previous testing, but has a major change in chassis design or components, it must be re-tested. This re-testing is only a partial testing, however. The CFR defines a major change in chassis as a vehicle “not manufactured on a third-party chassis” with “a change in frame structure, material or configuration, or a change in chassis suspension type” (48). The criteria for a major change in component are divided into two parts—the first for vehicles not manufactured on a third-party chassis and the second for vehicles that are manufactured on a third-party chassis:

- “[A] change in a vehicle’s engine, axle, transmission, suspension, or steering components.”
- “[A] change in the vehicle’s chassis from one major design to another.”

It is anticipated that the test bed will use the existing transit buses that passed the Altoona Bus Testing requirements, and that the technologies being implemented do not meet the requirements for retesting. The required procedures will be followed if this is not the case.



## **Federal Transit Administration Public Transportation Safety Program and State Safety Oversight**

Congress required FTA to develop a comprehensive public transportation safety program in the Moving Ahead for Progress in the 21st Century (MAP-21) Act in 2012. The safety program in MAP-21 was reauthorized in the FAST Act in 2015. Congress expanded FTA's authority in overseeing safety on heavy rail, light rail, buses, ferries, and streetcars and placed additional requirements on states for safety oversight (50, 51). MAP-21 required FTA to develop a National Transportation Safety Plan establishing national safety standards and criteria on transit. States must implement these new standards and meet the criteria by establishing a Public Transportation Agency Safety Plan, a State Safety Oversight Program, and a State Safety Oversight Agency (52). FTA is further required to oversee these requirements by monitoring states' progress at meeting the goals and standards established in the National Transportation Safety Plan. If states do not meet these targets, FTA is authorized to withhold federal funds as an incentive.

MAP-21 required states to include a variety of safety components as part of the Public Transportation Agency Safety Plan (52). FTA published a Notices of Proposal Rule Making in August 2015 on the components of the plan. Within one year of FTA promulgating its final rule, states must develop a Public Transportation Agency Safety Plan with the following components:

1. A requirement that the board of directors (or equivalent entity) approve the agency safety plan and any updates to the agency safety plan.
2. Methods for identifying and evaluating safety risks throughout all elements of the public transportation system.
3. Strategies to minimize the exposure of the public, personnel, and property to hazards and unsafe conditions.
4. A process and timeline for conducting an annual review and update of the safety plan.
5. Performance targets based on the safety performance criteria and state of good repair standards.
6. Assignment of an adequately trained safety officer who reports directly to the general manager...or equivalent officer.
7. A comprehensive staff training program for the operations personnel and personnel directly responsible for safety (52).

In addition, MAP-21 required state safety oversight programs establish a financially and legally independent state safety oversight agency with broad powers to oversee and audit public transit in the state. MAP-21 required that the state oversight agency:

1. Is financially and legally independent from any public transportation entity that the state safety oversight agency oversees.
2. Does not directly provide public transportation services in an area with a rail fixed guideway public transportation system subject to the requirements of this section.
3. Does not employ any individual who is also responsible for the administration of rail fixed guideway public transportation programs subject to the requirements of this section.
4. Has the authority to review, approve, oversee, and enforce the implementation by the rail fixed guideway public transportation agency of the public transportation agency safety plan.
5. Has investigative and enforcement authority with respect to the safety of rail fixed guideway public transportation systems of the eligible state.
6. Audits, at least once triennially, the compliance of the rail fixed guideway public transportation systems in the eligible state subject to this subsection with the public transportation agency safety plan.
7. Provides, at least once annually, a status report on the safety of the rail fixed guideway public transportation systems the state safety oversight agency oversees to FTA, the state governor, and the board of directors (or equivalent body) that the state agency oversees (52).

These rules greatly expand the responsibilities of both states and FTA in overseeing transit safety.

TxDOT has been designated by the Texas Legislature as the responsible state safety oversight agency for implementing and administering 49 U.S.C. 5330 and meeting the requirements of 49 CFR Part 659. These responsibilities are outlined in the Texas Transportation Code, Section 455.005, Rail Fixed Guideway Mass Transportation System Safety Oversight (53). Since candidate applications do not pertain to rail fixed guideway systems, this is out of the scope for the study.

### **Federal Guidance on Connected Vehicle**

FHWA, National Highway Transportation Safety Administration (NHTSA), and other federal agencies are also developing guidance regulations related to CVs and have numerous

demonstrations and program activities underway. The first formal regulations for CVs are under development at NHTSA, which would mandate the deployment of CV systems on all new light vehicles. In August 2014, NHTSA released the *Advanced Notice of Proposed Rulemaking* on the CV systems (54, 55). The proposed rule would create a new FMVSS, FMVSS No. 150, which would “require V2V communication capability for light vehicles (passenger cars and light truck vehicles) and to create minimum performance requirements for V2V devices and messages” (55, 56).

While formal regulations are not available, the federal government has provided implementation guidance and other technical advice through technical reports and other documents. For example, FHWA provides guidance on deploying CV infrastructure in *Vehicle to Infrastructure Deployment Guidance and Products* (57). The agency addresses concerns related to ensuring standardized signing by noting that V2I applications providing traffic control information to drivers should be consistent with the *Manual on Uniform Traffic Control Devices* (MUTCD) (57).

The report also recommends that the information the OBU receives should be sufficient for it to generate the appropriate sign/symbols or convey that information in a manner consistent with the MUTCD. In addition, all information conveyed to the driver should comply with and cannot contradict information conveyed by the signs, signals, and markings on and along the road (as defined by the MUTCD). In-vehicle systems should also convey priority captured by signs, signals, and markings (e.g., regulatory signs take priority over warning signs) (57).

With regard to installing CV systems on public fleets, FHWA guidance states that components will need to comply and be consistent with CV architecture and standards. The report also provides guidance on designing software applications for public fleet vehicles. According to the report, federal-aid highway funds can be used to procure components that enable V2I applications that are installed on public sector vehicles (57).

## **STATE AND LOCAL LAWS AND REGULATIONS**

This section summarizes legislation and regulations in Texas and other states related to CVs identified and reviewed by the research team. In addition, legislation in Texas addressing the operation and regulations of public transit vehicles is provided, along with information on local laws governing bicycles and pedestrians.

### **Texas Motor Vehicle Laws and Regulations**

This section reviews elements of the Texas Transportation Code (53) that may influence the testing and operation of CVs. Table 9 presents the elements of the Texas Transportation Code that may need to be considered in the test bed implementation.

**Table 9. Relevant Texas Transportation Code Elements.**

Area	Chapter and Title	Text or Summary	Potential Relevance to CV
Financing	456.004: General Financing Application Requirements	An application for state financing must be certified and contain a statement by the applicant that the proposed public transportation project is consistent with the continuing, cooperative, and comprehensive (3C) regional transportation planning process implemented in accordance with the Federal Transit Act and the Federal-Aid Highway Act.	If CV project seeks state financing, it must meet the 3C planning requirements.
Vehicles and Traffic	545: General Provisions	This section of the transportation code governs how vehicles operate on roads, addressing areas such as passing and following another vehicle, signaling and turning at an intersection, driving around streetcars, yielding to emergency vehicles, speeding restrictions, and many other specific requirements.	CV project must meet these requirements.
	547.101: Rules and Standards in General	TxDOT may adopt standards for vehicle equipment to protect the public from unreasonable risk of death or injury; and enforce safety standards of the United States as permitted under the federal motor vehicle act.	CV must consider TxDOT standards for vehicle equipment to ensure its safety.
	547.203: Vehicle Equipment Testing: Department Standards	TxDOT shall prescribe standards for and approve testing facilities to review test data submitted by a manufacturer to show compliance with a department standard; and test an item of vehicle equipment independently in connection with a proceeding to determine compliance with a department standard. TxDOT may not impose a product certification or approval fee, including a fee for testing facility approval. TxDOT may by rule require a manufacturer of an item of vehicle equipment sold in this state to submit adequate test data to show that the item complies with department standards; periodically require a manufacturer to submit revised test data to demonstrate continuing compliance; purchase an item of vehicle equipment at retail for the purpose of review and testing; and enter into cooperative arrangements with other states and interstate agencies to reduce duplication of testing and to facilitate compliance.	CV project must meet any TxDOT safety standards and tests to ensure that the equipment meets the state's standards.
Vehicles and Traffic	547.204: Vehicle Equipment Testing: Federal Standards.	For a vehicle or item of vehicle equipment subject to FMVSS, TxDOT may: require the manufacturer to submit adequate test data to show that the vehicle or item of vehicle equipment complies with standards of the United States; review the manufacturer's laboratory test data and the qualifications of the laboratory; and independently test the vehicle or item of vehicle equipment.	CV project must meet any TxDOT requirements that a vehicle meets the FMVSS.
	547: General Lighting Requirements For Vehicles	This chapter addresses a variety of required equipment lighting on vehicles, such as taillights, headlights, reflectors, and other types of lighting.	CV project must meet the vehicle lighting equipment requirements in this section.

**Table 9. Relevant Texas Transportation Code Elements.**

Area	Chapter and Title	Text or Summary	Potential Relevance to CV
Vehicles and Traffic	547.501: Audible Warning Devices	A vehicle may not be equipped with, and a person may not use on a vehicle, a siren, whistle, or bell unless the vehicle is a commercial vehicle that is equipped with a theft alarm signal device arranged so that the device cannot be used as an ordinary warning signal; or an authorized emergency vehicle that is equipped with a siren, whistle, or bell that complies with Section 547.702. A warning device, including a horn, may not emit an unreasonably loud or harsh sound or a whistle.	CV project using auditory warning devices must comply with this standard and not use “a siren, whistle or bell.”
	547.611: Use of Certain Video Equipment and Television Receivers	A motor vehicle may be equipped with video receiving equipment, including a television, a digital video disc player, a videocassette player, or similar equipment, only if the equipment is located so that the video display is not visible from the operator’s seat unless the vehicle’s transmission is in park or the vehicle’s parking brake is applied. This section does not prohibit the use of equipment used exclusively for a safety or law enforcement purpose, if each installation is approved by the department.	CV project that includes video equipment visible to the driver will need TxDOT approval.

Source: TTI based on the Texas Transportation Code.

## **Texas State Bicycle and Pedestrian Laws and Regulations**

The Texas Transportation Code also addresses bicycles and pedestrians in Sections 551 Subchapter B and 551, respectively (53). Section 551 grants bicyclists the same rights and duties as those applying to motor vehicle drivers. It requires bicyclists to travel as close to the curb as possible if traveling slower than other traffic unless they are preparing to turn left or if the lane is too narrow for a bicycle and a motor vehicle to safely travel side by side, in which case the bicyclist may take the lane. It requires bicycles to have certain safety equipment, including brakes, a white headlamp on the front of the bicycle, and a red reflector or lamp on the rear if cycling at night.

Section 552 addresses requirements for pedestrians in the following areas:

- Traffic control signals and right-of-way—directs how pedestrians should interact with traffic signals, giving them the right-of-way in certain circumstances.
- Use of sidewalk—describes how, when, and where pedestrians should walk on a sidewalk.
- Solicitation by pedestrians—prohibits hitchhiking and selling services in the roadway.

Section 545.418 addresses crashes that occur when a motorist opens the door into the path of the bicyclist, commonly called dooring crashes. It states that a person may not open the door unless it is opened without interfering with moving traffic. To minimize dooring crashes, some cities use striping to encourage bicyclists to ride outside of the door zone.

In 2010, a policy statement was released by the USDOT concerning walking, bicycling, and recommended actions that transportation agencies may consider to make walking and bicycling safer and more convenient. To comply with this policy, TxDOT issued guidance in 2011 that states that the inclusion of bicycle and pedestrian facilities shall be considered when the project is scoped. It applies in both urban and rural settings for different project types including new construction and reconstruction.

## **Texas Local Motor Vehicle, Bicycle, Pedestrian Laws, and Regulations**

Local governments also play an important role in regulating vehicle traffic and may have additional laws relating to transit vehicles, bicycle, and pedestrians. Cities and counties are responsible for the day-to-day operations of many elements the local traffic system, which may include traffic signals and other traffic control devices, sidewalks, and bicycle paths. Examples of local laws, regulations, and approaches were discussed in the meetings and workshops. Additional information from cities in the state was obtained and reviewed.

The City of Austin has several measures relating to bicycling, including requiring a helmet for children, restricting parking in bicycle lanes, and restricting riding a bicycle on certain sidewalks

(58). Austin also has an ordinance requiring motor vehicle operators to yield to bicyclists when turning across a bicycle lane (59). In 2014, the City of Austin passed an ordinance prohibiting the use of portable electronic devices while operating a motor vehicle or bicycle (60). San Antonio passed a similar law banning any handheld mobile devices. A total of 40 cities in Texas have bans on texting while driving.

The City of Houston addresses bicycles in Chapter 45, Article 12 – Bicycles (61), which includes general provisions and helmet requirements. The general provisions restrict bicycle usage on sidewalks in the business district and allow the safety engineer to erect signs banning bicycling on certain streets. The helmet section requires children to wear a helmet.

Design standards exist in many cities about accommodating pedestrians and bicyclists. Houston, San Antonio, Austin and other cities in the state have endorsed complete streets policies, which focus on designing and operating roadways for all users, including bicyclists and pedestrians. In May 2014, the El Paso City Council adopted the National Association of City Transportation Officials “Urban Street Design Guide” and “Urban Bikeway Design Guide” as the official design guidelines. The Brownsville City Council adopted these guides in 2014 as well.

Texas does not have a Safe Passing or Three-Foot law at the state level, but several cities have approved ordinances requiring safe passing of vulnerable users. Austin, Beaumont, Corpus Christi, Denton, El Paso, Fort Worth, Plano, and San Antonio all have some type of law addressing the topic (62). Safe passing laws typically require motor vehicles passing a bicyclist operating on a roadway to vacate the lane in which the bicyclist is using if the roadway has two or more marked lanes in each direction of travel or to pass the bicyclist at a safe distance defined as at least 3 ft if the motor vehicle is a passenger car or light truck and 6 ft if the vehicle is a truck or a commercial motor vehicle (62, 63, 64). As commercial motor vehicles, transit buses are required to provide at least 6 ft when passing a vulnerable user.

Both Austin and Houston have used undercover police to enforce the safe passing law (65, 66). In addition, technology exists to assist in the enforcement of safe passing laws. Developed in Austin, C3FT is a device that bounces ultrasonic waves off passing vehicles and calculates a distance. The device is being used in Houston and is being purchased for Austin (67).

San Antonio has a local law (Section 19-291) to address dooring crashes prohibiting the opening of doors of any vehicle unless it can be done without endangering pedestrians on the sidewalk or bicyclists in the moving lane.

Vision Zero is an initiative that has been gaining attention in recent years. It is a data-driven approach to reducing transportation-related injuries and saving lives. With a goal of zero fatalities, both Austin and San Antonio are considering the adoption of Vision Zero policies. In January 2016, the Vision Zero Network selected 10 focus cities to model the Vision Zero policy

in the United States. Austin was selected as one of these 10 focus cities, and San Antonio was mentioned as an “emerging Vision Zero city” (68).

Transit priority lanes exist in several Texas cities. Local laws restrict the use of the lane. Austin Ordinance 12-5-43 states that a person may not stop, stand, or park a motor vehicle in a transit priority lane designated as a bus only lane unless it is authorized to do so, to execute a right turn, as a bicycle passing an authorized vehicle, or to yield to emergency vehicles. Houston Transportation Code (Article XIII, Section 45) states that it is unlawful for any person to operate any vehicle in a restricted access lane, other than a driver in an authorized vehicle, during the hours that access is restricted.



## CHAPTER 5: ENABLING AV/CV TECHNOLOGIES AND MAPPING TO CONCEPT APPLICATIONS

### INVESTIGATE ENABLING AV/CV TECHNOLOGIES

A number of sources were used to identify possible AV/CV technologies that may be appropriate for use with the transit, bicycle, and pedestrian safety applications identified through the literature review, meetings, and workshops. Information from the six case studies and research activities were used in this analysis, the 22 stakeholder meetings, and four stakeholder workshops; and the initial roundtable forum was used to identify possible AV/CV technologies. In addition, the USDOT V2P Technical Scan Summary and other related documents were reviewed. The USDOT conducted a technical scan of V2P technologies. A total of 86 research and development concepts, simulations, field tests, demonstration, prototypes, and related projects were identified and reviewed. Table 10 highlights examples of available technologies.

**Table 10. Possible Technologies for Near-Term Applications.**

<b>Technology</b>	<b>Description</b>	<b>Example</b>
<i><b>Vehicle Turn Sensors</b></i>	<ul style="list-style-type: none"> <li>• Trigger warnings to pedestrians when turns of 45 degrees or more are initiated</li> <li>• Warnings include audible (beeps or instructional message) and visual (LED flashers/strobes)</li> <li>• Audible warnings are sensitive to environment and increase/decrease volume depending on time-of-day and ambient noise</li> </ul>	Protran Safe Turn Alert
<i><b>Computer Imaging</b></i>	<ul style="list-style-type: none"> <li>• Cameras mounted to vehicle exterior capture images of the world</li> <li>• Computer program analyzes the images, scanning for traffic signals, other vehicles, pedestrians and bicycles, and other safety relevant visual cues</li> <li>• If computer senses a safety concern, alerts or autonomous actions are triggered based on vehicle's proximity to the condition in question</li> </ul>	Mobileye Shield+
<i><b>Radar</b></i>	<ul style="list-style-type: none"> <li>• Vehicle-based unit emits a radio wave that bounces off objects in the area and then returns to the vehicle's receiver</li> <li>• Unit calculates the distance to each object within range and alerts operator of unsafe conditions</li> <li>• Appropriate for mid- to long-range applications (up to approximately 300 ft)</li> </ul>	Delta Mobile Systems AR20 Smart Sensor System
<i><b>Lidar</b></i>	<ul style="list-style-type: none"> <li>• Functionally similar to radar, but capable of more detailed imaging</li> <li>• Emits a laser that bounces off objects in the area and then returns to the vehicle's receiver</li> <li>• Unit calculates the distance to each object within range and alerts operator of unsafe conditions</li> <li>• Appropriate for mid-range applications (up to approximately 60 ft)</li> </ul>	Fort Bragg Automated Shuttles
<i><b>Ultrasonic Sensor</b></i>	<ul style="list-style-type: none"> <li>• Functionally similar to radar, but with limited range</li> <li>• Vehicle-based unit emits an ultrasonic signal that bounces off objects in the area and then returns to the vehicle's receiver</li> <li>• Unit calculates the distance to each object within range and alerts operator of unsafe conditions</li> <li>• Limited to short-range applications (approximately 12 ft)</li> </ul>	Delta Mobile Systems AR20 Smart Sensor System

**Table 10. Possible Technologies for Near-Term Applications.**

Technology	Description	Example
<i>Sonar</i>	<ul style="list-style-type: none"> <li>• Functionally similar to radar</li> <li>• Emits a sound wave that bounces off objects in the area and then returns to the vehicle’s receiver</li> <li>• Unit calculates the distance to each object within range and alerts operator of unsafe conditions</li> </ul>	Novel Collision Avoidance System for Bicycles
<i>Active Infrared (AIR) and Passive Infrared (PIR)</i>	<ul style="list-style-type: none"> <li>• AIR functions similar to door buzzers in retail establishments               <ul style="list-style-type: none"> <li>○ Infrared beam is directed at a reflector that returns the beam</li> <li>○ A broken beam triggers the system to alert that an object is present</li> </ul> </li> <li>• PIR functions similar to household motion detectors               <ul style="list-style-type: none"> <li>○ Infrared beam is directed in target direction</li> <li>○ System defines normal conditions as the absence of objects</li> <li>○ Introduction of an object triggers an alert</li> <li>○ PIR is challenged by bright light (i.e., sunshine) and is likely best for night use</li> </ul> </li> </ul>	Infrared Pedestrian Detection System
<i>Bluetooth Low Energy (BLE)</i>	<ul style="list-style-type: none"> <li>• Enables communication between smartphone users (cyclists, pedestrians, and motorists) and infrastructure</li> <li>• Shares information such as user/vehicle type, user/vehicle speed and trajectory, and known road hazards</li> <li>• For example, pedestrians with BLE-enabled device and the appropriate app could receive a message from a crosswalk indicator stating it is not safe to cross, or transit vehicles approaching an intersection could receive advanced warning of pedestrian presence</li> <li>• BLE also communicates location and wayfinding information</li> </ul>	Tug Pedestrian Alert App
<i>Wi-Fi</i>	<ul style="list-style-type: none"> <li>• Enables communication between smartphone users (cyclists, pedestrians, other motorists) and other vehicles or infrastructure</li> <li>• Smartphone apps use WiFi to broadcast approximate position and likely travel path to recipients</li> <li>• Location and likely travel path information is used to trigger impending danger type warnings to all users</li> </ul>	Wi-Fi Honk App
<i>DSRC</i>	<ul style="list-style-type: none"> <li>• Functionally similar to WiFi, with faster communication speeds</li> <li>• Enables communication between smartphone users and vehicles or infrastructure</li> <li>• Communicates user location and likely travel path</li> <li>• Triggers warnings when unsafe situations are detected</li> <li>• Faster communication speeds (compared to WiFi) allows DSRC to act as an additional sensor to identify other road users or objects, as well as function in non-line-of-sight scenarios to reduce crashes and relieve congestion by enabling vehicles to travel at reduced headways and higher speeds, while communicating about potential road hazards ahead</li> <li>• As of April 2016, not commercially available in smartphones</li> </ul>	Honda/Qualcomm V2P Demonstration
<i>RFID</i>	<ul style="list-style-type: none"> <li>• RFID chips broadcast identifying information that is preprogrammed on the device</li> <li>• Safety-focused RFID’s identify users as cyclist or pedestrians</li> <li>• Vehicle-based RFID readers scan for cyclists and pedestrians</li> <li>• Vehicle system alerts operator when a cyclist or pedestrian is, potentially, in danger</li> </ul>	Smart Bicycle Racks

Source: TTI.

## **MAPPING TECHNOLOGIES TO CONCEPT APPLICATIONS FOR NEAR-TERM TESTING**

The following seven candidate applications were initially identified by the research team based on the results of the stakeholder meetings and workshops:

- Avoiding conflicts with turning buses at intersections and other locations.
- Avoiding conflicts with buses traveling adjacent to bicycle lanes.
- Avoiding conflicts with buses and bicycles sharing a lane.
- Avoiding conflicts with personal and commercial vehicles hitting buses.
- Identifying and avoiding bus conflicts in confined spaces.
- Alerting distracted pedestrians and bicyclists to buses.
- Avoiding conflicts with bike rack and bike storage use and providing autonomous transit vehicles.

Based on additional analysis, the research team combined some of the applications, resulting in the following applications, which were given further consideration:

- Collision avoidance when turning.
- Collision avoidance with straight line travel.
- Bike rack-on-buses safety.
- Collision avoidance with fixed objects and hazards.
- Non-transit-initiated collision avoidance.
- Partial/full transit automation.

Researchers mapped the available and emerging technologies with these six candidate applications. Table 11 presents the results of this analysis. As illustrated, the applications addressing collision avoidance with turning buses and straight-line travel have been the focus of the most projects and technologies.

**Table 11. Mapping of Technologies to Candidate Applications.**

Technology/Project Example	Agency	Date(s)	Application #1: Collision Avoidance when Turning	Application #2: Collision Avoidance with Straight-Line Travel	Application #3: Bike Rack-on-Buses Safety	Application #4: Collision Avoidance with Fixed Objects and Hazards	Application #5: Non-Transit-Initiated Collision Avoidance	Application #6: Partial/Full Transit Automation
Safe Turn Alert	Portland TRIMET	March 2014	✓					
Clever Devices Turn Warning System	Portland TRIMET	March 2014	✓					
DINEX STAR LED	Portland TRIMET	March 2014	✓					
CycleEye®	Transport for London	Summer 2014	✓	✓				
Cycle Safety Shield	Transport for London	Summer 2014	✓					
Cycle Alert (RFID)	Transport for London	Summer 2014	✓	✓				
Driver Assist System (DAS)	MN UPA	October 2010						✓ (lane keeping)
Transit Safety Retrofit Package	MI Safety Pilot Deployment	Feb–Sept 2013 Feb–Mar 2014	✓	✓				
CityMobil2 Automated Road Transport System (ARTS)	European Commission	Sept 2012 to 2016	✓	✓		✓		✓
Connected Intersections & Mobile Apps (Vision Zero)	AT&T Challenge	June–Oct 2014	✓				✓	
Novel Collision Avoidance System for Bicycles	U of Minnesota Roadway Safety Institute	May 2014–Dec 2016	✓	✓			✓	
Pedestrian and Bicyclists Notification Systems	U of Iowa Safety Research using Simulation (SAFER-SIM)	June 2014–November 2015	✓	✓			✓	
Advanced Bicycle Detection	Kimley-Horn and City of Austin	Ongoing					✓	
Ft. Bragg Automated Shuttles	Applied Robotics for Installations and Base Operations	July 2015	✓	✓		✓		✓
Evaluation of Camera-Based Systems to Reduce Collisions	CUTR	March 2010	✓	✓	✓			
Geofencing for Fleet & Freight Management	CETE Lyon, France	2009	✓	✓		✓		

Source: TTI.

The research team further analyzed the seven candidate applications by the following key factors:

- Short term implementation potential.
- Perceived safety benefits.
- Affordable technology or hardware cost.
- Product availability.
- Ease of integration.
- Free of major limitations.
- Overall rank.

Each factor was given a high (H), medium (M), or low (L) ranking. Table 12 presents the results of this analysis. Based on this analysis, the following applications emerged as the top candidates for moving forward into the ConOps plan:

- Collision avoidance with turning buses.
- Collision avoidance with straight-line travel.
- Bike rack-on-buses safety.
- Collision avoidance with fixed objects and hazards.

**Table 12. Candidate Applications Ranked by Key Factors.**

<b>Application</b>	<b>Short-Term Implementation Potential</b>	<b>Perceived Safety Benefits</b>	<b>Affordable Technology or Hardware Cost</b>	<b>Product Availability</b>	<b>Ease of Integration</b>	<b>Free of Major Limitations</b>	<b>Overall Rank</b>
Collision Avoidance with Turning Buses	H	H	H	H	M	M	H
Collision Avoidance with Straight-Line Travel	H	M	H	M	M	H	H
Bike Rack-on-Buses Safety	H	M	H	M	M	H	H
Collision Avoidance with Fixed Objects and Hazards	H	H	H	H	H	M	H
Non-Transit-Initiated Collision Avoidance	M	H	M	M	L	L	M
Partial/Full Transit Automation	L	H	L	M	L	L	L

H – High; M – Medium; L – Low.  
Source: TTI.

The research team examined the technologies and approaches that could be used with the collision avoidance with turning buses candidate application. Table 13 presents three different approaches that could be used with this application. The first approach would deliver a warning at all times when a bus is turning. The second approach would deliver a warning only when bicycles and pedestrians are present. The third approach would connect and warn all user groups. This information was used in developing the ConOps plan presented in Chapter 6.

**Table 13. Collision Avoidance with Turning Buses Applications.**

<b>Attribute</b>	<b>“Unintelligent” Warning</b>	<b>Presence-Specific Warning</b>	<b>Connected Users</b>
Method of Activation	Turn Signal or Tire Rotation	“Passive” Sensors, Activate Only When Voice Response Units (VRUs) Present	“Active” Communication Between Transit and VRUs (DSRC or WiFi)
Warning Recipient	Transit Operator, VRU	Transit Operator, VRU	Transit Operator, VRU
Type of Warning	Auditory, Visual	Auditory, Visual	Auditory, Visual, Haptic
Technology Location	Transit Vehicle	Transit Vehicle	Transit Vehicle, VRU
Advantages	Existing Technologies	1) Presence-Specific 2) Turns and Straight-Line Travel	Very Reliable, Customizable VRU Detection and Warning
Disadvantages	1) Warnings Everywhere 2) Only on Turns	Still Maturing Technologies	1) Requires VRU to have Technology 2) Uncertain Deployment Timeframe

Source: TTI.





## CHAPTER 6: CONCEPT OF OPERATIONS PLAN

### PURPOSE OF CONCEPT OF OPERATIONS PLAN

This chapter presents the ConOps Plan for the AV/CV Test Bed to Improve Transit, Bicycle, and Pedestrian Safety. As illustrated in Figure 14, the plan presents the overarching vision and goals for the test bed and the test bed locations and functions. It describes the goals, objectives, and operational scenarios for the near-term candidate applications focusing on warning-based systems for bus drivers, bicyclists, and pedestrians. The candidate applications address smart buses, smart intersections, smart bicycles, smart pedestrians, and smart bike racks. The ConOps Plan also includes an assessment and evaluation component and an implementation plan.

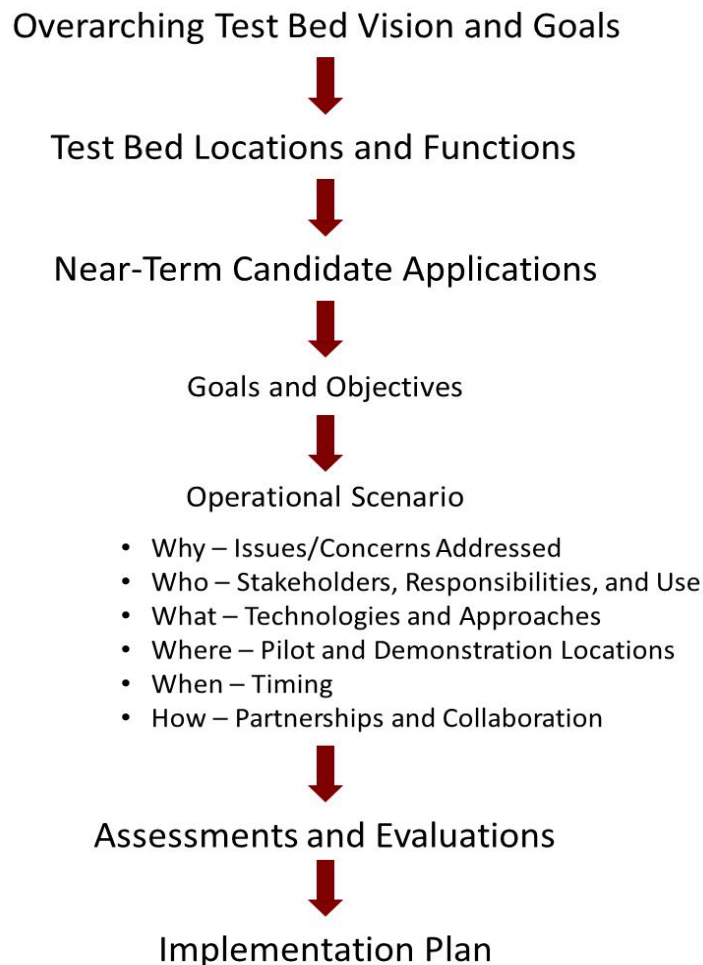

Source: TTI.

**Figure 14. ConOps Plan Overview.**

The ConOps Plan provides the foundation for the development of the AV/CV Test Bed to Improve Transit, Bicycle, and Pedestrian Safety. The plan is a high-level resource for the

development of engineering requirements for the near-term candidate applications. It is an early and important step in the engineering process. The plan will be used by TxDOT, TTI researchers, and public and private sector partners in designing, developing, testing, piloting, and demonstrating the near-term candidate applications.

The ConOps Plan describes the basic why, who, what, where, when, and how for each of the six candidate applications. The why is presented first as it defines the issues being addressed and the goals and objectives of the candidate applications:

- Why – highlights the issues the application will address and includes the goals and objectives for the application.
- Who – describes the roles and responsibilities of the stakeholders.
- What – outlines the system components and high-level system architecture.
- Where – identifies the location of design and testing activities, pilots, and demonstrations.
- When – presents the general timing of activities.
- How – identifies possible partners and collaboration opportunities.

## **TEST BED VISION, GOALS, AND CANDIDATE APPLICATIONS**

This section presents the overarching vision and goals for the AV/CV Test Bed to Improve Transit, Bicycle, and Pedestrian Safety. The near-term, mid-term, and long-term candidate applications are also highlighted. The near-term candidate applications—smart buses, smart intersections, smart bicycles, smart pedestrians, and smart bike racks—focus on a warning-based system for bus drivers, bicyclists, and pedestrians. The mid-term candidate applications center on an automated vehicle response to warnings. Autonomous transit vehicles represent the long-term application. The mid-term and long-term candidate applications are provided as examples of future test bed research and deployment.

### **Overarching Test Bed Vision and Goals**

The overarching vision is to establish a test bed to research, develop, test, pilot, and deploy AV/CV technologies to improve transit, bicyclist, and pedestrian safety. The test bed consists of several facilities in different operating environments, including the Texas A&M University System (TAMUS) Riverside Campus, the TAMU campus, and transit systems in rural, small urban, and large metropolitan areas throughout the state. The vision will be realized with the participation of TxDOT, TTI, TAMU, and numerous public and private sector partners:

- Overarching Goal 1 – Reduce crashes involving transit vehicles, bicyclists, and pedestrians.
- Overarching Goal 2 – Leverage public and private resources to conduct the test bed activities.
- Overarching Goal 3 – Provide objective and unbiased assessments of technologies and techniques.
- Overarching Goal 4 – Provide transferable lessons learned to other prospective deployers in Texas and the nation.

### **Near-Term Candidate Applications**

The near-term candidate applications focus on collision avoidance with straight running and turning buses, bicyclists, and pedestrians using warning-based applications. The smart buses, smart intersections, smart bicycles, smart pedestrians, and smart bike racks use different approaches to reducing crashes. The applications focus on different user groups and transit operator responsibilities. The applications should not be considered mutually exclusive. Working together, multiple applications could greatly improve transit, bicyclist, and pedestrian safety in different environments and settings.

- **Candidate Application 1 – Smart Buses: Vehicle-Based Collision-Warning System.** The first candidate application focuses on avoiding crashes involving buses, bicyclists, and pedestrians through the use of collision-warning systems on buses. These warning systems may use cameras, sensors, and other technologies to detect bicyclists and pedestrians close to transit vehicles and alert the bus driver of their presence.
- **Candidate Application 2 – Smart Buses: Collision Avoidance with Fixed Objects and Hazards.** The second candidate application addresses reducing bus collisions with fixed objects and hazards through the use of cameras, sensors, infrared, radar, light detection and ranging (Lidar), dedicated short-range communication (DSRC), and other technologies to detect fixed objects and hazards in the path of a transit vehicle and alert the driver of their presence.
- **Candidate Application 3 – Smart Intersections: Collision Avoidance with Intersection-Based Warning Systems.** The third candidate application focuses on avoiding crashes involving buses, bicyclists, and pedestrians at signalized intersections through the use of on-vehicle technologies automatically communicating with visual and/or audible technologies at the signal. This application may use cameras, sensors, infrared, DSRC, and other technologies to communicate the presence of a turning bus to the traffic signal and activate a visual or audio warning to bicyclists and pedestrians.
- **Candidate Application 4 – Smart Bicycles: Sensors on Bicycles.** The fourth candidate application focuses on providing warnings to bicyclists about vehicles, including buses,

in close proximity and imminent bicycle-vehicle crashes. Bicycles would be equipped with sensors and other technologies to detect vehicles in the path of the bicycle or approaching the bicycle. Collision-prediction algorithms will be developed and included in the bicycle technology to warn bicyclists through tactile or haptic feedback means in the seat and handle bars and/or through sounds. The sounds could also be used to alert the driver of the approaching vehicle.

- **Candidate Application 5 – Smart Pedestrians: Smartphone Applications (Apps).**  
The fifth candidate application uses a smartphone app to warn pedestrians of approaching buses and other vehicles. Path prediction algorithms will be developed and used to warn pedestrians of approaching buses.
- **Candidate Application 6 – Smart Bike Rack: Automated Alerts for Bus Operators.**  
The sixth candidate application addresses improving the safe operation of bike racks on buses. Technologies and techniques focus on enhancing the safety of bicyclists using front-mounted bike racks. Possible technologies and approaches include sensors, cameras, infrared, and networked wireless communication devices on buses and bicycles.

### **Mid-Term Candidate Applications**

The mid-term candidate applications build on the near-term vehicle-based collision-warning systems by adding automated vehicle braking on transit buses. These applications will take advantage of automated collision-avoidance/braking systems currently available in some personal vehicles. Other systems combine the object detection system with the lane departure warning to cause the vehicle to actively resist moving out of the lane or help direct the vehicle back into the lane to avoid a crash through light braking or minor steering adjustments.

### **Long-Term Candidate Applications**

The long-term candidate application focuses on a longer term view of eliminating bus, bicycle, and pedestrian crashes through the deployment of autonomous transit vehicles. This application will leverage the full range of trusted communication technologies among vehicles, infrastructure, and travelers that are reflected in V2V, V2I, V2P, and vehicle to everything applications. It will build on the current pilots and tests of autonomous transit vehicles underway in Europe, China, and the United States.

## TEST BEDS

The AV/CV Test Bed to Improve Transit, Bicycle, and Pedestrian Safety consists of several facilities in different operating environments, including the TAMUS Riverside Campus, the TAMU campus, and transit systems in rural, small urban, and metropolitan areas throughout the state. This section summarizes the characteristics and anticipated use of these test beds.

Figure 15 illustrates the anticipated functions of the different test beds. Research, experimentation, and preliminary testing will occur at the TAMUS Riverside Campus. Demonstrations, pilots, and field tests will occur on the TAMU campus. Large-scale demonstrations, deployment, and integration with other transit and transportation systems will occur at transit agencies throughout the state. Assessments and evaluations will accompany the activities at each test bed.

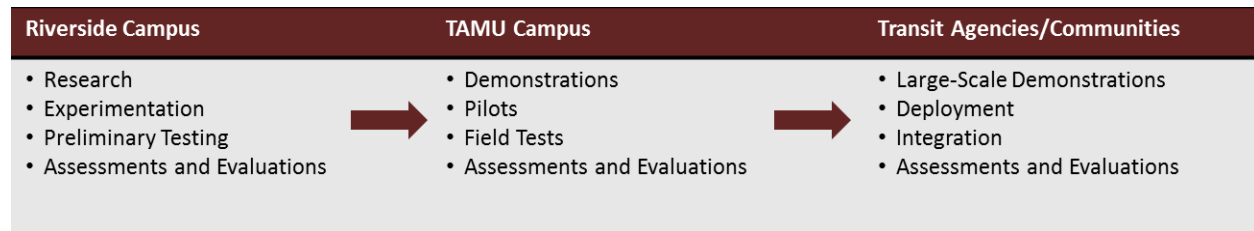

Source: TTI.

**Figure 15. Test Bed Functions.**

### Riverside Campus Test Bed

The TAMUS Riverside Campus is a 2,000-acre facility, located approximately 15 miles from the TAMU campus. As illustrated in Figure 16, the former U.S. Air Force Base includes four inactive runways, one active runway, and a large out-of-service concrete apron. This facility has low- and high-speed testing capacity and can serve multiple testing purposes simultaneously. In addition, the Riverside Campus has numerous paved secondary roads positioned in a grid-type arrangement, which could be used for further testing of candidate applications.

The Riverside Campus is currently used simultaneously by multiple divisions within TTI and by other TAMUS organizations. For example, the TTI Roadside Safety and Physical Security Division uses portions of the Riverside facility for low- and high-speed full-scale roadside safety and physical security crash tests. With an average of 60 to 100 full-scale crash tests each year, multiple test installations are under construction at any given time. Human factors and safety studies are also conducted at the Riverside Campus. The runways are used for studies to examine driver performance in response to vehicle-based or infrastructure-based technologies.



(a) Aerial View



(b) Map

Source: TTI and TAMU.

**Figure 16. TAMUS Riverside Campus.**

The Riverside Campus Test Bed will be used for research, experimentation, and preliminary testing of the potential technologies and approaches for the candidate transit, bicyclist, and pedestrian applications. For example, design, prototyping, and testing of the Smart Bicycle application will occur at the Riverside Campus. Figure 17 illustrates related research conducted at Riverside using cardboard pedestrians. The research was part of a closed-course study sponsored by FHWA examining the use of rectangular rapid-flashing beacons. The ability of drivers to see the cardboard pedestrians depending on the brightness, flash patterns, and location of LEDs on the signs was tested.



Source: TTI.

**Figure 17. Cardboard Pedestrians Used in Research at the Riverside Campus.**

### **TAMU Campus**

The TAMU campus in College Station is the second test bed for improving transit, bicyclist, and pedestrian safety. Figure 18 shows the major buildings, streets, and landmarks on the TAMU campus. The main area of the campus is approximately 800 acres. The larger extended campus includes Easterwood Airport and additional veterinary and agricultural areas.

The TAMU campus Test Bed will be used for pilots, demonstrations, and field testing. The pilot of the Mobileye Shield+™ collision-avoidance system described later in this chapter provides an example of the use of the TAMU campus Test Bed. Assessments and evaluations will be conducted on these pilots, demonstrations, and field tests, in coordination with TAMU.

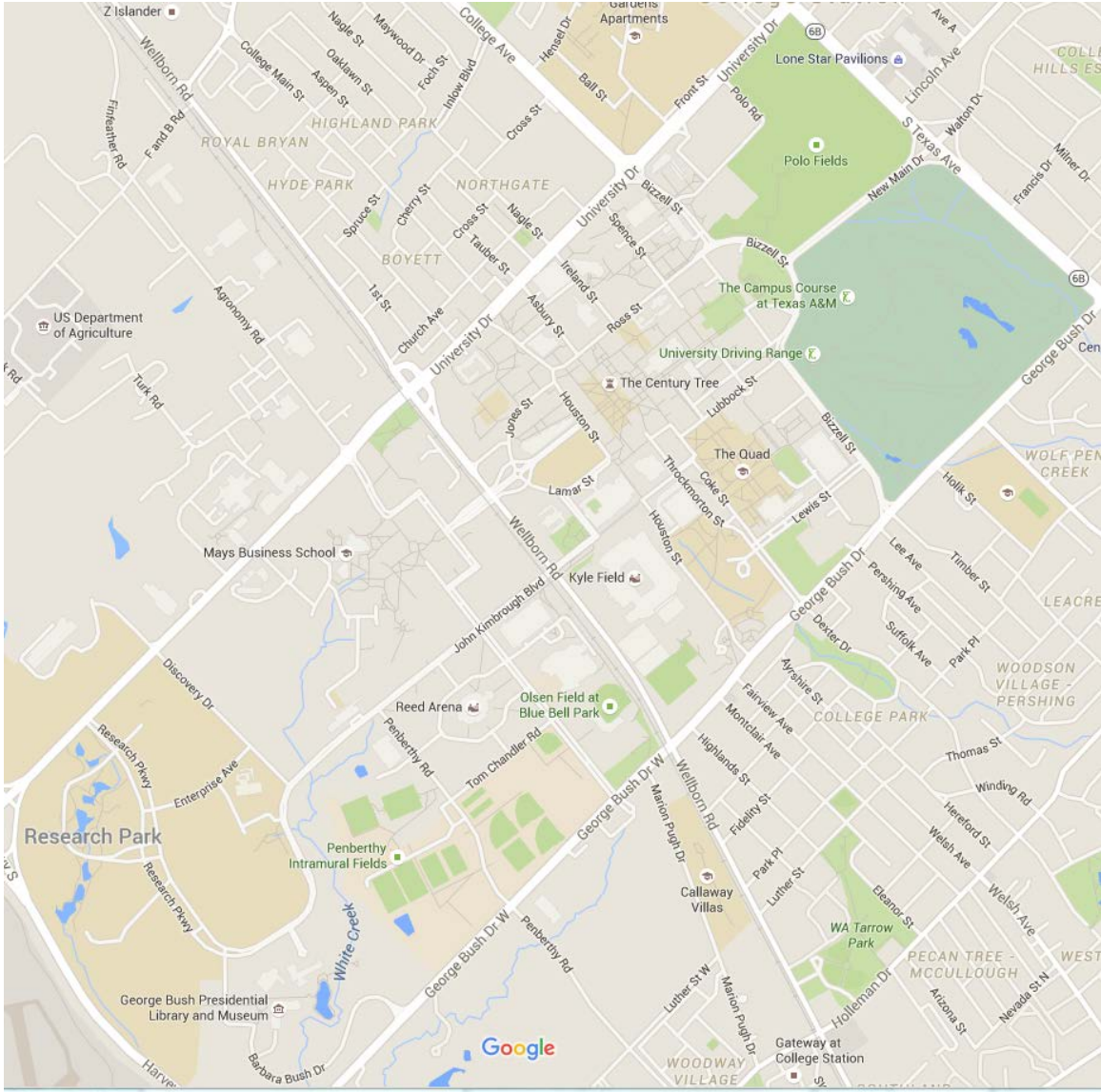

Source: Google.

**Figure 18. TAMU Campus.**

**Transit Agency and Community Test Beds**

Transit agencies in rural, small urban, and metropolitan areas throughout the state represent the third type of test bed. As illustrated in Figure 19, there are 75 public transit systems in Texas—8 metropolitan transit authorities serving the large urban areas of the state, 30 transit districts in smaller cities, and 37 rural transit districts. Representatives from some of these transit systems have been actively involved in the AV/CV Test Bed to Improve Transit, Bicycle, and Pedestrian Safety project and have expressed interest in participating in future activities.

The transit agency and community test beds will focus on large-scale demonstrations, deployment, and integration with other transit system elements. Assessments and evaluations



will be conducted on these activities, which will be conducted in partnership with the transit agencies, communities, MPOs, and other groups.

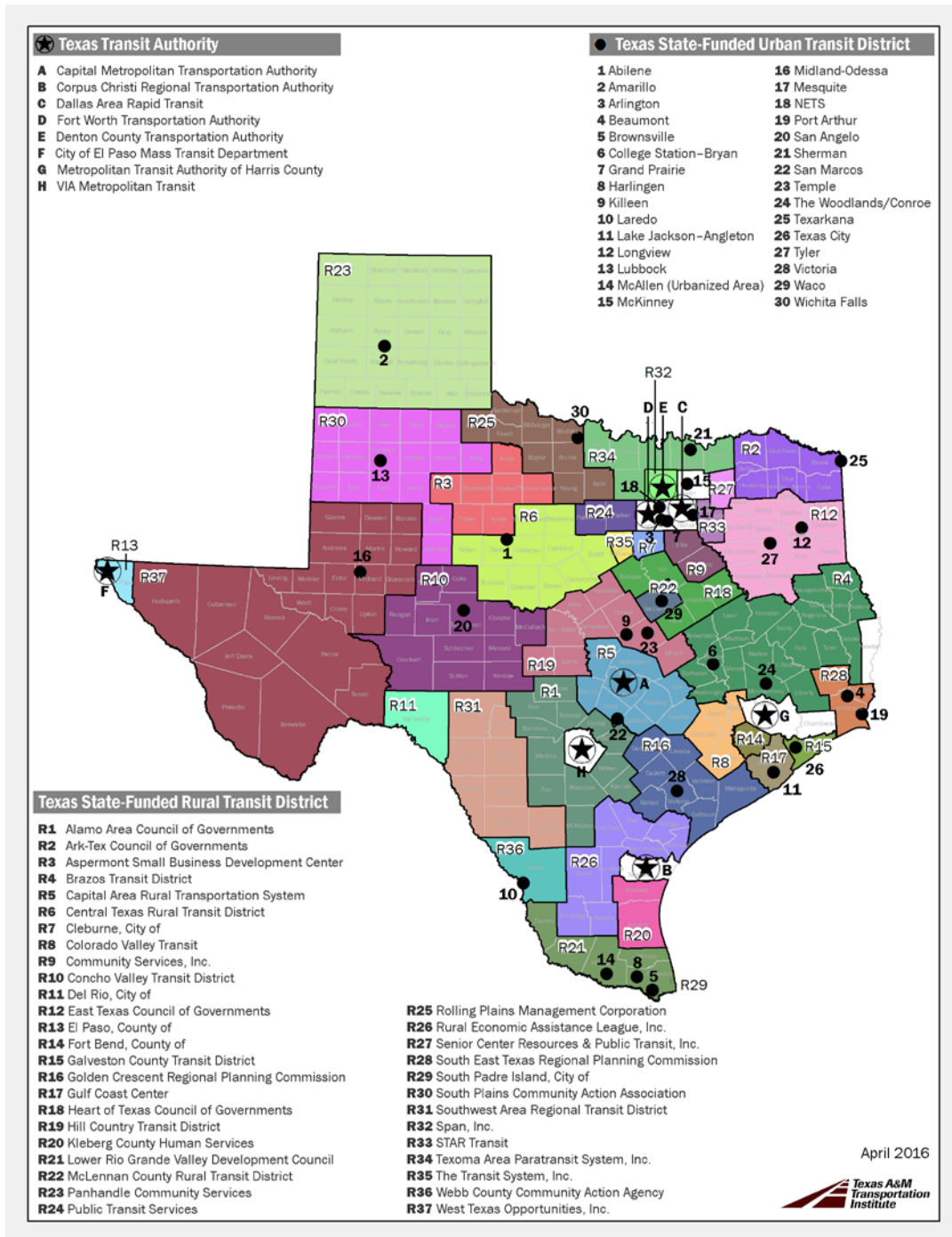

Source: TTI.

**Figure 19. Texas Public Transit Systems.**

## **NEAR-TERM CANDIDATE APPLICATION OPERATIONAL SCENARIOS**

### **Candidate Application 1 – Smart Buses: Vehicle-Based Collision-Warning System**

#### *Why*

The first candidate application focuses on avoiding crashes involving buses, bicyclists, and pedestrians through the use of collision-warning systems on buses. These warning systems may use cameras, sensors, and other technologies to detect bicyclists and pedestrians close to transit vehicles and alert the driver of their presence.

Following are the goals and objectives for this candidate application:

- Goal 1.1 – Reduce crashes involving transit vehicles, bicyclists, and pedestrians.
  - Objective 1.1.1 – Reduce the number of crashes.
  - Objective 1.1.2 – Reduce the severity of crashes and personal injury and property damage.
- Goal 1.2 – Develop cost-effective approaches that require minimum alterations to bus designs and use available technologies.
  - Objective 1.2.1 – Pilot test available vehicle-based collision-avoidance systems on the TAMU campus and with transit agencies throughout the state.
  - Objective 1.2.2 – Assess the use of different technologies from both a quantitative and qualitative standpoint.
  - Objective 1.2.3 – Identify enhancements to available technologies and systems based on the result of the pilot assessments and work with companies to implement these enhancements.

#### *Who*

Transit agencies operating fixed-route and paratransit services have the major responsibility with this application. The collision-avoidance technology is located on the transit vehicle, alerting the driver to pedestrians and bicyclists near the vehicle and possible collisions. The driver is responsible for taking action. The transit agency is also responsible for the ongoing maintenance and operation of the system. School districts operating bus services for students may also be interested in this application.

#### *What*

The bus-based collision-warning system uses cameras, sensors, and other technologies on the vehicle to detect bicyclists and pedestrians in close proximity to the bus. Warnings are provided

to the bus driver when bicyclists or pedestrians are within certain ranges. Commercially available bus-based collision-warning systems have recently been introduced on the market.

As part of this project, TTI was able to partner with TxDOT, TAMU Transportation Services, and the private firms, Mobileye and Rosco, to conduct a pilot of the Mobileye Shield+™ collision-warning system on one TAMU bus. The pilot was used to inform this ConOps Plan. The elements of the system are described here as an example of the technology that may be used in the candidate application. The Delta Mobile System’s AR20 Smart Sensor System, which Capital Metro in Austin is evaluating, represents another collision-warning technology.

The Mobileye/Rosco Shield+™ warning system was installed on TAMU bus #120. Figure 20 illustrates the location of the on-bus system elements. These components included the cameras/intelligent vision sensors, the front center master camera added for this pilot, and three pedestrian displays. The four cameras are mounted on the right and left side at the front and rear of the bus.

The multivision sensor system identifies a variety of potential dangers—vehicles, bicyclists, and pedestrians. It includes algorithms to track the distance and speeds of these objects, which are continuously measured to calculate the risk of a collision.

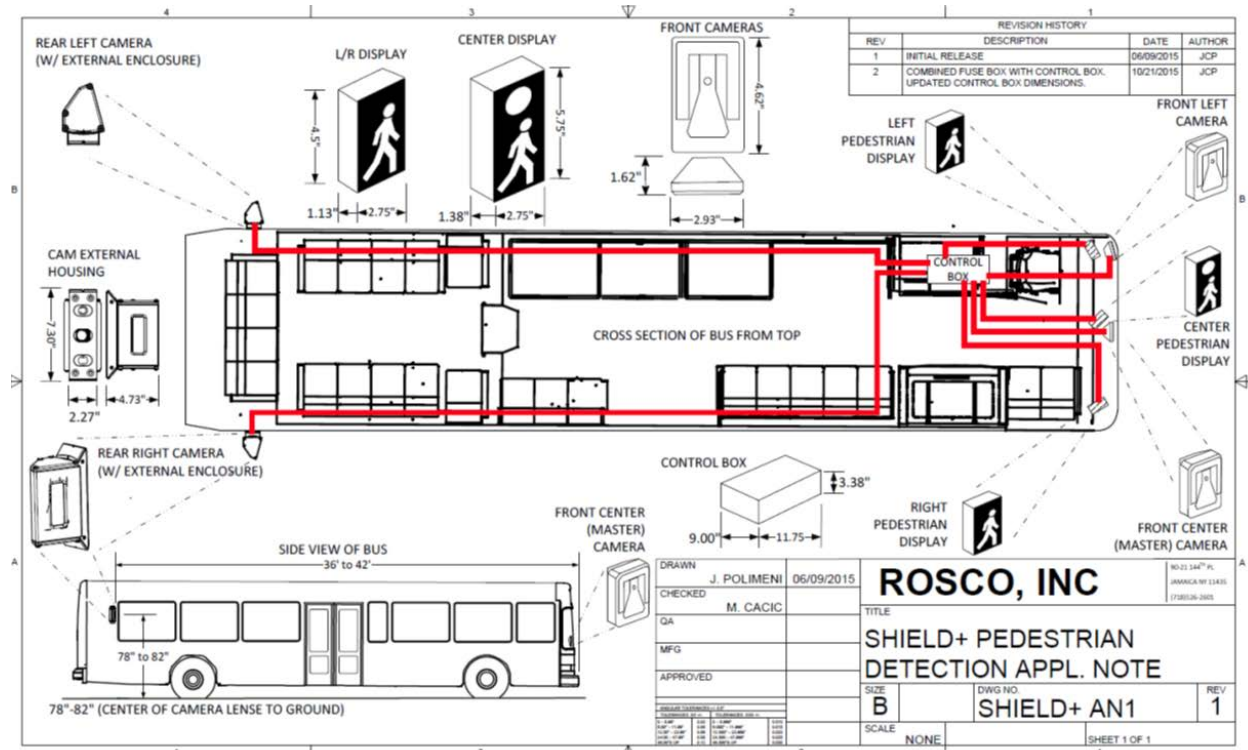

Source: Rosco, Inc.

**Figure 20. Mobileye Shield+ Design for TAMU Bus #120.**

As illustrated in Figure 21, the system includes displays located to the right, center, and left of the driver. The displays provide two types of warnings. A yellow light is illuminated when a bicyclist or pedestrian is detected near the right, center, or left of the bus. The yellow light indicates that the driver should exercise additional caution until confirming that the danger of a collision has passed. A flashing red light is illuminated with a beeping sound when a collision with a bicyclist or pedestrian is predicted, alerting the driver to stop in order to avoid a crash. The Mobileye/Rosco Shield+™ also includes additional “EyeWatch” features. These features include lane departure warning (LDW), speed limit indicator (SLI), headway monitoring (HM), headway monitoring warning (HMW), and FCW. All these features, except for the LDW, were included on the TAMU bus.

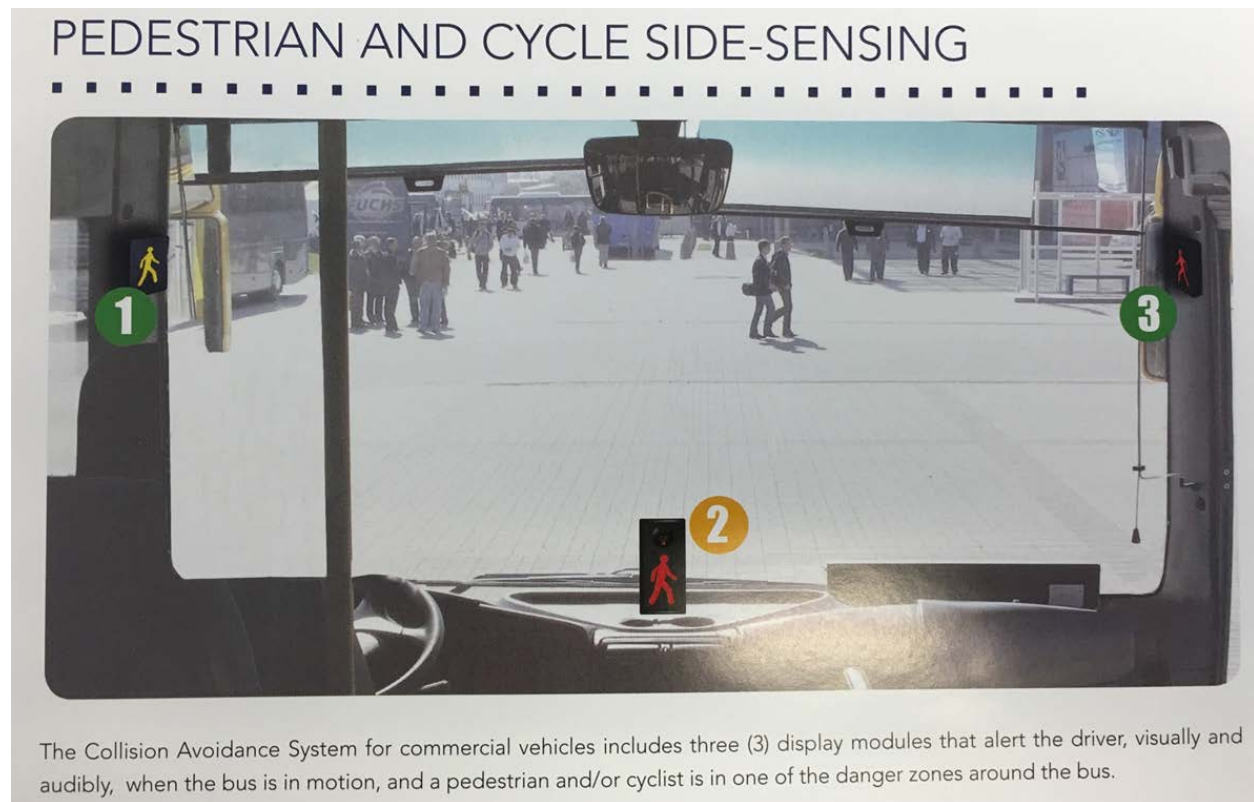

Source: Mobileye/Rosco.

**Figure 21. Example Placements of the Three Pedestrian Warning Indicators.**

*Where*

The Mobileye Shield+ system was installed on one TAMU bus that was assigned to the Bonfire Route, which is illustrated in Figure 22. The Bonfire Route traverses several crowded areas on the TAMU campus, including Joe Routt transitway by the Memorial Student Center, Lubbock Street/Commons area, and Ross Street shared bike and bus lanes, with buses routinely operating in close proximity to pedestrians and bicyclists. Bonfire Route also traverses University

Dr./Stotzer Parkway from Asbury to Olsen Blvd., which includes several high-traffic pedestrian crossings. The assessment conducted on the pilot is described later in this chapter.

Additional pilots of other technologies will be undertaken on the TAMU campus and with transit agencies in diverse operating environments. For example, evaluating a possible pilot of the AR20 Smart Sensor System will be explored in cooperation with Capital Metro in Austin.

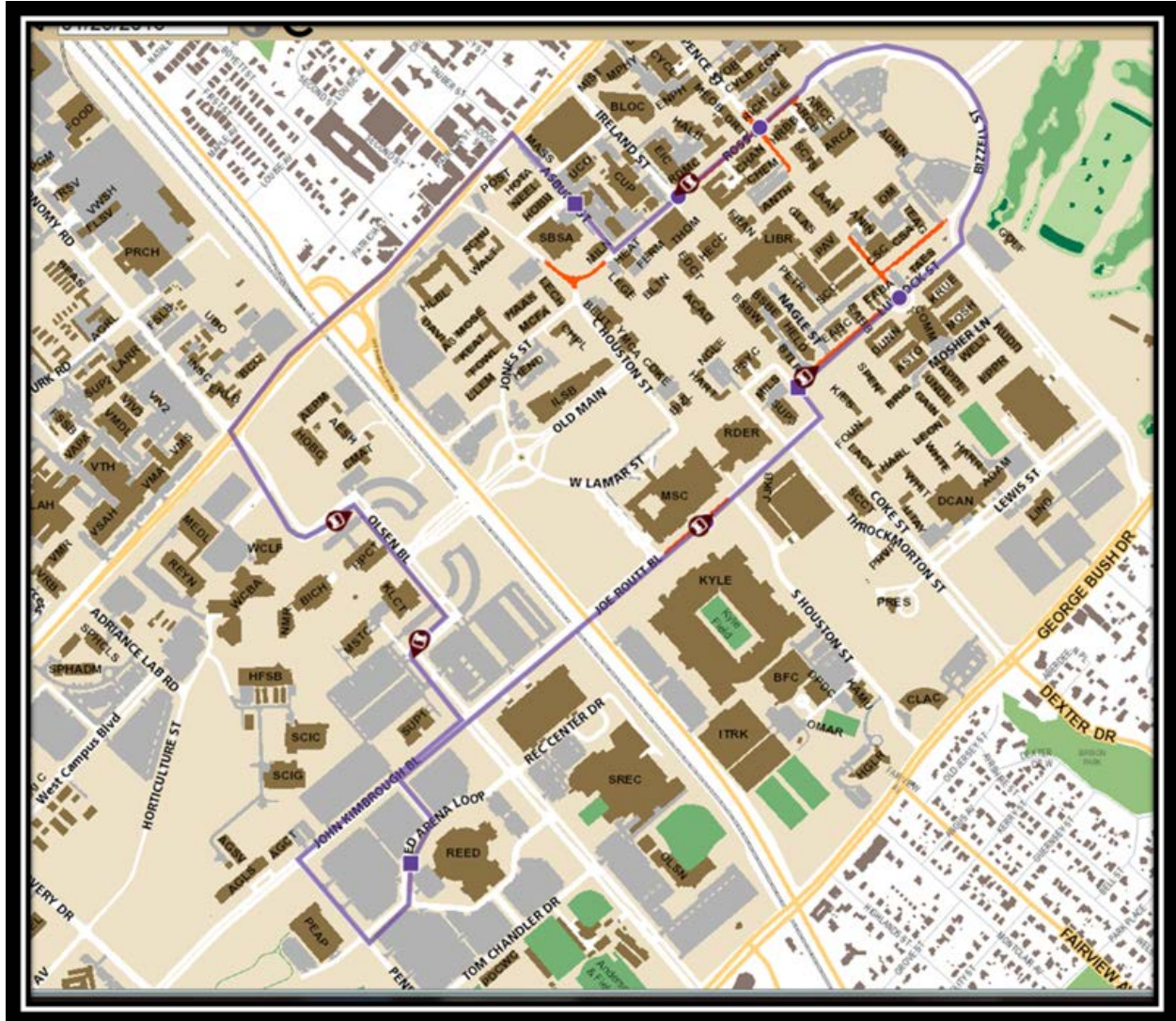

Source: TAMU.

**Figure 22. Map of the Bonfire Route on the TAMU Campus.**

*When*

An initial pilot and assessment of the Mobileye Shield+™ collision-avoidance system were conducted as part of developing this ConOps Plan. Additional pilots and assessments will be conducted during the first year of the test bed. It is anticipated that the AR20 Smart Sensor

System will be piloted on the TAMU campus and/or with Capital Metro in Austin. Other technologies will also be examined and tested.

### *How*

The ongoing piloting of vehicle-based collision-avoidance systems will be conducted in partnership with TxDOT, TTI, TAMU, transit agencies, and technology companies. These partnerships will build on the collaboration established with the Mobileye/Rosco pilot. School districts may also participate in the pilots.

## **Candidate Application 2 – Smart Buses: Collision Avoidance with Fixed Objects and Hazards**

### *Why*

The second candidate application addresses reducing bus collisions with fixed objects and hazards using cameras, sensors, infrared, radar, Lidar, DSRC, and other technologies to detect fixed objects and hazards in the path of a transit vehicle and alert the driver of their presence.

Transit vehicle collisions with fixed objects are a concern for many transit agencies in Texas. The property damage cost for collisions with fixed objects can be high. Buses collide with construction barriers, high curbs, awnings and overhead signs, utility poles, signs, trash cans, mailboxes, fire hydrants, and tree branches. Buses may stray out of the lane of travel and collide with parked cars or adjacent embankments. Collisions with fixed objects also occur with paratransit vehicles, which are typically small buses and vans, as drivers are required to maneuver in tight spaces and may be required to drive in reverse to position the vehicle before moving forward.

Following are the goals and objectives for this candidate application:

- Goal 2.1 – Reduce crashes involving transit vehicles and fixed objects and hazards.
  - Objective 2.1.1 – Reduce the number of crashes.
  - Objective 2.1.2 – Reduce the amount of property damage when a crash occurs.
- Goal 2.2 – Develop cost-effective approaches that require minimum alternatives to bus designs and use available technologies.
  - Objective 2.2.1 – Evaluate various types of sensors, such as cameras, radar, and Lidar to detect when a transit vehicle is getting too close to a fixed object.

- Objective 2.2.2 – Evaluate cameras and ultrasonic warning devices to reduce crashes when operating in reverse.
- Objective 2.2.3 – Evaluate night vision assist technologies to produce an enhanced view of the road ahead to reduce crashes with fixed objects that may be hard to detect at night.

*Who*

The application to address bus collisions with fixed objects and hazards will involve the transit agency operating fixed route and paratransit service. This application will build on lessons learned in the previous application for a bus-based collision-warning system to detect bicyclists and pedestrians in close proximity to the bus. School districts operating bus services for students may also be interested in this application.

*What*

Object detection systems use various types of cameras, ultrasonic, radar, and Lidar to detect when a transit vehicle is close to a fixed object and then warn the driver. Some systems brake automatically if the driver does not respond to the warning. Figure 23 illustrates the Delta Mobile Systems AR20 Smart Sensor Systems.

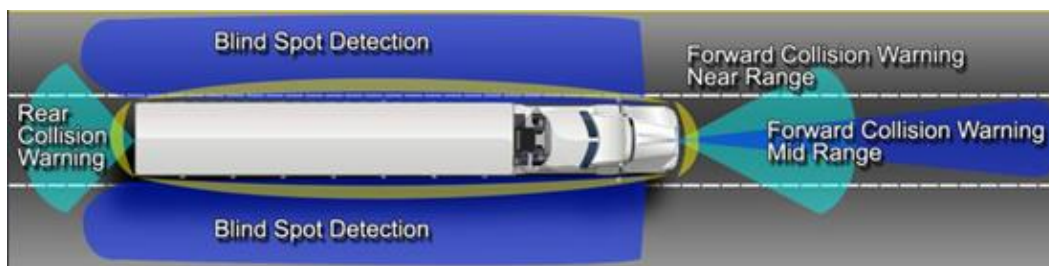

Source: Delta Mobile Systems.

**Figure 23. Delta Mobile Systems AR20 Smart Sensor System Detection Area.**

The following techniques will be considered for use in this application:

- Lidar technology uses light beams to detect nearby objects through a reflected signal. The system's detection range is generally 6–100 ft. Lidar performance is diminished by weather conditions, such as fog, however. Most systems issue a warning to the driver and precharge the brakes to maximize their effect if the driver brakes.
- Similar to Lidar, radar systems can detect objects to a range of approximately 500 ft and are not hampered by weather conditions. However, radar systems have a higher cost of implementation and may have poor detection abilities in the medium range of 100–200 ft.
- Ultrasonic-based systems emit high-frequency signals to a distance of 12 ft. The system can detect distinct echoes that can be used to calculate distance and relative speed.

Ultrasonic-based systems are similar to the back-up sensors available on personal automobiles and typically work in combination with cameras. These systems are relatively inexpensive to implement. Ultrasonic-based systems can detect objects with a solid, reflective surface and are not intended for use to detect pedestrians.

- Night vision assists use infrared imaging to produce an enhanced vision of the road ahead. Some systems provide an audible or visual alert if there is an object detected ahead.

These systems alert the driver if the vehicle is in danger of striking an object. Some systems use audible or visual warnings using DSRC, while other systems use haptic warnings such as steering wheel or seat vibration. The evaluation of different technologies will include testing which type of driver warning is more effective under what conditions. If the near-term vehicle based collision warning systems are effective, there are additional opportunities for mid-term candidate applications.

Some systems can cause the vehicle to brake automatically if the driver does not respond. An autobrake system may not always prevent a crash, but may reduce vehicle speed, reducing the severity of the crash. Some systems combine the object detecting system with the lane departure warning system to cause the vehicle to actively resist moving out of the lane or help direct the vehicle back into the lane (to avoid the crash with a fixed object) through light braking or minor steering adjustments.

#### *Where*

The initial system design, development, and prototyping will occur at the TAMUS Riverside Campus. A pilot will be conducted on the TAMU campus, with a larger demonstration project suggested for implementation in cooperation with Capital Metro in Austin.

#### *When*

The smart bus collision avoidance with fixed objects application will be initiated during the first year of the test bed. Building on the experience with the Mobileye Shield+™ pilot and available technologies, including the AR20, the design and prototyping will take six months. The pilot on the TAMU campus will then be initiated, with the pilot involving Capital Metro occurring in the second year.

#### *How*

The smart bus collision avoidance with fixed objects application will be designed, developed, and tested through a partnership with TxDOT, TTI, TAMU, one or more technology companies, and one or more public transit agencies in Texas. The Mobileye/Rosco Shield+™ warning system is a possible private sector partner, as TTI is currently working with them on other applications. Another possible technology is the AR20 Smart Sensor System by Delta Mobile



Systems, which uses radar-based sensing technology. The AR20 is being examined by Capital Metro for possible use.

### **Candidate Application 3 – Smart Intersections: Collision Avoidance with Intersection-Based Warning Systems**

#### *Why*

The third candidate application focuses on avoiding crashes involving buses, bicyclists, and pedestrians at signalized intersections through the use of smart buses automatically communicating with smart traffic signals to provide visual and audio warnings to bicyclists and pedestrians. Signalized intersections with high volumes of pedestrians and bicyclists crossing the street and buses making left and right hand turns are key targets for reducing crashes and improving safety.

Following are the goals and objectives for this candidate application:

- Goal 3.1 – Reduce crashes involving transit vehicles turning at intersections and bicyclists and pedestrians crossing the street.
  - Objective 3.1.1 – Design and develop a prototype smart intersection at the TAMUS Riverside Campus.
  - Objective 3.1.2 – Conduct a pilot of the smart intersection on the TAMU campus.
  - Objective 3.1.3 – Assess the pilot and make enhancements to the system as needed.
  - Objective 3.1.4 – Conduct a demonstration of the smart intersection in one urban area.
- Goals 3.2 – Develop a cost-effective smart intersection application that takes advantage of existing technologies and systems.
  - Objective 3.2.1 – Use existing traffic signal systems and communication technologies in developing the Smart Intersections application.
  - Objective 3.2.2 – Select the demonstration location based on interest and available supporting technologies.

#### *Who*

The Smart Intersections application involves the transit agency and the entity responsible for operating the traffic signal system, which is typically the city, county, or state transportation agency. Some transit and transportation agencies have signal priority systems in place, allowing a bus to receive special treatment at a signal by adjusting the Signal Phase and Timing, such as extending the green phase or shortening the red phase.

What

Figure 24 illustrates a simplified systems architecture for the Smart Intersections application.

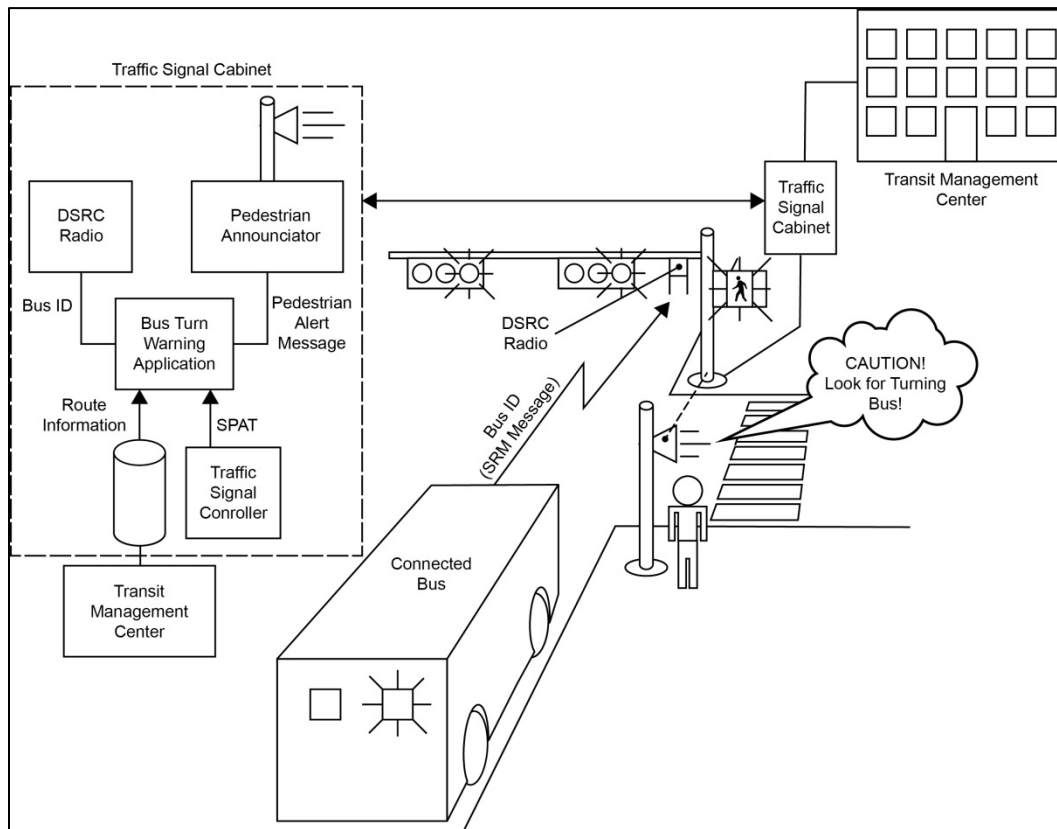

Source: TTI.

**Figure 24. High-Level System Architecture for Smart Intersections Application.**

The basic elements of the system are outlined in the following:

- The smart bus sends a Signal Request Message (SRM) via DSRC to the DSRC radio, which is connected to the traffic signal control cabinet. The traffic signal control cabinet is connected electronically to the transit management center.
- The bus identification (ID) is communicated to the traffic signal cabinet through the SRM, which is the SAE J 2735 DSRC message set for use by vehicles requesting priority service at a traffic signal.
- The traffic signal cabinet is linked electronically to the transit management center, which provides daily information on the buses assigned to specific routes. The system also contains route information including if the bus route (and the bus) turns right or left at the intersection.

- The system automatically compares the bus ID with the route information for the assigned bus. If the system determines that the approaching bus is turning left or right across an active pedestrian phase, a verbal and/or visual warning alert is broadcast. The verbal alert would be provided through a link to the Accessible Pedestrian Signal if available or an announcement system installed for the project. The verbal alert could be “Caution! Look for turning bus” or a related message. The visual warning could be accomplished by automatic communications with pedestrian lights or signing that meet the *Manual of Uniform Traffic Control Devices* requirements.

#### *Where*

The initial system design, development, and prototyping will occur at the TAMUS Riverside Campus. A pilot will be conducted on the TAMU campus. A larger demonstration project will be implemented in one of the urban areas of the state with existing bus and traffic signal technologies.

#### *When*

The Smart Intersections application will be initiated during the first year of the test bed. It is anticipated that the design and prototyping will take eight months, with a pilot on the TAMU campus occurring at the end of the first year. The assessment of the pilot will be conducted during the second year, with the demonstration also initiated during the second year.

#### *How*

The Smart Intersections candidate application will be designed, developed, and tested through a partnership with TxDOT, TTI, a signal system company, and TAMU. Econolite is a possible private sector partner, as TTI is currently working with them on other opportunities.

### **Candidate Application 4 – Smart Bicycles: Sensors on Bicycles**

#### *Why*

The fourth candidate application focuses on providing warning messages to bicyclists about close proximity or imminent crashes with other road users, including buses, other motorized vehicles, other bicyclists, and pedestrians. In this application, the bicyclist and/or the bicycle are equipped with sensors or other communications technologies capable of detecting the presence and travel path of other road users in their vicinity. Path prediction algorithms are used to estimate close proximity and imminent collisions with other road users, and warning messages are provided to the bicyclist through visual, audio, or haptic (i.e., vibratory) means. If these other road users have two-way communication capability, a similar warning message is sent from the bicyclist to the other road users about the bicyclist’s presence and path.

Following are the goals and objectives for this candidate application:

- Goal 4.1 – Reduce crashes involving bicyclists and other road users.
  - Objective 4.1.1 – Design and develop a prototype smart bicycle application at the TAMUS Riverside Campus.
  - Objective 4.1.2 – Conduct a pilot of the smart bicycle application on the TAMU campus.
  - Objective 4.1.3 – Assess the pilot and make adjustments to the system as needed.
  - Objective 4.1.4 – Use a variety of technology transfer methods to disseminate information on the smart bicycle application.
- Goal 4.2 – Develop a cost-effective smart bicycle application that takes advantage of existing technologies and systems.
  - Objective 4.2.1 – Explore opportunities with private companies providing needed components.
  - Objective 4.2.2 – Use available technology for the prototype.

#### *Who*

The primary user of this application is a bicyclist, who would benefit by having more information about other road users that are in close proximity or an imminent collision threat. Upon receiving a warning message, the bicyclist could then respond to avoid the conflict or collision threat.

If the bicyclist in this application has instantaneous communication with other road users, then these road users would also benefit by knowing the projected path of the bicyclist. For example, large trucks or buses could know the position and projected path of a bicyclist riding in their blind spot in an adjacent parallel bicycle lane. That is, the bicyclist could be broadcasting his/her position to any other road user who is capable of hearing the broadcast.

#### *What*

The core functional requirements for a smart bicycle are:

- Detect other road users in close proximity and determine their projected paths.
- Provide a warning message to the bicyclist.
- Provide the bicyclist's location and projected path to other road users.

The first functional requirement is the ability to detect other road users in close proximity and determine their projected path. This detection and path projection capability could be provided in at least two different ways:

- **Bicycle-Mounted Sensor(s)** – In this scenario, one or more sensors are mounted on the bicycle that can detect other road users in all other directions. Alternatively, the sensors could be mounted on the bicyclist, such as the helmet, to provide better line of sight for those sensors that may require it.
- **Communication Capability with Other Road Users** – In this scenario, other road users with a specialized communication capability are broadcasting their current location and projected path at all times. Similarly, bicyclists with similar communication capability can hear these other road users broadcasting their position and projected paths once they are within range of the broadcast. This is the basic concept envisioned in the USDOT’s Connected Vehicles Program, and there are DSRC technologies that exist and could be used to meet this functional requirement. The primary hurdle at this time is widespread deployment DSRC-capable equipment among consumer vehicles and other road users.

The second functional requirement is the ability to provide a warning message to the bicyclist about close proximity or imminent collision threat with other road users. The warning message can be provided in several ways (e.g., visual, auditory, haptic/vibratory) and through several different types of devices (e.g., smartphone, handlebar-mounted dashboard gauge, vibrating handlebar grips, seat, or pedals). Figure 25, Figure 26, and Figure 27 show several existing technologies for providing warning messages to bicyclists.



Source: (69).

**Figure 25. Possible Ways to Communicate Warning Messages to Bicyclists: Brabus E-bike with Bike Dashboard and Smartphone Mount.**



Source: (70).

**Figure 26. Possible Ways to Communicate Warning Messages to Bicyclists: SmartHalo Simplified Dashboard Paired with Smartphone.**



Source: (71).

**Figure 27. Possible Ways to Communicate Warning Messages to Bicyclists: COBI Integrated System for Connected Bicycles.**

The design of the warning message system should take into account that bicyclists are extreme multitaskers during most of their travel:

- Their bodies are balanced over two skinny rotating wheels.
- Their legs are typically in an up-and-down pedaling motion.

- Both of their arms and hands are needed for balance and steering control.
- Their eyes are scanning for possible collision threats in all directions, including backward glances for passing traffic, as well as downward for potholes and pavement seams that could severely disrupt their forward motion.

The third functional requirement is the ability to provide the bicyclist’s location and projected path to other road users. This capability could be used to assist these other road users in avoiding a conflict or imminent crash with the bicyclist. The most likely implementation of this requirement is to have the bicycle broadcast a signal that could be communicated and heard by other road users with similar communications capabilities (e.g., DSRC). The location and projected path of the bicyclist could be determined by bicycle-mounted sensors or by a smartphone carried by the bicyclist. Figure 28 provides an example of possible bicycle-mounted sensors.

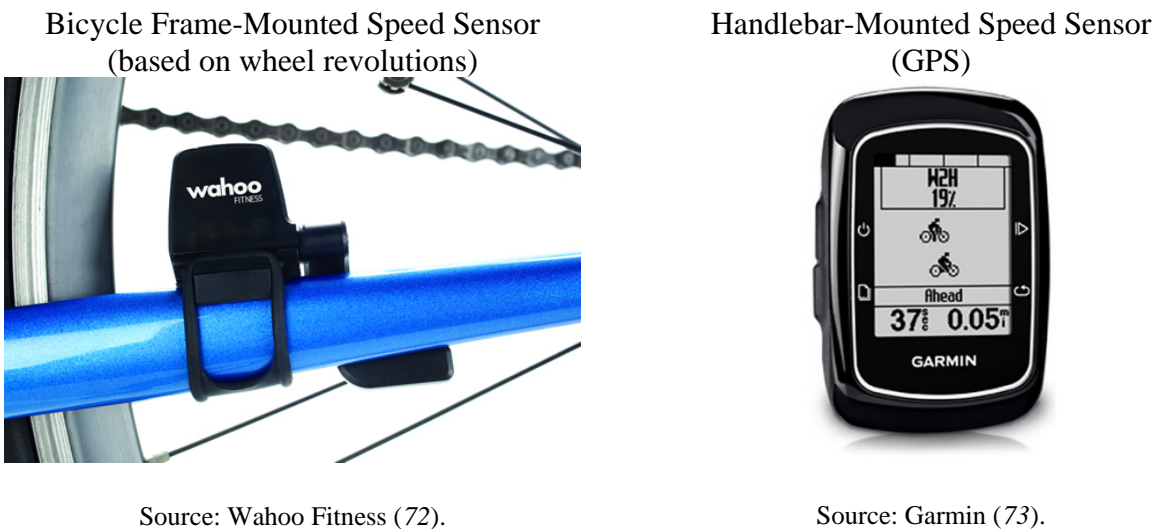
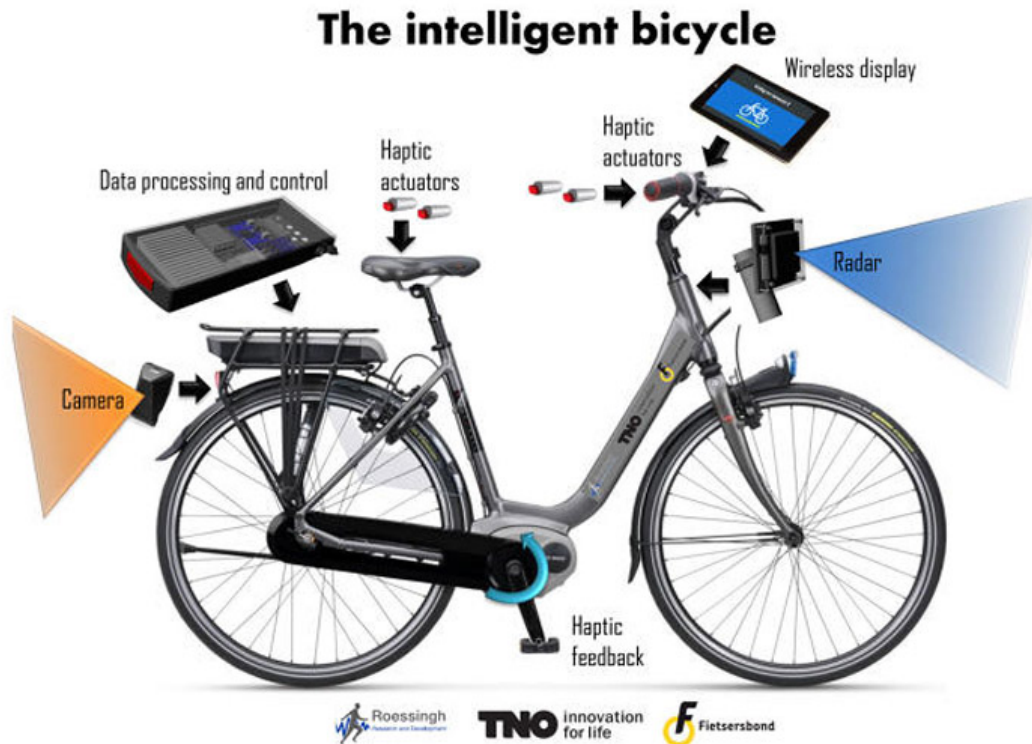

**Figure 28. Possible Ways to Determine Bicyclist Location and Projected Path.**

The creation of a smart bicycle requires the integration of several different technological elements to create a seamless user experience. There are several different technologies and applications that already exist, but they have yet to be assembled and distributed commercially.

In October 2015, the USDOT issued a request for proposals (RFP) in their Small Business Innovation Research Program for a *Connected Bicycle* that is capable of broadcasting a Basic Safety Message for Bicycles through DSRC. The RFP also indicated that the Connected Bicycle should interface with a bicycle-mounted sensor (capable of measuring bicycle location and speed) and a smartphone carried by a bicyclist. No awards under this RFP have been made public at this time. The design and development of a prototype smart bicycle will monitor the status of any awards under this program.

As illustrated in Figure 29, the Dutch research organization TNO (in English, Netherlands Organization for Applied Scientific Research) has developed a smart bicycle that includes radar-based sensors, a handlebar-mounted warning system, haptic handlebar grips and seat, and an on-board data processing unit. The smart bike prototype weighs about 55 pounds and is expected to cost between \$2,000 and \$4,000 (74).



Source: (70).

**Figure 29. TNO Smart Bike with Multiple Features.**

### *Where*

The smart bicycle should be capable of meeting these functional requirements in a wide range of operating environments: crowded city streets with fast-moving car, truck, and bus traffic and hundreds of nearby pedestrians; off-road shared use paths that are frequented by many types of non-motorized users, including users with various physical or visual disabilities, other inexperienced bicyclists, and even small children; and finally, for rural highways that are used by long-distance recreational cyclists.

Current information indicates that the majority of bicycle-involved crashes in urban areas tend to occur at intersections and driveways, where turning motor vehicle traffic conflicts with straight-ahead bicyclist travel. However, bicycle-involved crashes in rural areas tend to occur away from



intersections. Regardless of the location, though, smart bicycles must be capable of assessing imminent collision threats from all directions.

The initial design, development, and prototyping of the smart bicycle application will occur at the TAMUS Riverside Campus. A pilot will be conducted on the TAMU campus.

#### *When*

The smart bicycle application will be initiated during the first year of the test bed. It is anticipated that the design prototyping will take a year. The pilot on the TAMU campus will be conducted during the second year. The assessment of the pilot would also occur during the second year, with modifications made to the application based on the assessment.

#### *How*

The smart bicycle application will be designed, developed, and tested in partnership with one or more technology companies. The pilot will be conducted in cooperation with TAMU and bicycle organizations in the Bryan-College Station area.

### **Candidate Application 5 – Smart Pedestrians: Smartphone Applications (Apps)**

#### *Why*

The fifth candidate application focuses on providing warning messages to pedestrians about close proximity or imminent crashes with other road users, including buses and other motorized vehicles and bicyclists. In this application, pedestrians are equipped with sensors or other communications technologies capable of detecting the presence and travel paths of other road users in their vicinity. Path prediction algorithms are used to estimate close proximity and imminent collisions with other road users, and warning messages are provided to the pedestrian through a smartphone app or other available technology. If these other road users have two-way communication capability, a similar warning message is sent from the pedestrian to the other road users.

Following are the goals and objectives for the candidate application:

- Goal 5.1 – Reduce crashes involving pedestrians and other road users.
  - Objective 5.1.1 – Reduce the number of crashes involving pedestrians and buses.
  - Objective 5.1.2 – Reduce the severity of crashes involving pedestrians and buses.
- Goal 5.2 – Examine issues associated with a smartphone app and identify design features of a prototype app.

- Objective 5.2.1 – Conduct human factors research examining issues associated with alert frequency and type, pedestrian user limitations and distractions, and compatibility with user modes.
- Objective 5.2.2 – Identify design features of a prototype smart pedestrian smartphone app, using the Destination Aggieland app as a possible platform.

### *Who*

The primary user of this application is a pedestrian, who could benefit by having more information about other road users that are in close proximity or an imminent collision threat. Upon receiving a warning message, in some cases the pedestrian could quickly respond to avoid the conflict or collision threat.

If the pedestrian in this application has instantaneous communication with other road users, then these road users could greatly benefit by knowing the projected path of the pedestrian. For example, buses, other transit vehicles, and trucks could know the position and projected path of a pedestrian who is about to cross the road in a crosswalk or at an intersection. Operationally, the pedestrian could be broadcasting his/her position to any other road user who is capable of hearing the broadcast.

### *What*

The core functional requirements for a smart pedestrian app are:

- Detect other road users in close proximity and determine their projected paths.
- Provide a warning message to the pedestrian.
- Provide the pedestrian's location and projected path to other road users.

The first functional requirement is the ability to detect other road users in close proximity and determine their projected path. With pedestrians, the use of supplemental sensors and instrumentation is very limited. The most powerful sensor being carried by most pedestrians in 2016 is their smartphone. Therefore, the smart pedestrian app relies on pedestrians' smartphones to communicate with other road users about their positions and projected paths.

DSRC technology is currently viewed as the basis for this V2P communication. The University of Michigan is planning to test DSRC-equipped smartphones carried by pedestrians as part of their M-City initiative (75). In 2013, Honda and Qualcomm demonstrated a V2P smartphone app that relied on a DSRC- and GPS-enabled smartphone.

University of Missouri researchers have proposed other communications alternatives to DSRC. For example, the inventors of WiFi-Honk (76) have proposed using readily available WiFi on a

smartphone as an alternative to DSRC. Their proposed system could operate without requiring DSRC chips in all new smartphones.

The second functional requirement is the ability to provide a warning message to the pedestrian about close proximity or an imminent collision threat with other road users. The most logical means to provide this warning message is via the smartphone app. The type and nature of the message could vary depending upon the current use pattern of the phone. If the phone is currently active, then visual alert may be ideal. If the phone has been inactive and is perhaps stored in the user's pocket or carried bag, then an audible alert could be most effective. Human factors testing could also be used to help with message content. For example, should the expected direction or nature (e.g., car, bicyclist) of the threat be provided? Figure 30 shows simple smartphone alerts used in Honda's V2P demonstration project.

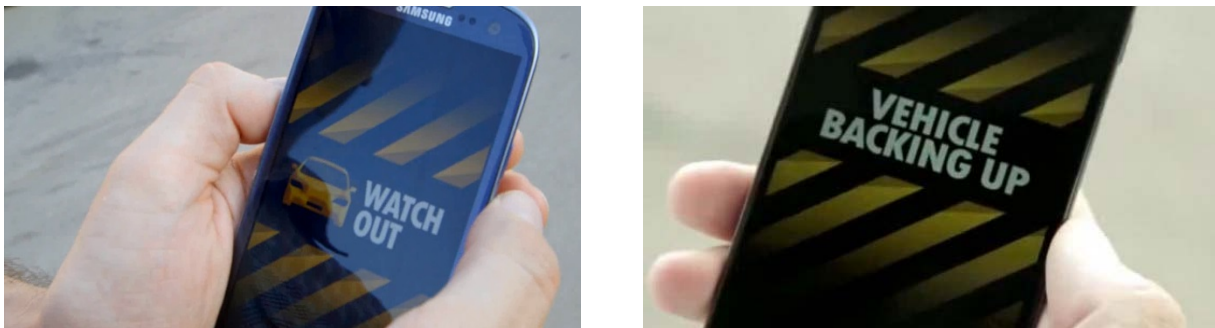

Source: Honda.

**Figure 30. Smartphone-Based Warning Messages Used in Honda's V2P Demonstration.**

The third functional requirement is the ability to provide the pedestrian's location and projected path to other road users. This capability could be used to assist these other road users in avoiding a conflict or imminent crash with the pedestrian. The most likely implementation of this requirement is to have the pedestrian broadcast a signal that could be communicated and heard by other road users with similar communications capabilities (e.g., DSRC). The location and projected path of the pedestrian could be determined by the smartphone app using GPS and inertial sensors on the smartphone.

#### *What*

The technical feasibility of a V2P smartphone app has been demonstrated by Honda and Qualcomm. In fact, this cooperative demonstration won a "Best of ITS" award from ITS America in June 2015. However, it is still unknown if/when smartphone manufacturers will include the DSRC radio in consumer smartphones and how quickly the consumer uptake could be for a premium feature such as this.

There are also numerous human factors questions that arise when considering a smartphone as the warning system for pedestrians. For example, what type of warning is provided for

pedestrians whose smartphone is not in their hands? Would a loud audible alert coming from a pedestrian's pants pocket or backpack be an appropriate warning for a threat that could be coming from any direction? Even if a threat warning is received by a pedestrian, does he/she have enough reaction and response time to move out of the path of a fast-moving motor vehicle? It could be that the greatest value of a pedestrian smartphone app is notifying other road users of that pedestrian's location and projected path.

An FHWA-funded study of V2P systems (77) had similar findings and questions:

- Several V2P smartphone apps have been developed in research and development, but no system is commercially available.
- Those V2P applications that require two-way, high-speed communication (i.e., DSRC) are likely to be the most effective, but also require significant market penetration to be effective.
- There are several human factors issues related to user interface that still require significant additional research. These include topics related to alert frequency and type, pedestrian user limitations, distraction, personalization, integration with existing systems, and compatibility between user modes.

#### *Where*

As with the smart bicycle candidate application, the smart pedestrian app should be capable of meeting the functional requirements in a wide range of operating environments. Pedestrians are not bound to fixed travel paths as with motor vehicles and are therefore capable of being nearly anywhere in or away from the roadway environment.

To illustrate the wide range of location scenarios, this pedestrian smartphone app may be useful on an unlit rural highway where no paved shoulder exists and the pedestrian either walks in the motor vehicle travel lane or just outside the travel lane on an unpaved shoulder. The smartphone app could also be used in busy, crowded parking lots by a pedestrian in a motorized wheelchair who has limited visibility around the parked cars. The smartphone app could also be used in shared space environments (e.g., pedestrian plaza or campus environment) where bicyclists and other non-motorized users are required to navigate blind corners or busy sidewalks.

The initial smart pedestrian human factors research will be conducted at the TAMUS Riverside Campus. It will focus on alert frequency and type, pedestrian limitations and distractions, integrating with existing systems, and capability between user methods. The basic elements of a possible smartphone app will be identified in partnership with TAMU Transportation Services as part of the Destination Aggieland app. Developing a prototype app would occur when the needed DSRC is readily available on smartphones or some other technology is in place.

### *When*

The smart pedestrian application will be initiated during the first year of the test bed. The human factors research will be undertaken first. Depending on the results, the basic elements of a prototype smartphone app will be developed in the second year.

### *How*

The smart pedestrian application human factors research and the identification of basic elements of a smartphone app will occur at the TAMUS Riverside Campus and at TTI research facilities on the TAMU campus. The examination of a smartphone app will be conducted in partnership with TAMU Transportation Services, using the existing Destination Aggieland app as a possible platform.

## **Candidate Application 6 – Smart Bike Rack: Automated Alerts for Bus Operators**

### *Why*

The sixth candidate application addresses improving the safe operation of front-mounted bike racks on buses. Many communities in Texas are pursuing integrating bicycles and transit to promote alternative modes of transportation, increase transit ridership, improve public health, and reduce traffic congestion. Improving the safety of riders loading and unloading bicycles is important for increasing use of multiple travel modes. Ensuring that bus drivers are able to safely operate buses with bike racks is also important.

Following are the goals and objectives for this candidate application:

- Goal 6.1 – Reduce the risk of accidents involving riders loading and unloading bicycles from front-mounted bike racks.
  - Objective 6.1.1 – Design and develop a smart bike rack prototype at the TAMUS Riverside Campus.
  - Objective 6.1.2 – Pilot the smart bike rack in one or two urban areas.
  - Objective 6.1.3 – Assess and evaluate the pilots and make enhancements to the system as needed.
  - Objective 6.1.4 – Use a variety of technology transfer methods to disseminate information on the smart bike rack.
- Goal 6.2 – Develop a cost-effective smart bike rack that takes advantage of existing technologies and systems.

- Objective 6.2.1 – Use existing technologies in designing and prototyping the smart bike rack.
- Objective 6.2.2 – Select pilots based on interest from local stakeholders, including transit agencies, bicycles groups, and private sector partners.

### *Who*

Transit agencies have the primary responsibility for the smart bike rack application. Transit systems will be responsible for implementing and maintaining the smart bike rack application on their buses. The participation of bus manufacturing and bike rack companies in the development and testing of the smart bike rack application will be pursued. The involvement of bicycle groups and bus riders who use bike racks is another key element of the pilot.

### *What*

Many transit agencies provide bicycle racks on the buses. Bike racks typically carry two or three bicycles on a first come, first served, basis. Figure 31 illustrates a bicycle rack that holds three bicycles. Safety issues may arise with the use of front-mounted bike racks in some situations. Bikes need to be loaded and unloaded quickly from the bus by bicyclists without causing delays to the bus. Racks can be folded up against the front of the bus when not in use. When bicyclists load their bikes, they pull the rack down so that it is parallel to the ground and secure the bike on the rack with a spring-loaded hook before boarding the bus. Figure 32 shows a bus rider deploying a front-mounted bike rack. Visibility of the rider loading and unloading a bicycle may be a concern for bus drivers. Additionally, if an empty rack is left down, the driver may not realize that he or she has limited front clearance.



Source: TTI.

**Figure 31. Bicycle Rack (Three-Bike Capacity) in Use by Capital Metropolitan Transportation Authority Buses in Austin, Texas.**



Source: TTI.

**Figure 32. Bus Rider Deploying Bike Rack in Austin, Texas.**

Racks holding three bicycles extend the bus overhang distance, increasing the swept area of the bus. The additional space may interfere with headlamps and turn signals on certain types of buses. Also, the three-bike racks provide less space between the closest bicycle and the bus, which may cause interference with the windshield wipers and visibility. To maximize the driver's vision, most transit agencies have policies concerning attachments on bicycles positioned on bike racks. For example, child seats and baskets, as well as items that may fly off or flap around, are typically not allowed.

To address these concerns, some transit agencies, including Santa Monica Big Blue Bus and Central Florida Regional Transportation Authority (LYNX), have installed bike rack deployed indicator lights on the dashboard that alerts the bus driver when the bike rack is down. Figure 33 illustrates the LYNX system. The indicator light is illuminated while the rack is in the down position. After the rack is returned to the upright position, the indicator lamp turns off. The light is on the panel at eye level in the figure. However, on the newer Gillig buses, the light is on the panel above the transit operator's head. Locating extra mirrors on the bus that allow the drivers to see the bike rack and riders loading and unloading bicycles are also in use by many transit systems.



Source: Douglas Robinson, LYNX.

**Figure 33. Bike Rack Deployed Indicator in a Gillig Bus.**

The candidate application builds on these existing systems through the use of sensors and cameras. One approach will develop and test the use of sensors retrofitted on existing bus bike racks. The system will include pressure sensors located in the wheel wells connected to a display visible to the driver. The display will be illuminated when a bicycle is present on the rack. A second approach will use a small camera focused on the bike rack in the driver's blind spot. The driver will be able to monitor the display from the camera at a bus stop to check for passengers using the bike rack. A third approach will use sensors on bicycles, which will be detected by readers on the bus, with an alert sent to the driver when a bike is being placed on a rack, stationary on a rack, or being removed from a rack. A final approach might include a link to bus riders smart fare card with a bicycle user chip.

#### *Where*

The initial smart bike rack system design, development, and prototyping will occur at the TAMUS Riverside Campus. A pilot will be conducted in partnership with a transit agency in the state and local bicycle groups, with Capital Metro in Austin and Sun Metro in El Paso as possible candidates.



### *When*

The smart bike rack application will be initiated during the first year of the test bed. It is anticipated that the design and prototyping will take eight months, with the pilot and assessment following into the second year.

### *How*

The design, testing, and piloting of the smart bike rack will be conducted in partnership with TxDOT, TTI, technology companies, transit agencies, and bus and bike rack manufacturing companies.

## **ASSESSMENTS AND EVALUATIONS**

Conducting assessments and evaluations of the candidate application tests, pilots, and demonstrations is an important component of the AV/CV Test Bed to Improve Transit, Bicycle, and Pedestrian Safety. These assessments will include both quantitative and qualitative components. The quantitative analysis will focus on the capabilities, accuracy, and functionality of the technologies and the applications. The qualitative analysis will focus on the users' and operators' perspective of the application.

As described previously, the Mobileye Shield+ collision avoidance system was installed on TAMU bus number 120 in December 2015. The Mobile Shield+ system installed on the TAMU bus also included the Mobileye EyeWatch SLI, HM, HMW, and FCW. Training was provided to TAMU bus drivers operating bus number 120 in January before the beginning of the spring semester. The bus began regular service on January 19, the first day of the spring semester.

### **Preliminary Assessment of Vehicle-Based Collision Warning System**

The preliminary assessment of the Mobileye Shield+ pilot provides an example of the scope and scale of the analysis that will be conducted as part of the test bed. The objectives for the assessment of Mobileye Shield + on the TAMU campus included:

- Evaluate the accuracy of the collision warning system to detect and report a near collision.
- Gather information from drivers to assess the value of the collision warning system.
- Identify limitations and possible enhancements for future assessment.
- Design appropriate evaluations of the vehicle-based collision warning system for a ConOps in Phase II.

The preliminary assessment of the Mobileye Shield+ system focused on a quantitative analysis of system accuracy in detecting pedestrians and bicyclists in close proximity to the bus and

qualitative feedback from bus drivers who were exposed to the system during the pilot test. The results of these preliminary assessments are presented in this chapter to help guide future test bed evaluations.

### **Quantitative Accuracy Assessment**

This part of the analysis examined the accuracy of the Mobileye Shield+ collision alerts as compared to actual on-the-street conditions. That is, for every time the Shield+ system issued a collision alert, was a pedestrian or bicyclist in close proximity to the bus such that a collision could possibly occur?

The primary measure for system accuracy is the false alarm rate, defined as:

$$\text{False Alarm Rate (\%)} = \left[ \frac{\text{Total number of "false alerts"}}{\text{Total number of alerts}} \right].$$

A *false alert* occurs when the Shield+ system provides a collision alert (which occurs when the time to collision between the bus and pedestrian/bicyclist is less than 1.5 seconds) and that condition has not been met. In the pilot test, it was not possible to calculate a time to collision with the video. As a result, a close proximity was defined to mean that the bus passes near a pedestrian or bicyclist where the trajectories could result in a collision. Video of the bus travel path was collected independently of the Shield+ system and was used to evaluate all Shield+ system alerts. These benchmark values from independently collected video was considered ground truth and was compared to the Shield+ system's event log from a telematics website report to determine when and if a false alert occurred.

As a part of this pilot, Mobileye, and its partner and systems integrator Rosco Vision Systems, provided TTI with access to a telematics website where data for specific events can be plotted on a map, as captured in Figure 34, and specific system event and alert data could be downloaded into a spreadsheet-based report with user-selected fields. Figure 35 shows an example of an available report. The sample report captures information at the time of alert: event time, heading, speed, warning type (Status Name), latitude, and longitude.

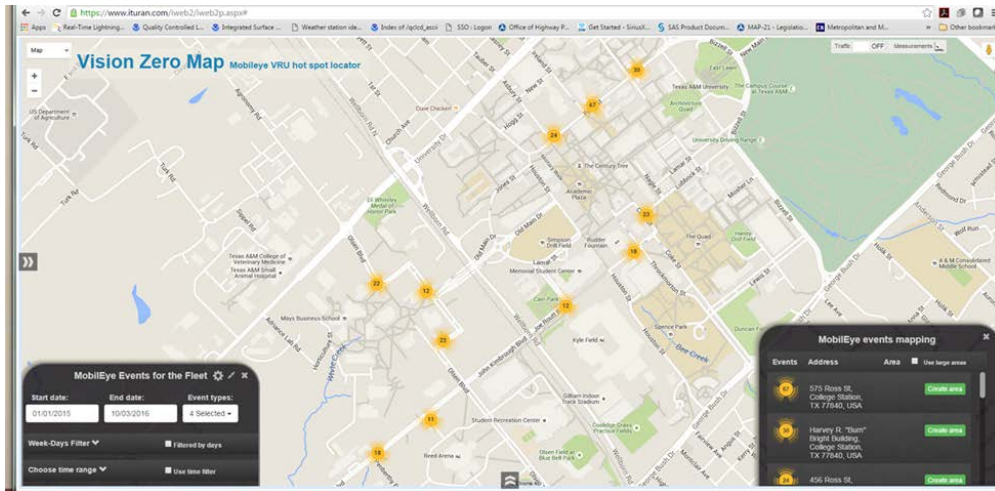

Source: TTI and Mobileye.

**Figure 34. Screen Capture of Mobileye Vision Zero Map with Hotspots.**

ITURAN

Show 41 records

Show 1 to 41 out of 41 records

**MessageReport**  
Customer : ROSCO USA  
User : Texas A M

Report Name : -  
Number of selected vehicles : 1 Information exists for 1 of 1 vehicles selected  
Time Period: 19/01/2016 00:00:00 - 29/02/2016 23:59:29  
Total Records : 41

Loc Time	Vehicle name	Heading	Distance in Miles	Mileage	Address	Speed	Status Name	Latitude	Longitude
19/01/2016 18:23:11	Texas A&M Bus #120	NE	81.23	109.42	Coke St, College Station, TX 77840, USA	7	PCW-RR	30.614336	-96.338731
19/01/2016 18:41:39	Texas A&M Bus #120	NW	84.02	112.21	730 Olsen Blvd, College Station, TX 77845, USA	9	PCW-LR	30.605405	-96.346835
20/01/2016 13:27:08	Texas A&M Bus #120	-	146.68	174.87	456 Ross St, College Station, TX 77840, USA	-	PCW-LR	30.617173	-96.342213
21/01/2016 08:44:57	Texas A&M Bus #120	N	215.74	243.93	400 Joe Rouff Blvd, College Station, TX 77840, USA	6	PCW-RR	30.613555	-96.338316
21/01/2016 10:57:31	Texas A&M Bus #120	SW	230.89	259.08	Asbury St, College Station, TX 77840, USA	5	PCW-RR	30.61692	-96.342406
21/01/2016 13:26:09	Texas A&M Bus #120	-	248.52	276.72	456 Ross St, College Station, TX 77840, USA	-	PCW-LR	30.61701	-96.342198
21/01/2016 14:46:31	Texas A&M Bus #120	N	258.09	286.28	Coke St, College Station, TX 77840, USA	4	PCW-LR	30.614191	-96.338723
25/01/2016 09:58:16	Texas A&M Bus #120	SW	323.79	351.98	456 Ross St, College Station, TX 77840, USA	4	PCW-LR	30.616993	-96.342236
25/01/2016 17:16:22	Texas A&M Bus #120	NE	375.64	403.84	Coke St, College Station, TX 77840, USA	7	PCW-RR	30.614161	-96.33845
26/01/2016 17:13:08	Texas A&M Bus #120	E	433.4	461.59	233 Houston St, College Station, TX 77840, USA	9	PCW-RR	30.6164	-96.343563
27/01/2016 10:16:47	Texas A&M Bus #120	N	485.62	513.82	Coke St, College Station, TX 77840, USA	5	PCW-LR	30.6142	-96.338651
27/01/2016 15:48:50	Texas A&M Bus #120	NE	524.37	552.57	Coke St, College Station, TX 77840, USA	4	PCW-RR	30.614241	-96.338651
01/02/2016 09:56:12	Texas A&M Bus #120	NW	688.44	716.63	Asbury St, College Station, TX 77840, USA	6	PCW-LR	30.616943	-96.342516
01/02/2016 12:16:45	Texas A&M Bus #120	E	705.02	733.21	Coke St, College Station, TX 77840, USA	5	PCW-LR	30.614293	-96.338663
02/02/2016 08:53:29	Texas A&M Bus #120	NW	779.36	807.55	Asbury St, College Station, TX 77840, USA	9	PCW-LR	30.617068	-96.34253
02/02/2016 11:55:33	Texas A&M Bus #120	NW	800.59	828.79	Asbury St, College Station, TX 77840, USA	6	PCW-LR	30.617038	-96.342401
02/02/2016 16:56:28	Texas A&M Bus #120	NW	835.74	863.94	Ross St, College Station, TX 77840, USA	7	PCW-LR	30.616826	-96.342535
03/02/2016 12:08:34	Texas A&M Bus #120	N	903.8	932	John Kimbrough Blvd, College Station, TX 77840, USA	7	PCW-RR	30.6072	-96.347496

Source: TTI and Mobileye.

**Figure 35. Screen Capture of Event Report from Rosco/Mobileye Telematics Website.**

When evaluating the Mobileye Shield+ system alerts, TTI researchers used the following two video recording systems:

- Rosco Dual-Vision XC system (Figure 36) – This system was temporarily installed for the pilot. The video cameras were mounted on the bus front windshield and recorded the forward-facing view out the bus windshield and the rear-facing view of the bus interior.
- Texas A&M Transportation Services (Figure 37) – This system is permanently installed and is the primary operating video system for TAMU Transportation Services. This system includes eight unique camera views.

The combination of these two video systems provided a full view of what was happening around the bus.



Source: TTI and Rosco/Mobileye.

**Figure 36. Screen Capture of Rosco/Mobileye Shield+ Video Player.**



Source: TTI and TAMU Transportation Services.

**Figure 37. Screen Capture of TAMU Transportation Services Video Player.**

The Mobileye Shield+ system accurately detected pedestrians and bicyclists in close proximity to the bus during the study period. The telematics website reports showed the bus accumulated 41 PCW incidents during the 27 days included in the assessment. The telematics website report provided a detailed record for the Left Rear (PCW-LR) and the Right Rear (PCW-RR) Sensor PCWs. The telematics website did not report data for two other possible collision warnings sensors, Forward (ME-PCW) and Left Forward (PCW-LF). While collision warnings were observed being generated from the Forward and Left Front sensors, these warnings were not included in the telematics website report. The assessment obtained useable and viewable video on 37 of the 41 events. Video review showed there was a pedestrian, bicyclist, or motorcyclist in proximity to the bus for each of the 37 warnings resulting in a 0 percent false alarm rate.

$$\text{False Alarm Rate (\%)} = \left[ \frac{\text{Total number of "false alerts"}}{\text{Total number of alerts}} \right] = \frac{0}{37} = 0\%$$

While the False Alarm Rate was 0 percent, there needed to be some context applied to the warnings and the inability for TTI to replicate a time to collision. Proximity was determined from the video using the best estimate of the minimum distance between the bus and the pedestrian or cyclist. Frequently the bus would be operating in routine conditions and a warning

would go off for a person walking on the sidewalk who happened to be on a trajectory that instantaneously intersected with the bus’s trajectory. In these 37 cases, there never appears to be an abrupt, reactive, or corrective type maneuver made by a driver as a result of the situation that caused the warning, indicating that the warnings were provided in an appropriate yellow, rather than the red zone. Table 14 shows a summary of the number of warnings by proximity.

**Table 14. Proximity of Bus and Pedestrian or Cyclist.**

Proximity	# of Warnings
0-5 Feet	10
5-10 Feet	14
10-15 Feet	8
15-20 Feet	2
<b>Grand Total</b>	<b>37</b>

Source: TTI.

While the warnings were dependent on the projected trajectory of the bus, the projected trajectory of the pedestrian, and the calculated time to collision, there were different ranges when the warning was activated depending on where and how quickly a person or cyclist was moving. Table 15 tabulates the relationship between left and right turns and the proximity of the reason for the warning along with which sensor, left rear (PCW-LR) or right rear (PCW-RR), that indicated the warning. As expected along this route, the pedestrians made up a majority of the collision warnings.

**Table 15. Bus Trajectory and Proximity of Pedestrian or Bicyclist.**

Proximity	Left Turn			Right Turn			Grand Total
	PCW-LR	PCW-RR	Total	PCW-LR	PCW-RR	Total	
<b>0-5 Feet</b>							
Bicycle	0	0	0	0	2	2	2
Pedestrian	1	0	1	1	6	7	8
<b>5-10 Feet</b>							
Bicycle	0	0	0	2	0	2	2
Motorcycle	1	0	1	0	0		1
Pedestrian	0	0	0	12	2	14	14
<b>10-15 Feet</b>							
Bicycle	0	0	0	2	1	3	3
Pedestrian	2	0	2	2	0	2	4
Skateboard	1	0	1	0	0	0	1
<b>15-20 Feet</b>							
Motorcycle	1	0	1	0	0	0	1
Pedestrian	0	0	0	1	0	1	1
<b>Grand Total</b>	<b>6</b>	<b>0</b>	<b>6</b>	<b>20</b>	<b>11</b>	<b>31</b>	<b>37</b>

Source: TTI.

A majority, 20 of 37, of the warnings were from the left rear sensor on right hand turns. Many of these warnings appear to be triggered during what would be considered routine turns where there are pedestrians walking on a narrow sidewalk near a building and the bus swings into the lane

nearest the pedestrians to complete the turn. In a similar manner, the rear right sensor on right hand turns would often pick up pedestrians walking on the sidewalk as the bus completed its right hand turn with the front approaching the curb as the bus rolled out straight ahead and continued on the route. Table 16 presents the roads where these warnings occur most frequently. Figure 38 displays the top three roadways on a map and reinforces the notion that most warnings occur in areas with heavy pedestrian traffic. As illustrated in Table 16 and Figure 38, the highest number of warnings was recorded on Coke Street, which is a heavily traveled pedestrian and bus route.

**Table 16. Roads Where Collision Warnings Occurred.**

Roadway	Left Turn			Right Turn			Grand Total
	PCW-LR	PCW-RR	Total	PCW-LR	PCW-RR	Total	
Coke Street	1	0	1	6	5	11	12
Asbury Street	0	0	0	7	1	8	8
Ross Street	0	0	0	5	1	6	6
Olsen Boulevard	2	0	2	2	0	2	4
University Drive	2	0	2	0	0	0	2
John Kimbrough Blvd	0	0	0	0	2	2	2
Houston Street	1	0	1	0	0	0	1
Joe Routt Blvd	0	0	0	0	1	1	1
Lubbock Street	0	0	0	0	1	1	1
<b>Grand Total</b>	<b>6</b>	<b>0</b>	<b>6</b>	<b>20</b>	<b>11</b>	<b>31</b>	<b>37</b>

Source: TTI.

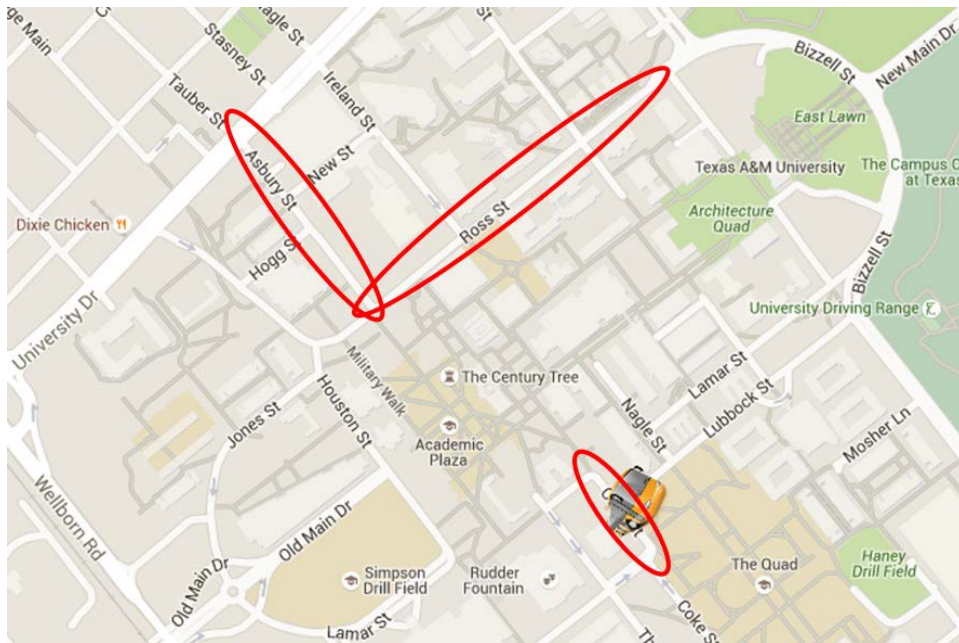

Source: TTI.

**Figure 38. Mapped Locations of Frequently Occurring Pedestrian Collision Warnings.**

During the pilot, the bus was typically in operation on the route from 7:00 a.m. to 8:00 p.m. Figure 39 shows that the distribution of events was fairly level throughout the daylight hours of

7:00 a.m. to 5:00 p.m. The Mobileye Shield+ system is not advertised to work in the dark; however, in well-lit areas the sensors may be able pick up pedestrians. This was not the case during the pilot as the latest recorded warning occurred was about 10 minutes before sunset, and the bus was on the route after sunrise so there were no warnings recorded pre-dawn.

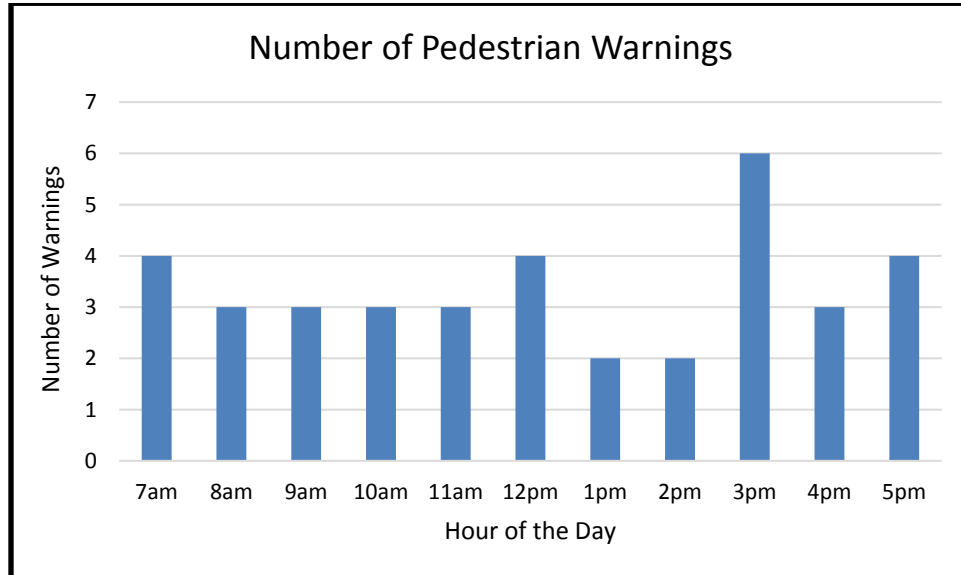

Source: TTI.

**Figure 39. Distribution of Warnings by Hour of the Day.**

As previously mentioned, the forward sensor PCWs were observed during the study period; however, precise time, date, and quantity information were not readily available from the telematics website report to allow video retrieval, and therefore, were not included as a part of the systematic video review portion of the study. The telematics data have been subsequently made available for these front sensor PCWs and will be studied in the future. A partial, randomly selected review of some forward facing video showed there was typically an individual in front of the bus or the geometry of the road allowed individuals to be detected who were on the sidewalk during a long left turn when the Forward PCW audio warning sounded. Subsequent to the study period, adjustments were made to the system algorithm to reduce sensitivity for individuals on the sidewalk even when facing them. A review of the system performance in the period after the study is being considered.

While not an assessment measure, the amount of yellow detection events that were displayed during the pilot was examined. Over the 27 days the bus operated, there were approximately 13,500 yellow detection events. Table 17 displays the frequency and sensor location on the bus that resulted in yellow detection lights.



**Table 17. Number of Yellow Detections by Location.**

<b>Sensor Location</b>	<b>Number of Detections</b>
Front	10,112
Front Left	4
Left Rear	1,131
Right Rear	2,273
<b>Total</b>	<b>13,520</b>

Source: TTI.

### **Qualitative Assessment**

To obtain qualitative feedback on the system, TTI researchers interviewed the TAMU bus drivers participating in the pilot from January 18 to February 29, a period of approximately six weeks. All drivers operating the bus received training on use of the system. The interview questions, provided in Figure 40, focused on the drivers' opinions about the effectiveness of the Shield+ collision-warning system. The names of the bus drivers were not recorded during the interviews to ensure privacy and open and honest feedback.

### BUS DRIVER INTERVIEW QUESTIONS

1. Please rate your overall bus driving experience as either: High, Medium, or Low
2. How long have you been driving Texas A&M buses?
3. Prior to Texas A&M, did you have bus driving experience with other transit agencies?
4. If so, how long was this experience with other transit agencies?
5. Before this month, how often did you drive on the Bonfire Route? Very frequent (at least once a week)? Somewhat frequent (several times per month)? Or not that frequent (one or fewer times per month)?
6. Have you ever driven another vehicle that has a collision warning system like this bus? (some newer luxury car models have a pedestrian collision warning system)
7. What are your overall impressions of this collision warning system? (open-ended, more specific later)
8. Overall, how effective do you think the collision warning system is at identifying potential collisions in which pedestrians and bicyclists are in very close proximity to a moving bus?
9. In your opinion, were the warnings provided by this system accurate? That is, was there a possible collision when the visual warning was provided? Was there an imminent collision when the audible warning was provided?
10. In your opinion, was the system more likely to provide a warning when a warning was not warranted (i.e., false alarm), or was the system more likely to miss providing a warning when a collision was possible?
11. In your opinion, were the visual indicators on the warning system effective? Do you think they can be improved? If so, how could they be improved?
12. In your opinion, were the audible indicators on the warning system effective? Do you think they can be improved? If so, how could they be improved?
13. In your opinion, are there other improvements that could be made to the collision warning system? If so, please describe these improvements.
14. Is there anything else that you'd like to share with us regarding the effectiveness of this experimental collision warning system?

Source: TTI.

### Figure 40. Interview Questions for TAMU Bus Drivers.

TTI researchers interviewed nine TAMU bus drivers who had driven the bus equipped with the Shield+ warning system. The level of exposure varied among drivers based on their assigned work shifts, but all drivers had at least a few shifts driving the Shield+ pilot bus. All nine drivers were considered to have sufficient exposure to the Shield+ warning system to offer informed driver feedback.

The following general themes emerged from the driver interviews:

- Comments on the EyeWatch elements of the Shield+ system (the headway, speeding, and forward collision monitoring) were very positive and more numerous than expected. Drivers liked these functions, especially the headway feature.
  - “Very effective and helpful on University Drive with speed and time to collision.”
- The general opinion voiced by the drivers was that the system worked and was usually helpful; however, a few drivers questioned the value of the system when they could see everything the system was seeing.

- “Helpful.”
- “Audio indicators are effective... annoying, which is a good thing.”
- “Overall not worth it, after a few days I started to ignore it.”
- “It works...in front it never warned me of something I hadn’t already seen. In back, it helped bring an awareness to what was going on.”
- “I really liked it, helped with being a more consistent driver.”
- Drivers indicated that a system like this is most needed at nighttime, when human vision is much more challenged in low light.
  - “It would be great if it worked at night or in low light.”
- Drivers noted that the system was more likely to detect a pedestrian than miss the detection.
  - “Went off when it should.”
  - “It didn’t miss anyone.”
- Drivers voiced mixed opinions on whether or not alerts would give enough time for driver to react.
  - “Effective, however it may catch things a little late.”
  - “Pedestrian display seemed a little delayed, driver saw something and then it would display.”
  - “Warned with time to react.”
- Nearly all the drivers mentioned Ross Street and the Trigon/Main Campus stops as areas where they got the most pedestrian indications.

### **Summary of Findings Based on the Preliminary Assessment**

The preliminary assessment of the Mobileye Shield+ found the vehicle-based collision-warning system accurately detected pedestrians and bicyclists in close proximity to the bus during the 27-day study period. The assessment obtained useable and viewable video on 37 of the 41 events. Video review showed there was a 0 percent false alarm rate. The general opinion voiced by the drivers was that the system worked and was usually helpful. Drivers voiced mixed opinion on whether or not alerts would give enough time for driver to react. Drivers also stated the need for a similar system that would work at night.

The preliminary assessment of the Mobileye Shield+ system informed the appropriate evaluations for vehicle-based collision warning systems for the ConOps Plan. Through a partnership with TxDOT, TAMU, one or more technology companies, and one or more public transit agencies in Texas, TTI researchers anticipate evaluating additional technologies and other

possible collision warnings, including technologies that will work at night. Additional pilots and assessments will be conducted during the first year of the ConOps Plan for the test bed.

## **IMPLEMENTATION PLAN**

This section presents the implementation plan for the AV/CV Test Bed to Improve Transit, Bicycle, and Pedestrian Safety. It consolidates the when and how contained in the near-term candidate application operational scenarios described previously. The anticipated schedule of activities is presented first. The partners assisting with the implementation of the test bed activities are highlighted second.

### **Test Bed Schedule of Activities**

As illustrated in Figure 41, the major test bed activities focus on designing and prototyping the candidate applications, conducting tests and pilots, and pursuing larger demonstrations. The two ongoing activities are conducting assessments and evaluations and sharing information and technology transfer. The results of the assessments and evaluations will feedback into the design and prototyping activities. Table 18 presents the anticipated schedule for these activities.

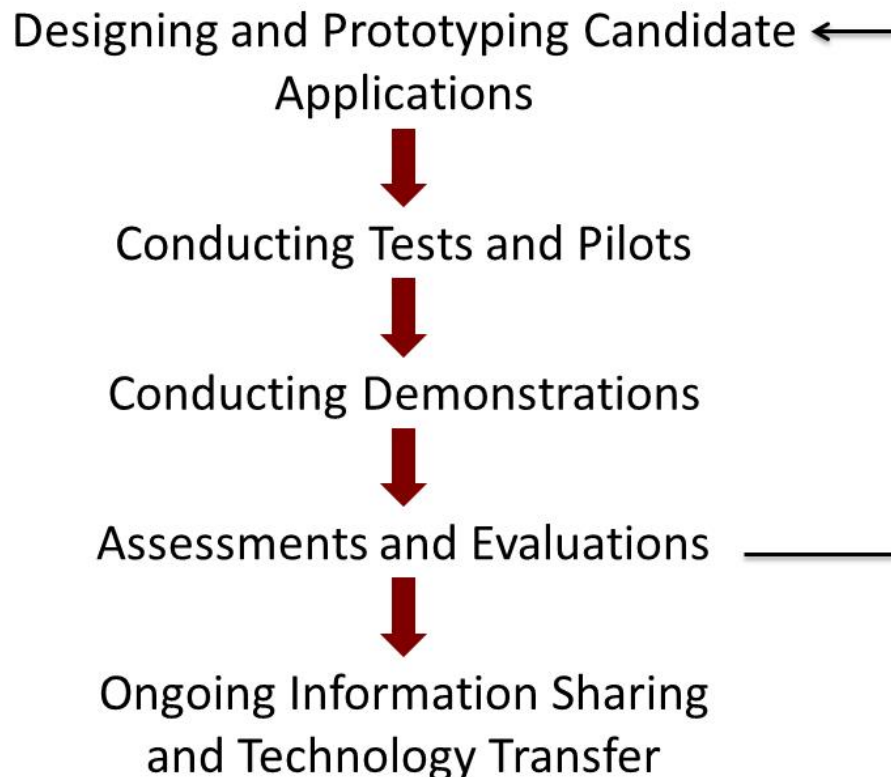

Source: TTI.

**Figure 41. Major Activities to Implement Test Bed Candidate Applications.**

**Table 18. Anticipated Schedule of Test Bed Activities.**

Activity	Year 1				Year 2			
	Q1	Q2	Q3	Q4	Q1	Q2	Q3	Q4
Design/Prototype								
Test and Pilots								
Demonstrations								
Assessments/Evaluations								
Information Sharing and Technology Transfer								

As presented in Table 18, the design and prototyping activities will occur over the first year, with some completed during the second and third quarters. The tests and pilots will be conducted during the second half of year one and the first half of year two. The larger demonstration projects will occur in the second year. The assessments and evaluations will be initiated with the start of the first tests and pilots. The information sharing and technology transfer activities will occur throughout the two-year time frame. The following activities are anticipated to be conducted on the candidate applications over the next two years:

- Execute and evaluate additional pilots with different types of on-bus collision-warning systems and identify enhancements, including examining systems for reducing bus crashes with fixed objects and hazards on TAMU buses and in selected transit systems.
- Design, develop, and pilot the Smart Intersections application, which focuses on avoiding crashes involving buses, bicyclists, and pedestrians at signalized intersections through the use of smart buses automatically communicating with smart traffic signals to provide visual and audio warnings to bicyclists and pedestrians on the TAMUS Riverside Campus and the TAMU campus.
- Analyze the availability of sensors and other communications technologies needed for the design and development of a smart bicycle prototype. The technologies should be capable of detecting the presence and travel path of other road users in the vicinity of a bicyclist.
- Conduct human factors research on the smart pedestrian smartphone application focusing on alert type and frequency, pedestrian limitations and distractions, and communication device preferences.

- Design, develop, and pilot a smart bike rack system focusing on adding sensors to existing front-mounted bike racks and adding cameras to the front of buses to alert bus drivers to passengers loading and unloading bicycles. The design and development will occur at the TAMUS Riverside Campus, and the pilots are anticipated to occur at Capital Metro in Austin and Sun Metro in El Paso.

### **Implementation Partners**

As stressed throughout this ConOps Plan, the success of the test bed will depend on partnerships among public sector agencies and partnerships with the private sector. Implementation of the ConOps Plan will build on the partnerships established during the first phase of the project. The key partners—TxDOT, TTI, TAMU, transit agencies, and private sector businesses—are highlighted in the following:

- TxDOT – The department will continue its leadership on the project by funding the second phase and TxDOT personnel will continue to provide overall guidance to the research team, reviewing key milestones, and participating in outreach and partnership activities.
- TTI – TTI researchers will lead the design and prototype development activities, and arrange for and assist with the test, pilots, and demonstrations. TTI will be responsible for conducting the assessments and evaluations. TTI personnel will work with public and private sector partners on these activities. TTI researchers will also conduct ongoing information sharing and technology transfer activities.
- TAMU – TAMU Transportation Services will continue to be a key partner in the design, development, and piloting of candidate applications. The pilot of the collision avoidance system on one TAMU bus provides an indication of the important role TAMU played in this project. It is anticipated that additional pilots will be conducted on TAMU buses, as well as at cross walks and intersections on campus.
- Transit Agencies – Transit agencies in the state will take the lead in testing, piloting, and demonstrating the candidate applications. Based on interest expressed during the first phase of the project, it is anticipated that TAMU Transportation Services, Brazos Transit, Houston METRO, Capital Metro in Austin, and Sun Metro in El Paso will participate in the tests, pilots, and demonstrations. Other transit systems may also assist in testing some of the candidate applications.
- Private Sector Businesses – Technology companies, bus and bike rack manufacturers, and other businesses will also be key participants in the implementation of the candidate applications. The partnership with Mobileye and Rosco to pilot the Shield+ collision-avoidance system on one TAMU bus during the first phase of the project provides an example of possible approaches that will be used to implement the test bed candidate applications.

## REFERENCES

- 1 Transit Cooperative Research Program. *Guidebook for Mitigating Fixed-Route Bus-and-Pedestrian Collisions*. Transportation Research Board, TCRP Report 125, 2008, Washington, D.C.
- 2 Burka, A, A. Qin, and D. Lee. “An Application of Parametric Speaker Technology to Bus-Pedestrian Collision Warning.” Paper presented at the 2014 IEEE 17<sup>th</sup> International Conference on Intelligent Transportation Systems, October 8-11, 2014. Qingdao, China.
- 3 Washington Metropolitan Area Transit Authority. “Metro testing turn warning device on Metrobuses.” Metro Press Release, 23, November 2010.  
[http://www.wmata.com/about\\_metro/news/PressReleaseDetail.cfm?ReleaseID=4752](http://www.wmata.com/about_metro/news/PressReleaseDetail.cfm?ReleaseID=4752), accessed June 9, 2015.
- 4 Annear, S. “MBTA Testing New ‘Turn Alert System’ on Select Buses.” *Boston Magazine*, May 6, 2014, <http://www.bostonmagazine.com/news/blog/2014/05/06/mbta-testing-new-turn-alert-system-select-buses/>, accessed June 12, 2015.
- 5 Dresser, Michael. “‘Talking’ buses alert pedestrians.” *The Baltimore Sun*, March 28, 2011.
- 6 Maryland Department of Transportation, Maryland Transit Administration. “MTA Tests New ‘Talking’ Alert System for Pedestrian Safety.” MTA Maryland Press Release.  
<http://mta.maryland.gov/mta-tests-new-talking-alert-system-pedestrian-safety>, accessed June 9, 2015.
- 7 Saporta, H. and K.K. Pecheux. “Pedestrian Collision Warning Demonstration Project: Approach and Findings.” Presentation made at the 2015 APTA Bus and Paratransit Conference. May 5, 2015.
- 8 Alstadt, R. “TriMet’s demonstration of pedestrian warning systems ends October 3.” TriMet press release, September 30, 2014. <http://news.trimet.org/2014/09/trimets-demonstration-of-pedestrian-warning-systems-ends-october-3/>, accessed June 9, 2015.
- 9 Pecheux, K., J. Kennedy, and J. Strathman. “Evaluation of Transit Bus Turn Warning Systems for Pedestrians and Cyclists. Draft Final Report.” Federal Transit Administration Report No. 0084, Washington, D.C. May 2015.
- 10 Transport for London: New Bus Sensor Technology Trial.  
<http://www.tfl.gov.uk/infofor/media/press-releases/2014/august/new-bus-sensor-technology-trial>, accessed June 12, 2015.
- 11 Bristol City Council. New Bus Trial to Improve Cyclist Safety.  
<http://www.bristol.gov.uk/press/new-bus-trial-improve-cyclist-safety>, accessed June 12, 2015.

- 12 Lin, P., C. Lee, A. Kourtellis, and M. Saxena. *Evaluation of Camera-Based Systems to Reduce Transit Bus Side Collisions. Final Report*, Prepared for the Florida Department of Transportation, March 31, 2010.
- 13 Rankin, J. "Race to Test New Cycle Safety Technology." *The Guardian*. December 26, 2013. <http://www.theguardian.com/lifeandstyle/2013/dec/26/uk-race-test-new-cycle-safety-technology>, accessed June 12, 2015.
- 14 Mobileye Brochure. "Collision Avoidance with Pedestrian Side Sensing." Mobileye and ROSCO Systems marketing brochure.
- 15 Rice, C. "New Tech Helps Drivers Avoid Bikes By Using Audio Alert." *BBC News*. December 12, 2013. <http://www.bbc.com/news/technology-25316837>, accessed June 13, 2015.
- 16 Network. "New Cycling Detecting Technology for Buses." <http://www.networkvehicles.com/news/new-cyclist-detecting-technology-for-buses-25638.aspx>, accessed June 10, 2015.
- 17 Bristol City Council. Minutes of City Development, Traffic management. [http://www.bristol.gov.uk/sites/default/files/documents/transport\\_and\\_streets/cycling/bike\\_forum/Bike%20Forum%20Jan%202014%20minutes.pdf](http://www.bristol.gov.uk/sites/default/files/documents/transport_and_streets/cycling/bike_forum/Bike%20Forum%20Jan%202014%20minutes.pdf), accessed June 12, 2015.
- 18 *The Bristol Post*. "Bristol Firm Driving Forward Project For Driverless Cars." December 10, 2014. <http://www.bristolpost.co.uk/Bristol-firm-driving-forward-project-driverless/story-25501795-detail/story.html>, accessed June 13, 2015.
- 19 Pessaro, B., and C. Van Nostrand. *Cedar Avenue Driver Assist System Evaluation Report*. FTA Report No. 0010, Federal Transit Administration, December 2011.
- 20 *Battelle Minnesota Urban Partnership Agreement National Evaluation Plan*. Federal Highway Administration (FHWA), Office of Operations, Washington, D.C., April 2009.
- 21 Valentine, D., R. Zimmer, S. Mortensen, and R. Sheehan. "Transit Safety Retrofit Package (TRP): Leveraging DSRC for Transit Safety – Fielding Results and Lessons Learned." Completed for the United States Department of Transportation Intelligent Transportation Systems Joint Program Office, Federal Highway Administration and Federal Transit Administration, November 2014.
- 22 Zimmer, R. E., M. Burt, G.J. Zink, D.A. Valentine, and W.J. Knox, Jr. "Transit Safety Retrofit Package Development: Final Report." Completed for the United States Department of Transportation Intelligent Transportation Systems Joint Program Office, Federal Highway Administration and Federal Transit Administration, Washington, D.C., Report No. FHWA-JPO-14-12, July 2014.



- 23 Csepinszky, A., G. Giustiniani, C. Holguin, M. Parent, M. Flament, and A. Alessandrini. “Safe Integration of Fully Automated Road Transport Systems in Urban Environments: The Basis for the Missing Legal Framework.” Presented at 94<sup>th</sup> Annual Meeting of the Transportation Research Board, Washington, D.C., 2015.
- 24 Alessandrini, A., C. Holguin, and D. Stam. “The Safe Way to Integrate Automated Road Transport in Urban Areas.”
- 25 CityMobil2. *Cities Demonstrating Automated Road Passenger Transport*. [www.citymobil2.eu/en/](http://www.citymobil2.eu/en/), accessed May 6, 2015.
- 26 Alessandrini, A. *Automated Road Transport Systems in European Cities*. Microsoft PowerPoint presentation. January 10, 2013. [www.imobilitysupport.eu/library/imobility-forum/working-groups/active/automation/workshops-3/1-oct-2013/2275-vra-presentation-06-citymobil2-1-oct-2013/file](http://www.imobilitysupport.eu/library/imobility-forum/working-groups/active/automation/workshops-3/1-oct-2013/2275-vra-presentation-06-citymobil2-1-oct-2013/file), accessed May 22, 2015.
- 27 Benmimoun, A., M. Lowson, A. Marques, G. Giustiniani, and M. Parent. “Demonstration of Advanced Transport Applications in CityMobil Project.” *Transportation Research Record: Journal of the Transportation Research Board*, No. 2110, Transportation Research Board of the National Academies, Washington, D.C., 2009, pp. 9-17.
- 28 *CityMobil: Advanced Transport for the Urban Environment. Final Brochure*. December 19, 2011. [www.citymobil-project.eu/site/en/newsDetail.php?nid=107](http://www.citymobil-project.eu/site/en/newsDetail.php?nid=107), accessed May 22, 2015.
- 29 CityMobil2 NewsLetter. “Oristano demonstration.” No. 4, February 2015. [www.citymobil2.eu/en/upload/Dissemination\\_materials/citymobil2%20newsletter%20final.pdf](http://www.citymobil2.eu/en/upload/Dissemination_materials/citymobil2%20newsletter%20final.pdf), accessed May 22, 2015.
- 30 CityMobil2. *Oristano leads the way to ARTS demonstrations*. [www.citymobil2.eu/en/upload/public-docs/City%20mobil%20%20Oristano%20demo.pdf](http://www.citymobil2.eu/en/upload/public-docs/City%20mobil%20%20Oristano%20demo.pdf), accessed May 24, 2015.
- 31 CityMobil2. *La Rochelle*. <http://www.citymobil2.eu/en/City-activities/Large-Scale-Demonstration/La-Rochelle/>, accessed May 24, 2015.
- 32 Nair, S. *La Rochelle’s Demo- Infrastructures*. Microsoft PowerPoint presentation, April 2, 2015. [www.citymobil2.eu/en/upload/RG\\_meeting/Pres-20150330-CM2-DemoLaRochelle-INFRA%20\[Compatibility%20Mode\].pdf](http://www.citymobil2.eu/en/upload/RG_meeting/Pres-20150330-CM2-DemoLaRochelle-INFRA%20[Compatibility%20Mode].pdf), accessed May 25, 2015.
- 33 *Vision Zero Action Plan*. City of New York, Mayor Bill de Blasio, 2014. <http://www.nyc.gov/html/visionzero/pdf/nyc-vision-zero-action-plan.pdf>, accessed June 16, 2015.

- 34 PRNewswire. "AT&T Launches 'Connected Intersections' Initiative To Improve Pedestrian Safety On New York City Streets." June 2, 2014. <http://www.prnewswire.com/news-releases/att-launches-connected-intersections-initiative-to-improve-pedestrian-safety-on-new-york-city-streets-261507491.html>, accessed June 16, 2015.
- 35 Zeichner, N., P. Perry, M. Sita, L. Barbera, and T. Nering. "Exploring How Mobile Technologies Impact Pedestrian Safety." NYC Media Lab, Integrated Digital Media Program, Polytechnic School of Engineering of New York University. Prepared for AT&T, April 2014.
- 36 PRNewswire. "AT&T Announces Winners Of The \$50,000 'Connected Intersections' Traffic Safety Innovation Challenge." October 21, 2015. <http://www.prnewswire.com/news-releases/att-announces-winners-of-the-50000-connected-intersections-traffic-safety-innovation-challenge-675699803.html>, accessed June 16, 2015.
- 37 University of Minnesota. *Novel Collision Avoidance System Project*, <http://www.its.umn.edu/Research/ProjectDetail.html?id=2015020>.
- 38 Galluzzo, G. "UI Studies Safer Road Use by Texting Pedestrians," *IowaNow*. University of Iowa. April 29, 2015. <http://now.uiowa.edu/2015/04/ui-studies-safer-road-use-texting-pedestrians>.
- 39 City of Austin, Bicycle Detection Smart Phone App. <https://www.youtube.com/watch?v=1aS80jHWTRM>.
- 40 Brooks, D. "Driverless Cars in the Near Future for Fort Bragg," *Fayobserver.com*. April 29, 2015. [http://www.fayobserver.com/news/local/driverless-cars-in-the-near-future-for-fort-bragg/article\\_9ab20600-c91a-5360-b1a4-be8bcc90dce1.html](http://www.fayobserver.com/news/local/driverless-cars-in-the-near-future-for-fort-bragg/article_9ab20600-c91a-5360-b1a4-be8bcc90dce1.html).
- 41 TARDEC Public Affairs. *ARIBO Drives Acceptance of Automated Vehicles at SmartAmerica Challenge*, June 18, 2014. [http://www.army.mil/article/128291/ARIBO\\_drives\\_acceptance\\_of\\_automated\\_vehicles\\_at\\_SmartAmerica\\_Challenge/](http://www.army.mil/article/128291/ARIBO_drives_acceptance_of_automated_vehicles_at_SmartAmerica_Challenge/).
- 42 Willis, L. and Desvaux, J-M. *EasyMile and GoMentum Station Announce Exclusive Agreement*. Press Release, October 2015. <http://gomentumstation.net/wp-content/uploads/2015/10/Press-Release-Easymile-Gomentum-Station-Announce-Exclusive-Agreement-October-5-2015-1.pdf>.
- 43 Lin, P-S., Lee, C., Kourtellis, A., and Saxena, M. *Evaluation of Camera-Based Systems to Reduce Transit Bus Side Collisions*. University of South Florida, Center for Urban Transportation Research. March 31, 2010. <http://www.nctr.usf.edu/wp-content/uploads/2011/04/77905.pdf>, accessed July 24, 2015.

- 44 Reclus, F., and K. Drouard. "Geofencing for fleet & freight management." In Proceedings of the Intelligent Transport Systems Telecommunications (ITST) 2009 9th International Conference, pp. 353-356, [http://webstaff.itn.liu.se/~davgu/tnsl06/geofencing\\_paper.pdf](http://webstaff.itn.liu.se/~davgu/tnsl06/geofencing_paper.pdf), accessed July 24, 2015.
- 45 Federal Motor Carrier Safety Administration. 49 CFR Parts 300-399. Regulations. 2015. <http://www.fmcsa.dot.gov/regulations/title49/b/5/3>.
- 46 United States Department of Transportation. Federal Motor Vehicle Safety Standards. NHTSA.gov. <http://www.nhtsa.gov/cars/rules/import/FMVSS/>.
- 47 Federal Transit Administration. PART 661-BUY AMERICA REQUIREMENTS. ELECTRONIC CODE OF FEDERAL REGULATIONS. <http://www.ecfr.gov/cgi-bin/text-idx?rgn=div5;node=49%3A7.1.2.1.18>.
- 48 Federal Transit Administration. PART 665-BUS TESTING. Code of Federal Regulations. 2015. <http://www.gpo.gov/fdsys/pkg/CFR-2012-title49-vol7/xml/CFR-2012-title49-vol7-part665.xml>.
- 49 Penn State University. *The Altoona Bus Research and Testing Center*. Homepage. Federal Transit Administration. <http://altoonabustest.psu.edu/>.
- 50 Federal Transit Administration. Fact Sheet: Transit Safety and Oversight Section 5329. FTA.DOT.GOV. [http://www.fta.dot.gov/documents/MAP-21\\_Fact\\_Sheet\\_-\\_Transit\\_Safety\\_and\\_Oversight.pdf](http://www.fta.dot.gov/documents/MAP-21_Fact_Sheet_-_Transit_Safety_and_Oversight.pdf).
- 51 United States Congress. 49 CFR, §5334 - Administrative provisions. United States Government Publishing Office. 2012. <http://www.gpo.gov/fdsys/pkg/USCODE-2012-title49/html/USCODE-2012-title49-subtitleIII-chap53-sec5334.htm>.
- 52 49 CFR, §5330. State safety oversight. United States Government Publishing Office. 2012. <http://www.gpo.gov/fdsys/pkg/USCODE-2012-title49/html/USCODE-2012-title49-subtitleIII-chap53-sec5330.htm>.
- 53 State of Texas. Title 7, Subtitle C, Chapter 551 Subchapter A. *Transportation Code*. August 2015. <http://www.statutes.legis.state.tx.us/Docs/TN/htm/TN.551.htm>.
- 54 National Highway Traffic Safety Administration. United States Department of Transportation releases policy on automated vehicle development. NHTSA.gov. May 30, 2013. <http://www.nhtsa.gov/About+NHTSA/Press+Releases/U.S.+Department+of+Transportation+Releases+Policy+on+Automated+Vehicle+Development>.
- 55 Department of Transportation Issues Advance Notice of Proposed Rulemaking to Begin Implementation of Vehicle-to-Vehicle Communications Technology. August 2014. <http://www.nhtsa.gov/About+NHTSA/Press+Releases/NHTSA-issues-advanced-notice-of-proposed-rulemaking-on-V2V-communications>.

- 56 Federal Motor Vehicle Safety: Vehicle-to-Vehicle (V2V) Communications. 49 CFR Part 571. August 18, 2014. [http://www.nhtsa.gov/staticfiles/rulemaking/pdf/V2V/V2V-ANPRM\\_081514.pdf](http://www.nhtsa.gov/staticfiles/rulemaking/pdf/V2V/V2V-ANPRM_081514.pdf).
- 57 Federal Highway Administration. 2015 FHWA Vehicle to Infrastructure Deployment Guidance and Products. ITS.DOT.GOV. September 29, 2014. [http://www.its.dot.gov/meetings/pdf/V2I\\_DeploymentGuidanceDraftv9.pdf](http://www.its.dot.gov/meetings/pdf/V2I_DeploymentGuidanceDraftv9.pdf).
- 58 City of Austin. Chapter 12-2 - Bicycles. *AustinTexas.gov*. 2015. [https://www.municode.com/library/tx/austin/codes/code\\_of\\_ordinances?nodeId=TIT12TRRRE\\_CH12-2BI\\_ART3BIHE\\_S12-2-31HERE&showChanges](https://www.municode.com/library/tx/austin/codes/code_of_ordinances?nodeId=TIT12TRRRE_CH12-2BI_ART3BIHE_S12-2-31HERE&showChanges).
- 59 Code Section 16-1-13; Ord. 031204-13; Ord. 031211-11; Ord. 050310-13. Austin: City of Austin Municipal Code of Ordinances, 1992.
- 60 Ord. 20091022-028; Ord. 20091217-090; Ord. No. 20140828-041. Austin: City of Austin Municipal Code of Ordinances. Pt. 1, 1-1-15.
- 61 City of Houston. Bicycles. *Houston, Texas Code of Ordinance*. 2015. [https://library.municode.com/HTML/10123/level3/COOR\\_CH45TR\\_ARTXIIBI.html#fn\\_185](https://library.municode.com/HTML/10123/level3/COOR_CH45TR_ARTXIIBI.html#fn_185).
- 62 Bike Texas. Safe Ordinance FAQ. *Bike Texas*. 2010. <http://www.biketexas.org/en/advocacy/safe-passing/safe-passing-faqs>.
- 63 City of Austin. Municipal Code of Ordinances. Austin : s.n. Ord. 20091022-030.
- 64 City of Houston. Houston Complete Streets and Transportation Plan. City of Houston. [Online] 2013. [http://s3.amazonaws.com/static.texastribune.org/media/documents/Complete\\_Streets\\_Executive\\_Order.pdf](http://s3.amazonaws.com/static.texastribune.org/media/documents/Complete_Streets_Executive_Order.pdf). E.O. No: 1-15.
- 65 KHOU staff. "Undercover stings target drivers endangering bicyclists." *KHOU.com*. March 25, 2014. <http://www.khou.com/story/news/local/2014/07/25/12413394/>.
- 66 McLeod, K. "Austin Ramp up Enforcement of Passing Law." The League of American Bicyclists. August 12, 2013. <http://bikeleague.org/content/austin-ramps-enforcement-passing-law>.
- 67 Healey, W. "3 feet or else: Chattanooga police use ultrasound technology to enforce law for cyclist safety." *Times Free Press*. June 7, 2015. <http://www.timesfreepress.com/news/local/story/2015/jun/07/3-feet-or-else/308339/>.
- 68 Schmitt, A. "10 Cities Chosen to Help Model Vision Zero Policy in the U.S." *StreetsBlogUSA*. January 27, 2016. <http://usa.streetsblog.org/2016/01/27/10-cities-chosen-to-help-model-vision-zero-policy-in-the-u-s/>.
- 69 Hicks, E. "Smart Brabus E-bike." *ElectricBike.com*. March 23, 2012. <https://www.electricbike.com/brabus/>.

- 70 SmartHalo. Homepage. <https://www.smarthalo.bike/>.
- 71 COBI. Homepage. <http://cobi.bike/>.
- 72 Wahoo Fitness. Homepage. <http://www.wahoofitness.com>.
- 73 Garmin. Homepage. <http://www.garmin.com>.
- 74 Peters, A. "This Bike Warns You if a Car is about to Hit You." *FastCoExist.com*. January 8, 2015. <http://www.fastcoexist.com/3040096/this-bike-warns-you-if-a-car-is-about-to-hit-you>.
- 75 Mobility Transformation Center. *Mcity Test Facility*. University of Michigan. <http://www.mtc.umich.edu/test-facility>.
- 76 Lewin, S. "WiFi-Honk! Smartphone App Gets Pedestrians out of the Way." *IEEE Spectrum*. July 14, 2014. <http://spectrum.ieee.org/cars-that-think/transportation/safety/wifihonk-smartphone-app-for-drivers-and-pedestrians-gets-you-out-of-the-way>.
- 77 *Vehicle to Pedestrian (V2P) a Technology Scan, Needs Assessment, and Research Implementation Plan: Task 5 V2P Research Implementation Plan*, FHWA Office of Safety, May 19, 2015.