

**Correlation of DCPI with Deformation under Proof Roller loading to Assess
Soft Subgrade Stabilization Criterion**

Addendum to NCDOT Final Report 2011-05, Entitled:

**“Field Verification of Undercut Criteria and Alternatives for Subgrade
Stabilization in the Piedmont Area**

S. Hamed Mousavi, M. A. Gabr, Ph.D., P.E., and R. H. Borden, Ph.D,
P.E.

Department of Civil, Construction, and Environmental Engineering
North Carolina State University
NCDOT Project 2011-05

FHWA/NC/2011-05

Date: November 21, 2016

Correlation of DCPI with Deformation under Proof Roller loading to Assess Soft Subgrade Stabilization Criterion

Introduction

Work presented herein is an addendum to the final report for NCDOT Project 2011-05 entitled “Field Verification of Undercut Criteria and Alternatives for Subgrade Stabilization in the Piedmont Area.” The objective of the addendum work is to provide NCDOT colleagues with insight regarding the use of the Dynamic Cone Penetrometer Index (DCPI) as an indication for the need to undercut and replace soft soils. Numerical analyses were conducted using the computer program PLAXIS 3-D with the soil domain subjected to two cycles of proof rolling load. The analyses were based on assuming various DCPI values in each of three 1 ft - thick (12”) layers and the corresponding soil strength and modulus properties. Two passes of proof roll loading were applied, and the pass/fail criterion was based on the resulting subgrade deformation exceeding one-inch. The analyses utilized three subsurface layers with the objective of exploring the significance of the soft-layer location within the domain impacted by the stress bulb, and the resulting decision as to whether or not undercutting will be needed.

Subgrade Soil Properties

The CBR values for subgrade soils were estimated from the NCDOT recommended correlation (NCDOT, 1998) with DCPI, as expressed in Eq. 1. The undrained shear strength of subgrade soils was assumed to be 11 times the CBR values as recommended by Cross and Gregory (2007) for soil materials with a CBR value between 3.5 to 16.

$$\text{Log}(CBR) = 2.60 - 1.07 \times \log(DCPI) \qquad \text{Eq. (1)}$$

$$S_{u_{subgrade\ soil}} = 11CBR \quad \text{Eq. (2)}$$

The modulus properties of the subgrade soils were estimated using the DCPI values following the model by Mousavi et al. (2016). In this approach, the DCPI values are used to predict the coefficients of MEPDG model, k_1 , k_2 , and k_3 , as presented in Eq. 3. The E_{ur} value is assumed to be equal to the resilient modulus value at applied deviatoric stress of 41.4 kPa (6 psi) and confining pressure 13.8 kPa (2 psi), following recommendation by Mohammad et al. (2008), Rahim (2004).

$$k_i = C_1 + C_2 \ln(\text{DCPI}), \quad i:1,2,3 \quad \text{Eq. (3)}$$

Where C_1 , C_2 , are summarized in Table 1.

Table 1, model coefficients.

Coefficients	C_1	C_2
k_1	2310 (911) ¹	-377
k_2	-0.3 (0.7) ¹	0.3
k_3	-10 (-4.5) ¹	1.7

()¹ English Unit
 SI Unit: DCPI: mm/blow,
 English Unit: DCPI: in./blow

The analyses were performed using an E_{ur}/E_{50} ratio of 6, as reported by Lee (2015) for residual soil. It was assumed that E_{ode} is equal to E_{50} , and m value (stress dependency parameter) of 0.5. The maximum shear modulus is calculated using Eq. 4 (NCHRP 2008), and assuming poisson's ration (ν) of 0.2 under cyclic loading.

$$G_{\max} = \frac{M_r}{2(1+\nu)} \quad \text{Eq. (4)}$$

Subgrade stabilization charts

The geometry of the model domain is shown in Figure 1 and consists of three sublayers, each having a thickness of 30.5 cm (12 in.), underlain by a uniform 36.55 cm (144 in.) thick layer. The assumption in this case is the 3-ft profile thickness is sufficient to include the zone of stress bulb. The domain boundaries were placed approximately at 10 times the diameter of the loaded area. DCPI values of 20, 38, and 60 mm/blow, were chosen and assumed to represent, good, marginal, and poor subgrade sublayers, respectively. The DCPI of 38 mm/blow is the current recommended criterion for undercutting the soft subgrade soils.

Given the three sublayers, there are 27 possible combinations for the subgrade profile. The shear strength and stiffness properties of the subgrade layers were determined by Eqs. 1, and 2, as previously mentioned. As a baseline case, the M_r/E_{50} value of 6 was selected to reach to 25 mm (1 in.) surface deformation after two proof roller passes for subgrade with DCPI value of 38 mm/blow. This is consistent with the 38 mm/blow NCDOT undercut criterion; which has been validated for Coastal plain and Piedmont residual soil by Cowell et al. (2012) and Mousavi et al. (2016), respectively. The properties of subgrade layers implemented in these numerical analyses are presented in Table 2.

Table 2. Subgrade layers properties.

Soil type	DCPI (mm/blow)	CBR	Su(kPa)	Mr. (MPa)	G _{max} (MPa)
C1	20	16	178	44	18
C2	38	8	89	41	17
C3	60	5	55	37	16

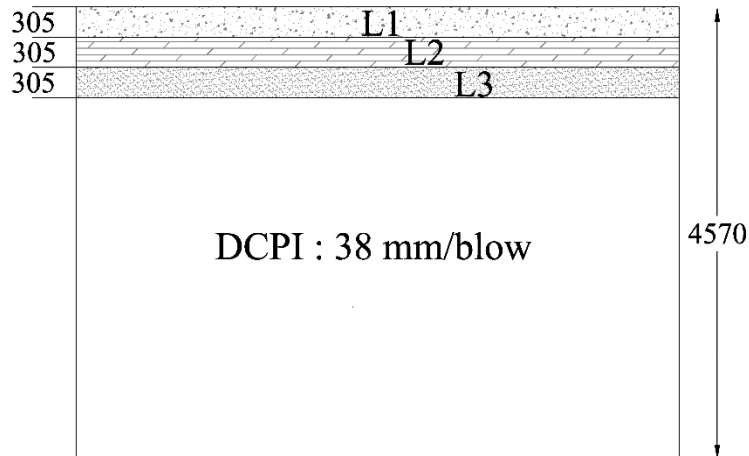

Figure 1. Subgrade layers configuration (dimension in mm)

Figure 2 (a-c) shows the computed permanent surface deformation of the analyses cases when the top 30 cm (12 in.) subgrade soil, L1, consists of soil type C1, C2, and C3, respectively, (as defined in Table 2). The stable subgrade zone is designated by the shaded rectangular area in Figure 2, based on the criterion of 25 cm (1 in.) plastic rut depth on top of the subgrade after two proof roller load passes. The subgrade stability on the basis of the proof roller test for any other cases with DCPI value between 20 to 60 mm/blow, can be approximated by interpolating from the results of the computed cases. It should also be noted that while the numerical deformation criterion is 25 cm (1 in.) for an acceptable subgrade profile, marginal cases are expected for cases where the deformation is slightly less than the 25 cm (1 in.) value.

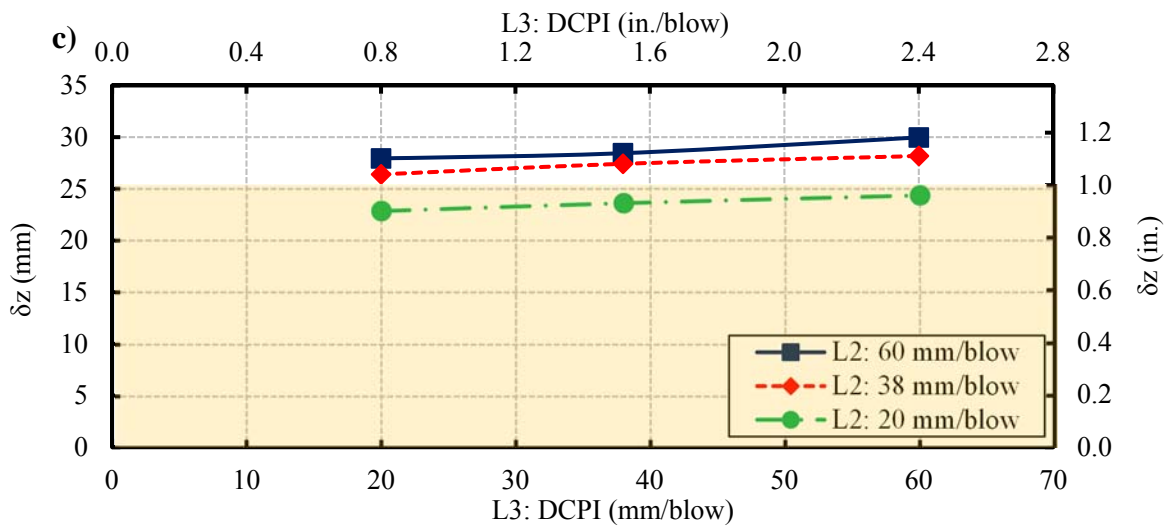
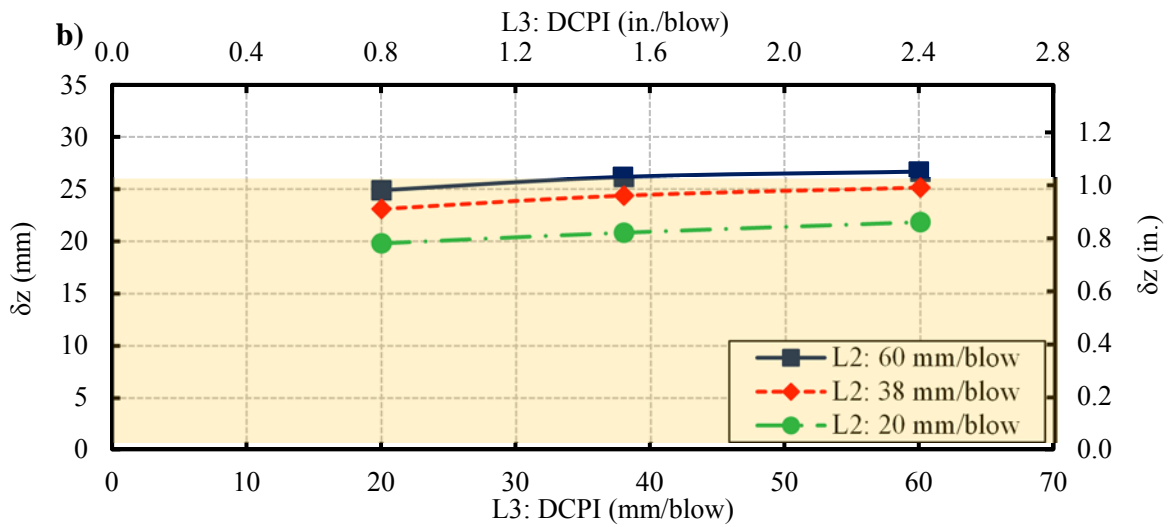
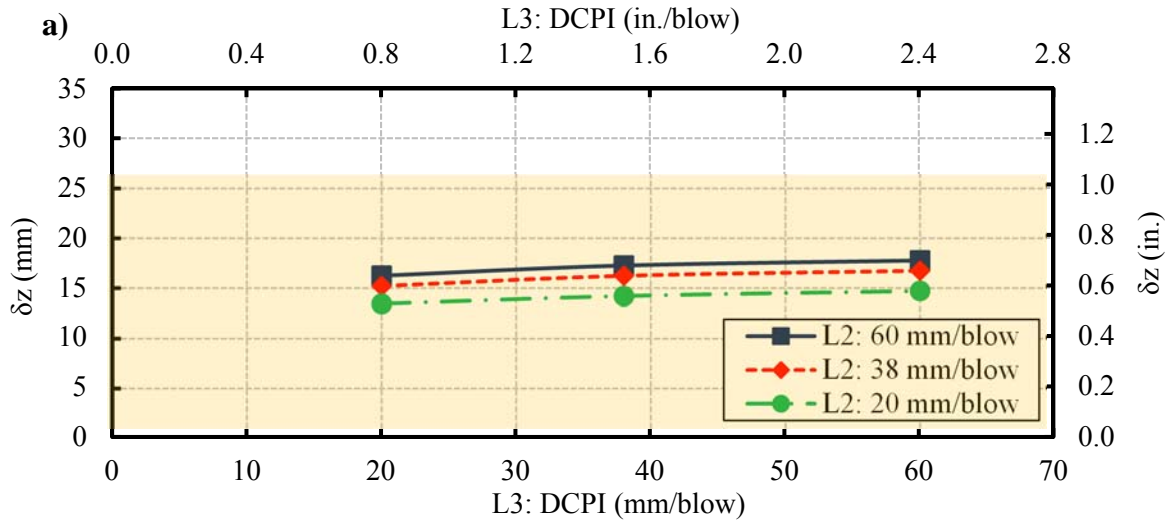
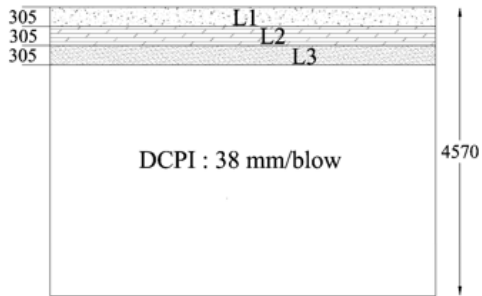

Figure 2. Permanent surface deformation a) L1: DCPI 20 mm/blow, b) L1: DCPI 38 mm/blow, c) L1: DCPI 60 mm/blow

Figure 3 presents the developed “Subgrade Stabilization Recommendation Chart”, based on criterion of 25 cm (1 in.) plastic rut depth on top of the subgrade after two passes of the proof roller load. The results indicate that a subgrade with a 30 cm (12 in.) C1 layer (with DCPI value of 20 mm/blow) on top does not require a stabilization measure, given the assumed properties of the lower subgrade layers. If the subgrade has a 30 cm (12 in.) thick layer of soil type C2 on top, subgrade stabilization would be required if the second 30 cm sublayer is composed of either soil types C2 or C3. If the top 30 cm layer of the subgrade consists of soil type C3, subgrade stabilization would be required unless the second 30 cm sublayer is composed of stiff soil, type C1. The chart shown in Figure 3 summarizes the study findings and can be utilized by a field engineer to discern the need for undercut when the subgrade profile is composed of sublayers having different properties.

Soil type	DCPI (mm/blow)	CBR
C1	20	16
C2	38	8
C3	60	5



Note: Undercut depth depends on the quality of the back fill material

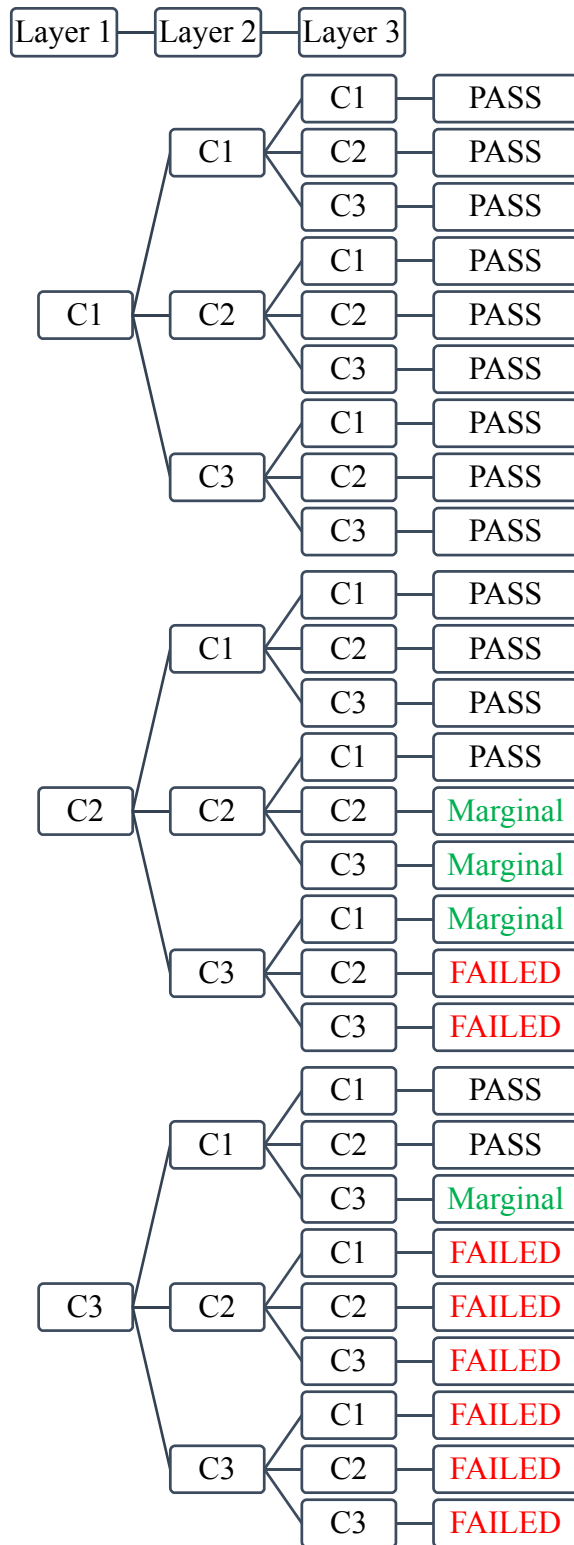

Figure 3. Subgrade Stabilization Recommendation Chart.

Application Examples

Two examples for evaluating subgrade soil stability are demonstrated in this section. These examples utilize field-measured DCP data, which are presented in NCDOT Project 2011-05 report, and implement such data into the recommended stabilization chart. DCP data need to be interpreted to obtain a representative value of the DCPI for each layer. Allbright (2002) suggested using a weighted average over the arithmetic average to calculate the DCPI value, as presented in Equation 5. This method provides a smaller standard deviation value and better observed correlation with other field test results.

$$DCPI_{wt. avg.} = \frac{1}{H} \sum_{i=1}^N (DCPI_i \times z_i) \quad \text{Eq. (5)}$$

Where,

z = depth of penetration per blow (mm/in)

H = total depth of the soil layer (mm/in)

Figure 4, shows the field measured DCP data at station S21 of the test site in Greensboro. It can be seen that soil profile in station S21, consists of three sublayers with DCPI values of 35, 62, and 46 mm/blow. By implementing the calculated DCPI values into the appropriate section of the recommended chart, as illustrated in Figure 5, it can be concluded that the subgrade stabilization is required in this station. It is worthwhile to mention that implementing the DCP data into a general 38 mm/blow undercut criteria, indicates stable top 300 mm (1ft) subgrade over the weak subgrade, as shown with hatched triangle in Figure 6.

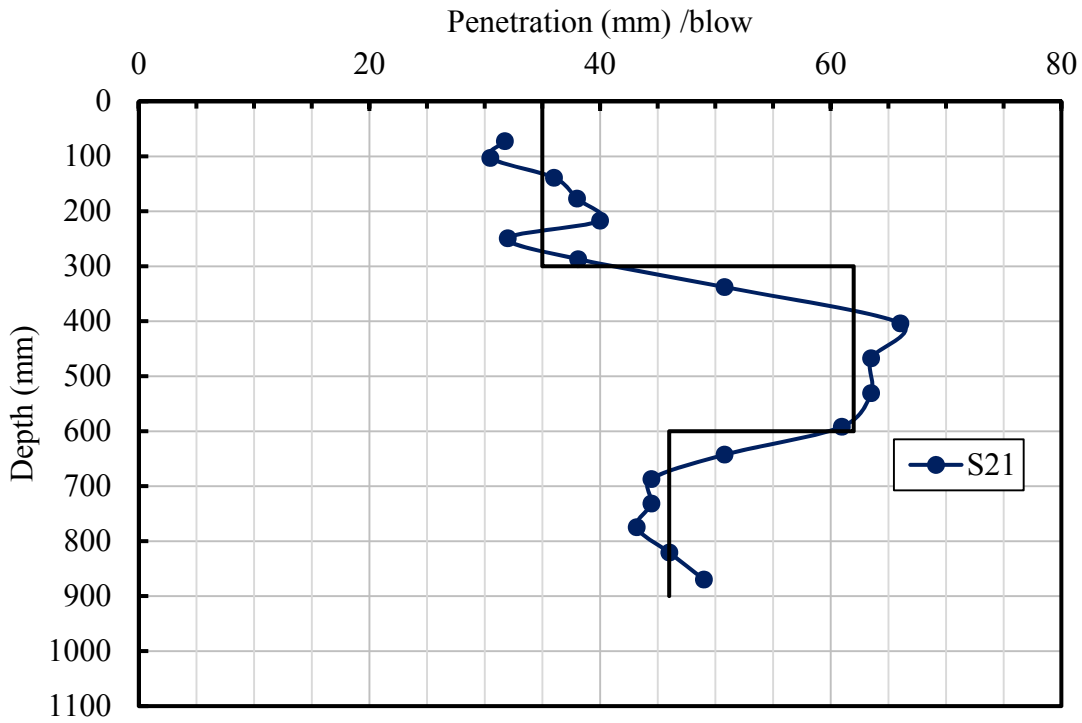

Figure 4. Field measured DCP data in station S21.

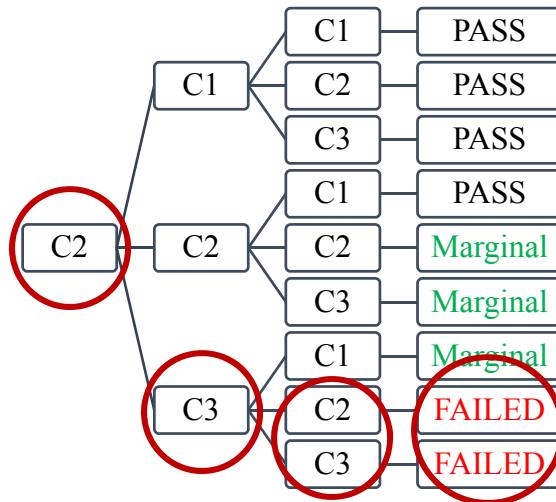

Figure 5. Evaluating stability of subgrade soil in station S21

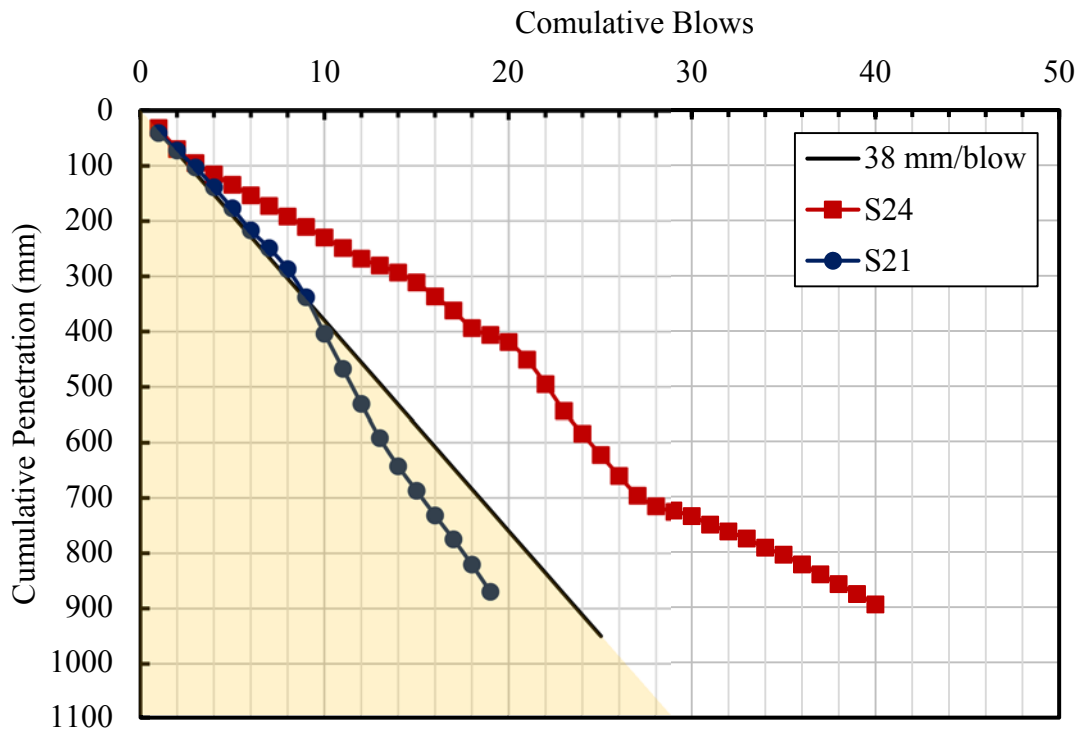

Figure 6. Stability of subgrade soils based on NCDOT 38 mm/blow undercut criteria.

Field measured DCP data in station S24, is presented in Figure 7. The primary evaluation determined that the soil profile is composed of the top layer with DCPI value of 20, with a marginal layer with DCPI value of 32 mm/blow at the middle, and good quality material with DCPI value of 15 mm/blow underneath. As shown in Figure 6, based on the NCDOT 38 mm/blow, no subgrade soil improvement requires at this station. As illustrated in Figure 8, the results from the recommended stabilization chart also indicates that the subgrade soil in this station is stable.

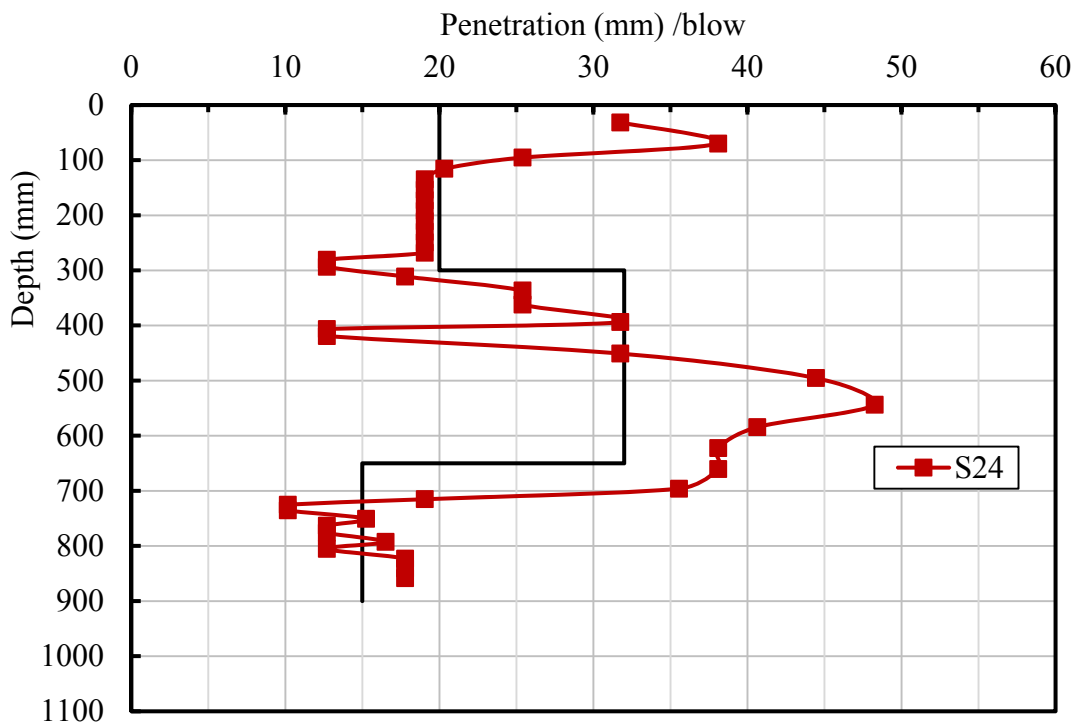

Figure 7. Field measured DCP data in station S24.

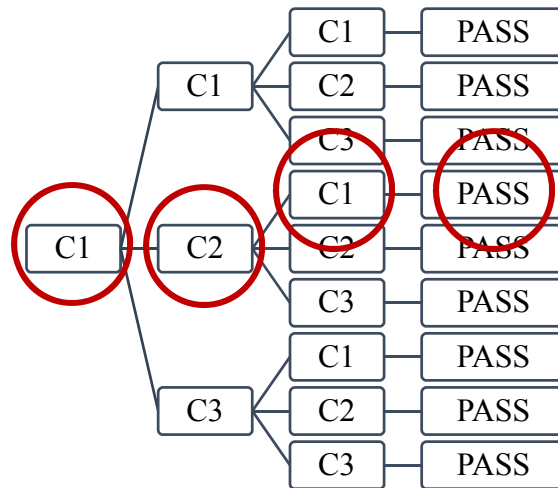

Figure 8. Evaluating stability of subgrade soil in station S24

References

- Cowell, T. D., Pyo, S. C., Gabr, M. A., and Borden, R. H., (2012). Field Verification of Undercut Criteria and Alternatives for Subgrade Stabilization—Coastal Plain (No. FHWA/NC/2008-13).
- Gregory, G. H., & Cross, S. A. (2007). Correlation of CBR with Shear Strength Parameters, June 24-27, 1-14. In Proceedings of 9th International Conference on Low Volume Roads.
- Lee, J. (2015). Analysis and Design of Temporary Slopes and Excavation Support Systems in Unsaturated Piedmont Residual Soils.
- Mohammad, L. N., Herath, A., Gudishala, R., Nazzal, M. D., Abu-Farsakh, M. Y. and Alshibli, K., 2008, “Development of Models to Estimate the Subgrade and Subbase Layers’ Resilient Modulus from In situ Devices Test Results for Construction Control”, *Publication FHWA-LA-406*. FHWA, U.S. Department of Transportation.
- Mousavi, S. H., Gabr, M. A., and Borden, R.H., (2016). “Filed Verification of Undercut Criteria and Alternatives for Subgrade Stabilization in the Piedmont Area of North Carolina”. FHWA/NC/2011-05
- North Carolina Department of Transportation (NCDOT), (2006), “Standard Specifications for Roads and Structures”. NCDOT Department of Project Services, Raleigh, NC.
- Rahim, A. M., and George, K. P., 2004, “Subgrade Soil Index Properties to Estimate Resilient Modulus”, *Transportation Research Board of the National Academies*, Washington, D.C.