

Impact of Cold Climates on Vehicle Emissions:

The Cold Start Air Toxics Pulse

CESTiCC Project 101409

Final Report

Tom Jobson and Yibo Huangfu

Department of Civil & Environmental Engineering

Washington State University

Pullman, WA

September 21, 2016

REPORT DOCUMENTATION PAGE			Form approved OMB No.
Public reporting for this collection of information is estimated to average 1 hour per response, including the time for reviewing instructions, searching existing data sources, gathering and maintaining the data needed, and completing and reviewing the collection of information. Send comments regarding this burden estimate or any other aspect of this collection of information, including suggestion for reducing this burden to Washington Headquarters Services, Directorate for Information Operations and Reports, 1215 Jefferson Davis Highway, Suite 1204, Arlington, VA 22202-4302, and to the Office of Management and Budget, Paperwork Reduction Project (0704-1833), Washington, DC 20503			
1. AGENCY USE ONLY (LEAVE BLANK)	2. REPORT DATE 10/2016	3. REPORT TYPE AND DATES COVERED Final Report: 10/2014 – 10/2016	
4. Title: Impact of Cold Climates on Vehicle Emissions: The Cold Start Air Toxics Pulse		5. FUNDING NUMBERS	
6. AUTHOR(S) Tom Jobson, Professor, Laboratory for Atmospheric Research, Department of Civil & Environmental Engineering Washington State University			
7. PERFORMING ORGANIZATION NAME(S) AND ADDRESS(ES) Laboratory for Atmospheric Research Washington State University PACCUR Environmental Technology Building 2001 Grimes way Pullman, WA 99164		8. PERFORMING ORGANIZATION REPORT NUMBER	
9. SPONSORING/MONITORING AGENCY NAME(S) AND ADDRESS(ES) U.S. Department of Transportation 1200 New Jersey Avenue, SE Washington, DC 20590		10. SPONSORING/MONITORING AGENCY REPORT NUMBER	
11. SUPPLEMENTARY NOTES			
12a. DISTRIBUTION / AVAILABILITY STATEMENT No restrictions		12b. DISTRIBUTION CODE	
13. ABSTRACT (Maximum 200 words) This project measured cold start emissions from four vehicles in winter using fast response instrumentation to accurately measure the time variation of the cold start emission pulse. Seventeen successful tests were conducted over a temperature range of -4°C to 10°C in winter 2015 at the Washington State University campus. Vehicle cold starts are thought to be a significant source of air toxic compounds in cold winter environments due to the rapid increase in mass emission rates with decreasing temperature. We used a proton transfer reaction mass spectrometer for high time resolution measurement of the emissions the air toxic compounds benzene, formaldehyde, acetaldehyde, in addition to toluene and C ₂ -alkylbenzenes. Measured molar emission ratios relative to toluene in the cold start pulse were compared with cold start emission profiles for E10 fueled vehicles used in the EPA MOVES2014 model. We found that the measured acetaldehyde-to-toluene emission ratio was about a factor of 8 greater than the emission ratio used in MOVES2014. Measured formaldehyde-to-toluene emission ratios were a factor of 5 greater. Our study suggests that emission of the air toxics acetaldehyde and, likely, formaldehyde is significantly underestimated in wintertime by the MOVES2014 model.			
14- KEYWORDS : pollution, environmental monitoring		15. NUMBER OF PAGES 30	16. PRICE CODE N/A
17. SECURITY CLASSIFICATION OF REPORT Unclassified	18. SECURITY CLASSIFICATION OF THIS PAGE Unclassified	19. SECURITY CLASSIFICATION OF ABSTRACT Unclassified	20. LIMITATION OF ABSTRACT N/A

DISCLAIMER

This document is disseminated under the sponsorship of the U.S. Department of Transportation in the interest of information exchange. The U.S. Government assumes no liability for the use of the information contained in this document. The U.S. Government does not endorse products or manufacturers. Trademarks or manufacturers' names appear in this report only because they are considered essential to the objective of the document.

Opinions and conclusions expressed or implied in the report are those of the author(s). They are not necessarily those of the funding agencies.

METRIC (SI*) CONVERSION FACTORS

APPROXIMATE CONVERSIONS TO SI UNITS

Symbol	When You Know	Multiply By	To Find	Symbol
<u>LENGTH</u>				
in	inches	25.4		mm
ft	feet	0.3048		m
yd	yards	0.914		m
mi	Miles (statute)	1.61		km
<u>AREA</u>				
in ²	square inches	645.2	millimeters squared	cm ²
ft ²	square feet	0.0929	meters squared	m ²
yd ²	square yards	0.836	meters squared	m ²
mi ²	square miles	2.59	kilometers squared	km ²
ac	acres	0.4046	hectares	ha
<u>MASS (weight)</u>				
oz	Ounces (avdp)	28.35	grams	g
lb	Pounds (avdp)	0.454	kilograms	kg
T	Short tons (2000 lb)	0.907	megagrams	mg
<u>VOLUME</u>				
fl oz	fluid ounces (US)	29.57	milliliters	mL
gal	Gallons (liq)	3.785	liters	liters
ft ³	cubic feet	0.0283	meters cubed	m ³
yd ³	cubic yards	0.765	meters cubed	m ³
Note: Volumes greater than 1000 L shall be shown in m ³				
<u>TEMPERATURE (exact)</u>				
°F	Fahrenheit temperature	5/9 (°F-32)	Celsius temperature	°C
<u>ILLUMINATION</u>				
fc	Foot-candles	10.76	lux	lx
fl	foot-lamberts	3.426	candela/m ²	lx
<u>FORCE and PRESSURE or STRESS</u>				
lbf	pound-force	4.45	newtons	N
psi	pound-force per square inch	6.89	kilopascals	kPa

These factors conform to the requirement of FHWA Order 5190.1A *SI is the symbol for the International System of Measurements

APPROXIMATE CONVERSIONS FROM SI UNITS

Symbol	When You Know	Multiply By	To Find	Symbol
<u>LENGTH</u>				
mm	millimeters	0.039	inches	in
m	meters	3.28	feet	ft
m	meters	1.09	yards	yd
km	kilometers	0.621	Miles (statute)	mi
<u>AREA</u>				
mm ²	millimeters squared	0.0016	square inches	in ²
cm ²	square centimeters	10.764	square feet	ft ²
m ²	kilometers squared	2.471	acres	ac
mi ²	hectares (10,000 m ²)			
<u>MASS (weight)</u>				
g	grams	0.0353	Ounces (avdp)	oz
kg	kilograms	2.205	Pounds (avdp)	lb
kg)	1.103 short tons	T		megagrams (1000)
<u>VOLUME</u>				
mL	milliliters	0.034	fluid ounces (US)	fl oz
liters	liters	0.264	Gallons (liq)	gal
m ³	meters cubed	35.315	cubic feet	ft ³
m ³	meters cubed	1.308	cubic yards	yd ³
<u>TEMPERATURE (exact)</u>				
°C	Celsius temperature	9/5 °C+32	Fahrenheit temperature	°F
<u>ILLUMINATION</u>				
lx	lux	0.0929	foot-candles	fc
cd/cm ²	candela/m ²	0.2919	foot-lamberts	fl
<u>FORCE and PRESSURE or STRESS</u>				
N	newtons	0.225	pound-force	lbf
kPa	kilopascals	0.145	pound-force per square inch	psi

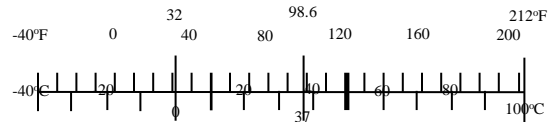

TABLE OF CONTENTS

DISCLAIMER	ii
LIST OF FIGURES	v
LIST OF TABLES	vi
EXECUTIVE SUMMARY	1
CHAPTER 1. INTRODUCTION	2
1.1 Problem Statement	2
1.2 Background	2
1.3 Determination of Cold Start Emissions: Test Driving Cycles	4
1.4 Temperature Dependence of Cold Start Emissions.....	6
1.5 Parameterization of Cold Start Emissions in MOVES.....	7
1.6 Organic Compound Speciation of Cold Start Emissions in MOVES	8
CHAPTER 2. PROCEDURE.....	13
2.1 Cold Start Test Procedure	17
CHAPTER 3. RESULTS	18
3.1 Testing Conditions	18
3.2 Carbon Monoxide and Nitric Oxide Data	19
3.3 Comparison of Organic Compound Molar Emission Ratios to MOVES	26
CHAPTER 4. CONCLUSIONS	28
CHAPTER 5. REFERENCES	30

LIST OF FIGURES

Figure 1.1 The FTP 75 drive cycle used for emission testing in the United States. The drive cycle is divided into 3 phases as indicated. Exhaust samples are either continuously measured or are collected into Teflon sampling bags at each phase for analysis of exhaust emissions.....	5
Figure 1.2 Variation of cold start emission-enhancement factors with temperature as parameterized in MOVES for 1995–2000 light duty vehicles. Enhancements are relative to cold start emissions at 75°F.	8
Figure 2.1 Photograph of the cold start testing facility at WSU, showing vehicles and the field trailer that housed the monitoring equipment.....	14
Figure 2.2 Schematic of exhaust sampling, illustrating use of an ejector diluter	17
Figure 3.1 Carbon monoxide (left panel) and nitrogen oxide (right panel) abundance in the exhaust of a 2015 Subaru Forester for 5 different cold start tests	20
Figure 3.2 Cold start emission of CO (shaded blue trace) and NO (black trace) from a 2004 Pontiac Vibe. Left panel shows data from the Mar. 4 test, and right panel, from the Mar. 6 test. Both tests show that CO emissions rapidly declined after ~ 60 seconds to steady-state idle concentrations of several hundred ppmv. The NO emissions displayed different temporal behavior, and NO displayed a secondary maxima after CO emissions declined.	22
Figure 3.3 Cold start emission of CO (shaded blue trace) and NO (black trace) from a 1995 Ford Mustang. Left panel shows data from the Feb. 21 test and right panel, from the Feb. 23 test. Both tests show a long period of elevated CO emissions before CO emissions stabilize at ~ 170 ppmv. The CO and NO emissions display different temporal behavior. The NO displayed a secondary maxima about 200 seconds after an initial engine start NO spike.	23
Figure 3.4 Proton-transfer-reaction mass spectrum of idling emissions from a Pontiac Vibe. Instrument response (Hz) is normalized to the reagent ion count rate. Given a 10 Hz/ppbv response factor for benzene, the benzene signal shown equates to a ~ 60 ppbv mixing ratio.....	24
Figure 3.5 An example of Pontiac Vibe cold start VOC data from the PTR-MS, showing correspondence with CO mixing ratios in diluted engine exhaust during an engine cold start, delayed response of acetaldehyde, and absence of a formaldehyde peak.....	25
Figure 3.6 An example of Pontiac Vibe cold start VOC data from the PTR-MS, showing correspondence with CO mixing ratios and better agreement of acetaldehyde and formaldehyde time traces with CO and aromatics as a result of improvements in sample line heating.....	26

LIST OF TABLES

Table 1.1 Speciation Profile #8757 used in MOVES2014 to represent cold start and running emissions from Tier 2 vehicles operating on E10 fuel. Identification of compounds as hazardous air pollutants (HAPS) by the EPA is noted. Bold type indicates compounds measured in this project.	10
Table 1.2 Speciation Profile #8751a used in MOVES2014 to represent cold start and running emissions from pre Tier 2 vehicles operating on E10 fuel. Identification of compounds as hazardous air pollutants (HAPS) by the EPA is noted. Bold type indicates compounds measured in this project.	11
Table 1.3 Speciation Profile #8775 used in MOVES2014 to represent cold start and running emissions from post 2007 diesel engine vehicles. Identification of compounds as hazardous air pollutants (HAPS) by the EPA is noted. Bold type indicates compounds measured in this project.	12
Table 2.1 Vehicles tested in this study and emission factor legislation.....	13
Table 2.2 Instrumentation used to measure exhaust composition	15
Table 3.1 List of cold start experiments showing start temperature and exhaust dilution factor	18
Table 3.2 Mass CO and NO emitted during engine cold start for the 2015 Subaru Forester	21
Table 3.3 Molar emission ratios with respect to toluene used in the MOVES2014 speciation profiles for cold start emissions (E10 fuel) compared with average values determined from cold start experiments. Values listed are in units of %.	27

EXECUTIVE SUMMARY

This project measured cold start emissions from four vehicles in winter using fast response instrumentation to accurately measure the time variation of the cold start emission pulse. Seventeen successful tests were conducted over a temperature range of -4°C to 10°C in winter 2015 at the Washington State University campus. Vehicle cold starts are thought to be a significant source of air toxic compounds in cold winter environments due to the rapid increase in mass emission rates with decreasing temperature. While data exist for CO, NO, and total hydrocarbon emissions from federal testing procedures for vehicle emission certification, little is known about the emission rates of individual volatile organic compounds, in particular the air toxics benzene, formaldehyde, and acetaldehyde. We used a proton transfer reaction mass spectrometer for high time resolution measurement of the emission of these compounds, in addition to toluene and C_2 -alkylbenzenes (sum of xylene isomers plus ethylbenzene). Measured molar emission ratios relative to toluene in the cold start pulse were compared with cold start emission profiles for E10 fueled vehicles used in the EPA MOVES2014 model. We found that the measured acetaldehyde-to-toluene emission ratio was about a factor of 8 greater than the emission ratio used in MOVES2014. Measured formaldehyde-to-toluene emission ratios were a factor of 5 greater. The measured benzene-to-toluene and C_2 -alkylbenzene-to-toluene emission ratios compared well with those used in MOVES. Our study suggests that emission of the air toxics acetaldehyde and, likely, formaldehyde is significantly underestimated in wintertime by the MOVES2014 model.

CHAPTER 1. INTRODUCTION

1.1 Problem Statement

This project relates to CESTiCC's fifth research thrust area, "environmental impact assessment" - specifically the unique effect of cold air temperatures on vehicle exhaust emissions and the resulting exposure of humans to air toxics. Exposure to vehicle exhaust emissions is a major cause of cardiovascular disease and a cancer risk factor (HEI 2010). Vehicle emissions models, such as the U.S. Environmental Protection Agency's Motor Vehicle Emissions Simulator (MOVES) suggest that in cold climates, the majority of pollutant mass emitted by vehicles occurs during engine cold starts and idling, not when the vehicle is moving along the road. In winter, cold starts in combination with meteorological conditions that trap vehicle emissions under low-lying temperature inversions lead to significantly elevated pollutant concentrations. People living in colder climates are potentially exposed to significantly higher concentrations of air toxics than people who are living in warmer climates because of enhanced cold start and idling emissions and lower pollution dispersion rates. However, vehicle emissions data for cold climates are sparse, and the accuracy of vehicle emissions model parameterizations for air toxics in cold climates is not known. Clarifying the importance of vehicle cold start and engine idling emissions in cold climates is the focus of this study.

1.2 Background

Vehicle cold start emissions are said to occur when a vehicle's engine and emission control equipment temperatures are at or near ambient air temperatures when the vehicle is started (EPA 2010). The engine and catalytic converters require time to warm up to normal working temperatures, which is about 110°C for engines and above 200°C for three-way

catalytic converters (Favez et al. 2009). Starting a vehicle after it has been off for 12 hours or more is considered a cold start, implying that after this time vehicle temperatures are similar to ambient conditions (Favez et al. 2009). Cold start emissions are a strong function of temperature. Emissions of carbon monoxide (CO) and volatile organic compounds (VOC) significantly increase with decreasing air temperature for temperatures below 75°F. Emissions of VOCs and CO are thought to be elevated during engine cold starts because of condensation of fuel on cold surfaces and because of colder, less efficient catalytic converters. Modern gasoline and diesel engine vehicles have very low running emissions, meeting increasingly stringent pollutant emission requirements set by the U.S. Environmental Protection Agency (EPA). Because of reduced running emissions, the relative importance of engine cold starts to overall vehicle emissions is increasing, particularly in cold environments. For example, field measurement work with the Idaho Department of Environmental Quality (IDEQ) and Washington State Department of Ecology on wintertime air quality issues in the intermountain west has identified vehicle emission cold starts as a major source of wintertime air pollution (Wallace et al. 2012), accounting for 50% of CO and VOCs emitted from vehicles in Boise, Idaho, in winter.

In the United States, cold start emissions data come from Federal Test Procedure (FTP) conducted by manufacturers and the EPA to verify vehicle emission standards and fuel efficiency specifications. Emissions data for CO, nitrogen oxide (NO_x), and total hydrocarbons are determined at three temperatures: 75°, 50°, and 20°F. Almost no testing has been done below 20°F, and data on the emission of specific air toxic compounds (i.e., benzene, formaldehyde) are extremely limited. Information on particulate matter emissions at cold temperatures is also extremely limited for all test temperatures. It has been shown that extended idling after cold starts, a common practice in cold winter environments, prolongs the period of elevated emissions

of air toxic compounds (Sentoff et al. 2010). Engine starts during the morning rush hour produce a large pulse of air toxics emissions that become trapped under low-lying temperature inversions (a common occurrence in winter), producing high concentrations of pollutants and enhanced human exposure to disease-causing compounds. People living in colder climates may thus be experiencing much greater exposure to compounds that lead to cardiovascular disease and cancer than people living in warm climates, producing regional differences in the public health impact of vehicle emissions.

The objective of our project was to compare emissions of the air toxic compounds benzene, formaldehyde, and acetaldehyde to the emissions used in MOVES, the primary model used in the United States and Canada for vehicle emissions inventory development for air quality modeling.

1.3 Determination of Cold Start Emissions: Test Driving Cycles

Vehicle emissions are determined by measuring exhaust composition from vehicles, using a chassis dynamometer to simulate driving conditions and real-world engine loads. A number of such dynamometer drive cycles are used worldwide to simulate urban driving conditions for vehicle emission testing purposes. In the United States, the Federal Test Procedure (FTP) is the standard drive cycle test method for emissions certification. The vehicle speed variation for FTP is shown in Figure 1.1. This cycle consists of three phases: a 505-second cold start phase, an 867-second stabilized phase, and a 505-second hot start phase. Phase 1 and Phase 3 are identical drive cycles. Before the hot start phase, the vehicle is turned off for 10 minutes and then restarted. Note that during the FTP-75 cold start phase, the engine idles for only 20 seconds before the vehicle speed is ramped up; the average speed is 25 mph for the first phase of

the test cycle. A more realistic scenario in cold climate winters is that the engine idles for several minutes to warm up the vehicle before it is driven.

The emitted engine exhaust for each phase is sampled, often by whole air sample collection into Teflon bags, for determination of pollutant concentrations. Emission factors (units of grams / km) are calculated from the measured pollutant mixing ratios. The difference in concentration between the Phase 1 bag sample and the Phase 3 bag sample is attributed to extra emissions due to the engine cold start in Phase 1 and is reported in units of grams (EPA 2010).

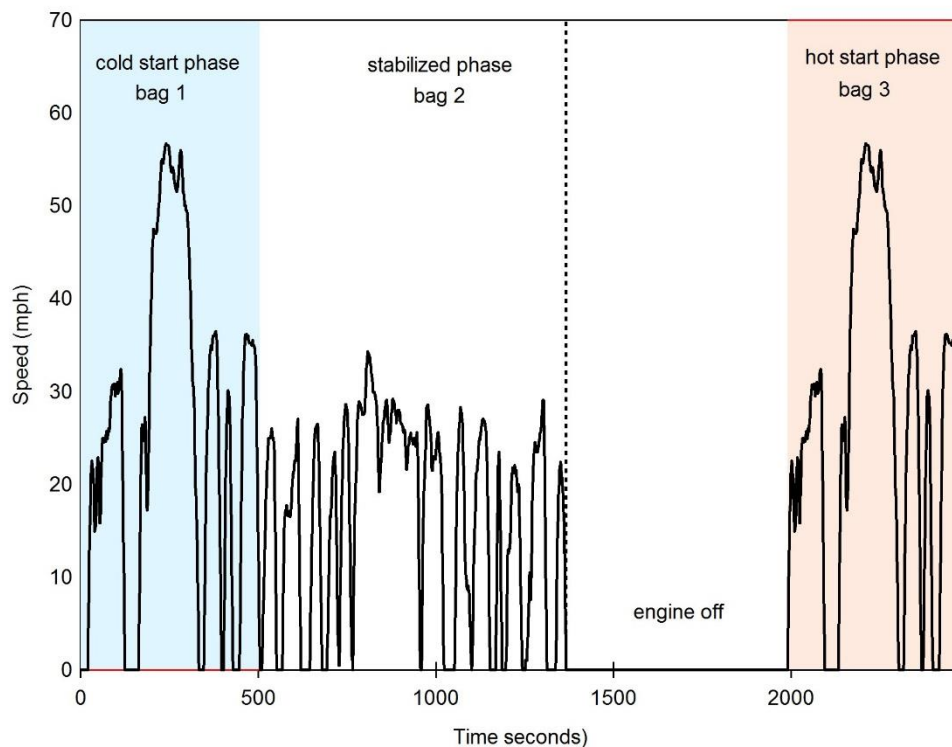

Figure 1.1 The FTP 75 drive cycle used for emission testing in the United States. The drive cycle is divided into 3 phases as indicated. Exhaust samples are either continuously measured or are collected into Teflon sampling bags at each phase for analysis of exhaust emissions.

Cold start emissions vary, depending on the specific drive cycles test used, because of differences in idling time, vehicle speed during the first phase, and bag sampling time.

Differences in the standard emission testing drive cycles used in Europe, Japan, and the United

States lead to differences in cold start emissions and, thus, the temperature dependence of these emissions (Laurikko 1995; Joumard et al. 2000; Weilenmann et al. 2005). For example, Laurikko (1995) compared the FTP-75 driving cycle with the ECE driving cycle used in Europe and found that the engine and the catalyst warmed more rapidly in the FTP-75 cycle than in the ECE cycle because of differences in vehicles speeds, resulting in lower emissions for the FTP test. Emission factors for CO and hydrocarbons for the ECE drive cycle test were about a factor of 2 larger than the FTP cycle emissions.

1.4 Temperature Dependence of Cold Start Emissions

Cold start emissions have been shown to be temperature dependent. Lower engine temperatures reduce combustion efficiency and prolong the time it takes to heat the catalytic converter to 200°C, the temperature required to be fully effective. Warm-up times have been measured by Bielaczyc et al. (2011), who showed that at 7°C, it takes a small-engine vehicle approximately 18 minutes to fully warm up.

Much of the published research on engine cold starts has been conducted in Europe. We summarize a few notable publications here. Laurikko (1995) studied the temperature effect on three gasoline vehicles; cold start emissions were measured as the mass in grams of pollutant in the first bag of ECE cycle tests. About five times more CO and HC (hydrocarbons) were measured at -7°C compared with 22°C. Ludykar et al. (1999) tested gasoline vehicles at three levels of ambient temperature including +22°C, -7°C, and -20°C. Hydrocarbon emissions increased with decreasing temperature; emissions at -20°C were 14.7 times higher than emissions at 20°C, while CO emission factors increased by a factor of 2.6. Weilenmann et al. (2005) tested gasoline vehicles under ambient temperatures of 23°C, -7°C, and -20°C, and showed that the average hydrocarbon extra emission was 26 g per start higher at -20°C than at

23°C. For CO, the extra emission was 182 g per start higher at -20°C compared with 23°C. Weilenmann et al. (2009) reported that cold start emissions at -20°C for CO were 15 times greater and for hydrocarbons were 30 times greater than cold start emissions at 23°C. Remarkably, these cold start mass emission rates at -20°C are equivalent to driving 5000 km (Weilenmann et al. 2009; Bielaczyc et al. 2011).

1.5 Parameterization of Cold Start Emissions in MOVES

Temperature effects of cold start emissions are parameterized in MOVES based on “bag data” collected by FTP and LA-92 drive cycle testing (EPA 2010). Emissions are enhanced for temperatures less than 75°F and have been parameterized based on fits to data collected at temperatures from 0°F (-18°C) to 75°F (24°C) due to anomalous data at -20°C skewing the fits for warmer temperature trends (EPA 2010). The resulting cold start emission-enhancement factors have the following temperature dependence for model years 1990 to 2005, where temperature (T) is in degrees F (EPA 2010):

$$\text{CO} = 1.1141434 * (T - 75)$$

$$\text{total hydrocarbons} = 0.00292424 * (T - 75)^2$$

$$\text{NO}_x = 0.009431682 * (T - 75)$$

The temperature dependence for total hydrocarbon (THC) emissions is non-linear. The THC metric includes methane and all organic compounds that respond to a flame ionization detector (FID), including oxygenate compound. It is assumed that all compounds have the same carbon atom response factor as propane (EPA 2015). Carbon monoxide and total hydrocarbon and emissions enhancements increase rapidly with decreasing temperature, as illustrated in Figure 1.2. The CO emission enhancement factor at 0°C is 48, while for total hydrocarbons it is a factor of 5.4. At -20°C, the CO enhancement factor is 88, while for hydrocarbons it is a factor of 18. It

is not clear if emission factors for all hydrocarbons are increased by the same amount. Very little information is available on speciated hydrocarbon cold start emissions.

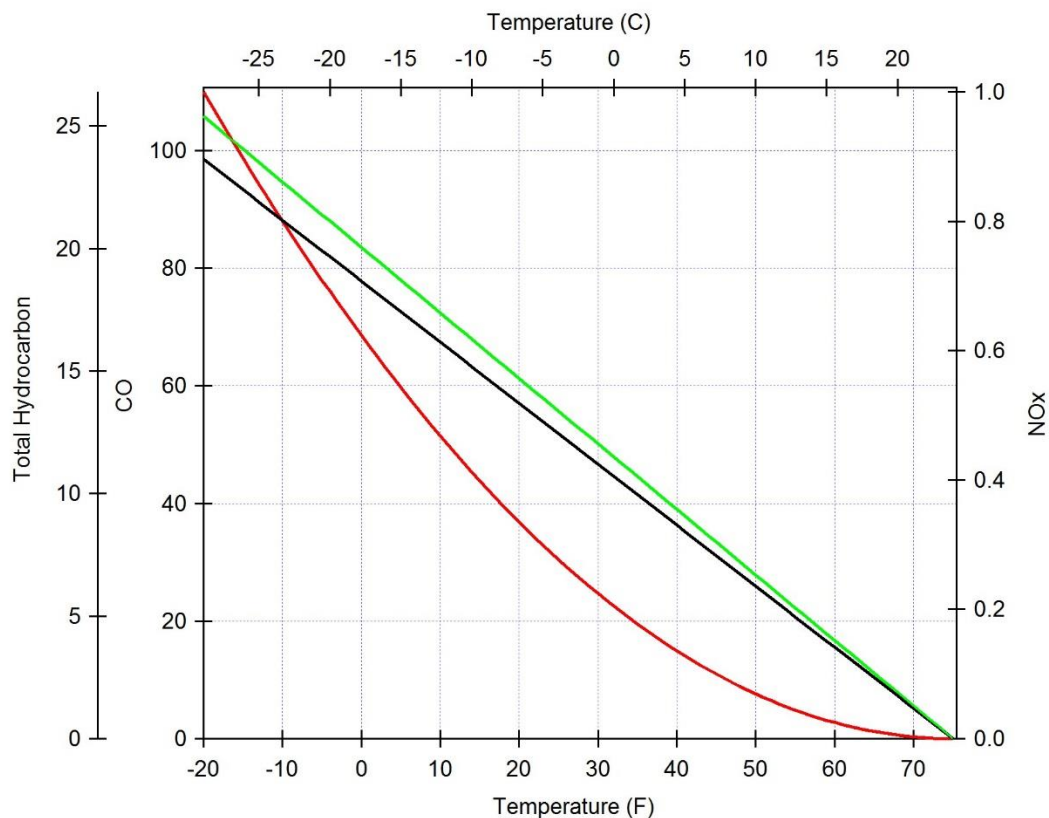

Figure 1.2 Variation of cold start emission-enhancement factors with temperature as parameterized in MOVES for 1995–2000 light duty vehicles. Enhancements are relative to cold start emissions at 75°F.

1.6 Organic Compound Speciation of Cold Start Emissions in MOVES

In the latest MOVES version, MOVES2014, cold start emissions of gas phase organic compounds have the same speciation profile as running emissions (EPA 2015). There is no accounting for relative compositional changes in the emission profile as a function of engine load or cold start temperature. The EPA speciation profile used for cold starts and running emission for Tier 2 vehicles operating with E10 fuel is profile #8757. The top 25 compounds (out of 120 listed) in this profile, accounting for 85% of total mass emissions, are given in Table 1.1. Compounds were measured in this project and are highlighted in bold. For pre Tier 2 vehicles,

speciation profile 8751a (E10 fuel) is used, and the top 25 compounds, accounting for 77% of total mass emissions, are listed in Table 1.2. For diesel engine vehicles, EPA speciation profile 8775 is used for cold starts and running emissions (EPA 2015), and the top 25 compounds (out of 83 listed) in the profile, accounting for 92% of the mass emissions, are listed in

Table 1.3.

Table 1.1 Speciation Profile #8757 used in MOVES2014 to represent cold start and running emissions from Tier 2 vehicles operating on E10 fuel. Identification of compounds as hazardous air pollutants (HAPS) by the EPA is noted. Bold type indicates compounds measured in this project.

Ranking	Compound	Weight %	HAPS
1	Methane	17.36	
2	Ethylene	10.05	
3	Toluene	7.44	Y
4	Cyclohexane	5.62	
5	p-xylene & m- xylene	4.35	Y
6	Propylene	3.99	
7	Ethyl alcohol	3.81	
8	Benzene	3.79	Y
9	N-butane	3.55	
10	N-hexane	2.91	Y
11	Ethane	2.70	
12	C9-C12 isoalkanes	2.18	
13	Isobutylene	1.92	
14	o-xylene	1.70	Y
15	Ethylbenzene	1.66	Y
16	Acetylene	1.65	
17	Acetaldehyde	1.61	Y
18	1-Methyl-3-ethylbenzene	1.35	
19	2,2,4-trimethylpentane	1.23	Y
20	1,2,4-trimethylbenzene + 1,3,4-trimethylbenzene	1.14	
21	3-methylpentane	1.14	
22	2-methylpentane	1.01	
23	1,3-butadiene	0.89	Y
24	Formaldehyde	0.87	Y
25	1-butene	0.68	

Table 1.2 Speciation Profile #8751a used in MOVES2014 to represent cold start and running emissions from pre Tier 2 vehicles operating on E10 fuel. Identification of compounds as hazardous air pollutants (HAPS) by the EPA is noted. Bold type indicates compounds measured in this project.

Ranking	Compound	Weight %	HAPS
1	Methane	14.16	
2	Toluene	7.77	Y
3	Ethylene	5.96	
4	Isopentane	5.35	
5	p-xylene & m-xylene	4.89	Y
6	Benzene	4.14	Y
7	Propylene	3.86	
8	Acetylene	3.27	
9	Ethane	2.34	
10	2,2,4-trimethylpentane	2.24	Y
11	2-methylpentane	2.08	
12	1-butene & isobutene	2.07	
13	O-xylene	1.88	Y
14	Ethylbenzene	1.86	Y
15	1,2,4-trimethylbenzene + 1,3,4-trimethylbenzene	1.63	
16	3-methylpentane	1.60	
17	Ethyl alcohol	1.58	
18	N-hexane	1.50	Y
19	1-Methyl-3-ethylbenzene	1.43	
20	N-pentane	1.40	
21	Formaldehyde	1.36	Y
22	Acetaldehyde	1.27	Y
23	2-methylhexane	1.19	
24	3-methylhexane	1.14	
25	2,3-dimethylpentane	1.13	

Table 1.3 Speciation Profile #8775 used in MOVES2014 to represent cold start and running emissions from post 2007 diesel engine vehicles. Identification of compounds as hazardous air pollutants (HAPS) by the EPA is noted. Bold type indicates compounds measured in this project.

Ranking	Compound	Weight %	HAPS
1	Methane	51.64	
2	Formaldehyde	10.05	Y
3	unknown	4.35	
4	Acetaldehyde	3.36	Y
5	Ethylene	3.07	
6	N-dodecane	2.34	
7	N-undecane	1.75	
8	Ethane	1.34	
9	Toluene	1.24	Y
10	N-butane	1.10	
11	p-xylene & m-xylene	1.04	Y
12	N-pentane	1.01	
13	Isobutylene	0.97	
14	Propylene	0.94	
15	Methylcyclohexane	0.89	
16	Benzaldehyde	0.79	
17	Acetone	0.76	
18	1,2,4-trimethylbenzene + 1,3,4-trimethylbenzene	0.75	
19	2,2-dimethylpropane	0.68	
20	2,2-dimethylhexane	0.66	
21	o-xylene	0.65	Y
22	Benzene	0.61	Y
23	Acetylene (ACETYL) [PAMS]	0.58	
24	2,3,4-trimethylpentane	0.54	
25	2,3,3-trimethylpentane	0.52	

CHAPTER 2. PROCEDURE

Vehicle cold start emissions were investigated for the four-spark ignition vehicles listed in **Error! Reference source not found.** No dynamometer was used in the testing. The procedure simply involved starting the vehicle and measuring how exhaust concentration changed with time as the car idled. Exhaust was sampled using fast response continuous monitors for CO, NO_x, carbon dioxide (CO₂), and volatile organic compounds (VOCs), with data collection frequency of 1 Hz. Measurements were conducted at Washington State University (WSU) during winter 2015 inside an unheated storage building. Instruments were housed inside a temperature-controlled field trailer within the building. Vehicles were stored inside the building overnight, and emissions tests were conducted in the early morning. Figure 2.1 is a photograph showing the storage building with two of the test vehicles inside. Behind the vehicles is the field trailer that housed the measurement equipment.

Table 2.1 Vehicles tested in this study and emission factor legislation

					Regulatory emission rates (g/mi)				
					10 years/100 K miles				50K miles
Made	Model	Year	Engine size (L)	Tier	CO	NO _x	PM	HCHO	Cold start CO
Ford	Mustang	1995	5	1	4.2	0.6	0.1	-	-
Honda	Civic	1996	1.6	1	4.2	0.6	0.1	-	-
Pontiac	Vibe	2004	1.6	2	4.2	0.07	0.01	0.018	10 (@-7°C)
Subaru	Forester	2015	2.5	2	4.2	0.07	0.01	0.018	10 (@-7°C)



Figure 2.1 Photograph of the cold start testing facility at WSU, showing vehicles and the field trailer that housed the monitoring equipment

Table 2.2 lists the instrumentation used to measure CO, NO_x, CO₂, and speciated VOCs. Unique to this project was the use of fast-responding instrumentation to measure CO, NO_x, and VOCs. Initially, we used a slower responding NO_x analyzer (TECO 42C), but switched to the faster responding Air Quality Design instrument on February 21, 2015, when the instrument became available. Thus, about half the experiments were done with TECO 42C, and these data are not useful. Several different VOCs could be measured in real time using a proton-transfer-reaction mass spectrometer (PTR-MS), which allowed us to measure formaldehyde, acetaldehyde, toluene, and benzene, key hazardous air pollutants and air toxic compounds. With this instrument, rapid changes in exhaust composition could be followed as the engine and catalytic converter warmed up. Temperatures were measured with Type K thermocouples. The engine temperature was measured by putting the thermocouple close to the engine surface. Two temperature loggers (OMEGA) were used to record the real-time temperature of the exhaust and

the outside temperature of the catalytic converter with a frequency of 1 second. The thermocouple for the exhaust measurement was put in the center of the tailpipe.

Table 2.2 Instrumentation used to measure exhaust composition

Pollutant	Instrument	Manufacturer	Response time
Carbon monoxide (CO)	Vacuum UV CO	Aerolaser GmbH	< 1 second
Nitrogen oxides (NO _x)	TECO 42C	Thermoelectron Corp	40 second
Nitrogen oxides (NO _x)	2-channel NO _x y	Air Quality Design	~ 1 second
Volatile organic compounds (VOCs)	PTR-MS	Ionicon Analytik	~1 second
Carbon dioxide (CO ₂)	LiCor 840a	LiCor	< 1 second

The PTR-MS identifies compounds by molecular weight via chemical ionization by H₃O⁺. We have used this instrument in air-quality field experiments and exhaust sampling studies over the last 10 years (Jobson et al. 2005; Jobson et al. 2010; Erickson et al. 2014). The instrument was set to measure a few selected compounds that are abundant in exhaust and that are reliably measured with this technology: formaldehyde, acetaldehyde, acetone, and propanal, benzene, toluene, C₂-alkylbenzenes (this includes the xylene isomers + ethylbenzene), and C₃-alkylbenzenes (ethyl toluene isomers + trimethyl benzene isomers + i-propyl and n-propyl benzene). The PTR-MS response was calibrated using an external compressed air standard (Scott Marrin), containing these components and others with a stated concentration accuracy of ±5%. The standard was diluted with humidified zero air to obtain mixing ratios of 20 ppbv (parts per billion by volume) to determine the instrument response factors. The instrument response to formaldehyde was determined using a permeation device (Kin Tek).

Carbon monoxide was measured using a vacuum ultraviolet (UV) fluorescence instrument (Aerolaser, Germany), and the response was calibrated with a compressed gas CO

standard (Scott Marrin, 1% accuracy). Nitrogen oxide (NO_x) measurements were made using a Thermolectron model 42C instrument and a fast response two-channel NO_x instrument from Air Quality Design. The instruments were spanned using an NO compressed gas standard (Scott Marrin, 1% accuracy) diluted with dry zero air. The LiCor 840a CO₂ monitor was factory calibrated.

Vehicle exhaust was sampled using an ejector diluter (Air-Vac TD110HSS). A zero airflow of 20 L min⁻¹ was forced through the ejector diluter, creating a vacuum that pulled a smaller flow of air from the exhaust. The zero airflow was regulated with a mass flow controller (MKS Instruments). The sample flow pulling exhaust into the ejector diluter was controlled by using a variable length of 0.030" ID by 1/16" OD tubing, specially coated to make it chemically inert (Restek). This capillary tubing restricted the flow of exhaust into the ejector diluter. The exhaust flow was thus diluted by the ratio of the sample flow divided by the 20 L min⁻¹ zero airflow. Exhaust dilutions that spanned a range of 100 to 1000 were used in the experiments. Dilution was necessary to ensure that measured mixing ratios were within the analytical response range of the instruments. The air exited the ejector diluter and flowed through 1/2" OD PFA Teflon tubing to the field trailer, where it was sub-sampled by the respective analyzers. A schematic of the setup is shown in Figure 2.2. The 1/16" sample line and ejector diluter were wrapped with a heating cord to warm them and prevent water condensation. The sample line was heated to 100°C, and the ejector diluter was heated to 60°C. A stainless steel filter was attached to the 1/16" sample line to remove particles. The filter was difficult to heat effectively and may have caused losses of some compounds due to condensation of water on its surfaces.

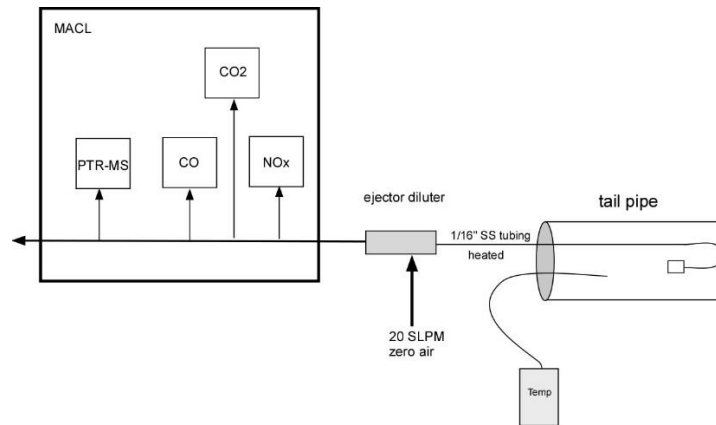

Figure 2.2 Schematic of exhaust sampling, illustrating use of an ejector diluter

2.1 Cold Start Test Procedure

The 1/16" OD sampling line was inserted about 4" into the tail pipe, and the zero airflow was set to 20 L min⁻¹. The heating cords were turned on, and the lines and ejector diluter were allowed to rise to temperature. The analyzers then recorded "background" data for about 10 minutes. This background data are simply ambient air diluted by zero airflow. The temperatures of the engine and catalytic converter were recorded during this period. After the background data period, the vehicle was started and left idling until exhaust concentrations of CO, CO₂, NO_x, and hydrocarbons reached a steady state, typically 20 minutes.

CHAPTER 3. RESULTS

3.1 Testing Conditions

Seventeen tests were conducted on four different vehicles. The ignitions of all vehicles employed in this experiment were off for more than 12 hours before testing began. Two of the vehicles tested, the 2004 Pontiac Vibe and the 2015 Subaru Forester, were tested under a reasonably wide range of temperatures, from -4.3°C to 10.4°C and from 0.6°C to 4.6°C , respectively. During the relatively warm winter in Pullman, Washington, in 2015, colder temperatures did not occur, and most data collected were within 5°C of the freezing point. Table 3.1 lists the tests and start temperatures conducted in February and March 2015.

Table 3.1 List of cold start experiments showing start temperature and exhaust dilution factor

Test #	Date	Vehicle	Temp ($^{\circ}\text{C}$)	Dilution factor
1	5 Feb	Pontiac Vibe 2004	10.4	3180
2	11 Feb	Pontiac Vibe 2004	6.8	2565
3	13 Feb	Pontiac Vibe 2004	7.5	1880
4	18 Feb	Pontiac Vibe 2004	2.1	1317
5	19 Feb	Pontiac Vibe 2004	3.5	1300
6	20 Feb	Mustang GT 1995	6.7	1350
7	21 Feb	Honda Civic 1996	3.0	603
8	21 Feb	Ford Mustang GT 1995	3.6	960
9	23 Feb	Ford Mustang GT 1995	-0.9	1018
10	24 Feb	Subaru Forester 2015	0.6	1160
11	26 Feb	Subaru Forester 2015	4.6	980
12	27 Feb	Subaru Forester 2015	2.6	1125
13	28 Feb	Subaru Forester 2015	1.3	190
14	2 Mar	Subaru Forester 2015	3.4	230
15	3 Mar	Pontiac Vibe 2004	-1.6	330

Test #	Date	Vehicle	Temp (°C)	Dilution factor
16	4 Mar	Pontiac Vibe 2004	-4.3	260
17	6 Mar	Pontiac Vibe 2004	3.4	215

3.2 Carbon Monoxide and Nitric Oxide Data

An example time series of the cold start CO and NO emissions from the Subaru Forester is illustrated in Figure 3.1. The measured mixing ratios were corrected for the dilution factor. Carbon monoxide abundance in exhaust reached a maximum of a few percent and then quickly declined to a steady-state mixing ratio of about 10 ppmv (parts per million by volume), representing idling emissions from a warmed-up vehicle. The excess CO above the 10 ppmv steady-state threshold was considered the cold start emission. From engine start to steady-state idling, CO levels of 10 ppmv took approximately 70 seconds for this vehicle. The short-lived pulse was well characterized by the fast response CO instrument. Elevated emissions of NO were even briefer, lasting about 40 seconds, and declining 3 orders of magnitude in a period of 60 seconds to a steady-state engine idle mixing ratio of less than 0.1 ppmv.

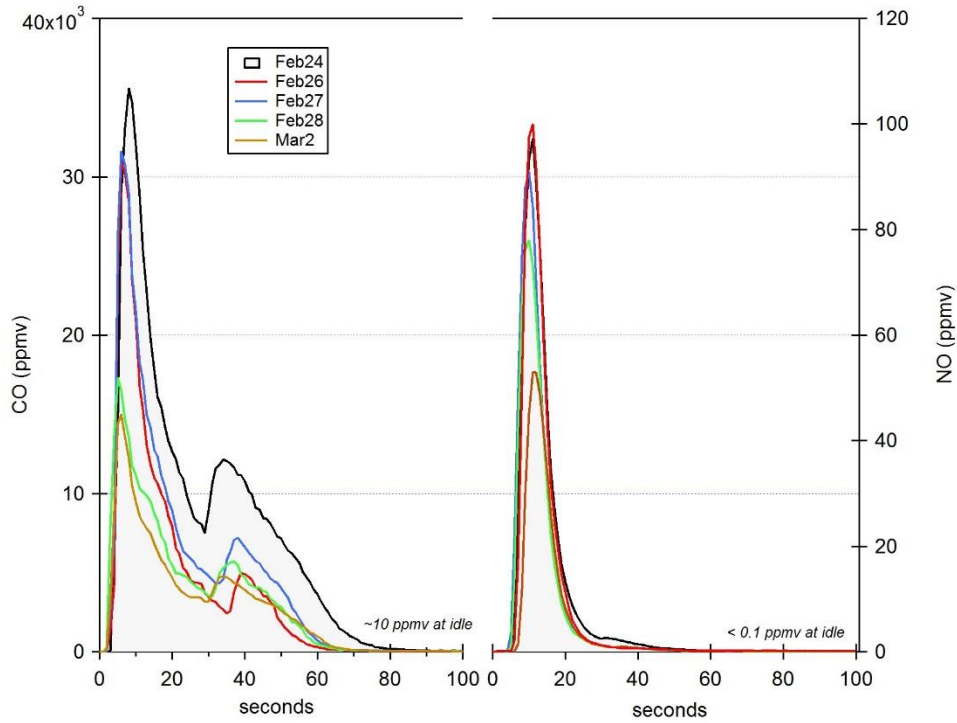

Figure 3.1 Carbon monoxide (left panel) and nitric oxide (right panel) abundance in the exhaust of a 2015 Subaru Forester for 5 different cold start tests

An estimate of the CO and NO mass emission per cold start was calculated by determining the area under the cold start concentration peak (units of $\text{mg m}^{-3} \text{s}$) and multiplying this value by the estimated exhaust flow rate ($\text{m}^3 \text{s}^{-1}$). The exhaust flow rate, given by equation (1), was estimated from the engine idle RPM, as indicated on the dashboard tachometer, and engine displacement of 2.5 L.

$$\text{Exhaust flow (m}^3 \text{s}^{-1}) = 0.5 * \text{RPM} * 2.5 \text{ L} * 0.0167 \text{ min s}^{-1} * 10^{-3} \text{ L m}^{-3} \quad (1)$$

Estimated mass emission values are shown in Table 3.2 for the Forester. No clear trend of CO emissions and temperature was apparent, in part because of the limited temperature range, though CO emissions varied by a factor of 3. The variability in CO emissions was greater than for NO, perhaps reflecting greater start-to-start variability due to the catalytic converter performance and the combustion process. Average CO mass emission was $10.5 \text{ g} \pm 40\%$. Nitric

oxide mass emission was less variable; average mass emission was $17.0 \text{ mg} \pm 22\%$. The average CO-to-NO_x molar emission ratio was $654 \pm 23\%$, far larger than typical roadway running emission ratios of 5 to 7 (Wallace et al. 2012).

Table 3.2 Mass CO and NO emitted during engine cold start for the 2015 Subaru Forester

Forester test date	Temp. (°C)	Dilution factor	CO cold start mass emission (grams)	NO cold start mass emission (mg)	CO-to-NO molar emission ratio
24 Feb	0.6	1160	17.3	21	891
26 Feb	4.6	980	9.4	19	528
27 Feb	2.6	1125	11.5	18	685
28 Feb	1.3	190	7.8	16	521
2 Mar	2.4	230	6.6	11	647

The older Pontiac Vice (2004), like the Forester a Tier 2 emissions vehicle, displayed a rapid decline in CO emissions, as illustrated in Figure 3.2. Carbon monoxide emissions declined rapidly over about 60 seconds to a steady-state engine idle value of $\sim 1200 \text{ ppmv}$. This value is much higher (factor of 100) than the Forester and indicates that the catalytic converter was not working as well. The NO emission profile was also different from the Forester; after an initial engine start pulse, concentrations briefly declined, only to rise to higher values, which slowly decreased over the course of the test. In this case, it was not clear what was considered a cold start emission of NO.

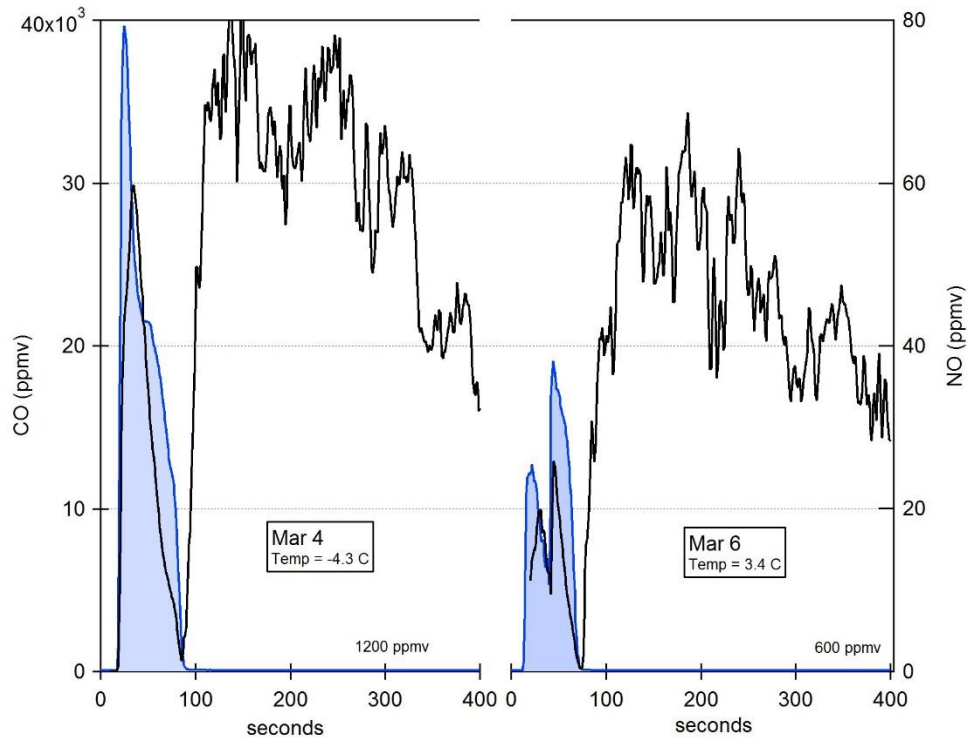

Figure 3.2 Cold start emission of CO (shaded blue trace) and NO (black trace) from a 2004 Pontiac Vibe. Left panel shows data from the Mar. 4 test, and right panel, from the Mar. 6 test. Both tests show that CO emissions rapidly declined after ~ 60 seconds to steady-state idle concentrations of several hundred ppmv. The NO emissions displayed different temporal behavior, and NO displayed a secondary maxima after CO emissions declined.

In contrast to the rapid decrease of CO observed for the Tier 2 vehicles, Figure 3.3 shows CO emission from a 1995 Ford Mustang GT. Carbon monoxide emissions took a much longer time to stabilize at ~ 170 ppmv (> 600 seconds), presumably due to the longer time it took for the catalytic converter to warm up to full efficiency, compared with the 2015 Subaru Forester. Note that CO emissions were a factor of 10 greater at idle than for the Forester, and a factor of 10 less at idle than for the Pontiac Vibe. Such differences between vehicles would have a significant impact on choice of testing procedures to evaluate real-world cold start emissions.

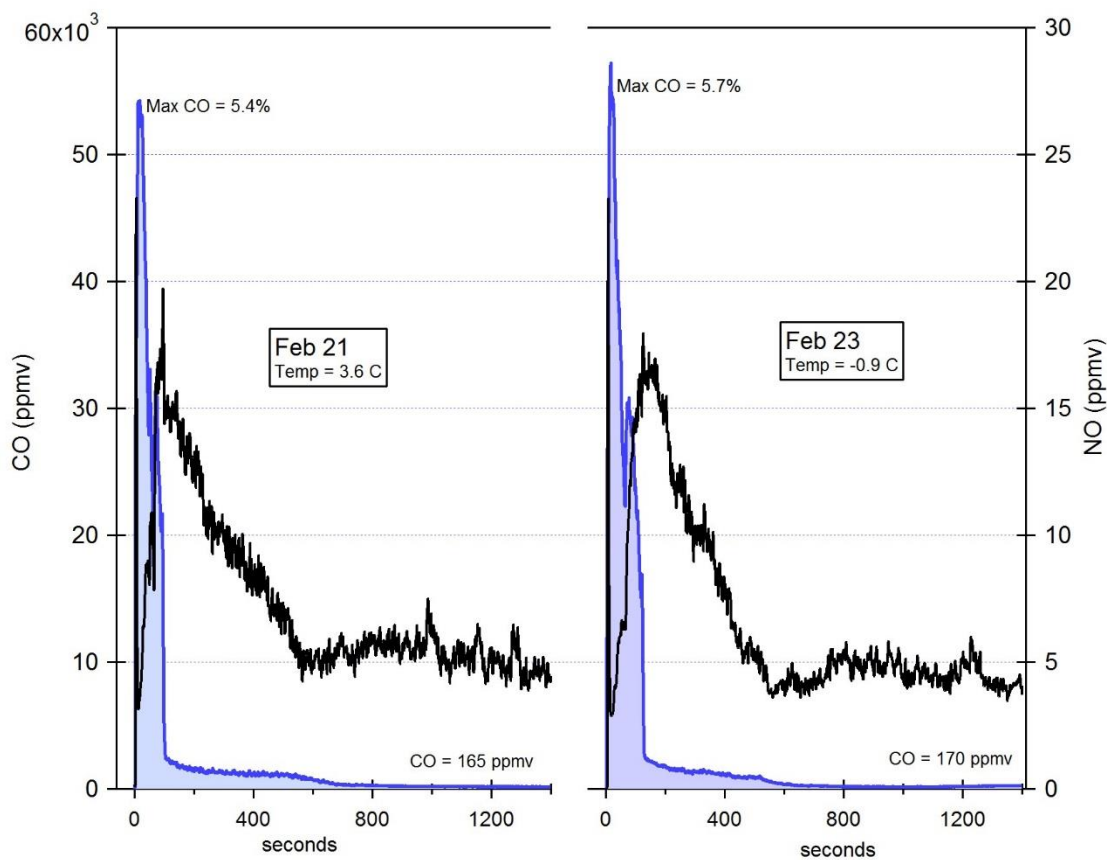

Figure 3.3 Cold start emission of CO (shaded blue trace) and NO (black trace) from a 1995 Ford Mustang. Left panel shows data from the Feb. 21 test and right panel, from the Feb. 23 test. Both tests show a long period of elevated CO emissions before CO emissions stabilize at ~ 170 ppmv. The CO and NO emissions display different temporal behavior. The NO displayed a secondary maxima about 200 seconds after an initial engine start NO spike.

An example of VOC loading in exhaust, as measured by the PTR-MS, is shown in Figure 3.4 for idling emissions from the Pontiac Vibe. Shown is a mass spectrum displaying instrument response versus the detected ion mass-to-charge ratio. The mass-to-charge ratio is interpreted as the molecular weight of the compound + 1. For example, benzene with a molecular weight of 78 grams mol⁻¹ is detected at m/z of 79. The PTR-MS does not respond to CO, CO₂, NO_x, or light molecular weight alkanes, so no response is given to alkane compounds in the C₁ (methane) to C₈ (octane), which are abundant in auto exhaust. The mass spectrum is dominated by aromatic compounds: benzene (m/z 79); toluene (m/z 93); C₂-alkylbenzenes (m/z 107); C₃-alkylbenzenes

(m/z 121); and C_4 -alkylbenzenes (m/z 135). Formaldehyde (m/z 31) and acetaldehyde (m/z 45) show significant responses in the mass spectrum. During testing, only benzene, toluene, C_2 -alkylbenzenes, C_3 -alkylbenzenes, formaldehyde, and acetaldehyde were measured, yielding data at ~ 1 Hz collection frequency.

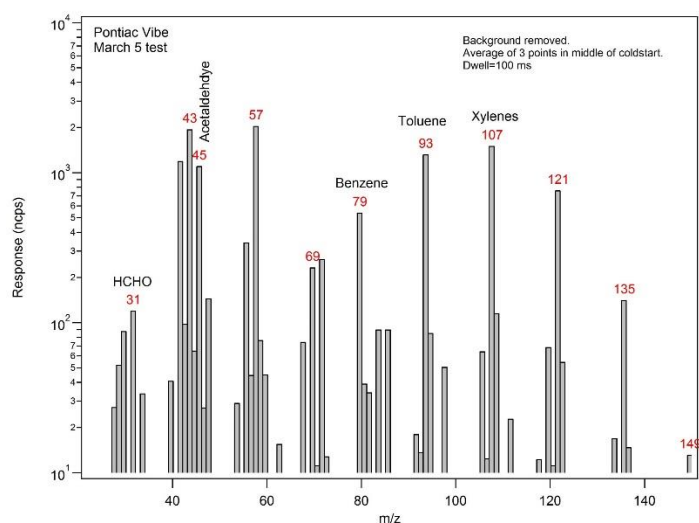

Figure 3.4 Proton-transfer-reaction mass spectrum of idling emissions from a Pontiac Vibe. Instrument response (Hz) is normalized to the reagent ion count rate. Given a 10 Hz/ppbv response factor for benzene, the benzene signal shown equates to a ~ 60 ppbv mixing ratio.

When sampling for VOCs, problems were experienced that we attributed to condensation of water in the sample line, likely on the stainless steel particulate filter. The filter must have been a cold spot and occasionally accumulated water that caused losses of formaldehyde, which is water soluble. We experimented with heating the line differently, and consider the formaldehyde data good for the last three tests (test # 15, 16, 17) conducted on the Pontiac Vibe. Otherwise, formaldehyde was seldom observed. An example of PTR-MS data is shown in Figure 3.5. The aromatic VOCs displayed good temporal correspondence with CO, but the acetaldehyde peak was delayed in time, and no formaldehyde was observed, a result we consider a sampling issue. Figure 3.6 shows improvement made because of better heating of the sample line.

Formaldehyde was detected, and the acetaldehyde peak has better correspondence with the aromatics.

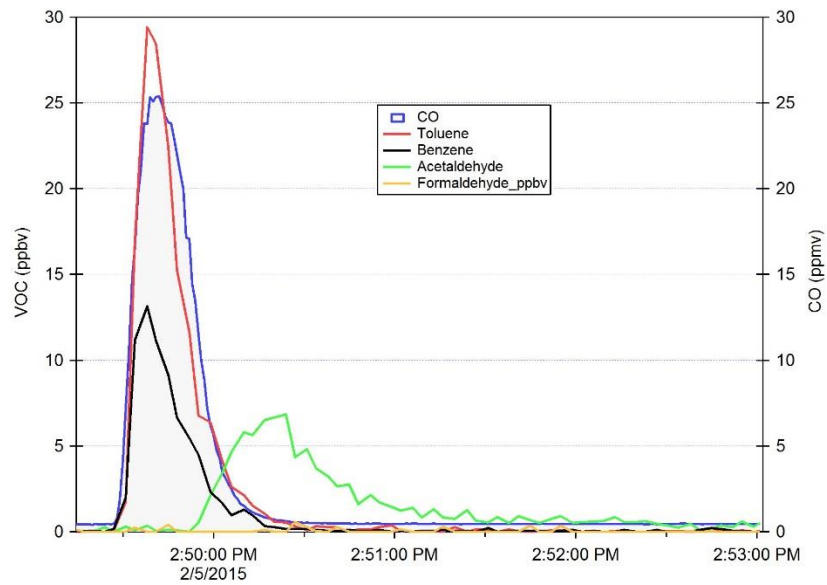

Figure 3.5 An example of Pontiac Vibe cold start VOC data from the PTR-MS, showing correspondence with CO mixing ratios in diluted engine exhaust during an engine cold start, delayed response of acetaldehyde, and absence of a formaldehyde peak.

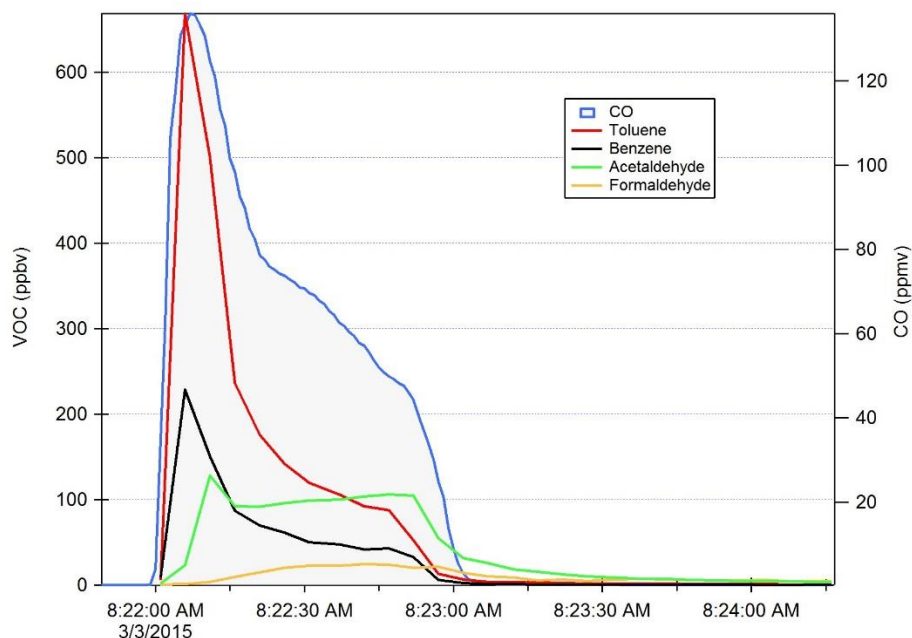

Figure 3.6 An example of Pontiac Vibe cold start VOC data from the PTR-MS, showing correspondence with CO mixing ratios and better agreement of acetaldehyde and formaldehyde time traces with CO and aromatics as a result of improvements in sample line heating.

3.3 Comparison of Organic Compound Molar Emission Ratios to MOVES

The relative abundance of compounds measured in cold start emissions was compared with the speciation profiles used for cold start emissions in MOVES2014. Molar emission ratios were calculated with respect to toluene. These ratios were determined by calculating the area under the cold start peak as defined by the toluene time series. **Table 3.3** lists the molar emission ratios used in MOVES compared with the average ratios measured in the cold start tests. In general, the emission ratio of benzene and C₂-benzenes to toluene agreed reasonably well with emission ratios from the speciation profiles used in MOVES2014. However, measured cold start acetaldehyde emissions relative to toluene were a factor of 8 higher than used in MOVES. The limited data that we obtained for formaldehyde suggests cold start emissions are much higher than used in the MOVES speciation profile. Thus, emission of the air toxics formaldehyde and

acetaldehyde are likely significantly underestimated in vehicle emission inventories for cold climates.

Table 3.3 Molar emission ratios with respect to toluene used in the MOVES2014 speciation profiles for cold start emissions (E10 fuel) compared with average values determined from cold start experiments. Values listed are in units of %.

Chemical Species	Pre Tier 2			Tier 2		
	MOVES	1995 Ford Mustang	1996 Honda Civic ¹	MOVES	2015 Subaru Forester	2004 Pontiac Vibe
Formaldehyde	5.8	NA	NA	3.9	NA	19 ± 61 ²
Acetaldehyde	8.0	64 ± 50	54	11	89 ± 17	86 ± 91
Benzene	46	55 ± 4	55	44	75 ± 10	48 ± 22
C ₂ -alkylbenzenes	131	105 ± 2	132	122	68 ± 20	101 ± 45

¹ Only 1 test conducted

² Average of 3 tests

CHAPTER 4. CONCLUSIONS

Vehicle cold start emissions were measured in winter 2015 from four vehicles: a 2015 Subaru Forester, a 2004 Pontiac Vibe, a 1996 Honda Civic, and a 1995 Ford Mustang GT. Fast response instrumentation (~ 1 Hz data collection rates) was used to measure concentrations from the tailpipe as the vehicle was started and left to idle. Cold start temperatures spanned from -4.0°C to 10°C . Exhaust was sampled from the tailpipe using an ejector diluter. Measurements were made of CO, NO, benzene, toluene, C₂-alkylbenzenes (sum of xylene isomers plus ethylbenzene), acetaldehyde, and formaldehyde. No clear trend with temperature was noted for CO or VOC emissions. For the Subaru Forester, the cold start pulse of elevated emission of CO, NO, and VOCs lasted only 60 seconds. The CO-to-NO molar ratios were about $654 \pm 23\%$ for the cold start period, significantly higher than running emission ratios of 5 to 7. The Pontiac Vibe also displayed a reasonably short period (approximately 60 seconds) of elevated emissions of CO and VOCs, but NO_x emission remained elevated for a longer period. In contrast, the Ford Mustang displayed elevated CO and VOC emissions for about 600 seconds.

Emission data for VOCs were compared with the MOVES2014 speciation profiles used to represent cold start emissions for Tier 2 and pre Tier 2 vehicles using E10 fuel. We compared measured molar emission ratios to toluene with those reported for speciation profile #8757 (Tier 2) and #8751a (pre Tier 2), as listed in the EPA SPECIATE 4.4 database. We found that benzene-to-toluene and C₂-alkylbenzene-to-toluene molar emission ratios agreed reasonably well with the speciation profiles. However, the acetaldehyde-to-toluene molar emission ratio was approximately a factor of 8 larger. The highest acetaldehyde-to-toluene emission ratios were for the Forester ($0.89 \pm 17\%$) and Pontiac Vibe ($0.86 \pm 91\%$) compared with the speciation profile

value of 0.11. Formaldehyde was difficult to measure in exhaust, likely due to losses in the sampling apparatus. Reasonable formaldehyde data were obtained in three tests with the Pontiac Vibe, indicating a formaldehyde-to-toluene molar ratio in the cold start pulse of $0.19 \pm 61\%$, approximately a factor of 5 higher than the speciation profile. Our data suggest that emissions of the air toxics acetaldehyde and formaldehyde are significantly underestimated in MOVES2014 parametrization of cold start emissions for E10 fueled vehicles.

CHAPTER 5. REFERENCES

- Bielaczyc, P., Szczotka, A., and Woodburn, J. (2011). “The effect of a low ambient temperature on the cold-start emissions and fuel consumption of passenger cars.” *Proc. Inst. Mech. Eng. Part D-J. Automob. Eng.*, 225, (D9), 1253–1264.
- EPA (U.S. Environmental Protection Agency). (2010). “MOVES2010: Highway vehicle temperature, humidity, air conditioning, and inspection and maintenance adjustments.” EPA-420-R-10-027.
- EPA (U.S. Environmental Protection Agency). (2015). “Speciation of total organic gas and particulate matter emissions from on-road vehicles in MOVES2014.” EPA-420-R-15-022.
- Erickson, M. H., Gueneron, M., and Jobson, B. T. (2014). “Measuring long chain alkane in diesel engine exhaust by thermal desorption PTR-MS.” *Atmos. Meas. Tech.*, 7, 225–239.
- Favez, J.-Y., Weilenmann, M., and Stilli, J. (2009). “Cold start extra emissions as a function of engine stop time: Evolution over the last 10 years.” *Atmospheric Environment*, 43(5), 996–1007.
- HEI (Health Effects Institute). (2010). “Traffic related air pollution: A critical review of the literature of emissions, exposure, and health effects.” Special Report #17, Health Effects Institute, Boston, MA.
- Jobson, B. T., and McCoskey, J. K. (2010). “Sample drying to improve formaldehyde measurements by PTR-MS instruments.” *Atmospheric Chemistry and Physics*, 10, 1821–1835, 2010.
- Jobson, B. T., Alexander, M. L., Maupin, G. D., and Muntean, G. G. (2005). “On-line analysis of organic compounds in diesel exhaust using proton transfer reaction mass spectrometry.” *International Journal of Mass Spectrometry*, 245, 78–89.
- Joumard, R., André, M., Vidon, R., Tassel, P., and Pruvost, C. (2000). “Influence of driving cycles on unit emissions from passenger cars.” *Atmospheric Environment*, 34(27), 4621–4628.
- Laurikko, J. (1995). “Ambient temperature effect on automotive exhaust emissions: FTP and ECE test cycle responses.” *Sci. Total Environ.*, 169(1–3), 195–204.
- Ludykar, D., Westerholm, R., and Almen, J. (1999). “Cold start emissions at 22, -7 and -20 degrees C ambient temperatures from a three-way catalyst (TWC) car: Regulated and unregulated exhaust components.” *Sci. Total Environ.* 235(1–3), 65–69.
- Sentoff, K. M., Robinson, M. K., and Holmen, B.A. (2010). “Second-by-second characterization of cold-start gas phase and air toxic emissions from a light duty vehicle.” *Transportation Research Record*, 2158, 95–104.

Wallace, H. W., Jobson, B. T., Erickson, M. H., McCoskey, J. K., VanReken, T. M., Lamb, B. K., Vaughan, J. K., Hardy, R. J., Cole, J. L., Strachan, S. M., and Zhang, W. (2012). “Comparison of wintertime CO-to-NO_x ratios to MOVES and MOBILE6.2 on-road emission inventories.” *Atmospheric Environment*, 63, 289–297.

Weilenmann, M., Soltic, P., Saxer, C., Forss, A. M., and Heeb, N. (2005). “Regulated and nonregulated diesel and gasoline cold start emissions at different temperatures.” *Atmospheric Environment*, 39(13), 2433–2441.

Weilenmann, M., Favez, J.-Y., and Alvarez, R. (2009). “Cold-start emissions of modern passenger cars at different low ambient temperatures and their evolution over vehicle legislation categories.” *Atmospheric Environment*, 43(15), 2419–2429.