

TRCLC 14-09
August 31, 2015



Alternatives for Providing a Safe Passage for Non-motorized Traffic across an Existing Highway Bridge

FINAL REPORT

U. B. Attanayake and L. A. Lopez



**Transportation Research Center
for Livable Communities
Western Michigan University**



Western Michigan University | University of Texas at Arlington | Utah State University | Wayne State University | Tennessee State University

**Technical Report
Documentation Page**

1. Report No. TRCLC 14-09	2. Government Accession No. N/A	3. Recipient's Catalog No. N/A	
4. Title and Subtitle Alternatives for Providing a Safe Passage for Non-motorized Traffic across an Existing Highway Bridge		5. Report Date August 31, 2015	
		6. Performing Organization Code N/A	
7. Author(s) U. B. Attanayake and L. A. Lopez		8. Performing Org. Report No. N/A	
9. Performing Organization Name and Address Western Michigan University 1903 West Michigan Avenue Kalamazoo, MI 49008		10. Work Unit No. (TRAIS) N/A	
		11. Contract No. TRCLC 14-09	
12. Sponsoring Agency Name and Address Transportation Research Center for Livable Communities (TRCLC) 1903 W. Michigan Ave., Kalamazoo, MI 49008-5316		13. Type of Report & Period Covered Final Report 9/1/2014 - 8/31/2015	
		14. Sponsoring Agency Code N/A	
15. Supplementary Notes			
16. Abstract Non-motorized transportation increases mobility choices, relieves congestion, promotes local economy, reduces greenhouse gas emission, promotes a healthy lifestyle, and improves quality of life. Recently, there is an emphasis on developing integrated transportation systems with off-road shared use paths and on-road facilities. A majority of highway bridges that are located on the planned or existing non-motorized paths have become bottle-necks for non-motorized traffic. Therefore, there is a need to evaluate the bridges on non-motorized paths to identify safe passage alternatives to non-motorized traffic. The owner agencies need to have access to a methodological process to evaluate a site for the best possible alternatives and develop accurate cost estimates for funding proposals. This report presents case studies, safe passage alternatives for non-motorized traffic across an existing bridge, alternative analysis methodology, analysis process, and a software platform developed to automate the analysis process. Finally, a few examples are presented to demonstrate implementation of the alternative analysis methodology.			
17. Key Words Alternative analysis, Bicycles, Bridge, Non-motorized traffic, Pedestrians		18. Distribution Statement No restrictions. This document is available to the public through the Michigan Department of Transportation.	
19. Security Classification - report Unclassified	20. Security Classification - page Unclassified	21. No. of Pages 73	22. Price N/A

DISCLAIMER

The contents of this report reflect the views of the authors, who are solely responsible for the facts and the accuracy of the information presented herein. This publication is disseminated under the sponsorship of the U.S. Department of Transportation's University Transportation Centers Program, in the interest of information exchange. This report does not necessarily reflect the official views or policies of the U.S. government, or the Transportation Research Center for Livable Communities, who assume no liability for the contents or use thereof. This report does not represent standards, specifications, or regulations.

ACKNOWLEDGMENTS

This research was funded by the US Department of Transportation through the Transportation Research Center for Livable Communities (TRC-LC), a Tier 1 University Transportation Center. Authors would like to thank TRC-LC at Western Michigan University for funding this study through a grant received from the United States Department of Transportation (USDOT) under the University Transportation Centers (UTC) program. The authors would also like to thank all the Departments of Transportation (DOTs), counties, and consultants who provided access to case studies and other relevant documents to make this study a success.

TABLE OF CONTENTS

DISCLAIMER.....III

ACKNOWLEDGMENTSIII

LIST OF TABLES VII

TABLE OF FIGURES.....VIII

1 INTRODUCTION..... 1

 1.1 Overview 1

 1.2 Project Objective and Scope..... 2

 1.3 Report Organization 3

2 STATE-OF-THE-ART AND PRACTICE 4

 2.1 Objective and Approach 4

 2.2 Route 10 Bridge over the St. Jones River, Delaware 4

 2.2.1 Site Characteristics.....4

 2.2.2 Non-motorized Passage Alternatives 5

 2.3 Ashley River Bridge in Charleston..... 6

 2.3.1 Site Characteristics..... 6

 2.3.2 Non-motorized Passage Alternatives 7

 2.4 Novi Road Bridge over I-96, Michigan..... 8

 2.4.1 Site Characteristics..... 8

 2.4.2 Non-motorized Passage Alternatives 8

 2.5 Huron Street Bridge over I-94 10

 2.5.1 Site Characteristics..... 10

 2.5.2 Non-motorized Passage Alternatives 10

 2.6 M-43 Bridge over US-131 12

 2.6.1 Site Characteristics..... 12

 2.6.2 Non-motorized Passage Alternatives 12

 2.7 Mosel Avenue Bridge over the Kalamazoo River..... 13

 2.7.1 Site Characteristics..... 14

 2.7.2 Non-motorized Passage Alternatives 15

 2.8 US-131 Underpass for the Kalamazoo River Valley Trail..... 17

 2.8.1 Non-motorized Passage Alternatives 17

Alternatives for Providing a Safe Passage for Non-motorized Traffic across an Existing Highway Bridge

2.9 Meadowbrook Road Bridge over I-96.....	18
2.9.1 Site Characteristics.....	20
2.9.2 Non-motorized Passage Alternatives	20
2.10 Scio Road Bridge over I-94.....	22
2.10.1 Site Characteristics.....	22
2.10.2 Non-motorized Passage Alternatives	23
2.11 Ann Arbor-Saline Road Bridge over I-94	25
2.11.1 Site Characteristics.....	25
2.11.2 Non-motorized Passage Alternatives	25
3 SPECIFICATIONS AND GUIDELINES.....	28
3.1 Objective and Approach	28
3.2 Horizontal Design Criteria	28
3.3 Additional Considerations.....	29
4 SAFE PASSAGE ALTERNATIVE ANALYSIS	31
4.1 Objective and Approach	31
4.2 Safe Passage Alternatives.....	31
4.2.1 Terminology and Definitions.....	32
4.2.2 Passage Alternatives within an Existing Bridge	32
4.2.3 Passage Alternatives outside an Existing Bridge.....	34
4.3 Alternative Analysis Methodology.....	36
4.4 <i>Safe Passage</i> - Alternative Analysis Software	38
5 IMPLEMENTATION EXAMPLES	40
5.1 Objective.....	40
5.2 9 th Street Bridge over I-94.....	40
5.2.1 Site Characteristics.....	40
5.2.2 Safe Passage Alternatives	42
5.3 44 th Street Bridge over I-196.....	44
5.3.1 Site Characteristics.....	44
5.3.2 Safe Passage Alternatives	45
5.4 102 nd Avenue Bridge over us-131	47
5.4.1 Site Characteristics.....	48
5.4.2 Safe Passage Alternatives	48

Alternatives for Providing a Safe Passage for Non-motorized Traffic across an Existing Highway Bridge

6 SUMMARY, CONCLUSIONS, AND RECOMMENDATIONS 51

 6.1 Summary and Conclusions 51

 6.2 Recommendations 52

7 REFERENCES..... 53

APPENDIX A: ABBREVIATIONS 55

APPENDIX B: IMPLEMENTATION EXAMPLES 58

Alternatives for Providing a Safe Passage for Non-motorized Traffic across an Existing Highway Bridge

LIST OF TABLES

Table 2-1. Non-motorized Passage Alternatives for Route 10 Bridge over the St. Jones River ...	6
Table 2-2. Design Exceptions for Chief Engineer’s Approval	6
Table 2-3. Non-motorized Passage Alternatives for US-17 Bridge over the Ashley River	8
Table 2-4. Non-motorized Passage Alternatives for Novi Road Bridge over I-96.....	9
Table 3-1. Relevant AASHTO Specification and Guide Requirements.....	28
Table 3-2. Relevant AASHTO and ADA Guidelines	30
Table 5-1. Cost Estimates for the 9 th Street Bridge over I-94 Safe Passage Alternatives	43
Table 5-2. Cost Estimates for the 44 th Street Bridge over I-196 Safe Passage Alternatives	46
Table 5-3. Cost Estimate for Providing a Hanging Structure	50

Alternatives for Providing a Safe Passage for Non-motorized Traffic across an Existing Highway Bridge

TABLE OF FIGURES

Figure 2-1. Eastbound and westbound bridges on Route 10	5
Figure 2-2. Eastbound route 10 bridge with 6 ft wide shared use path	6
Figure 2-3. Northbound and southbound bridges on US-17	7
Figure 2-4. Existing cross-section of Novi Road bridge over I-96.....	8
Figure 2-5. Barrier-separated sidewalk crossing on the west side of the bridge	9
Figure 2-6. Cross-section of Novi Road bridge over I-96 with barrier-separated sidewalk.....	10
Figure 2-7. Existing cross-section of Huron Street bridge over I-94.....	10
Figure 2-8. Cross-section depicting Alternative 5	12
Figure 2-9. Six-foot wide cantilevered sidewalk	13
Figure 2-10. Brackets supporting the cantilevered structure	13
Figure 2-11. Transverse diaphragms at each bracket.....	13
Figure 2-12. Shared use path on Mosel Avenue over the Kalamazoo River.....	14
Figure 2-13. Mosel Avenue bridge before integrating a non-motorized facility.....	15
Figure 2-14. Kalamazoo River Trail approach to Mosel Avenue bridge	15
Figure 2-15. Mosel Avenue bridge after incorporating a non-motorized facility.....	16
Figure 2-16. Non-motorized facility on the bridge.....	16
Figure 2-17. Railing connection detail (Source: Kalamazoo County Road Commission).....	16
Figure 2-18. Non-motorized route considered for alternative 2	18
Figure 2-19. A box culvert as the US-131 underpass	18
Figure 2-20. Arial view of the site (Source: Google map)	19
Figure 2-21. I-275 Metro Trail and Bridge Street (Source: Google maps)	19
Figure 2-22. Cross-section prior to integration of a non-motorized facility.....	20
Figure 2-23. Shared use path (looking north)	21
Figure 2-24. Fence and rail tube construction	21
Figure 2-25. Cross-section with a non-motorized passage (Source: City of Novi).....	22
Figure 2-26. Scio Church Road bridge over I-94 (Source: Google maps)	23
Figure 2-27. A suspended bridge for non-motorized traffic	24
Figure 2-28. Scio Road bridge over I-94 after integrating a non-motorized facility.....	25
Figure 2-29. Pedestrian sidewalk on the east side of the bridge.....	26

Alternatives for Providing a Safe Passage for Non-motorized Traffic across an Existing Highway Bridge

Figure 2-30. NB bike lane.....	26
Figure 2-31. SB bike lane (Source: Google Maps).....	27
Figure 4-1. Typical features of a bridge superstructure with non-motorized facilities	32
Figure 4-2. Bridge superstructure configurations with non-motorized passage alternatives.....	34
Figure 4-3. Passage alternatives outside an existing bridge	36
Figure 4-4. Alternative analysis methodology.....	37
Figure 4-5. <i>Safe Passage</i> graphical user interface (GUI)	39
Figure 5-1. Aerial view of the site (Source: Google maps)	41
Figure 5-2. Discontinued sidewalk on either side of the bridge (Source: Google maps)	41
Figure 5-3. 9 th Street bridge over I-94 (Source: Google maps)	42
Figure 5-4. Safe passage alternative analysis for the 9 th Street bridge over I-94	43
Figure 5-5. 44 th Street bridge over I-196 (Source: Google maps)	44
Figure 5-6. Safe passage alternative analysis for 44 th Street bridge over I-196	46
Figure 5-7. 102 nd Avenue bridge over US-131 (Source: Google maps).....	47
Figure 5-8. Safe passage alternative analysis for 102 nd Avenue bridge over US-131	49
Figure 5-9. Hanging structure as an alternative to provide passage outside the bridge.....	49

1 INTRODUCTION

1.1 OVERVIEW

In addition to promoting a healthy lifestyle and improving the quality of life, non-motorized transportation increases mobility choices, relieves congestion, promotes local economy, and reduces greenhouse gas emission. Compared to many countries such as Netherlands, Denmark, Spain, Belgium etc., a small population in the U.S. is currently relying on non-motorized modes of travel, such as cycling and walking, to commute to work, school, recreation amenities, and other places. In the capital city of the Netherlands, 58% of the trips are made by foot and cycles. Similarly, the trips made by foot and cycles in Copenhagen (Denmark), Vitoria (Spain), and Brujas (Belgium) are 47%, 66%, and 27%, respectively (ADONIS 1999). In the U.S., cycling and walking account for approximately 1% and 10.4% of all the trips taken in the country. For perspective, it is important to note that in 2009, over 4 billion bicycle trips and nearly 41 billion walking trips were recorded in the United States (NHTS 2009). According to the United States Census Bureau, 2% of the population employs non-motorized transportation (bicycling or walking) to commute to work (United States Census Bureau 2013). In addition, a cultural shift has been noticed in modes of transportation resulting in a 38% increase of bicycle use from 2009 to 2014 (STATISTA 2014). There are clearly a significant number of people for whom walking (or perhaps cycling) is the only or preferred mode of transportation. In 2005, Congress created the Safe Routes to School (SRTS) program to enable and encourage children, including those with disabilities, to walk or bicycle to and from school. Increasing walking, biking, and other modes of active travel holds promise for reducing childhood physical health problems and improving mental health, while reducing transportation costs and traffic congestion.

Nearly every motorized trip involves a walking trip at the beginning and the end, a process that is duplicated if an evening commute is in order... To address the access needs, non-motorized plans are developed. Bridges are an integral part of every road or path. A majority of highway bridges that are located on the planned or existing non-motorized paths have become bottlenecks for non-motorized traffic. Consequently, cycling and walking appears much less appealing. At the local level, trails and sidewalks that are disconnected make such networks less attractive for those who would have chosen to walk or bike to work or school; the inconvenience

Alternatives for Providing a Safe Passage for Non-motorized Traffic across an Existing Highway Bridge

or danger is enough to make them feel obligated to use their own vehicle. At the regional level, non-motorized facilities, which are not properly integrated, are less attractive to long-distance cyclists or trail hikers. Hence, such facilities impact the tourism and economy of such regions. Therefore, there is a need to evaluate the bridges on non-motorized paths to identify safe passage alternatives to incorporate non-motorized facilities.

On the other hand, when bridge owners develop funding proposals to incorporate non-motorized facilities, extra care needs to be taken during project scoping to identify feasible alternatives and develop accurate cost estimates. If the submitted project is selected and the cost is underestimated, interagency funding agreements may allow requesting an additional funding to not more than 20 percent. If the underestimate is excessive, the agency may self-fund the amount over the 20 percent threshold, or may resubmit the application with a revised cost estimate for the next meeting of the corresponding bridge council. In order to alleviate project scoping and cost estimation challenges, the owner agencies need to have access to a methodological process and a tool to evaluate a site for the best possible alternatives and to develop corresponding cost estimates.

1.2 PROJECT OBJECTIVE AND SCOPE

As stated in the problem statement, providing safe passages for non-motorized traffic over existing bridges is a critical need. When developing funding proposals to incorporate non-motorized facilities, the bridge owners need to have access to a methodological process to evaluate a site for identifying the best alternatives. Hence, the objective of this study is to develop a methodology for evaluating safe passage alternatives for non-motorized traffic across an existing bridge.

In order to accomplish the objective, the project is organized around the following tasks:

- Review state-of-the-art and practices literature: Primarily, case studies are reviewed. Project scoping process and alternatives considered for the case studies are documented.
- Review specification and guidelines: Specifications and guidelines published by the American Association of State Highway and Transportation Officials (AASHTO) and the highway agencies are documented.

Alternatives for Providing a Safe Passage for Non-motorized Traffic across an Existing Highway Bridge

- Develop safe passage alternatives: Based on the state-of-the art and practice, several alternatives are developed to provide access for non-motorized traffic across an existing bridge.
- Develop a safe passage alternative analysis methodology: An alternative analysis process is developed to identify safe passage alternatives for a given site. Then, a few examples are developed and presented to demonstrate the application of the process.

1.3 REPORT ORGANIZATION

The report is organized into 7 chapters:

- Chapter 1 includes an overview and project objective and scope.
- Chapter 2 includes case studies that were obtained from State Departments of Transportation (DOTs) and reviewed for detailed understanding of the alternatives analyzed by several agencies and consultants for providing a safe passage across an existing bridge. Site characteristics and justifications for the acceptance or rejection of alternatives are also presented. This chapter also describes the resources required for developing the content for Chapter 4.
- Chapter 3 includes specifications and guidelines published by AASHTO related to motorized and non-motorized traffic. The Americans with Disabilities Act (ADA) guidelines related to ground surface and change in level are also presented.
- Chapter 4 presents terminology and definitions used to describe the alternatives developed for providing a passage within or outside a bridge. This chapter also presents an alternative analysis process for identifying the most suitable passage alternative for a given site.
- Chapter 5 presents a limited number of examples to demonstrate the application of the alternative analysis process and cost estimation.
- Chapter 6 provides a summary, conclusions, and recommendations.
- Chapter 7 includes the reference list.

The report appendices include the following:

- Appendix A: Abbreviations
- Appendix B: Implementation Examples

2 STATE-OF-THE-ART AND PRACTICE

2.1 OBJECTIVE AND APPROACH

The objective is to review several case studies and document site characteristics, non-motorized passage alternatives considered for a given site, and the decision-making process implemented to identify the most suitable configuration. The information presented here provides the basis for developing an alternative analysis process, as discussed later in the report, for identifying the most suitable alternative for a given site.

2.2 ROUTE 10 BRIDGE OVER THE ST. JONES RIVER, DELAWARE

The Dover/Kent County Metropolitan Planning Organization (MPO), in cooperation with Division of Planning at the Delaware Department of Transportation's (DelDOT) and Division of Parks and Recreation at the Delaware Department of Natural Resources and Environmental Control (DNREC), evaluated alternatives to provide non-motorized access across the St. Jones River (Dover/Kent County MPO 2012).

2.2.1 Site Characteristics

Two bridges, each 300 ft long, carry eastbound and westbound lanes of Route 10 over the St. Jones River. In 2010, Route 10, a minor arterial, carried an average annual daily traffic volume of 23,187 vehicles. The designated speed limit is 50 mph. The existing lane width is 12 ft. The eastbound bridge has a 4 ft wide inside shoulder and a 10 ft wide outside shoulder (Figure 2-1a). The westbound bridge has no shoulders (Figure 2-1b).

Alternatives for Providing a Safe Passage for Non-motorized Traffic across an Existing Highway Bridge



(a) Eastbound bridge



(b) Westbound bridge

Figure 2-1. Eastbound and westbound bridges on Route 10

2.2.2 Non-motorized Passage Alternatives

Three alternatives were considered for this site. These alternatives, selection decisions, and justifications for the decisions are listed in Table 2-1. Two alternatives were rejected mainly due to cost and inadequate funding. The final decision was to accommodate non-motorized traffic within the 10 ft wide shoulder on the eastbound bridge by providing a barrier-separated shared use path. However, due to limited space on the bridge, three design exceptions were submitted for approval by DelDOT's chief engineer. As per the AASHTO specifications, a lane width of 12 ft, outside shoulder width of 8 ft (i.e. barrier offset of 8 ft from the lane), and shared use path width of 8 ft are required. As shown in Table 2-2, it was proposed to reduce these dimensions to 11 ft, 4 ft, and 6 ft, respectively. With the approval of the design exceptions, a barrier-separated shared use path was implemented (Figure 2-2).

Alternatives for Providing a Safe Passage for Non-motorized Traffic across an Existing Highway Bridge

Table 2-1. Non-motorized Passage Alternatives for Route 10 Bridge over the St. Jones River

Alternative	Decision	Justification
A separate bridge as a shared use path (new construction)	Rejected	<ul style="list-style-type: none"> • Significant environmental impact • Cost
A separate bridge attached to the existing eastbound Route 10 bridge as a shared use path	Rejected	<ul style="list-style-type: none"> • Existing bridge is not classified as structurally deficient or functionally obsolete. Hence, the project is not eligible for Federal Bridge Funding.
A barrier-separated shared use path on the existing eastbound Route 10 shoulder	Accepted	<ul style="list-style-type: none"> • Utilization of an existing shoulder • Delineated area for non-motorized use • Less costly • Quicker implementation

Table 2-2. Design Exceptions for Chief Engineer's Approval

Feature	Minimum Dimensions as per Specifications	Proposed Dimensions for Engineer's Approval
Lane width, ft	12	11
Barrier offset, ft	8	4
Shared use path width, ft	8	6



Figure 2-2. Eastbound route 10 bridge with 6 ft wide shared use path

2.3 ASHLEY RIVER BRIDGE IN CHARLESTON

In 2007, Charleston County RoadWise hired Atlantic South Consulting Services and the Dennis Corporation to evaluate alternatives to provide non-motorized access across Ashley River (Atlantic South Consulting Services and Dennis Corporation 2007).

2.3.1 Site Characteristics

Two separate bascule span bridges connect the West Ashley community and downtown Charleston. These bridges carry US 17 vehicular northbound and southbound traffic across the

Alternatives for Providing a Safe Passage for Non-motorized Traffic across an Existing Highway Bridge

Ashley River. The northbound and southbound bridges have four lanes and three lanes, respectively (Figure 2-3). The total length of northbound and southbound bridges is 1634 ft and 1733 ft, respectively. In 2010, the bridges carried an average daily traffic of 29,100 vehicles. The designated speed limit is 35 mph.



(a) Northbound bridge



(b) Southbound bridge

Figure 2-3. Northbound and southbound bridges on US-17

2.3.2 Non-motorized Passage Alternatives

Both of these routes lack adequate bicycle and pedestrian facilities, which makes non-motorized travel across the Ashley River between the West Ashley community and downtown Charleston challenging and unsafe. Two alternatives considered for the site, selection decision, and the justification for each decision are presented in Table 2-3. The final decision was to accommodate non-motorized traffic on the northbound US-17 bridge. Originally, mounting a separate bridge to the existing northbound bridge, as a shared path, was studied. However, that option was rejected due to the loading constraints of the bascule span. As the second alternative, a barrier-separated shared use path on the outside lane of northbound US 17 bridge was evaluated. This alternative was selected after conducting a traffic study to evaluate a possible road diet.

Alternatives for Providing a Safe Passage for Non-motorized Traffic across an Existing Highway Bridge

Table 2-3. Non-motorized Passage Alternatives for US-17 Bridge over the Ashley River

Alternative	Decision	Justification
Separate bridge attached to the existing northbound bridge as a shared path	Rejected	<ul style="list-style-type: none"> Loading constraints on the bascule span deters using this alternative.
A barrier-separated shared use path on the outside lane of northbound US 17 bridge	Accepted	<ul style="list-style-type: none"> Traffic study showed that lane reduction is possible with minimum impact to traffic.

2.4 NOVI ROAD BRIDGE OVER I-96, MICHIGAN

In 2012, the City of Novi, the Michigan Department of Transportation (MDOT), and the Road Commission for Oakland County (RCOC) worked with Orchard, Hiltz & McCliment, Inc. (OHM) to evaluate potential alternatives for providing non-motorized access over I-96 (OHM 2012).

2.4.1 Site Characteristics

The Novi Road bridge over I-96 has seven 12 ft wide lanes and two 8 ft wide shoulders on each side (Figure 2-4). The total width of the bridge is 100 ft. In 2010, Novi Road carried an average annual daily traffic volume of 33,400 vehicles. The designated speed limit is 40 mph.

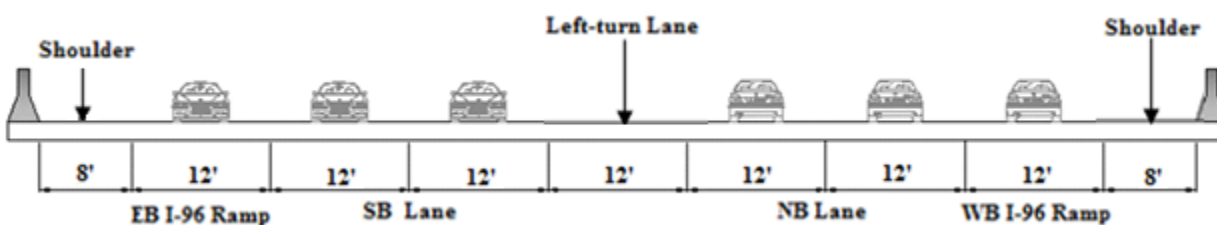

Figure 2-4. Existing cross-section of Novi Road bridge over I-96

2.4.2 Non-motorized Passage Alternatives

Five non-motorized passage alternatives were considered for the site. These alternatives, selection decisions, and the justifications for the decisions are listed in Table 2-4. The preferred alternative was a barrier-separated sidewalk crossing on the west side of the bridge with realignment of the ramp (Figure 2-5). This alternative was favored after evaluating pedestrian safety and cost. As shown in Figure 2-6, all 12 ft wide traffic travel lanes are maintained while the center lane width is reduced from 12 ft to 8.5 ft.

Alternatives for Providing a Safe Passage for Non-motorized Traffic across an Existing Highway Bridge

Table 2-4. Non-motorized Passage Alternatives for Novi Road Bridge over I-96

Alternative	Decision	Justification
Barrier-separated sidewalk crossing on both sides of the bridge	Rejected	<ul style="list-style-type: none"> • Eliminates shoulder along the Novi Road • Crossing conflicts between vehicles and non-motorized traffic
Barrier-separated sidewalk crossing on the west side of the bridge. Option includes realignment of the existing EB entrance loop ramp.	Accepted	<ul style="list-style-type: none"> • Most cost effective • Maintains 12 ft wide traffic lanes • Maintains an 8 ft wide shoulder on NB • No free flow pedestrians crossing the ramp
Barrier-separated sidewalk crossing in the median	Rejected	<ul style="list-style-type: none"> • May make pedestrian uncomfortable walking between two lanes of traffic • Protecting barrier ends is problematic • Narrower lanes (11 ft -11.5 ft)
A separate bridge as a shared use path (new construction)	Rejected	<ul style="list-style-type: none"> • Highest cost • May conflict with power lines
A separate bridge attached to the existing structure supported off the fascia or railing	Rejected	<ul style="list-style-type: none"> • Not aesthetically pleasing • May overload fascia beam or railing • Cost estimates are not readily obtainable (Non-standard work).



Legend

- Barrier-separated path
- Ramp realignment

Figure 2-5. Barrier-separated sidewalk crossing on the west side of the bridge

Alternatives for Providing a Safe Passage for Non-motorized Traffic across an Existing Highway Bridge

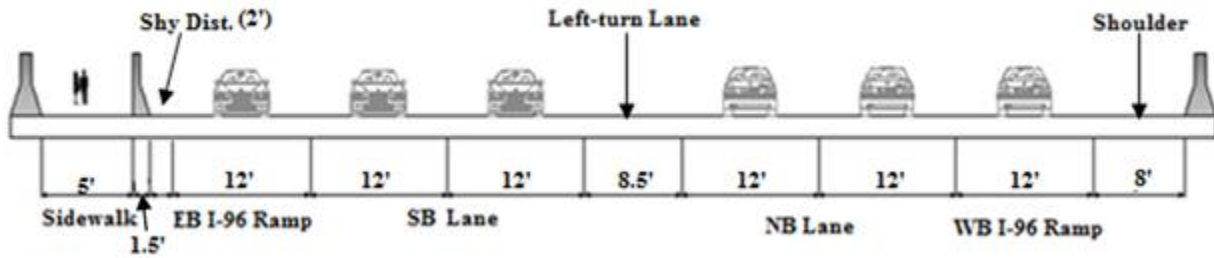

Figure 2-6. Cross-section of Novi Road bridge over I-96 with barrier-separated sidewalk

2.5 HURON STREET BRIDGE OVER I-94

A steering committee that involved representatives from the City of Ypsilanti, Charter Township of Ypsilanti, Washtenaw Area Transportation Study (WATS), and MDOT requested that Hamilton Anderson Associates study the development of a non-motorized passage across Huron Street bridge over I-94 (Hamilton Anderson Associates and Midwest Consulting LLC 2004).

2.5.1 Site Characteristics

Huron Street provides a north/south vehicular connection to the City of Ypsilanti and Ypsilanti Township. The bridge has two 14 ft wide northbound lanes and three 13 ft wide southbound lanes. Each route has a 2 ft wide shoulder. An 8 ft wide raised concrete curb/median separates northbound and southbound lanes (Figure 2-7). In 2010, Huron Street carried an average annual daily traffic volume of 14,400 vehicles. The designated speed limit is 45 mph.

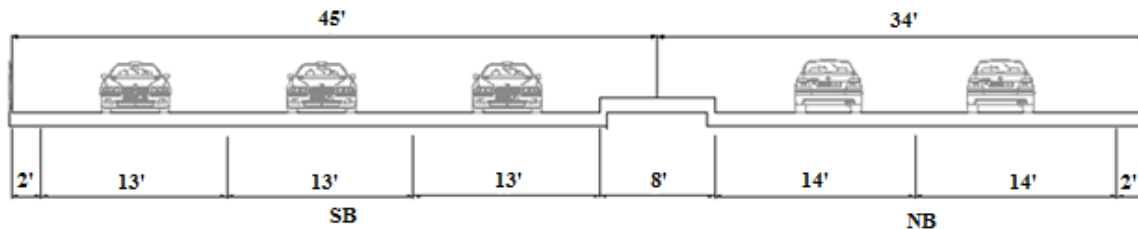

Figure 2-7. Existing cross-section of Huron Street bridge over I-94

2.5.2 Non-motorized Passage Alternatives

Six alternatives were developed for the site. The steering committee evaluated the alternatives based on ten key components: accomplishes goal, path width, traffic interface, community linkages, safety, accessibility, constructability, cost, pedestrian comfort, and public input. The following list of alternatives were considered for the site:

Alternatives for Providing a Safe Passage for Non-motorized Traffic across an Existing Highway Bridge

1. Narrowed Lanes on northbound (NB) Huron Street: Access for non-motorized traffic is provided within the bridge by narrowing the median and NB lanes. The path is proposed on the right side of traffic and separated by a barrier.
2. A shared use path on the west side of the bridge and NB bike lane on the east side of the bridge: Access for non-motorized traffic is provided within the bridge by narrowing the median and all traffic lanes to 11 ft. The shared use path is 10 ft wide with a 4 ft wide shy distance from the road. The NB bike lane is 5 ft wide with a 2 ft wide shy distance from the road.
3. A median pedestrian path and northbound/southbound inside bike lanes: Access for non-motorized traffic within the bridge is provided by narrowing all traffic lanes to 11 ft. The proposal is to have two 5 ft wide bike lanes running in each direction, and a 5 ft wide pedestrian path in the median that is separated from traffic by barriers on either side.
4. A separate bridge as a shared use path: A new 8 ft wide non-motorized structure is proposed to be located outside the existing bridge as a separate structure.
5. A path within southbound (SB) Huron Street with a reconfigured ramp: A 10 ft - 6 in. wide non-motorized path within the bridge is proposed by eliminating the far right SB lane.

The committee gave precedence to alternatives that could be implemented in a near-term timeframe without major changes to the existing structure. Alternative 5 (Figure 2-8) was selected due to the following considerations:

- Placement of users in the center of the bridge may create difficult compliance challenges for safety and ADA requirements.
- Construction of two new barrier walls for a center-running alternative increases cost as well compromises safety during construction.
- Center-running options led to an overall increase in the number of pedestrian and bicycle conflict points with the expressway ramps.

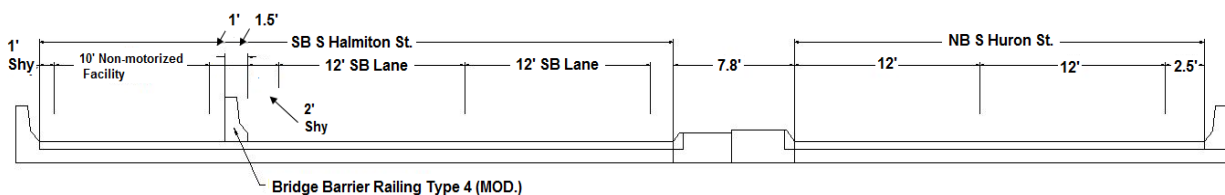

Alternatives for Providing a Safe Passage for Non-motorized Traffic across an Existing Highway Bridge

Figure 2-8. Cross-section depicting Alternative 5

2.6 M-43 BRIDGE OVER US-131

The M-43 bridge over US-131 is the primary link between the community of Oshtemo Township and the rest of the Kalamazoo County. It also serves as an interchange with US-131. In July 2013, MDOT started replacing deck joints, bridge railing, and pins and hangers; along with recoating structural steel and repairing the substructure. The project also included the addition of a sidewalk (MDOT 2013).

2.6.1 Site Characteristics

The M-43 bridge over US-131 consists of four main spans with a total length of 230 ft. The bridge has 5 lanes and carries east and westbound traffic. There are two lanes in each direction with a middle left-turn lane. In 2013, the bridge carried an average annual daily traffic of 29,300 vehicles. The designated speed limit is 45 mph.

2.6.2 Non-motorized Passage Alternatives

In 2013, a pedestrian sidewalk was added to the south side of the bridge. It is a feature that the Oshtemo Township officials have worked together with MDOT to add to the project. In order to provide a shared use path of at least 11 ft wide (bi-directional bicycle traffic and pedestrian), an additional girder line was required to be added to bridge superstructure. The cost estimation for bridge widening had a unit price of \$210/ft², not including approach work, maintenance of traffic, mobilization, contingency, and engineering fees. Due to budgetary constraints, a 6 ft wide cantilever pedestrian facility was provided (Figure 2-9).



Alternatives for Providing a Safe Passage for Non-motorized Traffic across an Existing Highway Bridge

Figure 2-9. Six-foot wide cantilevered sidewalk

The cantilever is supported by brackets attached to the steel fascia beam. The brackets are located along the length of the cantilevered pedestrian structure (Figure 2-10). The brackets are connected to the fascia beam by L-angles and bolts. At each bracket location, an intermediate diaphragm line was installed across the entire width of the bridge (Figure 2-11).

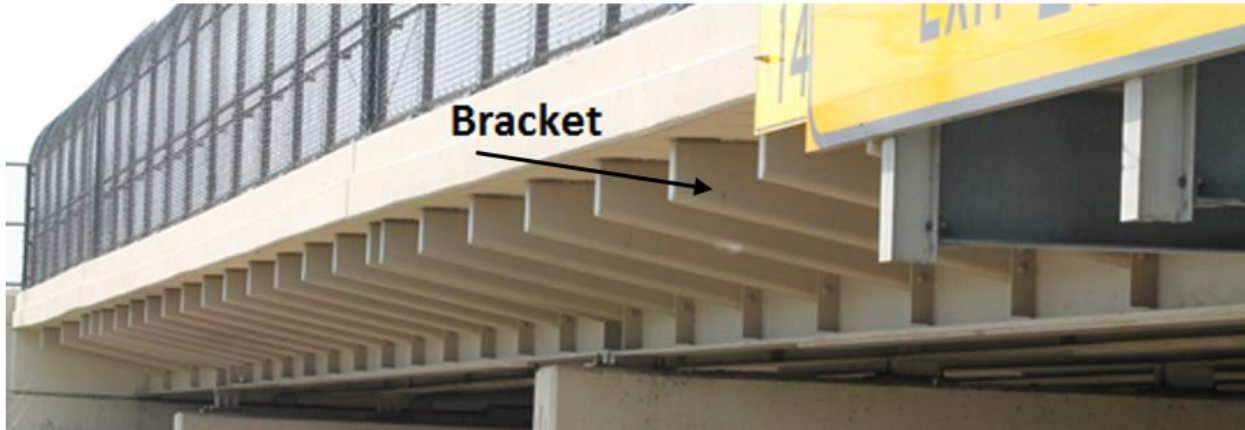

Figure 2-10. Brackets supporting the cantilevered structure

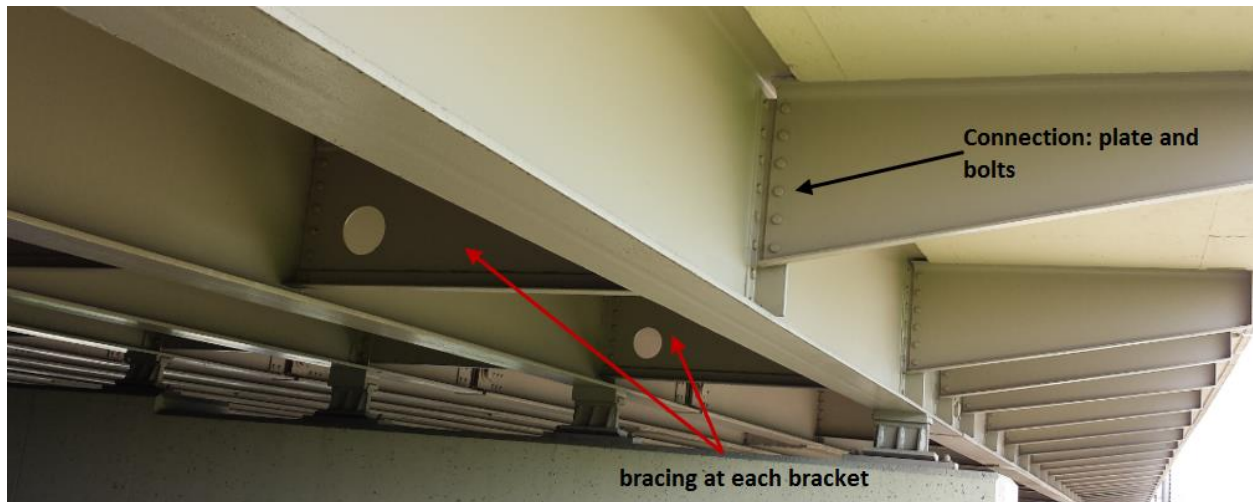

Figure 2-11. Transverse diaphragms at each bracket

2.7 MOSEL AVENUE BRIDGE OVER THE KALAMAZOO RIVER

The Kalamazoo River Valley Trail is a 12 ft wide paved-asphalt surface. It is a shared use trail for non-motorized transportation and recreation. Once completed, the trail will encompass 35

Alternatives for Providing a Safe Passage for Non-motorized Traffic across an Existing Highway Bridge

miles throughout Kalamazoo County (Kalamazoo County Government 2015). In 2009, the Scott Civil Engineering Company prepared plans for the construction of a shared use path segment on Mosel Avenue over the Kalamazoo River that now serves as part of the 22 miles of completed trail. Figure 2-12 shows the limits of work (red) presented in this case study.



Figure 2-12. Shared use path on Mosel Avenue over the Kalamazoo River

2.7.1 Site Characteristics

The Mosel Avenue bridge over the Kalamazoo River has three spans with a total length of 222.1 ft. Before integrating the non-motorized facility, the bridge consisted of two 5ft – 6 in. wide sidewalks, three eastbound lanes, and two westbound lanes. The two outside lanes were 13 ft – 6 in. wide, and the three inside lanes were 12 ft wide. Clear width of the bridge is 76 ft and 5 in. (Figure 2-13). In 2012, Mosel Avenue, a minor arterial, carried an average daily traffic of 16,997 vehicles. The designated speed limit is 40 mph.

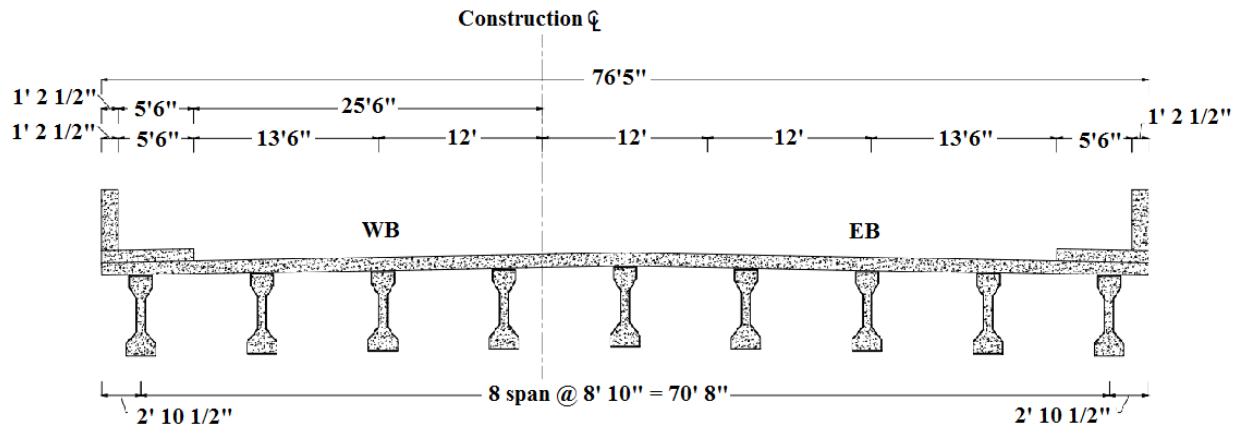

Alternatives for Providing a Safe Passage for Non-motorized Traffic across an Existing Highway Bridge

Figure 2-13. Mosel Avenue bridge before integrating a non-motorized facility

2.7.2 Non-motorized Passage Alternatives

In order to match the 12 ft wide trail, an 8.5 ft wide addition to the sidewalk was proposed (Figure 2-14). After a traffic study, a lane reduction was implemented on the westbound lane. The road has now two eastbound lanes, one westbound lane, and a left-turn lane (Figure 2-15). The final shared use path has a clear width of 14 ft (Figure 2-16).

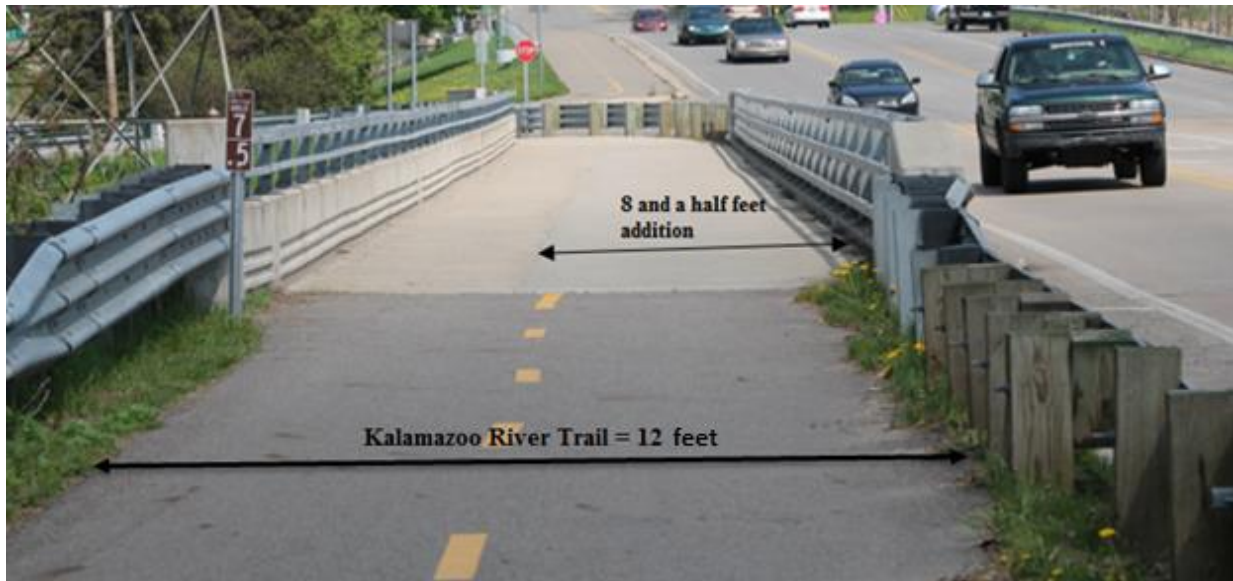

Figure 2-14. Kalamazoo River Trail approach to Mosel Avenue bridge



Alternatives for Providing a Safe Passage for Non-motorized Traffic across an Existing Highway Bridge

Figure 2-15. Mosel Avenue bridge after incorporating a non-motorized facility

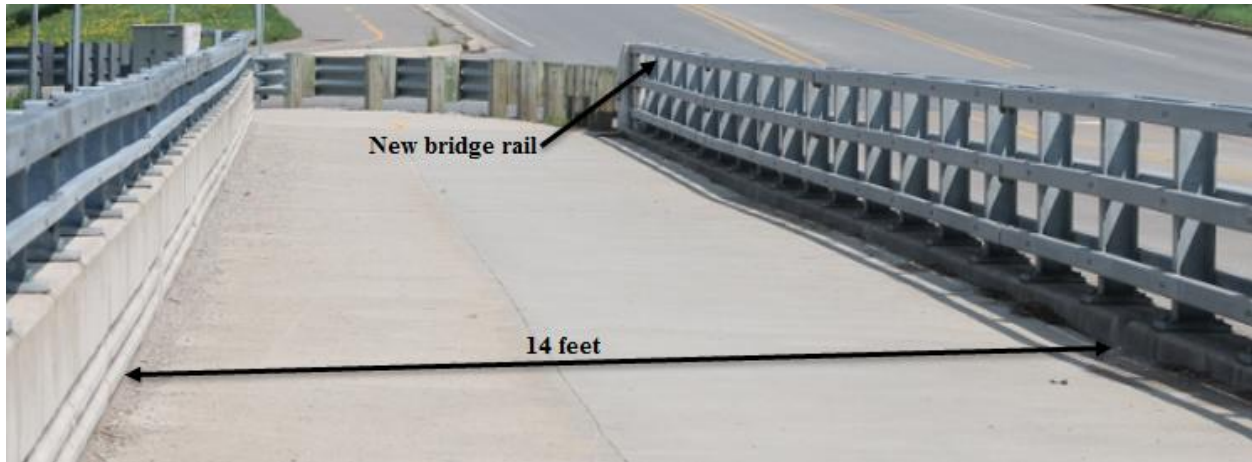

Figure 2-16. Non-motorized facility on the bridge

The new addition included a new bridge rail. The height of the rail is 3 ft and 6 in. The rail connection to the bridge deck is shown in Figure 2-17. A transverse reinforcing bar connects the rail to the existing sidewalk. One end of the bar is fixed to the rail by anchor bars, and the other end is embedded 6 in. into the existing sidewalk. The thickness of the new addition to sidewalk ranges from 8 in. to 5 in.

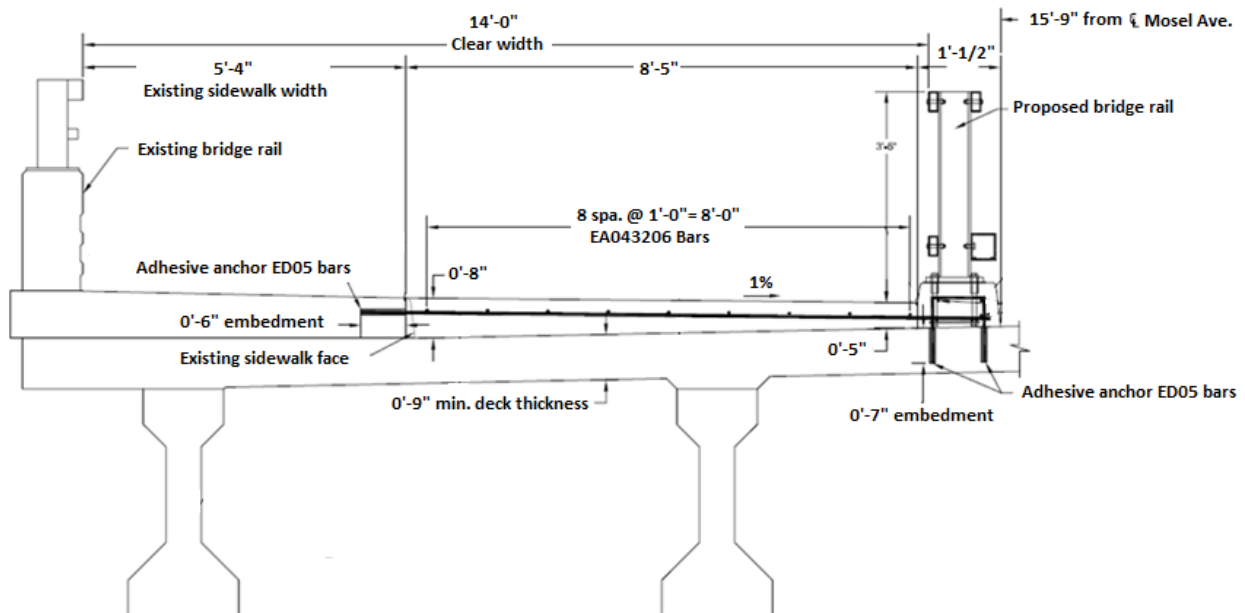

Figure 2-17. Railing connection detail (Source: Kalamazoo County Road Commission)

Alternatives for Providing a Safe Passage for Non-motorized Traffic across an Existing Highway Bridge

2.8 US-131 UNDERPASS FOR THE KALAMAZOO RIVER VALLEY TRAIL

The Kal-Haven Trail originally ran 33.5 miles between South Haven and 10th Street located just west of the City of Kalamazoo, Michigan. At 10th Street, there is a trailhead known as Kal-Haven Trail State Park. In 2004, the trail was extended east from the trailhead towards downtown Kalamazoo as part of the Kalamazoo River Valley Trail.

2.8.1 Non-motorized Passage Alternatives

Before 2004, U.S-131 was an obstacle that prevented connection of the Kal-Haven Trail and Kalamazoo River Valley Trail. The vision had always been to extend the trail through Kalamazoo County. In order to mitigate this major impediment, the Kalamazoo County Road Commission (KCRC) considered three alternatives: (1) provide a passage over US-131 using a separate free standing bridge, (2) direct traffic to H Avenue located south of the trail and retrofit the H Avenue bridge over US-131 to incorporate non-motorized facilities, and (3) install a box culvert underneath US-131 as an underpass. Alternative one was rejected mainly due to cost and unavailability of funding. Alternative two was rejected because H Avenue was not in line with the trail and required routing non-motorized traffic along the roads that do not have non-motorized facilities (Figure 2-18). Also, it was determined that the H Avenue bridge was too narrow to retrofit for non-motorized traffic. The final decision was to install a box culvert under US-131 (Figure 2-19). This alternative was cost effective since it would coincide with an active US-131 resurfacing project.

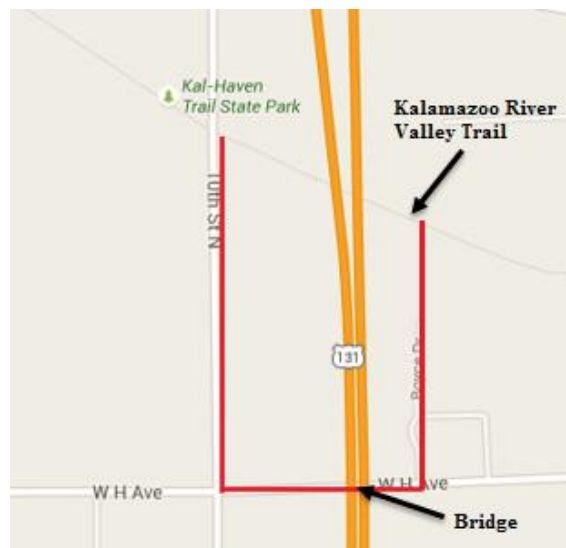

Alternatives for Providing a Safe Passage for Non-motorized Traffic across an Existing Highway Bridge

Figure 2-18. Non-motorized route considered for alternative 2

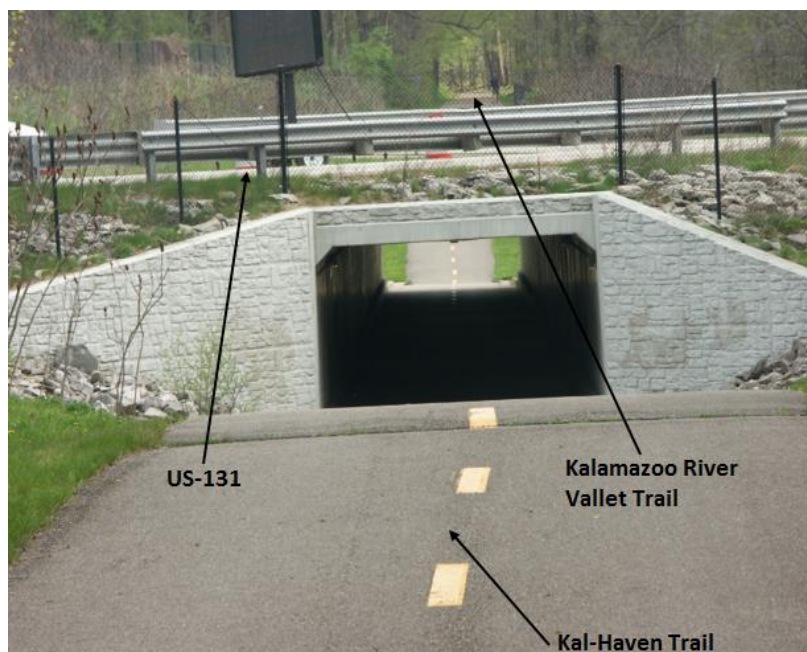

Figure 2-19. A box culvert as the US-131 underpass

2.9 MEADOWBROOK ROAD BRIDGE OVER I-96

As shown in Figure 2-20, the Southeast Regional Exchange of Michigan State University is located at the northwest corner of Twelve Mile Road and Meadowbrook Road. The I-275 Metro Trail ends at Meadowbrook Road, just north of Bridge Street (Figure 2-21). Since no non-motorized facilities connected the Southeast Regional Exchange of Michigan State University and the I-275 Metro Trail, in 2013, plans were developed for construction of a shared use path along Meadowbrook Road starting at Bridge Street and ending just past Twelve Mile Road. This route would include a bridge that carries Meadowbrook Road traffic over I -96 and I-696/I-275 ramps.

Alternatives for Providing a Safe Passage for Non-motorized Traffic across an Existing Highway Bridge

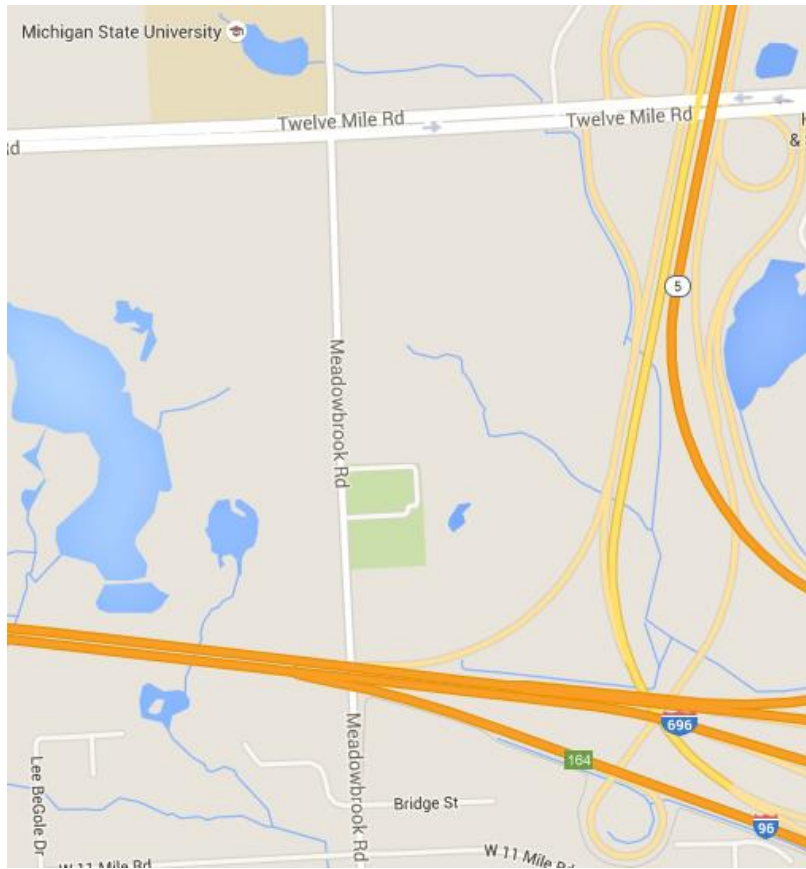

Figure 2-20. Aerial view of the site (Source: Google map)

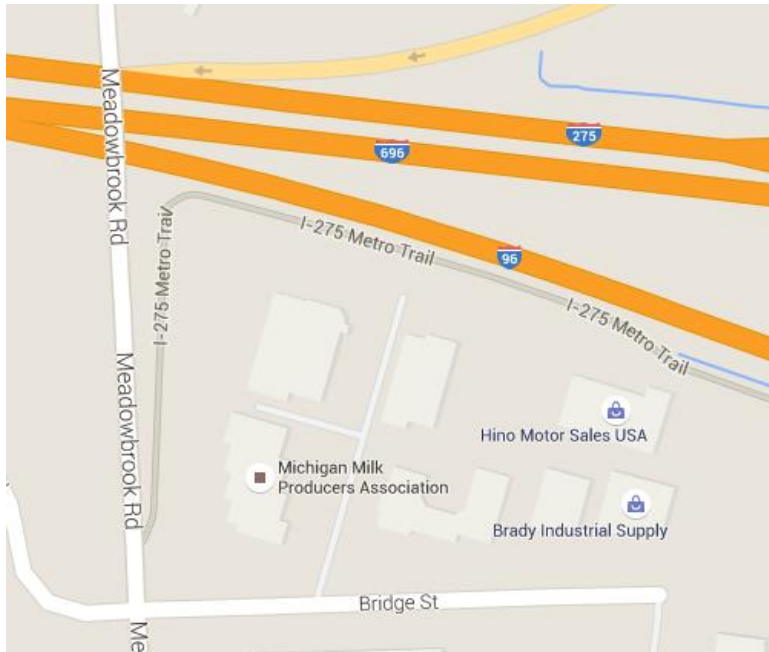

Figure 2-21. I-275 Metro Trail and Bridge Street (Source: Google maps)

Alternatives for Providing a Safe Passage for Non-motorized Traffic across an Existing Highway Bridge

2.9.1 Site Characteristics

The Meadowbrook Road bridge has two spans with a total length of 287.1 ft. Before incorporating non-motorized facilities, the bridge had two 12 ft wide lanes and two 8 ft wide shoulders in each direction. The total bridge width is 40 ft (Figure 2-22). In 2013, the bridge carried an average daily traffic of 10,400 vehicles. The designated speed limit is 40 mph.

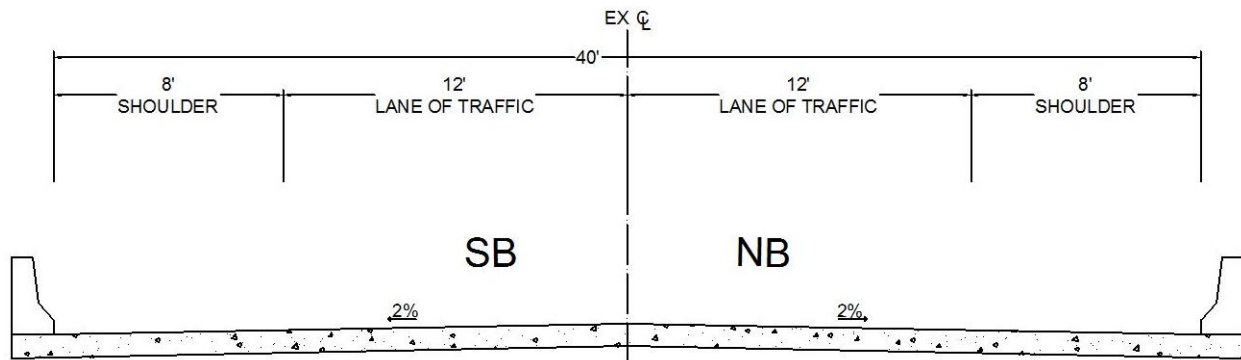

Figure 2-22. Cross-section prior to integration of a non-motorized facility

2.9.2 Non-motorized Passage Alternatives

As a non-motorized facility, a shared use path was selected. The approaching trail width is 10 ft. Due to space constraint on the bridge, width of the shared use path was limited to 8 ft. The path is protected by using a traffic safety barrier on one side and a 7 ft tall fence along the edge of the bridge deck (Figure 2-23). Previously, a very short rail was mounted on the southbound (SB) safety barrier (Figure 2-24). In order to mount the new fence, the old rail tubes were removed, and the rail bolts were flush cut (Figure 2-24a). Figure 2-24b shows a new fence support and the location of an old rail tube.

Alternatives for Providing a Safe Passage for Non-motorized Traffic across an Existing Highway Bridge

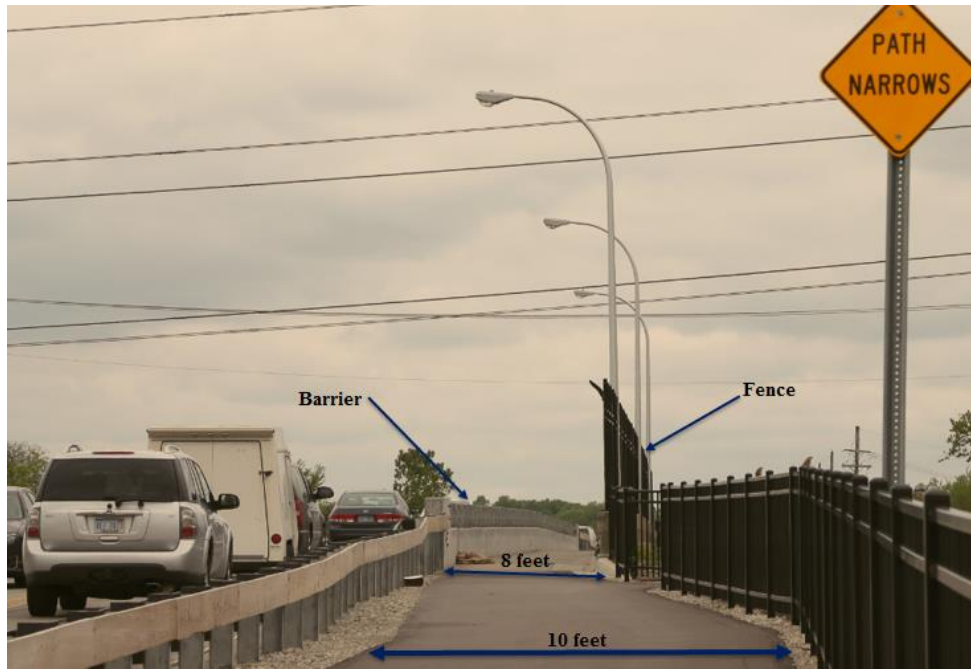
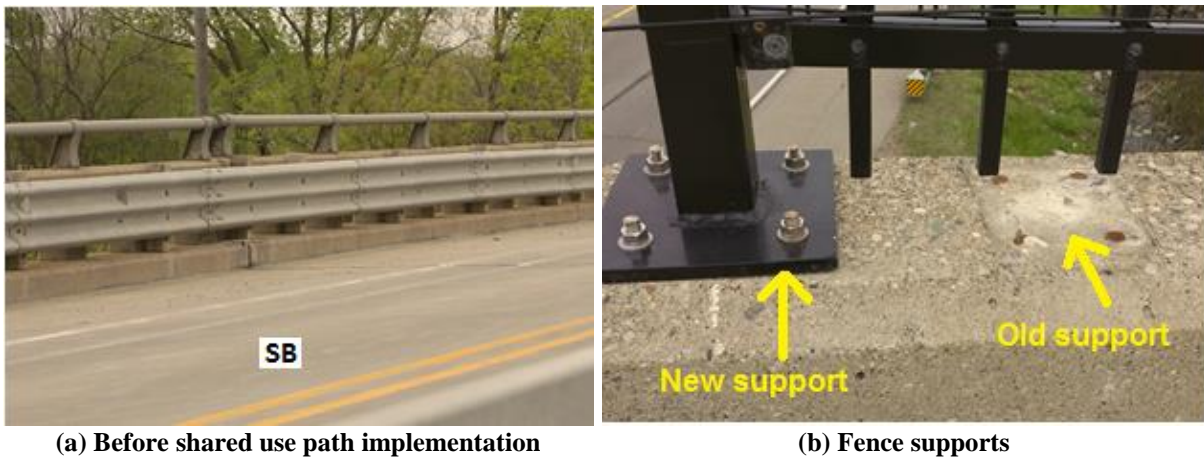

Figure 2-23. Shared use path (looking north)



(a) Before shared use path implementation

(b) Fence supports

Figure 2-24. Fence and rail tube construction

Necessary space for the shared use path was acquired by reducing the curb, shoulder, and lane widths. The curbs were reduced from 8 in. to 4 in. The center line of the bridge was shifted 2 ft towards SB, and the lane width was reduced from 12 ft to 11 ft. The SB shoulder width was reduced from 8 to 7 ft while the NB shoulder was reduced from 8 to 2 ft (Figure 2-25).

Alternatives for Providing a Safe Passage for Non-motorized Traffic across an Existing Highway Bridge

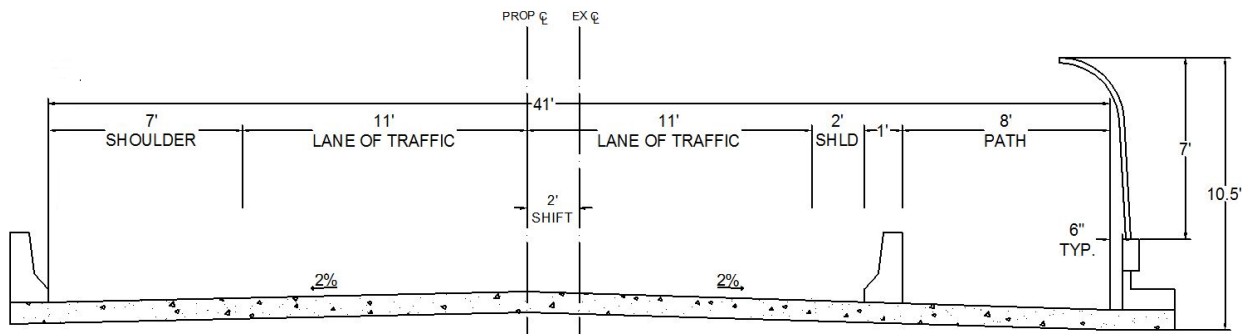

Figure 2-25. Cross-section with a non-motorized passage (Source: City of Novi)

2.10 SCIO ROAD BRIDGE OVER I-94

In 1998, design plans were prepared for rehabilitation of Scio Church Road bridge over I-94, Washtenaw County, Michigan. The work covered included a deep resurfacing of the existing bridge deck, substructure patching, railing replacement, joint replacement, and construction of a pedestrian facility.

2.10.1 Site Characteristics

The Scio Church Road bridge over I-94 has 4 spans with a total length of 264.8 ft. The bridge has one lane in each direction (Figure 2-26). The total width of the bridge from barrier to barrier is 28 ft. In 2012, Scio Church Road carried an average daily traffic volume of 11,472 vehicles. The designated speed limit is 35 mph.

Alternatives for Providing a Safe Passage for Non-motorized Traffic across an Existing Highway Bridge



Figure 2-26. Scio Church Road bridge over I-94 (Source: Google maps)

2.10.2 Non-motorized Passage Alternatives

Due to space constraint within the bridge, a decision was taken to attach a 5 ft wide bridge outside the existing bridge for non-motorized traffic. The new bridge is suspended on the traffic barrier using cap brackets (Figure 2-27a) and L shaped frames spaced at 4 ft (Figure 2-27b and c). The non-motorized traffic is separated from the road by a traffic barrier. A 10 ft tall chain link fence is mounted at the outer edge. The bridge cross-section with non-motorized access is presented in Figure 2-28.

Alternatives for Providing a Safe Passage for Non-motorized Traffic across an Existing Highway Bridge



(a) Cap brackets

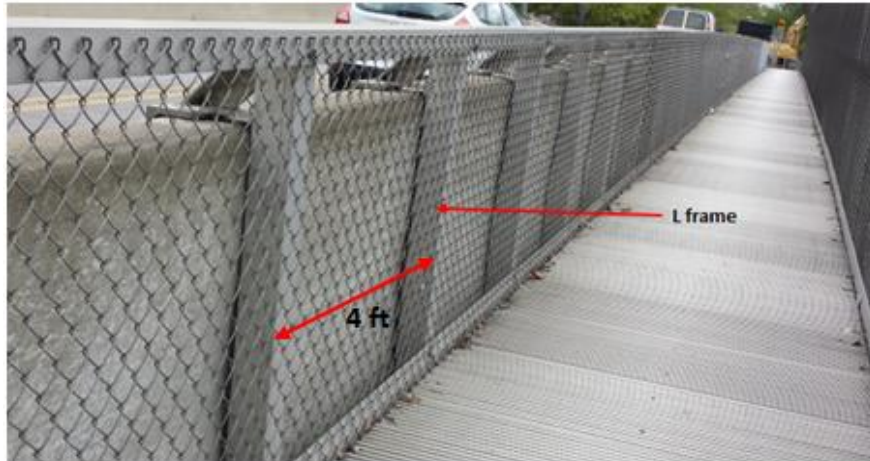

(b) L frame posts



(c) L frame end

Figure 2-27. A suspended bridge for non-motorized traffic

Alternatives for Providing a Safe Passage for Non-motorized Traffic across an Existing Highway Bridge

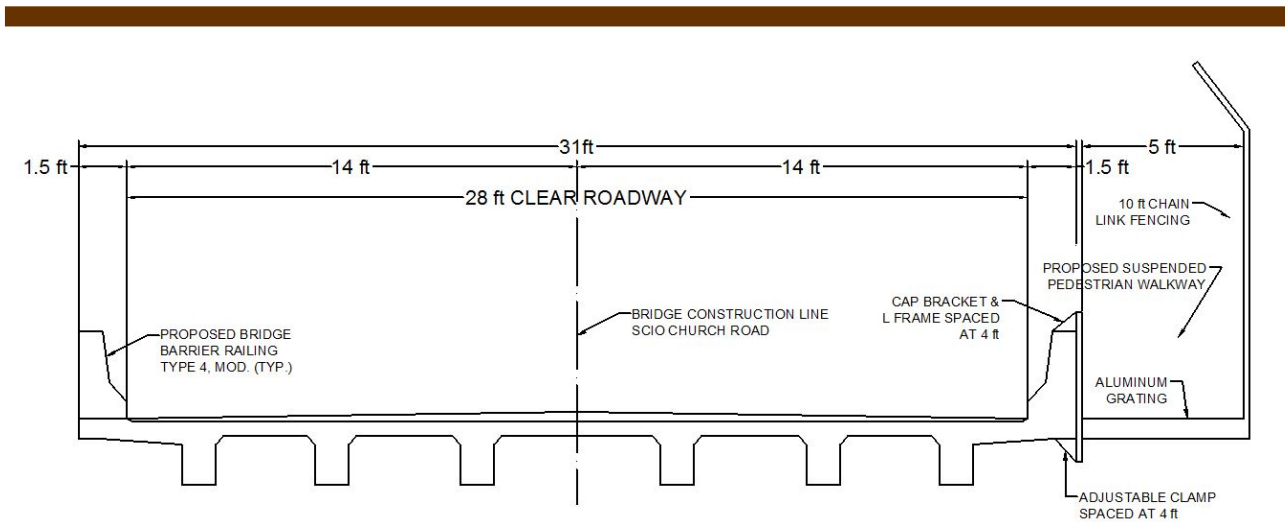

Figure 2-28. Scio Road bridge over I-94 after integrating a non-motorized facility

2.11 ANN ARBOR-SALINE ROAD BRIDGE OVER I-94

In April 2014, the city of Ann Arbor, Pittsfield Township, Washtenaw County Road Commission, and MDOT initiated Ann Arbor-Saline Road improvement project. The scope of the improvements included rehabilitation/reconstruction of the existing pavement and non-motorized accommodation within the bridge. Ann Arbor-Saline Road serves as connection between City of Ann Arbor and Pittsfield Township.

2.11.1 Site Characteristics

The Ann Arbor-Saline Road bridge over I-94 has two spans with a total length of 207 ft. The bridge has two NB lanes, two SB lanes, an EB on-ramp lane, and a left-turn lane. The total width of the bridge is 87.9 ft. In 2012, Ann Arbor-Saline Road carried an average annual daily traffic volume of 23,043 vehicles. The designated speed limit is 45 mph.

2.11.2 Non-motorized Passage Alternatives

The non-motorized accommodation on the bridge was provided by a pedestrian sidewalk on the east side (Figure 2-29) and bike lanes located outside the NB and SB lanes. The NB bike lane is located next to the pedestrian sidewalk (Figure 2-30). The SB bike lane is located in between EB on-ramp lane and SB traffic lanes (Figure 2-31).

Alternatives for Providing a Safe Passage for Non-motorized Traffic across an Existing Highway Bridge



Figure 2-29. Pedestrian sidewalk on the east side of the bridge



Figure 2-30. NB bike lane

Alternatives for Providing a Safe Passage for Non-motorized Traffic across an Existing Highway Bridge



Figure 2-31. SB bike lane (Source: Google Maps)

3 SPECIFICATIONS AND GUIDELINES

3.1 OBJECTIVE AND APPROACH

This chapter presents relevant information from the American Association of State Highway and Transportation Officials (AASHTO) guides and specifications to provide a safe passage for non-motorized and motorized facilities. Also, relevant guidelines and information from the Americans with Disabilities Act (ADA) are presented.

3.2 HORIZONTAL DESIGN CRITERIA

One of the major constraints for providing a passage for non-motorized traffic within an existing bridge is the space that remains available on the bridge after providing the minimum required space for motorized traffic. The minimum dimensions required for various features on a bridge with non-motorized facilities and motorized traffic, as per AASHTO specifications, are presented in Table 3-1. As discussed later in the report, these specifications are used in evaluating non-motorized passage alternatives for a given bridge configuration.

Table 3-1. Relevant AASHTO Specification and Guide Requirements

Feature	Reference	Minimum Dimensions
Shared use path	AASHTO Guide for the Development of Bicycles Facilities (2012)	10 ft 8 ft
Shy distance	AASHTO Geometric Design of Highways and Streets (2011a) AASHTO Guide for the Development of Bicycles Facilities (2012)	2 ft on each side
Barrier average width	AASHTO Roadside Design Guide (2011b)	2 ft
Vehicle lane	AASHTO Geometric Design of Highways and Streets (2011a)	11 ft 10 ft 9 ft
Sidewalk	AASHTO Guide for Planning, Design, and Operation of Pedestrian Facilities (2004)	5 ft
Bicycle lane	AASHTO Guide for the Development of Bicycles Facilities (2012)	4 ft (minimum) low-speed roads with curbs but no gutters 6 ft to 8 ft in areas of high bicycle use
Shared lane	AASHTO Guide for the Development of Bicycles Facilities (2012)	13 ft 14 ft 16 ft

Alternatives for Providing a Safe Passage for Non-motorized Traffic across an Existing Highway Bridge

For a shared use path, the AASHTO Guide for the Development of Bicycles Facilities (2012) allows using a reduced width of 8 ft when the following conditions prevail:

- Bicycle traffic is expected to be low (even on peak days or during peak hours).
- Pedestrian use is only occasional.
- Horizontal and vertical alignments provide frequent, well designed passing and resting opportunities.
- The path will not be regularly subjected to maintenance.
- The path covers a short distance due to physical constraints (eg. distance between bridge abutments).

Under the following conditions, the AASHTO Geometric Design of Highways and Streets (2011a) allows using traffic lane width less than 12 ft:

- In urban areas where pedestrian crossings, right-of-way, or existing development become stringent controls on lane widths, the use of 11 ft lanes may be appropriate.
- On low-speed roads, 10 ft lanes are acceptable.
- On low-volume roads, 9 ft lanes are appropriate. AASHTO (2011a) refers to the NCHRP Report 362 (1994) on Roadway Widths for Low-Traffic Volume Roads (i.e., ADT \leq 400) for further information.

For shared lanes, the AASHTO Guide for the Development of Bicycles Facilities (2012) recommends the following:

- Lane widths of 13 ft to allow motorists to encroach part way into the next lane to pass a bicyclist with an adequate and comfortable clearance.
- Lane widths that are 14 ft or greater to allow motorists to pass bicyclists without encroaching into the adjacent lane.
- Lane widths of 16 ft in extremely congested areas.

3.3 ADDITIONAL CONSIDERATIONS

Table 3-2 lists AASHTO and ADA guidelines for railings, ground surface, and surface elevations related to non-motorized facilities.

Alternatives for Providing a Safe Passage for Non-motorized Traffic across an Existing Highway Bridge

Table 3-2. Relevant AASHTO and ADA Guidelines

Other Design Criteria	Source	Minimum
Railing or barrier height	AASHTO Guide for the Development of Bicycles Facilities (2012)	42 in. (refer to the paragraph give below) 48 in. (refer to the paragraph give below)
Ground surface	ADA Guidelines (2002)	A static coefficient of friction of 0.6 is recommended for accessible routes and 0.8 for ramps.
Changes in level	ADA Guidelines (2002)	Vertical level change up to 1/4 in. maximum can be used without edge treatment. Vertical level changes between 1/4 in. and 1/2 in. shall be beveled with a slope no greater than 1:2.

According to the AASHTO Guide for the Development of Bicycles Facilities (2012), the minimum height of protective railings, fences, or barriers on a stand-alone structure should be 42 in. However, there are certain locations where 48 in. height protective structures are considered. Following are three examples of such locations:

- On bridges where high speed bicycles are likely (e.g., downgrade)
- On curved bridges (25 degree angle or greater) where a cyclist could impact a barrier
- On a descending grade where the curve radius is less than that appropriate for the design speed or anticipated speed.

Even though most projects are expected to meet at least the minimum dimensions specified in AASHTO publications, design exceptions can be submitted for the approval of the chief engineer of the respective highway department.

4 SAFE PASSAGE ALTERNATIVE ANALYSIS

4.1 OBJECTIVE AND APPROACH

This chapter presents a process that incorporates bridge geometric parameters, site characteristics, safe passage alternatives, and specification/guidelines requirements, to methodologically evaluate a bridge site and identify the most suitable and cost effective alternative to provide non-motorized access across an existing bridge. The methodology is based on AASHTO specifications, mainly horizontal design criteria, such as the minimum width for shared use path, shy distance, vehicle lane, sidewalk, bicycle lanes, and shared lanes.

The definitions and terminology that are commonly used to describe non-motorized facilities are presented. Non-motorized passage alternatives that can be used to provide access across an existing bridge are identified from the case studies listed in chapter 2 and presented in this chapter. Then, this chapter presents a process that incorporates bridge geometric parameters, site characteristics, safe passage alternatives, and specification/guidelines requirements; the purpose of this is to methodologically evaluate a bridge site to identify the most suitable alternative for providing non-motorized access across an existing bridge. The alternative analysis process is automated using Excel/Visual Basic, and an overview of the software platform is provided.

4.2 SAFE PASSAGE ALTERNATIVES

There are two primary alternatives to provide a passage to non-motorized traffic across an existing highway bridge; and to provide a passage within the bridge or outside the bridge. Typical features of a bridge with non-motorized passages within a bridge are shown in Figure 4-1. Accommodation of one or more of these features depends on many parameters as discussed later in this chapter.

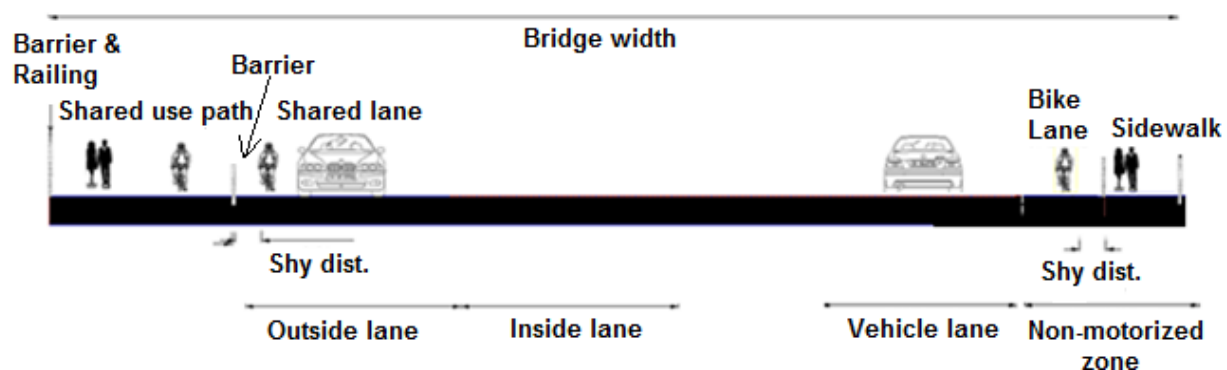

Alternatives for Providing a Safe Passage for Non-motorized Traffic across an Existing Highway Bridge

Figure 4-1. Typical features of a bridge superstructure with non-motorized facilities

4.2.1 Terminology and Definitions

In order to help understanding the content of this chapter as well as the subsequent chapters, the following list of terminology and the definitions are presented:

- Bicycle lane: a portion of the roadway designated for bicyclists
- Barrier: reinforced concrete member used for crash protection
- Inside lane(s): lanes other than the outside lanes
- Non-motorized zone: a portion of the roadway designated for bicyclists and pedestrians
- Outside lane: the lane closest to the edge of the road
- Railing: a structure provided for protection of the facility users
- Shared lane: a lane where bicyclists and vehicles share the roadway without any portion of the lane specially designated for the bicycle use. For a low volume of bicycle traffic, shared lane width is maintained at the same width as a typical traffic lane (i.e., no special provisions). If the expected bicycle volume is high, shared lane width is increased allowing the motorists to overtake the bicyclists without encroaching into an adjacent lane.
- Shared use path: a wide pathway shared by bicyclists and pedestrians
- Shy distance: a space that pedestrians, bicyclists, and motorists naturally keep between themselves and a vertical obstruction such as a wall, curb, or a barrier
- Sidewalk: a portion of the roadway width designated for preferential use by pedestrians
- Vehicle lane: portion of the roadway designated for vehicles.

4.2.2 Passage Alternatives within an Existing Bridge

A large number of case studies were reviewed to identify non-motorized passage alternatives. One of the following 5 alternatives can be considered for providing a safe passage within a bridge:

- A shared use path and shared lanes with no special provisions
- A sidewalk and wider shared lanes
- A sidewalk and bike lanes
- A shared use path and wider shared lanes

Alternatives for Providing a Safe Passage for Non-motorized Traffic across an Existing Highway Bridge

- A shared use path and bike lanes.

Figure 4-2 is a graphical representation of the above listed alternatives. A brief description of each alternative is presented below. The alternatives are listed in an increasing order of space required for implementation.

Alternative 1: consists of a shared use path and shared lanes with no special provisions (Figure 4-2a). The shared lanes are commonly used by experienced bicyclist that are often comfortable with riding on the road. However, the width of the lanes is not modified to accommodate bicyclists; thus, they might go on the road at their own risk. This configuration is recommended in rural areas where ADT is less or equal to 1000 and the speed is less than or equal to 55 mph; it is also recommended in urban neighborhoods or local streets with a speed limit between 20 to 30 mph.

Alternative 2: consists of a sidewalk and wider shared lanes (Figure 4-2b). This configuration is suitable when it is not possible to provide separate bike lanes due to space constraints or other limitations. In this configuration, motorists are much less likely to encroach into the adjacent lane when passing a bicyclist, making it more appealing to experienced bicyclists who are often commuters. However, some bicyclists may still ride on the sidewalk.

Alternative 3: consists of a sidewalk and bike lanes in both directions (Figure 4-2c). Bike lanes are the appropriate and preferred bicycle facility for thoroughfares in both urban and near urban areas. State laws and local ordinances should be considered when implementing bike lanes, as they may have an impact on bike lane design, such as the placement of dashed lane lines. Children and less comfortable bicyclists may be expected on the sidewalk.

Alternative 4: consists of a shared use path and wider shared lanes (Figure 4-2d). This configuration is often recommended for busy urban areas where high non-motorized traffic is expected and enough space is available.

Alternative 5: consists of a shared use path and bike lanes (Figure 4-2e). This configuration is often recommended for busy urban areas with adequate space. Designated facilities, like bike lanes, alert motorists of the presence of bicyclists in the

Alternatives for Providing a Safe Passage for Non-motorized Traffic across an Existing Highway Bridge

roadway. Presence of designated bike lanes appeals to experienced bicyclists who are often commuters.



(a) A shared use path and shared lanes with no special provisions



(b) A sidewalk and wider shared lanes



(c) A sidewalk and bike lanes



(d) A shared use path and wider shared lanes



(e) A shared use path and bike lanes

Figure 4-2. Bridge superstructure configurations with non-motorized passage alternatives

4.2.3 Passage Alternatives outside an Existing Bridge

A passage outside of an existing bridge can be provided by using a cantilevered structure (Figure 4-3a), hanging structure (Figure 4-3b), or a free standing structure (Figure 4-3c). These alternatives are implemented when the geometry of a bridge does not allow non-motorized traffic accommodation within the bridge. These alternatives are costlier than providing a passage

Alternatives for Providing a Safe Passage for Non-motorized Traffic across an Existing Highway Bridge

within a bridge. Use of a cantilevered or hanging structure requires condition assessment and detailed analysis of the existing structure.



(a) Cantilevered structure



(b) Hanging structure

Alternatives for Providing a Safe Passage for Non-motorized Traffic across an Existing Highway Bridge



(c) Free standing structure

Figure 4-3. Passage alternatives outside an existing bridge

4.3 ALTERNATIVE ANALYSIS METHODOLOGY

Figure 4-4 presents a process that incorporates bridge geometric parameters, site characteristics, safe passage alternatives, and specification/guidelines requirements, to methodologically evaluate a bridge site; this process identifies the most suitable and safe alternative to provide non-motorized access across an existing bridge.

The first step is to identify if the bridge is scheduled for replacement. If the bridge is scheduled for replacement within the next couple of years, designers are expected to make provisions for non-motorized access. If the bridge is not scheduled for replacement, providing safe access for non-motorized traffic across the bridge is evaluated. Site information such as road classification (urban or rural), traffic data (ADT and speed), bridge geometry and traffic lane dimensions, number of lanes, and AASHTO specifications and guidelines requirements are used to identify the minimum required space for traffic. The traffic lane dimension used for the analysis is the minimum traffic lane width required as per AASHTO Geometric Design of Highways and Streets (2011a) for the specific site conditions. This ensures that the maximum available space for non-motorized traffic is obtained. If a traffic study shows road diet, there is a possibility to reduce the number of lanes in order to provide additional space for non-motorized traffic. Knowing the bridge geometry and the space needed for traffic, the space available for non-motorized traffic within the bridge is calculated. Out of the five alternatives listed above, Alternative 1 requires the minimum space to provide access within a bridge. Therefore, when the minimum space required for incorporating non-motorized passage is available, Alternative 1 is calculated based on the bridge superstructure configuration, traffic speed, non-motorized traffic volume, and AASHTO specifications and guidelines related to non-motorized traffic. The

Alternatives for Providing a Safe Passage for Non-motorized Traffic across an Existing Highway Bridge

minimum space required to accommodate non-motorized traffic within the bridge is then compared with the space available for non-motorized traffic. If the available space for non-motorized traffic is greater than or equal to the minimum space required for non-motorized traffic, safe passage alternatives to accommodate non-motorized traffic on the bridge are evaluated. All the possible alternatives to accommodate non-motorized traffic within the bridge are identified using specifications and guidelines for non-motorized traffic and site information such as road classification, traffic speed, number of lanes, traffic lane dimensions, expected non-motorized volume, and the space available for non-motorized traffic. When the minimum required space is greater than the available space, design exceptions are requested. If the approval is not granted, providing access using a structure attached to the bridge (cantilevered or hanging) or a separate free standing structure adjacent to the existing structure is considered.

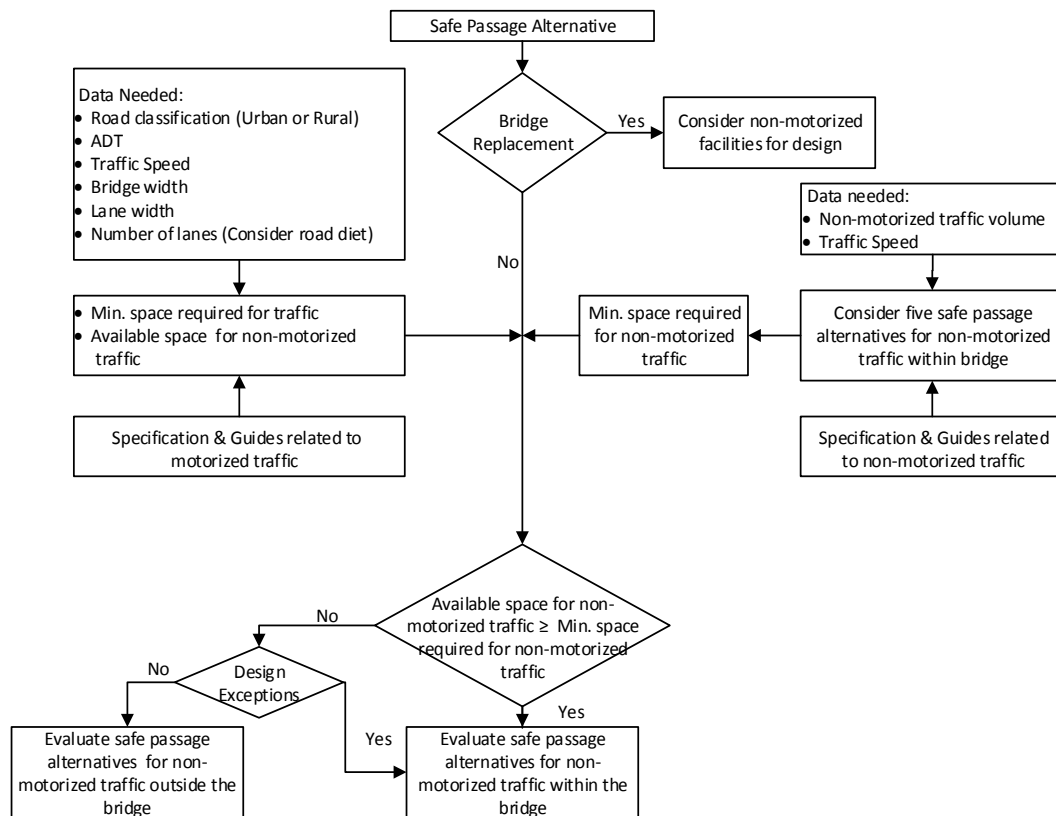

Figure 4-4. Alternative analysis methodology

Alternatives for Providing a Safe Passage for Non-motorized Traffic across an Existing Highway Bridge

4.4 SAFE PASSAGE - ALTERNATIVE ANALYSIS SOFTWARE

Safe Passage is the software platform developed using Excel/Visual Basic to facilitate the alternative analysis process. The graphical user interface (GUI) is shown in Figure 4-5. The user is expected to provide a user name, agency, bridge name, etc, and click on the *Analyze* button. When the space available on the bridge is greater than or equal to the minimum space required to provide access, all possible alternatives are displayed. Cost estimates are needed for funding proposal development. Therefore, the software includes cost data from past similar projects to develop cost estimates. Hence, the program allows selecting the most cost effective and safest alternative to develop funding proposals.

The current version of the software is based on the AASHTO *Guide for the Development of Bicycles Facilities* 4th Edition (2012), AASHTO *Guide for Planning, Design, and Operation of Pedestrian Facilities* (2004), AASHTO *Geometric Design of Highways and Streets* (2011a), AASHTO *Roadside Design Guide* (2011b) specifications, and cost data from recently completed projects prorated to 2015. The software provides an opportunity for the user to customize the specification/guideline requirements and cost data to adapt them to an agency's business practice. Also, the cost estimates are prorated to the year of project implementation. When the space available within the bridge is less than the minimum space required to accommodate any of the five alternatives, a message is displayed asking to evaluate the possibility of using a passage outside the bridge. However, the current version does not suggest the type of outside passages to be used. The type of structure to be used for outside passage is left to the engineer's judgment. The software, *Safe Passage*, is available to the public through the official Transportation Research Center for Livable Communities (TRC-LC) website <http://www.wmich.edu/transportationcenter>.

Alternatives for Providing a Safe Passage for Non-motorized Traffic across an Existing Highway Bridge

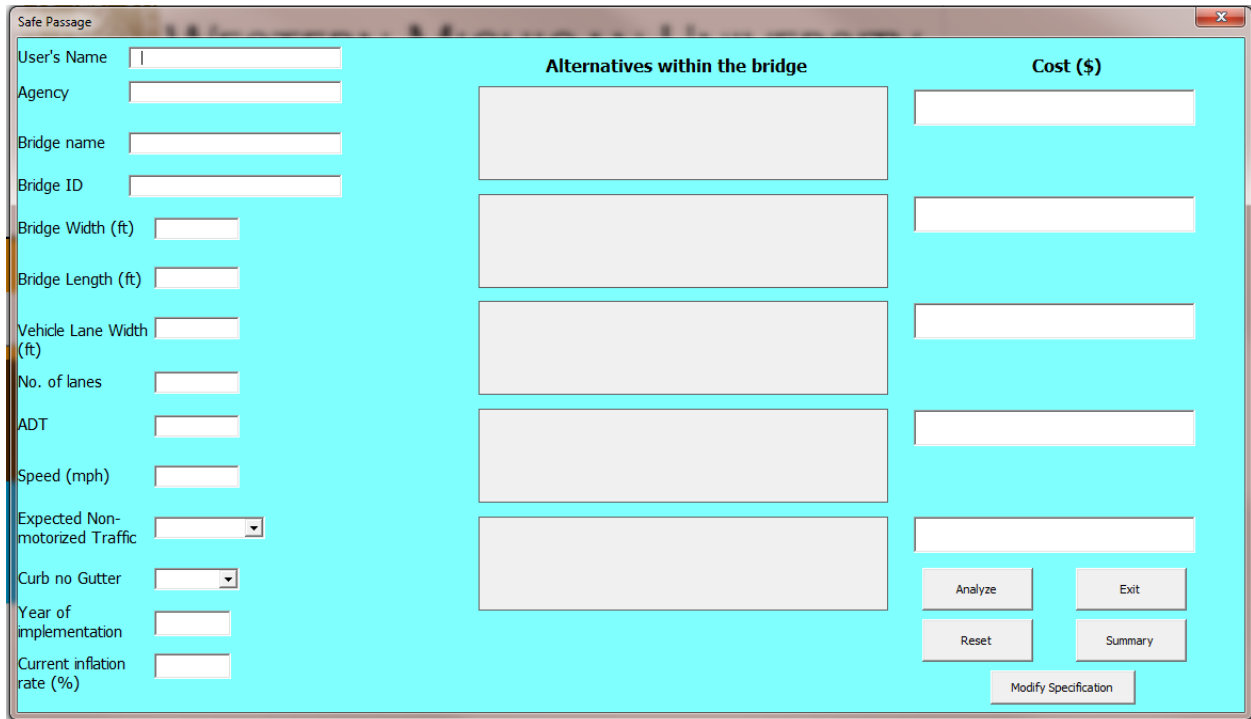

Figure 4-5. *Safe Passage* graphical user interface (GUI)

5 IMPLEMENTATION EXAMPLES

5.1 OBJECTIVE

Three examples are presented to demonstrate implementation of the alternative analysis process presented in chapter 4. While this chapter presents a summary of the examples, Appendix B presents relevant calculations. Cost estimates are also presented with each alternative. Cost estimates are prepared using data from past project documents and the data provided by MDOT and local engineering firms. Cost data obtained from past projects are adjusted to reflect fiscal year 2015 values. Pre-design, design, bidding, construction administration fees, and contingencies are not included in the cost estimates.

5.2 9TH STREET BRIDGE OVER I-94

The bridge on 9th street is a minor arterial that carries traffic over I-94. It is owned by the state of Michigan and was built in 1996. The location is in an urban area of Kalamazoo. This bridge is the connection between several businesses located north of the bridge (Mc Donald's, Old Burdick, Culver's, UPS store, etc.) and residential areas, hotels, and Kalamazoo Valley Community College located south of the bridge (Figure 5-1). Kalamazoo Valley Community College is a two-year college with an enrollment of about 13,000 students (Kalamazoo Valley Community College 2015).

As shown in Figure 5-2, the sidewalk does not continue over the bridge. The length of the discontinued section is about 1,530 ft. This discontinuity exposes non-motorized traffic to unsafe conditions when trying to cross the bridge (Figure 5-2). Thus, there is a need to evaluate the bridge site to identify safe passage alternatives for non-motorized traffic.

5.2.1 Site Characteristics

The bridge has five 12 ft wide lanes (four traffic lanes and one left-turn lane) and two 9 ft wide shoulders (Figure 5-3). Hence, the total width of the bridge is 78 ft. The length of the bridge is 270 ft. In 2012, the bridge carried an average annual daily traffic volume of 19,000 vehicles. The designated speed limit is 45 mph.

Alternatives for Providing a Safe Passage for Non-motorized Traffic across an Existing Highway Bridge



Figure 5-1. Aerial view of the site (Source: Google maps)

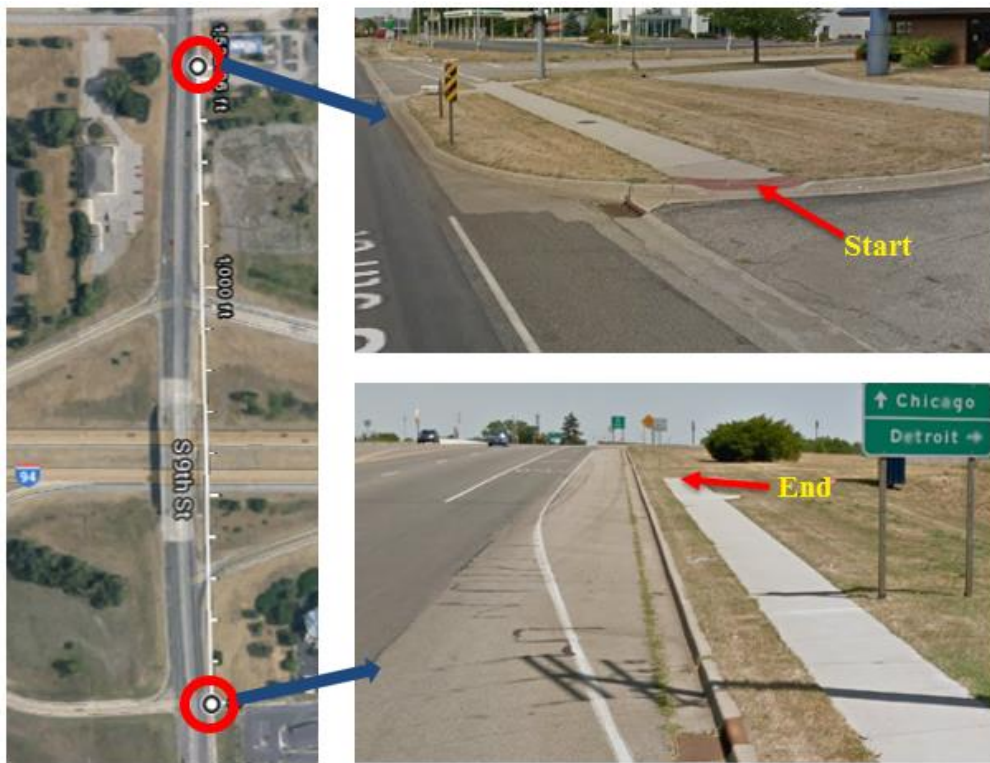

Figure 5-2. Discontinued sidewalk on either side of the bridge (Source: Google maps)

Alternatives for Providing a Safe Passage for Non-motorized Traffic across an Existing Highway Bridge



Figure 5-3. 9th Street bridge over I-94 (Source: Google maps)

5.2.2 Safe Passage Alternatives

As shown in Figure 5-4, the first step in the alternative analysis procedure is to identify if the bridge is scheduled for replacement. According to the National Bridge Inventory (NBI) data, in September 2012, the bridge deck, superstructure, and substructure condition rating was 7 (good). Also, the sufficiency rating (SC) was 95.6%. This shows that the bridge is not scheduled for replacement in near future. Hence, alternatives for providing a safe passage for non-motorized traffic across the bridge is evaluated.

Based on the bridge geometry, traffic data, and specification/guideline requirements, the space available on the bridge for non-motorized traffic is 23 ft. The traffic lane dimension used for the analysis is the minimum traffic lane width required as per the AASHTO Geometric Design of Highways and Streets (2011a) for the specific site conditions (Figure 5-4). As this site is neither a low-speed nor a low-volume facility, a minimum traffic lane width of 11 ft is used. The minimum space required to accommodate non-motorized traffic is 16 ft. Hence, there is an adequate space to accommodate non-motorized traffic within the bridge. Further evaluations showed that the space required to implement Alternatives 1, 2, 3, and 4 is 16 ft, 17 ft, 19 ft and 22 ft. Hence, accommodating all four alternatives within the bridge is possible. Table 5-1 shows the cost for Alternatives 1, 2, 3 and 4. When there is not much difference in the cost, the alternative selection is based on safety and user's comfort level.

Alternatives for Providing a Safe Passage for Non-motorized Traffic across an Existing Highway Bridge

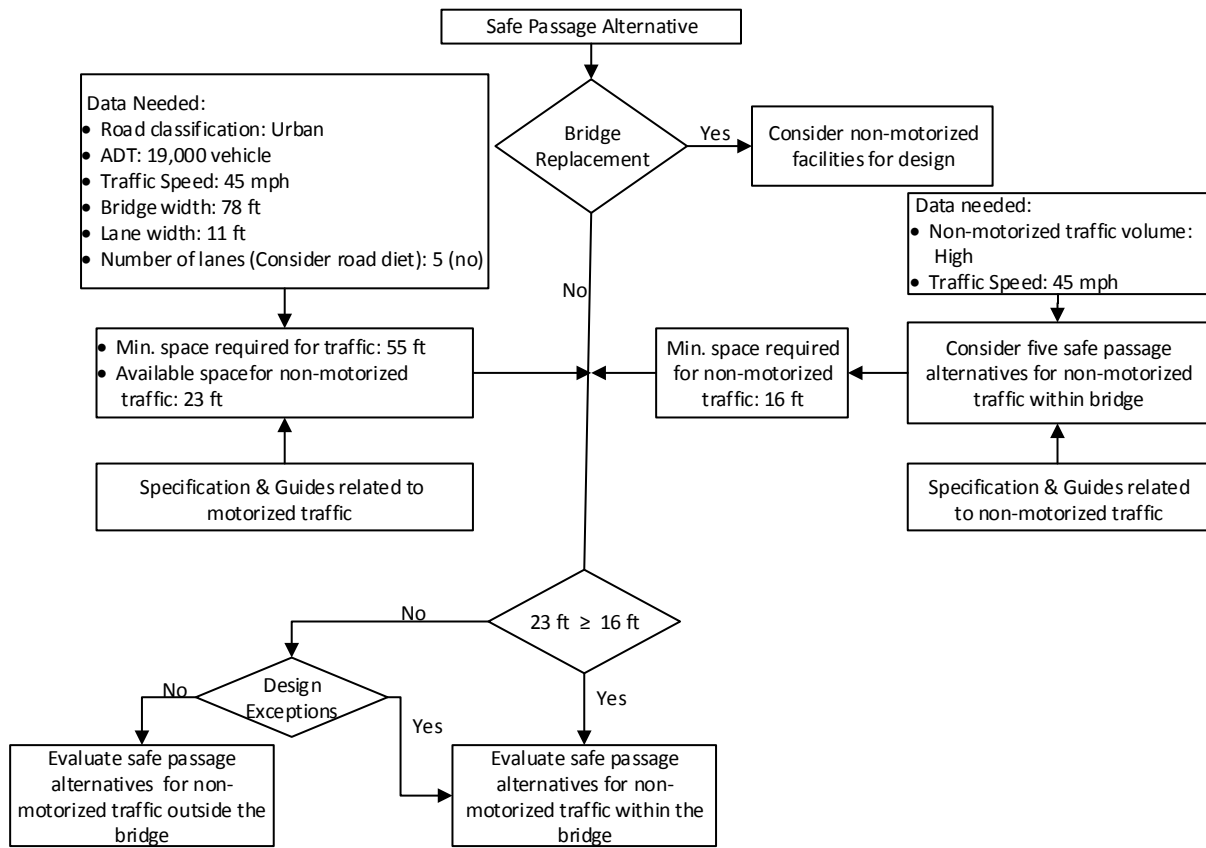

Figure 5-4. Safe passage alternative analysis for the 9th Street bridge over I-94

Table 5-1. Cost Estimates for the 9th Street Bridge over I-94 Safe Passage Alternatives

Description	Unit	Unit price (\$)	Alternative 1 (\$)	Alternative 2 (\$)	Alternative 3 (\$)	Alternative 4 (\$)
4 in. thick concrete sidewalk	ft ²	5	na	2,250.00	2,250.00	na
Fence, chain link	ft	15	4,050.00	4,050.00	4,050.00	4,050.00
Shared use path, HMA	ton	80	5,220.00	na	na	5,220.00
Striping	ft	6	9,720.00	9,720.00	12,960.00	9,720.00
Concrete barrier, Type 4, Mod	ft	95	25,650.00	25,650.00	25,650.00	25,650.00
Total			44,640.00	41,670.00	44,910.00	44,640.00

Alternatives for Providing a Safe Passage for Non-motorized Traffic across an Existing Highway Bridge

5.3 44TH STREET BRIDGE OVER I-196

The bridge on 44th street is a collector that carries traffic over I-196. The bridge was built in 1972 and located in an urban area. The bridge is the connection between residential areas on the west and the businesses and a high school on the east of I-196 (Figure 5-5a). Grandville high school is home to over 1,800 students annually (Grandville High School 2015). The location of residential areas, businesses, and high school demands non-motorized access across the bridge. However, the bridge does not include designated non-motorized facilities (Figure 5-5b).



(a) Aerial view of the site



(b) A view of the bridge deck

Figure 5-5. 44th Street bridge over I-196 (Source: Google maps)

5.3.1 Site Characteristics

The bridge has six 12 ft wide lanes: four traffic lanes, one left-turn lane, and one on-ramp lane. It also has two 8 ft wide shoulders (Figure 5-5b). Hence, the total width of the bridge is 88 ft.

Alternatives for Providing a Safe Passage for Non-motorized Traffic across an Existing Highway Bridge

The length of the bridge is 240 ft. In 2007, the bridge carried an average annual daily traffic volume of 24,200 vehicles. The designated speed limit is 45 mph.

5.3.2 Safe Passage Alternatives

In 2012, the NBI rating of the deck and superstructure was 7 (good), and the substructure was 6 (satisfactory). The sufficiency rating was 90.3%. Therefore, the bridge is not scheduled for replacement in near future. Based on the bridge geometry, traffic data, and specification/guideline requirements, the space available on the bridge for non-motorized traffic is 22 ft (Figure 5-6). The minimum space required to accommodate non-motorized traffic is 16 ft. Hence, there is an adequate space to accommodate non-motorized traffic within the bridge. Further evaluations showed that the space required to implement Alternative 1, 2 and 3 is 16 ft, 17 ft and 19 ft. As a result, accommodating Alternatives 1, 2 and 3 within the bridge is possible.

Table 5-2 shows the cost for Alternatives 1, 2 and 3. When there is not much difference in the cost, the alternative selection is based on safety and user's comfort level.

Alternatives for Providing a Safe Passage for Non-motorized Traffic across an Existing Highway Bridge

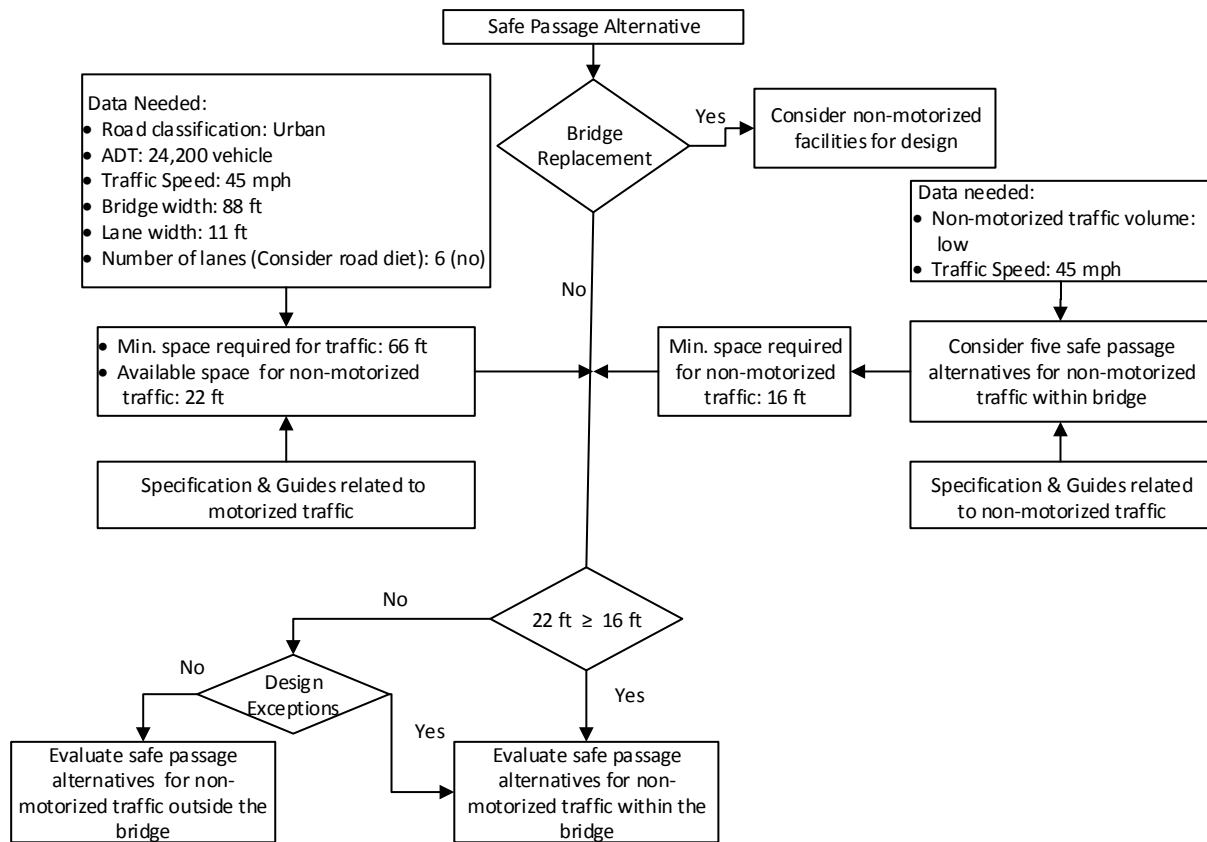

Figure 5-6. Safe passage alternative analysis for 44th Street bridge over I-196

Table 5-2. Cost Estimates for the 44th Street Bridge over I-196 Safe Passage Alternatives

Description	Unit	Unit price (\$)	Alternative 1 (\$)	Alternative 2 (\$)	Alternative 3 (\$)
4 in. thick concrete sidewalk	ft ²	5	na	2,000.00	2,000.00
Fence, chain link	ft	15	3,600.00	3,600.00	3,600.00
Shared use path, HMA	ton	80	4,640.00	na	na
Striping	ft	6	10,080.00	10,080.00	12,960.00
Concrete barrier, Type 4, Mod	ft	95	22,800.00	22,800.00	22,800.00
Total			41,120.00	38,480.00	41,360.00

Alternatives for Providing a Safe Passage for Non-motorized Traffic across an Existing Highway Bridge

5.4 102ND AVENUE BRIDGE OVER US-131

Built in 1962, the bridge is located in a rural area just outside of Kalamazoo in Allegan County. The 102nd Avenue bridge over US-131 is the connection between residential areas and a major high school in Plainwell (Figure 5-7a). As shown in Figure 5-7b, there is no designated passage for non-motorized traffic provided across the bridge.



(a) Aerial view of the site



(b) A view of the bridge deck

Figure 5-7. 102nd Avenue bridge over US-131 (Source: Google maps)

Alternatives for Providing a Safe Passage for Non-motorized Traffic across an Existing Highway Bridge

5.4.1 Site Characteristics

The bridge has two 10 ft wide lanes and two 3 ft wide shoulders (Figure 5-7b). Hence, the total width of the bridge is 26 ft. The length of the bridge is 210 ft. In 2013, the bridge carried an average annual daily traffic volume of 6,092 vehicles. The designated speed limit is 45 mph.

5.4.2 Safe Passage Alternatives

In 2013, the NBI rating of the deck and superstructure was 6 (satisfactory), and the substructure was 5 (fair). Due to existing geometry, the bridge was evaluated as functionally obsolete. The sufficiency rating was 66.3%. To be eligible for federal aid for replacement, the bridge must have a sufficiency rating of less than 50%. Therefore, based on this information, it was assumed that this structure is not scheduled for replacement in the near future. Hence, providing safe passage alternatives across the bridge was evaluated.

The space available for non-motorized traffic is 4 ft while the minimum space required for non-motorized traffic passage alternatives is 16 ft (Figure 5-8). Please note that providing only a sidewalk restricts the cyclists' freedom because sidewalks are designed as per the AASHTO Guide for the Planning, Design, and Operation of Pedestrian Facilities (2004) for use by pedestrians. Hence, it was not considered as an alternative presented in this report. In a rare instance, as a short-term solution, providing only a sidewalk can be considered. However, for this specific site, even if design exceptions are requested, the geometry of the bridge would not allow providing at least a sidewalk for pedestrian use with adequate space for shy distance. The minimum distance specified by the AASHTO Guide for the Planning, Design, and Operation of Pedestrian Facilities (2004) and the AASHTO Geometric Design of Highways and Streets (2011a) for a sidewalk and shy distance is 5 ft and 2 ft, respectively. Because of the speed limit over the bridge, a safety barrier is required between the sidewalk and traffic lanes. The minimum space required for providing a sidewalk is 11 ft (width of the sidewalk, barrier width, and shy distances on either side) and the space available for non-motorized traffic is only 4 ft.

When the space within the bridge is not adequate, the next alternative is to provide access by using a hanging structure, a cantilevered structure, or a free standing structure. The selection of the type of structure is not addressed within the scope of this report. Based on the documented

Alternatives for Providing a Safe Passage for Non-motorized Traffic across an Existing Highway Bridge

case studies, a 5 ft wide hanging structure is selected to provide non-motorized traffic access across this prestressed concrete girder bridge (Figure 5-9). Use of such a structure requires replacing the safety barrier. A cost estimate was prepared and presented in Table 5-3.

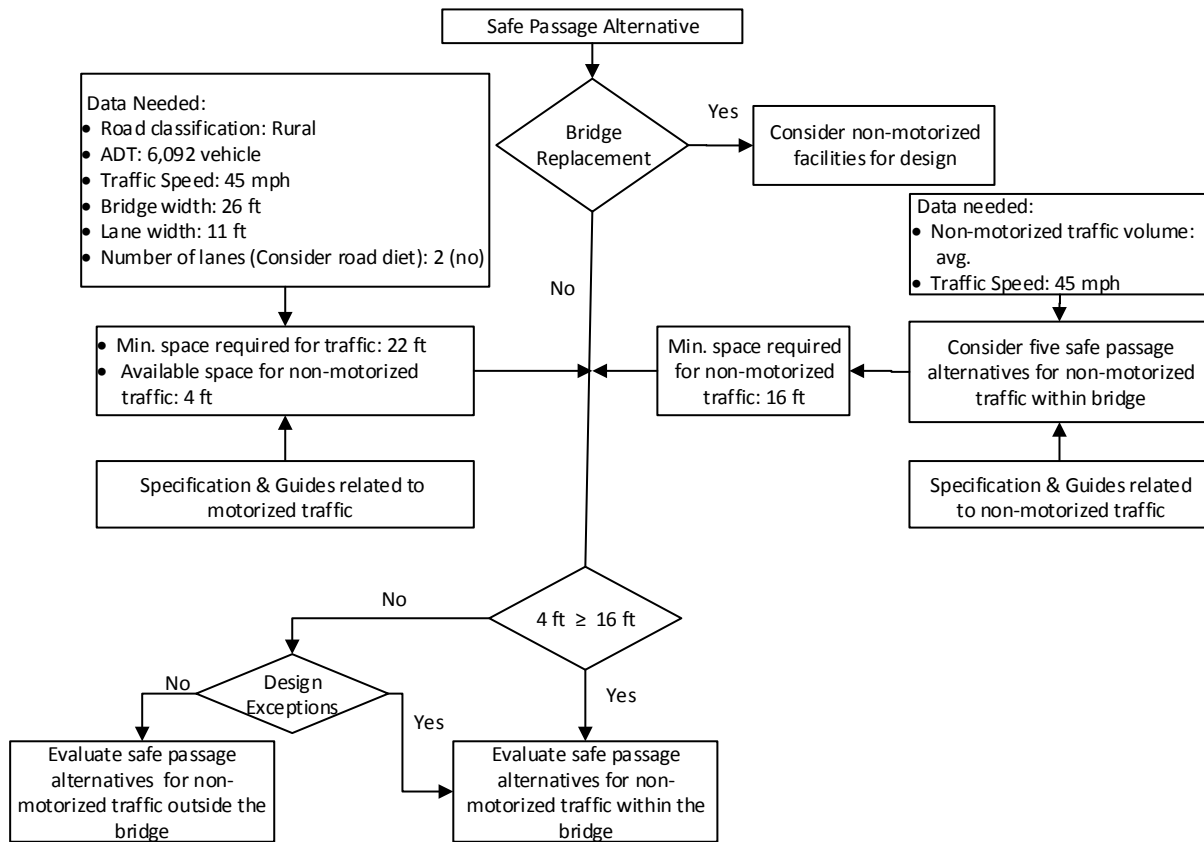

Figure 5-8. Safe passage alternative analysis for 102nd Avenue bridge over US-131

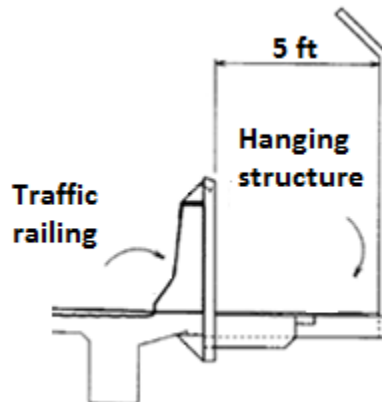

Figure 5-9. Hanging structure as an alternative to provide passage outside the bridge

Alternatives for Providing a Safe Passage for Non-motorized Traffic across an Existing Highway Bridge

Table 5-3. Cost Estimate for Providing a Hanging Structure

Description	Unit	Unit price (\$)	Amount (\$)
Concrete Barrier, Single Face, Type 4, Modified	ft	95.0	39,900.00
Hanging structure	ft ²	217.0	227,850.00
Fence, chain link	ft	15.0	3,150.00
		Total	270,900.00

6 SUMMARY, CONCLUSIONS, AND RECOMMENDATIONS

6.1 SUMMARY AND CONCLUSIONS

Recently, there is an emphasis on developing integrated transportation systems with off-road shared use paths and on-road facilities. A majority of highway bridges that are located on the planned or existing non-motorized paths have become bottle-necks for non-motorized traffic. Hence, there is a need to evaluate the bridges on non-motorized paths to identify safe passage alternatives for non-motorized traffic. In the meantime, the owner agencies need to have access to a methodological process to evaluate a site for the best possible alternatives and develop accurate cost estimates for funding proposals. Multiple case studies were reviewed to synthesize project scoping processes, alternatives, and cost. The specifications and guidelines related to motorized and non-motorized facilities for evaluating safe passage alternatives across an existing bridge were synthesized. Alternatives for providing safe passage within and outside a bridge were identified.

Understanding the need, a methodological process was developed to evaluate possible alternatives to provide non-motorized access across an existing bridge. Three examples were presented to demonstrate the implementation of the alternative analysis process. In order to promote the implementation of the alternative analysis process by highway agencies, a software platform was developed using Excel/Visual Basic and made available through the Transportation Research Center for Livable Communities website at <http://www.wmich.edu/transportationcenter>. The software program provides an opportunity for the user to customize the specification/guideline requirements and cost data to adapt them to the business practice of an agency.

The current version of the program is limited to providing alternatives within the bridge. The current version identifies the need of providing access outside the bridge, but it does not suggest the type of structure to be used. Further, the alternative analysis is solely based on quantitative data. The program needs to be updated also to include qualitative data and risk analysis to evaluate a site more comprehensively. In addition to providing alternatives, cost estimates are presented for selected alternatives. Only the direct cost of the specific alternative is presented.

Alternatives for Providing a Safe Passage for Non-motorized Traffic across an Existing Highway Bridge

The cost data needs to be updated to include pre-design, design, bidding, construction administration fees, contingency, risk, etc.

6.2 RECOMMENDATIONS

- Evaluate safety aspects of the non-motorized passage alternatives presented in this report.
- Perform traffic safety studies to determine the number of non-motorized traffic conflict points and develop recommendations to improve safety.
- Evaluate available live load models and analyze procedures to develop a unified approach.

Alternatives for Providing a Safe Passage for Non-motorized Traffic across an Existing Highway Bridge

7 REFERENCES

1. AASHTO (2011a). Geometric Design of Highways and Streets. American Association of State Highway and Transportation Officials, Washington, DC.
2. AASHTO (2011b). Roadside Design Guide. American Association of State Highway and Transportation Officials, Washington, DC.
3. AASHTO (2012). Guide for the Development of Bicycles Facilities. American Association of State Highway and Transportation Officials, Washington, DC.
4. AASHTO (2004). Guide for Planning, Design, and Operation of Pedestrian Facilities. American Association of State Highway and Transportation Officials, Washington, DC.
5. ADA Accessibility Guidelines (2002) <http://www.access-board.gov/guidelines-and-standards/buildings-and-sites/about-the-ada-standards/background/adaag#4.5> (August 14, 2015)
6. ADONIS. (1999). “Best Practice to Promote Cycling and Walking and How to Substitute Short Car Trips by Cycling and Walking” ADONIS Transport RTD Program, www.cordis.lu/transport/src/adonisrep.htm (Aug. 10, 2015).
7. Atlantic South Consulting Services and Dennis Corporation. (2007). Ashley River Bridge Pedestrian/Bicycle Facility Retrofit – Feasibility Study. Charleston: South Carolina Department of Transportation.
8. Dover/Kent County MPO. (2012). Route 10 Bicycle and Pedestrian Study. Dover: Delaware Department of Transportation.
9. Grandville High School (2015) http://hs.gpsbulldogs.org/apps/pages/index.jsp?uREC_ID=272675&type=d&pREC_ID=628582 (June 6, 2015).
10. Hamilton Anderson Associates and Midwest Consulting LLC. (2004). I-94 at Huron Street Interchange Non-Motorized Crossing. Ypsilanti: Michigan Department of Transportation.
11. Kalamazoo County Government. (2015). “Kalamazoo River Valley Trail”. <http://www.kalcounty.com/parks/krvt/> (June 2, 2015).
12. Kalamazoo Valley Community College (2015). <https://www.kvcc.edu/about/historyofinstitution.htm> (June 6, 2015).

Alternatives for Providing a Safe Passage for Non-motorized Traffic across an Existing Highway Bridge

13. Michigan Department of Transportation (MDOT) – News and Information. (2013).
<http://www.michigan.gov/mdot/0,4616,7-151-9620-306326--,00.html> (June 2, 2015).
14. National Household Travel Survey (NHTS). (2009). <<http://nhts.ornl.gov/>>. (June 23, 2015)
15. OHM. (2012). Novi Road Pedestrian Route Study over I-96. City of Novi: Michigan Department of Transportation.
16. United States Census Bureau (2013).
http://factfinder.census.gov/faces/tableservices/jsf/pages/productview.xhtml?pid=ACS_13_5_YR_B08006&prodType=table (March 26, 2015).
17. STATISTA. (2015). Statistic Portals, Statista Inc.,
<http://www.statista.com/statistics/227415/number-of-cyclists-and-bike-riders-usa/> (June 23, 2015)

APPENDIX A: ABBREVIATIONS

Alternatives for Providing a Safe Passage for Non-motorized Traffic across an Existing Highway Bridge

A

AASHTO	American Association of State Highway and Transportation Officials
ADA	Americans with Disabilities Act
ADT	Average Daily Traffic

D

DelDOT	Delaware Department of Transportation
DNREC	Department of Natural Resources and Environmental Control
DOT	Department of Transportation

E

EB	Eastbound
----	-----------

G

GUI	Graphical User Interface
-----	--------------------------

K

KCRC	Kalamazoo County Road Commission
------	----------------------------------

M

MDOT	Michigan Department of Transportation
MPO	Metropolitan Planning Organization

N

NB	Northbound
NBI	National Bridge Inventory
NCHRP	National Cooperative Highway Research Program
NHTS	National Household Travel Survey

O

OHM	Orchard, Hiltz & McCliment
-----	----------------------------

Alternatives for Providing a Safe Passage for Non-motorized Traffic across an Existing Highway Bridge

R

RCOC Road Commission for Oakland County

S

SB Southbound

SC Sufficiency Rating

SRTS Safe Route to School

T

TRC-LC Transportation Research Center for Livable Communities

U

USDOT United States Department of Transportation

UTC University Transportation Centers

W

WATS Washtenaw Area Transportation Study

WB Westbound

APPENDIX B: IMPLEMENTATION EXAMPLES

Alternatives for Providing a Safe Passage for Non-motorized Traffic across an Existing Highway Bridge

9TH STREET OVER I-94 BRIDGE

Safe Passage Alternatives

- Minimum space required for motorized traffic = lane width \times number of lanes
 $= 11 \text{ ft}^a \times 5 = 55 \text{ ft}$

^a AASHTO Geometric Design of Highways and Streets (2011) allows a reduction of 12 ft traffic lanes to 11 ft when in urban areas where pedestrian crossings, right-of-way, or existing development become stringent controls on lane widths.

- Space available for non-motorized traffic = Bridge width – Min. space required for non-motorized traffic
 $= 78 \text{ ft} - 55 \text{ ft} = 23 \text{ ft}$

- Minimum space required for non-motorized traffic in alternative 1 (Figure 1).

Shared use path = 10 ft

Barrier = 2 ft (traffic speed > 45mph)

Shy distance = 2 ft \times 2 = 4 ft

Minimum space required for non-motorized traffic = 10 + 2 + 4 = 16 ft



Figure 1. Alternative 1

- Minimum space required for non-motorized traffic in alternative 2 (Figure 2)

Sidewalk = 5 ft

Barrier = 2 ft (traffic speed > 45mph)

Shy distance = 4 ft (2 ft away from barrier on the road)

Outside lanes = (width recommended by AASHTO – existing width) (No. of outside lanes needed)

$$= (14 \text{ ft}^b - 11 \text{ ft}) (2) = 6 \text{ ft}$$

^b For shared lanes, the AASHTO Guide for the Development of Bicycles Facilities (2012) recommends lane widths that are 14 ft or greater to allow motorists to pass bicyclists without encroaching into the adjacent lane.

Minimum space required for non-motorized traffic = 5 + 2 + 4 + 6 = 17 ft

Alternatives for Providing a Safe Passage for Non-motorized Traffic across an Existing Highway Bridge



Figure 2. Alternative 2

- Minimum space required for non-motorized traffic in alternative 3 (Figure 3)

Sidewalk = 5 ft

Barrier = 2 ft (traffic speed > 45mph)

Shy distance = 4 ft (2 ft away from barrier on the road)

Bike lanes = 4 ft × 2 (each direction) = 8 ft

Minimum space required for non-motorized traffic = 5 + 2 + 4 + 8 = 19 ft



Figure 3. Alternative 3

- Minimum space required for non-motorized traffic in alternative 4 (Figure 4).

Shared use path = 10 ft

Barrier = 2 ft (traffic speed > 45mph)

Shy distance = 2 ft × 2 = 4 ft

Outside lanes = (width recommended by AASHTO – existing width) (No. of outside lanes needed)

$$= (14 \text{ ft}^c - 11 \text{ ft}) (2) = 6 \text{ ft}$$

^c For shared lanes, the AASHTO Guide for the Development of Bicycles Facilities (2012) recommends lane widths that are 14 ft or greater to allow motorist to pass bicyclists without encroaching into the adjacent lane.

Minimum space required for non-motorized traffic = 10 + 2 + 4 + 6 = 22 ft

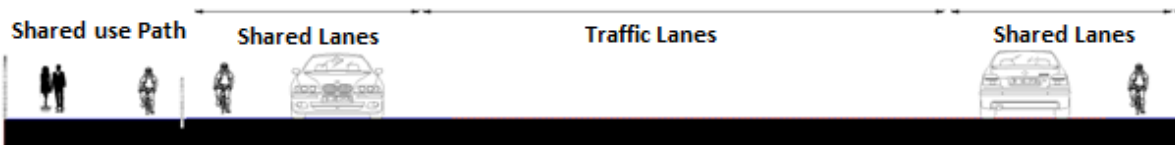

Figure 4. Alternative 4

Alternatives for Providing a Safe Passage for Non-motorized Traffic across an Existing Highway Bridge

- Minimum space required for non-motorized traffic in alternative 5 (Figure 5).
Shared use path = 10 ft
Barrier = 2 ft (traffic speed > 45mph)
Shy distance = 2 ft × 2 = 4 ft
Bike lanes = 4 ft × 2 (each direction) = 8 ft
Minimum space required for non-motorized traffic = 10 + 2 + 4 + 8 = 24 ft > 23 ft
(Not feasible)



Figure 5. Alternative 5

Alternatives for Providing a Safe Passage for Non-motorized Traffic across an Existing Highway Bridge

44TH STREET OVER I-196 BRIDGE

Safe Passage Alternatives

- Minimum space required for non-motorized traffic = lane width × number of lanes
 $= 11 \text{ ft}^d \times 6 = 66 \text{ ft}$

^d AASHTO Geometric Design of Highways and Streets (2011) allows a reduction of 12-ft traffic lanes to 11-ft when in urban areas where pedestrian crossings, right-of-way, or existing development become stringent controls on lane widths.

- Space available for non-motorized traffic = Bridge width – Min. space required for non-motorized traffic
 $= 88 \text{ ft} - 66 \text{ ft} = 22 \text{ ft}$

- Minimum space required for non-motorized traffic in alternative 1 (Figure 6).

Shared use path = 10 ft

Barrier = 2 ft (traffic speed > 45mph)

Shy distance = 2 ft × 2 = 4 ft

Minimum space required for non-motorized traffic = 10 + 2 + 4 = 16 ft

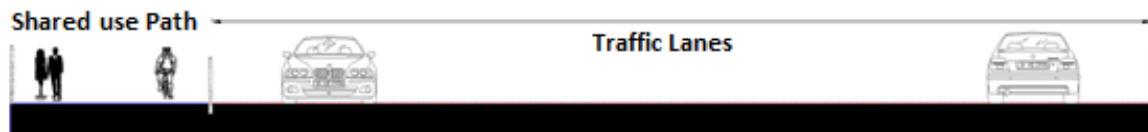

Figure 6. Alternative 1

- Minimum space required for non-motorized traffic in alternative 2 (Figure 7)

Sidewalk = 5 ft

Barrier = 2 ft (traffic speed > 45mph)

Shy distance = 4 ft (2 ft away from barrier on the road)

Outside lanes = (width recommended by AASHTO – existing width) (No. of outside lanes needed)

$$= (14 \text{ ft}^e - 11 \text{ ft}) (2) = 6 \text{ ft}$$

Alternatives for Providing a Safe Passage for Non-motorized Traffic across an Existing Highway Bridge

- ° For shared lanes, the AASHTO Guide for the Development of Bicycles Facilities (2012) recommends lane widths that are 14 ft or greater to allow motorist to pass bicyclists without encroaching into the adjacent lane.

Minimum space required for non-motorized traffic = 5 + 2 + 4 + 6 = 17 ft

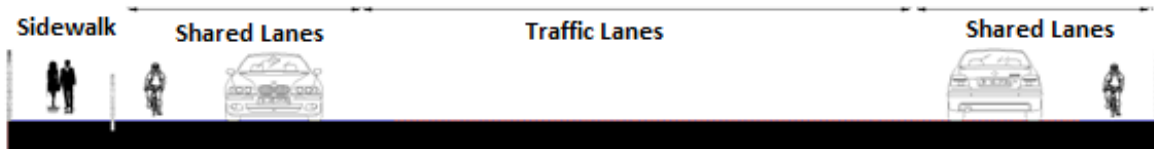

Figure 7. Alternative 2

- Minimum space required for non-motorized traffic in alternative 3 (Figure 8)

Sidewalk = 5 ft

Barrier = 2 ft (traffic speed > 45mph)

Shy distance = 4 ft (2 ft away from barrier on the road)

Bike lanes = 4 ft × 2 (each direction) = 8 ft

Minimum space required for non-motorized traffic = 5 + 2 + 4 + 8 = 19 ft



Figure 8. Alternative 3

- Minimum space required for non-motorized traffic in alternative 4 (Figure 9).

Shared use path = 10 ft

Barrier = 2 ft (traffic speed > 45mph)

Shy distance = 2 ft × 2 = 4 ft

Outside lanes = (width recommended by AASHTO – existing width) (No. of outside lanes needed)

$$= (14 \text{ ft}^f - 11 \text{ ft}) (2) = 6 \text{ ft}$$

Alternatives for Providing a Safe Passage for Non-motorized Traffic across an Existing Highway Bridge

^f For shared lanes, the AASHTO Guide for the Development of Bicycles Facilities (2012) recommends lane widths that are 14 ft or greater to allow motorist to pass bicyclists without encroaching into the adjacent lane.

Minimum space required for non-motorized traffic = $10 + 2 + 4 + 6 = 22 \text{ ft} = 22 \text{ ft}$

(Not feasible).

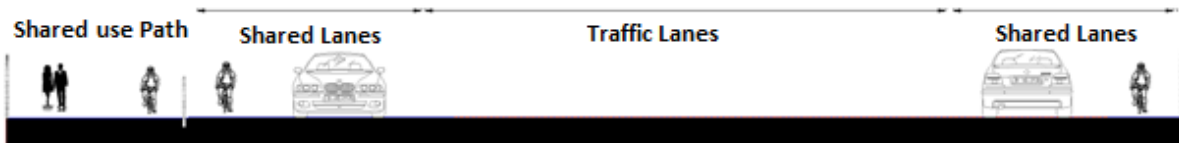

Figure 9. Alternative 4

- Minimum space required for non-motorized traffic in alternative 5 (Figure 10).

Shared use path = 10 ft

Barrier = 2 ft (traffic speed > 45mph)

Shy distance = $2 \text{ ft} \times 2 = 4 \text{ ft}$

Bike lanes = $4 \text{ ft} \times 2$ (each direction) = 8 ft

Minimum space required for non-motorized traffic = $10 + 2 + 4 + 8 = 24 \text{ ft} > 22 \text{ ft}$

(Not feasible)



Figure 10. Alternative 5

Alternatives for Providing a Safe Passage for Non-motorized Traffic across an Existing Highway Bridge

102ND AVENUE OVER I-196 BRIDGE

Safe Passage Alternatives

- Minimum space required for non-motorized traffic = lane width × number of lanes
= 11 ft^g × 2 = 22 ft

^g AASHTO Geometric Design of Highways and Streets (2011) allows a reduction of 12-ft traffic lanes to 11-ft when in urban areas where pedestrian crossings, right-of-way, or existing development become stringent controls on lane widths.

- Space available for non-motorized traffic = Bridge width – Min. space required for non-motorized traffic
= 26 ft – 22 ft = 4 ft

- Minimum space required for non-motorized traffic in alternative 1 (Figure 11).

Shared use path = 10 ft

Barrier = 2 ft (traffic speed > 45mph)

Shy distance = 2 ft × 2 = 4 ft

Minimum space required for non-motorized traffic = 10 + 2 + 4 = 16 ft > 4 ft

(Not feasible)

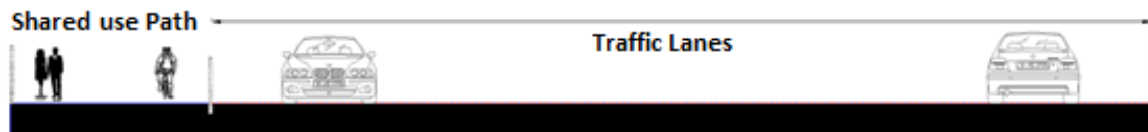

Figure 11. Alternative 1

Since alternative 1 requires the least space compared to the rest of the alternatives, none of the passage alternatives can be provided within the bridge. Hence, an alternative for providing passage outside the bridge needs to be evaluated.