

HE  
18.5  
.A34  
no.  
DOT-  
TSC-  
NHTSA-  
81-13

RT NOS. DOT-TSC-NHTSA-81-13

HS-805 833

## EVALUATION OF TECHNIQUES FOR REDUCING IN-USE AUTOMOTIVE FUEL CONSUMPTION

L. Forrest  
W. B. Lee  
W. M. Smalley

THE AEROSPACE CORPORATION  
Environment and Energy Conservation Division  
El Segundo CA 90245



APRIL 1981  
FINAL REPORT

DOCUMENT IS AVAILABLE TO THE PUBLIC  
THROUGH THE NATIONAL TECHNICAL  
INFORMATION SERVICE, SPRINGFIELD,  
VIRGINIA 22161

Prepared for  
U.S. DEPARTMENT OF TRANSPORTATION  
NATIONAL HIGHWAY TRAFFIC SAFETY ADMINISTRATION  
Office of Research and Development  
Washington DC 20590

NOTICE

This document is disseminated under the sponsorship of the Department of Transportation in the interest of information exchange. The United States Government assumes no liability for its contents or use thereof.

NOTICE

The United States Government does not endorse products or manufacturers. Trade or manufacturer's names appear herein solely because they are considered essential to the object of this report.

NOTICE

The views and conclusions contained in the document are those of the author(s) and should not be interpreted as necessarily representing the official policies or opinions, either expressed or implied, of the Department of Transportation.

1. Report No. HS-805 833		2. Government Accession No.		3. Recipient's Catalog No.	
4. Title and Subtitle EVALUATION OF TECHNIQUES FOR REDUCING IN-USE AUTOMOTIVE FUEL CONSUMPTION				5. Report Date April 1981	
				6. Performing Organization Code	
7. Author(s) L. Forrest, W.B. Lee, W.M. Smalley				8. Performing Organization Report No. DOT-TSC-NHTSA-81-13	
9. Performing Organization Name and Address The Aerospace Corporation* Environment and Energy Conservation Division El Segundo CA 90245				10. Work Unit No. (TRAIS) HS153/R1415	
				11. Contract or Grant No. F04701-77-C-0078	
12. Sponsoring Agency Name and Address U.S. Department of Transportation National Highway Traffic Safety Administration Office of Research and Development Washington DC 20590				13. Type of Report and Period Covered FINAL REPORT June 1976-March 1978	
				14. Sponsoring Agency Code	
15. Supplementary Notes *Under Contract to		U.S. Department of Transportation Research and Special Programs Administration Transportation Systems Center Cambridge MA 02142			
16. Abstract This report presents an assessment of proposed techniques for reducing fuel consumption in the in-use light duty road vehicle fleet. Three general classes of techniques are treated: (1) modification of vehicles. (2) modification of traffic flow, and (3) modification of driver behavior. Examples of techniques in each category are (1) spark augmentation devices, improved carburetors, variable accessory operation; (2) right turn on red, intersection control; and (3) driver training, driver aid devices. In total, 17 different techniques, including 33 specific devices/concepts, are examined and evaluated. Factors included in the evaluation are fuel economy effects, safety impacts, availability for fleet implementation, and unit price. In addition, the implementation of each technique is assessed with regard to number of vehicles impacted, fuel savings effected, national cost, potential problems, and required lead time. A principal finding is the ranking of cost effective techniques in terms of their assessed potential for reducing fleet fuel consumption.					
17. Key Words Automotive Retrofit Devices Driver Aid Devices Driver Training Traffic Flow Improvement				18. Distribution Statement LIBRARY DOCUMENT IS AVAILABLE TO THE PUBLIC THROUGH THE NATIONAL TECHNICAL INFORMATION SERVICE, SPRINGFIELD, VIRGINIA 22161	
19. Security Classif. (of this report) Unclassified		20. Security Classif. (of this page) Unclassified		21. No. of Pages 332	22. Price

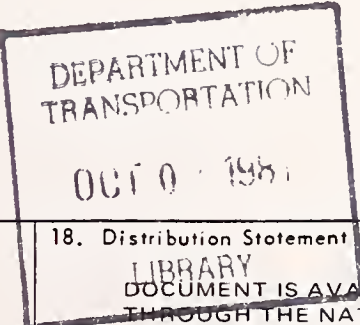





## PREFACE

This report was prepared by The Aerospace Corporation for the U.S. Department of Transportation (DOT), Transportation Systems Center, as part of the DOT Vehicle In-Use Energy Conservation Program. The report presents an assessment of proposed techniques for reducing fuel consumption in the in-use light duty road vehicle fleet. The technical base for this assessment was derived in part from preliminary screening studies and other analyses conducted under the Vehicle In-Use program, and from a review of the current report literature on the subject of automotive fuel economy improvement.

The study treats three general classes of techniques for reducing in-use vehicle fuel consumption: modification of vehicles, modification of traffic flow, and modification of driver behavior. Techniques chosen for examination in the category of vehicle and driver behavior modifications were mutually selected by DOT/Aerospace using guidelines suggested by the results of earlier studies in the Vehicle In-Use program. Techniques chosen for examination in the category of traffic flow modifications were obtained from a brief examination of the subject literature and were necessarily limited to a few representative approaches for which fuel consumption effects and related data were found to be available. In total, 17 different techniques, including 33 specific devices/concepts, were examined. A principal element of the study was the evaluation and ranking of these techniques in terms of their potential contribution to the reduction of fuel consumption in the 1982 vehicle fleet.

Appreciation is acknowledged for the guidance and assistance provided by Walter F. Harriott and Robert A. Walter of the Department of Transportation, Transportation Systems Center, who served as DOT/TSC Technical Monitors for this study.

Funding for this effort was processed through SAMSO (AFSC) Contract No. F04701-77-C-0078 under an interagency agreement.

## METRIC CONVERSION FACTORS

Approximate Conversions to Metric Measures				Approximate Conversions from Metric Measures			
Symbol	When You Know	Multiply by	To Find	Symbol	When You Know	Multiply by	To Find
<b>LENGTH</b>							
in	inches	2.5	centimeters	mm	millimeters	0.04	inches
ft	feet	30	centimeters	cm	centimeters	0.4	inches
yd	yards	0.9	meters	m	meters	3.3	feet
mi	miles	1.6	kilometers	km	kilometers	0.6	yards
<b>AREA</b>							
in <sup>2</sup>	square inches	6.5	square centimeters	cm <sup>2</sup>	square centimeters	0.16	square inches
ft <sup>2</sup>	square feet	0.09	square meters	m <sup>2</sup>	square meters	1.2	square yards
yd <sup>2</sup>	square yards	0.8	square meters	km <sup>2</sup>	square kilometers	0.4	square miles
mi <sup>2</sup>	square miles	2.6	square kilometers	ha	hectares (10,000 m <sup>2</sup> )	2.5	acres
<b>MASS (weight)</b>							
oz	ounces	28	grams	g	grams	0.035	ounces
lb	pounds	0.45	kilograms	kg	kilograms	2.2	pounds
	short tons	0.9	tonnes	t	tonnes (1,000 kg)	1.1	short tons
	(2,000 lb)						
<b>VOLUME</b>							
tsp	teaspoons	5	milliliters	ml	milliliters	0.03	fluid ounces
Tbsp	tablespoons	15	milliliters	l	liters	2.1	pints
fl oz	fluid ounces	30	milliliters	l	liters	1.06	quarts
c	cups	0.24	liters	l	liters	0.26	gallons
pt	pints	0.47	liters	m <sup>3</sup>	cubic meters	35	cubic feet
qt	quarts	0.95	liters	m <sup>3</sup>	cubic meters	1.3	cubic yards
gal	gallons	3.8	liters				
ft <sup>3</sup>	cubic feet	0.03	cubic meters				
yd <sup>3</sup>	cubic yards	0.76	cubic meters				
<b>TEMPERATURE (exact)</b>							
F	Fahrenheit temperature	5/9 (after subtracting 32)	Celsius temperature	°C	Celsius temperature	9/5 (then add 32)	Fahrenheit temperature

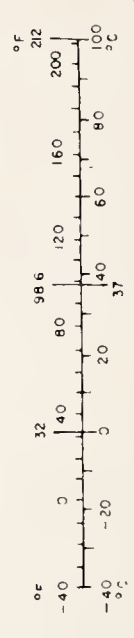
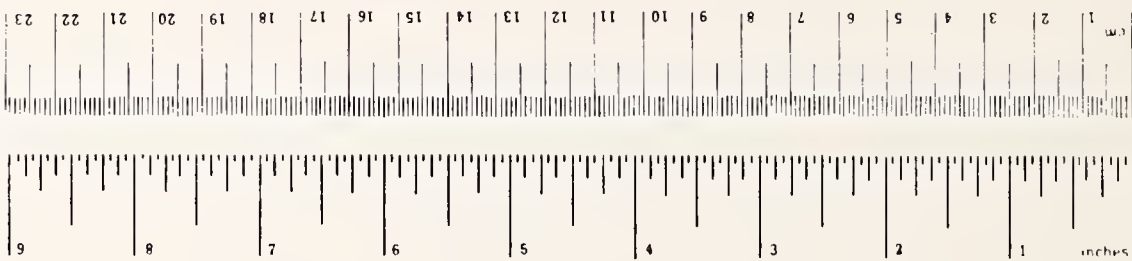

## TABLE OF CONTENTS

<u>Section</u>	<u>Page</u>
SUMMARY . . . . .	S-1
S. 1 Techniques Considered . . . . .	S-1
S. 2 General Approach . . . . .	S-2
S. 3 Summary of Characteristics and Implementation Factors . . . . .	S-4
S. 3.1 Vehicle Modifications . . . . .	S-4
S. 3.2 Traffic Modifications . . . . .	S-11
S. 3.3 Driver Behavior Modifications . . . . .	S-14
S. 4 Integrated Fuel Savings Effects . . . . .	S-15
S. 4.1 Maximum Case . . . . .	S-15
S. 4.2 More Likely Maximum Case . . . . .	S-18
S. 5 Relative Ranking of Techniques . . . . .	S-19
1. INTRODUCTION . . . . .	1-1
1.1 Background and Objective . . . . .	1-1
1.2 Study Scope and Approach . . . . .	1-1
1.3 Organization of Report . . . . .	1-3
2. ANALYTICAL APPROACH . . . . .	2-1
2.1 General . . . . .	2-1
2.2 Characteristics of the In-Use Vehicle Fleet . . . . .	2-1
2.2.1 Distribution of Vehicle Population by Model Year . . . . .	2-1
2.2.2 Annual Mileage by Vehicle Age . . . . .	2-5
2.2.3 Fuel Economy as a Function of Model Year and Market Class . . . . .	2-5
2.2.4 Summary of Fleet Characteristics . . . . .	2-16
2.3 Methodology for Determining National Fuel Savings and Cost Factors . . . . .	2-16
2.4 References . . . . .	2-19
3. CHARACTERIZATION OF TECHNIQUES . . . . .	3-1
3.1 Vehicle Modifications . . . . .	3-1

TABLE OF CONTENTS (Continued)

<u>Section</u>		<u>Page</u>
3.1.1	Spark Augmentation Devices . . . . .	3-1
3.1.2	Improved Carburetors . . . . .	3-10
3.1.3	Variable Accessory Operation . . . . .	3-16
3.1.4	Variable Cylinder Engine Operation . . . . .	3-25
3.1.5	Intake Air Temperature Control . . . . .	3-34
3.1.6	Engine Preheater . . . . .	3-35
3.1.7	Tire Modifications . . . . .	3-41
3.1.8	Drag Reduction Devices . . . . .	3-49
3.1.9	Improved Lubricants . . . . .	3-68
3.1.10	Improved Maintenance . . . . .	3-86
3.2	Traffic Modifications . . . . .	3-104
3.2.1	Right Turn on Red . . . . .	3-104
3.2.2	One-Way Streets . . . . .	3-109
3.2.3	Intersection Control . . . . .	3-111
3.2.4	Network Control . . . . .	3-122
3.2.5	Exclusive Bus Lanes . . . . .	3-126
3.3	Driver Behavior Modifications . . . . .	3-129
3.3.1	Driver Training . . . . .	3-129
3.3.2	Driver Aid Devices . . . . .	3-138
3.4	Characterization Summary . . . . .	3-173
3.5	References . . . . .	3-178
4.	IMPLEMENTATION ANALYSIS . . . . .	4-1
4.1	Vehicle Modifications . . . . .	4-1
4.1.1	Spark Augmentation Devices . . . . .	4-1
4.1.2	Improved Carburetors . . . . .	4-6
4.1.3	Variable Accessory Operation . . . . .	4-11
4.1.4	Variable Cylinder Engine Operation . . . . .	4-17
4.1.5	Intake Air Temperature Control . . . . .	4-23
4.1.6	Engine Preheater . . . . .	4-23
4.1.7	Tire Modifications . . . . .	4-27
4.1.8	Drag Reduction Devices . . . . .	4-33

TABLE OF CONTENTS (Continued)

<u>Section</u>	<u>Page</u>
4.1.9 Improved Lubricants . . . . .	4-38
4.1.10 Improved Maintenance . . . . .	4-42
4.2 Traffic Modifications . . . . .	4-48
4.2.1 Right Turn on Red . . . . .	4-48
4.2.2 One-Way Streets . . . . .	4-53
4.2.3 Intersection Control . . . . .	4-53
4.2.4 Network Control . . . . .	4-59
4.3 Driver Behavior Modifications . . . . .	4-63
4.3.1 Driver Training . . . . .	4-63
4.3.2 Driver Aid Devices . . . . .	4-69
4.4 Implementation Summary . . . . .	4-74
4.5 References . . . . .	4-79
5. INTEGRATED EFFECTS . . . . .	5-1
5.1 Introduction . . . . .	5-1
5.2 Vehicle Modifications . . . . .	5-1
5.3 Traffic Modifications . . . . .	5-1
5.4 Driver Behavior Modifications . . . . .	5-4
APPENDIX - REPORT OF NEW TECHNOLOGY . . . . .	A-1



## LIST OF ILLUSTRATIONS

<u>Figure</u>	<u>Page</u>
2-1. Survivability Characteristics for Passenger Cars . . . . .	2-3
2-2. Survivability Characteristics for Light Duty Trucks (Class I and II) . . . . .	2-4
2-3. Average Annual Miles Driven by Vehicle Age (Passenger Cars) . . . . .	2-12
2-4. 50-State Composite Fuel Economy Trends for Passenger Cars . . . . .	2-15
3-1. State of Timing and Dwell Conditions in Vehicle Sample . . .	3-5
3-2. Variable Ratio Belt Drive System . . . . .	3-18
3-3. Power Requirements for Accessories in Standard Size Car . . . . .	3-19
3-4. Comparison of Accessory Horsepower Loads, Garrett Variable Speed Drive System . . . . .	3-21
3-5. V-8 Intake Manifold . . . . .	3-26
3-6. Variable-Cylinder Engine Friction and Pumping Losses . . .	3-29
3-7. Fuel Economy Results for the Carburetor-Controlled Variable-Cylinder Engine . . . . .	3-31
3-8. Engine Preheater Installation . . . . .	3-37
3-9. Cold Start and Short Trip Fuel Economy . . . . .	3-37
3-10. Contributions of Tires, Choke, and Coolant Heat Transfer to Warm-up Losses . . . . .	3-39
3-11. Combined Effects of Tires, Choke, and Coolant Heat Loss . . . . .	3-39
3-12. Basic Tire Designs . . . . .	3-42
3-13. Rolling Resistance Versus Speed for Different Tire Construction Types . . . . .	3-43
3-14. Relative Fuel Efficiency for Three Types of Tires . . . . .	3-45
3-15. New Car Tire Trends (Passenger Cars) . . . . .	3-48
3-16. Aftermarket Tire Trends (Passenger Cars) . . . . .	3-48

LIST OF ILLUSTRATIONS (Continued)

<u>Figure</u>		<u>Page</u>
3-17.	Radial Truck Tire Trends . . . . .	3-49
3-18.	JPL Front Air Dam on 1974 Mustang II . . . . .	3-53
3-19.	Typical Lift and Drag Effects of Front Dams . . . . .	3-56
3-20.	Proposed Flow Field Effects of Front Dams . . . . .	3-56
3-21.	JPL Spoiler on Rear Deck of 1974 Mustang . . . . .	3-58
3-22.	Proposed Rear Flow Field Effect of a Deck Lip . . . . .	3-61
3-23.	Average Fuel Economies in EPA Urban Cycle Tests with High and Low Viscosity Engine Oils and Rear Axle Lubricants . . . . .	3-77
3-24.	Pre-Timed and Fully Actuated Signal Systems (Portion of Hawthorne Blvd. Arterial, Los Angeles) . . . . .	3-113
3-25.	Fuel Consumption Versus Cycle Length, Gainesville, Fla. CBD . . . . .	3-115
3-26.	Fuel Consumption and Delay as a Function of Cycle Length for Hawthorne Blvd. Network . . . . .	3-116
3-27.	Fuel Consumption and Delay as a Function of Cycle Length for UTCS Network . . . . .	3-117
3-28.	Fuel Consumption Variation with Cycle Length . . . . .	3-118
3-29.	Average Fuel Consumption per Unit Distance Versus Average Trip Time per Unit Distance for Trips Under Various Driver Instructions . . . . .	3-144
4-1.	Percent of Vehicles Equipped with Electronic Ignition . . . . .	4-2
4-2.	Distribution of Vehicle-Miles Driven by Autos in USA Versus Ambient Temperature . . . . .	4-24

## LIST OF TABLES

<u>Table</u>		<u>Page</u>
S-1.	TECHNIQUES CONSIDERED . . . . .	S-2
S-2.	SUMMARY OF FLEET CHARACTERISTICS . . . . .	S-3
S-3.	SUMMARY OF CHARACTERISTICS AND IMPLEMENTA- TION FACTORS--PROJECTED 1982 IN-USE FLEET . . . . .	S-5
S-4.	INTEGRATED FUEL SAVINGS EFFECTS OF VARIOUS CLASSES OF TECHNIQUES--PROJECTED 1982 IN-USE FLEET . . . . .	S-16
S-5.	RELATIVE RANKING OF EFFECTIVITY OF VARIOUS TECHNIQUES (BASED ON 1982 IN-USE FLEET CHARACTERISTICS).	S-20
1-1.	TECHNIQUES CONSIDERED . . . . .	1-2
2-1.	CHARACTERISTICS OF THE 1976 PASSENGER CAR FLEET . . . . .	2-6
2-2.	CHARACTERISTICS OF THE 1976 LIGHT DUTY TRUCK FLEET (<6000 lb) . . . . .	2-7
2-3.	CHARACTERISTICS OF THE 1976 LIGHT DUTY TRUCK FLEET (6001-10,000 lb) . . . . .	2-8
2-4.	CHARACTERISTICS OF THE 1982 PASSENGER CAR FLEET . . . . .	2-9
2-5.	CHARACTERISTICS OF THE 1982 CLASS I LIGHT DUTY TRUCK FLEET (<6000 lb) . . . . .	2-10
2-6.	CHARACTERISTICS OF THE 1982 CLASS II LIGHT DUTY TRUCK FLEET (6001-10,000 lb) . . . . .	2-11
2-7.	SALES FRACTIONS AS A FUNCTION OF INERTIA WEIGHT AND MODEL YEAR . . . . .	2-13
2-8.	CITY/HIGHWAY COMBINED FUEL ECONOMY BY MODEL YEAR AND WEIGHT CLASS . . . . .	2-13
2-9.	SUMMARY OF FLEET CHARACTERISTICS . . . . .	2-17
3-1.	DATA BASE FOR SPARK AUGMENTATION SYSTEMS . . . . .	3-3
3-2.	VARIABLE RATIO ACCESSORY DRIVE--DRIVING CYCLE FUEL ECONOMY . . . . .	3-22

LIST OF TABLES (Continued)

<u>Table</u>	<u>Page</u>
3-3. MAXIMUM FUEL ECONOMY IMPROVEMENT WITH VARIABLE CYLINDER ENGINE OPERATION . . . . .	3-32
3-4. FUEL ECONOMY GAINS OVER URBAN DRIVING CYCLE--VARIABLE CYLINDER OPERATION . . . . .	3-32
3-5. SUMMARY OF RADIAL TIRE EFFECTS ON FUEL ECONOMY . . . . .	3-44
3-6. TEST RESULTS FOR FRONT AIR DAMS . . . . .	3-54
3-7. TEST RESULTS FOR REAR SPOILER . . . . .	3-59
3-8. TEST RESULTS FOR FRONT DAM AND REAR SPOILER USED TOGETHER . . . . .	3-62
3-9. EFFECT OF DRAG REDUCTION ON EPA COMPOSITE CYCLE FUEL ECONOMY . . . . .	3-65
3-10. DATA BASE ON FUEL ECONOMY EFFECTS OF IMPROVED LUBRICANTS . . . . .	3-70
3-11. INITIAL EFFECT OF MPC TUNE-UP . . . . .	3-89
3-12. EFFECT OF 6 MONTHS IN-USE OPERATION AFTER MPC TUNE-UP . . . . .	3-90
3-13. TEST PLAN FOR EMISSIONS DEGRADATION STUDY . . . . .	3-92
3-14. FUEL ECONOMY RESULTS OF EMISSIONS DEGRADATION STUDY . . . . .	3-94
3-15. FUEL ECONOMY EFFECTS OF MAINTENANCE BASED ON EMISSION INSPECTION TEST . . . . .	3-95
3-16. PERCENT OF VEHICLES REQUIRING IGNITION MAINTENANCE . . . . .	3-98
3-17. FUEL SAVINGS FROM RTOR AS REPORTED FOR THE COMMONWEALTH OF VIRGINIA . . . . .	3-106
3-18. FUEL ECONOMY AND EMISSIONS EFFECTS OF RTOR IN CENTRAL BUSINESS DISTRICT, WASHINGTON, D.C. . . . .	3-106
3-19. EFFECTS OF PEDESTRIAN SCRAMBLE SYSTEM . . . . .	3-119

LIST OF TABLES (Continued)

<u>Table</u>		<u>Page</u>
3-20.	SIGNAL TIMING EVALUATION OF URBAN NETWORK . . . . .	3-124
3-21.	EFFECTS OF EXCLUSIVE BUS LANE OPERATION . . . . .	3-128
3-22.	FUEL ECONOMY VERSUS DRIVING HABITS--TEST RESULTS . . . . .	3-130
3-23.	COMPARISON OF SIMULATION RESULTS FOR CRUISE VERSUS ACCELERATION FUEL ECONOMY IN URBAN CYCLE . . . . .	3-136
3-24.	FUEL ECONOMY TESTS OF MANIFOLD VACUUM DEVICES . . . . .	3-141
3-25.	EFFECT OF DRIVING PRACTICE ON FUEL ECONOMY . . . . .	3-142
3-26.	SUMMARY OF RESULTS PERTAINING TO VACUUM GAGE TESTING AS REPORTED IN "PASSENGER CAR FUEL CONSERVATION" . . . . .	3-146
3-27.	COMPUTED FUEL ECONOMY BENEFITS FOR AUTOMATIC CRUISE CONTROL . . . . .	3-161
3-28.	CHARACTERIZATION SUMMARY . . . . .	3-174
4-1.	FLEET FUEL SAVINGS ATTRIBUTABLE TO SPARK AUGMENTATION DEVICES . . . . .	4-4
4-2.	COST FACTORS FOR SPARK AUGMENTATION DEVICES . . . . .	4-5
4-3.	FLEET FUEL SAVINGS ATTRIBUTABLE TO IMPROVED CARBURETORS . . . . .	4-8
4-4.	COST FACTORS FOR IMPROVED CARBURETORS . . . . .	4-10
4-5.	FLEET FUEL SAVINGS ATTRIBUTABLE TO VARIABLE ACCESSORY OPERATION . . . . .	4-13
4-6.	COST FACTORS FOR VARIABLE ACCESSORY OPERATION . . . . .	4-14
4-7.	FLEET FUEL SAVINGS ATTRIBUTABLE TO VARIABLE CYLINDER ENGINE OPERATION . . . . .	4-19
4-8.	COST FACTORS FOR VARIABLE CYLINDER ENGINE OPERATION . . . . .	4-21



LIST OF TABLES (Continued)

<u>Table</u>		<u>Page</u>
4-9.	COST FACTORS FOR ENGINE PREHEATER . . . . .	4-26
4-10.	FLEET FUEL SAVINGS ATTRIBUTABLE TO CONVERSION TO RADIAL TIRES . . . . .	4-27
4-11.	FLEET FUEL SAVINGS ATTRIBUTABLE TO TIRE INFLATION PRESSURE. . . . .	4-29
4-12.	COST FACTORS FOR TIRE MODIFICATIONS . . . . .	4-31
4-13.	FLEET FUEL SAVINGS ATTRIBUTABLE TO DRAG REDUCTION DEVICES . . . . .	4-35
4-14.	COST FACTORS FOR DRAG REDUCTION DEVICES . . . . .	4-36
4-15.	FLEET FUEL SAVINGS ATTRIBUTABLE TO IMPROVED LUBRICANTS . . . . .	4-39
4-16.	COST FACTORS FOR IMPROVED LUBRICANTS . . . . .	4-41
4-17.	FLEET FUEL SAVINGS ATTRIBUTABLE TO TUNE-UP MAINTENANCE . . . . .	4-43
4-18.	COST FACTORS FOR CONVENTIONAL TUNE-UP MAINTENANCE . . . . .	4-44
4-19.	COST FACTORS FOR TUNE-UP MAINTENANCE BASED ON DIAGNOSTIC EXHAUST EMISSIONS TEST . . . . .	4-46
4-20.	FLEET FUEL SAVINGS ATTRIBUTABLE TO RTOR. . . . .	4-50
4-21.	FLEET FUEL SAVINGS ATTRIBUTABLE TO INTERSECTION CONTROL . . . . .	4-56
4-22.	COST FACTORS FOR INTERSECTION CONTROL . . . . .	4-57
4-23.	FLEET FUEL SAVINGS ATTRIBUTABLE TO NETWORK CONTROL . . . . .	4-61
4-24.	COST FACTORS FOR NETWORK CONTROL . . . . .	4-61
4-25.	FLEET FUEL SAVINGS ATTRIBUTABLE TO DRIVER TRAINING . . . . .	4-66
4-26.	COST FACTORS FOR DRIVER TRAINING . . . . .	4-67

LIST OF TABLES (Continued)

<u>Table</u>		<u>Page</u>
4-27.	APPLICABILITY OF DRIVER AID DEVICES TO NATIONAL FLEET. . . . .	4-70
4-28.	FLEET FUEL SAVINGS ATTRIBUTABLE TO DRIVER AID DEVICES . . . . .	4-71
4-29.	COST FACTORS FOR DRIVER AID DEVICES . . . . .	4-73
4-30.	IMPLEMENTATION SUMMARY . . . . .	4-75
5-1.	AGGREGATE FUEL SAVINGS AND COST EFFECTS . . . . .	5-2
5-2.	SCENARIOS ADOPTED IN DETERMINING AGGREGATE FUEL SAVINGS AND COST EFFECTS FOR VEHICLE MODIFICATION TECHNIQUES . . . . .	5-3

## SUMMARY

An analysis and evaluation were made of the potential of techniques for reducing the fuel consumption of in-use passenger cars and light duty trucks. Three general classes of techniques were examined: (1) modification of vehicles, (2) modification of traffic flow, and (3) modification of driver performance. Within each of these general classes, a large number of potentially beneficial devices, concepts, and approaches were evaluated. The evaluation focused on potential fuel savings, cost, safety impacts, probable lead time to implementation, and the identification of those techniques offering the greatest benefit at the least cost.

An extensive review was conducted of the available descriptive material, test data, and analyses performed by others for representative techniques or classes of techniques which have been postulated to enable fuel consumption reduction. In general, there are insufficient test data or analysis results to firmly quantify potential fuel savings, costs, or probable implementation rate. Therefore, a best estimate of each factor was made for each technique examined; ranges of possible error in the selected estimate are discussed at length throughout the report.

The following are brief highlights which summarize (1) the techniques examined, (2) the approach followed in the evaluation, (3) the important characteristics and implementation factors for each technique, (4) the integrated fuel economy savings for each general technique class, and (5) conclusions as to the relative efficacy, or ranking, of the individual techniques.

### S.1 TECHNIQUES CONSIDERED

The devices and techniques examined in this study are listed in Table S-1. The choice of candidate approaches was based in part on the results of recent DOT-sponsored studies in the areas of aftermarket devices and driver aid devices and on guidelines established by the DOT/TSC Vehicle In-use Energy Conservation Seminar and Workshop of September 1976. In the area of traffic modification techniques, the approaches selected were obtained from a brief examination of the subject literature and were necessarily limited to a few representative approaches for which fuel consumption effects or related data were found to be available.

TABLE S-1. TECHNIQUES CONSIDERED

Vehicle Modifications	Traffic Modifications	Driver Performance Modifications
Spark Augmentation Devices Improved Carburetors Variable Accessory Operation <ul style="list-style-type: none"> <li>- Viscous Clutch Fan</li> <li>- Electric Fan</li> <li>- Variable Accessory Drive</li> </ul> Variable Cylinder Operation Intake Air Temperature Control Engine Preheater Tire Modifications <ul style="list-style-type: none"> <li>- Radial Tires</li> <li>- Maintaining Pressure</li> <li>- Overinflation</li> </ul> Drag Reduction Devices Improved Lubricants Improved Maintenance	Right Turn on Red One-way Streets Intersection Control <ul style="list-style-type: none"> <li>- Traffic Actuated Signals</li> <li>- Optimized Signal Cycle Length</li> </ul> Network Control Exclusive Bus Lanes	Driver Training Driver Aid Devices <ul style="list-style-type: none"> <li>- Manifold Vacuum Gage</li> <li>- Accelerometer</li> <li>- Accelerator Pedal Feedback</li> <li>- Cruise Control</li> <li>- MPG Meter</li> <li>- Fuel Totalizer</li> </ul>

S. 2 GENERAL APPROACH

The general approach adopted in this study for determining fleet fuel savings effects was as follows. The year 1982 was selected as the time frame of reference for determining the applicability and fuel consumption benefits of the various devices and approaches considered. A model of the 1982 passenger car and light duty truck fleets was developed to establish the baseline characteristics of potentially applicable vehicles. A second model, that of the 1976 light duty fleet, was developed and was used for comparison purposes. The salient characteristics of these two fleets are shown in Table S-2. A survey was then made of available literature and reports on the devices and techniques under consideration, and on the basis of the evidence so compiled, a best judgment was made of the potential of each device for improving vehicle fuel economy. The fleet fuel savings attributable to each technique were then established by applying their fuel economy benefit to the total number of applicable vehicles in the fleet.

TABLE S-2. SUMMARY OF FLEET CHARACTERISTICS

	1976			1982			
	Passenger Cars	Light Duty Trucks		Passenger Cars	Light Duty Trucks		Fleet
		≤6000 GVW	6-10,000 GVW		≤6000 GVW	6-10,000 GVW	
In Operation, millions (diesels)	99.7 (0.08)	15.1 (0)	6.7 (0)	109.3 (4.3)	20.2 (0.4)	11.6 (0)	141.1 (4.7)
Vehicles Miles Traveled, billions	1107.7	159.0	80.7	1224.8	212.2	131.7	1568.7
Fuel Consumed, gal, billions	73.4	11.0	8.1	65.2	11.4	13.2	89.8
Average Miles/Yr	11,100	10,600	12,100	11,200	10,500	11,300	11,100
Average MPG	15.1	14.4	10.0	18.8	18.6	10.0	17.5



The fuel savings for the several techniques within a general class were then integrated to obtain an aggregate fuel savings effect.

This dual model of the in-use vehicle fleet served two purposes. First, the 1982 time frame allows sufficient time for the substantial implementation of the various proposed techniques for reducing fuel consumption in the fleet. Second, the difference in the features of the current and 1982 fleets provides the basis for assessing the changing applicability and effective lifetime of a given technique, thereby yielding a measure of its net value as referenced to a projected implementation timetable.

### S. 3        SUMMARY OF CHARACTERISTICS AND IMPLEMENTATION FACTORS

Table S-3 contains a summary of the more important characteristics and implementation factors which bear upon the utility or viability of the fuel consumption reduction techniques examined. Each technique is briefly discussed below.

#### S. 3. 1     Vehicle Modifications

##### S. 3. 1. 1   Spark Augmentation Devices

The spark augmentation device category includes electronic, high energy, and multiple spark ignition systems. They are assumed applicable to all spark ignition vehicles not already OEM\* or aftermarket-equipped with such systems. Starting in 1975, all domestic new cars have been equipped with breakerless electronic ignition systems. Thus, in 1982, these aftermarket devices will be applicable to only 28.5% of the 141,100,000 vehicle passenger car plus light duty truck fleet. Their use is estimated to result in an average fuel economy (miles per gallon) increase of only 0.25%; this provides a fuel savings for the 1982 total vehicle fleet of about 0.05 billion gallons of gasoline in that single year, or 0.05% of the 89.8 billion gallons projected for consumption in the absence of the fuel savings techniques considered here. The uncertainty in the estimate of fuel economy improvement could result in an actual fuel savings of from 0 to 0.19 billion gallons. The nominal value of 0.05 billion gallons saved provides a cost

---

\* OEM = Original Equipment Supplied by Manufacturer.

TABLE S-3. SUMMARY OF CHARACTERISTICS AND IMPLEMENTATION FACTORS--PROJECTED 1982 IN-USE FLEET

Technique	Fuel Economy Improvement (percent)	Applicability to Fleet (percent)	Number of Vehicles (Millions)	Fleet Fuel Savings <sup>a</sup>			Fleet Fuel Cost Savings <sup>b</sup> (\$Billions)	Unit Cost of Technique (\$)	National Cost <sup>d</sup> (\$Billions)	Payback Time Required <sup>e</sup> (years)
				(10 <sup>9</sup> gal)	(percent)	Uncertainty Range (10 <sup>9</sup> gal)				
<b>VEHICLE MODIFICATIONS</b>										
o Spark Augmentation Devices	0.25	28.5	40.2	0.05	0.05	0 - 0.19	0.034	75	3.01	88.53
o Improved Carburetors	1.0	94.0	132.6	0.83	0.93	0 - 2.44	0.582	150	19.89	34.18
o Variable Accessory Operation	0.4	45.9	64.8	0.19	0.21	0 - 0.19	0.132	45	2.92	22.12
o Viscous Clutch Fan	2.0	100.0	141.1	1.78	1.98	1.33-2.33	1.245	100	14.11	11.33
o Electric Fan	5.4/2.8 <sup>f</sup>	100.0	141.1	3.56	3.96	3.00-4.06	2.494	80	11.29	3.65/6.31 <sup>f</sup>
o Variable Accessory Drive	8.7	54.0	77.0	3.94	4.39	2.72-5.65	2.758	100	7.70	2.79
o Variable Cylinder Operation	1.0	34.0	48.0	0.10	0.11	0 - 0.10	0.070	62	3.69	Infinite
o Engine Preheater									(2.97 fixed cost plus 0.72 annual operating cost)	
o Tire Modifications	2.5	27.0	38.0	0.67	0.75	0.47-0.77	0.469	125	4.75	10.13
o Radial Tires	1.9/0.8 <sup>g</sup>	100.0	141.1	1.02	1.14	0.38-1.31	0.714	7	0.99	1.39
o Maintaining Pressure	0.0/2.4 <sup>h</sup>	100.0	141.1	4.01	4.47	1.97-4.01	2.807	7	0.99	0.35
o Overinflation	2.0/1.0 <sup>i</sup>	86.3	121.7	1.33	1.48	0.70-1.98	0.933	100/65 <sup>i</sup>	11.67	12.51
o Drag Reduction Devices	3.0	100.0	141.1	2.62	2.91	1.76-5.08	1.831	8.80	1.24	0.68
o Improved Lubricants									(yearly)	
o Improved Maintenance	0.75/1.1 <sup>j</sup>	67.5	95.5	0.63	0.70	0 - 1.24	0.438	42/10 <sup>k</sup>	4.01/0.95 <sup>k</sup>	Infinite

TABLE S-3. SUMMARY OF CHARACTERISTICS AND IMPLEMENTATION FACTORS--PROJECTED 1982 IN-USE FLEET (Continued)

Technique	Fuel Economy Improvement (percent)	Applicability to Fleet (percent)	Number of Vehicles (Millions)	Fleet Fuel Savings <sup>a</sup>			Fleet Fuel Cost Savings <sup>b</sup> (\$Billions)	Unit Cost of Technique <sup>c</sup> (\$)	National Costd (\$Billions)	Payback Time Required <sup>e</sup> (years)
				(10 <sup>9</sup> gal)	(percent)	Uncertainty Range (10 <sup>7</sup> gal)				
<b>TRAFFIC MODIFICATIONS</b>										
o Right Turn on Red	2.6/4.9 <sup>l</sup>	N.A.	N.A.	0.02	0.02	0.007-0.043	0.011	50	0.0006	0.06
o One-Way Streets	12.0	N.A.	N.A.	NO DATA AVAILABLE TO PERMIT QUANTIFICATION OF BENEFITS						
o Intersection Control										
o Traffic Actuated	10.0/5.0 <sup>m</sup>	N.A.	N.A.	0.86	0.96	0.39-1.42	0.602	8000	0.70	1.17
o Optimum Signal Lengths	0.5	N.A.	N.A.	0.55	0.61	0.27-0.83	0.385	300	0.07	0.18
o Network Control	6.0	N.A.	N.A.	0.68	0.76	0.20-1.38	0.477	2,000,000 <sup>n</sup>	1.16	2.43
o Exclusive Bus Lanes	Negative	N.A.	N.A.	NOT A VIABLE APPROACH FOR REDUCTION OF AUTOMOBILE FUEL CONSUMPTION						
<b>DRIVER BEHAVIOR MODIFICATIONS</b>										
o Driver Training	5.0	100/10 <sup>p</sup>	142.6/20.2 <sup>p,q</sup>	4.27/0.43 <sup>p</sup>	4.76/0.48	0.89/0.09-6.65/0.67	2.989/0.295 <sup>p</sup>	55	7.84/1.11 <sup>p</sup>	2.62/3.70 <sup>p</sup>
o Driver Aid Devices (Manifold Vacuum Gauge)	3.0	96.5	136.4	2.52	2.81	0.43-4.12	1.764	35	4.77	2.70

Footnotes:

- <sup>a</sup>Fleet fuel savings are based on projected mileage accumulated/gasoline consumed in year 1982 (150.9 x 10<sup>9</sup> miles, 89.8 x 10<sup>9</sup> gallons).
- <sup>b</sup>Based on fuel cost of \$0.70/gallon.
- <sup>c</sup>Procurement and installation of equipment or services.
- <sup>d</sup>Total cost to implement technique for applicable vehicles in fleet.
- <sup>e</sup>Time to recover total national cost via annual fuel cost savings indicated for 1982.
- <sup>f</sup>Vehicles with/without air conditioning.
- <sup>g</sup>Bias ply/radial
- <sup>h</sup>Bias ply/radial, based on 8 psi overinflation (passenger cars)
- <sup>i</sup>Front dam plus rear spoiler/front dam alone.
- <sup>j</sup>Vehicles with mechanical breaker points/ vehicles with breakerless electronic systems.
- <sup>k</sup>Conventional diagnosis/exhaust gas analysis.
- <sup>l</sup>Urban areas/central business districts.
- <sup>m</sup>6-lane arterials/r-lane arterials.
- <sup>n</sup>Based on \$20,000 per intersection and 100 intersections per network.
- <sup>p</sup>Mandatory training for all drivers/training for licensing of new drivers, starting in 1978.
- <sup>q</sup>Number of trained drivers, millions.
- N.A. = Not Applicable.

savings of \$0.03 billion (based on a fuel cost of \$0.70/gallon).<sup>\*</sup> At an estimated unit cost of \$75, the national cost to have equipped the applicable 40,200,000 vehicles is \$3.01 billion. With the yearly cost savings value noted above, it would require over 88 years to recover the cost incurred in equipping the vehicles with these devices.

#### S. 3.1.2. Improved Carburetors

A sonic carburetor, as typified by the Dresserator system, was selected to represent the improved retrofit carburetor class. By 1982, they could be incorporated in 94% of the vehicle fleet (132,600,000 vehicles). With an estimated average effective mpg increase of 1.0%, a fuel savings of 0.83 billion gallons could be realized in the year 1982 (0.93%), with a fuel cost savings of \$0.58 billion. With an estimated installed cost of \$150 each, the total national cost is \$19.89 billion. Over 34 years would be required to recover this cost from fuel cost savings at the above stated rate.

#### S. 3.1.3 Variable Accessory Operation

a. Viscous clutch fan -- this system is used extensively on cars equipped with factory-installed air conditioning. It provides maximum fan performance at low speeds and reduces power consumption at higher engine speeds by lowering the fan-to-engine speed ratio. It could be applicable to 45.9% of the 1982 vehicle fleet. With an estimated overall mpg improvement of 0.4%, 0.19 billion gallons of gasoline could be saved in the year 1982 (0.21%), with a cost savings value of \$0.13 billion. With a unit cost of \$45, the total national cost would be \$2.92 billion, which would require over 22 years to pay back at the above fuel cost savings annual rate.

b. Electric fan -- the replacement of the engine-driven fan with an electrically driven, thermostatically controlled fan permits a better mounting arrangement which improves fan efficiency and enables the fan to be turned on and off in response to cooling needs. The resulting estimated mpg increase is 2.0%. When applied to all vehicles in the 1982 fleet, it would result in a fleet fuel savings of 1.78 billion gallons in 1982 (1.98%), with an associated fuel cost savings of \$1.24 billion. With a unit cost

---

\* The value of cost savings is directly proportional to the assumed value of fuel cost.



of \$100, however, it would result in a total national cost of \$14.11 billion and require over 11 years to recover this cost through annual fuel cost savings.

c. Variable accessory drive -- the use of a variable ratio accessory drive system can result in a significant reduction in the overall power requirements of the accessories. Tests indicate composite fuel economy benefits of 2.8% without air conditioning and 5.4% with air conditioning. This type of system could be applicable to the entire 1982 fleet and provide fuel savings in that year of 3.56 billion gallons or 3.96% at a fuel cost savings of \$2.49 billion. At a unit cost of \$80, the total national cost would be \$11.29 billion. About 3-1/2 years would be required to recover costs via annual fuel cost savings for air conditioned vehicles in the fleet, and over 6 years for non-air conditioned vehicles.

#### S. 3. 1. 4 Variable Cylinder Operation

In the variable cylinder engine concept, fuel economy improvements are achieved by deactivating every other cylinder in the firing order, thereby effectively reducing the displacement of the engine. In a V-8 engine, this may be accomplished at the carburetor by terminating fuel flow to one-half of the cylinders. This type of system could be retrofitted to approximately 54% of the 1982 vehicle fleet. Computer simulations predict an average fuel economy increase of 8.7%. This would result in a fuel savings of 3.94 billion gallons in 1982 (4.39%), with a fuel cost savings of \$2.7 billion. At a \$100 unit cost, the total national cost would be \$7.7 billion. This cost could be recovered in slightly under 3 years at the annual fuel cost savings value noted above.

#### S. 3. 1. 5 Engine Preheater

The engine preheater is an electrical resistance heating device which is installed in the engine coolant line and acts to heat and recirculate the engine coolant. It is offered as an aid to quick and easy starts in cold weather and may also minimize engine wear effects related to cold starting. An average fuel economy improvement of 1.0% was estimated for this device, at cold start ambient conditions at or below freezing. Approximately 11.3% of the vehicle fleet vehicle-miles-traveled (VMT) occurs in this temperature



range. For this fraction of the VMT, a 1% mpg improvement would yield a fuel savings of about 100 million gallons in 1982 (0.11%), and a fuel cost savings of \$0.07 billion. At a unit cost of \$62, this results in a total national fixed cost of \$2.97 billion. However, there is an additional annual operating cost of \$0.72 billion, which exceeds the annual fuel cost savings. Thus, the procurement and installation costs of this device are not recoverable via fuel savings.

#### S. 3.1.6 Tire Modifications

a. Radial tires -- radial tires are currently in production by tire manufacturers for all sectors of the motor vehicle population, including installation on new passenger cars and light duty trucks. On a retrofit basis, it is estimated that radial tires could be added to 27% of the 1982 fleet, at an average overall fuel economy improvement value of 2.5%. This would result in a fuel savings of 0.67 billion gallons in that year (0.75%), and a fuel cost savings of \$0.47 billion. At a unit cost per vehicle of \$125, the total national cost would be \$4.75 billion, which would require 10 years to recover via annual fuel cost savings. However, the longer life and/or improved safety of radial tires would have to be considered by the consumer as well as the projected fuel cost savings.

b. Maintaining tire pressure -- maintaining the recommended inflation pressure provides an immediate way of recovering fuel losses caused by vehicles operating on underinflated tires. Based on current characteristics, it is estimated that 30% of the fleet would be operating at 4 psi below the recommended pressure and the remaining 70% of the fleet at 2 psi under the recommended pressure. At an effective fuel economy improvement of 1.9% for bias ply tires and 0.8% for radial tires, maintaining recommended tire pressure in the 1982 fleet would save 1.02 billion gallons (1.14%), with a fuel cost savings of \$0.71 billion in that year. At a unit cost of \$7 (for a set of valve stem pressure indicators and a tire pressure gage), the total national cost is \$0.99 billion. This cost could be offset by the annual fuel cost savings in a little under 1-1/2 years.

c. Overinflation -- operating the passenger car and light duty truck fleets at the maximum rated pressure of +8 psi and +15 psi, respectively, would result in a greater fuel savings than either converting to

radials or maintaining recommended tire pressure. At an average fuel economy improvement of 6.0% for bias ply tires and 2.4% for radial tires, the 1982 fleet could have a fuel savings of 4.01 billion gallons (4.47% of 1982 consumption) over that achievable by maintaining pressure, and a fuel cost saving of \$2.81 billion. Though the equipment is not essential, a unit cost of \$7 based on the purchase of valve stem pressure indicators and a tire pressure gage was assumed to be incurred; on this basis, the national cost would be \$0.99 billion. This could be offset by annual fuel cost savings in less than 1/2 year.

#### S. 3. 1. 7 Drag Reduction Devices

Front dam and rear spoiler combinations installed on passenger cars are estimated to improve average fuel economy by 2.0%, and 1.0% for the front dam alone. It is estimated that these devices are applicable to 86% of the 1982 fleet (front dam only on light duty trucks). This would result in a fuel savings of 1.33 billion gallons in 1982 (1.48%), and a fuel cost savings of \$0.93 billion. Based on a unit cost of \$100 for the dam plus spoiler and \$65 for the front dam alone, the total national cost would be \$11.67 billion. This would require over 12 years to recover via fuel cost savings.

#### S. 3. 1. 8 Improved Lubricants

Synthetic lubricants and mineral oils with improved friction-modifying additives are being developed and marketed to reduce engine and differential friction and thus improve fuel economy. The available vehicle test data are scattered. An average fuel economy benefit of 3% due to the combined effect of improved engine and differential oils was selected as a representative value. When applied to the total 1982 fleet, this resulted in a fuel savings of 2.62 billion gallons and a fuel cost savings of \$1.83 billion. These cost figures are based on the use of a friction-modified mineral-based engine oil at an average cost of \$1.40/qt, in place of conventional oil at \$0.80/qt. The oil consumption rate was assumed to remain unchanged at 3 quarts per year, and the oil was assumed to be changed every 6 months at 4.5 quarts per change. This resulted in an additional annual expense of \$7.20. The average yearly cost for differential fluid replacement (occurring once every 5 years) was \$1.60, resulting in a total annual additional expense

of \$8.80. This resulted in a total national cost in 1982 of \$1.24 billion, which is more than offset by the fuel cost savings indicated.

#### S. 3.1.9 Improved Maintenance

The concept of improved maintenance assumes the incorporation of a 6-month tune-up interval for 70% of the spark ignition vehicles which are currently on a 12-month tune-up maintenance interval (the remaining 30% are considered to already be on a fixed, short-term maintenance schedule). It is estimated that the fuel economy improvements for this increased-frequency tune-up schedule are 1.1% for vehicles with breakerless electronic ignition systems and 0.75% for those with mechanical breaker point ignition systems. In the 1982 fleet, this would result in a fuel savings of 0.63 billion gallons for that year (0.7%), and a fuel cost savings of \$0.44 billion. Two cost factors were considered. The first assumed a conventional diagnostic procedure costing \$42 per vehicle test. The second assumed tune-up adjustments were made in accordance with indicated requirements of a diagnostic exhaust emission test, and at a cost of \$10 in addition to the present average annual tune-up cost per vehicle. On the first basis the annual national tune-up costs are \$4.01 billion, and in the second case the annual costs are \$0.95 billion. In the last case, the average annual repair cost is about twice the dollar value of the average annual fuel savings.

#### S. 3.2 Traffic Modifications

##### S. 3.2.1 Right Turn on Red

The concept of right turn on red (RTOR) permits the driver of a vehicle to turn right on a red traffic signal. Under one rule, a driver is permitted to turn right on red only where designated by sign (the sign permissive or "eastern" rule). The second rule permits a right turn unless a sign is posted to prohibit it (the general permissive or "western" rule). It is estimated that RTOR increases average urban fuel economy by 2.6%, except in central business districts where the improvement is 4.9%. By extending the general permissive RTOR rule to those areas where it is not now in effect, it is estimated for 1982 that 0.02 billion gallons of fuel (0.02%) would be saved, with an attendant fuel cost savings of \$0.01 billion. At a unit cost of \$50 for sign installation where required, the total national cost in these additional metropolitan areas is \$0.0006 billion. These fixed



costs could be recovered in about 1 month from the associated fuel cost savings.

#### S. 3. 2. 2 One-Way Streets

Two-way streets can be converted to one-way operation as a means of reducing congestion and increasing the capacity. Simulations of a portion of the Washington, D. C. network, for example, showed an average increase in fuel economy of 12% while average speed increased 22%. However, the applicability of one-way streets on a nationwide basis is indeterminate because of insufficient information regarding the miles of one-way streets in operation at the present time, the fraction of urban VMT traveled on one-way streets, or the growth potential for additional one-way streets.\*

#### S. 3. 2. 3 Intersection Control

a. Traffic actuated control -- in traffic actuated control, the time of each green signal interval is determined in response to the volume of traffic as indicated by traffic detectors. It is assumed to be applicable to 4- and 6-lane arterials nationwide and is estimated to provide a 10% fuel economy improvement for 6-lane arterials and a 5% improvement for 4-lane arterials. About 6% of the urban VMT is traveled on 6-lane arterials and about 20% on 4-lane arterials. These factors combine to provide a fleet fuel savings of 0.86 billion gallons in 1982 (0.96%), with a fuel cost savings of \$0.60 billion. Approximately 88,000 pre-timed intersections could be converted to traffic actuated signal control by 1982 (in addition to conversions anticipated). At a unit cost of \$8000 per intersection, the total national cost would be \$0.70 billion. The annual fuel cost savings nearly equals the estimated implementation costs; thus this approach is very cost effective.

b. Optimized signal length -- pre-timed traffic control operates according to a pre-set cycle length and division (split) of the cycle between various road approaches to the intersection. Based on studies of three metropolitan traffic networks, it is estimated that by extending the normal 90-second cycle length to about 120 seconds, a fuel savings of 1/2 gallon

---

\*The fuel savings potential of one-way streets appears sufficiently promising to warrant government sponsorship of survey studies in individual municipalities to establish the benefits and cost of implementing this approach on a large scale.

per intersection per hour per day could be achieved. Applying these savings nationwide to all intersections would provide a fuel savings of 0.55 billion gallons (0.61%) in the year 1982, with an associated fuel cost savings of \$0.39 billion. At a unit cost of \$300 per intersection, the total national cost would be \$0.07 billion. With the annual fuel cost savings noted above, these fixed costs could be recovered in slightly over 2 months.

#### S. 3. 2. 4 Network Control

Network control represents the integrated utilization of a traffic signal complex consisting of either pre-timed or traffic actuated controllers or a combination of both types. In its simplest form the control system may consist of a series of independent signal controllers timed to operate in a prescribed relationship so as to optimize the movement of traffic through a network; its most sophisticated embodiment may incorporate an on-line computer, operating in real time, which receives data on traffic conditions and resets signal timing conditions to meet the changing demands of traffic flow. Based on the performance of computer-controlled systems installed in San Jose and Los Angeles, California, and Atlanta, Georgia, it is estimated that a fuel economy improvement of 6% relative to conventional traffic network systems could be achieved through the increase in average traffic speed effected by the utilization of a computer-controlled network. Applying this improvement to the estimated number of applicable networks nationwide in 1982, it is estimated that about 0.68 billion gallons of fuel (0.76%) would be saved, along with a fuel cost savings of \$0.48 billion. This could be accomplished at a national cost of \$1.2 billion, with an estimated payback period of about 2.4 years.

#### S. 3. 2. 5 Exclusive Bus Lanes

The concept of exclusive bus lanes involves the dedication of one or more lanes of roadway to the exclusive use of bus traffic, with the objective of reducing interference with the larger number of passenger cars and commercial vehicles and of improving average transit speeds and service so as to attract additional patronage. Examination of several such concepts revealed that it has a negative effect on overall network fuel consumption, even when the factor of increased bus ridership and its concomitant influence on reducing private passenger car use is taken into consideration.



Therefore, this is not a viable traffic control approach to the reduction of automotive fuel consumption.

### S. 3. 3 Driver Behavior Modifications

#### S. 3. 3. 1 Driver Training

Basic engineering considerations, common sense, and empirical evidence all indicate that the personal driving habits of the motor vehicle operator can have a pronounced effect on vehicle fuel economy. From the data base of tests conducted immediately after fuel-economy-oriented driver training/instruction was administered, a nominal fuel economy improvement of approximately 10% is indicated. It is expected that there will be a decay in effectiveness with the passage of time, and that the rate and extent of this decay will be highly variable among different drivers. In addition, considerations of safety may inhibit or deny the use of fuel-efficient driving tactics in various traffic environments. Accordingly, an effective, sustained fuel economy benefit of 5% was assumed for driver training. With 100% driver training, this would produce a fuel savings of 4.27 billion gallons in 1982 (4.76%), with a fuel cost savings of \$2.99 billion. At an estimated unit cost of \$55 for such training, the total national cost would be \$7.84 billion. It would require in excess of 2-1/2 years to recover these fixed costs through annual fuel cost savings.

In a second scenario, where training is a mandatory condition for the licensing of new drivers, implementation commencing in 1978 would result in a fuel savings of 0.43 billion gallons in 1982, and a fuel cost savings of \$0.30 billion. The associated national costs would be \$1.11 billion. This approach would require over 3-1/2 years to recover fixed costs through annual fuel cost savings.

#### S. 3. 3. 2 Driver Aid Device (Manifold Vacuum Gage)

In principle, all that is required of a driver to achieve improved mileage is to be aware of and apply basic fuel-efficient driving techniques. Driver training alone may suffice for this purpose. In this case, the main value of a driver aid device would be to prompt or remind the driver if he starts to slip back into pre-training driving habits.

It is also argued that some driver aids may perform the instructional task themselves; i. e. , a motivated driver may learn all he needs to

know by observing and responding to the device readings or other output signals, while continued use of the aids would maintain these driving habits. The fuel economy benefits of various driver aid devices were assessed on this basis, and fuel economy improvement values ranging from 1 to 6% were estimated, with the manifold vacuum gage ranked highest in benefit. These values represented the maximum improvement to be anticipated for the average driver making diligent use of the device daily. To account for non-diligence and flagging interest (as well as possible restrictions imposed by traffic safety), these values were reduced by one-half to estimate fleet fuel savings. On this basis, 2.52 billion gallons could be saved in the 1982 fleet (2.81%), with a fuel cost savings of \$1.76 billion. At a unit cost of \$35, the national cost would be \$4.77 billion. It would require nearly 3 years to recover these costs via annual fuel cost savings.

#### S. 4 INTEGRATED FUEL SAVINGS EFFECTS

##### S. 4.1 Maximum Case

Table S-4 lists the maximum fleet fuel savings that can be obtained in the year 1982 by the then in-use vehicle fleet by each technique and class of technique examined in the study. Some techniques are mutually exclusive. For example, the variable accessory drive device encompasses the benefits of reduced fan power, therefore viscous clutch fans and electric fans are not additive to the variable accessory drive benefits. In the case of tire modifications, the techniques of maintaining pressure and over-inflation, while additive to each other, both assume the radial vs bias-ply tire mix projected for 1982. Thus, fitting all cars with radial tires is not additive as a benefit to these two techniques at the values shown. In addition, some techniques used in combination with others have a different effectivity than when used alone. This applies in the case of improved carburetors combined with variable cylinder operation and in the case of improved maintenance combined with spark augmentation devices. The values shown in Table S-4 reflect this effect in terms of the maximum case fleet fuel savings attributed to these devices. In the case of driver training and driver aids, these two techniques are essentially mutually exclusive for the maximum cases shown in Table S-3 (100% implementation of driver training), insofar as the fuel economy improvement benefits are concerned. However, an additional 1/2% improvement (above training only) in fuel

TABLE S-4. INTEGRATED FUEL SAVINGS EFFECTS OF VARIOUS CLASSES OF TECHNIQUES - -PROJECTED 1982 IN-USE FLEET

Class/Technique	Maximum Case <sup>a</sup> Fleet Fuel Savings (10 <sup>9</sup> gal)	More Likely Maximum Case <sup>b</sup> Fleet Fuel Savings (10 <sup>9</sup> gal)
<u>VEHICLE MODIFICATIONS</u>		
o Spark Augmentation Devices	0.048	(c)
o Improved Carburetors	0.589 <sup>d</sup>	(c)
o Variable Accessory Operation		
--Viscous Clutch Fan	(e)	(e)
--Electric Fan	(e)	(e)
--Variable Accessory Drive	3.560	3.560
o Variable Cylinder Operation	3.940	3.940
o Engine Preheater	0.100	(c)
o Tire Modifications		
--Radial Tires	(f)	0.650 <sup>g</sup>
--Maintaining Pressure	1.020	0.698 <sup>g</sup>
--Overinflation <sup>h</sup>	4.010	0.796 <sup>g, i</sup>
o Drag Reduction Devices	1.330	(c)
o Improved Lubricants	2.615	2.615
o Improved Maintenance	0.674 <sup>j</sup>	(c)
Total	17.886 (72.5%) <sup>k</sup> (19.9%) <sup>l</sup>	12.259 (82.9%) <sup>k</sup> (13.7%) <sup>l</sup>
<u>TRAFFIC MODIFICATIONS</u>		
o Right Turn on Red	0.016	0.016
o One-Way Streets	(m)	(m)
o Intersection Control		
--Traffic Actuated	0.860	0.860
--Optimized Signal Length	0.550	0.550
o Network Control Strategies	0.681	0.681
o Exclusive Bus Lanes	(n)	(n)
Total	2.107 (8.5%) <sup>k</sup> (2.3%) <sup>l</sup>	2.107 (14.2%) <sup>k</sup> (2.3%) <sup>l</sup>
<u>DRIVER BEHAVIOR MODIFICATIONS</u>		
o Driver Training	4.270	0.427
o Driver Aid (Manifold Vacuum Gage)	0.405	(p)
Total	4.675 (19.6%) <sup>k</sup> (5.2%) <sup>l</sup>	0.427 (2.9%) <sup>k</sup> (0.5%) <sup>l</sup>
Overall Total	24.674 <sup>q</sup> (100%) <sup>k</sup> (27.5%) <sup>l</sup>	14.793 (100%) <sup>k</sup> (16.5%) <sup>l</sup>

TABLE S-4. INTEGRATED FUEL SAVINGS EFFECTS OF VARIOUS CLASSES OF TECHNIQUES--PROJECTED 1982 IN-USE FLEET (Continued)

Footnotes:

- <sup>a</sup>Without regard to anticipated implementation factors such as cost, consumer acceptance of devices, etc.
- <sup>b</sup>A selected scenario which reflects impact of cost effectiveness and (to a limited extent) consumer inclinations.
- <sup>c</sup>Not cost effective.
- <sup>d</sup>One-half of the normal improvement for V-8 engines; assumes aftermarket implementation of variable cylinder operation.
- <sup>e</sup>Benefits included under variable accessory drive device.
- <sup>f</sup>Not additive to benefits of tire pressure modifications.
- <sup>g</sup>100% radial tires in fleet; requires reduction in efficiency of maintaining tire pressure over that for projected radial/bias-ply mix in 1982 fleet.
- <sup>h</sup>Over and above maintaining recommended pressure.
- <sup>i</sup>Assumes a 20% effectivity in implementing benefits of overinflation.
- <sup>j</sup>Assumes aftermarket implementation of electronic ignition systems. This value would be 0.630 without such implementation.
- <sup>k</sup>Percent of the total savings in 1982 for the case examined.
- <sup>l</sup>Percent of the fuel consumed by the 1982 fleet (89.8 billion gallons) without incorporation of fuel savings techniques.
- <sup>m</sup>Data needed to evaluate fleet fuel savings is lacking.
- <sup>n</sup>Not a viable approach for reduction of automobile fuel consumption.
- <sup>p</sup>Not cost effective in conjunction with driver training.
- <sup>q</sup>Fuel consumed by 1982 fleet without above techniques is 89.8 billion gallons.



economy is included for driver aids in consideration of their potential value in reinforcing good driving habits when used in conjunction with driver training.

As can be seen in the table, vehicle modifications alone can result in a maximum fleet fuel savings of 17.89 billion gallons in 1982. Traffic modifications can result in savings of 2.11 billion gallons, while the combined effect of driver training and driver aids can result in savings of 4.68 billion gallons. The total combined maximum savings in 1982 is 24.67 billion gallons which is 27.5% of the 89.8 billion gallons projected to be used by the 1982 fleet without the fuel saving techniques examined herein. Vehicle modifications can result in a maximum 19.9% reduction in fleet fuel consumption, while traffic modifications represent a 2.3% reduction and driver performance modifications represent a 5.2% reduction potential.

#### S. 4.2 More Likely Maximum Case

The scenario discussed in Section S. 4. 1 represented maximum potential only and did not consider any factors bearing on the likelihood of implementation by the public. A "more likely" maximum fuel savings case was developed and is also shown in Table S-4 for comparative purposes. In this scenario, all techniques except radial tires, which required 5 years or more to recover implementation costs through annual fuel cost savings, were considered unlikely to be implemented by the public. In the case of radial tires, consideration of extended tire life plus fuel cost savings (above bias-ply tire life) could make them cost effective. Except for driver training, all techniques in the more likely category were assumed to be implemented in 100% of the applicable-vehicle fleet segment.\*

With regard to the tire modification category, the case shown assumes full implementation of radial tires in the 1982 fleet. The effect of maintaining recommended tire pressure is reduced from the "maximum case" value of 1.02 because that value represented a radial/bias-ply mix in the 1982 fleet. The combined effect of all radial tires plus maintained pressure then exceeds the maintain-pressure case with the radial/bias-ply mix.

---

\* Note that the "more likely" case is not a most likely case. The latter would consider public acceptance and marketing factors influencing the degree or extent of implementation. The determination of these factors was beyond the scope of the present study.



With regard to overinflation, it is felt that the public will not voluntarily accede to overinflating their tires to the maximum values for reasons of personal riding comfort and perhaps suspected more rapid wear of shock absorbers and other components of the suspension. It is more likely that some of the public responding to the inducement of overinflation benefits will tend to overinflate their tires to a lesser degree. On this basis, a fuel savings value equal to 20% of that maximum achievable has been included in the "more likely maximum" case.

Since all traffic modifications included are cost effective, there should be no strong barrier to their implementation by 1982.

In the case of driver training, it is felt to be highly unlikely that 100% of the driving public could or would be adequately trained by 1982. Therefore the case where limited training programs are instituted in 1978 has been adopted for the "more likely maximum" scenario.

In this scenario, vehicle modifications alone now result in a savings of 12.26 billion gallons. Traffic modifications result in the same savings of 2.11 billion gallons (as in the "maximum" scenario), and driver training results in savings of 0.43 billion gallons. The total combined savings in this scenario in 1982 is 14.79 billion gallons, which is 16.5% of the 89.8 billion gallons projected to be used by the 1982 fleet without the fuel saving techniques included in this scenario.

Vehicle modifications can result in a 13.7% reduction in fleet fuel consumption, while traffic modifications represent a 2.3% reduction and driver training represents a 0.5% reduction potential.

## S. 5 RELATIVE RANKING OF TECHNIQUES

Table S-5 lists the various techniques examined in the order of their effectiveness in reducing the fuel consumption of the 1982 vehicle fleet, if implemented on an individual basis. Those techniques identified as not cost effective (on an absolute basis or requiring in excess of 5 years to recover investment costs via fuel cost savings) are not anticipated to be implemented by the consuming public on the scale necessary to achieve the fleet fuel savings potential which was the basis for their numerical ranking.

Tire overinflation, to the maximum rated pressure, is found to be the most effective fuel consumption reduction technique. However, as noted earlier, it is doubtful that the public would fully implement this approach

TABLE S-5. RELATIVE RANKING OF EFFECTIVITY OF VARIOUS TECHNIQUES (BASED ON 1982 IN-USE FLEET CHARACTERISTICS)

Technique	Fleet Fuel Savings Potential <sup>a</sup> (10 <sup>9</sup> gal)
1. Tire overinflation to maximum	5.03 (relative to present under-inflated conditions)
2. Driver training (100%)	4.27
3. Variable cylinder operation	3.94
4. Variable accessory drive	3.56
5. Improved lubricants	2.62
6. Driver aid (manifold vacuum gage)	2.52 (instead of driver training)
7. Electric fan	1.78 (NCE) <sup>b</sup>
8. Drag reduction devices	1.33 (NCE)
9. Maintaining tire pressure to recommended values	1.02 (relative to present under-inflated conditions)
10. Traffic actuated intersection control	0.86
11. Improved carburetion	0.83 (NCE)
12. Network control	0.68
13. Radial tires	0.67
14. Improved maintenance	0.63 (NCE)
15. Optimized signal length intersection control	0.55
16. Viscous clutch fan	0.19 (NCE)
17. Engine preheater	0.10 (NCE)
18. Spark-augmentation devices	0.05 (NCE)
19. Right turn on red	0.02

<sup>a</sup>Based on mileage accumulated in 1982.

<sup>b</sup>(NCE) = not cost effective.

because of personal comfort and possible suspension wear problems. Driver training, the next highest technique, again is faced with severe implementation problems. The logistics of planning and staffing a sufficient number of training centers and the motivation of the public towards such training are factors which indicate that the full potential of this approach will not be reached in 1982.

Variable cylinder operation and variable accessory drive techniques are hardware retrofit options. Even though shown to be effective, they would have a difficult time meeting 100% acceptance by owners of applicable vehicles due to the demonstrated reluctance of the public in general to invest \$80 to \$100 in used cars. As the price of fuel increases, however, this situation could change.

Although synthetic oils at their present price levels are not cost effective, improved engine and differential lubricants in the form of mineral-based oils with friction modifiers provide similar fuel savings advantages, are attractive in terms of cost/benefit, and show definite promise for widespread implementation in the fleet.

Driver aid devices, per se, are not as effective as driver training, and would probably require a strong federal/state/local agency program to cause the public to buy and use them. Since driver training is the preferable single approach, any government program in this regard would probably best be served by focusing attention on driver training, not the driver aid device, except as a supplementary option for those drivers motivated enough to use them.

The traffic modification techniques listed are all cost effective; local, state, and federal agencies should be encouraged to accelerate their implementation rate.

Aside from the use of radial tires and maintaining tire pressure, the remaining vehicle modifications either result in minor fuel economy improvements or are not cost effective.



## 1. INTRODUCTION

### 1.1 BACKGROUND AND OBJECTIVE

Any sound national plan for the conservation of fuel resources in the transportation sector must consider the benefits which would accrue from improvements in the fuel consumption characteristics of automotive vehicles in the existing light duty fleet. In 1976 this fleet comprised 100 million passenger cars and 22 million light duty trucks ( $\leq 10,000$  lb GVW), and by 1982 it may be expected to grow to 109 million passenger cars and 32 million light duty trucks.

A large number of devices and techniques have been proposed as means to reduce fuel consumption in the light duty vehicle fleet. In the course of a comprehensive program by the U.S. Department of Transportation to evaluate such methods, three general classes of techniques whereby fuel savings could be effected were identified: (a) modification of vehicles, (b) modification of traffic flow, and (c) modification of driver performance. Within each of these general classes a large number of potentially beneficial devices, concepts, and approaches were evaluated. It is the objective of this report to review the matrix of proposed concepts in each general class, to evaluate the various techniques in terms of potential fuel savings, cost, safety impacts, and probable lead time to implementation, and to identify those techniques offering the greatest benefit at least cost.

### 1.2 STUDY SCOPE AND APPROACH

The devices and techniques examined in this study were selected jointly by The Aerospace Corporation and DOT/TSC. A list of these items is provided in Table 1-1. The choice of candidate techniques was based in part on the results of recent DOT-sponsored studies conducted by The Aerospace Corporation in the areas of aftermarket devices and driver aid devices and on guidelines established by the DOT/TSC Vehicle In-Use Energy Conservation Seminar and Workshop of September, 1976. In the category of traffic modifications, the techniques selected for examination were obtained from a brief review of the subject literature and were necessarily limited to a few representative approaches for which fuel consumption effects or related data were found to be available.



TABLE 1-1. TECHNIQUES CONSIDERED

Vehicle Modifications	Traffic Modifications	Driver Performance Modifications
Spark Augmentation Devices	Right Turn on Red	Driver Training
Improved Carburetors	One-way Streets	Driver Aid Devices
Variable Accessory Operation	Intersection Control	- Manifold Vacuum Gage
- Viscous Clutch Fan	- Traffic Actuated Signals	- Accelerometer
- Electric Fan	- Optimized Signal Cycle Length	- Accelerator Pedal Feedback
- Variable Accessory Drive	Network Control	- Cruise Control
Variable Cylinder Operation	Exclusive Bus Lanes	- MPG Meter
Intake Air Temperature Control		- Fuel Totalizer
Engine Preheater		
Tire Modifications		
- Radial Tires		
- Maintaining Pressure		
- Overinflation		
Drag Reduction Devices		
Improved Lubricants		
Improved Maintenance		

The general approach adopted in this study for determining fleet fuel savings effects was as follows. The year 1982 was selected as the time frame of reference for determining the applicability and fuel consumption benefits of the various devices and approaches considered. A model of the 1982 passenger car and light duty truck fleets was developed to establish the baseline characteristics of potentially applicable vehicles. A second model, that of the 1976 light duty fleet, was developed and was used for comparison purposes. A survey was then made of available literature and reports on the devices and techniques under consideration, and on the basis of the evidence so compiled, a best judgment was made of the potential of each device for improving vehicle fuel economy. The fleet fuel savings attributable to each technique were then established by applying its fuel economy benefit to the total number of applicable vehicles in the fleet. The fuel savings for the several techniques within a general class were then integrated to obtain an aggregate fuel savings effect.

### 1.3 ORGANIZATION OF REPORT

Section 2 of this report provides a detailed description of the methods used in developing the baseline vehicle fleets and in computing fleet fuel savings and cost effects. In Section 3, the candidate fuel savings techniques are characterized in terms of fuel economy benefits, safety effects, cost, and availability for implementation. Section 4 examines each device with regard to its fleet applicability, potential fuel savings, and national cost. Other significant parameters examined in Section 4 include potential implementation problems, lead time to implementation, and possible uncertainties in the estimation of technique benefits and costs. Section 5 provides an estimate of the maximum aggregate fuel savings which would accrue for the 1976 and 1982 fleets if all techniques and devices in a general class were implemented concurrently, assuming 100% acceptance by the public. The 1982 case is displayed in the Summary section in contrast with a more likely scenario which accounts for the likelihood of implementation by the public. A ranking of the various techniques in order of their fuel savings effectiveness is also provided in the Summary.



## 2. ANALYTICAL APPROACH

### 2.1 GENERAL

The key data developed in this study are founded upon the characteristics of two light duty fleets: a 1976 fleet, representing automotive technology of the recent past, and a 1982 fleet, reflecting the influence of future vehicle population growth and current technology developments aimed at improving new car fuel efficiency. This dual model of the in-use vehicle fleet serves two purposes. First, the 1982 time frame allows sufficient time for the substantial implementation of the various proposed techniques for reducing fuel consumption in the fleet. Second, the difference in the features of the current and 1982 fleets provides the basis for assessing the changing applicability and effective lifetime of a given technique, thereby yielding a measure of its net value as referenced to a projected implementation timetable.

This section of the report provides a general description of the methods and data base used to develop the characteristics of the 1976 and 1982 fleet models, and discusses the general methodology employed in assessing fleet fuel consumption and cost factors associated with the implementation of the candidate techniques.

### 2.2 CHARACTERISTICS OF THE IN-USE VEHICLE FLEET

As noted above, two vehicle fleets are used as a baseline in assessing the benefits of techniques for reducing in-use vehicle fuel consumption: a 1976 fleet and a 1982 fleet. Both passenger cars and light duty trucks (GVW  $\leq$  10,000 lb) are considered. The fleet characteristics of interest are as follows:

- a. Distribution of vehicle population by model year
- b. Annual mileage by vehicle age
- c. Fuel economy as a function of model year and market class

These elements are discussed in the following paragraphs.

#### 2.2.1 Distribution of Vehicle Population by Model Year

The basic data source used to obtain the population characteristics of the 1976 fleet were the Automotive News Almanac issues for model years

1959 through 1976 (Ref. 2-1). This relatively broad span of 17 years was felt to be necessary in order to adequately characterize the fleet with regard to the applicability of various retrofit devices which might only be suitable for use in older, non-catalyst-equipped or non-controlled cars.

Two data elements are required to establish the vehicle population: vehicle sales for each model year and survivability. Passenger car and truck sales data were obtained directly from Reference 2-1. Survivability characteristics were developed from registration data by model year, also given in Ref. 2-1. These data are displayed in smoothed form in Figure 2-1 for passenger cars and in Figure 2-2 for light duty trucks.

Referring to the passenger car data in Figure 2-1, it is interesting to note that the survivability characteristics for the 1974, 1975, and 1976 fleets are closely clustered and are significantly higher than the survivability characteristics for older fleets as represented by the curve shown for 1970. Thus, for example, while only 42% of 10-year-old cars were on the road in 1970, 64% of the cars this age were on the road in 1976. Shown for comparison with these curves is a survivability characteristic taken from a recent DOT report, Ref. 2-2, which appears to conform generally to the older fleet characteristic. On the basis of the closely clustered results shown for the last three years, and because it is the most recent information available, the 1976 curve was adopted for use in predicting the composition of the 1982 fleet as well as for the composition of the 1976 fleet.\* Similarly, the smoothed 1976 light duty truck characteristic shown in Figure 2-2 was used both for the 1982 and 1976 truck fleets.

Passenger car sales for model years 1977 through 1982, required for the development of the new car component of the 1982 fleet, were predicated on a 2% yearly growth in production (referenced to 1976) as suggested by the 300-day study (Ref. 2-3). Lacking projections for light duty truck sales, an analysis was made of recent trends in truck sales, and on this basis, a 5% growth was assigned to trucks under 6000 lb GVW and 6% to trucks of 6000 to 10,000 lb GVW.

---

\* Integration of the vehicles in the 1976 fleet using actual sales data and the smoothed survivability curve yields  $99.7 \times 10^6$  vehicles, compared with about  $100 \times 10^6$  vehicles projected from 1 July 1976 registration data.



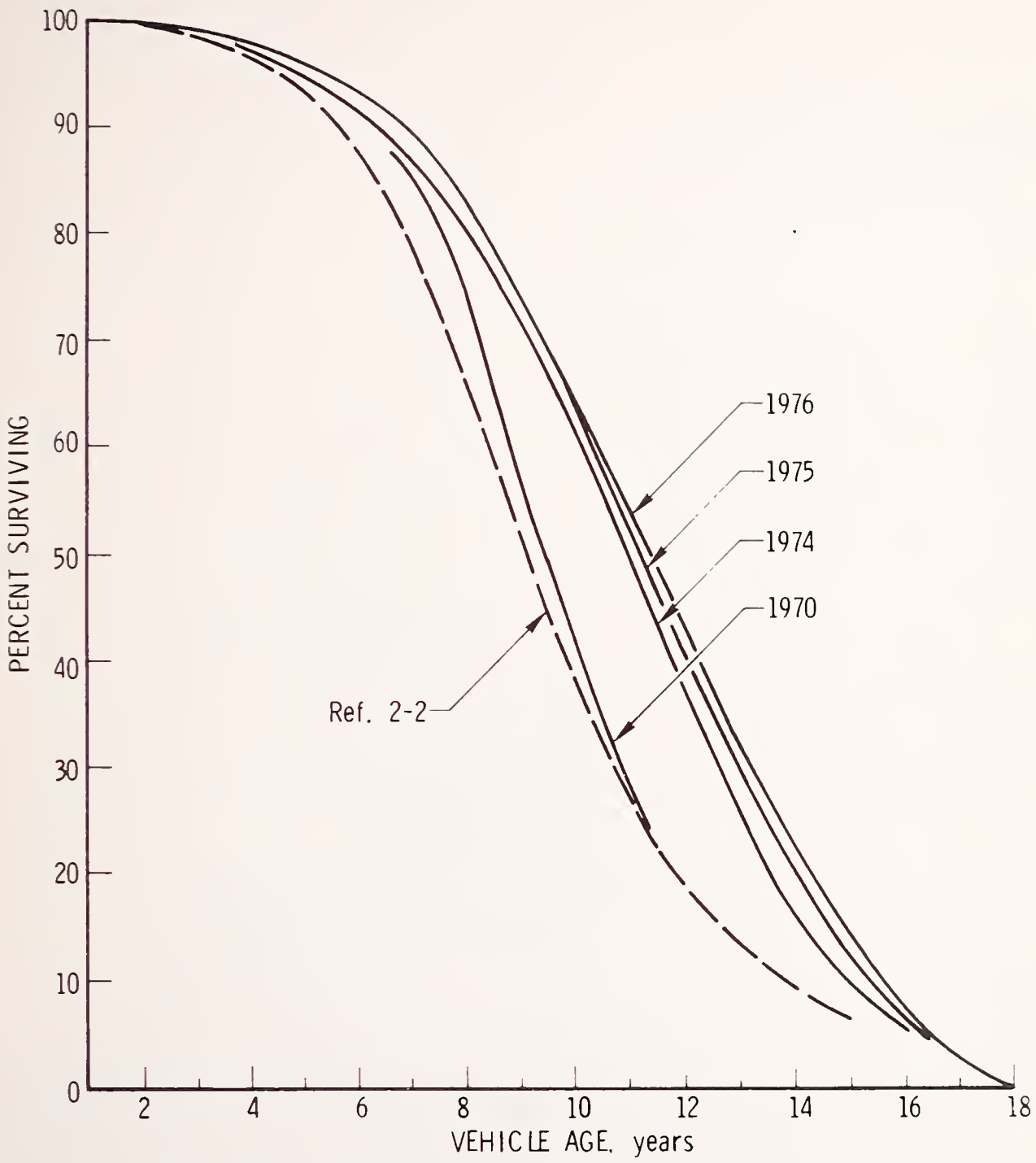

FIGURE 2-1. SURVIVABILITY CHARACTERISTICS FOR PASSENGER CARS

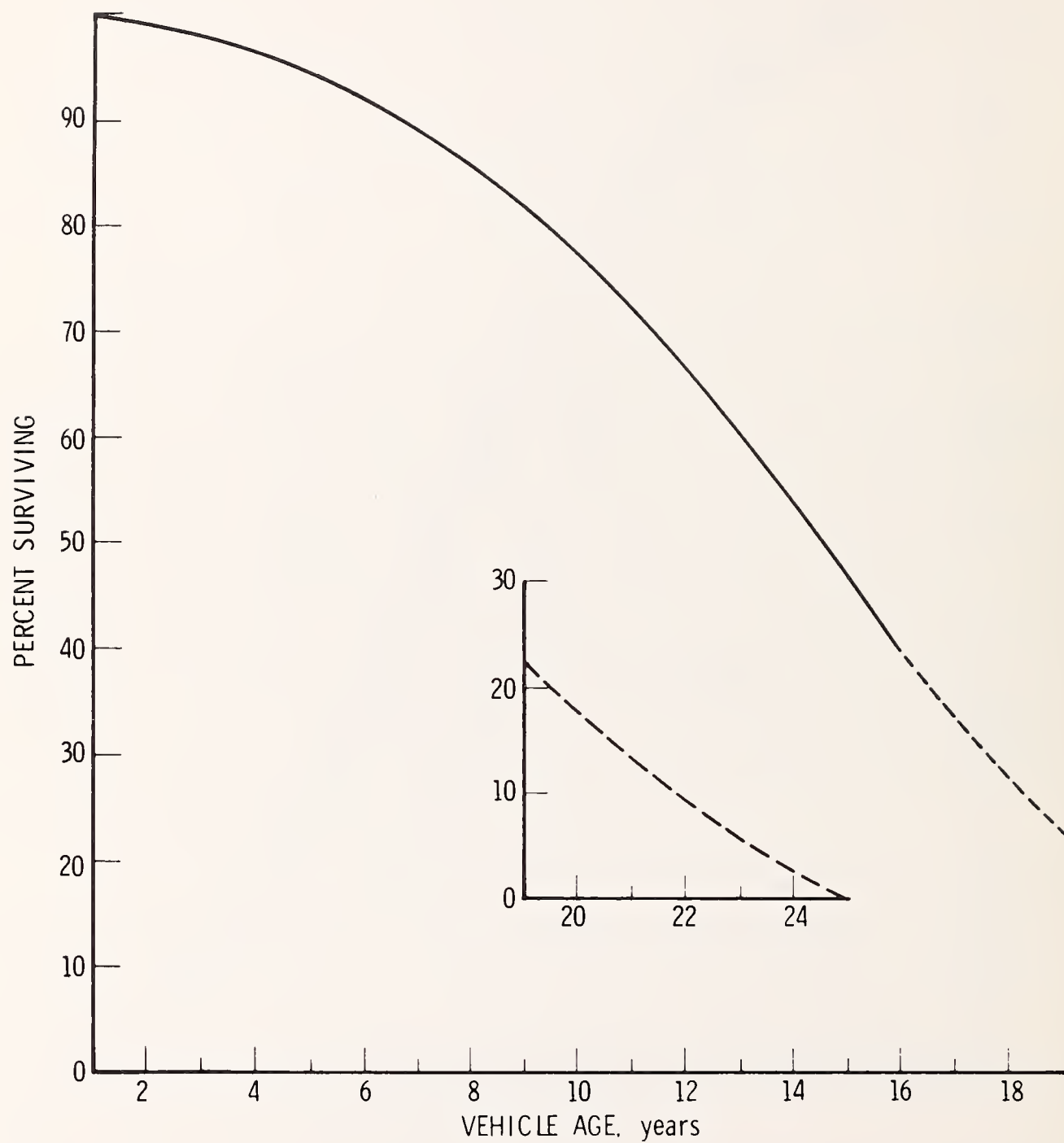

FIGURE 2-2. SURVIVABILITY CHARACTERISTICS FOR LIGHT DUTY TRUCKS (CLASS I AND II)

The data thus developed pertaining to sales, survivability, and the resulting numbers of vehicles in each model year on the road are presented in Tables 2-1 through 2-6. Other characteristics of the in-use fleets shown in the tables are discussed in the following paragraphs.

### 2.2.2 Annual Mileage by Vehicle Age

The data on annual mileage by vehicle age are relatively sparse for passenger vehicles and even less plentiful for trucks. Three sources were examined for the required information: the 300-day study (Ref. 2-3), a recent DOT summary report on automobile fuel economy standards (Ref. 2-2), and EPA document AP-42 (Ref. 2-4). The first two sources provided no information on trucks. The passenger car data in the 300-day study were found to be constrained to the assumption of a 10-year, 100,000-mile vehicle lifetime and were therefore rejected as unsuitable to the objectives of the present study. The DOT report exhibited an unusually high first year mileage (18,000) and provided no references as to the source of the information provided. The present study, therefore, utilized the mileage characteristics for passenger cars and light duty trucks as given in the EPA document "Compilation of Air Pollution Emission Factors" (Ref. 2-4), smoothed and extrapolated in the case of passenger cars from age 11 to 17 years as indicated in Figure 2-3. The numerical quantities employed and the corresponding VMT generated in the 1976 and 1982 fleets are included in the tabulated data of Tables 2-1 through 2-6.

### 2.2.3 Fuel Economy as a Function of Model Year and Market Class

#### 2.2.3.1 Passenger Cars

The historical data base for passenger car fuel economy trends applicable to the 1976 fleet and to the older segment of the 1982 fleet is given in Tables 2-7 and 2-8 taken from Ref. 2-5. The sales-weighted average fuel economy (50-state composite) for a given model year may be obtained by applying the sales fraction by inertia weight shown in Table 2-7 to the fuel economy for the corresponding inertia weight shown in Table 2-8, and summing these products. These are the data that appear for 1977 and earlier model year cars in Tables 2-1 and 2-4.

TABLE 2-1. CHARACTERISTICS OF THE 1976 PASSENGER CAR FLEET

Age	Model Yr	Sales (10 <sup>6</sup> )	Surv.	No. Cars (10 <sup>6</sup> )	Miles/Yr	VMT (10 <sup>9</sup> )	Model Yr MPG	Model Yr Gal (10 <sup>9</sup> )
1	1976	10.102	0.998	10.082	15,900	160.301	17.8	9.006
2	1975	8.262	0.995	8.221	15,000	123.310	15.6	7.905
3	1974	8.701	0.985	8.570	14,000	119.987	13.9	8.632
4	1973	11.351	0.975	11.067	13,100	144.981	14.0	10.356
5	1972	10.488	0.955	10.016	12,200	122.196	14.5	8.427
6	1971	9.830	0.925	9.093	11,300	102.748	14.7	6.990
7	1970	8.388	0.880	7.381	10,300	76.029	15.1	5.035
8	1969	9.447	0.823	7.775	9,400	73.084	14.7	4.972
9	1968	9.404	0.735	6.912	8,500	58.751	15.0	3.917
10	1967	8.357	0.641	5.357	7,600	40.712	15.5	2.627
11	1966	9.008	0.525	4.729	6,700	31.686	15.5	2.044
12	1965	9.314	0.421	3.921	6,000	23.527	15.5	1.518
13	1964	8.065	0.327	2.637	5,300	13.977	15.5	0.902
14	1963	9.557	0.233	2.227	4,600	10.243	15.5	0.661
15	1962	6.939	0.156	1.082	3,900	4.222	15.5	0.272
16	1961	5.855	0.076	0.455	3,200	1.424	15.5	0.092
17	1960	6.577	0.030	0.197	2,500	0.493	15.5	0.032
18	1959	6.041	0	0	0	0	0	0
Fleet Total, or				99.722	11,108	1107.671	15.09	73.388
Average								



TABLE 2-2. CHARACTERISTICS OF THE 1976 CLASS I LIGHT DUTY TRUCK FLEET (< 6000 lb)

Age	Model Yr	Sales (10 <sup>6</sup> )	Surv.	No. LDT's (10 <sup>6</sup> )	Miles/Yr	VMT (10 <sup>9</sup> )	Model Yr MPG	Model Yr Gal (10 <sup>6</sup> )
1	1976	1.285	0.995	1.279	15,900	20.329	17.4	1.168
2	1975	1.204	0.991	1.193	15,000	17.897	15.2	1.177
3	1974	1.616	0.980	1.584	14,000	22.172	13.6	1.630
4	1973	1.843	0.961	1.771	13,100	23.202	13.7	1.706
5	1972	1.471	0.940	1.383	12,200	16.869	14.2	1.188
6	1971	1.210	0.915	1.107	11,300	12.511	14.4	0.869
7	1970	1.049	0.885	0.928	10,300	9.562	14.8	0.646
8	1969	1.117	0.855	0.955	9,400	8.977	14.4	0.623
9	1968	1.069	0.819	0.876	8,500	7.442	14.7	0.506
10	1967	0.919	0.775	0.712	7,600	5.413	15.2	0.356
11	1966	0.970	0.725	0.703	6,700	4.712	15.2	0.310
12	1965	0.940	0.660	0.620	6,000	3.722	15.2	0.245
13	1964	0.844	0.588	0.496	5,300	2.630	15.2	0.173
14	1963	0.745	0.518	0.386	4,500	1.737	15.2	0.114
15	1962	0.625	0.455	0.284	4,500	1.280	15.2	0.084
16	1961	0.541	0.390	0.211	4,500	0.949	15.2	0.062
17	1960	0.521	0.330	0.172	4,500	0.774	15.2	0.051
18	1959	0.505	0.276	0.139	4,500	0.627	15.2	0.041
19	1958	0.382	0.225	0.086	4,500	0.387	15.2	0.025
20	1957	0.451	0.175	0.079	4,500	0.355	15.2	0.023
21	1956	0.400	0.130	0.052	4,500	0.234	15.2	0.015
22	1955	0.350	0.090	0.032	4,500	0.142	15.2	0.009
23	1954	0.300	0.055	0.017	4,500	0.074	15.2	0.005
24	1953	0.250	0.025	0.006	4,500	0.028	15.2	0.002
25	1952	---	0	0	0	0	--	0
Fleet Total, or Average				15.071	10,552	159.025	14.42	11.028

TABLE 2-3. CHARACTERISTICS OF THE 1976 CLASS II LIGHT DUTY TRUCK FLEET  
(6001 - 10,000 lb)

Age	Model Yr	Sales (10 <sup>6</sup> )	Surv.	No. LDT's (10 <sup>6</sup> )	Miles/Yr	VMT (10 <sup>9</sup> )	Model Yr MPG	Model Yr Gal (10 <sup>9</sup> )
1	1976	1.440	0.995	1.433	15,900	22.782	10.0	2.278
2	1975	0.896	0.991	0.888	15,000	13.319	10.0	1.332
3	1974	0.640	0.980	0.627	14,000	8.781	10.0	0.878
4	1973	0.717	0.961	0.689	13,100	9.026	10.0	0.903
5	1972	0.539	0.940	0.507	12,200	6.181	10.0	0.618
6	1971	0.447	0.915	0.409	11,300	4.622	10.0	0.462
7	1970	0.408	0.885	0.361	10,300	3.719	10.0	0.372
8	1969	0.412	0.855	0.352	9,400	3.311	10.0	0.331
9	1968	0.376	0.819	0.308	8,500	2.618	10.0	0.262
10	1967	0.276	0.775	0.214	7,600	1.626	10.0	0.163
11	1966	0.279	0.725	0.202	6,700	1.355	10.0	0.136
12	1965	0.254	0.660	0.168	6,000	1.006	10.0	0.101
13	1964	0.207	0.588	0.122	5,300	0.645	10.0	0.065
14	1963	0.189	0.518	0.098	4,500	0.441	10.0	0.044
15	1962	0.161	0.455	0.073	4,500	0.330	10.0	0.033
16	1961	0.132	0.390	0.051	4,500	0.232	10.0	0.023
17	1960	0.137	0.330	0.045	4,500	0.203	10.0	0.020
18	1959	0.134	0.276	0.037	4,500	0.166	10.0	0.017
19	1958	0.103	0.225	0.023	4,500	0.104	10.0	0.010
20	1957	0.125	0.175	0.022	4,500	0.098	10.0	0.010
21	1956	0.124	0.130	0.016	4,500	0.073	10.0	0.007
22	1955	0.123	0.090	0.011	4,500	0.050	10.0	0.005
23	1954	0.122	0.055	0.007	4,500	0.030	10.0	0.003
24	1953	0.120	0.025	0.003	4,500	0.014	10.0	0.001
25	1952	---	0	0	4,500	0	10.0	0
Fleet Total, or Average						80.732		8.073
							10.0	
						12,111		

TABLE 2-4. CHARACTERISTICS OF THE 1982 PASSENGER CAR FLEET

Age	Model Yr	Sales (10 <sup>6</sup> )	Surv.	No. Cars (10 <sup>6</sup> )	Miles/Yr	VMT (10 <sup>9</sup> )	Model Yr MPG	Model Yr Gal (10 <sup>6</sup> )
1	1982	11,376	0.998	11.353	15,900	180,517	23.5	7,682
2	1981	11,153	0.995	11.097	15,000	166,459	22.0	7,566
3	1980	10,935	0.985	10.771	14,000	150,794	20.7	7,285
4	1979	10,720	0.975	10.452	13,100	136,921	19.9	6,880
5	1978	10,510	0.955	10.037	12,200	122,452	19.1	6,411
6	1977	10,304	0.925	9.531	11,300	107,703	18.6	5,790
7	1976	10,102	0.880	8.890	10,300	41,565	17.8	5,144
8	1975	8,262	0.823	6.800	9,400	63,916	15.6	4,097
9	1974	8,701	0.735	6.395	8,500	54,359	13.9	3,911
10	1973	11,351	0.641	7.276	7,600	55,298	14.0	3,950
11	1972	10,488	0.525	5.506	6,700	36,892	14.5	2,544
12	1971	9,630	0.421	4.138	6,000	24,831	14.7	1,689
13	1970	8,388	0.327	2.743	5,300	14,537	15.1	0,963
14	1969	9,447	0.233	2.201	4,600	10,125	14.7	0,689
15	1968	9,404	0.156	1.467	3,900	5,721	15.0	0,381
16	1967	8,357	0.076	0.635	3,200	2,032	15.5	0,131
17	1966	9,008	0.030	0.270	2,500	0,676	15.5	0,044
18	1965	9,314	0	0	0	0	--	0
Fleet Total, or Average				109.262	11,210	1224,798	18.80	65,157

TABLE 2-5. CHARACTERISTICS OF THE 1982 CLASS I LIGHT DUTY TRUCK FLEET (<6000 lb)

Age	Model Yr	Sales* (10 <sup>6</sup> )	Surv.	No. LDT's (10 <sup>6</sup> )	Miles/Yr	VMT (10 <sup>9</sup> )	Model Yr MPG	Model Yr Gal (10 <sup>9</sup> )
1	1982	2.010	0.995	2.000	15,900	31.799	24.0	1.325
2	1981	1.910	0.991	1.893	15,000	28.392	22.5	1.262
3	1980	1.820	0.980	1.784	14,000	24.970	21.1	1.183
4	1979	1.740	0.961	1.672	13,100	21.905	20.3	1.079
5	1978	1.650	0.940	1.551	12,200	18.922	19.5	0.970
6	1977	1.580	0.915	1.446	11,300	16.336	19.0	0.860
7	1976	1.285	0.885	1.137	10,300	11.713	17.4	0.673
8	1975	1.204	0.855	1.029	9,400	9.667	15.2	0.636
9	1974	1.616	0.819	1.324	8,500	11.250	13.6	0.827
10	1973	1.843	0.775	1.428	7,600	10.855	13.7	0.792
11	1972	1.471	0.725	1.066	6,700	7.145	14.2	0.503
12	1971	1.210	0.660	0.799	6,000	4.792	14.4	0.333
13	1970	1.049	0.588	0.617	5,300	3.269	14.8	0.221
14	1969	1.117	0.518	0.579	4,500	2.604	14.4	0.181
15	1968	1.069	0.455	0.486	4,500	2.189	14.7	0.149
16	1967	0.919	0.390	0.358	4,500	1.613	14.7	0.110
17	1966	0.970	0.330	0.320	4,500	1.440	14.7	0.098
18	1965	0.940	0.276	0.259	4,500	1.167	14.7	0.079
19	1964	0.844	0.225	0.190	4,500	0.855	14.7	0.058
20	1963	0.745	0.175	0.130	4,500	0.587	14.7	0.040
21	1962	0.625	0.130	0.081	4,500	0.366	14.7	0.025
22	1961	0.541	0.090	0.049	4,500	0.219	14.7	0.015
23	1960	0.521	0.055	0.029	4,500	0.129	14.7	0.009
24	1959	0.505	0.025	0.013	4,500	0.057	14.7	0.004
Fleet Total, or Average						212.241		11.431
						10,486		18.57

\* Sales estimated for 1977-1982 at 5%/yr growth from 1975.



TABLE 2-6. CHARACTERISTICS OF THE 1982 CLASS II LIGHT DUTY TRUCK FLEET  
(6001-10,000 lb)

Age	Model Yr	Sales* (10 <sup>6</sup> )	Surv.	No. LDT's (10 <sup>6</sup> )	Miles/Yr	VMT (10 <sup>9</sup> )	Model Yr MPG	Model Yr Gal (10 <sup>9</sup> )
1	1982	1.350	0.995	1.343	15,900	21.358	10.0	2.136
2	1981	1.280	0.991	1.268	15,000	19.027	10.0	1.903
3	1980	1.200	0.980	1.176	14,000	16.464	10.0	1.645
4	1979	1.140	0.961	1.096	13,100	14.352	10.0	1.435
5	1978	1.070	0.940	1.006	12,200	12.271	10.0	1.227
6	1977	1.010	0.915	0.924	11,300	10.443	10.0	1.044
7	1976	1.440	0.885	1.274	10,300	13.126	10.0	1.313
8	1975	0.896	0.855	0.766	9,400	7.201	10.0	0.720
9	1974	0.640	0.819	0.524	8,500	4.455	10.0	0.446
10	1973	0.716	0.775	0.555	7,600	4.217	10.0	0.422
11	1972	0.539	0.725	0.391	6,700	2.618	10.0	0.262
12	1971	0.447	0.660	0.295	5,300	1.564	10.0	0.156
13	1970	0.408	0.588	0.240	4,500	1.080	10.0	0.108
14	1969	0.412	0.518	0.213	4,500	0.960	10.0	0.096
15	1968	0.376	0.455	0.171	4,500	0.770	10.0	0.077
16	1967	0.276	0.390	0.108	4,500	0.484	10.0	0.048
17	1966	0.279	0.330	0.092	4,500	0.414	10.0	0.041
18	1965	0.254	0.276	0.070	4,500	0.315	10.0	0.032
19	1964	0.207	0.225	0.047	4,500	0.210	10.0	0.021
20	1963	0.189	0.175	0.033	4,500	0.149	10.0	0.015
21	1962	0.161	0.130	0.021	4,500	0.094	10.0	0.009
22	1961	0.132	0.090	0.012	4,500	0.053	10.0	0.005
23	1960	0.137	0.055	0.008	4,500	0.034	10.0	0.003
24	1959	0.134	0.025	0.003	4,500	0.015	10.0	0.002
Fleet Total, or					11.316	131.674	10.0	13.167
Average								

\* Sales estimated for 1977-1982 at 5%/yr growth from 1975.

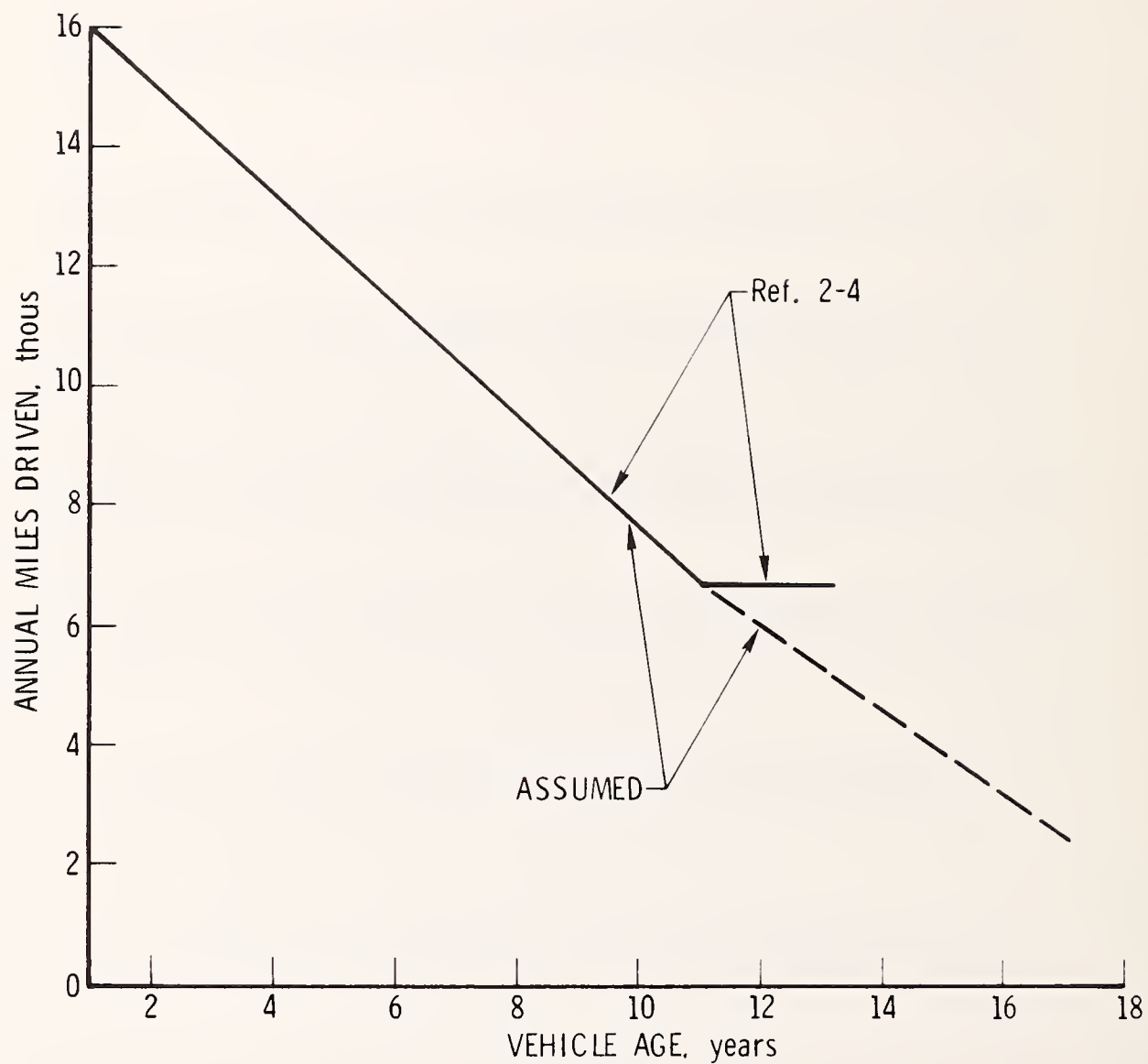

FIGURE 2-3. AVERAGE ANNUAL MILES DRIVEN BY VEHICLE AGE (PASSENGER CARS)

TABLE 2-7. SALES FRACTIONS AS A FUNCTION OF INERTIA WEIGHT AND MODEL YEAR (Ref. 2-5)

Model Year	1750	2000	2250	2500	2750	3000	3500	4000	4500	5000	5500
1958	.0106	.0265	.0094	.0187	.0012	.0125	.1171	.5377	.2177	.0416	.0070
1959	.0175	.0244	.0147	.0206	.0264	.0437	.0932	.4673	.2157	.0473	.0291
1960	.0060	.0293	.0116	.0122	.1155	.0933	.0486	.3654	.2474	.0421	.0286
1961	.0059	.0310	.0086	.0085	.1409	.1384	.0598	.3446	.2161	.0352	.0104
1962	.0050	.0250	.0022	.0050	.0786	.1669	.1779	.2827	.1829	.0654	.0083
1963	.0024	.0293	.0064	.0046	.0366	.2159	.1573	.2845	.2122	.0441	.0067
1964	.0039	.0382	.0043	.0063	.0269	.1916	.1972	.2931	.1812	.0496	.0077
1965	.0029	.0395	.0058	.0052	.0044	.1505	.2193	.2975	.2076	.0606	.0069
1966	.0015	.0394	.0061	.0135	.0008	.1403	.1884	.3313	.2053	.0657	.0077
1967	.0028	.0085	.0495	.0199	.0022	.0970	.1717	.3798	.1709	.0836	.0061
1968	.0003	.0049	.0543	.0263	.0007	.0384	.2652	.3411	.1873	.0730	.0056
1969	.0015	.0118	.0561	.0218	.0307	.0317	.2353	.1623	.3334	.1060	.0094
1970	.0014	.0114	.0737	.0344	.0502	.0600	.1262	.2388	.2916	.0914	.0209
1971	.0021	.0090	.0882	.0736	.0238	.0549	.1184	.1984	.2656	.1298	.0362
1972	.0019	.0097	.0463	.0656	.0680	.0478	.1249	.2033	.2466	.1242	.0617
1973	.0030	.0128	.0438	.0573	.0945	.0577	.1181	.1221	.2545	.1681	.0681
1974	-	.0025	.0436	.0439	.0609	.1289	.1220	.1065	.2187	.1730	.0993
1975	-	-	.0454	.0442	.0219	.1266	.1258	.1487	.1840	.1933	.1101
1976	-	.0109	.0681	.0389	.0232	.1302	.1412	.1464	.2049	.1534	.0828
1977	-	-	.0674	.0328	.0353	.0898	.0906	.2806	.2908	.0907	.0220

1958-1972 data are from registration summations.

1974 data are based on some production figures and some manufacturer estimates.

1975-1977 data are based on manufacturers' sales estimates.

TABLE 2-8. CITY/HIGHWAY COMBINED FUEL ECONOMY BY MODEL YEAR AND WEIGHT CLASS (Ref. 2-5)

Model Year	2000	2250	2500	2750	3000	3500	4000	4500	5000	5500
'57-'67 avg.	27.8	26.3	23.1	20.7	18.5	16.3	15.2	14.0	13.1	12.7
1968	23.3	24.7	22.3	23.8	18.8	16.0	14.5	13.6	11.2	10.7
1969	26.9	24.5	22.7	20.3	18.6	16.0	14.4	13.6	11.0	13.0
1970	28.2	23.3	21.1	22.3	19.2	16.0	14.5	13.1	12.2	11.9
1971	27.3	25.8	23.3	22.1	17.8	14.7	14.1	12.9	11.6	13.1
1972	27.7	26.4	23.6	24.1	17.4	16.0	13.4	12.9	11.6	11.2
1973	28.7	26.4	23.8	21.1	18.8	16.8	13.0	12.2	11.2	10.4
1974	31.2	25.7	23.6	22.5	20.6	18.3	13.5	11.8	10.8	9.9
1975	31.3	28.1	24.5	22.4	21.6	17.6	15.5	14.6	12.8	12.0
1976	32.1	29.1	25.9	24.4	23.4	19.1	17.4	15.6	14.6	13.3
1977	-	31.8	28.7	26.4	24.4	20.1	18.2	16.6	14.3	12.7

In addition to the model year aggregate quantities described above, a breakdown by market class for each model year was obtained, using the following procedure. Market class was expressed in terms of passenger capacity, using the classifications employed and guidelines suggested in Ref. 2-3; that is, 4-, 5-, and 6-passenger vehicle classes were delineated and were classified by inertia weight range as follows:

4-passenger:	1750 - 3000
5-passenger:	3500 - 4000
6-passenger:	4500 - 5500

The sales-weighted fuel economy for each market class was obtained by aggregating the data of Tables 2-7 and 2-8 in the above inertia weight groups. The results of this computation are displayed in Figure 2-4.

In addition to the historical data, Figure 2-4 also displays projected trends in fuel economy by market class for model years 1978 through 1982. These trends were constructed largely from projections made in the 300-day study (Ref. 2-3) for Scenario No. 6. Scenario 6 assumes that the best current lightweight structure and the best existing 1975 spark ignition engine technology is phased into the new car fleet starting in 1975 and a weight-conscious diesel vehicle is introduced into the new car fleet starting in 1980. The market class curves shown in Figure 2-4 differ from the projections made for Scenario 6 in Reference 2-3 only in that the curves were adjusted upward so as to intersect actual data now available for the 1977 model year (Ref. 2-5). The curve for the aggregate new car fleet shown in the figure was constructed from the market class trends, assuming a 25, 25, and 50% mix for the 4-, 5-, and 6-passenger classes, respectively, based on the approach adopted in Ref. 2-3. This fleet curve was the basis for the new car fuel economy values shown for the 1977 through 1982 model years in Table 2-4.

### 2.2.3.2 Light Duty Trucks

The light duty truck fleet was treated in two parts: Class I vehicles, i. e., those  $\leq 6000$  lb GVW; and Class II vehicles, those from 6001 to 10,000 lb GVW.

The data base on which the Class I model year fuel economy values were constructed was obtained from Ref. 2-5, which quotes sales-weighted composite fuel economy values for the 1976 and 1977 Class I model years.



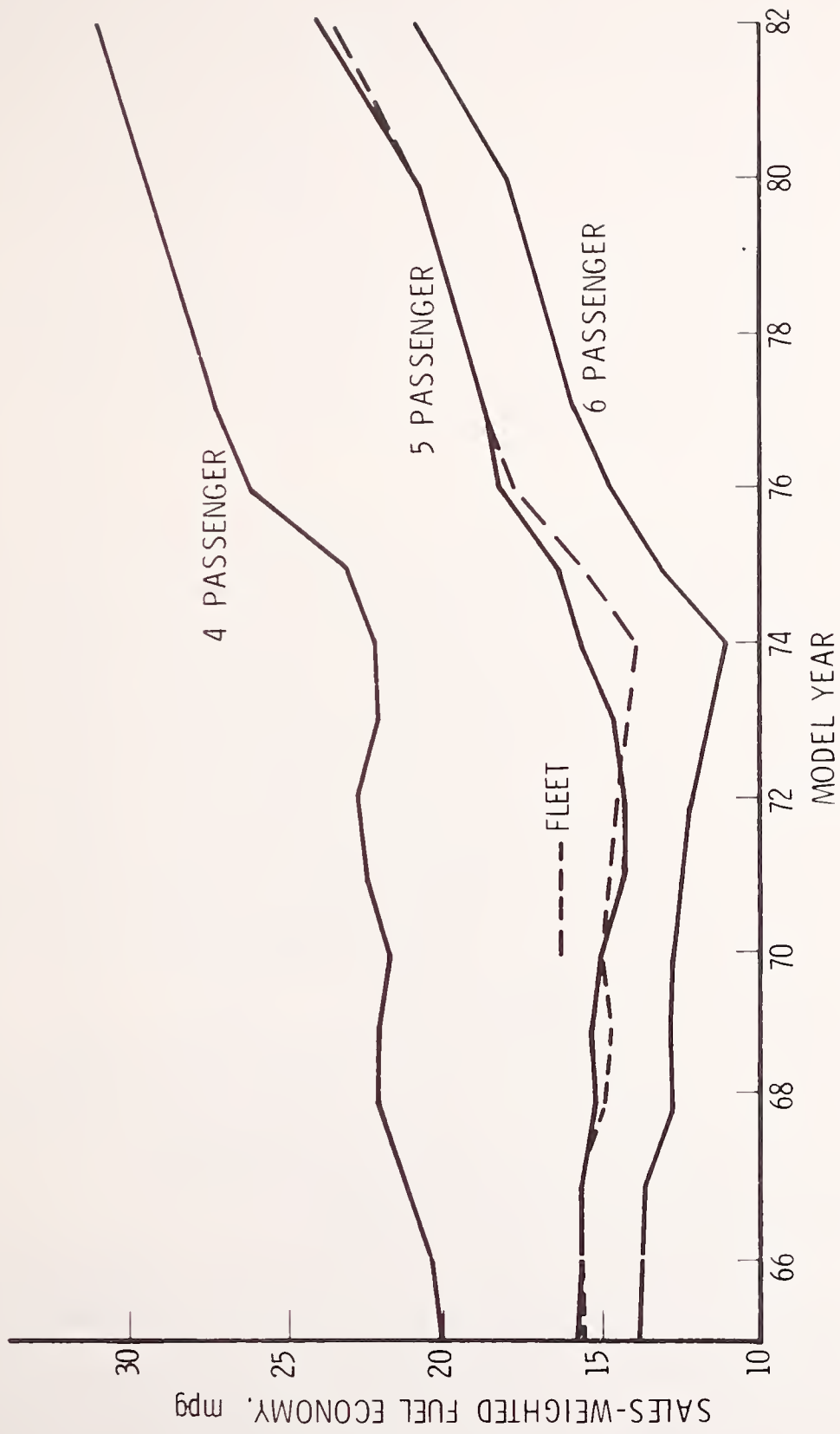

FIGURE 2-4. 50-STATE COMPOSITE FUEL ECONOMY TRENDS FOR PASSENGER CARS

The present study adopted these values for use in the applicable years. Lacking explicit data for other model years, it was assumed that the fuel economy would vary in fixed relation to passenger car fuel economy trends. For vehicles older than 1976, a constant factor (0.98), given by the ratio of the 1976 Class I and 1976 passenger car fuel economies, was employed to generate the Class I numbers. For vehicle model years beyond 1977, the constant factor used was the ratio of the 1977 Class I fuel economy and the 1977 passenger car fuel economy (1.02). The values so generated are entered under Model Yr MPG in Tables 2-2 and 2-5.

The available data on Class II truck fuel economy is meager. Based on evidence given in Refs. 2-3, 2-6, and 2-7, a value of 10 mpg was adopted as a constant for all model years of interest. This constant value appears under Model Yr MPG in Tables 2-3 and 2-6.

#### 2.2.3.3 Diesels

Aside from their contribution to the fleet fuel consumption characteristics, the population of diesels in the fleet had to be established in order to properly account for the applicability of various techniques under consideration which are engine-type-peculiar. To this end, historical sales data were used to determine the diesel fraction of cars and trucks for the 1976 fleet, while the dieselization scheme in Scenario 6 of the 300-day study (Ref. 2-3) was used, with slight modification, as a basis for projecting future model year diesels in the 1982 passenger car fleet. Class I light duty trucks were assumed to be dieselized at about one-half the installation rate projected for passenger cars. No Class II diesels were considered.

#### 2.2.4 Summary of Fleet Characteristics

Total or average fleet values for the several categories of vehicles discussed above are summarized in Table 2-9 for convenient reference.

### 2.3 METHODOLOGY FOR DETERMINING NATIONAL FUEL SAVINGS AND COST FACTORS

The general procedure used in establishing the national fuel savings and cost factors associated with a given approach to reducing in-use vehicle fuel consumption was as follows. As a first step, the available data on the fuel economy benefits of the approach were reviewed and a best judgment was made as to (a) the magnitude of the vehicle fuel economy benefit

TABLE 2-9. SUMMARY OF FLEET CHARACTERISTICS

	1976			1982			
	Passenger Cars	Light Duty Trucks		Passenger Cars	Light Duty Trucks		Fleet
		≤6000 GVW	6-10,000 GVW		≤6000 GVW	6-10,000 GVW	
In Operation, millions (diesels)	99.7 (0.08)	15.1 (0)	6.7 (0)	109.3 (4.3)	20.2 (0.4)	11.6 (0)	141.1 (4.7)
Vehicles Miles Traveled, billions	1107.7	159.0	80.7	1224.8	212.2	131.7	1568.7
Fuel Consumed, gal, billions	73.4	11.0	8.1	65.2	11.4	13.2	89.8
Average Miles/Yr	11,100	10,600	12,100	11,200	10,500	11,300	11,100
Average MPG	15.1	14.4	10.0	18.8	18.6	10.0	17.5

(%ΔFE), (b) the possible variation of benefit with vehicle size or market class, and (c) the elements and associated fraction of the fleet to which the approach could be applied (%AP). Then the following relations were used to calculate the national fuel savings and cost factors.

$$\% \Delta FC = \left( \frac{1}{1 + \frac{\% \Delta FE}{100}} - 1 \right) 100$$

$$FFC = \sum_{ijk} \frac{N_{ijk} S_{ik} (MPY)_{ik}}{(SWMPG)_{ijk}}$$

$$FFS = \sum_{ijk} \frac{N_{ijk} S_{ik} (MPY)_{ik}}{(SWMPG)_{ijk}} \frac{(\%AP)_{ijk}}{100} \frac{(\% \Delta FC)_{ijk}}{100}$$

$$C = \sum_{ijk} N_{ijk} S_{ik} \frac{(\%AP)_{ijk}}{100} c_{ijk}$$

where

%ΔFC	=	percent change in vehicle fuel consumption
FFC	=	fleet fuel consumed, gal
FFS	=	fleet fuel saved, gal
C	=	national cost, \$
c	=	unit cost, \$
N	=	vehicle sales
S	=	surviving fraction
MPY	=	miles per year
SWMPG	=	sales weighted miles-per-gallon (composite)
i	=	model year
j	=	market class
k	=	duty class (passenger car or truck)

For a given fuel savings approach, %ΔFC was assumed to be invariant with vehicle model year. The surviving fraction, S, and the miles per year travelled, MPY, were taken to be the same for all market classes.



2.4 REFERENCES

- 2-1. Automotive News Almanac, issues for years 1959 through 1976.
- 2-2. Data and Analysis for 1981-1984 Passenger Automobile Fuel Economy Standards, Summary Report, U.S. Department of Transportation, National Highway Traffic Safety Administration (28 February 1977).
- 2-3. The Report by the Federal Task Force on Motor Vehicle Goals Beyond 1980, Volume 2 Task Force Report (2 September 1976).
- 2-4. Compilation of Air Pollutant Emission Factors, 2nd ed., AP-42, U.S. Environmental Protection Agency (April 1973).
- 2-5. J. D. Murrell, et al., "Light Duty Automotive Fuel Economy-Trends through 1977," SAE Paper No. 760795.
- 2-6. Motor Vehicle Facts & Figures '76, Motor Vehicle Manufacturers Association.
- 2-7. Medium Duty Vehicle Emission Control Cost Effectiveness Comparisons, Report No. ATR-74(7327)-1, The Aerospace Corporation, El Segundo, Calif. (January 1974).



### 3. CHARACTERIZATION OF TECHNIQUES

This portion of the report provides a brief review, assessment, and characterization of the fuel economy improvement potential, unit cost, and other fundamental features/aspects of the fuel savings techniques selected for examination in this study. Each system is discussed in the following format:

Introduction and Background .  
Fuel Economy Effects  
Safety Considerations  
Availability for Implementation  
Cost Factors

A characterization summary for the spectrum of techniques examined is provided in Subsection 3.4.

#### 3.1 VEHICLE MODIFICATIONS

Fuel savings techniques included in this category are aftermarket devices (e.g., retrofit ignition systems, carburetors), improved lubricants, and improved maintenance.

##### 3.1.1 Spark Augmentation Devices

###### 3.1.1.1 Introduction and Background

This section discusses several devices that are designed to enhance one or more functional characteristics of the ignition sparking system, including spark energy, spark duration, and the stability of the spark timing setting. The devices treated are breakerless electronic ignition, high energy ignition, and multiple or sustained discharge ignition systems. The latter two systems are typically breakerless also.

A breakerless electronic ignition system is one in which the conventional mechanical breaker point system is replaced by one of several alternative techniques of sensing distributor angular position, such as a magnetic pulse sensor, a light activated pickup, or a metal proximity detector. The main advantages of the breakerless systems are that they eliminate the gradual drift in spark timing caused by rubbing block wear and the burning of the ignition points, which can result in a weaker spark and

possible misfire. Beginning in 1975, all U. S. automobiles were factory equipped with breakerless-type ignition systems.

High energy ignition systems provide a higher voltage to the spark electrode (typically 35 kV or more), thereby permitting firing under some conditions of plug fouling or enlarged (eroded) spark plug gap. The Delco-Remy High Energy Ignition (HEI) system, which is now standard equipment on all domestic GM cars and light duty trucks, is one such system. Multiple discharge ignition systems provide a high energy spark which is repeated a number of times for each cylinder ignition episode. The potential advantage of such systems is that they enhance the probability of achieving satisfactory ignition under conditions where a single spark discharge may result in misfire.

In general, these devices offer benefits in several areas of vehicle operation, including emission control, starting under adverse conditions, and vehicle response and driveability. There is considerable evidence that these systems do not offer any fuel economy advantage over a conventional system in a well-tuned engine operating at normal conditions. However, they are treated here with particular regard to their possible value when utilized under typical in-use vehicle state-of-maintenance conditions.

### 3.1.1.2 Fuel Economy Effects

#### 3.1.1.2.1 Data Base

The available data base on fuel economy effects for spark augmentation systems is summarized in Table 3-1, with additional details given in Figure 3-1. The following paragraphs highlight the significant findings.

In general, none of the data provide direct experimental information on the magnitude of the device benefits as applied to the in-use fleet, and therefore these benefits must be deduced from the indirect evidence available. In the case of electronic ignition, The Aerospace Corporation studies (Refs. 3-1, 3-2) found no significant fuel economy advantage for electronic ignition relative to a well-tuned conventional ignition system. However, the issue at hand concerns the possible benefits of the device as applied to the average in-use vehicle which is in a condition characterized by a less-than-perfect state of tune. For this reason, the information provided by Chrysler Corporation (Ref. 3-3) and by Champion Spark Plug

TABLE 3-1. DATA BASE FOR SPARK AUGMENTATION SYSTEMS

System/Device	Data Source	Description	Synopsis of Findings
Electronic Ignition	The Aerospace Corporation, "Highway Vehicle Retrofit Evaluation," Phase I, Ref. 3-1.	1975 state-of-the-art assessment of passenger car retrofit devices, including ignition systems.	<p>{ No significant fuel economy advantage relative to a well-tuned conventional ignition system.</p>
	The Aerospace Corporation, "Assessment of the Effects of Short Term Drive Train Options on the Automobile and Related Industries," Ref. 3-2.	Literature and industry survey on alternative approaches to meeting Energy Policy and Conservation Act fuel economy standards for 1978-1985 new car fleets.	
	Chrysler Corporation, Champion Ignition and Engine Performance Conference, Ref. 3-3.	Data on rubbing block wear effects on spark retard trends with time.	Wear of 0.1 mm, yielding spark retard of 5°, is common. Initial wear has maximum effect on retard. No statistical information on average retard conditions for in-use fleet provided.
	Champion Spark Plug Co., Mobile Proving Ground Project, Ref. 3-4.	Diagnostic tests of 5666 vehicles (1968-1976 model year) in 27 cities, including measurement of spark timing, dwell angle. 90% of cars had mechanical breaker point ignition systems.	Plot of in-use vehicle timing conditions shown in Fig. 3-1 indicates distribution is approximately centered about manufacturer's specifications, slightly skewed toward spark advance. No difference in average state of timing between standard and electronic ignition-equipped cars. Dwell condition also uniformly distributed about manufacturer's specifications, with 53% of cars at specified dwell conditions.
	EPA, "Effect of Ignition Timing Modifications on Emissions and Fuel Economy," Ref. 3-5.	Dynamometer fuel economy tests of ten 1975 model year cars with stock timing altered by -5° to +5°.	Composite cycle fuel economy decreases about 1% for each degree of retard over range tested.
High Energy Ignition	No direct proof of benefit available. Some indication of potential value in maintaining spark quality may be deduced from Champion Spark Plug Company, "Tune-Up: Its Effect on Fuel Economy, Emissions and Performance," Ref. 3-6.	Dynamometer tests (Champion duty cycle) of 216 in-use vehicles selected from larger test sample on basis of maximum need for maintenance. Vehicles tested as received, and after new plugs were installed.	3.4% average increase in fuel economy due to spark plug change alone. About 1/3 of total cars tested (5600) needed new spark plugs.



TABLE 3-1. DATA BASE FOR SPARK AUGMENTATION SYSTEMS  
(Continued)

System/Device	Data Source	Description	Synopsis of Findings
Multiple Discharge Systems	The Aerospace Corporation, "Highway Vehicle Retrofit Evaluation, Phase II," Ref. 3-7.	Comparative engine dynamometer tests of capacitive (MSD-2) and inductive (MRI) multiple discharge systems in 1973 Chev. 350 CID engine under steady-state conditions. A/F ratio varied to lean limit at MBT timing.	No difference in engine specific fuel consumption in A/F regime where conventional system was operable.
	Avis Car Rental Co., El Paso, Refs. 3-8, 3-9.	Chassis dynamometer tests of MSD-2 vs conventional ignition in 1973 350 CID Chev. Impala over EPA urban and highway cycles and cruise at 35 and 55 mph.	MSD-2 showed no change or slightly lower fuel economy compared to conventional ignition. HC and CO emissions for MSD-2 were significantly lower.
	U.S. Forest Service, San Dimas, Ca., Ref. 3-10.	Road evaluation of rental cars with MSD-2. Tune-up at initial installation with spark timing advanced 10-12° and spark plug gap increased to 0.050 in. from 0.035 in.	Average fuel economy increase of 18% claimed.
		10,000 mi road evaluation of MSD-2 in 75% city/suburban and 25% highway driving (one car only).	No significant difference in fuel economy found.

TIMING DIFFERENCES BETWEEN STANDARD  
AND ELECTRONIC IGNITION EQUIPPED CARS

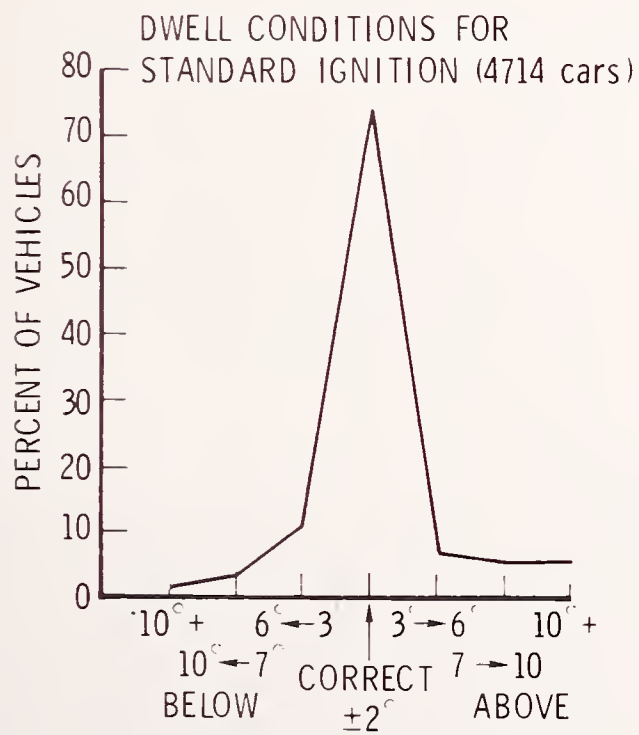
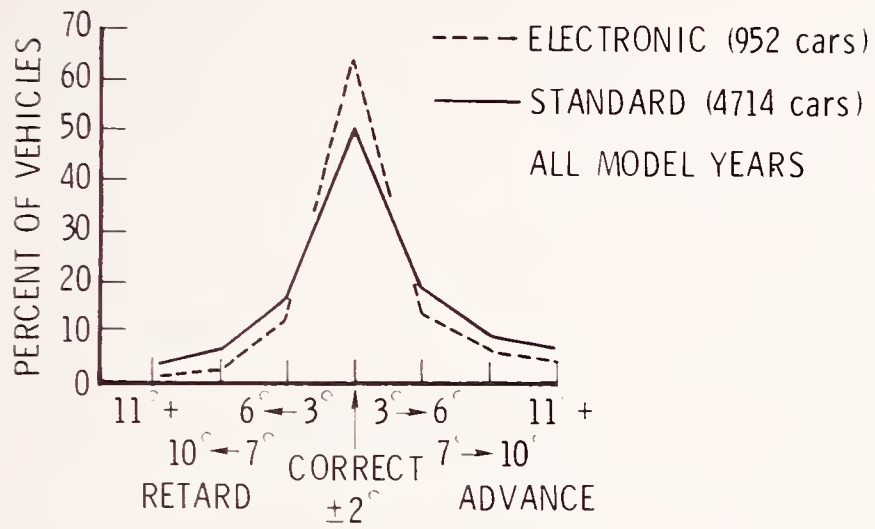

FIGURE 3-1. STATE OF TIMING AND DWELL  
CONDITIONS IN VEHICLE SAMPLE  
(Ref. 3-3)

(Ref. 3-4) relating to the state of tune for in-use vehicles with mechanical breaker point ignition systems is of more direct interest. The Chrysler information states that rubbing block wear to the extent of producing 5 degrees of timing retard is "common", but provides no statistical evidence that would indicate that a retard condition is representative for the in-use fleet. The Champion Spark Plug data show that both timing and dwell conditions in a sample of 5666 in-use cars were uniformly distributed about the manufacturer's specifications. The effect of timing retard on fuel economy can be significant, as demonstrated by the EPA tests of Ref. 3-5, indicating about a 1% decrease in fuel economy for each degree of retard.

There are no available data on the potential of high energy ignition systems for improving fuel economy. An upper limit on the influence that spark quality might have on fuel economy might be deduced from the effects of replacing spark plugs as reported by Champion Spark Plug in Ref. 3-6, showing a gain of 3.4%.

With regard to multiple spark discharge devices, the data base includes both steady-state engine dynamometer tests and chassis dynamometer tests conducted by The Aerospace Corporation (reported in Ref. 3-7), both test series showing no benefits with reference to a well-tuned vehicle baseline. The available data on application to non-tuned vehicles as represented by road test results are conflicting; Avis Car Rental, El Paso claimed an average fuel economy increase of 18% (reported in Refs. 3-8, 3-9), while a 10,000 mile road evaluation by the U. S. Forest Service (Ref. 3-10) showed no improvement in fuel economy.

#### 3.1.1.2.2 Assessment of Benefits

The key questions relating to the benefit of electronic ignition concern the extent of spark retard, dwell time change, and other out-of-tune effects which occur as a result of wear in ignition systems utilizing mechanical breaker points and condensers. There appears to be a degree of discrepancy in the quantitative implications of the Chrysler and Champion data on spark retard effects. However, the Champion data undeniably speaks with more authority since it directly addresses the state of timing conditions in a substantial sample of cars taken from the in-use fleet. Assuming that the fuel economy effects of both timing and dwell are linear, the Champion data indicate that no fuel economy benefits related to out-of-time or dwell

conditions would be derived from the use of electronic ignition, since the timing and dwell characteristics for the fleet sample are uniformly distributed about the manufacturer's specifications (see Fig. 3-1). Not treated in either of these data sources, however, are the conditions and effects of ignition point burning, condenser deterioration, and other component degradations in mechanical systems, which may also have a bearing on the fuel economy advantage assignable to electronic ignition. Chrysler states that ignition point deterioration is an item of major importance as it relates to misfire effects on fuel consumption, power, and emissions (Ref. 3-3). However, no quantitative information related to fuel economy is provided.

With regard to high energy ignition systems, some beneficial effect might accrue due to more reliable or consistent firing of the spark in ignition systems needing maintenance, but there are no data that would permit a reasonable estimation of the magnitude of these benefits. The Table 3-1 entry showing a 3.4% increase in fuel economy relates to the effects reported in Ref. 3-6 of replacing spark plugs in a sample of 216 in-use vehicles badly in need of maintenance. However, this number is neither representative of effects to be expected in the average fleet vehicle nor directly equatable to the potential value of high energy ignition.

The multiple spark discharge device, also a high energy system, might be expected to offer the same benefits mentioned under high energy ignition, with perhaps some incremental advantage due to the increased probability that the multiple discharge feature would produce ignition under marginal mixture conditions. However, the data base shown in Table 3-1 does not provide a quantitative basis for postulating a fuel economy increase for this device. In this regard, it must be noted that the reported high results obtained in the field evaluation of the MSD-2 conducted by Avis Car Rental (reported in Refs. 3-8 and 3-9) must be discounted since the magnitude of the gains could be attributed to the spark advance (10 to 12 degrees) and tune-up adjustments made.

As noted earlier, the fuel economy advantages associated with these devices are typically assigned to their value in maintaining improved and more efficient performance over the interval between tune-ups or in extending the interval of time before tune-up is required. It is postulated that most people will, unless a new car warranty is operative, tend to drive their car until its behavior deteriorates below some threshold level of



acceptable performance, at which time they will seek and obtain the necessary maintenance required to restore vehicle performance to its previous state. If the deterioration in vehicle performance and its associated fuel economy losses are roughly linear with mileage (and the available evidence does not refute this), then it can be stated that, under the condition postulated, no benefit in fuel economy will be realized with advanced ignition systems. For, although the period of time between tune-ups is extended, the vehicle will operate between the same upper and lower levels of performance and presumably, therefore, at the same average level of fuel economy over its mileage lifetime.

However, considering that some small fraction of the driving population would continue to obtain maintenance at a fixed mileage interval rather than at a fixed performance decrement, a small value of fuel economy improvement, say 1/4%, will be assigned to the use of such systems in the vehicle fleet. No distinction in benefit will be made among any of these advanced systems or among the vehicle classes to which they apply as retrofit devices.

#### 3. 1. 1. 3     Safety Considerations

No adverse safety effects are identified for spark augmentation systems.

#### 3. 1. 1. 4     Availability for Implementation

Electronic breakerless ignition systems were installed on some domestic new car production (by Chrysler) in 1972, with increasing extent of OEM implementation up to the 1975 model year when this type of ignition system was adopted for all domestic new car production. Aftermarket electronic ignition kits are marketed by a large number of manufacturers, including Fairchild, Borg-Warner, Motorola, and Prestolite. Total aftermarket sales figures of all these suppliers are not available, but it is clear that major manufacturers such as those listed above have adequate production capability to fully meet the implementation requirements of the in-use fleet.

In addition to being breakerless, the ignition systems in all domestic GM production cars and light duty trucks starting with the 1976 model year incorporate a high energy inductive discharge feature. The manufacturer (Delco-Remy division of GM) supplies only GM needs; there



is no aftermarket sales of this specific system. However, high performance ignition coils which provide a secondary voltage rating of up to 40 kV are available through several suppliers and are marketed through large merchandisers such as J. C. Whitney of Chicago. These devices do not incorporate all the advantageous features of the Delco-Remy OEM system, however. Production levels for these high performance coils are not known precisely but are believed to be rather low.

Autotronic Controls Corporation of El Paso, Texas, manufactures a line of high energy, multiple spark ignition systems (as well as other induction systems and engine performance-related devices) for the aftermarket. The MSD-2 system mentioned under fuel economy effects has been replaced by the MSD-6, an improved capacitive-discharge type system of similar design. Autotronic now markets, in addition, a lower priced inductive discharge system with a lower spark repetition rate. This system, the MSD-5, can be used with either mechanical breaker points or electronic ignition. An MSD-7 capacitive discharge system intended for high performance and drag strip use is also available.

The manufacturer states that approximately 60,000 MSD-2 units were sold. Production of the replacement MSD-5 system is presently running at about 7000 units per month. This production rate could be increased many times, within existing capacity, according to the manufacturer (Ref. 3-9).

#### 3.1.1.5 Cost Factors

Complete electronic ignition systems cost about \$120 to \$150 in the aftermarket. Simpler conversion kits, which do not replace all components of the ignition system but which do provide the breakerless feature, are priced at about \$50 to \$75. These costs do not include installation. This report will assume an average conversion kit charge of \$60 plus \$15 for installation, for an installed cost of \$75.

Mail order prices of high performance coils are about \$10, and installation charge should not exceed about \$5. As mentioned earlier, however, this unit does not provide the full benefits of the GM HEI systems. There do not appear to be systems available through the aftermarket which are essentially the same as the GM system. An aftermarket unit comparable

to the GM system is estimated to have an installed cost similar to the after-market multiple discharge system discussed in the following paragraphs; i. e., about \$60.

The retail price of the MSD-5 inductive multiple discharge system is reported by the manufacturer to be \$50, not installed. The manufacturer states that typically, the MSD-5 can be installed in 30 minutes and that installation instruction and equipment accompany each unit. For wide-scale implementation purposes, an installation cost of \$10 for the MSD-5 is assumed, for an installed cost of \$60.

For any of the systems discussed above, the cost benefit as perceived by many motorists may be marginal. Applied to a vehicle that averages 15 mpg and is driven 10,000 mpy, the savings in fuel cost (at 70¢/gal) at the assumed 1/4% increase in fuel economy is only \$1. More significant cost advantages may accrue due to the decreased need for tune-up. Assuming that the device will permit the owner to omit one tune-up at \$42 (Tuneup Masters) in each of the first 2 years of device operation, the dollar savings in 2 years would be \$84, or slightly more than the installed cost of the most expensive system. There may be other, intangible benefits, such as more reliable starting, which may add to the perceived value of the device.

### 3.1.2 Improved Carburetors

#### 3.1.2.1 Introduction and Background

The recent Highway Vehicle Retrofit Evaluation study performed by The Aerospace Corporation for DOT/TSC (Ref. 3-1) reviewed in detail a number of carburetor concepts which have been proposed for improved fuel economy as retrofit devices. Of some 16 different concepts examined, only two advanced basic carburetor concepts were identified as having potential merit: sonic flow carburetion and ultrasonic carburetion. In Phase II of the Aerospace study (Ref. 3-7) an experimental prototype device incorporating the ultrasonic principle was tested with negative results. The sonic concept was not available for testing. The present study re-examines these two carburetor concepts from the vantage point of the current state of knowledge concerning their performance effects, fuel economy benefits, and availability as hardware for fleet implementation.

The Dresserator is the best known and most extensively developed example of a sonic carburetor. This device is a development of Environmental Technology, Santa Ana, California, a division of Dresser Industries, Inc., Dallas, Texas. It is a variable geometry venturi atomizer which is linked with a fuel metering apparatus, permitting control of air-fuel ratio (A/F) to some nominal level which is typically a lean A/F of about 18 or 19. The distinguishing feature is that the venturi is a mechanically actuated variable area device which is designed to maintain sonic flow of air and fuel through the throat over most of the operating range of the engine. Downstream of the throat, a region of supersonic flow exists which terminates in a shock wave where flow becomes subsonic. It is claimed that these features produce a very homogeneous A/F mixture which behaves like a colloidal suspension, producing more uniform cylinder-to-cylinder distribution. The sonic flow aspect is also claimed to permit very close control of A/F ratio as a result of the choked flow acting as a mass flow indicator and control device.

The ultrasonic atomizing technique has been privately developed by at least two sources. The basic feature of both versions is a surface which vibrates at ultrasonic frequencies (typically 20 to 40 kHz) against which the fuel is impinged. The high frequency vibrations are intended to disperse the fuel into a fine mist, which should promote good mixing with the air stream and vaporization of the small fuel droplets. These devices also incorporate some form of computer-controlled fuel metering as well as other features which are described below for the electrosonic device.

The Electrosonic Fuel Induction System, of Autotronic Controls Corp., El Paso, Texas, incorporates four principal components: an air flow transducer, a fuel metering pump, an ultrasonic atomizing and fuel mixing chamber, and a fuel flow computer-controller. The atomizing and mixing chamber replaces the conventional carburetor. Engine power is modulated by means of a conventional accelerator-pedal linkage which operates an air-control butterfly valve or throttle at the intake of the mixing chamber. The inducted air is measured volumetrically by a turbine flowmeter. This, together with sensed pressure and temperature, generates computer input signals which establish the mass flow of the intake air. Fuel flow is computer-derived and controlled in proper relation to the measured air flow so as to maintain a preset (nominal) air/fuel mixture. Metered



fuel is delivered to the atomizing and mixing chamber of a positive displacement pump, which also provides a tachometer output to the computer-controller for closed-loop pump rpm control. The system provides for mixture enrichment under warm-up, idle, and acceleration conditions as sensed by various engine signals.

### 3.1.2.2 Fuel Economy Effects

#### 3.1.2.2.1 Data Base

The Dresserator system has been extensively developed by Dresser Industries and by the two principal licensees, Ford Motor Co. and Holley Carburetor Division of Colt Industries. Work by the latter two companies is proprietary and no fuel economy results have been divulged. Dresser Industries has released information concerning a limited amount of testing of their own, and in addition has submitted two Dresserator-equipped cars to EPA for testing. These tests were performed on model year 1973 vehicles retrofitted with the Dresserator; the results were compared to EPA certification and urban fuel economy data for the corresponding stock vehicle. The percentage improvement was therefore not based on the specific vehicle in which the Dresserator was installed. The test results show significant reduction in all three pollutants versus the certification values for the respective vehicles. A sizeable fuel economy increase of 14% was indicated for a Dresser-equipped Capri tested at an inertia weight of 2750 lb and compared with the certification value for that type of car. There was a 3% change in fuel economy for a Monte Carlo tested at an inertia weight of 4500 lb.

Similar results were obtained in tests performed by Dresser. It must be noted that the test vehicles incorporated other modifications which could impact fuel economy. The Monte Carlo had an Edelbrock single plane manifold, a 1970 distributor with idle retard, no vacuum advance, no EGR and no air pump. Other items were standard equipment. The center divider of the Capri manifold was removed in the plenum area. The stock cam was exchanged for one with slightly less overlap, reducing internal EGR. It had no EGR or vacuum advance. Enlarged and lagged (insulated) exhaust manifolds were installed. Other items were standard equipment.

Under contract to EPA, Holley Carburetor Division of Colt Industries, Warren, Michigan, recently completed a comparative evaluation of a California certified 1975 Dodge Dart in stock condition, and equipped with a Dresser-type carburetor (Ref. 3-11). Approximately 20 tests of the Dresserator, covering a number of modifications to various induction system parameters, were conducted in this program. The results showed no significant improvement in fuel economy or emissions.

General Dynamics Corporation, working with Autronic Controls Corporation, installed an Electrosonic Fuel Induction System in a 1976 Ford Pinto MPG with a four-cylinder 140 CID engine and four-speed manual transmission; this vehicle was tested by EPA (Ref. 3-12). As manufactured, the Pinto was equipped with oxidation catalyst, air pump, and EGR, but these control devices were all removed or deactivated in the vehicle tested by EPA. Baseline data on the unmodified vehicle are not available. The EPA test report compares the as-measured fuel economy with that of the corresponding certification vehicle. On this basis, the Pinto with Electrosonic system showed a 2% increase in composite cycle fuel economy and a large reduction in FTP  $\text{NO}_x$  (1.7 gram/mile vs 2.6 for the certification vehicle).

Another ultrasonic fuel atomization device is the Ultrasonic Fuel Induction System, developed by A. K. Thatcher of Merrit Island, Florida, and E. McCarter of Orlando, Florida. This system was tested in Phase II of The Aerospace Corporation's Highway Vehicle Retrofit Evaluation (Ref. 3-7). The system was installed by the device developer on a 1972 Plymouth Duster. The test plan consisted of two replicate test series for each of three configurations. The first configuration consisted of the fully operational ultrasonic system. In the second, the ultrasonic vibrator was disconnected to distinguish between the effects of air-fuel ratio control and fuel atomization for different operating conditions, such as the cold and hot start portions of the Federal Test Procedure (FTP). The third test configuration comprised complete deactivation of the fuel induction system and replacement with a new stock carburetor. In this configuration, the carburetor was adjusted according to the vehicle manufacturer's recommended procedure, with no other changes to any vehicle or engine parameter. Each configuration was tested twice by the 1975 FTP, the EPA Highway Fuel Economy Test (HWFET), and two steady-state speeds.



With the ultrasonic device fully operational, the vehicle fuel economy was approximately 3% poorer than the stock vehicle on the FTP, and approximately 2% better on the Highway Driving Cycle. It had a 6% improvement at 35 mph, and 3% improvement at 55 mph. With the ultrasound disconnected, the results were not greatly different except at the 55 mph conditions. The emission data with the ultrasonic device operational showed significant reductions in HC and CO, but an increase in NO<sub>x</sub>. These results are consistent with a somewhat leaner, more uniform fuel-air mixture promoting a higher flame temperature, but without a sufficient increase in air-fuel ratio to bring about a reduction in NO<sub>x</sub>. All emissions were increased when the ultrasound feature alone was deactivated.

#### 3.1.2.2.2 Assessment of Benefits

Much of the available data on the Dresserator suggest that a substantial fuel economy potential exists, but the interpretation of these data is frequently obscured by (a) the unquantified effect of other changes which were made to the engine/induction system as part of the Dresserator installation, and (b) the absence of a vehicle-specific baseline. The recent tests by Holley Carburetor Division (Ref. 3-11) are free of these deficiencies and showed no significant fuel economy advantage for the Dresserator system. It must be noted that EPA has decided to conduct further tests of a similar nature on the Dresserator vehicle tested by Holley, and this program is now under way at the EPA facilities in Ann Arbor (Ref. 3-13). The Holley results, nevertheless, must be given considerable weight.

The Electrosonic system installed on the Pinto tested by EPA indicates a small fuel economy gain of about 2%, relative to the corresponding stock certification vehicle (not the specific car tested with the device). The Ultrasonic Fuel Induction System, compared on a vehicle-specific basis, showed a small gain at the steady-state speeds at which it was tested, but the composite fuel economy showed no advantage.

The small number of tests and vehicles does not permit a statistical evaluation to be made of the efficacy of these devices. Nevertheless, there are sufficient data to justify assigning a small fuel economy benefit to their use as retrofit systems. A value of 1% will be assumed. No distinction in benefit will be made between the sonic flow and ultrasonic approaches, and the 1% will be assumed to apply to all classes of light duty vehicles.

### 3.1.2.3 Safety Considerations

No adverse safety effects are identified for improved carburetor devices.

### 3.1.2.4 Availability for Implementation

The primary development thrust for all these systems has been toward OEM installation rather than the aftermarket. Ford Motor Company may introduce a sonic flow carburetor in the 1979 model year, with Holley Carburetor following a little later in developing a capacity to supply sonic devices to other automobile manufacturers (Ref. 3-2). Aftermarket applications remain a possibility if this implementation is successful, as Holley Carburetor is a major manufacturer of aftermarket and replacement carburetors.

Autotronic Controls Corporation, developer of the Electrosonic system, is a major aftermarket supplier in the areas of ignition system, fuel induction systems, and performance-oriented instrumentation. Present production is restricted to research and development uses.

### 3.1.2.5 Cost Factors

None of the devices treated in this section have been offered for sale through the aftermarket.

Cost aspects of the Dresserator are considered proprietary by Dresser Industries and its licensees and no cost data have been released. Reference 3-2 estimated the new-car incremental cost to the consumer of a sonic flow carburetor to be \$30. On a replacement basis, the incremental cost added to the aftermarket price of a conventional carburetor yields an estimated cost for the sonic carburetor of about \$150 installed.

Autotronic Controls Corporation stated that no retail price has yet been established for the Electrosonic Fuel Induction System, but indicated that \$200 may be an upper limit. A product brochure indicates an OEM cost for this system of \$70. Using this as a base, it is estimated that the aftermarket cost of this device is \$180 installed. A similar cost will be assigned to the Ultrasonic system.

### 3.1.3 Variable Accessory Operation

#### 3.1.3.1 Introduction and Background

A certain amount of power generated in the automobile engine is required to drive a wide variety of accessories which are coupled to the engine through flexible v-belts attached to pulleys on the front end of the engine crankshaft. These include engine-related accessories, such as water pump, fan, alternator, and air injection pump, and vehicle-related accessories, such as air conditioning and power steering. All accessories combined can account for a significant portion of the total vehicle power requirement at normal operating speeds.

This section will address two approaches by which the power requirements of the accessories could be reduced, thereby resulting in a potential fuel economy gain. One approach will deal with the engine cooling fan, the other with an accessory drive system that will reduce the total accessory load.

The primary function of the cooling fan is to draw cool air in through the radiator and blow it back over the engine during periods when there is insufficient ram air supplied by the forward motion of the vehicle. At low speeds, the fan is needed to provide adequate cooling. At speeds above approximately 50 mph, there is sufficient ram pressure to provide the necessary air coolant flow across the radiator, and the fan is actually not needed. Thus, the power used by the fan above approximately 2000 rpm represents excessive power consumption and constitutes an area where improvement could yield benefits in increased vehicle fuel economy.

One alternative retrofit scheme for reducing fan power at high engine speeds involves the use of blades which have variable pitch control. These fan blades will decamber with increasing speed, thus requiring less power.

Another approach to the reduction in fan horsepower is the use of a viscous clutch fan drive. The viscous clutch provides maximum fan output at low speeds and reduces power consumption (and noise) at higher engine speeds by lowering the fan-to-engine speed ratio. The viscous clutch fan drive usually has a temperature-sensitive control which senses the temperature of the cooling system and varies the fan-to-engine



speed ratio according to actual cooling requirements. This system is extensively used on cars equipped with factory-installed air conditioning.

A third alternative with respect to the cooling fan would be the replacement of the engine driven fan with an electrically driven, thermostatically controlled fan. This has the added advantage of improved fan efficiency, since the removal of the fan from the flexibly mounted engine allows the fan shroud to fit more closely. This reduces fan power consumption, resulting in a small electric motor (Ref. 3-14). This configuration is currently in use on several imported cars. Typical thermostat operating temperatures call for the fan to be turned on when the coolant temperature reaches 199°F and for the fan to be turned off at 186°F.

The use of a variable ratio accessory drive system compared to the fixed ratio drive currently in use can result in a significant reduction in the overall power requirements of the accessories. A variable ratio belt drive system currently under development by the Garrett Corporation (Ref. 3-15) utilizes an engine-driven variable ratio belt drive which in turn drives the vehicle accessories. The installation layout of this system is illustrated in Figure 3-2.

### 3.1.3.2 Fuel Economy Effects

#### 3.1.3.2.1 Data Base

Typical accessory power requirements for a standard-size car are shown in Figure 3-3 as a function of engine speed (Ref. 3-16). In general, the magnitude of the accessory power characteristics will vary with vehicle size, but the trends shown in Figure 3-3 will be assumed to be representative of vehicles in all market classes.

Included in Figure 3-3 is a comparison of conventional and flex-fan power requirements, showing that essentially no difference in power demand occurs until the engine speed exceeds approximately 3000 rpm. At this engine speed, a standard Chevrolet (with an  $N/V^*$  of 38.8) would be at a road speed of over 75 mph. Thus, the flex-fan offers essentially no reduction in power requirements in the engine speed range of interest, (i.e., below 55 mph), and hence, is not expected to offer any significant reduction in fuel consumption.

---

\*  $N/V$  = engine rpm/road speed (mph)

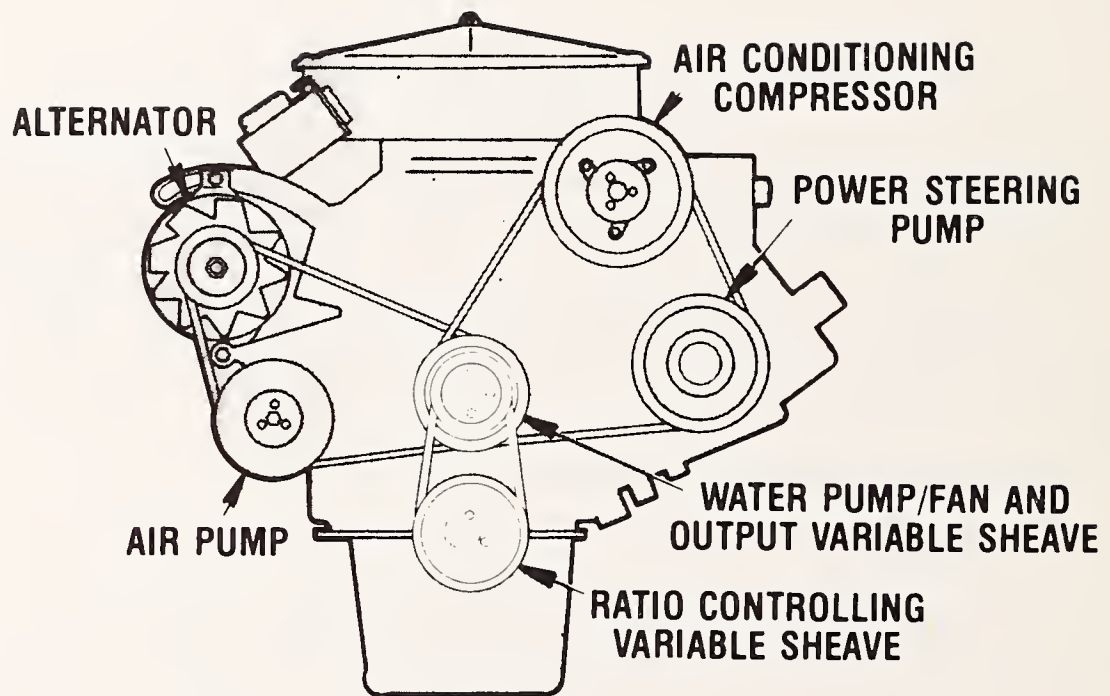

FIGURE 3-2. VARIABLE RATIO BELT DRIVE SYSTEM (Ref. 3-15)



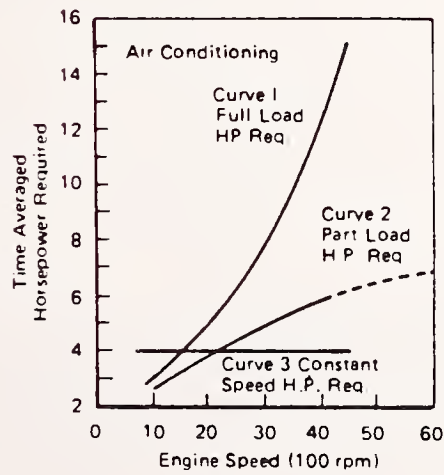
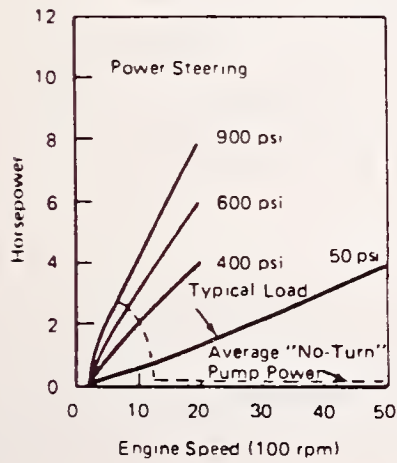
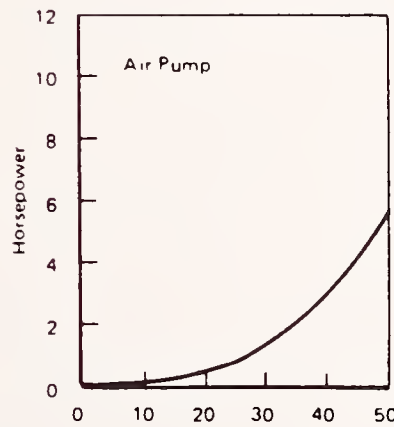
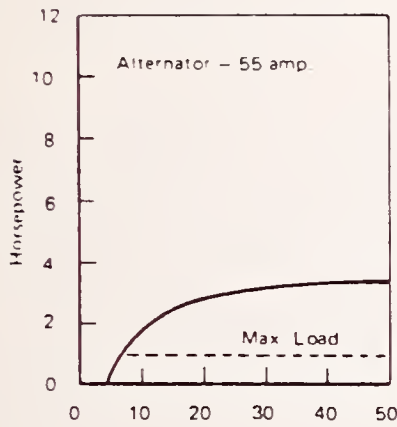
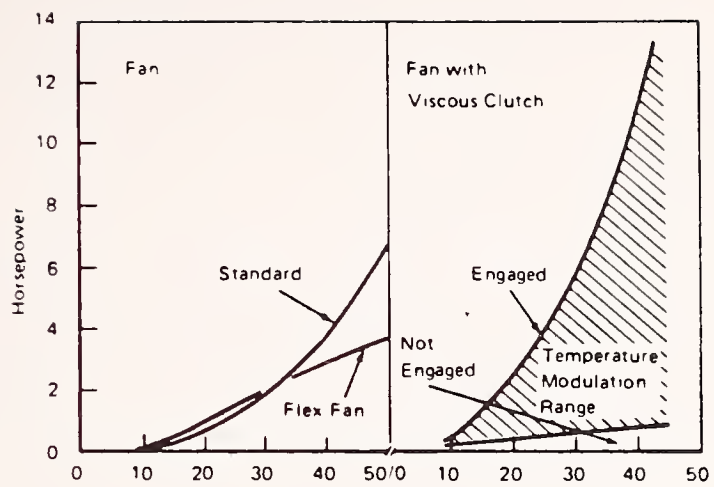
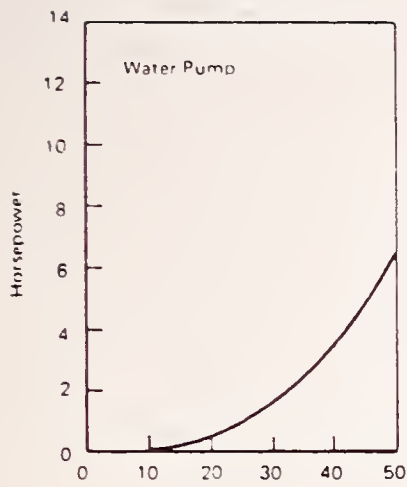

FIGURE 3-3. POWER REQUIREMENTS FOR ACCESSORIES IN STANDARD-SIZE CAR (Ref. 3-16)

No quantitative data are available on the fuel savings that would be realized by the use of the viscous clutch fan as compared to the standard fan. The operating power characteristics of a typical temperature-modulated fan with viscous clutch are included in Figure 3-3. Activation of the clutch is thermostatically controlled and hence the relative time the fan is in the partially disengaged mode over a specific driving cycle and the resulting power saving are difficult to assess. The maximum power reduction that could be achieved would be the difference between the HP requirements of the standard fan and the viscous clutch fan at its lowest power demand (clutch not engaged). Examination and comparison of the standard fan and viscous clutch fan curves in Figure 3-3 indicate no power reduction below about 1500 rpm and less than 1.5 HP reduction at 3000 rpm.

The electrically powered fan would effectively transfer the fan power load from the engine to the vehicle electrical system. No explicit data on the fuel economy benefits of this device are available.

Garrett Corporation data on their variable speed ratio accessory drive system indicate a significant reduction in the total accessory horsepower requirements as installed in a 1975 Mustang II. These effects are shown in Figure 3-4 (Ref. 3-15). At the rated engine speed of 4800 rpm, a reduction of 17 HP (-68%) was achieved. Below about 1500 rpm, the accessory drive system is seen to require slightly more power (up to 1 HP) than the conventional system. Fuel economy tests of this system showed steady-state fuel economy improvements of 4.0%, 6.6% and 11.4% at 40, 50 and 60 mph, respectively, with the maximum accessory loads including air conditioning. Tests were also conducted over the urban and highway cycle, both with and without air conditioning. These results are summarized in Table 3-2.

#### 3.1.3.2.2 Assessment of Benefits

The use of a flex fan has been shown to be beneficial only at high engine speeds well above the 55 mph speed limit. Therefore, no fuel economy benefit referenced to the urban or highway driving cycle will be assigned to this device.

An upper limit estimate of the fuel economy benefit for the viscous clutch fan can be obtained by assuming that the system always operates with the clutch disengaged so that the power demand is given by

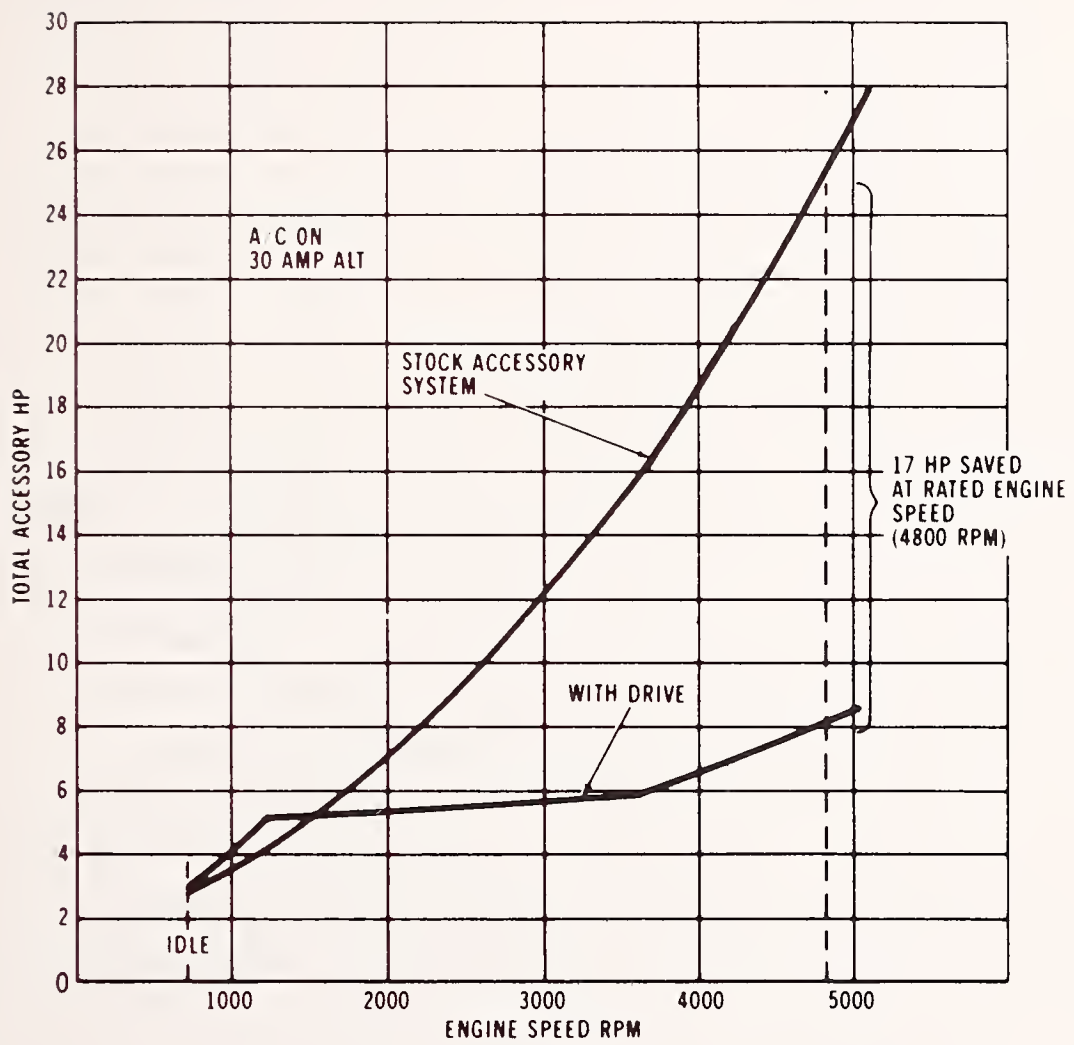

FIGURE 3-4. COMPARISON OF ACCESSORY HORSEPOWER LOADS, GARRETT VARIABLE SPEED DRIVE SYSTEM (Ref. 3-15)

TABLE 3-2. VARIABLE RATIO ACCESSORY  
DRIVE -- DRIVING CYCLE  
FUEL ECONOMY (Ref. 3-15)

Driving Cycle	Percent Fuel Economy Improvement with Accessory Drive	
	A/C Off	A/C On
Urban (FDC)	1.0	3.5
Highway (HWFET)	5.2	7.8

the "not engaged" curve shown in Figure 3-3. Integrating the power reduction effects over the urban cycle rpm range yields a net average reduction of 0.1 HP, representing a 0.6% reduction in average vehicle power output. According to EPA data (Ref. 3-17), the percent gain in fuel economy will be approximately 2/3 of the percent reduction in power, so that a maximum fuel economy improvement of 0.4% over the urban cycle can be assigned to the viscous clutch fan. Similarly, the net average reduction in power over the highway driving cycle is about 0.25 HP. This represents about a 0.7% reduction in the average power requirement over the highway driving cycle, or a 0.5% gain in fuel economy. The corresponding composite fuel economy gain that would be expected with the viscous clutch fan is then a maximum of about 0.4%. This benefit will be assumed to apply to all cars in the vehicle fleet that are not presently equipped with air conditioning.

The electric powered fan would effectively transfer the fan power requirements from the engine to the vehicle electrical system. The total accessory load, including air conditioning, over the urban and highway driving cycles, based on a full-size vehicle simulation conducted in a previous Aerospace study for the EPA (Ref. 3-18), is 5.8 and 9 HP, respectively. Based on the accessory power requirements in Figure 3-3, the standard fan consumes approximately 10% of the total accessory load. Thus, eliminating the fan would result in a reduction of about 0.6 HP over the urban cycle and 0.9 HP over the highway cycle. These constitute about a 3% reduction in the average vehicle power output over the driving cycles, resulting in a 2% improvement in composite fuel economy.

For the variable speed accessory drive, the Garrett test results given in Table 3-2 indicate composite fuel economy benefits of 2.8% without air conditioning and 5.4% with air conditioning.



In assessing the effect of reductions in fan or total accessory power requirements, it is recognized that the absolute magnitude of the accessory power requirements will vary according to the size of the vehicle. For the purposes of this evaluation, it will be assumed that the accessory power requirements will be proportional to the vehicle engine power. On the basis of this assumption, then, the fuel economy gains on a percentage basis would be the same for all sizes of vehicles.

#### 3.1.3.3 Safety Considerations

In general, the use of devices for variable accessory operation is not expected to have any adverse effects on vehicle safety. However, one safety related aspect concerning the use of the flex-fan was recently reported which involved failure of fan blades in Ford vehicles (Ref. 3-19). It was speculated that the constant flexing may have caused the blades to crack or break off. Failure of the fan blades was reported to have resulted in a number of cases of damage to other parts of the engine, several injuries, and the death of one mechanic.

#### 3.1.3.4 Availability for Implementation

The flex-fan is reported to have been installed on about 6 million Ford Motor Company passenger cars and trucks between 1970 and 1977 (Ref. 3-19). This represents about 28% of the total Ford Motor Company passenger car and light duty truck registrations from 1970 through 1976 and indicates that at least one domestic manufacturer has a production capability of 500 thousand to 1 million units per year. The flex-fan is also offered by at least one major aftermarket supplier, J. C. Whitney, for most domestic and import cars (Ref. 3-20).

The viscous clutch fan is currently in production and is utilized in cars with air conditioning. This currently (1976) constitutes about 75% of the new domestic cars each year and suggests that production could be increased to either equip 100% of the new cars with the viscous clutch fan each year or a significant segment of the aftermarket. The viscous clutch fan is also available in the aftermarket from J. C. Whitney; quantities that are produced are not known.

The electrically driven fan is presently in use only on a few imports, (e.g., VW, Subaru). It is not in use on domestic passenger cars

or light duty trucks, nor does it appear to be available on the aftermarket. This could present a major problem with respect to near-term implementation (see Sections 4.1.3.4, 4.1.3.5).

The variable accessory drive system has been under development by the Garrett Corporation and is not in production. The developmental phase of the particular accessory drive system discussed in this report was completed in September, 1976. Additional developmental work on other types of accessory drive systems is part of an ongoing program currently scheduled for completion in 1978.

### 3.1.3.5 Cost Factors

The flex-fan is available in the aftermarket with a typical mail order price of \$15 for domestic passenger cars, \$20 for imported cars, and \$25 for pickup trucks (Ref. 3-21). This same source also lists fan clutches for most domestic and import cars at \$13 for the clutch and \$6.50 for the fan, or about \$20 for the combination. The domestic passenger car clutch replacement costs range from \$35 to \$55, with an average or typical cost of about \$45, based on Ref. 3-22.

The electric cooling fan system replacement costs (Ref. 3-21) are \$10.80 for the thermostick, \$56 for the 100 W motor/fan assembly and \$75 for the 200 W assembly.

Installation costs of the above items are based on replacement labor charges reported in Ref. 3-22 for the same or similar items. The flex-fan, for example, is assumed to be comparable to the standard fan. Installation time for the standard fan (removal and replacement) is given as 0.5 hours. If the labor charge is assumed to be \$18/hr, this would amount to \$9 for the flex-fan.

The replacement and renewal of the fan clutch is given as 0.7-0.9 hours, or \$12.50 to \$16. Replacement of the electric fan is given at 0.8-1.0 hours, or about \$14 to \$18.

In summary, total cost of the flex-fan, including installation, is estimated to be about \$30, the clutch fan about \$45, and the electric fan about \$80 to \$100.

The cost of the accessory drive system has been estimated by Garrett to run about \$80 as an add-on device. The net cost would be

reduced to an estimated \$19 as an OEM drive installation, which reflects savings in pulleys, brackets, and fan modifications which could be effected.

### 3.1.4 Variable Cylinder Engine Operation

#### 3.1.4.1 Introduction and Background

In the variable cylinder engine concept, fuel economy improvements are achieved by deactivating every other cylinder in the firing order, thereby effectively reducing the displacement of the engine. This is accomplished by terminating fuel flow to one-half of the cylinder's.

As applied to a V-8 engine, the variable cylinder engine would operate on four cylinders for the light-load modes of operation and would switch to full eight cylinder operation when the load (brake mean effective pressure) in the four operating cylinders is increased to some preset maximum level. The transition from four to eight cylinders could be triggered automatically in response to an engine operating condition such as manifold vacuum or it could be accomplished manually by the operator.

Two basic configurations have been under development. In one approach, which will be referred to as the carburetor-controlled system, cylinders are deactivated by cutting off the fuel flow in one of the two primary barrels feeding each side of the divided plenum V-8 intake manifold. In the other approach, the valve train is so modified that, upon an external signal, the intake and exhaust valves in the deactivated cylinders remain closed. This latter configuration, because of the greater mechanical complexity of the engine, is felt to be more appropriately applicable to new engine configurations where it can be incorporated into the initial design of the engine. It will not, therefore, be considered as a potential aftermarket device.

The operational concept of the carburetor-controlled system may be described as follows. The conventional carbureted V-8 engine is equipped with a divided plenum intake manifold with two sets of four ports, as shown in Figure 3-5 (Ref. 3-23). Each set is fed by one primary barrel in the case of a two-barrel carburetor and by one primary and a secondary in the case of a four-barrel carburetor. When flow in one of the two carburetor primaries is shut off, the engine will operate on four cylinders, two in each bank of the V-8. For the firing order shown in Figure 3-5, if the fuel flow is cut off to barrel A, cylinders 8, 3, 5 and 2 will be deactivated,



while cylinders 1, 4, 6 and 7 will receive fuel from barrel B. This mode of operation would be used under light-load conditions such as cruise, deceleration, and idle. Higher loads would reactivate barrel A and the engine will fire on all eight cylinders.

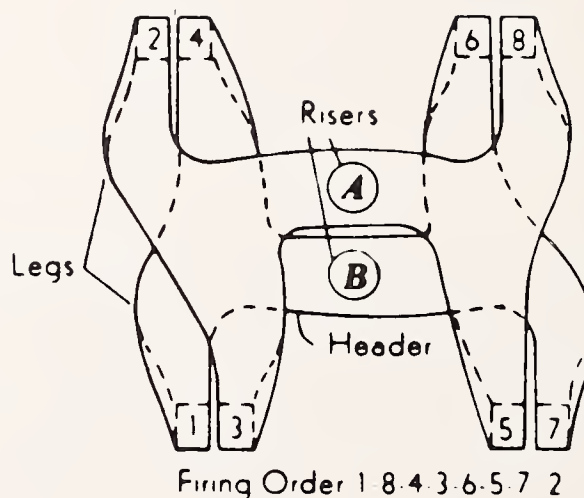

FIGURE 3-5. V-8 INTAKE MANIFOLD  
(Ref. 3-23)

One embodiment of this concept under development by inventor A. Garabedian of Fullerton, California, utilizes a specially modified Quadrajets (four-barrel) carburetor to control fuel flow to the cylinders of a 350 CID Nova. The secondary barrels operate in a normal manner. The modified primary is equipped with a special spring-loaded valve which is normally closed under light load conditions. When the engine vacuum drops below a preset threshold value, the spring force opens the valve, allowing the second primary to flow. Another modification in the Garabedian design involves the reshaping of one idle jet to ensure fuel cut-off to four cylinders in the idle mode (Ref. 3-24).

#### 3.1.4.2 Fuel Economy Effects

##### 3.1.4.2.1 Data Base

The potential fuel economy benefits relating to engine operation at reduced displacement and therefore higher BMEP have been demonstrated by a number of different systems. However, the magnitude of the benefits



attainable by this general approach varies with the specific method used to achieve reduced displacement and with the design strategy employed in selecting engine operating regimes for reduced displacement activity. For example, an advanced technique under development at Sandia Laboratories, Livermore, California, employs an unthrottled engine in which the piston stroke is continuously varied to meet torque requirements. For this system, the potential fuel economy gain relative to a conventional engine has been determined to be 30% (EPA urban driving cycle, 3500 lb car, automatic transmission), based on computer simulations utilizing engine dynamometer test data (Ref. 3-25). A Ford development, referred to as a dual displacement engine, utilizes a rocker arm actuator device developed by Eaton Corporation to deactivate the valves and lock out operation on half the engine cylinders at certain light load operating conditions. The system is designed so that cylinder lock-out occurs only at vehicle speeds over 45 mph and in deceleration down to 25 mph (Ref. 3-26). This system has shown a 6% composite fuel economy gain in a six-cylinder van tested over the EPA urban and highway driving cycles (Ref. 3-27).

In the carburetor-controlled variable cylinder concept, the only known system potentially suitable for retrofit, reduced displacement is achieved in a V-8 engine by terminating flow in one of the two primary barrels of the carburetor, thereby deactivating four of the eight cylinders. In this scheme, the valves in the deactivated cylinders continue to operate; reduced displacement operation would be triggered at idle, low speed cruise, and other low load conditions. Thus the system differs in several respects from the devices described above.

As noted earlier, the carburetor-controlled variable cylinder engine is still in the development stage; no reliable fuel economy test data specific to this device are available. However, this concept was previously assessed by The Aerospace Corporation in a study conducted for the Law Enforcement Assistance Administration (Ref. 3-28). In this study, the fuel economy potential of the variable cylinder concept was evaluated utilizing computer simulations of vehicle operation over both the urban and highway driving cycles.

In developing the simulation model used in this analysis, several engine operating effects had to be taken into consideration. When the system is in the economy mode of operation, four of the eight cylinders in a V-8

engine are deactivated by terminating fuel flow in one (primary) carburetor barrel. The pistons in the deactivated cylinders continue to move, however, and exert frictional and pumping resistance to the motion of the active cylinders. The four active cylinders must provide sufficient power to meet the vehicle road-load requirement. If no losses were imposed by the inactive cylinders, each active cylinder would have to operate at twice the brake mean effective pressure (BMEP) at which all eight cylinders operate. This pressure, however, must be further increased by the friction mean effective pressure (FMEP) representing the losses in the inactive cylinders. Thus, the appropriate brake mean effective pressure to be used in evaluating fuel consumption during economy mode operation is

$$(BMEP)_4 = 2(BMEP)_8 + (FMEP)_{inactive}$$

The general approach taken in the analysis was to first establish the frictional loss level in the active cylinders and then determine the magnitude of the loss components not applicable to the inactive cylinders. By difference, the FMEP of the inactive cylinders was determined. The active cylinder FMEP characteristics were established from General Motors Corporation friction loss data developed for a 1973 350 cubic inch displacement V-8 engine (Ref. 3-29). Individual friction and pumping losses attributable to the inactive cylinders were assessed according to the methods developed by Bishop (Ref. 3-30) in which empirical equations were developed which describe the most important factors determining the friction of an engine, as derived from experimental data. Differences in the FMEP between the inactive cylinders and active cylinders as a function of piston speed are shown in Figure 3-6.

Computer simulations of the carburetor-controlled variable cylinder engine were run over both the urban and highway driving cycles. The vehicle used as a baseline in evaluating the potential fuel economy benefits was a 1975 401 CID Matador police patrol vehicle with a loaded weight of 4535 lb. All simulation runs for both the baseline vehicle and the variable cylinder engine system included a full complement of accessories, including air conditioning and power steering.

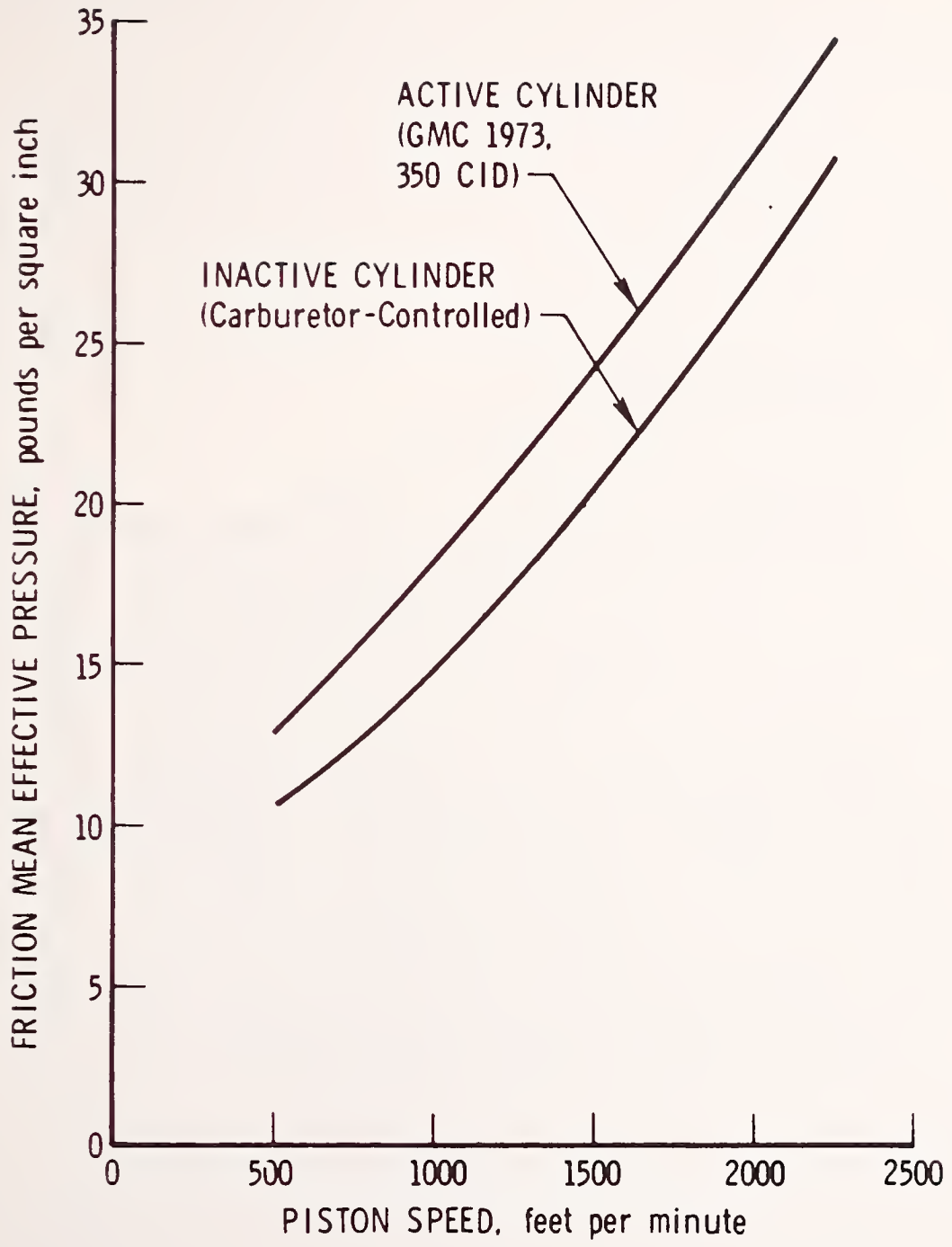

FIGURE 3-6. VARIABLE-CYLINDER ENGINE FRICTION AND PUMPING LOSSES (Ref. 3-28)

As a part of this evaluation, a use-mode factor was utilized to denote the fraction of maximum torque at which vehicle operation was switched from the economy mode of operation to the full eight-cylinder operation. The use-mode factor  $k$  was varied over a range of values from zero to one to establish the value of the torque (load) ratio which yields the maximum fuel economy for a specified driving cycle.

The fuel economy improvements achieved by the variable cylinder engine are shown in Figure 3-7. Fuel economy gains are seen to be significantly higher over the urban driving cycle than over the highway cycle. These higher gains over the urban cycle are attributable to the reduced fuel consumption of the system in the idle, cruise, and deceleration modes of operation. The maximum fuel economy improvement shown over each driving cycle is summarized in Table 3-3.

#### 3.1.4.2.2 Assessment of Benefits

The carburetor-controlled variable cylinder engine concept was found to offer the potential for a significant improvement in fuel economy for the 401 CID, 4500-lb police patrol vehicle, as described in Section 3.1.4.2.1. In order to determine whether or not similar fuel economy gains might be expected for vehicles with different inertia weights and engine sizes, the theoretical considerations relating to variable cylinder operation were applied to urban cycle computer simulation results contained in Ref. 3-18, a previous study conducted by The Aerospace Corporation for EPA. These simulation results covered a wide variety of vehicle inertia weights and engine displacements and summarized the fuel consumed in each of four vehicle operating modes: cruise, acceleration, deceleration, and idle. The reductions in fuel consumption for variable cylinder operation in these modes were evaluated on theoretical grounds and were applied to the simulation results to obtain an adjusted fuel economy for variable cylinder operation. The fuel economy gains relative to full-cylinder operation are shown in Table 3-4. An average fuel economy improvement of 13.3% is indicated, which agrees with the value obtained for the police patrol vehicle simulation in Ref. 3-28. No significant trend with vehicle weight, engine displacement, or a combination of these parameters is indicated. On the basis of these results, it will be assumed that the 8.7% improvement in composite cycle fuel economy obtained in the police patrol vehicle simulation



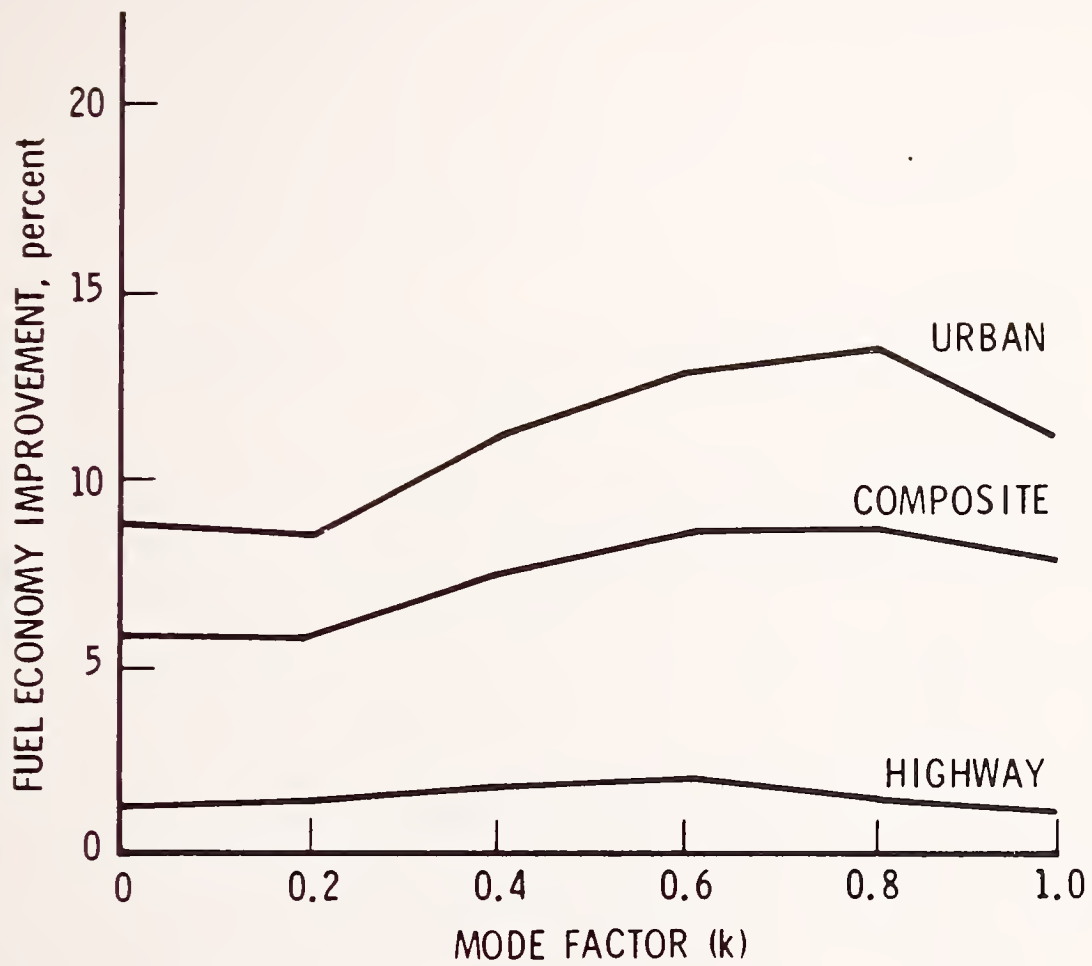

FIGURE 3-7. FUEL ECONOMY RESULTS FOR THE CARBURETOR-CONTROLLED VARIABLE-CYLINDER ENGINE (Ref. 3-28)

TABLE 3-3. MAXIMUM FUEL ECONOMY IMPROVEMENT WITH VARIABLE CYLINDER ENGINE OPERATION (Ref. 3-28)

Driving Cycle	Percent Fuel Economy Improvement
Urban	13.3
Highway	2.1
Composite	8.7

TABLE 3-4. FUEL ECONOMY GAINS OVER URBAN DRIVING CYCLE -- VARIABLE CYLINDER OPERATION

Vehicle Inertia Weight (lb)	Engine CID	Transmission	Fuel Economy Gain (%)
5000	400	A-3	11.3
5000	350	A-3	10.6
4500	318	A-3	13.9
4500	318	M-3	14.5
4000	258	A-3	13.8
4000	258	M-3	14.1
3500	225	A-3	15.3
3500	225	M-3	15.8
3000	140	M-3	13.3
2500	98	M-4	10.1
			Average
4500*	401*	A-3*	13.3*

\* Police patrol vehicle simulated in Ref. 3-28.

is representative of the gain to be expected for all classes of vehicles in the fleet that can be equipped for variable cylinder operation. Only V-8 engines will be considered for this application.

#### 3.1.4.3 Safety Considerations

The variable cylinder engine configuration is not expected to result in any adverse performance characteristics which might result in an unsafe condition, since full eight-cylinder operation is available as needed for passing, or other high power demand maneuvers.

#### 3.1.4.4 Availability for Implementation

None of the variable cylinder engine concepts are commercially available at the present time. However, a number of activities in variable cylinder engine development have been and are being pursued by the automobile and automobile-supply industries. These include development work at General Motors on a four-by-six-by-eight valve-controlled V-8 engine, and past activity at Holley Carburetor on a four-by-eight engine carburetor-controlled mechanism. A valve-controlled four-by-eight variable cylinder engine concept developed by Eaton Corporation has been tested by General Motors in a 350 cubic-inch displacement Oldsmobile Omega vehicle. In September, 1976, Ford Motor Company announced plans to introduce by model year 1978 a valve-controlled three-by-six engine that would be used initially on some Ford light trucks (Ref. 3-31). More recent information (Refs. 3-27, 3-32) indicates that this plan now has been dropped, partly because operating tests of this engine showed a much smaller fuel economy improvement (6%) than had been expected. However, the concept is still being considered for V-8 engines, in both light duty trucks and passenger cars (there is a greater potential for fuel economy gain in the lightly loaded larger engine sizes).

In addition to the activities discussed above, inventor Arthur Garabedian of Fullerton, California, has developed mechanisms for variable cylinder operation in both fuel-injected and carbureted engines. Although no significant details concerning the component structure of the carburetor-controlled device are known, the requisite engine modifications appear to be largely confined to the carburetor, and thus the system appears to be well suited for retrofit applications. An operating prototype is presently installed

in a 1975 350 CID Nova vehicle. On the basis of discussions with the inventor, it appears that some additional development time, perhaps 1 year, might be required to optimize interactions between performance, fuel economy, and emissions. Thus, this system is not immediately available for implementation, but conceivably could be in production within 2 years or less.

#### 3.1.4.5 Cost Factors

Factors which could influence the incremental acquisition cost of the carburetor-controlled variable cylinder engine include carburetor modifications and controls, and manifold vacuum or other sensor devices to signal the transition between four- and eight-cylinder operation. These costs have been estimated to be not more than \$100 installed (Ref. 3-25).

The potential fuel economy gains for the variable cylinder engine configuration can result in significant savings in fuel costs if the maximum fuel economy potential is achieved. On the basis of the optimum k-mode factor fuel economy gains over each of the driving cycles discussed in Section 3.1.4.2.1, the composite fuel economy gain of +8.7% would result in an annual fuel cost savings of \$37.00 based on 10,000 mpy at 15 mpg and a fuel cost of \$0.70/gal. Thus the device would pay for itself in a period slightly under 3 years.

#### 3.1.5 Intake Air Temperature Control

An analysis made of the fuel economy improvement potential of intake air temperature control led to the conclusion that this technique offers negligible benefits in terms of its limited applicability to the in-use fleet. This option was therefore not further considered in this study. The background of this conclusion is summarized below.

Intake air temperature control is an emission control technique widely used on an OEM basis to provide intake air to the carburetor at essentially constant temperature, regardless of ambient conditions. Its purpose is to assist the carburetor in providing close control of the air/fuel ratio required to meet emission standards. Its use is normally associated with a carburetor that is calibrated to provide a leaner air/fuel ratio (compared to pre-emission control cars).

The air preheater is typically a sheet metal baffle attached to the outer surface of the exhaust manifold. Engine compartment air flows



through this preheater, and then to the underside of the air intake horn, where a valve actuated both by air temperature (bimetallic element) and manifold vacuum regulates the flow of preheated air in relation to the normal under-hood air flow entering the air inlet horn. Low manifold vacuum corresponding to heavily loaded engine conditions causes the regulating valve to block off all flow of preheated air.

This system has a potential fuel economy benefit for retrofit applications by reducing the time in which the choke is operative in cold starts. It is estimated that this could result in an EPA composite cycle fuel economy improvement on the order of half a percent. Such a potential benefit is not insignificant; however, considerations of retrofit applicability to the national fleet eliminated this technique from further consideration. Intake air temperature control started appearing on many California cars in 1966 (Ref. 3-33), and in a very large fraction of the 1968 model year cars in the 49 states (Ref. 3-34). Some form of intake air heating or other form of short choke operation has been in almost universal use at the OEM level since then. Thus, the retrofit of intake air temperature control would be applicable to only about 20% of the 1976 light duty fleet and virtually none of the 1982 passenger car fleet.

### 3.1.6 Engine Preheater

#### 3.1.6.1 Introduction and Background

The engine preheater is an electrical resistance heating device that is designed to maintain the engine at a relatively warm condition above ambient levels when the engine is not in operation (e.g., garaged overnight). The system is offered as an aid to quick and easy starts in cold weather and is claimed to eliminate engine wear effects related to cold starting. While explicit claims of improved fuel economy are not emphasized in the advertisements of this device, it is possible that some benefits in reducing fuel consumption in the warm-up phase of engine operation could be achieved. This section examines the potentialities of the device with respect to such effects.

The system is installed in the engine coolant line and acts to heat and recirculate the engine coolant. It is thermostatically controlled; a typical thermostat operating range is 120°F to 140°F. An installation schematic for such a device designed for use on engines of up to 350 CID is

shown in Figure 3-8 (Ref. 3-35). Units are available for gasoline and diesel engines of up to 1200 CID. The system is sized according to the desired operating temperature range and engine displacement. The criteria for selecting the required power rating of the heater are given in Ref. 3-35 as 3 watts per cubic inch displacement for ambient temperatures down to  $-20^{\circ}\text{F}$ , and 5 watts per cubic inch below  $-20^{\circ}\text{F}$ . Units are available for either 115 volt or 230 volt operation.

#### 3.1.6.2 Fuel Economy Benefits

Vehicle fuel economy is significantly affected by the extent to which vehicle and engine systems are warmed up. Factors that contribute to increased fuel consumption during warm-up are (a) lower engine thermal efficiency because of richer than normal air/fuel ratios with choke operation, reduced fuel vaporization in the induction system, and greater heat losses to the cooling system; (b) higher rolling resistance of cold tires; and (c) increased engine and driveline friction because of the higher viscosity of the cold lubricants (Ref. 3-36). The progressive change in fuel economy due to these effects was measured in Ref. 3-37 and is shown in Figure 3-9 where the cumulative percent of fully warmed-up fuel economy is given as a function of trip length and ambient temperature. The potential value of the engine preheater resides in its ability to raise the level of these curves, effectively accelerating the rate at which the vehicle reaches 100% warmed-up fuel economy.

##### 3.1.6.2.1 Data Base

No actual test data are available on the potential fuel economy benefits associated with the use of the engine preheater. However, the following discussion treats several theoretical considerations which provide the basis for estimating these effects.

Of the several losses encountered during a cold start, as discussed above, the heater can only be expected to reduce the warm-up losses in the area of engine heat losses to the cooling system and losses attributable to cold engine lubricant effects.

In a previous study conducted by The Aerospace Corporation (Ref. 3-36), the contribution of several identifiable sources to the warm-up losses were evaluated. The individual effects of tire warm-up, choke operation for 1 mile (2 minutes), and heat loss to the coolant are shown in

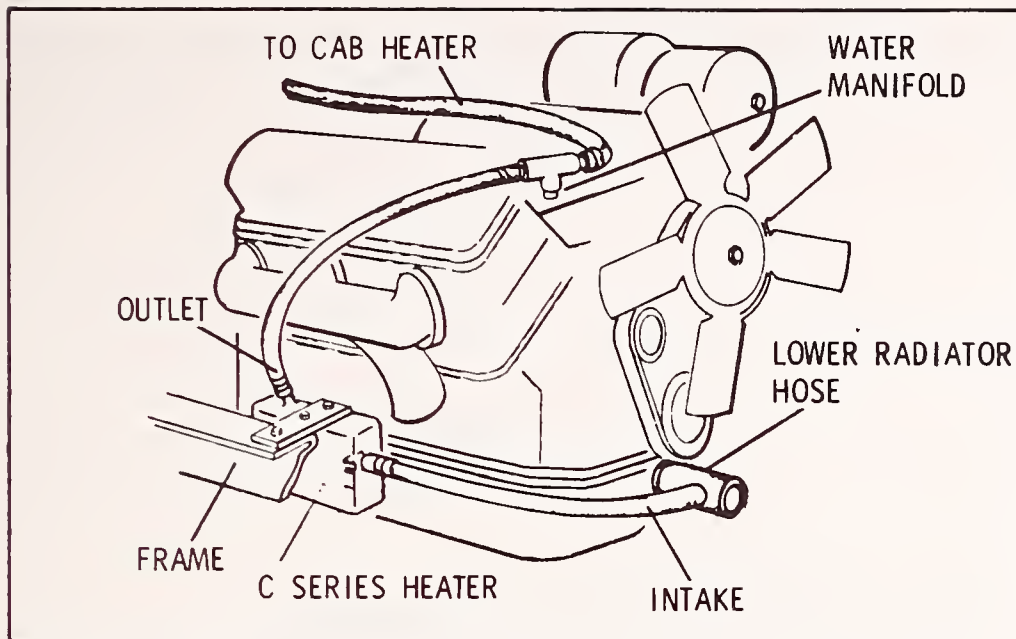

FIGURE 3-8. ENGINE PREHEATER INSTALLATION  
(Ref. 3-35)

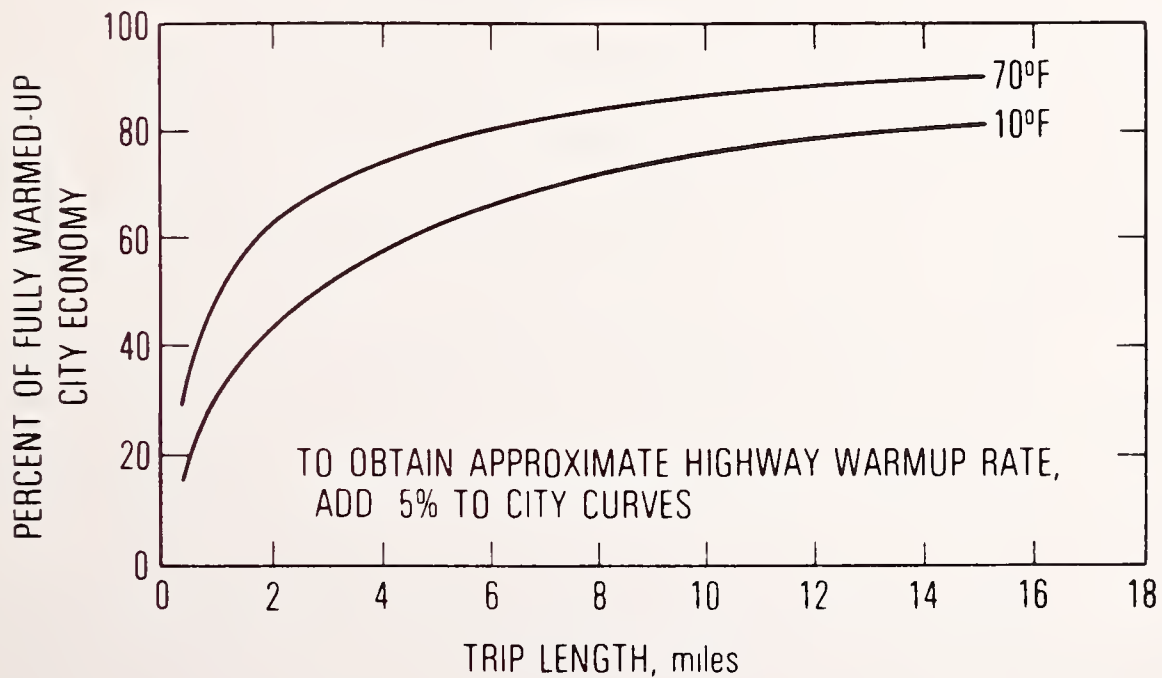

FIGURE 3-9. COLD START AND SHORT TRIP FUEL ECONOMY (Ref. 3-37)

Figure 3-10 as compared with the 70°F cold start fuel economy characteristics taken from Figure 3-9. Of the three sources indicated, tires were found to produce the largest contribution to the total loss, the choke produced the next largest effect, while the heat loss to the coolant was found to be negligible by comparison. The coolant loss was estimated to be on the order of only 1% of the identifiable losses and contributed approximately 0.6% to the fuel economy losses over the warm-up period.

The combined effects of the tire, choke, and coolant losses on fuel economy are compared in Figure 3-11 to the measured 70°F warm-up fuel economy characteristic. The unexplained portion of the losses, although not quantifiable due to a lack of data, is believed to be due primarily to losses attributable to engine oil and driveline lubricant viscosity effects.

#### 3.1.6.2.2 Assessment of Benefits

The curves presented in Figures 3-10 and 3-11 were based on a cold start at a relatively high ambient temperature of 70°F. As indicated in Figure 3-9, the losses at lower ambient temperature can be appreciably greater. However, these increased losses are believed to be attributable primarily to driveline lubricant viscosity and tire effects, since choke operation is not expected to be significantly influenced by reduced ambient temperature. With regard to the coolant loss at low ambient cold start conditions, this remains very small by comparison with the other influences on cold start fuel economy. For example, the coolant loss effect at a 0°F ambient start condition was calculated, based on cylinder heat transfer considerations, to result in about a 1% loss in fuel economy when integrated over the warm-up period.

Some additional benefit for the engine preheater may be anticipated due to its potential influence in raising engine oil temperature above ambient, thereby reducing its viscosity on startup. The temperature benefit, however, is expected to be small, and therefore the net influence on fuel economy due to this effect will be assumed to be negligible.

A realistic appraisal of this system indicates that its greatest appeal lies in its ability to provide quick and easy starts under freezing conditions. Accordingly, it will be assumed that the applicability and operation of the preheater will only apply to travel at ambient cold start conditions at or below 32°F. For this temperature range, a 1% fuel economy benefit



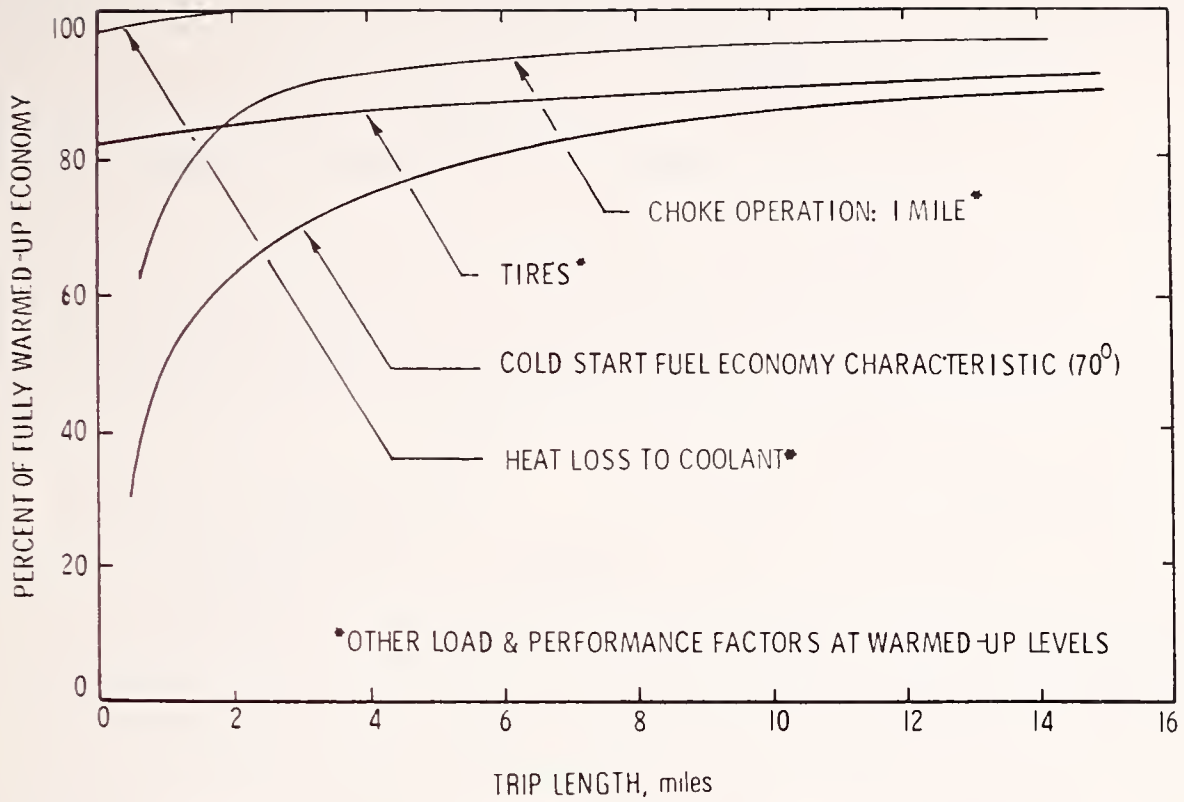

FIGURE 3-10. CONTRIBUTIONS OF TIRES, CHOKE, AND COOLANT HEAT TRANSFER TO WARM-UP LOSSES (Ref. 3-36)

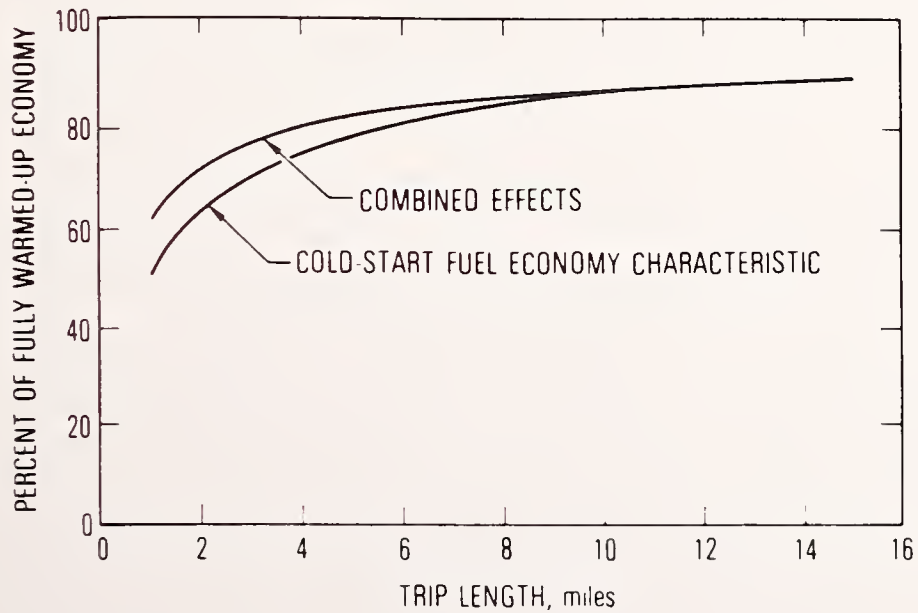

FIGURE 3-11. COMBINED EFFECTS OF TIRES, CHOKE, AND COOLANT HEAT LOSS (Ref. 3-36)

will be assigned to the system. These values and use limits will be employed for both passenger cars and light duty trucks.

#### 3.1.6.3 Safety Considerations

No adverse safety effects are identified for the engine preheater system.

#### 3.1.6.4 Availability for Implementation

Electric engine preheaters are currently manufactured in both the United States and Canada. Production of one principal U. S. manufacturer, Kim Hotstart Manufacturing Co., Spokane, Washington, is currently at 10,000 passenger car units per year, with a production capability of 30,000 units per year in existing facilities. This production capacity will be doubled by the end of 1977 with the addition of new facilities. There are a number of other manufacturers of devices of this type, but none of any known significant size.

#### 3.1.6.5 Cost Factors

Heaters designed for automotive use, including an integral thermostat, list for \$38.25 for engines up to 350 CID for the 750 W unit. Typical OEM prices are about \$21, but will be dependent on the quantity ordered (Ref. 3-38). Included in the price are all necessary mounting brackets and fittings. Any required additional hose is not included in the price. Optimum operation of the unit requires (1) that it be mounted at the low level of the engine coolant system to ensure adequate head pressure and (2) that a 6- to 24-inch rise exist between the heater outlet and the return point to the engine coolant lines. This can impose installation problems in that the mounting bracket may have to be welded to the frame. Because of this, in addition to draining and refilling the coolant, installation time was estimated by the manufacturer to be about 1-1/2 hours. Assuming a labor charge of about \$18/hour, this would result in a \$24 installation cost.

Operating costs for these units will depend upon several factors: the coolant capacity of the engine, the heater wattage and coolant temperature to be maintained, the ambient temperature, and the exposure to the ambient temperature. Discussions with one manufacturer (Ref. 3-38) indicate that the system would probably be operating about one half of the time in order to maintain a coolant temperature of 120°F to 140°F in an ambient

air temperature of 0°F (excluding any wind chill factor). Assuming the vehicle is garaged 8 hours per night, the unit would be in operation for about 4 hours. For an electric utility rate of \$0.055 per kW-hr, typical operating costs would be about \$0.17 per night for a 750 W unit. This cost is reduced at warmer ambient temperatures; the system would operate about one fourth to one third of the time at temperatures 10°F to 20°F (Ref. 3-38). This would place the operating cost at \$0.085 to \$0.11 per night. Thus, if it were further assumed that the unit was in operation 4 months of the year, typical annual operating costs would range from \$10 to \$20, for an average of \$15.

### 3.1.7 Tire Modifications

#### 3.1.7.1 Introduction and Background

Power losses attributable to tires have been estimated to amount to approximately 25% of the total vehicle losses over the Federal Driving Cycle and 32 to 55% at steady-state cruise speeds (Ref. 3-39). These losses stem from rolling resistance effects made up of the following three factors: (1) frictional slippage of the tread at the road/tire interface, which contributes 5 to 10% of the total tire loss, (2) windage losses, which constitute 1.5 to 3% of the total tire loss and vary with the size and shape of the tire, and (3) hysteresis losses due to the deformation of the rubber and cord components. Under steady-state driving conditions, the hysteresis losses comprise 90 to 95% of the total tire loss (Refs. 3-40 and 3-41).

Tire construction can have an appreciable effect on rolling resistance. Three types of tire construction are currently used in the U. S. These include the bias-ply, the belted-bias, and the radial belted tire. These designations refer to the way the tire body plies are aligned or wrapped, as shown in Figure 3-12 (Ref. 3-2).

Tire inflation pressure will also have an effect on rolling resistance; higher inflation pressures reduce hysteresis losses and also increase the effective spring rate of the tire sidewalls, which reduces tire inertia losses at higher speeds (Ref. 3-41).

Reductions in tire rolling resistance are directly relatable to vehicle fuel economy. As a rule of thumb, the percent change in fuel economy is approximately one-fifth the percent change in rolling resistance



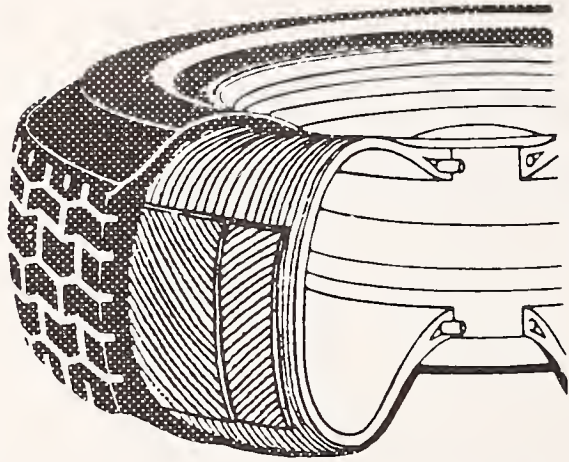

**Radial**

The body cords of radial tires run at right angles (radially) to the center line of the treads; the belt cords are arranged in a herringbone pattern. The radial body cords allow sidewalls to flex so that the tread maintains maximum surface contact with the road during turns.

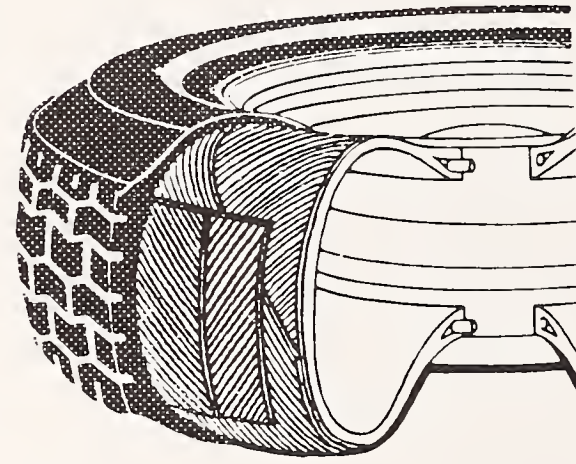

**Belted-Bias**

The body plies of belted-bias tires crisscross diagonally, like those of bias-ply tires, to ensure strong sidewalls. The added belts are two or more cord strips that are cut on the bias and alternated, in herringbone fashion, around the perimeter of the tire between the body plies and the tread.



**Bias-Ply**

The standard tire is a bias-ply. Its cord strips are arranged diagonally (that is, at a bias) to the center line of the tread and alternate plies are reversed across at a 30° or 40° angle.

FIGURE 3-12. BASIC TIRE DESIGNS (Ref. 3-2)



(Ref. 3-2). Thus a 10% reduction in rolling resistance would be expected to result in a 2% improvement in fuel economy.

### 3.1.7.2 Fuel Economy Effects

#### 3.1.7.2.1 Data Base

Numerous test results have been reported in the literature for the differences in rolling resistance between bias-ply, bias-belted, and radial ply tires (Refs. 3-39, -40, -41, -42). Typical of these are the characteristics shown in Figure 3-13 (Ref. 3-41). It will be noted that the radial ply tire shows a 25 to 30% lower rolling resistance than bias-ply and bias-belted tires at all speeds below the present 55 mph speed limit. This would imply a gain in fuel economy of 6%. Vehicle tests in which fuel economy was actually measured at various steady-state speeds indicate fuel economy benefits of 3 to 6% for the radial tire (Refs. 3-40 and 3-41).

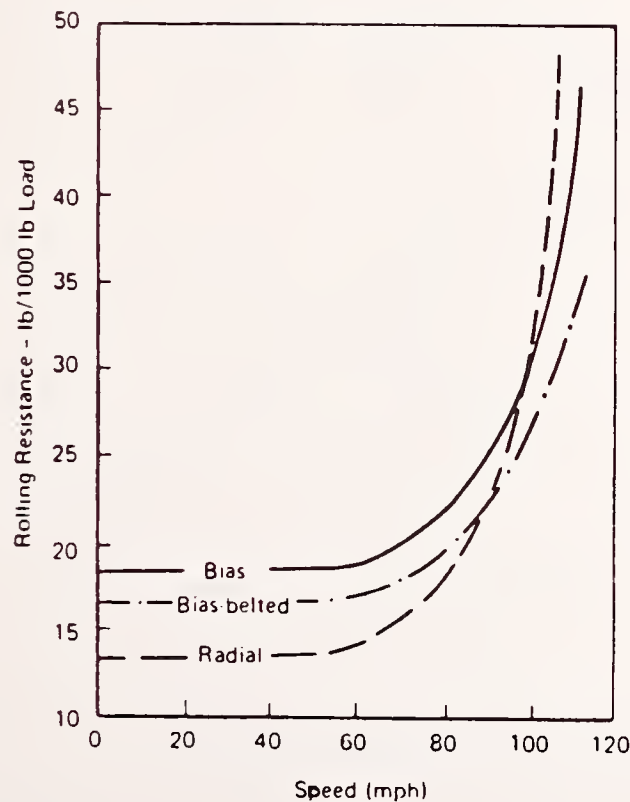

FIGURE 3-13. ROLLING RESISTANCE VERSUS SPEED FOR DIFFERENT TIRE CONSTRUCTION TYPES (Ref. 3-41)

The data discussed above are based on steady speed conditions and do not necessarily reflect the gains that might be expected in a representative urban driving cycle that includes numerous stops and starts. The potential fuel economy gain associated with radial tires has been evaluated over the urban and highway driving cycles by several sources using computer simulation techniques. These simulations assumed various levels of rolling resistance reduction attributable to the radial tire, and in some cases also examined the effect of radial tires in different size vehicles. These simulation results are summarized in Table 3-5. Included in the table are estimates of the expected gains as quoted by EPA/DOT in the 120-day study (Ref. 3-43). These data indicate a fuel economy benefit due to radial tires of from 2.5 to 3%.

TABLE 3-5. SUMMARY OF RADIAL TIRE EFFECTS ON FUEL ECONOMY

Vehicle Size	Rolling Resistance Reduction (%)	Fuel Economy Improvement (%)			Ref.
		Urban Cycle	Highway Cycle	Composite	
4-Pass.	25	2.1	3.8	2.9	JPL (3-14)
	--	---	---	2.5	EPA/DOT (3-43)
5-Pass.	25	1.7	3.5	2.5	JPL (3-14)
	15	2.2	---	---	ADL (3-16)
	--	---	---	2.5	EPA/DOT (3-43)
6-Pass.	25	1.6	3.6	2.5	JPL (3-14)
	15	1.8	---	---	ADL (3-16)
	30	4.0	---	---	SWRI (3-44)
	--	---	---	2.5	EPA/DOT (3-43)

A second area of potential fuel savings is related to tire inflation pressure. Two aspects of possible improvement to fleet vehicles can be considered: increasing the nominal inflation pressure, and eliminating underinflation. With regard to the former, it is noted that the manufacturer's nominal or recommended inflation pressure can be increased up to

some specified higher pressure without exceeding the design limits of the tire. The passenger car tire operating at a nominal pressure of 24 to 26 psi can be inflated to a maximum allowable pressure of 32 psi, or 6 to 8 psi above nominal. Typical truck tires operating at a nominal pressure of 35 psi can be inflated to 50 psi, or 15 psi above nominal (Ref. 3-45).

For non-radial tires there is about a 5% reduction in rolling resistance for each 2 psi change in inflation pressure over the range of 24 to 32 psi (Ref. 3-2). This means that if the nominal pressure of a bias-ply tire is increased 8 psi (to 32 psi), rolling resistance will be reduced 20% and, based on the rule of thumb mentioned earlier, fuel economy will be increased 4%.

Information of a more specific nature reported by Goodyear (Ref. 3-40) and shown in Figure 3-14 indicates a 6% improvement in steady speed fuel economy when tire pressure is increased by 8 psi. Radial tires, however, were found to be considerably less sensitive to inflation pressure changes, showing only 2.4% change in fuel economy.

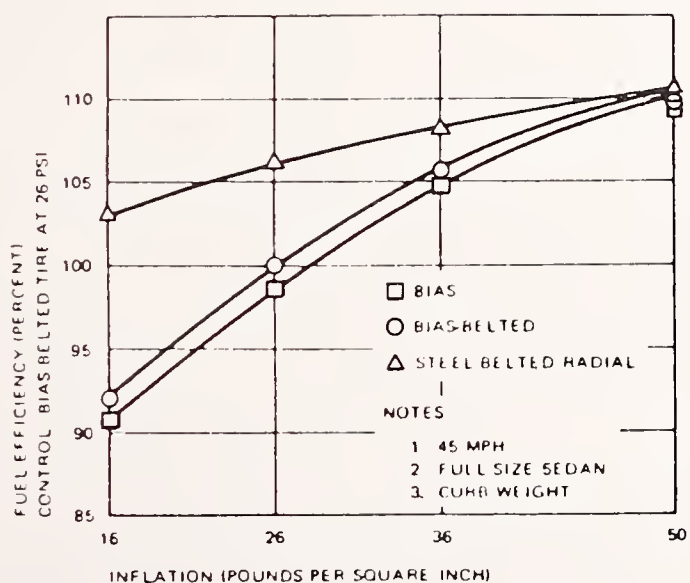

FIGURE 3-14. RELATIVE FUEL EFFICIENCY FOR THREE TYPES OF TIRES (Ref. 3-40)

Similar effects can be expected when the underinflated tire is brought to nominal inflation conditions. Little quantitative information is available on what portion of the in-use fleet is being operated on under-inflated tires. Goodyear expressed the opinion (Ref. 3-46) that most cars are being driven in an underinflated condition, since all tires slowly lose

pressure and therefore tend to average out at less than the manufacturer's recommended value. Reference 3-47 indicates that more than 25% of all tires are severely (4 psi or more) underinflated. According to this reference, Uniroyal made a check of some 1900 cars and found that about 28% were severely underinflated.

#### 3.1.7.2.2 Assessment of Benefits

Based on the data shown in Table 3-5, it will be assumed that the use of the radial tire will provide about a 2-1/2% increase in composite fuel economy over the bias ply and bias-belted tires. This is assumed to apply to all three classes of passenger car vehicles since the data in the table does not suggest a strong trend with vehicle size. Data on truck tires are extremely limited; only data for vehicles in the 35,000 to 55,000 GVW class are reported. These showed reductions in rolling resistance of 25 to 30% using radial tires (Ref. 3-41). From this it can be inferred that radial tires in the light duty truck fleet will exhibit characteristics similar to those of passenger car tires.

Increasing the inflation pressure from a typical value of 24 psi up to the rated maximum pressure of 32 psi has been shown to provide a 6% fuel economy improvement in non-radial tires and a 2.4% improvement for radials. Thus, inflating the non-radial tires to 32 psi would provide greater fuel economy improvement than the radial tire at 24 psi, based on data at steady-state speeds.

In view of the rather limited data on the magnitude and extent of underinflation pressure, the effect on fleet fuel consumption will be examined in two parts. Thirty percent of the applicable fleet will be assumed to be operating at 4 psi underinflated (based on Ref. 3-47) and the remainder (70%) at 2 psi underinflated. Overcoming the losses due to the 4 psi underinflation pressure would result in a 3% fuel economy gain for vehicles equipped with non-radial tires and 1.2% for vehicles equipped with radial tires.

#### 3.1.7.3 Safety Considerations

A shift from non-radial to steel-belted radial tires would offer increased safety due to increased damage resistance of the tire. Raising the inflation pressure to 32 psi would not be expected to affect safety.



#### 3.1.7.4 Availability for Implementation

The use of passenger car radial tires has increased at a rapid rate since 1972. The historical installation rate together with projection to 1980 for the OEM market is shown in Figure 3-15, with the current installation rate indicated to be about 70% and about 85% projected for 1980 (Ref. 3-48).

In the replacement market, the growth in usage is at a somewhat lower rate, comprising about 30% of the present market, but in combination with the increased usage in the OEM market, the projected use is expected to increase to about 70% of the replacement market in 1980. This after-market trend is shown in Figure 3-16 (Ref. 3-48).

Radial tire usage in the truck fleet is at a lower level than for passenger cars, as indicated in Figure 3-17 (Ref. 3-49), with only 5% of the light duty truck fleet using radial tires in 1976 and 11% projected for 1980. These radial tire usage rates would suggest that by 1982 the radial tire may account for 90% of the passenger car replacement market and about 15% of the light duty truck market. These levels of penetration will be used in assessing the potential fuel economy gains associated with the radial tire.

#### 3.1.7.5 Cost Factors

Based on cost information contained in Refs. 3-48 and 3-50 for years 1977 and 1978, the price differential between radials and bias ply tires will be taken at \$25 for both the 1976 and 1982 fleets. Thus, if the vehicle owner were to change to radial tire use, his incremental cost would be \$125 based on five tires per vehicle.

With regard to maintaining the desired inflation pressure, little or no cost would be involved. Service station tire gages could continue to be used at no cost to the vehicle owner. Or, at the owners option, an individual gage could be purchased. These are currently available to many types of retail outlets and range in price from \$1 to \$5 depending on the type of construction; i. e., pencil or dial type. Valve stem pressure indicators are also available at \$4.95 per set of five.

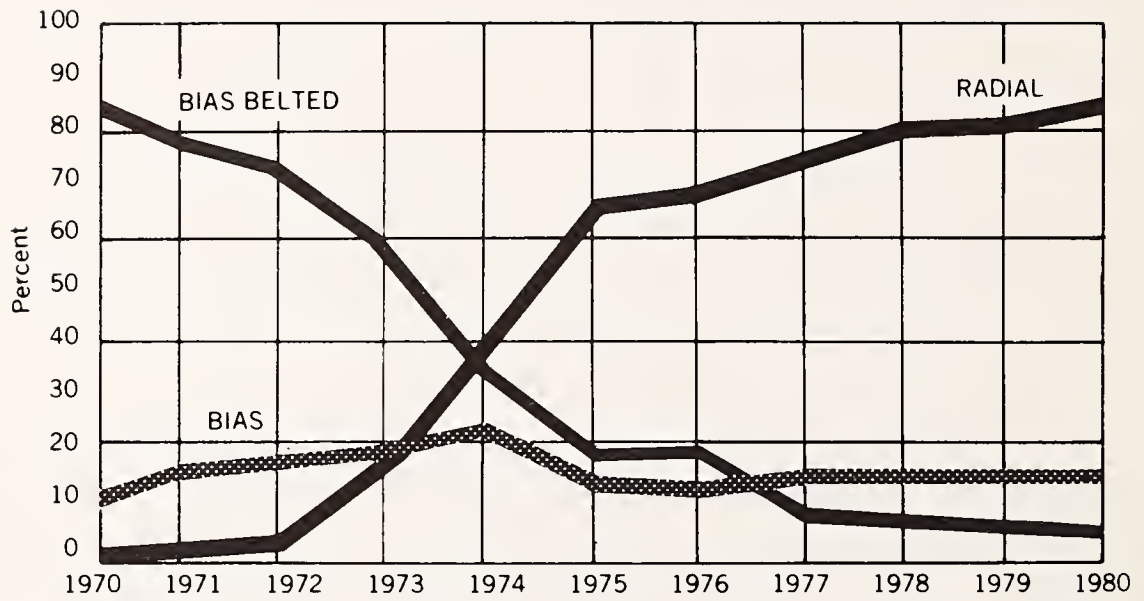

FIGURE 3-15. NEW CAR TIRE TRENDS  
(PASSENGER CARS)  
(Ref. 3-48)

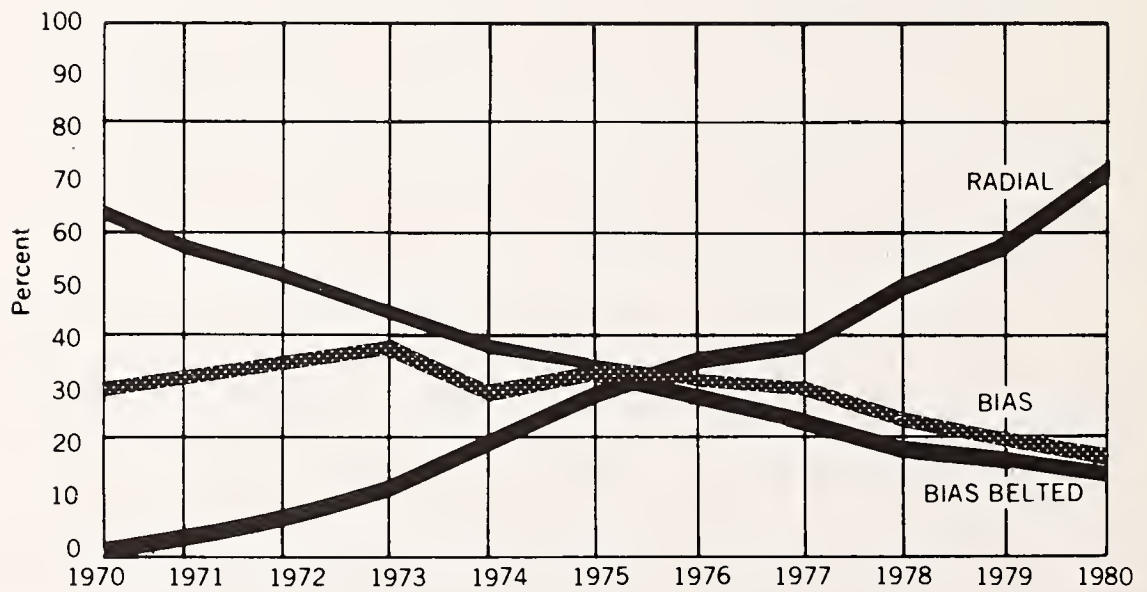

FIGURE 3-16. AFTERMARKET TIRE TRENDS  
(PASSENGER CARS) (Ref. 3-48)

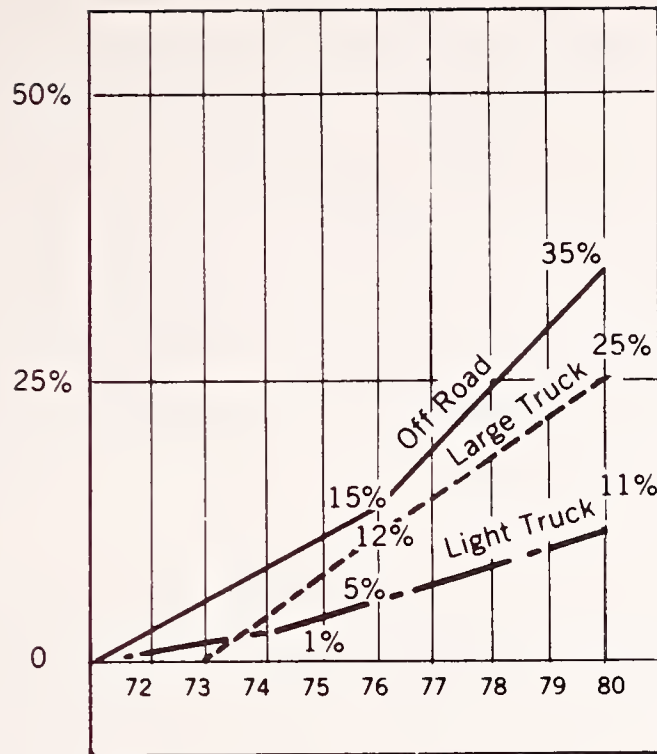

FIGURE 3-17. RADIAL TRUCK TIRE TRENDS (Ref. 3-49)

### 3.1.8 Drag Reduction Devices

#### 3.1.8.1 Introduction and Background

This section examines and evaluates the attributes of aerodynamic drag reduction devices as an aftermarket approach to reducing fuel consumption in the in-use vehicle fleet. Traditionally, aerodynamic design factors for passenger cars have yielded to styling considerations, so that there may be worthwhile room for aerodynamic improvement for many cars in the vehicle fleet. Moreover, the preponderance of light duty trucks, characterized by pickup vehicles in the 6000 lb-or-less weight classification, incorporate many of the styling features and use characteristics of passenger cars, so that these vehicles may similarly benefit from aerodynamic improvements identified for passenger cars. In general, such benefits will only be realized for driving modes in the moderate and higher speed regimes.

#### 3.1.8.2 Fuel Economy Effects

The literature on automobile aerodynamic drag emphasizes new car design modifications and does not provide an abundance of information

that directly correlates fuel economy with design modifications applicable to retrofit devices. Nevertheless, some of this work is useful in delineating areas in which retrofit devices are likely to produce beneficial results, and it also serves to bound the magnitude of the fuel economy effects to be expected. Several prime examples of such data are briefly reviewed in this section. Also included are the results of road tests of retrofit aerodynamic devices, as described in the Aerospace Corporation retrofit study report (Ref. 3-1). This discussion is followed by a summary assessment of retrofit-significant findings, categorized as applicable to vehicle front end, rear end, and underbody modifications.

#### 3.1.8.2.1 Data Base

The data base comprises five primary sources of information. Each of these sources investigated a variety of effects and aspects of vehicle aerodynamic devices/design modifications, including stability, lift, and yaw angle factors, which are only peripherally important to normal driving situations. These factors are not included in the summarization of relevant data which follows.

The Motor Industry Research Association (MIRA) of England has been active for many years in measuring drag coefficients of passenger cars in a full-scale wind tunnel facility. MIRA has developed extensive correlations for predicting overall vehicle drag coefficients in terms of shape factors for various external geometric elements of a vehicle (Ref. 3-51). Recent MIRA work (Ref. 3-52) has been directed specifically toward the subject of fuel economy increase due to the use of add-on aerodynamic aids. This work involved full-scale wind tunnel tests, limited coast-down tests, and measurements of vehicle fuel consumption in road tests. The test vehicle was an Austin Maxi 5-door, an English car of the hatchback type. The fifth door is built into the rear deck surface, which slopes down at an angle of approximately  $45^\circ$ . Retrofit aids examined were front air dams, rear spoilers, fairings around the A-post (front roof support), flush hub caps, and spats (exterior covers across the rear wheel well).

Volkswagenwerk AG provides a detailed account of the effect on drag coefficient of numerous but rather minor modifications to a base new car configuration (Ref. 3-53). The drag coefficient data were obtained from



wind tunnel tests of full-scale models and actual vehicles. Configurations studied were front end designs, front air dams, A-post modifications, rear end designs, and rear spoilers.

General Motors examined the mechanism of drag reduction due to the use of front dams and rear spoilers (Ref. 3-54). Drag coefficients were measured by wind tunnel tests of a 3/8-scale model notchback sedan.

Jet Propulsion Laboratory, under contract to DOT/TSC, measured drag coefficients for configuration changes applicable to new vehicles (Ref. 3-55). Some of the results are pertinent to retrofit installations. Aerodynamic modifications tested were changes to front and rear end geometry, air dams, rear spoilers, underpans, and fairings at the interface between the windshield/front door and the roof. Drag coefficients were measured by scale model wind tunnel tests on a 0.4-scale model 1974 Mustang II, by full-scale wind tunnel tests on a 1974 Mustang II, a 1975 Impala and a 1975 Valiant, and by coast-down tests of the same model 1975 Impala as was used in the full-scale wind tunnel tests.

High speed road fuel economy tests of some aerodynamic aids described in the popular automotive press (Refs. 3-56 and 3-57) were summarized in the Aerospace Corporation retrofit study (Ref. 3-1). Simple aerodynamic modifications were made to a 1974 Pinto Runabout and a 1973 Datsun 240Z. The effects of these changes were observed by means of fuel consumption tests performed at a constant indicated speed of 70 mph on an oval driving track. The devices tested were a front air dam, rear deck spoiler, blockage of part of grill inlet flow area, and streamlined fairings over headlamp sockets.

Of the front end modifications tested by the sources described above, the devices most applicable to retrofit applications are the various types of air dams. Three air dams were tested by MIRA; all projected forward like a locomotive cowcatcher, all had the same ground clearance of 5.9 inches, and all had a forward cant angle of 45°. These devices differed in the extent of coverage of the front of the vehicle. The largest air dam covered the entire radiator grill, one commenced at the top of the bumper, while the smallest dam was mounted still lower. Volkswagen tested a variety of shapes, sizes, and locations. The GM scale model test used a simple flat sheet mounted directly under the bumper. The dam height was varied up to a maximum of 11.8 inches (full-scale equivalent)

which reached essentially to the ground plane. Reference 3-54 (GM) states that production-feasible dams are typically limited to approximately half of this range. The front dams used by JPL were similar to those used by GM, except that the ends of the dam were curved rearward to follow the contour of the lower front body exterior. Ground clearances of 6 and 8.5 inches were used (full-scale equivalent). Figure 3-18 is a photograph of a front dam used in the JPL tests. Disregarding the other front end modifications shown, this could be representative of a typical retrofit front dam installation.

A problem which arises in connection with analyzing results on drag reduction is that often the device of immediate interest is tested in conjunction with one or more other aerodynamic aids. A common practice is to assign a " $\Delta C_d$ " effect to the device (or combination of devices) tested by subtracting the  $C_d$  of the baseline unmodified vehicle from the overall  $C_d$  of the baseline vehicle equipped with the aerodynamic aid being investigated. The assumption is sometimes made that the  $\Delta C_d$  effects for individual devices are directly additive for two or more aids used together. Data in the Volkswagen and JPL reports (Refs. 3-53 and 3-55) provide several examples which demonstrate that this assumption can lead to significant errors on either the high or the low side. This tends to limit the quantitative comparisons that can be drawn from the available data base.

Table 3-6 shows the results of those cases in which a front dam was tested alone. The Volkswagen data (Ref. 3-53) indicate low improvements of 0 to 3% reduction in  $C_d$ , but the cited reference comments that decreases of up to 15% have been obtained, depending on the car. The GM and JPL data both indicate that about a 6% reduction in  $C_d$  was obtained with the front dam alone. Thus, this limited data base suggests that front dams (suitable for retrofit) could reduce  $C_d$  by about 6%. It may be noted that VW (Ref. 3-53) provides the results for a combination of front trim fairing and air dam. These data are considered to be vehicle specific and are not generally applicable to the national fleet.

MIRA did not test any of their air dams separately, but rather in combination with other types of aerodynamic aids. The combination of front air dams with all other aids yielded an overall decrease in  $C_d$  ranging from 18.8 to 30.5% as the size of the dam increased. The other aids, with no air dam, produced a 12.6% decrease in  $C_d$ . These results suggest that



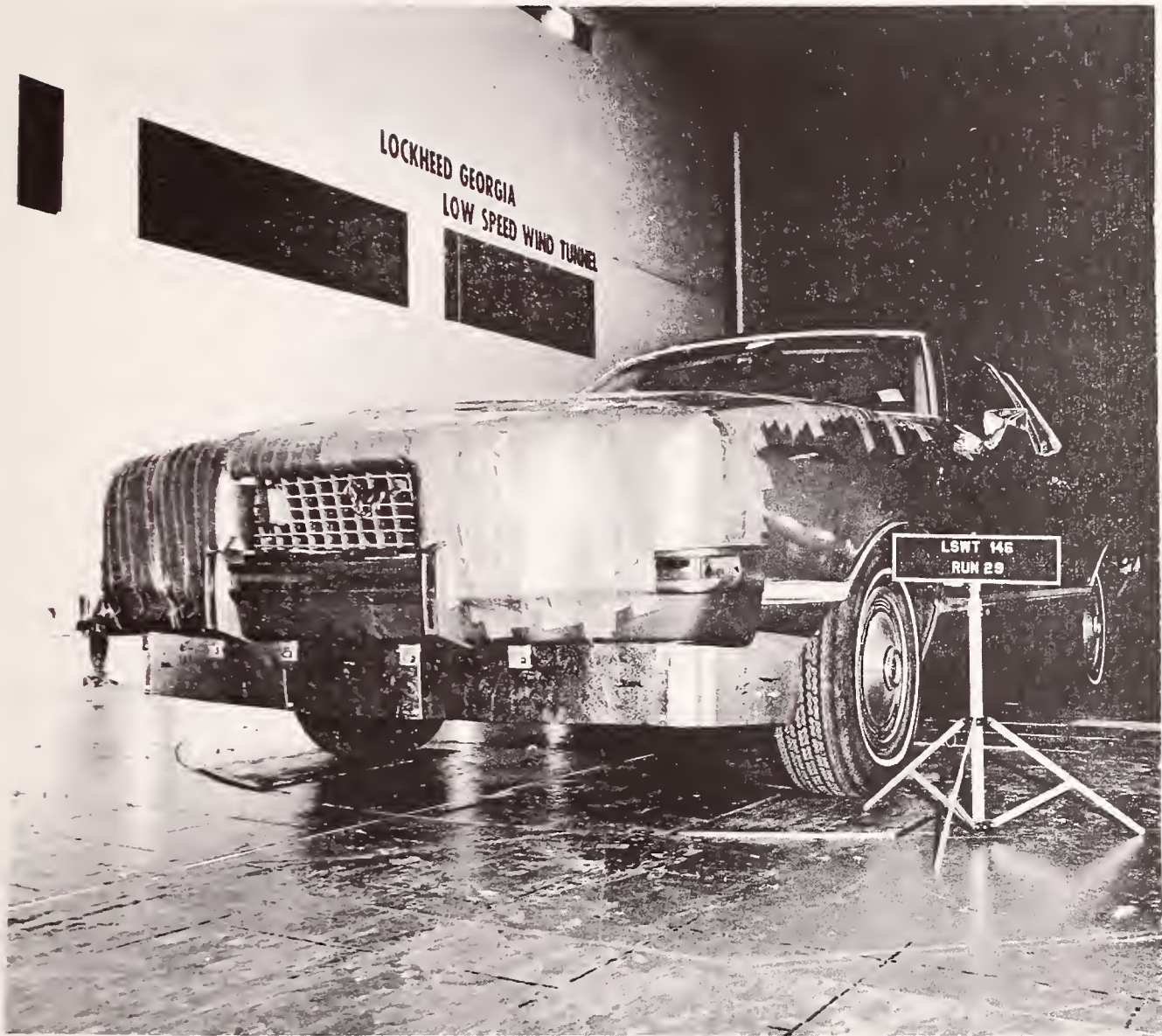

FIGURE 3-18. JPL FRONT AIR DAM ON 1974 MUSTANG II (Ref. 3-55)

TABLE 3-6. TEST RESULTS FOR FRONT AIR DAMS\*

Data Source	Device Configuration	Stock Vehicle	% $\Delta C_d$ , Compared to Stock Vehicle	Comments
Volkswagen (Ref. 3-53)	Vertical plate; 3 positions, 3 heights (0.8 to 2.4 in.) Plate canted forward 1 position, 3 heights (3.1 to 6.3 in.) Not specified	1600X Coupe (VW of Brazil)  1600X Coupe (VW of Brazil)  Not specified	From $\approx +1\%$ (increase in $C_d$ ) to $\approx -3\%$ (decrease in $C_d$ )  0 to $-1\%$  "up to $-15\%$ , depending on car"  $-2\%$	Overall $\% \Delta C_d = -8\%$ when combined with front trim add-on, which produced $-2\%$ when tested alone
General Motors (Ref. 3-54)	Vertical plate under bumper; location and width fixed, height varied	3/8 scale notchback coupe, semi-detailed	$\Delta C_d = 0$ to $\approx -0.03$ for dam heights of 0 to 8 in. (ground clearance $\approx 3.8$ in.); increase in $C_d$ for greater heights	Only $\Delta C_d$ reported; no absolute values. Assuming 0.5 for stock $C_d$ , max $\% \Delta C_d \approx -6$ .
JPL (Ref. 3-55)	Vertical plate under bumper; 8.5 in. ground clearance	0.4 scale 1974 Mustang II  1974 Mustang II car	$-6.6$  $-6.5$	

\* Used alone (no other aerodynamic devices)



larger dams could yield superior results compared to the 6% assessment developed from Table 3-6. However, the larger MIRA configurations are not considered to be promising candidates for retrofit installation because of their susceptibility to damage in use.

In the road tests performed on a 1974 Pinto by Car and Driver Magazine (Ref. 3-56), the front air dam had 2 inches of ground clearance. The fuel economy improvement effects measured at a steady speed of 70 mph were reported to be: for the front air dam, 5.8%; for the front air dam plus grill inlet reduction, 9.1%; and for a streamlined fairing over the headlamps, 0.6%. These aids were test specimens specially fabricated for testing purposes and were not production aftermarket parts.

In road tests on a Datsun 240Z conducted by the same source (Ref. 3-57), both aftermarket and specially made front dams were used. The improvement in steady-state 70 mph fuel economy varied from zero to about 3.6%, with the larger, specially made dam showing the highest improvement. Use of aftermarket streamlined headlamp fairings produced about 0.9% fuel economy improvement.

GM supplies additional pertinent information in Ref. 3-54 on the effect of dam height on  $C_d$ . The data are shown in Figure 3-19. Note that the drag coefficient shows a shallow minimum at a dam height of about 100 mm (3.9 inches); dam heights above about 200 mm (7.9 inches) caused an increase in drag. Thus the optimum height for this vehicle was somewhat less than the production-feasible maximum height mentioned earlier.

Reference 3-54 (GM) concluded that (1) the lift and drag reductions produced by dams are primarily a result of front underbody and engine compartment pressure reductions due to the downward deflection and acceleration of the air flowing under the dam; (2) drag reductions occur primarily on the engine compartment rear bulkhead, the toe pan, the front suspension and cross member, and the engine block; and (3) depending on dam size, drag reductions are partially or completely offset by drag increases at the dam, radiator, and model exterior. The flow field effects as visualized by GM are shown in Figure 3-20.

Of the rear end modifications tested in the sources discussed above, the only type applicable to retrofit use are rear spoilers. MIRA tested rear spoilers at two locations: the end of the roof and the end of the rear deck. Each location was tested in three configurations, varying in

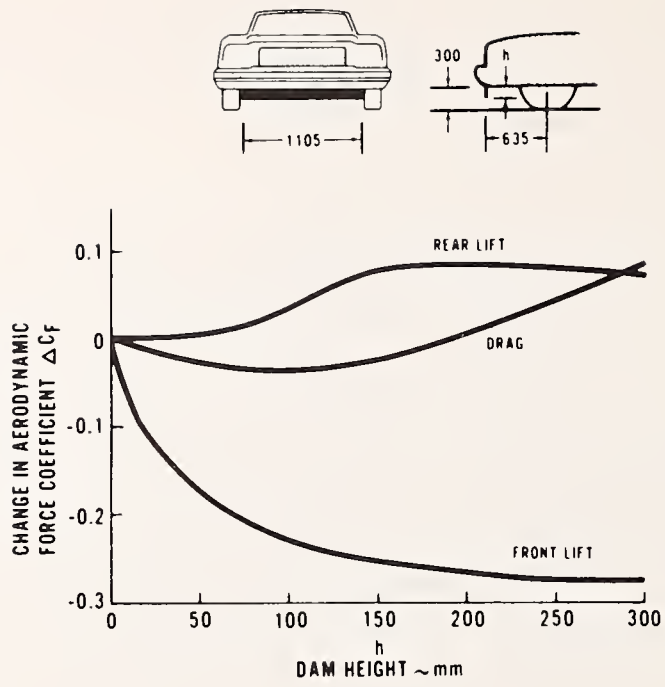

FIGURE 3-19. TYPICAL LIFT AND DRAG EFFECTS OF FRONT DAMS (Ref. 3-54)

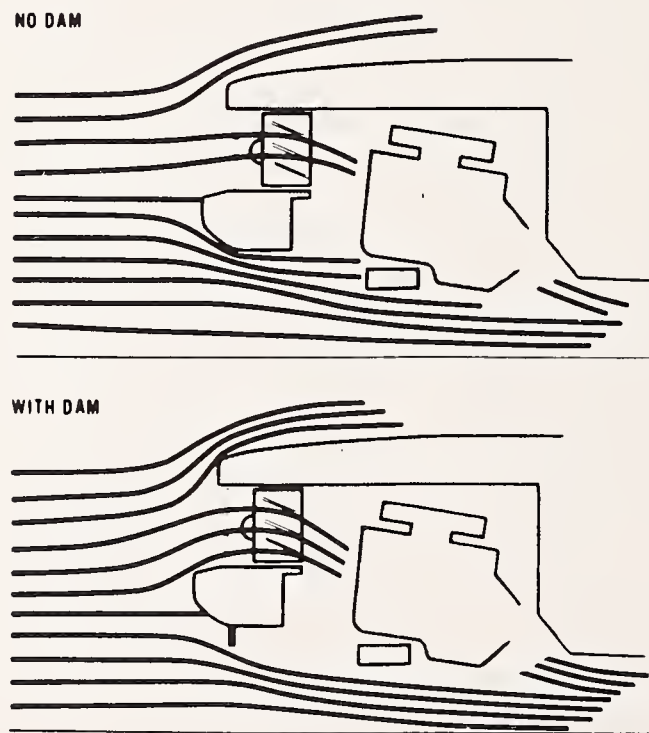

FIGURE 3-20. PROPOSED FLOW FIELD EFFECTS OF FRONT DAMS (Ref. 3-54)

spoiler height and/or angle of attachment (the latter were all small variations about a horizontal position). Volkswagen tested five versions attached at or near the rear deck of an unspecified fastback coupe. Differences in the VW versions involved shape, location, and effective spoiler height (the latter from 1.6 to 2.4 inches). GM tests of spoilers used a flat plate at the end of the rear deck of the 3/8-scale notchback. GM spoiler location, width, and angle ( $20^\circ$  rearward of the vertical) were held constant, while spoiler height was varied up to 3.9 inches (a spoiler height of about 0.8 inches was found to be optimum). JPL used a 2-inch-high spoiler mounted at the end of the rear deck and oriented  $90^\circ$  to the trunk rear deck surface. Figure 3-21 shows the JPL spoiler mounted on the 1974 Mustang II test vehicle. The general dimensions and location of the system depicted may be considered to be representative of a typical retrofit installation.

Table 3-7 summarizes the results obtained by the various sources for those tests in which a rear spoiler was tested alone. These data all indicate a potential for drag reduction of 5 or 6%. The limited data base does not permit categorization of the drag reduction effect by vehicle type or size.

MIRA did not test any rear spoilers separately, but rather in combination with three other types of aids. Spoilers located at the end of the roof in combination with other aids produced overall decreases in  $C_d$  relative to the stock vehicle of from 10.4 to 14.4%. The effectiveness increased as the spoiler angle was reduced. The other aids tested without any rear spoilers gave an overall decrease in  $C_d$  of 5.1%. These data suggest that the MIRA roof spoilers have an effectiveness comparable to that of the rear deck spoilers shown in Table 3-7. The rear deck spoilers tested by MIRA, in combination with the other aerodynamic devices yielded an overall decrease in  $C_d$  of from 5.3 to 9.3%, with effectiveness increasing as the spoiler angle was increased from the horizontal. The MIRA data therefore imply a higher effectiveness for the roof spoiler than for the rear deck spoiler. MIRA concluded (1) that the roof spoiler acted to prevent reattachment of the air stream, which is separated at the roof end by the relatively steep slope of the hatchback and (2) that for a shallower "fastback" design, a spoiler location at the boot (end of the rear deck) would be preferable. Similar conclusions were stated by Volkswagen (Ref. 3-53) in an analogous discussion of the effect of vehicle rear end geometry.



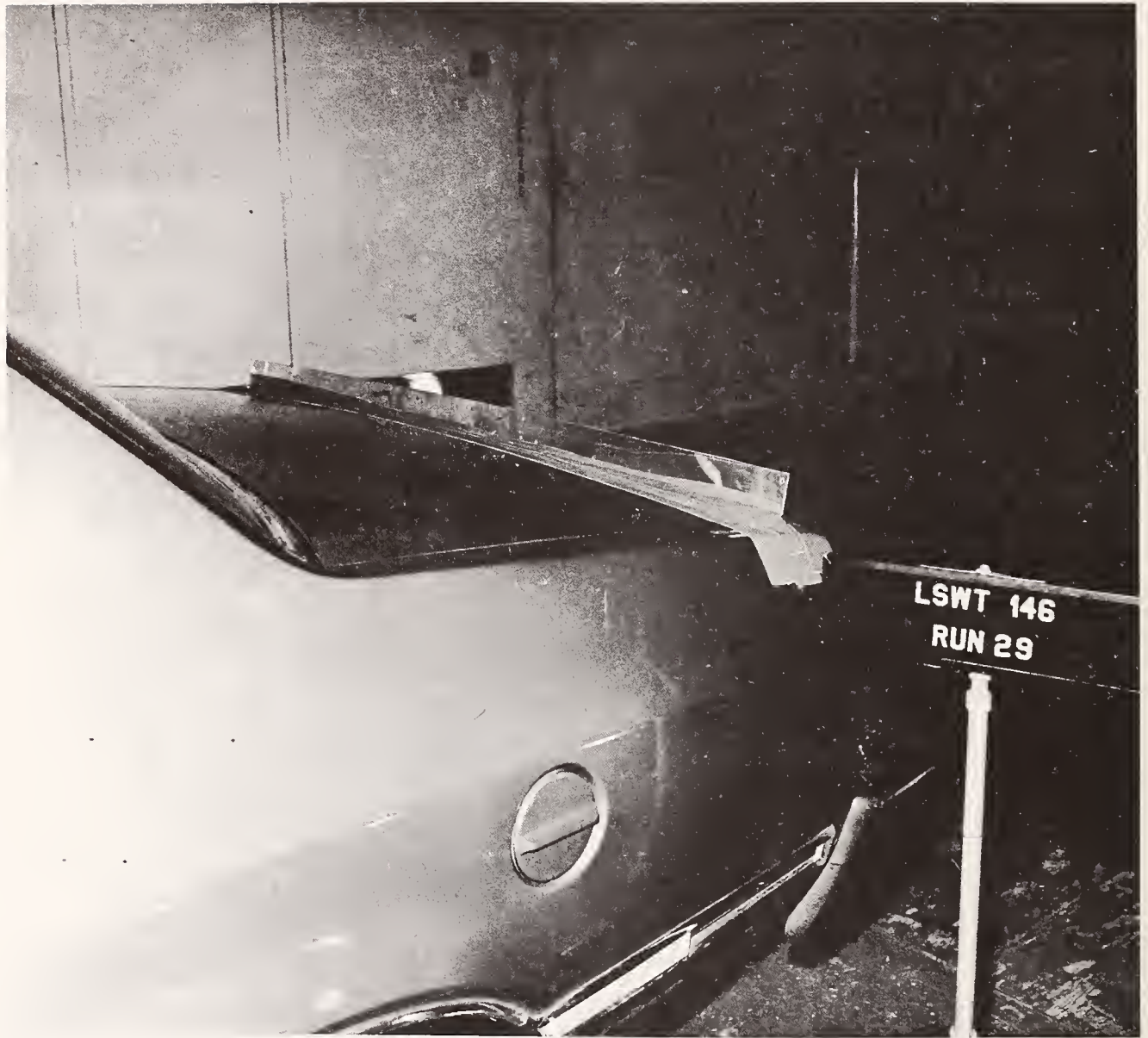

FIGURE 3-21. JPL SPOILER ON REAR DECK  
OF 1974 MUSTANG (Ref. 3-55)



TABLE 3-7. TEST RESULTS FOR REAR SPOILER\*

Data Source	Device Configuration	Stock Vehicle	% $\Delta C_d$ Compared to Stock Vehicle	Comments
Volkswagen (Ref. 3-53)	5 configurations at or near end of rear deck. Various shapes, locations and heights (latter from 1.6 to 2.4 in.)	Unidentified fastback coupe	-5 to -8	
General Motors (Ref. 3-54)	Flat plate at end of rear deck. Width, location, angle fixed; height varied	3/8-scale notchback coupe, semi-detailed	$\Delta C_d = 0$ to $\approx -0.03$ min. $C_d$ at height of $\approx 0.8$ in.	Only $\Delta C_d$ reported, no absolute values. Assuming 0.5 for stock $C_d$ , max $\Delta C_d \approx -6\%$
JPL (Ref. 3-55)	Flat plate at end of rear deck, 2 in. high	1974 Mustang II car	-5.3	

\*Used alone (no other aerodynamic drag devices).

Car and Driver Magazine road tests of the 1974 Pinto equipped with a test specimen 6-inch-high aluminum sheet rear spoiler showed 70 mph fuel economy increases of 1.3% with the rear spoiler horizontal and 7.4% with the rear spoiler at angle of 30° to horizontal. In similar tests by the same source, a Datsun 240Z using both an aftermarket and specially made rear spoiler showed a maximum increase in 70 mph fuel economy of about 0.9%.

GM concludes in Ref. 3-54 that rear deck lips placed at the deck trailing edge divert the downwash air which would otherwise impinge on the rear deck and groundplane. The vertical deflection of the rear flow field reduces its overall streamline curvature, resulting in a rise in static pressure over an area extending upstream of the lip to about the middle of roof. This reduces lift and lift-induced drag. The net drag change due to rear deck lips is primarily a result of the opposing trends of drag reduction on the rear glass and rear deck surfaces and drag increases on the lip and rear underbody area. The rear deck flow pattern as visualized by GM is shown in Figure 3-22.

Another test category of interest in the sources examined concerns those cases in which a front dam and a rear spoiler were tested together, with no other devices included. This occurred in tests by MIRA and JPL. MIRA used the intermediate size air dam described previously, and the optimum roof spoiler configuration of the three variants of this device which were tested. JPL used the identical front dam and rear spoiler described in Tables 3-6 and 3-7, respectively, and in addition tested a front dam of different height with that same type of spoiler. The results of these tests are shown in Table 3-8.

It is seen from the JPL data that the 8.5-inch ground clearance front dam and the 2-inch-high rear spoiler produced a  $C_d$  reduction of 10.3% (simple addition of the separate effects shown in Tables 3-6 and 3-7 would give 11.8%). The percentage reduction in  $C_d$  for the 1975 Impala is less, due possibly to a non-optimum dam height. It appears appropriate, for the purpose of this discussion, to discount somewhat the higher result obtained at MIRA, due to the nature of the dam configuration, as discussed previously. It also seems appropriate to give greater weight to the full-scale results on the Mustang, as opposed to the 0.4-scale model. These considerations superimposed on the data of Table 3-8 indicate that the combined use of a

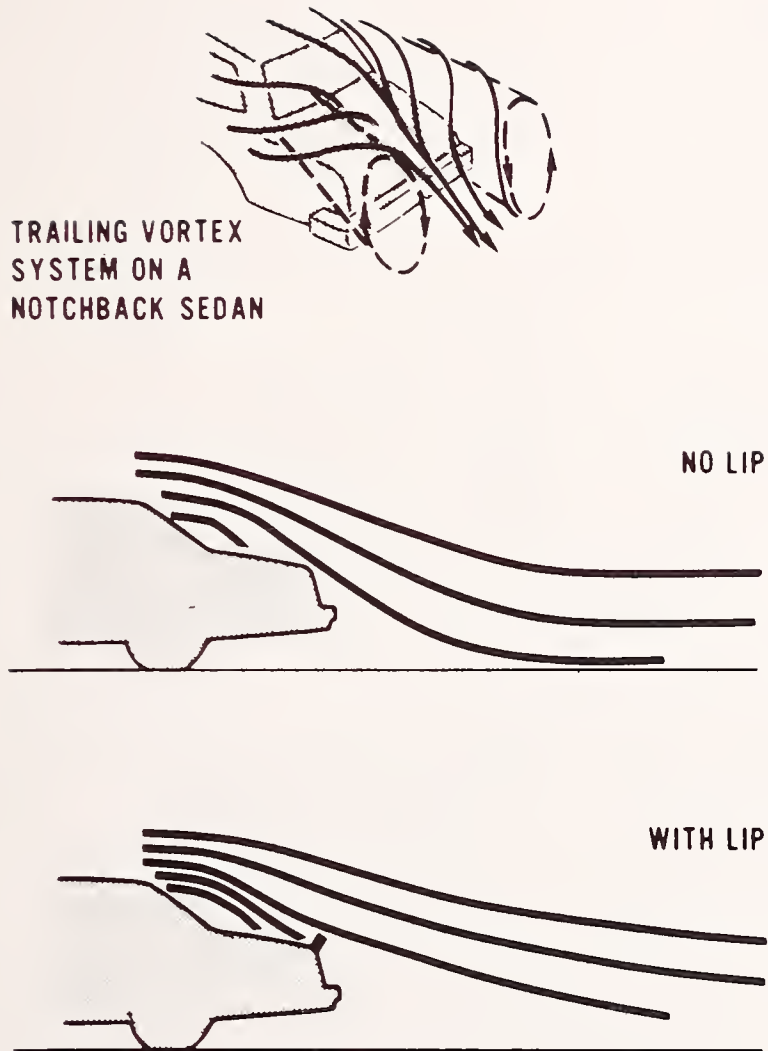

FIGURE 3-22. PROPOSED REAR FLOW FIELD  
EFFECT OF A DECK LIP  
(Ref. 3-54)

TABLE 3-8. TEST RESULTS FOR FRONT DAM AND REAR SPOILER  
USED TOGETHER\*

Data Source	Device Configuration	Stock Vehicle	% $\Delta C_d$ Compared to Stock Vehicle
MIRA (Ref. 3-51)	Intermediate size front dam with optimum roof spoiler	Austin Maxi (hatchback)	-14
JPL (Ref. 3-55)	Front dam with 8.5-in. ground clearance, 2-in. high spoiler at end of rear deck	0.4-Scale 1974 Mustang II	-13.0
	Front dam with 6-in. ground clearance, 2-in. high spoiler at end of rear deck	1974 Mustang II car	-10.3
		1975 Impala 4-door sport sedan	- 8.1

\*No other aerodynamic modifications included.



front air dam and a rear spoiler has a potential for reducing overall  $C_d$  by about 10%. Approximately the same conclusion would be inferred from an examination of Tables 3-6 and 3-7 alone.

The Car and Driver Magazine tests of the 1974 Pinto, using front dam and rear spoilers, as well as a grill air inlet reduction and headlamp streamlining, showed a 14.9% improvement in 70 mph fuel economy vs the stock car. For the Datsun 240Z, testing of the same devices produced an increase in 70 mph fuel economy of about 5.4%.

The benefits of vehicle underpans were examined only in the JPL tests (although they have been the subject of many earlier investigations). The JPL tests, which examined the effects of underpans combined with other aids, indicate that underpans are relatively effective aids. However, comparable or greater benefits may be obtained from the use of front air dams.

The effects of geometry change around the A-post and/or front roof area were examined by Volkswagen, MIRA, and JPL, but the changes treated by Volkswagen are applicable to a new car design only. Neither MIRA nor JPL tested any of these configurations separately. The work at MIRA considered both small and large versions of fairings around the A-post, both of which were tested in conjunction with two aids of other types. The other aids produced an overall reduction in  $C_d$  of 1.5%. Incorporation of the large A-post fairings reduced overall  $C_d$  by 5.1% while the smaller A-post fairings reduced overall  $C_d$  by 4.2%. JPL also tested their A-post aerodynamic aids only in conjunction with aids of other types. A decrease in overall  $C_d$  relative to stock of 21.3% was obtained with the A-post aids, vs 19.5% without the A-post aids.

These results by MIRA and JPL indicate that fairings and vanes in the vicinity of the A-post have the potential of reducing  $C_d$  by roughly 2%.

MIRA found the effect of flush hub caps, tested alone, to be negligible (a 0.7% increase in  $C_d$  was measured), while the combination of flush hub caps and rear wheel spats showed a 1.5% reduction in  $C_d$  relative to the stock configuration.

This concludes the discussion of the quantifiable data base pertaining to the effect on drag coefficient of retrofit aerodynamic aids. Another pertinent aspect of the data base concerns the effect of a decrease in drag coefficient on composite cycle fuel economy. Volkswagenwerk AG presents computed results on this subject in Ref. 3-53. These calculations

were performed for a 2330 lb vehicle with a projected frontal area of  $19.1 \text{ ft}^2$ . According to these computations, a 20% reduction in  $C_d$  (from 0.5 to 0.4) caused a 5% increase in EPA composite fuel economy, while a 40% reduction in  $C_d$  (from 0.5 to 0.3) produced an 11% increase in composite fuel economy.

In addition to these data, Ref. 3-58 (DOT/TSC) presents the computed effect on fuel economy of a 20% reduction in drag coefficient, for three different sizes of passenger cars, plus a van. The driving cycles used in this work included the EPA urban cycle and steady-state speeds of 30, 50, and 70 mph. If the 50 mph data are assumed to represent EPA highway cycle effects, the DOT results can be expressed in terms of composite cycle fuel economy. This has been done in Table 3-9 showing both the Volkswagen and (modified) DOT/TSC data. Note that the DOT/TSC results show the expected trend with weight for passenger cars, reflecting the increasing relative importance of rolling resistance with increasing vehicle weight (the delivery van represents a separate family of data; its bluff shape and resulting high drag tends to increase the relative importance of aerodynamic drag for a given vehicle weight). If the other ingredients of the data base were sufficiently well defined, it would thus be appropriate on the basis of the trend shown to scale the percentage fuel economy effect for a given percentage reduction in drag coefficient in terms of vehicle weight or market class. However, the uncertainty in the average values for percentage reduction in  $C_d$  obscures this relationship, and its use would imply a precision in the final estimate of fuel economy that is not justified. Moreover, the magnitude of the fuel economy improvement for aerodynamic aids is relatively small; i.e., 1 or 2%, and there is little value in distinguishing between the resulting size effects of only a few tenths of a percent. Accordingly, it will be assumed that the average percentage increase in fuel economy is numerically equal to one-fifth of the percentage reduction in drag coefficient, and that this approximation is applicable to passenger vehicles of all market classes. Referring to Table 3-9, this approximation is seen to be equivalent to adopting the relationship shown for the 3300 lb passenger car.

TABLE 3-9. EFFECT OF DRAG REDUCTION ON  
EPA COMPOSITE CYCLE FUEL  
ECONOMY

Data Source	Vehicle	A	B
		% Decrease in Drag	% Increase in EPA Composite Fuel Economy
Volkswagen (Ref. 3-52)	2330 lb pass. car	20	5
		40	11
DOT/TSC (Ref. 3-58)	2300 lb pass. car	20	5.3
	3300 lb pass. car	20	4.0
	4300 lb pass. car	20	2.7
	4600 lb delivery van	20	4.3

### 3.1.8.2.2 Assessment of Benefits

It is concluded that the devices of primary interest for retrofit application are the front air dam and the rear deck spoiler. The dam would be useful for all vehicles, while the spoiler would be principally beneficial for cars of the fastback, hatchback, or notchback configurations. These two aids are among the more effective forms for drag reduction from the viewpoint of both the magnitude of the benefit and the reliability of producing some beneficial effect even if the specific arrangement is not optimum. These devices are also the most amenable to retrofit installation with a minimum of cost and undesirable side effects. Modified front and rear end geometries may be quite effective in drag reduction but represent a considerably more costly installation and pose some safety and damagability problems. They are primarily of interest to new car design optimization. Underpans cause an undesirable reduced accessibility for inspection and maintenance of underbody parts and appear to be less effective than a well designed front air dam. Fairings around the A-post, headlamp, wheel hubs, and wheel covers show only very small improvements.

Based on the data discussed earlier, the maximum reduction in overall drag that can be anticipated due to retrofit installation of air dams and rear spoilers on passenger cars is about 10%. This is equivalent to a maximum average fuel economy increase of 2%. There is no basis at present for differentiating this effect in terms of car size or shape.



With regard to the application and benefits of these aerodynamic aids as applied to light trucks, two duty-specific factors must be considered: drag coefficient effects related to vehicle geometry, and vehicle use modes. No reliable data have been found concerning retrofitable aerodynamic aids for pickup trucks, vans, and other non-passenger car shapes. There is a basic similarity, however, in front end and undercar geometry between passenger cars and most pickup trucks under 6000 lb GVW. This, combined with fundamental considerations pertaining to the origin of front dam drag reduction, suggests that front dams may have a comparable effect on pickup trucks. According to Ref. 3-59, personal transportation is the major use of 53% of all light duty trucks (under 10,000 lb GVW). This percentage may be expected to be considerably higher for smaller pickup trucks. It is accordingly assumed that front dams applied to pickup trucks under 6000 lb GVW will show approximately the same reduction in drag coefficient as indicated in Table 3-6 for passenger cars (6%), and that the effect on fuel economy will be about the same as for passenger cars, considering similarities in driving patterns. Accordingly, an average fuel economy reduction of about 1% is assigned to pickup trucks under 6000 lb GVW using front air dams.

It is probable that most of the vans below 6000 lb GVW are also used primarily for personal transportation and may be amenable to the application of front dams. However, there are no data available at present to justify a fuel economy increase for this retrofit application.

No fuel economy gain will be assigned to other types of light duty trucks. Heavier pickup trucks are normally associated with a higher ground clearance design, which makes the reliability of estimating drag reduction effects due to the use of dams more uncertain. Approximately 30% of this group are used in wholesale and retail trades (Ref. 3-59) and are likely to see a relatively lower speed, urban-oriented duty cycle where drag improvements would have little impact on overall fuel consumption.

#### 3.1.8.3 Safety Considerations

No adverse safety effects are identified in connection with retrofit applications of front dams and rear spoilers. These devices cause a reduction in lift which tends to produce better tire traction at higher speeds. However, the magnitude of this effect is probably insignificant at normal cruise speeds for the relatively small spoiler and dam sizes considered here.



#### 3.1.8.4 Availability for Implementation

At present there is no significant level of aftermarket sales of aerodynamic aid devices for light duty vehicles. Some aftermarket devices of this general type are available; for example, Datsun offers a front dam as an accessory item, and Interpart Corporation of El Segundo, California, sells both front and rear end spoilers for a number of high performance cars. These devices are primarily directed at sport car enthusiasts; their main purpose appears to be to improve vehicle handling qualities by reducing high speed lift, rather than to improve fuel economy.

However, the basic configuration of air dams and rear spoilers as drag reduction devices is very simple, comprising simply a section of sheet metal (or fiberglass) shaped to fit and attach under or behind the front bumper or across the rear deck. These devices should therefore be within the manufacturing capabilities of many companies who are presently involved in supplying a variety of components to the automotive aftermarket.

No data on current production levels or capability for expansion are available. Because the product must be tailored to fit a specific car model, the risks associated with overestimating the market may be particularly severe.

#### 3.1.8.5 Cost Factors

Interpart Corporation estimated current retail prices for front dams to be in the range \$29 to \$66 and for rear spoilers to be \$25 to \$35. These units are designed for small cars (Datsuns, Toyotas, Capris, Vegas, etc.), the only market presently served by Interpart. The front dam offered by Datsun costs \$75. These prices do not include installation. The Interpart models are mounted by drilling holes through the body for attachment, while the Datsun's front dam unit bolts on. Both types of mounting are within the capability of most buyers in the market presently being served, but self-installation may not serve the requirements of the general driving public. Assuming a \$15 installation cost for each device alone, the total unit cost for front dams will be taken as \$45 to \$80 (average of \$65), while the cost for the rear spoiler will be taken as \$45. The average unit cost for both devices installed together is taken to be \$100.

### 3. 1. 9 Improved Lubricants

#### 3. 1. 9. 1 Introduction and Background

Automotive lubricants encompass a broad spectrum of products, including engine and differential oils, transmission fluid, and bearing greases. Inasmuch as the major thrust of this study is the reduction of automotive fuel consumption, attention here is primarily focused on engine and differential oils as offering the greatest potential in this regard.

Improvements in lubricants have followed three main paths. The first has been to upgrade conventional mineral oil lubricants, both by improved refining of the base oil and by the development of a wide range of additives. Additives now account for almost a fifth of the contents by volume of premium grade engine oil and almost half its price. These perform many useful functions (e.g., alter viscosity characteristics, inhibit corrosion, extend drain period), the most important of which from the standpoint of fuel consumption is the attainment of suitable viscosity characteristics over a much wider range than possible with the base oil.

The second main path has been the development of synthetic oils. Many types have been investigated and commercialized, but of most interest to automotive applications are the synthetic hydrocarbon fluids (olefin oligomers) and organic esters. These materials are currently prepared from petroleum stocks, although in principle they could be obtained from other sources such as coal or animal products. One or more of these base fluids are combined with special additive packages to produce synthetic motor oils. Their primary fuel economy benefit derives from reduced low temperature viscosity (relative to mineral-based oils with additives) without adverse effects on other lubrication requirements. They also offer the potential of extended drain intervals over that of conventional lubricants.

Blends of mineral oil with synthetic base fluids are also being developed in an effort to achieve many of the advantages offered by purely synthetic lubricants, at a price closer to that of conventional oils.

The third path in the development of improved lubricants has been to utilize a lubricating solid suspended colloiddally in a conventional oil. Molybdenum disulfide and graphite are the most commonly used solids, but other materials (such as Teflon) have been proposed or experimentally developed.

### 3.1.9.2 Fuel Economy Effects

#### 3.1.9.2.1 Data Base

The literature sources on this subject are numerous, consisting primarily of contributions by oil companies engaged in the development of improved lubricants, suppliers of oil additives (for use in both mineral-based oils and synthetic lubricants), and automobile manufacturers. Consideration is given here only to those references which most directly and quantitatively treat fuel economy effects and which provide a complete description of test conditions. The salient findings of these references are briefly described below. Table 3-10 summarizes the test data from these sources.

Mobil Oil Corporation provides an update of their synthetic lubricant development work in Ref. 3-60. Mobil is presently marketing such a material under the trade name Mobil 1, which utilizes an olefin oligomer/organic ester blend as base fluid. Reference 3-60 states that the synthetic lubricant showed an average 4.2% fuel economy advantage over mineral oils in tests performed in the same vehicle, using various test cycles, speeds, and commercial engine oils. The baseline mineral oil was mostly SAE 10W-40 or 10W-50 while the synthetic lubricant had an SAE viscosity classification of 5W-20. Based on additional information supplied by Mobil and reported in Ref. 3-2, a 24,000 mile test using a baseline SAE 5W-20 mineral oil for comparison showed that fuel economy improved by 1.5%, but that engine wear was evident when the light mineral oil was used. Reference 3-60 presents other test data showing that SAE 5W-20 Mobil 1 gave comparable or greater wear protection and oil economy than SAE 10W-40 or 10W-50 mineral oils. According to Mobil also, calculations based on the test data indicate that Mobil 1 would yield an average fuel economy improvement of over 5% (referenced mostly to 10W-40 and 10W-50 mineral oils) in cold start, short trip service (6 miles) with a 40/60 mix of urban/highway driving.

In tests conducted by an independent laboratory, General Motors compared the fuel economy effects of three different synthetic lubricants against a conventional engine oil (Ref. 3-61). The conventional oil and two of the synthetics (organic ester base) were of SAE viscosity classification 10W-40, while the third synthetic (olefin oligomer base) was 5W-20. The purpose of these tests was to compare synthetics with mineral oils, both of the same viscosity ratings. Neither the brand name nor manufacturer was



TABLE 3-10. DATA BASE ON FUEL ECONOMY EFFECTS OF IMPROVED LUBRICANTS

Source	Reference	Type of Lubricant <sup>a</sup>	Test Conditions	Test Results <sup>b</sup>
Mobil	3-60	Synthetic 5W-20 (Mobil 1)	Multiple vehicle tests performed over variety of driving cycles.	+4.2% vs 10W-40 mineral oils, +1.5% vs 5W-40 mineral oils, but latter provided inadequate lubrication.
GM	3-61	3 synthetics 10W-40 and 5W-40	Highway driving, 4 vehicles (454 CID), one to each type of oil (plus a control with 10W-40 mineral oil). Test driving not identical. 40,000 mile test duration.	3 cars with synthetic oils all showed lower FE (-3.9% to -5.7%) than control car.
Emery Industries	3-62	Synthetic 10W-40	70 mph highway driving, 2 cars, one for synthetic oil, other for conventional 10W-40 oil. 50,000 mile test duration, identical driving schedules for both cars.	+3.8% for car with synthetic oil vs car with conventional oil.
GM	3-63	Commercial and experimental mineral-based engine, transmission and differential oils of varying viscosity	Vehicle road tests (455 CID, 5500 lb) FE measured over warmed-up SAE and GM urban, suburban and highway driving cycles, and steady state speeds. Also cold start (40° to 64°F) tests over GM city-suburban cycle.	Extreme comparison was for experimental engine/transmission/differential lubricants for SAE grades 5W/5W/75, respectively vs 40/40/90: +1% to 5% in warmed-up tests, maximum benefit at 70 mph steady state.  Commercial lubricant comparison was 10W/DEXRON JC/80W vs 20W-50/DEXRON J/90: +2% to +3% at warmed-up steady speeds, -1% to +2% in warmed-up driving cycles, +5.4% in cold start GM city-suburban cycle.  Effect of 80W vs 90 differential oil only: approx. +1% at warmed-up steady speeds.  Effect of 10W vs 20W-40 engine oil only: approx. +2% at warmed-up steady speeds.



TABLE 3-10. DATA BASE ON FUEL ECONOMY EFFECTS OF IMPROVED LUBRICANTS (Continued)

Source	Reference	Type of Lubricant <sup>a</sup>	Test Conditions	Test Results <sup>b</sup>
GM	3-64	Commercial mineral-based engine and differential oils	EPA test cycles, 3500 lb IW vehicle, 231 CID 10W/75 vs 10W-30/90 engine/differential oils.	EPA urban: +1.4% EPA highway: +3.0% EPA composite: +2.3% Portions of EPA urban cold start: +3.0% cold stabilized: +1.2% hot start: +0.2%
GM	3-65	Commercially available improved engine and differential oils	Multiple tests over EPA composite cycle, 5000 lb IW pickup truck, 350 CID.	+11.7%
Exxon	3-66	New "Uniflo", a mineral oil with improved friction modifiers, SAE 10W-40, compared with conventional 10W-40 oils	6 vehicle test over EPA composite cycle. 20 vehicle field test.	+15.5% average +4.5% average
Atlantic Richfield	3-67	"ARCOgraphite" a dispersion of graphite in a mineral-based engine oil, SAE 10W-40	Vehicle field tests, 147 cars comparing ARCOgraphite vs conventional 10W-40 oil.	+3.8% average benefit attributed to use of ARCOgraphite

TABLE 3-10. DATA BASE ON FUEL ECONOMY EFFECTS OF IMPROVED LUBRICANTS (Continued)

Source	Reference	Type of Lubricant <sup>a</sup>	Test Conditions	Test Results <sup>b</sup>
Lubrizol	3-68	Synthetic engine oil 10W-40, synthetic differential oil 75W	Cold start (35° F) vehicle test on chassis dyno. Driving cycle was 10 successive California 7 mode tests (8.3 mile trip), full-size and compact vehicles.	10W-40 synthetic engine oil vs 10W-40 mineral-based oil; +0.9% full-size cars, +1.9% compacts.  Synthetic engine oil combined with synthetic differential oil (75W vs baseline 80W-90); +2.2% full-size cars, +2.7% compacts.
Lubrizol	3-69	Selected engine oils and powertrain lubricants (mineral-based and synthetic)	Cold start (≈ 50° F) and warm engine vehicle road test over 75 mile driving cycle (1st 10 laps of EPA durability driving schedule).	Engine oil: 10W-40 mineral vs 40W mineral. Cold start: +2.2%, warm engine: +1.1%.  Engine oil: 10W-40 synthetic vs 40W mineral. Differential oil: 75W synthetic vs 90W mineral. Automatic transmission fluid: "high density" synthetic vs conventional mineral oil ATF. Cold start: +1.3%, warm engine: +0.5%.  Differences due to cold start said to be statistically significant, but not difference due to warm engine.
Climax Molybdenum	3-70	Colloidal dispersion of MoS <sub>2</sub> in mineral-based oils	Historical survey 1965-74; dyno, track and fleet tests.	Average +4.6% for use of 1% MoS <sub>2</sub> properly dispersed in engine oil.
Climax Molybdenum	3-71	Molybdenum based additives to differential oils (80W & 90)	Steady-state axle dynamometer tests.	+2% with commercially available MoS <sub>2</sub> dispersion, +2 to +5% with experimental MoS <sub>2</sub> dispersions.

TABLE 3-10. DATA BASE ON FUEL ECONOMY EFFECTS OF IMPROVED LUBRICANTS (Continued)

Source	Reference	Type of Lubricant <sup>a</sup>	Test Conditions	Test Results <sup>b</sup>
Univ. of Michigan Automotive Lab	3-72	Colloidal dispersion of MoS <sub>2</sub> and graphite in mineral-based oils	7-vehicle test, 6000 miles of highway driving followed by tune-up and FE test by SAE driving cycles.	Range of values vs same grade of oil without colloidal dispersion: SAE urban -0.3% to +22.4%, suburban -1.9% to +8.2%, interstate -4.1% to +9.6%.
Ford	3-73	Differential lubricants of improved low temperature viscosity compared with conventional SAE 90 gear oil	Engine dyno, steady state 55 mph road load. Data from axle dynamometer testing used in vehicle simulation computer program.	+2% vs same grade of oil without colloidal dispersion Approximately 2% for cold start, short trips; less than 1% for EPA urban and highway test conditions.

<sup>a</sup>Engine oil except as noted.

<sup>b</sup>Percent change in fuel economy.

<sup>c</sup>DEXRON J, typical of GM factory fill ATF.

identified for any of these oils. Four 1973 vehicles of the same model were used (454 CID), and each car was assigned only one type of oil. The state of tune of each car was checked prior to initiating the tests. The test mileage accumulated by each car was approximately 40,000, and the oil drain periods used for each type of lubricant was 20,000 miles. The test schedules were not identical for these cars, but the test routes were similar and the test severity was considered to be about the same for all vehicles. Vehicle speeds were in the range 40 to 60 mph. These tests showed no statistically significant differences in fuel economy among lubricants; in fact, the three cars with the synthetic lubricants all got lower overall average fuel economies (by 3.9% to 5.7%) than the car with the conventional engine oil.

Conflicting results were obtained in tests conducted by Emery Industries (Ref. 3-62), which compared a diester-based synthetic engine oil with a conventional mineral oil, both SAE 10W-40. Two identical 1973 455 CID Oldsmobiles were used; each car was assigned only one type of lubricant. The test covered 50,000 miles, which were accumulated at the rate of 1000 miles per day at a speed of approximately 70 mph. The control car with the conventional lubricant was driven over the same roads at the same time. The synthetic oil was not drained during the test, while the conventional oil was drained at the normal 6000 mile points. The car with the synthetic lubricant averaged 3.8% better fuel economy over the 50,000 mile test than did the control car.

In Ref. 3-63, General Motors examined the effect of reduced-viscosity engine oils and differential lubricants as used in a vehicle with 455 CID engine, tested over various GM and SAE driving cycles and steady-state speeds. The lubricants tested were classified by GM as either "experimental" or "commercial" (high and low viscosity representatives of each were tested); all the lubricants were mineral oil-based (not synthetics). With one exception, a high viscosity commercial engine oil, all the lubricants were single viscosity grades; i. e., they contained no additives to improve viscosity index. The thrust of these tests was to examine the fuel economy effect of lubricant viscosity, as opposed to the GM work reported in Ref. 3-61, which compared the effect of synthetic vs mineral oil, both of the same viscosity classification. Aspects of durability and wear were not evaluated.



The most extreme comparison involved the experimental lubricants, in which engine/transmission/differential lubricants of SAE grades 5W/5W/75, respectively, were compared with SAE grade 40/40/90 lubricants. The set of low viscosity lubricants showed fuel economy benefits ranging from 1 to 5%, with the maximum benefit occurring at 70 mph steady state. These tests were performed only in the warmed-up condition.

GM also compared the effect of the above experimental automatic transmission fluids alone (SAE 5W vs SAE 40, using conventional 10W and 80W engine and differential oils, respectively) and found a 2% fuel economy benefit in the warmed-up GM city-suburban driving cycle.\* However, this test was (intentionally) artificial with respect to the transmission fluids compared, and GM concluded that no significant fuel economy improvement could be obtained relative to currently used automatic transmission fluids (nominally SAE 7W).

Compared to the experimental lubricants, the commercial lubricants tested in Ref. 3-63 had a considerably narrower range of viscosity: 10W vs 20W-50 engine oil, and 80W vs 90 gear oil. DEXRON J, a fluid typical of all GM factory fill for passenger cars, was used as the automatic transmission fluid in these tests. The combined effect of the 10W and 80W oils (vs the 20W-50 and 90 combination) showed a 2 to 3% fuel economy advantage in the warmed-up steady-state tests and from -1 to +2% in the various warmed-up driving cycle tests. No fuel economy benefit for the lower viscosity commercial lubricants was observed in warmed-up city and suburban driving. In the cold start (40 to 64°F) GM city-suburban cycle, the lower viscosity commercial lubricants showed a 5.4% fuel economy advantage, which, according to GM, is attributable to the fact that the engine power needed to shear lower viscosity lubricants is reduced.

The effect of the lower viscosity engine oil alone (10W vs 20W-50) was found to be 1.8% and 1.9% at steady speeds of 50 and 70 mph, respectively, while the effect of the lower viscosity gear oil alone (80W vs 90) was reported as 1.1% and 1.4%. Thus, the fuel economy advantages of lower viscosity engine oil and differential oil appear to be in the ratio of about 60/40.

---

\* 3.7 miles, 6 stops, 24 mph average speed.

In Ref. 3-64, GM provides data concerning the effect of reduced viscosity lubricants on EPA composite fuel economy. The test vehicle was a compact size car, 3500 lb inertia weight, 231 CID. Three tests each were made with high viscosity (10W-30/90) and low viscosity (10W/75W) commercial, mineral oil lubricants. The lower viscosity lubricants yielded a 1.4% fuel economy increase in the EPA urban cycle, a 3.0% increase in the EPA highway cycle, and a 2.3% increase for the EPA composite fuel economy.

Figure 3-23 (GM, Ref. 3-64) provides interesting information concerning the effect of trip length and start-up temperatures on lubricant fuel economy effects as measured over different portions of the Federal Driving Cycle (FDC). Over the cold start portion of the FDC (bag 1 of the FTP, 3.6 miles in length), a 3% fuel economy increase due to the reduced viscosity lubricants was observed. The cold stabilized portion of the FDC (bag 2 of the FTP, 3.9 miles in length) showed a 1.2% fuel economy increase for the reduced viscosity lubricants, while the hot start portion (bag 3 of the FTP) showed only a 0.2% fuel economy increase. Bags 1 and 3 of the FTP are identical except for the engine start-up temperature (cold vs warmed-up). Reference 3-64 concluded that about two-thirds of the observed overall improvement resulted from the engine oil viscosity reduction, and the other third from the rear axle lubricant viscosity reduction.

In a recent communication to NHTSA concerning fuel economy of nonpassenger automobiles (Ref. 3-65), GM presented data for a 5000-lb inertia weight pickup truck with a 350 CID engine, in which the EPA composite fuel economy effect of reduced viscosity lubricants (5W-30 engine oil and 75W differential oil) was measured. The baseline engine and differential lubricants had SAE grades of 10W-30 and 90, respectively. Six tests were conducted, showing an average 1.7% improvement due to the lower viscosity lubricants. These results were stated to be typical of the data obtained in extensive testing of nonpassenger automobiles. GM attributed approximately 1.0% of this improvement to the engine oil, and the remaining 0.7% to the differential oil.

Reference 3-65 also states that GM is actively evaluating friction-modified engine oils of the type that are now being introduced by some oil companies. The results of testing to date are inclusive, but it appears that

COMPACT CAR  
 231 CID ENGINE  
 AUTOMATIC TRANSMISSION  
 3500 lb INERTIA WEIGHT

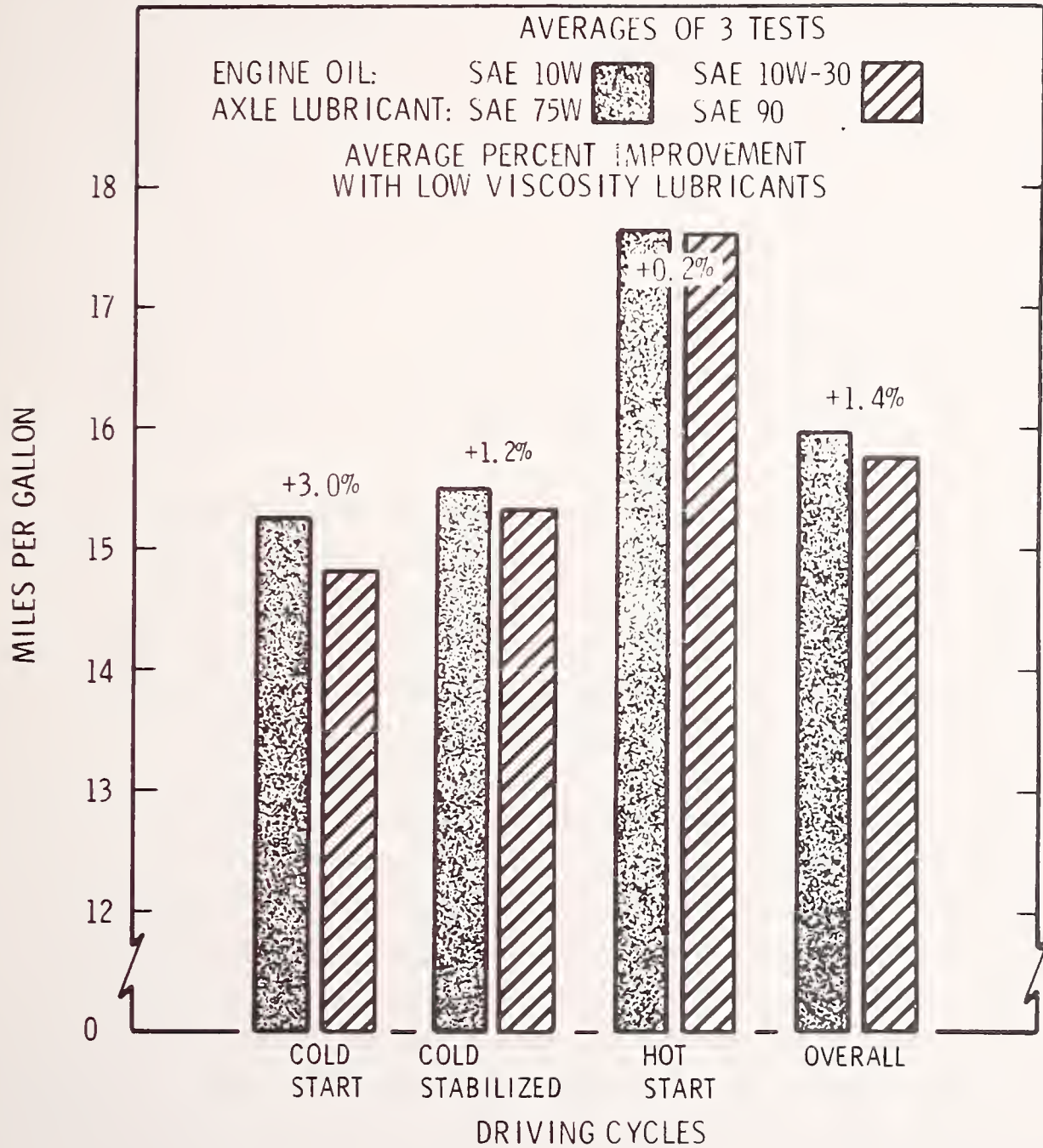

FIGURE 3-23. AVERAGE FUEL ECONOMIES IN EPA URBAN CYCLE TESTS WITH HIGH AND LOW VISCOSITY ENGINE OILS AND REAR AXLE LUBRICANTS (Ref. 3-64)



fuel economy may be improved by about 1.5 to 4%.<sup>\*</sup> According to the reference, additional required development and nationwide all-season qualification testing of new engine oil additive technology will not be completed before the 1982/83 model years.

Additional information on the subject of friction-modified engine oils is provided by Exxon (Ref. 3-66). Exxon claims substantial gains for their new Uniflo, a mineral oil with improved friction modifier additive package. This product replaces a conventional oil of the same brand name and viscosity grade (SAE 10W-40). Six 1975/76 model year cars were tested over the EPA urban and highway cycles, and the new Uniflo was compared with the previous conventional Uniflo product. Each oil was tested a minimum of three times in each car, and was run 2000 miles before the EPA cycle fuel economy tests were run. On average, the results showed a 3.9% fuel economy increase over the EPA urban cycle and 9.0% over the highway cycle, yielding a composite fuel economy increase of 5.5%. The improvement in composite fuel economy for the individual cars ranged from 1.5% to 12.0%.

Exxon also tested 20 cars selected to approximate the 1970-77 car population. These cars were road tested over a fixed route comprised of about 10% city, 50% suburban, and 40% highway driving. After a conditioning period of about 1500 miles, the fleet average fuel economy improvement leveled off at 4.5% (referenced to the previous Uniflo product and other comparable conventional engine oils).

Comparable field test results for another friction-modified oil are reported by Atlantic Richfield (ARCO) for their ARCOgraphite, an SAE 10W-40 mineral-based engine oil containing a colloidal dispersion of graphite (Ref. 3-67). In these tests, 118 vehicles using ARCOgraphite were compared with 29 control vehicles using both ARCOgraphite and a premium quality conventional oil of the same viscosity grade. These were employee-owned cars for which the driving pattern, though not restricted, was recorded to sort out the influence of city vs highway driving, cold start vs hot start trips, etc. The test duration was 2-1/2 months with 300,000 total accumulated miles. ARCO states that the average fuel economy

---

<sup>\*</sup>Not additive to the improvement quoted for low viscosity oils.



improvement due to the ARCOgraphite engine oil was 4.8%, with 95% confidence that the mean was between 1.0 and 8.7%.

The Lubrizol Corporation conducted chassis dynamometer tests to evaluate the fuel economy effects of synthetic vs mineral-based engine and differential lubricants for typical short trips in winter (Ref. 3-68). Each test consisted of 10 successive cycles of the California seven-mode test, each cycle representing 0.83 miles at an average speed of 21.8 mph. The resulting trip length of 8.3 miles was stated to be representative of the national average winter trip. The average ambient temperature in these cold start tests was 35°F. The test vehicles were three 1975 full-size sedans with 350 CID V-8 engine and three 1975 compact sedans with 140 CID 4-cylinder engines. An SAE 10W-40 synthetic engine oil, compared to a similar mineral-based oil, showed a 0.9% improvement in fuel economy for the full-size sedans, and a 1.9% increase in fuel economy for the compact cars. When this synthetic engine oil was combined with a synthetic rear axle lubricant (SAE 75W vs the baseline SAE 80W-90), the fuel economy benefit was found to be 2.2% for the full-size sedans and 2.7% for the compact cars. These data represent the average of multiple runs in each car with lubricants rotated among the test vehicles.

Another paper by Lubrizol (Ref. 3-69) provides information on the fuel economy effect of selected engine and drive train lubricants, but under very different test conditions than those of the preceding reference. The test cycle employed was a modification of the EPA durability driving schedule used to accumulate mileage during vehicle emission certification testing. Three vehicles were used, all identical 1975 model year sedans with 350 CID engines. Three sets of lubricants were employed. Set 1, the baseline, consisted of an SAE 40 engine oil, a conventional automatic transmission fluid, and an SAE 90 differential oil. Set 2 differed only in that an SAE 10W-40 conventional mineral oil replaced the heavier baseline grade of engine oil. Set 3 utilized synthetic lubricants entirely; an SAE 10W-40 engine oil, an experimental high-density automatic transmission fluid, and an SAE 75W differential oil. Set 3, it should be noted not only used synthetic lubricants but also employed a lower viscosity grade for the engine and differential oils. The drivers and lubricant sets were rotated among the three vehicles to minimize driver and vehicle specific effects. There were therefore a total of 27 cold start tests and 27 warm engine tests. The warm

engine tests showed an average 0.5% fuel economy improvement for lubricant Set 3 (all synthetic) vs Set 1 (baseline), and an average 1.1% improvement for lubricant Set 2 vs Set 1. These differences were stated to be statistically insignificant. The cold start tests showed an average fuel economy improvement of 1.3% for lubricant Set 3 vs Set 1, and an average 2.2% for lubricant Set 2 vs Set 1, and these differences were stated to be statistically significant. It is noted that lubricant Set 3 (containing the lower viscosity synthetic differential oil) showed poorer fuel economy than did lubricant Set 2 (with 10W-40 mineral engine oil). It is not known if this poorer performance was due to the synthetic engine oil, the automatic transmission fluid, the lower viscosity differential oil, or to other causes.

Reference 3-70 presents a historical review by Climax Molybdenum Co. on the use of  $\text{MoS}_2$  as an additive in engine oil. It is stated that data obtained from dynamometer, track, and fleet testing over the period 1963-74 show an average fuel economy benefit of 4.6% for the use of about 1% of  $\text{MoS}_2$  properly dispersed in the engine oil.

Another publication by Climax (Ref. 3-71) addresses the effect of  $\text{MoS}_2$  additives to differential oils on steady-state gear efficiency. It was reported that the addition of 3%  $\text{MoS}_2$ , obtained with a commercially available dispersion, provided improvements in gear efficiency of about 2%, implying a corresponding percentage reduction in fuel consumption. Greater improvements in efficiency of 2 to 5% were reported for a non-commercial  $\text{MoS}_2$  dispersion with unusual viscosity characteristics.

Colloidal suspensions of lubricating solids have also been tested at the University of Michigan Automotive Lab (Ref. 3-72). In the first phase of these tests, each of seven 1973 cars with 400 CID engines was evaluated with a conventional SAE 10W-40 SE engine oil for 6000 miles, followed by two successive 6000 mile evaluations with the same grade of engine oil containing 1% of a lubricating solid ( $\text{MoS}_2$  or graphite). Mileage was accumulated at the rate of about 5000 to 6000 miles of highway driving per week. At each 6000 mile test interval, new spark plugs and breaker points were installed and the ignition timing was checked. After this, fuel economy was measured over the SAE urban, suburban, and interstate (70 mph) driving cycles. The percentage changes in fuel economy observed were: for the SAE urban cycle, -0.3 to 22.4%; for the suburban cycle, -1.9 to 8.2%; and for the interstate cycle, -4.1 to 9.6%. The authors stated that these results

were consistent with the fact that engine friction represents the greatest percentage of indicated horsepower at light loads typified by the SAE urban cycle.

The most promising of three colloidal additives tested in the seven-car fleet was then evaluated in an engine dynamometer test of a 1975 350 CID engine operated at 55 mph road load conditions. This test showed a 2% decrease in BSFC (equivalent to about 2% increase in 55 mph steady-state fuel economy), which the authors believe is statistically significant.

Reference 3-73 describes work by Ford concerning the fuel economy effects of drive axle lubricants. This work involved dynamometer testing of a rear axle assembly with the fuel economy effects determined by applying the axle dynamometer data to a vehicle simulation computer program. Two improved lubricants were compared with a conventional SAE 90 gear oil. The test lubricants were not identified, except that they were noted to have improved low temperature viscosity characteristics. The computational results indicated a fuel economy advantage for the test lubricants on the order of 5% for short trip winter driving but less than 1% for the EPA urban and highway test procedures.

This reference also described limited testing of a conventional SAE 90 gear oil fortified with dispersed solid lubricants (graphite and MoS<sub>2</sub>), and indicated that a low viscosity (75W) conventional axle lubricant containing solid lubricants may give superior performance over a wide temperature range compared to a standard SAE 90 gear oil.

#### 3.1.9.2.2 Assessment of Benefits

The data base presented above reflects a wide range of test conditions and numerical results. Some of the data sources emphasize the beneficial effects of improved lubricants on short trips originating with a cold start (especially starts below the 77° ± 9°F "cold start" of the FTP). Other data sources concentrate on high speed driving conditions. Taken as a whole, the data base illustrates a lack of consensus in the industry concerning the magnitude and applicability of benefits achievable through improved lubricants technology.

Whereas the mode-specific data (e.g., short trip/cold start) are interesting and serve to complete the view of current test activities in the improved lubricants area, they are difficult to assess in terms of



"average" or representative driving conditions. The data most directly useful for the purpose of determining fleet fuel consumption effects are those measured over the EPA composite cycle. Accordingly, primary attention in the assessment which follows will be focused on the data presented by GM (Refs. 3-64 and 3-67) and by Exxon (Ref. 3-66).

The GM references indicate that the maximum benefit attributable to lower viscosity lubricants (engine and differential combined) is about 2% and, from the viewpoint of fuel economy effect, it is immaterial whether this reduced viscosity is achieved in a mineral or a synthetic oil. Although the number of data points displayed in Refs. 3-64 and 3-65 is limited, GM states (Ref. 3-74) that the results cited are representative of extensive fuel economy testing by the EPA procedure, and that the claimed benefits may be considered to accurately reflect the composite fuel economy benefit due to reduced lubricant viscosity.

GM takes the position that no significant further reduction in engine friction is possible through the use of lower viscosity lubricants, citing durability and wear problems with the lower viscosity grades in general use such as 5W-20 and 5W-30. With regard to friction-modified oils, GM indicates that fuel economy benefits of perhaps 1.5 to 4% may result, but emphasizes that their data on this subject are still inconclusive, and that extensive development, testing, and evaluation of new friction-modifier additives remain to be done to verify their potential.

The Exxon data for the new friction-modified Uniflo show a 5.5% average improvement for six cars due to the improved engine oil. Though the Exxon data base is limited and shows a relatively high variability (vehicle average improvements varied from 1.5 to 12.0%), it seems appropriate to give it weight and to project a higher potential fuel economy advantage than the 2% assigned by GM to reduced-viscosity engine and differential lubricants.

The above argument is buttressed by other contributions to the data base which give directionally similar indications. The ARCO friction-modified oil data, although not representing EPA composite fuel economy, shows fleet test results similar to those obtained in the more limited fleet testing reported by Exxon.

The Mobil finding for their Mobil 1 synthetic lubricant is also of considerable interest, but their reported result (4.2% fuel economy improvement) represents an average value over a number of different driving cycles



(in addition to the EPA urban and highway cycles), including cruise operation and various types of road tests. This makes the result difficult to relate to an EPA composite fuel economy value. GM, for example, found a considerable disparity between the results of FTP tests and road tests in their evaluation of synthetic motor oils (Ref. 3-65).

This report assumes a 2-1/2% increase in fuel economy due to the use of improved engine oils. The Ford projection of Ref. 3-73 and the GM estimates of Refs. 3-64 and 3-65 all attribute a fuel economy benefit due to improved differential oil of something less than 1%. This report therefore assigns 1/2% to this effect, for a total fuel economy benefit due to improved lubricants of 3% as measured over the EPA composite cycle. In consideration of the similarity between the fuel economy effects measured by GM for passenger cars (Ref. 3-64) and pickup trucks/ other nonpassenger automobiles (Ref. 3-65), the value of 3% will be assumed to apply to all vehicles in the light-duty fleet.

#### 3.1.9.3 Safety Considerations

No safety effects are identified in connection with improved lubricants.

#### 3.1.9.4 Availability for Implementation

All of the three general types of improved lubricants described in Section 3.1.9.1 are now being marketed. A fully synthetic motor oil (Mobil 1) is available nationwide; other suppliers, such as Emery Industries, are currently selling synthetic lubricants only to commercial fleet users, primarily in cold winter areas. Gulf is presently test-marketing a synthetic motor oil, and in addition sells a poly alpha-olefin base fluid to other suppliers.

Blends of mineral and synthetic oils are presently available nationwide through at least one supplier (Pennzoil PZL motor oil), and other companies are pursuing work in this area. Pennzoil does not make specific fuel economy claims for their PZL motor oil.

Exxon Uniflo, a mineral oil with improved friction modifier additive package, is also sold nationwide through service stations and, in some areas, by mass merchandisers.

Mineral oils compounded with solid lubricants are represented by ARCOgraphite and Black Gold, a dispersion of MoS<sub>2</sub> marketed by U. S. Molybdenum Company. Fuel economy claims for the latter product are made based on the data of Climax Molybdenum Company (supplier of the MoS<sub>2</sub>), which were reported in Section 3.1.9.2.1. Both ARCOgraphite and Black Gold are available nationwide, the former through service stations and/or mass merchandisers, the latter through distributors to auto parts stores, etc.

All of the above suppliers declined to provide information concerning sales volume, but present production levels are believed to be relatively low. There appear to be no obstacles to greatly increased production levels of the improved mineral oil-based lubricants should the demand increase, but a significant rise in sales of synthetic lubricants would probably require the construction of new production facilities.

Less information is available concerning the availability of improved differential oils; the lubricant manufacturers have given primary attention to the higher sales volume engine oil market. The same basic approaches used with engine oils are available to improved differential oils, and many of the same manufacturers would be involved. Expanded use of improved differential oils should follow as a natural course if improved engine oils are implemented on a large scale.

#### 3.1.9.5 Cost Factors

Mobil 1 presently sells for about \$4/qt at service stations. It has recently become available through some mass merchandisers at retail prices of about \$3.70 to \$3.90/qt (Ref. 3-75). According to information supplied by Mobil and other oil companies (Ref. 3-2) there is little chance of reducing the price significantly, nor is it likely that other specific types of synthetic lubricants could be offered at a substantially cheaper price. An effective reduction in cost for Mobil 1 and other improved engine oils could be achieved if the oil drain intervals were greatly extended over that of conventional oils. Although Mobil 1 and other types of synthetic lubricants (and some improved mineral oil lubricants) have been tested under extended drain conditions, this potential was not promoted in the initial advertising campaign for Mobil 1. Mobil took the position that the engine manufacturer's recommendations concerning drain interval should be followed (Ref. 3-2).

Mobil still makes this recommendation for the warranty period but otherwise is advertising the potential for 15,000 miles or 1 year (in normal service) between oil changes. The new car warranty may become less of a consideration in the future if the prevailing trend of increasing the drain interval (as recommended by the car manufacturer) continues. On the other hand, extended drain intervals would not be applicable to vehicles of the in-use fleet with high oil consumption problems (e.g., due to worn parts or poor mechanical condition).

The price of some of the mineral oils with improved friction modifier additives (such as Exxon Uniflo and ARCOgraphite) are considerably lower than that of synthetic lubricants, running approximately \$1.40 to \$1.60/qt at service stations, and sometimes made available at prices down to \$1/qt by certain mass merchandisers. Extended drain is not a feature of this type of improved lubricant and their manufacturers make no such claims. Some mineral oils with extended drain additive packages (such as STP motor oil) do have extended drain capability, but since the basic friction characteristics are not altered, no fuel economy impact should be anticipated and none is claimed by the manufacturer. Development effort has been reported by some suppliers concerning the incorporation of both improved friction modifier and extended drain additive packages, but no test data are available.

This report assumes that the primary implementation of improved lubricants in the national fleet will occur through the use of mineral oils with improved friction modifiers due to their significantly lower price as compared to synthetics.\* An average unit cost to the consumer of \$1.40/qt for improved lubricants will be assumed.

The cost of improved differential lubricants is assumed to increase by approximately the same factor as occurs for improved engine oils. A cost of approximately \$4/qt is therefore indicated for an improved mineral oil-based differential lubricant. The additional annual cost per vehicle for the use of these improved lubricants is estimated in Section 4.1.9.3 to be \$8.80.

---

\* Although the synthetics provide the additional advantage of an extended drain interval, this report assumes that this feature will be discounted by most consumers in the face of their higher price.



### 3. 1. 10 Improved Maintenance

#### 3. 1. 10. 1 Introduction and Background

The aspects of maintenance of chief interest to this study are those applicable to components that are most directly related to the basic engine combustion process, and which are characterized by severe service conditions and wear, such that repair, replacement, or adjustment becomes necessary one or more times during the normal service life of the vehicle. The principal components in this category are contained in the engine ignition system and the fuel/air induction system. The maintenance of these items is normally covered by the work done in a major tune-up. Other component maintenance such as chassis and wheel bearing lubrication, wheel alignment, etc., although capable of exerting an influence on vehicle fuel economy, primarily impact vehicle safety and operating costs (e.g., premature wear effects due to inadequate or improper lubrication, alignment, or adjustment).

Another aspect of maintenance that is addressed in this section concerns diagnostic procedures. This refers to methods which assist the owner in identifying an incipient engine tune condition which may adversely affect vehicle fuel economy. It does not pertain to the instrumentation used in service facilities, which are properly part of the maintenance operation itself.

Diagnostic procedures that can be used by the owner include "no-cost" items such as maintaining ongoing records of vehicle fuel economy, maintenance, and repairs. Also included are on-board diagnostic aids. The simplest and cheapest of these probably would be a manifold vacuum gage, calibrated in inches of mercury. In order to properly use this device as a diagnostic aid, the driver must have a certain minimum knowledge of basic engine operating characteristics. It should be noted that this represents a different application of the vacuum gage than its use as a driver aid, discussed in Section 3. 3. 2. Another simple and relatively inexpensive retrofit on-board indicator would be an odometer-based display which would flag the intervals for such maintenance items as a tune-up, lubrication, oil change, etc. While such a display requires no driver evaluation, it has the shortcoming that mileage alone may not be a sufficient criterion for performing tune-up maintenance.



An approach that may circumvent these disadvantages would be a quick, low-cost idle emissions test at service stations or state inspection lanes, in which the driver receives simply a printed statement as to the probable out-of-tune conditions, if any. This diagnosis would be based on the close correlation between idle exhaust emissions and some kinds of ignition/induction system defects. A more accurate diagnosis could be performed using a loaded, dynamometer emissions test, but with an attendant increase in cost (and some additional time) required of the participating drivers.

The interrelationship between these diagnostic procedures and the cost efficiency of tune-up maintenance forms the subject matter of this section.

There are many references in the popular and semi-technical automotive literature to large fuel economy improvements of 15% and more due to tune-up. While substantiating data and specifics are most often lacking, there may be little reason to doubt such claims, since they are frequently based on vehicles in a severely deteriorated state of tune. This report, however, is concerned with fuel economy and cost effects as they apply to average conditions in the national fleet.

### 3. 1. 10. 2 Fuel Economy Effects

#### 3. 1. 10. 2. 1 Data Base

Several field evaluation programs have examined the effect of tune-up maintenance on the in-use vehicle fleet. These programs were primarily directed toward exhaust emission effects, but useful fuel economy data were developed in some cases.

Reference 3-76 describes field work done by the Clean Air Research Company for the California Air Resources Board (CARB) in the period 1971 to 1973. Three hundred in-use vehicles representative of the 1957-70 California vehicle population were tested as follows. The as-received vehicles were subjected to the 7-mode test procedure for emissions and fuel consumption. All such tests throughout the program were performed by the California Air Resources Board. Following this initial test, a special tune-up procedure, devised by the contractor, called MPC (minimum pollution capability) was performed on each vehicle. The procedure involved inspection and diagnosis of the ignition system and carburetion similar to a conventional

tune-up, but differed from the conventional procedure in three main respects. One of these was that the criterion for tune-up was the level of idle HC and CO emissions. Another was the discretion used in the selection of components to be replaced or repaired. For example, the replacement of breaker points was intentionally de-emphasized (only about 4% were replaced) because, according to Ref. 3-76, these are routinely changed, often unnecessarily, by most mechanics when performing a tune-up. On the other hand, the mechanics were directed to repair or replace (within certain limits) those components which appeared as if they would cause a significant deterioration in emissions. In all cases, the ignition was adjusted to manufacturer's specification within tolerances of  $+0^\circ$ ,  $-2^\circ$ .

Immediately following the MPC tune-up, each car was again subjected to a 7-mode test. The results of the testing are summarized in Table 3-11. In discussing these data it is important to distinguish between the results obtained for the "uncontrolled" cars and those obtained for the "controlled" cars. All cars originally sold in California from the 1966 model year on are designated controlled cars. In addition to the effect of the control equipment used in the 1966-70 model years, there was a difference in carburetor adjustment procedure used in the MPC tune-up for the controlled group. These cars were adjusted essentially to manufacturer specifications, while the uncontrolled cars were adjusted to leaner air/fuel ratios than manufacturer specifications. Data for the controlled cars are of primary interest to this report, as pre-1966 passenger cars make no detectable contribution to the 1982 national fleet characteristics. It is seen from Table 3-11 that the controlled group showed a 2.8% increase in 7-mode fuel economy vs a 7.3 % increase for the uncontrolled group. The composite fleet 7-mode fuel economy increase was 5.2%.

After the MPC tune-up and the subsequent 7-mode test, cars were then turned over to their owners for normal use for 6 months. At this time, 267\* of the 300 cars were re-tested (with no additional adjustments) by the 7-mode procedure. Seven-mode fuel consumption measurements were performed on 221 of these 267 cars. It was intended that this service period be devoid of tune-up maintenance, but it was necessary for the contractor to perform maintenance on some of the cars during this period

---

\*The remaining 33 cars were no longer available to the program.

TABLE 3-11. INITIAL EFFECT OF MPC TUNE-UP  
(Ref. 3-76)

Car Class	No. of Vehicles in Class	Avg. % Change in 7-Mode Fuel Economy, from As-Recvd. Cond.
Controlled	141	+2.8
Uncontrolled	159	+7.3
Composite	300	+5.2

in response to owner complaints. It was further evident, upon examination of the cars after the 6-month 7-mode test, that some had been subjected to unauthorized maintenance by the owners during the 6-month service period. Table 3-12 summarizes the data on the fuel economy effects of 6 months of service. These data indicate surprisingly little decay in the tune-up fuel economy benefit during the 6-month service period. Reference 3-76 stated that the most common cause of fuel economy degradation was spark plug fouling in engines with excessive oil consumption.

The California Air Resources Board also sponsored a more recent program to evaluate the air pollution control effectiveness of a vehicle inspection program, and some of the results are applicable to the fuel economy effects of tune-up maintenance. Reference 3-77 is a summary by CARB of the cost effectiveness and administrative implications of the study, while Ref. 3-78 is a presentation by the test contractor of the experimental results of an emissions degradation evaluation which was performed in support of the CARB analysis.

In the field evaluation described by Ref. 3-78, 4 groups of 144 cars each were subjected to different maintenance regimes. The cars were privately owned, of model years 1955 to 1974, and were intended to be representative of the California vehicle population. All vehicles were screened prior to acceptance into the program to eliminate vehicles in need of major maintenance with respect to the powertrain, emission control

TABLE 3-12. EFFECT OF 6 MONTHS\* IN-USE OPERATION AFTER MPC TUNE-UP  
(Ref. 3-76)

Car Class	No. of Vehicles for Which 7-Mode Fuel Consumption Was Measured	Avg % Change in 7-Mode Fuel Economy Just-Tuned Condition	Fraction of FE Gain Due to MPC Tune-up Still Indicated After 6 Months of Service
No Additional Tune-up Maintenance (Includes Controlled and Uncontrolled Cars)	140	-0.4	0.90
Additional Tune-up Maintenance Received (Includes Controlled and Uncontrolled Cars)	81	-2.8	0.58
Controlled (Includes Cars With and Without Additional Tune-up Maintenance)	111	-0.2	0.92
Uncontrolled (Includes Cars With and Without Additional Tune-up Maintenance)	110	-3.2	0.62
All Cars	221	-1.3	0.74

\* Average mileage = 6000, 4600, and 5300 for controlled, uncontrolled, and composite groups, respectively.



system, or safety. The program consisted of a 12-month study of the emissions deterioration after an initial set of maintenance operations. Emissions were measured by the 1972 Federal Test Procedure (FTP) from which fuel economy in miles/gallon was computed by the standard EPA carbon balance method. During the 12-month test period the vehicles were operated by their owners in a normal manner. Table 3-13 summarizes the program structure, while Table 3-14 abstracts the fuel economy results.

It is seen from Table 3-14 that there was an average increase in fuel economy (1972 FTP) of approximately 2% due to the initial maintenance. There does not appear to be a statistically significant difference between the three different types of maintenance (Ref. 3-78 did not specifically address this subject). All the groups, on average, showed a decay in fuel economy during the 12-month program, but this rate was highly variable among the groups. The detailed data provided in Ref. 3-78 show a very wide range of fuel economy for each group at each test interval. The uncontrolled group showed the largest 12-month decay in fuel economy, but Group IV, which received the most extensive maintenance, showed the second highest decay in 12-month fuel economy. Reference 3-78 conducted regression analysis of the degradation data with primary emphasis on emissions. It was stated that emissions returned, on the average, to the pre-tune-up baseline after about 1 year, and that a linear regression adequately expressed the degradation rates of emissions and fuel economy. CARB extended this conclusion in their analysis, stating that the fuel consumption after repairs was assumed to deteriorate linearly to the before-repair condition in 1 year (Ref. 3-77).

In Ref. 3-77 CARB analyzes and compares the cost effectiveness of an idle mode test vs a loaded dynamometer type of mandatory emission inspection test. A total of 631 in-use cars of 1955 to 1974 model years were subjected randomly to either the idle or the loaded mode emission test (essentially the Clayton Keymode test). The emissions standards for each test were set so as to fail approximately 35% of the vehicle population. All vehicles which failed the emission inspection test were subjected to a 1975 FTP, after which they were repaired by Class A mechanics working for privately owned state-licensed automobile service centers. Each repaired vehicle was subjected to the same emission inspection test as before, and then a second 1975 FTP was performed. The mechanics were expected to base their repairs on a standardized diagnostic evaluation of the results of

TABLE 3-13. TEST PLAN FOR EMISSIONS DEGRADATION STUDY (Ref. 3-78)

Group	Designation	Tune-up Maintenance			1972 FTP Test Intervals (months)
		Initial (After Initial FTP)	Final (After 12 Mo. FTP)	During 12 Mo. Period	
I	Control (car owners received minimum information about test program)	None.	Adjust to manufacturer's specs.	Owner's responsibility. No maintenance instructions given, but owners asked to keep records of maintenance performed.	0, 12
II	Inspection Group (subjected to prototype idle emissions inspection and maintenance test at beginning of program)	Vehicles failing idle test: repaired only as required to pass test, using standard diagnostic equipment. Vehicles passing idle test: none. Group II represents present situation in states using an idle test inspection.	Adjust all vehicles to manufacturer's specs.	Same as Group I.	0, 1, 3, 6, 9, 12

TABLE 3-13. TEST PLAN FOR EMISSIONS DEGRADATION STUDY (Continued)

Group	Designation	Tune-up Maintenance			1972 FTP Test Intervals (months)
		Initial (After Initial FTP)	Final (After 12-Mo. FTP)	During 12-Mo. Period	
III	Manufacturer Specification Group	Restorative maintenance to manufacturer's specs. Repair/replace as required to meet manufacturer's tune-up and emissions specs.	Same as initial maintenance.	Vehicle owners asked to bring car to test contractor for all scheduled and unscheduled maintenance.	0, 1, 3, 6, 9, 12
IV	Mandatory Maintenance Parametric Inspection Group	Mandatory replacement of plugs, points, rotor, condenser, air filter, PCV valve. Repair/replace other components as required to meet manufacturer's tune-up and emissions specs.	Same as initial maintenance.	Same as Group III.	0, 1, 3, 6, 9, 12





each type of emissions inspection test. The repair, ideally, would have affected only those components which caused the vehicle to fail the emission test.

The fuel economy results of this program are summarized in Table 3-15. These results show a greater fuel economy benefit for the idle mode inspection, but Ref. 3-77 states that this difference is not statistically significant.

The lack of fuel economy benefit of the loaded mode test may be surprising, as this test is capable of providing the mechanic with considerably more diagnostic information than an idle test. This result was attributed by CARB at least in part to the lack of preparedness on the part of the service industry to correctly utilize this more detailed information. Reference 3-77 treats this factor in detail, and considers it to be a serious problem with regard to implementation of a mandatory vehicle inspection program.

TABLE 3-15. FUEL ECONOMY EFFECTS OF MAINTENANCE BASED ON EMISSION INSPECTION TEST (Ref. 3-77)

Vehicle Category	Average Fuel Economy Benefit* (%Δ FE)	
	Loaded Test	Idle Test
Failed Vehicles, Test Program of Ref. 3-77	+1.08	+3.92
California Vehicle Population	+0.36	+1.31
California Vehicle Population with Deterioration of Repair Benefit to Zero in 1 Year	+0.18	+0.65

\* 1975 FTP fuel economy.

Reference 3-79, a summary report on the New Jersey motor vehicle emission inspection program, states that during Phase I of that program (which lasted from February 1974 to October 1975), 6.63 million

vehicles were inspected, of which 12% were rejected. The repairs to this rejected group (required to enable these cars to pass the emission inspection) resulted in an annual gasoline savings of approximately 22 million gallons. No supporting data were provided, however, and no other quantitative statements were made concerning the fuel economy aspects of the New Jersey emission inspection program.

Whereas the preceding references dealt with experimentally determined effects of emissions-oriented repair on fuel economy, Ref. 3-80 (Exxon) presents a computational approach to the same subject. Thirty-four pre-1975 cars were used in a simplified dynamometer test procedure to develop regression equations for baseline vehicle fuel economy. A series of tune-up malfunctions was introduced into the 34 test cars, each was retested, and regression equations were developed to express the malfunction effects on fuel economy as computed from the retests. Data previously obtained on a 105 car fleet that had been part of an emission inspection program were used to establish the distribution of malfunctions in the in-use fleet. Calculations indicated that a 6.6% initial fuel economy improvement would result from an emission inspection program which rejects 50% of the inspected vehicles.\* From various assumptions and analyses, Ref. 3-80 postulated that the tune-up benefit would deteriorate in a nonlinear fashion and would be completely lost in a period of 12 months. When the deterioration effects were applied to the initial benefit of 6.6%, the net average gain in fuel economy was determined to be 2%. This result was stated to be statistically insignificant, implying that tune-up maintenance might provide no net fuel economy benefit for the in-use fleet.

The Mobile Proving Ground project of Champion Spark Plug Company (described in Section 3.1.1) provided experimental data on the effect of tune-up maintenance for 216 cars out of a total of 5666 cars tested. The 216 cars selected were those determined to be the most in need of some kind of tune-up maintenance, as indicated by high emissions and visual or electronic diagnostic evidence of maladjusted or defective parts (Ref. 3-6).

---

\* The test data used to determine fuel economy improvement were obtained from simplified hot 1972 FTP and EPA highway tests and were computer-adjusted to EPA composite cycle values.

These 216 cars were tested on a mobile dynamometer in the as-received condition at three steady-state speeds and over the Champion variable speed cycle (representing a mix of urban and highway driving). New spark plugs were then installed, and the cars were retested by the same procedures. An average fuel economy improvement of 3.4% over the variable speed cycle was obtained, due, evidently, to the new spark plugs. The cars were then given the balance of a complete tune-up to manufacturer's specifications, after which they were tested a third time. The average fuel economy improvement for the group after this complete tune-up (including new spark plugs) was 11.4% over the variable speed cycle.

Concerning the state of maintenance of the in-use vehicle fleet, the Champion survey of 5266 cars found that (according to owner's statements) the average mileage since the last tune-up was about 6700 (about half the average annual mileage). A significant finding of the diagnostic analysis of these cars was that the distributions of ignition timing and dwell angle were centered nearly symmetrically about the manufacturer's specifications. Assuming that the fuel economy-spark advance relationship is linear (as discussed in Section 3.1.1), these data suggest that on the average there is little fuel economy benefit to be obtained by readjustment of ignition timing and dwell angle in the fleet population of cars.

Table 3-16 (from Ref. 3-3) shows the ignition system maintenance requirements found by Champion for the 5266 car sample. It is of interest to note that the percentage of defects appears to be nearly independent of vehicle age, excepting those of the then-current model years. Isolating the 1973-76 model year cars, Champion found that 50% of the cars with mechanical breaker points required ignition system maintenance vs 34% of the cars with electronic ignition systems.

Reference 3-81, a report by P. Claffey prepared for the Federal Highway Administration, describes fuel consumption tests on 22 privately owned cars of model years 1970 to 1974 which were performed before and after tune-up maintenance. The fuel consumption was measured by an on-board fuel totalizer over a test site which was a 4000-ft straight stretch of level highway. Test driving consisted of eight steady-state speeds covering the range of 10 to 70 mph, and seven different stop cycle driving schedules. The latter consisted of a pre-selected number of stops from a base speed which varied from 10 to 60 mph. The stop cycle trips were



TABLE 3-16. PERCENT OF VEHICLES REQUIRING  
IGNITION MAINTENANCE (Ref. 3-3)

Model Yr. (No. of Vehicles)	Ignition Maintenance Required	Ignition Reserve Low	Replace Cap Rotor	Replace Ignition Leads	Replace Spark Plugs
Pre-1968 (902)	57%	22%	10%	25%	33%
1968-69 (833)	54%	28%	7%	25%	35%
1970-74 (3491)	51%	25%	5%	19%	33%
1975-76 (440)	35%	10%	2%	3%	16%

performed with the aid of an accelerometer to achieve reproducible driving schedules.

Maintenance equivalent to a major tune-up was performed on each car after it had been tested in the as-received condition (the tune-up was performed by the service department of a car dealership which sold that make and model car). Spark plugs, breaker points, and condenser were replaced on each car regardless of the as-received condition of these components. Other ignition and induction system components were inspected (visually and/or by diagnostic equipment) and were repaired, replaced, or adjusted as the mechanic deemed necessary.

The driving tests described above were repeated for each car after the tune-up. The fuel economy benefits of the tune-up, as detected by these driving schedules, were marginal. Eight of the 22 cars showed an increase in fuel economy either at steady-state speeds, stop cycles, or both. Twelve of the vehicles had essentially no change in fuel economy, while the remaining two showed a decrease in fuel economy either for steady-state speeds or for the stop cycles. Mileage interval since the preceding tune-up (as determined from owner records) varied from 5000 to 36,000. This had no discernible influence on the fuel economy effect of the tune-up performed as part of the test program.

Reference 3-81 concluded that the principal benefits of tune-up occur when certain malfunctioning components are replaced and corrected,



and that the thrust of a tune-up procedure should be to identify and replace those parts of the ignition and induction system which are not operating properly. According to this source, blanket replacement of plugs, points, and condenser, etc. may produce little if any fuel economy benefit unless one or more of these components are defective.

### 3. 1. 10. 2. 2 Assessment of Benefits

In making comparisons of the data presented above, it must be noted that no two data sources used the same driving cycle for measuring the fuel economy effects, and in most cases the driving cycles were significantly different. This introduces uncertainty into the comparisons, even though the results of each study are expressed in terms of relative change in fuel economy. With this reservation, it may be stated that the data obtained under experimental conditions simulating an emissions inspection program (Refs. 3-76, 3-77, and 3-78) indicate fuel economy benefits just after tune-up in the range of 1 to 4%. There was no correlation in these studies between the fuel economy improvement and the extent of tune-up maintenance. That is, a tune-up maintenance philosophy of repairing only as needed to pass a simple idle emission test appeared to be at least as beneficial (under existing service industry capabilities) as tune-ups involving more extensive parts replacement. The 1 to 4% results are significantly lower than the Champion Spark Plug results, which showed an average fuel economy increase after tune-up of 11.4%. However, the Champion tune-ups were restricted to vehicles most in need of tune-up maintenance and therefore are not representative of the average benefit to be expected for the in-use fleet. References 3-76 and 3-77 performed an initial screening to eliminate grossly defective vehicles. This was necessary for good program management, but suggests that the results may be biased somewhat on the low side. The CARB program of Ref. 3-77 was a voluntary program without benefit to the applicant, and for this reason may not have captured a representative sample of vehicles below average tune conditions. In summary, there exists no data truly representative of maintenance effects as applied to the average in-use vehicle.

Compared to the data discussed above, the Exxon result of 7% for the fuel economy increase after maintenance (Ref. 3-80) appears high. This result is considered to have a somewhat less secure empirical base than the data from other sources and is therefore discounted.

The Claffey report (Ref. 3-81) is in general agreement with the conclusion of Refs. 3-76, 3-77, and 3-78, in that tune-up maintenance has a relatively small average effect, with greatest benefits obtained when specific malfunctioning components are corrected.

Taking the above factors into consideration, it is the assessment of this report that the average initial fuel economy improvement due to tune-up maintenance is about 3%. This judgment is based primarily on the combination of results obtained by the Clean Air Research Company, the CARB, and by Olson Labs (Refs. 3-76, 3-77, 3-78).

In order to establish the net benefit of maintenance on fleet fuel consumption, it is necessary to estimate (1) the rate at which the fuel economy improvement due to tune-up decays with time and (2) the present frequency of tune-up for the average in-use vehicle. With regard to decay, this study will adopt the CARB assumption (based on Olson Labs emission test results) that the benefits of tune-up will decay linearly to pre-tune-up levels in a period of 12 months (Ref. 3-76). The frequency of tune-ups in the in-use fleet may be deduced from the Champion survey (Ref. 3-6) which found that the average time lapse since previous tune-up as reported by car owners was about 6 months. Assuming that the rate of tune-ups in the national fleet is constant throughout the year, this would indicate that the average interval between tune-ups is 12 months. In summary, this report makes the following assumptions regarding the present status and fuel economy effects of tune-up maintenance in the light duty fleet:

1. The increase in fuel economy due to tune-up is 3%.
2. The fuel economy benefit degrades linearly to the before tune-up condition after 12 months of service.
3. The average vehicle is retuned at 12-month intervals.
4. On this basis, the existing benefit of tune-up is a 1.5% increase in fuel economy over the non-tuned condition.

One approach to improving the existing benefits of maintenance is to increase the frequency of tune-ups. Accordingly, this study will examine the case in which the interval between tune-ups is reduced from the present duration of 12 months to a duration of 6 months (i. e., from an accumulated mileage between tune-ups of about 12,000 to 6,000 miles). Based on the assumptions listed above, it can be shown that the fuel

economy benefit due to the increased frequency of tune-ups will be  $3/4\%$ .

It is noted that the data base for the above assessment was composed almost entirely of pre-1975 model year vehicles. Due to the use of electronic ignition, the maintenance aspects for 1975 and later model year vehicles are somewhat different. In this regard, the Champion data indicate that ignition system maintenance is not required as frequently as with mechanical breaker point systems. This is in agreement with one of the principal advantages claimed for electronic ignition; namely, that the interval between tune-ups may be increased. As discussed in Section 3.1.1.2.2, if the interval between tune-ups for cars with electronic ignition systems is lengthened until the same level of driver-perceived performance decay occurs, there would be no difference in the time average fuel economy benefit of tune-up maintenance for electronic vs breaker point ignition. If, however, cars with electronic ignition were tuned at the same proposed semi-annual rate as those with mechanical breaker points, an improvement of  $1-1/8\%$  over existing maintenance benefits is indicated.

It should be noted that a small fuel economy benefit was assigned to retrofit electronic ignition systems in Section 3.1.1, predicated on the assumption that a fraction of the fleet so retrofitted would continue to be tuned on a relatively short duration periodic basis. This assumption will be accounted for in assessing the net benefits of maintenance on fleet fuel consumption.

There are no quantitative data on the efficacy of owner diagnosis, but the bulk of the data presented in the preceding subsection indicates that rapid identification of an out-of-tune condition, and the replacement or correction of just those components that are not operating properly, could be as beneficial from the standpoint of fuel economy as a more extensive tune-up replacement performed at regular time or mileage intervals. The key problem is the method by which such diagnostic information can be presented in an unmistakable form to the driver. The "on-board" aids described in Section 3.3.2 (record keeping, manifold vacuum gage, odometer-based signal of maintenance schedule) are not promising in that they provide little or no indication of the specific cause for a degradation in fuel economy or performance, even if such a degradation is detected.



Another approach to detecting the onset of tune deficiencies involves the concept of a diagnostic test center which would be capable of conducting a quick and low cost analysis of potential vehicle deficiencies. Such a service might be utilized on a periodic six-month basis, or more frequently if cost and time factors would permit. The only technique offering this potential is an idle emission test procedure utilizing diagnostics based on exhaust pollutant concentrations keyed to vehicle model year. Clearly, such a diagnosis cannot identify some kinds of ignition or carburetion defects and will result in incorrect diagnoses a certain fraction of the time. Based on the data base of this report, however, this simplified approach offers the potential of providing, on the average, approximately the same fuel economy benefit as that assessed above, at a lower total cost to the car owner.

#### 3. 1. 10. 3 Safety Considerations

No adverse safety effects are identified in the area of tune-up maintenance.

#### 3. 1. 10. 4 Availability for Implementation

Service industry facilities are already in existence which have or could rapidly develop the capability of performing an annual diagnostic tune-up on every vehicle in the national fleet. Of particular interest are those chains of tune-up service centers (e. g. , Tuneup Masters) which charge a fixed amount (usually scaled by number of cylinders) for a diagnostic tune-up using a loaded dynamometer test. This type of tune-up may in general be categorized as "repair-only-as-needed. " These stations usually do not offer diagnosis-only as a separate service. Service centers of many new car dealerships and many independent garages, unless given special instructions to the contrary, still appear to tend toward the "mandatory replacement" concept of tune-up in which such components as spark plugs, points, and condenser are often replaced as a matter of routine.

The CARB tests of Ref. 3-77 raise a question concerning the state of preparedness of the service industry to respond to the requirements of a diagnostic test. It must be noted, however, that the mechanics who performed the repairs in the CARB study did not perform the diagnostic tests. This was a necessary condition in that study to accurately simulate a mandatory vehicle inspection program, but the results do not necessarily apply to commercial stations in which one person (usually) performs both diagnostic



tests and repairs.

The quick, low cost idle emissions diagnostic test referred to earlier is not now available for implementation. Such a program probably would have to be monitored by a state agency to ensure that a uniform set of procedures and guidelines was employed.

States which have a mandatory emission inspection test have the potential of incorporating such a diagnostic service into their program. Presently only two states have mandatory programs, however. These are New Jersey and Arizona, and the latter operation applies only in two counties.

### 3.1.10.5 Cost Factors

Diagnostic tune-ups utilizing a loaded dynamometer test are available at \$42 (including diagnostics, parts and labor) for an 8-cylinder engine from Tuneup Masters, a chain specializing in this activity. Tune-up prices quoted by service centers of new car dealerships for major tune-up typically run considerably higher; over \$100 for an 8-cylinder engine with a 4-barrel carburetor. This discrepancy reflects primarily the difference between "repair-only-as-needed" and "mandatory replacement," as described in the preceding discussion.

A quick, low cost emissions diagnostic test, for the purpose of supplying fuel economy-oriented tune-up diagnostic information to the driver, is not now available commercially, at least not on a uniformly administered basis. Cost analysis figures prepared by CARB in Ref. 3-77 indicate an inspection fee for an idle emission test of about \$3 to \$4, but this does not cover all administrative or operational costs. This report assumes that it will be possible for commercial service stations to profitably offer this diagnostic service for \$5, a figure only slightly higher than the CARB partial-cost estimate based on the consideration that many of the administrative and facility costs used in the CARB analysis will probably not apply to a program utilizing existing service industry facilities and labor. It will be assumed that the cost of the specific repair work (covering only the items identified in the emission test) is \$21; that is, half the charge for a complete diagnostic repair (\$42). The value of one half is based on the ratio of average tune-up costs quoted for Group II\* and Group III\*\* vehicles in Ref. 3-77.

---

\* Repair as needed to pass idle emission test.

\*\* Repair as needed to meet manufacturer's tune-up and emissions specifications.

## 3.2 TRAFFIC MODIFICATIONS

### 3.2.1 Right Turn on Red

#### 3.2.1.1 Introduction and Background

The concept of right turn on red (RTOR) permits the driver of a vehicle to turn right on a red traffic signal. This concept is usually implemented in one of two ways. Under one rule, a driver is permitted to turn right on red only where designated by sign. This rule is variously referred to as the sign-permissive or "eastern" rule. The second rule permits a right turn on red unless a sign is posted to prohibit it. This has been referred to as the general permissive or "western" rule. Two states, Nevada and New Mexico, use a total permissive rule; i. e., there is no provision for a prohibitory sign (Ref. 3-82). Under both of these rules, the driver first must stop and yield the right of way.

The general permissive RTOR rule was first adopted in California in 1947 (Ref. 3-83) and subsequently was adopted by other western states, hence the reference to the western rule. Numerous other states, many of which were located in the eastern portion of the country, adopted the sign-permissive or eastern rule. Of these, many have since changed to the general permissive rule (Refs. 3-82, 3-83).

Arguments supporting RTOR are that it increases intersection capacity, reduces delay and fuel usage, and does not result in increased accidents.

#### 3.2.1.2 Fuel Economy Effects

##### 3.2.1.2.1 Data Base

Data regarding the potential savings resulting from the use of the RTOR rule are based on both on-site measurements of reductions in delay time (and estimates of the concomitant fuel savings) and on computer simulations.

The Commonwealth of Virginia implemented the sign-permissive or eastern rule in 1972 and in 1975 conducted a study to determine whether that rule should be retained, rescinded, or amended (Ref. 3-82). This study surveyed RTOR rules and extent of usage in nine states including Virginia and found:

1. The RTOR implementation rate in Virginia was 8.6%. The rate for other states using the eastern rule seldom exceeded 10%. The implementation rate has a direct bearing on the potential fuel savings.
2. The implementation rate for the general permissive rule was 80 to 90%.
3. The effect of the RTOR maneuver in Virginia was to reduce vehicle delay time by an average of 14 seconds for each delayed right turning vehicle, or a total time delay savings of 5647 seconds per RTOR approach per day.

Virginia has a total of 2955 signalized intersections involving some 11,360 approaches. The fuel savings estimated to result from various implementation scenarios are summarized in Table 3-17. In estimating these fuel savings, a median idle fuel consumption value of 0.7 gal/hr was used in conjunction with the study findings of time delay savings of 5647 seconds per RTOR approach per day. The implementation rates assumed are indicated in the table. Results for the then current implementation rate of 8.6% for the sign-permissive rule are also shown. As indicated, the unit fuel savings are identical for the sign-permissive and general permissive cases. The 50% implementation rate shown for the sign-permissive case was a "maximum economical percentage", presumably based on a cost-benefit optimization, while the 80% maximum implementation rate for the general permissive case was based on experience in other states pertaining to intersections suitable for RTOR. It can be seen that the maximum fuel savings attributable to RTOR for the state of Virginia is relatively small; i. e. , only 0.13% of the state's total gasoline consumption. However, based on both fuel savings and cost considerations, the Virginia legislature adopted the general permissive rule in 1976 (effective 1 January 1977) in place of the sign-permissive rule which had been in effect since 1972 (Ref. 3-83).

With reference to CBD effects, Ref. 3-84 reports RTOR results based on a computer simulation of a portion of the CBD network in Washington, D. C. utilizing a. m. peak hour traffic volumes. The effects of increasing or decreasing these volumes by 20% were evaluated as were the effects on emissions. These results are shown in Table 3-18. The fuel economy improvement attributable to RTOR shows a noticeable sensitivity to traffic volume, ranging from 3.9% at the reduced traffic volume to 8.6%

TABLE 3-17. FUEL SAVINGS FROM RTOR AS REPORTED FOR THE COMMONWEALTH OF VIRGINIA (Ref. 3-82)

	Sign Permissive, 8.6% Implementation	Sign Permissive, Max 50% Implementation	General Permissive, 80% Implementation
Annual Fuel Savings, 10 <sup>6</sup> gal	0.33	1.95	3.12
Fuel Savings, % of State Total Gasoline Consumption	0.01	0.08	0.13

TABLE 3-18. FUEL ECONOMY AND EMISSIONS EFFECTS OF RTOR IN CENTRAL BUSINESS DISTRICT, WASHINGTON, D. C. (Ref. 3-84)

	Fuel Economy Improvement (% mpg)	Emissions Reduction (%)		
		HC	CO	NO <sub>x</sub>
Volume Reduced 20%	3.9	4.9	6.1	1.7
A. M. Peak Hour Volume	4.9	5.8	7.1	1.7
Volume Increased 20%	8.6	9.6	11.5	2.4



at the heavier than normal volume. It is also of interest to note that these simulations also indicated a reduction in all three pollutants when the RTOR condition was simulated.

In addition to the above data, another computer simulation of the Washington, D. C. urban area was conducted by Alan M. Voorhees & Associates (Ref. 3-85). This study examined a network of 18 signalized intersections and concluded that a general permissive RTOR strategy in urban areas such as Washington, D. C. would provide an average fuel consumption savings of 2.6%\* for all vehicles in the system. Based on an 80% RTOR implementation rate for urban areas nationwide, the Voorhees study concluded that between 136 and 187 million gallons of fuel per year could be saved. The lower value of 136 million gallons was based on an extrapolation of the state of Virginia findings, and assumed that the number of traffic signals are directly proportional to the population and hence the RTOR savings would also be proportional to the population. The savings of 187 million gallons was established by applying the average urban fuel consumption reduction of 2.6% to an estimate given in Ref. 3-86 that 9 billion gallons are lost annually at all intersections because of traffic delays.

A value of fuel savings similar in magnitude to the Voorhees results can be obtained based on the number of signalized intersections in the U.S., which has been estimated to be about 200,000 (Ref. 3-87). In the urban network studied in Ref. 3-85, a total of 18 intersections were modeled. The use of RTOR resulted in a network fuel savings of 2.9 gallons over a period of 32 minutes. Ratioing this savings of 2.9 gallons over 18 intersections to the estimated 200,000 intersections, assuming 80% implementation of RTOR, yields a fuel savings rate of 805 gallons per minute or a total savings of 212 million gallons annually, assuming the savings rate is applicable 12 hours a day.

#### 3.2.1.2.2 Assessment of Benefits

The potential fuel economy savings attributable to RTOR appears to be quite sensitive to several factors. The degree of implementation will obviously impact any fuel savings since it will directly affect the number of

---

\* For a traffic system that includes buses; a fuel consumption reduction of 7.5% is indicated for a traffic system without buses.

vehicles involved. The sign-permissive, or eastern rule, appears generally to result in a significantly lower implementation rate than the general permissive rule; i. e. , about 10% compared to a level of 80 to 90% (Ref. 3-82).

The fuel savings is also highly dependent on the traffic volume (or density). The high traffic density central business district within the urban area appears to offer savings of 4 to 9%, depending on the traffic volume, with a savings of 4.9% at peak hour traffic volumes. The value of 4.9% will be assumed to be typical of the CBD. In the general urban case, a fuel savings nationwide of 200 million gallons yearly (based primarily on the Voorhees urban simulation results) will be used in the absence of any other information. The comparatively low level of fuel savings attributable to the use of RTOR in Virginia on a statewide basis, as shown in Table 3-17, may represent a "minimum" condition in view of the fact that 85% of the total roads and streets are classified as rural and 54% of total vehicle miles travelled are on rural roads compared to 46% on municipal roads (Ref. 3-88).

#### 3.2.1.3 Safety Considerations

The consensus of studies and surveys of RTOR operation indicates that no significant change in the frequency or severity of traffic accidents will occur as a result of the implementation of RTOR (Refs. 3-82, 3-83).

#### 3.2.1.4 Availability for Implementation

The implementation of the RTOR concept requires enactment by the appropriate legislative body having jurisdiction over the area of concern. At present, the only jurisdictions which prohibit RTOR are the state of Massachusetts and Washington, D.C. In addition, three jurisdictions with RTOR utilize the sign-permissive rule and are therefore candidates for conversion to the more pervasive general permissive approach. These jurisdictions are: Connecticut, Maine, and New York City.

#### 3.2.1.5 Cost Factors

The implementation of RTOR requires that appropriate signs be placed at the intersection approaches. In the case of the sign-permissive rule, signs are installed at all intersection approaches where an RTOR maneuver is permitted. Under the general permissive rule, signs are placed at those intersections where a right turn on red is prohibited.

The cost factors to be used in this study will be based on the data reported in Ref. 3-82. These costs were given as \$31 for labor and material for sign installation and an additional cost of \$19 for each intersection study (to determine applicability of RTOR on each approach), for a total of \$50 per sign. It may be noted that this cost was stated to be conservatively high since early studies on intersections were generally more expensive than later ones.

### 3.2.2 One-Way Streets

#### 3.2.2.1 Introduction and Background

Two-way streets can be converted to one-way operation as a means of reducing congestion and increasing the capacity of an existing two-way street. One-way streets are commonly employed in parallel pairs, one street in each direction. One-way streets can be operated in several ways; i. e., as streets on which traffic moves in one direction at all times; as streets that are normally one-way but at certain times may be operated in the reverse direction in order to provide additional capacity in the predominant direction of flow; or as streets that normally carry two-way traffic but which during peak traffic hours may be operated as one-way streets (Ref. 3-89). The potential benefits of one-way streets include a reduction in travel time, the elimination of conflicts between left turn and through traffic at an intersection, and more efficient signal timing. Elsewhere in the network, some additional turning may be required due to rerouting because of the presence of the one-way streets. The disruptions so caused may partially offset the improvement obtained by the addition of one-way streets in a network.

#### 3.2.2.2 Fuel Economy Benefits

##### 3.2.2.2.1 Data Base

Numerous field studies of individual streets are reported in the literature which indicate improvement in average speed and a reduction in the number of stops for one-way street operation compared to two-way operation (Refs. 3-90 and 3-91). These studies did not relate the findings to quantitative fuel savings. An assessment of the fuel savings can be made, however, based on methods discussed in Section 3.2.3, in which fuel economy is related to average traffic speed or number of stops. Applying this



approach to the data in the cited references, it was found that the average fuel economy gain as derived from changes in velocity was about 18%, while the average fuel economy gain based on the percentage reduction in the number of stops was about 15%.

Simulations of a portion of the Washington, D. C. network were reported by the Honeywell Traffic Management Center (Ref. 3-92). These simulations modelled the network in both the two-way street configuration and with certain streets in the network converted to one-way operation. Both p.m. peak and off-peak traffic demand characteristics were modelled. The one-way street network showed, on the average, an increase in fuel economy of 12% while average speed increased 22%. Slightly better network performance (for both the one-way and two-way street configurations) was found for the peak period condition than for the off-peak condition. This was attributed to the more random nature of travel patterns in the off-peak case, which resulted in more delays due to increased turning movements. These slight differences between peak and off-peak conditions were not statistically significant, however.

#### 3.2.2.2.2 Assessment of Benefits

Fuel economy gains attributable to the use of one-way streets were found to be somewhat higher in the case of individual streets compared to the network condition evaluated in the Honeywell simulation. These differences would be expected because of the interactive effects on travel patterns, turning movements and pedestrian patterns which would be encompassed in a network evaluation, but which would not necessarily be reflected in an evaluation of a single one-way street. For this reason, the results of the Honeywell network simulation of a 12% fuel economy gain (10.7% fuel consumption reduction) are believed to be more representative of the benefits to be expected for the conversion of a portion of a given network to one-way street operation.

#### 3.2.2.3 Safety Considerations

Traffic safety is reported to be generally increased by one-way streets because they provide a divided highway effect. Vehicles also platoon better with signals progressed for one-way operation. Such groupings provide gaps in traffic for safer movement of vehicles and pedestrians from cross streets across the one-way street (Ref. 3-89).



#### 3.2.2.4 Availability for Implementation

The implementation of one-way streets would be dependent only on traffic engineering considerations regarding the suitability of a one-way street in place of an existing two-way street. General considerations would include such factors as the ability of the one-way street to relieve a specific traffic problem, provide adequate traffic service through the area traversed, and provide a safe transition to two-way operation at the end points of the one-way sections.

#### 3.2.2.5 Cost Factors

The change to a one-way street operation involves the consideration of several factors which would affect the cost of such a conversion. For example, parking restrictions may be revised and if appropriate, speed limits altered. Parking meters would also have to be relocated where necessary. In addition, traffic route markings would have to be changed as would traffic signal locations and timing (Ref. 3-89).

The magnitude of these changes and the effect on cost have to be assessed on an individual basis for streets under consideration. Discussions with the City of Los Angeles (Ref. 3-93) regarding costs yielded the information that no separate breakout was maintained, and that such costs were a part of the general operating budget. No other information relating to cost was found.

### 3.2.3 Intersection Control

#### 3.2.3.1 Introduction and Background

Two major types of traffic signal control systems are being used to handle vehicular traffic at intersections: pre-timed control and traffic actuated control (Ref. 3-94). The pre-timed control operates according to a pre-set cycle length and division (split) of the cycle between various road approaches to the intersection. The sequence in which the signal indications are shown and the time relation of the signal to other signals also are preset. Any or all of these features can be changed to accommodate specific needs.

The cycle length refers to the time required for the controller to go through one complete set of signal indications; i.e., from the beginning of one green interval to the beginning of the next green interval. Under all

but the most extreme traffic conditions, a cycle length of 60 to 90 seconds is reported to be most efficient in terms of moving traffic with the least delay (Ref. 3-94).

In traffic actuated control, the time of each green signal interval is determined in response to the volume of traffic as indicated by traffic detectors. Traffic actuated signals are classified as semi-traffic actuated or fully traffic actuated. In the former system, traffic actuation is provided on some, but not all, of the approaches to the intersection. A fully traffic actuated signal is one for which traffic actuation is provided on all the approaches to the intersection.

The purpose of a fully actuated signal control system is to provide variable length phases and cycles that reflect fluctuations in traffic volume in order to minimize red signal delay. Any green time not required by a minor intersection approach is yielded to the main street traffic. Thus, for arterials with relatively low cross street traffic volume, there is a potential for decreased signal delay since the controller will tend to rest in the main street green phase.

This section will address the effect on fuel economy of the above factors as they influence traffic flow, considering pre-timed and fully actuated traffic control systems, the effect of varying signal cycle length, and the influence of pedestrian traffic combined with various vehicle turning movements.

### 3.2.3.2 Fuel Economy Effects

#### 3.2.3.2.1 Data Base

The effect of pre-timed and fully actuated traffic signal control systems on fuel economy was simulated in the Honeywell Traffic Management Center (Ref. 3-92) for two test networks; a portion of M Street in Washington, D.C., and a portion of Hawthorne Boulevard in Los Angeles, California. Both of these streets are major 6-lane arterials. The Hawthorne Boulevard network is shown schematically in Figure 3-24. Intersections not actually on the arterials but within the test networks remained in the pre-timed mode for all tests, with only the signals on M Street and Hawthorne Boulevard modelled in both the pre-timed and traffic actuated modes.

The results of the M Street simulation indicated that the use of the fully actuated traffic signals resulted in an average fuel economy

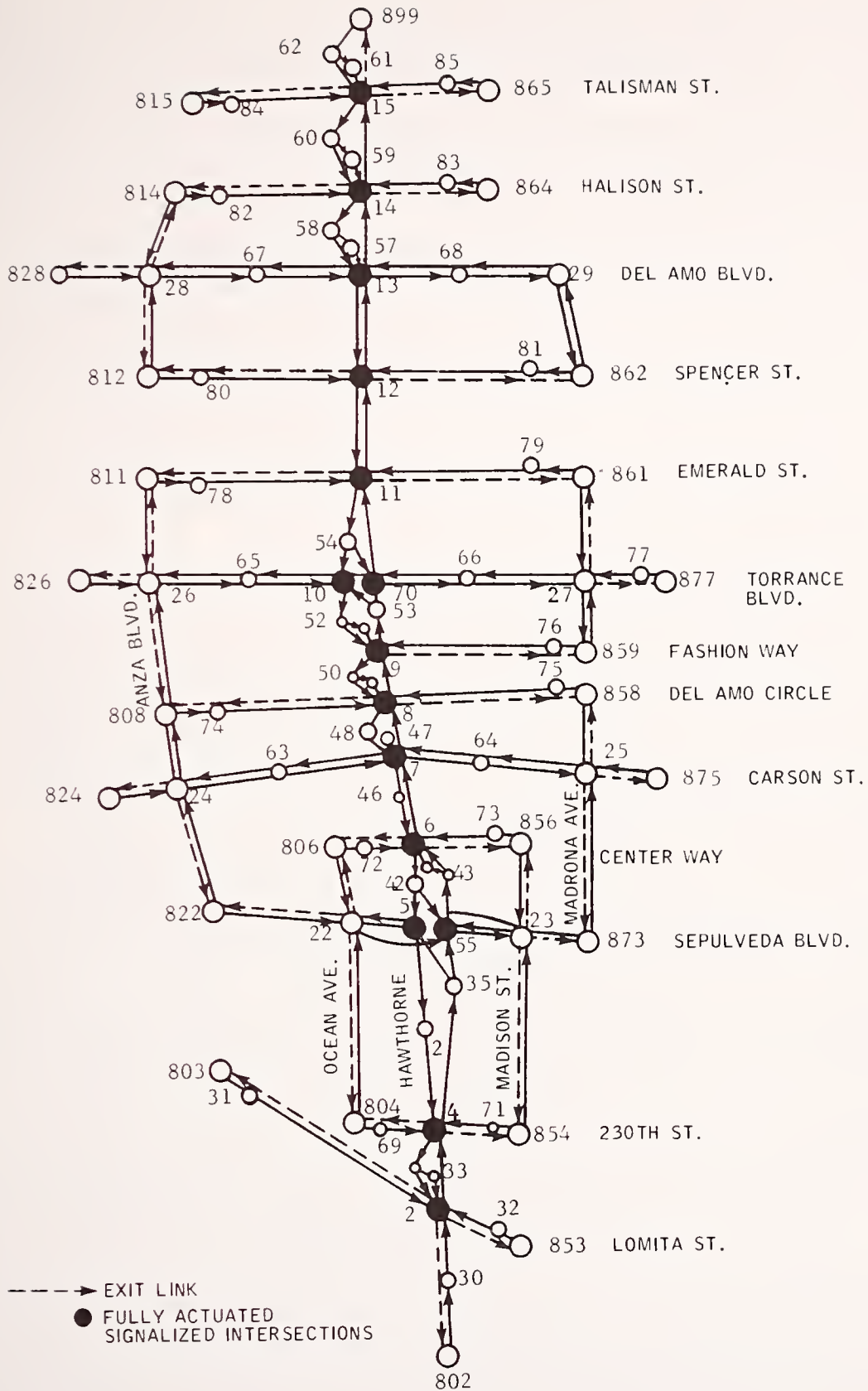

FIGURE 3-24. PRE-TIMED AND FULLY ACTUATED SIGNAL SYSTEMS (PORTION OF HAWTHORNE BLVD. ARTERIAL, LOS ANGELES) (Ref. 3-92)



improvement of 30% compared to the pre-timed signal control system. The Hawthorne Boulevard network, by comparison, showed an average fuel economy improvement of about 10% in the fully actuated mode. The difference in fuel economy gains attributable to the use of a fully actuated traffic signal system was reported to be inversely related to the amount of cross street traffic. In the case of the M Street network, the traffic volume on M Street was approximately seven times greater than the cross street volume at any intersection. This resulted in several minor phases being skipped in the fully actuated mode, yielding long main street green phases. The cross street traffic volume for the Hawthorne Boulevard network were reported to represent a greater percentage (not quantified) of the total traffic than the case of the M Street network, and was believed responsible for the less significant improvement relative to the M Street network.

From these results, Honeywell concluded that in the case of a balanced volume of traffic between main and side streets, the fully actuated system might show no advantage at all. This study also concluded that the M Street simulation was not typical of average in-use network volume ratios. In a more recent communication concerning this work (Ref. 3-95), the Hawthorne Boulevard simulation was stated to be roughly representative of effects to be expected in main arterial networks nationwide.

In examining the data base on traffic signal cycle length, it is found that cycle lengths of 60 to 90 seconds are reported to be most efficient in moving traffic with the least delay (Ref. 3-94). Studies have indicated, however, that the optimum cycle length for minimizing delay is shorter than the optimum cycle length for minimizing fuel consumption. This is attributed to the fact that as the cycle length increases, the number of stops and accelerations/decelerations decrease, with a resulting decrease in fuel consumption (Ref. 3-92). A point is reached, however, where the number of vehicles at idle in the network increases to an extent that their fuel consumption becomes more significant than the fuel savings due to the reduced starting and stopping maneuvers, and thus the network fuel consumption increases.

A study of the Gainesville, Florida, CBD (Ref. 3-87) showed that a minimum fuel consumption occurred at a cycle length of 140 seconds compared to the minimum delay time of 90 seconds, as shown in Figure 3-25. On the basis of these findings, the authors estimated that for the signal network considered; i. e., 26 signalized intersections in the Gainesville central



business district, a savings of approximately 1 gallon per hour could be achieved without resorting to unreasonable cycle lengths (e.g., > 120 seconds). A direct extrapolation to an estimated 200,000 signalized intersections in the U. S. showed an annual fuel savings of about 1 billion gallons, assuming the benefits of 1 gallon per hour per intersection would apply for one half of each day. The maximum possible fuel saving was estimated to be about twice this amount, but would require a cycle length of 140 seconds, which is not considered practical by most traffic engineers and is also beyond the operating range of many types of pre-timed equipment (Ref. 3-87).

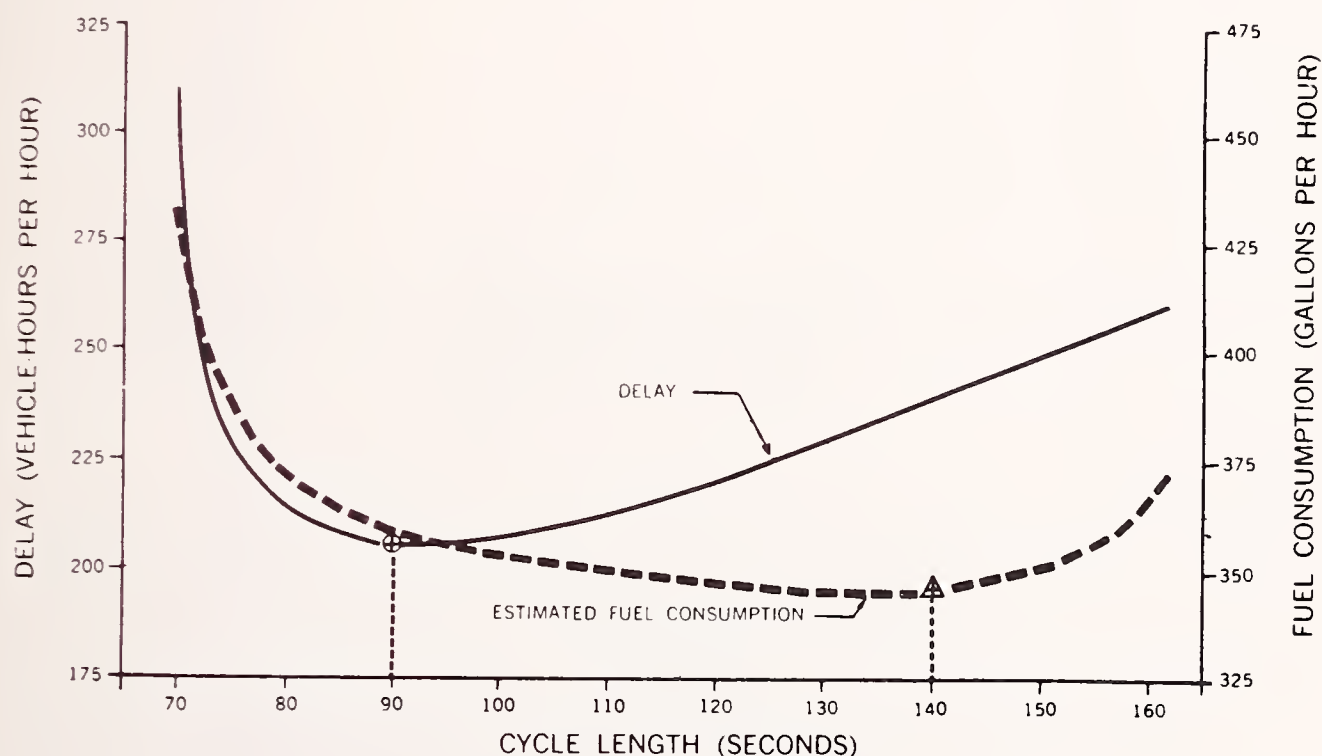

FIGURE 3-25. FUEL CONSUMPTION VERSUS CYCLE LENGTH, GAINESVILLE, FLA. CBD (Ref. 3-87)

The effect of cycle length was also examined in the study conducted by the Honeywell Traffic Management Center (Ref. 3-92). Two different networks were examined for this purpose: Hawthorne Boulevard in Los Angeles and a portion of the UTCS (Urban Traffic Control System) network in Washington, D.C. The results for the Hawthorne Boulevard

simulation indicated in Figure 3-26 exhibit similar characteristics to those of the Gainesville study. The network was modelled as a single arterial with few turning movements, no mid-block sources, no pedestrian interference, and low cross traffic volume. These characteristics were reported to have two effects. First, vehicle platoons experienced little interference and could take advantage of the long green intervals at each intersection. Second, the low cross street traffic contributed only a slow rise in idling fuel consumption.

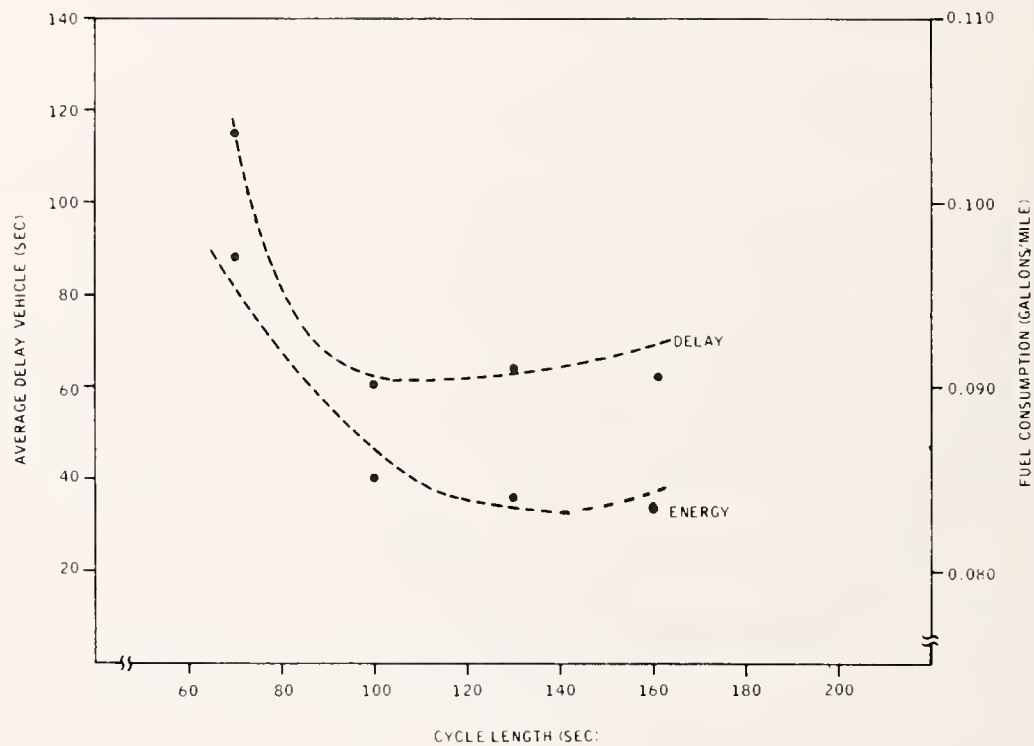

FIGURE 3-26. FUEL CONSUMPTION AND DELAY AS A FUNCTION OF CYCLE LENGTH FOR HAWTHORNE BLVD. NETWORK (Ref. 3-92)

For the Washington, D.C. network, however, an increase in cycle length resulted in an increase in both delay and fuel consumption, as shown in Figure 3-27. This network was characterized by significant volumes on all intersection approaches, high turning movements and several mid-block sources. These factors reduced the platooning tendencies and increased the magnitude of idling fuel consumption, since traffic queued up quickly on intersection approaches with a red signal.

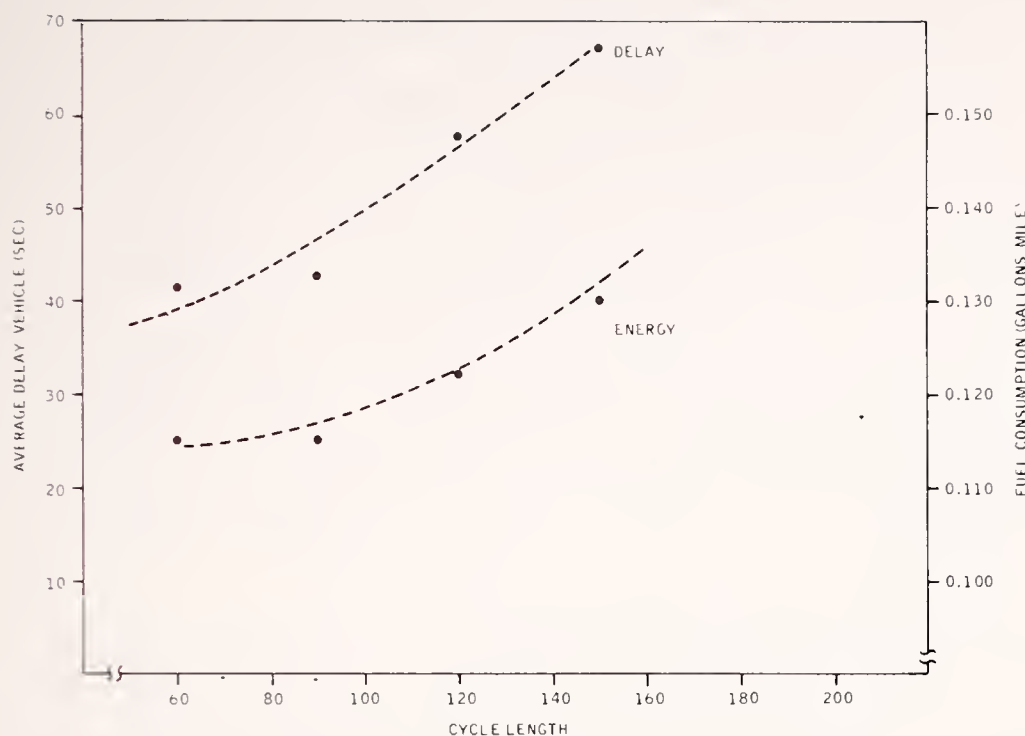

FIGURE 3-27. FUEL CONSUMPTION AND DELAY AS A FUNCTION OF CYCLE LENGTH FOR UTCS NETWORK (Ref. 3-92)

A comparison of the results reported in Refs. 3-92 and 3-87 is presented in Figure 3-28. The variation in fuel consumption as a function of cycle length is expressed as a percentage of the value reported for a cycle length of 90 seconds for ease of comparison. The impact of differences in cross traffic volumes between the Washington, D.C. network and Hawthorne Boulevard is clearly evident as is the similarity between the Hawthorne Boulevard and Gainesville, Florida, simulations.

Pedestrian traffic interferes with turning vehicles in a conventional system where pedestrian movement is concurrent with vehicle movement. To evaluate this effect, three levels of vehicle turning movement (0, 10 and 20%) were tested by Honeywell in conjunction with two pedestrian movement systems (Ref. 3-92). A conventional pedestrian movement system was modelled as well as a pedestrian scramble system, which allowed pedestrian movements in all directions, including a diagonal movement across the intersection during a separate portion of the signal cycle. In this investigation, a separate intersection with an average volume of 500

pedestrians per hour was modelled. To model the pedestrian scramble system, pedestrian interference during vehicular movement was eliminated and an all-red interval for pedestrian servicing was introduced. These simulations indicated that the use of a pedestrian scramble system implemented by an all-red interval resulted in a greater disruption to vehicle flow than the conventional pedestrian movement system and with corresponding reductions in fuel economy. Results of these simulations, showing the fuel economy average speed and vehicle delay for each pedestrian movement system and vehicles turning rates, are summarized in Table 3-19. In view of these negative results, no further consideration will be given to the pedestrian scramble system.

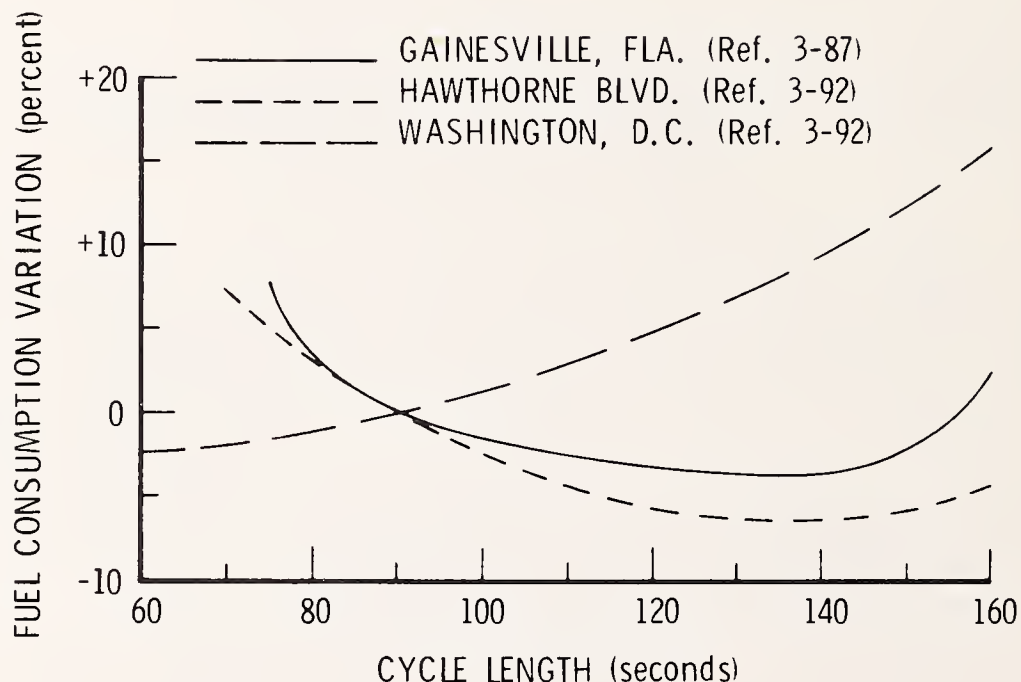

FIGURE 3-28. FUEL CONSUMPTION VARIATION WITH CYCLE LENGTH



TABLE 3-19. EFFECTS OF PEDESTRIAN SCRAMBLE SYSTEM (Ref. 3-92)

Pedestrian Movement	Vehicle Turning Movement		
	No Turning	10% Turning	20% Turning
<u>No Scramble</u>			
Average Speed (mph)	23.0	11.6	6.48
Delay (vehicle-hours/hr)	13.7	69.5	131.0
Fuel Economy (mpg)	15.5	10.3	6.99
<u>Scramble</u>			
Average Speed (mph)	7.81	4.93	3.71
(% Change)	(-66)	(-58)	(-43)
Delay (vehicle-hours/hr)	112	234	204
(% Change)	(+718)	(+237)	(+56)
Fuel Economy (mpg)	8.02	4.66	4.53
(% Change)	(-48)	(-45)	(-35)

3.2.3.2.2 Assessment of Benefits

The available data comparing fully actuated and pre-timed traffic signal control systems indicates that the fuel consumption benefit of fully actuated control may be highly variable with cross flow traffic volume. With the encouragement provided by Ref. 3-95, this study will adopt the 10% improvement obtained by the Honeywell study for Hawthorne Boulevard and will assume that this value applies to all 6-lane urban arterials nationwide. A smaller improvement for 4-lane arterials is suggested by the Honeywell findings that the benefits of fully actuated control are related directly to the ratio of main to cross street traffic volume. Accordingly, this study will arbitrarily assume that the improvement for a 4-lane arterial is one-half that for 6-lanes, or 5%. The applicability of these values to urban VMT and national fuel savings is treated in Section 4, Implementation Analysis.

The Gainesville, Florida, study (Ref. 3-87) concluded that a savings of approximately 1 gallon per intersection per hour per day could be achieved by extending traffic signal cycle lengths to about 120 seconds

from the 90 second cycle length which produced minimum delay. On the other hand, the Honeywell simulation of the Washington, D.C. network at these same cycle lengths indicates an increase in fuel consumption for a case representative of high traffic volume at all intersection approaches. This suggests that the Gainesville estimate may be relatively optimistic as applied to the nationwide complex of signalized intersections. This report will assume that the average savings due to optimizing traffic signal cycle length for fuel economy is one-half the Gainesville value, or 1/2%.

#### 3.2.3.3 Safety Considerations

The intersection control techniques examined in this section represent operational variations in intersection control and would not be expected to result in any adverse safety effects.

#### 3.2.3.4 Availability for Implementation

A nationwide survey of traffic control equipment inventories conducted by The American City Magazine (Ref. 3-96) indicated that two-thirds of the traffic controllers in use are of the pre-timed type and one-third the traffic actuated type. This survey also indicated a noticeable trend toward the purchase of traffic actuated controllers, which constituted 60% of the total purchases in the 1972 through 1974 period, or about 3900 units in the 139 municipal county and state jurisdictions surveyed. Extrapolating this to a nationwide basis would indicate that 20,000 traffic actuated controllers were purchased in that 3-year interval and may be somewhat indicative of the rate at which these units could be supplied.

Changing the cycle length would require only a resetting of cycle times to existing units and would not therefore present any implementation problems related to hardware. In order to optimize the cycle length, however, the particular network under consideration would have to be evaluated in terms of fuel economy and delay versus cycle length.

#### 3.2.3.5 Cost Factors

Discussions with the Los Angeles County Road Department (Ref. 3-97) indicate that the costs of a traffic actuated intersection control system can vary widely, depending on the number of lanes to be detected and controlled. According to this source, the most economical approach is to utilize a semi-actuated system in which only the traffic on the cross streets

is sensed and controlled. This system gives preference to the main street traffic, which remains on green unless a cross traffic demand is detected. This system is particularly applicable where the main street carries considerably more traffic than the cross street. The cost for the controller, loop detectors, and sensors was estimated to be about \$5500 to \$6000 with 4 lanes of cross traffic actuated. Fully actuated systems would require additional detectors and sensors as well as a more complex controller. Such a system was estimated to cost in excess of \$15,000.

For the purpose of this study, a value of \$8,000 per intersection will be used in assessing the cost to convert to a traffic actuated system, recognizing that some intersections will require elements of the more complex control approach in order to achieve the full fuel economy potential of this system.

Optimization of traffic signal cycle length is not expected, in general, to require any additional hardware, assuming that the operating range of all controllers in the network can accommodate the selected cycle length. Because of the interactive effects of main street and cross street traffic, it would be necessary to conduct a separate evaluation of each major network in the traffic system to identify optimum cycle lengths and, indeed, to determine if a potential for fuel savings exists. Such an evaluation, properly performed, is judged to require the use of a computer traffic simulation and timing optimization program, and would involve a survey and assessment of network traffic flow and signal characteristics to provide the necessary simulation inputs. The costs for conducting such studies, including data acquisition and reduction, program setup and input preparation, simulation runs, and results analysis, are estimated to be on the order of \$12,000 to \$15,000 for a 50-intersection network. The upper figure results in a cost per intersection of \$300. This value will be used in assessing the national costs for traffic signal timing optimization.\*

---

\*Some additional annual operating expense may also be incurred as a result of the possible need for adjusting cycle timing in consonance with seasonal or other changes in traffic flow patterns.

### 3.2.4 Network Control

#### 3.2.4.1 Introduction and Background

Network traffic control is accomplished through the integrated utilization of a traffic signal complex which may consist of either pre-timed or traffic actuated controllers, or a combination of both types. The system may consist of a series of independent controllers timed to operate in a prescribed relationship so as to optimize the movement of traffic through the system, or a group of interconnected intersection controllers. The system may have only one operating mode, or it may have several, including the capacity to operate with several different cycle lengths, interval timings, and changes of sequence and signal status feedback (Ref. 3-94).

Computer control of traffic network systems offers the potential advantage of increased flexibility in adjusting traffic signal timings to traffic conditions in the network. The computer receives data on traffic conditions which has been sensed by detectors in the network and resets the signal timing. This may be accomplished in several ways. A library of stored traffic patterns may be compared to the actual traffic condition and the signals reset to the pattern that most closely matches the actual conditions. Other techniques include the selection of a timing plan based on the time of day or by special logic that responds to fluctuations of traffic parameters at selected detector locations (Ref. 3-89).

This section reviews and assesses the available information on the fuel economy effects of various network traffic control systems currently in operation, under development, and under study for future application.

#### 3.2.4.2 Fuel Economy Effects

##### 3.2.4.2.1 Data Base

Improvements in network traffic control, directed toward improving flow and reducing the number of stops, can be expected to result in parallel reductions in fuel consumption. Honeywell (Ref. 3-92), for example, has expressed fuel economy in terms of average urban network speed in miles per hour as:

$$FE = 0.412S + 3.61$$



where

FE = the predicted fuel economy in miles per gallon.

S = average speed, miles per hour.

Similar findings have been reported by General Motors (Ref. 3-98), in which the average fuel consumption per unit distance is expressed as a function of the time per unit distance (the reciprocal of average speed). Other sources have related the reduction in fuel consumption to the reduction in the number of stops. This relationship indicates that a .1% reduction in the number of stops would result in a 0.2% reduction in fuel consumption (Ref. 3-99).

The use of computer-controlled systems to improve network traffic control is gaining increased application in the U.S., with over 150 cities reported to have computer systems in operation or under development (Ref. 3-89). Only limited information has been reported in the literature regarding any potential fuel savings which might be attributable to the implementation of a computerized system.

The installation of an online computerized traffic control system in San Jose is reported to have resulted in fuel savings of 338 gallons per day (Ref. 3-100). This network consists of 60 intersections and carries an estimated 75,000 vehicle miles of travel per day. This level of daily travel would indicate a daily fuel consumption of 5970 gallons based on the 1976 fleet-average urban fuel economy. On this basis, the savings of 338 gallons per day would represent a 5.7% reduction in fuel consumption.

The installation of a 28-intersection computer-controlled network in Atlanta resulted in a 53% reduction in the number of stops (which suggests a 10% reduction in fuel consumption on the basis of the 5 to 1 relationship between the percentage reduction in the number of stops and the percentage reduction in fuel consumption). This larger improvement was attributed to a traffic pattern which lent itself better to signal timing improvements and less-than-optimal signal timing before the computer system was installed. By comparison, the 112-intersection traffic-responsive system in Los Angeles resulted in a reported time savings of only about 5% (Ref. 3-101), which was attributed to the relatively high performance of the system prior to the installation of the computerized system, which included progressive timing and arterial signal patterns which varied with the time of day.

An assessment of the fuel savings resulting from a time savings would require an estimate of the average speed. This was not reported for the Los Angeles network, but an estimate of the potential fuel savings over a range of average speeds (i. e., 5-35 mph), using the Honeywell and General Motors equations relating fuel economy to average speed, suggests that the 5% time savings may result in a fuel savings of perhaps 2-1/2 to 3%.

The sensitivity of network fuel consumption to different signal timing patterns generated by different algorithms was assessed by Lieberman and Cohen (Ref. 3-84). In this study, a section of the UTCS network was simulated using the Traffic Signal Optimization Program (SIGOP), and the Traffic Network Study Tool (TRANSYT). The SIGOP program optimizes cycle lengths, phase splits and offsets for a traffic network. The TRANSYT program optimizes traffic flow in a network by computing a performance index which is a measure of the overall impedance to traffic flow in the network. The optimization process minimizes the performance index of signal offsets and phase lengths. Although it does not compute the optimum cycle length, TRANSYT can be used to derive an optimum performance index of a network for different cycle lengths and hence the most suitable cycle to use (Ref. 3-94). The results of the evaluation of these two systems show a marked difference in fuel economy (17%) and in other reported measures of effectiveness, as indicated in Table 3-20.

TABLE 3-20. SIGNAL TIMING EVALUATION OF URBAN NETWORK (Ref. 3-84)

Signal Timing Algorithm	Vehicle Miles	Mean Speed, mph	Stops per Vehicle	Fuel Economy, mpg
SIGOP	2337	8.7	2.46	7.6
TRANSYT	2247	11.1	1.92	8.9

The effect of various network traffic control scenarios was tested in the Washington, D.C. area over the urban traffic control system (UTCS) network (Ref. 3-102). In this evaluation, traffic flow within the network was monitored and each of several control scenarios, developed offline, were put into operation to determine the effectivity of each alternative approach. Among the control alternatives evaluated was a set of seven separate control

patterns, implemented by time of day, a critical intersection control pattern for those intersections where approaches become highly congested and intersection blockages occur, and a traffic-responsive pattern matching plan utilizing the same control strategies developed for the time-of-day scenario, but which selected a particular control pattern in response to measured on-street traffic conditions. The relative effectiveness of the current pre-timed traffic control system in use in Washington, D.C. was also compared.

This test program reported only various traffic flow characteristics and did not address the fuel economy effects of the various control scenarios. The reported average network speeds resulting from the different control strategies were examined in an attempt to assess any fuel savings. However, the narrow range of average network speeds (6.2 - 7.4 mph) due to the congestion effectively masked any significant differences between the various control measures. These fuel economy differences were estimated to range from -1% to +2%.

#### 3.2.4.2.2 Assessment of Benefits

The potential fuel savings which might be achieved through the implementation of a computer-controlled network will depend on several factors. If, for example, the network has a more efficient system prior to the use of computerized control, the degree of improvement may be small. The level of congestion within the network will also have a strong effect on the potential benefits.

In view of the many unknowns regarding these factors as they apply to a "typical" or representative network, an average of the San Jose, Atlanta and Los Angeles estimated fuel savings, or 6%, will be used in assessing the potential network fuel savings.

#### 3.2.4.3 Safety Considerations

The implementation of improved traffic network control considered in this section represents improvements in expediting the flow of traffic through the network which would not be expected to have any adverse safety effects.

#### 3.2.4.4 Availability for Implementation

The implementation of a computer-controlled traffic network system would require that the necessary intersection hardware be available,



e.g., signals, detectors, and controllers, and that these be interconnected with the computer to derive optimum benefit from such a system. Studies would have to be made to determine the most efficient control algorithm for a given network.

Based on a survey of traffic control equipment inventories (Ref. 3-95), the many sensors or controllers which may be required would appear to be readily available.

Specific computer hardware may have to be tailored to meet the requirements of a specific network; such hardware does not appear to present any specific problems with regard to availability (Ref. 3-103).

Several traffic control algorithms such as SIGOP and TRANSYT have been developed and should be capable of online use.

#### 3.2.4.5 Cost Factors

The costs associated with an online computer-controlled traffic network system have been reported as a function of the number of intersections to be controlled (Ref. 3-100). These were given as \$0.67 million (30 intersections), \$1.3 million (70 intersections), and \$3.3 million (200 intersections).

For the purpose of assessing representative costs associated with a computerized network, a figure of \$20,000 per intersection will be used, based on the above figures.

#### 3.2.5 Exclusive Bus Lanes

##### 3.2.5.1 Introduction and Background

The concept of exclusive bus lanes would provide one or more lanes of roadway for the exclusive use of bus traffic, with the objectives of reducing interference with other vehicular traffic in the network and improving average transit speeds and service so as to attract additional patronage. However, the presence of buses in an urban traffic network system can result in an adverse effect on the overall network traffic flow due to the interference created for right-turning vehicles and the frequent stops made to load and unload passengers.



### 3.2.5.2 Fuel Economy Effects

#### 3.2.5.2.1 Data Base

The effect of bus traffic on overall network performance was evaluated by the Honeywell Traffic Management Center (Ref. 3-92) over a portion of the M Street network in Washington, D.C. Simulations of both conventional bus operation and operation with an exclusive bus lane were evaluated over four different routes. Two levels of bus headway were examined for each route. Previous work had indicated that when bus traffic was superimposed on this network, severe congestion and network saturation were likely to occur. Therefore, as the number of buses increased (when bus headway decreased), auto input volumes were adjusted to keep total vehicle trips constant.

The results of the Honeywell findings are summarized in Table 3-21. These results indicate that exclusive bus lane operation results in a reduction in network fuel economy of 37 to 41% compared to no buses in the network and reductions of 15 to 35% compared to conventional bus operation.

In terms of passenger miles per gallon, the exclusive bus lane operation (as well as conventional bus operation) showed a marked increase of 19 to 61% over a network with no buses, but indicated a reduction of 7 to 32% compared to conventional bus operation. The Honeywell findings also indicated that the exclusive bus lane operation resulted in reduced average network speed of 18 to 45% compared to conventional bus operation.

#### 3.2.5.2.2 Assessment of Benefits

The use of exclusive bus lanes has been found to result in a reduction in network fuel economy (miles per gallon) and average network speed when compared to both conventional bus operation and to a network operating without buses. This system also indicates a reduction in passenger miles per gallon compared to conventional bus operation.

In view of these findings, the use of exclusive bus lanes does not appear to be a viable alternative for reducing automotive fuel consumption and will not be given further consideration in this study.

TABLE 3-21. EFFECTS OF EXCLUSIVE BUS LANE OPERATION (Ref. 3-92)

Network Performance	No Buses	Conventional Bus Operation		Exclusive Bus Lane	
		Headway No. 1	Headway No. 2	Headway No. 1	Headway No. 2
Vehicle Fuel Economy, mpg	5.94	5.33	4.40	3.49	3.76
Passenger Fuel Economy, mpg	7.13	12.4	12.4	8.46	11.5
Average Speed, mph	6.06	5.86	4.59	3.25	3.77

### 3.3 DRIVER BEHAVIOR MODIFICATIONS

#### 3.3.1 Driver Training

##### 3.3.1.1 Introduction and Background

Basic engineering considerations, common sense, and empirical evidence all indicate that the personal driving habits of the motor vehicle operator can have a pronounced effect on vehicle fuel economy. Accordingly, there may be considerable value in promoting increased public awareness of fuel efficient driving habits by means of driver training. This section summarizes the work that has been done in this area, and assesses the potential fuel economy benefits as they apply to the operation of light duty passenger cars and trucks.

##### 3.3.1.2 Fuel Economy Effects

###### 3.3.1.2.1 Data Base

Reference 3-104 discusses a number of field evaluations that have been made to test the effect of various operator driving habits on fuel economy. Highlights of these tests are shown in Table 3-22 and are summarized in the following paragraphs.

The Shell Oil Company performed a test in which 23 untutored drivers were selected to drive a 22.3-mile test course that included both town and freeway driving. The car used for the test was a 1972 Chevrolet with a 350-CID engine. The test car was equipped with a meter to measure gasoline consumption to 1/1000 of a gallon. Before the first test, the car was detuned to simulate a car that was not maintained well. The drivers all drove the same test course with this car. Before the next test, and unknown to the drivers, the car was tuned to manufacturer's specification and steel-belted radial tires were substituted for four-ply polyester tires. The drivers again drove the test course with the tuned car. In these first two tests, the drivers were asked to drive the course as they normally would and the real purpose of the tests was not disclosed. For the third test, the drivers were all told about the purpose of the test. During this third test, they were accompanied and coached by an expert in gas-saving techniques. Compared to the first test with the untuned car, the drivers in the second test with the tuned car achieved a 14.6% average gasoline mileage improvement. For the third test in which they were coached in fuel economy techniques, the drivers

TABLE 3-22. FUEL ECONOMY VERSUS DRIVING HABITS--  
TEST RESULTS (Ref. 3-104)

Company/ Agency	Purpose of Test	Results of Test
Shell Oil Company	Improvement due to coaching in gas saving techniques (23 drivers, 1 car, 22.3-mile course)	8.9% improvement over well-tuned car with radials
Mobil Oil Corporation	Improvement due to reading driving instruction manual (20 drivers, 1 car, 18-mile course)	15% improvement
	Effect of using vacuum gage after reading manual (8 drivers, 1 car, 18-mile course)	1% improvement over 15% achieved by read- ing only
TSC/NHTSA	Pilot test to determine im- pact of training (10 drivers with no training, 10 drivers with 1 hour training, 9-mile route, 1 car)	~10% short term improvement for driver with 1 hour of training
Douglas Aircraft Company	Determine impact of driver training program on fleet drivers. Instruction in driv- ing techniques and training in vehicles equipped with MPG meter, vacuum gage, pyro- meter (15-driver test group)	22.1% improvement due to training program with 15 drivers
Auto Club of Michigan	Determine effect of bad driv- ing habits as compared to good driving techniques (22.8-mile commuter route, 10-mile expressway route, 1 car)	44% loss due to bad driving on commuter route 23% loss due to bad driving on expressway route
Auto Club of Southern California	Determine effect of accelera- tion levels (1 driver, 20 cars, 1/4 mile, standing start to 40-mph speed)	12.4% loss due to "mod- erate" acceleration 27.2% loss due to "heavy" acceleration



achieved an 8.9% average gasoline mileage improvement over the second test. The results for the third test varied from 0.3 to 21.8% improvement.

The Mobil Oil Corporation conducted a test to determine if economy driving techniques can be self-taught. Twenty employees not associated with automotive-oriented areas were selected. They were asked to drive an 18-mile test course in their normal manner. The car used was a 1973 Chevrolet with a 350-CID engine and automatic transmission; the vehicle was warmed up prior to each test run. The course provided a 50-50 mix of urban and suburban driving, and had 14 traffic signals and 12 stop signs. After the first test, the purpose of the test was revealed to the participants and manuals providing instructions on economy driving were given to them. They were asked to read the manuals, but they did not receive any other instructions in driving techniques. Several days later the drivers again drove the test course. The drivers recorded a 15% average improvement in miles per gallon for this run. The improvement varied from 4 to 26%. A third test was conducted in which eight participants who had achieved high, medium, and low levels of gas mileage improvements were asked to drive the test course using a vacuum gage (a Stewart-Warner Motor Minder). They achieved an additional gas mileage improvement of 1% over the second test.

The DOT Transportation Systems Center (TSC) and the National Highway Traffic Safety Administration (NHTSA) conducted a joint pilot test program to determine the impact of driver training on fuel economy. The program involved 20 drivers: 10 with no training and 10 with 1 hour of training. A single car was used over a 9-mile test route, primarily in heavy urban traffic in the Boston area. Approximately 10% improvement in fuel economy was observed for the class of drivers with the 1 hour of training. It should be noted, however, that a follow-up questionnaire indicated that almost all the participants subsequently abandoned the driving techniques they had been taught. The common reason cited was a concern about safety caused by the press of traffic. The participants indicated that, in effect, they felt insecure about being slow moving objects in a fast moving stream (Refs. 3-104, 3-105).

The Douglas Aircraft Company test represents a continuing program that is more comprehensive than the other tests described, but deals with commercial fleet drivers only. The drivers are not only given

instruction in driving techniques but are also trained in vehicles (passenger cars, pickup trucks and vans) equipped with various driver aids. Driver performance in the Douglas program is supervised closely by means of an ongoing review with each driver of the results of tachograph/speedograph-type records of vehicle speed and time parameters. An evaluation performed early in the Douglas program reported a 22% improvement with a 15-driver test group. Douglas now estimates that the ongoing effectiveness of its program is an approximate 20% increase in fuel economy for all fleet operations covering passenger cars, light duty trucks, and heavier vehicles up through cross-country trailer trucks. The ongoing close control of driver performance is a key factor in achieving this increase (Ref. 3-106).

The two auto club tests shown in the table were conducted to demonstrate the effects of "bad" rather than "good" driving habits, and illustrate that high accelerations and excessive speeds can result in fuel economy penalties from 12 to 44%, depending upon the degree of bad driving and the driving route.

A large-scale test program involving both driver training and driver aids has been conducted by the Department of Energy (DOE) through its Nevada Office. The program is called the Driver Aid and Education Test Project (Ref. 3-107). Testing, which was recently completed, involved a fleet of 336 vehicles, 70% of which were pickup trucks, with the remainder split approximately equally between compacts and intermediate/full size sedans. There were five sub fleets or groups, each comprising approximately one-fifth of the total fleet. The disposition of each group was as follows. Group 1 used a Vac Tach driver aid with no driver training. Vac Tach is the trademark name of a plunger type manifold vacuum device. Details on its operation and features are given in Section 3.3.2. Group 2 was a control group, which received no driver instruction or driver aids. Group 3 received driver training only, while Group 4 received the same driving training, and then used a conventional circular dial vacuum gage, the Stewart-Warner Motor Minder, while driving. Group 5 used the Motor Minder vacuum gage with no driver training. The drivers were employees of DOE or of DOE contractors. No attempt was made to motivate drivers after the formal phase of driver training was completed.

This was a 12-month program, divided into 6 months of driving and evaluation to establish baseline fuel economies and 6 months of device/

technique testing. Testing was completed in the fall of 1977, but the data analysis has not yet been completed, and no formal program results are currently available except for the driver instruction phase (Ref. 3-108). This consisted of two separate 2-hour sessions, normally scheduled on different days. In the first session, attendees viewed instructional movies and slides and were lectured on the principles of carburetor and engine operation. The second session involved driver instruction in an instrumented car. The route for this instruction was a round-trip course of approximately 4.5 miles, located at the DOE Yucca Lake facilities near Las Vegas, Nevada. Average driving speed on this instruction route was about 28 mph. During a first run, the student was asked to drive normally, and the fuel consumption was measured to the nearest 0.001 gallon. After this, the instructor got behind the wheel and demonstrated all the techniques that the student had to adopt in order to improve fuel economy. Then the student drove the course again, as economically as he could, with the instructor advising when certain techniques could be applied. The fuel consumption on this economy run was recorded, and the percentage fuel economy change between the first "driving as usual" run and the economy run was computed. The average improvement for 131 drivers was 10.0% with a range of individual values from -0.2% to 30% improvement.

#### 3.3.1.2.2 Assessment of Benefits

The data base presented in the previous section encompasses two basically dissimilar families of data. One of these, the Douglas Aircraft Company results, represents what can be done when a high degree of regulation and control of driver performance can be implemented. In general, such control is only applicable to commercial fleets, which contribute a very small fraction of the total VMT by the light duty fleet; i. e., about 7%, assuming that all light duty truck operations that are not personal transportation fall into the commercial fleet category. For such operations, it seems reasonable to adopt a fuel economy improvement due to driver training that is somewhat lower than the Douglas achievement (20%), since a variety of driver aid devices are employed in the Douglas program which, presumably, contribute to the end effect. Additionally, fleet operator motivational factors will tend to reduce the level of success which can be expected



for smaller fleet operations where vehicle fuel consumption is a less significant operational expense factor and/or where a closely controlled program cannot be implemented.

The second family of data comprises the results obtained by voluntary response to driver training as represented by the Shell Oil Company data, the Mobil Oil Corporation data, and the interim results of the DOE program. These data more closely approximate the response to be expected from drivers in the general (light duty) vehicle population. In this category, the indicated potential for fuel economy improvement ranges from 9 to 15%.

It is noted that the average 10% improvement recorded for the participants in the DOE test was measured against a baseline which included the effects of 2 hours of classroom instruction. This suggests that a greater percentage increase would apply against a baseline of normal, no-instruction driving. On the other hand, it also seems reasonable to scale down the results of the Shell, Mobil, and DOE tests in order to bring them more nearly in line with effects expected under more representative urban driving conditions nationwide. In moderate to congested traffic some options of fuel efficient driving may be removed from the driver by the constraints of traffic. In the Mobil tests, for example, the stated 50-50 mix of urban and suburban driving (Princeton, N. J. area) corresponds approximately to national VMT characteristics, but it appears that little or none of the test driving occurred during normal commuting periods (Ref. 3-109). The driving route duration was about 45 minutes, with most runs starting within the time periods 9:00 to 10:30 a. m. and 1:00 to 3:00 p. m. ; no test was made prior to 8:45 a. m. or after 3:10 p. m. Traffic conditions prevailing during the DOE driver instruction at Yucca Flats, Nevada, were not specified in Ref. 3-107, but the route appears to be in a region of relatively low traffic density.

Based on the above considerations, the potential for fuel economy improvement due to driver training as applied to noncommercial driving will be taken as 10%. This figure represents the maximum improvement that can be expected assuming that the student/participant conscientiously applies the principles of the instruction to his driving. In view of the uncertainties in the data base, and considering the small fraction of VMT involved, no attempt will be made to differentiate the commercial sector of the fleet from



the larger population of private vehicles. Also, this figure will be taken to apply equally to all classes of vehicles in the fleet. The rationale for this latter assumption follows.

Consider that the ideal outcome of driver training would be to convert all acceleration/deceleration driving to cruise operation. An indication of the fuel economy effect that this would have on vehicles in different market classes is shown in Table 3-23. These data represent the results of computer simulations performed in Ref. 3-18 for vehicle operation over the EPA urban driving cycle. The ratio of fuel economy results for the acceleration and cruise modes of the urban cycle is shown along with values normalized with respect to the 4000-lb car (sales-weighted average inertia weight for newer cars in the fleet). It will be noted from the normalized column that the variation of improvement among vehicles of widely different specifications is only 10%. While some trend with respect to inertia weight is indicated, the nature of the data base on driver training does not justify a correction for this factor.

#### 3.3.1.3 Safety Considerations

No adverse safety effects related to fuel-efficient driving are identified, assuming that such driving does not result in gross disparities in vehicle speed and driving maneuvers within a given traffic flow situation. Some evidence exists, however (Ref. 3-105), that there is a subjective feeling of unsafeness in driving to any degree slower than the traffic stream, and initially this may tend to inhibit the implementation of the strategy.

#### 3.3.1.4 Potentialities for Implementation

A hierarchy of three levels of driver training may be identified, representing successively lower levels of driver control but with increasing numerical coverage of drivers. Representative examples of each type are:

- a. Controlled groups - characterized by organizations whose directors and personnel may be expected to be motivated to participate in a training experiment involving instruction time and careful record keeping. Examples:
  1. Federal agencies (DOT, DOE, EPA)
  2. State and municipal agencies having jurisdiction over automobile regulation, traffic management, air pollution, etc.

TABLE 3-23. COMPARISON OF SIMULATION RESULTS FOR  
CRUISE VERSUS ACCELERATION FUEL  
ECONOMY IN URBAN CYCLE (Ref. 3-18)

Manufacturer	IW	CID	Tran.	Axle Ratio	R <sup>a</sup>	R/R <sub>0</sub> <sup>b</sup>
---	5000	400	A	3.08	1.815	.970
GMC	5000	350	A	3.08	1.893	1.012
Chrysler	4500	318	A	3.21	1.831	.979
Chrysler	4500	318	M-3	3.21	1.740	.934
AMC	4000	258	A	3.15	1.870	1.000
AMC	4000	258	M-3	3.15	1.894	1.013
Chrysler	3500	225	A	3.21	1.724	.922
Chrysler	3500	225	M-3	3.21	1.752	.937
GMC	3000	140	M-3	2.92	1.738	.929
---	2500	97.6	M-4	3.70	1.680	.898

<sup>a</sup>Ratio of cruise fuel economy to acceleration fuel economy

<sup>b</sup>R<sub>0</sub> is ratio for 4000-lb car with automatic transmission

- b. Semi-controlled groups - characterized by large organizations which may be amenable to providing facilities (and perhaps other services) for instruction of participants. Record keeping would probably be done by participants on a voluntary basis. Examples:
  - 1. Large government and industry employers
  - 2. High school driver training courses
  - 3. Adult education classes
- c. Non-controlled drivers - general public. Driver training by use of government publications, mass media messages, information distributed by government agency or auto manufacturers to car dealerships, etc.

An example of driver training in the controlled group category is the DOE program described in Section 3.3.1.2.1. Training and testing of semi-controlled groups would differ from the Shell and Mobil tests in that future programs would evaluate the effect of instruction on the longer term driving habits of the participants and would encompass commuter driving within the data base. There are no known programs of this type in existence.

Three basic levels of driver training are possible: individualized instruction behind the wheel, classroom instruction, and reading by the individual driver of instructional literature. The present data base does not permit an assessment of the relative effectiveness of each of these three levels as applied to drivers nationwide, but it is assumed that an effective driver training program must consist of some type of formal instruction such as classroom presentation with visual aids, preferably augmented by instruction behind the wheel. Although the Mobil data indicate a benefit potential due simply to reading instructional material, the test group (all Mobil employees) probably displayed considerably greater motivation than could be expected of the general public.

#### 3.3.1.5 Cost Factors

Based upon the driver training programs reviewed in this section, it appears that an effective driver training program would consist of about 3 hours of classroom presentation, using appropriate demonstrational and visual aids. This would be followed by about 2 hours of instruction and demonstration behind the wheel of an instrumented car, preferably one in

which an on-board fuel totalizer permits the participant to directly observe the net result of the various driving techniques.

Current instruction rates for commercial driving schools are about \$10 per half hour, which would result in a charge to each participant of approximately \$40 for this phase of instruction. If the classroom training were to be given through existing educational facilities, such as adult evening programs now widely offered by high schools, a one-time course cost of approximately \$15 per participant is indicated, for a total program cost per driver of approximately \$55.

The cost of a federal- or state-sponsored mass mailing of instructional pamphlets or booklets would have a very low indirect cost to each driver, but such an approach may have little useful effect, even if buttressed by a promotional campaign utilizing television or other mass communication media. Analysis of the costs and impacts of such a program is beyond the scope of this study.

### 3.3.2 Driver Aid Devices

In principle, all that is required of a driver to achieve improved mileage from a tankful of gasoline is to be aware of several basic fuel-efficient driving techniques, and to apply these in his daily driving. This knowledge may perhaps be attained and applied through driver training alone. Should this be the case, the main value of a driver aid device may be to prompt or remind the driver if he starts to slip back into his pre-training driving habits.

Alternatively, it may be argued that some driver aids, alone or in combination, may perform the instructional task themselves. According to this concept, a motivated driver may learn all he needs to know to drive in a fuel efficient manner by observing and responding to the device readings or other output signals, while continued use of the aids would maintain these driving habits. In either event, driver aids may be useful in helping a driver to reduce his driving fuel consumption.

A large number of driver aid devices were examined and evaluated in The Aerospace Corporation driver aid study of Ref. 3-104. Based on that study, plus other recent work described subsequently, the following list was selected as representing the devices offering the greatest promise.



- a. Manifold vacuum gage
- b. Accelerometer
- c. Accelerator pedal active driver-feedback system
- d. Automatic cruise control
- e. Miles per gallon (MPG) meter
- f. Fuel totalizer

This section examines and evaluates these devices with regard to their potential for reducing fuel consumption in the light duty fleet.

### 3.3.2.1 Manifold Vacuum Gage

#### 3.3.2.1.1 Introduction and Background

A manifold vacuum gage senses and measures the pressure below atmospheric in the engine intake manifold and provides some form of visual or audible display to the driver. Manifold vacuum is a sensitive indicator of throttle position, and hence engine load. The amount of fuel being used is also directly related to the load on the engine, and therefore the intake manifold vacuum is related to the amount of fuel being consumed. It has been recognized for many years (principally by those involved in automobile performance testing, racing, or economy runs) that gages which measure the intake manifold vacuum can be useful for monitoring engine operating conditions that relate to fuel consumption.

The principal information gained from using a vacuum gage is that, to maintain high engine vacuum, one should accelerate the car slowly, and if possible, one should decelerate somewhat going up hills. Since the vacuum gage is quite sensitive to moderate accelerations and decelerations, it also indicates to the driver if he is maintaining a steady foot on the accelerator. Driver action consists simply of trying to maintain as high a value of vacuum as possible, consistent with the driving and traffic demands.

A wide variety of vacuum gage types are currently available in the aftermarket. The operating principles are similar, all being basically diaphragm devices in which one side of the diaphragm is exposed to ambient pressure, the other to intake manifold pressure. Change in pressure cause the diaphragm to move. The main difference between the various types of gages is the method of display. A common arrangement utilizes a mechanical linkage to operate a dial indicator needle. Some gages display a numerical reading of 0 to 30 in. Hg of manifold vacuum, sometimes in combination

with colored zones corresponding to poor, fair, and good fuel economy. Many gages have no numerical scale at all, relying on colored zones to convey information to the driver. Typical color formats are red for the range 0 to 5 in. Hg, yellow from 5 to 10, green from 10 to 22, and blue above 22.

Light displays are available, in which the vacuum gage diaphragm operates a switching device either to actuate a light when the vacuum reading drops below a certain level or to turn on different colored lights corresponding to the different economy zones. Other display types include a diaphragm-actuated plunger in which the magnitude of plunger movement indicates the vacuum level. The display may be augmented by such features as variation in color of the exposed portion of the plunger, and an audible signal when the manifold vacuum drops below a certain level.

### 3.3.2.1.2 Fuel Economy Effects

#### a. Data Base

Reference 3-104 presented a review of all known fuel economy testing of manifold vacuum gages as of mid-1975. These tests are summarized in Table 3-24. Discounting a few tests which appear to have been very poorly defined with respect to test versus baseline driving, the reported effects on fuel economy ranged from fuel economy decreases (not shown in the table) to increases as high as 17%, with most results falling in the range of about 7 to 10%. The negative results (2 to 17% decrease in fuel economy) were obtained on four 1/4-ton mail delivery vehicles operated by the U. S. Postal Service; two similar vehicles in the same test showed a 9% fuel economy increase. Three 1/2-ton mail delivery vehicles operated by the U. S. Postal System showed a fuel economy increase of 1 to 7% for two different types of vacuum gage displays.

The tests discussed above represent a very limited data base. Also, the results are generally confounded by the unquantified effect of varying degrees of driver instruction. Moreover, the aspect of driver motivation appears to have been highly variable among the tests.

Claims of fuel economy improvement by the manufacturers of vacuum devices typically range from 10 to 25%, but these claims are either totally unsupported or have not been substantiated with statistically meaningful data.

TABLE 3-24. FUEL ECONOMY TESTS OF MANIFOLD VACUUM DEVICES<sup>a, b, c</sup> (Ref. 3-104)

Device	Tested By	Vehicle	Fuel Economy Results
Econ-O-Lite	Postal Service	One 1/2-ton truck Six 1/4-ton trucks	~0.1 mpg improvement ~1.0 mpg improvement for two of six trucks
Pontiac Vacuum Gage	Employees of WWJ-TV, Detroit	Pontiac	6.9% improvement
Ford Vacuum Gage	"	Ford	24.6% improvement
Plymouth Fuel Pacer	"	Plymouth	23.1% improvement
Accelerite	Ryder Truck Lines		10.2% improvement
	Postal Service	One 1/2-ton truck One 1/2-ton truck	3% improvement 7% improvement
	S. V. Shelton, Georgia Institute of Technology	Five vehicles	11.37% average improvement (between 8.5 and 13.6% with 95% confidence level)
	City of Jacksonville, Florida	Five 1/2-ton trucks	17% improvement
	National Park Service	Four vehicles	10% improvement

<sup>a</sup> Above tests all very limited

<sup>b</sup> Impossible to separate effects of device and instructions.

<sup>c</sup> Motivation may be extremely important factor (more negative results involved fleet vehicles).

As part of a program of determining and analyzing driving patterns, General Motors examined the effect on fuel economy when drivers alter their normal driving practices in a variety of ways, including the rigorous use of a vacuum gage to control their driving (Ref. 3-110). Nine drivers made 34 test runs over a fixed route of about 17 miles in suburban Detroit, each run being performed in accordance with one instruction selected from the set of seven instructions shown in Table 3-25.

TABLE 3-25. EFFECT OF DRIVING PRACTICE ON FUEL ECONOMY (Ref. 3-110)

Instruction	No. of Runs	% Changes in Fuel Economy vs Baseline Correlation
1. Drive normally with the traffic.	11	0
2. Minimize trip time.	6	- 9.0
3. Use vigorous acceleration and deceleration.	3	-14.8
4. Minimize fuel consumption.	8	+11.6
5. Maintain fuel economy meter in green region.	1	- 1.9
6. Maintain fuel economy meter in green or orange region.	2	+ 5.8
7. Drive like a hypothetical very cautious driver.	3	+ 7.4

The driver aid device used was a vacuum gage with a dial divided into three color regions: green for good fuel economy and orange and red for high power with correspondingly reduced fuel economy. Driver responses to the instructions shown in the table were described in Ref. 3-110 as follows:

"For instruction 2, drivers generally used vigorous acceleration up to an appropriate speed for the route, changed lanes freely, and adjusted their speed so as to pass through traffic lights when possible. For instruction 3, drivers attempted to maintain the maximum appropriate speed whenever possible. They did not use foresight to anticipate situations in which a temporary



speed reduction might lead to a reduced total trip time, as under instruction 2. The driver responses to instruction 4 can be classified into two groups: those who responded mainly by reducing acceleration and speed and those who reduced the number of stops through appropriate speed adjustments, by using rather high accelerations in some instances. The instruction to maintain the economy meter in the green could only be achieved by limiting accelerations to values much lower than those that ordinarily occur in traffic. Keeping the meter in the orange also required rather low accelerations, but they did not seem outside the range of those normally used in traffic. For instruction 7, drivers used low acceleration and speed and avoided lane change."

The results of the tests described above are summarized in Figure 3-29. The straight line is the correlation for different drivers driving normally in a wide range of urban traffic situations, while the data points represent average results for the special instruction driving. Although the data sample representing special instruction driving is small, some interesting trends are displayed, as discussed in Ref. 3-110. First, it is noted that the points representing altered driving patterns do not fit the regression line for normal urban driving; rather, a least squares fit of the raw data would be approximately orthogonal to the regression line for normal urban driving. This is a direct statistical inference that changes in fuel economy may in fact be produced by altered driving patterns. Reference 3-110 notes that the group of nine drivers involved was not expected to be typical of any specific sample of the driving population, but that the results should be useful in indicating the extremes of fuel consumption and trip time that might be found on that particular route.

Another interesting feature of the data displayed is the isolated data point for instruction 5 (maintain fuel economy meter in green region). This point indicates a substantially longer trip time per unit distance, with a slight (1.9%) decrease in fuel economy relative to (baseline) instruction 1 (drive normally with the traffic). This result presumably was caused by this driver having to stop at a higher fraction of traffic signals (the test route contained 56) with resulting increase in delay and idle fuel consumption. Instruction 6 (keeping vacuum gage in green or orange reading) produced an average 5.8% increase in fuel economy over that of the baseline (instruction 1) case, while instruction 4 (minimize fuel consumption) yielded an average 11.6% increase in fuel economy. Thus, the simple instruction to

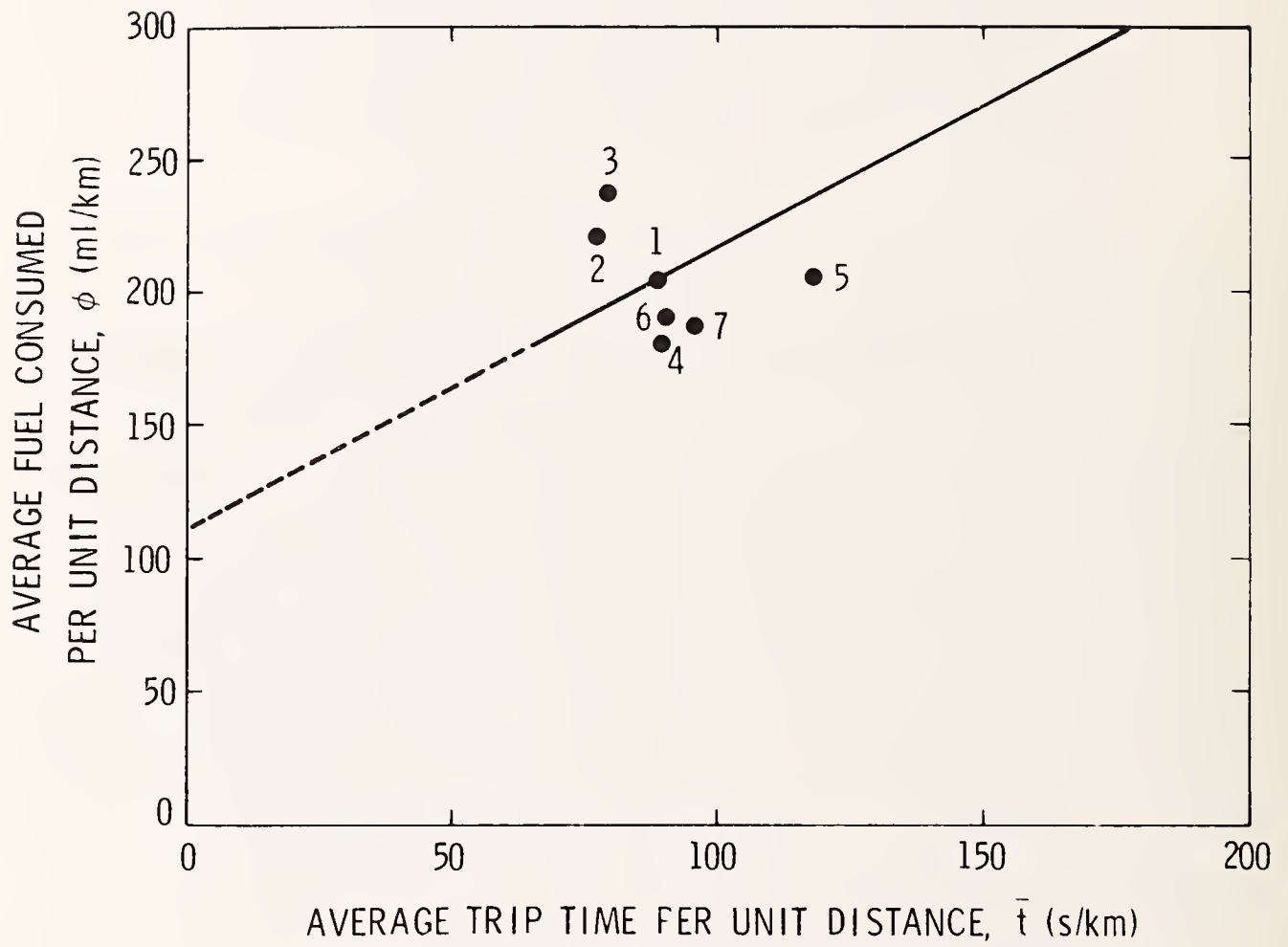

FIGURE 3-29. AVERAGE FUEL CONSUMPTION PER UNIT DISTANCE VERSUS AVERAGE TRIP TIME PER UNIT DISTANCE FOR TRIPS UNDER VARIOUS DRIVER INSTRUCTIONS (Ref. 3-110)

minimize fuel consumption without specific guidance relative to the use of the driver aid device produced the largest benefits of all. Reference 3-110 cautions that most of these data were obtained for drivers who were more knowledgeable about fuel consumption than the average driver, and that without specific instruction large-scale attempts by the general public to minimize fuel consumption might actually produce an increase in fuel consumption for the total traffic system.

A large-scale test program relating to the use of manifold vacuum gages, with and without driver training, has been conducted by DOE at their Nevada Operations Office, as described in Section 3.3.1. Two types of vacuum gages are being evaluated in this program. One is Vac Tach, a trademark of C & E Enterprises, Inc., Jacksonville, Florida, for a device with plunger type display which also incorporates an audible signal and a vacuum-drop totalizer. If manifold vacuum falls to about 12 in. Hg, an audible signal is emitted. If the vacuum continues to fall, the audible signal ceases, but the driver receives a peripheral vision signal of movement and color change as the plunger displacement increases. If the vacuum falls to about 6 in. Hg, the incident is recorded as one "count" on the vacuum-drop totalizer. The frequency with which these counts accumulate is intended to be a signal to the driver of poor driving habits or of an engine or ignition system malfunction which requires unduly large throttle openings for a given power level.

The other vacuum gage used in the DOE tests is the Motor Minder, a trademark of Stewart-Warner Corp. of Chicago, Ill. It has a conventional circular dial and pointer display color-coded into four areas corresponding to good, fair, and poor fuel economy and deceleration. No DOE test results concerning the use of these vacuum gages are available at this time.

Other data on the use of the manifold vacuum gage driver aid device are given in "Passenger Car Fuel Conservation," Ref. 3-81, a recent study conducted for the FHWA. Details of the vacuum gage tests reported in this reference are provided in Table 3-26, along with additional pertinent data reported for the results of driver training tests using an accelerometer as a teaching aid. This test program was conducted on a driving route which entailed two successive replicate loops along village streets typified by very low traffic volume. The total driving distance of the route was about 2 miles.

TABLE 3-26. SUMMARY OF RESULTS PERTAINING TO VACUUM GAGE TESTING AS REPORTED IN "PASSENGER CAR FUEL CONSERVATION "(Ref. 3-81)

Test Objective	No. of Drivers	Driving Instructions	Method of Adhering to Driver Instructions	Average % Change in Fuel Economy vs Baseline	Is Difference Statistically Significant? <sup>a</sup>	Conclusions of Ref. 3-81
1. Evaluate effect of manifold vacuum gage as driver aid	46	Keep manifold vacuum above 10 in. Hg (stated in Ref. 3-81 to correspond to maximum acceleration of $\approx 4$ mi/hr/sec)	Vacuum gage visible to driver, color coded: <u>Red</u> below 10 in., <u>Green</u> from 10 to 17 in.	+0.8	No	Little, if any, net fuel savings would result from installation of vacuum gages; only $\approx 1/3$ of drivers would benefit
Same as above, but using sub-set of 15 drivers who depressed manifold vac. below 10 in. on normal acceleration in baseline driving	15	Same as above	Same as above	+4.2	Yes	
Same as above, but using sub-set of 31 drivers who did not depress manifold vac. below 10 in. in normal acceleration in baseline driving	31	Same as above	Same as above	-0.8	No	
2. Evaluate effect of fuel conservation driving	8 <sup>b</sup>	"Full Fuel Conservation" driving defined as: accel. rates $\approx 3.5$ mi/hr/sec, decel. rates $\leq 4.5$ mi/hr/sec, manifold vac. $\geq 13$ in., <sup>c</sup> avg. speed 18.1 mi/hr <sup>c</sup>	Practice runs using accelerometer; no driver aids used during test run	+5.3	No	Substantial reduction in fuel consumption possible by use of fuel conservation driving

<sup>a</sup> Double-ended "t" test at 95% confidence level.

<sup>b</sup> Not part of above group.

<sup>c</sup> Probably not an explicit instruction.

Notes: (1) Vehicle:

1 car; 1968 Plymouth sedan, 383 CID engine, 2 BBL carburetor, test weight 4500 lb, no air conditioning, odometer  $\approx 100,000$  miles, received major tune-up prior to tests.

(2) Drivers:

Selected to cover range of age, sex and occupation representative of nationwide driver population.

(3) Driving Route:

$\approx 2$  mile route through village streets with very low traffic volume, 10 stop signs, 8 right turns.

(4) Baseline:

Each driver drove route twice following normal practice, with no driver aids or instruction.

(5) Data Collection:

Observer accompanied driver on all runs, baseline and test, noting readings of manifold vacuum gage and accelerometer which were not visible to driver; fuel consumption measured by on-board fuel totalizer, reading to 0.001 gallon.



comprising 8 right turns and 10 stop signs. The route was level road with good asphalt pavement. One test car was used.

Fifty-five drivers were selected, covering a range of conditions of sex, age, and occupation which was intended to be representative of the nationwide driver population. Of this group, 46 were assigned to the vacuum gage test. Each drove the test route twice using normal driving practice with no driver aids or instruction, to establish a baseline. In all test route driving, baseline and test, an observer accompanied the driver and noted the readings of a manifold vacuum gage and an accelerometer which were not visible to the driver. The drivers then repeated the course with instructions to keep the manifold vacuum (as displayed on a gage which was now visible to the driver) above 10 in. Hg. The gage was color-coded red below 10 in. Hg, and green from 10 to 17 in.

The 46 drivers showed an average fuel economy increase with the use of the vacuum gage of only 0.8% (this result was not statistically significant). Reference 3-81 stated that, of the 46 drivers, only 15 depressed the manifold vacuum below 10 in. Hg on normal accelerations. Treating these 15 drivers as a distinct sub-group showed an average fuel economy increase with the use of the manifold vacuum gage vs baseline of 4.2% (this result was statistically significant). The other sub-group of 26 drivers who did not depress the manifold vacuum below 10 in. Hg on normal accelerations, when treated as a separate sub-group, showed an average fuel economy decrease with the use of a manifold gage vs baseline of 0.8%. From these results, Ref. 3-81 concluded that installation of vacuum gages in all cars would result in very little, if any, net savings in fuel consumption.

Eight of the remaining drivers in the group of 55 were selected for the driver training tests. Using an accelerometer as a guide, each driver made practice driving runs following instructions to limit accelerations and to otherwise drive to conserve fuel as described in Table 3-26. After these initial training runs, test runs were made without driver aids, yielding a 5.3% average fuel economy increase. Reference 3-81 concluded from this test that driver training in fuel conservation techniques could provide substantial benefits.

b. Assessment of Benefits

The quantifiable data base relating to the use of manifold vacuum gages is at present very limited, both in terms of test duration and the number of vehicles and drivers involved. The negative test results discussed above all involved fleet vehicles (U.S. Postal System) and there is some question concerning whether or not the test drivers were motivated to increase fuel economy. These results are discounted in this assessment, not because they are negative, but rather because they are not considered to be representative of a motivated driver. The GM results for driving with the manifold gage reading always in the green region also yielded a negative fuel economy effect (Ref. 3-110). As stated in that reference, however, this was an extreme test condition, with results not necessarily representative of most drivers. It is considered unlikely that many drivers would continue to restrict their vehicles to such gentle accelerations as required to satisfy this test constraint. The GM result of a 6% increase in fuel economy by driving with the vacuum gage display in the green or orange region is considered to be more typical of the actions of a motivated driver.

The higher figures (up to about 25% fuel economy gain) which have been quoted by various sources, including device manufacturers' promotional literature, are also discounted in this assessment. These higher claims either have not been properly substantiated, or they apply to extreme cases which are not representative of average national driving patterns. The data presented in Table 3-24 suggest a fuel economy improvement potential for manifold vacuum gages ranging from a few percent up to about 10% or more.

Two major factors undermine the significance of the vacuum gage test reported in the FHWA study of Ref. 3-81. One is its use of a highly constrained driving duty cycle, which has the potential effect of suppressing the degree and range of driver responses encountered in normal traffic driving situations. The other factor is the discrepancy between the negative results reported for the use of the vacuum gage and the positive results reported for driver training, both of which tests were apparently conducted under very similar driving guidelines with regard to acceleration and manifold vacuum (see Table 3-26). For these reasons, the results of this program pertaining to manifold vacuum gages will be discounted.

This report gives greatest weight to the GM results of a 6% fuel economy increase for keeping the vacuum gage display in the green or orange zones. This is considered to most closely represent the ideal case of a driver conscientiously following a device display without benefit of driver training. Also, the baseline against which this fuel economy gain was measured is more pertinent to nationwide driving practices than that for any of the other data sources. It is therefore the assessment of this report that the fuel economy benefit potential for the use of a manifold vacuum driver aid is 6%. There is no basis at present for distinguishing possible advantages between any of the more common types of displays which are presently available. Also, in accordance with the discussion of Section 3.3.1.2.2 and lacking data to the contrary, this assigned improvement potential of 6% will be applied to all classes of vehicles. The results of the DOE Phase II Driver Aid and Education Test Project, when available, should permit a reassessment of this latter assumption.

It is further assumed that a manifold vacuum gage used in conjunction with driver training will not produce a directly additive effect to the fuel economy benefit potential assigned to driver training alone (Section 3.3.1.2.2). However, the use of a vacuum gage driver aid in conjunction with driver training should serve to buttress this training by warning the driver when or if his driving habits start to deteriorate. Thus, some net benefit should accrue when these techniques are used in combination.

#### 3.3.2.1.3 Safety Considerations

The possibility of driver distraction due to monitoring the display of a driver aid is a major safety consideration. Display types which are of most concern in this regard are those which require the driver to observe and comprehend the reading of a numerical scale or a digital display. The instructional aspects of the vacuum gage device are such that the driver will be required to observe the display most closely in situations when his vision is needed to watch traffic and/or pedestrians (e.g., departure from a traffic light or stop sign, acceleration for lane change). The hazards involved may be alleviated through the use of a peripheral vision display. A variety of devices have been adopted or proposed for this purpose, involving such features as a dial with colored scales, a moveable colored plunger or a light display which turns on, flashes, or changes color or intensity when the



device senses the vehicle entering a regime of poor fuel economy. This approach lacks the precision of a numerical display, but may still be capable of conveying sufficient information to guide fuel efficient driving behavior.

Additional information bearing on the issue of safety was supplied by Ford Motor Company in their reply to Ref. 3-111, the DOT request for information and public comment on the subject of miles-per-gallon meters. Ford stated that mounting locations for the device that meet crash safety requirements and afford good visibility of the gage are essential. Finding such a location is difficult, and for this reason Ford does not offer its accessory vacuum gage on many of its automobiles (Ref. 3-112).

#### 3.3.2.1.4 Availability for Implementation

Vacuum gages are manufactured by a number of companies for the aftermarket, and are offered as new-car options by the domestic automobile manufacturers. Both new car and aftermarket production levels are small due to the limited demand. Some manufacturers of vacuum gages have the capability of greatly increasing their present production levels in a short time. This is the case for the Stewart-Warner Corporation of Chicago, Illinois, manufacturers of the Motor Minder, a conventional vacuum gage with circular pointer and color-coded dial denoting regimes of good, fair, and poor fuel economy, and a zone denoting closed throttle coasting. This trademark is sold only through the aftermarket, but Stewart-Warner sells similar types of gages to the OEM market. According to Ref. 3-113, Stewart-Warner observed an upswing in the aftermarket during the 1973 OPEC boycott, but sales fell off as soon as this condition ceased. Aftermarket sales of the Motor Minder are presently receiving relatively low priority. The cited reference claims that Stewart-Warner could easily supply vacuum gages for every car in the fleet; the company is primarily a high volume producer of a variety of instrument panel gages for the automotive OEM market. It was pointed out, however, that it is getting more difficult to find places to install the gages as a retrofit; some states have restrictions against retrofit gages mounted above or below the dash.



Tomco Company of St. Louis, Missouri, manufacturers of the Accelerite and Vac Tach aftermarket vacuum gage devices\*, reports that there is currently no production of the Accelerite device; current inventory is being used to supply the present small demand (Ref. 3-114). The company is a leading manufacturer of various aftermarket devices (principally carburetor repair kits) and could, according to the cited reference, commence large-scale production of vacuum gages on short notice if required by market demand.

C & E Enterprises, Jacksonville, Florida, distributors of the Accelerite and Vac Tach devices for the government market, reports (Ref. 3-115) that sales of the Vac Tach device are also very low at present, reflecting the generally depressed aftermarket for fuel economy devices (in contrast with items whose primary appeal is performance or styling). C & E Enterprises fabricates the counter mechanism used in the Vac Tach device. Low production levels have so far precluded the establishment of mass production arrangements for the counter mechanism.

#### 3.3.2.1.5 Cost Factors

The Motor Minder circular vacuum gage is sold in two sizes: a 2-1/2-inch diameter gage at \$25.60 retail, and a 2-inch diameter gage at \$24.10 retail. Each unit contains installation instructions and parts. The installation of this and other types of vacuum gages is not difficult, but mounting the gage may be troublesome for many people. For wide-scale retrofit implementation, therefore, it seems appropriate to assume an installation time of about 1 hour (\$18), for a total price to the purchaser of \$43.

The current retail price of the Accelerite gage is \$18. Installation of the Accelerite should be very simple as the unit utilizes an adhesive base and therefore no drilling in the dash area is required. For wide-scale implementation, an installation charge of \$9 will be assumed, for a total installed cost of \$27. This cost applies to the Accelerite model; the additional features which distinguish the Vac Tach are directed primarily at fleet operation, rather than personal transportation.

---

\*Vac Tach features a low-vacuum counter mechanism; these devices are otherwise identical.

For implementation analysis purposes, it will be assumed that approximately half of the vacuum gages sold will be of the conventional circular-dial, color-coded type such as the Motor Minder, while the other half will be a peripheral vision display type such as the Accelerite. On this basis, a composite installed unit cost of about \$35 will be assumed.

### 3.3.2.2 Accelerometer

#### 3.3.2.2.1 Introduction and Background

An accelerometer driver aid determines acceleration by sensing vehicle speed (usually by means of a transducer installed in the speedometer cable) and electronically converting the velocity vs time data into acceleration. The output may be displayed by means of a conventional circular dial calibrated in g's, or by an indicator panel with colored lights. The latter arrangement would typically be green, yellow, and red lights for low, intermediate, and strong accelerations (or decelerations), respectively. All output displays signal deceleration as well as acceleration; this is a unique advantage of the accelerometer, as no other type of driver aid unambiguously delineates rapid, as opposed to normal, deceleration rates. Excessive and frequent deceleration is an indication of poor driving associated with unnecessarily high accelerations and speeds. A driver can reduce the number of large decelerations by not accelerating to a speed that is too high for traffic conditions and by anticipating traffic conditions ahead to avoid sudden stops. A useful driver aid device may be one that alerts the driver when he decelerates above a certain value which has been determined as the upper limit for good economical driving.

An accelerometer has several disadvantages as a driver aid. It cannot respond to steady-speed fuel economy influences and therefore cannot indicate to the driver the difference in fuel economy between steady cruise at, for example, 45 and 65 mph, although the fuel economy difference at these speeds could be considerable. Also, upgrades and downgrades can strongly affect fuel consumption. The accelerometer provides no information as to desirable speeds for negotiating these grades.

### 3.3.2.2.2 Fuel Economy Effects

#### a. Data Base

There are no known data on the fuel economy effects of accelerometers used as driver aids. Autotronic Controls Corporation of El Paso, Texas, manufactures an accelerometer specifically for aftermarket automotive use. It is called the Dynamic Dynamometer. Readout is by pointer and circular scale. Acceleration readout can be selected in two modes: acceleration in g's and power-to-weight ratio. The promotional literature distributed by the manufacturer stresses its application to high performance, drag strip use, with qualitative reference to mileage improvements possible by tuning or otherwise modifying the vehicle for optimum power to weight. In a discussion on this subject with the manufacturer, it was stated that the device should be capable of an indirect effect on fuel economy by detecting engine and ignition systems malfunctions that cause a power (and hence fuel economy) loss under load. The manufacturer recommends wide open throttle testing for this purpose, however (due to greater reproducibility of test conditions), and this is clearly not suitable for widespread public use. This manufacturer formerly marketed an accelerometer unit called the Model 702 Pacesetter, which appears to differ from the Dynamic Dynamometer only in the display (colored lights coded for differing severity of acceleration). The promotional literature of that unit was directed toward fuel economy benefits due to improved driving habits, but no numerical claims were made. The Pacesetter model has been discontinued by the manufacturer due to lack of demand.

#### b. Assessment of Benefits

As noted above, there are no quantifiable data on the fuel economy effect of accelerometer driver aid devices. However, the following considerations may be of value in estimating its potential relative to the benefits of a manifold vacuum gage.

Field evaluations described in Section 3.3.1.2.1 demonstrate that excessive acceleration can have a major effect on reducing fuel economy. Both the manifold vacuum gage and the accelerometer provide an instantaneous response to acceleration. The accelerometer displays acceleration in a quantitatively correct scale while the vacuum gage does not. This feature



of the accelerometer may be beneficial in terms of information conveyed to the driver, but its relative value in improving driving behavior is uncertain.

The accelerometer does have a distinct advantage over a vacuum gage (or any of the other driver aids treated herein) in that it is the only aid which will detect and unambiguously indicate excessive decelerations, and in quantitatively correct scale. Since strong decelerations frequently occur as a result of over-accelerations, some fuel economy benefit may accrue from improved driving habits from a signal to the driver that both aspects of the acceleration-deceleration pattern contribute to fuel intensive driving.

The accelerometer is clearly inferior to the vacuum gage for use on grades. The vacuum gage will correctly signal the driver that the most fuel efficient process is to allow the vehicle speed to drop somewhat when climbing a grade, whereas the accelerometer will provide no information concerning optimum driving techniques under this condition. In addition, the vacuum gage functions at any speed, including idle, while the accelerometer typically requires a minimum vehicle speed of about 10 mph in order to generate a usable signal (Ref. 3-116).

Based on the above considerations, it is concluded that the accelerometer device, while useful, is inferior to the vacuum gage in terms of the information conveyed to the driver concerning fuel-wasteful driving maneuvers and, therefore, that its probable potential for improving fuel economy is lower. For the purpose of ranking the various driver aid devices in terms of benefit, a value for fuel economy improvement of two-thirds that for the vacuum gage, or 4%, will be assigned to the accelerometer.

#### 3.3.2.2.3 Safety Considerations

In general, any of the driver aid devices which require the scanning of a dial readout by the driver constitutes a potential safety hazard in that this action temporarily removes the driver's attention from the road. Thus the remarks made in Section 3.3.2.1.3 for manifold vacuum gages apply as well to the accelerometer driver aid. Likewise, the alternatives available for peripheral vision signals discussed in that section are applicable to the accelerometer. The Pacesetter device described earlier, which uses a colored light display in the dash panel area, is an example of what can be done in this regard.



#### 3.3.2.2.4 Availability for Implementation

There are no accelerometers presently on the market that are considered suitable for fleet implementation as driver aid devices. One accelerometer device, the Model 701 Dynamic Dynamometer, manufactured by Autotronics Control Corporation, incorporates several features that are directed primarily at high performance vehicle applications. These units are manufactured at a very low production level.

Autotronics formerly offered a lower priced, colored light display accelerometer unit (described in the preceding section) which was intended as a driver aid to reduce fuel consumption. It was called the Model 702 Pacesetter, and utilized the same sensing elements as the more expensive Dynamic Dynamometer. This model has been discontinued due to lack of demand (Ref. 3-117). Likewise, SpaceKom, Inc., of Santa Barbara, California, once offered a circular dial and pointer type of accelerometer to the automotive aftermarket, but this unit has also been discontinued due to lack of demand. SpaceKom remains active in the manufacture of other driver aid devices described in Sections 3.3.2.5 and 3.3.2.6 (Ref. 3-118).

Each of the above manufacturers would be capable of large-scale production of accelerometer driver aids.

#### 3.3.2.2.5 Cost Factors

The Dynamic Dynamometer is currently available at a retail price of about \$100 (without installation). The discontinued Pacesetter model (colored light display) had a retail list of \$35 (Ref. 3-117). Installation of either unit involves installing a speed sensor where the speedometer cable connects to the transmission housing. Other than disconnecting and then reconnecting this fitting, no change to the existing speedometer cable is required. An installation fee of \$18 for the Pacesetter model is assumed, for a total installed cost of \$53. This applies only to domestic cars. Installation on an import could be considerably more expensive, since special fittings and/or cutting into the speedometer cable might be involved (Ref. 3-117).

### 3.3.2.3 Accelerator Pedal Feedback System

#### 3.3.2.3.1 Introduction and Background

The accelerator pedal feedback system provides a resistance to accelerator travel or motion, thereby directly counteracting driver behavior which would lead to poor fuel economy. The only known commercial device using this technique was the TEST Gas Saver, a product of Tanner Electronics System Technology, Inc. of Van Nuys, California. It utilized a manifold vacuum-operated spring-loaded bellows to increase resistance to downward motion of the accelerator pedal. The TEST device is no longer in production.

#### 3.3.2.3.2 Fuel Economy Effects

##### a. Data Base

Reference 3-104 summarized the existing data on the fuel economy effects of the TEST Gas Saver. These tests were made by the U.S. Postal Service. The device was installed on five one-quarter-ton delivery trucks. The fuel consumption was monitored for approximately 6 weeks with the device and subsequently for 6 more weeks without the device to obtain a baseline. A control vehicle, which never had the Gas Saver device installed for the entire period, was also monitored for the 12-week period. One vehicle with the TEST Gas Saver achieved a 5.1% mile-per-gallon increase. On the other four vehicles, decreases in fuel economy ranging from 2.3% to 25.3% were observed. The fuel economy of the control vehicle without the Gas Saver did not change. The manufacturer of the TEST Gas Saver tested the device on seven automobiles and claimed to have achieved an average fuel economy improvement of about 20%, but no test details were provided.

##### b. Assessment of Benefits

The test results of the only known commercial implementation of such a system (the TEST Gas Saver produced by Tanner Electronics Systems Technology, Inc.) were mixed, as discussed above. Tests of this type, conducted by commercial fleet drivers, always introduce the question of driver motivation. That is, the drivers of the test vehicles may or may not have felt a need to diligently apply themselves in utilizing the device to improve

fuel economy. Positive driver motivation is an essential element in the use of driver aids to improve driving behavior. It is therefore considered that these tests by the U. S. Postal Service do not provide sufficient basis for discounting the value of the accelerator pedal device as applied to drivers nationwide.

Independent of the above results, a number of potential problems associated with the use and efficacy of the device can be identified. For example, the accelerator pedal resistance required for satisfactory driving response and the force required to overcome this resistance may be quite different for various drivers of the car. The throttle feedback device must have an override; that is, if the driver requires extra power he must be able to depress the accelerator pedal further although it may require more pressure to do so. This requirement introduces a potential problem area, in that the required amount of force should not be so large that certain drivers will not be able to press the pedal as far or as fast as needed for satisfactory response in emergency accelerations such as sometimes required in passing maneuvers. On the other hand, too small an override force would mitigate the value of the device for conserving fuel. Another difficulty with this device is its potential tendency to cause overshoot of the desired pedal position, with consequent additional and unnecessary consumption of fuel. A number of different devices or means of adjusting the pedal pressure would probably be required to suit all drivers and to minimize overshoot effects.

The above considerations do not provide a basis for estimating the fuel economy improvement potential of this device in a quantitative sense. Intuitively, it is expected that the ability to properly interpret foot pedal resistance signals will vary widely among drivers and that the necessary resistance for satisfactory operation will result in frequent overshooting of the desired pedal position, thereby offsetting the potential fuel savings benefits of the device. Because of these deficiencies, the accelerator pedal feedback system will be ranked lower than the vacuum gage device. A level of effectiveness approximately equivalent to half that of a vacuum gage, or 3%, will be assumed.

#### 3.3.2.3.3 Safety Considerations

The accelerator pedal active driver-feedback type of driver aid has a unique safety advantage compared to other driver aids in that there are

no demands on the driver's vision or hearing, the device response being conveyed directly by increasing or decreasing foot throttle resistance felt by the driver. A potential safety problem arises with this device, however, in that the driver must be capable of overriding the increased foot throttle resistance when maximum power is demanded for emergency accelerations such as sometimes is required in passing maneuvers. In the test evaluations of this device by the Postal Service, it was reported that several of the drivers complained that they almost got in serious trouble when they needed more acceleration and apparently forgot that the device could be overridden (Ref. 3-119).

#### 3.3.2.3.4 Availability for Implementation

The only known application of this approach to driver behavior modification was the Tanner TEST Gas Saver, which was produced only in small experimental quantities and was discontinued when no market appeared. Tanner is a high volume manufacturer of ignition systems and other components for the automotive aftermarket, and would be capable of mass producing the Gas Saver or a related device if the market warranted it.

#### 3.3.2.3.5 Cost Factors

A retail price was never established for the Gas Saver, as it was never manufactured in quantity. It is estimated that the device would cost about \$50 installed.

#### 3.3.2.4 Automatic Cruise Control

##### 3.3.2.4.1 Introduction and Background

Automatic cruise controls are devices that automatically manipulate the throttle to maintain a constant engine or vehicle speed. While not considered a driver aid device per se, since no information is output to the driver, cruise controls are included here because fuel economy claims have been made regarding their use. These devices are offered as options by all four major car manufacturers and as retrofit items by the aftermarket industry; they are intended for use in vehicles with automatic transmissions and appear to be popular sales items.

There are four main components to a cruise control device: (1) a speed sensor detecting either engine or vehicle speed, (2) a servo



mechanism for changing throttle position in response to commands from (3) a "computer," and (4) a driver control. In operation, the desired speed is first achieved manually, and the driver then actuates system control, such as by pressing a speed set button. This speed is then continually compared within the computer to the actual speed detected by the speed sensor. If the actual speed is different than that desired, the computer commands the servo to increase or decrease the throttle opening, as required. The control system usually remains active until switched off or until the brake pedal is touched. Use of the accelerator for higher speeds simply overrides the speed control until the driver's foot is again removed from the accelerator, when control reverts to the device.

The principal fuel economy potential of this device is associated with its use in highway driving to maintain speed at or below the 55 mph limit, thereby avoiding fuel consumption penalties at higher speed conditions which the driver would otherwise subconsciously assume. An advantage should also accrue due to a reduction in amplitude and frequency of throttle movements as compared to manual driving. The main potential disadvantage of this device, other than its restriction to use in relatively open highway driving, is that it is completely insensitive to load. This can result, for example, in operation with an excessively open throttle up long grades as the device tries to maintain constant speed.

#### 3.3.2.4.2 Fuel Economy Effects

##### a. Data Base

The literature on cruise control devices consistently suggests that fuel economy benefits will accrue from their use but rarely do these advertisements provide any numbers. An exception to this is the promotional literature by Annuncionics of Los Angeles, manufacturer of the Pacesetter cruise control device (no connection with the Pacesetter accelerometer discussed earlier). Annuncionics claims that their device will achieve decreases in fuel consumption of up to 20% for passenger cars and up to 40% for recreational vehicles, based on data obtained by an independent testing organization. These benefits are said to result from eliminating the pattern of speedup and slowdown inherent to manual speed control.

b. Assessment of Benefits

Two possible sources of fuel economy benefit from the use of a cruise control device can be identified. One benefit derives from the assumption that drivers will use the device to maintain the legal speed limit of 55 mph whenever it is safe and practicable to do so, rather than some higher average speed. The second factor that could contribute to a fuel economy benefit is smoother throttle action, with smaller speed perturbations. Lacking any related test data, fuel economy estimates of these effects were made using a four-step computational approach described in the following paragraphs and summarized in Table 3-27.

Addressing the effect due to limiting top speed, the key data input is the average highway speed presently prevailing under uncongested driving conditions. Information on this subject is provided by a field survey conducted in 1973/1974 by General Motors to assess driver responses to the then current fuel crisis and the imposition of the 55 mph national speed limit (Ref. 3-120). Spot speed observations were made on a 4-lane suburban freeway near Detroit from early November 1973 to June 1974. Speeds were recorded in 15-minute intervals in mid-afternoons on 39 days. These data show that the average driving speed was about 58 mph (a 1974 national statistic given by FHWA in Ref. 3-88 indicates 56 mph). The 58 mph number was taken as representative of nationwide driving practice at the present time.

The effect of reduced highway cruise speed on fuel economy was estimated from data given in Ref. 3-42 (DOT/TSC), which presents computer-derived EPA urban cycle and steady-state fuel economy data for three different size passenger cars (2300, 3300 and 4300 lb) and a 4600 lb van, each with four different road load parameters. Using these data as a basis of computation, a speed reduction of 3 mph (from 58 to 55 mph) for these vehicles was determined to produce an average steady-state fuel economy increase of 3.6%.

A basis for estimating the possible influence of smoother throttle action due to the use of cruise control was obtained from urban cycle test data provided by Ford Motor Company (Ref. 3-121). Ford conducted tests on a 1975 car equipped with a 400 CID engine, in which measured fuel economy over the urban Federal driving cycle (FDC) was compared with

TABLE 3-27. COMPUTED FUEL ECONOMY BENEFITS FOR AUTOMATIC CRUISE CONTROL

Vehicle Type	Data <sup>a</sup>		Effect of Speed Reduction from 58 to 55 mph		Effect of Speed Reduction Plus Smoother Throttle Movement	Conversion of % $\Delta$ (FE) <sup>1</sup> to EPA Composite Value						
	Curb Wt.	Road Load	FE <sub>55</sub> <sup>a</sup>	FE <sub>58</sub> <sup>a</sup>		% $\Delta$ (FE)	FE <sup>a</sup> (FTP)	FE <sub>50</sub> <sup>a</sup>	FE <sup>b</sup> (HWFE)	FE <sup>b</sup> (Comp)	FE <sup>ab</sup> (Comp)	% $\Delta$ (FE) <sup>b</sup> (Comp)
Passenger Car	2300	Min	30.6	29.6	3.4	5.4	21.1	32.0	33.73	25.38	24.92	1.8
		Max	25.55	24.6	3.9		19.9	27.0	28.59	23.05	22.57	2.1
Passenger Car	3300	Min	25.55	24.45	4.5	6.5	17.1	27.2	28.97	20.97	20.53	2.1
		Max	21.05	20.15	4.5		16.2	22.5	23.96	18.96	18.54	2.3
Passenger Car	4300	Min	21.1	20.75	1.7	3.7	12.5	21.5	22.30	15.58	15.40	1.2
		Max	18.8	18.4	2.2		12.05	19.3	20.11	14.70	14.50	1.4
Van	4600	Min	16.0	15.4	3.9	5.9	11.5	16.8	17.79	13.68	13.40	2.1
		Max	13.7	13.1	4.6		10.9	14.6	15.58	12.60	12.30	2.4
				$\bar{X}$ 3.6	$\bar{X}$ 5.6						$\bar{X}$ 1.9	

<sup>a</sup>Source: Ref. 3-42.

<sup>b</sup>Assumes FE<sub>50</sub> (fuel economy at 50 mph cruise) is equal to EPA HWFE.

measured fuel economy over a smoothed approximation to the FDC consisting of a significantly reduced number of linear accelerations and decelerations. The fuel economy increase over the simplified driving cycle was approximately 6%. This improvement resulted from a considerably greater reduction in throttle movement than can be postulated for an automatic cruise control device operating at highway conditions. It was therefore felt appropriate to assign a much smaller percentage increase for the cruise control throttle movement effect and a value of 2% was arbitrarily selected. This value was added to the 3.6% increase obtained for the reduced highway speed effect to obtain 5.6% for a total effect applicable to cruise conditions.

Finally, the 5.6% increase was applied to the 50 mph component of the DOT/TSC fuel economy data given in Ref. 3-42, and this was combined with the urban cycle fuel economy data given in the cited reference, weighted in the ratio 45/55, to obtain an estimate of the composite cycle fuel economy and fuel economy improvement due to cruise control. The results of this computation are included in Table 3-27. The average composite cycle fuel economy benefit due to the use of an automatic cruise control was computed to be 1.9%. As indicated in the table, results for individual vehicle-road load combinations varied from 1.2 to 2.4%, with the van and 3300 lb passenger car showing the highest average increases. In view of the small value of the improvement, it was not considered meaningful to classify this effect in terms of vehicle size. Accordingly, a 2% average fuel economy increase is assigned to the use of automatic cruise controls; this number applies to all applicable vehicles in the national fleet.

One adverse effect of cruise control should be noted: its insensitivity to load; i. e., it will maintain the set speed on an uphill grade (if this is within the capacity of the powertrain) rather than allowing a more fuel efficient decrease in speed to keep the engine load constant. No penalty effect was assigned for this characteristic, on the basis of the assumption that most operators, driving manually, tend to maintain a given speed when an upgrade is encountered.

#### 3.3.2.4.3 Safety Considerations

No adverse safety effects are identified for those versions of automatic cruise control devices (such as Dana Corporation's Speedostat)



which do not require the driver to take his eyes off the road to activate the device or to make an adjustment to the speed setting. The Pacesetter made by Annuncionics requires the driver to make a manual adjustment of a control setting in order to select a new speed setting, and this could be distracting, especially at night, as the control panel is not lighted. No further visual attention by the driver is required once a desired speed index setting has been established. It appears likely that, after the driver has acquired some familiarity with the unit, changes to the speed setting could be made without taking his eyes off the road.

There are no other driver demands with any of the devices, and the method of override deactivation (pressing the brake pedal sufficiently to energize the stop light circuit) is the natural response of drivers when a reduction in speed is appropriate.

Some safety advantage may exist due to reduced driver fatigue on long trips and to less frequent need for the driver to take his eyes off the road to glance at the speedometer.

#### 3.3.2.4.4 Availability for Implementation

The two principal aftermarket suppliers of automatic cruise controls are Annuncionics, Inc., of Los Angeles, California (Pacesetter) and the Perfect Circle Control Division of Dana Corporation, Hagarstown, Indiana (Speedostat). Both units are offered through the catalog order departments of Sears, Montgomery Ward, and J. C. Penney and also through other large merchandisers.

The Speedostat unit has been produced with mechanical cable pickup of vehicle speed; Perfect Circle recently added to its product line a version which senses vehicle speed by magnetic pickup of drive shaft rpm. Both models incorporate a speed control system which utilizes a manifold vacuum-powered bellows connected mechanically to the throttle. Perfect Circle estimates the combined current production rate for both models to be approximately 300,000 units per year; the manufacturer states that this production could be increased substantially within about 2 months if required (Ref. 3-122). Annuncionics, manufacturer of the Pacesetter unit, indicates that its present production rate is about 150,000 units per year; this rate could be approximately doubled before new facilities would be required (Ref. 3-123).

Automatic cruise controls are a popular option for new car purchases; 35% of total domestic production of 1977 model year cars through December 31, 1976 included a cruise control device (Ref. 3-124). Installation rates increase as car size increases. Examples in the Chevrolet line are: Nova 5%, Camaro 11%, Chevelle 17%, Monte Carlo 44%, Chevrolet 50%. Installation rates for luxury cars are 80 to 90% and more.

#### 3.3.2.4.5 Cost Factors

Prices of both the Speedostat and Pacesetter unit appear to be comparable. The manufacturer of the Speedostat indicated a retail list price of about \$110, but catalog price quotes from two large merchandising outlets were \$80 and \$90, respectively. Catalog price quotes from two similar sources for the Pacesetter were \$90 and \$100. According to the manufacturer, however, the nationwide average retail price for the Pacesetter is in the range of \$75 to \$85. These are device costs only and do not include installation. Each manufacturer stated that the average car owner can install the device themselves, and detailed installation instructions accompany each unit. For more widespread implementation, however, installation by a service station is probably more appropriate. The automotive service departments of three large merchandisers who carry these cruise control units quoted installation costs of from \$35 to \$50, with passenger cars at the low end of the range. This study will assume a device cost of \$90 and an installation charge of \$35, for an installed cost of \$125.

#### 3.3.2.5 Miles per Gallon (MPG) Meter

##### 3.3.2.5.1 Introduction and Background

The MPG meter gives the driver an instantaneous indication of the miles per gallon being obtained by his car. This is accomplished by simultaneously measuring the vehicle speed with a speed sensor and the fuel consumption with a flowmeter. Transducers convert each measured parameter to electrical signals which are processed electronically to yield miles per gallon output. Displays are available in both analog (scale and pointer) and digital readout formats. The display of the digital type is updated at a rate determined by the time required for a minimum quantity of fuel to pass through the fuel flow sensing device; this update period may vary over a range of 2 to 15 seconds, depending on fuel flow rate to the engine.

### 3.3.2.5.2 Fuel Economy Effects

#### a. Data Base

The only quantified information on the fuel economy effects of MPG meters is provided by a field evaluation performed by the Automobile Club of Southern California (ACSC) under DOT/TSC sponsorship (Ref. 3-125). Additional background on these tests, as well as other aspects of MPG meters and other driver aids, are contained in the DOT/TSC report to the President and to Congress (Ref. 3-112).

The key features of this test program are as follows. Two fleets of 70 cars each were used; one fleet was a control group, the other was equipped with MPG meters produced by FloScan Instrument Company of Seattle, Washington. The device display consisted of a circular gage reading from 0 to 80 mpg, with the scale compressed at the high end. The gage was fastened on top of the steering column by a hose clamp. The installation was performed by ACSC mechanics in accordance with the standard installation instructions supplied by the manufacturer. Each fleet was composed of 1974/75 model year, domestically produced vehicles, all owned by ACSC. The historical average mileage per month and fuel economy for each car was obtained from ACSC records for the preceding year. The cars were then randomly divided into the two groups. Each group contained approximately the same number of cars with monthly mileage and fuel economy characteristics that ranged above and below the median values for all the cars. The average mpg performance values for the two groups were virtually identical (13.59 vs 13.62). Each car was permanently assigned to an individual employee of ACSC stationed at the Los Angeles office for use in his normal transportation needs, including commuting to work, weekend, and other uses.

Prior to the start of data collection, each vehicle was given an engine tune-up, consisting of changing the spark plugs and, if so equipped, distributor points and condenser, adjusting the ignition timing and idle rpm to manufacturer's specifications, and changing the fuel and air filters.

The drivers of both the control and the experimental groups were given an EPA booklet on tips for increased driving economy, a letter describing the purpose of the study, and instructions on the test data collection procedures. Drivers in the experimental group were, in addition, given



information on how to best use the MPG meter. The test duration was 12 weeks (March to June 1976), with data collection for each car occurring every 3 weeks. This consisted of topping off the tank at the ACSC fuel dispenser, and collecting the fuel receipts and odometer readings kept by each driver. A fuel use report was given to each driver after each 3-week collection period. This report included the historical average fuel economy of the car, the average fuel economy for the just-completed 3-week period, and the number of barrels of fuel which would be saved or lost annually if all the drivers in the U.S. were to change their fuel economy by the same amount. Drivers of both the control and experimental groups who showed an increase in fuel economy received the cash difference between their fuel cost for that 3-week period and what it would have been at that mileage based on the vehicle's historical fuel economy.

The vehicles accumulated an average of about 1400 miles per month during the test. The average fuel economy of the 70 MPG-meter-equipped cars for the 12-week period was 13.89 mpg, which was 2.8% higher than the average 13.51 mpg obtained for the 70 cars of the control group. Analysis of variance showed that this difference was not statistically significant. This test, therefore, provides no basis for postulating an improvement in fuel economy due to the use of MPG meters.

Prior to initiating the field testing by ACSC, DOT/TSC installed MPG meters in 10 cars owned by DOT/TSC staff who used them for commuting and general urban and highway driving (Ref. 3-112). Apparently, this program was a qualitative evaluation; no miles per gallon or percentage changes were given in the cited reference. However, an 8-week evaluation led to several significant conclusions, of which the following appear to be revealing relative to the ACSC test results.

- a. MPG meters have to be monitored closely to be used effectively.
- b. MPG meter indications lag behind the driver's actions that produce them. This lag masks the effects of speed variation on fuel economy. The extent of lag varied from 1 to 5 seconds among the 10 cars.
- c. When cars accelerate over the short distance common in stop-and-go-traffic, the MPG meter indications do not respond sufficiently and quickly enough to assist the driver in selecting economical acceleration rates.



b. Assessment of Benefits

According to the results of the field evaluation of MPG meters conducted by ACSC, there is no statistical basis for postulating an improvement in fuel economy due to the use of this device. It may be noted that the ACSC field evaluation test included driving in commuter traffic in the Los Angeles central business district. Under congested urban traffic conditions such as this, it is likely that driver aid devices will show at their poorest, since the driver has little choice of driving mode. The MPG meter, in particular, may be extremely ineffective under such driving conditions (short duration accelerations and decelerations) because of its insensitivity and lag characteristics.

An MPG meter may be of greater benefit in light traffic where speed changes are usually more gradual and the driver has more opportunity to observe and respond to the meter readings. These benefits are most likely to be realized in uncongested urban and suburban driving in which the operator has the option of selecting his own speed but where the 55 mph limit is impractical due to safety or legal restraints. Under these conditions the MPG meter may help the driver in achieving and maintaining an optimum fuel economy cruise speed. In uncongested highway driving, however, it is expected that trip time considerations will dominate driver behavior, so that the vast majority of drivers (with or without an MPG meter) will fix their speed in the vicinity of the legal limit of 55 mph (safety permitting), rather than selecting a more fuel efficient lower speed of say 40 to 45 mph. An MPG meter would not be expected to provide any benefit under these conditions.

For the purpose of ranking this device in relation to other driver aids considered in this report, a fuel economy benefit of 1% will be assigned to the MPG meter, in consideration of its potential value in reminding the driver in discretionary driving situations that his maximum fuel economy is attained at the lower cruise speeds.

3.3.2.5.3 Safety Considerations

The remarks concerning possible driver distraction made in Section 3.3.2.1.3 apply here as well. The only displays developed to date for MPG meters are the pointer with numerical scale and the digital readout

type, but there is no fundamental reason why peripheral vision displays could not be employed with MPG meters.

A potential hazard in the retrofit installation of MPG meters (and fuel totalizers) arises due to the necessity (with present systems) of cutting into the fuel line to install the fuel flow transducer. Improper installation could result in fuel leakage with resultant fire hazard, partial blockage of the fuel line, or disturbance of the fuel and/or vapor return features present on many newer automobiles. In response to a DOT request for information and public comment (Ref. 3-111), General Motors contended that under no condition would it be prudent to equip used cars with such devices. They stated that fuel systems are designed to meet rigid safety, crash-worthiness, and emission standards and contain a minimum of joints and connections to minimize leaks and potential fires. Reference 3-112 adds that cutting into fuel lines to install fuel meters will undoubtedly result in serious problems for many motorists and might even cause damage to the automobile. Manufacturers of SpaceKom and FloScan MPG meters and fuel totalizers disagree with this claim, asserting that they have encountered no safety problems in any of their installations.

#### 3.3.2.5.4 Availability for Implementation

There are two main manufacturers of MPG meters: SpaceKom of Santa Barbara, California and FloScan Instrument Company of Seattle, Washington; these two companies take very different views on the aftermarket installation of MPG meters. SpaceKom is marketing their Autocomp digital readout MPG meter through Sears. This is a new model, which replaces all of SpaceKom's previous models. SpaceKom anticipates near term production rates of approximately 500 per month, with demand expected to increase.

FloScan, on the other hand, states that their present small production is directed almost entirely toward professional users such as testing labs, automobile manufacturers, new car dealers for demonstration purposes, and research workers (Ref. 3-126). FloScan will fill consumer orders on request, but is making no effort to penetrate the general consumer aftermarket. Their position is that on-board automotive fuel flow measurement is a technically demanding task which is best accomplished at the OEM level during new car manufacture for reasons of both cost and quality control.

They state that small-scale production associated with aftermarket demand results in a price which discourages most consumers. While disagreeing strongly with the safety question raised by GM (Section 3.3.2.5.3) FloScan feels that there would be real difficulty in getting uniform overall quality of installation in a large-scale aftermarket operation.

#### 3.3.2.5.5 Cost Factors

The Autocomp MPG meter manufactured by SpaceKom has a retail price of \$130. Installation instructions are provided with each unit; SpaceKom feels that installation is well within the capability of the average buyer. The Autocomp is directed toward domestic cars; installation becomes more complex and costly for foreign cars as the speedometer cable must be modified.

The FloScan Model 660 MPG meter includes a fuel totalizer that reads to 0.01 gallon. The retail price of this unit is \$265. It has scales in miles per gallon and gallons per hour (as well as miles per hour), and includes a speed calibration feature permitting its use on foreign as well as domestic cars.

No data on the specific installation costs for the Autocomp are available. Reference 3-112 allowed 6 hours for the installation of an unspecified type of MPG meter by an experienced mechanic, while the Automobile Club of Southern California in Reference 3-125 estimated 8 hours, provided that the mechanic is well qualified in both the electrical and fuel systems of the subject vehicle. These estimates apply to the installation of one or a few units at the present level of skill in the repair industry. Reference 3-125 stated that the installation time was reduced to about 4 hours after experience had been gained. The latter figure is considered to be more appropriate for wide-scale implementation, and will be used here for both presently available MPG meters. Assuming \$18 per hour for labor, the installation charge becomes \$72, for an installed cost of \$202 for the SpaceKom Autocomp for domestic vehicles, and \$337 for the FloScan Model 660.



### 3.3.2.6 Fuel Totalizer

#### 3.3.2.6.1 Introduction and Background

A fuel totalizer combines a fuel flowmeter with electronic counter circuitry which integrates the instantaneous fuel flow over any driver-selected time interval. The principal advantage of a fuel totalizer meter is that it gives the driver a direct measurement of the quantity that he is trying to minimize; namely, the amount of fuel used for any trip route or portion thereof. Without a fuel totalizer device a driver cannot determine how much fuel he has used until he refills his tank at the service station. Since it may take days or even weeks in some cases to use a tank of gasoline, and since many different types of driving may be involved such as commuting, pleasure, and shopping, it is difficult for the driver to utilize this information to improve his driving habits.

The totalizer meter can be used in a number of different ways. For example, a driver may wish to minimize the amount of fuel he uses in driving to work by varying his rate of acceleration and cruising speed. The meter would indicate if lowering his rate of acceleration reduces his fuel consumption or which cruising speed minimizes the amount of fuel used. The driver could also use the device to select a route to work that minimizes his fuel consumption. Another advantage of a fuel totalizer is that it provides a direct indication of how much fuel is used in unnecessary trips; that is, trips which could be eliminated by planning, combining trips, or utilizing some form of pooled or mass transportation, if available.

A disadvantage of this device is that it does not give the driver an instantaneous indication of how he should drive more economically. In the absence of information from other types of driver aid devices, he must determine this by varying his driving habits by trial and error over a number of trips.

#### 3.3.2.6.2 Fuel Economy Effects

##### a. Data Base

There are no known test data on the use of fuel totalizers as a driver aid.

It may be noted that fuel totalizers were included as part of the equipment package used in the ACSC field test of MPG meters described



earlier (Ref. 3-125). However, these fuel totalizer gages were installed under the hood where they were not readily accessible to the driver. Their only purpose was to permit a check on the accuracy of the fuel transducer of the MPG meter. This was done by comparing the fuel totalizer readings with the total gasoline consumption as indicated by the fuel purchase receipts accumulated over each report period.

b. Assessment of Benefits

Consideration of the possible use modes for this driver aid device suggests that its fuel economy improvement potential in the hands of the average driver will be relatively small if it is used without benefit of some form of driving instruction. The principal basis for this assertion is that the device itself conveys no direct information to the driver concerning poor (or good) driving behavior, and only an extraordinarily high level of motivation and involvement on the part of the driver could produce significant results. An example of the self-instruction process that this might entail would consist of recording the fuel totalizer readings for a frequently traveled route or portion thereof over a number of trips to establish a baseline. The driver would then consciously adopt some specific fuel-efficient driving techniques over these routes for a number of days, note the average improvement, and evaluate the effect of each technique accordingly. Such a procedure, followed consistently and in a logical order, would probably produce beneficial results, but it is unreasonable to credit the ability to carry out a systematic regimen of this type to any but a very small fraction of drivers. It appears more realistic to postulate that a slight fuel economy benefit, say 1% on the average, may accrue by drivers noting the effect on a total trip (such as a round-trip commute) of such gross changes in driving habits as the use of milder accelerations, reduced frequency of lane changes, etc.

Two other potential benefits of the fuel totalizer are noted. One of these is its possible value as a mechanism for curtailing the number of trips taken. This function might be made most effective if the device display is expressed in dollars and cents (either fuel cost or approximate total operating cost), thereby providing a direct readout for the actual price of travel. Intuitively, it is felt that where the driver has personal discretion as to foregoing travel or as to combining several trips into one, this device

would be useful in encouraging no-travel decisions. Also, when combined, with a vacuum gage, accelerometer, or other instantaneous readout driver aid, the totalizer may act to encourage and reinforce improved driving behavior by directly correlating such behavior with its monetary value to the driver. However, the quantitative effects of such benefits on the reduction of fleet fuel consumption cannot be estimated.

#### 3.3.2.6.3 Safety Considerations

The fuel totalizer is free of driver distractions. The only actions required of the driver are to reset the counter to zero at the beginning of a trip or sub-trip, and to note the meter reading at the conclusion of the trip. However, the comments made in Section 3.3.2.5.3 concerning possible safety effects involved in cutting into the fuel line are applicable here also.

#### 3.3.2.6.4 Availability for Implementation

Most of the general comments on implementation made in Section 3.3.2.5.4 for the MPG meter apply to the fuel totalizer; the manufacturers of MPG meters are also the manufacturers of fuel totalizers. The fuel totalizer feature receives less attention from these suppliers as a separate driver aid than does the MPG meter. FloScan feels that the fuel totalizer is a necessary adjunct to a MPG meter for maximum effectiveness. They do not sell the fuel totalizer separately, as this would represent a non-standardized item which would presently cost nearly as much as their standardized Model 660 MPG meter which includes fuel totalizer.

SpaceKom supplies a Model 5100 fuel totalizer on special order only. It is not marketed through any other merchandiser as is their MPG meter.

#### 3.3.2.6.5 Cost Factors

The Model 5100 SpaceKom fuel totalizer is available at \$60. FloScan does not presently offer a fuel totalizer as a separate device. Information contained in Ref. 3-125 suggests that the installation time for a fuel totalizer should be about 2.5 man-hours (based on the observation that installation of the fuel transducer and associated equipment required 65% of the total MPG meter installation time). At a labor rate of \$18/hour, this implies an installation charge of \$45, for a total installed cost of \$105.

Table 3-28 provides a summarization of characteristics for the spectrum of techniques reviewed in this section. In the area of vehicle modifications, variable cylinder operation (8.7%), tire overpressure operation (6.0% for bias ply tires), and the variable accessory drive system as applied to air-conditioned cars (5.4%) provide the highest fuel economy improvement potential. In the traffic modifications group, one-way streets (12%) and right turn on red in the CBD (4.9%) show relatively high potential and at low unit cost. As will be shown later, however, the applicability of some of these approaches on a nationwide basis is limited because their implementation is already widespread. Under driver behavior modifications, driver training is assigned a high fuel economy improvement potential of 10%. This value, it must be noted, represents the short term benefits to be expected from the average driver who makes a conscientious effort to use his training to best advantage. Some deterioration in performance with time is anticipated, however, so that the fleet-average effective value for driver training is considerably lower than 10%. Similar considerations apply to the driver aid devices, for which the manifold vacuum gage indicates the highest benefit of 6%.

No significant adverse safety effects are identified for any of the techniques examined with the exception of driver aid devices which require the monitoring of an instantaneous output display. Included in this category are the manifold vacuum gage, the accelerometer, and the MPG meter. As noted in the table, however, the use of an audible output or peripheral vision display techniques would reduce the hazards involved.

TABLE 3-28. CHARACTERIZATION SUMMARY

Technique	Assigned Fuel Economy Improvement Potential (%)	Unit Cost <sup>a</sup> (\$)	Safety Considerations	Potentialities for Implementation
<u>VEHICLE MODIFICATIONS</u>				
Spark Augmentation Devices				
Electronic Ignition	0.25	75	None	Present aftermarket suppliers have adequate capacity to meet future fleet requirements.
High Energy Ignition		60		
Multiple Discharge		60		
Improved Carburetors				
Sonic Flow	1.0	150	None	Presently in R&D. Holley could become major manufacturer of aftermarket/replacement units for sonic systems.
Ultrasonic		180		
Variable Accessory Operation				
Flex-Fan	0	30	None - Repetition of recent Ford flex-fan failures can be obviated by proper design.	Variable accessory drive in R&D. Other systems currently in production for new cars. Viscous clutch sold in aftermarket.
Viscous Clutch Fan	0.4	45		
Electric Drive	2.0	100		
Variable Accessory Drive	(2.8/5.4) <sup>b</sup>	80		
Variable Cylinder Operation <sup>c</sup>	8.7	100 <sup>d</sup>	None	Presently in R&D. Could be produced in quantity by major carburetor manufacturer such as Holley.
Intake Air Temperature Control	Small, not assigned	Not assigned	None	Extensive OEM implementation, beginning in 1966 model year, precludes significant retrofit implementation.



TABLE 3-28. CHARACTERIZATION SUMMARY (Continued)

Technique	Assigned Fuel Economy Improvement Potential (%)	Unit Cost <sup>a</sup> (\$)	Safety Considerations	Potentialities for Implementation
Engine Preheater	1.0	62	None.	Currently produced in small quantities by several manufacturers ( $\leq 100,000$ units/yr)
Tire Modifications				
Radial Tires	2.5	125	Radial tires could provide safety advantage. Overpressure to rated limit not expected to impact safety.	Industry expected to have adequate capacity to supply 100% of fleet demand for radials in 1982.
Underpressure	1.9/0.8 <sup>e</sup>	7 <sup>f</sup>		
Overpressure	6.0/2.4 <sup>g</sup>	7 <sup>f</sup>		
Drag Reduction Devices				
Front Dams	1.0	65	None.	Presently produced in small quantities for OEM and aftermarket use. Production capacity could quickly be expanded.
Rear Spoilers	1.0	45		
Improved Lubricants	3.0	9	None.	Synthetic and friction-modified mineral-base engine oils presently marketed by a number of firms.
Maintenance	(0.75/1.1) <sup>h</sup>	(42/10) <sup>i</sup>	None.	Service establishment for conventional tune-ups exists (e.g., Tuneup Masters).
<b><u>TRAFFIC MODIFICATIONS</u></b>				
Right Turn on Red	(2.6/4.9) <sup>j</sup>	50	No significant increase in frequency or severity of accidents with RTOR.	RTOR implemented nationwide except D.C. and Mass; Conn. & Maine on sign-permissive RTOR. Implementation requires only enabling legislation.

TABLE 3-28. CHARACTERIZATION SUMMARY (Continued)

Technique	Assigned Fuel Economy Improvement Potential (%)	Unit <sup>a</sup> Cost (\$)	Safety Considerations	Potentialities for Implementation
One-Way Streets	12.0	(k)	Vehicle and pedestrian safety generally improved due to divided highway effect.	Implementation dependent only on traffic engineering assessment of benefits.
Intersection Control	10.0/5.0 <sup>l</sup>	8000 <sup>m</sup> 300 <sup>n</sup>	None	Implementation dependent on assessment of potential benefits.
Traffic Actuated Signals	0.5	2,000,000 <sup>p</sup>	None	Implementation dependent on assessment of benefits. Cost may be pacing item.
Optimized Signal Cycle Length	6.0	(q)	None	(q)
Network Control	Negative			
Exclusive Bus Lanes				
<u>DRIVER BEHAVIOR MODIFICATIONS</u>				
Driver Training	10.0 <sup>r</sup>	55	None	Implementation mechanisms include federal/state agency employee programs, high school driver training, adult education classes, promotional campaigns for general public.

TABLE 3-28. CHARACTERIZATION SUMMARY (Continued)

Technique	Assigned Fuel Economy Improvement Potential (%)	Unit Cost <sup>a</sup> (\$)	Safety Considerations	Potentialities for Implementation
Driver Aid Devices				
Manifold Vacuum Gage	6.0	35	Driver distraction while monitoring driver aid display is a major safety concern for instantaneous readout devices.	Vacuum gage is currently manufactured in quantity for OEM and aftermarket use. Stewart-Warner could easily increase capacity to supply every car in the fleet. No accelerometers now on market are suitable for fleet implementation, but capability for manufacture of suitable instrument in large quantities exists.
Accelerometer	4.0	53		
Accelerator Pedal Feedback	3.0	50		
Cruise Control	2.0	125	Audible or peripheral vision techniques can reduce the safety hazard, but could incur some loss in effectivity.	
MPG Meter	1.0	200		
Fuel Totalizer	1.0	105		

<sup>a</sup> Incremental cost to consumer, including installation.

<sup>b</sup> Without/with air conditioning.

<sup>c</sup> Carburetor-controlled system.

<sup>d</sup> Could be reduced significantly in mass production.

<sup>e</sup> Bias ply/radial; 30% 4 psi underinflated, 70% 2 psi underinflated.

<sup>f</sup> Cost for valve stem pressure indicators and tire pressure gage.

<sup>g</sup> Bias ply/radial, based on 8 psi overinflation (passenger cars).

<sup>h</sup> Vehicles with conventional ignition/vehicles with breakerless electronic ignition.

<sup>i</sup> Conventional diagnosis/exhaust gas analysis diagnosis.

<sup>j</sup> Urban/CBD traffic networks.

<sup>k</sup> No data.

<sup>l</sup> 6 lane/4 lane arterials.

<sup>m</sup> Per intersection.

<sup>n</sup> Based on study evaluation costs of \$15,000 for 50 intersections.

<sup>p</sup> Based on \$20,000 per intersection and 100 intersections per network.

<sup>q</sup> Not a viable technique for reducing in-use automotive fuel consumption.

<sup>r</sup> Assumes no deterioration in driver performance.

3.5 REFERENCES

- 3-1. M. G. Hinton, et al., Highway Vehicle Retrofit Evaluation, Phase I, Analysis and Preliminary Evaluation Results, Report No. DOT-TSC-OST-75-48.11, The Aerospace Corporation, El Segundo, Calif., prepared for U.S. Department of Transportation, Transportation Systems Center (November 1975).
- 3-2. L. Forrest, et al., Assessment of the Effects of Short-Term Drive Train Options on the Automobile and Related Industries, Report No. ATR-77(7541)-1, The Aerospace Corporation, El Segundo, Calif., prepared for National Science Foundation, Division of Policy Research and Analysis (December 1976).
- 3-3. Champion Ignition and Engine Performance Conference, Vienna, Austria, 1976, Champion Spark Plug Company, Automotive Technical Services, Toledo, Ohio.
- 3-4. Mobile Proving Ground Project; Guide to Data Analysis, ATSD 7-236, Champion Spark Plug Company, Automotive Technical Services Dept., Toledo, Ohio (17 August 1976).
- 3-5. The Effect of Ignition Timing Modifications on Emissions and Fuel Economy, Test Report 76-4-AW, U.S. Environmental Protection Agency Emission Control Technology Division, Ann Arbor, Mich. (October 1975).
- 3-6. "Tune-up: Its Effect on Fuel Economy, Emissions and Performance," Champion Spark Plug Company, Automotive Technical Services Dept., Toledo, Ohio, undated brochure describing results of 1976-76 Mobile Proving Ground project.
- 3-7. M. G. Hinton, et al., Highway Vehicle Retrofit Evaluation, Phase II, Report, Testing and Final Evaluation Result, Report No. DOT-TSC-OST-76-19, The Aerospace Corporation, El Segundo, Calif., prepared for U.S. Department of Transportation, Transportation Systems Center (November 1976).
- 3-8. W. Bilott, Avis Car Rental, El Paso, Texas, Private Communication (3 June 1977).
- 3-9. J. Priegel, Autotronic Controls Corporation, El Paso, Texas, Private Communication (26 May 1977).
- 3-10. C. Benner, U.S. Forest Service, San Dimas, Calif., Private Communication (3 June 1977).
- 3-11. W. Cowles and P. McCabe, Advanced Fuel Metering Demonstration, Report No. EPA-460/3-77-003, Holley Carburetor Division, Warren Michigan, prepared for U.S. Environmental Protection Agency, Emission Control Technology Division (April 1977).
- 3-12. Exhaust Emissions from a Ford Pinto Equipped with the General Dynamics Electrosonic Control System, 77-2 AW, U.S. Environmental Protection Agency, Emission Control Technology Division, Ann Arbor, Mich. (October 1976).



- 3-13. A. Kaupert, U.S. Environmental Protection Agency, Ann Arbor, Mich., Private Communication (15 June 1977).
- 3-14. "Should We Have a New Engine?", Jet Propulsion Laboratory, California Institute of Technology, Pasadena, Calif. (August 1975).
- 3-15. "Improving Automotive Fuel Economy with Accessory Drives," booklet distributed at ERDA/TEC Contractors Coordination Meeting, Ann Arbor, Mich., The Garrett Corp. (October 1976).
- 3-16. D. A. Hurter, et al., A Study of Technological Improvements in Automobile Fuel Consumption, Vol II Report No. DOT-TSC-OST-74-40.II, Arthur D. Little, Inc., Cambridge, Mass. (December 1974).
- 3-17. "Factors Affecting Automobile Fuel Economy," U.S. Environmental Protection Agency (September 1975).
- 3-18. L. Forrest, et al., Analysis of Timing and Carburetion Calibrations, Report No. ATR-77(7358-01)-1, The Aerospace Corporation, El Segundo, Calif. (October 1976).
- 3-19. "Death of Mechanic is Blamed on Failure of Fan in Ford Auto," Wall Street Journal (10 June 1976).
- 3-20. "Automotive Parts and Accessories," J.C. Whitney and Co., Chicago, Ill.
- 3-21. Kendon Volkswagen, Harbor City, Calif., Private Communication (8 June 1976).
- 3-22. "Chilton's Professional Labor Guide and Parts Manual, 1977," Chilton Co., Radnor, Pa. (1976).
- 3-23. E. F. Obert, The Internal Combustion Engine, 3rd ed., International Textbook Co., Scranton, Pa. (1970).
- 3-24. Arthur Garabedian, Fullerton, Calif., Private Communication (26 November 1975).
- 3-25. Progress on the Variable Displacement Spark-Ignition Engine, Report No. SAND 76-8512, Sandia Laboratories, Livermore, Calif. (October 1976).
- 3-26. "Dual Displacement Engine Boosts Fuel Economy," Machine Design (21 October 1976).
- 3-27. "Ford's Dual-Displacement Program Shifts to V-8," Ward's Automotive Reports (16 January 1978).
- 3-28. L. Forrest, R. J. Nichols, and W. M. Smalley, Assessment of Drive-Train Systems for Dual Mode Performance in Police Patrol Vehicles, Report No. ATR-76(7914-05)-1, The Aerospace Corporation, El Segundo, Calif. (May 1976).

- 3-29. Jet Propulsion Laboratory, Pasadena, Calif., Private Communication (April 1975).
- 3-30. I. N. Bishop, "Effect of Design Variables on Friction and Economy," SAE Paper No. 812A (January 1964).
- 3-31. "Ford Plans New Engine to Shift Cylinders and Save 10% in Fuel," New York Times (22 September 1976).
- 3-32. "Ford Varicube Engine Hits Snag," Ward's Engine Update, Vol. 4, No. 1, Ward's Communications, Inc., Detroit, Mich. (6 January 1978).
- 3-33. "Handbook for Installation and Inspection Stations. Pollution Control Device," California Dept. of Consumer Affairs, Bureau of Automotive Repair, Sacramento, Calif. (June 1972).
- 3-34. Controlling Exhaust Emissions, Technical Note PCDTN 268, Ethyl Corp., Ferndale, Mich.
- 3-35. Brochure, Kim Hotstart Manufacturing Co., Spokane, Wash.
- 3-36. T. Iura, W. U. Roessler, and H. M. White, Research Plan for Achieving Reduced Automotive Fuel Consumption, Report No. ATR-76(7467)-1, The Aerospace Corporation, El Segundo, Calif. (October 1975).
- 3-37. C. E. Shefler and G. W. Niepoth, "Customer Fuel Economy Estimated from Engineering Tests," SAE Paper 650861 (1965).
- 3-38. R. Flaherty, Kim Hotstart Manufacturing Co., Spokane, Wash., Private Communication (17 May 1976).
- 3-39. D. J. Schuring, Rolling Resistance of Tires Measured Under Transient and Equilibrium Conditions on Calspan's Tire Research Facility, Report No. DOT-TSC-OST-76-9, U.S. Department of Transportation (March 1976).
- 3-40. D. A. Glemming and P. A. Bowers, "Tire Testing for Rolling Resistance and Fuel Economy," SAE Paper No. 750457 (February 1975).
- 3-41. S. K. Clark, et al., Rolling Resistance of Pneumatic Tires, Report No. DOT-TSC-OST-74-33, U.S. Department of Transportation (May 1975).
- 3-42. K. F. Kaiser, Improved Fuel Economy Through Reduced Aerodynamic Drag and Rolling Resistance, Report No. PM-T-22, U.S. Department of Transportation (January 1975).
- 3-43. Study of Potential for Motor Vehicle Fuel Economy Improvement, Report No. 4 of Seven Panel Report, U.S. Environmental Protection Agency and the U.S. Department of Transportation (10 January 1975).
- 3-44. C. W. Coon, et al., Technological Improvements to Automobile Fuel Consumption, Vol. IIA, Report No. DOT-TSC-74-39.IIA, Southwest Research Institute (December 1974).

- 3-45. "1975 Year Book," The Tire and Rim Association, Inc., Akron, Ohio (1975).
- 3-46. Goodyear Tire & Rubber Co., Akron, Ohio, Private Communication (25 May 1977).
- 3-47. Tire Industry Safety Council, Washington, D.C., Private Communication (25 May 1977).
- 3-48. "Tire Industry Facts," Modern Tire Dealer, Akron, Ohio (January 1977).
- 3-49. "Tire Industry Facts," Modern Tire Dealer, Akron, Ohio (January 1975).
- 3-50. "Tire Industry Facts," Modern Tire Dealer, Akron, Ohio (January 1978).
- 3-51. R. G. S. White, Motor Industry Research Association (United Kingdom), "A Method of Estimating Automotive Drag Coefficients," SAE Paper 690189 (January 1969).
- 3-52. G. W. Carr, Motor Industry Research Association (United Kingdom), "Reducing Fuel Consumption by Means of Aerodynamic Add-On Devices," SAE Paper 760187 (February 1976).
- 3-53. W. H. Hucho, et al. (Volkswagenwerk AG Germany), "The Optimization of Body Details - A Method for Reducing the Aerodynamic Drag of Road Vehicles," SAE Paper 760185 (February 1976).
- 3-54. F. K. Schenkel (General Motors Corp., Warren, Mich.), "The Origin of Drag and Lift Reductions on Automobiles with Front and Rear Spoilers," SAE Paper 770389.
- 3-55. J. Marte, et al., A Study of Automotive Aerodynamic Drag, Report No. DOT-TSC-OST-75-28, Jet Propulsion Laboratory, Pasadena, Calif. (September 1975).
- 3-56. D. Sherman, "Project Car: Crisis-Fighter Pinto," Car and Driver Magazine, p. 44 (March 1974).
- 3-57. D. Sherman, "Project Car: Crisis Fighter Z-Car," ibid., p. 39 (May 1974).
- 3-58. K. F. Kaiser, Improved Fuel Economy Through Reduced Aerodynamic Drag and Rolling Resistance, Report No. PM-T-22, U.S. Department of Transportation, Transportation Systems Center (January 1975).
- 3-59. "1974 Motor Truck Facts," Motor Vehicle Manufacturers Association, Detroit, Mich.



- 3-60. J. Krulish, et al. (Mobil Oil Corp., Paulsboro, N.J.), "An Update on Synthesized Engine Oil Technology," SAE Paper 770634 (June 1977).
- 3-61. J. J. Roger, et al. (General Motors Corp., Research Laboratories, Warren, Mich.), "Vehicle Evaluation of Synthetic and Conventional Engine Oils," SAE Paper 750827 (September 1975).
- 3-62. R. R. Boehringer (Emery Industries, Inc.), "Diester Synthetic Lubricants for Automotive and Diesel Applications," SAE Paper 750686 (June 1975).
- 3-63. E. D. Davison, et al. (General Motors Corp., Research Laboratories, Warren, Mich.), "Lubricant Viscosity Effects on Passenger Car Fuel Economy," SAE Paper 750675 (June 1975).
- 3-64. M. L. Haviland, Automotive Fuel Economy Gains Through Lubricant Technology, Research Publication GMR-2343, F&L-618, General Motors Corp., Warren, Mich. (8 February 1977).
- 3-65. "Comments on Notice of Proposed Rulemaking for Nonpassenger Automobile Average Fuel Economy Standards, Model Years 1980-81," General Motors Corp., Warren, Mich. (submitted to National Highway Traffic Safety Administration, Washington, D.C.) (30 January 1978).
- 3-66. "Comments for National Highway Traffic Safety Administration Hearing on Docket No. FE-77-5, Nonpassenger Automobile Average Fuel Economy Standards, Model Years 1980-81," Exxon Co., U.S.A., Houston, Tex. (16 January 1978).
- 3-67. "The Story of ARCOgraphite Motor Oil," undated brochure of Atlantic Richfield Company, Los Angeles, Calif.
- 3-68. T. J. Sheahan, et al. (The Lubrizol Corp.), "Lubricant Related Fuel Savings in Short Trip Cold Weather Service," SAE Paper 750676 (June 1975).
- 3-69. W. B. Chamberlin, et al. (The Lubrizol Corp.), "Automotive Fuel Savings Through Selected Lubricants," SAE Paper 750377 (February 1975).
- 3-70. T. Risdon, et al. (Climax Molybdenum Co.), "An Historical Review of Reductions in Fuel Consumption of U.S. and European Engines with MoS<sub>2</sub>," SAE Paper 750674 (June 1975).
- 3-71. D. A. Gresty, et al. (Climax Molybdenum Co.), "The Effect of MoS<sub>2</sub> Based Lubricants on Automotive Gear Efficiency and Operating Temperatures," SAE Paper 770834 (September 1977).
- 3-72. J. Bennington, et al. (University of Michigan), "Stable Colloid Additives for Engine Oils - Potential Improvement in Fuel Economy," SAE Paper 750677 (June 1975).



- 3-73. P. A. Willermet, et al. (Ford Motor Co.), "Fuel Economy-Contribution of the Rear Axle Lubricant," SAE Paper 770835 (September 1977).
- 3-74. M. Haviland, Fuels and Lubricants Department, General Motors Corp., Warren, Mich., Private Communication (11 January 1978).
- 3-75. R. W. Downing, Mobil Oil Co., New York City, Private Communication (5 January 1978).
- 3-76. J. Gockel, An Evaluation of the Effectiveness of Automobile Engine Adjustments to Reduce Exhaust Emissions and an Evaluation of the Training Required . . ., Report No. NTIS PB-237 040, Clean Air Research Company, Pico Rivera, Calif., prepared for California Air Resources Board, Sacramento, Calif. (22 June 1973).
- 3-77. Evaluation of Mandatory Vehicle Inspection and Maintenance Programs, Summary Report, California Air Resources Board, Sacramento, Calif. (May 1976).
- 3-78. Degradation Effects on Motor Vehicle Exhaust Emission, Final Report, Olson Laboratories, Anaheim, Calif., prepared for California Air Resources Board (March 1976).
- 3-79. New Jersey Motor Vehicle Emission Inspection Program. Summary and Report - Phase I, New Jersey Department of Environmental Protection, Trenton, N.J. (June 1976).
- 3-80. J. Panzer (Exxon Research and Engineering Company, Linden, N.J.), "Fuel Economy Improvements Through Emissions Inspection/Maintenance," SAE Paper 760003 (February 1976).
- 3-81. P. Claffey, Potsdam, N.Y., Passenger Car Fuel Conservation, Report No. FHWA-PL-77009, prepared for Federal Highway Administration, Office of Highway Planning, Washington, D.C. (January 1977).
- 3-82. Right Turn on Red, A Report to the Governor and General Assembly of Virginia, Report No. VHTRC 76-9R, Virginia Highway and Transportation Research Council, Charlottesville, Va. (September 1975).
- 3-83. "State Laws Allowing Drivers to Turn on Red Lights," Vol. 6, No. 1, Traffic Laws Commentary, U.S. Department of Transportation, National Highway Traffic Safety Administration, Washington, D.C. (January 1977).
- 3-84. E. B. Lieberman and S. Cohen, "New Techniques for Evaluating Urban Traffic Energy Consumption and Emissions," paper published in Transportation Research Record 599, Transportation Research Board, Natl. Academy of Sciences (1976).
- 3-85. Right Turn on Red, Allan M. Voorhees and Associates and KLD and Associates, Report No. FHWA-RD-76-89, Vol. I, II (May 1976).

- 3-86. K. G. Courage, Reducing Fuel Consumption Through Traffic Signal Turning, prepared for North Central Florida Regional Planning Council (March 1975).
- 3-87. K. G. Courage and G. M. Paraper, "Delay and Fuel Consumption at Traffic Signals," Traffic Engineering (November 1973).
- 3-88. "Highway Statistics," Federal Highway Administration, U.S. Department of Transportation (1974).
- 3-89. J. E. Baerwald, ed., Transportation and Traffic Engineering Handbook, Third Edition, Revised, Prentice-Hall, Inc., Englewood Cliffs, N.J. (1976).
- 3-90. W. E. Pontier, et al., Optimizing Flow on Existing Street Networks, Report 113, National Cooperative Highway Research Program (1971).
- 3-91. J. A. Bruce, One-Way Major Arterial Streets: Improved Street Utilization Through Traffic Engineering, Special Report 92, Highway Research Board (1967).
- 3-92. "Fuel Consumption Study, Urban Traffic Control System (UTCS) Software Support Project," Report No. FHWA-RD-76-81, Honeywell Traffic Management Center, Honeywell Inc., Hopkins, Minn. (February 1976).
- 3-93. M. Paetzold, City of Los Angeles, Transportation Department, Telecon (1 July 1977).
- 3-94. "Traffic Control Devices Handbook, An Operating Guide," The National Advisory Committee on Uniform Traffic Control Devices (1 December 1974).
- 3-95. P. Christofferson, Honeywell Traffic Management Center, Hopkins, Minn., Private Communication (1 July 1977).
- 3-96. J. B. Scott and M. Saunders, Traffic Control Equipment Study, Annual Expenditures and Current Inventories for U.S. Local Governments, Report No. E4-574, The American City Magazine, Pittsfield, Mass. (1974).
- 3-97. R. Hobbes, Los Angeles County Road Department, Private Communication (1 July 1977).
- 3-98. L. Evans and R. Herman, "A Simplified Approach to Calculation of Fuel Consumption in Urban Traffic Systems," Traffic Engineering & Control, Vol. 17, Nos. 8 & 9, Research Laboratories, General Motors Corp. (August/September 1976).
- 3-99. P. Benjamin, "Effect of Urban Traffic Flow Modifications Upon Automobile Petroleum Consumption," DOT Transportation Systems Center, Discussion Paper No. DP-SA-6 (October 1973).

- 3-100. D. W. Ross, "San Jose: An Example of an Area Traffic Control System - Impact on Energy Consumption," Cal Tech Seminar Series on Energy Consumption in Private Transportation, Report No. DOT-TST-75-7, California Institute of Technology, Pasadena, Calif. (30 June 1974).
- 3-101. K. A. Godfrey, Jr., "Computerized Traffic Signals: Goal for My City?", Civil Engineering-ASCE (November 1975).
- 3-102. J. L. Kay, J. C. Allen, and J. M. Bruggeman, Evaluation of First Generation UTCS/BPS Control Strategy, Vols. I, II, III, Report Nos. FWHA-RD-75-26, 27, 28, J. H. K. and Associates, Alexandria, Va., and Peat, Marwick, Mitchell and Co., Washington, D. C. (February 1975).
- 3-103. J. McGowan, Office of Research and Development, Federal Highway Administration, McLean, Va., Private Communication (2 February 1978).
- 3-104. M. G. Hinton, et al., Evaluation of Driver Aid Devices for Improved Fuel Economy, Report No. DOT-TSC-OST-76-45, The Aerospace Corporation, El Segundo, Calif., prepared for U.S. Department of Transportation (November 1976).
- 3-105. W. Harriot, U.S. Department of Transportation, Transportation Systems Center, Cambridge, Mass., Private Communication (11 January 1978).
- 3-106. R. D. Allen, Manager of Transportation, Douglas Aircraft Co., McDonnell Douglas Corp., Long Beach, Calif., Private Communication (20 May 1977).
- 3-107. D. Malcheski, Status Report - Driver Aid and Education Test Project, Nevada Operations Office, Department of Energy, Las Vegas, Nev. (19 April 1977).
- 3-108. D. Malcheski, Nevada Operations Office, Department of Energy, Las Vegas, Nev., Private Communication (3 February 1978).
- 3-109. R. W. Grosser and W. F. Hergueter, "Economy Driving Project," Internal Communication, Mobile Technical Center, Mobil Oil Corp., Princeton, N. J. (27 June 1974).
- 3-110. M. F. Chang, et al., The Influence on Vehicle Characteristics, Driver Behavior, and Ambient Temperature on Gasoline Consumption in Urban Traffic, Research Publications GMR-1950, General Motors Research Laboratories, Warren, Mich. (20 January 1976).
- 3-111. U.S. Department of Transportation, "Request for Information and Public Comment," Federal Register (3 March 1976).
- 3-112. M. S. Huntley, et al., The Effectiveness of Miles-Per-Gallon Meters as a Means to Conserve Gasoline in Automobiles, Report No. DOT-TSC-OST-76-38, U.S. Department of Transportation, Transportation Systems Center, Cambridge, Mass. (October 1976).



- 3-113. Mr. Blankely, Alemite Division of Stewart-Warner Corp., Chicago, Ill., Private Communication (25 May 1977).
- 3-114. E. Henne, Tomco Co., St. Louis, Mo., Private Communication (25 May 1977).
- 3-115. F. Edwards, C&E Enterprises, Inc., Jacksonville, Fla., Private Communication (25 May 1977).
- 3-116. "Installation and Instruction Manual for Dynamic Dynamometer Model 701," Autotronic Controls Corp., El Paso, Texas (27 July 1973).
- 3-117. J. Priegel, Autotronic Controls Corp., El Paso, Texas, Private Communication (20 May 1977).
- 3-118. SpaceKom, Inc., Santa Barbara, Calif., Private Communication (27 May 1977).
- 3-119. B. L. Wildermuth, U.S. Postal Service, Office of Maintenance Management, Internal Communication (6 March 1975).
- 3-120. T. N. Lamb and P. Wasielewski, "Driver Response to the 55 mph Maximum Speed Limit . . .," paper published in Transportation Research Record 567, Transportation Research Board, Natl. Academy of Sciences.
- 3-121. W. M. Brehob, Ford Motor Company, Dearborn, Mich., Private Communication (15 September 1975).
- 3-122. D. Busby, "Perfect Circle Central Division of Dana Corp., Hagarstown, Ind., Private Communication (25 May 1977).
- 3-123. A. Berry, Annuncionics, Inc., Los Angeles, Calif., Private Communication (25 May 1977).
- 3-124. "Percent of Factory-Installed Equipment on U.S. 77 Model Cars," Ward's Automotive Report, Detroit, Mich. (4 April 1977).
- 3-125. R. A. Banowetz, et al., Field Evaluation of Driver Aids, Project No. TSC/640-0235-GF, Automobile Club of Southern California, Los Angeles, Calif., prepared for U.S. Department of Transportation, Transportation Systems Center (October 1976).
- 3-126. C. I. Wurster, General Manager, Flo Scan Instrument Company, Seattle, Wash., Private Communication (26 May 1977).



## 4. IMPLEMENTATION ANALYSIS

The characterization results and data base developed earlier in this report for the various fuel savings techniques are utilized in this section to evaluate a number of significant parameters associated with their nation-wide implementation. For each candidate approach, the following implementation factors are examined and assessed:

- Applicability to National Fleet
- Fleet Fuel Savings
- National Cost
- Potential Implementation Problems
- Estimated Lead Time to Implementation
- Areas of Uncertainty and Magnitude of Possible Errors

A tabular summary of results for the spectrum of techniques examined is provided in Subsection 4.7.

- 4.1            VEHICLE MODIFICATIONS
- 4.1.1        Spark Augmentation Devices
- 4.1.1.1     Applicability to National Fleet

The spark augmentation devices treated in this report (electronic, high energy, and multiple spark ignition systems) are applicable to all spark ignition vehicles not already OEM- or aftermarket-equipped with such systems. In this regard, it is noted that the use of breakerless electronic systems in new vehicles has steadily increased in recent years. Starting in 1975, all domestic new cars have been equipped with breakerless electronic ignition systems.

Lacking specific information on new car and aftermarket sales of electronic systems in earlier model years and for import vehicles, the sample of 5666 in-use vehicles provided by Champion Spark Plug Company in their Mobile Proving Ground Project (described in Section 3.1.1.2.1) will be utilized to establish the fraction of vehicles presently equipped with electronic ignition systems. These data, shown in Figure 4-1, are assumed to be representative of all market classes of both passenger cars and light duty trucks.

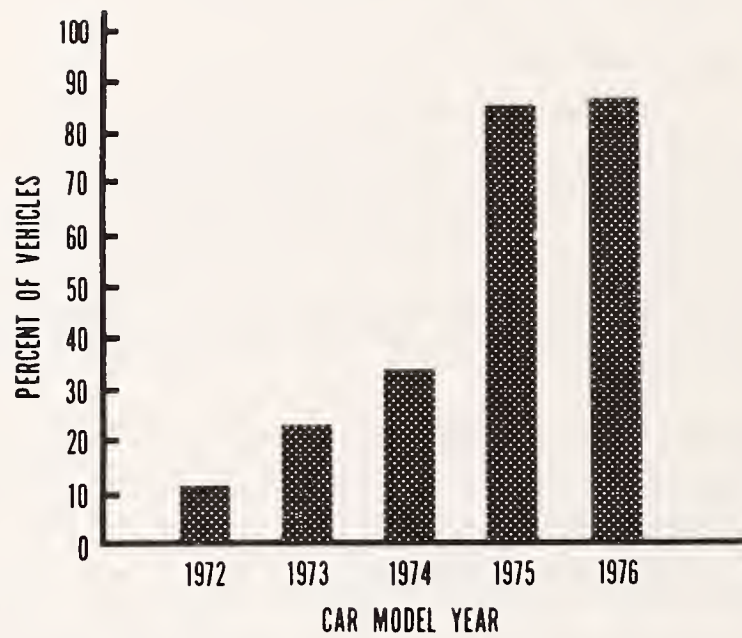

FIGURE 4-1. PERCENT OF VEHICLES EQUIPPED WITH ELECTRONIC IGNITION (Ref. 4-1)

With regard to future model year cars, it will be assumed that the percentage equipped with electronic ignition will grow linearly from the 1976 level indicated by the Champion data to 100% in model year 1978. In determining applicability, account is made of the population fraction in both fleets that are non-spark-ignition systems (diesels).

#### 4.1.1.2 Fleet Fuel Savings

The fuel economy benefit assigned to spark augmentation devices in Section 3.1.1 was 1/4%. No attempt will be made to differentiate among devices, and no allowance will be made for the superposition of one or more devices on an existing vehicle already equipped with electronic ignition. On this basis, and using the applicability data discussed above, the fuel savings for various components of the light duty fleet appear as shown in Table 4-1. The total fuel savings are 0.17 billion gallons for the 1976 fleet, and 0.048 billion gallons for the 1982 fleet. These results clearly indicate the diminishing option for retrofitting spark augmentation devices created by the high percentage of OEM-equipped vehicles introduced in 1975 and subsequent model years. The percentage of applicable vehicles decreases from about 78% in the 1976 in-use fleet to about 28% in the 1982 fleet.

#### 4.1.1.3 National Cost

In Section 3.1.1.5, the installed unit cost for an electronic breakerless ignition system was determined to be \$75. Somewhat lower costs were indicated for the other types of spark augmentation devices examined. However, the high energy system is not available in the aftermarket, and the electronic breakerless system is considered to be a somewhat more practical substitution for conventional ignition systems than MSD. On this basis, the higher cost figure will be adopted in computing the national cost for implementing spark augmentation devices.

The resulting fleet cost data are shown in Table 4-2. Cost to retrofit the national fleet of 1976 would be \$7.1 billion. The corresponding figure for the 1982 fleet is \$3 billion, reflecting the smaller number of applicable vehicles in 1982. Fuel cost savings are negligible in comparison to the installed cost; these are only about 2% and 1% of the installed costs for the 1976 and 1982 fleets, respectively. As discussed in Section 3, more significant benefits may accrue from the reduced deterioration rate of electronic

TABLE 4-1. FLEET FUEL SAVINGS ATTRIBUTABLE TO SPARK AUGMENTATION DEVICES

Fleet Sector	1976 Fleet		1982 Fleet	
	Percent Applicable	Fleet Fuel Savings* (10 <sup>9</sup> gal)	Percent Applicable	Fleet Fuel Savings* (10 <sup>9</sup> gal)
Passenger Cars	78.9	0.139	27.4	0.0351
Light Duty Trucks				
Class I LDT	80.0	0.020	36.4	0.0082
Class II LDT	66.1	0.012	24.8	0.0048
Total LDT	75.7	0.032	32.2	0.0130
Total Fleet	78.3	0.171	28.5	0.0481

\*Based on fleet mileage accumulated for the year indicated.



TABLE 4-2. COST FACTORS FOR SPARK AUGMENTATION DEVICES

Fleet Sector	1976 Fleet			1982 Fleet		
	Applicable Vehicles (Millions)	Fleet Cost (\$ Billions)	Fleet Fuel Cost Savings* (\$ Billions)	Applicable Vehicles (Millions)	Fleet Cost (\$ Billions)	Fleet Fuel Cost Savings* (\$ Billions)
Passenger Cars	78.68	5.901	0.098	29.93	2.245	0.025
Light Duty Trucks						
Class I LDT	12.06	0.904	0.014	7.37	0.553	0.005
Class II LDT	4.40	0.330	0.008	2.89	0.217	0.004
Total LDT	16.46	1.234	0.022	10.26	0.770	0.009
Total Fleet	95.14	7.135	0.120	40.19	3.014	0.034

\* Based on \$0.70 per gallon and fleet mileage accumulated for year indicated.

systems if the driver opts to increase the interval between regular tune-ups. This option, if exercised, tends to obviate the small fuel economy benefit ascribed to the spark augmentation system.

#### 4.1.1.4 Potential Implementation Problems

A major implementation problem identified for the spark augmentation device is its poor cost/benefit characteristic and its likely lack of appeal on the grounds of fuel cost savings alone. Other possible advantages of this system, such as increased starting reliability, improved vehicle driveability, and reduced frequency of maintenance, may, however, make the system more attractive than otherwise indicated.

#### 4.1.1.5 Estimated Lead Time to Implementation

Electronic ignition systems are currently available from many large suppliers to the aftermarket, and production could be very quickly increased to satisfy the full demand of the applicable fleet.

#### 4.1.1.6 Areas of Uncertainty and Magnitude of Possible Errors

The key element of uncertainty in the estimates made for the spark augmentation system is the value assigned to its fleet-average fuel economy benefit. The actual value depends on the fraction of cars with electronic ignition that are tuned at the conventional interval vs the fraction that are allowed to deteriorate to the same driver-perceived level of performance decay. The former group should show an average fuel economy improvement relative to conventional ignition systems while the latter probably will not, as discussed in Section 3.1.1.2.2. These effects are highly uncertain, and it is quite possible that the fuel economy improvement could lie anywhere in the range from 0 to 1%.

#### 4.1.2 Improved Carburetors

##### 4.1.2.1 Applicability to National Fleet

Whereas some OEM implementation of improved carburetors may occur as early as the 1979 model year, as described in Section 3.1.2.4, there is no basis at present for assigning a quantitative level to these early offerings. It is considered unlikely that they would strongly influence the total number of vehicles suitable for retrofit in the 1982 fleet. Thus the improved carburetor

devices will be assumed to be applicable to all light duty vehicles that are not equipped with fuel injected engines. The population fraction that is fuel injected is discussed in the following paragraphs.

Sales data for cars with fuel injected gasoline engines show a growth trend which accounts for approximately 3% of passenger car sales (domestic plus imports) in 1976, as compared to about 1.8% in 1974. Extrapolation of these data indicates a fleet penetration level of about 5% (passenger cars) in 1982.

Diesel passenger car sales have been nearly constant at a low level of about 0.2% in recent years. The penetration in future model years is assumed to proceed in accordance with the model described in Section 2.2, indicating diesel engine implementation in passenger cars to a level of 5% in 1980, 10% in 1981, and 20% in 1982.

Class I light duty trucks ( $\leq 6000$  lb GVW) are subject to a fuel economy standard which may make the diesel engine attractive, but this standard is lower than that for passenger cars; thus a lower implementation rate appears likely. On this basis, it will be assumed that the introduction of diesel engines in Class I LDT's will proceed at half the rate for passenger cars. No diesel engine implementation is postulated for Class II LDT's. Fuel economy standards for this group have not yet been established, and therefore there is no compensating benefit for the higher price tag that a diesel engine in these vehicles would engender. No allowance will be made for the possible use of fuel injected gasoline engines in the light duty truck fleet.

#### 4.1.2.2 Fleet Fuel Savings

The postulated fuel economy benefit of 1%, combined with the number of applicable vehicles determined as described above, produces a total fleet fuel savings of 0.9 billion gallons for the 1976 fleet and 0.83 billion gallons for the 1982 fleet. The data are shown in Table 4-3.

#### 4.1.2.3 National Cost

Of the two carburetor systems discussed in Section 3.1.2, the sonic carburetor typified by the Dresserator system is presently undergoing more intensive development and therefore is more likely to be available for

TABLE 4-3. FLEET FUEL SAVINGS ATTRIBUTABLE TO IMPROVED CARBURETORS

Fleet Sector	1976 Fleet		1982 Fleet	
	Percent Applicable	Fleet Fuel Savings* (10 <sup>9</sup> gal)	Percent Applicable	Fleet Fuel Savings* (10 <sup>9</sup> gal)
Passenger Cars	98.2	0.711	92.5	0.590
Light Duty Trucks				
Class I LDT	100	0.109	98.1	0.111
Class II LDT	100	0.0799	100.0	0.130
Total LDT	100	0.189	98.8	0.241
Total Fleet	98.5	0.900	94.0	0.831

\*Based on applicable mileage accumulated in year indicated.



retrofit application. For this reason, the \$150 installed cost for the sonic system will be adopted in calculating the national cost for implementing improved carburetor devices. Utilizing this installed cost and the data of Table 4-3, the national cost for implementation is determined to be about \$18 billion for the 1976 fleet and \$20 billion for the 1982 fleet. These and other cost factors are shown in Table 4-4. The fuel cost savings are insignificant at about 3% of the installed cost.

#### 4.1.2.4 Potential Implementation Problems

In addition to its poor cost benefit aspects which are apparent from Table 4-4, the improved carburetor concept may also encounter implementation problems related to emission control. Since the carburetor is an intrinsic part of the emission control system, there may be regulatory restrictions placed on the replacement of OEM carburetors with nonstandard equipment. This could take the form of requiring extensive emissions testing by the device manufacturer; for a small entrepreneur, the cost of such testing could strongly impact the sales price of the device. It is possible that some states (or the EPA) would require that the carburetor devices be installed, or at least approved, by state-authorized (licensed) stations. All these factors could have a strong bearing on both the installed cost and the supply logistics of aftermarket carburetor systems.

#### 4.1.2.5 Estimated Lead Time to Implementation

Because of both cost considerations and the emission control aspects of carburetor developments, it is likely that significant aftermarket penetration of the sonic carburetor will not occur until after its introduction in the new car fleet. Initial OEM offerings of the Dresserator type of sonic flow carburetor may take place in 1979 or 1980. Allowing time for evaluation of in-use performance by manufacturers and regulatory agencies, significant aftermarket implementation probably would not occur until about 1982.

#### 4.1.2.6 Areas of Uncertainty and Magnitude of Possible Errors

As discussed in Section 3.1.2, the data base on improved carburetors shows highly variable results for fuel economy improvement, and a benefit significantly larger than the 1% improvement adopted in this study must be considered possible. It is estimated that the actual improvement could be

TABLE 4-4. COST FACTORS FOR IMPROVED CARBURETORS

Fleet Sector	1976 Fleet			1982 Fleet		
	Applicable Vehicles (Millions)	Fleet Cost <sup>a</sup> (\$ Billions)	Fleet Fuel Cost Savings <sup>b</sup> (\$ Billions)	Applicable Vehicles (Millions)	Fleet Cost <sup>a</sup> (\$ Billions)	Fleet Fuel Cost Savings <sup>b</sup> (\$ Billions)
Passenger Cars	97.93	14.69	0.498	101.10	15.16	0.413
Light Duty Trucks						
Class I LDT	15.07	2.26	0.076	19.86	2.98	0.078
Class II LDT	6.67	1.00	0.056	11.64	1.75	0.091
LDT Total	21.74	3.26	0.132	31.50	4.72	0.169
Total Fleet	119.67	17.95	0.630	132.60	19.89	0.582

<sup>a</sup> Based on \$150 unit cost installed.

<sup>b</sup> Based on \$0.70 per gallon and applicable fleet mileage accumulated in year indicated.

anywhere in the range from 0 to 3%. At the upper value, the fleet fuel savings would increase from the levels shown in Table 4-3 to 2.65 and 2.44 billion gallons for the 1976 and 1982 fleets, respectively.

#### 4.1.3 Variable Accessory Operation

##### 4.1.3.1 Applicability to National Fleet

It can be assumed, with small error, that the applicability of the viscous clutch fan is essentially dependent on the number of cars in the vehicle fleet that are not equipped with factory-installed air conditioning. For, while viscous fans are sometimes employed for heavy-duty use in non-air-conditioned vehicles and while the earliest models of air-conditioned vehicles in the fleet may not be viscous-fan-equipped, the cars in these two categories are negligibly few.

An integration of the data on new car air conditioning sales shows that approximately 51% of the passenger cars in the 1976 fleet are equipped with air conditioning, indicating that about 49% of the 1976 fleet could be converted to the use of the viscous clutch fan. A similar integration of the projected 1982 fleet indicates that about 64% of the vehicles will be equipped with air conditioning, leaving about 36% that could be fitted with the viscous clutch device.

Insufficient data are available to make a similar evaluation of the light duty truck fleet. The annual installation rate for air conditioning in domestic light duty trucks has increased slowly from an installation rate of 28.5% in 1973 to 30% in 1975 (Ref. 4-2). Current installation rates of air conditioning show that 33% of the 1976 model year domestic light duty trucks were equipped with air conditioning and about 7% of the import light duty trucks. On a sales-weighted basis, this means that about 31% of the 1976 light duty truck production was equipped with air conditioning. On the basis of the limited information available, it is estimated that about 10% of the 1976 light duty truck fleet is equipped with air conditioning. For the 1982 fleet, this is projected to rise to about 20% of the fleet. These estimated fleet characteristics then suggest that about 90% of the 1976 fleet and about 80% of the 1982 fleet could be equipped with the viscous clutch fan.

The electrically driven fan could be applied to essentially all of the vehicles in the 1976 fleet, since only a few late model import cars (predominantly the transverse engine, front wheel drive vehicles, e.g., VW, Subaru, Renault, Honda), currently utilize such a system. The present plans of the domestic auto industry to change over to front wheel drive on many models within the next few years suggests that some segment of the domestic fleet may be equipped with electric powered fans by the early 1980's. It is not expected, however, that these vehicles would constitute more than 10% of the 1982 in-use fleet.

The variable accessory drive system currently under development by Garrett is applicable to the entire fleet. No consideration will be given to the flex-fan, since it was shown in Section 3.1.3 to have no fuel economy benefit.

#### 4.1.3.2 Fleet Fuel Savings

The fleet fuel savings for each of the accessory options considered in this study is a function of the fuel economy gain associated with the device, the fraction of applicable vehicles in the fleet, and the fleet fuel consumption of these vehicles. The applicable portion of the fleet and estimated annual fuel savings relating to each of the options considered are summarized in Table 4-5 for the 1976 and 1982 fleets.

#### 4.1.3.3 National Cost

The national costs associated with implementing each of the options are summarized in Table 4-6. These values are based on the unit cost information developed in Section 3.1.3, combined with the fleet applicability percentages discussed in Section 4.1.3.1. Also shown are the fleet fuel cost savings which result from the use of these devices. These savings are based on the estimated fleet fuel savings developed in Section 4.1.3.2, a fuel cost of \$0.70/gallon, and the applicable mileage accumulated in the year indicated.

#### 4.1.3.4 Potential Implementation Problems

A major implementation problem relating to the viscous clutch and electric fan devices is consumer acceptance in the face of the poor cost-benefit characteristics of these items. The viscous clutch fan, with an estimated fuel economy gain of about 0.4%, results in a fuel cost savings of about



TABLE 4-5. FLEET FUEL SAVINGS ATTRIBUTABLE TO VARIABLE ACCESSORY OPERATION

Option	1976 Fleet		1982 Fleet	
	Percent Applicable	Fleet Fuel Savings (10 <sup>9</sup> gal)*	Percent Applicable	Fleet Fuel Savings (10 <sup>9</sup> gal)*
<u>Viscous Clutch Fan</u>				
Passenger Cars	49	0.16	36	0.11
Trucks	90	0.08	80	0.08
Total Fleet		0.24		0.19
<u>Electric Fan</u>				
Passenger Cars	100	1.47	100	1.30
Trucks	100	0.37	100	0.48
Total Fleet		1.84		1.78
<u>Variable Accessory Drive</u>				
Passenger Cars	100	2.90	100	2.78
Trucks	100	0.56	100	0.78
Total Fleet		3.46		3.56
Fleet Fraction with AC	44	2.02	54	2.38

\* Based on fleet mileage accumulated for year indicated.

TABLE 4-6. COST FACTORS FOR VARIABLE ACCESSORY OPERATION

Option	1976 Fleet			1982 Fleet		
	Applicable Vehicles (Millions)	Fleet Cost (\$ Billions)	Fleet Fuel Cost Savings* (\$ Billions)	Applicable Vehicles (Millions)	Fleet Cost (\$ Billions)	Fleet Fuel Cost Savings* (\$ Billions)
Viscous Clutch Fan						
Passenger Cars	48.9	2.20	0.11	39.4	1.77	0.07
Trucks	19.6	0.88	0.05	25.4	1.15	0.06
Total Fleet	68.5	3.08	0.16	64.8	2.92	0.13
Electric Fan						
Passenger Cars	99.7	9.97	1.03	109.3	10.93	0.91
Trucks	21.8	2.18	0.25	31.8	3.18	0.33
Total Fleet	121.5	12.15	1.28	141.1	14.11	1.24
Variable Drive						
Passenger Cars	99.7	7.98	2.03	109.3	8.74	1.94
Trucks	21.8	1.74	0.39	31.8	2.55	0.55
Total Fleet	121.5	9.72	2.42	141.1	11.29	2.49
Fleet Fraction with A/C	53.0	4.24	1.41	76.3	6.11	1.67

\*Based on \$0.70 per gallon and mileage accumulated for year indicated.

\$2 per year per vehicle for both the 1976 and 1982 fleets. The electric fan offers higher annual fuel cost savings, but would still require 9 to 11 years to recover the initial cost (\$100). These devices can be considered equally unattractive from a cost point of view.

The variable accessory drive results in significantly higher fuel economy gains, particularly for vehicles equipped with air conditioning (5.4%) and may be more attractive to the consumer for that reason. The fuel cost savings for vehicles equipped with air conditioning would amount to \$27 per year per vehicle for the 1976 fleet and \$22 per year per vehicle for the 1982 fleet. At the estimated cost of \$80, this would require 3 to 3-1/2 years to recover the initial cost. For those vehicles not equipped with air conditioning, the fuel economy gain of 2.8% would result in fuel cost savings of only \$14.50 and \$12.50 per vehicle per year for the 1976 and 1982 fleets, thus requiring 5-1/2 to 6-1/2 years to recover the cost. This is not likely to encourage retrofit of non-air-conditioned cars with the variable accessory drive system.

The viscous clutch fan is currently in extensive use in the fleet. No explicit information is available on the production capacity relating to these units; aftermarket requirements probably could be met by a modest expansion in the automotive production facilities now in existence.

The electric fan is in extremely limited use on only a few import cars at the present time and is not available as a retrofit device. Hence, production of this unit would have to be started from the ground up before it could become available. This may take several years, as discussed in Section 4.1.3.5.

The variable accessory drive is in the development state only, with no announced plans to produce the unit. Thus, this device would not be available on a production basis for several years and possibly not within the next 5 years.

#### 4.1.3.5 Estimated Lead Time to Implementation

The estimated lead time for implementation of the devices considered in this section is expected, in general, to parallel the lead time practices in the automobile industry as reported in Ref. 4-3 for current radiator fan production. If the fan is of a type and size range that has been

in production, the lead time to production is paced by the tooling lead time, and is about 8 months. This increases to 14 months if new assembly-line equipment is required by the design of the product. If the production rate is significantly increased, a new facility is required. This adds an additional 12 months to the lead time. Thus a substantially increased production capacity for new fan designs might involve a lead time of over 2 years.

The flex-fan and viscous clutch fan are currently in production, although actual production rates are not known. On the basis of the foregoing lead time intervals, it is estimated that existing production facilities for the standard fan could be converted in an 8-month period. Such a changeover would be sufficient to equip 100% of the new car fleet each year. Additional facilities and equipment would be required to significantly increase this production rate to equip older vehicles in the fleet. Thus a substantial supply of new fans for aftermarket use could not be expected before 2 or 3 years. Several additional years of production would be needed to equip the entire fleet.

In the case of the variable accessory drive system, further development work is evidently required, suggesting that this system would not be available in substantial quantities for possibly 5 years.

#### 4.1.3.6 Areas of Uncertainty and Magnitude of Possible Errors

The estimates made for the viscous clutch were based on the horsepower differences between the standard fan and the viscous clutch fan in the disengaged mode and therefore represent the maximum possible benefits that could be expected. The duty cycle of the viscous clutch fan is not known, but may well be such that the fuel economy gain is considerably smaller than estimated. Lacking precise information, a lower limit of zero fuel economy improvement will be adopted for the purpose of estimating the uncertainty range of fuel savings for this device.

The use of the electric fan has been assumed to effectively delete the fan power requirements from the engine and has been evaluated in terms of the estimated average fan horsepower load, based on simulated driving cycles. Some additional alternator burden may be imposed on the engine, so that the actual reduction in fan load is not known precisely. If an error of



25% in the estimated fuel economy benefit is assumed, an error in the estimated fuel savings of about 450 million gallons per year for both the 1976 and 1982 fleets would result.

The potential fuel economy gain associated with the use of the variable accessory drive system is based on the results achieved for one vehicle over the urban and highway driving cycles. It is estimated that the fuel savings could vary by  $\pm 15\%$  among vehicles of different weight, size, and accessory complement.

#### 4.1.4 Variable Cylinder Engine Operation

##### 4.1.4.1 Applicability to National Fleet

The carburetor-controlled variable cylinder engine concept, as discussed in Section 3.1.4.2.2, is applicable only to that portion of the fleet equipped with V-8 engines (the intake manifolds of V-6 and in-line engines are unsuitable for this purpose).

Historical data on passenger cars equipped with V-8 engines as a percentage of new passenger car sales by model year (Ref. 4-4) indicate a V-8 engine market penetration ranging from 50 to 80% in the 1960's. Current (1976-77) installation in new cars is about 70% of domestic sales. Integration of the yearly installation rate for model years comprising the 1976 passenger car fleet indicates that about 67% of the fleet is equipped with V-8 engines. No projections on V-8 engine sales for future model years are available. The literature dealing with automobile industry options for meeting statutory fuel economy standards is in general agreement that engine down-sizing will occur. However, a number of sources indicate that, although some V-8's may be replaced by V-6's, many V-8's will themselves be down-sized (Refs. 4-4, 4-5). On the basis of these general comments regarding trends in engine sizes, it will be assumed that the use of V-8 engines in domestic new car production will decline approximately linearly to a rate in 1982 that is one-half of the 1976-77 rate, or about 35%. Assuming further that domestic passenger cars will continue to constitute about 85% of the total (domestic and import) passenger car fleet, and on the basis of the fleet composition by model year discussed in Section 2.2, it is determined that V-8 engines will comprise about 53% of the 1982 in-use passenger car fleet.

With regard to the light duty truck fleet, considerably less information on V-8 engine use is available. Over the past 3 years, approximately 75 to 80% of the domestic light duty trucks (under 10,000 lb GVW) have been equipped with V-8 engines (Ref. 4-6). The domestic trucks make up about 92% of the total light duty truck fleet, indicating a V-8 engine usage of about 70% in the 1976 model year. In the absence of any other information, it will be assumed that this figure applies to the entire 1976 light duty truck fleet. For the 1982 fleet, some reduction in the use of V-8 engines may be anticipated in view of the fuel economy standard already set for 1979 model year under-6000-lb non-passenger automobiles (e.g., pickup trucks and vans) and for four-wheel drive jeep type vehicles (Ref. 4-7). It will therefore be assumed for the 1982 in-use fleet that approximately 70% of the domestic light duty trucks or about 60% of the total fleet will be equipped with V-8 engines.

#### 4.1.4.2 Fleet Fuel Savings

The use of the variable cylinder engine concept was shown in Section 3.1.4.2 to provide a composite fuel economy gain of 8.7% (fuel consumption reduction of 8.0%). Applying this to the applicable vehicles in the 1976 and 1982 fleets as developed above yields the data presented in Table 4-7, showing the fuel savings that would be realized if this concept were to be retrofitted to all applicable vehicles in the respective fleets. The total savings are 5.0 billion gallons for the 1976 fleet, and 3.9 billion gallons for the 1982 fleet. These numbers are based on the fleet mileage accumulations for a 1-year period of time.

#### 4.1.4.3 National Cost

The installed unit cost for variable cylinder engine operation was estimated in Section 3.1.4.5 to be about \$100. Based on the 1976 and 1982 fleet composition (Section 2.2) and the distribution of V-8 engines in the fleet, some 82 million vehicles in the 1976 fleet and about 77 million vehicles in the 1982 fleet could be retrofitted with this concept. At a conversion cost of \$100, this would involve a national investment of about \$8.2 billion for the 1976 fleet and \$7.7 billion for the 1982 fleet.

Offsetting these costs are the savings in fuel costs which result from the improvement in vehicle fuel economy. These fuel cost savings are

TABLE 4-7. FLEET FUEL SAVINGS ATTRIBUTABLE TO  
VARIABLE CYLINDER ENGINE OPERATION

Fleet Sector	1976 Fleet		1982 Fleet	
	Percent Applicable	Fleet Fuel Savings* (10 <sup>9</sup> gal)	Percent Applicable	Fleet Fuel Savings* (10 <sup>9</sup> gal)
Passenger Cars	67	3.94	53	2.76
Light Duty Trucks	70	1.07	60	1.18
Total Fleet	68	5.00	54	3.94

\* Based on applicable mileage accumulated for the year indicated.

estimated to amount to about \$3.5 billion for the 1976 fleet and \$2.7 billion for the 1982 fleet, based on a fuel cost of \$0.70/gallon.

Cost factors associated with the variable cylinder engine concept are summarized in Table 4-8.

#### 4.1.4.4 Potential Implementation Problems

Neither cost-benefit considerations nor vehicle performance effects are expected to strongly hinder consumer acceptance in the case of the variable cylinder engine concept. Nevertheless, at a cost of \$100 and at a return of only \$42 per year for the 1976 fleet and \$36 per year for the 1982 fleet, it is difficult to make a strong case for the appeal of this system. In this regard, it is noted that the available market for variable cylinder operation is effectively truncated at cars 14 years and older since the expected lifetime of such cars does not allow a net monetary benefit to be realized through ownership of the device (see survivability curve in Section 2.2). However, the fuel consumption of this segment of the market is too small to influence the magnitude of the fleet fuel savings quoted earlier.

One factor impacting the early implementation of this device is its present state of commercial development. This system is still in an experimental stage, and no production capability exists. This is discussed further under Estimated Lead Time to Implementation.

Several technical problems may also affect the implementation of the carburetor-controlled variable-cylinder engine concept. Although developmental models have been demonstrated, no FTP emission testing has been conducted. Thus the ability of this system to meet specific model year emissions standards is at present unknown. Theoretical considerations would indicate that  $\text{NO}_x$  would increase due to the higher BMEP when the engine is in the 4-cylinder operating mode. Hydrocarbon and carbon monoxide emissions may also increase over the driving cycle due to the on-off operation of four of the cylinders. On-off operation may also affect the durability of the engine in terms of uneven wear. Extensive life demonstration tests may be required. The possible effect, if any, on catalyst-equipped vehicles also has to be evaluated and could influence the number of vehicles to which the concept is applicable.



TABLE 4-8. COST FACTORS FOR VARIABLE CYLINDER  
ENGINE OPERATION

Fleet Sector	1976 Fleet			1982 Fleet		
	Applicable Vehicles (Millions)	Fleet Cost (\$Billions)	Fleet Fuel Cost Savings (\$Billions)*	Applicable Vehicles (Millions)	Fleet Cost (\$Billions)	Fleet Fuel Cost Savings (\$Billions)*
Passenger Cars	66.8	6.68	2.8	57.9	5.79	1.9
Light Duty Trucks	15.3	1.53	0.7	19.1	1.91	0.8
Total Fleet	82.1	8.21	3.5	77.0	7.70	2.7

\*Based on \$0.70 per gallon and mileage accumulated for the year indicated.

#### 4.1.4.5 Estimated Lead Time to Implementation

As discussed in Section 3.1.4.4, at least one retrofit experimental device for variable cylinder operation is under development, with about 1 year additional development required. Also, additional time must be allocated for the development of a production capability to meet a potential aftermarket of 50 to 60 million vehicles.

The tooling required to produce conventional 2- and 4-barrel carburetors probably could be used to produce the modified jets and other mechanisms required in this system. Thus if the major carburetor manufacturers, e.g., Carter, Holley, Rochester, were to produce the necessary parts required for this system, it is expected that existing facilities could be utilized. Changeover probably could be accomplished in 1 to 1-1/2 years, compared to the 2 years required for production engineering and tooling of an all-new system (Ref. 4-8). Thus a minimum lead time of 2 to 2-1/2 years is required to establish a substantial parts production capability for the variable cylinder retrofit concept, while total fleet implementation cannot be expected to take place sooner than 3 to 3-1/2 years.

#### 4.1.4.6 Areas of Uncertainty and Magnitude of Possible Errors

The potential fuel savings that might be realized by implementing the variable cylinder engine concept has been based on computer simulations and theoretical analyses rather than on actual test data over the urban and highway driving cycles. Thus, while a potential for reducing fuel consumption is quite evident, the absolute magnitude must be demonstrated for a wide variety of vehicles in order to accurately assess the value of this system. It is estimated that the FMEP assumptions used in the assessment of part-cylinder operating effects could be in error by  $\pm 20\%$ . Based on a sensitivity analysis conducted in The Aerospace Corporation study of this system (Ref. 4-9), this error could change the estimated fuel economy improvement potential for this device from 8.7% to values ranging from about 6 to 13%. In terms of fleet fuel consumption savings, this means that the numbers quoted earlier actually could be lower by 30% or higher by about 45%.

An additional area of uncertainty lies in the number of vehicles for which this system is applicable. It has been assumed, for the purposes of this study, that all V-8 engines could be converted. The number of

applicable vehicles might be reduced, however, if durability testing of the system indicates that catalyst-equipped vehicles could not be utilized because of adverse effects on catalyst life. In this case, the indicated fuel savings for the 1976 fleet would be reduced by 23% and for the 1982 fleet by 78%, assuming that all 1975 and subsequent model year cars are catalyst-equipped.

#### 4.1.5 Intake Air Temperature Control

An analysis made of the fuel economy improvement potential of intake air temperature control led to the conclusion that this technique offers negligible fuel savings because of its limited applicability to the in-use fleet. Additional details concerning this assessment are provided in Section 3.1.5.

#### 4.1.6 Engine Preheater

##### 4.1.6.1 Applicability to National Fleet

No restrictions on the applicability of the engine preheater are identified except those related to ambient temperature and its effect on usage and fuel economy benefits. It was established in Section 3.1.6 that the engine preheater is likely to be utilized at cold start ambient conditions at or below freezing, and that at these conditions the device could provide a 1% improvement in fuel economy. In general, this benefit will be realized for short trips only. In this regard, Ref. 4-10 provides data showing that over 90% of all trips and 60% of all vehicle-miles traveled (VMT) occur in short trips under 20 miles, where the fuel economy benefits of the cold start heater at the 1% improvement level would be expected to apply. This study employs an upper limit estimate of the fuel consumption benefits of the preheater based on the assumption that the system is utilized, and the 1% fuel economy improvement applies, for all VMT at ambient conditions in the temperature range of interest.

##### 4.1.6.2 Fleet Fuel Savings

The distribution of VMT in the U.S. versus ambient temperature is shown in Figure 4-2 (Ref. 4-10). Since no significant difference is seen between urban and rural driving, this variable need not be considered in the applicability of the engine preheater to the national fleet. An integration of this data indicates that 11.3% of the fleet VMT occurs at or below the 32°F level. For this fraction of the VMT, a 1% fuel economy improvement would yield a fuel savings of about 100 million gallons for both the 1976 and 1982 fleets.

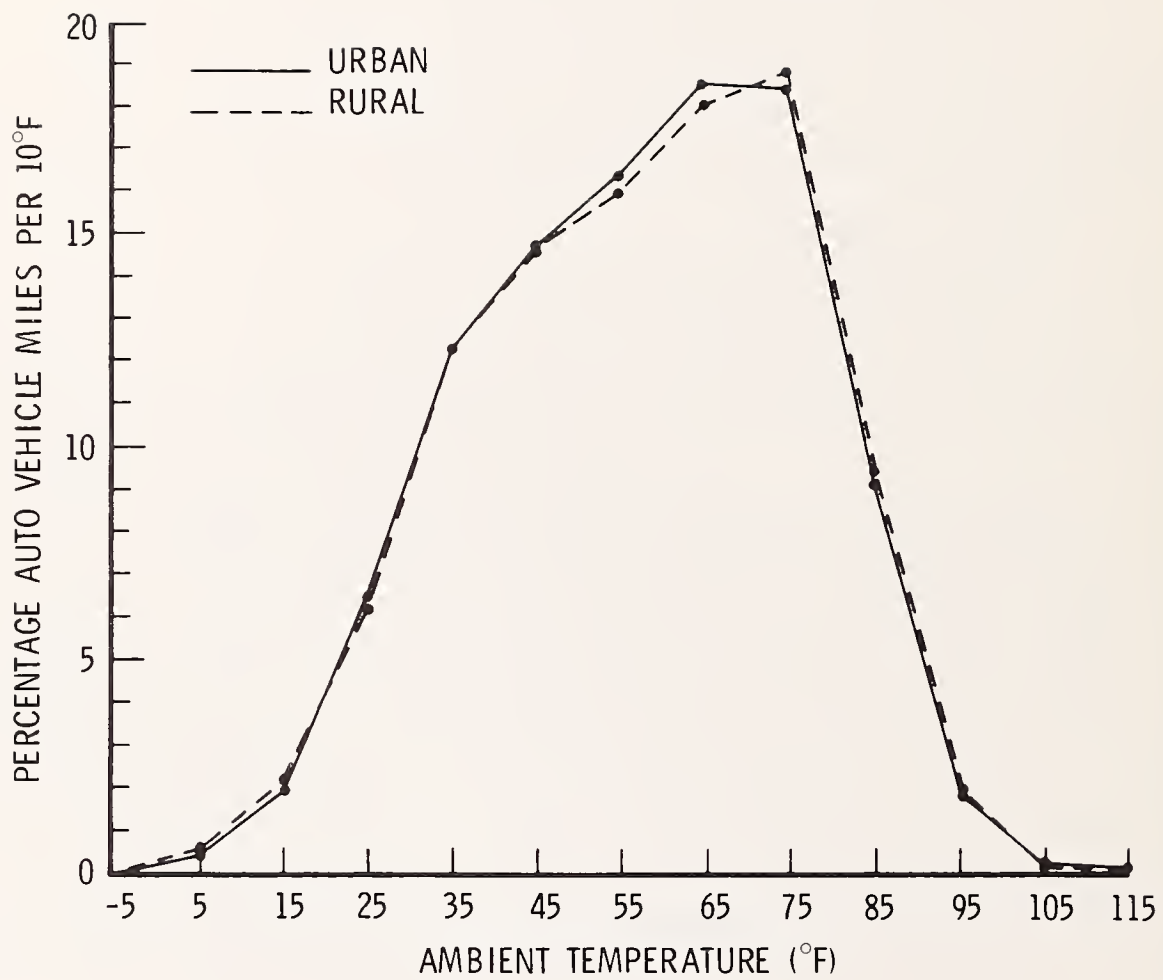

FIGURE 4-2. DISTRIBUTION OF VEHICLE-MILES DRIVEN BY AUTOS IN USA VERSUS AMBIENT TEMPERATURE (Ref. 4-10)



#### 4.1.6.3 National Cost

In assessing the national cost, several factors must be taken into consideration: initial cost, operating costs (electrical power), and fuel cost savings. On an individual car basis, the initial cost, including installation, has been estimated to be about \$60 (Section 3.1.6.5), while annual operating costs are estimated to be \$15. A rough estimate of the number of vehicles to which these costs apply may be obtained by assuming that the national VMT under cold conditions is accumulated uniformly at the average national mileage rate over a 4-month period. This estimate is developed in Table 4-9, showing also the national cost and fleet fuel cost savings factors for this device. As expected, the engine preheater is highly cost-ineffective; the operating costs exceed the fleet fuel savings by factors of nearly 8 and 9 for the 1976 and 1982 fleets, respectively.

#### 4.1.6.4 Potential Implementation Problems

The most significant implementation problem identified for this device is its potentially low appeal to the consumer in regard to fuel economy benefit versus purchase price and operating cost. The operating cost is not recoverable through fuel cost savings. Although some value must be assigned to the primary purpose of the device, that of providing easier starts under cold conditions, that value may be minimal in the view of all but a small number of drivers represented by the present sales market.

#### 4.1.6.5 Estimated Lead Time to Implementation

As noted in Section 3.1.6, present production rates of the engine preheater are extremely low. One manufacturer, Kim Hotstart Manufacturing Co. (Ref. 4-11) estimates that the current nationwide production capacity might be 100,000 units. Nevertheless, it is not expected that more than a 2-year lead time would be required to increase production capacity by a factor of 10 or more. The total fleet demand could easily be met in a period of 3 to 4 years. Such capabilities have been demonstrated, for example, by manufacturers and suppliers of automotive ignition systems.

#### 4.1.6.6 Areas of Uncertainty and Magnitude of Possible Errors

The nature of the use characteristics of this device has necessitated a number of broad assumptions concerning its implementation and operation in the national fleet. Most of these assumptions tend to inflate the

TABLE 4-9. COST FACTORS FOR ENGINE PREHEATER

	1976 Fleet	1982 Fleet
Fleet VMT, $10^9$ mi	1347	1569
Applicable VMT, $10^9$ mi	152	169
Average Annual Vehicle Miles	11,100	11,100
Applicable Vehicles, Millions	41	48
Fleet Installation Cost, \$ Billions	2.55	2.97
Fleet Operating Cost, \$ Billions	0.62	0.72
Fleet Total Cost (1 yr) <sup>a</sup> , \$ Billions	3.17	3.69
Fleet Fuel Savings, $10^9$ gal	0.103	0.100
Fleet Fuel Cost Savings, <sup>b</sup> \$ Millions	72.4	70.3

<sup>a</sup> Includes initial cost plus operating cost for 1 year.

<sup>b</sup> Based on \$0.70 per gallon and applicable mileage accumulated for the year indicated.

magnitude of the national fleet savings assigned to this device. It is estimated that these savings, small as they are, could be in error by as much as a factor of 2 to 3 on the high side.

#### 4.1.7 Tire Modifications

##### 4.1.7.1 Applicability to National Fleet

Radial tires are currently used in all sectors of the motor vehicle population, including heavy duty trucks and off-road vehicles (Ref. 4-12). The primary constraint on radial tire conversion would therefore appear to be the rate at which radial tires might be placed in operation, rather than their applicability. As discussed in Section 3.1.7.4, the current usage of radial tires is approximately 30% for the passenger car fleet and 5% for the light duty truck fleet. Projections to 1982 indicate that 90% of the passenger cars and 15% of the light duty trucks will be using radial tires. For projection purposes, these aftermarket penetration rates will be assumed to be indicative of the in-use radial tire population.

100 percent applicability is assumed for maintaining recommended tire pressures and for operating at overinflated tire pressures.

##### 4.1.7.2 Fleet Fuel Savings

The fuel economy gain attributable to the use of radial tires has been estimated at 2.5%, as discussed in Section 3.1.7.2 for both the passenger car and light duty truck fleets. Fleet fuel savings based on this 2.5% improvement in fuel economy and the fraction of the fleet operating on non-radial tires which could convert to radial usage are presented in Table 4-10.

TABLE 4-10. FLEET FUEL SAVINGS ATTRIBUTABLE TO CONVERSION TO RADIAL TIRES

Fleet Sector	1976 Fleet		1982 Fleet	
	Percent Applicable	Fleet Fuel Savings* (10 <sup>9</sup> gal)	Percent Applicable	Fleet Fuel Savings* (10 <sup>9</sup> gal)
Passenger Cars	70	1.25	10	0.16
Light Duty Trucks	95	0.44	85	0.51
Total Fleet Savings		1.69		0.67

\*Based on applicable mileage for year indicated.

Thus, if the indicated portions of the fleet could be converted to radial tires, a maximum potential fuel savings of about 1.7 billion gallons per year could be realized for the 1976 fleet (1.8% of the total fleet fuel consumption). In terms of the 1982 fleet, the total savings would be about 0.67 billion gallons per year (0.7% of the total fleet fuel consumption). This reduced value relative to 1976 savings results from the considerably smaller fraction of vehicles projected to be using non-radial tires in 1982.

Maintaining the recommended inflation pressure provides an immediate way to recover fuel losses caused by vehicles operating on under-inflated tires. Fleet fuel savings attributable to this approach are shown in Table 4-11. Based on the assumptions discussed in Section 3.1.7.2 that 30% of the fleet would be operating at 4 psi below the recommended pressure and the remaining 70% of the fleet at 2 psi under the recommended pressure, this approach would yield a fuel savings of 1.53 billion gallons for the 1976 fleet and about 1 billion gallons for the 1982 fleet. The reduced savings in the 1982 fleet reflects a higher fraction of cars equipped with radial tires.

Operating the passenger car and light duty truck fleets at the maximum rated pressures of +8 psi and +15 psi, respectively, would result in greater fuel savings than either the conversion to radial tires or maintaining the fleet at the recommended tire pressures. The data for this approach is included in Table 4-11. The fuel savings would be 5.3 billion gallons for the 1976 fleet and 4.0 billion gallons for the 1982 fleet.

It is of interest to note that maintaining the recommended tire inflation pressure will result in essentially the same fuel savings as a conversion to radial tires with respect to the 1976 fleet and greater savings with respect to the 1982 fleet. This is of particular significance because of the marked cost differential between the two.



TABLE 4-11. FLEET FUEL SAVINGS ATTRIBUTABLE TO TIRE INFLATION PRESSURE

Technique	1976 Fleet		1982 Fleet	
	Percent Applicable	Fleet Fuel Savings (10 <sup>9</sup> gal)*	Percent Applicable	Fleet Fuel Savings (10 <sup>9</sup> gal)*
<u>Maintaining Recommended Pressures</u>				
Passenger Cars	100	1.17	100	0.59
Trucks	100	0.36	100	0.43
Total Fleet	100	1.53	100	1.02
<u>Operation at Overinflation Pressures</u>				
Passenger Cars	100	3.42	100	1.74
Trucks	100	1.88	100	2.27
Total Fleet	100	5.30	100	4.01

\*Based on applicable VMT for year indicated.

#### 4.1.7.3 National Cost

The conversion to radial tires of those vehicles which are not so equipped would involve about 90 million vehicles in the 1976 fleet and about 38 million vehicles in the 1982 fleet based on the radial tire usage rates estimated in Section 3.1.7.4 for these time periods. With an incremental cost of \$25 per tire and 5 tires per vehicle, conversion costs would be about \$11.3 billion for the 1976 fleet and \$4.7 billion for the 1982 fleet.

Maintaining the recommended tire pressure could actually be achieved at no cost to the vehicle operator simply by using existing service station tire pressure gages. However, in order to assess the potential maximum costs involved, it has been assumed that each vehicle is equipped with

an individual tire pressure gage (\$2) and that the tires are fitted with a set of valve stem pressure indicators (\$5 for set of 5). This would result in a maximum fleet cost of about \$850 million in 1976 and \$990 million in 1982.

Operating the vehicle at tire inflation pressures above the recommended value represents an extension of the underinflation case and would not result in any increased cost.

Each of the foregoing implementation costs would be offset by fuel cost savings. These and other cost factors relating to tires are summarized in Table 4-12. Costs related to maintaining inflation pressure are identical for the under- and overinflation cases, since the tire pressure gage and valve stem pressure indicators would be used in the implementation of either approach.

#### 4.1.7.4 Potential Implementation Problems

Two factors appear to be predominant in terms of implementing the application of radial tires to the entire fleet. As previously indicated, the domestic tire industry does not now have the production capacity to achieve a 100% installation rate. The industry currently can meet 100% of the new car requirements, but only a fraction of the aftermarket (Ref. 4-8). Thus, either additional facilities or the conversion of existing facilities to radial tire production would be required. The projected radial tire trends shown in Section 3.1.7.4 suggest that the production capacity is being increased and may be capable of supplying 100% radials by 1982. The other factor involves the differential cost of radial and non-radial tires in the replacement market. Since the radial tire costs about \$25 more than the non-radial tire, considerable buyer resistance may be encountered, particularly in the older car sector of the market. Approximately 15% of the cars in the 1976 and 1982 fleets are over 10 years of age and are probably not regarded to be of sufficient value to warrant extra expenditure for radial tires.

With regard to inflation pressure, two problem areas are evident. One is the general accuracy of gas station gages, which Goodyear has indicated to be very poor (Ref. 4-8). As a result, Goodyear suggested that perhaps the most meaningful approach to reducing fuel consumption due to underinflation would be to require that service stations tire gages be certified to

TABLE 4-12. COST FACTORS FOR TIRE MODIFICATIONS

Technique	1976 Fleet			1982 Fleet		
	Applicable Vehicles (Millions)	Fleet Cost (\$ Billions)	Fleet Fuel Cost Savings (\$ Billions)	Applicable Vehicles (Millions)	Fleet Cost (\$ Billions)	Fleet Fuel Cost Savings (\$ Billions)
<u>Conversion to Radial Tires</u>						
Passenger Cars	69.79	8.72	0.88	10.93	1.37	0.11
Trucks	20.71	2.59	0.31	27.03	3.38	0.36
Total Fleet	90.50	11.31	1.19	37.96	4.75	0.57
<u>Inflation Pressure Effects</u>						
<u>Maintaining Recommended Pressure</u>						
Passenger Cars	99.70		0.82	109.3	*	0.41
Trucks	21.80		0.25	31.8	*	0.30
Total Fleet	121.50		1.07	141.1	*	0.71
<u>Maintaining Overinflated Pressure</u>						
Passenger Cars	99.70		2.40	109.3	*	1.22
Trucks	21.80		1.31	31.8	*	1.59
Total Fleet	121.50		3.71	141.1	*	2.81
<u>Combined Inflation Pressure Effects</u>						
Passenger Cars	99.70	0.70	3.22	109.3	0.77	1.63
Trucks	21.80	0.15	1.56	31.8	0.22	1.89
Total Fleet	121.50	0.85	4.78	141.1	0.99	3.52

\* Shown under combined effects.

be within certain accuracy limits. The other alternative, of course, would be for the vehicle owner to purchase his own tire gage. But in either case, whether or not the owner would make proper use of the gage is a moot question. Here, it would seem that an educational and promotional program would be of considerable benefit.

#### 4.1.7.5 Estimated Lead Time to Implementation

The trends in radial tire usage discussed in Section 3.1.7.4 represent the industry's estimation of the market growth and are indirect evidence that the industry will be able to meet the projected demand through an existing or planned capacity for increased production. These trends suggest that the complete passenger car fleet could be equipped by 1982; there is no reason to believe that the truck fleet could not be similarly serviced if the demand existed. The shortest possible lead time to total fleet implementation is estimated at 4 years, based on the potential replacement market which becomes available as present tires wear at an assumed mileage accumulation rate of 10,000 mpy.

#### 4.1.7.6 Areas of Uncertainty and Magnitude of Possible Errors

There are several uncertainties in the assessment of potential fuel consumption benefits which might be derived from a fleet transition to radial tires. One is the actual in-use fuel economy gain; the other is the number of vehicles to which it applies. The gain has been estimated to be on the order of 2-1/2%, which results in a fuel savings of about 1.7 billion gallons annually when applied to 75% of the 1976 nationwide fleet. It is estimated that the percent fuel economy gain for radial tires could be in error by as much as 1/2%, corresponding to a difference in fuel savings of about 330 and 130 million gallons for the 1976 and 1982 fleets, respectively. If the fleet applicability does not include the 15% of cars older than 10 years, then the fuel savings would be less by 103 and 68 million gallons per year for the 1976 and 1982 fleets. These effects could be offsetting, in which case the decrement in the estimated savings would be smaller than the numbers quoted above. If additive on the low side, however, the estimated savings could be off by as much as 400 million gallons in the case of the 1976 fleet.



Very few statistics on tire underinflation are available, and the estimate of 30% at an underinflation of 4 psi or more and 70% at 2 psi could be considerably in error. The sensitivity of the results to the assumptions may be judged by noting that if the calculations were based on 100% underinflation at 2 psi, the savings would change from 1.53 to 1.18 billion gallons for the 1976 fleet and from 1.01 to 0.78 billion gallons for the 1982 fleet. Moreover, the sustained cooperation of the car operator is required in order to achieve the results quoted. It is quite possible that the net effective savings could be reduced by 50% due solely to driver loss of interest after a period of time.

#### 4.1.8 Drag Reduction Devices

##### 4.1.8.1 Applicability to National Fleet

The aftermarket use of both front dams and rear spoilers is assumed to be applicable to all passenger cars in the 1976 fleet. There are some high performance car models for which these aids (primarily the front dam) are available as a new car option, but the number of cars so equipped is negligible. Recently proposed EPA fuel economy test procedures would add credit to the test-derived value of fuel economy for patently superior vehicle aerodynamic features. This may encourage automobile manufacturers to incorporate front dams and/or rear spoilers as standard equipment on some car lines to help meet mandated fuel economy standards. It is therefore assumed that increased OEM implementation of these aids will occur to a level of, say, 5% in the 1981 model year and 10% in the 1982 model year.

As discussed in Section 3.1.8, the aftermarket for front dams is assumed to include Class I pickup trucks (but not any other type of LDT). Publications of the Motor Vehicle Manufacturing Association (Refs. 4-13 and 4-14) show that in 1971, 70.7% of Class I LDT sales were pickup trucks; the corresponding figure for 1976 sales was 69.3%. On the basis of these values, it will be assumed that 70% of Class I LDT sales for all model years are suitable for retrofitting a front dam. No allowance will be made for OEM implementation of front dams in LDT's.

#### 4.1.8.2 Fleet Fuel Savings

The fleet fuel savings for drag reduction devices will be based on the assumption that the front dam and rear spoilers will be installed in combination for all passenger cars, and the front dam alone will be installed in all Class I pickup trucks. A fuel economy benefit potential of 2% for the combination of front dam and rear spoiler, and 1% for the front dam alone, was established in Section 3.1.8.2. These values, combined with the vehicle applicability data described above, result in the fleet fuel consumption factors shown in Table 4-13. Savings in fleet fuel consumption of 1.5 billion gallons are computed for the 1976 national fleet, and 1.3 billion gallons for the 1982 fleet. Approximately 95% of these savings are attributable to the passenger car fleet.

#### 4.1.8.3 National Cost

Using the unit installed costs developed in Section 3.1.8.5 of \$100 for the front dam and rear spoiler combined and \$65 for the front dam alone, the fleet costs for the implementation of drag reduction devices are computed as shown in Table 4-14. The costs are \$10.7 billion for the 1976 fleet, and \$11.7 billion for the 1982 fleet. This approach is clearly cost-ineffective; for passenger cars, the savings in fuel costs is only about 10% of the installed cost.

#### 4.1.8.4 Potential Implementation Problems

The implementation problems identified for drag reduction devices relate primarily to negative consumer acceptance stemming from the following factors: (a) high cost, (b) poor (unusual) visual appearance of the hardware as mounted, and (c) potential ground clearance problems in the case of the front dam. In addition to car owners who may object to the retrofit installation of these devices on the basis of appearance, others may recognize that the front dam could cause ground clearance problems. Although the front dams considered in this report extend downward no further (as a maximum) than the vehicle underbody, the location of the front dam just behind the bumper may still cause problems in some cases. An example would be when entering a driveway which slopes up sharply from the road surface.

TABLE 4-13. FLEET FUEL SAVINGS ATTRIBUTABLE TO DRAG REDUCTION DEVICES<sup>a</sup>

Fleet Sector	1976 Fleet		1982 Fleet	
	Percent Applicable	Fleet Fuel Savings <sup>b</sup> (10 <sup>9</sup> gal)	Percent Applicable	Fleet Fuel Savings <sup>b</sup> (10 <sup>9</sup> gal)
Passenger Cars	100	1.439	98.5	1.255
Light Duty Trucks				
Class I LDT	70.0	0.076	70.0	0.079
Class II LDT	0	0	0	0
LDT Total	48.5	0.076	44.5	0.079
Total Fleet	90.8	1.515	86.3	1.334

<sup>a</sup>Front dam and rear spoilers for passenger cars; front dam only for Class I pickup trucks.

<sup>b</sup>Based on applicable mileage accumulated for year indicated.

TABLE 4-14. COST FACTORS FOR DRAG REDUCTION DEVICES

Fleet Sector	1976 Fleet			1982 Fleet		
	Applicable Vehicles (Millions)	Fleet Cost <sup>a</sup> (\$ Billions)	Fleet Fuel Cost Savings <sup>b</sup> (\$ Billions)	Applicable Vehicles (Millions)	Fleet Cost <sup>a</sup> (\$ Billions)	Fleet Fuel Cost Savings <sup>b</sup> (\$ Billions)
Passenger Cars	99.72	9.97	1.007	107.52	10.75	0.878
Light Duty Trucks						
Class I LDT	10.55	0.69	0.053	14.17	0.92	0.055
Class II LDT	0	0	0	0	0	0
LDT Total	10.55	0.69	0.053	14.17	0.92	0.055
Total Fleet	110.27	10.66	1.060	121.74	11.67	0.933

<sup>a</sup>Based on installment cost of \$100 for front dam and rear spoiler combined, \$65 for front dam only.

<sup>b</sup>Based on applicable accumulated mileage for year indicated.



The simple configuration of these aerodynamic devices suggests that mass production techniques could lower the prices substantially below those used in this analysis. Militating against this possibility, however, is the fact that many model-specific configurations may be required, so that inventory effects could inhibit a substantial reduction in the device cost.

#### 4.1.8.5 Estimated Lead Time to Implementation

No significant problems in manufacturing these devices are identified. It seems likely that many of the current producers of aero devices for large trucks (e.g., Air Flo Company, Elkhart, Indiana; Aerovironment, Inc., Pasadena, California; Rudkin-Wiley Company, Stratford, Connecticut; General Motors) would be eager to expand their product lines to encompass passenger car systems if a substantial market for such devices existed. Such suppliers, it is estimated, could commence production of passenger car and light duty truck devices within 14 months and could achieve a substantial production capacity in 2 years. Thus, much, if not all, of the in-use fleet could be equipped by 1982.

#### 4.1.8.6 Areas of Uncertainty and Magnitude of Possible Errors

Based on the experimental work summarized in Section 3.1.8.2, it appears that the beneficial effects of the front dam may be nearly universal for the spectrum of passenger car geometries in the national fleet. The benefits of the rear spoiler may be more dependent on model-specific rear-end geometry. Experimental work has concentrated on the presently popular types of rear end configurations (i.e., hatchback, notchback, and fastback), and the benefits and proper location of rear spoilers appear to be reasonably well defined for these shapes. These data may be applicable to many, but perhaps not all, of the geometries of older cars in the national fleet. For example, the VW "Beetle" may not be adequately characterized by the work done to date. In addition, add-on equipment such as luggage racks may alter the rear-end air flow pattern in vehicles with otherwise conventional shapes.

The above exceptions notwithstanding, it appears that the benefits of aerodynamic aid devices are reasonably well defined. It is estimated that the average fuel economy improvement obtainable with a front dam combined with rear spoiler will be in the range from 1 to 3%. The lower figure would

reduce the fuel savings shown in Table 4-13 to 0.8 and 0.7 billion gallons for the 1976 and 1982 fleets, respectively.

#### 4.1.9 Improved Lubricants

##### 4.1.9.1 Applicability to National Fleet

The improved lubricants described in Section 3.1.9 are assumed to be applicable to every vehicle in the national fleet. It is recognized that the current data base for automotive use of improved engine oils does not explicitly cover diesel engines. However, there is no known reason why these lubricants may not be successfully used in diesel engines (and some have been so tested), while the use of improved differential oils would be applicable in any event.

##### 4.1.9.2 Fleet Fuel Savings

An average fuel economy benefit of 3% due to the combined effect of improved engine and differential oils (as described in Section 3.1.9) is assigned to all vehicles. Fleet fuel savings are shown in Table 4-15.

##### 4.1.9.3 National Cost

Estimates of the national cost related to improved lubricants are based on the present average retail price for mineral oils with improved friction modifier additives, i.e., about \$1.40 per quart, and on the present price of conventional oils, taken as \$0.80 per quart. As discussed in Section 3.1.9.5, other types of improved lubricants such as fully synthetic oils appear to offer essentially the same EPA fuel economy benefit but at a substantially higher price. Although these higher priced lubricants may possess additional advantages such as extended drain capability and improved performance under conditions of severe weather or engine loading, this report assumes that these additional benefits will be discounted by most consumers in the face of the higher price. It is therefore likely that the lower priced mineral oils with improved friction modifier packages will be most widely implemented in the national fleet. An average drain interval of 6 months is assumed with an average of 1.5 quarts make-up oil added between drains. Taking the average engine oil capacity as 4.5 quarts, the extra annual cost of using the improved engine oil is  $(4.5 + 1.5) \times 2 \times (\$1.40 - 0.80) = \$7.20$ .

TABLE 4-15. FLEET FUEL SAVINGS ATTRIBUTABLE TO IMPROVED LUBRICANTS

Fleet Sector	1976 Fleet		1982 Fleet	
	Percent Applicable	Fleet Fuel Savings* (10 <sup>9</sup> gal)	Percent Applicable	Fleet Fuel Savings* (10 <sup>9</sup> gal)
Passenger Cars	100	2.138	100	1.898
Light Duty Trucks				
Class I LDT	100	0.321	100	0.333
Class II LDT	100	0.235	100	0.384
Total LDT	100	0.556	100	0.717
Total Fleet	100	2.694	100	2.615

\*Based on applicable mileage accumulated for year indicated.

Replacement of the conventional differential fluid with an improved lubricant is considered to be a one-time-only event. The average cost involved is estimated to be \$1.60 when spread over an assumed 5-year average service life after installation. Thus the total annual cost per vehicle for improved engine oil and differential lubricant would be \$8.80.

The resulting cost factors for the national fleet are shown in Table 4-16. It is seen that the dollar value of the fuel savings is approximately 76% higher than the fleet average costs for the 1976 national fleet, and about 47% higher for the 1982 national fleet. The implementation of improved lubricants under the above assumed conditions is therefore a cost-effective option.

#### 4.1.9.4 Potential Implementation Problems

There are no known major logistic obstacles to the implementation of mineral oils with improved friction modifier additives, but additional testing would probably be required to verify if these oils are fully satisfactory for new and late model vehicle applications under general use conditions.

A potential obstacle to future significant growth in the sale of synthetic oils is a limitation in production capacity. It is noted that synthetic lubricants presently utilize petroleum feedstocks as the raw material, and the process energy requirement to manufacture synthetics is higher than that for mineral oils.

#### 4.1.9.5 Estimated Lead Time to Implementation

Improved mineral oil-based lubricants are currently being marketed by at least two major oil companies, and wide-scale implementation should be possible within approximately 2 years assuming that these oils satisfy durability and compatibility requirements. Major changes to refining techniques and production facilities may be required for wide-scale implementation of synthetic lubricants, and this process could take several years. A significant production level is not likely earlier than 1981 (Ref. 4-8).

#### 4.1.9.6 Areas of Uncertainty and Magnitude of Possible Errors

It appears that the average fuel economy benefit of improved engine and drive train lubricants could lie anywhere in the range from about



TABLE 4-16. COST FACTORS FOR IMPROVED LUBRICANTS

Fleet Sector	1976 Fleet			1982 Fleet		
	Applicable Vehicles (Millions)	Fleet Cost <sup>a</sup> (\$ Billions)	Fleet Fuel Cost Savings <sup>b</sup> (\$ Billions)	Applicable Vehicles (Millions)	Fleet Cost <sup>a</sup> (\$ Billions)	Fleet Fuel Cost Savings <sup>b</sup> (\$ Billions)
Passenger Cars	99.72	0.878	1.497	109.26	0.961	1.329
Light Duty Trucks						
Class I LDT	15.07	0.133	0.225	20.24	0.178	0.233
Class II LDT	6.67	0.059	0.165	11.64	0.102	0.269
Total LDT	21.74	0.191	0.389	31.88	0.281	0.502
Total Fleet	121.46	1.069	1.886	141.14	1.242	1.831

<sup>a</sup>Based on 6-month drain interval +2 qts/yr make-up + differential oil (\$8.80 additional annual expense).

<sup>b</sup>Based on \$0.70 per gallon and fleet mileage accumulated for year indicated.

2% to about 6%. Primary uncertainty is in the upper end of this range due to the relatively limited FTP fuel economy testing performed on some of the more recent promising improved lubricants.

#### 4.1.10 Improved Maintenance

##### 4.1.10.1 Applicability to National Fleet

There are no data available that would indicate the distribution of the interval between tune-up maintenance about the assumed national average of 12 months (see Section 3.1.10.2). Lacking such information, it will be assumed arbitrarily that the proposed, more frequent 6-month tune-up interval discussed in Section 3.1.10.2 is applicable to, say, 70% of all spark ignition engine vehicles in the in-use fleet. The 30% balance will be considered to be already on a fixed, short-term maintenance schedule. Table 4-17 indicates the percentage of vehicles affected for the 1976 and 1982 fleets.

##### 4.1.10.2 Fleet Fuel Savings

As discussed in Section 3.1.10.2, the fuel economy improvement benefits attributable to adopting a 6-month tune-up maintenance schedule in place of the present (national average) 12-month schedule are: 0.75% for vehicles with mechanical breaker point ignition systems and about 1.1% for vehicles with breakerless electronic ignition systems. The assignment of vehicles with OEM electronic ignition is described in Section 4.1.1.1. The present analysis assumes no aftermarket implementation of electronic ignition. The resulting fleet fuel savings are shown in Table 4-17.

##### 4.1.10.3 National Cost

Cost factors for two maintenance scenarios involving tune-up at 6-month intervals will be considered. One of these assumes that all applicable vehicles are tuned using conventional diagnostic procedures such as employed by Tuneup Masters. The other assumes that tune-up adjustments are made in accordance with the indicated requirements of a diagnostic exhaust emission test. Based on the data developed in Section 3.1.10.5, the average cost for tune-up maintenance in the first scenario will be taken as \$42. The cost factors for this approach are shown in Table 4-18, from which it is seen that

TABLE 4-17. FLEET FUEL SAVINGS ATTRIBUTABLE TO TUNE-UP MAINTENANCE<sup>a</sup>

Fleet Sector	1976 Fleet		1982 Fleet	
	Percent Applicable	Fleet Fuel Savings (10 <sup>9</sup> gal) <sup>b</sup>	Percent Applicable	Fleet Fuel Savings (10 <sup>9</sup> gal) <sup>b</sup>
Passenger Cars	69.9	0.436	67.2	0.450
Light Duty Trucks				
Class I LDT	70.0	0.065	68.5	0.078
Class II LDT	70.0	0.052	70.0	0.098
Total LDT	70.0	0.117	69.0	0.176
Total Fleet	69.9	0.553	67.5	0.626

<sup>a</sup> Assumes no aftermarket implementation of electronic ignition.

<sup>b</sup> Based on fleet mileage accumulated for year indicated.

TABLE 4-18. COST FACTORS FOR CONVENTIONAL  
TUNE-UP MAINTENANCE

Fleet Sector	1976 Fleet			1982 Fleet		
	Applicable Vehicles (Millions)	Fleet Cost <sup>a</sup> (\$ Billions)	Fleet Fuel Savings <sup>b</sup> (\$ Billions)	Applicable Vehicles (Millions)	Fleet Cost <sup>a</sup> (\$ Billions)	Fleet Fuel Savings <sup>b</sup> (\$ Billions)
Passenger Cars	69.7	2.930	0.305	73.5	3.086	0.315
Light Duty Trucks						
Class I LDT	10.5	0.443	0.046	13.9	0.582	0.055
Class II LDT	4.7	0.196	0.036	8.1	0.342	0.069
Total LDT	15.2	0.639	0.082	22.0	0.924	0.123
Total Fleet	84.9	3.569	0.387	95.5	4.010	0.438

<sup>a</sup>Increase in tune-up cost over present 12-month schedule, assuming \$42 per tune-up.

<sup>b</sup>Based on \$0.70 per gallon and fleet mileage accumulated for year indicated.



the annual tune-up maintenance costs\* are approximately nine times the dollar value of the annual fuel savings.

The second scenario assumes that diagnostic exhaust emission tests are available at a charge of \$5; this charge would include a checklist form showing the general areas of the ignition and induction system that are indicated as being in need of correction. It is assumed the test is performed every 6 months, and that the average repair cost per vehicle (including those for which no maintenance is indicated and none is performed) is \$21, as discussed in Section 3.1.10.5. The average annual repair cost per vehicle then becomes  $(\$5 + \$21) \times 2 = \$52$ , or \$10 more than the assumed present average annual tune-up cost per vehicle. Cost factors for this scenario are shown in Table 4-19. The data show that this approach, though better than the first scenario, is still not cost effective, the average additional annual repair cost being about twice the dollar value of the average annual fuel savings.

#### 4.1.10.4 Potential Implementation Problems

Poor cost effectiveness is the major implementation problem associated with maintenance. It would be difficult indeed to sell the average driver on a more frequent tune-up schedule when neither perceived performance benefits or cost advantages can be demonstrated.

In the case of the lower-cost approach based on exhaust emission tests, other problems arise. A major potential problem concerns (1) the state of maintenance and calibration of service station analyzers and (2) the capability of the service industry to properly diagnose the emissions data and then to properly perform the indicated maintenance. In an experimental evaluation of an exhaust emissions inspection test program by the CARB (Ref. 4-15), it was found necessary to give special attention to all the above aspects in order to achieve meaningful results. It appears that some form of monitoring or regulation by government (probably at the state level) would be required to provide a consistent set of guidelines and procedures for conducting the emissions tests and diagnosing the results.

---

\* Cost in excess of present (12-month) maintenance schedule.

TABLE 4-19. COST FACTORS FOR TUNE-UP MAINTENANCE BASED ON DIAGNOSTIC EXHAUST EMISSIONS TEST

Fleet Sector	1976 Fleet			1982 Fleet		
	Applicable Vehicles (Millions)	Fleet Cost <sup>a</sup> (\$ Billions)	Fleet Fuel Savings <sup>b</sup> (\$ Billions)	Applicable Vehicles (Millions)	Fleet Cost <sup>a</sup> (\$ Billions)	Fleet Fuel Savings <sup>b</sup> (\$ Billions)
Passenger Cars	69.8	0.697	0.305	73.5	0.735	0.315
Light Duty Trucks						
Class I LDT	10.5	0.105	0.046	13.9	0.139	0.055
Class II LDT	4.7	0.047	0.036	8.1	0.081	0.069
Total LDT	15.2	0.152	0.082	22.0	0.220	0.123
Total Fleet	85.0	0.850	0.387	95.5	0.954	0.438

<sup>a</sup>Increase in tune-up cost over present 12-month schedule, assuming \$26 per tune-up.

<sup>b</sup>Based on \$0.70 per gallon and fleet mileage per year indicated.

A potential problem related to hardware stems from the fact that the exhaust sample for catalyst-equipped cars must be taken upstream of the catalyst and such a sampling port is not provided on many catalyst-equipped models. Even on non-catalyst-equipped cars, it would be desirable to have one or more conveniently located probes in the exhaust system which are accessible from the engine compartment. This would not only obviate the possibility of the analysis being affected by defective muffler and tailpipe, but, for some engine configurations at least, could provide more specific diagnostic information. These considerations suggest that for many vehicles there may be an additional first cost associated with the need to provide proper and/or convenient exhaust sample ports.

#### 4.1.10.5 Estimated Lead Time to Implementation

Any broad-based maintenance program of the scale suggested in these discussions would undoubtedly have to be promulgated by government, probably on the state level. Such programs would require enabling legislation and the establishment of a fairly complex administrative and surveillance bureaucracy. This would suggest minimum lead times on the order of several years.

#### 4.1.10.6 Areas of Uncertainty and Magnitude of Possible Errors

A key uncertainty concerns the variability of the experimental data base and the lack of uniformity in test procedure by which fuel economy improvements have been measured. A second significant uncertainty concerns the frequency of tune-up maintenance as it presently exists in the national fleet. A third uncertainty pertaining to maintenance based on exhaust analysis concerns the ability of the present automobile service industry to effectively diagnose and properly correct tune-up malfunctions based on exhaust gas analysis. It is considered that the average fuel economy benefit due to more frequent tune-up maintenance could lie anywhere in the range of 0 to about 2%, while the cost aspects of basing tune-up repairs on exhaust emission measurement could vary by about  $\pm 50\%$  from the values assigned.

## 4.2 TRAFFIC MODIFICATIONS

### 4.2.1 Right Turn on Red

#### 4.2.1.1 Applicability to National Fleet

As of 1 January 1977 the legislatures of 43 states had adopted laws allowing drivers to turn right on red, after stopping and yielding the right of way, unless a sign prohibited the turn (general permissive, or western rule). Six other states had laws allowing turns when permitted by sign (sign-permissive, or eastern rule) (Ref. 4-16). Subsequently, several states changed from the eastern rule to the western rule and as of April 1977, a total of 47 states had adopted, or were in the process of adopting, the general permissive or western rule (Ref. 4-17). Two states, Connecticut and Maine, are on the eastern rule, while two jurisdictions currently prohibit right turn on red: Massachusetts and Washington, D.C. When the state of New York adopted the general permissive RTOR rule, cities within the state having a population of 1 million or more were excluded from the provisions of the state law and were authorized to adopt an individual city ordinance. New York City elected to adopt the sign-permissive rule in contrast to the state-wide general permissive rule.

Based on the foregoing, those jurisdictions in which the greatest potential fuel savings could be expected include Massachusetts and Washington, D.C. Some additional fuel savings conceivably could be achieved in those jurisdictions currently on the eastern rule (Connecticut, Maine, and New York City) by shifting to the western rule.

#### 4.2.1.2 Fleet Fuel Savings

The estimate made in Section 3.2.1 that 200 million gallons yearly could be saved by implementing the general permissive RTOR rule in urban areas represents an upper limit to the expected fuel savings. In terms of the 1976 fleet, most states have already implemented either the general permissive or sign-permissive RTOR rule. Hence any potential fuel savings in these areas have already been realized and only those jurisdictions not yet utilizing the general permissive rule would be expected to realize any additional savings.



In estimating the fuel savings attributable to these areas, the following procedures will be adopted. The fuel savings in a given state /jurisdiction will be assumed to be proportional to that state's urban VMT as a percentage of the U.S. total VMT. This ratio will then be applied to the estimated 200 million gallons saved on a nationwide basis. For those states currently on the sign-permissive rule, only those savings attributable to the different implementation rates, i.e., 80% for the general permissive rule compared to 10% for the sign-permissive rule as discussed in Section 3.2.1.2, will be assumed applicable. In the case of New York City, it will be assumed that Manhattan will reflect the 4.9% savings of the Washington, D.C. central business district network (see Section 3.2.1.2), while the remaining portion of the city will reflect average urban savings. These estimated savings are summarized in Table 4-20. The 1982 values shown reflect an assumed 10% growth in the number of intersections that could be involved if RTOR were implemented in that time frame.

#### 4.2.1.3 National Cost

The cost to implement RTOR has been estimated at \$50 per sign, as discussed in Section 3.2.1.5. In the absence of any information regarding the number of intersection approaches available for RTOR consideration in the applicable jurisdiction, national cost factors will be estimated based on the following assumptions:

- a. The fraction of urban VMT in the applicable jurisdictions which were developed in Section 4.2.1.2 will be applied to the estimated 200,000 intersections in the U.S., which will be assumed to have four intersection approaches.
- b. Eighty percent of the total intersection approaches will be suitable for RTOR, leaving 20% which will have to be signed prohibiting RTOR.

On the basis of these assumptions, it is estimated that the total number of applicable intersection approaches would be about 60,800, of which 20%, or about 12,100, would have to be signed. Using the estimated cost of \$50 per sign, this would amount to a total estimated cost of implementation in the remaining jurisdictions not now on the general permissive rule of about \$605,000 in 1976 and \$665,000 in 1982.

TABLE 4-20. FLEET FUEL SAVINGS ATTRIBUTABLE TO RTOR

Jurisdiction	RTOR Rule In Effect	Percent U.S. <sup>a</sup> Urban VMT <sup>a</sup>	Fleet Fuel Savings (10 <sup>6</sup> gal)	
			1976	1982
Massachusetts	None	3.16	6.3 <sup>c</sup>	6.8 <sup>c</sup>
District of Columbia	None	0.42	0.8 <sup>c</sup>	0.9 <sup>c</sup>
Connecticut	Sign	1.99	3.5 <sup>d</sup>	3.7 <sup>d</sup>
Maine	Sign	0.26	0.5 <sup>d</sup>	0.5 <sup>d</sup>
NYC (Excl. Manhattan)	Sign	1.45 <sup>b</sup>	2.5 <sup>d</sup>	2.7 <sup>d</sup>
Manhattan	Sign	0.31 <sup>b</sup>	1.0 <sup>e</sup>	1.1 <sup>e</sup>
			14.6	15.7

<sup>a</sup>Reference 4-18.

<sup>b</sup>Reference 4-19.

<sup>c</sup>General Permissive Rule, 80% intersection implementation assumed.

<sup>d</sup>Allowance made for 10% implementation under existing sign rule.

<sup>e</sup>As above (d). Assumed to be 100% CBD.

Compared with the estimated implementation cost of \$605,000, the estimated fuel cost savings would be about \$10.2 million using an assumed fuel cost of \$0.70 per gallon. Thus even though the implementation of the general permissive RTOR rule is not estimated to result in a significant fuel savings, it is cost effective, with fuel cost savings outweighing the implementation cost by a factor of about 17 to 1.

#### 4.2.1.4 Potential Implementation Problems

Field surveys of the attitudes of both motorists and pedestrians in states where RTOR has been implemented indicate that motorists are in favor of RTOR and would prefer to see it in extensive use. Pedestrians were somewhat less enthusiastic and many, although not a majority, felt that it created an added danger in crossing signalized intersections. This attitude was more predominant among the elderly. The overall positive attitude of the public was concluded to be supportive of RTOR under the general permissive rule (Ref. 4-20) and instrumental in changing to the general permissive rule in several states.

#### 4.2.1.5 Estimated Lead Time to Implementation

The implementation of RTOR is dependent only on the enactment of appropriate legislation and the time required to install the necessary signs at intersection approaches where RTOR is prohibited. An examination of the year the RTOR rule was adopted (given only by year) compared to the effective date (Ref. 4-16) indicates that, in all cases, the effective date of implementation occurred either in the same calendar year as the enactment of enabling legislation or on the first of the following year. Thus it would appear that the lead time to implementation is less than 1 year and may be a matter of a few months. Nebraska, for example, is reported to have adopted the RTOR rule in 1972, with an effective date of 15 February 1972.

With regard to the implementation of the RTOR rule, it has been estimated by the National Committee on Uniform Traffic Laws (Ref. 4-17) that the entire country will have adopted the general permissive rule by not later than 1 January 1980.

#### 4.2.1.6 Areas of Uncertainties and Magnitude of Possible Errors

Uncertainties in estimating the fuel savings attributable to RTOR fall in two broad categories. The first has to do with the selection of a representative value relative to computer simulations or other estimates for a comparatively small area (e. g., a single urban area or CBD) where results indicate a high sensitivity to such factors as the presence or absence of buses, the volume (density) of vehicles and pedestrian traffic, the number of approach lanes, and the number of right turning vehicles. The estimated savings of 14.6 million gallons shown in Table 4-20 was predicated on the average savings over an urban network encompassing most of the variables mentioned above. In particular, this figure was based on a network with heavy bus traffic, which tends to impede access of vehicular traffic to the right lane. Simulations of the same urban network without buses yielded a 7.5% fuel consumption reduction. This figure, if used in estimating the nationwide fuel savings, would have resulted in a savings of about 42 million gallons compared to the 14.6 million obtained using the 2.6% figure.

The second category of possible error lies in extrapolating these simulations to a state or nationwide estimate. Such factors as the number of intersection approaches which permit RTOR, the number of vehicles actually turning right, the fraction of the day over which RTOR is effective at the levels indicated, and the influence of bus traffic, all impact the extrapolation. For example, if the bus traffic were lighter to the extent that the fuel savings were increased 50% to 3.9%, this would result in an additional savings of about 7.5 million gallons. Similarly, if the effective traffic signal operation interval were increased from 12 hours to 18 hours, an additional savings of 7.5 million gallons would be estimated. Similarly, if the 4.9% savings in the CBD were applied to the extrapolations, an additional 3.5 million gallons would be estimated. Combined, these could result in an additional 18.5 million gallons, or a total of 43 million gallons, compared to the 14.6 million calculated. With regard to low end effects, the values adopted for percent fuel consumption reduction (2.6, 4.9) could easily be in error by 50%, which would then yield a fuel savings of 7.3 million gallons compared to the calculated value of 14.6 million.



#### 4.2.2 One-Way Streets

##### 4.2.2.1 Applicability to National Fleet

The applicability of one-way streets on a nationwide basis is virtually indeterminate because of insufficient information regarding the miles of one-way streets presently in operation nationwide, the fraction of urban VMT on one-way streets, and the growth potential for additional one-way streets.

Discussions with representatives of the City and County of Los Angeles and the State of California (Refs. 4-21, 4-22, 4-23), for example, indicate that each level of government maintains records of road mileage only on those roads over which they have jurisdiction. These contacts did not have, nor were they aware of, any compilation of such one-way street data, even on a statewide basis. These discussions also revealed that the state and county (unincorporated portion only) did not have any one-way streets. County records, moreover, did not include any data on any of the 77 incorporated areas within the county. The City of Los Angeles, on the other hand, indicated that out of a total of about 6500 miles under the city's jurisdiction, 94 miles, or about 1-1/2%, are one-way streets. Insufficient information is available to determine whether or not this is representative of the nationwide use of one-way streets, or if it is indicative of the potential application of additional one-way streets. Because of the lack of information on which to base an estimate, a nationwide assessment of the applicability and concomitant fuel savings for one-way streets will not be attempted.

#### 4.2.3 Intersection Control

##### 4.2.3.1 Applicability to National Fleet

The use of traffic activated signals would be applicable to all intersections where the change from a pre-timed signal control system could be shown to result in an overall improvement in fuel economy. As discussed in Section 3.2.3.2, the fuel economy effect is a highly variable quantity which depends on the intersection geometry and traffic characteristics. Even if the fuel economy benefits as a function of intersection characteristics were known with great precision (and they are not), an optimization study of enormous magnitude would still be required to determine the type and number of

nationwide intersections which would produce a maximum return for a minimum investment. It is noted that a literature search failed even to reveal information on the present distribution of traffic signals by type of roadway. Discussions with the Los Angeles County Road Department (Ref. 4-24) and the Traffic Department, City of Los Angeles (Ref. 4-23) also indicated that such information was not available. Lacking further data in this subject area, this study will assume that the implementation of fully actuated traffic signal control is applicable nationwide to all 4- and 6-lane arterials not now equipped.

A nationwide survey covering the 1972-1974 time period (Ref. 4-25) indicates that about one-third of the traffic controllers in use at the end of 1973 were the traffic-actuated type but constituted about 60% of the controllers being purchased from 1972 through 1974. On the basis of the rapid increase (17% per year) in the purchases of traffic actuated controllers over the time period covered in this survey, it is estimated that they constitute approximately 40% of the in-use total in 1976. This means that about 60% of the in-use controllers are pre-timed units. Extrapolating these reported growth rates in the usage of traffic actuated controllers suggests a 50% use level in 1982.

It has been estimated that there are currently about 200,000 signalized intersections in the U.S. (Ref. 4-26). On the basis that 60% of these (or about 120,000) are pre-timed, and assuming that 80% of the 120,000 are arterially placed, then about 96,000 intersections would be applicable for consideration in 1976. In the 1982 time period a growth rate of 10% (proportional to VMT) in the total number of signalized intersections will be assumed. Of these, one-half or 110,000 would be pre-timed, 80% of which, or 88,000, are assumed to be applicable for consideration.

With regard to signal cycle length optimization, it will be assumed that all signalized intersections are applicable for consideration. This assumption is in consonance with the reduced average fuel savings adopted as representative for this technique.

#### 4.2.3.2 Fleet Fuel Savings

As indicated earlier, traffic actuated control is assumed to be applicable to 4- and 6-lane arterials nationwide. Information contained in Ref. 4-27, which relates the distribution of vehicle-miles traveled to urban

area population, shows that about 6% of the VMT is on 6-lane arterials and about 20% on 4-lane arterials. These VMT rates, in combination with the fuel economy benefits developed in Section 3.2.3.2, will be applied to the estimated urban fuel consumption in order to assess the potential fuel savings in 1976 and 1982.

The ratio of urban to highway fleet VMT is assumed to be 55:45, the same as that used by the EPA in calculating vehicle fuel economy. The EPA certification data also indicate that the highway fuel economy is, on the average, 1.45 times the urban fuel economy. Application of this ratio to the 1976 and 1982 fleet average fuel economy results in a calculated fleet average urban fuel economy which, combined with the fleet urban VMT, indicates an urban fuel consumption of 59.2 billion gallons for the 1976 fleet and 57.4 billion gallons for the 1982 fleet. These values are used as the basis for estimating the urban fuel savings attributable to the use of traffic actuated signals. The results, shown in Table 4-21, indicate a nationwide fuel savings of 0.89 billion gallons for the 1976 fleet and 0.86 billion gallons for the 1982 fleet. These estimated savings constitute approximately 1% of the total fleet fuel consumption for both the 1976 and 1982 fleets.

The nationwide fuel savings attributable to optimizing traffic signal cycle length was estimated in Ref. 4-26 to be about 1 billion gallons per year based on an extrapolation of the Gainesville, Florida, study. This estimate assumes that the savings of 1 gallon per intersection per hour determined for the Gainesville CBD would be equally applicable to all intersections nationwide. As discussed in Section 3.2.3.2, the present study adopts a value that is one half of the Gainesville result, leading to a savings of 500 million gallons per year based on the present (1976) number of intersections (200,000). For 1982, the savings would increase to 550 million gallons, assuming a 10% increase in the number of intersections. These values are included in Table 4-21.

#### 4.2.3.3 National Cost

It has been estimated that there are 96,000 pre-timed intersections that could be converted to traffic actuated signal control in 1976 and about 88,000 in 1982. On the basis of the unit costs developed in Section 3.2.3.5



TABLE 4-21. FLEET FUEL SAVINGS ATTRIBUTABLE TO INTERSECTION CONTROL

Intersection Control System	1976 Fleet		1982 Fleet	
	Percent Applicable Intersections	Fleet Fuel Savings (10 <sup>9</sup> gal)	Percent Applicable Intersections	Fleet Fuel Savings (10 <sup>9</sup> gal)
Traffic Actuated Signal Control	48	0.886	40	0.860
Optimized Signal Cycle Lengths	100	0.500	100	0.550

of \$8000 per intersection, this would place the national cost for traffic actuated control at \$768 million in 1976 and \$704 million in 1982. Offsetting these costs are the fuel cost savings resulting from the use of the traffic actuated signals. These cost factors are summarized in Table 4-22. It is seen that the annual fuel cost savings nearly equals the estimated costs for implementation, and thus this approach appears to be cost effective.

National implementation costs for optimized signal cycle length are based on the unit cost of \$300 per intersection developed in Section 3.2.3.5. These data are included in Table 4-22 and indicate a high cost effectiveness for this approach.

#### 4.2.3.4 Potential Implementation Problems

A major cost problem is identified in connection with the implementation of traffic actuated signals. The cost of conversion from a pre-timed to a traffic actuated system has been found to be about \$8000 per intersection. Budgetary constraints may limit the ability of a local jurisdiction to implement a program of this nature. Other costs, not included in this estimate, may also be involved. For example, the benefits of traffic actuated signals can vary widely, depending on network traffic volumes, the relationship between main and crosstraffic volumes, and the presence or absence of arterials. This strongly suggests that a thorough study has to be made to determine whether or not a given network should be converted. Because of the interactive effect of the foregoing variables, such an assessment could require a computer simulation for each network of interest, adding to the cost of implementation.



TABLE 4-22. COST FACTORS FOR INTERSECTION CONTROL

Intersection Control System	1976 Fleet			1982 Fleet		
	Applicable Intersections	Implementation Cost (\$ Billions)	Fleet Fuel Cost Savings (\$ Billions)	Applicable Intersections	Implementation Cost (\$ Billions)	Fleet Fuel Cost Savings (\$ Billions)
Traffic Actuated Signal Control	96,000	0.768	0.620	88,000	0.704	0.602
Optimized Signal Cycle Length	200,000	0.060	0.350	220,000	0.071	0.385

#### 4.2.3.5 Estimated Lead Time to Implementation

The traffic equipment survey reported in Ref. 4-25 indicates a rapid increase in the procurement rate of traffic control units. Of the 154 municipal, county, and state jurisdictions surveyed, a total of 2604 traffic controllers were added in 1973, or about 6.5% of the total of 41,000 in operation in these jurisdictions. Extrapolating these data nationwide would suggest that a total of about 120,000 controllers are purchased annually in the U.S. At this procurement rate, and assuming that all controllers purchased are of the traffic-actuated type, it would require about 8 years to equip the 96,000 intersections applicable for conversion to traffic-actuated signal control. However, there is no reason to assume that the present procurement rate represents an upper limit on the maximum rate of implementation. It is estimated that a substantial fraction of the applicable intersections could be converted by 1982, assuming that budgetary constraints were not pacing.

No significant lead time requirement is identified for traffic signal cycle length optimization. A program of this type might be implemented nationwide in a 2- to 3-year period.

#### 4.2.3.6 Areas of Uncertainty and Magnitude of Possible Errors

The potential fuel savings attributable to the use of traffic-actuated signals has been shown to vary over a wide range depending on network traffic volumes and the ratio of main street to cross street volumes. This study has used an estimated fuel economy gain of 10% applicable to 6-lane arterials and 5% for 4-lane arterials. These estimates could easily be in error by  $\pm 50\%$ . Additionally, the applicable VMT could be in error by  $\pm 10\%$  or more. Assuming these effects are additive, then the fuel savings for the 1982 fleet could have a value ranging from 0.400 to 1.375 billion gallons.

Similar error magnitudes apply to the results quoted for signal cycle length optimization. On the basis of a  $\pm 50\%$  error, the 1982 fleet savings could range from 0.275 to 0.825 billion gallons.

Cost estimates are also a function of several uncertain variables: the total number of intersections, the number of pre-timed controllers in use which could potentially be converted, and the applicable fraction whose conversion would result in a fuel savings. The estimated values relating to the

total number of intersections and the number of pre-timed controllers in use are derived from survey data and believed to be correct to within  $\pm 10\%$ . The estimated fraction of pre-timed controllers which could potentially be converted could be in error by  $\pm 20\%$ . These uncertainties combined would result in a cost estimate ranging from \$0.489 billion to \$1.096 billion for 1976 (compared to the value of \$0.755 billion shown in Table 4-22). Similarly, the 1982 cost estimate would range from \$0.457 billion to \$1.024 billion compared to the estimated value of \$0.705 billion.

#### 4.2.4 Network Control

##### 4.2.4.1 Applicability to National Fleet

There are currently about 150 computerized traffic network systems in the U.S. (Ref. 4-28). The number of controlled intersections reported within each network varies widely, with no discernable pattern evident. Therefore, for the purpose of this study an arbitrary value of 100 intersections per network will be assumed.

As pointed out in Section 4.2.3.1, there are an estimated 200,000 signalized intersections in the U.S., some portion of which would be suitable for incorporation into a computerized network. A determination of the actual number of intersections nationwide which may be suitable would require a study of tremendous magnitude. In lieu of this, it will be assumed that 40% of the total or about 80,000 intersections may be applicable for incorporation into a computerized network. Then, on the basis of the assumed 100 intersections per network, a potential 800 networks may be considered applicable in 1976. On the basis of an estimated growth of about 10% in the number of signalized intersections, 880 networks would be applicable in 1982.

Based on the foregoing assumptions, a possible 650 networks could be converted over and above the 150 currently in existence in terms of the 1976 fleet. If it is further assumed that the number of such networks may double by 1982, then an additional 580 would be applicable.

##### 4.2.4.2 Fleet Fuel Savings

As discussed earlier, approximately 26% of the urban vehicle miles of travel occur on 4- and 6-lane arterials. In addition to arterial traffic,

network systems would in all probability incorporate certain local, or non-arterial, streets. In consideration of these factors, it will be assumed that 30% of the urban VMT will be affected by traffic network systems.

The fleet urban fuel consumption, as derived from urban VMT and fuel economy in Section 4.2.3.2, was found to be 59.2 billion gallons for the 1976 fleet and 57.4 billion gallons for the 1982 fleet and will be used in assessing the fleet fuel savings attributable to computerized traffic network control.

In terms of the 1976 fleet, the conversion of 650 networks to computerized control would result in an estimated fuel savings of 0.865 billion gallons.

In 1982, fuel savings of 0.681 billion gallons could be achieved, based on the foregoing assumption that 580 networks were converted. These fuel savings, summarized in Table 4-23, would constitute approximately 1% of the 1976 fleet total fuel consumption and about 0.75% of the 1982 fleet fuel consumption.

#### 4.2.4.3 National Cost

It has been estimated that there are 650 networks that could be converted to computerized network control in 1976 and about 580 in 1982. On the basis of the cost of \$20,000 per intersection developed in Section 3.2.4.5 with each network comprised of 100 intersections, the nationwide cost would be \$1.3 billion in 1976 and \$1.16 billion in 1982.

Offsetting these costs, as summarized in Table 4-24, are the fuel cost savings resulting from the use of the computer-controlled traffic networks, which would amount to \$0.606 billion in 1976 and \$0.477 billion in 1982.

#### 4.2.4.4 Potential Implementation Problems

Cost would appear to be a major problem in connection with the implementation of a computer-controlled traffic network system. The cost of conversion has been found to be about \$20,000 per intersection, or \$2 million for a network comprised of 100 intersections. In addition, other costs may be incurred. For example, the benefits of a computerized network may vary widely depending on the network traffic volumes, the potential margin of improvement over the existing non-computerized network, and the control



TABLE 4-23. FLEET FUEL SAVINGS ATTRIBUTABLE TO NETWORK CONTROL

Network System	1976 Fleet		1982 Fleet	
	Estimated Applicable No. of Networks	Fleet Fuel Savings (10 <sup>9</sup> gal)	Estimated Applicable No. of Networks	Fleet Fuel Savings (10 <sup>9</sup> gal)
Computer Controlled	650	0.865	580	0.681

TABLE 4-24. COST FACTORS FOR NETWORK CONTROL

Network System	1976 Fleet			1982 Fleet		
	Estimated Applicable No. of Networks	Implementation Cost (\$ Billions)	Fleet Fuel Cost Savings (\$ Billions)	Estimated Applicable No. of Networks	Implementation Cost (\$ Billions)	Fleet Fuel Cost Savings (\$ Billions)
Computer Controlled	650	1.30	0.606	580	1.16	0.477

algorithm determined to be optimum. This strongly suggests that a fairly complex study would have to be made to determine whether or not a given network should be converted. Because of the interactive effect of these variables, such an assessment could require a computer simulation for each network of interest.

#### 4.2.4.5 Estimated Lead Time to Implementation

The lead time to implement a computer-controlled traffic network system would include the time required to assess the potential benefits relative to a specific network, the time to install (and interconnect) the system, and a post-installation checkout period.

The implementation of the San Jose network (Ref. 4-28) is reported to have required over 3 years from the initial study to operational status. Of this interval, feasibility and engineering studies required about 1-1/2 years, installation about 6 months, and tests and evaluation after installation about 1-1/2 years.

The high cost associated with a computerized traffic network control system may, because of budgetary constraints, further extend this implementation time, and actually may be the pacing item.

Although it is recognized that each network is a separate entity and that each could conceivably be implemented concurrently, it appears doubtful that this would occur because of the technical and budgetary considerations involved in the decision making process. Thus, on a nationwide basis, a period of 10 years or more may be required.

#### 4.2.4.6 Areas of Uncertainty and Magnitude of Possible Errors

The potential fuel savings attributable to the use of a computer-controlled traffic network system have been found to vary over a wide range, depending on network traffic volumes and the efficiency of the network control system prior to implementation of the computerized system. This study has used an estimated fuel savings of 6%, which may be in error by  $\pm 50\%$ . Other factors which affect the estimated fuel savings include the applicable fraction of urban VMT which would be subjected to network control. This was estimated to be 30%, which also may be in error by  $\pm 50\%$ . Another factor affecting the estimated fuel savings is the potential number of networks which could

be implemented. This study used a value of 40% which could vary by  $\pm 25\%$ . The estimated fuel savings would also depend on the number of intersections in a given network. A value of 100 intersections per network was used in assessing the nationwide fuel savings. A variation of  $\pm 50\%$ , in combination with the other uncertainties, would, if additive, result in a fuel savings range of 0.23 to 1.86 billion gallons in 1976 compared to an estimated value of 0.865 billion gallons, and a range of 0.20 billion gallons to 1.37 billion gallons in 1982 compared to the estimated value of 0.681 billion gallons.

Two of the variables discussed above and their associated uncertainties would also affect the estimated cost. These are the number of intersections per network and the applicable portion of the networks which would be suitable for conversion. Other variables which would affect the cost include the estimated cost per intersection to convert to computer control of the network. This will vary with the size of the network and may vary by  $\pm 20\%$ , based on available information. These uncertainties combined would change the 1976 cost estimate of \$1.30 billion to values ranging from \$0.756 billion to \$2.045 billion. Similarly, the 1982 estimate of \$1.16 billion would range from \$0.734 billion to \$1.717 billion.

#### 4.3 DRIVER BEHAVIOR MODIFICATIONS

##### 4.3.1 Driver Training

As noted in Section 3.3.1.2, the commercial sector of the light duty fleet contributes a relatively small fraction of the total VMT. The following discussion, therefore, concentrates on the implementation of driver training as it applies to the larger population of privately owned and operated vehicles.

##### 4.3.1.1 Applicability to National Fleet

Two scenarios pertaining to the penetration of improved driver performance effects in the fleet are considered. One of these is a hypothetical upper limit case in which the number of drivers receiving training in fuel efficient driving is taken to be the entire driving population. The vehicle applicability in this case is, of course, 100%. The second scenario is one in which training is made a mandatory condition for the licensing of new drivers.

Such training could be incorporated into high school driver education programs or could be obtained through private instruction. In either case, it is assumed that every person of high school age obtains on-the-road training in fuel efficient driving. No formal driver training is assigned to the remainder of the driving population. This second scenario is assumed to commence in 1978 and to continue each year, successively impacting the new driver population of age group 17.

Projected population statistics given in Ref. 4-29 were used to compute the cumulative impact of the Scenario 2 approach. After implementation for a period of 5 years (1978 through 1982), the number of trained drivers would be about 20.23 million, or 14.2% of the 143 million licensed drivers in 1982 (the latter figure is a projection based on the statistics of Ref. 4-29 for the age group 17 years and older). Driving statistics given in Ref. 4-14 indicate that in 1975 the age group 17 through 21 comprised 12.8% of the driving population and accounted for about 9% of the national VMT. This same ratio of driving population to VMT is assumed to apply to the 1982 fleet, thereby indicating that  $14.2 \times 9/12.8$  or 10% of the 1982 VMT will be accumulated by drivers in the trained age group of 17 through 21. This VMT is assumed to be distributed uniformly among all vehicles in the various categories of interest, so that the 10% figure represents the fraction of applicable vehicles in each fleet component.

#### 4.3.1.2 Fleet Fuel Savings

In Section 3.3.1.2, the benefit of driver training was assigned a fuel economy improvement potential of 10%. This value was drawn from a data base of tests conducted immediately after driver training/instruction was administered. It seems appropriate to expect that there will be some decay in the effectiveness of training with the passage of time, and that the rate and extent of this decay will be highly variable among different drivers. In the absence of any data on the subject, this study will assume that the effective, sustained fuel economy benefit of driver training will be one-half the short-term effect, or 5%\*. This 5% assessment, combined with the vehicle

---

\*There is some justification for believing that the effective benefit of driver training will be increased through the use of a driver aid device, such as a manifold vacuum gage, to remind the driver of his training and to reinforce the significance of good driving performance.



applicability assignment of the preceding subsection, yields the fleet fuel savings results shown in Table 4-25. Scenario 1 (100% driver training) shows a savings in fuel consumption of 4.3 billion gallons, while Scenario 2 (new driver training implemented starting in 1978) shows a savings of 0.43 billion gallons in 1982.

#### 4.3.1.3 National Cost

In accordance with the discussion of Section 3.3.5, a cost per participant of \$55 for driver training is assumed. This figure is applied to both scenarios, although the cost of Scenario 2, if accomplished through high school training, might be borne by the public rather than by the individual driver participant.

The number of participants in Scenario 1 is taken as the total number of licensed drivers in the nation, 131 million in 1976 and 142.6 million in 1982. The number of participants in Scenario 2 is the 20.23 million persons who have received high school driver training instruction in the time period 1978 through 1982.

The resulting cost factors are given in Table 4-26. For Scenario 1 in 1982, the dollar value of the fleet fuel savings is approximately 38% of the cost of driver training; while for Scenario 2, this figure is 27% of the cost.

#### 4.3.1.4 Potential Implementation Problems

Scenario 1 (universal driver training) has potentially major implementation problems which are not necessarily connected with the technical and logistic aspects of providing the training. The control could be enforced by requiring all licensed drivers to show evidence of successfully completing a course in driver training in order to obtain their driver's license renewal. The program could be tied to vehicle registration renewal in states which may not require driver's license renewal. Commercial driving schools could serve as the basis for developing a large-scale capability in behind-the-wheel instruction, while existing adult education programs of high schools (which commonly offer courses in automotive related topics such as vehicle maintenance) could be developed into sources of classroom instruction. By these procedures, instructional capabilities could probably be developed in a relatively short time which could serve a large percentage of the population.

TABLE 4-25. FLEET FUEL SAVINGS ATTRIBUTABLE TO DRIVER TRAINING

Fleet Sector	1976 Fleet (Scenario 1)		1982 Fleet (Scenario 1/Scenario 2)	
	Percent Applicable	Fleet Fuel Savings* (10 <sup>9</sup> gal)	Percent Applicable	Fleet Fuel Savings* (10 <sup>9</sup> gal)
Passenger Cars	100	3.494	100/10	3.103/.310
Light Duty Trucks				
Class I LDT	100	0.525	100/10	0.544/.055
Class II LDT	100	0.349	100/10	0.627/.063
LDT Total	100	0.875	100/10	1.171/.117
Total Fleet	100	4.369	100/10	4.274/.428

\* Based on applicable VMT for year indicated.

TABLE 4-26. COST FACTORS FOR DRIVER TRAINING

Fleet Sector	1976 Fleet (Scenario 1)			1982 Fleet (Scenario 1/Scenario 2)		
	Participants (Millions)	Fleet Cost <sup>a</sup> (\$ Billions)	Fleet Fuel Cost Savings <sup>b</sup> (\$ Billions)	Participants (Millions)	Fleet Cost <sup>a</sup> (\$ Billions)	Fleet Fuel Cost Savings <sup>b</sup> (\$ Billions)
Passenger Cars	-----	-----	-----	-----	-----	2.17/.217
Light Duty Trucks						
Class I LDT	-----	-----	-----	-----	-----	0.38/.039
Class I LDT	-----	-----	-----	-----	-----	0.44/.044
LDT Total	-----	-----	-----	-----	-----	0.82/.082
Total Fleet	131.0	7.20	3.08	142.6/20.2	7.84/1.113	2.99/.300

<sup>a</sup> Based on \$55 cost per participant.

<sup>b</sup> Based on \$0.70 per gallon and applicable mileage accumulated in year indicated.

Two potential problems arise in connection with this approach. First, it is doubtful that classroom instruction is as effective as on-the-road training. Second, a program of mandatory compliance directed at drivers already licensed is likely to generate negative reactions which will not be conducive to driver cooperation and useful results. If the program is voluntary, a very low level of participation might be expected.

Scenario 2, the evolutionary approach, which in part would build on existing high school driver training programs, also has disadvantages (primarily in the time required to realize significantly useful results), but could be more effective in terms of actual fuel savings per dollar spent. It is possible that some combination of the two approaches; e.g., a promotional campaign directed at existing drivers plus mandatory training of new drivers might be useful.

#### 4.3.1.5 Estimated Lead Time to Implementation

Implementation of Scenario 2 could be initiated probably within a year, although widespread availability of fully instrumented training cars would take longer. Scenario 1 would probably have to be preceded by enabling legislation at both the federal and state levels. This process could consume about 2 years or more, followed by perhaps another year for initial implementation of instruction.

#### 4.3.1.6 Areas of Uncertainty and Magnitude of Possible Errors

Any estimate made at this time of the benefits of driver training is subject to great uncertainty. On the high side, it seems very unlikely that the average, short-term fuel economy benefit of driver training can exceed about 15%. A lower level of not less than some 2 or 3% seems justified, considering the significance of duty cycle in relation to engine operating efficiency. Perhaps the key uncertainties are the degree of motivation which can be instilled in the driving population to make a conscious effort to improve its driving habits, and to what extent the improved techniques will be retained as permanent behavior. External factors (such as sharply increased gasoline prices or gasoline rationing) may provide the necessary motivation in a general sense, but there still may be great variability in the response of individual drivers. Some decay in everyday driving habits from the newly trained,



motivated level seems unavoidable. Taking the above factors into account, it appears that the average long-term fuel economy benefit potential of driver training should lie within the range of about 1 to 8%. Some improvement over these levels is likely if a driver aid such as a manifold vacuum gage or accelerometer is used in post-instruction driving to bolster the effects of training.

#### 4.3.2 Driver Aid Devices

##### 4.3.2.1 Applicability to National Fleet

Fleet applicability considerations pertaining to driver aid devices are summarized in Table 4-27. With regard to the Accelerator Pedal Feedback device, it may be noted that techniques other than manifold vacuum could be utilized for sensing and mechanizing the pedal resistance required, but with greater complexity and cost. Thus, this device is assumed to be limited to throttled engines. On a similar basis, the MPG meter is assumed to be limited to engines that are not fuel injected.

##### 4.3.2.2 Fleet Fuel Savings

In Section 3.3.2, the fuel economy benefits of driver aid devices were assessed and values ranging from 1 to 6% were assigned to the various devices, with the manifold vacuum gage ranked highest in benefit. These fuel economy improvement values, it was noted, represent the maximum improvement anticipated for the average driver, assuming that he makes a diligent effort to utilize the device in his daily driving. For the purpose of estimating fleet fuel savings attributable to driver aid devices, it is necessary to make an appropriate allowance for those drivers whose diligence in responding to the device readout or in maintaining good driving behavior will flag after a period of time. This report will arbitrarily assume (in the absence of any data on the subject) that half the driver population falls into the latter category. On the basis of this assumption, the effective fuel economy improvement levels for the nation's drivers are reduced to one half the values assigned in Section 3.3.2. Then, using the applicability assumptions delineated in Table 4-27, the fleet fuel savings effects appear as shown in Table 4-28. The best of the devices, the manifold vacuum gage, yields a total fleet fuel savings of about 2.7 billion gallons for the 1976 fleet and 2.5 billion gallons for the 1982 fleet.

TABLE 4-27. APPLICABILITY OF DRIVER AID DEVICES TO NATIONAL FLEET

Device	Technical Demarcations	OEM Penetration
Manifold Vacuum Gage	Limited to throttled engines (no diesels)	Negligible
Accelerometer	Unlimited (100% applicability)	Negligible
Accelerator Pedal Feedback System	Assumed limited to throttled engines	Negligible
Automatic Cruise Control	Limited to personal transportation vehicles with automatic transmissions (85% of passenger cars, 70% of Class I LDT, 20% of Class II LDT)	Variable by model year. Passenger cars: 1965 = 0, 1976 = 30%, 1982 = 45%; LDT Class I = 1/3 & LDT Class II = 1/15 of passenger cars
MPG Meter	Assumed not applicable to fuel injected engines because of complexity and cost	Negligible
Fuel Totalizer	Same as MPG meter above	Negligible

TABLE 4-28. FLEET FUEL SAVINGS ATTRIBUTABLE TO DRIVER AID DEVICES

Device	Fleet Sector	1976 Fleet		1982 Fleet	
		Percent Applicable	Fleet Fuel Savings * (10 <sup>9</sup> gal)	Percent Applicable	Fleet Fuel Savings * (10 <sup>9</sup> gal)
Manifold Vacuum Gage	Passenger Cars	99.9	2.13	96.1	1.81
	Trucks	100	0.56	98.6	0.71
	Total Fleet	99.9	2.69	96.5	2.52
Accelerometer	Passenger Cars	100	1.44	100	1.28
	Trucks	100	0.37	100	0.48
	Total Fleet	100	1.81	100	1.76
Accelerator Pedal Feedback System	Passenger Cars	99.9	1.08	96.1	0.92
	Trucks	100	0.28	98.6	0.36
	Total Fleet	99.9	1.36	96.5	1.28
Automatic Cruise Control	Passenger Cars	76.9	0.55	56.7	0.35
	Trucks	39.9	0.07	33.8	0.07
	Total Fleet	70.3	0.62	51.5	0.42
MPG Meter	Passenger Cars	98.2	0.36	92.5	0.30
	Trucks	100	0.09	98.8	0.12
	Total Fleet	98.5	0.45	94.0	0.42
Fuel Totalizer	Passenger Cars	98.2	0.36	92.5	0.30
	Trucks	100	0.09	98.8	0.12
	Total Fleet	98.5	0.45	94.0	0.42

\*Based on applicable VMT accumulated for year indicated.

#### 4.3.2.3 National Cost

The installed unit cost data developed in Section 3.3.2 and the applicability and fuel savings information discussed earlier combine to produce the cost factors shown in Table 4-29. The vacuum gage is indicated to be the most cost effective of the driver aid devices, yielding a fuel cost savings that is about 44% of the installed cost for the 1976 fleet and about 37% for the 1982 fleet.

#### 4.3.2.4 Potential Implementation Problems

With the possible exception of the manifold vacuum gage, cost and cost benefit factors are expected to be the major barriers to the implementation of all driver aid devices. The manifold vacuum gage has a payback period of about 2-1/2 years; for comparison, the next best device, the accelerometer, has a payback period of nearly 8 years.\*

#### 4.3.2.5 Estimated Lead Time to Implementation

It seems likely that a substantial production capacity could be developed rather quickly for any of the devices considered here. It is estimated that production levels on the order of tens of millions could be achieved in a period of 14 to 18 months. The MPG meter could require a somewhat larger lead time if accurate fuel flow measurement, requiring a high level of quality control in manufacturing and assembly, were an end objective. For any of the devices, however, the fleet demand could easily be met by 1982.

#### 4.3.2.6 Areas of Uncertainty and Magnitude of Possible Errors

Both the magnitude of the fuel economy improvements assigned to driver aid devices in Section 3.3.2 and the net effectiveness assumptions made earlier in this section are highly uncertain. In the case of the manifold vacuum gage, for example, it is considered possible that the effective average fuel economy benefit could range from a value as low as 0.5% to as high as 4 or 5%. Similarly, large uncertainties apply to the values assigned to the other devices examined.

---

\*For individual drivers who are conscientious in the use of such devices, the payback periods are half of the quoted (fleet average) values.



TABLE 4-29. COST FACTORS FOR DRIVER AID DEVICES

Device	Unit Cost (\$)	Fleet Sector	1976 Fleet			1982 Fleet		
			Applicable Vehicles (Millions)	Fleet Cost (\$ Billions)	Fleet Fuel Cost Savings* (\$ Billions)	Applicable Vehicles (Millions)	Fleet Cost (\$ Billions)	Fleet Fuel Cost Savings* (\$ Billions)
Manifold Vacuum Gage	35	Passenger Cars	99.64	3.49	1.49	104.96	3.67	1.27
		Trucks	21.74	0.76	0.39	31.44	1.10	0.50
		Total	121.38	4.25	1.88	136.40	4.77	1.77
Accelerometer	53	Passenger Cars	99.72	5.29	1.01	109.26	5.79	0.89
		Trucks	21.74	1.15	0.26	31.88	1.09	0.34
		Total	121.46	6.44	1.27	141.44	7.48	1.23
Accelerator Pedal Feedback System	50	Passenger Cars	99.64	4.98	0.76	104.96	5.25	0.64
		Trucks	21.74	1.09	0.20	31.44	1.57	0.25
		Total	121.38	6.07	0.96	136.40	6.82	0.89
Automatic Cruise Control	125	Passenger Cars	76.68	9.59	0.38	61.93	7.74	0.24
		Trucks	8.68	1.08	0.05	10.78	1.35	0.05
		Total	85.36	10.67	0.43	72.71	9.09	0.29
Miles Per Gallon Meter	200	Passenger Cars	97.93	19.58	0.25	101.10	20.22	0.21
		Trucks	21.74	4.35	0.07	31.50	6.30	0.08
		Total	119.67	23.93	0.32	132.60	26.52	0.29
Fuel Totalizer	100	Passenger Cars	97.93	10.28	0.25	101.10	10.62	0.21
		Trucks	21.74	2.28	0.07	31.50	3.31	0.08
		Total	119.67	12.56	0.32	132.60	13.93	0.29

\*Based on applicable VMF accumulated in year indicated.

Table 4-30 provides a summary of implementation factors for the spectrum of techniques reviewed in this section. In general, those devices / techniques which were shown in Section 3 to have relatively high fuel economy improvement potential are also those systems which yield the greatest fleet fuel savings. However, the effects of fleet applicability alter somewhat the relative magnitude of the benefits among systems. Thus, in the category of vehicle modifications, the techniques having greatest benefit in terms of 1976 fleet fuel savings in billions of gallons are (1) tire overpressure operation (5.30), (2) variable cylinder operation (5.00), and (3) variable accessory drive (3.46). Note that for variable cylinder operation and tire overpressure operation there is an effect of reduced applicability in the transition from the 1976 to the 1982 fleet which tends to produce approximately equal fuel savings for the three techniques of greatest benefit. With regard to traffic and driver behavior modifications, the difference in fuel savings between the 1976 and 1982 fleets is slight, primarily reflecting a reduction in fleet fuel consumption resulting from a higher population fraction of fuel efficient vehicles.

For most of the techniques listed, high cost and/or poor cost-benefit are indicated to be potential implementation problems. Several outstanding exceptions to this observation are: for vehicle modifications, tire pressure maintenance and overpressure operation; for traffic modifications, right turn on red and one-way streets; and for driver performance modifications, driver training.

All of the techniques considered appear to be implementable in quantity or to a substantial extent by 1982.

TABLE 4-30. IMPLEMENTATION SUMMARY

Technique	1976 Fleet		1982 Fleet		Potential Implementation Problems	Projected Availability in Quantity	Magnitude of Possible Error Effects on 1982 Fleet Fuel Savings (10 <sup>9</sup> gal)
	Fleet Fuel Savings (10 <sup>9</sup> gal) <sup>a</sup>	Fleet Cost (\$ Billions)	Fleet Fuel Savings (10 <sup>9</sup> gal) <sup>a</sup>	Fleet Cost (\$ Billions)			
<b>VEHICLE MODIFICATIONS</b>							
Spark Augmentation Devices	0.17	7.14	0.05	3.01	Poor cost-benefit.	Current	0 - 0.19
Improved Carburetors	0.90	17.95	0.83	19.89	High cost, poor cost-benefit, emission control certification may be required.	1981	0 - 2.44
Variable Accessory Operation	0.24	3.08	0.19	2.92	Poor cost-benefit (Variable Accessory Drive for fleet fraction with AC is best in this regard).	1979	0 - 0.19
Viscous Clutch Fan	1.84	12.15	1.78	14.11		1979	1.33 - 2.23
Electric Fan	(3.46/ <sub>b</sub> 2.02)	(9.72/ <sub>b</sub> 4.24)	(3.56/ <sub>b</sub> 2.38)	(11.29/ <sub>b</sub> 6.11)		1982	3.00 - 4.06
Variable Accessory Drive	5.00	8.21	3.94	7.70	Additional development possibly required, with particular regard to emissions control.	1981	2.72 - 5.65
Variable Cylinder Operation	Negligible	(c)	Negligible	(c)	(c)	(c)	(c)
Intake Air Temp. Control	0.10	3.17	0.10	3.69	Poor cost-benefit based on fuel savings.	1979	0 - 0.10
Engine Preheater							

TABLE 4-30. IMPLEMENTATION SUMMARY (Continued)

Technique	1976 Fleet		1982 Fleet		Potential Implementation Problems	Projected Availability in Quantity	Magnitude of Possible Error Effects on 1982 Fleet Fuel Savings (10 <sup>9</sup> gal)
	Fleet Fuel Savings (10 <sup>9</sup> gal) <sup>a</sup>	Fleet Cost (\$ Billions)	Fleet Fuel Savings (10 <sup>9</sup> gal) <sup>a</sup>	Fleet Cost (\$ Billions)			
Tire Modifications							
Radial Tires	1.69	11.3	0.67	4.7	High differential cost for radial tires; sustained cooperation of driver population required for effectivity of tire inflation program.	Current	0.47 - 0.77
Maintaining Pressure	1.53	0.85	1.02	0.99		-----	0.38 - 1.31
Overinflation Operation	5.30	0.85	4.01	0.99		-----	1.97 - 4.01
Drag Reduction Devices	1.51	10.66	1.33	11.67	Poor cost-benefit, poor (unusual) visual appeal, possible ground clearance problem for front dam.	1979	0.70 - 1.98
Improved Lubricants	2.69	1.07	2.62	1.24	Production capacity: presently limited for synthetics, not for friction-modified mineral oils.	1980 - 1981	1.76 - 5.08
Improved Maintenance	0.55	(3.57/ <sub>0.85</sub> ) <sup>d</sup>	0.63	(4.01/.95) <sup>d</sup>	Poor cost-benefit. Lack of equipment/training in service industry to handle diagnosis based on exhaust analysis.	Current	0 - 1.24
<u>TRAFFIC MODIFICATIONS</u>							
Right Turn on Red	0.02	605 x 10 <sup>-3</sup>	0.02	.67 x 10 <sup>-3</sup>	Requires enabling legislation by jurisdictions involved.	1978	0.007 - 0.043



TABLE 4-30. IMPLEMENTATION SUMMARY (Continued)

Technique	1976 Fleet		1982 Fleet		Potential Implementation Problems	Projected Availability in Quantity	Magnitude of Possible Error Effects on 1982 Fleet Fuel Savings (10 <sup>9</sup> gal)
	Fleet Fuel Savings (10 <sup>9</sup> gal) <sup>a</sup>	Fleet Cost (\$ Billions)	Fleet Fuel Savings (10 <sup>9</sup> gal) <sup>a</sup>	Fleet Cost (\$ Billions)			
One-Way Streets	(e)	(e)	(e)	(e)	(e)	(e)	(e)
Intersection Control							
Traffic Actuated Signals	0.89	0.77	0.86	0.70	High cost for traffic-actuated signals.	1982	.40 - 1.38
Optimized Signal Cycle Length	0.50	0.06	0.55	0.07			.27 - 0.83
Network Control	0.87	1.30	0.68	1.16	High cost for computerized network control.	1985	.20 - 1.37
Exclusive Bus Lanes	(Negative) <sup>f</sup>	(f)	(f)	(f)	(f)	(f)	(f)
<u>DRIVER PERFORMANCE MODIFICATIONS</u>							
Driver Training	4.37 <sup>b</sup>	7.20	(4.27/.43) <sup>h</sup>	7.84/1.11	Scenario 1 (mandatory compliance, all drivers) likely to generate negative reactions. Scenario 2 (mandatory compliance, new drivers) requires time to generate useful results. Enabling legislation for either approach probably difficult to promulgate.	1980/1982	0.89/0.09 - 6.65/0.67

TABLE 4-30. IMPLEMENTATION SUMMARY (Continued)

Technique	1976 Fleet		1982 Fleet		Potential Implementation Problems	Projected Availability in Quantity	Magnitude of Possible Error Effects on 1982 Fleet Fuel Savings (10 <sup>9</sup> gal)
	Fleet Fuel Savings (10 <sup>9</sup> gal) <sup>a</sup>	Fleet Cost (\$ Billions)	Fleet Fuel Savings (10 <sup>9</sup> gal) <sup>a</sup>	Fleet Cost (\$ Billions)			
Driver Aid Devices							
Manifold Vacuum Gage	2.69	4.25	2.52	4.77	Poor cost-benefit for all devices except vacuum gage and possibly accelerometer (as viewed by an individual potential customer).	1979	0.43 - 4.12
Accelerometer	1.81	6.44	1.76	7.48		1979	----
Accelerator Pedal Feedback	1.36	6.07	1.28	6.82		1979	----
Cruise Control	0.62	10.67	0.42	9.09		1979	----
MPG Meter	0.45	23.93	0.42	26.52		1979	----
Fuel Totalizer	0.45	12.56	0.42	13.93		1979	----

<sup>a</sup>Based on applicable mileage accumulated for year indicated; represents fuel cost savings in \$ billions at fuel price of \$1.00/gal.

<sup>b</sup>Fleet total/fleet fraction equipped with air conditioning.

<sup>c</sup>Deleted from analysis; negligible retrofit applicability.

<sup>d</sup>Conventional diagnosis/exhaust gas analysis diagnosis.

<sup>e</sup>Implementation data lacking.

<sup>f</sup>Not a viable technique for reducing in-use automotive fuel consumption.

<sup>g</sup>Scenario 1: mandatory training for all drivers.

<sup>h</sup>Scenario 1/Scenario 2.

4.5 REFERENCES

- 4-1. Champion Ignition and Engine Performance Conference, Vienna, Austria, 1976, Champion Spark Plug Co., Automotive Technical Services, Toledo, Ohio.
- 4-2. Ward's Automotive Yearbooks, Ward's Communications, Inc., Detroit, Mich. (1974-1977).
- 4-3. D. E. Lapedes, Final Report, Assessment of Domestic Auto Industry Production Lead Time for 1975/76 Model Years, Report No. ATR-73(7321)-1, Vol. II, The Aerospace Corporation, El Segundo, Calif. (15 December 1972).
- 4-4. "Automotive News 1977 Market Data Book Issue," Crain Automotive Group, Inc., Detroit, Mich. (27 April 1977).
- 4-5. "Ward's Automotive Reports," Vol. 52, No. 22, Ward's Automotive Reports, Detroit, Mich. (30 May 1977).
- 4-6. Ward's Automotive Yearbooks, Ward's Communications, Inc., Detroit, Mich. (1974-1976).
- 4-7. Federal Register, Vol. 42, No. 49 (14 March 1977).
- 4-8. L. Forrest, et al, Assessment of the Effects of Short Term Drive Train Options on the Automobile and Related Industries, Report No. ATR-77(7541)-1, Vol. II, The Aerospace Corporation, El Segundo, Calif. (December 1976).
- 4-9. L. Forrest, et al, Assessment of Drivetrain Systems for Dual Mode Performance in Police Patrol Vehicles, Report No. ATR-76(7914-05)-1, The Aerospace Corporation, El Segundo, Calif. (May 1976).
- 4-10. The Sensitivity to Projected Aggregate Fuel Consumption to the Conditions of Individual Fuel Economy Tests, Transportation Systems Center, U.S. Department of Transportation, Cambridge, Mass. (May 1974).
- 4-11. R. Flaherty, Kim Hotstart Manufacturing Co., Spokane, Wash., Private Communication (17 May 1977).
- 4-12. Ward's 1975 Automotive Yearbook, 37th ed., Ward's Communications, Inc., Detroit, Mich.
- 4-13. "1973 Motor Truck Facts," Motor Vehicle Manufacturers Association of the U.S., Inc., Detroit, Mich.
- 4-14. "Motor Vehicle Facts and Figures '76," Motor Vehicle Manufacturers Association of the U.S., Inc., Detroit, Mich.

- 4-15. "Evaluation of Mandatory Vehicle Inspection and Maintenance Programs," California Air Resources Board, Sacramento, Calif. (May 1976).
- 4-16. "Commentary Reviews Right Turn on Red Lanes," Bulletin, National Committee on Uniform Traffic Laws (25 February 1977).
- 4-17. E. F. Kearney, National Committee on Uniform Traffic Laws and Ordinances, Private Communication (12 April 1977).
- 4-18. "Highway Statistics, 1974," Federal Highway Administration, U. S. Department of Transportation (1974).
- 4-19. M. G. Hinton, et al, Medium Duty Vehicle Emission Control Cost Effectiveness, Vol. II, Report No. ATR-74(7327)-1, The Aerospace Corporation, El Segundo, Calif. (January 1974).
- 4-20. H. W. McGee, et al, Right-Turn on Red, Vol. I, Report No. FHWA-RD-76-89, Alan M. Voorhees and Associates, Inc./KLD Associates, Inc. (May 1976).
- 4-21. M. Caltzel, State of California, Department of Transportation, Private Communication (1 July 1977).
- 4-22. R. Hablis, Los Angeles County Road Department, Private Communication (1 July 1977).
- 4-23. M. Paetzold, City of Los Angeles, Transportation Department, Private Communication (1 July 1977).
- 4-24. Mr. R. Hobbs, Los Angeles County Road Department, Los Angeles, Calif., Private Communication (1 July 1977).
- 4-25. J. B. Scott and M. Saunders, "Traffic Control Equipment Study, Annual Expenditures and Current Inventories for U.S. Local Governments," The American City Magazine, Pittsfield, Mass. (1974).
- 4-26. K. G. Courage and S. M. Parapar, "Delay and Fuel Consumption at Traffic Signals," Traffic Engineering (November 1975).
- 4-27. J. E. Baerwald, ed., Transportation and Traffic Engineering Handbook, Prentice Hall, Inc., Englewood Cliffs, N.J. (1976).
- 4-28. P. Benjamin, "Effect of Urban Traffic Flow Modifications Upon Automobile Petroleum Consumption," DOT Transportation Systems Center, Discussion Paper No. DP-SA-6 (Oct. 1973).
- 4-29. "Statistical Abstract of the United States, 1976," U.S. Department of Commerce, Bureau of the Census, Washington, D. C.



## 5. INTEGRATED EFFECTS

### 5.1 INTRODUCTION

The preceding sections of this report have examined the fuel savings and costs associated with the implementation of various techniques for reducing fuel consumption in the in-use fleet. Three major approaches have been considered: Vehicle Modifications, Traffic Modifications, and Driver Behavior Modifications. This section of the report presents an estimate of the total fuel savings and cost penalties which would result if all mutually compatible techniques within each major approach were to be implemented concurrently, assuming 100% acceptance by the public ( a maximum case). This estimate is shown in Table 5-1. The development of these quantities involved a rationalization of overlapping benefits and effects between several techniques in each category. The assumptions made and scenarios adopted for this purpose are briefly discussed in the following paragraphs.

### 5.2 VEHICLE MODIFICATIONS

The techniques in this category include aftermarket devices, improved lubricants, and improved maintenance. The compatibility issues which arise in connection with the concurrent implementation of various techniques in this category are listed in Table 5-2, along with the respective assumptions or scenarios which were adopted in developing the aggregate fuel savings and cost quantities displayed in Table 5-1. As noted, the principal issues concern mutually opposing or synergistic effects such as those associated with spark augmentation devices vs maintenance, improved carburetion vs variable cylinder operation, and radial tires vs increased inflation pressure. The resolution of these issues is treated as indicated in the self-explanatory notes provided in Table 5-2.

### 5.3 TRAFFIC MODIFICATIONS

The candidate fuel saving approaches in this category include RTOR (right turn on red), one-way streets, intersection control, network control, and exclusive bus lanes. Implementation data for one-way streets were not available, so the fuel savings by this approach could not be included in the integrated value for traffic control techniques shown in the table. Excluded also are the effects of exclusive bus lanes, which were found to have

TABLE 5-1. AGGREGATE FUEL SAVINGS AND COST EFFECTS

Technique	National Fuel Savings (10 <sup>9</sup> gallons)		National Cost (\$ Billions)	
	1976	1982	1976	1982
<u>VEHICLE MODIFICATIONS</u>				
Spark Augmentation Devices	0.171	0.048	7.135	3.014
Improved Carburetors	0.589	0.586	17.950	19.890
Variable Accessory Operation				
Viscous Clutch Fan	(a)	(a)	(a)	(a)
Electric Fan	(a)	(a)	(a)	(a)
Variable Access. Drive	3.460	3.560	9.720	11.290
Variable Cylinder Oper.	5.000	3.940	8.241	7.700
Engine Preheater	0.103	0.100	3.170	3.700
Tire Modifications				
Radial Tires	(b)	(b)	(b)	(b)
Maintaining Pressure	1.530	1.020	0.850	0.990
Overinflation	5.300	4.010	(c)	(c)
Drag Reduction Devices	1.515	1.334	10.660	11.670
Improved Lubricants	2.694	2.615	1.069	1.242
Improved Maintenance	0.720	0.674	3.569	4.010
Combined Effect	21.082	17.887	62.333	63.506
<u>TRAFFIC MODIFICATIONS</u>				
Right Turn on Red	0.015	0.016	0.0006	0.0007
One-Way Streets	(d)	(d)	(d)	(d)
Intersection Control				
Traffic-Actuated	0.881	0.860	0.768	0.704
Optimized Signal Length	0.500	0.550	0.060	0.071
Network Control Strategies	0.865	0.681	0.300	1.160
Exclusive Bus Lanes	(e)	(e)		(e)
Combined Effect	2.261	2.107	0.127	1.935
<u>DRIVER BEHAVIOR MODIFICATIONS</u>				
Driver Training	4.369	4.274	7.200	7.840
Driver Aid Devices (Mani- fold Vacuum Gage)	0.414 <sup>(f)</sup>	0.405 <sup>(f)</sup>	4.250	4.770
Combined Effect	4.783	4.679	11.450	12.610
Overall Total	28.126	24.673	75.912	78.051

- (a) Benefits included under variable accessory drive.  
(b) Not additive to benefits of tire pressure modifications.  
(c) Not additive to cost of maintaining pressure.  
(d) Data needed to evaluate this technique is lacking.  
(e) Not a viable approach for reduction of automobile fuel consumption.  
(f) Based on 1/2% fuel economy improvement when used in conjunction with driver training.

TABLE 5 -2. SCENARIOS ADOPTED IN DETERMINING AGGREGATE FUEL SAVINGS AND COST EFFECTS FOR VEHICLE MODIFICATION TECHNIQUES

Technique	Potential Interfaces with Other Techniques (Compatibility Issues)	Assumptions/Scenarios
<u>AFTERMARKET DEVICES</u> Spark Augmentation Devices	Maintenance (ignition system fuel economy benefits evolve from fixed-schedule maintenance; see Section 3.1.1).	Ignition system benefits delineated in Section 4 are applicable as specified. Maintenance benefits to be assigned only to driver population not already on regular maintenance schedule.
Carburetors	Variable Cylinder Operation (cyclic operation in 4 cylinders may obviate benefits of improved carburetion).	Assume 50% of benefit delineated in Section 4 for advanced carburetion as applied to V-8 engines; 100% for all other engine types.
Variable Accessory Operation	No compatibility issues identified.	Adopt benefits delineated in Section 4 for Variable Accessory Drive System.
Variable Cylinder Operation	No compatibility issues identified.	Applicable to all V-8 engines, as assumed in Section 4.
Intake Air Temperature Control	No compatibility issues identified.	Applicable to all vehicles not so equipped, as assumed in Section 4.
Engine Preheater	No compatibility issues identified.	Applicable to national VMT under cold conditions, as assumed in Section 4.
Tire Modifications	Radial Tires vs increased inflation pressure (net benefit decreases with increased use of radial tires)	Adopt benefits delineated in Section 4 for increased inflation pressure (sum of under- and over-inflation effects).
<u>IMPROVED LUBRICANTS</u>	No compatibility issues identified.	Applicable to all vehicles in excess of current or projected sales, as assumed in Section 4.
<u>IMPROVED MAINTENANCE:</u>	Spark Augmentation Devices (electronic ignition systems deteriorate at slower rate than conventional, mechanical types).	Assume fleet implementation of spark augmentation devices and adopt maintenance benefit applicable to electronic ignition as defined in Section 4.

a negative influence on fuel consumption. The fuel savings attributable to the other approaches in this category were judged to be directly additive.

#### 5.4 DRIVER BEHAVIOR MODIFICATIONS

The techniques in this category include driving training and driver aid devices. The fuel savings and cost entries shown in Table 5-1 for driver training are values developed in Section 4.3.1. The costs indicated for driver training are those associated with individual driving instruction (see Section 3.3.2.1). The cost entries shown for driver aids are values developed for the manifold vacuum gage in Section 4.3.2. It should be noted that the combined fuel savings shown for Driver Behavior Modifications is significantly less than the sum of the effects for driver training and driver aids (manifold vacuum gage) if used individually. This combined effect was derived by assigning a 1/2% improvement in fuel economy to driver aid devices in consideration of their potential value in reinforcing good driving habits when used in conjunction with driver training.



APPENDIX  
REPORT OF NEW TECHNOLOGY

No new technology is reported here. However, various techniques are examined for increasing the fuel economy of the in-use automotive fleet. The techniques are examined in detail, including their characteristics, implementation and cost effectiveness. These techniques are summarized in pages S-1 through S-21/S-22.

