

TE  
662  
.A3  
no.  
FHWA-  
RD-  
75-508

Report No. FHWA-RD-75-508

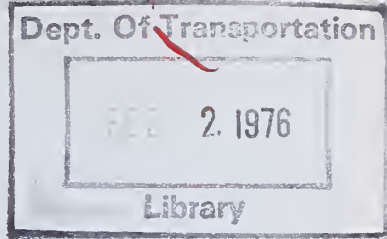

# ALBERT OUTLET PROTECTION DESIGN: COMPUTER PROGRAM DOCUMENTATION

M. G. Schilling



**March 1975**  
**Final Report**

This document is available to the public  
through the National Technical Information  
Service, Springfield, Virginia 22161

**Prepared for**  
**FEDERAL HIGHWAY ADMINISTRATION**  
**Offices of Research & Development**  
**Washington, D.C. 20590**

## NOTICE

This computer program or the information and data generated by the computer program was developed and is being disseminated under the sponsorship of the Federal Highway Administration, U. S. Department of Transportation, in the interest of information exchange. Neither the United States Government, nor any person acting on behalf of the United States Government, assumes any liability resulting from use of the computer program or the information and data generated by the computer program, or warrants that such use will be free from privately owned rights.

TE  
662

.A3  
no.

FHWA  
RD-  
75-508

1. Report No. FHWA-RD-75-508,		2. Government Accession No.		3. Recipient's Catalog No.	
4. Title and Subtitle // Culvert Outlet Protection Design: Computer Program Documentation.			5. Report Date March 1975		
			6. Performing Organization Code		
7. Author(s) M. G. Schilling			8. Performing Organization Report No.		
9. Performing Organization Name and Address Wyoming Highway Department P. O. Box 1708 Cheyenne, Wyoming 82001			10. Work Unit No. (TRAIS)		
			11. Contract or Grant No. DOT-FH-11-7936		
12. Sponsoring Agency Name and Address U. S. Department of Transportation Federal Highway Administration, Office of Development (HDV-21) Washington, D.C. 20590			13. Type of Report and Period Covered Final Report		
			14. Sponsoring Agency Code		
15. Supplementary Notes FHWA Contract Manager: L. J. Harrison, Region 8 FHWA Implementation Manager: Milo D. Cress, Implementation Division					
16. Abstract  This computer program is capable of estimating the scour extent at culvert outlets and designing both rigid and rock riprapped stilling basins. It provides protection for the local scour problem only and not the gully scour situation. The types of erosion protection available include U. S. Army Waterways Experiment Station Estimate of Scour Extent, U. S. Army Waterways Experiment Station Rock Riprapped Basins, Colorado State University Rock Riprapped Basins, Vertical Stilling Well, St. Anthony Falls Stilling Basin, U. S. Bureau of Reclamation Type VI Basin, U. S. Bureau of Reclamation Type I Basin, U. S. Bureau of Reclamation Type II Basin, U. S. Bureau of Reclamation Type III Basin, U. S. Bureau of Reclamation Type IV Basin, and Colorado State University Smooth-Floor Flared Basin. The computer program was developed in a modular framework to facilitate the addition of new design methods that may be implemented in the future.  This report supersedes Report No. FHWA-RD-74-501 dated January 1974.					
17. Key Words Culvert Erosion Protection, Scour Energy Dissipator, Stilling Bain, Rock Riprapped Basin			18. Distribution Statement No restrictions. This document is available to the public through the National Technical Information Service, Springfield, Virginia 22151		
19. Security Classif. (of this report) Unclassified		20. Security Classif. (of this page) Unclassified		21. No. of Pages 243	22. Price





## ACKNOWLEDGMENTS

This document and computer design program was prepared as a composite of culvert outlet protection methods. The primary credit is extended to the originators of these methods. Needless to say, there would be no basis to this project without their contributions.

The project was reviewed in various stages by Mr. Larry Harrison (FHWA), Mr. Milo Cress (FHWA), Mr. Murray Corry (FHWA), Mr. Victor Grimm (FHWA), and Mr. Mainard Wacker (WHD).

Project coordination, programming, and documentation were accomplished by Mr. Michael Schilling (WHD). Mr. Fredric Hoffman, Jr. (WHD) assisted in programming and preparation of the figures. Miss Kathy Chilcoat (WHD) provided documentation typing. Mr. David Johnson (WHD) also prepared various figures. Mr. Philip Thompson (FHWA) contributed multiple regression analysis for some of the design curves.

TABLE OF CONTENTS

Section		Page
	TITLE . . . . .	i
	ACKNOWLEDGEMENTS . . . . .	iii
	TABLE OF CONTENTS . . . . .	iv
	LIST OF FIGURES . . . . .	v
	CULVERT EROSION PROTECTION GLOSSARY . . . . .	vii
	DEFINITION OF EQUATION VARIABLES . . . . .	ix
I.	PROBLEM STATEMENT . . . . .	1
II.	DESCRIPTION OF TECHNICAL PROCEDURES . . . . .	3
	A. U. S. Army Waterways Experiment Station Estimate of Scour Extent . . . . .	5
	B. U. S. Army Waterways Experiment Station Rock Riprapped Basins . . . . .	7
	1. Horizontal Riprap Blanket . . . . .	8
	2. Lined Channel Expansion . . . . .	8
	3. Preformed Scour Hole . . . . .	9
	C. Colorado State University Rock Riprapped Basins . . . . .	10
	1. Non-Scouring Basin . . . . .	14
	2. Scouring Basin . . . . .	16
	3. Hybrid Basin . . . . .	17
	D. Vertical Stilling Well . . . . .	18
	E. U. S. Bureau of Reclamation Type VI Basin . . . . .	19
	F. Hydraulic Jump Energy Dissipator . . . . .	21
	G. St. Anthony Falls Stilling Basin . . . . .	23
	H. U. S. Bureau of Reclamation Type I Basin . . . . .	24
	I. U. S. Bureau of Reclamation Type II Basin . . . . .	25
	J. U. S. Bureau of Reclamation Type III Basin . . . . .	26
	K. U. S. Bureau of Reclamation Type IV Basin . . . . .	28
	L. Colorado State University Smooth-Floor Flared Basin . . . . .	29
	Figures (1-42) . . . . .	31
III.	DESCRIPTION OF INPUT . . . . .	73
	Figures (43-46). . . . .	79
IV.	DESCRIPTION OF OUTPUT . . . . .	83
V.	SAMPLE PROBLEMS . . . . .	86
VI.	PROGRAM DESCRIPTION . . . . .	151
VII.	DEFINITION OF PROGRAM SYMBOLS . . . . .	154
VIII.	PROGRAM FLOWCHART . . . . .	186
IX.	SOURCE PROGRAM LISTING . . . . .	190
X.	REFERENCES . . . . .	242

## List of Figures

### Figure

- 1 Recommended Median Diameter of Protective Stone
- 2 Horizontal Riprap Blanket (Minimum Tailwater)
- 3 Horizontal Riprap Blanket Thickness (Minimum Tailwater)
- 4 Horizontal Riprap Blanket (Maximum Tailwater)
- 5 Horizontal Riprap Blanket Thickness (Maximum Tailwater)
- 6 Lined Channel Expansion
- 7 Preformed Scour Hole
- 8 Standard Non-Scouring Riprapped Basin
- 9 Standard Hybrid Riprapped Basin
- 10 Standard Scouring Riprapped Basin
- 11 Effect of Tailwater on Brink Depth: Horizontal and Mild Sloping Rectangular Culverts
- 12 Effect of Tailwater on Brink Depth: Horizontal and Mild Sloping Circular Culverts
- 13 Discharge Ratios for the Two-Dimensional Flow Approximation
- 14 Scour: Plain Rectangular Outlet
- 15 Scour: Plain Rectangular Outlet
- 16 Scour: Plain Circular Outlet
- 17 Scour: Plain Circular Outlet
- 18 Scour: Plain Circular Outlet
- 19 Scour Depth Classification Curve
- 20 An Estimate of the Angle of Lateral Expansion for Horizontal and Mild Sloping Circular Culverts
- 21 An Estimate of the Angle of Lateral Expansion for Horizontal and Mild Sloping Rectangular Culverts
- 22 Distribution of Centerline Velocity for Flow from Submerged Outlets
- 23 Length of Scour Hole
- 24 Basin Length

Figure

- 25 Width of Scour Hole
- 26 Vertical Stilling Well
- 27 Vertical Stilling Well Depth Below Inflow Pipe Invert
- 28 St. Anthony Falls Basin
- 29 U.S. Bureau of Reclamation Type VI Basin
- 30 U.S. Bureau of Reclamation Type VI Basin Width
- 31 U.S. Bureau of Reclamation Type I Basin
- 32 U.S. Bureau of Reclamation Type I Basin Hydraulic Jump Length
- 33 U.S. Bureau of Reclamation Type II Basin
- 34 U.S. Bureau of Reclamation Type II Basin Hydraulic Jump Length
- 35 U.S. Bureau of Reclamation Type III Basin
- 36 U.S. Bureau of Reclamation Type III Basin Hydraulic Jump Length
- 37 U.S. Bureau of Reclamation Type III Basin Baffle Blocks and End Sill Heights
- 38 U.S. Bureau of Reclamation Type IV Basin
- 39 U.S. Bureau of Reclamation Type IV Basin Hydraulic Jump Length
- 40 Smooth Floor Flared Basin
- 41 Typical Culvert-Stilling Basin Transition
- 42 Angle of Repose of Non-cohesive Material
- 43 Input Data Batch Order
- 44 Input Data Coding Form
- 45 Input Data Entry Form No. 1
- 46 Input Data Entry Form No. 2

## CULVERT EROSION PROTECTION GLOSSARY

CHANNEL AVERAGE VELOCITY - The average channel velocity immediately downstream of the culvert outlet computed as the total discharge divided by the channel water area.

CHANNEL MAXIMUM VELOCITY - The maximum velocity in the channel immediately downstream of the culvert outlet.

CHANNEL TAILWATER - The maximum channel flow depth immediately downstream of the culvert outlet.

CRITICAL FLOW - Flow characterized by inertial forces equal to gravity forces or a Froude number equal to one.

CULVERT BARREL - The structural tube conveying the discharge.

CULVERT BARREL DISCHARGE - The outflow of water conveyed by a single culvert barrel.

CULVERT BARREL SPACING - The horizontal distance measured between the outside of adjacent culvert barrels.

CULVERT BRINK DEPTH - The maximum depth of water at the center of the culvert outlet measured from the culvert flowline to the water surface.

CULVERT OUTLET AVERAGE VELOCITY - The average velocity of flow at the culvert outlet computed as the culvert barrel discharge divided by the water area of the barrel.

CULVERT RISE - The maximum, inside, vertical height at the culvert outlet.

CULVERT SLOPE - The slope of the culvert barrel measured as the vertical distance from inlet to outlet divided by the horizontal distance from inlet to outlet.

CULVERT SPAN - The maximum, inside, horizontal width at the culvert outlet.

ENERGY DISSIPATOR - A device or control structure for dissipation of excess kinetic energy present at the culvert outlet.

FROUDE NUMBER - The ratio of the stream velocity (inertial effects) to the wave velocity (gravitational effects).

GULLY SCOUR - Scour attributable to an unstable stream slope seeking a stable slope relative to a specific discharge.

HYDRAULIC JUMP - A hydraulic phenomenon accompanied by considerable turbulence and energy dissipation where the flow changes from supercritical to subcritical.

INITIAL DEPTH - The depth of water before the hydraulic jump. This is the upstream conjugate depth.



MOMENTUM - The motion property of water expressed as the product of a momentum coefficient, the unit weight of water, the discharge, the mean velocity, and the reciprocal of the gravitational acceleration.

RIPRAP EMBANKMENT SLOPE - The slope of the embankment or fill at the culvert outlet. (horizontal/vertical)

RIPRAP END SLOPE - The slope of the outlet end of the riprap basin. (horizontal/vertical)

RIPRAP ROCK EFFECTIVE DIAMETER - The diameter of a rock mixture equal to or greater than the median diameter. It weights the coarse fractions more than the fine fractions. Refer to Colorado State University Rock Riprapped Basins for equation.

RIPRAP ROCK MAXIMUM DIAMETER - The diameter of a rock mixture of which 100% by weight is finer.

RIPRAP ROCK MEDIAN DIAMETER - The diameter of a rock mixture of which 50% by weight is finer.

RIPRAP SIDE SLOPE - The slope of the sides of the riprap basin or downstream channel. (horizontal/vertical)

ROCK SPECIFIC GRAVITY - The ratio of the unit weight density of a rock sample to the unit weight density of water.

SCOUR HOLE - A local depression at the culvert outlet resulting from the energy of the water.

SEQUENT DEPTH - The depth of water after the hydraulic jump. This is the downstream conjugate depth.

SUBCRITICAL FLOW - Flow characterized by gravity forces exceeding inertial forces or a Froude number smaller than one.

SUPERCritical FLOW - Flow characterized by inertial forces exceeding gravity forces or a Froude number greater than one.

TOTAL ENERGY HEAD - The total energy of water equal to the sum of the height of the bed above datum, the depth of water, and the velocity head.



## DEFINITION OF EQUATION VARIABLES

<u>Variable</u>	<u>Description</u>
A	Basin inlet width, well diameter (ft)
B	Basin outlet width, well height above invert, baffle height above floor (ft)
$B_1, B_2$	Momentum correction coefficients
C	Basin length, well depth below invert (ft)
D	Basin height, basin thickness (ft)
$D_i$	Sieve diameters of rock for which 0%, 10%, 20%, 30%, 40%, 50%, 60%, 70%, 80%, 90%, and 100% of material by weight is finer (ft)
$d_1$	Basin inlet flow depth (ft)
$d_2$	Sequent flow depth of $d_1$ (ft)
$D_M, d_m$	Effective rock diameter (ft)
$D_o$	Culvert diameter, culvert span (ft)
$d_{50}$	Median stone diameter (ft)
$d_s$	Scour depth (ft)
$D_{sm}$	Maximum scour depth (ft)
$E, W_o, W$	Culvert span, basin top ridge (ft)
$E_o$	Culvert outlet energy (ft)
$E_1$	Basin inlet energy (ft)
$E_2$	Basin outlet energy (ft)
F	Basin depression depth, baffle lip (ft)
$F_o$	Culvert outlet Froude number
$F_1$	Basin inlet Froude number
$F_2$	Basin outlet Froude number

$g$	Gravitational acceleration (ft/sec <sup>2</sup> )
$G$	Baffle height (ft)
$H_0$	Culvert rise (ft)
$H$	Basin outlet height (ft)
$h_L$	Spillway transition head loss (ft)
$L$	Hydraulic jump length, rock depth (ft)
$L_S$	Scour length (ft)
$L_{sm}$	Maximum scour length (ft)
$L_T$	Spillway transition length (ft)
$M$	Rock length (ft)
$M_0$	Culvert outlet momentum (lb/ft)
$M_x$	Downstream momentum (lb/ft)
$N$	Number of culvert barrels
$Q$	Culvert discharge/barrel (cfs)
$R$	Spillway transition flare parameter (ft)
$\rho$	Mass density of water (lb-sec <sup>2</sup> /ft <sup>4</sup> )
$S$	Vertical Stilling Well incoming pipe slope (vertical/horizontal) (ft)
$t$	Duration of peak discharge (min)
$T$	Spacing (equal) between culvert barrels (ft)
$TW, d_t, d_2', Y_x$	Tailwater depth (ft)
$\theta$	Basin flare angle (deg)
$V_1$	Basin entrance velocity (fps), Basin apron volume (cu. yd)
$V_2$	Basin end slope volume (cu. yd)
$V_3$	Basin embankment slope volume (cu. yd)

$V_4$	Basin under slope volume (cu. yd)
$V_5$	Basin side slope volume (cu. yd)
$V$	Basin total volume (cu. yd)
$V_a, V_x$	Channel average velocity (fps)
$V_o$	Culvert outlet velocity (fps)
$V_s$	Scour volume (cu. yd)
$V_{oave}$	Average maximum culvert outlet velocity (fps)
$V_{xave}$	Average maximum downstream channel velocity (fps)
$W_x$	Downstream channel width (ft)
$W_s$	Single culvert barrel width scour (ft)
$W_{sm}$	Maximum scour width (ft)
$W_{sn}$	Multiple culvert barrel width of scour (ft)
$Y_o$	Culvert brink depth (ft)
$Z$	Datum or fall distance from culvert outlet flowline to stilling basin floor, basin side wall freeboard (ft)
$Z_2$	Riprap side slope, under slope (ft/ft)
$Z_1$	Riprap embankment slope (ft/ft)
$Z_3$	Riprap end slope (ft/ft)



SECTION I  
PROBLEM STATEMENT

## PROBLEM STATEMENT

Scour at the culvert outlet is a significant problem encountered in hydraulic design. Negligence of the situation can result in severe scour holes, excessive downstream deposition, and structure failure due to undermining. Often the optimum solution for protection of the culvert outlet is elusive. This is in many cases due to numerous and laborious manual design methods. Automation of various culvert protection methods by computer results in a powerful analysis tool. Many alternatives may be evaluated within specific constraints to yield an economical optimum solution.

The design capability of this program is extended to both rigid energy dissipators and rock riprapped basins. An estimate of the extent of scour excluding any protection is also provided as this may be a satisfactory solution if not excessive in the judgment of the designer.

It is recommended that the program be used as a guide to design rather than a substitute for judgment. Many different factors influence a design and variance of parameters can significantly affect the final design. It is advisable to evaluate discharges of different frequencies, for example, in the design of a stilling basin. This approach is similar to the performance curves used in culvert design. Culvert hydrograph design that utilizes upstream site storage is an excellent method of reducing erosion protection over culvert peak design that ignores storage. The designer is strongly urged to refer to the program documentation as well as the basic research literature in the bibliography for a sound understanding of the program output.

Two types of scour occur at a culvert outlet. This program is intended for design of protection against local scour only. It will not provide adequate protection for gully scour or headcutting characterized by an unstable channel slope seeking a stable slope. The designer is referred to studies performed in Oklahoma listed in the bibliography in order to resolve this class of problems.

The computer program was developed in a modular framework to facilitate the addition of new design methods that may be implemented in the future. A description of the program and techniques utilized is included in the following pages. The types of erosion protection available include U.S. Army Waterways Experiment Station Estimate of Scour Extent, U.S. Army Waterways Experiment Station Rock Riprapped Basins, Colorado State University Rock Riprapped Basins, Vertical Stilling Well, St. Anthony Falls Stilling Basin, U.S. Bureau of Reclamation Type VI Basin, U.S. Bureau of Reclamation Type I Basin, U.S. Bureau of Reclamation Type II Basin, U.S. Bureau of Reclamation Type III Basin, U.S. Bureau of Reclamation Type IV Basin, and Colorado State University Smooth-Floor Flared Basin.



SECTION II  
DESCRIPTION OF TECHNICAL PROCEDURES

## DESCRIPTION OF TECHNICAL PROCEDURES

This section explains the basic design methods employed in culvert outlet protection. A glossary of terms is provided to facilitate understanding of the design techniques. It is useful in preparation of input data as described in Section III. The standard presentation for a design includes a technical description, design limitations, basic equations, and illustrative figures. Identification of the various symbols in the design equations is found in a definition of equation variables section. It is strongly recommended that the user consult references in Section X for additional background or clarification of procedures.

## A. U. S. Army Waterways Experiment Station Estimate of Scour Extent

Two basic types of channel erosion occur at a culvert outlet. The first type, gully scour, is characterized by an unstable channel slope. Gully scour starts at a stable point downstream and progresses upstream throughout the region of instability. Control of this type of scour is effected by decreasing the channel Froude number. This is best accomplished by incorporating drop structures to maintain a stable slope and prevent erosion. The second type, a scour hole, occurs at the culvert outlet even if the downstream channel is stable. The scour hole is the only type of scour computed by the program. Empirical equations have been developed by the U. S. Army Corps of Engineers to predict the scour extent based on the design discharge, culvert diameter or span, design discharge duration, and tailwater depth. The research was performed in a horizontal sand bed with an effective or median sand diameter of approximately .001 feet. This gradation of material probably produces the maximum scour condition and would be a conservative estimate if a larger gradation existed at a culvert outlet site.

The extent of scour is provided automatically and can be used to evaluate the need for culvert erosion protection. If the location of the culvert, or the extent of the scour hole, or the existing channel material renders the scour hole unobjectionable, an economical solution is available in the formation of the scour hole. The scour hole acts as an efficient energy dissipator. The culvert is still subject to undermining and adequate protection is required by using a cutoff wall at the culvert outlet approximately 70% of the maximum expected scour depth in the minimum tailwater case. Minimum tailwater is characterized by a tailwater depth less than half the culvert rise. The maximum tailwater case is characterized by a tailwater depth greater than or equal to half the culvert rise. No undermining is anticipated in the maximum tailwater case. If the formation of the scour hole is undesirable, other measures of protection must be investigated. At any rate, quantification of the scour hole problem is a vital part of the decision process.

### Limitations:

1. The maximum peak discharge duration is 1440 minutes (24 hours).

Design Modules: HYDCOE

Empirical Scour Extent Equations:

#### Maximum Depth of Scour

$$D_{Sm} = 0.80D_0(Q/D_0^{5/2})^{0.375}t^{0.10} \quad \text{Tailwater} < 0.5D_0$$

$$D_{Sm} = 0.74D_0(Q/D_0^{5/2})^{0.375}t^{0.10} \quad \text{Tailwater} \geq 0.5D_0$$

### Maximum Width of Scour

$$W_{Sm} = 1.00D_o(Q/D_o^{5/2})^{0.915}t^{0.15} \quad \text{Tailwater} < 0.5D_o$$

$$W_{Sm} = 0.72D_o(Q/D_o^{5/2})^{0.915}t^{0.15} \quad \text{Tailwater} \geq 0.5D_o$$

### Maximum Length of Scour

$$L_{Sm} = 2.40D_o(Q/D_o^{5/2})^{0.71}t^{0.125} \quad \text{Tailwater} < 0.5D_o$$

$$L_{Sm} = 4.10D_o(Q/D_o^{5/2})^{0.71}t^{0.125} \quad \text{Tailwater} \geq 0.5D_o$$

### Volume of Scour

$$V_S = 0.73D_o^3(Q/D_o^{5/2})^2t^{0.375} \quad \text{Tailwater} < 0.5D_o$$

$$V_S = 0.62D_o^3(Q/D_o^{5/2})^2t^{0.375} \quad \text{Tailwater} \geq 0.5D_o$$

References: Fletcher, B. P. and Grace, J. L., Jr. (3)  
Bohan, J. P. (7)

## B. U. S. Army Waterways Experiment Station Rock Riprapped Basins

The design of this class of rock riprapped basins is based on empirical research performed by the U. S. Army Corps of Engineers. The various types of basins are related to a stable or non-scouring stone size as shown in Figure (1). There are three basic types of rock riprapped basins. The first type shown in Figure (2) and Figure (4) is the Horizontal Riprap Blanket. The second type shown in Figure (6) is the Lined Channel Expansion. The third type shown in Figure (7) is the Preformed Scour Hole. Selection of the type of basin to use is necessarily based on stone size, volume, and existing channel geometry. The limitations for these basins are based on research.

### Limitations:

1. Froude number range 0. - 4.
2. Maximum flow parameter  $(Q/W_0 H_0^{1.5})$  is 10.

Design Modules: HYDCOE

References: Fletcher, B. P. and Grace, J. L., Jr. (3)  
Bohan, J. P. (7)

## B. 1 Horizontal Riprap Blanket

The Horizontal Riprap Blanket is available in two configurations to adapt to minimum or maximum tailwater conditions. This allows lateral expansion to occur without creating erosion. This basin is non-scouring. Figure (2) illustrates the basin geometry for the minimum tailwater case. Figure (3) is used to compute the thickness of the basin for this case. Figure (4) illustrates the basin geometry for the maximum tailwater case. Figure (5) is used to compute the thickness of the basin for this case.

Empirical Horizontal Riprap Blanket Equations:

$D_{50} = (0.02(D_0)^2/TW)(Q/D_0^{2.5})^{1.333}$	Median Stone Diameter (ft) Figure (1)
$C = 1.7(D_0)(Q/D_0^{2.5})+8.$	Basin Length(ft) Figures (2), (4)
$D = .5(D_0)F_0$	Basin Thickness-Minimum Tailwater (ft) Figure (3)
$D = .5(D_0)F_0-.3D_0$	Basin Thickness-Maximum Tailwater (ft) Figure (5)
$A = 3.D_0$	Basin Inlet Width (ft) Figures (2) and (4)
$B = A+ C$	Basin Outlet Width-Minimum Tailwater (ft) Figure (2)
$B = A + .4C$	Basin Outlet Width-Maximum Tailwater (ft) Figure (4)

## B. 2 Lined Channel Expansion

The Lined Channel Expansion is basically a protective channel lining downstream of the culvert outlet. It permits lateral expansion and minimizes boundary attack.

Empirical Lined Channel Expansion Equations:

$D_{50} = (0.016D_0^2/TW)(Q/D_0^{2.5})^{1.333}$	Stable Median Stone Diameter (ft) Figure (1)
$C = 5.D_0$	Basin Length (ft) Figure (6)
$A = 3.D_0$	Basin Inlet Width (ft) Figure (6)
$B = 5.D_0$	Basin Outlet Width (ft) Figure (6)
$D = 2.D_{50}$	Basin Thickness (ft) Figure (6)



### B. 3 Preformed Scour Hole

The Preformed Scour Hole is an excavated hole or depression which is lined with rock riprap of a stable size to prevent scouring. The depression provides both vertical and lateral expansion downstream of the culvert outlet to permit dissipation of excessive energy in turbulence. A significant reduction in stone size is achieved by the excavation. The first type is depressed one-half the culvert rise and the second type is depressed the full culvert rise.

Empirical Preformed Scour Hole Equations:

$$D_{50} = (.0125D_0^2/TW)(Q/D_0^{2.5})^{1.333} \quad \text{Stable Stone Diameter-.5D}_0 \text{ Depression (ft) Figure (1)}$$

$$D_{50} = (.0082D_0^2/TW)(Q/D_0^{2.5})^{1.333} \quad \text{Stable Stone Diameter-D}_0 \text{ Depression (ft) Figure (1)}$$

$$C = 3.D_0 + 6.F \quad \text{Basin Length (ft) Figure (7)}$$

$$A = 2.D_0 + 6.F \quad \text{Basin Inlet Width (ft) Figure (7)}$$

$$B = 2.D_0 + 6.F \quad \text{Basin Outlet Width (ft) Figure (7)}$$

$$D = 2.D_{50} \quad \text{Basin Thickness (ft) Figure (7)}$$

$$E = D_0 \quad \text{Culvert Span (ft) Figure (7)}$$

$$F = .5D_0 \text{ or } D_0 \quad \text{Basin Depression (ft) Figure (7)}$$

### C. Colorado State University Rock Riprapped Basins

There are three standard types of rock riprapped basins developed from Colorado State University research. The first type shown in Figure (8) is the Non-Scouring Riprapped Basin. The second type shown in Figure (9) is the Hybrid Riprapped Basin. The third type shown in Figure (10) is the Scouring Riprapped Basin. The basins depict dimensions with straight lines; however, in actual construction, this is not possible and should not be a rigid requirement. The Non-Scouring Riprapped Basin is composed of a stable rock size that does not permit scouring to occur. In general, this basin is most economical with regard to quantity, but requires the largest size of rock. At the other extreme, the Scouring Riprapped Basin permits scouring, but requires a larger quantity of rock that is smaller in size. The Hybrid Riprapped Basin is a compromise between these two basins with regard to rock size and volume of material. It is permitted to scour slightly. In all basins where scouring is permitted, the extent of scour with regard to depth, length, and width is computed and directly influences the size of the basin.

One of the most important design parameters used to scale scour phenomena is the effective rock diameter (DM) of the riprap mixture. It is an indicator of the degree of gradation in a mixture which is essential to proper sizing of the basin. It weights the coarser fractions in the mixture more than the finer fractions. The standard measure of a mixture is the median rock diameter (D50). It is always less than or equal to the effective rock diameter (DM). A uniformly graded rock mixture is poorly graded with all rock sizes equivalent. In this case, the effective rock diameter equals the median rock diameter. A well graded mixture in comparison has a substantial range of sizes. In this case, the effective rock diameter is greater than the median rock diameter. Recognizing the fact that the median rock diameter is easier to obtain than the effective rock diameter, the former may be used in lieu of the latter with judgment. Since the effective rock diameter is generally larger than the median rock diameter, a conservative design is introduced by using the median rock diameter. In many cases, there is negligible difference. In other cases, the resulting design may be larger than required. Provisions are incorporated to allow the user to input an available effective rock diameter (median rock diameter) or riprap gradation indicating the 0%, 10%, 20%, 30%, 40%, 50%, 60%, 70%, 80%, 90%, 100% finer by weight rock sieve diameters. If the riprap gradation is submitted in lieu of the effective rock diameter, the effective rock diameter will be computed in subroutine HYDDM by using the effective rock diameter equation.

Compensation for specific gravity is also provided in the program for rock having a different specific gravity than 2.70 used in the CSU research. Adjustment is made automatically by coding in the specific gravity of the available riprap rock. Computed rock diameters are multiplied internally by  $(2.70/\text{Riprap Rock Specific Gravity})^{5/6}$ . This factor is based on particle weight and fluid drag considerations.

Volumes of the three basin types are computed to assist the designer in basin selection on an economical basis. It is necessary to input the embankment slope, the side slope, and the end slope for the riprap basins. The embankment slope is actually the embankment slope at the culvert outlet. The side slope is the slope of the channel downstream of the culvert outlet. The end slope is the slope at the end of the basin which is similar to a cutoff wall to protect the basin. Consideration should be given to the angle of stability for rock to eliminate sliding. Figure (42) is of value in estimating this parameter.

The basic design procedure common to all three basins is derived from scour research at Colorado State University. Design is controlled by the subroutine HYDPRK. Initially the culvert outlet flow parameters are used to determine if the culvert is performing in a steep slope or mild slope condition.

Steep sloping pipes cause the outlet flow to be parallel with the walls and floor of the conduit. Mild sloping pipes cause considerable curvature of the streamlines at the outlet and direct the velocity more into the rock bed. A culvert flowing full aligns the streamlines approximately straight and parallel at the outlet. This minimizes the effect of culvert slope on scour depth. The velocity, tailwater depth, and culvert size are then the important parameters in scouring.

The determination of steep sloping or mild sloping conditions is achieved by use of Figure (11) or Figure (12). The effect of tailwater on brink depth is evaluated by these curves. Entering the appropriate graph (rectangular or circular shape) with the tailwater depth/culvert rise for the discharge flow parameter yields a brink depth/culvert rise ratio. If this latter ratio is greater than the actual brink depth/culvert rise ratio, the culvert is steep sloping and will require conversion. If this ratio is less than or equal to the actual ratio, the culvert is mild sloping and will not require conversion. These figures are represented by data coordinates in the subroutine HYDBTW.

The Colorado State University conversion method employed transforms the outfall flow conditions of the steep sloping culvert into equivalent conditions for a mildly sloping culvert flowing full. In effect, the culvert rise is set equal to the brink depth to simulate full flow conditions. A new discharge flow parameter is computed as well as a new tailwater depth/culvert rise ratio.

Another conversion employed regardless of steep sloping or mild sloping conditions is to convert the discharge flow parameter from rectangular (circular) to circular (rectangular) by Figure (13). This provides additional data points from the existing scour depth curves. An equation for this curve was developed from multiple regression of data points.

The next step common to all three basins is to obtain scour depths for various effective rock diameters by use of Figure (14), Figure (15), Figure (16), Figure (17) and Figure (18). These figures are represented by data coordinates in the subroutine HYDPRK. Tailwater depth/culvert



rise ratio and discharge flow parameter are used to obtain the scour depth/culvert rise ratios for a specific effective rock diameter/culvert rise ratio. The program provides interpolation. At least two sets of effective points must be available to effect a solution. The end result is the elements of a curve shown in Figure (19). The curve is divided into three zones which are the three types of basins. The division between the Non-Scouring Riprapped Basin and the Hybrid Riprapped Basin occurs at a scour depth of zero. The division between the Hybrid Riprapped Basin and the Scouring Riprapped Basin occurs at a point where the scour depth is twice the effective rock diameter. The scour length, scour width, basin length, basin thickness, and basin volumes are more appropriately discussed under the specific types of basin later.

The resultant volumes and rock sizes should then be considered in conjunction with available materials and requirements to effect an optimum solution.

It is possible to use multiple barrels if all barrels are the same size and carry equal discharges. The scour depth and scour length of a multiple barrel culvert carrying the total discharge is the same as a single barrel culvert carrying its equal fraction of the total discharge. The width of the scour hole is computed by the multiple barrel scour width equation. If one barrel of a multiple barrel becomes blocked with debris, more flow is diverted to the other barrels, greatly increasing chance for failure of the basin.

Limitations:

1. Maximum discharge flow parameter  $(Q/(W_0)(H_0)^{1.5})$  is 15.

Design Modules: HYDPRK, HYDSCR, HYDBTW, HYDVOL, HYDDM

Colorado State University Rock Riprapped Basin General Equations:

$$W_{sn} = W_s + (N-1)(W_0 + T) \quad \text{Multiple Barrel Scour Width (ft)}$$

$$DM = \left( \left( \sum_{i=1}^{10} ((D_{(i-1)10} + D_{(i)10})/2.)^3 \right) / 10. \right)^{1/3} \quad \text{Effective Rock Diameter (ft)}$$

$$(Q/W_0 H_0^{1.5}) / (Q/D_0^{2.5}) = 2.53211 - 3.52885x + 2.26965x^2 \quad \text{Discharge Ratios for the Two-Dimensional Flow Approximation-Figure (13)}$$

$$X = Y_0/H_0 \text{ or } Y_0/D_0$$

References: Simons, D. B., Stevens, M. A., and Watts, F. J. (5)

Colorado State University Rock Riprapped Basin Volume Equations

Non-Scouring and Hybrid Types (Figures (8), (9))

$V_1 = C/2. ((A+B)E+(F-E)/4.) (3.A+B))$	Apron Volume
$V_2 = E(B)E(Z_3^2+1.)^{1/2}$	End Slope Volume
$V_3 = 2.25E(D)^2Z_2(Z_1^2+1.)^{1/2}$	Embankment Slope Volume
$V_4 = (E/2.) (Z_1^2+1.)^{1/2}E(A)$	Under Slope Volume
$V_5 = (2.C(\tan^2\theta+1.)^{1/2}+2.E(Z_3^2+1.)^{1/2}+1.5D(Z_1))$ $(E(1.5D)(Z_2^2+1.)^{1/2}+(E)^2(Z_2^2+1.)/(2.Z_2))$	Side Slope Volume
$V = (V_1 + V_2 + V_3 + V_4 + V_5)/27.$	Total Volume (cu. yd)

Scouring Type (Figure (10))

$V_1 = C(E)B+.53C(B)(F-E)$	Apron Volume
$V_2 = E(B)E(Z_3^2+1.)^{1/2}$	End Slope Volume
$V_3 = E(B-W_0+1.5D(Z_2))(1.5D(Z_1^2+1.))$	Embankment Slope Volume
$V_4 = (E/2.) (Z_1^2+1.)^{1/2}(F)B$	Under Slope Volume
$V_5 = E(3.D(Z_2^2+1.)^{1/2}+E(Z_2^2+1.)/Z_2)(1.5D(Z_1)$ $+C+E(Z_3^2+1.)^{1/2})$	Side Slope Volume
$V = (V_1 + V_2 + V_3 + V_4 + V_5)/27.$	Total Volume (cu. yd)

## C. 1 Colorado State University Non-Scouring Riprapped Basin

The basic function of this basin is to allow the high velocity jet at the culvert outlet to expand laterally until the flow velocity is reduced to a stable level in the natural channel. The expansion angle of the velocity jet is duplicated by the basin geometry to eliminate scour. No advantage is gained in protecting for velocities less than those that occur naturally.

Two design procedures are employed in the Non-Scouring Riprapped Basin. The first case is the low tailwater design where the tailwater is less than the culvert rise. The second case is the high tailwater design where the tailwater is equal to or greater than the culvert rise. The methods are identical excepting the basin length and flare angle calculations. In both cases, the scour hole depth, length, and width will be zero if a non-scouring rock size is used.

In the low tailwater case, the length of basin depends on the channel allowable average velocity. Figure (20) and Figure (21) for circular and rectangular shapes respectively, yield estimates of the required flare angle. The curves are entered with a tailwater depth/brink depth ratio to obtain the flare angle in terms of the tangent of the angle. The curves are based on outlet Froude numbers of 1.5 and 1.4. Compensation for larger or smaller Froude numbers is accomplished by multiplying the flare angle by 1.5/Froude number for circular culverts and 1.4/Froude number for rectangular culverts. Using the tangent of the angle, the discharge, the tailwater depth, the allowable average channel velocity, and the basin inlet width, the basin outlet width is then obtained by the continuity equation based on conservation of mass. The basin inlet width is combined with the basin outlet width and flare angle to compute the basin length.

The high tailwater case employs Figure (22) to compute the basin length by using the arithmetic mean of the velocities measured along a vertical centerline at the culvert outlet and the arithmetic mean of the velocities measured along a vertical centerline at X distance downstream. The former is computed by multiplying the culvert outlet average velocity by 1.10 (smooth pipe) or 1.15 (rough pipe). The latter is estimated by using the channel maximum velocity. The distance X or basin length is then obtained from the curve. The outlet width of the basin is found by using the continuity equation. The possible diversion of the jet from side to side depends on the ratio of basin outlet width to basin inlet width. If the basin outlet width is greater than four times the basin inlet width, the danger of jet attachment to a wall is minimum. The high tailwater problem can also be solved by riprapping the downstream channel banks.

Equations:

$$C = (1/.2 \cdot \tan \theta) ((Q / ((TW) (V_a))) - W_o) \quad \text{Non-Scouring Basin Length (ft) Figure (8)}$$

$$B = Q / ((TW) (V_a)) \quad \text{Non-Scouring Basin Outlet Width (ft) Figure (8)}$$



An Estimate of the Angle of Lateral Expansion for Horizontal and Mild Sloping Circular Culverts - Figure (20)

These equations were derived from multiple regression analysis of Figure (20)

$$\tan\theta = 1.8 - 5.5(d_t/Y_0) \quad (d_t/Y_0 \text{ range } 0.0-0.23)$$

$$\tan\theta = 0.0714(d_t/Y_0)^{-1.42} \quad (d_t/Y_0 \text{ range } 0.23-0.40)$$

$$\tan\theta = 0.0495(d_t/Y_0)^{-1.82} \quad (d_t/Y_0 \text{ range } 0.40-1.20)$$

Minimum  $\tan\theta = 0.05$

An Estimate of the Angle of Lateral Expansion for Horizontal and Mild Sloping Rectangular Culverts - Figure (21)

These equations were derived from multiple regression analysis of Figure (21)

$$\tan\theta = 0.90 + 4.67(0.20 - d_t/Y_0) \quad (d_t/Y_0 \text{ range } 0.0-0.20)$$

$$\tan\theta = 0.05 + 1.3158(1. - d_t/Y_0)^{1.91624} \quad (d_t/Y_0 \text{ range } 0.20-1.20)$$

Minimum  $\tan\theta = 0.05$

Distribution of Centerline Velocity for Flow from Submerged Outlets-Figure (22)

$$X = 6.W_0V_{oave}/V_{xave} \quad (V_{xave}/V_{oave} \text{ range } 0.1-0.6)$$

$$X = W_0(22.62474 + 98.61093(V_{xave}/V_{oave})^3 - 33.01651(V_{xave}/V_{oave})^5 - 87.13084(V_{xave}/V_{oave})^2) \quad (V_{xave}/V_{oave} \text{ range } 0.6-1.0)$$

## C. 2 Colorado State University Scouring Riprapped Basin

This type of basin permits scouring in the basin which dissipates the flow energy of the jet in a boil and roller that forms in the hole. The basin is constructed by placing the riprap apron level with the culvert outlet flowline and on the same slope as the barrel. The formation of a scour hole and mound is done by the water. The mound is an essential part of the basin and its absence would increase scour. The basin length is not governed by the allowable channel velocity downstream, but by the need for a suitable mound base to prevent its failure. If an adequate base downstream exists, this part of the basin is not necessary. An adequate mound base is characterized by a rock size gradation that prevents leaching of fine material underneath the mound and its consequent failure by collapse. If a suitable gradation exists, the portion of rock basin underlying the mound in Figure (10) may be eliminated. This is usually not the case, however.

For a selected effective rock diameter, the length of scour hole is obtained from Figure (23). Similarly the basin length is found from Figure (24). The width of scour is obtained from Figure (25). The volume of basin rock required increases with decrease in effective rock diameter size.

Equations:

Length of Scour Hole (ft)  
Figure (23)

For  $d_s/d_m < 27.5$

$$L_s = (0.01503 (27.5 - (d_s/d_m))^{2.22123} + 11.) (1. + 5.S) (d_t/Y_o + d_s)$$

For  $d_s/d_m \geq 27.5$

$$L_s = 11. (1. + 5.S) (d_t/Y_o + d_s)$$

Length of Basin (ft)  
Figure (24)

$$L = 1.9 L_s$$

Width of Scour Hole (ft)  
Figure (25)

For  $d_s/d_m \leq 10.$

$$W_s = 11.474 d_m (d_s/d_m)^{0.64489}$$

For  $d_s/d_m > 10.$

$$W_s = d_m (3. (d_s/d_m) + 20.)$$

### C. 3 Colorado State University Hybrid Riprapped Basin

The Hybrid Riprapped Basin is a compromise between the Scouring Riprapped Basin and the Non-Scouring Riprapped Basin. It scours slightly but does not give the efficient type of energy dissipation common to large scour holes. The scour depth is limited to twice the effective rock diameter. This is because the thickness of the Non-Scouring Riprapped Basin is equal to twice the effective rock diameter and scouring deeper than this value presumes failure of the Non-Scouring Riprapped Basin. In the range of this type of basin, the basin dimensions are obtained by interpolation between the scouring and non-scouring extremes. These extremes are determined by computing the maximum effective rock diameter Scouring Riprapped Basin and the minimum effective rock diameter Non-Scouring Riprapped Basin.

## D. Vertical Stilling Well

This basin shown in Figure (26) consists of a vertical section of circular pipe connected to an incoming pipe outlet. Energy dissipation is effected by flow expansion in the well, jet impact on the wall and base of the well, and momentum change as a result of flow redirection. Advantages of this basin include a no tailwater depth requirement and economical construction without concrete formwork. The top of the well must be located at the flow-line elevation of the drainage channel. The area surrounding the well may be protected with riprap or paving. If there is no erosion problem within two well diameters of the periphery of the well, this protection is not required. Debris could be a problem if it were capable of clogging the basin.

The height of the stilling well above the incoming pipe is twice the incoming pipe diameter. The depth of the well below the incoming pipe invert is dependent on the incoming pipe slope and well diameter. Figure (27) indicates this relationship.

### Limitations:

These limitations are based on research tests.

1. Circular incoming pipe.
2. Maximum discharge parameter  $Q/D_0^{5/2}$  is 10.
3. Maximum incoming pipe slope is  $45^\circ$  (1.00)
4. Not recommended for debris-laden flow.
5. Open well is potentially dangerous in urban areas.
6. Maximum well diameter is five incoming pipe diameters.

Design Modules: VSWELL

### Equations:

$A = 0.53D_0(Q/D_0^{5/2})$	Stilling Well Diameter (ft) Figure (26)
$C = DW(0.00041+1.3725S-1.30498S^2+0.50383S^3)$	Well Depth Below Invert (ft) Figure (26), (27)
$B = 2.D_0$	Well Height Above Invert (ft) Figure (26)

References: Grace, J. L., Jr. and Pickering, G. A. (2)



## E. U.S. Bureau of Reclamation Type VI Basin (Impact Stilling Basin)

This basin shown in Figure (29) is an impact type of energy dissipator which is an effective stilling device even with deficient tailwater where the discharge is relatively small and the incoming velocity into a basin does not exceed 30 feet per second. It can be used with either an open chute or a closed conduit structure. The design is satisfactory for discharges up to 400 second-feet as shown in Figure (30). Larger discharges have been accommodated by placing multiple basins side by side.

Energy dissipation is initiated by flow striking the vertical hanging baffle and directing upstream by the horizontal portion of the baffle and the floor, in vertical eddies. The structure, therefore, requires no tailwater for energy dissipation as is necessary for a hydraulic jump basin. Best hydraulic action is obtained when the tailwater height approaches but does not exceed a level halfway up the height of the baffle. For proper performance, the bottom of the baffle should be at the same level as the invert of the culvert outlet. The entrance pipe may be tilted downward slightly without affecting performance adversely. A limit of  $15^{\circ}$  is a suggested maximum although the loss in efficiency at  $20^{\circ}$  may not cause excessive scour. For greater slopes, use a horizontal or sloping pipe (up to  $15^{\circ}$ ) two or more diameters long just upstream from the stilling basin.

The notches shown in the baffle are provided to aid in cleaning out the basin. When the basin is full of sediment before the start of the spill, the notches provide concentrated jets of water to clean the basin. If cleaning action is not considered necessary, the notches need not be constructed as the basin is designed to carry the full discharge over the top of the baffle if the space beneath the baffle becomes clogged. Performance is not as good, but is acceptable. With the basin operating normally, the notches provide some concentration of flow passing over the end sill, resulting in minor erosion. Riprap, as shown, will provide ample protection in the usual installation, but if the best performance is desired, it is recommended that the alternate end sill and  $45^{\circ}$  end walls be used. The extra sill length reduces flow concentration, scour and waves in the downstream channel.

This type of basin is subject to large dynamic forces and turbulences which must be considered in the structural design. The structure must be stable to resist sliding against the impact load on the baffle wall. The entire structure must resist severe vibrations inherent in this type of device, and the individual structural members must be sufficiently strong to withstand the large dynamic loads.

### Limitations:

1. Best hydraulic action is obtained when the tailwater elevation approaches, but does not exceed, a level halfway up the height of the baffle. Excessive tailwater, on the other hand, will cause some flow to pass over the top of the baffle.

2. With outlet velocities less than 2 fps, the incoming jet could possibly ride underneath the hanging baffle. Consequently, this basin is not recommended with velocities less than 2 feet per second.
3. This program limits the outlet velocities to a maximum of 30 feet per second as a result of research.
4. Maximum discharge limit is 400 cubic feet per second.
5. Not recommended for debris-laden flow.

Design Modules: USBR6

Equations:

$A = 1.56025 Q^{0.4034}$	Basin Width (ft) Figure (29), (30)
$B = 0.167 A$	Baffle Height Above Floor (ft) Figure (30)
$G = 0.375 A$	Baffle Height (ft) Figure (30)
$F = .167 A$	Baffle Lip (ft) Figure (30)
$C = 1.333 A$	Basin Length (ft) Figure (30)
$D = 0.75 A$	Basin Height (ft) Figure (30)
$H = 0.42 A$	Basin Outlet Height (ft) Figure (30)
$K = 0.58 A$	Basin Top Length (ft) Figure (30)
$E = 0.0833 A$	Basin Top Ridge (ft) Figure (30)
$I = 0.0833 A$	Baffle Notch Width (ft) Figure (30)
$J = 0.125$	Baffle Notch Height (ft) Figure (30)
$M = 4 W O$	Rock Length (ft) Figure (30)
$L = 1.5 \text{ (ft)}$	Rock Depth (ft) Figure (30)

References: Bradley, J. N. and Peterka, A. M. (1)  
U. S. Bureau of Reclamation (4)



## F. Hydraulic Jump Energy Dissipators

One of the most effective means of energy dissipation is the hydraulic jump. Rectangular stilling basins provide the best shape for a stable and complete hydraulic jump. Five stilling basins that qualify as rectangular, hydraulic jump basins include the St. Anthony Falls Basin, and the U.S. Bureau of Reclamation Types I, II, III, and IV Basins. For best hydraulic performance, the energy dissipator sidewalls should be vertical since the geometry of trapezoidal basins produces jump interferences along the triangular sidewalls.

Due to the flow confinement by a culvert, it is often desirable hydraulically to provide a stilling basin wider than the culvert outlet span. In order to effect a satisfactory jump, the depth of flow and velocity entering the basin must be uniform across the basin width. High Froude numbers at culvert outlets are uncommon and it is often necessary to increase the Froude number to effect a hydraulic jump consistent with the tailwater depth to use one of the basins. Low Froude numbers do not produce stable hydraulic jumps and adequate energy dissipation. Consequently, Froude numbers may be increased to the desired range by incorporating a basin depression below the streambed and/or a flared transition to spread the flow into a uniform sheet. Figure (41) illustrates the geometry of a typical spillway transition to a depressed basin.

A long, gradual transition is usually best for hydraulic performance, but is often uneconomical. A short transition is often undesirable as it does not allow uniform spreading. The flare angle is of primary importance in providing the correct transition. Empirical equations have been developed to compute the required transition flare and transition length for both circular and rectangular culverts. In the case of the circular shape, a short, rectangular section equal to one-half the culvert diameter should precede the transition. This allows the circular jet to adjust to the rectangular section prior to the transition.

Selection of the basin width for the U.S. Bureau of Reclamation Types I, II, III, IV, Basins is done by the designer. This allows the designer to input a width that will be compatible with existing channel geometry and economics. The minimum width designed is equal to the culvert span. Basin width also influences the depth of basin depression below the streambed at the culvert outlet. Generally, a smaller width will require a deeper depression than a larger width. In some cases the basin outlet velocity is smaller than the average channel velocity and the basin may be over designed. However, varying the basin width will result in the basin outlet velocity and average channel velocity being more compatible.

The specific energy equation is used to compute the depth-velocity relationship at the basin entrance to effect a hydraulic jump. It is necessary to depress the basin floor in many cases to achieve the required Froude number for a basin, to prevent extent of the chute blocks into the culvert and to effect the hydraulic jump. The user is required to use judgment in deciding if the depression is excessive. A transition head loss due to boundary friction and shock loss is deducted from the culvert outlet energy prior to computing the basin inlet or entrance energy. The hydraulic jump equation is used to compute the required sequent or conjugate depth. The sum of the tailwater depth and basin depression must at least equal the sequent depth. The floor of the basin is zero datum. In order to stabilize the jump at the basin entrance, it is recommended to use a 3:1 slope. Flatter slopes than 4:1 tend to destroy the quality of the hydraulic jump. The jet should be supported in the transition to aid spreading and eliminate separation from the floor.

The subroutine HYDENG computes specific energy data and the subroutine FLARE computes spillway flare transition geometry.

Design Modules: HYDENG, FLARE

Equations:

$$R = (W/D_0 - 1.)^{1/3} / (4. + 1.7F_0)$$

Transition Sidewall Flare-Circular  
Culvert (ft) Figure (41)

$$R = (W/B - 1.)^{1/3} / (4. + 1.6F_0)$$

Transition Sidewall Flare-Rectangular  
Culvert (ft) Figure (41)

$$L_T = (W - D_0) / 2.R$$

Spillway Transition Length (ft)  
Figure (41)

$$h_L = 0.15V_0^2 / 2g$$

Transition Head Loss (ft)

$$E_0 = Y_0 + Z + V_0^2 / 2g$$

Culvert Outlet Energy (ft)

$$E_1 = d_1 + V_1^2 / 2g - h_L$$

Basin Inlet Energy (ft)

$$E_2 = TW + Z + V_2^2 / 2g$$

Basin Outlet Energy (ft)

References: Smith, C. D. (6)

## G. St. Anthony Falls Stilling Basin

This energy dissipator is a hydraulic jump basin similar to the U.S. Bureau of Reclamation Type III Basin, but is applicable to a greater range of Froude numbers from 1.73-17.3 and is considerably shorter. The reduction in length is due to the chute blocks, baffle blocks, and end sill. The St. Anthony Falls Basin is shown in Figure (28). The rectangular version was selected in lieu of the trapezoidal for hydraulic jump stability. This type of basin is used with a spillway transition as described under F. Hydraulic Jump Energy Dissipators. The designer has no direct control over the width of this basin. If direct control over the width is desired, the U.S. Bureau of Reclamation Type III basin is recommended.

In spite of the similarity between the St. Anthony Falls and the U.S. Bureau of Reclamation Type III basins, there are notable differences. The SAF basin does not dissipate energy as completely as the Type III basin and the downstream channel will be subject to scour. The end sill of the SAF basin protects the stream bed and the basin performance is satisfactory, however. The baffle blocks of the Type III basin are not staggered with the chute blocks. It is desirable to employ staggering with the SAF Basin for best performance. Baffle piers reveal desirable action in helping to correct non-uniform depths at the basin entrance.

### Limitations:

1. Froude number range 1.73-17.32
2. Maximum discharge parameter  $(Q/W_0H_0^{1.5})$  is 9.5.

### Design Modules: SAF

### Equations:

$d_2 = (d_1/2.)(-1.+(8.F_1^2+1.)^{1/2})$	Sequent Depth (ft)
$Z = d_2/3.$	Basin Sidewall Freeboard (ft)
$D = d_2' + Z$	Basin Height (ft) Figure (28)
$C = 4.5d_2/(F_1^2)^{0.38}$	Basin Length (ft) Figure (28)
$0.07d_2$	End Sill Height (ft) Figure (28)
$A = 0.3D_0(Q/D_0^{2.5})$	Basin Width (ft) Figure (28)
$d_2' = (1.10-F_1^2/120.)d_2$	Tailwater Depth (ft) (Froude numbers 1.73-5.48)
$d_2' = 0.85d_2$	Tailwater Depth (ft) (Froude numbers 5.48-10.95)
$d_2' = (1.00-F_1^2/800.)d_2$	Tailwater Depth (ft) (Froude numbers 10.95-17.32)



## H. U.S. Bureau of Reclamation Type I Basin

This type of basin shown in Figure (31) is a hydraulic jump energy dissipator. It is basically a horizontal, concrete apron with side walls. No basin devices such as blocks, baffles, or sills are necessary. The use of this basin is restricted to the range of Froude numbers from 4.5 to 9. A stable, well-balanced jump with confined turbulence and a relatively smooth, downstream water surface is then available. Energy dissipation varies from forty-five to seventy percent in this range. Above the Froude number of 9, the jump turbulence increases and rough surface waves persist downstream. The jump also becomes more sensitive to the tailwater depth with increasing Froude number and a very deep, uneconomical basin is often required. Below the Froude number of 4.5, the hydraulic jump is in a transition stage or a prejump stage. The U.S. Bureau of Reclamation Type IV Basin is applicable in the transition range where oscillating flow is a problem. The prejump stage is characterized by relatively smooth flow and very low energy dissipation in the jump. Other basin types are more efficient and practical in this area.

Figure (32) indicates the length of jump (basin) to be used for a specific Froude number applicable for the U.S. Bureau of Reclamation Type I Basin. The designer may input a selected width for this basin.

### Limitations:

This limitation is based on research and field tests.

1. Froude number range 4.5 - 9.

Design Modules: USBR1

### Equations:

$d_2 = (d_1/2.)((1.+8.F_1^2)^{1/2}-1.)$	Sequent Depth (ft)
$TW = d_2$	Minimum Tailwater Depth (ft)
$L = \text{Minimum}(.2d_2F_1+4.9 d_2), 6.1d_2)$	Length of Jump (ft) Figure (32)
$C = L$	Basin Length (ft) Figure (31)
$D = 1.1d_2+.1v_1$	Basin Height (ft) Figure (31)

References: Bradley, J. N. and Peterka, A. M. (1)  
U. S. Bureau of Reclamation (4)

## I. U.S. Bureau of Reclamation Type II Basin

This basin shown in Figure (33) is most appropriately used for incoming velocities in excess of 50 feet per second and Froude numbers from 4.5 to 14.5. Dissipation is accomplished primarily in the hydraulic jump with chute blocks and a dentated end sill decreasing the jump length. The chute blocks tend to corrugate and lift the jet to improve the jump action.

The jump is sensitive to tailwater depth deficiency and it is recommended to incorporate a five percent safety factor in the conjugate depth. Figure (34) provides the length of jump (basin) to be used for a specific Froude number. The designer may input a selected width for this basin.

### Limitations:

These limitations are based on research and field tests.

1. Froude number range 4.5 - 14.5
2. Discharge limit of 500. cfs per foot of basin width.

Design Modules: USBR2

### Equations:

$d_2 = (d_1/2.)((1.+8.F_1^2)^{1/2}-1.)$	Conjugate Depth (ft)
$TW = 1.05d_2$	Minimum Tailwater Depth (ft)
$L = d_2(1.97363+0.57325F_1-0.04572F_1^2+0.00119F_1^3)$	Length of Jump (ft) Figure (34)
$C = L$	Basin Length (ft) Figure (33)
$D = 1.1d_2+.1v_1$	Basin Height (ft) Figure (33)
$d_1$	Chute Block Width (ft) Figure (33)
$d_1$	Chute Block Spacing (ft) Figure (33)
$d_1$	Chute Block Height (ft) Figure (33)
$.2d_2$	Dentated End Sill Element Height (ft) Figure (33)
$.15d_2$	Dentated End Sill Element Width (ft) Figure (33)
$.15d_2$	Dentated End Sill Element Spacing (ft) Figure (33)
$.02d_2$	Dentated End Sill Element Top Width (ft) Figure (33)

## J. U.S. Bureau of Reclamation Type III Basin

This impact dissipation type of basin shown in Figure (35) is used where incoming velocities do not exceed 50 feet per second and Froude numbers vary from 4.5 to 16.5. The basin employs chute blocks, impact baffle blocks, and end sill, and jump turbulence for energy dissipation. Stilling basin action is very stable and satisfactory for all Froude numbers in the applicable range. The front of the hydraulic jump is steep and wave action downstream is minimal. This type of basin is superior to either the Type I basin or Type II basin. It has a large safety factor against hydraulic jump sweepout.

It is important to follow the recommended position and dimensions of the baffle blocks on the apron to obtain the best action. Full conjugate tailwater depth is advised for best operation. Figure (36) is used to obtain the length of jump (basin) for a selected Froude number. Figure (37) is employed to compute the height of the baffle blocks and the end sill. The designer may input a selected width for this basin.

### Limitations:

These limitations are based on research and field tests.

1. Froude number range 4.5 - 16.5
2. Discharge limit of 200. cfs per foot of basin width.

Design Modules: USBR3

### Equations:

$d_2 = (d_1/2.)((1.+8.F_1^2)^{1/2}-1.)$	Conjugate Depth (ft)
$TW = d_2$	Minimum Tailwater Depth (ft)
$L = d_2(0.92179+0.40607F_1-0.02953F_1^2+0.00070F_1^3)$	Length of Jump (ft) Figure (36)
$D = 1.1d_2+.1v_1$	Basin Height (ft) Figure (35)
$C = L$	Basin Length (ft) Figure (35)
$d_1$	Chute Block Height (ft) Figure (35)
$d_1$	Chute Block Width (ft) Figure (35)
$d_1$	Chute Block Spacing (ft) Figure (35)
$d_1(.17F_1+.57)$	Baffle Block Height (ft) Figure (35), Figure (37)



$.75d_1(.17F_1+.57)$	Baffle Block Spacing (ft) Figure (35)
$.75d_1(.17F_1+.57)$	Baffle Block Width (ft) Figure (35)
$.2d_1(.17F_1+.57)$	Baffle Block Top Surface Width (ft) Figure (35)
$d_1(.0555F_1+1.)$	End Sill Height (ft) Figure (35), (37)

References: Bradley, J. N. and Peterka, A. M. (1)  
U. S. Bureau of Reclamation (4)

## K. U.S. Bureau of Reclamation Type IV Basin

This type of basin shown in Figure (38) is applicable for the range of Froude numbers from 2.5 to 4.5. Hydraulic jumps in this range are of an immature, oscillatory nature causing excessive wave action downstream of the jump.

The chief purpose of the Type IV basin is to minimize wave action by stabilizing the jump. Large chute blocks are installed to direct the flow jet into the base of the roller to intensify its action. If designed for maximum discharge, the basin will perform adequately for lower discharges. The jump is very sensitive to tailwater depth in the lower Froude number range and it is advised to use a tailwater depth ten percent greater than the conjugate depth. A small tailwater deficiency could allow the jump to escape the basin. The upper block surfaces are sloped down slightly to improve the action at lower discharges. Figure (39) indicates the length of jump (basin) to be used for a specific Froude number. The designer may input a selected width for this basin.

### Limitations:

This limitation is based on research and field tests.

1. Froude number range 2.5 - 4.5

Design Modules: USBR4

### Equations:

$d_2 = (d_1/2.)((1.+8.F_1^2)^{1/2}-1.)$	Sequent Depth (ft)
$TW = 1.1d_2$	Minimum Tailwater Depth (ft)
$L = 3.50d_2F_1^{0.358}$	Length of Jump (ft) Figure (39)
$C = L$	Basin Length (ft) Figure (38)
$2d_1$	Chute Block Height (ft) Figure (38)
$d_1$	Chute Block Width (ft) Figure (38)
$2.5d_1$	Chute Block Spacing (ft) Figure (38)
$2d_1$	Chute Block Top Length (ft) Figure (38)
$D = 1.1d_2+.1v_1$	Basin Height (ft) Figure (38)
$1.25d_1$	End Sill Height (ft) Figure (38)

## L. Colorado State University Smooth-Floor Flared Basin

This basin shown in Figure (40) is a hydraulic jump basin. It is characterized by flared vertical walls and a horizontal, smooth floor. The basin is generally constructed with concrete, but may be built of wire-enclosed rock. The wire is subject to abrasion and failure more rapidly, however.

Energy dissipation is produced by a hydraulic jump which reduces the culvert exit velocity to a subcritical level compatible with the downstream channel. The momentum flux and resultant pressure force at the basin inlet must balance the resultant pressure force and momentum flux at a point X slightly downstream of the hydraulic jump. Hydrostatic pressure variation and uniform velocity distribution are assumed. A flare angle based on the culvert outlet Froude number assures that the entire width of cross section at point X will be used by flow in the downstream direction.

Equating the outfall section momentum and the X section momentum creates a quadratic equation yielding two solutions of basin length. The maximum length is selected as it is the most stable jump position. In contrast, the minimum basin length is too close to the culvert outlet and may be inundated. The basin floor shear force and the diverging walls pressure force were not evaluated in the design. The forces tend to cancel each other and a conservative estimate of basin length is obtained.

In computing the position of the hydraulic jump and basin length, it is assumed that the tailwater depth is constant across the width of the basin. It is recommended to incorporate a safety factor against a downstream shift in the hydraulic jump position. A minimum distance of six times the tailwater depth is added to the basin length to contain the jump.

Exit velocities from the basin should be checked for minimum tailwater conditions. The basin walls must be high enough to prevent tailwater from flowing over the walls and submerging the high velocity jet. This would result in downstream scour.

In some cases, this design results in unrealistically large structures. The method seems most appropriate for higher culvert outlet velocities. It is possible that the minimum basin length solution is adequate, but lack of field verification required use of the conservative maximum solution. At any rate, caution and judgment should be employed with this design.

### Limitations:

1. Culvert outlet Froude number must exceed 1.00

Design Modules: HYDPPA

Equations:

### Momentum at Basin Inlet Section

$$M_O = \beta_1 \gamma (Y_O^2/2) (W_O/2) + \beta_2 \rho V_O Q/2.$$

### Momentum at Section X

$$M_X = \rho Q^2 / (4L_1 \tan\theta Y_X) + (L_1 \tan\theta) (\gamma Y_X^2/2)$$

### Basin Flare Angle

$$\tan\theta = 1. / (3.F_O)$$

### Basin Length

$$C = L_1 - W_O/2 \tan\theta + 6Y_X$$

### Basin Inlet Width

$$A = W_O$$

### Basin Outlet Width

$$B = A + 2C \tan\theta$$

### Basin Height

$$D = 1.5(\text{Maximum value of } Y_O \text{ or } Y_X)$$

References: Simons, D. B., Stevens, M. A., and Watts, F. J. (5)

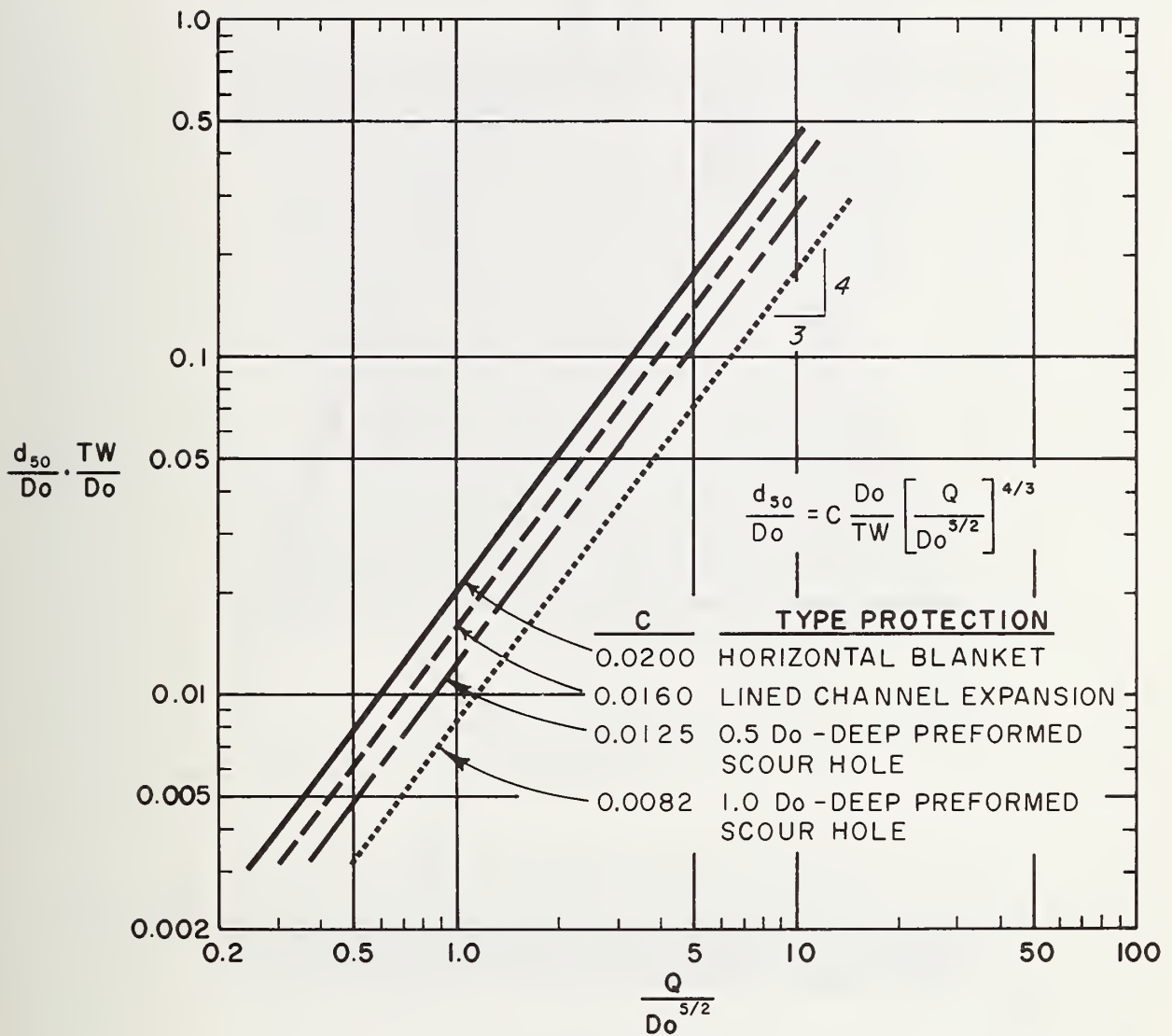

**FIGURE I RECOMMENDED MEDIAN DIAMETER OF PROTECTIVE STONE  
U.S. ARMY WATERWAYS EXPERIMENT STATION ROCK BASINS**



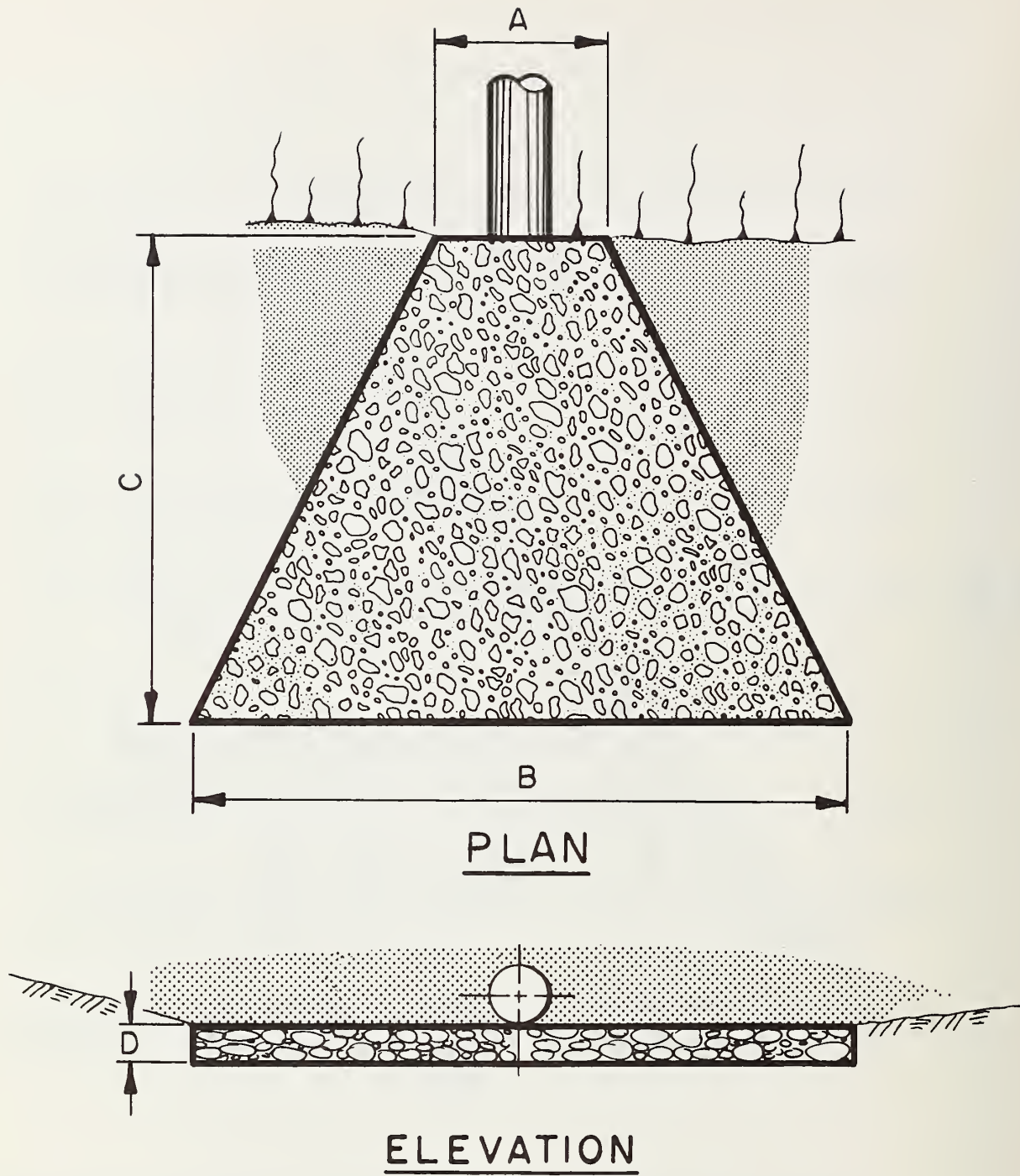
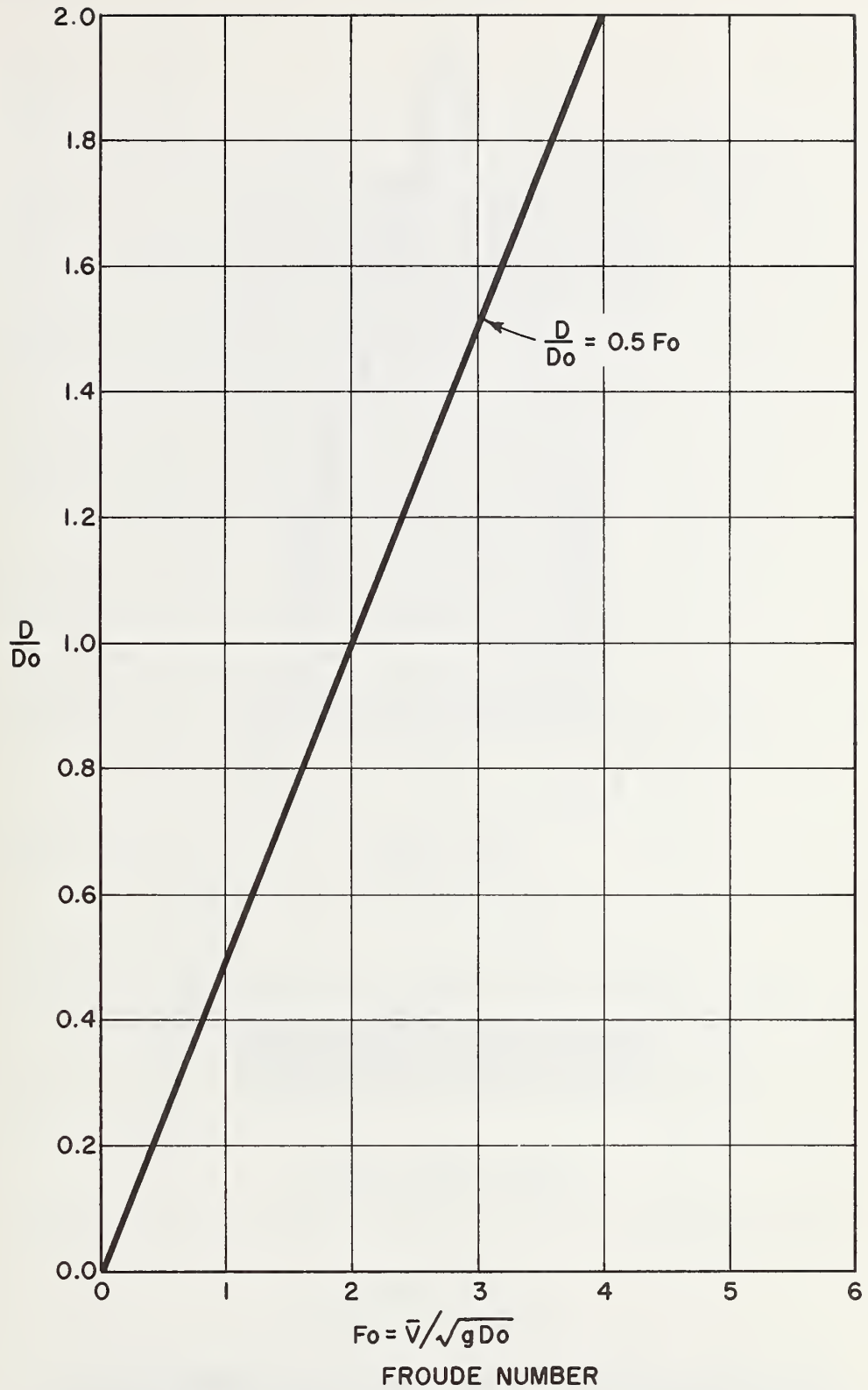
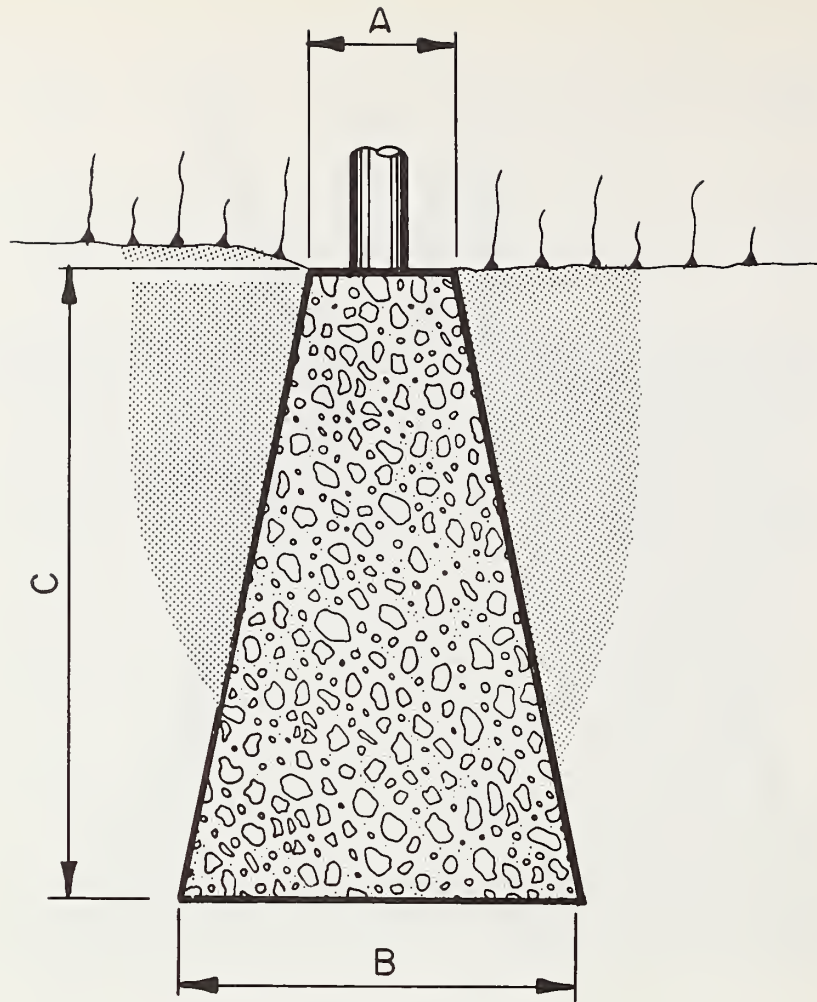

Figure 2. Horizontal Riprap Blanket  
(Minimum Tailwater)



**FIGURE 3. HORIZONTAL RIPRAP THICKNESS (MIN. TAILWATER)  
U.S. ARMY WATERWAYS EXPERIMENT STATION ROCK BASINS**



PLAN

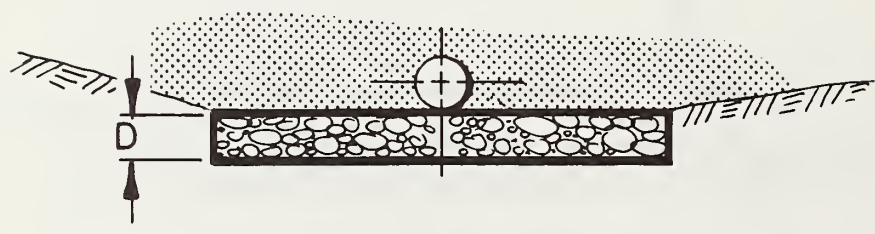

ELEVATION

Figure 4. Horizontal Riprap Blanket  
(Maximum Tailwater)

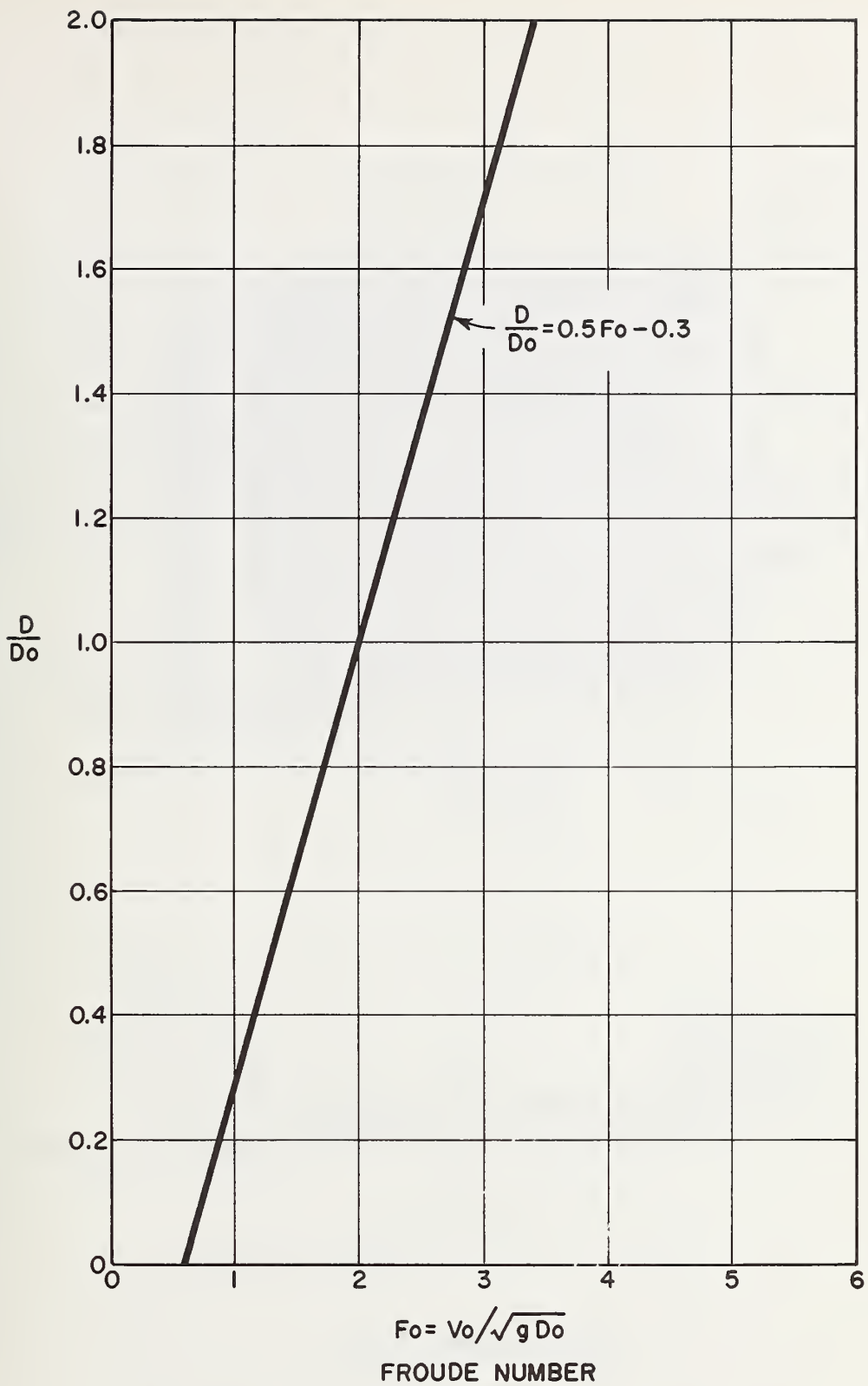

FIGURE 5. HORIZONTAL RIPRAP THICKNESS (MAX. TAILWATER)  
U.S. ARMY WATERWAYS EXPERIMENT STATION ROCK BASINS

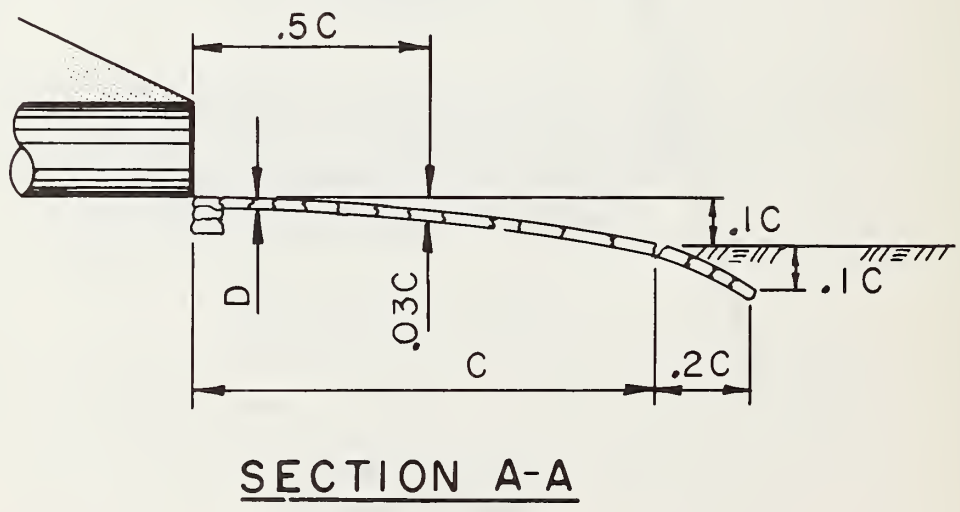
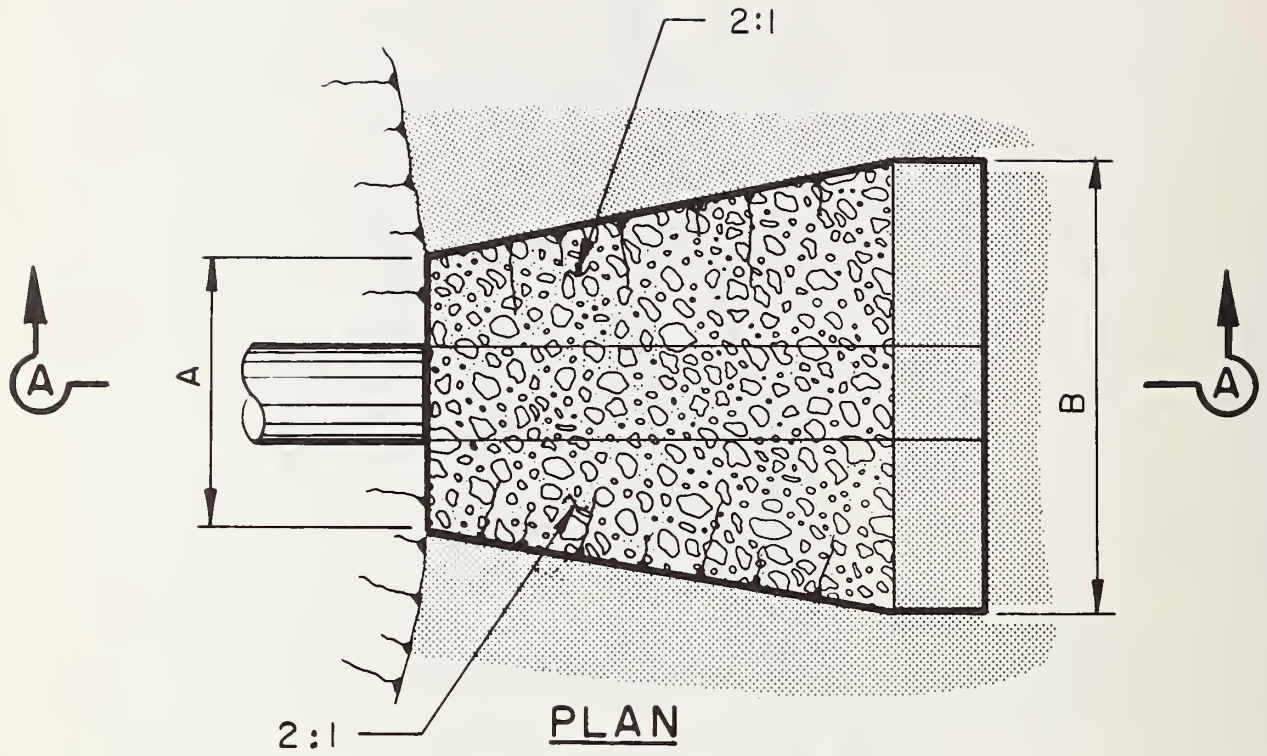
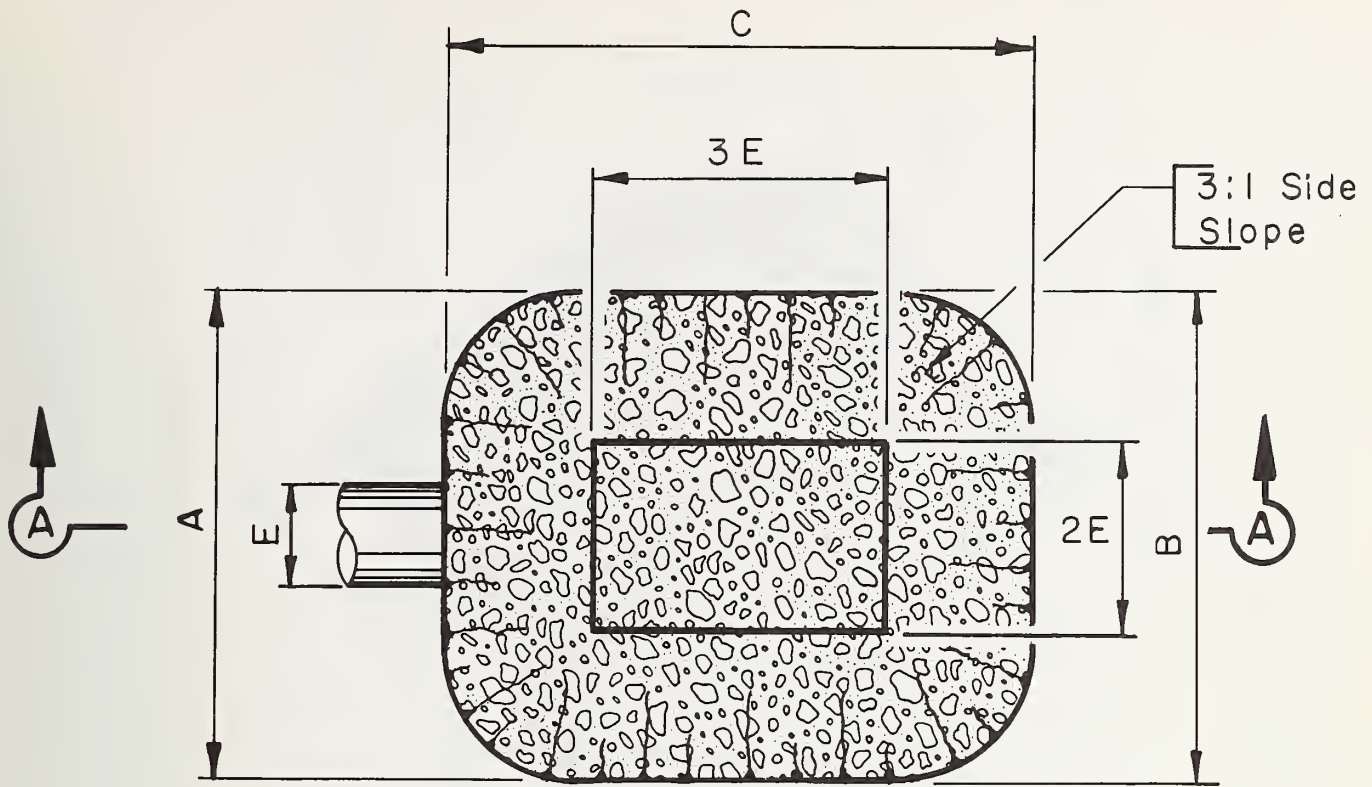
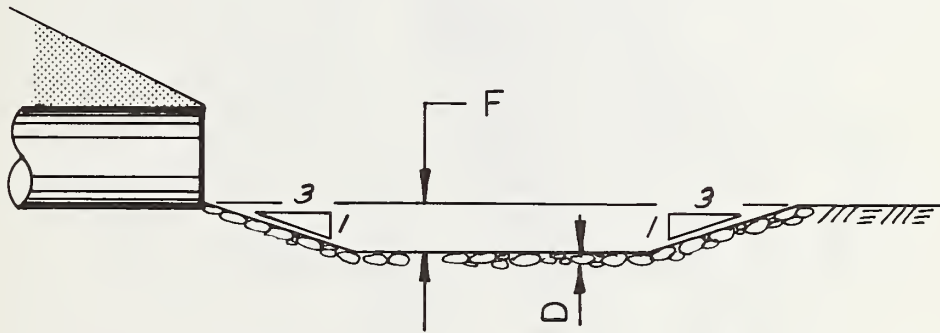

Figure 6. Lined Channel Expansion





PLAN



SECTION A A

Figure 7. Preformed Scour Hole

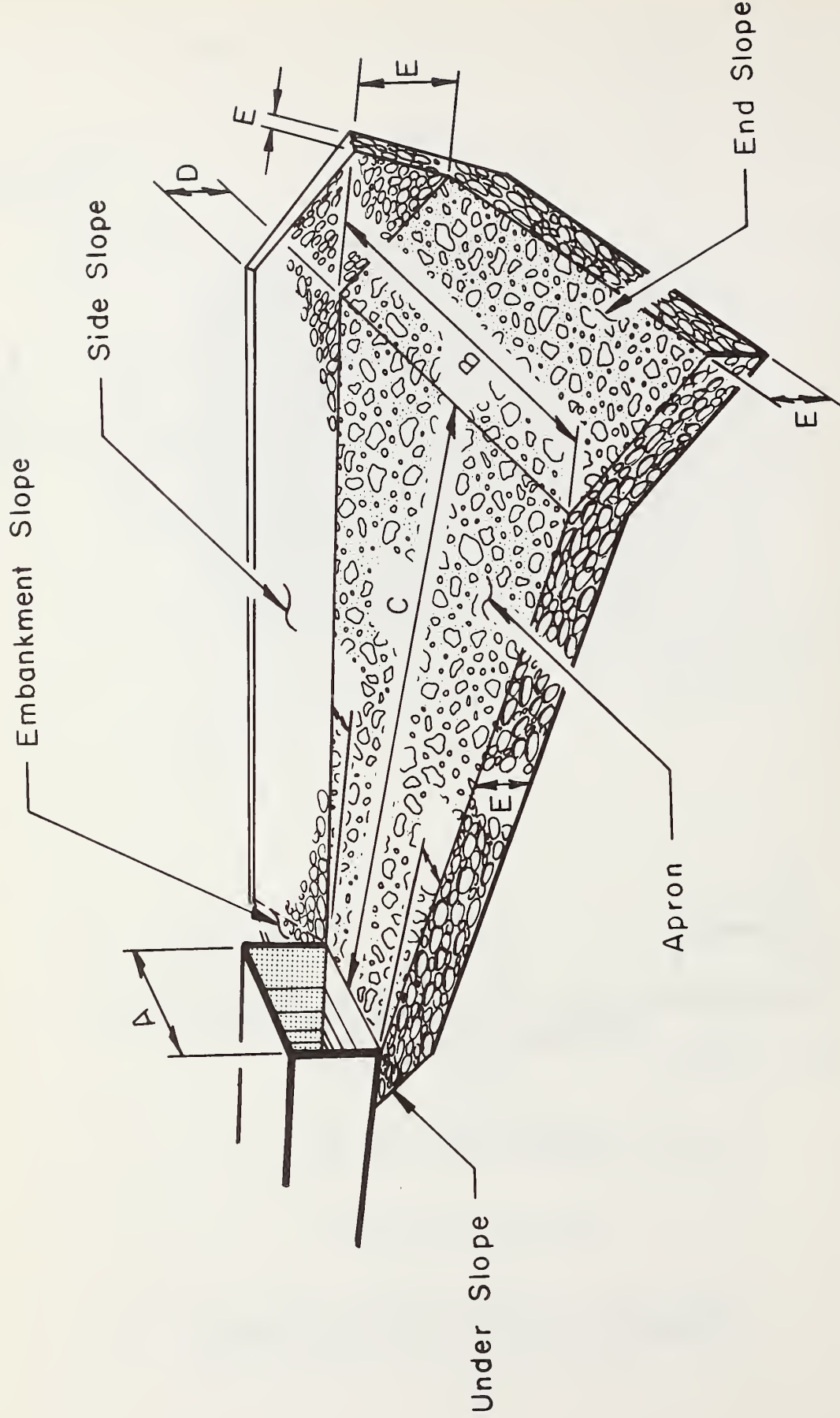

Figure 8. Standard Non-Scouring Riprapped Basin

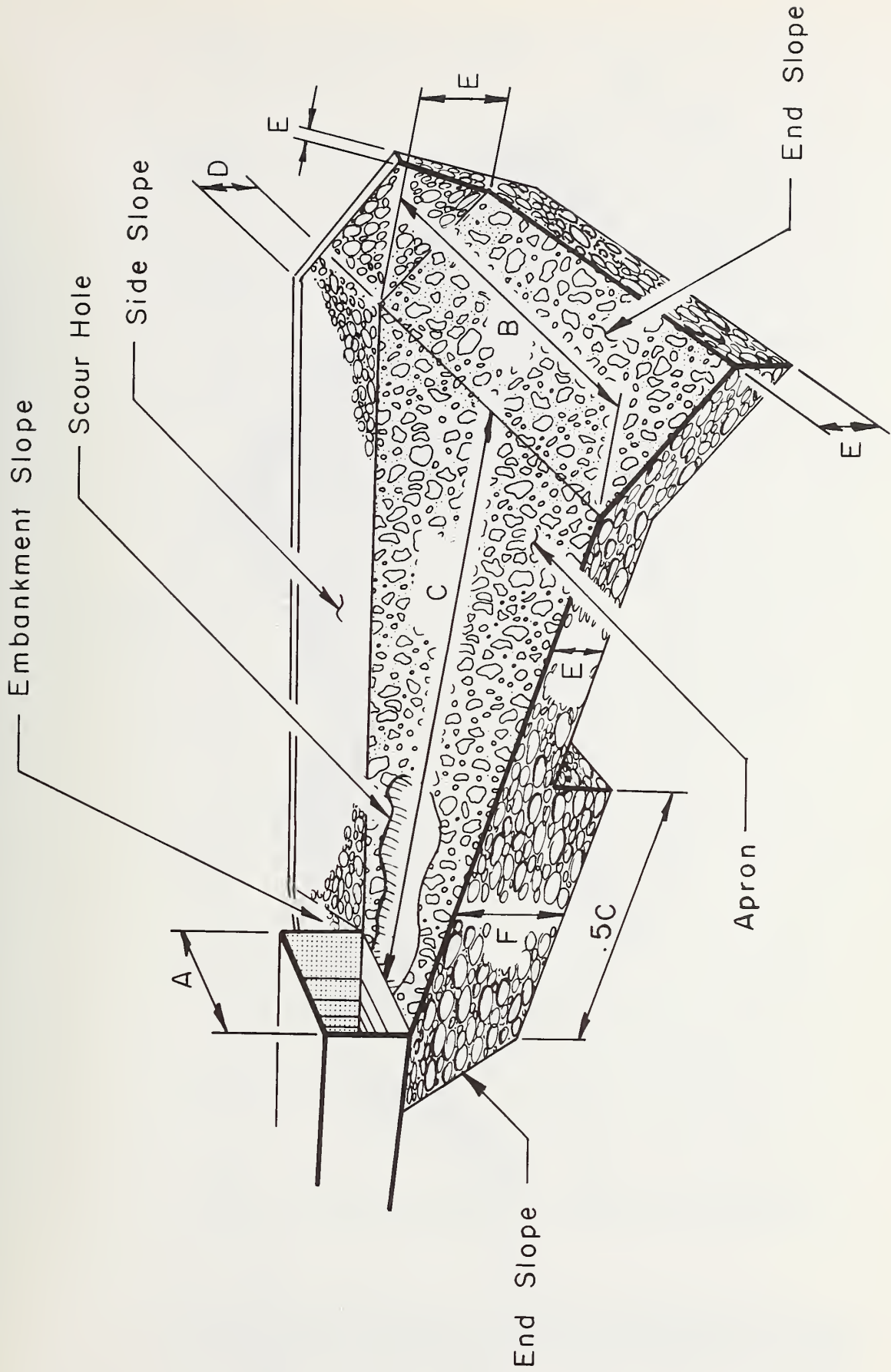

Figure 9. Standard Hybrid Riprapped Basin

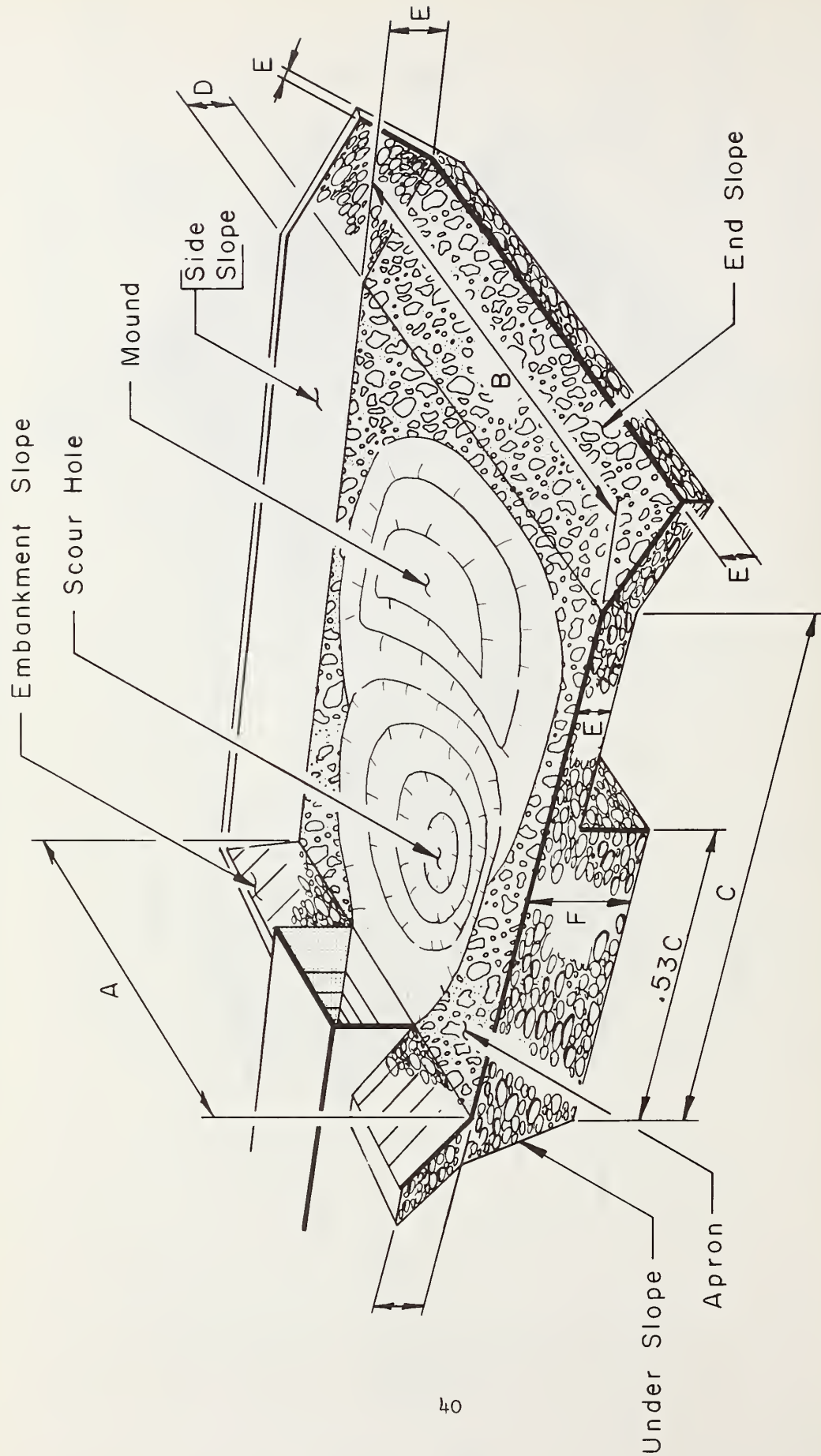

Figure 10. Standard Scouring Riprapped Basin



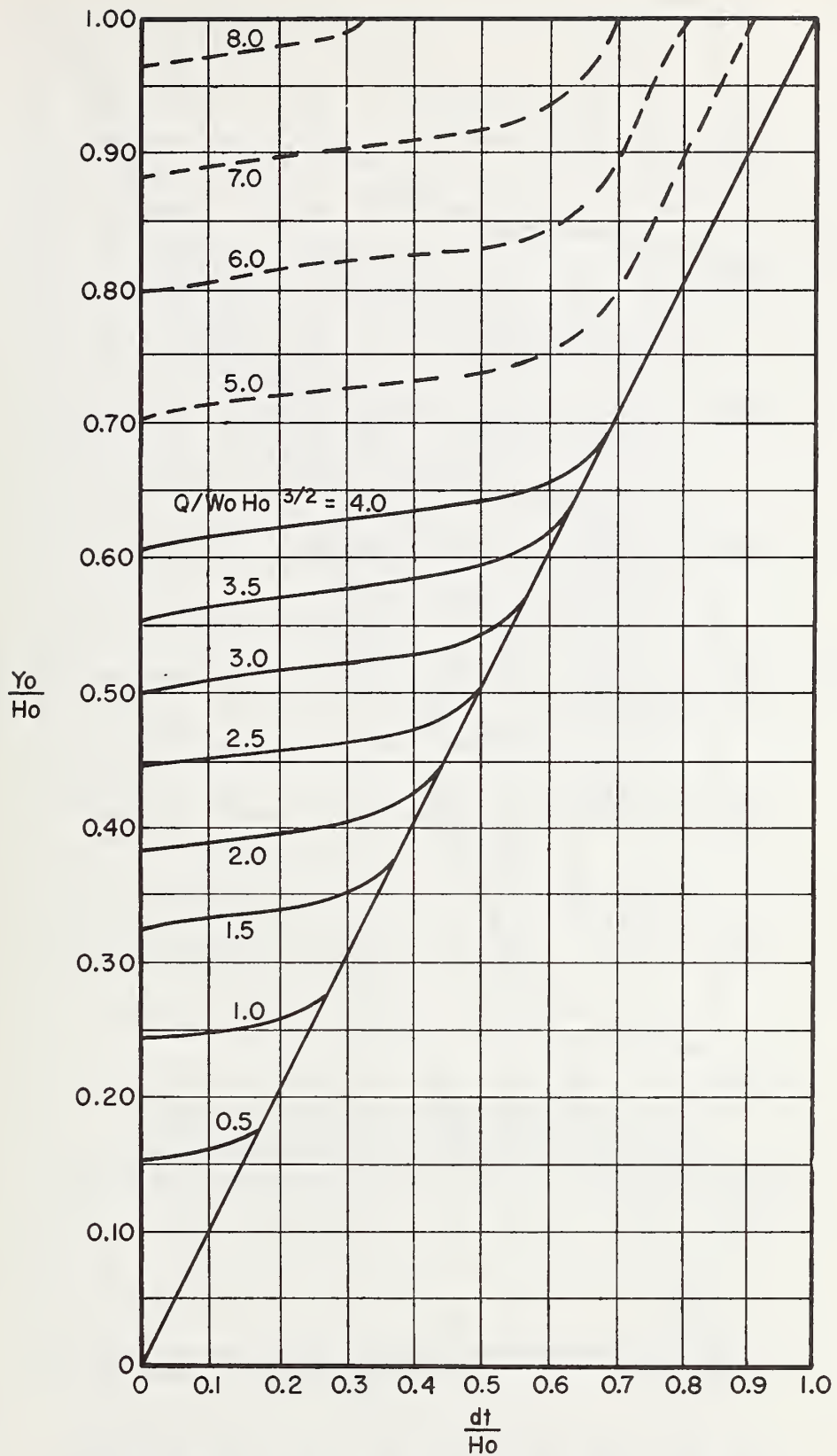

FIGURE II. EFFECT OF TAILWATER ON BRINK DEPTH:  
HORIZONTAL AND MILD SLOPING RECTANGULAR CULVERTS  
COLORADO STATE UNIVERSITY ROCK RIPRAPPED BASIN



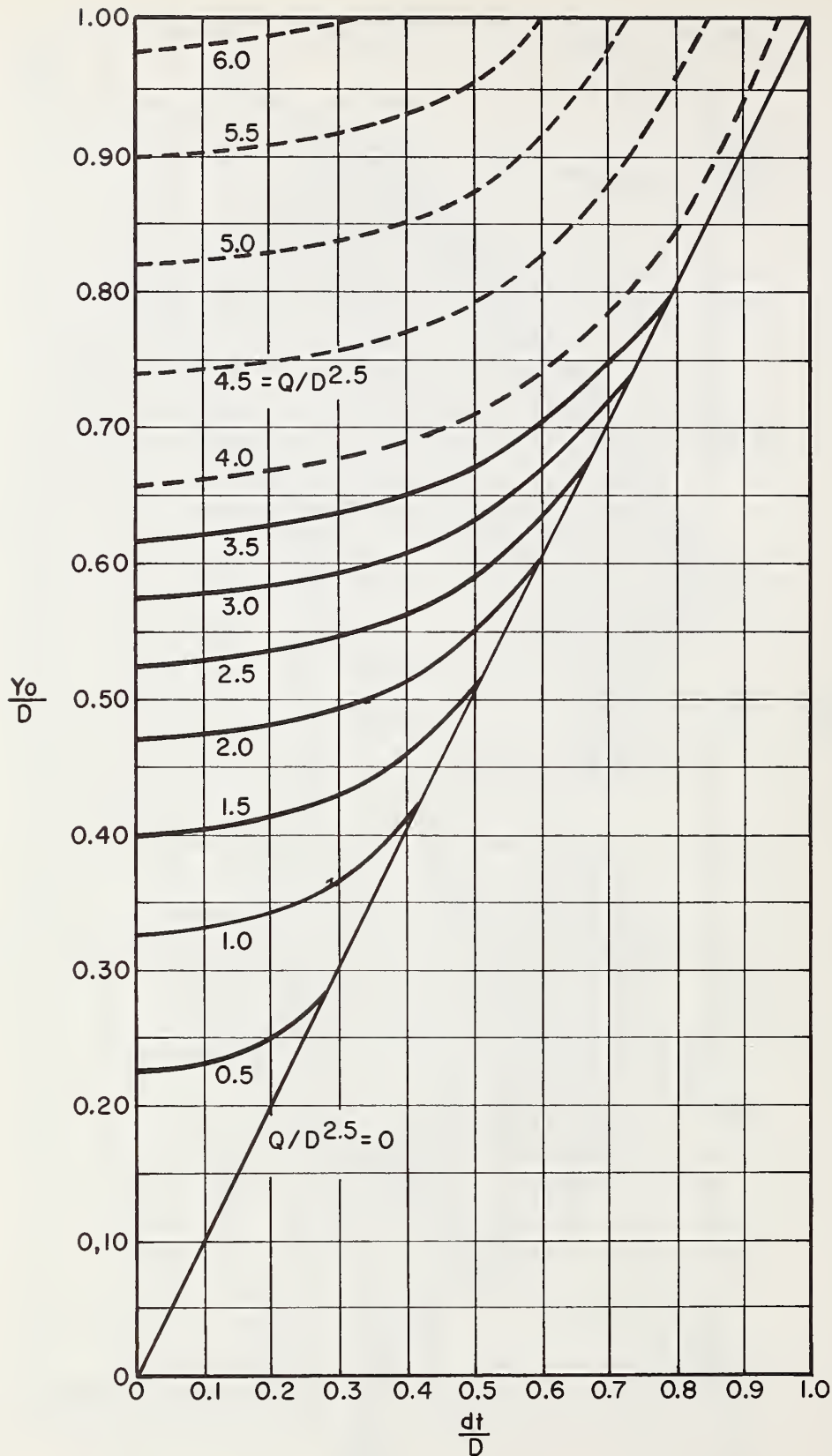

FIGURE 12. EFFECT OF TAILWATER ON BRINK DEPTH:  
HORIZONTAL AND MILD SLOPING CIRCULAR CULVERTS  
COLORADO STATE UNIVERSITY ROCK RIPRAPPED BASIN

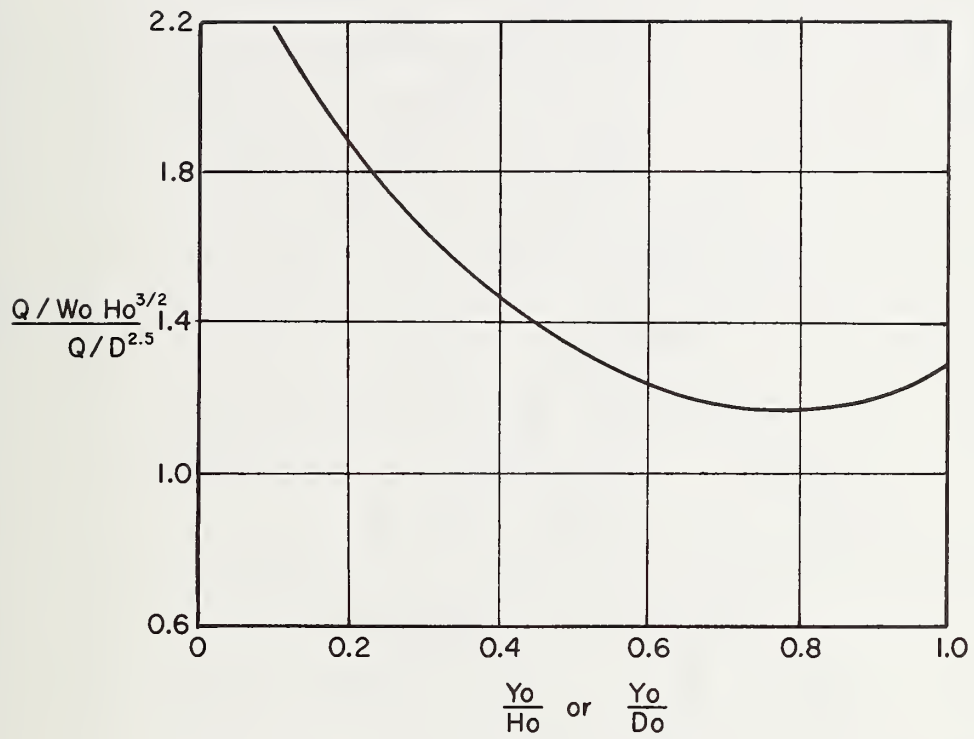

FIGURE 13. DISCHARGE RATIOS FOR THE  
TWO-DIMENSIONAL FLOW APPROXIMATION  
COLORADO STATE UNIVERSITY ROCK RIPRAPED BASIN

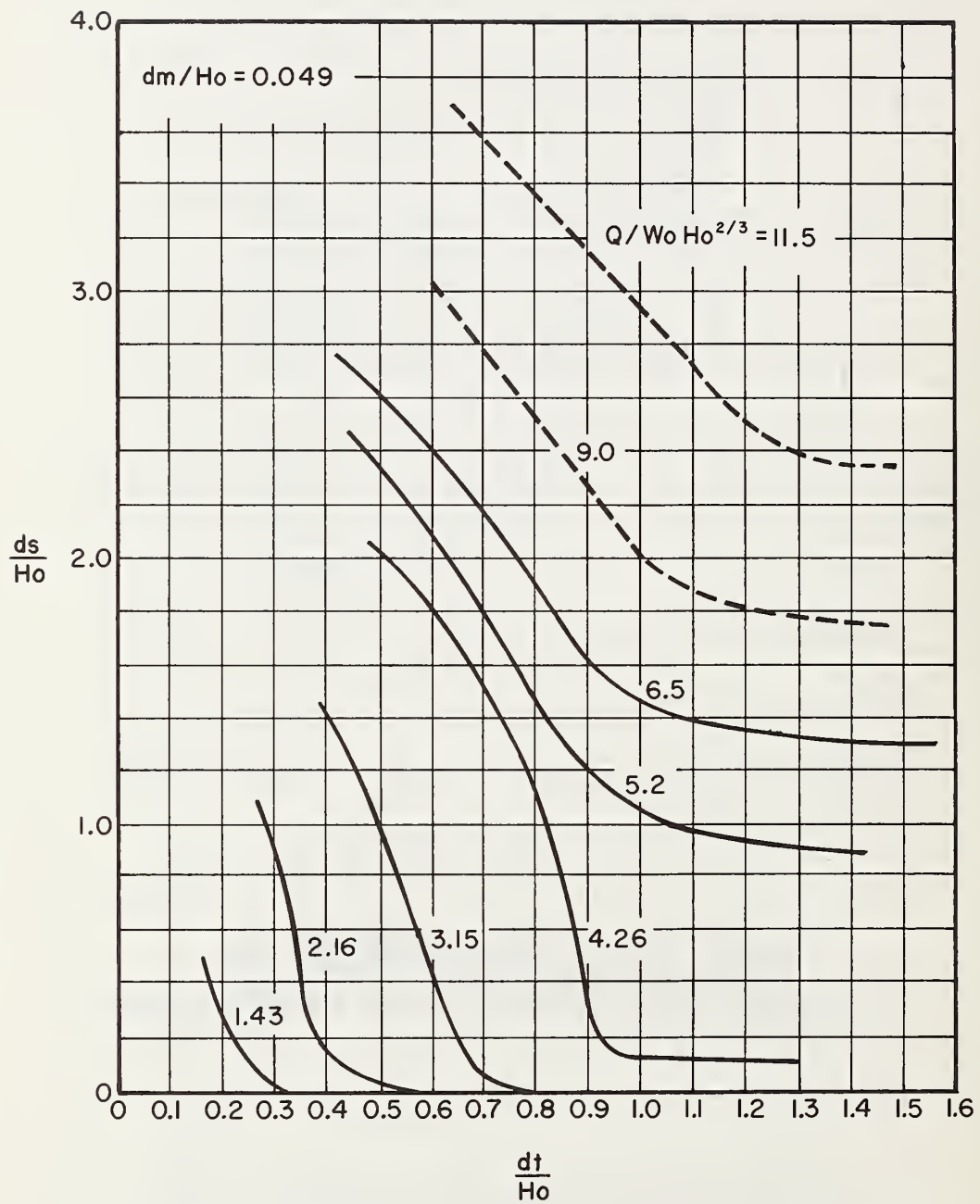

FIGURE 14. SCOUR: PLAIN RECTANGULAR OUTLET  
COLORADO STATE UNIVERSITY ROCK RIPRAPPED BASIN

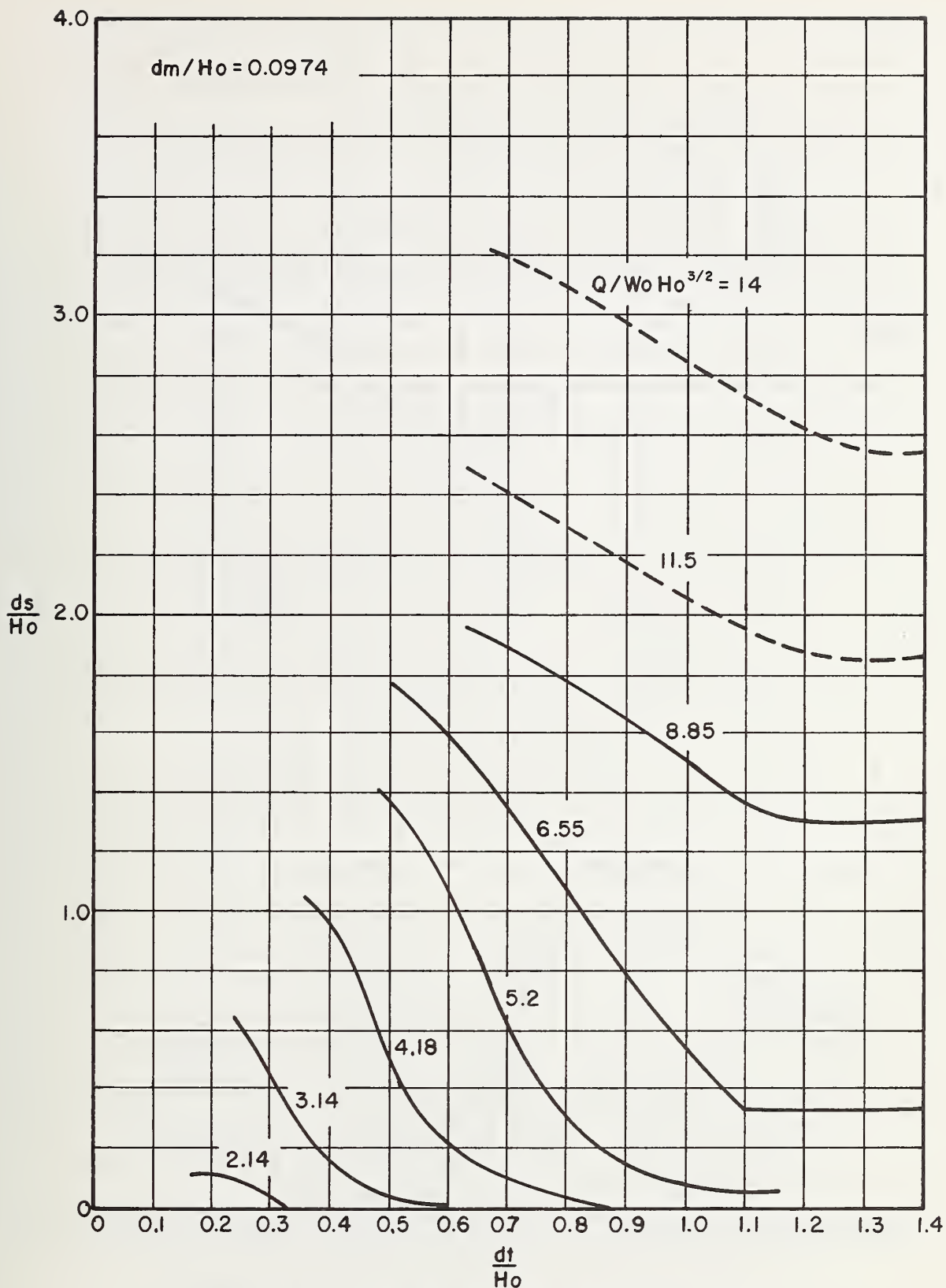

FIGURE 15. SCOUR: PLAIN RECTANGULAR OUTLET  
COLORADO STATE UNIVERSITY ROCK RIPRAPPED BASIN

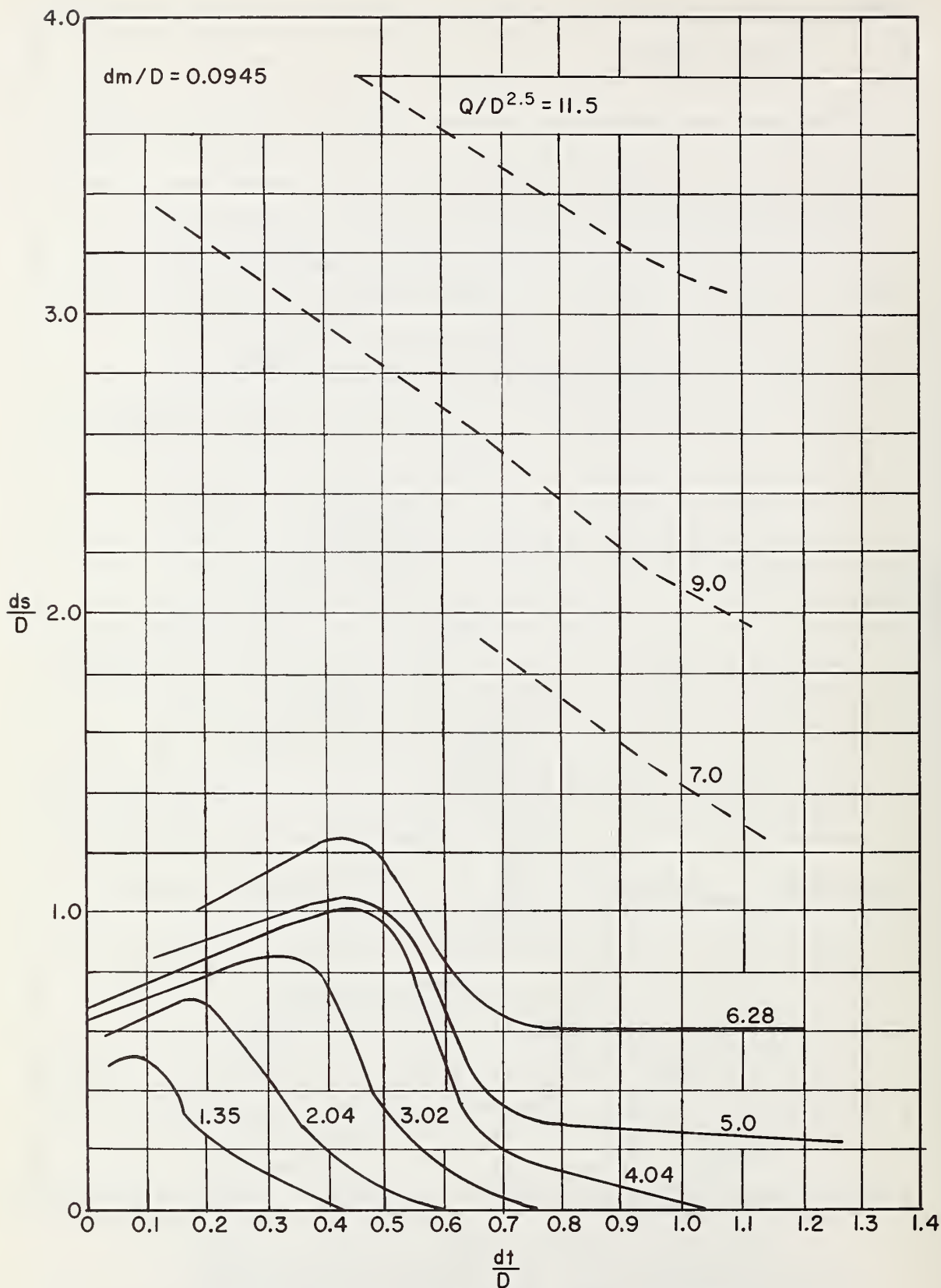

FIGURE 16. SCOUR: PLAIN CIRCULAR OUTLET  
COLORADO STATE UNIVERSITY ROCK RIPRAPPED BASIN



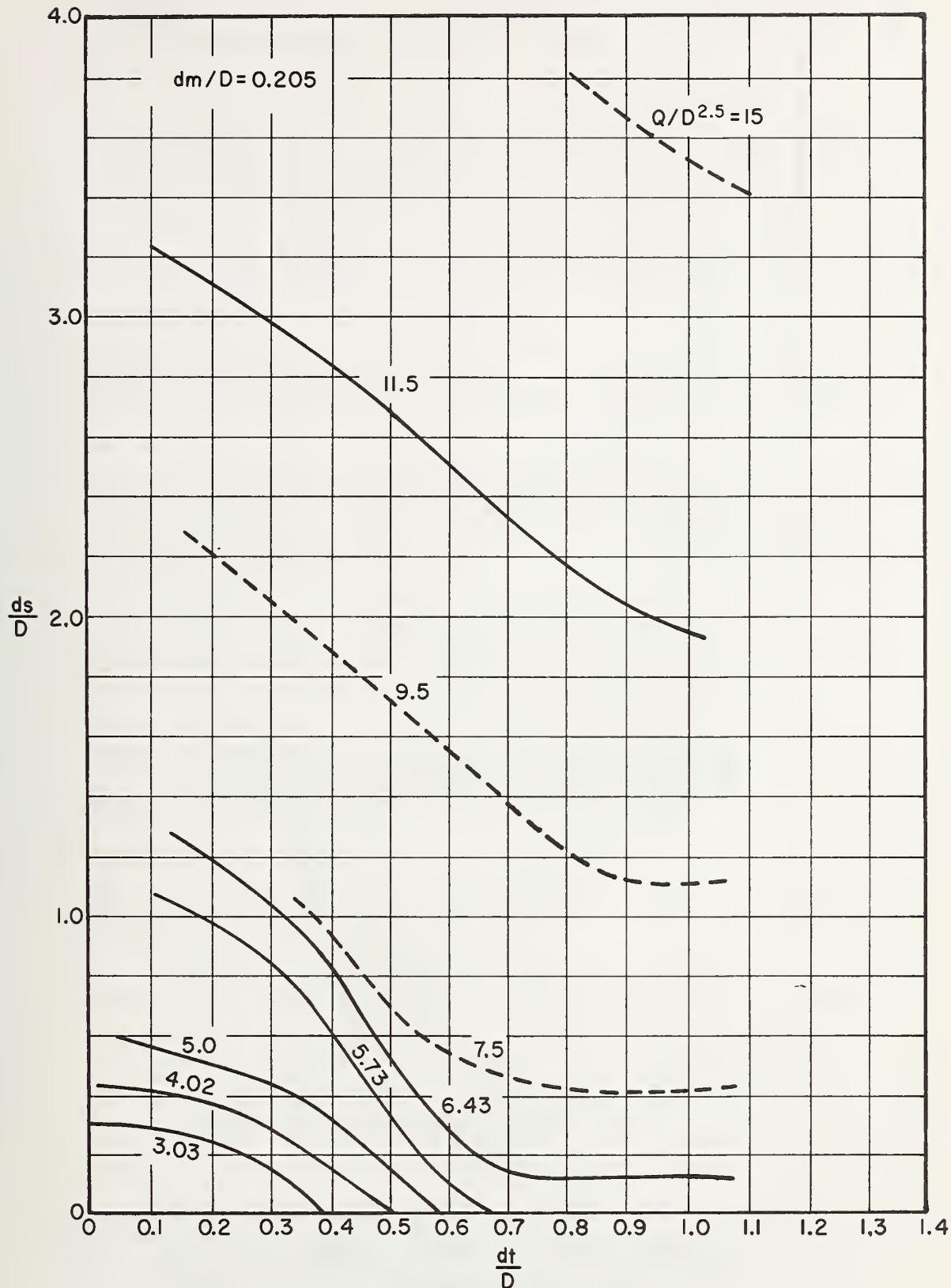

FIGURE 17. SCOUR: PLAIN CIRCULAR OUTLET  
 COLORADO STATE UNIVERSITY ROCK RIPRAPPED BASIN

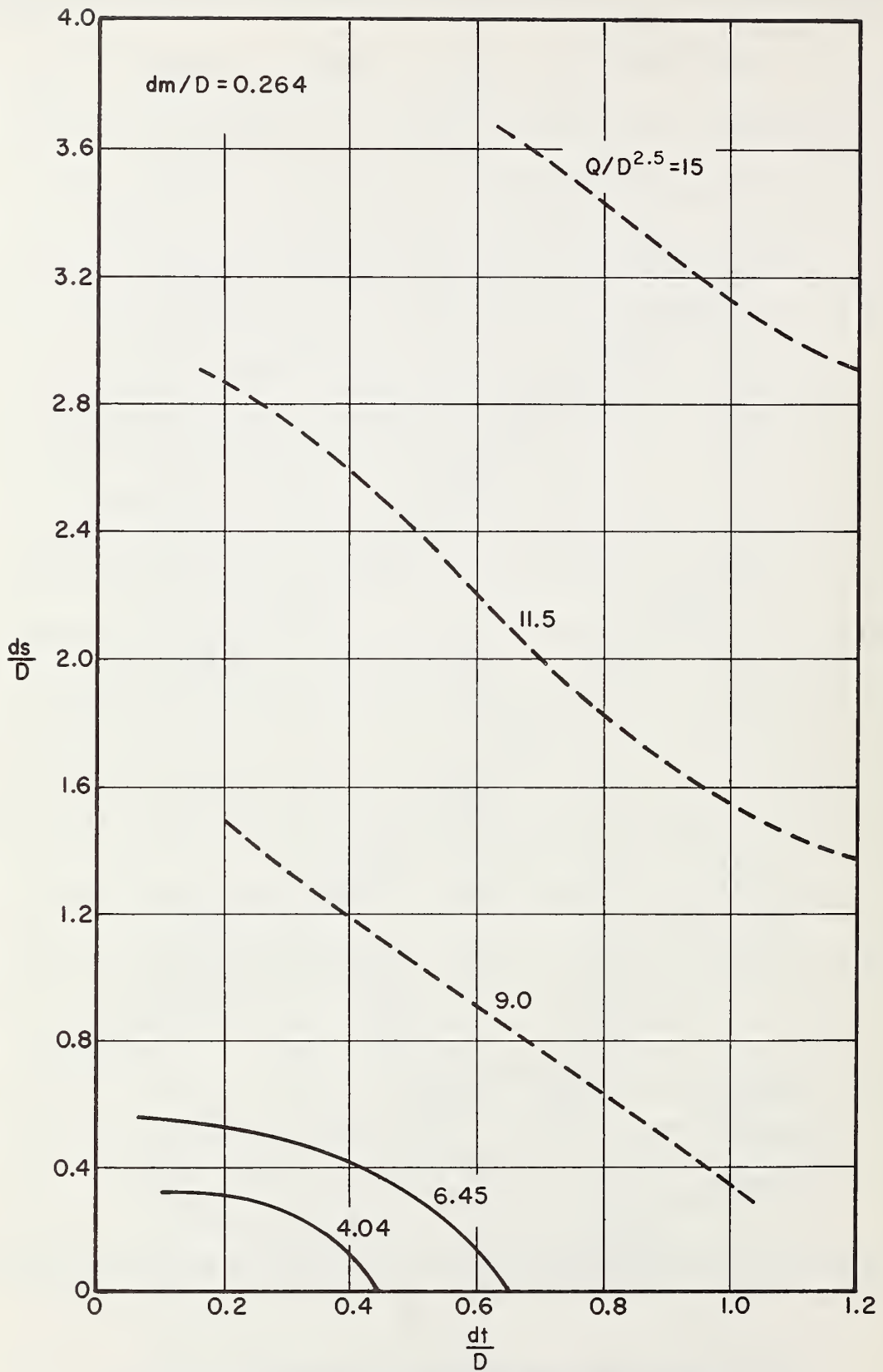

FIGURE 18. SCOUR: PLAIN CIRCULAR OUTLET  
COLORADO STATE UNIVERSITY ROCK RIPRAPPED BASINS

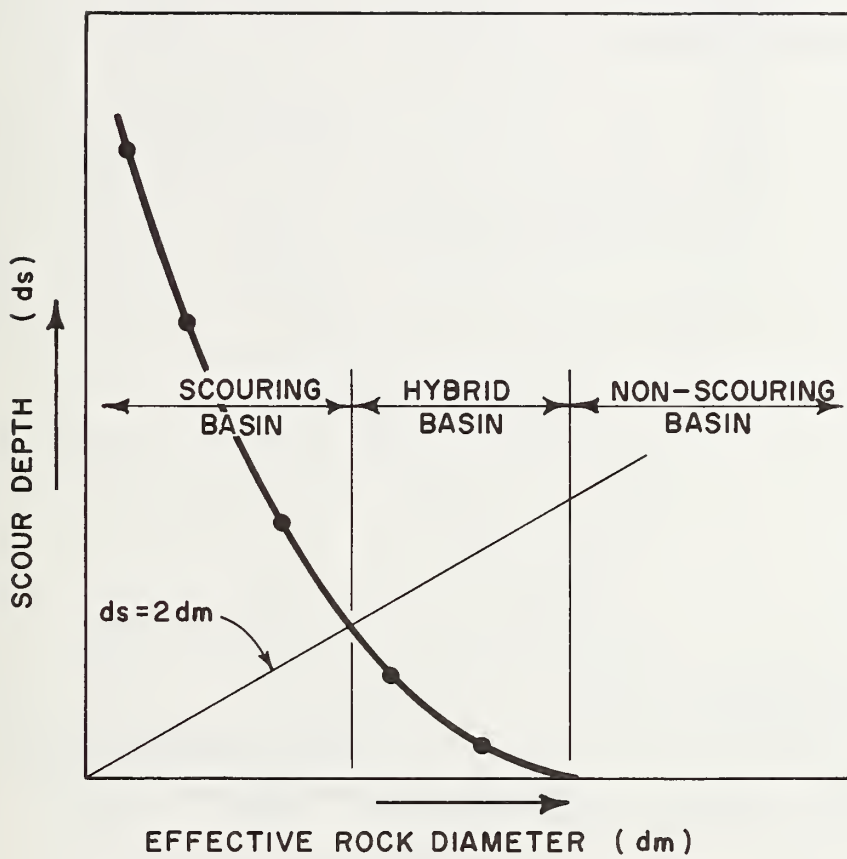

FIGURE 19. SCOUR DEPTH CLASSIFICATION CURVE  
COLORADO STATE UNIVERSITY ROCK RIPRAPPED BASINS

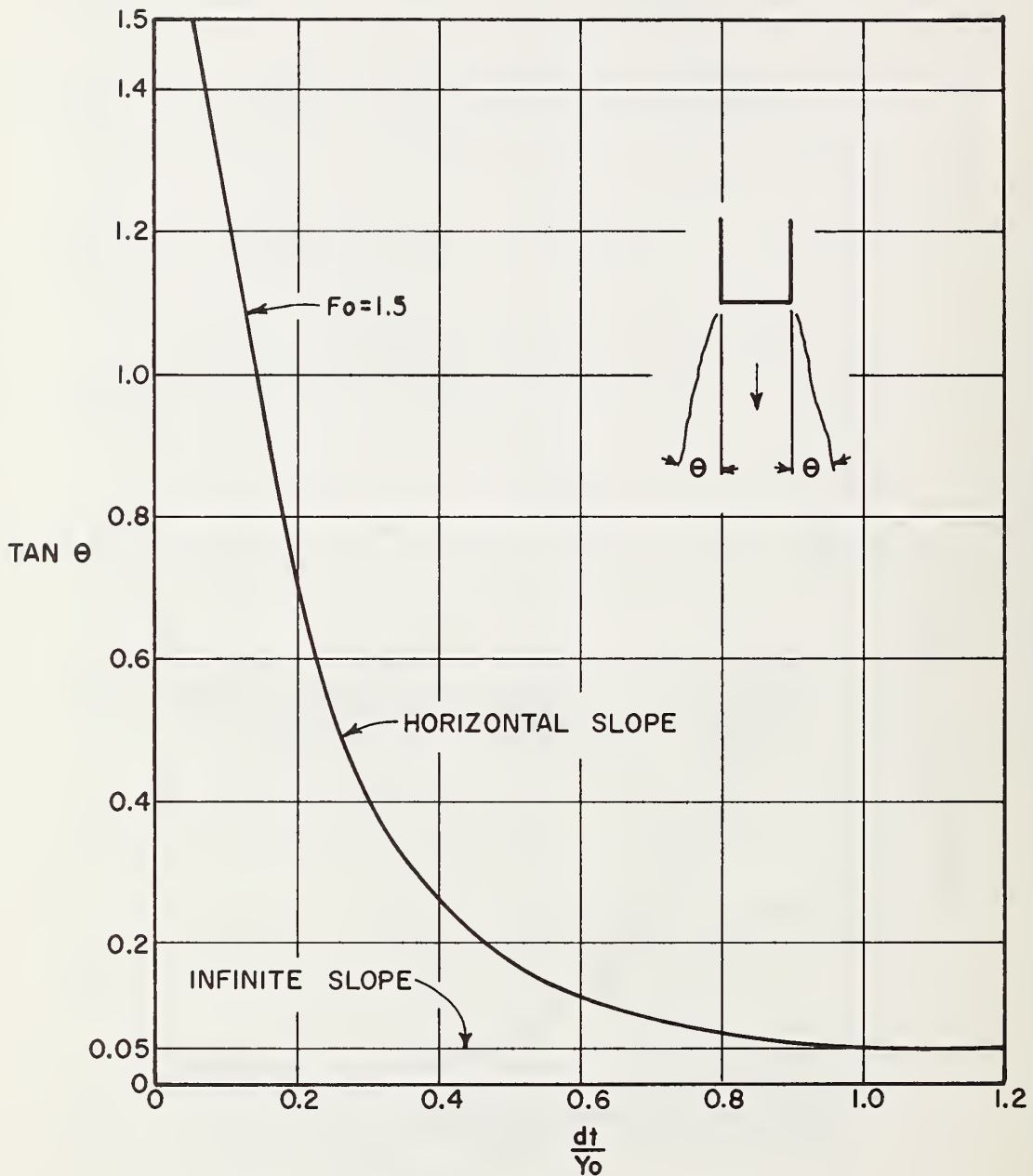

FIGURE 20. AN ESTIMATE OF THE ANGLE OF LATERAL EXPANSION FOR HORIZONTAL AND MILD SLOPING CIRCULAR CULVERTS COLORADO STATE UNIVERSITY ROCK RIPRAPED BASINS

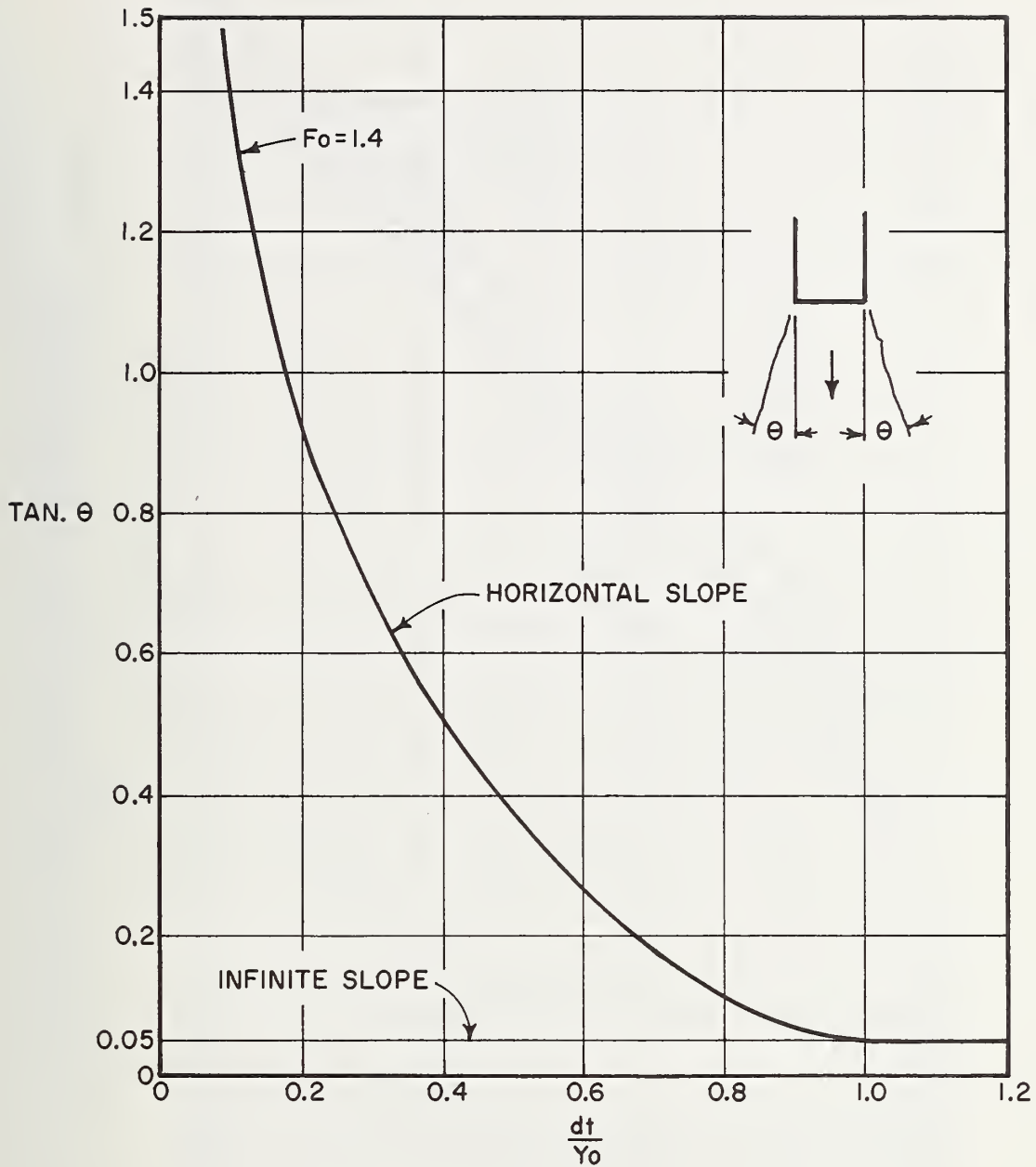

FIGURE 21. AN ESTIMATE OF THE ANGLE OF LATERAL EXPANSION FOR HORIZONTAL AND MILD SLOPING RECTANGULAR CULVERTS COLORADO STATE UNIVERSITY ROCK RIPRAPED BASINS



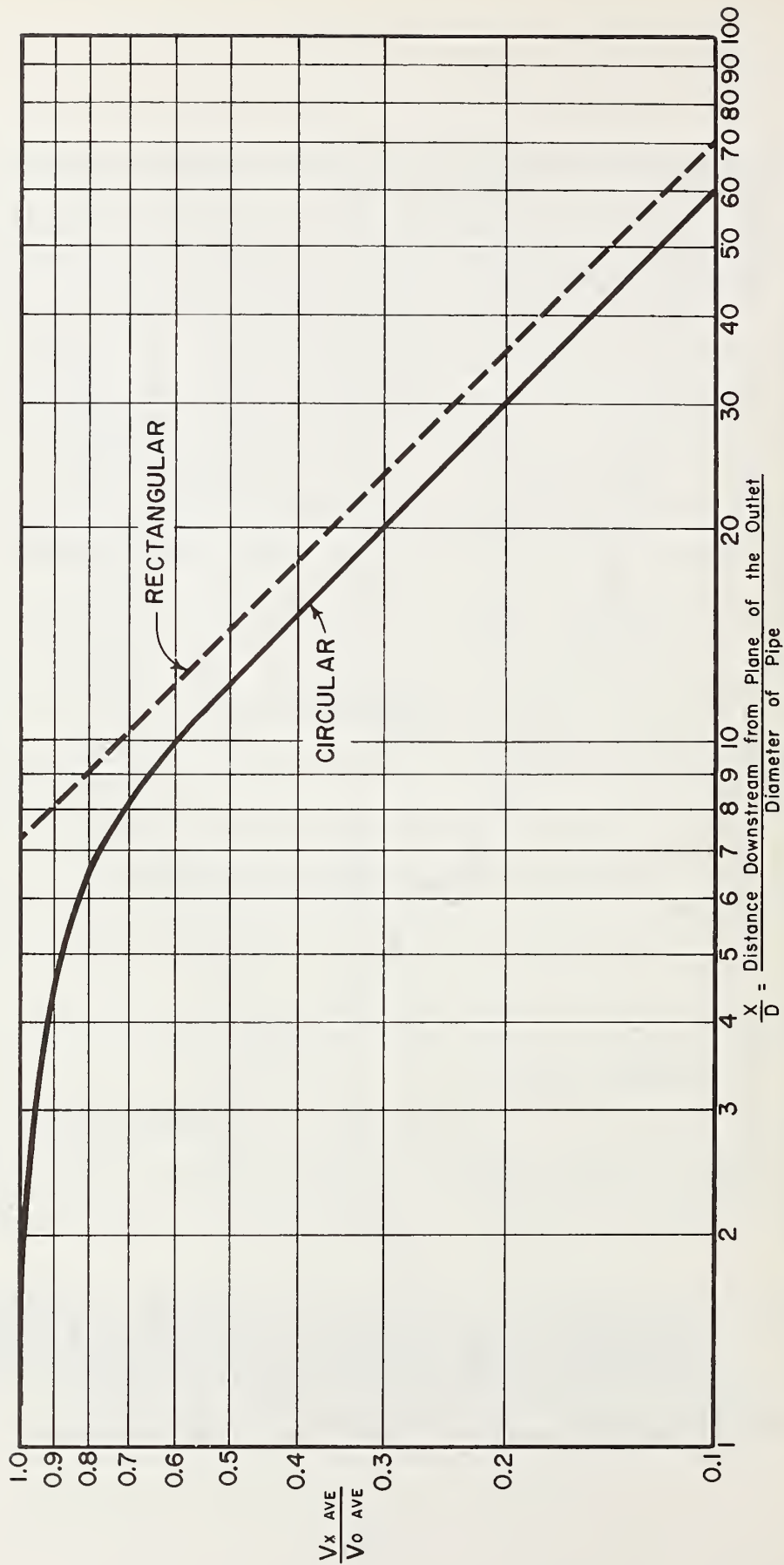

FIGURE 22. DISTRIBUTION OF CENTERLINE VELOCITY FOR FLOW FROM SUBMERGED OUTLETS  
 COLORADO STATE UNIVERSITY ROCK RIPRAPPED BASIN

Increases  $\frac{L_s/ds}{dt/Y_0}$  5%  
for Each Increment of  
1% Culvert Slope

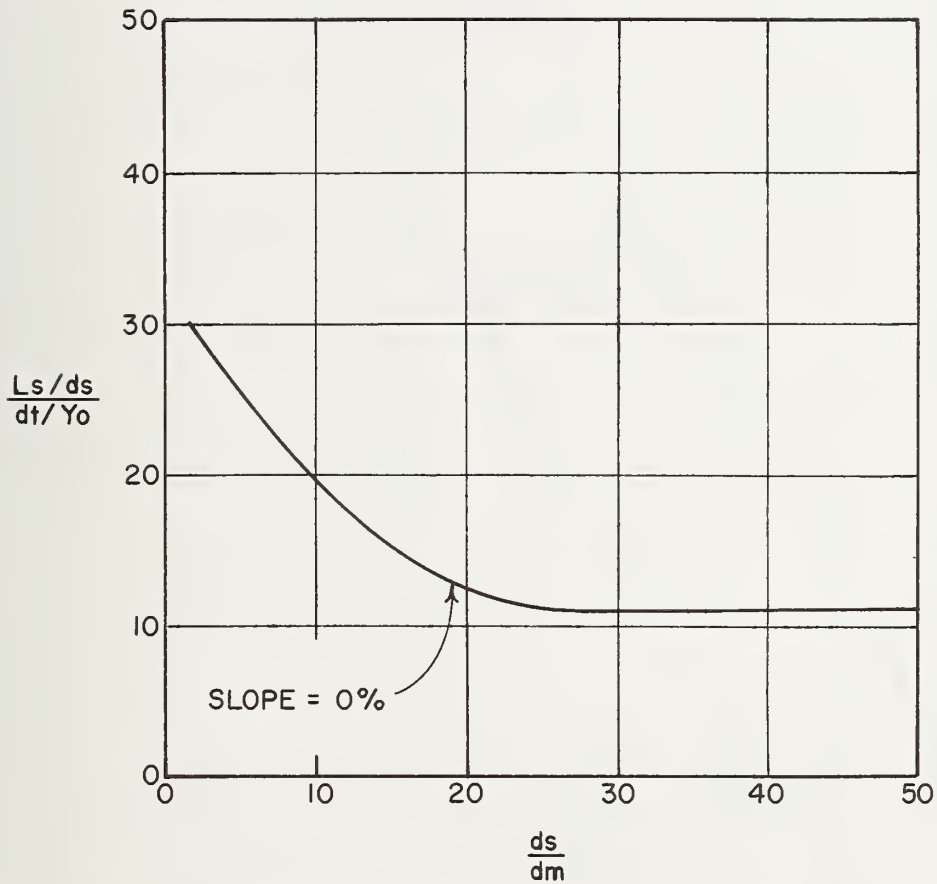

FIGURE 23. LENGTH OF SCOUR HOLE  
COLORADO STATE UNIVERSITY ROCK RIPRAPPED BASIN

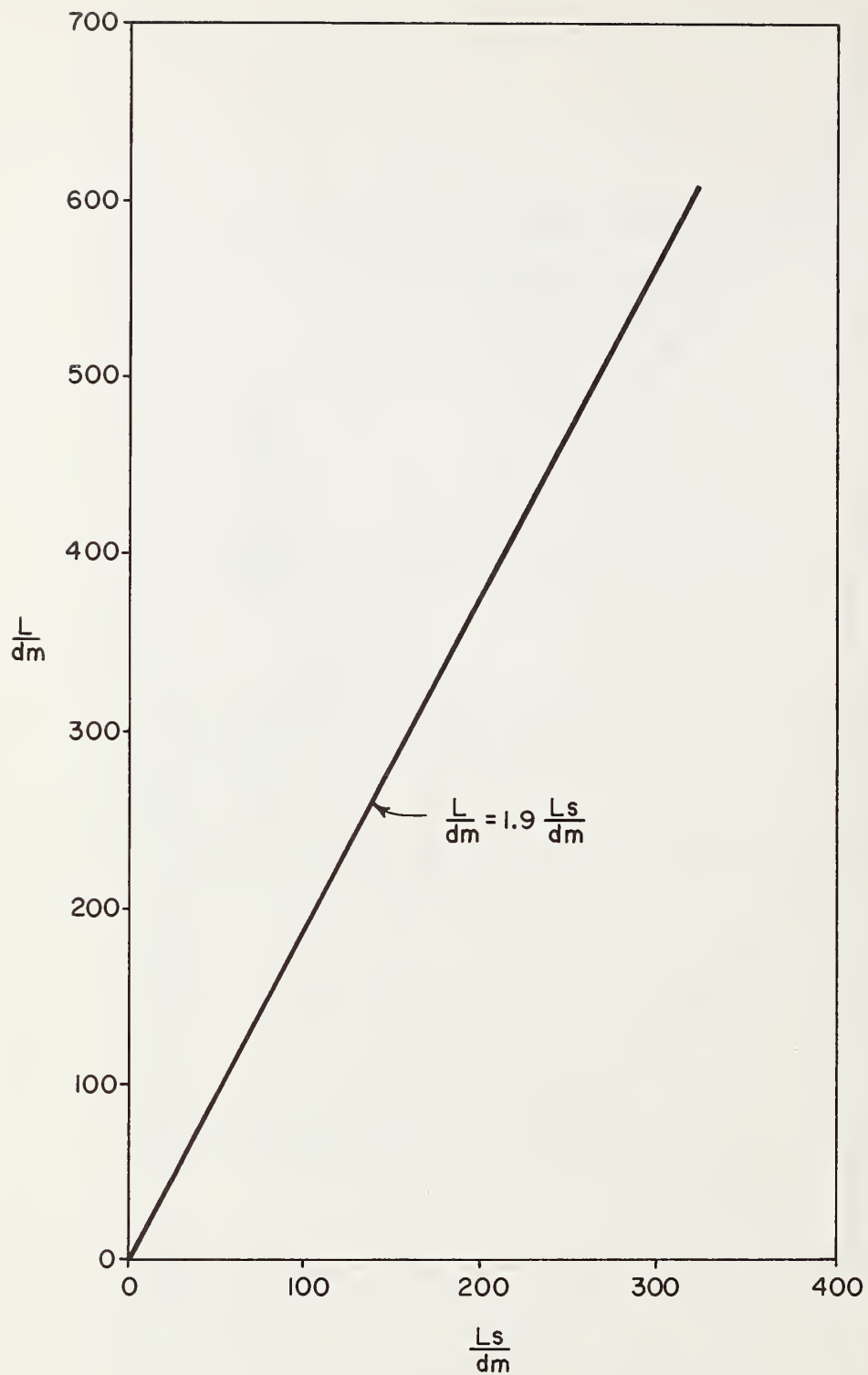

FIGURE 24. BASIN LENGTH  
COLORADO STATE UNIVERSITY ROCK RIPRAPPED BASINS

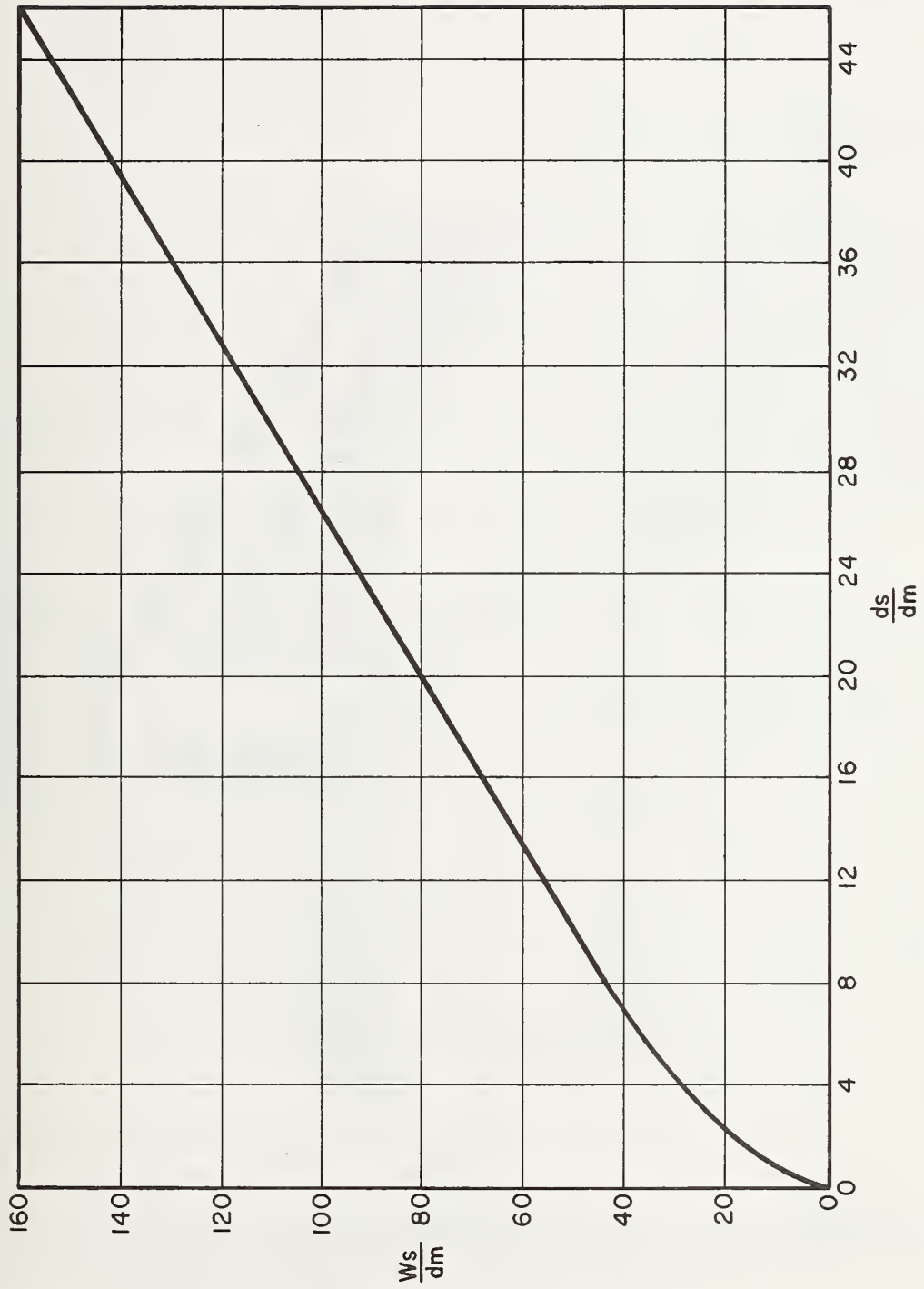
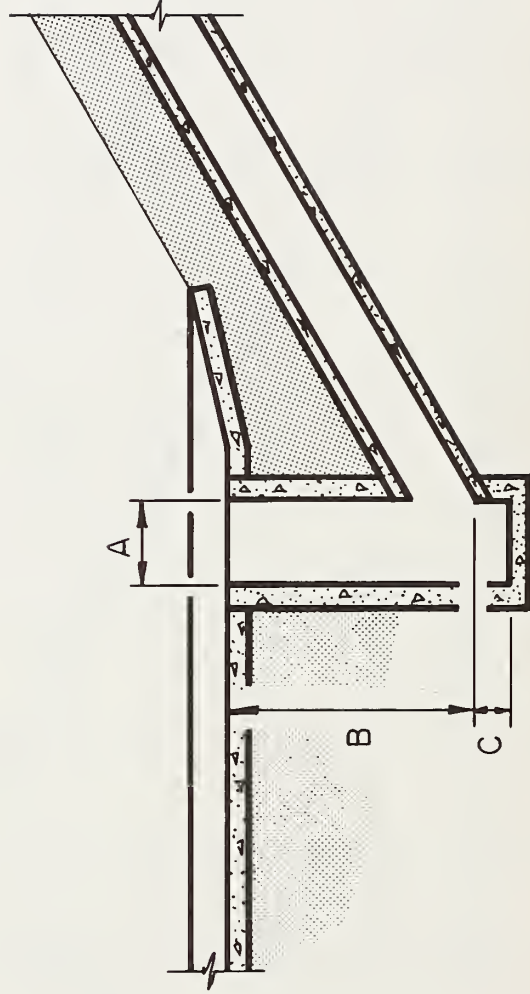
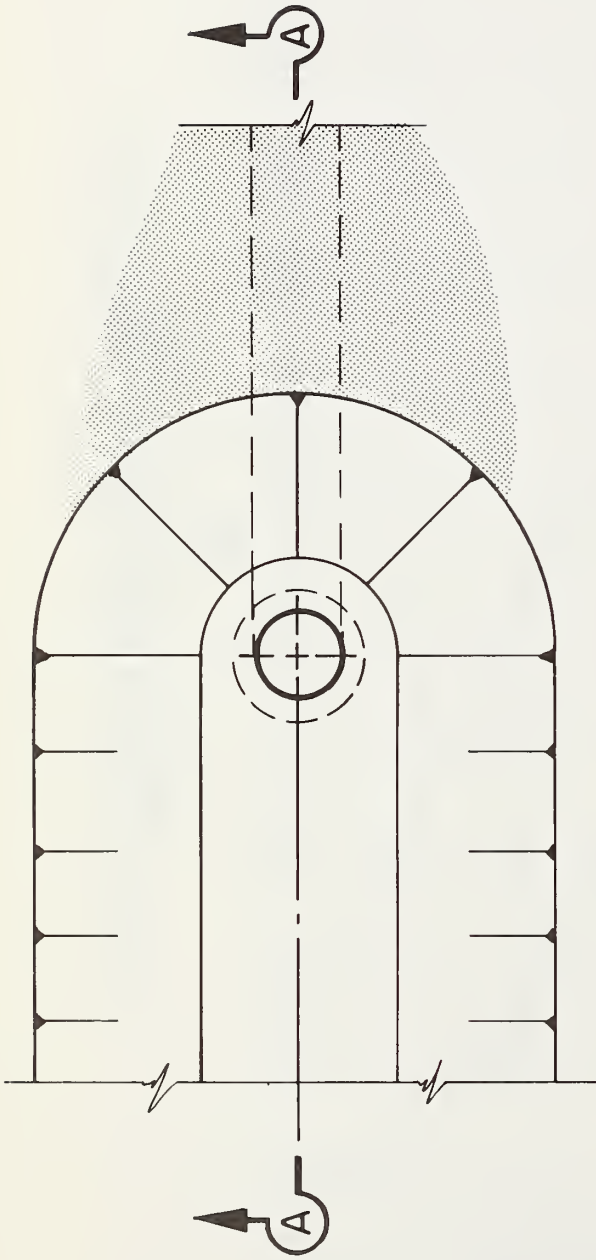

FIGURE 25. WIDTH OF SCOUR HOLE  
 COLORADO STATE UNIVERSITY ROCK RIPRAPED BASINS



SECTION A-A

Figure 26. Vertical Stilling Well



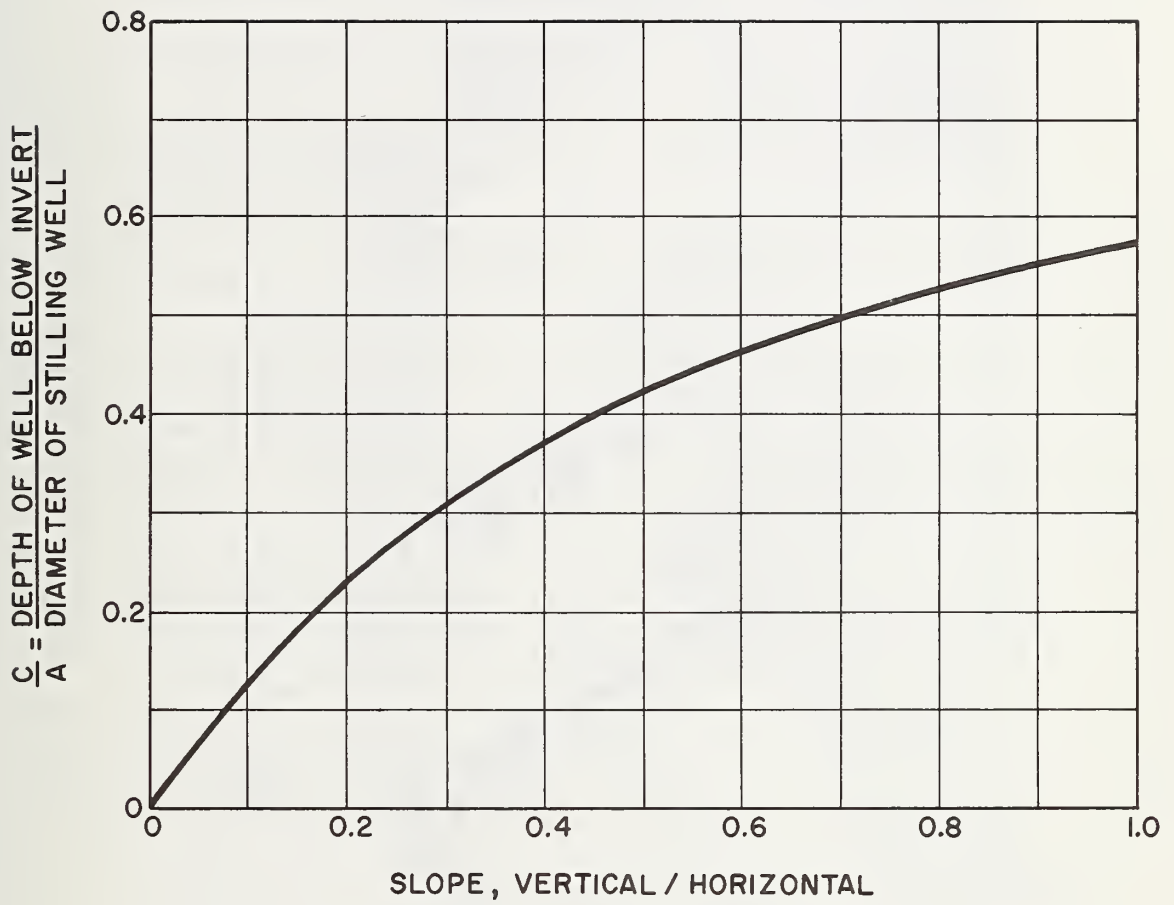

FIGURE 27. VERTICAL STILLING WELL DEPTH BELOW INFLOW PIPE INVERT

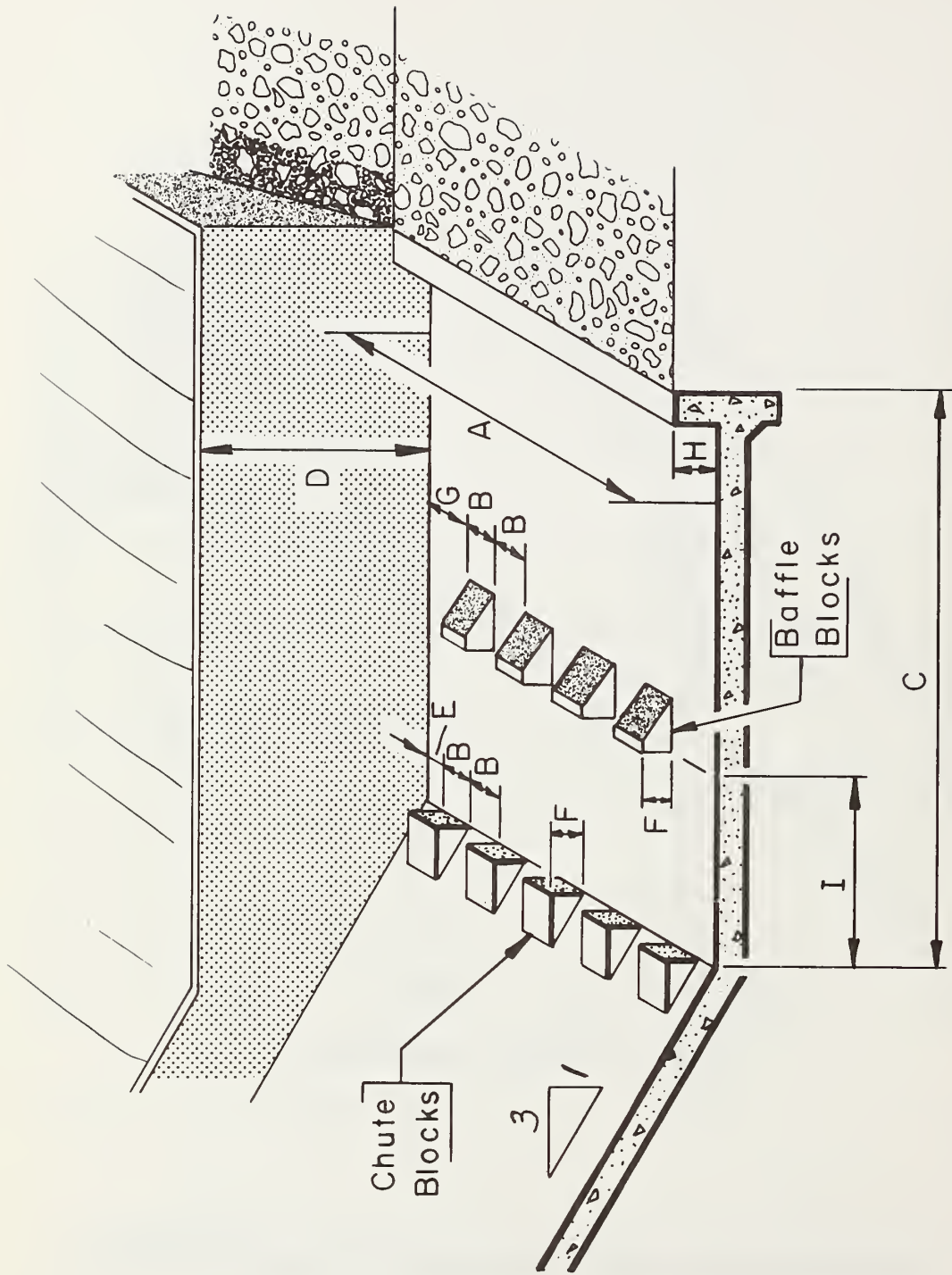

Figure 28. St. Anthony Falls Basin

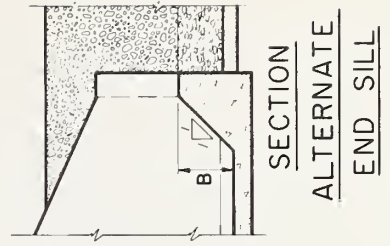
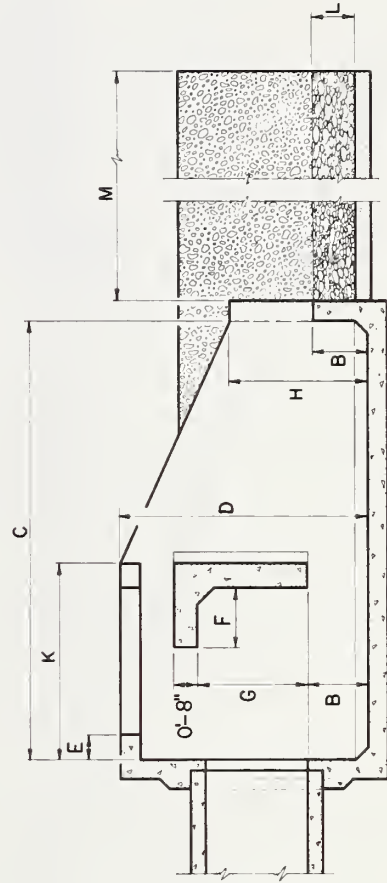
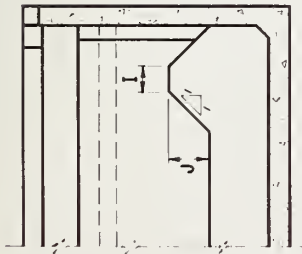
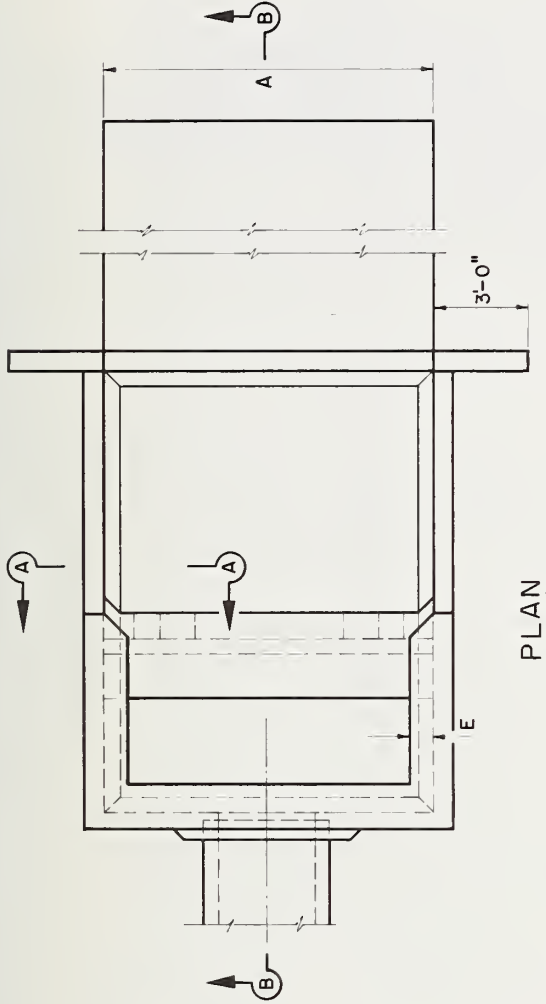
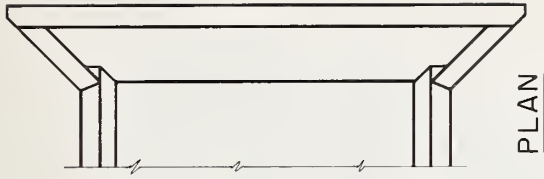

Figure 29. U.S. Bureau of Reclamation Type VI BASIN

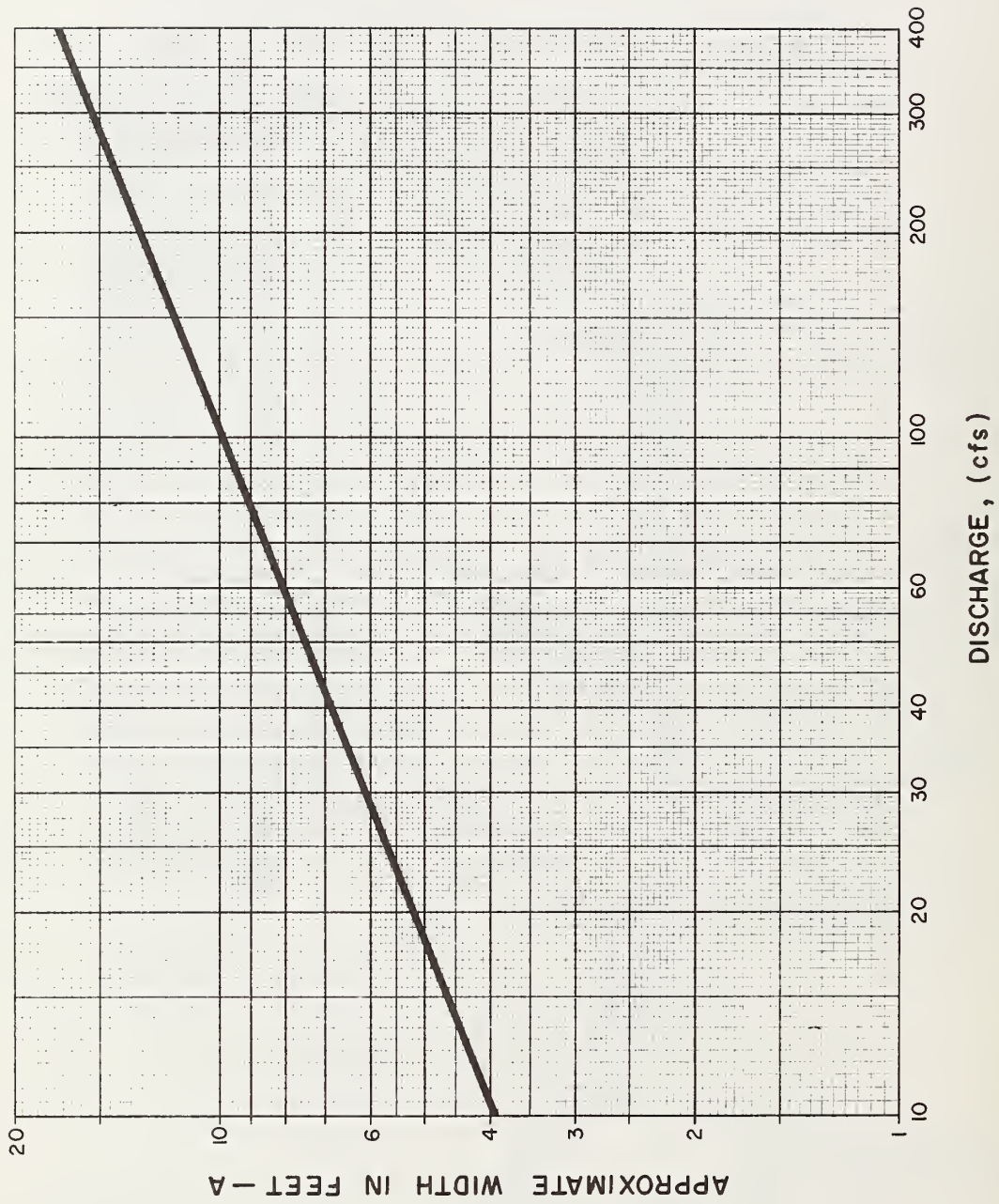

FIGURE 30. U.S. BUREAU OF RECLAMATION TYPE VI BASIN

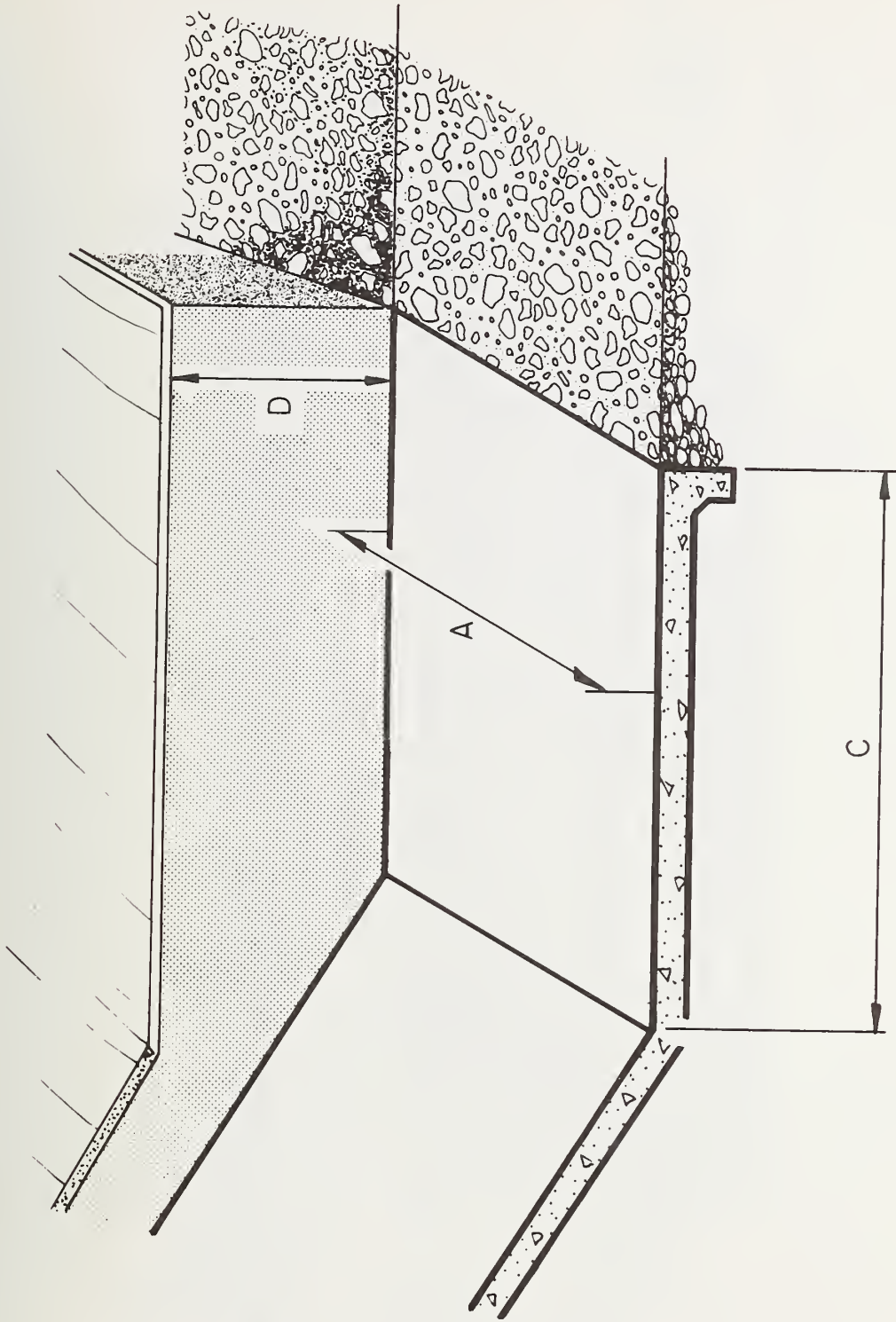

Figure 31. U.S. Bureau of Reclamation Type I Basin



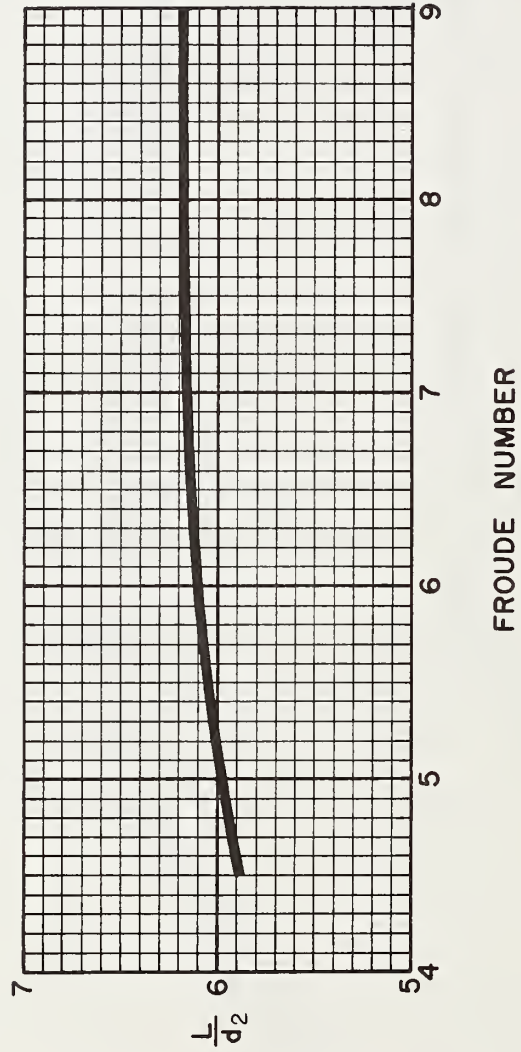

FIGURE 32. U.S. BUREAU OF RECLAMATION TYPE I BASIN HYDRAULIC JUMP LENGTH

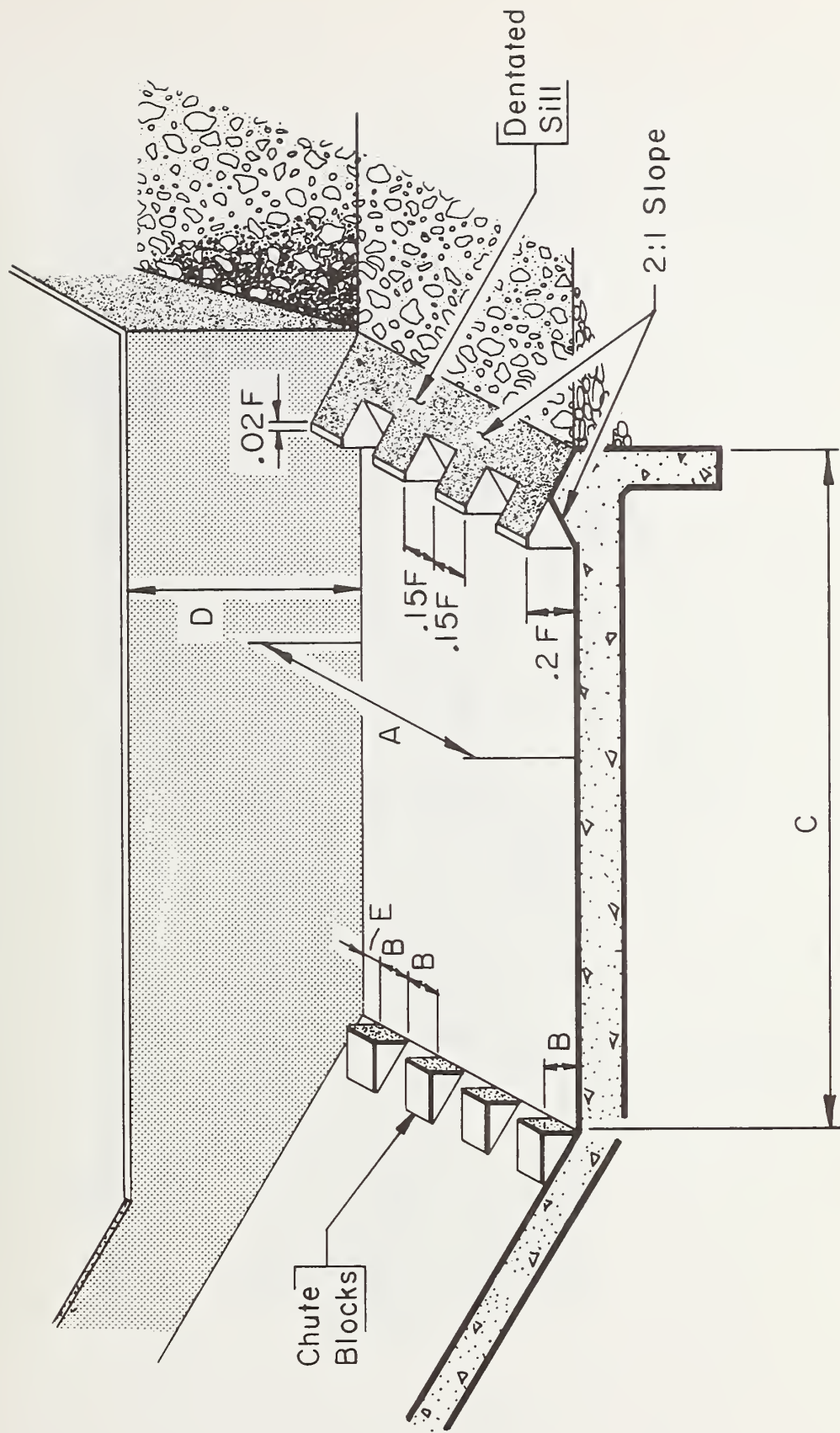

Figure 33. U.S. Bureau of Reclamation Type II Basin

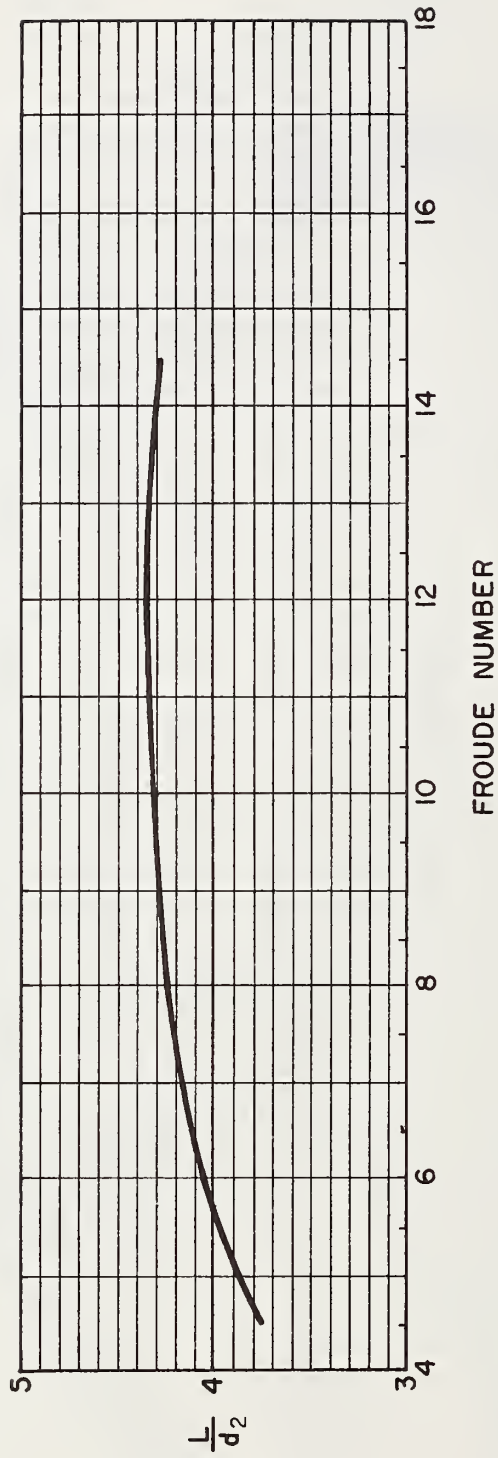

FIGURE 34. U.S. BUREAU OF RECLAMATION TYPE II BASIN HYDRAULIC JUMP LENGTH

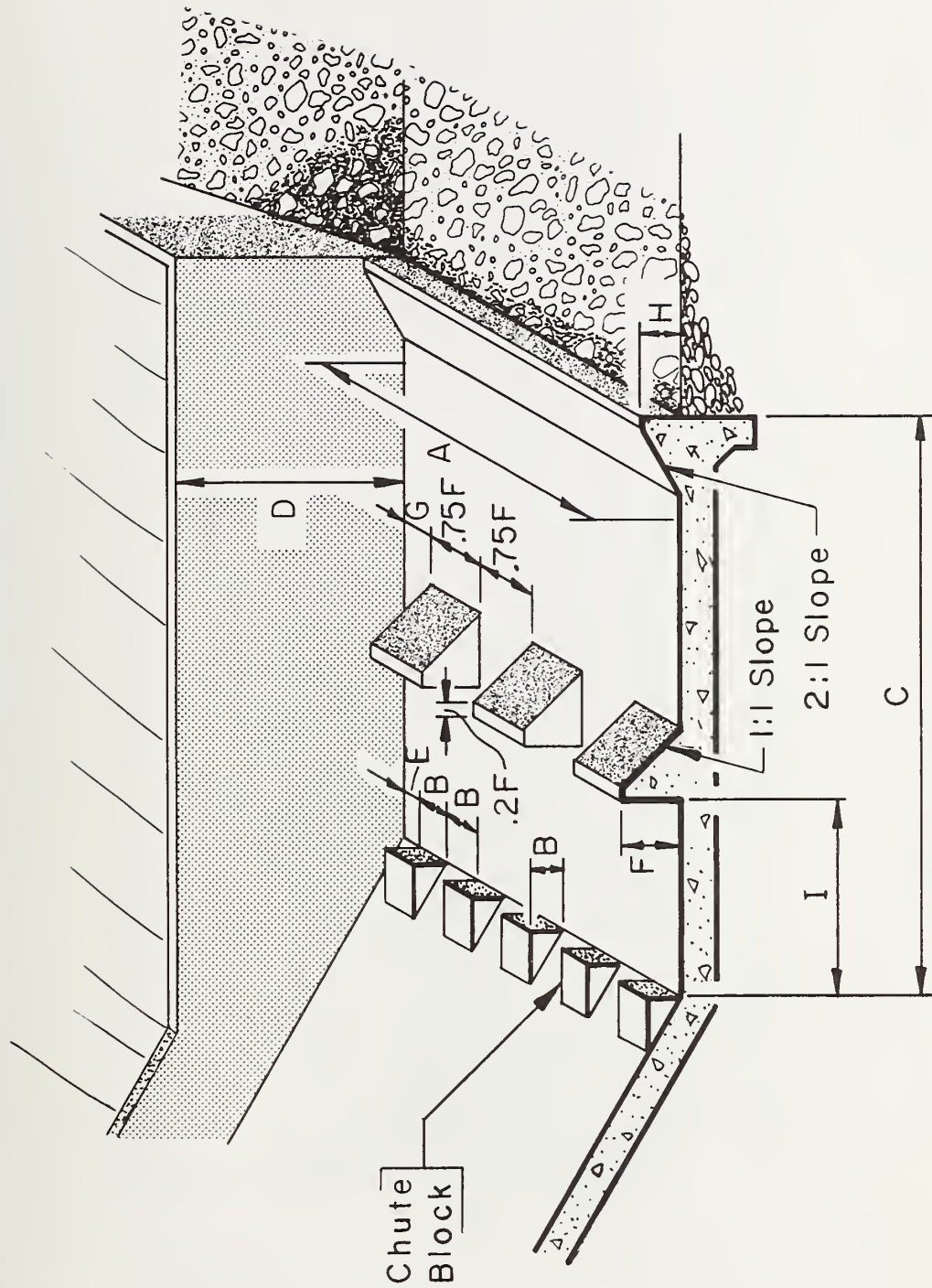

Figure 35. U. S. Bureau of Reclamation Type III Basin

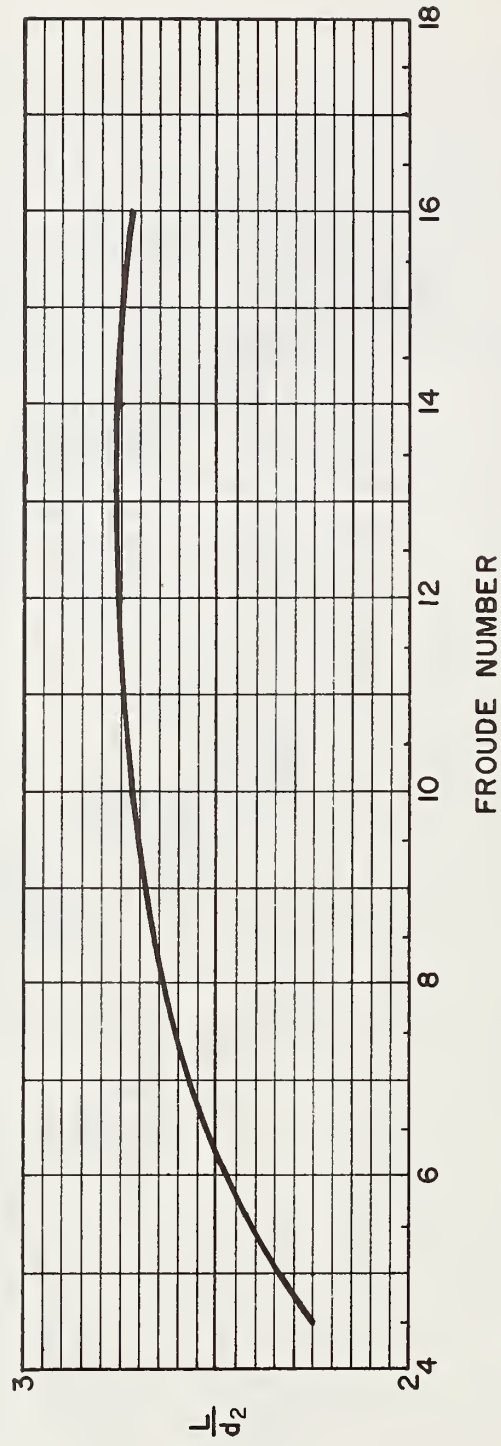

FIGURE 36. U.S. BUREAU OF RECLAMATION TYPE III BASIN HYDRAULIC JUMP LENGTH



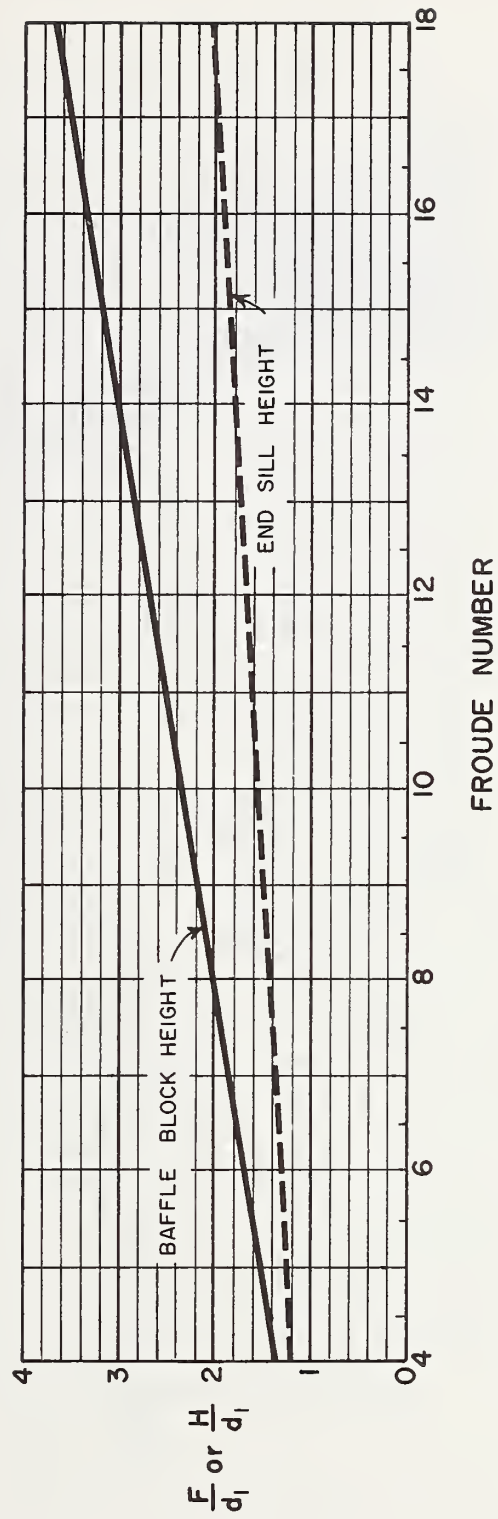

FIGURE 37. U.S. BUREAU OF RECLAMATION TYPE III BASIN  
BAFFLE BLOCKS AND END SILL HEIGHTS

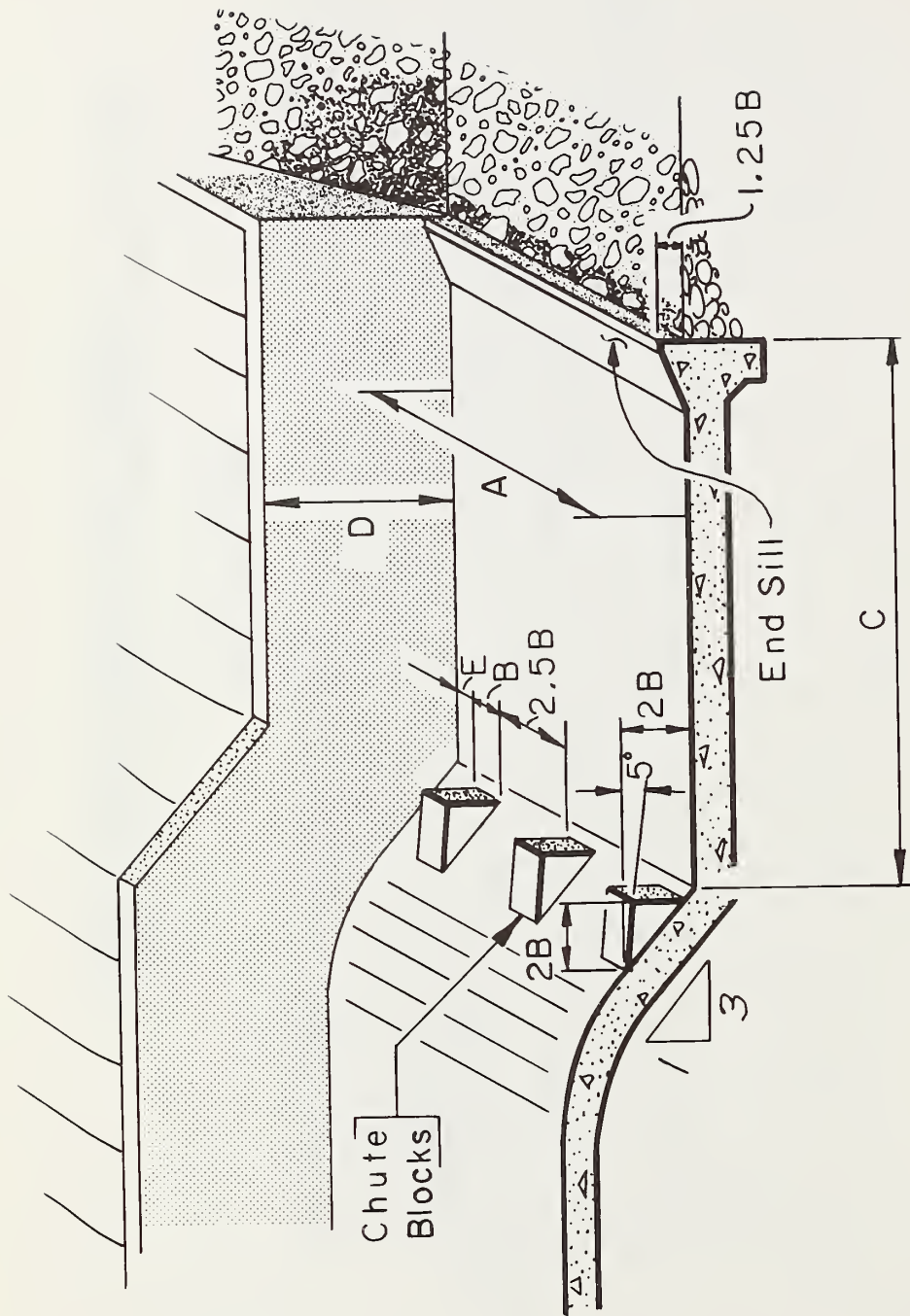

Figure 38. U. S. Bureau of Reclamation Type IV Basin

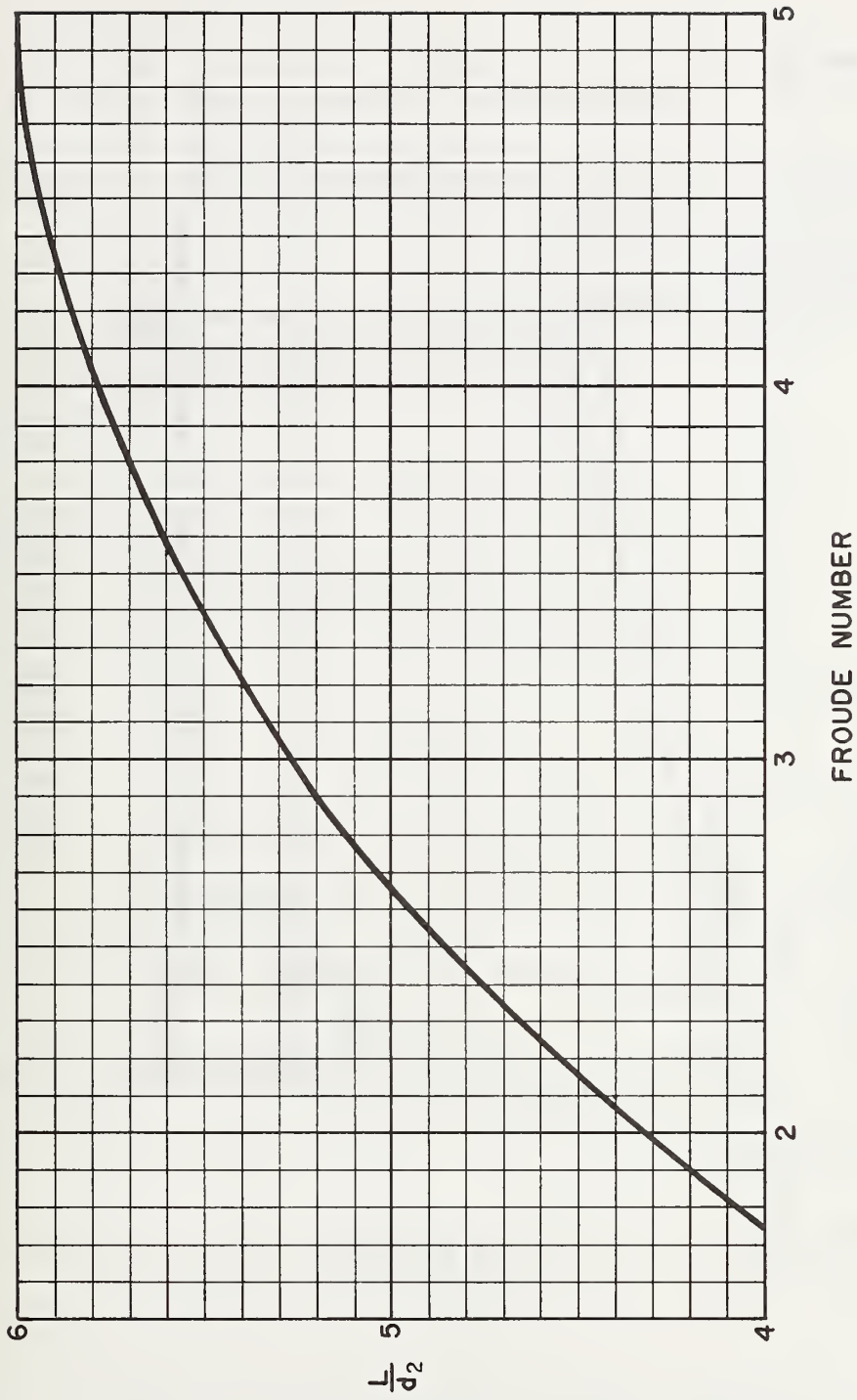
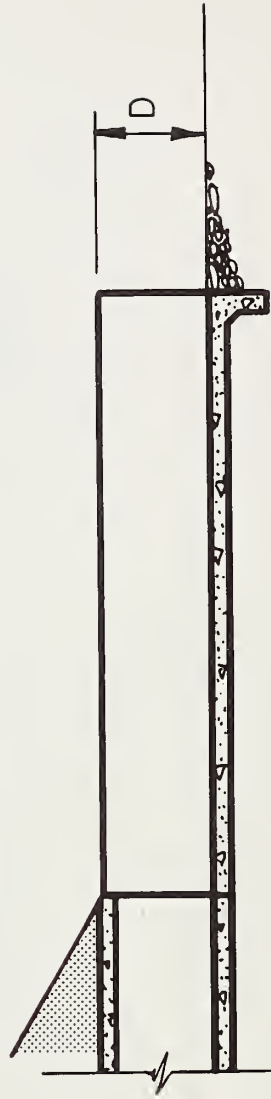
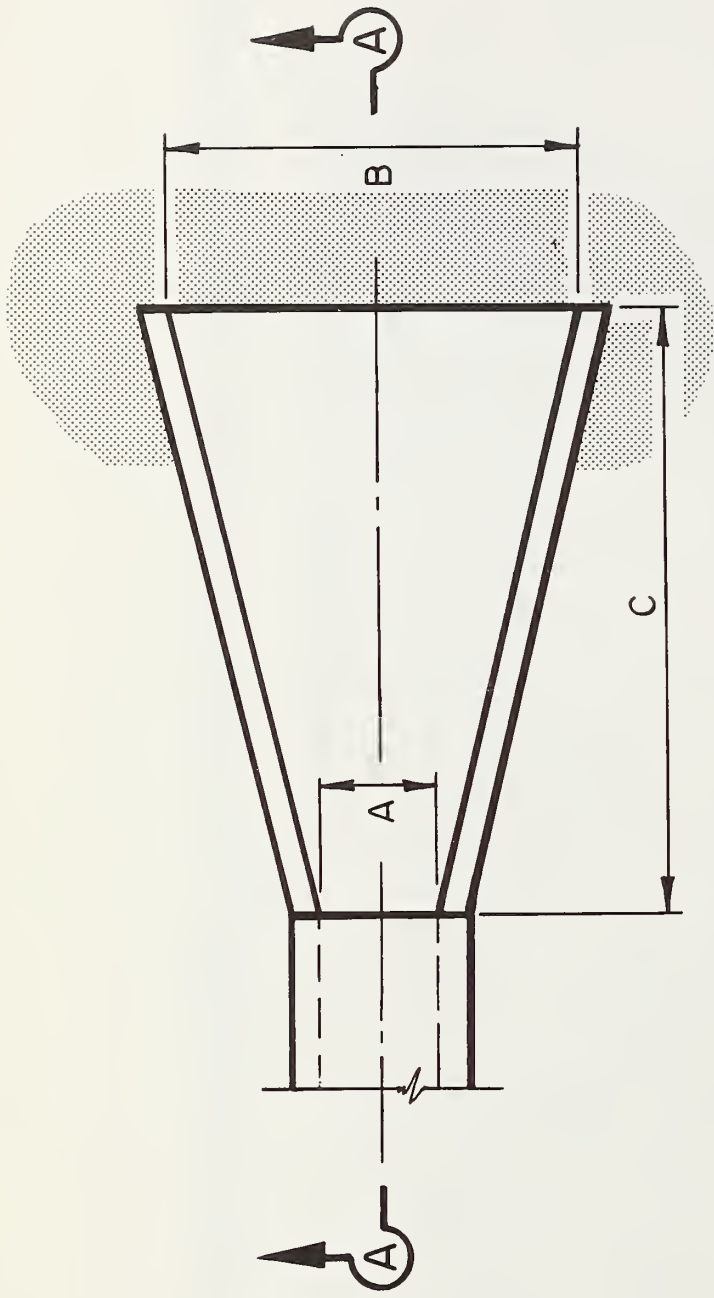
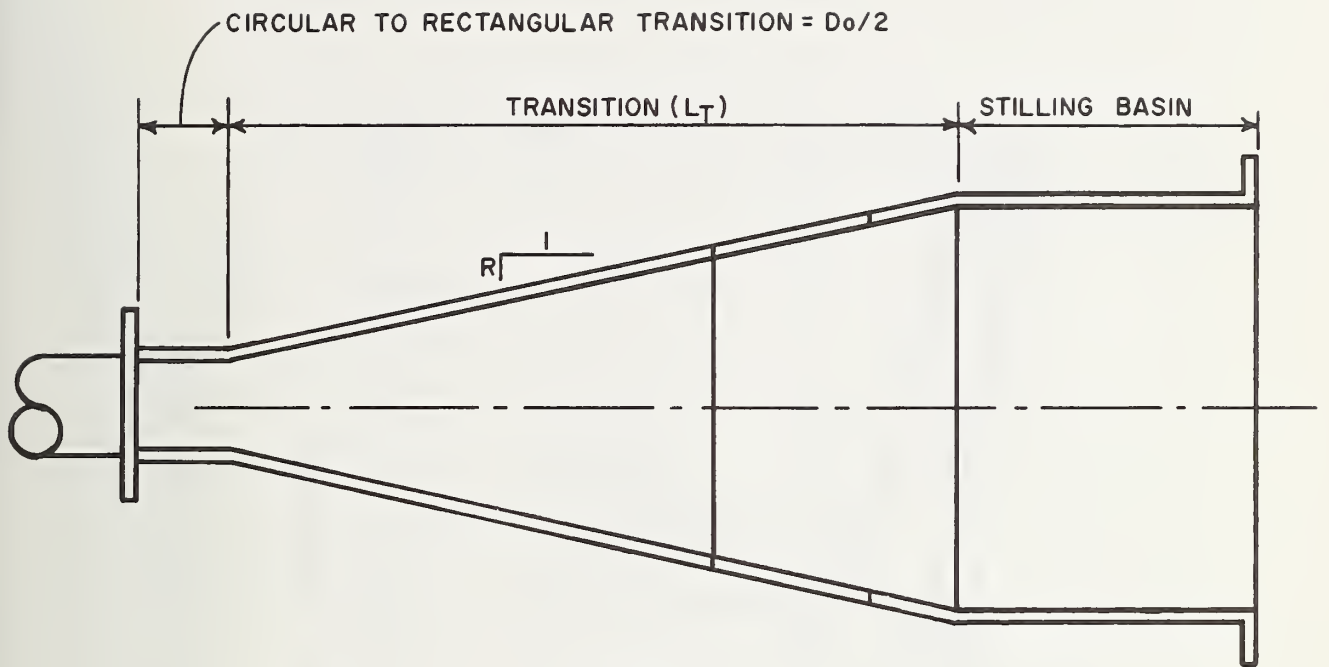

FIGURE 39. U.S. BUREAU OF RECLAMATION TYPE IV BASIN HYDRAULIC JUMP LENGTH



SECTION A-A

Figure 40. Smooth Floor Flared Basin



PLAN

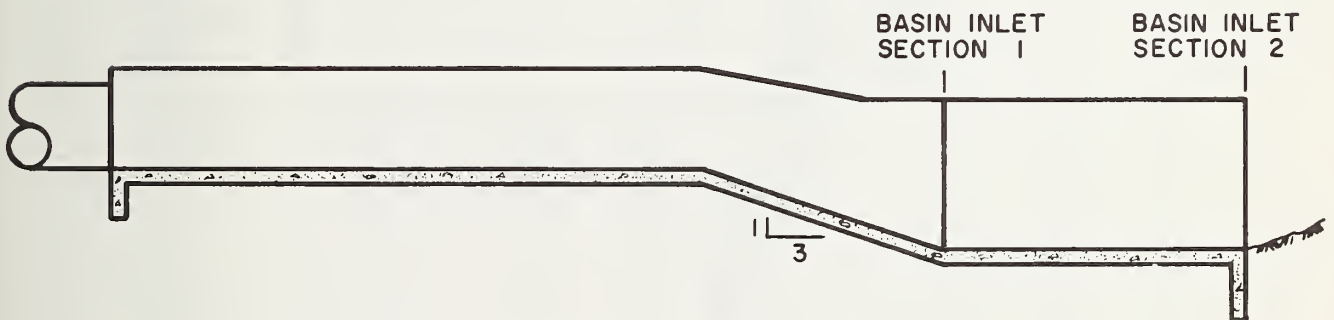

PROFILE

FIGURE 41 TYPICAL CULVERT-STILLING BASIN TRANSITION



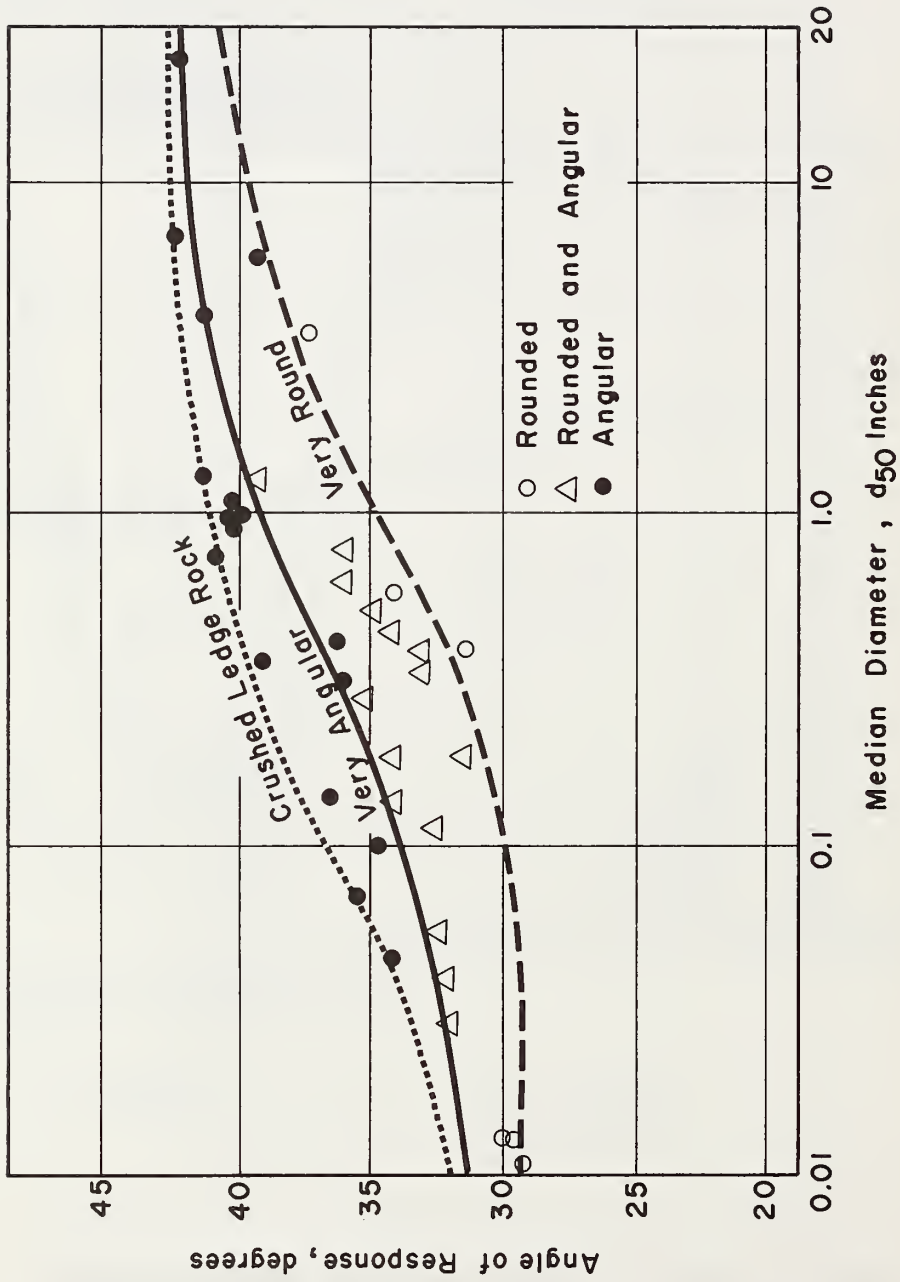

FIGURE 42 ANGLE OF REPOSE OF NON-COHESIVE MATERIAL  
 COLORADO STATE UNIVERSITY ROCK RIPRAPPED BASIN

SECTION III  
DESCRIPTION OF INPUT

## DESCRIPTION OF INPUT

This section describes the input parameter requirements of the program. This includes data types, card types, coding format instructions, and batching procedures. The designer is advised to use the glossary in SECTION II for resolving parameter terminology questions. A diagram of proper card type order and multiple job batching is provided. Please follow the instructions below carefully.

1. Refer to the standard input form (C-16) for coding input data.
2. The COMMENT CARD line is intended for site identification or commentary. This line represents one card. There must be one comment card for each data set.
3. Below the COMMENT CARD line, DATA CARD lines are available. Each line contains a WORK CODE entry, a DATA CODE entry, ENTRY 1, ENTRY 2, ENTRY 3, ENTRY 4, ENTRY 5, ENTRY 6, and a CONT entry. The WORK CODE entry contains an integer for card type identification to insure proper ordering of data cards. It must be coded for each card or the program will not run. No entry is required in the DATA CODE entry. ENTRY 1 - ENTRY 6 are intended to contain specific data in floating point form. Be certain to CODE IN ALL DECIMAL POINTS for data in these entries. The CONT entry is a continuation indicator and should be used as specified later.
4. Below the DATA CARD lines is a TRAILER CARD line used for program termination. It should only be used once at the end of all input data. Cross this line out on all C-16 forms except the last one.
5. Eight types of DATA CARDS are available for input. Each type will be described in detail in succession. Acceptable orders of cards following the COMMENT CARD by WORK CODE are (1,2,3,4,5,6,7,8), (1,2,3,4,6,7,8), (1,2,3,6,7,8), (1,2,3,4,5,6), (1,2,3,4,6), (1,2,3,6), (1,2,3,4,5,6), (1,2,3,4) and (1,2,3). Additional sites or data sets may follow each other if these arrangements are used. Remember to precede each data set with a COMMENT CARD and provide only one '999' TRAILER CARD at the end of all input data. Refer to Figure (43).
6. CULVERT EROSION PROTECTION CONTROL CARD  
Always include this card.

### WORK CODE - Code 1

ENTRY 1 - This entry contains two options to control the direction of analysis. Code 1. for user selected energy dissipators to alert the program that specific basin designs are requested. Code 2. for all applicable energy dissipators. The U.S. Army Waterways Experiment Station Scour Extent will always be computed under this option. In both cases, the energy dissipators will be tested and excluded if outside the basin design limitations.

ENTRY 2 - Code 1. if debris passage through the basin is desired. This results in exclusion of the Vertical Stilling Well and U.S. Bureau of Reclamation Type VI basins. No entry will include these designs. Engineering judgment is recommended.

ENTRY 3 - This entry restricts type of basin material. Code 1. if only concrete basins are to be designed. Code 2. if only rock basins are to be designed. No entry is necessary if no restriction is imposed.

ENTRY 4 - This entry designates the culvert shape and roughness. Shape refers to circular or rectangular. Roughness refers to concrete (smooth) or corrugated metal (rough) culverts. Code 1. for smooth, circular culvert. Code 2. for smooth rectangular culvert. Code 3. for rough, circular culvert. Code 4. for rough, rectangular culvert.

ENTRY 5 - This entry affords the designer the opportunity to use judgment in selecting the width of the energy dissipator. This is mandatory in order to obtain designs for U.S. Bureau of Reclamation Basin Types I, II, III, and IV. These are the only designs applicable to this control. The selected width of the basin must be based on downstream channel width and economics.

7. CULVERT PARAMETER CARD  
Always include this card.

WORK CODE - Code 2

ENTRY 1 - Code duration of culvert peak discharge in minutes. This is used in computing scour extent in sandy material.

ENTRY 2 - Code number of culvert barrels. Multiple barrel design is possible only for the Colorado State Univ. Rock Riprapped Basins.

ENTRY 3 - Code culvert barrel spacing in feet. No entry for one barrel.

ENTRY 4 - Code maximum culvert barrel rise or height in feet.

ENTRY 5 - Code maximum culvert barrel span or width in feet.

ENTRY 6 - Code culvert slope in feet/feet.

8. CULVERT FLOW CARD  
Always include this card.

WORK CODE - Code 3

ENTRY 1 - Code culvert discharge per barrel in cubic feet per second.

ENTRY 2 - Code culvert brink or outlet depth relative to invert in feet.

ENTRY 3 - Code culvert outlet average velocity in feet per second.

ENTRY 4 - Code channel tailwater depth relative to invert at outlet in feet.

ENTRY 5 - Code channel average velocity in feet per second.

ENTRY 6 - Code channel maximum velocity in feet per second.

9. BASIN SELECTION CARD NO. 1

This card is necessary only if ENTRY 1 of the CULVERT EROSION PROTECTION CONTROL CARD is 1. It indicates user selected basins. No entry is required if a basin is not desired.

WORK CODE - Code 4

ENTRY 1 - Code 1. if U.S. Army Waterways Experiment Station Scour Extent in sandy material is desired.

ENTRY 2 - Code 1. if U.S. Army Waterways Experiment Station Rock Riprapped Basins are desired.

ENTRY 3 - Code 1. if Colorado State University Rock Riprapped Basins are desired.

ENTRY 4 - Code 1. if Vertical Stilling Well is desired.

ENTRY 5 - Code 1. if St. Anthony Falls Stilling Basin is desired.

ENTRY 6 - Code 1. if U.S. Bureau of Reclamation Type VI Basin is desired.

CONT - Code 1. if BASIN SELECTION CARD NO. 2 follows.

10. BASIN SELECTION CARD NO. 2

This card is necessary only if the CONT column of BASIN SELECTION CARD NO. 1 is 1

WORK CODE - Code 5

ENTRY 1 - Code 1. if U.S. Bureau of Reclamation Type I Basin is desired.

ENTRY 2 - Code 1. if U.S. Bureau of Reclamation Type II Basin is desired.

ENTRY 3 - Code 1. if U.S. Bureau of Reclamation Type III Basin is desired.

ENTRY 4 - Code 1. if U.S. Bureau of Reclamation Type IV Basin is desired.

ENTRY 5 - Code 1. if Colorado State University Smooth-Floor Flared Basin is desired.

11. RIPRAP PARAMETER CARD NO. 1

This card is necessary unless ENTRY 3 of the CULVERT EROSION PROTECTION CONTROL CARD is 1. or ENTRY 3 of the BASIN SELECTION CARD NO. 1 has no entry.



WORK CODE - Code 6

ENTRY 1 - Code effective diameter in feet of riprap rock if available. No entry is required if not available or RIPRAP PARAMETER CARDS NO. 2 and 3 are submitted.

ENTRY 2 - Code specific gravity of riprap rock if available. No entry is required if ENTRY 1 is not coded. If ENTRY 1 is coded and no specific gravity is available, code 2.70.

ENTRY 3 - Code maximum diameter in feet of riprap rock if available. No entry is required if ENTRY 1 and ENTRY 2 are not coded.

ENTRY 4 - Code riprap embankment slope in feet/feet. This is the slope of the embankment at the culvert outlet.

ENTRY 5 - Code riprap side slope in feet/feet. This is the slope of the existing channel or channel change sides downstream of the culvert outlet.

ENTRY 6 - Code riprap end slope in feet/feet. This is the desired slope of the outlet end of the basin.

CONT - Code 1 only if ENTRY 1, ENTRY 2, and ENTRY 3 have no entries and RIPRAP PARAMETER CARDS NO. 2 and 3 follow with riprap gradation data.

12. RIPRAP PARAMETER CARD NO. 2  
This card is included only if RIPRAP PARAMETER CARD NO. 1 has ENTRY 1, ENTRY 2, ENTRY 3 with no entries and the CONT column with a 1. This indicates that a gradation of riprap rock is available to compute the effective diameter.

WORK CODE - Code 7

ENTRY 1 - Code the 0% finer by weight rock diameter in feet.

ENTRY 2 - Code the 10% finer by weight rock diameter in feet.

ENTRY 3 - Code the 20% finer by weight rock diameter in feet.

ENTRY 4 - Code the 30% finer by weight rock diameter in feet.

ENTRY 5 - Code the 40% finer by weight rock diameter in feet.

ENTRY 6 - Code the 50% finer by weight rock diameter in feet.

13. RIPRAP PARAMETER CARD NO. 3  
This card is included only if RIPRAP PARAMETER CARD NO. 2 is included.

WORK CODE - Code 8

ENTRY 1 - Code the 60% finer by weight rock diameter in feet.

ENTRY 2 - Code the 70% finer by weight rock diameter in feet.

ENTRY 3 - Code the 80% finer by weight rock diameter in feet.

ENTRY 4 - Code the 90% finer by weight rock diameter in feet.

ENTRY 5 - Code the 100% finer by weight rock diameter in feet. This is equivalent to the maximum rock diameter.

ENTRY 6 - Code specific gravity of riprap rock available. If not available, code 2.70

14. Include additional data sets (no limit) if desired. At the end of all input data always include a '999' TRAILER CARD. There is only one '999' TRAILER CARD per batch.

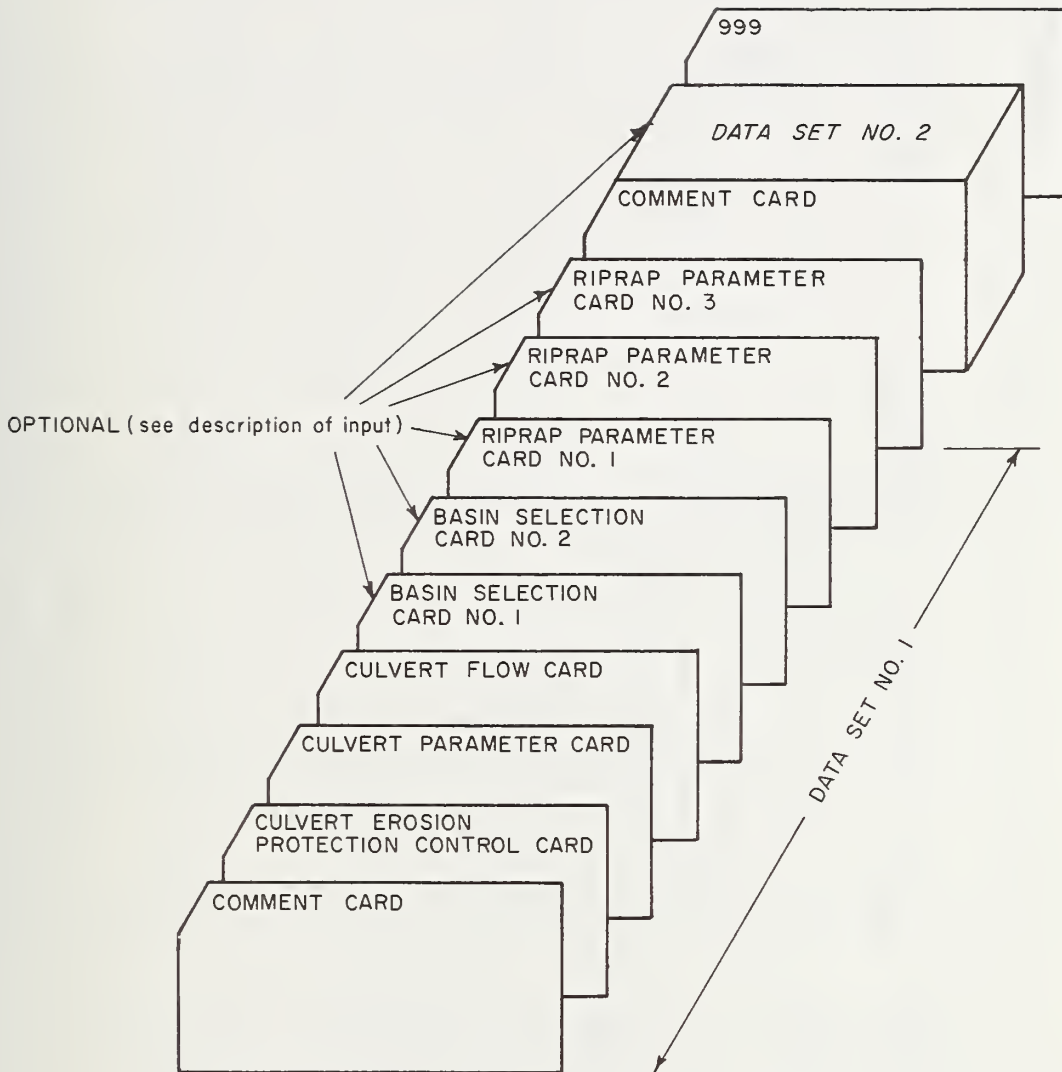

**FIGURE 43 INPUT DATA BATCH ORDER**

WYOMING STATE HIGHWAY DEPARTMENT  
CHEYENNE WYOMING  
BRIDGE DIVISION

SHEET NO. \_\_\_\_\_ OF \_\_\_\_\_  
BY \_\_\_\_\_ DATE \_\_\_\_\_

//EXEC BRSYSØØ

DESIGN SYSTEM

Employee No.	Dept. Code	Job Code	Work Code	Str. No.
65				80

1 COMMENT CARD  
1 Ø Ø \_\_\_\_\_ 64

66	ENTRY 1	ENTRY 2	ENTRY 3	ENTRY 4	ENTRY 5	ENTRY 6	65
6	15	25	35	45	55	65	C O N T
1	W						
2	O						
3	O						
4	R						
5	D						
6	A						
7	T						
8	A						
9	E						

TRAILER CARD

9,9,9  
1-3

NOTE: A trailer card must follow the last structure card containing data

Code 1 if  
card 5 follows

WORK CODE	1	2	3	4
ENTRY 6			Culvert Slope (ft/ft) Vertical/Horizontal	Channel Maximum Velocity (fps)
ENTRY 5	Energy Dissipator Selected Width (ft.) U. S. Bureau of Reclamation Types I, II, III, IV Only		Culvert Span (ft)	Channel Average Velocity (fps)
ENTRY 4	Culvert Shape Indicator Circular, Smooth-Code 1. Rectangular, Smooth-Code 2. Circular, Rough-Code 3. Rectangular, Rough-Code 4.		Culvert Rise (ft)	Channel Tailwater (ft)
ENTRY 3	Energy Dissipator Material Restriction Code 1.-Concrete only Code 2.-Rock Riprap only No entry-No restriction		Culvert Barrel Spacing (ft) No entry for single barrel or zero spacing	Culvert Outlet Average Velocity (fps)
ENTRY 2	Energy Dissipator Debris Passage Code 1. if desired		Number of Culvert Barrels	Culvert Brink Depth (ft)
ENTRY 1	Analysis Options Code 1.-User selected methods Code 2.-All applicable methods		Duration of Culvert Peak Discharge (min)	Culvert Discharge/Barrel (cfs)
DATA CODE	CULVERT EROSION PROTECTION CONTROL CARD		CULVERT PARAMETER CARD	CULVERT FLOW CARD
				BASIN SELECTION CARD NO. 1

FIGURE 45 INPUT DATA ENTRY FORM NO. 1



Code 1 if cards 7 and 8 follow

ENTRY 6		Riprap End Slope (ft/ft) Horizontal/Vertical	50% Finer Rock Diameter (ft)	Riprap Rock Specific Gravity
ENTRY 5	Colorado State University Smooth-Floor Flared Basin Code 1. if desired	Riprap Side Slope (ft/ft) Horizontal/Vertical	40% Finer Rock Diameter (ft)	100% Finer Rock Diameter (ft)
ENTRY 4	U. S. Bureau of Reclamation Type IV Basin Code 1. if desired	Riprap Embankment Slope (ft/ft) Horizontal/Vertical	30% Finer Rock Diameter (ft)	90% Finer Rock Diameter (ft)
ENTRY 3	U. S. Bureau of Reclamation Type III Basin Code 1. if desired	Maximum Rock Diameter of Riprap (ft)	20% Finer Rock Diameter (ft)	80% Finer Rock Diameter (ft)
ENTRY 2	U. S. Bureau of Reclamation Type II Basin Code 1. if desired	Riprap Rock Specific Gravity	10% Finer Rock Diameter (ft)	70% Finer Rock Diameter (ft)
ENTRY 1	U. S. Bureau of Reclamation Type I Basin Code 1. if desired	Effective Rock Diameter of Riprap (ft)	0% Finer Rock Diameter (ft)	60% Finer Rock Diameter (ft)
DATA CODE	BASIN SELECTION CARD NO. 2	RIPRAP PARAMETER CARD NO. 1	RIPRAP PARAMETER CARD NO. 2	RIPRAP PARAMETER CARD NO. 3
	5	6	7	8

SECTION IV  
DESCRIPTION OF OUTPUT

## DESCRIPTION OF OUTPUT

Three basic types of computer output are presented to the designer. The first type of output displays all input data for verification. It is important to check each item for validity before using any design output. Input data is classified into four groups specifying culvert geometry, culvert outlet flow, downstream channel flow, and riprap parameters.

The second type of output presents design computations for selected energy dissipators. Each culvert protection method is titled and various dimensions are described and referenced alphabetically to a corresponding figure of the energy dissipator. An important message stating that the design is for a single culvert barrel only is printed for each method except the Colorado State University Rock Riprapped Basins. In this case, multiple culvert barrel design is permitted, but is more susceptible to failure. The designer is referred to Section V, Sample Problems for specific examples of output.

The third type of output provides diagnostic description of errors or program problems related to input parameters or design terminations. An explanation of each type of error is beneficial at this point.

Error:                   \*\*\*INPUT PARAMETER CARD ERROR - NO. \_\_\_\_\_ CARD TYPE OUT OF SEQUENCE\*\*\*

Explanation:           Input parameter card errors are associated with improper card sequence and cause immediate program termination. The identification number for the first card out of sequence is printed. The designer should refer to Section III, Description of Input, for proper card order.

Error:                   \*\*\*INSUFFICIENT NUMBER OF EFFECTIVE ROCK DIAMETER, SCOUR DEPTH VALUES AVAILABLE\*\*\*  
\*\*\*COLORADO STATE UNIVERSITY ROCK RIPRAPPED BASIN DESIGN TERMINATED\*\*\*

Explanation:           Less than two scour depth, effective rock diameter points are available from research data for specified input data.

Error:                   \*\*\*NO ENERGY DISSIPATOR DESIGN MEETS LIMITS\*\*\*

Explanation:           All methods exceed their limitations for specified input data.

Error:                   \*\*\*TAILWATER EXCEEDS SEQUENT DEPTH OF CULVERT BRINK DEPTH\*\*\*

Explanation:           This message applies to the St. Anthony Falls and U. S. Bureau of Reclamation Types I, II, III, and IV Basins. It indicates that a hydraulic jump will occur at the culvert outlet.

Error: \*\*\*CHUTE BLOCKS EXTEND INTO THE CULVERT\*\*\*

Explanation: This message applies to the St. Anthony Falls and U. S. Bureau of Reclamation Types II, III, and IV Basins. The required chute block height exceeds the fall from the culvert outlet invert to the basin floor. Selecting a narrower basin width may resolve this problem.

Error: \*\*\*ALLOWABLE BASIN ENTRANCE FROUDE NUMBER EXCEEDED\*\*\*

Explanation: This message applies to the hydraulic jump energy dissipators requiring a specific Froude number to effect a hydraulic jump or best performance of the basin.

Error: \*\*\*BASIN ENTRANCE FROUDE NUMBER OF \_\_\_\_\_ IS LESS THAN MINIMUM VALUE - RECOMMEND INCREASING BASIN WIDTH TO COMPLY WITH MINIMUM FROUDE NUMBER\*\*\*

Explanation: This message applies to hydraulic jump basins to insure that the minimum Froude number for a basin is observed. Increasing the width of a basin will decrease the initial depth which will increase the Froude number.

Error: \*\*\*VERTICAL STILLING WELL DESIGN TERMINATED - WELL DIAMETER EXCEEDS FIVE INCOMING PIPE DIAMETERS\*\*\*

Explanation: This indicates an upper limit established by research and testing.

Error: \*\*\*VERTICAL STILLING WELL DESIGN FOR CIRCULAR PIPE ONLY\*\*\*

Explanation: An attempt by the user to design a Vertical Stilling Well for a rectangular culvert has occurred.

Error: \*\*\*DISCHARGE PARAMETER LIMIT EXCEEDED\*\*\*

Explanation: The discharge parameter  $Q/W_0H_0^{3/2}$  is exceeded for a selected basin and specific input data.

Error: \*\*\* U. S. BUREAU OF RECLAMATION TYPE VI BASIN TERMINATED - BARREL DISCHARGE EXCEEDS 400. CFS\*\*\*

Explanation: Optimum performance limit exceeded.

Error: \*\*\*U. S. BUREAU OF RECLAMATION TYPE VI BASIN TERMINATED - TAILWATER EXCEEDS HALF OF BAFFLE HEIGHT\*\*\*

Explanation: Optimum performance limit exceeded.

Error: \*\*\*U. S. BUREAU OF RECLAMATION TYPE VI BASIN TERMINATED - OUTLET VELOCITY IS LESS THAN 2 FPS OR GREATER THAN 30 FPS\*\*\*

Explanation: Optimum performance limit exceeded.

SECTION V  
SAMPLE PROBLEMS



Example No. 1

Predict scour extent and design rock riprapped basins for the mild slope culvert parameters below.

Culvert Type:	1 circular, structural plate pipe
Culvert Rise:	9 ft
Culvert Span:	9 ft
Culvert Slope:	0.017 ft/ft
Culvert Brink Depth	5.3 ft
Peak Discharge:	680 cfs
Channel Tailwater Depth:	3.6 ft
Peak Discharge Duration:	360 min.
Culvert Outlet Velocity:	17.4 fps
Culvert Outlet Froude No:	1.46
Maximum Channel Velocity:	13.2 fps
Average Channel Velocity:	8.8 fps

WYOMING STATE HIGHWAY DEPARTMENT  
CHEYENNE WYOMING  
BRIDGE DIVISION

SHEET NO.          OF           
BY          DATE         

//EXEC BRSYSØØ

DESIGN SYSTEM

CHECKED

Employee No.	Dept. Code	Job Code	Work Code	Str. No.
65			75	80

1 COMMENT CARD

1.00 EXAMPLE NO. 1

1 WORK CODE	2	3 DATE	4 ENTRY 1	5 ENTRY 2	6 ENTRY 3	7 ENTRY 4	8 ENTRY 5	9 ENTRY 6	10 C O N T
1			1.00	15	25	35	45	55	65
2			1.00	1.00	2.00	3.00	9.00	9.00	9.00
3			5.3	5.3	17.4	3.6	8.8	13.2	13.2
4			1.00	1.00	1.00	4.00	1.5	2.00	2.00
6			1.00	2.7	1.00	1.00	1.00	1.00	1.00

TRAILER CARD

9.99  
1.3

NOTE: A trailer card must follow the last structure card containing data

CULVERT EROSION PROTECTION

EXAMPLE NO. 1

INPUT PARAMETERS

\*\*\*CULVERT\*\*\*  
TYPE = CIRCULAR  
SLOPE = 0.0170 FT/FT  
RISE = 9.0 FT  
SPAN = 9.0 FT  
NO. OF BARRELS = 1.  
BARREL SPACING = 0.0 FT

\*\*\*OUTLET\*\*\*  
VELOCITY = 17.4 FPS  
DEPTH = 5.3 FT  
FROUDE NO. = 1.46  
DISCHARGE/BARREL = 680.0 CFS  
PEAK DISCHARGE DURATION = 360. MIN

\*\*\*CHANNEL\*\*\*  
TAILWATER = 3.6 FT  
MAXIMUM VELOCITY = 13.2 FPS  
AVERAGE VELOCITY = 8.8 FPS

\*\*\*RIPRAP\*\*\*  
EFFECTIVE ROCK DIAMETER = 1.000 FT  
RIPRAP ROCK SPECIFIC GRAVITY = 2.70  
MAXIMUM ROCK DIAMETER = 1.000 FT  
UNDER SLOPE = 4.00 FT/FT  
ERBANKMENT SLOPE = 1.50 FT/FT  
END SLOPE = 2.00 FT/FT  
SIDE SLOPE = 4.00 FT/FT

CULVERT EROSION PROTECTION

EXAMPLE NO. 1

\*\*\*DESIGNED FOR SINGLE BARREL DISCHARGE\*\*\*

U. S. ARMY WATERWAYS EXPERIMENT STATION

SCOUR HOLE EXTENT ESTIMATION

SANDY MATERIAL - EFFECTIVE DIAMETER = .001 FT

MAXIMUM SCOUR DEPTH = 19.1 FT

MAXIMUM SCOUR LENGTH = 93.6 FT

MAXIMUM SCOUR WIDTH = 55.8 FT

MAXIMUM SCOUR VOLUME = 1403. CU YD

DISCHARGE = 680. CFS

CULVERT EROSION PROTECTION

EXAMPLE NO. 1

\*\*\*DESIGNED FOR SINGLE BARREL DISCHARGE\*\*\*

U. S. ARMY WATERWAYS EXPERIMENT STATION ROCK RIPRAPPED BASINS

TYPE	MEDIAN ROCK DIAMETER	BASIN INLET		BASIN OUTLET		BASIN LENGTH		BASIN THICKNESS		BASIN DEPRESSION		BASIN VOLUME	
		WIDTH	WIDTH	WIDTH	WIDTH	LENGTH	LENGTH	THICKNESS	THICKNESS	DEPRESSION	DEPRESSION	VOLUME	VOLUME
		-A-	-B-	-B-	-C-	-D-	-F-						
HORIZONTAL BLANKET	1.774 FT	27.0 FT	77.8 FT	77.8 FT	50.8 FT	6.6 FT	0.0 FT	6.6 FT	6.6 FT	0.0 FT	0.0 FT	648.8 CU YD	
LINED CHANNEL EXPANSION	1.419 FT	27.0 FT	45.0 FT	45.0 FT	45.0 FT	2.8 FT	0.0 FT	2.8 FT	2.8 FT	0.0 FT	0.0 FT	212.9 CU YD	
PREFORMED SCOUR HOLE	1.109 FT	45.0 FT	45.0 FT	45.0 FT	54.0 FT	2.2 FT	4.5 FT	2.2 FT	2.2 FT	4.5 FT	4.5 FT	166.3 CU YD	
PREFORMED SCOUR HOLE	3.727 FT	72.0 FT	72.0 FT	72.0 FT	81.0 FT	1.5 FT	9.0 FT	1.5 FT	1.5 FT	9.0 FT	9.0 FT	279.3 CU YD	



CULVERT EROSION PROTECTION

EXAMPLE NO. 1

\*\*\*DESIGNED FOR SINGLE BARREL DISCHARGE\*\*\*

COLORADO STATE UNIVERSITY

ROCK RIPRAPPED BASINS

BASIN TYPE	EFFECTIVE ROCK DIAMETER	SCOUR DEPTH	SCOUR LENGTH	SCOUR WIDTH	SCOUR	BASIN INLET			BASIN OUTLET			BASIN LENGTH	BASIN HEIGHT	BASIN THICKNESS	BASIN THICKNESS	BASIN VOLUME
						WIDTH	DIAMETER	DIAMETER	WIDTH	DIAMETER	DIAMETER					
SCOURING	0.44 FT	15.0 FT	121.5 FT	53.8 FT	71.8 FT	71.8 FT	71.8 FT	71.8 FT	230.8 FT	7.9 FT	1.0 FT	16.0 FT	6618. CU YD			
SCOURING	0.85 FT	5.7 FT	100.0 FT	33.4 FT	51.4 FT	51.4 FT	51.4 FT	51.4 FT	190.1 FT	7.9 FT	1.7 FT	7.4 FT	3251. CU YD			
NON-SCOURING	1.84 FT	0.0 FT	0.0 FT	0.0 FT	9.0 FT	9.0 FT	21.5 FT	62.3 FT	7.9 FT	3.7 FT	3.7 FT	943. CU YD				
HYBRID	1.37 FT	2.7 FT	62.6 FT	24.6 FT	42.6 FT	42.6 FT	42.6 FT	118.9 FT	7.9 FT	2.7 FT	5.5 FT	1653. CU YD				
SCOURING	1.00 FT	4.9 FT	94.6 FT	31.9 FT	49.9 FT	49.9 FT	49.9 FT	179.8 FT	7.9 FT	2.0 FT	6.9 FT	3280. CU YD				

## U.S. Army Waterways Experiment Station Estimate of Scour Extent

This is an estimate of the scour extent in sandy material with an approximate effective rock diameter of 0.001 ft.

The first procedure is to determine if the minimum tailwater or the maximum tailwater case applies.

Since the tailwater depth (3.6ft) is less than half of the culvert rise (4.5ft), the minimum case applies.

Estimate the maximum depth of scour

$$D_{Sm} = 0.80 D_o (Q/D_o^{2.5})^{0.375} t^{0.10}$$

$$D_{Sm} = (0.80)(9.)(680/9^{2.5})^{0.375} 360^{0.10} = 19.1 \text{ ft}$$

Estimate the maximum width of scour

$$W_{Sm} = 1.00 D_o (Q/D_o^{2.5})^{0.915} t^{0.15}$$

$$W_{Sm} = (1.)(9.)(680/9^{2.5})^{0.915} 360^{0.15} = 55.8 \text{ ft}$$

Estimate the maximum length of scour

$$L_{Sm} = 2.40 D_o (Q/D_o^{2.5})^{0.71} t^{0.125}$$

$$L_{Sm} = (2.40)(9.)(680/9^{2.5})^{0.71} 360^{0.125} = 93.6 \text{ ft}$$

Estimate the maximum volume of scour

$$V_s = 0.73 D_o^3 (Q/D_o^{2.5})^2 t^{0.375} / 27$$

$$V_s = 0.73 (9)^3 (680/9^{2.5})^2 360^{0.375} / 27 = 1403 \text{ cu. yd.}$$

In many cases this data can be used with the CSU rock riprapped basin design values to define the scour extent without protection. It represents the probable maximum scour that will occur. If the channel material is significantly different, this data will exceed the actual situation. Layers of rock, soil plastic, index, and material gradation are examples of scour control.

U. S. Army Waterways Experiment Station Rock Riprapped Basins

Horizontal Riprap Blanket Option

Compute the stable, median stone diameter

$$D_{50} = (0.02(D_0)^2/TW) (Q/D_0^{2.5})^{1.333}$$

$$D_{50} = (0.02(9)^2/3.6) (680/9^{2.5})^{1.333} = 1.77 \text{ ft.}$$

Compute the basin length

$$C = 1.7(D_0) (Q/D_0^{2.5}) + 8.$$

$$C = 1.7(9) (680/9^{2.5}) + 8. = 50.8 \text{ ft.}$$

Compute the basin thickness

$$D = 0.5(D_0)F_0$$

$$D = 0.5(9) (1.46) = 6.6 \text{ ft.}$$

Compute the basin inlet width

$$A = 3.D_0$$

$$A = 3.(9.) = 27. \text{ ft.}$$

Compute the basin outlet width

$$B = A+C$$

$$B = 77.8 \text{ ft.}$$

Lined Channel Expansion Option

Compute the stable, median stone diameter

$$D_{50} = (0.016(D_0)^2/TW) (Q/D_0^{2.5})^{1.333}$$

$$D_{50} = (0.016 \times 9^2/3.6) (680/9^{2.5})^{1.333} = 1.42 \text{ ft.}$$

Compute the basin length

$$C = 5.D_0$$

$$C = 5.(9.) = 45. \text{ ft.}$$

Compute the basin inlet width

$$A = 3.D_0$$

$$A = 3.(9.) = 27. \text{ ft.}$$

Compute the basin outlet width

$$B = 5.D_0$$

$$B = 5.(9.) = 45. \text{ ft.}$$

Compute the basin thickness

$$D = 2.D_{50}$$

$$D = 2.(1.42) = 2.8 \text{ ft.}$$

### Preformed Scour Hole Option 1

Compute the basin depression

$$F = .5D_0$$

$$F = .5(9) = 4.5 \text{ ft.}$$

Compute the stable, median stone diameter

$$D_{50} = (.0125(D_0)^2/TW) (Q/D_0^{2.5})^{1.333}$$

$$D_{50} = (.0125(9)^2/3.6) (680/9^{2.5})^{1.333} = 1.11 \text{ ft.}$$

Compute the basin length

$$C = 3.D_0 + 6.F$$

$$C = 3.(9) + 6.(4.5) = 54. \text{ ft.}$$

Compute the basin inlet width

$$A = 2.D_0 + 6.F$$

$$A = 2.(9.) + 6.(4.5) = 45. \text{ ft.}$$

Compute the basin outlet width

$$B = 2.D_0 + 6.F$$

$$B = 2.(9.) + 6.(4.5) = 45. \text{ ft.}$$

Compute the basin thickness

$$D = 2.D_{50}$$

$$D = (2.) (1.11) = 2.2 \text{ ft.}$$

Compute the culvert span

$$E = D_0$$

$$E = 9. \text{ ft.}$$

Preformed Scour Hole Option 2

Compute the basin depression

$$F = D_0$$

$$F = 9. \text{ ft.}$$

Compute the stable, median stone diameter

$$D_{50} = (.0082(D_0)^2/TW) (Q/D_0^{2.5})^{1.333}$$

$$D_{50} = (.0082(9)^2/3.6) (680/9^{2.5})^{1.333} = 0.73 \text{ ft.}$$

Compute the basin length

$$C = 3.D_0 + 6.F$$

$$C = 3.(9.) + 6.(9.) = 81. \text{ ft.}$$

Compute the basin inlet width

$$A = 2.D_0 + 6.F$$

$$A = 2.(9.) + 6.(9.) = 72. \text{ ft.}$$

Compute the basin outlet width

$$B = 2.D_0 + 6.F$$

$$B = 2.(9.) + 6.(9.) = 72. \text{ ft.}$$

Compute the basin thickness

$$D = 2.D_{50}$$

$$D = 2.(.73) = 1.5 \text{ ft.}$$

Compute the culvert span

$$E = D_0$$

$$E = 9. \text{ ft.}$$



## Colorado State University Rock Riprapped Basin Design

Compute outlet flow parameters

$$Q/D^{2.5} = 680/9^{2.5} = 2.80 \text{ cfs/ft}^{5/2}$$

$$d_t/D = 3.6/9 = 0.40$$

$$d_t/Y_0 = 3.6/5.3 = 0.68$$

$$Y_0/D = 5.3/9 = 0.59$$

Test if culvert is in a mild slope case

$$\text{For } Q/D^{2.5} = 2.80 \text{ cfs/ft}^{5/2}$$

$$\text{and } d_t/D = 0.40$$

Figure (12) indicates that for a mild slope culvert  $Y_0/D = 0.59$ . No modification for a steep slope culvert is required as the Figure (12) value is equal to or greater than the original  $Y_0/D$  value.

### Scour Depth Values

Reference Figures (14), (16), (17), (18) for scour depth values.

Since Figure (14) is for rectangular culverts, it is necessary to apply a conversion factor for circular culverts.

From Figure (13), for  $Y_0/D = 0.59$

$$(Q/W_0H_0^{1.5}) / (Q/D^{2.5}) = 1.26$$

$$Q/W_0H_0^{1.5} = 1.26 \times 2.80 = 3.53 \text{ cfs/ft}^{5/2}$$

for the same relative brink depth

$$Y_0/H_0 = Y_0/D = 0.59$$

Then, from Figure (14), for  $d_t/D = d_t/H_0 = 0.40$

$$\text{and } Q/W_0H_0^{1.5} = 3.53$$

$$d_s/H_0 = 1.67$$

The depth scour is  $d_s = 1.67 \times 9.0 = 15.0$  ft

$$d_m/H_0 = 0.049$$

The effective rock diameter is  $d_m = 0.049 \times 9 = 0.44$  ft

From Figure (16), for  $d_t/D = 0.40$  and  $Q/D^{2.5} = 2.80$  cfs/ft<sup>5/2</sup>

$$d_s/D = 0.63$$

$$d_s = 0.63 \times 9.0 = 5.7$$
 ft

$$d_m/D = 0.0945$$

$$d_m = 0.0945 \times 9.0 = 0.85$$
 ft

From Figure (17) for  $d_t/D = 0.40$  and  $Q/D^{2.5} = 2.80$  cfs/ft<sup>5/2</sup>

$$d_s/D = 0.0$$

$$d_s = 0.0 \times 9.0 = 0.0$$
 ft

$$d_m/D = 0.205$$

$$d_m = 0.205 \times 9.0 = 1.84$$
 ft

There is no need to obtain a value from Figure (18) as it only represents a larger, non-scouring rock size.

The next step is to plot the values of scour depth and effective rock diameter. Straight lines connect these points for interpolation.

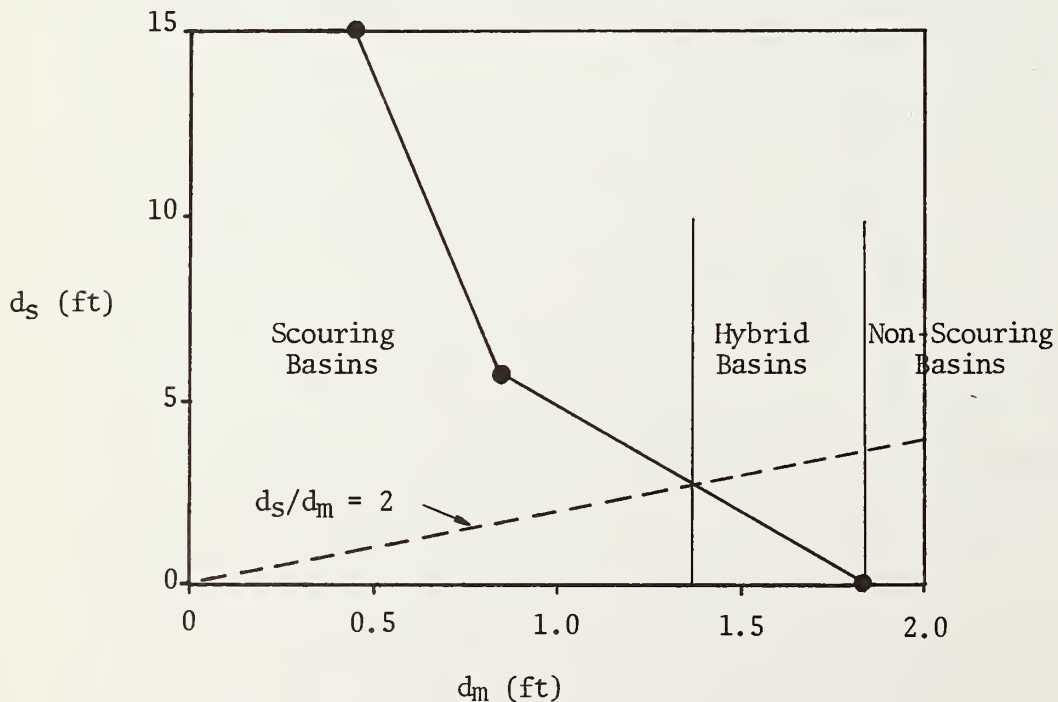

The division between scouring and hybrid basins occurs at a point on the scour depth curve where the scour depth is twice the effective rock diameter. The division between hybrid and non-scouring basins occurs at the minimum effective rock diameter where the depth of scour is zero.

The next step is to compute the length of scour hole by Figure (23) for the scouring and non-scouring basins.

The multiplication factor for a slope of 1.7% is  $M = 1. + 0.05 \times 1.7 = 1.085$  and  $d_t/Y_0 = 0.68$

Compute scour depth and effective diameter ratios.

$$d_S/d_m = 15.0/0.44 = 34.1$$

By Figure (23)

$$(L_S/d_S)/(d_t/Y_0) = 11$$

$$M(L_S/d_S)/(d_t/Y_0) = 1.085 \times 11 = 11.9$$

$$L_S/d_S = 11.9 \times 0.68 = 8.1$$

Compute length of scour hole

$$L_S = 15.0 \times 8.1 = 121.5 \text{ ft}$$

Similarly, for

$$d_S/d_m = 5.7/0.85 = 6.71$$

By Figure (23)

$$M(L_S/d_S)/(d_t/Y_0) = 1.085 \times 24 = 26.0$$

$$L_S/d_S = 26.0 \times 0.68 = 17.7$$

$$L_S = 17.7 \times 5.7 = 101.0 \text{ ft}$$

Similarly, for

$$d_S/d_m = 2.7/1.37 = 1.97$$

From Figure (23)

$$M(L_S/d_S)/(d_t/Y_0) = 1.085 \times 31 = 33.7$$

$$L_S/d_S = 33.7 \times 0.68 = 22.9$$

$$L_S = 22.9 \times 2.7 = 62.0 \text{ ft}$$

For  $d_s/d_m = 0.0/1.84 = 0.0$  the length of scour,  $L_s = 0.0$  ft

Plotting the values of length of scour and effective rock diameter, results in the curve shown below.

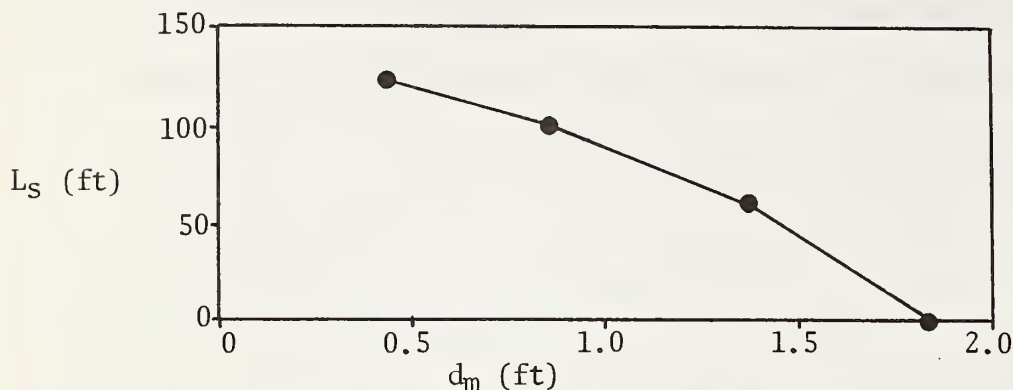

The next procedure is to compute the length of basin for each type. The scouring basins are computed by Figure (24).

$$L = 1.9L_s$$

For  $d_m = 0.44$  ft

$$L = 1.9 \times 121.5 = 231 \text{ ft}$$

For  $d_m = 0.85$  ft

$$L = 1.9 \times 101.0 = 192 \text{ ft}$$

For  $d_m = 1.37$  ft

$$L = 1.9 \times 62.0 = 118 \text{ ft}$$

In the non-scouring basin case, the length of basin is computed differently. It depends on the maximum allowable average velocity in the downstream channel. Figure (20) is used to obtain the angle of lateral expansion for the jet.

For  $d_t/Y_0 = 0.68$

$$\tan \theta = 0.10$$

The depth, at a distance  $L$ , downstream of the culvert outlet is

$$d_t = 3.6 \text{ ft}$$

The average velocity at  $L$  will be  $V_a = 8.8$  fps

By continuity, the length of basin is

$$L = (1/2 \tan \theta) (Q / (d_t V_a) - D)$$

$$L = (1/0.2) (680 / (3.6 \times 8.8) - 9)$$

$$L = 62.3 \text{ ft}$$

A plot of the basin lengths is necessary to provide interpolation points for the hybrid basin range.

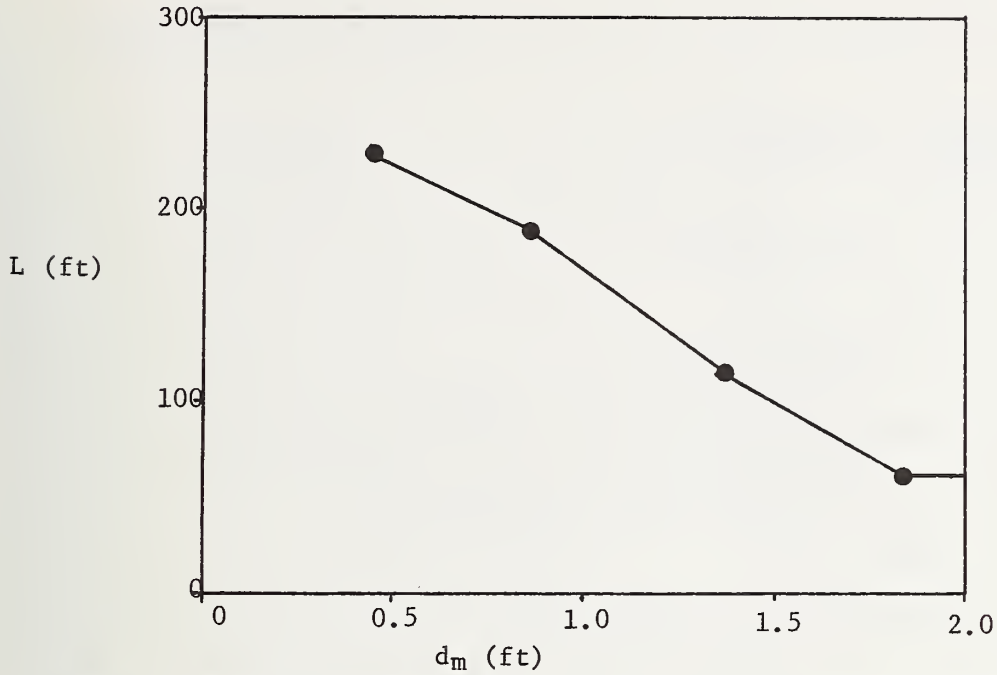

The next step provides scour widths for the selected effective rock diameters. Figure (25) is used in computing the scour width.

$$\text{For } d_s/d_m = 15.0/0.44 = 34.1$$

By Figure (25)

$$W_s/d_m = 123$$

$$W_s = 123 \times 0.44 = 54.1 \text{ ft}$$

$$\text{For } d_s/d_m = 5.7/0.85 = 6.71$$

$$W_s/d_m = 39$$

$$W_s = 39 \times 0.85 = 33.2 \text{ ft}$$

$$\text{For } d_s/d_m = 2.7/1.37 = 1.97$$

$$W_s/d_m = 18$$

$$W_s = 18 \times 1.37 = 24.7 \text{ ft}$$

$$\text{For } d_s/d_m = 0/1.84 = 0$$

$$W_s/d_m = 0$$

$$W_s = 0 \times 1.84 = 0.0 \text{ ft}$$



The basin widths for scouring basins are computed by adding twice the culvert span to the appropriate width of scour.

For  $d_m = 0.44$  ft

$$W_b = W_s + 2 \times D$$

$$W_b = 54.1 + 2 \times 9 = 72.1 \text{ ft}$$

For  $d_m = 0.85$  ft

$$W_b = 33.1 + 2 \times 9 = 51.1 \text{ ft}$$

For  $d_m = 1.37$  ft

$$W_b = 24.7 + 2 \times 9 = 42.7 \text{ ft}$$

These widths are applicable to both basin inlet and outlet.

The width of the non-scouring basin is obtained by

$$W_b = 2 L \tan\theta + D$$

$$W_b = (2)(62.3)(0.10) + 9. = 21.5 \text{ ft}$$

A plot of the scour widths, basin widths and effective rock diameters is required for interpolation in the hybrid basin range.

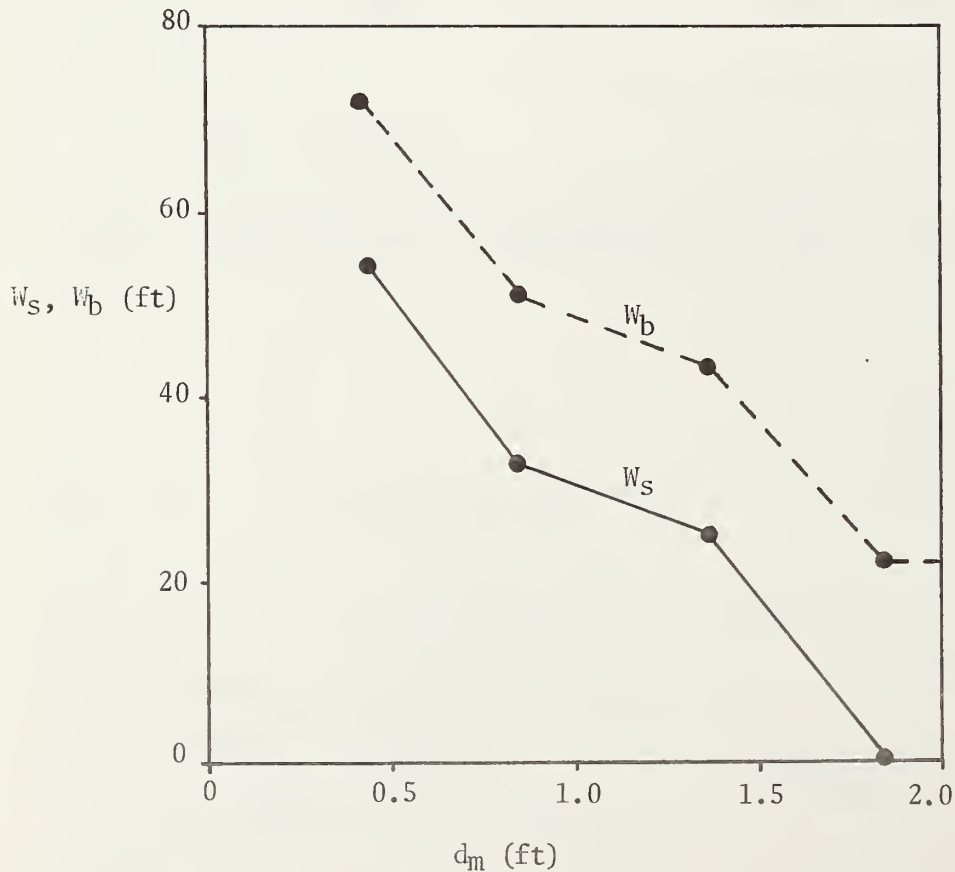

Example No. 2

Design Colorado State University rock riprapped basins for the steep slope culvert parameters below.

Culvert Type:	1 circular, structural plate pipe
Culvert Rise:	9 ft
Culvert Span:	9 ft
Culvert Slope:	0.05 ft/ft
Culvert Brink Depth:	4.5 ft
Peak Discharge:	680. cfs
Channel Tailwater Depth:	3.6 ft
Culvert Outlet Velocity:	21.4 fps
Culvert Outlet Froude No.:	2.00
Maximum Channel Velocity:	13.2 fps
Average Channel Velocity:	8.8 fps

WYOMING STATE HIGHWAY DEPARTMENT  
CHEYENNE WYOMING  
BRIDGE DIVISION

SHEET NO. \_\_\_\_\_ OF \_\_\_\_\_  
BY \_\_\_\_\_ DATE \_\_\_\_\_

//EXEC BRSYSØØ

DESIGN SYSTEM

CHECKED \_\_\_\_\_

Employee No.	Dept. No.	Per/Job Code	Work Code	Str. No.
65	68			80

COMMENT CARD

1.ØØ *EXAMPLE NO. 2*

1 W O R K	2 C O D E	3 D A T A	4 C O D E	5 D A T A	6 E N T R Y 1 15	7 E N T R Y 2 25	8 E N T R Y 3 35	9 E N T R Y 4 45	10 E N T R Y 5 55	11 E N T R Y 6 65	12 C O N T 66
1					1.ØØ	2.ØØ	3.ØØ	4.ØØ	5.ØØ	6.ØØ	
2					1.ØØ	2.ØØ	3.ØØ	4.ØØ	5.ØØ	6.ØØ	
3					4.5	21.4	3.6	8.8	Ø.Ø5	13.2	
4					1.ØØ	1.ØØ	4.ØØ	1.5	2.ØØ		
5											
6											

TRAILER CARD

9.9.9

NOTE: A trailer card must follow the last structure card containing data

CULVERT EROSION PROTECTION

EXAMPLE NO. 2

INPUT PARAMETERS

\*\*\*CULVERT\*\*\*  
TYPE = CIRCULAR  
SLOPE = 0.0500 FT/FT  
RISE = 9.0 FT  
SPAN = 9.0 FT  
NO. OF BARRELS = 1.  
BARREL SPACING = 0.0 FT

\*\*\*OUTLET\*\*\*  
VELOCITY = 21.4 FPS  
DEPTH = 4.5 FT  
FROUDE NO. = 2.01  
DISCHARGE/BARREL = 680.0 CFS  
PEAK DISCHARGE DURATICN = 0. MIN

\*\*\*CHANNEL\*\*\*  
TAILWATER = 3.6 FT  
MAXIMUM VELOCITY = 13.2 FPS  
AVERAGE VELOCITY = 8.8 FPS

\*\*\*RIPRAP\*\*\*  
EFFECTIVE ROCK DIAMETER = 1.000 FT  
RIPRAP ROCK SPECIFIC GRAVITY = 2.70  
MAXIMUM ROCK DIAMETER = 1.000 FT  
UNDER SLOPE = 4.00 FT/FT  
EMBANKMENT SLOPE = 1.50 FT/FT  
END SLOPE = 2.00 FT/FT  
SIDE SLOPE = 4.00 FT/FT

CULVERT EROSION PROTECTION

EXAMPLE NO. 2

\*\*\*DESIGNED FOR SINGLE BARREL DISCHARGE\*\*\*

COLORADO STATE UNIVERSITY

ROCK RIPRAPPED BASINS

BASIN TYPE	EFFECTIVE ROCK DIAMETER	SCOUR DEPTH	SCOUR LENGTH	SCOUR WIDTH	SCOUR INLET WIDTH	BASIN INLET WIDTH	BASIN OUTLET WIDTH	BASIN LENGTH	BASIN HEIGHT	BASIN THICKNESS	BASIN THICKNESS	BASIN VOLUME
						-A-	-B-	-C-	-D-	-E-	-F-	
SCOURING	0.22 FT	13.1 FT	144.4 FT	43.8 FT	61.8 FT	61.8 FT	61.8 FT	274.3 FT	6.8 FT	1.0 FT	14.1 FT	5921. CU YD
SCOURING	0.43 FT	9.1 FT	107.8 FT	35.8 FT	53.8 FT	53.8 FT	53.8 FT	204.7 FT	6.8 FT	1.0 FT	10.1 FT	3149. CU YD
SCOURING	0.92 FT	2.7 FT	79.6 FT	21.2 FT	39.2 FT	39.2 FT	39.2 FT	151.3 FT	6.8 FT	1.8 FT	4.6 FT	1830. CU YD
HYBRID	1.19 FT	1.6 FT	50.0 FT	14.5 FT	30.3 FT	33.3 FT	33.3 FT	115.2 FT	6.8 FT	2.4 FT	4.0 FT	1031. CU YD
NON-SCOURING	1.58 FT	0.0 FT	0.0 FT	0.0 FT	9.0 FT	21.5 FT	83.9 FT	83.9 FT	6.8 FT	3.2 FT	3.2 FT	813. CU YD
HYBRID	1.06 FT	2.1 FT	65.9 FT	19.1 FT	37.1 FT	37.1 FT	37.1 FT	125.2 FT	6.8 FT	2.1 FT	4.3 FT	1113. CU YD
SCOURING	1.00 FT	2.4 FT	72.4 FT	20.1 FT	38.1 FT	38.1 FT	38.1 FT	137.6 FT	6.8 FT	2.0 FT	4.4 FT	1788. CU YD



Compute outlet flow parameters

$$Q/D^{2.5} = 680/9^{2.5} = 2.80 \text{ cfs/ft}^{5/2}$$

$$d_t/D = 3.6/9 = 0.40$$

$$d_t/Y_0 = 3.6/4.5 = 0.80$$

$$Y_0/D = 4.5/9 = 0.50$$

Test if culvert is in a steep slope case

$$\text{For } Q/D^{2.5} = 2.80 \text{ cfs/ft}^{5/2}$$

$$\text{And } d_t/D = 0.40$$

Figure (12) indicates that for a mild slope culvert  $Y_0/D = 0.59$ . Since the outlet flow parameter  $Y_0/D = 0.50$  is less than  $Y_0/D = 0.59$ , modification for a steep slope culvert is required.

Convert  $Q/D^{2.5}$  to an equivalent  $Q/D^{2.5}$  for a pipe flowing full with the culvert rise equal to the brink depth

$$\text{Culvert Rise } D = Y_0 = 4.5 \text{ ft}$$

$$\text{Culvert outlet velocity } V_0 = 21.4 \text{ fps}$$

The rationale behind the conversion is if a culvert flows full, the streamlines are essentially straight and parallel at the outlet. The slope of the culvert then has little or no effect on the depth of scour. Only the culvert outlet velocity, tailwater depth, and the culvert size are important.

Compute an equivalent  $Q/D^{2.5}$ , recognizing that  $Q$  is computed as the product of a 4.5 ft diameter pipe and the culvert outlet velocity.

$$\text{The equivalent } Q/D^{2.5} = (21.4 \times \pi/4 \times 4.5^2)/4.5^{2.5} = 7.93 \text{ cfs/ft}^{5/2}$$

$$\text{The equivalent tailwater/culvert diameter ratio is } d_t/D = 3.6/4.5 = 0.80$$

$$\text{and the equivalent culvert brink depth/culvert diameter ratio is } Y_0/D = 4.5/4.5 = 1.00$$

From Figure (13) for  $Y_0/D = 1.00$

$$(Q/W_0H_0^{1.5})/(Q/D^{2.5}) = 1.275$$

$$Q/W_0H_0^{1.5} = 7.93 \times 1.275 = 10.1 \text{ cfs/ft}^{5/2}$$

$$\text{and } d_t/H_0 = 3.6/4.5 = 0.80$$

$Q/D^{2.5}$  and  $d_t/D$  is valid for circular pipe scour depths.

$Q/W_0H_0^{1.5}$  and  $d_t/H_0$  is valid for rectangular pipe scour depths.

### Scour Depth Values

From Figure (14), for  $d_t/H_0 = 0.80$  and  $Q/W_0H_0^{1.5} = 10.1 \text{ cfs/ft}^{5/2}$

$$d_s/H_0 = 2.9 \qquad d_m/H_0 = 0.049$$

The scour depth  $d_s = 2.9 \times 4.5 = 13.1 \text{ ft}$

The effective rock diameter  $d_m = 0.049 \times 4.5 = 0.22 \text{ ft}$

$d_t/D = 0.80$  and  $Q/D^{2.5} = 7.93 \text{ cfs/ft}^{5/2}$  are applicable to Figures (16), (17) and (18).

From Figure (16)

$$d_s/D = 2.04 \qquad d_m/D = 0.0945$$

The scour depth  $d_s = 2.04 \times 4.5 = 9.2 \text{ ft}$

The effective rock diameter  $d_m = 0.0945 \times 4.5 = 0.43 \text{ ft}$

From Figure (17)

$$d_s/D = 0.60 \qquad d_m/D = 0.205$$

The scour depth  $d_s = 0.60 \times 4.5 = 2.7 \text{ ft}$

The effective rock diameter  $d_m = 0.205 \times 4.5 = 0.92 \text{ ft}$

From Figure (18)

$$d_s/D = 0.36 \qquad d_m/D = 0.264$$

The scour depth  $d_s = 0.36 \times 4.5 = 1.6 \text{ ft}$

The effective rock diameter  $d_m = 1.19 \text{ ft}$

Plot the values of scour depth and effective rock diameter.

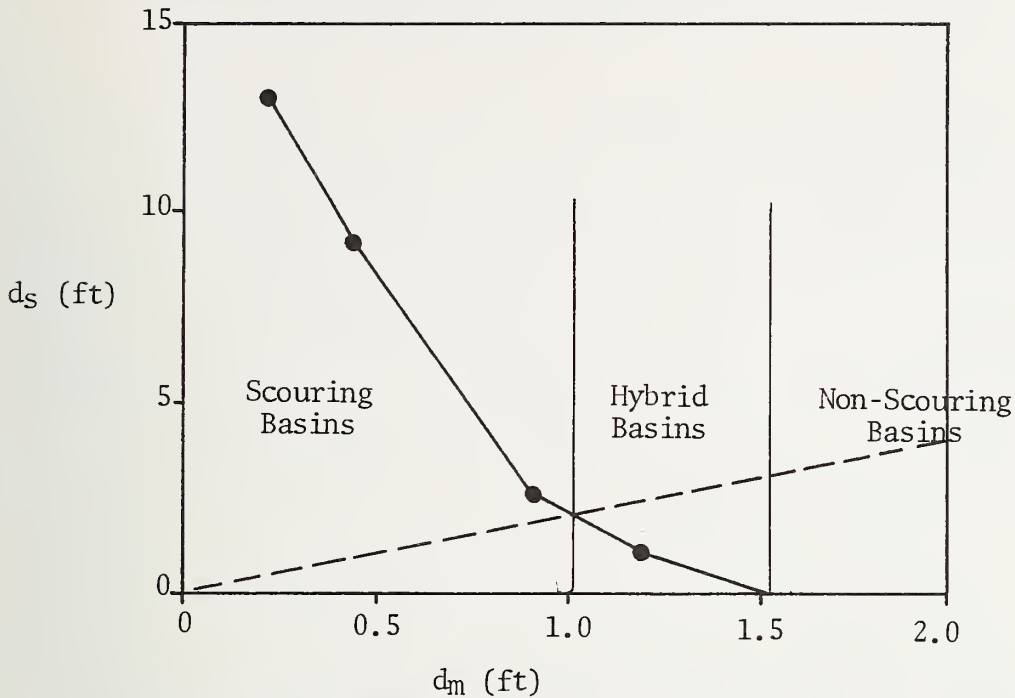

The division between scouring and hybrid basins occurs at a point on the scour depth curve where the scour depth is twice the effective rock diameter. This occurs at  $d_m = 1.06$  ft. The division between hybrid and non-scouring basins occurs at the minimum effective rock diameter where the depth of scour is zero. This occurs at  $d_m = 1.58$  ft.

The next step is to compute the length of scour hole by Figure (23) for the scouring and non-scouring basins.

The multiplication factor for a slope of 5.0% is  $M = 1. + 0.05 \times 5.0 = 1.25$

Compute scour depth and effective diameter ratio.

$$d_s/d_m = 13.1/0.22 = 5.95$$

By Figure (23)

$$(L_s/d_s)/(d_t/Y_0) = 11$$

$$M(L_s/d_s)/(d_t/Y_0) = 1.25 \times 11 = 13.75$$

$$L_s/d_s = 13.75 \times 0.80 = 11$$

Compute length of scour hole

$$L_s = 13.1 \times 11 = 144. \text{ ft}$$

Similarly, for

$$d_S/d_m = 9.2/0.43 = 21.4$$

By Figure (23)

$$M(L_S/d_S)/(d_t/Y_0) = 1.25 \times 12 = 15.0$$

$$L_S/d_S = 15.0 \times 0.80 = 12$$

$$L_S = 12 \times 9.1 = 109. \text{ ft}$$

Similarly, for

$$d_S/d_m = 2.7/0.92 = 2.94$$

By Figure (23)

$$M(L_S/d_S)/(d_t/Y_0) = 1.25 \times 28 = 35$$

$$L_S/d_S = 35 \times 0.80 = 28$$

$$L_S = 28 \times 2.7 = 76. \text{ ft}$$

Similarly, for

$$d_S/d_m = 2.1/1.06 = 2.04$$

By Figure (23)

$$M(L_S/d_S)/(d_t/Y_0) = 1.25 \times 31.5 = 39.2$$

$$L_S/d_S = 39.2 \times 0.80 = 30.4$$

$$L_S = 30.4 \times 2.1 = 66. \text{ ft}$$

Plotting the values of length of scour and effective rock diameter results in the curve shown below.

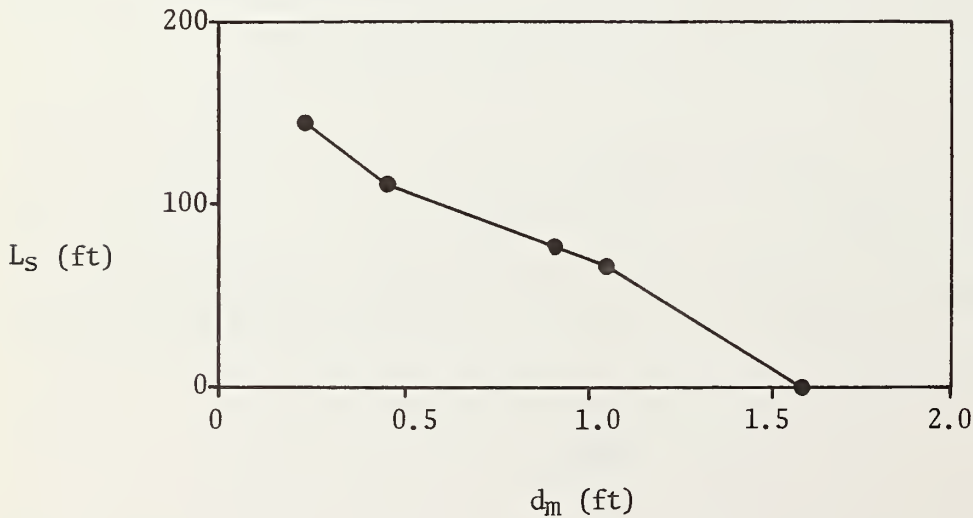

The next procedure is to compute the length of basin for each type. The scouring basins are computed by Figure (24).

$$L = 1.9 L_S$$

$$\text{For } d_m = 0.22 \text{ ft}$$

$$L = 1.9 \times 144 = 274 \text{ ft}$$

$$\text{For } d_m = 0.43 \text{ ft}$$

$$L = 1.9 \times 109 = 207 \text{ ft}$$

$$\text{For } d_m = 0.92 \text{ ft}$$

$$L = 1.9 \times 76 = 144 \text{ ft}$$

$$\text{For } d_m = 1.06 \text{ ft}$$

$$L = 1.9 \times 66 = 125 \text{ ft}$$

In the non-scouring basin case, the length of basin is computed differently. It depends on the maximum allowable average velocity in the downstream channel. Figure (20) is used to obtain the angle of lateral expansion for the jet.

$$\text{For } d_t/Y_0 = 0.80$$

$$\tan \theta = 0.07$$

The depth, at a distance L, downstream of the culvert outlet is

$$d_t = 3.6 \text{ ft}$$

The average velocity at L will be  $V_a = 8.8 \text{ fps}$

By continuity, the length of basin is

$$L = (1/(2 \tan \theta)) (Q/(d_t V_a) - D)$$

$$L = (1/.14) (680/(3.6 \times 8.8) - 9)$$

$$L = 88.5$$

A plot of the basin lengths is necessary to provide interpolation points for the hybrid basin range.



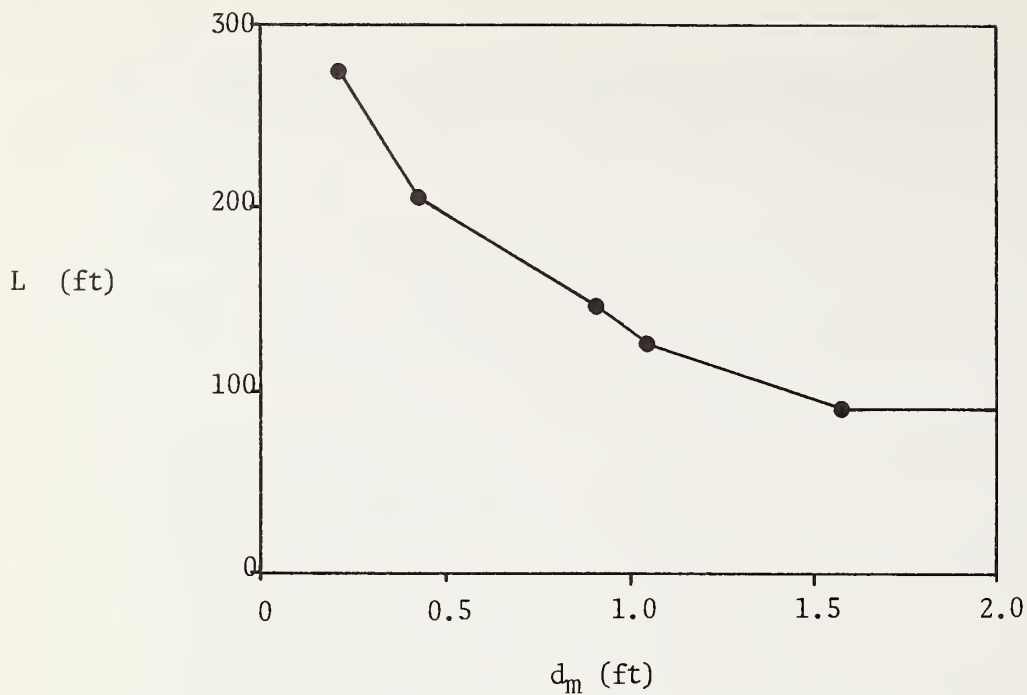

The next step provides scour widths for the selected effective rock diameters. Figure (25) is used in computing the scour width.

$$\text{For } d_s/d_m = 13.1/0.22 = 59.5$$

$$W_S/d_m = 195$$

$$W_S = 195 \times .22 = 43. \text{ ft}$$

$$\text{For } d_s/d_m = 9.2/0.43 = 21.4$$

$$W_S/d_m = 85$$

$$W_S = 85 \times 0.43 = 36.6 \text{ ft}$$

$$\text{For } d_s/d_m = 2.7/0.92 = 2.94$$

$$W_S/d_m = 23$$

$$W_S = 23 \times 0.92 = 21.2 \text{ ft}$$

$$\text{For } d_s/d_m = 2.1/1.06 = 1.98$$

$$W_S/d_m = 18$$

$$W_S = 18 \times 1.06 = 19.1 \text{ ft}$$

The basin widths for scouring basins are computed by adding twice the culvert span to the appropriate width of scour.

For  $d_m = 0.22$  ft

$$W_b = W_s + 2 \times D$$

$$W_b = 43. + 2 \times 9 = 61. \text{ ft}$$

For  $d_m = 0.43$  ft

$$W_b = 36.6 + 2 \times 9 = 54.6 \text{ ft}$$

For  $d_m = 0.92$  ft

$$W_b = 21.2 + 2 \times 9 = 39.2 \text{ ft}$$

For  $d_m = 1.06$  ft

$$W_b = 19.1 + 2 \times 9 = 37.1 \text{ ft}$$

These widths are applicable to both basin inlet and outlet in the scouring range.

The outlet width of the non-scouring basin is obtained by

$$W_b = 2 L \tan \theta + D$$

$$W_b = (2)(88.5)(.07) + 9 = 21.4 \text{ ft}$$

The inlet width of the non-scouring basin is equal to the culvert outlet span.  $W_b = 9.$  ft

A plot of the scour widths, basin widths and effective rock diameters is required for interpolation in the hybrid basin range.

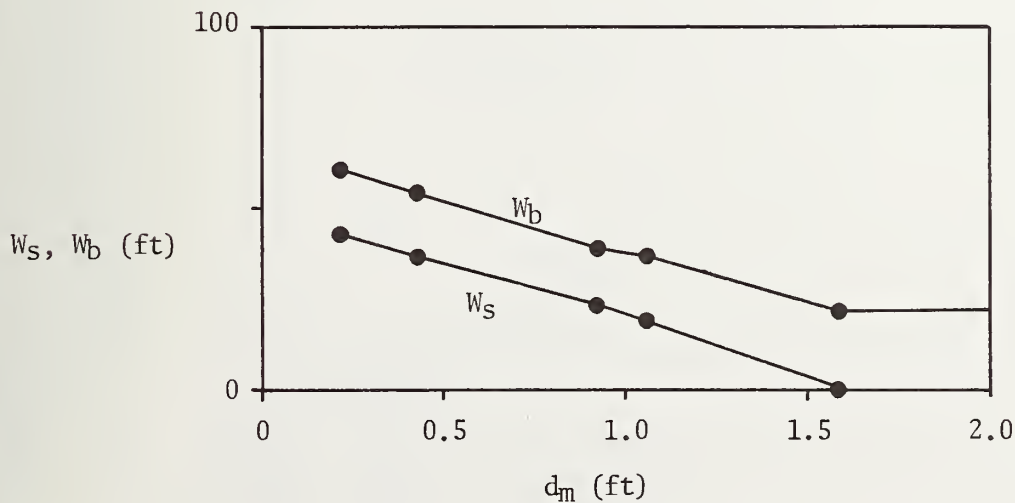

Example No. 3

Design a Colorado State University Non-Scouring Basin for the high tail-water case below.

Culvert Type:	1 circular, concrete pipe
Culvert Rise:	6 ft
Culvert Span:	6 ft
Culvert Slope:	0.001 ft/ft
Culvert Brink Depth:	6 ft
Peak Discharge:	330 cfs
Channel Tailwater Depth:	6 ft
Culvert Outlet Velocity:	11.7 fps
Maximum Channel Velocity:	7.7 fps
Average Channel Velocity:	5.1 fps



CULVERT EROSION PROTECTION

EXAMPLE NO. 3

INPUT PARAMETERS

\*\*\*CULVERT\*\*\*

TYPE = CIRCULAR

SLOPE = 0.0010 FT/FT

RISE = 6.0 FT

SPAN = 6.0 FT

NO. OF BARRELS = 1.

BARREL SPACING = 0.0 FT

\*\*\*OUTLET\*\*\*

VELOCITY = 11.7 FPS

DEPTH = 6.0 FT

FROUDE NO. = 0.84

DISCHARGE/BARREL = 330.0 CFS

PEAK DISCHARGE DURATION = 0. MIN

\*\*\*CHANNEL\*\*\*

TAILWATER = 6.0 FT

MAXIMUM VELOCITY = 7.7 FPS

AVERAGE VELOCITY = 5.1 FPS

\*\*\*RIPRAP\*\*\*

EFFECTIVE ROCK DIAMETER = 0.0 FT

RIPRAP ROCK SPECIFIC GRAVITY = 2.70

MAXIMUM ROCK DIAMETER = 0.0 FT

UNDER SLOPE = 4.00 FT/FT

EMBANKMENT SLOPE = 1.50 FT/FT

END SLOPE = 2.00 FT/FT

SIDE SLOPE = 4.00 FT/FT

CULVERT EROSION PROTECTION

EXAMPLE NO. 3

\*\*\*DESIGNED FOR SINGLE BARREL DISCHARGE\*\*\*

COLORADO STATE UNIVERSITY

ROCK RIPRAPPED BASINS

BASIN TYPE	EFFECTIVE ROCK DIAMETER	SCOUR DEPTH	SCOUR LENGTH	SCOUR WIDTH	BASIN INLET WIDTH	BASIN OUTLET WIDTH	BASIN LENGTH	BASIN HEIGHT	BASIN THICKNESS	BASIN THICKNESS	BASIN THICKNESS	BASIN VOLUME
SCOURING	0.29 FT	3.8 FT	63.9 FT	17.2 FT	29.2 FT	29.2 FT	121.4 FT	9.0 FT	0.6 FT	4.4 FT	754. CU YD	
HYBRID	0.57 FT	0.1 FT	2.6 FT	0.8 FT	7.3 FT	11.6 FT	60.1 FT	9.0 FT	1.1 FT	1.2 FT	267. CU YD	
NON-SCOURING	1.23 FT	0.0 FT	0.0 FT	0.0 FT	6.0 FT	10.8 FT	60.2 FT	9.0 FT	2.5 FT	2.5 FT	614. CU YD	
NON-SCOURING	1.58 FT	0.0 FT	0.0 FT	0.0 FT	6.0 FT	10.8 FT	60.2 FT	9.0 FT	3.2 FT	3.2 FT	820. CU YD	
NON-SCOURING	0.57 FT	0.0 FT	0.0 FT	0.0 FT	6.0 FT	10.8 FT	60.2 FT	9.0 FT	1.1 FT	1.1 FT	266. CU YD	
HYBRID	0.50 FT	1.0 FT	31.1 FT	9.0 FT	21.0 FT	21.0 FT	59.1 FT	9.0 FT	1.0 FT	2.0 FT	280. CU YD	



Colorado State University Rock Riprapped Basin Design

Compute Culvert outlet flow parameters

$$Q/D^{2.5} = 330/6^{2.5} = 3.75 \text{ cfs/ft}^{5/2}$$

$$d_t/D = 6/6 = 1.00$$

$$Y_o/D = 6/6 = 1.00$$

From Figure (16) it is apparent for  $d_m/D = 0.0945$ ,  $Q/D^{2.5} = 3.75 \text{ cfs/ft}^{5/2}$ , and  $d_t/D = 1.00$  that  $d_s/D = 0.0 \text{ ft}$ .

The rock size required to prevent scour is  $d_m = 0.0945 \times 6 = 0.57 \text{ ft}$

Compute the average culvert outlet velocity on the culvert centerline vertical

$$V_{oave} = KV_o$$

$K = 1.10$  for smooth pipe. This factor relates  $V_o$  to the arithmetic mean of the vertical velocity profile.

$$V_{oave} = 1.10 \times 11.7 \text{ fps} = 12.9 \text{ fps}$$

The average maximum channel velocity on the vertical centerline is

$$V_{xave} = 7.7 \text{ fps}$$

Refer to Figure (22)

$$V_{xave}/V_{oave} = 7.7/12.9 = .60$$

The distance downstream from the plane of the culvert outlet to where the basin can be safely terminated is-

$$X/D = 10 \text{ by Figure (22)}$$

$$X = 10 \times 6 = 60 \text{ ft}$$

The required basin outlet width is computed by applying the continuity equation using the average channel velocity.

$$B = Q/d_t V_a$$

$$B = 330/(6 \times 5.1) = 10.8 \text{ ft}$$

The basin inlet width equals the culvert span

$$A = 6 \text{ ft}$$

Example No. 4

Design a St. Anthony Falls Stilling Basin and U. S. Bureau of Reclamation Types I, II, and III Basins for the culvert parameters given below.

Culvert Type:	1, rectangular, reinforced box culvert
Culvert Rise:	4 ft
Culvert Span:	5 ft
Culvert Slope:	0.0645 ft/ft
Culvert Brink Depth:	0.7 ft
Peak Discharge:	70 cfs
Channel Tailwater Depth:	0.3 ft
Culvert Outlet Velocity:	20.6 fps
Culvert Outlet Froude No.:	4.40
Maximum Channel Velocity:	2.6 fps
Average Channel Velocity:	2.6 fps



CULVERT EROSION PROTECTION

EXAMPLE NO. 4

INPUT PARAMETERS

\*\*\*CULVERT\*\*\*

TYPE = RECTANGULAR

SLOPE = 0.0645 FT/FT

RISE = 4.0 FT

SPAN = 5.0 FT

NO. OF BARRELS = 1.

BARREL SPACING = 0.0 FT

\*\*\*OUTLET\*\*\*

VELOCITY = 20.6 FPS

DEPTH = 0.7 FT

FROUDE NC. = 4.34

DISCHARGE/BARREL = 70.0 CFS

PEAK DISCHARGE DURATION = 0. MIN

\*\*\*CHANNEL\*\*\*

TAILWATER = 0.3 FT

MAXIMUM VELOCITY = 2.6 FPS

AVERAGE VELOCITY = 2.6 FPS

CULVERT EROSION PROTECTION

EXAMPLE NO. 4

\*\*\*DESIGNED FOR SINGLE BARREL DISCHARGE\*\*\*

ST. ANTHONY FALLS  
STILLING BASIN

--- LENGTH -C-	BASIN WIDTH -A-	HEIGHT -D-	HEIGHT -F-	WIDTH -B-	SPACING -B-	BLOCKS FROM WALL -E-	FROM WALL -G-	ROW SPACING -I-	SILL HEIGHT -H-	FLARE NO	BASIN APPROACH FALL LENGTH
5.22 FT	5.00 FT	5.10 FT	0.58 FT	0.42 FT	0.42 FT	0.21 FT	0.62 FT	1.74 FT	0.30 FT	NO	3.40 FT 10.20 FT

ENERGY DISSIPATOR HYDRAULIC JUMP ANALYSIS

ENERGY	FROUDE NUMBER	VELOCITY	DEPTH OF FLOW
BASIN INLET 9.70 FT	5.62	24.24 FPS	0.58 FT
BASIN OUTLET 3.92 FT	0.35	3.78 FPS	3.70 FT

CULVERT EROSION PROTECTION

EXAMPLE NO. 4

\*\*\*DESIGNED FOR SINGLE BARREL DISCHARGE\*\*\*

U.S. BUREAU OF RECLAMATION  
TYPE I BASIN

----- BASIN -----		----- BASIN APPROACH-----	
WIDTH	LENGTH	FLARE	FALL
-A-	-C-		
8.00 FT	21.08 FT	YES	3.20 FT
			19.46 FT

ENERGY DISSIPATOR HYDRAULIC JUMP ANALYSIS

ENERGY	FRUDE NUMBER	VELOCITY	DEPTH OF FLOW
BASIN INLET	7.12	24.26 FPS	0.36 FT
BASIN OUTLET	0.24	2.50 FPS	3.50 FT



CULVERT EROSION PROTECTION

EXAMPLE NO. 4

\*\*\*DESIGNED FOR SINGLE BARREL DISCHARGE\*\*\*

U.S. BUREAU OF RECLAMATION  
TYPE II BASIN

-----	BASIN	-----	BLOCK	-----	FLARE	-----	BASIN APPROACH	-----
WIDTH	HEIGHT	LENGTH	FROM	HEIGHT	HEIGHT	FALL	LENGTH	
-A-	-D-	-C-	WALL	-B-	-E-	YES		
8.00 FT	6.52 FT	14.53 FT	0.25 FT	3.48 FT	3.40 FT		19.46 FT	

ENERGY DISSIPATOR HYDRAULIC JUMP ANALYSIS

ENERGY	FRUDE NUMBER	VELOCITY	DEPTH OF FLOW
BASIN INLET	7.24	24.53 FPS	0.36 FT
BASIN OUTLET	0.22	2.36 FPS	3.70 FT

CULVERT EROSION PROTECTION

EXAMPLE NO. 4

\*\*\*DESIGNED FOR SINGLE BARREL DISCHARGE\*\*\*

U.S. BUREAU OF RECLAMATION  
TYPE III BASIN

BASIN		BLOCK		BASIN APPROACH	
WIDTH	HEIGHT	FROM WALL	HEIGHT	FLARE	LENGTH
-A- 8.00 FT	-D- 6.28 FT	-E- 0.21 FT	-F- 0.64 FT	-G- 0.39 FT	-H- 0.50 FT
-C- 8.88 FT	-B- 0.36 FT	-I- 2.76 FT		YES	3.20 FT
					19.46 FT

ENERGY DISSIPATOR HYDRAULIC JUMP ANALYSIS

ENERGY	FROUDE NUMBER	VELOCITY	DEPTH OF FLOW
BASIN INLET 9.50 FT	7.12	24.26 FPS	0.36 FT
BASIN OUTLET 3.60 FT	0.24	2.50 FPS	3.50 FT

## St. Anthony Falls Stilling Basin Design

### Reference Figure (28)

$$\text{Basin width (A)} = 0.3 D_0(Q/D_0^{2.5}) = 0.3(5)(70/5^{2.5}) = 1.87 \text{ ft}$$

Since computed basin width (A) is less than the culvert width, let the basin width (A) equal the box span or 5 ft.

$$\text{Energy at culvert outlet} = (V_0^2/2g) + Y_0 = (20.6^2/(2)(32.2)) + 0.7 = 7.29 \text{ ft.}$$

$$\text{Transition head loss (h}_L) = 0.15(V_0^2/2g) = 0.15(20.6^2/(2)(32.2)) = 1.0 \text{ ft.}$$

$$\text{Let } E_0 - h_L + Z_0 = \text{Energy at basin inlet (E}_1) + Z_1$$

Determine required basin fall

$$\text{Let } Z_1 = 0$$

$$\text{Try } Z_0 = 3 \text{ ft.}$$

$$7.29 - 1.0 + 3 = (V_1^2/2g) + d_1$$

$$\text{Where } V_1^2 = Q^2/\text{Area}^2 = Q^2/A^2 d_1^2$$

$$9.29 = (Q^2/(2gA^2 d_1^2)) + d_1 = (70^2/(2(32.2)(5)^2 d_1^2)) + d_1$$

$$9.29 = (3.04/d_1^2) + d_1$$

$$\text{Try } d_1 = 0.59 \text{ ft.}$$

$$9.29 = (3.04/(.59)^2) + .59 = 9.3$$

Compute basin entrance velocity

$$V_1 = Q/(A d_1) = 70/(5(0.59)) = 23.7 \text{ ft/sec}$$

Compute basin entrance Froude No.

$$Fr_1 = V_1/\sqrt{g d_1} = 23.7/\sqrt{32.2(0.59)} = 5.44$$

$$d_2 = d_1 (-1 + \sqrt{8Fr_1^2 + 1}) / 2 = 0.59 (-1 + \sqrt{8(5.44)^2 + 1}) / 2 = 7.51 \text{ ft.}$$

for  $1.73 \leq Fr < 5.48$

$$d_2^1 = (1.1 - Fr^2/120) d_2 = (1.1 - (5.44)^2/120) 7.51 = 6.4 \text{ ft.}$$

$$\text{Tailwater depth} + Z_0 = 0.3 + 3 = 3.3 \text{ ft}$$

Note 3.3 ft < 6.4 ft

Therefore:  $Z_0$  must be greater than 3 ft.

Try  $Z_0 = 3.4$  ft

$$7.29 - 1 + 3.4 = (3.04/d_1^2) + d_1$$

$$9.69 = (3.04/d_1^2) + d_1$$

Try  $d_1 = 0.578$  ft.

$$9.68 = (3.04/(0.578)^2) + 0.578 = 9.68$$

$$V_1 = Q/(Ad_1) = 70/(5(0.578)) = 24.22 \text{ fps}$$

$$F_r = V_1/\sqrt{gd_1} = 24.22/\sqrt{32.2(0.578)} = 5.61$$

$$d_2 = d_1(-1 + \sqrt{8F_r^2+1})/2 = 0.578(-1 + \sqrt{8(5.61)^2+1})/2 = 4.3 \text{ ft}$$

for  $5.48 \leq F_r < 10.98$

$$d_2^1 = 0.85d_2 = 0.85(4.3) = 3.66 \text{ ft}$$

Tailwater depth +  $Z_0 = 0.3 + 3.4 = 3.7$  ft

Since  $3.66 \approx 3.7$   $Z_0 = 3.4$  is an adequate fall depth in the transition to the basin

$$\text{Basin length (C)} = 4.5 d_2/(F_r^2)^{0.38} = 4.5 (4.3)/(5.61^2)^{0.38} = 5.2 \text{ ft}$$

$$\text{Basin sidewall freeboard (Z)} = d_2/3 = 4.3/3 = 1.4$$

$$\text{Basin height (D)} = d_2^1 + Z = 3.66 + 1.4 = 5.06 \text{ ft}$$

$$\text{Block height (F)} = d_1 = 0.578 \text{ ft}$$

$$\text{Number of blocks (N)} = A/(1.5d_1) = 5/(1.5(0.578)) = 6 \text{ (round off to nearest integer)}$$

$$\text{Width of blocks (B)} = \text{Block Spacing (B)} = A/(2N) = 5/(2(6)) = 0.42 \text{ ft}$$

$$\text{Block distance from wall (E)} = B/2 = 0.42/2 = 0.21 \text{ ft}$$

$$\text{Block distance from wall (G)} = B + E = 0.42 + 0.21 = 0.63 \text{ ft}$$

$$\text{Block Row Spacing (I)} = C/3 = 5.2/3 = 1.73 \text{ ft}$$

$$\text{Sill Height (H)} = 0.07d_2 = 0.07(4.3) = 0.3 \text{ ft}$$

$$\text{Basin outlet depth} = Z_0 + TW = 3.4 + 0.3 = 3.7 \text{ ft}$$

$$\text{Basin outlet velocity} = Q / ((3.7)(5)) = 70 / (3.7(5)) = 3.78 \text{ ft/sec}$$

$$\text{Basin outlet Froude number} = 3.78 / \sqrt{32.2(3.7)} = 0.35$$

$$\text{Basin outlet energy} = (3.78)^2 / (2(32.2)) + 3.7 = 3.92 \text{ ft}$$

Since the basin width equals the box width, there is no flare in the transition.

$$\text{The fall in the transition} = Z_0 = 3.4 \text{ ft.}$$

$$\text{At a 3:1 slope the transition length} = 3Z_0 = 3(3.4) = 10.2 \text{ ft.}$$

U.S. Bureau of Reclamation Type I Basin Design

Reference Figure (31)

Basin width parameter (A) = 8 ft. (designer's choice)

$$\text{Energy at culvert outlet} = (V_0^2/2g) + Y_0 = (20.6^2/(2)(32.2)) + 0.7 = 7.29 \text{ ft}$$

$$\text{Transition head loss } (h_L) = 0.15 (V_0^2/2g) = 0.15(20.6^2/(2)(32.2)) = 1.0 \text{ ft}$$

$$\text{Let } E_0 - h_L + Z_0 = \text{Energy at basin inlet } (E_1) + Z_1$$

$$\text{Let } Z_1 = 0$$

Select basin depression or fall

$$\text{Try } Z_0 = 3.2 \text{ ft}$$

$$7.29 - 1 + 3.2 = V_1^2/2g + d_1$$

$$V_1^2 = Q^2/(A^2d_1^2)$$

$$9.49 = (Q^2/(A^2d_1^22g)) + d_1 = (70^2/((8^2)(2)(32.2)d_1^2)) + d_1$$

$$9.49 = (1.19/d_1^2) + d_1$$

$$\text{Try } d_1 = 0.361 \text{ ft}$$

$$9.49 = (1.19/(0.361)^2) + 0.361 = 9.48$$

Compute the basin entrance velocity

$$V_1 = Q/Ad_1 = 70/(8(0.361)) = 24.23 \text{ ft/sec}$$

Compute the basin entrance Froude No.

$$Fr_1 = V_1/\sqrt{gd_1} = 24.23/\sqrt{32.2(0.361)} = 7.1$$

Compute the conjugate depth

$$d_2 = d_1 (-1 + \sqrt{8Fr_1^2 + 1})/2 = 0.361(-1 + \sqrt{8(7.1)^2 + 1})/2 = 3.5 \text{ ft}$$

Compute the length of basin

$$\text{From Figure (32) and } Fr = 7.1$$



$$C/d_2 = 6$$

$$C = 6 \times d_2 = 6(3.5) = 21.0 \text{ ft}$$

Compute the basin height

$$\text{Basin height (D)} = 1.1d_2 + .1V_1 = 1.1(3.5) + 0.1(24.23) = 6.27 \text{ ft}$$

Since the basin width (A) is greater than box width, there is a flare in the transition.

The transition fall is  $Z_0 = 3.2 \text{ ft}$ .

Reference Figure (41)

$$R = (W/B - 1.0)^{1/3} / (4. + 1.6 \text{ Fro})$$

Where  $W = A$

$B = \text{Box width}$

$\text{Fro} = \text{Froude number of culvert outlet}$

The flare parameter is-

$$R = (8/5 - 1)^{1/3} / (4. + 1.6(4.4)) = 0.0764$$

The length of transition is-

$$L_t = (A - B) / 2R = (8 - 5) / 2(0.0764) = 19.63 \text{ ft}$$

U.S. Bureau of Reclamation Type II Basin Design

Basin Width (A) = 8 ft. (designer's choice)

Energy at culvert outlet =  $(V_o^2/2g) + d_o = (20.6^2/(2)(32.2)) + 0.7 = 7.29$  ft.

Transition head loss ( $h_L$ ) =  $0.15(V_o^2/2g) = 0.15(20.6^2/2(32.2)) = 1.0$  ft.

Let  $E_o - h_L + Z_o =$  Energy at basin inlet ( $E_1$ ) +  $Z_1$

Let  $Z_1 = 0$

Determine required basin fall

Try  $Z_o = 3.4$  ft.

$7.29 - 1.0 + 3.4 = (V_1^2/2g) + d_1$

where  $V_1^2 = Q^2/d_1^2A^2$

$9.68 = Q^2/(2gd_1^2A^2) + d_1 = 70^2/(2(32.2)(8)^2d_1^2) + d_1$

$9.68 = (1.19/d_1^2) + d_1$

Try  $d_1 = 0.357$  ft.

$9.68 = (1.19/(0.357)^2) + 0.357 = 9.68$

Compute basin entrance velocity

$V_1 = Q/d_1A = 70/(0.357(8)) = 24.5$  ft/sec

Compute basin entrance Froude number

$F_{r1} = V_1/\sqrt{gd_1} = 24.5/\sqrt{32.2(0.357)} = 7.22$

Compute conjugate depth

$d_2 = d_1 (-1 + \sqrt{8F_{r1}^2 + 1})/2 = 0.357(-1 + \sqrt{8(0.357)^2 + 1})/2 = 3.47$

Minimum tailwater depth (TW) =  $1.05d_2$  for a 5% safety factor =  $1.05(3.47) = 3.65$  ft.

Actual tailwater =  $Z_o + \text{tailwater} = 3.4 + 0.3 = 3.7$  ft

Since the actual tailwater (3.7 ft.) is greater than the minimum tailwater (3.65 ft.), a fall of 3.4 ft. is sufficient.

From Figure 34  $L/d_2 = 4.15$

$$L = C = 4.15d_2 = 4.15 (3.47) = 14.4 \text{ ft.}$$

The height, width, and spacing of the chute blocks are equal to  $d_1$  or ( $B = 0.357 \text{ ft.}$ )

Number of blocks and spaces (N) equals the integer of  $(A/2d_1)$  or  $N = (8/2(0.357)) = 11$

The blocks distance from the wall (E) =  $(A - d_1(2N - 1))/2$  or  $E = (8 - 0.357(2(11) - 1))/2 = 0.25 \text{ ft.}$

Note  $F = d_2$

Therefore:

Dentated end sill element height =  $0.2F = 0.2(3.47) = 0.69 \text{ ft.}$

Dentated end sill element width =  $0.15F = 0.15(3.47) = 0.52 \text{ ft.}$

Dentated end sill element spacing =  $0.15F = 0.52 \text{ ft.}$

Dentated end sill element top width =  $0.02F = 0.02(3.47) = 0.07 \text{ ft.}$

Since the basin width is greater than the box width, there is a flare in the transition.

The transition fall is  $Z_0 = 3.4 \text{ ft}$

Reference Figure (41)

$$R = (W/B - 1)^{1/3} / (4 + 1.6 F_{ro})$$

Where  $W = A$

$B =$  Box width

$F_{ro} =$  Froude number of culvert outlet

$$R = (8/5 - 1)^{1/3} / (4 + 1.6(4.4)) = 0.0764$$

$$L_t = (A - B) / 2R = (8 - 5) / 2(0.0764) = 19.63 \text{ ft.}$$

Basin outlet depth =  $Z_0 +$  Tailwater depth or  $3.4 + 0.3 = 3.7 \text{ ft.}$

$$\text{Basin outlet velocity} = Q/\text{Area} \text{ or } \underline{V} = 70/3.7(8) = 2.36 \text{ ft/sec}$$

$$\text{Basin outlet Froude number} = V/\sqrt{32.2(\text{outlet depth})} \text{ or } \underline{Fr} = 2.36/\sqrt{32.2(3.7)} = 0.22$$

$$\text{Basin outlet Energy} = V^2/2g + \text{Outlet depth} \text{ or } (2.36)^2/2(32.2) + 3.7 = 3.79 \text{ ft.}$$

U. S. Bureau of Reclamation Type III Basin Design

Basin width (A) = 8. ft (designer's choice)

The following parameters are equivalent to the U. S. Bureau of Reclamation Type I Basin design and the computational process will not be repeated.

Energy at culvert outlet ( $E_0$ ) = 7.29 ft

Transition head loss ( $h_L$ ) = 1.0 ft

Basin depression ( $Z_0$ ) = 3.2 ft

Basin inlet depth ( $d_1$ ) = 0.36 ft

Basin inlet velocity ( $V_1$ ) = 24.26 fps

Basin inlet energy ( $E_1$ ) = 9.50 ft

Basin inlet Froude number ( $Fr_1$ ) = 7.12 ft

Basin outlet depth ( $d_2$ ) = 3.50 ft

Basin outlet velocity ( $V_2$ ) = 2.50 fps

Basin outlet energy ( $E_2$ ) = 3.60 ft

Basin outlet Froude number ( $Fr_2$ ) = 0.24 ft

Transition flare length ( $L_t$ ) = 19.46 ft

Compute the length of hydraulic jump

From Figure (36)

$$Fr_1 = 7.12$$

$$L/d_2 = 2.58$$

$$L = 2.56 \times 3.50 = 8.95 \text{ ft}$$

The basin length is  $C = L = 8.95 \text{ ft}$

Compute the chute block height, width, and spacing

$$B = d_1 = 0.36 \text{ ft}$$

The number of chute blocks (N) equals the integer of  $(A/2B)$  or  
 $N = (8/2(.36)) = 11$

The block's distance from the wall equals

$$E = (A - B(2N - 1))/2$$

$$E = (8 - 0.36(2(11) - 1))/2 = 0.22 \text{ ft}$$

Compute the baffle block height (F) from Figure (37) for  $F_1 = 7.12$

$$F/d_1 = 1.8(.36) = 0.65 \text{ ft}$$

The width of the baffle blocks and interior spaces equals  $0.75F$  or  $0.49 \text{ ft}$

The number of baffle blocks (N) equals the integer of  $A/1.5F$  or  
 $N = (8/1.5(0.65)) = 8$

The block's distance from the wall

$$G = (A - 0.75F(2N - 1))/2$$

$$G = (8 - 0.75(.65)(2(8) - 1))/2 = 0.38 \text{ ft}$$

Compute the end sill height

$$H = d_1(.0555F_1 + 1.)$$

$$H = 0.36(.0555(7.12) + 1.) = 0.50 \text{ ft}$$

Compute the row spacing I

$$I = 0.8d_2 = 0.8(3.50) = 2.8 \text{ ft}$$

Compute basin height

$$D = 1.1d_2 + .1V_1$$

$$D = 1.1(3.50) + .1(24.3) = 6.28 \text{ ft}$$



Example No. 5

Design a Vertical Stilling Well, a U. S. Bureau of Reclamation Type VI Basin, a U. S. Bureau of Reclamation Type IV Basin and a Colorado State University Smooth Floor Flared Basin for the culvert parameters below.

Culvert Type:	1, circular, concrete pipe
Culvert Rise:	3 ft
Culvert Span:	3 ft
Culvert Slope:	0.02 ft/ft
Culvert Brink Depth:	2.4 ft
Peak Discharge:	85 cfs
Channel Tailwater Depth:	1.0 ft
Culvert Outlet Velocity:	14.3 fps
Culvert Outlet Froude No:	1.59
Average Channel Velocity:	4.0 fps
Maximum Channel Velocity	5.0 fps

WYOMING STATE HIGHWAY DEPARTMENT  
CHEYENNE WYOMING  
BRIDGE DIVISION

SHEET NO. \_\_\_\_\_ OF \_\_\_\_\_  
BY \_\_\_\_\_ DATE \_\_\_\_\_

// EXEC BRSYS00

DESIGN SYSTEM

CHECKED \_\_\_\_\_

65	Employee No.	Dept. Code	P. Job Code	75	Work Code	Str. No.
						80

1 COMMENT CARD

1,0,0 EXAMPLE NO. 5

W O R K C O D E	1	2	3	4	5	ENTRY 1	ENTRY 2	ENTRY 3	ENTRY 4	ENTRY 5	ENTRY 6	65	66
						15	25	35	45	55			C O N T
1	/					/	/	/	/	/			
2													
3	85	1.A	14.3										
4													
5													

TRAILER CARD

9.9.9

NOTE: A trailer card must follow the last structure card containing data

CULVERT EROSION PROTECTION

EXAMPLE NO. 5

INPUT PARAMETERS

```
***CULVERT***
TYPE = CIRCULAR
SLOPE = 0.0200 FT/FT
RISE = 3.0 FT
SPAN = 3.0 FT
NO. OF BARRELS = 1.
BARREL SPACING = 0.0 FT

***OUTLET***
VELOCITY = 14.3 FPS
DEPTH = 2.4 FT
FROUDE NC. = 1.59
DISCHARGE/BARREL = 85.0 CFS
PEAK DISCHARGE DURATION = 0. MIN

***CHANNEL***
TAILWATER = 1.0 FT
MAXIMUM VELOCITY = 5.0 FPS
AVERAGE VELOCITY = 4.0 FPS
```

CULVERT EROSION PROTECTION

EXAMPLE NO. 5

\*\*\*DESIGNED FOR SINGLE BARREL DISCHARGE\*\*\*

VERTICAL STILLING WELL  
WELL WELL SUBWELL  
DIAMETER HEIGHT DEPTH

-A- -B- -C-

8.67 FT 6.00 FT 0.24 FT

CULVERT EROSION PROTECTION

EXAMPLE NO. 5

\*\*\*DESIGNED FOR SINGLE BARREL DISCHARGE\*\*\*

BUREAU OF RECLAMATION  
IMPACT TYPE STILLING BASIN  
TYPE VI

BASIN			BAFFLE			NOTCH			ROCK		
LENGTH	WIDTH	HEIGHT	HEIGHT	HEIGHT	LIP	HEIGHT	WIDTH	LENGTH	LENGTH	DEPTH	DEPTH
-C-	-A-	-D-	-H-	-G-	-F-	-J-	-I-	-M-	-L-	-L-	-L-
12.48 FT	9.37 FT	7.02 FT	3.93 FT	3.51 FT	1.56 FT	1.17 FT	0.78 FT	12.00 FT	12.00 FT	1.50 FT	1.50 FT

CULVERT EROSION PROTECTION

EXAMPLE NO. 5

\*\*\*DESIGNED FOR SINGLE BARREL DISCHARGE \*\*\*

U.S. BUREAU OF RECLAMATION  
TYPE IV BASIN

-----	BASIN	-----	-----	BLOCK	-----	-----	BASIN APPROACH	-----
WIDTH	HEIGHT	LENGTH	WIDTH	FROM	FLARE	FALL	LENGTH	
				WALL				
-A-	-D-	-C-	-B-	-E-				
3.00 FT	9.86 FT	35.35 FT	1.14 FT	0.93 FT	NO	5.70 FT	17.10 FT	

ENERGY DISSIPATOR HYDRAULIC JUMP ANALYSIS

	ENERGY	FROUDE NUMBER	VELOCITY	DEPTH OF FLOW
BASIN INLET	10.80 FT	4.13	24.95 FPS	1.14 FT
BASIN OUTLET	6.98 FT	0.29	4.23 FPS	6.70 FT



CULVERT EROSION PROTECTION

EXAMPLE NO. 5

\*\*\*DESIGNED FOR SINGLE BARREL DISCHARGE\*\*\*

SMOOTH FLOOR FLARED BASIN

BASIN	BASIN	BASIN	BASIN
INLET	OUTLET	LENGTH	HEIGHT
WIDTH	WIDTH		
-A-	-B-	-C-	-D-
3.0	82.3	188.5	3.6
FT	FT	FT	FT

## Vertical Stilling Well Design

Compute the stilling well diameter

$$A = 0.53D_o (Q/D_o^{5/2})$$

$$A = 0.53(3)(85/3^{5/2}) = 8.67 \text{ ft}$$

Compute well depth below invert - Reference Figures (26) and (27)

$$C = DW(0.00041+1.3725S-1.30498S^2+0.50383S^3)$$

$$C = 8.67(0.00041+1.3725(.02)-1.30498(.02)^2+0.50383(.02)^3)$$

$$C = .24 \text{ ft}$$

Compute well height above invert - Reference Figure (26)

$$B = 2D_o$$

$$B = 2(3) = 6 \text{ ft}$$

U.S. Bureau of Reclamation Type VI Basin

The input parameters do not exceed the limitations established for the impact stilling basin. Refer to Figure (29) for a diagram of the basin.

Compute the basin width (Figure(30))

$$A = 1.56025 Q^{0.4034}$$

$$A = 1.56025 (85)^{0.4034} = 9.37 \text{ ft}$$

Compute the baffle height above the basin floor

$$B = 0.167A$$

$$B = 0.167 (9.37) = 1.56 \text{ ft}$$

Compute the baffle height

$$G = 0.375A$$

$$G = 0.375 (9.37) = 3.51 \text{ ft}$$

Compute the baffle lip

$$F = 0.167A$$

$$F = 0.167 (9.37) = 1.56 \text{ ft}$$

Compute the basin length

$$C = 1.333A$$

$$C = 1.333 (9.37) = 12.48 \text{ ft}$$

Compute the basin height

$$D = 0.75A$$

$$D = 0.75 (9.37) = 7.02 \text{ ft}$$

Compute the basin outlet height

$$H = 0.42A$$

$$H = 0.42 (9.37) = 3.93 \text{ ft}$$

Compute the basin top length

$$K = 0.58A$$

$$K = 0.58 (9.37) = 5.43 \text{ ft}$$

Compute the basin top ridge

$$E = 0.0833A$$

$$E = 0.0833 (9.37) = 0.78 \text{ ft}$$

Compute the baffle notch width

$$I = 0.0833A$$

$$I = 0.0833 (9.37) = 0.78 \text{ ft}$$

Compute the baffle notch height

$$J = 0.125A$$

$$J = 0.125 (9.37) = 1.17 \text{ ft}$$

Compute the rock length

$$M = 4W_0$$

$$M = 4 (3) = 12. \text{ ft}$$

Compute the rock depth

$$L = 1.5 \text{ ft}$$

U. S. Bureau of Reclamation Type IV Basin Design

Selected basin width (A) = 3. ft

Compute the culvert outlet energy

$$E_0 = (V_0^2/2g) + Y_0 = (14.3^2/(2)(32.2)) + 2.4 = 5.58 \text{ ft}$$

Compute the transition head loss

$$h_L = 0.15 (V_0^2/2g) = 0.15(14.3^2/(2)(32.2)) = 0.48 \text{ ft}$$

Set up the energy balance

$$E_0 - h_L + Z = E_1$$

Select basin depression

$$\text{Try } Z = 5.70 \text{ ft}$$

Compute the basin inlet energy

$$5.58 - 0.48 + 5.70 = E_1$$

$$10.80 = V_1^2/2g + d_1$$

$$10.80 = Q^2/(A^2 d_1^2 2g) + d_1$$

$$10.80 = 85^2/(3^2 d_1^2 (2)(32.2)) + d_1$$

$$10.80 = 12.5/d_1^2 + d_1$$

Compute basin inlet depth

$$d_1 = 1.14 \text{ ft}$$

Compute basin inlet velocity

$$V_1 = Q/Ad_1 = 85/(3)(1.14) = 24.95 \text{ fps}$$

Compute basin inlet Froude number

$$F_1 = V_1 / (gd_1)^{1/2} = 24.95 / (32.2 \times 1.14)^{1/2} = 4.13$$

Compute sequent depth

$$d_2 = (d_1/2) ((1 + 8F_1^2)^{1/2} - 1)$$

$$d_2 = (1.14/2) ((1 + 8(4.13)^2)^{1/2} - 1) = 6.10 \text{ ft}$$

Compute the minimum tailwater depth

$$TW = 1.1d_2 = 1.1(6.10) = 6.71 \text{ ft}$$

Compute basin outlet velocity

$$V_2 = Q / (A) (TW) = 85 / (3 \times 6.71) = 4.23 \text{ fps}$$

Compute basin outlet Froude number

$$F_2 = V_2 / (g(TW))^{1/2} = 4.23 / ((32.2)6.71)^{1/2} = 0.29$$

Compute basin outlet energy

$$E_2 = V_2^2 / 2g + TW = (4.23)^2 / 2(32.2) + 6.71 = 6.98 \text{ ft}$$

Compute the hydraulic jump length by Figure (39)

$$L = 3.50d_2F_1^{0.358}$$

$$L = (3.50)(6.10)(4.13)^{0.358} = 35.4 \text{ ft}$$

Compute the basin dimensions shown in Figure (38)

$$\text{Basin Length} = C = L = 35.4 \text{ ft}$$

$$\text{Chute block height} = 2d_1 = 2(1.14) = 2.28 \text{ ft}$$

$$\text{Chute block width} = d_1 = 1.14 \text{ ft}$$



Chute block spacing =  $2.5d_1 = 2.5(1.14) = 2.85$  ft

Chute block top length =  $2d_1 = 2(1.14) = 2.28$  ft

End sill height =  $1.25d_1 = 1.25(1.14) = 1.43$  ft

Basin Height =  $D = 1.1TW + .1V_1 = (1.1)(6.71) + .1(24.95) = 9.86$  ft

One chute block will be required with a spacing from the wall of  $E = 0.93$  ft

#### Basin Flare Geometry

No flare will be required as the basin width equals the culvert width.

The basin depression is 5.70 ft

A 3:1 floor slope is achieved by a basin approach length of  $(3)(5.70) = 17.10$  ft

Colorado State University Smooth Floor Flared Basin Design

Compute basin flare angle

$$\tan\theta = 1./3.F_0 = 1./(3. \times 1.59) = 0.21$$

Compute the nonuniform pressure distribution factor

$$\beta_1 = 0.46452 + 0.35468(d_t/Y_0) + 0.02237 Q/W_0^{2.5}$$

$$\beta_1 = 0.46452 + 0.35468(1.0/2.4) + 0.02237(85/3^{2.5}) = 0.74$$

Test if  $6\beta_1$  is less than  $Q/W_0^{2.5}$

$$6(0.74) < 85/3^{2.5}$$

$$4.44 < 5.45$$

Since this test is true,  $\beta_1$  must be recalculated

$$\beta_1 = 0.82666 + 0.75654(d_t/Y_0) - 0.10305 Q/W_0^{2.5}$$

$$\beta_1 = 0.82666 + 0.75654(1.0/2.4) - 0.10305(85/3^{2.5}) = 0.58$$

Compute the nonuniform velocity distribution factor for circular pipe

$$\beta_2 = 1.02$$

Compute culvert outlet (basin inlet) momentum

$$M_0 = \beta_1 \gamma Y_0^2 W_0 / 4 + \beta_2 \rho V_0 Q / 2$$

$$M_0 = 0.58(62.4)(2.4)^2(3)/4 + 1.02(1.94)(14.3)(85)/2 = 1330 \text{ lb}$$

Compute section x momentum

$$M_x = \rho Q^2 / (4L_1 \tan\theta Y_x) + (L_1 \tan\theta)(\gamma Y_x^2 / 2)$$

$$M_x = 1.94(85)^2 / (L_1(4)(0.21)(1.0)) + (0.21L_1)(62.4(1.0)^2 / 2)$$

$$M_x = 16686/L_1 + 6.55L_1$$

The hydraulic jump forms at the point where  $M_O = M_X$

$$1330 = 16686/L_1 + 6.55L_1$$

$$L_1^2 - 203.3 + 2547.5$$

Solution by quadratic equation yields

$$L_1 = \frac{203.3 \pm ((203.3)^2 - 4(1)(2547.5))^{1/2}}{2(1)} = 189.9 \text{ ft (maximum solution)}$$

$$L = L_1 - W_O/2 \tan\theta$$

$$L = 189.9 - 3/2(0.21) = 182.75$$

Compute basin length with safety factor

$$C = L + 6Y_X$$

$$C = 182.75 \text{ ft} + 6(1.0) = 188.8 \text{ ft}$$

Compute basin inlet width

$$A = 3.0 \text{ ft}$$

Compute basin outlet width

$$B = A + 2C \tan\theta$$

$$B = 3.0 + 2(188.8)(0.21) = 82.3 \text{ ft}$$

Compute basin height

$$D = 1.5(\text{Maximum value of } Y_O \text{ or } Y_X)$$

$$D = 1.5(2.4) = 3.6 \text{ ft}$$

SECTION VI  
PROGRAM DESCRIPTION

## PROGRAM DESCRIPTION

The program is composed of a main control program and eighteen subroutines. A detailed description of each module is presented in the section in addition to an outline of general program operation. The required storage is 72K bytes exclusive of the supervisor.

<u>MODULE</u>	<u>DESCRIPTION</u>
HYDCEP	Main control module
HYDOUT	Output printing
HYDERR	Diagnostic error messages
HYDDM	CSU rock basin effective rock diameter
HYDPRK	CSU rock basin design
HYDSCR	CSU rock basin scour data
HYDBTW	CSU rock basin tailwater effect
HYDVOL	Volume of rock basins
HYDCOE	U. S. Army scour and rock basin design
HYDENG	Energy calculations
HYDPPA	CSU Smooth-Floor Flared basin design
SAF	St. Anthony Falls basin design
USBR1	U.S. Bureau of Reclamation Type I design
USBR2	U.S. Bureau of Reclamation Type II design
USBR3	U.S. Bureau of Reclamation Type III design
USBR4	U.S. Bureau of Reclamation Type IV design
USBR6	U.S. Bureau of Reclamation Type VI design
FLARE	Spillway transition design
VSWELL	Vertical Stilling Well design

Execution commences in the main program HYDCEP where each input data card is read and edited for proper sequence. In the event a card is out of order, the run is terminated with a diagnostic message printed by HYDERR. A minimum of four cards containing identification, program control, culvert, outlet, and channel input is always read and printed by multiple entry into an output subroutine.

At this point in the module a branch controlling energy dissipator or basin selection is encountered. If the selections are manual instead of automatic, one or two basin selection cards must be read. Selected basins are initialized to a value of one by the user. Any remaining basins are automatically initialized to zero. If the selections are automatic, the basins are first initialized to zero and set to one if required limitations are met.

If a material restriction has been imposed by a user selected program control variable, either rock basins or concrete basins will be excluded. This is done by equating the excluded basins to zero.

The next step involves limitation testing of the basins. Each basin will be tested under automatic selection only for conformance to specific design ranges. If a basin meets its limitations it is initialized to one. User selected basins will not be interrogated in this area, but will be tested

in the design subroutines. This provides an error message in the event a user selected basin does not meet its limitations. Under automatic selection, this is not warranted as the user is not expecting the design of a specific basin.

If the Colorado State University Rock Riprapped Basins are selected automatically or manually, the first riprap parameter card must be read and printed as input data. If a gradation is submitted for computation of the effective rock diameter, the second and third riprap parameter cards must also be read. The effective rock diameter will then be computed by the subroutine HYDDM and will be printed with the standard riprap material input.

With the completion of basin initialization, the appropriate design subroutines are called in a loop which tests if a specific basin is equal to one or zero.

Design and design support modules include HYDPRK, HYDSCR, HYDBTW, HYDVOL, HYDCOE, HYDENG, HYDPPA, SAF, USBR1, USBR 2, USBR 3, USBR 4, USBR 6, FLARE and VSWELL.

If a specific design cannot be concluded, a diagnostic error message will be printed by HYDERR. Valid design output will be printed by HYDOUT.

If another set of data is encountered, the process is repetitive. Program termination results whenever a "999" trailer card is read.



SECTION VII  
DEFINITION OF PROGRAM SYMBOLS

## DEFINITION OF PROGRAM SYMBOLS

The following is a list of significant symbols used in the computer program together with their definitions. The symbols are grouped according to the subroutines with which they are associated. A given symbol name may be used in more than one subroutine, and can have a different definition depending upon the subroutine in which it occurs.

# MAIN PROGRAM HYDCEP

TITLE: Culvert Erosion Protection Control

CALLING MODULES:

CALLED MODULES: HYDOUT, HYDERR, HYDCOE, HYDPRK, VSWELL, SAF, USBR6,  
USBR1, USBR2, USBR3, USBR4, HYDPPA

DESCRIPTION: This module directly or indirectly controls all subroutines. It performs input and output device initialization and reads all input data. Testing is provided to insure that proper input data card order is observed. Culvert outlet flow parameters are computed for use in subsequent testing.

Two basic paths are incorporated in this module. One method employs basin selection by the user. In this case basin limitation testing and error diagnosis is provided in the specific subroutine selected. The other method employs automatic basin selection which selects energy dissipators based on limitations testing in the main program.

After all input data has been verified, printed and basin selection is complete, the program calls each selected basin subroutine for its computations. Upon completion of one site the program checks for additional sites. The process is repetitive for additional sites until a trailer card is encountered to terminate the run.

SYMBOLS:

EC	Intermediate input data array
B	Basin type array
IRD	Input device
IWT	Output device
IWC	Work code variable
IDC	Data code variable
IC	Card continuation column indicator
IERR	Error number index
IDENT	Site identification array
BWS	Selected basin width (ft)
KAPPA	Culvert shape-roughness indicator
PK	Culvert vertical velocity profile constant

TIME	Culvert peak discharge duration (min)
PIPES	Number of culvert barrels
T	Culvert barrel spacing (ft)
HO	Culvert rise (ft)
WO	Culvert span (ft)
SO	Culvert slope (ft/ft)
QD	Culvert discharge/barrel (cfs)
YO	Culvert brink depth (ft)
VO	Culvert outlet velocity (fps)
TW	Channel tailwater (ft)
VS	Channel average velocity (fps)
VM	Channel maximum velocity (fps)
QDP	Discharge flow parameter (cfs/ft <sup>5/2</sup> )
FR	Culvert outlet Froude number
EO	Culvert outlet energy (ft)
M	Intermediate index
I	Array index
J	Intermediate index
DE	Effective rock diameter of riprap (ft)
RSG	Riprap rock specific gravity
DMAX	Maximum rock diameter of riprap (ft)
Z 2	Riprap embankment slope (ft/ft)
Z 1	Riprap side slope (ft/ft)
Z 3	Riprap end slope (ft/ft)
PHI	Riprap rock sieve diameter array

## SUBROUTINE HYDOUT

TITLE: Culvert Erosion Protection Output

CALLING MODULES: HYDCEP, HYDPRK, HYDCOE, VSWELL, SAF, USBR1, USBR2, USBR3,  
USBR4, USBR6, HYDPPA

CALLED MODULES:

DESCRIPTION: Prints output for control modules consisting of basin titles and dimensions, scour data, hydraulic jump data, and commentary. This is a multiple entry subroutine with a specific section allotted to each basin.

SYMBOLS:

DIM	Array containing dimensions and title words
KAPPA	Culvert shape-roughness indicator
M	Array Index
VO	Culvert outlet velocity (fps)
TW	Tailwater depth (ft)
SO	Culvert slope (ft/ft)
YO	Culvert brink depth (ft)
VM	Maximum channel velocity (fps)
HO	Culvert rise (ft)
FR	Culvert outlet Froude number
VS	Channel average velocity (fps)
WO	Culvert span (ft)
QD	Culvert discharge/barrel (cfs)
PIPES	Number of culvert barrels
T	Spacing between culvert barrels (ft)
IBASIN	Basin type indicator
IWT	Output device index
DM	Effective rock diameter (ft)
DS	Scour depth (ft)
SL	Scour length (ft)

WS	Scour width (ft)
BW1	Inlet basin width (ft)
BW2	Outlet basin width (ft)
SVOL	Scour volume (cu yd)
IDENT	Site identification
BL	Basin length (ft)
BHT	Basin height (ft)
TF	Basin floor thickness (ft)
TS	Basin side thickness (ft)
VOL	Basin volume (cu yd)
DE	Effective rock diameter (ft)
RSG	Riprap rock specific gravity
DMAX	Maximum rock diameter (ft)
Z1	Riprap under slope (ft/ft)
Z2	Riprap embankment slope (ft/ft)
Z3	Riprap end slope (ft/ft)
PHI(6)	Median rock diameter (ft)
IFLARE	Transition flare index
PHI	Basin dimension array
EZ	Basin inlet energy (ft)
F1	Basin inlet Froude number
VZ	Basin inlet velocity (fps)
DZ	Basin inlet depth (ft)
EZZ	Basin outlet energy (ft)
FZ	Basin outlet Froude number
VZZ	Basin outlet velocity (fps)
HTW	Basin outlet depth (ft)



SUBROUTINE HYDERR

TITLE: Culvert Erosion Protection Error Diagnostics

CALLING MODULES: HYDCEP, HYDPRK, USBR6, VSWELL, HYDVOL, USBR1, USBR2,  
USBR3, USBR4, SAF

CALLED MODULES:

DESCRIPTION: Receives error number index from control modules and prints  
a diagnostic message revealing the nature of the error.

SYMBOLS:

IERR	Error number index
IWT	Output device index
IBASIN	Basin type indicator

SUBROUTINE HYDDM

TITLE: Colorado State University Effective Rock Diameter Computation

CALLING MODULES: HYDCEP

CALLED MODULES:

DESCRIPTION:

Computes effective rock diameter of a given riprap gradation expressed in terms of 0%, 10%, 20%, 30%, 40%, 50%, 60%, 70%, 80%, 90%, and 100% finer by weight.

SYMBOLS:

SUM	Gradation Sum
PHI	Array containing sieve gradations
DI	Array containing average sieve gradations
DE	Effective rock diameter (ft)

SUBROUTINE HYDPRK

TITLE: Colorado State University Rock Riprapped Basins

CALLING MODULES: HYDCEP

CALLED MODULES: HYDBTW, HYDSCR, HYDOUT, HYDVOL, HYDERR

DESCRIPTION: Performs and controls three Colorado State University rock riprapped basin design calculations. The three classes of basins include non-scouring, hybrid, and scouring designs. All dimensions of basins, scour extents, and basin volumes are determined for each rock size and basin type.

SYMBOLS:

SIZE	Array containing effective rock diameters and scour depths for minimum non-scouring and hybrid rock sizes and a user selected rock size
DMHO	Array containing effective rock diameter/culvert rise ratios
QDP	Discharge flow parameter (cfs/ft <sup>5/2</sup> )
QD	Culvert discharge/barrel (cfs)
YO	Culvert brink depth (ft)
WO	Culvert span (ft)
HO	Culvert rise (ft)
OH	Steep slope culvert rise (ft)
TW	Tailwater depth (ft)
TWD	Tailwater depth/culvert rise
DTY	Tailwater depth/culvert brink depth
YTD	Culvert brink depth/culvert rise
YCD	Mild slope culvert brink depth/culvert rise
FPC	Circular culvert flow parameter
FPR	Rectangular culvert flow parameter
KAPPA	Culvert shape-roughness indicator
AO	Culvert outlet flow area (sq ft)

VO	Culvert outlet velocity (fps)
X	Array of effective rock diameters (ft)
Y	Array of scour depths (ft)
NP	Number of effective rock diameter, scour depth coordinate sets in V array
V	Array of effective rock diameters and scour depths (ft)
I	Array index
IERR	Error index number
ZERO	Minimum non-scouring effective rock diameter (ft)
HYBRID	Minimum hybrid rock diameter (ft)
DE	User selected effective rock diameter (ft)
SD	Scour depth corresponding to user selected effective rock diameter (ft)
J	Array index
MP	Number of effective rock diameter, scour depth coordinate sets in SIZE array
VS	Average channel velocity (fps)
RSG	User selected riprap rock specific gravity
VM	Maximum channel velocity (fps)
PK	Culvert vertical velocity profile constant
U	Maximum channel velocity/adjusted culvert outlet velocity (fps)
ZL	Minimum non-scouring effective rock diameter basin length (ft)
ZW1	Minimum non-scouring effective rock diameter inlet basin width (ft)
ZW2	Minimum non-scouring effective rock diameter outlet basin width (ft)
FO	Mild slope culvert outlet Froude number
TO	Tangent of basin flare angle

SUBROUTINE HYDSCR

TITLE: Colorado State University Rock Scour Depths

CALLING MODULES: HYDPRK

CALLED MODULES:

DESCRIPTION: Obtains and relays scour depth/culvert rise ratios within tailwater/culvert rise ratios, flow parameters, and effective rock diameter/culvert rise ratios. Scour depth/culvert rise ratios not available are relayed to control module as negative values. Subroutine contains data arrays that provide values by indexing and interpolation.

SYMBOLS:

F48, F49, F50, F51, F52	Arrays containing scour depth/culvert rise values for various effective rock diameter/culvert rise ratios, tailwater depth/culvert rise, and flow parameters.
R48, R49, R50, R51, R52	Arrays containing flow parameters
Z	Array containing starting tailwater depth/culvert rise, maximum number of rows, ending tailwater depth/culvert rise
I	Array index
NC	Column index
CN	Intermediate column interpolation factor
C	Final column interpolation factor
NROW	Number of Rows
TWD	Tailwater/culvert rise ratio
FPR	Rectangular culvert flow parameter
FPC	Circular culvert flow parameter
J	Array index
DSD	Intermeditate scour depth/culvert rise ratios
SDEPR	Final scour depth/culvert rise ratios
R	Row interpolation factor
NR	Row index

PIPES	Number of culvert barrels
HLS	Minimum hybrid effective rock diameter scour length (ft)
T	Spacing between culvert barrels (ft)
HL	Minimum hybrid effective rock diameter basin length (ft)
HW1	Minimum hybrid effective rock diameter inlet basin width (ft)
HW2	Minimum hybrid effective rock diameter outlet basin width (ft)
BHT	Basin height (ft)
DM	Effective rock diameter (ft)
DS	Scour depth (ft)
WS	Scour width (ft)
SL	Scour length (ft)
DMAX	Maximum riprap rock diameter (ft)
BW1	Inlet basin width (ft)
BW2	Outlet basin width (ft)
BL	Basin length (ft)
TS	Basin side thickness (ft)
TF	Basin floor thickness (ft)



SUBROUTINE HYDBTW

TITLE: Colorado State University Tailwater Effect on Brink Depth

CALLING MODULES: HYDPRK

CALLED MODULES:

DESCRIPTION: Evaluates tailwater effect on culvert brink depth to determine if culvert is mild sloping or steep sloping. Returns brink depth/culvert rise ratio to control module for comparison with original ratio. Subroutine contains data values in a two-dimensional array that are selected by indexing and interpolation.

SYMBOLS:

R16	Array containing rectangular culvert brink depth/culvert rise ratios for various tailwater/culvert rise ratios and flow parameters
C17	Array containing circular culvert brink depth/culvert rise ratios for various tailwater/culvert rise ratios and flow parameters
KAPPA	Culvert shape-roughness indicator
TWD	Tailwater/culvert rise ratio
QDP	Flow parameter
NC	Column index
CN	Intermediate column interpolation factor
C	Final column interpolation factor
NR	Row index
RN	Intermediate row interpolation factor
R	Final row interpolation factor
YOD	Intermediate brink depth/culvert rise ratio
YCD	Final brink depth/culvert rise ratio

SUBROUTINE HYDVOL

TITLE: Rock Riprapped Basin Volume Calculations

CALLING MODULES: HYDPRK, HYDCOE

CALLED MODULES:

DESCRIPTION: This module is a multiple entry subroutine. The first section computes volumes for the Colorado State University rock riprapped basins. The total volume is the summation of the apron, end slope, embankment slope, under slope, and side slope portions. The second section provides volumes for the U. S. Army Waterways Experiment Station rock riprapped basins.

SYMBOLS:

VOL	Basin volume (cu yd)
BL	Basin length (ft)
BW1	Basin inlet width (ft)
BW2	Basin outlet width (ft)
TF	Basin floor thickness (ft)
DS	Scour depth (ft)
TS	Basin side thickness (ft)
BHT	Basin height (ft)
Z1	Riprap under or side slope (ft/ft)
Z2	Riprap embankment slope (ft/ft)
Z3	Riprap end slope (ft/ft)
WO	Culvert span (ft)
IBASIN	Basin type indicator

SUBROUTINE HYDCOE

TITLE: U. S. Army Waterways Experiment Station Scour Extent and Stable Rock Riprapped Basins.

CALLING MODULES: HYDCEP

CALLED MODULES: HYDOUT, HYDVOL

DESCRIPTION: This is a multiple entry subroutine. The first section computes anticipated scour hole extent for a sandy material with an estimated effective rock diameter of .001 ft. Length of scour, width of scour, depth of scour, and volume of scour are computed for minimum and maximum tailwaters.

Stable horizontal blanket, lined channel expansion, and preformed scour hole riprap basins are computed directly in the second section.

SYMBOLS:

TIME	Duration of culvert peak discharge (min)
TWD	Tailwater depth/culvert rise
DS	Scour depth (ft)
QD	Culvert discharge/barrel (cfs)
WO	Culvert span (ft)
WS	Scour width (ft)
SL	Scour Length (ft)
SVOL	Scour volume (cu yd)
PIPES	Number of culvert barrels
T	Spacing between culvert barrels (ft)
BW1	Basin inlet width (ft)
BW2	Basin outlet width (ft)
BL	Basin length (ft)
BHT	Basin height (ft)
D50	Median rock diameter (ft)
PHI(6)	Median rock diameter (ft)

I	Array index
TW	Tailwater depth (ft)
HO	Culvert rise (ft)

SUBROUTINE HYDENG

TITLE: Hydraulic jump basin energy

CALLING MODULES: USBR1, USBR2, USBR3, USBR4, SAF

CALLED MODULES:

DESCRIPTION: This module determines the basin inlet depth and velocity for any value of basin inlet energy. It is situated in an iteration loop of the calling modules and returns depth and velocity values until Froude number and conjugate depth constraints are met.

SYMBOLS:

DELTA	Incrementation variable (ft)
ISSET	Accuracy indicator
P	Intermediate basin inlet depth (ft)
EZ	Basin inlet energy (ft)
G	Gravitational acceleration (ft/sec <sup>2</sup> )
BW1, W	Basin inlet width (ft)
QD	Culvert discharge/barrel (cfs)
DZ	Basin inlet depth (ft)
VZ	Basin inlet velocity (fps)

TITLE: Colorado State University Smooth-Floor Flared Basin

CALLING MODULES: HYDCEP

CALLED MODULES: HYDOUT, HYDERR

DESCRIPTION: Initially the module checks the Froude number to insure that it is supercritical. Dependent on the culvert shape, the momentum correction factors are computed and used to obtain the culvert outlet momentum. The momentum slightly downstream of the hydraulic jump is computed to balance the culvert outlet momentum. Employing the momentum balance, the culvert outlet Froude number flare angle, and a hydraulic jump safety factor, the basin geometry is then directly computed.

SYMBOLS:

RHO	Mass density of water (slugs/ft <sup>3</sup> )
GAMMA	Unit weight density of water (lb/cu ft)
IERR	Error number index
QD	Culvert discharge/barrel (cfs)
VO	Culvert outlet velocity (fps)
AO	Culvert outlet water area (sq. ft)
KAPPA	Culvert shape-roughness factor
B1	Momentum correction factor for non-uniform pressure distribution at culvert outlet.
B2	Momentum correction factor for non-uniform velocity distribution at culvert outlet.
TW	Channel tailwater depth (ft)
YO	Culvert outlet brink depth (ft)
WO	Culvert span (ft)
FR	Culvert outlet Froude number
TO	Tangent of flare angle
XCOF(1)	Quadratic equation constant c
XCOF(2)	Quadratic equation constant b
XCOF(3)	Quadratic equation constant a



QUAD	Quadratic equation radical term
BL	Basin length (ft)
CMO	Culvert outlet momentum (lb/ft)
BHT	Basin height (ft)

SUBROUTINE SAF

TITLE: St. Anthony Falls Stilling Basin

CALLING MODULES: HYDCEP

CALLED MODULES: HYDENG, HYDOUT, HYDERR, FLARE

DESCRIPTION: This subroutine designs the St. Anthony Falls Basin. It provides testing of input parameters to insure that the energy dissipator limitations are met. It determines required basin depression for selected basin width in order to comply with required Froude number range and hydraulic jump conjugate depths. The basin length is computed from the basin sequent depth and basin inlet Froude number. The basin height is determined by the maximum depth of water in the basin and the basin sequent depth to insure that freeboard is present. Chute block, baffle block, and end sill dimensions are computed. Transition geometry is also controlled by this program. Energy, depth, velocity, and Froude number values are computed for both basin inlet and outlet.

SYMBOLS:

IBASIN	Basin type indicator
IERR	Error number index
FR	Culvert outlet Froude number
YO	Culvert brink depth (ft)
TW	Tailwater depth (ft)
H, PHI(9)	Basin depth below culvert outlet invert (ft)
EZ	Basin inlet energy (ft)
EO	Culvert outlet energy (ft)
VO	Culvert outlet velocity (fps)
BWL	Basin width (ft)
WO	Culvert span (ft)
FI	Basin inlet Froude number
VZ	Basin inlet velocity (fps)
DZ	Basin inlet depth (ft)
DZZ	Basin sequent depth (ft)

BL	Basin Length (ft)
HTW	Basin outlet depth (ft)
F2	Basin outlet Froude number
EZZ	Basin outlet energy (ft)
VZZ	Basin outlet velocity(fps)
QDP	Discharge flow parameter (cfs/ft <sup>5/2</sup> )
F	Basin inlet Froude number squared
PHI(1)	Basin height (ft)
PHI(2)	Chute block, baffle block height (ft)
PHI(3)	Chute block, baffle block width (ft)
PHI(4)	Chute block, Baffle block interior spacing (ft)
PHI(5)	Chute block wall spacing (ft)
PHI(6)	Baffle block wall spacing (ft)
PHI(7)	Row spacing between chute and baffle blocks (ft)
PHI(8)	End sill height (ft)

SUBROUTINE USBR1

TITLE: U. S. Bureau of Reclamation Type I Basin

CALLING MODULES: HYDCEP

CALLED MODULES: HYDENG, HYDOUT, HYDERR, FLARE

DESCRIPTION: This subroutine designs the USBR Type I Basin. It provides testing of input parameters to insure that the energy dissipator limitations are met. It determines required basin depression for selected basin width in order to comply with required Froude number range and hydraulic jump conjugate depths. The hydraulic jump length is equivalent to the required basin length. The basin height is determined by the maximum depth of water in the basin and the basin inlet velocity to insure that freeboard is present. Transition geometry is also controlled by this program. Energy, depth, velocity, and Froude number values are computed for both basin inlet and outlet.

SYMBOLS:

IBASIN	Basin type indicator
IERR	Error number index
FR	Culvert outlet Froude number
YO	Culvert brink depth (ft)
TW	Tailwater depth (ft)
H, PHI(9)	Basin depth below culvert outlet invert (ft)
EZ	Basin inlet energy (ft)
EO	Culvert outlet energy (ft)
VO	Culvert outlet velocity (fps)
BW1	Basin width (ft)
BWS	Basin width (Designer's choice) (ft)
WO	Culvert span (ft)
F1	Basin inlet Froude number
VZ	Basin inlet velocity (fps)
DZ	Basin inlet depth (ft)

DZZ	Basin sequent depth (ft)
BL	Basin Length (ft)
HTW	Basin outlet depth (ft)
BHT	Basin height (ft)
F2	Basin outlet Froude number
EZZ	Basin outlet energy (ft)
VZZ	Basin outlet velocity (fps)

SUBROUTINE USBR2

TITLE: U S. Bureau of Reclamation Type II Basin

CALLING MODULES: HYDCEP

CALLED MODULES: HYDENG, HYDOUT, HYDERR, FLARE

DESCRIPTION: This subroutine designs the USBR Type II Basin. It provides testing of input parameters to insure that the energy dissipator limitations are met. It determines required basin depression for selected basin width in order to comply with required Froude number range and hydraulic jump conjugate depths. The length of basin is equivalent to the hydraulic jump length. The basin height is computed by using the basin outlet depth and the basin inlet velocity to insure that freeboard is present. The chute block dimensions are based on the basin inlet depth. The dentated end sill dimensions are based on the basin outlet sequent depth. Flare transition geometry is controlled by this module.

SYMBOLS:

IBASIN	Basin type indicator
IERR	Error number index
FR	Culvert outlet Froude number
YO	Culvert brink depth (ft)
TW	Tailwater depth (ft)
H, PHI (9)	Basin depth below culvert outlet invert (ft)
EZ	Basin inlet energy (ft)
EO	Culvert outlet energy (ft)
VO	Culvert outlet velocity (fps)
BW1	Basin width (ft)
BWS	Basin width (Designer's choice) (ft)
WO	Culvert span (ft)
F1	Basin inlet Froude number
VZ	Basin inlet velocity (fps)
DZ	Basin inlet depth (ft)
DZZ	Basin sequent depth (ft)



BL	Basin length (ft)
HTW	Basin outlet depth (ft)
BHT	Basin height (ft)
F2	Basin outlet Froude number
EZZ	Basin outlet energy (ft)
VZZ	Basin outlet velocity (fps)
QD	Culvert discharge/barrel (cfs)
PHI (1)	Chute block height, width (ft)
PHI (2)	Chute block wall spacing (ft)
PHI (3)	End sill parameter (ft)
N	Number of chute blocks and interior spaces
A	Number of chute blocks

## SUBROUTINE USBR3

TITLE: U. S. Bureau of Reclamation Type III Basin

CALLING MODULES: HYDCEP

CALLED MODULES: HYDENG, HYDOUT, HYDERR, FLARE

DESCRIPTION: This subroutine designs the USBR Type III Basin. It provides testing of input parameters to insure that the energy dissipator limitations are met. It determines required basin depression for selected basin width in order to comply with required Froude number range and hydraulic jump conjugate depths. The hydraulic jump length is equivalent to the required basin length. The basin height is determined by the maximum depth of water in the basin and the basin inlet velocity to insure that freeboard is present. Chute blocks, baffle blocks, and end sill dimensions are computed for the basin. Transition geometry is also controlled by this program. Energy, depth, velocity, and Froude number values are computed for both basin inlet and outlet.

### SYMBOLS:

IBASIN	Basin type indicator
IERR	Error number index
FR	Culvert outlet Froude number
YO	Culvert brink depth (ft)
TW	Tailwater depth (ft)
H, PHI (9)	Basin depth below culvert outlet invert (ft)
EZ	Basin inlet energy (ft)
EO	Culvert outlet energy (ft)
VO	Culvert outlet velocity (fps)
BW1	Basin width (ft)
BWS	Basin width (Designer's choice) (ft)
WO	Culvert span (ft)
F1	Basin inlet Froude number
VZ	Basin inlet velocity (fps)
DZ	Basin inlet depth (ft)

DZZ	Basin Sequent depth (ft)
BL	Basin Length (ft)
HTW	Basin outlet depth (ft)
BHT	Basin height (ft)
F2	Basin outlet Froude number
EZZ	Basin outlet energy (ft)
VZZ	Basin outlet velocity (fps)
QD	Culvert discharge/barrel (cfs)
N	Number of chute or baffle blocks and interior spaces
A	Number of chute blocks
B	Number of baffle blocks
PHI (1)	Chute block height, width (ft)
PHI (2)	Chute block wall spacing (ft)
PHI (3)	Baffle block height (ft)
PHI (4)	Baffle block wall spacing (ft)
PHI (5)	End sill height (ft)

SUBROUTINE USBR4

TITLE: U. S. Bureau of Reclamation Type IV Basin

CALLING MODULES: HYDCEP

CALLED MODULES: HYDENG, HYDOUT, HYDERR, FLARE

DESCRIPTION: This subroutine designs the USBR Type IV Basin. It provides testing of input parameters to insure that the energy dissipator limitations are met. It determines required basin depression for selected basin width in order to comply with required Froude number range and hydraulic jump conjugate depths. The hydraulic jump length is equivalent to the required basin length. The basin height is determined by the maximum depth of water in the basin and the basin inlet velocity to insure that freeboard is present. Chute blocks and end sill dimensions are computed for the basin. Transition geometry is also controlled by this program. Energy, depth, velocity, and Froude number values are computed for both basin inlet and outlet.

SYMBOLS:

IBASIN	Basin type indicator
IERR	Error number index
FR	Culvert outlet Froude number
YO	Culvert brink depth (ft)
TW	Tailwater depth (ft)
H,PHI (9)	Basin depth below culvert outlet invert (ft)
EZ	Basin inlet energy (ft)
EO	Culvert outlet energy (ft)
VO	Culvert outlet velocity (fps)
BW1	Basin width (ft)
BWS	Basin width (Designer's Choice) (ft)
WO	Culvert span (ft)
F1	Basin inlet Froude number
VZ	Basin inlet velocity (fps)
DZ	Basin inlet depth (ft)

DZZ	Basin sequent depth (ft)
BL	Basin Length (ft)
HTW	Basin outlet depth (ft)
BHT	Basin height (ft)
F2	Basin outlet Froude number
EZZ	Basin outlet energy (ft)
VZZ	Basin outlet velocity (fps)
PHI (1)	Chute block width (ft)
N	Number of chute blocks and interior spaces
A	Number of chute blocks
PHI (2)	Chute block wall spacing (ft)

SUBROUTINE USBR6

TITLE: U. S. Bureau of Reclamation Type VI Basin (Impact Stilling Basin)

CALLING MODULES: HYDCEP

CALLED MODULES: HYDERR, HYDOUT

DESCRIPTION: Limitation testing is initially performed on the USBR Type VI Basin input data to insure that the discharge flow parameter, the culvert outlet velocity, and the barrel discharge criteria are met. If this is the case, the various dimensions of the basin are then directly computed.

SYMBOLS:

BW1	Basin inlet width (ft)
BW2	Basin outlet width (ft)
WO	Culvert Span (ft)
PHI(1)	Height of baffle (ft)
PHI(2)	Height of baffle above floor, length of baffle lip (ft)
PHI(3)	Length of basin (ft)
PHI(4)	Height of basin (ft)
PHI(5)	Height of basin outlet (ft)
PHI(6)	Top length of basin (ft)
PHI(7)	Top ridge of basin, width of baffle notch (ft)
PHI(8)	Height of baffle notch (ft)
PHI(9)	Length of rock (ft)
PHI(10)	Depth of rock (ft)
QD	Culvert discharge/barrel (cfs)
IBASIN	Basin type indicator
IERR	Error number index



SUBROUTINE FLARE

TITLE: Spillway flare transition geometry

CALLING MODULES: USBR1, USBR2, USBR3, USBR4, SAF

CALLED MODULES:

DESCRIPTION: This module initially determines if the basin inlet width is equal to the culvert span. If it is equal, no flare is required and only the basin depression is checked for proper slope. If the basin inlet width exceeds the culvert span, a transition sidewall flare and spillway transition length are also computed based on the culvert outlet Froude number.

SYMBOLS:

BW1	Basin width (ft)
WO	Culvert span (ft)
FR	Culvert outlet Froude number
R	Transition sidewall flare (ft)
PHI (9)	Depression of basin floor below culvert outlet invert (ft)
PHI (10)	Spillway transition length (ft)

SUBROUTINE VSWELL

TITLE: Vertical Stilling Well

CALLING MODULES: HYDCEP

CALLED MODULES: HYDOUT, HYDERR

DESCRIPTION: Initially this module performs limitation testing of culvert shape and discharge flow parameter. If the limitations are met, direct computations of the Vertical Stilling Well dimensions are then performed.

SYMBOLS:

IERR	Error number index
KAPPA	Culvert shape-roughness indicator
QDP	Discharge flow parameter (cfs/ft <sup>5/2</sup> )
PHI(1)	Stilling well diameter (ft)
WO	Culvert span (ft)
QD	Culvert discharge/barrel (cfs)
SO	Inflow pipe slope (ft/ft)
PHI(2)	Well depth below inflow pipe invert
PHI(3)	Height of well above inflow pipe invert

SECTION VIII  
PROGRAM FLOWCHART

CULVERT EROSION PROTECTION SYSTEMS FLOWCHART

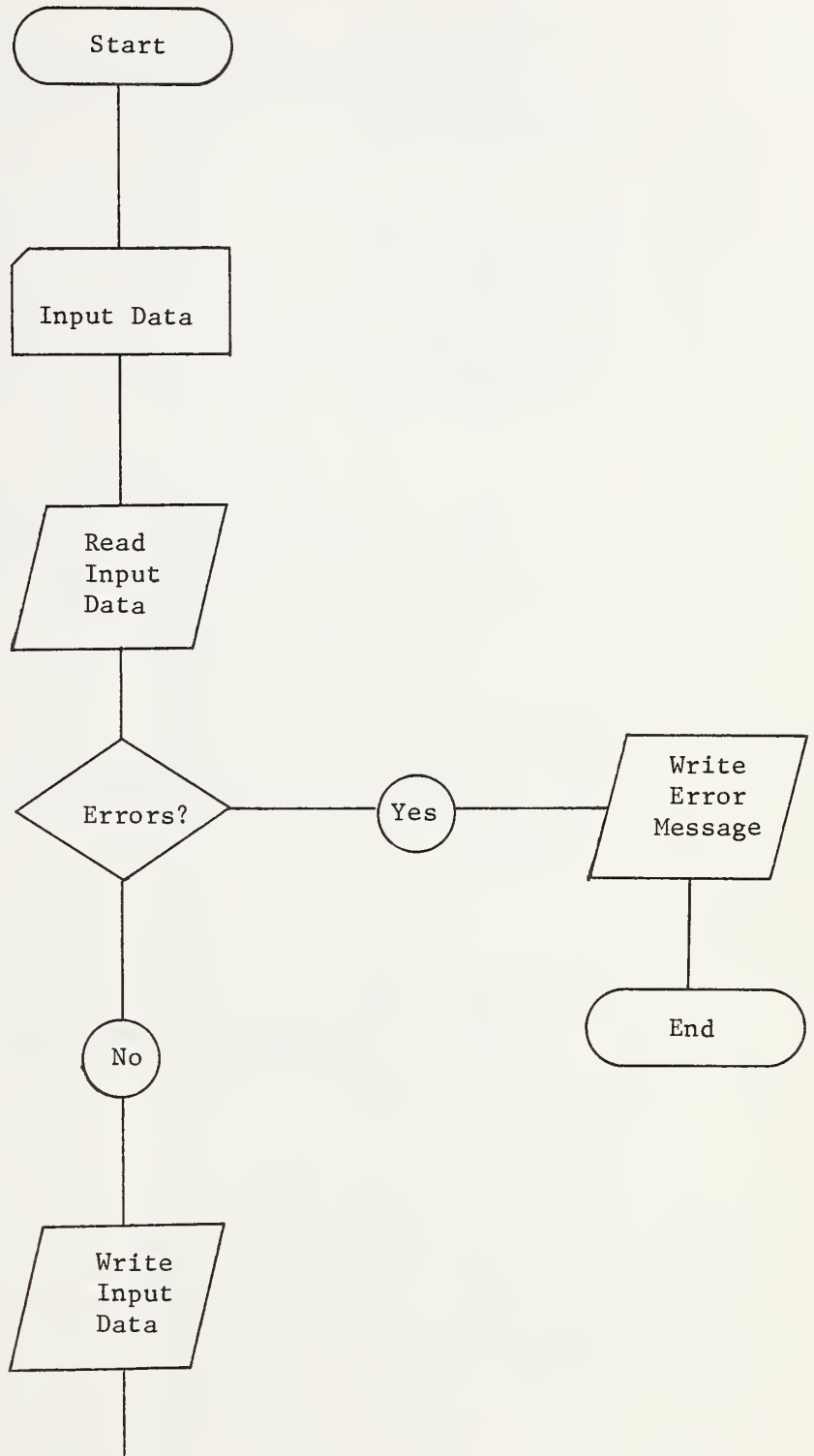

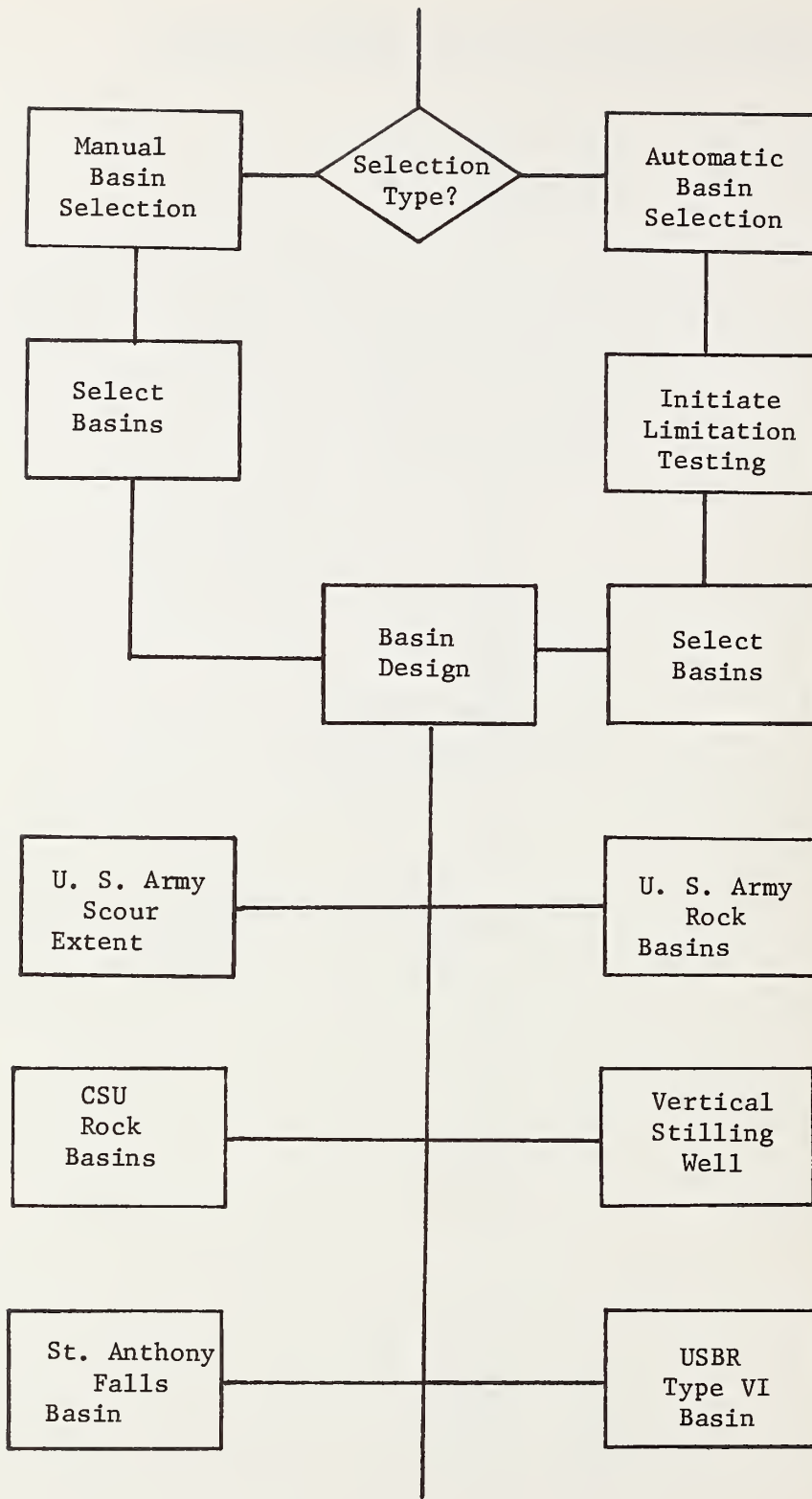

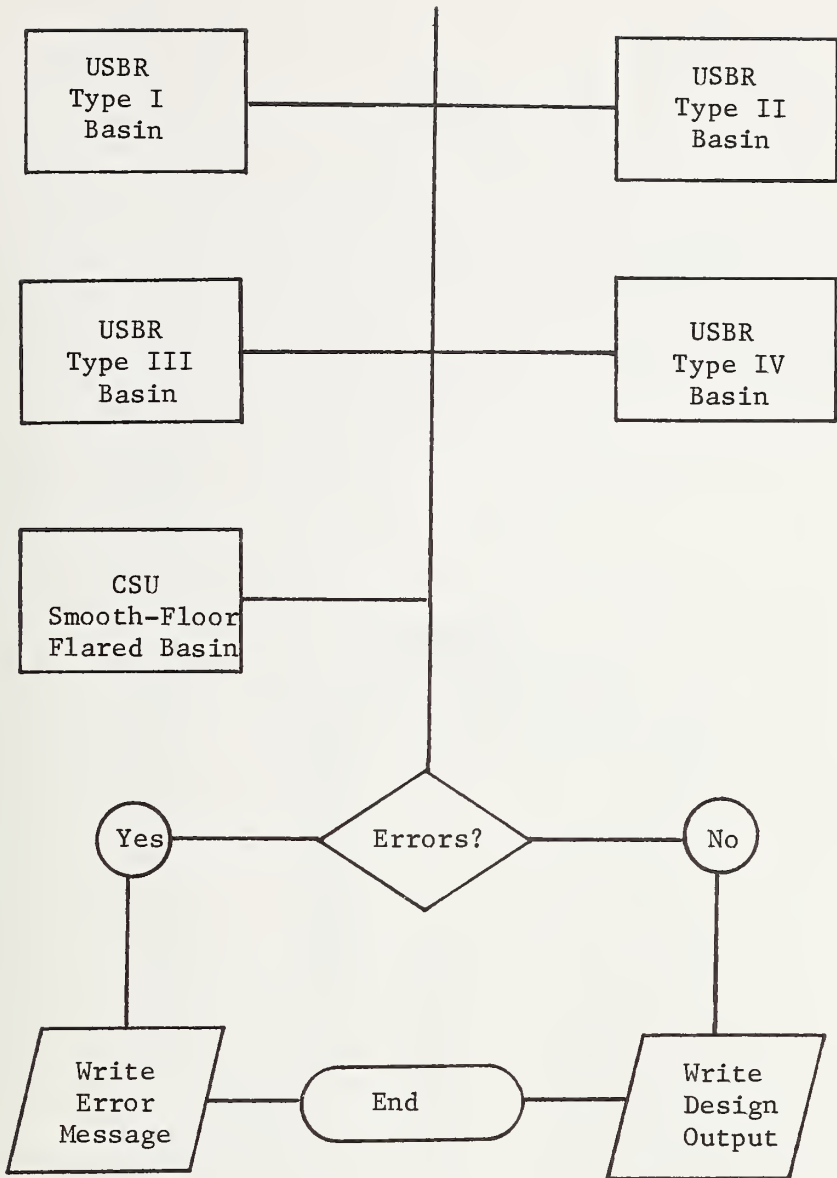



SECTION IX  
SOURCE PROGRAM LISTING

```

C----- CULVERT EROSION PROTECTION
C----- MICHAEL G. SCHILLING
C----- HYDCEP - MAIN CONTROL PROGRAM
COMMON / INDICE / IRD, IWT, IERR, I BASIN, IDENT(15)
COMMON / PIPE / KAPPA, PIPES, HO, WO, SO, QD, YO, VU, T, PK
COMMON / FLOW / QDP, FPC, FPR, YCD, TWD, DTY, YTD, FR, EG, EZ, VZ, DZ, HTW, VZZ
A, F1, F2, EZZ
COMMON / ROCK / DM, X(5), ZERO, HYBRID, DE, RSG, PHI(11), DMAX
COMMON / BASIN / BW1, BW2, TS, TF, BL, VOL, BHT, Z1, Z2, Z3, TQ, BWS
COMMON / SCOUR / SDEPR(5), Y(5), V(2,8), DS, WS, SL, TIME, SVOL
COMMON / STREAM / TW, VS, VM
DIMENSION EC(6), B(11)
6 FORMAT(I2, IX, 15A4)
11 FORMAT(I2, I3, 6F10.0, I1)
C----- INPUT - OUTPUT DEVICE INITIALIZATION
IRD=1
IWT=3
C----- BASIN TYPE INITIALIZATION
1 B(1)=1.
DO 7 I=2, 11
B(I)=3.
7 CONTINUE
C----- READ IDENTIFICATION CARD
READ(IRC, 6) IWC, IDENT
IF(IWC.EQ.99) GO TO 10
C----- READ CULVERT EROSION PROTECTION CONTROL CARD
READ(IRD, 11) IWC, IDC, EC, IC
IF(IWC.EQ.99) GO TO 10
IERR=1
IF(IWC.NE.IERR) GO TO 2
BWS=EC(5)
KAPPA=EC(4)
PK=1.10
IF(KAPPA.GT.2) GO TO 4
GO TO 5
4 PK=1.15

```

```

KAPPA=KAPPA-2
C----- READ CULVERT PARAMETER CARD
5 READ (IRD,11)IWC,IDC,TIME ,PIPES,T,HD,W0,S0,IC
  IF(IWC.EQ.99) GO TO 10
  IERR=2
C----- IF(IWC.NE.IERR) GO TO 2
  READ CULVERT FLOW CARD
  READ (IRD,11)IWC,IDC,QD,Y0,VC,TW,VS,VM,IC
  IF(IWC.EQ.99) GO TO 10
  IERR=3
C----- IF(IWC.NE.IERR) GO TO 2
  COMPUTE CULVERT OUTLET FLOW PARAMETER
  QDP=QD/(W0*HD**1.5)
C----- COMPUTE OUTLET FROUDE NUMBER BY HYDRAULIC DEPTH
  IF(Y0.EQ.HD) GO TO 42
  GO TO (43,42),KAPPA
42 HD=Y0
  GO TO 48
43 IF(Y0-(HD/2.))44,45,46
44 D=HD/2.-Y0
  A=2.*ARCOS(D/(HD/2.))
  HD=(HD*HD/8.*(A-SIN(A)))/(2.*SQR T(HD*HD/4.-D*D))
  GO TO 48
45 HD=3.1416*HD/8.
  GO TO 48
46 D=Y0-HD/2.
  A=2.*ARCOS(D/(HD/2.))
  HD=(3.1416*HD*HD/4.-HD*HD/8.*(A-SIN(A)))/(2.*SQR T(HD*HD/4.-D*D))
C----- COMPUTE OUTLET ENERGY
  EQ=V0*V0/64.4*Y0
C----- PRINT CULVERT,OUTLET,CHANNEL INPUT
  CALL HYD005
  CALL HYC001
C----- ANALYSIS OPTION BRANCH
  IF(EC(1).NE.1.) GO TO 12

```

```

C----- READ BASIN SELECTION CARDS
          READ(IR,11)IWC,IDC,(B(I),I=1,6),IC
          IF(IWC.EQ.99) GO TO 10
          IERR=4
          IF(IWC.NE.IERR) GO TO 2
          IF(IC.EQ.0) GO TO 12
          READ(IR,11)IWC,IDC,(B(I),I=7,11),EC(6),IC
          IF(IWC.EQ.99) GO TO 10
          IERR=5
          IF(IWC.NE.IERR) GO TO 2
C----- ENERGY DISSIPATOR MATERIAL RESTRICTION TEST
          12 IF(EC(3).FQ.0.) GO TO 15
              M=EC(3)
              GO TO (13,14),M
          13 B(2)=0.
              B(3)=0.
              GO TO 15
          14 DO 16 I=4,11
              B(I)=0.
          16 CONTINUE
              GO TO 8
          15 IF(EC(1).EQ.1.) GO TO 40
              DO 9 I=4,11
                  J=I-3
              GO TO (32,33,34,35,36,37,38,41),J
C----- VERTICAL STILLING WELL LIMITS
          32 IF((KAPPA.EQ.1).AND.(QDP.LE.10.).OR.(FC(2).EQ.1.).OR.(SG.LE.1.))
              AB(4)=1.
              GO TO 9
C----- ST. ANTHONY FALLS STILLING BASIN LIMITS
          33 IF((QDP.LE.9.5).AND.(FR.LE.17.3)) B(5)=1.
              GO TO 9
C----- USBR TYPE 6 BASIN LIMITS
          34 IF((QDP.LE.21.).AND.(VO.LE.30.).AND.(VO.LE.30.).OR.(EC(2).EQ.1.)) B
              A(6)=1.
              GO TO 9

```

```

C----- USBR TYPE 1 BASIN LIMITS
35 IF(FR.LE.9.) B(7)=1.
   GO TO 9
C----- USBR TYPE 2 BASIN LIMITS
36 IF(FR.LE.14.5) B(8)=1.
   GO TO 9
C----- USBR TYPE 3 BASIN LIMITS
37 IF(FR.LE.16.5) B(9)=1.
   GO TO 9
C----- USBR TYPE 4 BASIN LIMITS
38 IF(FR.LE.4.5) B(10)=1.
   GO TO 9
C----- CSU SMOOTH-FLOOR FLARED BASIN LIMITS
41 IF((FR.GT.1.00).OR.(YO.EQ.HO)) B(11)=1.
   9 CONTINUE
   IF(EC(3).EQ.1.) GO TO 17
C----- US ARMY WATERWAYS EXPERIMENT STATION ROCK RIPRAPPED BASIN LIMITS
8 IF((EC(1).EQ.1.).AND.(B(2).EQ.0.)) GO TO 39
   IF((QDP.LE.10.).AND.(FR.LE.4.)) B(2)=1.
C----- COLORADO STATE UNIVERSITY ROCK RIPRAPPED BASIN LIMITS
39 IF((EC(1).EQ.1.).AND.(B(3).EQ.0.)) GO TO 40
   IF(QDP.LE.15.) B(3)=1.
40 IF(B(3).EQ.0.) GO TO 17
C----- READ RIPRAP PARAMETER CARD NO. 1
   READ(IRC,11)IWC,IDC,DE,RSG,DMAX,Z1,Z2,Z3,IC
   IF(IWC.EQ.99) GO TO 10
   IERR=5
   IF(IWC.NE.IERR) GO TO 2
   IF((DE.FQ.0.).AND.(IC.EQ.1)) GO TO 3
   GO TO 18
C----- READ RIPRAP PARAMETER CARD NO. 2
3 READ(IRC,11) IWC,IDC,(PHI(I),I=1,6),IC
   IF(IWC.EQ.99) GO TO 10
   IERR=7
   IF(IWC.NE.IERR) GO TO 2
C----- READ RIPRAP PARAMETER CARD NO. 3

```

```

READ(IRD,11) IWC,IDC,(PHI(I),I=7,11),RSG,IC
DMAX=PHI(11)
IF(IWC.FQ.99) GO TO 10
IERR=8
IF(IWC.NE.IERR) GO TO 2
C----- COMPUTE EFFECTIVE DIAMETER OF RCCK RIPRAP
CALL HYDDM
C----- PRINT RIPRAP INPUT
18 IF(RSG.EQ.0.) RSG=2.70
CALL HYD006
17 J=0
C----- COMMENT ENERGY DISSIPATOR DESIGN
DO 19 I=1,11
IF(B(I).EQ.0.) GO TO 20
CALL HYD005
GO TO (21,22,23,24,25,26,27,28,29,30,31),I
21 CALL HYD001
GO TO 19
22 CALL HYD002
GO TO 19
23 CALL HYDPRK
GO TO 19
24 CALL VSWELL
GO TO 19
25 CALL SAF
GO TO 19
26 CALL USBR6
GO TO 19
27 CALL USBR1
GO TO 19
28 CALL USBR2
GO TO 19
29 CALL USBR3
GO TO 19
30 CALL USBR4
GO TO 19

```



```
31 CALL HYDPPA
   GO TO 19
20 J=J+1
19 CONTINUE
   IF(J.LT.11) GO TO 1
   IERR=9
   2 CALL HYDERR
10 CALL EXIT
   END
```

```

C-----
SUBROUTINE HYDOUT
OUTPUT SUBROUTINE
COMMON / INDICE / IKD,IWT,IERR,IBASIN,IDENT(15)
COMMON / PIPE / KAPPA,PIPES,HO,WC,SO,QD,YU,VO,T,PK
COMMON / FLOW / QDP,FPC,FPR,YCD,TWD,DTY,YTD,FR,EO,EZ,VZ,DZ,HTW,VZZ
A,F1,F2,EZZ
COMMON / ROCK / DM,X(5),ZERO,HYBRID,DE,RSG,PHI(11),DMAX
COMMON / BASIN / BW1,BW2,TS,TF,BL,VOL,BHT,Z1,Z2,Z3,TO,BWS
COMMON / SCOUR / SDEPR(5),Y(5),V(2,8),DS,WS,SL,TIME,SVOL
COMMON / STREAM / TW,VS,VM
INTEGER DIM(30)
DATA DIM /CIRC,'ULAR','RECT','ANGU','LAR','FT','FPS',
A' CFS','CU','YD','FT','FT','MIN','YES','NO',
B' I','II','III','IV','A-','-D-','-C-','-B-','-E-','-
CF-','-G-','-H-','-I- '/'
ENTRY HYD001
M=KAPPA*KAPPA
WRITE(IWT,1)DIM(M),DIM(M+1),DIM(M+2),VO,DIM(8),TW,DIM(7),SO,DIM(12
A),DIM(13),YO,DIM(7),VM,DIM(8),HO,DIM(7),FR,VS,DIM(8),WD,DIM(7),QD,
BDIM(9),PIPES,TIME,DIM(15),T,DIM(7)
1 FORMAT(1H, //48X, 'INPUT PARAMETERS, //,1X, '***CULVERT***, 27X, '***
AOUTLET***, 27X, '***CHANNEL***, //,1X, 'TYPE = ', 3A4, 21X, 'VELOCITY =
B', F5.1, A4, 19X, 'TAILWATER = ', F5.1, A4, //, 1X, 'SLOPE = ', F8.4, 2A4, 16
CX, 'DEPTH = ', F5.1, A4, 22X, 'MAXIMUM VELOCITY = ', F5.1, A4, //, 1X, 'RISE
D = ', F5.1, A4, 24X, 'FROUDE NO. = ', F5.2, 21X, 'AVERAGE VELOCITY = ', F5
E.1, A4, //, 1X, 'SPAN = ', F5.1, A4, 24X, 'DISCHARGE/BARREL = ', F7.1, A4, //
F, 1X, 'NO. OF BARRELS = ', F3.0, 20X, 'PEAK DISCHARGE DURATION = ', F6.0
G, A4, //, 1X, 'BARREL SPACING = ', F6.1, A4, //)
GO TO 50
ENTRY HYD002
IF(PIPES.GT.1.) WRITE(IWT,75)
75 FORMAT(1H, //35X, '***DESIGNED FOR MULTIPLE BARREL DISCHARGE***,/)
IF(PIPES.EQ.1.) WRITE(IWT,76)
76 FORMAT(1H, //35X, '***DESIGNED FOR SINGLE BARREL DISCHARGE***,/)
WRITE(IWT,49)
49 FORMAT(1H, //42X, 'COLORADO STATE UNIVERSITY',/)

```

```

WRITE(IWT,11)
11 FORMAT(1H ,44X,'ROCK RIPRAPPED BASINS',//1X,'BASIN EFFECT
ALIVE',4X,3('SCOUR',5X),7('BASIN',5X),
B //1X,'TYPE ROCK DEPT
CH LENGTH WIDTH INLET OUTLET LENGTH HEIGHT
CTHICKNESS THICKNESS VOLUME',//16X,'DIAMETER',35X,'WIDTH WIDTH'
E//62X,'-A-',7X,'-B-',7X,'-C-',7X,'-D-',7X,'-E-',7X,'-F-',///)
GO TO 5C
ENTRY HYD003
GO TO (3,4,5),IBASIN
3 WRITE(IWT,6)
6 FORMAT(1HC,'NON-SCOURING')
GO TO 9
4 WRITE(IWT,7)
7 FORMAT(1HC,'HYBRID')
GO TO 9
5 WRITE(IWT,8)
8 FORMAT(1HC,'SCOURING')
9 WRITE(IWT,10)DM,DIM(7),DS,DIM(7),SL,DIM(7),WS,DIM(7),8W1,DIM(7),HW
A2,DIM(7),BL,DI4(7),BHT,DIM(7),IF,DIM(7),TS,DIM(7),VOL,DIM(10),DIM(
B11)
10 FORMAT(1H+,15X,F5.2,A4,9(F6.1,A4),F6.0,2A4)
GO TO 5C
ENTRY HYD004
WRITE(IWT,48)
48 FORMAT(1H ,//37X,'U. S. ARMY WATERWAYS EXPERIMENT STATION',/)
WRITE(IWT,2)DS,DIM(7),SL,DIM(7),WS,DIM(7),SVOL,DIM(10),DIM(11),QD,
ADIM(9)
2 FORMAT(1H ,//42X,'SCOUR HOLE EXTENT ESTIMATION',//33X,'SANDY MATER
IAL - EFFECTIVE DIAMETER = .001 FT',//10X,'MAXIMUM SCOUR DEPTH =
B',F8.1,A4,//10X,'MAXIMUM SCOUR LENGTH = ',F8.1,A4,//10X,'MAXIMUM S
COUR WIDTH = ',F8.1,A4,//10X,'MAXIMUM SCOUR VOLUME = ',F8.0,2A4,//
D10X,'DISCHARGE = ',F8.0,A4)
GO TO 5C
ENTRY HYD005
WRITE(IWT,12)IDENT

```

```

12 FORMAT(IH1, //43X, 'CULVERT EROSION PROTECTION', //26X, 15A4, //)
GO TO 5C
ENTRY HYD006
WRITE (IWT, 13) DE, DIM(7), RSG, DMAX, DIM(7), Z1, DIM(12), DIM(13), Z2,
ADIM(12), DIM(13), Z3, DIM(12), DIM(13), Z1, DIM(12), DIM(13)
13 FORMAT (IH, //, 1X, '***RIPRAP***', //, 1X, 'EFFECTIVE ROCK DIAMETER =
A, F6.3, A4, //1X, 'RIPRAP ROCK SPECIFIC GRAVITY = ', F4.2, //1X, 'MAXIMU
BM ROCK DIAMETER = ', F6.3, A4, //1X, 'UNDER SLOPE = ', F5.2, 2A4, //1X, 'E
CMBANKMENT SLOPE = ', F5.2, 2A4, //1X, 'END SLOPE = ', F5.2, 2A4, //1X, 'SI
DDE SLOPE = ', F5.2, 2A4)
GO TO 5C
ENTRY HYD007
WRITE(IWT, 23)
23 FORMAT(IH, //26X, 'U. S. ARMY WATERWAYS EXPERIMENT STATION ROCK RIP
ARAPPEC BASINS', //11X, 'TYPE', 25X, 'MEDIAN', 11X, 6('BASIN', 7X), //40X, '
BROCK', 13X, 'INLET', 7X, 'OUTLET', 6X, 'LENGTH', 6X, 'THICKNESS', 3X, 'DEPRE
SSION', 2X, 'VOLUME', //40X, 'DIAMETER', 9X, 'WIDTH', 7X, 'WIDTH', //58X, '
DA-', 9X, '-B-', 9X, '-C-', 9X, '-D-', 9X, '-F-', //)
GO TO 5C
ENTRY HYD008
GO TO (14, 15, 16, 17), IBASIN
14 WRITE(IWT, 19)
19 FORMAT(IH, 10X, 'HORIZONTAL BLANKET')
GO TO 18
15 WRITE(IWT, 20)
20 FORMAT(IH, 10X, 'LINED CHANNEL EXPANSION')
GO TO 18
16 WRITE(IWT, 21)
21 FORMAT(IH, 10X, 'PREFORMED SCOUR HOLE')
GO TO 18
17 WRITE(IWT, 21)
18 WRITE(IWT, 24) PHI(6), DIM(7), BW1, DIM(7), BW2, DIM(7), BL, DIM(7), TF, DIM(
A7), BHT, CIM(7), VOL, DIM(10), DIM(11)
24 FORMAT(IH, 38X, F6.3, A4, F12.1, A4, 4(F8.1, A4), F8.1, 2A4)
GO TO 5C
ENTRY HYD009

```

```

WRITE(IWT,65)(DIM(14),I=1,24),PHI(3),DIM(7),BW1,DIM(7),PHI(4),DIM(
A7),PHI(5),DIM(7),PHI(6),DIM(7),PHI(7),DIM(7),PHI(2),DIM(7),PHI(1),
BDIM(7),PHI(2),DIM(7),PHI(8),DIM(7),PHI(7),DIM(7),PHI(9),DIM(7),PHI
C(10),DIM(7)
65 FORMAT(1H,48X,'BUREAU OF RECLAMATION',/47X,'IMPACT TYPE STILLING
ABASIN',/57X,'TYPE VI',/3X,6A4,' BASIN ',5A4,'--',5X,5A4,' BAFFLE '
B,4A4,'--',5X,A4,'-- ROCK ',A4,/93X,A4,' NOTCH ',A4,/3X,'LENGTH WI
CDTH HEIGHT OUTLET TOP DEPTH',/32X,'HEIGHT L
D LIP HEIGHT WIDTH LENGTH ABOVE HEIGHT
EENGTG RIDGE FLOOR',/4X,'-C- -A- -D- -H-
F -K- -E- -B- -G- -F- -J- -I
G- -M- -L-',/1X,F5.2,A4,12(F6.2,A4))
GO TO 50
ENTRY HYD010
WRITE(IWT,25)PHI(1),DIM(7),PHI(3),DIM(7),PHI(2),DIM(7)
25 FORMAT (1H,42X,'VERTICAL STILLING WELL',/42X,'WELL WELL S
AUBWELL',/40X,'DIAMETER HEIGHT DEPTH',/42X,'-A- -B-
B -C-',/40X,3(F6.2,A4))
GO TO 50
ENTRY HYD011
WRITE(IWT,71)
71 FORMAT(1H, //35X, '***DESIGNED FOR SINGLE BARREL DISCHARGE***, //)
GO TO 50
ENTRY HYD012
IFLARE=DIM(17)
IF(BW1.GT.WO) IFLARE=DIM(16)
72 FORMAT(1H,50X,'ST. ANTHONY FALLS',/52X,'STILLING BASIN',/1H,2X,
A2A4,' BASIN ',2A4,4X,6A4,' BLOCKS ',6A4,1X,A4,' SILL',A+,3X,A4,
R' BASIN APPROACH',A4,/129H LENGTH WIDTH HEIGHT HEIGHT
CT WIDTH SPACING FROM ROW HEIGHT
D FLARE FALL LENGTH,/65X,'WALL WALL SPACING',/1H,4X
E,10(A4,6X),/1H,2X,10(F6.2,A4),4X,A4,2X,2(F6.2,A4))
WRITE(IWT,72)(DIM(14),I=1,20),DIM(24),DIM(22),DIM(23),DIM(27),DIM(
A25),DIM(25),DIM(26),DIM(28),DIM(30),DIM(29),BL,DIM(7),BW1,DIM(7),
B(PHI(1),DIM(7),I=1,8),IFLARE,(PHI(I),DIM(7),I=9,17)
GO TO 51

```

```

ENTRY HYD013
WRITE(IWT,56)BW1,BW2,BL,BHT,(DIM(7),I=1,--)
56 FORMAT(1H0,40X,'SMOOTH FLOOR FLARED BASIN',//37X,'BASIN BASIN
      I BASIN BASIN',/37X,'INLET CUTLET LENGTH HEIGHT',/
      237X,'WIDTH WIDTH',/38X,'-A- -B- -C- -D-',/35
      3X,4(F6.1,4X),/,1H+,35X,4(6X,A4))
GO TO 50
ENTRY HYD014
IFLARE=DIM(17)
IF(BW1.GT.WO)IFLARE=DIM(16)
WRITE(IWT,100) DIM(IBASIN)
100 FORMAT(1H0,43X,'U.S. BUREAU OF RECLAMATION',/49X,'TYPE',A+, ' BASIN
      A')
      IBASIN=IBASIN-17
GO TO (101,103,105,107),IBASIN
101 WRITE(IWT,102)(DIM(14),I=1,6),DIM(3),DIM(14),DIM(14),DIM(1),I=22,
      A24),BW1,DIM(7),BHT,DIM(7),BL,DIM(7),IFLARE,PHI(9),DIM(7),PHI(10),D
      BIM(7)
102 FORMAT(1H0,23X,3A4,' BASIN ',5A4,' BASIN APPROACH',A+,/1H ,27X,'W
      AIDTH',4X,'HEIGHT',4X,'LENGTH',5X,'FLARE',5X,'FALL',5X,'LENGTH',/27
      BX,3(A4,6X),/,1H ,24X,3(F6.2,A4),4X,A4,2(F5.2,A4))
GO TO 51
103 WRITE(IWT,104)(DIM(14),I=1,10),(DIM(3),I=1,7),(DIM(1),I=22,27),BW1
      A,DIM(7),BHT,DIM(7),BL,DIM(7),(PHI(1),DIM(7),I=1,3),IFLARE,PHI(9),D
      BIM(7),PHI(10),DIM(7)
104 FORMAT(1H0,12X,2A4,' BASIN ',2A4,7X,2A4,' BLOCK ',2A4,7X,A+, ' BASI
      AN APPROACH ',A4,/1H ,12X,'WIDTH',A4,'HEIGHT',A4,'LENGTH',A4,'HEIG
      BHT ',A4,'FROM',A4,' HEIGHT',A4,'FLARE',6X,'FALL',A4,' LENGTH',/53X
      C,'WALL',/,13X,6(A4,6X),/1H ,10X,6(F6.2,A4),2X,A4,4X,2(F6.2,A4))
GO TO 51
105 WRITE(IWT,106)(DIM(14),I=1,18),(DIM(3),I=1,11),(DIM(1),I=22,30),BW
      A1,DIM(7),BHT,DIM(7),BL,DIM(7),(PHI(1),DIM(7),I=1,6),IFLARE,PHI(9),
      BDIM(7),PHI(10),DIM(7)
106 FORMAT(1H0,1X,2A4,' BASIN ',2A4,9X,6A4,' BLOCK ',6A4,6X,A4,' BASIN
      A APPROACH ',A4,/1H ,3X,'WIDTH',A4,'HEIGHT',A4,'LENGTH',A4,'HEIGHT
      B ',A4,'FROM',A4,' HEIGHT ',A4,'FROM',A4,' HEIGHT ',A4,' ROW',A4,'

```



```

C FLARE',A4,' FALL ',A4,' LENGTH',/44X,' WALL',16X,' WALL',17X,' SPACE
D',/1H,4X,9(A4,6X),/1F,1X,9(F6.2,A4),2X,A4,4X,2(F5.2,A4))
GO TO 51
107 WRITE(IWT,108)(DIM(14),I=1,8),(DIM(I),I=22,26),BWL,DIM(7),BHT,DIM(
A7),BL,DIM(7),(PHI(I),DIM(7),I=1,2),IFLARE,(PHI(I),DIM(7),I=9,10)
108 FORMAT(1HC,17X,2A4,' BASIN ',2A4,7X,A4,' BLOCCK ',A4,6X,A4,' BASIN
A APPROACH ',A4,/1H,17X,' WIDTH HEIGHT LENGTH WIDTH FR
BOM FLARE FALL LENGTH ',/1H,57X,' WALL',/1H,18X,5(A4
C,6X),/1F,16X,5(F6.2,A4),2X,A4,4X,2(F6.2,A4))
51 WRITE(IWT,109)EZ,DIM(7),F1,VZ,DIM(8),DZ,DIM(7),EZZ,DIM(7),F2,VZZ,D
AIM(8),HTW,DIM(7)
109 FORMAT(1HC,4CX,' ENERGY DISSIPATOR HYDRAULIC JUMP ANALYSIS',//20X,'
A ENERGY',14X,' FROUDE NUMBER',17X,' VELOCITY',12X,' DEPTH OF FLCW',//5
BX,' BASIN INLET',F10.2,A4,F19.2,21X,F6.2,A4,10X,F6.2,A4,//5X,' BASIN
C OUTLET',F9.2,A4,F19.2,21X,F6.2,A4,10X,F6.2,A4)
50 RETURN
END

```

```

SUBROUTINE HYDERR
ERROR DIAGNOSTICS
COMMON / INDICE / IRD,IWT,IFRR,IBASIN,IDENT(15)
COMMON / PIPE / KAPPA,PIPES,HQ,WC,SO,QD,YO,VO,T,PK
COMMON / FLOW / QDP,FPC,FPR,YCD,TWD,DTY,YTD,FR,EO,EZ,VZ,DZ,HTW,VZZ
A,F1,F2,EZZ
COMMON / ROCK / DM,X(5),ZERC,HYBRID,DE,RSG,PHI(11),DMAX
COMMON / BASIN / BW1,BW2,TS,TF,BL,VOL,BHT,Z1,Z2,Z3,TO,BWS
COMMON / SCOUR / SDEPR(5),Y(5),V(2,8),DS,WS,SL,TIME,SVOL
COMMON / STREAM / TW,V5,VM
GO TO (1,1,1,1,1,1,1,3,4,2,5,5,9,10,10,10,10,10,10,10,17,18,10),
AIERR
1 WRITE(IWT,101)IERR
101 FORMAT(1H0,5X,'***INPUT PARAMETER CARD ERROR - NO. ',I2,' CARC TYP
AE OUT OF SEQUENCE***')
GO TO 50
2 WRITE(IWT,102)
102 FORMAT(1H0,5X,'***INSUFFICIENT NUMBER OF EFFECTIVE ROCK DIAMETER,S
ACOUR DEPTH VALUES AVAILABLE***',/6X,'***COLCRADO STATE UNIVERSITY
BROCK RIPRAPPED BASIN DESIGN TERMINATED***')
GO TO 50
3 WRITE(IWT,103)
103 FORMAT(1H0,5X,'***NO ENERGY DISSIPATR DESIGN MEETS LIMITS***')
GO TO 50
4 WRITE(IWT,105)
WRITE(IWT,116)
GO TO 50
5 IERR=IERR-11
WRITE(IWT,105)
105 FORMAT(1H0,5X,'***ST. ANTHONY FALLS STILLING BASIN DESIGN TERMINAT
AED - ')
GO TO (8,6),IERR
8 WRITE(IWT,106)
106 FORMAT(1H+,62X,'TAILWATER EXCEEDS SEQUENT DEPTH OF CULVERT BRINK D
AEPTH***')
GO TO 50

```

```

6 WRITE(IWT,107)
107 FORMAT(1H+,62X,'CHUTE BLOCKS EXTEND INTO THE CULVERT***')
GO TO 50
9 WRITE(IWT,109)
109 FORMAT(1H0,5X,'**VERTICAL STILLING WELL DESIGN TERMINATED - WELL
DIAMETER EXCEEDS FIVE INCOMING PIPE DIAMETERS***')
GO TO 50
10 IBASIN=IBASIN-17
WRITE(IWT,110)IBASIN
110 FORMAT(1H0,5X,'**U. S. BUREAU OF RECLAMATION TYPE ',I1,' BASIN TE
ARMINATED - ')
IF(IERR.EQ.24) GO TO 19
IERR=IERR-14
GO TO (7,11,12,13,14,15),IERR
7 WRITE(IWT,111)
111 FORMAT(1H+,62X,'ALLOWABLE BASIN ENTRANCE FROUDE NUMBER EXCEEDED***
A')
GO TO 50
11 WRITE(IWT,106)
GO TO 50
12 WRITE(IWT,107)
GO TO 50
13 WRITE(IWT,113)
113 FORMAT(1H+,62X,'BARREL DISCHARGE EXCEEDS 400. CFS***')
GO TO 50
14 WRITE(IWT,114)
114 FORMAT(1H+,62X,'TAILWATER EXCEEDS HALF OF BAFFLE HEIGHT***')
GO TO 50
15 WRITE(IWT,115)
115 FORMAT(1H+,62X,'OUTLET VELOCITY IS LESS THAN 2 FPS OR GREATER THAN
A 30 FPS***')
GO TO 50
19 WRITE(IWT,119)F1
119 FORMAT(1H+,62X,'BASIN ENTRANCE FROUDE NUMBER OF ',F5.2,' IS LESS T
HAN MINIMUM VALUE',//63X,'RECOMMEND INCREASING BASIN WIDTH TO COMP
BLY WITH MINIMUM FROUDE NUMBER')
GO TO 50

```

```

16 WRITE(IWT,116)
116 FORMAT(IH+,62X,'DISCHARGE PARAMETER LIMIT EXCEEDED***')
GO TO 50
17 WRITE(IWT,117)
117 FORMAT(IH0,5X,'***VERTICAL STILLING WELL DESIGN FOR CIRCULAR PIPE
AONLY***')
GO TO 50
18 WRITE(IWT,118)
118 FORMAT(IH0,15X,'***VERTICAL STILLING WELL DESIGN TERMINATED - ')
WRITE(IWT,116)
50 RETURN
END

```

```

SUBROUTINE HYDDM
C-----EFFECTIVE GRAIN-SIZE DIAMETER OF A ROCK MIXTURE
COMMON / INCICE / IRD,IWT,IERR,IBASIN,IDENT(15)
COMMON / PIPE / KAPPA,PIPES,HO,WO,SO,QD,YO,VO,T,PK
COMMON / FLOW / QDP,FPC,FPR,YCD,TWD,DTY,YTD,FR,EC,EZ,VZ,DZ,HTW,VZZ
A,F1,F2,EZZ
COMMON / ROCK / DM,X(5),ZERO,HYBRID,DE,RSG,PHI(11),DMAX
COMMON / BASIN / BW1,BW2,TS,TF,BL,VUL,BHT,Z1,Z2,Z3,TO,BWS
COMMON / SCOUR / SDEPR(5),Y(5),V(2,8),DS,WS,SL,TIME,SVOL
COMMON / STREAM / TW,VS,VM
DIMENSION DI(10)
SUM=0.
DO 1 I=1,10
DI(I)=(PHI(I)+PHI(I+1))/2.
SUM=SUM+DI(I)*DI(I)
1 CONTINUE
C----- EFFECTIVE ROCK DIAMETER
DE=(SUM/10.)**0.333
RETURN
END

```

```

SUBROUTINE HYDPKK
COLORADC STATE UNIVERSITY ROCK R IPRAPPED BASINS
COMMON / INDICE / IRD,IWT,IERR,IRASIN,IDENT(15)
COMMON / PIPE / KAPPA,PIPES,H0,WC,SO,GD,YC,VO,I,PK
COMMON / FLOW / QDP,FPC,FPR,YCD,TWD,DTY,YTD,FR,EO,EZ,VZ,DZ,HTW,VZZ
A,F1,F2,EZZ
COMMON / ROCK / DM,X(5),ZERO,HYBRID,DE,RS6,PHI(11),DMAX
COMMON / BASIN / BW1,BW2,TS,TF,BL,VOL,BHT,Z1,Z2,Z3,TO,BWS
COMMON / SCOUR / SDEPR(5),Y(5),V(2,8),DS,W,S,SL,TIME,SVOL
COMMON / STREAM / TW,VS,VM
DIMENSION SIZE(2,3)
DIMENSION DMHO(5)
DATA DMHO /0.049,0.0945,0.0974,0.205,0.264/
C----- COMPUTE CULVERT OUTLET FLOW PARAMETERS
TWD=TW/H0+.001
DTY=TW/YO
YTD=YD/HO
OH=HO
C----- TEST FOR MILD OR STEEP SLOPE CASE
CALL HYDBTW
IF((YTD+.01).LT.YCD) GO TO 1
C----- MILD SLOPE CASE
C----- FLOW PARAMETER MODIFICATION
FPC=QDP
FPR=QDP
IF(KAPPA.EQ.1) GO TO 4
IF(KAPPA.EQ.2) GO TO 3
C----- STEEP SLOPE CASE
1 OH=YO
TWD=TW/OH
IF(KAPPA.EQ.2) GO TO 2
C----- CIRCULAR CULVERT
AO=3.1416/4.*OH#OH
FPC=VO*AO/(OH**2.5)
C----- COMPUTE FLOW PARAMETER FOR EQUIVALENT RECTANGULAR CULVERT
4 FPR=FPC*(2.532-3.529*(YO/OH)+2.270*(YO/OH)**2)

```



```

GO TO 5
C----- RECTANGULAR CULVERT
2 A0=WD*OH
FPR=V0*A0/(W0*3)*1.5)
C----- COMPUTE FLOW PARAMETER FOR EQUIVALENT CIRCULAR CULVERT
3 FPC=FPR/(2.532-3.529*(YG/OH)+2.270*(YG/OH)**2)
5 CALL HYCSCR
IF((SDEPR(2).GE.0.).AND.(SDEPR(3).GE.0.)) GC TC 45
GO TO 44
45 IF(KAPPA.EQ.1) SDEPR(3)=-1.0
IF(KAPPA.EQ.2) SDEPR(2)=-1.0
44 DO 6 I=1,5
X(I)=DMFO(I)*OH
Y(I)=SDEPR(I)*OH
6 CONTINUE
C----- BUILD EFFECTIVE DIAMETER VS SCOUR DEPTH ARRAY
NP=0
DC 7 I=1,5
IF(Y(I).LT.0.) GO TO 8
NP=NP+1
V(1,NP)=X(I)
V(2,NP)=Y(I)
C----- TWO COORDINATE SETS MINIMUM TEST
8 IF((I.EQ.5).AND.(NP.LT.2)) GO TO 9
GO TO 7
9 IERR=11
GO TO 23
7 CONTINUE
C----- PRINT OUTPUT TITLES
CALL HYDOG2
C----- COMPUTE EFFECTIVE DIAMETER FOR NCN-SCOURING BASIN
11 DO 15 I=1,NP
IF(V(2,I)-0.)14,14,15
14 ZERO=V(1,I)
IF(I.LE.2) GO TO 12
IF((V(2,I-1)-V(2,I))/(V(1,I)-V(1,I-1))).GE..5) GO TO 12

```

```

ZERO=V(1,I-2)-((V(1,I-1)-V(2,I-2))/(V(2,I-1)-V(2,I-2)))*V(2,I-2)
GO TO 12
15 CONTINUE
ZERO=V(1,NP-1)-V(2,NP-1)*((V(1,NP)-V(1,NP-1))/(V(2,NP)-V(2,NP-1)))
C----- COMPUTE EFFECTIVE DIAMETER FOR HYBRID/SCOURING BASIN ZONE DIVISION
12 DO 17 I=1,NP
IF((2.*V(1,I))-V(2,I))17,18,19
18 HYBRID=V(1,I)
GO TO 13
19 IF(1.EQ.1) GO TO 31
GO TO 30
17 CONTINUE
30 HYBRID=(V(2,I-1)-(V(2,I)-V(2,I-1)))/(V(1,I)-V(1,I-1))*V(1,I-1)/(2.
A-(V(2,I)-V(2,I-1))/(V(1,I)-V(1,I-1))
GO TO 13
31 IF(V(2,I)) 32,32,33
32 HYBRID=ZERO
GO TO 13
33 HYBRID=(V(2,I)-(V(2,I+1)-V(2,I)))/(V(1,I+1)-V(1,I))*V(1,I)/(2.-(V
A2,I+1)-V(2,I))/(V(1,I+1)-V(1,I))
C----- COMPUTE SCOUR DEPTH FOR RIPRAP EFFECTIVE DIAMETER
13 IF(DE.GE.ZERO) SD=0.0
IF((DE.GE.ZERO).OR.(DE.EQ.0.0)) GO TO 39
DO 34 I=1,NP
IF(V(1,I)-DE)34,35,36
35 SD=V(2,I)
GO TO 39
36 J=I
IF(1.EQ.1) J=2
GO TO 37
34 CONTINUE
J=NP
37 SD=V(2,J-1)+(DE-V(1,J-1))*V(2,J)-V(2,J-1)/(V(1,J)-V(1,J-1))
39 MP=1
SIZE(1,MP)=ZERO
SIZE(2,MP)=0.

```

```

IF(HYBRID.EQ.ZERO) GO TC 40
MP=MP+1
SIZE(1,MP)=HYBRID
SIZE(2,MP)=2.*HYBRID
40 IF((HYBRID.EQ.ZERO).AND.(DE.LE.ZERO)).OR.(DE.EQ.O.)) GO TC 41
MP=MP+1
SIZE(1,MP)=DE
SIZE(2,MP)=SD
41 DO 42 J=1,MP
DO 43 I=1,NP
IF(SIZE(1,J).EQ.V(1,I)) GO TO 42
43 CONTINUE
NP=NP+1
V(1,NP)=SIZE(1,J)
V(2,NP)=SIZE(2,J)
42 CONTINUE
IF(RSG.FQ.2.7G) GO TO 46
C----- COMPENSATION FOR RIPRAP SPECIFIC GRAVITY NOT EQUAL TO 2.7G
DO 29 I=1,NP
IF(V(1,I).EQ.DE) GO TO 29
V(1,I)=V(1,I)*(2.70/RSG)**(5./6.)
29 CONTINUE
C----- COMPUTE NCN-SCOURING BASIN DIMENSICNS
46 IF((TW/HQ+.001).LT.1.0G) GO TO 1C
C----- HIGH TAILWATER CASE
U=VM/(PK*VO)
IF(U.LE..6) ZL=6.*WO*PK*VO/VM
IF(U.GT..6) ZL=WO*(22.62474+98.61993*U**3-33.01651*U**5-87.13084*U
A**2)
ZW1=PIPES*WO+(PIPES-1.)*T
ZW2=QD*PIPES/(TW*VS)
GO TO 38
10 GO TO (26,27),KAPPA
26 FO=1.5
IF(DTY.LE..23) TO=1.8-5.5*DTY
IF((DTY.GT..23).AND.(DTY.LE..40)) TO=.0714/DTY**1.42

```

```

IF(DTY.GT..40) TO=.0495/DTY**1.82
GO TO 28
27 FJ=1.4
IF(DTY.LF..20) TO=.9+4.67*(.2-DTY)
IF((DTY.GT..2).AND.(DTY.LT.1.))TC=.05+1.3158*(1.-DTY)**1.91624
IF(DTY.GE.1.) TC=.05
28 IF(TO.LT..05) TC=.05
ZL=0.5/TO*(QD/(TW*VS)-WO)
ZW1=PIPES*WO+(PIPES-1.)*T
ZW2=ZW1+2.*ZL*TC
C----- COMPUTE MINIMUM SCOURING BASIN DIMENSICNS
38 HLS=31.*(1.+5.*SO)*DTY*2.*HYBRID
HL=1.9*HLS
HWS=17.94*HYBRID
HW1=HWS+(PIPES-1.)*(WO+T)+2.*HO
HW2=HW1
HWS=HWS+(PIPES-1.)*(WO+T)
C----- COMPUTE BASIN HEIGHT
BHT=1.5*AMAX1(YO,TW)
DO 16 I=1,NP
DM=V(1,I)
DS=V(2,I)
TS=AMAX1(CMAX,(2.*DM))
TF=TS
IF(V(1,I).GE.ZERO) GO TC 20
IF(HYBRID.EQ.ZERO) GO TC 16
IF((V(1,I).GE.HYBRID).AND.(V(1,I).LT.ZERO)) GO TO 21
IF(V(1,I).LT.HYBRID) GO TO 22
C----- NON-SCOURING BASIN
20 IBASIN=1
WS=0.
SL=0.
BL=ZL
BW1=ZW1
BW2=ZW2
GO TO 24

```

```

C----- HYBRIC BASIN
21 IBASIN=2
F=(DM-HYBRID)/(ZERO-HYBRID)
WS=HWS*(1.-F)
SL=HLS*(1.-F)
BL=HL+F*(ZL-HL)
BW1=HW1+F*(ZW1-HW1)
BW2=HW2+F*(ZW2-HW2)
GO TO 24
C----- SCOURING BASIN
22 IBASIN=3
SL=11.
C----- COMPUTE SCOUR LENGTH
IF((DS/DM).LT.27.5) SL=0.01503*(27.5-(DS/DM))**2.22123+11.
SL=SL*(1.+0.05*SC*100.)*DTY#DS
C----- COMPUTE BASIN LENGTH - SCOURING BASINS
BL=1.9*SL
C----- COMPUTE WIDTH OF SCOUR
IF((DS/DM).LE.10.) WS=11.474*DM*(DS/DM)**0.64489
IF((DS/DM).GT.10.) WS=DM*(3.*(DS/DM)+20.)
BW1=WS+(PIPES-1.)*(WO+T)+2.*HO
BW2=BW1
WS=WS+(PIPES-1.)*(WO+T)
C----- COMPUTE BASIN VOLUME
24 CALL HYCV01
C----- PRINT OUTPUT
TS=DS+TF
CALL HYC003
16 CONTINUE
GO TO 25
23 CALL HYDERR
25 RETURN
END

```

```

SUBROUTINE HYDSCR
COLORADC STATE UNIVERSITY ROCK SCOUR DEPTH SUBROUTINE
COMMON / INCICE / IPD,IWT,IERR,I BASIN,IDENT(15)
COMMON / PIPE / KAPPA,PIPES,HO,WO,SO,QD,YG,VU,T,PK
COMMON / FLOW / QDP,FPC,FPR,YCD,TWD,DTY,YTD,FR,ED,EZ,VZ,DZ,HT,W,VZZ
A,F1,F2,EZZ
COMMON / ROCK / DM,X(5),ZERO,HYBRID,DE,RSG,PHI(11),DMAX
COMMON / BASIN / BW1,BW2,TS,TF,BL,VOL,BHT,Z1,Z2,Z3,T0,BWS
COMMON / SCOUR / SDEPR(5),Y(5),V(2,8),DS,WS,SL,TIME,SVOL
COMMON / STREAM / Tw,VS,VM
DIMENSION F48(16,8),F49(14,9),F5C(14,10),F51(12,10),F52(13,6),R48(
18),R49(5),R50(10),R51(10),R52(6),Z(5,3),DSO(2)
C----- SCOUR DEPTH RATIOS - PLAIN RECTANGULAR OUTLET (DM/HO=0.049)
DATA F48 /0.80,0.25,0.0,0.0,0.0,0.0,0.0,0.0,0.0,0.0,0.0,0.0,0.0,0.0,0.0,0.0,0.0,0.0,
10,0.0,0.0,-1.0,1.40,0.95,0.12,0.02,0.0,0.0,0.0,0.0,0.0,0.0,0.0,0.0,0.0,0.0,0.0,
20,0.0,0.0,0.0,-1.0,-1.0,-1.0,1.45,1.02,0.40,0.05,0.0,0.0,0.0,0.0,0.0,0.0,0.0,
30,0.0,0.0,0.0,-1.0,-1.0,-1.0,2.26,2.05,1.83,1.55,1.15,0.40,0.12,0.0,
412,0.12,0.12,-1.0,-1.0,-1.0,-1.0,-1.0,-1.0,2.60,2.35,2.10,1.82,1.5
50,1.24,1.07,0.97,0.95,0.93,0.90,0.86,-1.0,-1.0,-1.0,-1.0,-1.0,2.83,2.63
6,2.42,2.20,1.93,1.65,1.47,1.38,1.35,1.33,1.31,1.3,1.30,-1.0,-1.0,-1.0,
7-1.0,-1.0,3.20,3.04,2.80,2.56,2.27,2.03,1.87,1.80,1.77,1.75,1.74,-
81.0,-1.0,-1.0,-1.0,-1.0,-1.0,3.77,3.58,3.38,3.18,2.95,2.73,2.52,2.
938,2.34,2.32,-1.0/
C----- SCOUR DEPTH RATIOS - PLAIN CIRCULAR CUTLET (DM/D= .0945)
DATA F5C /0.20,0.0,0.0,0.0,0.0,0.0,0.0,0.0,0.0,0.0,0.0,0.0,0.0,0.0,0.0,0.0,0.0,0.0,
A,0.40,0.50,0.27,0.10,0.03,0.0,0.0,0.0,0.0,0.0,0.0,0.0,0.0,0.0,0.0,0.0,0.0,0.0,
B,0.0,0.55,0.65,0.70,0.43,0.20,0.07,0.0,0.0,0.0,0.0,0.0,0.0,0.0,0.0,0.0,0.0,0.0,0.0,
C,0.64,0.72,0.77,0.83,0.77,0.33,0.13,0.04,0.0,0.0,0.0,0.0,0.0,0.0,0.0,0.0,0.0,0.0,0.0,
D,67,0.76,0.85,0.93,0.98,0.95,0.50,0.20,0.11,0.06,0.02,0.0,0.0,0.0,0.0,0.0,0.0,0.0,0.0,
E-1.0,0.84,0.90,0.97,1.03,1.00,0.70,0.35,0.28,0.27,0.25,0.24,0.23,0
F,22,-1.0,-1.0,1.0,1.13,1.23,1.16,0.83,0.65,0.60,0.60,0.60,0.60,0.60,0.60,0.60,0.60,0.60,0.60,
G60,-1.0,-1.0,-1.0,-1.0,-1.0,-1.0,-1.0,-1.0,2.0,1.86,1.72,1.56,1.42,1.3
H0,1.17,-1.0,-1.0,3.37,3.25,3.11,2.96,2.83,2.69,2.53,2.38,2.20,2.06
I,1.97,-1.0,-1.0,-1.0,-1.0,-1.0,-1.0,-1.0,3.73,3.62,3.48,3.36,3.24,
J3.12,3.06,-1.0,-1.0/
C----- SCOUR DEPTH RATIOS - PLAIN RECTANGULAR OUTLET (DM/HO= .0974)

```





C----- TAILWATER/CULVERT RISE RATIO LIMITATIONS

IF(TWD.LT.Z(I,1)) GO TO 27  
IF(TWD.GT.Z(I,3)) GO TO 27  
NC=(TWD\*10.+(C.1-Z(I,1))\*10.)  
CN=NC-1  
C=(TWD-(0.1\*CN+Z(I,1)))/0.1

C----- ROW INDEX

NROW=Z(I,2)

DO 2 J=1,NROW

GO TO (3,4,5,6,7),I

3 IF(FPR-R48(J))8,8,2

4 IF(FPC-R50(J))8,8,2

5 IF(FPR-R49(J))8,8,2

6 IF(FPC-R51(J))8,8,2

7 IF(FPC-R52(J))8,8,2

8 IF(J.EQ.1) GO TO 27

GO TO (11,12,13,14,15),I

11 R=((FPR-R48(J-1))/(R48(J)-R48(J-1)))

GO TO 16

12 R=((FPC-R50(J-1))/(R50(J)-R50(J-1)))

GO TO 16

13 R=((FPR-R49(J-1))/(R49(J)-R49(J-1)))

GO TO 16

14 R=((FPC-R51(J-1))/(R51(J)-R51(J-1)))

GO TO 16

15 R=((FPC-R52(J-1))/(R52(J)-R52(J-1)))

16 NR=J-1

GO TO 17

2 CONTINUE

GO TO 27

C----- TEST FOR NULL DATA POINTS PRIOR TO INTERPOLATION

17 GO TO (21,22,23,24,25),I

21 IF((F48(NC,NR).EQ.-1.0).OR.(F48(NC,NR+1).EQ.-1.0)) GO TO 27

IF((C.GT.C.).AND.((F48(NC+1,NR).EQ.-1.0).OR.(F48(NC+1,NR+1).EQ.-1.

10)) GO TO 27

DSD(1)=F48(NC,NR)+C\*(F48(NC+1,NR)-F48(NC,NR))

```

DSD(2)=F48(NC,NR+1)+C*(F48(NC+1,NR+1)-F48(NC,NR+1))
GO TO 26
22 IF((F50(NC,NR).EQ.-1.0).OR.(F50(NC,NR+1).EQ.-1.0)) GO TO 27
IF((C.GT.0.).AND.((F50(NC+1,NR).EQ.-1.0).OR.(F50(NC+1,NR+1).EQ.-1.
10))) GO TO 27
DSD(1)=F50(NC,NR)+C*(F50(NC+1,NR)-F50(NC,NR))
DSD(2)=F50(NC,NR+1)+C*(F50(NC+1,NR+1)-F50(NC,NR+1))
GO TO 26
23 IF((F49(NC,NR).EQ.-1.0).OR.(F49(NC,NR+1).EQ.-1.0)) GO TO 27
IF((C.GT.0.).AND.((F49(NC+1,NR).EQ.-1.0).OR.(F49(NC+1,NR+1).EQ.-1.
10))) GO TO 27
DSD(1)=F49(NC,NR)+C*(F49(NC+1,NR)-F49(NC,NR))
DSD(2)=F49(NC,NR+1)+C*(F49(NC+1,NR+1)-F49(NC,NR+1))
GO TO 26
24 IF((F51(NC,NR).EQ.-1.0).OR.(F51(NC,NR+1).EQ.-1.0)) GO TO 27
IF((C.GT.0.).AND.((F51(NC+1,NR).EQ.-1.0).OR.(F51(NC+1,NR+1).EQ.-1.
10))) GO TO 27
DSD(1)=F51(NC,NR)+C*(F51(NC+1,NR)-F51(NC,NR))
DSD(2)=F51(NC,NR+1)+C*(F51(NC+1,NR+1)-F51(NC,NR+1))
GO TO 26
25 IF((F52(NC,NR).EQ.-1.0).OR.(F52(NC,NR+1).EQ.-1.0)) GO TO 27
IF((C.GT.0.).AND.((F52(NC+1,NR).EQ.-1.0).OR.(F52(NC+1,NR+1).EQ.-1.
10))) GO TO 27
DSD(1)=F52(NC,NR)+C*(F52(NC+1,NR)-F52(NC,NR))
DSD(2)=F52(NC,NR+1)+C*(F52(NC+1,NR+1)-F52(NC,NR+1))
GO TO 26
27 SDEPR(I)=-1.0
GO TO 1
C----- SCOUR DEPTH/CULVERT RISE RATIOS
26 SDEPR(I)=DSD(1)+R*(DSD(2)-DSD(1))
1 CONTINUE
30 RETURN
END

```

```

SUBROUTINE HYDBTW
C----- MILD SLOPE - STEEP SLOPE TEST SUBROUTINE
COMMON / INDICE / IRD,IWT,IFRR,IBASIN,IDENT(15)
COMMON / PIPE / KAPPA,PIPES,HU,WC,SC,QD,YC,VO,T,PK
COMMON / FLCW / QDP,FPC,FPR,YCD,TWD,DTY,YTD,FR,EO,EZ,VZ,DZ,HTW,VZZ
A,F1,F2,EZ
COMMON / ROCK / DM,X(5),ZERO,HYBRID,DE,RSG,PHI(11),DMAX
COMMON / BASIN / BWL,BW2,TS,TF,BL,VCL,BHT,Z1,Z2,Z3,TO,RWS
COMMON / SCOUR / SDEPR(5),Y(5),V(2,8),DS,WS,SL,TIME,SVOL
COMMON / STREAM / TW,VS,VM
DIMENSION R16(13,11),C17(13,11),YOD(2)
C----- EFFECT CF TAILWATER ON BRINK DEPTH - HORIZONTAL AND MILD SLOPING
C----- RECTANGULAR CULVERTS
DATA R16 / 0.0,0.15,0.24,0.325,0.38,0.44,0.50,0.55,0.61,0.71,0.80,0
A.88,0.97,0.10,0.16,0.25,0.33,0.39,0.45,0.51,0.57,0.62,0.72,0.81,0.
B89,0.97,0.20,0.26,0.33,0.39,0.45,0.52,0.57,0.625,0.72,0.82,0.
C90,0.98,0.30,0.30,0.34,0.40,0.47,0.52,0.58,0.63,0.725,0.82,0.
D91,0.98,0.40,0.40,0.40,0.42,0.475,0.53,0.58,0.63,0.73,0.825,0
E.91,1.00,0.50,0.50,0.50,0.50,0.51,0.54,0.59,0.64,0.73,0.83,0.
F92,1.00,0.60,0.60,0.60,0.60,0.60,0.60,0.62,0.66,0.75,0.84,0.9
G3,1.00,0.70,0.70,0.70,0.70,0.70,0.70,0.70,0.71,0.79,0.88,1.00
H,1.00,0.80,0.80,0.80,0.80,0.80,0.80,0.80,0.80,0.89,0.98,1.00,1
I,1.00,0.90,0.90,0.90,0.90,0.90,0.90,0.90,0.90,0.99,1.00,1.00,1
J.00,1.00,1.00,1.00,1.00,1.00,1.00,1.00,1.00,1.00,1.00,1.00,1.
K00/
C----- EFFECT CF TAILWATER ON BRINK DEPTH - HORIZONTAL AND MILD SLOPING
C----- CIRCULAR CULVERTS
DATA C17 / 0.0,0.225,0.325,0.40,0.47,0.525,0.575,0.62,0.66,0.74,0.8
A2,0.90,0.98,0.10,0.23,0.33,0.41,0.475,0.53,0.575,0.62,0.66,0.74,0.
B82,0.90,0.98,0.20,0.25,0.34,0.42,0.48,0.53,0.58,0.625,0.67,0.75,0.
C825,0.91,0.98,0.30,0.30,0.37,0.43,0.49,0.55,0.59,0.63,0.675,0.76,0
D.84,0.92,0.99,0.40,0.40,0.41,0.46,0.52,0.57,0.61,0.65,0.69,0.77,0.
E85,0.93,1.00,0.50,0.50,0.50,0.51,0.55,0.59,0.63,0.67,0.71,0.79,0.8
F7,0.95,1.00,0.60,0.60,0.60,0.61,0.63,0.67,0.70,0.74,0.825,0.9
G1,1.00,1.00,0.70,0.70,0.70,0.70,0.70,0.70,0.75,0.78,0.875,0.9
H75,1.00,1.00,0.80,0.80,0.80,0.80,0.80,0.80,0.80,0.84,0.95,1.0

```

```

I0,1.00,1.00,0.90,0.90,0.90,0.90,0.90,0.90,0.90,0.90,0.90,0.90,0.94,1.00,1.00
J,1.00,1.00,1.00,1.00,1.00,1.00,1.00,1.00,1.00,1.00,1.00,1.00,1.00,1.00,1.00,
K1.00,1.00/
IF(TWD.GE.1.00) GO TO 6
IF((KAPPA.EQ.1).AND.(QDP.GT.6.)) GO TO 6
IF((KAPPA.EQ.2).AND.(QDP.GT.8.)) GO TO 6
C----- COLUMN INDEX
NC=(10.*TWD+1.)
CN=NC-1
C=(TWD-CN*0.1)/C.1
C----- ROW INDEX
C----- CIRCULAR CULVERT - RECTANGULAR CULVERT BRANCH
IF((KAPPA.EQ.2).AND.(QDP.GT.4.)) GO TO 1
NR=(QDP/0.5+1.)
RN=NR-1
R=(QDP-RN*0.5)/C.5
GO TO 2
1 NR=(QDP+5.)
RN=NR-5
R=(QDP-RN)
2 GO TO (3,4),KAPPA
3 YOD(1)=C17(NR,NC)+C*(C17(NR,NC+1))-C17(NR,NC))
YOD(2)=C17(NR+1,NC)+C*(C17(NR+1,NC+1))-C17(NR+1,NC))
GO TO 8
4 YOD(1)=R16(NR,NC)+C*(R16(NR,NC+1))-R16(NR,NC))
YOD(2)=R16(NR+1,NC)+C*(R16(NR+1,NC+1))-R16(NR+1,NC))
8 YCD=YOD(1)+R*(YOD(2)-YOD(1))
GO TO 5
6 YCD=1.0C
5 RETURN
END

```



```

SUBROUTINE HYDVOL
  BASIN VOLUME CALCULATIONS
  COMMON / INCICE / IRD,IWT,IERR,IBASIN,IDENT(L5)
  COMMON / PIPE / KAPPA,PIPES,HO,WC,SO,QD,YO,VO,T,PK
  COMMON / FLOW / QDP,FPC,FPR,YCD,TWD,DTY,YTD,FR,EO,EZ,VZ,DZ,HTW,VZZ
  A,F1,F2,EZZ
  COMMON / ROCK / DM,X(5),ZERO,HYBRID,CE,RSG,PHI(11),DMAX
  COMMON / BASIN / BW1,BW2,TS,TF,BL,VOL,HHT,Z1,Z2,Z3,TO,BWS
  COMMON / SCOUR / SOEPR(5),Y(5),V(2,8),DS,WS,SL,TIME,SVCL
  COMMON / STREAM / TW,V,S,VM
  ENTRY HYDVOL
  C----- NON-SCOURING, HYBRID, SCOURING BASIN VOLUMES
  VOL=0.
  IF (IBASIN.EQ.3) GO TO 1
  C----- APRON VOLUME FOR NON-SCOURING AND HYBRID BASINS
  VOL=VOL+BL/2.*( (BW1+BW2)*TF+DS/4.*(3.*BW1+BW2) )
  C----- END SLOPE VOLUME FOR NON-SCOURING AND HYBRID BASINS
  VOL=VOL+TS*BW2*TF*SQRT(Z3*Z3+1.)
  C----- EMBANKMENT SLOPE VOLUME FOR NON-SCOURING AND HYBRID BASINS
  VOL=VOL+2.25*TS*BHT*BHT*SQRT(Z1*Z1+1.)*Z2
  C----- UNDER SLOPE VOLUME FOR NON-SCOURING AND HYBRID BASINS
  VOL=VOL+TS/2.*SQRT(Z1*Z1+1.)*TF*BW1
  C----- SIDE SLOPE VOLUME - NON-SCOURING AND HYBRID BASINS
  VOL=VOL+(2.*BL*SQRT(TO*TO+1.)+2.*TF*SQRT(Z3*Z3+1.)+1.5*BHT*Z1)*(TS
  A*1.5*BHT*SQRT(Z2*Z2+1.)+TS*TS*(Z2*Z2+1.))/(2.*Z2)
  GO TO 24
  C----- APRON VOLUME FOR SCOURING BASINS
  1 VOL=VOL+BL*TS*BW2+SL*BW2*(DS+TF-TS)
  C----- END SLOPE VOLUME FOR SCOURING BASINS
  VOL=VOL+TS*BW2*TF*SQRT(Z3*Z3+1.)
  C----- EMBANKMENT SLOPE VOLUME - SCOURING BASINS
  VOL=VOL+TS*(BW2-WO+1.5*BHT*Z2)*(1.5*BHT*(Z1*Z1+1.))
  C----- UNDER SLOPE VOLUME FOR SCOURING BASINS
  VOL=VOL+TS/2.*SQRT(Z1*Z1+1.)*(DS+TF)*BW2
  C----- SIDE SLOPE VOLUME - SCOURING BASINS
  VOL=VOL+TS*(3.*BHT*SQRT(Z2*Z2+1.)+TS*(Z2*Z2+1.)/Z2)*(1.5*BHT*Z1+BL

```



```

A+TF*SQRT(Z3*Z3+1.))
24 VOL=VOL/27.
GO TO 25
ENTRY HYDVC2
C----- U. S. ARMY ENGINEER WATERWAYS EXPERIMENT STATION BASIN VOLUMES
GO TO (2,3,4,4),IBASIN
2 VOL=((BW1+BW2)/2.*BL*TF)/27.
GO TO 25
3 VOL=((BW1+BW2)/2.*5.*WO+BW2*WO)*TF/27.
GO TO 25
4 VOL=BW1*BW2*TF/27.
25 RETURN
END

```

```

SUBROUTINE HYDCGE
C----- U. S. ARMY ENGINEER WATERWAYS EXPERIMENT STATION EROSION STUDY
COMMON / INDICE / IRD,IWT,IERR,IBASIN,IDENT(15)
COMMON / PIPE / KAPPA,PIPES,HO,WC,SO,QD,YC,VO,T,PK
COMMON / FLOW / QDP,FPC,FPR,YCD,TWD,CTY,YTD,FR,EO,EZ,VZ,DZ,HTW,VZZ
A,F1,F2,EZZ
COMMON / ROCK / DM,X(5),ZERO,HYBRID,DE,RSG,PHI(11),DMAX
COMMON / BASIN / BW1,BW2,TS,TF,BL,VOL,BHT,Z1,Z2,Z3,TO,BWS
COMMON / SCOUR / SDEPR(5),Y(5),V(2,8),DS,WS,SL,TIME,SVOL
COMMON / STREAM / TW,VS,VM
DIMENSION C(4)
DATA C/.020,.016,.0125,.0082/
ENTRY HYDC01
C----- ANTICIPATED SCOUR HOLE EXTENT - EFFECTIVE ROCK DIAMETER = .001
IF((TW/HO).GE..50) GO TC 1
C----- MAXIMUM DEPTH OF SCOUR (TAILWATER < 0.5WC)
DS=0.8*WO*(QD/WO**2.5)**C.375*TIME**C.1
C----- MAXIMUM WIDTH OF SCOUR (TAILWATER < 0.5WC)
WS=1.*WO*(QD/WO**2.5)**C.915*TIME**C.0.15
C----- MAXIMUM LENGTH OF SCOUR (TAILWATER < 0.5WC)
SL=2.4*WO*(QD/WO**2.5)**C.71*TIME**C.0.125
C----- VOLUME OF SCOUR (TAILWATER < 0.5WC)
SVOL=WO**3.*.73*(QD/WO**2.5)**2.*TIME**C.375
GO TO 3
C----- MAXIMUM DEPTH OF SCOUR (TAILWATER > = 0.5WC)
1 DS=0.74*WO*(QD/WO**2.5)**C.375*TIME**C.1
C----- MAXIMUM WIDTH OF SCOUR (TAILWATER > = 0.5WC)
WS=.72*WO*(QD/WO**2.5)**C.915*TIME**C.15
C----- MAXIMUM LENGTH OF SCOUR (TAILWATER > = 0.5WC)
SL=4.1*WO*(QD/WO**2.5)**C.71*TIME**C.0.125
C----- VOLUME OF SCOUR (TAILWATER > = 0.5WC)
SVOL=.62*WO**3.*(QD/WO**2.5)**2.*TIME**C.375
3 SVOL=SVCL/27.
CALL HYDC01
CALL HYDC04
GO TO 25

```

```

ENTRY HYDC02
IF((FR.GT.4.).OR.(QDP.GT.10.)) GC TC 25
CALL HYC011
CALL HYC007
DO 8 I=1,4
  IRASIN=I
C-----MINIMUM AVERAGE SIZE OF STONE
D50=C(I)*WO*((WD/TW)*(QD/WD**2.5)**1.333
PHI(6)=C50
GO TO (2,4,5,6),I
C----- 1 - HORIZONTAL RIPRAP BLANKET
C-----LENGTH OF STONE PROTECTION
  2 BL=1.7*WO*(QD/WD**2.5)+8.
  BW1=3.*WO
  BHT=0.
C-----IF(TW.GF.(0.5*HC)) GO TC 9
C-----RECOMMENDED WIDTH OF STONE PROTECTION FOR MINIMUM TAILWATER
  BW2=BW1+BL
  TF=WD*FR/2.
GO TO 13
C-----RECOMMENDED WIDTH OF STONE PROTECTION FOR MAXIMUM TAILWATER
  9 BW2=BW1+.4*BL
  TF=WO*(.5*FR-.3)
  13 IF((TF.LT.D50) TF=D50
GO TO 7
C----- 2 - LINED CHANNEL EXPANSION
  4 BW1=3.*WO
  BW2=5.*WO
  BL=5.*WO
  TF=2.*D50
  BHT=0.0
GO TO 7
C----- 3 - 0.5WD DEEP PREFORMED SCOUR HCLE
  5 BHT=.5*WO
  TF=2.*D50
GO TO 26

```

C----- 4 - 1.0WD DEEP PREFORMED SCOUR HCLE

```
6 BHT=WO
  TF=2.*D50
26 BW1=2.*WO+6.*BHT
   BW2=BA1
   BL=3.*WO+6.*BHT
  7 CALL HYDV02
   8 CALL HYD008
25 CONTINUE
   END
```

```

C-----
SUBROUTINE HYDENG
BASIN ENTRANCE ENERGY
COMMON / INCICE / IRD, IWT, IERR, IRASIN, IDENT(15)
COMMON / PIPE / KAPPA, PIPES, HO, WC, SO, QD, YO, VO, T, PK
COMMON / FLOW / QDP, FPC, FPR, YCD, TWD, DTY, YTD, FR, EC, EZ, VZ, DZ, HTW, VZZ
A, F1, F2, EZZ
COMMON / ROCK / DM, X(5), ZERO, HYBRID, CE, RSG, PHI(11), DMAX
COMMON / BASIN / BW1, BW2, TS, TF, BL, VOL, BHT, Z1, Z2, Z3, TC, BWS
COMMON / SCOUR / SDEPR(5), Y(5), V(2, 8), CS, WS, SL, TIME, SVOL
COMMON / STREAM / TW, VS, VM
C-----
SUPERCRITICAL DEPTH AND SPILLWAY VELOCITY COMPUTATIONS
DELTA=0.1
ISET=0
P=2./3.*EZ
G=64.4
W=BW1
1 A=G*W*W*P*P*P-G*W*W*EZ*P*P+QD*QD
  IF(A) 2, 3, 4
2 P=P-DELTA
  GO TO 1
4 P=P+DELTA
  DELTA=DELTA/10.
  P=P-DELTA
  IF(ISET-5) 5, 3, 3
5 ISET=ISET+1
  GO TO 1
3 DZ=P
  VZ=QD/(W*DZ)
  RETURN
  END

```

```

SUBROUTINE HYDPPA
SMOOTH-FLOOR FLARED BASIN
COMMON / INCICE / IRD,IWT,IERR,IBASIN,IDENT(15)
COMMON / PIPE / KAPPA,PIPES,HO,WC,SO,QD,YO,VO,T,PK
COMMON / FLOW / QDP,FPC,FPR,YCD,TWD,DTY,YTD,FR,EO,EZ,VZ,DZ,HTW,VZZ
A,F1,F2,EZZ
COMMON / ROCK / DM,X(5),ZERO,HYBRID,DE,RSG,PHI(11),DMAX
COMMON / BASIN / BW1,BW2,TS,TF,BL,VOL,BHT,Z1,Z2,Z3,TO,BWS
COMMON / SCOUR / SDEPR(5),Y(5),V(2,8),DS,WS,SL,TIME,SVOL
COMMON / STREAM / TW,VS,VM
DIMENSION XCOF(3)
IF((FR.LE.1.00).AND.(YO.LT.HO)) GO TO 5
RHO=1.94
GAMMA=62.4
CALCULATE CULVERT OUTLET FLOW AREA
AO=QD/VC
CALCULATE MOMENTUM CORRECTION COEFFICIENTS
GO TO (1,2),KAPPA
FOR CIRCULAR PIPE
1 B2=1.02
B1=0.46452+C.35468*(TW/YO)+C.02237*QC/(WO**2.5)
IF(6.*B1.LT.QD/(WO**2.5)) B1=0.82666+0.75654*(TW/YO)-0.10305*QD/(W
AO**2.5)
GO TO 3
FOR RECTANGULAR CULVERT
2 B2=1.0
IF(TW.LT.YO) GO TO 4
B1=1.
GO TO 3
4 B1=1.-0.33646*(1.0-(TW/YO))**0.40975
IF(B1.GT.1.0)B1=1.0
CALCULATE CULVERT OUTLET MOMENTUM
3 CMU=.5*(.5*B1+GAMMA*YO*AO+B2*RHG*VO*QD)
CALCULATE TANGENT OF FLARE ANGLE
TO=1./((3.*FR)
XCOF(1)=RHO*QD*QD

```



```

XC0F(2)=-4.*CM0*TW*TO
XC0F(3)=2.*GAMMA*TW*TW*TW*TO*TO
QUAD=XC0F(2)*XC0F(2)-4.*XC0F(3)*XC0F(1)
IF(QUAD.LE.0.) GO TO 7
HL=AMAX1((-XC0F(2)+SQRT(QUAD))/(2.*XC0F(3)),(-XC0F(2)-SQRT(QUAD)) /
1(2.*XC0F(3)))
BL=BL-(W0/2./TO)+6.*TW
GO TO 6
7 HL=0.0
C----- CALCULATE UPSTREAM BASIN WIDTH
6 HW1=W0
C----- CALCULATE DOWNSTREAM BASIN WIDTH
HW2=HW1+2.*HL*TO
C----- COMPUTE BASIN HEIGHT
HHT=1.5*4MAX1(Y0,TW)
CALL HYD011
CALL HYD013
5 RETURN
END

```

```

SUBROUTINE SAF
C-----ST. ANTHONY FALLS STILLING BASIN
C-----TYPE - HYDRAULIC JUMP BASIN
COMMON / INCICE / IRD,IWT,IERR,I,BASIN,IDENT(15)
COMMON / PIPE / KAPPA,PIPES,HO,WO,SO,QD,YO,VO,T,PK
COMMON / FLOW / QDP,FPC,FPR,YCD,TWD,DTY,YTD,FR,EO,EZ,VZ,DZ,HT,h,VZZ
A,F1,F2,EZZ
COMMON / ROCK / DM,X(5),ZERO,HYBRID,DE,RSG,PHI(11),DMAX
COMMON / BASIN / BW1,BW2,TS,TF,BL,VOL,BHT,Z1,Z2,Z3,TO,BWS
COMMON / SCOUR / SDEPR(5),Y(5),V(2,8),DS,WS,SL,TIME,SVOL
COMMON / STREAM / Tw,VS,VM
IERR=10
IF(QDP.GT.9.5) GO TO 10
C----- COMPUTE CULVERT OUTLET ENERGY-TRANSITION HEAD LOSS
H=0.
EZ=EO-(0.15*VO*VC/64.4)
C----- COMPUTE BASIN WIDTH
BW1=0.3*WO*QDP
IERR=12
C----- TEST FOR BASIN WIDTH LESS THAN CULVERT SPAN
IF(BW1.LT.WO)BW1=WO
C----- TEST FOR ADEQUATE TAILWATER DEPTH FOR HYDRAULIC JUMP
IF(FP.LE.1.00) GO TO 1
IF((YO*(-1.+SQRT(8.*FR*FR+1.))/2.)-Tw)10,10,1
1 EZ=EZ+0.1
H=H+0.1
CALL HYDENG
F=VZ*VZ/(32.2*DZ)
F1=SQRT(F)
IF(F.LT.3.) GO TO 1
DZZ=DZ/2.*(-1.+SQRT(8.*F+1.))
IF((F.LE.3.).AND.(F.LE.30.))PHI(2)=(1.1-F/120.)*DZZ
IF((F.GT.30.).AND.(F.LE.120.)) PHI(2)=0.85*DZZ
IF((F.GT.120.).AND.(F.LE.300.)) PHI(2)=(1.0-F/800.)*DZZ
C----- TEST FOR CHUTE BLOCKS EXTENDING INTO CULVERT
IF(PHI(2)-(TW+H))2,2,1

```

```

2 IERR=13
  IF(DZ-H)3,3,10
3 BL=4.5*DZZ/F*.38
  PHI(1)=DZZ/3.+PHI(2)
  PHI(8)=C.07*DZZ
  PHI(7)=RL/3.
  PHI(2)=CZ
  N=BW1/(1.5*DZ)+C.5
  PHI(3)=BW1/(2.*FLOAT(N))
  PHI(4)=PHI(3)
  PHI(5)=PHI(3)/2.
  PHI(6)=PHI(5)+PHI(4)
C----- BASIN DEPTH BELOW CULVERT INVERT
  PHI(9)=F
  CALL FLARE
  HTW=H+Tw
  VZZ=QD/(BW1*HTW)
  F2=VZZ/SQRT(32.2*HTW)
  EZZ=VZZ*VZZ/64.4+HTW
  CALL HYCO11
  CALL HYCO12
  GO TO 11
10 CALL HYDEPP
11 RETURN
  END

```

```

SUBROUTINE USBR1
  USBR TYPE 1 BASIN
  COMMON / INDICE / IFD, IWT, IERP, I BASIN, IDENT(15)
  COMMON / PIPE / KAPPA, PIPES, HO, WC, SO, QD, YC, VO, T, PK
  COMMON / FLOW / GDP, FPC, FPR, YCD, TWD, DTY, YTD, FR, FC, EZ, VZ, DZ, HT, h, VZZ
  A, F1, F2, EZZ
  COMMON / ROCK / DM, X(5), ZERO, HYBRID, DE, RSG, PHI(11), DMAX
  COMMON / BASIN / BW1, BW2, TS, TF, BL, VOL, BHT, Z1, Z2, Z3, TO, BWS
  COMMON / SCOUR / SDEPR(5), Y(5), V(2,8), DS, WS, SL, TIME, SVCL
  COMMON / STREAM / TW, VS, VM
  IRASIN=18
  IERR=16
  IF(FR.LE.1.00) GO TO 3
  IF((YD*(SQRT(8.*FR*FR+1.)-1.)/2.).LE.TW) GO TO 10
  C----- COMPUTE CULVERT OUTLET ENERGY-TRANSITION HEAD LOSS
  3 H=0.
  EZ=EO-(0.15*VO*VO/64.4)
  C----- COMPUTE BASIN WIDTH
  BW1=BWS
  C----- TEST FOR BASIN WIDTH LESS THAN CULVERT SPAN
  IF(BW1.LT.WO) BW1=WO
  C----- INCREMENT ENERGY
  1 EZ=EZ+0.1
  C----- INCREMENT HEIGHT ABOVE DATUM
  H=H+0.1
  CALL HYDENG
  C----- COMPUTE BASIN ENTRANCE FROUDE NUMBER
  F1=VZ/SQRT(32.2*DZ)
  IERR=15
  IF(F1.GT.9.) GO TO 10
  C----- COMPUTE CONJUGATE DEPTH
  DZZ=(DZ/2.)*(SQRT(1.+8.*F1*F1)-1.)
  C----- TEST FOR SUFFICIENT TAILWATER DEPTH FOR HYDRAULIC JUMP
  IF(DZZ.GT.(TW+H)) GO TO 1
  IERR=24
  IF(F1.LT.4.5) GO TO 10

```

```

C----- COMPUTE BASIN LENGTH
BL=AMINI((0.2*DZZ*F1+4.9*DZZ),6.1*DZZ)
C----- COMPUTE BASIN HEIGHT
HTW=H+TW
BHT=1.1*HTW+C.1*VZ
C----- BASIN DEPTH BELOW CULVERT INVERT
PHI(9)=H
CALL FLARE
VZZ=QD/(BW1*HTW)
F2=VZZ/SQRT(32.2*HTW)
EZZ=VZZ*VZZ/64.4+HTW
CALL HYCO11
CALL HYDO14
GO TO 2
10 CALL HYDERR
2 RETURN
END

```

```

SUBROUTINE USBR2
  USHR TYPE 2 BASIN
  COMMON / INDICE / IRD, IWT, IERR, IBASIN, IDENT(15)
  COMMON / PIPE / KAPPA, PIPES, HO, WC, SO, QD, YO, VO, T, PK
  COMMON / FLOW / QDP, FPC, FPR, YCD, TWD, DIY, YTD, FR, EO, EZ, VZ, DZ, HTW, VZZ
  A, F1, F2, EZZ
  COMMON / ROCK / DM, X(5), ZERO, HYBRID, DE, RSG, PHI(11), DMAX
  COMMON / BASIN / BW1, BW2, TS, TF, BL, VOL, BHT, Z1, Z2, Z3, TD, BWS
  COMMON / SCOUR / SDEPR(5), Y(5), V(2,8), DS, WS, SL, TIME, SVCL
  COMMON / STREAM / TW, VS, VM
  IBASIN=19
  IERR=16
  IF(FR.LE.1.00) GO TO 3
  IF((YO*(SQRT(8.*FR*FR+1.)-1.)/2.).LE.TW) GO TO 10
  C----- COMPUTE CULVERT OUTLET ENERGY-TRANSITION HEAD LOSS
  3 H=0.
  EZ=EO-(0.15*VO*VO/64.4)
  C----- COMPUTE BASIN WIDTH
  BW1=BWS
  C----- TEST FOR BASIN WIDTH LESS THAN CULVERT SPAN
  IF(BW1.LT.WC) BW1=WC
  IF((QD/BW1).GT.500.) BW1=QD/500.
  C----- INCREMENT ENERGY
  1 EZ=EZ+0.1
  C----- INCREMENT HEIGHT ABOVE DATUM
  H=H+0.1
  CALL HYDENG
  C----- COMPUTE BASIN ENTRANCE FROUDE NUMBER
  IERR=15
  F1=VZ/SQRT(32.2*DZ)
  IF(F1.GT.14.5) GO TO 10
  C----- COMPUTE CONJUGATE DEPTH
  DZZ=(DZ/2.)*(SQRT(1.+8.*F1*F1)-1.)
  C----- TEST FOR SUFFICIENT TAILWATER DEPTH FOR HYDRAULIC JUMP
  IF((1.05*DZZ).GT.(TW+H)) GO TO 1
  IERR=24

```



```

IF(F1.LT.4.5) GO TO 10
IERR=17
IF(DZ.GT.H) GO TO 1C
C----- COMPUTE BASIN LENGTH
BL=DZZ*(1.97363+0.57325*F1-0.04572*F1*F1+0.00119*F1*F1*F1)
C----- COMPUTE BASIN HEIGHT
HTW=H+TW
BHT=1.1*HTW+0.1*VZ
C----- COMPUTE CHUTE BLOCK WIDTH, HEIGHT, SPACING
PHI(1)=DZ
IF(PHI(1).GT.BW1) GO TO 2
N=BW1/(2.*PHI(1))
IF(N.EQ.0) N=1
A=2*N-1
PHI(2)=(BW1-PHI(1)*A)/2.
C----- COMPUTE DENTATED END SILL DIMENSION
PHI(3)=DZZ
C----- BASIN DEPTH BELOW CULVERT INVERT
PHI(9)=F
CALL FLARE
VZZ=QD/(BW1*HTW)
F2=VZZ/SQRT(32.2*HTW)
EZZ=VZZ*VZZ/64.4+HTW
CALL HYC011
CALL HYC014
GO TO 2
10 CALL HYDERR
2 RETURN
END

```

```

C----- SUBROUTINE USBR3
          USBR TYPE 3 BASIN
COMMON / INDICE / IRD, IWT, IERR, IBASIN, IDENT(15)
COMMON / PIPE / KAPPA, PIPES, HO, WO, SO, QD, YO, VO, T, PK
COMMON / FLOW / QDP, FPC, FPR, YCD, TWD, DTY, YTD, FR, EC, EZ, VZ, DZ, HTW, VZZ
A, F1, F2, EZZ
COMMON / ROCK / DM, X(5), ZER0, HYBRID, DE, RSG, PHI(11), DMAX
COMMON / BASIN / BW1, BW2, TS, TF, BL, VOL, BHT, Z1, Z2, Z3, TO, BWS
COMMON / SCOUR / SDEPR(5), Y(5), V(2, 8), DS, WS, SL, TIME, SVOL
COMMON / STREAM / TW, VS, VM
          IBASIN=20
          IERR=16
          IF(FR.LE.1.00) GO TO 3
          IF((YO*(SQRT(8.*FR*FR+1.)-1.)/2.).LE.TW) GO TO 10
C----- COMPUTE CULVERT OUTLET ENERGY-TRANSITION HEAD LOSS
          3 H=0.
          EZ=EO-(0.15*VO*VO/64.4)
C----- COMPUTE BASIN WIDTH
          BW1=BWS
C----- TEST FOR BASIN WIDTH LESS THAN CULVERT SPAN
          IF(BW1.LT.WO) BW1=WO
          IF((QD/BW1).GT.200.) BW1=QD/200.
C----- INCREMENT ENERGY
          1 EZ=EZ+0.1
C----- INCREMENT FEIGHT ABOVE DATUM
          H=H+0.1
          CALL HYDENG
C----- COMPUTE BASIN ENTRANCE FROUDE NUMBER
          F1=VZ/SQRT(32.2*DZ)
          IERR=15
          IF(F1.GT.16.5) GO TO 10
C----- COMPUTE CONJUGATE DEPTH
          DZZ=(DZ/2.)*(SQRT(1.+8.*F1*F1)-1.)
C----- TEST FOR SUFFICIENT TAILWATER DEPTH FOR HYDRAULIC JUMP
          IF(DZZ.GT.(TW+H)) GO TO 1
          IERR=24

```

```

IF(F1.LT.4.5) GO TO 10
IERR=17
IF(DZ.GT.H) GO TO 10
C----- COMPUTE BASIN LENGTH
BL=DZZ*(.92179+0.40607*F1-0.02953*F1*F1+0.00070*F1*F1*F1)
C----- COMPUTE BASIN HEIGHT
HTW=H+TW
BHT=1.1*HTW+0.1*VZ
C----- COMPUTE CHUTE BLOCK WIDTH,HEIGHT,SPACING
PHI(1)=DZ
IF(PHI(1).GT.BW1) GO TO 2
N=BW1/(2.*PHI(1))
IF(N.EQ.0) N=1
A=2*N-1
PHI(2)=(BW1-PHI(1)*A)/2.
C----- COMPUTE RAFFLE BLOCK DIMENSIONS
PHI(3)=DZ*(C.17*F1+C.57)
IF((0.75*PHI(3)).GT.BW1) GO TO 2
N=BW1/(1.5*PHI(3))
IF(N.EQ.0) N=1
B=2*N-1
PHI(4)=(BW1-0.75*PHI(3)*B)/2.
C----- COMPUTE END SILL HEIGHT
PHI(5)=DZ*(C.0555*F1+1.)
C----- COMPUTE ROW SPACING
PHI(6)=C.8*DZZ
C----- BASIN DEPTH BELOW CULVERT INVERT
PHI(9)=F
CALL FLARE
VZZ=QD/(BW1*HTW)
F2=VZZ/SQRT(32.2*HTW)
EZZ=VZZ*VZZ/64.4+HTW
CALL HYCOL1
CALL HYDOL4
GO TO 2
10 CALL HYCERR

```

2 RETURN  
END

```

SUBROUTINE USBR4
C----- USBR TYPE 4 BASIN
COMMON / INDICE / IRD, IWT, IERR, I BASIN, IDENT(15)
COMMON / PIPE / KAPPA, PIPES, HO, WC, SO, QD, YC, VO, T, PK
COMMON / FLOW / QDP, FPC, FPR, YCD, TWD, DTY, YTD, FR, EC, EZ, VZ, DL, HTW, VZZ
A, F1, F2, EZZ
COMMON / ROCK / DM, X(5), ZERC, HYBRID, DE, RSG, PHI(11), DMAX
COMMON / BASIN / BW1, BW2, TS, TF, BL, VOL, BHT, Z1, Z2, Z3, TO, BWS
COMMON / SCOUR / SDEPR(5), Y(5), V(2, 8), DS, WS, SL, TIME, SVOL
COMMON / STREAM / Tw, VS, VM
IBASIN=21
IERR=16
IF(FR.LE.1.00) GO TO 3
IF((YD*(SQRT(8.*FR*FR+1.)-1.)/2.).LE.Tw) GO TO 10
C----- COMPUTE CULVERT OUTLET ENERGY-TRANSITION HEAD LOSS
3 H=C.
EZ=EO-(0.15*VO*VC/64.4)
C----- COMPUTE BASIN WIDTH
BW1=BWS
C----- TEST FOR BASIN WIDTH LESS THAN CULVERT SPAN
IF(BW1.LT.WC) BW1=WC
C----- INCREMENT ENERGY
1 EZ=EZ+0.1
C----- INCREMENT HEIGHT ABOVE DATUM
H=H+0.1
CALL HYDENG
C----- COMPUTE BASIN ENTRANCE FROUDE NUMBER
F1=VZ/SQRT(32.2*DZ)
IERR=15
IF(F1.GT.4.5) GO TO 10
C----- COMPUTE CONJUGATE DEPTH
DZZ=(DZ/2.)*(SQRT(1.+8.*F1*F1)-1.)
C----- TEST FOR SUFFICIENT TAILWATER DEPTH FOR HYDRAULIC JUMP
IF((1.10*DZZ).GT.(Tw+H)) GO TO 1
IERR=24
IF(F1.LT.2.5) GO TO 10

```

```

IERR=17
IF(DZ.GT.H) GO TO 10
C----- COMPUTE BASIN LENGTH
BL=3.50*DZZ#FI#0.358
C----- COMPUTE BASIN HEIGHT
HTW=H*TW
BHT=1.1*HTW+0.1*VZ
C----- COMPUTE CHUTE BLOCK DIMENSIONS
PHI(1)=DZ
IF(PHI(1).GT.8W1) GO TO 2
N=BW1/(3.5*PHI(1))
IF(N.EQ.0) N=1
GO TO 4
5 N = N + 1
4 A = N
PHI(2)=(BW1-PHI(1)*(1.+(A-1.)*3.5))/2.
IF (PHI(2).GT.(1.75*PHI(1))) GO TO 5
C----- BASIN DEPTH BELOW CULVERT INVERT
PHI(9)=H
CALL FLARE
VZZ=QD/(BW1*HTW)
F2=VZZ/SQRT(32.2*HTW)
EZZ=VZZ*VZZ/64.4+HTW
CALL HYD011
CALL HYD014
GO TO 2
10 CALL HYDERR
2 RETURN
END

```



```

SUBROUTINE USBR6
C-----
  USBR TYPE 6 BASIN
  COMMON / INCICE / IRD,IWT,IERR,IBASIN,IDENT(15)
  COMMON / PIPE / KAPPA,PIPES,HO,WC,SC,GD,YO,VO,T,PK
  COMMON / FLCW / QDP,FPC,FPR,YCD,TWD,DIY,YTD,FR,EO,EZ,VZ,DZ,HTW,VZZ
  A,F1,F2,EZZ
  COMMON / ROCK / DM,X(5),ZERO,HYBRID,DE,RSG,PHI(11),DMAX
  COMMON / BASIN / BW1,BW2,TS,TF,HL,VOL,BHT,Z1,Z2,Z3,TO,BWS
  COMMON / SCOUR / SDEPR(5),Y(5),V(2,8),DS,WS,SL,TIME,SVCL
  COMMON / STREAM / TW,VS,VM
  IBASIN=23
  IERR=18
  IF(QD.GT.400.) GO TO 3
  IERR=20
  IF((VO.LT.2.).OR.(VO.GT.30.)) GO TO 3
  IERR=21
  IF(QDP.GT.21.) GO TO 3
  CALL HYD011
  ENERGY DISSIPATOR DIMENSIONS
  BASIN WIDTH
  BW1=1.56025*QD*.4034
  IF(BW1.LT.WO) BW1=WO
  BW2=BW1
C-----
  BAFFLE HEIGHT,HEIGHT ABOVE FLOOR,BAFFLE OVERHANG
  PHI(1)=.375*BW1
  PHI(2)=.167*BW1
  IF(TW.GT.(PHI(1)/2.)) GC TO 2
C-----
  BASIN LENGTH
  PHI(3)=1.333*BW1
C-----
  BASIN INLET HEIGHT
  PHI(4)=0.75*BW1
C-----
  BASIN OUTLET HEIGHT
  PHI(5)=0.42*BW1
C-----
  BASIN INLET TOP LENGTH
  PHI(6)=0.58*BW1
C-----
  BASIN NOTCH,TOP RIDGE

```

```
PHI(8)=0.125*BW1  
PHI(7)=0.0833*BW1  
PHI(9)=4.*WO  
PHI(10)=1.5  
CALL HYDOC9  
GO TO 1  
2 IERR=19  
3 CALL HYDERR  
1 RETURN  
END
```

```

C----- SUBROUTINE FLARE
          SPILLWAY FLARE COMPUTATIONS
COMMON / INCICE / IRD,IWT,IERK,IBASIN,IDENT(15)
COMMON / PIPE / KAPPA,PIPES,HO,WC,SC,QD,YO,VO,T,PK
COMMON / FLOW / QCP,FPC,FPR,YCD,TWD,CTY,YTC,FR,EO,EZ,VZ,DZ,HT,W,VZZ
          A,F1,F2,EZZ
COMMON / ROCK / DM,X(5),ZERO,HYBRID,DE,RSG,PHI(11),DMAX
COMMON / BASIN / BW1,BW2,IS,TF,RL,VOL,BHT,Z1,Z2,Z3,TO,BWS
COMMON / SCOUR / SDEPR(5),Y(5),V(2,8),DS,MS,SL,TIME,SVOL
COMMON / STREAM / TW,VS,VM
C----- SPILLWAY FLARE TEST
          IF(BW1.LE.WC) GO TO 3
          GO TO (5,6),KAPPA
          5 R=(BW1/WO-1.)*C.233/(4.+1.7*FR)
          GO TO 7
          6 R=(BW1/WO-1.)*C.333/(4.+1.6*FR)
C----- COMPUTE LENGTH OF SPILLWAY TRANSITION
          7 PHI(1)=(BW1-WO)/(2.*R)
          GO TO 2
          3 PHI(1)=3.*PHI(9)
          GO TO 4
          2 IF(PHI(10).LT.(3.*PHI(9))) PHI(1)=3.*PHI(9)
          4 RETURN
          END

```

```

C-----
SUBROUTINE VSWELL
  TYPE - VERTICAL STILLING WELL
  COMMON / INDICE / IRD,IWT,IERR,IBASIN,IDENT(15)
  COMMON / PIPE / KAPPA,PIPES,HO,WC,SO,QD,YG,VO,T,PK
  COMMON / FLOW / QDP,FPC,FPR,YCD,TWD,DTY,YTD,FR,EG,EZ,VZ,DL,HTW,VZZ
  A,F1,F2,EZ
  COMMON / ROCK / DM,X(5),ZERO,HYBRID,CE,RSG,PHI(11),DMAX
  COMMON / BASIN / BW1,BW2,TS,TF,BL,VOL,BHT,Z1,Z2,Z3,TO,BWS
  COMMON / SCOUR / SDEPR(5),Y(5),V(2,8),DS,WS,SL,TIME,SVQL
  COMMON / STREAM / TW,VS,VM
  IERR=22
  IF(KAPPA.EQ.2) GO TO 1
  IERR=23
  IF(QDP.GT.10.) GO TO 1
C----- COMPUTE DIAMETER OF STILLING WELL
  PHI(1)=WO*0.53*QD/WC**2.5
C----- TEST FOR EXCESSIVE WELL DIAMETER
  IERR=14
  IF(PHI(1).GT.(5.*WO)) GC TO 1
C----- COMPUTE WELL DEPTH BELOW INFLOW PIPE INVERT
  PHI(2)=(0.00041+1.37252*SO-1.30298*SO*SO+0.50383*SO*SO*SO)*PHI(1)
C----- COMPUTE HEIGHT OF WELL ABOVE INFLOW PIPE INVERT
  PHI(3)=2.*WC
  CALL HYC011
  CALL HYC010
  GO TO 2
  1 CALL HYDERR
  2 RETURN
  END

```

SECTION X  
REFERENCES

R E F E R E N C E S

- (1) Bradley, J. N., and Peterka, A. M., "Hydraulic Design of Stilling Basins: Small Basins for Pipe or Open Channel Outlets - No Tailwater Required (Basin VI)", ASCE Proceedings, vol. 83, October, 1957, Journal of the Hydraulics Division, No. HY5, Paper No. 1406.
- (2) Highway Research Record, "Design of Culverts, Energy Dissipators, and Filter Systems", Number 373, 1971.
- (3) Fletcher, B. P., and Grace, J. L., Jr., "Practical Guidance for Estimating and Controlling Erosion at Culvert Outlets", U.S. Army Engineer Waterways Experiment Station, Vicksburg, Mississippi, Miscellaneous Paper H-72-5.
- (4) U.S. Bureau of Reclamation, "Design of Small Dams", First Edition 1960, U.S. Government Printing Office, Washington D.C.
- (5) Simons, D.B., Stevens, M.A., and Watts, F.J., "Flood Protection at Culvert Outlets", Colorado State University, Fort Collins, Colorado 1970, CER69-70DBS-MAS-FJW4.
- (6) Smith, C.D., "Hydraulic Structures 401A", University of Saskatchewan, Canada, 1969.
- (7) Bohan, J.P., "Erosion and Riprap Requirements at Culvert and Storm Drain Outlets", U.S. Army Engineer Waterways Experiment Station, Vicksburg, Mississippi, Research Report H-70-2.
- (8) Keeley, J. W., "Soil Erosion Studies in Oklahoma; Part III, Culvert Outlet Conditions and Downstream Channel Stability," 1963, U. S. Bureau of Public Roads, Oklahoma Division, Oklahoma City, Oklahoma.
- (9) Keeley, J. W., "Soil Erosion Studies in Oklahoma; Part 1, Water Erosion in Narrow Ditches and Channels; Part II, Erosion Control Devices for Ditches and Channels," 1961, U. S. Bureau of Public Roads, Oklahoma Division, Oklahoma City, Oklahoma.
- (10) Keeley, J. W., "Soil Sedimentation Studies in Oklahoma; Deposition in Culverts and Channels," 1967, Federal Highway Administration, Bureau of Public Roads, Oklahoma Division, Oklahoma City, Oklahoma.





TE 662

A3 no.  
FHWA-RD-  
75-508

U.S.

Re  
ou  
docu

BORROWER

Blank lined area for borrower information.

Form DOT F 1720.2 (8  
FORMERLY FORM DOT F 1700)

DOT LIBRARY



00054864

