

TE
662
.A3
no.
FHWA-
RD-
76-
141

Report No. FHWA-RD-76-141

POLLUTION AND ROADWAY CONSTRUCTION, DESIGN, AND OPERATION

PRELIMINARY STUDY OF DISTRIBUTION OF CARBON MONOXIDE CONCENTRATIONS ON AND ADJACENT TO FREEWAYS

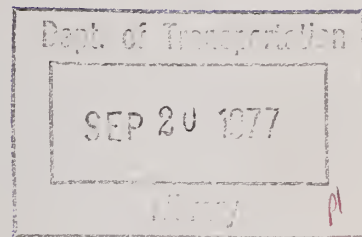

September 1976
Interim Report

This document is available to the public
through the National Technical Information
Service, Springfield, Virginia 22161

Prepared for
FEDERAL HIGHWAY ADMINISTRATION
Offices of Research & Development
Washington, D. C. 20590

FOREWORD

This report discusses the dispersion of carbon monoxide from highways and will be of interest to engineers and researchers concerned with air quality impact assessment of highways.

The report presents the preliminary results of the California Department of Transportation research effort "Air Pollution and Roadway Location, Design, and Operation." The project was conducted for the Federal Highway Administration, Office of Research, Washington, D.C. under Contract DOT-FH-11-7730.

The report has been authored by Andrew J. Ranzieri, Senior Materials and Research Engineer, and Gerald R. Bemis, Associate Materials and Research Engineer, under the supervision of John B. Skog, and later Earl C. Shirley, Supervising Materials and Research Engineers. Acknowledgement is given to Kenneth O. Pinkerman, Associate Air Sanitation Engineer, and Robert Breazile, Air Instrumentation Technician for their efforts in the installation of the carbon monoxide analyzer and development of the operation and calibration procedures. Special acknowledgement is given to Messrs. Ian Grant, Jim Warren, Rudy Abangan, and Arnold Mahalona of the California Department of Transportation, District 7, for their work in the field operations.

for *D. Solomon*
Charles F. Scheffey
Director, Office of Research
Federal Highway Administration

NOTICE

This document is disseminated under the sponsorship of the Department of Transportation in the interest of information exchange. The United States Government assumes no liability for its contents or use thereof.

The contents of this report reflect the views of the Office of Research of the Federal Highway Administration, which is responsible for the facts and the accuracy of the data presented herein. The contents do not necessarily reflect the official views or policy of the Department of Transportation.

This report does not constitute a standard, specification, or regulation.

1. Report No. FHWA-RD-76-141		2. Government Accession No.		3. Recipient's Catalog No.	
4. Title and Subtitle AIR POLLUTION AND ROADWAY LOCATION, DESIGN, AND OPERATION - PRELIMINARY STUDY OF DISTRIBUTION OF CARBON MONOXIDE ON AND ADJACENT TO FREEWAYS				5. Report Date September 1976	
				6. Performing Organization Code	
7. Author(s) A.J.Ranzieri, G.R.Bemis, and E.C.Shirley				8. Performing Organization Report No. CA-DOT-TL-7080-2-75-15	
9. Performing Organization Name and Address California Department of Transportation Office of Transportation Laboratory 5900 Folsom Boulevard Sacramento, California 95819				10. Work Unit No. (TRAIS) FCP 33F3032	
				11. Contract or Grant No. DOT-FH-11-7730	
12. Sponsoring Agency Name and Address Office of Research and Development Federal Highway Administration U. S. Department of Transportation Washington, D. C. 20590				13. Type of Report and Period Covered Interim Report	
				14. Sponsoring Agency Code E0261	
15. Supplementary Notes FHWA's Contract Manager: K. E. Jones					
16. Abstract <p>The air quality measurements used to characterize the temporal and spatial distributions of carbon monoxide (CO) downwind from highway line sources are discussed. Three different highway geometrics were monitored within the Los Angeles area. They included two depressed sections, an at-grade section and a fill section. Measurements for this study, at any one site, consisted of (1) as many as 24 carbon monoxide sampling points for the integrated one hour CO concentrations, (2) one hour values of surface wind speeds and directions, and (3) one hour traffic counts. All CO measurements were made using bag sampling techniques. The data were analyzed to determine the vertical and horizontal dispersion rates, the effects of surface roughness on the dispersion of CO and CO spatial distribution during a period of relatively high concentrations. The data base collected for this study will provide information to verify and calibrate line source diffusion models.</p>					
17. Key Words Atmospheric bag sampling and material carbon monoxide dispersion, temporal and spatial distributions dispersion model, CO data base.			18. Distribution Statement No restrictions. This document is available to the public through the National Technical Information Service, Springfield, VA 22161		
19. Security Classif. (of this report) Unclassified		20. Security Classif. (of this page) Unclassified		21. No. of Pages 211	22. Price

Dept. of Transportation
SEP 20 1977

TABLE OF CONTENTS

	<u>Page</u>
ACKNOWLEDGMENTS	1
INTRODUCTION	3
CONCLUSIONS	9
SITE DESCRIPTION	11
Santa Monica Freeway at 4th Avenue Pedestrian Overcrossing	21
Harbor Freeway at 146th Avenue Pedestrian Overcrossing	21
San Diego Freeway at Weigh Station	26
San Diego Freeway at National Blvd.	32
San Diego Freeway at 122nd Street	39
DATA COLLECTION SCHEME	46
Carbon Monoxide Bag Sampling	46
Meterological Data	49
Traffic Data	49
DESIGN OF EXPERIMENT	57
Carbon Monoxide Averaging Time	57
Exposure of Instrumentation	58
Design of Sampling Program Associated With Changes in Traffic and Meteorological Conditions	58
Sampling Scheme For the Evaluation of CO	68
Temporal and Spatial Distributions of CO	68
SYSTEM SETUP AND RELIABILITY	70

TABLE OF CONTENTS (Con't.)

	<u>Page</u>
Variability of CO Concentration With Location	70
Effects of Bag Sampling Time on CO Concentrations	70
Evaluation of Bag Materials in Bag Sampling.	73
Carbon Monoxide Decay With Time.	77
Effect of Types of Tubing on Carbon Monoxide Concentrations	78
DESCRIPTION OF DATA BASE.	83
Meteorological Data Base	83
Carbon Monoxide Data Base.	84
Traffic Data Base.	84
Time Period of Data Base	86
Limitations of Data Base	86
DATA ANALYSIS	88
Mixing Cell Variability.	88
Vertical and Horizontal Dispersion Rates	100
Effects of Surface Roughness on Dispersion	106
Minimal Sampling Plan For Spatial Distribution of CO	107
Spatial Distribution of CO During Periods of High Concentrations	116
Further Statistical Studies.	116
REFERENCES.	119
APPENDIX A - BAG SAMPLING STUDY DATA BASE	121

LIST OF TABLES

<u>No.</u>	<u>Title</u>	<u>Page</u>
1	Summary of Sites Selected for Bag Sampling Study	45
2	Relationships of Various Averaging Times to Hourly Averages	72
3	Mylar Bags Filled With Zero Gas	74
4	Mylar Bags Filled With 90 ppm CO.	74
5	Mylar Bags Filled With 23 ppm CO.	75
6	Mylar Bags Filled With Zero Air at 70°F	75
7	Mylar Bags Filled With Zero Air Exposed to Environmental Conditions	75
8	Comparison of Scotchpak Bags, Mylar Bags, and Opaque Mylar Bags	76
9	Summary of Variations in NDIR Response When Using Scotchpak Bags	77
10	Effects of Sampling Line Materials on NDIR Readings	79
11.	Response of NDIR to CO Passed Through Aged and New Tubing	82
12.	Time period for Data Base	86
13.	Summary of CO Gradient	105

LIST OF FIGURES

<u>No.</u>	<u>Title</u>	<u>Page</u>
1	Microscale Region	3
2	Tentative Air Quality Sampling Sites	5
3	Surface Streamlines for December AM	13
4	Surface Streamlines for December Midday	14
5	Surface Streamlines for December PM	15
6	Surface Streamlines for August AM	16
7	Surface Streamlines for August Midday	17
8	Surface Streamlines for August PM	18
9	Geometrics of Site 1 - Santa Monica Freeway at 4th Avenue Pedestrian Overcrossing	22
10	View of Site 1 From Freeway Looking East	23
11	View of Site 1 Looking North and Away From Freeway	24
13	View of Site 1 Looking South and Away From Freeway	25
13	Geometrics of Site 2 - Harbor Freeway at 146th Street Pedestrian Overcrossing	27
14	Aerodynamic Eddies in Cut Section	28
15	View of Site 2 From Freeway Looking North	29
16	View of Site 2 From the East Side Looking West Towards Freeway	30
17	View of Site 2 From the West Side Looking East Towards Freeway	31
18	View of Site 3 - San Diego Freeway at Weigh Station as Viewed From Freeway	33

LIST OF FIGURES (Con't.)

<u>No.</u>	<u>Title</u>	<u>Page</u>
19	View of Site 3 From the East Side Looking West Towards Freeway	34
20	View of Sites Looking West Away From Freeway .	35
21	View of Site 4 - San Diego Freeway at National Blvd. as Viewed From Freeway Looking North. . .	36
22	View of Site 4 - East Side Looking East Away From Freeway	37
23	View of Site 4 - East Side Looking West Across Freeway	38
24	Geometrics of Site 5 - San Diego Freeway at 122nd Ave.	40
25	Aerodynamic Eddies of Air Flow For Fill Section	41
26	View of Site 5 From Freeway Looking North . .	42
27	View of Site 5 - East Side Looking West Towards Freeway	43
28	View of Site 5 - West Side Looking East Towards Freeway	44
29	Setup Below Pedestrian Overcrossing Structure For Depressed Freeway Section	47
30	Typical Off-Freeway Probe Setup	48
31	Construction Trailer at Site 1 Housing CO Analyzer	50
32	CO Analyzer in Construction Trailer	51
33	Mechanical Weather Station at Site 1	52
34	Close Up View of Mechanical Weather Station .	53
35	Typical Output From Mechanical Weather Station	54

LIST OF FIGURES (Con't.)

<u>No.</u>	<u>Title</u>	<u>Page</u>
36	Hand Held Wind System	55
37	Probe Locations, Santa Monica Freeway at 4th Ave. P.O.C. Downwind Study	59
38	Probe Locations, Santa Monica Freeway at 4th Ave. P.O.C. In-Section Study	60
39	Probe Locations, Harbor Freeway at 146th Ave. Downwind Study	61
40	Probe Locations, Harbor Freeway at 146th Ave. In-Section Study	62
41	Probe Locations, San Diego Freeway at Weigh Station Downwind Study	63
42	Probe Locations, San Diego Freeway at National Blvd. Downwind Study	64
43	Probe Locations, San Diego Freeway at National Blvd. In-Section Study	65
44	Probe Locations San Diego Freeway at 122nd Ave. Downwind Study	66
45	Probe Locations, San Diego Freeway at 122nd Ave. In-Section Study	67
46	Variability of CO Concentration With Location .	71
47	Mean and Standard Deviations of CO at 4th Ave. P.O.C. In-Section Study	91
48	Mean and Standard Deviations of CO at 4th Ave. P.O.C. Downwind Study	92
49	Mean and Standard Deviations of CO at 146th Ave. P.O.C. In-Section Study	93
50	Mean and Standard Deviations of CO at 146th Ave. P.O.C. Downwind Study	94

LIST OF FIGURES (Con't.)

<u>No.</u>	<u>Title</u>	<u>Page</u>
51	Mean and Standard Deviations of CO at Weigh Station Downwind Study	95
52	Mean and Standard Deviations of CO at National Blvd. In-Section Study	96
53	Mean and Standard Deviations of CO at National Blvd. Downwind Study	97
54	Mean and Standard Deviations of CO at 122nd Ave. In-Section Study	98
55	Mean and Standard Deviations of CO at 122nd Ave. Downwind Study	99
56	Horizontal and Vertical Profiles of CO For 4th Ave. P.O.C.	101
57	Horizontal and Vertical Profiles of CO For 146th Ave. P.O.C.	102
58	Horizontal and Vertical Profiles of CO For 122nd Ave.	103
59	Spatial Distribution of CO at 4th Ave. P.O.C. .	108
60	Spatial Distribution of CO at 146th Ave. P.O.C.	109
61	Spatial Distribution of CO at Weigh Station . .	110
62	Spatial Distribution of CO at 122nd Ave.	111
63	Attainment of Background Levels of CO-At-Grade Sections in Flat Open Areas	112
64	Attainment of Background Levels of CO-Depressed Sections in Urban Areas	113
65	Attainment of Background Levels of CO-Fill Sections in Flat Open Areas	114
66	Typical Sampling Plans to Measure the Spatial Distribution of CO On and Near Highways.	115

LIST OF FIGURES (Con't.)

<u>No.</u>	<u>Title</u>	<u>Page</u>
67	CO During a Period of High Concentration in the Entire Los Angeles Area	117

ACKNOWLEDGMENTS

This report has been authored by Andrew J. Ranzieri, Senior Materials and Research Engineer, and Gerald R. Bemis, Associate Materials and Research Engineer, under the supervision of John B. Skog, and later Earl C. Shirley, Supervising Materials and Research Engineers.

The authors wish to express their appreciation to Kenneth O. Pinkerman, Associate Air Sanitation Engineer, and Robert Breazile, Air Instrumentation Technician, for their efforts in installation of the CO analyzer in the trailer and development of the operation and calibration procedures.

Special acknowledgement is given to Ian Grant, Jim Warren, Rudy Abangan and Arnold Mahalona of the California Department of Transportation, District 07, for their work in the field operations. Without their innovative efforts this project would have been much more difficult.

METRIC CONVERSION FACTORS

Approximate Conversions to Metric Measures

Symbol	When You Know	Multiply by	To Find	Symbol
LENGTH				
in	inches	*2.5	centimeters	cm
ft	feet	30	centimeters	m
yd	yards	0.9	meters	km
mi	miles	1.6	kilometers	
AREA				
in ²	square inches	6.5	square centimeters	cm ²
ft ²	square feet	0.09	square meters	m ²
yd ²	square yards	0.8	square meters	m ²
mi ²	square miles	2.6	square kilometers	km ²
	acres	0.4	hectares	ha
MASS (weight)				
oz	ounces	28	grams	g
lb	pounds	0.45	kilograms	kg
	short tons	0.9	tonnes	t
	(2000 lb)			
VOLUME				
tsp	teaspoons	5	milliliters	ml
Tbsp	tablespoons	15	milliliters	ml
fl oz	fluid ounces	30	milliliters	ml
c	cups	0.24	liters	l
pt	pints	0.47	liters	l
qt	quarts	0.95	liters	l
gal	gallons	3.8	liters	l
ft ³	cubic feet	0.03	cubic meters	m ³
yd ³	cubic yards	0.76	cubic meters	m ³
TEMPERATURE (exact)				
°F	Fahrenheit temperature	5/9 (after subtracting 32)	Celsius temperature	°C

Approximate Conversions from Metric Measures

Symbol	When You Know	Multiply by	To Find	Symbol
LENGTH				
mm	millimeters	0.04	inches	in
cm	centimeters	0.4	inches	in
m	meters	3.3	feet	ft
m	meters	1.1	yards	yd
km	kilometers	0.6	miles	mi
AREA				
cm ²	square centimeters	0.16	square inches	in ²
m ²	square meters	1.2	square yards	yd ²
km ²	square kilometers	0.4	square miles	mi ²
ha	hectares (10,000 m ²)	2.5	acres	
MASS (weight)				
g	grams	0.035	ounces	oz
kg	kilograms	2.2	pounds	lb
t	tonnes (1000 kg)	1.1	short tons	
VOLUME				
ml	milliliters	0.03	fluid ounces	fl oz
l	liters	2.1	pints	pt
l	liters	1.06	quarts	qt
l	liters	0.26	gallons	gal
m ³	cubic meters	35	cubic feet	ft ³
m ³	cubic meters	1.3	cubic yards	yd ³
TEMPERATURE (exact)				
°C	Celsius temperature	9/5 (then add 32)	Fahrenheit temperature	°F

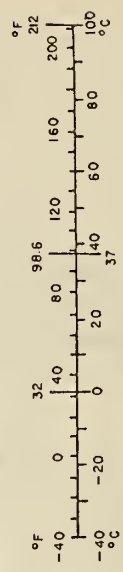
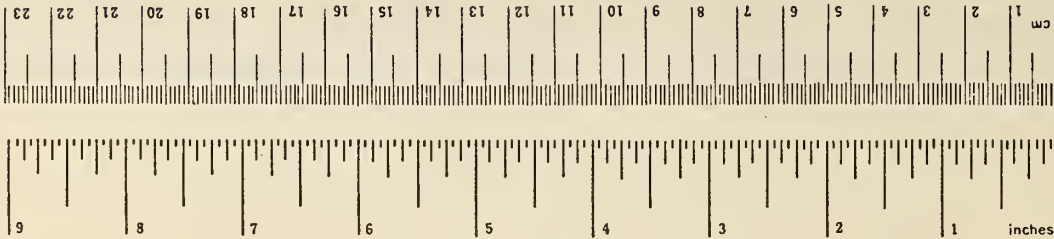

* 1 in = 2.54 (exactly). For other exact conversions and more detailed tables, see NBS Misc. Publ. 286, Units of Weights and Measures, Price \$2.25, SD Catalog No. C13.10-286.

INTRODUCTION

The California Department of Transportation, Transportation Laboratory, has a research project funded by the Federal Highway Administration for the purpose of developing methods and criteria to consider air quality when planning, designing, and operating a highway system.

The tasks involved in this project are:

- A. Establishment of a Project Advisory Committee.
- B. Technical Background Review and Planning - Adapt existing line source models and develop new models for verification using data from this project.
- C. Development of a Data Acquisition Program and Instrumentation.
- D. Site Selection.
- E. Field measurements of traffic, pollutants emitted from vehicles (gases and particulates), and micrometeorology.
- F. Analysis of Results, including evaluation of line source models.

All of the tasks above are aimed at providing a data base for line source model validation. The models used to predict pollutant concentrations relate (1) traffic volumes, (2) emission factors, (3) meteorology, and (4) type of highway design. The modeling efforts of this research project are limited to the microscale region. The microscale region can be defined as the region extending from the point where the pollutants are generated by the traffic (highway) downwind to the point where ambient pollutant levels are again reached. Figure 1 illustrates the microscale region.

For this research project a total of 18 possible experimental sites were selected, all located in the Los Angeles Basin. These sites consist of highways located on (1) fill sections, (2) cut sections, and (3) at grade sections.

Most of the aerometric data collected on this project were taken in the Los Angeles area along freeway routes

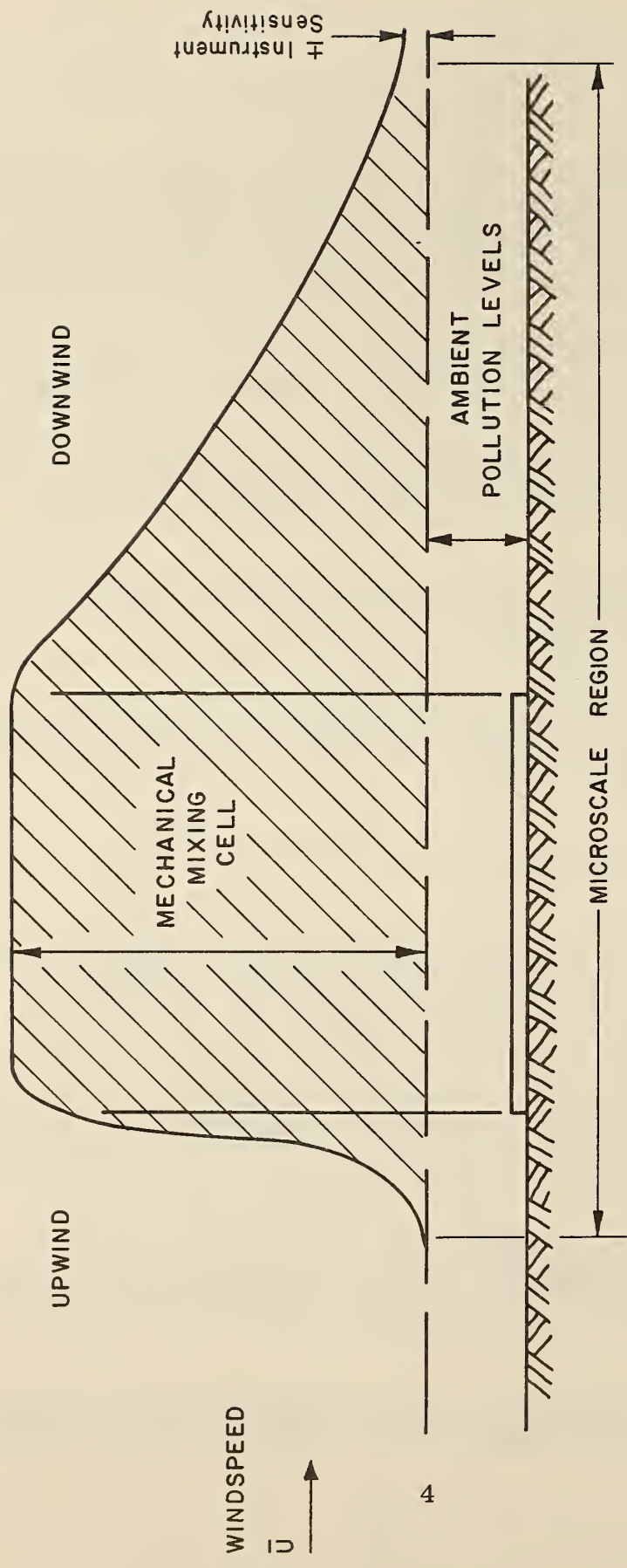

$$\text{TOTAL POLLUTANT CONCENTRATION} = \text{AMBIENT POLLUTANT LEVELS} + \text{POLLUTANTS GENERATED FROM HWYS.}$$

FIG. 1 MICROSCALE REGION

which are a part of a Freeway Surveillance and Control Project that includes three of the most heavily traveled freeways in Los Angeles. They are the Santa Monica, San Diego, and Harbor Freeways, as shown in Figure 2. This surveillance loop project is 42 miles in length; has within or near its boundaries 56 freeway interchanges and a portion of downtown Los Angeles; and passes in the vicinity of Los Angeles International Airport. The electronic surveillance system is comprised of a total of 700 traffic sensors embedded in the freeway at 1/2-mile intervals. The information is telemetered to a central computer control over telephone lines. This surveillance project provides traffic data on an almost continuous basis for use in this research project. Most of the experimental air quality sites are located along the 42-mile loop; however, a few locations are outside of the loop area to allow the monitoring of all types of highway design.

For each experimental site the following meteorological parameters are monitored:

1. Wind speed and direction
2. Wind shear
3. Vertical temperature gradients
4. Relative humidity
5. Solar radiation
6. Atmospheric turbulence

For each experimental site the following air pollutants are monitored:

1. Carbon monoxide (CO)
2. Ozone (O₃)
3. Total hydrocarbons (THC)
4. Methane (CH₄)
5. Nitrogen Oxide (NO)
6. Nitrogen Dioxide (NO₂)



7. Total Suspended Particulates
8. Sulphur
9. Lead

Measurements are made using instruments housed in two mobile laboratories. These vans have the capacity to draw in samples of surrounding air for analysis as well as the capacity to analyze bag samples which are taken at other locations and transported to the mobile laboratories. The vans are equipped with a 45-foot tower to monitor the meteorological parameters. The mobile van also houses a mini-computer. The primary purpose of the mini-computer is to (1) control approximately 200 valves, (2) serve as a data acquisition system and store the data on magnetic tape to be processed later, and (3) to completely automate the operation of the van.

There are two types of sampling systems used, involving continuous and bag sampling techniques. There are a maximum of 15 air monitoring probes that can be used to completely describe the highway configuration under study. The only pollutant to be monitored almost continuously is carbon monoxide. Bag sampling is used where the distance limitation from the freeway does not permit the use of a continuous sampling probe. The other pollutants are monitored only once every hour. However, the frequency of the measurements can increase depending on the number of probes to be used to describe the dispersion characteristics. The research project is more fully described in the interim report titled "Air Pollution and Roadway Location, Design and Operation - Overview of Project" (1).

In order to adequately design an experiment of this magnitude, it is necessary to know the variability of pollutant concentrations within the microscale region of study. Unfortunately, at the time this research was proposed, there was little empirical information on the dispersion characteristics of pollutants generated from highways. Because of lack of quantitative data, the California Department of Transportation's Research Laboratory deemed it necessary to conduct a preliminary study with the following objectives:

- 1) To define the microscale region.

- 2) To determine the optimum number of probes to measure the carbon monoxide dispersion characteristics (on highway downwind) for different types of highway designs and surface roughness* characteristics.
- 3) To gain actual field experience in using air quality instrumentation and bag sampling procedures prior to large scale sampling.
- 4) To qualitatively describe the transport and diffusion of CO downwind of roadways.
- 7) To develop a data bank of pollutant concentrations, meteorological parameters, and traffic volumes that could be used to begin the initial calibration of mathematical models to predict the pollutant concentration generated from highways.

To meet the objectives above, an air quality investigation was made using carbon monoxide as a tracer gas. There were five experimental sites monitored - all located in Los Angeles. Three sites were located on the San Diego Freeway, one on the Harbor Freeway, and one on the Santa Monica Freeway. These were sites selected (out of a possible 18) at the second meeting of the Project's Advisory Committee (2) as being representative of typical highway design for depressed sections, fill sections, and at-grade sections. All sites except for one were on the Surveillance Loop Project. A total of 405 hours of monitoring provided data from all sites. Site locations are shown on Figure 2.

CONCLUSIONS

The following conclusions were derived from this preliminary CO study. They are based on the data collected during the period from May through October 1972. These conclusions are subject to the traffic and meteorological conditions encountered in the field and should not be considered representative of other geographic areas unless these parameters have been normalized.

- 1) Sampling probes to describe the mixing cell concentrations should be located at both shoulders and the median at heights of 4 and 12 feet above the pavement. This also allows analysis of CO levels to which drivers are subjected while driving in areas of high traffic density.
- 2) Sampling probes to describe the downwind transport and diffusion characteristics of CO should be spaced 100 to 150 feet apart up to distances of 400 to 500 feet away from highways.
- 3) Background levels of CO in urban areas are generally reached at about 300 feet downwind from the edge of the traveled roadway. This is attributed to the induced roughness characteristics of the land uses in urban areas and the differences in heat fluxes caused by man-made materials.
- 4) Background CO levels in relatively flat rural areas are generally reached at distances greater than 400 feet downwind from the edge of the traveled roadway. This is attributed to the fact that there is less ground level turbulence as compared to urban areas.
- 5) Within the air monitoring capabilities of this project there is no observed downwind vertical gradient of CO from the ground surface up to 29 feet for urban and rural areas. The thorough mixing in this region is most probably caused by mechanical and thermal turbulence.
- 6) The vertical diffusion rates of CO are about 3 times larger than the horizontal diffusion rates. This was observed for highways located in depressed, at-grade, and fill sections.

- 7) Generally for high traffic densities (greater than 13,000 vph), the CO concentration coming directly off the roadway (mixing cell) ranges from 8 to 25 parts per million (ppm) above background for the conditions monitored.
- 8) Downwind CO concentrations 150 feet from the edge of traveled way generally range from 1 to 4 ppm above ambient levels for both urban and rural sites.
- 9) Bag sampling for CO using aluminized polyester bags gave no significant decay of CO for storage times of over 95 hours.
- 10) Test results indicate that clear Mylar is undesirable for use in bag sampling for CO where the NDIR analysis technique is used. Exposure to sunlight apparently causes increases in CO readings.
- 11) Where new teflon tubing is used for CO intake lines, it is recommended that the teflon be exposed to atmospheric conditions for at least three days prior to use to avoid high indicated CO concentrations. Apparently green polyvinyl-chloride and tygon tubing can be used as intake lines for CO without any observed change in indicated CO concentrations.

SITE DESCRIPTION

The sites selected for this study represent typical highway designs and land use patterns existing adjacent to highways.

The major factors considered in site selection were (1) wind flow patterns, (2) background interference for local streets, (3) highway geometric design, and (4) monitoring feasibility.

For any air quality study one of the most important parameters to consider is meteorology. In preliminary microscale studies, we have found that the meteorological parameters of most importance are wind speed and direction. Analysis of surface wind patterns assisted in selecting sites with crosswind and parallel wind conditions with respect to the highway alignment. This allows a comparison of the CO dispersion characteristics for the extremes in wind directions (normal to parallel). Fortunately, the meteorology within the Los Angeles area is well documented. There are numerous meteorological sources giving historical wind speeds and direction in the vicinity of the surveillance project. From this information one can construct the surface streamlines of winds for different time periods throughout the seasons of the year. The meteorological sources include (1) the Los Angeles International Airport, (2) Los Angeles Air Pollution Control District's (LAAPCD) monitoring stations, and (3) studies made by other investigators within the Los Angeles Basin. The California Transportation Laboratory, purchased five years of meteorological data from the LAAPCD and ten years of information for Los Angeles International Airport from the National Weather Record Center in Nashville, North Carolina. These data included wind speed and direction information recorded at each station.

It should be pointed out that most of the APCD stations monitoring wind speed and direction have improper exposure for measurement of surface winds (3). Generally the wind systems are located about 6 feet from the roof top of a building. These wind systems are subjected to local air flow disturbances caused by the building, trees, etc. This has been confirmed in studies made by Grisinger (4). This disturbance is probably most pronounced for the light land breezes in the morning period. During the strong sea breeze regime this effect is probably minimized. However, in spite of this, and considering the density of wind systems over our study area, this information was used to illustrate the

general air flow movement. To supplement the LAAPCD stations and to assist in designing the experiment, the Transportation Laboratory used six mechanical weather stations, manufactured by Meteorology Research Incorporated, to continuously record wind speed and direction. Before exact locations for the six wind systems were determined, a careful field meteorological survey was conducted. This survey considered the available data and exposure, the possible topographic effects on the air flow caused by the Santa Monica Mountains and Palo Verdes Hills, and the possible locations of the experimental sites. The following sites were selected as being most representative to monitor the surface winds for the objectives of this study.

<u>Location</u>	<u>Length of Record</u>
Santa Monica Freeway at 6th Avenue	October 1971 through February 1972
San Diego Freeway at Truck Weigh Station	August 1971 through August 1972
Harbor Freeway at 220th Street	September 1971 through December 1971
Harbor Freeway at Rosecrans	September 1971 through February 1972
Santa Monica Freeway at Ethel	September 1971 through January 1972
San Diego Freeway at El Segundo	January 1972 through April 1972
San Diego Freeway at Venice Blvd.	March 1972 through April 1972

Mechanical problems with the wind systems and time limitations prevented continuous monitoring at all sites. These wind systems were mounted on light standards and telephone poles well above the boundary flow effects of houses, buildings, etc. In general, they were about 30 to 40 feet above the ground surface depending on the surface roughness characteristics.

All of the data from the LAAPCD stations and the Transportation Laboratory wind systems were summarized by the hour in a tabular wind rose form for each month. From this information, monthly surface wind streamline analyses

were made for time periods associated with certain traffic conditions. These time periods were (1) peak morning traffic hours (AM) - 0600-0900, (2) off-peak traffic hours (midday) - 1100-1300, and (3) evening peak traffic hours (PM) - 1600-1800. From the streamline analyses, sites could be selected for prevailing wind directions ranging from normal to parallel with respect to the highway alignment. Figures 3 through 8 show the surface streamlines for the months of July and December for different periods of the day. These months give the extreme conditions in surface streamlines.

Figure 3 illustrates the general flow of the land and drainage winds. This is primarily caused by the temperature difference between the land and the ocean. These land winds generally range from 4 to 6 mph along the coastline and decrease somewhat inland. During these wind regimes, surface atmospheric conditions are generally stable and ground level concentrations of CO may be high.

Figures 4 and 5 illustrate the general flow during the sea breeze regime. This also is primarily caused by the difference in temperature of the ocean and land. These sea breezes generally range from 8 to 10 mph along the coast and decrease somewhat inland. Figures 3 and 4 also illustrate the topographic effects that the Palo Verdes Hills have on the surface air flow by causing the flow to go around the hills.

Figures 6 through 8 indicate typical conditions that exist during the summer months. The morning period (Figure 6) is generally associated with light winds varying in direction. This is a transitory period from a land to sea breeze regime. Figures 7 and 8 illustrate the strong summer sea breezes generally occurring after midday and ranging from 10 to 15 mph along the coast decreasing somewhat inland.

The following is a summary of the factors considered in the final selection of all experimental sites:

I) Wind Patterns

1. Prevailing wind speeds and directions
2. Occurrences of calms or stagnant conditions

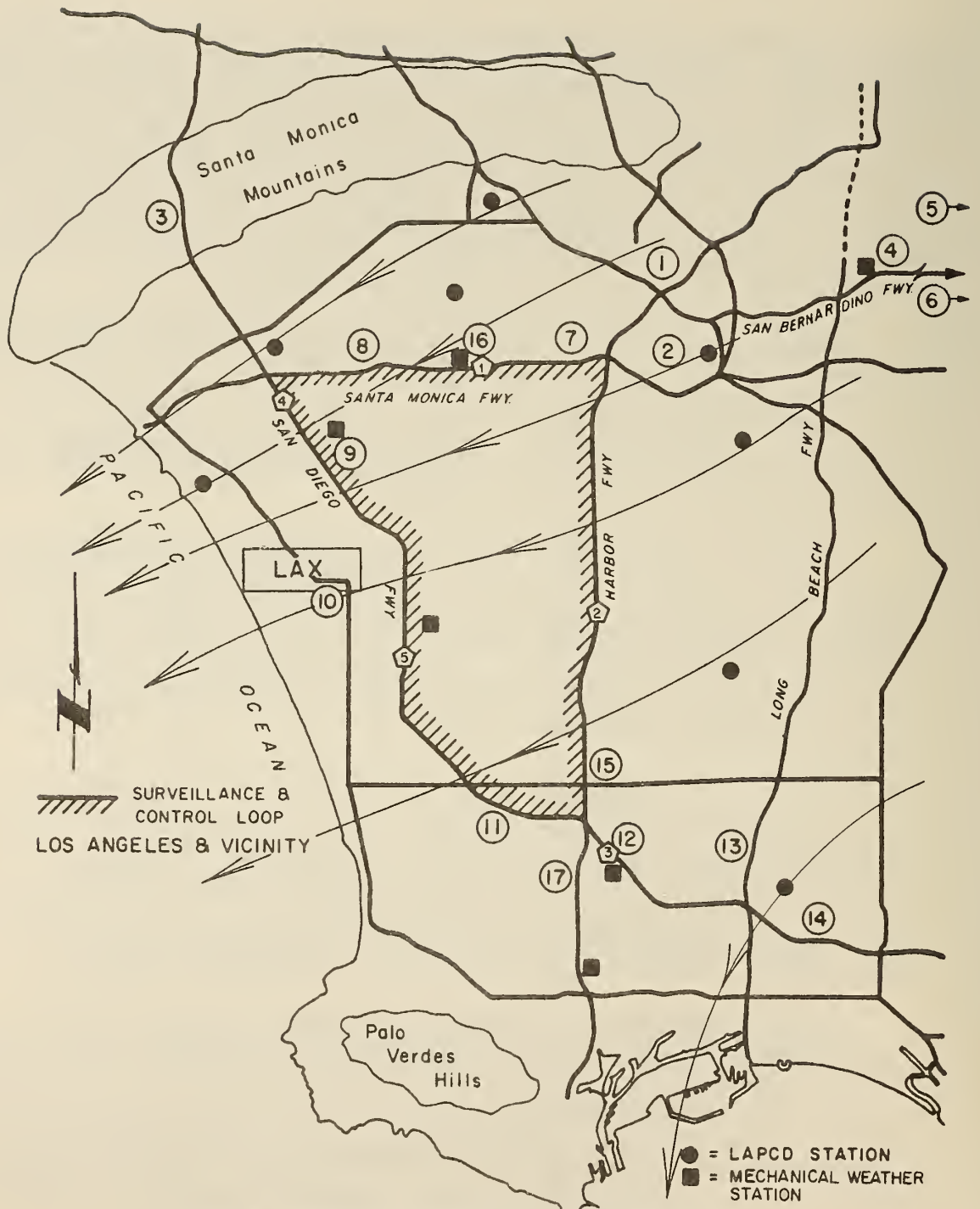

FIG. 3 SURFACE STREAMLINES FOR DECEMBER AM

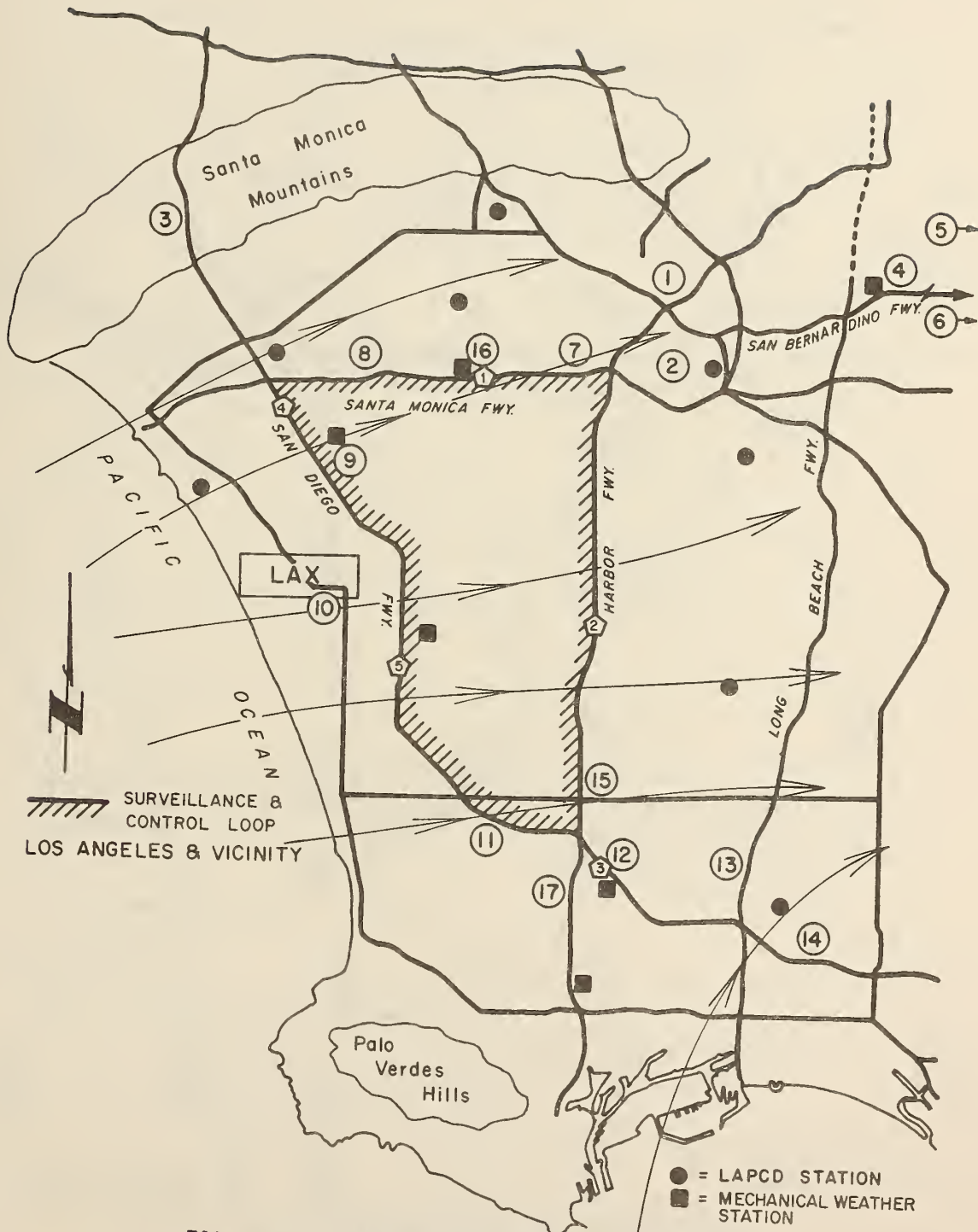

FIG. 4 SURFACE STREAMLINES FOR DECEMBER MIDDAY

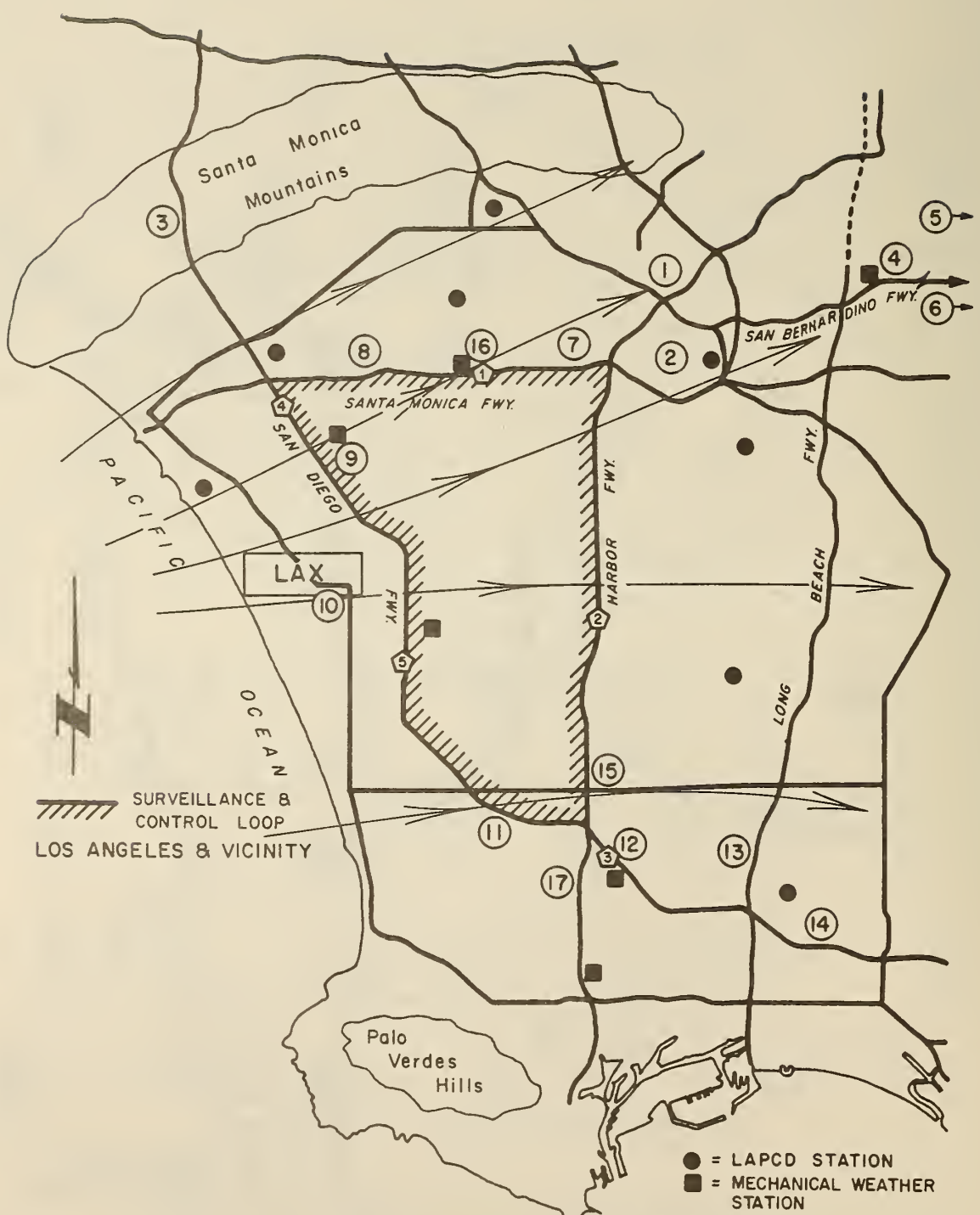

FIG. 5 SURFACE STREAMLINES FOR DECEMBER PM

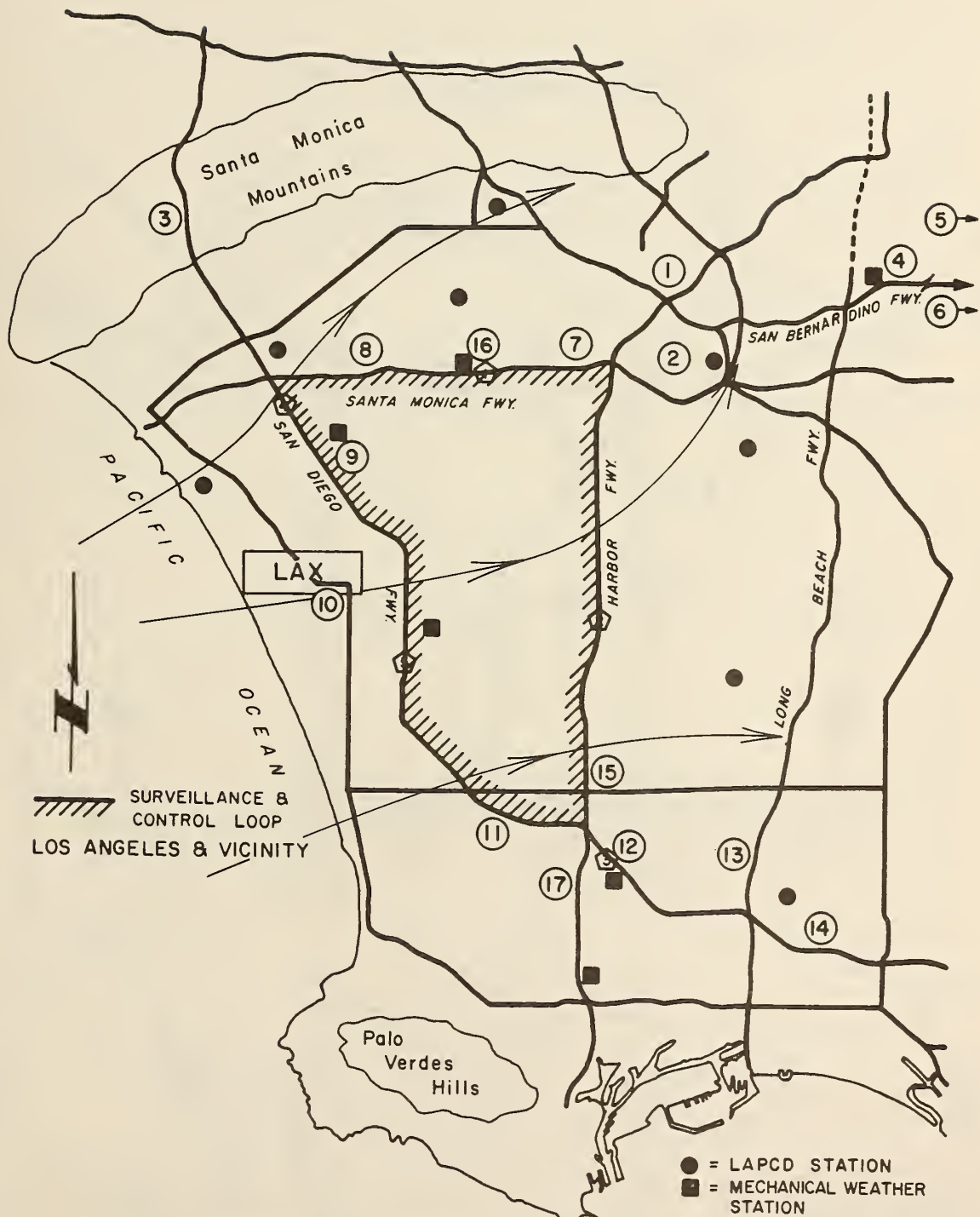

FIG. 6 SURFACE STREAMLINES FOR AUGUST AM

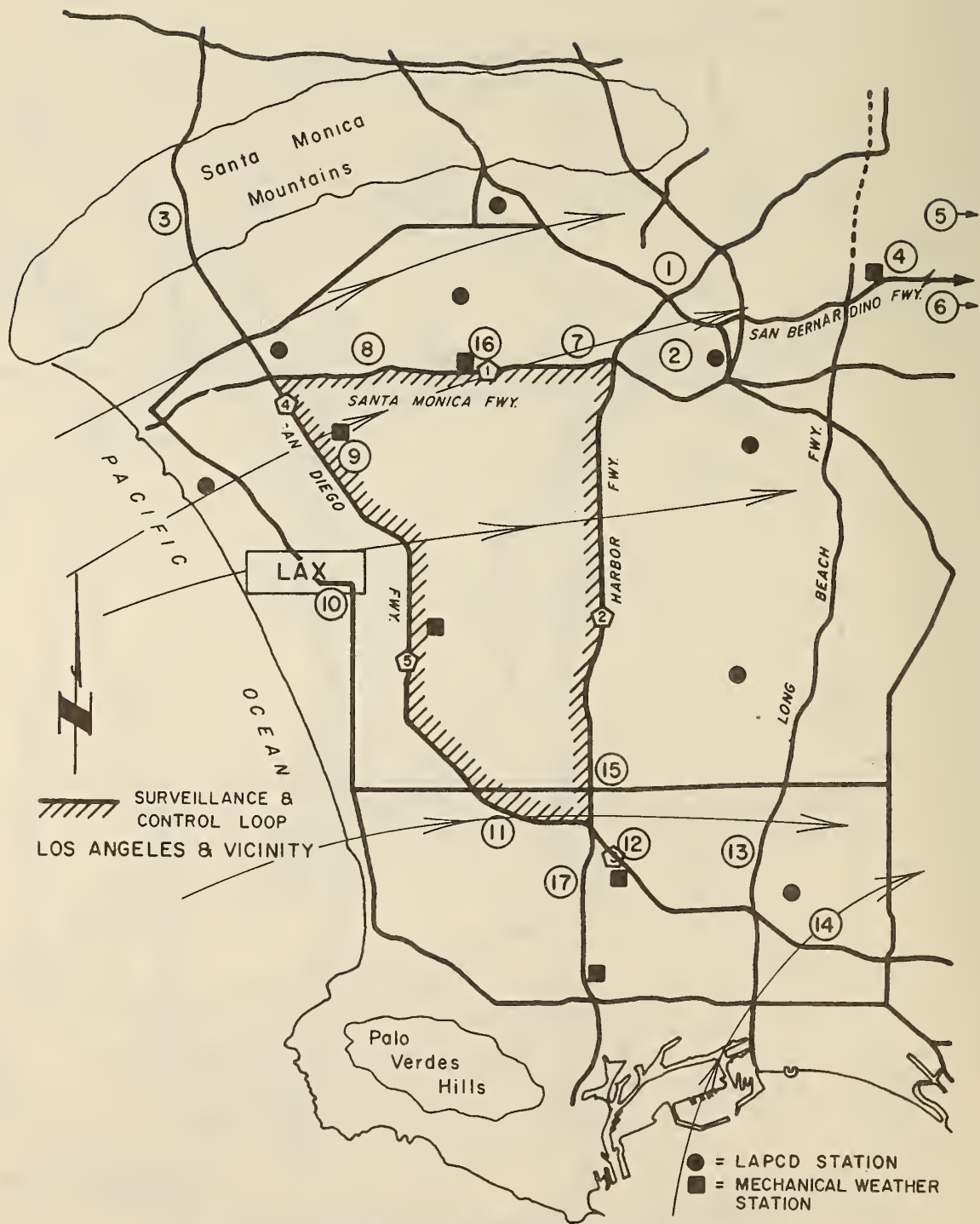

FIG. 7 SURFACE STREAMLINES FOR AUGUST MIDDAY

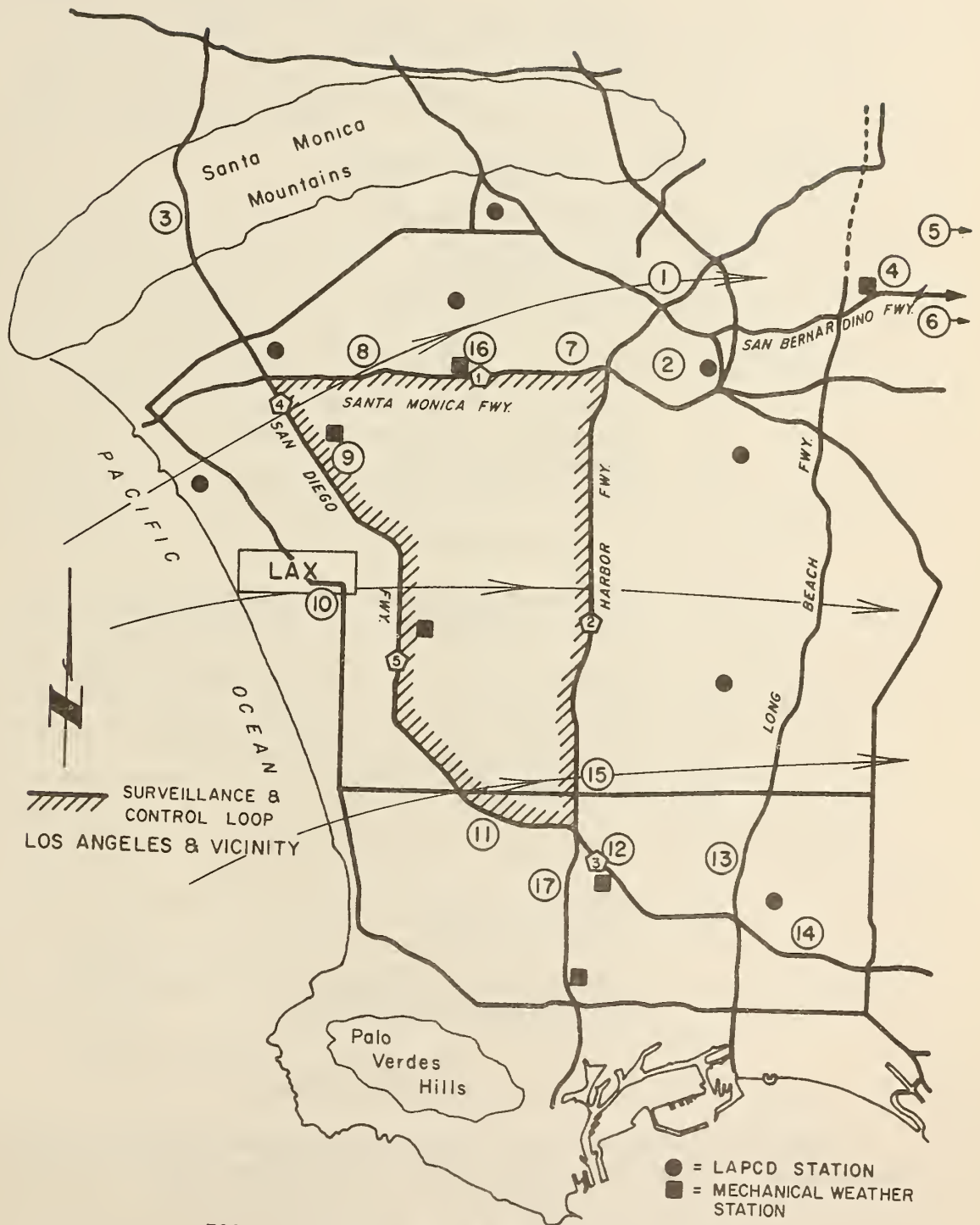

FIG. 8 SURFACE STREAMLINES FOR AUGUST PM

II) Background Interference

1. Proximity of other freeways and surface streets with respect to sampling site
2. Proximity of other local sources of air pollution, i.e. industry, airports, etc.

III) Type of Highway Geometry

1. At-grade sections
2. Fill sections
3. Cut sections
4. Viaduct sections

IV) Land Use Patterns

1. Single residential areas
2. Two-story residential area
3. Commercial areas
4. Open or semi-rural areas

V) Monitoring Feasibility

1. Traffic impedance by equipment and field personnel
2. Time of day or seasonal limitations
3. Vandalism
4. Accessibility to sensor points
5. Cross section coverage
6. Van parking

VI) Miscellaneous Considerations

1. Public exposure to pollution in monitored area
2. Availability of ambient air quality and meteorological data
3. Access to Surveillance Project data
4. Local aerodynamic effects

Using the above criteria, five experimental sites were selected by the Advisory Committee as previously discussed.

The following is a description of each site and the reasons for its selection.

Santa Monica Freeway at 4th Avenue Pedestrian Overcrossing

This site is a typical example of a depressed section located in an urban area. The depth of cut is 24 feet. This section consists of a 10 lane freeway with two on and off ramps for a total of 12 lanes. Figure 9 shows the geometrics of the section. This site is representative of a highway located within a mixed single and two story residential area. The heights of the dwellings range from 20 to 30 feet above the ground surface. The highway alignment is essentially east-west. Based on a surface wind streamline analysis, this section has prevailing surface winds (sea breeze) generally parallel to the highway alignment from about midday through sunset. This allows a study of the parallel wind effects during this period.

During the mornings typical land breezes occur generally over the area. This land breeze is generally a crosswind with respect to the highway alignment.

This site is far removed from any other localized pollutant source for CO. There are no freeways or main surface streets in the immediate area to generate additional CO to confound the measurements. The only outside pollutant source could be the local people going to work in the morning and returning in the evening. However, this should be minor compared to the freeway generated pollutants because this site is located at the end of a cul-de-sac. This site has a pedestrian overcrossing which allows accessibility to locate CO sensors on both shoulders and the median of the highway. Bag samples can be taken readily along the residential street to monitor the horizontal dispersion of CO. There is adequate room to park a van, housing all of the instrumentation, on both the south and north sides of the freeway. This site is on the Surveillance Project from which traffic volumes and speed estimates can be obtained. Pictures of this site and the surrounding area are shown in Figures 10 to 12.

Harbor freeway at 146th Avenue Pedestrian Overcrossing

This site is another typical 8 lane urban depressed section. Figure 13 shows the geometrics of the section. This site is representative of a highway located within a single story residential area. The average height of dwellings ranges from 15 to 20 feet above the ground surface.

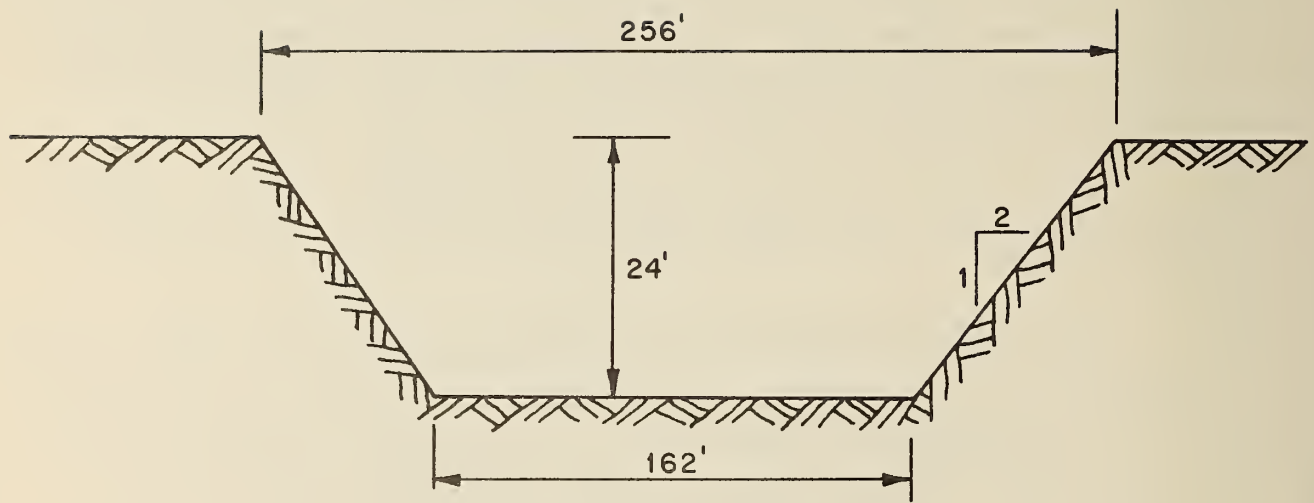

FIG. 9 GEOMETRICS OF SANTA MONICA FREEWAY
AT 4TH AVE PEDESTRIAN OVERCROSSING
(NOT TO SCALE)



FIG 10 VIEW OF SITE 1 FROM FREEWAY
LOOKING EAST



FIG. 11 VIEW OF SITE 1 LOOKING NORTH
AND AWAY FROM FREEWAY



FIG. 12 VIEW OF SITE 1 LOOKING SOUTH
AND AWAY FROM FREEWAY

The highway alignment is essentially a north-south direction. One of the most important reasons this site was selected is that the prevailing sea breeze is nearly normal to the highway alignment. This will allow a study to be made to determine the aerodynamic effects of the air flow within the depressed section on the CO concentrations to which drivers are subjected when using the facilities. It also enables a study of the downwind dispersion of CO. This site can be compared to the Santa Monica Freeway site for comparisons of CO concentrations for parallel and crosswind conditions. These aerodynamic eddies are caused by the air flow separation due to the configuration of the highway cut. Figure 14 illustrates the aerodynamic eddies to be studied. This site is located at the end of a cul-de-sac which minimizes the outside pollutant sources other than the freeway. The pedestrian overcrossing and residential streets provide access to locate sensors on the shoulder and median of the highway and in the downwind direction to study the dispersion of CO. This site is located on the Surveillance Project. Pictures of the site and surrounding area are shown in Figures 15 to 17.

San Diego Freeway at Weigh Station

This site is typical of an at-grade 8 lane highway section. This site is representative of a highway located in a rural area with a flat open fetch in the up and downwind directions. The area surrounding the highway consists of an open grassy field on the east side and a golf course on the west side. The total width of highway from edge of pavement to edge of pavement is 138 feet. There are no other local freeways or surface streets within the immediate area to contribute to the pollutant levels other than the highway itself. This site was selected to compare the effects of different land uses (flat open areas) adjacent to highways to those of the other urban sites (residential areas) and to evaluate the effects of land use on the dispersion of pollutants. Study of the surface streamline analysis indicates prevailing surface winds are generally in a crosswind direction with respect to the highway alignment.

Pictures of the site and surrounding area are shown in Figures 18 through 20. This site is ideal for model validation because of the simplicity of the terrain. This site is off of the Surveillance Project; however, traffic monitoring pads for traffic census are located approximately 1/4 miles from the site. Traffic volumes can be obtained from the District 07 Traffic Department. The CO measurements on the highway are limited to both shoulders of the pavement because there

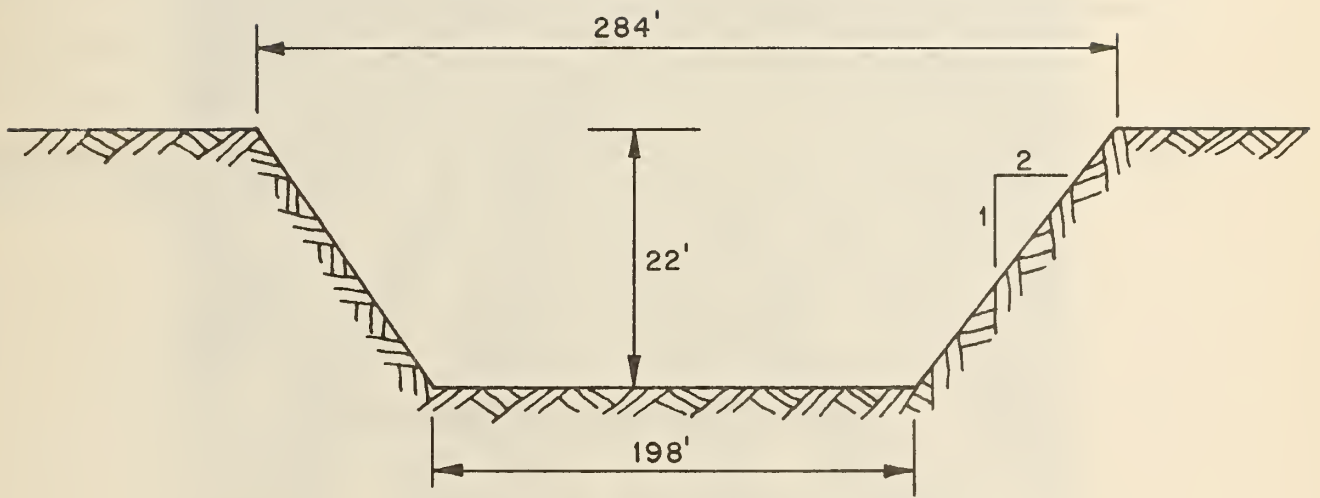

FIG. 13 GEOMETRICS OF HARBOR FREEWAY
AT 146TH ST. PEDESTRIAN OVERCROSSING
(NOT TO SCALE)

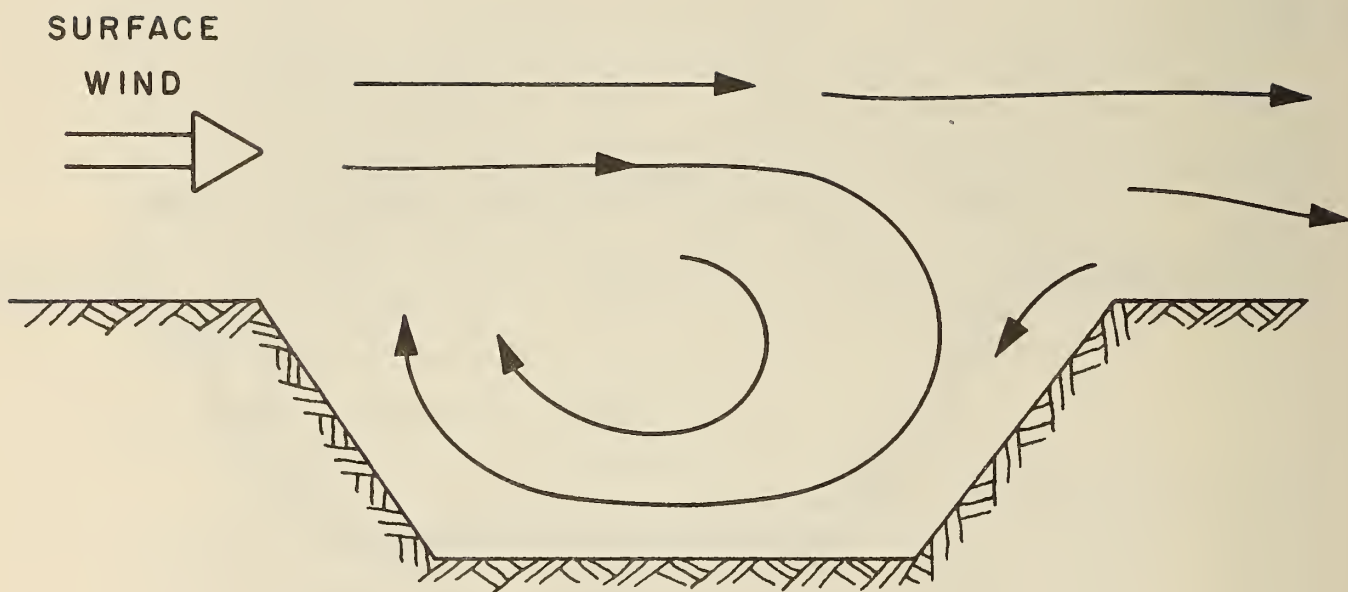

FIG. 14 AERODYNAMIC EDDIES IN CUT SECTION
(NOT TO SCALE)

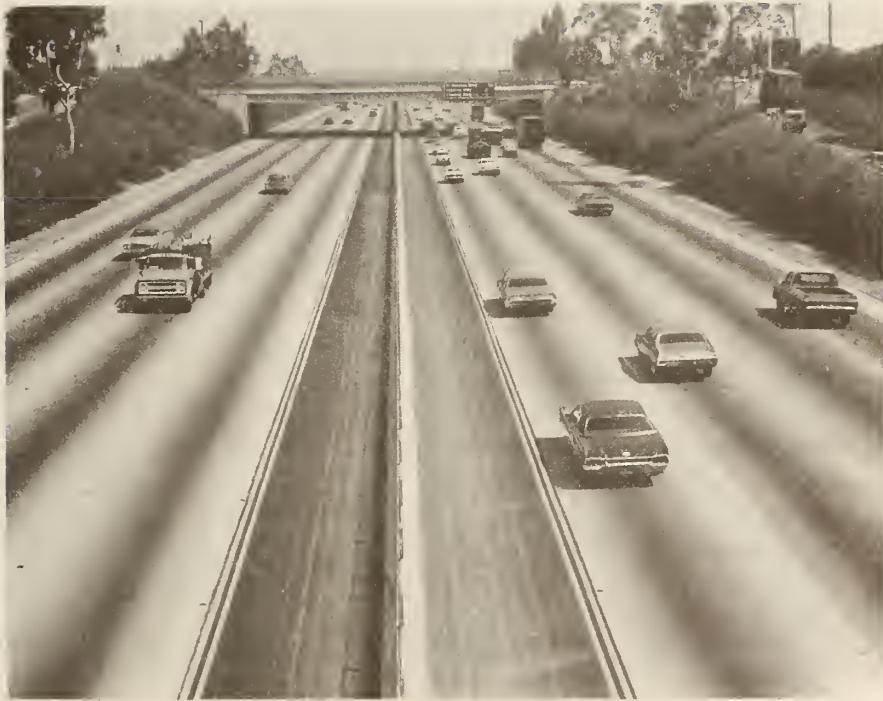

FIG. 15 VIEW OF SITE 2 FROM FREEWAY
LOOKING NORTH



FIG. 16 VIEW OF SITE 2 FROM THE EAST
SIDE LOOKING WEST TOWARD
FREEWAY



FIG. 17 VIEW OF SITE 2 FROM THE WEST
LOOKING EAST TOWARD FREEWAY

are no support structures located in the median to mount the CO sensors. The measurement of the horizontal dispersion of CO is limited to 400 feet from the shoulder in the easterly direction because of a local flood control channel. On the western side of the freeway the maximum distance from the shoulder is limited to about 60 feet because of the golf course facilities. This site can be used only to describe the dispersion of CO for a wind from the westerly direction which in this case is the dominating sea breeze.

San Diego Freeway at National Boulevard

This site is typical of an at-grade 8 lane freeway, including an off ramp, in an urban area. The width of freeway from edge of shoulder to edge of shoulder is 130' not including the off ramp. The area surrounding both sides of the site consists of an apartment complex providing housing for students at the University of California at Los Angeles. These are two-story structures. This particular site is also located near a major freeway interchange of the Santa Monica and San Diego Freeways. The site is approximately 1/4 mile south of the interchange. This interchange is heavily congested during peak morning and evening traffic hours. There are also two major surface streets running parallel to the highway located about 300 feet from both shoulders of the highway. These surface streets are also heavily traveled during the morning and evening traffic hours. Also numerous car garages for the apartment dwellings are located about 20 feet away from the highway on both sides. This site was selected because of the (1) close proximity of human receptors to the highway (approximately 50 feet minimum distance) and (2) the possible interaction of the major freeway interchange and local streets with the CO concentrations.

From the streamline analyses, the prevailing surface winds are generally in a crosswind direction with respect to the highway alignment. This site is on the Surveillance Project. A road sign across the northbound lanes was used to support sensors to monitor CO on the median and on the east shoulder of the highway. On the west side, a light standard was used to support the CO sensor. The measurements of the downwind CO dispersion are limited to about 300 feet before the major surface streets are reached. Pictures of the site and surrounding area are shown in Figures 21 through 23. This site is not the most ideal site for model validation because of the proximity of local background source; however, the pollutant measurements at this site can give valuable information to assess the impact of highways on air quality for receptors located near major interchanges.



FIG. 18 VIEW OF SITE 3 - SAN DIEGO FREEWAY
AT WEIGH STATION AS VIEWED FROM
FREEWAY



FIG. 19 VIEW OF SITE 3 FROM THE EAST
LOOKING WEST TOWARDS FREEWAY



FIG. 20 VIEW OF SITE 3 LOOKING WEST
AWAY FROM FREEWAY



FIG. 21 VIEW OF SITE 4 - SAN DIEGO FREEWAY
AT NATIONAL BLVD. AS VIEWED FROM
FREEWAY LOOKING NORTH



FIG. 22 VIEW OF SITE 4 - EAST SIDE
LOOKING EAST AWAY FROM FREEWAY



FIG. 23 VIEW OF SITE 4 - EAST SIDE
LOOKING WEST ACROSS FREEWAY

San Diego Freeway at 122nd Street

This site is typical of an 8 lane freeway on a fill in an urban area. The height of the fill is 14 feet above the surrounding terrain. Figure 24 shows the geometrics of the section. The area adjacent to the site provides a flat open fetch in both directions. A road sign located over the northbound lanes was used to support sensors to monitor CO on the east shoulder and the median of the highway. On the west side a light standard supported the sensor for the monitoring of CO. There were no other background interferences on CO from other freeways or local surface streets in the immediate area. The prevailing surface winds are in a crosswind direction with respect to the highway alignment. The site is located on the Surveillance Project.

The major factors in selecting this site were to: (1) evaluate the effect that an elevated source has on the ground level concentrations, (2) evaluate the aerodynamic effects of the air flow over the fill on the ground level concentrations (Figure 25), (3) compare elevated highways with at-grade and depressed sections, and (4) evaluate a sampling plan for a fill section to determine the extension of the microscale region. Pictures of the site and surrounding area are shown in Figures 26 through 28.

Table 1 gives a general summary of the sites.

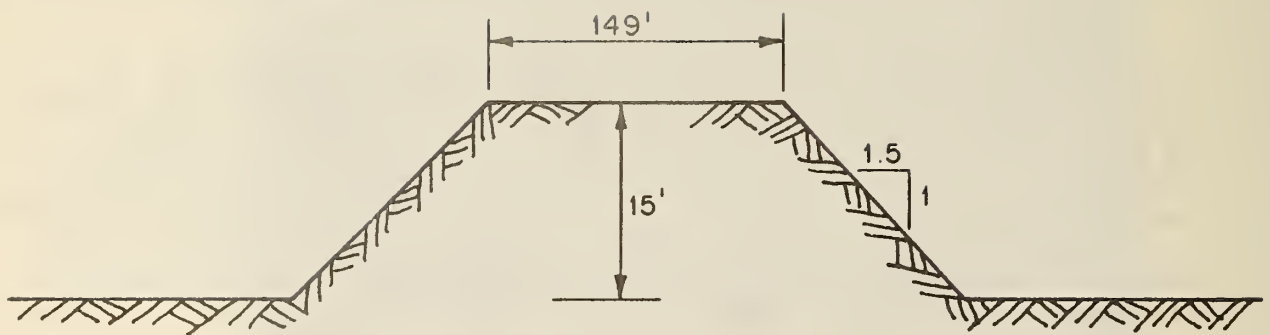

FIG. 24 GEOMETRICS OF SAN DIEGO FREEWAY
AT 122ND AVE SITE
(NOT TO SCALE)

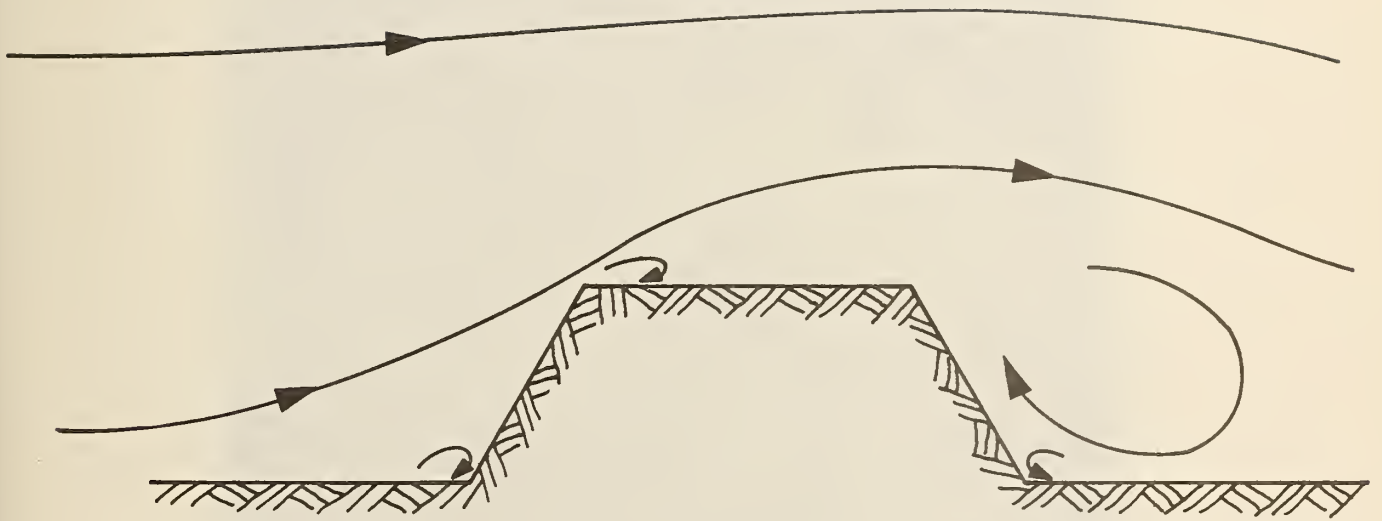

FIG. 25 AERODYNAMIC EDDIES OF AIR FLOW FOR FILL SECTION



FIG. 26 VIEW OF SITE 5 FROM FREEWAY
LOOKING NORTH



FIG. 27 VIEW OF SITE 5 EAST SIDE LOOKING
WEST TOWARDS FREEWAY



FIG. 28 VIEW OF SITE 5 WEST SIDE SITE
LOOKING EAST TOWARDS FREEWAY

TABLE 1

SUMMARY FOR SITE SELECTION FOR BAG SAMPLING STUDY

Site Location	Wind Pattern	Background Interference	Type of Highway Design	Monitoring Feasibility	Miscellaneous
Santa Monica Freeway at 4th Avenue Pedestrian overcrossing	Prevailing winds are generally parallel to freeway	Minor. Site is located on a cul-de-sac in mixed one- and two-story residential area	Depressed	Pedestrian overcrossing & city streets provide excellent monitoring capabilities	Site located in the Surveillance Loop Project
Harbor Freeway at 146th Avenue Pedestrian Overcrossing	Prevailing winds are generally normal to freeway	Minor. Site is located on a cul-de-sac in single story residential area	Depressed	Pedestrian overcrossing & city streets provide excellent monitoring capabilities	Site located on the Surveillance Loop Project
San Diego Freeway at Weigh Station	Prevailing winds are generally in a crosswind direction	No background interference. Site is located in flat open area (semi-rural)	At-grade	Excellent monitoring capabilities except the median of freeway is not accessible for monitoring	Site is not located on Surveillance Loop Project. However, traffic census pad are located in immediate area for traffic data
San Diego Freeway at National Blvd.	Prevailing winds are generally normal to freeway	Background interference may be a problem. However, this site is representative of CO levels of receptor located near major highway interchanges and parallel streets	At-grade	Excellent monitoring capabilities on freeway; however, limited in horizontal direction to about 300 feet from highway	Site is located on Surveillance Loop Project
San Diego Freeway at 122nd Street	Prevailing winds are generally normal to freeway	No background interference. Site is located in a flat open area	Fill	Excellent monitoring capabilities on the freeway and horizontally	Site is located on Surveillance Loop Project

DATA COLLECTION SCHEME

In all experimental designs, it is necessary to know the capabilities and limitations of the instrumentation used to monitor the variables under study. It is the purpose of this section to discuss the type of sampling apparatus used to monitor the CO concentrations, meteorological, and traffic parameters. The exact sampling procedures will also be discussed.

Carbon Monoxide Bag Sampling

For this preliminary study, the bag sampling technique was employed. This is one of the methods that has been used by the California Air Resources Board and the California State Department of Health. For this technique, the air from the desired sampling location is pumped through tubing to a flexible bag for collection. Variable flow pumps (2 liter per minute maximum) manufactured by Atmospheric Sciences, Incorporated, draw air samples through 3/8" teflon and tygon tubing into 12" x 18" aluminized polyester bags. These bags have about a 10 liter capacity. These bags were made by the California Air and Industrial Hygiene Laboratory and the Transportation Laboratory. The pumps were powered by a 6 volt dry cell battery that can be purchased at most hardware stores. To determine the vertical dispersion of CO, lightweight aluminum poles were used. These poles can telescope up to about 30 feet above the ground surface and provide a portable, easy to raise framework for monitoring CO at moderate elevations. Guy wires must be used to support these poles in their fully extended position. The exposure of each probe and sampling time to fill a bag sample will be discussed in the next sections. Figures 29 and 30 show a typical sampling setup for on and off freeway locations, respectively.

A Beckman 315BL nondispersive infrared (NDIR) analyzer located in a construction trailer adjacent to the monitoring sites was used to analyze the CO bag samples. The analyzer has two ranges, 0-100 ppm and 0-300 ppm. The accuracy of the analyzer is + 1% of full range. The analyzer uses a narrow band pass filter to screen out interferences from carbon dioxide and water vapor. Sample flow rates were manually adjusted by a regulator valve to one liter per minute as measured with a rotameter. The sample cell operates at atmospheric conditions. Bag samples are directed into the NDIR analyzers at a constant flow, by manually squeezing the bags. The analyzer was calibrated once a day with a zero and 90 ppm span gas. A separate and independent calibration

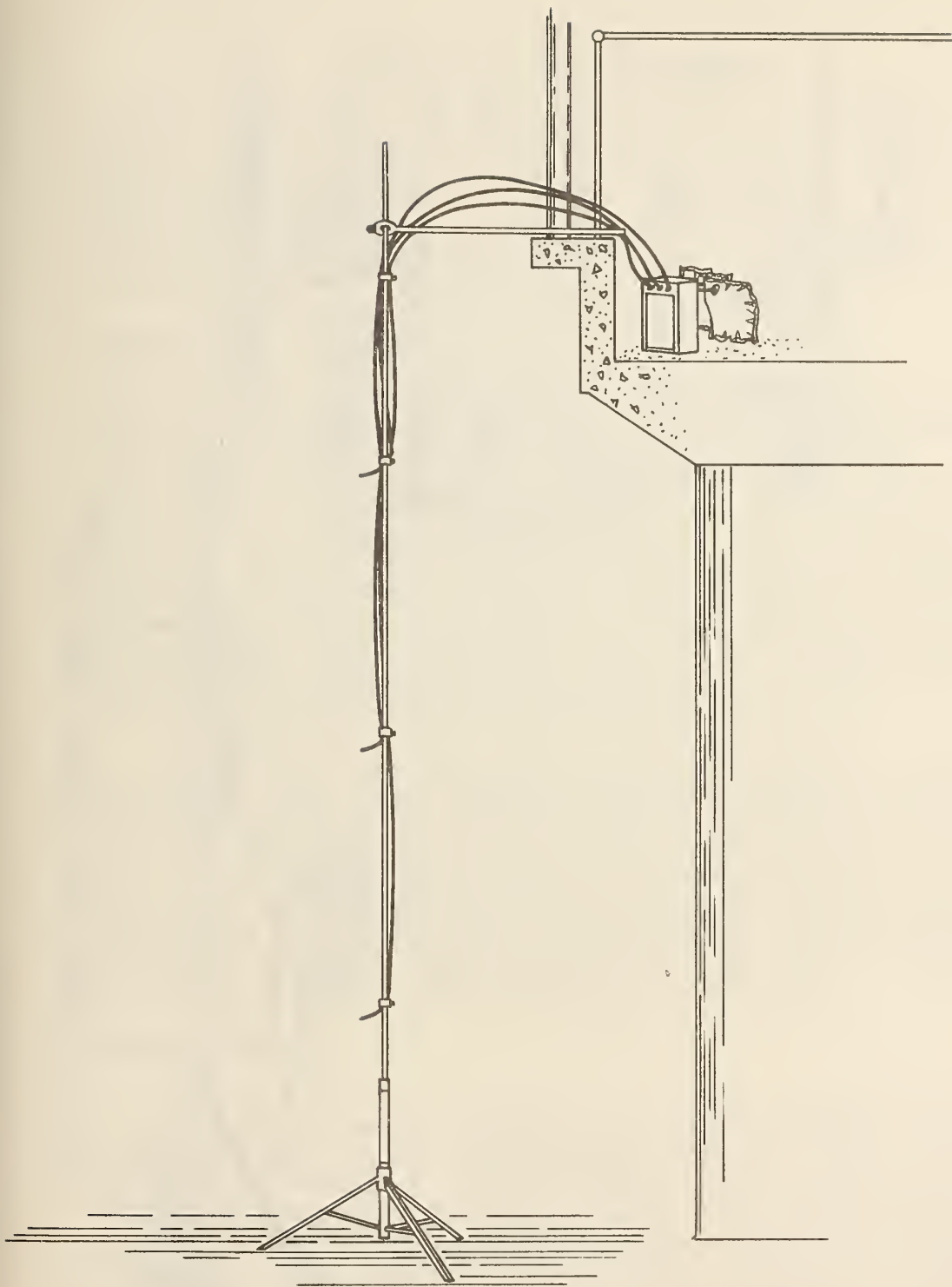

FIG 29 SETUP BELOW P.O.C. STRUCTURE FOR DEPRESSED FREEWAY SECTION

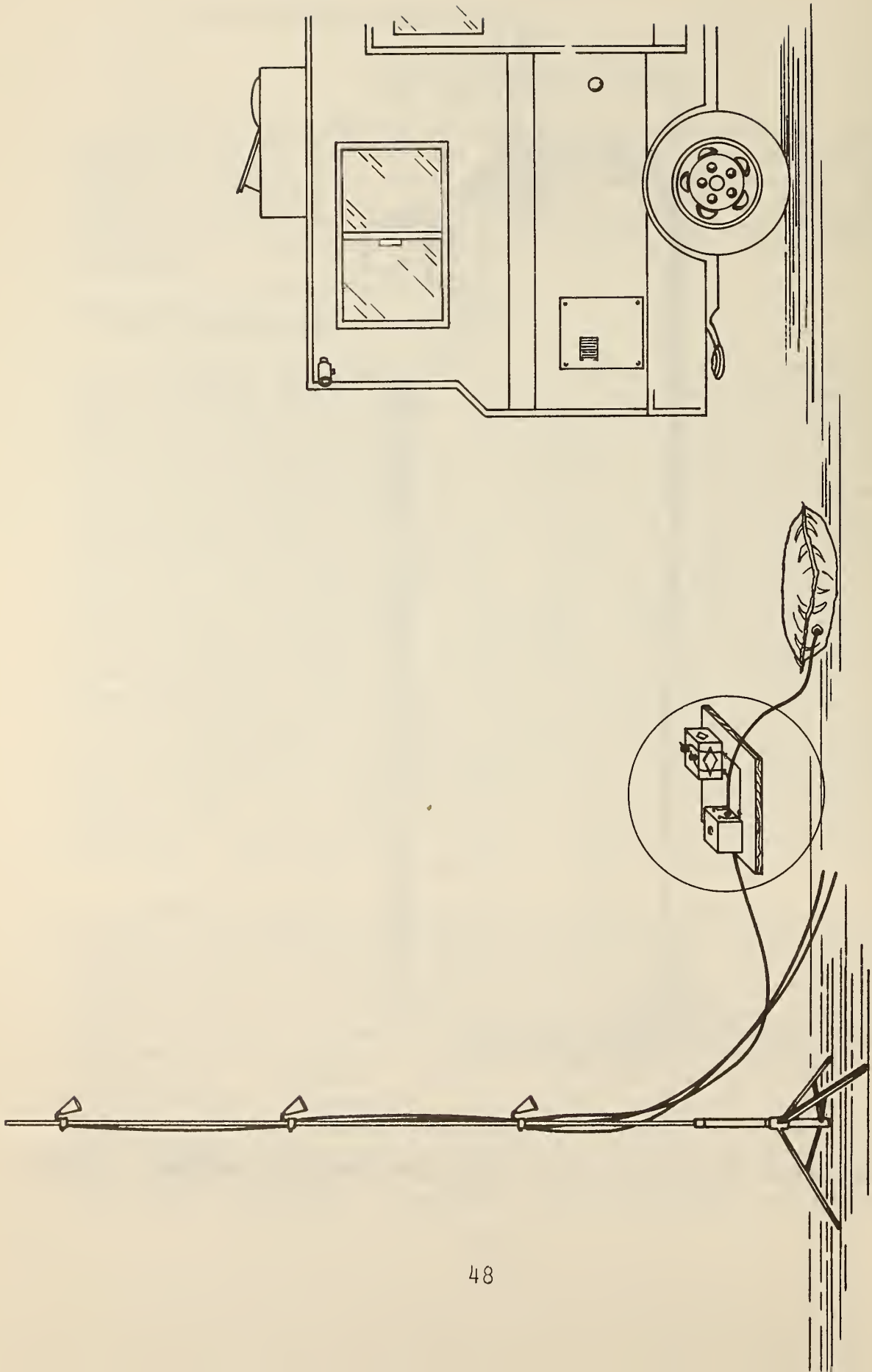

FIG 30 TYPICAL OFF-FREEWAY PROBE SETUP

of the CO analyzer was also made by the California Air Resources Board. The results of their calibration were well within the allowable experimental error (5). The output from the analyzer was recorded on a strip chart, Power for the analyzer was obtained from a hookup to a nearby power pole. Figures 31 and 32 are pictures of the construction trailer and CO analyzer.

Meteorological Data

Surface wind speeds, directions, and temperatures were monitored using a MRI Model 1071 Mechanical Weather Station (MWS). The outputs are on pressure sensitive chart paper. A battery wound drive powers the chart paper. The chart was changed once a month. The starting threshold speed and direction are 0.50 mph and 0.75 mph, respectively. The overall accuracy for wind speed is + 2% of full scale while the overall direction accuracy is + 1% of full range. The relative accuracy of the temperature sensor is + 3°F. Figure 33 is a picture of the MRI mechanical weather station at Site 1. Figure 34 is a close up view of the MWS and Figure 35 is a typical example of the output from the strip chart recorder.

To measure the localized wind flow fields within adjacent streets at each site, a Belfort Hand Held wind system was used intermittently. This wind system measures wind speed and direction by means of a rotor and a vane. The wind speed can be read on two ranges (0 to 15 knots and 0 to 60 knots). The wind direction ranges from 0° to 360°. The overall accuracy of the wind speed and direction is + 3% and + 2%, respectively. The starting speed is 1.0 knot. Figure 36 is a picture of this wind system.

Traffic Data

All of the traffic data for the experimental sites (except the San Diego Freeway site at the weigh station) were obtained from the computerized Surveillance Project. The traffic data included a cumulative vehicle count at 5 minute intervals along with estimated traffic speeds. This information was obtained from traffic monitoring pads located at one half mile along the loop. Studies made by the California Department of Transportation, District 07, Freeway Operations Section, indicated the accuracy of the traffic data was within + 10%. Generally the traffic volumes were averaged over a 30 minute or 1 hour averaging time.



FIG. 31 CONSTRUCTION TRAILER AT SITE 1
HOUSING CO ANALYZER



FIG. 32 CO ANALYZER IN CONSTRUCTION
TRAILER



FIG. 33 MECHANICAL WEATHER STATION
AT SITE 1



FIG. 34 CLOSE UP VIEW OF MECHANICAL WEATHER STATION. (THIS SET-UP NOT USED FOR DATA COLLECTION)

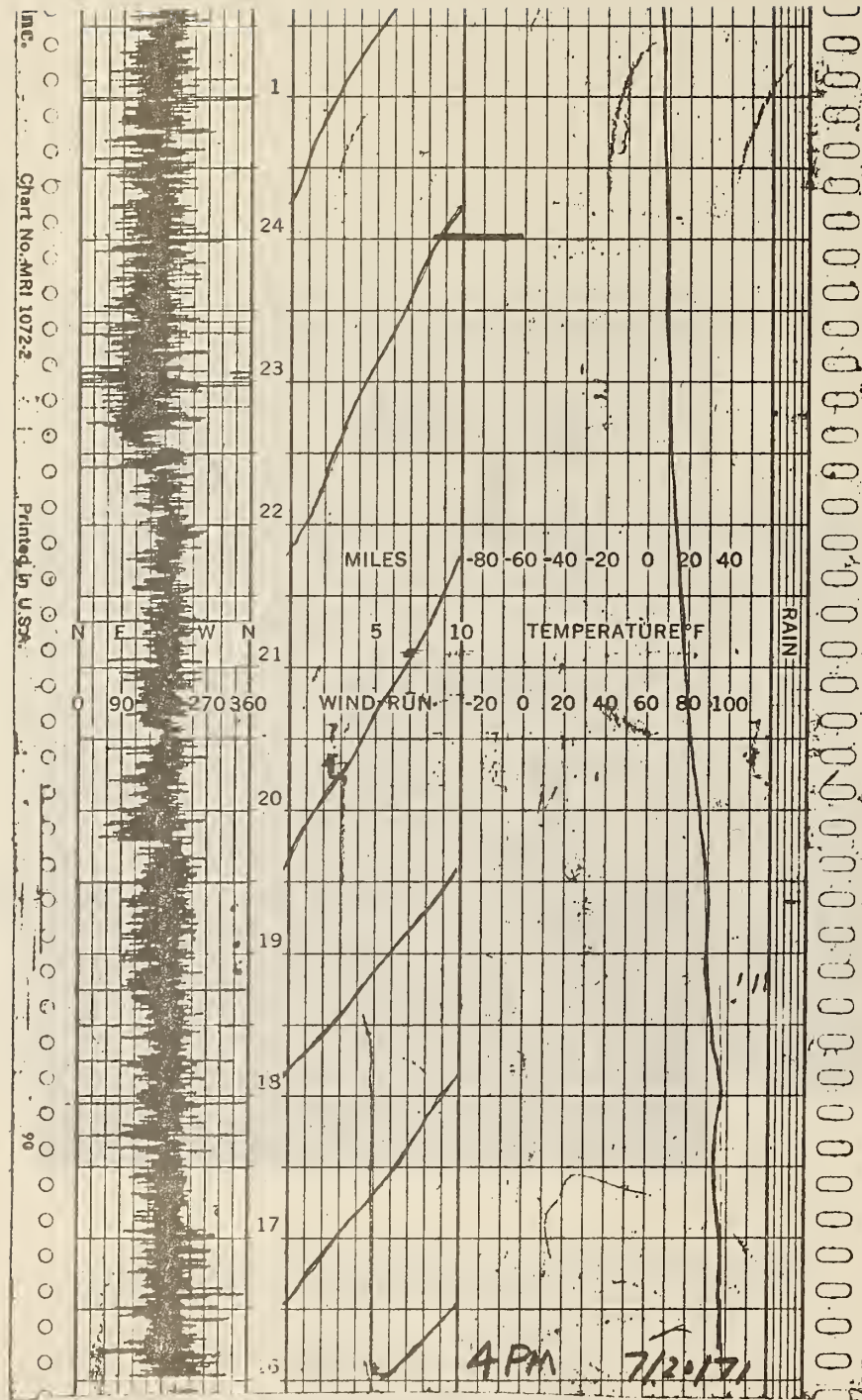

FIG 35 TYPICAL OUTPUT FROM MECHANICAL WEATHER STATION



FIG. 36 HAND HELD WIND SYSTEM

The traffic data for the site on the San Diego Freeway at the weigh station were obtained from yearly traffic census pads located approximately one-quarter of a mile from the site. The District 07 Traffic Department indicated that the traffic volumes were within + 10%. Speed estimates (mph) were obtained by "floating" a car in the traffic stream on the freeway in both directions. This was done periodically during peak and off-peak traffic hours.

DESIGN OF EXPERIMENT

As mentioned previously, one of the major objectives of this preliminary study was to characterize the dispersion of CO from a highway line source. In order to study the dispersion of CO it is necessary to determine the temporal and spatial distribution of the pollutant. This means that all sampling points at each site must be sampled at the same time. To meet all of the objectives of this study, the following items had to be considered:

- 1) Determination of the averaging time for CO bag sampling that would be most practical for field studies.
- 2) Standardized exposure of the meteorological instrumentation and air probes for all sites.
- 3) A sampling program which would be associated with changes in traffic volumes (on and off-peak hours) and meteorological conditions.
- 4) A sampling scheme to encompass
 - (a) in-section study
 - (b) Downwind dispersion study
 - (c) vertical dispersion study
 - (d) microscale region for ambient levels.
- 5) Practicality in terms of manpower and equipment.

Carbon Monoxide Averaging Time

Determination of a minimum averaging time to collect an air sample which would adequately represent a continuous one-hour sample was the first step in the study. It was necessary to determine whether (1) a bag sample of 5 minutes averaging time (12 samples average to obtain 1 hour average), (2) a 30 minute averaging time (2 samples averaged to obtain 1 hour average) or (3) a one-hour integrated sample (1 hour to fill an air sample bag) was most representative of a continuous one-hour air analysis. The averaging time selected should be as practical as possible because of equipment and manpower limitations. It must also be statistically representative of the continuous one-hour analysis. A complete discussion of the averaging time study is found in the section on Data Analyses.

Exposure of Instrumentation

Standardization for instrument exposure is extremely important when statistically comparing the CO concentrations of one site to another. The vertical extent of CO measurements downwind from the highway in this study was limited to about 30 feet above the ground surface. This resulted from the physical height limitation of the sampling mast, which is about 30 feet. Standard exposure of probes for measurements of CO downwind of all sites were selected to be at heights of 5, 17, and 29 feet above the ground surface. The five-foot level would be representative of the air that receptors receive at ground level. The 17- and 29-foot levels are representative of the air that high level receptors (apartments buildings, etc.) would receive.

To examine the CO concentrations to which drivers are subjected, standard measurements of CO were made at both shoulders and the median (where possible) of the freeway section. These standard heights were selected at 4, 8, 12, 16, and 20 feet above the pavement. Also measurements at 36, 44, 52, and 60 feet above the pavement on the median were made where possible. Figures 37 through 44 show a typical sampling scheme. Note that bag samples are taken on both sides of the freeway site. This allows an ambient CO level to be determined depending on the wind direction.

Proper exposure of meteorological sensors is critical in built up and urban areas. Large roughness characteristics in these areas create dramatic wind shears along with localized aerodynamic effects. Obstructions (houses, trees, etc.) near the sensor can completely disturb the wind flow field by generating local aerodynamic eddies. In order to minimize these effects and provide comparative measurement of wind speeds and directions at all sites, a standard height of 10 meters or its equivalent (3) was followed as close as possible. This standard height of 10 meters was applied to the exposure of the MRI Mechanical Weather Stations. Localized wind flow fields were measured with hand held wind systems held above and away from one's body to minimize the air flow disturbance.

Design of Sampling Program Associated with Changes In Traffic and Meteorological Conditions

Variation in pollutant source strength and meteorology are important considerations when field data are collected and used for any type of model validation or dispersion study. Traffic volumes and average route speed are a direct measure

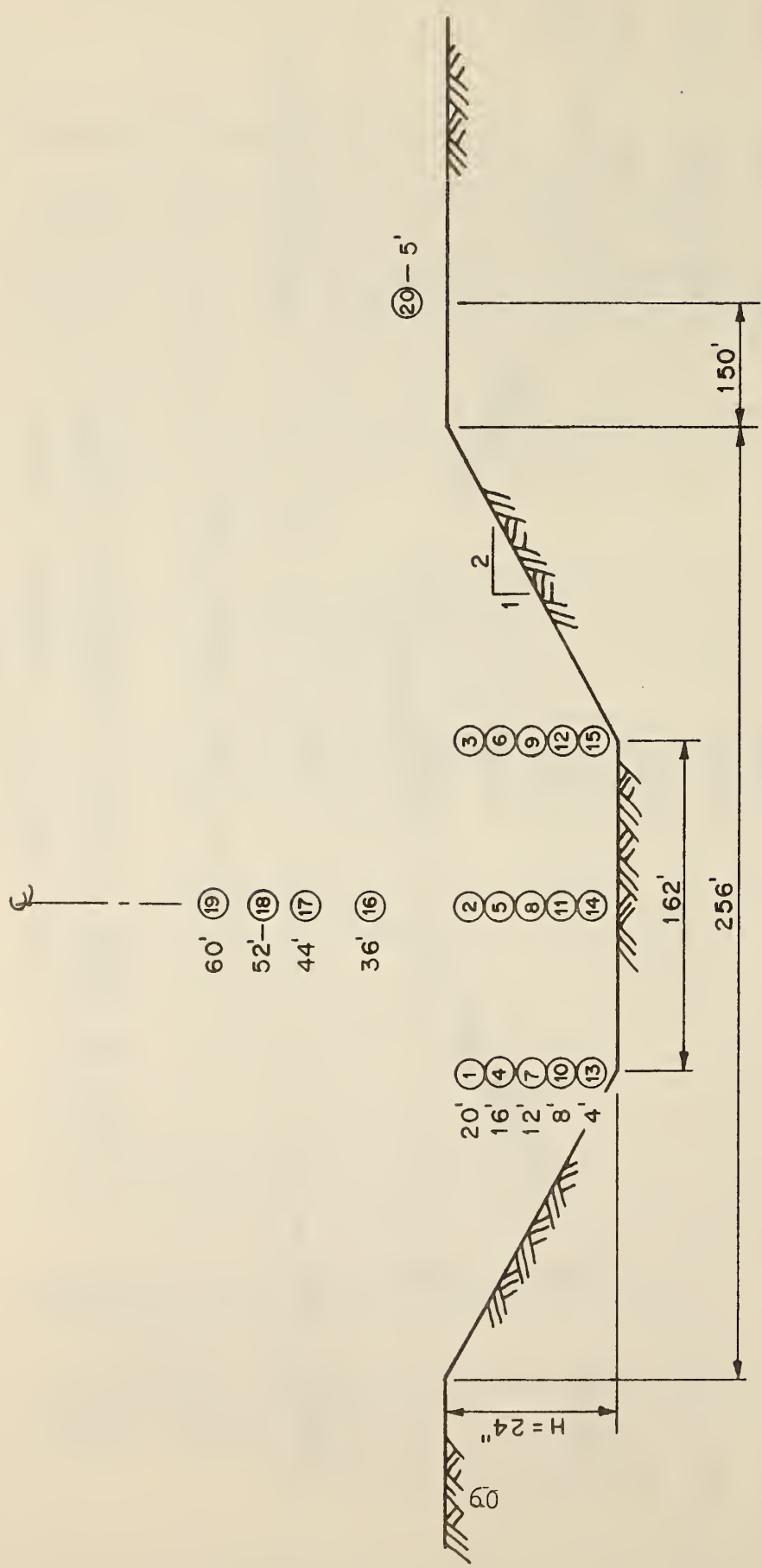

① - DENOTES PROBE NUMBER

FIG. 38 PROBE LOCATIONS, SANTA MONICA FREEWAY
 AT 4TH AVE P.O.C. IN-SECTION STUDY
 (NOT TO SCALE)

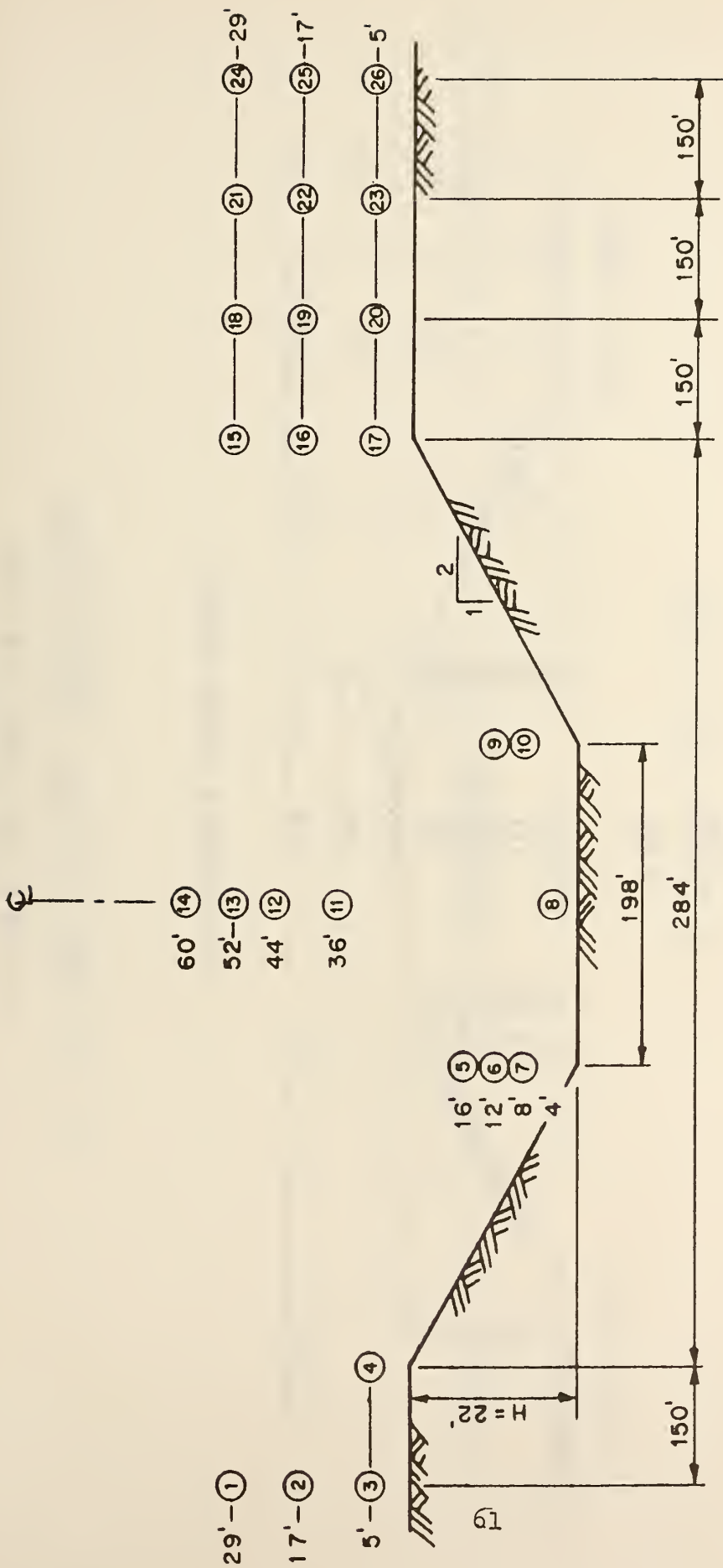

① - DENOTES PROBE NUMBER

FIG. 39 PROBE LOCATIONS, HARBOR FREEWAY
AT 146TH AVE DOWNWIND STUDY
(NOT TO SCALE)

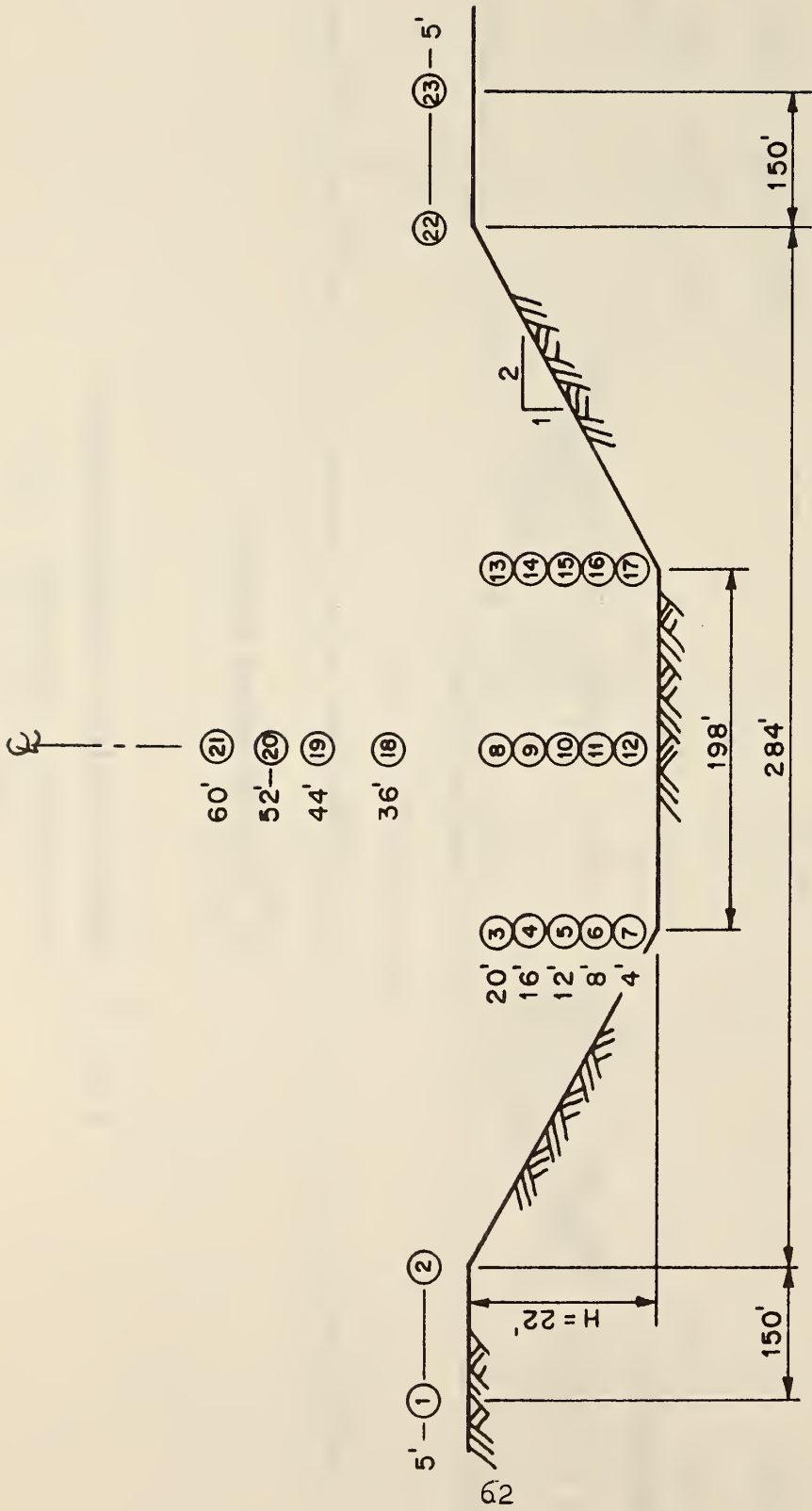
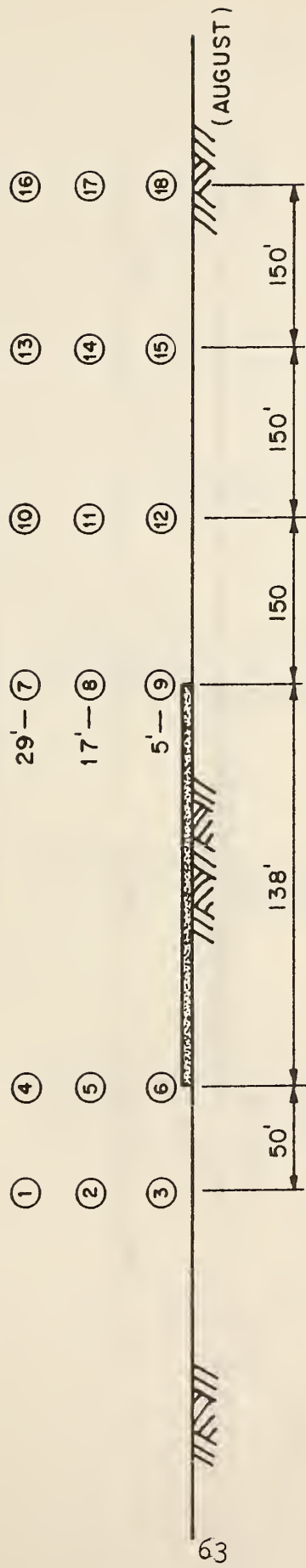
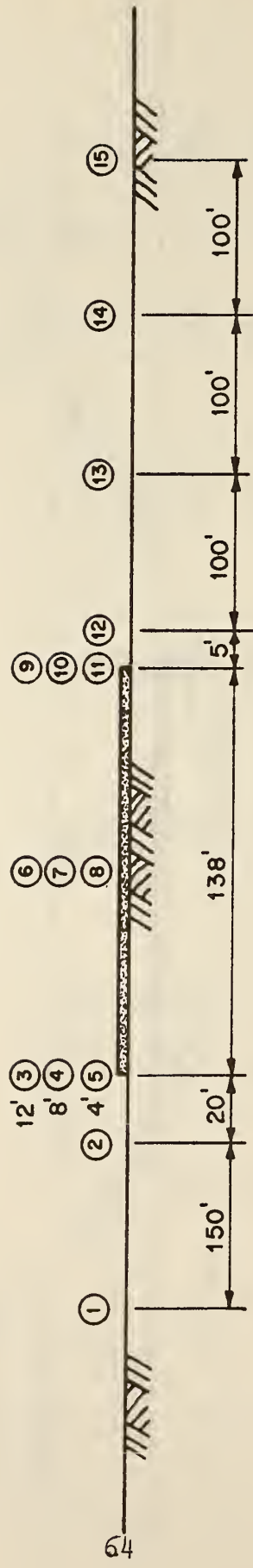

FIG. 40 PROBE LOCATIONS, HARBOR FREEWAY
 AT 146TH AVE IN-SECTION STUDY
 (NOT TO SCALE)



① DENOTES PROBE NUMBER

FIG. 41 PROBE LOCATIONS, SAN DIEGO FREEWAY
 AT WEIGH STATION, DOWNWIND STUDY
 (NOT TO SCALE)



① DENOTES PROBE NUMBER

FIG. 42 PROBE LOCATION, SAN DIEGO FREEWAY
 AT NATIONAL BLVD. DOWNWIND STUDY
 (NOT TO SCALE)

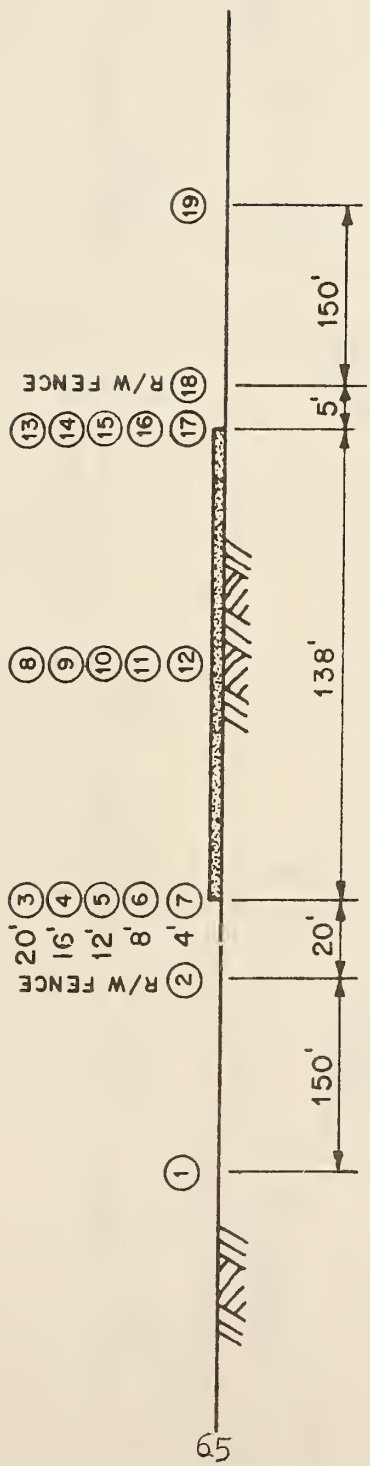

① DENOTES PROBE NUMBER

FIG. 43 PROBE LOCATION, SAN DIEGO FREEWAY
 AT NATIONAL BLVD. IN-SECTION STUDY
 (NOT TO SCALE)

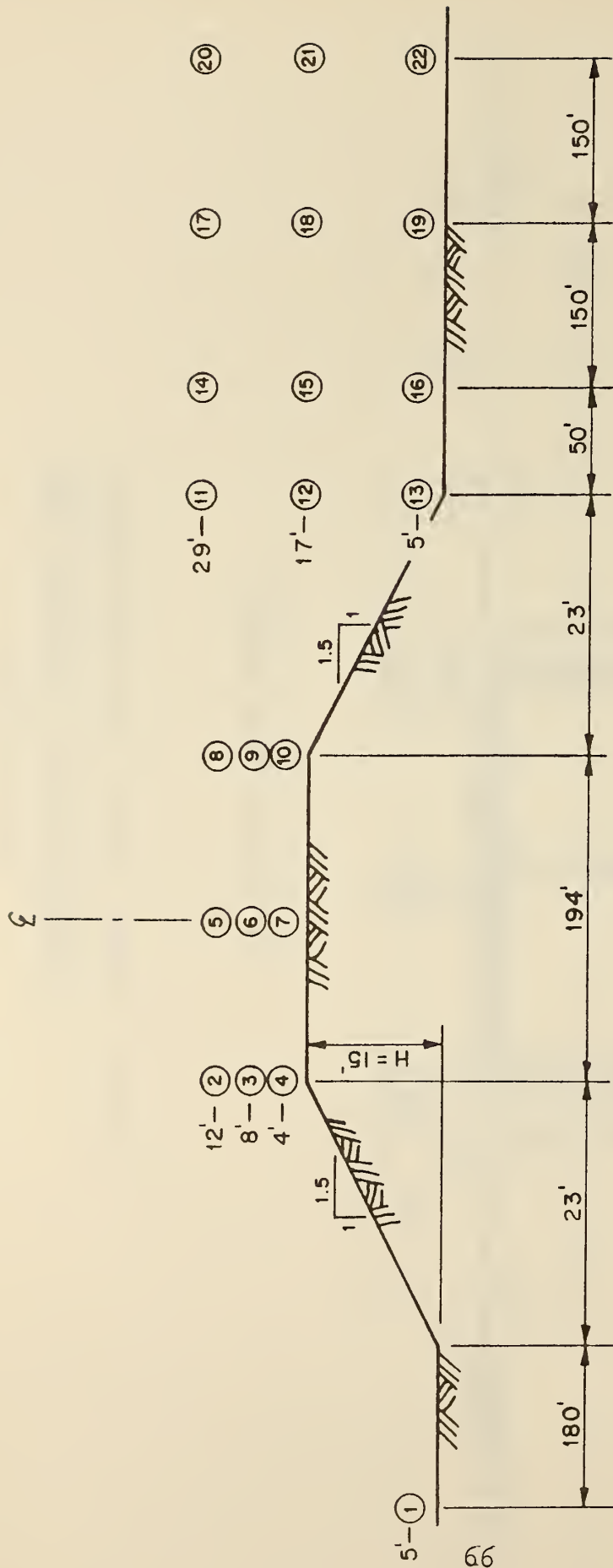

① - DENOTES PROBE NUMBER

FIG. 44 PROBE LOCATIONS, SAN DIEGO FREEWAY
 AT 122ND AVE DOWNWIND STUDY
 (NOT TO SCALE)

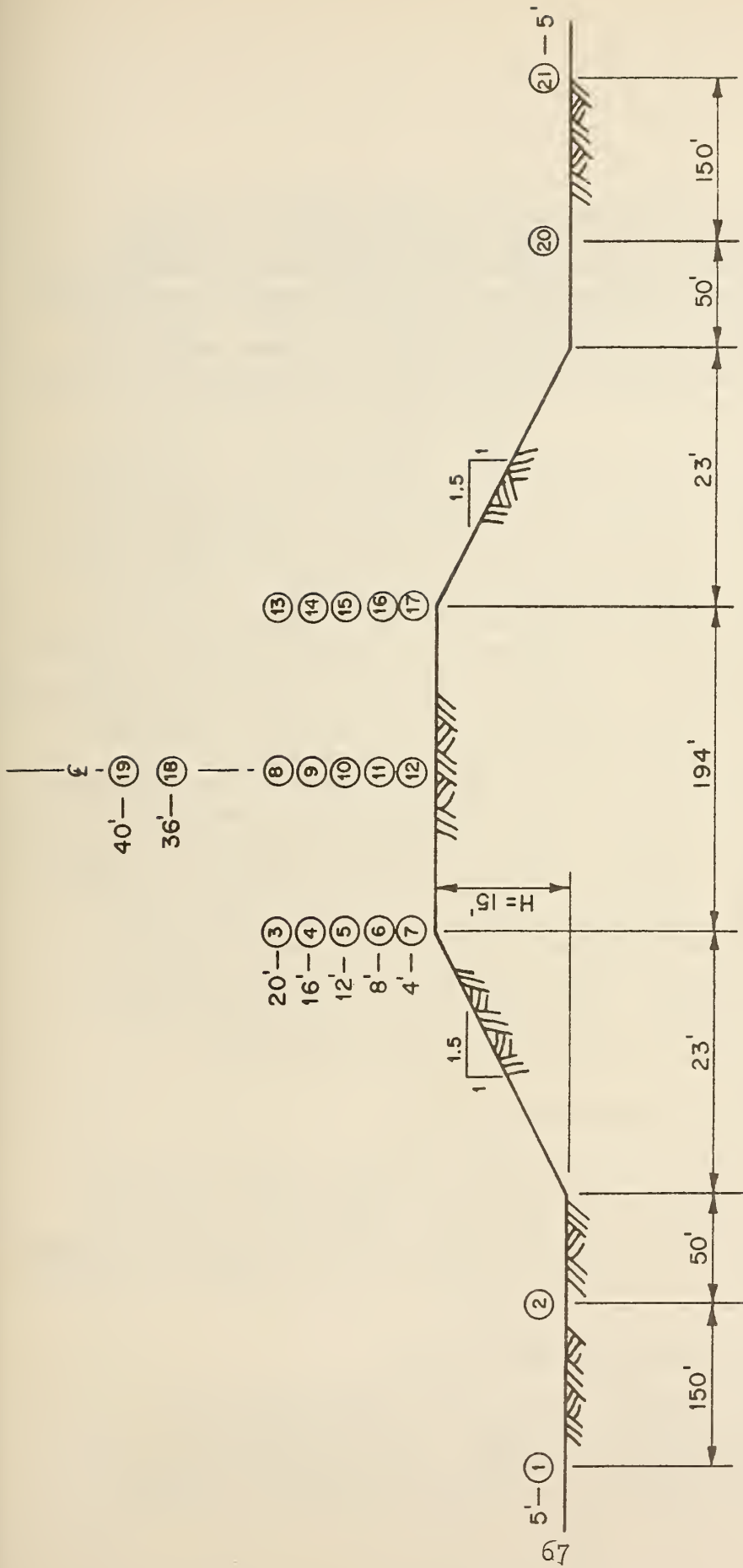

① - DENOTES PROBE NUMBER

FIG. 45 PROBE LOCATIONS, SAN DIEGO FREEWAY
 AT 122ND AVE IN-SECTION STUDY
 (NOT TO SCALE)

of source strength, or the amount of CO generated. It is generally accepted that the higher the average route speed, the lower the emissions of CO (6). The lower the average route speed, the higher the CO emissions. Traffic volume can change significantly from peak to off-peak hours. It is a necessity to design and schedule a sampling program to cover peak and off-peak periods to be able to characterize the source strength and dispersion.

Meteorology is another important parameter to consider when designing any air quality study. Meteorology determines the extent to which the pollutants generated on highways will be transported and dispersed. A stable surface atmospheric condition can restrict the dispersion of pollutants from line sources causing high ground level concentrations. Unstable surface atmospheric conditions enhance the dispersion of pollutants from line sources and tend to minimize ground level concentrations. Generally a stable surface atmospheric condition occurs with light winds and clear skies and is associated with a nighttime or late evening or early morning condition. Peak morning traffic hours occasionally occur with stable atmospheric conditions in the Los Angeles Basin. The unstable conditions generally occur in the daytime associated with clear skies and light winds. This is a typical condition within the Los Angeles Basin during late morning and early afternoon. The wind speed also influences ground level pollutant concentrations. Generally the higher the wind speed, the lower the ground level concentrations. Dominating sea breezes generally occur in the Los Angeles Basin beginning in early and mid-afternoon periods. To completely characterize the transport and dispersion of CO, the sampling program must include different types of meteorological conditions.

Sampling Scheme For the Evaluation of CO

A sampling plan to define the microscale region and also to encompass the temporal and spatial variations of CO for (1) in-section dispersion, (2) downwind dispersion, and (3) vertical dispersion was designed on the availability of manpower and equipment. Based on these limitations the sampling scheme used is shown in Figures 37 through 45.

Temporal and Spatial Distributions of CO

For any field study of dispersion, the measurements of pollutant concentrations must be made simultaneously at each sampling point to be comparable. Measurements made at one point for a given duration of time followed by a move

to another point for another measurement does not give the temporal and spatial distributions of pollutants. The data measured under these conditions are not simultaneous and contain large variations in meteorological parameters from point to point. Also, the traffic conditions, which are a function of time, can significantly affect pollutant concentrations. All measurements of CO in this study were made simultaneously to determine and characterize the temporal and spatial distribution of CO at each site.

SYSTEM SETUP AND RELIABILITY

Prior to the beginning of monitoring operations, numerous tests were run to determine the accuracy of the bag sampling techniques and equipment used in the preliminary study. The following is a discussion of each test made.

Variability of CO Concentration With Location

In this study, all of the monitoring equipment was stored overnight at or near each site in a trailer. For an experimental design requiring more than one day of sampling, the equipment must be relocated in the same position. Therefore, the degree of precision required in setting up each day was important. This was determined by comparing readings from several bags sampled at the same location. Since variations of carbon monoxide are larger near the source of emissions, this test (one day) was conducted adjacent to the top of the cut on the 4th Avenue site on the Santa Monica Freeway. The test consisted of four probes separated at horizontal distances up to 8 feet. Each air sample was taken 5 feet above the ground surface. A 5 minute bag sampling time was used. Figure 46 shows a layout of the test and the data. The range of the standard deviation was 0.045 as indicated.

The measured CO concentrations showed the maximum difference in site concentration to be 1 ppm. Most of the differences were 0.5 ppm or less. This is well within the accuracy of the operator and instrumentation to measure CO concentrations. For this reason, and the small number of tests, no statistical analysis of the variability was made.

The measurements for this test were made on only one day. Other micrometeorological conditions of surface stability may possibly cause a greater variance depending on the amount of atmospheric turbulence to diffuse the pollutant plume. Since the measurements were made close to the source, where a large variability would be expected, it is reasonable to assume that under other atmospheric conditions the variance will be similar.

Effects of Bag Sampling Time on CO Concentrations

Bag sampling averaging time was an important consideration in this preliminary study because of the necessity of using a scheme which would conserve manpower and equipment. Comparative tests were made in which air was sampled simultaneously with air bags while continuous monitoring was done by the

ELAPSED TIME	5 MINUTE SAMPLING SCALE READING			$\bar{X}_0 = 6.458$ $\sigma_0 = \pm 1.815$	$\bar{X}_2 = 6.375$ $\sigma_2 = \pm 1.860$	$\bar{X}_4 = 6.417$ $\sigma_4 = \pm 1.832$	$\bar{X}_8 = 6.333$ $\sigma_8 = \pm 1.826$
	0+0'	0+2'	0+4'				
:05	5	5	5	5	5	5	5
:10	7	7	6.5				
:15	10	10	10	10	10	10	10
:20	8	8	8				
:25	9	9	9	8.5	8.5	8.5	8.5
:30	6	6	6				
:35	6.5	6	6	6	6	6	6
:40	7	7	7.5				
:45	5	5	5	5	5	5	5
:50	4.5	4.5	4.5				
:55	4.5	4.5	4.5	4.5	4.5	4.5	4.5
:60	5	4.5	5				

17

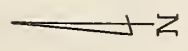

1:5:1

1:5:1

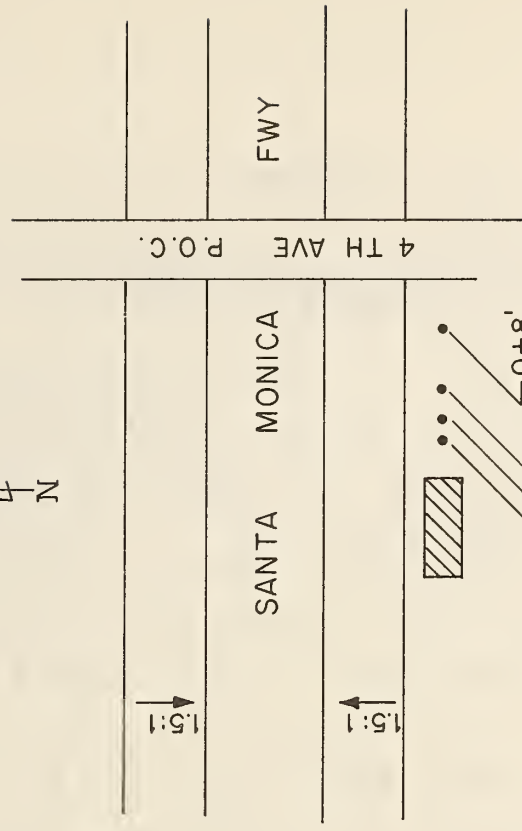

DATE: 3-21-72
 TIME: 0905-1005

\bar{x}_2 = MEAN CONCENTRATION OF CO,
 2 FEET FROM REFERENCE POINT
 σ_8 = STANDARD DEVIATION OF CO,
 8 FEET FROM REFERENCE POINT

FIG 46 VARIABILITY OF CO CONCENTRATION WITH LOCATION

TABLE 2

RELATIONSHIPS OF VARIOUS AVERAGING TIMES
TO HOURLY AVERAGES

Run No.	Date	Time	Bag Sampling Averaging Time			
			5 Min.	30 Min.	1 Hour	1 Hour Integrated
1	3/20/72	0835-0935	19.2	18.3	17.5	18.0
2	3/20/72	1025-1125	11.6	11.8	12.0	12.5
3	3/20/72	1240-1340	9.3	9.3	10.0	9.0
4	3/21/72	0730-0830	26.0	26.0	26.0	26.0

All values are in ppm.

NDIR analyzer at the same location. The probes were located within the cut section on the 4th Avenue Pedestrian Overcrossing on the Santa Monica Freeway, about 15 feet from the edge of the pavement. The probes were located near the vehicular emission source to obtain maximum variability of CO concentration. In these tests, bag samples of different averaging times (5 minutes to one hour) were analyzed and compared to the integrated hourly average of the continuously recorded trace from the NDIR analyzer. The integrated one hour average from the NDIR analyzer was determined using a planimeter. Table 2 shows the data measured and the average values. A statistical test was made to determine if there was a significant difference in the averaging times to measure the one hour CO concentrations. The nonparametric Friedman Two Way Analysis of Variance test was used. This test was used because of the small sample size and lack of information about the distribution of the data. The results of this test at the 5% level of significance indicate that there is no significant difference in CO concentrations for the various averaging times. It was concluded that the bag sampling provides accuracy and repeatability within 1 ppm of reading obtained by direct continuous NDIR analyses for all the averaging times examined.

Evaluation of Bag Materials in Bag Sampling

During the course of this study on the dispersion of carbon monoxide from highways, various sampling bag materials were tested: aluminized polyester (Scotchpak), clear Mylar, and opaque Mylar. Prior to the use of any bags in the research, exhaustive tests were run to establish the repeatability and validity of CO data taken using the bags. A significant anomaly was discovered using Mylar bags purchased from Specialty Converting Incorporated, South El Monte, California. These bags were clear Mylar, 5 mil., 16" x 16" in size, and were equipped with Halkey-Robert's valves. The inconsistency with the Mylar bags was initially noticed when performing tests comparing these bags with previously tested aluminized Scotchpak (3M Company) bags received from the California Air and Industrial Hygiene Laboratory (AIHL) in Berkeley. These comparison tests resulted in the Mylar bags yielding consistently higher (sometimes more than double) readings than the Scotchpak bags when collecting the same ambient sample. Subsequent to this discovery, five of the Mylar bags were tested under different environmental conditions with varying CO concentrations. The procedure and results of these tests which were conducted on March 28, 29, and 30, 1972, follow:

Test No. 1

A clear Mylar bag was flushed thoroughly with zero gas (CO=0 ppm, hydrocarbon - free air) and then filled with zero gas. It was analyzed and then exposed to direct sunlight. During exposure the bag was analyzed hourly using a Beckman Model 315 BL NDIR. Table 3 shows the results.

Table 3 Mylar Bags Filled With Zero Gas

	<u>Time</u>	<u>% Full Scale*</u>
(Filled and analyzed)	10:30	0
	11:30	3
	12:30	9.5
	13:30	19
	14:30	36
	15:30	70+ (bag exhausted with meter still deflecting upwards)

*NDIR meter deflection is percent full scale and only slightly higher than concentration in ppm for the 0 - 100 ppm range used (e.g., 36 percent full scale = 32 ppm)

Test No. 2

A clear Mylar bag was flushed and then filled with 90 ppm CO span gas (92.8 meter deflection). The bag was then analyzed, placed in sunlight as before, and analyzed hourly. The results are shown in Table 4.

Table 4 Mylar Bags Filled With 90 ppm CO

	<u>Time</u>	<u>% Full Scale</u>
(Filled and analyzed)	10:45	92.8
	11:45	95.5
	- Misplaced in shade from 1145 to 1310 -	
	14:10	100+ (exceed limit of scale with this range)

Test No. 3

A clear Mylar bag was filled with a mix of CO span gas and analyzed to be 23.5 percent full scale. It was then subjected to the same conditions as previous tests (direct sunlight) and analyzed hourly. Table 5 shows the results.

Table 5 Mylar Bags Filled With 23 ppm CO

	<u>Time</u>	<u>% Full Scale</u>
(Filled and analyzed)	11:15	23.5
	12:15	26.5
	13:15	32.0
	14:15	43.5
	15:15	64.0

Test No. 4

A clear Mylar bag was flushed and filled with zero gas and placed inside the monitoring trailer at 70°F where it was analyzed hourly. The results are shown in Table 6.

Table 6 Mylar Bags Filled With Zero Air at 70°F

	<u>Time</u>	<u>% Full Scale</u>
(Filled and analyzed)	12:00	0
	13:00	0.8
	14:00	1.0
	15:00	2.0

Test No. 5

A clear Mylar bag was flushed and filled with zero gas and then placed out of the sun in a closed automobile. It was analyzed and the temperature recorded at each hour. Table 7 shows the results.

Table 7 Mylar Bags Filled With Zero Air Exposed to Environmental Conditions

	<u>Time</u>	<u>% Full Scale</u>	<u>Temperature</u>
(Filled and analyzed)	12:30	0	Not available
	13:30	1	94°F
	14:30	1.5	94°F
	15:30	2.0	88°F

It was apparent after these tests that Mylar, when exposed to the direct sunlight, reacts with ambient air to produce a substance which the NDIR detected as CO. This may be caused by: (1) mixture of gases in the bag undergoing photochemical changes, (2) the ultraviolet (uv) wave lengths in solar radiation may cause out-gassing of plasticizers or other compounds from the bag wall, and (3) combination of both of the above. The product of the chemical reactions discussed above is either CO or a compound which the NDIR identifies as CO. No studies were made to investigate the effects of aging the bags before sampling.

The bags which were held out of the sun but at different temperatures (Tests Nos. 4 and 5) yielded only a slight increase in recorded CO, a difference that could possibly be attributed to instrument repeatability, human error, or even reflected sunlight. An attempt was therefore made to protect the Mylar bags from the sunlight by spraying the external surface with aluminum paint to make the bag opaque. Tests were then run comparing three bag types: Scotchpak, clear Mylar, and opaque Mylar. These bags were filled with zero gas and placed in the sunlight for hourly analyses. Table 8 shows the results where Bag No. 1 - Scotchpak, Bag No. 2 - clear Mylar, and Bag No. 3 - aluminum sprayed Mylar.

Table 8 Comparison of Scotchpak Bags, Clear Mylar Bags and Opaque Mylar Bags

Test No. 6A

<u>Time</u>	<u>% Full Scale</u>		
	<u>Bag No. 1</u>	<u>Bag No. 2</u>	<u>Bag No. 3</u>
0830	0	0	0
0930	0	4.5	0.5
1030	0	6.0	0
1130	0	11.5	0.5

Test No. 6B (Same test as 6A)

<u>Time</u>	<u>% Full Scale</u>		
	<u>Bag No. 1</u>	<u>Bag No. 2</u>	<u>Bag No. 3</u>
0630	0	0	0
0730	0	1	0
0830	0	1	0
0930	0	2	0
1030	0	11	0

The above test results indicate that clear Mylar is undesirable for use in ambient air bag sampling for NDIR analysis. Substantial test data indicate that sunlight on these bags produces high NDIR readings for carbon monoxide. Because of these results Scotchpak bags were used exclusively for the bag sampling of carbon monoxide.

Carbon Monoxide Decay With Time

All CO air samples were collected using bags. Studies made by the California Air Resources Board and the California Department of Health indicate that CO is relatively inert. This implies that CO concentrations would not decay with time when using the bag sampling techniques. To verify this assumption, studies were made by the Transportation Laboratory to simulate bag sampling in typical field temperature and humidity conditions. For this test 14 air sample bags were filled in the laboratory with a span gas (41 ppm) which was certified by the California Air Resources Board. Seven of these bags were placed in a large cardboard box exposed outside in the sunlight. This was to simulate field environmental conditions. The diurnal change in surface temperature ranged from a low of 60°F to a high of 100°F. The other seven were placed in a large cardboard box and were placed inside of the laboratory under controlled environmental conditions of about 75°F. All bag samples for the inside and outside environmental conditions were analyzed 1, 3, 17, 46, 70 and 95 hours after filling. All of the air samples were analyzed by a Beckman 315 BL nondispersive infrared (NDIR) analyzer located in the Transportation Laboratory. Table 9 is a summary of the results.

Table 9

Summary of Variations in NDIR Response When Using Scotchpak Bags

<u>Date</u>	<u>Time</u>	<u>Reading PPM</u>		<u>Decay Time Hrs.</u>	<u>Remarks</u>
		<u>Outside</u>	<u>Inside</u>		
8-28-72	1100	41	41	--	Bags filled
	1200	41	41	1	
8-28-72	1400	40	40	3	
8-29-72	0900	41	41	17	
8-30-72	0900	40	40	46	
8-31-72	0900	40	41	70	
9-1-72	1030	41	40	95.5	

The difference between samples exposed to the two environments is 1 ppm which is well within the accuracy of the equipment. This result indicates that there is no decay in CO concentration when the sample is held in a bag made of approved material, such as Scotchpak.

Effects of Types of Tubing on Carbon Monoxide Concentrations

During this preliminary study, all air samples were collected using Scotchpak air sample bags and 3/8" I.D. teflon tubing. Extensive use was made of teflon tubing because of its inert characteristics with respect to automobile exhaust pollutants; that is, carbon monoxide, hydrocarbons, oxides of nitrogen, and secondary pollutants such as ozone.

Field experience indicated one problem with teflon tubing in that great care must be taken to not kink the tubing when making small radius bends. It was apparent that a more flexible tubing material would be desirable provided it was inert to CO. The California Air Resources Board, State Department of Health, and various manufacturers of air monitoring instrumentation suggested that tygon tubing would be adequate to satisfy our needs in terms of flexibility and inertness. In addition, the cost of tygon was about one half that of teflon making it desirable from an economic standpoint.

To minimize costs and to provide for ease of field installation, it was decided to test four different types of tubing material for reaction with CO: teflon, tygon, green polyvinylchloride, and white polyvinylchloride. The lengths of tubing were about 50 feet. The primary purpose for testing the polyvinylchloride tubing was not because of its additional flexibility compared to teflon, but its minimal cost. Therefore, the primary objective of this experiment was to (1) simulate field sampling conditions, and (2) determine if the tygon and polyvinylchloride tubing would provide valid samples as compared to teflon. To simulate field conditions the tubing lines were placed on a grass and concrete surface. A known span gas of 41 ppm was run through each type of tubing and collected in a Scotchpak bag at the end of each line. Table 10 is a summary of these results.

In Table 10 the column heading "previous total exposure time", refers to the length of time the tubing was exposed to direct sunlight prior to testing.

TABLE 10
EFFECTS OF SAMPLING LINE MATERIAL
ON NDIR READINGS

Date	Test No.	Tubing Type	Previous Total Exposure Time Hours	Measured Concentration ppm	Sampling Duration Hours	
9-8-72	1	White-PVC*	0	49	1	New tubing exposed in hot sun + 95° F
	1	Green-PVC	0	42	1	
	1	Tygon	0	51	1	
	1	Teflon	0	100+**	1	
9-8-72	2	White-PVC.	1	49	1	Same as above
	2	Green-PVC	1	41	1	
	2	Tygon	1	50	1	
	2	Teflon	1	100+**	1	
9-8-72	3	White-PVC	2	44	0.5	Same as above
	3	Green-PVC	2	41	0.5	
	3	Tygon	2	42	0.5	
	3	Teflon	2	96	0.5	
	4	White-PVC	3	40	0.5	All tubing was put inside a black conduit
	4	Green-PVC	3	40	0.5	
	4	Tygon	3	40	0.5	
	4	Teflon	3	41	0.5	

*Polyvinylchloride

**Exceeded limit of scale (100 ppm) on Beckman NDIR Analyzer.

Span gas 41 ppm certified by Calif Air Resources Board.

Examination of Table 10 clearly indicates that some kind of a reaction occurred with white polyvinylchloride, tygon, and teflon tubing when exposed to the direct sunlight. The most significant reaction occurred with the teflon tubing, much to our surprise, which more than doubled the NDIR reading of the span gas concentration of 41 ppm. Of all the tubing exposed to the direct sunlight, only the green polyvinylchloride tubing appeared to provide good values of CO. Generally, the longer the exposure of the tubing to direct sunlight, the more stable the CO reading. In Test 4 in, Table 10, all the tubing was put into a black conduit to screen out sunlight. This test was made because of the results from the green polyvinylchloride.

The results from Test 4 showed essentially no difference (± 1 ppm) in the measured concentration and the known span gas value. It should also be noted that in Test 3, for the teflon tubing with 2 hours of exposure in direct sunlight, the CO concentration measured was 96 ppm compared to 100 ppm plus in Test 1. When the teflon tubing was placed inside the black conduit, the CO measured was 41 ppm (same as the span gas). The limited amount of data suggests that certain wave lengths of the incoming solar radiation may possibly cause a reaction inside the tubing which produces either CO or a compound which interfere in the NDIR analysis.

The conclusion from the Tests 1 through 4 indicates that green polyvinylchloride and tygon tubing can be used as an intake line to sample CO. This assumes that the tubing has been exposed to direct sunlight for at least 3 hours prior to use. It is interesting to note that most of the recommendations stating that teflon was chemically inert in the NDIR analysis of CO were based primarily on experience of local air monitoring districts and air surveillance networks. In most all of these cases, the length of teflon tubing exposed in direct sunlight is minimal because all of the CO analyzers are located in buildings and the probe placed just outside a window. The shielding effect of the building and tubing support is not representative of field conditions when sampling along highways.

Further studies were made on teflon tubing with different sunlight exposure times. These studies were also conducted at the Transportation Laboratory. For these studies, previous total exposure times ranged from zero hours up to one week. A known span gas of 41 ppm was used for comparison. Table 11 is a summary of results. It is interesting to note that in Test 5 with the new teflon, the measured CO concentration

exceeded 100 ppm. This tubing was stored in a trailer and was not exposed to the direct sunlight until the test. This gave the same results as Test 1 on September 8, 1972. In Test 5, CO concentration measured in the early morning with 51 hours of previous exposure was 45 ppm, while that measured at midday was 59 ppm. This constitutes an error of 12.2% and 42.8% from the known span gas concentration of 41 ppm. This again suggests that some wave lengths of the radiation received from the sun acts as a catalyst causing the reaction. However, the possibility that the tubing sample received from the manufacturer could have been contaminated should not be overlooked.

In Tests 6 and 7, all the teflon tubing was exposed over the weekend to direct sunlight. The measured CO concentrations under these conditions were within experimental error and agreed well with the known span gas of 41 ppm.

Based on these studies, it is recommended that when teflon tubing is used for sampling CO, the teflon be exposed to atmospheric conditions for at least three days prior to use.

TABLE 11
 RESPONSE OF NDIR TO CO PASSED THROUGH AGED
 AND NEW TUBING

Date	Trial No.	Tubing Type	Previous Total Exposure Time	Measured Concentration ppm	Sampling Duration Hours	Weather	Remarks
9-11-72	5	Teflon	51 hours	45	1	Cool morning sun	All tubing was exposed in a trailer over the weekend; not exposed to direct sunlight
	5	Teflon(new)	0 hours	100+*	1	Noon hot sun	
	5	Teflon	51 hours	59	1	Noon, hot sun Temperature range 54-77°F	
9-12-72	6	Teflon	1/2 week	41	1	Temperature range 49-81°F	All tubing was exposed in direct sunlight over weekend
	6	Teflon	1 week	41	1		
9-12-72	7	Teflon	1/2 week	43	2	Temperature range 49-81°F	All tubing was exposed in direct sunlight over weekend
	7	Teflon	1 week	45	2		

*Exceeded limit of scale (100 ppm) on Beckman NDIR Analyzer.

DESCRIPTION OF DATA BASE

The data base for this study (Appendix A) consists of hourly values of (1) carbon monoxide concentrations, (2) meteorological parameters (wind speed and direction), and (3) traffic volumes. The location and measurement procedures for these parameters have been discussed previously. The data base is described by the site location, bearing of roadway, geometry of highway design, and height of the wind speed and direction sensors above surrounding terrain. The data bases in Appendix A are divided into site location: Site 1 - Santa Monica Freeway, Site 2 - Harbor Freeway, Site 3 - San Diego Freeway at Weigh Station, Site 4 - San Diego Freeway at National Boulevard, and Site 5 - San Diego Freeway at 122nd Street.

Meteorological Data Base

For the meteorological data base, the cloud cover and ceiling height were obtained from the U.S. Weather Bureau station at the Los Angeles International Airport. No measurements of these parameters were made directly at each site. However, cloud cover and ceiling height are generally a mesoscale phenomenon. Because of the homogeneity of the terrain for the sites on the Surveillance Loop and the close proximity (2 to 10 miles) to the Airport, these data were assumed to be representative for all locations. The wind speed and direction were measured at each site and are in units of miles per hour and degrees from true north respectively. The column labeled STAB is the estimate of the surface stability class of the atmosphere for each location. The surface stability classes were determined using methods employed by Pasquill (3), and from an objective system of classifying stabilities using meteorological observations as suggested by Turner (3). Turner's approach considers the cloud cover, ceiling height, wind speed, insolation, time of day, and season of year. The stability classifications are as follows:

A = extremely unstable

B = unstable

C = slightly unstable

D = neutral

E = slightly stable

F = stable

Stability Class A is associated with a daytime condition with light winds and clear skies. Stability Class D is associated with a day or nighttime condition with strong winds or overcast skies. Stability Class F is associated with nighttime, late evening, and early morning conditions with light winds and clear skies. In general the unstable atmospheric conditions near the ground surface for a microscale condition result in relatively low pollutant concentrations. On the other hand, a stable surface atmospheric condition restricts the dispersion of pollutants resulting in high ground level concentrations.

The numbers above the wind direction, e.g., 5-2-72, 0900, 3, are interpreted in the following manner:

- 5-2-72 - represents the month, day, and year data were measured.
- 0900 - means integrated average from 900 to 1000 and beginning sampling time for that day.
- 3 - indicates three subsequent hours, 1000 to 1100, 1100 to 1200, and 1200 to 1300.

Carbon Monoxide Data Base

Each CO measurement location is identified by a Probe Number ranging from 1 to 26 depending on the site monitored. The vertical and horizontal relationships of the probe locations with respect to the freeway are indicated in Figures 37 through 44. They are also repeated and shown in Appendix A before the CO data base. The symbol (e.g. 1) means Probe 1 location, etc. The number below the probe number in the data base is the concentration of CO in parts per million (ppm). If, in the data base, the number -1 appears, it indicates that no data are available. This means that (1) no measurement at this probe location was made for that particular day and/or hour or (2) possible equipment malfunction. Again as in the meteorological data base, the number below "Pollutant Concentration" indicates the month, day, year, beginning of air sample, and subsequent hours of sampling.

Traffic Data Base

The traffic data base is identified by the site location and highway geometrics. The traffic data are divided into the following:

- 1) directional lane volumes (vehicles per hour)
- 2) directional lane occupancy (percent)
- 3) directional lane speeds (miles per hour)
- 4) total vehicles per hour for both directions
- 5) average speeds for both lanes (miles per hour).

Occupancy is defined as the percentage of time that a traffic loop detector is occupied. By knowing the vehicles per hour, the occupancy, the average length of vehicle, and number of lanes, the route speed can be estimated using the following equation (7):

$$RS = \frac{vph}{(NL) \times Occ. \times \frac{5280}{ALV}}$$

where RS = route speed in miles per hour

vph = vehicle per hour

NL = number of lanes

Occ = occupancy in percent (decimal)

ALV = average length of vehicle in feet

The ALV for the freeway site locations are as follows:

Santa Monica, ALV = 19.84 feet

All other sites, ALV = 21.38 feet

When the number or symbol -1 occurs in the data base, this indicates that no data are available. The notation, "* = Derived Data", indicates that the speeds were calculated using the above equation. The average speed for both directional lanes is the arithmetic average of both directional lanes rounded off to the nearest whole number. For the site located on the San Diego Freeway at the Weigh Station, no monitoring of occupancy was available. For this site the traffic volumes were generally in a free flow mode of operation during peak and off peak hours ranging from 45 to 70 mph. These estimates were made by driving a State vehicle randomly throughout several time periods for a given day.

Time Period of Data Base

The time period for the data base is given in Table 12.

Table 12

Time Period For Data Base			
<u>Site Location</u>	<u>Month(s)</u>	<u>Number of Days Sampled</u>	<u>Total Hours</u>
Santa Monica 4th Ave. P.O.C.	May & June	21	95
Harbor 146th Street	August	8	74
San Diego at Weigh Station	April & August	13	101
San Diego at National	August	8	52
San Diego at 122nd Street	Sept. & Oct.	15	83

Limitations of Data Base

All of the measurements in the data base were from the beginning of May through mid-October. Five years of historical air quality data from the Los Angeles Air Pollution Control District (LAAPCD) air monitoring stations at Lennox and Pomona were analyzed. The analysis indicated that the highest carbon monoxide concentrations within the Los Angeles Basin generally occur within the winter months (November through February). These air monitoring stations are located in close proximity to major surface streets. They measure the effects of local traffic densities and possibly aerodynamic eddies (4, 8, and 9). They are not representative of general ambient levels that exist away from these influences. Similar effects have also been observed in this study and are discussed in detail later in the report.

The LAAPCD stations can indicate the general seasonal trends in CO concentration. The highest values generally occur during the morning rush hours with very stable air. There is a greater chance for stable surface atmospheric

conditions to occur during the winter months (in absence of frontal activity) because of solar geometry and the amount of incoming radiation. The nights are longer and there is less incoming radiation during the morning hours (peak traffic) to destroy the surface based inversions. Due to project scheduling, monitoring was not done during the winter seasons where the expected ambient concentrations of CO would be the highest. Also limited data were acquired for conditions when the surface winds were parallel to the highway alignment. Some data were available with strong surface winds greater than 10 mph; however, no data were taken for light winds parallel to the highways under stable atmospheric conditions.

Because the traffic patterns are nearly reproducible daily, the major cause for the CO variations is change in meteorology. For the study period, the daily meteorological conditions did not change significantly and much of the CO data monitored were very reproducible on a daily basis. This strongly indicates that to fully identify the important transport and diffusion parameters the monitoring program should cover the extreme ranges of meteorological conditions. This should include monitoring for seasonal variations in meteorology so that the extremes of surface atmospheric stability will be encountered. In light of the above discussion, one should not consider the measured CO concentrations representative of the typical winter season. The data should be viewed as representative for the May through October season only.

DATA ANALYSIS

A statistical analysis of the data was performed in order to evaluate the effects of the following variables on the carbon monoxide dispersion rates downwind of the sampling sites:

- 1) The size and extent of the mechanical mixing caused by the turbulent wake of the vehicles on the roadway.
- 2) The effect of surface roughness and associated microscale turbulence (a function of the land use both upwind and downwind from the various sampling sites).

The rates of dispersion in both the vertical and horizontal directions were determined from the data. These dispersion rates are functions of atmospheric stability, wind speed, vehicle speed and spacing on the roadway, and adjacent land uses. These dispersion rates may or may not be applicable to other sites.

The optimum spacing of the probes and the minimum sampling time necessary for an adequate hourly carbon monoxide average were also evaluated.

Mixing Cell Variability

Figures 47 through 55 show the locations of the probes at each of the sampling sites monitored. In addition, the one hour arithmetic means (\bar{X}) and arithmetic standard deviations (σ) of carbon monoxide levels at each of the probes are indicated.

For the depressed freeway section on the Santa Monica Freeway (Figure 47), a visual inspection of the means within the highway section ranged from 10.7 ppm to 17.2 ppm. The corresponding standard deviations ranged from 3.8 ppm to 5.6 ppm. These values are for CO measured on both shoulders of the roadway and at the center of the roadway, at heights of 4 feet to 20 feet above the pavement surface.

It is apparent from these data that the sides of the depressed freeway section tend to restrict the lateral dispersion of carbon monoxide. This can be observed from the relative uniformity of the mean concentrations at these points. The uniformity is even more evident for the lower

probes (at 4, 8, and 12 feet above the pavement). The homogeneity of the standard deviations is also surprising. The physical parameters that may cause changes in the standard deviations are:

- 1) Traffic volumes and operating modes.
- 2) Meteorology.
- 3) Combinations of 1) and 2).

If one considers the mechanical mixing cell to be a region where the turbulence caused by the moving vehicles on the roadway creates a homogenous mixing process, then one would expect a uniform concentration within this cell.

If the standard deviations (σ) of the measured CO values are considered to represent the extent of turbulent mixing in the air, then it is possible to evaluate the extent of the mixing process by looking at the σ values. Within the depressed section, the σ values range from 3.8 ppm to 5.6 ppm while the σ value at the 36 to 60 feet levels are lower. This indicates that there may be less turbulence in the air above the freeway than within the depressed section. The turbulence within the mechanical mixing cell is also greater than that at the higher probe locations.

The relatively high standard deviations could possibly be due to large changes in traffic densities. In the absence of vehicles, the carbon monoxide levels would be very low. As a group of cars pass the sampling site, a "cloud" of carbon monoxide is released, causing the CO values to go up. This is the concept of what microscale modelers call the cloud, or "puff" model. This might indeed be the case for values averaged over a few minutes or less. However, since the traffic volumes are as high as 17,000 VPH, the traffic stream is probably too uniform for this to be the cause of the high σ values when averaged over 60 minutes. Therefore, it can be concluded that on the roadway, mechanical turbulence is the dominant dispersion parameter.

Another interesting observation of the data in Figures 47 through 55 concerns the downwind values of \bar{X} 's and σ 's. As mentioned previously, CO values were measured at 5, 17, and 29 feet above the ground surface for all sites for the downwind studies. There is little variability in the \bar{X} 's and σ 's for all of the levels at each site. The σ 's downwind at all levels for sites located in residential and open areas indicate that there is enough turbulence to produce a complete

mixing process from ground level up to 29 feet. For residential areas this indicates that the mechanical turbulence, caused by the air flow over and around obstructions (i.e., houses, trees, etc.), and thermal turbulence provide thorough mixing in this region. For the open sites (on the San Diego Freeway at the Weigh Station and 122nd Street) the mechanical turbulence caused by the wind shear or momentum transfer of energy creates enough turbulent eddies to thoroughly mix the CO in this region.

In order to plan for further monitoring using the minimum number of probes both on the roadway and in the downwind region, it was necessary to determine the temporal and spatial distributions for carbon monoxide adjacent to roadways. For a maximum benefit at a minimum cost, it was decided to combine the in-section and downwind probe locations for all future field sampling. For the two depressed freeway sections, the Santa Monica and Harbor Freeway sites, the average CO concentrations from the 4 to 20 feet levels are fairly constant. To test the homogeneity of the concentrations within these sections, the nonparametric statistical test, Friedman Two-way Analysis of Variance, was used. The nonparametric test was used rather than the parametric test because no assumptions are made about the distribution of the data, and nonparametric tests are most appropriate for non-random data. The Friedman Test was made for probes (1) through (15) and probes (3) through (17) for the Santa Monica and Harbor Freeway sites respectively. Analyses were made for each hour for the total time sampled at each site.

For both sites, at the 5% level of significance, the test indicates that the spatial distribution of the CO values was significantly different for all probes for the hours sampled. Even though there is a statistically significant difference between all probes, one can still describe the probe location that would be most representative of the CO concentrations to which drivers on roadways are subjected by combining statistics and physical reasoning. As previously discussed, the mechanical mixing cell is defined as the region where there is a zone of intense mixing and turbulence. The height of the cell has been found analytically (10) and experimentally (11) to be approximately twice the height of a vehicle. This region should be fairly representative of the air breathed by drivers of vehicles using a highway facility.

To supplement the Friedman Test a simple statistical averaging analysis was made using the mean CO values for the entire sampling period for the sites (Figures 47, 49 and 55).

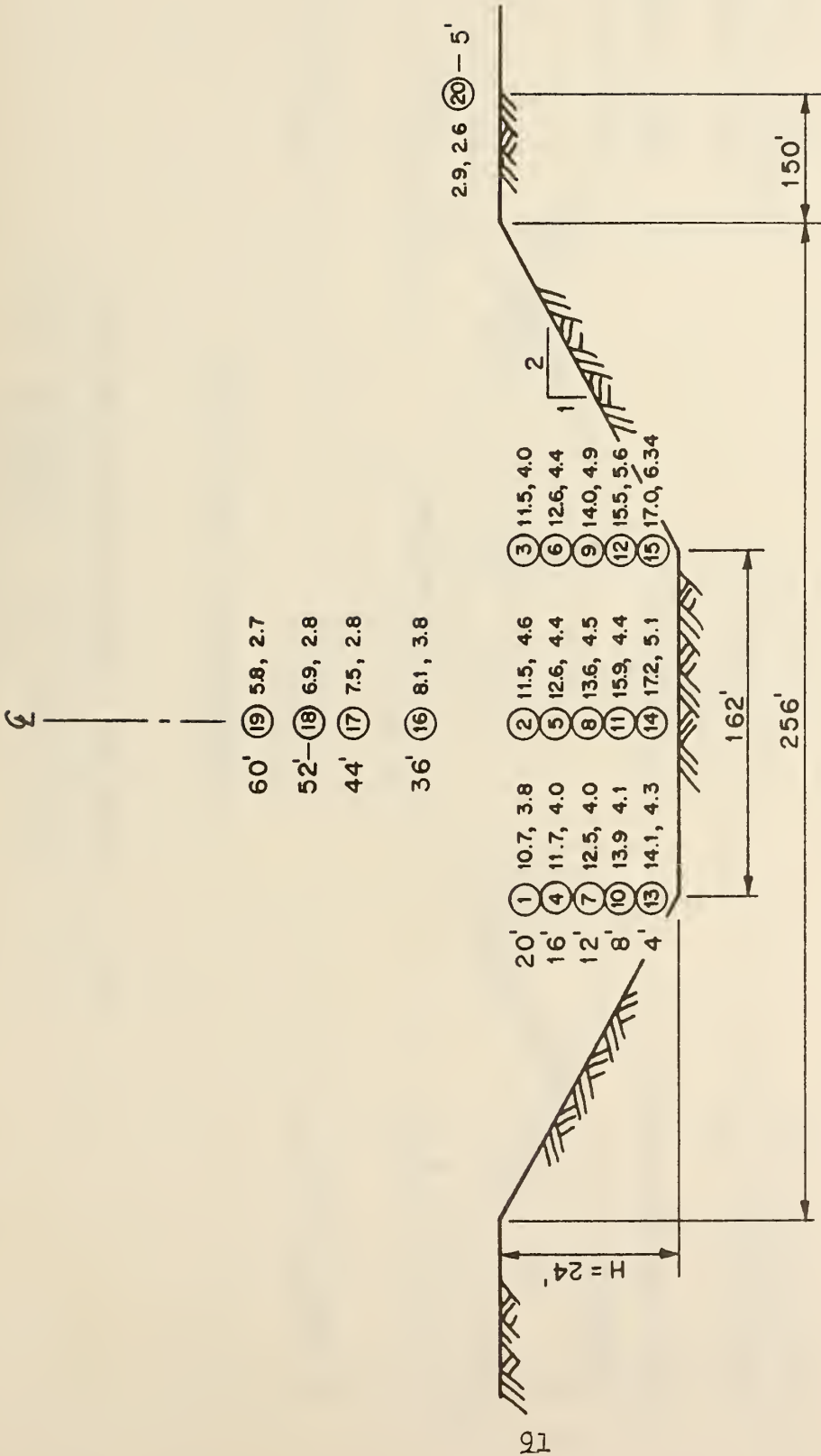

① - DENOTES PROBE NUMBER

FIG. 47 MEAN AND STANDARD DEVIATIONS OF CO
 AT 4TH AVE P.O.C. IN SECTION STUDY
 (NOT TO SCALE)

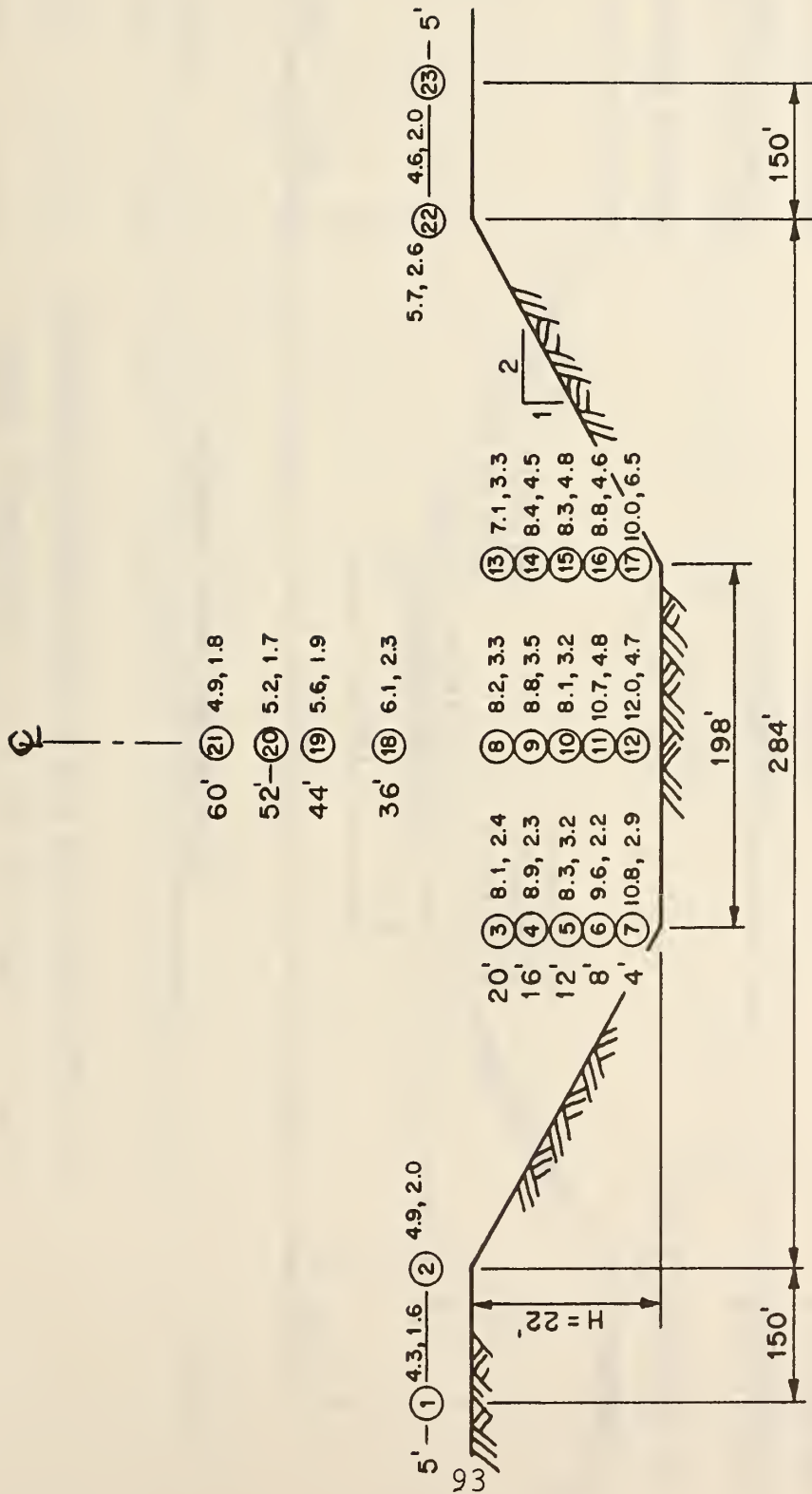

① - DENOTES PROBE NUMBER

FIG. 49 MEAN AND STANDARD DEVIATIONS OF CO
AT 146TH AVE P.O.C. IN-SECTION STUDY
(NOT TO SCALE)

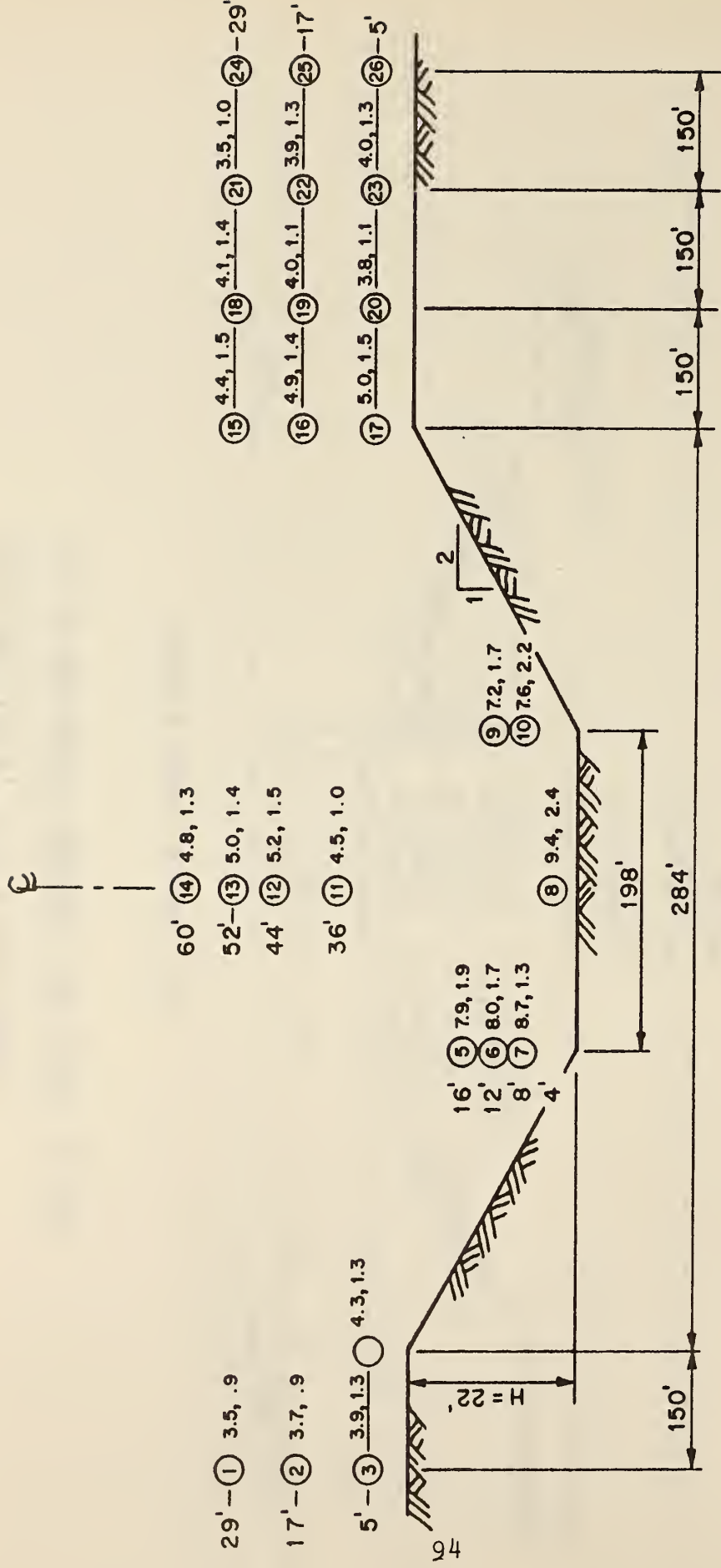

① - DENOTES PROBE NUMBER

FIG. 50 MEAN AND STANDARD DEVIATIONS OF CO
AT 146 AVE P.O.C. HORIZONTAL STUDY
(NOT TO SCALE)

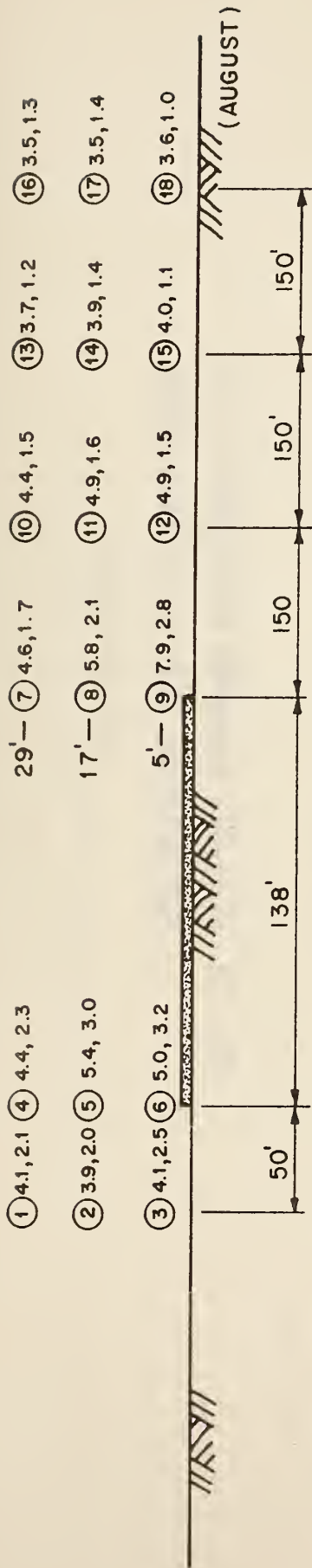

① DENOTES PROBE NUMBER

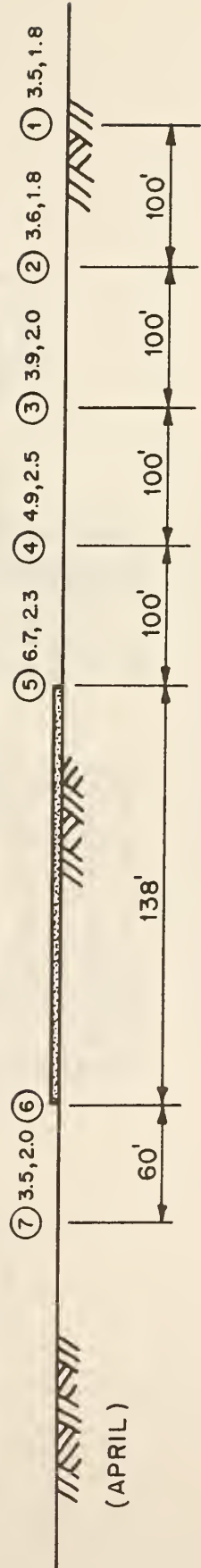
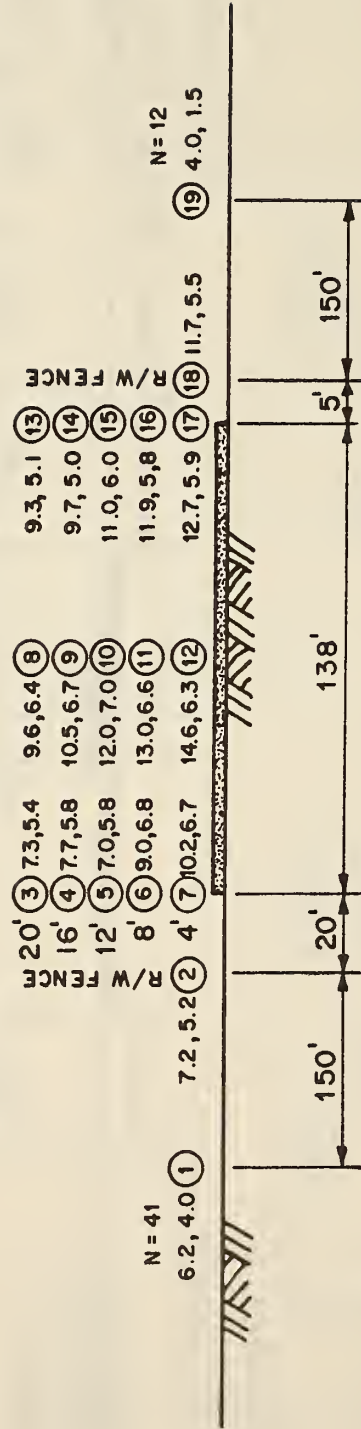
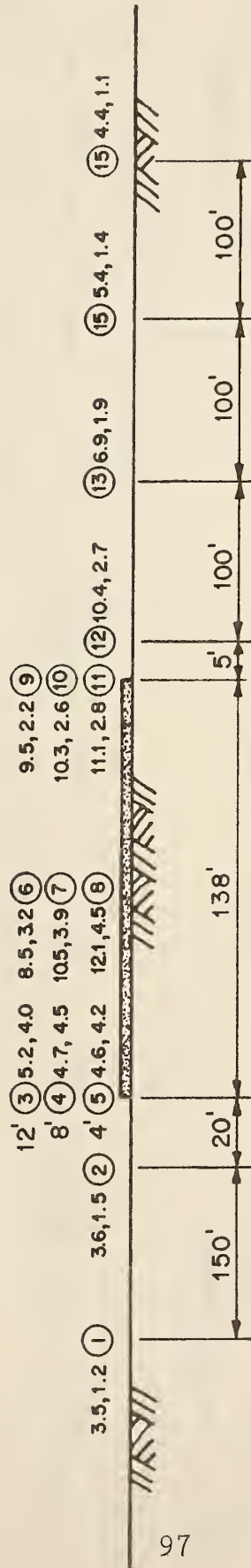

FIG. 51 MEAN AND STANDARD DEVIATIONS OF CO
AT WEIGH STATION DOWNWIND STUDY
(NOT TO SCALE)



① DENOTES PROBE NUMBER

FIG. 52 MEAN AND STANDARD DEVIATIONS OF CU
FOR NATIONAL BLVD IN-SECTION STUDY
(NOT TO SCALE)



① DENOTES PROBE NUMBER

FIG. 53 MEAN AND STANDARD DEVIATIONS OF CO
AT NATIONAL BLVD DOWNWIND STUDY
(NOT TO SCALE)

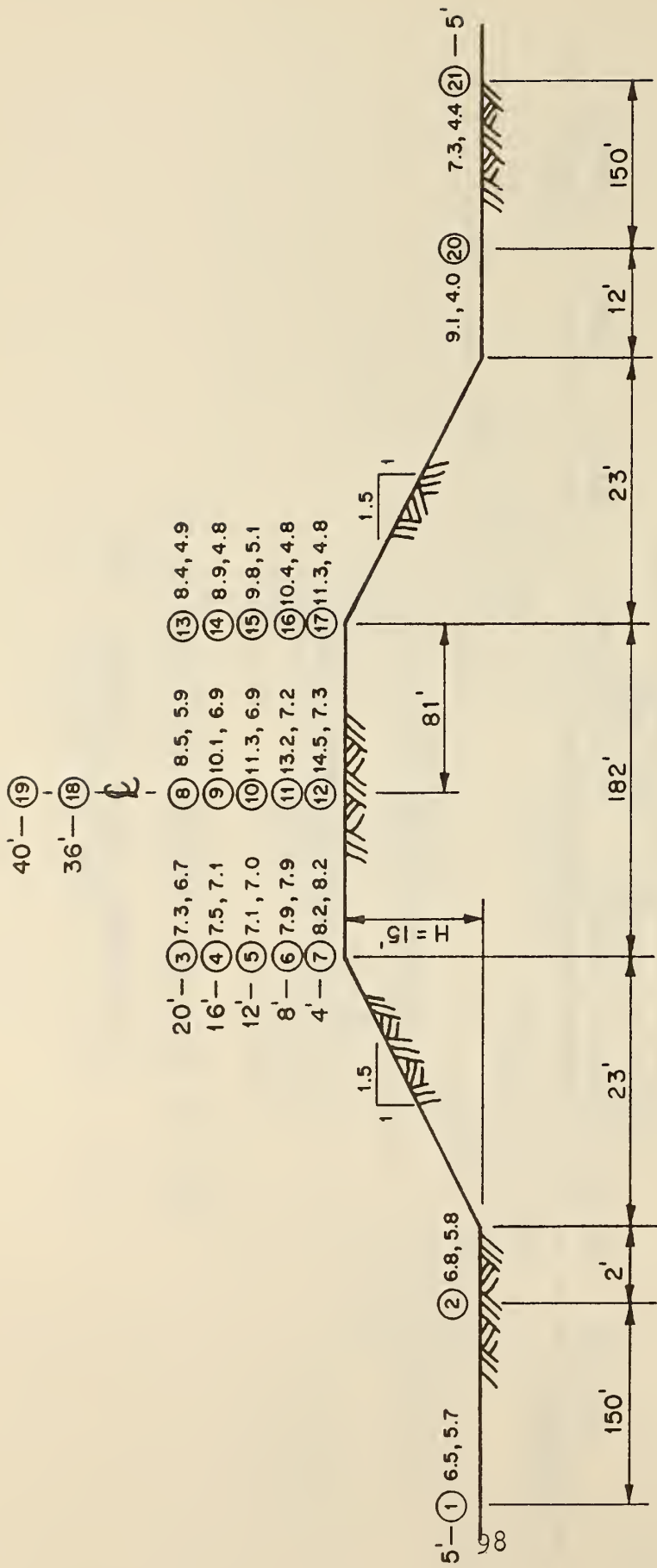

①--DENOTES PROBE NUMBER

FIG. 54 MEAN AND STANDARD DEVIATIONS OF C0
AT 122ND AVE IN-SECTION STUDY
(NOT TO SCALE)

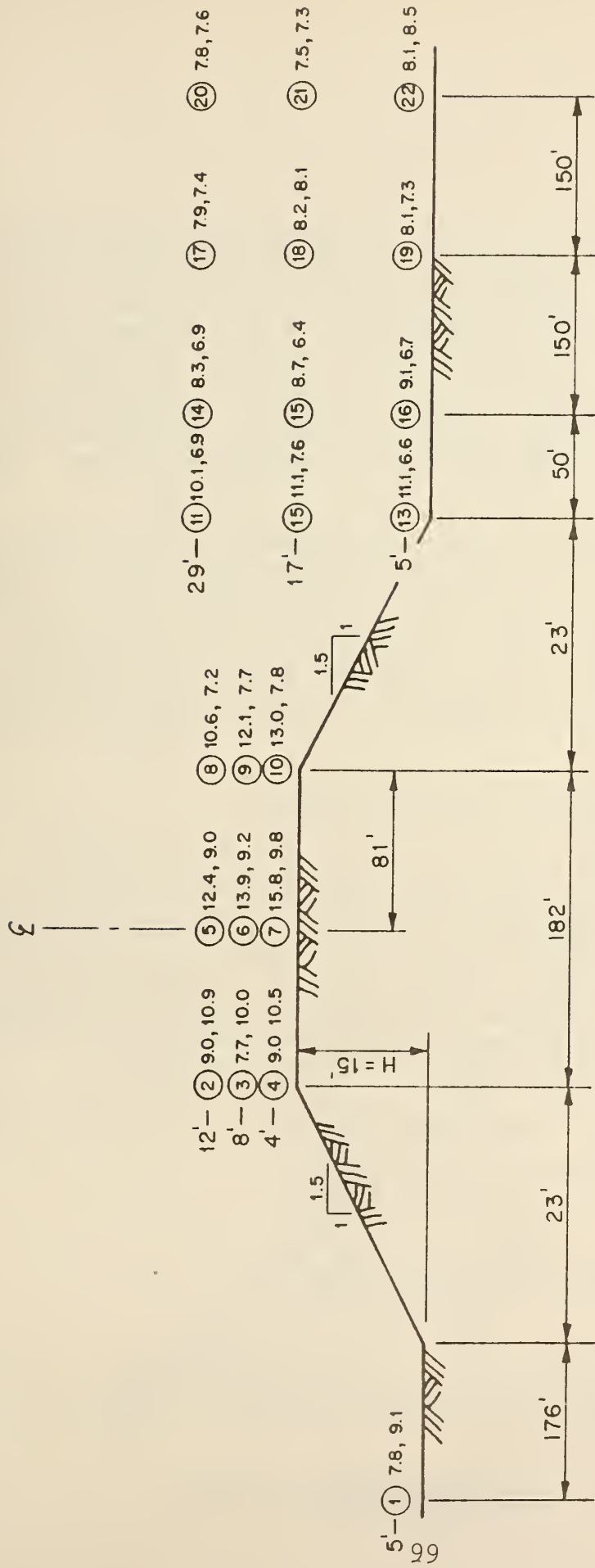

① - DENOTES PROBE NUMBER

FIG. 55 MEAN AND STANDARD DEVIATIONS OF CO
AT 122ND AVE DOWNWIND STUDY
(NOT TO SCALE)

For each highway section a mean CO value was calculated for the 4, 8, and 12 foot probes for both shoulders and the median. These probes were considered to be well within the turbulent mixing cell. This approach involved using the mean CO concentrations for the entire data base for the 9 probes located at the 4, 8 and 12 foot locations. Then the arithmetic mean for the lower paired probes of 4 and 8 feet (6 probes) and the upper paired probes of 4 and 12 feet (6 probes) were calculated. The percent change (or error) of the mean CO concentrations was compared to the 9 possible probes. This analysis was made for the cut and fill sections.

From the above analysis, the maximum error for both the lower and upper pairs of probes was less than 12%. It was concluded that the probes at the 8 feet height were really not necessary and only the 4 feet and 12 feet probes will be used in future field work. The 4 feet and 12 feet probe locations will allow one to study the possible effects of heavy duty vehicles on turbulence in the mechanical mixing cell and the consequent effects on downwind transport and dispersion.

Vertical and Horizontal Dispersion Rates

An analysis was made to characterize the relative importance of vertical and horizontal dispersion rates. The data used for this analysis were the averages of the hourly CO concentrations measured at each site (entire data base) for a particular probe location. The data used for each site are shown in Figures 47 through 55. Horizontal and vertical dispersion curves are shown in Figures 56 through 58. The gradients for the at-grade sections were not analyzed because of the limited height of CO measurements.

There are two concentration gradients defined as follows:

$$\text{Vertical Gradient} = \frac{C}{Z} = \frac{C_1 - C_2}{Z_1 - Z_2}$$

$$\text{Horizontal Gradient} = \frac{C}{X} = \frac{C_1 - C_2}{X_1 - X_2}$$

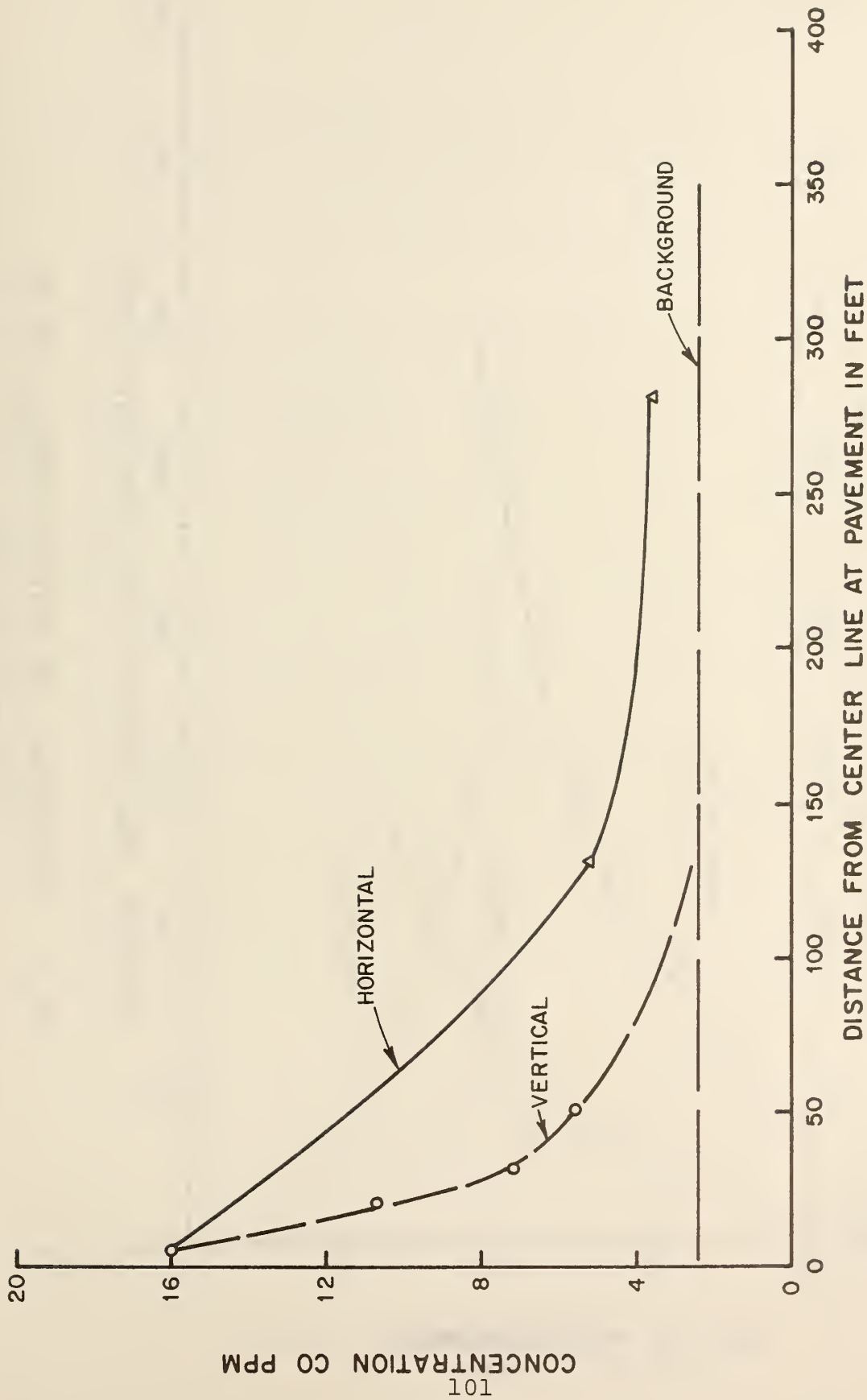

FIG. 56 HORIZONTAL AND VERTICAL PROFILES OF CO
FOR 4TH AVE P.O.C.

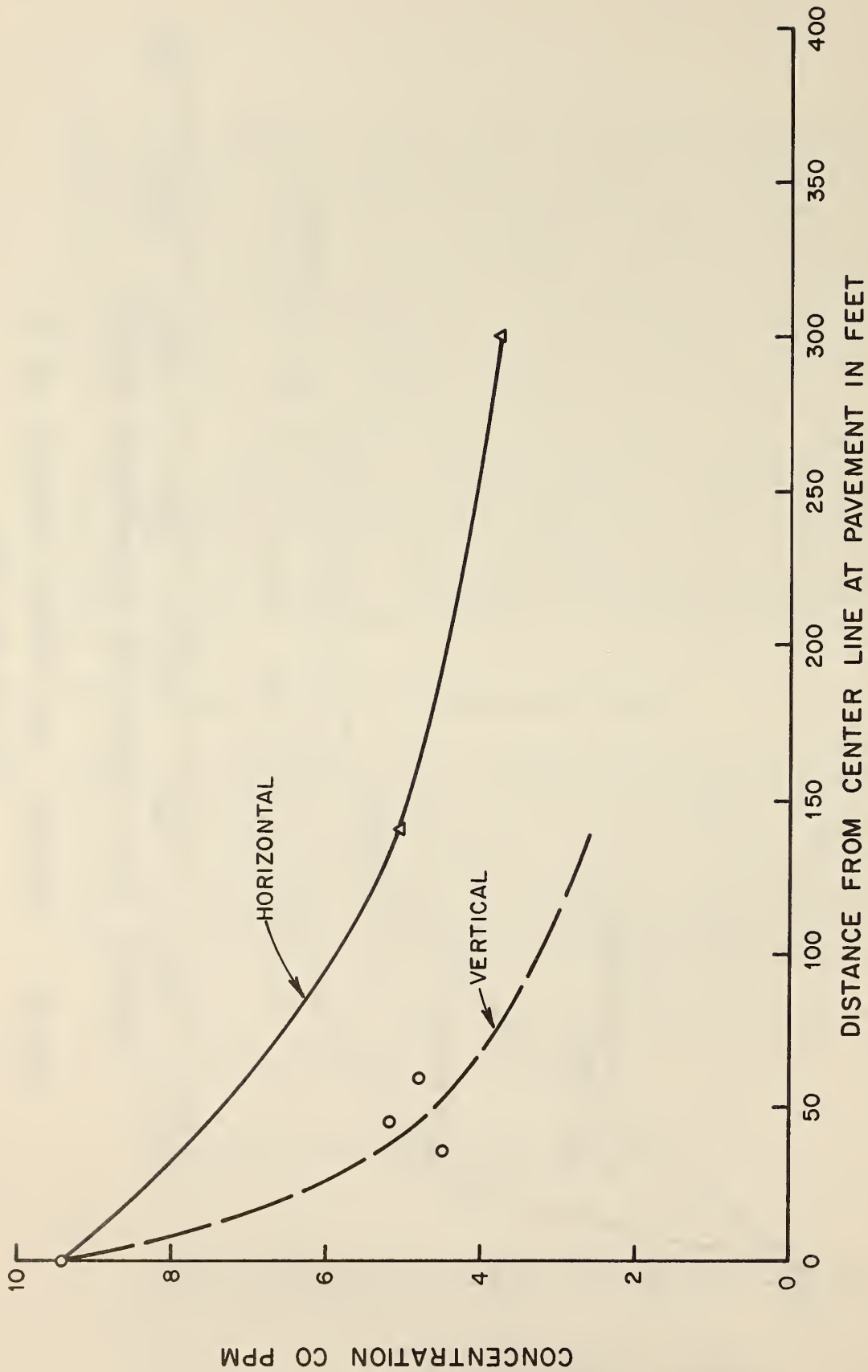

FIG. 57 HORIZONTAL AND VERTICAL PROFILES OF CO FOR 146TH AVE POC.

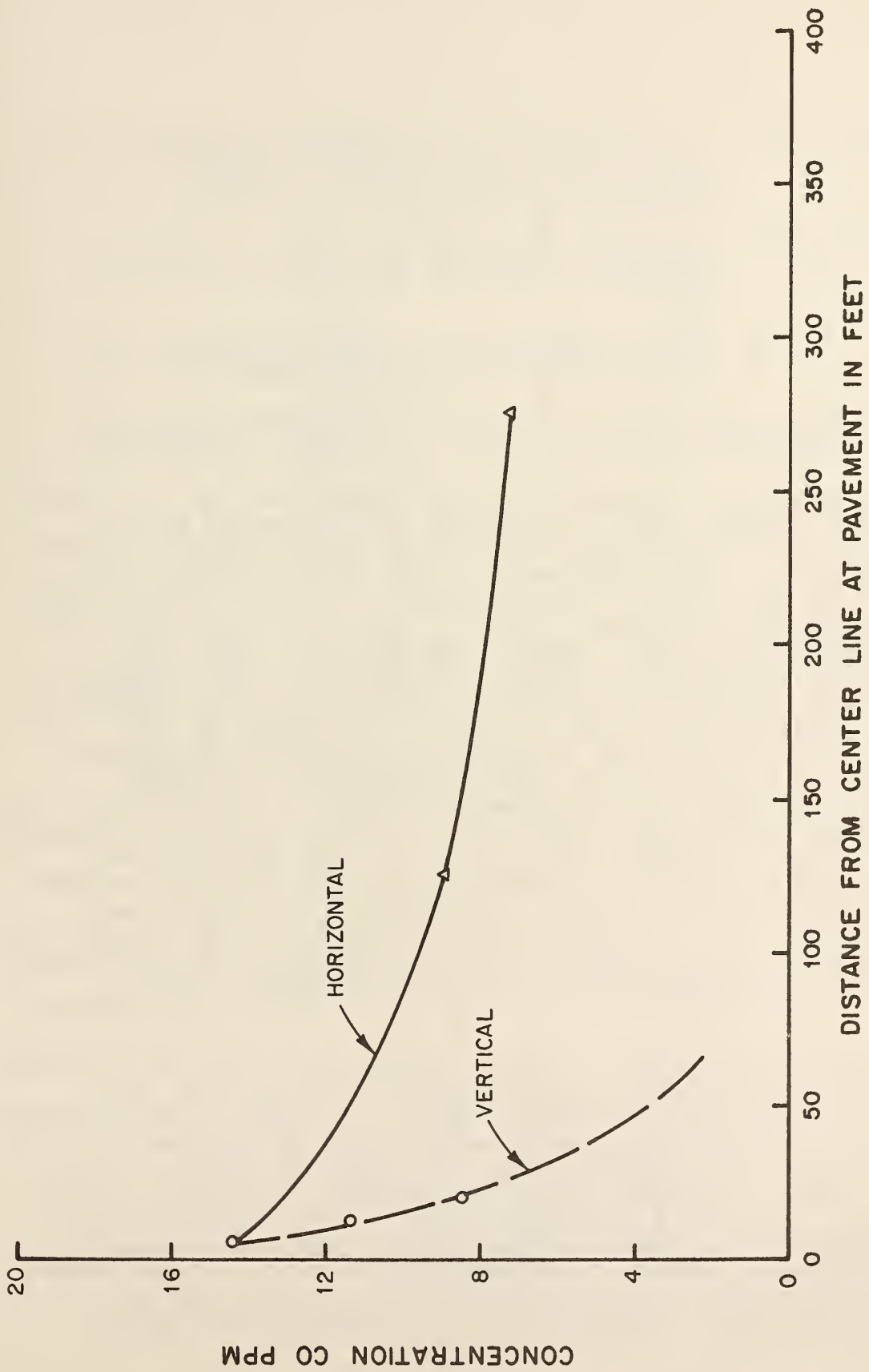

FIG. 58 HORIZONTAL AND VERTICAL PROFILES OF CO FOR 122ND AVE

Where $\frac{C}{Z}$ is the vertical concentration gradient over the highway section, $\frac{C}{X}$ is the horizontal gradient downwind from the roadway,

and C_1, C_2 are measured average CO values at two different locations in parts per million (ppm)

Z_1, Z_2 are the distances in feet from the ground surface that C_1 and C_2 are measured.

The subscripts X and Z in the above gradient equation refer to the horizontal and vertical gradients respectively.

The method for calculating these gradients was to compute a vertical gradient over the roadway on the median and an equivalent horizontal gradient from the median to the nearest downwind probe. The word "equivalent" is used because an attempt was made to make the distances over which the changes in CO values were measured ($Z_1 - Z_2$) and ($X_1 - X_2$) equal in the gradient equations. This is important so that actual, rather than interpolated gradients can be compared. However, the physical geometry and sensor locations of the different highway sections prevented the exact equivalence of ($Z_1 - Z_2$) and ($X_1 - X_2$). With this in mind the calculated gradients should be considered to be order of magnitude estimates. The vertical change in CO concentration $(C_1 - C_2)_Z$ for the roadway was taken, where possible, to be the difference between the CO values at 60 and 4 foot levels at the median. The horizontal change in CO concentrations $(C_1 - C_2)_X$ corresponds to the difference between the CO values in the mixing cell at the median and the downwind probe closest to the roadway. Table 13 shows the calculated vertical and horizontal gradients in ppm per foot along with the probes considered and the distances between the horizontal (X) and vertical (Z) probes.

The data summarized in Table 13 indicate that the vertical dispersion gradients for all sections monitored were much greater than the horizontal gradients. It might be hypothesized that this vertical mixing is caused by (1) differences in temperature of the exhaust gases emitted from vehicles (approximately 250°F) and the ambient air causing a vertical acceleration of pollutants, (2) different thermal properties and heat fluxes of the concrete pavement and the land adjacent to the roadways, and (3) a combination of both. In any event, this analysis does imply the importance of measuring the vertical pollutant distributions over roadways for future studies.

TABLE 13

SUMMARY OF CO GRADIENTS (PPM/FT)

Freeway Site	Vertical Gradient		Horizontal Gradient			
	Probes	Distance (ft)	ppm/ft	Probes	Distance (ft)	ppm/ft
Santa Monica Freeway 4th Ave	10 - 12	48	0.219	10 - 9	128	0.0836
Harbor Freeway at 146th Ave	8 - 14	56	0.0823	8 - 17	147	0.0310
San Diego Freeway at 122nd	12 - 8	16	0.375	12 - 20	116	0.0465

Effects of Surface Roughness on Dispersion

Land use adjacent to the roadway is considered an important parameter to describe the downwind transport and diffusion of pollutants. The land use can be characterized aerodynamically in terms of surface roughness. This is analogous to the effects of wall roughness on water flow in pipes. It can be shown, from fluid dynamics theory, that the larger the surface roughness elements, the greater the viscous shear within the fluid layers near the surface. This viscous shear is associated with large energy dissipation rates. The result is a large rate of transfer of vertical momentum from one shear layer to adjacent layers. These are called mechanically produced turbulent eddies. Near the ground surface, the degree of mechanical turbulence is a function of the wind speed and the height of the surface roughness elements.

There is also another form of turbulence that plays an important role in the dispersion of pollutants. This is thermal turbulence. Thermal turbulence is caused by nonuniform heating of the ground surface by the sun. The air near the ground surface is warmed as a result and tends to rise. The surface of the earth cannot support a vacuum, therefore, cold air aloft descends to take its place thus creating a convective cell with vertical air movement. Thermal turbulence can be considered to be a function of the thermal conductivities of the land surface (houses, trees, concrete, etc.), incoming radiation and wind speed. It is most dominating during the daytime with light wind and clear skies. It is the interaction of mechanical and thermal turbulence that enhances the diffusion of pollutants.

For this preliminary study the effects of surface roughness on the generation of turbulence were evaluated. Figures 59 through 62 show typical sites where the temporal and spatial distributions of CO were measured. There are two striking effects that can be observed from the measured data. At the Santa Monica site, where the surface roughness heights range from 20 to 30 feet, there is enough mechanical and thermal turbulence present to thoroughly mix the air from the ground surface up to at least 29 feet. The same applies for the Harbor Freeway site where the surface roughness heights range from 15 to 20 feet above the ground. Surprisingly, for the two open sites at the Weigh Station and the Fill Site, the combination of turbulence caused by wind shear and thermal effects also was great enough to thoroughly mix the air from the ground surface up to 29 feet. However, there is a significant effect

of surface roughness on the downwind distance over which the CO from the freeway approaches ambient levels. For a given set of meteorological and traffic conditions, ambient levels are approached about 200-300 feet downwind in areas with moderate surface roughness. For the open section (Figures 61 and 62) with small surface roughness effects, ambient levels are generally approached about 400 feet or more downwind. This indicates that the larger the surface roughness, the greater the turbulence and thus the sooner the pollutant levels return to their upwind values. Figures 63 through 65 are cumulative frequency plots showing downwind CO for different highway designs.

From this analysis of the downwind transport and diffusion of CO, recommendations for the location of air sampling locations to describe the microscale region can be made. For all the sampling sites monitored, air sensors placed at intervals of 100 to 150 feet apart in the downwind direction are adequate for measuring CO. This distance downwind should extend at least 400 feet from the edge of the nearest highway pavement.

Since the vertical distribution of CO is fairly uniform, it is necessary to monitor only at one height up to 29 feet above the ground surface downwind of the highway. This is because atmospheric turbulence causes a thorough mixing in this area and there is little change in CO concentration with respect to height. It is therefore recommended that CO measurements be standardized at 5 feet above the ground surface since this is the typical height at which air is inhaled.

With these recommendations a spatial sampling plan can be designed to describe adequately the downwind transport and diffusion characteristics of CO for different types of land use and highway geometry.

Minimal Sampling Plan For Spatial Distribution of CO

Based on the above findings, a minimum sampling plan to measure the temporal and spatial distributions of CO emitted from a line source is shown in Figure 66. The sampling plan shown will serve two purposes: (1) to monitor the air quality to which motorists are subjected while driving, and (2) to characterize the downwind transport and diffusion of CO. The above design does not apply to those areas where localized topographic effects alter the surface winds. A monitoring plan for those areas will require a special investigation beyond the scope of this study. The sampling plan presented here should be applied to urban and rural areas with relatively flat topography.

MAY 8, 1972
 TIME: 08:00 - 09:00
 TRAFFIC: 14202 VPH
 \bar{U} ←

METEOROLOGICAL CONDITIONS
 WIND SPEED = 3 MPH
 WIND ANGLE = 30°
 STABILITY CLASS D
 SURFACE ROUGHNESS CHARACTERISTICS:
 RESIDENTIAL AREA, MIXED, SINGLE &
 TWO STORY.

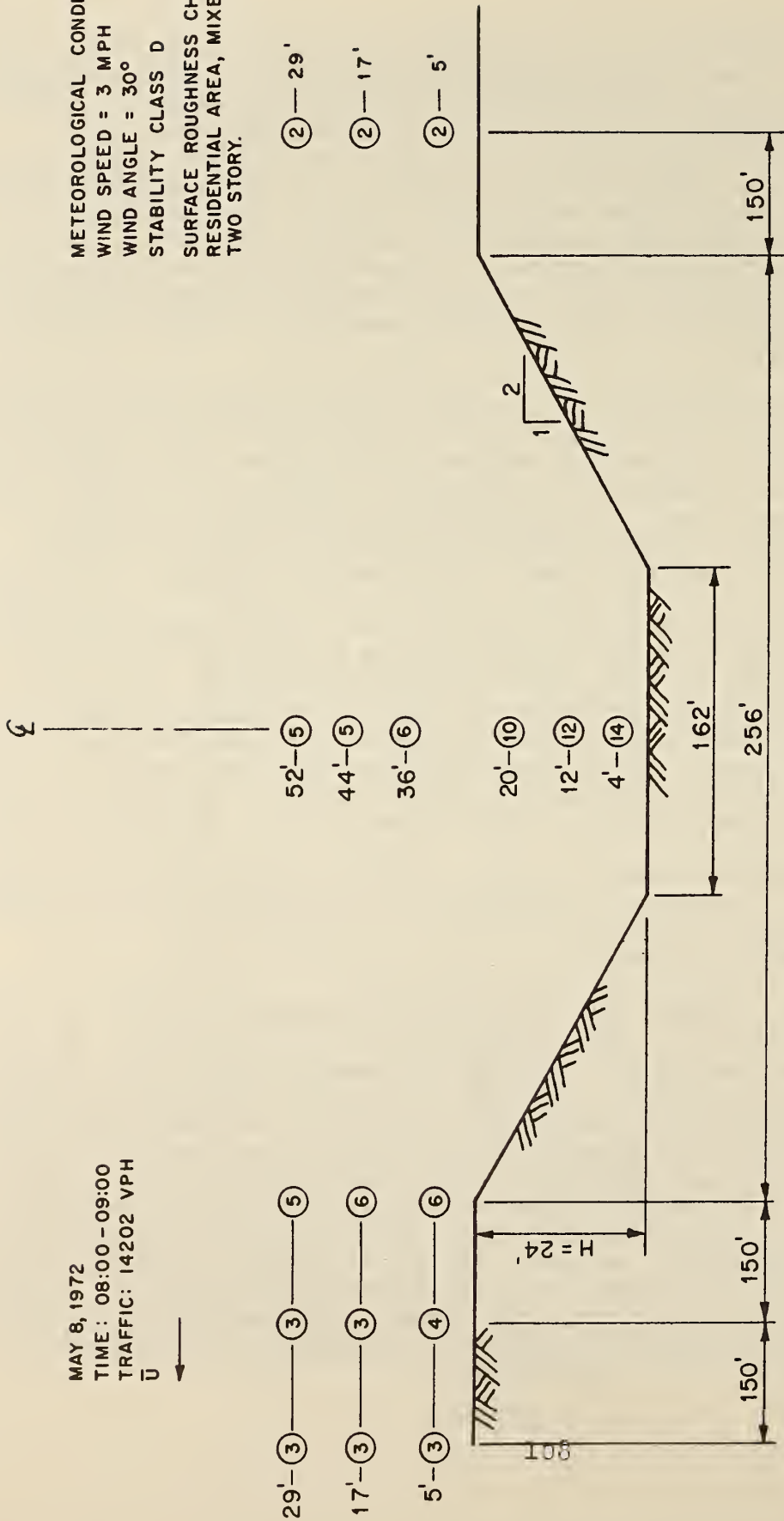

① - DENOTES PROBE NUMBER

FIG. 59 SPATIAL DISTRIBUTION OF CO AT 4TH AVE, P.O.C.
 (NOT TO SCALE)

AUGUST 9, 1972
 TIME: 12:00 - 13:00
 TRAFFIC:
 \bar{u} →

METEOROLOGICAL CONDITIONS
 \bar{u} =
 ϕ =
 STABILITY CLASS
 SURFACE ROUGHNESS CHARACTERISTICS:
 RESIDENTIAL AREA, SINGLE LEVEL.

④
 60'
 52'
 44'

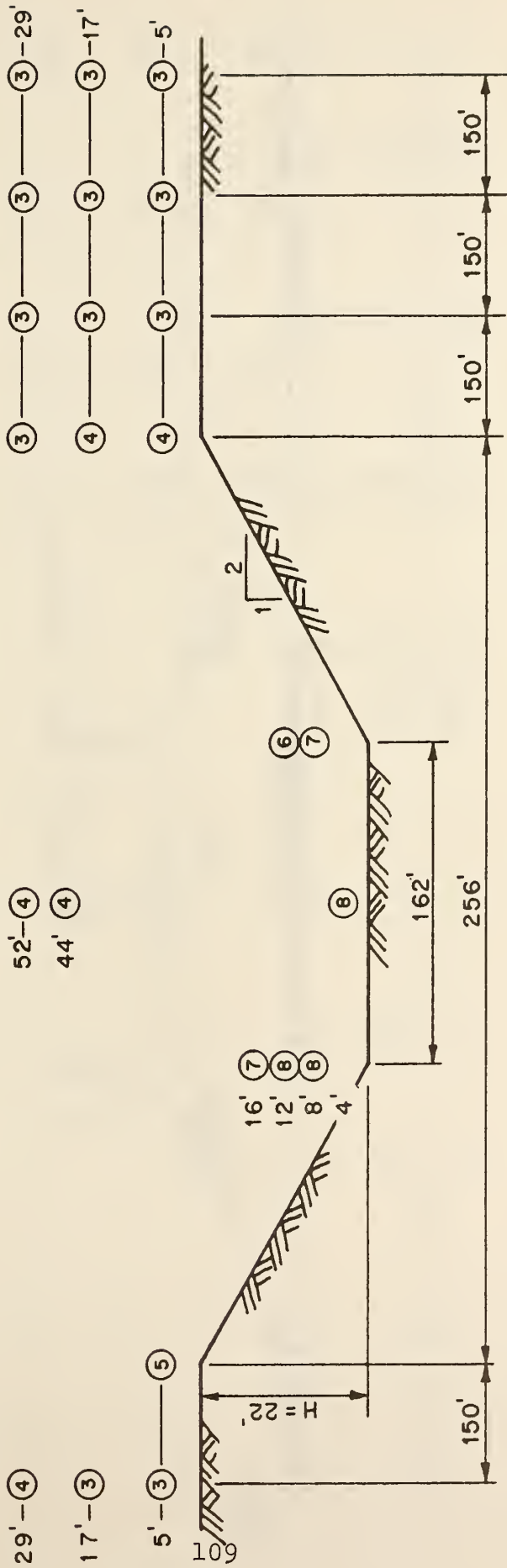

① - DENOTES PROBE NUMBER

FIG. 60 SPATIAL DISTRIBUTION OF CO AT 146TH AVE P.O.C.

(NOT TO SCALE)

AUG. 14, 1972
 TIME: 07:00 - 08:00
 TRAFFIC:
 U →

METEOROLOGICAL CONDITIONS:
 WIND SPEED =
 WIND ANGLE =
 STABILITY CLASS D
 SURFACE ROUGHNESS CHARACTERISTICS:
 FLAT, OPEN FIELD AT GRADE SECTION.

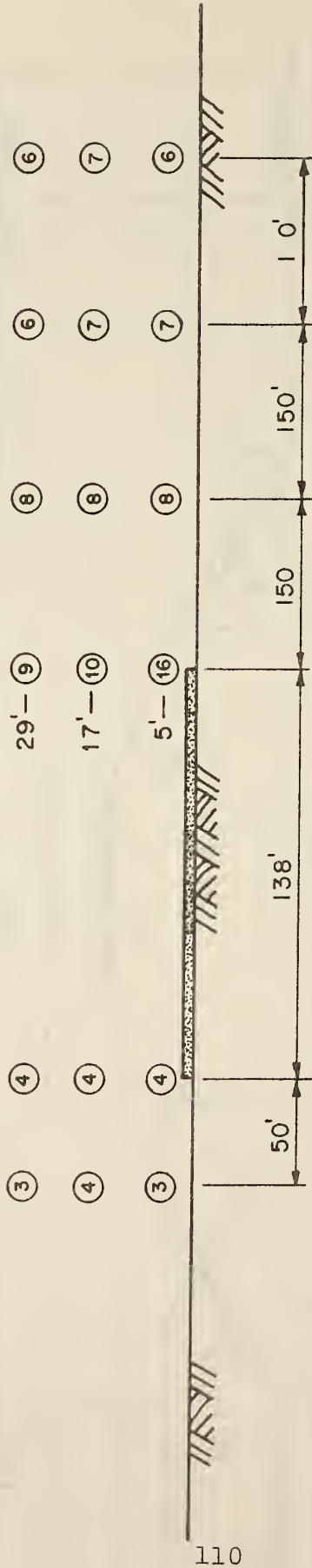

① DENOTES PROBE NUMBER

FIG. 61 SPATIAL DISTRIBUTION OF CO AT WEIGH STATION
 (NOT TO SCALE)

METEOROLOGICAL CONDITIONS: SUNNY
 WIND SPEED = 7 MPH
 WIND ANGLE = 50°
 SURFACE ROUGHNESS CHARACTERISTICS:
 FLAT, OPEN FETCH UPWIND &
 DOWNWIND OF SITE.

OCT. 10, 1972
 TIME: 13:00 - 14:00
 TRAFFIC: 10100 VPH

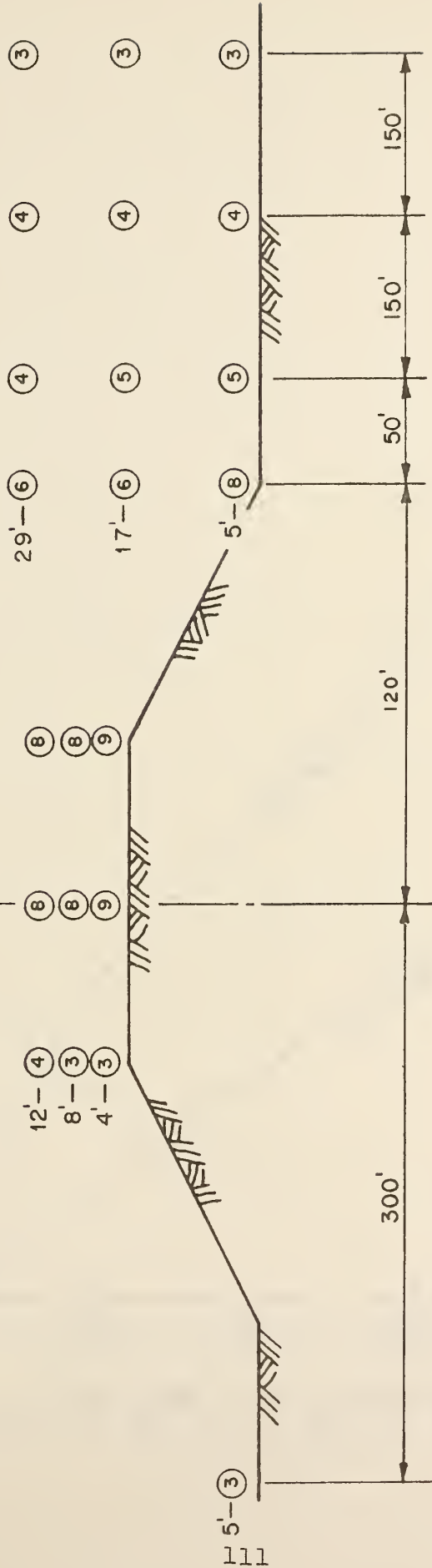

① - DENOTES PROBE NUMBER

FIG. 62 SPATIAL DISTRIBUTION OF CO AT 122ND AVE

(NOT TO SCALE)

SAN DIEGO FREEWAY AT WEIGH STATION
(COMBINED PEAK & OFF-PEAK HOURS)

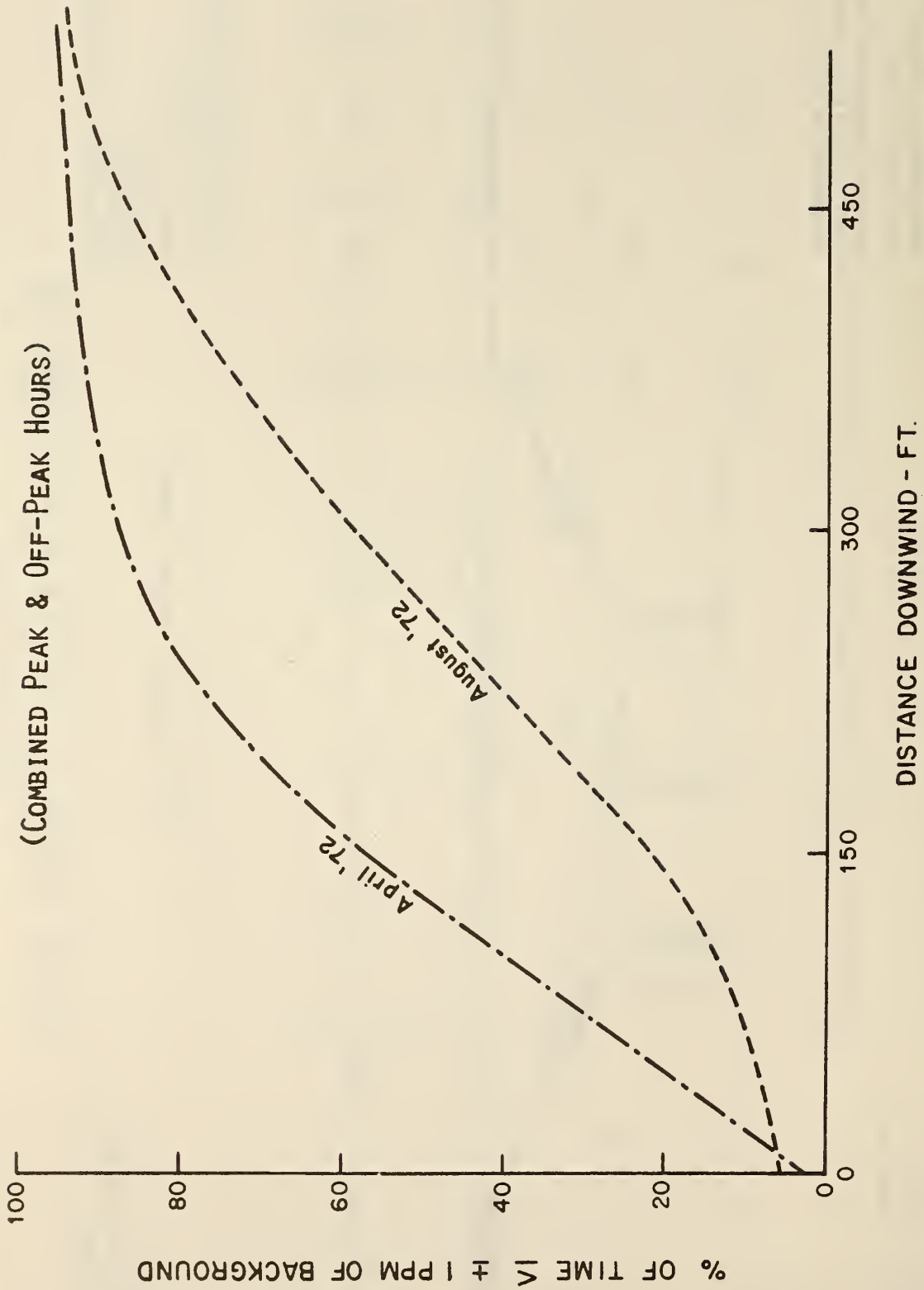

FIG 63 ATTAINMENT OF BACKGROUND LEVELS OF CO-
AT-GRADE SECTIONS IN FLAT OPEN AREAS

SANTA MONICA FREEWAY AT 4TH AVE. P.O.C.
(COMBINED PEAK & OFF-PEAK HOURS)

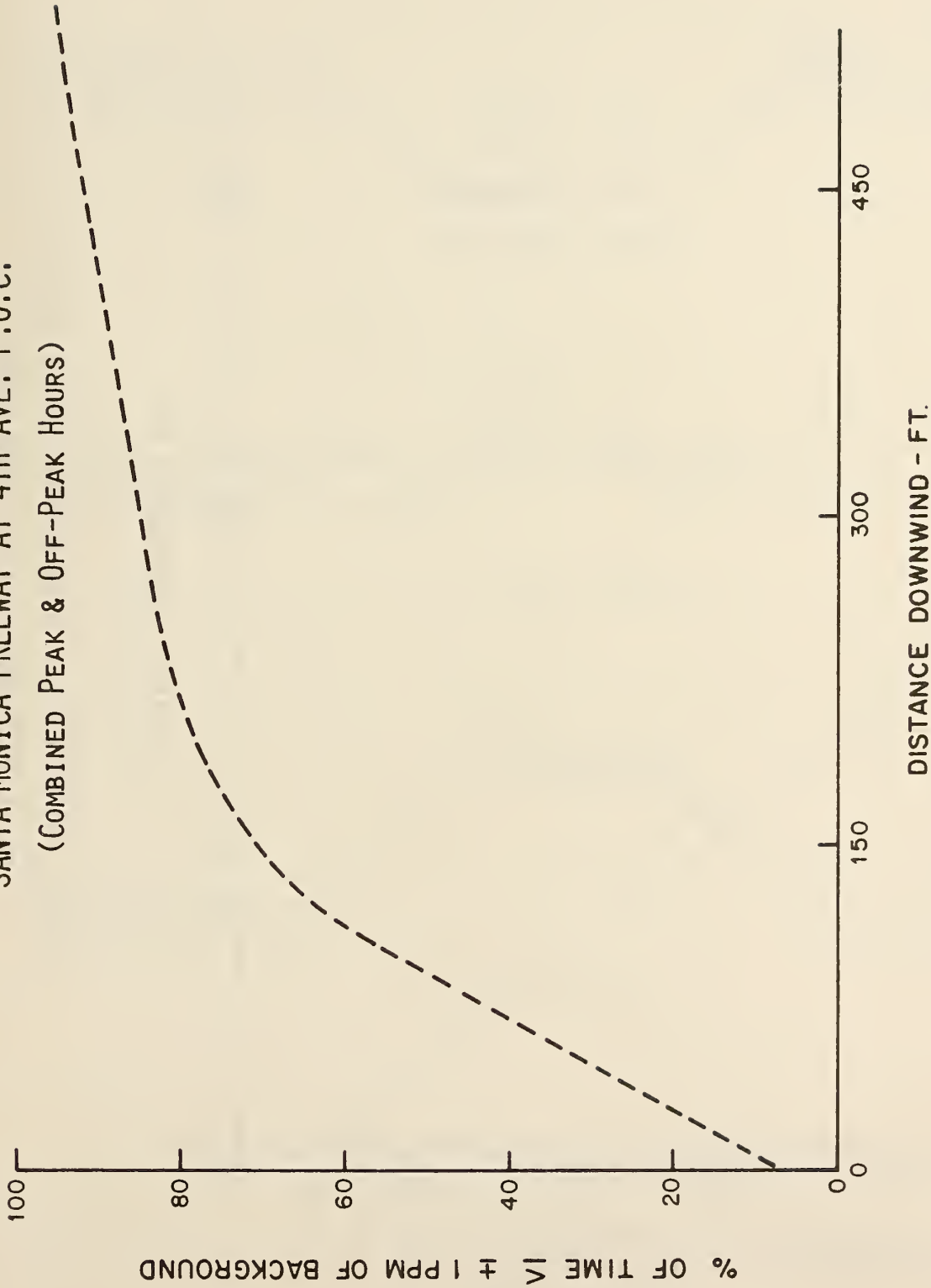

FIG 64 ATTAINMENT OF BACKGROUND LEVELS OF CO -
DEPRESSED SECTIONS IN URBAN AREAS.

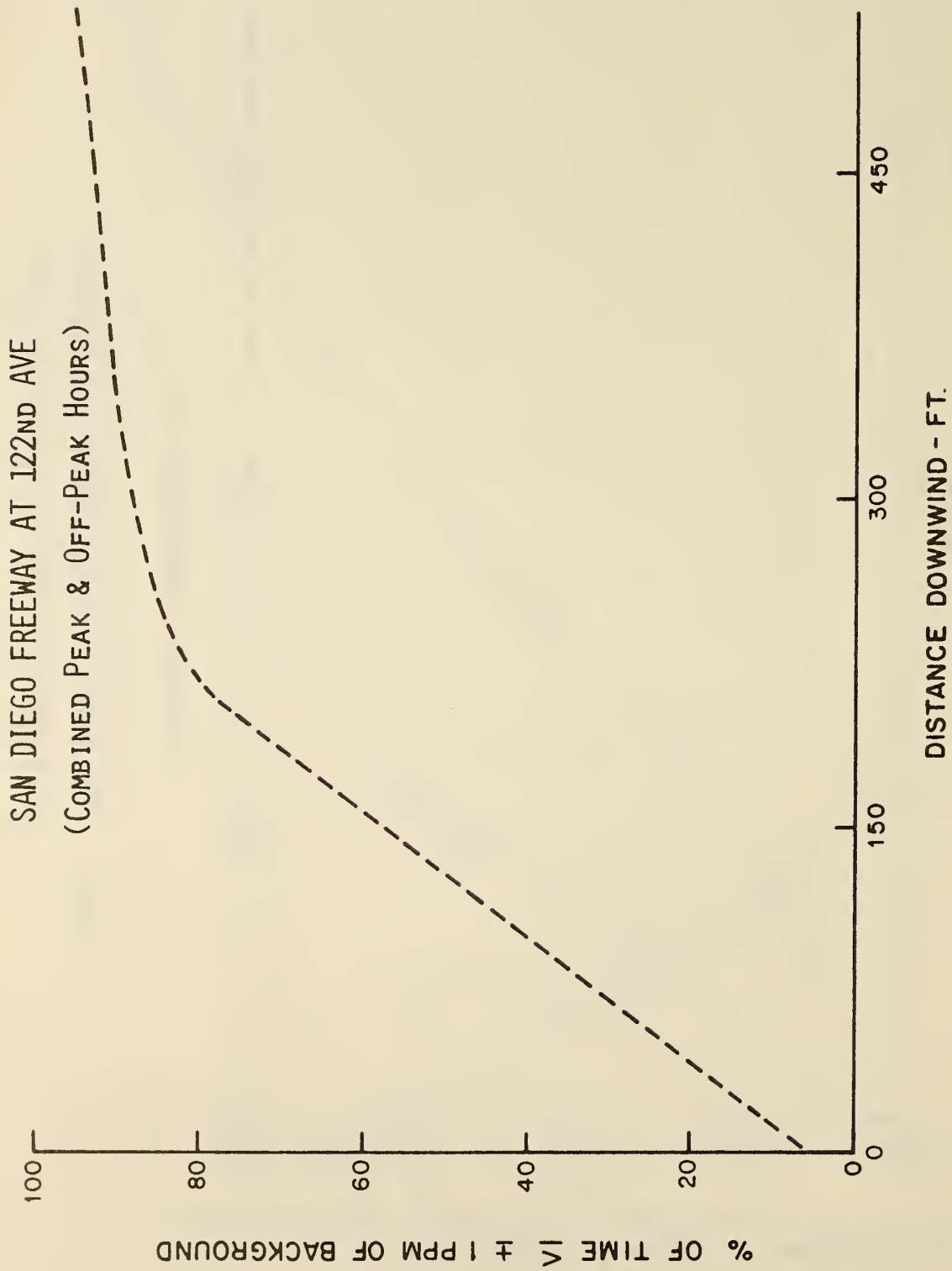

FIG 65 ATTAINMENT OF BACKGROUND LEVELS OF CO-
FILL SECTIONS IN FLAT OPEN AREAS

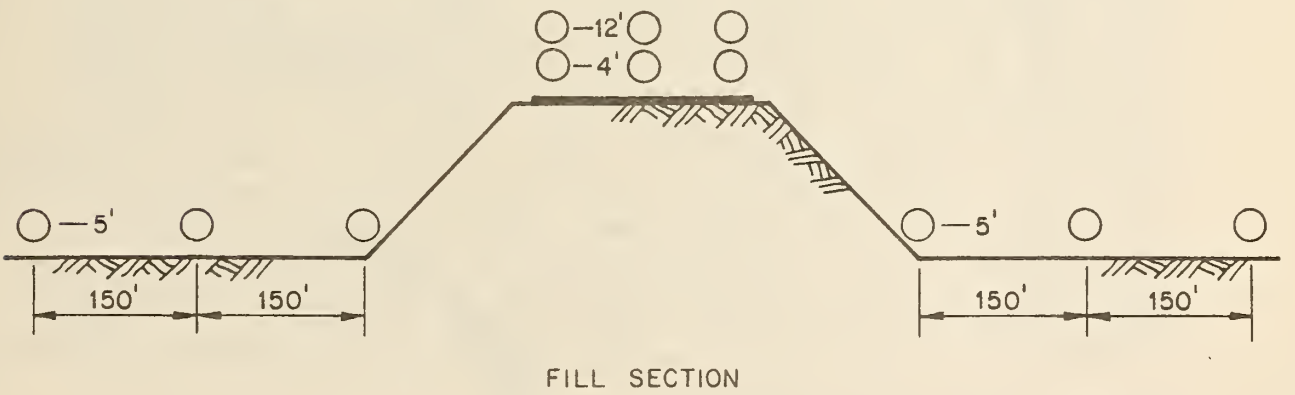
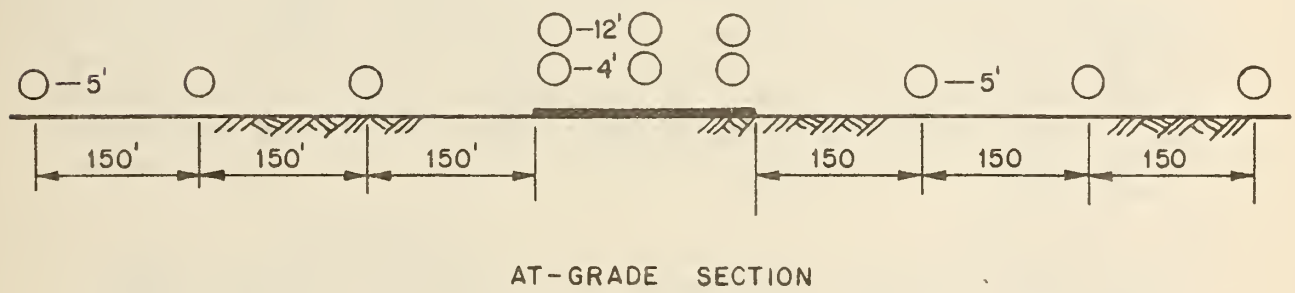
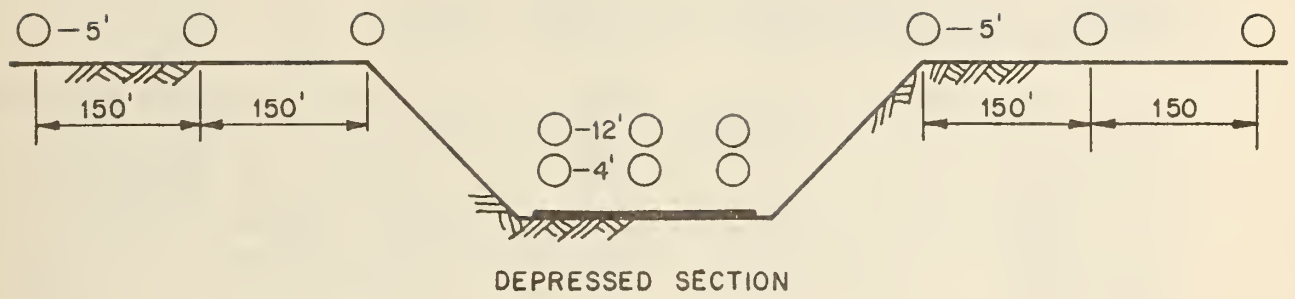

FIG 66 TYPICAL SAMPLING PLANS TO MEASURE THE
SPATIAL DISTRIBUTION OF CO ON OR NEAR
HIGHWAYS

(NOT TO SCALE)
115

Spatial Distribution of CO During Periods of High Concentrations

The highest CO concentrations measured during the sampling period occurred on October 6, 1972 from 0800 to 0900 in the morning. On this particular day, CO sampling was being done on the highway fill section (San Diego Freeway at 122nd Street). The highest measured one hour CO value was 46 ppm, measured in the median at a height of 4 feet above the pavement. Upwind values of CO measured simultaneously ranged from 33 to 35 ppm. The carbon monoxide levels for this hour are shown in Figure 67.

It is interesting to note that the vertical concentrations of CO on the upwind side of the roadway are relatively uniform, ranging from 33 to 35 ppm. This indicates that even in this period of stable air (stability F was estimated for 0700 to 0800 and stability B was estimated for 0800 to 0900) there is enough atmospheric turbulence near the ground surface to thoroughly disperse CO, at least up to 29 feet above ground level.

It is also interesting to note that if the ambient CO concentration were considered to be 33 ppm (lowest value measured in Figure 67) that the maximum contribution of CO coming off the roadway at the 4 foot median is only 13 ppm. Upon analyzing the data from all sites it can generally be said that the highest contributions of CO from the roadway occur at the median probe 4 feet above the pavement. The concentrations at this point range from about 10 to 25 ppm above background. This, of course, applies to the meteorological and traffic conditions that existed in the Los Angeles areas for those days monitored. These values, or ranges, should not be representative for other roadways where traffic and meteorology differ significantly from those conditions in Los Angeles. Typical CO concentrations upwind and downwind from the highway for all sites range from 1 to about 5 ppm above background levels for all meteorological and traffic conditions.

Further Statistical Studies

When analyzing the CO data, there are various statistical distributions that may exist. One possible distribution is the gaussian or normal distribution which is characterized by a mean and a standard deviation. These are measures of the central point and spread of the well known bell shaped curve. Previous studies made by Saltzman (12) and Larsen (13) in analyzing air pollutant data indicated that a normal curve

generally does not describe the distribution. Larsen (13) has shown that the log-normal distribution more accurately describes the pollutant concentrations measured in the atmosphere. In the log-normal distributions the concentrations must be transformed to their logarithms of base 10. Once this transform has been made, a statistical analysis of the data can follow. The antilogarithm of the standard deviation of the logarithm is the standard geometric deviation. It has been suggested by Saltzman (12) that log normal distributions are applicable only if the sampling is random. The concentrations of pollutants fluctuate in cycles depending on the meteorological conditions. Random samples of pollutants must be collected over a period of time long enough to include many cycles. Sampling over a period of one month can possibly provide values which deviate seriously from random sampling relationships (12). Because of the shortcomings of determining the statistical distribution of CO for a short period of record, no attempt was made in this study to determine if these data followed a log normal distribution.

The importance of the distribution of pollutant data should be emphasized. If the distribution is known, statistical inferences can be drawn concerning the CO concentrations in the microscale region. Also, once the distribution is known, the frequency of occurrence of exceeding air quality standards can be determined for a given time period. The use of the above information can be of great value in air quality studies to assess the impact of transportation systems on the air environment. It is recommended that further research be conducted in this area as such work is beyond the scope of this preliminary study.

REFERENCES

1. Ranzieri, A. J., Bemis, G. R., "Air Pollution and Freeway location, Design and Operation - Overview of Project," California Department of Transportation, Transportation Laboratory, to be published.
2. Minutes of the Second Advisory Committee Meeting "Air Pollution and Roadway Location, Design and Operation," Los Angeles, California, June 29-30, 1972.
3. Beaton, J. L.; Skog, J. B.; Shirley, E. C.; and Ranzieri, A. J., "Meteorology and Its Influence on the Dispersion of Pollutants From Highway Line Sources," California Division of Highway Research Report No. CA-HWY-MR-657082(1)-72-11, April 1972.
4. Grisinger, John E., "Survey of Los Angeles County Air Pollution Control District's Meteorological and Air Monitoring Sensor Exposures," California Department of Transportation, District 07, May 1973.
5. Field calibration made by Don Crow, California Air Resources Board, August 17, 1972.
6. U. S. Environmental Protection Agency, "Compilation of Air Pollutant Emission Factors," Second Edition, April 1973.
7. Grant, Ian, California Department of Transportation, Freeway Operations, District 07, telephone conversation.
8. Johnson, W. B., et al, "Field Study for Evaluation of Urban Diffusion Model for Carbon Monoxide," Stanford Research Institute, January 1971.
9. Ott, W. "An Urban Survey Technique For Measuring the Spatial Variation of Carbon Monoxide Concentrations in Cities," Department of Civil Engineering, Stanford University, October 1971.
10. Eschenroeder, A. Q., "An Approach for Modeling the Effects of Carbon Monoxide on the Urban Freeway User," General Research Corporation, January 1970.
11. California Department of Transportation, Research Laboratory, unpublished study, "Project Smoke," April 1971.

12. Saltzman, B. E., "Simplified Methods for Statistical Interpolation of Monitoring Data," Journal of the Air Pollution Control Association, February 1972.
13. Larsen, R. I., "A Mathematical Model for Modeling Air Quality Measurements to Air Quality Standards," Environmental Protection Agency, November 1971.

APPENDIX

BAG SAMPLING STUDY DATA BASE

SITE 1

SAN MONICA FREEWAY

AT

4th AVE. P.O.C.

DEPRESSED SECTION

SANTA MONICA FREEWAY @ 4TH AVE P.O.C.
 MAY 2, 1972 TO JUNE 2, 1972
 BEARING: N 80 12'53"E

5 LANES EACH DIRECTION
 22 FT MEDIAN
 TOP WIDTH OF CUT = 256 FT
 BOTTOM WIDTH OF CUT = 162 FT
 WIDTH OF ROADWAY = 160 FT

DEPTH OF CUT = 24 FT
 SIDE SLOPES = 2:1

WIND MEASURED AT 10 METER HEIGHT (OR EQUIVALENT)

M E T E O R L O G I C A L D A T A

DATE=5-2-72 STARTING HR= 900 NO. OF HRS= 3

CEIL.	WIND DIRE.	WIND MPH	SKY CODE	STAB.
9	200	2	5	C
200	240	3	2	B
200	230	7	2	B

DATE=5-3-72 STARTING HR= 700 NO. OF HRS= 5

CEIL.	WIND DIRE.	WIND MPH	SKY CODE	STAB.
9	240	2	8	D
9	260	3	8	D
200	260	3	5	B
200	190	4	2	B
200	220	4	2	A

DATE=5-4-72 STARTING HR= 700 NO. OF HRS= 5

CEIL.	WIND DIRE.	WIND MPH	SKY CODE	STAB.
25	220	5	8	D
27	230	5	8	D
30	220	4	8	D
35	210	5	8	D
25	230	5	8	D

PAGE 2

SANTA MONICA FREEWAY @ 4TH AVE P.O.C.

DATE=5-5-72 STARTING HR= 700 NO. OF HRS= 5

CEIL.	WIND DIRE.	WIND MPH	SKY CODE	STAB.
40	240	5	8	D
40	200	3	5	C
40	240	4	5	C
40	210	5	5	D
40	220	7	5	C

DATE=5-8-72 STARTING HR= 700 NO. OF HRS= 5

CEIL.	WIND DIRE.	WIND MPH	SKY CODE	STAB.
-1	80	3	-1	-1
27	80	3	8	D
25	120	4	5	C
25	90	4	5	C
200	150	4	2	A

DATE=5-9-72 STARTING HR= 700 NO. OF HRS= 5

CEIL.	WIND DIRE.	WIND MPH	SKY CODE	STAB.
200	190	2	2	B
200	190	3	2	B
15	200	4	5	C
200	200	5	2	B
200	220	7	2	B

DATE=5-10-72 STARTING HR= 700 NO. OF HRS= 4

CEIL.	WIND DIRE.	WIND MPH	SKY CODE	STAB.
200	40	2	2	B
12	150	3	8	D
12	50	4	8	D
16	360	4	5	C

SANTA MONICA FREEWAY @ 4TH AVE P.O.C.

DATE=5-11-72 STARTING HR= 700 NO. OF HRS= 4

CEIL.	WIND DIRE.	WIND MPH	SKY CODE	STAB.
200	100	2	0	B
200	140	2	2	B
200	170	3	2	B
200	230	4	0	B

DATE=5-12-72 STARTING HR= 700 NO. OF HRS= 5

CEIL.	WIND DIRE.	WIND MPH	SKY CODE	STAB.
-1	130	2	-1	-1
2	180	2	8	D
200	210	3	2	B
200	240	5	1	B
-1	240	8	-1	-1

DATE=5-15-72 STARTING HR= 700 NO. OF HRS= 4

CEIL.	WIND DIRE.	WIND MPH	SKY CODE	STAB.
6	180	2	8	D
8	130	2	8	D
11	170	4	8	D
-1	160	5	-1	-1

DATE=5-16-72 STARTING HR= 700 NO. OF HRS= 4

CEIL.	WIND DIRE.	WIND MPH	SKY CODE	STAB.
22	170	3	8	D
23	190	3	8	D
25	210	4	5	C
26	230	6	5	D

SANTA MONICA FREEWAY @ 4TH AVE P.O.C.

DATE=5-17-72 STARTING HR= 700 NO. OF HRS= 4

CEIL.	WIND DIRE.	WIND MPH	SKY CODE	STAB.
30	220	5	8	D
30	230	4	8	D
30	210	3	8	D
27	220	4	8	D

DATE=5-18-72 STARTING HR= 700 NO. OF HRS= 4

CEIL.	WIND DIRE.	WIND MPH	SKY CODE	STAB.
160	200	2	8	C
250	200	3	8	B
230	190	4	8	B
300	180	4	8	B

DATE=5-19-72 STARTING HR= 700 NO. OF HRS= 4

CEIL.	WIND DIRE.	WIND MPH	SKY CODE	STAB.
55	170	3	5	C
38	190	6	5	D
60	190	5	8	D
38	180	7	8	D

DATE=5-23-72 STARTING HR= 700 NO. OF HRS= 5

CEIL.	WIND DIRE.	WIND MPH	SKY CODE	STAB.
17	130	3	8	D
19	140	3	8	D
22	140	4	8	D
25	140	4	8	D
200	210	5	2	A

PAGE 5

SANTA MONICA FREEWAY @ 4TH AVE P.O.C.

DATE=5-24-72 STARTING HR= 700 NO. OF HRS= 5

CEIL.	WIND DIRE.	WIND MPH	SKY CODE	STAB.
21	130	2	8	D
25	130	4	8	D
25	140	4	8	D
25	140	5	8	D
20	140	4	8	D

DATE=5-25-72 STARTING HR= 700 NO. OF HRS= 5

CEIL.	WIND DIRE.	WIND MPH	SKY CODE	STAB.
19	220	3	8	D
19	210	3	8	D
35	200	5	5	D
15	220	7	8	D
35	230	8	5	C

DATE=5-26-72 STARTING HR= 700 NO. OF HRS= 4

CEIL.	WIND DIRE.	WIND MPH	SKY CODE	STAB.
23	280	2	8	D
23	280	3	8	D
20	250	3	8	D
30	230	5	8	D

DATE=5-31-72 STARTING HR= 800 NO. OF HRS= 4

CEIL.	WIND DIRE.	WIND MPH	SKY CODE	STAB.
140	140	2	5	B
140	220	4	8	C
140	210	4	8	B
160	230	8	5	B

PAGE 6

SANTA MONICA FREEWAY @ 4TH AVE P.O.C.

DATE=6-1-72 STARTING HR= 700 NO. OF HRS=10

CEIL.	WIND DIRE.	WIND MPH	SKY CODE	STAR.
13	180	2	5	C
13	130	2	4	C
200	140	2	2	B
200	220	3	2	A
200	250	9	2	B
300	240	7	7	B
300	240	10	7	C
300	230	10	7	C
300	230	8	7	C
300	220	7	7	C

DATE=6-2-72 STARTING HR= 700 NO. OF HRS= 1

CEIL.	WIND DIRE.	WIND MPH	SKY CODE	STAR.
12	210	4	8	D

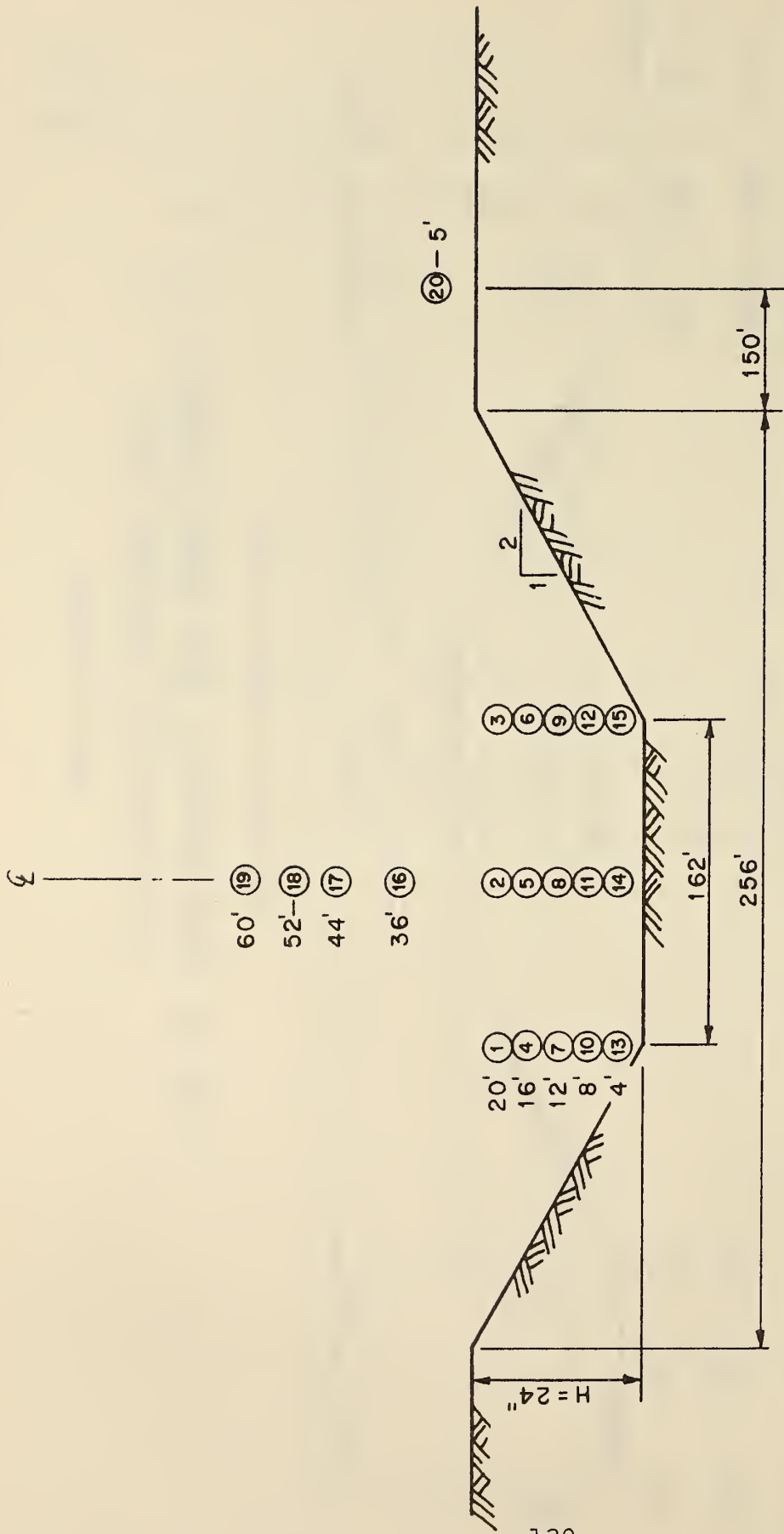

① - DENOTES PROBE NUMBER

FIG. 69 PROBE LOCATIONS, SANTA MONICA FREEWAY
 AT 4TH P.O.C. IN SECTION STUDY
 (NOT TO SCALE)

SANTA MONICA FREEWAY @ 4TH AVE P.O.C.
 MAY 2, 1972 TO JUNE 2, 1972
 BEARING: N 80 12'53"E

5 LANES EACH DIRECTION
 22 FT MEDIAN
 TOP WIDTH OF CUT = 256 FT
 BOTTOM WIDTH OF CUT = 162 FT
 WIDTH OF ROADWAY = 160 FT

DEPTH OF CUT = 24 FT
 SIDE SLOPES = 2:1

P O L L U T A N T C O N C E N T R A T I O N S

DATE=5-2-72 STARTING HR= 900 NO. OF HRS= 3

P R O B E N U M B E R S																							
1	2	3	4	5	6	7	8	9	10	11	12	13	14	15	16	17	18	19	20	21	22	23	24
5	4	5	4	4	5	4	5	5	16	14	12	8	8	6	-1	3	-1	-1	3	-1	-1	3	-1
4	2	4	3	4	4	3	4	4	-1	10	7	5	6	4	-1	3	-1	-1	2	-1	-1	2	-1
2	0	3	-1	1	2	0	2	2	8	7	5	3	3	2	-1	1	-1	-1	0	-1	-1	0	-1

DATE=5-3-72 STARTING HR= 700 NO. OF HRS= 5

P R O B E N U M B E R S																							
1	2	3	4	5	6	7	8	9	10	11	12	13	14	15	16	17	18	19	20	21	22	23	24
-1	3	6	-1	3	5	-1	3	5	19	18	14	10	8	7	-1	3	-1	-1	3	-1	-1	3	-1
-1	3	3	-1	3	3	-1	3	3	14	13	11	8	6	6	-1	4	-1	-1	4	-1	-1	5	-1
-1	4	6	-1	3	5	-1	3	5	13	12	9	7	6	5	-1	3	-1	-1	3	-1	-1	3	-1
-1	2	2	-1	1	2	-1	1	2	8	8	6	3	3	3	-1	0	-1	-1	0	-1	-1	0	-1
-1	0	0	-1	-1	1	-1	0	2	9	9	7	4	3	3	-1	0	-1	-1	1	-1	-1	1	-1

DATE=5-4-72 STARTING HR= 700 NO. OF HRS= 5

P R O B E N U M B E R S																							
1	2	3	4	5	6	7	8	9	10	11	12	13	14	15	16	17	18	19	20	21	22	23	24
-1	3	6	-1	3	6	-1	3	6	18	19	11	8	7	7	-1	5	-1	-1	2	-1	-1	2	-1
-1	3	7	-1	3	7	-1	3	7	17	19	11	8	6	5	-1	3	-1	-1	2	-1	-1	3	-1
-1	3	4	-1	3	5	-1	3	5	13	13	8	7	5	4	-1	2	-1	-1	2	-1	-1	2	-1
-1	3	4	-1	3	4	-1	3	4	12	11	7	6	4	3	-1	2	-1	-1	1	-1	-1	1	-1
-1	2	3	-1	2	4	-1	2	4	10	10	6	4	3	3	-1	1	-1	-1	1	-1	-1	0	-1

PAGE 2

SANTA MONICA FREEWAY @ 4TH AVE P.O.C.

DATE=5-5-72 STARTING HR= 700 NO. OF HRS= 5

P R O B E N U M B E R S																							
1	2	3	4	5	6	7	8	9	10	11	12	13	14	15	16	17	18	19	20	21	22	23	24
-1	-1	-1	-1	-1	-1	-1	-1	-1	-1	-1	-1	-1	-1	-1	-1	-1	-1	-1	-1	-1	-1	-1	-1
-1	3	6	-1	3	5	-1	3	5	20	17	13	8	7	7	-1	2	-1	-1	2	-1	-1	2	-1
-1	3	4	-1	3	4	-1	3	4	15	13	10	7	6	6	-1	2	-1	-1	2	-1	-1	2	-1
-1	3	4	-1	3	4	-1	3	4	14	11	8	5	4	4	-1	1	-1	-1	1	-1	-1	1	-1
-1	2	3	-1	2	4	-1	2	4	13	10	8	4	3	3	-1	0	-1	-1	0	-1	-1	0	-1

DATE=5-8-72 STARTING HR= 700 NO. OF HRS= 5

P R O B E N U M B E R S																							
1	2	3	4	5	6	7	8	9	10	11	12	13	14	15	16	17	18	19	20	21	22	23	24
-1	-1	-1	-1	-1	-1	-1	-1	-1	-1	-1	-1	-1	-1	-1	-1	-1	-1	-1	-1	-1	-1	-1	-1
4	4	5	4	4	6	-1	4	7	14	12	10	6	6	5	-1	2	-1	-1	2	-1	-1	3	-1
3	3	4	3	3	5	3	3	5	14	12	10	7	6	-1	-1	2	-1	-1	2	-1	-1	2	-1
2	2	3	2	3	3	2	3	4	11	9	8	4	4	4	-1	2	-1	-1	2	-1	-1	2	-1
2	2	3	2	2	3	2	2	4	11	9	7	4	3	3	-1	1	-1	-1	1	-1	-1	1	-1

DATE=5-9-72 STARTING HR= 700 NO. OF HRS= 5

P R O B E N U M B E R S																							
1	2	3	4	5	6	7	8	9	10	11	12	13	14	15	16	17	18	19	20	21	22	23	24
6	7	10	7	7	9	6	6	8	21	21	17	13	11	10	-1	8	-1	-1	8	-1	-1	8	-1
3	4	7	3	4	6	3	5	6	17	16	13	9	8	7	-1	3	-1	-1	3	-1	-1	3	-1
3	4	6	4	4	7	3	4	7	14	14	11	8	7	7	-1	3	-1	-1	3	-1	-1	3	-1
3	3	4	3	3	4	-1	3	4	11	10	8	5	4	4	-1	2	-1	-1	2	-1	-1	2	-1
2	2	3	2	2	3	2	2	4	10	9	7	4	3	3	-1	1	-1	-1	1	-1	-1	1	-1

DATE=5-10-72 STARTING HR= 700 NO. OF HRS= 4

P R O B E N U M B E R S																							
1	2	3	4	5	6	7	8	9	10	11	12	13	14	15	16	17	18	19	20	21	22	23	24
4	4	4	4	4	4	4	4	4	23	20	14	10	9	7	-1	6	-1	-1	6	-1	-1	5	-1
3	4	7	3	4	7	3	4	7	20	17	13	9	8	7	-1	3	-1	-1	3	-1	-1	3	-1
3	3	3	3	3	3	3	3	3	14	13	10	7	6	5	-1	3	-1	-1	3	-1	-1	3	-1
2	3	3	2	2	3	2	2	3	13	11	8	5	4	3	-1	3	-1	-1	3	-1	-1	3	-1

SANTA MONICA FREEWAY @ 4TH AVE P.O.C.

DATE=5-11-72 STARTING HR= 700 NO. OF HRS= 4

P R O B E N U M B E R S																							
1	2	3	4	5	6	7	8	9	10	11	12	13	14	15	16	17	18	19	20	21	22	23	24
7	8	10	7	8	10	7	7	9	29	26	21	14	12	11	-1	5	-1	-1	6	-1	-1	5	-1
5	6	8	5	6	-1	5	6	8	22	20	15	10	9	9	-1	4	-1	-1	4	-1	-1	4	-1
4	4	6	4	4	5	4	4	5	16	14	10	8	7	6	-1	4	-1	-1	3	-1	-1	3	-1
-1	-1	-1	-1	-1	-1	-1	-1	-1	-1	-1	-1	-1	-1	-1	-1	-1	-1	-1	-1	-1	-1	-1	-1

DATE=5-12-72 STARTING HR= 700 NO. OF HRS= 5

P R O B E N U M B E R S																							
1	2	3	4	5	6	7	8	9	10	11	12	13	14	15	16	17	18	19	20	21	22	23	24
-1	-1	-1	-1	-1	-1	-1	-1	-1	-1	-1	-1	-1	-1	-1	-1	-1	-1	-1	-1	-1	-1	-1	-1
7	8	10	7	8	10	6	8	9	24	21	18	13	11	10	-1	5	-1	-1	5	-1	-1	5	-1
5	6	8	5	6	8	5	6	8	19	16	13	10	8	8	-1	5	-1	-1	5	-1	-1	5	-1
3	4	4	3	4	4	3	4	4	14	13	9	7	5	4	-1	3	-1	-1	3	-1	-1	3	-1
-1	-1	-1	-1	-1	-1	-1	-1	-1	-1	-1	-1	-1	-1	-1	-1	-1	-1	-1	-1	-1	-1	-1	-1

DATE=5-15-72 STARTING HR= 700 NO. OF HRS= 4

P R O B E N U M B E R S																							
1	2	3	4	5	6	7	8	9	10	11	12	13	14	15	16	17	18	19	20	21	22	23	24
4	5	8	4	5	8	4	5	6	24	22	17	9	8	7	-1	3	-1	-1	3	-1	-1	3	-1
4	4	6	4	4	6	4	4	6	16	14	12	8	8	7	-1	3	-1	-1	3	-1	-1	3	-1
4	5	6	5	5	7	5	5	7	14	12	10	7	7	6	-1	3	-1	-1	3	-1	-1	3	-1
-1	-1	-1	-1	-1	-1	-1	-1	-1	-1	-1	-1	-1	-1	-1	-1	-1	-1	-1	-1	-1	-1	-1	-1

DATE=5-16-72 STARTING HR= 700 NO. OF HRS= 4

P R O B E N U M B E R S																							
1	2	3	4	5	6	7	8	9	10	11	12	13	14	15	16	17	18	19	20	21	22	23	24
4	6	9	4	6	9	4	5	9	23	21	17	11	9	8	-1	2	-1	-1	2	-1	-1	2	-1
3	4	6	3	4	7	3	4	7	20	17	14	9	8	7	-1	2	-1	-1	2	-1	-1	2	-1
3	3	5	3	3	5	3	3	5	14	12	10	6	5	5	-1	2	-1	-1	2	-1	-1	2	-1
1	2	3	2	2	3	2	2	3	11	8	7	4	3	3	-1	1	-1	-1	2	-1	-1	2	-1

PAGE 4

SANTA MONICA FREEWAY @ 4TH AVE P.O.C.

DATE=5-17-72 STARTING HR= 700 NO. OF HRS= 4

P R O B E N U M B E R S																							
1	2	3	4	5	6	7	8	9	10	11	12	13	14	15	16	17	18	19	20	21	22	23	24
-1	4	6	-1	4	6	-1	4	7	22	20	15	10	9	7	-1	2	-1	-1	3	-1	-1	3	-1
-1	4	6	-1	4	6	-1	4	7	20	17	14	9	8	7	-1	3	-1	-1	3	-1	-1	3	-1
-1	3	4	-1	3	4	-1	3	4	15	13	11	7	6	5	-1	2	-1	-1	2	-1	-1	2	-1
-1	3	4	-1	3	4	-1	3	5	13	11	8	6	5	4	-1	2	-1	-1	2	-1	-1	2	-1

DATE=5-18-72 STARTING HR= 700 NO. OF HRS= 4

P R O B E N U M B E R S																							
1	2	3	4	5	6	7	8	9	10	11	12	13	14	15	16	17	18	19	20	21	22	23	24
-1	5	7	-1	5	7	-1	5	7	27	23	-1	13	-1	8	-1	3	-1	-1	3	-1	-1	3	-1
-1	5	7	-1	5	8	-1	5	8	22	20	16	10	8	7	-1	2	-1	-1	2	-1	-1	-1	-1
-1	4	5	-1	4	6	-1	4	7	16	14	11	8	7	5	-1	3	-1	-1	3	-1	-1	3	-1
-1	3	4	-1	3	5	-1	3	5	14	13	10	7	8	5	-1	2	-1	-1	2	-1	-1	2	-1

DATE=5-19-72 STARTING HR= 700 NO. OF HRS= 4

P R O B E N U M B E R S																							
1	2	3	4	5	6	7	8	9	10	11	12	13	14	15	16	17	18	19	20	21	22	23	24
-1	5	-1	-1	5	8	-1	5	8	22	18	14	8	7	6	-1	2	-1	-1	2	-1	-1	2	-1
-1	3	-1	-1	3	5	-1	3	5	17	14	12	8	7	6	-1	2	-1	-1	2	-1	-1	2	-1
-1	3	4	-1	3	5	-1	3	5	13	11	9	6	5	4	-1	1	-1	-1	1	-1	-1	1	-1
-1	3	4	-1	3	4	-1	3	5	12	10	7	5	4	3	-1	1	-1	-1	1	-1	-1	1	-1

DATE=5-23-72 STARTING HR= 700 NO. OF HRS= 5

P R O B E N U M B E R S																			
1	2	3	4	5	6	7	8	9	10	11	12	13	14	15	16	17	18	19	20
16	20	16	17	22	18	19	24	21	20	25	24	20	25	27	-1	-1	-1	-1	3
12	16	14	13	17	16	15	19	19	16	20	22	16	19	25	-1	-1	-1	-1	3
8	9	11	9	11	11	10	-1	13	11	13	14	11	-1	15	-1	-1	-1	-1	2
8	7	8	8	8	8	9	9	9	9	13	10	10	-1	11	-1	-1	-1	-1	1
6	6	8	7	8	8	8	8	8	8	13	9	8	9	9	-1	-1	-1	-1	0

PAGE 5

SANTA MONICA FREEWAY @ 4TH AVE P.O.C.

DATE=5-24-72 STARTING HR= 700 NO. OF HRS= 5

P R O B E N U M B E R S																			
1	2	3	4	5	6	7	8	9	10	11	12	13	14	15	16	17	18	19	20
17	20	15	19	22	17	20	22	21	22	24	24	22	27	24	-1	-1	-1	-1	2
13	15	12	13	14	13	15	15	16	15	18	17	16	18	20	-1	-1	-1	-1	3
10	9	9	12	11	11	12	11	12	13	14	13	14	14	14	-1	-1	-1	-1	2
8	8	8	9	9	9	10	9	10	10	12	11	11	13	12	-1	-1	-1	-1	2
9	9	9	10	11	10	10	11	11	13	14	12	12	14	13	-1	-1	-1	-1	2

DATE=5-25-72 STARTING HR= 700 NO. OF HRS= 5

P R O B E N U M B E R S																			
1	2	3	4	5	6	7	8	9	10	11	12	13	14	15	16	17	18	19	20
14	15	10	16	17	12	17	19	14	18	22	15	17	22	17	-1	-1	-1	-1	2
10	11	11	12	12	12	13	14	14	14	15	15	13	16	16	-1	-1	-1	-1	2
8	8	9	9	9	10	10	11	11	10	13	13	9	14	14	-1	-1	-1	-1	1
8	8	7	8	9	8	9	10	8	10	12	9	9	13	10	-1	-1	-1	-1	1
8	8	7	8	9	8	9	11	9	11	13	10	10	14	10	-1	-1	-1	-1	1

DATE=5-26-72 STARTING HR= 700 NO. OF HRS= 4

P R O B E N U M B E R S																			
1	2	3	4	5	6	7	8	9	10	11	12	13	14	15	16	17	18	19	20
11	13	19	13	14	21	13	16	24	14	18	28	15	19	30	-1	-1	-1	-1	4
10	9	13	11	10	15	11	12	17	13	14	19	14	14	22	-1	-1	-1	-1	3
9	9	9	9	10	11	9	12	12	11	14	13	11	14	15	-1	-1	-1	-1	2
6	7	8	7	8	8	7	9	8	9	10	10	9	11	11	-1	-1	-1	-1	0

DATE=5-31-72 STARTING HR= 800 NO. OF HRS= 4

P R O B E N U M B E R S																			
1	2	3	4	5	6	7	8	9	10	11	12	13	14	15	16	17	18	19	20
22	23	20	23	-1	21	24	-1	23	25	-1	27	25	29	29	-1	-1	-1	-1	9
17	16	17	18	18	18	18	19	18	19	21	20	20	21	20	-1	-1	-1	-1	8
11	12	12	12	14	13	12	14	13	13	16	15	14	17	15	-1	-1	-1	-1	5
8	8	8	10	9	9	11	11	9	13	12	11	13	13	12	-1	-1	-1	-1	3

PAGE 6

SANTA MONICA FREEWAY @ 4TH AVE P.O.C.

DATE=6-1-72 STARTING HR= 700 NO. OF HRS=10

P R O B E N U M B E R S																			
1	2	3	4	5	6	7	8	9	10	11	12	13	14	15	16	17	18	19	20
16	19	17	17	21	18	18	22	20	20	25	19	21	25	26	14	12	11	10	4
15	18	20	15	19	21	16	-1	23	17	23	26	18	24	30	13	11	10	9	6
14	14	16	15	15	17	14	16	18	16	18	19	17	19	21	10	10	9	9	7
12	13	14	14	14	14	13	15	15	15	16	16	15	17	16	10	9	8	8	6
8	8	9	9	9	10	10	10	11	13	12	12	13	13	13	6	6	5	5	3
7	8	8	8	8	8	9	9	9	11	11	9	12	11	11	4	5	4	4	2
7	7	8	7	8	9	8	9	8	9	10	10	9	12	11	4	4	4	3	2
8	8	8	8	9	9	9	10	10	11	12	11	12	-1	12	5	5	4	3	1
9	8	10	10	-1	12	12	12	13	14	14	14	15	16	15	5	5	-1	3	2
9	9	9	10	11	11	12	14	13	16	16	13	-1	19	15	-1	6	-1	4	1

DATE=6-2-72 STARTING HR= 700 NO. OF HRS= 1

P R O B E N U M B E R S																			
1	2	3	4	5	6	7	8	9	10	11	12	13	14	15	16	17	18	19	20
-1	15	-1	-1	17	-1	-1	19	-1	-1	20	-1	-1	22	-1	10	9	7	6	3

FILE DOES NOT EXIST

SANTA MONICA FREEWAY @ 4TH AVE P.O.C.
 MAY 2, 1972 TO JUNE 2, 1972
 BEARING: N 80 12'53"E

5 LANES EACH DIRECTION
 22 FT MEDIAN
 TOP WIDTH OF CUT = 256 FT
 BOTTOM WIDTH OF CUT = 162 FT
 WIDTH OF ROADWAY = 160 FT

DEPTH OF CUT = 24 FT
 SIDE SLOPES = 2:1

T R A F F I C D A T A

DATE=5-2-72 STARTING HR= 900 NO. OF HRS= 3

EASTBOUND			WESTBOUND			TOTAL VPH	AVG. SPEED
VPH	OCC.	SPEED	VPH	OCC.	SPEED		
5233	.10	39	3669	.08	34	8902	37
-1	-1.00	-1	-1	-1.00	-1	-1	-1
-1	-1.00	-1	-1	-1.00	-1	-1	-1

DATE=5-3-72 STARTING HR= 700 NO. OF HRS= 5

EASTBOUND			WESTBOUND			TOTAL VPH	AVG. SPEED
VPH	OCC.	SPEED	VPH	OCC.	SPEED		
9529	.11	65	7361	.10	55	16890	61
9562	.15	48	6954	.11	48	16516	48
7819	.09	65	6202	.08	58	14021	62
7416	.07	70	5905	.07	63	13321	67
7236	.08	68	6649	.08	62	13885	65

DATE=5-4-72 STARTING HR= 700 NO. OF HRS= 5

EASTBOUND			WESTBOUND			TOTAL VPH	AVG. SPEED
VPH	OCC.	SPEED	VPH	OCC.	SPEED		
9850	.14	53	7401	.15	37	17251	46
9492	.14	51	7026	.11	48	16518	50
8069	.08	70	5948	.08	56	14017	64
7207	.07	70	6081	.07	65	13288	68
7155	.07	70	6497	.08	61	13652	66

SANTA MONICA FREEWAY @ 4TH AVE P.O.C.

DATE=5-5-72 STARTING HR= 700 NO. OF HRS= 5

VPH	EASTBOUND		VPH	WESTBOUND		TOTAL VPH	AVG. SPEED
	OCC.	SPEED		OCC.	SPEED		
9252	.14	50	7264	.19	29	16516	40
9008	.18	38	6912	.16	32	15920	35
8598	.13	50	6005	.10	45	14603	48
7503	.09	63	6142	.10	46	13645	55
-1	-1.00	-1	-1	-1.00	-1	-1	-1

DATE=5-8-72 STARTING HR= 700 NO. OF HRS= 5

VPH	EASTBOUND		VPH	WESTBOUND		TOTAL VPH	AVG. SPEED
	OCC.	SPEED		OCC.	SPEED		
-1	-1.00	-1	-1	-1.00	-1	-1	-1
7706	.08	70	6579	.09	55	14285	63
7722	.08	70	5762	.08	54	13484	63
7266	.08	68	5777	.07	62	13043	66
6845	.08	64	6397	.08	60	13242	62

DATE=5-9-72 STARTING HR= 700 NO. OF HRS= 5

VPH	EASTBOUND		VPH	WESTBOUND		TOTAL VPH	AVG. SPEED
	OCC.	SPEED		OCC.	SPEED		
9359	.12	59	7081	.14	38	16440	50
9202	.14	49	6552	.13	38	15754	45
8774	.09	70	6169	.09	52	14943	62
-1	-1.00	-1	-1	-1.00	-1	-1	-1
7163	.08	67	6883	.08	65	14046	66

DATE=5-10-72 STARTING HR= 700 NO. OF HRS= 4

VPH	EASTBOUND		VPH	WESTBOUND		TOTAL VPH	AVG. SPEED
	OCC.	SPEED		OCC.	SPEED		
8240	.15	41	7205	.19	29	15445	35
9125	.13	53	6799	.14	37	15924	46
8341	.09	70	5809	.08	55	14150	63
7344	.07	70	5837	.07	63	13181	67

SANTA MONICA FREEWAY @ 4TH AVE P.O.C.

DATE=5-11-72 STARTING HR= 700 NO. OF HRS= 4

VPH	EASTBOUND		VPH	WESTBOUND		TOTAL VPH	AVG. SPEED
	OCC.	SPEED		OCC.	SPEED		
9356	.14	50	7206	.14	39	16562	45
9467	.15	47	6892	.13	40	16359	44
-1	-1.00	-1	-1	-1.00	-1	-1	-1
-1	-1.00	-1	-1	-1.00	-1	-1	-1

DATE=5-12-72 STARTING HR= 700 NO. OF HRS= 5

VPH	EASTBOUND		VPH	WESTBOUND		TOTAL VPH	AVG. SPEED
	OCC.	SPEED		OCC.	SPEED		
-1	-1.00	-1	-1	-1.00	-1	-1	-1
-1	-1.00	-1	-1	-1.00	-1	-1	-1
-1	-1.00	-1	-1	-1.00	-1	-1	-1
-1	-1.00	-1	-1	-1.00	-1	-1	-1
-1	-1.00	-1	-1	-1.00	-1	-1	-1

DATE=5-15-72 STARTING HR= 700 NO. OF HRS= 4

VPH	EASTBOUND		VPH	WESTBOUND		TOTAL VPH	AVG. SPEED
	OCC.	SPEED		OCC.	SPEED		
9363	.14	50	7129	.15	36	16492	44
8923	.12	56	6745	.11	46	15668	52
8351	.09	70	5881	.08	55	14232	64
-1	-1.00	-1	-1	-1.00	-1	-1	-1

DATE=5-16-72 STARTING HR= 700 NO. OF HRS= 4

VPH	EASTBOUND		VPH	WESTBOUND		TOTAL VPH	AVG. SPEED
	OCC.	SPEED		OCC.	SPEED		
9479	.14	51	7337	.17	32	16816	43
9352	.16	44	6844	.15	34	16196	40
8857	.13	51	5857	.08	55	14714	53
7117	.07	70	5941	.07	64	13058	67

PAGE 4

SANTA MONICA FREEWAY @ 4TH AVE P.O.C.

DATE=5-17-72 STARTING HR= 700 NO. OF HRS= 4

VPH	EASTBOUND		VPH	WESTBOUND		TOTAL VPH	AVG. SPEED
	OCC.	SPEED		OCC.	SPEED		
9688	.13	56	7304	.15	37	16992	48
9510	.15	48	6942	.08	65	16452	55
8175	.08	70	6025	.08	57	14200	64
7174	.07	70	6045	.07	65	13219	68

DATE=5-18-72 STARTING HR= 700 NO. OF HRS= 4

VPH	EASTBOUND		VPH	WESTBOUND		TOTAL VPH	AVG. SPEED
	OCC.	SPEED		OCC.	SPEED		
-1	-1.00	-1	-1	-1.00	-1	-1	-1
-1	-1.00	-1	-1	-1.00	-1	-1	-1
-1	-1.00	-1	-1	-1.00	-1	-1	-1
-1	-1.00	-1	-1	-1.00	-1	-1	-1

DATE=5-19-72 STARTING HR= 700 NO. OF HRS= 4

VPH	EASTBOUND		VPH	WESTBOUND		TOTAL VPH	AVG. SPEED
	OCC.	SPEED		OCC.	SPEED		
9171	.17	41	7178	.17	32	16349	37
8788	.13	51	6703	.17	30	15491	42
8370	.13	48	5880	.09	49	14250	49
7296	.09	61	6173	.09	52	13469	57

DATE=5-23-72 STARTING HR= 700 NO. OF HRS= 5

VPH	EASTBOUND		VPH	WESTBOUND		TOTAL VPH	AVG. SPEED
	OCC.	SPEED		OCC.	SPEED		
9556	.14	51	7329	.17	32	16885	43
9355	.16	44	6858	.12	43	16213	44
8444	.09	70	6009	.08	56	14453	64
7469	.07	70	6214	.08	58	13683	65
6968	.08	65	6784	.08	64	13752	65

SANTA MONICA FREEWAY @ 4TH AVE P.O.C.

DATE=5-24-72 STARTING HR= 700 NO. OF HRS= 5

VPH	EASTBOUND		VPH	WESTBOUND		TOTAL VPH	AVG. SPEED
	OCC.	SPEED		OCC.	SPEED		
9600	.15	48	7448	.16	35	17048	42
9411	.14	51	6577	.10	49	15988	50
8364	.09	70	6249	.08	59	14613	65
7181	.07	70	6102	.05	70	13283	70
7017	.07	70	6588	.08	62	13605	66

DATE=5-25-72 STARTING HR= 700 NO. OF HRS= 5

VPH	EASTBOUND		VPH	WESTBOUND		TOTAL VPH	AVG. SPEED
	OCC.	SPEED		OCC.	SPEED		
9781	.14	53	7463	.14	40	17244	47
9477	.13	55	6924	.11	47	16401	52
8250	.08	70	5867	.08	55	14117	64
7367	.07	70	6144	.08	58	13511	64
-1	-1.00	-1	-1	-1.00	-1	-1	-1

DATE=5-26-72 STARTING HR= 700 NO. OF HRS= 4

VPH	EASTBOUND		VPH	WESTBOUND		TOTAL VPH	AVG. SPEED
	OCC.	SPEED		OCC.	SPEED		
9600	.14	52	7470	.15	37	17070	45
9414	.15	47	6810	.11	47	16224	47
8316	.08	70	5901	.08	55	14217	64
7757	.07	70	6429	.09	54	14186	63

DATE=5-31-72 STARTING HR= 800 NO. OF HRS= 4

VPH	EASTBOUND		VPH	WESTBOUND		TOTAL VPH	AVG. SPEED
	OCC.	SPEED		OCC.	SPEED		
9506	.15	48	6956	.14	37	16462	43
8278	.09	69	6179	.09	52	14457	62
7571	.08	70	6555	.08	62	14126	66
7191	.08	68	6889	.09	58	14080	63

PAGE 6

SANTA MONICA FREEWAY @ 4TH AVE P.O.C.

DATE=6-1-72 STARTING HR= 700 NO. OF HRS=10

VPH	EASTBOUND		VPH	WESTBOUND		TOTAL VPH	AVG. SPEED
	OCC.	SPEED		OCC.	SPEED		
9497	.14	51	7236	.16	34	16733	44
9239	.15	46	6845	.15	34	16084	41
8452	.10	64	6188	.08	58	14640	61
7159	.07	70	6415	.08	60	13574	65
7014	.08	66	7122	.08	67	14136	66
6969	.07	70	6618	.08	62	13587	66
7255	.08	68	6880	.08	65	14135	66
-1	-1.00	-1	-1	-1.00	-1	-1	-1
8368	.12	52	9377	.13	54	17745	53
7221	.22	25	9432	.14	51	16653	39

DATE=6-2-72 STARTING HR= 700 NO. OF HRS= 1

VPH	EASTBOUND		VPH	WESTBOUND		TOTAL VPH	AVG. SPEED
	OCC.	SPEED		OCC.	SPEED		
-1	-1.00	-1	-1	-1.00	-1	-1	-1

SITE 2

HARBOR FREEWAY
AT
146th AVE. P.O.C.

DEPRESSED SECTION

HARBOR FREEWAY @ 146TH AVE
 JULY 25, 1972 TO AUGUST 10, 1972
 BEARING: N 00 06' 57"E

4 LANES EACH DIRECTION
 22 FT MEDIAN
 TOP WIDTH OF CUT = 284 FT
 BOTTOM WIDTH OF CUT = 198 FT
 WIDTH OF ROADWAY = 134 FT

DEPTH OF CUT = 22 FT
 SIDE SLOPES = 2:1

WIND MEASURED AT 10 METER HEIGHT (OR EQUIVALENT)

M E T E O R L O G I C A L D A T A

DATE=7-25-72 STARTING HR= 700 NO. OF HRS=11

CEIL.	WIND DIRE.	WIND MPH	SKY CODE	STAB.
200	-1	-1	2	-1
200	-1	-1	0	-1
-1	-1	-1	-1	-1
-1	-1	-1	-1	-1
-1	-1	-1	-1	-1
200	-1	-1	0	-1
200	-1	-1	0	-1
200	-1	-1	0	-1
200	-1	-1	0	-1
200	-1	-1	0	-1
200	-1	-1	0	-1

DATE=7-26-72 STARTING HR= 700 NO. OF HRS= 6

CEIL.	WIND DIRE.	WIND MPH	SKY CODE	STAB.
200	-1	-1	2	-1
200	-1	-1	2	-1
200	-1	-1	0	-1
200	-1	-1	0	-1
200	-1	-1	0	-1
200	-1	-1	0	-1

HARBOR FREEWAY @ 146TH AVE

DATE=7-28-72 STARTING HR= 700 NO. OF HRS=11

CEIL.	WIND DIRE.	WIND MPH	SKY CODE	STAB.
200	-1	-1	2	-1
200	-1	-1	2	-1
200	-1	-1	2	-1
200	-1	-1	1	-1
200	-1	-1	1	-1
200	-1	-1	1	-1
250	-1	-1	4	-1
250	-1	-1	4	-1
250	-1	-1	4	-1
-1	-1	-1	-1	-1
-1	-1	-1	-1	-1

DATE=7-31-72 STARTING HR= 700 NO. OF HRS=10

CEIL.	WIND DIRE.	WIND MPH	SKY CODE	STAB.
200	-1	-1	0	-1
200	-1	-1	0	-1
200	-1	-1	0	-1
200	-1	-1	0	-1
200	260	8	0	B
200	240	11	0	C
200	260	12	0	C
200	250	12	0	C
200	240	11	0	C
-1	260	9	-1	-1

PAGE 3

HARBOR FREEWAY @ 146TH AVE

DATE=8-2-72 STARTING HR= 700 NO. OF HRS=11

CEIL.	WIND DIRE.	WIND MPH	SKY CODE	STAB.
200	100	3	0	B
200	140	4	0	B
200	170	6	0	B
200	170	10	0	C
200	160	8	0	B
200	160	10	0	B
200	170	9	0	B
200	160	9	0	C
200	150	8	0	B
200	150	6	0	C
-1	-1	-1	-1	-1

DATE=8-8-72 STARTING HR= 800 NO. OF HRS=10

CEIL.	WIND DIRE.	WIND MPH	SKY CODE	STAB.
200	180	3	0	B
200	270	5	1	B
200	220	5	0	B
200	210	8	0	B
200	250	9	0	B
200	240	10	0	B
200	250	10	0	C
200	240	11	0	C
200	250	12	0	D
-1	-1	-1	-1	-1

PAGE 4

HARBOR FREEWAY @ 146TH AVE

DATE=8-9-72 STARTING HR= 800 NO. OF HRS=10

CEIL.	WIND DIRE.	WIND MPH	SKY CODE	STAB.
15	210	3	8	D
15	240	5	8	D
16	230	6	8	D
200	210	6	2	A
200	210	6	0	A
200	230	7	0	B
200	240	8	0	B
200	250	8	0	B
200	240	8	0	C
-1	240	8	-1	-1

DATE=8-10-72 STARTING HR= 700 NO. OF HRS= 5

CEIL.	WIND DIRE.	WIND MPH	SKY CODE	STAB.
200	260	2	0	B
200	200	3	0	B
200	180	3	0	B
200	210	5	0	B
200	220	7	1	B

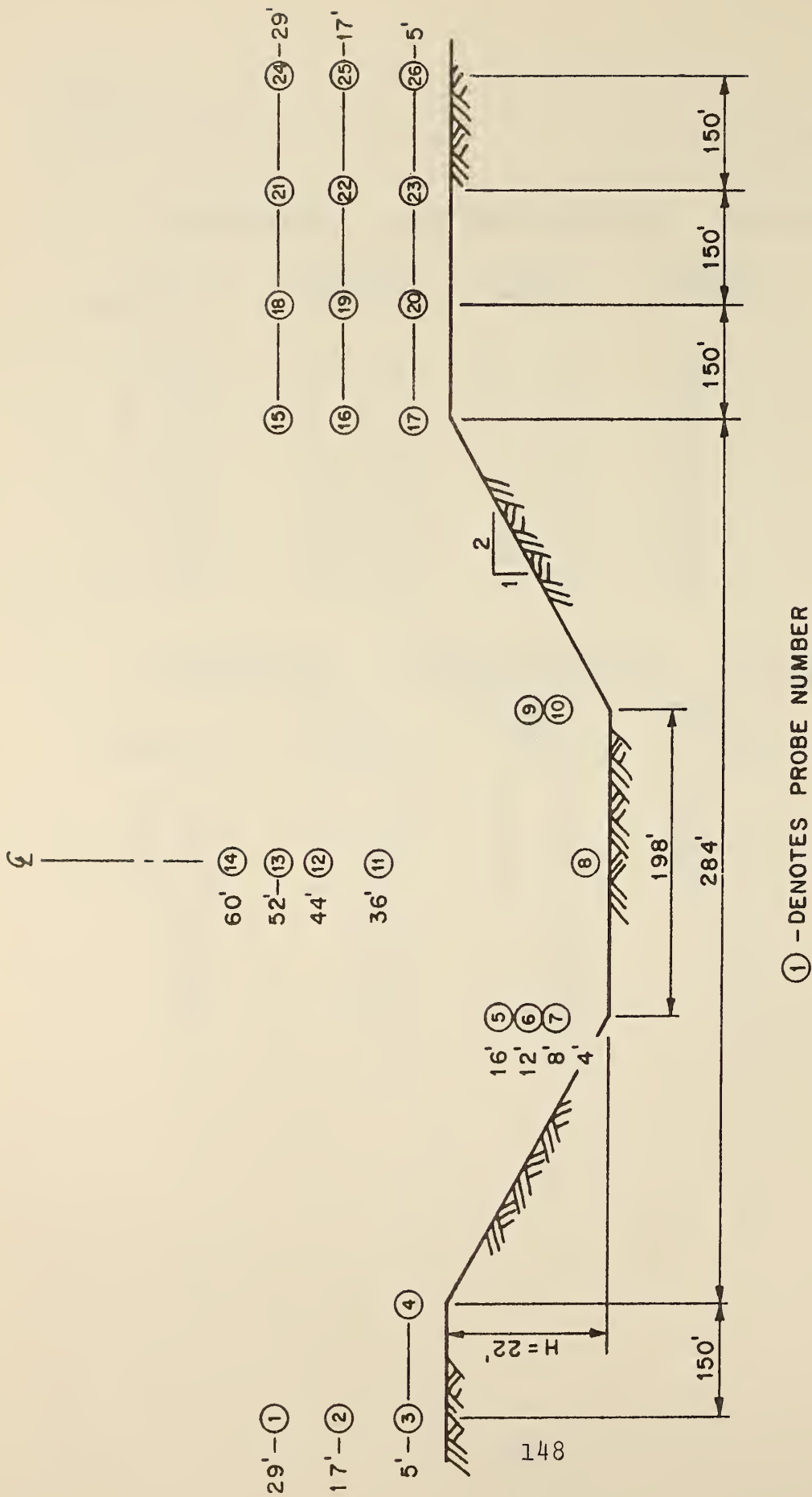
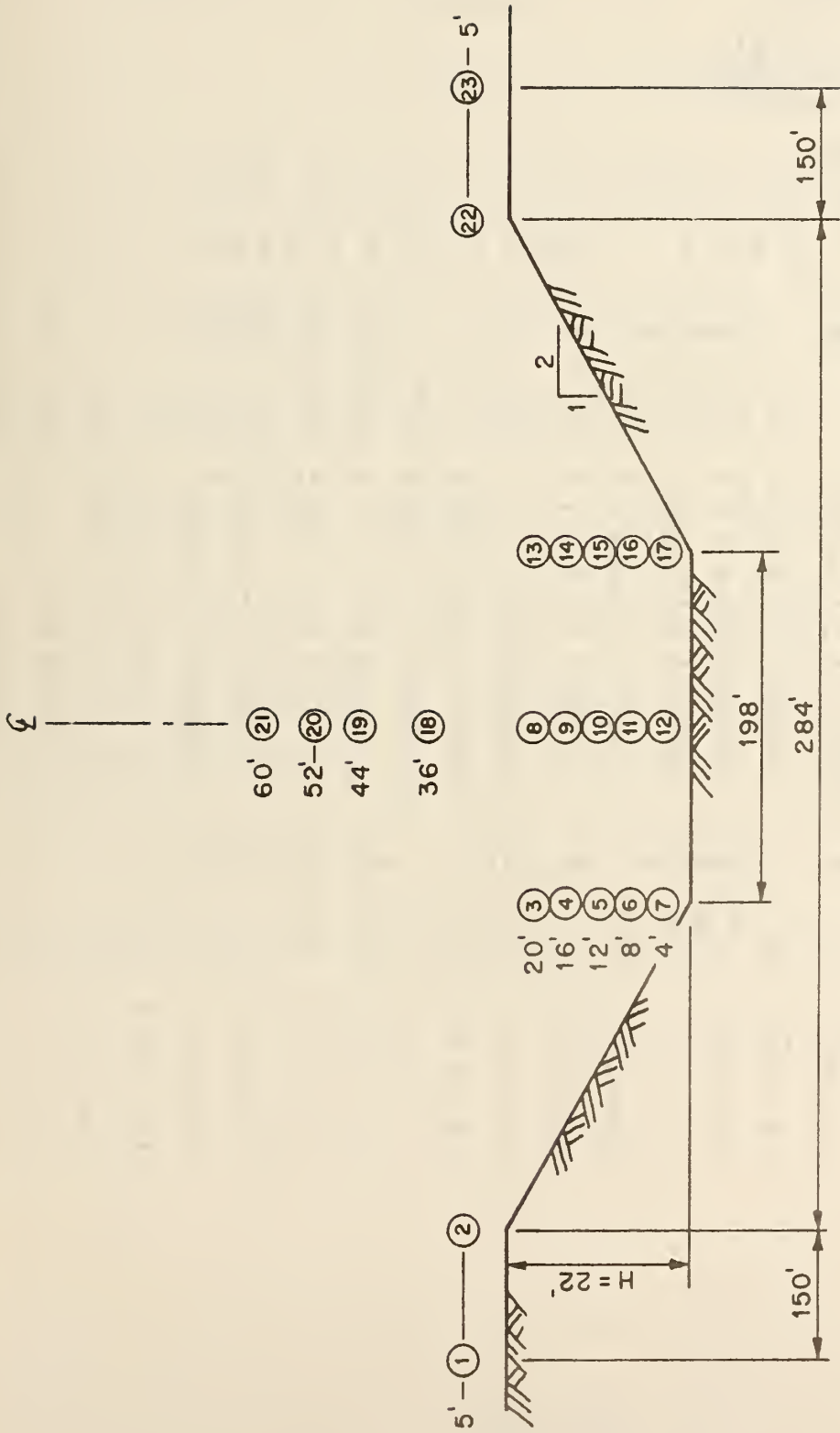

FIG. 70 PROBE LOCATIONS. HARBOR FREEWAY
 AT 146TH AVE HORIZONTAL STUDY
 (NOT TO SCALE)



① - DENOTES PROBE NUMBER

FIG. 71 PROBE LOCATIONS, HARBOR FREEWAY
AT 146TH AVE IN-SECTION STUDY

(NOT TO SCALE)

HARBOR FREEWAY @ 146TH AVE
 JULY 25, 1972 TO AUGUST 10, 1972
 BEARING: N 00 06'57"E

4 LANES EACH DIRECTION
 22 FT MEDIAN
 TOP WIDTH OF CUT = 284 FT
 BOTTOM WIDTH OF CUT = 198 FT
 WIDTH OF ROADWAY = 134 FT

DEPTH OF CUT = 22 FT
 SIDE SLOPES = 2:1

P O L L U T A N T C O N C E N T R A T I O N

DATE=7-25-72 STARTING HR= 700 NO. OF HRS=11

P R O B E N U M B E R S																						
1	2	3	4	5	6	7	8	9	10	11	12	13	14	15	16	17	18	19	20	21	22	23
6	9	14	-1	-1	14	18	16	19	16	28	25	-1	20	26	19	33	10	-1	8	11	11	4
5	8	11	12	11	11	14	13	14	10	17	17	10	10	13	8	10	8	8	7	6	5	12
2	3	-1	9	3	8	8	5	6	5	8	-1	-1	6	-1	4	7	4	8	3	-1	4	3
2	2	5	7	2	7	8	4	4	5	5	-1	-1	4	2	4	4	3	3	3	2	3	2
-1	-1	-1	-1	-1	-1	-1	-1	-1	-1	-1	-1	-1	-1	-1	-1	-1	-1	-1	-1	-1	-1	-1
-1	-1	-1	-1	-1	-1	-1	-1	-1	-1	-1	-1	-1	-1	-1	-1	-1	-1	-1	-1	-1	-1	-1
-1	-1	-1	-1	-1	-1	-1	-1	-1	-1	-1	-1	-1	-1	-1	-1	-1	-1	-1	-1	-1	-1	-1
3	2	7	9	3	8	8	5	5	6	6	-1	4	5	4	5	5	3	3	3	3	-1	3
3	3	8	10	4	9	9	8	8	10	8	14	5	6	4	6	7	4	5	8	3	4	3
3	3	8	10	4	11	11	8	8	8	9	11	7	6	4	6	7	5	5	4	4	4	4
3	3	8	10	4	11	12	7	8	8	9	10	5	6	4	7	7	5	4	4	4	5	4

DATE=7-26-72 STARTING HR= 700 NO. OF HRS= 6

P R O B E N U M B E R S																						
1	2	3	4	5	6	7	8	9	10	11	12	13	14	15	16	17	18	19	20	21	22	23
6	6	12	13	13	12	16	14	16	19	19	22	19	22	23	19	27	10	9	8	7	14	8
4	6	8	9	9	9	12	10	10	11	12	12	8	8	9	10	11	8	7	6	6	7	4
2	3	6	6	6	6	8	7	8	6	8	9	5	6	6	7	7	4	3	3	3	3	3
3	3	5	7	6	7	8	6	8	6	8	9	6	7	7	7	8	5	4	4	4	4	3
3	3	5	7	8	7	9	6	7	7	8	9	5	6	7	6	7	4	4	4	3	5	3
3	3	5	6	6	6	8	5	6	7	7	8	4	5	6	5	6	-1	4	3	3	3	3

HARBOR FREEWAY @ 146TH AVE

DATE=7-28-72 STARTING HR= 700 NO. OF HRS=11

		P R O B E N U M B E R S																						
1	2	3	4	5	6	7	8	9	10	11	12	13	14	15	16	17	18	19	20	21	22	23		
8	7	14	14	14	15	17	17	17	16	22	22	17	22	12	24	27	11	9	8	8	14	9		
7	7	12	12	13	14	15	14	14	12	16	17	12	13	10	15	16	10	9	8	8	11	9		
5	5	9	-1	9	10	12	9	10	8	11	12	8	9	8	10	7	7	7	7	7	8	6		
4	4	8	8	8	10	10	8	8	8	10	10	7	-1	7	8	8	6	5	5	5	7	5		
4	5	8	-1	9	11	11	8	8	8	9	10	7	8	7	8	9	6	6	6	5	8	6		
5	5	8	-1	-1	10	11	8	8	7	8	9	6	7	6	7	8	6	5	5	5	6	5		
4	4	8	8	8	10	11	6	7	6	8	8	5	6	5	5	6	6	5	5	5	5	5		
3	4	8	8	8	9	10	7	7	6	9	9	5	-1	5	6	6	5	5	4	4	4	5		
3	3	8	9	9	10	13	8	7	7	10	11	6	7	6	-1	8	6	-1	5	-1	4	6		
5	5	11	12	12	14	15	9	11	9	13	15	7	9	9	10	11	7	7	6	6	6	8		
3	6	8	9	8	11	13	9	9	9	12	12	7	7	6	9	9	7	6	6	4	7	4		

DATE=7-31-72 STARTING HR= 700 NO. OF HRS=10

		P R O B E N U M B E R S																						
1	2	3	4	5	6	7	8	9	10	11	12	13	14	15	16	17	18	19	20	21	22	23		
5	5	10	11	10	12	13	14	10	10	19	20	-1	17	19	22	24	10	-1	7	-1	8	5		
3	3	8	8	11	10	11	10	12	8	13	15	11	12	14	15	16	7	7	6	6	8	5		
4	3	8	8	17	8	9	9	9	8	10	11	7	7	8	8	8	7	7	6	5	6	4		
4	3	8	8	11	8	10	6	7	6	8	8	5	5	6	7	7	5	4	4	4	5	3		
3	3	6	7	8	8	8	5	6	5	7	8	4	5	5	6	6	4	6	3	3	4	3		
3	3	6	7	7	8	8	5	5	4	6	7	4	5	5	5	5	4	3	3	3	3	3		
2	3	5	6	5	8	8	4	4	5	6	6	4	5	6	4	4	3	4	3	3	3	3		
2	7	7	6	8	7	8	5	6	4	6	7	4	4	4	4	4	3	3	3	3	3	3		
-1	5	7	8	7	8	9	5	5	5	6	-1	4	4	5	8	4	4	3	-1	-1	3	3		
3	5	9	15	9	12	14	8	9	7	10	12	8	7	7	7	8	5	4	4	4	6	4		

PAGE 3

HARBOR FREEWAY @ 146TH AVE

DATE=8-2-72 STARTING HR= 700 NO. OF HRS=11

P R O B E N U M B E R S																						
1	2	3	4	5	6	7	8	9	10	11	12	13	14	15	16	17	18	19	20	21	22	23
7	11	14	14	15	14	17	16	18	16	21	22	14	16	16	10	21	12	9	8	7	5	5
6	8	9	10	9	11	13	10	12	10	15	16	10	11	12	13	16	9	8	7	5	5	5
5	7	8	8	8	9	10	8	8	8	10	12	7	8	8	8	9	7	6	6	5	5	5
6	6	8	8	8	9	9	8	8	8	9	9	7	8	8	8	8	6	6	6	5	6	5
6	7	7	7	7	8	8	6	6	6	8	8	6	6	6	8	8	5	5	5	5	5	4
6	6	7	8	8	8	8	6	8	7	8	9	7	8	8	8	8	6	5	5	5	6	4
6	6	7	8	8	8	8	6	7	7	8	8	6	8	8	8	9	5	8	8	7	5	-1
6	6	6	7	8	8	9	6	7	7	8	-1	6	6	7	7	7	5	5	5	5	5	4
6	7	8	8	9	10	11	8	8	8	10	11	7	8	8	8	9	7	7	6	7	6	5
5	6	7	9	9	10	9	8	9	9	12	12	7	7	9	9	10	6	6	5	5	5	4
5	5	4	8	6	8	8	6	8	6	10	10	6	6	7	8	8	4	5	3	4	4	3

DATE=8-8-72 STARTING HR= 800 NO. OF HRS=10

P R O B E N U M B E R S																									
1	2	3	4	5	6	7	8	9	10	11	12	13	14	15	16	17	18	19	20	21	22	23	24	25	26
3	-1	3	5	6	8	8	11	6	7	6	6	5	3	2	3	3	2	-1	3	2	3	2	-1	3	3
3	-1	3	4	7	7	8	9	8	7	4	-1	-1	5	4	4	4	3	3	3	3	3	-1	4	4	3
3	-1	3	4	5	5	7	7	6	6	5	3	4	4	5	4	5	3	3	3	3	3	3	4	3	3
2	-1	3	2	6	6	7	7	5	5	3	3	3	3	3	3	3	3	3	3	2	3	3	3	3	2
3	-1	3	3	6	6	8	7	5	5	3	3	3	3	3	4	3	3	3	3	3	3	3	3	3	3
3	-1	3	3	6	6	7	6	4	5	4	3	3	4	3	3	3	3	3	3	3	3	3	3	3	3
3	-1	3	-1	8	-1	12	8	7	12	5	7	6	4	4	4	4	7	4	3	4	4	4	-1	3	3
3	-1	3	3	8	9	9	9	-1	8	5	-1	4	3	4	5	5	3	4	4	4	4	-1	4	4	4
4	-1	6	5	11	12	12	12	8	10	5	5	5	6	7	6	8	6	5	6	4	4	7	5	4	4
3	-1	4	4	13	9	9	9	7	6	5	5	4	5	4	5	6	5	7	4	4	7	7	6	6	5

PAGE 4

HARROR FREEWAY @ 146TH AVE

DATE=8-9-72 STARTING HR= 800 NO. OF HRS=10

P R O B E N U M B E R S																									
1	2	3	4	5	6	7	8	9	10	11	12	13	14	15	16	17	18	19	20	21	22	23	24	25	26
3	3	3	3	7	7	9	10	8	5	-1	6	5	5	4	5	5	4	4	3	3	3	3	3	3	3
3	3	4	5	5	8	8	10	8	8	-1	6	5	5	5	5	5	4	4	4	3	3	3	3	3	3
3	3	6	4	8	8	8	9	7	8	-1	5	5	5	4	5	5	3	3	4	3	3	4	3	3	3
3	3	3	4	8	8	8	8	7	8	-1	5	5	5	4	4	5	3	4	3	3	3	3	3	3	3
4	3	3	5	7	8	8	8	6	7	-1	4	4	4	3	4	4	3	3	3	3	3	3	3	3	3
3	3	5	4	7	7	8	7	6	6	-1	4	4	4	3	-1	4	3	3	3	3	3	-1	-1	3	3
3	-1	3	-1	7	-1	8	8	7	7	-1	4	4	4	3	4	4	5	3	3	3	3	3	4	3	3
3	3	3	3	8	8	9	8	7	7	-1	5	5	4	4	5	5	3	4	3	3	3	5	3	4	3
3	3	3	3	9	8	10	9	8	8	-1	5	4	4	3	4	5	3	3	3	3	3	3	3	3	3
4	4	4	4	11	10	10	12	7	7	-1	6	6	6	5	5	5	4	4	4	4	4	5	4	4	4

DATE=8-10-72 STARTING HR= 700 NO. OF HRS= 5

P R O B E N U M B E R S																									
1	2	3	4	5	6	7	8	9	10	11	12	13	14	15	16	17	18	19	20	21	22	23	24	25	26
4	4	4	5	10	11	10	15	13	14	-1	8	8	7	8	8	8	5	5	5	4	4	4	4	4	4
5	5	5	6	9	10	9	14	8	10	-1	8	7	7	6	6	6	6	5	6	6	5	5	5	5	5
6	5	5	7	8	8	8	14	8	8	-1	7	8	7	7	7	7	6	5	5	5	6	5	5	5	5
5	5	6	7	9	-1	9	10	8	9	-1	6	6	6	6	7	7	6	-1	6	5	5	6	5	5	5
5	5	7	6	8	8	8	9	8	8	-1	6	6	6	6	7	7	6	6	5	5	6	6	5	6	6

HARBOR FREEWAY @ 146TH AVE
 JULY 25, 1972 TO AUGUST 10, 1972
 BEARING: N 00 06'57"E

4 LANES EACH DIRECTION
 22 FT MEDIAN
 TOP WIDTH OF CUT = 284 FT
 BOTTOM WIDTH OF CUT = 190 FT
 WIDTH OF ROADWAY = 134 FT

DEPTH OF CUT = 22 FT
 SIDE SLOPES = 2:1

T R A F F I C D A T A

DATE=7-25-72 STARTING HR= 700 NO. OF HRS=11

NORTHBOUND			SOUTHBOUND			TOTAL VPH	AVG. SPEED
VPH	OCC.	SPEED	VPH	OCC.	SPEED		
6632	.18	37	4610	.05	70	11242	51
6352	.13	49	2830	.03	70	9182	56
2984	.03	70	3364	.03	70	6348	70
3198	.03	70	3394	.03	70	6592	70
3414	.04	70	3828	.04	70	7242	70
4614	.06	70	5548	.06	70	10162	70
5292	.07	70	6146	.08	70	11438	70
3684	.04	70	7508	.10	70	11192	70
4614	.06	70	5548	.06	70	10162	70
5292	.07	70	6146	.08	70	11438	70
3684	.04	70	7508	.10	70	11192	70

DATE=7-26-72 STARTING HR= 700 NO. OF HRS= 6

NORTHBOUND			SOUTHBOUND			TOTAL VPH	AVG. SPEED
VPH	OCC.	SPEED	VPH	OCC.	SPEED		
6904	.21	33	4502	.05	70	11406	48
6256	.09	70	2720	.03	70	8976	70
4350	.05	70	2572	.03	70	6922	70
3408	.04	70	2875	.03	70	6283	70
3170	.03	70	3308	.03	70	6478	70
2582	.03	70	3386	.03	70	5968	70

PAGE 2

HARBOR FREEWAY @ 146TH AVE

DATE=7-28-72 STARTING HR= 700 NO. OF HRS=11

NORTHBOUND			SOUTHBOUND			TOTAL	AVG.
VPH	OCC.	SPEED	VPH	OCC.	SPEED	VPH	SPEED
6786	.20	34	4494	.05	70	11280	49
6180	.09	70	2772	.03	70	8952	70
4412	.05	70	2608	.03	70	7020	70
3524	.05	70	3060	.03	70	6584	70
3258	.03	70	3672	.04	70	6930	70
3470	.03	70	3440	.03	70	6910	70
3192	.03	70	3646	.04	70	6838	70
3324	.04	70	4250	.05	70	7574	70
4733	.06	70	5972	.07	70	10705	70
5120	.07	70	6524	.09	70	11644	70
3558	.04	70	7200	.10	70	10758	70

DATE=7-31-72 STARTING HR= 700 NO. OF HRS=10

NORTHBOUND			SOUTHBOUND			TOTAL	AVG.
VPH	OCC.	SPEED	VPH	OCC.	SPEED	VPH	SPEED
6800	.22	31	4454	.05	70	11254	47
6082	.11	56	2618	.03	70	8700	60
4536	.05	70	2398	.03	70	6934	70
3476	.04	70	2770	.03	70	6246	70
3052	.03	70	3310	.03	70	6362	70
2780	.03	70	3256	.03	70	6036	70
-1	-1.00	-1	-1	-1.00	-1	-1	-1
-1	-1.00	-1	-1	-1.00	-1	-1	-1
4448	.06	70	5452	.07	70	9900	70
5058	.07	70	5810	.07	70	10868	70

HARBOR FREEWAY @ 146TH AVE

DATE=8-2-72 STARTING HR= 700 NO. OF HRS=11

NORTHBOUND			SOUTHBOUND			TOTAL VPH	AVG. SPEED
VPH	OCC.	SPEED	VPH	OCC.	SPEED		
6854	.17	41	4620	.05	70	11474	53
6024	.11	55	2770	.03	70	8794	60
4294	.05	70	2474	.03	70	6768	70
3602	.04	70	2764	.03	70	6366	70
5226	.03	70	3130	.03	70	6356	70
2888	.03	70	3356	.03	70	6244	70
3052	.03	70	3288	.03	70	6340	70
3412	.04	70	4002	.04	70	7414	70
4644	.06	70	5562	.06	70	10206	70
5204	.07	70	6280	.08	70	11484	70
-1	-1.00	-1	-1	-1.00	-1	-1	-1

DATE=8-8-72 STARTING HR= 800 NO. OF HRS=10

NORTHBOUND			SOUTHBOUND			TOTAL VPH	AVG. SPEED
VPH	OCC.	SPEED	VPH	OCC.	SPEED		
-1	-1.00	-1	-1	-1.00	-1	-1	-1
-1	-1.00	-1	-1	-1.00	-1	-1	-1
-1	-1.00	-1	-1	-1.00	-1	-1	-1
-1	-1.00	-1	-1	-1.00	-1	-1	-1
-1	-1.00	-1	-1	-1.00	-1	-1	-1
-1	-1.00	-1	-1	-1.00	-1	-1	-1
-1	-1.00	-1	-1	-1.00	-1	-1	-1
-1	-1.00	-1	-1	-1.00	-1	-1	-1
-1	-1.00	-1	-1	-1.00	-1	-1	-1
-1	-1.00	-1	-1	-1.00	-1	-1	-1

HARBOR FREEWAY @ 146TH AVE

DATE=8-9-72 STARTING HR= 800 NO. OF HRS=10

NORTHBOUND			SOUTHBOUND			TOTAL VPH	AVG. SPEED
VPH	OCC.	SPEED	VPH	OCC.	SPEED		
-1	-1.00	-1	-1	-1.00	-1	-1	-1
-1	-1.00	-1	-1	-1.00	-1	-1	-1
-1	-1.00	-1	-1	-1.00	-1	-1	-1
3212	.04	70	3246	.04	70	6458	70
2818	.05	70	3128	.03	70	5946	70
2932	.03	70	3190	.03	70	6122	70
3481	.04	70	4058	.04	70	7539	70
4648	.06	70	5590	.06	70	10238	70
5360	.07	70	6432	.08	70	11792	70
3632	.04	70	7528	.10	70	11160	70

DATE=8-10-72 STARTING HR= 700 NO. OF HRS= 5

NORTHBOUND			SOUTHBOUND			TOTAL VPH	AVG. SPEED
VPH	OCC.	SPEED	VPH	OCC.	SPEED		
7080	.14	51	4548	.05	70	11628	59
5946	.08	70	2622	.03	70	8568	70
4494	.05	70	2498	.03	70	6992	70
3568	.05	70	2830	.03	70	6398	70
3214	.03	70	3216	.03	70	6430	70

SITE 3

SAN DIEGO FREEWAY
AT WEIGH STATION
AT-GRADE SECTION

SAN DIEGO FREEWAY @ WEIGH STATION
APRIL 5, 1972 TO AUGUST 17, 1972
BEARING: N 50 25'00"W

4 LANES EACH DIRECTION
22 FT MEDIAN
AT-GRADE SECTION

WIDTH OF ROADWAY = 138 FT

WIND MEASURED AT 10 METER HEIGHT (OR EQUIVALENT)

M E T E O R L O G I C A L D A T A

DATE=4-5-72 STARTING HR= 700 NO. OF HRS= 7

CEIL.	WIND DIRE.	WIND MPH	SKY CODE	STAB.
250	270	3	8	C
250	250	7	4	C
230	280	8	8	C
230	280	7	5	B
180	270	8	5	B
160	270	10	8	C
140	280	11	8	D

DATE=4-6-72 STARTING HR= 700 NO. OF HRS= 6

CEIL.	WIND DIRE.	WIND MPH	SKY CODE	STAB.
200	280	7	0	C
200	300	4	2	B
200	160	4	1	B
200	260	12	0	C
200	270	16	0	D
200	260	15	0	C

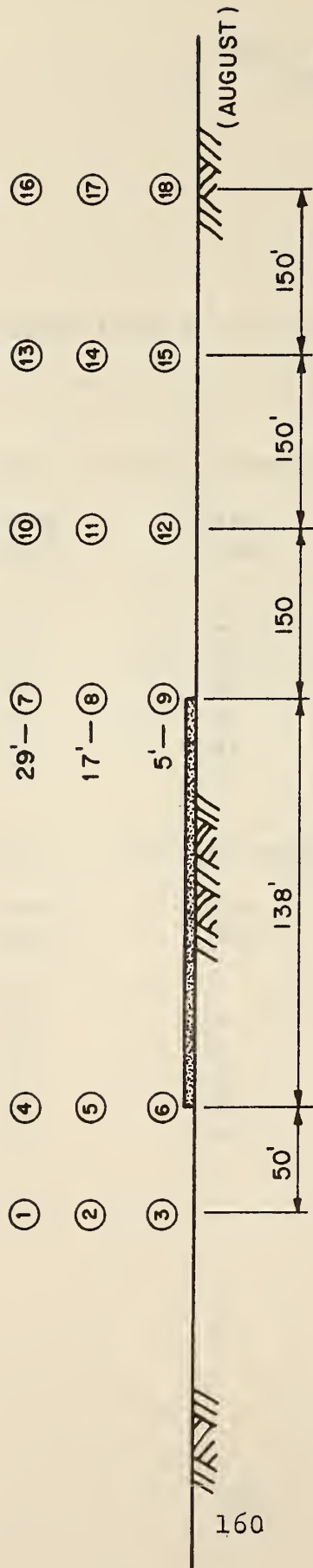

① DENOTES PROBE NUMBER

FIG. 72 PROBE LOCATION SAN DIEGO FREEWAY
 AT WEIGH STATION, HORIZONTAL STUDY
 (NOT TO SCALE)

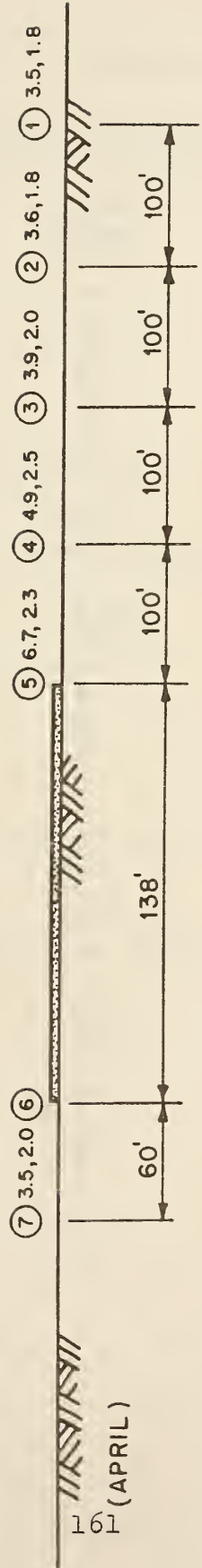

FIG. 73 MEAN AND STANDARD DEVIATIONS OF CO
 AT WEIGH STATION HORIZONTAL STUDY
 (NOT TO SCALE)

PAGE 2

SAN DIEGO FREEWAY @ WEIGH STATION

DATE=4-7-72 STARTING HR= 700 NO. OF HRS= 7

CEIL.	WIND DIRE.	WIND MPH	SKY CODE	STAB.
12	130	4	5	C
200	360	3	2	B
200	300	2	0	B
200	260	3	0	B
200	180	6	0	B
200	260	10	0	B
200	250	16	0	D

DATE=4-10-72 STARTING HR= 700 NO. OF HRS= 7

CEIL.	WIND DIRE.	WIND MPH	SKY CODE	STAB.
100	240	4	8	C
200	160	3	8	C
200	30	3	8	B
200	360	2	8	B
200	120	4	8	B
180	190	12	8	C
160	260	12	8	C

DATE=4-11-72 STARTING HR= 700 NO. OF HRS= 7

CEIL.	WIND DIRE.	WIND MPH	SKY CODE	STAB.
120	300	8	8	D
120	20	5	8	D
120	110	4	8	C
120	210	4	8	C
120	230	4	8	B
120	260	9	8	C
100	270	11	8	D

SAN DIEGO FREEWAY W WEIGH STATION

DATE=4-12-72 STARTING HR= 700 NO. OF HRS= 4

CEIL.	WIND DIRE.	WIND MPH	SKY CODE	STAB.
65	20	4	5	C
200	280	10	2	C
200	270	10	2	C
200	260	13	2	C

DATE=4-13-72 STARTING HR= 700 NO. OF HRS= 6

CEIL.	WIND DIRE.	WIND MPH	SKY CODE	STAB.
200	280	17	0	D
200	270	19	0	D
200	270	13	1	C
200	280	14	1	D
200	280	15	0	C
200	270	16	0	C

DATE=4-14-72 STARTING HR= 700 NO. OF HRS= 7

CEIL.	WIND DIRE.	WIND MPH	SKY CODE	STAB.
200	230	4	0	B
200	240	3	0	B
200	190	4	0	B
200	180	8	0	B
200	200	9	0	B
200	260	13	0	C
200	260	16	0	C

SAN DIEGO FREEWAY @ WEIGH STATION

DATE=8-11-72 STARTING HR= 700 NO. OF HRS=11

CEIL.	WIND DIRE.	WIND MPH	SKY CODE	STAB.
9	360	3	8	D
9	20	3	8	D
200	100	2	2	B
200	200	4	2	B
200	240	6	2	A
200	270	9	2	B
200	260	13	2	C
10	260	13	5	D
200	270	14	2	D
200	260	14	2	D
200	260	10	0	C

DATE=8-14-72 STARTING HR= 700 NO. OF HRS= 6

CEIL.	WIND DIRE.	WIND MPH	SKY CODE	STAB.
38	240	4	5	C
38	270	4	5	C
200	290	5	2	B
200	250	5	2	B
200	220	5	2	A
200	240	7	2	B

DATE=8-15-72 STARTING HR= 700 NO. OF HRS=11

CEIL.	WIND DIRE.	WIND MPH	SKY CODE	STAB.
200	30	4	2	B
200	70	3	2	B
200	170	5	2	B
20	180	6	5	D
200	170	6	2	A
200	180	7	2	B
200	180	8	0	B
200	220	9	0	C
200	270	15	0	D
200	260	15	0	D
200	260	16	2	D

SAN DIEGO FREEWAY @ WEIGH STATION

DATE=8-16-72 STARTING HR= 700 NO. OF HRS=11

CEIL.	WIND DIRE.	WIND MPH	SKY CODE	STAB.
200	300	2	0	B
200	50	3	0	B
200	100	3	0	B
200	170	5	0	B
200	160	5	0	A
200	160	7	0	B
200	260	12	0	C
200	270	15	0	D
200	260	14	0	D
200	270	14	0	D
200	250	13	0	D

DATE=8-17-72 STARTING HR= 700 NO. OF HRS=11

CEIL.	WIND DIRE	WIND MPH	SKY CODE	STAB.
8	130	4	5	C
200	100	4	0	B
200	130	4	0	B
200	150	7	0	B
200	190	8	0	B
200	180	7	0	B
200	160	8	0	B
200	160	11	0	C
200	240	12	0	C
200	250	14	0	D
200	26	12	2	D

SAN DIEGO FREEWAY @ WEIGH STATION
 APRIL 5, 1972 TO AUGUST 17, 1972
 BEARING: N 50 25'00"W

4 LANES EACH DIRECTION
 22 FT MEDIAN
 AT-GRADE SECTION

WIDTH OF ROADWAY = 138 FT

P O L L U T A N T C O N C E N T R A T I O N S

DATE=4-5-72 STARTING HR= 700 NO. OF HRS= 7

P R O B E N U M B E R S

1 2 3 4 5 6 7

12 13 14 16 -1 -1 11
 9 9 9 12 -1 -1 8
 5 5 6 8 -1 -1 -1
 5 5 -1 7 -1 -1 4
 4 4 5 6 -1 -1 4
 4 4 5 6 -1 -1 3
 3 3 4 5 -1 -1 3

DATE=4-6-72 STARTING HR= 700 NO. OF HRS= 6

P R O B E N U M B E R S

1 2 3 4 5 6 7

3 3 4 6 -1 -1 3
 3 3 3 3 -1 -1 5
 4 5 6 -1 -1 -1 5
 4 4 5 6 -1 -1 4
 -1 -1 -1 -1 -1 -1 -1
 4 4 4 5 -1 -1 3

DATE=4-7-72 STARTING HR= 700 NO. OF HRS= 7

P R O B E N U M B E R S

1 2 3 4 5 6 7

3 3 3 3 -1 -1 7
 3 3 3 3 -1 -1 4
 -1 2 3 -1 -1 -1 4
 4 4 -1 5 -1 -1 6
 4 5 5 6 -1 -1 4
 4 4 5 6 -1 -1 3
 4 4 5 5 -1 -1 3

PAGE 2

SAN DIEGO FREEWAY @ WEIGH STATION

DATE=4-10-72 STARTING HR= 700 NO. OF HRS= 7

P R O B E			N U M B E R S			
1	2	3	4	5	6	7
3	3	4	7	13	-1	3
2	2	2	3	5	-1	4
3	3	3	3	5	-1	5
4	4	4	4	6	-1	6
-1	-1	-1	-1	-1	-1	-1
4	4	4	6	8	-1	3
3	3	3	4	7	-1	3

DATE=4-11-72 STARTING HR= 700 NO. OF HRS= 7

P R O B E			N U M B E R S			
1	2	3	4	5	6	7
3	3	4	5	8	-1	5
2	3	3	2	3	-1	6
3	3	3	4	6	-1	4
3	3	4	6	12	-1	2
-1	-1	-1	5	8	-1	3
1	3	3	3	7	-1	2
3	3	3	3	6	-1	1

DATE=4-12-72 STARTING HR= 700 NO. OF HRS= 4

P R O B E			N U M B E R S			
1	2	3	4	5	6	7
-1	-1	-1	-1	-1	-1	-1
-1	3	3	4	7	-1	2
1	1	2	3	4	-1	0
2	2	2	4	5	-1	0

SAN DIEGO FREEWAY @ WEIGH STATION

DATE=4-13-72 STARTING HR= 700 NO. OF HRS= 6

P R O B E N U M B E R S						
1	2	3	4	5	6	7
2	3	3	4	7	-1	1
2	2	3	4	5	-1	-1
2	2	3	4	6	-1	1
3	3	3	4	7	-1	3
3	3	3	4	7	-1	3
3	3	3	4	6	-1	3

DATE=4-14-72 STARTING HR= 700 NO. OF HRS= 7

P R O B E N U M B E R S						
1	2	3	4	5	6	7
4	4	5	8	12	-1	4
2	3	3	4	7	-1	2
-1	3	3	3	-1	-1	3
3	3	3	4	6	-1	3
3	3	3	4	6	-1	3
3	3	3	3	5	-1	2
3	3	3	3	4	-1	2

DATE=8-11-72 STARTING HR= 700 NO. OF HRS=11

P R O B E N U M B E R S																	
1	2	3	4	5	6	7	8	9	10	11	12	13	14	15	16	17	18
8	8	9	-1	10	13	3	4	3	-1	3	3	3	4	4	4	4	4
7	4	8	8	10	9	3	3	4	3	3	3	3	3	3	3	3	3
5	5	4	7	6	6	7	8	9	4	4	5	-1	3	4	3	3	4
4	-1	4	5	5	5	6	8	10	6	5	6	4	4	5	4	4	4
4	4	3	4	4	4	6	8	10	5	6	6	4	5	5	5	-1	4
4	4	3	4	4	4	6	7	9	5	5	5	4	4	4	4	-1	4
3	3	3	5	3	3	4	6	9	6	6	6	5	5	5	4	4	4
3	3	3	4	3	3	5	7	9	4	5	6	4	4	5	4	4	4
3	4	5	3	5	6	3	8	13	5	7	8	6	6	6	-1	-1	-1
4	3	3	3	5	4	5	8	12	5	6	-1	-1	5	6	4	4	5
3	3	5	3	3	3	4	7	11	5	6	7	4	4	5	4	4	4

SAN DIEGO FREEWAY @ WEIGH STATION

DATE=8-14-72 STARTING HR= 700 NO. OF HRS= 6

P R O B E N U M B E R S																	
1	2	3	4	5	6	7	8	9	10	11	12	13	14	15	16	17	18
3	4	3	4	4	4	9	10	16	8	8	8	6	7	7	6	7	6
4	4	3	4	5	5	7	9	13	6	6	5	4	5	5	4	6	5
5	4	4	5	6	6	6	7	8	5	4	4	4	4	4	4	4	3
4	4	5	4	5	4	6	7	9	4	4	5	4	4	4	3	3	3
4	4	4	5	5	6	6	7	8	5	5	5	4	4	4	4	4	4
3	3	3	3	4	4	5	8	8	6	6	5	4	4	4	3	4	4

DATE=8-15-72 STARTING HR= 700 NO. OF HRS=11

P R O B E N U M B E R S																	
1	2	3	4	5	6	7	8	9	10	11	12	13	14	15	16	17	18
10	-1	14	12	13	15	6	7	7	8	8	8	7	7	6	7	7	7
6	-1	7	6	9	8	3	4	4	-1	-1	3	-1	3	3	3	-1	-1
4	5	4	4	6	6	3	5	7	3	4	4	3	3	3	3	3	3
3	3	3	3	3	3	4	7	8	4	4	5	3	3	3	3	3	3
3	3	4	4	5	5	5	6	7	4	4	4	3	3	3	3	3	3
3	3	3	3	3	4	4	5	8	-1	-1	5	4	4	4	3	3	3
-1	-1	-1	-1	-1	-1	-1	-1	-1	-1	-1	-1	-1	-1	-1	-1	-1	-1
-1	-1	3	-1	-1	4	-1	-1	8	-1	-1	5	-1	-1	5	-1	-1	4
-1	-1	3	-1	-1	3	-1	-1	10	-1	-1	6	-1	-1	5	-1	-1	4
-1	-1	3	-1	-1	3	-1	-1	9	-1	-1	4	-1	-1	5	-1	-1	4
-1	-1	3	-1	-1	3	-1	-1	10	-1	-1	6	-1	-1	5	-1	-1	3

DATE=8-16-72 STARTING HR= 700 NO. OF HRS=11

P R O B E N U M B E R S																	
1	2	3	4	5	6	7	8	9	10	11	12	13	14	15	16	17	18
8	10	10	9	14	15	7	8	8	5	6	5	6	6	5	6	4	4
6	6	6	6	8	8	4	4	4	4	3	5	3	4	4	4	3	3
4	5	6	5	8	8	3	3	4	3	3	4	3	3	3	2	2	3
3	4	4	4	4	4	4	4	5	3	3	3	3	3	3	3	2	3
0	0	0	0	1	1	2	2	4	2	2	3	1	1	3	1	1	1
0	0	1	1	2	1	2	3	4	2	2	3	2	1	1	1	1	2
-1	-1	-1	-1	-1	-1	-1	-1	-1	-1	-1	-1	-1	-1	-1	-1	-1	-1
-1	-1	2	-1	-1	2	-1	-1	6	-1	-1	3	-1	-1	3	-1	-1	2
-1	-1	2	-1	-1	2	-1	-1	8	-1	-1	4	-1	-1	3	-1	-1	3
-1	-1	2	-1	-1	2	-1	-1	9	-1	-1	5	-1	-1	3	-1	-1	3
-1	-1	2	-1	-1	2	-1	-1	8	-1	-1	5	-1	-1	3	-1	-1	3

SAN DIEGO FREEWAY @ WEIGH STATION

DATE=8-17-72 STARTING HR= 700 NO. OF HRS=11

P R O B E N U M B E R S																	
1	2	3	4	5	6	7	8	9	10	11	12	13	14	15	16	17	18
7	7	8	8	-1	10	-1	5	-1	4	4	4	4	5	4	3	3	-1
5	5	6	4	5	8	4	5	6	3	3	3	3	3	3	3	3	-1
3	4	5	3	-1	5	3	3	4	3	3	3	3	3	3	3	3	3
3	3	4	4	5	4	3	3	5	3	2	3	2	2	3	2	2	3
3	2	2	2	3	-1	3	4	7	4	4	7	4	3	3	2	3	3
2	2	2	2	3	3	4	4	6	4	4	6	3	3	3	3	3	-1
-1	-1	-1	-1	-1	-1	-1	-1	-1	-1	-1	-1	-1	-1	-1	-1	-1	-1
-1	-1	3	-1	-1	4	-1	-1	8	-1	-1	-1	-1	-1	4	-1	-1	4
-1	-1	3	-1	-1	3	-1	-1	10	-1	-1	6	-1	-1	5	-1	-1	4
-1	-1	3	-1	-1	3	-1	-1	10	-1	-1	7	-1	-1	4	-1	-1	4
-1	-1	2	-1	-1	2	-1	-1	9	-1	-1	6	-1	-1	4	-1	-1	4

SAN DIEGO FREEWAY @ WEIGH STATION
 APRIL 5, 1972 TO AUGUST 17, 1972
 BEARING: N 50 25'00"W

4 LANES EACH DIRECTION
 22 FT MEDIAN
 AT-GRADE SECTION

WIDTH OF ROADWAY = 138 FT

T R A F F I C D A T A

* = DERIVED DATA

DATE=4-5-72 STARTING HR= 700 NO. OF HRS= 7

NORTHBOUND			SOUTHBOUND			TOTAL VPH	AVG. SPEED*
VPH	OCC.	SPEED*	VPH	OCC.	SPEED*		
6939	-1.00	45	6489	-1.00	45	13428	45
6222	-1.00	45	4892	-1.00	45	11114	45
4957	-1.00	45	4075	-1.00	60	9032	52
4592	-1.00	60	3926	-1.00	60	8518	60
4299	-1.00	60	4040	-1.00	60	8339	60
4225	-1.00	60	3712	-1.00	60	7937	60
4239	-1.00	60	4249	-1.00	60	8488	60

DATE=4-6-72 STARTING HR= 700 NO. OF HRS= 6

NORTHBOUND			SOUTHBOUND			TOTAL VPH	AVG. SPEED*
VPH	OCC.	SPEED*	VPH	OCC.	SPEED*		
6939	-1.00	45	6489	-1.00	45	13428	45
6222	-1.00	45	4892	-1.00	45	11114	45
4957	-1.00	45	4075	-1.00	60	9032	52
4592	-1.00	60	3926	-1.00	60	8518	60
-1	-1.00	-1	-1	-1.00	-1	-1	-1
4225	-1.00	60	3712	-1.00	60	7937	60

SAN DIEGO FREEWAY @ WEIGH STATION

DATE=4-7-72 STARTING HR= 700 NO. OF HRS= 7

NORTHBOUND			SOUTHBOUND			TOTAL VPH	AVG. SPEED*
VPH	OCC.	SPEED*	VPH	OCC.	SPEED*		
7083	-1.00	45	6835	-1.00	45	13918	45
6613	-1.00	45	5217	-1.00	45	11830	45
5113	-1.00	45	4133	-1.00	60	9246	52
4580	-1.00	60	3917	-1.00	60	8497	60
4469	-1.00	60	3978	-1.00	60	8447	60
4212	-1.00	60	3675	-1.00	60	7887	60
4124	-1.00	60	4194	-1.00	60	8318	60

DATE=4-10-72 STARTING HR= 700 NO. OF HRS= 7

NORTHBOUND			SOUTHBOUND			TOTAL VPH	AVG. SPEED*
VPH	OCC.	SPEED*	VPH	OCC.	SPEED*		
6939	-1.00	45	6489	-1.00	45	13428	45
6222	-1.00	45	4892	-1.00	45	11114	45
4957	-1.00	45	4075	-1.00	60	9032	52
4592	-1.00	60	3926	-1.00	60	8518	60
-1	-1.00	-1	-1	-1.00	-1	-1	-1
4225	-1.00	60	3712	-1.00	60	7937	60
4239	-1.00	60	4249	-1.00	60	8488	60

DATE=4-11-72 STARTING HR= 700 NO. OF HRS= 7

NORTHBOUND			SOUTHBOUND			TOTAL VPH	AVG. SPEED*
VPH	OCC.	SPEED*	VPH	OCC.	SPEED*		
7083	-1.00	45	6835	-1.00	45	13918	45
6613	-1.00	45	5217	-1.00	45	11830	45
5113	-1.00	45	4133	-1.00	60	9246	52
4580	-1.00	60	3917	-1.00	60	8497	60
4469	-1.00	60	3978	-1.00	60	8447	60
4212	-1.00	60	3675	-1.00	60	7887	60
4124	-1.00	60	4194	-1.00	60	8318	60

SAN DIEGO FREEWAY @ WEIGH STATION

DATE=4-12-72 STARTING HR= 700 NO. OF HRS= 4

NORTHBOUND			SOUTHBOUND			TOTAL VPH	AVG. SPEED*
VPH	OCC.	SPEED*	VPH	OCC.	SPEED*		
-1	-1.00	-1	-1	-1.00	-1	-1	-1
6613	-1.00	45	5217	-1.00	45	11830	45
5113	-1.00	45	4133	-1.00	60	9246	52
4580	-1.00	60	3917	-1.00	60	8497	60

DATE=4-13-72 STARTING HR= 700 NO. OF HRS= 6

NORTHBOUND			SOUTHBOUND			TOTAL VPH	AVG. SPEED*
VPH	OCC.	SPEED*	VPH	OCC.	SPEED*		
7083	-1.00	45	6835	-1.00	45	13918	45
6613	-1.00	45	5217	-1.00	45	11830	45
5113	-1.00	45	4133	-1.00	60	9246	52
4580	-1.00	60	3917	-1.00	60	8497	60
4469	-1.00	60	3978	-1.00	60	8447	60
4212	-1.00	60	3675	-1.00	60	7887	60

DATE=4-14-72 STARTING HR= 700 NO. OF HRS= 7

NORTHBOUND			SOUTHBOUND			TOTAL VPH	AVG. SPEED*
VPH	OCC.	SPEED*	VPH	OCC.	SPEED*		
7083	-1.00	45	6835	-1.00	45	13918	45
6613	-1.00	45	5217	-1.00	45	11830	45
5113	-1.00	45	4133	-1.00	60	9246	52
4580	-1.00	60	3917	-1.00	60	8497	60
4469	-1.00	60	3978	-1.00	60	8447	60
4212	-1.00	60	3675	-1.00	60	7887	60
4124	-1.00	60	4194	-1.00	60	8318	60

SAN DIEGO FREEWAY @ WEIGH STATION

DATE=8-11-72 STARTING HR= 700 NO. OF HRS=11

NORTHBOUND			SOUTHBOUND			TOTAL VPH	AVG. SPEED*
VPH	OCC.	SPEED*	VPH	OCC.	SPEED*		
6972	-1.00	45	6007	-1.00	45	12979	45
6837	-1.00	45	4690	-1.00	60	11527	51
5966	-1.00	45	4420	-1.00	60	10386	51
5810	-1.00	45	5042	-1.00	45	10852	45
5758	-1.00	45	5416	-1.00	45	11174	45
5395	-1.00	45	5426	-1.00	45	10821	45
5478	-1.00	45	5468	-1.00	45	10946	45
6121	-1.00	45	6121	-1.00	45	12242	45
6920	-1.00	45	5841	-1.00	45	12761	45
7325	-1.00	45	5478	-1.00	45	12803	45
6430	-1.00	45	5748	-1.00	45	12178	45

DATE=8-14-72 STARTING HR= 700 NO. OF HRS= 6

NORTHBOUND			SOUTHBOUND			TOTAL VPH	AVG. SPEED*
VPH	OCC.	SPEED*	VPH	OCC.	SPEED*		
7584	-1.00	45	6080	-1.00	45	13664	45
6796	-1.00	45	4835	-1.00	45	11631	45
6215	-1.00	45	4420	-1.00	60	10635	51
5841	-1.00	45	4814	-1.00	45	10655	45
5416	-1.00	45	5053	-1.00	45	10469	45
4928	-1.00	45	4835	-1.00	45	9763	45

DATE=8-15-72 STARTING HR= 700 NO. OF HRS=11

NORTHBOUND			SOUTHBOUND			TOTAL VPH	AVG. SPEED*
VPH	OCC.	SPEED*	VPH	OCC.	SPEED*		
7501	-1.00	45	6059	-1.00	45	13560	45
6785	-1.00	45	4804	-1.00	45	11589	45
6069	-1.00	45	4399	-1.00	60	10468	51
5654	-1.00	45	4949	-1.00	45	10603	45
5312	-1.00	45	5001	-1.00	45	10313	45
4918	-1.00	45	4897	-1.00	45	9815	45
-1	-1.00	-1	-1	-1.00	-1	-1	-1
-1	-1.00	-1	-1	-1.00	-1	-1	-1
-1	-1.00	-1	-1	-1.00	-1	-1	-1
-1	-1.00	-1	-1	-1.00	-1	-1	-1
-1	-1.00	-1	-1	-1.00	-1	-1	-1

SAN DIEGO FREEWAY @ WEIGH STATION

DATE=8-16-72 STARTING HR= 700 NO. OF HRS=11

NORTHBOUND			SOUTHBOUND			TOTAL VPH	AVG. SPEED*
VPH	OCC.	SPEED*	VPH	OCC.	SPEED*		
6982	-1.00	45	6049	-1.00	45	13031	45
6267	-1.00	45	4814	-1.00	45	11081	45
6137	-1.00	45	4762	-1.00	45	10899	45
5758	-1.00	45	5063	-1.00	45	10821	45
5312	-1.00	45	5074	-1.00	45	10386	45
4648	-1.00	60	4939	-1.00	45	9587	52
-1	-1.00	-1	-1	-1.00	-1	-1	-1
-1	-1.00	-1	-1	-1.00	-1	-1	-1
-1	-1.00	-1	-1	-1.00	-1	-1	-1
-1	-1.00	-1	-1	-1.00	-1	-1	-1
-1	-1.00	-1	-1	-1.00	-1	-1	-1

DATE=8-17-72 STARTING HR= 700 NO. OF HRS=11

NORTHBOUND			SOUTHBOUND			TOTAL VPH	AVG. SPEED*
VPH	OCC.	SPEED*	VPH	OCC.	SPEED*		
7128	-1.00	45	5997	-1.00	45	13125	45
6516	-1.00	45	4472	-1.00	60	10988	51
5966	-1.00	45	4596	-1.00	60	10562	52
5758	-1.00	45	5032	-1.00	45	10790	45
5446	-1.00	45	5250	-1.00	45	10696	45
4762	-1.00	45	4876	-1.00	45	9638	45
-1	-1.00	-1	-1	-1.00	-1	-1	-1
-1	-1.00	-1	-1	-1.00	-1	-1	-1
-1	-1.00	-1	-1	-1.00	-1	-1	-1
-1	-1.00	-1	-1	-1.00	-1	-1	-1
-1	-1.00	-1	-1	-1.00	-1	-1	-1

SITE 4

SAN DIEGO FREEWAY
AT NATIONAL BLVD.
AT-GRADE SECTION

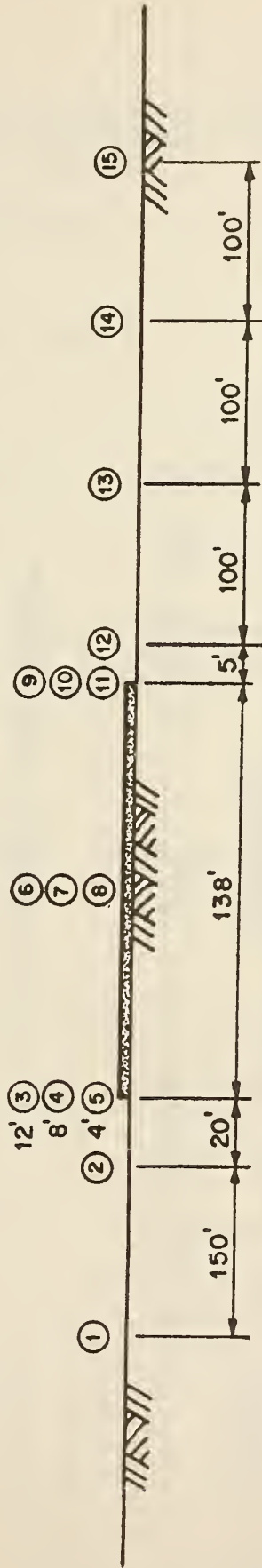

① DENOTES PROBE NUMBER

FIG. 74 PROBE LOCATION, SAN DIEGO FREEWAY
 AT NATIONAL BLVD. HORIZONTAL STUDY
 (NOT TO SCALE)

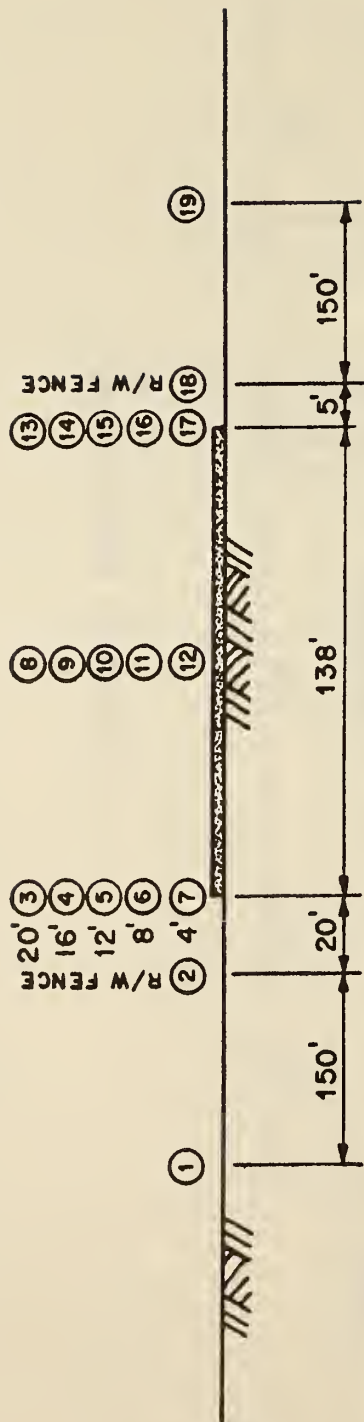

① DENOTES PROBE NUMBER

FIG. 75 PROBE LOCATION, SAN DIEGO FREEWAY
 AT NATIONAL BLVD. IN-SECTION STUDY
 (NOT TO SCALE)

SAN DIEGO FREEWAY @ NATIONAL BLVD.
 AUGUST 22, 1972 TO SEPTEMBER 11, 1972
 BEARING: N 33 19'31"W

4 LANES EACH DIRECTION
 22 FT MEDIAN
 AT-GRADE SECTION

WIDTH OF ROADWAY= 138 FT

P O L L U T A N T C O N C E N T R A T I O N S

DATE=8-22-72 STARTING HR= 700 NO. OF HRS= 6

P R O B E N U M B E R S																		
1	2	3	4	5	6	7	8	9	10	11	12	13	14	15	16	17	18	19
17	15	16	18	-1	19	22	31	33	34	-1	-1	24	-1	27	27	29	23	-1
14	14	15	16	-1	17	19	26	28	29	36	37	21	26	32	30	30	29	-1
11	9	11	8	-1	13	14	14	18	17	21	24	16	18	19	20	20	19	-1
5	3	4	4	5	6	7	7	8	8	11	12	9	11	12	13	14	13	-1
3	2	3	2	3	3	4	5	6	5	8	10	8	9	9	11	11	10	-1
3	1	3	3	3	2	3	3	4	4	7	8	6	8	8	9	9	8	-1

DATE=8-23-72 STARTING HR= 700 NO. OF HRS= 6

P R O B E N U M B E R S																		
1	2	3	4	5	6	7	8	9	10	11	12	13	14	15	16	17	18	19
14	19	20	22	23	25	26	19	21	22	23	25	13	14	15	16	17	15	-1
13	20	20	22	24	26	28	19	18	21	23	26	14	12	13	14	14	12	-1
8	11	14	12	-1	15	16	15	18	20	21	21	9	9	10	11	12	9	-1
5	-1	6	8	7	8	9	10	10	14	14	16	9	9	10	11	12	10	-1
4	4	5	6	5	6	7	7	8	7	9	12	9	10	10	13	14	13	-1
4	3	3	4	3	4	5	5	6	8	8	10	8	9	9	10	11	10	-1

DATE=8-24-72 STARTING HR= 700 NO. OF HRS= 6

P R O B E N U M B E R S																		
1	2	3	4	5	6	7	8	9	10	11	12	13	14	15	16	17	18	19
6	13	9	11	13	14	15	8	9	11	13	14	2	2	3	3	3	3	3
7	13	9	10	-1	14	15	7	8	9	11	13	4	3	3	3	4	5	4
3	7	8	7	8	10	11	9	10	12	13	14	4	5	6	7	8	5	3
3	3	3	3	4	4	6	8	8	10	11	13	9	10	11	12	13	13	6
3	3	3	3	3	3	3	5	6	7	8	9	8	8	10	11	13	12	7
3	3	3	3	3	3	3	5	5	7	8	9	8	8	9	10	11	11	6

SAN DIEGO FREEWAY @ NATIONAL BLVD.

DATE=8-25-72 STARTING HR= 700 NO. OF HRS= 6

P R O B E N U M B E R S																		
1	2	3	4	5	6	7	8	9	10	11	12	13	14	15	16	17	18	19
6	13	11	13	14	15	17	8	9	8	9	14	3	3	4	5	6	4	3
5	10	8	9	9	11	12	9	11	14	14	17	3	3	3	3	5	3	3
5	9	8	9	8	11	-1	9	9	13	12	14	3	3	3	4	3	3	3
3	7	8	9	9	10	12	8	10	11	13	14	3	3	4	5	6	5	3
3	7	7	8	9	9	11	9	10	12	12	14	5	6	6	6	6	6	3
3	3	3	3	4	4	5	8	8	9	-1	13	7	7	9	8	11	10	4

DATE=8-28-72 STARTING HR= 1200 NO. OF HRS= 6

P R O B E N U M B E R S																		
1	2	3	4	5	6	7	8	9	10	11	12	13	14	15	16	17	18	19
6	4	4	4	4	5	6	6	6	8	8	12	8	9	10	11	12	11	-1
5	4	4	5	6	4	5	5	5	6	7	8	8	8	9	11	11	10	-1
5	6	4	3	3	4	5	5	5	7	8	9	6	8	9	11	11	10	-1
3	3	3	3	4	3	4	4	5	6	7	9	9	8	9	11	12	11	-1
4	4	3	3	3	4	6	5	6	7	11	10	8	10	11	13	14	13	-1
4	4	4	4	4	4	6	8	9	12	14	20	10	12	14	15	16	14	-1

DATE=8-29-72 STARTING HR= 700 NO. OF HRS=11

P R O B E N U M B E R S																		
1	2	3	4	5	6	7	8	9	10	11	12	13	14	15	16	17	18	19
14	16	19	20	21	23	22	19	19	19	22	22	11	12	14	14	14	13	-1
14	15	17	18	-1	21	20	22	22	25	26	24	18	19	18	19	21	20	-1
12	10	13	12	14	15	14	15	18	22	22	21	22	22	22	22	24	22	-1
8	6	5	6	5	8	9	10	11	15	14	15	12	14	14	15	15	15	-1
5	4	4	4	4	5	7	8	8	8	10	12	12	12	12	14	15	14	-1
5	4	3	4	4	4	7	6	6	8	9	11	11	11	11	12	13	13	-1
4	3	3	3	3	3	6	6	6	7	8	9	8	9	10	10	11	11	-1
4	3	3	3	3	3	4	5	5	6	7	9	8	8	9	10	11	10	-1
3	3	3	3	3	3	4	3	5	6	8	9	8	8	9	10	11	11	-1
3	3	3	3	3	3	5	6	6	8	10	13	8	10	11	13	14	13	-1
4	3	3	3	4	5	7	6	6	8	9	11	9	11	13	14	15	16	-1

PAGE 3

SAN DIEGO FREEWAY @ NATIONAL BLVD.

DATE=9-6-72 STARTING HR= 800 NO. OF HRS= 5

P R O B E N U M B E R S														
1	2	3	4	5	6	7	8	9	10	11	12	13	14	15
4	8	17	18	17	14	16	19	7	7	7	6	4	3	4
3	3	5	3	3	10	11	12	10	11	13	12	8	6	5
3	3	4	3	3	6	8	9	10	11	12	11	8	6	-1
3	3	3	3	3	9	12	15	10	11	13	11	8	6	5
3	3	4	3	3	8	9	11	8	8	9	9	6	5	4

DATE=9-11-72 STARTING HR= 700 NO. OF HRS= 6

P R O B E N U M B E R S														
1	2	3	4	5	6	7	8	9	10	11	12	13	14	15
7	4	5	4	5	12	14	12	14	15	16	15	10	8	6
4	4	5	4	4	12	17	21	12	14	14	14	9	6	6
3	3	5	5	4	8	9	11	11	11	12	11	7	5	4
3	3	3	3	3	6	7	8	8	8	9	8	5	4	3
3	3	3	3	3	5	6	7	8	9	9	9	6	6	4
3	3	3	3	3	4	6	8	7	8	8	8	5	4	3

SAN DIEGO FREEWAY @ NATIONAL BLVD.
 AUGUST 22, 1972 TO SEPTEMBER 11, 1972
 BEARING: N 33 19' 31" W

4 LANES EACH DIRECTION
 22 FT MEDIAN
 AT-GRADE SECTION

WIDTH OF ROADWAY = 138 FT

T R A F F I C D A T A

DATE=8-22-72 STARTING HR= 700 NO. OF HRS= 6

NORTHBOUND			SOUTHBOUND			TOTAL VPH	AVG. SPEED
VPH	OCC.	SPEED	VPH	OCC.	SPEED		
7564	.18	43	7460	.28	27	15024	35
6940	.20	35	6780	.13	53	13720	44
6894	.18	39	6238	.10	63	13132	50
6792	.15	46	6448	.11	59	13240	52
6610	.13	51	6914	.12	58	13524	55
6246	.12	53	6286	.10	64	12532	58

DATE=8-23-72 STARTING HR= 700 NO. OF HRS= 6

NORTHBOUND			SOUTHBOUND			TOTAL VPH	AVG. SPEED
VPH	OCC.	SPEED	VPH	OCC.	SPEED		
7082	.18	40	7443	.20	38	14525	39
7432	.18	42	6941	.18	39	14373	40
6886	.13	54	6241	.09	70	13127	61
6274	.13	49	6641	.14	48	12915	48
6674	.13	52	6796	.11	63	13470	57
6382	.10	65	6223	.10	63	12605	64

DATE=8-24-72 STARTING HR= 700 NO. OF HRS= 6

NORTHBOUND			SOUTHBOUND			TOTAL VPH	AVG. SPEED
VPH	OCC.	SPEED	VPH	OCC.	SPEED		
7680	.15	52	5718	.19	30	13398	43
7236	.15	49	5083	.18	29	12319	40
6826	.12	58	4726	.09	53	11552	56
6527	.12	55	5143	.11	47	11670	52
6762	.13	50	5146	.10	52	11908	52
6814	.13	53	4761	.09	54	11575	53

SAN DIEGO FREEWAY @ NATIONAL BLVD.

DATE=3-25-72 STARTING HR= 700 NO. OF HRS= 6

NORTHBOUND			SOUTHBOUND			TOTAL VPH	AVG. SPEED
VPH	OCC.	SPEED	VPH	OCC.	SPEED		
7198	.14	52	7781	.15	53	14979	52
7214	.13	56	6362	.09	70	13576	63
6776	.11	62	6210	.09	70	12986	66
6666	.11	61	6529	.10	66	13195	64
7050	.15	48	7097	.11	65	14147	56
7152	.16	45	6613	.10	67	13765	56

DATE=8-28-72 STARTING HR= 1200 NO. OF HRS= 6

NORTHBOUND			SOUTHBOUND			TOTAL VPH	AVG. SPEED
VPH	OCC.	SPEED	VPH	OCC.	SPEED		
6824	.12	58	6285	.09	70	13109	64
6662	.10	67	6160	.09	69	12822	68
6920	.12	58	6857	.11	63	13777	61
7156	.15	48	7192	.13	56	14348	52
7276	.13	57	7353	.17	44	14629	50
6994	.11	64	6502	.14	47	13496	56

DATE=8-29-72 STARTING HR= 700 NO. OF HRS=11

NORTHBOUND			SOUTHBOUND			TOTAL VPH	AVG. SPEED
VPH	OCC.	SPEED	VPH	OCC.	SPEED		
7354	.18	41	7629	.19	41	14983	41
7344	.18	41	6651	.15	45	13995	43
7058	.13	55	6220	.08	70	13278	62
6198	.13	48	6485	.10	66	12683	57
6676	.14	48	6764	.10	68	13440	58
6706	.11	62	6181	.09	70	12887	65
6562	.10	66	6013	.09	68	12575	67
6932	.11	64	6836	.10	69	13768	66
7448	.15	50	7380	.11	68	14828	59
7094	.12	60	7328	.12	62	14422	61
6582	.22	30	7X228	.11	67	13810	49

SAN DIEGO FREEWAY @ NATIONAL BLVD.

DATE=9-6-72 STARTING HR= 800 NO. OF HRS= 5

NORTHBOUND			SOUTHBOUND			TOTAL VPH	AVG. SPEED
VPH	OCC.	SPEED	VPH	OCC.	SPEED		
7414	.16	47	7052	.20	36	14466	41
7006	.12	59	6344	.10	64	13350	62
6824	.12	58	5990	.20	30	12814	45
6632	.13	52	6055	.31	20	12687	36
6514	.11	60	6113	.09	69	12627	64

DATE=9-11-72 STARTING HR= 700 NO. OF HRS= 6

NORTHBOUND			SOUTHBOUND			TOTAL VPH	AVG. SPEED
VPH	OCC.	SPEED	VPH	OCC.	SPEED		
8180	.16	52	7787	.16	49	15967	51
7260	.13	57	6997	.20	35	14257	46
7012	.13	55	6000	.08	70	13012	62
6448	.11	59	5634	.08	70	12082	64
6430	.11	59	6150	.09	69	12580	64
6146	.16	39	5824	.08	70	11970	54

SITE 5

SAN DIEGO FREEWAY
AT 122nd AVE.
FILL SECTION

SAN DIEGO FREEWAY @ 122ND AVE
SEPTEMBER 20, 1972 TO OCTOBER 12, 1972

5 LANES NORTHBOUND--4 LANES SOUTHBOUND
22 FT MEDIAN

15 FT FILL SECTION
WIDTH OF ROADWAY = 150 FT

SIDE SLOPES = 1.5:1

WIND MEASURED AT 10 METER HEIGHT (OR EQUIVALENT)

M E T E O R L O G I C A L D A T A

DATE=9-20-72 STARTING HR= 700 NO. OF HRS= 5

CEIL.	WIND DIRE.	WIND MPH	SKY CODE	STAB.
200	320	3	0	C
200	40	3	0	B
200	80	3	0	B
200	260	7	0	B
200	260	9	0	C

DATE=9-21-72 STARTING HR= 700 NO. OF HRS= 6

CEIL.	WIND DIRE.	WIND MPH	SKY CODE	STAB.
200	30	3	1	C
250	50	3	4	B
250	60	3	4	R
250	250	5	4	R
250	260	9	4	C
250	260	10	4	C

DATE=9-22-72 STARTING HR= 700 NO. OF HRS= 6

CEIL.	WIND DIRE.	WIND MPH	SKY CODE	STAB.
250	100	3	7	C
250	120	4	7	C
250	170	4	7	C
250	250	7	7	C
250	240	5	7	C
250	240	5	5	B

PAGE 2

SAN DIEGO FREFWAY @ 122ND AVE

DATE=9-25-72 STARTING HR= 700 NO. OF HRS= 6

CEIL.	WIND DIRE.	WIND MPH	SKY CODE	STAB.
40	110	3	5	C
40	120	3	5	C
40	120	3	5	C
28	240	5	5	D
200	230	8	2	B
200	220	10	2	C

DATE=9-26-72 STARTING HR= 1200 NO. OF HRS= 6

CEIL.	WIND DIRE.	WIND MPH	SKY CODE	STAB.
200	260	8	2	B
200	250	9	2	C
200	250	10	0	C
200	270	11	0	D
200	260	12	0	D
200	260	12	0	E

DATE=9-27-72 STARTING HR= 1200 NO. OF HRS= 6

CEIL.	WIND DIRE.	WIND MPH	SKY CODE	STAB.
23	40	7	5	D
250	80	9	4	C
250	90	11	7	D
250	230	11	8	D
250	230	10	8	D
250	220	10	5	D

SAN DIEGO FREEWAY @ 122ND AVE

DATE=9-28-72 STARTING HR= 1200 NO. OF HRS= 6

CEIL.	WIND DIRE.	WIND MPH	SKY CODE	STAB.
250	250	10	5	C
200	240	11	2	C
200	240	11	2	C
200	240	11	1	D
200	240	10	1	C
160	250	10	5	D

DATE=10-2-72 STARTING HR= 1300 NO. OF HRS= 4

CEIL.	WIND DIRE.	WIND MPH	SKY CODE	STAB.
200	200	13	2	C
200	210	13	2	C
200	220	10	2	C
200	220	8	2	C

DATE=10-3-72 STARTING HR= 1300 NO. OF HRS= 5

CEIL.	WIND DIRE.	WIND MPH	SKY CODE	STAB.
95	250	9	8	D
95	260	9	5	C
100	250	9	5	D
200	260	8	2	C
-1	-1	-1	-1	-1

DATE=10-4-72 STARTING HR= 1300 NO. OF HRS= 5

CEIL.	WIND DIRE.	WIND MPH	SKY CODE	STAB.
200	260	13	0	C
200	240	14	0	D
200	230	13	0	D
200	230	13	0	D
200	240	10	0	E

SAN DIEGO FREEWAY @ 122ND AVE

DATE=10-5-72 STARTING HR= 1200 NO. OF HRS= 6

CEIL.	WIND DIRE.	WIND MPH	SKY CODE	STAB.
250	60	5	7	C
250	250	7	7	C
250	240	9	7	C
250	240	10	8	D
250	270	7	7	D
250	250	4	7	F

DATE=10-6-72 STARTING HR= 700 NO. OF HRS= 5

CEIL.	WIND DIRE.	WIND MPH	SKY CODE	STAB.
200	140	3	2	F
200	160	3	2	B
250	110	2	5	B
250	120	4	5	B
250	130	4	5	B

DATE=10-10-72 STARTING HR= 1200 NO. OF HRS= 5

CEIL.	WIND DIRE.	WIND MPH	SKY CODE	STAB.
120	210	6	8	D
120	230	7	8	D
200	230	12	5	C
200	210	9	2	C
200	210	9	2	C

DATE=10-11-72 STARTING HR= 1200 NO. OF HRS= 6

CEIL.	WIND DIRE.	WIND MPH	SKY CODE	STAB.
250	240	8	4	B
250	250	9	4	C
250	240	10	4	C
200	260	12	1	D
250	250	13	4	D
250	250	13	4	D

PAGE 5

SAN DIEGO FREEWAY @ 122ND AVE

DATE=10-12-72 STARTING HR= 700 NO. OF HRS= 6

CEIL.	WIND DIRE.	WIND MPH	SKY CODE	STAB.
100	30	4	5	F
90	70	3	5	C
90	90	3	5	C
90	60	3	8	C
90	100	4	8	C
90	110	5	8	D

SAN DIEGO FREEWAY @ 122ND AVE
 SEPTEMBER 20, 1972 TO OCTOBER 12, 1972
 BEARING: N 10 32'09"E

5 LANES NORTHBOUND--4 LANES SOUGHBOUND
 22 FT MEDIAN

15 FT FILL SECTION
 WIDTH OF ROADWAY = 150 FT

SIDE SLOPES = 1.5:1

P O L L U T A N T C O N C E N T R A T I O N S

DATE=9-20-72 STARTING HR= 700 NO. OF HRS= 5

P R O B E N U M B E R S																				
1	2	3	4	5	6	7	8	9	10	11	12	13	14	15	16	17	18	19	20	21
15	14	14	14	15	16	18	21	22	23	25	26	20	22	23	24	25	15	14	21	18
13	14	17	19	-1	19	22	-1	20	21	23	23	14	13	14	14	15	15	14	12	13
12	13	14	14	17	24	16	14	14	15	16	17	10	9	20	21	10	11	10	9	11
8	8	9	10	10	9	10	12	13	15	14	17	13	11	11	12	10	11	10	11	9
7	6	6	6	6	6	6	7	8	9	9	11	11	8	10	10	8	7	6	11	8

DATE=9-21-72 STARTING HR= 700 NO. OF HRS= 6

P R O B E N U M B E R S																				
1	2	3	4	5	6	7	8	9	10	11	12	13	14	15	16	17	18	19	20	21
24	22	23	24	24	26	26	24	27	29	29	30	22	24	24	25	26	19	16	19	14
23	22	24	26	21	24	29	-1	27	26	31	31	21	20	22	19	22	22	22	20	21
13	14	16	17	17	18	19	17	19	20	22	22	14	15	13	12	14	16	14	13	13
9	13	12	12	11	12	14	14	14	15	17	17	10	12	10	12	11	13	10	9	8
6	5	5	6	5	5	5	7	8	9	10	11	9	11	9	10	11	7	6	10	8
6	6	5	5	6	5	6	6	7	8	9	9	7	8	8	8	11	6	5	9	7

DATE=9-22-72 STARTING HR= 700 NO. OF HRS= 6

P R O B E N U M B E R S																				
1	2	3	4	5	6	7	8	9	10	11	12	13	14	15	16	17	18	19	20	21
20	20	24	25	25	27	28	21	22	25	26	28	17	19	19	19	21	18	17	10	15
16	18	21	22	-1	20	24	-1	25	22	28	28	15	14	16	14	16	18	17	14	16
8	10	13	14	14	14	14	14	15	16	17	19	10	10	11	9	12	12	11	9	8
5	7	4	4	5	4	6	8	10	9	12	12	8	8	9	10	12	8	8	10	8
4	4	4	5	4	4	5	6	6	8	8	9	8	8	9	9	11	3	3	8	6
6	5	5	5	-1	5	6	8	9	10	12	13	8	9	9	10	12	6	6	8	6

PAGE 2

SAN DIEGO FREEWAY @ 122ND AVE

DATE=9-25-72 STARTING HR= 700 NO. OF HRS= 6

P R O B E N U M B E R S																				
1	2	3	4	5	6	7	8	9	10	11	12	13	14	15	16	17	18	19	20	21
12	14	16	17	18	21	21	19	21	22	22	24	14	10	14	14	16	14	13	7	8
10	-1	12	14	16	18	17	-1	18	15	21	21	9	7	10	7	10	13	9	8	8
3	5	7	7	7	8	8	8	8	9	11	11	4	4	4	4	4	6	6	3	3
3	3	3	4	3	-1	4	7	7	8	-1	9	6	6	6	7	8	6	-1	4	3
3	3	3	3	3	3	3	4	4	5	7	8	5	5	6	7	8	3	3	6	3
3	3	3	2	-1	2	3	-1	4	6	8	8	4	5	5	7	8	-1	3	6	3

DATE=9-26-72 STARTING HR= 1200 NO. OF HRS= 6

P R O B E N U M B E R S																				
1	2	3	4	5	6	7	8	9	10	11	12	13	14	15	16	17	18	19	20	21
3	3	3	3	3	3	3	5	5	5	7	8	6	6	6	8	8	4	3	6	5
3	3	3	3	2	2	2	-1	4	5	6	8	4	5	5	6	8	3	3	5	4
3	3	3	3	3	3	3	3	4	5	7	8	4	5	6	7	8	3	3	7	4
3	7	3	3	3	3	3	4	8	6	8	10	6	7	8	8	10	3	7	10	5
3	3	3	3	3	3	3	4	6	8	12	16	6	7	8	10	13	3	3	9	6
3	3	3	3	-1	3	3	-1	5	8	11	15	6	8	8	10	13	3	3	10	6

DATE=9-27-72 STARTING HR= 1200 NO. OF HRS= 6

P R O B E N U M B E R S																				
1	2	3	4	5	6	7	8	9	10	11	12	13	14	15	16	17	18	19	20	21
3	4	3	3	3	3	3	4	5	6	7	8	7	7	7	8	8	3	3	-1	-1
3	3	3	2	2	2	2	4	3	5	6	7	4	4	5	6	7	2	2	6	-1
3	3	2	3	3	3	2	3	4	5	6	8	4	5	5	7	8	3	2	7	4
3	3	3	3	3	3	3	6	7	8	9	10	6	7	8	11	11	3	3	9	6
3	3	3	3	3	3	3	7	9	10	15	19	8	9	10	12	14	8	3	12	7
3	5	3	3	3	3	3	-1	8	12	16	22	8	10	11	14	15	3	3	13	8

SAN DIEGO FREEWAY @ 122ND AVE

DATE=9-28-72 STARTING HR= 1200 NO. OF HRS= 6

P R O B E N U M B E R S																				
1	2	3	4	5	6	7	8	9	10	11	12	13	14	15	16	17	18	19	20	21
3	3	5	3	3	3	3	5	6	7	8	8	6	7	8	8	8	4	3	6	4
3	3	3	3	3	3	3	3	4	6	7	8	4	5	6	6	8	3	3	6	4
3	3	3	3	3	3	3	3	4	5	7	8	4	5	6	7	8	3	3	6	4
3	3	3	3	3	3	3	5	6	6	8	9	5	7	8	8	10	3	4	8	4
3	3	2	2	2	2	2	10	7	-1	12	15	6	7	8	10	12	2	3	10	5
3	3	2	3	2	2	3	14	8	12	13	19	6	8	9	11	7	3	2	11	7

DATE=10-2-72 STARTING HR= 1300 NO. OF HRS= 4

P R O B E N U M B E R S																				
1	2	3	4	5	6	7	8	9	10	11	12	13	14	15	16	17	18	19	20	21
2	2	2	2	2	2	2	3	5	-1	-1	-1	3	3	3	4	5	-1	-1	3	3
2	2	-1	2	2	2	2	3	3	4	5	5	3	3	4	5	6	-1	-1	4	3
3	3	3	2	2	2	3	4	5	6	7	8	4	7	7	8	8	-1	-1	7	3
3	3	3	3	3	3	3	8	9	12	-1	-1	8	11	14	14	14	-1	-1	10	6

DATE=10-3-72 STARTING HR= 1300 NO. OF HRS= 5

P R O B E N U M B E R S																					
1	2	3	4	5	6	7	8	9	10	11	12	13	14	15	16	17	18	19	20	21	22
3	3	3	5	6	8	6	5	6	8	4	6	6	3	3	4	3	3	4	4	3	3
2	3	3	3	4	-1	-1	5	7	8	4	6	6	3	4	3	3	3	3	3	3	3
2	2	2	2	6	6	10	7	8	8	5	6	8	3	4	5	3	3	3	3	3	3
3	2	1	2	12	15	15	10	13	14	7	10	11	5	7	7	3	4	5	3	3	3
3	3	2	2	7	8	14	6	7	8	5	6	6	3	4	4	3	3	3	4	3	3

DATE=10-4-72 STARTING HR= 1300 NO. OF HRS= 5

P R O B E N U M B E R S																					
1	2	3	4	5	6	7	8	9	10	11	12	13	14	15	16	17	18	19	20	21	22
2	2	2	2	4	6	7	4	5	6	-1	4	4	3	3	3	2	2	2	2	2	2
2	1	1	1	3	4	6	3	4	6	3	-1	4	3	3	5	2	2	2	2	2	2
3	3	2	2	5	7	8	6	8	8	5	7	8	4	4	6	4	3	3	3	3	3
3	2	2	2	8	11	12	6	7	9	6	8	8	4	-1	6	4	3	4	3	3	3
2	2	1	1	8	10	14	8	9	11	5	9	9	4	-1	7	5	4	4	-1	4	3

SAN DIEGO FREEWAY @ 122ND AVE

DATE=10-5-72 STARTING HR= 1200 NO. OF HRS= 6

P R O B E N U M B E R S																					
1	2	3	4	5	6	7	8	9	10	11	12	13	14	15	16	17	18	19	20	21	22
6	8	8	8	10	15	15	26	15	14	8	13	8	8	7	7	7	6	6	12	6	9
6	6	6	6	11	12	13	10	11	12	-1	10	11	8	8	8	7	7	8	6	6	6
6	6	6	6	11	12	14	11	13	14	10	10	12	8	8	9	8	8	8	7	8	8
6	6	6	6	12	14	15	12	14	15	11	14	14	8	10	16	9	9	9	8	8	8
6	4	4	5	15	20	23	15	16	17	11	14	14	8	9	11	8	8	8	8	7	8
5	4	5	6	16	23	26	15	17	19	12	15	15	9	11	12	8	8	9	-1	8	8

DATE=10-6-72 STARTING HR= 700 NO. OF HRS= 5

P R O B E N U M B E R S																					
1	2	3	4	5	6	7	8	9	10	11	12	13	14	15	16	17	18	19	20	21	22
33	33	33	33	31	40	40	-1	34	36	27	31	31	23	-1	28	23	31	26	22	24	26
36	39	39	42	42	44	46	38	40	40	32	41	34	33	33	34	34	35	33	35	33	35
24	31	33	33	36	32	38	31	28	29	29	-1	26	29	26	20	31	26	28	26	28	28
11	14	22	19	22	18	22	14	14	15	14	14	13	14	14	-1	8	12	14	6	14	16
7	11	8	10	14	14	14	10	9	9	8	7	7	6	6	6	5	6	5	5	5	5

DATE=10-10-72 STARTING HR= 1200 NO. OF HRS= 5

P R O B E N U M B E R S																					
1	2	3	4	5	6	7	8	9	10	11	12	13	14	15	16	17	18	19	20	21	22
3	4	3	3	8	8	9	8	8	9	7	7	7	5	5	5	4	4	4	5	3	3
3	4	3	3	8	8	9	8	8	9	6	6	8	4	5	5	4	4	4	3	3	3
3	3	3	3	9	8	9	8	8	8	7	7	8	5	5	5	4	4	4	3	3	3
3	3	3	3	-1	12	12	8	9	9	9	8	8	8	6	6	6	4	4	4	3	3
3	3	3	3	-1	16	20	8	8	-1	9	-1	11	7	8	8	5	7	6	4	4	4

DATE=10-11-72 STARTING HR= 1200 NO. OF HRS= 6

P R O B E N U M B E R S																					
1	2	3	4	5	6	7	8	9	10	11	12	13	14	15	16	17	18	19	20	21	22
3	4	3	4	-1	5	22	8	8	9	7	9	8	5	6	6	5	4	5	4	4	4
3	3	3	3	7	-1	10	7	8	8	-1	6	8	5	5	5	4	4	4	4	3	4
3	3	3	3	6	7	8	6	8	8	8	7	7	5	5	5	4	4	4	4	4	4
3	3	3	3	8	8	9	8	9	11	7	8	9	5	6	8	5	5	5	6	4	4
4	3	3	3	9	10	10	8	10	12	8	10	11	6	8	8	5	5	5	4	5	5
4	4	3	3	9	12	16	11	12	14	8	11	11	7	8	9	6	7	7	5	5	5

PAGE 5

SAN DIEGO FREEWAY @ 122ND AVE

DATE=10-12-72 STARTING HR= 700 NO. OF HRS= 6

P R O B E N U M B E R S																					
1	2	3	4	5	6	7	8	9	10	11	12	13	14	15	16	17	18	19	20	21	22
33	42	-1	29	-1	-1	-1	9	23	23	18	25	20	17	24	17	21	28	19	25	19	33
19	26	-1	24	22	22	25	17	17	18	18	20	14	14	14	14	14	14	17	14	14	14
14	18	19	20	19	-1	-1	13	13	13	12	12	13	12	12	12	13	11	12	12	13	13
9	13	14	15	14	14	11	9	10	10	9	10	9	9	9	-1	8	9	9	8	9	9
9	13	12	13	11	14	-1	8	8	8	7	7	8	7	7	8	8	7	6	7	8	7
6	8	9	11	9	10	8	6	6	6	6	6	6	6	6	6	6	6	6	5	6	6

SAN DIEGO FREEWAY @ 122ND AVE
 SEPTEMBER 20, 1972 TO OCTOBER 12, 1972
 BEARING: N 10 32'09"E

5 LANES NORTHBOUND--4 LANES SOUTHBOUND
 22 FT MEDIAN

15 FT FILL SECTION
 WIDTH OF ROADWAY = 150 FT

SIDE SLOPES = 1.5:1

T R A F F I C D A T A

DATE=9-20-72 STARTING HR= 700 NO. OF HRS= 5

NORTHBOUND			SOUTHBOUND			TOTAL VPH	AVG. SPEED
VPH	OCC.	SPEED	VPH	OCC.	SPEED		
8610	.11	63	8151	.08	70	16761	67
8180	.10	66	7794	.08	70	15974	68
6440	.07	70	5788	.05	70	12228	70
5436	.05	70	5470	.05	70	10906	70
5274	.05	70	5506	.05	70	10780	70

DATE=9-21-72 STARTING HR= 700 NO. OF HRS= 6

NORTHBOUND			SOUTHBOUND			TOTAL VPH	AVG. SPEED
VPH	OCC.	SPEED	VPH	OCC.	SPEED		
8738	.11	64	8181	.09	70	16919	67
7921	.10	64	7572	.08	70	15493	67
6160	.06	70	5704	.05	70	11864	70
5247	.05	70	5428	.05	70	10675	70
5021	.05	70	5550	.05	70	10571	70
4895	.05	70	5314	.05	70	10209	70

DATE=9-22-72 STARTING HR= 700 NO. OF HRS= 6

NORTHBOUND			SOUTHBOUND			TOTAL VPH	AVG. SPEED
VPH	OCC.	SPEED	VPH	OCC.	SPEED		
8587	.11	63	8004	.09	70	16591	66
7891	.09	70	7406	.08	70	15297	70
6381	.07	70	5582	.05	70	11963	70
5293	.05	70	5305	.05	70	10598	70
5494	.05	70	5618	.05	70	11112	70
5511	.05	70	6002	.05	70	11513	70

SAN DIEGO FREEWAY @ 122ND AVE

DATE=9-25-72 STARTING HR= 700 NO. OF HRS= 6

NORTHBOUND			SOUTHBOUND			TOTAL VPH	AVG. SPEED
VPH	OCC.	SPEED	VPH	OCC.	SPEED		
8805	.11	65	8134	.09	70	16939	67
8306	.10	67	7419	.08	70	15725	69
6208	.06	70	5145	.05	70	11353	70
5144	.05	70	4985	.05	70	10129	70
4718	.05	70	5189	.05	70	9907	70
4776	.05	70	5371	.05	70	10147	70

DATE=9-26-72 STARTING HR= 1200 NO. OF HRS= 6

NORTHBOUND			SOUTHBOUND			TOTAL VPH	AVG. SPEED
VPH	OCC.	SPEED	VPH	OCC.	SPEED		
4462	.05	70	5050	.05	70	9512	70
4541	.05	70	5340	.05	70	9881	70
5163	.05	70	6256	.06	70	11419	70
6577	.08	67	8355	.15	56	14932	61
7306	.09	66	7988	.25	32	15294	48
7564	.09	68	7385	.28	27	14949	48

DATE=9-27-72 STARTING HR= 1200 NO. OF HRS= 6

NORTHBOUND			SOUTHBOUND			TOTAL VPH	AVG. SPEED
VPH	OCC.	SPEED	VPH	OCC.	SPEED		
4648	.05	70	5185	.05	70	9833	70
4650	.05	70	5441	.05	70	10091	70
5360	.05	70	6324	.06	70	11684	70
6895	.08	70	8355	.17	50	15250	59
6869	.08	70	7818	.27	29	14687	48
7699	.09	69	7171	.32	23	14870	47

SAN DIEGO FREEWAY @ 122ND AVE

DATE=9-28-72 STARTING HR= 1200 NO. OF HRS= 6

NORTHBOUND			SOUTHBOUND			TOTAL VPH	AVG. SPEED
VPH	OCC.	SPEED	VPH	OCC.	SPEED		
4608	.05	70	5271	.05	70	9879	70
4625	.05	70	5570	.05	70	10195	70
5435	.05	70	6486	.07	70	11921	70
6630	.08	67	8480	.11	70	15110	69
7473	.09	67	7731	.26	30	15204	48
7689	.10	62	7118	.33	22	14807	43

DATE=10-2-72 STARTING HR= 1300 NO. OF HRS= 4

NORTHBOUND			SOUTHBOUND			TOTAL VPH	AVG. SPEED
VPH	OCC.	SPEED	VPH	OCC.	SPEED		
4456	.05	70	5204	.05	70	9660	70
5166	.05	70	6026	.06	70	11192	70
6461	.07	70	8249	.13	64	14710	67
7026	.08	70	7499	.32	24	14525	46

DATE=10-3-72 STARTING HR= 1300 NO. OF HRS= 5

NORTHBOUND			SOUTHBOUND			TOTAL VPH	AVG. SPEED
VPH	OCC.	SPEED	VPH	OCC.	SPEED		
4319	.05	70	5084	.05	70	9403	70
5044	.05	70	6111	.06	70	11155	70
6433	.07	70	8236	.14	60	14669	64
7167	.08	70	7554	.31	25	14721	47
7493	.09	67	7055	.34	21	14548	45

DATE=10-4-72 STARTING HR= 1300 NO. OF HRS= 5

NORTHBOUND			SOUTHBOUND			TOTAL VPH	AVG. SPEED
VPH	OCC.	SPEED	VPH	OCC.	SPEED		
4479	.05	70	5599	.05	70	10078	70
5381	.05	70	6726	.05	70	12107	70
6646	.07	70	8308	.07	70	14954	70
7301	.09	66	9251	.09	70	16552	68
7649	.09	69	9561	.09	70	17210	69

SAN DIEGO FREEWAY @ 122ND AVE

DATE=10-5-72 STARTING HR= 1200 NO. OF HRS= 6

NORTHBOUND			SOUTHBOUND			TOTAL VPH	AVG. SPEED
VPH	OCC.	SPEED	VPH	OCC.	SPEED		
4646	.05	70	5350	.05	70	9996	70
4698	.05	70	5604	.05	70	10302	70
5427	.05	70	6286	.06	70	11713	70
6840	.08	69	8246	.17	49	15086	58
7247	.09	65	7486	.32	24	14733	44
7591	.10	61	6688	.35	19	14279	42

DATE=10-6-72 STARTING HR= 700 NO. OF HRS= 5

NORTHBOUND			SOUTHBOUND			TOTAL VPH	AVG. SPEED
VPH	OCC.	SPEED	VPH	OCC.	SPEED		
8729	.13	54	7966	.10	70	16695	62
7814	.11	58	7287	.09	70	15101	64
6055	.08	61	5464	.07	70	11519	65
5448	.07	63	5251	.07	70	10699	66
5399	.07	62	5914	.07	70	11313	66

DATE=10-10-72 STARTING HR= 1200 NO. OF HRS= 5

NORTHBOUND			SOUTHBOUND			TOTAL VPH	AVG. SPEED
VPH	OCC.	SPEED	VPH	OCC.	SPEED		
4615	.05	70	4950	.05	70	9565	70
4693	.05	70	5400	.05	70	10093	70
5232	.05	70	6166	.06	70	11398	70
6718	.08	68	8470	.14	61	15188	64
7163	.10	58	7328	.32	23	14491	40

DATE=10-11-72 STARTING HR= 1200 NO. OF HRS= 6

NORTHBOUND			SOUTHBOUND			TOTAL VPH	AVG. SPEED
VPH	OCC.	SPEED	VPH	OCC.	SPEED		
4645	.05	70	4999	.05	70	9644	70
4346	.04	70	5240	.05	70	9586	70
4992	.05	70	6346	.06	70	11338	70
6713	.08	68	8401	.14	61	15114	64
7330	.09	66	7656	.31	25	14986	45
7525	.09	68	7148	.33	22	14673	45

SAN DIEGO FREEWAY @ 122ND AVE

DATE=10-12-72 STARTING HR= 700 NO. OF HRS= 6

NORTHBOUND			SOUTHBOUND			TOTAL VPH	AVG. SPEED
VPH	OCC.	SPEED	VPH	OCC.	SPEED		
8751	.11	64	8175	.09	70	16926	67
8168	.10	66	7505	.08	70	15673	68
5965	.06	70	5408	.05	70	11373	70
5000	.05	70	4948	.05	70	9948	70
5051	.05	70	5244	.05	70	10295	70
4665	.05	70	5094	.05	70	9759	70

TE 662

.A3

no. FHWA-RD-

~~76-141~~ BORROWER

Form DOT F 1720
FORMERLY FORM DO

DOT LIBRARY



00055219

