

Automated Transit Networks (ATN): A Review of the State of the Industry and Prospects for the Future



MTI Report 12-31



MINETA TRANSPORTATION INSTITUTE

The Norman Y. Mineta International Institute for Surface Transportation Policy Studies was established by Congress in the Intermodal Surface Transportation Efficiency Act of 1991 (ISTEA). The Institute's Board of Trustees revised the name to Mineta Transportation Institute (MTI) in 1996. Reauthorized in 1998, MTI was selected by the U.S. Department of Transportation through a competitive process in 2002 as a national "Center of Excellence." The Institute is funded by Congress through the United States Department of Transportation's Research and Innovative Technology Administration, the California Legislature through the Department of Transportation (Caltrans), and by private grants and donations.

The Institute receives oversight from an internationally respected Board of Trustees whose members represent all major surface transportation modes. MTI's focus on policy and management resulted from a Board assessment of the industry's unmet needs and led directly to the choice of the San José State University College of Business as the Institute's home. The Board provides policy direction, assists with needs assessment, and connects the Institute and its programs with the international transportation community.

MTI's transportation policy work is centered on three primary responsibilities:

Research

MTI works to provide policy-oriented research for all levels of government and the private sector to foster the development of optimum surface transportation systems. Research areas include: transportation security; planning and policy development; interrelationships among transportation, land use, and the environment; transportation finance; and collaborative labor-management relations. Certified Research Associates conduct the research. Certification requires an advanced degree, generally a Ph.D., a record of academic publications, and professional references. Research projects culminate in a peer-reviewed publication, available both in hardcopy and on TransWeb, the MTI website (<http://transweb.sjsu.edu>).

Education

The educational goal of the Institute is to provide graduate-level education to students seeking a career in the development and operation of surface transportation programs. MTI, through San José State University, offers an AACSB-accredited Master of Science in Transportation Management and a graduate Certificate in Transportation Management that serve to prepare the nation's transportation managers for the 21st century. The master's degree is the highest conferred by the California State University system. With the active assistance of the California

Department of Transportation, MTI delivers its classes over a state-of-the-art videoconference network throughout the state of California and via webcasting beyond, allowing working transportation professionals to pursue an advanced degree regardless of their location. To meet the needs of employers seeking a diverse workforce, MTI's education program promotes enrollment to under-represented groups.

Information and Technology Transfer

MTI promotes the availability of completed research to professional organizations and journals and works to integrate the research findings into the graduate education program. In addition to publishing the studies, the Institute also sponsors symposia to disseminate research results to transportation professionals and encourages Research Associates to present their findings at conferences. The World in Motion, MTI's quarterly newsletter, covers innovation in the Institute's research and education programs. MTI's extensive collection of transportation-related publications is integrated into San José State University's world-class Martin Luther King, Jr. Library.

DISCLAIMER

The contents of this report reflect the views of the authors, who are responsible for the facts and accuracy of the information presented herein. This document is disseminated under the sponsorship of the U.S. Department of Transportation, University Transportation Centers Program and the California Department of Transportation, in the interest of information exchange. This report does not necessarily reflect the official views or policies of the U.S. government, State of California, or the Mineta Transportation Institute, who assume no liability for the contents or use thereof. This report does not constitute a standard specification, design standard, or regulation.

REPORT 12-31

**AUTOMATED TRANSIT NETWORKS (ATN):
A REVIEW OF THE STATE OF THE INDUSTRY AND
PROSPECTS FOR THE FUTURE**

Burford Furman, Ph.D.
Lawrence Fabian
Sam Ellis
Peter Muller
Ron Swenson

September 2014

A publication of

Mineta Transportation Institute

Created by Congress in 1991

College of Business
San José State University
San José, CA 95192-0219

TECHNICAL REPORT DOCUMENTATION PAGE

1. Report No. CA-MTI-14-1227	2. Government Accession No.	3. Recipient's Catalog No.	
4. Title and Subtitle Automated Transit Networks (ATN): A Review of the State of the Industry and Prospects for the Future		5. Report Date September 2014	
		6. Performing Organization Code	
7. Authors Burford Furman, Ph.D., Lawrence Fabian, Sam Ellis, Peter Muller, and Ron Swenson		8. Performing Organization Report MTI Report 12-31	
9. Performing Organization Name and Address Mineta Transportation Institute College of Business San José State University San José, CA 95192-0219		10. Work Unit No.	
		11. Contract or Grant No.	
12. Sponsoring Agency Name and Address California Department of Transportation U.S. Department of Transportation Office of Research—MS42 Research & Innovative Technology Admin. P.O. Box 942873 1200 New Jersey Avenue, SE Sacramento, CA 94273-0001 Washington, DC 20590		13. Type of Report and Period Covered Final Report	
		14. Sponsoring Agency Code	
15. Supplemental Notes			
16. Abstract The concept of Automated Transit Networks (ATN) - in which fully automated vehicles on exclusive, grade-separated guideways provide on-demand, primarily non-stop, origin-to-destination service over an area network – has been around since the 1950s. However, only a few systems are in current operation around the world. ATN does not appear “on the radar” of urban planners, transit professionals, or policy makers when it comes to designing solutions for current transit problems in urban areas. This study explains ATN technology, setting it in the larger context of Automated Guideway Transit (AGT); looks at the current status of ATN suppliers, the status of the ATN industry, and the prospects of a U.S.-based ATN industry; summarizes and organizes proceedings from the seven Podcar City conferences that have been held since 2006; documents the U.S./Sweden Memorandum of Cooperation on Sustainable Transport; discusses how ATN could expand the coverage of existing transit systems; explains the opportunities and challenges in planning and funding ATN systems and approaches for procuring ATN systems; and concludes with a summary of the existing challenges and opportunities for ATN technology. The study is intended to be an informative tool for planners, urban designers, and those involved in public policy, especially for urban transit, to provide a reference for history and background on ATN, and to use for policy development and research.			
17. Key Words Automated transit; ATN; PRT; Podcars; Urban transportation	18. Distribution Statement No restrictions. This document is available to the public through The National Technical Information Service, Springfield, VA 22161		
19. Security Classif. (of this report) Unclassified	20. Security Classif. (of this page) Unclassified	21. No. of Pages 236	22. Price \$15.00

Copyright © 2014
by **Mineta Transportation Institute**
All rights reserved

Library of Congress Catalog Card Number:
2014949891

To order this publication, please contact:

Mineta Transportation Institute
College of Business
San José State University
San José, CA 95192-0219

Tel: (408) 924-7560
Fax: (408) 924-7565
Email: mineta-institute@sjsu.edu

transweb.sjsu.edu

ACKNOWLEDGMENTS

The authors acknowledge the enlightened support of the **Project Advisory Board** for this study:

- Rod Diridon, Mineta Transportation Institute at San José State University
- Magnus Hunhammar, Kompass (Association of Swedish Municipalities)
- Hans Larsen, City of San José Department of Transportation
- Matthew Lesh, USDOT, Federal Transit Administration
- Christer Lindstrom, International Institute for Sustainable Transportation (INIST)
- David Little, Lea+Elliott, Inc.
- Jeral Poskey, Google, Inc., Mountain View, CA
- Laura Stuchinsky, City of San José Department of Transportation

Special mention goes to Larry Fabian who not only participated in the research but simultaneously spearheaded the effort to edit the report into a cohesive whole. The authors also acknowledge the contributions of Grant Kleinman who assembled most of the tables that catalog the Podcar City conferences.

Beyond this project group, we acknowledge the contributions of the legions of inventors, entrepreneurs, and visionaries who dedicated their time and funds to laying the foundations of the ATN industry. This includes currently active companies and individuals who contributed their time and non-proprietary information to our survey and those now in retirement or departed from this polluted and troubled world. Their work is the basis of a vision for a better future.

The authors also thank MTI staff, including Executive Director Karen Philbrick, Ph.D.; Director of Communications and Technology Transfer Donna Maurillo; Research Support Manager Joseph Mercado; and Webmaster Frances Cherman. Additional editorial and publication support was provided by Donna Maurillo.

TABLE OF CONTENTS

Executive Summary	1
I. Introduction	5
II. Automated Transit Network (ATN) – Definition and Modal Context	7
Components of an ATN System	10
Existing ATN Systems	12
III. The Array of ATN Suppliers and Promoters	15
IV. ATN Industry Status and Market Potential	21
Market Dynamics	21
ATN Not Yet at the Threshold of a Market	23
Related Industries	27
Are We Missing the Forest for the Trees?	27
Driverless Cars Force Dual-mode Re-think	30
V. Planning Parameters	33
Introduction	33
Overview of ATN Planning	36
ATN Networking Principles	36
Urban Integration	54
Planning Campus-type ATN Projects	59
Project Implementation	60
VI. ATN System Funding and Procurement	63
Introduction	63
ATN Project Delivery	63
MPO Process	66
Funding and Financing of ATN Projects	68
The Fixed Guideway Transit Procurement Process	70
Recent ATN Procurements	71
Procurement Process Comparison	75
Conclusions	76
VII. Prospects for U.S. ATN Development	77
Market Prospects and Megatrends	77
So, Which Way Forward?	82

Broad Societal Trends	84
Public-Private Partnerships	87
Capital Resources	89
VIII. Challenges and Opportunities	91
Infrastructure in Crisis	91
The Essence of the Challenge	93
Shifting a Complex Market	94
Three Major ATN Planning Challenges	98
Exploring the Opportunities	100
IX. Conclusions and Recommendations	103
Bibliography	111
Appendix 1 – A Brief History of ATN	123
Appendix 2 – Data from ATN Suppliers	131
About the Data	131
Appendix 3 – U.S.-Sweden Memorandum of Cooperation on Sustainable Transportation	191
What is the Memorandum of Cooperation?	191
How did it come to be?	191
What are the MOC’s Main Objectives?	192
Activities Being Pursued Under the MOC: A Chronology	193
What are Potential Impacts of the MOC on the Prospects of a US-based ATN Industry?	201
What are the Potential Impacts of the MOC on ATN Linkages to Existing Transit Systems and High-Speed Rail?	201
What are the Financing Challenges and Opportunities?	202
What Unique Benefits does Sweden bring to the MOC?	202
Lessons Learned	203
Conclusions	203
Appendix 4 - Podcar City Conferences	207
Background on the Conferences	207
Uppsala	207
Ithaca	209
Malmö	211

San José	213
Stockholm	214
Berlin	217
Washington, DC	219
Supplementary Tables	224
Glossary	227
About the Authors	233
Peer Review	235

LIST OF FIGURES

1. APM and ATN Guideway Layouts	9
2. System Expansion Capability of ATN	10
3. Decisions on Details of ATN Guideways	11
4. ATN Systems in Operation	13
5. JPods ATN Guideway and Vehicles	19
6. Costs to Implement an ATN System	21
7. Bombardier Manufacturing Facility Outside Pittsburgh, PA	22
8. ATN Vehicle and Station at London Heathrow Airport	23
9. Jacksonville's Downtown People Mover (DPM)	24
10. Podcar City 7 Conference	25
11. Non-U.S. Research and Development of ATN	28
12. 1990s Mock-up of an Accessible Station and Vehicle Done Without USDOT Funds	29
13. Self-driving Cars in Europe	31
14. Near-grade Guideway Placement	35
15. At-grade Stations for Underground Guideway Segments	35
16. A Concatenated Network for Cleveland, OH	37
17. Looped Network	38
18. Merge/Diverge Network	38
19. Diverge/Merge Network	39
20. Alternative Merge/Diverge Layout	39
21. ATN Station Bay Configurations	39
22. Offline Bays with No Reversing Required	40

23. Large Series/Parallel Station	40
24. Station Options	42
25. ROW Footprint of ATN Guideway Placements	42
26. Open Guideway System (Rivium Metro Shuttle by 2getthere)	44
27. Captive Bogey System (Vectus)	44
28. Suspended System (MISTER)	45
29. Cabintaxi Supported and Suspended Vehicles	45
30. Morgantown PRT	49
31. ATN Control Room at London Heathrow Airport	51
32. Blending ATN Guideways into Existing Infrastructure	53
33. Capital Costs	54
34. Urban Road Section – Sidewalk with Trees	55
35. Urban Road Section – Parking Lane	56
36. Urban Road Section – Middle of the Road	56
37. Urban Road Section – Sidewalk without Trees	57
38. Urban Road Section – Sidewalk, Adjacent to Building	58
39. Urban Road Section – Integrated Design	58
40. Urban Road Section – Restricted Vehicle Access	59
41. No Vehicular Access	60
42. Integration of Components of an ATN	64
43. MPO Process in Jacksonville DPM	65
44. MPOs and System-wide Planning	66
45. The MPO Process	67
46. Infrastructure Implementation	71

47. Rivium Shuttle	72
48. ULTra PRT at London Heathrow Airport	73
49. Masdar City ATN	74
50. Suncheon PRT Planning	75
51. London's Docklands Light Railway Tram	78
52. Modal Priorities and Urban Design	79
53. Section of Guideway for the Downtown People Mover in Detroit, MI	80
54. Charlotte, NC Light Rail	81
55. ATN and TOD	81
56. Trend in Atmospheric CO ₂	82
57. Urban Community Garden in Cleveland	83
58. Bikeshare Kiosk	86
59. Considerations in the Use of Public Funds for Transportation	88
60. Copenhagen Driverless Metro	90
61. Directionality of Metropolitan Travel	91
62. Shortage of Government Funding for Infrastructure	92
63. Swedish and European Support for ATN Research	93
64. ATN Integration with the Built Environment	95
65. ATN Configuration Flexibility	96
66. Offline Stations	97
67. ATN Integration into Urban Settings	97
68. Architectural Sketch of Small Elevated Station	98
69. ATN Network Concept for Minneapolis-St. Paul	99
70. Huntsville Hospital's APM	101

71. Multi-modal Simulation Analysis in Sweden	104
72. Role of ATN in Developing More Livable Communities	105
73. ATN Vehicle Mock-up	107
74. Blending ATN into Urban Settings	109
75. ATN Development Timeline	124
76. Aerospace Corporation 1/10 th Scale Model	125
77. Aerospace Corporation PRT Concepts	126
78. Morgantown PRT	127
79. Cabintaxi PRT	128
80. Taxi2000 Vehicle and Raytheon Final Design for Phase 2 of the RTA PRT Program	130
81. Gävle Study Spårtaxi Illustration	192
82. Lt. Gov Garamendi and Minister of the Environment Carlgren	195
83. Signing of MoC by Swedish State Secretary Leif Zetterberg and U.S. Deputy Secretary of Transportation John D. Porcari	197

LIST OF TABLES

1. Differences Between APM and ATN Systems	8
2. APM Suppliers in 2013	16
3. ATN Suppliers in 2013	18
4. Trends in APM Projects	26
5. Design Parameters Affecting Guideway Configuration	34
6. Required Radius for Guideways as a Function of Superelevation	46
7. Headways and Speeds for Several ATN Systems	48
8. Key MPO Planning Products	68
9. 2getthere	132
10. Ultra	139
11. Vectus	144
12. Beamways	149
13. BubbleMotion	154
14. Cabintaxi	159
15. CyberTran	164
16. PRT International	168
17. SkyCabs	173
18. SkyWeb Express	178
19. TriTrack	183
20. Podcar City Conference 1: Uppsala, Sweden, 2007-10-01 to 02	208
21. Podcar City Conference 2: Ithaca, New York, 2008-9-14 to 16	209
22. Podcar City Conference 3: Malmö, Sweden, 2009-12-9 to 10	211
23. Podcar City Conference 4: San José, California, 2010-10-27 to 29	213

24. Podcar City Conference 5: Stockholm, Sweden, 2011-09-06 to 08	215
25. Podcar City Conference 6: Berlin, Germany, 2012-09-19 to 20	217
26. Podcar City Conference 7: Washington, D.C., 2013-10-23 to 25	219
27. ATN Suppliers' Participation in Podcar City Conferences	224
28. Podcar City Conference Presentations Sorted by Category	225

EXECUTIVE SUMMARY

The purpose of this report is to provide an informative tool for planners, urban designers, and those involved in public policy, especially for urban transit, about automated transit networks (ATN): what they are, where they fit within the larger category of automated guideway transit (AGT), what unique challenges they pose for planning and funding, what is the state of the ATN industry, and what are its prospects for the future.

ATN – sometimes referred to as personal rapid transit (PRT) or Podcars – is a unique transportation mode that features:

- Direct origin-to-destination service with no need to transfer or stop at intermediate stations
- Small vehicles available for the exclusive use of an individual or small group traveling together by choice
- Service available on demand by the user rather than on fixed schedules
- Fully automated vehicles (no human drivers) that can be available for use 24 hours a day, 7 days a week
- Vehicles captive to a guideway that is reserved for their exclusive use¹
- Small guideways (narrow and light relative to light rail transit or LRT and bus rapid transit or BRT) that are usually elevated but that also can be at or near ground level or underground
- Vehicles able to use all guideways and stations on a fully connected network

The concept of ATN has been around since the 1950s, but presently only five installations exist around the world that even begin to embody the full set of operational features. These are in Morgantown WV USA; Heathrow Airport, London; Masdar City, Abu Dhabi; Rotterdam, Netherlands; and Suncheon Bay, South Korea.

ATN poses unique challenges and opportunities compared with conventional transit modes. This report presents basic factors that must be considered for planning and designing small ATN systems. Conceptually, the network nature of ATN and its use of offline stations suggest that it could provide relatively high service levels by flexible station placements within a wide area compared with more conventional transit that aggregates demand in corridors. When guideways are elevated above grade, their design and location require careful consideration to minimize visual intrusion.

ATN procurement has followed a design/build approach in which the implementation team (supplier, contractor, and engineers) is responsible for the detailed design as well

¹ The scope of the study excludes what is called, 'dual mode transit', where vehicles are allowed to enter and exit the guideway.

as construction, manufacture, and system operations. Funding and financing have been similar to automated people movers (APM) and fixed guideway transit systems. The American Society of Civil Engineering (ASCE) automated people mover (APM) standards are considered suitable and applicable to small ATN applications with very few changes.

This research on the current state of ATN found that:

- The ATN industry is in an early, tentative stage of commercialization. There are only a handful of credible suppliers who are struggling to find buyers or venture capital, and they have limited resources. As such, no market for ATN presently exists.
- ATN has been implemented thus far essentially as line shuttles, which have not reached beyond approximately five stations each.
- ATN appears to have potential as a new mode of urban transit, with excellent levels of service and environmental sustainability if its infrastructure is integrated with solar power collection.
- Only a few credible suppliers are likely able to deliver an ATN project consisting of 5–15 stations within two or three years from start of construction.
- More research, development, and validation are needed, however, before complex, wide-area network implementations will occur and before planners, developers, and transit professionals will take ATN seriously.

The research suggests that a number of steps should be taken to advance a broad quantitative and qualitative appreciation of the significant societal benefits possible with ATN:

1. Develop a program digest of the U.S. Department of Transportation (USDOT, formerly the Urban Mass Transit Administration or UMTA) AGT programs of the 1970s to inform metropolitan planning organization (MPO) planners and transportation policy makers about AGT.
2. Synthesize Swedish research on ATN from the 1970s to the present. U.S. transportation planners have little awareness of nor access to Swedish accomplishments and experience in general urban planning and management, and in particular, to ATN analysis.
3. Sponsor research into the costs and risks of below- and above-grade implementations of APM and ATN systems.
4. Sponsor research into how elevated ATN infrastructure (especially guideways and stations) can be conceived and used as attractive urban furniture.
5. Perform a generic alternatives analysis for an MPO region or on a national scale to determine how urban mobility would be improved with investment in open (dual-mode) and closed (captive vehicle) ATN in comparison with other modes –

-
- conventional, maglev, LRT, BRT, car sharing, high-occupancy vehicle (HOV) lanes, and walking/biking.
6. Continue research and development of solar photovoltaic integration with ATN.
 7. Investigate feasibility, costs, and benefits of ground-level ATN stations and/or of integrating stations into buildings.
 8. Investigate the economic impacts of small-scale ATN stations on land values compared with those of conventional rail.
 9. Investigate how ATN networks might impact demand forecasting and transit mode split models.
 10. Incentivize MPOs to develop concepts using ATN to further sustainable transportation by issuing a request for proposals (RFP) for ideas. The best ideas could receive modest funds for a preliminary feasibility analysis.
 11. Fund research into the urban economics of mobility, including simulations that allow “what-if” testing of ATNs in the full modal context of U.S. cities, towns, and districts.
 12. Encourage and fund ATN demonstration programs. Much more work is necessary to validate ATN applications in more complex networks and under more demanding use cases than presently exist.

I. INTRODUCTION

This document is intended to be an informative tool for planners, urban designers, and those involved in public policy (especially regarding urban transit) about automated transit networks (ATN). It provides some history and a primer on ATN and its features, and it presents the unique aspects of ATN from the perspectives of urban, land use, and transit planners. It also presents considerations regarding funding and procuring ATN systems. The report also assesses the status of an ATN industry and the prospects for its growth in the U.S. Additionally, appendices to the report contain a compilation of system specifications collected from ATN suppliers; a compilation and organization of information presented at the seven Podcar City conferences; and an explication of the background, history, and importance of the U.S.-Sweden Memorandum of Cooperation on Sustainable Transportation, a bilateral agreement that has been significant in furthering ATN development between the two countries.

The need for this report arose because most urban transportation project planners, developers, and policy makers are generally not aware of ATN and its potential benefits, tradeoffs, and implications. Nor are they aware of the current state of potential suppliers, whether there is a market for ATN, and what is entailed in planning, procuring, and funding ATN systems. As the U.S. contemplates the future of highway infrastructure, measures out a sustainable energy future, and accommodates historic demographic shifts back to growth in urban cores, this report should find multiple uses on a national level.

Several in-depth feasibility studies of ATN have been completed within the last decade (Carnegie and Hoffman 2007; Meyer and Maroche 2010; Kimley-Horn and Associates 2010; Paige 2012), but these have largely focused on assessing the feasibility of ATN for specific locales – New Jersey; Ithaca NY; Fresno CA; and San José CA – rather than on providing more general information about ATN for planning and policy reference.

This report is organized by first laying out a definition for ATN and indicating where it fits within a modal context. It then summarizes the array of potential suppliers and the state of what might be considered a proto-ATN industry. Next, it explains the unique aspects of planning, funding, and procuring ATN systems, all of which introduce peculiarities, challenges, and unique opportunities compared with more familiar modes of urban transportation. The final chapters explore the prospects for more widespread implementation of ATN in the U.S., the challenges and opportunities involved, and some recommendations for research and development. The appendices provide a brief historical background of ATN; data obtained from potential ATN suppliers on their ATN products; the nature and background of a Memorandum of Cooperation on Sustainable Transportation between Sweden and the U.S., which bears on ATN development; and a compilation and categorization of sessions from the seven Podcar City conferences that have taken place to date.

II. AUTOMATED TRANSIT NETWORK (ATN) – DEFINITION AND MODAL CONTEXT

Automated transit network (ATN) is a relatively new designation for a specific transit mode that falls under the larger umbrella of automated guideway transit (AGT). Before 2010, the name “personal rapid transit (PRT)” was used to refer to the ATN concept. In Europe, ATN is often referred to as “podcars”². This chapter describes the ATN concept and places it within the larger family of automated transit modes.

Like all forms of AGT, ATN is composed of automated vehicles that run on dedicated guideways carrying passengers from station to station. ATN is unique, however, in that stations are off-line, and vehicles travel from origin to destination without intermediate stops or transfers. Furthermore, with ATN, service is typically non-scheduled, like a taxi, and travelers can choose to travel alone or with companions. ATN configuration parameters are quite different from other forms of AGT as well as BRT, LRT and streetcars. These configuration parameters will be addressed in detail in Chapter 5. Appendix 1 also presents a brief history of ATN.

The Advanced Transit Association (ATRA) published an evaluation of ATN in 2003 that lists its main features (ATRA 2003³)⁴:

1. Direct origin-to-destination service with no need to transfer or stop at intermediate stations
2. Small vehicles available for the exclusive use of an individual or small group traveling together by choice
3. Service available on demand by the user rather than on fixed schedules
4. Fully automated vehicles (no human drivers) that can be available for use 24 hours a day, seven days a week
5. Vehicles captive to a guideway that is reserved for their exclusive use⁵
6. Small (narrow and light relative to LRT and BRT) guideways usually elevated but also at or near ground level or underground
7. Vehicles able to use all guideways and stations on a fully connected network

² The Glossary entry for Automated Transit Network toward the end of the chapter lists other designations.

³ *Personal Automated Transit: Status and Potential of Personal Rapid Transit: Technology Evaluation*. Assembled by a committee of 15 ATRA members under the leadership of Bob Dunning. Ian Ford was the final editor. ATRA's address then was in Maple Valley WA. www.advancedtransit.net.

⁴ The authors use the ATRA list of features as the basic description of ATN for this research report.

⁵ Some designers have envisioned systems in which vehicles may enter and exit the guideway from streets. Likewise, street-running vehicles are admitted onto the guideway. This was labeled dual-mode transit (DMT) in the 1970s. Recent activity in the private sector on self-driving vehicles has reintroduced to transit discussions the prospect of DMT, but consideration of DMT will be left for another research study.

In summary, the core characteristics of ATN are that it operates like a fleet of automated taxis on dedicated rights-of-way without fixed routes or schedules, that vehicles travel non-stop from origin to destination, that stations are located off the main line, and that passengers typically travel alone or with chosen companions.

ATN functionality is significantly different from other transit modes, yet it shares some similarities with the more familiar automated people movers (APM) found in many airports. Table 1 lists the major differences between APM and ATN, and Figure 1 contrasts the typical guideway arrangements for APM versus ATN's potential to cover an urban area with a network of guideways. Figure 2 shows how a guideway network could expand.

Table 1. Differences Between APM and ATN Systems

APM	ATN
Operates like an automated bus: fixed route, vehicle may have multiple stops and starts from origin to destination, and stations may be on or off the main line (but are typically on the main line)	Operates like an automated taxi: no fixed route, vehicle travels non-stop from origin station to destination station, and stations are located off the main line
Passengers gather in groups with strangers	Passengers can travel alone or with chosen companions
Passengers must wait for a vehicle on a fixed schedule	Passengers may schedule vehicles at their convenience

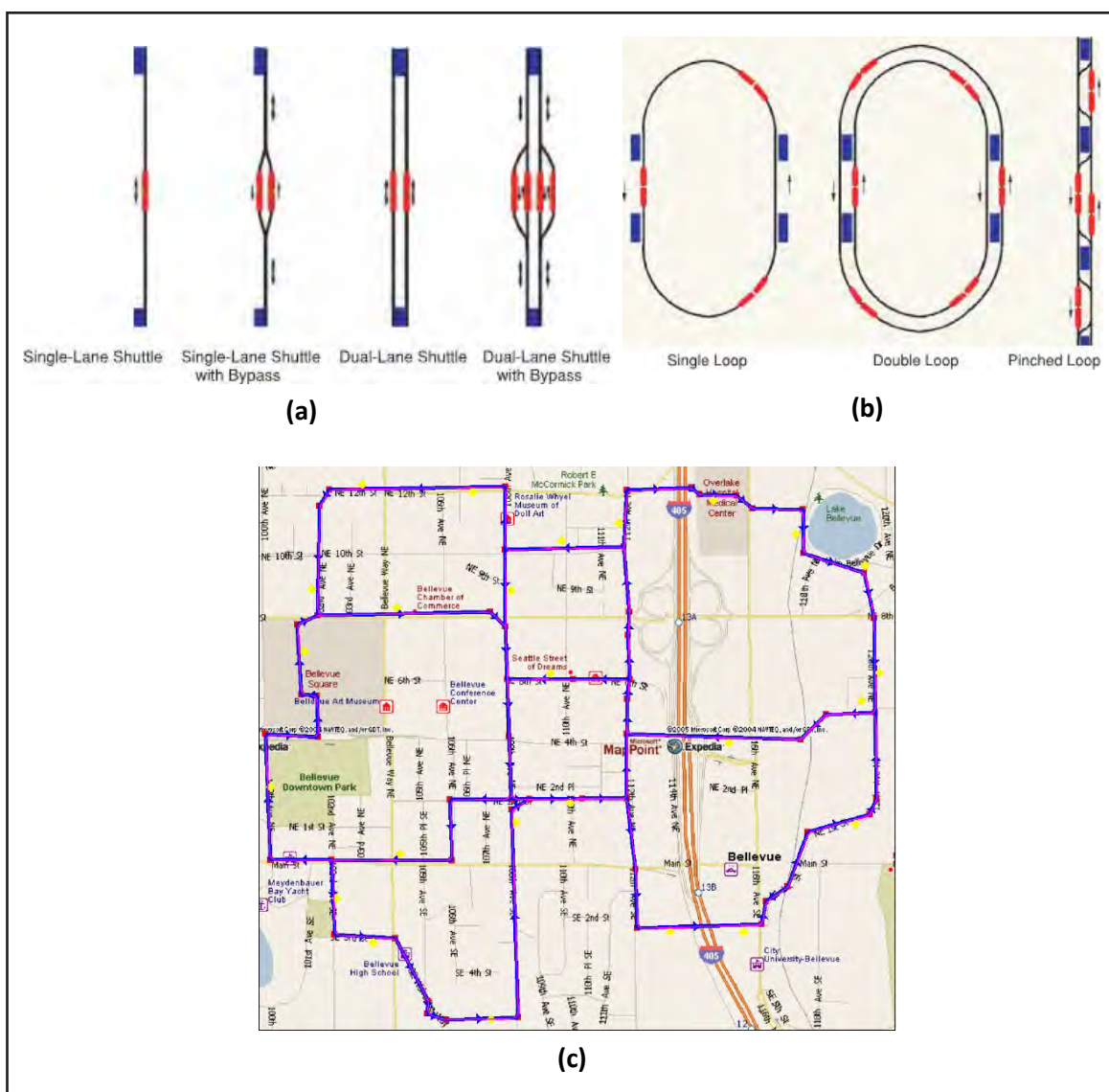

Figure 1. APM and ATN Guideway Layouts

Note: (a) Shuttle-type and (b) Loop-type guideway configurations for APM systems (source: Airport Cooperative Research Program 2010). (c) Network area coverage of ATN (source: Schneider and Raney 2005).

The American Society of Civil Engineers (ASCE) includes ATN within the family of automated people movers (APM) covered by its safety standards that also are relevant to driverless metros, shuttles, and district circulators (ASCE 2013)⁶, although expanded standards for complex ATN implementation may be needed. ATNs, like APMs, require no staff on-board vehicles nor in stations; however, there must be a supervisory center with human staff. These personnel act primarily as system monitors with very limited control requirements.

⁶ The system characteristics of APM and ATN are discussed more fully in Chapter 5 and Appendix 2.

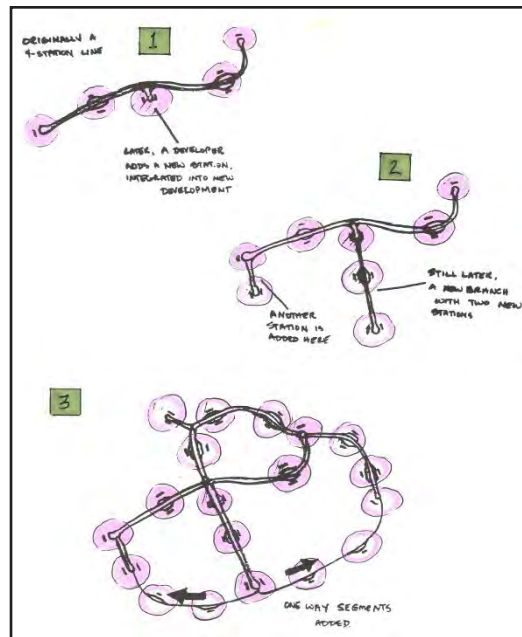

Figure 2. System Expansion Capability of ATN

Note: ATNs are designed to accommodate system expansion. The large network (3) is 15 times more complex than a five-station network (1).

Source: Trans.21.

ATN is different from self-driving cars running on city streets in that ATN has most often been conceived as a public transit mode similar to a train or bus rather than as a privately owned consumer product such as a car. As will be discussed in greater detail below and later in the report, ATN relies primarily on central control management for vehicle operation on the network. By comparison, self-driving cars are autonomous and rely on self-contained sensors to navigate, operate within restricted rights-of-way, and respond to other vehicles or obstacles.

COMPONENTS OF AN ATN SYSTEM

An ATN is a complex, large-scale, and geographically extensive mobility device consisting of the following components:

(a) Software

Software is the core of an ATN system. It integrates all the other components, orchestrating them to deliver a functioning mobility service. Central controls manage vehicle movements, on-demand trip scheduling in real time, empty vehicle management, and responses to irregular operations including accidents, guideway intrusions, crime, and terrorist incidents. They require debugging, maintenance, and protection by skilled technicians.

(b) Electric/electronic hardware

Electric and electronic components, comprising power rails (or battery changing, recharging), substations, communications, sensing, and station equipment.

(c) Guideways

Guideways, their columns, and their footings, as shown from a concept study in Figure 3, are generally the most visible and expensive component of an ATN system. They are essentially materials (concrete, steel, etc.) that are assembled using civil engineering processes that require specialized equipment for the construction tasks. Some sections may be in-tunnel, introducing additional civil elements. Others may be at or near grade and typically protected from intrusion by pedestrians or other modes. Local conditions may impose special aesthetic elements and mitigating measures.

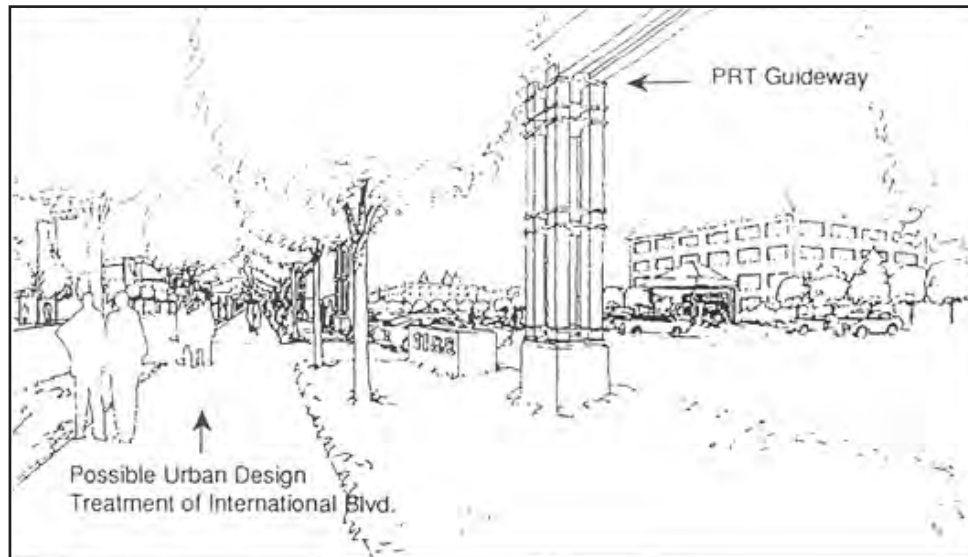

Figure 3. Decisions on Details of ATN Guideways

Note: An ATN supplier may specify civil details of the guideway, or it could leave those details to the client.
Source: Trans.21 archives.

(d) Vehicles

Vehicles are basic to the passenger experience. They are of a certain size, with a certain number of seats, perhaps room for standees, and may include amenities. Vehicles must satisfy Americans with Disabilities Act (ADA) requirements.

(e) Stations: structure, equipment, etc.

From a real estate perspective, and for urban life in general, stations are the most important elements of an ATN. In this sense, the flexibility of ATN configuration and station placement are very interesting, as the chapter on Planning Parameters will discuss in more detail.

(f) Power sources

All ATNs are powered electrically, either by batteries carried in the vehicles or by wayside pick-up. The opportunity to design solar and wind power collection into ATN infrastructure was claimed in a U.S. patent issued in 2004⁷ and was included as an

⁷ U.S. Patent 6,810,817

objective in the City of San Jose's Automated Transit Network Project in 2009⁸. The International Institute of Sustainable Transportation (INIST) issued a challenge in 2012 to student teams to develop a solar-powered ATN⁹. These alternatives are also being explored at several universities, including San José State University¹⁰. ATNs utilizing solar photovoltaic (PV) panels could be designed to return power surpluses to the electrical grid at certain times of the day while drawing power at other times. Whatever the source, electricity must be supplied. Power lines and substations are integral to an ATN implementation.

(g) Operations and maintenance facilities:

As mentioned earlier, facilities are necessary for the control center, vehicle storage, maintenance areas, and equipment. These are typically centralized in one location, but not necessarily. As ATNs grow, multiple locations that provide these functions may become the norm.

EXISTING ATN SYSTEMS

Currently, 167 APMs are operating around the world: roughly one-third at airports, one-third in institutional contexts, and one-third as mass transit. Of these systems carrying passengers daily, five qualify as ATNs¹¹:

- The Morgantown PRT at West Virginia University (1975)
- The Parkshuttle Rivium metro-feeder outside Rotterdam (1999)
- The Masdar City PRT in Abu Dhabi (2010)
- The Terminal 5 shuttle at London Heathrow Airport (2011)
- The nature park shuttle in Suncheon Bay, South Korea (2014)

These systems are shown in Figure 4. It must be pointed out that Masdar and Suncheon are essentially shuttles and embody ATN functionality to a rather limited extent. Heathrow's ATN has a fork at one end and thus is more than a simple shuttle, but even it is well below full ATN functionality. The Rivium guideway is not exclusive over most of its network.

This chapter has presented the ATN concept, where it fits under the umbrella of automated guideway transit systems, and where it has been implemented to date. The next chapter will look at the array of existing and potential ATN suppliers.

⁸ http://www.bidsync.com/DPXViewer/RFP_09-10-DOTAD-003_FFRDC.pdf?ac=auction&auc=501489&rndid=576211&docid=1777310

⁹ <http://www.inist.org/challenge/> and <https://www.inist.org/>

¹⁰ <http://www.engr.sjsu.edu/smssv/>

¹¹ More details on ATN suppliers and an assessment of the ATN industry are described in Chapters 2 and 3 and in Appendix 2.

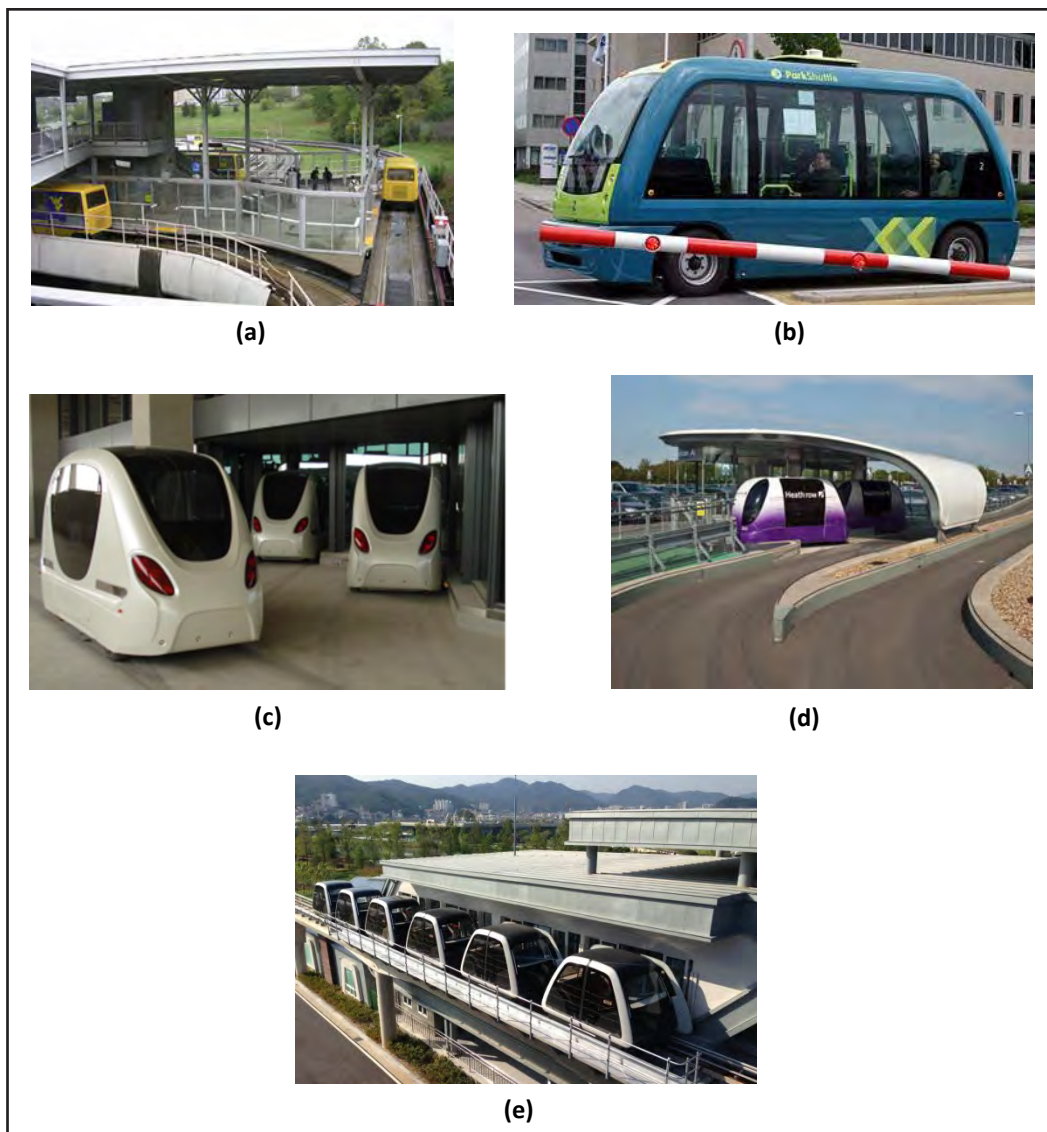

Figure 4. ATN Systems in Operation

Note: (a) Morgantown PRT (Trans.21). (b) ParkShuttle service at the Rivium office park (photo courtesy of Trans.21) (c) Masdar City PRT (2gether 2011). (d) Terminal 5 shuttle at London Heathrow Airport (<http://www.ultraglobalprt.com/photos-videos/photos/>). (e) Suncheon Bay PRT (<http://www.tdi.uk.com/uploads/5269352ECE3A4.jpg>).

III. THE ARRAY OF ATN SUPPLIERS AND PROMOTERS

An objective of this report is to assess the state of an industry that designs, manufactures, installs, and integrates ATNs. This is different from assessing the status of ATN technology. The difference is significant.

In other words, the subject here is the commercial delivery of service-ready, passenger-carrying systems within a reasonable timeframe and firm budget. The salient question is this: Are there companies that have or are capable of supplying safety-assured passenger carrying systems in an urban, airport, or campus context? A full ATN implementation goes well beyond the hardware and software elements of ATN technology. ATN implementations require a team of civil contractors with professional oversight. They must work integrally with public officials and impacted communities. All urban ATN projects must gain public approvals and permits. If they are public or semi-public, they must go through MPO evaluation and prioritization as well. Moreover, urban projects are subject to the vagaries of unforeseeable weather, political, labor, and public relations developments.

As noted earlier, an ATN system consists of a fleet of vehicles, a network of guideways, electrification, stations, a supervisory center, a service facility with necessary operations and maintenance (O&M) equipment and supplies, and – at its core – communications and control hardware and software subsystems. All components are selected and integrated so owners can be assured that the systems will operate safely and reliably, and that they can meet their performance requirements.

Looking across the U.S. and beyond, this study judged that several companies appear to be capable of delivering a modest ATN product within two or three years from the start of construction based on the maturity of their research and development efforts, their level of commercialization, and their ability to deliver a project. A “modest ATN” means a ten-station implementation or smaller in which the ability to handle large surges in demand at stations is not problematic¹². A cautious outlook might temper this conclusion back to the scale of a five-station project, comparable in scale to the Morgantown PRT or smaller. A more aggressive outlook argues that a 20-station implementation is possible within the same timeframe. With diligent design, engineering, and program management, and without unforeseen circumstance that would disrupt schedules, USDOT, MPOs, state DOTs, and municipalities can, with technological confidence, undertake a 5-15 station ATN project.

The suppliers for the world APM industry are listed in Table 2, which represents a snapshot in autumn 2013¹³. There are 45 entities that have supplied or are actively pursuing the delivery of automated passenger systems, and many are also seeking R&D financing. Sixteen of them (indicated in bold) qualify as ATN suppliers or hopeful suppliers, and seven others offer

¹² The recent study of ATN at the Norman Mineta International Airport in San José CA by the Aerospace Corporation raised serious concerns that currently available ATN designs were “rudimentary, suitable for low-speed, low-demand applications.” (Paige 2012, 3)

¹³ Data source: Trans.21, which has monitored developments in the APM industry since the 1980s and has published several editions of *A Planner's Guide to APMs*. Current news and data are now posted at <http://www.podcar.org/>.

technologies amenable to ATN characteristics. Large, experienced manufacturers of transit equipment are obvious potential contributors in an ATN supply chain, but they have not yet indicated interest in the concept. Two such firms are SDI and Bombardier.

Table 3 lists 24 actual or potential ATN suppliers rated for their capability to deliver a fully functioning ATN system using five criteria:

1. *Conceptual*: Companies and individuals with ATN conceptual designs and/or development strategies: BM Design, Glideway, JPods, Minnesota PRT, and Skycabs
2. *R&D*: Companies with mock-ups or scale models showing concepts in detail, perhaps with some testing and simulations: Beamways, GTS, PRT International, SkyTran, and Tritrack
3. *Demo*: Companies with some level of test experience: Cybertran, EcoMobility, MoveMile, Skycab, and Taxi 2000
4. *Testing*: Companies with extensive full-scale testing (thousands of miles): Cabintaxi, Induct, Intamin, Modutram, Vectus, and WGH
5. *Market-ready*: Companies capable of delivering a ten-station network in a benign setting within two years: Boeing, 2getthere, and Ultra (Vectus may soon move into this category.)

More detailed information on the technology, experience, and corporate identity of the 11 suppliers who responded to requests for information for this research (indicated as bold names in Table 2) are provided in Appendix 2.

Table 2. APM Suppliers in 2013

Company	Country	Status	Description
American Maglev	USA	R&D	Maglev transit
Alstom	France	established	Driverless metro
Ansaldo	Italy	established	Driverless metro
Beamways	Sweden	conceptual	Beamways PRT
BM Designs	Finland	conceptual	Ultra-light PRT
*Bombardier	Canada	established	Skytrain, Innova
Cabintaxi	USAGerm	petrified	Both supported and suspended vehicles
Coester	Brazil	R&D	Aeromovel, pneumatic propulsion
<i>Cybertran</i>	USA	R&D	Cybertran, energy efficient transport
Doppelmayr	Austria	established	DCC cable-drawn
EcoMobility	Poland	R&D	Warsaw Tech Univ. - Prof. Choronmanski
<i>Fastransit</i>	USA	R&D	SyncPark, automated parking
Force Engineering	UK	propulsion	Linear motors
Glideway	USA	conceptual	BiModal (dual mode) 120 mph
GTS	Sweden	conceptual	General PRT - Dual Mode
Hitachi	Japan	established	Monorail

Company	Country	Status	Description
HSST	Japan	established	Maglev (high-speed)
Hyundai Rotem	Korea	established	Maglev
IHI	Japan	established	Niigata NTS
<i>Induct</i>	France	R&D	Navia driverless vehicles
<i>Intamin</i>	Switzerland	established	Monorail, rides, PRT designs
Jpods	USA	conceptual	Solar ATN, Secaucus, NJ MOU
Leitner (-Poma)	Italy	established	MiniMetro - cabledrawn
MagnaForce	USA	conceptual	Maglev
MagneMotion	USA	established	Propulsion-controls, experience non-pax
MegaRail	USA	conceptual	Dual-mode
Minnesota PRT	USA	conceptual	PRT
Mitsubishi Hvy Ind.	Japan	established	CrystalLiner APM
Modutram	Mexico	R&D	Renamed 'Autotren', GRT demo
<i>MoveMile</i>	Portugal	R&D	Driverless vehicles
PRT International	USA	conceptual	Classic PRT by J.E. Anderson
Scomi	Malaysia	established	Monorail (non-automated)
*SDI	USA	established	Cable shuttles and self-propelled monorails
Siemens Mobility	GermFran	estaablished	VAL driverless metro (H-bahn)
Skycab	Sweden	R&D	Suspended PRT
Skycabs	NZ	R&D	Suspended GRT with ties to PRT International
SkyTran	USA	R&D	Unimodal - suspended 2-pax vehicle PRT
Sumitomo	Japan-US	established	CrystalLiner APM (MHI)
SwiftTram	USA	conceptual	Suspended GRT
Taxi 2000	USA	R&D	Skyweb Express classic PRT
<i>TriTrack</i>	USA	conceptual	Texas-style dual mode monorail

Notes: The list includes ATN (PRT) suppliers.

Bold means explicitly ATN (PRT).

Italics means 'marginally' PRT.

* means might be persuaded to enter ATN market given favorable economic conditions.

Source: Trans.21.

Table 3. ATN Suppliers in 2013

Company	Country	Status	Description
Beamways	Sweden	2	Suspended vehicles
BM Design	Finland	1	Ultra-light
Boeing	US	5*	Morgantown, disinterested
Cabintaxi	US-Germany	4**	Both supported and suspended vehicles
Cybertran	US	3	Energy-efficiency
EcoMobility	Poland	3	Warsaw Tech Univ
Glideway	US	1	120 mph dual-mode concept
GTS	Sweden	2	Generic dual-mode and more
Induct	France	4	Navia driverless vehicle
Intamin	Switzerland	4	Rides, monorails and more
Jpods	US	1	Suspended vehicles
Minnesota PRT	US	1	Very small vehicle, 60 mph PRT
Modutram	Mexico	4	Renamed Autotren, GRT
MoveMile	Portugal	3	Driverless vehicles
PRT International	US	2	Classic PRT by Ed Anderson
Skycab	Sweden	3	Suspended vehicles
Skycabs	New Zealand	1	GRT, ties to PRT International
Skytran	US	2	Unimodal - suspended vehicles
Taxi 2000	US	3	Skyweb Express
Tritrack	US	2	Dual Mode
2getthere	Netherlands	5	Driverless vehicle PRT
Ultra	UK	5	Battery-powered vehicles
Vectus	Korea	4	Classic PRT, 6-pax vehicles
WGH	UK	5	Leisure, low-speed people movers

Notes: Companies in **bold** responded to a request for information (data in Appendix).

* 1970s, 2000, inactive.

** active 1970s/80s.

Status Key:

- 1 concept only
- 2 analyzed and stimulated
- 3 mockups, scale models
- 4 full test track
- 5 revenue service

Source: Trans.21.

Our observations on the status of ATN suppliers are:

1. With a mandate from USDOT, Boeing, Bombardier, Google, GM, and many others might respond to activate ATN R&D¹⁴. All others with market-ready products are non-U.S.: 2getthere, Ultra, and Vectus. It should be noted that there are dozens of other individuals and start-up corporations that proposed ATN-like technologies but lack credibility. Moreover, scores of others have “tried and died,” so to speak. These are not included in this study.

¹⁴ However, Boeing, the prime contractor for the successful Morgantown PRT, has not shown commercial interest in this. Were it to respond positively to a national challenge, Boeing could become the only U.S. ATN supplier.

2. As summarized in Appendix 1, Cabintaxi (or, Cabinentaxi) was a well-developed ATN technology that underwent significant engineering and testing in the late 1970/1980s¹⁵. However the individual who holds the intellectual property does not consider himself to be a supplier but rather a service provider. In private conversations, he states that he seeks a business arrangement and would supply Cabintaxi technology to public or private entities.
3. PRT International and Skytran have invested time and resources into ATN R&D, but they fall short of full-scale testing. U.S. concept proposers include Glideway, JPods (see Figure 5), and Minnesota PRT.



Figure 5. JPods ATN Guideway and Vehicles

Note: JPods is distinctive in that it integrates solar photovoltaic (PV) panels on the guideway to collect energy to power its vehicles.

4. WGH is a small British firm that has supplied many automated people movers for leisure applications¹⁶. U.S. suppliers with demonstrated concepts that are pursuing other applications are Cybertran and Taxi 2000.

In summary, three experienced suppliers (2getthere, Ultra, and Vectus) are capable of delivering a modest ATN system, and a handful of potential ATN suppliers are in various states of readiness. The larger issue, to be addressed in the next chapter, is whether a market exists or will come to exist for ATN, which would allow any of these suppliers to flourish.

¹⁵ The Cabintaxi technology was developed to such an extent that the parent company, Demag-Fördertechnik/MBB, was approved as an eligible system supplier for the U.S. Downtown People Mover (DPM) Project in the mid-1970s (DeMarco 1976; and Burger 2013).

¹⁶ Transport systems for passengers enjoying entertainment and informational displays, usually indoors (sometimes referred to as “dark rides”). WGH also participated in the Vectus R&D work for the test facility in Uppsala, Sweden.

IV. ATN INDUSTRY STATUS AND MARKET POTENTIAL

The previous chapter surveyed the array of established and potential suppliers of ATN systems and concluded that only a handful are capable of delivering even a modest sized ATN of between five to 15 stations. This chapter will examine whether an ATN market exists, and if not, its potential to develop.

For a market to exist, there must be at least one buyer and one seller. As will be shown here, at best the situation could be described as a proto- or nascent market because there are sellers but no real buyers at this time.

MARKET DYNAMICS

The purchase of an ATN, like any large urban infrastructure project, is not a simple consumer choice, such as an individual deciding to purchase a new computer. Designing and procuring an ATN is somewhat comparable to a large corporation acquiring a company-wide communications system that involves hardware, software, and technical staff. It is the type of purchase that affects day-to-day operations and ultimately the corporation's survival. However, ATN procurements are even more complicated, because they are in the public realm, and they require the consensus of contending forces to expend millions – if not billions – of dollars. They entail detailed engineering, approvals, and certifications. Construction requires time, and it impacts neighborhoods (Figure 6). Operations and safety also are necessary commitments.

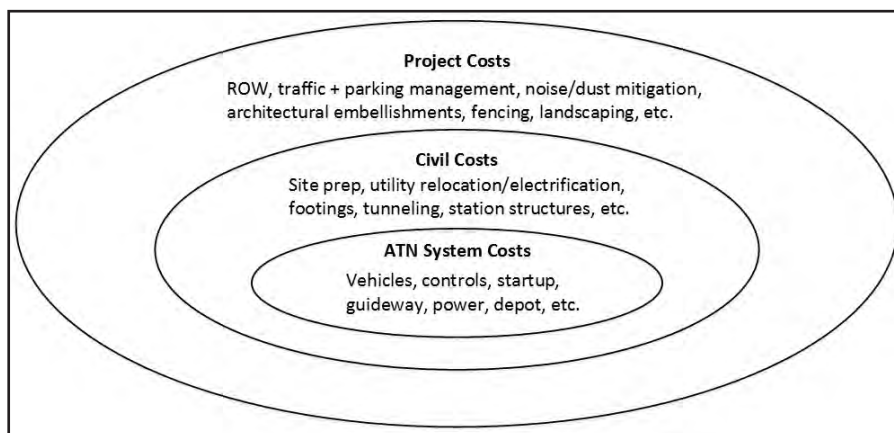

Figure 6. Costs to Implement an ATN System

For example, the government of a small town with hills and traffic problems, such as Saint Joseph, MO, could visualize traffic and parking relief for a 21st-century district by means of a modest ATN project. However, they may ask, along with many stakeholders, whether an ATN technology supplier can secure a \$100-million bond and deliver the project on time and on budget. Will it be attractive and non-problematic? In the minds of those who make the final decisions and fund transportation projects, details of the technology are not central.

If the federal government, a state, or other governmental unit were to shift policies to procure several ATNs, the private sector would likely respond as they did in the

late 1960s when the aerospace industry was experiencing difficult challenges. Several major corporations developed the early APM products, and most exited quickly around 1976 – Ford, Otis, Bendix, to name a few of the major developers (MacKinnon 1974). This current research has uncovered no inclination toward ATN development and commercialization among those named developers. Bombardier operates an APM manufacturing plant in southwest Pennsylvania (Figure 7). This Canadian APM supplier participated in several ATRA-organized workshops¹⁷ held at West Virginia University¹⁸ and submitted qualifications in response to the City of San Jose’s 2009 Request for Information (RFI) for a proposed APM to connect the Mineta San José International Airport with a future terminus of the Bay Area Rapid Transit (BART) system.



Figure 7. Bombardier Manufacturing Facility Outside Pittsburgh, PA

Note: Bombardier could become a major supplier of ATN technology.

Source: Trans.21.

The research and development effort on driverless cars by Google, Ford, Volvo, and others holds promise to change (even “disrupt”) urban mobility markets. Others, such as Microsoft or LG, could follow. What could be the prospects for Finland’s start-up BM Design to gain R&D funds in the small nation that dominated the rapid spread of mobile telephones worldwide during the telecommunication industry’s early stages in the last century?

The Aerospace Corporation report that evaluated the feasibility of implementing ATN technology at the Mineta San José International Airport (Paige 2012) cautiously provides a snapshot of the industry based on an appreciation for the precision required for successful integration of complex technological systems. The report states that current designs are “rudimentary,”¹⁹ but recent “tantalizing” progress has been made. Still, no one has designed and built a 20-station ATN system with significant surges in station demand. That number

¹⁷ The William Alden Seminar, October 7-8, 2005 focused on O&M issues and the Ed Neumann Seminar, May 4-5, 2007 focus on PRT futures. CDs of presentations are available from ATRA. A third workshop (2009) involved a design competition for landscape architecture students for a park outside the downtown station.

¹⁸ Bombardier marketing executive Paul Didrikson confirmed interest in ATN but not commitment to it in personal conversation in December 2013.

¹⁹ Rudimentary relative to the claims of potential performance being made.

of stations is arbitrarily taken to be a threshold size at which the attractiveness of non-stop origin-to-destination service draws high levels of ridership. It also is considered a size at which fleet management requirements are quite complex. While that number is arbitrary, it still is useful for assessing the status and potential of an ATN industry in the U.S. as a stretch beyond the ten stations (+/- 5) deemed within reach in the previous chapter.

It is worth noting again that as 2013 drew to its close, implementations of even a ten-station network are nowhere to be found in the world. The venerable five-station Morgantown PRT is almost 40 years old (Sproule and Neumann 1991). It has 20 (5x4) origin-destination (O/D) pairs in its service matrix. The O/D matrix of a 20-station network has 380 cells (20x19) – 19 times as many as Morgantown. The Parkshuttle Rivium and the three recent implementations of ATN in Masdar City, London-Heathrow Airport, and Suncheon Bay, South Korea are little more than shuttles. Heathrow has three stations, and it splits to serve one of two parking areas (Figure 8). The Masdar shuttle has only two passenger stations, plus three cargo stations that are not in current use.



Figure 8. ATN Vehicle and Station at London Heathrow Airport

Note: The station shown is one of two parking stations providing taxi-like service to Terminal 5.

Source: PRT Consulting.

The long Vectus shuttle in the Suncheon Bay Ecological Park in South Korea is expected to go into full service in 2014. In Mexico, Modutram may have a firm project for its AutoTren soon.

ATN NOT YET AT THE THRESHOLD OF A MARKET

Four projects in the last several years are not enough to claim that there is an active market sufficient to support an industry. For a thriving market, there must be multiple suppliers and numerous buyers who conduct business on a regular basis. The world transit industry produces many thousands of rail vehicles and even more buses because a market is in place. Many active rail companies exist, although none is based in the U.S. Globally, a metro industry has hundreds of operating lines and an APM industry with dozens of operating systems, such as the downtown people mover (DPM) in Jacksonville, FL (Figure 9). These

industries have official and non-official lines of communication and transactions. ATN suppliers and buyers do not.



Figure 9. Jacksonville's Downtown People Mover (DPM)

Note: The Jacksonville DPM and others in Detroit and Miami have a basic APM supply, along with an operation and maintenance (O&M) industry, thanks largely to the airport market.

Source: Trans.21.

Elevators are part of a mature transportation industry of a scale to which ATN might be expected to evolve (or explode, according to some²⁰). This is a \$21-billion²¹ market composed of a wide array of technologists, manufacturers, installers, O&M servicers, inspectors, and components suppliers. To provide a better understanding of this industry's size, approximately 900,000 elevators are in use in the U.S., and about 20,000 new units are installed each year. Whereas APMs come under the purview of the American Society of Civil Engineers (ASCE), it is the American Society of Mechanical Engineers (ASME) that addresses standards for vertical transportation systems: The U.S. elevator industry includes an authoritative publisher that actively communicates with professional associations of contractors, safety officials, manufacturers, and consultants. Each meets every year and has officers. The many lines of formal and informal communications comprise the nervous system of a larger, dynamic industry. Most states and major cities have an elevator association, along with associations for contractors, safety officials, consultants, and/or researchers. This is an active industry with a calendar of meetings, seminars and conferences.

The ATN industry has some small groupings; however, they are not sufficient to suggest that the industry is anywhere close to maturity. The Advanced Transit Association (ATRA) has existed since 1976 as a forum of advanced transit thinking and collaboration²². Since 1983, Trans.21 has published *TransitPulse*, a bi-monthly newsletter on APM news and views, including ATN²³. ATRA now has an international industry group composed of members

²⁰ In 2008, Frost & Sullivan presented a potential revenue analysis for the global ATN market with scenarios ranging from conservative (10 billion Euros in 2020) to optimistic (80 billion Euros in 2020) (Frost & Sullivan 2008).

²¹ Elevator World annual industry report, 2012 (Mobile, AL).

²² <http://www.advancedtransit.org/>

²³ Based in Boston (55 Virginia St, Dorchester MA 01225). (617) 825-2318 or lfabian21@gmail.com. *TransitPulse* began as a mailed, paper version, but is now in digital format and is increasingly the newsletter for ATRA news.

actively providing systems and services relevant to ATN. The Stockholm-based Institute for Sustainable Transportation in 2007 launched the annual Podcar City conferences, the seventh of which was held in Arlington, VA, in October 2013 (Figure 10)²⁴. Dedicated consultants also are included in the industry, such as PRT Consulting based in Colorado²⁵, LogistikCentrum²⁶, and Beamways²⁷ in Sweden.



Figure 10. Podcar City 7 Conference

Note: Swedish official Hakan Jansson (left) and Matthew Lesh of USDOT exchanged views in Arlington, VA, October 23-25, 2013.

ATN Supply and Demand Struggles

The snapshot of the ATN industry given in the previous chapter shows its status as of autumn 2013. The supply side in 2014 and onward is likely to change substantially. For a new group or individual, the barriers to creating a corporation that claims it can deliver an ATN are not high, but obtaining valid patents and a working test track require more substantial resources. Putting an implementation into revenue service entails even larger budgets. Because no buyers have materialized with authorized budgets, how does a technologist move forward? Based on regular conversations with ATN developers, most of them are seeking investment funds.

On the other hand, it is quite easy for an ATN supplier to quit the field. ATN history is littered with companies that tried their best but still failed.

Table 4 shows the trend of APM projects, dividing them into three institutional sectors: architectural (within a single property), institutional (involving more than a single property), and transit. Notable is the steady growth of driverless metros, almost completely outside the U.S., compared with the decline in architectural (primarily airport) implementations, and the uneven pattern for institutional projects (airport-rail connectors, universities, and special districts). The Suncheon project in South Korea was carried forward as an active project (included in Table 4) because its start of service, planned for spring 2013, was delayed.

²⁴ <http://www.podcarcity.org/home/>. See <http://www.advancedtransit.org/industry-group/profile/>, and Appendix 3.

²⁵ <http://www.prtcons.com/>

²⁶ <http://www.ctr.kth.se/persons.php?person=ingmar>

²⁷ <http://beamways.se/>

Table 4. Trends in APM Projects

In billions of dollars (excluding O&M)

Level of Project	Year									
	2004	2005	2006	2007	2008	2009	2010	2011	2012	2013
Architectural	1.31	1.12	1.10	0.97	0.83	0.99	0.51	0.68	0.52	0.41
Institutional	1.07	0.71	0.90	2.82	2.38	2.57	2.88	2.14	1.48	1.18
Transit	4.98	4.90	9.12	7.7	7.49	5.88	7.23	12.4	15.2	18.8
Total	8.0	7.4	11.56	13.31	13.0	11.5	13.0	15.2	17.2	20.4

Note: The table shows the trend of world APM project costs. ATN projects are miniscule by comparison.

Source: Trans.21.

Even ATN insiders do not know Suncheon project costs, nor has Vectus published them. Trans.21's estimate is \$100 million, which is dwarfed (0.5%) within the \$20.4 billion APM Pipeline. To summarize, no new ATN implementations have been identified, nor is there a self-sustaining ATN industry within the U.S. or globally.

Over the last decade, ATN listings have appeared in the Trans.21 pipeline for upgrades to the Morgantown PRT and for the installations at Heathrow and Masdar²⁸. From 2011 onward, there was considerable news about an eight-km, seven-station ATN implementation in Amritsar²⁹, India, but construction is not yet underway. Morgantown is currently upgrading its controls, but the supplier has not yet been announced³⁰. Thus, there are prospects for some ATN contractual activity, but not enough to create the base for a functioning industry or market.

The Boeing controls that have operated safely in Morgantown are public domain, free, and available from West Virginia University since the 1980s. By today's standards, they are rudimentary but totally safe. Supplied by Boeing, they are the starting point in any effort to supply ATN controls today. Who are other potential controls suppliers? More elaborated and updated versions are available, potentially from Noventus³¹, LogistikCentrum³², Taxi 2000, Beamways, PRT International, Aerospace Corporation, and Transit Control Solutions³³. Large technology groups such as Microsoft, Google, and others are known to be developing self-driving cars and may be working on – or could potentially mobilize teams to work on – ATN software development.

²⁸ Over the last decade there have been ATN listings in the Trans.21 pipeline for upgrades to the Morgantown PRT and for the installations at Heathrow and Masdar.

²⁹ http://en.wikipedia.org/wiki/ULTra_%28rapid_transit%29

³⁰ <http://wvutoday.wvu.edu/n/2010/05/04/prt-facilities-master-plan-public-meeting-set-for-may-5> Clement Solomon, WVU Director of Traffic and Parking, November 2013 and in subsequent telephone conversations.

³¹ <http://www.noventus.se/spartaxi.html>

³² <http://www.ctr.kth.se/persons.php?person=ingmar>

³³ <http://www.transitcontrolsolutions.com/>

Minnesota-based Taxi2000 has developed controls and simulations. It was paid to develop a 300-station network in Abu Dhabi in collaboration with Wilbur Smith Associates. It formalized commitments of collaboration with several prominent corporations in 2008, and these may be valid today.

What has been presented above summarizes the status of the supply side of the emerging ATN industry. Several firms are capable of delivering a 3-5 station project with service in approximately one year, and up to 10-station projects in two or three years. If one or two additional years are allowed to develop and integrate an ATN system, an array of potential suppliers broadens beyond 2getthere, Ultra, and Vectus.

RELATED INDUSTRIES

In addition to the elevator and APM industries already discussed, many other firms deliver transport systems for parcels and cargo whose expertise and engineering could be the basis of ATN R&D work. For example, airport baggage handling systems are supplied by an array of companies. Other companies supply systems to move parts, equipment, and products at modern manufacturing, warehousing, and port complexes.

The new field of self-driving robots and drones for a wide range of applications is growing quickly. Their control hardware and software are likely to have relevance to ATN development efforts. A chasm of sorts exists between companies that move things and those that move people. For example, liability issues form a formidable barrier that blocks goods handlers from taking on passenger services.

Additionally, there are many other promoters of systems with ATN characteristics beyond the scope of this chapter³⁴.

ARE WE MISSING THE FOREST FOR THE TREES?

It may be instructive to step back from this current detailed survey of companies promoting ATN and ATN-like products and take a broader look at what the ATN industry could be if governmental units – whether federal, state or local – provide incentives for ATN development. This can come in the form of absorbing part of the risk for clients to procure relatively unproven ATN systems. Might large corporations with R&D and marketing capabilities take interest in commercializing ATN projects (example in Figure 11)? This section addresses that “what-if” speculation.

³⁴ A good source on new concepts is <http://faculty.washington.edu/jbs/itrans/>



Figure 11. Non-U.S. Research and Development of ATN

Note: The Japanese government funded the CVS program in the 1970s and 1980s with a multi-car track in Okinawa.

Source: Trans.21.

Might Boeing be interested in re-entering the field? It has shown no such inclination thus far. Nor have Raytheon and Otis – both international New England-based firms that have supplied a PRT test facility and a dozen APMs, respectively.

Might Raytheon resurrect its PRT program of the 1990s that produced the mock-up of an accessible station and vehicle shown in Figure 12? Might Bombardier see it profitable to expand its current APM and rail product line to include ATN? It examined the ATN field several years ago and decided not to pursue it. How might interest change if a coalition of states, for example, the Carolinas and Georgia, announced public policies to tame auto addictions and develop green villages in which ATN franchises will be accommodated and sought? If such demand for ATN were expressed, might the major European suppliers of driverless metros – Alcatel, Alstom, Ansaldo, Siemens and Thales – restructure their marketing and product development to include ATN controls?



Figure 12. 1990s Mock-up of an Accessible Station and Vehicle Done Without USDOT Funds

Source: Trans.21 archive.

What will Google's commitments to driverless car research and its need to mitigate expansion plans at its main facilities in Mountain View, CA, lead to if public sector cooperation is forthcoming?

Smaller, flexible firms are in place with experience in APM innovation, such as Schwager Davis Inc.³⁵ (San José, CA) and Intamin³⁶ (Leichtenstein), that might invest in ATN development were the public sector to show commitments. Or perhaps large private developer such as Disney, Universal Studios, and Las Colinas (Irving, TX) might take internal R&D investments to satisfy their own circulation needs.

The U.S. economy operates within the larger world. Overseas companies will surely be attracted to the U.S. market if governmental policies and market prospects are positive. In Mexico, a private sector initiative called Modutram, in collaboration with auto companies, has advanced an ATN development named Autotrén. A full-scale test facility is in place in Guadalajara and a demonstration implementation in Cuernavaca, México. Will their advances prod U.S. companies and agencies to invest in ATN?

Because conventional rail transit equipment is largely imported to the U.S., the possibility that future ATN hardware and software will also come from overseas is real. Such a scenario would not generate many U.S. jobs. Public policy will largely determine which future ATN jobs are appropriate for the U.S. and which for overseas. The U.S. is fortunate to have an official government-to-government agreement with Sweden, the Memorandum of Cooperation on Sustainable Transportation (MOC), that it can leverage. Sweden

³⁵ <http://www.schwagerdavis.com/>

³⁶ <http://www.intaminworldwide.com/>

has developed considerable expertise in ATN, urban planning, and industrial design, and significant collaboration is occurring as a result. The annual Podcar City conference is but one example. Appendix 3 documents the background and significance of the MOC, and Appendix 4 catalogs and organizes the information presented at the Podcar City conferences to date.

Many unknowns surround prospects for a domestic ATN industry, to be explored in the chapters on Prospects for U.S. ATN Development and Challenges and Opportunities. The problem of setting standards is one of the most important issues before policy-makers who will determine the future of ATN development.

DRIVERLESS CARS FORCE DUAL-MODE RE-THINK

Outside of the conventional transit industry and quite remote from the APM industry, major private sector R&D is quickly raising the intelligence of the common car (Figure 13). The term “driverless car” is new, and there are many others: autonomous car, automated car, robocar, automated valet, self-driving car, etc.³⁷

“It’s a game-changer,” says the website editor, Alain L. Kornhauser of Princeton University. “What I think is going to happen is that nobody will own a car. ... If you can get [mobility] by the drink, you won’t buy the bottle... The problem with buying the drink today is that the labor cost of on-demand taxi service is enormous. As a result, we buy the bottle (own a car) just in case we want a drink (need to drive). Driverless cars change the whole equation.”

Prominent corporations both within the traditional auto industry and those outside are developing an increasing number of intelligent autonomous vehicles. They may evolve as consumer vehicles that individuals own. Or perhaps not, hypothesizes Kornhauser. Why not just subscribe to a mobility service that you can summon? Several major international corporations expect to have commercially ready consumer products for on-street operation within a few years. Early deployments of 100 vehicles are planned at the University of Michigan/Ann Arbor as part of a decade-long program³⁸, and the University of West Florida/Pensacola has planned a system with a much shorter timeframe³⁹. Similar programs were announced by the UK’s Automotive Council for Milton Keynes (UK)⁴⁰ and by Volvo for Gothenburg (Sweden)⁴¹ in late 2013. The Greenville, SC region is showing interest in becoming a center of robocar and ATN industries⁴².

³⁷ One lively source of news on this sector is <http://www.smartdrivingcar.com/>

³⁸ <http://ns.umich.edu/new/multimedia/videos/21817-driverless-networked-cars-on-ann-arbor-roads-by-2021>

³⁹ Project Greenleaf. Source: Corey Clothier US agent Navia supplied by France’s Induct. (810) 599-6299 or coreyclothier@gmail.com

⁴⁰ <http://www.theguardian.com/technology/2013/nov/07/driverless-cars-coming-to-milton-keynes>

⁴¹ <http://www.telegraph.co.uk/motoring/news/10484839/Large-scale-trial-of-driverless-cars-to-begin-on-public-roads.html>

⁴² www.innoventure.com



Figure 13. Self-driving Cars in Europe

Note: The European Commission has supported demonstration of self-driving cars, such as these in La Rochelle, France.

Source: Trans.21.

A decade ago, prototype robocars operated in several European cities. Publicity about resourceful firms with innovative accomplishments such as Google is raising awareness about the coming reality of robocars. Among urban transportation planners, this raises the possibility that local circulation needs can be satisfied with driverless fleets. This can best happen in settings where rapid vehicular traffic is excluded. In such settings, local traffic volumes are often minor and can be further tamed by street management measures. In such settings, high-quality local transit can be provided without costly guideways, which are often perceived as visual and environmental intrusions. Guideway-less ATN has a more interesting business case.

Robocars in local service are most likely to be battery powered. This limits range and speed. If battery-powered road vehicles can be introduced onto exclusive guideways for longer-distance travel at higher speeds, batteries can also be recharged from the guideway. The implications of dual-mode transit (DMT) are vast. Many find them very promising and well suited to America's love of low-density living.

However promising DMT may be, a detailed assessment is beyond the scope of this report. It is worthy of analysis and is mentioned among other desirable research projects in the chapter on Challenges and Opportunities.

V. PLANNING PARAMETERS

INTRODUCTION

Urban and regional planners and economic developers, especially those who are part of or that collaborate with an MPO, all must engage in spatial thinking. They coordinate data geographically by zones – population, employment, trips, etc. This chapter presents information on the physical dimensions of the various components of an ATN project to provide the planner guidance for network configuration.

Guideways and stations are the two prominent and highly visible parts of an ATN system, which must be configured to fit into urban environments that can range from dense, congested districts to open suburban sites, from institutional campus and airport districts to greenfield sites.

To integrate ATN into such settings, transportation infrastructure engineers and urban designers must expand from a two-dimensional perspective into the third dimension. Highways, parking structures, and transit systems all have vertical aspects. Their designers work in plan, profile, and section views. This is likewise true for designing the various elements of an ATN system. The vertical dimensions of stations and guideways must be placed within a dynamic urban context. For planning teams, this is challenging and pivotal to approval of a project.

When planners forecast passenger loads, the vehicle is a significant part of an ATN system. However, the vehicle itself is less important to those configuring a network of guideways and stations. The siting and design of the maintenance facility and control center are seldom problematic because they can be located anywhere along or at the periphery of the network without affecting service.

The design of stations and guideways is impacted by the choice of suspended versus supported vehicles. Suspended-vehicle systems have different envelope requirements, especially if the vehicle swings away from hanging vertically, extending into adjacent space as it rounds curves. This is a dilemma for the planner because the choice of which technology to use may not have been made at the time when routes are being defined. The result can be that only supported-vehicle systems are considered.

The planner's task of altering the placement of guideways in the vertical dimension during the initial network planning is facilitated by significant grade-climbing and -descending capabilities. Because ATN vehicles can typically ascend and descend gradients of at least 10% (with some claiming up to 30%), the length of transition areas to take an elevated guideway to grade or underground is much shorter than conventional rail vehicles. For conventional rail transit, the maximum grade is two or three percent, and ideally zero (horizontal). Table 1 presents minimum guideway radius of curvature and maximum slope for a sample of ATN suppliers that responded to this study's queries.

Table 5. Design Parameters Affecting Guideway Configuration

Supplier	Min. Headway, s	Deceleration, m/s/s	Min. Guideway Radius (C.L.), m	Max. Slope, %
2getthere	5 in service, 2.5 possible	1 normal, 4.7 max	5.5	10
Beamways	3 initial, 2 planned	5	3	30
Bubble Motion	< 1	-NA-	5 initial, 3 planned	any, via three modes
Cybertran	-NA-	0.25	23 to 910*	10
PRT International	0.5	8	15	10+
Skycabs	6	per ASCE PM std.	8	20
Skyweb Express	0.5	-NA-	~11	15
TriTrack	1.9 per guideway	6.7	-NA-	10
ULTra	6 in service, 2 possible	0.5 typical	5	10
Vectus	3 to 4	2	20 in Suncheon, 5 possible	10

* Large radius is for high-speed intercity networks.

In general, ATN parameters offer noteworthy flexibility to guideway planners as they determine elevated, near-grade (Figure 14), or underground placement. Underground segments are more expensive to construct, but they make possible minimal, less costly surface stations, and they provide energy efficiencies with up-grade deceleration and down-grade acceleration (Figure 15). Stations can also be installed within buildings at grade or at mezzanine levels. (See also Figure 28.)

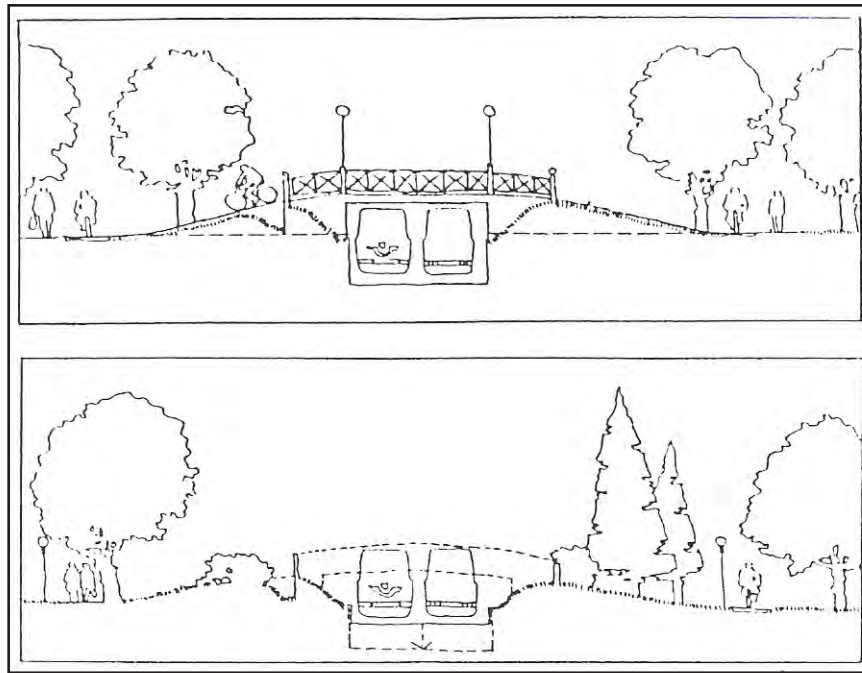

Figure 14. Near-grade Guideway Placement

Note: With modern security enhancements, near-grade guideway placement is possible.
 Source: Swedish KFB, Trans.21 archives.

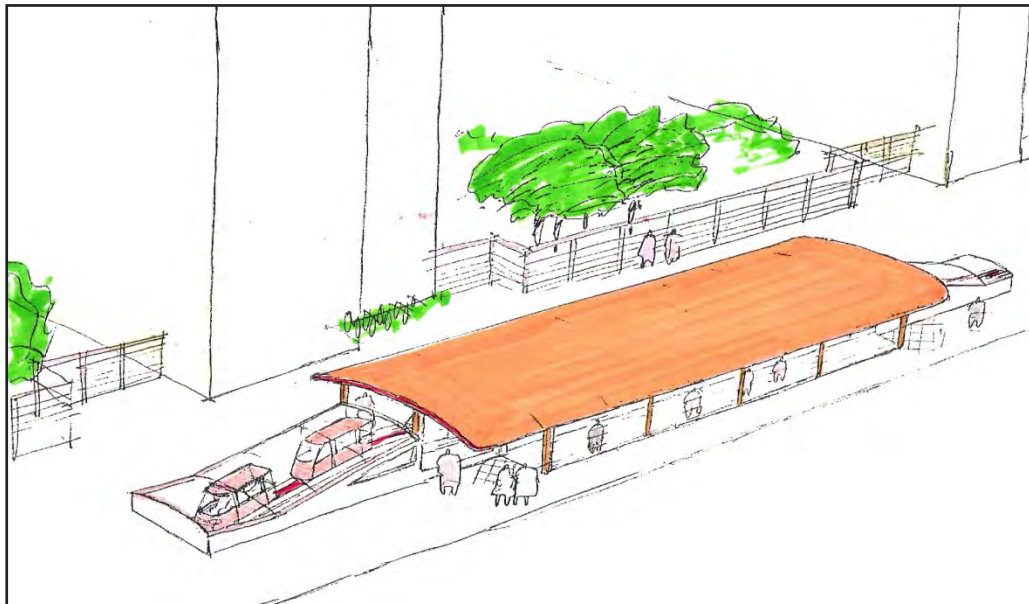

Figure 15. At-grade Stations for Underground Guideway Segments

Note: Stations along underground sections can be at surface levels, costing less and saving energy.
 Source: Swedish KFB, Trans.21 archives.

Compared with conventional rail, ATN guideways and ramps can be designed with smaller turning radii. This similarly makes insertion in urban environments more flexible. Data on turning radii and other parameters from those suppliers who responded to requests for information is presented in Appendix 2.

OVERVIEW OF ATN PLANNING

For an industry that is barely established, ATN has a relatively long history, with the first project coming on line in 1975 (See also Appendix 1). The concept was first described by Donn Fichter in the 1950s. The Aerospace Corporation undertook important work on the topic from 1968 to 1976 (Irving 1978). A number of studies and even implementations of ATN-like systems took place in the 1970s and 1980s. As described in Chapter 2, the known ATN (or ATN-like) projects presently in public operation include:

- Morgantown, WV, U.S., 1975
- Rivium, Rotterdam, The Netherlands, 1999
- Masdar City, UAE, 2010
- Heathrow International Airport, U.K., 2011
- Suncheon, South Korea, 2013

Other known publicly available ATN planning projects undertaken in the last 20 years include those by: BRW 1997; Raney 2003; Raney, et.al. 2007; Buchanan 2007; Carnegie and Hoffman 2007; Sinclair 2008; Young 2009; PRT Consulting 2009; Redfors 2009, C&S Companies 2010; Gannett-Fleming 2010, Kimley-Horn 2010, Paige 2012; Arup 2012.

Many of the above planning documents express concerns regarding the technical capabilities and scalability of ATN systems, along with the capital and operating costs of ATN systems.

ATN NETWORKING PRINCIPLES

For an ATN to be developed into a serious implementation, stakeholders must understand it as one of several options in a specific setting. These modal scenarios will be compared one to the other and assessed for their effectiveness in meeting the broader transportation and development goals (such as reducing congestion, or allowing traffic-exacerbating growth). This, of course, takes place within constraints imposed by the existing conditions in the project service area and the availability of funds.

This section describes four ATN configuration characteristics that differ significantly from other forms of guideway transit. First, it is a network, not a line or even a set of lines. Second, the placement of stations is extremely flexible. Third, the capacity of a station is a variable – often quite small. Finally, guideways can be flexibly conceived and designed in three dimensions.

Corridors vs. Networks of Guideways

Almost all conventional fixed-guideway transit operates in corridors with two-way track. Station spacing is constrained because of a design dilemma or conflict: two tendencies

fight with each other. One tends to have many, closely spaced stations to enhance system coverage of trip generators. The other tendency is to minimize their number to maximize service speed for passengers. Thus, stations are limiting and limited. Another characteristic of stations in conventional line-haul rail is that all stations are uniformly large. As shown in Figure 16, an ATN plan is actually a concatenation – the piecing together of segments in ways that can be flexibly connected.

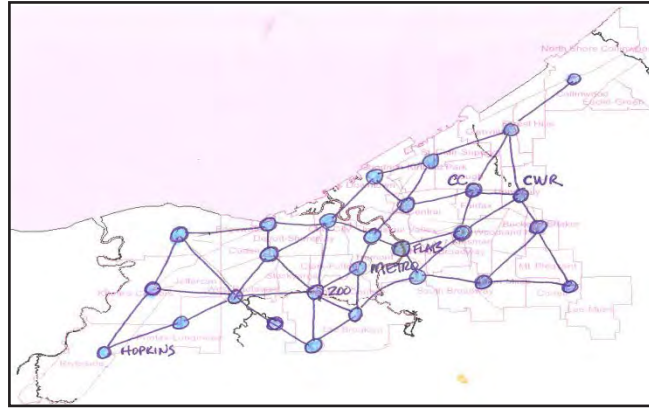

Figure 16. A Concatenated Network for Cleveland, OH

Source: Trans.21.

ATN can provide two-way corridor service, as is evident in the Morgantown PRT. However station and intersection geometries become relatively complex, eliminating some of the savings gained by having one segment of guideway supporting two tracks. Configuring the guideways as a series of one-way loops may be less expensive and allow more coverage of the city. The cost savings from two-way track may be offset by the added complexity of installing stations.

For planning purposes the cost of an ATN system is roughly proportional to the length of one-way track, almost regardless of whether it is installed as a two-way corridor or a set of one-way loops. The cost-effectiveness of loops with greater station coverage will usually disfavor corridors. For example, consider a two-mile long corridor with two-way track and a station every half-mile. Five stations are served by four miles of track, thus the five-station system has 20 station pairs ($5 \times 4 = 20$). If the two-way track were separated so there was one half-mile between each track and there were connecting tracks every half-mile forming a looped network (Figure 17), there would be 6.5 miles of track (an increase of 62.5%). If there were a station at each node, there would be ten stations (an increase of 100%) and 90 station pairs (an increase of 350%).

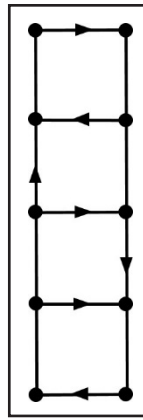

Figure 17. Looped Network

Passengers perceive out-of-vehicle time at about twice the value of in-vehicle time (Kittelson & Associates, et.al. 2007). Facilitating access to stations and minimizing wait times are key goals of all transit planning. If ATN guideways are spaced about one-half mile apart and stations are placed at about one-half mile intervals, the walking time to a station will typically be less than five minutes for the area covered by the network. In summary, advantages may appear in an ATN system laid out like many metropolitan bus networks – that is, ATN in a two-way guideway corridor. Unlike buses, however, ATN vehicles travel nonstop, bypassing stations that are not their destinations.

Networks that are formed by joining a series of loops with no overpasses are called merge/diverge networks because, at each intersection, a merge precedes a diverge. The link between a merge and a diverge becomes a bottleneck because it carries the traffic from both of the preceding links. Observe that trips from top to bottom and right to left in Figure 18 share two links.

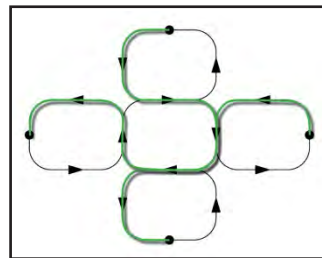

Figure 18. Merge/Diverge Network

Networks that have grade-separated intersections, as illustrated in Figure 19, are called diverge/merge networks. Here a diverge precedes a merge, and the intersection itself does not become a bottleneck. The extra cost of the grade separation and the turning ramps in these networks is, at least in part, offset by the less circuitous routing, which results in shorter trip times and the need for fewer pods.

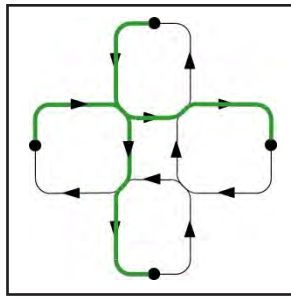

Figure 19. Diverge/Merge Network

Figure 20 shows an alternative merge/diverge layout that has three advantages over the layout shown in Figure 20. The routes are less circuitous, and empty vehicles returning to the station of origin (e.g., going south to north) do not traverse any of the same links they previously traveled (e.g., going north to south) – reducing link overload. Finally, this layout could more easily be converted to a diverge/merge layout at a later date at key intersections.

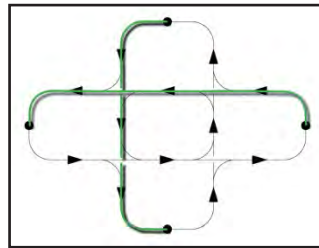

Figure 20. Alternative Merge/Diverge Layout

Station Placement and Sizing

The spacing and sizing of ATN stations is very different from conventional rail, in which all stations must accommodate the train length along the entire corridor. ATN stations operate off the main line and are sized to the volume of passengers and vehicles that planning studies have determined. Compared with conventional rail, ATN stations are small, and many of them may be very small – similar to bus shelters rather than to a rail station. Two possibilities for a simple, single-siding station are shown in Figure 21.

Station bays can be in line (a) with each other (series), offline (b) from each other (parallel), or in a combination. In very lightly trafficked areas, it may be frugal to have even more minimal inline stations.

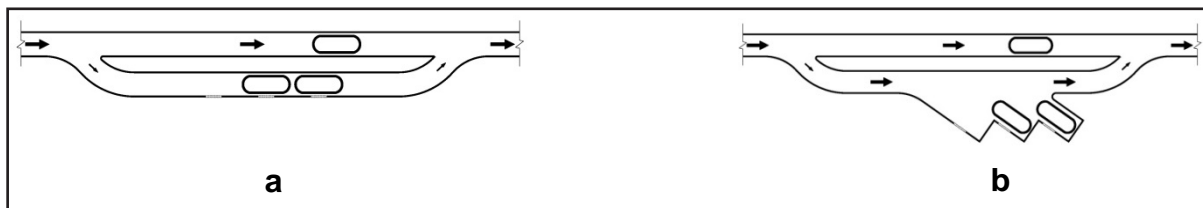

Figure 21. ATN Station Bay Configurations

In places where higher station throughputs must be accommodated, more bays can be added (Figure 9). Even more potent for high-capacity stations is the addition of parallel sidings, but they come with significantly increased costs due to the need for vertical passenger circulation. Indeed, a station could comprise multi-levels – such as at an airport. These design issues have not been explored and are worthy of more study. Stations with very high capacity can be designed, although they will require more space and budget.

Inline station bays tend to have shorter in-station vehicle dwell times, but they could suffer if a vehicle is delayed in the station, thus blocking it. The number of offline station bays in a station is limited to the extent in which vehicles backing out of bays interfere with others⁴³. Figure 22 shows how vehicle backing can be avoided, but this requires a somewhat longer platform (Lowson 2007).

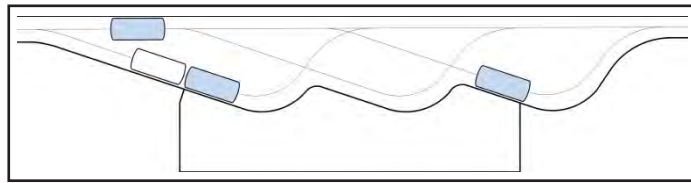

Figure 22. Offline Bays with No Reversing Required

Figure 23 shows a layout for a nine-bay station combining the in-line and offline bay concepts and providing significant empty vehicle storage to accommodate a surge of passengers. Note that, as in Figure 22, some ATN configurations may not be able to accommodate the guideway crossings shown.

The Heathrow Airport and Masdar City ATN applications both have offline station bays, while the Suncheon application has in-line bays.

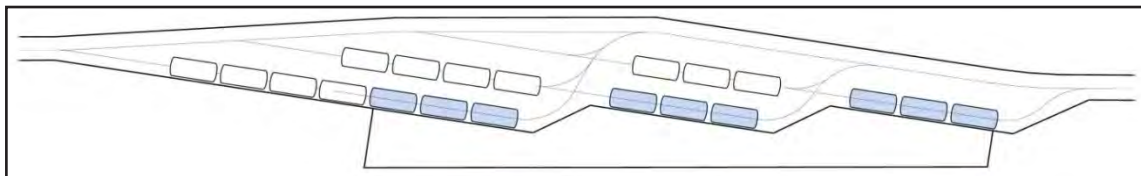

Figure 23. Large Series/Parallel Station

Station platform sizing and layout considerations are similar to those for other transit systems. Planners should consider the desired level of service to be provided and space for way-finding maps, ticketing, and other desired amenities. Determining the expected crowd size of waiting passengers typically requires system simulation, which is beyond the scope of this chapter.

Way-finding map requirements for ATN are simpler than those for conventional systems, which often require transfers. All the passenger must know is the name or number of his or her destination station, with no need for a route map or schedule. Once passengers arrive

⁴³ The late Professor Martin Lowson patented an improved offline station bay layout in 2007 or earlier.

at their destination, they can be re-oriented by way of an area map showing landmarks around the station.

Destination selection kiosks can be mounted adjacent to specific bays, helping the passenger to know which vehicle to use. Alternatively, the destination could be selected as part of the ticketing process or made once inside the vehicle, as in an elevator.

Automated platform doors synchronized to open and close with vehicle doors (and not to do so when no vehicle is in the bay) have been provided on all three modern ATN applications. It should be pointed out that such doors are expensive to install and maintain. The Morgantown PRT does not have platform doors and has operated injury-free for over 35 years. The ASCE Automated People Mover Standards (ANSI/ASCE/T&DI 2013) allow many options to protect the platform edge other than platform doors.

In addition to considering the configuration of station elements, the planners and stakeholders must consider how many stations to provide and where they should be located. This, of course, will impact the traffic forecast for each one. The planning process should also explore how stations can be connected to adjoining infrastructure and whether they will function better at ground level, below-grade, or joined to upper levels as desired by the building owner.

ATN stations can be added without slowing through-traffic. Major considerations for station spacing are the location of trip generators, the feasibility of new development near the station, and parking supply. Any given station can be sized to meet forecast use, but adding another station or two may better meet the demand. Station ramps can begin to interfere with each other if stations are too close. One strategy is to have a guideway siding serve more than one station.

Station vertical circulation is a significant issue because stair climbing is an impediment to passenger use. Elevators and escalators are expensive and require maintenance. Stairs and elevators take up space and are difficult to navigate with baggage and are prone to causing slip/fall accidents. At-grade stations are thus desirable, but they require space that is often not readily available. One compromise is to provide a partially elevated station (Figure 24a). Another is to attach the station to a suitable building (Figure 24b), such as a large commercial building perhaps with a second-floor food court. The ATN passengers then utilize the building's vertical circulation systems while enhancing business opportunities.

Note that the relative absence of noise and vibration in an ATN system is conducive to attaching stations to buildings or even locating them inside buildings. Stations inside buildings require guideway penetration of the interior space and should generally be avoided unless the system is needed to provide circulation within the building. Utilizing the station platform doors to separate the conditioned air from the outside air is an efficient solution.

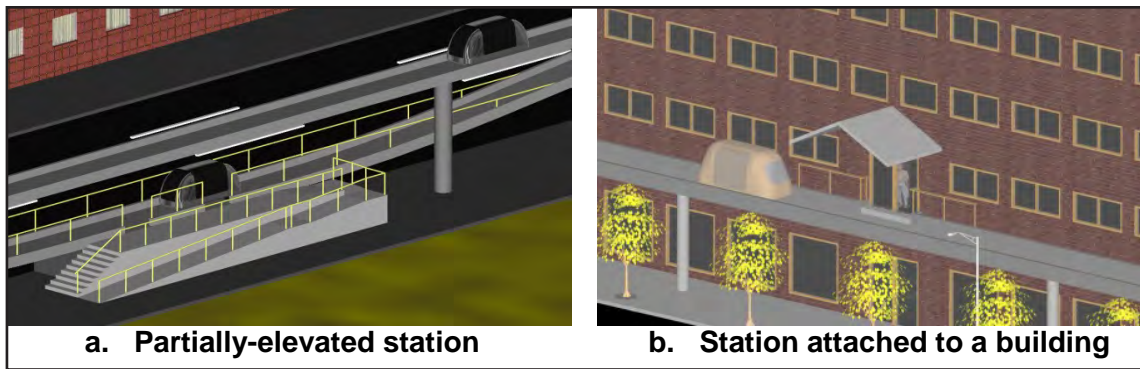

Figure 24. Station Options

An-elevated station (Figure 11) can have a footprint consisting only of the support column footings and the land-take of the stairs and elevator. Stations such as this with distinctive architecture can facilitate passengers' visual location of the nearest station. Figure 25 is a good illustration of the minimal surface right-of-way required by guideway columns, which is discussed in the next section.

Station Capacity

The capacity of an ATN station depends on a number of factors, including:

- Average vehicle occupancy for arriving vehicles
- Average vehicle occupancy for departing vehicles
- Number of bays
- Bay configuration (in-line or offline)
- Vehicle dwell time in station (maneuvering time, plus door opening time, plus unloading time, plus loading time, plus door closing time, plus maneuvering time).
- Delays due to other vehicles, including waiting for a bay to open up
- Delays waiting to enter the main guideway

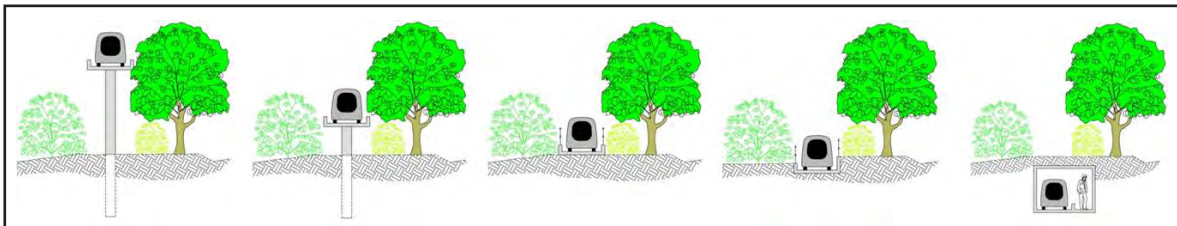

Figure 25. ROW Footprint of ATN Guideway Placements

All these factors tend to interact with each other in fairly complex ways; computer simulation is considered the best way to determine station capacity (Daszczuk, et.al. 2013; Castangia and Guala 2011). For preliminary calculations, assuming a 5 mph station speed and an average 30-second dwell time can be used to calculate approximate station capacity – provided that consideration is given to delays caused by vehicle interactions. One bay with a 30-second dwell time and average vehicle occupancy of two passengers will thus be able to process four passengers per minute or 240 per hour.

Station design must consider all elements including ramps that connect the station bays to the main guideway, platforms that provide pedestrian access to vehicles in bays, and the means to access station platforms such as walkways, stairs, elevators, and/or escalators. Knowing the station passenger demand, planners can design platform access no differently than they would for any transit platform.

Platforms are sized to adequately accommodate the required number of bays. This gives the length of platform required (i.e., straight for series bays and saw-tooth for parallel bays). The platform area is determined by conventional planning methods based on the maximum crowd size and the desired level of service. With cost penalties, higher station capacity can be achieved with parallel sidings at the same level, requiring space and expense for vertical circulation. In theory, it is possible to further increase station capacity by adding levels of sidings and their bays in the third dimension.

Guideway Placement

Guideways can be placed at grade, elevated slightly or fully, below grade and protected, or fully underground (Figure 25). ATN guideways typically must be separated from crossing pedestrian or vehicular traffic (Rivium and Masdar being exceptions, but also in many low-speed driverless applications) and are therefore usually above or below grade. However, capital costs for elevated systems tend to be about three times those for at-grade systems, and below grade systems tend to cost about three times that of an elevated system or nine times that of an at-grade placement.

Considerations for Suspended-Vehicle ATN

Two primary options are available for the guideway/vehicle interface:

- Supported (the guideway is under the vehicle, supporting it from below)
- Suspended (the guideway is above the vehicle, supporting it from above)

Supported systems have two further options:

- Open guideway (the vehicle steers itself)
- Captive bogey (the guideway steers the vehicle)

The envelope requirement varies between the two options.

Some ATN designs electrify the guideway so vehicles draw power from an outside source – either a larger grid or solar collectors incorporated into the guideway and station infrastructure (e.g., Morgantown, Vectus, and Cabintaxi). The ATNs at Rivium (Figure 26), Masdar City, and Heathrow Airport use power from on-board batteries, which eliminates the need for guideway electrification. Vehicles in these installations are also not captive within the guideway. The vehicles at Rivium and Masdar City rely on magnets imbedded in the pavement for guidance. The system at Heathrow Airport uses lasers to sense sidewalls for lateral navigation assistance and gaps in the sidewalls for longitudinal navigation assistance.



Figure 26. Open Guideway System (Rivium Metro Shuttle by 2getthere)

Vehicles having captive bogey systems (Figure 27) draw power from the wayside (third rail) and therefore have unlimited range, but they also tend to have difficulty achieving tight turning radii⁴⁴.



Figure 27. Captive Bogey System (Vectus)

All suspended systems are, of necessity, captive bogey systems. They have an inherent advantage in that the guideway automatically provides weather protection to the bogey. In addition, the vehicles automatically bank themselves through curves (although damping of this movement is also required), thereby enhancing passenger comfort. Another major

⁴⁴ The Vectus website claims a 17-foot radius, but its Suncheon project appears to use a minimum radius of about 65 feet.

advantage is the potential to navigate steep grades while keeping the cabin level and allowing at-grade stations (Figure 28).



Figure 28. Suspended System (MISTER)

Note: The rendering illustrates how a suspended system could be configured with an at-grade station.

Source: http://www.mist-er.com/images/Wiz_02_02_web.jpg

Disadvantages for suspended vehicle ATN stem from the need for taller, eccentrically-loaded guideway columns and the possible need to provide emergency walkways. These systems are well suited to incorporate solar panels above the vehicle.

The PRT development program undertaken by Cabintaxi in Germany in the 1980s incorporated guideways that simultaneously accommodated supported and suspended vehicles (Figure 29). They claimed this was highly efficient even though it required two different vehicle designs, and every station required two levels.



Figure 29. Cabintaxi Supported and Suspended Vehicles

Captive bogey systems (supported or suspended) that have unlimited range and the ability to achieve higher speeds are well suited for widespread urban transportation use, feeding other transit systems and competing with buses and, potentially, rail-based systems.

Superelevation of Guideways and Other Configuration Considerations

Key factors in guideway geometric design are horizontal and vertical curvature and guideway gradients. The basic design parameters are no different from those for other forms of surface transportation. Horizontal curves are defined by their radii, gradients are defined by the percent rise or fall per unit of distance, and vertical curves are typically parabolic and defined by their length and the approach and departure gradients.

From an aesthetic standpoint, large-radius horizontal curves are desirable but can be more expensive to construct. Short-radius curves limit the speed that can be used. Superelevation (banking) of the guideway will slightly increase the allowable speed. Table 6 provides the radius for a given speed with and without superelevation while limiting lateral acceleration to 0.25 g (the maximum permitted by the APM Standards).

Table 6. Required Radius for Guideways as a Function of Superelevation

Speed (mph)	Radius for Specified Superelevation (in feet)		
	0%	5%	10%
5	7	6	5
10	27	22	19
20	107	89	76
30	240	200	171
40	427	356	305
50	667	556	476

To minimize lateral jerk, horizontal curvature and any associated superelevation should be introduced gradually. The transition length required for this introduction increases with speed and is often facilitated by the use of spiral curves at each end of each horizontal curve. Spiral curves (and probably superelevation, as well) are less necessary for low-speed systems. This is particularly true for open-guideway systems in which vehicles will naturally provide some transition by wandering slightly at the entry and exit from horizontal curves. It should be noted that Ultra chose not to superelevate its guideways at Heathrow, and neither the Masdar nor the Suncheon systems appear to have incorporated superelevation.

Guideway gradients are typically defined more by passenger comfort than by system capability. Most systems claim they can achieve 10% gradients, which is the gradient commonly accepted as maximum for passenger comfort. However it must be understood that power capabilities and cooling requirements may limit the speed at which steep grades can be climbed and/or the length of gradient that can be negotiated. Similarly, emergency braking and minimum headway requirements may limit the speed on down gradients.

Vertical curves are necessary wherever the guideway gradient changes unless the change is small and the speed low. Long vertical curves will improve aesthetics, as will containing vertical curves within horizontal curves. However, the resulting complex curvature is likely to result in increased guideway costs. Short vertical curves can impede the ability of a vehicle to sense the vehicle ahead or any objects on the guideway (not a requirement

for all systems). For this reason, highway standards for vertical curves, which account for stopping sight distance, are probably applicable to most ATN systems. Since this is a fairly complex system-specific topic, more appropriate to design than planning, it is not addressed further here.

The columns that support ATN guideways can be as small as two feet in diameter and are typically spaced 50-100 feet apart. Larger spans are possible but are not as cost effective. When road vehicles can accidentally impact columns, they must be larger or protected at the height of impact to withstand potential collisions. Guideway footings can be designed to incorporate benches and planting areas. They can be themed to their urban contexts and incorporate local artwork.

Station Ramps

Station ramps serve to transition vehicles from full speed on the main guideway to speeds on the order of 5 mph in the vicinity of vehicle bays. Ramps can provide vehicle-holding areas. The design should allow vehicles to maintain full speed until after they have left the main guideway and to regain it before they rejoin the main guideway⁴⁵.

On a level guideway, full deceleration from 25 mph (or acceleration to 25 mph) will require about 100 feet, using allowable rates of jerk and deceleration specified in the APM standards for seated passengers. A reasonable guideline would be to add length to accommodate half as many vehicles, temporarily stopped on each of the off- and on-guideways, as there are bays in the station.

Guideway Capacity and Speed

ATN capacity must be understood not along a line, as in conventional rail, but as a network. With conventional rail, blockage of any line closes down the entire line. The blockage of any segment of an ATN does not shut down the entire network. Similarly, network capacity can be increased by adding new links in the network.

Two primary factors determine theoretical maximum capacity – minimum headway (time between vehicles) and vehicle passenger load. The architecture of the ATN determines its network capacity. As indicated above, opening alternative paths can relieve congested links.

In general, planned capacity should be less than the theoretical capacity for two reasons. Typically, each vehicle is not fully loaded. Secondly, 100% guideway slot occupancy is not possible or practical.

Minimum headways are required for safety reasons. Because ATN vehicles typically travel on exclusive guideways, they are protected from colliding with crossing traffic or pedestrians. Minimum headways are imposed to protect them from colliding with each other. A criterion developed to prevent trains from colliding with each other, called “brick

⁴⁵ Robert Whitten of Alden Self-Transit Systems Corp. studied the feasibility and benefits of allowing deceleration to start on the main guideway in the 1970s in a contract with the Volpe Center. However, for safety reasons, some open-guideway systems may require reduced speeds at diverges.

wall stop” or BWS, has been applied to automated vehicles and ATN systems (American Society of Civil Engineers 2013). Under this criterion, a vehicle must be able to stop without hitting the preceding one if the predecessor comes to an instant stop (i.e., instantly becomes a “brick wall”). The result of applying this criterion is that an ATN system with a maximum speed of 25 mph will have a minimum headway of about three seconds, while one with a speed of 40 mph will achieve a minimum headway of only about four seconds. Essentially, the BWS criterion applied to higher speeds leads to lower capacities, thus it imposes quite significant restrictions on ATN capacity and speed. Group rapid transit (GRT) systems achieve high capacity by utilizing larger vehicles that require extensive ridesharing and often also require intermediate stops. Many ATN proponents argue that BWS should not be applicable to automated systems with high reliability and safety standards. If ATN is not required to comply with BWS, headways as low as one second at speeds as high as 60 mph are probably possible. This would then allow high-speed operations at three or four times the capacity that would result if BWS is adhered to. This is a very important distinction and an indication of future ATN capabilities.

Shorter headways are indeed possible. Cars on highways often travel at one-second headways. The Japanese Computer-controlled Vehicle System (CVS) R&D program demonstrated half-second headways on a test track in the 1970s (United States 1980; Ishii, et.al 1975). Most ATN developers and designers assume or have developed short headway capabilities. Planners of near-term ATN implementations should use headways and speeds judged proven by the Advanced Transit Association (ATRA n.d.) as listed in Table 7:

Table 7. Headways and Speeds for Several ATN Systems

System	Headway, sec	Speed, mph
2getthere	5	25
ULTra	6	25
Vectus	3 – 4	43

A minimum headway of three seconds means that vehicles pass a fixed point on a guideway once every three seconds. This would result in a theoretical capacity of 1,200 vehicles per hour. However, systems with asynchronous control, which merge by maneuvering individual vehicles just prior to the merge point, should not be designed to 100% capacity on any link. Any extra demand would result in merge conflicts, which would cause backups on the guideway – an undesirable situation. Unless other mitigating measures are in effect, such systems are usually designed to stay within 70-75% of their theoretical maximum capacity (of vehicles on one guideway link). Synchronous (or clear path) control systems, on the other hand, can accommodate links that are filled to capacity. On such systems, any additional demand results in backups in stations – a slightly preferable situation because passengers can choose to leave the station, negotiate to share rides, or simply wait a while⁴⁶.

⁴⁶ The Aerospace Corp. report on the feasibility of ATN for the City of San José (Paige 2012) emphasized that service delays become exponentially worse as the system is more heavily loaded: “An ATN system must be designed such that it possesses capacity adequate for smoothly servicing peak expected demand and, when doing so, be operated at some fraction of this maximum; this to account for variability in operations.” (p. 129)

Capacity and Load Factors

Best practices have assumed that ATN vehicle occupancy is based on the size of parties travelling together. There are many ways in which individuals and/or parties can be encouraged to share rides:

- Common courtesy
 - Users of the Heathrow and Masdar PRT systems have been found to hold the doors for others just as they would when entering an elevator. This has been found to effectively increase capacity by as much as 100% during peak periods.
- Pay-per-vehicle
 - Sharing both the vehicle and the cost reduces everyone's fare.
- Backups in the station
 - If the system causes people to wait in the station, they will naturally attempt to share rides to common destinations. This is particularly true if travelers desire only a few major destinations.
- Organized ridesharing
 - The Morgantown PRT (Figure 30) operates by assigning a destination for each vehicle waiting in the station. It delays departure until vehicles are sufficiently full or until approximately five minutes have passed.
 - Johnson 2005, Andréasson 2005, and Muller, et.al. 2012 have each proposed alternative ridesharing methodologies that can be applied to increase vehicle occupancy.



Figure 30. Morgantown PRT

Note: Ride-sharing strategies are incorporated into PRT operation.
Source: Trans.21.

Transit systems are often compared on the basis of guideway capacity. This simple comparison is satisfactory for comparing systems that have similar guideway costs and space requirements. However, ATN guideways can cost as little as one-quarter the cost of other guideways and occupy less than one-half the space. A further consideration is that ATN systems often can be more effectively deployed in a network rather than in a corridor. Comparisons that consider only guideway capacity are thus almost always misleading.

Network Capacity

For network capacity determination, consideration is given here to the interaction among numerous guideways and stations. Manual calculations are possible but quickly become complex. Therefore, computer simulation using software specifically developed for ATN is recommended. CityMobil uses a simple simulation tool that was developed in cooperation with Ultra Global and is publicly available⁴⁷. It is critical to consider the impacts of empty vehicle management in an ATN. These impacts can vary significantly, particularly with layouts of the merge/diverge type (Figure 18). Empty vehicle management algorithms vary from supplier to supplier. Good algorithms will reduce wait times while avoiding unnecessary empty-vehicle movement. This is important because a system that has low average waiting times while leaving a few people stranded for long times would probably be unsatisfactory. This also would be true for a system that had many empty vehicles roaming the guideways looking for passengers.

Control System Primer

While onboard switching is the key to offline stations and short headways, the control system enables the ATN to function with no human intervention (controllers act primarily as observers), though all systems have control room, an example of which is shown in Figure 31. This section helps a planner understand aspects of control systems that can influence system capabilities and design⁴⁸.

⁴⁷ <http://www.ultraglobalprt.com/about-us/library/ultra-simulator/> Caution should be used to understand the limitations of this software and the assumptions made regarding its operating parameters. However, it does account for empty vehicle movement and is useful for quickly laying out networks and approximating their operations.

⁴⁸ A brief primer on vehicle control can be found in (Szillat 2001).



Figure 31. ATN Control Room at London Heathrow Airport

Note: Control rooms enable personnel to observe operation of the system and resolve events.

Source: ULTra PRT: http://www.ultraprt.net/cms/f10_control_room.jpg

Safety is the paramount goal. A primary function is to prevent vehicles from colliding with each other. This is accomplished by protecting a block of space around each vehicle. Fixed-block systems define fixed areas of the guideway. Vehicles are sensed as they move from one block to another, and no vehicle is allowed to enter an occupied block. Moving-block systems define a block behind each vehicle that is kept free of other vehicles and change the size of the block depending on vehicle speed. Minimum headways will typically decrease for moving-block over fixed-block and dynamic moving-block over moving-block.

The other primary function is to move the vehicles around the network in an organized manner, transferring passengers from points A to B. Two different approaches are available: synchronous and asynchronous. In synchronous (or clear path) control systems, vehicles follow imaginary points in time/space as they move around the guideway. These points typically travel at a fixed time spacing equal to or greater than the minimum allowable headway. Before the vehicle leaves the station, the central control system finds a clear path for it defined by a moving point that will travel from trip beginning to end through merges and diverges without ever conflicting with another moving point that has a vehicle assigned to it. The clear path may include reserving a station bay at the destination station, which is difficult to accomplish at the beginning of a long trip. An alternative is to plan for the station to be likely able to receive the vehicle and to have a means to wave off the vehicle (after it has entered the station guideway) in the unlikely event there is no room for it. Vehicles that have been waved off will usually circle around for another attempt. When a link reaches capacity, no additional trips can be accepted for it, and any vehicles planning to pass through it are held in the station

Asynchronous control systems are analogous to cars on a freeway: they leave the station with no pre-planning and adjust speeds at merges as necessary. Similar to a freeway, traffic jams can form at merges unless the system has a method to meter the traffic. If a vehicle arrives at a station that has no room for it, it is waved off before it enters the station guideway.

ATN control systems also can be synchronous/asynchronous hybrids. It is possible to have asynchronous control on the guideways and synchronous control in station areas. Also synchronous control systems can approach asynchronicity by having vehicles slide backward or forward to adjust their position at strategic times.

In general terms, asynchronous systems are likely to have more distributed control systems that are readily scalable. On the other hand, jams that may occur on the guideway are undesirable.

Synchronous control systems also are problematic in that merges must be reserved in advance, and the more merges that are necessary, the less available they become. However, taking into account that merges are less booked-up the further away they are in time, and allowing a vehicle to slip back up to two slots in any one link, it has been found that up to 14 merges can be reserved in a reasonable time period (PRT Consulting, unpublished).

Synchronous systems likely deal with partial or total system shutdowns and subsequent restart less easily than asynchronous systems. A significant advantage is that, when overloaded, backups occur in stations rather than on guideways. Passengers stranded in stations have many options, such as sharing rides (automatically increasing system capacity), using alternative modes, or simply engaging in other activities during the wait time.

Scalability

ATN systems are typically laid out in a series of one-way loops, so it is apparent that they should be readily scalable simply by adding more loops. Most systems are designed with distributed controls that facilitate expansion. However, controlling thousands of vehicles simultaneously on hundreds of miles of guideway among hundreds of stations has never been demonstrated, and potential owners should investigate the scalability of ATN systems they are acquiring.

Fortunately there is a relatively easy solution, should a system prove not to be sufficiently scalable. Because transfers between PRT systems can be seamless (cross-platform walk followed by a wait of typically less than a minute) – unlike a transfer between buses – it will usually be acceptable to expand one PRT network with another by a different supplier. The ability to do this could also alleviate concerns of being locked into one supplier for an entire citywide network.

Aesthetics

Visual intrusion is often cited as a detriment of ATN systems and should be considered in the planning process. There are four different approaches that can be taken to mitigate visual intrusion:

1. Embrace it, and make the system an iconic feature of the environment
2. Blend the new infrastructure into the existing (Figure 32)

3. Avoid sensitive view-scapes – route guideways down back alleys
4. Find the means to put sensitive segments underground

Elevated ATN structures are much smaller than those of conventional rail transit systems, but they potentially have the disadvantage visually of being more widely implemented. Different ATN systems require differently sized structures at different elevations. Smaller infrastructure that is at a higher elevation will tend to be less obtrusive from the ground. However, appearance from ground level is only one consideration. The view and field of view from the vehicles must also be considered, as well as those of non-passengers along the corridor. ATN has the potential to provide passengers a previously unseen view of the service area. This could provide a wonderful experience or glimpses of undesirable features, such as automobile junkyards. In addition, the ability of passengers to see into private backyards or bedroom windows must be considered and potentially mitigated by switchable electric frosted glass in the ATN vehicle.

ATN guideways can be designed for aesthetic appeal, and attention to aesthetics will help gain public acceptance of the system. However, beauty is in the eye of the beholder, and issues regarding visual intrusion are likely to be raised. The planner is cautioned to address this topic early in the planning process with visuals and polling the public for their preferences. In this way, concerns over visual intrusion can be addressed and mitigated.



Figure 32. Blending ATN Guideways into Existing Infrastructure

Note: The figure shows a rendering of a guideway in an urban setting.

Source: Skyweb Express

Capital Costs

While three modern ATN systems have been built and brought into public operation, not much cost information is generally available. Costs will vary greatly based on the system's capacity and the installation environment. Costs can be decreased if portions of the system can be placed at grade, but they would increase if portions were required to be underground. For medium-capacity applications, system and major civil costs of \$10-

\$20 million per elevated one-way mile appear to be reasonable (Figure 33). This includes guideways, stations, vehicles, maintenance/storage facilities, control systems, etc., but it excludes external costs (utility relocations, right-of-way acquisition, special artwork, etc.). Kerr, James, and Craig in 2005 found that ATN infrastructure per mile costs about one-third of that for APM, and ATN stations cost about one-half of that for APM⁴⁹.

URBAN INTEGRATION

Most urban ATN projects involve retrofitting the system into existing urban fabric and community life. Each station typically will be in a unique environment, demanding attention to details from planners. This includes consideration of pedestrian and vehicular access and ancillary facilities such as parking. Zoning and building massing around the station should be coordinated in line with established TOD guidelines.

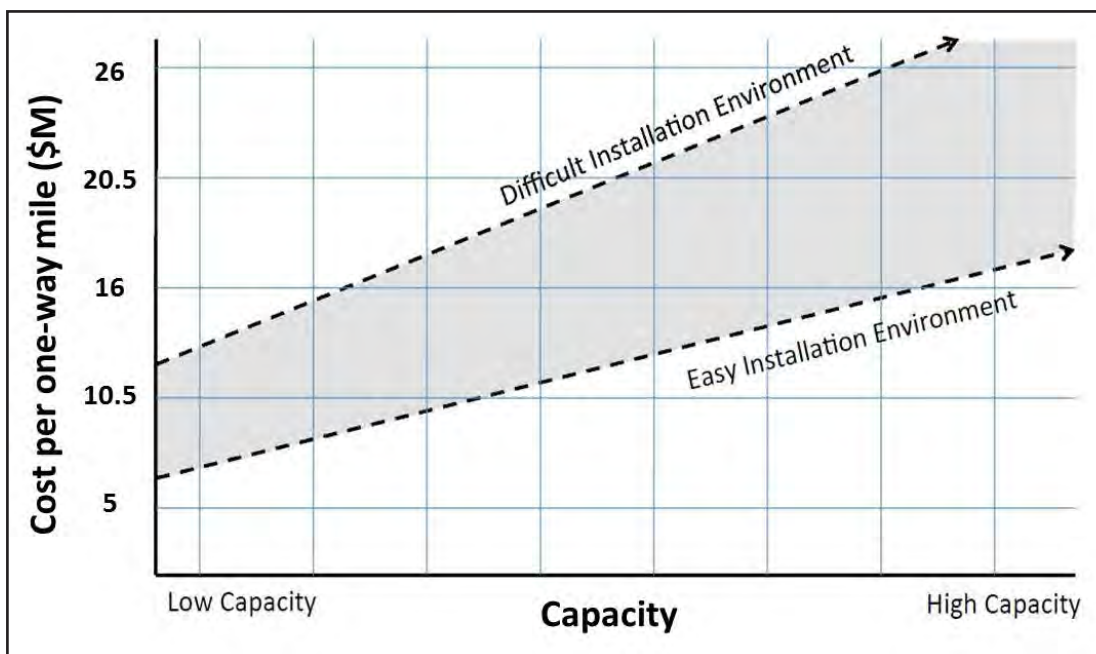

Figure 33. Capital Costs

Source: ULTRa Global PRT.

The linear nature of guideways presents several special design considerations, especially along streets. The following illustrations (Figure 34-Figure 41) are intended to provide ideas for accommodating guideways in urban streets. Each figure shows two variations, a lower and an upper location. The lower locations illustrate the guideway as sufficiently high only to accommodate pedestrians underneath (8-10 feet), while the upper locations are high enough to accommodate crossing traffic underneath (14-16 feet).

Figure 34 shows the guideway located adjacent to the sidewalk. This placement poses two issues – the guideway interferes with any trees, and vehicles pass close to buildings. The trees may require removal or trimming.

⁴⁹ They analyzed 23 APM projects in 2005 and determined the median cost for APM infrastructure to be \$12.8 million/mi, and \$1.5 million as the average cost for an APM station.

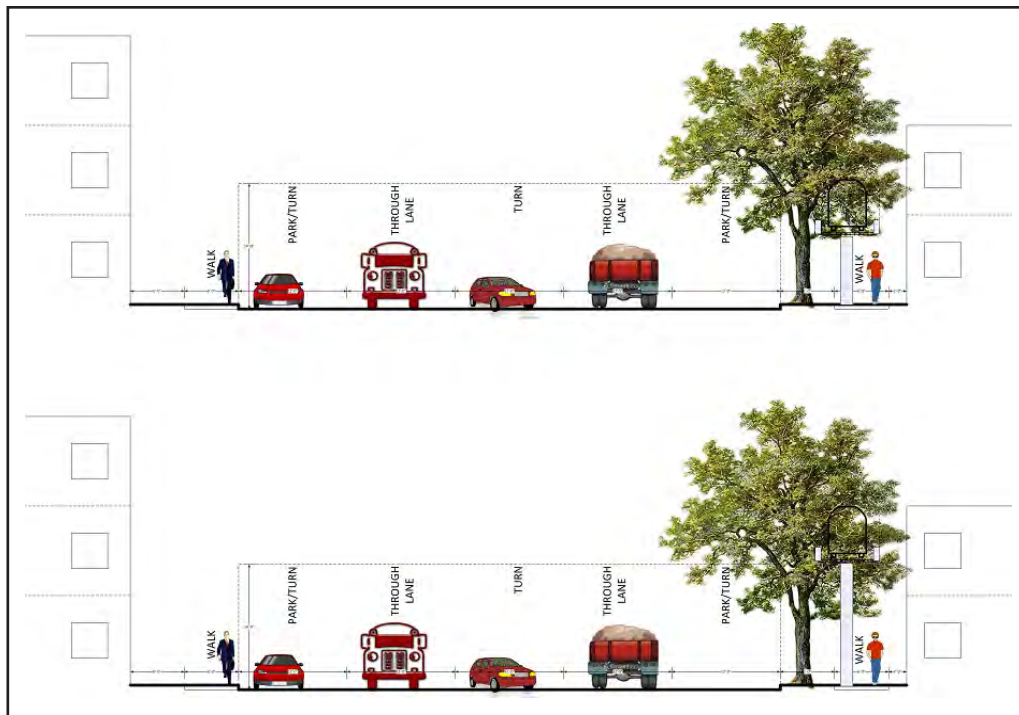

Figure 34. Urban Road Section – Sidewalk with Trees

Note: Possible guideway placement is shown to the right of the trees.

Being close to buildings should not present any problems regarding noise and vibration, but it could be a concern because riders could see into windows. Even the small diameter (about 24 inches) of a guideway column may be an obstruction in a narrow sidewalk.

The next potential location (Figure 35) is in the parking lane. Once again, trees can be a potential problem. Some interference with vehicle parking could be minimized by moving the guideway closer to the curb line.

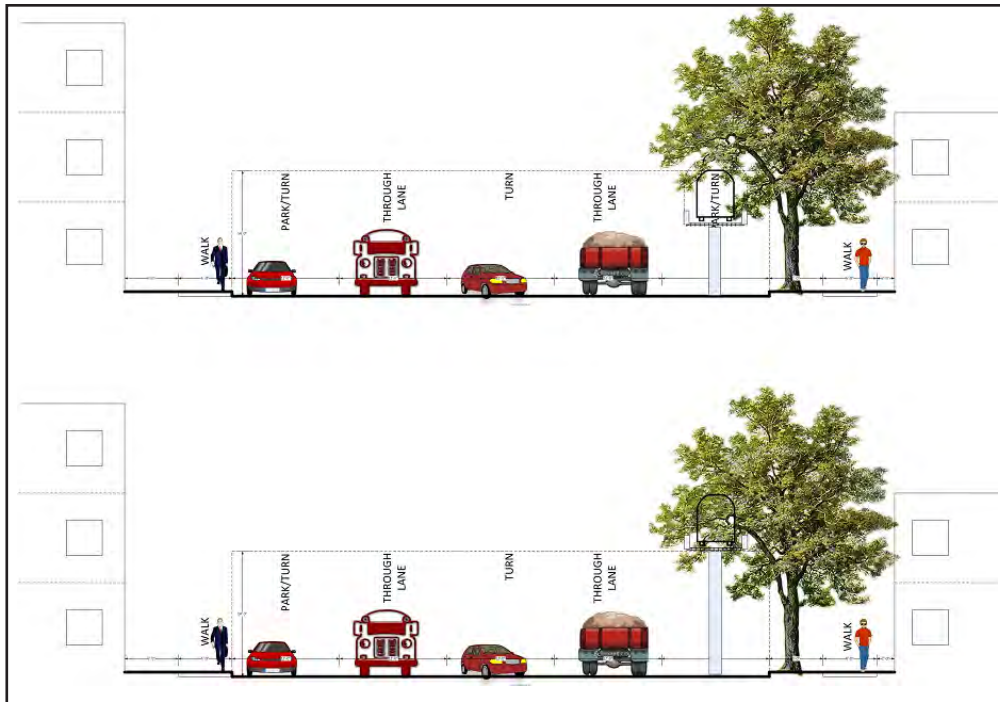

Figure 35. Urban Road Section – Parking Lane

Placing the guideway in the middle of the street (Figure 36) is probably the best solution. However, columns in this location may interfere with through or turning lanes. In this event, supporting the system on a portal frame spanning the active lanes (Figure 37) is a potential solution. Protecting columns in the middle of the street is necessary, such as with Jersey-barrier style walls.

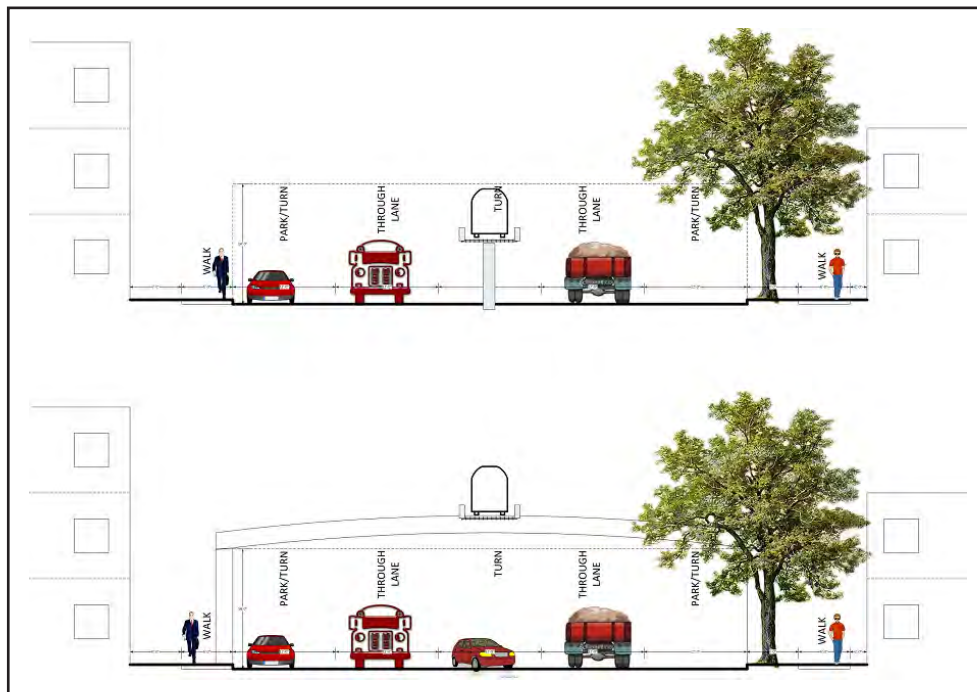

Figure 36. Urban Road Section – Middle of the Road

Figure 37 illustrates a sidewalk-mounted guideway at some distance from adjoining buildings. Note that adequate clearances must be provided.

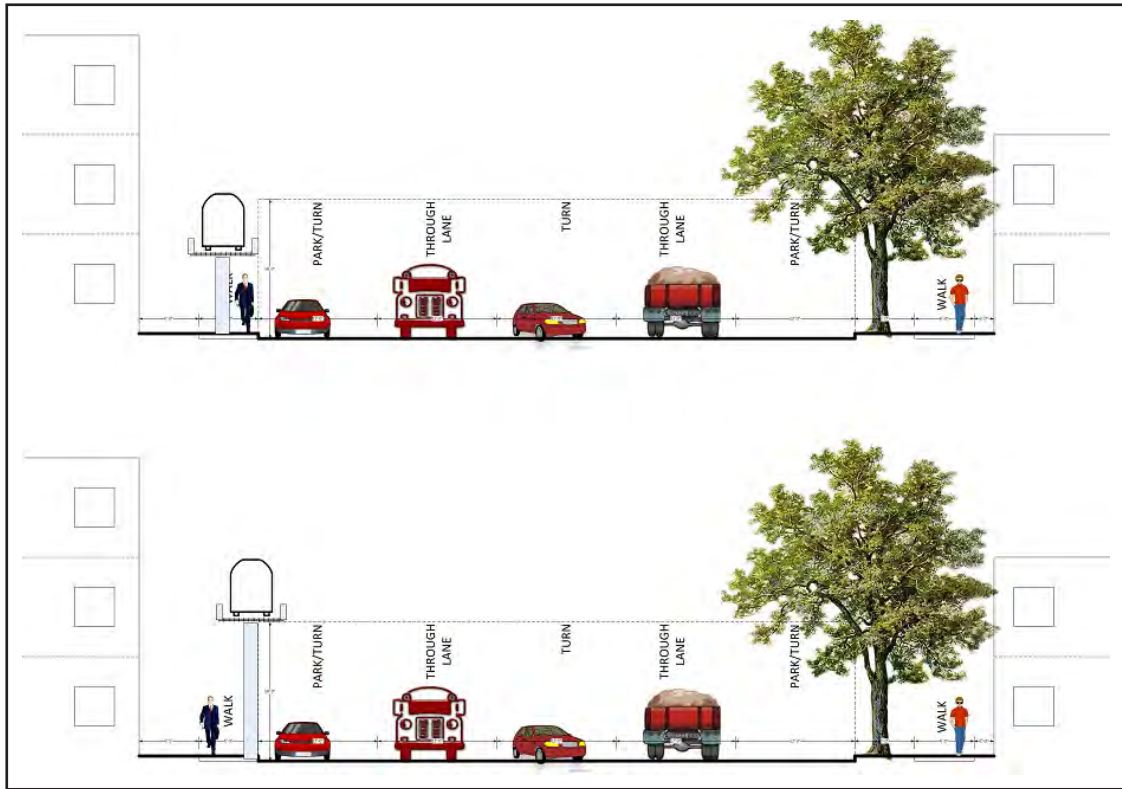

Figure 37. Urban Road Section – Sidewalk without Trees

In Figure 38, the guideway is adjacent to the building. Another possibility is to have it attached to buildings. Note that it may be possible to locate it vertically in such a way that it does not obstruct windows and that passing vehicles are difficult to see from the windows. Accomplishing this is much easier when the buildings are designed concurrently with the guideway rather than in a retrofit situation.

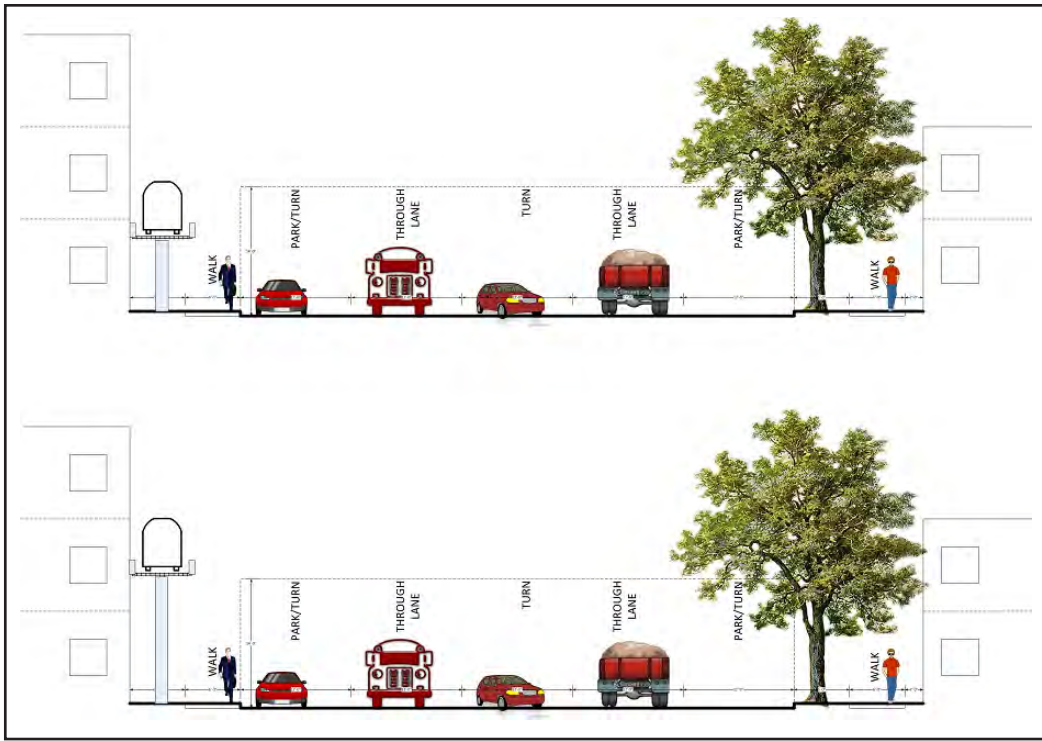

Figure 38. Urban Road Section – Sidewalk, Adjacent to Building

Figure 39 illustrates how a coordinated design effort could greatly reduce the visual impacts of the guideway on the streetscape.

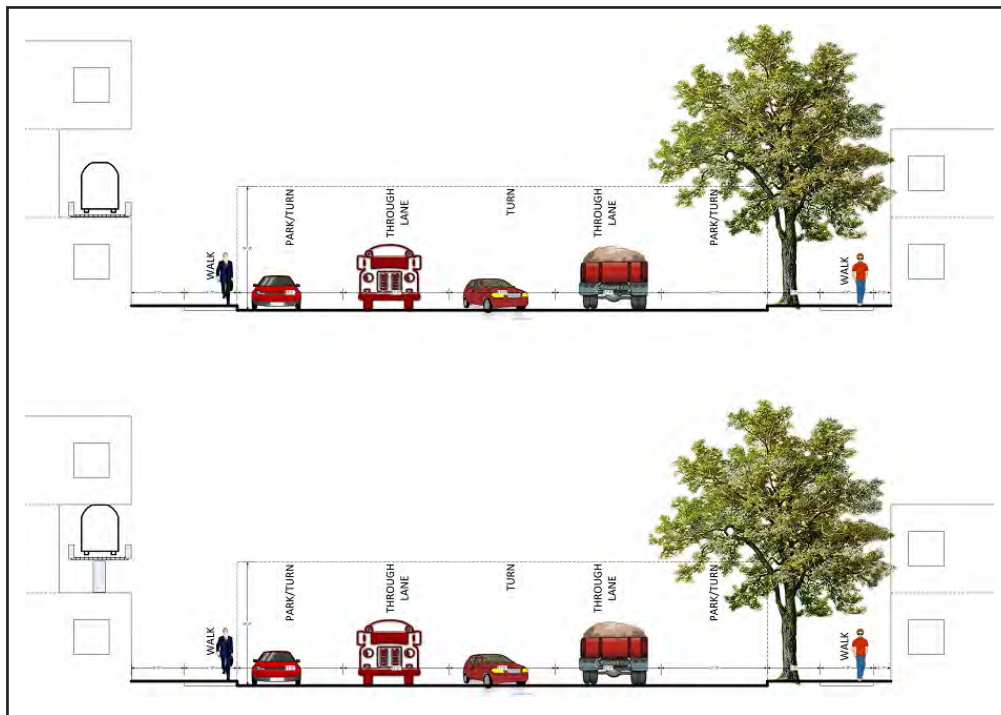

Figure 39. Urban Road Section – Integrated Design

When ATN is integral to community design, use of automobiles can be restricted. Figure 40 shows how the street cross section could change if the street was needed only for service and emergency vehicles.



Figure 40. Urban Road Section – Restricted Vehicle Access

Figure 41 illustrates complete removal of all surface vehicles, allowing the street to be park-like and to serve only pedestrians and cyclists – and possibly other low-impact vehicles.

Utilities have not been shown in the illustrations. Guideway and station design must consider both overhead and underground utilities. These utilities are typically protected by easements (just as the guideway usually will be), and the guideway placement planners must consider how best to avoid them. In some cases, such as with streetlights and overhead power cables, it may be possible to move the utility out of the way by attaching it to the guideway.

PLANNING CAMPUS-TYPE ATN PROJECTS

This section addresses implementation planned to serve confined facilities such as universities and airports. It is wise to plan for a larger system than is initially necessary. This will help to ensure that the initial system can be scaled up later.

In campus applications, travel demand is likely to come in many shorter periods, unlike the morning and evening peaks that dominate transit operations. Often, walking will be the primary competitive mode. The interplay of these factors impacts ATN viability. Understanding the strengths and weaknesses of different ATN operating parameters is vital in order to confidently plan for campus applications with high demand. Some examples are discussed below.



Figure 41. No Vehicular Access

In a university campus application, the peak demand typically occurs between classes. Unlike airport travelers, students usually do not carry much baggage and are often amenable to sharing rides to the point of cramming into the available space. High vehicle occupancies can thus be expected. Estimating ridership is usually based on known movements of airport passengers or university students and staff.

Perhaps the primary advantage of ATN for university or airport applications is its potential ability to change institutional operations. In Morgantown, prior to the PRT, West Virginia University (WVU) students were limited in class choices on different campuses. Now the PRT enhances those choices.

Airport operations could be greatly improved by using a central terminal linked to remote concourses by ATNs that are small and flexible enough that one system could travel out from the central terminal and then turn to serve stations in the concourses. At international terminals, the long corridors separating incoming foreign travelers could be replaced with PRT guideways at a cost savings.

PROJECT IMPLEMENTATION

Once the project has been planned, its implementation includes final design, procurement, construction, manufacture, installation, testing, certification, and service entry. Procurement usually includes the detailed design, as well as right-of-way acquisition. This is described in more detail in the next chapter.

If the project is acquired through an unsolicited proposal process, the proposer supplies the preliminary design. If the project is acquired through a design/build procurement process, the owner's design team usually will undertake preliminary design. Like the planning process, the preliminary design must accommodate the range of ATN capabilities considered suitable for the project. It is important that this range be broad enough to attract competitive bids while not being so broad that it results in an unwieldy design. The preliminary design will include the preparation of procurement documents (sometimes called bridging documents) that describe the project in sufficient detail to allow competitive bidding while not being so prescriptive as to require suppliers to redevelop their systems unnecessarily. These documents should seek to specify the required service levels to be provided rather than the method of providing the service.

The preliminary design process will often include research into permitting and property requirements, while the actual acquisition of permits and property usually will be accomplished at a later stage. Permitting and other requirements vary from state to state and even from community to community.

VI. ATN SYSTEM FUNDING AND PROCUREMENT

INTRODUCTION

This chapter addresses the costs, funding, and financing of future ATN projects within the larger context of the U.S. urban transportation infrastructure planning process as institutionalized by the federal government. Transportation planning plays a fundamental role in the state, region, or community vision for its future. In its idealized form, it maximizes public welfare as defined by our democratic forms of government – central cities, suburbs, villages, unincorporated areas, counties, and marine port and airport authorities. In some small states, such as Rhode Island and Maryland, state agencies often dominate metropolitan planning (Providence, Baltimore).

The federal government has mandated a planning process to assure that necessary cooperation exists among these public entities whose interests often are competitive and non-cooperative. By law, every demographic agglomeration of more than 50,000 residents must have a Metropolitan Planning Organization (MPO) to develop long-range plans and allocate funds each year according to federal guidelines in decision budgets for annual highway, transit, bike-pedestrian, and, in some locales, railroad projects.

The MPO is a transportation policy-making body made up of representatives from local government and transportation agencies with authority and responsibility in metropolitan planning areas. Details of its process are given in a later section.

ATN PROJECT DELIVERY

Implementing an ATN is a complex public works and technology project with costs in the tens of millions of dollars. Large urban projects run several years and involve several stages. The larger and more complex the project, the greater will be the delivery team requirements. These stages or elements, each one of which can each require several months and even years and which incur substantial costs, include:

- a. Planning
- b. Design
- c. Engineering
- d. Permitting, including environmental impact assessment
- e. Site preparation, including utility relocation
- f. Construction, including impact mitigation, landscaping, civic embellishments and artwork
- g. System installation

- h. System integration (Figure 42) and safety certification
- i. Training and launch of revenue service
- j. Operations and maintenance

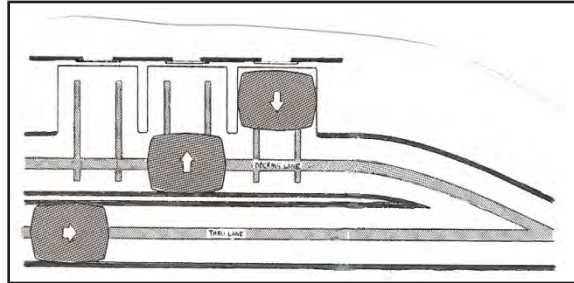

Figure 42. Integration of Components of an ATN

Note: Integration of all components of an ATN system is key, such as in this GRT system, delivered by Otis at Duke University Hospital, now dismantled. The main guideway is at the bottom. The station ramp and off-line bays are shown, along with three vehicles.

Source: Trans.21 archives.

ATN projects are of such scale and complexity that they require professional project management with contingencies for unforeseen circumstances. An ATN implementation can be structured in several ways. A public or private entity can procure the various components and then assume responsibility for assembly and integration into a working system. BAA (formerly the British Airports Authority) has done that for APMs at Heathrow, Gatwick, and Stanstead Airports.

Most governments and corporations do not have and do not want to acquire such technical expertise and project management skills. For them, there are alternative strategies known as Design-Build (DB), Design-Build-Operation (DBO), and Design-Build-Operate-Transfer (DBOT) in which the ATN supplier and builder integrate and then turn the project over to the owner after an agreed number of years.

Planning for transit projects is conducted and coordinated through MPOs, which often hire consultants. There are no examples of ATNs that have gone through this process, Three DPMs did go through the process as part of a special demonstration program in the 1970s⁵⁰ One is the Jacksonville DPM (Figure 43). Likely, all but the smallest of private projects also will go through the MPO process.

⁵⁰ See Chapter 4, 6, 7.



Figure 43. MPO Process in Jacksonville DPM

Note: The MPO process guided planning of the Jacksonville DPM, shown here as designed for expansion.

Source: Trans.21.

When established in the 1970s, MPO activities were primarily coordinative. The Clean Air Act Amendments of 1990 (CAAA)⁵¹ and the Intermodal Surface Transportation Efficiency Act of 1991 (ISTEA)⁵² significantly changed how MPOs conduct transportation planning. According to comprehensive reviews of nine metropolitan areas by USDOT's Volpe Center⁵³, ISTEA and the CAAA introduced the expectation that MPOs provide leadership in defining a regional vision, selecting projects, and improving air quality. They must overcome a period of diminished resources, technical capabilities, and institutional roles. Many MPOs approach ISTEA as a lever to overcome local governmental fragmentation and lead regions toward system-wide planning (Figure 44).

To realize the promise of ISTEA and CAAA, long-range plans must become strategic, framing and evaluating financially realistic alternatives that can guide elected officials and the public through the difficult choices required to balance air quality and transportation concerns. Transportation improvement programs, which often consolidate decisions made outside the MPO process, must demonstrate links to the long-range plan and how projects are selected to accomplish regional objectives.

⁵¹ http://epa.gov/oar/caa/caaa_overview.html

⁵² <http://ntl.bts.gov/DOCS/istea.html>

⁵³ Transportation Research Record No. 1466, 1994. *Issues in land use and transportation planning, models, and applications*, Accession number 01401286, by William M Lyons, U.S. Volpe Center, Cambridge MA. Also, Lyons, William M. 1994. "Federal Transit Administration-Federal Highway Administration (FHWA) Metropolitan Planning Organization (MPO) Reviews - Planning Practice Under the Intermodal Surface Transportation Efficiency Act (ISTEA) of 1991 and the Clean Air Act Amendments (CAAA) of 1990." TRB Paper No. 94-0639. <http://ntl.bts.gov/DOCS/fta.html>

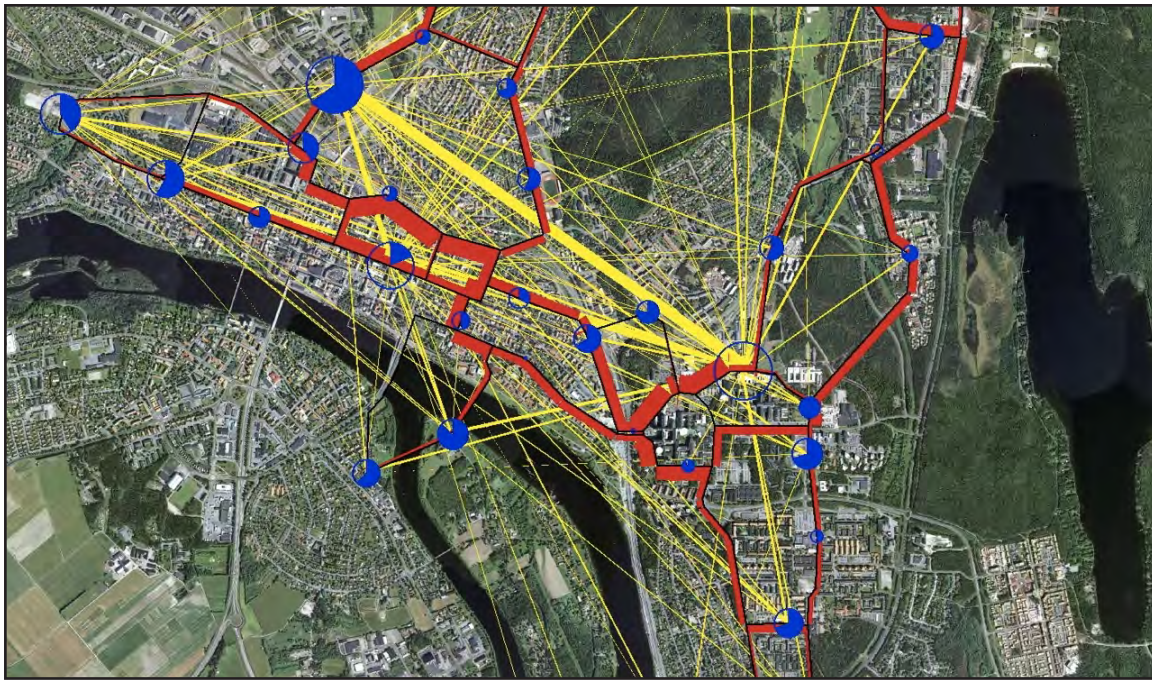

Figure 44. MPOs and System-wide Planning

Note: MPO planners develop two-dimensional portrayals of urban mobility.

Source: LogistikCentrum.

Some MPOs do play significant roles through managing the 3-C (comprehensive, coordinated, and continuous) planning process, which by intent is a collaborative undertaking. The most effective MPOs work with voting members, transportation agencies, other stakeholders, the public, etc., to develop plans to set the 20-year direction for the region. Based on those plans, MPOs develop criteria to select projects. While DOTs have responsibility for highway projects and transit authorities for transit projects within these areas, both should participate.

MPOs as institutions don't select projects for implementation, but ideally they manage the process that picks them. In other words, MPOs are not *originators* in general, and especially not of innovative new projects, such as an ATN. In this sense, MPOs have not examined ATN alternatives, to the disappointment of ATN advocates and promoters⁵⁴.

MPO PROCESS

A Federal Highway Administration (FHWA) and Federal Transit Administration (FTA) document entitled *Transportation Planning Capacity Building Program 2007*⁵⁵ stresses that the MPO process should include a comprehensive consideration of possible strategies, an evaluation process that encompasses diverse viewpoints. The participation of transportation-related agencies and organizations with open, timely, and meaningful public involvement is critical to foster involvement by users, such as the business

⁵⁴ Except the Denver studies on the mid-1970s. More recently the MPO for Cincinnati (OKI) considered but rejected a cross-river ATN option.

⁵⁵ http://www.planning.dot.gov/documents/briefingbook/bbook_07.pdf

community, community groups, environmental organizations, travelers, freight operators, and the general public.

As idealized in Figure 45, nine distinct components of the MPO process make up a continuing, cooperative, and comprehensive (3-C) planning process that is meant to be repetitive and on-going, with feedback loops. As shown, this process starts with visions and goals for the community, creates a plan, and implements it as individual projects. Then evaluation of those projects and their impacts and operations may alter the goals and cause new alternatives to be explored.

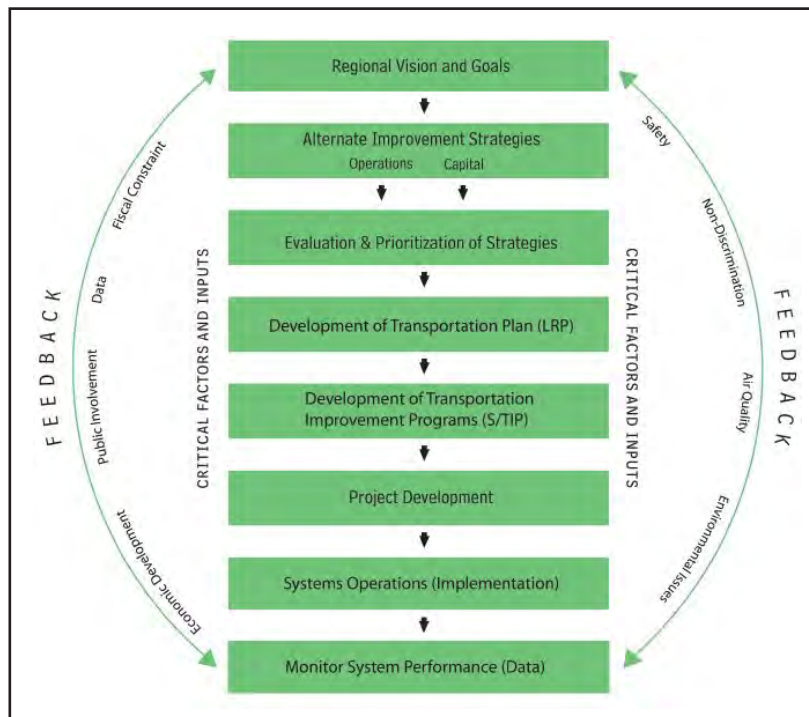

Figure 45. The MPO Process

Source: http://planning.dot.gov/documents/briefingbook/bbook_07.pdf

Some large MPOs are found within agencies such as Regional Planning Organizations (RPOs) and Councils of Governments (COGs). Smaller MPOs may be part of the county government.

Most MPOs generally do not take the lead in implementing transportation projects but instead provide an overall coordination role. In metropolitan areas, the MPO is responsible for actively seeking the participation of all relevant agencies and stakeholders in the planning process; similarly, the state DOT is responsible for activities outside metropolitan areas. The MPO and state DOT also work together. For example, a state DOT staff person may sit on the MPO board.

The MPO process generates several discrete documents whose acronyms are shown in the left column of Table 8. The Unified Planning Work Program (UPWP) lists the transportation studies and tasks to be performed by the MPO staff or a member agency. The Metropolitan

Transportation Plan (MTP) or the Long-Range Transportation Plan (LRTP) are statements of the ways the region plans to invest in the transportation system.

Table 8. Key MPO Planning Products

	Who Develops?	Who Approves?	Time Horizon	Content	Update Requirements
UPWP	MPO	MPO	1 or 2 Years	Planning Studies and Tasks	Annually
MTP	MPO	MPO	20 Years	Future Goals, Strategies, and Projects	Every 5 Years 4 years for nonattainment and maintenance areas
TIP	MPO	MPO/Governor	4 Years	Transportation Investments	Every 4 Years
LRSTP	State DOT	State DOT	20 Years	Future Goals, Strategies, and Projects	Not Specified
STIP	State DOT	US DOT	4 Years	Transportation Investments	Every 4 Years

Source: http://planning.dot.gov/documents/briefingbook/bbook_07.pdf

The Transportation Improvement Program (TIP) is a working document in which the MPO identifies the transportation projects and strategies from the MTP that are to be undertaken over the next four years.

The State Planning and Research (SPR) Program lists the transportation studies, research, and tasks to be performed by the state DOT staff or its consultants. State DOTs must also develop a Long-Range Statewide Transportation Plan (LRSTP), which may be policy-oriented.

The Statewide Transportation Improvement Program (STIP) identifies priorities for transportation projects on a statewide level that must be fiscally constrained.

FUNDING AND FINANCING OF ATN PROJECTS

The funding for transportation projects can come from a variety of sources. Beyond the federal government, state governments, special authorities, public or private tolls, local assessment districts, and local government general fund contributions (such as local property and sales taxes), and impact fees can pay for transportation improvements and new starts. Federal funding – transferred to states and then distributed to metropolitan areas – is typically the primary funding source for major plans and projects. It is noteworthy that most FHWA funding is administered by the state DOTs, which then allocate the funds to local entities based on state and local priorities and needs. Most transit funds for urban areas are sent directly from the FTA to the transit operator. Transit funds for rural areas are administered by the state DOT.

Given that ATN is a fixed guideway transit system, it would be eligible for federal funding through the FTA, just as other fixed guideway projects are. Since the 1990s, after the DPMs went into service, UMTA/FTA stopped insisting that APMs were not eligible for funding, as it did in 1976. Little was done to promote or encourage such APM and therefore ATN proposals, but in theory, they were permissible. To receive Federal funding, ATN implementations must undergo the conventional planning process described above and be selected as the locally preferred alternative, demonstrating performance superior to the other alternatives.

Even when federal funding is received, it seldom covers 100% of the costs. Local matching funds are necessary. State and local public funds commonly constitute 50% of total costs.

Federal and local government funds for transit projects are constrained by larger budgetary and debt concerns. The formation of public-private partnerships (PPP) is one way to introduce other sources of funding for urban projects. In theory, this could include ATN suppliers and constructors. Many states are enabled to let private parties submit unsolicited proposals for PPPs to solve transportation issues. For example, regarding transit projects, the Regional Transportation District in Colorado has been particularly successful in implementing PPP projects in the Denver metropolitan area⁵⁶. Each state and/or a development agency within a state typically have developed their own unique requirements for PPPs.

ATNs have not yet been implemented through the MPO process, nor have ATN proposals been given full consideration. As a result, there are no examples to examine. Planning, however, deals with hypothetical ideas. It is possible to speculate, then, about how a team led by a large engineering-procurement-construction (EPC) project, turnkey management company might implement an ATN project. The team would include engineering consultants, construction contractors, a system supplier, a financing institution, and others as appropriate. The agency receiving the proposal might accept it or put it out for competitive bidding before making an award.

The EPC or construction company may bond the project (often requiring the ATN supplier to bond its system) and will often provide some or all of the financing. In addition to designing, building, and financing the project, the unsolicited proposal may include operations and maintenance (O&M) services for a period of time. Financial terms will usually include a schedule of payments, sometimes including a down payment.

Transit is widely perceived to bring public benefits to an area (such as reduced accidents and energy use and increased property values) over and above just the provision of transportation. For this reason, transit capital and operating costs are subsidized. Based on findings from modal comparisons by many cities, primarily in Sweden, Britain, and other European countries, there is evidence that ATN will require less of a subsidy than conventional transit. For many ATN applications, analysis has indicated that fare revenues

⁵⁶ <http://www.rtd-denver.com/FF-EagleP3.shtml>

would cover operating costs. In some situations, it may also cover capital costs from fare box revenues (PRT Consulting, 2009). This is more likely to be the case where external benefits such as increased property values can be monetized. Hong Kong is an example where the transit authority is self-sustaining because it owns station-area properties⁵⁷.

Campus-type ATN projects are less likely to require federal funds. They are also less likely to charge a fare and will often derive revenues from related facilities. Airports are the classic example in which APM and shuttle bus services are typically provided free of charge, with revenues being derived from parking fees or rental car charges. When federal funding is not involved, many people believe that substantial cost savings are possible by exemption from the National Environmental Policy Act⁵⁸, Davis-Bacon wage rates⁵⁹, and Buy America requirements⁶⁰.

THE FIXED GUIDEWAY TRANSIT PROCUREMENT PROCESS

The MPO process described above is continuous and comparative. Highway and transit projects are typically proposed in response to perceived needs due to growing congestion or expected impacts of new development. Attention is often drawn to radial corridors, sometimes complemented with circumferentials, and then corridors are prioritized. A comparison of modes (often both highway and transit) is made for priority corridors, and those chosen for further analysis receive preliminary engineering and assessment of environmental impacts. The mode(s) embodied in the preferred option is then defined as a project for the next steps of final engineering and procurement.

For conventional modes such as light rail, commuter rail, and heavy rail (metro), the infrastructure requirements are well known and standardized. The civil and system components making up such projects are often purchased in separate procurements. One step, for example, may be hoisting guideway sections into place (Figure 46).

In other words, the state of MPO planning processes leaves little room for bidders to offer innovative solutions such as ATN.

On the other hand, a fixed guideway project can also be procured turnkey, in which one supplier team completes preliminary design and engineering, resulting in a permitted project, then procures all components, undertakes basic civil work, installs and integrates all the components, and delivers an operating system. Such a procurement has four elements: design (D), bid (B), building (B), and operate (O). Turnkey projects can be DB, DBB, DBBO, DBO, etc.⁶¹

⁵⁷ See for example: <http://www.theatlantic.com/china/archive/2013/09/the-unique-genius-of-hong-kongs-public-transportation-system/279528/>

⁵⁸ <http://www.epa.gov/compliance/nepa/>

⁵⁹ <http://www.dol.gov/whd/govcontracts/dbra.htm>

⁶⁰ <http://www.dot.gov/highlights/buyamerica>

⁶¹ Sometimes the letter F can be added to these combinations when the supplier is expected to provide some or all of the financing.



Figure 46. Infrastructure Implementation

Note: Many Stages and Components Compose a Guideway Implementation.
Source: Trans.21 archives.

This kind of procurement process using DB and its variants lends itself to the selection of the lowest qualified bidder (as required by most public agencies) for each portion of the project. Quality must be assured by intensive project inspection, holding the low bidder compliant to the detailed plans and specifications. An advantage of the design/bid/build process is that different pieces of the project, such as vehicles, track, earthwork, stations, etc., can be parceled out to specialists. A further advantage is that, for example, an owner can lump the vehicle purchases for multiple projects into one acquisition process, thus receiving lower unit prices due to economies of scale.

Conventional large APMs, as commonly seen at airports, are typically acquired through a design/build process. Here the owner's planning engineers prepare a preliminary design suitable for a generic APM system, as well as project specifications. Elements of APM projects that are sometimes procured separately include stations and tunneling. Occasionally a generic guideway is procured and designed to accommodate several APM suppliers who will be procured in the future. This may limit the suppliers for the project or result in an overbuilt guideway should the supplier of a lightweight system be selected.

RECENT ATN PROCUREMENTS

The procurement processes for four recent ATN procurements are outlined here chronologically⁶²:

1. Rivium, near Rotterdam, The Netherlands (information provided by Robbert Lohmann, 2getthere) (Figure 47)

⁶² Procurement of the Morgantown PRT was done in the 1970s as a federal demonstration program. It is an exceptional example and therefore irrelevant to current and future ATN planners and proponents.

This project was initiated by the supplier 2getthere in the 1990s. The Dutch city, Capelle aan den IJssel outside of Rotterdam, liked the concept and decided to start a pilot project, which did not require public tenders (procurement). The contract for the supply and installation for the system was negotiated between the supplier and the city. Passenger tests began in 1999. The infrastructure was procured under a separate contract. It was then expanded, linking suburban office buildings to a rail station.



Figure 47. Rivium Shuttle

Note: The Rivium shuttle has more than a decade of experience.

Source: Trans.21 archives.

2. London Heathrow Airport, U.K. (information provided by Robbert Lohmann, 2getthere, and David Holdcroft, formerly with the project owner BAA)

Ultra, the supplier, initiated this project. Because it was determined that more than one supplier could provide the technology, a tender process was undertaken. About 30 initial expressions of interest were received, evaluated, and short-listed down to four based on the criteria that suppliers must 1) have a test track carrying passengers or being built, 2) meet the dimensional requirements of the existing tunnel at Heathrow to be used by their plan, and 3) have a system that could carry four passengers plus luggage and meet additional requirements.

BAA assembled a group of experts (primarily external) in topics such as software development, communications, transportation, and simulation. These experts and the commercial/retail department at Heathrow Airport developed a long list of questions. The responses helped narrow the potential suppliers to Ultra and 2getthere.

Supplier submittals included:

- Detailed responses to technical questions
- Price quote for the first phase
- Indication for the entire airport build out

Meetings were held with the suppliers, and Ultra was selected by a small margin. The system and the infrastructure were included in one contract.

Contract negotiations involved much detail and took many months. In financial terms, the contract was open-ended, with monthly payments. The airport knew the situation it was becoming involved in and tried not to be too prescriptive while being clear about the required performance. The airport gave priority to passenger perceptions (Figure 48). BAA took control of delivery of infrastructure items (about 70% of the project), and, with hindsight, probably should have done so from the beginning. BAA invested in Ultra, which resulted in some conflicting interests, but it was probably necessary to complete the project. BAA played a major role in items that had not been demonstrated previously. BAA was experienced with understanding passengers, while Ultra was adept technically.



Figure 48. ULTra PRT at London Heathrow Airport

Note: Owner-supplier cooperation resulted in close attention to passenger interfacing on the London Heathrow PRT.
Source: <http://www.ultraglobalprt.com/photos-videos/photos/#>

In general, problems tended to be caused by communication and organizational shortcomings rather than by technical issues. David Holdcroft's⁶³ recommendations to project planners include⁶⁴:

- Require extensive testing, mockups, etc.
- Conduct extensive simulations and emulations
- When breaking new ground, condition payments to milestones
- Conduct a thorough assessment of organizational ability

⁶³ David Holdcroft is Regional Manager (UK) at BNP Associates, Inc., and was the project leader for BAA for the Heathrow PRT project.

⁶⁴ http://www.riminvestiture.it/binary/rimini_venture_new/seminari/Heathrow.1292930661.pdf

3. Masdar City, Abu Dhabi, United Arab Emirates (information provided by Robbert Lohmann, 2getthere)

The architect and consultant working for the investment branch of the government of Abu Dhabi initiated this project before 2007. Norman Foster & Partners planned a large district, and Mott MacDonald engineered it as a zero-emissions township based on traditional desert city forms of low-rise, high-density using pedestrian circulation (Figure 49). Foster used Systematica, WSP, and Ernst & Young as consultants for the internal circulation component. Cars were to be stopped at parking intercepts and banned from entering, with circulation primarily by pedestrians and by PRT, with eventual service by a metro.

The program manager issued a tender soliciting an ATN technical proposal and a bid/quotation. Eleven companies responded and were invited to visit the site and make presentations. The customer, program manager, consultant, and outside experts scored the submittals and selected two candidates. Two-day visits were made to the short-listed candidates, who then had the opportunity to submit clarifications to their bids. 2getthere was selected. The supply contract included the station at the parking facility and the track, but it excluded the station at the university and the track foundation underneath the university.

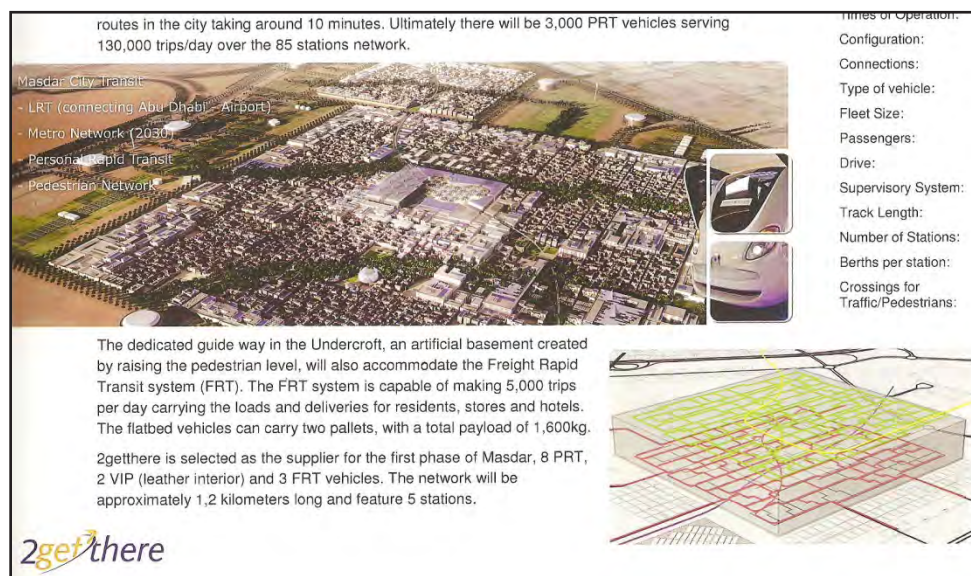

Figure 49. Masdar City ATN

Note: The Masdar ATN is in the subcroft of a master planned urban district designed to yield zero net carbon dioxide.

Source: 2getthere.

4. Suncheon, South Korea (information provided by Jörgen Gustafsson, Vectus) (Figure 50)

The supplier initiated the project, and there was no competitive procurement. The city's effort was minimal in terms of specifications, consultants, studies, etc. Prior to signing the final contract, the supplier managed contacts with relevant authorities, specified, and described the final system in high detail. Vectus was responsible for all specialist studies, such as geological and environmental. These pre-contract activities took several years to complete.



Figure 50. Suncheon PRT Planning

Note: Suncheon PRT planning paid special attention to the station's visual impact.
Source: vectusprt.com.

It is understood that this project is design/build/operate, with ownership being transferred to the city after 30 years.

PROCUREMENT PROCESS COMPARISON

Four very different projects in various countries are not enough to define a pattern. This is especially true because they were initiated by suppliers seeking a first-in installation to become established. This ATN experience is similar to the procurements of the first airport APMs – Dallas Love Field (Jetrail), Tampa (Westinghouse-Bombardier), and Dallas Fort Worth (Airtrans)⁶⁵. Airport procurements that followed in the 1980s and 1990s built on early planning, engineering, and operating experience, eventually codified in the ASCE APM Standards (ASCE 2013).

Because ATN procurements to date have resembled the experience of early APM systems, one can expect that future planning and procurement will benefit from this experience and tend to more standardization. The design/build procurement process typically used for APM acquisition is well suited to accommodate and take advantage of variations and innovations that ATN systems introduce. This is likely to evolve as ATN projects increase in size and scope: a city-wide ATN procurement, for example, introduces a new level of complexity with concerns about cross-jurisdictional issues and supplier lock-in.

⁶⁵ A detailed technology and project assessment of all these and other APMs was published by USDOT in the 1970s.

CONCLUSIONS

Like ATN, APM is a fixed-guideway transit system, and scores of them, both driven and driverless, have been implemented every decade since the 1980s. The three DPMs in Detroit, Jacksonville, and Miami have been completed within an MPO context. The planning, design, funding, procurement, construction, and operation of the driverless metro underway in Honolulu are being implemented through an MPO process. In short, there is a modest base of MPO experience with APMs to guide the process of developing future ATN projects, which will be further influenced by the level of federal funding to be made available for ATN new starts in coming years. Those challenges and opportunities are addressed in Chapter 8. In addition, the standards used for APMs are applicable to ATN systems with few changes. Some possible exceptions are also discussed in Chapter 8.

VII. PROSPECTS FOR U.S. ATN DEVELOPMENT

MARKET PROSPECTS AND MEGATRENDS

As described in Chapter 4 (Market Potential), no pipeline of ATN implementations exists today. Without public support, the ATN industry is in an early, tentative stage of commercialization. A handful of credible suppliers struggles to find buyers, and they have limited resources. Beyond them are scores of ATN developers and proponents. MPOs, as institutionalized, are unlikely to create plans for them. Although the role of MPOs is basically coordination, MPOs are encouraged to lead efforts of long-range visioning. Emanating *not* from MPOs, recent expressions of interest in ATN have come forth from several U.S. communities, such as in California's Silicon Valley (several municipalities), Greenville, SC, and Secaucus, NJ. This chapter is a speculative look into the future to assess the desirability of establishing a domestic ATN industry. Note that this can happen only if the MPO process is altered to generate innovative plans informed by ATN and other modern modal options.

Today, contracts to supply ATNs are infrequent. As described in Chapter 4⁶⁶, the closest thing to an ATN market is the annual series of Podcar City conferences and ATRA's annual Technix⁶⁷, which takes place just before the January annual meetings of the Transportation Research Board (TRB). In both cases, ATN ideas are exchanged and contacts are made. However, contracts between buyers and sellers/suppliers are not signed. As 2013 closed, there were no new ATN implementations anywhere⁶⁸. In recent years, three simple shuttles with small automated vehicles have been put into service. An ATN program looks risky to the well mooted, moneyed, and litigated worlds of application engineering and capital investment operating within today's federal priorities and programs. Venture capital for ATN technology development and demonstration is not readily available.⁶⁹

It is appropriate to describe this situation as an ATN "proto-market." Whether the buyer is a city, a transit agency, an airport authority, an economic development entity, or a private developer, this buyer wanting to procure a ten-station ATN network will not find a company, corporation, or consortium that has already completed this type of project⁷⁰. Ten- or 20-station APMs have been implemented, such as the London Docklands Light Railway (Figure 51 and described later in this chapter), along with many driverless metros with more stations. However, there is no 10-station precedent for ATNs, let alone the 20-station

⁶⁶ <http://www.podcarcity.org/home/>

⁶⁷ <http://www.advancedtransit.org/>

⁶⁸ See Trans.21's annual APM Pipeline compilation. Available from Trans.21, 55 Virginia St, Dorchester MA 01225. (617) 825-2318 or lfabian21@gmail.com

⁶⁹ Todd Webber, MagneMotion (Ft Devin, MA, <http://www.magnemotion.com/>), telephone conversation December 12, 2013.

⁷⁰ PRT consultant Nathan Koren points out that experience in airport baggage handling systems includes years of O&M experience on large networks with many "stations." See <http://archive.podcar.org/blogs/nathan-koren/>. The ATN proto-market has little resemblance to the market for driverless metros. For example, Stockholm recently granted a US\$768 million contract to Bombardier for new trains capable of driverless operation. The London Docklands will soon grant a new 6.5-year contract to a private O&M service provider.

network hypothesized as a threshold at which PRT functionality becomes significant. As a result, beyond what was presented in the previous two chapters, little is available in the way of planning guidance or lessons of real world experience from which to learn. There are no governmental guidelines⁷¹. The ASCE's APM Standards are applicable because ATN can be understood to fit within the definition of APM as an exceptionally advanced form (ASCE 2013). ATN developers have thus far had no major difficulty complying with them, except for the “brick wall stop” requirement discussed in Chapter 5, which is a barrier to very short headway applications.

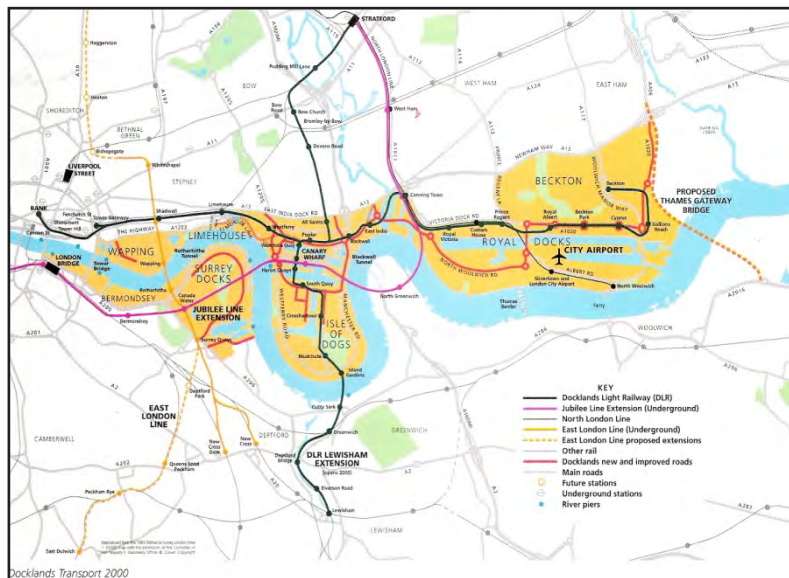

Figure 51. London's Docklands Light Railway Tram

Note: With many on-line stations, London's Dockland Light Railway trams have conductors but are driven by modern computer controls.

Source: Trans.21 archives.

What, then, are prospects for the emergence and growth of an ATN market in the U.S., and the corresponding establishment and profitability of an industry to supply components and services? Given the complex and geographically extensive nature of ATNs and the critical need to assure public safety, it is immediately obvious that the maturation of the ATN proto-industry into a full industry depends largely on public policy, which, in order to change, requires that a thorough case be made for ATNs. The following chapters present some of the challenges and opportunities toward making the case for ATN.

Broad social and economic issues dramatically affect the transport sector. Defense, security, and deficit concerns are dominant today. The state of the economy and level of unemployment are other factors. Other items on the federal agenda concern weather extremes and emergency responses, such as those for Hurricane Sandy, Gulf oil spills, and pipeline projects. Concerns over climate change are stronger in Europe than in current debates in Washington, in general, and at the USDOT in particular. In summary, presidential

⁷¹ Except perhaps the UK Tram's Design Advice published in 2012. <http://www.uktram.co.uk/Pages/GuidanceNotes.aspx>

and congressional politics are driven more often by large societal goals – such as peace, security, employment, economic, and moral issues – than by transportation per se.

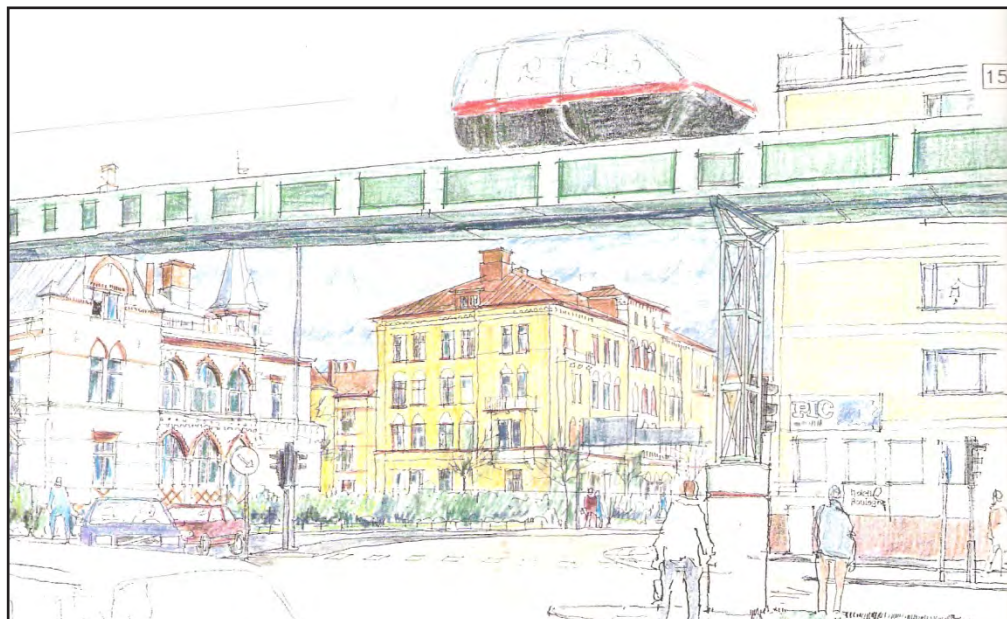

Figure 52. Modal Priorities and Urban Design

Note: Washington policies do not address details of modal priorities and urban design, such as exhibited by this Swedish rendering.

Source: Trans.21 archives.

Over the course of years and decades, governmental policies and priorities change, often dramatically. One example is the 1976 UMTA (predecessor of today's FTA) decision to abandon PRT and related AGT research programs after a congressional assessment found little of value in them (United States 1975). Under local pressure from West Virginia University, UMTA completed the then-controversial Morgantown PRT project and several socio-economic research programs in the late 1970s and 1980s, but USDOT ceased funding new PRT projects and research. The Downtown People Mover (DPM) program absorbed available innovation funds, while MPOs across the nation were directed to *exclude* automated modes from modal agendas of long-range transportation plans. This is why today MPO deliberations are dominated by bus, conventional rail, and bus rapid transit (BRT) and not by basic AGT or its more elaborate form, ATN. In 1976, funding was directed to a DPM program that funded APMs in the central business districts (CBDs) of Detroit (Figure 53), Jacksonville, and Miami.

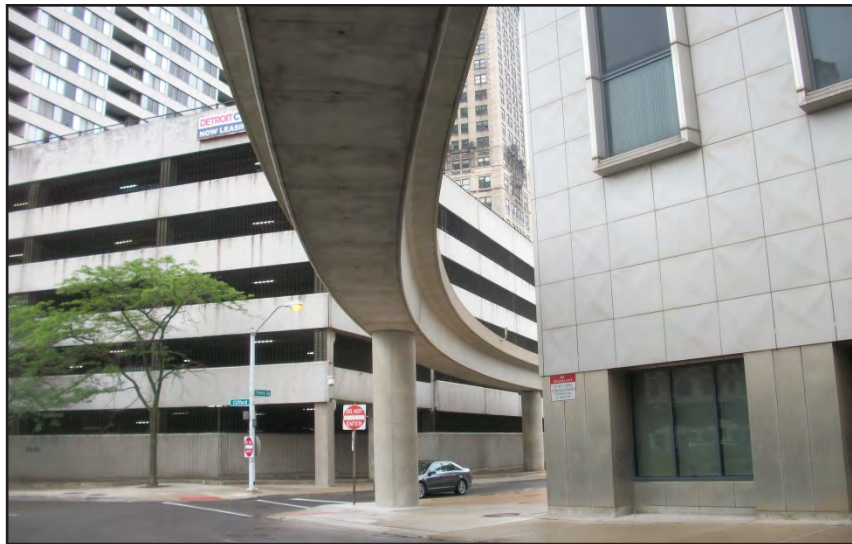

Figure 53. Section of Guideway for the Downtown People Mover in Detroit, MI

Source: Trans.21 archives.

The scope of U.S. transit planning has remained modally conventional. Innovation has occurred only on a subsystem level – propulsion, faring, universal access, paratransit vehicles, and wheelchair lifts. More recently, advances have been made in ways to provide real-time service information and to enhance security measures.

USDOT initiatives and priorities to emerge over the next two years under Secretary of Transportation Anthony Foxx will significantly affect the prospects for ATN. Some programs will survive budget cuts imposed by congress and USDOT priorities, while others will not. USDOT, in conjunction with the Department of Energy (DOE), Health and Human Services (HHS), and the Environmental Protection Agency (EPA), might pursue a broad program to expand green transport – walking, biking, and carsharing. Public health advocates will likely continue to push for more active lifestyles, in which walking and biking are encouraged. Transit and economic development policies may call for better ways to access and improve existing metro stations, thereby dramatically changing the prospects for transit-oriented development (TOD) applications of ATN. Transportation Secretary Foxx was previously the mayor of Charlotte, NC as it built and opened an LRT (Figure 54). In hearings before Congress, he stated that he would look upon local and state governments as “partners.”⁷²

⁷² <http://www.c-span.org/video/?312896-1/confirmation-hearing-new-transportation-secretary>, and transcript from http://www.commerce.senate.gov/public/?a=Files.Serve&File_id=e8f24e9d-b257-4bde-b833-f06ac8d9e18d



Figure 54. Charlotte, NC Light Rail

Note: What benefits might an ATN implementation have brought to Charlotte, which is building a \$1.2-billion, 9.3-miles extension to the existing 9.6-mile light-rail system?

Source: Light Rail Now <http://www.lightrailnow.org>

Washington commentators noted that Secretary Foxx is the first USDOT leader with a background in city government. Innovative auto-restricted, street-sharing zonal development around transit stations – enhanced TOD, if you will – may well receive more attention and funding at the FTA. ATN can arguably play a significant role by extending the zone of impact of stations. If such interest becomes official policy, metro-feeding projects, such as those illustrated in Figure 55, will increase investor interest in ATN development. Public officials would call for economic development benefits in the form of local jobs instead of sending dollars abroad.

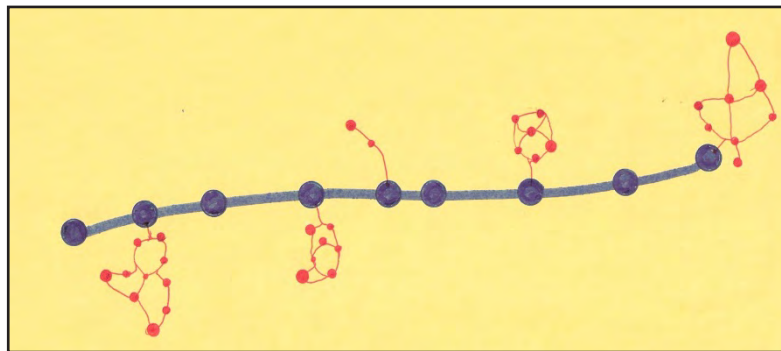

Figure 55. ATN and TOD

Note: ATNs can extend the range of transit-oriented development (TOD) by feeding existing and future rail stations.

Source: Trans.21 archives.

SO, WHICH WAY FORWARD?

Will alarm over climate change create new policies to radically reduce carbon dioxide emissions (Figure 56)?

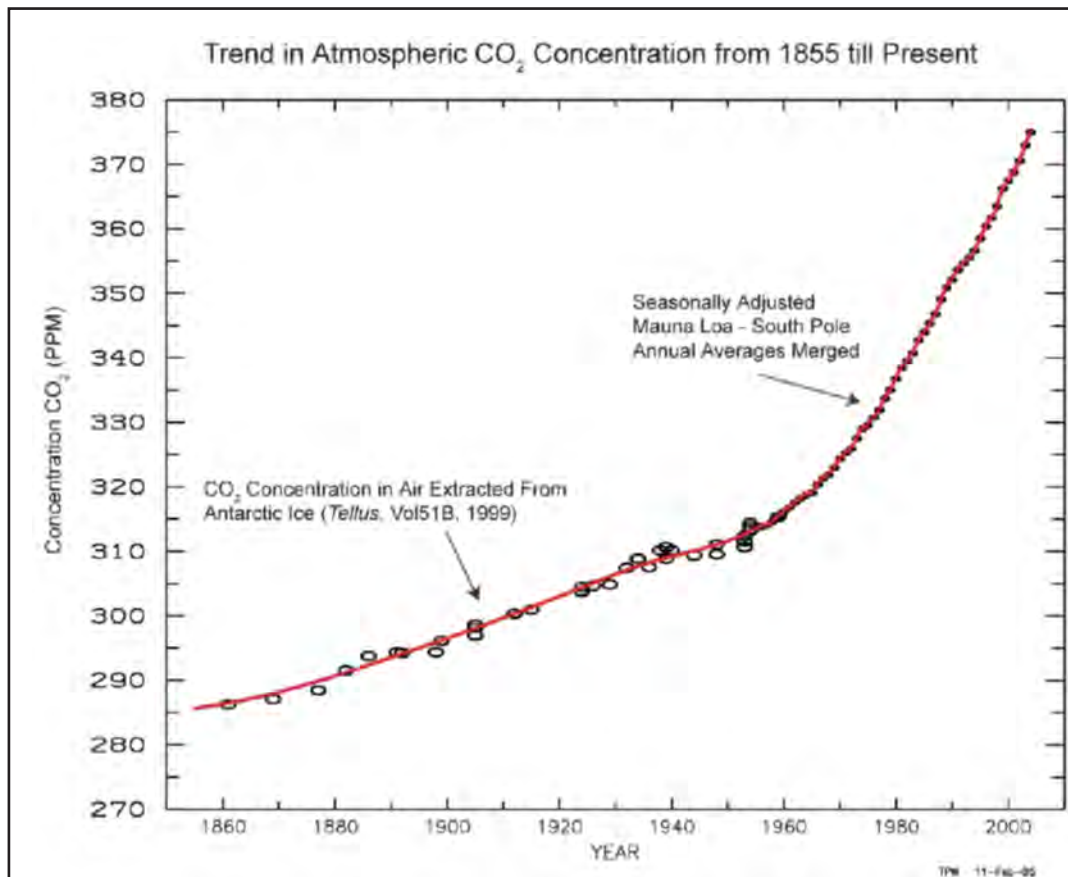

Figure 56. Trend in Atmospheric CO₂

Source: http://scrippsco2.ucsd.edu/talks/cdk_tyler_prize_lecture_2005.pdf

As already stated, the evolution of the ATN market depends fundamentally on public priorities and policies. Therefore, the key question is this: what are Federal and local government goals relative to urban transport modalities? This depends, more broadly, on what policies will be formulated toward carbon emissions, sustainable energy, and intensifying weather patterns. There is no actionable policy in Washington to reduce oil imports, as is the case in Sweden (no imports by 2020⁷³). This is unlikely to change as forecasts of ample U.S. oil and natural gas resources by means of fracking and tar sands circulate and nuclear generation facilities are retained. To what extent will renewable energy production and use in the U.S. be encouraged? Should the U.S. permit expansion of carbon dependencies by fracking and other extraction methods that involve environmental risks to extend the supply of fossil fuels and, thereby, U.S. addiction to fossil fuels? These issues are beyond the scope of this report, but they will significantly impact ATN prospects.

⁷³ http://www.erec.org/fileadmin/erec_docs/Projcet_Documents/RES2020/SWEDEN_RES_Policy_Review_Final.pdf

Will local governments seek to discourage sprawl and focus on infill development, creating more compact, transit-oriented cities⁷⁴? Will public health policies encourage walking, biking, and ultimately more car-free urban lifestyles with community gardens, such as at a school in a Cleveland neighborhood (Figure 57)? Will drivers pay more tolls to fund infrastructure maintenance, thereby making driving more expensive?



Figure 57. Urban Community Garden in Cleveland

Source: Trans.21 archives.

Such societal trends and broad governmental policies will influence the maturation and growth of the ATN industries and help to resolve the techno-policy issues that in 2012 led the Aerospace Corporation to conclude that significant risk would be entailed for the City of San José to move ahead with a possible plan to serve the Mineta San José Airport with ATN. On the positive side, the study concluded that it was likely that the City could probably build an ATN at the airport that would nominally meet most of its needs. However, the study was unable to conclusively determine the industry's ability to meet the system requirements or to verify the level of testing developers had performed (Larsen 2012). ATN developers must make their case, but this will be difficult to do without public policy and funding to help them do it.

Significant civic interest is shifting in favor of sustainable urban transportation. National civic leaders and elected officials have yet to respond fully.

Some of those benefits will be jobs for American technicians, designers, and suppliers. The number of jobs that can be expected is open to speculation. How much of this employment will be for U.S. citizens is another factor that is difficult to foresee and largely dependent on public policies.

What will be the size of the ATN industry? As mentioned earlier, in 2008, Frost and Sullivan identified *potential* PRT markets through 2020 as about \$40 billion (ranging from \$12 billion

⁷⁴ Federal policies historically have delegated urban land use decisions to state and local government.

conservatively to \$105 billion, assuming friendly policies for urban mobility innovation)⁷⁵. An ATN project will create local jobs for construction, installation, and O&M, as well as vehicle and guideway component manufacturing and servicing, much of which is unlikely to be local. What percentage of an ATN project will be covered by Buy American and local hiring policies?

Lawrence Fabian in 1999⁷⁶ forecast a ten-year market for APMs (including driverless metros, AGT, shuttles, and PRT) of \$24-\$63 billion. The PRT portion was extremely small. Fabian's yearly Trans.21 updates a list of active APM projects around world⁷⁷. It is called the APM Pipeline because it demonstrates the flow of money through the APM industry (excluding most civil work) – not the annual turnover. In 2005, that flow was \$7.4 billion, of which \$4.9 billion was in driverless metros. In 2010, it had jumped to \$13.0 billion, including \$7.3 billion for driverless metros. As 2014 began, it was calculated at \$20.4 billion. The PRT portion of this remained small. In contrast, the world elevator industry has a turnover of \$21 billion⁷⁸.

No public signs indicate that the U.S. transit industry today is interested in innovating with ATN. Several large engineering procurement and construction companies are preparing to submit, or already have submitted, unsolicited proposals to build and operate ATN systems. This lack of transit industry interest is also true in Europe – even in Sweden. In the U.K., BAA is ordering six more vehicles for the existing Ultra implementation at Heathrow Airport and is committed to a second, larger project in the near future.

BROAD SOCIETAL TRENDS

Public transit and conventional urban rail are not usually high priority topics in Washington politics and national discussions. What might change that? The U.S. currently consumes almost 7 billion barrels of fuels per year⁷⁹ (nearly 300 billion gallons or 2.5 gallons per person per day, 40% of which is imported⁸⁰ and over two-thirds (70%) for transportation). Questionable claims are made that the U.S. has ample supplies of oil and natural gas accessible with a controversial method known as fracking, such that the U.S. will import less and even export oil again in the future. However, dependence on such claims to shape national transportation policy is highly risky.

How will energy supply affect USDOT transit policies? The U.S. transit industry is well represented in Washington by the American Public Transportation Association (APTA). It holds regular conferences, workshops and training sessions for its members, and it

⁷⁵ Executive summary of this assessment is available at: http://beamways.com/file/Frost%20Sullivan_Personal%20Rapid%20Transit_dec08_Executive%20Summary.pdf

⁷⁶ *The World Market for Automated People-Movers* (Jane's Special Report, ISBN 0 7106 1939 1, March 1999).

⁷⁷ <http://airfront.us/apms.html> with the most recent on www.podcar.org.

⁷⁸ Elevator World, Mobile, AL. <http://www.elevatorworld.com/>

⁷⁹ <http://www.eia.gov/tools/faqs/faq.cfm?id=33&t=6> U.S. Energy Information Administration.

⁸⁰ www.fueleconomy.gov (USEPA).

lobbies Congress for desired legislation and funding⁸¹. Current APTA policies are to secure funds to refurbish existing rail infrastructure, not to pursue innovation with ATN⁸². UITP – the Brussels-based International Transit Association – is bringing discussions of driverless metros to U.S. transportation research deliberations.

Will U.S. development patterns continue to sprawl, causing further environmental degradation and loss of good agricultural land and other natural resources? Will the public and, therefore, local officials demand better managed growth in compact “green” districts, such as called for by the Greenville County (SC) Council, that already has a bikeshare program (Figure 8)⁸³?

Will lifestyles continue to shift toward living in large cities, especially in neighborhoods with walkable and bikable networks on streets and along special ways that will increase community demands for better transit⁸⁴? Innovative modal orientation is already evident in many senior communities. Will this continue and spread to the planning and management of general residential districts? Like many cities and towns, Greenville is investing in programs to promote alternatives means of mobility.

In summary, prospects for growth of a U.S. ATN industry are difficult to predict. Many energy and environmental factors are key elements, and they lie outside the scope of this report. Before discussing the ways that public-private partnerships can be the potential means by which ATN projects are implemented, it is appropriate to pose questions, the answers to which will impact their prospects.

⁸¹ APTA events are large, but those of UITP – the International Mass Transit Association – are larger, more diverse and sophisticated, reflecting the high political standing that transit has in most European and other world cities. For example, UITP’s May congress in Geneva drew 2097 participants from 78 countries, and 26,000 visited the exhibits.

⁸² Conversations with Charles Joseph of APTA, December 2013.

⁸³ See www.innoventures.com/ventures

⁸⁴ www.uspirg.org. For example, the FHWA reports that today 26% of Americans in 2009 aged 18-34 did not have a driver’s license, compared to 21% in 2009. National vehicle-miles traveled (VMT) peaked in 2004.



Figure 58. Bikeshare Kiosk

Note: Bikeshare programs are becoming popular in many cities.

Source: Trans.21 archives.

Will reactions against further “oil wars” to secure future energy sources grow stronger and demand a fast transformation to carbon-free mobility? This was advocated by Bill James of JPods, who claims that access to public rights-of-way should be granted to those who demonstrate high energy efficiency⁸⁵.

Will evidence of global warming and climate change overwhelm skeptics so federal priorities emerge to effect a rapid shift away from fossil fuels? ATNs can effect a major shift away from car travel. It also would facilitate installation of solar power collection units in urban areas because ATN infrastructure can be integrated with solar units, creating a powerful synergy between energy and mobility supply.

Will chronic highway congestion become so gridlocked that political pressure will arise to create better mobility options? The dangers of overdependence on highways were made painfully clear during Atlanta’s ice storm of early 2014.

Such broad societal issues can affect governmental policies that will transform the environment in which private investment is attracted. Are we at the threshold of a major shift in USDOT modal policies on par with that which occurred in 1976? This can be illustrated as:

1976	Can Do	→	Freeze on ATN
2014	Unfreeze	→	Must Do

⁸⁵ <http://www.jpods.com/>

PUBLIC-PRIVATE PARTNERSHIPS

How do new transit projects come about? In the U.S., transit agencies and the MPO typically hire national consultants, such as Parsons Brinckerhoff, Kimley-Horn, and many others, to perform studies to satisfy FTA and FHWA requirements for obtaining federal funds to cover a major portion of capital costs. That share was 80% in the late 20th century, but now it is more typically 50%. Competition for the FTA's limited New Starts funds is intense, and prospects for federally funded new guideway transit projects are not bright.⁸⁶ If a project obtains necessary environmental approvals, meets FTA criteria, and garners political support in Washington with commitments of local funds, it becomes a funded project and proceeds to procurement and construction. An urban transit project includes many components. If it is not a turnkey project, an implementation will involve several procurements – such as for detailed engineering and environmental studies, project management, civil work, electrification, fleet, communications and controls, system integration, impact mitigation, etc.

Transit-generated ATN projects can be implemented by turnkey arrangement or managed by the public sector. For example, would the City of San José manage an ATN implementation, or would it simply purchase one from a private consortium that produces the work? That consortium will require the right to use certain public rights-of-way. Typically, the transit authority obtains necessary permissions from state and local government agencies.

The transit industry has shown no interest in ATN projects. Working alone, a private investor cannot implement a project in an urban area, even if it looks profitable. Private investors must identify a return on investment (ROI) that is unlikely to arise from fare revenues alone. However, there is potential profit from increases in land value that an ATN will create. This is how Hong Kong's metro, London's Docklands Light Railway, and the driverless Copenhagen metro were financed. Moreover, solar-equipped ATN may generate power beyond its own use. This can be sold in urban areas, creating another revenue source. Other revenue sources may come from selling the use of conduits built into the guideway network to house power and communication wires and cables.

It is clear that an ATN project is necessarily complex with many stakeholders. A formal PPP of some type is necessary. This requires drafting a legal document and enabling legislation. The private sector relative to its investment should want, among others, the following items explained and defined:

1. Will the PPP have an exclusive right to provide ATN mobility services for a fee? How will it compete and interface with conventional transit, private shuttles, and taxis?
2. Will the PPP pay real estate taxes on its property, along with other taxes such as a sales tax?
3. Does it have the power to set fares and service parameters (such as hours of operation), or is it necessary to obtain approval from others?

⁸⁶ Conversation with AECOM transit executive Tom Waldron, December 17, 2013, in New York City.

4. Does the public sector guarantee some level of ridership? Will it encourage private employers to subsidize use by their employees?
5. Will public parking policies (metering, rates, and enforcement) encourage ATN ridership?
6. Will public programs provide and maintain landscaping around and maintain and secure easy access to ATN stations for pedestrians, bikers, taxis, vans, drop-offs, etc.?
7. Does the PPP have all rights to revenues from advertising in vehicles and station interiors and on guideway, vehicle and station exteriors? Can it sell trip data to interested parties? Is it possible to sell in-vehicle and in-station Wi-Fi access?
8. What income will accrue to the PPP from increases in property values near stations? How can this be structured?
9. Will the public sector implement urban arterial tolling policies, whether to raise revenue streams or to reduce congestion?⁸⁷ Public officials wishing to encourage private investment in ATN projects have a powerful option in road pricing to drive trip-making from the highway to ATN.



Figure 59. Considerations in the Use of Public Funds for Transportation

Note: Should limited resources be utilized to maintain old infrastructure or to create new, more sustainable modes?
Source: Trans.21 archives.

⁸⁷ London and several European cities have done so successfully. Singapore has a sophisticated program to eliminate congestion. NYC Mayor Bloomberg was unable to do this in Manhattan. Canada cancelled a study in 2008.

CAPITAL RESOURCES

There are many possible sources of capital funds to implement PPPs. It is beyond the scope of this report to identify them all and make recommendations. Beyond commercial banks, suffice it to mention some potential sources:

- Bonds sales, with and without public guarantees
- Pension funds
- Emergency “survival” gas tax
- International organizations such as the World Bank, the UN, and NGOs
- Federal agencies beyond USDOT include HHS, EPA, GSA, DOI, TRB, DOD
- State governments, whether through DOTs or other agencies
- Metro: MPO and counties, municipalities
- Special authorities, such as port and downtown redevelopment authorities, agencies for redeveloping surplus military bases, etc.

The search for a business model for ATN extends well into uncharted territory. The most viable and promising appears to be a real estate investment approach. Private funds will be invested more readily in an ATN project with the expectation of significant future incomes from the appreciation of urban land and building values at or near stations.

Two European examples of this real estate-based approach to transit development are in London and Copenhagen. The London Docklands Development Authority in the 1980s invested in a relatively low-cost automated light rail network that catalyzed large-scale investment in office towers. It has been upgraded and expanded in several stages, funded by revenues from real estate development⁸⁸. In Copenhagen, a special development authority was created to develop a large tract of land between the city center and the airport, and it was directed to serve with high levels of transit. It chose a driverless metro (Figure 60) that was largely funded by anticipated increases in land value⁸⁹.

⁸⁸ <http://www.lddc-history.org.uk/lddcachieve/> and http://en.wikipedia.org/wiki/London_Docklands_Development_Corporation; see also Figure 51 in this chapter.

⁸⁹ <http://www.railway-technology.com/projects/copenhagen/> and <http://intl.m.dk/#/>



Figure 60. Copenhagen Driverless Metro

Note: Copenhagen's driverless metro was largely financed by sale of public land.
A ring line is underway using a similar strategy.
Source: Trans.21 archives.

It has been extended through the city center, and now a second ring metro is underway, also funded by the sale of surplus public lands. A third example is available in Hong Kong, whose MTRC develops both transit and real estate.⁹⁰

Rail transit in the U.S. in the 1920s was often funded by profits from land development on the edges of the cities. Examples abound, with Shaker Heights, OH perhaps the best known. This is a transit-oriented streetcar suburb of Cleveland with an LRT/streetcar to downtown built by the developers.⁹¹

Similar development models can be used to develop land around airports or other special districts, especially increasing the densities around existing rail stations. This is the new ATN industry's cutting edge.

⁹⁰ <http://www.theatlantic.com/china/archive/2013/09/the-unique-genius-of-hong-kongs-public-transportation-system/279528/>

⁹¹ <http://shakeronline.com/assets/downloads/city-plans/wva%20tod%20final%20report.pdf>

VIII. CHALLENGES AND OPPORTUNITIES

Today the U.S. faces a future far different from anything imagined 20 years ago. The revolution in communications has impacted and is transforming every aspect of life – how people work, travel, shop, and socialize. Cities are essentially settlement patterns that facilitate interaction (Figure 61). A younger generation is taking on new social patterns and norms that older generations struggle to understand. The U.S. highway system is bankrupt. The dangers of over-reliance on highways and fossil fuels are clear. Alternative modes of urban transport may portend tremendous benefits.

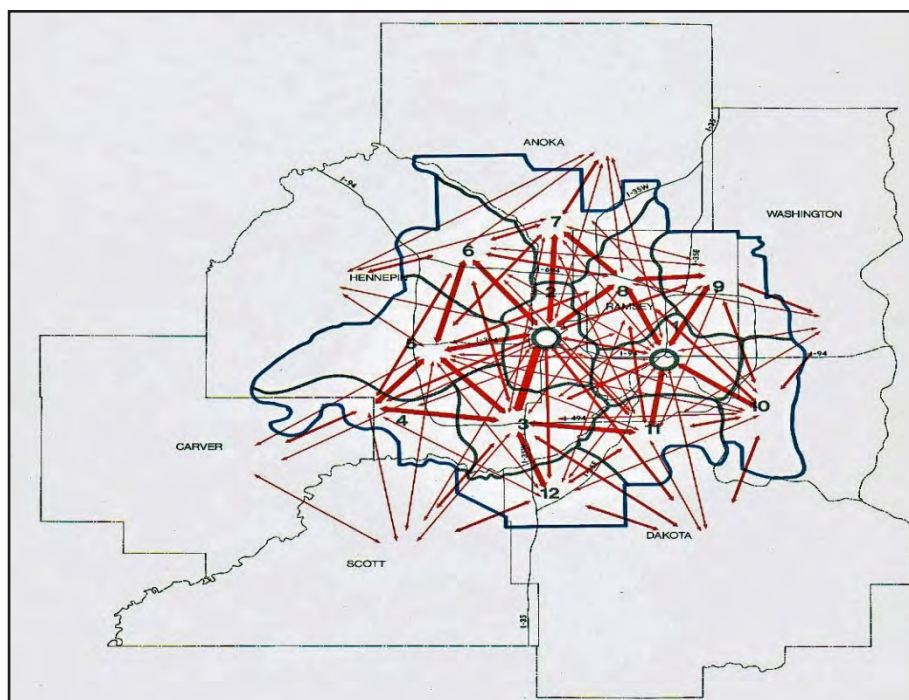

Figure 61. Directionality of Metropolitan Travel

Note: Metropolitan Trip-Making is Multi-Directional. ATN can satisfy most transit needs better than the linearity of conventional rail.

Source: Trans.21 archives.

Concurrently, the nation's economic and budget-focused crises are bringing change to the structure of governance, and these impact the ways that urban infrastructure is funded and planned. Coupled with the coming of driverless cars, this is a time of rapid change. Such is the context in which ATN will succeed or fail.

INFRASTRUCTURE IN CRISIS

Surface transportation – especially highways and transit – faces significant budget shortfalls. This is in contrast to the wealth generated by the largely unforeseen growth of silicon communications that power the nation's web-based economy, bringing trillions of dollars in foreign currency to American shores. The American Society of Civil Engineers (ASCE) reported that deterioration of the nation's roads and highways originated several

years ago⁹². For 2010, the Society estimated that deferred maintenance amounted to \$130 billion, and it forecast an alarming upward trend to \$912 billion in 2020 and \$3 trillion by 2040 (Figure 62).



Figure 62. Shortage of Government Funding for Infrastructure

Note: Federal, state and local governments search for adequate funds just to maintain existing bridges, roads, and transit.

Source: Trans.21 archives.

President Obama in his 2013 State of the Union address noted that the U.S. is home to approximately 70,000 structurally deficient bridges⁹³. His 2014 budget request for the USDOT is \$77 billion, an increase of 6% over 2012⁹⁴. Of this, \$53 billion is slated for highways, transit, and highway safety. Grants for all transit in 2013 totaled \$20 billion, including \$2.2 billion for new starts and expansions to 29 projects in 15 states. For 2014, the comparable request is \$2.1 billion, which includes \$151 million left over from previous years⁹⁵.

This is a minor part of the overall federal budget debates in Congress. Federal funds are limited and declining. In part due to cuts in FTA disbursements, transit properties are primarily in retrenchment – reducing service while increasing fares and shelving new starts.

The challenging U.S. policy question today is whether the nation should maintain the vast Eisenhower-era Interstate highway network and the auto-addicted way of life it has brought. Is it sustainable? Or should America's urban transportation infrastructure be transformed into something cleaner, safer, and more economical? With such a national priority, ATN can play a major role as part of a larger agenda of shifting modal balance to walking, biking, car-sharing, and mass transit. It is necessary to have objective analysis of the potential benefits from ATN implementations.

⁹² <http://www.asce.org/failuretoact/>

⁹³ <http://www.whitehouse.gov/the-press-office/2013/02/12/remarks-president-state-union-address>

⁹⁴ <http://www.dot.gov/sites/dot.dev/files/docs/FY%202014%20Budget%20Highlights.pdf>

⁹⁵ http://www.fta.dot.gov/12347_5221.html

THE ESSENCE OF THE CHALLENGE

As described in Chapter 3, there is no established ATN market, and only a handful of companies can credibly deliver a ten-station network within the next two to three years. Chapter 7 showed that the prospects for an ATN market to come into existence without public intervention are not encouraging. The challenge of creating an ATN industry is to nurture something from scratch. Currently, the U.S. has a way of living and conducting business that depends on roads and cars. If people purchase fewer cars, those who manufacture and sell them will suffer. If people possess fewer vehicles and use them less often, the income of those who make a living by maintaining and repairing them will decline. Revenues from vehicle registration and insurance will be reduced. Thus, many will oppose change from current conditions even if, on the whole, the situation is unsustainable.



Figure 63. Swedish and European Support for ATN Research

Note: Swedish and EU sources funded a simulation and evaluation of this ATN for Gavle in the 1990s.

There was no comparable US research activity.

Source: Trans.21 archives.

Although technical facets must be developed and resolved, the challenge of creating an ATN industry is not that of technology alone. The obstacles are also of an informational and institutional nature. The study done by Aerospace Corporation for the City of San José articulated the challenges well:

“...it is clear that local authorities need to engage not just in a procurement process, but in a preceding development process. This extends as well to the numerous other stakeholders on both sides of the transaction that define the broader value network necessary for both defining and supplying innovative systems. This network is not yet mature with respect to ATNs and is moreover not supported by the existing value network based on conventional systems. That is, the existing value network is not structured to tackle the large systems development issues associated with ATNs.”

Municipalities do not and will not have the technical, financial, or risk-taking capacity to lead or underwrite ATN development, but the above role is nevertheless essential. The natural next question to ask is how investment, risk, and rewards can be allocated such that development can proceed. This ultimately becomes an issue of development roadmapping and institutional design and is a more fundamental issue than the technology itself.” (Paige 2012, 64)

During the many stages of project formulation, many professionals and policy-makers need clear guidance, otherwise an ATN plan will not move forward to implementation. There are no widely accepted ATN specifications or planning guidelines for station and guideway dimensions. Architects, for example, need these specifications and guidelines so they can explore how to incorporate ATN into the built environment. There is a dearth of planning guidance for urban district managers and planners. The ASCE APM Safety Standards include ATN within their definition of APM. However, they do not address the unique characteristics of ATN that land use and transit planners find of great interest in terms of the flexibility they allow, such as station spacing and network topology.

Public policy must first and foremost assure safety and security. That requires thoroughly examined standards and informed engineering and legal professionals. Construction contractors, workers and inspectors need experience with ATN project components to the same extent that they are already familiar with conventional rail and, to a considerable degree, with APMs. Architects, planners and engineers need detailed information. The ASCE Standards, while adequately treating safety, do not address station sizing and location, land use implications and opportunities, and visual impacts.

Unfortunately, today’s legislators and policy makers are not familiar with ATN – neither the challenges nor the opportunities. These are not abstract issues. Police, security, and fire officials have other priorities and wield great power in local planning reviews that are required for permitting an ATN project. For example, they can veto street closures that might be desirable for transportation reasons by declaring that the closure will compromise public safety.

SHIFTING A COMPLEX MARKET

The marketplace for urban mobility is extremely complex. The buyers and sellers are not individuals trying to purchase (or sell) a proverbial widget. Transit infrastructure is publicly regulated even if it is privately owned. It typically crosses political boundaries. It is expensive and requires annual allocation for operation and maintenance. The transit system “buyer” is in reality a complex array of institutions with dynamic political significance. Chapter 6 showed that the current U.S. procurement process is awkward and cumbersome, leading to very expensive solutions. It needs rationalization and reform. ATN designers must work closely with architects and public safety officials to create useful urban projects (Figure 64).



Figure 64. ATN Integration with the Built Environment

Note: ATN offers the possibility of integration with buildings.

Source: Trans.21 archives.

ATN implementations require the collaboration of several professions, each of which has its specialized approaches, methodologies, vocabularies, and certifications. For landscape architects, current practices are not expected to present obstacles for ATN projects. For others involved in the design of rail systems, three conventional practices prevent leveraging the advantages of ATN. To overcome these obstacles requires a significant shift in professional thinking:

Lines versus Networks: Prevalent transit thinking is linear. The unit of construction and operation is a single corridor because that is how rail technology works. The addition of a branch makes operation more complex. However, today's auto-oriented urban development and, therefore, car-dependent trip-making patterns do not naturally configure themselves into corridors. Urban growth tends to sprawl, and trip-generators are likely to lie off a single corridor and thus be distant from the nearby rail corridor. For those contemplating the layout of guideway transit, the advantages of ATN networkability are dramatic. Loops and branches can be added to reach off-corridor destinations. ATN configurations are powerfully flexible to solve dispersed demand for circulation and parking (Figure 65).

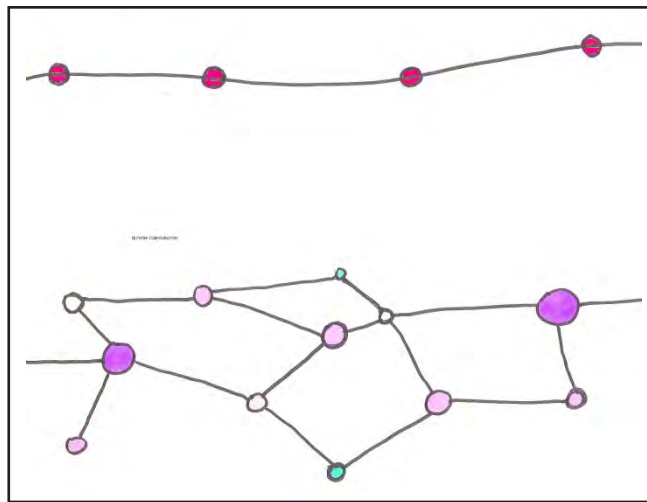

Figure 65. ATN Configuration Flexibility

Note: ATN can be implemented as a network, in contrast with a linear corridor.

Source: Roger Ericsson viaTrans.21.

Rigid versus Flexible Station Size and Location: Prevalent transit design and engineering require the regular placement of uniformly large stations. The maximum hourly demand of a line determines required train length, which in turn defines station length. Because trains stop at all stations, all stations must accommodate this maximum train length even if demand at less important stations is low. In other words, *the size of the least used station must be that of the most used station*. This drives up costs and visual impacts in ways that are largely wasteful. In contrast, when designing an ATN network, a minimal size is the starting point for the design of any given station. Only when forecasts show the need for a larger station with greater capacity is it necessary to enlarge beyond the minimal size. Off-line stations change the calculus of station location and sizing (Figure 66).

Moreover, conflict is inherent in spacing conventional rail stations along the length of track or guideway. On the one hand, there is a desire to have several stations to serve as many trip origins and destinations as possible. On the other hand, numerous stations along a line can slow the average travel speed, reducing the attractiveness of its service. Thus, a general design principle for conventional rail is to have station spacing no closer than one-half mile, or closer to two miles in low density areas. This imposes a tension between the desire for ample service coverage and the goal of high trip speeds to better compete with car and bus modes.

In stark contrast to this rail design dilemma, ATN stations can be closely spaced, limited only by the required length of deceleration and acceleration ramps. Adding a station does not slow travel time for trips that do not stop there.

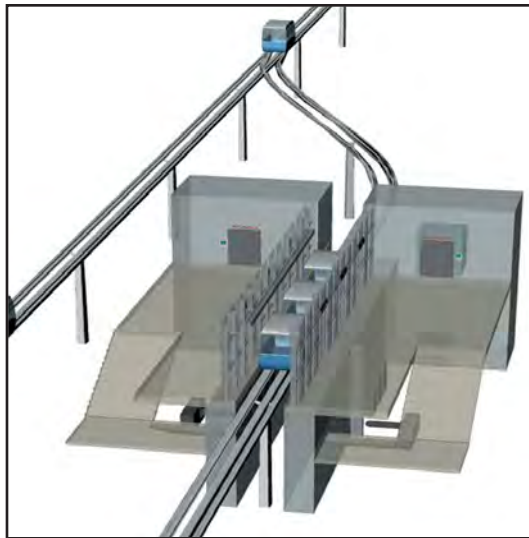

Figure 66. Offline Stations

Note: Offline stations add significant flexibility compared with conventional line haul transit approaches.
Source: Vectus, through Trans.21.

Moreover, passenger demand at a given station can be reduced by adding another station, avoiding the conflict described above for conventional rail. Local residents often do not like a conventional rail station close to their neighborhoods because they are large and attract traffic that uses local parking. In contrast, ATN stations can be small, intimate, and place-making (Figure 67).



Figure 67. ATN Integration into Urban Settings

Note: In dense settings, the cost of underground guideways may be offset by at-grade station savings.
Source: Trans.21 archives.

One-way versus Two-Way Guideways: Prevalent transit thinking assumes two-way corridors because that is how urban rail systems work. Another advantage of ATN is the viability and even desirability of less bulky one-way segments. This means that the size of a guideway can be smaller than conventional rail, not only because the vehicles are comparatively small and light, reducing structural requirements and costs, but also

because it is one-way – half the width of a two-way corridor. One-way guideways tend to be loops, which are easily expandable and scalable.

THREE MAJOR ATN PLANNING CHALLENGES

Within the context of the need to counter the above institutionalized rail planning practices, three major challenges exist for ATN planners:

Elevated Infrastructure: The aesthetic and environmental impacts of elevated guideway and stations are substantial and often controversial. This will depend on the design attitudes and styles that drive the implementation process. It will impose new physical realities with very real visual and aesthetic impacts on cities, suburbs, and towns (Figure 68).

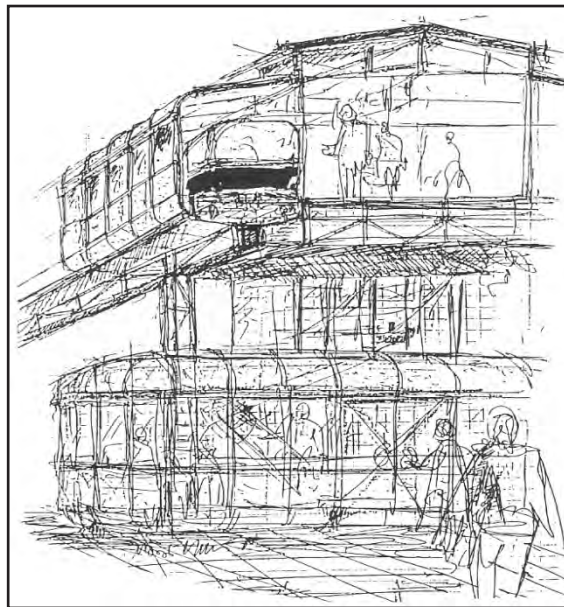

Figure 68. Architectural Sketch of Small Elevated Station

Source: KFB.

As is often said in design and engineering circles, the devil is in the detail. These include shadows caused by guideways and stations, views from vehicles on elevated guideways that violate privacy of abutters, and drippings and droppings from guideways. What materials, colors, and architectural embellishments can and should be used? Should the local public art community be involved? What landscaping and other urban amenities (benches, bike storage, public toilets, charge stations, etc.) will surround the stations and guideway column footings? Who will maintain them? This implies the need to engage professionals trained in such matters. Appropriate curricula and instruction are needed.

10. *The Complexity of Large Networks:* There will be software programming costs for the design and implementation of large network and geography-specific ATN configurations. The larger the network, the more complex trip scheduling and empty vehicle management become. The complexity increases with the square of the number of stations. Will surges in demand overwhelm real-time scheduling and fleet management functions of the control software? How will the system respond to

perturbations – such as accidents, power outages, fallen trees, medical emergencies, criminal and terrorist acts, etc.? Service must be as reliable, safe, and secure as possible. This implies the need for investment in advanced software development that can come from either the public or private sector. As concluded by Aerospace Corporation, significant work is required for the development, validation and verification necessary for large meshes of ATN (Paige 2012, 221-243). Federal funds would be well justified by the foreseeable benefits.

11. ***Making the Financial Numbers Work:*** There is at present no clear business model for ATN implementations. If ATNs are designed to feed and reinforce existing transit, how will revenues be shared? Can the flexibility of ATN configuration and phasing more easily bring a share of the rise in property values that accompanies transit access to help pay for the cost? How substantial will be the revenues from advertising, recharging, and in-guideway utility conduits? What can be learned from the growth of car rental and ride-sharing communities? Experience from privately funded APM projects is both positive (e.g., Huntsville, AL, and University of Indiana hospital complexes, the Getty Museum in Los Angeles) and negative (e.g., Harbour Island-Tampa, Wellington-Boston, Las Colinas-Texas, and Oeiras-Lisbon). Many problems and pitfalls must be avoided, but the benefits can be substantial. This implies the need for urban economists, entrepreneurs, and public policy analysts to examine these issues thoroughly to better quantify costs and benefits (Figure 69).

Solicitation of ideas from MPOs would both bring information to USDOT on current local preferences, and it should help MPOs take on the leadership roles to which they are encouraged.

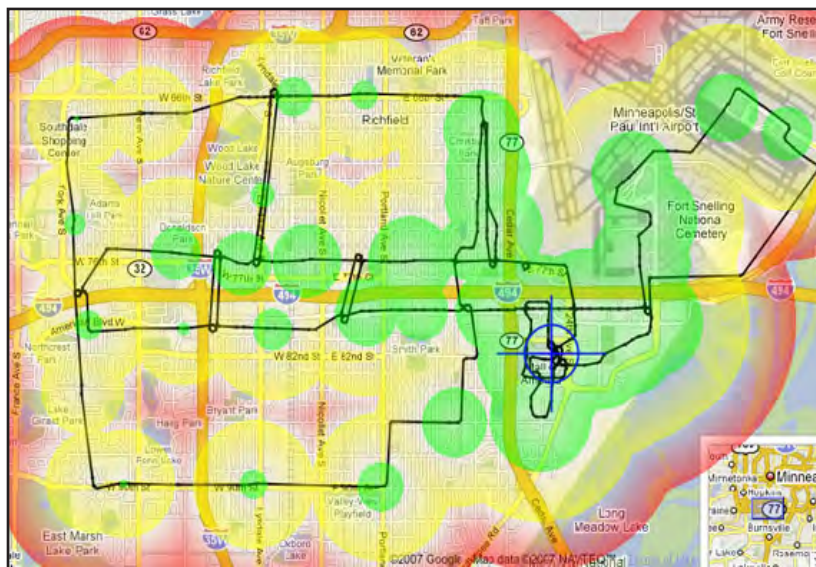

Figure 69. ATN Network Concept for Minneapolis-St. Paul

Source: Bill James, <http://www.jpods.com>

EXPLORING THE OPPORTUNITIES

Given the many challenges for ATN implementations described above, from a public viewpoint, what can be gained by ATN?

It is clear that existing transit properties can attract new clients, and therefore additional revenues, through station-feeding ATNs that increase the coverage of public transportation. The financial model of ATN-extended TOD strategies has not been explored in the U.S., but some Swedish studies have explored such scenarios (Tegner and Angelov 2009; Tegner and Fabian 2001; Tegner 1999). Funds are needed for their construction and operation, but since it is unlikely that substantial federal funds will be available to add feeders to existing transit stations, how can private investment be attracted? What PPP financial arrangements and guarantees can be established? What zoning, tax incentives, and protections are possible?

From a real estate and land market perspective, land values at sites served by outlying stations of transit-feeding ATN networks will rise. Remote trip generators (offices, medical and education facilities, retail, etc.) with easier access to rail network services via an ATN feeder are more attractive (Andreasson 2012). Because many trips to and from such sites will shift from car to transit, the need and cost of parking supply and local road capacity will be reduced. Will this reduction be 5%, 10%, or perhaps by as much as 50%? Research is necessary to determine the changes. Similarly, the need for access roads to a remote site may be lessened, introducing additional infrastructure savings. How can real estate investment benefit from and contribute to ATN financing?

If a comprehensive district approach is taken to the planning and management of an area beyond easy walking distance from a conventional rail station, a competition for ATN stations can be expected. Owners of individual parcels can decide whether or not to invest in bringing an ATN station onto their sites.

Transit Where Conventional Transit Is Not Feasible: Rail transit is expensive and justifiable only in large, dense cities where congestion is severe. There are many small and medium-sized cities with populations less than 250,000 in which conventional rail is not feasible because the economic case is so marginal. In contrast to this, the smaller scale and flexibility of ATN make it a more attractive option to provide basic public transit service that is better than bus service.

The same can be said for private complexes such as suburban shopping districts, office parks, educational, and medical campuses where the economics of conventional public transport do not work. The provision of ATN circulators can provide benefits of increased local interactions, institutional synergies, and reduced headaches for parking supply and ride-sharing.

ATN Infrastructure to House Utilities: As is clear from APM projects at airports and hospitals, ATN guideways can house conduits for power and communication wires and cables and tube delivery systems (Figure 70). Overhead, there are extensive areas for the collection of solar power. This is an option little explored in mass transit settings and

in ATN studies. Real opportunities can be explored in a city-wide ATN as an extensive power-collecting mesh. Compared to the rigidly radial nature of rail systems, ATN benefits could be substantial.



Figure 70. Huntsville Hospital's APM

Note: The inclusion of conduits in the guideway reduced the need to excavate for underground utilities.
Source: Trans.21 archives.

Given current budgetary challenges, and in particular, shortfall for highway and transit maintenance, the U.S. is in a situation where it must reexamine its ground transportation infrastructure strategies. In this dynamic and unpredictable context, the potential of ATN to solve significant urban transportation problems is certainly worthy of continued attention. To our knowledge, the extent of potential benefits has not yet been estimated, and the research tools and methodologies to do so are not yet readily identified. The concluding chapter addresses this with recommendations for discrete steps that federal and state policymakers can consider to meet the challenges of the 21st century.

IX. CONCLUSIONS AND RECOMMENDATIONS

The challenges to realizing the many benefits of ATN deployments described in the previous chapters bring up many questions that can be answered by research and demonstration programs; and barriers to entry could be lowered by reasonable adjustments to the way transit projects are implemented. The source of funds to carry out the research is not the main consideration here, rather what needs to be done going forward to get ATN to the point that it can be taken seriously by planners and consultants as a viable transit mode. Even in an age of constrained federal budgets, there may be funds to underwrite activity from the USDOT, the Department of Energy (DOE), the Department of Housing and Urban Development (HUD), the Department of Health and Human Services (HHS), and the Environmental Protection Agency (EPA). For example, existing TRB programs such as TCRP and ACRP are in place and might be used for ATN-related research. The Department of Defense (DOD) might wish to know how much interstate highway congestion costs them, and it may look for ways to mitigate it, etc. Moreover, greater interest and financial resources may be available at state DOTs. Programs for the growing senior population and those dealing with lifestyle shifts are other possibilities.

Below is a preliminary list of general ATN “problem statements” that merit consideration for research funds, whether from federal, state, or private funding. The findings of these research initiatives would be disseminated by various means, such as paper and digital publications, videos, social media, workshops, etc.

1. A program digest of the USDOT (UMTA) AGT programs of the 1970s is needed to inform MPO planners and transportation policy-makers. This would include (a) an MPO-friendly summary of the Morgantown experience from the perspectives of West Virginia University (WVU), city, and regional transport officials, and (b) recent capital improvements and current development needs and priorities there. This digest would have an international component as well, summarizing British, German, and French AGT programs.
2. A synthesis of Swedish research from the 1970s to the present is needed, done in a style and format that will be useful to American MPO planners and urban mobility stakeholders. Figure 71 is one result of sophisticated multi-modal analysis, here plotting origin-destination patterns. This synthesis can be organized and implemented under the MoC between the USDOT and the Swedish Ministry of Communications and Enterprise (see Chapter 4). One possibility would be to make this a special project for the TCRP program, with a dissemination plan as described above.

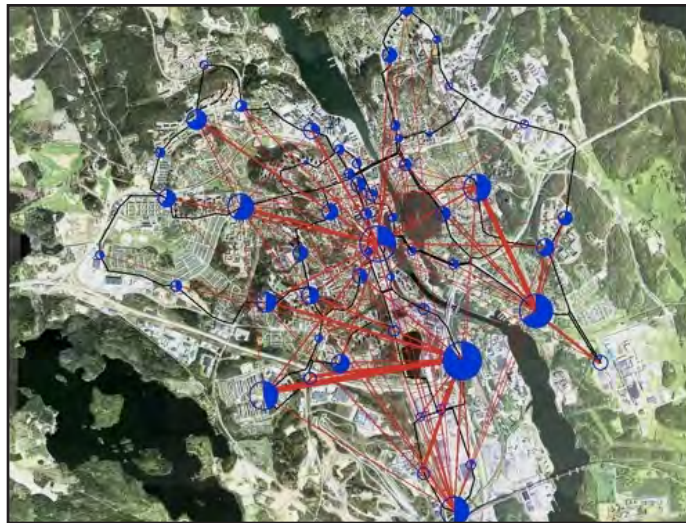

Figure 71. Multi-modal Simulation Analysis in Sweden

Note: The simulation of origins and destinations of trips in a Swedish city shows the diffuse nature of urban travel.

Source: LogistikCentrum.

3. US transportation planners have little awareness of, nor access to, Swedish accomplishments and experience in general urban planning and management, and in particular, ATN analysis. A team of promising young MPO officials might be assembled to benefit from workshops and tours with funding made available for this select group of perhaps 10-20 professionals to have participated in the eighth Podcar City conference held September 3-5, 2014 at Stockholm- Arlanda Airport, Sweden.
4. MPO planners have no data comparing costs and risks of semi-depressed and semi-elevated positions protected by fences and landscaped barriers. A security-oriented survey of APM experience, especially the recent ATN systems (e.g., Heathrow, Masdar City, and Suncheon Bay) would be of great value. What role can intrusion detection systems play and at what cost? State-of-the-art practices in security at airports, rail transit, and other security-sensitive settings would be surveyed and presented in a format useful to urban designers, landscape managers, architects, planners, and engineers.
5. Architects and urban designers need to know what building materials, coloring, and lighting options are available in order to produce ATN guideway and station designs acceptable and even desirable in urban settings. Can ATN infrastructure be conceived and used as attractive urban furniture? How can arts communities best be involved? How can conduits for wires, cables, and piping systems be incorporated?
6. Systems analysis of the differences between open (dual-mode) and closed ATN is needed to better understand the implications for metropolitan access and mobility. This can be a type of “generic alternatives analysis,” as UMTA did in the 1970s. With a horizon of 20 years or more, investigators would determine how urban mobility would be improved with investment in open and closed ATN in comparison

with other modes - conventional, maglev, LRT, BRT, car sharing, HOV lanes, and walking/biking.

Transportation is one of the most energy intensive of human activities, and every president since Richard Nixon has lamented the security risk of dependence on foreign oil. The elevated fixed guideway of ATN provides a ready platform for solar energy collection.



Figure 72. Role of ATN in Developing More Livable Communities

Note: What role can quiet, solar-powered ATN, carefully blended into pedestrian-friendly reuse of pre-Interstate arterials, play in the future of community life?

Sources: (top) Nerds 'n Squares, Uppsala Podcar Systems;
(bottom) Trans.21 based on sketch by Prof. Charles Harri

Furthermore, most transportation activity occurs during daylight hours, and its volume as a function of time rather closely matches that of solar insolation. ATN utilization of solar energy would reduce the need for energy storage, whether from fossil fuels (fundamentally stored energy extracted from nature's storehouse) or batteries (heavy and expensive) powering electric cars. Can solar energy systems meet the needs of ATN systems, sufficient to achieve net zero energy consumption? More research and development is needed to fully realize the potential of powering ATN using solar energy.

Stations, Station Districts, and TOD

Outside the technological perspectives of most ATN suppliers, community stakeholders look primarily at stations. ATN suppliers typically pay less attention to stations, instead

focusing on vehicles and controls. Infrastructure engineers search for corridors and rights-of-way that put their attention on guideways. To the larger world of community life and real estate development, however, the most interesting component of an ATN system is the station: where is the system putting down that valuable but invisible commodity – access? What are its dimensions of an ATN station? How much traffic will it attract? How much commercial activity will it induce, and how much parking will be required?

In Chapter 5, the authors pointed out the very attractive flexibility to be found in the location of ATN stations. An architect or site planner needs to understand these ATN parameters in their terms, with measures meaningful to them. It is necessary for a design manual to include:

- a. The feasibility of ground-level ATN stations. If guideways are elevated, deceleration and acceleration ramps can bring arriving vehicles to ground level so that only a small area is needed for the station. If guideways are below grade, how can they be brought up to ground level? What are the costs and benefits of these alternatives? A variation is to have elevated stations with access to buildings at the second-floor level. This can create new retail opportunities.
- b. What are the economic impacts of small-scale ATN stations on land values compared with those of conventional rail? How can they be predicted? What are the options for institutions to capture this value, to help finance the infrastructure?
- c. What are the architectural, structural and security problems created by integrating ATN guideways and stations into buildings? How can noise and vibration problems be minimized? Research on the APMs in downtown Detroit, MI, Jacksonville, FL, and Indianapolis, IN, the Huntsville (AL) Hospital, airports, and other relevant examples, such as the Getty Museum in Santa Monica, CA, can be highlighted to improve design guidelines.

In addition, there are many unknowns created by ATN for MPO analysis and traffic forecasting. These kinds of questions fit well with the scope of TCRP. It is not known how well existing demand forecasting and mode split models, traditionally oriented to radial corridors, can accommodate and simulate the dense meshes foreseen for ATN amidst the changing demographics. How will the taxi-like levels of ATN impact trip-making behavior and car ownership patterns? In line with that metropolitan outlook, how feasible is ATN as a “backbone” guideway transit in smaller urban regions? What are the thresholds in terms of size and density that make ATN feasible?

Car availability is taken as a given in traditional MPO analysis. However, the introduction of ATN services, growing car-sharing schemes, shifting life-styles, and other factors are expected to impact car ownership and use. How can future mode split analysis account for the impact of superior transit service on car ownership?

On the other hand, MPOs are valuable sources of practical ways in which ATN can be used to solve local problems. USDOT could ask them what ideas they have in a process reminiscent of the DPM Program in the late 1970s. UMTA asked cities to develop

concepts to use APM projects to help stabilize and revitalize downtown districts, and received almost 80 ideas. In the 1990s, the Chicago Regional Transit Authority reached out in a similar way for PRT concepts from suburbs. In 2014, with no commitment to capital cost funding, the FTA could ask cities, suburbs, and MPOs to deliver concepts for reward-promising ATN implementations.

Finally, in the important realm of project financing, unknowns on ATN abound. How reliable are estimates of capital and O&M costs? What are the right business models for ATN? It seems unlikely that New Start funds will be available for capital costs. How can private funds be attracted to a project? What are the best ways to benefit from the after-the-fact increases in real estate values predictably created by the ATN? Just as streets accommodate other infrastructure, how feasible is it for ATN investors to gain “extra” revenues by incorporating conduits to house wires, cables, and piping in the guideways? Similarly, what are the parameters for “extra” revenues from solar power collection? There is a need for analysis of land development with ATN from the perspective of real estate and economics. Funding a study of ATN economics by the Urban Land Institute is one way to produce useful data and guidelines.

Demonstration Programs

Any capital-intensive public transportation mode emerging in today’s heavily subsidized transit environment will be acquired mostly by public agencies subsidized by the federal government. These agencies are by nature risk averse and must have confidence in the technology they are acquiring. On the other hand, developers of innovative new capital-intensive public transportation modes tend to be underfunded and/or to direct their efforts at the low-hanging fruit. In the case of ATN, these two factors make public agencies reluctant to procure ATN systems. ATN developers therefore pursue niche applications rather than projects in mainstream public transportation. Demonstration programs are necessary to overcome these barriers to ATN market growth.

The three primary characteristics that must be demonstrated are capacity, scalability, and mode share.



Figure 73. ATN Vehicle Mock-up

Note: Full-scale mock-up of an ATN vehicle, short guideway segment, and small station in Sweden helps advance civic conversations.
Source: Institute for Sustainable Transportation (IST), <http://istcab.com>

Capacity. All four modern ATN systems in public service are limited in the capacity they can provide by the number of available vehicles. Independent “hardware in the loop” simulation (in which a simulation is integrated with the actual operation of real vehicles) could quickly demonstrate the actual capacity these systems would have if additional vehicles were available.

All the existing systems operate at minimum headways above three seconds, and all comply with the “brick wall” stop criteria developed for railroads. Three-second headways significantly limit capacity and reduce ATN cost-effectiveness. The only workarounds currently available are larger vehicles and platooning. Both of these have limited applicability and can lead to lower service levels. A demonstration program to develop and demonstrate safe operation at low headways and high speeds is needed. A target of one second at 60 mph is suggested to significantly raise the level of ATN speed and throughput. In addition to the capacity and service levels greatly increasing, the business case for ATN projects would become more attractive. ATN has the potential to become a relatively high-capacity, high level-of-service mode with much lower cost than other alternatives.

Scalability. In addition to demonstrating the capacity of a modest network of guideways, it is important that the scalability of such a network to a city-wide network be demonstrated. Again, techniques are available whereby a small network can comprise the “hardware in the loop” for a city-wide simulation demonstrating scalability of control and communication systems. This demonstration would thus be composed of an integrated computer simulation and an operating full-scale PRT system. The PRT system could be relatively small and confined, while the simulation and remote communications devices, as might be used at stations, could stretch over the entire city.

Part of this demonstration should also demonstrate/investigate transfers between ATN systems. Future developments could result in a city being served by more than one ATN supplier and/or inter-city travel could be provided by a system more suited to that purpose, which would need to interface with the intra-city system. If inter-system transfers can be proven to be seamless and not much of a deterrent to travel, concerns about scalability and monopoly may be lessened.

Mode share. Many Swedish, European, and U.S. mode share studies have indicated that widespread ATN service will quite dramatically boost transit mode share, however, none of these studies has been calibrated. One or more urban demonstration systems, where riders have many mode choices (unlike present PRT/ATN implementations, where riders have limited options beside the PRT/ATN) are needed in order to begin calibrating mode split models.

Conclusions

This document reports on a proto-industry that promises to provide public and private planners with an important new tool with which to address transportation issues. ATN has shown itself to be useful in niche applications, such as Heathrow Airport. This and other ATN implementations now in public service are all smaller and less demanding than the eventual capabilities of those technologies. This document attempts to help the reader better

understand the extent to which the capabilities of the existing technologies can be expanded. The ultimate capabilities of high-speed/high-capacity ATN are yet to be explored.



Figure 74. Blending ATN into Urban Settings

Note: To be useful, ATN must be delicately blended into the lives of thousands who call the setting home.

Source: Trans.21, courtesy of Ethel Vrana.

In an urban ATN implementation, technical risk is one of many elements in the overall project. Many risks are foreseeable and thus manageable. However, there are many unpredictable risks – climatic (e.g. extreme weather), logistics (e.g. deliveries delayed by local congestion), workers (e.g. a strike or work stoppage), political (e.g. new mayor), economic (e.g. inflation in component and energy prices), and acts of war. From this larger perspective, technology risks can be of minor concern.

ATN implementations require close cooperation from many kinds of local officials, and most probably will be implemented through a carefully negotiated public-private partnership (PPP). To the extent that this modest report and the follow-on projects suggested in this chapter help decision-makers to move forward to sustainable urban transportation, it can be considered a success.

BIBLIOGRAPHY

- 2getthere. 2011. Automated People Mover Infrastructure Considerations and Specifications. February.
- Advanced Transit Association, Inc (ATRA). PRT Application Characteristics. <http://www.advancedtransit.org/advanced-transit/comparison/prt-characteristics/> (accessed September 9, 2013).
- Advanced Transit Association, Inc. (ATRA) 2003. "Personal Automated Transportation: Status and Potential of Personal Rapid Transit - Technology Evaluation." January. <http://www.advancedtransit.org/wp-content/uploads/2011/08/ATRA-2003-Status-Potential.pdf>
- Advanced Transit Association, Inc. (ATRA) 1989. "Personal Rapid Transit (PRT) – Another Option for Urban Transit." Technical Committee on Personal Rapid Transit (PRT), March.
- Airport Cooperative Research Program. 2012. US Federal Aviation Administration, Lea+ Elliott, Inc, and Watchung Transportation, LLC. ACRP 037A *Guidebook for Measuring Performance of Automated People Mover Systems at Airports*. Vol. 37. Transportation Research Board National Research. http://onlinepubs.trb.org/onlinepubs/acrp/acrp_rpt_037A.pdf
- Airport Cooperative Research Program. 2010. US Federal Aviation Administration, Lea+ Elliott, Inc, Kimley-Horn and Associates, Inc., and Randolph Richardson Associates. ACRP 037 *Guidebook for Planning and Implementing Automated People Mover Systems at Airports*. http://onlinepubs.trb.org/onlinepubs/acrp/acrp_rpt_037.pdf
- American Public Transit Association. 1994. *Glossary of Transit Terminology*. http://www.apta.com/resources/reportsandpublications/Documents/Transit_Glossary_1994.pdf
- American Society of Civil Engineers (ASCE). 2013. Automated People Mover Standards, ANSI/ASCE/T&DI 21-13. Reston, VA, USA: American Society of Civil Engineers. <http://www.asce.org/Product.aspx?ID=2147487569&ProductID=188348169>
- Anderson, James Edward. 2009. "How to Design a PRT Guideway." In *Automated People Movers 2009: Connecting People, Connecting Places, Connecting Modes*. 12th International Conference of Automated People Movers, Atlanta, Georgia. May 31-June 3. 436-449.
- Anderson, James Edward. 2009. "Evolution of PRT." October 21. <http://faculty.washington.edu/jbs/itrans/Evolution%20of%20PRT1.pdf>
- Anderson, James Edward. 2005. "The Future of High-Capacity Personal Rapid Transit." http://www.prtncz.com/index2.php?option=com_docman&task=doc_view&gid=18&Itemid=37

- Anderson, James Edward. 2000. "A Review of the State of the Art of Personal Rapid Transit." *Journal of advanced transportation* 34, no. 1: 3-29.
- Anderson, James Edward. 1996. "Some Lessons from the History of Personal Rapid Transit (PRT)." <http://faculty.washington.edu/jbs/itrans/history.htm>
- Anderson, James Edward. 1978. *Transit Systems Theory*. Lexington, Massachusetts: D.C. Heath and Company.
- Anderson, James Edward. 1979. "The Urban Mass Transportation Administration's Program of Development and Deployment of Automated Guideway Transit," University of Minnesota. <http://faculty.washington.edu/jbs/itrans/jea-history-paper.pdf>
- Andréasson, Ingmar J. 2012. "Personal Rapid Transit as Feeder-Distributor to Rail." *Transportation Research Record: Journal of the Transportation Research Board* 2275, no. 1: pp. 88-93.
- Andréasson, Ingmar. 2005. "Ride-sharing on PRT." *Automated People Movers 2005: Moving to Mainstream*. pp. 1-7. ASCE doi:10.1061/40766(174)22 <http://faculty.washington.edu/jbs/itrans/andreasson-ridesharing.pdf>
- Andréasson, Ingmar. 1998. "PRT: A Suitable Transport System for Urban Areas in Sweden." Swedish Transport and Communications Research Board, Stockholm, Sweden. ISBN 9188371115. <http://ntl.bts.gov/lib/22000/22200/22283/PB99173973.pdf>
- Andréasson, Ingmar. 1994. "Vehicle Distribution In Large Personal Rapid Transit Systems." *Transportation Research Record*, Issue no. 1451, 95-99.
- Arup North America Limited. 2012. *San José International Airport Automated Transit Network Feasibility Study*, Final Report. <http://www.sanjoseca.gov/DocumentCenter/View/20662>
- "Automated Guideway Transit." In *Transportation Research Thesaurus*. <http://trt.trb.org/trt.asp?NN=Dcmvgyg> (accessed March 23, 2013).
- Bares, Frank. 2005. "Roped Automatic People Mover Systems." *Automated People Movers 2005: Moving to Mainstream*. pp. 1-10. ASCE doi: 10.1061/40766(174)2.
- Berggren, L. 1971. "The Uniflo Personal Rapid Transit System." SAE Technical Paper 710111, doi:10.4271/710111.
- Bjork, Joakim. 2013. "Solar Skyways, Conditions for a Personal Rapid Transit (PRT) System in Uppsala." Uppsala University. May 31.

- Blind, Knut, Andre Jungmittag, and Axel Mangelsdorf. 2011. "The Economic Benefits of Standardization." DIN German Institute for Standardization. http://www.din.de/sixcms_upload/media/2896/DIN_GNN_2011_engl_akt_neu.pdf and Summary of Results: http://www.din.de/sixcms_upload/media/2896/economic_benefits_standardization.pdf.
- Bondada, Murthy VA, and Richard L. Haury. 2002. "Impact of Automated People Movers on the Design of Airport Terminals." In *Designing, Constructing, Maintaining, and Financing Today's Airport Projects*, pp. 1-12. ASCE, (September, 2002).
- Bösch, Stephan, Torbjörn Einarsson, Malin Gibrand, Bengt Gustafsson. "Rapport Framtida kollektivtrafiksystem i Uppsala." (2011-09-09) http://www.uppsala.se/Upload/Dokumentarkiv/Extern/Dokument/Bostad_o_byggande/Oversiktsplan/Underlagsrapporter/framtida_kollektivtrafiksystem_i_uppsala.pdf
- BRW, Inc., Bruce C. Allen & Associates, Inc., Berk & Associates, Inc., Decision Economics, Inc., Inca Engineers, KJS Associates, Inc., William A. Wilde, Zimmer, Gunsul and Frasca Partnership. 1992. *Seatac People Mover Study*. City of Seatac, WA. http://www.advancedtransit.org/wp-content/uploads/2013/05/01-SeaTac_APM_A_Executive_Summary_small.pdf
- BRW, Inc., Arai/Jackson, Rob Bernstein, PE, Berger/ABAM Engineers, Inc., Exceltech, Hewitt-Isley, Hong West and Associates, Inc., Jakes Associates, Inc., JKH Mobility Services, Inc., KJS Associates, Inc., Larson Anthropological/Archeological Services, Molyneaux Associates, Pacific Rim Resources, and Dr. Jerry Schneider. 1997. *Personal Rapid Transit Feasibility Project*. City of Seatac, WA. <https://www.advancedtransit.net/content/seatac-prt-major-investment-study>
- Buchanan, Colin and Partners Limited. *Daventry Development Transport Study*. 2007. <http://www.daventrydc.gov.uk/EasySiteWeb/GatewayLink.aspx?allid=11541>
- Burger, Marsden. Private communication. July 23, 2013.
- Burke, Catherine G. 1979. *Innovation and Public Policy: The Case of Personal Rapid Transit*. D.C.Heath and Company, Lexington, MA.
- "Cabintaxi," <http://www.advancedtransit.net/atrawiki/index.php?title=Cabintaxi> (accessed June 14, 2013).
- Carnegie, J. A. and Paul S. Hoffman. 2007. *Viability of Personal Rapid Transit in New Jersey*. New Jersey Department of Transportation Bureau of Research and NJ Transit, New Jersey. <http://policy.rutgers.edu/vtc/reports/REPORTS/PRTfinalreport.pdf>
- Castangia, M., and L. Guala. 2011. "Modelling and simulation of a PRT network." *Urban transport XVII*. WIT Press, Southampton. pp. 459-472. <http://faculty.washington.edu/jbs/itrans/Castangia-Guala-WIT-Pisa-06-2011.pdf>

- Churchward, Craig, Palmer, James F., Nassauer, Joan I., and Carys A. Swanwick. 2013. Evaluation of Methodologies for Visual Impact Assessments.” National Cooperative Highway Research Program (NCHRP) Report 741. Transportation Research Board, Washington, DC 20001. http://onlinepubs.trb.org/onlinepubs/nchrp/nchrp_rpt_741.pdf
- Cole, Leon M. 1968. “Tomorrow’s Transportation: New Systems for the Urban Future.” Washington. http://ntl.bts.gov/lib/24000/24500/24577/Tomorrows_Transportation_srch.pdf
- Daszczuk, Wiktor, Waldemar Grabski, Jaroslaw Dyduch, Mariusz Maciejewski, and Pawel Brach. “Personal Rapid Transit (PRT) Computer Network Simulation and Analysis of Flow Capacity.” In *Automated People Movers and Transit Systems 2013: Half a Century of Automated Transit-Past, Present, and Future*, pp. 296-312. ASCE.
- DeLaurentiis, John, and Angela Johnson. 2000. “Personal Rapid Transit (PRT): Solving Traditional Mobility Problems with New Technology –The Chicago RTA Experience.” In *Urban Public Transportation Systems. Proceedings of the First International Conference, Miami, Florida, March 21-25, 1999*. American Society of Civil Engineers, Committee on Public Transport, Urban Transportation Division.
- DeMarco, Vincent R. 1976. Program Plan – The Downtown People Mover (DPM) Project. URD document control no. 76-08. Revised May 21.
- Dutta, Utpal, and Ramakrishna R. Tadi. 2005. “Detroit People Mover: Past, Present and Uncertain Future (?): Lessons Learned.” In *Automated People Movers 2005. Moving to the Mainstream. 10th International Conference on Automated People Movers*. May 1 – 4, 2005, ASCE.
- Fabian, Lawrence. 2013. “APM Statistics.” <http://airfront.us/apmguide2008/data/apmstats.html> (accessed March 30).
- Fabian, Lawrence. 2010. “The Supply of APMs.” <http://www.airfront.us/apmguide/suppliers/suppliers-2010.html> (accessed March 30, 2013).
- “Facts about the PRT,” http://transportation.wvu.edu/prt/facts_about_the_prt (accessed June 12, 2013).
- Federal Transit Administration (FTA). 2013. <http://1.usa.gov/ppvyVA> (accessed March 29, 2013).
- Fichter, Donn. 1964. *Individualized Automated Transit and the City*. BH Sikes, Providence, RI.

- Frost & Sullivan. 2008. Executive Analysis of the Global Emergence of Personal Rapid Transit Systems Market. Report M331-01-00-00-00. <http://www.frost.com/prod/servlet/report-brochure.pag?id=M331-01-00-00-00>. [Executive Summary available from: http://beamways.com/file/Frost%20Sullivan_Personal%20Rapid%20Transit_dec08_Executive%20Summary.pdf]
- Gannett-Fleming. 2010. *PRT Facilities Master Plan*. Available at: <http://transportation.wvu.edu/r/download/64099>
- Garrard, W. L., R. J. Caudill, and W. B. Reed. 1975. "Control Considerations for Automated Guideway Transit Systems." In *Decision and Control including the 14th Symposium on Adaptive Processes*, 1975 IEEE Conference on, vol. 14, pp. 567-572. IEEE.
- Gary, Dennis A., and C. Larry Henry. 1978. "The Otis Advanced Group Rapid Transit System." *Advanced transit and urban revitalization- An international dialogue* http://www.advancedtransit.net/system/files/PRT_IV_Session-I_05_Otis_Advanced_Group_Rapid_Transit_compressed.pdf
- Green Car Congress. 2006. "California and Sweden to Cooperate on Biomethane and Renewable Fuels." [press release] 29 June 2006. http://www.greencarcongress.com/2006/06/california_and_.html
- Gustafsson, Jörgen, and Svante Lennartsson. 2013. "Vectus PRT Concept and Test Track Experience." Vectus Ltd. <http://www.vectusppt.com/uploads/51828CFFA6B1A.pdf>
- Gustafsson, Jörgen. 2009. "Vectus—Intelligent Transport." *Proceedings of the IEEE*, vol. 97, no. 11, pp. 1856-1863.
- Hanson, Mark E. ed. 1966. *Project Metran: An Integrated, Evolutionary Transportation System for Urban Areas*. No. 8. MIT Press.
- Henderson, Clark. 1991. "New Public Transportation Technology." Chapter 24 in George Gray and Lester A. Hoel (Eds.), *Public Transportation* (2nd ed.). ntl.bts.gov/DOCS/11877/Chapter_24.htm
- Hill, J.H., Vivian J. Hobbs, W. Heckelmann, N. G. Patt. 1977. Development/Deployment Investigation of /Cabinlift System. No. DOT-TSC-UMTA-77-51 Final Rpt. (UMTA-MA-06-0067-77-2). Available from NTIS: <http://www.ntis.gov/search/product.aspx?ABBR=PB277184>
- Hsiung, Shang, Mary D. Stearns. 1979. "Phase I Morgantown People Mover Impact Evaluation," U.S. Department of Transportation Research and Special Programs Administration Transportation Systems Center, Office of AGT Application, Washington, DC. UMTA-MA-06-0026-80-1. <http://www.advancedtransit.net/files/UMTA-MA-06-0026-80-1.pdf>

- Irving, Jack ed. 1978. *Fundamentals of personal rapid transit*. D.C.Heath and Company, Lexington, MA. http://www.advancedtransit.net/files/Fundamentals_all.pdf
- Ishii, Takemochi, Masakazu Iguchi, and Masaki Koshi. 1975. "CVS: Computer-Controlled Vehicle System." In *Personal Rapid Transit III: Progress, Problems, and Potential of a Promising New Form of Public Transportation*. 1975 International Conference on Personal Rapid Transit, Denver, Colorado, September 16-19, 1975. pp. 77-83.
- Jansson, Håkan, personal communication, May 14, 2013. "Activities from August 2012 until May 2013, MoC between the Department of Transportation of the United States of America and the Ministry of Enterprise, Energy and Communications of the Kingdom of Sweden on cooperation in the field of Sustainable Transportation."
- Jansson, Kjell. 1996. Studie av spårtaxi i Gävle: delrapport, samhällsekonomiskbedömning. Gävle kommun, Tekniska kontoret, Kommunikationsforskningsberedningen, Sweden.
- Johnson, Robert E. 2005. "Doubling PRT Peak Capacity with Ride Sharing." *Transportation Research Record: Journal of the Transportation Research Board*, vol 1930, issue 1, pp. 107-112. <http://trb.metapress.com/content/k113p80155u40725/fulltext.pdf>
- Juster, Reuben and Paul Schonfeld. 2012. Internal Circulation Study Baltimore/Washington International Thurgood Marshall Airport. http://www.advancedtransit.org/wp-content/uploads/2013/07/BWI_Internal_Circulation_Draft.pdf
- Kautzky, Peter, Björn Salomonsson, and Björn Holmquist. 1994. Studie av spårtaxi i Gävle: delrapport, stadsbild. Gävle kommun, Stadsarkitektkontoret, Kommunikationsforsknings-beredningen, Statens råd för byggnadsforskning, Sweden. [Visual Intrusion Study of PRT Guideways in Gävle, Sweden. See summary and links to sketches at: <http://faculty.washington.edu/jbs/itrans/gavle.htm>]
- Kerr, A. D., and R. J. Oates. 2009. "Heathrow PRT Guideway: Lessons Learned." 12th International Conference of Automated People Movers. Atlanta, Georgia, May 31-June 3, 2009, pp. 450-470. <http://ascelibrary.org/doi/book/10.1061/9780784410387>
- Kerr, A. D., James, P. A, Craig, A. P. 2005. "Infrastructure Cost Comparisons for PRT and APM." ASCE APM05 Special Sessions on PRT. <http://www.advancedtransit.org/wp-content/uploads/2011/08/Infrastructure-Cost-Comparisons-A.D.-Kerr-P.A.-James-A.-Craig.pdf>
- Latour, Bruno (translated by Catherine Porter). 1996. *Aramis, or the love of technology*. Harvard University Press. Cambridge, Massachusetts. http://dss-edit.com/plu/Latour-B_Aramis-or-Love-of-Technology_1996.pdf
- Kimley-Horn and Associates, Inc. 2010. *Fresno County Council of Governments Public Transportation Infrastructure Study, Fresno, CA*. <http://www.kimley-horn.com/Projects/fasttrackfresnocounty/downloads.asp>

- Kittelson & Associates, Inc., Herbert S. Levinson Transportation Consultants, and DMJM+Harris. 2007. *Public Transit Bus Rapid Transit Practitioner's Guide*. Transit Cooperative Research Program (TCRP). Washington, DC 20001. http://onlinepubs.trb.org/onlinepubs/tcrp/tcrp_rpt_118.pdf
- Knez, Matjaž, Ali Naci Celik, and Tariq Muneer. 2013. "Solar Powered Transport Solution." *Mainstreaming Innovation*, issue 2, September. pp. 22-29. <http://www.mainstreaminginnovation.org/newsletter/issue02pdf.htm>
- Larsen, Hans. 2012. "Automated Transit Network Feasibility Study." Memo to the City of San José Transportation Environment Committee. October 17. <http://www.sanjoseca.gov/DocumentCenter/View/14332>
- Latvala, E. 1973. "The TTI Hovair PRT System." SAE Technical Paper 730162, doi:10.4271/730162.
- Lees-Miller, John D. 2011. Empty Vehicle Redistribution for Personal Rapid Transit. http://seis.bris.ac.uk/~enjdlm/thesis_v11_hyperref.pdf
- Lévy, Gérard. 1975. "The French Aramis System." In *Personal Rapid Transit III: Progress, Problems, and Potential of a Promising New Form of Public Transportation*. 1975 International Conference on Personal Rapid Transit, Denver, Colorado, September 16-19, 1965. pp. 75-76.
- Lowson, Martin V., Christopher V. Cook, and David G. Hughes. "Station Design for Personal Rapid Transport Systems." U.S. Patent 7,681,505, issued March 23, 2010. <http://www.google.com/patents/US20070137513?cl=en>
- MacKinnon, D. 1974. "Personal Rapid Transit Systems at TRANSPO 72." In *Personal Rapid Transit II: Progress, Problems, and Potential of a Promising New Form of Public Transportation*. 1973 International Conference on Personal Rapid Transit, Denver, Colorado, May 2-4, 1973. pp. 35-45.
- McDonald, Shannon S. 2013. "Personal Rapid Transit Personal Rapid Transit (PRT) System and Its Development." In *Transportation Technologies for Sustainability*, pp. 831-850. Springer New York.
- McGean, Thomas J. 1993. "Standardization of People Movers in America." Eds. Inouye, Takashi, Takeshi Kurokawa. In "Automated people movers iii." Proceedings of the Third International Conference on Automated People Movers, Yokohama, Japan, October 7-10, 1991. ASCE, 243-253.
- Meyer, Aileen Maguire and Robert Morache. 2010. *Feasibility of Personal Rapid Transit in Ithaca, New York*. <https://www.dot.ny.gov/divisions/engineering/technical-services/trans-r-and-d-repository/C-08-25%20Ithaca%20PRT%20Final%20Report%2009-30-10.pdf>

- Moore, Harley L. III 1993. "A Comparison of Japanese and North American Automated People Movers." Eds. Inouye, Takashi, Takeshi Kurokawa. In "Automated people movers iii." Proceedings of the Third International Conference on Automated People Movers, Yokohama, Japan, October 7-10, 1991. ASCE, 255-279.
- Morgantown Personal Rapid Transit System – System Operation Description Manual M-PRT-1-1. n.d. <http://transportation.wvu.edu/r/download/18440>
- Muller, Peter J., Steven B. Cornell, and Marek P. Kubesa. 2012. "Ridesharing Methodology for Increasing Personal Rapid Transit Capacity." In Transportation Research Board 91st Annual Meeting, no. 12-0882. <http://prtconsulting.com/docs/Personal%20Rapid%20Transit%20Ridesharing.pdf>
- Neumann, Edward S., and Murthy V. Bondada. 1985. "Automated People Movers: Engineering and Management in Major Activity Centers." Urban Transportation Division of ASCE, New York, NY: ASCE, 978-0-87262-488-7.
- Olsson, Björn. 2008. "Evaluation of Podcar Systems." Swedish Institute for Transport and Communications Analysis (SIKA). SIKA Report 2008:5. http://issuu.com/simplylovelife/docs/sika_prt_report
- Paige, Thomas. 2012. *Automated Transit Network Feasibility Evaluation – San José Mineta International Airport, San José, CA*. The Aerospace Corporation, Aerospace Report No. ATR-2012(5629)-1 Rev. A. <http://www.sanjoseca.gov/documentcenter/view/14328>
- Peakoil.net. 2014. Proceedings of the International Workshop on Oil Depletion, Uppsala, Sweden, May 23-25, 2002. [online] Available at: <http://www.peakoil.net/IWOOD2002/iwood2002proceeding.html> [Accessed: 9 Feb 2014]
- Persson, Göran. 2006. "Making Sweden an OIL-FREE Society." Swedish Commission on Oil Independence. June 21. <http://www.government.se/sb/d/2031/a/67096>
- PRT Consulting, Inc. 2009. *Preliminary Personal Rapid Transit Feasibility Study - The Mountain Post, Fort Carson, Colorado*. <http://www.advancedtransit.org/wp-content/uploads/2013/05/FtCarsonPrelimFeasibilityStudy.pdf>
- Raney, Steve, James Paxson, and David Maymudes. 2007 "Design of Personal Rapid Transit Circulator for Major Activity Center: Hacienda Business Park, Pleasanton, California." Transportation Research Record: Journal of the Transportation Research Board 2006, no. 1: 104-113. http://www.cities21.org/TRB_PRT_HBP.pdf
- Raney, Steve and Stan E. Young 2005. "Morgantown People Mover – Updated Description." Presented at the Transportation Research Board Annual Meeting, Circulation and Driverless Transit Committee (AP040), Washington, D.C., January 2005. Available at: http://www.cities21.org/morgantown_TRB_111504.pdf

-
- Raney, Steve. 2003. *Sustainable Suburb Silver Bullet: PRT Shuttle + New Mobility Halves Solo Commutes*, Palo Alto, California. http://www.cities21.org/_silverBullet.doc
- Redfors, Anton. 2009. *A Field Study of PRT in Shanghai*. Bachelor Thesis, Institution for Physics and Astronomy, Uppsala University. Sweden. http://s3.amazonaws.com/zanran_storage/www.tsl.uu.se/ContentPages/879045219.pdf
- Rosemont (Ill.), Trkla, Pettigrew, Allen & Payne, and Illinois. 1991. Proposal for a Personal Rapid Transit Demonstration System. [Rosemont, Ill.]: The Village. <http://archive.org/details/proposalforperso00rose>
- Schneider, Jerry. University of Washington, Innovative Transportation Technologies, "Cabintaxi PRT System." Last modified 09 20, 2012. <http://faculty.washington.edu/jbs/itrans/cabin.htm> (accessed June 14, 2013).
- Schneider, Jerry, and Steve Raney. 2005. Personal Rapid Transit for Microsoft and Bellevue. Available from: http://www.cities21.org/MS_Bellevue_PRT.pdf
- Schweizer, J., L. Mantecchini, and J. Greenwood. 2011. "Analytical Capacity Limits of Personal Rapid Transit Stations." In Proceedings of the 13th APM Conference in Paris, France: Automated People Movers and Transit Systems 2011: From People Movers to Fully Automated Urban Mass Transit. <http://ascelibrary.org/doi/book/10.1061/9780784411933>
- Sinclair Knight Merz. 2008. Daventry PRT Scoping Study. <http://faculty.washington.edu/jbs/itrans/big/Daventry%20PRT%20Scoping%20Study.pdf>
- Szillat, Markus Theodor. 2001. "A Low-level PRT Microsimulation." PhD diss., University of Bristol. <http://citeseerx.ist.psu.edu/viewdoc/download?doi=10.1.1.112.1156&rep=rep1&type=pdf>
- Sky Loop Cost Estimates for a Taxi 2000 Application in Cincinnati, Ohio 2001. Available at: <http://faculty.washington.edu/jbs/itrans/PRTcosttable.htm>
- Sommestad, Lena, Joseph Desmond, and James Boyd. 2006. "Memorandum of Understanding between the State of California and the Government of the Kingdom of Sweden on Renewable Fuels and Energy." June 15. <https://www.energimyndigheten.se/Global/Internationellt/MoU-CaliforniaSweden.pdf>
- Sproule, William J. 1993. "An Introduction To APM System And Applications." In *Automated People Movers IV: Enhancing Values in Major Activity Centers*, Proceedings of the Fourth International Conference, Irving, Texas, March 18-20, 1993. pp. 22-34. <http://trid.trb.org/view.aspx?id=427182>

- Sproule, William J., and William H. Leder. 2011. "Downtown People Movers—History and Future in US Cities." In *Proceedings of the Thirteenth International Conference on Automated People Movers and Transit Systems 2011: From People Movers to Fully Automated Urban Mass Transit*. (May)
- Sproule, William J., and Edward S. Neumann. 1991. "The Morgantown PRT: it is still running at West Virginia University." *Journal of advanced transportation* 25, no. 3: 269-279.
- Swedish Ministry of Enterprise, Energy and Communications. 2010. "Swedish-American Cooperation for Sustainable Development to be Expanded." [press release] 30 September 2010. <http://www.government.se/sb/d/586/a/152747>
- Swenson, Ron. 2012. "Personal Transportation, One Hundred Percent Solar Powered." Presented at ASES Solar World Congress, Denver, CO. May 13-18. <http://www.ecotopia.com/ases/solar2012/ASES2012PRT100PCTsolar.pdf>
- Swenson, Ron. 2007. "How Can We Turn Sun Radiation into Automotion?" Presented at The Future of Automotive Energy: Fossil Fuels, Agro Fuels or Photovoltaic Cells, SIKACHU, Stockholm, Sweden. November 6. <http://www.solarevolution.com/PRT/Sweden/SunPodcarsStockholm20071006.pdf> and <http://www.solarevolution.com/solutions/presentations/SIKA20071106.ppt>
- Talley, James A., and Pamela L. Ernst. 1989. "Automated People Movers in the Family of Transit Modes." *Journal of Advanced Transportation* 23, no. 2-3), pp. 165-182. doi:10.1002/atr.5670230207
- Tegnér, Göran, Magnus Hunhammar, Ingmar Andréasson, Jan-Erik Nowacki, Kjell Dahlström. 2007. "PRT in Sweden: From Feasibility Studies to Public Awareness." 11th International Conference on Automated People Movers, Vienna, Austria, April 22-25. <http://tinyurl.com/qabmlnv>
- Tegnér, Göran, and Elisabet Idar Angelov. 2009. "Financing Transit Usage with Podcars in 59 Swedish Cities, II." *Automated People Movers 2009*. pp. 257-296.
- Tegnér, Göran B. and Lawrence Fabian. 2001. "Comparison of Transit Modes for King's Curve, Huddinge, Sweden." *Bridges* 10, no. 40582: 52.
- Tegnér, Göran. 1999. "Personal Rapid Transit in Stockholm – Market demand and Economic Appraisal". Paper presented at the second Urban Transport Conference, Lund, Sweden, June 1999.
- ULTra Global PRT, Inc (ULTra). 2011. "ULTra System Description." <http://www.ultraglobalprt.com/> (see also: http://www.ultraprt.net/cms/07Infrastructure_ULTra.pdf)

-
- ULTra Global PRT, Inc (ULTra). 2012. "ULTra Global PRT: Low-Cost Transport for a Sustainable Future." [http://www.ultraglobalprt.com/wp-content/uploads/2012/07/ Ultra-Global-Brochure-PDF.pdf](http://www.ultraglobalprt.com/wp-content/uploads/2012/07/Ultra-Global-Brochure-PDF.pdf)
- United States. 1980. Congress. Office of Technology Assessment. *Impact of Advanced Group Rapid Transit Technology*. US Government Printing Office, Washington. DC. (January). <http://www.fas.org/ota/reports/8010.pdf>
- United States. 1978. Urban Mass Transportation Act of 1964, As Amended Through 1978 And Related Laws. Washington, D.C.: U.S. Department of Transportation, Urban Mass Transportation Administration. <http://catalog.hathitrust.org/Record/006176632>
- Visual Intrusion From PRT Systems. 2008. Beamways, AB. www.beamways.com
- United States. 1975. Congress. Office of Technology Assessment. *Automated Guideway Transit: An Assessment of PRT and Other New Systems*. US Government Printing Office, Washington. DC. (June) 54-370. <http://www.fas.org/ota/reports/7503.pdf>
- Uppsala Universitet. 2002. *World Oil Experts to Discuss Findings at First International Workshop on Oil Depletion*. [press release] 23-24 May, 2002. <http://www.peakoil.net/IWOOD2002/welcome.html>
- Wikipedia. 2013, s.v. "Bombardier Innovia APM 100." http://en.wikipedia.org/w/index.php?title=Bombardier_Innovia_APM_100&oldid=549561371 (accessed April 16).
- Wikipedia. 2013, s.v. "People Mover." http://en.wikipedia.org/w/index.php?title=People_mover&oldid=546712918 (accessed March 24).
- Wikipedia. 2013, s.v. "Personal rapid transit." http://en.wikipedia.org/wiki/Personal_rapid_transit (accessed March 24).
- Xithalis, Christos. 2008."Synchronous Control Method for Personal Rapid Transit Systems." In Proceedings of the 10th International Conference on Application of Advanced Technologies in Transportation.
- Young, Stan E., PRT Consulting, Inc., The University of Kansas Transportation Research Institute, BG Consultants, Inc., LTR, P.A., Transportation Research & Planning, and Patti Banks Associates. 2009. *KDOT Exploratory Concepts in Advanced Transport Mobility and Land Use Enhancements Enabled by Automated Small-Vehicle Transport Technologies at the Village West Development A Personal Rapid Transit Case Study*. <http://www.advancedtransit.org/wp-content/uploads/2013/05/APrtCaseStudy.pdf>
- Zarafu, Monica Elena. 2012. "A More Sustainable Transport Future: The Effectiveness of Personal Rapid Transport in Edge Cities." PhD Dissertation. University of Technology, Sydney. <https://epress.lib.uts.edu.au/research/bitstream/handle/10453/21886/01Front.pdf?sequence=1>

Zetterberg, Leif and John Porcari. 2010. "Memorandum of Cooperation between the Department of Transportation of the United States of America and the Ministry of Enterprise, Energy and Communications of the Kingdom of Sweden on Cooperation in the Field of Sustainable Transportation." September 30.

APPENDIX 1 – A BRIEF HISTORY OF ATN

ATN History

This section highlights some of the background and history of the development of ATN. The historical treatment here will be brief and selective, since there are a number of good references that cover the history of ATN in detail (McDonald 2013; Wikipedia 2013, s.v., “Personal rapid transit”; Anderson 2009, 2005, and 2000; Carnegie and Hoffman 2007, 22-35, and Burke 1979). Figure 75 attempts to summarize in timeline-form some of the major contributors and developments in ATN since the early 1950s. This diagram categorizes the history of ATN into three sections: Concepts and models, Full-scale prototypes, and Operational systems. The lower section (Concepts and models) identifies a few of the major contributors, formative conceptual work, and events that have taken place at a *concept-* or *scaled-model* level. The middle section (Full-scale prototypes) identifies ATN systems that were developed to the point of having *full-scale* vehicles and guideways. The upper section (Operational systems) identifies the three systems that are currently carrying passengers in a *fully operational* state⁹⁶.

As mentioned earlier in this chapter, the salient and defining characteristics⁹⁷ of ATN, in contrast to other modes of AGT, are that it provides:

1. *On-demand, non-stop, origin-to-destination service* (like a taxi rather than a bus)
2. *Relatively small, lightweight vehicles that carry just a few passengers* (like a taxi rather than a bus)

Much of the formative conceptual work on PRT/ATN was done in the mid-1950s to early 1980s, beginning with Donn Fichter in 1953. Fichter’s vision for an ATN system integrated into a city was described in his book, *Individualized Automated Transit and the City* (Fichter 1964). Anderson (2009) points out that various individual have independently arrived at the basic ideas and characteristics of ATN (which he and most others called, ‘Personal Rapid Transit’, or PRT⁹⁸), and that these ideas are essentially derivable by taking a *systems* approach to thinking about what a totally new transit system should be like.

⁹⁶ The Morgantown PRT system is considered by ‘purists’ to be a *GRT* system rather than an ATN or true PRT system, because its vehicles are relatively large (capacity of about 20 passengers), and it often operates in a scheduled mode (rather than on demand) (http://www.advancedtransit.net/atrawiki/index.php?title=Morgantown_PRT).

⁹⁷ Earlier definitions/descriptions, such as that from ATRA (Advanced Transit Association 1989, 2-3) list a few other characteristics, but the authors thought that such descriptions might be overly specific and hence overly restrictive with respect to future developments.

⁹⁸ The designation ‘ATN’ arose from an extensive feasibility study done by the Aerospace Corporation and Arup North America Ltd., which was sponsored by the City of San José and the Santa Clara Valley Transportation Authority (VTA) in 2010. The principals in the study felt that ATN better characterized the *network* aspect of the technology than the earlier designation, ‘PRT’.

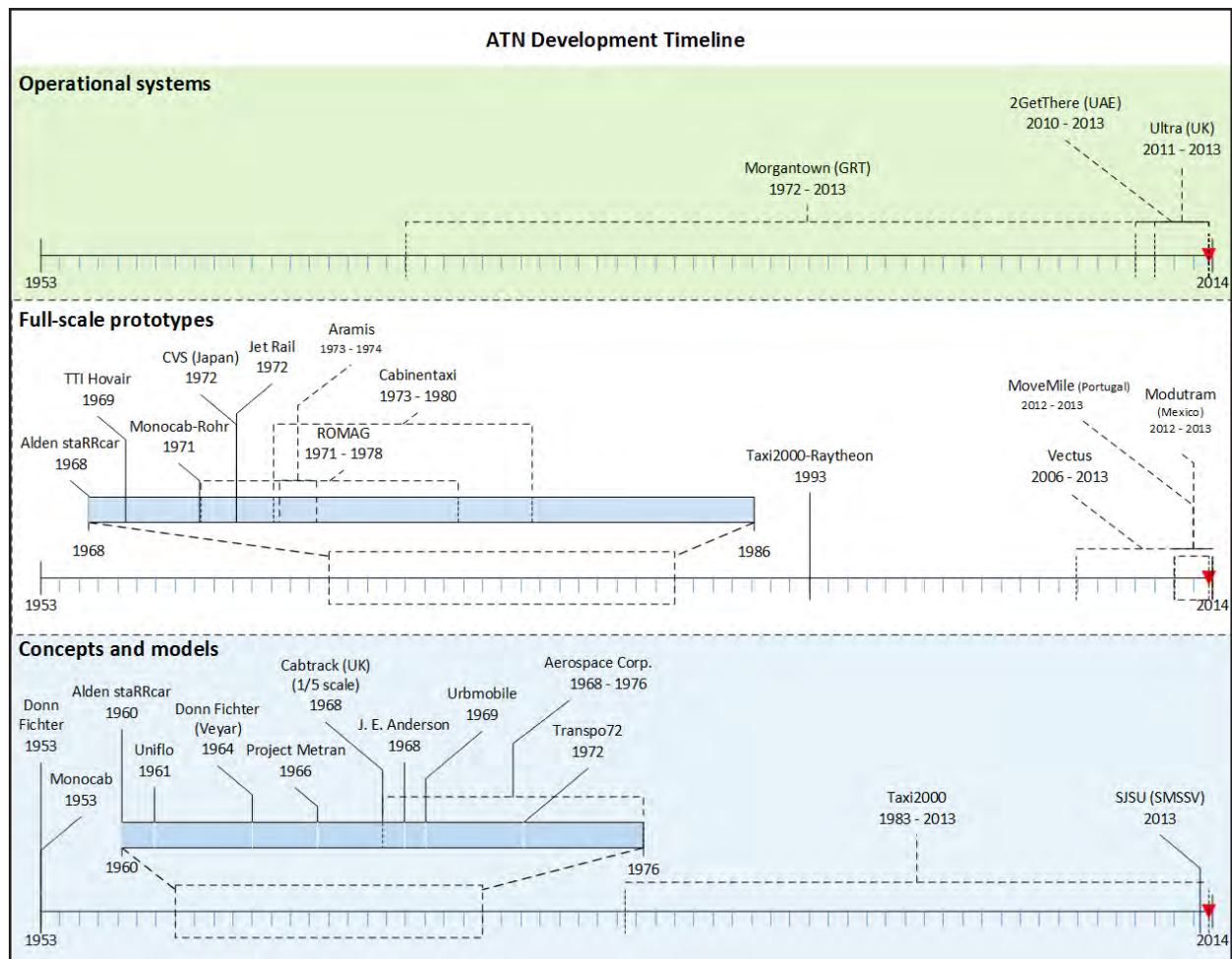

Figure 75. ATN Development Timeline

The largest stimulus for the development of ATN came through the Urban Mass Transportation Act of 1964 and the Reuss-Tydings Amendment to the Act in 1966, which called for the Secretary of Transportation⁹⁹ to:

“... undertake a project to study and prepare a program of research, development and demonstration of new systems of urban transportation that will carry people and goods within metropolitan areas speedily, safely, without polluting the air, and in a manner that will contribute to sound city planning. The program shall (1) concern itself with all aspects of new systems of urban transportation for metropolitan areas of various sizes, including technological, financial, economic, governmental, and social aspects; (2) take into account the most advanced available technologies and materials; and (3) provide national leadership to efforts of States, localities, private industry, universities, and foundations.” (United States 1978, 22).

⁹⁹ At the time of the Act, administrative functions for the Act were vested in the Administrator of the Housing and Home Finance Agency. These were later transferred to the Secretary of Housing and Urban Development, and still later transferred to the Secretary of Transportation (United States 1978, 1).

This stimulus unleashed a flurry of research and development activity both in the US and abroad in the late 1960s through the mid-1970s. Several of the early development efforts are especially noteworthy and are described briefly below.

The first of these is the work conducted by the Aerospace Corporation over the period from 1968 to 1976. The intent of this effort was to answer questions about the technical and economic feasibility of ATN that were raised by the HUD studies. In addition to analyses and computer simulation, Aerospace demonstrated their ideas for propulsion and control using a 1/10th scale model test track¹⁰⁰ shown in Figure 76 and Figure 77. Their preferred design consisted of an ‘over-riding’ or *supported* vehicle that was conveyed by wheels rolling in a U-shaped guideway and propelled by a linear pulsed DC motor. The importance of the work by Aerospace was underscored by Anderson (2009, 15-16) who wrote that they “developed the entire system concept to a more advanced state than anyone else in the United States”, and that “If the Aerospace Corporation had not entered the PRT field, I doubt if we would be talking about PRT today.” The work by the Aerospace Corporation culminated in a book published in 1978 entitled, *The Fundamentals of Personal Rapid Transit*. (Irving 1978).

Two other systems that were developed to the point of full-scale test tracks in the 1970s were the CVS (Computer-Controlled Vehicle System) in Japan (Ishii, et.al 1975) and the French Aramis system (Lévy 1975; Anderson 1996. Latour 1996). Both of these used 4-wheeled pneumatic-tired vehicles. Aramis was unique among the early systems in that it featured the approach of ‘platooning’ vehicles using optical or ultrasonic sensors and servo systems to maintain a 300 mm spacing between vehicles in the platoon. CVS was designed to also provide for freight movement (Ishii, et.al. 1975, 79).



Figure 76. Aerospace Corporation 1/10th Scale Model

Note: (Irving 1978) The functional scaled model demonstrated propulsion, switching, and control functions. Additional details and a video of its operation are available at: <http://faculty.washington.edu/jbs/itrans/aeromod1.htm>

¹⁰⁰ Additional details about the Aerospace scaled model can be found in Appendix B of *Fundamentals of Personal Rapid Transit* (Irving 1978), and a video of its operation can be seen at: <http://faculty.washington.edu/jbs/itrans/aeromod1.htm>

Another significant early development that resulted in a fully functional AGT system that is still operating today is the Morgantown PRT system. As mentioned earlier, the Morgantown system is technically more of an automated GRT system than a true PRT (or ATN) system because its vehicles are relatively large (capacity of about 20 passengers), and it often operates in a scheduled mode rather than on demand. To avoid confusion, some have referred to the Morgantown system as the Morgantown People Mover (MPM) (Raney and Young 2005). Construction of the Morgantown system began in October 1971, and passenger service began on October 3, 1975 (Sproule and Neumann 1991). The system consists of 8.7 miles of shallow U-shaped concrete guideways and five off-line stations. The guideway connects three separated sections of the University of West Virginia and the Morgantown central business district (Figure 78a). The vehicles, originally made by Boeing, are bus-like, consisting of a fiberglass shell with sliding doors on both sides and are carpeted. The cabin is mounted on a Dodge truck chassis, supported by four steerable rubber tires, that is driven by a 70 hp DC motor. The vehicles access power from 575 V electrical rails mounted on both sides of the guideway, have a top speed of 30 mph, and operate with a minimum headway of 15 seconds (Hsiung and Stearns 1979, 10) (Figure 78b). (Anderson 2009; Raney and Young 2005; Sproule and Neumann 1993; Morgantown PRT System Operation Description Manual n.d.)

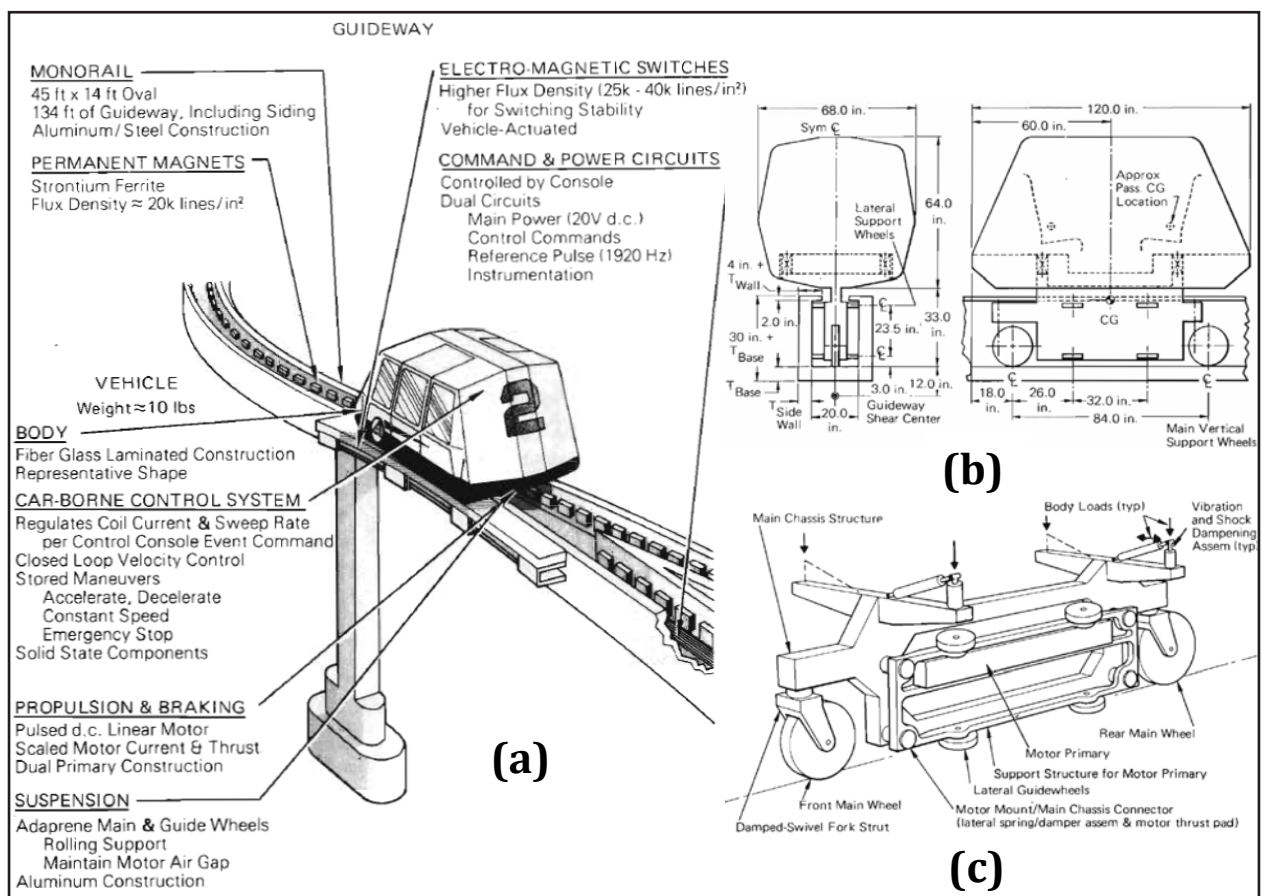

Figure 77. Aerospace Corporation PRT Concepts

Note: (Irving 1978, 318). (a) Summarizes the 1/10th scale model details. (b) Shows vehicle and guideway geometry for a full-scale implementation. (c) Shows the concept for the vehicle suspension.

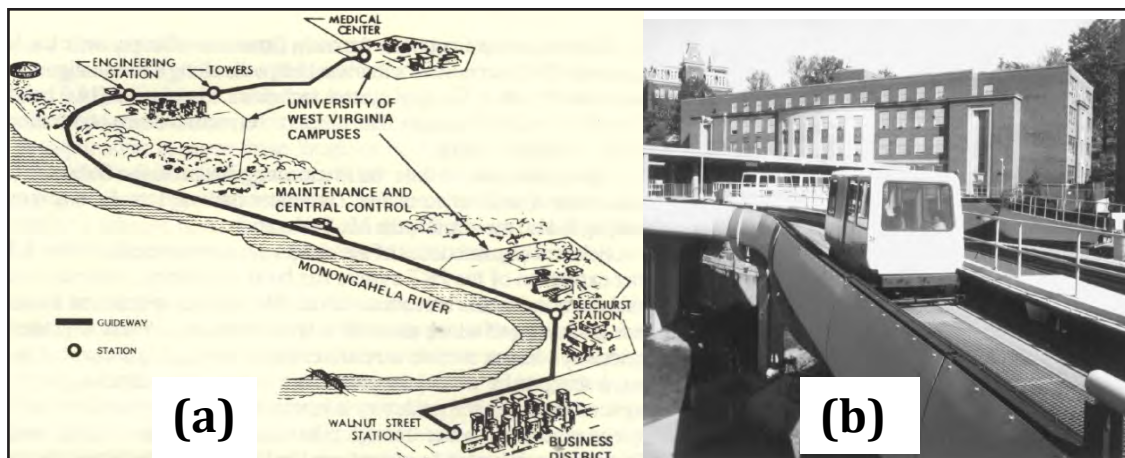

Figure 78. Morgantown PRT

Note: (a) The system route (Sproule and Neumann, 272). (b) A vehicle on the guideway with a station in the background (<http://web.archive.org/web/20070622051353/> and http://www.nis.wvu.edu/Releases_Old/wvu_beats_disney.html).

The Morgantown system serves about 15,000 people daily during the school year and has served about 60 million passengers since 1975. (“Facts about the PRT” n.d.).

The next early development effort that is regarded by many to have come the closest toward demonstrating the original vision of ATN was Cabintaxi (or Cabintaxi), a German system that was the product of a joint venture between Messerschmitt-Bölkow-Blohm (MBB) and DEMAG companies with sponsorship by the German Ministry of Research and Development. The design process began in 1969, and a relatively large and sophisticated full-scale test track was constructed in Hagen, Germany, beginning in 1973 (Hill, et. al. 1977). By 1976, the test facility had 1.9 km of guideway, six stations, and 24 vehicles (Schneider 2012). Plans for marketing the Cabintaxi technology were not confined to Germany. Cabintaxi was considered for possible selection for the UMTA’s Downtown People Mover program in the mid-1970s (DeMarco 1976)¹⁰¹.

Cabintaxi was an impressive development in a variety of ways. Its guideway arrangement was unique in that it allowed vehicles to ride on top (supported) and beneath (suspended) simultaneously. This arrangement (Figure 79), provided two-way access on a single guideway to all stations, which significantly reduced the total miles of guideways and greatly minimized cost because the guideway contributes the largest share of the total cost of an AGT system (Schneider 2012; Anderson 1979, 11).

¹⁰¹ The reference is an internal memo from the UMTA that lists the parent company of Cabintaxi as a qualified supplier for the DPM program.

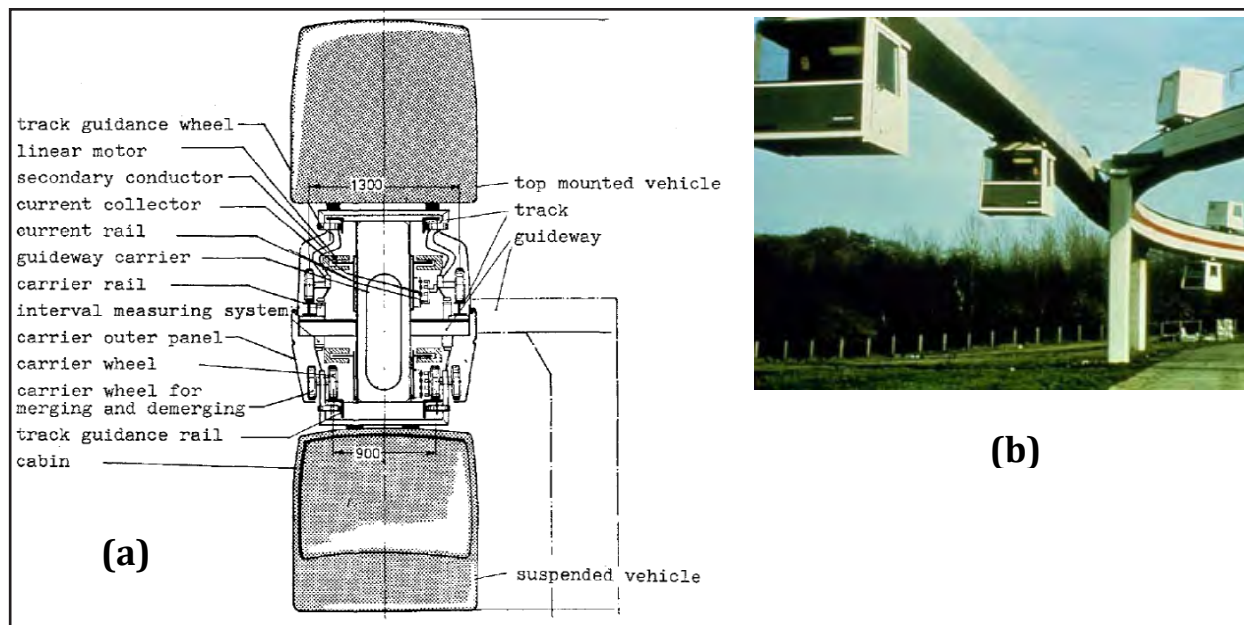

Figure 79. Cabintaxi PRT

Note: (a) Shows the bogie and guideway beam. (b) Shows vehicles on the test track in Hagen, Germany. The Cabintaxi guideway was designed for the simultaneous operation of supported and suspended vehicles. Such a design minimizes the cost and footprint of the guideways for a given network. (Hill, et. al. 1977, 4-12). Photo in (b) is from: <http://www.advancedtransit.net/atrawiki/images/d/db/288x216xCabtaxi6.jpeg>. pagespeed.ic.Wi_nZ-cmDc.jpg

The vehicles were propelled by linear induction motors (LIMs) and were capable of 36 km/hr (22 mph) with headways under three seconds¹⁰². Vehicles for three and 12 passengers (KK3 and KK12, respectively) were demonstrated, and vehicles for 12, 18, and 24 passengers as well as freight applications were designed. (Schneider 2012). Maximum single line capacity was estimated to be 7714 passengers/hr for KK3 and 27,000 passengers/hr for KK12. (Hill, et. al. 1977, 4-21).

The system was extensively tested, logging more than 400,000 vehicle miles and 17,500 hours of fleet endurance testing (Schneider 2012).

In 1977, the development and demonstration of the Cabintaxi technology had reached a point that it was expected that a 1.2 mile loop would be installed in the northern part of Hamburg initially, and some 20 miles of guideway with 180 vehicles would come later. Budgetary constraints apparently shelved these plans within months of the beginning of the project (Cabintaxi 2009).

Another notable development effort in the early history of ATN was that by Dr. J. Edward Anderson and collaborators. It resulted in the founding of the Taxi2000 Corporation in 1983. Anderson started his development program in 1981 at the University of Minnesota as a project for senior mechanical engineering design students (Anderson 2009). Anderson and his colleagues extended the pioneering work done by the Aerospace Corporation and eventually filed patent applications for their advancements of ATN technology in the spring

¹⁰² Headways of 0.5 seconds were demonstrated, but “brick wall” stopping ability required 2.5 second headways. (<http://www.advancedtransit.net/atrawiki/index.php?title=Cabintaxi>. Accessed June 14, 2013).

of 1982. A study by the Technical Committee on Personal Rapid Transit of the Advanced Transit Association (ATRA) on ATN gave credibility and visibility to the work of Anderson et.al. (ATRA 1989; Anderson 2009), and it, with support by executives at Raytheon Corporation, helped to capture the interest of the Chicago-Area Regional Transportation Authority (RTA) to consider PRT as a solution to their transportation problems at the time. RTA's interest led to a multi-phase development program beginning in early 1990 to “study, develop, and implement PRT systems for the Chicago region¹⁰³.” (Carnegie and Hoffman 2007, 28).

Phase 1 of the RTA program was an evaluation study of competing ATN technologies; Phase 2 was the development a test ATN system; and Phase 3 was to be the implementation of demonstration ATN system in a local community¹⁰⁴. The Taxi2000 system was selected as the preferred technology following the evaluation studies of Phase 1, and in June 1993, RTA selected Raytheon to join a public/private partnership to develop the technology for Phase 2. This resulted in the construction of a 2,200 ft. test track in Marlborough, MA, that had three vehicles and one off-line station. Testing was successful, but due to a variety of political, economic, and technical reasons, Phase 3 did not materialize (Carnegie and Hoffman 2007, 29).

The outcome of the RTA project might have been very different had Raytheon more faithfully used the Taxi2000 design. Instead, they opted for a more conventional approach to the vehicle design and propulsion system (rotary motors instead of a linear motor), which resulted in a much heavier vehicle (4x). In turn, this required a larger guideway (2x in width and height), which almost tripled the cost from the target of \$15M/mi to \$40M/mi. Figure 80 illustrates some of the differences in the two designs.

¹⁰³ One reason justifying the RTA's decision to investigate ATN was a statutory mandate that “The Authority and the Service Boards shall study public transportation problems and developments [and] encourage experimentation in developing new public transportation.” technology...” *Regional Transportation Authority Act, Chapter 70 ILCS, Section 2.09, Research and Development*. [quoted in DeLaurentiis and Johnson 1999, 161]

¹⁰⁴ Of four communities considered, the Village of Rosemont was selected. The selection was based on the results of a ridership study, an evaluation of the constructability of the various proposed alignments, and local commitment to the demonstration. (DeLaurentiis and Johnson 1999, 166).

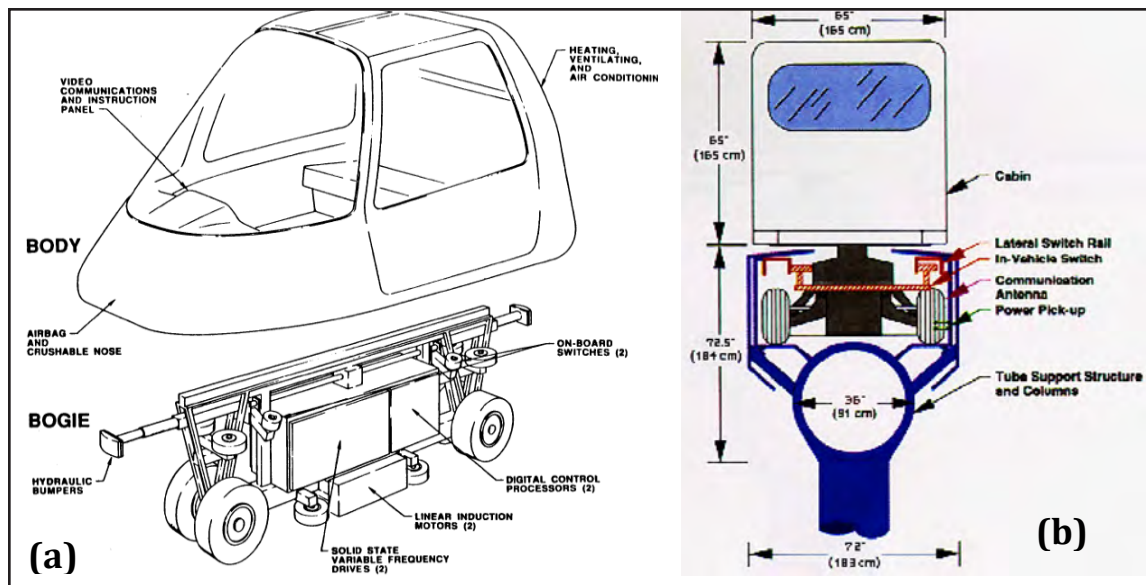

Figure 80. Taxi2000 Vehicle and Raytheon Final Design for Phase 2 of the RTA PRT Program

Note: (a) Shows the body and bogie of the original Taxi2000 design (ATRA 1989, 49). (b) Shows a cross section of the vehicle and guideway design that Raytheon came up with (Carnage and Hoffman 2007, 30). The Raytheon design significantly deviated from the Taxi2000 design and resulted in a much heavier vehicle, which required a much larger guideway, and ultimately almost tripled the projected cost from \$15M/mi to \$40M/mi.

Even though a successful installation did not occur, the RTA experience was significant for the evolution of ATN because it catalyzed interest by other cities and was influential in furthering private development by suppliers such as those included in Chapter 2 and Appendix 2 (Anderson 2009).

APPENDIX 2 – DATA FROM ATN SUPPLIERS

ABOUT THE DATA

This section presents system specifications collected from ATN suppliers. Suppliers responding to an RFI provided a portion of the data, while other data were collected through the study of supplier documentation and previous reports.

Data Tables

Tables 1-3 are for suppliers with systems in operation. Tables 4-10 are for systems in various states of design and operation.

Table 9. 2getthere

General	
Developer contact information	Robbert Lohmann, info@2getthere.eu
Licensees	
Patents	
System Description	
Installation Location	1. Masdar City PRT, UAE, 2. Floriade PRT, Netherlands 3. Schiphol Airport GRT, Amsterdam 4. Rivium business park GRT, Netherlands
System Performance	
Max. theoretical single direction capacity (psgrs/hr)	720, with 240 to 360 per berth, depending on station layout
Minimum headway (sec)	5 in application, 2.5 possible
Availability (hours of operation)	24 hours a day, 7 days a week
Type of service (shuttle, loop, network, etc.)	
Type of vehicle routing	
Minimum traveling unit	
Fleet Size	10 (+ 3 Freight Rapid Transit vehicles)
Vehicle Performance	
Cruise velocity (m/s)	11
Max. velocity (m/s)	11
Max. grade (%)	10
Service acceleration (m/s ²)	1.5, or 0.8 for comfort
Service deceleration (m/s ²)	1
Max. jerk (m/s ³)	
Emergency deceleration (m/s ²)	2.7 to 4.7
Stopping precision in station (mm)	
Degradation due to water, ice, or snow on guide way	
Energy consumption for propulsion (kWhr/vehicle-km)	0.11 (cruise), 0.39 (max grade). Inferred from 90A and 320A respectively
Minimum turn radius (m)	5.5
Noise (inside vehicle, dBA; outside vehicle, dBA)	Compliant with ASCE APM standards
Vehicle Design	
Overall length (m)	3.92
Overall width (m)	1.416

Overall height (m)	2.01
Empty weight (N)	1400kg
Vehicle design capacity (seated psgrs)	6, 4 adults and 2 children
Vehicle design capacity (maximum, seated plus standing psgrs)	
Maximum weight that can be carried (N)	900kg
Passenger space (m ³)	
Doorway width (m)	
Doorway height (m)	
Suspension	
Type (configuration)	
Design load (kg)	
Lateral guidance method	
Propulsion and Braking	
Motor type and number	Central AC motor, differential in rear axle
Motor placement	
Motor rating (kW)	8
Drive type	
Power type	230V or 400V AC at 50Hz
Power collection method	Battery, 400Ah at 48V DC, LiFePO4, 16 to 20 KWh effective
Service brake type	Electrical drive brake and pneumatic/mechanical brake when necessary
Emergency brake type	Spring-actuated and pneumatically released drum brake
Emergency brake reaction time (sec)	0.3, signal processing and actuation latency
Redundancy measures	
Switching	
Type and emplacement	On-board vehicle
Switch time (lock-to-lock) (sec)	0.3, signal processing and actuation latency
Speed through switch (m/s)	
Headway through switch (sec)	
Guideway	
Type/configuration (e.g., supported, suspended; box-beam, etc.)	Supported, surface (road)
Materials	Concrete over Asphalt, with steel if guideway is elevated

Type and construction of support columns	
Dimensions (m)	
Overall cross section width	Surface with lane width of 2m , with swept path estimated to be 1.720m wide
Overall cross section height	
Maximum span length	20
Running surface width	At, or above
Location relative to grade (e.g., above, at, below, and dimensions)	
Vehicle guidance/constraint relative to guideway	<ol style="list-style-type: none"> 1. Guided, no constraint. Rubber tires on surface. 2. Magnet measurement system, continuous longitudinal and lateral position calculations. External influences, such as wind, are automatically corrected for. Passive reference points merely serve to improve the accuracy even further (<4cm. at 22m/s). 3. Laser and Ultra sonic systems for collision detection and avoidance
Construction process (fab on site, pre-fabricated sections, etc.)	
Other Energy Usage	
Daily system energy (kWhr)	
Energy for HVAC (kWhr)	Considerable compared to other non-propulsion vehicle energy consumption
Other Energy (Control center, Stations, etc.) (kWhr)	
Conservation Measures	
Stations	
Type (offline, online, etc.)	Offline
Number of stations in installation	2 (+3 freight stations)
Ticket or fare collection method	Tickets
Security methods	Cameras
Boarding capacity (psgrs/hr/platform)	240 to 360/hr/berth
Deboarding capacity (psgrs/hr/platform)	
Max. wait time (min)	
Station Layout	
Station Footprint (length, area)	<p>Offline berths, angled, 6 berths per station</p> <ol style="list-style-type: none"> 1. 9.8m² for 1 berth station by below formula 2. Dependent on the lay-out and the throughput of the station 3. Min. platform width = (number of berths *3.92m) + 0.6m 4. Min. platform depth = 2.5m

Controls	
Control Type	Fixed block
Vital Systems/Circuitry	<ol style="list-style-type: none"> 1. Navigation system: 20 years, 4th system generation, matured reliability 2. Obstacle detection system: 15 years of experience 3. Vehicles are equipped with interior and exterior emergency buttons that generate a controlled stop. 4. Vehicles feature a bumper switch that applies the brakes when a vehicle would make contact. 5. Additional performance monitoring is done by independent systems that can issue an emergency stop by interrupting the emergency circuit when an inconsistency is detected.
Reliability and Safety	
Fail-safe operational features (describe)	<ol style="list-style-type: none"> 1. Multiple execution of components, such as 4 wheel encoders and 3 steering encoders. 2. "Limp home" capabilities 3. System alarm causes video images of the vehicle involved to immediately appear on an operator's screen in the control room. The operator can decide to take the appropriate action. 4. Emergency plan and evacuation plan, including shutting down and restarting of system
Total system mean-time-before-failure (MTBF) (hrs)	98.6% to 99.4% uptime over 4 month period, with 99.7% to 99.9% vehicle availability
Station MTBF (hrs)	
Station restore time after failure (hrs)	
Vehicle MTBF (hrs)	
Strategy for removal of failed vehicle	1. Manual Control Device 2. Manually driven tug vehicle
System restore time after failure (hrs)	
System lifetime (yrs)	12 or more
Vehicle lifetime (yrs)	
Maintenance	
Service Frequency (hrs)	
Construction/Procurement Costs (US dollars, if possible, or national currency)	
Total Overhead	
Guideway Procurement	
Vehicle Procurement	
Stations	
Construction/Installation	
EIR	

Other Procurement (explain)	Permanent development partners and (often local) project partners
Other Construction (explain)	Permanent development partners and (often local) project partners
Operational Costs (US dollars, if possible, or national currency)	
Total Annual Costs	
Energy Costs	
Maintenance Costs	
Administrative Costs	
Funding/Procurement method	
Public	
Private	
Other (explain)	
Revenue (US dollars, if possible, or national currency)	
Ticket Revenue	Most common
Advertising Revenue	
Land Valuation	
Public Subsidy	
Other (explain)	

Relevant regulations:

European and Dutch law and regulations:

1. Machine richtlijn: DIRECTIVE 2006/42/EC OF THE EUROPEAN PARLIAMENT AND OF THE COUNCIL of 17 May 2006 on machinery, and amending Directive 95/16/EC (recast)
2. Machine richtlijn 98/37/EG
3. NEN 1525 – Safety of attractions and playground equipment.
4. EN292-2 (1995): Safety of machinery. Technical principles and specifications.
5. EN294:1992: Safety of machinery. Safety distances to prevent danger zones being reached by the upper limbs
6. EN349:1993: Safety of machinery. Minimum gaps to avoid crushing of parts of the human body
7. EN811:1997: Safety of machinery. Safety distances to prevent danger zones being reached by the lower limbs
8. EN999:1999: Safety of machinery. The positioning of protective equipment in respect of approach speeds of parts of the human body
9. EN60204-1 (1992): Safety of machinery; Electrical equipment of machines. General requirements.
10. NEN-1010 Safety conditions for low voltage installations. European law and regulations for AGV's:
11. EN1525 Safety of industrial trucks - Driverless trucks and their systems
12. EN1526 Safety of industrial trucks - Additional requirements for automated functions on trucks
13. EN1726-1 Safety of industrial trucks. Self propelled trucks up to and including 10.000kg capacity and industrial tractors with drawbar pull up to and including 20.000N. General requirements.
14. EN50272-3 Safety requirements for secondary batteries and battery installations. Traction batteries. American Standards:
15. ASCE Automated People Mover Standards
16. ASME B56.5 Safety standard for guided industrial vehicles and automated functions of manned industrial vehicles.
17. NFPA-70 National Electric Code
18. NFPA 130 – Standard for Fixed Guideway Transit and Passenger Rail Systems
19. NFPA-255 Class A (fire spread rating) Project specific:

Relevant regulations: (Continued)

- 20. NEN-EN14010 - EN14010 Safety of machinery. Equipment for mechanized parking of motor vehicles. Safety and EMC requirements for design, manufacturing, erection and commissioning stages.
- 21. ISO12100-1 Safety of machinery – Basic concepts, general principles for design – (Part1, Basic terminology, methodology)
- 22. ISO12100-2 Safety of machinery – Basic concepts, general principles for design – (Part2, Technical Principles)

- 1, 2getthere_0_110315_SanJose.pdf
- 2, 2getthere_0a. Reaction structure.pdf
- 3, 2getthere_0c. Key Characteristics.pdf
- 4, 2getthere_01. System Design Specs.pdf
- 5, 2getthere_02. Vehicle Design Specs.pdf
- 6, 2getthere_03. TOMS Design Specs.pdf
- 7, 2getthere_04. Infrastructure Design Specs.pdf
- 8, 2getthere_05. Supply Consortium Organization.pdf
- 9, Masdar City application: http://www.2getthere.eu/?page_id=10
- 10, Masdar City 3 year anniversary: <http://www.2getthere.eu/?p=1156>

Table 10. Ultra

General	
Developer contact information	130 Aztec, Aztec West, Bristol, BS32 4UB, United Kingdom
Licensees	
Patents	
System Description	Ultra Personal Rapid Transit (PRT) is a new and innovative on-demand system for developed or urban environments. It is designed to meet the need for congestion free, multi-origin, multi-destination public transport. Using small, driverless electric vehicles that run on guideways, the lightweight and flexible nature of the system enables it to be retrofitted into a broad range of environments and provide transportation that is environmentally friendly and operationally efficient. Ultra has been designed with reliability and safety built-in as standard to ensure the comfort and security of its passengers.
Installation Location	Terminal 5, London's Heathrow Airport - Transports passengers between the terminal and Terminal 5's designated Business Car Park
System Performance	
Max. theoretical single direction capacity (psgrs/hr)	The capacity in a single direction can be sized to meet the demand. As demand increases the headway between vehicles can be decreased to allow more vehicles on the guideways. If demand is very high then additional guideways can be implemented to serve the demand. The configuration of the vehicle can also be changed to increase passenger carrying capability. For example at a 2s headway, with a vehicle designed to carry 6 people, each guideway could carry 10800 people per hour. At Heathrow a 12.8s headway is used as this is more than adequate to serve the relatively low demand, and with a 4 person vehicle this can theoretically serve 1125 people per hour.
Minimum headway (sec)	See above, projected headways of future systems could be down to 2s
Availability (hours of operation)	Monday-Friday 03:00-01:00. Saturday 03:00-23:00. Sunday 04:00-01:00 (Five hour shutdown on Saturday night allows for more intense maintenance and training). The hours of operation at Heathrow have been designed around the demand on the system, which reflect the timing of flights (typically no flights during the night). The maintenance period could be changed for different systems.
Type of service (shuttle, loop, network, etc.)	Typically a network, but the guideway can be configured as a point to point system or loop as well. Heathrow is a three station network.
Type of vehicle routing	
Minimum traveling unit	
Fleet Size	21 at Heathrow. Note that a large number of vehicles can be supported for future applications (no theoretical limit).
Vehicle Performance	
Cruise velocity (m/s)	10
Max. velocity (m/s)	11

Max. grade (%)	10
Service acceleration (m/s ²)	Speed dependent, typically 0.5
Service deceleration (m/s ²)	Speed dependent, typically 0.5
Max. jerk (m/s ³)	Configurable, currently 2.5
Emergency deceleration (m/s ²)	Configurable, currently 2.5
Stopping precision in station (mm)	Typically 10
Degradation due to water, ice, or snow on guideway	Speed reduction employed during extreme weather if required
Energy consumption for propulsion (kWhr/vehicle-km)	0.12
Minimum turn radius (m)	5
Noise (inside vehicle, dBA; outside vehicle, dBA)	Not known
Vehicle Design	Is it worth noting that vehicle design can be adjusted to suit application?
Overall length (m)	3.7
Overall width (m)	1.4
Overall height (m)	1.9
Empty weight (N)	8339
Vehicle design capacity (seated psgrs)	
Vehicle design capacity (maximum, seated plus standing psgrs)	
Maximum weight that can be carried (N)	4415
Passenger space (m ³)	6.4, passenger compartment
Doorway width (m)	1.5
Doorway height (m)	0.67
Suspension	
Type (configuration)	Wishbone, coil and damper
Design load (N)	Not known
Lateral guidance method	Steered front wheels
Propulsion and Braking	
Motor type and number	Asynchronous Motor
Motor placement	Under front compartment
Motor rating (kW)	7
Drive type	Transmission
Power type	48V

Power collection method	
Service brake type	Regenerative plus friction brakes
Emergency brake type	Typically 0.5s to full braking force
Emergency brake reaction time (sec)	Multiple fail safe brakes
Redundancy measures	
Switching	
Type and emplacement	N/A
Switch time (lock-to-lock) (sec)	N/A
Speed through switch (m/s)	N/A
Headway through switch (sec)	N/A
Guideway	Guideway design can be adjusted to suit application
Type/configuration (e.g., supported, suspended; box-beam, etc.)	Supported spans at Heathrow
Materials	Steel spans at Heathrow
Type and construction of support columns	Steel columns at Heathrow
Dimensions (m)	
Overall cross section width	Typically 2.1m for single and 4.0m for dual straight guideway at Heathrow
Overall cross section height	Typically 0.25m span depth (excluding guardrail)
Maximum span length	Variable dependent on application. Longest span 32m at Heathrow
Running surface width	1.4m
Location relative to grade (e.g., above, at, below, and dimensions)	Guideway can be run above, at and below grade. At Heathrow the guideway varies from grade to +9m above grade
Vehicle guidance/constraint relative to guideway	Not sure what the question means
Construction process (fab on site, pre-fabricated sections, etc.)	Prefab spans craned onto columns onsite
Other Energy Usage	
Daily system energy (kWhr)	Total system energy use typically 450
Energy for HVAC (kWhr)	Average 20 kWhr per day
Other Energy (Control center, Stations, etc.) (kWhr)	Average 80 kWhr per day
Conservation Measures	Regenerative braking
Stations	
Type (offline, online, etc.)	

Number of stations in installation	Three at Heathrow - one at Terminal 5 and two at the Business Car Park. Note that a large number of station can be supported for future applications (no theoretical limit)
Ticket or fare collection method	There is no fare - Ride on the system included within car park tariff
Security methods	Full CCTV coverage of vehicles, stations and guideways
Boarding capacity (psgrs/hr/platform)	Each station platform has a different number of boarding/deboarding bays, so the capacity depends on the number of bays. The number of bays is configured to suit the demand. At Heathrow the largest station has 4 bays and can theoretically board/deboard 1440 passengers per hour
Deboarding capacity (psgrs/hr/platform)	See above
Max. wait time (min)	There is no scheduled service, so wait times depend on demand. Average wait time is 10s, 80% of passengers have no wait
Station Layout	Configurable to match demand and space available
Station Footprint (length, area)	Variable, typical 4 bay station design 1200m ²
Controls	
Control Type	
Vital Systems/Circuitry	
Reliability and Safety	
Fail-safe operational features (describe)	Fail safe system to prevent vehicle collisions in the event of control system failure
Total system mean-time-before-failure (MTBF) (hrs)	Availability >99%. System MTBF 63 hours (based on last year's incidents causing loss of availability)
Station MTBF (hrs)	Not known
Station restore time after failure (hrs)	Not known
Vehicle MTBF (hrs)	3000 hrs
Strategy for removal of failed vehicle	Vehicles have comprehensive HUMS monitoring to capture failures before they affect the system. Vehicles also employ degraded and crawl home modes to remove themselves from the guideway if failures occur. Immobile vehicle can be towed off the guideway using a special recovery vehicle
System restore time after failure (hrs)	0.5 hours (based on last year's incidents causing loss of availability)
System lifetime (yrs)	Infrastructure design life at least 50 years
Vehicle lifetime (yrs)	Vehicle design life at least 8 years
Maintenance	
Service Frequency (hrs)	Maintenance conducted 24/7
Construction/Procurement Costs (US dollars, if possible, or national currency)	
Total Overhead	£30 Million - if built again we believe we could build a system for £20 Million.
Guideway Procurement	
Vehicle Procurement	

Stations	
Construction/Installation	
EIR	
Other Procurement (explain)	
Other Construction (explain)	
Operational Costs (US dollars, if possible, or national currency)	
Total Annual Costs	Commercially Confidential
Energy Costs	Commercially Confidential
Maintenance Costs	Commercially Confidential
Administrative Costs	Commercially Confidential
Funding/Procurement method	Commercially Confidential
Public	
Private	Private
Other (explain)	
Revenue (US dollars, if possible, or national currency)	Revenue generated through the tariff at the car park, the price of the car park was raised 20% with the introduction of PRT.
Ticket Revenue	None
Advertising Revenue	Commercially Confidential - Lucrative Six figure sum just agreed with Marriott Hotel Group
Land Valuation	None
Public Subsidy	None
Other (explain)	

- 1, RFI.
- 2, ULTraForNorthAmerica.pdf

Table 11. Vectus

General	
Developer contact information	jorgen.gustafsson@vectusprt.com
Licensees	
Patents	
System Description	
Installation Location	1. Suncheon Bay, South Korea 2. Test Track: Uppsala, Sweden
System Performance	
Max. theoretical single direction capacity (psgrs/hr)	7,200 passengers/hour
Minimum headway (sec)	3, small vehicles. 10, large vehicles
Availability (hours of operation)	
Type of service (shuttle, loop, network, etc.)	
Type of vehicle routing	
Minimum traveling unit	
Fleet Size	40
Vehicle Performance	
Cruise velocity (m/s)	13
Max. velocity (m/s)	Less than 19
Max. grade (%)	10
Service acceleration (m/s ²)	1.2 to 2
Service deceleration (m/s ²)	2
Max. jerk (m/s ³)	2.5
Emergency deceleration (m/s ²)	5
Stopping precision in station (mm)	
Degradation due to water, ice, or snow on guideway	Successfully tested in heavy snow conditions
Energy consumption for propulsion (kWhr/vehicle-km)	0.24 at 8.3m/s
Minimum turn radius (m)	15
Noise (inside vehicle, dBA; outside vehicle, dBA)	
Vehicle Design	
Overall length (m)	3.74

Overall width (m)	2.1
Overall height (m)	2.5
Empty weight (N)	
Vehicle design capacity (seated psgrs)	4 to 6, small vehicles
Vehicle design capacity (maximum, seated plus standing psgrs)	12 to 14, larger vehicles
Maximum weight that can be carried (N)	2,500kg total weight
Passenger space (m ³)	9.3m ² , larger vehicles
Doorway width (m)	
Doorway height (m)	
Suspension	
Type (configuration)	
Design load (N)	
Lateral guidance method	
Propulsion and Braking	
Motor type and number	LIM or direct (on-board) electric motor
Motor placement	Below vehicle if LIM. Or on-board if rotary.
Motor rating (kW)	
Drive type	
Power type	Electric
Power collection method	None if LIM, third rail otherwise
Service brake type	Mechanical or dynamic (electrical) braking if LIM
Emergency brake type	Spring-applied caliper brakes on rail
Emergency brake reaction time (sec)	
Redundancy measures	
Switching	
Type and emplacement	On-board vehicle
Switch time (lock-to-lock) (sec)	
Speed through switch (m/s)	No change
Headway through switch (sec)	No change
Guideway	
Type/configuration (e.g., supported, suspended; box-beam, etc.)	Supported

Materials	Steel
Type and construction of support columns	
Dimensions (m)	
Overall cross section width	
Overall cross section height	Under 0.30m
Maximum span length	
Running surface width	
Location relative to grade (e.g., above, at, below, and dimensions)	Optional
Vehicle guidance/constraint relative to guideway	Locked to guideway, captured rail
Construction process (fab on site, pre-fabricated sections, etc.)	
Other Energy Usage	
Daily system energy (kW/hr)	
Energy for HVAC (kW/hr)	
Other Energy (Control center, Stations, etc.) (kW/hr)	
Conservation Measures	
Stations	
Type (offline, online, etc.)	Offline
Number of stations in installation	
Ticket or fare collection method	Yes
Security methods	
Boarding capacity (psgrs/hr/platform)	
Deboarding capacity (psgrs/hr/platform)	
Max. wait time (min)	
Station Layout	Online berths, typically 4
Station Footprint (length, area)	Application dependent
Controls	
Control Type	Distributed, Asynchronous, Dynamic Moving Block
Vital Systems/Circuitry	CBTC, real time software (no operating system) at SIL 3
Reliability and Safety	
Fail-safe operational features (describe)	Compliance with: Swedish Rail Agency, FMECA, QRA, EN 50126/IEC62278 RAMS, and LCC, passenger risk was quantified to 0.165 fatalities per billion person kilometers: as high as or higher than the current performance of railway systems and metros in Western Europe

Total system mean-time-before-failure (MTBF) (hrs)

Station MTBF (hrs)

Station restore time after failure (hrs)

Vehicle MTBF (hrs)

Strategy for removal of failed vehicle

System restore time after failure (hrs)

System lifetime (yrs)

Vehicle lifetime (yrs)

Maintenance

Service Frequency (hrs)

Construction/Procurement Costs
(US dollars, if possible, or national currency)

Total Overhead

Guideway Procurement

Vehicle Procurement

Stations

Construction/Installation

EIR

Other Procurement (explain)

Other Construction (explain)

Operational Costs
(US dollars, if possible, or national currency)

Total Annual Costs

Energy Costs

Maintenance Costs

Administrative Costs

Funding/Procurement method

Public

Private

Other (explain)

Revenue (US dollars, if possible, or national currency)

Ticket Revenue

Advertising Revenue

Projected ridership of 5,000 people per day, Suncheon

Land Valuation	Anticipated
Public Subsidy	
Other (explain)	
	<ul style="list-style-type: none"> • 1, http://www.vectusprt.com/EN/vehicles/ • 2, http://www.vectusprt.com/EN/infrastructure/ • 3, http://www.vectusprt.com/EN/propulsion/ • 4, http://www.vectusprt.com/EN/tech-test-info/ • 5, http://www.vectusprt.com/EN/vectus-communications-system/ • 6, http://www.vectusprt.com/EN/vectus-performance/ • 7, http://www.vectusprt.com/EN/vectus-safety/ • 8, Vectus Overview Presentation, http://www.vectusprt.com/uploads/51AF38C040D0F.pdf • 9, Vectus PRT, Concept and Test Track Experience, http://www.vectusprt.com/uploads/51828CFFA6B1A.pdf • 10, The Track to Suncheon: Making APMs Intelligent, http://www.vectusprt.com/uploads/51838EEEB465F7.pdf • 11, Vectus – Intelligent Transport, http://www.vectusprt.com/uploads/518288B214A85.pdf • 12, Design Considerations for Capacity in PRT networks, http://www.vectusprt.com/uploads/51828897D6FFD.pdf • 13, VECTUS Intelligent Transport - 1 Cover Letter (RFI 10-11 DOTAD-002).pdf • 14, VECTUS Intelligent Transport - 2 General Description.pdf

Table 12. Beamways

General	
Developer contact information	info@beamways.com
Licensees	No
Patents	Yes, pending in 7 areas, approved in Russia.
System Description	Suspended, mostly double direction
Installation Location	None
System Performance	
Max. theoretical single direction capacity (psgrs/hr)	7,200 PRT, 20,000+ GRT, GRT vehicles are multi-articulated “trains” of 4 person cabins, each 2.5 m in length.
Minimum headway (sec)	Initial goal 3, long term < 2
Availability (hours of operation)	Up to 24h/7d, depends on application
Type of service (shuttle, loop, network, etc.)	Network
Type of vehicle routing	
Minimum traveling unit	
Fleet Size	Depends on application
Vehicle Performance	
Cruise velocity (m/s)	15
Max. velocity (m/s)	30
Max. grade (%)	30%, with horizontal floor thanks to cabin tilting.
Service acceleration (m/s ²)	5, note: possible thanks to cabin tilting backwards/forwards
Service deceleration (m/s ²)	5
Max. jerk (m/s ³)	3.5, tilting synchronized to acceleration to provide constant jerk
Emergency deceleration (m/s ²)	5
Stopping precision in station (mm)	25
Degradation due to water, ice, or snow on guideway	No, due to covered guideway and drive wheel in ceiling, with variable normal force
Energy consumption for propulsion (kWhr/vehicle-km)	Design goal 0.05, steel wheel almost eliminating rolling resistance
Minimum turn radius (m)	3
Noise (inside vehicle, dBA; outside vehicle, dBA)	Lower than standards, target “high end automobile” for inside noise levels and “electric car” for those outside

Vehicle Design	
Overall length (m)	3.6
Overall width (m)	1.8
Overall height (m)	1.9
Empty weight (N)	500kg
Vehicle design capacity (seated psgrs)	4, if operating as GRT: 4 times number of cabins.
Vehicle design capacity (maximum, seated plus standing psgrs)	4, if operating as GRT: All seated
Maximum weight that can be carried (N)	500kg, if operating as GRT: Per cabin
Passenger space (m ³)	Approximately 8, if operating as GRT: 6
Doorway width (m)	0.9, if operating as GRT: Only first and last cabin in "train" ADA-compliant
Doorway height (m)	1.7, Door extends partially into ceiling to simplify boarding.
Suspension	
Type (configuration)	2 one axle bogies
Design load (kg)	10,000
Lateral guidance method	Sideways facing wheels
Propulsion and Braking	
Motor type and number	Wheel motor, one per bogie. If operating as GRT: One per two bogies
Motor placement	Pressed against guideway ceiling by servo arm
Motor rating (kW)	2x20kW continuous, needed to get enough torque for 30% slopes with one motor out of order
Drive type	Brushless DC
Power type	
Power collection method	Power rail, 750 V, a 1kWh on board battery is used as backup and "boost" during acceleration/deceleration.
Service brake type	Integrated disc brake in drive wheel, regenerative
Emergency brake type	Direct shoe in ceiling
Emergency brake reaction time (sec)	0.3
Redundancy measures	Six independent brake functions. Each motor has regenerative and disc brake. Each bogie has brake shoe towards ceiling.
Switching	
Type and emplacement	Servo controlled on board wheel sets. On failure rail guides enforce default direction.
Switch time (lock-to-lock) (sec)	1
Speed through switch (m/s)	Same as on main line, can depend on radius.

Headway through switch (sec)	Same as on main line
Guideway	
Type/configuration (e.g., supported, suspended; box-beam, etc.)	Suspended, custom beam geometry. Same beam provides structural strength and wheel running surfaces.
Materials	Steel with plastic or aluminum covers
Type and construction of support columns	Steel with earth-bored foundations
Dimensions (m)	
Overall cross section width	0.5
Overall cross section height	0.8
Maximum span length	24
Running surface width	20mm
Location relative to grade (e.g., above, at, below, and dimensions)	Typically above grade. Height depends on what is underneath. Local laws apply.
Vehicle guidance/constraint relative to guideway	Bogie contained in guideway
Construction process (fab on site, pre-fabricated sections, etc.)	Prefabricated 12m guideway sections.
Other Energy Usage	
Daily system energy (kWhr)	Depends
Energy for HVAC (kWhr)	TBD, cabin designed with effective insulation and double glassing to reduce power use.
Other Energy (Control center, Stations, etc.) (kWhr)	TBD, local building rules apply. Customer normally specifies rules to use.
Conservation Measures	
Stations	
Type (offline, online, etc.)	Offline, inline. Large stations may need more than one row of berths.
Number of stations in installation	Depends on application. Customers normally mandate integration with preexisting fare system such as smart cards, etc.
Ticket or fare collection method	
Security methods	
Boarding capacity (psgrs/hr/platform)	240. Cycle time around 30sec possible according to Heathrow tests. We assume 2people/vehicle in rush hour (some sharing). Note that with many berths in a row the per-berth counts deteriorate.
Deboarding capacity (psgrs/hr/platform)	>240. Deboarding is typically somewhat faster, but not by a large percentage.
Max. wait time (min)	1, attainable for up to 99% of passengers
Station Layout	In-line, simple siding with berths one after another

Station Footprint (length, area)	5m/berth for GRT-capable stations. Every other door used for PRT, all doors for GRT modules.
Controls	
Control Type	Asynchronous
Vital Systems/Circuitry	On board only. Each vehicle is autonomous when it comes to safety. All wayside equipment is ancillary.
Reliability and Safety	
Fail-safe operational features (describe)	
Total system mean-time-before-failure (MTBF) (hrs)	TBD
Station MTBF (hrs)	TBD, perhaps a berth goes down, but rarely whole station
Station restore time after failure (hrs)	Depends on maintenance resources
Vehicle MTBF (hrs)	Vehicle failure very rare thanks to redundancy.
Strategy for removal of failed vehicle	Tow/push with another bogie or vehicle
System restore time after failure (hrs)	
System lifetime (yrs)	40, requires proper corrosion prevention maintenance for guideway parts.
Vehicle lifetime (yrs)	6 to 10, vehicles designed for 1 million km operation.
Maintenance	
Service Frequency (hrs)	Differs, maintenance program included in software keeps track of replacement intervals etc.
Construction/Procurement Costs (US dollars, if possible, or national currency)	
Total Overhead	Target total price \$10M /km, including vehicles, stations, guideways + on site work. Excludes RoW cost, planning, utility relocation.
Guideway Procurement	
Vehicle Procurement	
Stations	
Construction/Installation	
EIR	
Other Procurement (explain)	
Other Construction (explain)	
Operational Costs (US dollars, if possible, or national currency)	
Total Annual Costs	
Energy Costs	
Maintenance Costs	
Administrative Costs	

Funding/Procurement method	Any
Public	
Private	
Other (explain)	
Revenue (US dollars, if possible, or national currency)	No system running
Ticket Revenue	
Advertising Revenue	
Land Valuation	
Public Subsidy	
Other (explain)	

- 1, RFI.
- 2, Beamways cabin requirements.pdf
- 3, Beamways RFI 2011 response.pdf

Table 13. BubbleMotion

General	
Developer contact information	Asko Kauppi <asko@bmdesign.fi>
Licensees	None (still in early stage)
Patents	PCT application from 2010 (PCT/FI2010/050221); expired
System Description	BubbleMotion™ light weight PRT system
Installation Location	None (pilot talks ongoing for 2018)
System Performance	
Max. theoretical single direction capacity (psgrs/hr)	3600-5000, depends on minimum headway
Minimum headway (sec)	<1sec, depends on track structural strength
Availability (hours of operation)	24/7/365 capable
Type of service (shuttle, loop, network, etc.)	Any
Type of vehicle routing	Fixed and variable routs
Minimum traveling unit	Single vehicle, 2-3 seats
Fleet Size	Any
Vehicle Performance	
Cruise velocity (m/s)	12.5
Max. velocity (m/s)	20, on longer track sections without junctions
Max. grade (%)	Any, three different climb strategies: slope, track-assisted, elevator
Service acceleration (m/s ²)	
Service deceleration (m/s ²)	
Max. jerk (m/s ³)	
Emergency deceleration (m/s ²)	
Stopping precision in station (mm)	
Degradation due to water, ice, or snow on guideway	None (designed for harsh climate)
Energy consumption for propulsion (kWhr/vehicle-km)	0.0625, including empty-running vehicles
Minimum turn radius (m)	5, or possibly 3
Noise (inside vehicle, dBA; outside vehicle, dBA)	
Vehicle Design	
Overall length (m)	2.4
Overall width (m)	2.4
Overall height (m)	1.6 (above track) + 0.4 keel (below track)

Empty weight (N)	360kg
Vehicle design capacity (seated psgrs)	2-3, there is a bench/sofa, no individual seats
Vehicle design capacity (maximum, seated plus standing psgrs)	(As above – no standing)
Maximum weight that can be carried (N)	250kg
Passenger space (m ³)	~ 3.1
Doorway width (m)	~ 1.75
Doorway height (m)	~ 0.75
Suspension	
Type (configuration)	
Design load (N)	This is a function of vehicle weight (360kg + passengers ca. 250kg), allowed minimum headway and cost of support (both in beauty and in construction cost). Will be optimized for each customer case (i.e. how many vehicles are allowed on a single track segment: 1,2,3 or more).
Lateral guidance method	side rail & grabber arm mechanism
Propulsion and Braking	
Motor type and number	
Motor placement	Two motors
Motor rating (kW)	
Drive type	
Power type	Electric
Power collection method	Battery, keel carries the battery packs and is detachable (battery swap)
Service brake type	Motor braking
Emergency brake type	Clamp
Emergency brake reaction time (sec)	
Redundancy measures	
Switching	
Type and emplacement	In the vehicle (grabber side arms), explained in patent application
Switch time (lock-to-lock) (sec)	
Speed through switch (m/s)	10
Headway through switch (sec)	Any (as in normal cruise)
Guideway	
Type/configuration (e.g., supported, suspended; box-beam, etc.)	Supported, cylindrical main rail

Materials	Steel
Type and construction of support columns	Steel, cylindrical (diameter 20-30cm), diameter depends on track height
Dimensions (m)	
Overall cross section width	< 1
Overall cross section height	~ 0.4
Maximum span length	25m normally, with very long spans done using bridge-like constructions
Running surface width	0.1
Location relative to grade (e.g., above, at, below, and dimensions)	Any, usually above; i.e. 3.5m height
Vehicle guidance/constraint relative to guideway	Flange on main rail, grabber arms on side rail
Construction process (fab on site, pre-fabricated sections, etc.)	Pre-fabricated sections
Other Energy Usage	
Daily system energy (kWhr)	1295.0, estimate (pilot of 11km, 9000 daily passengers); total energy usage
Energy for HVAC (kWhr)	35.6, estimate (pilot of 11km, 9000 daily passengers)
Other Energy (Control center, Stations, etc.) (kWhr)	350.6, estimate (pilot of 11km, 9000 daily passengers); everything but vehicle movement & overall A/C
Conservation Measures	Vehicle elevators integrated with the track (vehicle batteries used for horizontal movement only). Regenerative motors in vehicle lifts. Optimizing A/C with open or covered station & vehicle storage designs
Stations	
Type (offline, online, etc.)	Offline, parallel station design can also be used online, if needed
Number of stations in installation	
Ticket or fare collection method	Integrated with local public transport ticketing system (i.e. travel card)
Security methods	Two exits, video surveillance, sensors in mixed human/vehicle accessible area
Boarding capacity (psgrs/hr/platform)	Any, parallel stations can be extended up to track congestion levels (3600 to 5000 pphpd)
Deboarding capacity (psgrs/hr/platform)	Any, parallel stations have separate platforms for outgoing and incoming traffic (both scalable without limits)
Max. wait time (min)	
Station Layout	Small station: sequential layout, mixed platform for both incoming and outgoing traffic. Parallel station: parallel layout, separate platforms for incoming & outgoing traffic, vehicles can leave and arrive at any time.
Station Footprint (length, area)	Small station: ca. 16m x 5m for three vehicle berths (slots) and two elevators (N*3 + M*4 x 5). Parallel station: ca. 24m x 10m for eight berths (N*3 x 10). Versatile layouts.
Controls	
Control Type	Mix of centralized and distributed control

Vital Systems/Circuitry	In-track communication cables; track/vehicle RF link; data warehouse at the maintenance pit / monitoring facility
Reliability and Safety	
Fail-safe operational features (describe)	Switches, routing, communications. In the event that vehicles are stranded can "cherry-pick" them off the track with a normal truck lift.
Total system mean-time-before-failure (MTBF) (hrs)	
Station MTBF (hrs)	
Station restore time after failure (hrs)	Depends on failure (i.e. structural damage to the station vs. animal or people)
Vehicle MTBF (hrs)	
Strategy for removal of failed vehicle	Pre-emptive monitoring and maintenance. Cherry-picking off the track in case of sudden problems.
System restore time after failure (hrs)	System remains operational even if part of it is off normal operation
System lifetime (yrs)	Unlimited; the track is planned for extensions and reductions; it can be completely remade multiple times during its operation. Track section life time is 10-20 years (tbd). This allows for technological upgrades in the form of more efficient batteries, vehicles, station hardware, and periodically updated software.
Vehicle lifetime (yrs)	~8
Maintenance	
Service Frequency (hrs)	Constant; vehicles visit maintenance pit multiple times a day for battery swap + cleanup. Sensors monitor the track and vehicles constantly and indicate any need for tuning or maintenance. We're anticipating very little operational down-time, even when changes to the track layout are being constructed. Connecting an extension to existing track could take 2 hours.
Construction/Procurement Costs (US dollars, if possible, or national currency)	Our cost target is about half the price level of existing PRT tracks. However, cost breakdown details remain classified for now. They also may not be so vital to the end customer, since the business model is to sell "transport as a service", not vehicles, stations or track. There is an initial fee for initiating a new track, and monthly recurring operation fees. Capacity etc. criteria are agreed with the customer and observed in real time. Not fulfilling them causes a reduction in operation fees. We'll be glad to share better cost estimates once a pilot is running.
Total Overhead	(see above)
Guideway Procurement	-"-
Vehicle Procurement	-"-
Stations	-"-
Construction/Installation	-"-
EIR	No environmental impact studies have been made. In practice, though, the design is beyond any current requirements (fully cradle-to-cradle, energy efficiency comparable to that of a bicycle). We're suggesting a 10x reduction in costs (compared to existing non-PRT transportation) as well as a neutralization of any externalities (= no pollution, no carbon, no lasting visual impact after dismantling). These are only the "basics" of what any 21 st century design must provide (cheap, clean, convenient).

Other Procurement (explain)	
Other Construction (explain)	
Operational Costs (US dollars, if possible, or national currency)	
Total Annual Costs	Costs depend on the customer case, and depend on track extent, construction terrain, capacity requirements and operating hours. We have internal estimates on the costs and they seem very favorable. Our internal cost target is 2Meur/km but the cost to the purchasing customer will be higher. The intended pilot would be 11km and cost 10-15 Meur + operational costs
Energy Costs	Negligible, see EIR item
Maintenance Costs	
Administrative Costs	
Funding/Procurement method	
Public	Sold as a service, with capacity etc. quality requirements observable by the customer in real time.
Private	See above
Other (explain)	
Revenue (US dollars, if possible, or national currency)	
Ticket Revenue	We're not intending to take ticket revenue (our customers might; ideally the systems are integrated to a regional, multi-modal transport card system)
Advertising Revenue	Stations may have conventional advertising, vehicles not
Land Valuation	Land (and air) usage rights remain on the customer's side
Public Subsidy	To be seen (hopefully subsidies go to our customers, not directly to us)
Other (explain)	

• 1, RFI.

Table 14. Cabintaxi

General	
Developer contact information	
Licensees	
Patents	
System Description	
Installation Location	
System Performance	
Max. theoretical single direction capacity (psgrs/hr)	21,600
Minimum headway (sec)	0.5 to 1.0
Availability (hours of operation)	24 hours a day, on demand
Type of service (shuttle, loop, network, etc.)	Limited area collection and distribution
Type of vehicle routing	Variable
Minimum traveling unit	1 vehicle, can hold up to 3 passengers
Fleet Size	
Vehicle Performance	
Cruise velocity (m/s)	10
Max. velocity (m/s)	10
Max. grade (%)	15
Service acceleration (m/s ²)	2.45
Service deceleration (m/s ²)	2.45
Max. jerk (m/s ³)	2.5
Emergency deceleration (m/s ²)	4.9
Stopping precision in station (mm)	< 100mm
Degradation due to water, ice, or snow on guideway	No change
Energy consumption for propulsion (kWhr/vehicle-km)	0.183
Minimum turn radius (m)	
Noise (inside vehicle, dBA; outside vehicle, dBA)	
Vehicle Design	
Overall length (m)	2.3
Overall width (m)	1.6
Overall height (m)	1.5

Empty weight (N)	600 kg
Vehicle design capacity (seated psgrs)	3
Vehicle design capacity (maximum, seated plus standing psgrs)	3, no standing
Maximum weight that can be carried (N)	400 kg
Passenger space (m ³)	3
Doorway width (m)	0.9
Doorway height (m)	1.4
Suspension	
Type (configuration)	Solid rubber wheels on bogies which ride inside guideway
Design load (N)	1,000 kg
Lateral guidance method	Constrained by lateral guide wheels
Propulsion and Braking	
Motor type and number	2 double-comb horizontal linear induction motors
Motor placement	On-vehicle
Motor rating (kW)	
Drive type	Linear motor
Power type	500 V, AC
Power collection method	Third rail, collection from in guideway power rails
Service brake type	Dynamic via LIM and drum brakes
Emergency brake type	Same as service brakes
Emergency brake reaction time (sec)	< .02
Redundancy measures	LIM and drum brakes
Switching	
Type and emplacement	On-board, mechanical branch-off mechanism
Switch time (lock-to-lock) (sec)	< 1
Speed through switch (m/s)	10, same as cruise velocity
Headway through switch (sec)	0.5, same as mainline
Guideway	
Type/configuration (e.g., supported, suspended; box-beam, etc.)	Box-beam, inverted U-shaped
Materials	Steel and/or concrete
Type and construction of support columns	As required, concrete and steel construction

Dimensions (m)	
Overall cross section width	1.42
Overall cross section height	0.910
Maximum span length	40
Running surface width	
Location relative to grade (e.g., above, at, below, and dimensions)	Above
Vehicle guidance/constraint relative to guideway	Suspended, supported, or a bi-directional configuration with both
Construction process (fab on site, pre-fabricated sections, etc.)	
Other Energy Usage	
Daily system energy (kW/hr)	
Energy for HVAC (kW/hr)	
Other Energy (Control center, Stations, etc.) (kW/hr)	
Conservation Measures	
Stations	
Type (offline, online, etc.)	Off-line
Number of stations in installation	An average of 1 station per 0.3 to 0.8 km of guideway
Ticket or fare collection method	
Security methods	Optional closed circuit TV
Boarding capacity (psgrs/hr/platform)	3,000 (psgrs/hr/berth)
Deboarding capacity (psgrs/hr/platform)	3,000 (psgrs/hr/berth)
Max. wait time (min)	0 during unsaturated operation
Station Layout	
Station Footprint (length, area)	110 m in length including guideway
Controls	
Control Type	Three tiered system: headway control and destination coding, station control, and empty-vehicle plus traffic optimization.
Vital Systems/Circuitry	
Reliability and Safety	Headway feedback via attenuation of high-frequency signal.
Fail-safe operational features (describe)	
Total system mean-time-before-failure (MTBF) (hrs)	Automatic redundant spacing control 25,000 as calculated from subsystems

Station MTBF (hrs)	
Station restore time after failure (hrs)	
Vehicle MTBF (hrs)	
Strategy for removal of failed vehicle	
System restore time after failure (hrs)	Short, due to modular construction
System lifetime (yrs)	50 for guideway
Vehicle lifetime (yrs)	10
Maintenance	Automatic cleaning of vehicles (interior and exterior), computer-aided checkout at regular intervals, modular construction of electronics, and semi-automatic guideway maintenance by special vehicles.
Service Frequency (hrs)	Regular intervals, semi and fully automated
Construction/Procurement Costs (US dollars, if possible, or national currency)	
Total Overhead	
Guideway Procurement	
Vehicle Procurement	
Stations	
Construction/Installation	
EIR	
Other Procurement (explain)	
Other Construction (explain)	
Operational Costs (US dollars, if possible, or national currency)	
Total Annual Costs	
Energy Costs	
Maintenance Costsa	
Administrative Costs	
Funding/Procurement method	
Public	
Private	
Other (explain)	
Revenue (US dollars, if possible, or national currency)	
Ticket Revenue	
Advertising Revenue	

Land Valuation

Public Subsidy

Other (explain)

Note: Pages for Cabintaxi from LeaTransitCompendium_vol_II_no_4-PRT.pdf

Table 15. CyberTran

General	
Developer contact information	
Licensees	None
Patents	
System Description	
Installation Location	
System Performance	
Max. theoretical single direction capacity (psgrs/hr)	16,000
Minimum headway (sec)	
Availability (hours of operation)	
Type of service (shuttle, loop, network, etc.)	
Type of vehicle routing	
Minimum traveling unit	
Fleet Size	
Vehicle Performance	
Cruise velocity (m/s)	13 - 45
Max. velocity (m/s)	45
Max. grade (%)	10%
Service acceleration (m/s ²)	0.25
Service deceleration (m/s ²)	0.25
Max. jerk (m/s ³)	
Emergency deceleration (m/s ²)	
Stopping precision in station (mm)	
Degradation due to water, ice, or snow on guideway	
Energy consumption for propulsion (kWhr/vehicle-km)	0.16 and 0.50, inferred from 15 kW at 60mph and 60 kW at 75mph respectively
Minimum turn radius (m)	23 at low speed, 910 at 67m/s
Noise (inside vehicle, dBA; outside vehicle, dBA)	Track/guideway adhesive, foam filled wheels and silent coupling track joints
Vehicle Design	
Overall length (m)	9.8 to 11.6m (6.1m internal dimension of passenger area)
Overall width (m)	1.8m (internal dimensions of passenger area)
Overall height (m)	2.1m (internal dimensions of passenger area)

Empty weight (kg)	
Vehicle design capacity (seated psgrs)	
Vehicle design capacity (maximum, seated plus standing psgrs)	
Maximum weight that can be carried (N)	4,500kg
Passenger space (m ³)	24
Doorway width (m)	3 sliding doors on each side
Doorway height (m)	
Suspension	
Type (configuration)	Sprung and damped axels
Design load (N)	4,500kg
Lateral guidance method	
Propulsion and Braking	
Motor type and number	2 AC flux vector driven electric motors
Motor placement	
Motor rating (kW)	75 each
Drive type	Single axle, steel wheel on steel rail, sprung and damped
Power type	Electric, AC
Power collection method	Third rail
Service brake type	
Emergency brake type	
Emergency brake reaction time (sec)	57.0 emergency stop, 229 feet normal at 27m/s
Redundancy measures	Solar panels over guideway, emergency generators
Switching	
Type and emplacement	
Switch time (lock-to-lock) (sec)	
Speed through switch (m/s)	
Headway through switch (sec)	
Guideway	
Type/configuration (e.g., supported, suspended; box-beam, etc.)	Supported
Materials	Structural steel or pre-stressed concrete trusses
Type and construction of support columns	3.3m ² footprint

Dimensions (m)	
Overall cross section width	4.9, right of way for two direction guideway
Overall cross section height	
Maximum span length	15
Running surface width	
Location relative to grade (e.g., above, at, below, and dimensions)	Above
Vehicle guidance/constraint relative to guideway	
Construction process (fab on site, pre-fabricated sections, etc.)	
Energy Usage	
Daily system energy (kWhr)	
Energy for HVAC (kWhr)	
Other Energy (Control center, Stations, etc.) (kWhr)	
Conservation Measures	
Stations	
Type (offline, online, etc.)	Offline, parallel to or on a spur from main line
Number of stations in installation	
Ticket or fare collection method	Debit or cash card
Security methods	Video surveillance, emergency communications, randomized patrol
Boarding capacity (psgrs/hr/platform)	Variable to meet demand load
Deboarding capacity (psgrs/hr/platform)	Variable to meet demand load
Max. wait time (min)	
Station Layout	
Station Footprint (length, area)	
Controls	
Control Type	Central and Vehicle
Vital Systems/Circuitry	
Reliability and Safety	
Fail-safe operational features (describe)	Emergency power, fire detection and suppression
Total system mean-time-before-failure (MTBF) (hrs)	
Station MTBF (hrs)	
Station restore time after failure (hrs)	

Vehicle MTBF (hrs)
Strategy for removal of failed vehicle
System restore time after failure (hrs)
System lifetime (yrs)
Vehicle lifetime (yrs)
Maintenance
Service Frequency (hrs)
Construction/Procurement Costs (US dollars, if possible, or national currency)
Total Overhead
Guideway Procurement
Vehicle Procurement
Stations
Construction/Installation
EIR
Other Procurement (explain)
Other Construction (explain)
Operational Costs (US dollars, if possible, or national currency)
Total Annual Costs
Energy Costs
Maintenance Costs
Administrative Costs
Funding/Procurement method
Public
Private
Other (explain)
Revenue (US dollars, if possible, or national currency)
Ticket Revenue
Advertising Revenue
Land Valuation
Public Subsidy
Other (explain)

• 1, CyberTran spec sheet 7-2013.docx

Table 16. PRT International

General	
Developer contact information	J. Edward Anderson
Licensees	none
Patents	5 patents expired
System Description	A PRT System with top-mounted, wheeled vehicles propelled by a pair of linear induction motors
Installation Location	To be determined
System Performance	
Max. theoretical single direction capacity (psgrs/hr)	Seats per hour: 36,000
Minimum headway (sec)	0.5
Availability (hours of operation)	99.97% availability
Type of service (shuttle, loop, network, etc.)	network
Type of vehicle routing	Within limits, any kind
Minimum traveling unit	One vehicle
Fleet Size	Up to 75 vehicles per km
Vehicle Performance	
Cruise velocity (m/s)	16 for early systems, later up to 45
Max. velocity (m/s)	45
Max. grade (%)	Usually 10%, but greater if needed
Service acceleration (m/s ²)	8
Service deceleration (m/s ²)	8
Max. jerk (m/s ³)	8
Emergency deceleration (m/s ²)	13
Stopping precision in station (mm)	5
Degradation due to water, ice, or snow on guideway	none
Energy consumption for propulsion (kWhr/vehicle-km)	0.11
Minimum turn radius (m)	15, non-operational, can decrease if needed
Noise (inside vehicle, dBA; outside vehicle, dBA)	Based on Cabintaxi, very quiet
Vehicle Design	
Overall length (m)	2.64
Overall width (m)	1.6
Overall height (m)	1.58 cabin, 0.76 chassis in guideway

Empty weight (N)	4000
Vehicle design capacity (seated psgrs)	3 adults + 2 children
Vehicle design capacity (maximum, seated plus standing psgrs)	same
Maximum weight that can be carried (N)	4000
Passenger space (m ³)	3.54
Doorway width (m)	0.9
Doorway height (m)	Inverted U door slides back, wide open at top
Suspension	
Type (configuration)	wheels
Design load (N)	2000 per each of four main-support wheels
Lateral guidance method	side wheels on vertical surfaces
Propulsion and Braking	
Motor type and number	2 linear induction motors
Motor placement	operate against running surface
Motor rating (kW)	20 per motor
Drive type	variable frequency drive
Power type	renewable
Power collection method	power pickup from power rails
Service brake type	LIMs
Emergency brake type	pair of brake shoes against running surface
Emergency brake reaction time (sec)	0.001 normal with LIM, 0.25 with brake shoes
Redundancy measures	Dual motors, brakes, position & speed sensors
Switching	
Type and emplacement	Switch arm rotates about longitudinal axis slightly above centerline between upper and lower lateral wheels
Switch time (lock-to-lock) (sec)	0.4
Speed through switch (m/s)	Normal, no slowdown
Headway through switch (sec)	0.5 minimum
Guideway	
Type/configuration (e.g., supported, suspended; box-beam, etc.)	U-shaped steel truss supports vehicles
Materials	Steel

Type and construction of support columns	Octagonal, tapered steel columns
Dimensions (m)	
Overall cross section width	0.89
Overall cross section height	0.96
Maximum span length	27.5
Running surface width	0.55
Location relative to grade (e.g., above, at, below, and dimensions)	Usually above grade, but planners decision
Vehicle guidance/constraint relative to guideway	Side wheels with vertical axes constrain vehicle in guideway
Construction process (fab on site, pre-fabricated sections, etc.)	Pre-fab, robotically welded
Other Energy Usage	
Daily system energy (kWhr)	Depends on application
Energy for HVAC (kWhr)	0.057 kWhr/vehicle-km
Other Energy (Control center, Stations, etc.) (kWhr)	340,000 kW-hr/yr for a 5.2 km system with 10 stations
Conservation Measures	Use of renewable energy
Stations	
Type (offline, online, etc.)	Off-line
Number of stations in installation	Depends on application
Ticket or fare collection method	Cash or debit card
Security methods	Lights, video scanning, communication with central
Boarding capacity (psgrs/hr/platform)	1200 psgrs/hr/berth
Deboarding capacity (psgrs/hr/platform)	1200 psgrs/hr/berth
Max. wait time (min)	Wait time of 3-sigma about 3 minutes
Station Layout	vehicles in tandem
Station Footprint (length, area)	Per berth, 3m long x 2.5m wide
Controls	
Control Type	Asynchronous point follower
Vital Systems/Circuitry	Described in paper "PRT Control" (www.prt.nz.com)
Reliability and Safety	
Fail-safe operational features (describe)	See "Overcoming Headway Limitations in PRT" Section 12, www.prt.nz.com
Total system mean-time-before-failure (MTBF) (hrs)	Depends on system size

Station MTBF (hrs)	500
Station restore time after failure (hrs)	1.7
Vehicle MTBF (hrs)	544
Strategy for removal of failed vehicle	Push to nearest station, then to maintenance
System restore time after failure (hrs)	1.7
System lifetime (yrs)	50
Vehicle lifetime (yrs)	20
Maintenance	
Service Frequency (hrs)	Depends on system size
Construction/Procurement Costs (US dollars, if possible, or national currency)	
Total Overhead	Company wishes not to reveal overhead.
Guideway Procurement	See paper "PRT Network Economics"
Vehicle Procurement	
Stations	
Construction/Installation	
EIR	
Other Procurement (explain)	
Other Construction (explain)	
Operational Costs (US dollars, if possible, or national currency)	For 5.2 km system with 10 stations:
Total Annual Costs	\$3,500,000
Energy Costs	\$126,000
Maintenance Costs	\$1,600,000
Administrative Costs	\$1,774,000
Funding/Procurement method	
Public	
Private	Private
Other (explain)	
Revenue (US dollars, if possible, or national currency)	Applies to operating system. We are not there yet.
Ticket Revenue	
Advertising Revenue	

Land Valuation	
Public Subsidy	None expected
Other (explain)	

- 1, RFI.
- prt int'l-2.pdf

Table 17. SkyCabs

General	
Developer contact information	Hugh Chapman, hugh.chapman@skycabs.co.nz
Licensees	
Patents	
System Description	
Installation Location	
System Performance	
Max. theoretical single direction capacity (psgrs/hr)	9000 or up to 35,000 with "Metropolis System"
Minimum headway (sec)	6
Availability (hours of operation)	
Type of service (shuttle, loop, network, etc.)	
Type of vehicle routing	
Minimum traveling unit	
Fleet Size	
Vehicle Performance	
Cruise velocity (m/s)	11 to 17 allowing for stops
Max. velocity (m/s)	22
Max. grade (%)	20
Service acceleration (m/s ²)	ASCE APM Standards
Service deceleration (m/s ²)	ASCE APM Standards
Max. jerk (m/s ³)	
Emergency deceleration (m/s ²)	Compliance with ASCE Code of Practice
Stopping precision in station (mm)	
Degradation due to water, ice, or snow on guideway	
Energy consumption for propulsion (kWhr/vehicle-km)	0.11
Minimum turn radius (m)	8
Noise (inside vehicle, dBA; outside vehicle, dBA)	Quiet interior sound levels
Vehicle Design	
Overall length (m)	6.4
Overall width (m)	1.5
Overall height (m)	2.5

Empty weight (N)	1999kg
Vehicle design capacity (seated psgrs)	8
Vehicle design capacity (maximum, seated plus standing psgrs)	16
Maximum weight that can be carried (N)	4000kg
Passenger space (m ³)	
Doorway width (m)	3
Doorway height (m)	
Suspension	
Type (configuration)	Vertical systems together with two semi active lateral systems
Design load (N)	
Lateral guidance method	Using the lateral systems, vehicles have tilt and sideways movement to facilitate speed around curves, cushion lateral wind effects and to ease transition into and out of switches so speeds through the switches are higher
Propulsion and Braking	
Motor type and number	Industrial rotary motor
Motor placement	Above vehicle. 2 bogies per vehicle. At least one motor per bogie
Motor rating (kW)	30kW
Drive type	
Power type	
Power collection method	Inductive pickup from guideway. Recharges battery onboard at all times except the maximum power required
Service brake type	The 4 support wheels and 4 pressure wheels can all be used for braking.
Emergency brake type	Redundancy in above braking method. See "service brake type"
Emergency brake reaction time (sec)	
Redundancy measures	
Switching	
Type and emplacement	In track, two motors. One fast acting lever action and one secondary holding motor
Switch time (lock-to-lock) (sec)	
Speed through switch (m/s)	
Headway through switch (sec)	
Guideway	
Type/configuration (e.g., supported, suspended; box-beam, etc.)	Suspended to side. Single beam has two tracks, allows bi-directional travel

Materials	Concrete or steel depending on requirements. Normally concrete beam with steel tracks (rails)
Type and construction of support columns	
Dimensions (m)	
Overall cross section width	0.6
Overall cross section height	0.8
Maximum span length	30, standard span. No maximum.
Running surface width	
Location relative to grade (e.g., above, at, below, and dimensions)	Above
Vehicle guidance/constraint relative to guideway	Locked to guideway
Construction process (fab on site, pre-fabricated sections, etc.)	Normally guideway is made of precast post tensioned light-weight concrete. Steel rails
Other Energy Usage	
Daily system energy (kWhr)	
Energy for HVAC (kWhr)	
Other Energy (Control center, Stations, etc.) (kWhr)	
Conservation Measures	Regenerative braking
Stations	
Type (offline, online, etc.)	Offline, with offline "bays", each bay has two online "ports". Such a configuration accommodates 4 vehicles
Number of stations in installation	Every 750m proposed
Ticket or fare collection method	Card or pre-bought to expedite boarding. No advance booking. Booking fee for unused ride
Security methods	Passenger contact with security.
Boarding capacity (psgrs/hr/platform)	
Deboarding capacity (psgrs/hr/platform)	
Max. wait time (min)	4, 20s normal
Station Layout	Ideally above other modality. Lift and stairs, escalators at larger stations. Accommodates bikes and wheelchairs
Station Footprint (length, area)	
Controls	
Control Type	
Vital Systems/Circuitry	
Reliability and Safety	

Fail-safe operational features (describe)	1. Redundancy: two bogies, two control systems, 3 forms of communication. 2. Manual control 3. Manual emergency stop 4. Bumper compression bars and crush space at both ends of cab
Total system mean-time-before-failure (MTBF) (hrs)	Goal of 99.9% availability
Station MTBF (hrs)	
Station restore time after failure (hrs)	
Vehicle MTBF (hrs)	
Strategy for removal of failed vehicle	Reverse drive capability
System restore time after failure (hrs)	15-30 minutes to replace switch with a maintenance vehicle. Seconds to replace the switch motor
System lifetime (yrs)	
Vehicle lifetime (yrs)	
Maintenance	
Service Frequency (hrs)	
Construction/Procurement Costs (US dollars, if possible, or national currency)	
Total Overhead	\$20 million per mile. For equal throughput the cost is half that of tram or rail and a quarter that of subway or highway
Guideway Procurement	
Vehicle Procurement	
Stations	
Construction/Installation	Modular
EIR	
Other Procurement (explain)	
Other Construction (explain)	
Operational Costs (US dollars, if possible, or national currency)	
Total Annual Costs	
Energy Costs	
Maintenance Costs	~20 for an ~250 vehicle system
Administrative Costs	~30 (other than maintenance and cleaning) for an ~250 vehicle system
Funding/Procurement method	
Public	

Private
Other (explain)
Revenue (US dollars, if possible, or national currency)
Ticket Revenue
Advertising Revenue
Land Valuation
Public Subsidy
Other (explain)

Note: SKYCABS ESGART-5.pdf
SkyCab_pp40-41_WWF_GlobalFocus_Report_ENG.pdf

Table 18. SkyWeb Express

General	
Developer contact information	post@innotrans.net
Licensees	
Patents	
System Description	
Installation Location	
System Performance	
Max. theoretical single direction capacity (psgrs/hr)	21,600 with 3psgrs/vehicle. 7,200 Vehicles/hr
Minimum headway (sec)	0.5
Availability (hours of operation)	
Type of service (shuttle, loop, network, etc.)	
Type of vehicle routing	
Minimum traveling unit	
Fleet Size	
Vehicle Performance	
Cruise velocity (m/s)	13.4 (listed, but not as cruise velocity)
Max. velocity (m/s)	
Max. grade (%)	15% (listed, but not as maximum)
Service acceleration (m/s ²)	0.25 max lateral
Service deceleration (m/s ²)	
Max. jerk (m/s ³)	
Emergency deceleration (m/s ²)	
Stopping precision in station (mm)	
Degradation due to water, ice, or snow on guideway	
Energy consumption for propulsion (kWhr/vehicle-km)	
Minimum turn radius (m)	11.0 at 6.25, banked guideway in curves
Noise (inside vehicle, dBA; outside vehicle, dBA)	
Vehicle Design	
Overall length (m)	2.87 Chassis, 2.504 Cabin
Overall width (m)	1.53
Overall height (m)	1.682

Empty weight (N)	453.6kg
Vehicle design capacity (seated psgrs)	2-3 (bench seat)
Vehicle design capacity (maximum, seated plus standing psgrs)	2-3, no standing
Maximum weight that can be carried (N)	294.9 kg (payload)
Passenger space (m ³)	
Doorway width (m)	
Doorway height (m)	
Suspension	
Type (configuration)	
Design load (N)	
Lateral guidance method	
Propulsion and Braking	
Motor type and number	LIM
Motor placement	Chassis under guideway, opposite cabin
Motor rating (kW)	
Drive type	
Power type	
Power collection method	
Service brake type	
Emergency brake type	
Emergency brake reaction time (sec)	
Redundancy measures	
Switching	
Type and emplacement	
Switch time (lock-to-lock) (sec)	
Speed through switch (m/s)	
Headway through switch (sec)	
Guideway	
Type/configuration (e.g., supported, suspended; box-beam, etc.)	Supported
Materials	Truss structure supported guideway. 200.9kg/m
Type and construction of support columns	At 4.88m high, post top and base diameters of 25.4cm and 55.9cm respectively

Dimensions (m)	
Overall cross section width	0.914
Overall cross section height	0.965
Maximum span length	27.4, for basic unmodified guideway
Running surface width	
Location relative to grade (e.g., above, at, below, and dimensions)	Above, usually 4.88m
Vehicle guidance/constraint relative to guideway	Locked, a 10.2cm wide slot runs longitudinally along the top of the guideway between the covers, through which pass the two pylons connecting the vehicle chassis and cabin
Construction process (fab on site, pre-fabricated sections, etc.)	
Other Energy Usage	
Daily system energy (kW/hr)	
Energy for HVAC (kW/hr)	
Other Energy (Control center, Stations, etc.) (kW/hr)	
Conservation Measures	
Stations	
Type (offline, online, etc.)	Offline
Number of stations in installation	
Ticket or fare collection method	For ticketing, single or multi-use fare cards
Security methods	
Boarding capacity (psgrs/hr/platform)	
Deboarding capacity (psgrs/hr/platform)	
Max. wait time (min)	
Station Layout	
Station Footprint (length, area)	Above grade, stairs and elevator for access. Or in-building station Length = $(2Nb + 2)Lb) + (2Lt)$, where: 1. Lo is the Length of the offline station guideway 2. Nb is the Number of berths 3. Lb is the Length of a berth (3.0m min.) 4. Lt is the Length of the transition as computed in "LT" program (ex: Lt = 25.8m at 32.3km/h)
Controls	
Control Type	

Vital Systems/Circuitry
Reliability and Safety
Fail-safe operational features (describe)
Total system mean-time-before-failure (MTBF) (hrs)
Station MTBF (hrs)
Station restore time after failure (hrs)
Vehicle MTBF (hrs)
Strategy for removal of failed vehicle
System restore time after failure (hrs)
System lifetime (yrs)
Vehicle lifetime (yrs)
Maintenance
Service Frequency (hrs)
Construction/Procurement Costs (US dollars, if possible, or national currency)
Total Overhead
Guideway Procurement
Vehicle Procurement
Stations
Construction/Installation
EIR
Other Procurement (explain)
Other Construction (explain)
Operational Costs (US dollars, if possible, or national currency)
Total Annual Costs
Energy Costs
Maintenance Costs
Administrative Costs
Funding/Procurement method
Public
Private
Other (explain)

Revenue (US dollars, if possible, or national currency)

Ticket Revenue
Advertising Revenue
Land Valuation
Public Subsidy
Other (explain)

Note: Basic Specifications of SkyWeb Express Innotrans.pdf

Table 19. TriTrack

General	
Developer contact information	Jerry Roane, jerry.roane@gmail.com, Roane Inventions Incorporated and MagLevTrans LLC
Licensees	100% IP ownership
Patents	3 US patents for TriTrack 19 patents by Jerry Roane China UK Germany Italy
System Description	Dual mode drives on the street as NEV or 3-wheel motorcycle then converts drops battery mule and transforms to guideway car linear motor launch but internal motor for cruise speed
Installation Location	Comfort, Texas
System Performance	
Max. theoretical single direction capacity (psgrs/hr)	Network answer to a line haul question -- more than the population is the network effect answer but to specifically look at a line haul guideway we computer launch a 4-passenger car onto one guideway every 1.9 seconds
Minimum headway (sec)	1.9 per guideway or 0.38 seconds per guideway grouping per direction
Availability (hours of operation)	24/7/365
Type of service (shuttle, loop, network, etc.)	Network
Type of vehicle routing	Central city routing then simple navigation system on the dashboard choice by choice directions as suggestion only. You can still drive anywhere you wish and the city will reroute itself several times a minute to accommodate the customer individual. We are very big on customer continual choices
Minimum traveling unit	1 car per launch. 1 car per guideway time slice. No intersecting guideways. No merges or possibility of a merge
Fleet Size	1300 is our proposed starter fleet for the I70 corridor between Denver and Vail with continued service to Aspen CO. 1300 cars come with 2000 patented battery mules
Vehicle Performance	
Cruise velocity (m/s)	From 18m/s to 80m/s in 9.3 seconds, same for deceleration. 0-18m/s in 31.1 seconds
Max. velocity (m/s)	80.4672
Max. grade (%)	80.4672
Service acceleration (m/s^2)	100
Service deceleration (m/s^2)	6.7
Max. jerk (m/s^3)	6.7
Emergency deceleration (m/s^2)	Computer smoothed
Stopping precision in station (mm)	392 for first car in string less as you go back in the stack see animation
Degradation due to water, ice, or snow on guideway	Not applicable, Google self-driving parking head-in
	Rolling coefficient is same as railroad performance

Energy consumption for propulsion (kWhr/vehicle-km)	<ol style="list-style-type: none"> 1. As a NEV, very low power 2. As a motorcycle you can buy, 7.8kW and up 3. As a launch linear motor car, 172kW 4. As a cruise vehicle at 80m/s have, 60.9kW. 5. As a decelerating linear motor regenerative system, 240kW negative 6. As a self-parking car on special parking guideway, 2kW. 7. This is the heart of the patents for energy. We only take the appropriate motor for the immediate task. We drop the dead weight baggage along the way. The general public answer is 5 cents energy per mile at 80m/s
Minimum turn radius (m)	Not Applicable as we turn on the street just like a regular car at 18m/s and less speed. At 80m/s we can track an Interstate highway like I-70 over the continental divide
Noise (inside vehicle, dBA; outside vehicle, dBA)	Tow gliders are the best example we have for the sound. The aero noise will be about the same volume as the motor hum and drive belt whir
Vehicle Design	
Overall length (m)	6.15
Overall width (m)	1.25, patented circular cross section
Overall height (m)	1.4, circle above clearance height
Empty weight (N)	Short answer: 1330 for guideway, 4893 street maxed-out battery pack. Multiple weights depending on which part of the journey you are on at the moment. Empty weight on guideway roughly 140kg to 180kg depending on fiber market prices (graphite versus advanced glass or manmade fibers). Prices vary so the composite weight will vary with daily prices of reinforcement fibers
Vehicle design capacity (seated psgrs)	4
Vehicle design capacity (maximum, seated plus standing psgrs)	standing is unsafe
Maximum weight that can be carried (N)	>328kg, four 82kg passengers plus luggage
Passenger space (m ³)	
Doorway width (m)	Hatch, no doors, opens 180 degrees
Doorway height (m)	Hatch, no doors, opens 180 degrees
Suspension	
Type (configuration)	Patented pre-knowledge suspension information based from previous car on guideway segment. This patent could be applied to data linked cars on the street also to drastically improve ride quality. Powered wheel movement with very fast reaction time

Design load (N)	Street design torsion bar rotational shock front standard motorcycle swing arm rear. Guideway electronic powered suspension to step over imperfections. Mostly we provide a far superior rolling surface using computer optimized guideway path trajectory. The spans flex while the cars roll over a very very precise trajectory including pitch yaw and roll considerations. This part of the patents breaks us out from all previous transportation forms as we control the road rather than use a reaction suspension to compensate for inferior rolling surfaces. Guideway is precision ground to loaded flat condition after all construction and geological shifts are added up. Guideway constantly adjusts for soil movement thermal expansion and pier shifting in real time
Lateral guidance method	Three sides of a triangle with preload on the wheels opposed 60 degrees from each other. Much like machine tool ways. 6 steel wheels and one rubber traction wheel&motor
Propulsion and Braking	
Motor type and number	Street motor 7.83kW brushless China origin low cost. Guideway motor China origin used in their train system but rewound for higher speed and less horsepower at 172kW, 1.52m sections. 460m long assembly. 60.0kW Remy motor for guideway travel at high speed. Regenerative linear generator 172kW
Motor placement	Battery mule for street rear luggage area for cruise motor parking trolley for auto-park guideway first 1500 feet within the equilateral triangle
Motor rating (kW)	7.83kW and 61kW and 171.5kW and -171.5kW and 2.23 kW parking
Drive type	Kevlar belt for street Buell Blast pulley arrangement. Wheel&motor guideway. Linear motor for 460m launch moving magnetic field
Power type	Battery for street and guideway power grid direct for launch
Power collection method	PV Solar high above the street just below the cars
Service brake type	No mechanical braking on the guideway only regenerative. On the street regeneration but with front disc hydraulic backup
Emergency brake type	Brake pad direct to guideway three sides of the triangle. This emergency brake skips traction of the tires to a road and is applied across the beam so incredible forces can be applied. Because it is heating the outer skin of the aluminum guideway heat cannot build up in the metal to fade braking. 40 Gs braking is very easy to accomplish using this direct pad to guideway brake. We never use this brake except in an emergency keeping it like new when it is finally needed. Mostly elevated guideway will not have as many vehicle to vehicle interactions to create emergency stops. We have a very long explanation that shows the reduced crash rate based on TriTrack street and guideway probabilities. It drops the US death toll to below 1,000 per year from tens of thousands
Emergency brake reaction time (sec)	5 milliseconds estimated
Redundancy measures	Every sensor is a voting set of sensors so single point failures do not take down the guideway. Having spent the last week in Disneyland with 1980s style controllers with single sensors at each control point the failure rate is too high. Several times the tram control systems failed and paused or stopped completely. All control computers are redundant and the control strategy is to allow for individual computer failures without ever making the customer wait. Computer hardware is so incredibly low cost it only makes sense to use hardware like water

Switching	Google style auto driving on the street and no switching on the guideway. By choosing the guideway the length you want to go in the direction you want to go that replaces the switch function. Patent one describes this network of guideways in a city that has no switching as part of the automated guideway system. Each grid line in the city is four or five parallel guideways (all one way for safety) each of these individual guideways is twice as long as the one next to it. Example 2 miles -- 4 miles -- 16 miles -- 32 miles -- 64 miles etc. (not converted for clarity). Every grid crossing has an entry point to the grid network. The city wide grid route solver routes the entire city and provides color coded driving instructions to the users. Follow the color dots on your dash and you arrive with no traffic congestion. Spread traffic density over available grid assets evenly
Type and emplacement	
Switch time (lock-to-lock) (sec)	Not applicable, or zero depending on how you want to consider it
Speed through switch (m/s)	18m/s through merge zone and full battery swap
Headway through switch (sec)	1.9
Guideway	
Type/configuration (e.g., supported, suspended; box-beam, etc.)	TriTrack is through the car body not suspended nor supported. Wheels go on all three sides on both ends of the car. For 15.6m spans we use TX-90 standardized highway beams then build our guideway on top of that. For most spans we use just TriTrack triangular beams. Internal to the soft aluminum shell we cure a concrete and steel pre-stressed modified I-beam. The aluminum is rolled to a patented computer derived shape and the concrete is pumped in section at a time with steel being pulled tight while the concrete sets in place. We use exotic steel and even more exotic concrete to keep the visual intrusion to a minimum. A 0.368m on a side equilateral triangle in the skyline
Materials	1400Mpa steel. Ductile from La Farge concrete 262Mpa. 6061 aluminum as rolled hardness
Type and construction of support columns	Oil field pipe, used or new. 0.30m, 9.53mm wall
Dimensions (m)	
Overall cross section width	
Overall cross section height	
Maximum span length	18 simple TriTrack span, 51.0m standard highway beam longer as a cable suspension bridge configuration
Running surface width	Two top sides of a triangle tires 15cm wide each. 7.9cm wide on the bottom two rollers. Rolling surface is always the same track on the triangle aluminum surface
Location relative to grade (e.g., above, at, below, and dimensions)	5.2m clearance over trucks on roads and 7.0m in the cross direction.
Vehicle guidance/constraint relative to guideway	Car swallows the guideway so even if the wheels fall off the car body cannot come off the guideway metal till it gets to the end of that piece of metal guideway (2 miles 4 miles 8 miles 16 miles 32 miles etc., unconverted for clarity)
Construction process (fab on site, pre-fabricated sections, etc.)	Patent number three is the TriTracker machine that automatically extrudes and rolls into shape guideway at walking speed in place. This can be extruded a block over and crane erected in locations where the TriTracker machine cannot not fit like a river or creek bed

Other Energy Usage	
Daily system energy (kWhr)	5 cents a mile for users at 80m/s
Energy for HVAC (kWhr)	SEER of 21 and 1.5kw for the compressor
Other Energy (Control center, Stations, etc.) (kWhr)	Minimal lighting on demand
Conservation Measures	Eagle boy scout is all about conservation of nature and energy
Stations	
Type (offline, online, etc.)	Offline merge zones that look very much like a Wal-Mart parking lot with angle head-in parking
Number of stations in installation	Battery swap is at the beginning and end of every guideway segment. Additional battery swap stations will be available for other lower tech battery electric cars to swap power modules
Ticket or fare collection method	Toll of 5 cents a mile to pay off the guideway mortgage. Electricity sold at market retail price bought at wholesale
Security methods	Massive number of cameras all high speed independent network connected. Every pole of the TriTrack is a repeater node of this very high speed network that provides control function and sensor network but also gives customers full Internet access and entertainment or infotainment data in the cars. Graffiti will not be tolerated and vandals will be tracked down and punished effectively
Boarding capacity (psgrs/hr/platform)	Because the merge zone also allows you to instant rent the spare cars you load by getting in the nearest car. The cars are all parked in the head-in parking spots just like a car rental lot at an airport. Just hop in swipe your credit card and you are on your way. This massively parallel loading can take the full population of a city in less than an hour. Because we advocate for personal car purchases mostly you will have your car not some randomly assigned taxi arrangement. Health reasons and cleanliness being part of the customer experience. We can force people into uncomfortable positions with used gum or diapers on the floor types of public access problems but we prefer to give the customer the very best experience that keeps the car interior with the family always. I can stand my own filth much better than I can stand another family's filth. Each parked car loads 4 passengers. Cars are parked all over town in the I-70 proposal. At 1,300 cars we can load 5,200 passengers at a time. This is a starter set
Deboarding capacity (psgrs/hr/platform)	
Max. wait time (min)	Same as boarding
Station Layout	Zero waiting is not what customers ask for No station structure at all the merge zone has a fence where the guideway comes down close to the ground so you don't walk into a moving car from above. This is not really a station but the closest thing we have to a station. The fence will be agriculturally matched to the built environment
Station Footprint (length, area)	2.1m wide, 6.1m long for car dropping to the ground
Controls	
Control Type	Custom computer controllers all networked on a private transportation network
Vital Systems/Circuitry	Redundant network using wire wireless and optic fiber along all guideway paths
Reliability and Safety	

Fail-safe operational features (describe)	Voting sensors and voting control computer network powered by grid and battery power through lightening
Total system mean-time-before-failure (MTBF) (hrs)	The \$64,000 question
Station MTBF (hrs)	
Station restore time after failure (hrs)	
Vehicle MTBF (hrs)	1111
Strategy for removal of failed vehicle	Special boom truck and guideway chase vehicle
System restore time after failure (hrs)	Minutes
System lifetime (yrs)	99 year lease with aircraft style continual maintenance (each and every part has a replacement schedule)
Vehicle lifetime (yrs)	320,000km
Maintenance	
Service Frequency (hrs)	24 hour manual inspection constant diagnostics in the control loop. Yearly rehab of interior to keep the colors fashion current K=Mart blue-green might have killed the company. It didn't help
Construction/Procurement Costs (US dollars, if possible, or national currency)	
Total Overhead	
Guideway Procurement	\$120,000 per km
Vehicle Procurement	\$10,000 customer retail
Stations	NA, we always assume city provided right of way free as part of the lease PPP
Construction/Installation	\$120,000 per km, includes guideway
EIR	We feel like we can eventually be granted a categorical exclusion to the EIR. Our completed project does less damage than a study and we clean up the air so much more than any other project that has an EIR done. The I70 project already has a study going. We can also build totally above ground if necessary
Other Procurement (explain)	Battery mules \$4000 each but rented out kilowatt-hour at a time by customers. Price differential between wholesale and retail electricity for the region will pay off the battery mule hardware cost
Other Construction (explain)	Battery mule redistribution network either underground tubes or trailers behind pickup trucks
Operational Costs (US dollars, if possible, or national currency)	
Total Annual Costs	
Energy Costs	5 cents a mile energy
Maintenance Costs	Near zero no brakes to wear out no tire treads to wear off no engines to tune or filter. No exhaust pipes to rust. Really a simple device with modules that cross ship overnight in the mail if there is a failure. Customer serviceable at the module level. Trade modules under warranty for free
Administrative Costs	No admin cost as we derive profits from selling energy

Funding/Procurement method

Public	We are offering the I-70 corridor estimated HSR 31 billion dollar project to CDOT for \$0 as a privately funded PPP
Private	\$120,000 per mile and \$10,000 per car that may be subsidized by the sale of energy patterned after the cell phone market. A monthly service you can sign up for that lowers the initial cost to the consumer. As a service we can price the use rather than price the hardware capturing the natural advantages of the all-electric car with PV solar panels powering the entire system from free sunshine. This is a classic investment opportunity where cash up front can create future value to the general public and the way they typically mismanage their money. User fees that cover all costs plus insane profits is the plan. The insane profits are a planet where my family can breathe and don't die of cancer from hydrocarbons of various ilks floating through our lungs. That is insane profits for my company. Also delaying the energy collapse of the civilized world by obsoleting oil and natural gas before greed (the love of money) kills us all
Other (explain)	Our goal is to give away miles of guideway to the developing world at a proportionate rate to the number of miles of guideway sold. The value of the guideway for water delivery and goods to market for the third world can make a huge difference in the lives of the indigenous peoples. They might not have to slash and burn the rain forest if they have some way to make a living that advanced transportation may be able to provide. Perhaps a naive hope but certainly better than an assured loss of all forests in the world in my (evil) generation
Revenue (US dollars, if possible, or national currency)	Proprietary but sufficient from user fees alone
Ticket Revenue	Credit card swipe at 10 cents a mile in easy terrain or 23 cents a mile over the top of the continental divide. Tickets are an old construct
Advertising Revenue	Although advertising may seem like free money to transit there is always a price to pay. The cool factor is gone as soon as you wrap a transportation vehicle in a tacky ad
Land Valuation	zero We assume as a PPP that right of way is provided by the local governments
Public Subsidy	zero or possibly negative if competition is encouraged
Other (explain)	

- RFI/
- TriTrack.pdf

APPENDIX 3 – U.S.-SWEDEN MEMORANDUM OF COOPERATION ON SUSTAINABLE TRANSPORTATION

The United States' ground transportation infrastructure faces a funding crisis amidst a larger deficit problem of the entire federal government. Maintaining existing highway and transit infrastructure alone is a significant challenge. Difficult decisions to secure funds lie ahead, and they are necessarily addressed within the larger issues of economic competitiveness and long-term environmental and energy sustainability. In this debate, it is appropriate to ask how much of available resources should shore up an unsustainable highway infrastructure, versus how much should be used to create a new more sustainable mode. These are large issues that raise many questions. It is like an individual calculating whether to spend \$1000 for a new energy-efficient refrigerator, thereby saving \$125 in annual costs. Putting off such decisions saves money, but it costs more in the long term.

As U.S. leaders and legislators grapple with these issues, particularly with developing ATN scenarios that seem to embody significant long-term benefits, they are fortunate to have available to them detailed and sophisticated planning and analysis from the Kingdom of Sweden. This small nation has accumulated expertise in this field that exists nowhere else in the world. They have offered to share this advanced expertise with the U.S. A 2010 Memorandum of Cooperation (MoC) between the U.S. and Sweden was a formality that opened the door for numerous international exchange missions. These have brought Sweden's knowledge and experience to the attention of key individuals in government, academia, and the private sector in the U.S.. The full MoC is available in Appendix 3.

WHAT IS THE MEMORANDUM OF COOPERATION?

A bilateral agreement, Memorandum of Cooperation, or MoC, for the development of sustainable transport systems was established between the USDOT and the Swedish Ministry of Enterprise on September 30, 2010 in Washington, DC, by Swedish State Secretary Leif Zetterberg and U.S. Deputy Secretary of Transportation John D. Porcari (Zetterberg and Porcari 2010).

The MoC provides a framework for cooperation between the two countries for information exchange and research at its inception, and it paves the way for bilateral trade and co-development. The MoC deals with advances in transportation and, as such, includes support for development of ATN/podcar systems.

HOW DID IT COME TO BE?

Research has been under way in Sweden for many years to develop the "spårtaxi" (literally, "train-track taxi," often translated to PRT) to serve as a public transportation alternative. An early study was done for Gothenburg in the 1970s with private sector interest from Volvo. Small research projects in the 1980s produced interesting plans, analyses, and sketches. In the 1990s it became more serious with an extensive study of an area-wide ATN for the city of Gävle. Figure 81 is a sketch illustrating what the system might look like.

“The City Architect’s Office presented an interim report of the PRT Study project in Gävle, where a guideway for PRT was studied, a driverless system where the route runs above ground with electric powered, driverless vehicles and separated from all other traffic. Benefits presented are high ride quality, small crash risk, moderate travel cost, increased street space for pedestrians, and a positive experience with outlooks over street life and urban buildings. A drawback is the guideway’s intrusion into the skyline. Gävle would be a pilot project in 2010. Expense amounted to two billion [krona] (about \$300M), of which the state would make a contribution of one half.”¹⁰⁵



Figure 81. Gävle Study Spårtaxi Illustration

Source: Trans.21 archives.

A multifaceted transportation agenda evolved from initial technology exchanges involving primarily biofuel companies, trade associations, and transportation/energy agencies, leading to a Memorandum of Understanding (MoU) between California and Sweden in June 2006. In subsequent exchanges, the delegations were joined by ATN/podcar specialists and government representatives interested in advancing cooperative ATN/podcar initiatives, notably the Institute for Sustainable Transportation (IST) of Sweden¹⁰⁶, a delegation from the Swedish Energy and Environmental Ministries, the California Energy Commission, and the Consulate General of Sweden in Los Angeles. Building upon those exchanges, the USDOT became involved, leading to an initiative at the national level.

WHAT ARE THE MOC’S MAIN OBJECTIVES?

As summarized by the parties in a mutual press release on September 30, 2010:

“The aim of this cooperation is for the United States and Sweden to engage in a mutual exchange of experience and transfer knowledge within areas such as road safety, urban transport, fossil-free vehicles, and access within the transport system.”

“The United States and Sweden have a long tradition of bilateral cooperation and in recent years issues concerning sustainable development have taken on an increasingly prominent role in these relations. The transport industry has been one of the contributing factors to climate change, but we are now ensuring, step by step, that it also becomes a natural part of the solution,” says Minister for Communications Åsa Torstensson.” (Swedish Ministry of Enterprise, Energy and Communications 2010)

¹⁰⁵ English translation of <http://gd.se/extra/geflefratillo/1.23598-spartaxi>

¹⁰⁶ <http://www.istcab.com/>

From the MoC (Zetterberg and Porcari 2010):

“The Participants intend that the cooperation and collaboration may include but not be limited to the following fields:

- Surface transportation;
- Intermodal transportation;
- Safety transportation;
- Environmentally friendly vehicles;
- Transportation for the mobility disabled; and
- Other fields of mutual interest.

“The Participants may pursue cooperation through one or more of the following methods:

- Exchange of scientific and technical information on subjects of mutual interest;
- Exchange of specialists, delegations, and scientific and technical personnel;
- Joint organization of symposia, seminars, and other meetings;
- Joint research in science and technology transportation; and
- Other forms of cooperation as mutually agreed.

After the signing, the parties agreed to organize the ongoing activity into four working groups:

- High Speed Rail
- Livability
- Traffic Safety
- PRT/GRT/ATN

ACTIVITIES BEING PURSUED UNDER THE MOC: A CHRONOLOGY

To provide an appropriate framework for understanding the role of the MoC in ATN development, the following is a detailed chronology of activities that have taken place leading up to and subsequent to the inauguration of the MoC.

2006*June 2006: Making Sweden an OIL-FREE Society*

In May 2002, the inaugural meeting of the Association for the Study of Peak Oil and Gas was held in Uppsala, Sweden. This international group of geologists, petroleum engineers, and scientists joined forces to raise concerns about global oil depletion (Uppsala Universitet 2002; Peakoil.net 2014).

Calling attention to this issue led the Swedish government to create the Commission on Oil Independence (Persson 2006):

“In December 2005, the Government appointed a commission to draw up a comprehensive programme to reduce Sweden’s dependence on oil. There were several reasons for this. The price of oil affects Sweden’s growth and employment. Oil still plays a major role for peace and security throughout the world. There is a great potential for Swedish raw materials as alternatives to oil. But, above all, the extensive burning of fossil fuels threatens the living conditions of future generations. Climate change is a fact which we politicians must face. Broad and long-term political efforts are needed.

“Interest in the Commission’s work is and has been enormous. Many people took part in the hearings which were the start of the Commission’s work... very many more took part by presenting proposals, criticising, and analysing problems and solutions.”

“Since the objective of ridding ourselves of our dependence on oil by the year 2020 is bold, and the issue embraces the whole of society, it was essential that the Commission should have a broad base. Experts from industry, agriculture and forestry, science – and special experts on energy efficiency and district heating – met for the discussions we had. In this way, the Commission was forced to examine conflicts of goals and different aspects of practically all the issues...”

June 2006: MoU between California and Sweden on Renewable Fuels and Energy

Coincident with the release of the report by the Commission on Oil Independence in June 2006, a delegation of energy and transportation specialists and officials from California went to Sweden, which led to the Memorandum of Understanding between the State of California and the Government of the Kingdom of Sweden on Renewable Fuels and Energy, signed by Lena Sommestad, Joseph Desmond, and James Boyd in Stockholm on June 15, 2006 (Sommestad, et.al. 2006). The agency’s press release summarized the objective:

“Through strong cooperation between its industry and government, Sweden is showing the world how bioenergy can be developed in a cost-effective manner that benefits its economy and environment. This MOU will provide a basis for intensified collaboration between our states to help California develop a thriving bioenergy industry.” (Green Car Congress. 2006)

Though it was focused primarily on biofuels, that MoU created the framework for further U.S.-Sweden exchange and introduced ATN/podcar developments as a centerpiece of the technology exchange.

2007

January 2007: California Visit by the Swedish Minister of the Environment

The MoU between California and Sweden resulted in an international exchange in which a team from Sweden traveled to Sacramento in January of 2007, with delegates from the Swedish biofuel industry, government officials, and a few podcar development professionals. In particular, representatives of Sweden's Institute for Sustainable Transportation (IST) took it upon themselves to apply the MoU's goal of exchange on renewable fuel, energy, and green transportation by encouraging California officials to consider podcar development.

Governor Arnold Schwarzenegger had recently broken his leg in a skiing accident and was not available to meet the head of the delegation, Minister of the Environment Andreas Carlgren. As a consequence, a meeting was arranged by Ron Swenson, CEO of Swenson Solar, with Lieutenant Governor John Garamendi, who had already been briefed and was enthusiastic about podcars powered by solar energy. Lt. Gov. Garamendi had taken office only a few days earlier, so Minister Carlgren was his first official visitor during his term as Lieutenant Governor (Figure 82).



Figure 82. Lt. Gov Garamendi and Minister of the Environment Carlgren

Source: Ron Swenson.

In December 2007, a seminar was hosted by the Swedish Institute for Transport and Communications Analysis (SIKA) for KTH (the Royal Institute of Technology) in Stockholm, Sweden¹⁰⁷. Ron Swenson, a renewable energy engineer, presented the case for podcars powered by solar photovoltaics directly on or over the guideway (Swenson 2007). Tadeusz Patzek, then Professor of Geosystems Engineering at UC Berkeley, challenged claims of the energy potential and scalability of biofuels, significantly curtailing the advocacy for

¹⁰⁷ *The Future of Automotive Energy: Fossil Fuels, Agro Fuels or Photovoltaic Cells* seminar on November 6, 2007. Stockholm, Sweden. <http://www.docstoc.com/docs/20994521/The-Future-of-Automotive-Energy-Fossil-Fuels-Agro-Fuels>

biofuel production in Sweden. Subsequently, the City of Uppsala decided to further study Swenson's proposal and determined that the City could build its first podcar network using solar power, potentially creating the longest solar installation in the world (Swenson 2012). (This potential was later explored in depth by a team of engineering students at Uppsala University in 2013 (Bjork 2013)).

2008

August 15, 2008: California Visit by the Swedish Parliament's Committee on Transport and Communications

Sweden's Parliamentary Committee on Transport and Communications deals with matters concerning roads and road transport, railways and rail transport, ports and shipping, airports and air transport, postal services, electronic communications, and IT policy. A delegation from this committee visited the California during the last two weeks of August 2008.

2009

December 7, 2009: Malmö and Stockholm Delegation for PRT/Podcar Evaluation

The Swedish Ministry of Enterprise and Swedish Rail invited Rod Diridon of the Mineta Transportation Institute in San José; Hans Larsen, transportation director, City of San José; Alain Kornhauser, professor at Princeton University in New Jersey; Debbie Cook, mayor of Huntington Beach, CA; and David Little, CEO of Lea+Elliott, Inc., based outside Washington, DC, to participate in the Podcar City Conference in Malmo, Sweden, during the Copenhagen Climate Change Conference (COP 15) conference in Copenhagen. They subsequently toured the Uppsala Vectus test track as well as conducted meetings with at the Ministry of Enterprise with participation from the Swedish Transportation Authority, Swedish Ministry of Environment, Institute for Sustainable Transportation, City of Uppsala, and the KOMPASS¹⁰⁸ City Network. These meetings built good will and led to further interest in bilateral cooperation.

2010

September 30, 2010: USA-Sweden MoC for Sustainable Transportation

Officially titled Memorandum of Cooperation between the Department of Transportation of the United States of America and Ministry of Enterprise, Energy and Communications of the Kingdom of Sweden on Cooperation in the Field of Sustainable Transportation, the bilateral MoC was established for the development of sustainable transport systems between the USDOT and the Swedish Ministry of Enterprise and was signed on September 30, 2010 by Swedish State Secretary Leif Zetterberg and U.S. Deputy Secretary of Transportation John D. Porcari (Figure 83). The MoC includes support for development of ATN systems (Zetterberg and Porcari 2010). Appendix 3 contains the full MoC.

¹⁰⁸ <http://www.xn--sprbilar-b0a.se/kompass>

The MoC encourages research and development and provides a framework for developing trade agreements whereby parties from either country can participate in governmental procurements for transportation systems, which might otherwise be limited to Buy America or Buy Sweden provisions.

As stated above, the MoC has served as the underlying framework for a number of trade delegations related to ATNs during its formative process in 2006 through 2009, upon signing in 2010, and subsequently from 2011 through the publishing of this report in 2014.



Figure 83. Signing of MoC by Swedish State Secretary Leif Zetterberg and U.S. Deputy Secretary of Transportation John D. Porcari

Source: http://a1.mndcdn.com/image/upload/t_next_gen_article_large_767/yj6tkwh4jj4w7v0roxckma.jpg

The MoC played a vital role by paving the way for Swedish and USA officials to participate in the fourth Podcar City Conference¹⁰⁹ in San José, presented by the International Institute of Sustainable Transportation (INIST)¹¹⁰. A delegation of 25 officials from Sweden – Swedish Transportation Authority, Consulate General of Sweden in Los Angeles, KOMPASS City Network¹¹¹, IST, and Rejlers Engineering – all met with their counterparts from cities in Silicon Valley, MTI, San José State University, Stanford University, ATRA, Google, City of San José, and many more.

2011

In 2011, discussions were held among Swedish officials and representatives of the USDOT to consider research on the potential for developing an ATN industry. The research that is the subject of this report evolved from those discussions.

¹⁰⁹ See Appendix 4 for a complete listing of the Podcar City Conferences and their programs

¹¹⁰ <https://www.inist.org/>

¹¹¹ <http://www.xn--sprbilar-b0a.se/kompass>

November 30, 2011: Washington DC Delegation from Sweden

In November 2011, a delegation from Sweden visited with USDOT and ATRA officials. The open attitude of DOT was reassuring and positive. There appeared to be interest for future cooperation above original expectations, which were reiterated in Washington at the subsequent January, 2012 Transportation Research Board (TRB) Annual Meeting. As a further consequence, it was determined to hold the 2013 Podcar City Conference in the Washington, DC, area to facilitate communication among officials from the two countries. The workshop addressed the following purposes and interim results:

1. A draft letter of intent between the Swedish DOT (Trafikverket¹¹²) and the Northern Dimension Environmental Partnership (NDEP) to continue this exchange of experiences and knowledge of ATN/PRT development mode problems and opportunities and
 - Encourage greater exchange and collaboration about ATN between Swedish and U.S. stakeholders such as cities/municipalities, universities/institutes, manufacturers, and suppliers;
 - Explore the possibilities of concrete development cooperation between Swedish and American participants;
 - Facilitate the commercialization and establishment of ATN/PRT solutions in the U.S. and Sweden, and eventually other countries.
2. A draft letter of intent (LOI) between Uppsala and San José, on the continuing exchange and cooperation in order to facilitate and accelerate the construction of PRT systems in the two cities¹¹³.
3. Establish the groundwork for cooperation between KOMPASS and a U.S. sister organization yet to be formed.
4. Draft letter of intent between Innovatum¹¹⁴ and Aerospace Corporation¹¹⁵ to discuss and analyze the conditions for the possible development cooperation linked to an envisioned development center in Trollhättan for ATN/podcars. Such an agreement should facilitate the financing and creation of a University Center of Technology (UCT). The Trollhättan Development Center would also tie with academics, especially nearby Chalmers University and/or the KTH Transport Platform.

¹¹² <http://www.trafikverket.se/>

¹¹³ At the time of this writing, the LOI has not yet been signed, nor must it be signed by officials in the two cities for work to continue.

¹¹⁴ http://www.innovatum.se/pages/new_in_english-4481.html

¹¹⁵ <https://www.aerospace.org/>

5. ATN developers Vectus¹¹⁶ and Beamways¹¹⁷ and subcontractors Noventus¹¹⁸ to form an association of small start-ups to expedite their common interest and give them collective strength, joining forces with KOMPASS to give substance to the role of participating municipalities.
6. A Letter of Intent between Innovatum and CTH and KTH could also contribute to the emergence of a UCT.

Participants at the meeting from the U.S. included Walter Kulyk – FTA; Hans Larsen – City of San José; Peter Muller – PRT Consulting; Eugene Nishinaga – CyberTran; Alain Kornhauser – ATRA; and Stan Young – ATRA.

2012

September 21, 2012: Stockholm, Swedish-US Exchange Seminar

A joint workshop was held for the High Speed Rail (HSR), Automated Transit Networks, and the Livability working groups established under the MoC. The aim of the seminar was to reconnect to the discussions in Washington in November 2011, exchange the latest news related to the MoC, and discuss future cooperation possibilities, as well as to share this information with additional participants. Items that are specifically related to PRT/GRT/ATN:

“A U.S. delegation visited Sweden in September, 2012 (following the 2012 Podcar Conference in Berlin). A seminar was organized in Stockholm where Rod Diridon, among others, made a presentation about California and High Speed Rail. The seminar connected Personal Rapid Transit and Automated Transportation Networks with High Speed Rail and Station Area planning, thereby combining the activities from three separate working groups in the MoC....” (Jansson 2013)

The group also toured Uppsala to meet local officials engaged in planning the first commercial ATN project in Sweden. A workshop following the tour built a strong sense of commitment amongst the players and firm resolve to further the research and development agenda for ATNs.

2013

In a memorandum prepared for a visit by U.S. Secretary of State John Kerry to Sweden in May 2013, the advancement of PRT/GRT/ATN was described as follows:

“... Uppsala and San José continue their exchange of information (following the signing of a Letter of Intent in December 2011). Uppsala has also applied for financing support from the European Investment Bank. Several other offsprings from the MoC are

¹¹⁶ <http://www.vectusprrt.com/EN/>

¹¹⁷ <http://beamways.se/>

¹¹⁸ http://www.noventus.se/personal_rapid_transit.html

making progress. A key event for 2013 will be “Innovations in Public Transportation” a conference in Washington D.C. on October 23-25. Co-organizers are Swedish and US organizations and research institutes, as well as FTA. Responsible for Sweden: Bo Olsson, Trafikverket. Responsible for the US: Matthew Lesh, FTA.” (Jansson 2013)

At this time, participation under the MoC for podcar development includes the following organizations (amongst others):

USA

- FTA/USDOT
- Mineta Transportation Institute (“MTI”)
- Advanced Transportation Association (“ATRA”)
- San José State University
- University of California, Irvine
- An informal group of cities in the Silicon Valley developing ATN/podcar projects
- International Institute of Sustainable Transportation (“INIST”)

Sweden

- Trafikverket (DOT)
- VINNOVA¹¹⁹
- City of Uppsala
- University of Uppsala
- Kompass (association of Swedish cities developing ATN/podcar projects)

October 24, 2013: Podcar City 7 Washington, DC

The Podcar City Seven conference took place in October 2013 in Washington, DC under the leadership of INIST. Again, a strong Swedish delegation interacted with USDOT/FTA officials.

Vince Valdes, FTA Associate Administrator for Research, Demonstration, and Innovation, said ATN needs a “trailblazer” who can convince the public that it is safe. U.S. Congressman Mike Honda, who represents Silicon Valley constituents, was excited: “It’s about time for

¹¹⁹ <http://www.vinnova.se/en/>

this to get traction.” He expressed hope that local officials would be paying attention to the possibilities.

“Something like podcars is within reach,” proclaimed retired U.S. Congressman James Oberstar (Chairman, House Committee on Transportation and Infrastructure, 2007-2011), noting the “great and growing interest worldwide.... We are now in the post-Interstate Era, wasting \$120 billion a year in time and imported liquid sunshine.”

After the conference, several members of the Swedish delegation toured the Morgantown PRT. They were very impressed with the performance of this automated system, which has been in place for nearly 40 years.

2014

As of this writing in early 2014, the prospects for cooperation are growing. A delegation from Sweden participated in the TRB in January, and they met with US representatives regarding expanding the scope of the US-Sweden MoC. There is interest, furthermore, in extending the MoC to include other countries from Europe and the Americas so the experience of active research and development groups can be more readily shared. Cooperation in the organization and promotion of the eighth PCC conference to be held at Stockholm Arlanda Airport is underway.

WHAT ARE POTENTIAL IMPACTS OF THE MOC ON THE PROSPECTS OF A US-BASED ATN INDUSTRY?

Though it was the leader in automated transit in the 1970s as a consequence of the Morgantown PRT demonstration project, the U.S. is now substantially behind other countries in ATN development. Sweden, the U.K., India, South Korea, the U.A.E., and Mexico all have systems in various stages of development, while except for the continuing success of the antiquated Morgantown PRT, not even a new test track exists in the U.S. The MoC offers, at the very least, a reference point for regulatory approval, building upon completion of the thorough testing of the Vectus system that was conducted in Uppsala, Sweden, and fully approved by the Swedish Rail Authority (now Trafikverket).

WHAT ARE THE POTENTIAL IMPACTS OF THE MOC ON ATN LINKAGES TO EXISTING TRANSIT SYSTEMS AND HIGH-SPEED RAIL?

In the bilateral exchanges, rail links, and especially the High Speed Rail Initiative (HSRI), “last mile” solutions have featured prominently in discussions. The rationale for ATN has been significantly enhanced by these considerations. For example, in his remarks at the Stockholm meetings in September, 2012, Rod Diridon showcased HSR development in California and stressed that its success depends on “last mile” solutions, which can best be met by ATN.

WHAT ARE THE FINANCING CHALLENGES AND OPPORTUNITIES?

Informal proposals have been offered to establish joint US-Sweden financing of podcar/ ATN demonstration projects. Working together, the parties can establish bilateral objectives to cooperate in R&D, and, where possible, share the results of accomplishments each for the benefit of the other. A challenge has been suggested whereby each government positions a substantial fund of \$50-\$100 million for demonstration, potentially aggregating sufficient demand that private sector stakeholders will invest risk capital to capture such market opportunities.

WHAT UNIQUE BENEFITS DOES SWEDEN BRING TO THE MOC?

In addition to its well-known reputation for excellence in engineering and design, Sweden's national awareness of, and willingness to plan for, the end of oil is a significant motivating force in the development of new transportation technology. In the U.S., it is politically difficult to talk openly about energy and environmental policies except in the most general terms. For example, eight consecutive presidents from Nixon to Obama have warned of the security threats and economic consequences of imported oil. Yet there is no explicit policy to wean the economy from oil, which logically would begin with transportation initiatives. To the contrary, the Obama Administration is embracing fracking to significantly increase U.S. gas and oil production.

Policy in Sweden, by contrast, is being constructed with awareness that the global supply of oil is finite and that there will be dire consequences for the global economy and the climate from continued burning of hydrocarbons. Swedish transportation experts are looking for alternatives to oil, as expressed in the 2006 report by the Swedish Commission on Oil Independence (Persson 2006):

“Declining access to conventional oil, in combination with our joint responsibility to stop global warming, will be a test of the world community's readiness to switch to energy systems that are more sustainable in the long term. Basically, it is a question of the will to show solidarity with present and future generations.

“Sweden accepts this challenge!”

This is an appropriate response to sustained high prices of oil, rapid depletion of existing oil provinces, and ever-more costly exploration for new reserves, and mounting evidence of global climate change impacts. If, as proposed, Sweden can demonstrate that solar energy is sufficient (with annual net zero energy consumption) to operate an advanced ATN at 60° North Latitude, then the potential in sunnier parts of the world is clear¹²⁰.

¹²⁰ Other countries are also recognizing the potential of solar energy for transportation purposes. See, for example (Knez, Celik, and Muneer 2013)

LESSONS LEARNED

Sweden

A major setback occurred in Sweden in 2012. Approval of the Uppsala project was in place from the City of Uppsala and Trafikverket (the Swedish National Transportation agency), with strong indications of support through the European Investment Bank's ELENA program. Nonetheless, the project did not receive approval from the regional governing agency which has primary budget responsibility for transportation services. The conclusion is that, in spite of the perceived advantages of ATN systems, there remain risks until there is direct experience of a successful implementation.

Meanwhile in other jurisdictions in Sweden, the potential remains strong, which demonstrates that a joint organization such as Kompass representing many jurisdictions is critical to success. A setback in one area can provide guidance for avoiding delays in another location.

USA

After a substantial investment in a study of ATN for the Mineta San José International Airport in San José, CA, the City of San José concluded that ATN had not yet been demonstrated to the level that would outweigh the risks of moving forward on implementation. They ascertained that there were still too many unanswered questions about ATN (e.g., the ability to handle load surges, etc.) for the kind of application that the City wanted, and that they could not responsibly proceed to procurement because of the consequent risk. This reinforces the value of research initiatives, such as those encouraged by the MoC, which continue to be critical to the success of ATN.

CONCLUSIONS

As expressed in the SIKA Report in 2008 (Olsson 2008):

“The Podcar technology appears to have reached the right level of maturity to enter a market that is seeking sustainable, safe, and accessible alternatives to existing transport systems. Analysis of traffic flows as well as analysis of financial flows show good functionality and profitability which can match established forms of transport and podcars can contribute considerably to the political goals set for the transport sector....”

“In the near future we can count on there being a handful of ATN suppliers that may be interested in taking part in an innovational bidding procedure...”

“In conclusion we have a quartet of possible buyers and the same number of possible suppliers. If a project is to materialize there is a requirement for effective financial and procurement solutions suitable for the current stage of development of ATN...”

“It is the opinion of the Inquiry that initially a financial solution with public funding (Swedish state, EU, publicly owned companies) and private entities (suppliers, real

estate owners, venture capital companies) is required, probably with state loan guarantees as a base. Further competitive dialogue should be tested for the initial phases of a bidding process. This requires that the procedure be implemented in Swedish law as is the case in many member states.”

“The Swedish Rail Administration should be given full authority as project leader. The State reference group for ATN issues should be supportive to the Rail Administration. In order not to lose pace, the project leading group should, as soon as possible, develop the analysis and proposals for procurement forms and funding alternatives, and in parallel, have a dialogue with the main potential buyers and suppliers in order to get a clear picture of the room to maneuver for the different stakeholders.”

“Early in the process, a program for the evaluation of pioneer projects in a relevant scientific setting should be established. Both technical, social, environmental, and industrial policy issues in a Podcar project need to be covered in an evaluation. This evaluation may then form the basis for further actions.”

The U.S. would do well to take a lesson from Sweden and follow the path laid out in the 2008 SIKA report.



MEMORANDUM OF COOPERATION
BETWEEN
THE DEPARTMENT OF TRANSPORTATION
OF THE UNITED STATES OF AMERICA
AND
THE MINISTRY OF ENTERPRISE, ENERGY AND COMMUNICATIONS
OF THE KINGDOM OF SWEDEN
ON COOPERATION
IN THE FIELD OF SUSTAINABLE TRANSPORTATION

The Department of Transportation of the United States of America and the Ministry of Enterprise, Energy and Communication of the Kingdom of Sweden (hereinafter referred to as "the Participants");

Recognizing that rapid developments in transportation and transport policy make a positive contribution towards safe and efficient flow of transport passengers, goods and services, and promote bilateral and international trade, livability, and best practices; and emphasizing the need to achieve a sustainable and viable transport system; and

Taking note of the Agreement on Science and Technology Cooperation between the Government of the United States of America and the Government of the Kingdom of Sweden signed on June 29, 2006, (hereinafter referred to as "the Agreement");

Desire to set forth this Memorandum of Cooperation (hereinafter referred to as "the Memorandum") to promote collaboration in the field of transportation as follows:

Section 1

The Participants intend to undertake cooperation and collaboration in transportation on the basis of equality, reciprocity and mutual benefit.

Section 2

The Participants intend that the cooperation and collaboration may include but not be limited to the following fields:

1. Surface transportation;
2. Intermodal transportation;
3. Safe transportation;
4. Environmentally friendly vehicles;
5. Transportation for the mobility disabled; and
6. Other fields of mutual interest.

Section 3

The Participants may pursue cooperation through one or more of the following methods:

1. Exchange of scientific and technical information on subjects of mutual interest;
2. Exchange of specialists, delegations, and scientific and technical personnel;
3. Joint organization of symposia, seminars, and other meetings;
4. Joint research in the science and technology of transportation; and
5. Other forms of cooperation as mutually agreed.

Section 4

With regard to the cooperative activities under the Memorandum, the Participants may allow, as appropriate, the participation of other relevant governmental agencies, researchers and organizations from all sectors of the research establishment, including universities, national laboratories, and the private sector.

Section 5

In order to coordinate the cooperative activities, each Participant may designate a representative to be responsible for determining the particular directions of cooperation and for ensuring the effectiveness of exchange. The representatives of the Participants or their designated coordinators should, by correspondence, consult with each other and define the cooperative activities and other related matters.

Section 6

The cooperation is subject to the availability of funds and personnel.

Section 7

Specific cooperative projects and activities may be embodied in separate memoranda or plans between the Participants, which may cover the subject, procedures, and terms of cooperation to be undertaken, the entities involved, funding, and other appropriate matters related to the conditions of such cooperation.

Section 8

The Participants may consult, as appropriate, in respect of any matter that may arise from, or in connection with, the Memorandum.

Section 9

Scientific and technical information of a non-proprietary nature derived from the cooperative activities conducted under the Memorandum may be made available to the public through customary channels and in accordance with the normal procedures and laws of the Participants and other governmental entities involved in the cooperative activities as under Annex 1 of the Agreement.

Section 10

Information transmitted by one Participant to the other under the Memorandum in accordance with national law should be accurate to the best knowledge and belief of the transmitting Participant, but the transmitting Participant does not intend to warrant the suitability of such information for any particular use or application by the receiving Participant.

Section 11

The activities under this Memorandum should commence on the date of signature below. Either Participant may end its cooperation under the Memorandum at any time, but should attempt to provide sixty (60) days prior written notification to the other Participant.

Signed at Washington September 30, 2010, in duplicate in the English and Swedish languages.

FOR THE DEPARTMENT OF
TRANSPORTATION OF
THE UNITED STATES OF AMERICA

DEPUTY SECRETARY JOHN D. PORCARI

FOR THE MINISTRY OF
ENTERPRISE, ENERGY AND
COMMUNICATIONS OF
THE KINGDOM OF SWEDEN

DEPUTY SECRETARY LEIF ZETTERBERG

APPENDIX 4 - PODCAR CITY CONFERENCES

BACKGROUND ON THE CONFERENCES

The Podcar City conferences are an annual event to help podcar (ATN) suppliers, researchers, and enthusiasts meet and share information. The events are organized primarily by the Institute for Sustainable Transportation (IST) in cooperation with the Advanced Transit Association (ATRA). Originally intended to be a single conference, the first conference in Uppsala, Sweden, was so successful that planning for the second annual conference was underway before the first had ended. This was also when a pattern of holding alternating conferences in Sweden and the United States was established, as the second conference was to be held in Ithaca, NY. Interest in the conferences has stayed consistent, maintaining a need for one every year since its inception.

The main events of the conferences are the speakers and panels, who are usually long-term members of the ATN industry. However, a few newer speakers always offer different perspectives, ranging from the public sector to green energy to real estate developers. The range of topics discussed allows for high flow of information among a variety of disciplines in a short time. Additionally, a large section of time is always set aside for various suppliers to show their progress, whether their product has been implemented, has a test track, or is still in the beginnings of the design phase. The ability to spread awareness of their product is particularly valuable to suppliers that are still in the early stages of development and would like to gain publicity and constructive criticism regarding their designs.

UPPSALA

The first Podcar City conference was held in Uppsala, Sweden, in 2007 and was organized by IST key members, Magnus Hunhammar and Christer Lindstrom. Along with IST and ATRA, it had the support of the city of Uppsala, the Swedish National Rail Administration, and the Swedish Institute for Transport and Communications Analysis. Much of the focus of this first conference was the fundamentals of podcars – what they were, how they worked, what options were available for design, along with introducing the major figures in the industry.

The primary attraction at Uppsala was the Vectus test track, which was the biggest development in the podcar industry that year. In addition to Vectus, several other major suppliers (ULTRa, 2getthere) made appearances as speakers, as well as a number of other less-developed suppliers.

Table 20. Podcar City Conference 1: Uppsala, Sweden, 2007-10-01 to 02

Subject	Presenters (Association)	Presentation No.
Opening	Eva Külper (Bjerking), Johan Böhlin (IST) and Russel Johnson (IST)	2007.1.1
Opening	Gunnar Hedberg (Lord Mayor, Uppsala)	2007.1.2
Opening	Magnus Hunhammar (IST)	2007.1.3
Keynote Session: Towards Sustainable Cities		
Sustainable Uppsala	Erik Pelling (Politician, Uppsala)	2007.1.4
Needs for New Transport	Kjell Dahlström (GTS)	2007.1.5
Podcars in Orange County	Gus Ayer (City Councilmember, Fountain Valley)	2007.1.6
Keynote Session: Urban demonstrations, Pilots, and Strategies for Market Growth		
CityMobil and Podcars/PRT	Jan van Dijke (CityMobil)	2007.1.7
Podcars and Daventry	Malcolm Buchanan (Colin Buchanan and Partners)	2007.1.8
Green Transport	Larry Fabian (Trans.21)	2007.1.9
Implementation Plan	Magnus Hunhammar (IST)	2007.1.10 (PPT)
Vendor Presentations		
Vectus PRT	Jeon-Young Lee (Vectus PRT)	2007.1.11
MIST-ER	Ollie Mikosza (MIST-ER)	2007.1.12
SkyWeb Express (Taxi 2000)	Mike Lester (Taxi2000)	2007.1.13
CyberCab (2getthere)	Robbert Lohmann (2getthere)	2007.1.14
Unimodal (SkyTran)	Christopher Perkins (Unimodal)	2007.1.15
SwedeTrack	Per Ribbing (SwedeTrack)	2007.1.16 (N/A)
RUF	Palle Jensen (RUF)	2007.1.17
Session A1: Visit Vectus Test Track	N/A	N/A
Session B1: Podcar Cities		
Uppsala and Podcars; Boländerna	Carl-Johan Engström (KTH)	2007.B1.1
Podcars and Värmdö-Nacka-Södermalm	Yvonne Blombäck (Stockholm Transportation Board)& Hans Lindqvist (KOMPASS)	2007.B1.2
PRT and Santa Cruz	Mike Rotkin	2007.B1.3
Session C1: Architectural Aspects		
PRT and Townplanning	Eva Külper (Bjerking)	2007.C1.1
Strategy for Masdar, Abu Dhabi	Luca Guala (Systematica)	2007.C1.2
Session A2: Renewable Energy and PRT		
Renewable Electricity	Hans Bernhoff (Uppsala University)	2007.A2.1
PRT and Solar	Ron Swenson (ASPO)	2007.A2.2
Session B2: Visit Vectus Test Track	N/A	N/A
Session C2: Economy and Financing		
Failings of Public Transport	Göran Tegnér (WSP)	2007.C2.1

Subject	Presenters (Association)	Presentation No.
Podcars and Real Estate	Marcus Svensson	2007.C2.2
Session A3: Past and Future		
Schiphol Airport in Amsterdam	Robbert Lohmann (2getthere)	2007.A3.1
Developing PRT Capabilities	Ingmar Andréasson (ATRA)	2007.A3.2
Session B3: Networking for Success		
Eskilstuna – Västerås Network	Lars-Erik Dahlin (Eskilstuna Municipality)	2007.B3.1
GTS Ecosystem	Christer Lindström (GTS/IST)	2007.B3.2
Network of Municipalities	KOMPASS	2007.B3.2
Session C3: Visit Vectus Test Track		
Podcar City – Opportunities and Obstacles	[Group discussion]	2007.2.1

Source: <http://www.podcarcity.org/upsala/>

ITHACA

The second conference was held in Ithaca, NY, in 2008. ULTRa's system at Heathrow Airport was nearing completion, making it a popular discussion topic. Attendees use a first-hand presentation on the progress and updates by Steve Raney of ULTRa. In addition, Poland's Mikosha MISTER announced it had received some orders from different cities that had set aside land for use of its podcar system. Skytran announced its own small-scale demonstration, and Beamways made its first appearance.

Table 21. Podcar City Conference 2: Ithaca, New York, 2008-9-14 to 16

Subject	Presenters (Association)	Presentation No.
Opening Address	Carolyn Peterson (Mayor, Ithaca)	2008.1.1
Morning Theme – Lessons Learned and Need for Change		
Sustainable Communities	Gay Nicholson (Sustainable Tompkins)	2008.1.2
Need for Joint Efforts	Hans Lindqvist (KOMPASS)	2008.1.3
California's Perspective	Gus Ayer (City Councilmember, Fountain Valley)	2008.1.4
Green Train	Bo Olsson (Swedish Transport Administration)	2008.1.5
Lessons Learned	Robbert Lohmann (2getthere)	2008.1.6
Video Message	Debbie Cook (Post Carbon Institute)	2008.1.7
Peak Oil and Renewable Energy	Ron Swenson (ASPO)	2008.1.8
Afternoon theme: Evolving Projects and Solutions		
Ecocities and Masdar Initiative	Joan Bokaer (Ecovillage Ithaca)	2008.1.9
City of Daventry	Malcolm Buchanan (Colin Buchanan and Partners)	2008.1.10
Dunstable Park and Masdar Plans	Martin Tillman (Steer Davies Gleave)	2008.1.11

Subject	Presenters (Association)	Presentation No.
Swedish Initiatives	Magnus Hunhammar (IST)	2008.1.12
Heathrow Project and ULTRa Update	Steve Raney (ULTRa PRT)	2008.1.13
Encitra Virtual City Initiative	Crista Lopes (Encitra)	2008.1.14
Panel Discussion	Moderator: David Muyres (Ongoing Transportation)	2008.1.15
Track A1 – Cities for the Future	Manufacturers/Exhibitors Display	N/A
Track B1 – Research and Innovation		
Morgantown, Currently	Vishakha Maskey (West Virginia University)	2008.B1.1
Extending PRT Capabilities	Ingmar Andréasson (ATRA)	2008.B1.2
Princeton Studies	Alain Kornhauser (ATRA)	2008.B1.3
Financing Paradigm Shift	Christer Lindström (GTS/IST) & Frost Travis (Travis and Travis Real Estate Development)	2008.B1.4
Approval Process for Vectus	Helene Jarefors (Swedish Rail Agency)	2008.B1.5
Track A2 – Cities for the Future		
Santa Cruz, California	Ed Porter	2008.A2.1 (PDF)
Varmndo, Sweden	Hans Lindqvist (KOMPASS) and Yvonne Blomback	2008.A2.2 (PDF)
Fountain Valley	Gus Ayer (City Councilmember, Fountain Valley)	2008.A2.3
Media Approach	Per Janse (IST)	2008.A2.4 (PDF)
Track B2 – Research Innovation	Manufacturers/Exhibitors Display	N/A
Track A3 – Cities for the Future		
City of Ithaca – Ideas and Discussions	Robert Morache, Frost Travis (Travis and Travis Real Estate Development)	2008.A3.1 (PDF)
Obstacles for Implenting PRT	KOMPASS	2008.A3.2 (PDF)
Track B3 – Research and Innovation		
SIKA Study	Kjell Dahlström (GTS)	2008.B3.1
Vinnova Study	Magnus Hunhammar (IST)	2008.B3.2
Sao Paolo, Brazil	Alexandra Lichtenberg (Urban Planner)	2008.B3.3
Discussions – What’s next in research?	[Group discussion]	2008.B4.4
Tracks Reconvene		
Connect Ithaca	Jacob Roberts (Connect Ithaca)	2008.2.1
Biofuels and Transportation	David Pimentel (Cornell University)	2008.2.2 (PDF)
Control System for Spaceship Earth	John Hogan (NASA)	2008.2.3
Panel Discussion	[Group discussion]	2008.2.4
Closing Speech	Christer Lindström (GTS/IST)	2008.2.5

Source: <http://www.podcarcity.org/ithaca/>

MALMÖ

The third conference was held in Malmö, Sweden, in 2009. Malmö was the first conference with a theme, which was the idea of moving from the design phase to reality. Previously, the conferences had primarily discussed theory behind what would make podcars work, both technologically and socially. The issue this conference intended to discuss was that of how to actually implement a system, and the challenges the industry was facing that had prevented many systems from getting past the design or test stage. As such, much of the focus was on existing podcar locations, such as those in Heathrow and Masdar City, as well as other podcar-like systems such as Morgantown. The information taken from those – “What was done right?” along with “What can be improved?” – was taken and applied to new locations to determine where it would make the most sense to implement a new system.

Table 22. Podcar City Conference 3: Malmö, Sweden, 2009-12-9 to 10

Subject	Presenters (Association)	Presentation No.
Opening	Hans Lindqvist (KOMPASS)	2009.1.1
Opening	Christer Lindström (GTS/IST), Magnus Hunhammar (IST)	2009.1.2
Opening	Malin Björns (Skane), Anders Rubin (Vice Mayor, Malmö)	2009.1.3
Opening	Åsa Torstensson (Minister for Communications, Sweden)	2009.1.4
MORNING THEME – State of World Mass Transportation and Possibilities		
Nano Car – Mobility Opportunity or Challenge	V Sumantran (Hinduja Automotive UK)	2009.1.5
Peak Oil and Transportation	Debbie Cook (Post Carbon Institute)	2009.1.6
Swedish Podcar Cities	Kjell Dahlström (GTS)	2009.1.7
Silicon Valley Challenge	Hans Larsen (City of San Jose)	2009.1.8
Industrial Outlook for Podcars	Nick Ford (ULTra PRT)	2009.1.9
AFTERNOON THEME – Implementation, Operation and Research		
ULTra at Heathrow	Malcolm Buchanan (Colin Buchanan and Partners)	2009.1.10
Podcars at Masdar	Robbert Lohmann (2getthere)	2009.1.11
Vectus system in Uppsala	Jörgen Gustafsson (Vectus PRT)	2009.1.12
Morgantown 35 years of operations	Vishakha Maskey (West Virginia University)	2009.1.13
Panel debate	Moderated by Larry Fabian (Trans.21)	2009.1.14
The Solar Transportation	Ron Swenson (ASPO), Bengt Gustafsson (Beamways)	2009.1.15
Modeling travel data	Göran Tegnér (WSP)	2009.1.16
Modeling and Software Innovation	Ingmar Andréasson (ATRA)	2009.1.17
Uppsala Virtual Travel Center	Darrell Musick, Christer Lindström (GTS/IST)	2009.1.18
Day 1 Panel Discussion	Moderator David Muyres (Ongoing Transportation)	2009.1.19

Subject	Presenters (Association)	Presentation No.
Dinner Speeches		
Doctors for the Environment	Åke Thörner (Doctor for the Environment)	2009.1.20
Information on the Memorandum of understanding between Sweden and California	Anna Carin Thomer (Consulate General of Sweden)	2009.1.21
Track S: KOMPASS & Real Estate invitation to attending Cities		
Introduction	Magnus Hunhammar (IST)	2009.S.1
Sustainable Retailing	Thomas Bergmark (IKEA)	2009.S.2
Via Academica – Connecting Stockholm Campus Areas with Podcars?	Sten Wetterblad (Akademiska Hus)	2009.S.3
The Design challenge – Lessons from PRT Studies at Heathrow, Bristol and Bath	Jochen Rabe (ARUP)	2009.S.4
Can Podcars Serve the City of Delhi, India?	Sonal Ahuja (Capita Symonds)	2009.S.5
Tendering and Financing of Podcars – Different options	Linda Andersson (Ernst & Young)	2009.S.6
KOMPASS Meeting	Hans Lindqvist (KOMPASS)	2009.S.7
Track R: ATRA Program: Innovation and Research Program		
KTH Inst. of Technology	Ingmar Andréasson (ATRA)	2009.R.1
Overcoming Headway Limitations in PRT Systems	J. Edward Anderson (PRT International)	2009.R.2
RUF Dualmode Network Considerations	Palle Jensen (RUF)	
Value Increase of Real Estate – Case Study in the Port of Rotterdam	Henk van Zuylen (Professor, Netherlands)	2009.R.4
Simulation modelling of PRT and other advanced transit concepts in CityMobil	David Jeffery (Southampton University)	2009.R.5
Podcars From a Sustainability Perspective	Lars Johansson (Södertälje Municipality)	2009.R.6
Personal Rapid Transit; Focusing on the Beginning Rather Than the End	Alain Kornhauser (ATRA)	2009.R.7
AFTERNOON THEME – Synergies: Podcars, Rail & Real Estate		
Sao Paolo Brazil – Rail systems, Real Estate and Podcars in a Mega City	Alexandra Lichtenberg (Urban Planner)	2009.2.1
Rail Station development from Real Estate Perspective	Ann Wiberg (Head of Urban Development, Jernhusen)	2009.2.2
California Program for High Speed Rail	Rod Diridon (Mineta Transportation Institute)	2009.2.3
Swedish Rail Initiatives	Bo Olsson (Swedish Transport Administration)	2009.2.4
Let's work together	Christer Lindström (GTS/IST) & Magnus Hunhammar (IST)	2009.2.5
Final Panel Discussion	Hans Lindqvist (KOMPASS)	2009.2.6

Source: <http://www.podcarcity.org/malmo/>

SAN JOSÉ

The fourth podcar conference was held in San José, CA, in 2010, with the theme of “Innovating Sustainable Communities.” The podcar industry had always been able to associate itself with green technology, but as interest in sustainability grew, it became a bigger factor. This theme is an umbrella that includes not only less personal car use to reduce energy consumption and exhaust pollution, but also potentially applying renewable energy sources such as solar, as well as talk of integration with a smart grid.

Table 23. Podcar City Conference 4: San José, California, 2010-10-27 to 29

Subject	Presenters (Association)	Presentation No.
Welcoming Remarks	Chuck Reed (Mayor of San Jose)	2010.1.1
Setting the Context: Three Perspectives on Podcars	Carl Guardino, Yvonne Bloombäck, Rod Diridon (Mineta Transportation Institute)	2010.1.2
The First Generation: Lessons Learned, Moderated Panel & Discussion		2010.1.3
Cutting the Ribbon at Heathrow	Nick Ford (ULTra PRT)	2010.1.4 (PDF)
Masdar City: Zero Emission Metropolis	Robbert Lohmann (2getthere)	2010.1.5 (PDF)
From Uppsala to Suncheon City	Jörgen Gustafsson (Vectus PRT)	2010.1.6
Lunch Speech – San Jose: Building Sustainable Cities of the Future	Steve Westly (Westly Group)	2010.1.7
Session A1 – The Next Generation: Podcar Projects in Development	Moderator: Peter Muller (PRT Consulting) Speakers: Hans Larsen (City of San Jose), Jacob Roberts (Connect Ithaca), Christopher Juniper (Fort Carson), Magnus Hunhammar (IST)	2010.A1.1
Session B1 – Building a Large-Scale Podcar System: Control System Alternatives	Moderator: Bernie Yoo (Aerospace Corporation) Speakers: Gano B Chatterji (UCSC), Sebastian Thrun (Stanford)	2010.B1.1
Session C1 – Podcars and Traditional Transit–Complement or Competition?	Moderator: David Little (Lea+Elliot) Panelists: Cindy Chavez (South Bay AFL-CIO Labor Council), Stacey Mortensen (Altamont Commuter Express), Lilia Scott (Valley Transportation Authority), Catherine Burke (USC)	2010.C1.1
Session A2 – Integrating Innovative Design into Existing Communities	Moderator: Magnus Hunhammar (IST) Panelists: Austin Smith (ARUP), Carl-Johan Engström (KTH), Geoff Wardle (Art Center College of Design), Thomas Höjemo (Chalmers University of Technology)	2010.A2.1
Session B2 – Financing Podcar Systems: Public and Private Options	Moderator: Christer Lindström (GTS/IST) Panelists: Ignacio Barandiaran (ARUP), Ian Ford (ATRA), Christer Lindström (GTS/IST)	2010.B2.1

Subject	Presenters (Association)	Presentation No.
Session C2 – Modeling Podcar Systems: Ridership and System Operations	Moderator: John Goble (Aerospace Corporation) Panelists: Sam Lott (Kimley-Horn & Associates), Peter Muller (PRT Consulting), Ingmar Andréasson (ATRA)	2010.C2.1
Dinner Speech	Introduction: Sam Liccardo (San Jose City Council) Speaker: Louise Bedsworth (Public Policy Institute of California)	2010.1.8
Session A3 – Podcars and Smart Growth	Moderator: Martin Tuttle (California Department of Transportation) Panelists: Alan Talansky (EBL&S), Elizabeth Deakin (UC Berkeley), Jim Daisa (Kimley-Horn & Associates)	2010.A3.1
Session B3 – Podcars in Emerging Markets	Moderator: Christer Lindström (GTS/IST) Panelists: Sonal Ahuja (Capita Symonds), Kjell Dahlström (GTS), Christer Lindström (GTS/IST)	2010.B3.1
Session C3 – Procurement Issues and Opportunities	Moderator: Steve Perliss (Lea+Elliott)	2010.C3.1
Session A4 – Podcars, Renewable Energy & the Grid	Moderator: Ron Swenson (ASPO) Panelists: Doug Payne (SolarTech), David Rubin (PG&E), Nick Ford (ULTra PRT)	2010.A4.1
Session B4 – The Human-Technology Interface	Panelists: Crista Lopes (Encitra), Will Ackel (ATRA)	2010.B4.1
Session C4 – Standards and Standardization, US and abroad	Moderator: Eric Phillips (Lea+Elliott) Panelists: Robbert Lohmann (2getthere), Steve Raney (ULTra PRT), Steve Artus (California Public Utility Commission)	2010.C4.1

Source: <http://www.podcarcity.org/sanjose/>

STOCKHOLM

The fifth conference was held in Stockholm, Sweden, in 2011, with the theme of “Living Tomorrow’s Lifestyle Today.” As the theme suggests, the focus was on showing how the future, or how people view the future, is attainable much sooner through podcars. Much like the previous theme of sustainability, there were several presentations on how current practices are impossible to maintain forever, or even in the near future, and that the time has come for change.

The main focus in terms of the industry was that Vectus had broken ground in Suncheon, South Korea, with aims to complete its podcar system in the next couple of years. 2getthere and ULTRa also gave updates on their existing systems as well as discussing the possibilities of additional locations or expansions. As had become standard for the conferences, emerging suppliers introduced their designs. BM Design (Bubblemotion), ModuTram, BeemCar, and AutoMate made their first conference appearances in 2011.

Table 24. Podcar City Conference 5: Stockholm, Sweden, 2011-09-06 to 08

Subject	Presenters (Association)	Presentation No.
Welcoming Remarks	Moderator: Magnus Hunhammar (IST)	2011.1.1
	Catharina Elmsäter-Svärd (Minister of Infrastructure, Sweden)	2011.1.2
	Hans Lindqvist (KOMPASS)	2011.1.3
	Inger Linge (Stockholm County Council)	2011.1.4
Heathrow PRT	Fraser Brown (ULTra)	2011.1.5
Public Transport for Tomorrow's Lifestyles	Moderator: David Holdcroft (formerly BAA PRT)	2011.1.6
Emerging Opportunities in a Messy Landscape	Debbie Cook (Post Carbon Institute)	2011.1.7
Transport 2030	Ulrika Francke (Tyréns)	2011.1.8
The Lifestyle Challenge	David Muyres (Ongoing Transportation)	2011.1.9
A1 – Swedish Plans for Sustainable Urban Transport	Moderator: Eva Külper (Bjerking)	2011.A1.1
Uppsala Municipality	Tom Karlsson (Uppsala Municipality)	2011.A1.2
Södertälje Municipality	Lars Johansson (Södertälje Municipality)	2011.A1.3
Väsby Municipality	Axel Nelstrand (Upplands Väsby Municipality)	2011.A1.4
B1 – Financing and Procurement	Moderator: Christer Lindström (GTS/IST)	2011.B1.1
Finance	David Little (Lea+Elliot)	2011.B1.2 (PDF)
Unknown	Ulf Westergård (Nordiska Investeringsbanken)	2011.B1.3
Maximizing Airport Land Value	Alain Kornhauser (ATRA)	2011.B1.4 (PDF)
Procurement and Finance	Nathan Koren (Capita Symonds)	2011.B1.5 (PDF)
C1 – Standards, control systems and safety regulations for podcars	Moderator: Mats Lithner (Rejlers)	2011.C1.1
Control Systems	Sven Assarsson (Rejlers)	2011.C1.2 (PDF)
Safety Integrity Levels in PRT Systems	Inge Alme (Scandpower Group)	2011.C1.3
A2 – Podcars in Cities and Districts around the World	Moderator: Larry Fabian (Trans.21)	2011.A2.1
35 years of experience of "PRT" in Morgantown, WV, US	Larry Fabian (Trans.21)	2011.A2.2
Masdar Project, Abu Dhabi	Robbert Lohmann (2getthere)	2011.A2.3
Suncheon Project, South Korea	Martin Pemberton (Vectus PRT)	2011.A2.4 (PDF)
PRT Passenger – System Interface Design	Karl Humphreys (MoMat)	2011.A2.5
B2 – Impacts of Declining Oil Supplies	Moderator: Russel Johnson (IST)	2011.B2.1
Delusion, illusion and solutions	Debbie Cook (Post Carbon Institute)	2011.B2.2 (PDF)

Subject	Presenters (Association)	Presentation No.
Solar Skyways, Mobility in a World Beyond Oil	Ron Swenson (ASPO)	2011.B2.3
C2 – Preparing for Podcars	Moderator: Ingmar Andréasson (ATRA)	2011.C2.1
How to Obtain Grassroots and Political Support for PRT	Peter Muller (PRT Consulting)	2011.C2.2 (PDF)
Potential modal shift from cars to PRT in European cities	Jörg Schweizer (University of Bologna)	2011.C2.3
Planning and Modelling of a PRT Network for the Zero-Carbon City	Luca Guala (Systematica)	2011.C2.4
A3 – Challenges and Opportunities in Urban Planning	Moderator: Kjell Dahlström (GTS)	
The role of the urban environment to attract creative people and companies	Carl-Johan Engström (KTH)	2011.A3.2
Virtual modeling, Encitra	Christer Lindström (GTS/IST)	2011.A3.3
B3 – Experiences in Project Realization: Key Aspects to Consider for New Applications	Moderator: David Holdcroft (formerly BAA PRT)	2011.B3.1
Operations and Maintenance	Robbert Lohmann (2getthere)	2011.B3.2 (PDF)
Configuration, Styling and architecture: vehicles and infrastructure	Jörgen Gustafsson (Vectus PRT)	2011.B3.3
Construction, installation and testing	Martin Lowson (ULTra)	2011.B4.4
C3 – The Next Frontier: Emerging PRT Systems	Moderator: Jan-Erik Nowacki	2011.C3.1
Beamways	Bengt Gustafsson (Beamways)	2011.C3.2 (PDF)
BM Design (Bubblemotion)	Asko Kauppi (BM Design)	2011.C3.3
ModuTram	Alexander Kyllmann (ModuTram)	2011.C3.4 (PDF)
BeemCar	Peter Lovering (BeemCar)	2011.C3.5 (PDF)
AutoMate	Nethanel Goldberg (AutoMate)	2011.C3.6a & 2011.C3.6b
A4 – Challenges and Opportunities in Urban Planning	Moderator: Carl-Johan Engström (KTH)	2011.A4.1
Effects on Urban Space	Eva Külper (Bjerking)	2011.A4.2
Caofeidian, a Swedish Designed Eco Town in China	Joakim Ax (Sweco)	2011.A4.3
Podcars at the Regional Core of Arlanda-Märsta	Marcus Ekström (Municipality of Sigtuna)	2011.A4.4
B4 – Podcars in Modern Multi-Modal Context	Moderator: Jörg Schweizer (University of Bologna)	2011.B4.1
Podcar Airport Concept	Peter Muller (PRT Consulting)	2011.B4.2 (PDF)

Subject	Presenters (Association)	Presentation No.
PRT and Rail: a Win-Win Combination	Ingmar Andréasson (ATRA)	2011.B4.3 (PDF)
Combination and Competition	Kjell Dahlström (GTS)	2011.B4.4 (PDF)
C4 – KOMPASS Open Meeting	Moderator: Hans Lindqvist (KOMPASS)	2011.C4.4
Plenary session – Be Profitable with Green Business	Moderator: Ron Swenson (ASPO)	2011.2.1
The train station as an entrance to the city – creating and caring for the flow	Ann Wiberg (Head of Urban Development, Jernhusen)	2011.2.2
Why PRT at Heathrow?	David Holdcroft (formerly BAA PRT)	2011.2.3
PRT in India: How is the Real Scenario	Sonal Ahuja (Capita Symonds)	2011.2.4
Closing Discussion: Where Do We Go From Here? / Closing Remarks	Moderator: Christer Lindström (GTS/IST) Panelists: Tore Helmersson, Bo Olsson (Swedish Transport Administration)	2011.2.5

Source: <http://www.podcarcity.org/stockholm/>

BERLIN

The sixth Podcar City conference was held in Berlin, Germany, in 2012, with the theme of returning the Podcar/PRT concept to Germany. The development of the Cabintaxi Project in Hagen, Germany in the 1970s by the consortium of Mannesmann Demag and MBB was stopped abruptly in late 1980. Now, more than 30 years later, the idea and concept of modern and innovative Personal Rapid Transit (PRT) was back in Germany. The conference was held at Technical University Berlin on September 19-20, 2012. The program covered topics such as Urbanization, Regional City Centers and Sustainable Transportation, Plans for Podcars in Built Environments, New Sustainable Transport Solutions, Plan for the Future Today, Expand the Use of Podcars/PRT, Strengthening the Investment of Podcars by Standards, and how Podcars Strengthen the Investments of the Built Environment – the existing railroads and airports.

Table 25. Podcar City Conference 6: Berlin, Germany, 2012-09-19 to 20

Subject	Presenters (Association)	Presentation No.
Urbanization, Regional City Centers and Sustainable Transportation		
Welcoming Remarks	Magnus Hunhammar (IST), Hans Lindqvist (KOMPASS)	2012.1.1
Opening Remarks	Rod Diridon (Mineta Transportation Institute)	2012.1.2 (PDF)
Experience from Podcars in Current Operations and Implementations		
Operating experience and passenger reactions for Heathrow PRT	John Hammersley (ULTra)	2012.1.3 (PDF)
2 years of operations of Masdar City, Abu Dhabi: status and lessons learned	Robbert Lohmann (2getthere)	2012.1.4

Subject	Presenters (Association)	Presentation No.
Upgrading the Podcar system in Morgantown West Virginia	David Little (Lea+Elliot)	2012.1.5 (PDF)
Update on the Suncheon PRT project in South Korea	Martin Pemberton (Vectus)	2012.1.6 (PDF)
Session A1 – Theme: Plans for Podcars in Built Environments	Moderator: Hans Lindqvist (KOMPASS)	2012.A1.1
Plans to connect university hospital, science park and central station by Podcars	Tom Karlsson (City of Uppsala)	2012.A1.2 (PDF)
Report on Barriers and Opportunities for San Jose's Automated Transit Network Project	Hans Larsen (City of San Jose)	2012.A1.3 (PDF)
Progress and plans for ULTra PRT in Amritsar, India	John Hammersley (ULTra)	2012.A1.4
Session B1 – Theme: New Sustainable Transport Solutions	Moderator: Jan-Erik Nowacki (GTS)	2012.B1.1
New and improved: passive maglev, podcars and mass transit	Jerry Sanders (SkyTran)	2012.B1.2
CityCoaster – Podcar on its own way	Patrick Teufelberger (CityCoaster Verkehrssysteme)	2012.B1.3
Beamways PRT system and software products	Bengt Gustafsson (Beamways)	2012.B1.4
Session A2 – Theme: Plan for the future today	Moderator: Larry Fabian (Trans.21)	2012.A2.1
Can Solar Podcars meet dramatic challenges of Post-Oil Society?	Ron Swenson (ASPO)	2012.A2.2
Urban planning with Podcars – Swedish examples	Magnus Hunhammar (IST)	2012.A2.3 (PDF)
Near-term examples to increase land values and revitalize urban areas using podcars	Alain Kornhauser (ATRA)	2012.A2.4 (PDF)
Session B2 – Theme: Expand the Use of Podcars / PRT	Moderator: Ingmar Andréasson (ATRA)	2012.B2.1
Freight PRT: Lessons from and for logistics	Nathan Koren (Capita Symonds)	2012.B2.2
PRT mode share estimations in western and eastern European cities	Jörg Schweizer (University of Bologna)	2012.B2.3
Supplementing Mass Transit with Podcars	Ingmar Andréasson (ATRA)	2012.B2.4
Panel Discussions		
Strengthening the investment of podcars by standards	Moderator: David Little (Lea+Elliot) Panelists: Eugene Nishinaga (Transit Control Solutions), Bo Olsson (Swedish Transport Administration), Robbert Lohmann (2getthere), Lars Anger (Innovatum Science Park)	2012.2.1

Subject	Presenters (Association)	Presentation No.
Can Podcars strengthen the investments of the build environment, the existing railroads or airports?	Moderator: Christer Lindström (GTS/IST) Panelists: Alain Kornhauser (ATRA), Stefan Hanna (Uppsala), Matthew Lesh (U.S. DOT)	2012.2.2

Source: <http://www.podcarcity.org/berlin/>

WASHINGTON, DC

The seventh Podcar City conference, Innovations in Public Transportation, was held in Washington, DC, (Arlington) October 23-25, 2013 at the George Mason University Arlington campus. The conference was presented in cooperation with the International Institute of Sustainable Transportation (INIST), U.S. Department of Transportation, Swedish Transportation Administration, KOMPASS Network, Mineta Transportation Institute, Encitra, Advanced Transit Association (ATRA), George Mason University, and Lea+Elliott.

The conference was also highlighted as the DOT's Advanced Transit Symposium. INIST and DOT joined forces to provide a networking environment to educate, facilitate, and convene for the free flow of thoughts, ideas, and concepts – to develop and showcase new and improved modes of transportation based on sustainability and renewable energy. Exhibits also featured innovations in transportation.

Conference keynote speakers were retired U.S. Congressman James Oberstar and U.S. Congressman Mike Honda. Congressman Oberstar served in the United States House of Representatives from 1975 to 2011. He was chairman of the House Transportation and Infrastructure Committee from 2007 to 2011 and was a member of the Democratic Party. (He has subsequently passed away.)

Congressman Mike Honda serves as the U.S. Representative for California's 17th congressional district, encompassing several cities in Silicon Valley. He is a member of the Democratic Party.

Table 26. Podcar City Conference 7: Washington, D.C., 2013-10-23 to 25

Subject	Presenters (Association)	Presentation No.
Wednesday, October 23		
Welcome Reception	Matthew Lesh (DOT)	
Welcoming Committee Remarks	Bo Olsson (Trafikverket)	
	Hans Lundqvist & Bo Anderson (Kompass)	
	Ron Swenson & Lizie Michel (INIST)	
	Karen Phibrick & Donna Maurillo (MTI)	
	David Little & Erica Brown (Lea+Elliott)	

Subject	Presenters (Association)	Presentation No.
Thursday, October 24		
Welcoming Remarks	Christer Lindstrom (INIST) Laurie Schintler (George Mason University) Vincent Valdes (Federal Transit Authority)	2013.1.1
Morning Keynote Speaker	Mike Honda, US House of Representatives	2013.1.2
Conference Overview and Workshop Info	ATN Projects Today – Stan Young, ATRA	2013.1.3
Summary information about the conference sessions by moderators for each track	Emerging Transportation Technologies – R&D – Alain Kornhauser (Princeton University) Urbanism & Transit – An overview – Shannon McDonald (Southern Illinois University) A General Transportation System – Kjell Dahlström (GTS Foundation) Planning in Practice – Examples – David Little (Lea+Elliott) Software Tools – R&D – Ingmar Andreasson (Logistikcentrum) Economics and Financing – New and Traditional Models – Karen Philbrick (MTI) Swedish-US Memorandum of Cooperation – Cities for Change – Matthew Lesh (US FTA) Station and Real Estate Transit Design – US and Sweden – Bo Olsson (Trafikverket)	
ATN Projects Today	Moderator: Stan Young (University of Maryland Center for Advanced Transportation Technology, and President, Advanced Transit Association)	2013.1.4
What is the status of the operational ATN systems today?		
What projects are we to expect in the near future, and what about the test tracks running?		
Three Operational Automated Transit Networks, A Case Study	Peter Muller (ATRA-IG, President PRT Consulting)	2013.1.5
Status of GRT Development and Implementation in Mexico	Alexander Kyllman (ModuTram)	2013.1.6
Presentations of Systems: Ultra, Vectus, 2getthere, Minimetro, and Modutram	Panel	2013.1.7
Emerging Transportation Technologies – R&D	Moderated by Alain Kornhauser, Princeton University	2013.1.8
A series of projects using self driving cars for new mobility solutions is emerging. How can this technology promote public transportation, and what is the state of art?		
Opportunities to Leverage Advances in Driverless Car Technology to Evolve Conventional Bus Transit Systems	Jerome Lutin (Former VP of Research at New Jersey Transit)	2013.1.9
Synergies Between PRT and Driverless Cars	Ingmar Andreasson (Logistikcentrum)	2013.1.10

Subject	Presenters (Association)	Presentation No.
Evolving APMs to ATNs Using Driverless Car Technology	Samuel Lott (Kimley Horn)	2013.1.11
Evolving Today's Low-speed Driverless Shuttles to Area-wide Transit Service	Adriano Alessandrini (University of Rome)	2013.1.12
What Arlington did along Metro - how it created a 50-100 year plan around the coming of the system, how it has successfully worked [Density by Desire!], and how it is doing along Columbia Pike (which will be served by future streetcars).	Peter Bass (PLB Development Advisory Services)	2013.1.13
A1 – Urbanism and Transit – an Overview	Moderator: Shannon McDonald (Southern Illinois University)	2013.A1.1
How do new ideas in transportation solutions play into the urbanism planning processes? What are the obstacles and possibilities?		
How PRT Will Change The World	Michael Gray (Public PRT Consortium, PPRTC)	2013.A1.2
Experience from the past, e.g. Underground in London, and ideas for the future with Podcars	Magnus Hunhammar (IST)	2013.A1.3
Automated vehicles and economic externalities of design: the reimagining of infrastructure	Brian O'Looney (Design Architect at Torti Gallas and Partners)	2013.A1.4
Design practices for Urban Transit Networks	Nathan Koren (Podaris Ltd)	2013.A1.5
B1 – A General Transportation System	Moderator: Kjell Dahlström (The GTS Foundation)	2013.B1.1
The GTS concept takes podcar technology to a globally standardized level. What would the implications be of a much larger network than just local feeders and distribution systems?		
What is GTS?	Kjell Dahlstrom (Architect GTS Foundation)	2013.B1.2
Development of GTS Technology	Jan-Erik Nowacki (professor, KTH)	2013.B1.3
Analysis, Fulfillment of Transportation Objectives	Arne Muñoz (Require AB)	2013.B1.4
How Habit Keeps Our Thinking in a Box	Per Ahlstrom (Journalist)	2013.B1.5
A2 – Planning in Practice	Moderator: David Little (Lea+Elliott)	2013.A2.1
A great deal of experience can be drawn from practical implementations in the US and elsewhere. Automated systems and new ideas can be challenging to accept for a transit agency, and the rise of these systems at congested areas shows potential for much more than what is implemented today.	Michele Jacobson Mike Hewitt Jeff Davis Fred Payne	2013.A2.2

Subject	Presenters (Association)	Presentation No.
B2 – Software Tools for Planning	Moderator: Ingmar Andreasson (Logistikcentrum)	2013.B2.1
A general problem with working with new modes of transportation is the fact that the current planning tools and software packages do not include such possibilities. However, a series of recent developments has proven to be effective for change. This session focuses on such ideas, in practice and theory		
ECO mobility in Poland - PRT development and modeling	Prof. W. Choromanski (University of Warsaw, Poland)	2013.B2.2
An idea for adaptive ATN - concept and modeling	Bengt Gustafsson (Beamways)	2013.B2.3
Simulating ATN ridership on multimodal travel paths	Sam Lott (Kimley-Horn)	2013.B2.4
Collaborative network design with web-based Podaris	Nathan Koren (Podaris)	2013.B2.5
Afternoon Keynote Speaker	Congressman James L. Oberstar (ret, Chairman, House Committee on Transportation and Infrastructure (2007-2011))	2013.1.14
Congressman Oberstar is a member of the board of directors of Geronimo Wind Energy of Edina MN, and the board of International Student House of Washington, DC. He is Senior Advisor to consulting firm NSI, Washington DC, which assists companies with state and local government procurement and policy issues. He is also an advisor to medical technology firm GeaCom, Inc., Duluth MN		
First Day Panel Discussion	Moderator: Congressman James L. Oberstar	2013.1.15
	Laura Stuchinsky (Director of Sustainability, Department of Transportation, City of San Jose) CA	2013.1.16
	Gösta Norén (Director of Planning, City of Upplands Väsby, Sweden)	2013.1.17
	Fred Payne (County Commissioner, Greenville SC)	2013.1.18
	Bo Andersson (Center Party Transportation Spokesperson, County of Stockholm)	2013.1.19
	Christer Lindvall (Chairman Umeå Social Democrats, City of Umeå. Sweden)	2013.1.20

Subject	Presenters (Association)	Presentation No.
Dinner Speakers		
Mr. Jansson is Senior Advisor at the Transport Division at the Ministry. He will update us on the current status of the US – Sweden Memorandum of Cooperation in the field of Sustainable Transportation.	Håkan Jansson (Swedish Ministry of Enterprise, Energy and Communication)	2013.1.21
Howard Jennings is Research, Policy, and Government Relations Director of Mobility Lab. He is an 18-year veteran of mobility management, former Executive Director of Ridefinders in Richmond, Virginia; Account Supervisor for Siddall Mateus and Coughter Advertising of Richmond; and is a member of the Association of Commuter Transportation's Public Policy Council and the Transportation Demand Management Committee of the Transportation Research Board.	Howard Jennings (Mobility Lab, Arlington)	2013.1.21
Friday, October 25		
The Swedish-US Memorandum of Cooperation – Current Projects and Initiatives	Matthew Lesh (US DOT) Christer Lindström (INIST)	2013.2.1
Since the agreement was signed in September 2010, a series of events and projects is underway. We will hear from US DOT, Trafikverket, KOMPASS, academia and businesses on what is happening now, plus from four cities working on change in Sweden and the USA.	Laura Stuchinsky (City of San Jose, CA)	2013.2.2
	Gösta Norén (City of Upplands Väsby, Sweden)	2013.2.3
	Fred Payne (City of Greensboro, SC)	2013.2.4
	Bo Andersson (City of Sigtuna, Sweden)	2013.2.5
	Financing & Risk Management – New and Traditional Models	Moderator: Dr. Karen Philbrick (Mineta Transportation Institute)
How do we finance new modes of transportation? What are the risks and how can we mitigate them? What is the government's role?	Sanjeev Shah (Strategic Project Development, Lea + Elliott)	2013.2.7
	Christer Lindström (Co-founder, INIST)	
	Peter Muller (CEO, PRT Consulting)	
HSR, Station, Transit, Bicycles – Connected Systems and Ideas	Moderator: Susanne Ingo (Trafikverket)	2013.2.8
Bicycles and Transit Lead the Way to a More Livable Community	Seth Garland (Associate Principal at KGP Design Studio)	2013.2.9
Stations in Sweden	Paul van Doninck (Architect at Jernhusen)	2013.2.10
From Regional Visions to Local Modal Change Points—Challenges in Sweden	Elisabetta Troglia (Researcher at KTH School of Architecture)	2013.2.11
The point of mode change is one of the strongest drivers of development, but it is also an Achilles heel of the transit system – we prefer not to change! What are the key characteristics of modern large railway (incl HSR) stations? How can station area planning help HSR fit into existing settings? How can connecting networks for transit, bikes, and ATN enhance the design and use of high-speed rail?	All panelists	2013.2.12

Subject	Presenters (Association)	Presentation No.
The MTI Report and Next Steps for Development of ATN in USA	Moderator: Buff Furman (San José State University)	2013.2.13
The Mineta Transportation Institute is working in collaboration with San José State University professor Buff Furman on a state-of-the-art study on ATN technology today.	The report will be presented by Professor Furman, collaborators, and students.	
Round table discussion with all panelists:		2013.2.14
End of Conference – Final Panel		
Solar Skyways Prize	Ron Swenson (INIST)	2013.2.15
Presentation of the Solar Skyways Challenge and the Winner	Håkan Jansson (Swedish Ministry of Enterprise, Energy and Communication)	
Final panel discussion	Moderators: Sam Ellis and Lizie Michel and students	2013.2.16

Source: <http://www.podcarcity.org/washington>

SUPPLEMENTARY TABLES

Table 27. ATN Suppliers' Participation in Podcar City Conferences

Supplier	2007	2008	2009	2010	2011	2012
Vectus	2007.1.11	2008.B1.5	2009.1.12	2010.1.6	2011.A2.4 2011.B3.3	2012.1.6
2getthere	2007.1.14 2007.A3.1	2008.1.6	2009.1.11	2010.1.5 2010.C4.1	2011.A2.3 2011.B3.2	2012.1.1 2012.1.4
ULTra		2008.1.13	2009.1.9	2010.1.4 2010.A4.1 2010.C4.1	2011.1.5 2011.B4.4	2012.1.3 2012.A1.4
MIST-ER	2007.1.12					
SkyWeb Express (Taxi 2000)	2007.1.13					
Unimodal (SkyTran)	2007.1.15					2012.B1.2
SwedeTrack	2007.1.16					
RUF	2007.1.17		2009.R.3			
Beamways					2011.C3.2	2012.B1.4
CityCoaster						2012.B1.3
BM Design (Bubblemotion)					2011.C3.3	
AutoMate					2011.C3.6	
BeemCar					2011.C3.5	
ModuTram					2011.C3.4	

Table 28. Podcar City Conference Presentations Sorted by Category

Category	2007	2008	2009	2010	2011	2012
Financing and Procurement	2007.C2.1	2008.A2.4	2009.S.6	2010.B2.1	2011.B1.2	2012.1.1
	2007.C2.2	2008.A3.2		2010.C3.1	2011.B1.4	2012.1.2
	2007.B3.2				2011.B1.5	
Planning	2007.1.6	2008.1.3	2009.1.7	2010.C1.1	2011.1.8	2012.A1.2
	2007.1.8	2008.1.4	2009.1.8	2010.A2.1	2011.A1.2	2012.A1.3
	2007.1.10	2008.1.9	2009.1.16	2010.C2.1	2011.A1.3	2012.A2.3
	2007.B1.1	2008.1.10	2009.1.18	2010.A3.1	2011.A1.4	2012.A2.4
	2007.B1.2	2008.1.11	2009.S.3	2010.B3.1	2011.C2.2	2012.B2.2
	2007.B1.3	2008.1.12	2009.S.4		2011.C2.3	2012.B2.3
	2007.C1.1	2008.1.14	2009.S.5		2011.C2.4	2012.B2.4
	2007.C1.2	2008.1.15	2009.R.2		2011.A3.2	
	2007.A3.1	2008.B1.1	2009.R.4		2011.A3.3	
	2007.A3.2	2008.A3.1	2009.R.7		2011.A4.2	
		2008.B3.1	2009.2.1			
			2009.2.2		2011.A4.3	
		2008.B3.2	2009.2.3		2011.A4.4	
			2009.2.4		2011.B4.2	
		2008.B3.3	2009.2.5		2011.B4.3	
					2011.B4.4	
				2011.2.2		
Sustainability	2007.1.4	2008.1.2	2009.1.6	2010.A4.1	2011.1.7	2012.A2.2
	2007.1.9	2008.1.5	2009.1.15		2011.1.9	
	2007.A2.1	2008.1.8	2009.1.20		2011.B2.2	
	2007.A2.2	2008.A2.1	2009.S.2		2011.B2.3	
		2008.A2.2	2009.R.6			
		2008.A2.3				
	2008.2.2					

GLOSSARY

Advanced Rapid Transit (ART): Fully-automated rapid transit system technology that originated from the Canadian Urban Transportation Development Corporation (UTDC) and was subsequently acquired and named by Bombardier Transportation.

AGRT: Advanced group rapid transit, or automated group rapid transit. *See Group Rapid Transit.*

AGT(S): *See Automated guideway transit (system)*

ALRT: Automated Light Rapid Transit

APM: *See Automated People Mover*

ART: *See Advanced Rapid Transit, or Automated Rapid Transit*

ATN: *See Automated Transit Network*

Automated Guideway Transit (AGT): A family of fully automated, driverless transportation systems operated on fixed guideways along an exclusive right-of-way.

Automated People Mover (APM): A type of AGT implementation, which falls in the GRT category of transit systems. Sometimes APM refers to *Airport* people mover, which is an APM system used on the airline side of an airport.

Automated Rapid Transit (ART): A synonym for ATN or PRT.

Automatic Train Control (ATC): The system for automatically controlling train movement, enforcing train safety, and directing train operations. ATC includes subsystems for automatic train operation (ATO), automatic train protection (ATP), and automatic train supervision (ATS). (American Society of Civil Engineers 2006, 13)

Automatic Train Operation (ATO): The subsystem within the ATC system that performs any or all of the functions of speed regulation, programmed stopping, door and dwell time control, and other functions otherwise assigned to the train operator. (American Society of Civil Engineers 2006, 13)

Automatic Train Protection (ATP): The subsystem within the ATC system which provides the primary protection for passengers, personnel, and equipment against the hazards of operations conducted under automatic control. (American Society of Civil Engineers 2006, 13)

Automatic Train Supervision (ATS): The subsystem within the ATC system that monitors and manages the overall operation of the APM system and provides the interface between the system and the central control operator. (American Society of Civil Engineers 2006, 13)

Automated Transit Network (ATN): A type of AGT implementation that features on-demand, non-stop, origin to destination transport over a service area (in contrast to a corridor) via a variety of paths (i.e., a network). Other names that refer to the same basic concept are: personal rapid transit (PRT), automated rapid transit (ART), personal automated transport (PAT), and podcar transit, or simply, podcars. (*See also the definition for Personal Rapid Transit.*)

Car: (Automobile-sense): A self-propelled conveyance meant to carry passengers. (Transit-sense): An individual passenger-carrying unit that cannot operate individually but must be connected and share equipment with other cars to form a *vehicle*. (*See Vehicle*) (Airport Cooperative Research Program 2012)

CBD: *See Central Business District*

Central Business District (CBD): The commercial and often geographic center of a city.

Consist: A unit of transit vehicles.

DOE: *See United States Department of Energy*

Downtown People Mover (DPM): An APM implementation that operates in a central business district (CBD).

DPM: *See Downtown People Mover*

EPA: *See United States Environmental Protection Agency*

Federal Transit Administration (FTA): The U.S. federal agency that “manages and administers programs that support a variety of local public transportation systems throughout the United States. Transportation systems can include buses, subways, light rail, commuter rail, streetcars, monorail, passenger ferry boats, inclined railways, or “people movers.” (Federal Transit Administration 2013)

FTA *See Federal Transit Administration*

Group Rapid Transit (GRT): A category of transit systems that has either on-line or off-line stations and vehicular capacities of 7 to 215 passengers. Vehicles may operate as single units or in trains. Service may be scheduled or demand responsive. Passengers or groups do not have exclusive use of the vehicle, and multiple stops are permitted. (Talley & Ernst, 1989)

GRT: *See Group Rapid Transit*

Guideway: The physical structure that supports and guides an AGT vehicle.

Headway: A measurement of the distance between vehicles in a transit system. Headway is most commonly measured as the distance between the leading tip of a transit consist to the tip of the next consist behind it. Sometimes headway is expressed as the time

measured when the tip of a transit consist passes a point to the time the tip of the next consist passes the point.

Heavy Rail: Synonym for Metro Rail (see below). “Heavy” as opposed to “light” refers to passenger capacity of the vehicles used in the system.

HHS: *See United States Department of Health and Human Services*

HUD: *See United States Department of Housing and Urban Development*

Line Haul: The movement of goods or passengers from origin to destination over relatively large distances. (e.g., city-to-city)

Light Rail (also Light Rail Transit, LRT): A transit system that uses rail track guided vehicles that may or may not use exclusive guideways or be grade separated. Examples include the Santa Clara Valley Transportation Authority (VTA) Light Rail, Dallas DART Rail, and Denver Regional Transportation District (RTD) Light Rail.

Metro (or Metro Rail): A rapid transit system that uses rail track guided vehicles on exclusive grade-separated guideways. Examples include the London Underground, Paris Metro, and Washington Metropolitan Area Transit Authority Metro.

Metropolitan Planning Organization (MPO): A federally mandated and federally funded transportation policy-making organization in the United States that is made up of representatives from local government and governmental transportation authorities (http://en.wikipedia.org/wiki/Metropolitan_planning_organization)

Minimum Train Consist: The minimum number of cars per train in a transit system (Talley and Ernst, 1989).

Minimum Traveling Unit (MTU): The product of the nominal capacity of a single vehicle (or married pair) and the number of vehicles (or married pairs) in a minimum train consist (Talley and Ernst, 1989).

MPO: *See Metropolitan Planning Organization*

MTU: *See Minimum Traveling Unit*

PRT: *See Personal Rapid Transit*

Personal Rapid Transit (PRT): A transit mode that tends to feature relatively small, fully automated vehicles that operate on (a network of) dedicated guideways with off-line stations. PRT systems can provide direct, non-stop, origin-to-destination connections for individuals or small groups travelling by choice, and typically operate on demand rather than on fixed schedules. Other names referring to the same basic concept are: automated transit network (ATN), automated rapid transit (ART), personal automated transport (PAT), podcar transit (or simply, podcars), and sometimes group rapid transit (GRT). (ATRA 2003).

Rapid Transit (RT): Rail or bus transit service that operates on grade-separated, exclusive right-of-way. (Glossary of transit, 1994)

ROW: *See Right-of-Way*

Right-of-Way (ROW): The area through which a transit vehicle travels

RT: *See Rapid Transit*

TCRP: *See Transit Cooperative Research Program*

TOD: *See Transit Oriented Development*

Train: A set of one or more system *vehicles* coupled together and operated as a single unit. (Airport Cooperative Research Program 2012)

Transit Cooperative Research Program (TCRP): TRB is one of six major divisions of the National Research Council, which promotes and progress in transportation through research. (<http://www.trb.org/>)

Transit Oriented Development (TOD): An approach to urban design that favors compact, mixed-use areas with reduced dependency on automobile usage and encouragement toward more use of public transit.

Transportation Research Board (TRB): TRB is one of six major divisions of the National Research Council, which promotes and progress in transportation through research. (<http://www.trb.org/>)

TRB: *See Transportation Research Board*

UMTA: *See Urban Mass Transportation Administration*

United States Department of Energy (DOE): U.S. federal agency whose mission is to: “*ensure America’s security and prosperity by addressing its energy, environmental and nuclear challenges through transformative science and technology solutions.*” (<http://www.doe.gov/>)

United States Department of Health and Human Services (HHS): U.S. federal agency principally responsible for protecting the health of all Americans and providing essential human services, especially for those who are least able to help themselves. (<http://www.hhs.gov/>)

United States Department of Housing and Urban Development (HUD): U.S. federal agency whose mission is to: “*create strong, sustainable, inclusive communities and quality affordable homes for all.*” (<http://www.hud.gov/>)

United States Department of Transportation (USDOT): U.S. federal agency whose mission is to: “*Serve the United States by ensuring a fast, safe, efficient, accessible and convenient transportation system that meets our vital national interests and enhances the quality of life of the American people, today and into the future.*” (<http://www.dot.gov/>)

United States Environmental Protection Agency: U.S. federal agency whose mission is to: “protect human health and the environment.” (<http://www.epa.gov/>)

Urban Mass Transportation Administration (UMTA): The US federal agency that began in 1964 through the Urban Mass Transportation Act of 1964, which was established to support and coordinate mass transportation development. Since 1991, the agency is now called the Federal Transit Administration (FTA).

USDOT: *See United States Department of Transportation*

Vehicle: The smallest passenger carrying unit that can operate individually. This may be a single unit or a permanently coupled set of dependent cars. A vehicle can also be coupled with one or more other vehicles to form a *train*. (Airport Cooperative Research Program 2012)

ABOUT THE AUTHORS

BURFORD (BUFF) FURMAN, PHD, PE

Dr. Furman is a professor in the Mechanical and Aerospace Engineering Department at San José State University, where he has been affiliated since 1994. He is also a registered professional engineer in the state of California in mechanical engineering since 1984. Prior to arriving at SJSU, he worked at IBM in San José in the development of disk drive actuators and spindle motors. He has also been a consultant in the optomechanical and laboratory automation industries. His areas of teaching and research are focused primarily in Automated Transit Networks, mechatronics, precision machine design, and engineering measurements.

SAM ELLIS

Mr. Ellis is a project manager for the International Institute of Sustainable Transportation. He co-authored the Solar Skyways Challenge, which spurred ATN focused projects at Uppsala University and San José State University. Having never owned a car, he is a committed public transportation rider as well as researcher. He holds degrees in physics and mathematics and has educated youth for over ten years. Within ATN research, his efforts have been broad, with contributions to the development of many subsystems, from routing algorithms to urban planning and drivetrain mechanics.

LAWRENCE FABIAN

Mr. Fabian is a city and regional planner with extensive international and cross-cultural experience. Since the 1980s at Trans.21, he has monitored world developments in automated transit and publishes two newsletters on this topic. He has held *pro bono publico* positions on TRB, ASCE, and APA committees and contributes significantly to ATRA activities. In 2013, INIST invited him to manage and edit www.podcar.org. He graduated *summa cum laude* from Dartmouth and holds a master's degree from the University of Pennsylvania. His collaborations with Swedish ATN professionals date from the 1970s.

PETER MULLER

Mr. Muller is a registered professional engineer with degrees in civil and environmental engineering from the universities of Cape Town and Colorado. His experience includes metropolitan transportation studies; and planning and engineering of roads, freeways, railroads, tunnels, airports and automated transit networks. He is president of PRT Consulting, which specializes in providing professional planning and engineering services relevant to advanced transit networks. He is a member of the Advanced Transit Industry Group. Mr. Muller is a past chairman of the Airport Consultants Council, a member of TRB Committee AP040, Automated Transit Systems, and he serves on the Executive Committee of the Advanced Transit Association.

RON SWENSON

Mr. Swenson is co-founder and president of the International Institute of Sustainable Transportation (INIST) and CEO of Encitra™ (Energy, Cities, Transportation). INIST is a non-profit group of professionals driven by the goal of creating an environmentally sound economy based on rapid innovation and best practices for sustainable living. Encitra is a comprehensive urban planning and real estate development modeling service that creates 4D visualization environments, thus allowing stakeholders to experience, modify, respond to, and collaborate on proposed sustainable urban and real estate development solutions and understand their long-term consequences quickly, clearly, and cost effectively.

Since rebuilding an electric car in 1979, Mr. Swenson has focused on solar-powered transportation – developing prototypes, a solar race car team in Mexico, electric bikes, and a Utility Solar Vehicle. Since 2006, he has organized industry, government and academic groups in Silicon Valley, Sweden, and elsewhere to create Solar Skyways – 100% solar-powered Automated Transportation Networks – to establish mobility solutions for a world beyond oil.

PEER REVIEW

San José State University, of the California State University system, and the MTI Board of Trustees have agreed upon a peer review process required for all research published by MTI. The purpose of the review process is to ensure that the results presented are based upon a professionally acceptable research protocol.

Research projects begin with the approval of a scope of work by the sponsoring entities, with in-process reviews by the MTI Research Director and the Research Associated Policy Oversight Committee (RAPOC). Review of the draft research product is conducted by the Research Committee of the Board of Trustees and may include invited critiques from other professionals in the subject field. The review is based on the professional propriety of the research methodology.

MTI FOUNDER

Hon. Norman Y. Mineta

MTI BOARD OF TRUSTEES

Founder, Honorable Norman Mineta (Ex-Officio)
Secretary (ret.), US Department of Transportation
Vice Chair
Hill & Knowlton, Inc.

Honorary Chair, Honorable Bill Shuster (Ex-Officio)
Chair
House Transportation and Infrastructure Committee
United States House of Representatives

Honorary Co-Chair, Honorable Nick Rahall (Ex-Officio)
Vice Chair
House Transportation and Infrastructure Committee
United States House of Representatives

Chair, Stephanie Pinson (TE 2015)
President/COO
Gilbert Tweed Associates, Inc.

Vice Chair, Nuria Fernandez (TE 2014)
General Manager/CEO
Valley Transportation Authority

Executive Director, Karen Philbrick, Ph.D.
Mineta Transportation Institute
San José State University

Thomas Barron (TE 2015)
Executive Vice President
Strategic Initiatives
Parsons Group

Joseph Boardman (Ex-Officio)
Chief Executive Officer
Amtrak

Donald Camph (TE 2016)
President
Aldaron, Inc.

Anne Canby (TE 2014)
Director
OneRail Coalition

Grace Crunican (TE 2016)
General Manager
Bay Area Rapid Transit District

William Dorey (TE 2014)
Board of Directors
Granite Construction, Inc.

Malcolm Dougherty (Ex-Officio)
Director
California Department of Transportation

Mortimer Downey* (TE 2015)
Senior Advisor
Parsons Brinckerhoff

Rose Guilbault (TE 2014)
Board Member
Peninsula Corridor Joint Powers Board (Caltrain)

Ed Hamberger (Ex-Officio)
President/CEO
Association of American Railroads

Steve Heminger (TE 2015)
Executive Director
Metropolitan Transportation Commission

Diane Woodend Jones (TE 2016)
Principal and Chair of Board
Lea+Elliot, Inc.

Will Kempton (TE 2016)
Executive Director
Transportation California

Jean-Pierre Loubinoux (Ex-Officio)
Director General
International Union of Railways (UIC)

Michael Melaniphy (Ex-Officio)
President & CEO
American Public Transportation Association (APTA)

Jeff Morales (TE 2016)
CEO
California High-Speed Rail Authority

David Steele, Ph.D. (Ex-Officio)
Dean, College of Business
San José State University

Beverly Swaim-Staley (TE 2016)
President
Union Station Redevelopment Corporation

Michael Townes* (TE 2014)
Senior Vice President
National Transit Services Leader
CDM Smith

Bud Wright (Ex-Officio)
Executive Director
American Association of State Highway and Transportation Officials (AASHTO)

Edward Wytkind (Ex-Officio)
President
Transportation Trades Dept., AFL-CIO

(TE) = Term Expiration or Ex-Officio
* = Past Chair, Board of Trustee

Directors

Karen Philbrick, Ph.D.
Executive Director

Hon. Rod Diridon, Sr.
Emeritus Executive Director

Peter Haas, Ph.D.
Education Director

Donna Maurillo
Communications Director

Brian Michael Jenkins
National Transportation Safety and Security Center

Asha Weinstein Agrawal, Ph.D.
National Transportation Finance Center

Research Associates Policy Oversight Committee

Asha Weinstein Agrawal, Ph.D.
Urban and Regional Planning
San José State University

Jan Botha, Ph.D.
Civil & Environmental Engineering
San José State University

Katherine Kao Cushing, Ph.D.
Environmental Science
San José State University

Dave Czerwinski, Ph.D.
Marketing and Decision Science
San José State University

Frances Edwards, Ph.D.
Political Science
San José State University

Taeho Park, Ph.D.
Organization and Management
San José State University

Diana Wu
Martin Luther King, Jr. Library
San José State University



MINETA
TRANSPORTATION INSTITUTE
MTI



SAN JOSÉ STATE
UNIVERSITY

Funded by U.S. Department of
Transportation and California
Department of Transportation

