

STATE OF CALIFORNIA DEPARTMENT OF TRANSPORTATION
TECHNICAL REPORT DOCUMENTATION PAGE

TR0003 (REV. 10/98)

1. REPORT NUMBER CA06-0247	2. GOVERNMENT ASSOCIATION NUMBER	3. RECIPIENT'S CATALOG NUMBER
4. TITLE AND SUBTITLE Seismic, Creep, and Tensile Testing of Various Epoxy Bonded Rebar Products in Hardened Concrete	5. REPORT DATE February 2006 (Revised 2007)	
	6. PERFORMING ORGANIZATION CODE	
7. AUTHOR(S) Robert J. Meline, Malinda Gallaher, Jacob Duane	8. PERFORMING ORGANIZATION REPORT NO. 65-680321 FHWA/CA/IR/2004/01	
9. PERFORMING ORGANIZATION NAME AND ADDRESS California Department of Transportation Division of Research and Innovation, MS-83 1227 O Street Sacramento CA 95814	10. WORK UNIT NUMBER	
	11. CONTRACT OR GRANT NUMBER F 01 IR 25	
12. SPONSORING AGENCY AND ADDRESS California Department of Transportation Division of Research and Innovation, MS-83 1227 O Street Sacramento, CA 95819	13. TYPE OF REPORT AND PERIOD COVERED Final Report July 2005 – December 2006	
	14. SPONSORING AGENCY CODE	
15. SUPPLEMENTAL NOTES This project was performed in cooperation with the US Department of Transportation, Federal Highway Administration, under the research project titled "Seismic, Creep, and Tensile Testing of Various Epoxy Bonded Rebar Products in Hardened Concrete"		
16. ABSTRACT <p>The objective of this project was to evaluate the performance of currently specified epoxy adhesive anchor systems on various epoxy-coated rebar under seismic, creep and tensile loading. Previous testing of dowel bonding materials for use in hardened concrete was performed on plain rebar, raising the question of their performance on epoxy coated rebar.</p> <p>The epoxy-coated rebar was found to meet the requirements of ICBO-AC58, Section 5.3.7.2.4, "Conditions of Acceptance" for tension and seismic loading when bonded into hardened concrete using an epoxy adhesive. However, the epoxy-coated rebar did not meet the requirements of the Caltrans Augmentation/Revisions to ICBO-AC58, Section 5.3.3.2, "Conditions of Acceptance" for creep loading when bonded into hardened concrete. The rebar bonded with Covert Operations CIA-Gel 7000 was found to meet the creep requirements, whereas the rebar bonded with Simpson SET22 and Red Head Epcon C6 did not meet the conditions of acceptance for creep loading.</p> <p>It was also noticed that, when compared to the manufacturer test data, the epoxy-coated rebar outperformed uncoated rebar in allowable tensile loads for two of the three epoxies tested. Simpson SET22 adhesive under performed the manufacturer test data. Revision (2007): Upon further review of the creep data for the rebar bonded with Simpson SET, it was determined that the adhesive met the creep requirement. Due to the load fluctuations, only the first 26 days of data were used for the logarithmic curve fit.</p>		
17. KEY WORDS Epoxy-Coated Rebar, Rebar Testing, Creep, Seismic, Tensile, Dowel Testing, Concrete.	18. DISTRIBUTION STATEMENT No restrictions. This document is available to the public through the National Technical Information Service, Springfield, VA 22161	
19. SECURITY CLASSIFICATION (of this report) Unclassified	20. NUMBER OF PAGES 118	21. PRICE



Division of Research
& Innovation

Seismic, Creep, and Tensile Testing of Various Epoxy Bonded Rebar Products in Hardened Concrete

Final Report

Report CA06-0247
February 2006
(Revised 2007)

Seismic, Creep, and Tensile Testing of Various Epoxy Bonded Rebar Products in Hardened Concrete

Final Report

Report No. CA06-0247

February 2006 (Revised 2007)

Prepared By:

Office Of Materials and Infrastructure
Division of Research and Innovation, MS-83
California Department of Transportation
1227 O Street
Sacramento CA 95814

Prepared For:

California Department of Transportation
Division of Research and Innovation, MS-83
1227 O Street
Sacramento, CA 95814

DISCLAIMER STATEMENT

This document is disseminated in the interest of information exchange. The contents of this report reflect the views of the authors who are responsible for the facts and accuracy of the data presented herein. The contents do not necessarily reflect the official views or policies of the State of California or the Federal Highway Administration. This publication does not constitute a standard, specification or regulation. This report does not constitute an endorsement by the Department of any product described herein.

For individuals with sensory disabilities, this document is available in Braille, large print, audiocassette, or compact disk. To obtain a copy of this document in one of these alternate formats, please contact: the Division of Research and Innovation, MS-83, California Department of Transportation, P.O. Box 942873, Sacramento, CA 94273-0001.

STATE OF CALIFORNIA
DEPARTMENT OF TRANSPORTATION
DIVISION OF RESEARCH AND INNOVATION
OFFICE OF MATERIALS AND INFRASTRUCTURE

**SEISMIC, CREEP, AND TENSILE TESTING OF VARIOUS EPOXY
BONDED REBAR PRODUCTS IN HARDENED CONCRETE**

Supervised by.....Tom Hoover, P.E.
Principal Investigator.....Robert Meline, P.E.
Report Prepared by.....Jacob Duane, P.E. & Malinda Gallaher
Research Performed.....Jacob Duane, P.E. & Malinda Gallaher

STATE OF CALIFORNIA DEPARTMENT OF TRANSPORTATION
TECHNICAL REPORT DOCUMENTATION PAGE

TR0003 (REV. 10/98)

1. REPORT NUMBER FHWA/CA/IR/2004/01	2. GOVERNMENT ASSOCIATION NUMBER	3. RECIPIENT'S CATALOG NUMBER
4. TITLE AND SUBTITLE Seismic, Creep, and Tensile Testing of Various Epoxy Bonded Rebar Products in Hardened Concrete	5. REPORT DATE February 2006 (Revised 2007)	6. PERFORMING ORGANIZATION CODE
	7. AUTHOR(S) Robert J. Meline, Malinda Gallaher, Jacob Duane	8. PERFORMING ORGANIZATION REPORT NO. 65-680321
9. PERFORMING ORGANIZATION NAME AND ADDRESS California Department of Transportation Division of Research and Innovation, MS-83 1227 O Street Sacramento CA 95814	10. WORK UNIT NUMBER	11. CONTRACT OR GRANT NUMBER F 01 IR 25
	12. SPONSORING AGENCY AND ADDRESS California Department of Transportation Sacramento, CA 95819	13. TYPE OF REPORT AND PERIOD COVERED FINAL
15. SUPPLEMENTAL NOTES	14. SPONSORING AGENCY CODE	

This project was performed in cooperation with the US Department of Transportation, Federal Highway Administration, under the research project titled "Seismic, Creep, and Tensile Testing of Various Epoxy Bonded Rebar Products in Hardened Concrete"

16. ABSTRACT	
<p>The objective of this project was to evaluate the performance of currently specified epoxy adhesive anchor systems on various epoxy-coated rebar under seismic, creep and tensile loading. Previous testing of dowel bonding materials for use in hardened concrete was performed on plain rebar, raising the question of their performance on epoxy coated rebar.</p> <p>The epoxy-coated rebar was found to meet the requirements of ICBO-AC58, Section 5.3.7.2.4, "Conditions of Acceptance" for tension and seismic loading when bonded into hardened concrete using an epoxy adhesive. However, the epoxy-coated rebar did not meet the requirements of the Caltrans Augmentation/Revisions to ICBO-AC58, Section 5.3.3.2, "Conditions of Acceptance" for creep loading when bonded into hardened concrete. The rebar bonded with Covert Operations CIA-Gel 7000 was found to meet the creep requirements, whereas the rebar bonded with Simpson SET22 and Red Head Epcon C6 did not meet the conditions of acceptance for creep loading.</p> <p>It was also noticed that, when compared to the manufacturer test data, the epoxy-coated rebar outperformed uncoated rebar in allowable tensile loads for two of the three epoxies tested. Simpson SET22 adhesive under performed the manufacturer test data. Revision (2007): Upon further review of the creep data for the rebar bonded with Simpson SET, it was determined that the adhesive met the creep requirement. Due to the load fluctuations, only the first 26 days of data were used for the logarithmic curve fit.</p>	

17. KEY WORDS Epoxy-Coated Rebar, Rebar Testing, Creep, Seismic, Tensile, Dowel Testing, Concrete.	18. DISTRIBUTION STATEMENT No restrictions. This document is available to the public through the National Technical Information Service, Springfield, VA 22161
19. SECURITY CLASSIFICATION (of this report)	20. NUMBER OF PAGES
	21. PRICE

Unclassified

Reproduction of completed page authorized

ACKNOWLEDGMENTS

Special appreciation is due to Malinda Gallaher for her enthusiastic and competent help on this project. Ronald Reese also contributed to the project with guidance and knowledge of this testing.

Other persons who made important contributions are Bill Poroshin, Martin Zanotti, and Mike Said with excellent machine shop services, and Fred McWhorter with instrumentation support. Student assistants John Means, Steve Kiyama, Natane Clarke, and John Black also lent aid in completing this project.

TABLE OF CONTENTS

1. INTRODUCTION.....	1
1.1 Problem Statement.....	1
1.2 Objective.....	1
1.3 Background.....	1
1.4 Scope.....	2
2. SUMMARY OF RESULTS	2
3. PRODUCT DESCRIPTIONS.....	3
3.1 Simpson Strong-Tie SET22.....	3
3.2 Red Head Epcon Ceramic 6.....	3
3.3 Covert Operations CIA-Gel 7000.....	4
4. TEST MATERIALS	5
4.1 Epoxy-Coated Rebar.....	5
4.2 Concrete	5
5. TEST EQUIPMENT.....	5
5.1 Tension and Seismic Loading.....	5
5.2 Creep Loading.....	7
5.3 Environmental Chamber	9
5.4 Other Equipment.....	9
6. INSTALLATION INSTRUCTIONS	11
7. TEST PROCEDURE.....	11
7.1 Tension and Seismic Tests.....	11
7.2 Creep Tests.....	12
8. TEST RESULTS	13
8.1 Tension and Seismic Tests.....	16
8.1.1 Simpson Strong-Tie SET22.....	17
8.1.2 Red Head Epcon Ceramic 6.....	18
8.1.3 Covert Operations CIA-Gel 7000.....	18
8.2 Creep Tests.....	18
8.2.1 Simpson Strong-Tie SET22.....	18
8.2.2 Red Head Epcon Ceramic 6.....	19
8.2.3 Covert Operations CIA-Gel 7000.....	19
9. CONCLUSION	20
10. RECOMMENDATION.....	20
11. IMPLEMENTATION	21
12. REFERENCES.....	21
APPENDIX.....	22

LIST OF FIGURES

Figure 5-1	267 kN (60 Kip) Load Frame.....	6
Figure 5-2	Cart with Controller and Hydraulic Pump	6
Figure 5-3	LVDT Bracket	7
Figure 5-4	Creep Loading Setup.....	8
Figure 5-5	LVDT Bracket for Creep Testing	8
Figure 5-6	Air Powered Pump.....	8
Figure 5-7	Concrete Cylinder Mover	10
Figure 5-8	Campbell Scientific CR10X Data logger.....	10
Figure 5-9	Rebar Gripper.....	10
Figure 5-10	LVDT Multiplexer	10
Figure 7-1	Seismic Loading Criteria	12
Figure A-1	Typical Concrete–Concrete/Adhesive Interface Failure.....	29
Figure A-2	Typical Concrete/Adhesive Interface Failure	29
Figure A-3	Typical Concrete/Adhesive –Adhesive/Rebar Interface Failure	30
Figure A-4	Typical Adhesive/Rebar Interface Failure	30
Figure A-5	Typical Rebar Failure	31
Figure A-6	SET22 12d Tensile Test #1	32
Figure A-7	SET22 12d Tensile Test #2.....	32
Figure A-8	SET22 12d Tensile Test #3.....	33
Figure A-9	SET22 12d Tensile Test #4.....	33
Figure A-10	SET22 12d Tensile Test #5.....	33
Figure A-11	SET22 12d Seismic Test #1	34
Figure A-12	SET22 12d Seismic Test #2.....	34
Figure A-13	SET22 12d Seismic Test #3.....	34
Figure A-14	SET22 12d Seismic Test #4.....	35
Figure A-15	SET22 12d Seismic Test #5.....	35
Figure A-16	SET22 9d Tensile Test #1	35
Figure A-17	SET22 9d Tensile Test #2.....	36
Figure A-18	SET22 9d Tensile Test #3.....	36
Figure A-19	SET22 9d Tensile Test #4.....	36
Figure A-20	SET22 9d Tensile Test #5.....	37
Figure A-21	SET22 9d Seismic Test #1	37
Figure A-22	SET22 9d Seismic Test #2.....	37
Figure A-23	SET22 9d Seismic Test #3.....	38
Figure A-24	SET22 9d Seismic Test #4.....	38
Figure A-25	SET22 9d Seismic Test #5.....	38
Figure A-26	SET22 Creep Displacements Over First 6 Hours	39
Figure A-27	SET22 Creep Displacement 600-Day Log Regression Analysis.....	39
Figure A-28	SET22 42-Day Creep Displacements	40
Figure A-29	SET22 Chamber and Concrete Temperatures.....	40
Figure A-30	SET22 Creep Load.....	40
Figure A-31	SET22 Elevated Temperature Tensile Tests.....	41
Figure A-32	SET22 Elevated Temperature Creep Tensile Tests	41
Figure A-33	Ceramic 6 12d Tensile Test #1	42

Figure A-34	Ceramic 6 12d Tensile Test #2	42
Figure A-35	Ceramic 6 12d Tensile Test #3	43
Figure A-36	Ceramic 6 12d Tensile Test #4	43
Figure A-37	Ceramic 6 12d Tensile Test #5	43
Figure A-38	Ceramic 6 12d Seismic Test #1	44
Figure A-39	Ceramic 6 12d Seismic Test #2	44
Figure A-40	Ceramic 6 12d Seismic Test #3	44
Figure A-41	Ceramic 6 12d Seismic Test #4	45
Figure A-42	Ceramic 6 12d Seismic Test #5	45
Figure A-43	Ceramic 6 9d Tensile Test #1	45
Figure A-44	Ceramic 6 9d Tensile Test #2	46
Figure A-45	Ceramic 6 9d Tensile Test #3	46
Figure A-46	Ceramic 6 9d Tensile Test #4	46
Figure A-47	Ceramic 6 9d Tensile Test #5	47
Figure A-48	Ceramic 6 9d Seismic Test #1	47
Figure A-49	Ceramic 6 9d Seismic Test #2	47
Figure A-50	Ceramic 6 9d Seismic Test #3	48
Figure A-51	Ceramic 6 9d Seismic Test #4	48
Figure A-52	Ceramic 6 9d Seismic Test #5	48
Figure A-53	Ceramic 6 Creep Displacements Over First 6 Hours.....	49
Figure A-54	Ceramic 6 Creep Displacement 600-Day Log Regression Analysis .	49
Figure A-55	Ceramic 6 42-Day Creep Displacements.....	50
Figure A-56	Ceramic 6 Chamber and Concrete Temperatures	50
Figure A-57	Ceramic 6 Creep Load	50
Figure A-58	Ceramic 6 Elevated Temperature Tensile Tests	51
Figure A-59	Ceramic 6 Elevated Temperature Creep Tensile Tests.....	51
Figure A-60	CIA-Gel 7000 12d Tensile Test #1	52
Figure A-61	CIA-Gel 7000 12d Tensile Test #2.....	52
Figure A-62	CIA-Gel 7000 12d Tensile Test #3.....	53
Figure A-63	CIA-Gel 7000 12d Tensile Test #4.....	53
Figure A-64	CIA-Gel 7000 12d Tensile Test #5.....	53
Figure A-65	CIA-Gel 7000 12d Seismic Test #1	54
Figure A-66	CIA-Gel 7000 12d Seismic Test #2.....	54
Figure A-67	CIA-Gel 7000 12d Seismic Test #3.....	54
Figure A-68	CIA-Gel 7000 12d Seismic Test #4.....	55
Figure A-69	CIA-Gel 7000 12d Seismic Test #5.....	55
Figure A-70	CIA-Gel 7000 9d Tensile Test #1	55
Figure A-71	CIA-Gel 7000 9d Tensile Test #2.....	56
Figure A-72	CIA-Gel 7000 9d Tensile Test #3.....	56
Figure A-73	CIA-Gel 7000 9d Tensile Test #4.....	56
Figure A-74	CIA-Gel 7000 9d Tensile Test #5.....	57
Figure A-75	CIA-Gel 7000 9d Seismic Test #1	57
Figure A-76	CIA-Gel 7000 9d Seismic Test #2.....	57
Figure A-77	CIA-Gel 7000 9d Seismic Test #3.....	58
Figure A-78	CIA-Gel 7000 9d Seismic Test #4.....	58
Figure A-79	CIA-Gel 7000 9d Seismic Test #5.....	58

Figure A-80	CIA-Gel 7000 Creep Displacements Over First 6 Hours	59
Figure A-81	CIA-Gel 7000 Creep Displacement 600-Day Log Regression Analysis 59	
Figure A-82	CIA-Gel 7000 42-Day Creep Displacements	60
Figure A-83	CIA-Gel 7000 Chamber and Concrete Temperatures.....	60
Figure A-84	CIA-Gel 7000 Creep Load.....	60
Figure A-85	CIA-Gel 7000 Elevated Temperature Tensile Tests.....	61
Figure A-86	CIA-Gel 7000 Elevated Temperature Creep Tensile Tests	61
Figure C-1	Rebar Puller	99
Figure C-2	Hydraulic Pump for Rebar Puller	100
Figure C-3	Cabinet Assembly for Rebar Puller	101
Figure C-4	Rebar Gripper – Collar.....	102
Figure C-5	Rebar Gripper – Jaw	103
Figure C-6	LVDT Bracket for Pullout and Seismic Testing – Front View	104
Figure C-7	LVDT Bracket for Pullout and Seismic Testing – Side View	104
Figure C-8	LVDT Bracket for Pullout and Seismic Testing – Top View.....	105
Figure C-9	LVDT Bracket for Pullout and Seismic Testing – 3D View	105
Figure C-10	LVDT Bracket for Creep Testing – Front View.....	106
Figure C-11	LVDT Bracket for Creep Testing – Side View	106
Figure C-12	LVDT Bracket for Creep Testing – Top View	107
Figure C-13	LVDT Bracket for Creep Testing – 3D View.....	107
Figure C-14	Creep Load Frame.....	108
Figure C-15	Cart – 3D View	108
Figure C-16	Cart – Side View.....	109
Figure C-17	LVDT Breakout Box Schematic.....	110

LIST OF TABLES

Table 1-1	Testing Quantities	2
Table 1-2	Testing Specifications	2
Table 3-1	Simpson SET22 Cure Times.....	3
Table 3-2	Red Head Epcon Ceramic 6 Cure times	4
Table 3-3	Covert Operations CIA-Gel 7000 Cure times.....	4
Table 8-1	Summary of Results for SET22 Epoxy Testing.....	13
Table 8-2	Summary of Results for Ceramic 6 Epoxy Testing	14
Table 8-3	Summary of Results for CIA-Gel 7000 Epoxy Testing.....	15
Table 8-4	Preliminary Test Results and Seismic Parameters.....	16
Table 8-5	Seismic Test Conditions of Acceptance	16
Table A-1	Concrete Pour Information	21
Table A-2	Epoxy Adhesive Information.....	21
Table A-3	SET22 Concrete Compressive Strengths	22
Table A-4	Ceramic 6 Concrete Compressive Strengths.....	23
Table A-5	CIA-GEL 7000 Concrete Compressive Strengths	24
Table A-6	SET22 Testing Failure Modes	22
Table A-7	Ceramic 6 Testing Failure Modes.....	23
Table A-8	CIA-Gel 7000 Testing Failure Modes	24

1. INTRODUCTION

1.1 Problem Statement

For certain applications, the California Department of Transportation (Caltrans) uses epoxy cartridge adhesives for bonding rebar into holes that are drilled in hardened concrete. Caltrans started using these adhesives on plain rebar since previous research and testing was completed on them. At some point, Caltrans used a large quantity of epoxy-coated rebar for earthquake retrofitted bridge structure rehabilitation projects. Concern was expressed about using epoxy-coated rebar with epoxy cartridge adhesives. Problems that could occur are *long-term creep* under sustained tensile loading and *slip or strength loss* during cyclic loading that takes place during a seismic event. The International Conference of Building Officials (ICBO) had suggested that bars with any coatings should be treated as a new, different bar and would require a new set of tests. These tests have yet to be completed.

Caltrans' Division of Materials Engineering and Testing Services recommended to Structures Design that a separate set of ICBO seismic tests be performed on epoxy-coated bars with epoxy cartridge adhesives. These tests would have to pass Caltrans' Augmentation to ICBO-AC58 [1] to be permitted for use in concrete structures. They also recommended that a considerable reduction in allowable loads be imposed on untested coated bars until the effects of coatings could be determined.

1.2 Objective

The objective of this project is to evaluate the performance of currently specified epoxy adhesive anchor systems on various epoxy-coated rebar under seismic, creep and tensile loading.

1.3 Background

Epoxy-coated reinforcing bars are used in concrete structures where corrosion protection is important. The epoxy-coated bars have a lower bond strength to concrete than the uncoated bars. An improved understanding of bond behavior is needed with the increasing application of epoxy-coated reinforcement, the conservative design guides, and the limited data on which those provisions are based. The goal is to improve economy and constructability, while maintaining an adequate margin of safety.

A large scale study, "Bond of Epoxy-Coated Reinforcement: Bar Parameters" [2], was carried out by Oan Chul Choi, Hossain Haje-Ghaffari, David Darwin, and Steven L. McCabe to determine the effects of coating thickness, deformation pattern, and bar size on the reduction in bond strength between reinforcing bars and concrete caused by epoxy coating. In general, their conclusion was that the reduction in bond strength caused by epoxy coating increases with bar size.

Adhesive-bonded anchors are increasingly used as structural fasteners for connections to hardened concrete. Due to their reliance on chemical and mechanical bond, adhesive anchors are uniquely susceptible to a number of potentially adverse

factors. Conditions that cause these factors can occur during installation and throughout the service life of the anchor.

Twenty different epoxy products (for a total of 765 tests) were evaluated by Ronald A. Cook and Robert C. Konz in their report entitled, “Factors influencing the Bond Strength of Adhesive Anchors” [3]. From their conclusions, the two substantial concerns were the temperature and condition of the drilled hole. Subjecting adhesive anchors to an elevated temperature of 43.3°C (110° F) can substantially influence bond strength along with increased product variation. Also, the condition of the drilled hole during installation can have a substantial influence on bond strength. Products installed into holes that were damp, wet, or not cleaned out generally showed reductions in bond strength with increased variation.

1.4 Scope

A total of 90 tests were performed according to the ICBO-AC58. The testing quantities and specifications established for this project are shown in Tables 1-1 and 1-2.

Epoxy Brand	Simpson		Red Head		Covert Operations	
Model	SET22		Ceramic 6		CIA-Gel 7000	
Embedment Depth	12d	9d	12d	9d	12d	9d
Tensile Test	5	5	5	5	5	5
Seismic Test	5	5	5	5	5	5
Aged Seismic Test	5	0	0	0	0	0
High Temp Tensile Test	0	5	0	5	0	5
Creep Test	0	5	0	5	0	5

Table 1-1: Testing Quantities

Rebar Size	M19 [19.1mm dia] (#6 [3/4" dia])
Drill Diameter	22.2mm (7/8")
Rebar Material	Grade A706
Coating Thickness	0.178-0.305 mm (7-12 mils)
Deformation Pattern	S (diagonal)
Concrete Dimensions	813mm (32") dia, 279mm (11") and 356mm (14") depth

Table 1-2: Testing Specifications

2. SUMMARY OF RESULTS

The epoxy-coated rebar tested with all three epoxy adhesive brands in tension and seismic loading met or exceeded the requirements of ICBO-AC58, Section 5.3.7.2.4, “Conditions of Acceptance”.

The epoxy-coated rebar tested with the Covert Operations CIA-Gel 7000 epoxy adhesive in creep loading met or exceeded the requirements of the Caltrans Augmentation/Revisions to ICBO-AC58, Section 5.3.3.2, “Conditions of Acceptance”. However, the Simpson Strong –Tie SET22 and Red Head Epcon Ceramic 6 epoxy adhesives did not meet the requirements for creep loading.

3. PRODUCT DESCRIPTIONS

3.1 *Simpson Strong-Tie SET22*

Simpson Strong-Tie SET22 epoxy is a two-component, low odor, 1:1 ratio, 100% solids epoxy-based adhesive for use as a high strength, non-shrink anchor grouting material. Resin and hardener are dispensed and mixed simultaneously through the mixing nozzle. SET22 meets the ASTM C-881 specification for Type I, II, IV and V, Grade 3, Class B and C.

Surfaces to receive epoxy must be clean. The base material temperature must be 4.44°C (40° F) or above at the time of installation. For best results, material should be 21.1°C - 26.7°C (70° - 80° F) at the time of application. The shelf life of an unopened side-by-side cartridge is two years from the date of manufacture. The batch number and expiration date is found on each cartridge. For best results cartridges should be stored between 7.22°C (45°F) and 32.2°C (90°F). The recommended cure times for different base material temperatures are shown in Table 3-1.

Base Material Temperature		Cure Time
°F	°C	
40	4	72 hrs.
65	18	24 hrs.
85	29	20 hrs.
90	32	16 hrs.

Table 3-1: *Simpson SET22 Cure Times*

SET22 samples were randomly chosen via purchase from White Cap Industries in Rancho Cordova, CA.

3.2 *Red Head Epcon Ceramic 6*

Red Head Epcon Ceramic 6 (or C6) is a two-component, 100% solids, non-sag paste adhesive formulated for use in concrete, stone, and hollow masonry. Epoxy components are dispensed through a static mixing nozzle that thoroughly mixes the material. It meets NSF Standard 61 for use in conjunction with drinking water systems, and meets ASTM C881-90, Type IV Grade 3, Class A, B, and C with the exception of gel time.

Surfaces to receive epoxy must be clean. At temperatures between -17.8°C - 10°C (0°F - 50°F), C6 should be heated to room temperature or up to 65.6°C (150°F) maximum to improve product flow and assure proper curing. The minimum shelf life for C6 is 3 years. Two codes, a four-letter batch code and five-number cartridge code, are printed on a single sticker affixed to each epoxy cartridge. Expiration dates were not found on the cartridges, but are available on the boxes. The expiration dates for each cartridge were obtained by calling the manufacturer. The recommended cure times for different base temperatures are shown in Table 3-2.

Base Material Temperature		Working Time	Full Cure Time
°F	°C		
40	4	45 min.	32 hrs.
50	10	20 min.	24 hrs.
60	16	10 min.	2 hrs.
70	20	7 min.	1 hr.
90	32	5 min.	1 hr.
120	49	4 min.	1 hr.

Table 3-2: Red Head Epcon C6 Cure times

C6 samples were randomly chosen via purchase from White Cap Industries in Rancho Cordova, CA and Rainbow Fasteners Inc. in Sacramento, CA.

3.3 Covert Operations CIA-Gel 7000

Covert Operations CIA-Gel 7000 epoxy is a 100% solids, two-component, non-sag structural adhesive designed to be used on a wide range of applications. It is a low odor, low toxicity, and non-shrink epoxy. CIA-Gel 7000 meets ASTM C881. Resin and hardener are simultaneously dispensed and mixed through a mixing nozzle.

Surfaces to receive epoxy must be clean. Application at a substrate temperature below 4.44°C (40°F) is not recommended. Exposure to temperature exceeding 43.3°C (110°F) for prolonged periods is not recommended. The shelf life for unopened containers is a minimum of one year. CIA-Gel 7000 is not sensitive to heat or UV light, but should be prevented from freezing. The epoxy should be stored in temperatures above 4.44°C (40°F). The lot number and expiration date are printed on a label affixed to each cartridge. The recommended cure times for different base temperatures are shown in Table 3-3.

Base Material Temperature		Initial Set Time	Bolt-Up Time	Cure Time
°F	°C			
40-50	4.44-10	5 hrs.	12 hrs.	96 hrs.
50-60	10-15.6	4 hrs.	8 hrs.	72 hrs.
60-70	15.6-21.1	3 hrs.	6 hrs.	48 hrs.
70-80	21.1-26.7	2 hrs.	4 hrs.	36 hrs.
80-90	26.7-32.2	1 hrs.	4 hrs.	24 hrs.

Table 3-3: Covert Operations CIA-Gel 7000 Cure times

CIA-Gel 7000 samples were randomly chosen via purchase from White Cap Industries in Rancho Cordova, CA.

4. TEST MATERIALS

4.1 *Epoxy-Coated Rebar*

The epoxy-coated rebar samples were specified to be M19 (#6), grade A706 rebar with an “S”, or diagonal, deformation pattern. The coating thickness was specified as 0.178-0.305 mm (7-12 mils) with a gray (rigid) coating. The rebar was from the same heat and the cut ends were coated. The epoxy-coated rebar was obtained from FBC Systems, Inc. in Vallejo, CA.

4.2 *Concrete*

All testing was performed in unreinforced and uncracked concrete. The Caltrans concrete mix design T0A6342A, which has a compressive strength of 31 ± 3.45 MPa (4500 ± 500 psi), was used instead of the 20.7 ± 3.45 MPa (3000 ± 500 psi) strength requirement of ICBO-AC58. This mix design was tested because it is more representative of the mix used in the construction of Caltrans structures, and it allowed the epoxy-coated rebar to be more accurately tested. Concrete was supplied by Teichert in Sacramento, CA.

The concrete structural samples were cylinders of 813 mm (32”) in diameter and either 279 mm (11”) or 356 mm (14”) in depth (depending on embedment depth). The test surface was rough, “screed” finished to replicate field applications.

Concrete compressive test cylinders were prepared and tested in accordance with CTM 521 and ASTM C39. The actual compressive strength of the concrete when tested ranged from 30.8 MPa (4470 psi) to 43.8 MPa (6350 psi). Additional concrete data is located in Appendix A.1.

5. TEST EQUIPMENT

5.1 *Tension and Seismic Loading*

Tension and seismic testing was conducted using equipment designed in compliance with ASTM E488. The equipment used for the tension and seismic loading of the epoxy-coated rebar was a custom made system designed in by Caltrans in conjunction with SATEC. The system includes a load frame, a Labtronic 8800 Digital Controller, and a hydraulic pump.

The load frame uses a 267 kN (60 kip), 254 mm (10”) stroke hydraulic actuator to apply tension force to the rebar samples. (See Figure 5-1) Attached in-line to the end of the actuator is a load cell, a linear alignment coupler, and a bolt holder. The linear alignment coupler is a ball-in-socket type coupler that allows small x-y movement of the bolt holder via rotation about a fixed point. It is used to prevent a moment from being applied to the rebar sample during testing. The bolt holder is a high-strength part that holds the rebar gripping device. The entire frame is supported by a ring that is 12.7 mm (½”) thick by 25.4 mm (1”) tall and has an internal diameter of 635 mm (25”). This ring allows the rebar sample to experience an unconstrained failure. Therefore, the rebar

sample can fail in a number of ways which best simulates actual failures in the field. The load frame was moved onto and off of the samples with a gantry crane due to its weight.

The Labtronic 8800 Digital Controller is a sophisticated device that allows a multitude of testing capabilities. The controller manages the hydraulics to perform the necessary tension and seismic loading conditions. The controller is connected to a laptop computer, which collects all of the pertinent test data. The controller is housed in a watertight cabinet and mounted to a cart along side the hydraulic pump. (See Figure 5-2)

The load measurements were obtained from the 267 kN (60 kip) load cell on the load frame. The displacement measurements were obtained by a pair of ± 25.4 mm (± 1 ") stroke AC LVDT's. The LVDT's were attached to the rebar by a custom made bracket that holds them 381 mm (15") away from the rebar in opposite directions. Using two LVDT's in this configuration and taking their average helps to minimize errors that can occur from misaligned samples. The displacements were measured relative to the concrete test surface. The LVDTs' were calibrated with the Labtronic controller at the beginning of each test day. (See Figure 5-3)



Figure 5-1: 267 kN (60 kip) Load Frame



Figure 5-2: Cart with Controller and Hydraulic Pump



Figure 5-3: LVDT Bracket

5.2 Creep Loading

In order to perform the testing in a timely manner, a method of applying a creep load to five samples simultaneously was developed. For each sample this method uses a hydraulic actuator, a spherical washer set, a *barlock* rebar clamp, a pair of LVDT's, an LVDT bracket, and a hydraulic actuator support frame. The *barlock* screws into the rebar to create a shoulder for the actuator to push against. The spherical washer is placed between the actuator piston and the *barlock*, and is used to minimize any moment in the system. The actuator support frame is made of two steel C-channels and two I-beams welded together, and holds the actuator above the concrete test surface. The I-beams support the actuator load and they sit on the concrete test surface allowing a clearance of about 229 mm (9") around the rebar. This clearance creates an unconstrained condition on the rebar and allows any type of failure mode. The LVDT's are mounted in the same manner as for the tension testing, however; they only allow 229 mm (9") of clearance around the rebar and have a full stroke of ± 12.7 mm (± 0.5 "). (See Figures 5-4 and 5-5)

An air-powered pump simultaneously pressurizes all five actuators. This pump is driven by a static compressed air supply, which converts air pressure to hydraulic pressure through a mechanical piston ratio. Once pressurized, the pump holds a constant pressure, which in turn applies a constant load on the rebar samples. (See Figure 5-6)



Figure 5-4: Creep Loading Setup



Figure 5-5: LVDT Bracket for Creep Testing



Figure 5-6: Air Powered Pump

5.3 Environmental Chamber

An environmental chamber was used to bring the samples to the appropriate temperatures for testing. The chamber that was used is a wooden shed that is fully insulated. It is equipped with an HVAC unit with enough capacity to bring the chamber to the necessary temperatures regardless of outside temperature. A programmable thermostat was used to maintain the necessary temperature tolerance.

5.4 Other Equipment

Testing could not be performed inside of the environmental chamber because it was too small. Therefore, a method of moving the heavy concrete test cylinders was necessary. A small steel cart was designed that would allow the cylinders to be moved in and out of the chamber one at a time as needed (see Figure 5-7).

The load frame was equipped with a bolt holder that is used to grip threaded rod outfitted with a nut and washer. Since there was not an easy method of attaching a nut and washer to the rebar, a gripping device was designed specially to grip the rebar and fit into the bolt holder. This rebar grip consists of three tapered conical jaws in a tapered cylindrical housing (see Figure 5-9). As the gripper is pulled up with a piece of rebar in the jaws, the jaws will grip into the rebar at a ratio of approximately 6:1 of the pulling load. This gives a firm grip on the rebar to minimize the possibility of rebar slippage during testing.

During the creep testing of the rebar, data must be collected at anywhere from minutely to daily during the span of testing. For this, a Campbell Scientific CR23X datalogger was used (see Figure 5-8). For the first 6 hours of testing, the datalogger was programmed to collect all data every three seconds. This gave more than enough data to accurately record the initial elastic deformation and the critical first six hours of rebar displacement. After the first six hours, the datalogger was programmed to collect all data on an hourly basis. This gave enough data to satisfy all requirements. The datalogger program is located in Appendix B.

To minimize the clutter of wiring from the 10 LVDT's, a multiplexer with integrated power supply was designed and fabricated (see Figure 5-10). This LVDT multiplexer allowed the 10 LVDT's to be plugged into it, gave the appropriate power to each LVDT, and output a clean set of 10 twisted wire pairs to be connected to the datalogger. This multiplexer greatly facilitated connecting and disconnecting the LVDT's between tests.



Figure 5-7: Concrete Cylinder Mover



Figure 5-8: Campbell Scientific Datalogger



Figure 5-9: Rebar Gripper



Figure 5-10: LVDT Multiplexer

More detailed information for most of the equipment described in this section may be found in Appendix C in the form of data sheets and/or drawings.

6. INSTALLATION INSTRUCTIONS

For each epoxy adhesive, the epoxy-coated rebar was installed into concrete cylinders measuring 813 mm (32") in diameter by 279 mm (11") deep for the 9d [171.5mm (6 3/4")] embedment depth, and 813 mm (32") in diameter by 356 mm (14") deep for the 12d [228.6mm (9")] embedment depth. Holes were drilled into the hardened concrete using a rotary hammer to depths of 171.5 mm (6 3/4") or 228.6 mm (9") depending on the test. The freshly drilled holes were blown out with compressed air, thoroughly brushed, and blown out again until no particles blew out. Tape was immediately put over each cleaned hole until the rebar was installed to prevent debris infiltration. The holes were drilled to a size of 22.2 mm (7/8") in diameter at less than 6° from vertical.

The concrete cylinders were brought to a temperature of $21.1^{\circ}\text{C} \pm 2.8^{\circ}\text{C}$ ($70^{\circ}\text{F} \pm 5^{\circ}\text{F}$) in an environmental chamber. The epoxy adhesive was dispensed into each hole from the bottom up, filling each hole approximately half way. The epoxy-coated rebar was then inserted into each adhesive filled hole with a twisting motion to help eliminate air pockets from forming. The epoxy adhesive was allowed to cure for 48 hours at $21.1^{\circ}\text{C} \pm 2.8^{\circ}\text{C}$ ($70^{\circ}\text{F} \pm 5^{\circ}\text{F}$) prior to testing.

7. TEST PROCEDURE

Testing was conducted in accordance with ICBO-AC58, ASTM E488-96, ASTM E1512-01, CTM 681, and Caltrans Augmentation/Revisions to ICBO-AC58, except for concrete compressive strength in which a higher strength than required was used.

7.1 *Tension and Seismic Tests*

Tension and seismic tests were first performed on the 12d embedment depth epoxy-coated rebar samples, and then the 9d. Ten samples were tested at a time; five samples for each tension and seismic loadings. One at a time, the cured samples were brought outside from an environmental chamber at $21.1^{\circ}\text{C} \pm 2.8^{\circ}\text{C}$ ($70^{\circ}\text{F} \pm 5^{\circ}\text{F}$) and quickly tested. The samples were unconstrained to allow any possible failure mode.

Five samples (controls) were tested in tension until failure and an average ultimate load was determined, T_{ref} . Loading criteria, N_s , N_i , and N_m , for the seismic tests were then calculated using the average ultimate load (see Figure 7-1). The remaining five samples were then tested in seismic loading at a frequency of 0.5 Hz and according to the calculated loading criteria. Immediately after the seismic loading was complete, the samples were pulled in tension until failure. An average ultimate tension load after seismic loading was calculated.

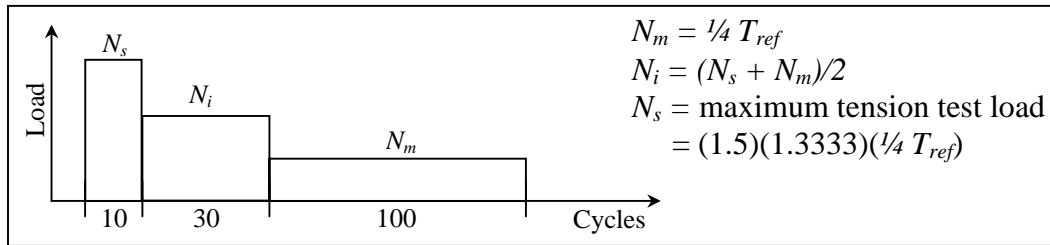

Figure 7-1: Seismic Loading Criteria

7.2 Creep Tests

High temperature creep tests were performed on samples with the 9d embedment depth only. Ten cured samples were brought up to $43.3\text{ }^{\circ}\text{C} \pm 1.65^{\circ}\text{C}$ ($110^{\circ}\text{F} \pm 3^{\circ}\text{F}$) in an environmental chamber in approximately 24 hours. Elevated temperature tension tests were first performed on five of the samples. One at a time, the heated samples were taken out of the heated environmental chamber and quickly tested. A maximum displacement at ultimate load was calculated from the five high temperature tests.

A sustained creep load of 40% of the average ultimate load, T_{ref} , was applied to the remaining five samples by the use of an air-powered hydraulic pump and five hydraulic actuators. Each sample was fitted with a hydraulic actuator, one set of spherical washers, a *barlock* clamping device, an actuator support fixture, and a bracket which held two LVDT's 228.6mm (9") away from the rebar in opposite directions. One of the five samples was also equipped with a load cell.

With the samples already up to temperature, a preload of approximately 4% of the sustained creep load was applied to the samples. The displacements were then zeroed, and the remaining sustained creep load was applied. The displacements were recorded every three seconds for the first six hours, and hourly until the end of the test cycle. Other data that was recorded hourly until the end of the test cycle includes: internal chamber temperature and humidity, tension force applied to the rebar, air pump pressure, sample concrete temperature, and outside temperature. The samples were left in the environmental chamber that was programmed to warm up to $43.3\text{ }^{\circ}\text{C} \pm 1.65^{\circ}\text{C}$ ($110^{\circ}\text{F} \pm 3^{\circ}\text{F}$) and maintain that temperature within $\pm 1.65^{\circ}\text{C}$ ($\pm 3^{\circ}\text{F}$) for at least 42 days. The sample concrete temperature was recorded by a thermocouple cast into two of the five samples 114 mm ($4\frac{1}{2}$ ") down from the test surface.

After the 42-day test cycle, the samples were unloaded and the fixtures were removed. The rebar was then cut to a length of approximately 203 mm (8") to both remove the marred section of rebar created by the *barlocks*, and to allow the sample to fit into the testing machine. One at a time, each sample was then taken out of the heated chamber and quickly tested in tension until failure.

Data and specific details for the above test procedure may be found in the Appendix, and are summarized in Section 8, Test Results.

8. TEST RESULTS

The testing revealed that epoxy-coated rebar bonded into hardened concrete generally outperforms uncoated rebar in tensile loading, however; it under performs uncoated rebar in creep loading. One interesting discovery was that failures occurred via the adhesive debonding from the epoxy coating on the rebar. For uncoated rebar, the adhesive rarely debonds from the rebar interface. The seismic testing revealed that the epoxy-coated rebar satisfied the ICBO-AC58 conditions of acceptance for each adhesive. A summary of all tests performed is displayed in Tables 8-1 through 8-3.

After performing the tests and having the concrete test cylinders compression tested, the concrete strength was found to be slightly higher than initially intended. The concrete strength was found to be in the range of 30.8 MPa (4470 psi) to 43.8 MPa (6350 psi). Even with the higher strength concrete, the epoxy-coated rebar still failed the creep tests for two adhesives.

Test Type	Sample #	Date	Time	Outside Temp		Max Load		Max Displacement		Method of Failure	Average Load N (lbf)	Average Disp mm (in)
				F	C	lbf	N	in	mm			
SET22 12d Tensile	1	10/01/03	9:35	63.8	35.4	38570	171637	0.1926	4.892	Adhesive	178436 (40098)	6.962 (0.2741)
	2	10/01/03	10:24	69.0	38.3	41320	183874	0.4361	11.077	Adhesive		
	3	10/01/03	11:16	74.6	41.4	40550	180448	-	-	Rebar Gripper		
	4	10/01/03	11:44	76.4	42.4	40590	180626	0.2702	6.863	Rebar		
	5	10/01/03	12:14	76.0	42.2	39460	175597	0.1975	5.017	Rebar		
SET22 12d Seismic	1	10/01/03	13:25	81.8	45.4	40160	178712	0.1802	4.576	Rebar	182121 (40926)	5.453 (0.2147)
	2	10/01/03	13:52	81.4	45.2	40910	182050	0.1610	4.090	Rebar		
	3	10/01/03	14:21	82.2	45.7	40980	182361	0.2926	7.432	Rebar		
	4	10/01/03	14:57	82.0	45.6	41090	182851	0.2420	6.148	Rebar		
	5	10/01/03	15:37	81.0	45.0	41490	184631	0.1977	5.021	Rebar		
SET22 9d Tensile	1	10/08/03	11:25	76.2	42.3	33960	151122	0.0982	2.495	Conc/Adhesive	149983 (33704)	2.654 (0.1045)
	2	10/08/03	11:51	77.8	43.2	32610	145115	0.0716	1.819	Conc/Adhesive		
	3	10/08/03	12:28	80.0	44.4	33290	148141	0.0998	2.535	Adhesive		
	4	10/08/03	12:50	81.6	45.3	33520	149164	0.1068	2.712	Adhesive		
	5	10/08/03	13:12	78.8	43.8	35140	156373	0.1461	3.711	Adhesive		
SET22 9d Seismic	1	10/08/03	14:20	82.2	45.7	33140	147473	0.0924	2.346	Adhesive	148354 (33338)	2.474 (0.0974)
	2	10/08/03	14:46	83.6	46.4	35110	156240	0.1229	3.122	Adhesive		
	3	10/08/03	15:10	83.6	46.4	32040	142578	0.0800	2.032	Adhesive		
	4	10/08/03	15:34	84.2	46.8	33580	149431	0.0942	2.392	Adhesive		
	5	10/08/03	15:55	83.4	46.3	32820	146049	0.0976	2.480	Adhesive		
SET22 9d Elevated Temperature Tensile	1	10/17/03	14:54	82.2	45.7	31500	140175	0.0717	1.822	Conc/Adhesive	139107 (31260)	6.312 (0.2485)
	2	10/17/03	15:16	82.2	45.7	29840	132788	0.1079	2.741	Conc/Adhesive		
	3	10/17/03	15:35	82.2	45.7	30880	137416	0.2774	7.045	Adhesive		
	4	10/17/03	15:51	82.0	45.6	32340	143913	0.3552	9.021	Adhesive		
	5	10/17/03	16:09	82.2	45.7	31740	141243	0.4304	10.931	Conc/Adhesive		
SET22 9d Elevated Temperature Creep Tensile	5	12/01/03	11:20	63.4	35.2	25790	114766	0.0578	1.467	Adhesive	117142 (26324)	1.359 (0.0535)
	1	12/01/03	11:47	63.8	35.4	29500	131275	0.0507	1.289	Adhesive		
	2	12/01/03	12:10	60.8	33.8	26290	116991	0.0440	1.117	Conc/Adhesive		
	4	12/01/03	12:31	59.4	33.0	25660	114187	0.0439	1.116	Conc/Adhesive		
	3	12/01/03	12:51	60.0	33.3	24380	108491	0.0711	1.807	Conc/Adhesive		

Table 8-1: Summary of Results for SET22 Epoxy Testing

Test Type	Sample #	Date	Time	Outside Temp		Max Load		Max Displacement		Method of Failure	Average Load N (lbf)	Average Disp mm (in)
				F	C	lbf	N	in	mm			
Ceramic 6 12d Tensile	1	12/05/03	9:39	56.4	31.3	37850	168433	0.2681	6.811	Adhesive	155323 (34904)	4.767 (0.1877)
	2	12/05/03	10:09	57.8	32.1	35790	159266	0.2041	5.185	Adhesive		
	3	12/05/03	10:32	58.6	32.6	38620	171859	0.2744	6.970	Adhesive		
	4	12/05/03	10:55	60.6	33.7	32520	144714	0.1255	3.188	Adhesive		
	5	12/05/03	11:18	60.0	33.3	29740	132343	0.0662	1.681	Adhesive		
Ceramic 6 12d Seismic	1	12/05/03	12:27	61.6	34.2	33560	149342	0.0668	1.696	Adhesive	148924 (37123)	4.807 (0.1893)
	2	12/05/03	12:54	62.0	34.4	36950	164428	0.2387	6.062	Adhesive		
	3	12/05/03	13:18	62.6	34.8	39900	177555	0.3157	8.020	Adhesive		
	4	12/05/03	13:46	63.0	35.0	38080	169456	0.2271	5.768	Adhesive		
	5	12/05/03	14:13	64.4	35.8	18840	83838	0.0980	2.489	Adhesive		
Ceramic 6 9d Tensile	1	12/10/03	9:06	58.6	32.6	29880	132966	0.1040	2.641	Adhesive	142178 (31950)	2.987 (0.1176)
	2	12/10/03	9:26	58.8	32.7	31380	139641	0.0798	2.028	Adhesive		
	3	12/10/03	9:44	57.4	31.9	32660	145337	0.1157	2.940	Adhesive		
	4	12/10/03	10:00	58.2	32.3	33470	148942	0.1515	3.847	Adhesive		
	5	12/10/03	10:17	58.8	32.7	32360	144002	0.1369	3.478	Adhesive		
Ceramic 6 9d Seismic	1	12/10/03	10:37	59.0	32.8	32430	144314	0.1298	3.298	Adhesive	140967 (31678)	2.761 (0.1087)
	2	12/10/03	10:57	60.2	33.4	31990	142356	0.0866	2.200	Adhesive		
	3	12/10/03	11:15	61.2	34.0	31440	139908	0.1292	3.281	Adhesive		
	4	12/10/03	11:34	60.2	33.4	31670	140932	0.1267	3.217	Adhesive		
	5	12/10/03	11:55	61.2	34.0	30860	137327	0.0711	1.807	Adhesive		
Ceramic 6 9d Elevated Temperature Tensile	1	12/18/03	14:09	60.0	33.3	29420	130919	0.1032	2.622	Adhesive	131435 (29536)	3.336 (0.1313)
	2	12/18/03	14:25	60.6	33.7	27630	122954	0.1292	3.282	Adhesive		
	3	12/18/03	14:40	60.2	33.4	29430	130964	0.1398	3.551	Adhesive		
	4	12/18/03	14:58	61.4	34.1	30550	135948	0.1063	2.700	Adhesive		
	5	12/18/03	15:13	61.2	34.0	30650	136393	0.1782	4.526	Adhesive		
Ceramic 6 9d Elevated Temperature Creep Tensile	5	01/30/04	11:09	50.6	28.1	31110	138440	0.2159	5.483	Adhesive	130897 (29415)	3.778 (0.1487)
	3	01/30/04	11:49	52.2	29.0	27850	123933	0.1125	2.858	Adhesive		
	2	01/30/04	12:10	54.2	30.1	27590	122776	0.0564	1.432	Adhesive		
	1	01/30/04	12:30	54.0	30.0	31110	138440	0.2101	5.337	Adhesive		
	4	01/30/04	-	-	-	FAILED	-	-	-	-		

Table 8-2: Summary of Results for Red Head Epcon C6 Epoxy Testing

Test Type	Sample #	Date	Time	Outside Temp		Max Load		Max Displacement		Method of Failure	Average Load N (lbf)	Average Disp mm (in)
				(F)	(C)	(lbf)	(N)	(in)	(mm)			
CIA-Gel 7000 12d Tensile	1	02/04/04	9:13	50.0	27.8	41060	182717	0.4179	10.615	Rebar	168148 (37786)	12.066 (0.475)
	2	02/04/04	9:36	50.6	28.1	38770	172527	0.6421	16.310	Adhesive		
	3	02/04/04	9:57	47.6	26.4	32210	143335	0.3222	8.183	Adhesive		
	4	02/04/04	10:25	49.6	27.6	38710	172260	0.4926	12.512	Adhesive		
	5	02/04/04	10:42	50.4	28.0	38180	169901	0.5003	12.708	Adhesive		
CIA-Gel 7000 12d Seismic	1	02/04/04	11:12	52.6	29.2	40460	180047	0.6411	16.283	Adhesive	179415 (40318)	15.522 (0.6111)
	2	02/04/04	11:42	55.8	31.0	40040	178178	0.5258	13.355	Adhesive		
	3	02/04/04	12:06	56.8	31.6	41610	185165	0.6961	17.681	Rebar		
	4	02/04/04	12:29	58.4	32.4	40260	179157	0.6216	15.789	Adhesive		
	5	02/04/04	12:52	59.6	33.1	39220	174529	0.5710	14.503	Adhesive		
CIA-Gel 7000 9d Tensile	1	02/11/04	9:32	54.0	30.0	29460	131097	0.0699	1.776	Adhesive	139890 (31436)	3.795 (0.1494)
	2	02/11/04	9:52	55.6	30.9	32210	143335	0.1772	4.500	Adhesive		
	3	02/11/04	10:09	57.0	31.7	28000	124600	0.1612	4.094	Adhesive		
	4	02/11/04	10:25	57.2	31.8	32230	143424	0.0838	2.129	Adhesive		
	5	02/11/04	10:37	56.8	31.6	35280	156996	0.2550	6.476	Adhesive		
CIA-Gel 7000 9d Seismic	1	02/11/04	10:55	60.4	33.6	32640	145248	0.1060	2.693	Conc/Adhesive	133865 (30082)	2.014 (0.0793)
	2	02/11/04	11:12	58.4	32.4	28910	128650	0.0661	1.680	Adhesive		
	3	02/11/04	12:30	68.0	37.8	28910	128650	0.0302	0.768	Conc/Adhesive		
	4	02/11/04	12:50	61.0	33.9	29490	131231	0.0904	2.295	Adhesive		
	5	02/11/04	13:08	61.4	34.1	30460	135547	0.1036	2.632	Adhesive		
CIA-Gel 7000 9d Elevated Temperature Tensile	1	02/20/04	9:19	54.4	30.2	28800	128160	0.0452	1.149	Adhesive	136437 (30660)	1.719 (0.0677)
	2	02/20/04	9:34	55.4	30.8	28430	126514	0.0473	1.201	Adhesive		
	3	02/20/04	9:47	56.2	31.2	32330	143869	0.0866	2.200	Conc/Adhesive		
	4	02/20/04	10:05	56.4	31.3	31230	138974	0.0663	1.683	Adhesive		
	5	02/20/04	10:23	58.4	32.4	32510	144670	0.0929	2.360	Conc/Adhesive		
CIA-Gel 7000 9d Elevated Temperature Creep Tensile	1	04/05/04	10:55	69.8	38.8	34330	152769	0.1285	3.263	Adhesive	139401 (31326)	2.025 (0.0797)
	2	04/06/04	11:17	66.4	36.9	33050	147073	0.0525	1.333	Adhesive		
	3	04/07/04	11:35	68.0	37.8	33200	147740	0.1296	3.292	Adhesive		
	4	04/08/04	11:50	62.6	34.8	29780	132521	0.0541	1.375	Adhesive		
	5	04/09/04	12:03	68.2	37.9	26270	116902	0.0340	0.864	Conc/Adhesive		

Table 8-3: Summary of Results for CIA-Gel 7000 7000 Epoxy Testing

8.1 Tension and Seismic Tests

For the CIA-Gel 7000 and Ceramic 6 adhesives, the average ultimate strength from tensile loading of the bonded epoxy-coated rebar was found to be slightly higher than the manufacturers specifications for uncoated rebar. However, the SET22 adhesive under performed the manufacturer specifications for uncoated rebar. This shows that epoxy-coated rebar bonded in hardened concrete generally performs comparable to uncoated rebar. Tables 8-4 and 8-5 summarize the tension and seismic test results and give the conditions of acceptance.

Preliminary Test Results and Seismic Parameters Tension and Seismic Test ICBO-AC58 4000 to 5000 psi Concrete (Caltrans Mix T0A6342A)								
Tension Seismic - M19 (19.1 mm) [#6 (0.75 in)] Rebar								
Embedment	Epoxy Type	Average Ultimate Tension - Controls (Tref)			Seismic Load Levels (N) @ 0.5 Hz			
		Avg. Load N (lb)	Preload N (lb)	Failure (%)	Ns 10 cycles	Ni 30 cycles	Nm 100 cycles	
228.6 mm (9") [12d]	SET22	178436 (40098)	4450 (1000)	2.49	2-epoxy 1-grip 2-rebar	89215 (20048)	66912 (15036)	44609 (10024)
	Red Head	155323 (34904)	4450 (1000)	2.86	5-epoxy	77659 (17451)	58245 (13089)	38831 (8726)
	CIA-GEL 7000	168148 (37786)	4450 (1000)	2.65	4-epoxy 1-rebar	84072 (18893)	63054 (14169)	42037 (9447)
171.5 mm (6-3/4") [9d]	SET22	149983 (33704)	4450 (1000)	2.97	3-epoxy 2-cnc/epy	74989 (16851)	56242 (12639)	37495 (8426)
	Red Head	142178 (31950)	4450 (1000)	3.13	5-epoxy	71087 (15975)	53316 (11981)	35544 (7987)
	CIA-GEL 7000	139890 (31436)	4450 (1000)	3.18	5-epoxy	69943 (15718)	52458 (11788)	34973 (7859)

Table 8-4: Preliminary Test Results and Seismic Parameters

Conditions of Acceptance Per Caltrans Augmentation to AC58 Section 5.3.7.2.2 Tension and Seismic Test ICBO-AC58 4000 to 5000 psi Concrete (Caltrans Mix T0A6342A)									
Tension Seismic - M19 (19.1 mm) [#6 (0.75 in)] Rebar									
Embedment	Epoxy Type	Average Ultimate Tension - After Seismic				Pass/ Fail	Maximum Peak Displacement, mm (in) ($\Delta_{ns} \leq (N_s/T_{ref}) * \Delta_{ult}$)		
		Avg. Load N (lb)	Preload N (lb)	Failure (%)	Failure Mode		Ns 10 cycles	Ni 30 cycles	Nm 100 cycles
228.6 mm (9") [12d]	SET22	182121 (40926)	4450 (1000)	2.44	5-rebar	Pass	$0.684 \leq 3.481$ (0.026 \leq 0.137)	$0.734 \leq 3.481$ (0.029 \leq 0.137)	$0.504 \leq 3.481$ (0.020 \leq 0.137)
	Red Head	148924 (33466)	4450 (1000)	2.99	5-epoxy	Pass	$1.563 \leq 2.383$ (0.062 \leq 0.0938)	$1.459 \leq 2.383$ (0.057 \leq 0.0938)	$1.291 \leq 2.383$ (0.051 \leq 0.0938)
	CIA-GEL 7000	179415 (40318)	4450 (1000)	2.48	4-epoxy 1-rebar	Pass	$0.664 \leq 6.033$ (0.026 \leq 0.238)	$0.604 \leq 6.033$ (0.024 \leq 0.238)	$0.537 \leq 6.033$ (0.021 \leq 0.238)
171.5 mm (6-3/4") [9d]	SET22	148354 (33338)	4450 (1000)	3.00	5-epoxy	Pass	$0.224 \leq 1.327$ (0.009 \leq 0.0522)	$0.177 \leq 1.327$ (0.007 \leq 0.0522)	$0.123 \leq 1.327$ (0.005 \leq 0.0522)
	Red Head	140967 (31678)	4450 (1000)	3.16	5-epoxy	Pass	$0.337 \leq 1.493$ (0.013 \leq 0.0588)	$0.286 \leq 1.493$ (0.011 \leq 0.0588)	$0.236 \leq 1.493$ (0.009 \leq 0.0588)
	CIA-GEL 7000	133865 (30082)	4450 (1000)	3.32	3-epoxy 2-epy/cnc	Pass	$0.373 \leq 1.897$ (0.015 \leq 0.0747)	$0.326 \leq 1.897$ (0.013 \leq 0.0747)	$0.274 \leq 1.897$ (0.011 \leq 0.0747)

Table 8-5: Seismic Test Conditions of Acceptance

8.1.1 Simpson SET22

This was the first epoxy tested and therefore, was the test with the most errors. The first two tension tests on the 12d embedment depth were performed without oversight. However, on the third test the rebar gripper slipped off of the rebar just before failure of the rebar due to the gripper being inadvertently placed over the lettering on the

rebar. The lettering created an area where the gripper could not fully engage the rebar, and therefore caused slippage. On tests 4 and 5, the LVDT bracket came loose from the rebar causing it to slip down the rebar just before failure, and thus creating inaccurate displacement data. This occurred because the LVDT bracket was unable to maintain a tight grip once the rebar began to neck. Figures A-6 through A-10 in the appendix show the load vs. displacement curves for the five 12d tension tests.

After the tension tests, the seismic tests for the 12d embedment depth were performed. For these tests, every failure was a rebar failure. This caused excessive necking in the rebar just before failure, which allowed the LVDT bracket to slip down on every test. This, again, created erroneous displacement data. The load vs. displacement plots for the 12d seismic tests can be seen in Figures A-11 through A-15.

The 9d embedment depth tests were performed next and done so without fault. Figures A-16 through A-25 show the results for the tension and seismic tests in graphical form. See Table 8-1 for all results from SET22 epoxy testing summarized in tabular form.

8.1.2 Red Head Epcon C6

For the testing of the Red Head Epoxy, the LVDT bracket was improved to accommodate for necking of the rebar. During its installation into the concrete, the epoxy adhesive began to harden before all ten 12d cylinders could be filled. This caused the need to use another epoxy cartridge to fill the last two samples. These two samples were numbers 1 and 3 of the tensile test group. During the tensile testing it was found that the two samples with the epoxy from the second cartridge had slightly higher strengths than the other three, however the values were within reasonable tolerances (see Table 8-2).

In addition to the premature hardening of the epoxy, sample #5 in the 12d seismic test group did not receive enough epoxy. After testing this sample, it was noticed that the strength was much lower than the other four samples, and therefore the data for this sample was neglected. Figures A-33 through A-42 show the results for the 12d tensile and seismic tests.

The 9d testing was performed without fault and the results can be found in Figures A-43 through A-52.

8.1.3 Covert Operations CIA-Gel 7000

All tensile and seismic tests for CIA-Gel 7000 were performed without errors and the results can be found in Figures A-60 through A-79. The results are also summarized in Table 8-3.

8.2 Creep Tests

8.2.1 Simpson SET22

During the elevated temperature creep tests for the SET22 epoxy, one of the hydraulic rams leaked out all of the hydraulic fluid from the pump on day 41 of testing.

This caused a complete loss of pressure, and therefore a complete loss of loading on the samples. Although the creep testing did not go for the minimum 42-day period, testing continued. The creep testing data and results are shown in Figures A-26 through A-30. In Figure A-29 some very large spikes can be seen in the temperature graph. These spikes are not actual temperature fluctuations, however they are due to electronic interference with the datalogging device and should therefore be ignored. The tension tests after creep were performed and the results can be found in Figure A-32.

The average displacement at ultimate load from the elevated temperature tensile tests was compared to the 1.52mm (0.06") requirement from the Caltrans Augmentation to ICBO-AC58, and was found to be a higher value (6.31 mm, [0.248"]). Therefore, the 1.52mm (0.06") displacement value is the requirement to be met. The average displacement at 600 days was found to be 1.50 mm (0.0591"), however this is the average of all five samples. One sample (sample #3) strayed from the other four, and those four samples all failed to meet the displacement limit, with an average of 1.59 mm (0.0626"). This leads to the conclusion that sample #3 should be neglected and that the epoxy-coated rebar bonded with SET22 did not meet the required displacement criteria.

Revision (2007): Due to the load fluctuations of 5.3 kN or about 10% of the creep load on day 27, it is recommended to use only the first 26 days of data were used for the logarithmic curve fit. The revised 600-day creep value is 1.02 mm.

8.2.2 Red Head Epcon C6

The displacement criteria for the Red Head epoxy testing was determined to be 1.52 mm (0.06"), because the average displacement at ultimate load of the elevated temperature tensile tests was found to be 3.34 mm (0.131"). The elevated temperature tensile tests results can be seen on Figure A-58.

During the elevated temperature creep testing with the Red Head epoxy, all five of the samples failed the Caltrans Augmentation to ICBO-AC58 displacement criteria (Section 5.3.3.2) before the 42-day creep cycle was over. Two of the samples displaced farther than the stroke of the LVDT's, with one of them pulling completely out of the concrete. This event can be seen on Figure A-55. Without a doubt, the epoxy-coated rebar bonded with Red Head Epcon C6 did not meet the required displacement criteria. The average displacement at 600 days was found to be 2.75 mm (0.108"). The results for this creep testing can be found on Figures A-53 through A-57, and the results for the tensile testing after creep can be found on Figure A-59. As in the SET22 testing, the spikes on Figure A-56 are not actual temperature fluctuations, but are due to electronic interference with the datalogger.

8.2.3 Covert Operations CIA-Gel 7000

The CIA-Gel 7000 average displacement at ultimate load for the elevated temperature tensile tests was found to be 1.72 mm (0.0676"). Since this value is higher than that set by the Caltrans Augmentation to ICBO-AC58, the displacement limit was set as 1.52 mm (0.06"). The elevated temperature tensile test results can be seen on Figure A-85.

The average displacement at 600 days for the epoxy-coated rebar bonded with CIA-Gel 7000 was found to be 0.538 mm (0.0212"). This shows that the epoxy-coated rebar bonded with CIA-Gel 7000 did meet the displacement criteria. The creep testing results are shown in Figures A-80 through A-84. Once again, the temperature spikes

during the first 11 days in Figure A-83 are not actual temperature fluctuations, but are due to electronic interference with the datalogger. The small jump and rebound in displacement near day 37 was due to a jump in pressure from pump inaccuracies. The pressure jump occurred over a weekend and was compensated for as soon as it was discovered. The results for the elevated temperature tensile tests after creep are shown in Figure A-86.

9. CONCLUSION

The epoxy-coated rebar was found to meet the conditions of acceptance for seismic loading when bonded into hardened concrete using an epoxy adhesive. However, the epoxy-coated rebar did not meet the conditions of acceptance for creep loading when bonded into hardened concrete. The rebar bonded with CIA-Gel 7000 was found to meet the creep requirements, whereas the rebar bonded with SET22 and Red Head Epcon C6 did not meet the conditions of acceptance for creep loading. It was also noticed that, when compared to the manufacturer test data, the epoxy-coated rebar outperformed uncoated rebar in allowable tensile loads for two of the three epoxies tested. SET22 adhesive under performed the manufacturer test data.

Although the testing procedures and instrumentation were burdened with error, the testing revealed enough accurate data to be valuable. The displacement data on the 12d testing with the SET22 epoxy was accurate until the last few seconds of each test, where the LVDT brackets slipped creating inaccurate data. Even though the displacement data was not complete, the loading data was complete and accurate. Beneficially, the incomplete portions of data did not affect the calculation of the conditions of acceptance. The interference in the instrumentation that created undesirable spikes in the temperature data was not found to be detrimental to the testing. The temperature was often checked manually to ensure that it was within the allowable tolerances.

The target concrete compressive strength was 31 ± 3.45 MPa (4500 ± 500 psi), however the actual strength ranged from 30.8 MPa (4470 psi) to 43.8 MPa (6350 psi). The concrete mix design used in this testing is representative of the mix used in the construction of Caltrans structures. Since this testing is designed to evaluate epoxy-coated rebar in actual use applications, the data obtained from the testing is in direct correlation.

Overall, this testing has proved to be valuable and has provided a better understanding of how epoxy-coated rebar reacts when bonded into hardened concrete with different epoxy adhesives.

10. RECOMMENDATION

It is recommended that a higher factor of safety be applied to epoxy-coated rebar than is to uncoated rebar when bonding it into hardened concrete. This can be done in the form of a deeper embedment depth or other method. The Reinforced Concrete Committee should determine whether a change in the general notes of the pre-qualified products list for cartridge epoxies / chemical adhesives is necessary to address the factor of safety modification. Also, the Reinforced Concrete Committee should review the

creep displacement acceptance criteria to determine if the value should be changed to accommodate epoxy-coated rebar, or if a separate set of specifications should be made for epoxy-coated rebar. The Red Head Epcon C6 epoxy is currently not on the Caltrans pre-qualified products list, and from the results in this testing, it is recommended that it stay off of the list.

11. IMPLEMENTATION

The Office of Structure Design will be responsible for the modification of the pre-qualified products list for cartridge epoxies / chemical adhesives and the bridge design aids for the use of epoxy-coated rebar bonded into hardened concrete.

12. REFERENCES

- [1] California Department of Transportation, Division of Engineering Services, "Caltrans Augmentation/Revisions to ICBO-AC58, Acceptance Criteria for Adhesive Anchors in Concrete and Masonry Elements", November 2001.
- [2] Choi, O. C., Hadje-Ghaffari, H., Darwin, D. and McCabe, S. L., "Bond of Epoxy-Coated Reinforcement: Bar Parameters", ACI Materials Journal, No. 88-M26, March-April 1991.
- [3] Cook, R. A. and Konz, R. C., "Factors Influencing Bond Strength of Adhesive Anchors," ACI Structural Journal, V.98, N.1, January-February 2001, pp. 76-86.

APPENDIX

Appendix A General Test Data

A.1 Kelly Ball and Slump Test Results

Epoxy	Time Date	Air Temp	Concrete Temp	Kelly Ball	Slump	Mix Design
SET22	12:00 9/2/2003	26.9°C (80.4°F)	28.6°C (83.4°F)	54 mm (2-1/8")	63.5 mm (2-1/2")	T0A6342A
Ceramic 6	14:30 11/5/2003	17.8°C (64.0°F)	22.7°C (72.8°F)	50.8 mm (2")	63.5 mm (2-1/2")	T0A6342A
CIA-GEL 7000	14:00 1/5/2004	10°C (50°F)	-	63.5 mm (2-1/2")	82.5mm (3-1/4")	T0A6342A

Table A-1: Concrete Pour Information

A.2 Epoxy Information

Epoxy	Lot Number	Expiration Date
SET22	M219N010	Jan-05
Ceramic 6		
<i>12d Tests</i>	EONS 47029	Jan-06
<i>12d Tests (tensile test samples 1 & 3)</i>	EONR 79212	Sep-05
<i>9d Tests</i>	EONT 51816	Nov-05
<i>9d Creep Tests</i>	EONT 51817	Nov-05
CIA-Gel 7000	745	Nov-04

Table A-2: Epoxy Adhesive Information

A.3 Concrete Test Results

TL No.: 134606

Contract No.: 65-680321

Cast Date: 9/2/2003

Break Date	Concrete Lab Sample No.	Cylinder No.	Cylinder Age	Peak Load	Compressive Strength	Test Result (Average)
9/29/03	CL031730	1/2	27 days	588 kN (132300 lbf)	32.3 MPa (4679 psi)	32.5 MPa (4710 psi)
		2/2		597 kN (134200 lbf)	32.7 MPa (4746 psi)	
10/1/03	CL031731	1/2	29 days	604 kN (135700 lbf)	33.1 MPa (4799 psi)	33.2 MPa (4810 psi)
		2/2		607 kN (136500 lbf)	33.3 MPa (4828 psi)	
10/8/03	CL031732	1/2	36 days	620 kN (139400 lbf)	34 MPa (4930 psi)	34.3 MPa (4970 psi)
		2/2		629 kN (141500 lbf)	34.5 MPa (5005 psi)	
10/17/03	CL031733	1/2	45 days	631 kN (141900 lbf)	34.6 MPa (5019 psi)	34.3 MPa (4970 psi)
		2/2		618 kN (138900 lbf)	33.9 MPa (4913 psi)	
12/1/03	CL031734	1/2	90 days	677 kN (152100 lbf)	37.1 MPa (5379 psi)	37 MPa (5370 psi)
		2/2		673 kN (151400 lbf)	36.9 MPa (5355 psi)	

Table A-3: Simpson SET22 Concrete Compressive Strengths

TL No.: 134607
Contract No.: 65-680321
Cast Date: 11/5/2003

Break Date	Concrete Lab Sample No.	Cylinder No.	Cylinder Age	Peak Load	Compressive Strength	Test Result (Average)
12/3/03	CL032361	1/2	28 days	641 kN (144200 lbf)	35.2 MPa (5100 psi)	34.3 MPa (4980 psi)
		2/2		612 kN (137500 lbf)	33.5 MPa (4863 psi)	
12/4/03	CL032360	1/2	29 days	628 kN (141100 lbf)	34.4 MPa (4990 psi)	33.9 MPa (4920 psi)
		2/2		610 kN (137100 lbf)	33.4 MPa (4849 psi)	
12/10/03	CL032359	1/2	35 days	658 kN (148000 lbf)	36.1 MPa (5234 psi)	35.9 MPa (5200 psi)
		2/2		650 kN (146100 lbf)	35.6 MPa (5167 psi)	
12/18/03	CL032358	1/2	43 days	694 kN (156000 lbf)	38 MPa (5517 psi)	38.2 MPa (5540 psi)
		2/2		701 kN (157500 lbf)	38.4 MPa (5570 psi)	
1/30/04	CL032357	1/2	86 days	790 kN (177700 lbf)	43.3 MPa (6285 psi)	43.5 MPa (6310 psi)
		2/2		797 kN (179200 lbf)	43.7 MPa (6338 psi)	

Table A-4: Red Head C6 Concrete Compressive Strengths

TL No.: 134608
Contract No.: 65-680321
Cast Date: 1/5/2004

Break Date	Concrete Lab Sample No.	Cylinder No.	Cylinder Age	Peak Load	Compressive Strength	Test Result (Average)
2/2/04	CL040169	1/2	28 days	520 kN (116900 lbf)	28.5 MPa (4134 psi)	28.4 MPa (4120 psi)
		2/2		516 kN (116000 lbf)	28.3 MPa (4103 psi)	
2/4/04	CL040168	1/2	30 days	557 kN (125200 lbf)	30.5 MPa (4428 psi)	30.8 MPa (4470 psi)
		2/2		568 kN (127600 lbf)	31.1 MPa (4513 psi)	
2/11/04	CL040166	1/2	37 days	604 kN (135800 lbf)	33.1 MPa (4803 psi)	33.2 MPa (4810 psi)
		2/2		606 kN (136200 lbf)	33.2 MPa (4817 psi)	
2/20/04	CL040167	1/2	46 days	664 kN (149300 lbf)	36.4 MPa (5280 psi)	36.6 MPa (5310 psi)
		2/2		672 kN (151000 lbf)	36.8 MPa (5341 psi)	
4/5/04	CL040170	1/2	91 days	813 kN (182800 lbf)	44.6 MPa (6465 psi)	43.8 MPa (6350 psi)
		2/2		785 kN (176400 lbf)	43 MPa (6239 psi)	

Table A-5: Covert Operations CIA-GEL 7000 Concrete Compressive Strengths

A.4 Failure Modes

Test	Sample #	Sample ID	Failure Mode				
			Concrete	Concrete-Adhesive Interface	Adhesive-Rebar Interface	Rebar	Other
SET22 12d Tensile	1	S1			X		
	2	S2			X		
	3	S3					Rebar Gripper Slipped
	4	S4				X	
	5	S5				X	
SET22 12d Seismic	1	S1S				X	
	2	S2S				X	
	3	S3S				X	
	4	S4S				X	
	5	S5S				X	
SET22 9d Tensile	1	S6	X	X	X		
	2	S7	X	X			Some adhesive removed
	3	S8		X			
	4	S9		X	X		
	5	S10			X		
SET22 9d Seismic	1	S6S			X		
	2	S7S			X		
	3	S8S			X		
	4	S9S			X		
	5	S10S			X		
SET22 9d Elevated Temperature Tensile	1	S1HT	X	X			
	2	S2HT	X	X			
	3	S3HT		X			
	4	S4HT		X			Significant concrete breakage
	5	S5HT	X	X			
SET22 9d Creep Tensile	1	E1/S1C		X			
	2	E1/S2C	X	X			
	3	E1/S3C	X	X			
	4	E1/S4C	X	X			
	5	E1/S5C		X			

Table A-6: Testing Failure Modes for Epoxy-Coated Rebar Bonded with SET22 Adhesive

Test	Sample #	Sample ID	Failure Mode				
			Concrete	Concrete-Adhesive Interface	Adhesive-Rebar Interface	Rebar	Other
Red Head 12d Tensile	1	E2/S1T/12d		X	X		
	2	E2/S2T/12d			X		
	3	E2/S3T/12d		X	X		
	4	E2/S4T/12d			X		
	5	E2/S5T/12d			X		
Red Head 12d Seismic	1	E2/S1S/12d		X			Some adhesive removed
	2	E2/S2S/12d			X		
	3	E2/S3S/12d		X	X		
	4	E2/S4S/12d			X		
	5	E2/S5S/12d			X		
Red Head 9d Tensile	1	E2/S1T/9d			X		
	2	E2/S2T/9d			X		
	3	E2/S3T/9d		X	X		
	4	E2/S4T/9d		X	X		
	5	E2/S5T/9d		X	X		
Red Head 9d Seismic	1	E2/S1S/9d			X		
	2	E2/S2S/9d			X		
	3	E2/S3S/9d		X	X		
	4	E2/S4S/9d		X	X		
	5	E2/S5S/9d			X		
Red Head 9d Elevated Temperature Tensile	1	E2/S1HT		X			Adhesive removed at bottom
	2	E2/S2HT		X			Adhesive removed at bottom
	3	E2/S3HT		X			Adhesive removed at bottom
	4	E2/S4HT		X			Adhesive removed at bottom
	5	E2/S5HT		X			Adhesive removed at bottom
Red Head 9d Creep Tensile	1	E2/S1C		X	X		
	2	E2/S2C		X	X		
	3	E2/S3C		X	X		
	4	E2/S4C					Failed during creep
	5	E2/S5C		X	X		

Table A-7: Testing Failure Modes for Epoxy-Coated Rebar Bonded with Ceramic 6 Adhesive

Test	Sample #	Sample ID	Failure Mode				
			Concrete	Concrete-Adhesive Interface	Adhesive-Rebar Interface	Rebar	Other
CIA-Gel 7000 12d Tensile	1	CG/S1T/12d				X	
	2	CG/S2T/12d		X			Some adhesive removed
	3	CG/S3T/12d		X			
	4	CG/S4T/12d		X			
	5	CG/S5T/12d		X			Some adhesive removed
CIA-Gel 7000 12d Seismic	1	CG/S1S/12d		X	X		
	2	CG/S2S/12d		X			
	3	CG/S3S/12d				X	
	4	CG/S4S/12d		X			
	5	CG/S5S/12d		X			
CIA-Gel 7000 9d Tensile	1	CG/S1T/9d		X			
	2	CG/S2T/9d		X			
	3	CG/S3T/9d		X			Some adhesive removed
	4	CG/S4T/9d		X			
	5	CG/S5T/9d		X	X		
CIA-Gel 7000 9d Seismic	1	CG/S1S/9d	X	X			
	2	CG/S2S/9d		X			
	3	CG/S3S/9d	X	X			
	4	CG/S4S/9d		X			
	5	CG/S5S/9d		X			
CIA-Gel 7000 9d Elevated Temperature Tensile	1	CG/S1HT		X			
	2	CG/S2HT		X			
	3	CG/S3HT	X	X			
	4	CG/S4HT		X			
	5	CG/S5HT	X	X			
CIA-Gel 7000 9d Creep Tensile	1	CG/S1C		X			
	2	CG/S2C		X			
	3	CG/S3C		X			
	4	CG/S4C		X			
	5	CG/S5C	X	X	X		

Table A-8: Testing Failure Modes for Epoxy-Coated Rebar Bonded with CIA-Gel 7000 Adhesive

A.5 Sample Failure Mode Photos



Figure A-1: Typical Concrete–Concrete/Adhesive Interface Failure



Figure A-2: Typical Concrete/Adhesive Interface Failure



Figure A-3: Typical Concrete/Adhesive Interface–Adhesive/Rebar Interface Failure



Figure A-4: Typical Adhesive/Rebar Interface Failure



Figure A-5: Typical Rebar Failure



Figure A-6: Red Head C6 Creep Failure

A.6 SET22 Test Data:

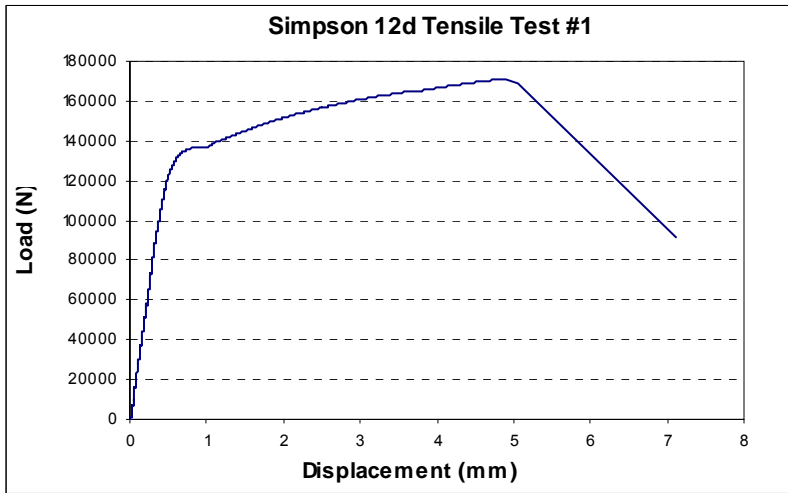

Figure A-6

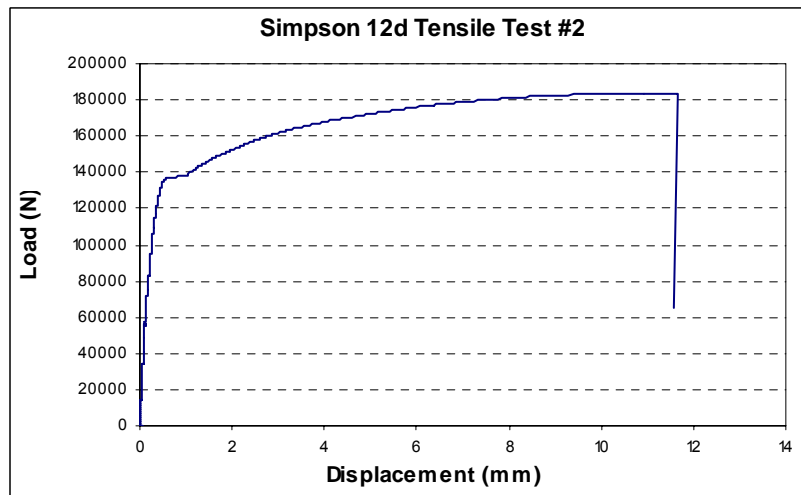

Figure A-7

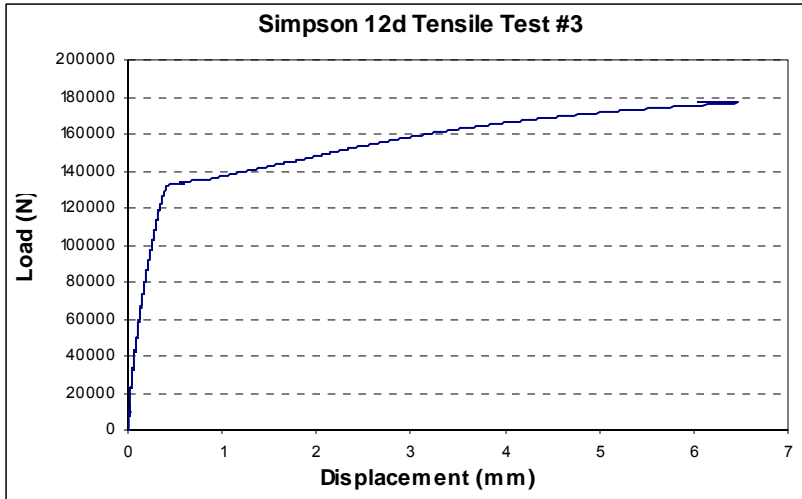

Figure A-8

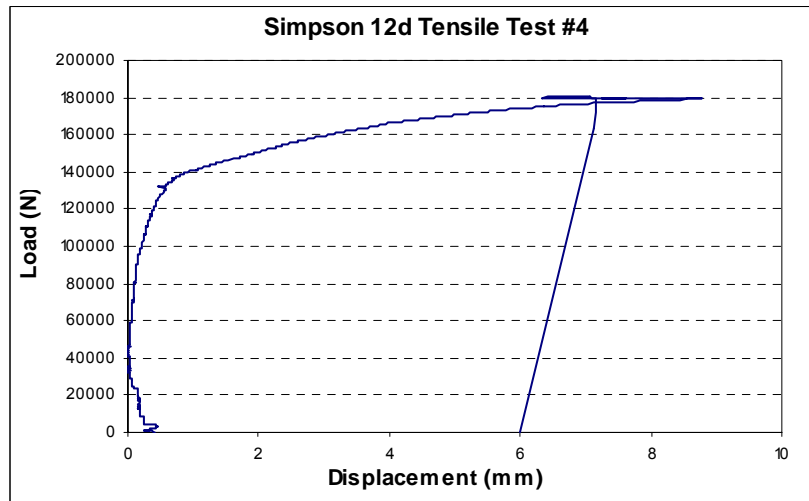

Figure A-9

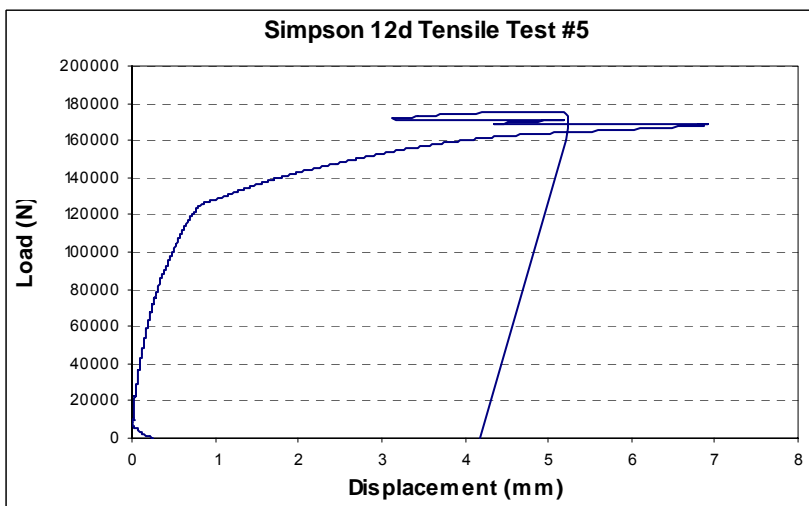

Figure A-10

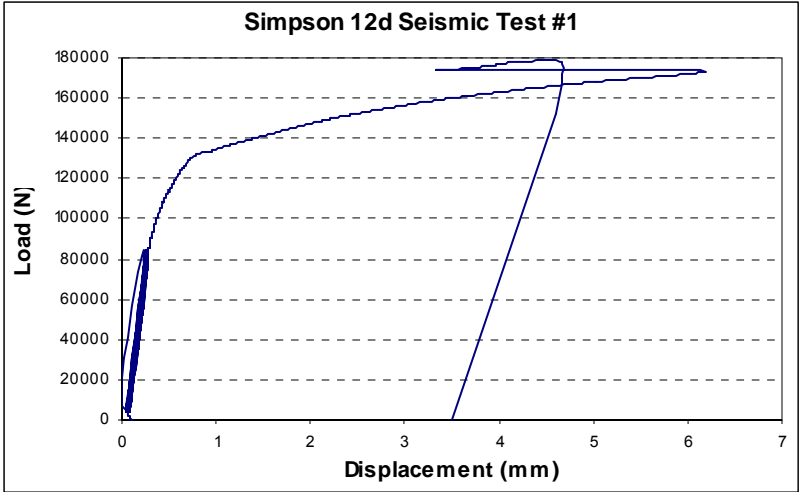

Figure A-11

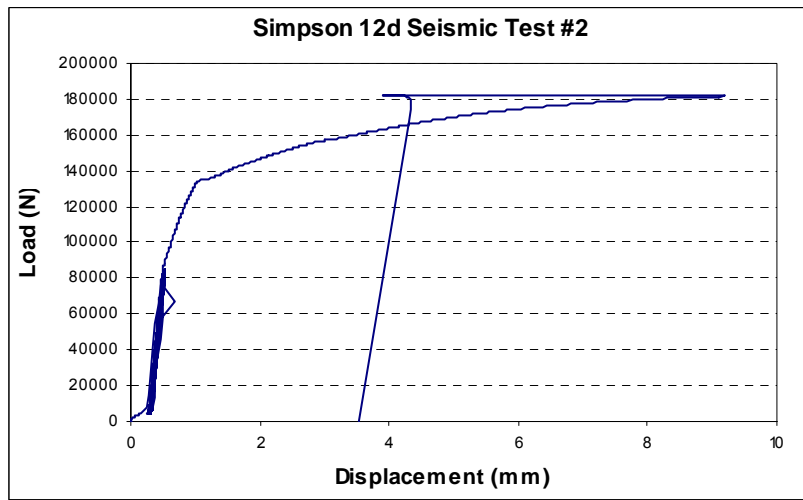

Figure A-12

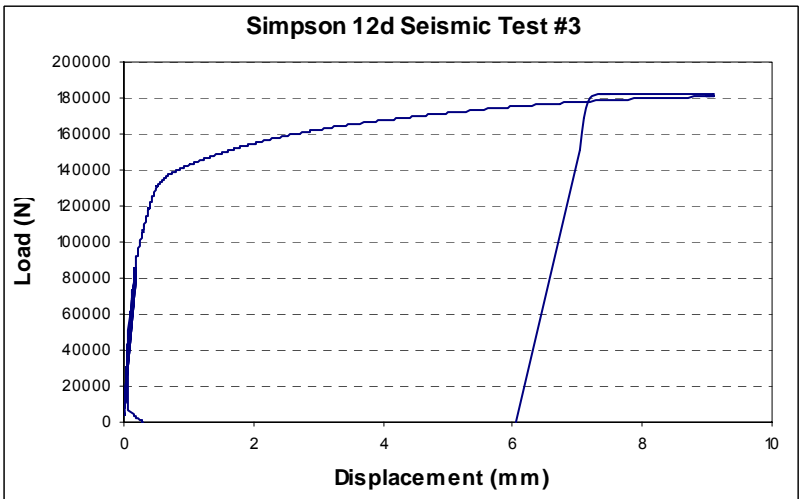

Figure A-13

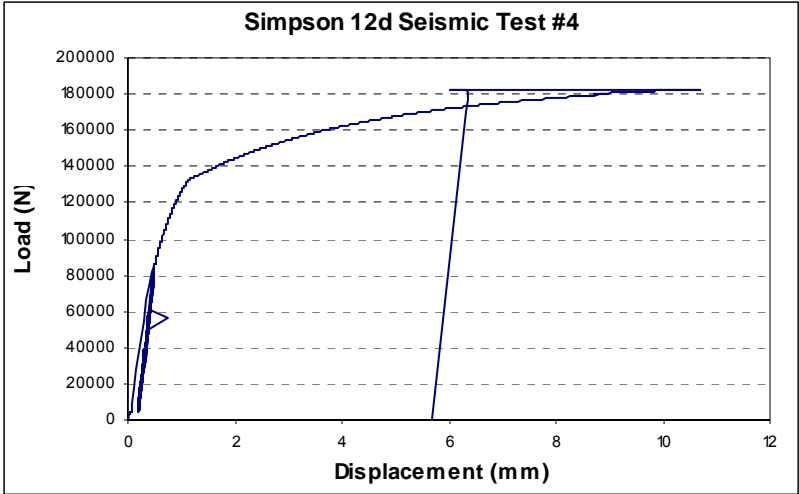

Figure A-14

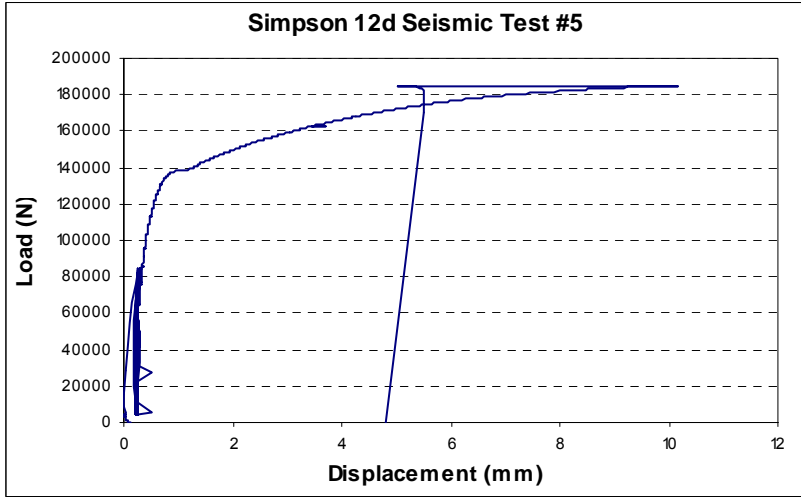

Figure A-15

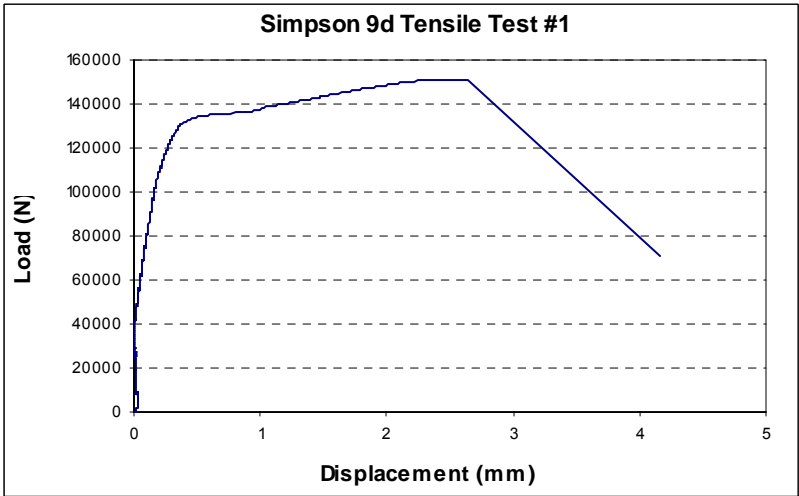

Figure A-16

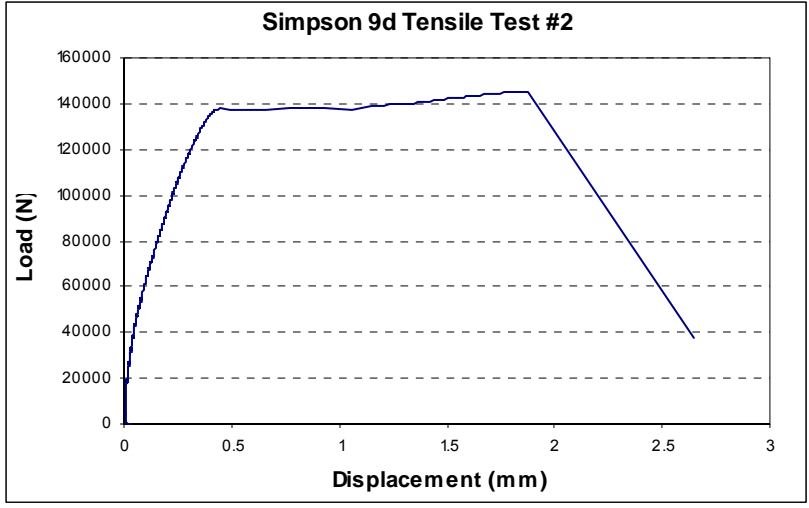

Figure A-17

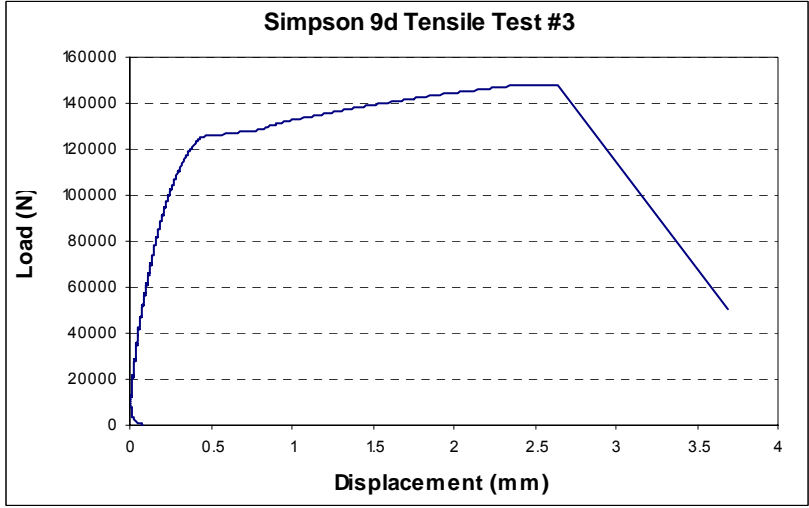

Figure A-18

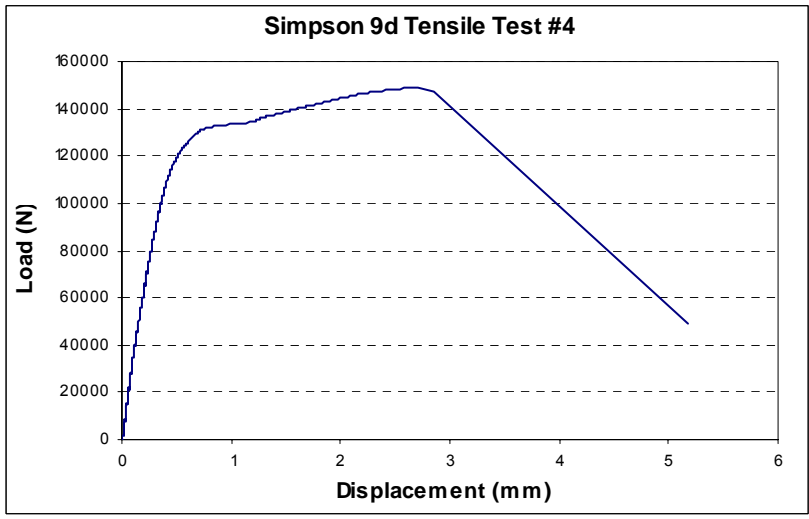

Figure A-19

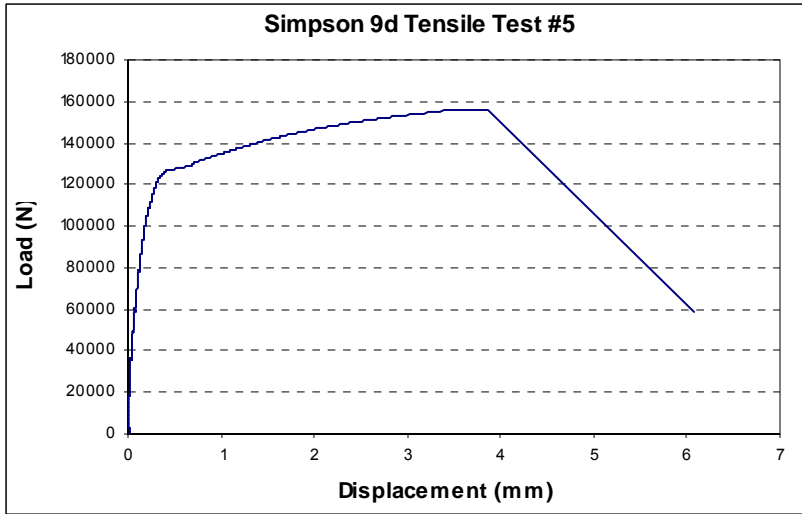

Figure A-20

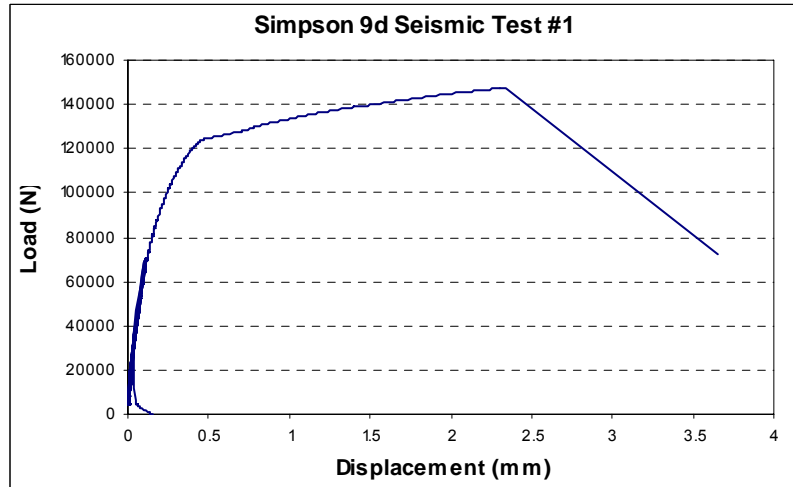

Figure A-21

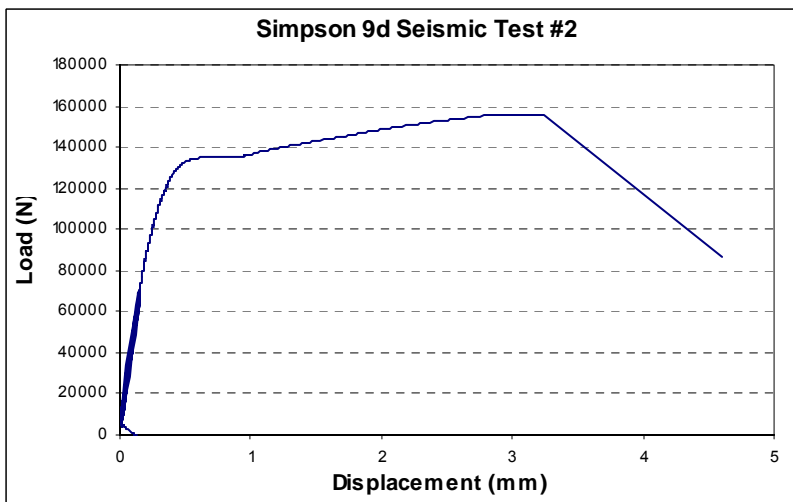

Figure A-22

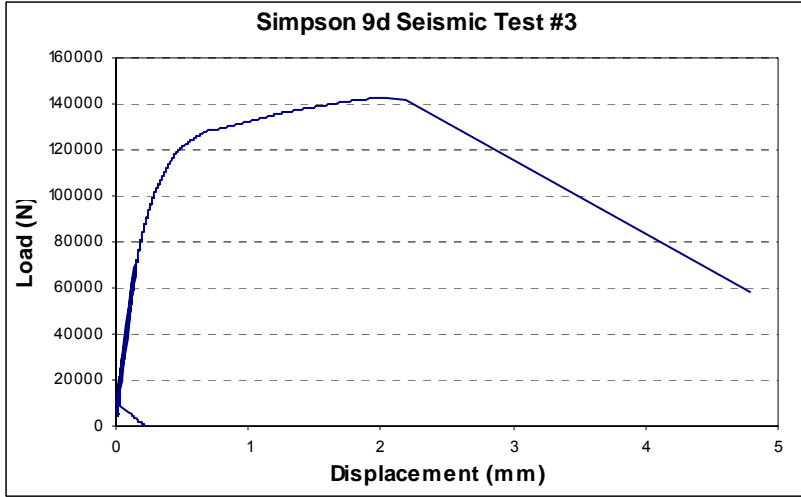

Figure A-23

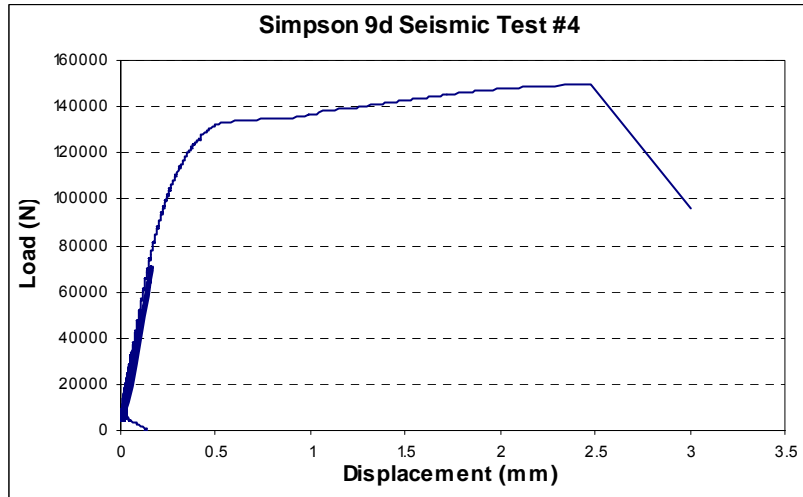

Figure A-24

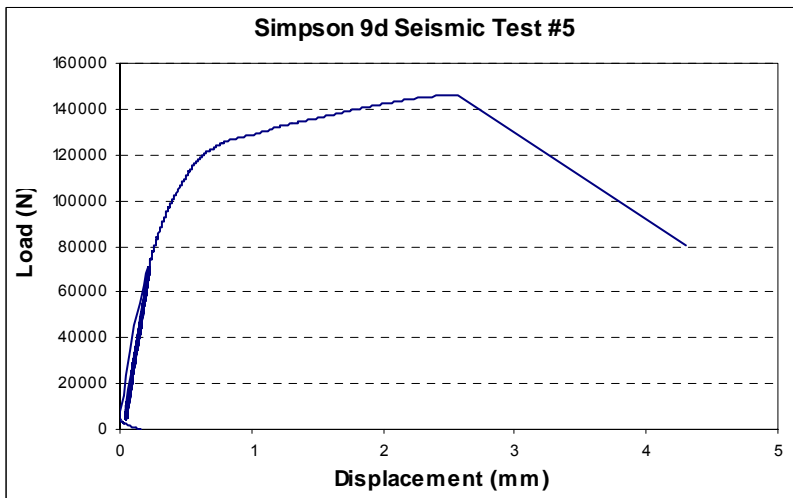

Figure A-25

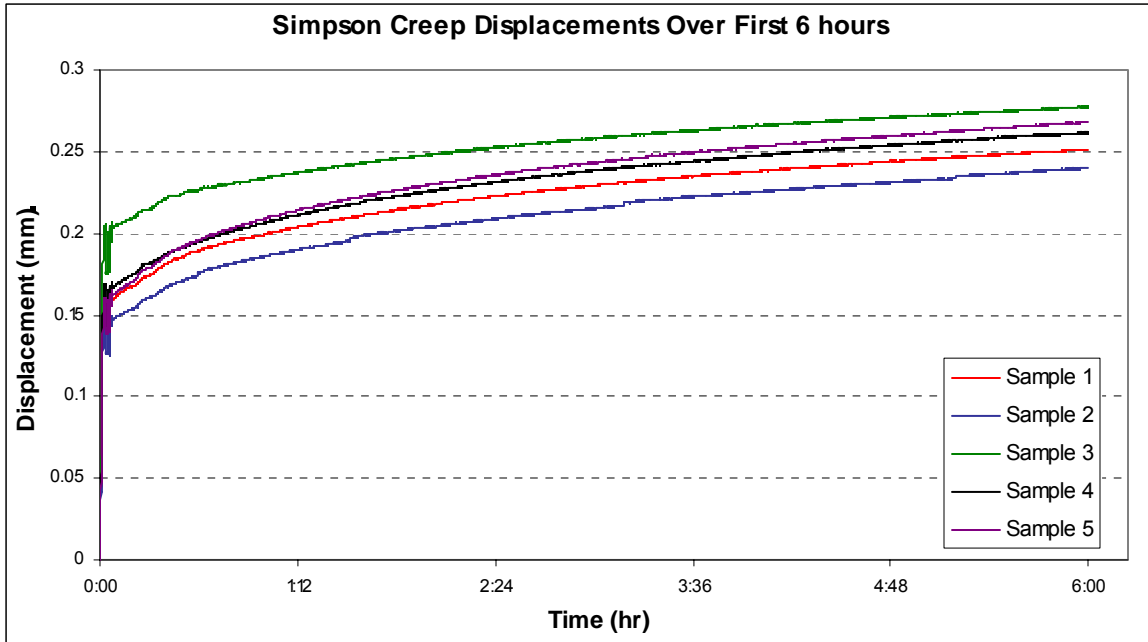

Figure A-26

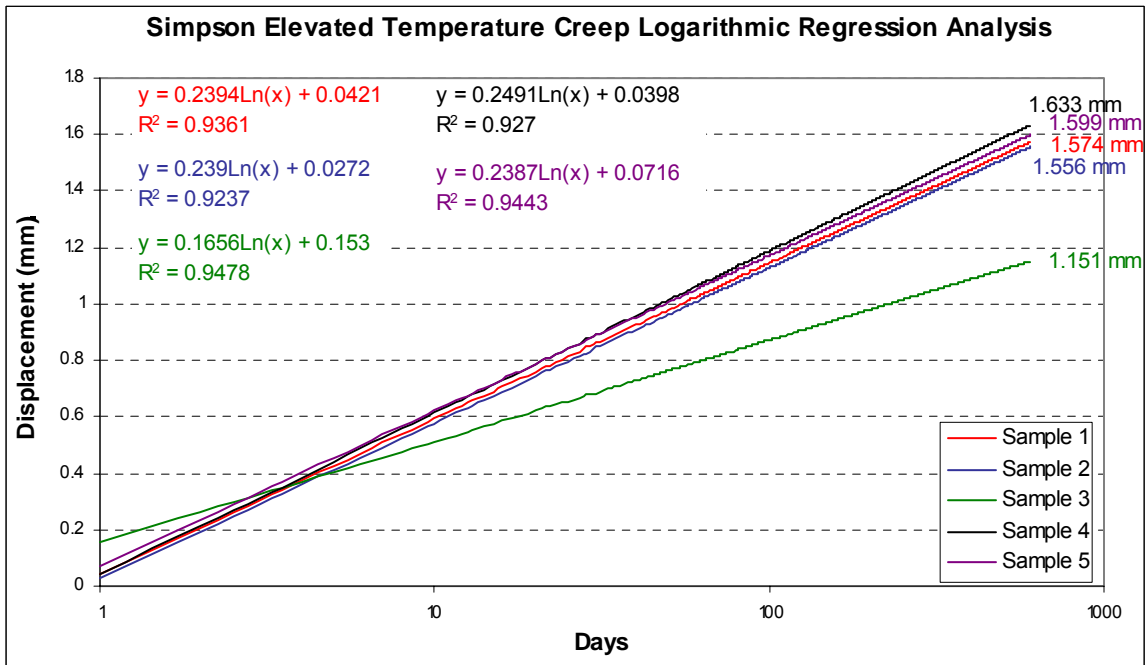

Figure A-27: SET22 Creep Displacement 600-Day Logarithmic Regression Analysis

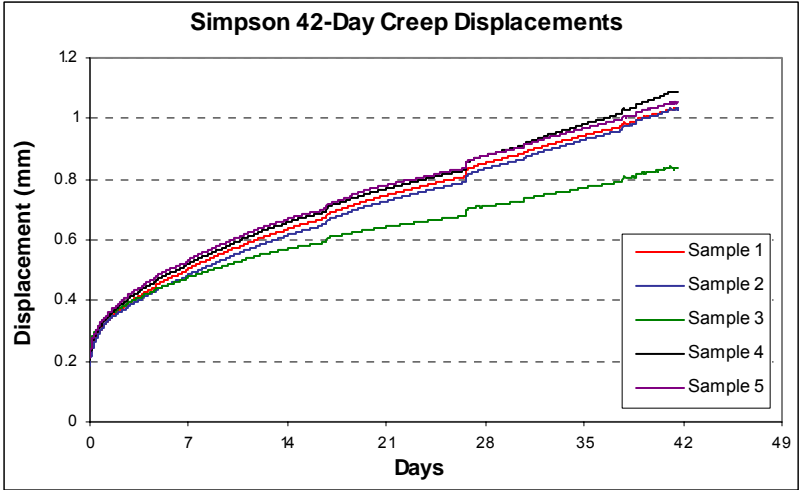

Figure A-28

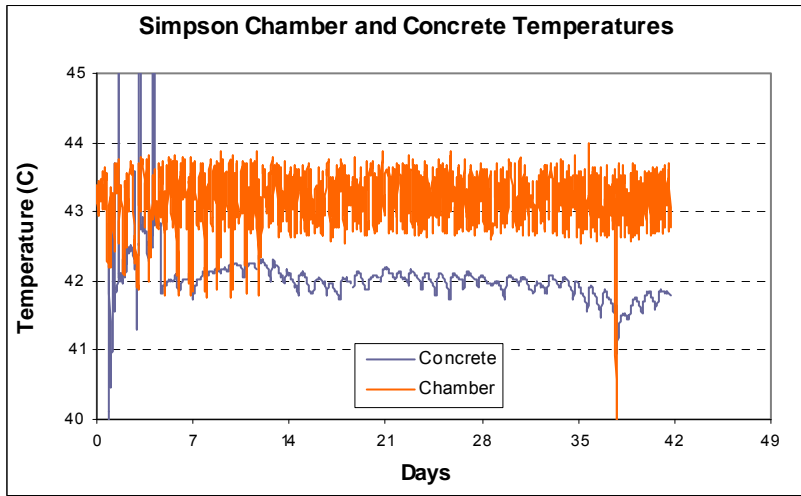

Figure A-29

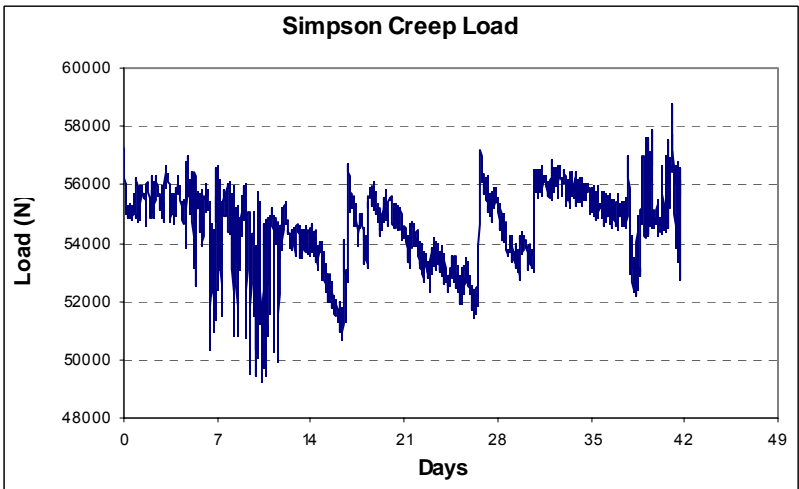

Figure A-30

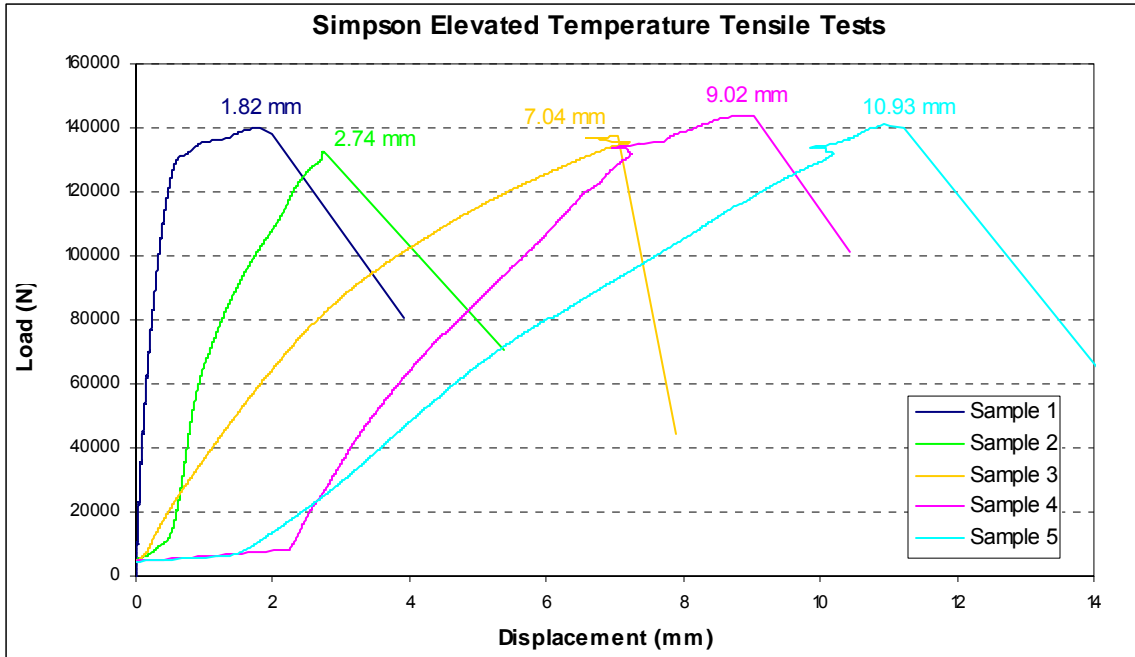

Figure A-31: Displacements at Maximum Load for SET22 Elevated Temperature Tensile Tests

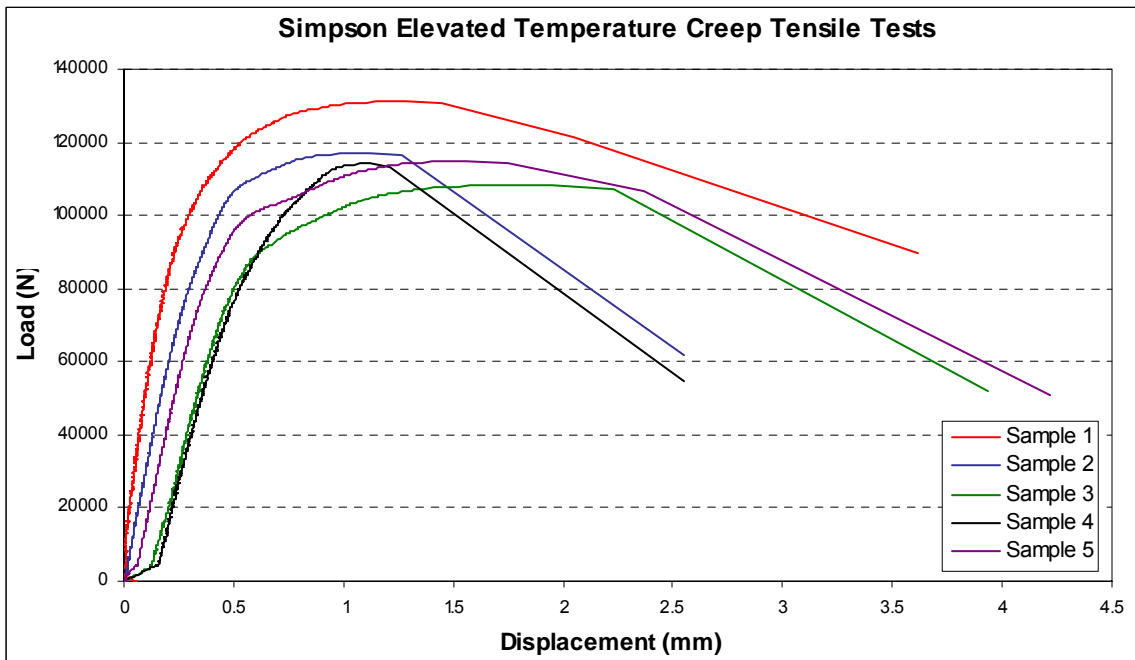

Figure A-32: SET22 Tensile Tests After 42-Day Creep Cycle

A.7 Red Head Epcon C6 Test Data:

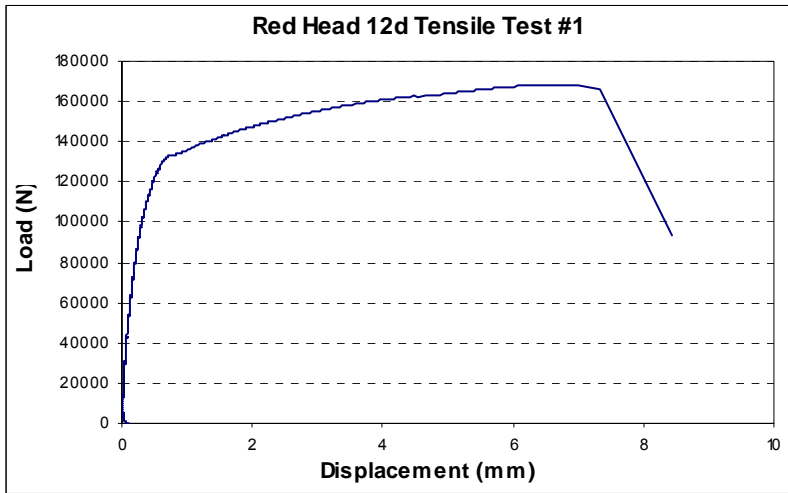

Figure A-33

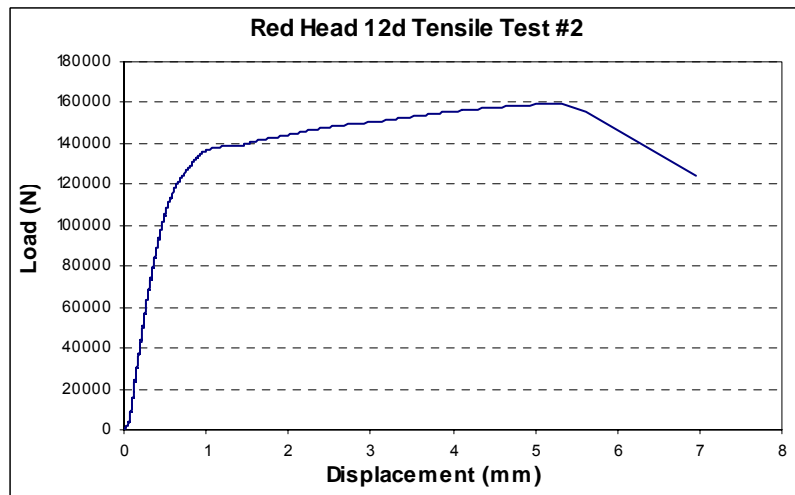

Figure A-34

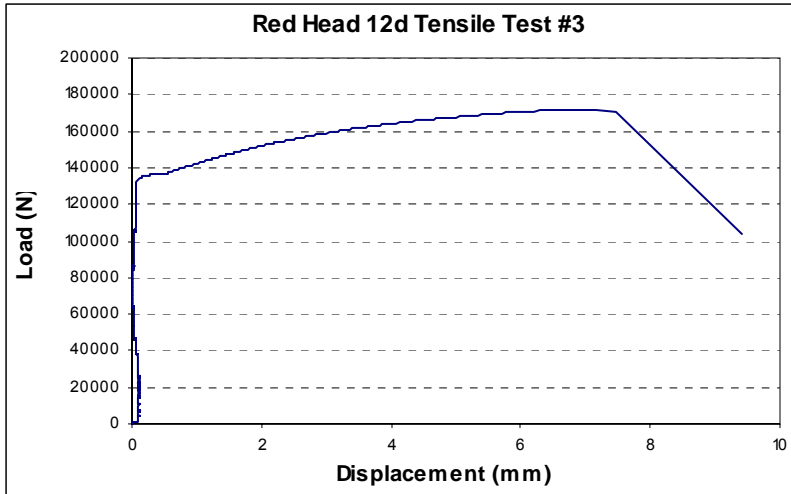

Figure A-35

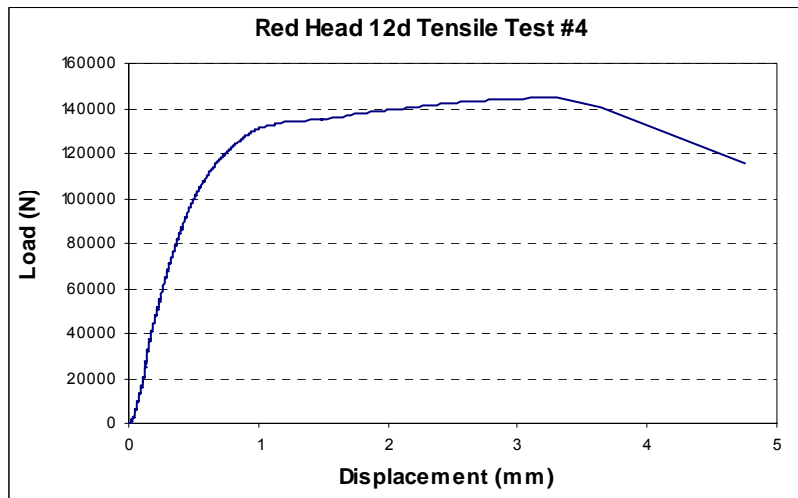

Figure A-36

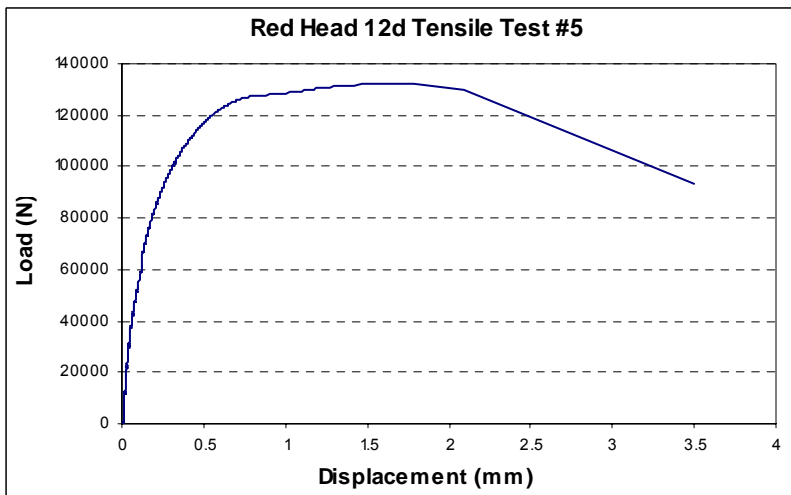

Figure A-37

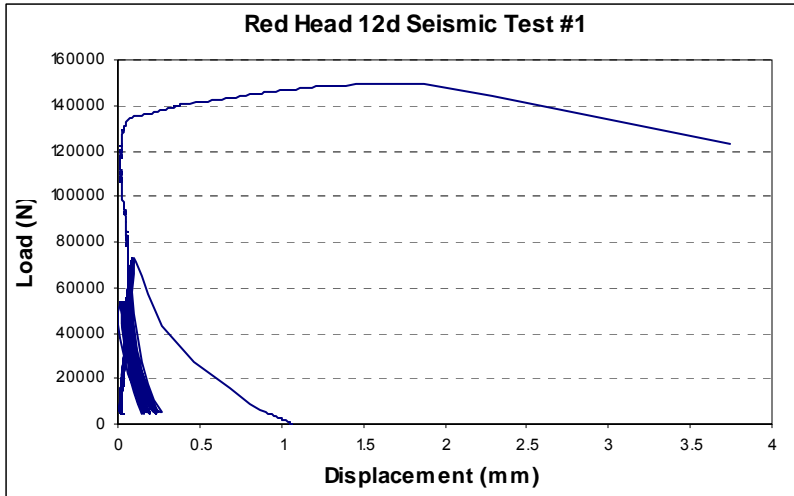

Figure A-38

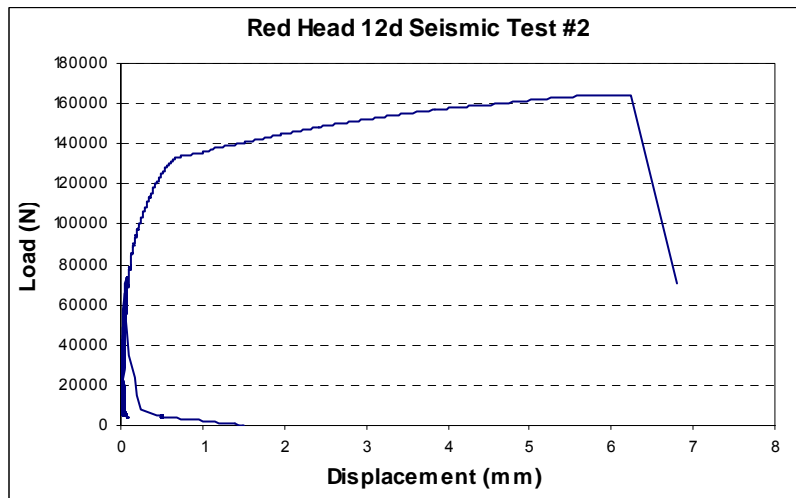

Figure A-39

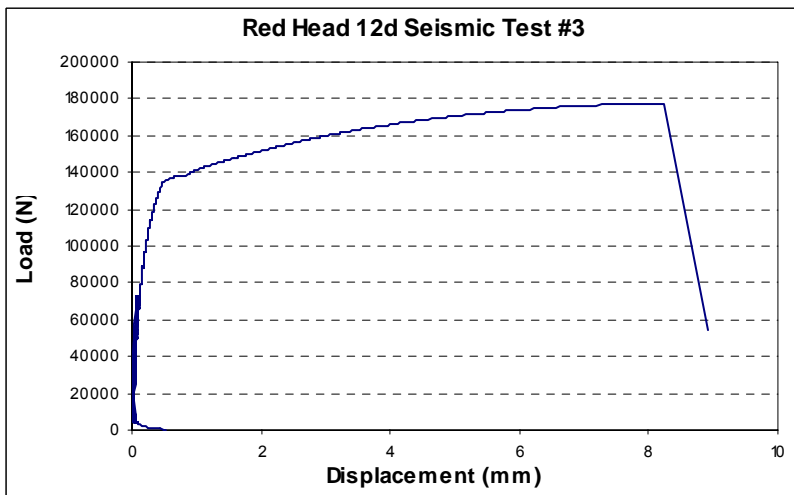

Figure A-40

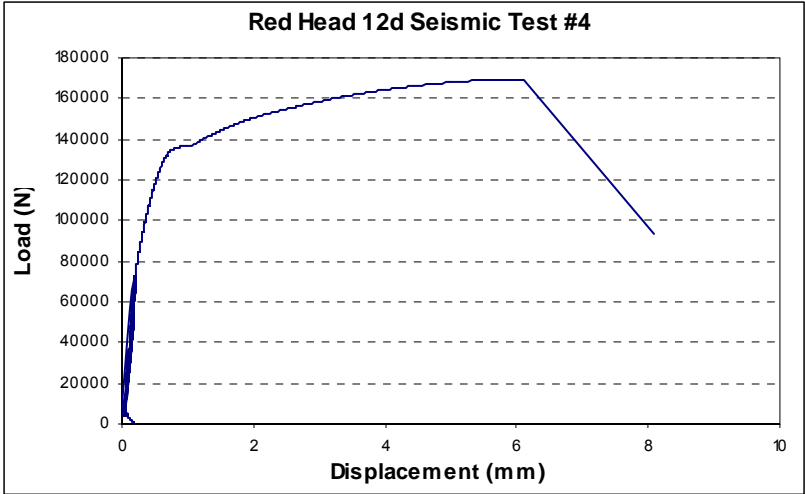

Figure A-41

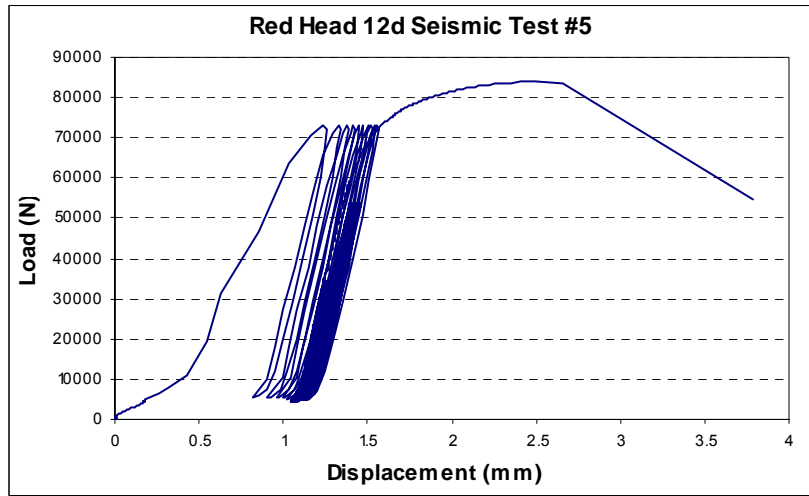

Figure A-42

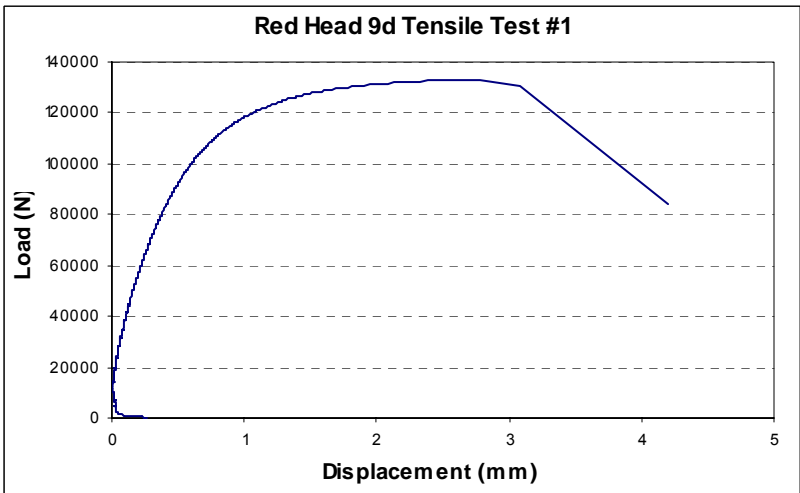

Figure A-43

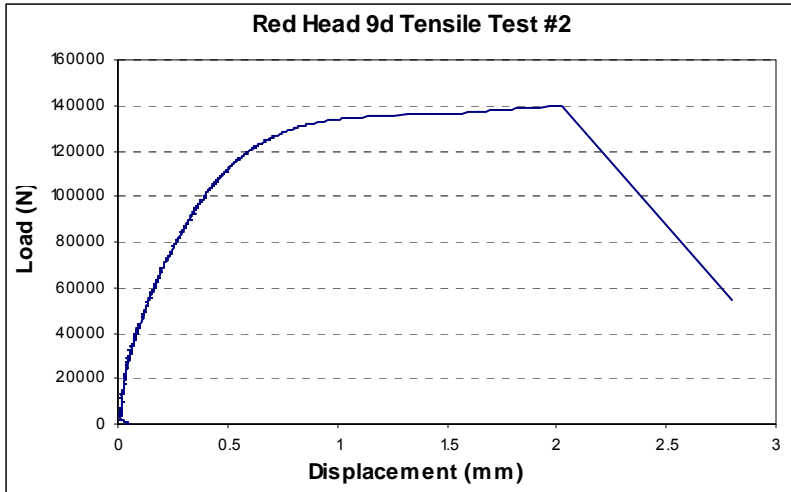

Figure A-44

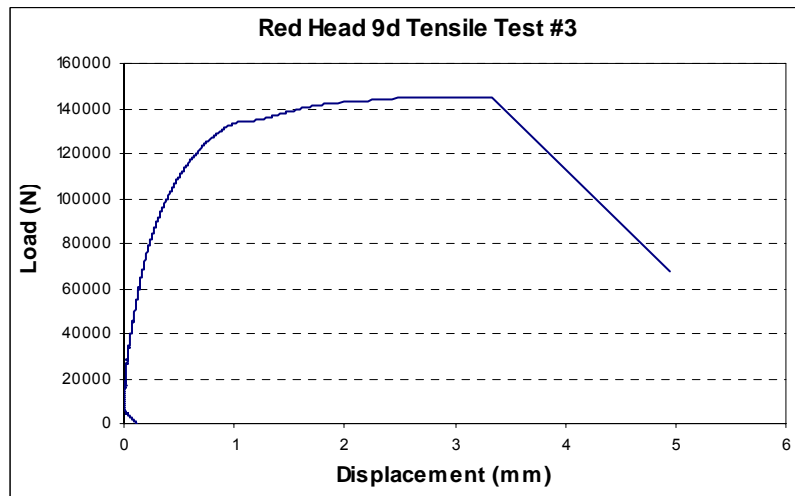

Figure A-45

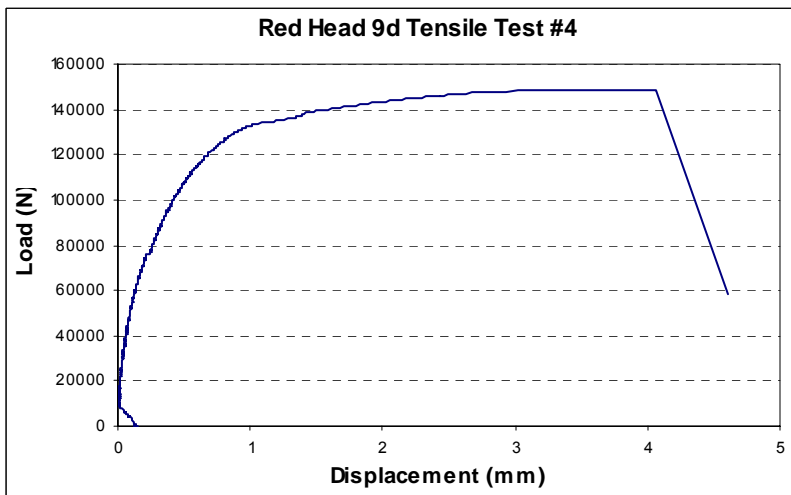

Figure A-46

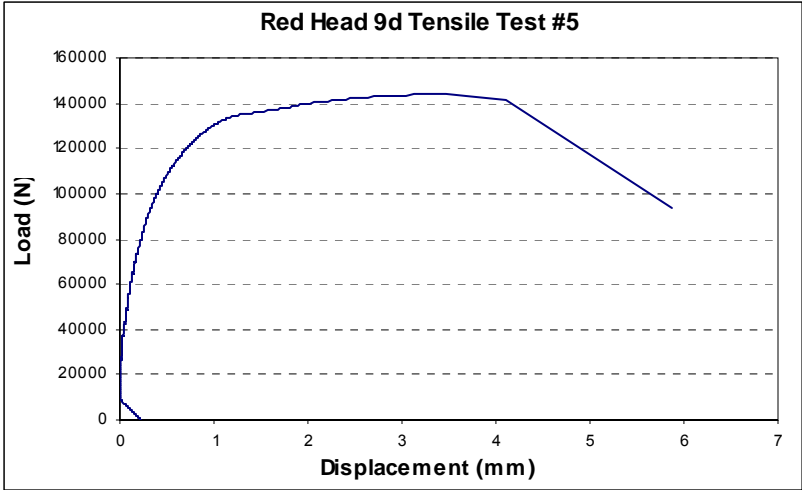

Figure A-47

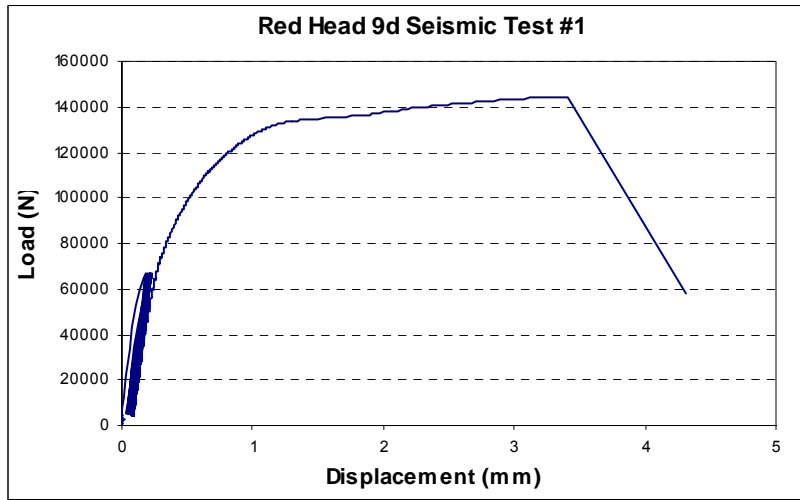

Figure A-48

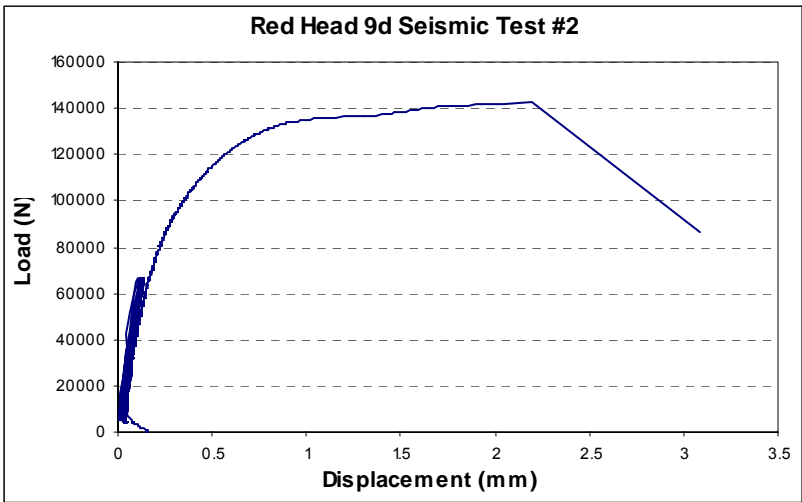

Figure A-49

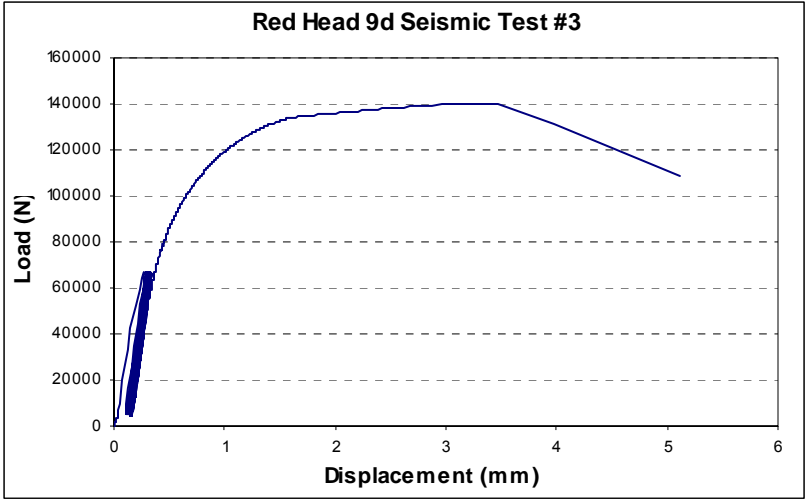

Figure A-50

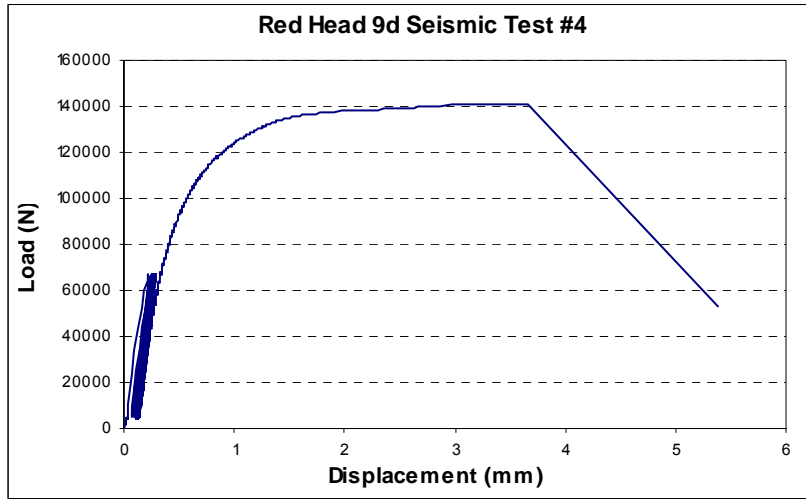

Figure A-51

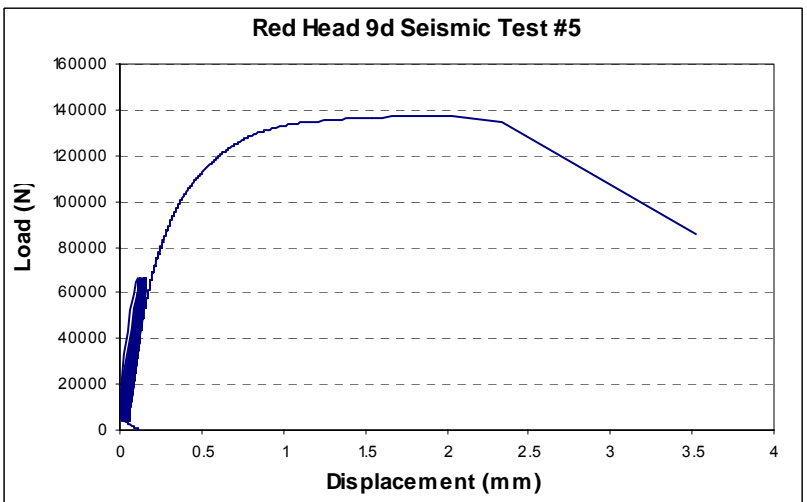

Figure A-52

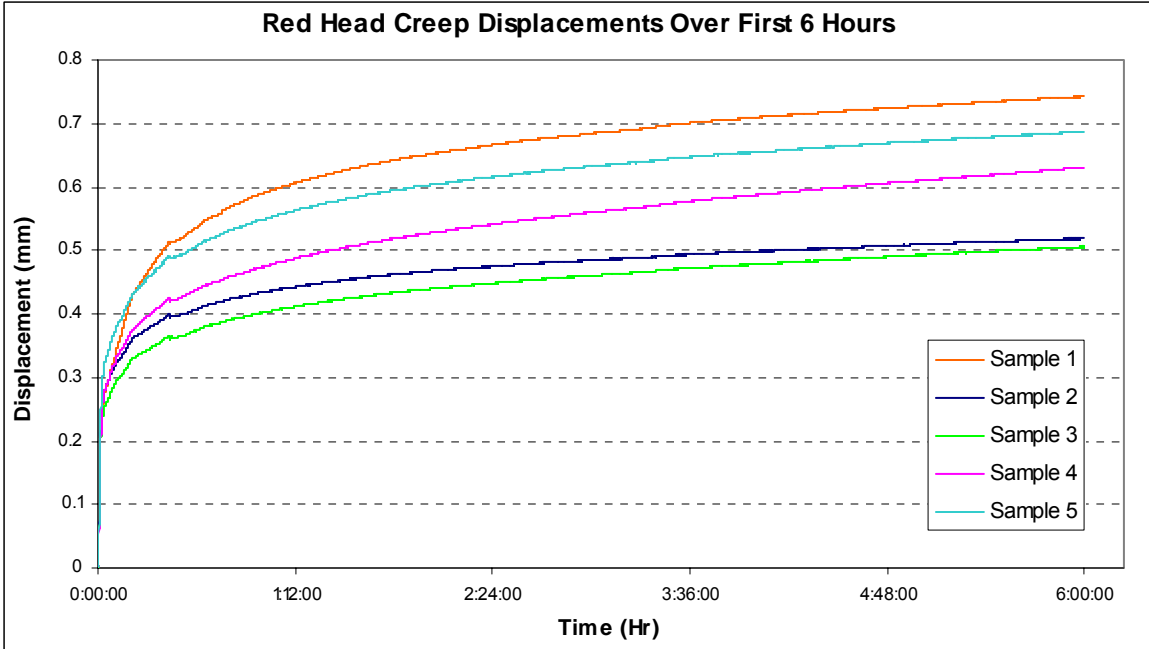

Figure A-53

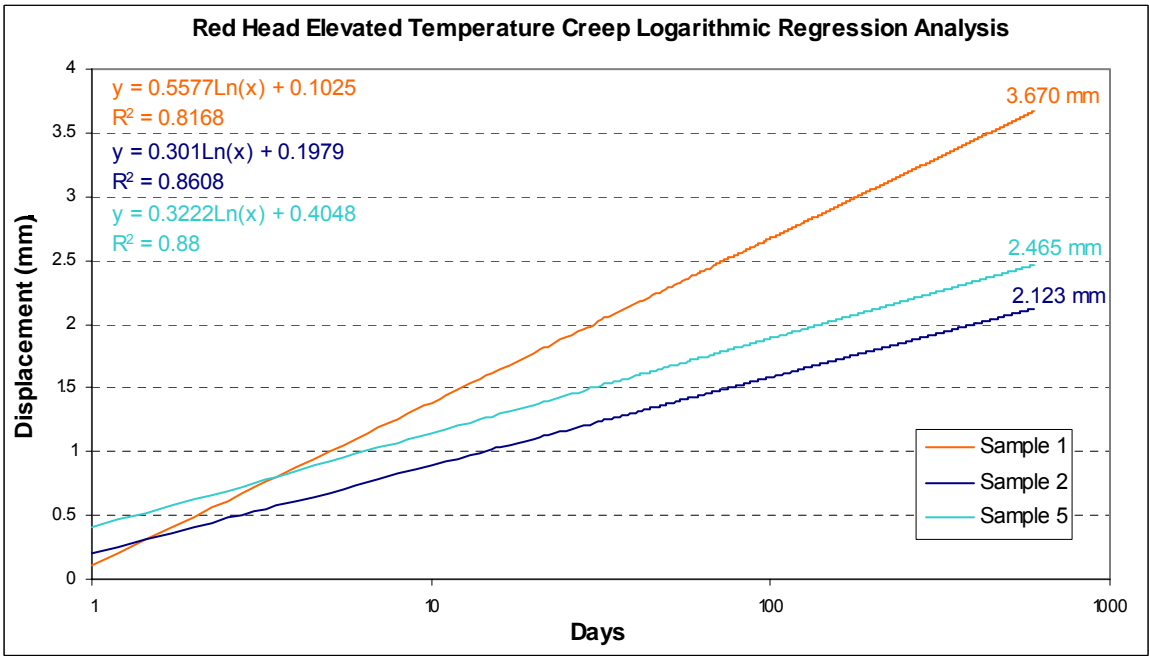

Figure A-54: Red Head Creep Displacement 600-Day Logarithmic Regression Analysis

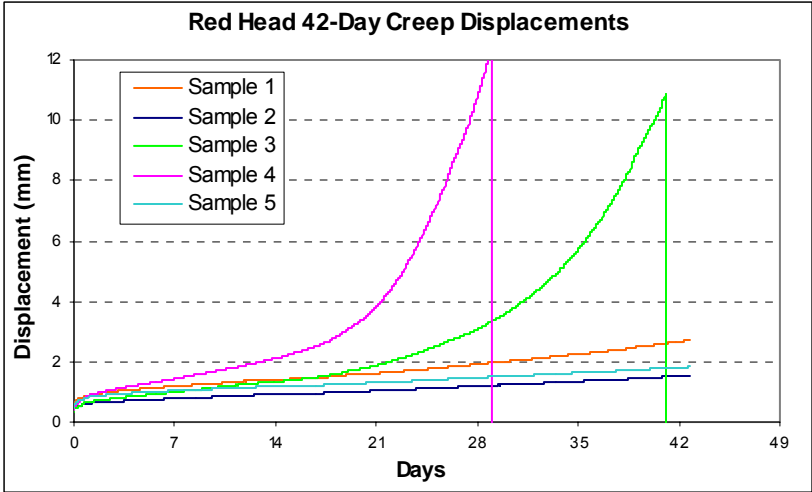

Figure A-55

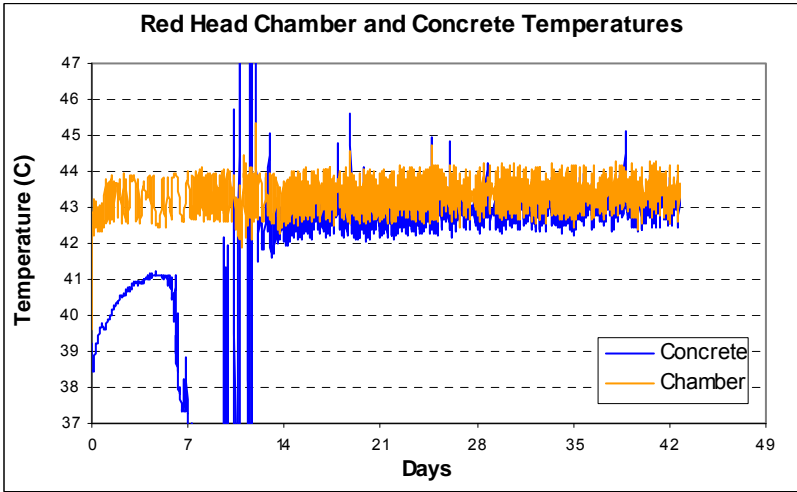

Figure A-56

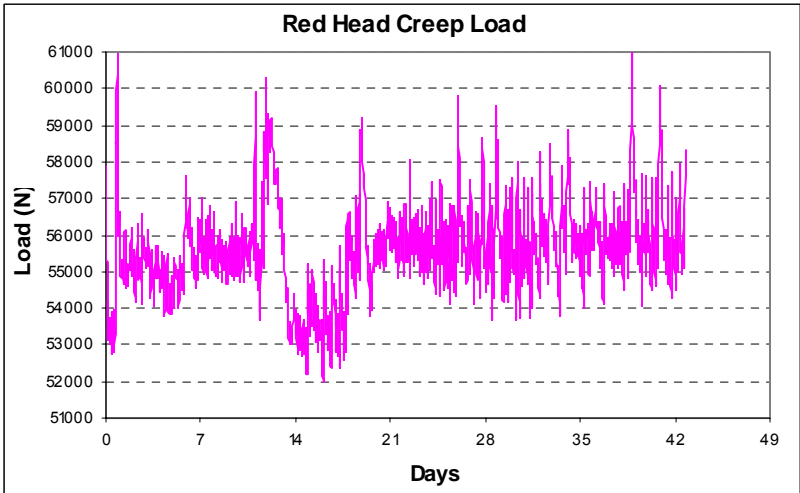

Figure A-57

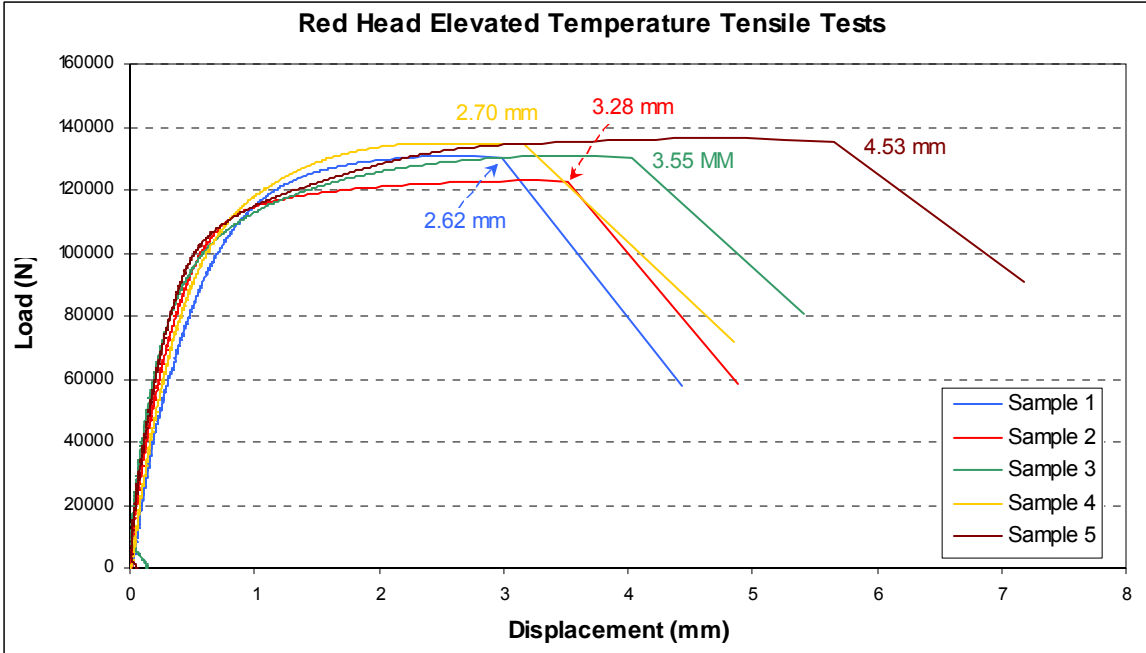

Figure A-58: Displacements at Maximum Load for Red Head Elevated Temperature Tensile Tests

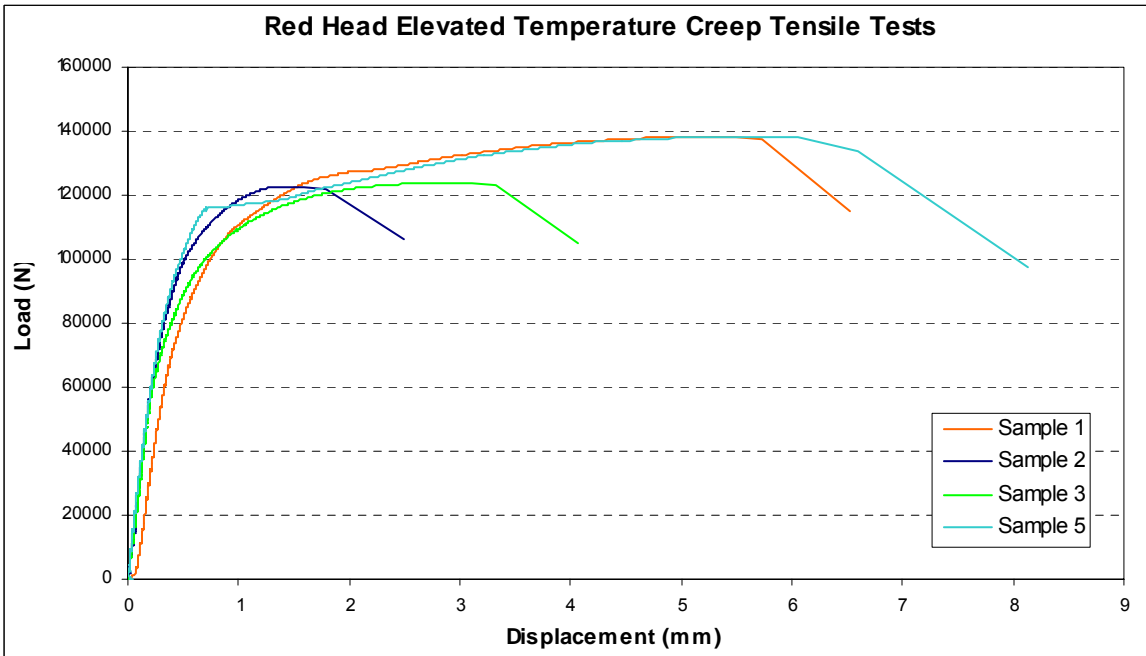

Figure A-59: Red Head Tensile Tests After 42-Day Creep Cycle

A.8 CIA-Gel 7000 Test Data:

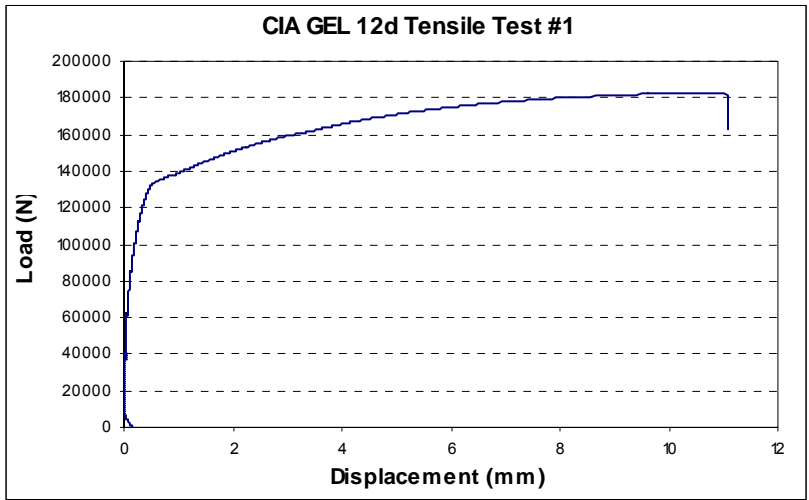

Figure A-60

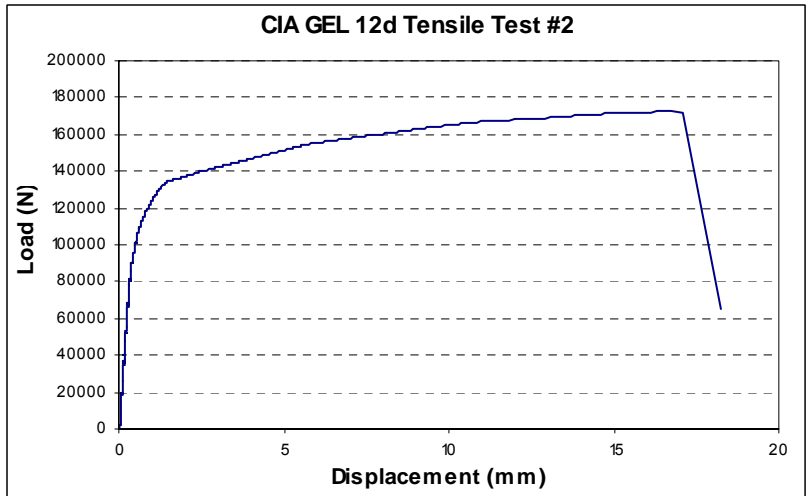

Figure A-61

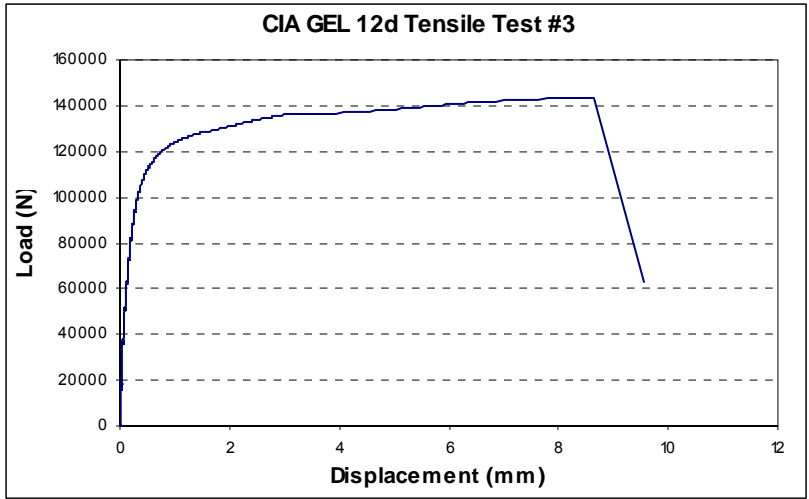

Figure A-62

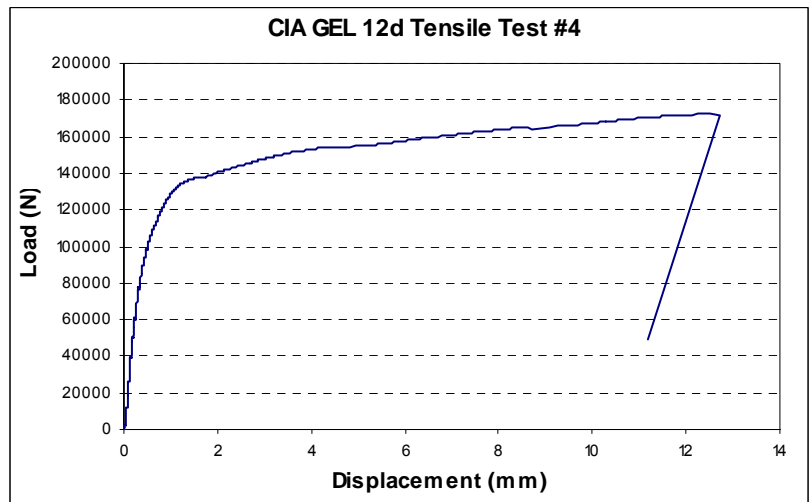

Figure A-63

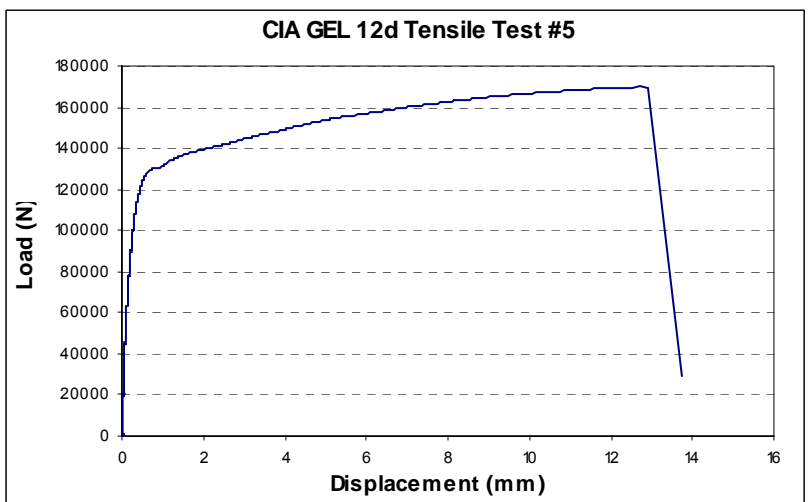

Figure A-64

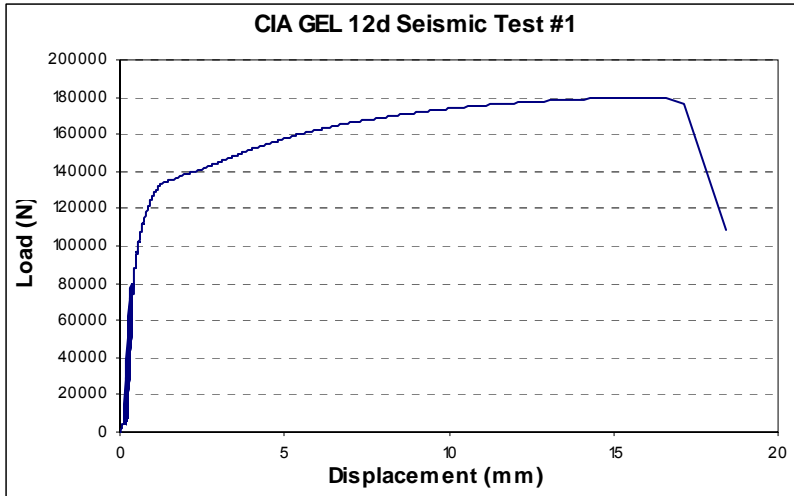

Figure A-65

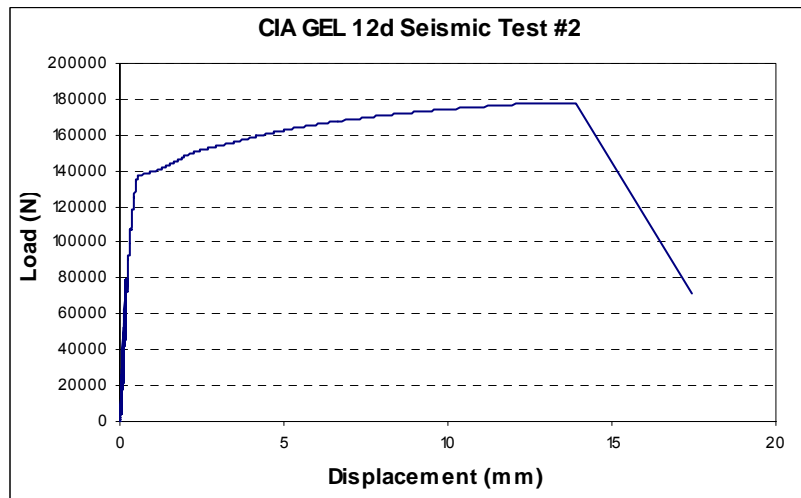

Figure A-66

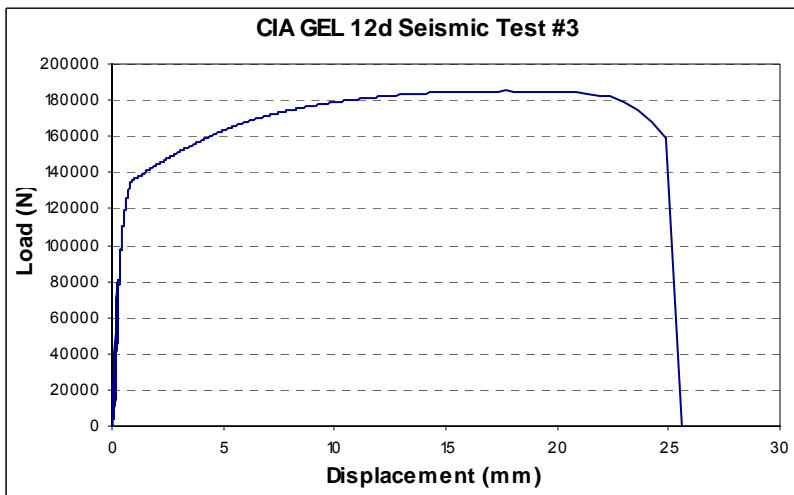

Figure A-67

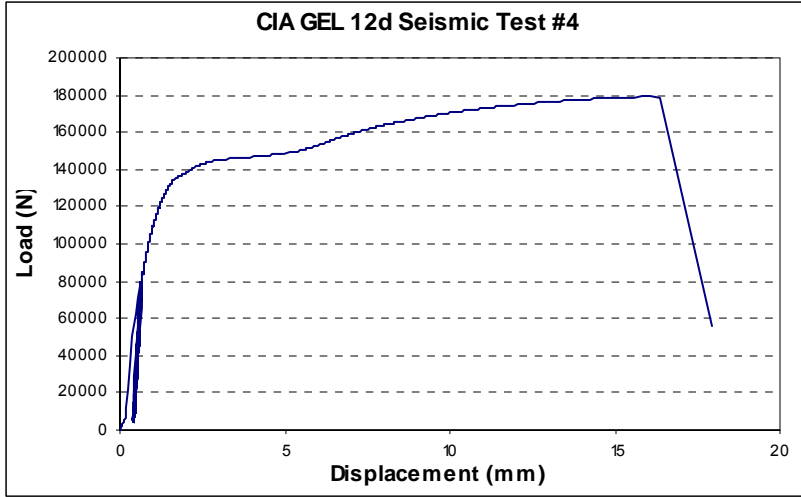

Figure A-68

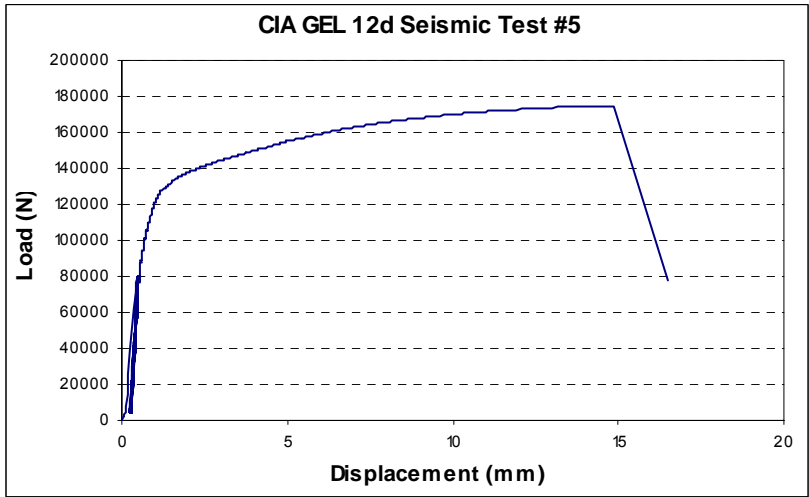

Figure A-69

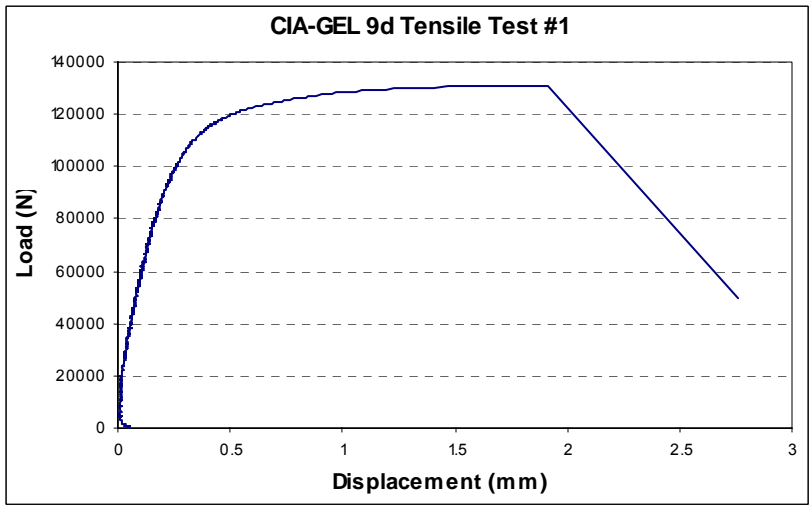

Figure A-70

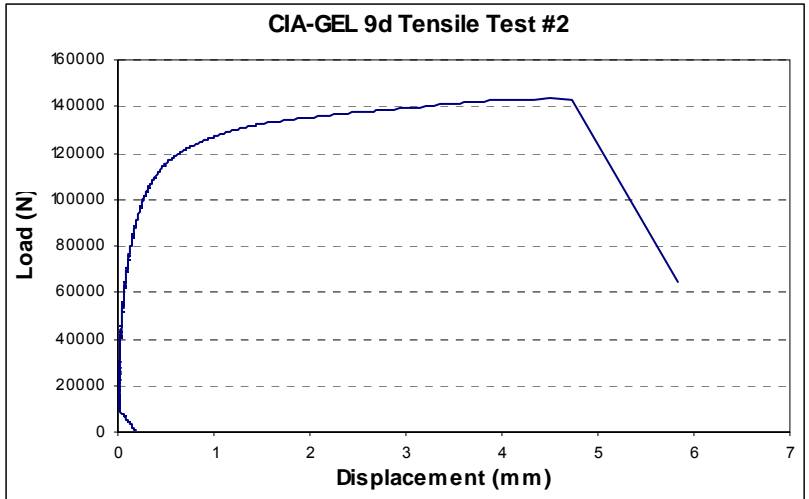

Figure A-71

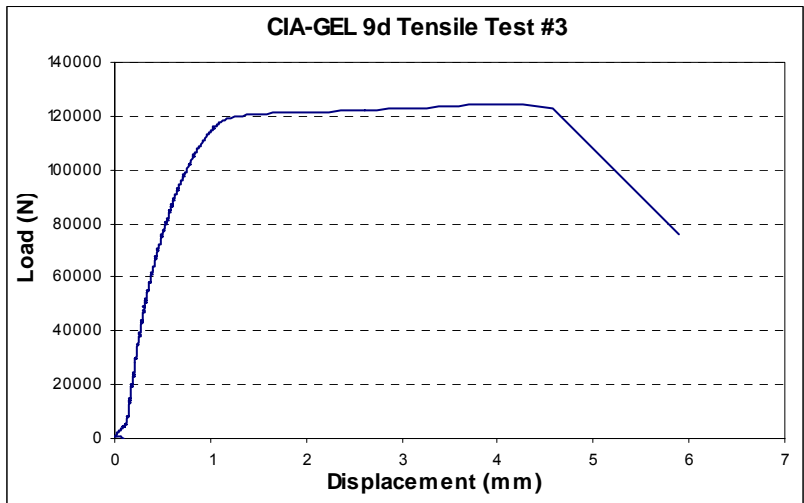

Figure A-72

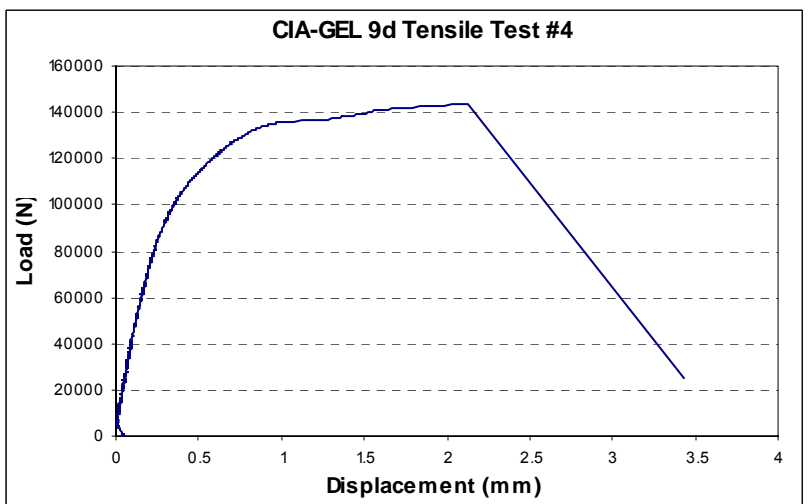

Figure A-73

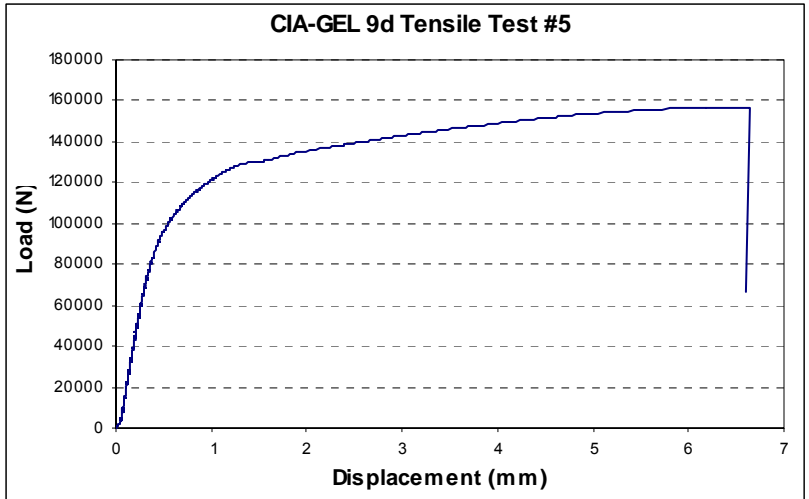

Figure A-74

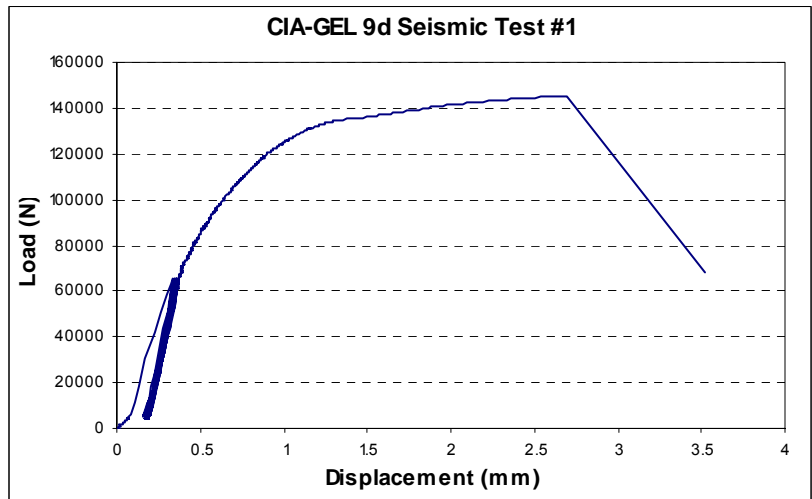

Figure A-75

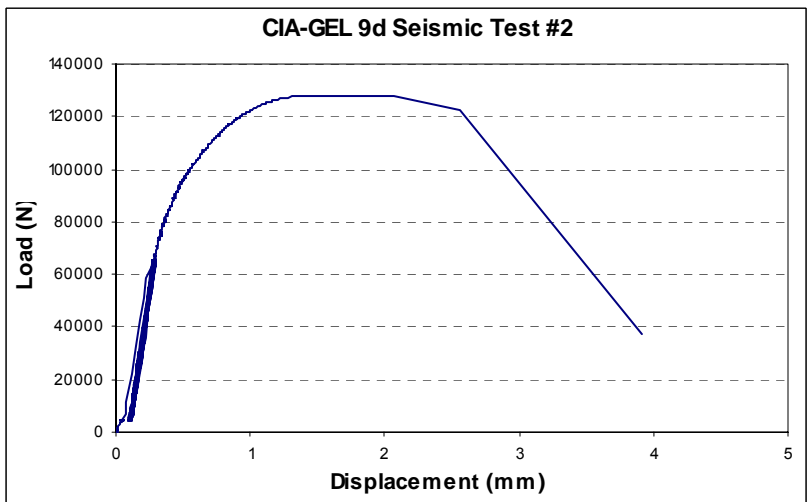

Figure A-76

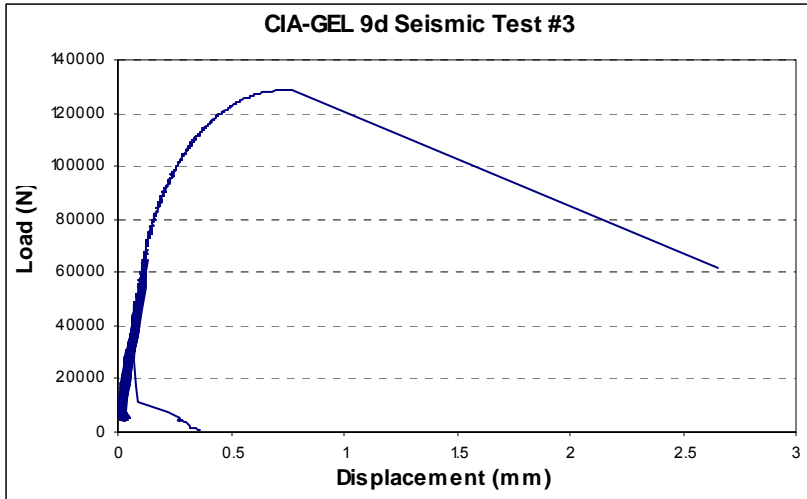

Figure A-77

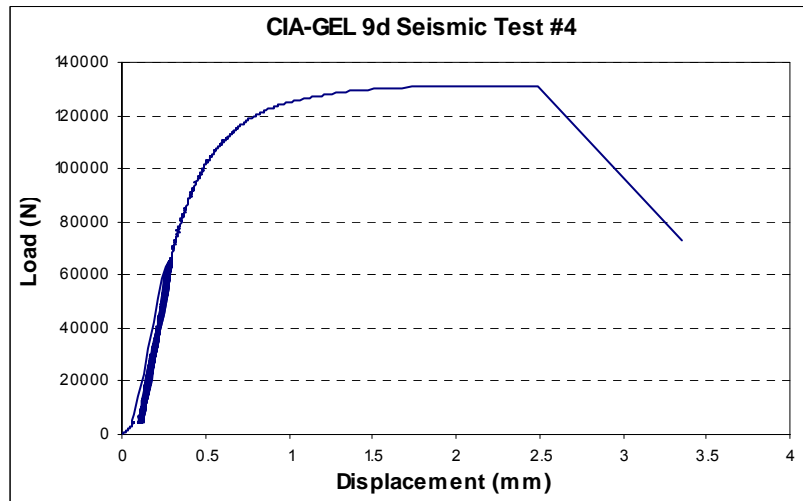

Figure A-78

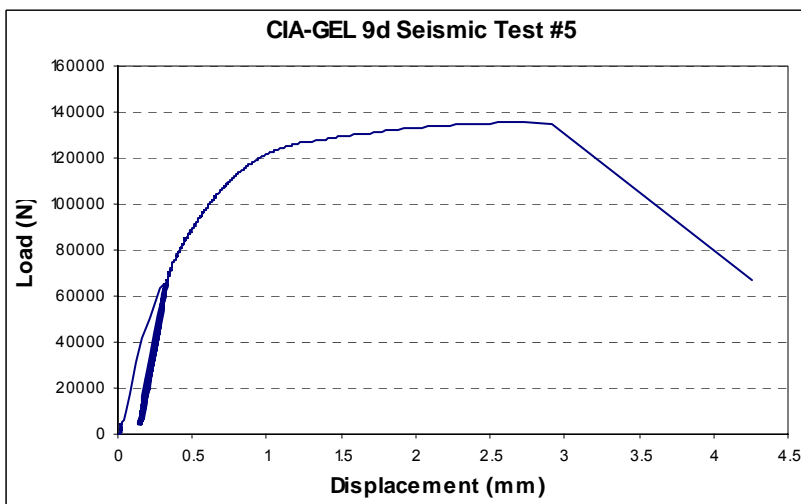

Figure A-79

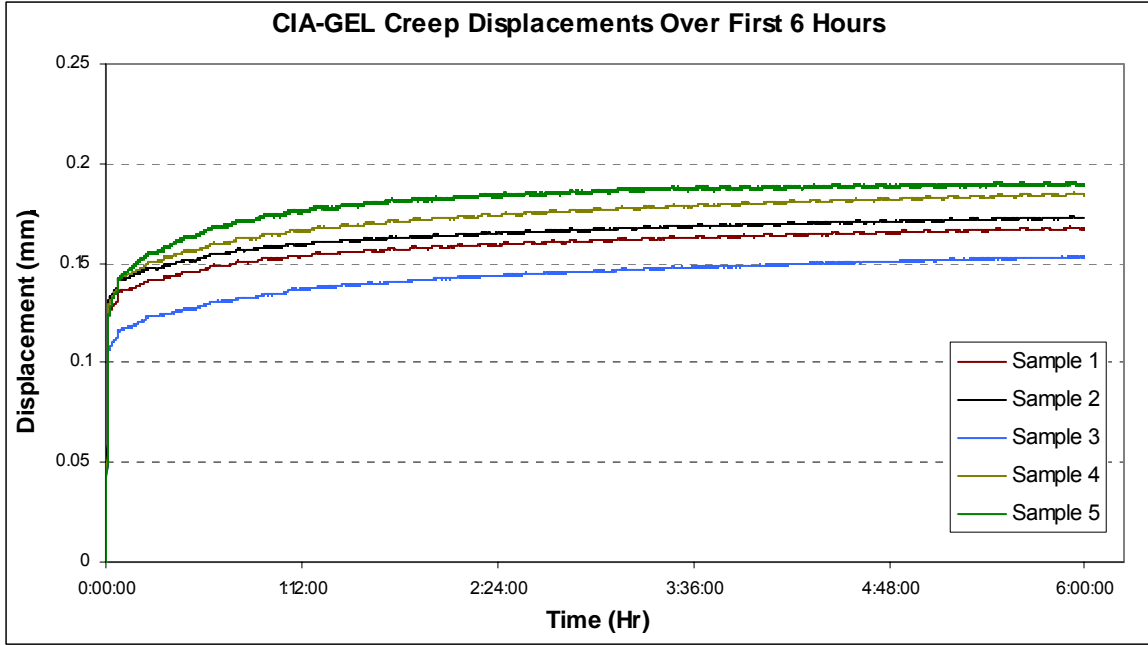

Figure A-80

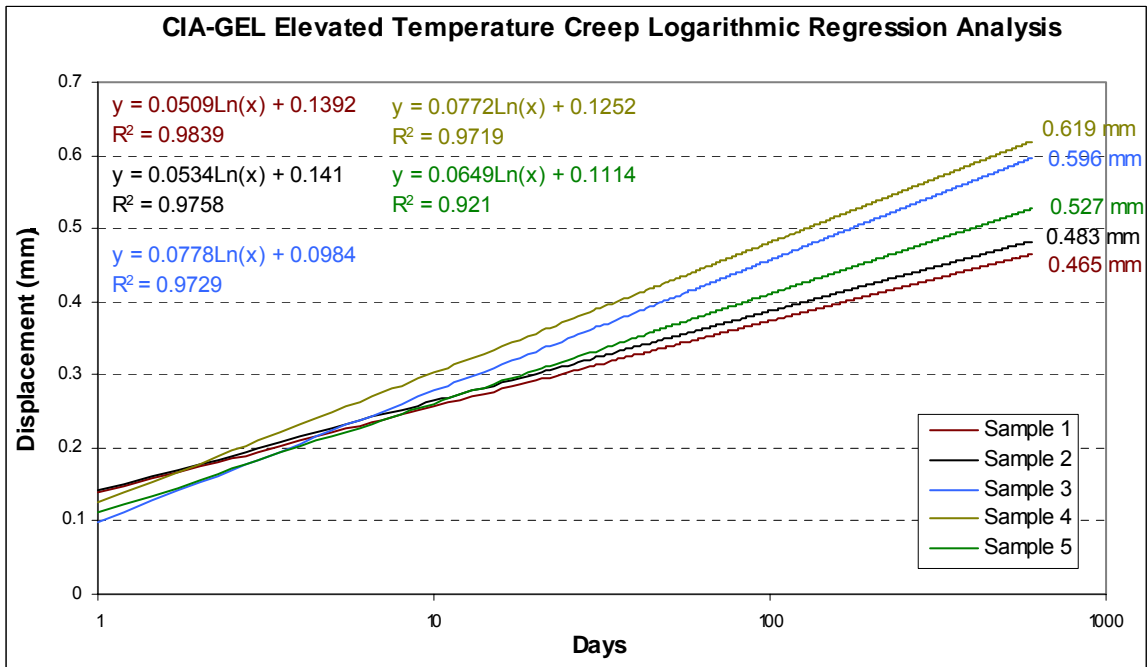

Figure A-81: CIA-GEL 7000 Creep Displacement 600-Day Logarithmic Regression Analysis

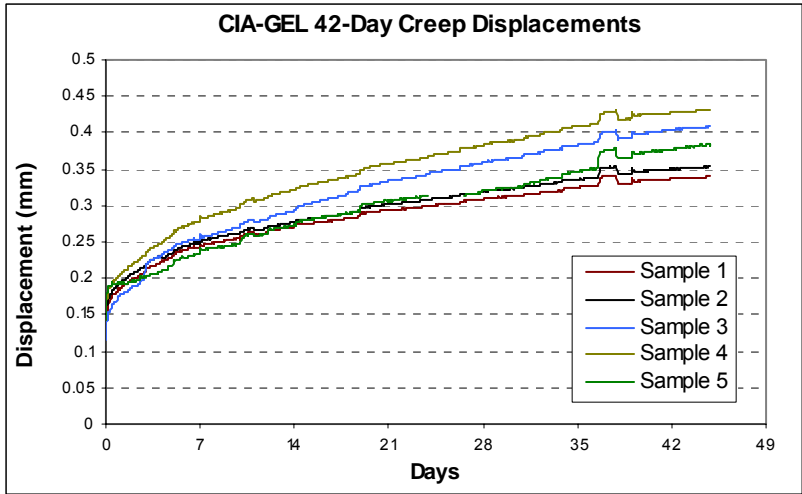

Figure A-82

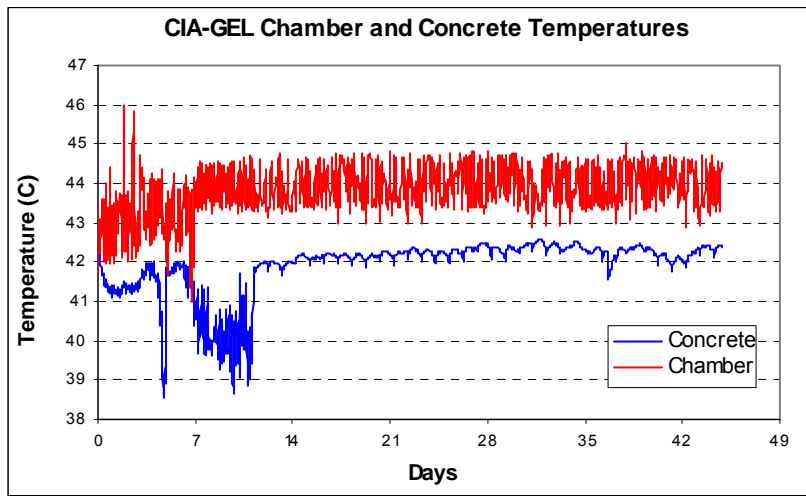

Figure A-83

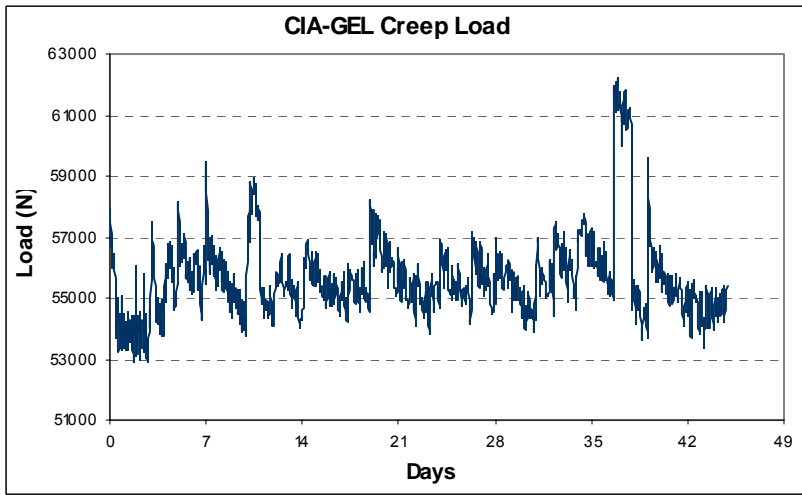

Figure A-84

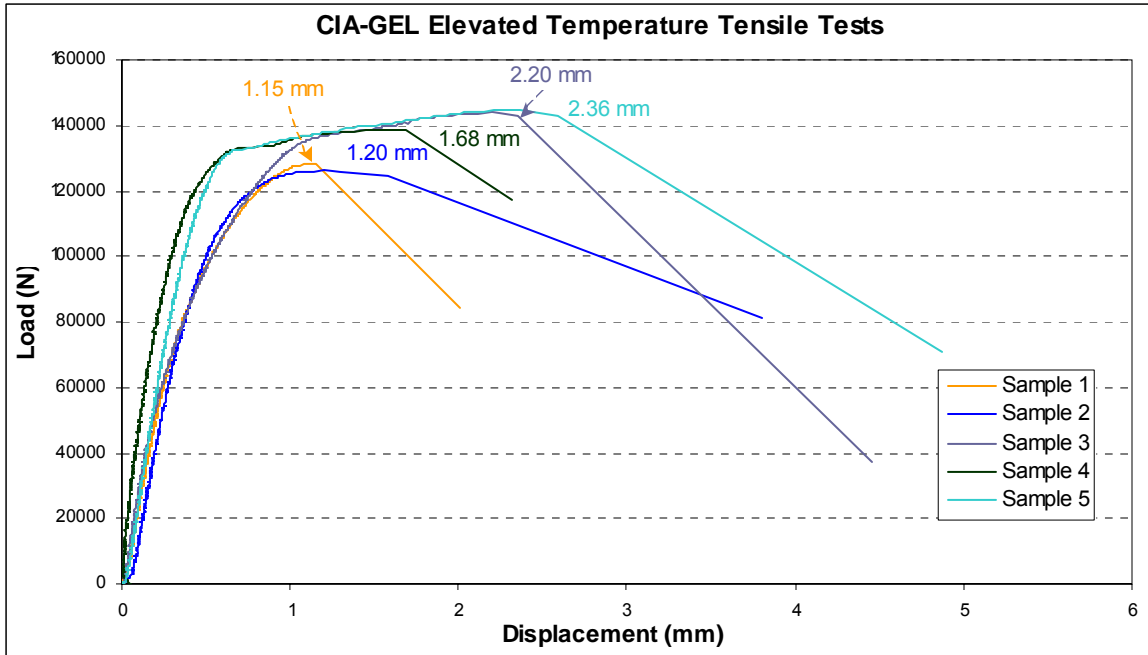

Figure A-85: Displacements at Maximum Load for CIA-GEL 7000 Elevated Temperature Tensile Tests

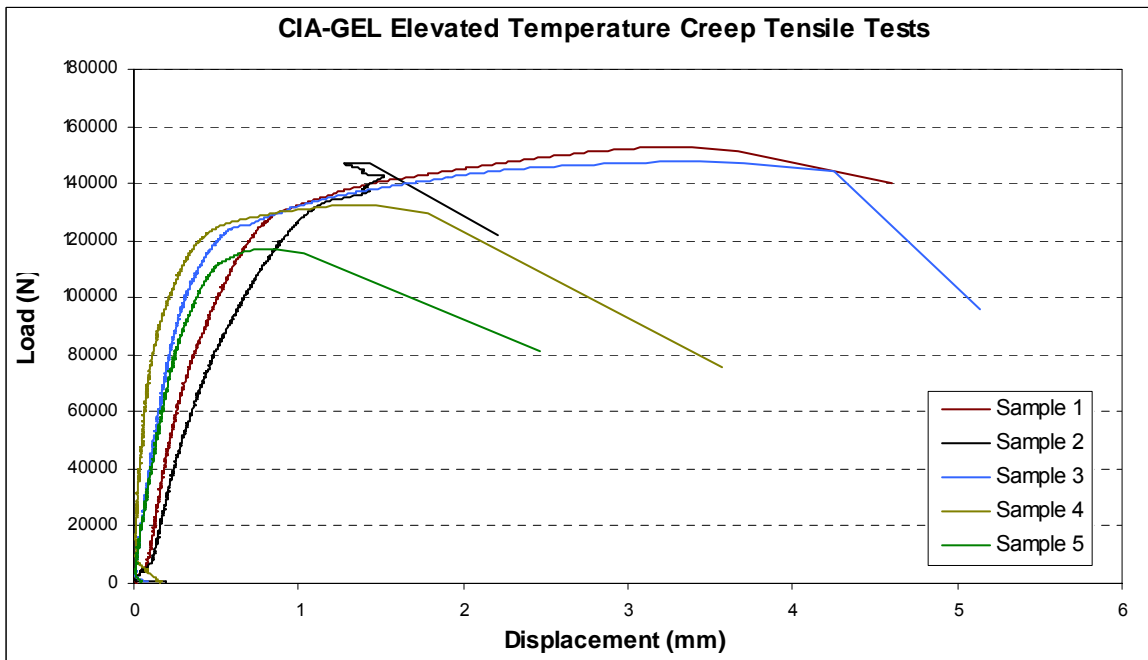

Figure A-86: CIA-GEL 7000 Tensile Tests After 42-Day Creep Cycle

Appendix B Data Logger Programs

B.1 Initial Creep Program (First 8 hours)

```
:{CR23X-TD}
;Epoxy Bonded Dowel Project
;
;
; This program collects data from thermocouples, temp/humidity
; probe, load cell, & pump digital gauge. Two tables have been
; set-up. Table 1 collects every hour, while Table 2 collects
; every 3 seconds for 8 hours.
;
;
; **This version is for 2 concrete thermocouple.**
;
; ***** TABLE 1 *****
;
; Collects data every hour and stores into final storage
;
; *Table 1 Program
; 01: 3600 Execution Interval (seconds)
;
; -----
; TEMPERATURE SECTION
; -----
; Reference temperature
;
; 1: Panel Temperature (P17)
; 1: 1 Loc [ PANEL_TEMP_C ]
;
; Convert reference temp from C to F
;
; 2: Z=X*F (P37)
; 1: 1 X Loc [ PANEL_TEMP_C ]
; 2: 1.8 F
; 3: 2 Z Loc [ PANEL_TEMP_F ]
;
; 3: Z=X+F (P34)
; 1: 2 X Loc [ PANEL_TEMP_F ]
; 2: 32 F
; 3: 2 Z Loc [ PANEL_TEMP_F ]
;
; -----
; CONCRETE 1
; Thermocouple 1 temp in F
;
; 4: Thermocouple Temp (DIFF) (P14)
; 1: 1 Repts
; 2: 21 10 mV, 60 Hz Reject, Slow Range
; 3: 1 DIFF Channel
; 4: 1 Type T (Copper-Constantan)
; 5: 1 Ref Temp (Deg. C) Loc [ PANEL_TEMP_C ]
; 6: 9 Loc [ C1_TEMP_F ]
; 7: 1.8 Mult
; 8: 32 Offset
```

```

; CONCRETE 2
; Thermocouple 2 temp in F
;
5: Thermocouple Temp (DIFF) (P14)
1: 1    Reps
2: 21   10 mV, 60 Hz Reject, Slow Range
3: 2    DIFF Channel
4: 1    Type T (Copper-Constantan)
5: 1    Ref Temp (Deg. C) Loc [ PANEL_TEMP_C ]
6: 10   Loc [ C2_TEMP_F ]
7: 1.8  Mult
8: 32   Offset

; OUTSIDE
; Thermocouple 3 temp in F
;
6: Thermocouple Temp (DIFF) (P14)
1: 1    Reps
2: 21   10 mV, 60 Hz Reject, Slow Range
3: 3    DIFF Channel ;
4: 1    Type T (Copper-Constantan)
5: 1    Ref Temp (Deg. C) Loc [ PANEL_TEMP_C ]
6: 11   Loc [ OUTSIDE_TEMP_F ]
7: 1.8  Mult
8: 32   Offset

; ENCLOSURE
; Thermocouple 4 temp in F
;
7: Thermocouple Temp (DIFF) (P14)
1: 1    Reps
2: 21   10 mV, 60 Hz Reject, Slow Range
3: 4    DIFF Channel
4: 1    Type T (Copper-Constantan)
5: 1    Ref Temp (Deg. C) Loc [ PANEL_TEMP_C ]
6: 12   Loc [ BOX_TEMP_F ]
7: 1.8  Mult
8: 32   Offset

;-----
; HMP45C TEMPERATURE AND RELATIVE HUMIDITY PROBE SECTION
;-----
; Temp/humidity probe on
;
8: Do (P86)
1: 41   Set Port 1 High

; Delay for probe stabilization
;
9: Delay w/Opt Excitation (P22)
1: 1    Ex Channel
2: 0    Delay W/Ex (0.01 sec units)
3: 15   Delay After Ex (0.01 sec units)
4: 0    mV Excitation

; Temp from probe

```

```

;
10: Volt (Diff) (P2)
1: 1    Reps
2: 24   1000 mV, 60 Hz Reject, Slow Range
3: 7    DIFF Channel
4: 3    Loc [ PROBE_TEMP_C ]
5: .1   Mult
6: -40  Offset

; Relative humidity from probe
;
11: Volt (Diff) (P2)
1: 1    Reps
2: 24   1000 mV, 60 Hz Reject, Slow Range
3: 8    DIFF Channel
4: 5    Loc [ REL_HUMIDITY ]
5: .1   Mult
6: 0.0  Offset

; Probe off
;
12: Do (P86)
1: 51   Set Port 1 Low

; -----
; Convert probe temp from C to F
;
13: Z=X*F (P37)
1: 3    X Loc [ PROBE_TEMP_C ]
2: 1.8  F
3: 4    Z Loc [ PROBE_TEMP_F ]

14: Z=X+F (P34)
1: 4    X Loc [ PROBE_TEMP_F ]
2: 32   F
3: 4    Z Loc [ PROBE_TEMP_F ]

; -----
; LVDT SECTION (MUX)
; -----
; Multiplexer on - power
;
15: Do (P86)
1: 43   Set Port 3 High

; Begin LVDT measurement loop (10 measurements)
;
16: Beginning of Loop (P87)
1: 0    Delay
2: 10   Loop Count

; Clock pulse - switch between ports LVDT's
;
17: Do (P86)
1: 74   Pulse Port 4

```

```

; Delay between pulses for LVDT stabilization
;
18: Delay w/Opt Excitation (P22)
1: 2    Ex Channel
2: 0    Delay W/Ex (0.01 sec units)
3: 1    Delay After Ex (0.01 sec units)
4: 0    mV Excitation

; LVDT displacement voltage reading
; w/ mV to V conversion
;
; NOTE: F4 is used to add "--" (location incrementor)
; in step 4.
;
19: Volt (Diff) (P2)
1: 1    Repts
2: 45   5000 mV, 60 Hz Reject, Fast Range
3: 10   DIFF Channel
4: 24   -- Loc [ LVDT_1_V    ]
5: .001 Mult
6: 0.0  Offset

; End loop
;
20: End (P95)

; Multiplexer off
;
21: Do (P86)
1: 53   Set Port 3 Low

;-----
; LVDT Factory Calibration (V/in)
;
;
; LVDT #1
;
22: Z=F x 10^n (P30)
1: 9.932 F
2: 0    n, Exponent of 10
3: 14   Z Loc [ CALIBRATION_1 ]

; LVDT #2
;
23: Z=F x 10^n (P30)
1: 9.959 F
2: 00   n, Exponent of 10
3: 15   Z Loc [ CALIBRATION_2 ]

; LVDT #3
;
24: Z=F x 10^n (P30)
1: 9.926 F
2: 00   n, Exponent of 10
3: 16   Z Loc [ CALIBRATION_3 ]

```

```

; LVDT #4
;
25: Z=F x 10^n (P30)
1: 9.914 F
2: 00 n, Exponent of 10
3: 17 Z Loc [ CALIBRATION_4 ]

; LVDT #5
;
26: Z=F x 10^n (P30)
1: 9.875 F
2: 00 n, Exponent of 10
3: 18 Z Loc [ CALIBRATION_5 ]

; LVDT #6
;
27: Z=F x 10^n (P30)
1: 9.938 F
2: 00 n, Exponent of 10
3: 19 Z Loc [ CALIBRATION_6 ]

; LVDT #7
;
28: Z=F x 10^n (P30)
1: 9.885 F
2: 00 n, Exponent of 10
3: 20 Z Loc [ CALIBRATION_7 ]

; LVDT #8
;
29: Z=F x 10^n (P30)
1: 9.980 F
2: 00 n, Exponent of 10
3: 21 Z Loc [ CALIBRATION_8 ]

; LVDT #9
;
30: Z=F x 10^n (P30)
1: 9.918 F
2: 00 n, Exponent of 10
3: 22 Z Loc [ CALIBRATION_9 ]

; LVDT #10
;
31: Z=F x 10^n (P30)
1: 9.926 F
2: 00 n, Exponent of 10
3: 23 Z Loc [ CALIBRATION_10 ]

; -----
; LVDT Reading (V) / Calibration Factor (V/in)
; = Linear Displacement (in)
;

; LVDT #1
;

```

```

32: Z=X/Y (P38)
1: 24 X Loc [ LVDT_1_V ]
2: 14 Y Loc [ CALIBRATION_1 ]
3: 34 Z Loc [ LVDT_1_IN ]

; LVDT #2
;
33: Z=X/Y (P38)
1: 25 X Loc [ LVDT_2_V ]
2: 15 Y Loc [ CALIBRATION_2 ]
3: 35 Z Loc [ LVDT_2_IN ]

; LVDT #3
;
34: Z=X/Y (P38)
1: 26 X Loc [ LVDT_3_V ]
2: 16 Y Loc [ CALIBRATION_3 ]
3: 36 Z Loc [ LVDT_3_IN ]

; LVDT #4
;
35: Z=X/Y (P38)
1: 27 X Loc [ LVDT_4_V ]
2: 17 Y Loc [ CALIBRATION_4 ]
3: 37 Z Loc [ LVDT_4_IN ]

; LVDT #5
;
36: Z=X/Y (P38)
1: 28 X Loc [ LVDT_5_V ]
2: 18 Y Loc [ CALIBRATION_5 ]
3: 38 Z Loc [ LVDT_5_IN ]

; LVDT #6
;
37: Z=X/Y (P38)
1: 29 X Loc [ LVDT_6_V ]
2: 19 Y Loc [ CALIBRATION_6 ]
3: 39 Z Loc [ LVDT_6_IN ]

; LVDT #7
;
38: Z=X/Y (P38)
1: 30 X Loc [ LVDT_7_V ]
2: 20 Y Loc [ CALIBRATION_7 ]
3: 40 Z Loc [ LVDT_7_IN ]

; LVDT #8
;
39: Z=X/Y (P38)
1: 31 X Loc [ LVDT_8_V ]
2: 21 Y Loc [ CALIBRATION_8 ]
3: 41 Z Loc [ LVDT_8_IN ]

; LVDT #9
;

```

```

40: Z=X/Y (P38)
1: 32   X Loc [ LVDT_9_V   ]
2: 22   Y Loc [ CALIBRATION_9 ]
3: 42   Z Loc [ LVDT_9_IN  ]

; LVDT #10
;
41: Z=X/Y (P38)
1: 33   X Loc [ LVDT_10_V  ]
2: 23   Y Loc [ CALIBRATION_10 ]
3: 43   Z Loc [ LVDT_10_IN ]

; -----
; Average reading
;

; LVDT 1 & 2 = Sample 1
42: Z=X+Y (P33)
1: 34   X Loc [ LVDT_1_IN  ]
2: 35   Y Loc [ LVDT_2_IN  ]
3: 44   Z Loc [ SMP_1_AVG_IN ]

43: Z=X*F (P37)
1: 44   X Loc [ SMP_1_AVG_IN ]
2: .5   F
3: 44   Z Loc [ SMP_1_AVG_IN ]

; LVDT 3 & 4 = Sample 2
44: Z=X+Y (P33)
1: 36   X Loc [ LVDT_3_IN  ]
2: 37   Y Loc [ LVDT_4_IN  ]
3: 45   Z Loc [ SMP_2_AVG_IN ]

45: Z=X*F (P37)
1: 45   X Loc [ SMP_2_AVG_IN ]
2: .5   F
3: 45   Z Loc [ SMP_2_AVG_IN ]

; LVDT 5 & 6 = Sample 3
46: Z=X+Y (P33)
1: 38   X Loc [ LVDT_5_IN  ]
2: 39   Y Loc [ LVDT_6_IN  ]
3: 46   Z Loc [ SMP_3_AVG_IN ]

47: Z=X*F (P37)
1: 46   X Loc [ SMP_3_AVG_IN ]
2: .5   F
3: 46   Z Loc [ SMP_3_AVG_IN ]

; LVDT 7 & 8 = Sample 4
48: Z=X+Y (P33)
1: 40   X Loc [ LVDT_7_IN  ]
2: 41   Y Loc [ LVDT_8_IN  ]
3: 47   Z Loc [ SMP_4_AVG_IN ]

49: Z=X*F (P37)

```



```
1: 47    X Loc [ SMP_4_AVG_IN ]
2: .5    F
3: 47    Z Loc [ SMP_4_AVG_IN ]
```

```
; LVDT 9 & 10 = Sample 5
```

```
50: Z=X+Y (P33)
```

```
1: 42    X Loc [ LVDT_9_IN   ]
2: 43    Y Loc [ LVDT_10_IN  ]
3: 48    Z Loc [ SMP_5_AVG_IN ]
```

```
51: Z=X*F (P37)
```

```
1: 48    X Loc [ SMP_5_AVG_IN ]
2: .5    F
3: 48    Z Loc [ SMP_5_AVG_IN ]
```

```
;-----
;
;                LOAD CELL SECTION
;-----
```

```
; Load cell reading
```

```
;
;
```

```
52: Full Bridge (P6)
```

```
1: 1     Repts
2: 11    10 mV, Fast Range
3: 12    DIFF Channel
4: 1     Excite all reps w/Exchan 1
5: 5000  mV Excitation
6: 6     Loc [ LOAD_CELL_1_LB ]
7: -26444 Mult
8: -153.49 Offset
```

```
;-----
;
;                PRESSURE SECTION (PUMP & RAMS)
;-----
```

```
; Pressure output
```

```
; (3000 psi / 2 V) * (1 V / 1000 mV) = 1.5 psi/mV
```

```
;
;
```

```
53: Volt (Diff) (P2)
```

```
1: 1     Repts
2: 15    5000 mV, Fast Range
3: 6     DIFF Channel
4: 7     Loc [ PRESSURE_PSIG ]
5: 1.5   Mult
6: 0.0   Offset
```

```
;-----
```

```
; Convert pressure into force using ram's effective area
```

```
; = 7.22 in^2
```

```
;
;
```

```
54: Z=X*F (P37)
```

```
1: 7     X Loc [ PRESSURE_PSIG ]
2: 7.22  F
3: 8     Z Loc [ RAM_FORCE1_LB ]
```

```
;-----
;
;                BATTERY MONITOR SECTION
;
```

```

;-----
; Monitor battery voltage
;
55: Batt Voltage (P10)
1: 13   Loc [ BAT_VOLTAGE_V ]

```

```

;-----
; DATA COLLECTION SECTION
;-----

```

```

; Collect data and put into table format
;
56: Data Table (P84)^27244
1: 0   Seconds into Interval
2: 0.0
3: 0.0 (0 = auto allocate, -x = redirect to inloc x)
4: EpoxyRebarData1   Table Name

```

```

; High resolution enabled (5 character)
;
57: Resolution (P78)
1: 1   High Resolution

```

```

; Store average into table
;
58: Average (P71)^25775
1: 13   Reps
2: 1   Loc [ PANEL_TEMP_C ]

```

```

59: Average (P71)^1908
1: 15   Reps
2: 34   Loc [ LVDT_1_IN ]

```

```

; ***** TABLE 2 *****
;

```

```

; Collects data every 3 seconds and stores into limited storage.
; 8 hours of data collected, but will continue to display results w/o storing.
;

```

```

*Table 2 Program
01: 3   Execution Interval (seconds)

```

```

;-----
; TEMPERATURE SECTION
;-----

```

```

; Reference temperature
;
1: Panel Temperature (P17)
1: 1   Loc [ PANEL_TEMP_C ]

; Convert reference temp from C to F
;
2: Z=X*F (P37)
1: 1   X Loc [ PANEL_TEMP_C ]
2: 1.8 F
3: 2   Z Loc [ PANEL_TEMP_F ]

```

```

3: Z=X+F (P34)
1: 2    X Loc [ PANEL_TEMP_F ]
2: 32    F
3: 2    Z Loc [ PANEL_TEMP_F ]

; -----
; CONCRETE 1
; Thermocouple 1 temp in F
;
4: Thermocouple Temp (DIFF) (P14)
1: 1    Reps
2: 21    10 mV, 60 Hz Reject, Slow Range
3: 1    DIFF Channel
4: 1    Type T (Copper-Constantan)
5: 1    Ref Temp (Deg. C) Loc [ PANEL_TEMP_C ]
6: 9    Loc [ C1_TEMP_F ]
7: 1.8    Mult
8: 32    Offset

; CONCRETE 2
; Thermocouple 2 temp in F
;
5: Thermocouple Temp (DIFF) (P14)
1: 1    Reps
2: 21    10 mV, 60 Hz Reject, Slow Range
3: 2    DIFF Channel
4: 1    Type T (Copper-Constantan)
5: 1    Ref Temp (Deg. C) Loc [ PANEL_TEMP_C ]
6: 10    Loc [ C2_TEMP_F ]
7: 1.8    Mult
8: 32    Offset

; OUTSIDE
; Thermocouple 3 temp in F
;
6: Thermocouple Temp (DIFF) (P14)
1: 1    Reps
2: 21    10 mV, 60 Hz Reject, Slow Range
3: 3    DIFF Channel ;
4: 1    Type T (Copper-Constantan)
5: 1    Ref Temp (Deg. C) Loc [ PANEL_TEMP_C ]
6: 11    Loc [ OUTSIDE_TEMP_F ]
7: 1.8    Mult
8: 32    Offset

; ENCLOSURE
; Thermocouple 4 temp in F
;
7: Thermocouple Temp (DIFF) (P14)
1: 1    Reps
2: 21    10 mV, 60 Hz Reject, Slow Range
3: 4    DIFF Channel
4: 1    Type T (Copper-Constantan)
5: 1    Ref Temp (Deg. C) Loc [ PANEL_TEMP_C ]
6: 12    Loc [ BOX_TEMP_F ]
7: 1.8    Mult

```

8: 32 Offset

; HMP45C TEMPERATURE AND RELATIVE HUMIDITY PROBE SECTION

; Temp/humidity probe on

8: Do (P86)

1: 41 Set Port 1 High

; Delay for probe stabilization

9: Delay w/Opt Excitation (P22)

1: 1 Ex Channel

2: 0 Delay W/Ex (0.01 sec units)

3: 15 Delay After Ex (0.01 sec units)

4: 0 mV Excitation

; Temp from probe

10: Volt (Diff) (P2)

1: 1 Repts

2: 24 1000 mV, 60 Hz Reject, Slow Range

3: 7 DIFF Channel

4: 3 Loc [PROBE_TEMP_C]

5: .1 Mult

6: -40 Offset

; Relative humidity from probe

11: Volt (Diff) (P2)

1: 1 Repts

2: 24 1000 mV, 60 Hz Reject, Slow Range

3: 8 DIFF Channel

4: 5 Loc [REL_HUMIDITY]

5: .1 Mult

6: 0.0 Offset

; Probe off

12: Do (P86)

1: 51 Set Port 1 Low

; Convert probe temp from C to F

13: Z=X*F (P37)

1: 3 X Loc [PROBE_TEMP_C]

2: 1.8 F

3: 4 Z Loc [PROBE_TEMP_F]

14: Z=X+F (P34)

1: 4 X Loc [PROBE_TEMP_F]

2: 32 F

3: 4 Z Loc [PROBE_TEMP_F]

```

;-----
; LVDT SECTION (MUX)
;-----
; Multiplexer on - power
;
15: Do (P86)
1: 43 Set Port 3 High

; Begin LVDT measurement loop (10 measurements)
;
16: Beginning of Loop (P87)
1: 0 Delay
2: 10 Loop Count

; Clock pulse - switch between ports LVDT's
;
17: Do (P86)
1: 74 Pulse Port 4

; Delay between pulses for LVDT stablization
;
18: Delay w/Opt Excitation (P22)
1: 2 Ex Channel
2: 0 Delay W/Ex (0.01 sec units)
3: 1 Delay After Ex (0.01 sec units)
4: 0 mV Excitation

; LVDT displacement voltage reading
; w/ mV to V conversion
;
; NOTE: F4 is used to add "--" (location incrementor)
; in step 4.
;
19: Volt (Diff) (P2)
1: 1 Reps
2: 45 5000 mV, 60 Hz Reject, Fast Range
3: 10 DIFF Channel
4: 24 -- Loc [ LVDT_1_V ]
5: .001 Mult
6: 0.0 Offset

; End loop
;
20: End (P95)

; Multiplexer off
;
21: Do (P86)
1: 53 Set Port 3 Low

;-----
; LVDT Factory Calibration (V/in)
;
;
; LVDT #1
;

```

```

22: Z=F x 10^n (P30)
1: 9.932 F
2: 0 n, Exponent of 10
3: 14 Z Loc [ CALIBRATION_1 ]

; LVDT #2
;
23: Z=F x 10^n (P30)
1: 9.959 F
2: 00 n, Exponent of 10
3: 15 Z Loc [ CALIBRATION_2 ]

; LVDT #3
;
24: Z=F x 10^n (P30)
1: 9.926 F
2: 00 n, Exponent of 10
3: 16 Z Loc [ CALIBRATION_3 ]

; LVDT #4
;
25: Z=F x 10^n (P30)
1: 9.914 F
2: 00 n, Exponent of 10
3: 17 Z Loc [ CALIBRATION_4 ]

; LVDT #5
;
26: Z=F x 10^n (P30)
1: 9.875 F
2: 00 n, Exponent of 10
3: 18 Z Loc [ CALIBRATION_5 ]

; LVDT #6
;
27: Z=F x 10^n (P30)
1: 9.938 F
2: 00 n, Exponent of 10
3: 19 Z Loc [ CALIBRATION_6 ]

; LVDT #7
;
28: Z=F x 10^n (P30)
1: 9.885 F
2: 00 n, Exponent of 10
3: 20 Z Loc [ CALIBRATION_7 ]

; LVDT #8
;
29: Z=F x 10^n (P30)
1: 9.980 F
2: 00 n, Exponent of 10
3: 21 Z Loc [ CALIBRATION_8 ]

; LVDT #9
;

```

```

30: Z=F x 10^n (P30)
1: 9.918 F
2: 00 n, Exponent of 10
3: 22 Z Loc [ CALIBRATION_9 ]

; LVDT #10
;
31: Z=F x 10^n (P30)
1: 9.926 F
2: 00 n, Exponent of 10
3: 23 Z Loc [ CALIBRATION_10 ]

; -----
; LVDT Reading (V) / Calibration Factor (V/in)
; = Linear Displacement (in)
;

; LVDT #1
;
32: Z=X/Y (P38)
1: 24 X Loc [ LVDT_1_V ]
2: 14 Y Loc [ CALIBRATION_1 ]
3: 34 Z Loc [ LVDT_1_IN ]

; LVDT #2
;
33: Z=X/Y (P38)
1: 25 X Loc [ LVDT_2_V ]
2: 15 Y Loc [ CALIBRATION_2 ]
3: 35 Z Loc [ LVDT_2_IN ]

; LVDT #3
;
34: Z=X/Y (P38)
1: 26 X Loc [ LVDT_3_V ]
2: 16 Y Loc [ CALIBRATION_3 ]
3: 36 Z Loc [ LVDT_3_IN ]

; LVDT #4
;
35: Z=X/Y (P38)
1: 27 X Loc [ LVDT_4_V ]
2: 17 Y Loc [ CALIBRATION_4 ]
3: 37 Z Loc [ LVDT_4_IN ]

; LVDT #5
;
36: Z=X/Y (P38)
1: 28 X Loc [ LVDT_5_V ]
2: 18 Y Loc [ CALIBRATION_5 ]
3: 38 Z Loc [ LVDT_5_IN ]

; LVDT #6
;
37: Z=X/Y (P38)
1: 29 X Loc [ LVDT_6_V ]

```

```
2: 19   Y Loc [ CALIBRATION_6 ]
3: 39   Z Loc [ LVDT_6_IN   ]
```

```
; LVDT #7
```

```
;
38: Z=X/Y (P38)
1: 30   X Loc [ LVDT_7_V   ]
2: 20   Y Loc [ CALIBRATION_7 ]
3: 40   Z Loc [ LVDT_7_IN   ]
```

```
; LVDT #8
```

```
;
39: Z=X/Y (P38)
1: 31   X Loc [ LVDT_8_V   ]
2: 21   Y Loc [ CALIBRATION_8 ]
3: 41   Z Loc [ LVDT_8_IN   ]
```

```
; LVDT #9
```

```
;
40: Z=X/Y (P38)
1: 32   X Loc [ LVDT_9_V   ]
2: 22   Y Loc [ CALIBRATION_9 ]
3: 42   Z Loc [ LVDT_9_IN   ]
```

```
; LVDT #10
```

```
;
41: Z=X/Y (P38)
1: 33   X Loc [ LVDT_10_V  ]
2: 23   Y Loc [ CALIBRATION_10 ]
3: 43   Z Loc [ LVDT_10_IN  ]
```

```
; -----
; Average reading
;
```

```
; LVDT 1 & 2 = Sample 1
```

```
42: Z=X+Y (P33)
1: 34   X Loc [ LVDT_1_IN   ]
2: 35   Y Loc [ LVDT_2_IN   ]
3: 44   Z Loc [ SMP_1_AVG_IN ]
```

```
43: Z=X*F (P37)
```

```
1: 44   X Loc [ SMP_1_AVG_IN ]
2: .5   F
3: 44   Z Loc [ SMP_1_AVG_IN ]
```

```
; LVDT 3 & 4 = Sample 2
```

```
44: Z=X+Y (P33)
1: 36   X Loc [ LVDT_3_IN   ]
2: 37   Y Loc [ LVDT_4_IN   ]
3: 45   Z Loc [ SMP_2_AVG_IN ]
```

```
45: Z=X*F (P37)
```

```
1: 45   X Loc [ SMP_2_AVG_IN ]
2: .5   F
3: 45   Z Loc [ SMP_2_AVG_IN ]
```



```
; LVDT 5 & 6 = Sample 3
46: Z=X+Y (P33)
1: 38 X Loc [ LVDT_5_IN ]
2: 39 Y Loc [ LVDT_6_IN ]
3: 46 Z Loc [ SMP_3_AVG_IN ]
```

```
47: Z=X*F (P37)
1: 46 X Loc [ SMP_3_AVG_IN ]
2: .5 F
3: 46 Z Loc [ SMP_3_AVG_IN ]
```

```
; LVDT 7 & 8 = Sample 4
48: Z=X+Y (P33)
1: 40 X Loc [ LVDT_7_IN ]
2: 41 Y Loc [ LVDT_8_IN ]
3: 47 Z Loc [ SMP_4_AVG_IN ]
```

```
49: Z=X*F (P37)
1: 47 X Loc [ SMP_4_AVG_IN ]
2: .5 F
3: 47 Z Loc [ SMP_4_AVG_IN ]
```

```
; LVDT 9 & 10 = Sample 5
50: Z=X+Y (P33)
1: 42 X Loc [ LVDT_9_IN ]
2: 43 Y Loc [ LVDT_10_IN ]
3: 48 Z Loc [ SMP_5_AVG_IN ]
```

```
51: Z=X*F (P37)
1: 48 X Loc [ SMP_5_AVG_IN ]
2: .5 F
3: 48 Z Loc [ SMP_5_AVG_IN ]
```

```
; -----
; LOAD CELL SECTION
; -----
```

```
; Load cell reading
;
52: Full Bridge (P6)
1: 1 Repts
2: 11 10 mV, Fast Range
3: 12 DIFF Channel
4: 1 Excite all reps w/Exchan 1
5: 5000 mV Excitation
6: 6 Loc [ LOAD_CELL_1_LB ]
7: -26444 Mult
8: -153.49 Offset
```

```
; -----
; PRESSURE SECTION (PUMP & RAMS)
; -----
```

```
; Pressure output
; When digital indicator is set to 0 - 3000 psi,
; the output is 1500 PSI/V
; (3000 psi / 2 V) * (1 V / 1000 mV) = 1.5 psi/mV
```

```

;
53: Volt (Diff) (P2)
1: 1    Reps
2: 15   5000 mV, Fast Range
3: 6    DIFF Channel
4: 7    Loc [ PRESSURE_PSIG ]
5: 1.5  Mult
6: 0.0  Offset

; -----
; Convert pressure into force using ram's effective area
; = 7.22 in^2
;
54: Z=X*F (P37)
1: 7    X Loc [ PRESSURE_PSIG ]
2: 7.22 F
3: 8    Z Loc [ RAM_FORCE1_LB ]

; -----
;
;           BATTERY MONITOR SECTION
; -----
; Monitor battery voltage
;
55: Batt Voltage (P10)
1: 13   Loc [ BAT_VOLTAGE_V ]

; -----
;
;           DATA COLLECTION SECTION
; -----
; Collect data and put into table format.
; Only 9600 records (8 hours) will be stored to conserve
; memory space.
;
56: If (X<=>F) (P89)
1: 49   X Loc [ COUNTER    ]
2: 4    <
3: 9600 F
4: 30   Then Do

57: Data Table (P84)^27244
1: 0    Seconds into Interval
2: 0.0  _____
3: 0    (0 = auto allocate, -x = redirect to inloc x)
4: EpoxyRebarData2      Table Name

; High resolution enabled (5 character)
;
58: Resolution (P78)
1: 1    High Resolution

; Store InLoc 1-13
;
59: Average (P71)^25775
1: 13   Reps
2: 1    Loc [ PANEL_TEMP_C ]

```

; Store LVDT displacement

;

60: Average (P71)^25355

1: 15 Repts

2: 34 Loc [LVDT_1_IN]

; Increment counter by 1

;

61: Z=Z+1 (P32)

1: 49 Z Loc [COUNTER]

62: End (P95)

*Table 3 Subroutines

End Program

B.2 Creep Program After Initial 8 Hours

```
;{CR23X-TD}
;Epoxy Bonded Dowel Project
;
; This program collects data from thermocouples, temp/humidity
; probe, load cell, & pump digital gauge. Two tables have been
; set-up. Table 1 collects and stores data every hour, while
; Table 2 collects every 3 seconds without storing data.
;
; **This version is for 2 concrete thermocouples.**

; ***** TABLE 1 *****
;
; Collects data every hour and stores into final storage
;
*Table 1 Program
01: 3600 Execution Interval (seconds)

; -----
; TEMPERATURE SECTION
; -----
; Reference temperature
;
1: Panel Temperature (P17)
1: 1 Loc [ PANEL_TEMP_C ]

; Convert reference temp from C to F
;
2: Z=X*F (P37)
1: 1 X Loc [ PANEL_TEMP_C ]
2: 1.8 F
3: 2 Z Loc [ PANEL_TEMP_F ]

3: Z=X+F (P34)
1: 2 X Loc [ PANEL_TEMP_F ]
2: 32 F
3: 2 Z Loc [ PANEL_TEMP_F ]

; -----
; CONCRETE 1
; Thermocouple 1 temp in F
;
4: Thermocouple Temp (DIFF) (P14)
1: 1 Repts
2: 21 10 mV, 60 Hz Reject, Slow Range
3: 1 DIFF Channel
4: 1 Type T (Copper-Constantan)
5: 1 Ref Temp (Deg. C) Loc [ PANEL_TEMP_C ]
6: 9 Loc [ C1_TEMP_F ]
7: 1.8 Mult
8: 32 Offset

; CONCRETE 2
; Thermocouple 2 temp in F
;
```

```

5: Thermocouple Temp (DIFF) (P14)
  1: 1    Reps
  2: 21   10 mV, 60 Hz Reject, Slow Range
  3: 2    DIFF Channel
  4: 1    Type T (Copper-Constantan)
  5: 1    Ref Temp (Deg. C) Loc [ PANEL_TEMP_C ]
  6: 10   Loc [ C2_TEMP_F ]
  7: 1.8  Mult
  8: 32   Offset

; OUTSIDE
; Thermocouple 3 temp in F
;
6: Thermocouple Temp (DIFF) (P14)
  1: 1    Reps
  2: 21   10 mV, 60 Hz Reject, Slow Range
  3: 3    DIFF Channel ;
  4: 1    Type T (Copper-Constantan)
  5: 1    Ref Temp (Deg. C) Loc [ PANEL_TEMP_C ]
  6: 11   Loc [ OUTSIDE_TEMP_F ]
  7: 1.8  Mult
  8: 32   Offset

; ENCLOSURE
; Thermocouple 4 temp in F
;
7: Thermocouple Temp (DIFF) (P14)
  1: 1    Reps
  2: 21   10 mV, 60 Hz Reject, Slow Range
  3: 4    DIFF Channel
  4: 1    Type T (Copper-Constantan)
  5: 1    Ref Temp (Deg. C) Loc [ PANEL_TEMP_C ]
  6: 12   Loc [ BOX_TEMP_F ]
  7: 1.8  Mult
  8: 32   Offset

; -----
; HMP45C TEMPERATURE AND RELATIVE HUMIDITY PROBE SECTION
; -----
; Temp/humidity probe on
;
8: Do (P86)
  1: 41   Set Port 1 High

; Delay for probe stabilization
;
9: Delay w/Opt Excitation (P22)
  1: 1    Ex Channel
  2: 0    Delay W/Ex (0.01 sec units)
  3: 15   Delay After Ex (0.01 sec units)
  4: 0    mV Excitation

; Temp from probe
;
10: Volt (Diff) (P2)
  1: 1    Reps

```

```

2: 24    1000 mV, 60 Hz Reject, Slow Range
3: 7     DIFF Channel
4: 3     Loc [ PROBE_TEMP_C ]
5: .1    Mult
6: -40   Offset

; Relative humidity from probe
;
11: Volt (Diff) (P2)
1: 1     Reps
2: 24    1000 mV, 60 Hz Reject, Slow Range
3: 8     DIFF Channel
4: 5     Loc [ REL_HUMIDITY ]
5: .1    Mult
6: 0.0   Offset

; Probe off
;
12: Do (P86)
1: 51    Set Port 1 Low

; -----
; Convert probe temp from C to F
;
13: Z=X*F (P37)
1: 3     X Loc [ PROBE_TEMP_C ]
2: 1.8   F
3: 4     Z Loc [ PROBE_TEMP_F ]

14: Z=X+F (P34)
1: 4     X Loc [ PROBE_TEMP_F ]
2: 32    F
3: 4     Z Loc [ PROBE_TEMP_F ]

; -----
; LVDT SECTION (MUX)
; -----
; Multiplexer on - power
;
15: Do (P86)
1: 43    Set Port 3 High

; Begin LVDT measurement loop (10 measurements)
;
16: Beginning of Loop (P87)
1: 0     Delay
2: 10    Loop Count

; Clock pulse - switch between ports LVDT's
;
17: Do (P86)
1: 74    Pulse Port 4

; Delay between pulses for LVDT stabilization
;
18: Delay w/Opt Excitation (P22)

```

```

1: 2    Ex Channel
2: 0    Delay W/Ex (0.01 sec units)
3: 1    Delay After Ex (0.01 sec units)
4: 0    mV Excitation

; LVDT displacement voltage reading
; w/ mV to V conversion
;
; NOTE: F4 is used to add "--" (location incrementor)
; in step 4.
;
19: Volt (Diff) (P2)
1: 1    Repts
2: 45    5000 mV, 60 Hz Reject, Fast Range
3: 10    DIFF Channel
4: 24    -- Loc [ LVDT_1_V    ]
5: .001    Mult
6: 0.0    Offset

; End loop
;
20: End (P95)

; Multiplexer off
;
21: Do (P86)
1: 53    Set Port 3 Low

;-----
; LVDT Factory Calibration (V/in)
;
;
; LVDT #1
;
22: Z=F x 10^n (P30)
1: 9.932    F
2: 0        n, Exponent of 10
3: 14      Z Loc [ CALIBRATION_1 ]

; LVDT #2
;
23: Z=F x 10^n (P30)
1: 9.959    F
2: 00      n, Exponent of 10
3: 15      Z Loc [ CALIBRATION_2 ]

; LVDT #3
;
24: Z=F x 10^n (P30)
1: 9.926    F
2: 00      n, Exponent of 10
3: 16      Z Loc [ CALIBRATION_3 ]

; LVDT #4
;
25: Z=F x 10^n (P30)

```

```

1: 9.914  F
2: 00    n, Exponent of 10
3: 17    Z Loc [ CALIBRATION_4 ]

; LVDT #5
;
26: Z=F x 10^n (P30)
1: 9.875  F
2: 00    n, Exponent of 10
3: 18    Z Loc [ CALIBRATION_5 ]

; LVDT #6
;
27: Z=F x 10^n (P30)
1: 9.938  F
2: 00    n, Exponent of 10
3: 19    Z Loc [ CALIBRATION_6 ]

; LVDT #7
;
28: Z=F x 10^n (P30)
1: 9.885  F
2: 00    n, Exponent of 10
3: 20    Z Loc [ CALIBRATION_7 ]

; LVDT #8
;
29: Z=F x 10^n (P30)
1: 9.980  F
2: 00    n, Exponent of 10
3: 21    Z Loc [ CALIBRATION_8 ]

; LVDT #9
;
30: Z=F x 10^n (P30)
1: 9.918  F
2: 00    n, Exponent of 10
3: 22    Z Loc [ CALIBRATION_9 ]

; LVDT #10
;
31: Z=F x 10^n (P30)
1: 9.926  F
2: 00    n, Exponent of 10
3: 23    Z Loc [ CALIBRATION_10 ]

; -----
; LVDT Reading (V) / Calibration Factor (V/in)
; = Linear Displacement (in)
;

; LVDT #1
;
32: Z=X/Y (P38)
1: 24    X Loc [ LVDT_1_V    ]
2: 14    Y Loc [ CALIBRATION_1 ]

```



```

3: 34    Z Loc [ LVDT_1_IN  ]

; LVDT #2
;
33: Z=X/Y (P38)
1: 25    X Loc [ LVDT_2_V   ]
2: 15    Y Loc [ CALIBRATION_2 ]
3: 35    Z Loc [ LVDT_2_IN  ]

; LVDT #3
;
34: Z=X/Y (P38)
1: 26    X Loc [ LVDT_3_V   ]
2: 16    Y Loc [ CALIBRATION_3 ]
3: 36    Z Loc [ LVDT_3_IN  ]

; LVDT #4
;
35: Z=X/Y (P38)
1: 27    X Loc [ LVDT_4_V   ]
2: 17    Y Loc [ CALIBRATION_4 ]
3: 37    Z Loc [ LVDT_4_IN  ]

; LVDT #5
;
36: Z=X/Y (P38)
1: 28    X Loc [ LVDT_5_V   ]
2: 18    Y Loc [ CALIBRATION_5 ]
3: 38    Z Loc [ LVDT_5_IN  ]

; LVDT #6
;
37: Z=X/Y (P38)
1: 29    X Loc [ LVDT_6_V   ]
2: 19    Y Loc [ CALIBRATION_6 ]
3: 39    Z Loc [ LVDT_6_IN  ]

; LVDT #7
;
38: Z=X/Y (P38)
1: 30    X Loc [ LVDT_7_V   ]
2: 20    Y Loc [ CALIBRATION_7 ]
3: 40    Z Loc [ LVDT_7_IN  ]

; LVDT #8
;
39: Z=X/Y (P38)
1: 31    X Loc [ LVDT_8_V   ]
2: 21    Y Loc [ CALIBRATION_8 ]
3: 41    Z Loc [ LVDT_8_IN  ]

; LVDT #9
;
40: Z=X/Y (P38)
1: 32    X Loc [ LVDT_9_V   ]
2: 22    Y Loc [ CALIBRATION_9 ]

```

```

3: 42    Z Loc [ LVDT_9_IN  ]

; LVDT #10
;
41: Z=X/Y (P38)
1: 33    X Loc [ LVDT_10_V  ]
2: 23    Y Loc [ CALIBRATION_10 ]
3: 43    Z Loc [ LVDT_10_IN  ]

; -----
; Average reading
;

; LVDT 1 & 2 = Sample 1
42: Z=X+Y (P33)
1: 34    X Loc [ LVDT_1_IN  ]
2: 35    Y Loc [ LVDT_2_IN  ]
3: 44    Z Loc [ S1_AVG_IN  ]

43: Z=X*F (P37)
1: 44    X Loc [ S1_AVG_IN  ]
2: .5    F
3: 44    Z Loc [ S1_AVG_IN  ]

; LVDT 3 & 4 = Sample 2
44: Z=X+Y (P33)
1: 36    X Loc [ LVDT_3_IN  ]
2: 37    Y Loc [ LVDT_4_IN  ]
3: 45    Z Loc [ S2_AVG_IN  ]

45: Z=X*F (P37)
1: 45    X Loc [ S2_AVG_IN  ]
2: .5    F
3: 45    Z Loc [ S2_AVG_IN  ]

; LVDT 5 & 6 = Sample 3
46: Z=X+Y (P33)
1: 38    X Loc [ LVDT_5_IN  ]
2: 39    Y Loc [ LVDT_6_IN  ]
3: 46    Z Loc [ S3_AVG_IN  ]

47: Z=X*F (P37)
1: 46    X Loc [ S3_AVG_IN  ]
2: .5    F
3: 46    Z Loc [ S3_AVG_IN  ]

; LVDT 7 & 8 = Sample 4
48: Z=X+Y (P33)
1: 40    X Loc [ LVDT_7_IN  ]
2: 41    Y Loc [ LVDT_8_IN  ]
3: 47    Z Loc [ S4_AVG_IN  ]

49: Z=X*F (P37)
1: 47    X Loc [ S4_AVG_IN  ]
2: .5    F
3: 47    Z Loc [ S4_AVG_IN  ]

```

```

; LVDT 9 & 10 = Sample 5
50: Z=X+Y (P33)
  1: 42   X Loc [ LVDT_9_IN   ]
  2: 43   Y Loc [ LVDT_10_IN  ]
  3: 48   Z Loc [ S5_AVG_IN   ]

51: Z=X*F (P37)
  1: 48   X Loc [ S5_AVG_IN   ]
  2: .5   F
  3: 48   Z Loc [ S5_AVG_IN   ]

; -----
; Total displacement

; Sample 1

52: Z=X+F (P34)
  1: 44   X Loc [ S1_AVG_IN   ]
  2: -.026186 F
  3: 49   Z Loc [ S1_TOT_DISP ]

; Sample 2

53: Z=X+F (P34)
  1: 45   X Loc [ S2_AVG_IN   ]
  2: -.011948 F
  3: 50   Z Loc [ S2_TOT_DISP ]

; Sample 3

54: Z=X+F (P34)
  1: 46   X Loc [ S3_AVG_IN   ]
  2: -.022722 F
  3: 51   Z Loc [ S3_TOT_DISP ]

; Sample 4

55: Z=X+F (P34)
  1: 47   X Loc [ S4_AVG_IN   ]
  2: -.025067 F
  3: 52   Z Loc [ S4_TOT_DISP ]

; Sample 5

56: Z=X+F (P34)
  1: 48   X Loc [ S5_AVG_IN   ]
  2: -.12509 F
  3: 53   Z Loc [ S5_TOT_DISP ]

; -----
;                               LOAD CELL SECTION
; -----
; Load cell reading
;
57: Full Bridge (P6)
  1: 1    Reps
  2: 11   10 mV, Fast Range
  3: 12   DIFF Channel
  4: 1    Excite all reps w/Exchan 1

```

5: 5000 mV Excitation
6: 6 Loc [LOAD_CELL_1_LB]
7: -26444 Mult
8: -153.49 Offset

; PRESSURE SECTION (PUMP & RAMS)

; Pressure output
; (3000 psi / 2 V) * (1 V / 1000 mV) = 1.5 psi/mV

58: Volt (Diff) (P2)
1: 1 Reps
2: 15 5000 mV, Fast Range
3: 6 DIFF Channel
4: 7 Loc [PRESSURE_PSIG]
5: 1.5 Mult
6: 0.0 Offset

; Convert pressure into force using ram's effective area
; = 7.22 in^2

59: Z=X*F (P37)
1: 7 X Loc [PRESSURE_PSIG]
2: 7.22 F
3: 8 Z Loc [RAM_FORCE1_LB]

; BATTERY MONITOR SECTION

; Monitor battery voltage

60: Batt Voltage (P10)
1: 13 Loc [BAT_VOLTAGE_V]

; DATA COLLECTION SECTION

; Collect data and put into table format

61: Data Table (P84)^27244
1: 0 Seconds into Interval
2: 0.0 _____
3: 0.0 (0 = auto allocate, -x = redirect to inloc x)
4: EpoxyRebarData1 Table Name

; High resolution enabled (5 character)

62: Resolution (P78)
1: 1 High Resolution

; Store average into table

63: Average (P71)^25775
1: 13 Reps

2: 1 Loc [PANEL_TEMP_C]

64: Average (P71)^2342

1: 20 Reps

2: 34 Loc [LVDT_1_IN]

***** TABLE 2 *****

; Collects data every 3 seconds and stores into limited storage.
; 8 hours of data collected, but will continue to update w/o storing.

*Table 2 Program

01: 3 Execution Interval (seconds)

; TEMPERATURE SECTION

; Reference temperature

1: Panel Temperature (P17)

1: 1 Loc [PANEL_TEMP_C]

; Convert reference temp from C to F

2: Z=X*F (P37)

1: 1 X Loc [PANEL_TEMP_C]

2: 1.8 F

3: 2 Z Loc [PANEL_TEMP_F]

3: Z=X+F (P34)

1: 2 X Loc [PANEL_TEMP_F]

2: 32 F

3: 2 Z Loc [PANEL_TEMP_F]

; CONCRETE 1

; Thermocouple 1 temp in F

4: Thermocouple Temp (DIFF) (P14)

1: 1 Reps

2: 21 10 mV, 60 Hz Reject, Slow Range

3: 1 DIFF Channel

4: 1 Type T (Copper-Constantan)

5: 1 Ref Temp (Deg. C) Loc [PANEL_TEMP_C]

6: 9 Loc [C1_TEMP_F]

7: 1.8 Mult

8: 32 Offset

; CONCRETE 2

; Thermocouple 2 temp in F

5: Thermocouple Temp (DIFF) (P14)

1: 1 Reps

2: 21 10 mV, 60 Hz Reject, Slow Range

3: 2 DIFF Channel

4: 1 Type T (Copper-Constantan)
5: 1 Ref Temp (Deg. C) Loc [PANEL_TEMP_C]
6: 10 Loc [C2_TEMP_F]
7: 1.8 Mult
8: 32 Offset

; OUTSIDE

; Thermocouple 3 temp in F

;

6: Thermocouple Temp (DIFF) (P14)

1: 1 Reps
2: 21 10 mV, 60 Hz Reject, Slow Range
3: 3 DIFF Channel ;
4: 1 Type T (Copper-Constantan)
5: 1 Ref Temp (Deg. C) Loc [PANEL_TEMP_C]
6: 11 Loc [OUTSIDE_TEMP_F]
7: 1.8 Mult
8: 32 Offset

; ENCLOSURE

; Thermocouple 4 temp in F

;

7: Thermocouple Temp (DIFF) (P14)

1: 1 Reps
2: 21 10 mV, 60 Hz Reject, Slow Range
3: 4 DIFF Channel
4: 1 Type T (Copper-Constantan)
5: 1 Ref Temp (Deg. C) Loc [PANEL_TEMP_C]
6: 12 Loc [BOX_TEMP_F]
7: 1.8 Mult
8: 32 Offset

; HMP45C TEMPERATURE AND RELATIVE HUMIDITY PROBE SECTION

; Temp/humidity probe on

;

8: Do (P86)

1: 41 Set Port 1 High

; Delay for probe stabilization

;

9: Delay w/Opt Excitation (P22)

1: 1 Ex Channel
2: 0 Delay W/Ex (0.01 sec units)
3: 15 Delay After Ex (0.01 sec units)
4: 0 mV Excitation

; Temp from probe

;

10: Volt (Diff) (P2)

1: 1 Reps
2: 24 1000 mV, 60 Hz Reject, Slow Range
3: 7 DIFF Channel
4: 3 Loc [PROBE_TEMP_C]
5: .1 Mult

```

6: -40    Offset

; Relative humidity from probe
;
11: Volt (Diff) (P2)
1: 1     Reps
2: 24    1000 mV, 60 Hz Reject, Slow Range
3: 8     DIFF Channel
4: 5     Loc [ REL_HUMIDITY ]
5: .1    Mult
6: 0.0   Offset

; Probe off
;
12: Do (P86)
1: 51    Set Port 1 Low

; -----
; Convert probe temp from C to F
;
13: Z=X*F (P37)
1: 3     X Loc [ PROBE_TEMP_C ]
2: 1.8   F
3: 4     Z Loc [ PROBE_TEMP_F ]

14: Z=X+F (P34)
1: 4     X Loc [ PROBE_TEMP_F ]
2: 32    F
3: 4     Z Loc [ PROBE_TEMP_F ]

; -----
;                               LVDT SECTION (MUX)
; -----
; Multiplexer on - power
;
15: Do (P86)
1: 43    Set Port 3 High

; Begin LVDT measurement loop (10 measurements)
;
16: Beginning of Loop (P87)
1: 0     Delay
2: 10    Loop Count

; Clock pulse - switch between ports LVDT's
;
17: Do (P86)
1: 74    Pulse Port 4

; Delay between pulses for LVDT stabilization
;
18: Delay w/Opt Excitation (P22)
1: 2     Ex Channel
2: 0     Delay W/Ex (0.01 sec units)
3: 1     Delay After Ex (0.01 sec units)
4: 0     mV Excitation

```

```

; LVDT displacement voltage reading
; w/ mV to V conversion
;
; NOTE: F4 is used to add "--" (location incrementor)
; in step 4.
;
19: Volt (Diff) (P2)
1: 1      Repts
2: 45     5000 mV, 60 Hz Reject, Fast Range
3: 10     DIFF Channel
4: 24     -- Loc [ LVDT_1_V      ]
5: .001   Mult
6: 0.0    Offset

; End loop
;
20: End (P95)

; Multiplexer off
;
21: Do (P86)
1: 53     Set Port 3 Low

;-----
; LVDT Factory Calibration (V/in)
;
; LVDT #1
;
22: Z=F x 10^n (P30)
1: 9.932  F
2: 0      n, Exponent of 10
3: 14     Z Loc [ CALIBRATION_1 ]

; LVDT #2
;
23: Z=F x 10^n (P30)
1: 9.959  F
2: 00     n, Exponent of 10
3: 15     Z Loc [ CALIBRATION_2 ]

; LVDT #3
;
24: Z=F x 10^n (P30)
1: 9.926  F
2: 00     n, Exponent of 10
3: 16     Z Loc [ CALIBRATION_3 ]

; LVDT #4
;
25: Z=F x 10^n (P30)
1: 9.914  F
2: 00     n, Exponent of 10
3: 17     Z Loc [ CALIBRATION_4 ]

```



```

; LVDT #5
;
26: Z=F x 10^n (P30)
1: 9.875 F
2: 00 n, Exponent of 10
3: 18 Z Loc [ CALIBRATION_5 ]

; LVDT #6
;
27: Z=F x 10^n (P30)
1: 9.938 F
2: 00 n, Exponent of 10
3: 19 Z Loc [ CALIBRATION_6 ]

; LVDT #7
;
28: Z=F x 10^n (P30)
1: 9.885 F
2: 00 n, Exponent of 10
3: 20 Z Loc [ CALIBRATION_7 ]

; LVDT #8
;
29: Z=F x 10^n (P30)
1: 9.980 F
2: 00 n, Exponent of 10
3: 21 Z Loc [ CALIBRATION_8 ]

; LVDT #9
;
30: Z=F x 10^n (P30)
1: 9.918 F
2: 00 n, Exponent of 10
3: 22 Z Loc [ CALIBRATION_9 ]

; LVDT #10
;
31: Z=F x 10^n (P30)
1: 9.926 F
2: 00 n, Exponent of 10
3: 23 Z Loc [ CALIBRATION_10 ]

; -----
; LVDT Reading (V) / Calibration Factor (V/in)
; = Linear Displacement (in)
;
; LVDT #1
;
32: Z=X/Y (P38)
1: 24 X Loc [ LVDT_1_V ]
2: 14 Y Loc [ CALIBRATION_1 ]
3: 34 Z Loc [ LVDT_1_IN ]

; LVDT #2
;

```

```

33: Z=X/Y (P38)
1: 25   X Loc [ LVDT_2_V   ]
2: 15   Y Loc [ CALIBRATION_2 ]
3: 35   Z Loc [ LVDT_2_IN ]

; LVDT #3
;
34: Z=X/Y (P38)
1: 26   X Loc [ LVDT_3_V   ]
2: 16   Y Loc [ CALIBRATION_3 ]
3: 36   Z Loc [ LVDT_3_IN ]

; LVDT #4
;
35: Z=X/Y (P38)
1: 27   X Loc [ LVDT_4_V   ]
2: 17   Y Loc [ CALIBRATION_4 ]
3: 37   Z Loc [ LVDT_4_IN ]

; LVDT #5
;
36: Z=X/Y (P38)
1: 28   X Loc [ LVDT_5_V   ]
2: 18   Y Loc [ CALIBRATION_5 ]
3: 38   Z Loc [ LVDT_5_IN ]

; LVDT #6
;
37: Z=X/Y (P38)
1: 29   X Loc [ LVDT_6_V   ]
2: 19   Y Loc [ CALIBRATION_6 ]
3: 39   Z Loc [ LVDT_6_IN ]

; LVDT #7
;
38: Z=X/Y (P38)
1: 30   X Loc [ LVDT_7_V   ]
2: 20   Y Loc [ CALIBRATION_7 ]
3: 40   Z Loc [ LVDT_7_IN ]

; LVDT #8
;
39: Z=X/Y (P38)
1: 31   X Loc [ LVDT_8_V   ]
2: 21   Y Loc [ CALIBRATION_8 ]
3: 41   Z Loc [ LVDT_8_IN ]

; LVDT #9
;
40: Z=X/Y (P38)
1: 32   X Loc [ LVDT_9_V   ]
2: 22   Y Loc [ CALIBRATION_9 ]
3: 42   Z Loc [ LVDT_9_IN ]

; LVDT #10
;

```

```

41: Z=X/Y (P38)
1: 33   X Loc [ LVDT_10_V   ]
2: 23   Y Loc [ CALIBRATION_10 ]
3: 43   Z Loc [ LVDT_10_IN  ]

; -----
; Average reading
;

; LVDT 1 & 2 = Sample 1
42: Z=X+Y (P33)
1: 34   X Loc [ LVDT_1_IN   ]
2: 35   Y Loc [ LVDT_2_IN   ]
3: 44   Z Loc [ S1_AVG_IN   ]

43: Z=X*F (P37)
1: 44   X Loc [ S1_AVG_IN   ]
2: .5   F
3: 44   Z Loc [ S1_AVG_IN   ]

; LVDT 3 & 4 = Sample 2
44: Z=X+Y (P33)
1: 36   X Loc [ LVDT_3_IN   ]
2: 37   Y Loc [ LVDT_4_IN   ]
3: 45   Z Loc [ S2_AVG_IN   ]

45: Z=X*F (P37)
1: 45   X Loc [ S2_AVG_IN   ]
2: .5   F
3: 45   Z Loc [ S2_AVG_IN   ]

; LVDT 5 & 6 = Sample 3
46: Z=X+Y (P33)
1: 38   X Loc [ LVDT_5_IN   ]
2: 39   Y Loc [ LVDT_6_IN   ]
3: 46   Z Loc [ S3_AVG_IN   ]

47: Z=X*F (P37)
1: 46   X Loc [ S3_AVG_IN   ]
2: .5   F
3: 46   Z Loc [ S3_AVG_IN   ]

; LVDT 7 & 8 = Sample 4
48: Z=X+Y (P33)
1: 40   X Loc [ LVDT_7_IN   ]
2: 41   Y Loc [ LVDT_8_IN   ]
3: 47   Z Loc [ S4_AVG_IN   ]

49: Z=X*F (P37)
1: 47   X Loc [ S4_AVG_IN   ]
2: .5   F
3: 47   Z Loc [ S4_AVG_IN   ]

; LVDT 9 & 10 = Sample 5
50: Z=X+Y (P33)
1: 42   X Loc [ LVDT_9_IN   ]

```

2: 43 Y Loc [LVDT_10_IN]
3: 48 Z Loc [S5_AVG_IN]

51: Z=X*F (P37)
1: 48 X Loc [S5_AVG_IN]
2: .5 F
3: 48 Z Loc [S5_AVG_IN]

; -----
; Total displacement

; Sample 1

52: Z=X+F (P34)
1: 44 X Loc [S1_AVG_IN]
2: -.026186 F
3: 49 Z Loc [S1_TOT_DISP]

; Sample 2

53: Z=X+F (P34)
1: 45 X Loc [S2_AVG_IN]
2: -.011948 F
3: 50 Z Loc [S2_TOT_DISP]

; Sample 3

54: Z=X+F (P34)
1: 46 X Loc [S3_AVG_IN]
2: -.022722 F
3: 51 Z Loc [S3_TOT_DISP]

; Sample 4

55: Z=X+F (P34)
1: 47 X Loc [S4_AVG_IN]
2: -.025067 F
3: 52 Z Loc [S4_TOT_DISP]

; Sample 5

56: Z=X+F (P34)
1: 48 X Loc [S5_AVG_IN]
2: -.12509 F
3: 53 Z Loc [S5_TOT_DISP]

; -----
; LOAD CELL SECTION
; -----

; Load cell reading

57: Full Bridge (P6)
1: 1 Reps
2: 11 10 mV, Fast Range
3: 12 DIFF Channel
4: 1 Excite all reps w/Exchan 1
5: 5000 mV Excitation
6: 6 Loc [LOAD_CELL_1_LB]
7: -26444 Mult
8: -153.49 Offset

```

;-----
; PRESSURE SECTION (PUMP & RAMS)
;-----
; Pressure output
; When digital indicator is set to 0 - 3000 psi,
; the output is 1500 PSI/V
; (3000 psi / 2 V) * (1 V / 1000 mV) = 1.5 psi/mV
;
58: Volt (Diff) (P2)
1: 1 Repr
2: 15 5000 mV, Fast Range
3: 6 DIFF Channel
4: 7 Loc [ PRESSURE_PSIG ]
5: 1.5 Mult
6: 0.0 Offset

;-----
; Convert pressure into force using ram's effective area
; = 7.22 in^2
;
59: Z=X*F (P37)
1: 7 X Loc [ PRESSURE_PSIG ]
2: 7.22 F
3: 8 Z Loc [ RAM_FORCE1_LB ]

;-----
; BATTERY MONITOR SECTION
;-----
; Monitor battery voltage
;
60: Batt Voltage (P10)
1: 13 Loc [ BAT_VOLTAGE_V ]

*Table 3 Subroutines

End Program

```

Appendix C Equipment Details

C.1 Rebar Puller Equipment

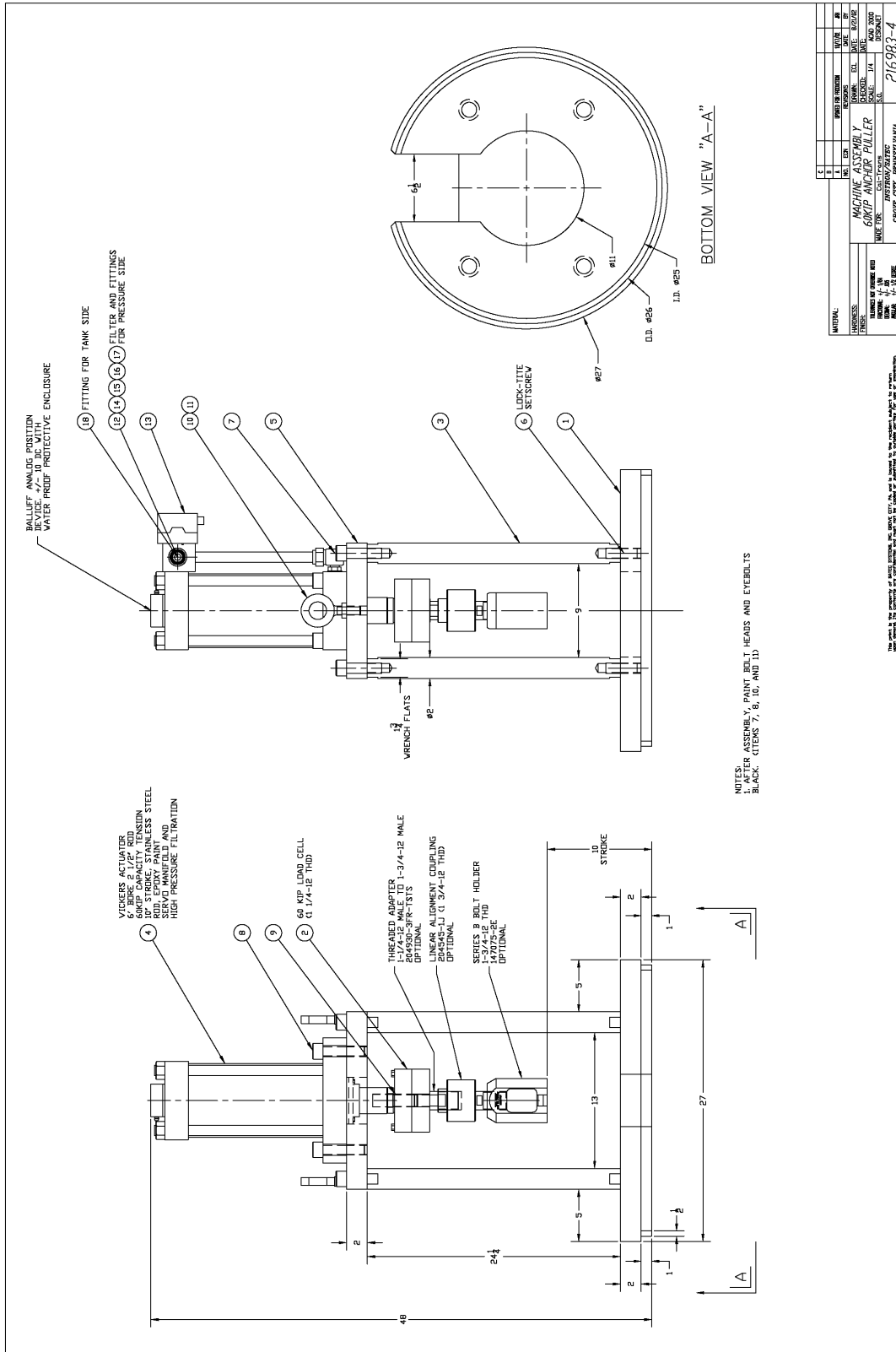

Figure C-1: Rebar Puller

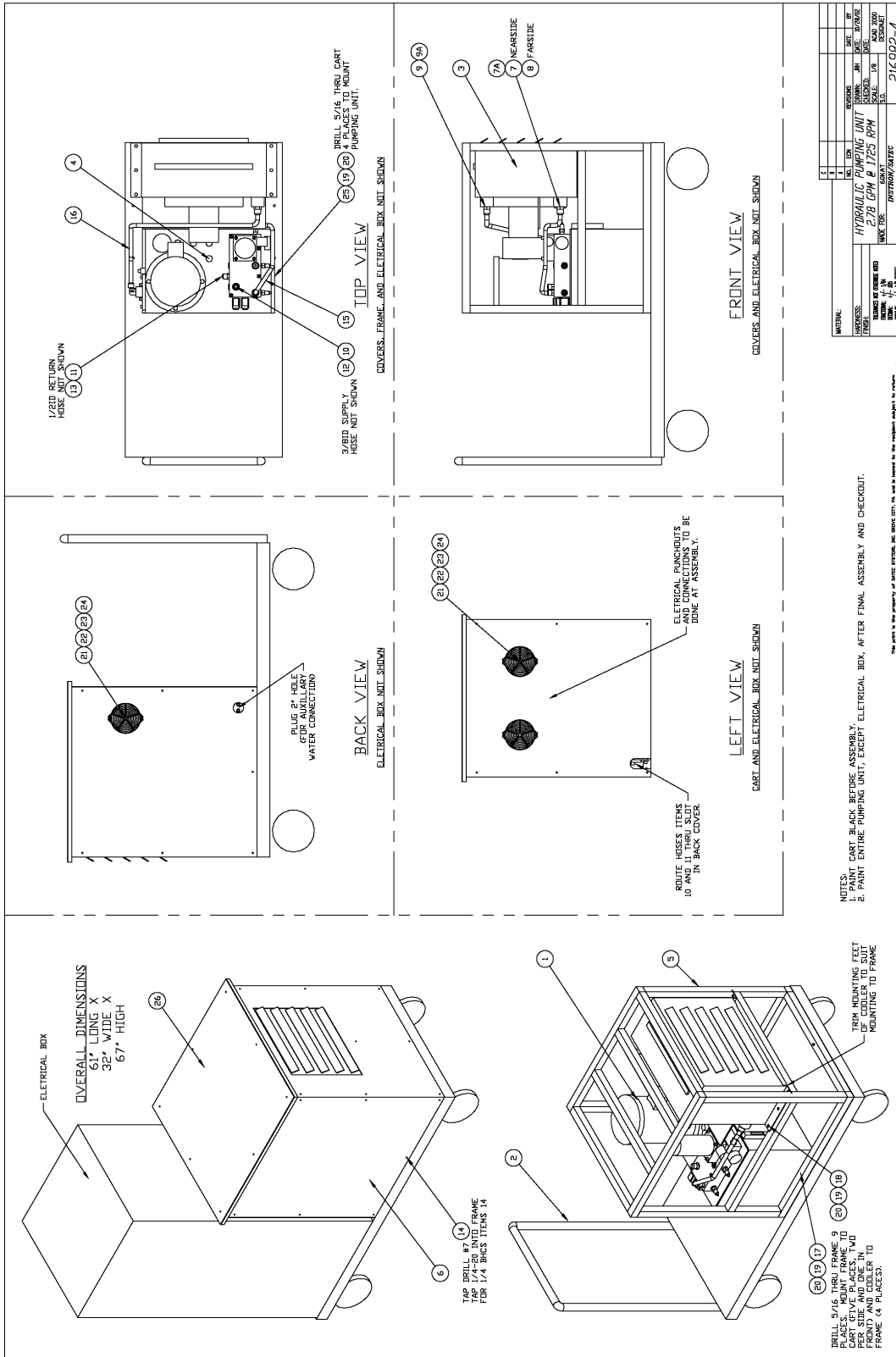
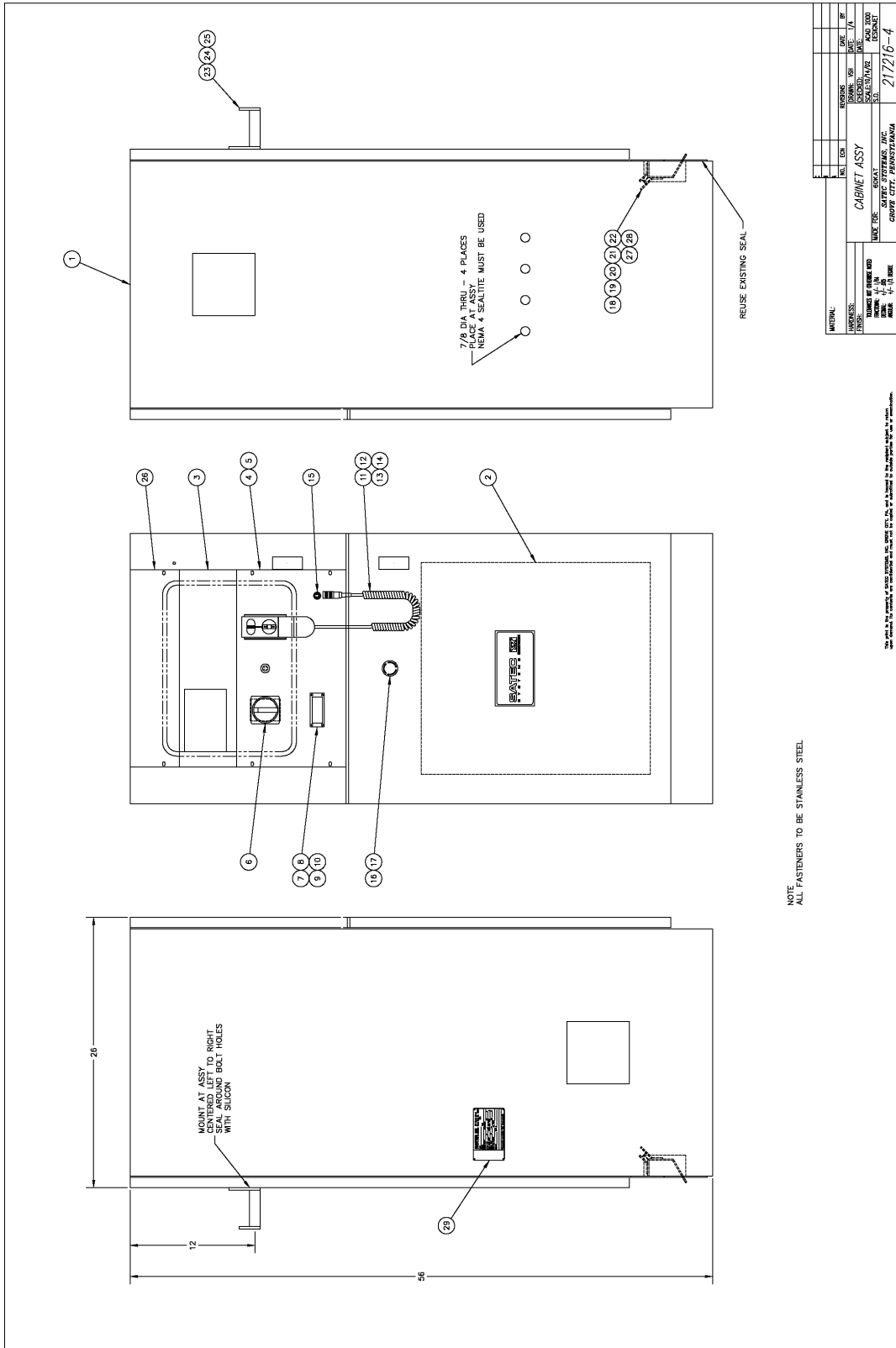

Figure C-2: Hydraulic Pump for Rebar Puller



C.2 Rebar Gripper Details

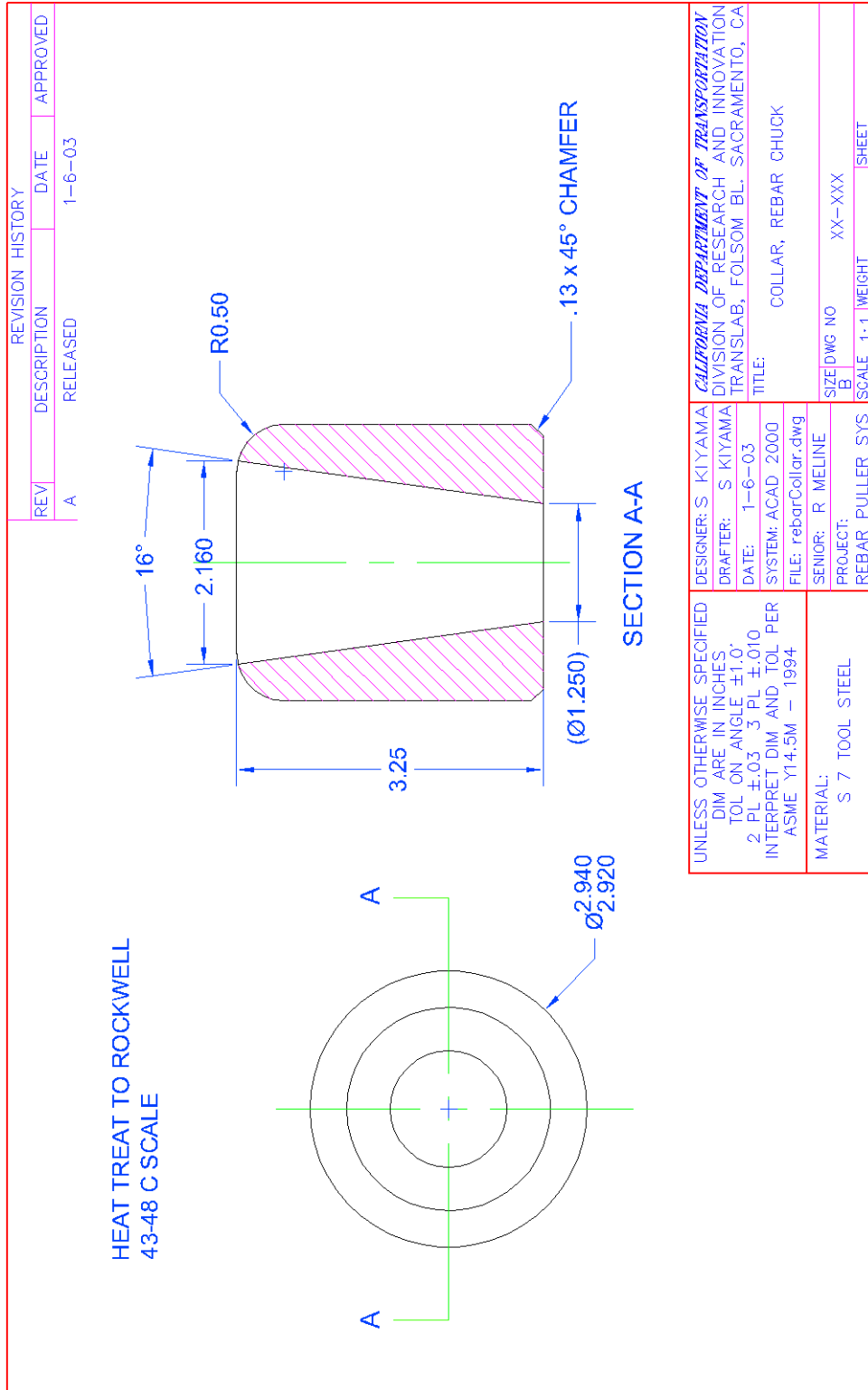

Figure C-4: Rebar Gripper – Collar Details

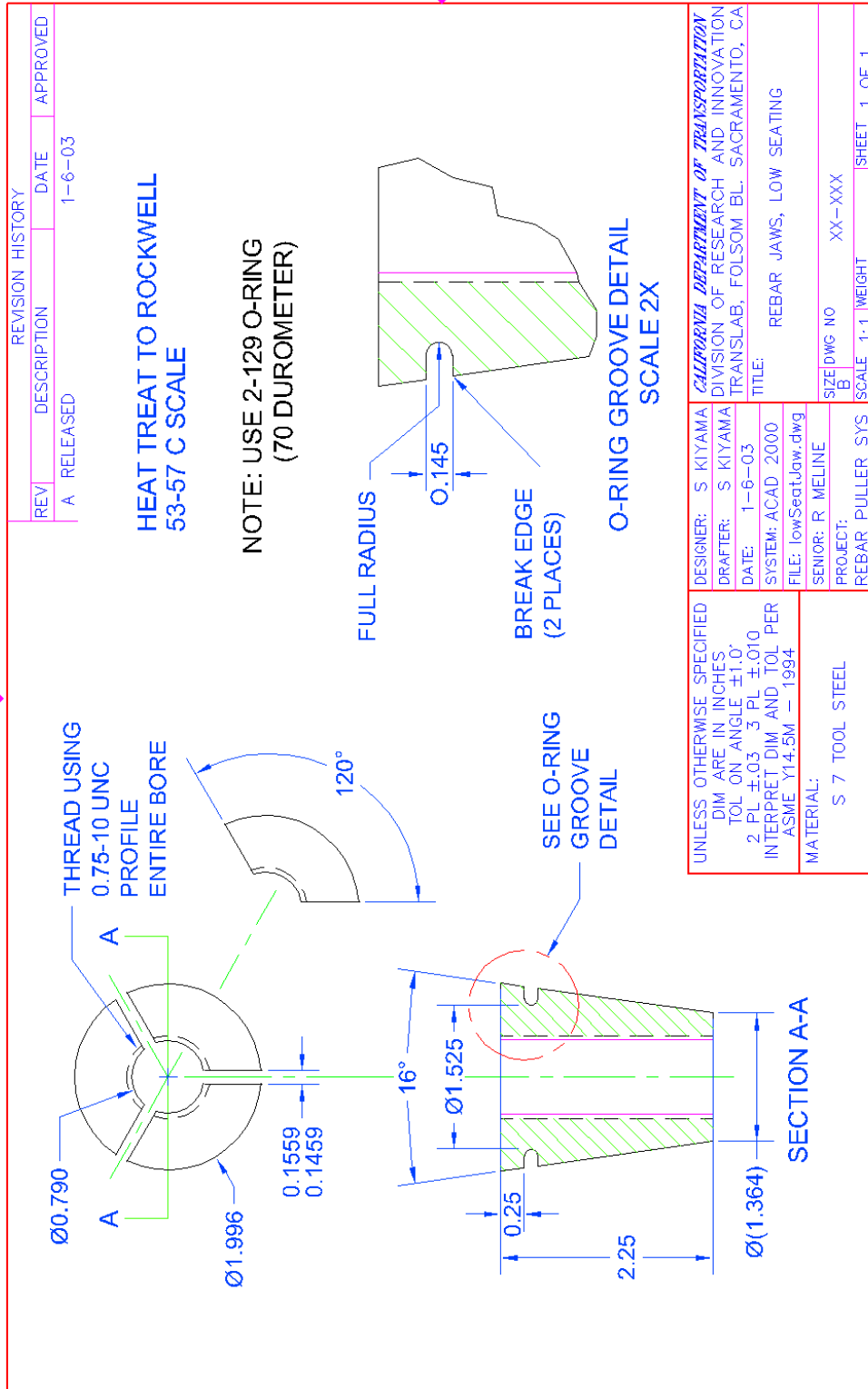

Figure C-5: Rebar Gripper – Jaw Details

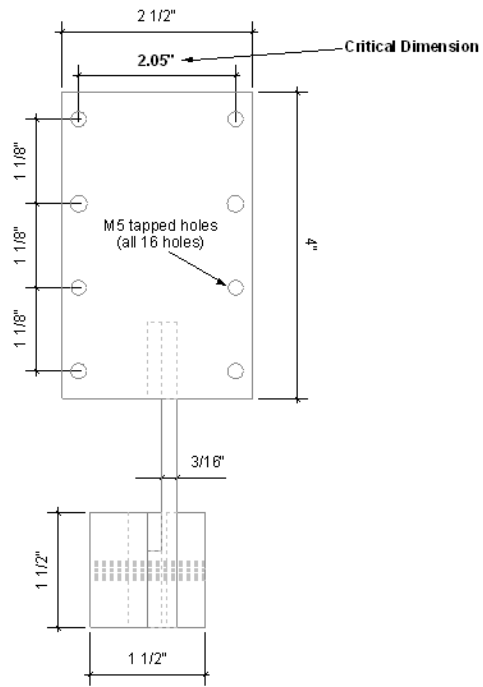

Figure C-8: LVDT Bracket for Pullout and Seismic Testing – Side View

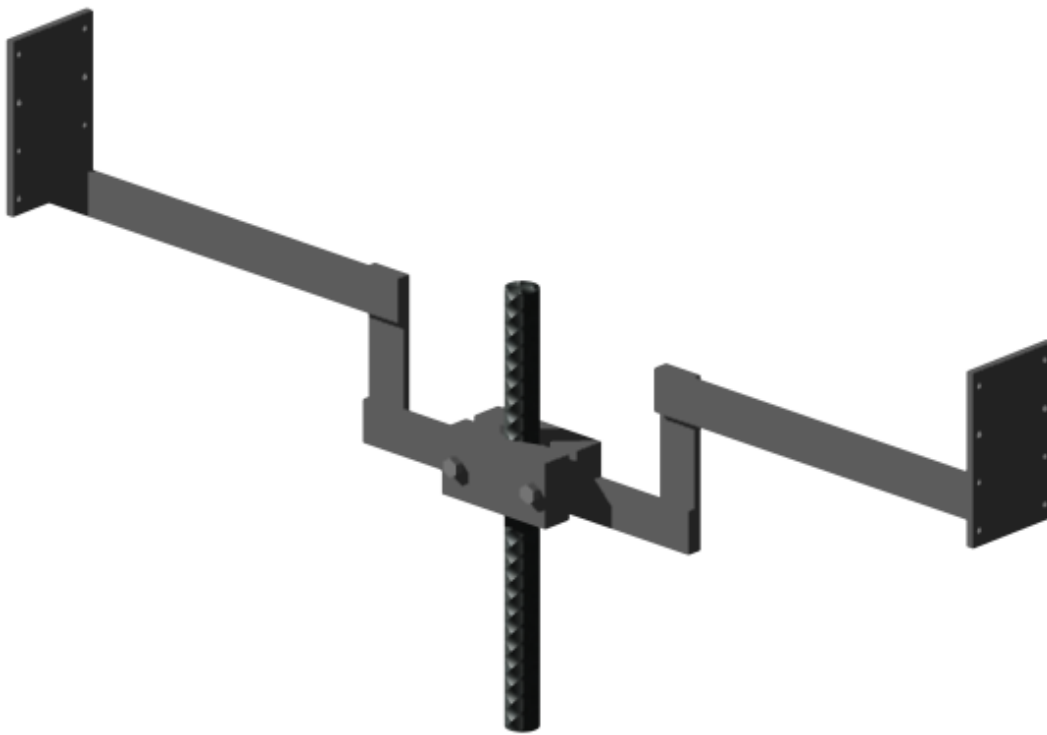

Figure C-9: LVDT Bracket for Pullout and Seismic Testing – 3D View

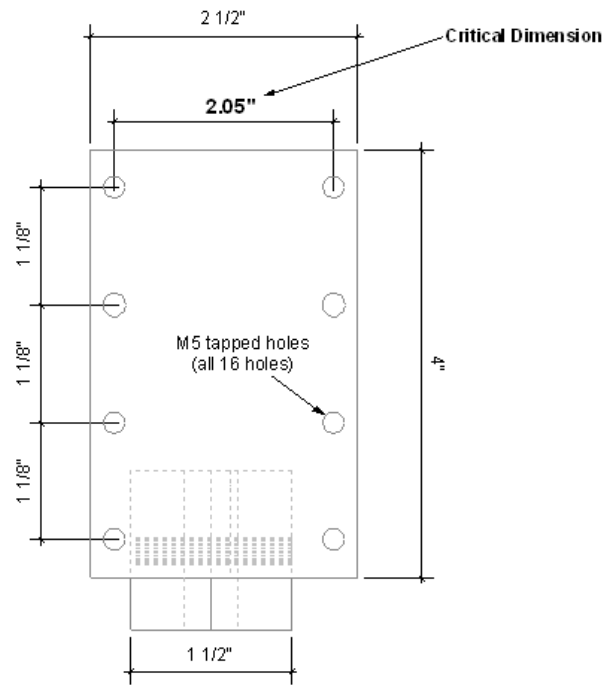

Figure C-12: LVDT Bracket for Creep Testing – Side View

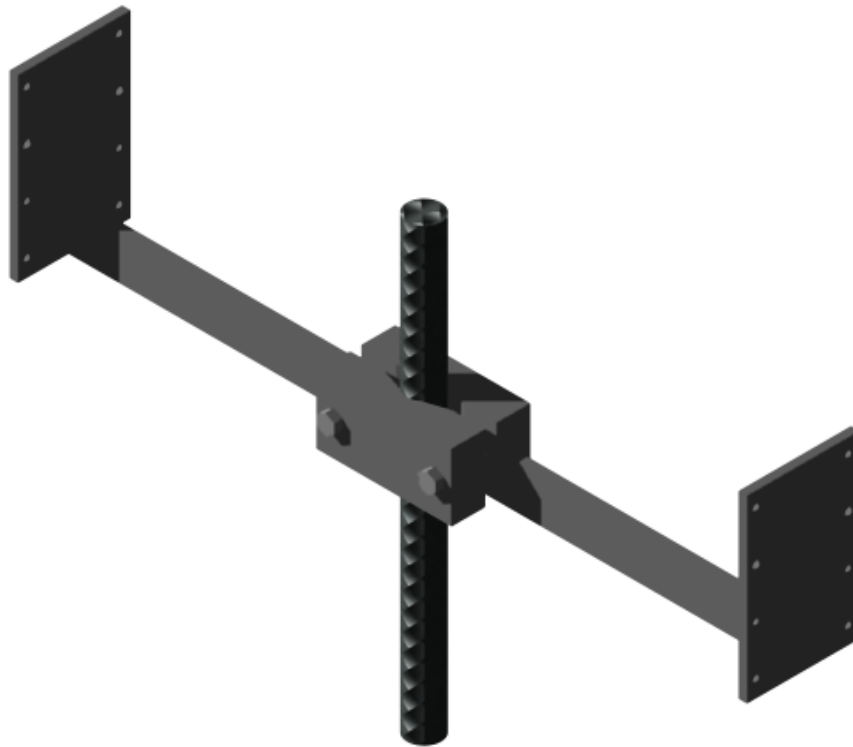

Figure C-13: LVDT Bracket for Creep Testing – 3D View

C.4 Creep Load Frame

All 10 fixtures should be interchangeable for ease of re-assembly after storage

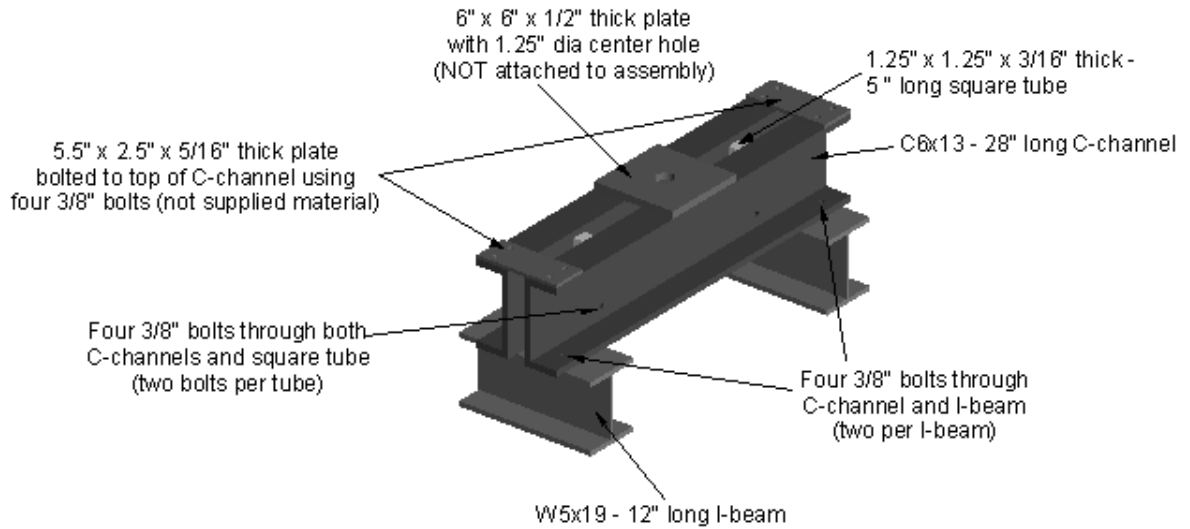

Figure C-14: Creep Load Frame

C.5 Concrete Mover Cart

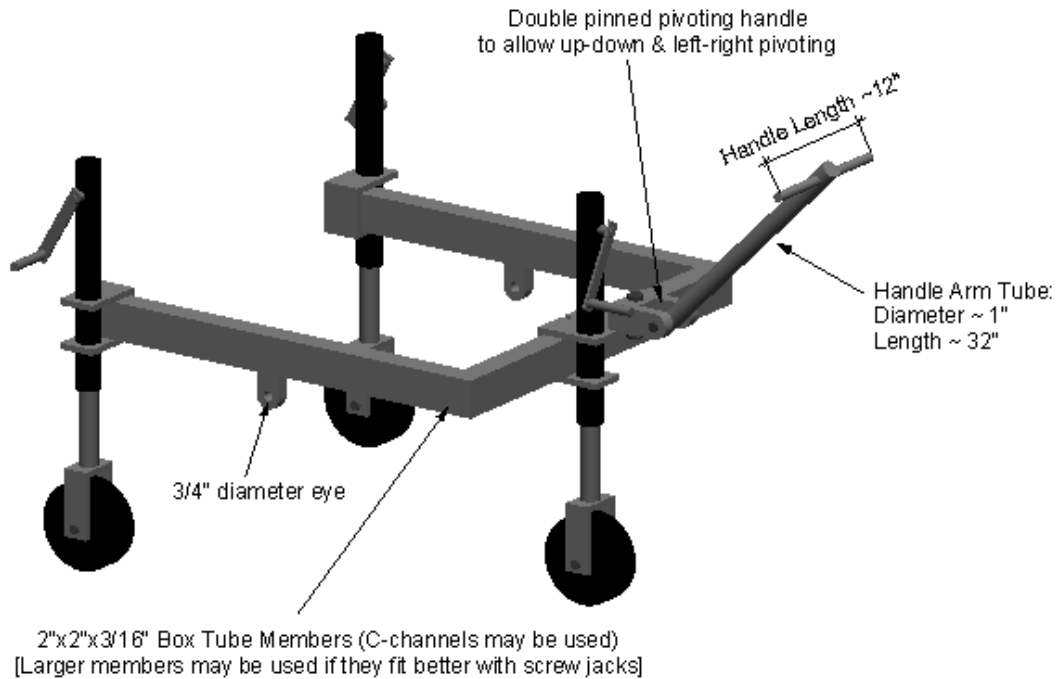

Figure C-15: Cart – 3D View

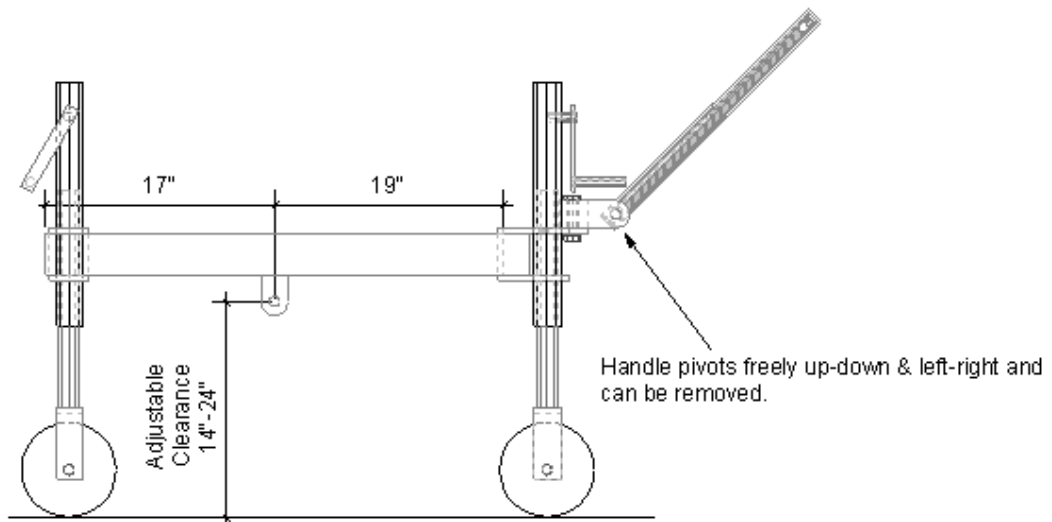

Figure C-16: Cart – Side View

C.6 LVDT Breakout Box and Power Supply

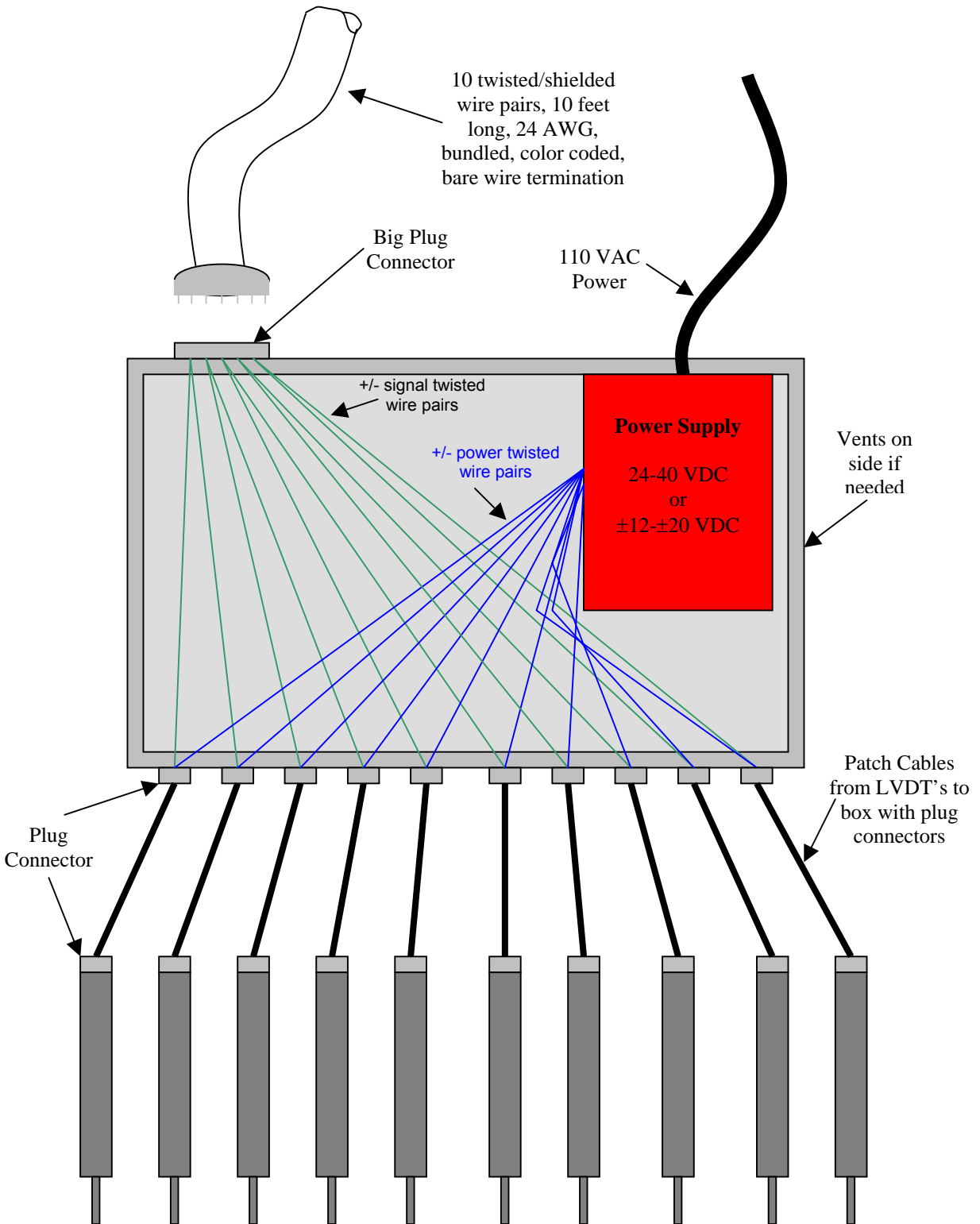

Figure C-17: LVDT Breakout Box Schematic