

Interim Report

# Development of Performance Specifications for Collision Avoidance Systems for Lane Change, Merging, and Backing

## Task 3 - Human Factors Assessment of the Driver Interfaces of Existing Collision Avoidance Systems

**NOTE TO READER:**

**THIS IS A LARGE DOCUMENT**

Due to its large size, this document has been segmented into multiple files. All files separate from this main document file are accessible from links ([blue type](#)) in the [table of contents](#) or the body of the document.



U.S. Department  
of Transportation

National Highway  
Traffic Safety  
Administration

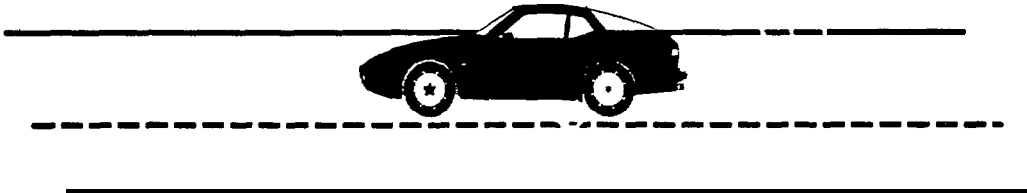
---

DOT HS  
Interim Report

April 1996

## **Development of Performance Specifications for Collision Avoidance Systems for Lane Change, Merging, and Backing**

### **Task 3 - Human Factors Assessment of the Driver Interfaces of Existing Collision Avoidance Systems**



---

This document is available to the public from the National Technical Information Service, Springfield, Virginia 22161.



This document has been prepared under the sponsorship of the United States Department of Transportation, National Highway Traffic Safety Administration. The opinions, findings, and conclusions expressed in this publication are those of the authors and not necessarily those of the Department of Transportation or the National Highway Traffic Safety Administration. The United States Government assumes no liability for its contents or use thereof. If trade or manufacturers' names or products are mentioned, it is only because they are considered essential to the object of the document and should not be construed as an endorsement. The United States Government does not endorse products or manufacturers.

## **Preface**

This is an interim report for presenting the test results obtained with the existing crash avoidance systems that were available for this project on lane change, merging, and backing. Given the limited availability of systems, the test results are in effect only for side “blind spot” and for backing systems. The report, which summarizes the work of Task 3 of Phase I of the project, consists of two volumes: “Sensor System Testing,” prepared mainly by TRW, and “Human Factors Assessment of the Driver Interfaces,” prepared mainly by VRTC.

In general, the results point out that more development is needed to have suitable crash avoidance systems. Significant efforts are necessary, for example, to better quantify the false and nuisance alarms of the systems, and to decrease the frequency rates of those alarms.

The recommendations presented in the report must be merely considered as preliminary. This is due to the limited number and duration of the tests, and to the limited investigation on the human factors related to the vehicle-driver interface.

It is expected that the research that will be conducted during the remaining Phases, II and III, of this project will significantly contribute to the development of pertinent crash avoidance systems. The current schedule calls for completion of this research project in the third quarter of 1997.

Josi L. Bascunana  
Project Manager  
Office of Crash Avoidance Research  
National Highway Traffic Safety Administration

1. Report No.		2. Government Accession No.		3. Recipient's Catalog No.	
4. Title and Subtitle  Development of Performance Specifications for Collision Avoidance Systems for Lane Change, Merging, and Backing  Task 3 - Human Factors Assessment of Driver Interfaces of Existing Collision Avoidance Systems				5. Report Date September, 1995	
				6. Performing Organization Code	
				8. Performing Organization Report No.	
7. Author(s) Elizabeth N. Mazzae, Transportation Research Center, Inc. W. Riley Garrott, NHTSA					
9. Performing Organization Name and Address National Highway Traffic Safety Administration Vehicle Research and Test Center P.O. Box 37 East Liberty, OH 43319				10. Work Unit No. (TRAIS)	
				11. Contract or Grant No.	
12. Sponsoring Agency Name and Address National Highway Traffic Safety Administration 400 Seventh Street, S.W. Washington, D.C. 20590				13. Type of Report and Period Covered Technical report	
				14. Sponsoring Agency Code NHTSA/NRD-50	
15. Supplementary Notes  The authors acknowledge the contributions of Thomas H. Rockwell and Steven M. Kiger of R & R Research Inc. for their valuable contributions to this research effort.					
16. Abstract  This report describes the assessment of the driver interfaces of a type of electronics-based collision avoidance systems that has been recently developed to assist drivers of passenger vehicles in avoiding certain types of collisions. The electronics-based crash avoidance systems studied included: those which <i>detect</i> the presence of objects located on the <i>left and/or right sides</i> of the vehicle, called Side-Looking Collision Avoidance Systems, or SCAS; those which detect the presence of objects located to the rear of the vehicle, referred to as Rear-Looking Collision Avoidance Systems, or RCAS; and those which <i>enhance the driver's ability</i> to see the presence of objects located to the rear of the vehicle using video cameras (also called RCAS). As many side and rear collision avoidance systems as could be obtained, including several pre-production prototypes, were acquired and tested. The testing focused on measuring the performance of the systems' sensors and assessing the qualities of the systems' driver interfaces. The sensor performance data is presented in an accompanying report by TRW.  One goal of this research was to evaluate, based upon the principles of human factors, how well the driver interfaces of the collision avoidance systems studied were designed. The strengths and weaknesses of each driver interface were determined. Overall, while none of the SCAS had an "ideal" interface, most of the systems had ergonomically acceptable interfaces. Not surprisingly, the commercially available systems tended to have better driver interfaces than did the prototypes. Another goal of this research was to provide advice to future designers of collision avoidance warning system driver interfaces as to ergonomically desirable or undesirable features. From the interface evaluations performed, the authors have developed a preliminary set of driver interface performance specifications that may be of aid to future SCAS driver interface designers.					
17. Keywords Collision Avoidance Systems, Crash Avoidance Countermeasures, Passenger Vehicles, ITS				18. Distribution statement Document is available to the public from the National Technical Information Service Springfield, VA 22161	
19. Security Classif. (of this report) Unclassified		20. Security Clwif. (of this page) Unclassified		21. No. of Pages	22. Price

## TABLE OF CONTENTS

<b>SECTION</b>	<b>PAGE</b>
LIST OF FIGURES .....	v
LIST OF TABLES .....	vii
1.0 Introduction....., .....	1 - 1
1.1 Purpose .....	1 - 1
1.2 Systems Examined .....	1- 2
2.0 Methodology Used to Assess the Driver Interfaces of Existing Collision Avoidance Systems .....	2 - 1
2.1 Human Factors Checklist – General Concepts .....	2 - 1
2.2 Description of Checklist Sections and Procedures .....	2 - 4
2.2.1 Explanation and Procedures for Section A: DESCRIPTIVE PROFILE .....	2 - 4
2.2.1.1 Visual Display Luminance Measurement Procedure .....	2 - 4
2.2.1.2 Auditory Display Measurement Procedure .....	2 - 8
2.2.2 Explanation and Procedures for Section B: HUMAN FACTORS ASSESSMENT .....	2 - 8
2.2.3 Explanation and Procedures for Section C: OPERATIONAL JUDGEMENTS .....	2 - 9
2.2.3.1 Driving Procedure for Side-Looking CAS .....	2 - 9
2.2.3.2 Driving Procedure for Rear-Looking CAS .....	2 - 9
2.3 Procedures for Scoring the Human Factors Checklist .....	2-13
3.0 Discussion of Human Factors Checklist Results .....	3 - 1
3.1 System A – Human Factors Checklist Results .....	3 - 2
3.1.1 System A – Description of Driver Interface .....	3 - 2
3.1.2 System A -- Section A of Human Factors Checklist .....	3 - 4
3.1.3 System A - Strengths and Weaknesses of the Driver Interface .....	3 - 12
3.1.3.1 Crash Avoidance Warning Visual Displays .....	3 - 12
3.1.3.2 Crash Avoidance Warning Auditory Displays .....	3 - 12
3.1.3.3 System Status Visual Displays .....	3 - 13
3.1.3.4 Controls .....	3-13
3.1.3.5 Overall Assessment of the Driver Interface for System A .....	3 - 13
3.2 System B -- Human Factors Checklist Results .....	3 - 14
3.2.1 System B – Description of Driver Interface .....	3 - 14
3.2.2 System B – Section A of Human Factors Checklist .....	3 - 16
3.2.3 SystemB- Strengths and Weaknesses of the Driver Interface.....	3-24
3.2.3.1 Crash Avoidance Warning Visual Displays .....	3 - 24
3.2.3.2 Crash Avoidance Warning Auditory Displays .....	3 - 24
3.2.3.3 System Status Visual Displays .....	3 - 24
3.2.3.4 Controls .....	3 - 24
3.2.3.5 Overall Assessment of the Driver Interface for System B .....	3 - 26
3.3 System D – Human Factors Checklist Results .....	3 -27
3.3.1 System D- Description of Driver Interface .....	3-27
3.3.2 System D -- Section A of Human Factors Checklist .....	3 - 29
3.3.3 System D -- Strengths and Weaknesses of the Driver Interface .....	3 - 38

## TABLE OF CONTENTS ‘(continued)

<u>SECTION</u>	<u>PAGE</u>	
3.3.3.1	Crash Avoidance Warning Visual Displays . . . . .	3 - 38
3.3.3.2	Crash Avoidance Warning Auditory Displays . . . . .	3 - 38
3.3.3.3	System Status Visual Displays . . . . .	3 - 38
3.3.3.4	Controls . . . . .	3-39
3.3.3.5	Overall Assessment of the Driver Interface for System D . . . . .	3 - 39
3.4	System E – Human Factors Checklist Results . . . . .	3 - 40
3.4.1	System E – Description of Driver Interface . . . . .	3 - 40
3.4.2	System E - Section A of Human Factors Checklist. . . . .	3- 41
3.4.3	System E – Strengths and Weaknesses of the Driver Interface . . . . .	3 - 49
3.4.3.1	Crash Avoidance Warning Visual Displays . . . . .	3 - 49
3.4.3.2	Crash Avoidance Warning Auditory Displays . . . . .	3 - 49
3.4.3.3	System Status Visual Displays . . . . .	3-49
3.4.3.4	Controls . . . . .	3-49
3.4.3.5	Overall Assessment of the Driver Interface for System E . . . . .	3 - 49
3.5	System F -- Human Factors Checklist Results . . . . .	3 - 50
3.5.1	System F - Description of Driver Interface . . . . .	3 - 50
3.5.2	System F -- Section A of Human Factors Checklist . . . . .	3 - 51
3.5.3	System F -- Strengths and Weaknesses of the Driver Interface . . . . .	3 - 59
3.5.3.1	Crash Avoidance Warning Visual Displays . . . . .	3 - 59
3.5.3.2	Crash Avoidance Warning Auditory Displays . . . . .	3 - 59
3.5.3.3	System Status Visual Displays . . . . .	3 - 59
3.5.3.4	Controls.. . . . .	3 -60
3.5.3.5	Overall Assessment of the Driver Interface for System F . . . . .	3 - 60
3.6	System G -r Human Factors Checklist Results . . . . .	3 - 61
3.6.1	System-G -- Description of Driver Interface . . . . .	3 - 61
3.6.2	System G – Section A of Human Factors Checklist . . . . .	3 - 62
3.6.3	System G -- Strengths and Weaknesses of the Driver Interface . . . . .	3 - 70
3.6.3.1	Crash Avoidance Warning Visual Displays . . . . .	3 - 70
3.6.3.2	Crash Avoidance Warning Auditory Displays . . . . .	3 - 70
3.6.3.3	System Status Visual Displays . . . . .	3 - 70
3.6.3.4	Controls . . . . .	3 - 70
3.6.3.5	Gverall Assessment of the Driver Interface for System G . . . . .	3 - 70
3.7	System H -- Human Factors Checklist Results . . . . .	3 - 72
3.7.1	System H -- Description of Driver Interface . . . . .	3 - 72
3.7.2	System H - Section A of Human Factors Checklist . . . . .	3-74
3.7.3	System H - Strengths and Weaknesse of the Drive Interface.. . . . .	3 -84.
3.7.3.1	Crash Avoidance Warning Visual Displays . . . . .	3 - 84
3.7.3.2	Crash Avoidance Warning Auditory Displays . . . . .	3 - 84
3.7.3.3	System Status Visual Displays . . . . .	3 - 84
3.7.3.4	Controls . . . . .	3 - 84
3.7.3.5	Overall Assessment of the Driver Interface for System H . . . . .	3 - 85
3.8	System P – Human Factors Checklist Results . . . . .	3 - 86
3.8.1	System P -- Description of Driver Interface . . . . .	3 - 86
3.8.2	System P -- Section A of Human Factors Checklist . . . . .	3 - 88
3.8.3	System P – Strengths and Weaknesses of the Driver Interface . . . . .	3 - 98

## TABLE OF CONTENTS (continued)

<b><u>SECTION</u></b>	<b>PAGE</b>
3.8.3.1	Crash Avoidance Warning Visual Displays . . . . . 3 - 98
3.8.3.2	Crash Avoidance Warning Auditory Displays . . . . . 3 - 98
3.8.3.3	System Status Visual Displays . . . . . 3 - 98
3.8.3.4	Controls . . . . . 3 - 98
3.8.3.5	Overall Assessment of the Driver Interface for System P . . . . . 3 - 99
3.9	System Q -- Human Factors Checklist Results . . . . . 3 - 100
3.9.1	System Q -- Description of Driver Interface . . . . . 3 - 100
3.9.2	System Q -- Section A of Human Factors Checklist . . . . . 3 - 101
3.9.3	System Q -- Strengths and Weaknesses of the Driver Interface . . . . . 3 - 109
3.9.3.1	Crash Avoidance Warning Visual Displays . . . . . 3 - 109
3.9.3.2	Crash Avoidance Warning Auditory Displays . . . . . 3 - 109
3.9.3.3	System Status Visual Displays . . . . . 3 - 109
3.9.3.4	Controls.. . . . . 3 - 109
3.9.3.5	Overall Assessment of the Driver Interface for System Q . . . . . 3 - 109
3.10	SystemR-HumanFactorsChecklistResults.. . . . . 3- 111
3.10.1	System R - Description of DriverInterface. . . . . 3- 111
3.10.2	System R - Section A of Human Factors Checklist . . . . . 3- 112
3.10.3	System R -- Strengths and Weaknesses of the Driver Interface . . . . . 3 - 120
3.10.3.1	Crash Avoidance Warning Visual Displays . . . . . 3 - 120
3.10.3.2	Crash Avoidance Warning Auditory Displays . . . . . 3 - 120
3.10.3.3	System Status Visual Displays . . . . . 3 - 121
3.10.3.4	Controls..... . . . . 3 - 121
3.10.3.5	Overall Assessment of the Driver Interface for System R . . . . . 3 - 121
3.11	System S - Human Factors Checklist Results . . . . . 3 - 122
3.11.1	System S -- Description of Driver Interface . . . . . 3 - 122
3.11.2	System S -- Section A of Human Factors Checklist . . . . . 3 - 122
3.11.3	System S -- Strengths and Weaknesses of the Driver Interface . . . . . 3 - 130
3.11.3.1	Crash Avoidance Warning Visual Displays . . . . . 3 - 130
3.11.3.2	Crash Avoidance Warning Auditory Displays . . . . . 3 - 130
3.11.3.3	System Status Visual Displays . . . . . 3 - 130
3.11.3.4	Controls..... . . . . 3 - 130
3.11.3.5	Overall Assessment of the Driver Interface for System S . . . . . 3 - 130
4.0	Human Factors Checklist Results -- Section C . . . . . 4-1
4.1	Static Evaluation Data Summary-Part I of Section C . . . . . 4- 1
4.2	DynamicEvaluationDataSummary- Part II of Section C . . . . . 4-2
4.3	Rear System Driver Performance Data. . . . . 4- 11
4.4	Results From Scoring the Human Factors Checklist Data. . . . . 4- 11
5.0	Summary and Conclusion . . . . . 5-1
5.1	Summary . . . . . 5 - 1
5.2	Conclusions . . . . . 5-3
6.0	References..... . . . . 6- 1



## TABLE OF CONTENTS (continued)

<b>APPENDICES</b> .....	<b>PAGE</b>
<b>APPENDIX A:</b> Human Factors Checklist .....	A - 1
Section A .....	A - 4
Section B .....	A-14
Section C .....	A-24
<b>APPENDIX B:</b> Data: Section A -- Part II of the Human Factors Checklist .....	B - 1
<b>APPENDIX C:</b> Data: Section B of the Human Factors Checklist .....	C - 1
<b>APPENDIX D:</b> Data: Section C of the Human Factors Checklist .....	D - 1
<b>APPENDIX E:</b> Data: Section C RCAS Driver Performance Data .....	E - 1

## LIST OF FIGURES

<b>FIGURE</b>	<b>PAGE</b>
2.1. Passenger car used as primary test vehicle (1991 Acura Legend) .....	2 - 3
2.2. HMMWV test vehicle .....	2-3
2.3. Driver's right side field of view for the Acura Legend measured using a 5th percentile male driver .....	2 - 4
2.4. Driver's right side field of view for the Acura Legend measured using a 95th percentile male driver .....	2 - 5
2.5. Driver's left side field of view for the Acura Legend measured using a 5th percentile male driver .....	2-6
2.6. Driver's left side field of view for the Acura Legend measured using a 95th percentile male driver .....	2-7
2.7. Driver's rear field of view for the Acura Legend measured using a 5th percentile and a 95th percentile male driver. ....	2-8
2.8. Driver's right side field of view for the HMMWV measured using a 5th percentile male driver .....	2-9
2.9. Driver's right side field of view for the HMMWV measured using a 95th percentile male driver .....	2- 10
2.10. Driver's left side field of view for the HMMWV measured using a 5thpercentilemaledriver.. ....	2- 11
2.11. Driver's left side field of view for the HMMWV measured using a 95th percentile male driver .....	2-12
2.12. Configurations used in measuring the luminances of collision avoidance system .... visual display components	2 - 6
2.13. 3-year-old child ATD centered in lane for backing trials .....	2 - 10
2.14. RCAS Human Factors backing test Scenarios# 1-4 .....	2- 11
2.15. RCAS Human Factors backing test Scenario #5 .....	2- 12
3.1. System A driver interface: Main display unit .....	3-2
3.2. System A main display unit as mounted for testing .....	3-3
3.3. System A driver interface: Auxiliary visual warning module .....	3-3
3.4. System B driver interface: Main control unit .....	3-14
3.5. System B driver interface: Crash avoidance warning visual display .....	3 -15
3.6. System B crash avoidance warning visual display as mounted for testing .....	3 -15
3.7. System D driver interface .....	3-28
3.8. System D driver interface as mounted for testing .....	3-28
3.9. System E driver interface .....	3-40
3.10. System F driver interface .....	3 -50
3.11. System F driver interface: Left side visual display as mounted for testing .....	3 -51
3.12. System G driver interface .....	3-61
3.13. System H driver interface: Main display unit .....	3 -73
3.14. System H driver interface: A-pillar crash avoidance warning visual display .....	3 -73

## LIST OF FIGURES (continued)

<b><u>FIGURE</u></b>	<b><u>PAGE</u></b>
3.15. System P driver interface . . . . .	3- 86
3.16. Rear of test vehicle showing rear-looking video cameras for System P (on left) , . . . . . and System Q (on right) mounted on roof	3- 87
3.17. System Q driver interface . . . . .	3-100
3.18. System R driver interface . . . . .	3-111
4.1. Part I, Question 5c: How easy to understand are the meanings of the . . . . . cautionary crash avoidance warning visual displays?	4 - 1
4.2. Part II, Question 3: While driving, how well could crash avoidance warning . . . . . visual displays be discriminated from any other nearby displays?	4 - 2
4.3. Part II, Question 4a: While driving, how distracting were the . . . . . visual system status displays?	4 - 3
4.4. Part II, Question 4b: While driving, how distracting were the . . . . . visual crash avoidance warning displays?	4 - 4
4.5. Part II, Question 5b: While driving how distracting were the following . . . . . auditory displays?	4 - 4
4.6. Part II, Question 6b: While driving, how annoying were the auditory . . . . . crash avoidance warning displays?	4 - 5
4.7. Part II, Question 9a: How effective was the visual crash avoidance warning display . . . . . in helping you to make right lane changes?	4 - 6
4.8. Part II, Question 9a: How effective was the visual crash avoidance warning display . . . . . in helping you to merge to the right?	4 - 6
4.9. Part II, Question 12a: How effective was the auditory crash avoidance warning . . . . . presentation in helping you to make right lane changes?	4 - 7
4.10. Part II, Question 13a: How effective was the auditory crash avoidance warning . . . . . presentation in helping you to merge to the right?	4 - 8
4.11. Part II, Question 11: How effective was the crash avoidance warning presentation . . . . . in helping you to perform backing maneuvers?	4 - 8
4.12. Part II, Question 14: In what percent of all lane changes did you use the . . . . . crash avoidance warning information presented by the system?	4 - 9
4.13. PartII, Question16: In what percent of all merges did you use the . . . . . crash avoidance warning information presented by the system?	4-10
4.14. Part II, Question 16: In what percent of backing maneuvers did you use the . . . . . crash avoidance warning information presented by the systems?	4 -10

## LIST OF TABLES

<b>TABLE</b>	<b><u>PAGE</u></b>
1.1. Characteristics of Side-Looking CAS Studied .....	1- 4
1.2. Characteristics of Rear-Looking CAS Studied .....	1- 4
2.1. Test Vehicle Ambient Noise Data .....	2- 2
2.2. Overall Design Category - Desirable Characteristics of a CAS Interface .....	2- 14
2.3. Visual Warning Display Conspicuity Category- Desirable Characteristics of a CAS Interface .....	2-15
2.4. Visual Warning Display Comprehensibility Category - Desirable Characteristics of a CAS Interface .....	2-15
2.5. Auditory Display Discriminability and Comprehensibility Category - Desirable Characteristics of a CAS Interface .....	2-16
2.6. System Status Display Conspicuity and Comprehensibility Category - Desirable Characteristics of a CAS Interface .....	2-16
2.7. Control ergonomics Category - Desirable Characteristics of a CAS Interface .....	2-17
3.1. Contrast Transfer Data for System P .....	3-88
3.2. Contrast Transfer Data for System Q. ....	3-101
4.1. System Ratings Based on Scoring of the Human Factors Checklist .....	4-12
<b>B.1.</b> Data for Section A - PartII: System Features .....	B-2
<b>C.1.</b> Data for Section B - Part I .....	C- 2
<b>C.2.</b> Data for Section B - Part 1 .....	C-3
C.3. Data for Section B - Part11 .....	C-4
C.4. Data for Section B - PartI .....	C-5
C.5. Data for Section B - PartV .....	C-5
<b>C.6.</b> Data for Section B - Part VI .....	C-6
<b>C.7.</b> Data for Section B - Part VII .....	C-6
<b>D.1.</b> Data for Section C - Part I: Stationary Evaluation .....	D-2
D.2. Data for Section C - PartI: Dynamic Evaluation .....	D-3
<b>E.1.</b> Final Distances Between the Rear of the Test Vehicle and the Scenario Object .....	E - 2
for the Five Backing Scenarios	

## 1.0 INTRODUCTION

This report describes the evaluation of driver interfaces of three types of electronics-based systems that have been recently developed to assist drivers of both light (passenger cars, pickup trucks, vans, and sport utility vehicles) and heavy (straight trucks and tractor-semitrailers) vehicles in avoiding certain types of crashes. The driver interface is defined as the displays and controls through which the driver interacts with the CAS and receives collision avoidance information. The three types of electronics-based Collision Avoidance Systems, or CAS, are: 1) those which *detect* the presence of objects located to the *rear* of the vehicle (referred to as rear-looking collision avoidance systems or RCAS), 2) those which *enhance the driver's ability to* see the presence of objects located to the *rear* of the vehicle (also referred to as rear-looking collision avoidance systems or RCAS), and 3) those which *detect the* presence of objects located on the *left and/or right sides* of the vehicle (referred to as side-looking collision avoidance systems or SCAS).

The rear-looking systems, whether of the object detection or vision enhancement type, are intended to aid drivers when backing their vehicles, typically at very low speeds, so that they do not strike fixed objects, parked cars, or pedestrians. The side-looking systems are intended primarily as supplements to the existing side- and rear-view mirror systems. The SCAS assist the driver during lane changes and merges by detecting adjacent vehicles.

The research described in this report was performed as part of a larger research program, "Development of Performance Specifications for Collision Avoidance Systems for Lane Change, Merging, and Backing." The entire program was sponsored by the National Highway Traffic Safety Administration (NHTSA) and performed by TRW's Space and Electronics Group with assistance, during the Phase 1 testing, from NHTSA's Vehicle Research and Test Center (VRTC) and a number of subcontractors.

A portion of Phase 1 (Laying the Foundation) of the research program "Development of Performance Specifications for Collision Avoidance Systems for Lane Change, Merging, and Backing" was devoted to examining existing collision avoidance systems. As many collision avoidance warning systems as could be obtained, including several pre-production prototypes, were acquired and tested by TRW and VRTC. This focus of this testing was on measuring the performance of the CAS sensors and assessing the qualities of their driver interfaces. This report documents the results of the evaluation of the CAS driver interfaces. A companion report, "Development of Performance Specifications for Collision Avoidance Systems for Lane Change, Merging, and Backing; Task 3 Interim Report: Test of Existing Hardware Systems" [1] documents the examination of the CAS sensors.

### 1.1 PURPOSE

The goals of this research to evaluate the design of existing CAS driver interfaces were:

1. To evaluate, based upon human factors principles, how well the driver interfaces of the collision avoidance warning systems studied were designed. This included examining such issues as the effectiveness of the interface designs in conveying information to the driver,

considering the effect interface designs might have on overall driver workload, and determining whether or not the interface designs would unduly distract or annoy drivers.

2. To provide preliminary advice to designers of CAS driver interfaces regarding potentially desirable or undesirable features and qualities of the interfaces as based upon the principles of Human Factors. The intent of this goal is to promote better driver interface designs by allowing designers to easily understand the strengths and weaknesses of current designs.
3. To identify CAS driver interface design issues that should be the focus of future research. While existing human factors literature provides recommendations about many aspects of man-machine interface design, there are several aspects important to collision avoidance warning systems for automobiles that are not addressed in the literature. Identification of important design issues will encourage future researchers to develop the needed guidance.
4. To improve methods for evaluating CAS driver interface designs. The development of better, standardized *methods* for evaluating driver interface designs for collision avoidance systems will both improve the quality of research on this topic and allow engineers to evaluate their own designs, resulting in more user-friendly products.

## **1.2 SYSTEMS EXAMINED**

For this research, the driver interfaces of four rear-looking CAS and seven side-looking CAS were studied. Of these eleven systems, five were commercially available and six were pre-production prototypes. The five commercially available systems constituted all of the commercially available CAS known to NHTSA at the time of initiation of the study. The six pre-production prototypes were all of the prototype CAS known to NHTSA at the time the study was initiated.

Two of the systems tested in this study, Systems E and Q, were originally acquired in early 1993 for a study of heavy truck side object detection systems. Manufacturers of these two systems, as well as the those of the other nine systems, may have released newer versions of their systems by the time of publication of this report.

While the focus of this research addressed the use of CAS for light vehicle applications (passenger cars, pickup trucks, vans, and sport utility vehicles, all with gross vehicle weight ratings below 44,500 Newtons) several of the systems evaluated were intended primarily for use on heavy trucks. The heavy truck systems were included in this study because:

1. There are no major functional differences between the operation of heavy truck and light vehicle CAS. Heavy truck and light vehicle CAS differ primarily in the size and shape of the zones around the vehicle in which driver's awareness of traffic pedestrians, and other obstacles needs to be improved. However, the fundamental functions of the CAS, detecting objects around the vehicle (or enhancing driver vision) and conveying information to the driver are the same for both heavy and light vehicles.

2. Examining many systems allowed for a better understanding of the available and desirable capabilities and qualities of CAS. Examining multiple systems maximizes the range of system capabilities seen and makes it less likely that an important capability may be overlooked. In this case involving CAS, although all available systems intended for use in both heavy and light vehicles were examined, there still were not very many systems of each type examined.

The objective of this report was to report findings related to the CAS driver interface. However, due to the methodology used in this study the performance of a system's driver interface was, to some extent, intertwined with the performance of that system's sensors. This study examined CAS as whole units. No attempt was made to disassociate a system's driver interface from a system's sensors (as could be done by, for example, connecting a driver interface to an "ideal" sensor). Therefore, to allow readers to better understand each collision avoidance warning system, a brief summary of the most important characteristics of each system's sensor performance is included below when each system is introduced. This material&as taken from "Development of Performance Specifications for Collision Avoidance Systems for Lane Change, Merging, and Backing; Task 3 Interim Report: Test of Existing Hardware Systems" [ 11; readers desiring more information about the performance of each system's sensors or how this data was gathered should consult this reference.

Seven SCAS were examined in this study. These systems were designated using letters as Systems A, B, and D through H. (System C was a pre-production prototype that originally was to be included in the study. However, due to delays in obtaining the system, it was not included in this report.)

The authors emphasize that the systems described were current models at the time that the study was initiated. Since that time, manufacturers may have released updated versions of their systems with potentially different designs and performance.

Table 1.1 summarizes general characteristics of each SCAS studied. The table shows whether or not each system was a pre-production prototype or commercially available, whether or not each system was originally designed for a light vehicle, whether the sensor detection zones covered only the left, only the right, or both sides of the vehicle, and the technology used by the sensors. The two rightmost columns show the time, in seconds, that it took for each system to react when an object moving parallel to vehicle entered (Delay Time) or exited (Persistence Time) the sensor's field of view. These columns are shown since they could have a substantial impact on a driver's perception of a warning signal provided by a SCAS. Due to problems with the sensors for System A, delay data was not able to be collected for this system.

Four RCAS were examined in this study. Table 1.2 summarizes general characteristics of each system studied. The table shows whether or not each system was an object detection or vision enhancement system, whether or not each system was a pre-production prototype or commercially available, whether or not each system was originally designed for a light vehicle, and the technology composing the sensors.

**TABLE 1.1. Characteristics of Side-Looking CAS Studied**

<b>System</b>	<b>Prototype System?</b>	<b>For Light Vehicle?</b>	<b>Sides Covered</b>	<b>Sensor Technology</b>	<b>Delay Time</b>	<b>Persistence Time</b>
<b>A</b>	No	Yes	Right	Ultrasonic	--	--
<b>B</b>	Yes	Yes	Right	Radar	0.07 s	0.51 s
<b>D</b>	Yes	No	Right	Radar	0.52 s	0.12 s
<b>E</b>	Yes	No	Right	Radar	0.62 s	1.23 s
<b>F</b>	Yes	Yes	Both	Infrared	0.04 s	0.92 s
<b>G</b>	Yes	Yes	Right	Radar	0.46 s	0.54 s
<b>H</b>	No	No	Right	Radar	1.03 s	1.80 s

**TABLE 1.2. Characteristics of Rear-Looking CAS Studied**

<b>System</b>	<b>Prototype System?</b>	<b>For Light Vehicle?</b>	<b>Sensor Technology</b>
<b>P</b>	No	No	Video
<b>Q</b>	No	No	Video
<b>R</b>	Yes	No	Ultrasonic
<b>S</b>	Yes	Yes	Ultrasonic



## **2.0 METHODOLOGY USED TO ASSESS THE DRIVER INTERFACES OF EXISTING COLLISION AVOIDANCE SYSTEMS**

The principal data collection instrument used to perform a human factors evaluation of existing collision avoidance systems was a “Human Factors Checklist” titled “Descriptive Profile, Human Factors Assessment, and Operational Judgements of the Collision Avoidance System Driver/System Interface”. The checklist was originally developed by COMSIS for the National Highway Traffic Safety Administration (NHTSA) as part of the heavy truck near object detection system study described in the report titled “A Study of Commercial Motor Vehicle Electronics-Based Rear and Side Object Detection Systems”[2]. The development of the Human Factors Checklist accompanied an effort by COMSIS to define the requirements for driver interface design for collision avoidance systems as outlined in “Preliminary Human Factors Guidelines for Crash Avoidance Warning Devices” [3]. The checklist was modified for this program by R & R Research Inc. and NHTSA’s Vehicle Research and Test Center (VRTC).

In an effort used to reduce the large quantity of data generated by the Human Factors Checklist, a scoring system was used. The scoring system used was originally developed by COMSIS and was modified for use in this program by VRTC.

### **2.1 HUMAN FACTORS CHECKLIST - GENERAL CONCEPTS**

The Human Factors Checklist was designed to be used both as a research device and a screening tool. This document served as a tool for the collection of qualitative and quantitative data characterizing CAS interfaces and their associated visual and auditory information displays and controls. The checklist was based generally on accepted human factors principles found in handbooks such as “Handbook of Human Factors” [4] and “Human Factors Design Handbook” [5] as well as on accepted automotive practices set forth in the Society of Automotive Engineer’s (SAE) Recommended Practices. However, in many cases, guidelines were lacking in necessary areas important to the design of collision avoidance system driver interfaces. In these cases, guidelines were extrapolated and judgements as to what design features were most appropriate based on the authors’ extensive experience with testing collision avoidance systems.

The checklist contained three sections. Section A was a descriptive profile which addressed the operation of the system hardware and driver displays. Section B consisted of an assessment of the extent to which the visual and auditory displays conform to established human factors guidelines. Section C consisted of a questionnaire used by human factors experts to assess the operational performance of the driver/system interface after having driven with the systems. Overall, the checklist provided a means by which the merits of the driver/system could be assessed. A copy of the Human Factors Checklist can be found in Appendix A.

The term “crash avoidance warning” was used during this research to refer to any information which a system provides to the driver to assist in preventing a collision. The information content of the warning is dependent on the category of the system. Crash avoidance warnings are divided into two categories: 1) cautionary and 2) imminent.

Cautionary crash avoidance warning information is any information provided by a system which warns the driver of a potentially dangerous situation (i.e., an obstructing vehicle in an adjacent lane when considering changing lanes, or an obstructing vehicle to the rear when backing). The term “imminent crash avoidance warning information” refers to any information which a system might provide to warn the driver of an impending collision.

Two test vehicles were used in this study: a 1991 Acura Legend and a U.S. Army’s High Mobility Multi-Wheeled Vehicle (HMMW). The passenger car, shown in Figure 2.1, was used to make measurements and gather information for Sections A and B of the Human Factors Checklist for each system. To obtain the data needed to complete Section C of the checklist, both the HMMW and the Acura Legend were equipped with the various systems and then driven by two human factors experts. The HMMW provided for testing, shown in Figure 2.2, was fitted with an ambulance body. The fields of view for these vehicles measured using a small (5th percentile) and a large (95th percentile height) male driver are given in Figures 3 through 7 for the passenger vehicle and in Figures 8 through 11 for the HMMW.

Field of view measurements for the passenger vehicle were made for standard and non-standard side-view mirror adjustments. Standard adjustment indicated that the side-view mirrors on both sides of the vehicle were adjusted such that the driver could just see a small portion of the side of the vehicle in the mirror view. For the non-standard adjustment of the left side-view mirror, the driver placed his head against the driver’s side window and adjusted the mirror such that he could just see a small portion of the left side of the vehicle in the mirror view. For the non-standard adjustment of the right side-view mirror, the driver positioned his head over the center-line of the vehicle and adjusted the mirror such that he could just see a small portion of the right side of the vehicle in the mirror view. Lane widths are depicted using dashed lines in the figures.

Field of view measurements for the HMMW were made using two different side-view mirror configurations. The first case used the original equipment (“stock”) side-view mirrors only. The second case used the original equipment side-view mirrors and a right side-mounted circular convex mirror (20.3 cm diameter, 66 cm radius of curvature) and a left side-mounted rectangular convex mirror (17.2 cm x 12.4 cm, 61 cm radius of curvature). These two cases are illustrated in Figures 8 through 11.

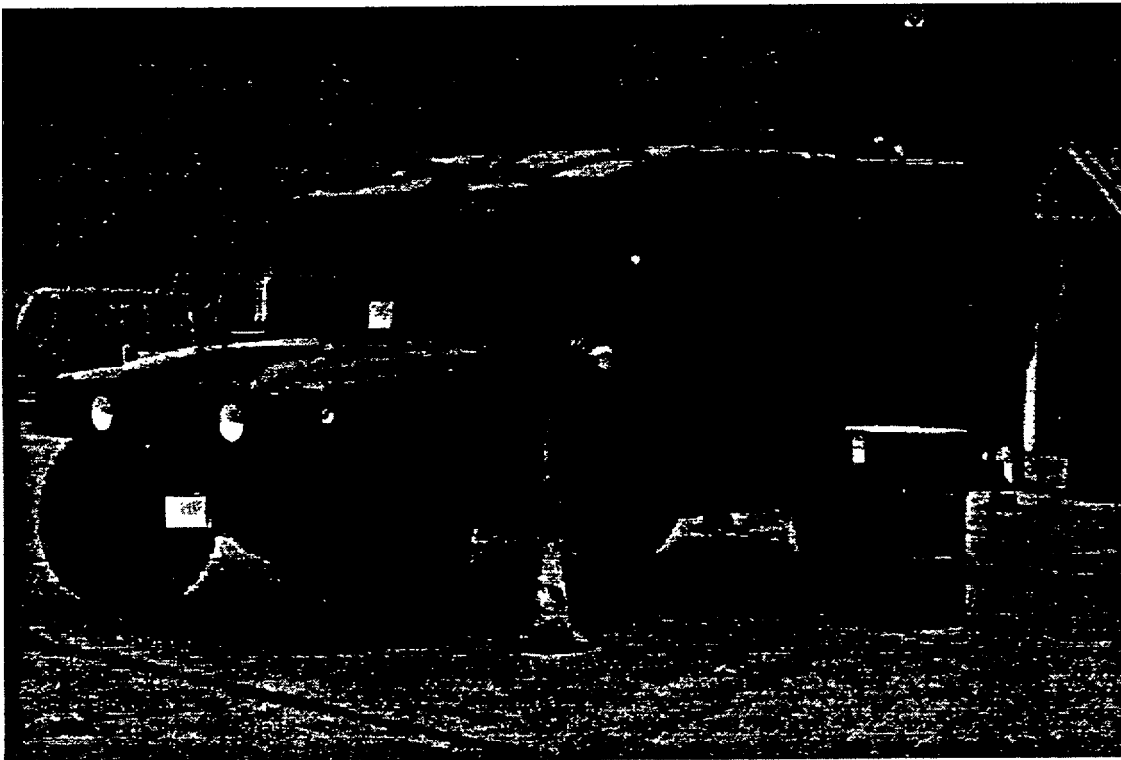
The ambient noise levels for both vehicles were recorded at idle and at 55 mph with the windows up and down. Sound level readings were taken at the driver ear point. These ambient noise data are listed in Table 2.1.

**TABLE 2.1.** Test Vehicle Ambient Noise Data (measured in units of dB(A))

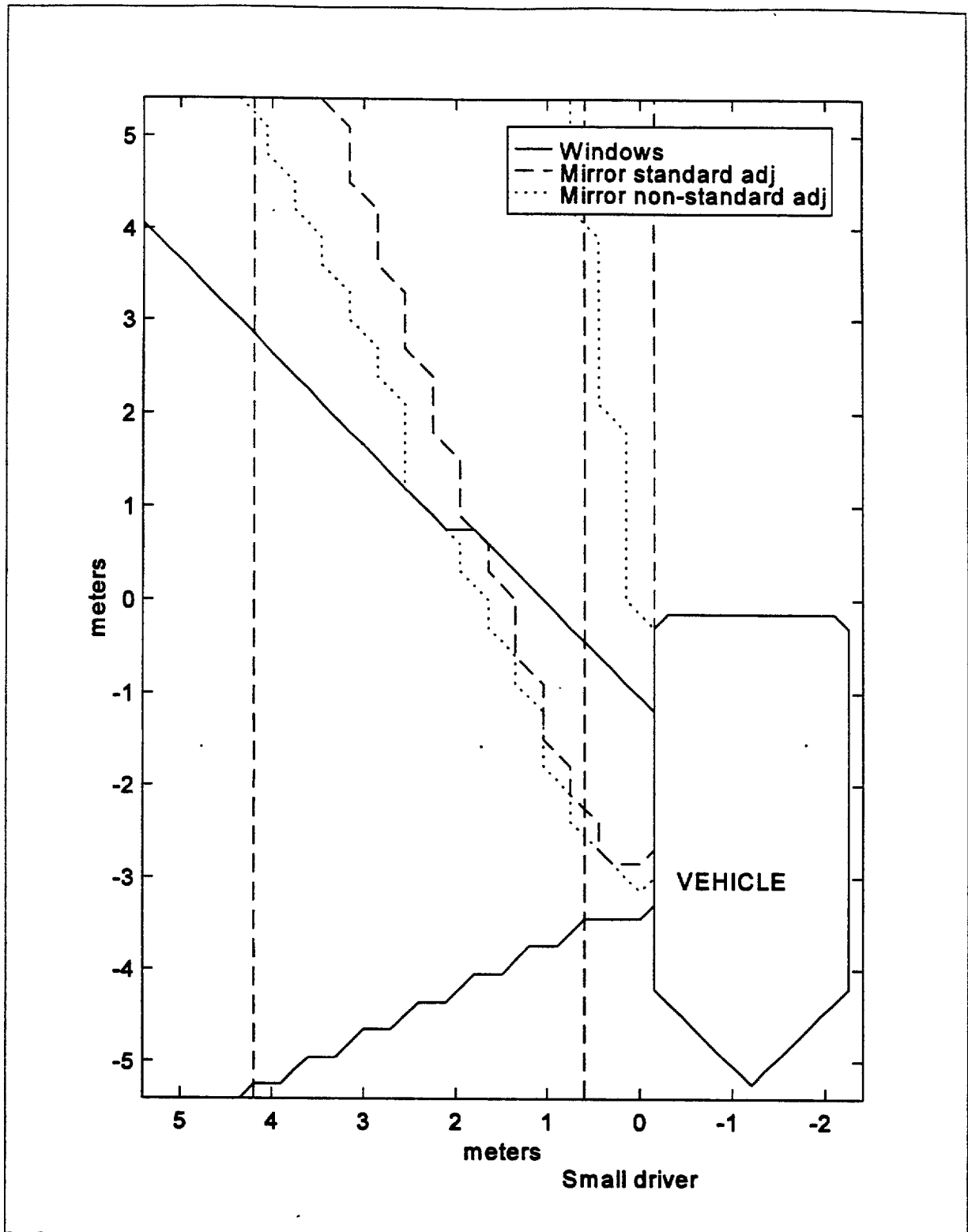
	Acura Legend		HMMWV	
	Windows Up	Windows Down	Windows Up	Windows Down
Idle	47.6	49.7	71.6	71.6
55 mph	84.8	69.0	85.0	86.0



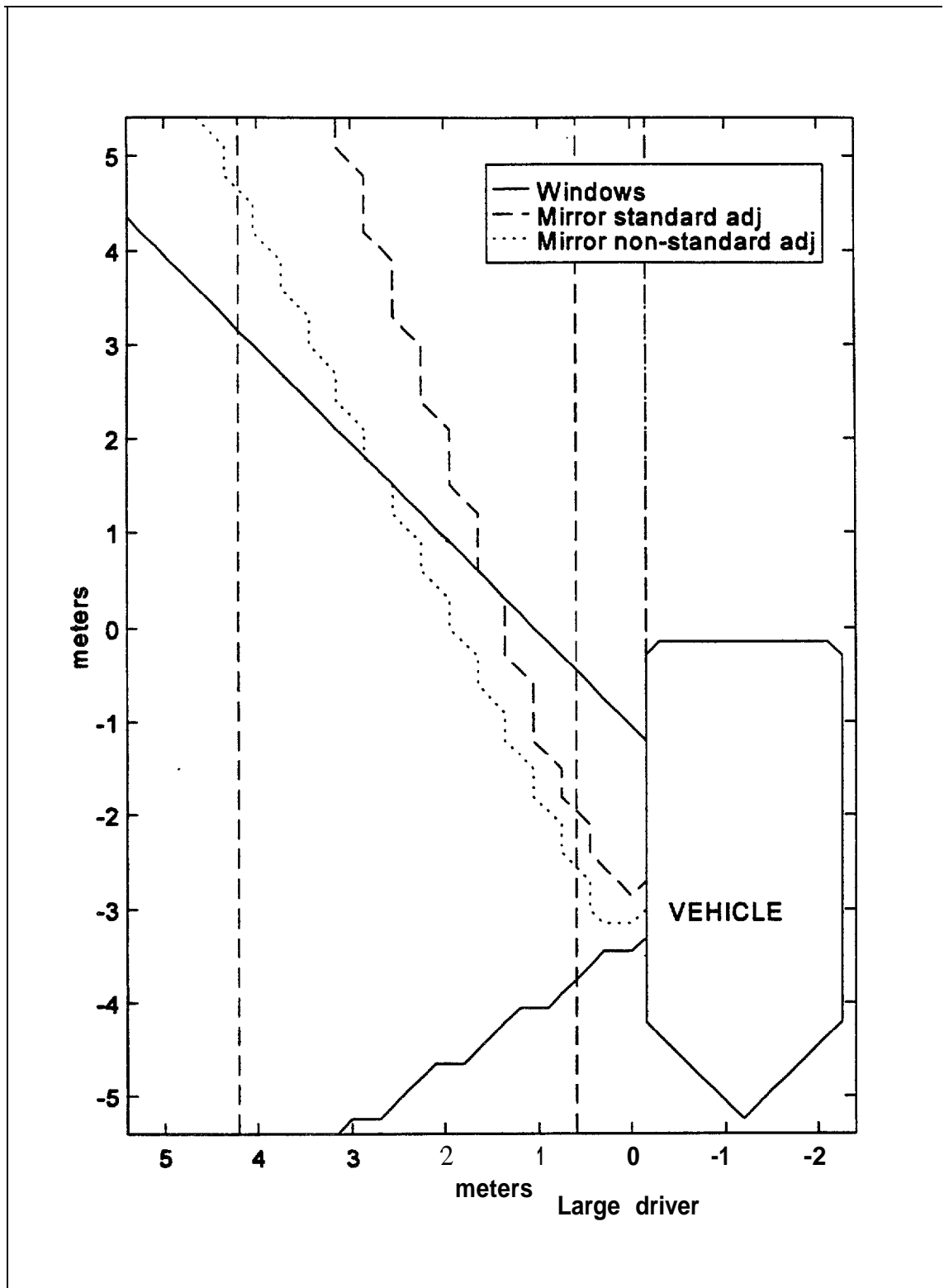
**Figure 2.1.** Passenger car used as primary test vehicle (1991 Acura Legend)



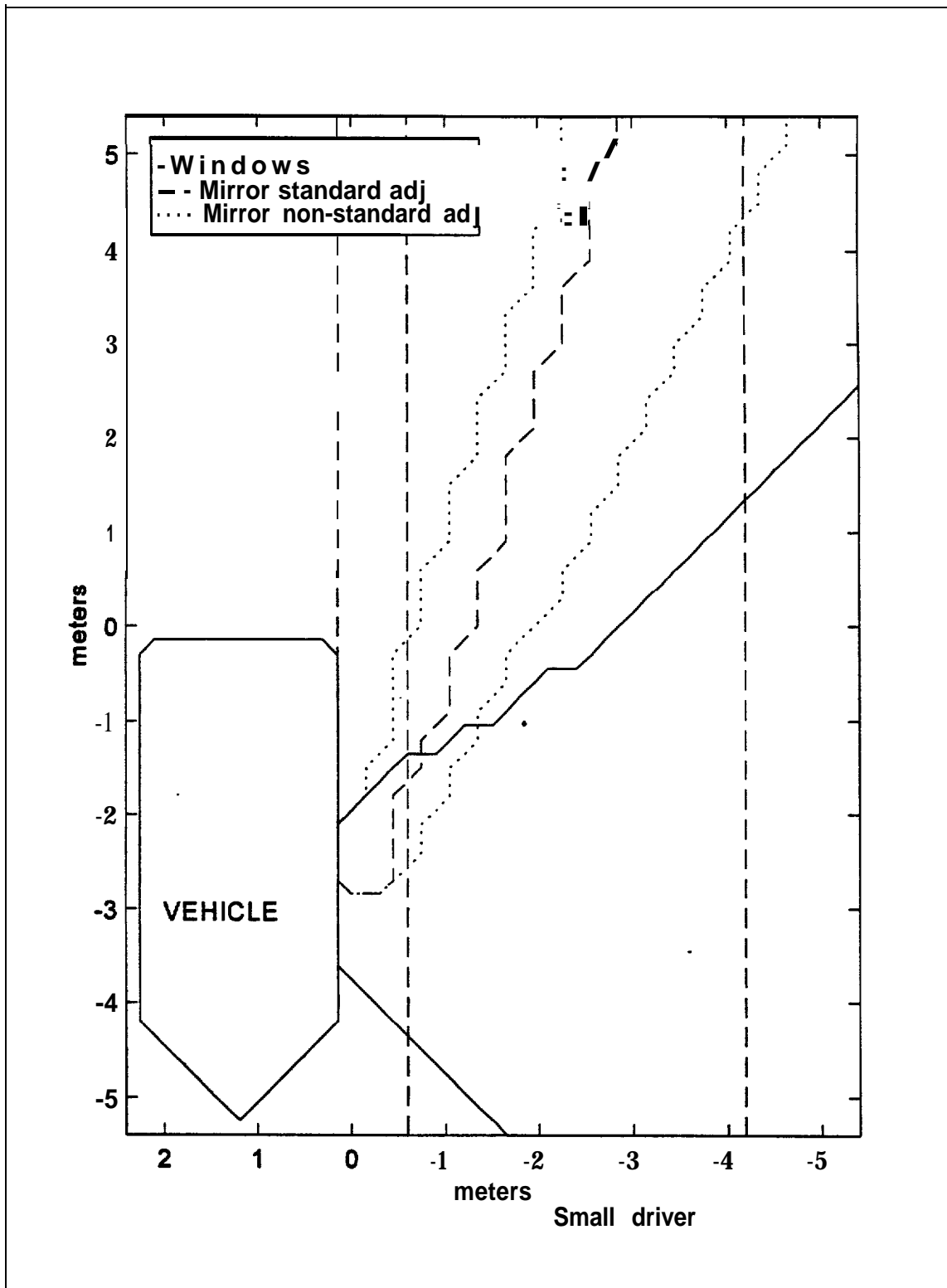
**Figure 2.2.** HMMWV test vehicle



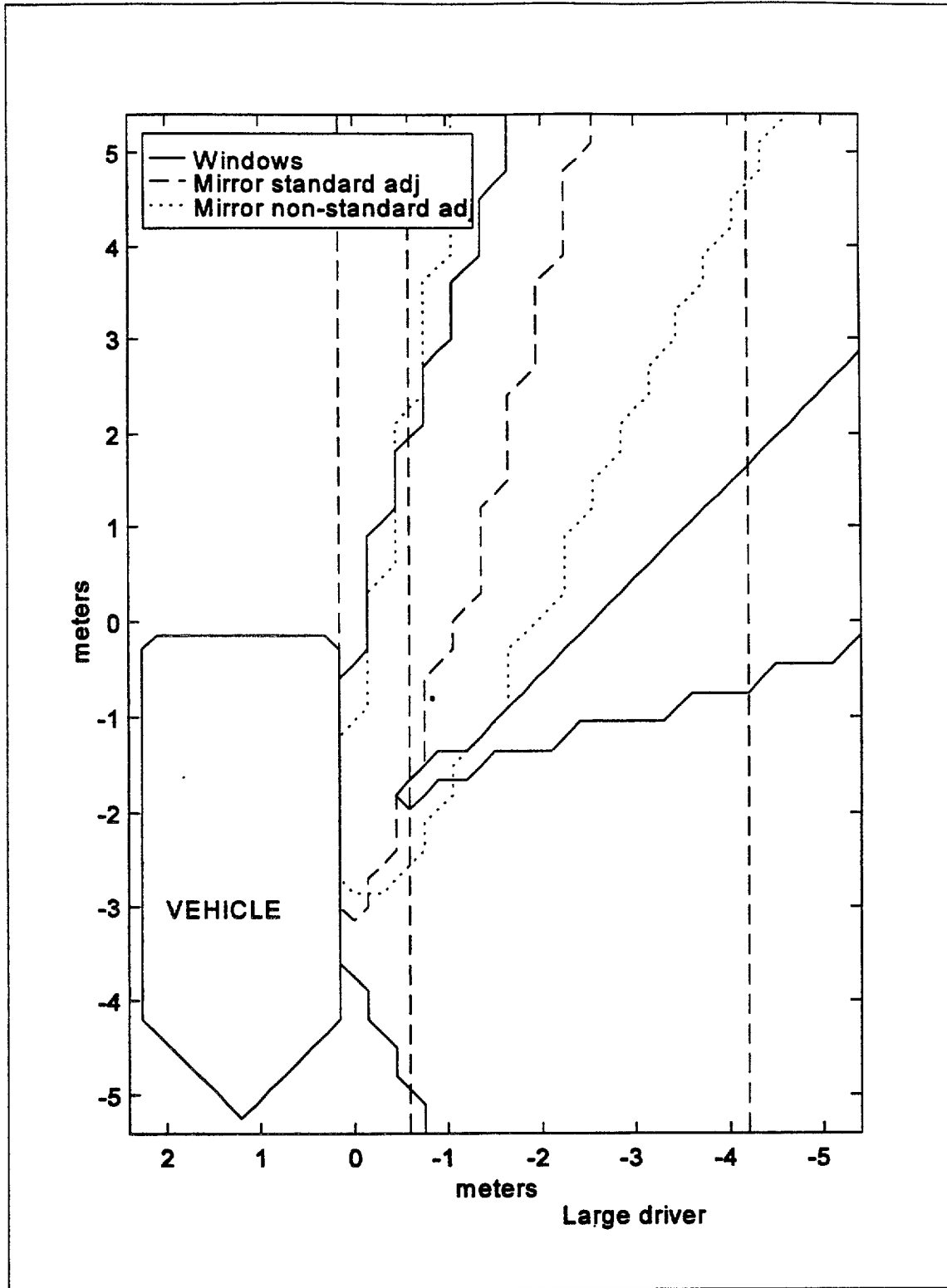
**Figure 2.3.** Driver's right side field of view for the Acura Legend measured using a 5th percentile male driver



**Figure 2.4.** Driver's right side field of view for the Acura Legend measured using a 95th percentile male driver

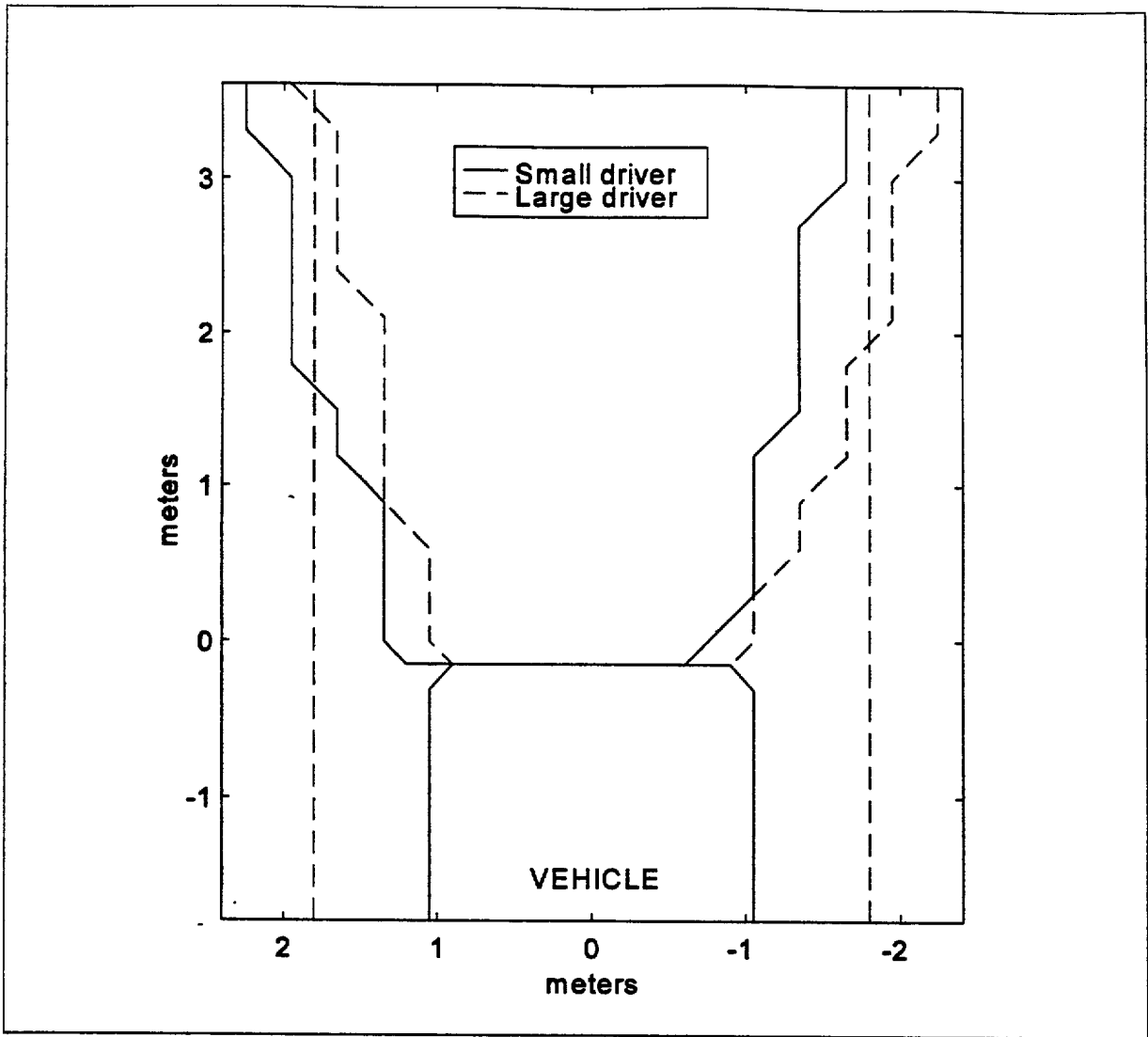


**Figure 2.5.** Driver's left side field of view for the Acura Legend measured using a 5th percentile male driver

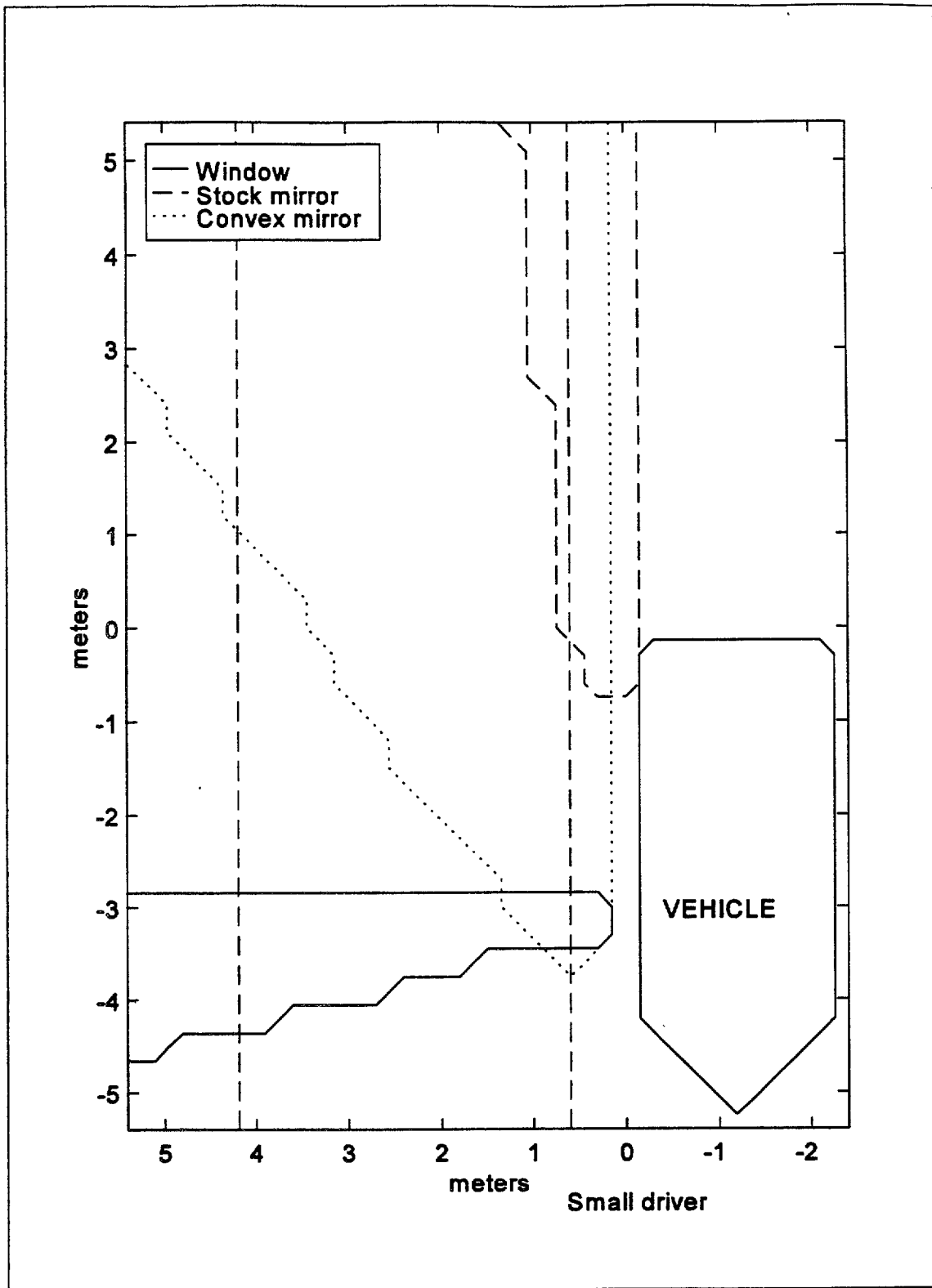


**Figure 2.6.** Driver's left side field of view for the Acura Legend measured using a 95th percentile male driver

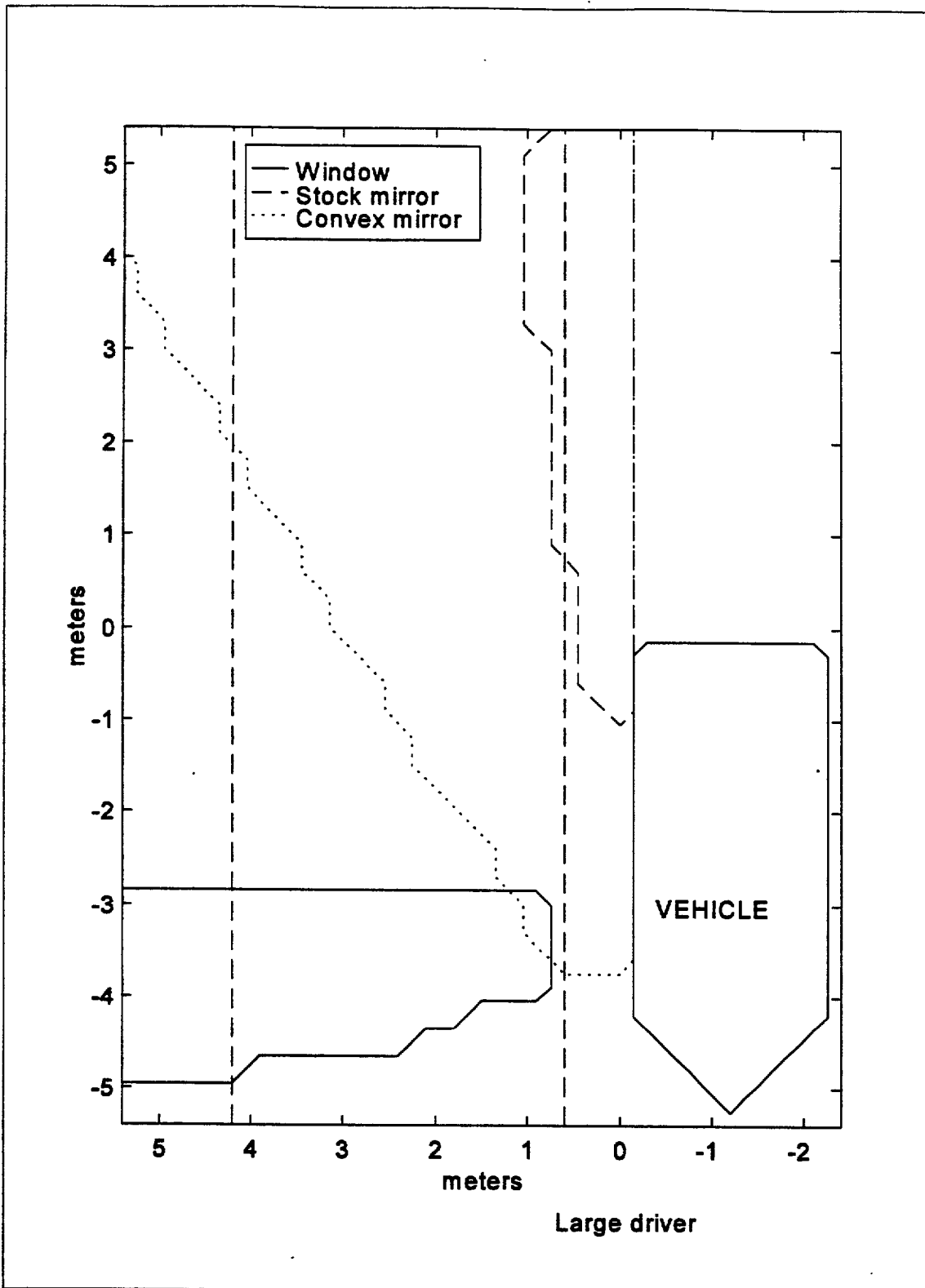




**Figure 2.7.** Driver's rear field of view for the Acura Legend measured using a 5th percentile and a 95th percentile male driver



**Figure 2.8.** Driver's right side field of view for the HMMWV measured using a 5th percentile male driver



**Figure 2.9.** Driver's right side field of view for the HMMWV measured using a 95th percentile male driver

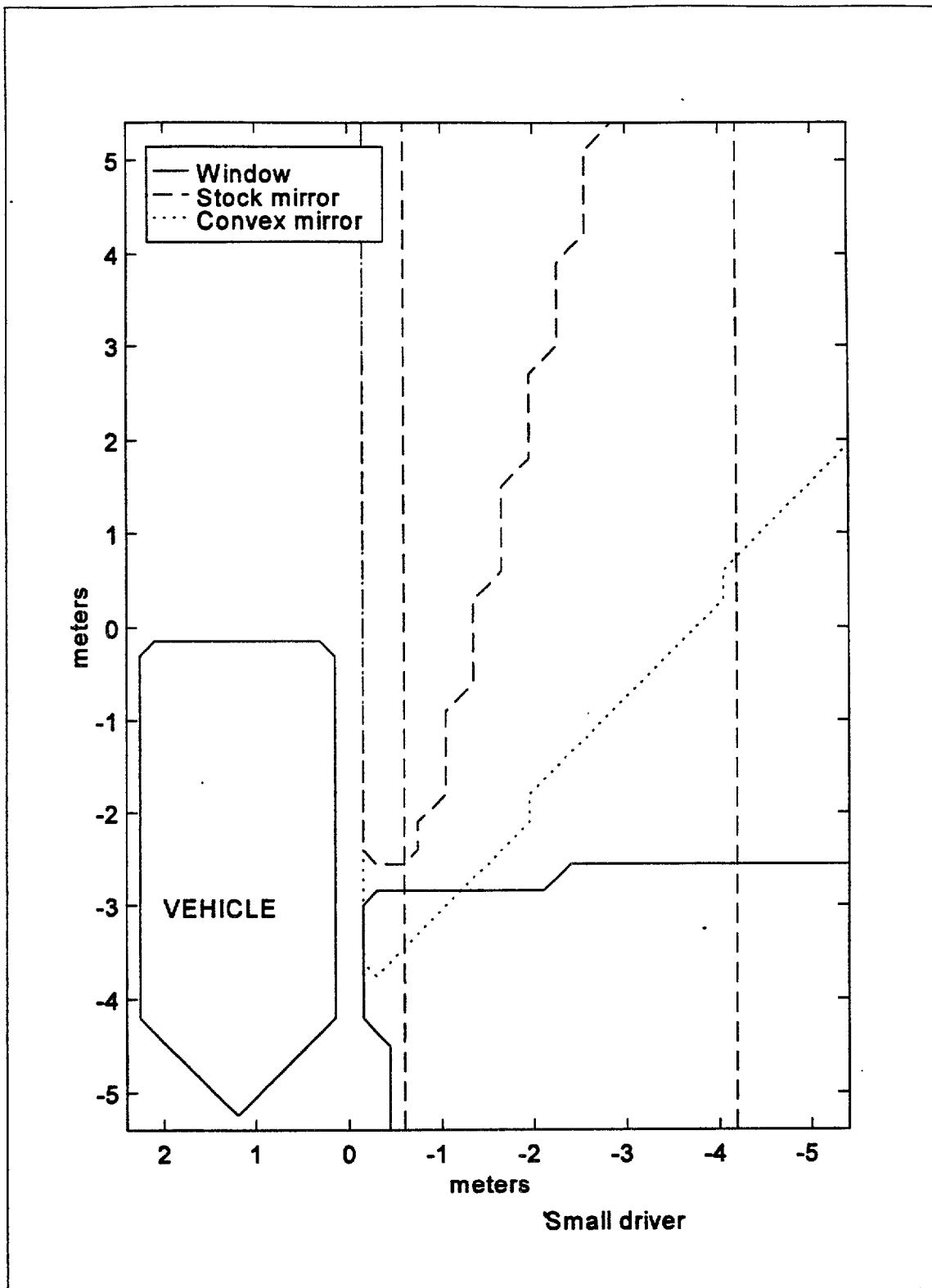
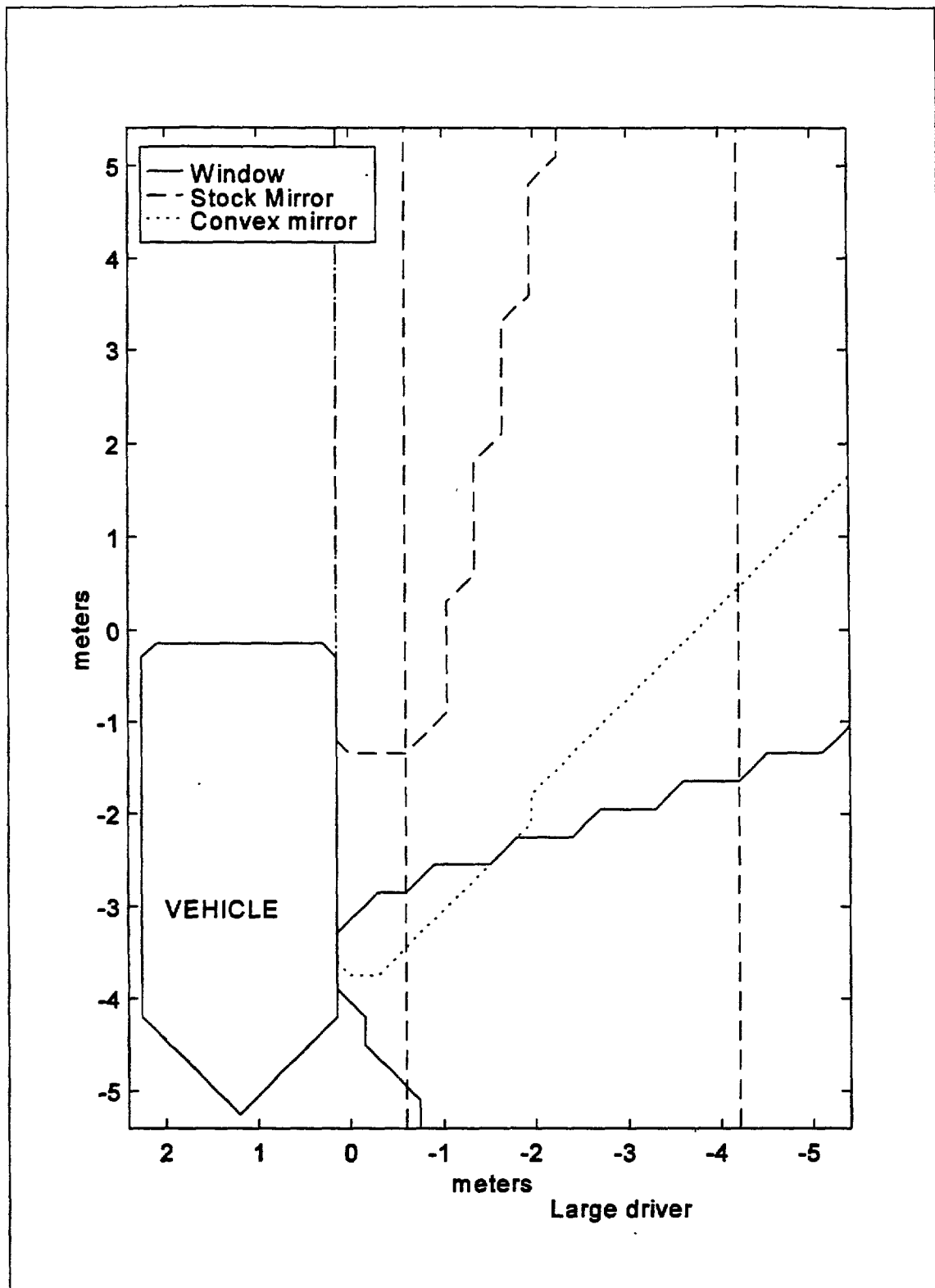


Figure 2.10. Driver's left side field of view for the HMMWV measured using a 5th percentile male driver



**Figure 2.11.** Driver's left side field of view for the HMMWV measured using a 95th percentile male driver

## **2.2 DESCRIPTION OF CHECKLIST SECTIONS AND PROCEDURES**

### **2.2.1 Explanation and Procedures For Section A: DESCRIPTIVE PROFILE**

The purpose of the descriptive profile was to record objective information regarding system operation, sensor configuration, and physical and functional characteristics of the visual and auditory driver displays and controls. These data were collected for use in evaluating the appropriateness of characteristics of the driver/system interface. This section was completed for each system by the same human factors expert.

Section A of the Human Factors Checklist consisted of two parts. Part I of Section A titled “General Information” was completed for each of the 11 systems. The data for Part I are provided in Section 3 in the form of a completed copy of Part I of Section A of the Human Factors Checklist for each system. Part II of Section A titled “Checklist of System Features” was completed for all systems except the two video-based rear-looking CAS. The data for Part II is summarized in Appendix B.

The information used to complete Section A was gathered from the documentation provided by the manufacturer (if any) and by examining the systems while they were installed on the Acura Legend test vehicle with the systems operational. The on-vehicle data was collected with the vehicle stationary and in a lab setting. General information was recorded about the systems including the type of sensor technology used, the size of detection zones, and the type of media used for the manufacturer’s documentation. Detailed information was collected to define the characteristics of each system’s visual and auditory displays.

Measurements of maximum display viewing distances and control reach distances were recorded based upon the manufacturer’s suggested location of driver/system interface components. If no suggested location of the interface was provided by the manufacturer, a central location on the dashboard was used. Measurements were also taken to define the physical characteristics of driver-operable controls. A short list of questions was used to determine whether or not systems incorporated certain features.

Detailed explanations of the procedures used to collect quantitative data describing visual and auditory display characteristics follow.

#### **2.2.1.1 Visual Display Luminance Measurement Procedure**

Measurements of the visual displays associated with each collision avoidance system’s driver/system interface were performed to obtain data requested in Table IV of the Human Factors Checklist (see Appendix A) . The visual display luminance information requested in the checklist included:

- I. Luminance of the visual display (performed for both minimum and maximum visual display brightness settings, if brightness is variable)
2. Luminance of the background of the visual display
3. Percent contrast of display background

Table IV of the Human Factors Checklist required that each of these measurements be taken under daytime and nighttime ambient illumination conditions according to the following specifications:

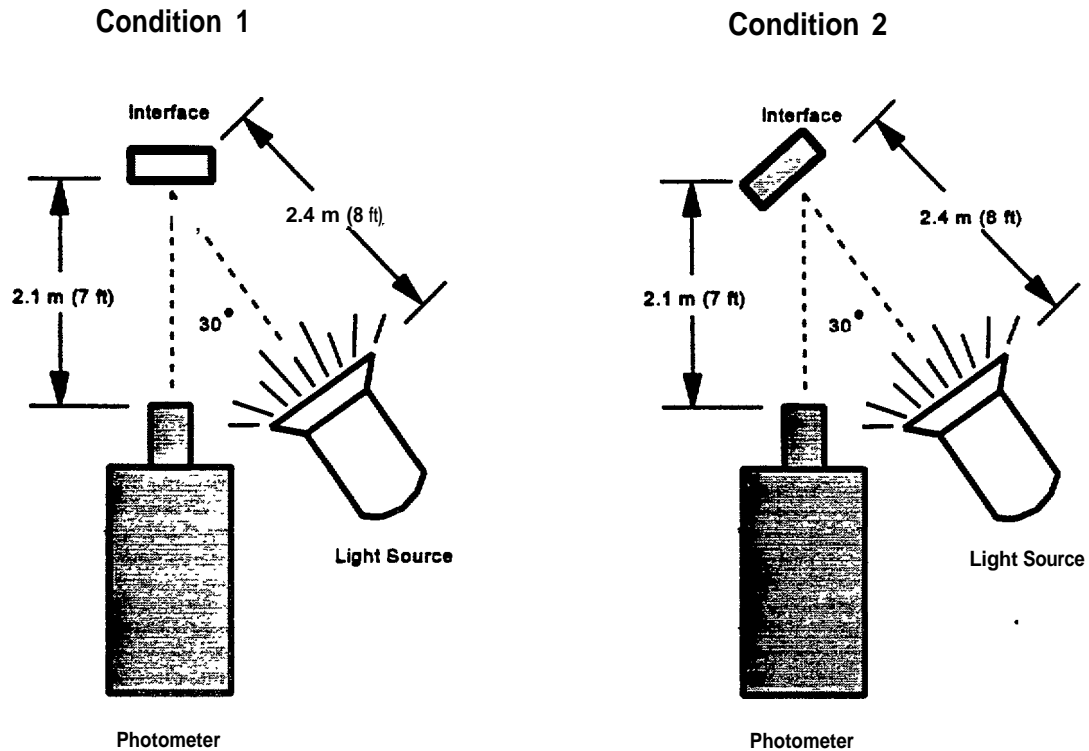
“Measure luminances with display removed from vehicle and in a laboratory where illumination levels can be controlled. The displays must be operational for these measurements. For this assessment, assume nighttime and daytime illumination levels of 0.32 lux (0.03 foot candles) and 10,760 lux (1,000 foot candles), respectively. Measure luminances with brightness adjustment control (if present) set at the minimum and maximum settings.”

**Luminance Measurements.** A PR-1980A Pritchard Photometer was used to collect the luminance data. The photometer was mounted on a tripod which was positioned between 1.8 and 2.4 meters (6 and 8 ft) from the driver interfaces. The angular size of the measuring field for the photometer was adjusted to be just smaller than each light component of the visual display (e.g., LED). Most often a 2 minutes of arc diameter field was chosen for measurements. The units of measurement used were candles per meter squared (Cd/m<sup>2</sup>)

The light source consisted of three incandescent lamps mounted closely together on a single stand and were positioned approximately 2.4 meters (8 ft) from the faces of the visual displays. These lamps provided the capability to produce the specified daytime illumination level of 10,760 lux (1000 foot candles) using a variable continuous controller. Measurements taken under “nighttime” conditions required only the background illumination in the lab to produce the required 0.32 lux. Background luminance measurements were not taken for nighttime lighting conditions as they were so low as to be indistinguishable from the zero level of the photometer.

Luminance measurements were performed with the photometer, light source, and CAS visual display interface arranged in two different configurations to simulate realistic in-vehicle ambient lighting conditions. These conditions were defined based on angular relationships between the light source, CAS display, and the photometer. Measurements were taken with the photometer’s visual axis perpendicular to the faces of the display units (Condition 1) and with the photometer’s visual axis at 30 degrees from the normal to the display unit faces (Condition 2). These conditions are pictured in Figure 2.3. For each measurement, the level of ambient illumination was set to the specified values at the face of the driver interface for each system.

Measurements of the luminance of the visual displays components were taken with the visual display’s lights both on-and off. This was done to help determine the ease with which a person could determine whether the light was illuminated or not. On some visual display components, the outer surface of the display light reflected enough of the illuminating light that it was difficult to discern whether it was on or off. Additionally, a small reflected image of the illuminating light source could often be seen in the visual display covering (e.g., outer surface of the LED). This reflection often added substantially to the luminance measurement.



**Figure 2.12.** Configurations used in measuring the luminance of collision avoidance system visual display components

The background luminance often varied depending whether it was measured to the right, left, above or below the display light and also depended on the geometrical design of the display unit face. In these circumstances, an effort was made to measure the luminance at a position of intermediate luminance.

**Contrast Transfer Measurement of Video Systems**, The quality of information transferred by the rear vision enhancement (video) systems was assessed by measuring the actual contrast of photographic reflectance plates and the image of the plates presented on the monitors. Two white and two gray plates (one light gray, one dark gray) were illuminated to four different levels (10.76, 107.6, 1,076, and 10,760 lux or 1) 10, 100, and 1,000 foot candles). The cameras of video-based rear-looking systems were positioned 0.91 m (3 ft) from the reflectance plates slightly below a line normal to the surface of the plates.

Contrast data listed in the completed checklists for Systems P and Q reflects measurements of luminance made of a white reflectance plate and the background. These measurements were taken both with 1,076 lux (100 foot candles) ambient illumination falling on the face of the display and with the 1,076 lux (100 foot candle) source present but with the light blocked such that it did not fall directly on the display and thus glare was not observed.



The luminances of the actual reflectance plates were measured when the illumination at the center of the plate was 1,076 lux (100 foot candles) as measured using the Pritchard photometer. The overall contrast was calculated by dividing the sums of the luminances of the white plates by the sum of the luminances of the gray plates. (This actual contrast was used as the standard for all illumination conditions, although it was measured using only 1,076 lux illumination.) This data is presented for both video-based systems in Section 3 of this report.

The luminances of the video images of the four reflectance plates were measured on the monitors for the four levels of plate illumination mentioned above. The contrasts of the monitor images of the reflectance plates were calculated at these four illumination levels using both the day and night settings for the systems. The photometer was positioned for these measurements with its visual axis normal to the monitor surface for the four illumination levels. An additional measurement was made with the photometer's visual axis tilted 30 degrees from the normal to the monitor surface for the 1,076 lux (100 foot candles) illumination level to determine the effect of non-normal viewing on the contrast of the image on the screen. This data is presented for both video-based systems in Section 3 of this report.

The actual contrast of the reflecting plates was divided into the contrast of the plates imaged on the monitors in order to determine the contrast transfer of the system at the four light levels used. This data is presented for both video-based systems in Section 3 of this report.

Calculations For All Systems. Measurements were performed for each visual display component present on each CAS driver interface. Data were collected according to the preceding specifications to facilitate calculation of the following values requested in the checklist:

- a. Calculate percent contrast using the following formula:

$$(L_D - L_B) / L_B$$

where,  $L_D$  = luminance of the displayed information in foot-lamberts  
 $L_B$  = luminance of the display background in foot-lamberts

- b. When measuring the size of alphanumeric characters (and icons) record the height and width of the character, as well as, the stroke width of the character. For alphanumeric characters, the stroke width is the minimum detail that must be resolved by the driver.

- c. Assume the maximum viewing distances, as listed in Table II. Compute the visual angle subtended (minutes of arc) using the following formula:

$$\text{Arctan} (0.5 \times H / D) \times 57.3 \frac{\text{degrees}}{\text{radian}} \times 60 \frac{\text{minutes}}{\text{degree}}$$

**where,** H = height of viewed object (or stroke width of character) in millimeters  
D = viewing distance in millimeters

### **2.2.1.2 Auditory Display Measurement Procedure**

Measurements of the collision avoidance systems' auditory warnings and other auditory messages were taken using a Bruel & Kjaer Type 2230 Sound Level Meter with a Pre-polarized Condenser Microphone Cartridge Type 4155. This instrument was used to determine the RMS/Average Sound Pressure Level (SPL). The settings used on the meter when measurements were taken were as follows: RMS Detector, Fast Time Weighting, SPL Display, Frontal Sound Incidence, and A Frequency Weighting.

Measurements of auditory crash avoidance warnings and any other auditory messages were taken with the measuring instrument situated at a location corresponding approximately to a position directly between the ears of a 95th percentile male seated in the driver's seat of the test vehicle. Auditory messages were triggered and the signal waveform was sampled using the sound level meter's AC output (after the A weighting network) at 100,000 samples per second. Matlab (a commercially available analysis software package) was then used to perform a power spectral density analysis. The frequency having the largest power associated with it was identified and recorded for the checklist. In addition, all frequency peaks with powers that were not more than 6 dB below the peak power were recorded. The 6 dB criteria was used because it was expected that frequencies having power peaks of at least one-fourth of the power of the frequency with the highest power would significantly affect the perceived sound.

### **2.2.2 Explanation and Procedures For Section B: HUMAN FACTORS ASSESSMENT**

The purpose of the human factors assessment was to examine the extent to which the design of a particular CAS driver interface conformed to accepted SAE Recommended Practices and human factors design principles. These objective data provided a means for making relative comparisons among systems. Section B of the Human Factors Checklist was completed for all systems except the two video-based RCAS. Data from Section B of the checklist is summarized in Appendix C. For ease of presentation, data from each of the seven parts of Section B are presented in separate tables.

Section B contained two types of questions. The majority of questions required "yes" or "no" answers. This type of question was used to collect information on cautionary and imminent visual and auditory crash avoidance warnings, visual and auditory system status displays, manual controls, legends, and system documentation. Appropriate responses to these questions were determined based on available SAE Recommended Practices and on guidelines and design criteria contained in various human factors references such as "The Handbook of Human Factors" [4] and the "Human Factors Design Handbook" [5]. The second type of question used a 5-point scale to allow the human factors expert completing this section to judge the extent to which SAE Recommended Practices and human factors design principles had been effectively applied to visual and auditory warnings.

The information used to complete Section B was gathered from the documentation provided by the manufacturers (if any) and by examining the systems in operation while installed on the Acura Legend test vehicle. The on-vehicle data was collected with the vehicle stationary in a laboratory.

### **2.2.3 Explanation and Procedures For Section C: OPERATIONAL JUDGEMENTS**

Section C consisted of a subjective assessment of each driver interface which was performed by two human factors experts after having driven with a system over a fixed route. This subjective assessment was completed for all systems. The subjective data collected facilitated the assessment of each system's driver interface from the human factors experts' point of view and provided a means for comparison of this subjective information with objective data collected in other parts of the checklist.

Section C consisted of a two-part questionnaire containing a static evaluation and a dynamic evaluation. Section C was completed for each side and rear system eight times according to the following 2 x 2 x 2 matrix:

- 2 Human factors-experts
- 2 Test vehicles (199 1 Acura Legend, HMMWV)
- 2 Lighting conditions (daytime, nighttime/darkness)

Therefore, each expert completed four driving sessions with each system.

To complete Section C, the experts first reviewed the manufacturer's documentation (if any) and became familiar with the operation of a system through examination of the device with the test vehicle stationary and the system operational. Next, Part I of the questionnaire, which addressed the characteristics of the driver/system interface which could be observed in a static setting, was completed. The experts then drove the defined test route with a system installed in a test vehicle. The procedure for this test driving differed for rear-looking CAS from that used for the side-looking systems. These two procedures are discussed in 2.2.3.1 and 2.2.3.2.

Part II of Section C was completed after the test drive had been conducted. In Part II the experts responded to questions based on their driving experience regarding the ease of perception of warning signals, distraction and annoyance experienced, effectiveness of warning presentations, system use, and changes in mirror sampling due to system presence. Questions also were asked to ascertain whether the experts encountered any problems while driving with the system and requested suggestions for possible improvements to the design of the interface and the system as a whole.

#### **2.2.3.1 Driving Procedure for Side-Looking CAS**

To complete Section C of the checklist for the side-looking collision avoidance systems, the experts first drove a defined route in traffic extending between and around East Liberty and Columbus, Ohio in daylight. This route took approximately two hours to traverse and contained equal amounts of driving time on arterial streets, freeways, and rural highways. The route was repeated at night.

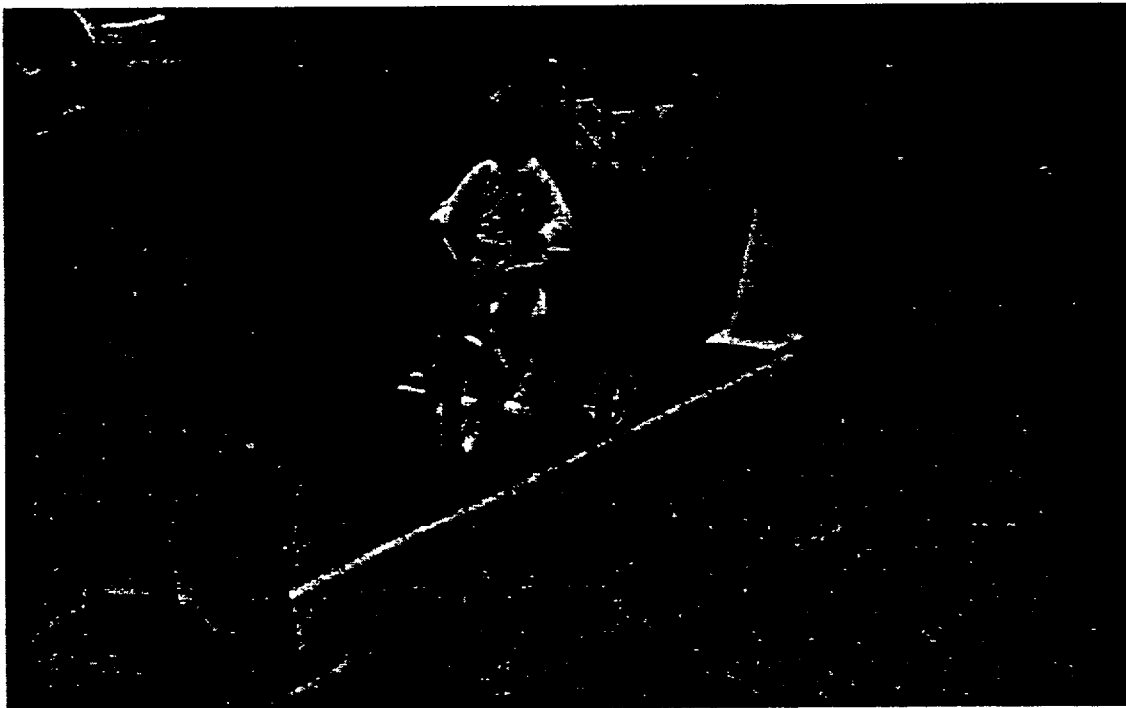
#### **2.2.3.2 Driving Procedure for Rear-Looking CAS**

For the rear-looking systems, the two experts performed a series of five backing maneuvers. These maneuvers were designed to simulate realistic backing scenarios and used familiar targets. Courses

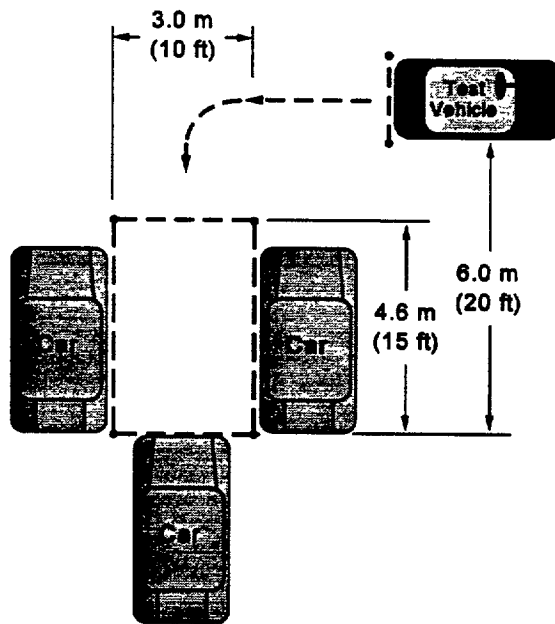
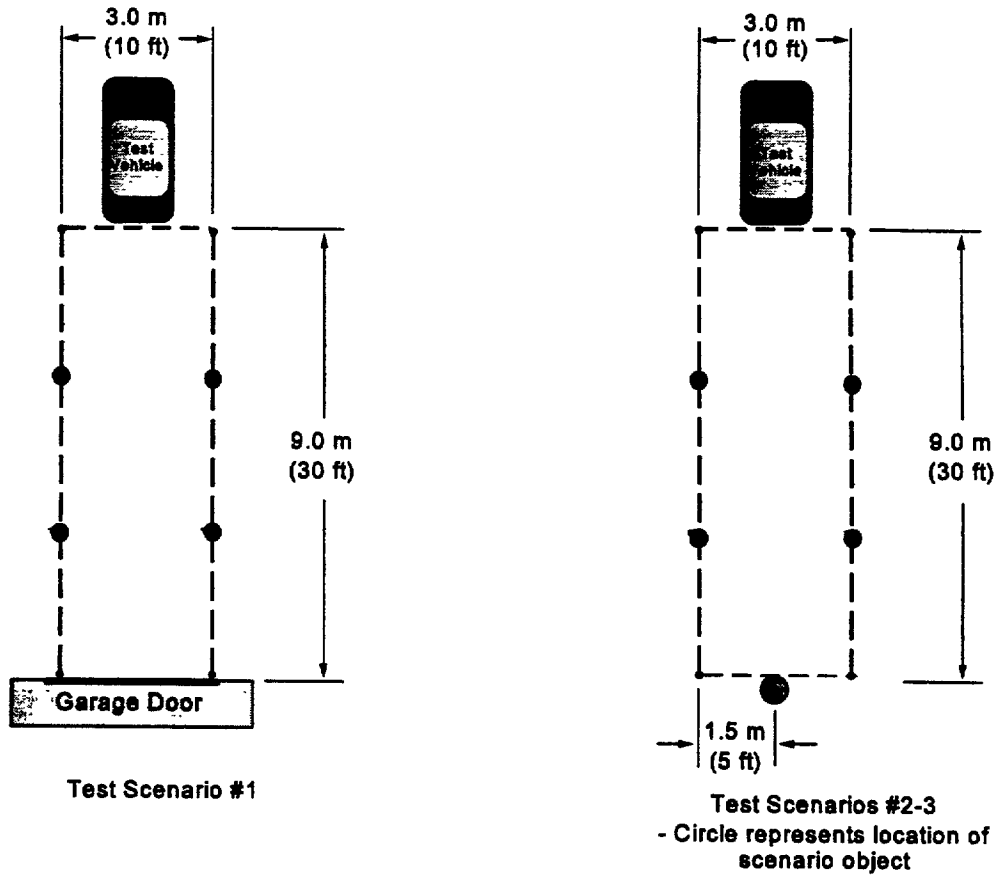
marked by cones were set up in an open parking lot at VRTC. The cones were spaced approximately 3.0 meters (10 ft) apart. For Scenario #5, 50-gallon steel drums were also placed between the cones to mark off the course. Obstacles used in test scenarios were placed at the center of the marked lane, as illustrated in Figure 2.4. For each scenario, the human factors experts were instructed to back up to each object and park as close as possible to the object without striking it. The five backing scenarios included:

1. Backing up to a garage door
2. Backing up to a seated 95th percentile male Anthropomorphic Test Device (ATD) (i.e., crash dummy)
3. Backing up to a 3-year old child ATD seated on a tricycle (shown in Figure 2.4)
4. Backing into a parking space with vehicles present in longitudinally and laterally adjacent spaces
5. Backing through a short serpentine course (see diagram in Figure 2.6)

These five scenarios are illustrated in Figures 2.5 and 2.6. For each scenario, the final distance between the test vehicle and the scenario object was measured and recorded for each trial. These data are given in Section 3.3.3. Section C (see Appendix A) of the Human Factors Checklist was completed after each human factors expert had completed all five test scenarios for a particular system.

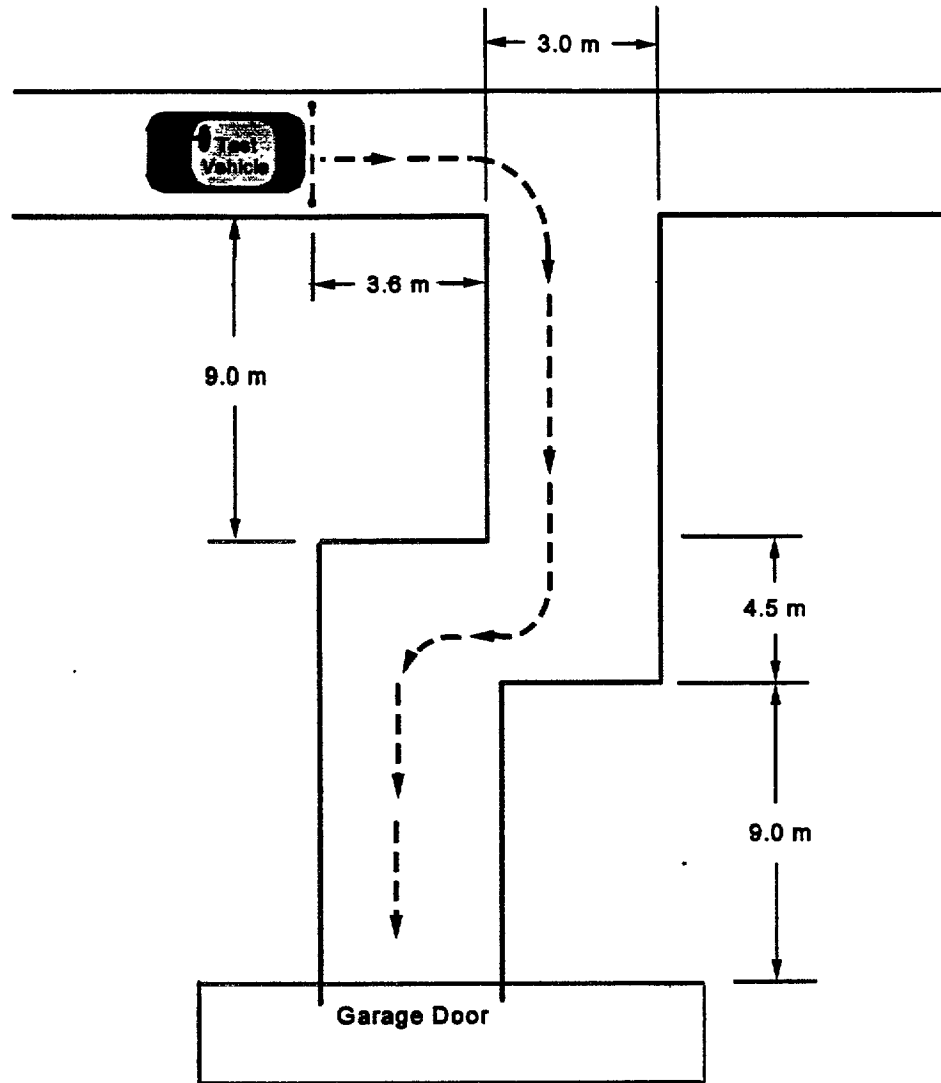


**Figure 2.13.** 3-year-old child ATD centered in lane for backing trials



Test Scenario #4

Figure 2.14. RCAS Backing Test Scenarios #1-4



**Figure 2.15. RCAS Backing Test Scenario #5**

## 23 Procedures for Scoring the Human Factors Checklist

The Human Factors Checklist responses for the side-looking and rear-looking CAS tested contain a considerable amount of data. Scoring was used in an attempt to summarize this large amount of data and assess which CAS driver interfaces had more appropriate features.

Given the state of the art in human factors, the checklist cannot be scored based solely upon information contained in human factors manuals and guidelines. These sources are general guidelines for equipment design and do not provide specific details for CAS design. Also, handbooks do not cover all design features and do not provide weighting criteria to distinguish the more important guidelines from ones of lesser importance for a particular application. These human factors guidelines were used to the maximum extent possible to determine the desirable characteristics of a driver interface. However, where there were gaps in the existing guidelines, the authors' judgement based upon experience with a substantial number of these interface was used.

The scoring system used only addressed the mostly objective data contained in Section A, Descriptive Profile, and Section B, Human Factors Assessment, of the Human Factors Checklist. Subjective data from Section C, Operational Judgements, was not used.

The scoring system used had six objective categories and one subjective one. The six objective categories were:

1. Overall Design
2. Visual Warning Display Conspicuity
3. Visual Warning Display Comprehensibility
4. Audio Warning Discriminability and Comprehensibility
5. System Status Display Conspicuity and Comprehensibility
6. Control Ergonomics

The one subjective category was Expert Professional Judgement.

A score was calculated for each of the above listed categories for each system tested. A different scoring system was used for each category. However, the same basic technique was used to develop the scoring systems for the individual objective categories.

First, the characteristics of an ideal CAS driver interface were listed for each category. Then, each listed characteristic of an ideal collision avoidance system driver interface was ranked as being either of "high" importance or of "low" or "less" importance. Since no basis is provided in the human factors guidelines to perform this ranking, the authors' judgement was used in most cases. Each listed characteristic of an ideal system (e.g., the driver interface included a visual warning display) was then associated with one or more Human Factors Checklist questions. For each question, the response which indicated that the characteristic of the system being evaluated was a desirable one was identified.

Weights were then assigned to each checklist question. Questions associated with ideal interface characteristics that were ranked as being of less importance received one-half the weight **of questions** associated with ideal interface characteristics that were considered to be of high importance. In cases

where multiple questions were associated with one ideal interface characteristic, the weight assigned to each of the multiple questions was reduced. This was done so as to keep the total weight associated with each ideal interface characteristic the same.

Two sums were then calculated for each category. The first sum, Score Weights or W, was incremented by the weight assigned to a question if the answer to the question was the “good” answer. The second sum, Total Weights or T, was incremented by the weight assigned to the question unless the answer to the question was Not Determinable (ND) or Not Applicable (N/A). The score for each category, S, was then calculated by the equation

$$S = 100 W/T$$

Tables 2.1 through 2.6 list the characteristics of an ideal system that were selected for each of the objective scoring categories.

**TABLE 2.2.** Overall Design Category - Desirable Characteristics of a CAS Interface

<p><b>Of High Importance:</b></p> <ol style="list-style-type: none"><li>1. Provides both audio and visual warnings.</li><li>2. Has no more than four levels of visual and auditory warnings.</li><li>3. Provides warnings whenever vehicle is turned on.</li><li>4. Automatically indicates system failure to driver.</li></ol> <p><b>Of Less Importance:</b></p> <ol style="list-style-type: none"><li>5. Has brightness and volume adjustments. These do not allow brightness or volume to be adjusted below a minimum acceptable level.</li><li>6. Does not allow driver to adjust sensor sensitivity.</li><li>7. For backing systems - Only active when backing: For side systems, audio warnings sound only when turn signal on or LCM being made.</li><li>8. Has a manual override to temporarily turn off warnings. *</li><li>9. Presents no information when no objects sensed.</li></ol>
---



**TABLE 23.** Visual Warning Display Conspicuity Category - Desirable Characteristics of a CAS Interface

<p><b>Of High Importance:</b></p> <ol style="list-style-type: none"><li>1. Display easy to discern in both daylight and darkness conditions.</li><li>2. For SCAS only, the display line-of-sight is either near the line-of-sight to the side view mirrors. For RCAS, there is no preferred display location.</li><li>3. Line-of-sight from driver to display is unobstructed.</li><li>4. Display easy to discern in light from specular glare sources.</li><li>5. The driver can easily discriminate warning display from other displays.</li></ol> <p><b>Of Less Importance:</b></p> <ol style="list-style-type: none"><li>6. Legends on display easily legible in both daylight and darkness.</li><li>7. Driver has unobstructed view of each legend.</li><li>8. Legends on display easily legible in light from specular glare sources.</li></ol>
---

**TABLE 2.4.** Visual Warning Display Comprehensibility Category - Desirable Characteristics of a CAS Interface

<p><b>Of High Importance:</b></p> <ol style="list-style-type: none"><li>1. Information should be organized to be quickly obtained while driving.</li><li>2. The information coding techniques used should correspond to population stereotypes (e.g., object present should be designated by a red light).</li></ol> <p><b>Of Less Importance:</b></p> <ol style="list-style-type: none"><li>3. The warning display should be labeled (have legends).</li><li>4. Functional legends should be easily discriminated from advertising.</li><li>5. Redundant visual information coding should be used.</li><li>6. Legends should be near their associated display.</li></ol>
---

**TABLE 2.5.** Auditory Display Discriminability and Comprehensibility Category - Desirable Characteristics of a CAS Interface

<p><b>Of High Importance:</b></p> <ol style="list-style-type: none"><li>1. The meaning of auditory warnings is readily apparent.</li><li>2. The information coding techniques used should correspond to population stereotypes.</li><li>3. The dominant frequency of the tone is between 500 and 3000 Hz.</li></ol> <p><b>Of Less Importance:</b></p> <ol style="list-style-type: none"><li>4. The volume range is from not more than 90 to not less than 60 dBA.</li><li>5. The driver can easily discriminate warning display from other sounds.</li><li>6. Complex tones are used for warnings.</li></ol>
--

**TABLE 2.6.** System Status Display Conspicuity and Comprehensibility Category - Desirable Characteristics of a CAS Interface

<p><b>Of High Importance:</b></p> <ol style="list-style-type: none"><li>1. Display easy to discern in both daylight and darkness conditions.</li><li>2. The display is organized so that the driver can quickly acquire system status information while driving.</li><li>3. The information coding techniques used are appropriate for the type of information presented and correspond to population stereotypes.</li><li>4. System status display can be easily discriminated from other displays.</li><li>5. Driver can easily tell from the display whether or not the system is on.</li><li>6. Display easy to discern in light from specular glare sources.</li></ol> <p><b>Of Less Importance:</b></p> <ol style="list-style-type: none"><li>7. The displayed system status information should have a legend.</li><li>8. The status display legend should be easily legible in both daylight and darkness.</li><li>9. Driver has unobstructed view of each legend.</li><li>10. Functional legends should be easily discriminated from advertising.</li><li>11. The system status display legend should be easily legible in light from specular glare sources.</li><li>12. Legends should be near their associated display.</li></ol>
--

**TABLE 2.7.** Control Ergonomics Category - Desirable Characteristics of a CAS Interface

<p><b>Of High Importance:</b></p> <ol style="list-style-type: none"><li>1. Controls are easy to reach and see.</li><li>2. Type of control used is appropriate for type of function controlled.</li><li>3. Movement of controls corresponds to population stereotypes (e.g., upward, right, or clockwise movements produce an increase in the value of the parameter).</li><li>4. Controls are coded for discrimination in blind operation.</li><li>5. Use of the control provides appropriate feedback.</li><li>6. Controls are separated to prevent accidental activation.</li></ol> <p><b>Of Less Importance:</b></p> <ol style="list-style-type: none"><li>7. Control setting can be discerned via visual or tactile inspection.</li><li>8. All controls have legends.</li><li>9. All control legends are legible in both day and night lighting conditions.</li></ol>
---

The one subjective category, Expert Professional Judgement, determines the subjective opinion of the human factors expert that filled out Section B of the checklist. The same human factors expert completed Section B of the checklist for all CAS interfaces evaluated.

The Expert Professional Judgement category score was calculated only from questions that were answered using a one to five rating scale. Five was always the best answer.

To calculate the score for the Expert Professional Judgement category, each one to five rating scale question in Section B was assigned a weight. One standard weight was used except for cases where two questions were closely correlated. In this situation, to avoid giving a topic too much importance, each question was assigned a weight one-half of the standard weight.

Two sums were then calculated for the Expert Professional Judgement category. The first sum, Score Weights or W, was incremented by the weight assigned to a question multiplied by the answer to the question minus one (unless the answer to the question was No Data (ND) or Not Applicable (N/A)). The second sum, Total Weights or T, was incremented by the four times the weight assigned to the question unless the answer to the question was Not Determinable (ND) or Not Applicable (N/A). The score for each category, S, was then calculated by the equation

$$S = 100 \frac{W}{T}$$

### **3.0 HUMAN FACTORS CHECKLIST RESULTS - INDIVIDUAL SYSTEMS**

The Human Factors Checklist used in this study was modified for this purpose from its original form developed specifically for use in a study of heavy truck side and rear object detection systems. In modifying this checklist for use in this study, many needed improvements were realized. However, many necessary modifications to the checklist were also not realized until the benefit of retrospect was acquired upon completion of the current study.

For this study, expert “evaluators” made multiple test runs in multiple test vehicles in varying conditions of ambient illumination to evaluate each system’s driver interface. Since there are a large number of types possible driver interfaces, it is a large and difficult task to create a tool which can be used to evaluate all CAS driver interfaces. While the current version of the Human Factors Checklist is significantly better than the original version, the current research showed that many more improvements are needed. Thus, the limitations of this checklist at this point in time are many.

The following discussion of the strengths and weaknesses of individual systems is based primarily on data from Section C of the Human Factors Checklist including data such as that given in Section 4 and the qualitative data obtained in Part III of Section C of the checklist. The ideas presented were based on responses to the Human Factors Checklist and a consensus of assessments of the human factors experts.

In general, the Human Factors Checklist proved to be a very useful tool in this application. The “open-ended” nature of the qualitative questions contained in Part III facilitated the receipt of many enlightening comments indicative of the quality of individual system interfaces and of system performance

The topics of some of these comments were not addressed in the checklist as used in this study. While the Human Factors Checklist was a very useful analysis tool for this study, the open ended comments provided ideas for additional questions and topics of interest which should be included to develop improved future versions of the checklist.

### 3.1 SYSTEM A - HUMAN FACTORS CHECKLIST RESULTS

System A was a commercially available ultrasonic side object detection system. This system had a single sensor used to create a detection zone on the right side of the vehicle. A more detailed description of the system's operation and driver interface characteristics can be found in the responses to the Human Factors Checklist for this system which can be found in the appendices.

#### 3.1.1 System A - Description of Driver Interface

System A had two parts to its driver interface. A main display unit, pictured in Figure 3.1, contained both visual and auditory crash avoidance warning displays as well as visual system status displays. This main display unit was mounted at the center of the dashboard, as shown in Figure 3.2. Commercial advertising labels have been omitted from the photographs. An auxiliary display unit, shown in Figure 3.3, was mounted at the right side A-pillar and provided the driver with an additional source of crash avoidance warning information. The system had no controls present on the driver interface. As a result, the brightness of visual crash avoidance warning and system status displays was constant as was the volume of the auditory crash avoidance warning.

On the main display unit was located a crash avoidance warning visual display which consisted of a single red LED labeled "NO TURN!". This display was located on the far right side of the face of the display unit. This warning light would illuminate steadily (i.e., steady burn, no blinking) whenever an obstacle was present in the detection zone. An additional visual crash avoidance warning display was located at the right A-pillar near the side view mirror. This auxiliary display consisted of a pictorial representation of a roadway complete with lane marking and a red "X"

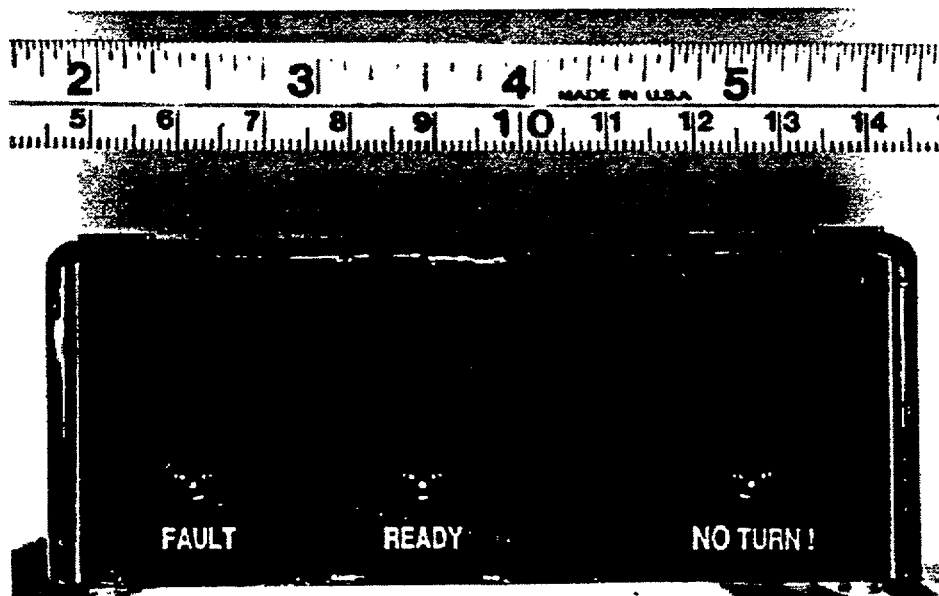
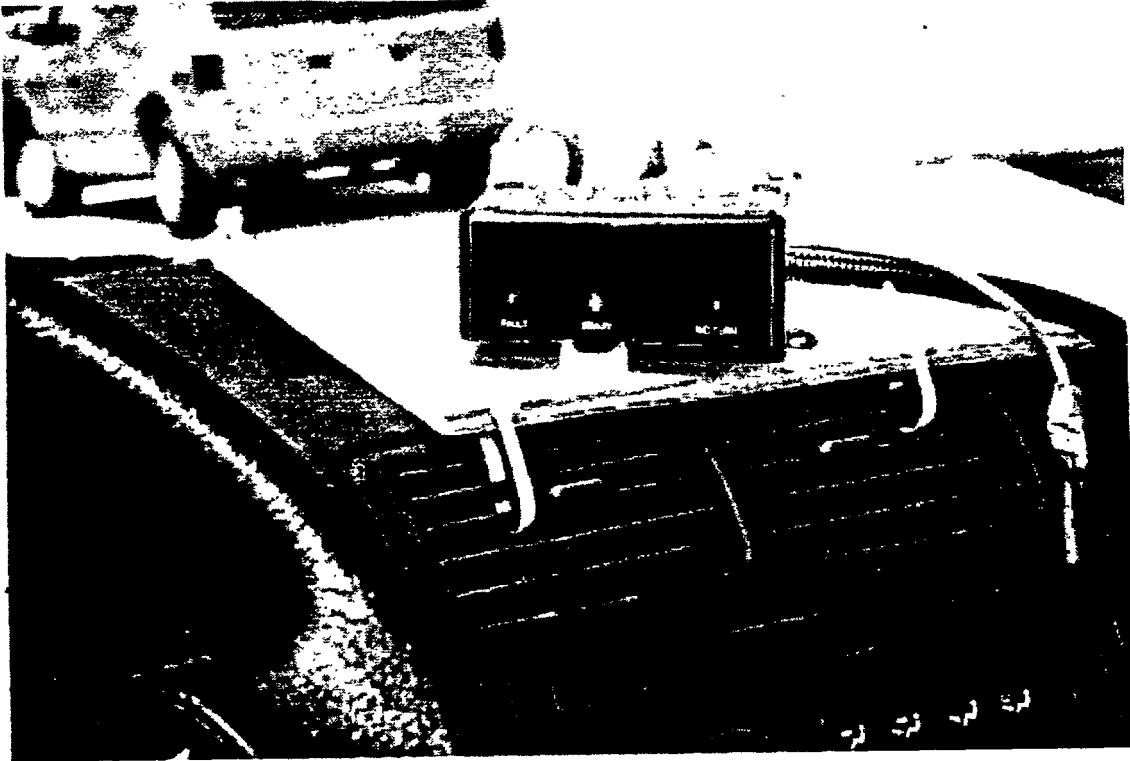
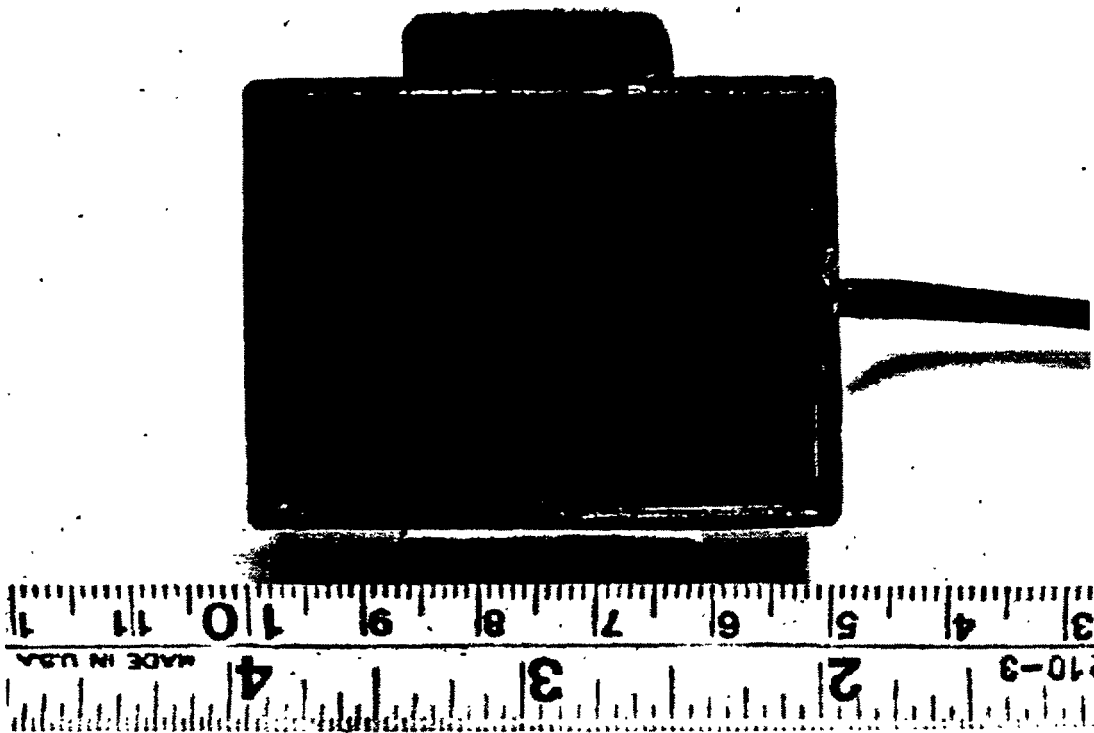


Figure 3.1. System A driver interface: Main display unit



**Figure 3.2.** System A main display unit as mounted for testing



**Figure 3.3.** System A driver interface: Auxiliary visual warning display

located in the right lane. This red “X” would illuminate in coordination with the visual warning LED on the main display unit to indicate the presence of an obstacle in the right adjacent lane. The system also had an auditory warning which would sound a constant tone whenever an obstacle was present in the detection zone.

System A had two system status displays located on its main display unit. A green LED labeled “READY” which was located at the center of the face of the unit illuminated to provide the driver with an indication that the system was successfully receiving power. A red LED labeled “FAULT” which was located at the far left side of the face of the display unit would illuminate only if the system self test detected a problem with the system hardware.

### **3.1.2 System A - Human Factors Checklist**

The completed Part I of Section A of the Human Factors Checklist for System A is provided in the following pages. Immediately following the checklist is a discussion of the results for System A.

**SYSTEM A**



**SECTION A**

**DESCRIPTIVE PROFILE OF SYSTEM AND DRIVER/SYSTEM INTERFACE**



**Part I            General Information**

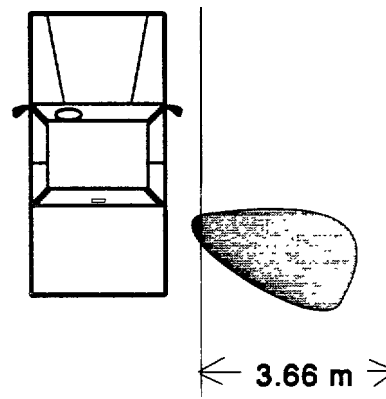
1. Brief system description:

a. What type of sensor technology (e.g., ultrasonic, position radar, etc.) does the system use?

“Ultrasonic ranging system”

b. How many sensors are used with the system and what areas of coverage are associated with each? Use the given picture to illustrate the detection zone(s) around the vehicle. Dimensions of the detection zone(s) need not be given since this illustration is intended to be an approximate representation.

1 sensor



c. What is the effective (or nominal) range of the sensors as stated in the manufacturer’s specifications?

9 feet (274.3 cm)

d. Based upon the descriptions contained in the table below, what is the system category? 1

	<b>Significance of Vehicle Posture</b>	<b>Action Needed</b>
<b>Category 1</b>	Potential for collision exists - vehicle(s) not on a collision course	Caution needed, but no immediate collision avoidance action is necessary
<b>Category 2</b>	Collision is imminent - vehicle(s) on a collision course	Immediate collision avoidance action by the driver is needed
<b>Category 3</b>	Collision is imminent - vehicle(s) on a collision course	Immediate collision avoidance action will be provided by an automatic control system

- e. On what type of algorithm are the crash avoidance warnings, levels of warning, or vehicle control based (e.g., detection of distance-to-target or time-to-target)? Check one.

Distance-to-target   X    
 Time-to-target             
 Other (specify)           

- f. what type of media is used for the manufacturer’s documentation? Indicate below with an ‘x’. Attach a copy of the manufacturer’s documentation to the back of Section A.

Type of media:                      Printed manual   X    
   Audio tape             
   Video tape             
   Other (specify)           

**TABLE I**  
**Mounting Locations and Overall Dimensions**

Display, Auditory Message or Control <u>                                  </u>	Manufacturer’s Recommended Mounting Location <u>                                  </u>	Overall Dimensions (For reference) (WxHxD) <u>                                  </u>
System status display	<u>  See "Single inteerated display"  </u>	<u>          </u> mm
Cautionary crash avoidance warning	<u>  See "Single intemated display"  </u>	<u>          </u> mm
Imminent crash avoidance warning	<u>  N/A  </u>	<u>          </u> mm
Other <u>  Singleintegrated display  </u> (specify)	<u>  "...mounted for easy operator viewing"  </u> <u>  Note: Single integrated display was mounte  </u> <u>  at the center of the dashboard  </u>	<u>  102X38X76  </u> m
Other <u>  Red "X" at A-pillar  </u> (specify)	<u>  "...obstacle warning lamo is mounted so that  </u> <u>  it is in the operator’s field of view when he  </u> <u>  he looks at his right side view mirrors."  </u>	<u>  m5 1x5 1  </u> m

**TABLE II**  
**Maximum Display Viewing Distances**

<b>Display</b>	<b>Viewing Distance</b>
System status display	<u>  915  </u> mm
Cautionary crash avoidance warning display	916 mm
Imminent crash avoidance warning display	N/A mm
Other display <u>          Fault light          </u> (specify)	914 mm
Other display <u>          Red "X" at A-pillar          </u> (specify)	1283 mm

**TABLE IV.  
Descriptive Profile - Visual Displays**

(If no display is present for an item listed, write N/A [not applicable] in the appropriate boxes.)

NAME OF DISPLAYED INFORMATION	TYPE OF INFORMATION DISPLAYED (e.g. distance to adjacent vehicle, object presence)	TRIGGERING EVENT (e.g., system power application, object presence)	TYPE OF DISPLAY USED (e.g., LCD, LED, icon)	TYPE OF COLOR CODING USED	DISPLAY LUMINANCE DAY (Cd/m <sup>2</sup> ) (record at min. & max. brightness settings)	BACKGROUND LUMINANCE DAY (Cd/m <sup>2</sup> )
system on/off "Ready"	Indication that integrated control/display unit is receiving power	Application of power by ignition	LED	Green	measured On 1233 Off 496  30 degrees On 800 off 311	Normal 52.1  30 degrees 515
Cautionary crash avoidance warning "No turn"	Presence of object within 9 feet (2743 mm) of sensor	Vehicle or object enters detection zone	LED	Red	<u>Normal</u> On 832 Off 116  30 degrees On 546 Off 251	Normal 51.6  30 degrees 50.5
imminent crash avoidance warning	N/A	N/A	N/A	N/A	N/A	N/A
<b>System malfunction</b> "Fault"	<b>Indication of internal failure</b>	<b>Internal failure</b>	LED	Red	<u>Normal</u> On 645 Off 171.6  <u>30 degrees</u> On 340 Off 134.4	<u>Normal</u> 43.8  <u>30 degrees</u> 58.3
<b>Other (list)</b> Red "X"	<b>Presence of object within 9 feet (2743 mm) of sensor</b>	<b>Vehicle or object enters detection zone and right turn signal is activated</b>	LED	Red	<u>Normal</u> On 280 Off 131.3  <u>30 degrees</u> On 222 Off 125.5	<u>Normal</u> 9.2  <u>30 degrees</u> 16.1

**TABLE IV**  
**Descriptive Profile - Visual Displays**  
**(Continued) (ND = Not determined/measurable)**

NAME OF DISPLAYED INFORMATION	DISPLAY LUMINANCE-NIGHT (record at min. & max. brightness settings)	BACKGROUND LUMINANCE - NIGHT	CONTRAST (day & night)	DUTY CYCLE (e.g., steady burn flash rate)	SIZE OF DISPLAYED INFORMATION (diameter, smallest, character, height, and width, stroke width)	VISUAL ANGLE SUBTENDED AT MAXIMUM VIEWING DISTANCE (minutes of arc)
System on/off "Ready"	<u>Normal</u> On 720  <u>30 degrees</u> On 574	ND	<u>DAY</u> <u>Normal</u> On 22.67 Off 8.52 On/Off 2.49  <u>30 degrees</u> On 2.07 Off 1.91 On/Off 1.05  <u>Night:</u> ND	Steady burn	3/16 in (4.8) diameter	18.06
Cautionary Crash avoidance Warning "No Turn"	<u>Normal</u> On 848  <u>30 degrees</u> On 392	ND	<u>DAY</u> <u>Normal</u> On 15.12 Off 1.25 On/Off 7.17  <u>30 degrees</u> On 9.81 Off 3.97 On/Off 2.17	Steady burn	3/16 in (4.8) diameter	18.02
Imminent crash avoidance warning	N/A	N/A	N/A	N/A	N/A	N/A
System Malfunction "Fault"	<u>Normal</u> On 397  <u>30 degrees</u> On 210	ND	<u>DAY</u> <u>Normal</u> On 13.73 Off 2.92 On/Off 3.76  <u>30 degrees</u> On 4.83 Off 1.31 On/Off 2.53  <u>Night :</u> ND	Steady burn	3/16 in (4.8mm) diameter	18.06
Other (list) Red "X"	<u>Normal</u> On 130.9  <u>30 degrees</u> 133.7	ND	<u>DAY</u> <u>Normal</u> On 29.44 Off 13.27 On/Off 2.13  <u>30 degrees</u> On 12.79 Off 6.80 On/Off 1.77 <u>Night :</u> ND	Steady burn	2 in X 2 in (25.4 X 25.4 mm)  Stroke width: 3.33 mm	8.92

**TABLE V**  
**Descriptive Profile -Auditory Warnings**

(If no display is present for an item listed in the leftmost column,  
write N/A [not applicable] in the appropriate boxes.)

NAME OF AUDITORY INFO	TYPE OF INFORMATION PRESENTED (e.g., distance to adjacent vehicle, object presence)	TRIGGERING EVENT e.g.system power application, object presence	TYPE OF WARNING (e.g., steady, warble, intermittent)	PITCH (frequency)	LOUDNESS (record at min & max. loudness settings)	DURATION OF AUDIBLE WARNING SIGNAL	DUTY CYCLE (if intermittent)	CHANGES AFTER ONSET
<b>System on</b>	Indication of system receiving power	Application of power to system	Single beep	600, 2420 Hz	75.4 dB(A)	N/A	N/A	N/A
<b>Cautionary crash avoidance warning</b>	Presence of object within 9 feet (2743 mm) of sensor	Vehicle or object enters detection zone and right turn signal is activated	Continuous tone	600 Hz	75.4 dB(A)	Tone sounds as long as the presence of an object in the detection zone is detected	N/A	N/A
<b>Imminent crash avoidance warning</b>	N/A	N/A	N/A	N/A	N/A	N/A	N/A	N/A
<b>System malfunction</b>	N/A	N/A	N/A	N/A	N/A	N/A	N/A	N/A

**TABLE VI**  
**Descriptive Profile - Manual Controls**

(If no display is present for an item listed in the leftmost column,  
write N/A [not applicable] in the appropriate boxes.)

<b>CONTROL FUNCTION</b>	<b>CONTROL TYPE (e.g., knob, toggle, push button, etc.)</b>	<b>CONTROL SIZE (width X height, diameter, length, etc.)(in mtn.)</b>	<b>DOES THE CONTROL OBSTRUCT THE DRIVER'S VIEW OF VISUAL WARNING DISPLAYS</b>	<b>TYPE OF ADJUSTMENT (discrete or continuous)</b>	<b>DESCRIBE TYPE OF CONTROL FEEDBACK (aural, visual, tactile)</b>
<b>System on/off</b>	N/A	N/A	N/A	N/A	N/A
<b>Volume adjustment</b>	N/A	N/A	N/A	N/A	N/A
<b>Light intensity (brightness) adjustment</b>	N/A	N/A	N/A	N/A	N/A
<b>Sensor sensitivity adjustment</b>	N/A	N/A	N/A	N/A	N/A
<b>Visual display override</b>	N/A	N/A	N/A	N/A	N/A
<b>Audible display override</b>	N/A	N/A	N/A	N/A	N/A

### **3.1.3 System A -Strengths and Weaknesses of the Driver Interface**

#### **3.1.3.1 Crash Avoidance Warning Visual Displays**

Some problems were observed with the layout of the face of the main display unit. Advertising labels covered a significant area of the face of the display and presented somewhat of a distraction, especially considering the mirror-like quality of the lettering. More importantly, the red “FAULT” LED was rather close to the red warning LED creating the potential for confusion of the driver in terms of determining which display is presenting a signal. In addition, the material covering the face of the display was somewhat reflective causing the potential for glare.

Problems were also encountered with the auxiliary visual warning display mounted at the right A-pillar. Meaning of symbology of this red “X” display was not obvious to one of the human factors experts who did not understand what the “underscore characters under the X” meant. In addition, this visual display was not bright enough to be seen in all levels of ambient illumination, especially in bright sunlight.

The choice of the color red for the crash avoidance visual displays was appropriate and contrasted well with the green system ‘READY LED. The auxiliary visual warning display located at the right A-pillar was found to be helpful. However, there does not appear to be a significant benefit provided by the use of two visual warning displays (i.e., one at the center of the dashboard and one at the A-pillar).

#### **3.13.2 Crash Avoidance Warning Auditory Displays**

The auditory warning for System A was reported to be both startling and annoying. However, as with many of the systems, the volume of the auditory warning was not loud enough to be heard under all conditions when driving the HMMWV. The presence of volume control with a reasonable range would alleviate this problem and accommodate individual differences between drivers with differing perceptual capabilities.

### **3.1.3.3 System Status Visual Displays**

The green “READY” LED provided drivers with an indication that the system was receiving power. This visual display was perceived as being very bright at night and therefore was found to be a source of distraction. The provision of a brightness control for the driver would have alleviated this problem. The red “FAULT” LED was used to indicate system failures to the driver. This display was found to be sufficient, however, it may not be necessary to have separate “system power” and “fault/failure indication” displays. A combined display which would illuminate green when the system is receiving power and operating properly and would change to yellow when a problem was detected with the system hardware may be more suitable. The suggestion of using the color yellow to indicate system failures stems from the desire to make the displays easily distinguishable from one another, and thus making the system failure display a different color than the visual warning display. The choice of green for the system “READY” LED was judged to be very appropriate.

### **3.1.3.4 Overall Assessment of the Driver Interface for System A**

Many problems associated with the hardware performance of System A were observed which affected the drivers’ use, and in many cases, tolerance, of the systems. Many false alarms and many missed vehicles were encountered with System A which was characterized as having extremely variable performance. The auditory warning was found to be significantly annoying, especially in the passenger car test vehicle which had a lower level of ambient noise in the cab than did the HMMWV. Visual warnings caused by false alarms at night were also found to be annoying to the human factors experts. This problem could be alleviated by designing the sensor hardware to filter out stationary objects to prevent the system from warning the driver of non-threatening objects such as light poles, trees, and guard rail. In addition, warning presentations were noticeably delayed from the time that an adjacent vehicle actually entered the detection zone that the warnings were often considered by the experts to be not useful.

Overall, the design of the display was considered to be largely appropriate and easy to use. The information presented by the displays was found by the experts to be easy to understand, despite the confusion about the meaning of the symbology used in the auxiliary visual warning display. The auditory was determined to be excessively loud for the passenger vehicle application. Some improvements could be made to make the displayed information more easy to perceive in all conditions, such as providing a volume control and a brightness control or automatically controlled brightness with appropriate range.



### 3.2 SYSTEM B - HUMAN FACTORS CHECKLIST RESULTS

System B was a prototype radar-based side object detection system intended for use on light vehicles. This system had a single sensor used to create a detection zone to the right side of the vehicle. A more detailed description of the characteristics of the system can be found in the results of the Human Factors Checklist for this system listed in the appendices.

#### 3.3.1 System B - Description of Driver Interface

System B had two parts to its driver interface. A control unit, pictured in Figure 3.4, was mounted at the center of the dashboard in a similar fashion to that pictured for System A in Figure 3.2. The crash avoidance warning display, pictured in Figure 3.5, was mounted at the bottom of the right side view mirror (as shown in Figure 3.6).

The control unit contained controls for system power, “buzzer level”, and brightness of the crash avoidance warning visual display. A label was provided for each control. This control unit also contained an amber system power LED which was illuminated whenever the system was receiving power. This unit was mounted at the center of the dashboard, similarly to that shown for System A in Figure 3.2.

The crash avoidance warning display was mounted at the bottom of the right side view mirror to provide the driver with crash avoidance warning information while looking at the mirror. This warning light would illuminate steadily whenever an obstacle was present in the detection zone. The system also had an auditory crash avoidance warning which would sound a constant steady tone whenever an obstacle was present in the detection zone and the right turn signal was activated.

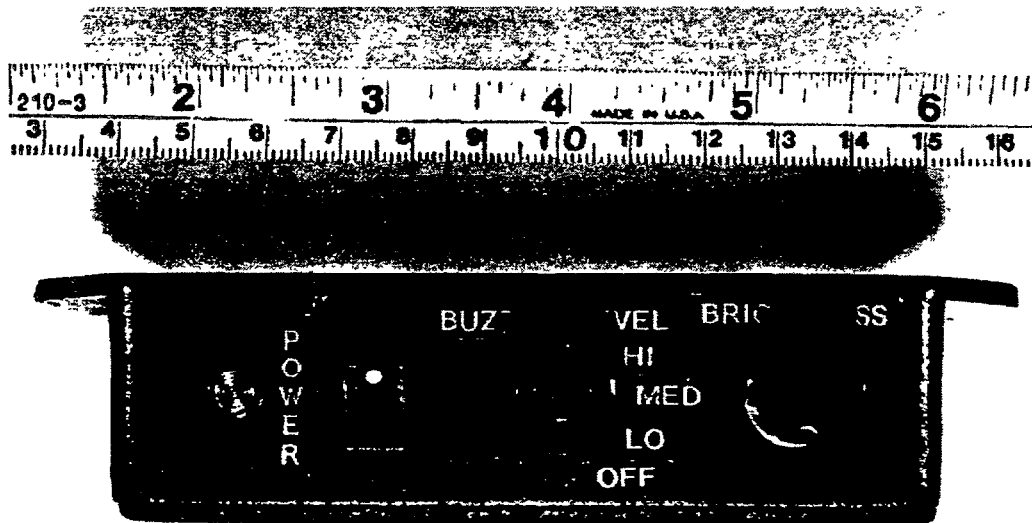


Figure 3.4. System B driver interface: Main control unit

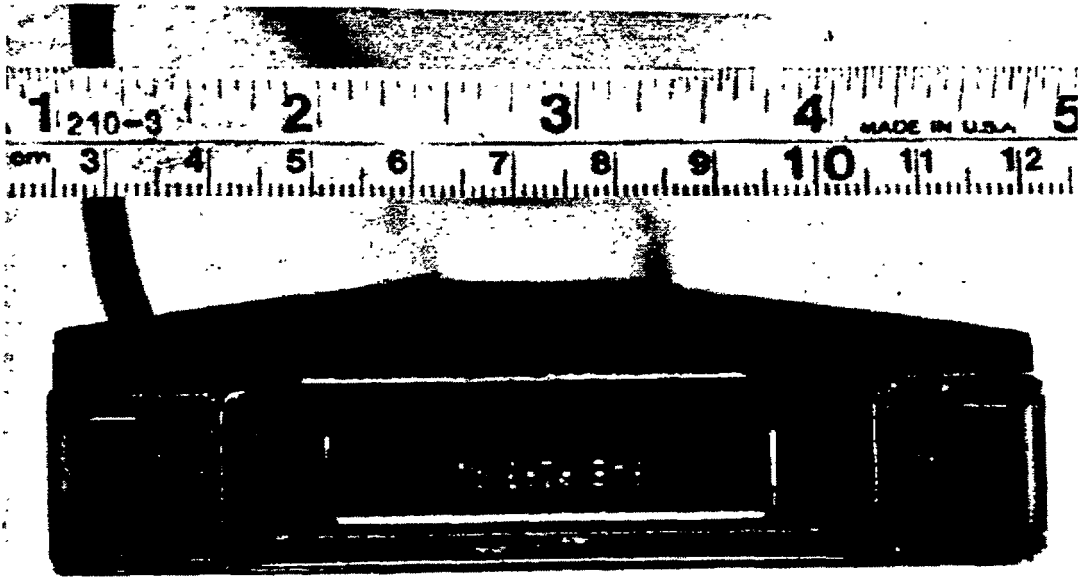


Figure 3.5. System B driver interface: Crash avoidance warning *visual display*

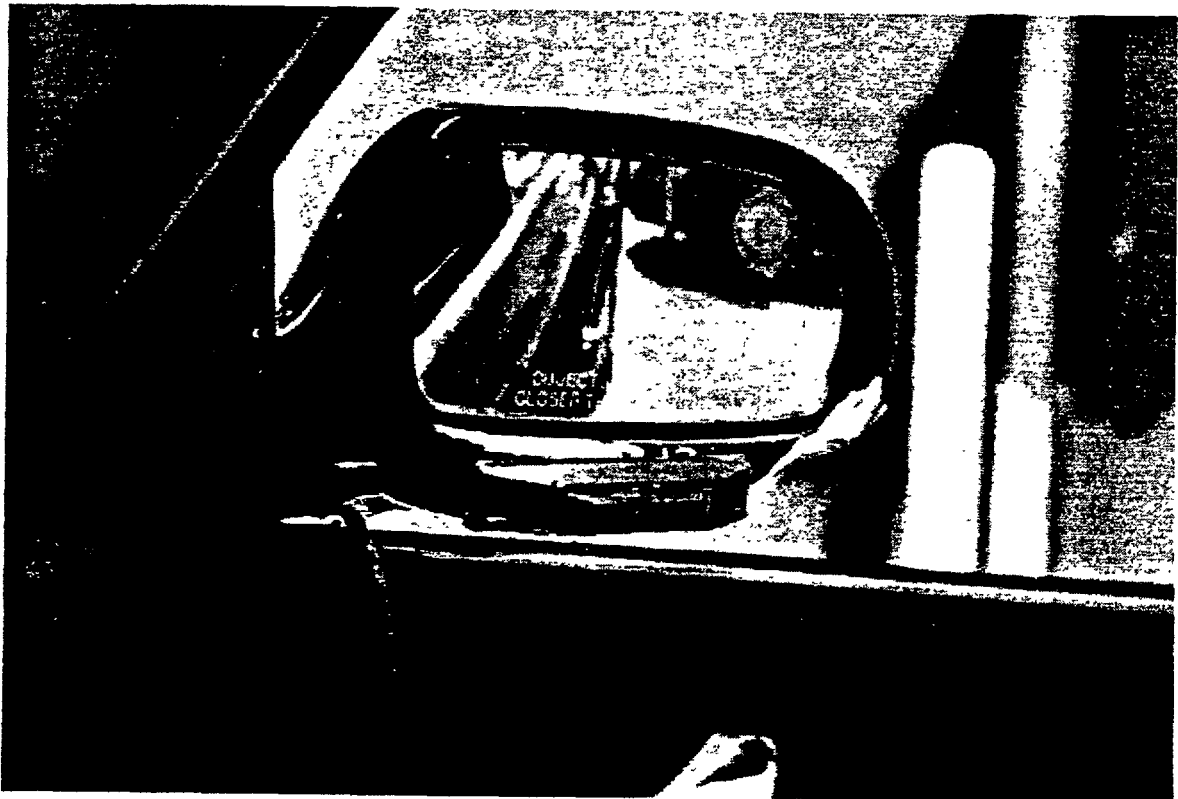


Figure 3.6. System B crash avoidance warning visual display as mounted for testing

### **3.2.2 System B - Human Factors Checklist**

The completed Part I of the Human Factors Checklist for System B is provided in the following pages. Immediately following the checklist is a discussion of the results for System B.

SYSTEM B

—

SECTION A

**DESCRIPTIVE PROFILE OF SYSTEM AND DRIVER/SYSTEM INTERFACE**

**Part I            General Information**

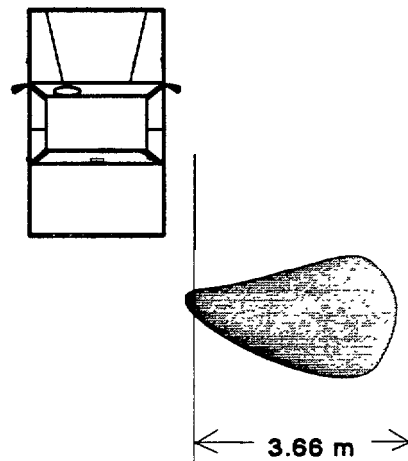
1. Brief system description:

- a. What type of sensor technology (e.g., ultrasonic, position radar, etc.) does the system use?

Position microwave radar

- b. How many sensors are used with the system and what areas of coverage are associated with each? Use the given picture to illustrate the detection zone(s) around the vehicle. No measurements are given since this is intended to be an approximate representation, not actual measurement.

1 sensor



- c. What is the effective (or nominal) range of the sensors as stated in the manufacturer's specifications?

12 feet (3.66 m)

- d. Based upon the descriptions contained in the table below, what is the system category? 1

	<b>Significance of Vehicle Posture</b>	<b>Action Needed</b>
<b>Category 1</b>	Potential for collision exists - <b>vehicle(s) <u>not</u> on a collision course</b>	Caution needed, but no immediate collision avoidance <b>action is necessary</b>
<b>Category 2</b>	<b>Collision is imminent - vehicle(s) on a collision course</b>	<b>Immediate collision avoidance action by the driver is needed</b>
<b>Category 3</b>	<b>Collision is imminent - vehicle(s) on a collision course</b>	<b>Immediate collision avoidance action will be provided by an automatic control system</b>

- e. On what type of algorithm are the crash avoidance warnings, levels of warning, or vehicle control based (e.g., detection of distance-to-target or time-to-target)? Check one.

Distance-to-target \_\_\_\_\_  
 Time-to-target   X    
 Other (specify) \_\_\_\_\_

- f. what type of media is used for the manufacturer's documentation? Indicate below with an 'X'. Attach a copy of the manufacturer's documentation to the back of Section A.

Type of media:                      Printed manual \_\_\_\_\_  
    Audio tape                      \_\_\_\_\_  
    Video tape                      \_\_\_\_\_  
    Other (specie)                  None  

**TABLE I**  
**Mounting Locations and Overall Dimensions**

<u>Display, of auditory Message or Control</u>	<u>Manufacturer's Recommended Mounting Location</u>	<u>Overall Dimensions (For reference) (WxHxD)</u>
System status display	<u>  N/A  </u>	<u>  114.3x38.1x7.6  </u> mm
Cautionary crash avoidance warning	<u>  Below right mirror  </u>	<u>  4.13x7.94  </u> mm
Imminent crash avoidance warning	<u>  N/A  </u>	<u>          </u> mm

**TABLE II**  
**Maximum Display Viewing Distances**

<u>Display</u>	<u>Viewing Distance</u>
System status display	<u>  889  </u> mm
Cautionary crash avoidance warning display	<u>  1409.7  </u> mm
Imminent crash avoidance warning display	<u>  N/A  </u> mm

**TABLE III**  
**Maximum Control Reach Distances**

<u>Control IJU</u>	<u>Reach Distance</u>
<u>  Power  </u> (Specify)(e.g., warning volume)	<u>  990.6  </u> mm
<u>  "Buzzer level"  </u> (Specify)	<u>  965.2  </u> mm
<u>  Brightness  </u> (Specify)	<u>  952.5  </u> mm

**TABLE IV  
Descriptive Profile - Visual Displays**

(If no display is present for an item listed in the leftmost column,  
write N/A [not applicable] in the appropriate boxes.)

NAME OF DISPLAYED INFORMATION	TYPE OF INFORMATION DISPLAYED (e.g., distance to adjacent vehicle, object presence)	TRIGGERING EVENT (e.g., system power application, object presence)	TYPE OF DISPLAY USED (e.g., LCD, LED, icon)	TYPE OF COLOR CODING USED	DISPLAY LUMINANCE-DAY (Cd/m <sup>2</sup> ) (record at min. & max. brightness settings)	BACKGROUND LUMINANCE-DAY (Cd/m <sup>2</sup> )
system on/off ‘Power’	Indication that system is receiving power	Application of power by ignition	LED	Yellow	<u>Normal</u> on 1534 Off 1142  <u>30 degrees</u> On 1646 Off 1564	Normal 228  <u>30 degrees</u> 537
<b>Cautionary crash avoidance warning</b>	Presence of object within detection zone	Vehicle or object enters detection zone	5 LEDs in a row behind a cover which form a single bar of light	Red	<u>MAX:</u> <u>Normal</u> On 8620 Off 390  <u>30 degrees</u> On 5030 Off 337  <u>MIN:</u> <u>Normal</u> On 665 Off 390  <u>30 degrees</u> On 505 Off 337	<u>MAX:</u> <u>Normal</u> 159  <u>30 degrees</u> 342  <u>MIN:</u> <u>Normal</u> 159  <u>30 degrees</u> 342
Imminent crash avoidance warning	N/A	N/A	N/A	N/A	N/A	N/A
<b>System malfunction</b>	N/A	N/A	N/A	N/A	N/A	N/A

**TABLE IV**  
**Descriptive Profile - Visual Displays**  
**(Continued) (ND = Not determined/measurable)**

NAME OF DISPLAYED INFORMATION	DISPLAY LUMINANCE- NIGHT (record at min. & max . brightness settings)	BACKGROUND LUMINANCE - NIGHT	CONTRAST (day & night)	DUTY CYCLE (e.g., steady bum flash rate)	SIZE OF DISPLAYED INFORMATION (diameter, smallest, character, height, and width, stroke width)	VISUAL ANGLE SUBTENDED AT MAXIMUM VIEWING DISTANCE (minutes of arc)
System on/off	<u>Normal</u> On 485  <u>30 degrees</u> On 138.6	ND	<u>DAY</u>  <u>Normal</u> On 5.73 Off 4.00 On/Off 1.34  <u>30 degrees</u> On 2.07 Off 1.91 On/Off 1.05  <u>Night: ND</u>	Steady burn	6.35mm diameter	24.56
Cautionary Crash avoidance Warning	<u>MAX.</u> <u>Normal</u> On 10950  <u>30 degrees</u> On 10430  <u>MIN</u> <u>Normal</u> On 407  <u>30 degrees</u> On 373	ND	<u>DAY</u>  <u>MAX.</u> <u>Normal</u> On 53.21 Off 1.45 On/Off 22.10  <u>30 degrees</u> On 13.71 Off 14.42 On/Off 14.93  <u>MIN.</u> <u>Normal</u> On 3.18 Off 1.45 On/Off 1.71  <u>30 degrees</u> On 0.48 Off 0.01 On/Off 1.50  <u>Night: ND</u>	Steady burn	Height: 7.94 Width: 41.28	19.36
Imminent crash avoidance warning	N/A	N/A	N/A	N/A	N/A	N/A
System Malfunction	N/A	N/A	N/A	N/A	N/A	N/A



**TABLE V**  
**Descriptive Profile - Auditory Warnings**

(If no display is present for an item listed in the leftmost column,  
write N/A [not applicable] in the appropriate boxes.)

NAME OF AUDITORY INFO	TYPE OF INFORMATION PRESENTED (e.g., distance to adjacent vehicle, object presence)	TRIGGERING EVENT (e.g., system power application, object Presence)	TYPE OF WARNING (e.g., steady warble, intermittent)	PITCH (frequency)	LOUDNESS (record at min. & max. loudness settings)	DURATION OF AUDIBLE WARNING SIGNAL	DUTY CYCLE (beep rate, intermittent)	CHANGES AFTER ONSET
<b>System on</b>	N/A	N/A	N/A	N/A	N/A	N/A	N/A	N/A
<b>Cautionary crash avoidance warning</b>	Indication of object presence in detection zone	Vehicle or object enters detection zone and turn signal is activated	Steady tone Driver can select one of 3 different levels	Hi: 2400 Hz Med: 2350 Hz Lo: 2990 Hz	Hi: 76 Med: 79 Lo: 66	Tone sounds as long as a vehicle is in the detection zone	N/A	N/A
<b>Imminent crash avoidance warning</b>	N/A	N/A	N/A	N/A	N/A	N/A	N/A	N/A
<b>System malfunction</b>	N/A	N/A	N/A	N/A	N/A	N/A	N/A	N/A

**TABLE VI**  
**Descriptive Profile - Manual Controls**

(If no display is present for an item listed in the leftmost column,  
write N/A [not applicable] in the appropriate boxes.)

CONTROL FUNCTION	CONTROL TYPE (e.g., knob, toggle, push button, etc.)	CONTROL SIZE (width X height, diameter, length, etc.)(in mm.)	DOES THE CONTROL OBSTRUCT THE DRIVER'S VIEW OF VISUAL WARNING DISPLAYS	TYPE OF ADJUSTMENT (discrete or continuous)	DESCRIBE TYPE OF CONTROL FEEDBACK (aural, visual, tactile)
<b>System on/off</b>	Vertical toggle switch	Height: 14.29 mm width: 7.94 mm	No	Discrete	Visual
<b>Volume adjustment</b> <b>"Buzzer Level"</b>	Knob	12.7 mm	No	Discrete	Visual, Tactile
<b>Light intensity (brightness) adjustment</b>	Knob	12.7 mm	No	Continuous	None
<b>sensor sensitivity adjustment</b>	N/A	N/A	No	N/A	N/A
<b>Visual display override</b>	N/A	N/A	N/A	N/A	N/A
<b>Audible display override</b>	Toggle switch	11.1 mm long 3.2 mm dia.	No	Discrete	Visual

### **3.2.3 System B -Strengths and Weaknesses of the Driver Interface**

#### **3.2.3.1 Crash Avoidance Warning Visual Displays**

The visual crash avoidance warning display was found to be useful and not distracting. The color and location of the warning display at the right side view mirror made the warnings easy to understand and easy to perceive. However, some difficulty was encountered in perceiving the visual warning display during the daytime due to insufficient brightness. This fault should be eliminated by increasing the upper limit for adjustment of the brightness level of the visual warnings. Also, the flat surface of the cover of the visual crash avoidance warning display was found to be a significant source of glare in conditions of bright sunlight. This problem at times was severe enough that it was difficult to distinguish whether or not the warning display was illuminated. Resolution of this problem may be achieved by replacing the smooth flat cover currently used on the display with a curved one. Overall this visual warning display was found to be simple and appealing.

#### **3.2.3.2 Crash Avoidance Warning Auditory Displays**

The design of the auditory warning for System B was found to be easy to understand. The characteristic of the auditory warning being active only when the turn signal was activated is considered to be a good feature. However, one of the human factors experts did report in their responses to Section C of the checklist, that the pitch of the auditory warning was too high and occasionally was slightly irritating. In addition, the volume of the auditory warning was not high enough to be audible under all ambient noise conditions experienced in the HMMWV. The use of a lower auditory warning tone and continuously adjustable volume control with an increased upper limit of volume would alleviate this problem.

#### **3.2.3.3 System Status Displays**

System B provided only visual presentation of system status information. The single system status visual display was found to be sufficient as an indication of the system being powered. However, the color chosen for the display, amber, is considered to be less appropriate for use in indicating to the driver that the system is operating properly than the color green. Since amber or yellow has an inherent meaning of "caution", the driver may mistakenly assume that the system is indicating a condition of system failure. This system did not appear to provide any indication of system failure. In addition, the flat surface of the power LED was a source of glare in bright sunlight.

#### **3.2.3.4 Controls**

The driver interface for System B provided a control which allowed the driver to turn the system on or off at will. Although the design of the control was acceptable, it is believed that the driver should not be given the ability to turn the warning system off. The same principle applies to the use of controls which allow the driver to disable the visual and/or auditory warnings at times when he or she knows an obstacle is present. Controls with this type of function place the responsibility of returning the system to a condition in which it is actively providing warnings on the driver. An alternative method of accomplishing the provision of a way for the driver to "block out" when they are judged

to be unnecessary would be to provide a button which would temporarily disable the auditory warnings for a short period of time (e.g., 10 seconds) at times when the driver is aware of an adjacent obstacle and does not require an announcement of its presence. The important idea about this type of control function is that the system would re-activate the warnings on its own, requiring no additional control manipulations by the driver. This function is considered not necessary for visual warning displays since the driver can ignore them or avert visual attention away from the display.

Also present was a knob which allowed the driver to vary the volume of the auditory crash avoidance warnings. Three undesirable characteristics were found to be associated with the design of this control. The design of this control was flawed in that the directions of motion for varying the volume contradicted population stereotypes for this type of operation. The control required the driver to rotate the knob in a counter-clockwise direction to produce an increase in volume of the auditory warning, or conversely, to rotate the knob in a clockwise direction to decrease the volume. The normal convention for the direction of motion of a control used to increase the value of a variable parameter is to rotate the control in a clockwise manner. This condition could be easily remedied by reversing the direction of motion of the control. In addition, only three levels of auditory warning volume were provided. These levels may not be sufficient to accommodate the full range of driver perceptual capabilities and individual differences. Therefore, continuous control of the auditory warning volume, rather than discrete control, would be preferable. Finally, no auditory feedback was provided when adjusting the volume of the auditory warnings. Designing the volume control for the auditory warning such that a short sample of the warning tone is presented to the driver when the control is manipulated would assist in the setting of the warning volume to a comfortable level.

A third control provided by System B was a brightness control for the visual crash avoidance warning display. The design of this control complied with accepted principles for control design in terms of direction of motion and shape of the control (it was visually distinguishable from the volume and power controls). However, three design problems were identified. First, the control was not distinguishable from the volume (“buzzer level”) control in a tactile sense. The provision of control shape features which allow the driver to distinguish between controls by touch facilitates ease of control discrimination in blind operation (e.g., in darkness, at night). Placing more distance between the brightness and volume controls would also assist in their blind operation as well as assist in preventing their inadvertent activation. Secondly, no indication of control status was provided to allow the driver to visually determine the status of the control setting. Providing markings on the display to indicate the minimum, maximum and median of the adjustable range of the control would be helpful to the user. Lastly, no visual feedback was provided when adjusting the brightness of the visual crash avoidance display unless a warning was being given at the time the brightness was being adjusted. This meant that the driver could not adjust the brightness of the visual crash avoidance warnings before initiating travel, but rather would have to wait until an obstacle was encountered which activated the visual warning display in order to adjust the brightness of the display to an acceptable level. This problem could be alleviated by activating the display when the brightness control was manipulated to allow the driver to observe the intensity of the visual warning display or to provide a “push-to-test” button which would allow the driver to activate the visual and auditory crash avoidance warnings for a short time (e.g., 5 seconds) to allow them to observe the effects of control manipulation in adjusting the levels of the displays and ensure that the levels are acceptable and facilitate quick perception of crash avoidance warnings.

The functions of each of the three controls contained in the driver interface were identified through the use of adhesive labels. These labels were sufficiently easy to read, but were found to be susceptible to glare in conditions of bright sunlight. Also, the labels were not backlit for viewing in conditions of darkness and thus were not sufficiently visible at night.

### **3.2.3.5 Overall Assessment of the Driver Interface for System B**

The overall design of System B was judged by the experts to be simple and straightforward. The crash avoidance warning information provided by the system was judged to be easy to understand, but not always useful since the sensor hardware did not filter out stationary objects and therefore produced many unnecessary warnings. These unnecessary warnings were primarily visual, since the auditory crash avoidance warning was only active when the turn the signal was activated. The unnecessary visual warnings were found to be a source of annoyance, especially at night. However, the cause of this annoyance is considered to be a sensor problem not an interface one. Overall, the human factors experts found the design of the driver interface to be appropriate and acceptable.

### **3.3 SYSTEM D - HUMAN FACTORS CHECKLIST RESULTS**

System D was a prototype Doppler radar-based side object detection system. This system had a single sensor used to create a detection zone located to the right side of the vehicle. A detailed description of the system and driver interface characteristics can be found in the responses to the Human Factors Checklist for this system which can be found in the appendices.

#### **3.3.1 System D - Description of Driver Interface**

The driver interface for System D consisted of a single display unit, shown in Figure 3.7. The display unit was mounted at the center of the dashboard, as shown in Figure 3.8. Commercial advertising labels have been omitted from the photographs.

System D had one system status display. The display consisted of an amber LED labeled “power” which would illuminate to indicate that the system was receiving power. One control was present on the face of the display unit. This control was required to be adjusted to one of two settings during the initial configuration of the sensor hardware, and was not intended for use by the driver during normal operation.

The crash avoidance warning information visual presentation for System D had two parts. The first part consisted of three LEDs aligned vertically at the center of the face of the display unit which were used to alert the driver to the presence of an adjacent obstacle and its direction of motion with respect to the subject vehicle (i.e., the vehicle on which the system is installed). The amber colored LED labeled “target” was used to indicate that an obstacle had been detected. This LED would remain illuminated as long as the presence of an obstacle was detected. If the detected adjacent vehicle was going faster than the subject vehicle, the red LED labeled “closing” would illuminate in addition to the “target” LED. In a similar fashion, if the detected adjacent vehicle was going slower than the subject vehicle, the green LED labeled “receding” would illuminate in addition to the amber “target” LED.

The second part of the crash avoidance warning visual display consisted of an LCD “speed” display located on the left half of the face of the display unit. This display would present the speed of the subject vehicle when no objects were detected by the system (i.e., the “target” LED was off) and would display the speed of the detected vehicle when an adjacent vehicle was present (i.e., the “target” LED was illuminated).

System D also had an auditory warning which would sound a constant high-pitched tone when a detected adjacent vehicle was traveling at least 10 mph faster than the subject vehicle.

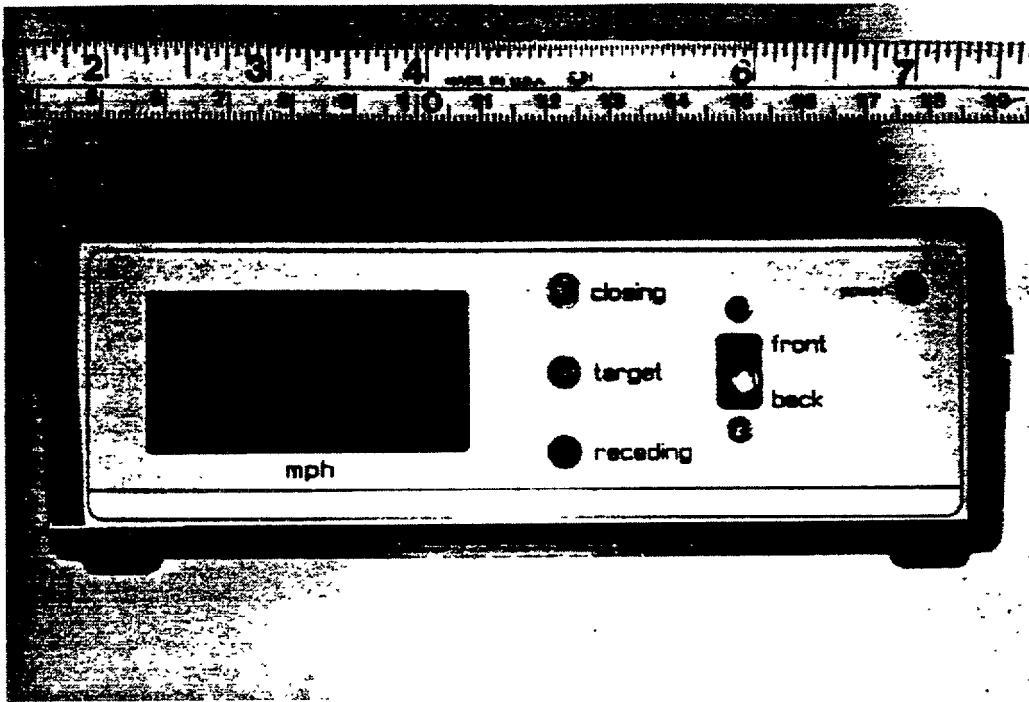


Figure 3.7. System D driver interface

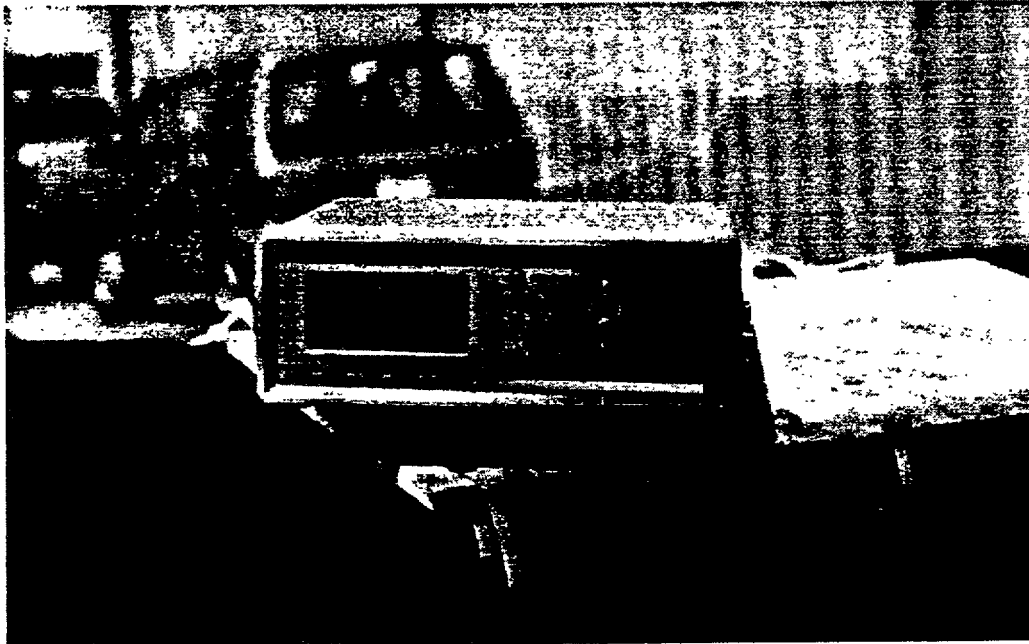


Figure 3.8 System D driver interface as mounted for testing

### **3.3.2 System D - Human Factors Checklist**

The completed Part I of the Human Factors Checklist for System D is provided in the following pages. Immediately following the checklist is a discussion of the results for System D.



**SYSTEM D**

—

**SECTION A**

**DESCRIPTIVE PROFILE OF SYSTEM AND DRIVER/SYSTEM INTERFACE**

**Part I            General Information**

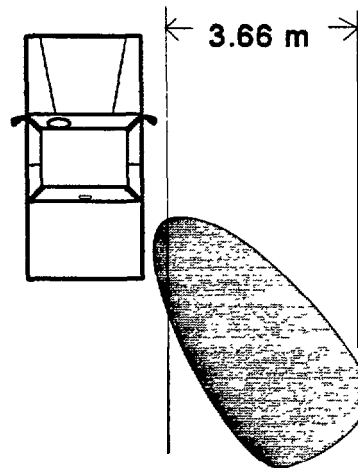
1. Brief system description:

- a. What type of sensor technology (e.g., ultrasonic, position radar) does the system use?

Doppler radar

- b. How many sensors are used with the system and what areas of coverage are associated with each? Use the given picture to illustrate the detection zone(s) around the vehicle. Dimensions of the detection zone(s) need not be given since this illustration is intended to be an approximate representation.

1 sensor



- c. What is the effective (or nominal) range of the sensors as stated in the manufacturer’s specifications?

For cars: 30 meters

For trucks: 60 meters

- d. Based upon the descriptions contained in the table below, what is the system category? 1

	<b>Significance of Vehicle Posture</b>	<b>Action Needed</b>
<b>Category 1</b>	Potential for collision exists - vehicle(s) not on a collision course	Caution needed, but no immediate collision avoidance action is necessary
<b>Category 2</b>	Collision is imminent - vehicle(s) on a collision course	immediate collision avoidance action by the driver is needed
<b>Category 3</b>	Collision is imminent - vehicle(s) on a collision course	Immediate collision avoidance action will be provided by an automatic control system

- e. On what type of algorithm are the crash avoidance warnings, levels of warning, or vehicle control based (e.g., detection of distance-to-target or time-to-target)? Check one.

Distance-to-target \_\_\_\_\_  
 Time-to-target   X    
 Other (specify)   Relative velocity  

- f. What type of media is used for the manufacturer’s documentation? Indicate below with an ‘X’. Attach a copy of the manufacturer’s documentation to the back of Section A.

Type of media:                      Printed manual \_\_\_\_\_  
    Audio tape \_\_\_\_\_  
    Video tape \_\_\_\_\_  
    Other (specify)   None  

**TABLE I**  
**Mounting Locations and Overall Dimensions**

<u>Display, Auditory Message or Control</u>	<u>Manufacturer’s Recommended Mounting Location</u>	<u>Overall Dimensions (For reference) (WxHxD)</u>
System status display	<u>  N/A  </u>	_____ mm
Cautionary crash avoidance warning	<u>  N/A  </u>	_____ mm
Imminent crash avoidance warning	<u>  N/A  </u>	_____ mm
Other <u>  Single Integrated display  </u> (specify)	<u>  N/A  </u>	<u>  150x52.5x170  </u> mm

**TABLE II**  
**Maximum Display Viewing Distances**

<u>Display</u>	<u>Viewing Distance</u>
System status display	857 mm
Cautionary crash avoidance warning display	<u>  864  </u> mm
Imminent crash avoidance warning display	<u>  N/A  </u> mm
Other display <u>  Adjacent vehicle speed  </u> (specify)	824 mm

**TABLE III**  
**Maximum Control Reach Distances**

<u>Control Unit</u>	<u>Reach Distance</u>
<u>  Front/back sensor switch  </u> (specify)(c.g., warning volume)	914 mm

**TABLE IV  
Descriptive Profile - Visual Displays**

**(If no display is present for an item listed in the leftmost column,  
write N/A [Not Applicable] in the appropriate boxes.)**

NAME OF DISPLAYED INFORMATION	TYPE OF INFORMATION DISPLAYED (e.g., distance to adjacent vehicle object presence)	TRIGGERING EVENT (e.g., system power application, object presence)	TYPE OF DISPLAY USED (e.g., LCD, LED, icon)	TYPE OF COLOR CODING USED	DISPLAY LUMINANCE-DAY (Cd/m <sup>2</sup> ) (record at min & max brightness settings)	BACKGROUND LUMINANCE-DAY (CD/m <sup>2</sup> )
System on/off	Indication that integrated control/ Display unit is receiving power	Application of power by ignition	LED	Diffused Yellow/ Amber	<u>Measured</u> <u>Normal</u> On 4660 Off 694  <u>30 degrees</u> On 1060 Off 783	<u>Normal</u> 3970  <u>30 degrees</u> 3490
Cautionary Crash avoidance Warning	"Closing": Indication that vehicle on right is closing	A vehicle enters the detection zone at a higher speed than the subject vehicle	LED	Red	<u>Normal</u> On 120000 Off 557  <u>30 Degrees</u> On 444 Off 344	<u>Normal</u> 3180  <u>30 degrees</u> 3897
	"Target" Indication that adjacent Vehicle has been detected	Vehicle enters the detection zone	LED	Orange	<u>Normal</u> On 4530 Off 714  <u>30 degrees</u> On 1436 Off 920	
	"Receding" Indication that a vehicle on your right is receding	A vehicle enters the detection zone at a lesser speed than the subject vehicle	LED	Green	<u>Normal</u> On 2000 Off 226  <u>30 degrees</u> On 850 Off 465	
Imminent crash avoidance warning	N/A	N/A	N/A	N/A	N/A	N/A
System Malfunction	N/A	N/A	N/A	N/A	N/A	N/A
Other (list) Speed	When no vehicle is detected it displays the speed of the subject vehicle, When a vehicle is detected it displays the speed of the detected vehicle	Power application operates continuously	LCD	Black numbers on dark grey background, Backlit green at night	<u>Normal</u> On 22 Off *  <u>30 degrees</u> On 38 Off *	<u>Normal</u> 516  <u>30 degrees</u> 723

**TABLE IV**  
**Descriptive Profile - Visual Displays**  
**(Continued) (ND = Not determined/measurable)**

NAME OF DISPLAYED INFORMATION	DISPLAY LUMINANCE-NIGHT (record at min. & max. brightness settings)	BACKGROUND LUMINANCE - NIGHT	CONTRAST (day & night)	DUTY CYCLE (e.g., steady burn flash rate)	SIZE OF DISPLAYED INFORMATION (diameter, smallest, character, height, and width, stroke width)	VISUAL ANGLE SUBTENDED AT MAXIMUM VIEWING DISTANCE (minutes of arc)
System on/off	<u>Normal</u> On 3860  <u>30 degrees</u> on 419	ND	DAY <u>Normal</u> On 0.17 Off 0.83 On/Off 6.72  <u>30 degrees</u> On 0.70 Off 0.78 On/Off 1.35  <u>Night</u> ND	Steady burn	5 mm diameter	20.06
Cautionary Crash avoidance Warning	<u>Closing</u> <u>Normal</u> On 91100  <u>30 degrees</u> On 153.3  <u>Target</u> <u>Normal</u> On 3560  <u>30 degrees</u> On 579  <u>Receding</u> <u>Normal</u> On 1550  <u>30 degrees</u> On 411	ND  ND  ND	DAY "Closing" <u>Normal</u> On 37.22 Off 0.82 On/Off 215.44 <u>30 degrees</u> On 0.88 Off 0.91 On/Off 1.29  <u>"Target"</u> <u>Normal</u> On 0.46 Off 0.77 On/Off 6.35 <u>30 degrees</u> On 0.62 Off 0.76 On/Off 1.56  "Receding" <u>Normal</u> On 0.39 Off 0.93 On/Off 8.85 <u>30 degrees</u> On 0.79 Off 0.89 On/Off 1.83  <u>Night</u> ND	Steady burn	5 mm diameter	19.90
Imminent crash avoidance warning	N/A	N/A	N/A	N/A	N/A	N/A
System Malfunction	N/A	N/A	N/A	N/A	N/A	N/A

NAME OF DISPLAYED INFORMATION	DISPLAY LUMINANCE-NIGHT (record at min. & max. brightness settings)	BACKGROUND LUMINANCE - NIGHT	CONTRAST (day & night)	DUTY CYCLE (e.g., steady burn flash rate)	SIZE OF DISPLAYED INFORMATION (diameter, smallest, character, height, and width, stroke width)	VISUAL ANGLE SUBTENDED AT MAXIMUM VIEWING DISTANCE (minutes of arc)
Other (list speed)	<u>Normal</u> On 0.1  <u>30 degrees</u> On 0.9	<u>Normal</u> 4.45  <u>30 degrees</u> 4.7	<u>DAY</u>  <u>Normal</u> On 0.96 Off ND On/Off ND  <u>30 degrees</u> On 0.95 Off ND On/Off ND  <u>NIGHT</u>  <u>Normal</u> On 1 Off ND On/Off ND  30 degrees On 0.8 Off ND On/Off ND	Steady burn	Height: 20mm Width: 10 mm Stroke width: 2mm	8.34

**TABLE V**  
**Descriptive Profile - Auditory Warnings**

(If no display is present for an item listed in the leftmost column,  
write N/A [Not Applicable] in the appropriate boxes.)

NAME OF AUDITORY REPORT	TYPE OF INFORMATION (e.g., distance to adjacent vehicle)	TRIGGERING EVENT (e.g., system power application, object presence)	TYPE OF WARNING (e.g., steady warble intermittent_	PITCH (frequency)	LOUDNESS (record at min & max loudness settings)	DURATION OF AUDIBLE WARNING SIGNAL (e.g., length of audible tone)	DUTY CYCLE (if intermittent)	CHANGES AFTER ONSET
System on	N/A	N/A	N/A	N/A	N/A	N/A	N/A	N/A
Cautionary crash avoidance warning	Indication that a vehicle is closing on the right	Adjacent detected vehicle is closing at a speed greater than 10 mph above that at which the subject vehicle is traveling	Steady tone	3230 Hz	60 dB(A)	As long as a vehicle remains in the detection zone while moving at a speed 10 mph greater than the subject vehicle	N/A	N/A
Imminent crash avoidance warning	N/A	N/A	N/A	N/A	N/A	N/A	N/A	N/A
System malfunction	N/A	N/A	N/A	N/A	N/A	N/A	N/A	N/A

**TABLE VI**  
**Descriptive Profile - Manual Controls**

(If no display is present for an item listed in the leftmost column,  
write N/A [not applicable] in the appropriate boxes.)

CONTROL FUNCTION	CONTROL TYPE (e.g., knob, toggle, push button, etc.)	CONTROL SIZE (width X height, diameter, length, etc.)(in mm.)	DOES THE CONTROL OBSTRUCT THE DRIVER'S VIEW OF VISUAL WARNING DISPLAYS	TYPE OF ADJUSTMENT (discrete or continuous)	DESCRIBE TYPE OF CONTROL FEEDBACK (aural, visual, tactile)
System on/off	N/A	N/A	N/A	N/A	N/A
Volume adjustment	N/A	N/A	N/A	N/A	N/A
Light intensity (brightness) adjustment	N/A	N/A	N/A	N/A	N/A
Sensor sensitivity adjustment	N/A	N/A	N/A	N/A	N/A
Visual display override	N/A	N/A	N/A	N/A	N/A
Audible display override	N/A	N/A	N/A	N/A	N/A
Other (list) Front/back Sensor orientation switch	Toggle switch (Not intended for use by driver when vehicle is in operation; should be set during system installation and then left alone.		No	Discrete	Visual



### **3.3.3 System D -Strengths and Weaknesses of the Driver Interface**

#### **3.3.3.1 Crash Avoidance Warning Visual Displays**

The LEDs composing the crash avoidance warning visual display were reported to be too bright during nighttime driving conditions. The red “closing” LED was reported to be especially bright and distracting at night. The “target” LED which indicated that an adjacent vehicle had been detected was the same color (amber) as the power LED presenting a potential source of confusion. The choice of the color green for the “receding” LED which was part of the crash avoidance warning visual display was considered to be inappropriate. Furthermore, the need for the “closing” and “receding” was questioned and preliminarily judged to be unnecessary.

The human factors experts reported that while driving with the system the visual crash avoidance warning LEDs would flash only momentarily to indicate the presence of an adjacent vehicle. The excessively short duration of the visual warning presentation was considered to be insufficient. In addition, the visual warnings LEDs would continue to flash erratically for some seconds after a vehicle had exited the detection zone creating a situation for potential driver confusion.

The LCD speed display was considered to be an unnecessary source of confusion for this side-looking collision avoidance system. The display would present the actual speed in miles per hour of an adjacent vehicle when one was present and would present the speed of the subject vehicle when no adjacent vehicle was detected. However, it was not obvious when the display switched from displaying the speed of the subject vehicle to displaying the speed of an adjacent vehicle. Due to the confusion associated with this speed display and the lack of a good reason for its presence, it was considered unnecessary.

#### **3.3.3.2 Crash Avoidance Warning Auditory Displays**

The auditory warning for System D consisted of a constant high-pitched tone which was presented when a detected adjacent vehicle was traveling at least 10 mph faster than the subject vehicle. The nature of the auditory warning and the conditions which triggered its presentation were not obvious since no documentation was provided with the system. The lack of information about this auditory warning which provided different information than the visual crash avoidance warning displays caused some confusion for the human factors experts when driving with the system. In addition, the human factors experts reported that the volume of the auditory crash avoidance warning was not high enough to be heard while driving the HMMWV which produced extremely high levels of ambient noise in the cab ranging from 71.6 to 86 dB(A). The use of a volume control with a reasonable range would contribute to eliminating this problem.

#### **3.3.3.3 System Status Displays**

System D had one system status display which provided the driver with an indication that the system was receiving power. Since this display presented only an indication that the system was in

operation and provided no indications of system failure or any other type of information, it was judged that a more appropriate color for the display would have been green.

#### **3.33.4 Controls**

A single control labeled "front/back" was present on the face of the display unit. This control was used in the initial configuration of the sensor hardware and was not intended for use by the driver. Since this control was not intended for use by the driver, but was intended for installation purposes only, it was not appropriate for the control to be located on the face of the display unit.

#### **3.3.3.5 Overall Assessment of the Driver Interface for System D**

Overall, the driver interface for System D was confusing. The information presented by the system seemed to be more than was necessary. The LCD speed display was judged unnecessary. In addition, the need for provision of directional information regarding the motion of a detected vehicle was questioned. The human factors experts considered the presentation of this information to be confusing and unnecessary. However, a detailed analysis of the needs of the driver in terms of what information is necessary for the driver to effectively avoid lane change/merge collisions should be performed.

The area of the face of the display unit surrounding the visual displays was reflective and created a source of glare in bright sunlight. The exterior housing of the system also reflected sunlight causing distraction and annoyance of the driver.

Despite the many problems associated with the driver interface for this system, System D did have a major advantage over other systems. This advantage was the capability of the sensor hardware to filter out stationary objects. This capability somewhat reduced the incidence of unnecessary warnings, but the reduction was not pronounced because of other problems with the sensor hardware. A downfall was associated with the method used to filter out stationary objects in that it accomplished this function by ignoring detected objects traveling at the same speed as the subject vehicle. This method creates the potential for collision in the event that an adjacent vehicle that the driver is not aware of is traveling at the same speed as the subject vehicle.

In summary, the driver interface for System D requires significant modifications to simplify and improve the exchange of information with the driver.

### 3.4 SYSTEM E - HUMAN FACTORS CHECKLIST RESULTS

System E was a prototype radar-based side object detection system. This system had a single sensor used to create a detection zone located to the right side of the vehicle. A detailed description of the system's operation and driver interface characteristics can be found in the responses to the Human Factors Checklist for this system which can be found in the appendices.

#### 3.4.1 System E - Description of Driver Interface

The driver interface for System E consisted of a single display unit intended for use in heavy trucks, shown in Figure 3.9. The display unit was mounted at the center of the dashboard, similarly to that shown for System D in Figure 3.8. Commercial advertising labels have been omitted from the photograph.

System E had one system status display. The display consisted of an green LED labeled "PWR" which would illuminate to indicate that the system was receiving power.

The crash avoidance warning visual displays for System E were only partially used since this system and its driver interface were intended for use in heavy trucks with trailers. The red LED labeled "CAB" was used to indicate that an obstacle had been detected. The LED labeled "TRLR" (trailer) was not used in this passenger car application and was inoperable during testing. The "CAB" LED would remain illuminated as long as the presence of an obstacle was detected.

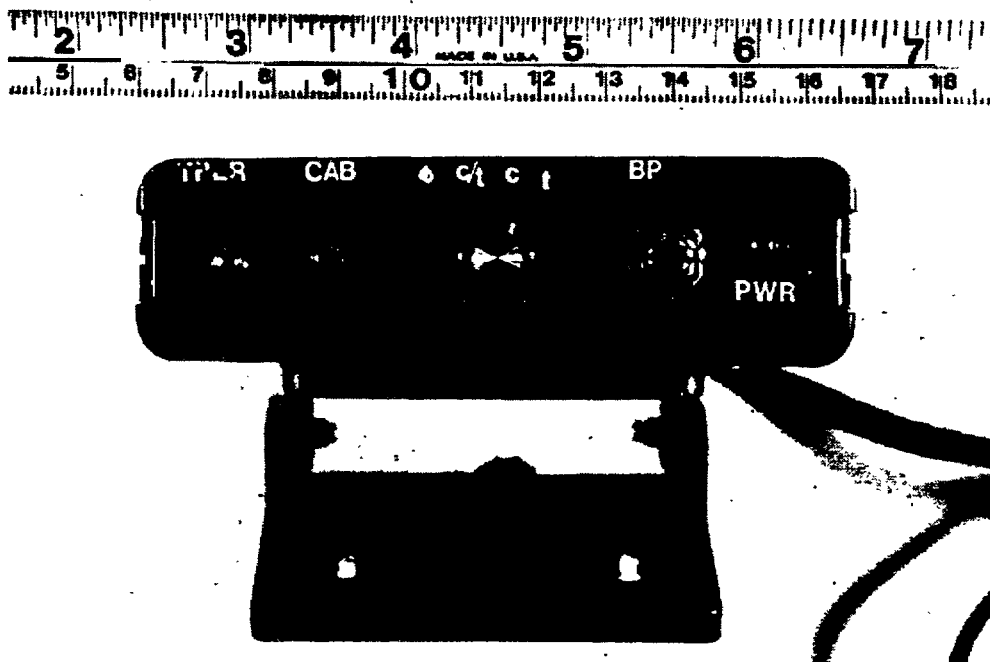


Figure 3.9. System E driver interface

This system also had an auditory warning which would sound a constant high-pitched tone when an adjacent vehicle was detected and the right turn signal was activated, A toggle switch labeled “BP” allowed the driver to switch between having the auditory warning operational at all times or only when the turn signal was activated.

### **3.4.2 System E - Human Factors Checklist**

The completed Part I of the Human Factors Checklist for System E is provided in the following pages. Immediately following the checklist is a discussion of the results for System E.

**SYSTEM E**

—

**SECTION A**

**DESCRIPTIVE PROFILE OF SYSTEM AND DRIVER/SYSTEM INTERFACE**

**Part I General Information**

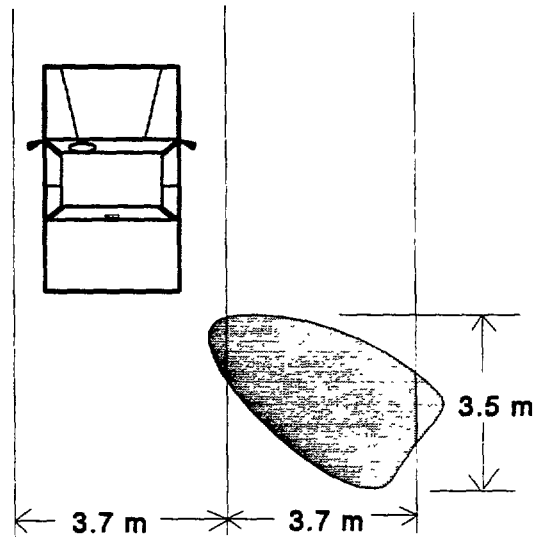
1. Brief system description:

- a. What type of sensor technology (e.g., ultrasonic, position radar, etc.) does the system use?

Position microwave radar

- b. How many sensors are used with the system and what areas of coverage are associated with each? Use the given picture to illustrate the detection zone(s) around the vehicle.

1 sensor



- c. What is the effective (or nominal) range of the sensors as stated in the manufacturer's specifications?

"Capable of detecting a stationary or moving object with a surface area of approximately 1 m<sup>2</sup> at a distance of ≤20 ft (6.1 m)."

- d. Based upon the descriptions contained in the table below, what is the system category? 1

	Significance of Vehicle Posture	Action Needed
Category 1	Potential for collision exists - vehicle(s) <u>not</u> on a collision course	Caution needed, but no immediate collision avoidance action is necessary
Category 2	Collision is imminent - vehicle(s) on a collision course	Immediate collision avoidance action by the driver is needed
Category 3	Collision is imminent - vehicle(s) on a collision course	Immediate collision avoidance action will be provided by an automatic control system

- e. On what type of algorithm are the crash avoidance warnings, levels of warning, or vehicle control based (e.g., detection of distance-to-target or time-to-target)? Check one.

Distance-to-target   X    
 Time-to-target             
 Other (specify)           

- f. What type of media is used for the manufacturer's documentation? Indicate below with an 'X'. Attach a copy of the manufacturer's documentation to the back of Section A.

Type of media:                      Printed manual      X  
   Audio tape                        
   Video tape                       
   Other (specify)                

**TABLE I**  
**Mounting Locations and Overall Dimensions**

<u>Display, Auditory Message per Control</u>	<u>Manufacturer's Recommended Mounting Location</u>	<u>Overall Dimensions (For reference) (WxHxD)</u>
System status display	<u>  N/A  </u>	<u>          </u> mm
Cautionary crash avoidance warning	<u>  N/A  </u>	<u>          </u> mm
Imminent crash avoidance warning	<u>  N/A  </u>	<u>          </u> mm
Other <u>Single Integrated display</u> (specify)	<u>  Dashboard  </u>	<u>  108X35x89  </u> m m

**TABLE II**  
**Maximum Display Viewing Distances**

<b>Display</b>	<u>Viewing Distance</u>	
System status display	908	mm
Cautionary crash avoidance warning display	889	mm
Imminent crash avoidance warning display	N/A	mm

**TABLE III**  
**Maximum Control Reach Distances**

<u>Control Unit</u>	<u>Reach Distance</u>	
<u>  Sensor Selector  </u> (Specify) (eg., warning volume)	965	mm
<u>  "BP"  </u>	<u>  953  </u>	mm

**TABLE IV**  
**Descriptive Profile - Visual Displays**  
**(ND = Not determined/measurable)**

(If no display is present for an item listed in the leftmost column,  
write N/A [Not Applicable] in the appropriate boxes.)

NAME OF DISPLAYED INFORMATION	TYPE OF INFORMATION DISPLAYED (e.g., distance to adjacent vehicle object presence)	TRIGGERING EVENT (e.g., system power application, object presence)	TYPE OF DISPLAY USED (e.g., LCD, LED, icon)	TYPE OF COLOR CODING USED	DISPLAY LUMINANCE-DAY(Cd/m <sup>2</sup> ) (record at min & max brightness settings)	BACKGROUND LUMINANCE-DAY (CD/m <sup>2</sup> )
System on/off	Indication that integrated control/ Display unit is receiving power	Application of power by ignition	LED	Green	<u>Measured</u> <u>Normal</u> On 1212 Off 582  <u>30 degrees</u> On 416 Off 251	<u>Normal</u> 115.5  <u>30 degrees</u> 53.5
Cautionary Crash avoidance Warning	Presence of object within detection zone	Vehicle or object enters detection zone	LED	Red	<u>Normal</u> On 6230 Off 582  <u>30 Degrees</u> On 416 Off 251	<u>Normal</u> 38.5  <u>30 degrees</u> 53.5
Imminent crash avoidance warning	N/A	N/A	N/A	N/A	N/A	N/A
System Malfunction	Indication of internal failure	Internal failure	Existing power and warning LEDs flash continually	No change in LED color from that listed above	ND	ND



**TABLE IV**  
**Descriptive Profile - Visual Displays**  
**(Continued) (ND = Not determined/measurable)**

**(If no display is present for an item listed in the leftmost column,  
write N/A [Not Applicable] in the appropriate boxes.)**

NAME OF DISPLAYED INFORMATION	DISPLAY LUMINANCE-NIGHT (record at min. & max. brightness settings)	BACKGROUND LUMINANCE - NIGHT	CONTRAST (day & night)	DUTY CYCLE (e.g., steady burn flash rate)	SIZE OF DISPLAYED INFORMATION (diameter, smallest, character, height, and width, stroke width)	VISUAL ANGLE SUBTENDED AT MAXIMUM VIEWING DISTANCE (minutes of arc)
System on/off	<u>Normal</u> On 586  <u>30 degrees</u> on 129.3	ND	DAY  <u>Normal</u> On 9.49 Off 4.04 On/Off 2.08  <u>30 degrees</u> On 6.78 Off 3.69 On/Off 1.66  <u>Night</u> ND	Steady burn	7 mm diameter	26.50
Cautionary Crash avoidance Warning	<u>Normal</u> On 6200  <u>30 degrees</u> On 129.3	ND	DAY  <u>Normal</u> On 159.98 Off 27.53 On/Off 5.64  <u>30 degrees</u> On 3.76 Off 3.42 On/Off 1.08  <u>Night</u> ND	Steady burn	7 mm diameter	27.07
Imminent crash avoidance warning	N/A	N/A	N/A	N/A	N/A	N/A
System Malfunction  (visual displays continually flash if a failure is detected)	N/A	N/A	N/A	N/A	N/A	N/A

**TABLE V**  
**Descriptive Profile - Auditory Warnings**

(If no display is present for an item listed in the leftmost column,  
write N/A [Not Applicable] in the appropriate boxes.)

NAME OF AUDITORY REPORT	TYPE OF INFORMATION (e.g., distance to adjacent vehicle)	TRIGGERING EVENT (e.g., system power application, object presence)	TYPE OF WARNING (e.g., steady warble intermittent_)	PITCH (frequency)	LOUDNESS (record at min & max loudness settings)	DURATION OF AUDIBLE WARNING SIGNAL (e.g., length of audible tone)	DUTY CYCLE (if intermittent)	CHANGES AFTER ONSET
System on	Indication of application of power to system	Power application to system	Steady tone	2207 Hz, 4414 Hz	73.8dB(A)	1.95 s	N/A	N/A
Cautionary crash avoidance warning	Indication of object presence in detection zone	Object enters detection zone	Steady pulsing beep	2207 Hz, 4414 Hz	738 dB(A)	Tone sounds as long as object is present in detection zone	N/A	N/A
Imminent crash avoidance warning	N/A	N/A	N/A	N/A	N/A	N/A	N/A	N/A
System malfunction	N/A	N/A	N/A	N/A	N/A	N/A	N/A	N/A

**TABLE VI**  
**Descriptive Profile - Manual Controls**

(If no display is present for an item listed in the leftmost column,  
write N/A [Not Applicable] in the appropriate boxes.)

CONTROL FUNCTION	CONTROL TYPE (e.g., knob, toggle, push button, etc.)	CONTROL SIZE (width X height, diameter, length, etc.) (in mm)	DOES THE CONTROL OBSTRUCT THE DRIVER'S VIEW OF VISUAL WARNING DISPLAYS	TYPE OF ADJUSTMENT (discrete or continuous)	DESCRIBE TYPE OF CONTROL FEEDBACK (aural, visual, tactile)
System on/off	N/A	N/A	N/A	N/A	N/A
Volume Adjustment	N/A	N/A	N/A	N/A	N/A
Light Intensity (dimming intensity)	N/A	N/A	N/A	N/A	N/A
Sensor sensitivity adjustment	N/A	N/A	N/A	N/A	N/A
Visual display override	N/A	N/A	N/A	N/A	N/A
Audible display override  "BP"	Toggle switch	11.1 mm long 3.2 mm dia.	No	Discrete	Visual
Other (list)  (Sensor selector)	Knob	12.7 mm long	No	Discrete	Visual

### **3.4.3 System E -Strengths and Weaknesses of the Driver Interface**

#### **3.4.3.1 Crash Avoidance Warning Visual Displays**

The visual crash avoidance warning display was not sufficiently conspicuous during daytime driving due to insufficient brightness of the LED and glare. The warning LED was also too directional and required direct glances perpendicular to the face of the display in order to adequately perceive a visual warning signal. The visual warning LED also remained illuminated for a significant period of time after an adjacent vehicle had left the detection zone causing some confusion for the experts while driving with the system.

#### **3.4.3.2 Crash Avoidance Warning Auditory Displays**

The auditory crash avoidance warning for System E was reported by the experts to be both "painfully loud" and "piercing". The pitch of the warning tone was considered to be excessively high, thus causing driver discomfort and annoyance. The use of a lower tone for the auditory warning combined with a volume control would be a significant improvement over the current design.

#### **3.4.3.3 System Status Displays**

The use of the color green for the system status LED labeled "PWR" was considered to be appropriate. However, due to insufficient brightness, it was difficult to discern whether or not the LED was illuminated when driving in conditions of high ambient illumination. This LED was also judged to be too bright for nighttime operation and was a source of annoyance for the driver. The provision of a brightness control would alleviate this problem.

#### **3.4.3.4 Controls**

The sensor selection rotary knob (used to allow selective sensor activation in the multiple-sensor heavy truck application) was unnecessary for this passenger car application since only one sensor was used. The meanings of the labels for this control were reported to be unclear.

The toggle switch labeled "BP" was allowed the driver to switch between having the auditory warning operational at all times or only when the turn signal was activated. The orientation of this toggle switch should have been vertical rather than horizontal to agree with accepted human factors principles.

#### **3.4.3.5 Overall Assessment of the Driver Interface for System E**

Overall, the driver interface for this prototype was judged to need a variety of general refinements to make the interface more effective and user-friendly. The visual crash avoidance warning displays required modifications to make them more perceptible in a wide range of ambient light conditions. The tone of the auditory alarm was unnecessarily high. Some of the problems with the auditory warning could have been solved with a volume control. In general, the driver interface for System E needs many refinements before it should be released as a commercial product in order to make it more effective.

### 3.5 SYSTEM F - HUMAN FACTORS CHECKLIST RESULTS

System F was a prototype infrared-based side object detection system intended for use on both light and heavy vehicles. This system had sensors for both the left and right sides of the vehicle. These sensors were used to create detection zones on both sides of the vehicle. A more detailed description of the system's operation and driver interface characteristics can be found in the results of the Human Factors Checklist for this system which can be found in the appendices.

#### 3.5.1 System F - Description of Driver Interface

The driver interface for System F consisted of two identical crash avoidance warning visual display units like the one pictured in Figure 3.10. One display unit received signals from the left side sensor and was mounted vertically at the left A-pillar as pictured in Figure 3.11. The other received signals from the right side sensor and was mounted on the right A-pillar in a similar fashion. Both of the visual display units contained a blue system status LED located at the top of the display. This LED would remain illuminated to indicate that the system was receiving power and would turn off if the system detected an internal failure. Visual crash avoidance warning information was presented by three yellow LEDs located on the lower half of the display unit. These three LEDs would illuminate simultaneously to indicate that an obstacle had been detected adjacent to the vehicle. An opening in the center of the visual display unit housed a light sensor which measured the ambient illumination level and automatically adjusted the intensity of the LEDs accordingly. The system had no auditory warnings of any kind.

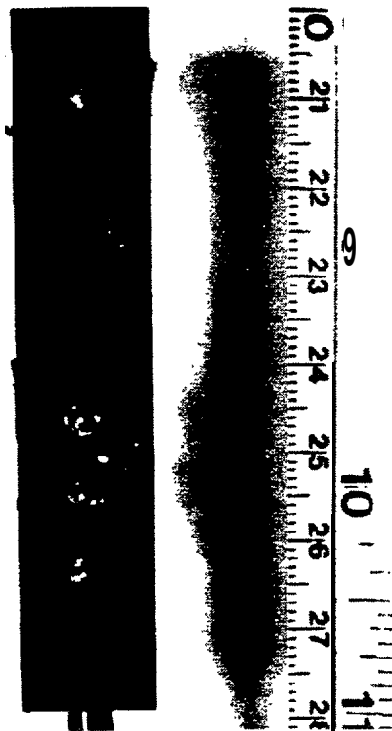
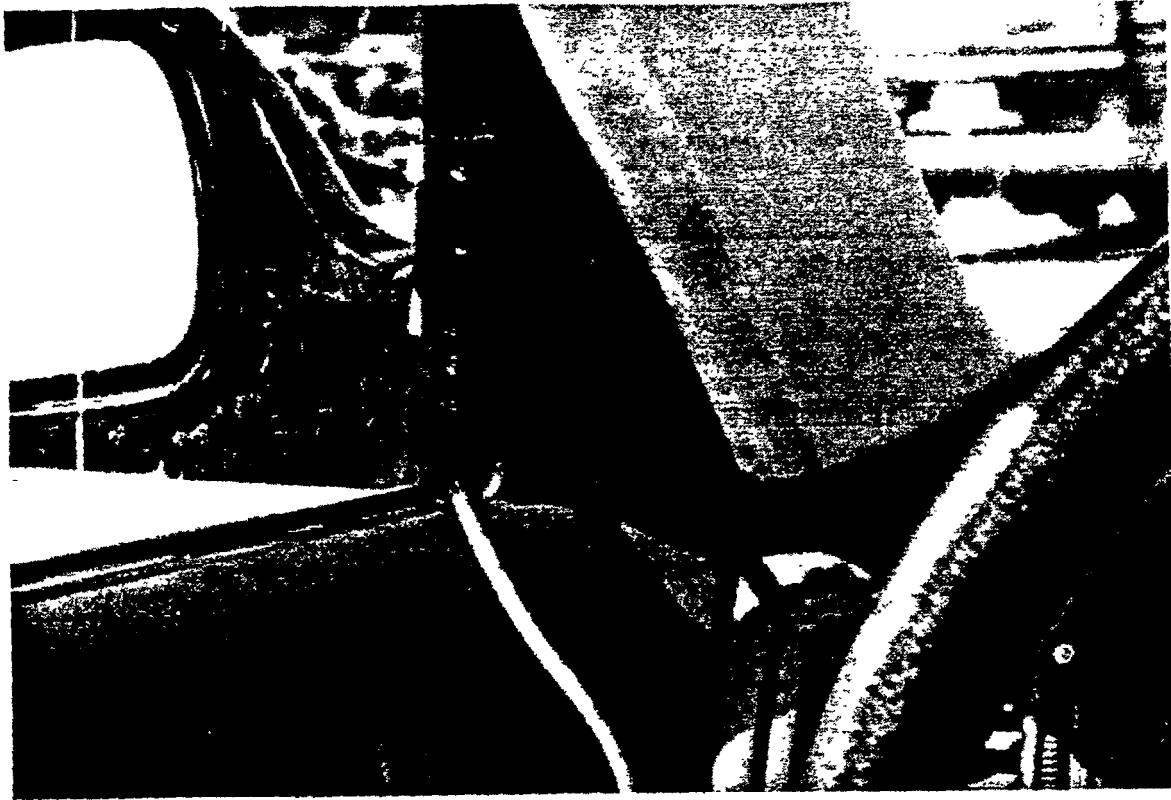


Figure 3.10. System F driver interface



**Figure 3.11.** System F driver interface: left side visual display as mounted for testing

### **3.5.2 System F – Human Factors Checklist**

The completed Human Factors Checklist for System F is provided in the following pages. Immediately following the checklist is a discussion of the results for System F.

**SYSTEM F**



**SECTION A**

**DESCRIPTIVE PROFILE OF SYSTEM AND DRIVER/SYSTEM INTERFACE**

**Part I            General Information**

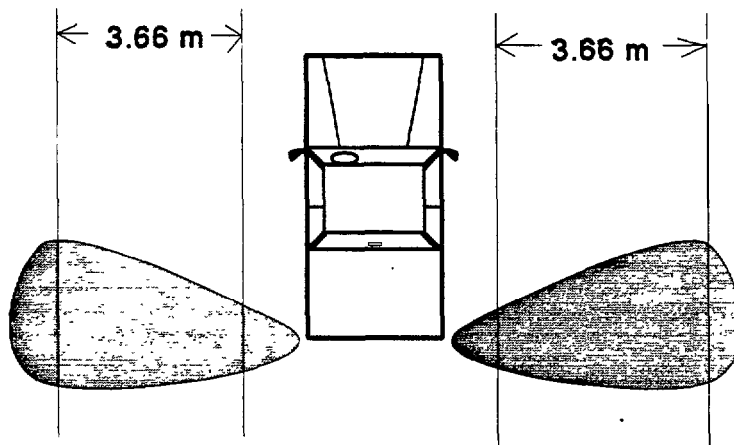
1. Brief system description:

- a. What type of sensor technology (e.g., ultrasonic, position radar, etc.) does the system use?

Infrared

- b. How many sensors are used with the system and what areas of coverage are associated with each?  
Use the given picture to illustrate the detection zone(s) around the vehicle. Dimensions of the detection zone(s) need not be given since this is intended to be an approximate representation.

2 sensors



- c. What is the effective (or nominal) range of the sensors as stated in the manufacturer’s specifications?

Specification not given

- d. Based upon the descriptions contained in the table below, what is the system category?   I

	<b>Significance of Vehicle Posture</b>	<b>Action Needed</b>
<b>Category 1</b>	Potential for collision exists - <b>vehicle(s) <u>not</u> on a collision course</b>	Caution needed, but no immediate collision avoidance <b>action is necessary</b>
<b>Category 2</b>	Collision is imminent - vehicle(s) on a collision course	Immediate collision avoidance action by the driver is needed
<b>Category 3</b>	Collision is imminent - vehicle(s) on a collision course	Immediate collision avoidance action will be provided by an automatic control system



- e. On what type of algorithm are the crash avoidance warnings, levels of warning, or vehicle control based (e.g., detection of distance-to-target or time-to-target)? Check one.

Distance-to-target X  
 Time-to-target \_\_\_\_\_  
 Other (specify) \_\_\_\_\_

- f. What type of media is used for the manufacturer's documentation? Indicate below with an 'X'. Attach a copy of the manufacturer's documentation to the back of Section A.

Type of media: Printed manual \_\_\_\_\_  
 Audio tape \_\_\_\_\_  
 Video tape \_\_\_\_\_  
 Other (specify) None

**TABLE I**  
**Mounting Locations and Overall Dimensions**

<u>Display, Auditory Message or Control</u>	<u>Manufacturer's Recommended Mounting Location</u>	<u>Overall Dimensions (For reference) (WxHxD)</u>
System status display	<u>N/A</u>	_____ mm
Cautionary crash avoidance warning	<u>Left and right A-pillars</u>	15x82.5x20 mm
Imminent crash avoidance warning	<u>N/A</u>	_____ mm

**TABLE II**  
**Maximum Display Viewing Distances**

<u>Display</u>	<u>Viewing Distance</u>
System status display	<u>left: 762 Right: 1400</u> mm
Cautionary crash avoidance warning display	<u>left 762 Right: 1400</u> mm
Imminent crash avoidance warning display	<u>N/A</u> mm
Other display _____ (specify) <u>N/A</u>	<u>N/A</u> mm

**TABLE III**  
**Maximum Control Reach Distances**

<u>Control Unit</u>	<u>Reach Distance</u>
<u>Sensor Selector</u> (Specify)(e.g., warning volume)	965.2 mm
<u>"BP"</u> (Specify)	952.5 mm

**TABLE IV  
Descriptive Profile - Visual Displays**

**(If no display is present for an item listed in the leftmost column,  
write N/A [Not Applicable] in the appropriate boxes.)**

NAME OF DISPLAYED INFORMATION	TYPE OF INFORMATION DISPLAYED (e.g., distance to adjacent vehicle object presence)	TRIGGERING EVENT (e.g., system power application, object presence)	TYPE OF DISPLAY USED (e.g., LCD, LED, icon)	TYPE OF COLOR CODING USED	DISPLAY LUMINANCE-DAY (record at min & max brightness settings)	BACKGROUND LUMINANCE-DAY
System on/off	Indication that system is receiving power	Application of power to system	LED	Blue	<u>MAX.</u> <u>Normal</u> On 424 Off 323  <u>30 degrees</u> On 7820 Off 963  <u>AUTO</u> <u>Normal</u> On 418 Off 323  <u>30 degrees</u> On 7880 Off 963	<u>Normal</u> 36.3  <u>30 degrees</u> 41.9
Cautionary Crash avoidance Warning	Presence of object within detection zone	Vehicle or object enters detection zone	3 LEDs in a vertical row	Yellow	<u>MAX.</u> <u>Normal</u> On 8300 Off 517  <u>30 degrees</u> On 3450 Off 572  <u>AUTO</u> <u>Normal</u> On 8100 Off 517  <u>30 degrees</u> On 3530 Off 572	<u>Normal</u> 80.8  <u>30 degrees</u> 37.1
Imminent crash avoidance warning	N/A	N/A	N/A	N/A	N/A	N/A
System Malfunction	N/A	N/A	N/A	N/A	N/A	N/A

**TABLE IV**  
**Descriptive Profile - Visual Displays (Continued)**

NAME OF DISPLAYED INFORMATION	DISPLAY LUMINANCE-NIGHT (record at min. & max . brightness settings)	BACKGROUND LUMINANCE - NIGHT	CONTRAST (day & night)	DUTY CYCLE (e.g., steady burn flash rate)	SIZE OF DISPLAYED INFORMATION (diameter, smallest, character, height, and width, stroke width)	VISUAL ANGLE SUBTENDED AT MAXIMUM VIEWING DISTANCE (minutes of arc)
System on/off	<u>MAX.</u> <u>Normal</u> On 221  <u>30 degrees</u> on 667  <u>AUTO</u> <u>Normal</u> On 1.6  <u>30 degrees</u> On 46	•	<u>MAX</u> <u>Normal</u> On 10.68 Off 7.90 On/Off 1.31  <u>30 degrees</u> On 185.64 Off 21.98 On/Off 8.12  <u>AUTO</u> <u>Normal</u> On 10.51 Off 7.90 On/Off 1.29  <u>30 degrees</u> On 187.07 Off 21.98 On/Off 8.18	Steady burn	5 mm diameter	Lt. 22.56  Rt. 12.28
Cautionary Crash avoidance Warning	<u>MAX.</u> <u>Normal</u> On 290  <u>30 degrees</u> On 4680  <u>AUTO</u> <u>Normal</u> On 2.1  <u>30 degrees</u> On 32.4	•	<u>MAX.</u> <u>Normal</u> On 101.72 Off 540 On/Off 16.50  <u>30 degrees</u> On 91.99 Off 14.42 On/Off 6.03  <u>AUTO</u> <u>Normal</u> On 99.25 Off 5.40 On/Off 15.67  <u>30 degrees</u> On 94.15 Off 14.42 On/Off 6.17  <u>Night*</u>	Steady burn	5 mm diameter	Lt. 22.56  Rt. 12.28
Imminent crash avoidance warning	N/A	N/A	N/A	N/A	N/A	N/A
System Malfunction	N/A	N/A	N/A	N/A	N/A	N/A

**TABLE V**  
**Descriptive Profile - Auditory Warnings**

(If no display is present for an item listed in the leftmost column,  
write N/A [Not Applicable] in the appropriate boxes.)

NAME OF AUDITORY REPORT	TYPE OF INFORMATION (e.g., distance to adjacent vehicle)	TRIGGERING EVENT (e.g., system power application, object presence)	TYPE OF WARNING (e.g., steady warble intermittent_)	PITCH (frequency)	LOUDNESS (record at min & max loudness settings)	DURATION OF AUDIBLE WARNING SIGNAL (e.g., length of audible tone)	DUTY CYCLE (if intermittent)	CHANGES AFTER ONSET
System on	N/A	N/A	N/A	N/A	N/A	N/A	N/A	N/A
Cautionary crash avoidance warning	N/A	N/A	N/A	N/A	N/A	N/A	N/A	N/A
Imminent crash avoidance warning	N/A	N/A	N/A	N/A	N/A	N/A	N/A	N/A
System malfunction	N/A	N/A	N/A	N/A	N/A	N/A	N/A	N/A

**TABLE VI**  
**Descriptive Profile - Manual Controls**

(If no display is present for an item listed in the leftmost column,  
write N/A [Not Applicable] in the appropriate boxes.)

CONTROL FUNCTION	CONTROL TYPE (e.g., knob, toggle, push button, etc.)	CONTROL SIZE (width X height, diameter, length, etc.) (in mm)	DOES THE CONTROL OBSTRUCT THE DRIVER'S VIEW OF VISUAL WARNING DISPLAYS	TYPE OF ADJUSTMENT (discrete or continuous)	DESCRIBE TYPE OF CONTROL FEEDBACK (aural, visual, tactile)
System on/off	N/A	N/A	N/A	N/A	N/A
Volume Adjustment	N/A	N/A	N/A	N/A	N/A
Light Intensity (dimming intensity)	N/A	N/A	N/A	N/A	N/A
Sensor sensitivity adjustment	N/A	N/A	N/A	N/A	N/A
Visual display override	N/A	N/A	N/A	N/A	N/A
Audible display override	N/A	N/A	N/A	N/A	N/A

### **3.5.3 System F -Strengths and Weaknesses of the Driver Interface**

#### **3.5.3.1 Crash Avoidance Warning Visual Displays**

The visual crash avoidance warnings for this system were considered to be well located and very visible when pointed directly at the driver. However, this visibility was significantly reduced if the axes of the LEDs were not exactly aligned with the driver's line of sight. This "highly directional" quality of the display LEDs is expected to be somewhat problematic with wide spread use of this type of visual warning display because the display must be aligned for a particular driver in order for it to be sufficiently visible and must be realigned for different individuals driving the same vehicle. Some method of moving the LEDs to adjust their direction such that it lines up with the driver's line of sight must be provided, much like the control of the position of a side view mirror in a passenger vehicle.

The use of yellow for the crash avoidance warning visual displays is considered to be less appropriate than red for this type of system. The color red has inherent meaning for the general population and therefore is believed to be a more effective way to present this type of warning information. The use of three separate LEDs to present the same warning message simultaneously is also questionable. Some confusion was experienced by the experts initially in determining whether these three LEDs presented three separate pieces of information to the driver or whether they were intended to constitute a single display. The latter was deduced to be the apparent function of the display. Since the three LEDs were designed to illuminate simultaneously to present a visual warning, confusion might be reduced by combining the three LEDs or placing a cover or shield over them to make them appear to the driver as a single display.

The visual crash avoidance warning displays were found to excessively bright at night and presented somewhat of a distraction to the driver. These LEDs were also found to be too dim for sufficient viewing in bright sunlight.

#### **3.5.3.2 Crash Avoidance Warning Auditory Displays**

This system had no auditory crash avoidance warning displays. This lack of an auditory was considered to be a disadvantage. Accepted human factors principles suggest the use of redundant visual and auditory displays for the presentation of warning information. In order to prevent distraction and annoyance of the driver by presenting auditory warnings when the driver is not intending to change lanes, the preferred method of implementing an auditory warning for this type of system would be to design it to be active (i.e., in a mode to produce warnings) only when the turn signal is activated.

#### **3.5.3.3 System Status Displays**

The driver interface for System F contained a visual system status display within the crash avoidance warning display mounted at the left and right A-pillars. This blue LED was positioned above the three yellow crash avoidance warning LEDs as pictured in Figures 3.10 and 3.11. This LED was judged to be too dim for easy viewing in daytime lighting conditions and too directional. This display caused some degree of initial confusion for both human factors experts who could not figure out what this blue LED was supposed to mean. (No user's manual was available for this system.)

The use of this display as an indication of system status at the A-pillars with the crash avoidance warning display was considered to be a good design feature, although it somewhat contradicts information presented in [3]. The presence of this display was found to be especially helpful at night when ambient illumination levels are low because it expedited the driver's visual search for the warning display. The reason for this is if the display was not present, the driver when preparing to make a lane change might spend some seconds visually searching for the warning display in the darkness if the warning light is not illuminated. The use of the status LED assisted the driver in quickly locating the visual warning display in darkness. An improvement to this design feature would be to illuminate a yellow LED, rather than a blue one, at the A-pillar to indicate that no vehicle is detected but that the driver should proceed with caution. In the same fashion, the use of a red LED, rather than a yellow one, is considered more appropriate for the presentation of a collision warning, especially in situations in which a collision is imminent [3]. The yellow LED should not be illuminated when the red visual warning LED is illuminated. This yellow LED could also be used to present system status information by flashing to indicate that a problem has been detected with the system hardware.

The use of the color blue for a system status display was considered to be less appropriate than the color green which is suggested for use in relating a "system ready" condition which was the intent of this display. However, the color green would not be appropriate for use to present system status information at the A-pillar as part of the warning display as this system was configured. The important point is that a green light should not be used in any way that it could be misconstrued as meaning that the adjacent lane is clear (e.g., the blue light as used in this system should not have been green).

#### **3.5.3.4 Controls**

The driver interface for System F had no controls associated with it. The provision of a control for use in allowing the driver to change the brightness of the visual warning displays would have been helpful.

#### **3.5.3.5 Overall Assessment of the Driver Interface for System F**

System F was the only system tested in this study which had both right and left side sensors for detecting adjacent vehicles. This was considered to be a very favorable feature for this type of system and was praised by the experts. The use of a left side sensor is also believed to be especially appropriate for this passenger car application based upon the nature of the lane change merge accident problem for passenger cars.

### 3.6 SYSTEM G - HUMAN FACTORS CHECKLIST RESULTS

System G was a prototype radar-based side object detection system. This system had a single sensor used to create a detection zone located to the right side of the vehicle. A detailed description of the operation of the system and the characteristics of the driver interface can be found in the responses to the Human Factors Checklist for this system which can be found in the appendices.

#### 3.6.1 System G - Description of Driver Interface

The driver interface for System G consisted of a single display unit, shown in Figure 3.12. The display unit was mounted at the center of the dashboard, similarly to that shown for System D in Figure 3.8. Commercial advertising labels have been omitted from the photograph.

Crash avoidance warning information presentation was presented visually using a single red LED labeled "STOP". This LED would remain illuminated as long as the presence of an adjacent obstacle was detected. This system also had an auditory warning which would sound a beeping tone when an obstacle was present to the right side of the vehicle. A toggle switch was present which allowed the driver to disable the auditory warning at will. When the auditory warning was disabled, the visual display continued to function normally.

System G had one system status display. The display consisted of a green LED labeled "OK" which illuminated to indicate that the system was receiving power.

A third display present ("WARN") was inoperative due to a design change made by the manufacturer.



Figure 3.12. System G driver interface



### **3.6.2 System G – Human Factors Checklist**

The completed Human Factors Checklist for System G is provided in the following pages. Immediately following the checklist is a discussion of the results for System G.

**SYSTEM G**

—

**SECTION A**

**DESCRIPTIVE PROFILE OF SYSTEM AND DRIVER/SYSTEM INTERFACE**

**Part I      General Information**

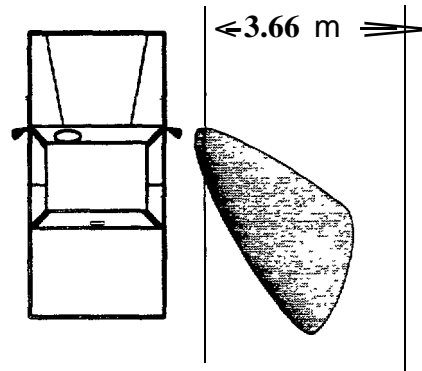
1. Brief system description:

a. What type of sensor technology (e.g., ultrasonic, position radar, etc.) does the system use?

radar

b. How many sensors are used with the system and what areas of coverage are associated with each? Use the given picture to illustrate the detection zone(s) around the vehicle. Measurements need not be included in the diagram since this is intended to be an approximate representation.

1 sensor



c. what is the effective (or nominal) range of the sensors as stated in the manufacturer's specifications?

ND (No specification given)

d. Based upon the descriptions contained in the table below, what is the system category?   1  

	Significance of Vehicle Posture	Action Needed
<b>Category 1</b>	Potential for collision exists - vehicle(s) not on a collision course	Caution needed, but no immediate collision avoidance action is necessary
<b>Category 2</b>	Collision is imminent - vehicle(s) on a collision course	Immediate collision avoidance action by the driver is needed
<b>Category 3</b>	Collision is imminent - vehicle(s) on a collision course	Immediate collision avoidance action will be provided by an automatic control system



**TABLE IV  
Descriptive Profile - Visual Displays**

**(If no display is present for an item listed in the leftmost column,  
write N/A [Not Applicable] in the appropriate boxes.)**

NAME OF DISPLAYED INFORMATION	TYPE OF INFORMATION DISPLAYED (e.g., distance to adjacent vehicle object presence)	TRIGGERING EVENT (e.g., system power application, object presence)	TYPE OF DISPLAY USED (e.g., LCD, LED, icon)	TYPE OF COLOR CODING USED	DISPLAY LUMINANCE-DAY (Cd/m <sup>2</sup> ) (record at min & max brightness settings)	BACKGROUND LUMINANCE-DAY (CD/m <sup>2</sup> )
System on/off "Ok"	Indication that integrated control/ Display unit is receiving power	Application of power by ignition	LED	Green	<u>Measured</u> <u>Normal</u> On 2290 Off 522  <u>30 degrees</u> On 1110 Off 692	<u>Normal</u> 281  <u>30 degrees</u> 339
Cautionary Crash avoidance Warning "Stop"	Presence of object in direction zone	Vehicle of object enters detection zone	LED	Red	<u>Normal</u> On 23100 Off 810  <u>30 Degrees</u> On 1233 Off 1220	<u>Normal</u> 332  <u>30 degrees</u> 298
Imminent crash avoidance warning	N/A	N/A	N/A	N/A	N/A	N/A
System Malfunction	N/A	N/A	N/A	N/A	N/A	N/A
Other (list) Speed "Warn" (Inoperative display)	None	N/A	LED	Yellow	N/A	N/A

**TABLE IV**  
**Descriptive Profile - Visual Displays**  
**(Continued)**

(If no display is present for an item listed in the leftmost column,  
write N/A [not applicable] in the appropriate boxes.)  
(ND = Not determined/measurable)

NAME OF DISPLAYED INFORMATION	DISPLAY LUMINANCE-NIGHT (record at min. & max. brightness settings)	BACKGROUND LUMINANCE - NIGHT	CONTRAST (day & night)	DUTY CYCLE (e.g., steady burn flash rate)	SIZE OF DISPLAYED INFORMATION (diameter, smallest, character, height, and width, stroke width)	VISUAL ANGLE SUBTENDED AT MAXIMUM VIEWING DISTANCE (minutes of arc)
System on/off  "OK"	<u>Normal</u> On 1846  <u>30 degrees</u> On 48.6	ND	<u>DAY</u> <u>Normal</u> On 7.15 Off 0.86 On/Off 4.39  <u>30 degrees</u> On 2.27 Off 1.04 On/Off 1.60  <u>Night: ND</u>	Steady burn	4 mm diameter	15.47
Cautionary Crash avoidance Warning  "Stop"	<u>Normal</u> On 20700  <u>30 degrees</u> On 253	ND	<u>DAY</u> <u>Normal</u> On 65.58 Off 1.44 On/Off 28.52  <u>30 degrees</u> On 3.14 Off 3.09 On/Off 1.01	Steady burn	10 mm diameter	37.57
Imminent crash avoidance warning	N/A	N/A	N/A	N/A	N/A	N/A
System Malfunction	N/A	N/A	N/A	N/A	N/A	N/A
Other (list)  "Warn" (Inoperative Display)	N/A	N/A	N/A	N/A	4 mm diameter	N/A

**TABLE V**  
**Descriptive Profile - Auditory Warnings**

(If no display is present for an item listed in the leftmost column, write N/A [Not Applicable] in the appropriate boxes.)

NAME OF AUDITORY REPORT	TYPE OF INFORMATION (e.g., distance to adjacent vehicle)	TRIGGERING EVENT (e.g., system power application, object presence)	TYPE OF WARNING (e.g., steady warble intermittent_)	PITCH (frequency)	LOUDNESS (record at min & max loudness settings)	DURATION OF AUDIBLE WARNING SIGNAL (e.g., length of audible tone)	DUTY CYCLE (if intermittent)	CHANGES AFTER ONSET
System on	Indication of application of power to system	Application of power to system	2 short beeps	2930 Hz 5860 Hz	61.5 dB(A)	2 short beeps	0.3 s (duration of two beeps separated by two short pause)	N/A
Cautionary crash avoidance warning	Presence of object within detection zone	Vehicle or object enters detection zone	Steady tone	2930 Hz 5861 Hz	61.5 dB(A)	As long as an object is detected in the detection zone	N/A	N/A
Imminent crash avoidance warning	N/A	N/A	N/A	N/A	N/A	N/A	N/A	N/A
System malfunction	N/A	N/A	N/A	N/A	N/A	N/A	N/A	N/A

**TABLE VI**  
**Descriptive Profile - Manual Controls**

(If no display is present for an item listed in the leftmost column,  
write N/A [Not Applicable] in the appropriate boxes.)

CONTROL FUNCTION	CONTROL TYPE (e.g., knob, toggle, push button, etc.)	CONTROL SIZE (width X height, diameter, length, etc.) (in mm)	DOES THE CONTROL OBSTRUCT THE DRIVER'S VIEW OF VISUAL WARNING DISPLAYS	TYPE OF ADJUSTMENT (discrete or continuous)	DESCRIBE TYPE OF CONTROL FEEDBACK (aural, visual, tactile)
System on/off	N/A	N/A	N/A	N/A	N/A
Volume Adjustment	N/A	N/A	N/A	N/A	N/A
Light Intensity (brightness adjustment)	N/A	N/A	N/A	N/A	N/A
Sensor sensitivity adjustment	N/A	N/A	N/A	N/A	N/A
Visual display override	N/A	N/A	N/A	N/A	N/A
Audible display override  "Beep"	Toggle	2 mm long 3 mm long	No	Discrete	Visual, tactile



### **3.6.3 System G – Strengths and Weaknesses of the Driver Interface**

#### **3.6.3.1 Crash Avoidance Warning Visual Displays**

The visual warning display for System G consisted of a large red LED labeled “STOP”. The choice of the color red for use in this display was considered to be most appropriate. However, this LED was highly directional and thus was difficult to discern whether or not it was illuminated unless the face of the display was perpendicular to the driver’s line of sight. The silver bezels around the LEDs created a source of glare in bright sunlight. The red warning LED was found to be excessively bright when driving in darkness. The provision of a brightness control for the driver to adjust the intensity of the visual displays would have alleviated this problem.

Labels for the visual displays were not backlit and thus were difficult to read in conditions of low light. These labels were reflective and thus constituted a source of glare in bright sunlight.

The provision of a crash avoidance warning visual display at the right mirror would have been helpful.

#### **3.6.3.2 Crash Avoidance Warning Auditory Displays**

The human factors experts found the pitch of the auditory warning tone to be too high. This tone was considered to be both annoying and distracting, especially due to the frequent incidence of unnecessary warnings produced by the system.

#### **3.6.3.3 System Status Displays**

The green light labeled “OK” provided the driver with a simple indication that the system was powered and functioning. However, this LED was highly directional and thus was difficult to discern whether or not it was illuminated unless the face of the display was perpendicular to the driver’s line of sight. This driver interface did not appear to provide any indication of system failure to the driver.

#### **3.6.3.4 Controls**

The toggle switch provided for control of the auditory warning status was too small. In addition, the direction of motion of this control was not in accordance with population stereotypes. The provision of volume and brightness controls would have been beneficial.

#### **3.6.3.5 Overall Assessment of the Driver Interface for System G**

Although the design of this driver interface incorporated the appropriate use of color and legends, the directional quality of display LEDs and the display’s proneness to glare proved to be significant disadvantages. The use of brightness and volume controls would benefit this design. This driver interface also was found to emit a high-pitched sound while the system was powered which was a source of annoyance and discomfort to one of the human factors experts who participated in the testing.

Overall, this driver interface needs much refinement before the system is released as a commercial product in order for drivers to use the system effectively.

### **3.7 SYSTEM H – HUMAN FACTORS CHECKLIST RESULTS**

System H was a commercially available radar-based right side and forward object detection system. This system had a single right side sensor used to create a detection zone adjacent to the vehicle. The forward-looking object detection capability of the system was not exercised in this study. A more detailed description of the system and characteristics of the driver interface can be found in the responses to the Human Factors Checklist for this system which can be found in the appendices.

#### **3.7.1 System H – Description of Driver Interface**

System H had two parts to its driver interface. The main display unit, pictured in Figure 3.13, was mounted at the center of the dashboard, in a similar fashion to that shown for System A in Figure 3.2. Commercial advertising labels have been omitted from the photographs. An additional crash avoidance warning display unit, shown in Figure 3.14, was mounted at the right side A-pillar and provided the driver with crash avoidance warning information.

The main display unit contained both system status displays, controls, and visual crash avoidance warning displays for the forward-looking sensor. System status displays included a green LED labeled “ON” which illuminated to indicate that the system was receiving power. Also present was a red LED labeled “FAIL” which illuminated to indicate that a system hardware failure had occurred. The remaining visual displays present on the face of the display unit were associated with the forward-looking sensor which is not addressed here. A control was present on the left side of the display which allowed the driver to turn the system on or off and also to control the volume of the auditory warning. The control on the right side of the face of the display unit was associated with the forward sensor. This system adjusted the brightness of all visual displays automatically to accommodate changing levels of ambient illumination.

The visual crash avoidance warning display for side object detection was located at the right A-pillar near the side view mirror. At the bottom of this display was a yellow LED which illuminated to indicate that no obstacles were present in the detection zone. When an obstacle was detected by the system, a red LED located at the top of the crash avoidance warning display unit would illuminate steadily. The component located between the two LEDs just described was actually a light sensor used to sense the level of ambient illumination and adjust the brightness of the crash avoidance warning displays accordingly.

The system also had an auditory warning which would sound a short chime when an obstacle was present in the side detection zone and the right turn signal was activated.

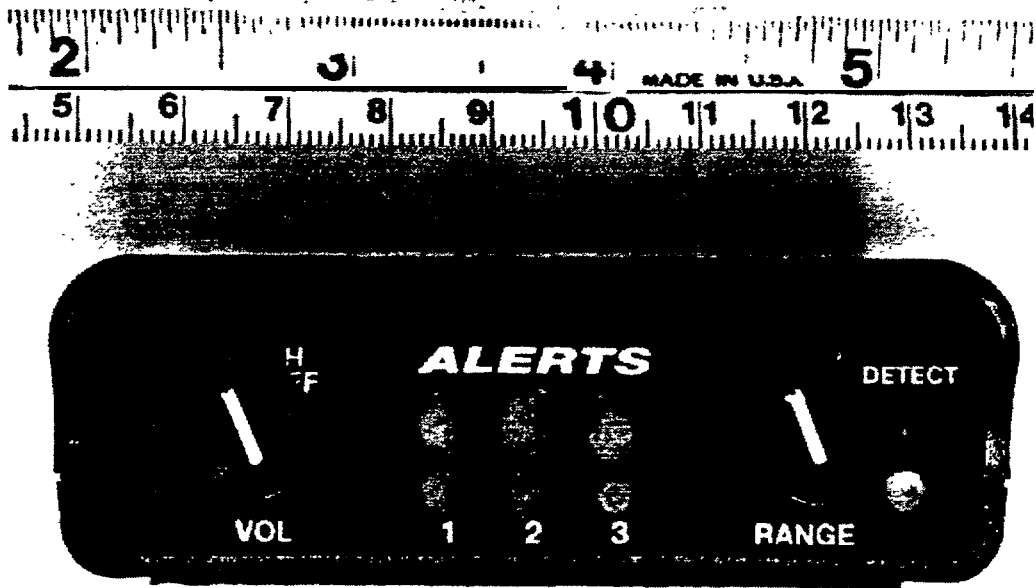


Figure 3.13. System H driver interface: Main display unit

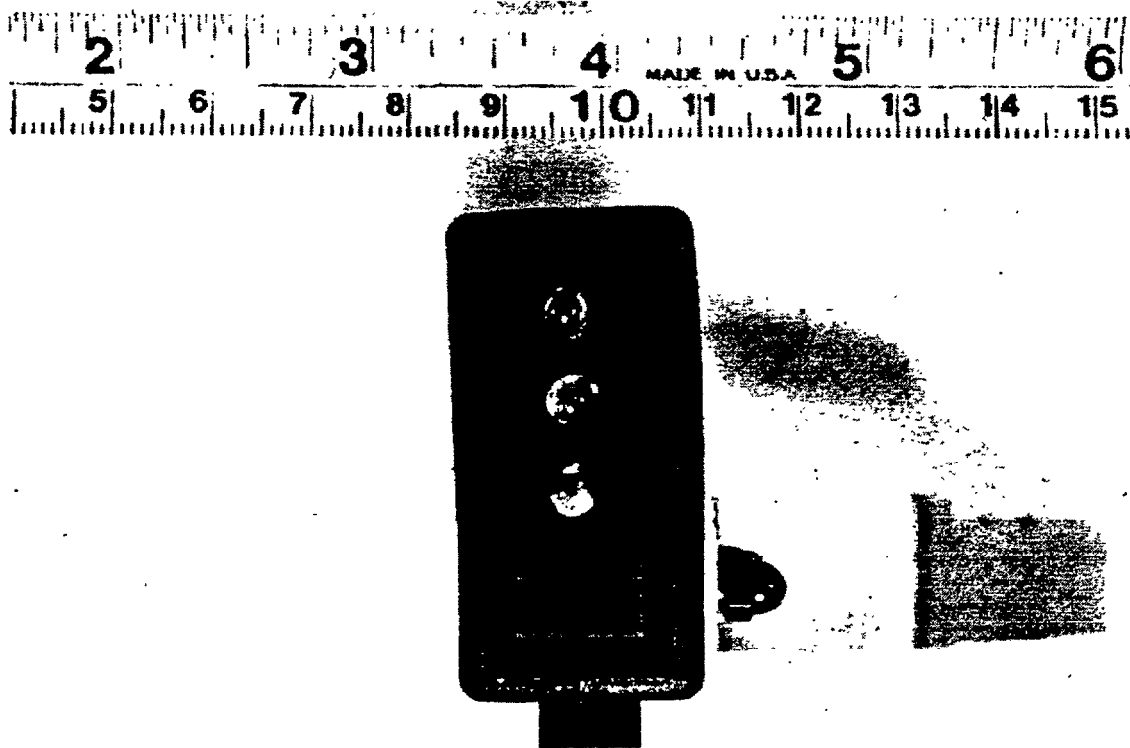


Figure 3.14. System H driver interface: A-pillar crash avoidance warning visual display

### **3.7.2 System H – Human Factors Checklist**

The completed Human Factors Checklist for System H is provided in the following pages. Immediately following the checklist is a discussion of the results for System H.

**SYSTEM H**

—

**SECTION A**

**DESCRIPTIVE PROFILE OF SYSTEM AND DRIVER/SYSTEM INTERFACE**

**Part I            General Information**

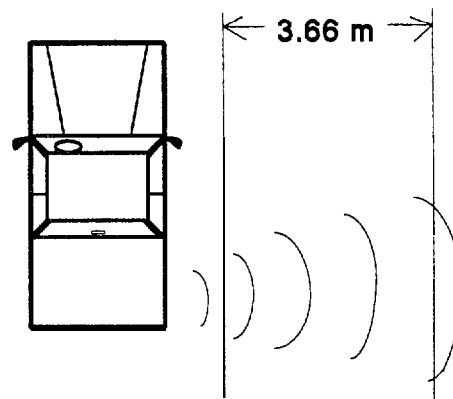
1. Brief system description:

- a. What type of sensor technology (e.g., ultrasonic, position radar, etc.) does the system use?

“Advanced technology” “high frequency radar system.”  
 Side sensor operates at 10.525 GHz, Forward-looking sensor operates at 24.725 GHz.

- b. How many sensors are used with the system and what areas of coverage are associated with each?  
 Use the given picture to illustrate the detection zone(s) around the vehicle. Measurements not necessary since this is intended to be an approximate representation.

1 right side sensor  
 1 forward-looking sensor  
 (present, but not examined in testing)



- c. What is the effective (or nominal) range of the sensors as stated in the manufacturer’s specifications?

Designed to detect small cars in adjacent lane, may detect large vehicles 2 lanes away. See above reproduction of manufacturer diagram found in the system’s “Driver reference manual.”

- d. Based upon the descriptions contained in the table below, what is the system category? 1

	<b>Significance of Vehicle Posture</b>	<b>Action Needed</b>
<b>Category 1</b>	Potential for collision exists - vehicle(s) <u>not</u> on a collision course	Caution needed, but no immediate collision avoidance action is necessary
<b>Category 2</b>	Collision is imminent - vehicle(s) on a collision course	Immediate collision avoidance action by the driver is needed
<b>Category 3</b>	Collision is imminent - vehicle(s) on a collision course	Immediate collision avoidance action will be provided by an automatic control system

- e. On what type of algorithm are the crash avoidance warnings, levels of warning, or vehicle control based (e.g., detection of distance-to-target or time-to-target)? Check one.

Distance-to-target  \_\_\_\_\_  
 Time-to-target \_\_\_\_\_  
 Other (specify) \_\_\_\_\_

- f. What type of media is used for the manufacturer's documentation? Indicate below with an 'x'. Attach a copy of the manufacturer's documentation to the back of Section A.

Type of media: Printed manual  \_\_\_\_\_  
 Audio tape \_\_\_\_\_  
 Video tape  \_\_\_\_\_  
 Other (specify) \_\_\_\_\_

**TABLE I**  
**Mounting Locations and Overall Dimensions**

Display, Auditory Message or Control _____	Manufacturer's Recommended Mounting Location _____	Overall Dimensions (For reference) (WxHxD)
System status display	On top of dashboard _____	90x30x95 mm
Cautionary crash avoidance warning	Right A-pillars _____	22.5x47.5x50mm
Imminent crash avoidance warning	N/A _____	_____ mm

**TABLE II**  
**Maximum Display Viewing Distances**

Display	Viewing Distance
System status display	889 mm
Cautionary crash avoidance warning display	1400 mm
Imminent crash avoidance warning display	N/A mm
Other display _____ all _____	889 mm
Other display _____ Forward warnings _____	914, 921, 928 mm
Other display _____ Detect _____	959 mm

**TABLE III**  
**Maximum Control Reach Distances**

Control Unit	Reach Distance
On/off volume _____ (specify)(e.g., Warning volume)	950 mm
Forward sensor range _____ (Specify)	968 mm



**TABLE IV  
Descriptive Profile - Visual Displays**

**(If no display is present for an item listed in the leftmost column,  
write N/A [Not Applicable] in the appropriate boxes.)**

NAME OF DISPLAYED INFORMATION	TYPE OF INFORMATION DISPLAYED (e.g., distance to adjacent vehicle object presence)	TRIGGERING EVENT (e.g., system power application, object presence)	TYPE OF DISPLAY USED (e.g., LCD, LED, icon)	TYPE OF COLOR CODING USED	DISPLAY LUMINANCE-DAY (Cd/m <sup>2</sup> ) (record at min & max brightness settings)	BACKGROUND LUMINANCE-DAY (CD/m <sup>2</sup> )
System on/off	Indication that system is receiving power	Application of power to system	Shielded LED	Green	<u>Measured Normal</u> On 455 Off 250  <u>30 degrees</u> On 995 Off 830	<u>Normal</u> 109.6  <u>30 degrees</u> 337
Cautionary Crash avoidance Warning  "Blind spot display"	Vehicle detected	Presence of vehicle is detected	Shielded LED	Red	<u>RED Normal</u> On 27400 Off 300  <u>30 Degrees</u> On 1080 Off 212	<u>RED Normal</u> 332  <u>30 degrees</u> 298
	No vehicle detected	Presence of vehicle is not detected i.e., no vehicles present in detection zone	Shielded LED	Yellow	<u>YELLOW Normal</u> On 2240 Off 856  <u>30 degrees</u> On 218 Off 185	<u>YELLOW Normal</u> 285  <u>30 degrees</u> 404
Imminent crash avoidance warning	N/A	N/A	N/A	N/A	N/A	N/A
System Malfunction	System failure	Reports problems found during internal test which is automatically performed every 15 seconds	Shielded LED	Red	<u>Normal</u> On 472 Off 184  <u>30 degrees</u> On 1008 Off 794	<u>Normal</u> 109.6  <u>30 degrees</u> 337

<p>Other (list)</p> <p>Forward distance alerts for forward-looking sensor</p>	<p>Indicates that a vehicle ahead is within the distance your vehicle will cover within:</p> <p>1<sup>st</sup> stage: 3 seconds</p> <p>2<sup>nd</sup> stage: 2 seconds</p> <p>3<sup>rd</sup> stage: 1 second</p>	<p>Vehicle ahead is within the distance your vehicle will cover within:</p> <p>1<sup>st</sup> stage: 3 seconds</p> <p>2<sup>nd</sup> stage: 2 seconds</p> <p>1<sup>st</sup> stage: 1 second</p>	<p>2 vertically aligned LEDs per stage</p>	<p>1<sup>st</sup> stage: YELLOW</p> <p>2<sup>nd</sup> stage: ORANGE</p> <p>3<sup>rd</sup> stage: RED</p>	<p><u>1:</u> <u>Normal</u> On 970 Off 780</p> <p><u>30 degrees</u> On 1062 Off 948</p> <p><u>2:</u> <u>Normal</u> On 916 Off 734</p> <p><u>30 degrees</u> On 1099 Off 985</p> <p><u>3:</u> <u>Normal</u> On 5000 Off 687</p> <p><u>30 degrees</u> On 1310 Off 970</p>	<p><u>1:</u> <u>Normal</u> 215</p> <p><u>30 degrees</u> 276</p> <p><u>2:</u> <u>Normal</u> 215</p> <p><u>30 degrees</u> 276</p> <p><u>3:</u> <u>Normal</u> 215</p> <p><u>30 degrees</u> 276</p>
<p>Other (list)</p> <p>Vehicle detection alert for forward-looking sensor</p>	<p>Indicates an object is detected in front of the vehicle</p>	<p>Object is detected within a range of 350 feet (106.7m)</p>	<p>Shielded LED</p>	<p>Amber</p>	<p><u>Normal</u> On 916 Off 723</p> <p><u>30 degrees</u> On 957 Off 862</p>	<p><u>Normal</u> 157</p> <p><u>30 degrees</u> 350</p>

**TABLE IV**  
**Descriptive Profile - Visual Displays**  
**(Continued)**

(If no display is present for an item listed in the leftmost column,  
write N/A [not applicable] in the appropriate boxes.)  
**(ND = Not determined/measurable)**

NAME OF DISPLAYED INFORMATION	DISPLAY LUMINANCE-NIGHT (record at min. & max . brightness settings)	BACKGROUND LUMINANCE - NIGHT	CONTRAST (day & night)	DUTY CYCLE (e.g., steady burn flash rate)	SIZE OF DISPLAYED INFORMATION (diameter, smallest, character, height, and width, stroke width)	VISUAL ANGLE SUBTENDED AT MAXIMUM VIEWING DISTANCE (minutes of arc)
System on/off	<u>Normal</u> 15.3  <u>30 degrees</u> 13.2	ND	<u>DAY</u> <u>Normal</u> On 3.15 Off 1.28 On/Off 1.82  <u>30 degrees</u> On 1.95 Off 1.46 On/Off 1.20  <u>Night: ND</u>	Steady burn	6 mm diameter	23.20
Cautionary Crash avoidance Warning	<u>RED:</u> <u>Normal</u> 9.2  <u>30 degrees</u> 4.1  <u>YELLOW:</u> <u>Normal</u> 55.6  <u>30 degrees</u> 0.6	ND	<u>DAY</u> <u>RED:</u> <u>Normal</u> On 95.14 Off 0.05 On/Off 91.33  <u>30 degrees</u> On 1.67 Off 0.47 On/Off 5.09  <u>YELLOW:</u> <u>Normal</u> On 6.86 Off 2.00 On/Off 2.62  <u>30 degrees</u> On 0.46 Off 0.54 On/Off 1.18  <u>Night: ND</u>	Steady burn	5 mm diameter	12.28
Imminent crash avoidance warning	N/A	N/A	N/A	N/A	N/A	N/A

System Malfunction	<u>Normal</u> 72.7  <u>30 degrees</u> 49	ND	<u>DAY</u>  <u>Normal</u> On 3.31 Off 0.68 On/Off 2.57  <u>30 degrees</u> On 1.99 Off 1.36 On/Off 1.27  <u>Night</u> : ND	Steady burn	3/16 in (4.8mm) diameter	18.06
Other (list)  Forward distance: alert for forward-looking sensor	<u>1:</u> <u>Normal</u> 26.3  <u>30 degrees</u> 12.2  <u>2:</u> <u>Normal</u> 19  <u>30 degrees</u> 10.7  <u>3:</u> <u>Normal</u> 500  <u>30 degrees</u> 1500	ND	<u>DAY</u>  <u>1:</u> <u>Normal</u> On 3.51 Off 1.28 On/Off 1.82  <u>30 degrees</u> On 12.79 Off 6.80 On/Off 1.77  <u>2:</u> <u>Normal</u> On 3.26 Off 2.41 On/ Off 1.21  <u>30 degrees</u> On 2.98 Off 2.57 On/Off 1.11  <u>2:</u> <u>Normal</u> On 22.26 Off 2.20 On/Off 7.28  <u>30 degrees</u> On 3.75 Off 2.51 On/Off 1.35  <u>Night</u> : ND	Steady burn	Height: 12.5 mm  Width: 6 mm	<u>1:</u> 22.57  <u>2:</u> 22.40  <u>3:</u> 22.23
Other (list)  Vehicle detection alert for forward-looking sensor	<u>Normal</u> 22  <u>30 degrees</u> 10.3	ND	<u>DAY</u>  <u>Normal</u> On 3.15 Off 1.28 On/Off 1.82  <u>30 degrees</u> On 1.95 Off 1.46 On/Off 1.20  <u>Night</u> : ND	Steady burn	6 mm diameter	21.51

**TABLE V**  
**Descriptive Profile - Auditory Warnings**

(If no display is present for an item listed in the leftmost column,  
write N/A [not applicable] in the appropriate boxes.)

NAME OF AUDITORY INFO.	TYPE OF INFORMATION PRESENTED (i.e., distance to adjacent vehicle, object presence)	TRIGGERING EVENT (e.g., system power application, object presence)	TYPE OF WARNING e.g., steady warble, intermittent)	PITCH (frequency)	LOUDNESS (record at min & max. loudness settings)	DURATION OF AUDIBLE WARNING SIGNAL	DUTY CYCLE (beep rate, if intermittent)	CHANGES AFTER ONSET
System on	System start-up	Power application/system start-up	Single short tone	670 Hz, 800 Hz	86.5 dB(A)	ND	N/A	N/A
Cautionary crash avoidance warning	Indication that an object has been detected by the blind spot sensor	Object in detection zone and right turn signal activated	Short tone; "sounds only once per operation of the turn signal"	670 Hz, 780 Hz	90.5 dB(A)	ND	N/A	N/A
Imminent crash avoidance warning	N/A	N/A	N/A	N/A	N/A	N/A	N/A	N/A
System malfunction	N/A	N/A	N/A	N/A	N/A	N/A	N/A	N/A

**TABLE VI**  
**Descriptive Profile - Manual Controls**

(If no display is present for an item listed in the leftmost column,  
write N/A [not applicable] in the appropriate boxes.)

CONTROL FUNCTION	CONTROL TYPE (e.g., knob, toggle, push button, etc.)	CONTROL SIZE width X height, diameter length etc.)(in mm.)	DOES THE CONTROL OBSTRUCT THE DRIVER'S VIEW OF VISUAL WARNING DISPLAYS	TYPE OF ADJUSTMENT (discrete or continuous)	DESCRIBE TYPE OF CONTROL FEEDBACK (aural, visual, tactile)
<b>System on/off</b>	Push button/knob controls system power and volume; Rushing knob allows the system to be turned off	Shaped like a teardrop; 10 mm diameter	No	Discrete	Tactile
<b>Volume adjustment</b>	Push button/knob controls system power and volume; Turning knob adjusts volume	Shaped like a teardrop; 10 mm diameter	No	Discrete	Aural, tactile
<b>Light intensity (brightness) adjustment</b>	N/A	N/A	N/A	N/A	N/A
<b>Sensor sensitivity adjustment</b>  "Range control" for forward sensor	Push button/knob controls range and accident recorder; turning knob adjusts system range from a max. of 3 seconds and a min. of 1 second to a max. of 1 second and a min. of 0.33 seconds	Shaped like a teardrop; 10 mm diameter	No	Discrete	Tactile
<b>Visual display override</b>	N/A	N/A	N/A	N/A	N/A
<b>Audible display override</b>	N/A	N/A	N/A	N/A	N/A
<b>Other (list)</b>  Accident recorder	Push button/knob controls range and accident recorder, pushing knob and holding for 2	Shaped like a teardrop; 10 mm diameter	No	Discrete	Tactile

### **3.7.3 System H --Strengths and Weaknesses of the Driver Interface**

#### **3.7.3.1 Crash Avoidance Warning Visual Displays**

The design of the crash avoidance warning visual displays for System H was considered to be good and in accordance with the design characteristics suggested later in this report, i.e., a yellow LED was used to relate to the driver that no adjacent vehicle was detected but that he or she should proceed with caution and a red LED was used to indicate that an adjacent vehicle had been detected. However, the human factors experts found that the LEDs used to present crash avoidance warning information were highly directional and not bright enough to be sufficiently visible while driving in darkness. This problem was considered correctable and not inherent to the design of the interface.

The light sensor used to measure ambient light levels and perform automatic brightness control of the visual warning displays was considered a potential for confusion of the driver. The reason for this is the light sensor looked like a non-functioning visual warning LED due to its shape and position between the yellow and red warning LEDs, as shown in Figure 3.13.

Another interesting phenomenon regarding the automatic brightness adjustment feature of this driver interface was observed while driving on a lighted highway in darkness. One human factors expert found that when driving under street lights on the highway, the brightness of the visual warning LEDs would change depending on the position of the vehicle with respect to the street light (i.e., under a street light, between two of them, etc.). Due to the nature of the system's abruptly discrete adjustment of the brightness of the displays, the LEDs appeared to be flashing when driving on this type of lighted roadway. This feature proved to be an interesting source of confusion and annoyance for the driver.

#### **3.7.3.2 Crash Avoidance Warning Auditory Displays**

The crash avoidance warning auditory display used a signal consisting of a short chime which was found to be easy to perceive and discern. The adjustability of the auditory warning volume via the provided control ensured that the warning signal could be heard in a wide range of ambient noise levels. Auditory warning were only provided when the turn signal was activated which was considered to be a good feature.

#### **3.7.3.3. System Status Displays**

The system status visual displays for System H showed an appropriate use of color with green being the color of the "ON" display and red the color of the "FAIL" display. The legend for the system status visual display **would** have been more easily visible if they were provided as separate larger sized text placed appropriately with respect to the warning light rather than using small text superimposed on a shield covering the warning LED.

#### **3.7.3.4 Controls**

The volume control provided by System H was considered to be very good in that it provided auditory feedback reflecting the setting of the volume level as the driver manipulated the control. The auditory

feedback consisted of the system sounding the short auditory warning chime at short intervals while the volume knob was being rotated by the driver. The legends used to label the controls present on the driver interface were considered to be good. However, it was not obvious without studying the driver manual thoroughly that the range control located on the right half of the face of the display was for the forward-looking sensor (not tested in this study).

### **3.7.3.5 Overall Assessment of the Driver Interface for System H**

Overall, the driver interface for System H was considered to be good. The appropriate use of color for visual displays, method of providing visual warnings, and location were all considered to be good qualities of this interface. Other favorable qualities included a good auditory warning signal which was active only when the turn signal was applied and a very well-designed volume control function which provided auditory feedback to the driver. An improvement to this driver interface would be the improvement of the automatic brightness control feature or the use of a manual brightness control. The only significant faults of this system, which were observed in this human factors testing but apply to the hardware of the systems, were the noticeably long delay time in presentation of crash avoidance warnings and small detection zone.



### 3.8 SYSTEM P – HUMAN FACTORS CHECKLIST RESULTS

System P was a commercially available video-based rear vision enhancement system. This system used a video camera mounted on the rear of the vehicle to view an area located to the rear of the vehicle and present this information using a black-and-white monitor located inside the vehicle. A detailed description of the operation of the system and driver interface characteristics can be found in the Human Factors Checklist data for this system which can be found in the appendices.

#### 3.8.1 System P – Description of Driver Interface

System P had a main display unit, pictured in Figure 3.15, consisting of a monitor with controls and visual system status displays located along the bottom of the face of the display unit. The monitor was mounted to the right of the center console in the test vehicles and angled toward the driver. Commercial advertising labels were omitted from the photograph. The camera for this system was mounted on the roof of the test vehicle above the rear window, as shown in Figure 3.16.

System P provided only visual crash avoidance information to the driver; there was no auditory warning. The monitor displayed to the driver the view being captured by the camera and presented it on the screen. A series of black dots on the screen provided the driver with perspective to judge what area in the view was directly behind the vehicle. Controls present included a button which allowed the driver to disable the video presentation labeled “VIDEO OFF”, two buttons for camera selection labeled “REAR” and “CAMERA” (the system provides an option for connecting a second camera in addition to the rear-looking one), a screen position knob, a brightness knob, a “DAY/NIGHT” selection button,

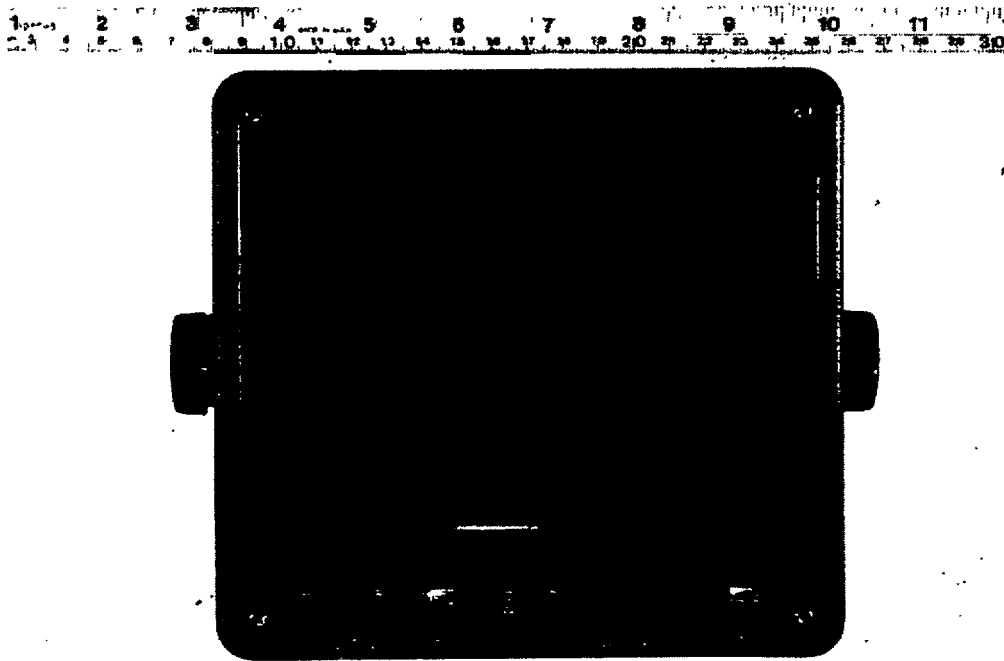
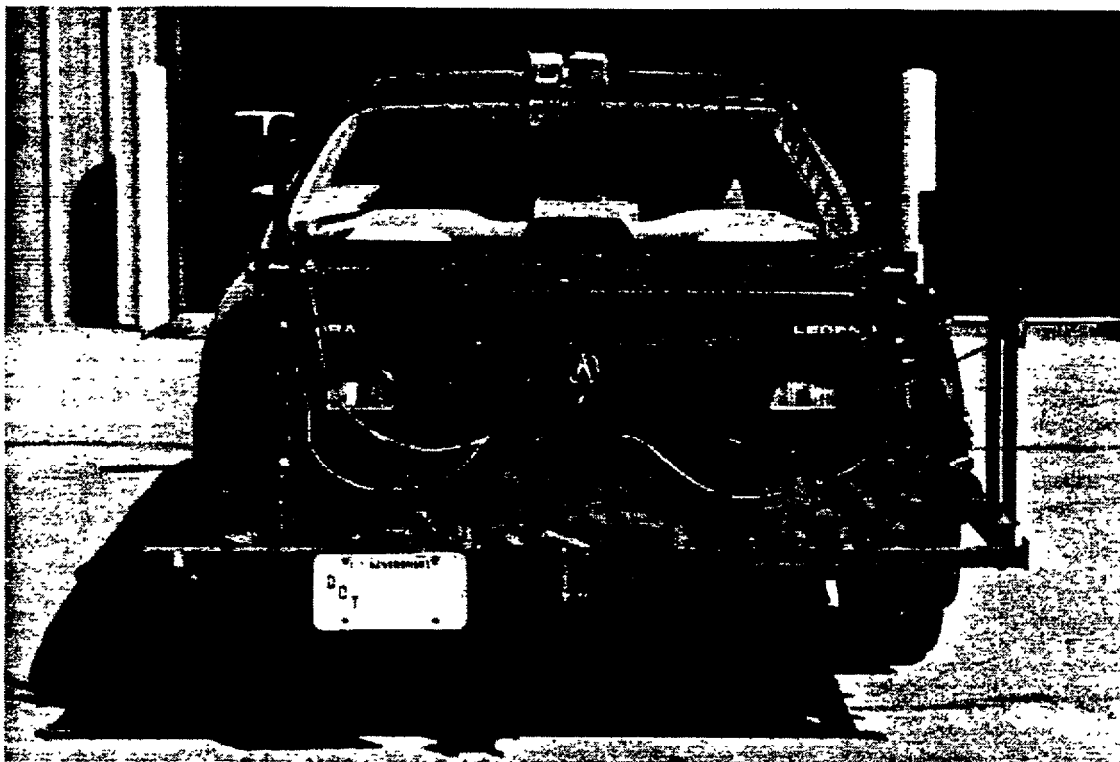


Figure 3.15. System P driver interface

and a button labeled "contrast" which allowed the driver to increase or decrease the contrast of the video picture. The "VIDEO OFF", "REAR", "CAMERA", and "DAY/NIGHT" controls each had an associated LED located to the left of the control. These LEDs changed color depending on the status of the control setting.



**Figure 3.16.** Rear of test vehicle showing rear-looking video cameras for System P (on left) and System Q (on right) mounted on the roof

Table 3.1 lists data specifying the contrast transfer measured for System P as described in Section 2.2.1. 1. As stated in that section, the row labeled "Actual Contrast" gives the values for the reflectance plates measured directly using the photometer. The other values represent the measured luminance of the plates as presented on the driver interface monitor at the given levels of illumination. The last column presents the result of the division of the calculated contrast by the actual contrast of the reflectance plates to determine the transfer of contrast from real space to video space. This value of contrast transfer is intimately related to the quality of the image presented on the video monitor. These data indicate that System P displayed images with much lower contrast than System Q at all illumination levels. System P also showed a significant reduction in contrast at the lowest illumination level. The contrast transfer for this system dropped from approximately 0.20 at higher light levels to 0.0 at 1 lumen/ft<sup>2</sup> for the nighttime lighting condition.

TABLE 3.1. Contrast Transfer Data for System P

Ambient Light Condition	Illumination Level (lumen/ft <sup>2</sup> )	White 1	White 2	Gray 1	Gray 2	Calculated Contrast: (White-1 + White-2) ÷ (Gray-1 + Gray-2)	Calculated Contrast ÷ Actual Contrast
Day/Night	Actual Contrast	286	340	231	185	0.505	1
Day	1000	116	115	105	106	0.095	0.188
	100	104.4	106.4	95.7	94.9	0.11	0.21
	10	106	109	97	99	0.097	0.19
	1	72	75	72	70	0.035	0.070
	100 at 30°	97	97	91	90	0.072	0.142
Night	1000	78	80	73	74	0.075	0.148
	100	69.9	71	62	61.5	0.141	0.279
	10	80	82	73	71	0.125	0.248
	1	46	48	48	46	0	0

### 3.8.2 System P – Human Factors Checklist

The completed Human Factors Checklist for System P is provided in the following pages. Immediately following the checklist is a discussion of the results for System P.

**SYSTEM P**

—

**SECTION A**

**DESCRIPTIVE PROFILE OF SYSTEM AND DRIVER/SYSTEM INTERFACE**

**Part I            General Information**

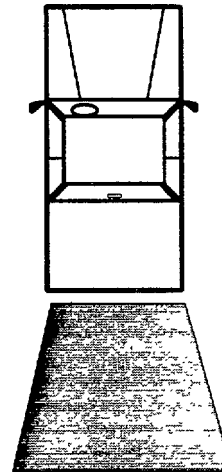
1. Brief system description:

- a. What type of sensor technology (e.g., ultrasonic, position radar, etc.) does the system use?

**Video**

- b. How many sensors are used with the system and what areas of coverage are associated with each? Use the given picture to illustrate the detection zone(s) around the vehicle. Dimensions need not be given since this is intended to be an approximate representation.

1 black and white video camera



- c. What is the effective (or nominal) range of the sensors as stated in the manufacturer's specifications?

Angle of view – 121 degrees horizontally, 91 degrees vertically.

- d. Based upon the descriptions contained in the table below, what is the system category? 1

	<b>Significance of Vehicle Posture</b>	<b>Action Needed</b>
Category 1	Potential for collision exists - vehicle(s) <u>not</u> on a collision course	Caution needed, but no immediate collision avoidance action is necessary
Category 2	Collision is imminent - vehicle(s) on a collision course	Immediate collision avoidance action by the driver is needed
Category 3	Collision is imminent - vehicle(s) on a collision course	Immediate collision avoidance action will be provided by an automatic control system

- e. On what type of algorithm are the crash avoidance warnings, levels of warning, or vehicle control based (e.g., detection of distance-to-target or time-to-target)? Check one.

Distance-to-target \_\_\_\_\_  
 Time-to-target \_\_\_\_\_  
 Other (specify) No warnings provided, only rear video image

- f. What type of media is used for the manufacturer's documentation? Indicate below with an 'x'. Attach a copy of the manufacturer's documentation to the back of Section A.

Type of media:                      Printed manual X \_\_\_\_\_  
    audio tape \_\_\_\_\_  
    Video tape \_\_\_\_\_  
    Other (specify) \_\_\_\_\_

**TABLE I**  
**Mounting Locations and Overall Dimensions**

Display, Auditory Message or Control _____	Manufacturer's Recommended Mounting Location _____	Overall Dimensions (For reference) (WxHxD)
System status display	<u>N/A</u>	_____ mm
Cautionary crash avoidance warning	<u>N/A</u>	_____ mm
Imminent crash avoidance warning	<u>N/A</u>	_____ mm
Other <u>Monitor</u> (specify)	<u>None</u>	<u>175x165x185</u> mm

**TABLE II**  
**Maximum Display Viewing Distances**

Display	Viewing Distance
System status display	N/A mm
Cautionary crash avoidance warning display	900 mm
Imminent crash avoidance warning display	N/A mm

**TABLE III**  
**Maximum Control Reach Distances**

Control Unit	Reach Distance
<u>Video off. Rear. Camera</u>	820 mm
<u>Screen Position. Brightness</u>	825 mm
<u>Day/Night</u>	<u>830</u> mm
<u>Contrast</u>	835 mm

**TABLE IV  
Descriptive Profile - Visual Displays**

(If no display is present for an item listed, write N/A [not applicable] in the appropriate boxes.)

NAME OF DISPLAYED INFORMATION	TYPE OF INFORMATION DISPLAYED (e.g., distance to adjacent vehicle, object presence)	TRIGGERING EVENT (e.g., system power application, object presence)	TYPE OF DISPLAY USED (e.g., LCD, LED, icon)	TYPE OF COLOR CODING USED	DISPLAY LUMINANCE-DAY (Cd/m2) (min. & max. brightness settings)	BACKGROUND LUMINANCE-DAY (Cd/m2)
System on/off "Video off"	Video off, indicates that system is powered. Also indicates whether or not a camera is selected.	Power application to system, camera selection	LED	Amber (when a camera is selected), Green (when system is powered and a camera is not selected)	GREEN: Normal On 138 off 60.3  <u>30 degrees</u> On Off  AMBER: Normal On 147 Off 60.3  <u>30 degrees</u> On Off	Normal 23  <u>30 degrees</u> 15.6
Cautionary crash avoidance warning	Dynamic video image of view behind vehicle	None	CRT	N/A	Normal <u>100 FC</u> On 286  <u>100 FC Blocked</u> On 90  <u>30 degrees</u> <u>100 FC</u> On 78.3  <u>100 FC Blocked</u> On 80.8	Normal <u>100 FC</u> On 261  <u>100 FC Blocked</u> On 78.6  <u>30 degrees</u> <u>100 FC</u> On 72.7  <u>100 FC Blocked</u> On 67.8
Imminent crash avoidance warning	N/A	N/A	N/A	N/A	N/A	N/A
System malfunction	N/A	N/A	N/A	N/A	N/A	N/A
Other (list) Rear	Indication that rear camera is selected for viewing	Camera view is activated by push button control	LED	Amber	AMBER: Normal On 98 Off 58.4  <u>30 degrees</u> On 82 Off 51.9	Normal 21.4  <u>30 degrees</u> 20.6

<p>Other (list) Day/Night</p>	<p>Indication of day/night setting status</p>	<p>Manipulation of push button control</p>	<p>LED</p>	<p>Amber (day) Green (night)</p>	<p><u>GREEN:</u> Normal On 138 Off 60.3</p> <p><u>30 degrees</u> On 136.3 Off 52</p> <p><u>AMBER:</u> Normal On 147 Off 60.3</p> <p><u>30 degrees</u> On 158.3 Off 52</p>	<p><u>Normal</u> 68.1</p> <p><u>30 degrees</u> 13.6</p>
<p>Other (list) Camera</p>	<p>Indication of selection of a second camera (other than rear one exists) is</p>	<p>Manipulation of push button control</p>	<p>LED</p>	<p>Amber</p>	<p><u>AMBER:</u> <u>Normal</u> On 147 Off 60.3</p> <p><u>30 degrees</u> On 158.3 Off 52</p>	<p><u>Normal</u> 23</p> <p><u>30 degrees</u> 15.6</p>



**TABLE IV**  
**Descriptive Profile - Visual Displays**  
**(Continued) (ND = Not determined/measurable)**

NAME OF DISPLAYED INFORMATION	DISPLAY LUMINANCE- NIGHT (record at min. & max . brightness settings)	BACKGROUND LUMINANCE - NIGHT	CONTRAST (day & night)	DUTY CYCLE (e.g., steady burn flash rate)	SIZE OF DISPLAYED INFORMATION (diameter, smallest, character, height, and width, stroke width)	VISUAL ANGLE SUBTENDED AT MAXIMUM VIEWING DISTANCE (minutes of arc)
System on/off	<u>GREEN:</u> <u>Normal</u> On 71.1  <u>30 degrees</u> On 65.5  <u>AMBER:</u> <u>Normal</u> On 78.5  <u>30 degrees</u> On 76	ND	<u>DAY</u>  <u>GREEN:</u> <u>Normal</u> On 4.99 Off 1.62 On/Off 2.29  <u>30 degrees</u> On 7.71 Off 2.76 On/Off 2.48  <u>AMBER:</u> <u>Normal</u> On 5.38 Off 1.62 On/Off 2.43	Steady burn	2 mm wide X 5mm high	8.28
Cautionary Crash avoidance Warning	ND	ND	<u>Normal</u> <u>100FC</u> On 0.10  <u>100FC blocked</u> On 0.15  <u>30 degrees</u> <u>100FC</u> On 0.08  <u>100 FC blocked</u> On 0.19	N/A	7 in (178 mm)	N/A
Imminent crash avoidance warning	N/A	N/A	N/A	N/A	N/A	N/A
System Malfunction	N/A	N/A	N/A	N/A	N/A	N/A

<p>Other (list)</p> <p>Rear</p>	<p><u>Normal</u> On 34</p> <p><u>30 degrees</u> On 31.1</p>	<p>ND</p>	<p><u>DAY</u></p> <p><u>Normal</u> On 3.59 Off 1.73 On/Off 1.68</p> <p><u>30 degrees</u> On 2.98 Off 1.52 On/Off 1.58</p> <p><u>Night: ND</u></p>	<p>Steady burn</p>	<p>2 mm wide x 5 mm high</p>	<p>8.09</p>
<p>Other (list)</p> <p>Day/Night</p>	<p><u>GREEN:</u> <u>Normal</u> On 95.5</p> <p><u>30 degrees</u> On 15.4</p> <p><u>AMBER:</u> <u>Normal</u> On 120.5</p> <p><u>30 degrees</u> On 95.6</p>	<p>ND</p>	<p><u>DAY</u></p> <p><u>GREEN:</u> <u>Normal</u> On 2.11 Off 0.77 On/ Off 1.76</p> <p><u>30 degrees</u> On 9.02 Off 2.82 On/Off 2.62</p> <p><u>AMBER:</u> <u>Normal</u> On 2.55 Off 0.77 On/Off 2.01</p> <p><u>30 degrees</u> On 10.64 Off 2.82 On/Off 3.04</p> <p><u>Night: ND</u></p>	<p>Steady burn</p>	<p>2 mm wide x 5 mm high</p>	<p>7.47</p>
<p>Other (list)</p> <p>Camera</p>	<p><u>Normal</u> On 120.5</p> <p><u>30 degrees</u> On 95.6</p>	<p>ND</p>	<p><u>DAY:</u></p> <p><u>Normal</u> On 2.55 Off 0.77 On/Off 2.01</p> <p><u>30 degrees</u> On 10.64 Off 2.82 On/Off 3.04</p> <p><u>Night: ND</u></p>	<p>Steady burn</p>	<p>2 mm wide x 5 mm high</p>	<p>7.95</p>

**TABLE V**  
**Descriptive Profile - Auditory Warnings**

(If no display is present for an item listed in the leftmost column,  
write N/A [not applicable] in the appropriate boxes.)

NAME OF AUDITORY INFO.	TYPE OF INFORMATION PRESENTED (e.g., distance to adjacent vehicle, object presence)	TRIGGERING EVENT (e.g., system power application, object presence)	TYPE OF WARNING (e.g., steady warble, intermittent)	PITCH (frequency)	LOUDNESS (min. & max loudness settings)	DURATION OF AUDIBLE WARNING SIGNAL	DUTY CYCLE (if intermittent)	CHANGES AFTER ONSET
<b>System on</b>	N/A	N/A	N/A	N/A	N/A	N/A	N/A	N/A
<b>Cautionary crash avoidance warning</b>	N/A	N/A	N/A	N/A	N/A	N/A	N/A	N/A
<b>Imminent crash avoidance warning</b>	N/A	N/A	N/A	N/A	N/A	N/A	N/A	N/A
<b>System malfunction</b>	N/A	N/A	N/A	N/A	N/A	N/A	N/A	N/A

**TABLE VI**  
**Descriptive Profile - Manual Controls**

(If no display is present for an item listed in the leftmost column,  
write N/A [not applicable] in the appropriate boxes.)

CONTROL FUNCTION	CONTROL TYPE (e.g., knob, toggle, push button, etc.)	CONTROL SIZE (width X height, diameter, length, etc.)(in mm.)	DOES THE CONTROL OBSTRUCT THE DRIVER'S VIEW OF VISUAL WARNING DISPLAYS	TYPE OF ADJUSTMENT (discrete <b>or</b> <b>continuous</b> )	DESCRIBE TYPE OF CONTROL FEEDBACK ( <b>aural</b> , visual, tactile)
System on/off "Video off"	Push button	8x5 mm	No	Discrete	None
Volume adjustment	N/A	N/A	N/A	N/A	N/A
Light intensity (brightness) adjustment "Brightness"	Knob	4 mm diameter	No	Continuous	None
Sensor sensitivity adjustment "Camera Day/Night Setting"	Push button	8x5 mm	No	Discrete	None
Visual display override	N/A	N/A	N/A	N/A	N/A
Audible display override	N/A	N/A	N/A	N/A	N/A
Other (list) Contrast	Integrated up/down push button	15x5 mm	No	Discrete	None
Other (list) Screen Position	Knob	4 mm diameter	No	Continuous	None
Others (list) Rear, Camera	Push button	8x5 mm each	No	Discrete	None

### **3.8.3 System P -Strengths and Weaknesses of the Driver Interface**

#### **3.8.3.1 Crash Avoidance Warning Visual Displays**

System P provided the driver with a video image of the view behind the vehicle via a television monitor in the cab of the vehicle. This system did not provide visual or auditory warnings, but did provide information which a driver could use to avoid a collision while backing. The information presented by System P was useful in assisting drivers to avoid collisions, but was different than that presented by other CAS because System P had no logic to determine whether or not an object was present in the zone covered by the camera and whether or not a collision is possible. The human factors experts found that although this system could be used in passenger car applications, it was not provide significant benefit over standard side and rear view mirrors and direct looks over the shoulder at the area behind the vehicle. However, this type of system was found to be very helpful when performing backing maneuvers in the HMMWV because of the blind spot directly behind the vehicle. The HMMWV used in this testing was fitted with an ambulance body which had no rear windows and thus precluded the drivers from making direct looks behind the vehicle or viewing the area with mirrors. In this case the rear-looking video system provided the driver with a view of the area which could not otherwise have been obtained.

The video image provided by this system was considered to be adequate for viewing in average daytime illumination conditions, but was very poor for conditions of low ambient illumination. Images presented by the system on the monitor had poor contrast and lacked sufficient sharpness. When driving with the system at night in either test vehicle with the headlights on, essentially no objects could be resolved in the image presentation with the “DAY/NIGHT” switch in either position.

#### **3.8.3.2 Crash Avoidance Warning Auditory Displays**

System P had no auditory presentation of any type. A simple auditory indication of the distance to an obstacle behind the vehicle would be a helpful addition to this driver interface.

#### **3.8.3.3 System Status Displays**

The system status displays for System P consisted of small LEDs positioned to the left of certain controls (e.g., camera selection buttons, day/night button). The choice of color (e.g., green, amber) used in visual system status displays presenting control status was not intuitive in all cases.

#### **3.8.3.4 Controls**

Many problems were found with the controls provided by this driver interface. In general, the controls were small, needed improvement in their method of displaying the status of individual controls to the driver, and had legends which were not illuminated for nighttime use.

The brightness and screen position controls were very small and difficult to grasp (required the driver to grasp the control with his or her fingernails in order to adjust the control). In addition, although these

controls did have an arrow on them, there were no marking to define the range of motion of the control and thus the control setting was difficult to determine.

The contrast control consisted of a rocker switch button with a down arrow on the left side and an up arrow on the right side. These arrows were not visible at night. No feedback, other than the tactile feedback of pressing the button, was provided. The range of adjustment of the contrast control was impractically small.

### **3.8.3.5 Overall Assessment of Driver Interface for System P**

Overall, the big advantage for this system was its camera field of view. Although the image presented to the driver was not as clear as it could be, it was found to be helpful when performing backing maneuvers in the HMMWV. The contrast of the image presented on the display was not sufficient to make the system useful in nighttime driving applications. In addition, the monitor for the system was difficult to mount in the cab of either test vehicle due to space constraints and difficulty in securing the unit.

### 3.9 SYSTEM Q – HUMAN FACTORS CHECKLIST RESULTS

System Q was a commercially available video-based rear vision enhancement system. This system used a video camera mounted on the rear of the vehicle to view an area located to the rear of the vehicle and present this information via a black-and-white monitor located inside the vehicle. Detailed information about the operation of the system and driver interface characteristics can be found in the Human Factors Checklist data for this system located in the appendices.

#### 3.9.1 System Q – Description of Driver Interface

System Q had a main display unit, pictured in Figure 3.17, consisting of a monitor with controls and a visual system status display located along the bottom of the face of the display unit. The monitor was mounted to the right of the center console in the test vehicles and angled toward the driver. Commercial advertising labels were omitted from the photograph.

System Q provided visual and auditory crash avoidance information to the driver. The monitor displayed to the driver the view being captured by the camera and presented it to the driver via the monitor. Two lines on the screen were present to provide the driver with perspective to judge what area in the view was directly behind the vehicle. A microphone within the camera housing allowed sounds from behind the vehicle also to be presented to the driver via the monitor. (This feature was not evaluated in this study.)

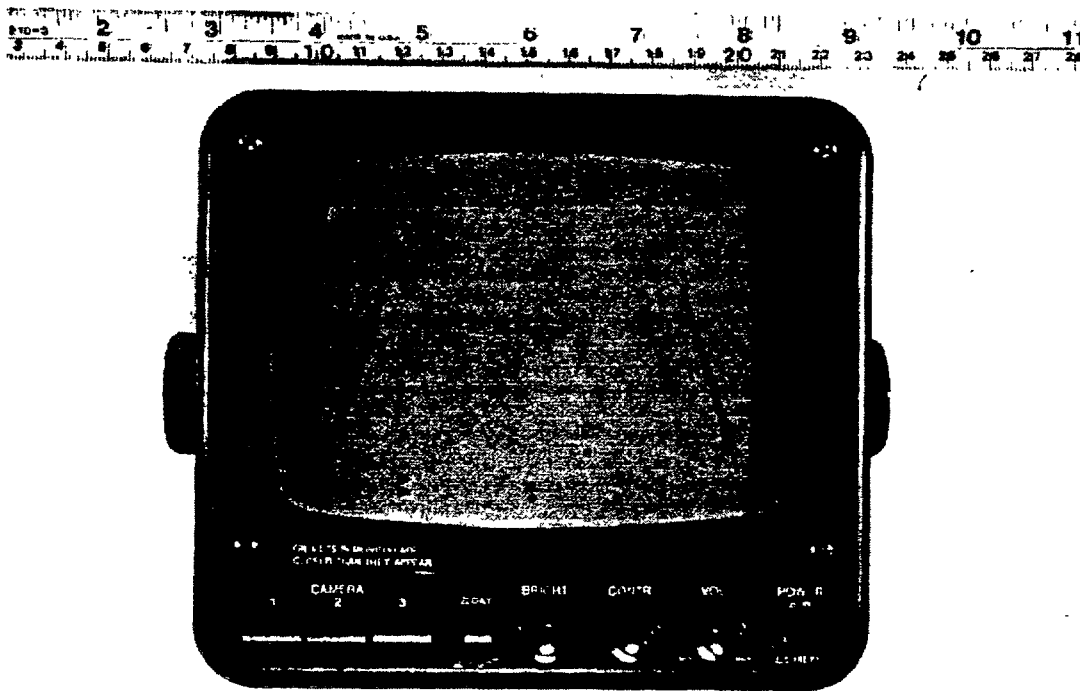


Figure 3.17. System Q driver interface

Controls on the driver interface included a “POWER” button, volume control knob, contrast control knob, brightness control knob, day/night setting button, and three buttons labeled “1”, “2”, and “3” which allowed for the driver to select a particular camera if more than one camera is present.

Table 3.2 lists data specifying the contrast transfer measured for System Q as described in Section 2.2.1.1. As stated in that section, the row labeled “Actual Contrast” gives the values for the reflectance plates measured directly using the photometer. The other values represent the measured luminance of the plates as presented on the driver interface monitor at the given levels of illumination. The last column present the result of the division of the calculated contrast by the actual contrast of the reflectance plates to determine the transfer of contrast from real space to video space. This value of contrast transfer is intimately related to the quality of the image presented on the video monitor. These data indicate that System Q would present an image to the driver with much higher contrast than that for System P. Additionally, the figures show that System Q performs nearly equally in all light levels examined.

**TABLE 3.2. Contrast Transfer Data for System Q**

Ambient Condition	Illumination Level (lumen/ft <sup>2</sup> )	White 1	White 2	Gray 1	Gray 2	Calculated Contrast: (White-1 + White-2 + (Gray-1 + Gray-2))	Calculated Contrast / Actual Contrast
Day/Night	Actual Contrast	286	340	231	185	0.505	1
Day	1000	699	641	602	531	0.183	0.362
	100	655	621	563	522	0.176	0.349
	10	652	622	564	525	0.170	0.337
	1	642	661	553	522	0.212	0.420
	100 at 30°	680	650	595	544	0.168	0.332
Night	1000	568	684	504	395	0.393	0.778
	100	482	499	419	406	0.189	0.375
	10	471	488	405	407	0.181	0.359
	1	474	527	414	425	0.193	0.383

### 3.9.2 System Q – Human Factors Checklist

The completed Human Factors Checklist for System Q is provided in the following pages. Immediately following the checklist is a discussion of the results for System Q.



**SYSTEM Q**

—

**SECTION A**

**DESCRIPTIVE PROFILE OF SYSTEM AND DRIVER/SYSTEM INTERFACE**

**Part I            General Information**

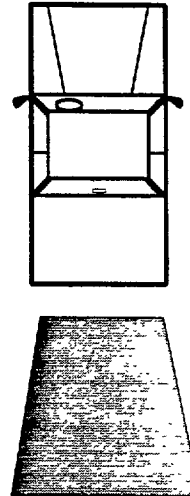
1. Brief system description:

- a. What type of sensor technology (e.g., ultrasonic, position radar, etc.) does the system use?

Video

- b. How many sensors are used with the system and what areas of coverage are associated with each? Use the given picture to illustrate the detection zone(s) around the vehicle. Dimensions need not be given since this is intended to be an approximate representation.

1 black and white video camera



- c. What is the effective (or nominal) range of the sensors as stated in the manufacturer's specifications?

Wide field of view -- 100 degrees horizontally, 80 degrees vertically.

- d. Based upon the descriptions contained in the table below, what is the system category?   1

	<b>Significance of Vehicle Posture</b>	<b>Action Needed</b>
<b>Category 1</b>	Potential for collision exists - vehicle(s) <u>not</u> on a collision course	Caution needed, but no immediate collision avoidance action is necessary
<b>Category 2</b>	Collision is imminent - vehicle(s) on a collision course	Immediate collision avoidance action by the driver is needed
<b>Category 3</b>	Collision is imminent - vehicle(s) on a collision course	Immediate collision avoidance action will be provided by an automatic control system

- e. On what type of algorithm are the crash avoidance warnings, levels of warning, or vehicle control based (e.g., detection of distance-to-target or time-to-target)? Check one.

Distance-to-target \_\_\_\_\_  
 Time-to-target \_\_\_\_\_  
 Other (specify) No warnings provided, only rear video image

- f. What type of media is used for the manufacturer's documentation? Indicate below with an 'X'. Attach a copy of the manufacturer's documentation to the back of Section A.

Type of media:                      Printed manual   X    
    Audio tape        \_\_\_\_\_  
    Video tape        \_\_\_\_\_  
    Other (specify)    \_\_\_\_\_

**TABLE I**  
**Mounting Locations and Overall Dimensions**

<u>Display, Auditory Message or Control</u>	<u>Manufacturer's Recommended Mounting Location</u>	<u>Overall Dimensions (For reference) (WxHxD)</u>
System status display	<u>N/A</u>	_____ mm
Cautionary crash avoidance warning	<u>N/A</u>	_____ mm
Imminent crash avoidance warning	<u>N/A</u>	_____ mm
Other <u>Monitor</u> (specify)	<u>On ceiling dashboard, or floor</u>	<u>140x160x200</u> mm

**TABLE II**  
**Maximum Display Viewing Distances**

<u>Display</u>	<u>Viewing Distance</u>
System status display	960 mm
Cautionary crash avoidance warning display	900 mm
Imminent crash avoidance warning display	<u>N/A</u> mm

**TABLE III**  
**Maximum Control Reach Distances**

<u>Control Unit</u>	<u>Reach</u>
<u>Power</u>	810 mm
<u>Brightness Contrast Volume</u>	805 mm
<u>Day&amp;Night</u>	800 mm
<u>Camera 1-2-3</u>	800 mm

**TABLE IV  
Descriptive Profile - Visual Displays**

**(If no display is present for an item listed in the leftmost column,  
write N/A [Not Applicable] in the appropriate boxes.)**

NAME OF DISPLAYED INFORMATION	TYPE OF INFORMATION DISPLAYED (e.g., distance to adjacent vehicle object presence)	TRIGGERING EVENT (e.g., system power application, object presence)	TYPE OF DISPLAY USED (e.g., LCD, LED, icon)	TYPE OF COLOR CODING USED	DISPLAY LUMINANCE-DAY (Cd/m <sup>2</sup> ) (record at min & max brightness settings)	BACKGROUND LUMINANCE-DAY (CD/m <sup>2</sup> )
System on/off	System powered	Power switch on	LED	Green	<u>Normal</u> On 536 Off 219  <u>30 degrees</u> On 373 Off 95	<u>Normal</u> 438  <u>30 degrees</u> 109.4
Cautionary Crash avoidance Warning	Dynamic video image of view behind vehicle	None	CRT	N/A	<u>Normal</u> <u>100 FC</u> On 1569  <u>100 FC blocked</u> On 213  <u>30 degrees</u> <u>100 FC</u> On 1171  <u>100 FC blocked</u> On 207	<u>Normal</u> <u>100 FC</u> 1608  <u>100 FC blocked</u> 149.3  <u>30 degrees</u> <u>100 FC</u> 1052  <u>100 FC Blocked</u> 139.7
Imminent crash avoidance warning	N/A	N/A	N/A	N/A	N/A	N/A
System Malfunction	N/A	N/A	N/A	N/A	N/A	N/A

**TABLE IV**  
**Descriptive Profile - Visual Displays**  
**(Continued) (ND = Not determined/measurable)**

(If no display is present for an item listed in the leftmost column,  
write N/A [not applicable] in the appropriate boxes.)

NAME OF DISPLAYED INFORMATION	DISPLAY LUMINANCE-NIGHT (record at min. & max. brightness settings)	BACKGROUND LUMINANCE - NIGHT	CONTRAST (day & night)	DUTY CYCLE (e.g., steady burn flash rate)	SIZE OF DISPLAYED INFORMATION (diameter, smallest, character, height, and width, stroke width)	VISUAL ANGLE SUBTENDED AT MAXIMUM VIEWING DISTANCE (minutes of arc)
System on/off	<u>Normal</u> On 316  <u>30 degrees</u> On 285	ND	<u>Normal</u> On 0.22 Off 0.50 On/Off 2.45  <u>30 degrees</u> On 2.41 Off 0.13 On/Off 3.93	Steady burn	2 mm diameter	7.16
Cautionary Crash avoidance Warning	ND	ND	<u>Normal</u> <u>100 FC</u> On 0.02  <u>100 FC blocked</u> On 0.43  <u>30 degrees</u> <u>100 FC</u> On 0.11  <u>100 FC blocked</u> On 0.48	N/A	5.5 in (14 cm)	N/A
Imminent crash avoidance warning	N/A	N/A	N/A	N/A	N/A	N/A
System Malfunction	N/A	N/A	N/A	N/A	N/A	N/A

**TABLE V**  
**Descriptive Profile - Auditory Warnings**

(If no display is present for an item listed in the leftmost column,  
write N/A [not applicable] in the appropriate boxes.)

NAME OF AUDITORY INFO.	TYPE OF INFORMATION PRESENTED (e.g., distance to adjacent vehicle, object presence)	TRIGGERING EVENT (e.g., application of system power, object presence)	TYPE OF WARNING (e.g., steady, warble, intermitten)	PITCH (frequency)	LOUDNESS (min. & m a x . loudness settings)	DURATION OF AUDIBLE WARNING SIGNAL	DUTY CYCLE (if intermittent)	CHANGES AFTER ONSET
System on	N/A	N/A	N/A	N/A	N/A	N/A	N/A	N/A
Cautionary crash avoidance warning	Continuous presentation of sounds behind vehicle	None	N/A	N/A	N/A	N/A	N/A	N/A
Imminent crash avoidance warning	N/A	N/A	N/A	N/A	N/A	N/A	N/A	N/A
System malfunction	N/A	N/A	N/A	N/A	N/A	N/A	N/A	N/A

**TABLE VI**  
**Descriptive Profile - Manual Controls**

(If no display is present for an item listed in the leftmost column,  
write N/A [not applicable] in the appropriate boxes.)

<b>CONTROL FUNCTION</b>	<b>CONTROL TYPE (e.g., knob, toggle, push button, etc.)</b>	<b>CONTROL SIZE (width X height, diameter, length, etc.)(in mm.)</b>	<b>DOES THE CONTROL OBSTRUCT THE DRIVER'S VIEW OF VISUAL WARNING DISPLAYS</b>	<b>TYPE OF ADJUSTMENT (discrete or continuous)</b>	<b>DESCRIBE TYPE OF CONTROL FEEDBACK (aural, visual, tactile)</b>
<b>System on/off</b>	Push button	10x5 mm	No	Discrete	Tactile, visual
<b>Volume adjustment</b>	Knob	8 mm diameter	No	Continuous	Visual
<b>Light intensity (brightness) adjustment "Brightness"</b>	Knob	8 mm diameter	No	Continuous	Visual
<b>Sensor sensitivity adjustment "Camera Day/Night Setting"</b>	Push button	7x5 mm	No	Discrete	Tactile, visual
<b>Visual display override</b>	N/A	N/A	N/A	N/A	N/A
<b>Audible display override</b>	N/A	N/A	N/A	N/A	N/A
<b>Other (list) Contrast</b>	Knob	8 mm diameter	No	Continuous	Visual
<b>Other (list) Camera (1-2-3)</b>	3 horizontally adjacent push buttons	14x5 mm	No	Discrete	Tactile

### **3.9.3 System Q -Strengths and Weaknesses of the Driver Interface**

#### **3.9.3.1 Crash Avoidance Warning Visual Displays**

System Q, like System P, provided the driver with a video image of the area behind the vehicle. This image was presented through a monitor located inside the vehicle. This system did not present any visual crash avoidance warnings, but did provide information which a driver could use in avoiding collisions while performing backing maneuvers. The information presented by System Q was useful in assisting drivers to avoid collisions, but was different than that presented by other CAS because it had no logic to determine whether or not an object was present in the zone covered by the camera and whether or not a collision is possible. This system was also found not to be necessary for passenger car use, but was very helpful when performing backing maneuvers in the HMMWV.

The image presented by System Q was found to be sufficiently visible both in conditions of daylight and darkness. Even in darkness, when the only available illumination was that from the tail lights of the test vehicle, images could be seen on the monitor with sufficient contrast and clarity to back the vehicle safely.

#### **3.9.3.2 Crash Avoidance Warning Auditory Displays**

This system provided the driver with continuous audio presentation of sounds behind the vehicle. No auditory warnings were presented, however. Although this feature was not assessed in this testing, it may be helpful in some situations. For example, if someone is behind the vehicle that the driver can't see, the person can verbally alert the driver to their presence. The use of an auditory warning to indicate the distance to objects behind the vehicle when backing would be helpful.

#### **3.9.3.3 System Status Displays**

A green LED was present on the monitor in the bottom right corner next to the power button to inform the driver that the unit was powered. The color of this display was appropriate. No apparent indication of system failure was provided by this system.

#### **3.9.3.4 Controls**

Overall, the controls for this system were well designed and sufficiently easy to manipulate. However, the control legends were not illuminated for nighttime driving and thus were not visible in conditions of darkness. Also, indications of the limits and/or center points of the ranges of the brightness and contrast controls would have been helpful.

#### **3.9.3.5 Overall Assessment of the Driver Interface of System Q**

Overall, although this system had a smaller field of view than System P, the image presented to the driver was far superior. This system would be benefitted by the addition of an auditory warning which would alert the driver to obstacles behind the vehicle when backing. As was the case with System P, this system was difficult to mount in the test vehicles. Although this system did not appear to provide



significant benefit when maneuvering a passenger car, it was very helpful when backing in the HMMWV. This benefit should be transferred to other vehicles with similarly limited driver fields of view.

### 3.10 SYSTEM R – HUMAN FACTORS CHECKLIST RESULTS

System R was a commercially available ultrasonic rear collision avoidance system. This system had a single sensor used to create a detection zone to the rear of the vehicle. A more detailed description of the operation of the system and driver interface characteristics can be found in the responses to the Human Factors Checklist for this system which can be found in the appendices.

#### 3.10.1 System R – Description of Driver Interface

System R had a main display unit, pictured in Figure 3.18, which contained visual system status displays. A green LED labeled “READY” provided the driver with an indication that the system was receiving power. A red LED labeled “FAULT” would illuminate to indicate a failure had occurred in the system hardware. This main display unit was mounted at the center of the dashboard, in a similar fashion to that as shown for System A in Figure 3.2. Commercial advertising labels were omitted from the photographs.

System R provided only auditory crash avoidance warnings to the driver. The system used three levels of auditory warnings to indicate that an obstacle was present to the rear of the vehicle. A low-pitched beeping tone sounded when an obstacle was within 1.83 to 2.44 meters (6 to 8 feet) of the rear of the vehicle. A high-pitched beeping tone sounded when an obstacle was within 0.91 to 1.83 m (3 to 6 feet) of the rear of the vehicle. A constant high-pitched tone would sound when an obstacle was less than 0.91 m (3 feet) from the sensor.

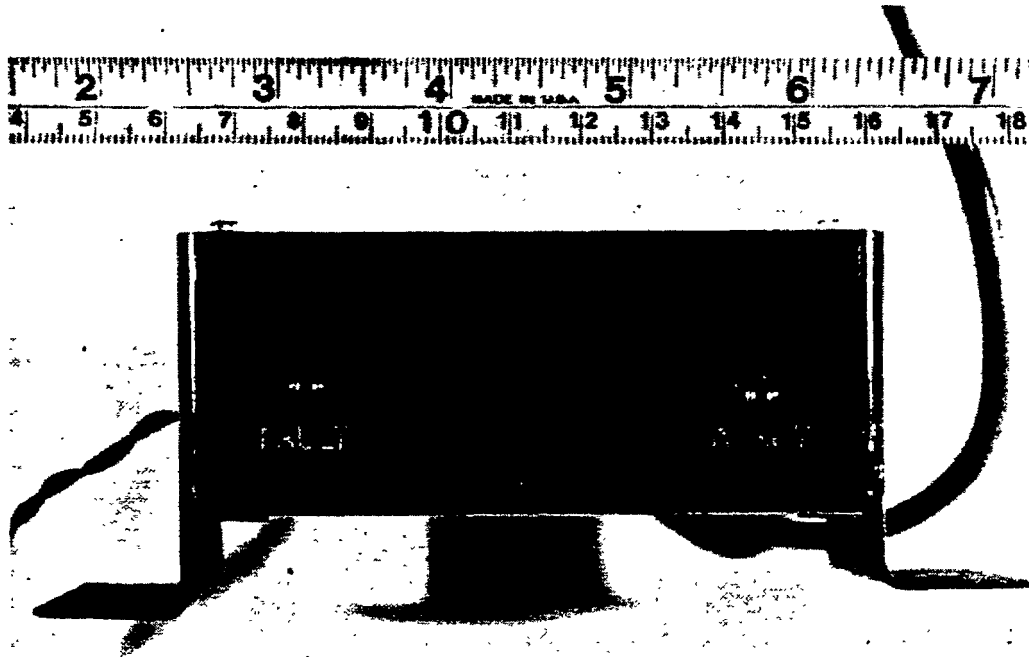


Figure 3.18. System R driver interface

### **3.10.2 System R – Human Factors Checklist**

The completed Human Factors Checklist for System R is provided in the following pages. Immediately following the checklist is a discussion of the results for System R.

**SYSTEM R**

---

**SECTION A**

**DESCRIPTIVE PROFILE OF SYSTEM AND DRIVER/SYSTEM INTERFACE**

**Part I            General Information**

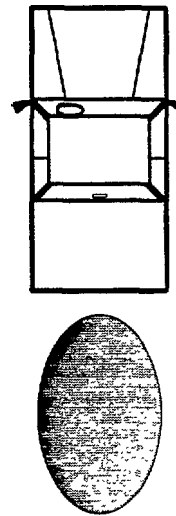
1. Brief system description:

- a. What type of sensor technology (e.g., ultrasonic, position radar, etc.) does the system use?

Ultrasonic ranging system

- b. How many sensors are used with the system and what areas of coverage are associated with each?  
Use the given picture to illustrate the detection zone(s) around the vehicle.

1 receiver/transmitter pair



- c. What is the effective (or nominal) range of the sensors as stated in the manufacturer's specifications?

8 feet (2.44 meters)

- d. Based upon the descriptions contained in the table below, what is the system category?   1

	<b>Significance of Vehicle Posture</b>	<b>Action Needed</b>
<b>Category 1</b>	Potential for collision exists - vehicle(s) <u>not</u> on a collision course	Caution needed, but no immediate collision avoidance action is necessary
Category 2	Collision is imminent - vehicle(s) on a collision course	Immediate collision avoidance action by the driver is needed
Category 3	Collision is imminent - vehicle(s) on a collision course	Immediate collision Avoidance ation Will be provided by an automatic control system

- e. On what type of algorithm are the crash avoidance warnings, levels of warning, or vehicle control based (e.g., detection of distance-to-target or time-to-target)? Check one.

Distance-to-target   X    
 Time-to-target             
 Other (specify)           

- f. What type of media is used for the manufacturer’s documentation? Indicate below with an ‘x’. Attach a copy of the manufacturer’s documentation to the back of Section A.

Type of media:                      Printed manual      X  
    Audio tape                        
    Video tape                        
    Other (specify)                

**TABLE I**  
**Mounting Locations and Overall Dimensions**

<u>Display, Auditory Message or Control</u>	<u>Manufacturer’s Recommended Mounting Location</u>	<u>Overall Dimensions (For reference) (WxHxD)</u>
System status display	<u>  N/A  </u>	<u>          </u> mm
Cautionary crash avoidance warning	<u>  N/A  </u>	<u>          </u> mm
Imminent crash avoidance warning	<u>  N/A  </u>	<u>          </u> mm
Other <u>Single Integrated display</u>	<u>  Dashboard  </u>	<u>  10x4x7.5  </u> m m

**TABLE II**  
**Maximum Display Viewing Distances**

<u>Display</u>	<u>Viewing Distance</u>
System status display	908.0      mm
Cautionary crash avoidance warning display	N/A      mm
Imminent crash avoidance warning display	<u>  N/A  </u> mm
Other display <u>  Fault indicator  </u>	889.0      mm

**TABLE III**  
**Maximum Control Reach Distances**

<u>Control Unit</u>	<u>Reach Distance</u>
<u>  N/A  </u> (Specify)(e.g., warning volume)	<u>          </u> mm
<u>  N/A  </u> (Specify)	<u>          </u> mm

**TABLE IV**  
**Descriptive Profile - Visual Displays**

(If no display is present for an item listed in the leftmost column,  
write N/A [not applicable] in the appropriate boxes.)

NAME OF DISPLAYED INFORMATION	TYPE OF INFORMATION DISPLAYED (e.g., distance to adjacent vehicle, object presence)	TRIGGERING EVENT (e.g., system power application, object presence)	TYPE OF DISPLAY USED (e.g., LCD, LED, icon)	TYPE OF COLOR CODING USED	DISPLAY LUMINANCE DAY (Cd/m <sup>2</sup> ) (min. & max. brightness settings)	BACKGROUND LUMINANCE DAY (Cd/m <sup>2</sup> )
system on/off  "Ready"	indication that integrated display unit is receiving power	Application of power by ignition	LED	Green	Normal on 2190 Off 640  <u>30 degrees</u> On 1900 Off 527	<u>Normal</u> 83.8  <u>30 degrees</u> 62.4
<b>Cautionary crash avoidance warning</b>	N/A	N/A	N/A	N/A	N/A	N/A
<b>Imminent crash avoidance warning</b>	N/A	N/A	N/A	N/A	N/A	N/A
<b>System malfunction</b>  "Fault"	Indication of internal failure	Internal failure	LED	Red	Normal On 973 Off 220  <u>30 degrees</u> On 811 Off 252	<u>Normal</u> 64.4  <u>30 degrees</u> 72.4

**TABLE IV**  
**Descriptive Profile - Visual Displays**  
**(Continued) (ND = Not determined/measurable)**

(If no display is present for an item listed in the leftmost column,  
write N/A [not applicable] in the appropriate boxes.)

NAME OF DISPLAYED INFORMATION	DISPLAY LUMINANCE-NIGHT (record at min. & max . brightness settings)	BACKGROUND LUMINANCE - NIGHT	CONTRAST (day & night)	DUTY CYCLE (e.g., steady burn flash rate)	SIZE OF DISPLAYED INFORMATION (diameter, smallest, character, height, and width, stroke width)	VISUAL ANGLE SUBTENDED AT MAXIMUM VIEWING DISTANCE (minutes of arc)
System on/off	<u>Normal</u> On 1653  <u>30 degrees</u> On 1030	ND	<u>DAY</u> <u>Normal</u> On 25.13 Off 6.64 On/Off 3.42  <u>30 degrees</u> On 29.45 Off 7.45 On/Off 3.61  Night: ND	Steady burn	3/16 in (4.8 mm) diameter	18.17
Cautionary Crash avoidance Warning	N/A	N/A	N/A	N/A	N/A	N/A
Imminent crash avoidance warning	N/A	N/A	N/A	N/A	N/A	N/A
System Malfunction	Normal On 725  30 degrees On 436	ND	<u>DAY</u> <u>Normal</u> On 14.11 Off 2.42 On/Off 4.42  30 degrees On 10.20 Off 2.48 On/Off 3.22	Steady burn	3/16 in (4.8 mm) diameter	18.56



**TABLE V**  
**Descriptive Profile - Auditory Warnings**

(If no display is present for an item listed in the leftmost column,  
write N/A [not applicable] in the appropriate boxes.)

<b>NAME OF AUDITORY INFO</b>	<b>TYPE OF INFORMATION PRESENTED</b> (e.g., distance to adjacent vehicle, object presence)	<b>TRIGGERING EVENT</b> (e.g., system power application, object presence)	<b>TYPE OF WARNING</b> e.g., steady w a r b l e intermittent	<b>PITCH</b> (frequency)	<b>LOUDNESS</b> (min& max loudness settings)	<b>DURATION OF AUDIBLE WARNING SIGNAL</b>	<b>DUTY CYCLE</b> (if intermittent)	<b>CHANGES AFTER ONSET</b>
<b>System on</b>	system powered	Vehicle ignition	2 clicks	N/A	N/A	N/A	N/A	N/A
<b>Cautionary crash avoidance warning</b>	Indication of object presence in detection zone at ≤9 feet (274 cm) from rear of vehicle	Object enters detection zone	Repeated low pitched beep	1210 Hz 2110 Hz 2720 Hz 3020 Hz 6645 Hz	70 dB(A)	As long as object remains at ≤9 feet from rear of vehicle	Beeps every 0.26 s	N/A
<b>Cautionary crash avoidance warning</b>	Indication of object at ≤6 feet (183 cm) from rear of vehicle	Object enters detection zone	Repeated high pitched beep	1160 Hz 2310 2890	71 dB(A)	As long as object remains at ≤6 feet from rear of vehicle	Beeps every 0.26 s	N/A
<b>Cautionary crash avoidance warning</b>	indication of object at <3 feet from rear of vehicle	Object enters detection zone	Steady high pitched tone	1169 Hz 2310 2890	71 dB(A)	As long as object remains at <3 feet from rear of vehicle	N/A	N/A
<b>Imminent crash avoidance warning</b>	N/A	N/A	N/A	N/A	N/A	N/A	N/A	N/A
<b>System malfunction</b>	N/A	N/A	N/A	N/A	N/A	N/A	N/A	N/A

**TABLE VI**  
**Descriptive Profile - Manual Controls**

(If no display is present for an item listed in the leftmost column,  
write N/A [not applicable] in the appropriate boxes.)

CONTROL FUNCTION	CONTROL TYPE (e.g., knob, toggle, push button, etc.)	CONTROL SIZE (width X height, diameter, length, etc.)(in mm.)	DOES THE CONTROL OBSTRUCT THE DRIVER'S VIEW OF VISUAL WARNING DISPLAYS	TYPE OF ADJUSTMENT (discrete or continuous)	DESCRIBE TYPE OF CONTROL FEEDBACK (aural, visual, tactile)
System on/off	N/A	N/A	N/A	N/A	N/A
Volume adjustment	N/A	N/A	N/A	N/A	N/A
Light intensity (dimming) adjustment	N / A	N/A	N/A	N/A	N/A
Sensor sensitivity adjustment	N/A	N/A	N/A	N/A	N/A
Visual display override	N/A	N/A	N/A	N/A	N/A
Audible display override	N/A	N/A	N/A	N/A	N/A

### **3.10.3 System R -Strengths and Weaknesses of the Driver Interface**

#### **3.10.3.1 Crash Avoidance Visual Warnings**

System R did not provide any crash avoidance visual warnings to the driver. Presentation of visual crash avoidance warnings was considered unnecessary for performing backing maneuvers.

#### **3.10.3.2 Crash Avoidance Auditory Warnings**

System R employed three separate warning signals to alert the driver the presence of an obstacle within one of three ranges from the rear of the vehicle (less than 0.91 m, between 0.91 m and 1.83 m, and between 1.83 and 2.44 m). These three signals were easy to distinguish from one another and easy to distinguish from other in-vehicle auditory signals. In most cases, however, the volume of the auditory warning was found to be excessively loud. The use of a volume control would have been useful in alleviated this problem as well as allow the system to better accommodate individual driver differences and differences between vehicles.

#### **3.10.3.3 System Status Displays**

The colors used to present system status information were judged to be appropriate. However, it may be preferable to use a smaller unit with a single display which would present a green signal when the system was powered and operating properly and a yellow light when a system failure is detected.

#### **3.10.3.4 Controls**

System A had no controls associated with its driver interface.

#### **3.10.3.5 Overall Assessment of the Driver Interface of System R**

Overall, the driver interface for System R had few problems. The levels of auditory warning were appropriate and useful for performing backing maneuvers. The auditory warning was too loud, but could easily be remedied with the provision of a volume control. The main problem with this system was hardware performance. The performance of this system varied with temperature and environmental conditions and, as noted in Section 3.3.3, thus precluded the performance of backup testing of this system.

### **3.11 SYSTEM S – HUMAN FACTORS CHECKLIST RESULTS**

System S was a commercially available ultrasonic rear collision avoidance system. This system had two transmitter/receiver pairs used to create a detection zone behind the vehicle. A more detailed description of the system, its operation, and driver interface characteristics can be found in the responses to the Human Factors Checklist for this system which can be found in the appendices.

#### **3.11.1 System S – Description of Driver Interface**

System S provided only auditory crash avoidance warnings to the driver. System S had no visual displays or controls associated with it. The auditory warnings consisted of voice synthesized announcements of the distance of an obstacle from the rear of the vehicle. A synthesized female voice announced distances from “eight” to “one” to indicate how far away an object was from the rear of the vehicle. The units of distance used by the system were deduced to be feet, as no documentation was provided by the manufacturer. The distances announced by the system were repeated at varying intervals as long as an obstacle was detected within the detection zone behind the vehicle.

#### **3.11.2 System S – Human Factors Checklist**

The completed Human Factors Checklist for System S is provided in the following pages. Immediately following the checklist is a discussion of the results for System S.

# **SYSTEM S**

-----

## **SECTION A**

### **DESCRIPTIVE PROFILE OF SYSTEM AND DRIVER/SYSTEM INTERFACE**

**Part I            General Information**

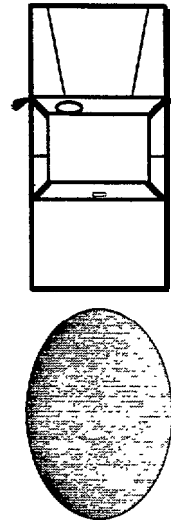
1. Brief system description:

- a. What type of sensor technology (e.g., ultrasonic, position radar, etc.) does the system use?

Ultrasonic

- b. How many sensors are used with the system and what areas of coverage are associated with each? Use the given picture to illustrate the detection zone(s) around the vehicle.

2 sensors



- c. What is the effective (or nominal) range of the sensors as stated in the manufacturer’s specifications?

Range far limit is “eight” from the rear of the vehicle to “one” behind the vehicle. No documentation was provided to define what units these numeric announcements refer to. Units were assumed to be feet.

- d. Based upon the descriptions contained in the table below, what is the system category?   1

	<b>Significance of Vehicle Posture</b>	<b>Action Needed</b>
<b>Category 1</b>	Potential for collision exists - vehicle(s) not on a collision course	Caution needed, but no immediate collision avoidance action is necessary
<b>Category 2</b>	Collision is imminent - vehicle(s) on a collision course	Immediate collision avoidance action by the driver is needed
<b>Category 3</b>	Collision is imminent - vehicle(s) on a collision course	Immediate collision avoidance action will be provided by an automatic control system

- e. On what type of algorithm are the crash avoidance warnings, levels of warning, or vehicle control based (e.g., detection of distance-to-target or time-to-target)? Check one.

Distance-to-target   X    
 Time-to-target             
 Other (specify)           

- f. What type of media is used for the manufacturer's documentation? Indicate below with an 'x'. Attach a copy of the manufacturer's documentation to the back of Section A.

Type of media:                      Printed manual             
   Audio tape             
   Video tape             
   Other (specify) None

**TABLE I**  
**Mounting Locations and Overall Dimensions**

<u>Display, Auditory Message or Control</u>	<u>Manufacturer's Recommended Mounting Location</u>	<u>Overall Dimensions (For reference) (WxHxD)</u>
System status display	<u>  N/A  </u>	<u>          </u> mm
Cautionary crash avoidance warning	<u>  N/A  </u>	<u>          </u> mm
Imminent crash avoidance warning	<u>  N/A  </u>	<u>          </u> mm
Other <u>  Speaker  </u> (specify)	<u>  140 (dia.) dashboard  </u>	<u>          </u> mm
Other <u>                  </u> (specify)	<u>  N/A  </u>	<u>          </u> mm

**TABLE II**  
**Maximum Display Viewing Distances**

<b>Display</b>	<u>Viewing Distance</u>
System status display	<u>  N/A  </u> mm
Cautionary crash avoidance warning display	<u>  N/A  </u> mm
Imminent crash avoidance warning display	<u>  N/A  </u> mm

**TABLE III**  
**Maximum Control Reach Distances**

<u>Control Unit</u>	<u>Reach Distance</u>
<u>  N/A  </u> (Specify)(e.g., warning volume)	<u>          </u> mm
<u>  N/A  </u>	<u>          </u> mm

**TABLE IV**  
**Descriptive Profile - Visual Displays**

(If no display is present for an item listed in the leftmost column,  
write N/A [not applicable] in the appropriate boxes.)

NAME OF DISPLAYED INFORMATION	TYPE OF INFORMATION DISPLAYED (e.g., distance to adjacent vehicle object presence)	TRIGGERING EVENT (e.g., system power application , object presence)	TYPE OF DISPLAY USED (e.g., LCD, LED, icon)	TYPE OF COLOR CODING USED	DISPLAY LUMINANCE DAY (Cd/m2) (min. & max brightness settings)	BACKGROUND LUMINANCE-DAY (Cd/m2)
System on/off	N/A	N/A	N/A	N/A	N/A	N/A
cautionary crash avoidance warning	N/A	N/A	N/A	N/A	N/A	N/A
Imminent crash avoidance warning	N/A	N/A	N/A	N/A	N/A	N/A
system malfunction	N/A	N/A	N/A	N/A	N/A	N/A



**TABLE IV**  
**Descriptive Profile - Visual Displays**  
(Continued) (ND = Not determinable/measurable)

(If no display is present for an item listed in the leftmost column,  
write N/A [not applicable] in the appropriate boxes.)

NAME OF DISPLAYED INFORMATION	DISPLAY LUMINANCE-NIGHT (min. & max. brightness settings)	BACKGROUND LUMINANCE - NIGHT	CONTRAST (day & night)	DUTY CYCLE (e.g., steady burn, flash rate)	SIZE OF DISPLAYED INFORMATION (diameter, smallest character height and width, stroke width)	VISUAL ANGLE SUBTENDED AT MAXIMUM VIEWING DISTANCE (minutes of arc)
System on/off	N/A	N/A	N/A	N/A	N/A	N/A
Cautionary crash avoidance warning	N/A	N/A	N/A	N/A	N/A	N/A
Imminent crash avoidance warning	N/A	N/A	N/A	N/A	N/A	N/A
System malfunction	N/A	N/A	N/A	N/A	N/A	N/A

**TABLE V**  
**Descriptive Profile - Auditory Warnings**

(If no display is present for an item listed in the leftmost column,  
write N/A [not applicable] in the appropriate boxes.)

NAME OF AUDITORY INFO.	TYPE OF INFORMATION PRESENTED (e.g., distance to adjacent vehicle, object presence)	TRIGGERING EVENT (e.g., system power application, object presence)	TYPE OF WARNING (e.g., steady, warble, intermittent)	PITCH (frequency)	LOUDNESS (min & max. loudness settings)	DURATION OF AUDIBLE WARNING SIGNAL	DUTY CYCLE (if intermittent)	CHANGES AFTER ONSET
System on	N/A	N/A	N/A	N/A	N/A	N/A	N/A	N/A
Cautionary crash avoidance warning	Distance indication of object behind vehicle: 8 ft 7 ft 6 ft 5 ft 4 ft 3 ft 2 ft 1 ft	Object present at the following longitudinal distance from the rear of the vehicle: 8 ft 7 ft 6 ft 5 ft 4 ft 3 ft 2 ft 1 ft	Synthesized female voice	8 ft: 2550, 2860 7 ft: 600, 1760 6 ft: 640, 2650, 2930 5 ft: 930, 1430, 2550 4 ft: 610, 1440 3 ft: 10000, 2880, 2440, 690 2 ft: 710, 1440, 1910, 2540 1 ft: 950, 1270, 1430	8 ft: 70 dB(A) 7 ft: 73 dB(A) 6 ft: 68 dB(A) 5 ft: 78 dB(A) 4 ft: 74 dB(A) 3 ft: 69 dB(A) 2 ft: 66 dB(A) 1 ft: 80 dB(A)	As long as object is present at a particular distance from the rear of the vehicle	8 ft: 0.53 7 ft: 0.59 6 ft: 0.64 5 ft: 0.71 4 ft: 0.53 3 ft: 0.56 2 ft: 0.46 1 ft: 0.43	N/A
Imminent crash avoidance warning	N/A	N/A	N/A	N/A	N/A	N/A	N/A	N/A
System malfunction	N/A	N/A	N/A	N/A	N/A	N/A	N/A	N/A

- Auditory warnings issued at 342 ft and 1 ft may be considered imminent crash avoidance warnings since the system tells the driver that he or she is very near an obstacle.

**TABLE VI**  
**Descriptive Profile - Manual Controls**

(If no display is present for an item listed in the leftmost column,  
write N/A [not applicable] in the appropriate boxes.)

<b>CONTROL FUNCTION</b>	<b>CONTROL TYPE</b> (e.g., knob, toggle, push button, etc.)	<b>CONTROL SIZE</b> (width X height, diameter, length, etc.)(in mm.)	<b>DOES THE CONTROL OBSTRUCT THE DRIVERS VIEW OF VISUAL WARNING DISPLAYS</b>	<b>TYPE OF ADJUSTMENT</b> (discrete or continuous)	<b>DESCRIBE TYPE OF CONTROL FEEDBACK</b> (aural, visual, tactile)
<b>System on/off</b>	N/A	N/A	N/A	N/A	N/A
<b>Volume adjustment</b>	N/A	N/A	N/A	N/A	N/A
<b>Light intensity (brightness) adjustment</b>	N/A	N/A	N/A	N/A	N/A
<b>Sensor sensitivity adjustment</b>	N/A	N/A	N/A	N/A	N/A
<b>Visual display override</b>	N/A	N/A	N/A	N/A	N/A
<b>Audible display override</b>	N/A	N/A	N/A	N/A	N/A

### **3.11.3 System S -Strengths and Weaknesses of the Driver Interface**

#### **3.11.3.1 Crash Avoidance Warning Visual Displays**

System S had no crash avoidance warning visual displays associated with its driver interface.

#### **3.11.3.2 Crash Avoidance Warning Auditory Displays**

The auditory warning feature of this system operated continuously regardless of whether or not the vehicle was in reverse gear. The system, while operating, emitted a ticking sound which was found to be annoying to the human factors experts while performing backing maneuvers with the system. The voice announcement of distance to an obstacle behind the vehicle was considered to be monotonous, repetitive, and annoying. The volume of the auditory warnings was insufficient and often could not be heard while performing backing maneuvers in the HMMWV.

#### **3.11.3.3 System Status Displays**

System S had no visual or auditory system status displays associated with its driver interface.

#### **3.11.3.4 Controls**

System S had no controls associated with its driver interface. The provision of a volume control for adjustment of the volume of the auditory crash avoidance warning would have been helpful.

#### **3.11.3.5 Overall Assessment of the Driver Interface for System S**

Overall, System S did provide some benefit when performing backing maneuvers in the HMMWV. Although some benefit may have been gained in the passenger car application, these are believed not significant enough to warrant its use in that vehicle type. A considerable problem with System S was the frequent inaccuracy of the distance announcements. This inaccuracy could lead to problems if a driver trusted the system literally based upon its distance announcements. The level of accuracy used by the system (0.3 m increments, or 1 foot) is probably not required in most backing situations. A design employing, for example, three zones as in the case of System R may be sufficient. Overall, System S requires some modification to improve the auditory warning presentation to make it more pleasant and tolerable to the driver. System S also would benefit from refinements to system hardware to improve its performance.

## **4.0 HUMAN FACTORS CHECKLIST RESULTS – BETWEEN SYSTEMS COMPARISONS**

This section contains the results of between systems comparisons for the different collision avoidance systems. Most of the analyses contained in this section are based on data from Section C of the Human Factors Checklist. At the end of the section, the results of the scoring that was performed on Sections A and B of the human factors checklist are presented.

The results presented graphically for Section C of the Human Factors Checklist were based solely on the responses of the two human factors experts after having driven with the CAS. Although responses were based on basic human factors principles and related expert professional judgements, some degree of individual differences are present in the data. In addition, although questions contained in the checklist focused on assessing the attributes of the driver interface, frequently it was found that factors related to system performance had some effect on the perceived effectiveness of the driver interface designs. Inconsistent or variable system performance could be attributed to weather, mechanical problems, or some other cause. Due to the inconsistent performance observed for many of the systems tested and the small sample size used, it is difficult to attribute variability in response data to any one source. In some cases, the differences in responses due to individual differences may be larger than the differences between the plotted data values. Therefore, the response data are not discussed as being statistically significant. However, in many cases, the data do show trends which allude to the effectiveness of individual CAS driver interface designs.

The data values listed in the following figures represent the means of the responses obtained for individual questions during the eight driving sessions (2 human factors experts; 2 test vehicles; day and night) conducted under Section C of the checklist for each system.

### **4.1 STATIC EVALUATION DATA SUMMARY -- Part I OF SECTION C**

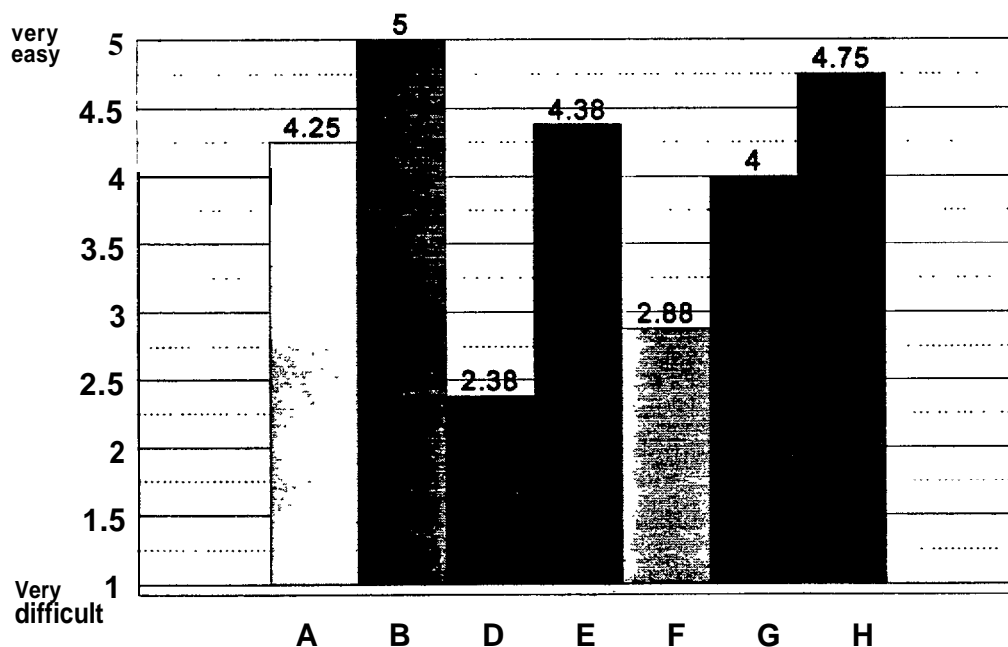
Two questions contained in the static evaluation addressed the adequacy of manufacturer supplied documentation describing the operation of the systems. Only 3 of the 7 side systems and 2 of the 4 rear systems had associated documentation. Only one of the five sets provided was very good, the others were barely adequate.

Some displays were simple enough that their meanings could be easily deduced. Others, as shown by the results of the human factors experts' static assessment of the meaning of crash avoidance warning visual displays for side-looking systems given in Figure 4.1, were not so easy to determine (e.g., the meaning of a blue light at the right A-pillar which illuminated constantly and was extinguished when a yellow light was illuminated). Overall, it was clear that complete descriptive documentation detailing the operation of the CAS and the function of all visual and auditory displays was essential for proper and effective use of both side-looking and rear-looking systems.

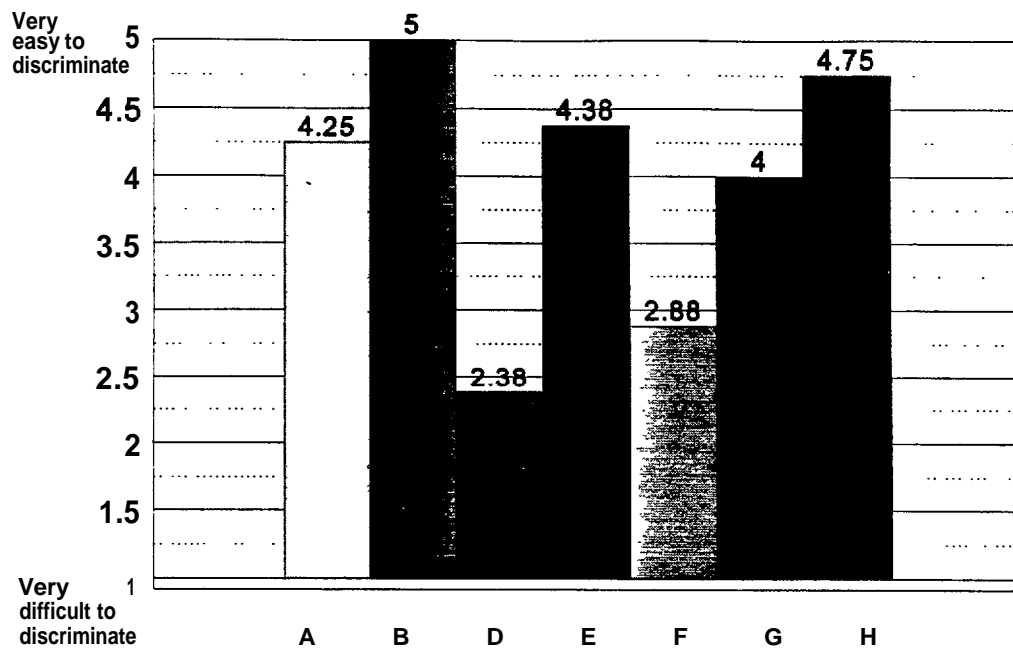
## 4.2 DYNAMIC EVALUATION DATA SUMMARY – Part II OF SECTION C

In Part II of Section C of the human factors checklist called “Dynamic Evaluation,” the questions address various interface design issues. Responses to these questions are made based upon the human factors experts’ experiences with driving the test vehicles equipped with each system; each expert drove four test runs each approximately 2.5 hours in length for each SCAS. The issues addressed were ones whose impacts were judged to be likely to contribute significantly to the utility and potential degree of benefit provided by the systems, i.e., the degree to which the systems contribute to decreasing the likelihood of a collision, or the degree to which they improve safety. Areas judged to be important for inferring the utility and ease of use of systems through “in-use” evaluation included the ease with which crash avoidance warning displays could be discriminated from other in-vehicle or same-system displays (see Figure 4.2), the degree to which the visual and auditory displays associated with a system were a source of distraction or annoyance to the driver (see Figures 4.3 through 4.6), and the perceived degree of effectiveness of the systems (illustrated in Figures 4.7 through 4.12).

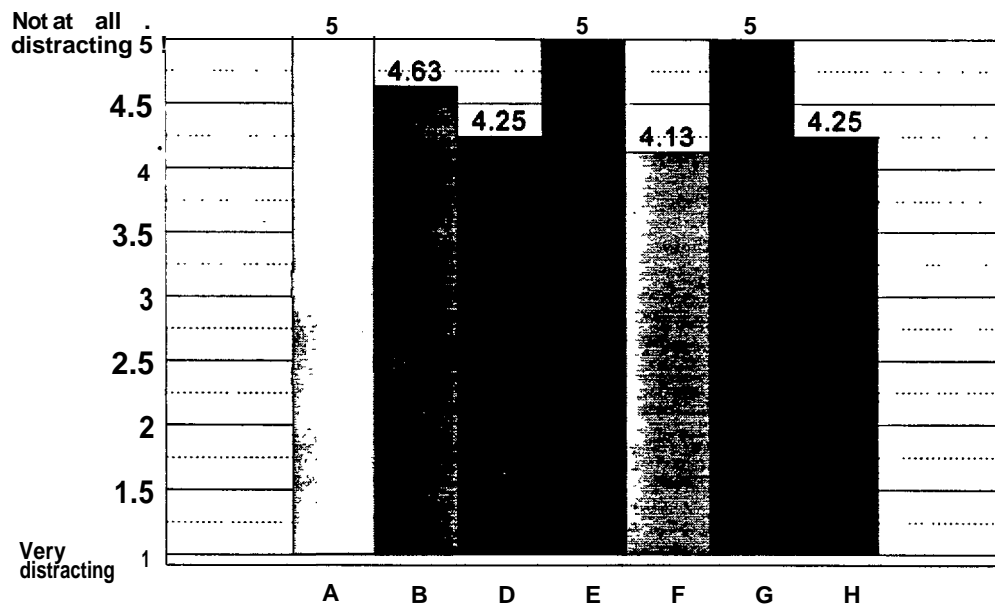
Figure 4.2 shows that, although the crash avoidance visual warnings for most systems could be easily identified, the driver interfaces for Systems D and F had designs which were confusing in terms of distinguishing between crash avoidance warning visual displays and system status visual displays. A common problem encountered with the systems tested was the inappropriate use of color in visual warning and system status displays. Detailed explanations of these deficiencies in Systems D and F



**Figure 4.1.** Part I, Question 5c: How easy to understand are the meanings of the cautionary crash avoidance warning visual displays?



**Figure 4.2.** Part II, Question 3: While driving, how well could crash avoidance warning visual displays be discriminated from any other nearby displays?



**Figure 4.3.** Part II, Question 4a: While driving, how distracting were the visual system status displays?

can be found in Section 3. Overall, the system status displays for the driver interfaces tested were not significantly distracting in most cases as shown in Figure 4.3. However, the visual displays used to present system status information for some systems were considered to be excessively bright for nighttime driving. Further explanation of these findings for each system can be found in Section 3.

Distraction presented more of a problem for some crash avoidance warning visual displays, as illustrated in Figure 4.4. The data presented in this graph corresponds well with the qualitative assessments of systems characteristics obtained in Part III of Section C of the human factors checklist and discussed in Section 3. The driver interface for System D, which rated a relatively low score for this measure as can be seen in Figure 4.4, was considered to be confusing by the human factors experts and was judged to present too much information to the driver. The warning LEDs for this system were also reported to be excessively bright for nighttime driving applications.

Systems F and G were also considered to be distracting due to excessively bright LEDs. This finding may be misleading for System F whose LEDs varied in apparent brightness depending on the angle at which they were viewed. Due to the nature of the type of LEDs used in the warning display for System F, if the display was not positioned such that the driver's line of sight was perpendicular to the LED, the illumination could be difficult to distinguish in some light conditions.

Distraction due to crash avoidance warning auditory displays was noted to be more of a problem for the human factors experts, as shown in Figure 4.5. Three of the six side-looking CAS (System F had no auditory warning display) were rated relatively poorly in this area. The auditory warning display for System E, which was characterized by the human factors experts as "shrill" and "piercing," received the lowest rating. System S, a backing system having a voice synthesized auditory warning which was considered to be repetitive and annoying, also was rated poorly.

The scores for the level of annoyance caused by the auditory crash avoidance warning displays, shown in Figure 4.6, correlate fairly well with the level of distraction data presented in Figure 4.5. The results show that certain of the systems examined require significant improvements to their auditory warning displays in order to make them more user-friendly and appealing, or at least tolerable, for drivers.

A question which was considered to be one of the most important ones in the checklist addressed the effectiveness of the collision avoidance systems tested. Results from this question are illustrated in Figure 4.7. Only minimal differences in the mean ratings of effectiveness for lane changes was observed between the two vehicles. This is surprising given the large right side blind spot area on the HMMWV. These minimal differences in the mean ratings do not correspond to the qualitative responses of the human factors experts obtained in Section C of the checklist. These data do correspond well with the scores which systems received in the categories of Visual Conspicuity and Visual Comprehension that are listed in Table 4.1.



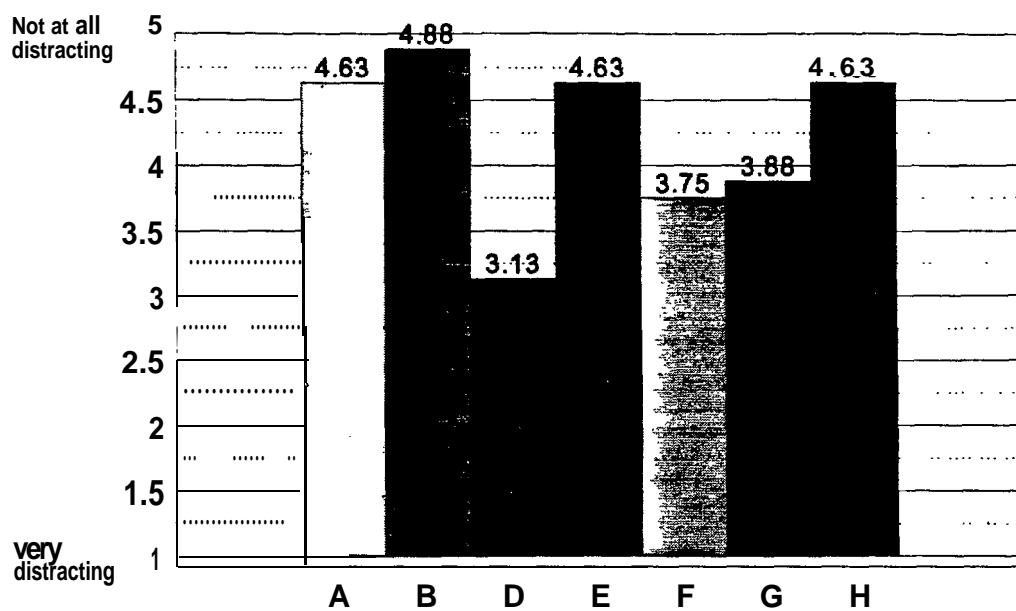


Figure 4.4. Part II, Question 4b: While driving, how distracting were the visual crash avoidance warning displays?

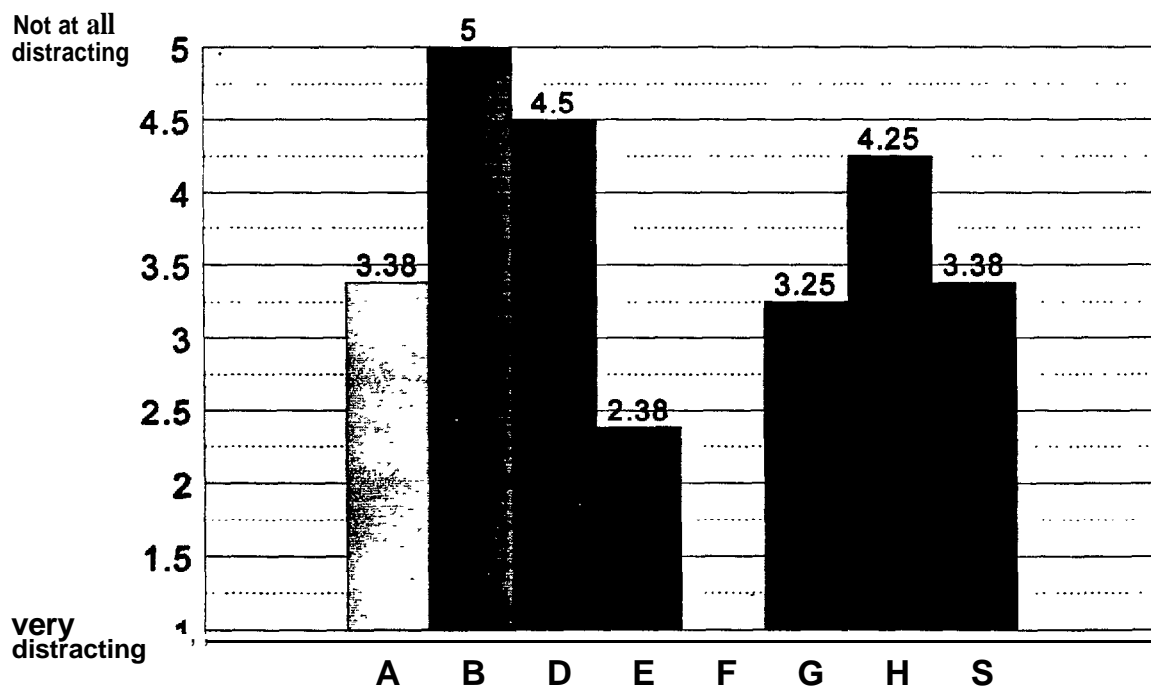
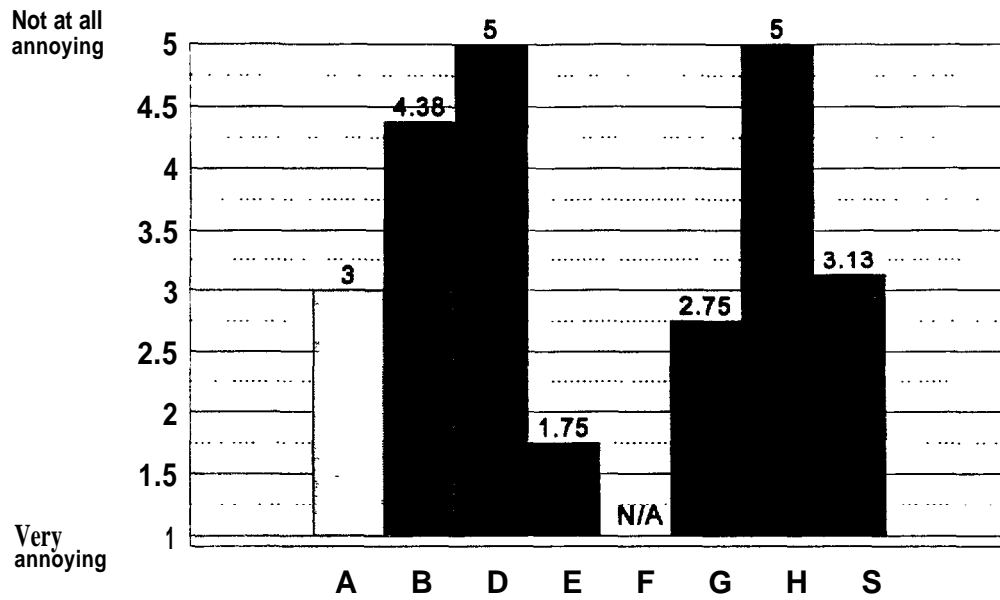
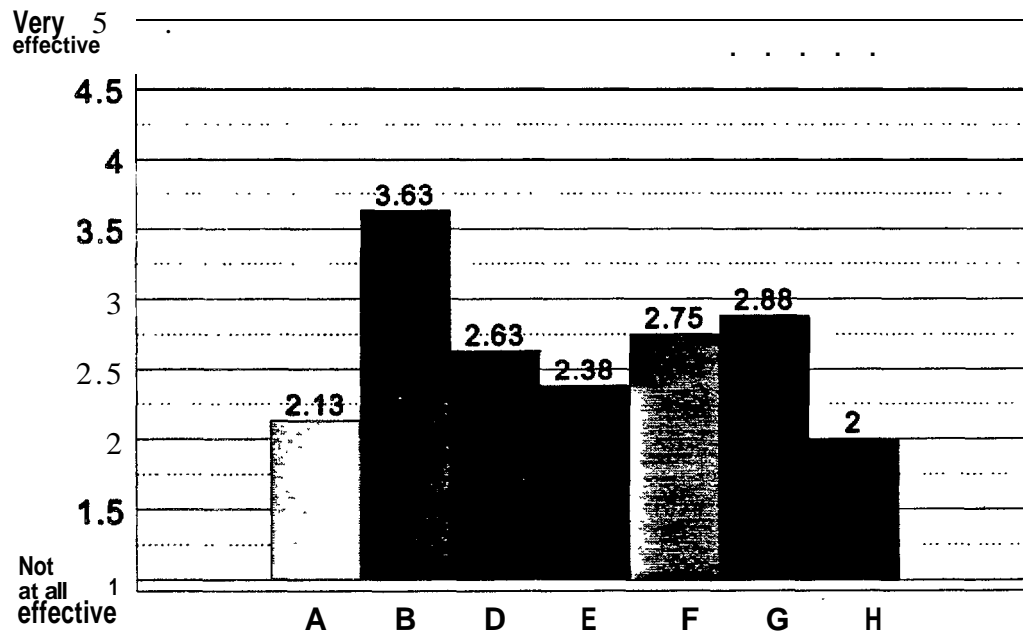


Figure 4.5. Part II, Question 5b: While driving, how distracting were the following auditory displays?



**Figure 4.6.** Part II, Question 6b: While driving, how annoying were the auditory crash avoidance warning displays?

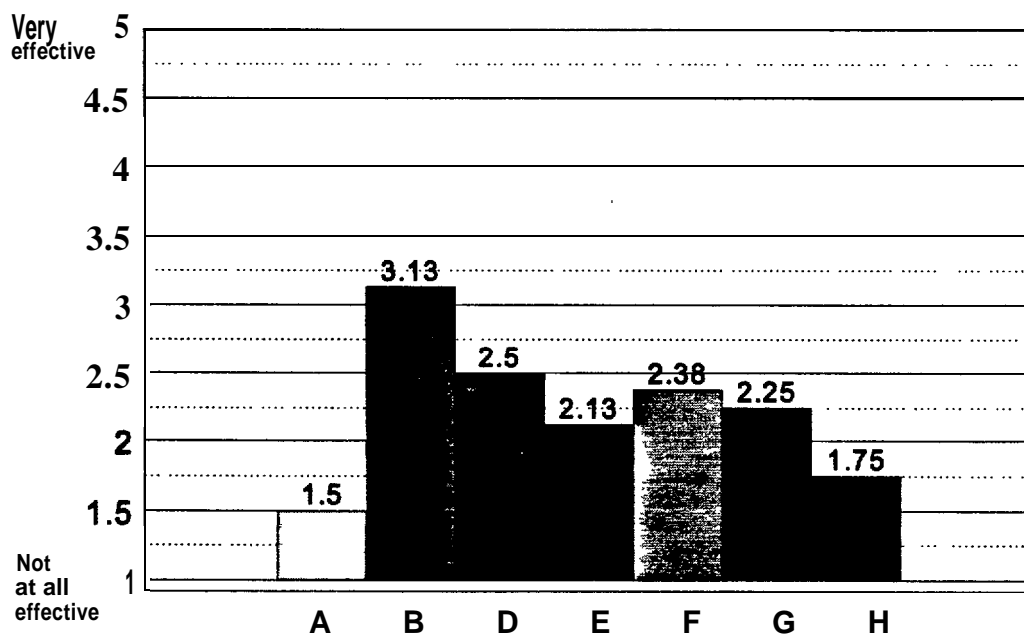


**Figure 4.7.** Part II, Question 9a: How effective was the visual crash avoidance warning display in helping you to make right lane changes?

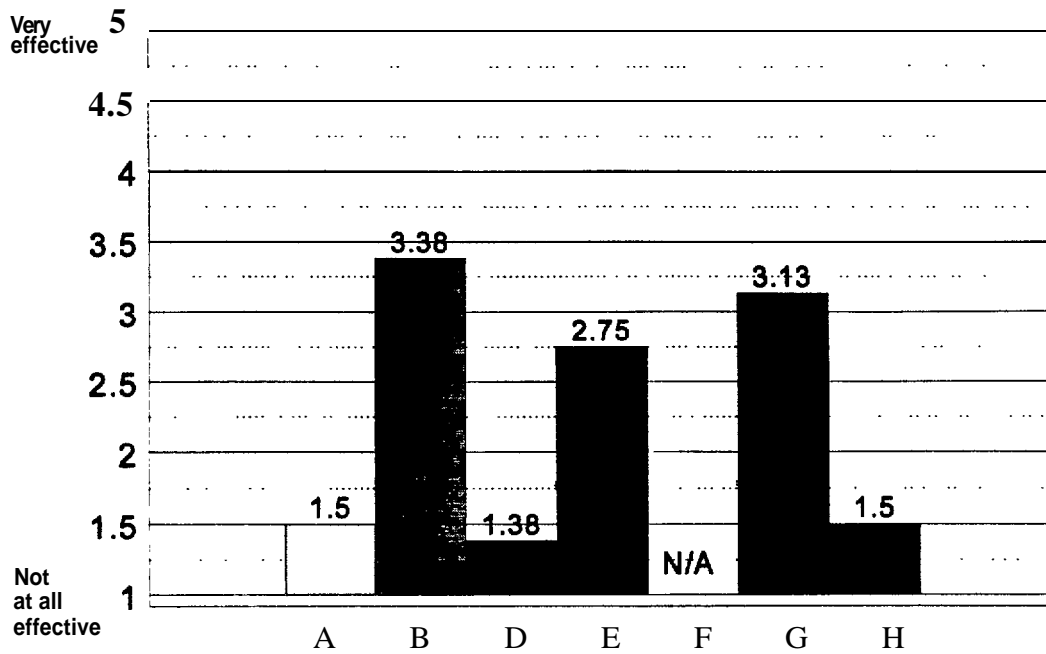
Ratings of the effectiveness of visual crash avoidance warnings in helping drivers to make right merges are given in Figure 4.8. These ratings are not significantly different from those obtained in regards to effectiveness of systems for helping drivers to make right lane changes. The information required by the driver to perform right merges is basically the same as that required for a driver to safely perform right lane changes. Therefore, the same type of visual display used for performing right lane changes should be suitable for right merge situations as well. However, the area in which the CAS detects obstacles needs to be different for the merging application in order to accommodate the greater distance and angle of approaching traffic.

Similar results as those obtained in regards to visual warning displays were observed for the ratings of the effectiveness of auditory crash avoidance warnings in helping drivers to make right lane changes. The results for the effectiveness of systems in right lane change applications, illustrated in Figure 4.9, show no significant differences from those obtained for right merges, as shown in Figure 4.10. These auditory warning displays are thought to require the same type information presentation to the driver whether the application is lane changes or merges, as was the case for visual crash avoidance warning displays.

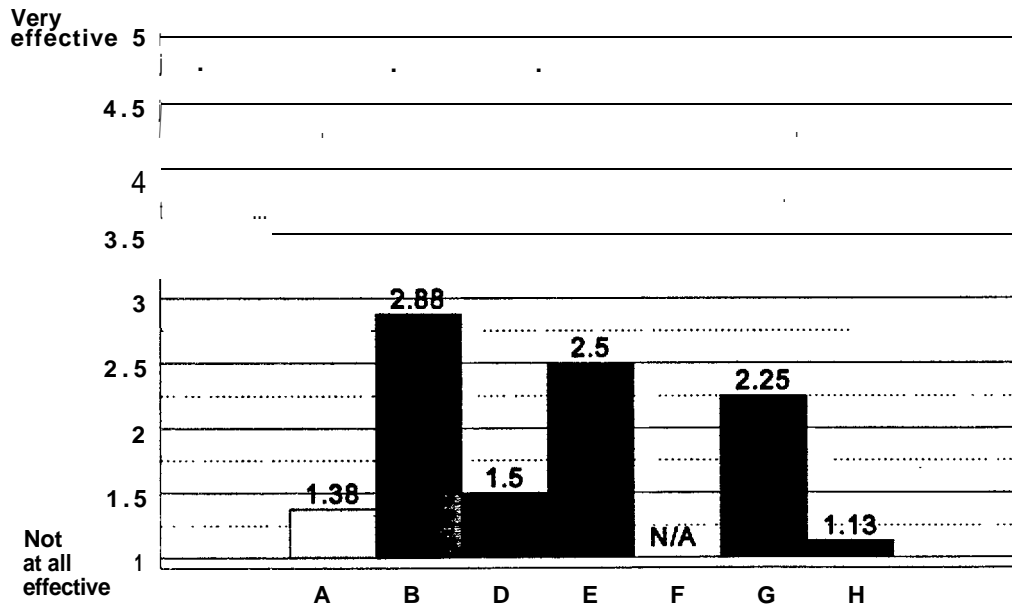
The same question of the effectiveness of the collision avoidance systems tested was asked for the RCAS. Figure 4.11 illustrates the response data for this question regarding the effectiveness of visual and/or auditory crash avoidance warning displays for rear-looking CAS in performing backing maneuvers. Data for System R are not listed due to performance problems during testing.



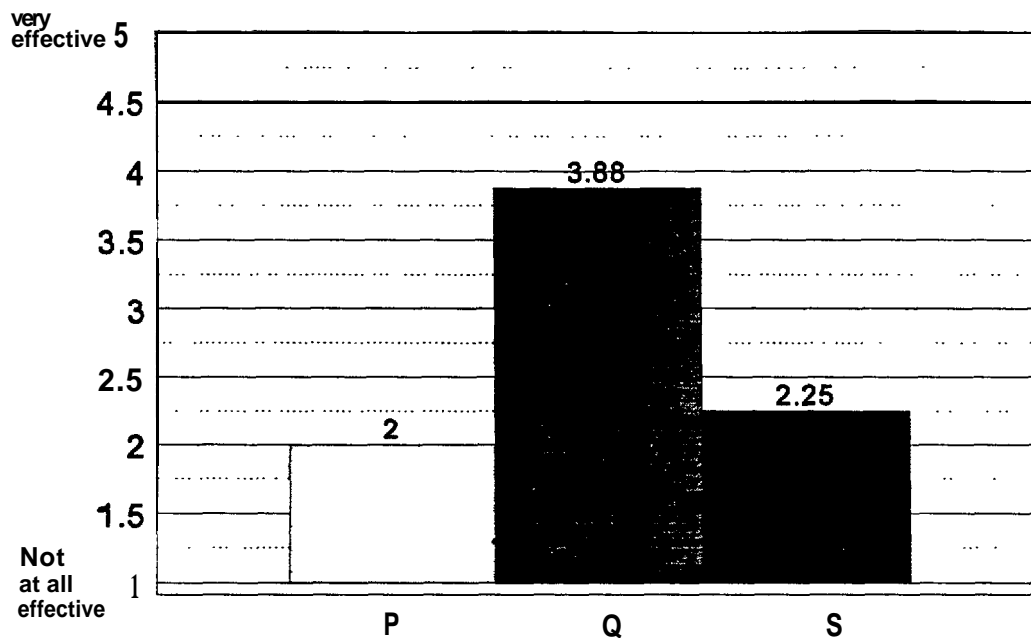
**Figure 4.8.** Part II, Question 9a: How effective was the visual crash avoidance warning display in helping you to merge to the right?



**Figure 4.9.** Part II, Question 12a: How effective was the auditory crash avoidance warning presentation in helping you to make right lane changes?



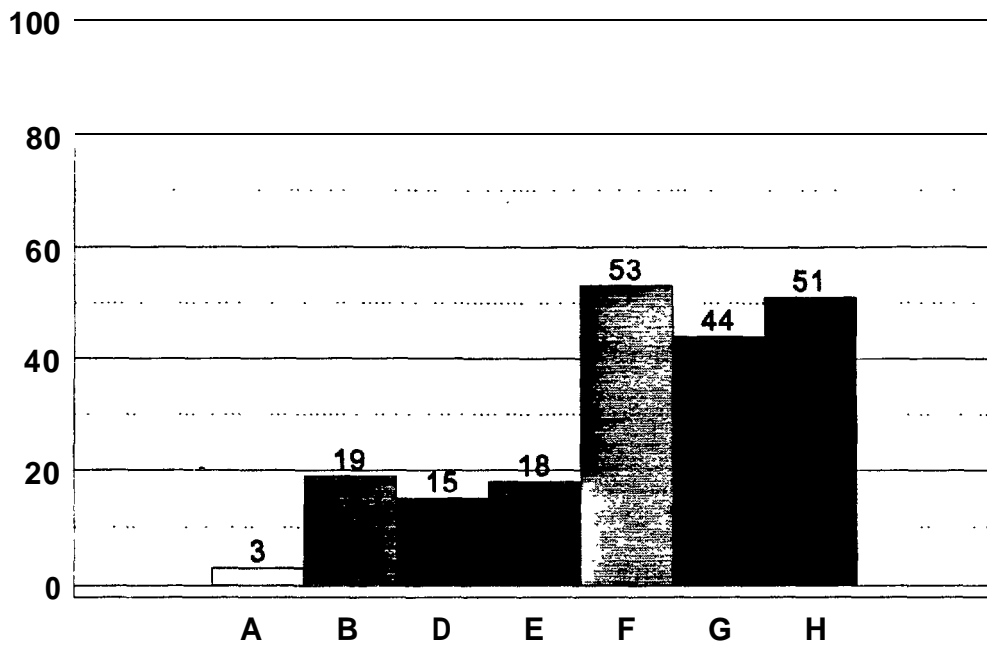
**Figure 4.10.** Part II, Question 13a: How effective was the auditory crash avoidance warning presentation in helping you to merge to the right?



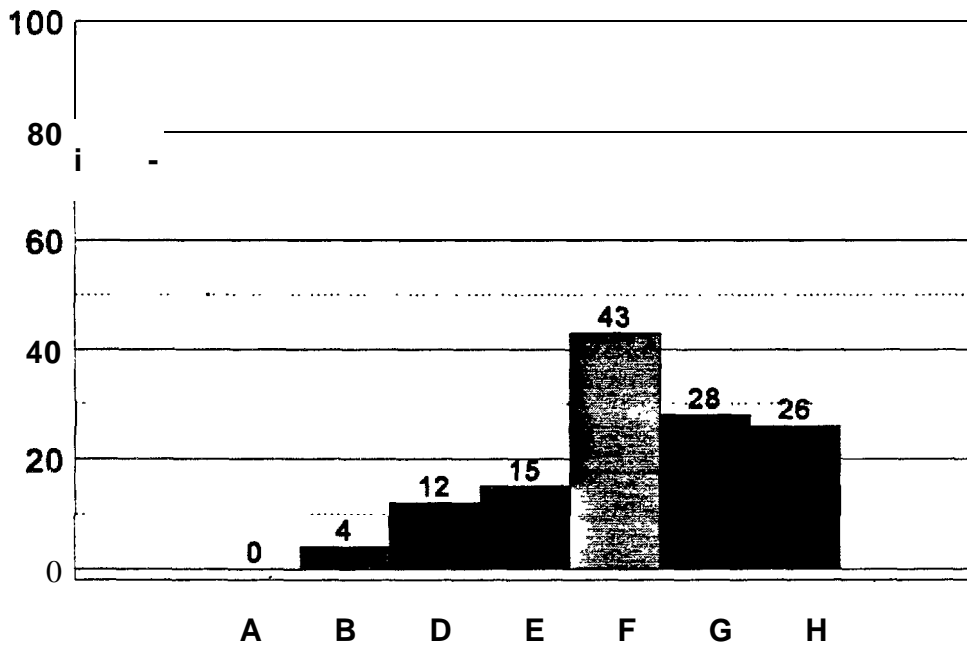
**Figure 4.11.** Part II, Question 11: How effective was the crash avoidance warning presentation in helping you to perform backing maneuvers?

Although both of the video-based systems were considered helpful, particularly in the HMMWV, the driver interface for System Q presented the image of the area behind the vehicle much more clearly and with higher contrast in all lighting conditions tested than did System P. Although System S was effective in informing the driver that an obstacle was behind the vehicle, the experts did experience some difficulty in judging the distance to an obstacle using the system.

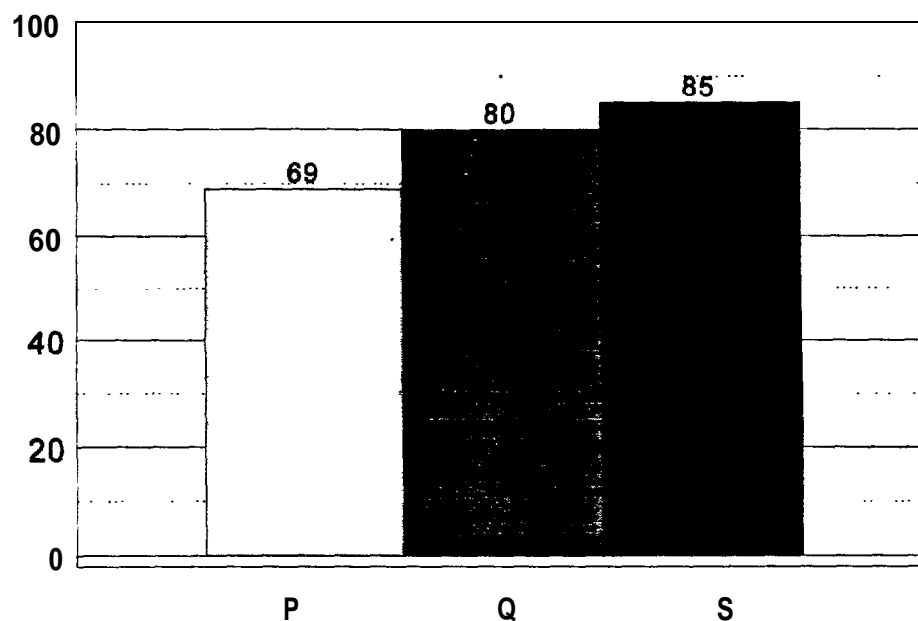
Also of interest was whether or not the human factors experts involved in this study actually used the systems during the required test driving portions of the interface evaluations performed using the Human Factors Checklist. The experts estimates of their frequency of system usage are illustrated in Figures 4.12 through 4.14. However, these data should be examined with the consideration that the experts drove no more than a total of 10 hours with each SCAS and no more than 1 hour (20 maneuvers) with each rear-looking collision avoidance system. In addition, although the question asked how often the system was used during maneuvers of interest, it does not address whether or not the use of the system actually assisted the driver in safely performing the maneuver. The data is also inherently related to system performance. The reason for this is that if a system was performing particularly poorly during a certain test driving session, then the driver would use the system less often. A fair degree of variability was observed due to inconsistent system performance for many of the systems. The low ratings for frequency of use during lane change maneuvers and merges received by System B is surprising given the high scores received for effectiveness of the crash avoidance warning displays. This reason for the low estimated use rate is not clear. High use of a system may be due to the intrusiveness of the warning method. If the crash avoidance warning is very distracting or annoying (e.g., an excessively loud auditory warning such as System G's), then the possibility that the driver will be able to ignore the information presented to him or her is low.



**Figure 4.12.** Part II, Question 14: In what percent of all lane changes did you use the crash avoidance warning information presented by the system?



**Figure 4.13.** Part II, Question 15: In what percent of all merges did you use the crash avoidance warning information presented by the system?



**Figure 4.14.** Part II, Question 16: In what percent of backing maneuvers did you use the crash avoidance warning information presented by the system?

### 4.3 REAR SYSTEM DRIVER PERFORMANCE DATA

In addition to the data collected using the Human Factors Checklist, measurements of driver performance were taken during the RCAS driving sessions. The distance between the test vehicle and the scenario object at the termination of each backing trial was recorded for both human factors experts. Data for each RCAS was compared to a baseline in which the experts performed the specified without the benefit of a RCAS in the test vehicle. Data is not included for System R because this system was not functioning properly at the time the testing was performed. The cause of the malfunction was believed to be the low temperature (approximately 44 degrees Fahrenheit). This data is listed in Table E. 1 of Appendix E.

### 4.4 RESULTS FROM SCORING HUMAN FACTORS CHECKLIST DATA

The data obtained for each system using the human factors checklist was scored according to the method defined in Section 2.2.2. The following table contains the scores that were calculated for the seven side-looking CAS and two rear-looking CAS. The seven categories for which scores were calculated were:

1. Overall Design
2. Visual Warning Display Conspicuity
3. Visual Warning Display Comprehensibility
4. Auditory Warning Discriminability and Comprehensibility
5. System Status Display Conspicuity and Comprehensibility
6. Controls Ergonomics
7. Expert Professional Judgement

It is important to note in viewing these results that, in many cases, human factors guidelines were not available for the specification of design characteristics. In these cases, the authors substituted information about desirable interface characteristics based on their extensive experience with CAS.

For Category 1, Overall Design, the range of scores in Table 4.1 for the side-looking systems was from 66.7 to 55.6. These small system to system differences in scores are not considered significant. Both rear-looking systems scored substantially lower than did the side systems. This is because the both rear systems only presented either audio or visual warnings, but not both. While not providing both types of warning is a design shortcoming for a SCAS, it may a beneficial quality of a RCAS. However, a RCAS should definitely provide an audio warning (which R and S had).

**TABLE 4.1. System Ratings Based on Scoring of the Human Factors Checklist**

Category	Side-Looking CAS							Rear-Looking CAS	
	A	B	D	E	F	G	H	R	S
1	57.3	64.0	55.6	63.3	56.4	66.7	62.0	40.4	41.3
2	80.8	80.0	62.8	59.8	100.0	91.0	93.8	N/A	N/A
3	100.0	72.8	50.0	62.5	54.6	100.0	72.8	N/A	N/A
4	88.9	88.9	33.3	77.8	N/A	88.9	25.0	100.0	88.9
5	86.1	73.0	87.0	79.8	81.1	82.4	92.3	81.8	N/A
6	N/A	46.7	87.2	82.2	N/A	75.6	73.3	N/A	N/A
7	60.0	67.5	37.5	40.0	68.8	35.0	72.5	66.7	25.0

For Category 2, Visual Warning Display Conspicuity, Table 4.1 shows some of the shortcomings of the current version of the human factors checklist. For this category, System F received the best possible rating. However, the human factors expert who filled out the checklist thought that the visual conspicuity of this warning display was actually below average. The problem, in this case, is that the System F visual warning display uses very directional LEDs. If the driver's are on or very near the visual axis of the display's LEDs then the conspicuity of the warning display is excellent. However,



if the driver's eyes are not along the visual axis of the LEDs then conspicuity is poor. There are no questions in the current version of the checklist that relate to this deficiency. For future use, the Human Factors Checklist will be modified to address this issue.

For Category 3, Visual Warning Display Comprehensibility, Table 4.1 shows that two systems, A and G, received the best possible scores. Two other systems, B and H, received scores of 72.8. Looking at the differences between the A-G answers and the B-H answers shows that B and H had the lower scores solely because they did not have legends. However, these are quite simple interfaces. For example, System B only has one light mounted beneath the side view mirror for its visual warning display. While legends are certainly needed on complex interfaces, perhaps they are not really necessary on simple interfaces.

For Category 4, Audio Warning Discriminability and Comprehensibility, two systems, D and H, had very low scores. For both of these systems, the human factors expert who filled out the forms believed that the meaning of the auditory warnings issued was not readily apparent.

For Category 5, System Status Display Conspicuity and Comprehensibility, the scores ranged from 92.3 to 73.0. This fairly small range of variation is not considered significant.

For Category 6, Control Ergonomics, System B scored poorly due to its violation of population stereotypes and its hard to distinguish controls. The other four SCAS had essentially the same scores.

For Category 7, Expert Professional Judgement, the three commercially available RCAS and SCAS all had good scores ranging from 72.5 to 60.0. While two of the prototype systems also had good scores, four prototype RCAS and SCAS had scores of 40.0 or less. This pattern of variation was expected since the commercially available systems should have more refined, more effective, driver interfaces.

The inconsistency between the scores for Categories 1 through 6 and those for Category 7 may be due to deficiencies in the scoring system. As the Human Factors Checklist is modified to improve areas in which it is lacking and it evolves into an improved driver interface evaluation tool, the scoring system also must be modified to improve the accuracy of its quantitative assessment of driver interface quality.

## 5. SUMMARY AND CONCLUSIONS

### 5.1 SUMMARY

This report describes the methodology and evaluation of driver interfaces of three types of electronics-based collision avoidance systems that have been recently developed to assist drivers of light vehicles (passenger cars, pickup trucks, vans, and sport utility vehicles). The three types of electronics-based collision avoidance systems are those which detect the presence of objects located to the **rear** of the vehicle (referred to as Rear-looking Collision Avoidance Systems or RCAS), **those** which **enhance the driver's ability** to see the presence of objects located to the rear of the vehicle (also referred to as Rear-looking Collision Avoidance Systems or RCAS), and **those** which **detect** the presence of objects located on **the left and right sides** of the vehicles (referred to as Side-looking Collision Avoidance Systems or SCAS).

The RCAS, whether of the object detection or vision enhancement type, are intended to aid drivers when backing their vehicles, typically at very low speeds, so that they do not strike fixed objects, parked cars, or pedestrians. The side-looking systems are intended primarily as supplements to the existing side- and rear-view mirror systems. The SCAS assist the driver during lane changes and merges by detecting adjacent vehicles and warning the driver of their presence.

A portion of Phase 1 of the research program "Development of Performance Specifications for Systems Which Assist in Avoiding Collisions During Lane Change, Merging, and Backing" was to evaluate the performance of existing systems of this type. As many collision avoidance systems as could be obtained, including several pre-production prototypes, were obtained and tested by TRW and the National Highway Traffic Safety Administration's Vehicle Research and Test Center. This testing focused on measuring the performance of the CAS sensors and evaluating the design of the driver interfaces based on human factors principles. This report documents the results of the assessment of the design of the CAS driver interfaces for the systems tested. A companion report documents the measured performance of the sensors of the CAS tested [ 1].

The goals of this assessment of the design of CAS driver interfaces were:

1. To evaluate, based upon the principles of ergonomics, how well the driver interfaces of the collision avoidance systems studied were designed.
2. To provide advice to future designers of collision avoidance system driver interfaces as to ergonomically desirable or undesirable feature.
3. To identify CAS driver interface design issues that should be the focus of future research.
4. To improve methods for evaluating CAS driver interface designs.

For this research, the driver interfaces of four RCAS, two of which detect objects to the rear of the vehicle and two of which enhance the driver's rearward vision, and seven SCAS were studied. Of these eleven systems, five were sold commercially at the time the study was initiated while six are pre-production prototypes. While the focus of this research was light vehicles (passenger cars, pickup trucks, vans, and sport utility vehicles, all with gross vehicle weight ratings below 44,500 Newtons), several of the systems evaluated were intended primarily for use on heavy trucks. These systems were studied because examining a large number of systems allowed for a better understanding of the needed capabilities of collision avoidance warning systems to be gained.

Seven SCAS were examined in this study. These systems were designated as Systems A, B, and D through H. Four RCAS, two which detect objects to the rear of the vehicle and two which enhance driver rearward vision through the use of rear-facing exterior-mounted video cameras were examined in this study. The rear vision enhancement RCAS were designated as Systems P and Q while the two object detection RCAS were designated as Systems R and S.

The principal data collection instrument used to perform a human factors assessment of existing collision avoidance system driver interfaces was a Human Factors Checklist titled 'Descriptive Profile, Human Factors Assessment, and Operational Judgements of the Collision Avoidance System Driver/System Interface'. The checklist was used both as a research device and as a screening tool. It consisted of a document containing qualitative and quantitative questions and tables. This document served as a tool for the collection of data characterizing collision avoidance system interfaces and their associated visual and auditory information displays and controls. The checklist was completed for seven side and four rear collision avoidance systems.

The checklist contained three sections. Section A was a descriptive profile which addressed the operation of the system hardware and driver displays. Section B consisted of an assessment of the extent to which the visual and auditory displays conform to established human factors guidelines. Section C consisted of a questionnaire used to assess the operational performance of the driver/system interface by human factors experts after having driven with the systems. Overall, the checklist provided a means by which the effectiveness of the driver/system interface and the merits of systems could be assessed. The data obtained by applying the checklist to each of the driver interfaces that was examined was summarized in Sections 3 and 4 and Appendices B through D.

In addition to other analyses, the Human Factors Checklist was scored. Scoring was used to reduce the quantity of data generated by the checklist so as to make more apparent the extent to which the driver interfaces incorporated desirable characteristics from a human factors perspective. Driver interface features were assessed based, upon human factors guidelines gathered mainly from information presented in the report "Preliminary Human Factors Guidelines for Crash Avoidance Warning Devices" [3] by COMSIS, SAE Recommended Practices, and accepted texts of human factors design principles. Where these sources lacked sufficient information to judge the appropriateness of certain interface characteristics, the authors' judgements based upon extensive experience with using and evaluating collision avoidance systems was substituted. The results of this scoring are summarized at the end of Section 4.

The Human Factors Checklist used in this assessment was modified for this purpose from its original form developed specifically for use in a study of heavy truck side and rear collision avoidance systems. In modifying this checklist for use in this program, many needed revisions were realized. However, many necessary modifications to the checklist were not apparent until the benefit of retrospect was acquired upon completion of the study. Thus, the limitations of this checklist at this point in time are many. However, the Human Factors Checklist has proved to be a useful resource for assessing CAS driver interfaces. In the future, the checklist should be modified to improve its form and extend its usefulness to encompass new and different CAS types.

Based upon analyses of the completed Human Factors Checklists, the category-by-category scores for each system, and discussions with the two human factors experts, the strengths and weaknesses of each system were identified. These points were summarized in Section 3.

## 5.2 CONCLUSIONS

The first goal of this research was to evaluate, based upon human factors principles, how well the driver interfaces of the collision avoidance systems studied were designed. The strengths and weaknesses of each individual system were discussed in Section 3. Overall, while none of systems had an “ideal” driver interface at this point in time, most of the driver interfaces were acceptable from an ergonomic perspective. These findings were similar to those presented in the report “A Study of Commercial Motor Vehicle Electronics-Based Side and Rear Object Detection Systems” [2] which presented results of an evaluation of collision avoidance systems for heavy trucks. Not surprisingly, the commercially available systems tended to have better driver interfaces than did the prototypes.

The second goal of this research was to provide advice to future designers of collision avoidance warning system driver interfaces as to ergonomically desirable or undesirable features. As part of the scoring system that was explained in Section 2, the authors developed a list, for each of six categories, of the characteristics of an ideal system. From these lists, with some minor refinements, the authors have developed their advice to designers.

The authors’ advice to designers of collision avoidance system driver interfaces regarding ergonomically desirable or undesirable features varies depending upon the type of system. For SCAS (either left side, right side, or both), Table 5.1 summarizes this advice.

The advice for driver interface designers that is contained in Table 5.1 agrees with the interface guidelines contained in “Preliminary Human Factors Guidelines for Crash Avoidance Warning Devices” [3] except for Items 8 and 9. These items recommend that there should be an amber light on the visual warning display that is lit when no object is detected. Therefore, there will always be either a red on amber light lit on the visual warning display. This contradicts conventional human factors wisdom and the interface guidelines contained in “Preliminary Human Factors Guidelines for Crash Avoidance Warning Devices.” However, some of the interfaces tested had this feature consisting of a light that was illuminated when no object was detected. Both of the human factors experts who evaluated the interfaces liked this feature and found it helpful for locating the warning display location in conditions of low ambient illumination. Therefore, this recommendation is listed in Table 5.1 even

though it contradicts conventional human factors wisdom. This issue should be the topic of additional, future research.

TABLE 5.1. Desirable Features of a Side-looking Collision Avoidance System Driver Interface

1. The SCAS driver interface should be very simple and straightforward (from the driver's perspective, not necessarily the manufacturer's!).
2. The SCAS driver interface should provide a crash avoidance warning visual display. The SCAS crash avoidance warning visual display should be located on or near the line of sight to the appropriate side view mirror.
3. The SCAS driver interface should provide a crash avoidance warning auditory display. The SCAS crash avoidance warning auditory display should provide a signal which is audible in a wide range of in-vehicle ambient noise conditions.
4. The SCAS driver interface should provide both auditory and visual crash avoidance warnings in situations when a collision is imminent (i.e., imminent crash avoidance warning).
5. The SCAS driver interface should provide only visual crash avoidance warnings when a collision is possible, but not imminent (i.e., cautionary crash avoidance warning).
6. The SCAS driver interface should provide auditory warnings only when the appropriate turn signal is activated (or when there is some indication that the driver is about to steer the vehicle to the left or right).
7. The SCAS crash avoidance warning visual display should indicate the presence of an object in the detection zone by illuminating a red light. No other visual displays in the proximity of the primary visual warning display should be illuminated when a visual warning is being issued.
8. The SCAS visual warning display should indicate that no object is present in the detection zone by turning on an amber light and extinguishing the red light.
9. Whenever the system is powered up and functioning properly either the amber light or the red light, but not both, on the driver warning visual display will be on.
10. The SCAS driver interface should provide a system status display. The system status should be located in the proximity of the crash avoidance warning visual display to provide the driver with an indication of whether or not the system is operating properly in a common, central location (i.e., near the crash avoidance warning visual display). If the crash avoidance warning visual display incorporates an amber-colored light which is illuminated when no vehicle is present in the detection zone, then this type system status light is not needed.
11. An additional system status visual display may be integrated in the vehicle's instrument panel with other common warning lights (e.g., battery voltage). This display should consist of a status light that is normally dark. The status light should illuminate momentarily when the vehicle is turned on and continuously if a system failure is detected.
12. The SCAS driver interface should provide a means for the driver to adjust the volume of the auditory warning display.
13. The SCAS driver interface should provide a means for the driver to adjust the brightness of the visual displays. Although they did not work well in the interfaces examined in this study, automatic adjustment of visual display brightness may be preferred.
14. Manual controls for volume and brightness should be located on the vehicle's instrument panel.
15. While controls are being manipulated by the driver to adjust the volume or brightness of visual or auditory displays, the SCAS interface should momentarily produce a warning signal to provide the operator with feedback regarding the level of the adjusted parameter.

For RCAS, three items of advice listed in Table 5.1 need to be adapted. These items include:

1. The auditory mode appears to be a more important warning mode than the visual mode for RCAS. Except in the case of hearing impaired drivers, it is not clear that rear-looking CAS require visual warnings.
2. It is not clear where the RCAS visual warning display should be located. The recommended SCAS location of on or near the line of sight to a side view mirror is probably not a good location to place a RCAS visual warning display.
3. The system should provide auditory warnings only when the vehicle is in reverse gear. If the RCAS has a visual warning display, it may be desirable to have this operational all of the time.

For rear-looking vision enhancement systems, a standard television interface appears to work well. This type of interface has the advantage that most people are familiar with this type of interface.

All of the above advice to designers is preliminary in that it was generated by the authors' experiences in examining, and driving with, a substantial number of systems.

The third goal of this research was to identify CAS driver interface design issues that should be the focus of future research. A very reasonable focus of future CAS driver interface design research would be to perform a more in-depth investigation of each of the items of advice for SCAS interface designers contained in Table 5.1 plus the three items that are different for RCAS interface designers. This in-depth investigation could include experiments to determine such things as driver reaction times using an interface designed in accordance with the authors' advice versus reaction times for interfaces which are based on different designs. However, it is important to realize that it is difficult to evaluate the driver interface of a CAS which has poor sensor performance. Improvements in sensor design as technologies mature should assist this effort.

The fourth goal of this research was to improve methods for evaluating driver interface designs. While the Human Factors Checklist used for this work was much improved over the original heavy truck version, it was apparent by the end of this project that the revised checklist still had many shortcomings. It is recommended that the Human Factors Checklist be revised based upon the findings of this study and adapted into a better tool for future research of this type.

## 6.0 REFERENCES

- [1] Talmadge, S., Yokoyama, K., Shreve, G., Johnston, S. (1995, In press). Development **of Performance Specifications for Collision Avoidance Systems for Lane Change, Merging, and Backing; Task 3 Interim Report: Test of Existing Hardware Systems.**
- [2] U.S. Department of Transportation, National Highway Traffic Safety Administration. (January, 1994). *A Study of Commercial Motor Vehicle Electronics-Based Rear and Side Object Detection Systems.* (DOT HS 808 075). Washington, D.C.: National Highway Traffic Safety Administration.
- [3] Lemer, N.D., Kotwal, B.M., Lyons, R.D., and Gardner-Bonneau, D.J. (COMSIS Corporation). (October, 1993). **Preliminary Human Factors Guidelines For Crash Avoidance Warning Devices.** (NHTSA Project No. DTNH22-9 1 -C-07004).
- [4] Salvendy, Gavriel(1987). **Handbook of Human Factors.** New York: John Wiley & Sons, Inc.
- [5] Woodson, W.E., Tillman, B., Tillman, P. (1992). **Human Factors Design Handbook 2nd edition.** New York: McGraw-Hill, Inc.