

Moving Beyond Teen Crash Fatality Statistics: The Go-Team Study

Final Report

April 8, 2013

Daniel V. McGehee

Michelle L. Reyes

Cher Carney



Contact information: Dr. Daniel V. McGehee, Human Factors and Vehicle Safety Research Division, University of Iowa, Public Policy Center, 205 South Quadrangle, Iowa City, Iowa 52242; daniel-mcgehee@uiowa.edu; Tel 319-335-6819.

Sponsored by the Iowa Department of Transportation and the Federal Highway Administration

Iowa DOT Project Number: SPR 90-00-GOTM-000

Disclaimer Notice

The contents of this report reflect the views of the authors, who are responsible for the facts and the accuracy of the information presented herein. The opinions, findings, and conclusions expressed in this publication are those of the authors and not necessarily of the sponsors.

The sponsors assume no liability for the contents or use of the information contained in this document. This report does not constitute a standard, specification, or regulation.

The sponsors do not endorse products or manufacturers. Trademarks or manufacturer's names appear in this report only because they are considered essential to the objectives of the document.

Statement of Non-Discrimination

Federal and state laws prohibit employment and/or public accommodation discrimination on the basis of age, color, creed, disability, gender identity, national origin, pregnancy, race, religion, sex, sexual orientation or veteran's status. If you believe you have been discriminated against, please contact the Iowa Civil Rights Commission at 800-457-4416 or Iowa Department of Transportation's affirmative action officer. If you need accommodations because of a disability to access the Iowa Department of Transportation's services, contact the agency's affirmative action officer at 800-262-0003.

| | | | | | |
|--|--|---|--|---|------------------|
| 1. Report No. SPR 90-00-GOTM-000 | | 2. Government Accession No. N/A | | 3. Recipient Catalog No. N/A | |
| 4. Title and Subtitle Moving Beyond Teen Crash Fatality Statistics: The Go-Team Study | | | | 5. Report Date April 8, 2013 | |
| | | | | 6. Performing Organization Code | |
| 7. Author(s) Daniel V. McGehee Michelle L. Reyes Cher Carney | | | | 8. Performing Organization Report No. | |
| 9. Performing Organization Name and Address University of Iowa Human Factors and Vehicle Safety Research Division Public Policy Center 205 South Quadrangle Iowa City, Iowa 52242 | | | | 10. Work Unit No. (TRAIS) N/A | |
| | | | | 11. Contract or Grant No. N/A | |
| 12. Sponsoring Organization Name and Address Iowa Department of Transportation 800 Lincoln Way Ames, Iowa 50010 Federal Highway Administration | | | | 13. Type of Report and Period Covered N/A | |
| | | | | 14. Sponsoring Agency Code SPR 90-00-GOTM-000 | |
| 15. Supplementary Notes | | | | | |
| 16. Abstract Despite a trend of decreasing teen fatalities due to motor vehicle crashes over the past decade, they remain the leading cause of adolescent fatalities in Iowa. The purpose of this study was to create detailed case studies of each fatal motor vehicle crash involving a driver under the age of 20 that occurred in Iowa in 2009, 2010, and 2011. Data for each crash were gathered from media sources, law enforcement agencies, and the Iowa Department of Transportation. The driving records of the teens, which included their licensure history, prior traffic citations, and prior crashes, were also acquired. In addition, data about the charges filed against a teen as a result of being involved in a fatal crash were obtained. A total of 126 crashes involving 131 teen drivers that resulted in 143 fatalities were analyzed. Many findings for fatal crashes involving teen drivers in Iowa are consistent with national trends, including the overrepresentation of male drivers, crash involvement that increases with age, crash involvement per vehicle miles traveled that decreases with age, and prevalence of single-vehicle road departure crashes. Relative to national statistics, teen fatalities from crashes in Iowa are more likely to occur from midnight to 6am and from 9am to noon. Crash type varied by driver age and county population level. Teen drivers contributed to the fatal crashes at a rate of 74%; contribution of the teen driver was unknown for 11% of crashes. Speed was a factor for about 25% of the crashes for which a teen driver was at fault. The same was also true of alcohol/drug impairment. Only 20% of the rear-seat occupants of the teen drivers' vehicles wore seat belts compared to 60% use for the front-seat occupants. Analysis of the teens' driving records prior to the fatal crash suggests at-fault crashes and speeding violations are associated with contributing to the fatal crash. | | | | | |
| 17. Key Words Teen drivers, young drivers, fatal motor vehicle crashes, case studies, graduated drivers licensing | | | 18. Distribution Statement No restrictions. This document is available to the public through the National Technical Information Service, Springfield, Virginia 22161 | | |
| 19. Security Classification (of this report) Unclassified | | 20. Security Classification (of this page) Unclassified | | 21. No. of pages 292 | 22. Price |

Contents

| | |
|---|----|
| Executive summary | 1 |
| Introduction | 3 |
| Purpose and objective | 4 |
| Methodology..... | 4 |
| Data sources..... | 4 |
| Inclusion and exclusion criteria..... | 5 |
| Crash case study summaries..... | 5 |
| Crash maps..... | 5 |
| Results..... | 6 |
| Crashes..... | 6 |
| Driver age and gender..... | 7 |
| Teen at fault..... | 9 |
| Time of day | 10 |
| Day of week..... | 11 |
| Month of year | 12 |
| Time of year | 12 |
| Number of vehicles and occupants involved | 13 |
| Manner of crash or collision | 14 |
| Major cause..... | 16 |
| Contributing factors | 17 |
| Fatalities..... | 18 |
| Teen driver fatalities by age and gender | 19 |
| Teen fatalities by time of day..... | 21 |
| Occupant protection | 22 |
| Ejections..... | 22 |
| Drivers..... | 22 |
| Vehicle type | 23 |
| License type | 23 |
| Teens charged..... | 24 |
| Prior violations on driving record | 25 |
| Discussion | 26 |

| | |
|--|-----|
| Conclusions | 28 |
| References | 28 |
| Appendices: Crash case study summaries | 30 |
| Appendix A: 2009 crashes | 31 |
| Appendix B: 2010 crashes | 115 |
| Appendix C: 2011 crashes | 211 |

Executive summary

Despite a trend of decreasing teen fatalities due to motor vehicle crashes over the past decade, they remain the leading cause of adolescent fatalities in Iowa. The purpose of this study was to combine data from a variety of sources in order to create detailed case studies of each fatal crash involving a driver under the age of 20 that occurred in Iowa in 2009, 2010, and 2011. A total of 126 crashes involving 131 teen drivers that resulted in 143 fatalities were analyzed. Key findings were:

- While the number of teen drivers involved in fatal crashes increased with teen driver age, the rate of fatal crash involvements after controlling for vehicle miles traveled (VMT) decreased with teen driver age.
- Nearly two thirds (63%) of the teen drivers involved in fatal crashes were male. The rate of fatal crash involvement for 16-year-olds after controlling for VMT was 2.5 times higher for males than females (13.6 and 5.3 involvements per 10 billion VMT).
- Teen drivers were found to contribute to 74% of the fatal crashes they were involved in.
- Crashes were most likely to occur in the late afternoon between 2 and 6 pm and during the early morning between 12 and 4 am. Almost 40% of the crashes occurred on weekends. Crashes were least likely to occur during the winter months. Hour of crash occurrence varied greatly depending on type of weekday (weekend or weekday) and time of year (school year or summer).
- Crashes were just as likely to involve a single vehicle as multiple vehicles.
- High vehicle occupancy was associated with single vehicle crashes; in the 32 single vehicle crashes where the teen driver was transporting passengers, two or more passengers were present 72% of the time.
- Single vehicle roadway departures were the most common type of crash, likely due to lack of driving experience for the younger teen drivers and alcohol or drug impairment for the older teen drivers. This type of crash was most likely to occur in the early morning in suburban counties.
- Driving too fast for conditions or speeding contributed to about one fourth of the crashes in which the teen contributed to the crash.
- Alcohol or drug impairment was a factor in about one fourth of all crashes, in 42% of crashes caused by speeding, and in 29% of crashes caused by running off the road.
- Relative to national statistics, teen MVC fatalities in Iowa are more likely to occur from midnight to 6am and from 9am to noon, and are less likely in the early afternoon, evening, and late evening.
- Only half of the occupants in the teens' vehicles (including the driver) were wearing seat belts. Teens in the front seat were buckled up 60% of the time while those in the back seat were buckled up only 20% of the time. More than half the front seat occupants who were unbelted experienced fatal injuries compared to less than a third of those who were using seat belts.
- There was an association between prior crashes and prior speeding violations and the teen being at fault in the fatal crash.

The most common type of crash was single-vehicle road departure and these crashes most often occurred in the early morning hours. The most common elements present when a teen driver contributed to a fatal crash were driving too fast for conditions/speeding and driving while impaired by alcohol and/or drugs. Motivating teens to refrain from driving when impaired by drugs or alcohol or riding with impaired drivers, to drive at appropriate speeds, and to buckle up every time they drive or ride in a vehicle continue to be the primary challenges to reducing teen MVC fatalities. Younger teen drivers have higher rates of fatal crash involvements after controlling for the amount they drive and most of their crashes are road departures, which may be indicative of inexperience. Encouraging families to increase the amount of driving that teens do under supervision and to restrict driving to limited, lower-risk situations (e.g., driving only from school to home in daylight hours) when teens first drive independently may help reduce the rate of fatal crash involvements for 15-, 16-, and even 17-year-old drivers. Limiting the number of passengers these new drivers can transport can also reduce fatalities. Working to curb poor driving habits after a teen receives a speeding or non-speeding traffic violation or is involved in an at-fault crash may also help to prevent subsequent fatal crash involvement.

Introduction

Fatal crash involvement of teen drivers has been the focus of much attention and research over the past 30 years. Despite dramatic decreases in motor vehicle crash (MVC) fatalities for teenagers since they peaked at nearly 10,000 fatalities per year in the late 1970s, MVCs remain the leading cause of injury and death among American teenagers. From 2000 to 2008, more than 23,000 drivers and 14,000 passengers aged 16 to 19 years were killed in car crashes (National Highway Traffic Safety Administration, 2010). In 2007, MVCs caused 37% of all 16- and 17-year-old deaths and 34% of all 18- and 19-year-old deaths in the US (Insurance Institute for Highway Safety, 2009).

Beginning in the late 1990s, new policies collectively termed graduated driver licensing (GDL) started to emerge. The goal of GDL policies is to allow new drivers to drive in situations with the least amount of risk, and then as they gain experience, progressively increase exposure to higher risk situations. GDL systems vary from state to state but generally consist of 3 phases: driving with a permit and adult supervisor in the vehicle, provisional or intermediate license with some restrictions, and full license.

Implemented in 1999, Iowa's GDL system, which only applies to drivers under 18 years old, includes the following components (Iowa Department of Transportation):

- Eligible for an instruction permit at age 14, may not drive without adult supervision
- Eligible for an intermediate license at age 16 after
 - holding an instruction permit for at least 6 months
 - successfully completing an approved driver's education course
 - completing 20 hours of supervised driving
 - being crash-free and violation-free for the last 6 months
- With intermediate license the teen may not drive between 12:30 am and 5 am without supervision or a waiver
- Eligible for full license after being crash-free and violation-free for 12 months with the intermediate license

Iowa's GDL system has been somewhat effective at reducing fatal crash involvements for teen drivers, as shown in Figure 1. The number of teen drivers involved in fatal MVCs has fallen by more than 30 percent since 2001. An analysis by Neyens, Donmez, and Boyle (2008) reviewed data for all crashes reported to law enforcement involving teen drivers and determined that Iowa's GDL system had reduced crash involvement for 16- and 17-year-old drivers but not for 18-year-old drivers.

A national review of GDL systems (McCartt, Teoh et al., 2010) concluded that strong nighttime restrictions and limits on the number of passengers a newly-licensed driver could have in their vehicle were the components most strongly associated with reductions in fatal crash involvements. Iowa's GDL system does not have either of these components.

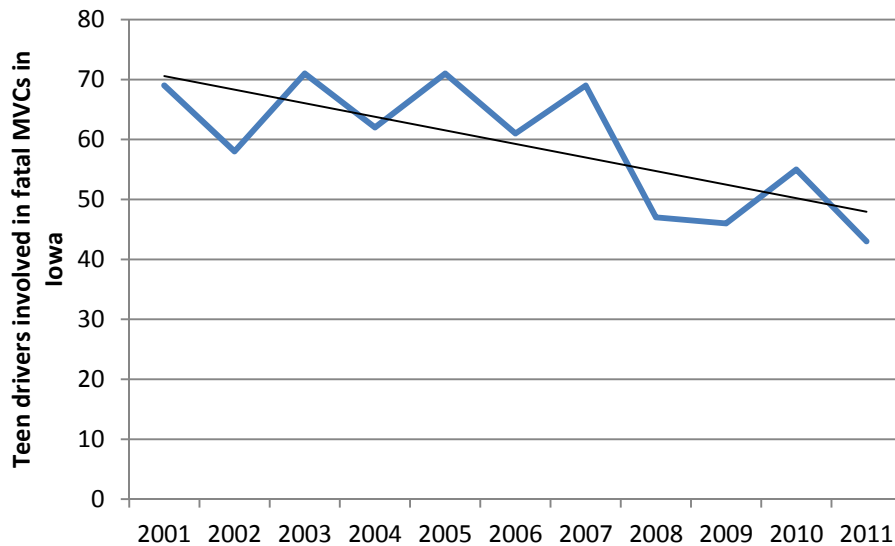

Figure 1. Teen driver fatal crash involvements (and trend) in Iowa from 2001 to 2011.

Purpose and objective

The purpose of this study was to take a closer look at each fatal crash in Iowa involving a teen driver in 2009, 2010, and 2011. This analysis goes beyond the typical analysis of fatal crashes as it includes detailed case study information on each crash. Data for each crash were gathered from media sources, law enforcement agencies, and the Iowa Department of Transportation. The driving records of the teens, which included their licensure history, prior traffic citations, and prior crashes, were also acquired. In addition, data about the charges filed against a teen as a result of being involved in a fatal crash were obtained from media sources, their driving record, and the Iowa court system (accessed through Iowa courts online). A database of crash and driver data was created for each year and used to create a detailed case study for each crash.

Methodology

Data sources

In order to receive early notification about fatal crashes involving teen drivers, an extensive set of automated Internet searches with email notifications were implemented. Additionally, the electronic crash reports posted online by the Iowa State Patrol were closely monitored. As soon as the team was aware of a new crash, it was entered into the crash database. As new media reports or crash reports became available, the information in the database was updated. When the project entered its second year, weekly reports of MVC fatalities compiled by the Iowa DOT were also received. During the second year driving records and court records were added as data sources. Initial efforts to be in contact with law enforcement as they conducted their crash investigations were not successful due to issues related to the potential for litigation. Because there was a possibility for criminal charges in each of these cases, formal communication was limited.

Inclusion and exclusion criteria

In order to be included in this analysis the crash had to

- occur within the State of Iowa on or after January 1, 2009, and before or on December 31, 2011
- result in at least one fatality
- the driver of at least one vehicle involved in the crash was not yet 20 years old and was operating a passenger vehicle or motorcycle

Crashes in which the teen driver was operating a non-passenger vehicle (i.e., moped, ATV, farm equipment, or golf cart) were excluded. Crashes were also excluded if the teen driver was not directly involved in the fatal crash (i.e., the teen's vehicle was in a secondary collision that occurred subsequent to the collision causing the fatality).

Crash case study summaries

A standard case study template was developed to present the data gathered for each crash. The case study for each fatal crash includes:

- time, day, date, location, road type, and manner of crash or collision for each fatal crash
- a matrix representing each vehicle, describing the age, gender, seating position, fatality/injury outcome, ejection status, and seat belt status of each occupant
- license status for each teen driver
- crash narrative, contributing factors, and other factors that could have had a potential impact on the crash
- reporting agency
- whether the teen was at fault (i.e., had contributed to the crash), their license history, criminal charges and outcome, civil litigation and outcome
- crash diagram/map

Information the case studies was last updated in May 2012. Case studies for all the crashes in 2009, 2010, and 2011 can be found in Appendices A, B, and C, respectively.

Crash maps

Using Google maps, the location of each crash was mapped. The color of the location marker indicates the manner of crash/collision while the shape of the marker indicates whether the teen was at fault for the crash. Each crash identifier on the map includes the year, month, day, time, year-to-date crash number assigned by the IDOT, age and gender of the teen driver, number of vehicles involved, and number of fatalities. There is also a brief description of each crash. The URLs for the three crash maps will be shared with IDOT contact(s) or made public upon request. A screen shot from a portion of the 2011 crash map can be seen in Figure 2.

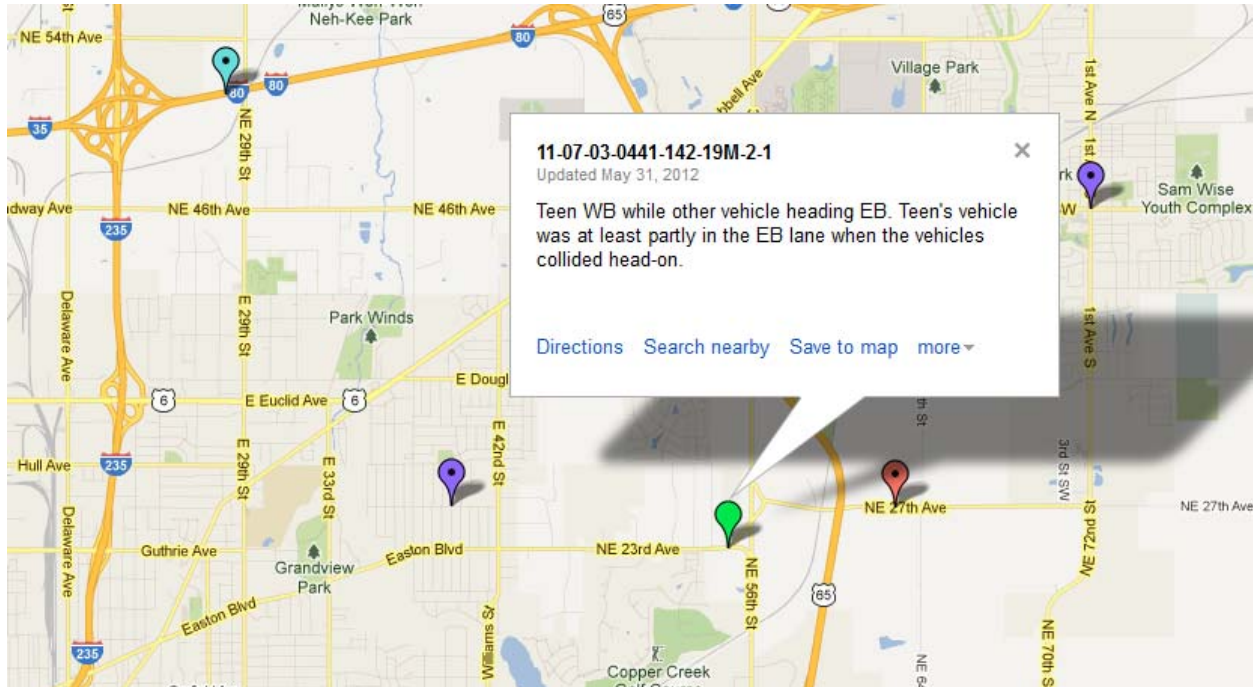

Figure 2. A screen shot from the 2011 crash map created using Google maps.

Results

Except where otherwise noted, any reference to “crashes” or “fatal crashes” refers to all fatal crashes in the State of Iowa involving teen drivers in 2009, 2010, and 2011, i.e., crashes that were the specific focus of this analysis. Analyses based on crashes, fatalities, and drivers were conducted.

Crashes

There were a total of 126 fatal crashes involving teen drivers in Iowa from 2009-2011. A total of 131 teen drivers and 72 non-teen drivers were involved in these crashes. All vehicle occupants (i.e., all drivers and passengers) totaled 370, and 11 non-motorists (8 pedestrians, 1 bicyclist, and 2 teens riding on the exterior of the vehicle) were involved. The crashes resulted in 143 fatalities and 52 major injuries. Table 1 shows these crash statistics for each of the three years considered in this study. In 2010 there were more crashes involving more drivers, more fatalities, and slightly more major injuries compared to both 2009 and 2011. However, motor vehicle crash (MVC) fatalities were up across the board in 2010, and the proportion of all MVC fatalities in the state as a results from crashes involving teen drivers has remained fairly consistent over the years analyzed: 12.4%, 13.8%, and 11.8% for 2009, 2010, and 2011 respectively.

Table 1. Fatal crashes involving teen drivers in Iowa from 2009 – 2011

| | 2009 | 2010 | 2011 | Total |
|--------------------------------------|-------------|-------------|-------------|--------------|
| Number of crashes | 41 | 47 | 38 | 126 |
| Number of teen drivers involved | 42 | 51 | 38 | 131 |
| Number of other drivers involved | 22 | 27 | 23 | 72 |
| Number of vehicle occupants involved | 115 | 138 | 117 | 370 |
| Number of non-motorists | 4 | 4 | 3 | 11 |
| Number of people with fatal injuries | 46 | 54 | 43 | 143 |
| Number of people with major injuries | 17 | 19 | 16 | 52 |

Driver age and gender

Fatal crash involvement for teen drivers varied by both age and gender. The number of teen drivers involved in fatal crashes increased steadily by driver age (see Figure 3), from twelve 15-year-old drivers up to 39 drivers who were 19 years old. A key factor in assessing the increase in crashes with age is exposure—with increasing age, teens drive more which puts them at greater risk for a crash. Therefore, some sort of adjustment for exposure is needed to put these crash counts into context. Because state-level exposure data for teen drivers are difficult to come by, data from the U.S. Department of Transportation’s 2009 National Household Travel Survey (NHTS) were used to estimate the rate of teen driver involvement in fatal MVCs in Iowa by age and exposure. The number of teen drivers involved at each age was divided by the annual vehicle miles traveled (VMT) for each age and scaled by 10,000 (i.e., crash involvement in Iowa per 10 billion VMT nationally). The fatal crash involvement adjusted for exposure was highest for 15-year-old drivers (10.6 involvements annually per 10B VMT) and steadily decreased over the next three years of driver age to level out at about 3.5 involvements annually for drivers ages 18 and 19 (see Figure 5).

Teen driver involvement in fatal crashes differed greatly by gender. Of the 131 teen drivers involved in fatal crashes, 83 (63%) were male. Nationally, 69.5% of young drivers age 20 and younger involved in fatal crashes in 2010 were male (National Highway Traffic Safety Administration, 2012). There is also an interaction of age with gender. Male drivers comprised 71%, 65% and 74% of the 16-, 18-, and 19-year-old drivers but only 42% and 52% of the 15- and 17-year-old drivers involved in fatal crashes (see Figure 4).

With the exception of 16-year-olds, there are not large gender differences by age in the adjusted teen driver crash involvements. Involvements for 16-year-old females were 5.3 per 10B VMT while involvements for males were more than twice that at 13.6.

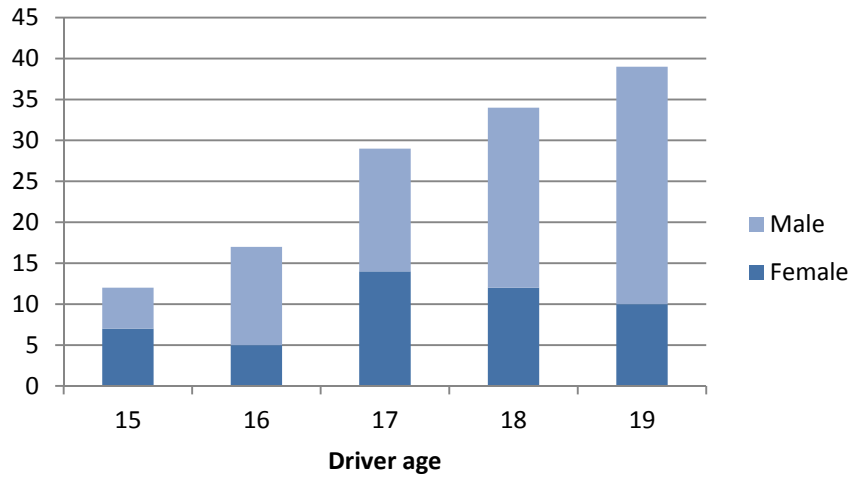

Figure 3. The number of teen drivers involved in fatal crashes by driver age and gender.

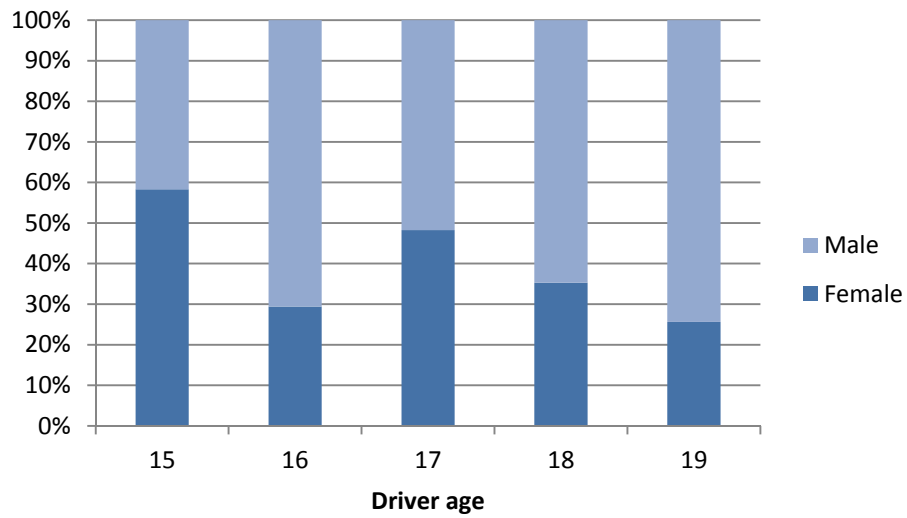

Figure 4. Proportion of teen drivers involved in fatal crashes by driver age and gender.

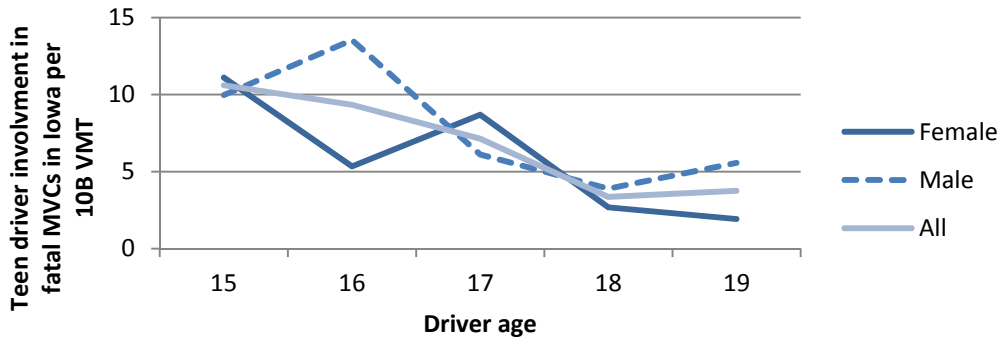

Figure 5. Average annual teen driver involvement in fatal MVCs in Iowa (2009-2011) per 10 billion vehicle miles traveled nationally (as estimated by the 2009 National Household Transportation Survey)

Teen at fault

The specific circumstances of each crash in this dataset were considered to determine whether the teen driver(s) involved contributed or did not contribute to the crash. If the teen was charged or if contributing circumstances were attributed to the teen driver, they were considered to have contributed. Unless the data specified external contributing circumstances (e.g., winter weather conditions or an animal in the roadway), all single-vehicle crashes were attributed to the teen driver. If no improper action was recorded on the part of the teen driver, the teen was classified as not contributing to the crash. If other external contributing circumstances existed, it was “unclear” if the teen driver’s actions contributed to the crash.

The teen drivers were determined to have contributed to the crash 74% of the time. About 15% of the time the teen driver did not contribute to the crash and about 11% of the time it was unclear whether the teen driver’s actions contributed to the crash. Five of the 13 crashes with unclear driver contribution involved collisions with pedestrians and four involved loss of vehicle control under winter road conditions.

Crash contribution was also considered by age of the teen driver. Figure 6 shows the proportion of teen drivers at each age by category of contribution. No clear patterns of age emerged, but a notable increase occurred between age 15 (67% of teen drivers this age contributed to the fatal crashes they were involved in) and ages 16 and 17 (82% and 79% contributed, respectively) before decreasing again at age 18 (68% contributed). A nationwide analysis of fatal single- and two-vehicle crashes from 1996-2000 found that young drivers age 16-19 were responsible for the crashes 80-86% of the time, more often than drivers age 20-69 (Williams and Shabanova, 2003). In this analysis, 75% of the drivers age 16-19 contributed to their crashes with contribution of another 12% of these drivers being unclear. (Charges against teen drivers as a result of crash contribution will be addressed later in this report.)

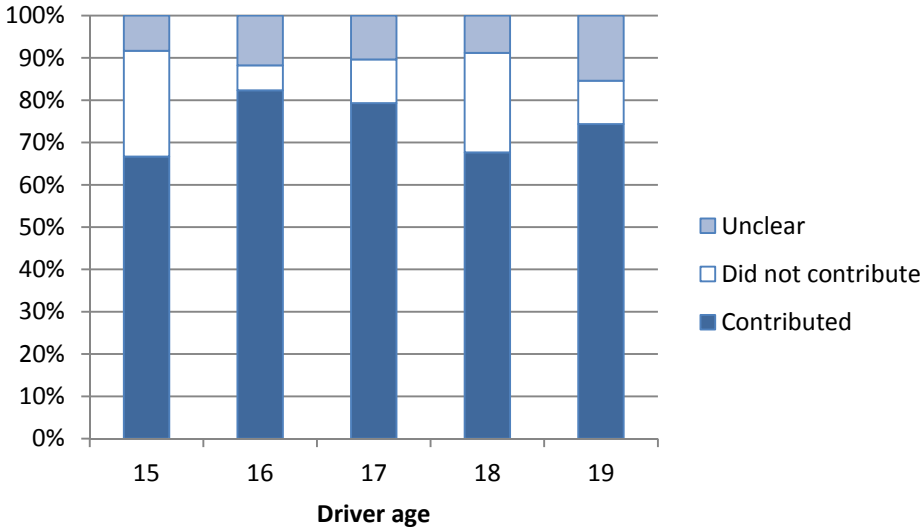

Figure 6. Proportion of teen drivers contributing to fatal crashes by age.

Time of day

Crashes most often occurred between the hours of 2 and 6 pm (also the hours that the most teens are on the road, according to the 2009 NHTS) and accounted for 23% of the crashes in this analysis (see Table 2). A slightly smaller peak in crashes occurred between 12 and 4 am and accounted for almost 20% of the crashes. The early morning crashes are significant since there are so few teen drivers on the road at that time; the 2009 NHTS data indicate that less than 2% of VMT by teens nationally occur during these hours. Figure 7 clearly illustrates the discrepancy. Crashes were least likely to occur in the early afternoon between noon and 2 pm.

Table 2. Number and percent of fatal crashes involving teen driver by time of day. 1000 vehicle miles traveled (VMT) annually by drivers age 14-19 as reported in the 2009 National Household Travel Survey.

| Time of day | Number of crashes | Percentage of crashes | 1000 VMT by teen drivers | Percentage of driving |
|-------------|-------------------|-----------------------|--------------------------|-----------------------|
| 12a-2a | 12 | 9.5% | 1178 | 1.3% |
| 2a-4a | 13 | 10.3% | 333 | 0.4% |
| 4a-6a | 9 | 7.1% | 1885 | 2.1% |
| 6a-8a | 9 | 7.1% | 8468 | 9.2% |
| 8a-10a | 9 | 7.1% | 6804 | 7.4% |
| 10a-12p | 11 | 8.7% | 7949 | 8.7% |
| 12p-2p | 5 | 4.0% | 11391 | 12.4% |
| 2p-4p | 14 | 11.1% | 13308 | 14.5% |
| 4p-6p | 15 | 11.9% | 13929 | 15.2% |
| 6p-8p | 8 | 6.3% | 11567 | 12.6% |
| 8p-10p | 11 | 8.7% | 8502 | 9.3% |
| 10p-12a | 10 | 7.9% | 6259 | 6.8% |

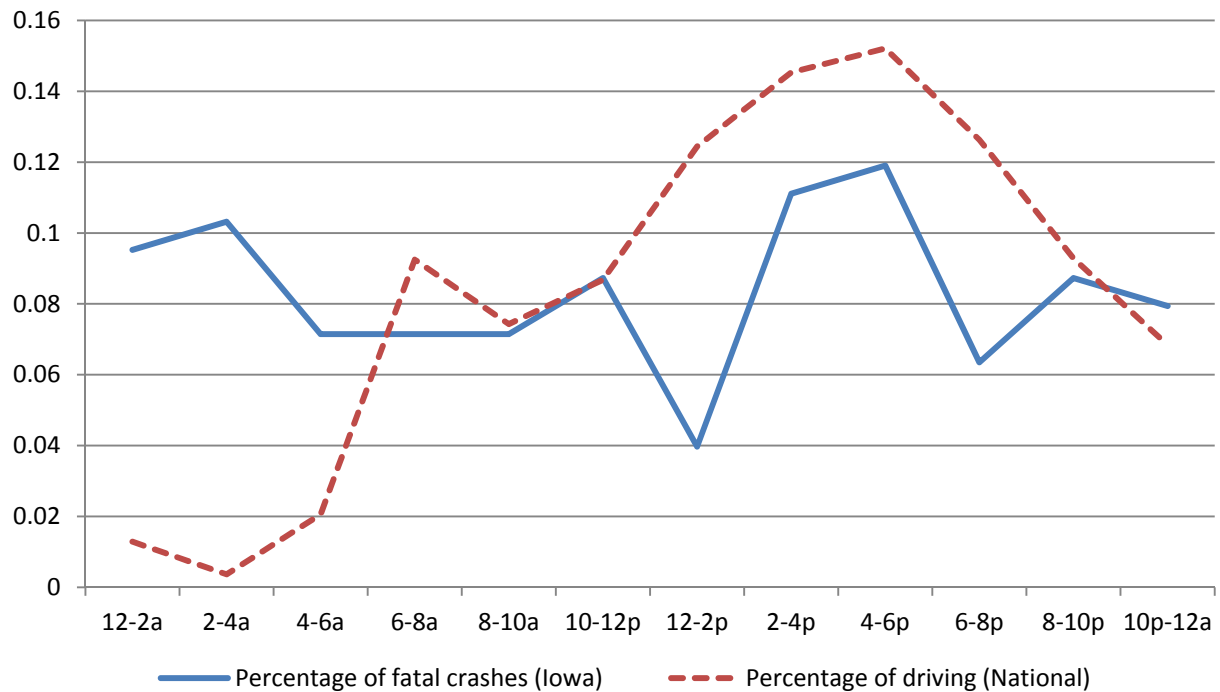

Figure 7. Percentage of fatal crashes compared to percentage of teen driving over time of day. Driving time is defined by the 2009 NHTS as vehicle miles traveled (VMT) for drivers age 14-19.

Day of week

Table 3 shows the distribution of the fatal crashes across the days of the week. Almost 40% of the fatal crashes occurred on weekend days. About one-fifth of the crashes occurred on Saturdays and another 19% occurred on Sundays. Crashes occurred slightly less on Wednesdays and Fridays compared to Mondays, Tuesdays, and Thursdays.

Table 3. Number and percent of crashes occurring by day of week.

| Day of Week | Number of crashes | % |
|-------------|-------------------|-------|
| Monday | 17 | 13.5% |
| Tuesday | 18 | 14.3% |
| Wednesday | 12 | 9.5% |
| Thursday | 17 | 13.5% |
| Friday | 13 | 10.3% |
| Saturday | 25 | 19.8% |
| Sunday | 24 | 19.0% |

Month of year

Table 4 shows the distribution of the crashes across month of the year for each year 2009-2011 and overall. Fatal crashes involving teen drivers most often occurred in August (almost 16%) and May (13.5%). Crashes were least likely to occur in winter months of December (4.8%), January (2.4%), February (5.6%), and March (5.6%). August 2010 was a by far the worst month in this analysis with 11 fatal crashes. May and November of 2010 each had 7 crashes.

Table 4. Number and percent of crashes occurring by month and by year.

| | 2009 | 2010 | 2011 | Total | Percent |
|-----------|------|------|------|-------|---------|
| January | 0 | 1 | 2 | 3 | 2.4% |
| February | 3 | 1 | 3 | 7 | 5.6% |
| March | 2 | 3 | 2 | 7 | 5.6% |
| April | 5 | 2 | 2 | 9 | 7.1% |
| May | 6 | 7 | 4 | 17 | 13.5% |
| June | 6 | 1 | 3 | 10 | 7.9% |
| July | 6 | 5 | 4 | 15 | 11.9% |
| August | 4 | 11 | 5 | 20 | 15.9% |
| September | 3 | 2 | 5 | 10 | 7.9% |
| October | 2 | 4 | 3 | 9 | 7.1% |
| November | 2 | 7 | 4 | 13 | 10.3% |
| December | 2 | 3 | 1 | 6 | 4.8% |

Time of year

A more detailed analysis was completed to determine during what combination of hour of day, day of week, and time of year fatal crashes were most likely to occur. For this analysis a crash was classified as a “weekend” crash if it occurred between 6 pm on Friday and 6 pm on Sunday. The total number of crashes during the one-hour time bin was divided by the applicable number days in the week (i.e., 2 for weekend, 5 for weekday, and 7 for overall) and then scaled to account for the applicable number of months in the time of year (12 for all year, 9 for school year, and 3 for summer). The resulting rates for all combinations of hour of day, day of week, and time of year are show in Table 5. It is important to note that these rates are calculated by weighting for time and not actual exposure (i.e., driving time).

The highest rate of crashes for the three years analyzed occurred on summer weekends in the 4 pm hour. Several other time windows tied for the second most-frequent rate of crashes on summer weekends: the 2 am, 4 am, and 10 pm hours. The highest rate of crashes in the school year is seen during the 1 am and 2 am hours on weekends. On weekdays during the school year, the 7 am and 9 pm hours have the highest crash rate. It is interesting to note that, at least in this data set, the rate of fatal crashes was quite high for the 4 pm hour during the summer but not during the school year. Historically, the dismissal from school is associated with a peek in fatal crashes (i.e., Williams, 2003) but that does not seem to be the trend for recent fatal crashes involving teen drivers in Iowa. In summary, the rate of fatal crashes involving teen drivers varies greatly by time of year and type of weekday.

Table 5. Rate of crashes by hour of day, day of week, and time of year. Rates greater than 2.00 are bolded; maximum rate in each column is noted with an asterisk.

| Hour | All year round | | | School year (Sept. – May) | | | Summer (June – Aug.) | | |
|------|----------------|---------|---------|---------------------------|---------|---------|----------------------|--------------|--------------|
| | Weekend | Weekday | Overall | Weekend | Weekday | Overall | Weekend | Weekday | Overall |
| 12a | 1.50 | 0.20 | 0.57 | 1.33 | 0 | 0.38 | 2.00 | 0.80 | 1.14 |
| 1a | 2.50 | 0.60 | 1.14 | 3.33* | 0.27 | 1.14 | 0 | 1.60 | 1.14 |
| 2a | 3.00* | 0.40 | 1.14 | 2.67 | 0.53 | 1.14 | 4.00 | 0 | 1.14 |
| 3a | 1.50 | 0.40 | 0.71 | 2.00 | 0 | 0.57 | 0 | 1.60 | 1.14 |
| 4a | 1.50 | 0.80 | 1.00 | 0.67 | 0.80 | 0.76 | 4.00 | 0.80 | 1.71 |
| 5a | 0 | 0.40 | 0.29 | 0 | 0.27 | 0.19 | 0 | 0.80 | 0.57 |
| 6a | 0.50 | 0.20 | 0.29 | 0 | 0.27 | 0.19 | 2.00 | 0 | 0.57 |
| 7a | 0.50 | 1.20* | 1.00 | 0.67 | 1.60* | 1.33* | 0 | 0 | 0 |
| 8a | 0 | 1.00 | 0.71 | 0 | 0.53 | 0.38 | 0 | 2.40 | 1.71 |
| 9a | 0 | 0.80 | 0.57 | 0 | 0.53 | 0.38 | 0 | 1.60 | 1.14 |
| 10a | 0 | 0.60 | 0.43 | 0 | 0.80 | 0.57 | 0 | 0 | 0 |
| 11a | 2.00 | 0.80 | 1.14 | 2.00 | 0.53 | 0.95 | 2.00 | 1.60 | 1.71 |
| 12p | 0.50 | 0.40 | 0.43 | 0.67 | 0.27 | 0.38 | 0 | 0.80 | 0.57 |
| 1p | 0 | 0.40 | 0.29 | 0 | 0.53 | 0.38 | 0 | 0 | 0 |
| 2p | 2.00 | 0.40 | 0.86 | 2.00 | 0.53 | 0.95 | 2.00 | 0 | 0.57 |
| 3p | 1.50 | 1.00 | 1.14 | 1.33 | 0.80 | 0.95 | 2.00 | 1.60 | 1.71 |
| 4p | 2.00 | 1.00 | 1.29* | 0.67 | 0.27 | 0.38 | 6.00* | 3.20* | 4.00* |
| 5p | 0.50 | 1.00 | 0.86 | 0.67 | 1.07 | 0.95 | 0 | 0.80 | 0.57 |
| 6p | 0 | 0.60 | 0.43 | 0 | 0 | 0 | 0 | 2.40 | 1.71 |
| 7p | 0.50 | 0.80 | 0.71 | 0 | 0.80 | 0.57 | 2.00 | 0.80 | 1.14 |
| 8p | 0.50 | 0.60 | 0.57 | 0.67 | 0.27 | 0.38 | 0 | 1.60 | 1.14 |
| 9p | 1.00 | 1.00 | 1.00 | 1.33 | 1.33 | 1.33* | 0 | 0 | 0 |
| 10p | 1.50 | 0.40 | 0.71 | 0.67 | 0.53 | 0.57 | 4.00 | 0 | 1.14 |
| 11p | 1.00 | 0.60 | 0.71 | 0.67 | 0.53 | 0.57 | 2.00 | 0.80 | 1.14 |

Number of vehicles and occupants involved

Table 6 shows the number of occupants in the teen’s vehicle by the number of vehicles involved. The crashes were evenly divided into single-vehicle and multiple-vehicle crashes. Of the 126 crashes in this analysis, 62 (49%) involved a single vehicle while 64 (51%) involved two or more vehicles. Nationally, just over 60% of all fatal crashes in 2009 and 2010 (regardless of driver age) involved a single vehicle (National Highway Traffic Safety Administration, 2010; 2012).

In 67 (51%) of the 131 teen vehicles, the teen driver was the only occupant; in 25 (19%) teen vehicles there was one passenger, and in 39 (30%) there were two or more passengers. For the 32 single-vehicle crashes in which the teen driver had passengers on board, more than one passenger was present 72% of the time. While exposure data are not available here to calculate the increased risk due to carrying passengers, an analysis using data from 2007-2010 estimates that 16-17 year olds increase their risk of a fatal crash by 44% when carrying one passenger under the age of 21, double their risk with two passengers, and quadruple their risk with three passengers (Tefft, Williams et al., 2012). An analysis of Michigan crash data found that male and female teen drivers were about 13 and 6.5 times more likely to

have a road departure crash when carrying passengers than male and female adult drivers, respectively (Bingham, Shope et al., 2007).

Table 6. Number of occupants in the teens' vehicles by number of vehicles involved in the crash.

| | Number of crashes | Occupants in teen's vehicle | | |
|-------------------|-------------------|-----------------------------|--------------------------|------------------------------------|
| | | Driver only | Driver and one passenger | Driver and more than one passenger |
| Single vehicle | 62 | 30 | 9 | 23 |
| Multiple vehicles | 64 | 37 | 16 | 16 |
| Total number | 126 | 67 | 25 | 39 |
| Percent | | 51% | 19% | 30% |

Manner of crash or collision

Each crash was classified as one of eight manners of crash or collision, i.e., crash types. The most frequent type of crash was road departure, accounting for fifty-two of 126 crashes (41%). The next most common crash types were broadside collision with 29 crashes (23%) and head-on collision with 16 crashes (13%). The other crash types were collision with non-motorist, rear-end collision, angle collision with oncoming traffic, and sideswipe crashes with traffic travelling in the same and opposite directions (see Table 7 for counts and percentages).

Manner of crash or collision by driver age and gender

Crash type was analyzed by teen driver age (see Table 7). Road departure crashes accounted for 55% and 60% of all crashes involving 15 and 16 year old drivers. One third of all 17-year-olds and one fourth of 18-year-olds had roadway departures. Previous research has shown that the rate of road departure crashes decreases substantially as new drivers gain experience (Sagberg, 1998; Mayhew, Simpson et al., 2003). Surprisingly this trend was not true for the oldest drivers in this analysis: the proportion of road departures accounted for nearly half of all the crashes involving 19-year-old drivers. A closer look revealed that for the older teens, alcohol or drugs were related to half of the road departure crashes (4 out of 8 road departures for the 18-year-olds and 10 out of 19 road departures for the 19-year-olds).

The second most common crash type, broadside (right angle) collision between two vehicles, accounted for about one quarter of the crashes and was represented across the teen driver ages quite uniformly.

More than half the head-on crashes involved drivers who were 18 years old. A potential explanation for this could not be found; no pattern of alcohol use, distraction, speeding, reckless or other reason was present.

Crash type also varied by teen driver gender. Considering that only 37% of the teen drivers involved in these crashes were female, young women were overrepresented in head-on (59%), sideswipe same direction (57%), and rear-end (56%) crashes.

Table 7. The number and percent of crashes by type and by driver age.

| | Driver age (% of each crash type within driver age) | | | | | Total (%) |
|------------------------------|---|---------|----------|---------|----------|-----------|
| | 15 | 16 | 17 | 18 | 19 | |
| Road departure | 6 (55%) | 9 (60%) | 10 (37%) | 8 (24%) | 19 (49%) | 52 (41%) |
| Collision with non-motorist | 0 | 1 (7%) | 2 (7%) | 3 (9%) | 5 (13%) | 11 (9%) |
| Head-on | 2 (18%) | 0 | 2 (7%) | 9 (26%) | 3 (8%) | 16 (13%) |
| Rear-end | 1 (9%) | 0 | 2 (7%) | 2 (6%) | 1 (3%) | 6 (5%) |
| Angle oncoming traffic | 0 | 0 | 2 (7%) | 1 (3%) | 0 | 3 (2%) |
| Broadside | 2 (18%) | 4 (27%) | 7 (26%) | 8 (24%) | 8 (21%) | 29 (23%) |
| Sideswipe same direction | 0 | 0 | 1 (4%) | 0 | 1 (3%) | 2 (2%) |
| Sideswipe opposite direction | 0 | 1 (18%) | 1 (4%) | 3 (9%) | 2 (5%) | 7 (5%) |
| Total | 11 | 15 | 27 | 34 | 39 | 126 |

Manner of crash or collision by time of day

Crash type was analyzed by time of day. Table 8 shows the results. While road departure crashes occurred around the clock, a significant proportion took place between 12am and 6am (23 of 52 crashes or 44%). Two thirds of all crashes between 12am and 6am were road departures. The analysis of Michigan crash data found that male and female teen drivers were 9 and 6 times more likely to have a fatal nighttime road departure crash than male and female adult drivers, respectively (Bingham et al., 2007). Although the 3pm to 6pm and the 9pm to 12am time bins had more crashes than most of the other time bins, in terms of proportion, relatively few crashes during these time periods were road departures.

Broadside collisions were proportionally more likely between 9 am and 3 pm and less likely between 6 pm and 12 am. Proportionally, head-on crashes were somewhat more common in the mornings from 6am to 12pm. Collisions with non-motorists mostly occurred after 3pm with 5 of the 11 collisions occurring between 9pm and 12am.

Table 8. Manner of crash or collision by time of day.

| | 12am-3am | 3am-6am | 6am-9am | 9am-12pm | 12pm-3pm | 3pm-6pm | 6pm-9pm | 9pm-12am | Total |
|------------------------------|----------|---------|---------|----------|----------|---------|---------|----------|-------|
| Road departure | 14 | 9 | 4 | 6 | 4 | 5 | 6 | 4 | 52 |
| Collision with non-motorist | 1 | 0 | 1 | 0 | 0 | 2 | 2 | 5 | 11 |
| Head-on | 0 | 1 | 3 | 3 | 2 | 2 | 2 | 3 | 16 |
| Rear-end | 0 | 1 | 0 | 0 | 0 | 3 | 0 | 2 | 6 |
| Angle oncoming traffic | 1 | 0 | 0 | 0 | 0 | 1 | 1 | 0 | 3 |
| Broadside | 4 | 2 | 4 | 5 | 5 | 6 | 1 | 2 | 29 |
| Sideswipe same direction | 0 | 0 | 0 | 1 | 0 | 1 | 0 | 0 | 2 |
| Sideswipe opposite direction | 0 | 1 | 2 | 0 | 0 | 3 | 0 | 1 | 7 |
| Total | 20 | 14 | 14 | 15 | 11 | 23 | 12 | 17 | 126 |

Manner of crash or collision by county class

Crash type was also categorized by the population of the county in which it occurred (see Table 9). “Urban” counties consisted of 9 most populous counties in Iowa (according to 2008 population estimates), each with a population greater than 85,000. “Suburban” counties have between 20,000 and 60,000 people, and counties with fewer than 20,000 people were classified as “rural.”

Road departures accounted for nearly 57% of the fatal crashes in suburban counties but only about 35% of the crashes in urban and rural counties. Broadside crashes accounted for about one quarter of the rural (28%) and urban (24%) crashes and about one of every six (16%) suburban crashes. Head-on crashes accounted for about one fifth (19%) of the rural crashes but only 11% and 9% of the rural and urban crashes, respectively. Two-thirds of the rear-end crashes (4 of 6) occurred in urban counties and half of the head-on collisions (4 of 8) occurred in rural counties.

When the number of total crashes in each county category is weighted by the total population in the category, rural counties had 5.5 fatal crashes involving teen drivers per 100,000 people compared to 4.6 for suburban and 3.2 for urban counties.

Table 9. Manner of crash or collision by county class.

| | Urban (%) | Suburban (%) | Rural (%) | Total (%) |
|---|-----------|--------------|-----------|-----------|
| Road departure | 16 (35%) | 21 (57%) | 15 (35%) | 52 (41%) |
| Collision with non-motorist | 5 (11%) | 2 (5%) | 4 (9%) | 11 (9%) |
| Head-on | 4 (9%) | 4 (11%) | 8 (19%) | 16 (13%) |
| Rear-end | 4 (9%) | 1 (3%) | 1 (2%) | 6 (5%) |
| Angle oncoming traffic | 2 (4%) | 0 | 1 (2%) | 3 (2%) |
| Broadside | 11 (23%) | 6 (16%) | 12 (28%) | 29 (23%) |
| Sideswipe same direction | 1 (2%) | 1 (3%) | 0 | 2 (2%) |
| Sideswipe opposite direction | 3 (7%) | 2 (5%) | 2 (5%) | 7 (5%) |
| Total crashes per county category | 46 | 37 | 43 | 126 |
| Total population in each county category* | 1426167 | 799426 | 776962 | 3002555 |
| Fatal crashes involving teen drivers per 100,000 people | 3.23 | 4.63 | 5.53 | 4.20 |

*2008 population estimates

Major cause

Law enforcement can designate one of more than 40 categories as the major cause of the crash. Major causes of the crashes in which the teen was determined to have contributed were tabulated and similar categories were combined. The results can be found in Table 10. Driving too fast for conditions or exceeding authorized speed was the primary cause of one quarter of the crashes. Running off the road accounted for about one fifth of the crashes and crossing the centerline or driving on the wrong side of the road was cited as the major cause for fourteen of the crashes. Additional major causes cited were: swerving or evasive action, failure to yield from a stop sign, running a traffic signal or stop sign, and failure to yield across a variety of categories. Alcohol or drug impairment was a major factor in one

quarter of all crashes, particularly crashes caused by driving too fast or speeding (10 out of 24 crashes with this cause) and running off road (7 out of 20 crashes).

Table 10. Major cause of fatal crashes in which the teen contributed to the crash

| Major cause of crash when teen contributed to the crash | Number of crashes (%) | Crashes involving alcohol or drugs |
|--|------------------------------|---|
| driving too fast for conditions/speeding | 24 (24.7%) | 10 |
| running off road | 20 (20.6%) | 7 |
| crossed centerline/wrong side of road | 14 (14.4%) | 3 |
| swerving/evasive action | 9 (9.3%) | 2 |
| FTYROW* from stop sign | 9 (9.3%) | |
| ran traffic signal/stop sign | 7 (7.2%) | 1 |
| FTYROW* other category | 7 (7.2%) | |
| loss of control/overcorrecting | 4 (4.1%) | 1 |
| reckless/car surfing | 3 (3.1%) | |
| Total | 97 | 24 |

*FTYROW = failure to yield right of way

Contributing factors

The crash report form requires the investigating officer to identify only one major cause but there are other fields to identify other contributing factors. Each crash was coded for a number of contributing factors: speeding, recklessness, alcohol and/or drugs, and distraction.

Speeding and recklessness

Speeding was a factor in 33 (26%) of the crashes. Recklessness was a factor in 19 (15%) crashes; 13 of these also involved speeding.

An analysis of the 2010 crash data (National Highway Traffic Safety Administration, 2012) reported that 16% of all motor vehicle crash fatalities in Iowa in 2010 involved speeding. In this analysis 34 of 143 fatalities or 24% involved speeding which suggests that speeding is a greater factor in fatal crashes for young drivers than it is for the general driving population in Iowa.

Alcohol or drugs

Of the 97 crashes that the teen drivers contributed to, the teen driver was under the influence of alcohol and/or drugs for 24 crashes (25%). More than 4 out of every 5 impaired teen drivers were male (20/24 or 83%) and more than half were age 19 (13/24 or 54%). Twenty percent were age 18 and 17% were age 17. About one quarter of all male teen drivers involved in a fatal MVC (20/83 or 24%) were impaired. This is very similar to the rate nationally, as 26% of the male drivers age 15-20 involved in fatal crashes in 2010 had BACs above 0.08. The rate for females in Iowa seems to be much lower than the national rate with only 4 of 48 female teen drivers involved in a fatal crash being impaired (8%) compared to 19 percent of female drivers age 15-20 involved in fatal crashes.

As described earlier, the most-frequently cited major cause of the fatal crashes involving impaired teen drivers was driving too fast for conditions or speeding (10/24 or 42%) followed by departing from the

road (7/24 or 29%). In forty-two percent of all crashes where the teen was determined to be driving too fast for conditions or speeding, the teen was under the influence. Of all crashes with running off the road as a major cause, 35% involved a teen driver under the influence.

Three quarters of the fatal crashes involving an impaired teen driver were single-vehicle crashes. Just over half of the impaired teen drivers (13/24 or 54% were carrying two or more passengers). Combining these categories, 10/24 or 42% of the fatal crashes involving an impaired teen driver were single-vehicle crashes with three or more occupants in the vehicle.

The impaired teen drivers themselves consisted in the sole fatalities for 11 of the 24 crashes. Thus, 19% of all teen drivers who died in MVCs were impaired. Only 2 of the driver fatalities for 16- and 17-year-olds were impaired (10%). Nationally 15% of drivers ages 16 and 17 killed in MVCs in 2010 had a blood alcohol content (BAC) of 0.08 or higher (Insurance Institute for Highway Safety, 2010). Another 11 crashes resulted in 13 fatalities for passengers of the teen driver. Two occupants of other vehicles died in crashes involving impaired teen drivers.

NHTSA (2011) reports that nationwide young drivers age 15-20 who had been drinking and were killed in a MVC in 2009 were not wearing seat belts 70% of the time. In this data set, there was not much difference in restraint use for the teen drivers who died: 50% of those who were impaired and 56% of those who were sober were wearing seat belts. A much larger difference is seen when considering *all* teen drivers involved in the fatal MVCs: about 78% of the sober teens (69 of the 89 teens with recorded occupant protection data) were properly belted while only 35% of the impaired teens (7 out of 20) were restrained.

Distraction

Distraction was determined to be a factor in only 8 (6.3%) of the crashes. Only one crash listed distraction as major cause (driver distracted by fallen object). Driver contributing circumstances for three crashes were listed as “inattentive/distracted by use of phone or other device” and media reports said texting was a factor in three other crashes. Distraction from passengers was a contributing circumstance in another crash.

Fatalities

The crashes in this data set resulted in a total of 143 fatalities. Teen drivers accounted for 40% of all fatalities. The passengers of teen drivers accounted for 33%. Drivers of other vehicles involved in crashes with teen drivers accounted for 17%, and passengers in other vehicles comprised 3.5% of the fatalities. Finally, nine pedestrians, a bicyclist, and a teen riding on the outside of a car accounted for 7% of the fatalities. Figure 8 shows the identities of the fatalities over the three years of data analyzed.

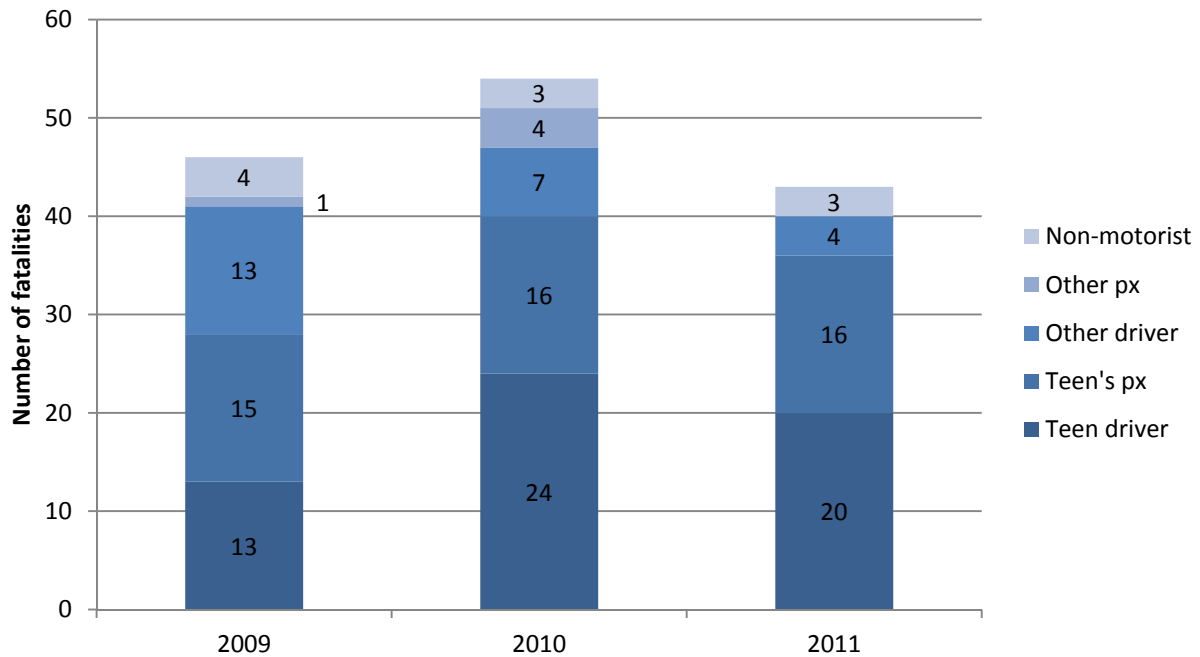

Figure 8. Identity of those who died in crashes included in this analysis by year.

Teen driver fatalities by age and gender

Teen driver fatalities were analyzed by age and gender (see Figure 9 and Figure 10). Of the 57 teen drivers who died in motor vehicle crashes, 30 (53%) were male. The number of teen drivers who died in crashes increased with age, which is to be expected given that teens drive more as they mature. The gender proportion of teen driver fatalities varies by age (see Figure 10), with 25%, 50% and 25% of 15-, 16-, and 17-year-old teen driver fatalities being male, respectively. For 18- and 19-year-olds, 62% and 70% of the teen driver fatalities were male.

When exposure to driving is taken into account (see Figure 11), again using the 2009 National Household Travel Survey, male teen driver fatalities peak at age 16 with 4.4 per 10 billion VMT but drops to 1.2 at age 17. Female teen driver fatalities are highest at age 17 with 5.6 per 10 billion VMT and fall to 1.1 at age 18.

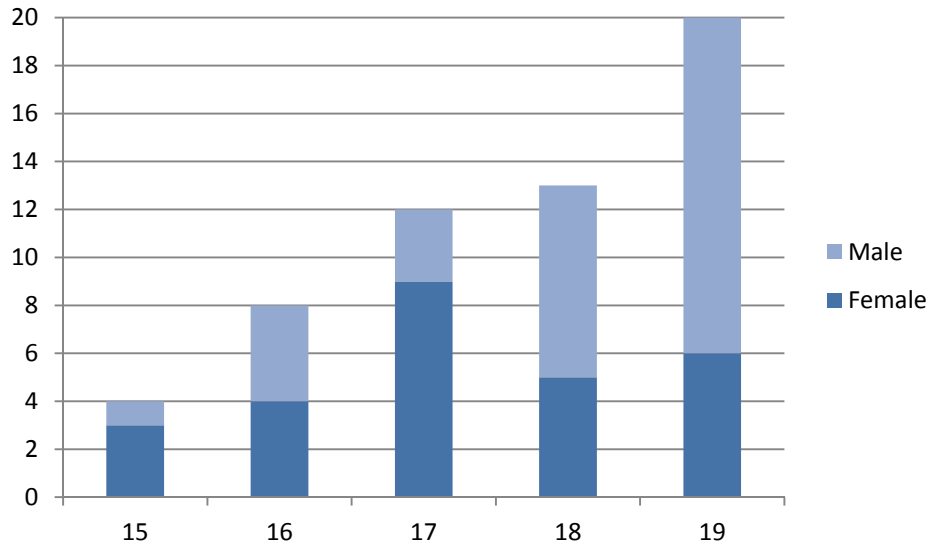

Figure 9. The number of teen drivers who died in crashes by driver age and gender.

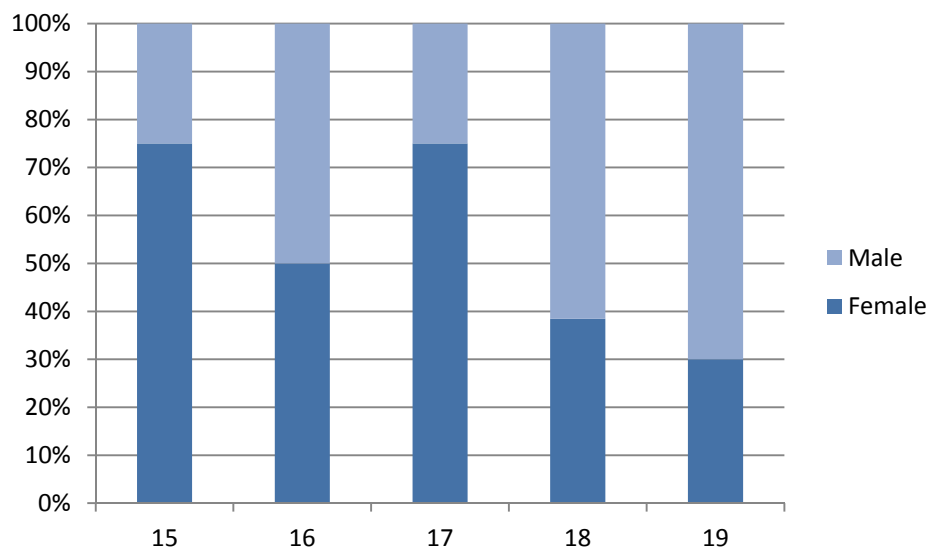

Figure 10. Proportion of teen drivers who died in crashes by driver age and gender.

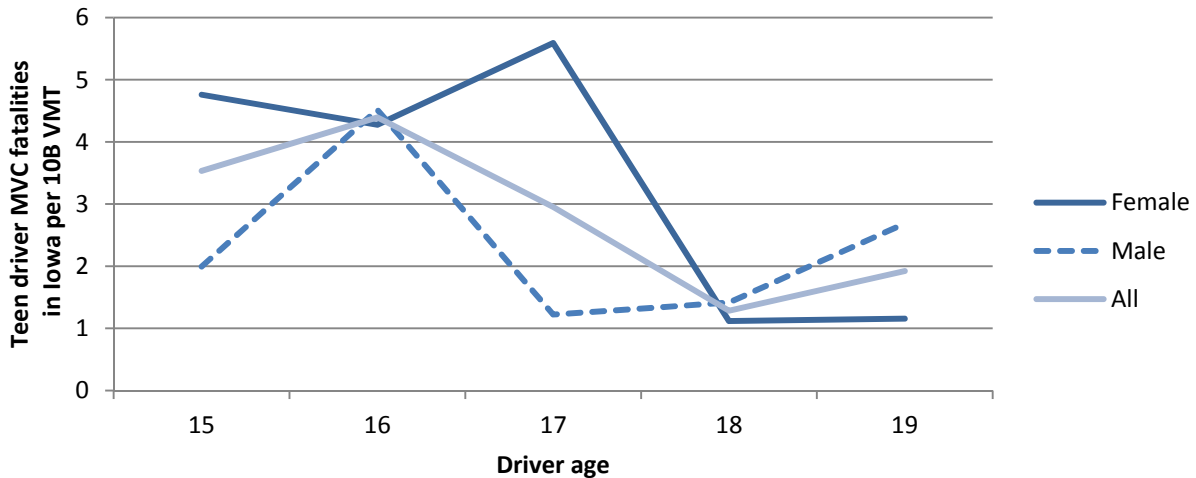

Figure 11. Teen driver fatalities in MVCs in Iowa per 10 billion VMT nationally.

Teen fatalities by time of day

All teen MVC fatalities, both drivers and passengers, were analyzed by time of day. A total of 95 teens were killed in MVCs involving a teen driver. In order to compare with available recent national statistics, this dataset was expanded to include an additional 14 teens who died as a result of MVCs that did not involve a teen driver.

Table 11. Motor vehicle crash fatalities for teens by time of day; Teen MVC deaths include all teens who died in MVCs regardless of driver age. Iowa numbers are from 2009 to 2011. US numbers are from 2010 (Insurance Institute for Highway Safety, 2010).

*excludes crashes without time recorded.

| | IOWA | | US | | Difference |
|-----------------|-----------------|------------|-----------------|------------|------------|
| Time of day | Teen MVC deaths | % | Teen MVC Deaths | % | % |
| Midnight – 3 am | 22 | 20 | 468 | 15 | 5.0 |
| 3 am – 6 am | 14 | 13 | 294 | 9 | 3.3 |
| 6 am – 9 am | 12 | 11 | 308 | 10 | 1.0 |
| 9 am – 12pm | 15 | 14 | 190 | 6 | 7.6 |
| 12 pm – 3 pm | 7 | 6 | 318 | 10 | -3.9 |
| 3 pm – 6 pm | 19 | 17 | 531 | 17 | 0.2 |
| 6 pm – 9 pm | 9 | 8 | 460 | 15 | -6.6 |
| 9 pm - Midnight | 11 | 10 | 517 | 17 | -6.7 |
| Total | 109 | 100 | 3086* | 100 | |

This comparison suggests that relative to the entire nation, teen MVC fatalities in Iowa are more likely to occur between midnight and 6am and 9am to noon and less likely between noon and 3pm and 6pm and midnight. In Iowa, the proportion of fatalities during the times that teens are most likely to be driving to and from school, from 6 am to 9am and from 3 pm to 6 pm, are very similar to the national proportion.

Occupant protection

The use or non-use of occupant protection plays a huge role in preventing and reducing MVC fatalities. Half of the teen vehicle occupants were using appropriate occupant protection when the crashes occurred. The use of occupant protection (i.e., seat belts) for all occupant positions in teen passenger vehicles (i.e., motorcycles were omitted) was analyzed (see Figure 12). Only 20% of the teen drivers' passengers seated in the rear of the vehicle were wearing seatbelts while 60% of the teen drivers and their front seat passengers were belted. Of the 48 unbelted teen drivers, 27 (56%) experienced fatal injuries compared to 24 of the 74 (32%) belted teen drivers. Similar numbers were seen for the teen driver's passengers in the front seat. Half of the 24 unbelted front seat passengers had fatal injuries while 11 of the 36 (31%) belted front seat passengers died.

Overall, about 40% of the teen vehicle occupants ages 14-20 who had fatal injuries were wearing seat belts. This is directly in line with the national statistics: 60% of all occupants age 16-20 killed in a fatal crash during 2010 were not wearing a seatbelt (National Highway Traffic Safety Administration, 2012).

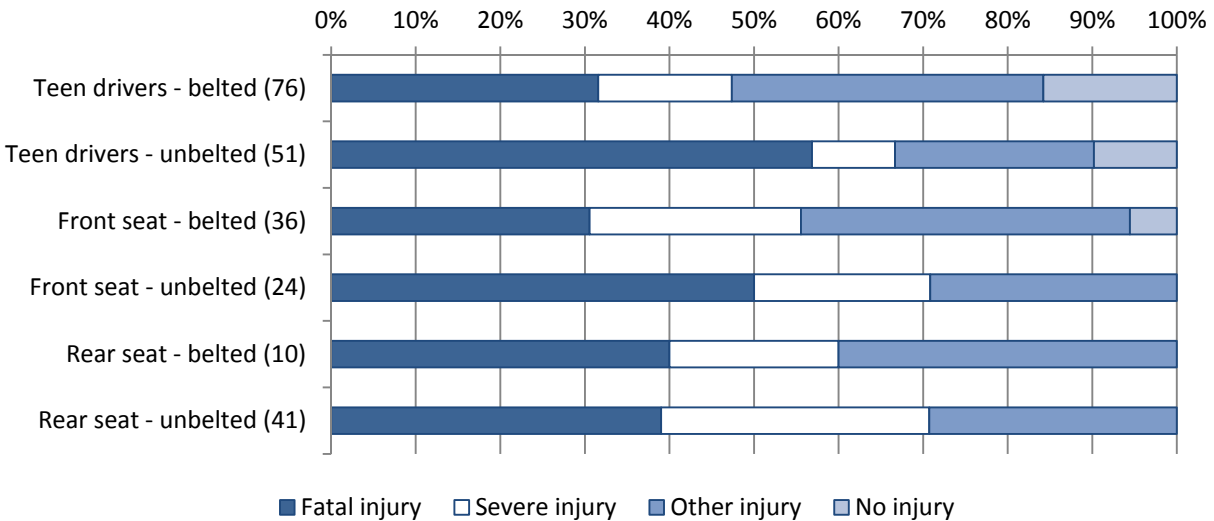

Figure 12. Occupant position and occupant protection status by injury outcome.

Ejections

A total of 62 ejections (52 full ejections and 10 partial ejections) were recorded for a total of 335 vehicle occupants. Overall, the ejections contributed to 46 fatalities. Twenty-one ejections were teen drivers (5 were wearing their seatbelts) and 39 of the ejections were passengers in the teen's vehicle (2 were wearing their seatbelts). Only 2 ejections were drivers of another vehicle involved in the crash (1 was wearing their seat belt).

Drivers

This analysis goes beyond the typical analysis of fatal crashes in that detailed information about the teen drivers was obtained. The driving records of the teens, which included their licensure history, prior

traffic citations, and prior crashes, were obtained. In addition, data about the charges filed against a teen as a result of being involved in a fatal crash were obtained from media sources, their driving record, and the Iowa court system (accessed through Iowa courts online).

Vehicle type

Teen drivers were operating passenger cars in over two-thirds of all the fatal crashes. About 15% were driving pick-up trucks and 11% were driving SUVs. They were driving vans or minivans and motorcycles about 4% and 3% of the time, respectively.

Figure 13 shows the proportion of each type of vehicle by driver age. The 19-year-old drivers showed the most variation in vehicle type. Only about half of these drivers were driving passenger cars, 18% were driving pick-ups and another 18% SUVs. Drivers were 15 years old in two of the five crashes in which the teen was driving a van or minivan.

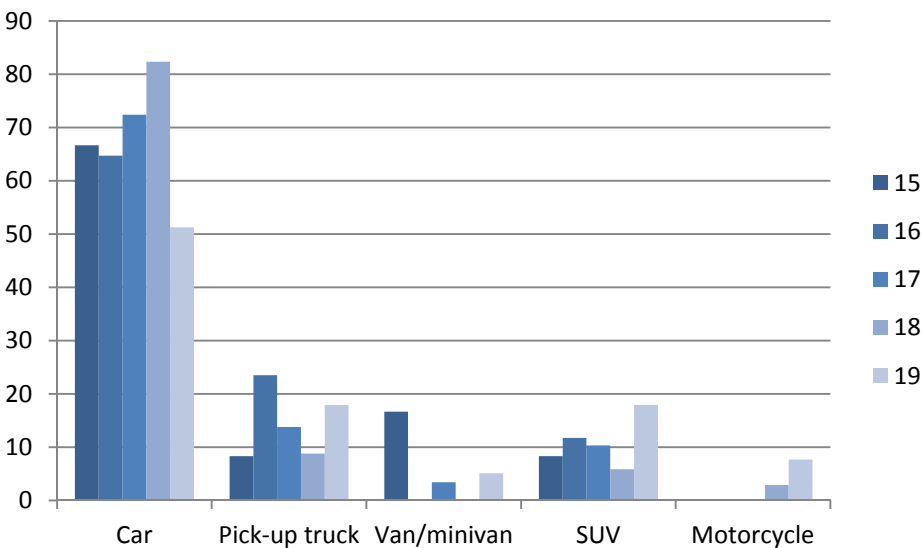

Figure 13. Vehicle types driven by teen drivers by driver age

Vehicle type was also considered in the context of crash type. As discussed in the previous section, road departures were the most common type of crash. Pick-up trucks were somewhat overrepresented in road departure crashes, with just over half of all crashes in which the teen was driving a pick-up truck being road departures. Three of the four crashes involving a teen driving a motorcycle were road departures. All nine vehicles involved in rear-end crashes were passenger cars. In fifteen of seventeen head-on crashes and eight of ten collisions with pedestrians, bicyclists, or animal, the teen was operating a car. Both of these proportions are slightly above the expected two-thirds proportion.

License type

The type of license held by each of the teen drivers at the time of the fatal crash they were involved in was provided by the Iowa Department of Transportation. As expected, type of license was closely associated with driver age. Because 17-year-olds are eligible for a full license after holding an intermediate license and maintaining a clean record, one unexpected finding was that about two thirds

of the 17-year-old drivers still held their intermediate license. Another interesting finding is that about 15% of the 18- and 19-year-olds involved in fatal crashes did not complete the GDL system, i.e., they turned 18 before they obtained a full license. Seven drivers, all age 17 or older, did not have a valid license when their crashes occurred.

Table 12. License type by driver age

| License type | Driver age | | | | | Total | Percent |
|----------------------|------------|----|----|-----|------|-------|---------|
| | 15 | 16 | 17 | 18 | 19 | | |
| Instruction permit | 3 | 1 | 1 | 0 | 0 | 5 | 4% |
| Minor school license | 9 | 0 | 0 | 0 | 0 | 9 | 7% |
| Intermediate | 0 | 16 | 19 | 0 | 0 | 35 | 27% |
| Full/Commercial | 0 | 0 | 6 | 28* | 30** | 64 | 49% |
| Invalid/none | 0 | 0 | 2 | 3 | 2 | 7 | 5% |
| Unknown | 0 | 0 | 1 | 3 | 7 | 11 | 8% |

* includes 5 teens who held intermediate licenses when they turned 18

** includes 4 teens who held intermediate licenses when they turned 18

Time since licensure

The length of time that the young drivers held their license prior to their involvement in the fatal crash was examined. There were 20 teen drivers who had held an intermediate license for less than 1 year when they contributed to a fatal crash. Of these, five (25%) held their intermediate license for less than 90 days and eight (40%) held it for 90 to 179 days. Two teens (10%) held their license for 180 to 269 days, and five (25%) for 270 to 364 days.

License violations

One question of interest is whether the teens involved in fatal crashes were operating motor vehicles within the limits of their current licensure. Three 15-year-olds, one 16-year-old, and one 17-year-old were involved in fatal crashes while holding an instruction permit; two of the 15-year-olds were driving with adults in the vehicle. Of the 9 teens involved in fatal crashes while holding a minor school license, five were driving to or from school, two were violating the rules of the license at the time they crashed, and we were unable to determine from available data whether the other two teens were operating their vehicles within the rules of the minor school license.

Teens with an intermediate license are restricted from driving between the hours of 12:30 am and 5 am. Thirty-five teens with intermediate licenses were involved in 32 crashes. Four of these crashes occurred during those restricted hours. Four additional crashes occurred between 11 pm and 12:30 am.

Teens charged

Almost half of the teen drivers who contributed to the fatal crashes they were involved in (47 of 97) did not survive the crash. Of those who survived, 88% (44 out of 50 drivers) were charged with a violation or crime as a result of the fatal crash. Six of the teens were determined to have contributed to the fatal crash they survived but were not charged.

Twenty-one of the 44 teen drivers charged (48%) driver faced serious charges, specifically vehicular manslaughter (reckless or OWI), involuntary manslaughter, and/or serious injury by vehicle. Of these 21 cases, seventeen teen drivers were convicted or pleaded guilty to serious charges and one was found not guilty at trial. Trials are pending for the other three cases.

The other 52% of drivers charged (23 of 44 drivers) faced traffic violations, e.g., failure to maintain control, failure to yield, failure to obey stop sign/signal, or speeding violation. More than 90% of these charges were upheld, one charge was dismissed, and one charge was dismissed after the teen took a remedial driving class.

Prior violations on driving record

Driving records were available for 123 of the teen drivers. Each record was examined for citations prior to their involvement in the fatal crash. The citations were classified as speeding, other driving violations, non-driving violations, and a crash to which the teen contributed. Then the prior violations were tabulated according to whether the teen was found to have contributed to the fatal crash. If they had contributed, the subcategories consisted of contributing to their own fatality, serious charges from the fatal crash (e.g., vehicular homicide or involuntary manslaughter), traffic violations from the fatal crash (e.g., failure to yield or speeding ticket), or were not charged.

Contributing to another crash prior to being involved in the fatal crash was highly indicative of fault in the fatal crash. Fourteen of the 78 teen drivers who were found to be at fault and for whom driving records were available had a prior “at fault” crash on their driving record (18%); all fourteen were found to have caused or contributed to the fatal crash. In other words, no teens who were not at fault or had “unknown” contribution to the fatal crash had a prior “at fault” crash on their record. Six of the fourteen with prior crashes (one had two prior crashes) contributed to their own fatality and six were charged with a serious offense as a result of the fatal crash.

There appears to be an association between having a prior speeding violation and being at fault in the fatal crash (see Figure 14). Twenty of the 46 (43%) teens who contributed to their own fatality and more than half the teens (11 of 21, or 52%) charged with a serious offense from the fatal crash had at least one previous speeding violation. Eleven drivers had more than one speeding ticket. On the other hand, only 18% (3 of 17) of the teen drivers who did not contribute to the fatal crash and 1 of the 14 (7%) where contribution was unable to be determined had a single prior speeding violation.

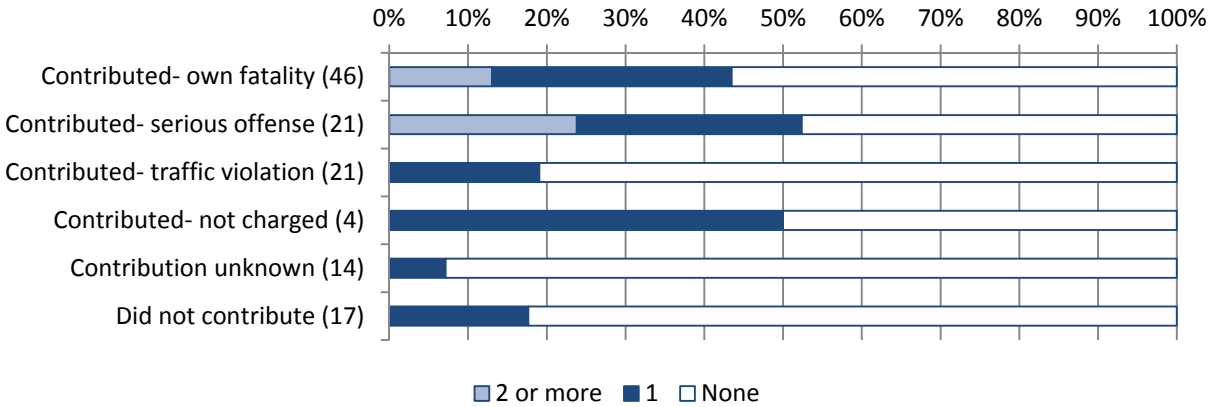

Figure 14. Number of prior speeding violations before fatal crash by outcome of fatal crash.

Discussion

This analysis examined a variety of data sources concerning fatal crashes involving young drivers in Iowa. Variables from the IDOT crash data base were considered in conjunction with variables not typically considered in crash analyses, including licensure status, prior violations or crashes on the teens’ driving records, and charges and convictions from the fatal MVC.

Many of the analyses show that trends for fatal crash involvement for teen drivers in Iowa are similar to those for the entire nation. A notable exception was that teen fatalities in Iowa due to MVCs seem to occur in higher proportions between 9 am to noon and between midnight and 6 am and in lower proportions from noon to 3 pm and from 6 pm to midnight compared to the national rates.

One unique analysis completed here considered how the hour of crash occurrence varied by type of weekday and time of year. Interestingly the rate of occurrence was highest for the 4 pm hour during the summer and not during the school year as expected (cf. Williams, 2003). Several other hours of high crash occurrence were observed during the summer months as well, especially on weekends. During the school year, crashes were most likely to occur in the 7 am hour on weekdays and in the very early morning hours on weekends.

Two components of graduated drivers licensing (GDL) systems that have been shown to be effective at reducing fatal crash involvements for teen drivers are limiting nighttime driving and reducing the number of passengers newly-licensed teens are allowed to have (McCartt et al., 2010; Fell, Todd et al., 2011; Masten, Foss et al., 2011). Sixteen- and seventeen-year-olds holding an intermediate license in Iowa cannot drive between 12:30 and 5 am, but this policy is weak compared to the restriction in place in many other states. This analysis showed that the share of fatalities occurring between midnight and 6 am greatly out proportion the driving teens do during these hours. About one third of MVC fatalities in Iowa for teens occur during these hours while national data indicate that less than 4% of teens’ driving occurs during these hours. One of every 8 crashes involving drivers with intermediate licenses occurred

during the restricted hours, which raises the issues of compliance with and enforcement of GDL policies. The risk of losing their intermediate license and/or delaying promotion to a full license is not an effective deterrent to these drivers. The number of crashes occurring immediately prior to the restricted hours is also significant: one of every eight fatal crashes involving an intermediate driver occurred between 11 pm and 12:30 am.

Iowa's GDL system does not limit the number of passengers that young drivers can transport in their vehicles. One-third of all fatalities in this analysis were the passengers of the teen drivers; a total of twenty passengers receiving fatal injuries and seven with severe injuries were in vehicles with drivers under the age of 18. The number of passengers also seems to be a factor in single vehicle crashes; when passengers were on board during a single vehicle crash, almost three-quarters of the time there were two or more passengers.

Of the teens holding an intermediate license who contributed to a fatal crash in their first year of driving, 65% crashed in the first 6 months of driving. While this analysis did not consider the length of time these specific teens held their learner's permits, requiring young drivers to hold their learner's permits for a minimum of 12 months to gain more driving experience before they obtain their intermediate license may reduce the risk of crash for Iowa's newest drivers.

Two key safety factors for preventing MVC fatalities among all drivers are wearing seat belts and not driving while impaired. These two factors played a significant role in the crashes analyzed here. Overall about 60% of the front-seat occupants of the teens' vehicles were wearing seatbelts which was associated with 20% lower fatality rate. However, only 20% of the rear seat passengers in the teens' vehicles were wearing their seatbelts.

Despite a "zero-tolerance" law for drivers under the age of 21, one of every five of the teen drivers in this analysis was under the influence of alcohol or drugs; most of them were male (83%) and one-third of all 19-year-old drivers were impaired (54% of all impaired drivers). Between 10% and 15% of the 16-, 17-, and 18-year-old drivers were impaired.

Prior crashes and speeding tickets were associated with contributing to the fatal crash. Every teen driver who contributed to a MVC prior to being involved in a fatal crash also contributed to the fatal crash. Nearly half of all drivers who contributed to a fatal crash had at least one prior speeding ticket compared to 18% of those who did not contribute.

Although distraction was cited as a contributing factor in only a small percentage of these crashes, distraction is difficult if not impossible to confirm for fatal crashes involving a single-vehicle with a single-occupant, particularly if the distraction did not involve an electronic device or involved a device that did not log the user's interactions. Otherwise law enforcement officers investigating fatal crashes must rely on witness reports or the driver admitting to being distracted.

This analysis included data from 126 crashes and 131 teen drivers. The size of this dataset limited the level of detail that could be analyzed; most often the analyses were limited to the consideration of only two factors (e.g., driver age and crash type but not driver age, crash type, and time of day). Although

the data indicate that patterns of crash factors differ for the youngest teen drivers and older teens who can drive without any restrictions, a larger dataset would be needed to investigate these patterns in detail. Another limitation of these analyses is that exposure data for teen drivers in Iowa is not available. National data from the 2009 NHTS was a reasonable substitute; however, there may indeed be significant differences in between the travel habits of Iowa teens and a national sample of teen drivers. This analysis included only fatal crashes which limits the kinds of conclusions that can be drawn about the teen drivers involved in fatal crashes compared to teen drivers who are in non-fatal crashes or do not crash at all.

Conclusions

The most common type of crash was single-vehicle road departure and these crashes most often occurred in the early morning hours. The most common elements present when a teen driver contributed to a fatal crash were driving too fast for conditions/speeding and driving while impaired by alcohol and/or drugs. Motivating teens to refrain from driving when impaired by drugs or alcohol or riding with impaired drivers, to drive at appropriate speeds, and to buckle up every time they drive or ride in a vehicle continue to be the primary challenges to reducing teen MVC fatalities. Younger teen drivers have higher rates of fatal crash involvements after controlling for the amount they drive and most of their crashes are road departures, which may be indicative of inexperience. Encouraging families to increase the amount of driving that teens do under supervision and to restrict driving to limited, lower-risk situations (e.g., driving only from school to home in daylight hours) when teens first drive independently may help reduce the rate of fatal crash involvements for 15-, 16-, and even 17-year-old drivers. Limiting the number of passengers these new drivers can transport can also reduce fatalities. Working to curb poor driving habits after a teen receives a speeding or non-speeding traffic violation or is involved in an at-fault crash may also help to prevent subsequent fatal crash involvement.

References

- Bingham, C. R., J. T. Shope, et al. (2007). Crash risk among teen drivers: identification and prediction of excess risk. The University of Michigan Transportation Research Institute. Ann Arbor, MI. Available <http://deepblue.lib.umich.edu/bitstream/2027.42/57284/1/UMTRI-2007-13.pdf>. Retrieved Dec. 1, 2012.
- Fell, J. C., M. Todd, et al. (2011). "A national evaluation of the nighttime and passenger restriction components of graduated driver licensing." *Journal of Safety Research* **42**(4): 283-290.
- Insurance Institute for Highway Safety. (2009). "Fatality Facts 2009: Teenagers." from <http://www.iihs.org/research/fatality.aspx?topicName=Teenagers&year=2009>.
- Insurance Institute for Highway Safety. (2010). "Fatality Facts 2010: Teenagers." Retrieved July 30, 2012, from <http://www.iihs.org/research/fatality.aspx?topicName=Teenagers&year=2010>.
- Iowa Department of Transportation. "Under age 18 - Iowa's graduated driver's licenses (GDL)." Retrieved January 30, 2013, from <http://www.iowadot.gov/mvd/ods/gdl.htm>.
- Masten, S. V., R. D. Foss, et al. (2011). "Graduated Driver Licensing and Fatal Crashes Involving 16-to 19-Year-Old Drivers." *JAMA-Journal of the American Medical Association* **306**(10): 1098-1103.
- Mayhew, D. R., H. M. Simpson, et al. (2003). "Changes in collision rates among novice drivers during the first months of driving." *Accident Analysis and Prevention* **35**(5): 683-691.
- McCartt, A. T., E. R. Teoh, et al. (2010). "Graduated Licensing Laws and Fatal Crashes of Teenage Drivers: A National Study." *Traffic Injury Prevention* **11**(3): 240-248.
- National Highway Traffic Safety Administration. Fatality Analysis Reporting System. <ftp://ftp.nhtsa.dot.gov/FARS>.

- National Highway Traffic Safety Administration. (2011). Young Drivers. National Center for Statistics and Analysis. Washington, DC. Available.
- National Highway Traffic Safety Administration. (2012). Occupant Protection. NHTSA's National Center for Statistics and Analysis. Washington, DC. Available <http://www-nrd.nhtsa.dot.gov/Pubs/811619.pdf>.
- National Highway Traffic Safety Administration. (2012). Traffic Safety Facts 2010: A Compilation of Motor Vehicle Crash Data from the Fatality Analysis Reporting System and the General Estimates System. National Center for Statistics and Analysis, U.S. Department of Transportation. Washington, DC. Available <http://www-nrd.nhtsa.dot.gov/Pubs/811659.pdf>.
- Neyens, D. M., B. Donmez, et al. (2008). "The Iowa graduated driver licensing program: Effectiveness in reducing crashes of teenage drivers." *Journal of Safety Research* **39**(4): 383-390.
- Sagberg, F. (1998). Month-by-month changes in accident risk among novice drivers. Proceedings of the 24th International Congress of Applied Psychology, San Francisco.
- Tefft, B. C., A. F. Williams, et al. (2012). Teen driver risk in relation to age and number of passengers. AAA Foundation for Traffic Safety. Available <http://www.aaafoundation.org/pdf/2012TeenDriverRiskAgePassengers.pdf>. Retrived Sept. 5, 2012.
- U.S. Department of Transportation - Federal Highway Administration. 2009 National Household Travel Survey. <http://nhts.ornl.gov>.
- Williams, A. F. (2003). "Teenage drivers: patterns of risk." *Journal of Safety Research* **34**(1): 5-15.
- Williams, A. F. and V. I. Shabanova (2003). "Responsibility of drivers, by age and gender, for motor-vehicle crash deaths." *Journal of Safety Research* **34**(5): 527-531.

Appendices: Crash case study summaries

Each case study has two pages, intended to be viewed side by side. The top of the first page (or odd numbered pages, if not viewing side by side) lists the time, day, and date of the crash. The number in the upper right is an index number. Then the location of the crash, the road and/or intersection type, and manner of crash/collision are described. Each vehicle involved in the crash is represented as a matrix. Each column of the matrix represents an occupant of the vehicle organized by seating position. The first column is for the driver of the vehicle, followed by column(s) for the front seat passenger(s), if any, and then rear seat passengers, if any. Each column indicates the occupant's age, gender, fatality (Y if a fatal injury occurred), injury level (2 = severe injury, 3 = minor injury, 4 = possible injury, and 5 = no injury), ejection status, and seat belt status of each occupant. Below the matrix the year, make, model, and vehicle type are listed, followed by the license status (type of license and days held) for the teen driver.

The next portion of the case study includes a narrative of the crash, contributing factors, other factors that might have contributed, and the law enforcement agency investigating the crash.

The second page of the case study (or even numbered pages, if not viewing side by side) includes fields that indicate whether the teen driver was at fault in the crash, a summary of any notable events in the teen driver's license history (i.e., driving record), whether any charges were filed for the fatal crash and whether any civil litigation was filed.

At the bottom of the second page of each case study is a crash diagram or (if crash diagram was unavailable) map of the crash location.

Information in the case studies was current as of May 2012.

Appendix A: 2009 crashes

8:38 AM

Tuesday

February 10, 2009

1

IA 100 and Tama St SE, Marion, Linn County
T-intersection of 4L State Route and 2L Municipal
Broadside

| | Teen driver | Front pass. | Rear pass. | Rear pass. | Rear pass. |
|-----------|-------------|-------------|------------|------------|------------|
| age | 18 | | | | |
| gender | M | | | | |
| fatality | Y | | | | |
| injury | | | | | |
| ejection | N | | | | |
| seat belt | Y | | | | |

2001 Hyundai Accent L Hatchback
full license 216 days

| | Other driver |
|-----------|--------------|
| age | 40 |
| gender | F |
| fatality | |
| injury | 5 |
| ejection | N |
| seat belt | Y |

school bus
11 passengers on bus

Crash Narrative

Teen was heading eastbound on through road (divided highway) and changing lanes. School bus was crossing eastbound lanes from south to turn left onto westbound lanes when teen struck the left rear corner of the bus in the intersection. Teen continued across median and car came to rest in area with trees north of through highway.

Contributing factors

Speed: teen was exceeding authorized speed but actual speed is not reported

Other factors

Bus driver's actions: unknown why bus was in intersection when teen was approaching

Reporting Agency: Marion Police Dept.

Teen driver at fault? Yes

License history:

 *License history data omitted for protection of privacy

Criminal charges:

 None

Civil litigation:

 Teen's parents filed suit against bus driver and school district; case was dismissed with prejudice

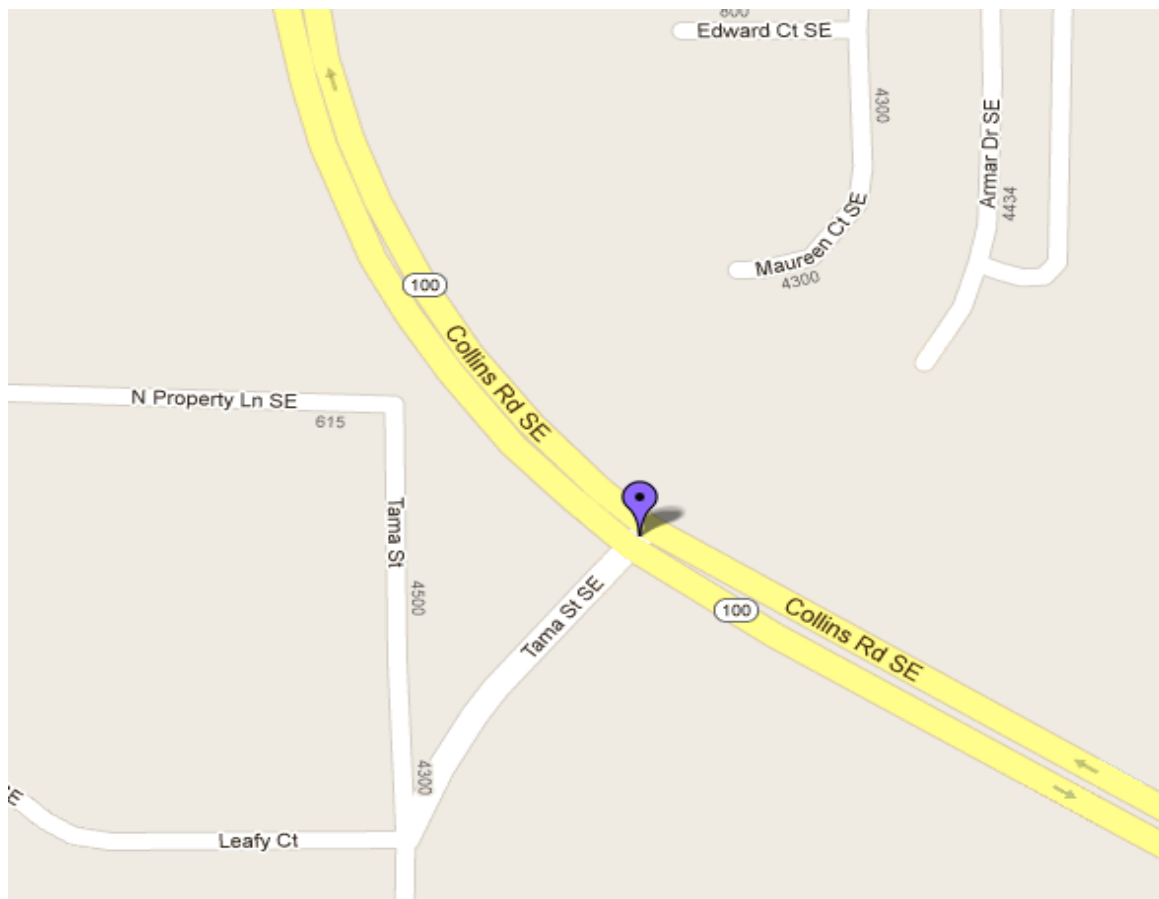

US 34 between 13th St & 665 Ave, Albia, Monroe County

US Route 2L

Sideswipe, opposite direction

| | Teen driver | Front pass. | Rear pass. | Rear pass. | Rear pass. |
|-----------|-------------|-------------|------------|------------|------------|
| age | 18 | 19 | | | |
| gender | F | M | | | |
| fatality | | Y | | | |
| injury | 2 | | | | |
| ejection | N | N | | | |
| seat belt | Y | Y | | | |

2006 Chevrolet Cobalt 2DR
full license 72 days

| | Other driver | Front pass. | Rear pass. | Rear pass. | Rear pass. |
|-----------|--------------|-------------|------------|------------|------------|
| age | 33 | | | | 7 |
| gender | F | | | | F |
| fatality | | | | | |
| injury | 4 | | | | 4 |
| ejection | N | | | | N |
| seat belt | Y | | | | Y |

2005 Hyundai Tucson SUV

Crash Narrative

Teen (Unit 1) was traveling west on US 34 when she lost control on the 100% snow covered roadway, crossed the centerline, and slid sideways into the eastbound lane in the path of the other vehicle (Unit 2). Teen's vehicle was struck in the passenger side door. After impact, teen's vehicle came to rest in the eastbound ditch. Other vehicle came to rest in east bound lane.

Contributing factors

Weather: road was 100% snow covered

Other factors

-

Reporting Agency: Iowa State Patrol

Teen driver at fault? Unclear

License history:

*License history data omitted for protection of privacy

Criminal charges:

None

Civil litigation:

Parents of deceased passenger in teen's vehicle filed suit against the teen, her family, and a radio station (presumed to be teen's employer); case against radio station dismissed w/o prejudice 12/30/10; case against teen dismissed w/ prejudice 2/28/11

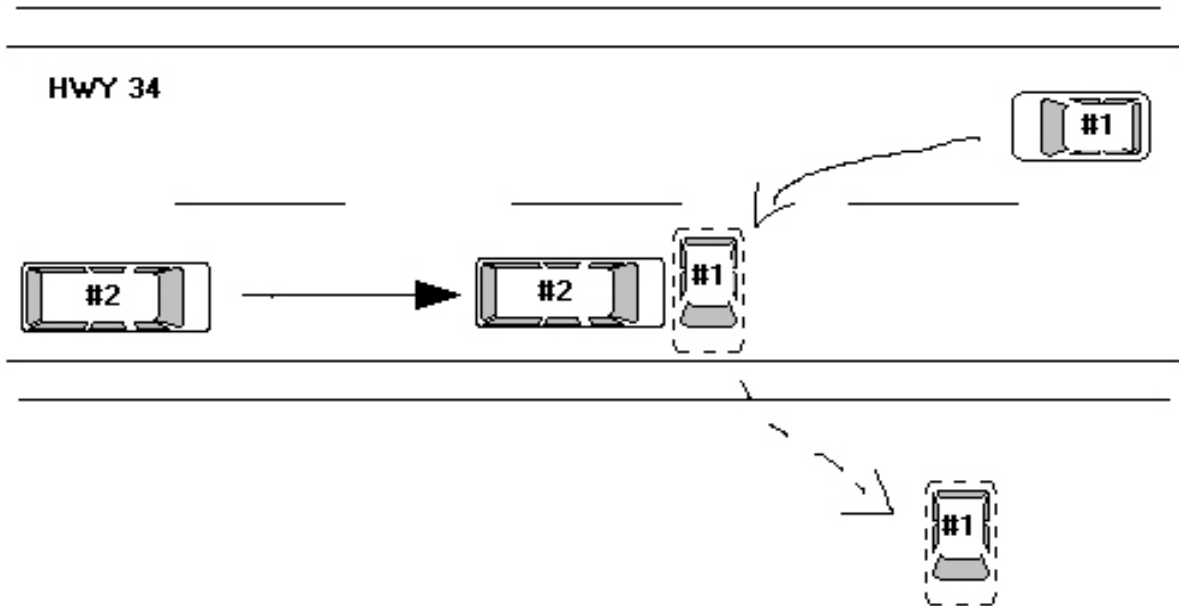

US 52 between Weber Rd & 400th St, Dubuque County

US route 2L

Head-on

| | Teen driver | Front pass. | Rear pass. | Rear pass. | Rear pass. |
|-----------|-------------|-------------|------------|------------|------------|
| age | 18 | 17 | | | |
| gender | M | F | | | |
| fatality | | | | | |
| injury | 3 | 2 | | | |
| ejection | N | N | | | |
| seat belt | Y | Y | | | |

1997 Ford Thunderbird LX 2D
full license 271 days

| | Other driver | Front pass. | Rear pass. | Rear pass. | Rear pass. |
|-----------|--------------|-------------|------------|------------|------------|
| age | 15 | 66 | 71 | | |
| gender | M | F | M | | |
| fatality | | Y | Y | | |
| injury | 3 | | | | |
| ejection | N | N | N | | |
| seat belt | Y | Y | N | | |

2002 Buick Centry Custom 4D
instruction permit 584 days

Crash Narrative

Teen was traveling southbound, crossed the center line, and hit the northbound vehicle head on.

Contributing factors

Distraction: teen was playing a video game while driving. Media reports teen was steering with knees.

Other factors

-

Reporting Agency: Dubuque County Sheriff

Teen driver at fault? Teen #1: Yes; Teen #2: No

License history:

*License history data omitted for protection of privacy

Criminal charges:

2 counts of homicide by vehicle; 2 counts of serious injury by vehicle; FTY half the road to oncoming veh; driving on wrong side of road. Pleaded guilty to 2 counts involuntary manslaughter; sentenced to 5 years for each count (to be served concurrently) on 8/11/10.

Civil litigation:

None

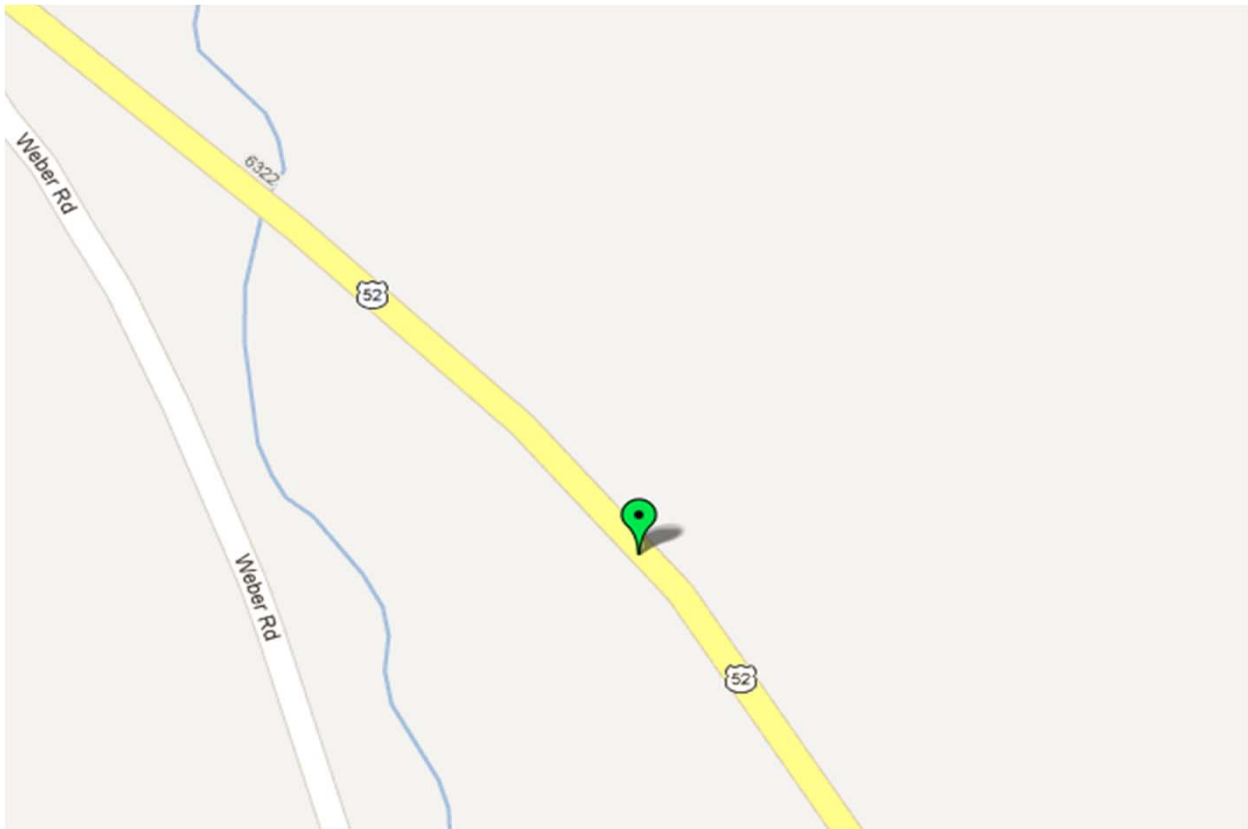

8:12 AM

Monday

March 2, 2009

4

Golden Rd, 0.6 mi east of US 18, Fayette County

Secondary 2L

Non-collision

| | Teen driver | Front pass. | Rear pass. | Rear pass. | Rear pass. |
|-----------|-------------|-------------|------------|------------|------------|
| age | 15 | 14 | | | |
| gender | F | F | | | |
| fatality | Y | | | | |
| injury | | 2 | | | |
| ejection | Y | N | | | |
| seat belt | N | Y | | | |

2004 Chevrolet Malibu
school license 196 days

Crash Narrative

Teen was driving west when she lost control and the car slid into the south ditch and rolled 1.5 times before coming to rest on its top.

Contributing factors

-

Other factors

-

Reporting Agency: Fayette County Sheriff

Teen driver at fault? Yes

License history:

*License history data omitted for protection of privacy

Criminal charges:

None

Civil litigation:

None

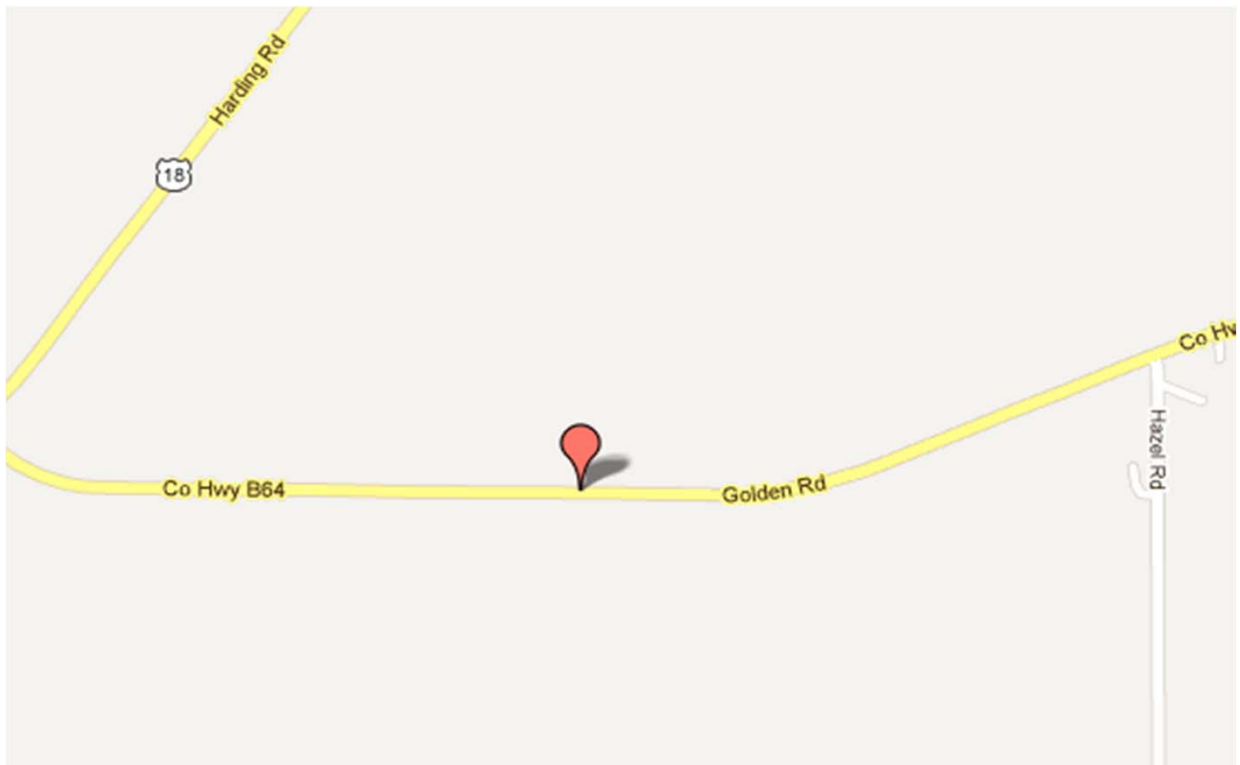

2:55 AM

Saturday

March 14, 2009

5

340th St, 0.19 mi west of Half Moon Ave, Johnson County

Secondary 2L

Non-collision

| | Teen driver | Front pass. | Rear pass. | Rear pass. | Rear pass. |
|-----------|-------------|-------------|------------|------------|------------|
| age | 16 | 17 | 18 | | |
| gender | M | F | M | | |
| fatality | | Y | | | |
| injury | 2 | | 2 | | |
| ejection | N | Y | N | | |
| seat belt | N | N | Y | | |

1998 Dodge Neon 4DR
intermediate license 78 days

Crash Narrative

Teen (Unit 1) was traveling westbound when it crested a hill and went airborne. Lost control and entered the south ditch. Rolled several times and came to rest upright facing eastbound in field south of roadway. Vehicle caught fire.

Autopsy reports presense of ethanol in blood at 0.09% and vitreous fluid at 0.06% (suggests alcohol was still be absorbed). Caffiene also present.

Contributing factors

Driver impairment: urine tested postive for drugs

Other factors

-

Reporting Agency: Iowa State Patrol

Teen driver at fault? Yes

License history:

*License history data omitted for protection of privacy

Criminal charges:

homicide by vehicle/OWI; serious injury by vehicle. Sentenced to residential facility and community service.

Civil litigation:

Estate of deceased teen passenger filed suit against teen and his father

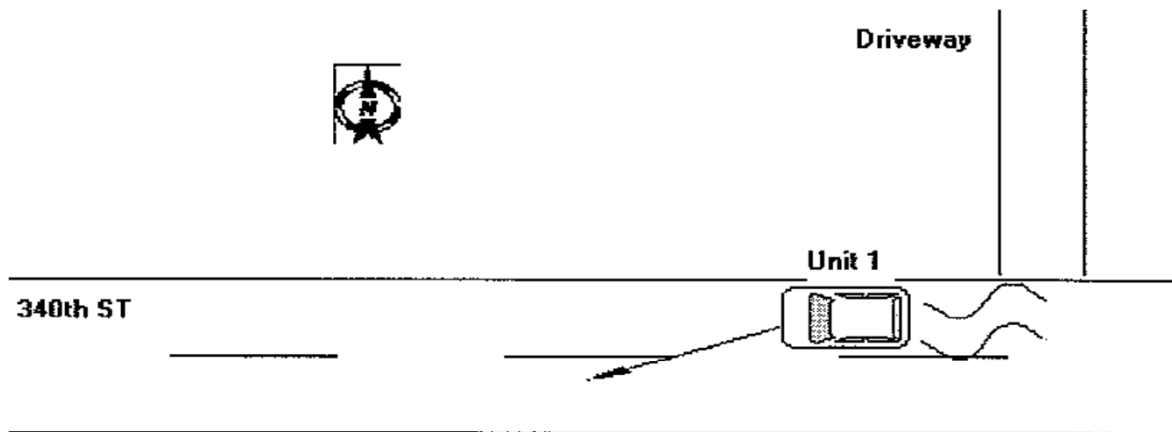

SB I-35 and US 30, Ames, Story County

Interstate 2L both directions plus merging lane from clover leaf interchange
Sideswipe, same direction

| | | | | | |
|-----------|-------------|-------------|------------|------------|------------|
| | Teen driver | Front pass. | Rear pass. | Rear pass. | Rear pass. |
| age | 17 | * | | | |
| gender | M | * | | | |
| fatality | | * | | | |
| injury | 5 | 5 | | | |
| ejection | | * | | | |
| seat belt | Y | * | | | |

2007 Nissan Armada
 full license 10 days
 *Passenger data unavailable

| | |
|-----------|--------------|
| | Other driver |
| age | 56 |
| gender | M |
| fatality | |
| injury | 5 |
| ejection | |
| seat belt | Y |

2006 Peterbilt Tractor

| | |
|-----------|--------------|
| | Other driver |
| age | 51 |
| gender | M |
| fatality | Y |
| injury | |
| ejection | Y |
| seat belt | Y |

2008 MT 55 Utility Boom

Crash Narrative

Teen (Unit 1) was merging onto SB 1-35 from WB Hwy 30 when he failed to yield to semi (Unit 2), which was traveling in the outside lane of travel. Driver side of teen's vehicle struck semi. Driver's side of semi struck another vehicle, a utility truck (Unit 3). Utility truck went off the roadway, through the bridge rail and rolled over, coming to rest on driver's side facing west on the guardrail wire in the median.

Contributing factors

-

Other factors

-

Reporting Agency: Iowa State Patrol

Teen driver at fault? Yes

License history:

*License history data omitted for protection of privacy

Criminal charges:

Failure to yield upon entering a through highway (\$35 fine).

Civil litigation:

None

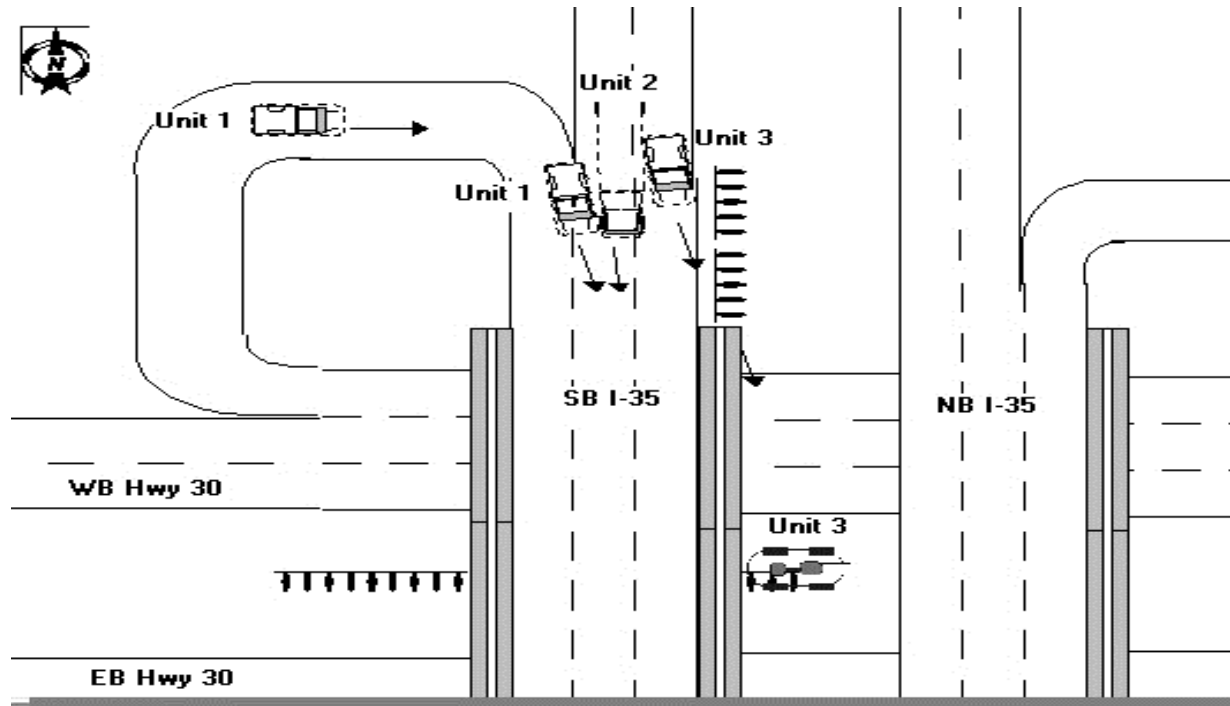

IA 25 at 150th St, Union County

State Route/Secondary 2L, 4-way controlled intersection, 150th St. east of intersection - gravel
Broadside

| | Teen driver | Front pass. | Rear pass. | Rear pass. | Rear pass. |
|-----------|-------------|-------------|------------|------------|------------|
| age | 19 | 20 | | | 3 |
| gender | F | M | | | F |
| fatality | | | | | Y |
| injury | 3 | 3 | | | |
| ejection | N | N | | | N |
| seat belt | Y | Y | | | Y |

1997 Pontiac Grand Prix GT Coupe
full license 179 days

| | Other driver | Front pass. | Rear pass. | Rear pass. | Rear pass. |
|-----------|--------------|-------------|------------|------------|------------|
| age | 41 | 44 | | | |
| gender | F | M | | | |
| fatality | | | | | |
| injury | 5 | 3 | | | |
| ejection | N | N | | | |
| seat belt | Y | Y | | | |

1995 Ford Bronco SUV

Crash Narrative

Teen (Unit 1) was westbound on 150th and failed to stop at a posted stop sign at the Hwy 25 intersection. Teen entered the path of other vehicle (Unit 2) which was southbound on Hwy 25. Other driver then struck teen's vehicle broadside. Teen's vehicle final rest was in the south ditch of 150th St.

Contributing factors

-

Other factors

-

Reporting Agency: Iowa State Patrol

Teen driver at fault? Yes

License history:

*License history data omitted for protection of privacy

Criminal charges:

Failure to obey stop or yield sign; dark window/windshield

Civil litigation:

Estate of deceased daughter against teen mother

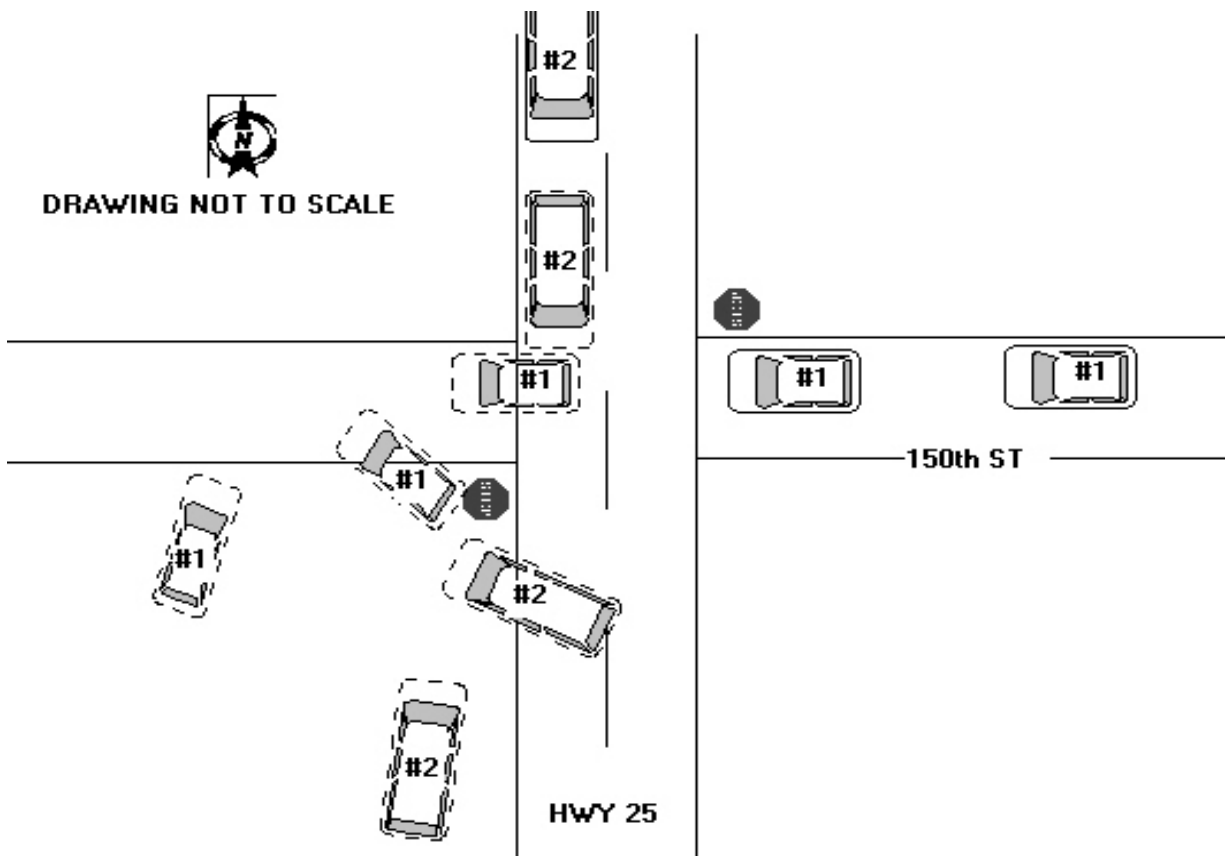

245th St and Q Ave, Tama County
 Secondary 2L, 4-way controlled intersection, gravel
 Broadside

| | Teen driver | Front pass. | Rear pass. | Rear pass. | Rear pass. |
|-----------|-------------|-------------|------------|------------|------------|
| age | 16 | | | | |
| gender | M | | | | |
| fatality | | | | | |
| injury | 2 | | | | |
| ejection | N | | | | |
| seat belt | N | | | | |

1999 Chevrolet K1500 Silverado pickup
 intermediate license 135 days

| | Other driver | Front pass. | Rear pass. | Rear pass. | Rear pass. |
|-----------|--------------|-------------|------------|------------|------------|
| age | 21 | 22 | | | |
| gender | M | M | | | |
| fatality | Y | | | | |
| injury | | 2 | | | |
| ejection | N | N | | | |
| seat belt | N | N | | | |

1997 Dodge RAM 1500 club cab pickup

Crash Narrative

Teen (Unit 1) was northbound on Q Ave and failed to obey the stop sign at the intersection of 245th St. Teen entered the intersections and struck other driver (Unit 2), which was westbound on 245th St. Teen struck other vehicle broadside in the front left drivers side wheel area. Teen's vehicle slid on gravel and left the roadway and came to rest in the northwest ditch of the intersection, facing south. Other vehicle was pushed into the northwest ditch of the intersection and came to rest facing north.

Contributing factors

-

Other factors

-

Reporting Agency: Iowa State Patrol

Teen driver at fault? Yes

License history:

*License history data omitted for protection of privacy

Criminal charges:

Failure to maintain safety belts; failure to obey stop or yield sign

Civil litigation:

None

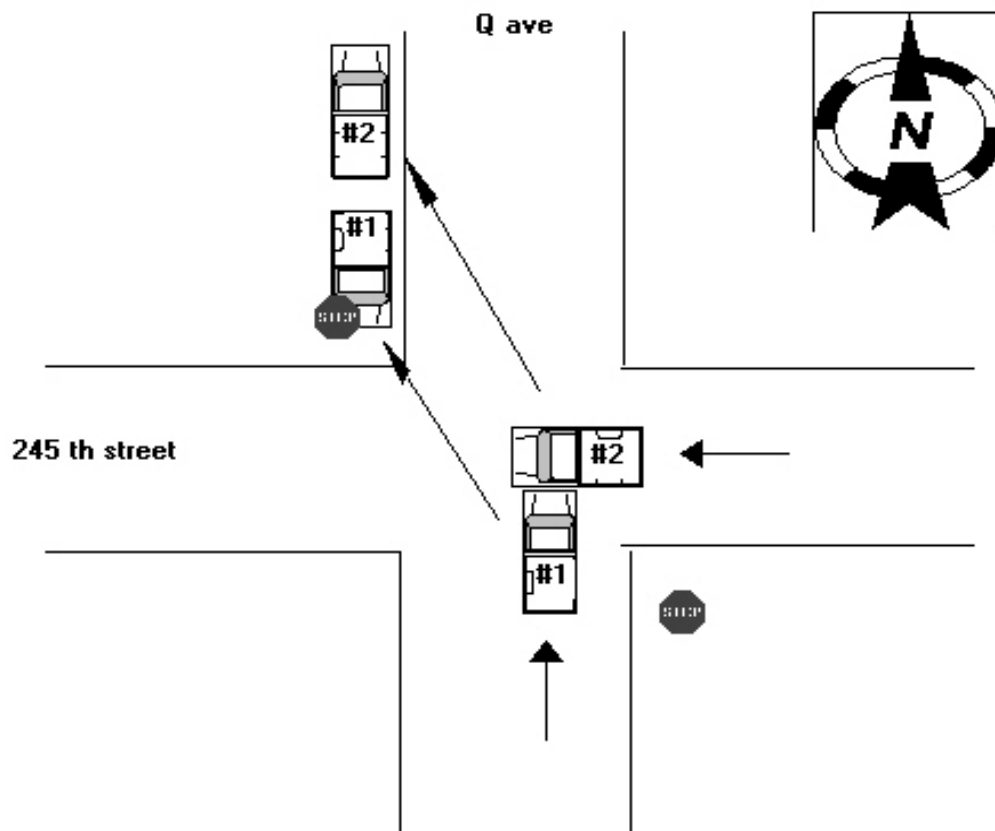

170th St and Juniper Ave, Washington County
 Secondary 2L, 4-way controlled intersection, 170th - paved, Juniper Ave - gravel
 Broadside

| | Teen driver | Front pass. | Rear pass. | Rear pass. | Rear pass. |
|-----------|-------------|-------------|------------|------------|------------|
| age | 15 | | | | |
| gender | M | | | | |
| fatality | | | | | |
| injury | 3 | | | | |
| ejection | N | | | | |
| seat belt | Y | | | | |

2002 Chevrolet Camaro coupe
 school license 248 days

| | Other driver | Front pass. | Rear pass. | Rear pass. | Rear pass. |
|-----------|--------------|-------------|------------|------------|------------|
| age | 24 | * | | | |
| gender | M | * | | | |
| fatality | Y | * | | | |
| injury | | 5 | | | |
| ejection | N | * | | | |
| seat belt | N | * | | | |

1992 Dodge Dakota pickup
 *Passenger data unavailable

Crash Narrative

Teen was traveling on north on Juniper Ave and failed to yield at a stop sign while turning left. Other driver was travelling east on 170th St and the front of other driver's vehicle struck the driver side front of teen. Both vehicles came to rest in the intersection.

Contributing factors

-

Other factors

Rain, wet road surface

Reporting Agency: Washington County Sheriff

Teen driver at fault? Yes

License history:

*License history data omitted for protection of privacy

Criminal charges:

Failure to yield upon entering a through highway

Civil litigation:

None

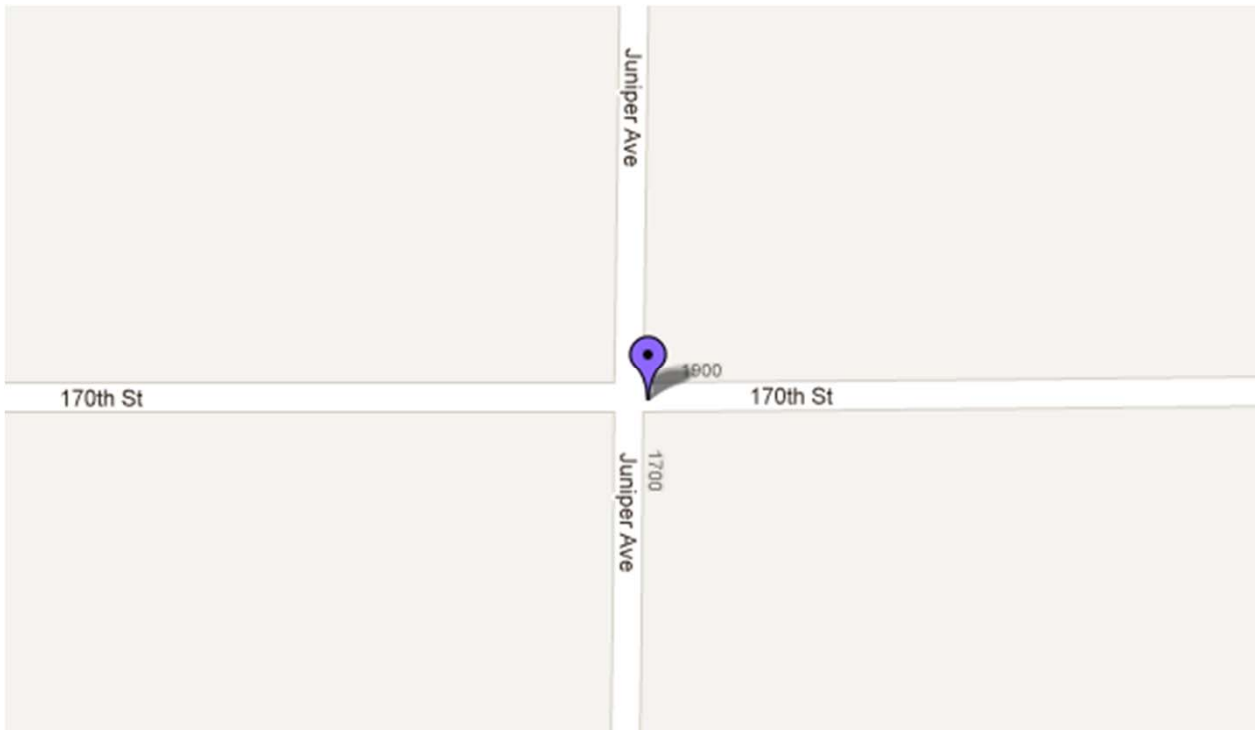

9:02 PM

Saturday

May 2, 2009

10

IA 122 between Georgia Ave & Jersey Ave, Mason City, Cerro Gordo

State Route 2L

Non-collision

| | Teen driver | Front pass. | Rear pass. | Rear pass. | Rear pass. |
|-----------|-------------|-------------|------------|------------|------------|
| age | 18 | | | | |
| gender | M | | | | |
| fatality | | | | | |
| injury | 5 | | | | |
| ejection | N | | | | |
| seat belt | ? | | | | |

| | |
|--------------------------------|---------------------------|
| | |
| 1999 Pontiac Grand Am SE coupe | pedestrian |
| full license 226 days | 10 years old, male, fatal |

Crash Narrative

Teen was westbound in left lane of IA 122 in Mason City. A group of children crossed the street in the middle of the block between S. Georgia and S. Jersey streets. One of the children stopped in the street and was struck.

Contributing factors

-

Other factors

-

Reporting Agency: Iowa State Patrol

Teen driver at fault? No

License history:

*License history data omitted for protection of privacy

Criminal charges:

None

Civil litigation:

None

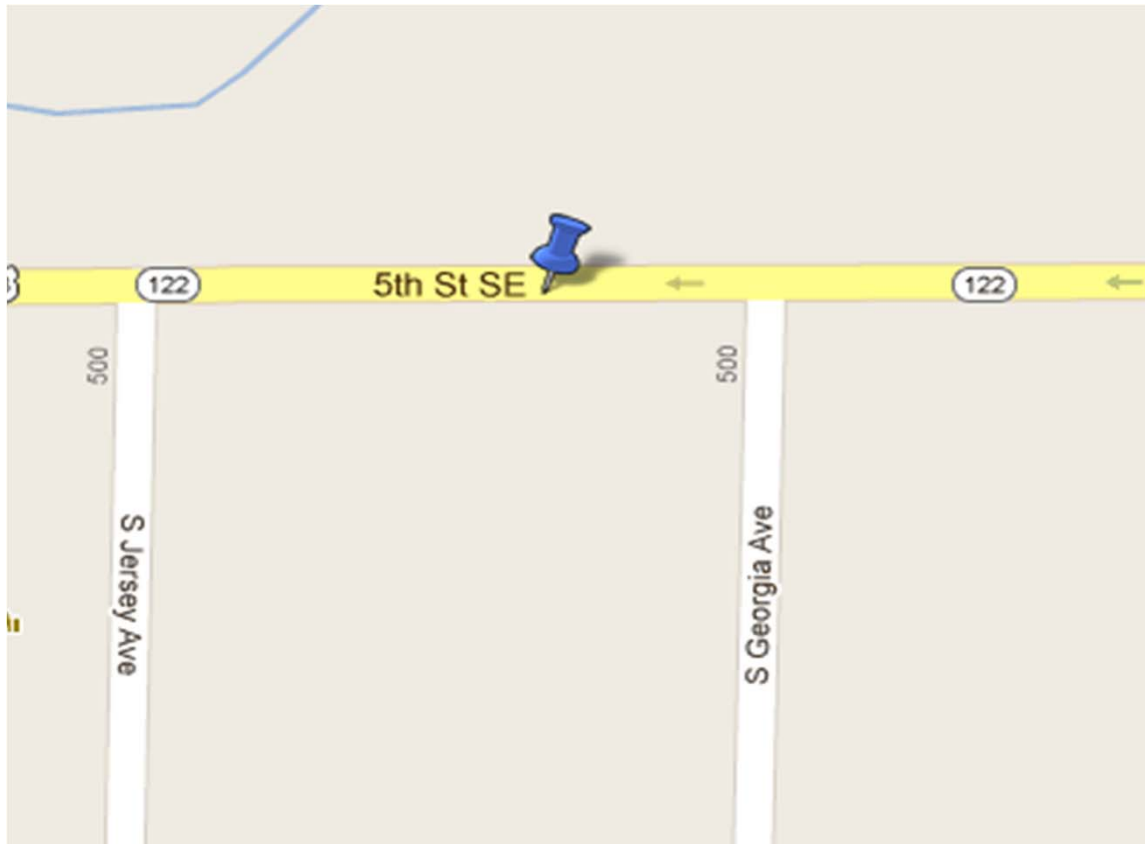

7:19 PM

Monday

May 11, 2009

11

US 18 just east of intersection with Kennedy Ave, Boyden, Sioux County

US Route 2L, with turning lane in WB lane

Head-on

| | Teen driver | Front pass. | Rear pass. | Rear pass. | Rear pass. |
|-----------|-------------|-------------|------------|------------|------------|
| age | 19 | | | | |
| gender | M | | | | |
| fatality | Y | | | | |
| injury | | | | | |
| ejection | N | | | | |
| seat belt | N | | | | |

1998 Chevrolet Camaro Z28 coupe
full license 1035 days

| | Other driver |
|-----------|--------------|
| age | 55 |
| gender | M |
| fatality | |
| injury | 4 |
| ejection | N |
| seat belt | Y |

2000 Freightliner tractor trailer

Crash Narrative

Teen was traveling east on Hwy 18 and veered into the westbound lane. Other vehicle swerved to avoid and front of other vehicle struck driver side - front of teen. Teen apparently was crossing centerline back to proper lane.

Contributing factors

-

Other factors

-

Reporting Agency: Sioux County Sheriff

Teen driver at fault? Yes

License history:

 *License history data omitted for protection of privacy

Criminal charges:

 None

Civil litigation:

 None

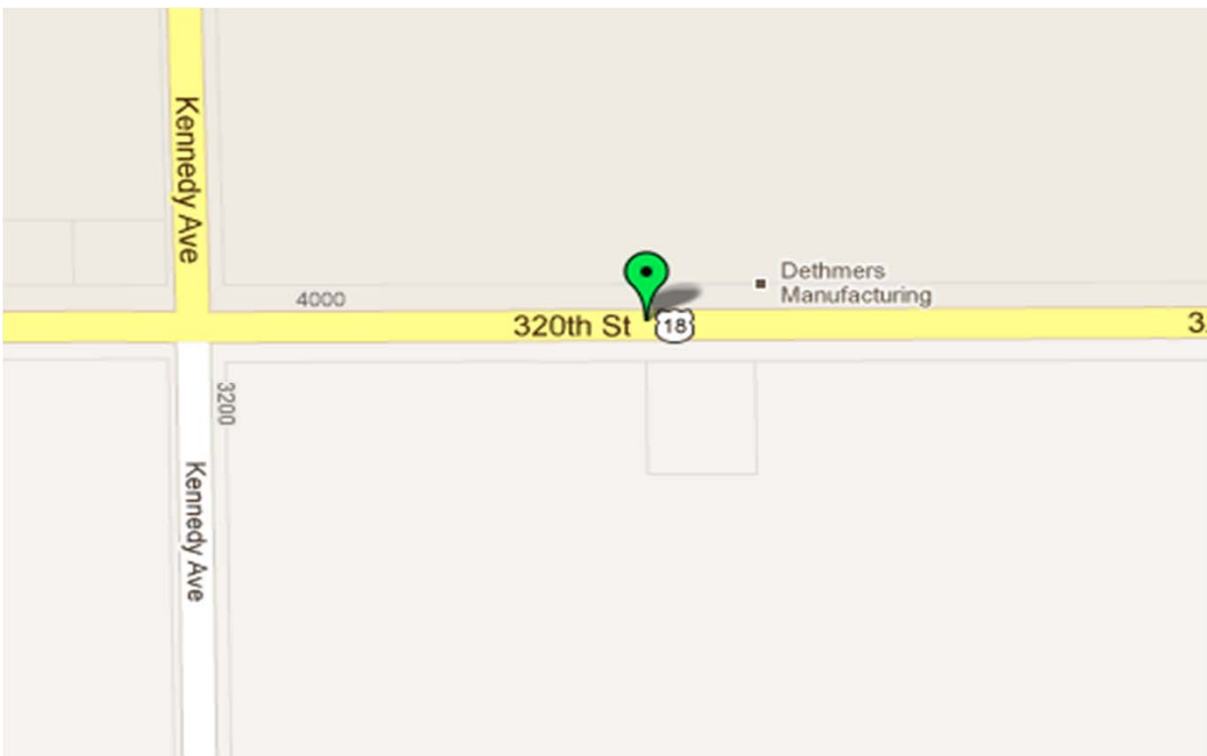

I-29 just south of US 75, Sioux City, Woodbury County

Interstate 2L each direction

Sideswipe, same direction

| | Teen driver | Front pass. | Rear pass. | Rear pass. | Rear pass. |
|-----------|-------------|-------------|------------|------------|------------|
| age | 18 | 19 | | | |
| gender | M | F | | | |
| fatality | | | | | |
| injury | 3 | 4 | | | |
| ejection | N | N | | | |
| seat belt | Y | Y | | | |

2000 Pontiac Grand Prix GT coupe
full license 319 days

| | Other driver | Front pass. | Rear pass. | Rear pass. | Rear pass. |
|-----------|--------------|-------------|------------|------------|------------|
| age | 61 | | | | |
| gender | M | | | | |
| fatality | Y | | | | |
| injury | | | | | |
| ejection | N | | | | |
| seat belt | N | | | | |

1999 Chevrolet K2500 pickup

Crash Narrative

CRASH FILE: teen loc; loss of control while changing lanes and trying to avoid an accident with vehicle ahead, sideswipe, same direction; swerving/evasive action - crossed center line. Front of teen vehicle struck driver side - middle of pickup truck. MEDIA and YTD: teen crossed median before striking PU.

Contributing factors

-

Other factors

-

Reporting Agency: Sioux City Police

Teen driver at fault? No

License history:

*License history data omitted for protection of privacy

Criminal charges:

Pleaded guilty to vehicular homicide/reckless or elude; initially sentenced to 10 years prison, asked for reconsideration; judge sentenced to 5 yr probation. Failure to maintain control (fine).

Civil litigation:

None

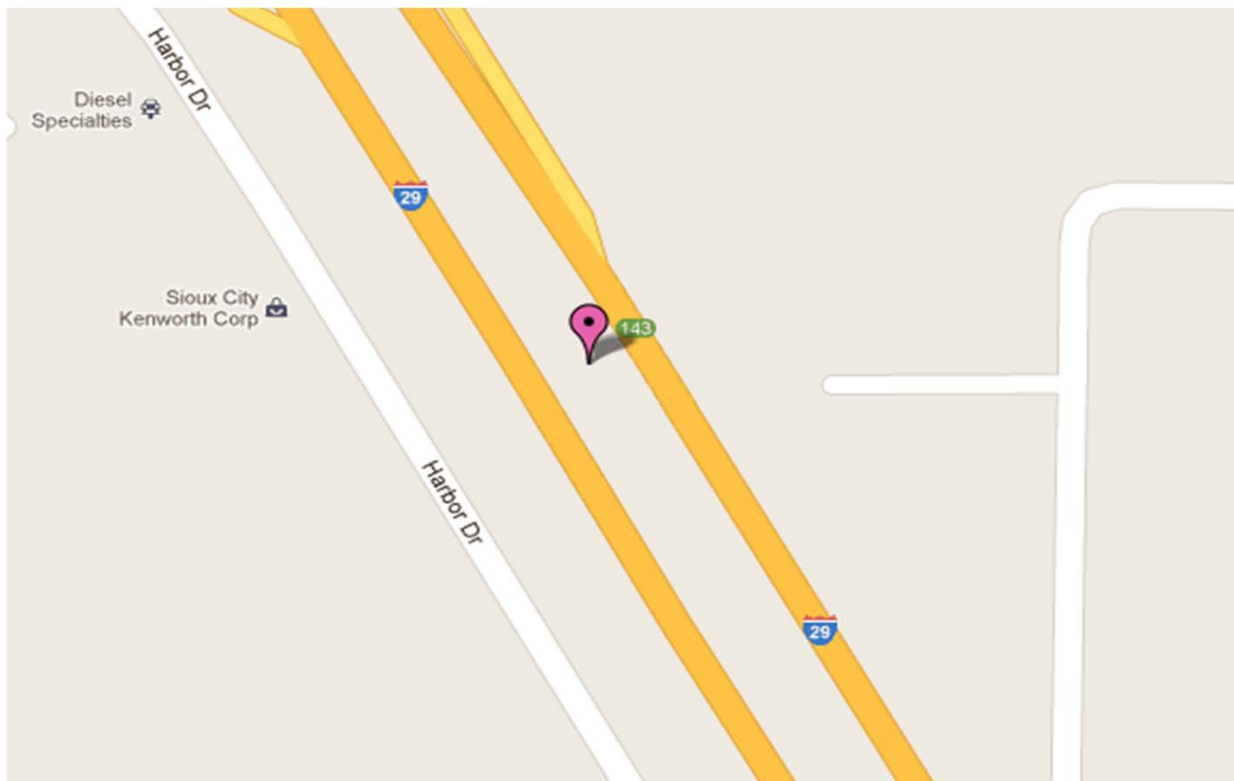

Kirkwood Blvd & Mississippi Ave, Davenport, Scott County
Municipal 2L, 4-way controlled intersection, EB/WB divided by grass median
Non-collision

| | Teen driver | Front pass. | Rear pass. | Rear pass. | Rear pass. |
|-----------|-------------|-------------|------------|------------|------------|
| age | 18 | 18 | | | |
| gender | M | M | | | |
| fatality | | Y | | | |
| injury | 3 | | | | |
| ejection | N | N | | | |
| seat belt | Y | Y | | | |

1997 Lincoln Continental 4D sedan
full license 65 days

Crash Narrative

Teen was traveling EB and exceeding authorized speed of 30 mph. Teen lost control on curve and after striking the grass island in the middle of the street, collided with a tree with the initial impact to the passenger side front of vehicle.

Contributing factors

Exceeded authorized speed

Other factors

-

Reporting Agency: Davenport Police

Teen driver at fault? Yes

License history:

*License history data omitted for protection of privacy

Criminal charges:

Speeding 55/30 (fine and suspension of license for 1 yr). Subsequent no insurance and operation w/o registration.

Civil litigation:

None

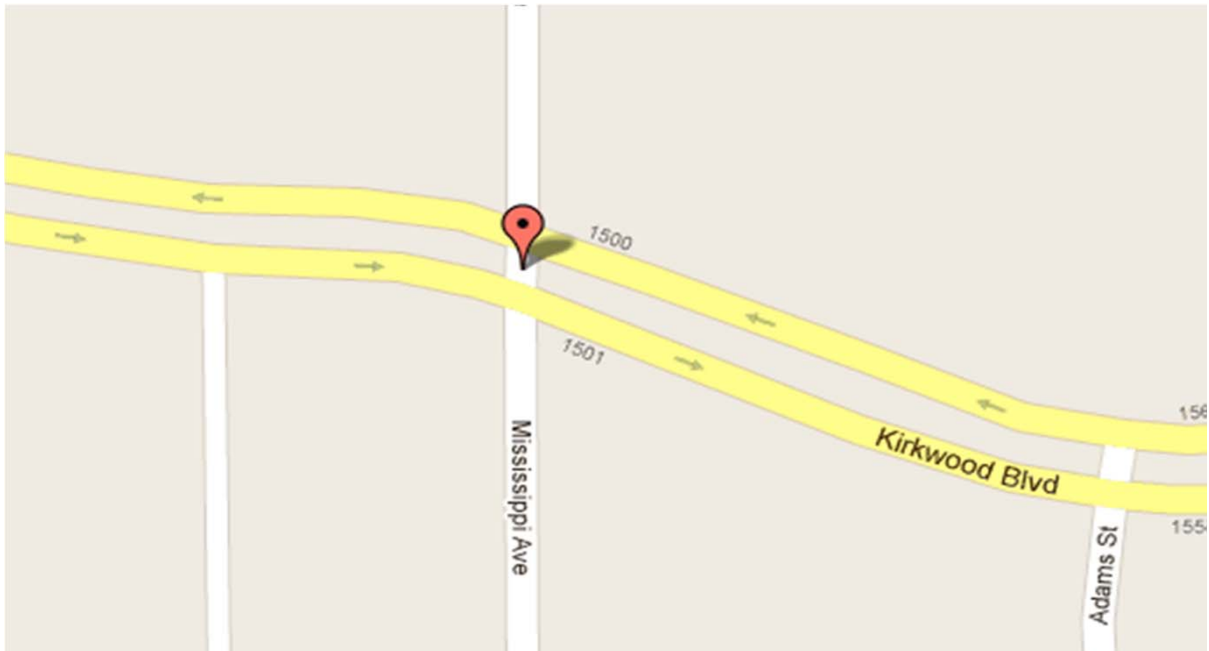

IA 92 and Lexington Blvd, Washington County
 State Route/Secondary 2L, 4-way controlled intersection, secondary - gravel
 Broadside

| | Teen driver | Front pass. | Rear pass. | Rear pass. | Rear pass. |
|-----------|-------------|-------------|------------|------------|------------|
| age | 17 | 19 | 15 | | 16 |
| gender | M | M | M | | M |
| fatality | | Y | | | |
| injury | 2 | | 3 | | 2 |
| ejection | N | N | N | | N |
| seat belt | Y | N | N | | N |

1997 Chevrolet K1500 pickup
 reinstated intermediate 352 days

| | Other driver | Other pass. |
|-----------|--------------|-------------|
| age | 30 | 29 |
| gender | M | F |
| fatality | Y | Y |
| injury | | |
| ejection | N | N |
| seat belt | Y | Y |

2006 Mercury Mountaineer Luxury
 4D wagon

| | Other driver |
|-----------|--------------|
| age | 26 |
| gender | M |
| fatality | |
| injury | 3 |
| ejection | N |
| seat belt | N |

1999 Mack CH600 Truck

Crash Narrative

Teen (Unit 1) was northbound on Lexington Blvd. Other driver (Unit 2) was eastbound on Hwy 92. Semi-truck (Unit 3) was westbound on Hwy 92. Teen (Unit 1) failed to stop at the stop sign and struck other driver (Unit 2) in the passenger side door area. This collision pushed other driver (Unit 2) into the westbound lane and semi-truck (Unit 3) struck other driver (Unit 2) in the driver side door. Other driver (Unit 2) then rolled over and caught on fire.

Contributing factors

-

Other factors

-

Reporting Agency: Iowa State Patrol

Teen driver at fault? Yes

License history:

*License history data omitted for protection of privacy

Criminal charges:

3 counts of vehicular homicide/reckless or elude (acquitted by jury)

Civil litigation:

2 civil cases: one of these is Haifley, D & D & T v. A & R Brock, motion to consolidate civil cases

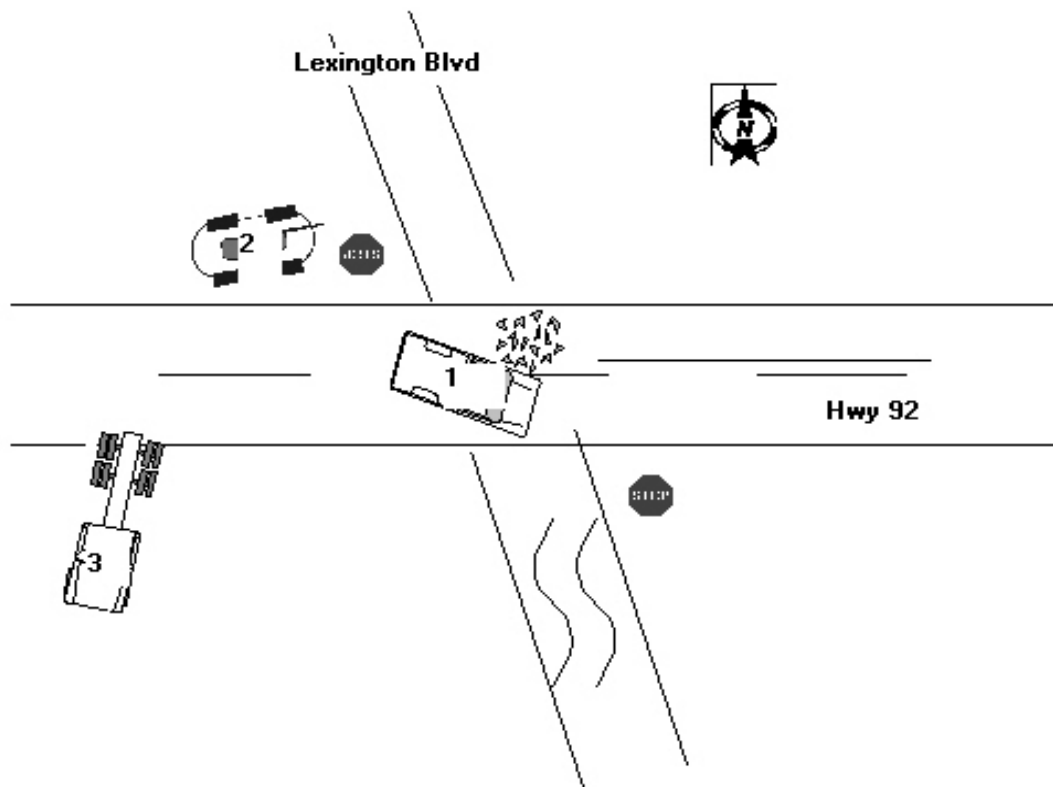

Co Hwy E53/240th St and I Ave, Greene County
 Secondary 2L, 4-way controlled intersection, gravel
 Broadside

| | Teen driver | Front pass. | Rear pass. | Rear pass. | Rear pass. |
|-----------|-------------|-------------|------------|------------|------------|
| age | 18 | | | | |
| gender | F | | | | |
| fatality | | | | | |
| injury | 4 | | | | |
| ejection | N | | | | |
| seat belt | Y | | | | |

1997 Ford Probe Hatchback 2D
 full license 146 days

| | Other driver | Front pass. | Rear pass. | Rear pass. | Rear pass. |
|-----------|--------------|-------------|------------|------------|------------|
| age | 54 | | | | |
| gender | M | | | | |
| fatality | Y | | | | |
| injury | | | | | |
| ejection | N | | | | |
| seat belt | N | | | | |

1991 Buick Lesabre Custom Sedan

Crash Narrative

Other driver (Unit 2) was northbound on I Ave when witnesses state it failed to stop at a stop sign and was struck broadside by teen (Unit 1) which was westbound on 240th St. Both vehicles continued into the northwest ditch landing in a cornfield where other vehicle (Unit 2) rolled over onto its top and was engulfed in fire.

Contributing factors

-

Other factors

-

Reporting Agency: Iowa State Patrol

Teen driver at fault? No

License history:

*License history data omitted for protection of privacy

Criminal charges:

None

Civil litigation:

None

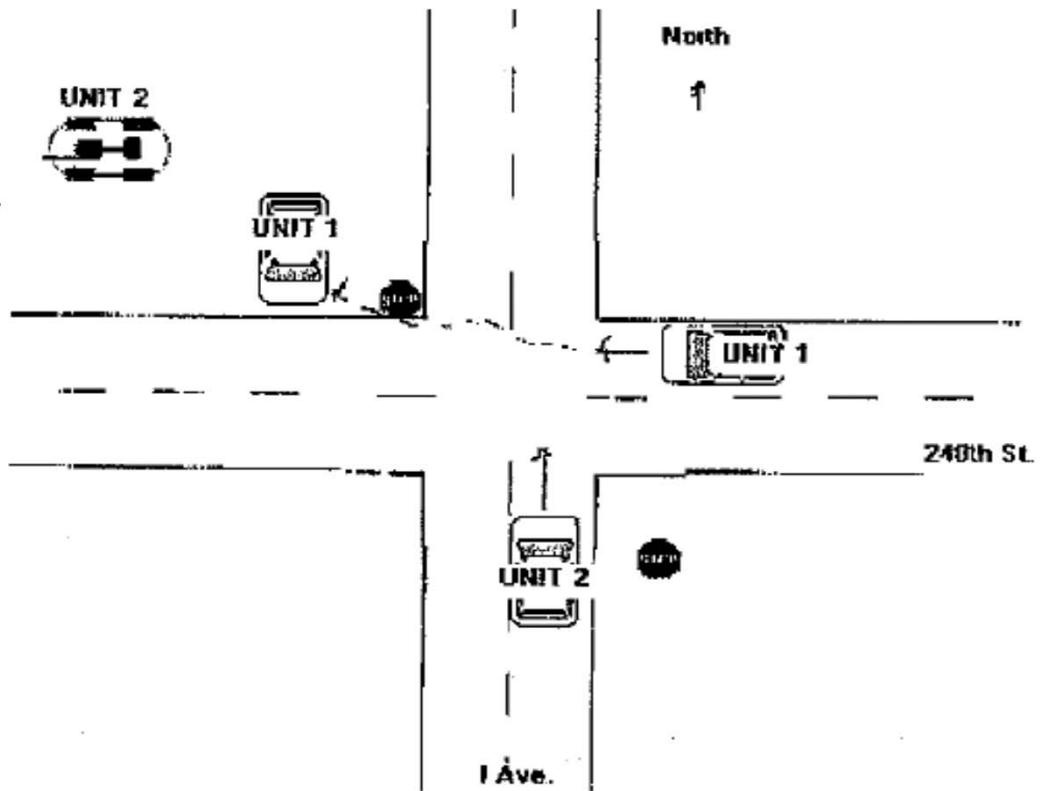

US Hwy 61 just north of intersection with 183rd Ave, Jackson County

US Route, 2L both directions divided highway

Non-collision

| | Teen driver | Front pass. | Rear pass. | Rear pass. | Rear pass. | Rear pass. |
|-----------|-------------|-------------|------------|------------|------------|------------|
| age | 15 | 50 | 44 | 10 | 13 | |
| gender | F | M | F | F | M | |
| fatality | | Y | Y | | | |
| injury | 2 | | | 2 | 3 | |
| ejection | N | Y | Y | Y | Y | |
| seat belt | Y | N | N | N | N | |

2003 Honda Oddesy Van
 instruction permit UNK days

Crash Narrative

Teen (Unit 1) was traveling southbound on Hwy 61 at mile marker 170 and went off onto right shoulder. Teen steered left overcorrecting losing control in roadway. Teen's vehicle left roadway on left side and traveled into median and began to rollover. Vehicle rolled several times ejecting all passengers. Vehicle came to rest on its wheels in the northbound left lane and shoulder facing east.

Contributing factors

-

Other factors

-

Reporting Agency: Iowa State Patrol

Teen driver at fault? Yes

License history:

*License history data omitted for protection of privacy

Criminal charges:

None

Civil litigation:

None

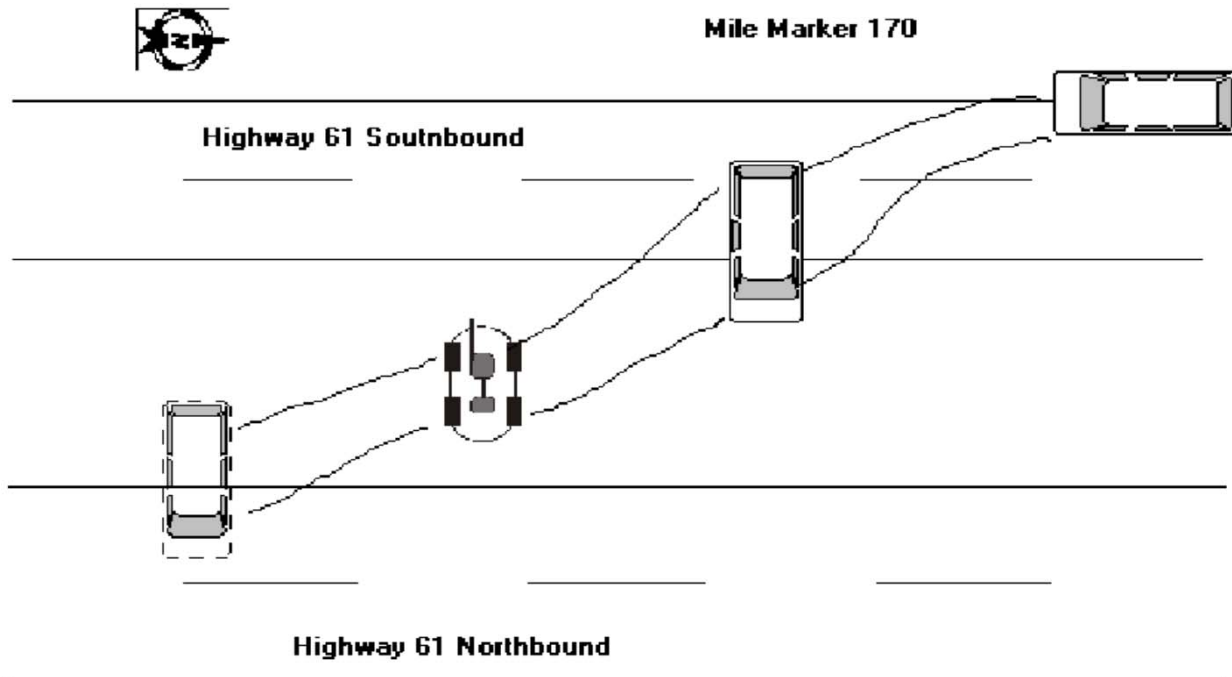

Co Hwy B14/330th and Yale Ave, Hancock County
 Secondary 2L, 4-way controlled intersection, gravel on secondary south of intersection
 Broadside

| | Teen driver | Front pass. | Rear pass. | Rear pass. | Rear pass. |
|-----------|-------------|-------------|------------|------------|------------|
| age | 19 | 19 | | 19 | |
| gender | M | M | | M | |
| fatality | | | | Y | |
| injury | 2 | 2 | | | |
| ejection | N | N | | Y | |
| seat belt | * | ? | | N | |

1998 Toyota Camry Sedan 4D
 full license 947 days

* lap belt only

| | Other driver | Front pass. | Rear pass. | Rear pass. | Rear pass. |
|-----------|--------------|-------------|------------|------------|------------|
| age | 58 | | | | |
| gender | M | | | | |
| fatality | Y | | | | |
| injury | | | | | |
| ejection | ? | | | | |
| seat belt | Y | | | | |

2007 Chevrolet Cobalt 4D

Crash Narrative

Teen (Unit 1) was southbound and failed to obey the stop sign at the intersection with B14. Teen struck other vehicle (Unit 2) which was westbound on B14. Both teen and other vehicle entered the southwest ditch where teen (Unit 1) struck a utility pole and they both rolled into the field.

Contributing factors

Teen had BAC of 0.074

Other factors

-

Reporting Agency: Iowa State Patrol

Teen driver at fault? Yes

License history:

*License history data omitted for protection of privacy

Criminal charges:

2 counts of homicide by vehicle/OWI; 1 count serious injury by vehicle. Sentenced on 9/14/10 to 10 yrs for 2 counts veh homicide/reckless or elude and 1 count serious injury by vehicle. \$300,000 restitution and up to \$27,000 in fines.

Civil litigation:

None

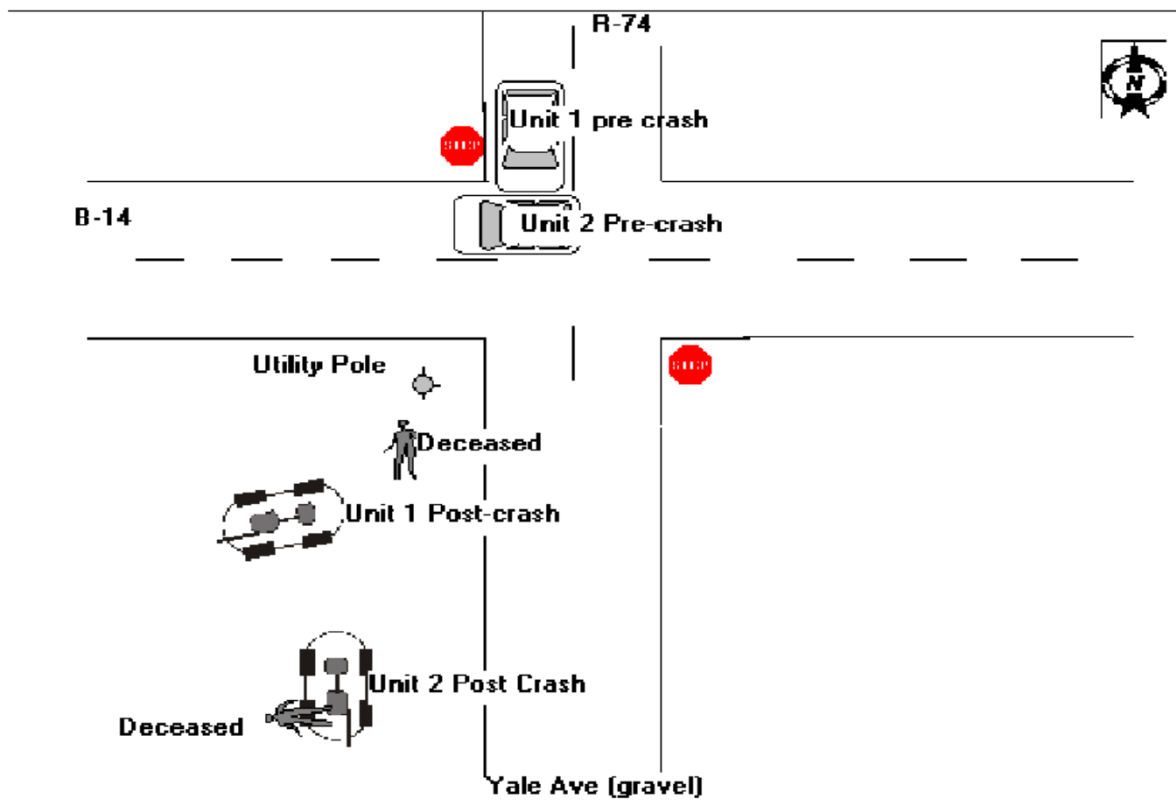

Libertyville Rd, between Key Blvd & Main St, Jefferson County
 Secondary 2L and residential driveway
 Angle, oncoming left turn

| | | | | | |
|-----------|-------------|-------------|------------|------------|------------|
| | Teen driver | Front pass. | Rear pass. | Rear pass. | Rear pass. |
| age | 17 | | | | |
| gender | M | | | | |
| fatality | | | | | |
| injury | 5 | | | | |
| ejection | N | | | | |
| seat belt | Y | | | | |

1993 Ford Ranger pickup
 intermediate license 444 days

| | |
|-----------|--------------|
| | Other driver |
| age | 60 |
| gender | M |
| fatality | Y |
| injury | |
| ejection | n/a |
| seat belt | N |

1982 Harley Davidson XLS motorcycle

Crash Narrative

Teen (Unit 1) was westbound on Libertyville Rd., preparing to turn left into a private driveway. Other driver (Unit 2) was eastbound on Libertyville Rd. As teen executed a left turn it was struck by other driver in the eastbound lane. The other driver was thrown from the motorcycle, coming to rest in the roadway. Teen's vehicle stopped in the driveway and other driver came to rest against the north curb.

Contributing factors

Crash occurred at dusk and Unit #1 was heading west

Other factors

-

Reporting Agency: Iowa State Patrol

Teen driver at fault? Yes

License history:

*License history data omitted for protection of privacy

Criminal charges:

failure to yield upon left turn (fine)

Civil litigation:

None

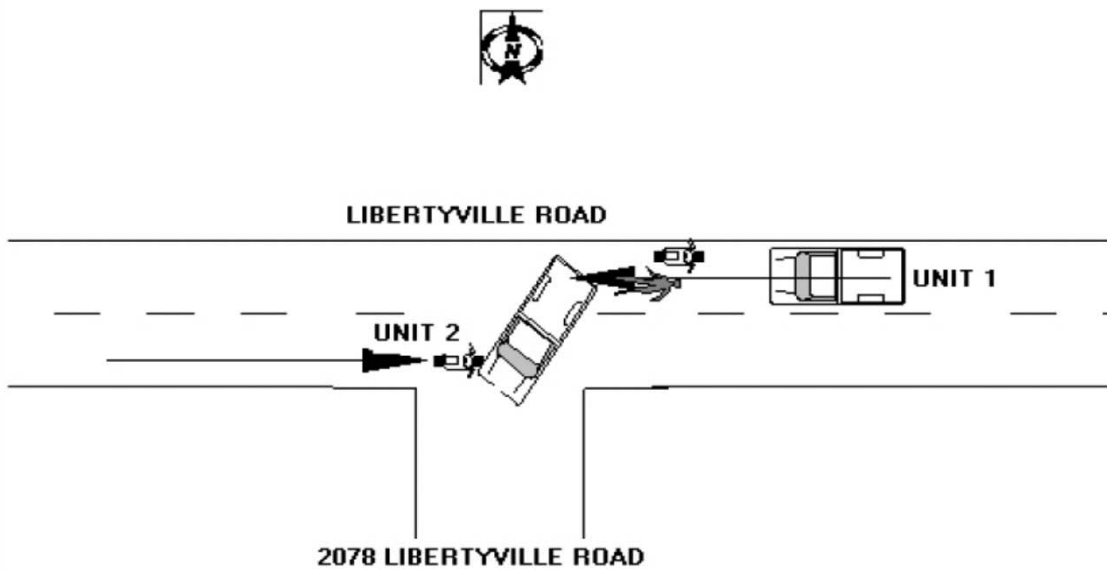

12:45 AM

Saturday

June 20, 2009

19

148th St just east of intersection with F Ave, Iowa County

Secondary 2L, gravel

Non-collision

| | Teen driver | Front pass. | Rear pass. | Rear pass. | Rear pass. |
|-----------|-------------|-------------|------------|------------|------------|
| age | 19 | | | | |
| gender | M | | | | |
| fatality | Y | | | | |
| injury | | | | | |
| ejection | Y | | | | |
| seat belt | N | | | | |

2000 Chevrolet K1500 Silverado pickup
full license 633 days

Crash Narrative

Teen was westbound on 148th St when driver swerved to avoid animal in the road. Teen collided with a calf in the road, entered the south ditch, and rolled several times.

Contributing factors

Animal in roadway

Other factors

-

Reporting Agency: Iowa County Sheriff

Teen driver at fault? Unclear

License history:

*License history data omitted for protection of privacy

Criminal charges:

None

Civil litigation:

None

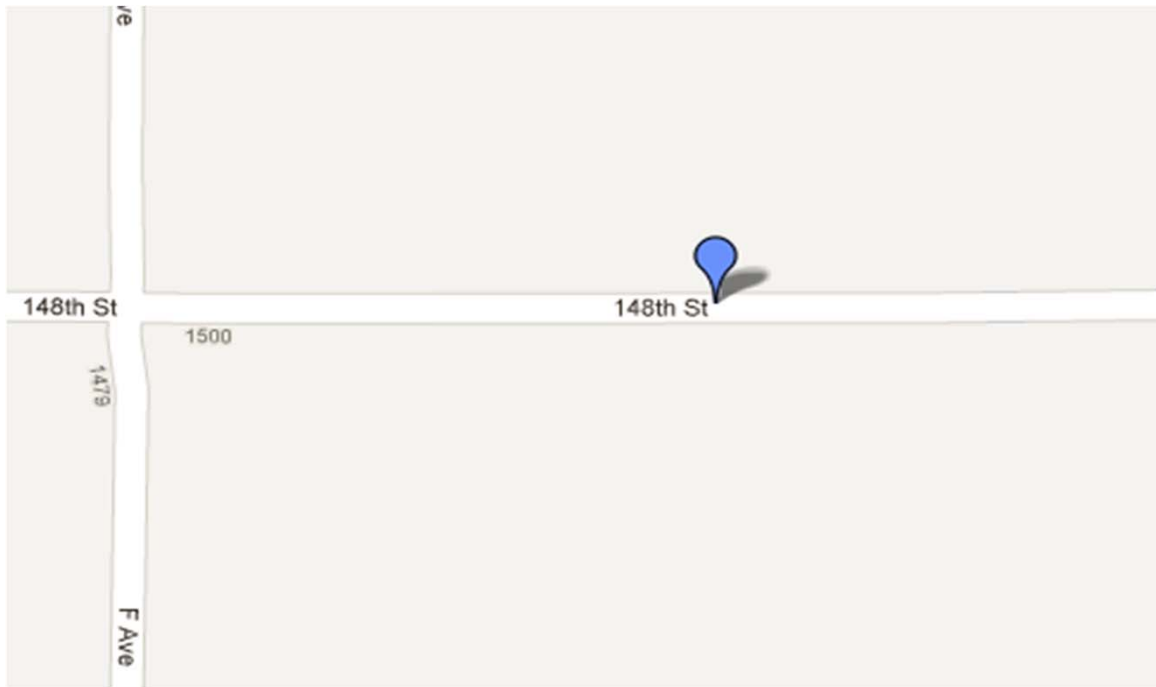

4:29 AM

Sunday

June 14, 2009

20

US Hwy 30 between 60th St & 400th Ave, Clinton County

US Route, 2L each direction, divided highway

Non-collision

| | Teen driver | Front pass. | Rear pass. | Rear pass. | Rear pass. |
|-----------|-------------|-------------|------------|------------|------------|
| age | 16 | | | | |
| gender | M | | | | |
| fatality | Y | | | | |
| injury | | | | | |
| ejection | N | | | | |
| seat belt | Y | | | | |

1997 Saturn SL2 Sedan
instruction permit 1080 days

Crash Narrative

Teen was driving east when vehicle traveled onto the north shoulder of the road, then back across both eastbound lanes into the south ditch, and rolled over.

Contributing factors

Teen had BAC of 0.10

Other factors

Evidence that teen was texting while driving just before the crash

Reporting Agency: Clinton Police

Teen driver at fault? Yes

License history:

*License history data omitted for protection of privacy

Criminal charges:

One male age 26 and one female age 23 were originally charged with Class D felony of providing alcohol to a minor resulting in death; jury convicted both with simple misdemeanor of providing alcohol to a minor. Each sentenced to a year probation and \$500 civil fine.

Civil litigation:

None

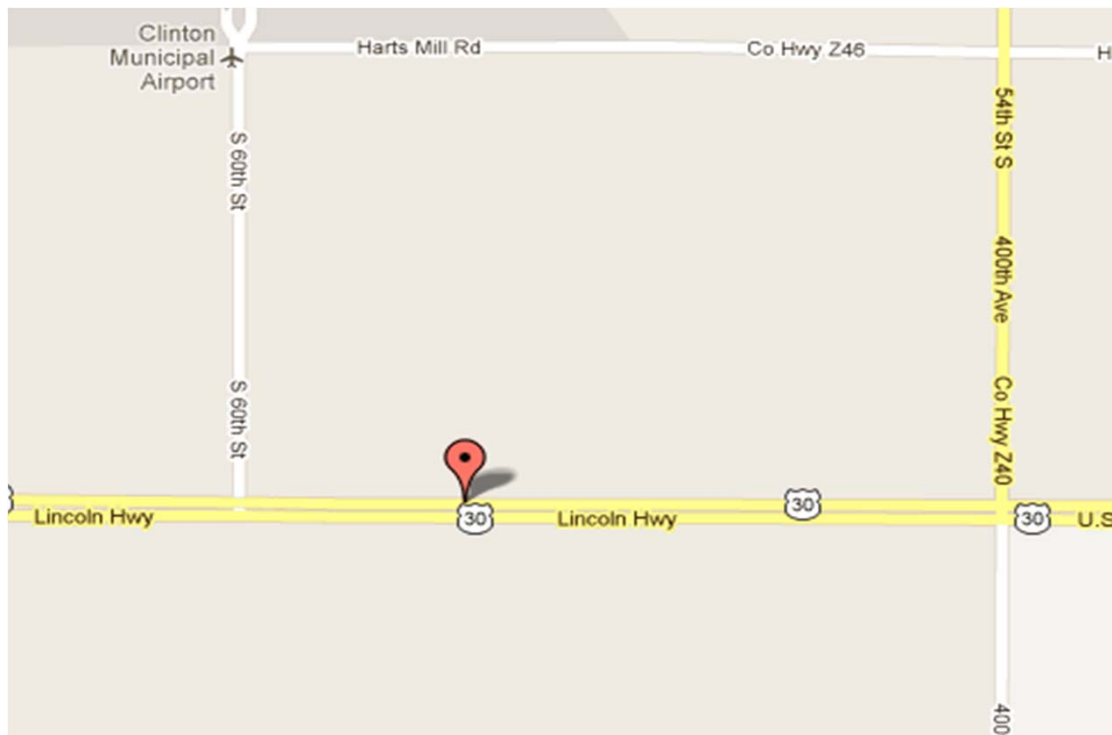

9:02 AM

Monday

June 29, 2009

21

285th St. between Dogwood Ave. & Dove Ave., Cerro Gordo County

Secondary 2L, gravel

Non-collision

| | Teen driver | Front pass. | Rear pass. | Rear pass. | Rear pass. |
|-----------|-------------|-------------|------------|------------|------------|
| age | 17 | | | | |
| gender | F | | | | |
| fatality | Y | | | | |
| injury | | | | | |
| ejection | Y | | | | |
| seat belt | N | | | | |

1996 Pontiac Grand Am Sedan
Intermediate license 374 days

Crash Narrative

Teen (Unit 1) was traveling eastbound on 285th St when she lost control, entered the south ditch, and overturned, rolling through the field fence. Teen was ejected through side window/door and both the driver and the car came to rest in the field south of the road.

Contributing factors

-

Other factors

-

Reporting Agency: Iowa State Patrol

Teen driver at fault? Yes

License history:

*License history data omitted for protection of privacy

Criminal charges:

None

Civil litigation:

None

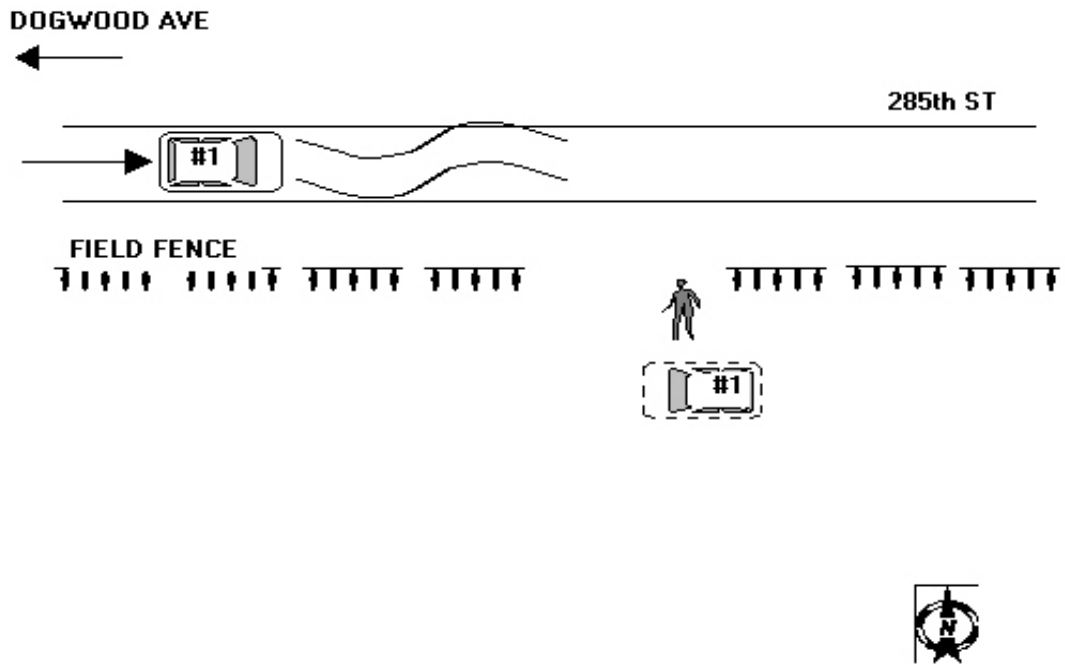

Co Rd N44/Timber Ave between 240th St & 250th St, Carroll County

Secondary 2L

Non-collision

| | Teen driver | Front pass. | Rear pass. | Rear pass. | Rear pass. |
|-----------|-------------|-------------|------------|------------|------------|
| age | 16 | 16 | | | |
| gender | M | M | | | |
| fatality | | Y | | | |
| injury | 3 | | | | |
| ejection | N | N | | | |
| seat belt | Y | Y | | | |

2001 Ford Escape XLS SUV
intermediate license 95 days

Crash Narrative

Teen (Unit 1) was driving south and attempted to pass another southbound vehicle just before the intersection. Teen drove off the left shoulder and attempted to bring the vehicle back onto the roadway. Teen lost control and slid across both lanes of traffic in front of the other vehicle and left the roadway on the west side. Teen rolled numerous times before coming to a stop on its wheels in a residential yard.

Contributing factors

-

Other factors

-

Reporting Agency: Iowa State Patrol

Teen driver at fault? Yes

License history:

*License history data omitted for protection of privacy

Criminal charges:

Passing too near bridge, intersection or railroad and Failure to maintain control (fines).

Civil litigation:

None

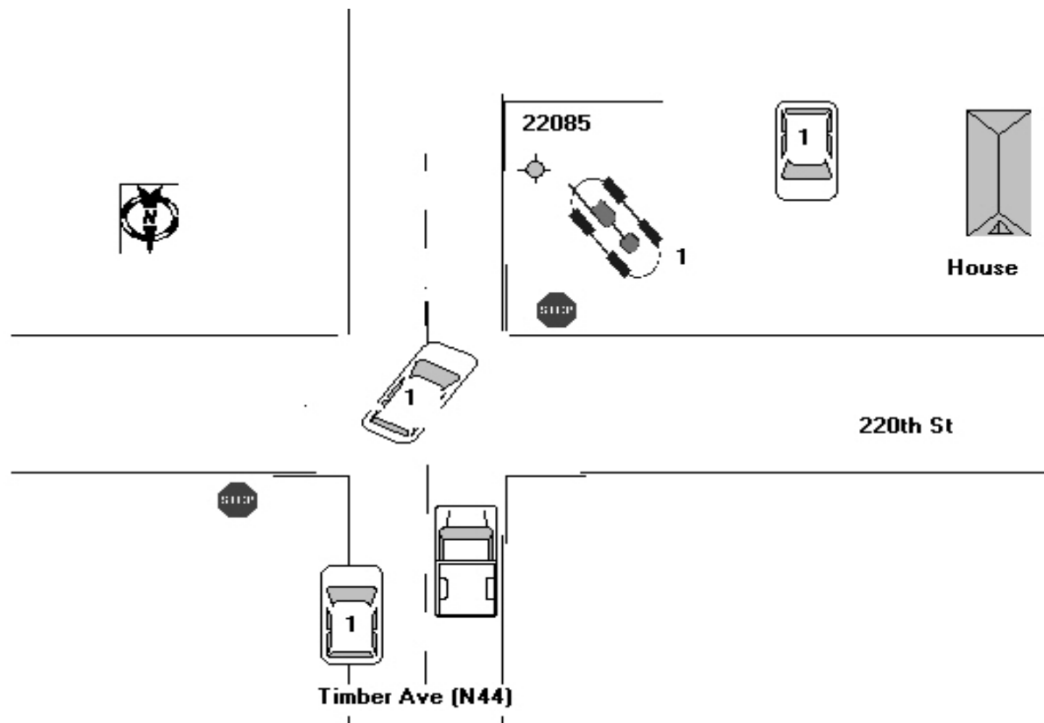

3:10 PM

Wednesday

July 1, 2009

23

Mm Ave near t-intersection with Keystone Ave, Hardin County

2L Secondary

Non-collision

| | Teen driver | Front pass. | Rear pass. | Rear pass. | Rear pass. |
|-----------|-------------|-------------|------------|------------|------------|
| age | 19 | 19 | | | |
| gender | M | M | | | |
| fatality | Y | | | | |
| injury | | 2 | | | |
| ejection | N | N | | | |
| seat belt | Y | Y | | | |

1998 Dodge Dakota Club Cab pickup
full license 510 days

Crash Narrative

Teen (Unit 1) was southbound on Mm Ave. Teen driver lost consciousness for an unknown reason. Front seat passenger tried to awaken driver but was unsuccessful. Passenger took control of the steering wheel and tried to negotiate a curve. Due to the driver still having his foot on the accelerator passenger steered around the curve at excessive speed, lost control, and tried to brake in a last ditch effort to avoid running off the roadway. Passenger was unable to stop vehicle and it entered the south ditch where is encountered a t-intersection. Vehicle valuted into the air and struck a tree on private property, coming to rest in a residential yard.

Contributing factors

Driver lost consciousness apparently due to illness

Other factors

-

Reporting Agency: Iowa State Patrol

Teen driver at fault? Unclear

License history:

*License history data omitted for protection of privacy

Criminal charges:

None

Civil litigation:

None

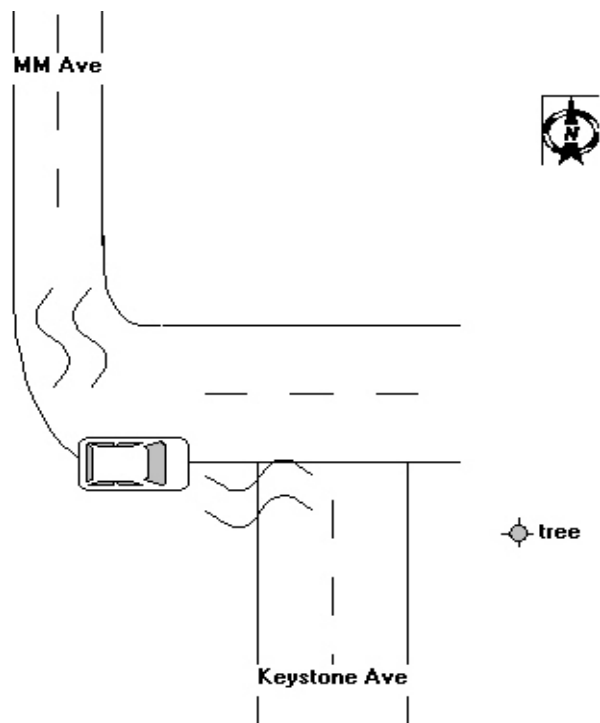

Bierman Rd & US Hwy 20, Epworth, Dubuque County

US route 2L both directions with divided highway, 2L Secondary/Municipal, gravel - municipal
Broadside

| | Teen driver | Front pass. | Rear pass. | Rear pass. | Rear pass. |
|-----------|-------------|-------------|------------|------------|------------|
| age | 19 | 19 | | | |
| gender | M | M | | | |
| fatality | Y | | | | |
| injury | | 2 | | | |
| ejection | N | N | | | |
| seat belt | N | N | | | |

1990 unknown make and model
full license 303 days

| | Other driver | Front pass. | Rear pass. | Rear pass. | Rear pass. |
|-----------|--------------|-------------|------------|------------|------------|
| age | 46 | 18 | | | |
| gender | F | M | | | |
| fatality | | | | | |
| injury | 3 | 3 | | | |
| ejection | N | N | | | |
| seat belt | Y | Y | | | |

2004 Dodge Dakota Quadcab pickup

Crash Narrative

Teen was southbound on Bierman Rd. Teen driver failed to yield from stop sign, vision obscured by moving vehicles. Other vehicle was westbound on Hwy 20 and struck teen's vehicle in the driver side - middle. Teen's vehicle then struck a sign post.

Contributing factors

-

Other factors

-

Reporting Agency: Dubuque County Sheriff

Teen driver at fault? Yes

License history:

*License history data omitted for protection of privacy

Criminal charges:

None

Civil litigation:

None



10:43 PM

Saturday

July 25, 2009

25

Cheyenne Rd just south of intersection with US Hwy 18, Chickasaw County

Secondary 2L, gravel

Non-collision

| | Teen driver | Front pass. | Rear pass. | Rear pass. | Rear pass. |
|-----------|-------------|-------------|------------|------------|------------|
| age | 18 | | | | |
| gender | M | | | | |
| fatality | | | | | |
| injury | 5 | | | | |
| ejection | N | | | | |
| seat belt | Y | | | | |

| | |
|---|---|
| <div style="background-color: black; height: 15px; width: 100%;"></div> <p>1995 Dodge Stratus Sedan full license 405 days</p> | <div style="background-color: black; height: 15px; width: 100%;"></div> <p>Pedestrian 52 years old, male, fatal</p> |
|---|---|

Crash Narrative

Teen (Unit 1) was traveling north on Cheyenne Road and collided with a pedestrian who was crossing the roadway.

Contributing factors

Pedestrian lying or sitting on roadway

Other factors

-

Reporting Agency: Iowa State Patrol

Teen driver at fault? No

License history:

*License history data omitted for protection of privacy

Criminal charges:

None

Civil litigation:

None

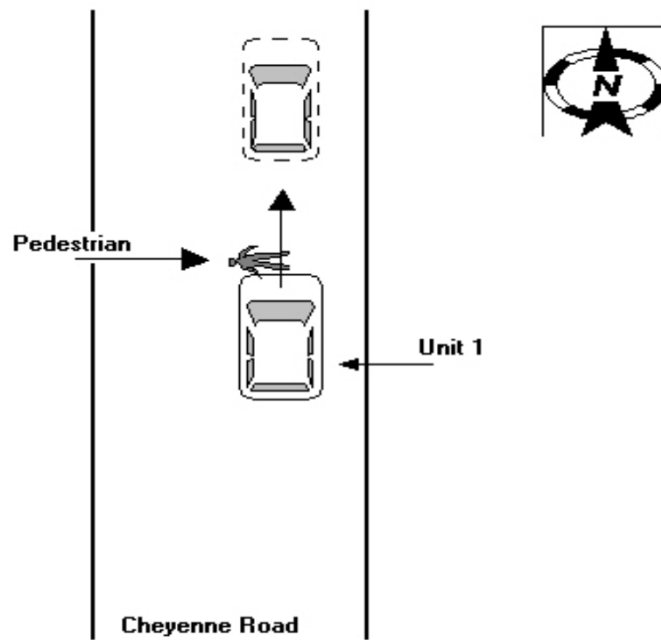

1:14 AM

Thursday

July 30, 2009

27

59th St. just west from 33rd Ave., Benton County
Secondary 2L, gravel
Non-collision

| | Teen driver | Front pass. | Rear pass. | Rear pass. | Rear pass. |
|-----------|-------------|-------------|------------|------------|------------|
| age | 19 | 18 | 18 | * | |
| gender | M | F | M | * | |
| fatality | | | Y | * | |
| injury | 4 | 2 | | 5 | |
| ejection | N | N | N | * | |
| seat belt | N | Y | ? | * | |

2006 Ford Ranger Super 4DR extended cab pickup
 full license 460 days
 *Passenger data unavailable

Crash Narrative

Teen was travelling south on gravel road. Driver was driving too fast for conditions. Teen LOC when he failed to negotiate a curve. Teen ran off road to left into a ditch and collided with a tree to the middle passenger side of the pickup.

Contributing factors

Driver under the influence of drugs/medication; exceeded authorized speeds

Other factors

-

Reporting Agency: Benton County Sheriff

Teen driver at fault? Yes

License history:

***License history data omitted for protection of privacy**

Criminal charges:

Charged on 12/15/10 with vehicular homicide/OWI, vehicular homicide/reckless or elude, and OWI first offense. Pre-trial conference set for July 2012.

Civil litigation:

None

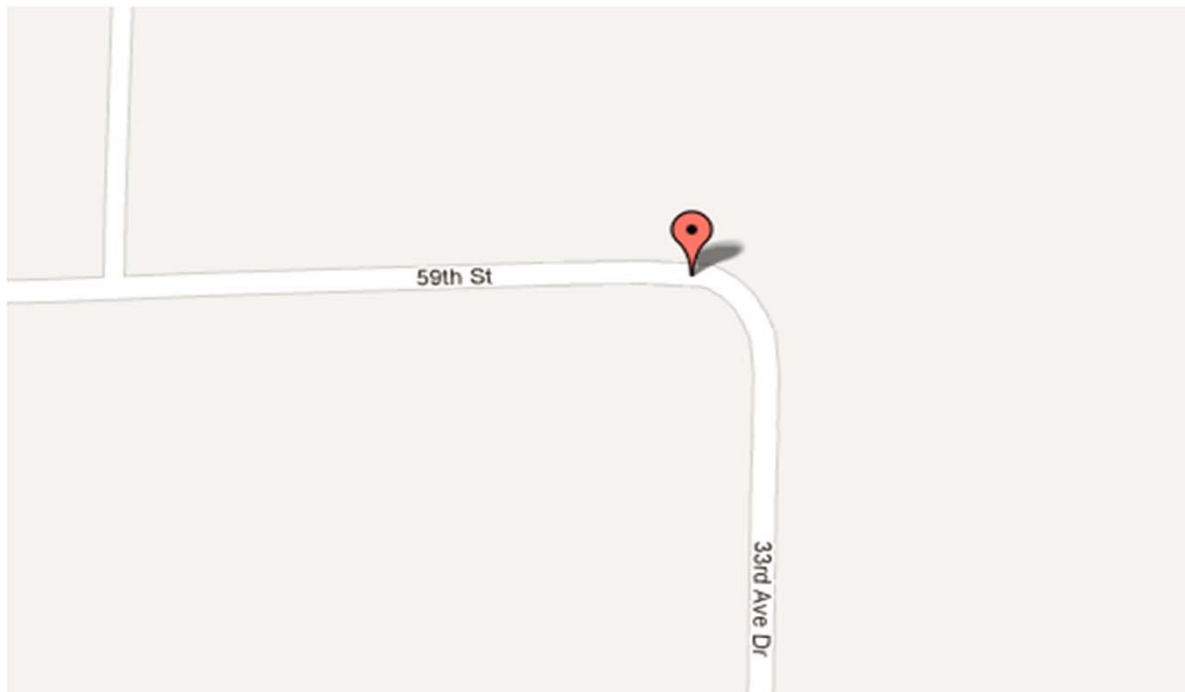

7:15 PM

Saturday

August 8, 2009

28

180th Ave between 98th Ave & State Hwy 206, Warren County

Secondary 2L, gravel, bridge

Non-collision

| | Teen driver | Front pass. | Rear pass. | Rear pass. | Rear pass. |
|-----------|-------------|-------------|------------|------------|------------|
| age | 16 | | | | |
| gender | F | | | | |
| fatality | Y | | | | |
| injury | | | | | |
| ejection | N | | | | |
| seat belt | Y | | | | |

1988 Chevrolet S10 pickup
intermediate license 150 days

Crash Narrative

Teen was northbound on 180th Ave when teen lost control and left the roadway to the right, striking a ditch embankment and vaulted into Cotton Creek on its top.

Contributing factors

Surface conditions: sand/mud/dirt/oil/gravel

Other factors

-

Reporting Agency: Iowa State Patrol

Teen driver at fault? Yes

License history:

*License history data omitted for protection of privacy

Criminal charges:

None

Civil litigation:

None

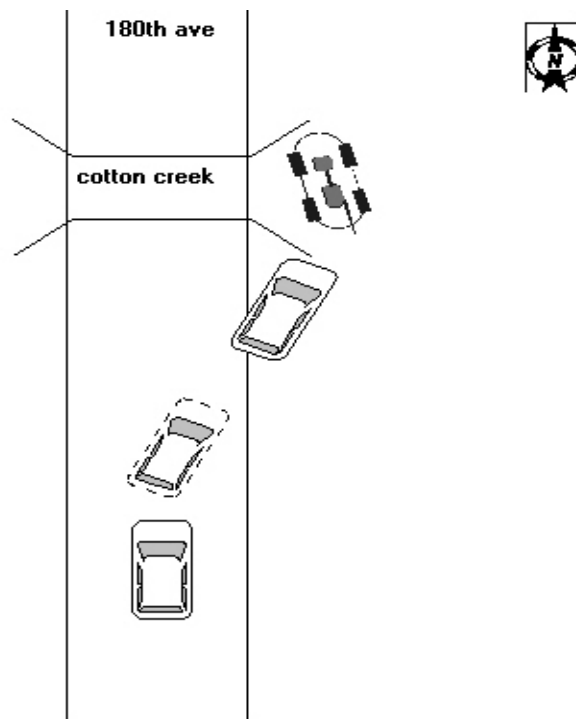

Co Hwy D15 between Q Ave & R Ave, Hardin County
 Secondary 2L
 Head-on

| | Teen driver | Front pass. | Rear pass. | Rear pass. | Rear pass. |
|-----------|-------------|-------------|------------|------------|------------|
| age | 18 | | | | |
| gender | F | | | | |
| fatality | | | | | |
| injury | 3 | | | | |
| ejection | N | | | | |
| seat belt | Y | | | | |

1991 Ford F250 supercab pickup
 full license 290 days

| | Other driver | Front pass. | Rear pass. | Rear pass. | Rear pass. |
|-----------|--------------|-------------|------------|------------|------------|
| age | 28 | | | | |
| gender | M | | | | |
| fatality | Y | | | | |
| injury | | | | | |
| ejection | N | | | | |
| seat belt | N | | | | |

1988 Honda Civic CRX DX hatchback 2DR

Crash Narrative

Other vehicle (Unit 2) was westbound on county road D15 but driving in the eastbound lane. Teen (Unit 1) was eastbound on D15. Teen driver saw other vehicle as it was approaching and attempted to stop to avoid a collision. Teen stated she was almost stopped at the time of impact. After the head-on collision, teen's vehicle rolled over onto its passenger side facing northeast in the eastbound lane. Other vehicle came to a rest in the westbound lane facing southwest.

Contributing factors

Driver of Unit #2 had 0.406 BAC

Other factors

-

Reporting Agency: Iowa State Patrol

Teen driver at fault? No

License history:

*License history data omitted for protection of privacy

Criminal charges:

None

Civil litigation:

Civil case against estate of other driver was dismissed w/o prejudice on 12/21/11

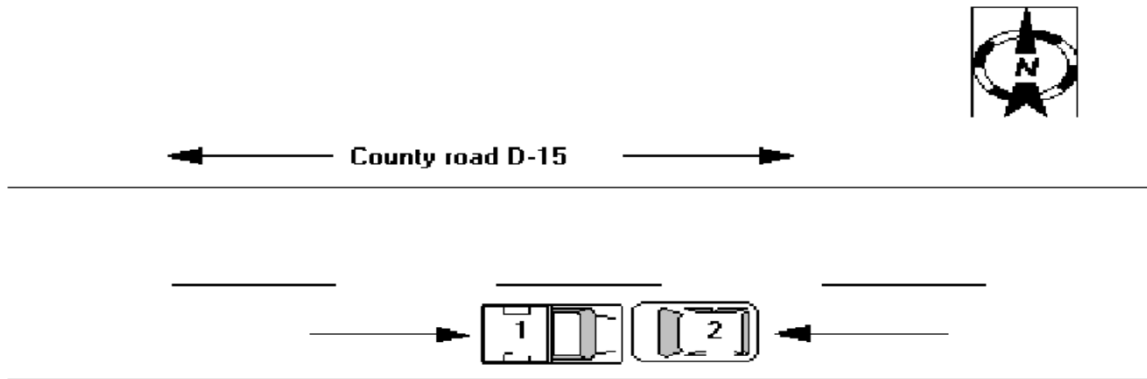

11:31 AM Thursday July 30, 2009 30
 W Mamie Eisenhower Ave, just east of intersection with Division St, Boone, Boone County
 Municipal 2L city street, shallow S curve
 Head-on

| | Teen driver | Front pass. | Rear pass. | Rear pass. | Rear pass. |
|-----------|-------------|-------------|------------|------------|------------|
| age | 18 | | | | |
| gender | F | | | | |
| fatality | | | | | |
| injury | 4 | | | | |
| ejection | N | | | | |
| seat belt | Y | | | | |

1992 Nissan Sentra Sedan 4 DR
 full license 588 days

| | Other driver |
|-----------|--------------|
| age | 40 |
| gender | M |
| fatality | Y |
| injury | |
| ejection | N/A |
| seat belt | N |

2007 Harley Davidson

Crash Narrative

Teen was eastbound on Mamie Eisenhower Ave. Other driver was westbound on Mamie Eisenhower Ave, approaching Division St intersection. Other driver passed one car in a no passing zone, and then attempted to pass a semi truck. Due to the S-curve near the Division St intersection, vision was obscured and the two vehicles collided head-on.

Contributing factors

Driver of Unit #2 was operating vehicle in an erratic/reckless/careless/negligent/aggressive manner

Other factors

Vision of both drivers obscured by moving vehicle

Reporting Agency: Boone County Sheriff

Teen driver at fault? No

License history:

*License history data omitted for protection of privacy

Criminal charges:

None

Civil litigation:

None

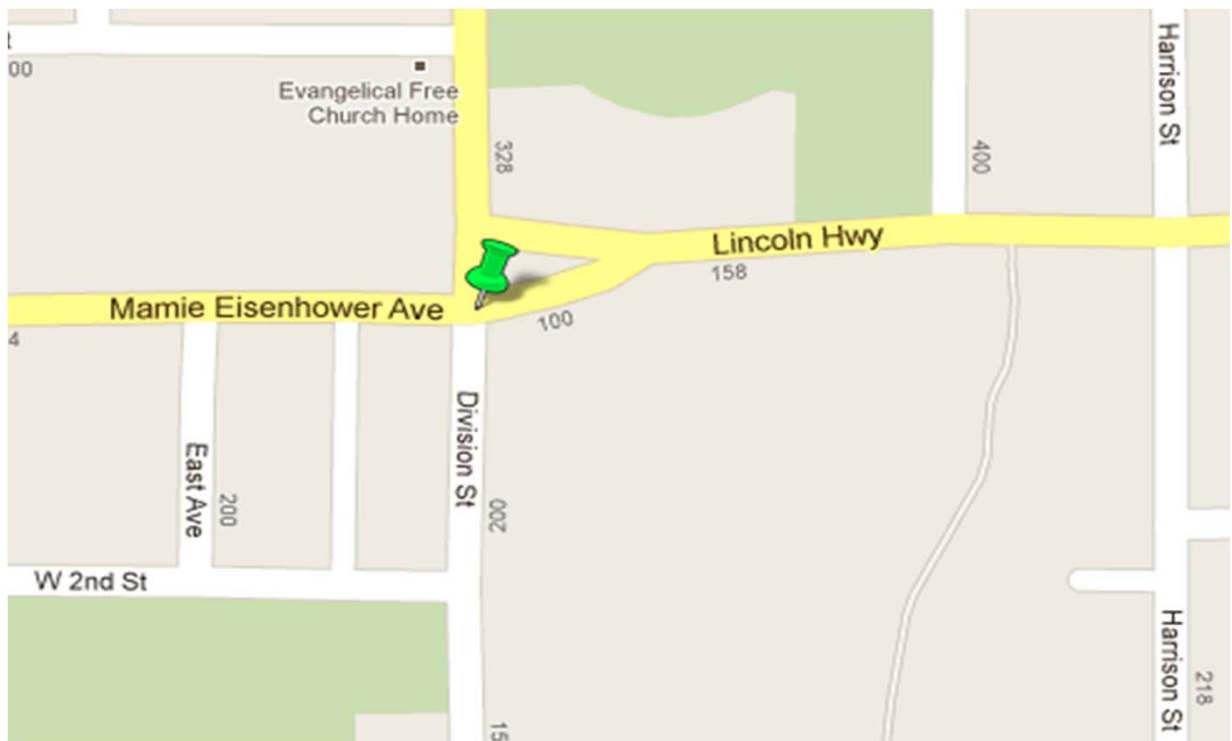

WB I-80 just east of SB I-29 split, Council Bluffs, Pottawattamie

Interstate highway split - 2L continue W, 2L go to SW

Rear-end

| | Teen driver | Front pass. | Rear pass. | Rear pass. | Rear pass. |
|-----------|-------------|-------------|------------|------------|------------|
| age | 19 | 19 | | | 19 |
| gender | M | M | | | M |
| fatality | | | | | |
| injury | 3 | 4 | | | 3 |
| ejection | N | N | | | N |
| seat belt | ? | ? | | | ? |

2004 Pontiac GTO Coupe
full license 718 days

| | Other driver | Front pass. | Rear pass. | Rear pass. | Rear pass. |
|-----------|--------------|-------------|------------|------------|------------|
| age | 53 | | | | |
| gender | M | | | | |
| fatality | Y | | | | |
| injury | | | | | |
| ejection | N | | | | |
| seat belt | Y | | | | |

1998 Chevrolet Malibu LS Sedan 4DR

Crash Narrative

Both teen and other driver were westbound on I-80. Teen was traveling in excess of 100 mph and witness stated teen was swerving in and out of traffic prior to striking the rear of the other vehicle and pushing it into a guardrail. After contact, teen's vehicle spun, striking the corner of the guardrail before crossing the westbound lanes and striking the left guardrail.

Contributing factors

Exceeded authorized speed and drove wrecklessly

Other factors

-

Reporting Agency: Council Bluffs Police

Teen driver at fault? Yes

License history:

 *License history data omitted for protection of privacy

Criminal charges:

Veh homicide/reckless or elude; deferred judgment - 120 days house arrest and electronic monitoring; supervised probation for 5 years, run ad in Daily Nonpareil on anniv date of incident each year of probation, participate no less than 4 reality education based programs per calendar year; \$150K restitution; privilege to operate a motor vehicle is revoked.

Civil litigation:

Civil trial brought by one of teen's passengers is in discovery phase and trial is set for November 2012.

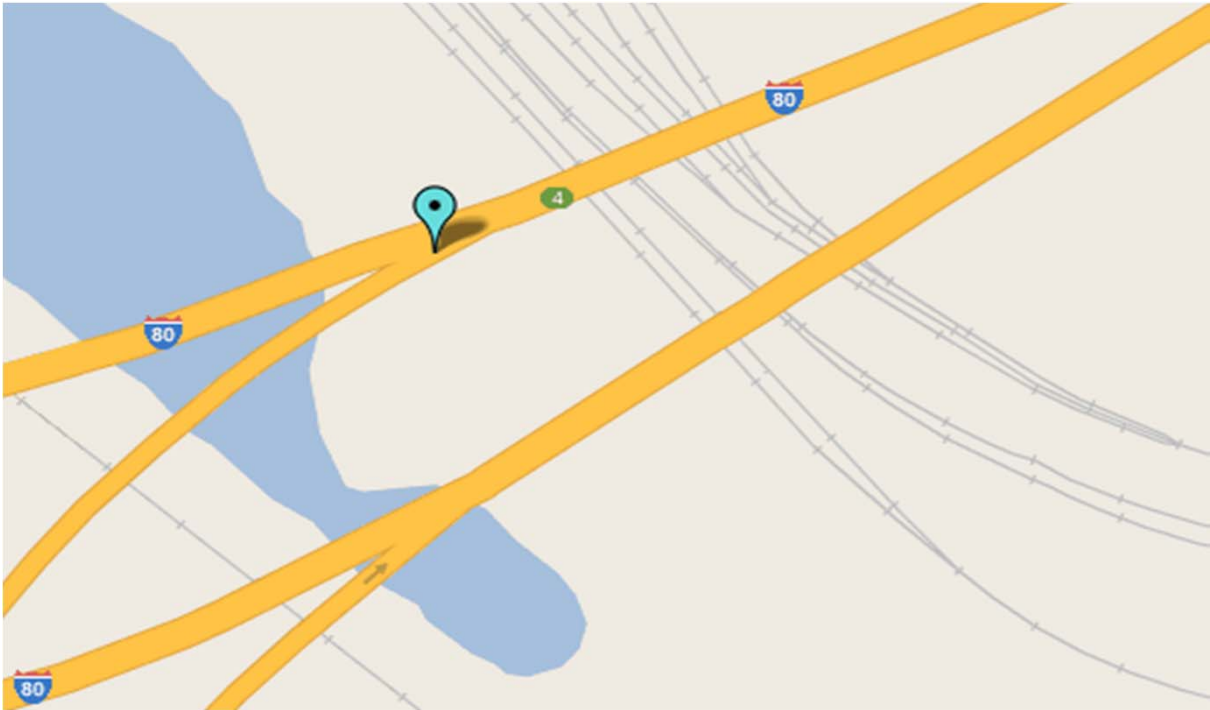

7:18 PM

Thursday

August 27, 2009

32

M50/160th Ave between 450th St & 460th St, Buena Vista County

Secondary 2L, gravel

Non-collision

| | Teen driver | Front pass. | Rear pass. | Rear pass. | Rear pass. |
|-----------|-------------|-------------|------------|------------|------------|
| age | 15 | | | | |
| gender | F | | | | |
| fatality | Y | | | | |
| injury | | | | | |
| ejection | Y | | | | |
| seat belt | N | | | | |

2004 Chevrolet pickup
school license 408 days

Crash Narrative

Teen was traveling northbound on M50/160th Ave when the driver's side wheels partially entered the ditch on west side. Teen driver overcorrected in an attempt to regain control and the pickup rolled over into the east side ditch.

Contributing factors

-

Other factors

-

Reporting Agency: Buena Vista County Sheriff

Teen driver at fault? Yes

License history:

*License history data omitted for protection of privacy

Criminal charges:

None

Civil litigation:

None



I-380 NB just north of Coralville Lake, Johnson County
 Interstate 2L each direction, divided highway
 Non-collision

| | Teen driver | Front pass. | Front pass. | Rear pass. | Rear pass. |
|-----------|-------------|-------------|-------------|------------|------------|
| age | 15 | 16 | 16 | | |
| gender | F | F | F | | |
| fatality | | | Y | | |
| injury | 3 | 3 | | | |
| ejection | | | Y | | |
| seat belt | Y | N | N | | |

2002 Chrysler Town & Country EL van
 instruction permit 446 days

Crash Narrative

Teen was northbound on I-380 where teen driver lost control of the vehicle after the right rear tire failed. Teen entered the median and rolled coming to rest on its top facing northwest in the southbound lanes of I-380.

Contributing factors

Tire defect

Other factors

All three occupants were seated in the front of the van

Reporting Agency: Iowa State Patrol

Teen driver at fault? Unclear

License history:

*License history data omitted for protection of privacy

Criminal charges:

Charged with failure to have a valid license while operating motor vehicle but was dismissed (06521 STA0050293 (JOHNSON)).

Civil litigation:

Civil trial brought by family of surviving passenger set for 1-9-12 (06521 LACV072228). Civil trial brought by family of deceased passenger set for 5-7-12 (06521 LACV072598).

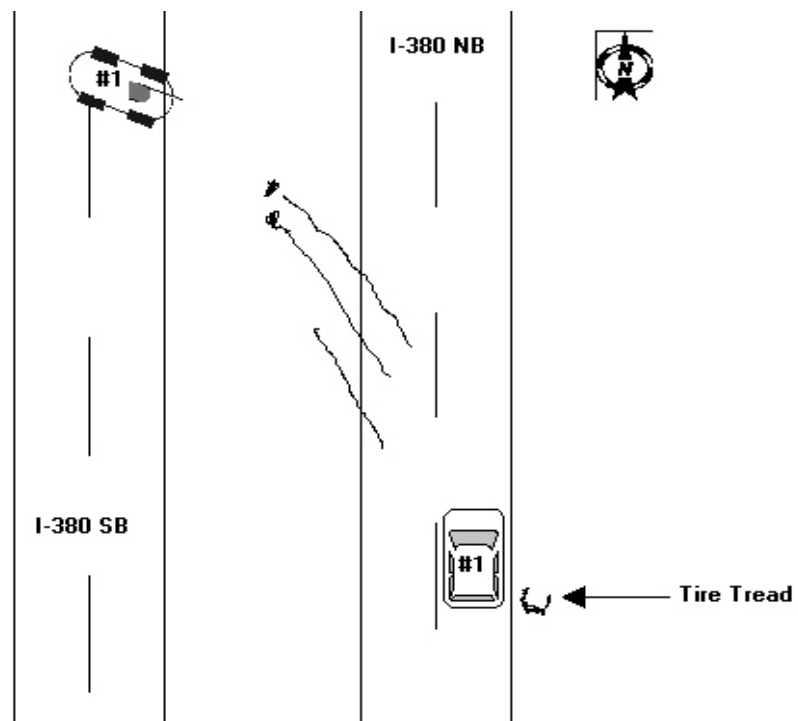

3:55 AM

Sunday

September 20, 2009

34

IA Hwy 16 just east of intersection with 223rd Ave, Lee County

State Route 2L

Non-collision

| | Teen driver | Front pass. | Rear pass. | Rear pass. | Rear pass. |
|-----------|-------------|-------------|------------|------------|------------|
| age | 19 | 19 | | 18 | |
| gender | M | M | | M | |
| fatality | | | | Y | |
| injury | 3 | 3 | | | |
| ejection | Y | Y | | Y | |
| seat belt | N | N | | N | |

1997 Pontiac Sunfire SE Coupe
full license 599 days

Crash Narrative

Teen was traveling eastbound on Iowa 16 (cardinal direction south, init dir east). Teen failed to negotiate curve when vehicle crossed centerline and ran off the road to the left. when the car entered the south ditch. The car struck a driveway, became airborne, traveled about 50 feet, impacted on the driver's side and rolled two or three times.

Contributing factors

Exceeded authorized speed; Teen driver had BAC of 0.07

Other factors

-

Reporting Agency: Lee County Sheriff

Teen driver at fault? Yes

License history:

*License history data omitted for protection of privacy

Criminal charges:

violation - financial liability - accident; failure to maintain control

Civil litigation:

None

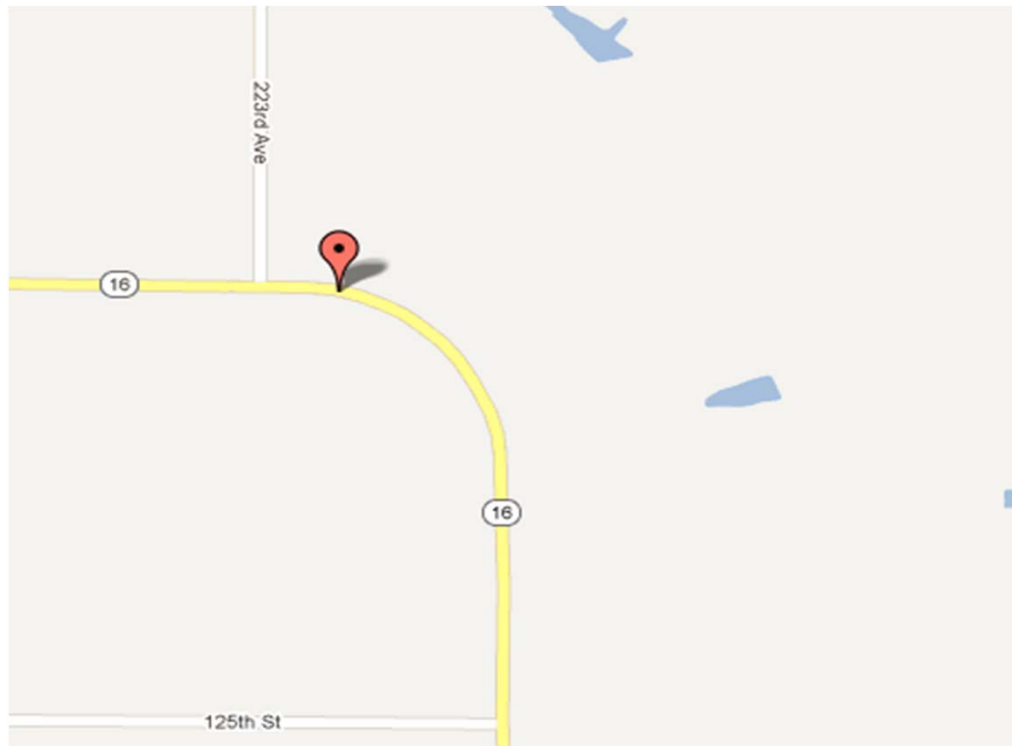

2:57 AM

Sunday

October 4, 2009

35

Larch Ave & 110th St, Washington County
Secondary 2L, t-intersection, gravel
Non-collision

| | Teen driver | Front pass. | Rear pass. | Rear pass. | Rear pass. |
|-----------|-------------|-------------|------------|------------|------------|
| age | 19 | | | | |
| gender | M | | | | |
| fatality | | | | | |
| injury | | | | | |
| ejection | N | | | | |
| seat belt | N | | | | |



1999 Chevrolet Monte Carlo Z34 Coupe
intermediate license* 1108 days

*Converted to full license at age 18

Crash Narrative

Teen was heading northbound on Larch Ave where he LOC and ran off the road to the left. Teen's vehicle struck a pole and came to rest on its wheels in the west ditch facing southeast.

Contributing factors

Teen had BAC of 0.148; exceeded authorized speed

Other factors

-

Reporting Agency: Iowa State Patrol

Teen driver at fault? Yes

License history:

*License history data omitted for protection of privacy

Criminal charges:

None

Civil litigation:

None

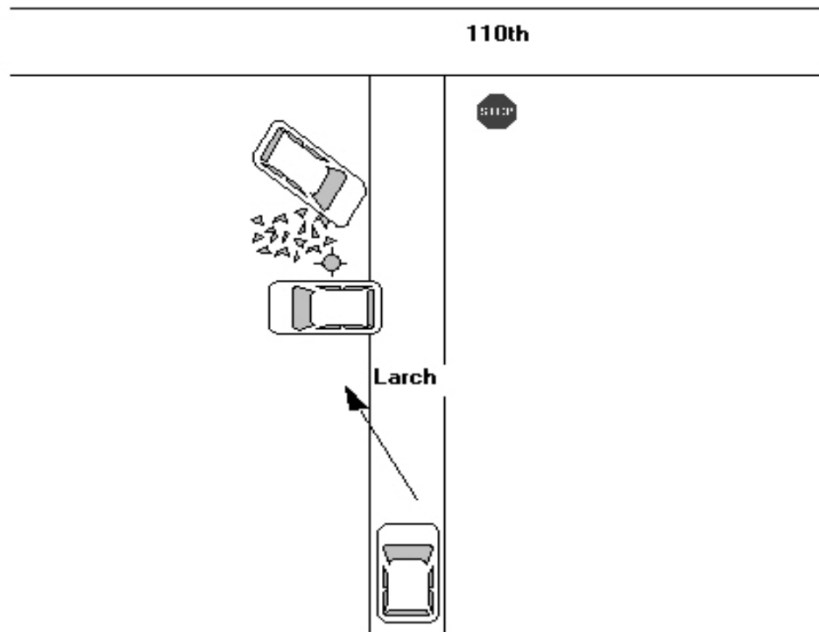

5:58 PM

Tuesday

September 8, 2009

36

US 61 between 35th St & 36th St, Fort Madison, Lee County

US Route 2L both directions, railroad crossing

Non-collision

| | Teen driver | Front pass. | Rear pass. | Rear pass. | Rear pass. |
|-----------|-------------|-------------|------------|------------|------------|
| age | 16 | | | | |
| gender | M | | | | |
| fatality | Y | | | | |
| injury | | | | | |
| ejection | N | | | | |
| seat belt | N | | | | |

1999 Buick Century Limited Sedan 4 Door
 intermediate license 7 days

Crash Narrative

Teen was travelling westbound when the teen accelerated, lost control and jumped the curb to the right before striking a railroad activator pole.

Contributing factors

Exceeded authorized speed

Other factors

-

Reporting Agency: Fort Madison Police

Teen driver at fault? Yes

License history:

*License history data omitted for protection of privacy

Criminal charges:

None

Civil litigation:

None

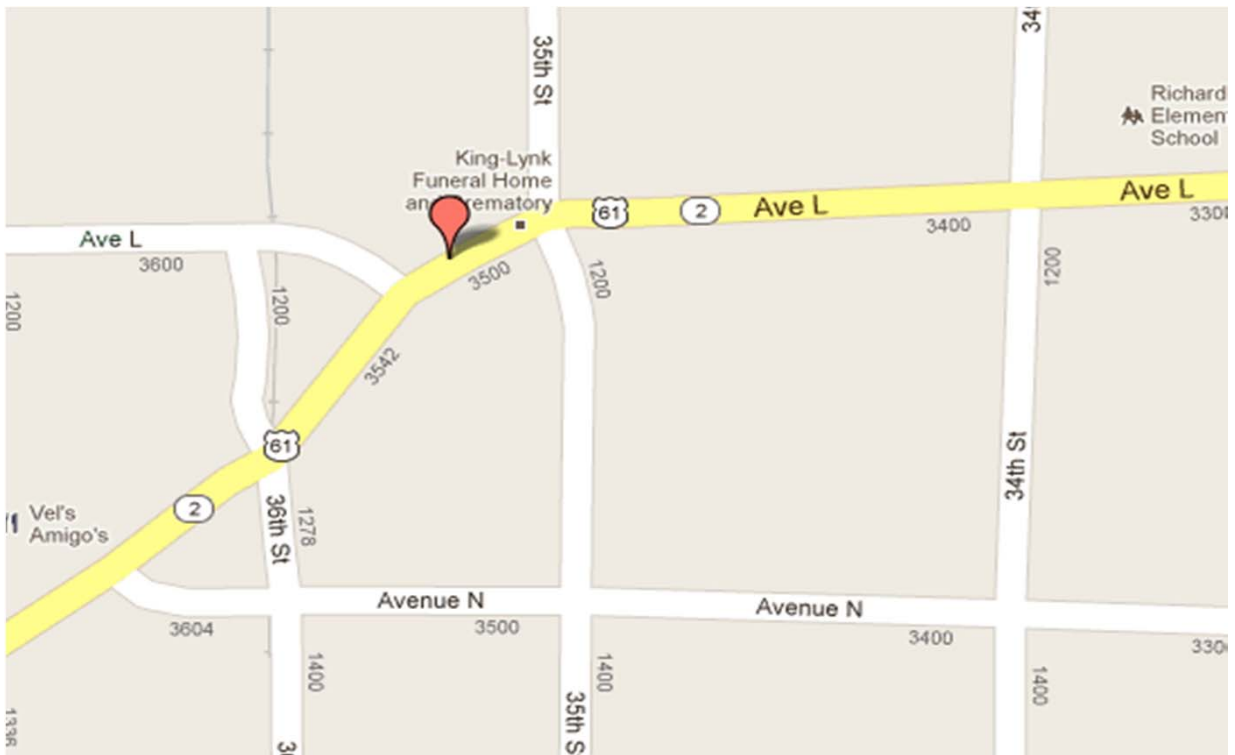

Sergeant Road and University Avenue, Waterloo, Blackhawk County

US Route, controlled 4-way intersection

Broadside

| | Teen driver | Front pass. | Rear pass. | Rear pass. | Rear pass. |
|-----------|-------------|-------------|------------|------------|------------|
| age | 18 | | | | |
| gender | F | | | | |
| fatality | Y | | | | |
| injury | | | | | |
| ejection | N | | | | |
| seat belt | Y | | | | |

2002 Chevrolet Trailblazer Wagon 4 Door
intermediate license* 961 days

*Converted to full license at age 18

| | Other driver | Front pass. | Rear pass. | Rear pass. | Rear pass. |
|-----------|--------------|-------------|------------|------------|------------|
| age | 37 | | | | |
| gender | M | | | | |
| fatality | | | | | |
| injury | 4 | | | | |
| ejection | N | | | | |
| seat belt | Y | | | | |

1998 Ford Econoline E150 Van

Crash Narrative

Teen was travelling south on Sergeant Road while other driver was travelling east on University Ave. Other driver FTY and hit teen on driver's side door. Other driver fled the scene.

Contributing factors

Other driver had BAC of 0.17

Other factors

-

Reporting Agency: Waterloo Police

Teen driver at fault? No

License history:

*License history data omitted for protection of privacy

Criminal charges:

Other driver charged with No liability insurance (dismissed); Failure to have valid license (dismissed); entered Alford pleas of guilt to vehicular homicide/reckless or elude (10 yr prison); leaving the scene of an injury accident (2 yr prison); OWI first offense (fine and 48 hr jail).

Civil litigation:

Civil case file by father of teen was dismissed by father 9/29/10.

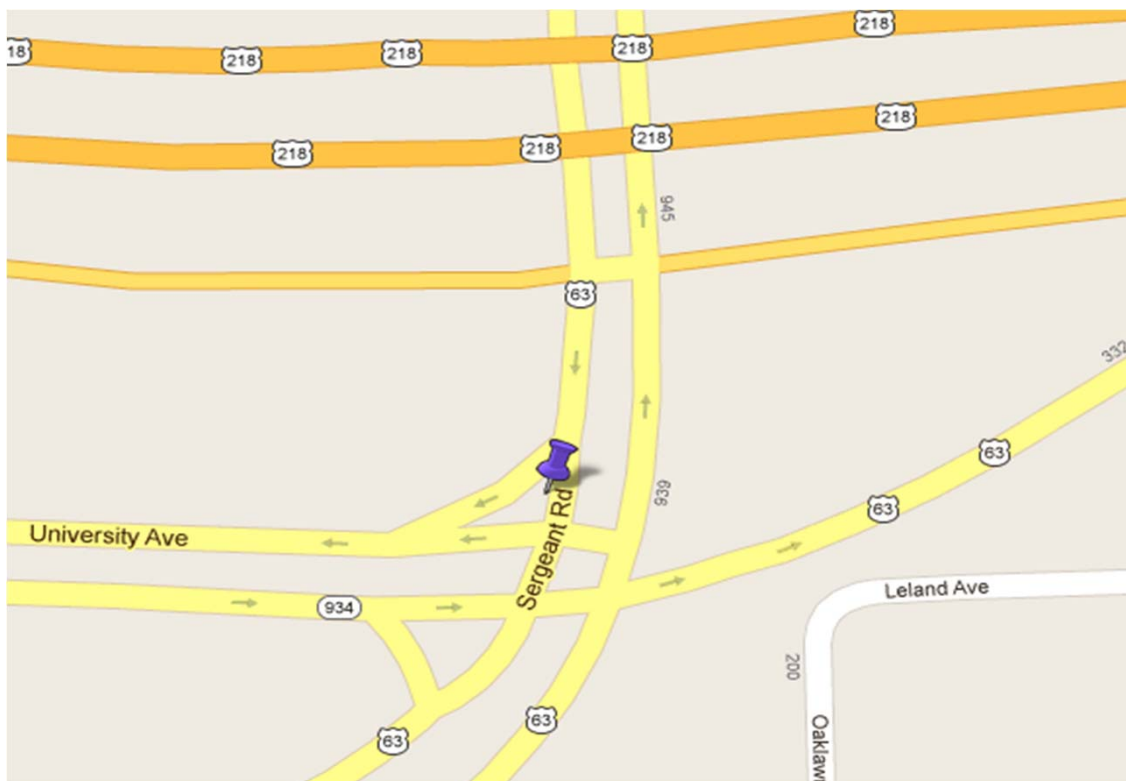

Co Rd D67 just west of intersection with Y Ave, Hardin County

Secondary 2L

Non-collision

| | Teen driver | Front pass. | Rear pass. | Rear pass. | Rear pass. |
|-----------|-------------|-------------|------------|------------|------------|
| age | 16 | 16 | 17 | | |
| gender | M | M | M | | |
| fatality | | | Y | | |
| injury | 3 | 3 | | | |
| ejection | N | N | Y | | |
| seat belt | Y | N | N | | |

1998 Honda Accord LX Sedan 4 Door
 intermediate license 232 days

Crash Narrative

Teen (Unit 1) was travelling westbound at an exceeded speed and could not make the curve and ran off the road to the left. Teen lost control into the opposite ditch and rolled several times landing upright in the ditch.

Contributing factors

Exceeded authorized speed

Other factors

-

Reporting Agency: Iowa State Patrol

Teen driver at fault? Yes

License history:

*License history data omitted for protection of privacy

Criminal charges:

failure to maintain control (fine)

Civil litigation:

None

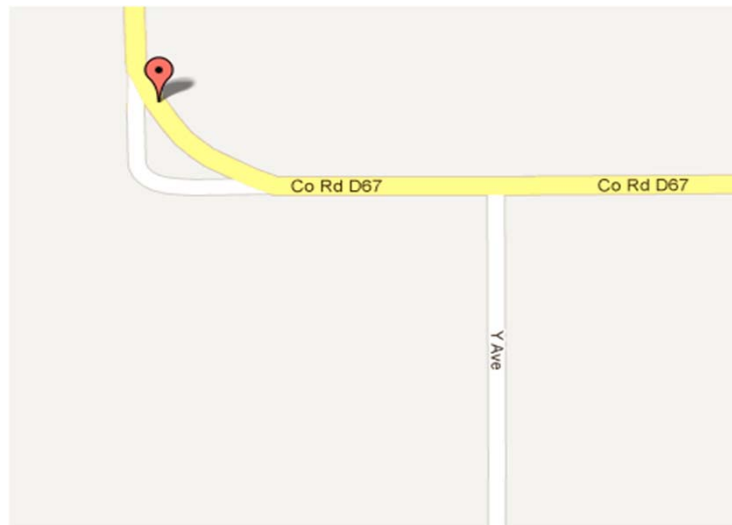
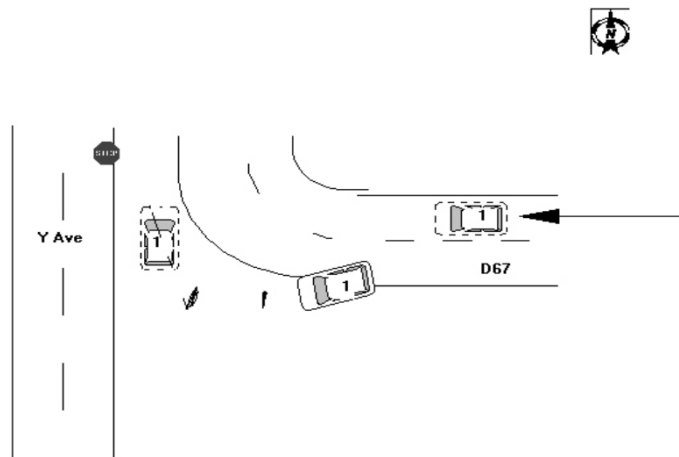

9:34 PM Tuesday November 24, 2009 39
 US 6, just south of intersection with Frank Kearney Rd, Oakland, Pottawattamie County
 US Route 2L
 Non-collision

| | Teen driver | Front pass. | Rear pass. | Rear pass. | Rear pass. |
|-----------|-------------|-------------|------------|------------|------------|
| age | 19 | | | | |
| gender | F | | | | |
| fatality | | | | | |
| injury | 5 | | | | |
| ejection | N | | | | |
| seat belt | Y | | | | |

| | |
|---|--|
| <p>2003 Buick Lesabre Custom, Sedan 4 Door full license 346 days</p> | <p>Pedestrian 26 years old, male, fatal</p> |
|---|--|

Crash Narrative

Teen was headed northbound on Highway 59. Driver noticed a pedestrian running alongside the road, headed SB. Pedestrian who veered onto road and fell in front of teen's car which then ran over the pedestrian.

Contributing factors

-

Other factors

-

Reporting Agency: Pottawattamie County Sheriff

Teen driver at fault? Unclear

License history:

*License history data omitted for protection of privacy

Criminal charges:

None

Civil litigation:

None

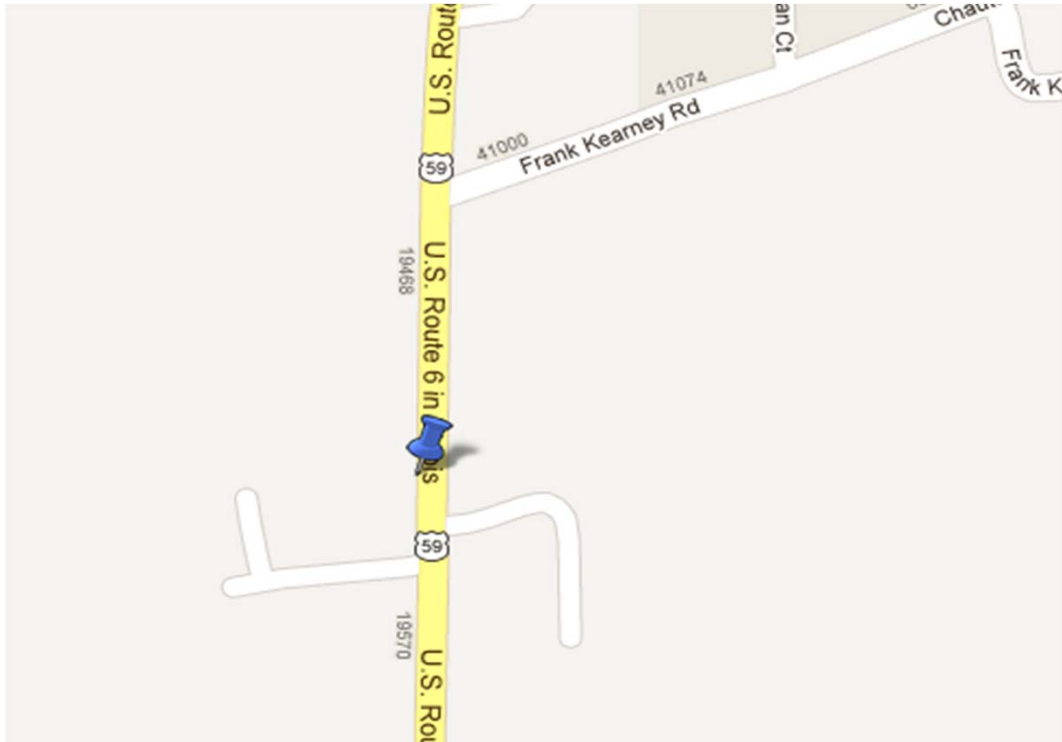

US 65 between Co Rd H50 & Fron St, Lucas County
US Route 2L
Head-on

| | Teen driver | Front pass. | Rear pass. | Rear pass. | Rear pass. |
|-----------|-------------|-------------|------------|------------|------------|
| age | 15 | | | | |
| gender | F | | | | |
| fatality | | | | | |
| injury | 2 | | | | |
| ejection | N | | | | |
| seat belt | Y | | | | |

1997 Chevrolet K1500 pickup
school license 121 days

| | Other driver | Front pass. | Rear pass. | Rear pass. | Rear pass. |
|-----------|--------------|-------------|------------|------------|------------|
| age | 29 | | | | |
| gender | M | | | | |
| fatality | Y | | | | |
| injury | | | | | |
| ejection | N | | | | |
| seat belt | N | | | | |

1988 Buick Lesabre Custom, Sedan 4 Door

Crash Narrative

Other driver (Unit 1) was northbound on Highway 65, crossed the center line and struck the teen (Unit 2) headon.

Contributing factors

-

Other factors

-

Reporting Agency: Iowa State Patrol

Teen driver at fault? No

License history:

*License history data omitted for protection of privacy

Criminal charges:

None

Civil litigation:

None



Drawing not to scale

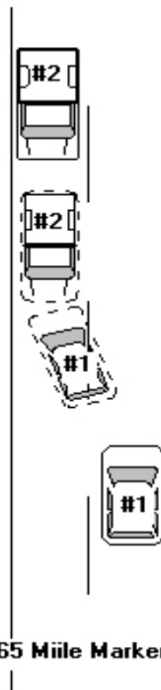

HWY 65 Mile Marker 25.5

7:00 AM

Wednesday

December 30, 2009

41

Mortenson Rd east of intersection with South Dakota Ave, Ames, Story County

Municipal 2L Secondary

Non-collision

| | Teen driver | Front pass. | Rear pass. | Rear pass. | Rear pass. |
|-----------|-------------|-------------|------------|------------|------------|
| age | 19 | | | | |
| gender | F | | | | |
| fatality | | | | | |
| injury | 5 | | | | |
| ejection | N | | | | |
| seat belt | Y | | | | |

1999 Pontiac Grand AM GT, Sedan 4 Door
 class D-3 Chauffeur license 903 days

Pedestrian
 71 years old, Male

Crash Narrative

Teen was driving westbound on Mortensen Rd and struck the pedestrian crossing street from south to north (at a non-crosswalk) headed to a bus stop. The initial impact was with the front of the vehicle.

Contributing factors

Snow

Other factors

-

Reporting Agency: Ames Police

Teen driver at fault? Unclear

License history:

*License history data omitted for protection of privacy

Criminal charges:

None

Civil litigation:

None

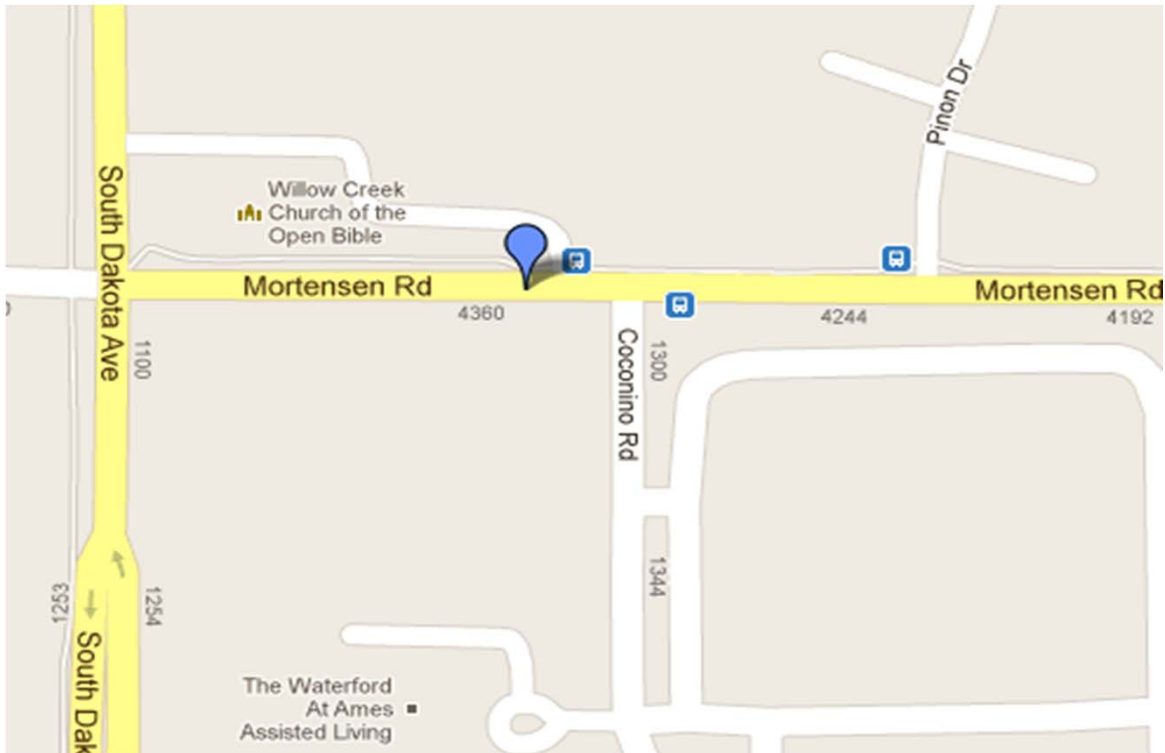

Kanesville Blvd and McKensie Ave, Council Bluffs, Pottawattamie County
US Route/Municipal, T intersection of divided 4L highway and 2L city street
Angle, oncoming left turn

| | Teen driver | Front pass. | Rear pass. | Rear pass. | Rear pass. |
|-----------|-------------|-------------|------------|------------|------------|
| age | 17 | | | | |
| gender | M | | | | |
| fatality | | | | | |
| injury | 5 | | | | |
| ejection | N | | | | |
| seat belt | ? | | | | |

1994 Nissan Altima 4DR
intermediate license 302 days

| | Other driver | Front pass. | Rear pass. | Rear pass. | Rear pass. |
|-----------|--------------|-------------|------------|------------|------------|
| age | 50 | | | | |
| gender | M | | | | |
| fatality | Y | | | | |
| injury | | | | | |
| ejection | Y | | | | |
| seat belt | N | | | | |

2006 Van

Crash Narrative

Other driver in van heading westbound. Teen was turning left, FTY to oncoming traffic, hit van middle of driver side, and van overturned.

Contributing factors

-

Other factors

-

Reporting Agency: N/A

Teen driver at fault? Yes

License history:

 *License history data omitted for protection of privacy

Criminal charges:

 Charge of "turning movements" was dismissed by court because teen took S.T.O.P. class

Civil litigation:

 None

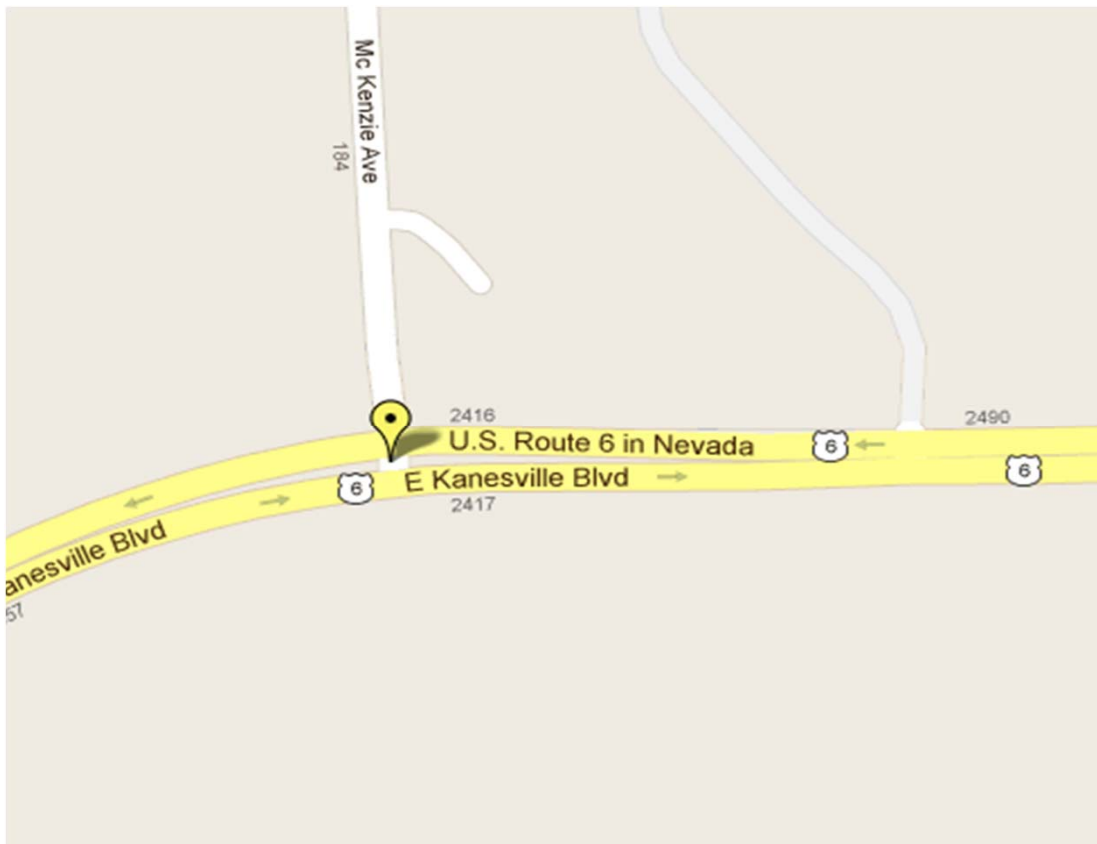

This page intentionally left blank

Appendix B: 2010 crashes

10:56 PM

Sunday

January 24, 2010

1

I-235 WB & 73rd St, Windsor Heights, Polk County
Interstate overpass (3L each direction)/Municipal (2L each direction)
Non-collision

| | Teen driver | Front pass. | Rear pass. | Rear pass. | Rear pass. |
|-----------|-------------|-------------|------------|------------|------------|
| age | 19 | | | | |
| gender | F | | | | |
| fatality | Y | | | | |
| injury | | | | | |
| ejection | N | | | | |
| seat belt | Y | | | | |

1994 NR
Out of state

Crash Narrative

Teen driver WB on interstate. LOC on overpass where she ran off road to the right and collided with the bridge rail where vehicle overturned and landed on its top on the street below.

Contributing factors

Road conditions - snow/ice

Other factors

-

Reporting Agency: Windsor Heights Police

Teen driver at fault? Unclear

License history:

*License history data omitted for protection of privacy

Criminal charges:

None

Civil litigation:

None

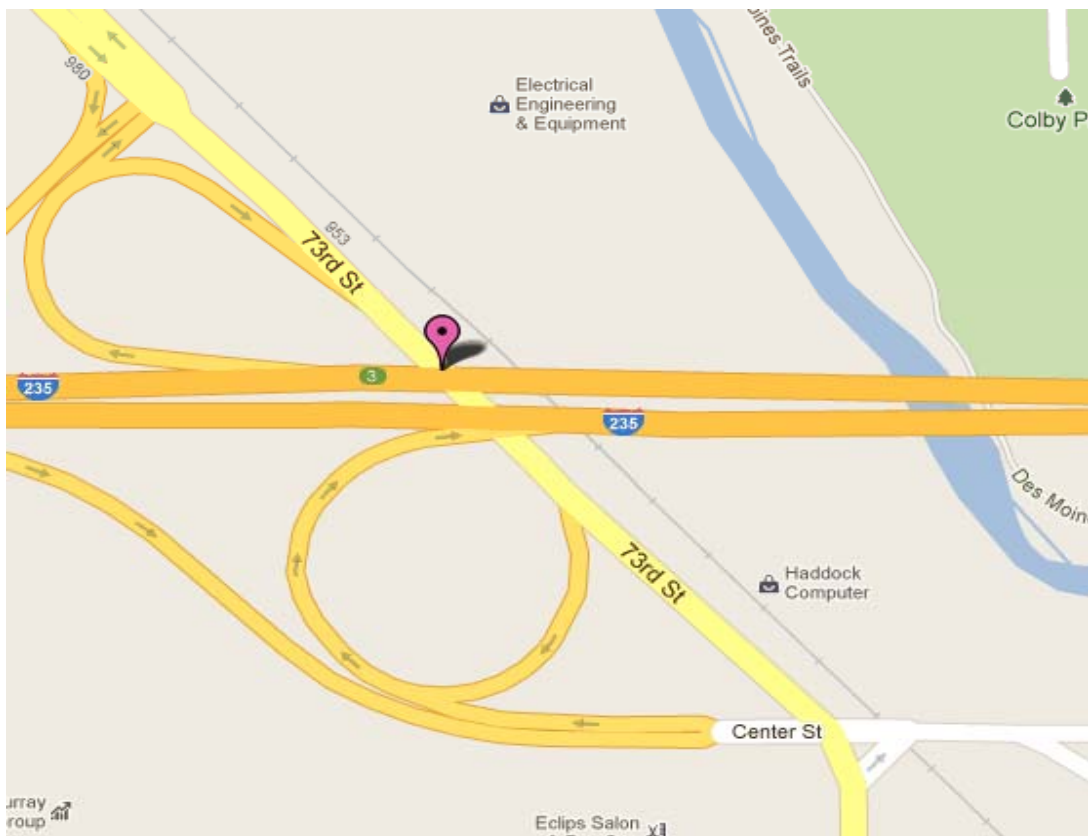

7:32 AM

Thursday

February 4, 2010

2

Hwy 4, between 320th St & 330th St, Palo Alto

State Route 2L

Head-on

| | Teen driver | Front pass. | Rear pass. | Rear pass. | Rear pass. |
|-----------|-------------|-------------|------------|------------|------------|
| age | 18 | | | | |
| gender | F | | | | |
| fatality | Y | | | | |
| injury | | | | | |
| ejection | N | | | | |
| seat belt | ? | | | | |

2006 Chevrolet Impala Sedan 4 Door
Full license 212 days

| | Other driver | Front pass. | Rear pass. | Rear pass. | Rear pass. |
|-----------|--------------|-------------|------------|------------|------------|
| age | 44 | | | | |
| gender | M | | | | |
| fatality | | | | | |
| injury | 4 | | | | |
| ejection | N | | | | |
| seat belt | ** | | | | |

Peterbilt Conventional 379 Tractor Truck
** Lap belt only

Crash Narrative

Teen (Unit 1) heading southbound. Teen lost control, crossed the center line and struck northbound semi truck (Unit 2) head-on on the right-front of teen's car. Both vehicles ended up in the northbound ditch.

Contributing factors

Road conditions - road 100% ice-covered

Other factors

-

Reporting Agency: ISP

Teen driver at fault? Unclear

License history:

*License history data omitted for protection of privacy

Criminal charges:

None

Civil litigation:

None

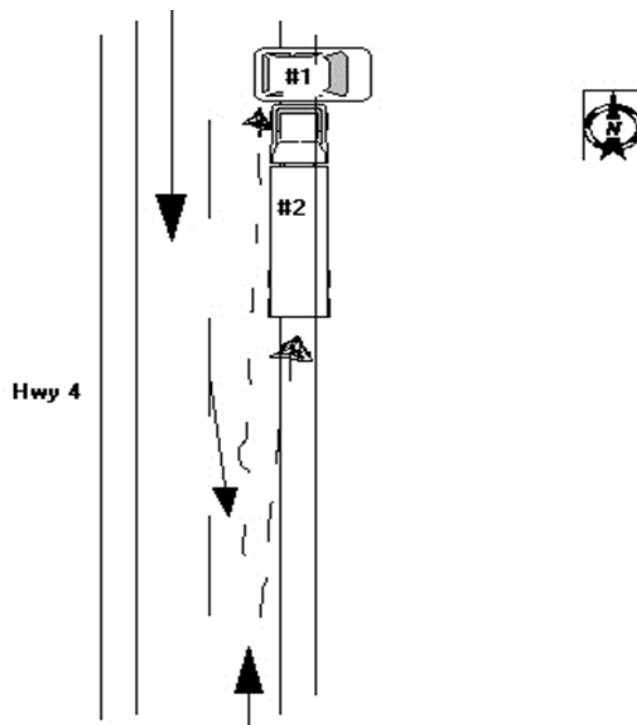

7:58 AM

Wednesday

March 17, 2010

3

IA Hwy 191, just south of 335th St, Harrison County

State Route 2L

Non-collision

| | Teen driver | Front pass. | Rear pass. | Rear pass. | Rear pass. |
|-----------|-------------|-------------|------------|------------|------------|
| age | 15 | 14 | 16 | 16 | |
| gender | F | F | F | F | |
| fatality | | Y | | | |
| injury | 2 | | 2 | 2 | |
| ejection | Y | Y | Y | Y | |
| seat belt | 4 | 4 | N | N | |

1994 Nissan Sentra, Sedan 4 Door

School license 223 days

Crash Narrative

Teen vehicle heading southbound. Teen LOC, swerved and entered the south bound ditch. The vehicle rolled several times and landed on its top. All four teen occupants were ejected.

Contributing factors

Exceeded authorized speed

Other factors

-

Reporting Agency: ISP

Teen driver at fault? Yes

License history:

*License history data omitted for protection of privacy

Criminal charges:

None

Civil litigation:

None

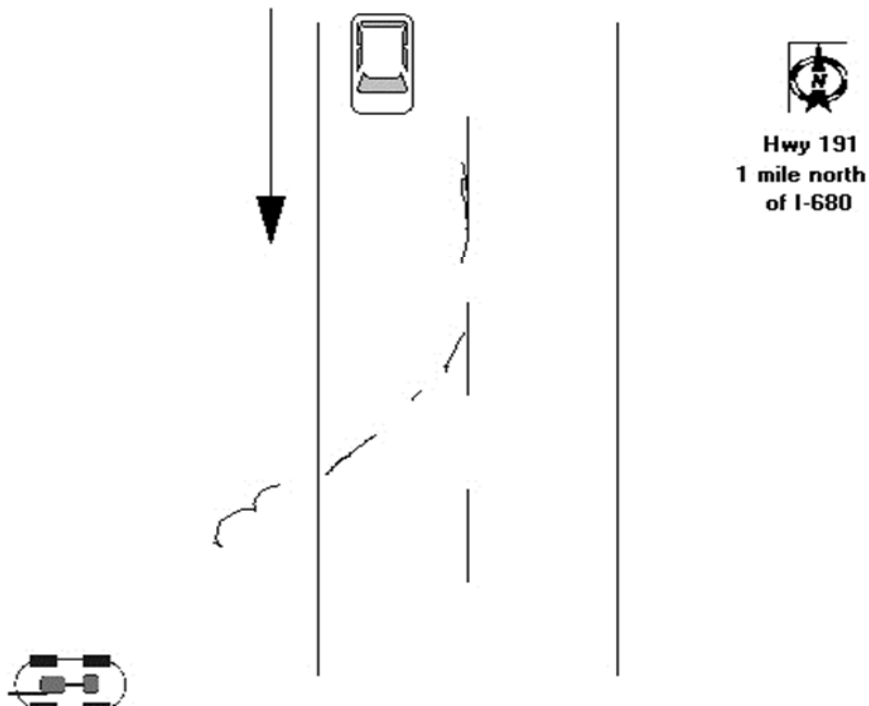

2:45 AM

Sunday

March 21, 2010

4

240th Street, between Bishop Ave & Dusty Ave, Bremer County

Secondary 2L, gravel

Non-collision

| | Teen driver | Front pass. | Rear pass. | Rear pass. | Rear pass. |
|-----------|-------------|-------------|------------|------------|------------|
| age | 17 | 18 | 16 | | |
| gender | M | M | M | | |
| fatality | | Y | | | |
| injury | 4 | | 4 | | |
| ejection | N | Y | N | | |
| seat belt | ? | ? | ? | | |

1998 Bonneville SE, Sedan 4 Door
 Reinstated intermediate 128 days

Crash Narrative

Teen driver WB when vehicle began to run off the road to the left. Teen over-corrected and swerved. The car overturned and rolled off road to the right where it came to a rest on its roof facing east in the north ditch.

Contributing factors

Teen driver had BAC of 0.158

Other factors

-

Reporting Agency: Bremer County

Teen driver at fault? Yes

License history:

***License history data omitted for protection of privacy**

Criminal charges:

Vehicular homicide/OWI. Trial still pending but BAC from blood samples has been ruled inadmissible.

Civil litigation:

None

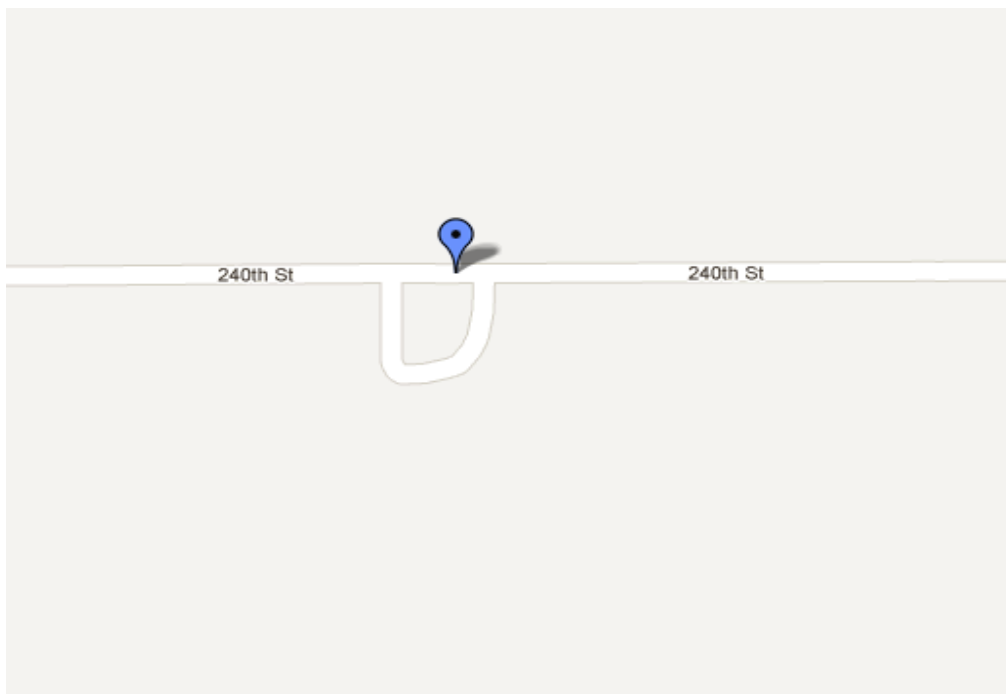

9:44 PM

Monday

March 29, 2010

5

NW 16th Street between NW 142 Ave & NW 150th Ave, Polk County

Secondary 2L, gravel

Non-collision

| | Teen driver | Front pass. | Rear pass. | Rear pass. | Rear pass. |
|-----------|-------------|-------------|------------|------------|------------|
| age | 18 | 24 | 20 | 21 | |
| gender | M | M | M | | |
| fatality | Y | | | | |
| injury | | 2 | 2 | 2 | |
| ejection | Y | Y | N | ? | |
| seat belt | N | N | ? | ? | |

2002 Mitsubishi Gelant, Sedan 4 door

Full license 146 days

Crash Narrative

Teen driver heading NB. He exceeded the authorized speed and lost control near where road turns to gravel. Vehicle ran off road to the left into ditch, rolled several times, and ejected driver.

Contributing factors

Teen driver had BAC of 0.051

Other factors

-

Reporting Agency: Polk County

Teen driver at fault? Yes

License history:

*License history data omitted for protection of privacy

Criminal charges:

None

Civil litigation:

None

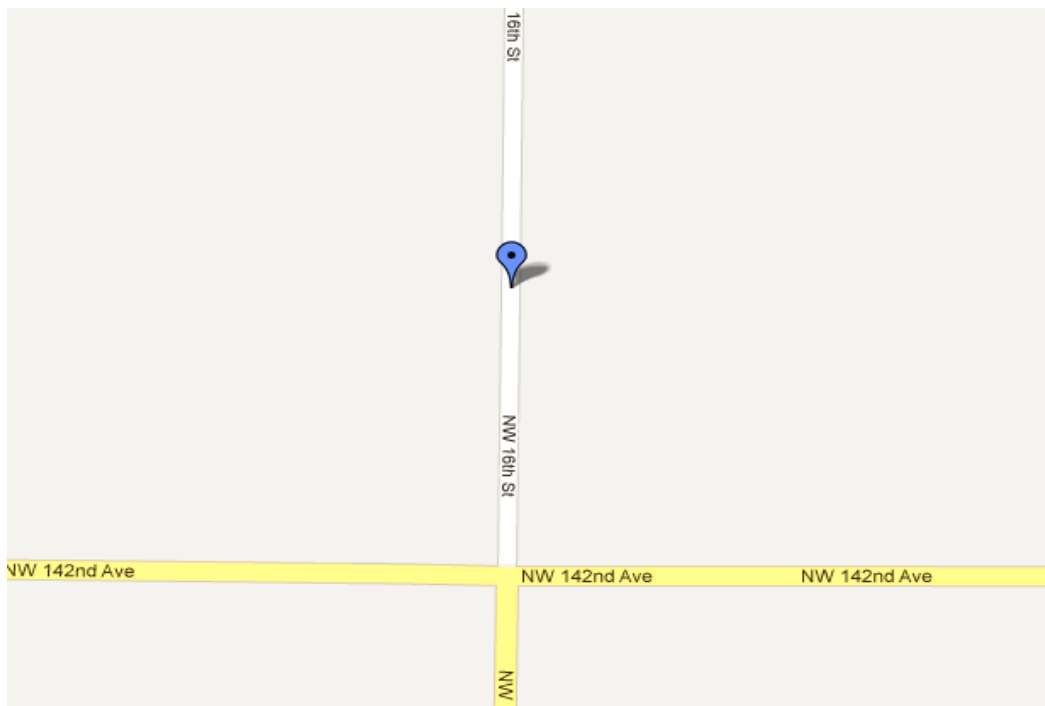

7:30 AM

Friday

April 9, 2010

6

US 52, just south of 215th St, Clayton County

US Route 2L

Head-on

| | Teen driver | Front pass. | Rear pass. | Rear pass. | Rear pass. |
|-----------|-------------|-------------|------------|------------|------------|
| age | 18 | | | | |
| gender | M | | | | |
| fatality | Y | | | | |
| injury | | | | | |
| ejection | N | | | | |
| seat belt | Y | | | | |

2000 Ford Escort ZX2, Coupe
Full license 49 days

| | Other driver | Front pass. | Rear pass. | Rear pass. | Rear pass. |
|-----------|--------------|-------------|------------|------------|------------|
| age | 60 | | | | |
| gender | M | | | | |
| fatality | | | | | |
| injury | 5 | | | | |
| ejection | N | | | | |
| seat belt | Y | | | | |

2009 semi tractor, NR

Crash Narrative

Teen driver SB and crossed center line into a NB semi-truck. Teen's car struck the driver's side of the semi head on.

Contributing factors

-

Other factors

-

Reporting Agency: Clayton County

Teen driver at fault? Yes

License history:

*License history data omitted for protection of privacy

Criminal charges:

None

Civil litigation:

None



US Hwy 65 & US Hwy 34, Lucas, Lucas County
 US Route 2L/Secondary 2L, controlled four-way intersection
 Broadside

| | Teen driver | Front pass. | Rear pass. | Rear pass. | Rear pass. |
|-----------|-------------|-------------|------------|------------|------------|
| age | 16 | | | | |
| gender | F | | | | |
| fatality | Y | | | | |
| injury | | | | | |
| ejection | N | | | | |
| seat belt | ? | | | | |

2003 Chevrolet S10, 3 door ext cab pk
 Intermediate 131 days

| | Other driver | Front pass. | Rear pass. | Rear pass. | Rear pass. |
|-----------|--------------|-------------|------------|------------|------------|
| age | 46 | | | | |
| gender | M | | | | |
| fatality | | | | | |
| injury | 5 | | | | |
| ejection | N | | | | |
| seat belt | Y | | | | |

2007 Semi (NR)

Crash Narrative

Teen NB on Hwy 65. Semi WB on Hwy 34. Teen pulled out in front of semi as she FTY at stop sign. The front of the semi struck the teen's passenger side middle.

Contributing factors

Teen operating vehicle in an erratic/reckless/careless/negligent/aggressive manner

Other factors

-

Reporting Agency: Lucas County

Teen driver at fault? Yes

License history:

*License history data omitted for protection of privacy

Criminal charges:

None

Civil litigation:

None

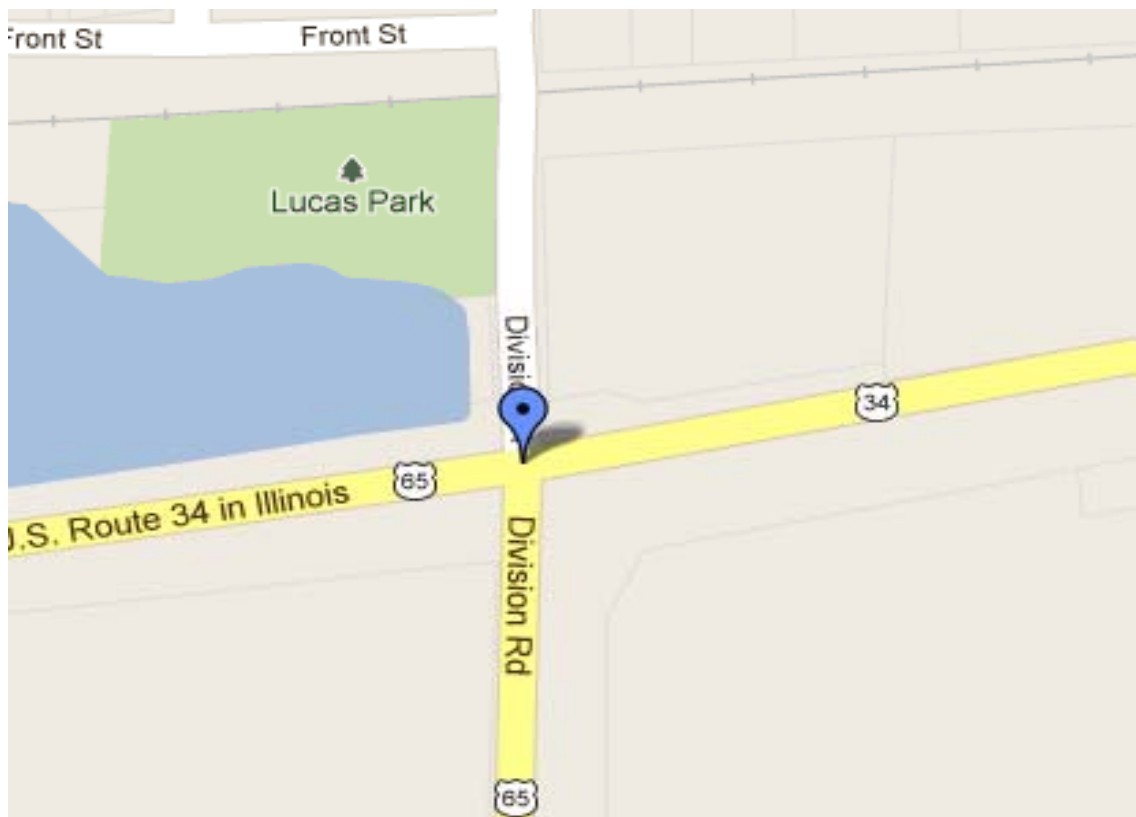

I-80 just west of I-235 interchange, Polk County
Interstate 4L each direction, divided
Non-collision

| | Teen driver | Front pass. | Rear pass. | Rear pass. | Rear pass. |
|-----------|-------------|-------------|------------|------------|------------|
| age | 19 | | | | |
| gender | M | | | | |
| fatality | Y | | | | |
| injury | | | | | |
| ejection | n/a | | | | |
| seat belt | * | | | | |

1996 Honda motorcycle

Out of state

* Teen wearing helmet

Crash Narrative

Teen motorcyclist was heading WB as he was entering 1-80 WB from 1-235 SB. Teen was merging into a lane at a high rate of speed, swerved, and lost control. Teen went into south shoulder (to the left) and made contact with guardrail. Driver was thrown into the median and the motorcycle slid down the shoulder coming to rest on the south shoulder.

Contributing factors

Teen operating vehicle in an erratic/reckless/careless/negligent/aggressive manner

Other factors

-

Reporting Agency: ISP

Teen driver at fault? Yes

License history:

*License history data omitted for protection of privacy

Criminal charges:

None

Civil litigation:

None

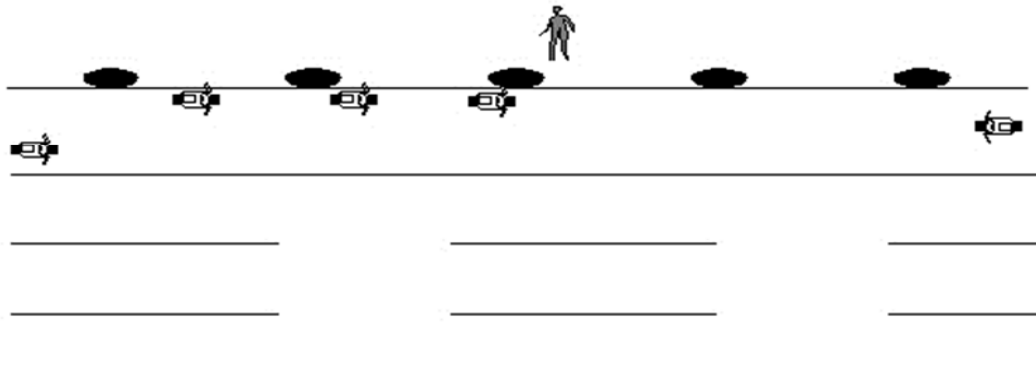

I-80/35 WB MM 137.5

Locust St, between Warren St & Brown St, Davenport, Scott County

Municipal 2L each direction

Head-on

| | Teen driver | Front pass. | Rear pass. | Rear pass. | Rear pass. |
|-----------|-------------|-------------|------------|------------|------------|
| age | 19 | 23 | 18 | | |
| gender | F | F | F | | |
| fatality | | Y | | | |
| injury | 3 | | 3 | | |
| ejection | N | N | N | | |
| seat belt | N | N | N | | |

1995 Cadillac Seville STS, Sedan 4 door
Full license 351 days

| | Other driver | Front pass. | Rear pass. | Rear pass. | Rear pass. |
|-----------|--------------|-------------|------------|------------|------------|
| age | 24 | | | | |
| gender | M | | | | |
| fatality | | | | | |
| injury | 3 | | | | |
| ejection | N | | | | |
| seat belt | Y | | | | |

1997 Chevrolet Suburban, SUV

Crash Narrative

Teen WB excessively speeding and crossed center line. Teen's vehicle smashed head-on into other vehicle heading EB. Both vehicles came to a rest on a resident's front lawn.

Contributing factors

Teen driver had a BAC of 0.115; exceeded authorized speed

Other factors

-

Reporting Agency: Davenport Police

Teen driver at fault? Yes

License history:

*License history data omitted for protection of privacy

Criminal charges:

Serious injury by vehicle (5 yrs prison suspended; 2 years probation and \$1500 fine). OWI first offense (suspended 118 days in jail - 1 yr probation) Violated her probation (alcohol, marijuana, cocaine) and got 180 days in jail.

Civil litigation:

other driver vs Shenanagans Irish Pub by serving Anne Carlson and carriage haus inc by serving Daniel Dearoff

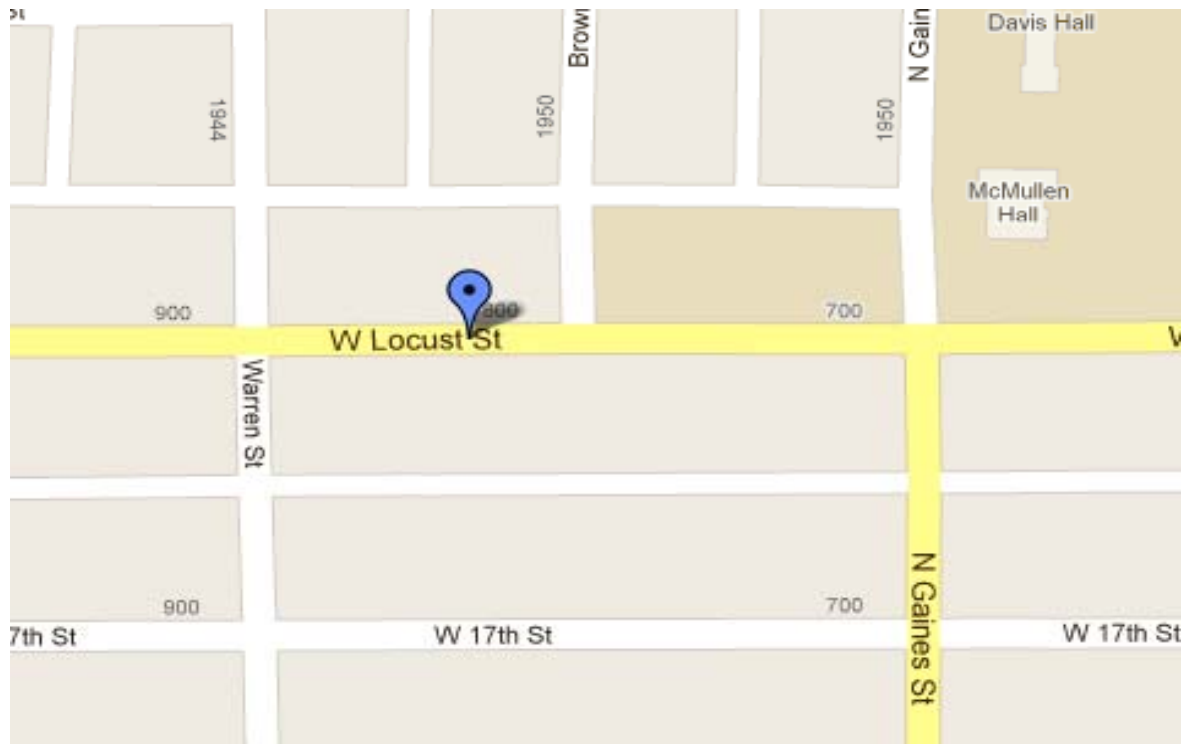

3:30 AM

Saturday

May 22, 2010

10

1-80 E, 1/2 mile east of Hwy 61, Davenport, Scott County

Interstate 2L each direction, divided

Rear-end

| | | | | | |
|-----------|--------------|--|--|--|--|
| | Teen driver | | | | |
| | Front pass. | | | | |
| | Rear pass. | | | | |
| | Rear pass. | | | | |
| | Rear pass. | | | | |
| age | 19 | | | | |
| gender | M | | | | |
| fatality | | | | | |
| injury | 4 | | | | |
| ejection | N | | | | |
| seat belt | Y | | | | |
| | | | | | |
| | NR, SUV | | | | |
| | Out of state | | | | |

| | |
|-----------|------------------|
| | Other driver |
| age | M |
| gender | 53 |
| fatality | |
| injury | 5 |
| ejection | N |
| seat belt | Y |
| | |
| | NR, Semi-trailer |

| | | | |
|-----------|--|----|----|
| | Other driver | | |
| | Front pass. | | |
| | Rear pass. | | |
| age | 30 | 24 | 35 |
| gender | M | F | F |
| fatality | | Y | |
| injury | 3 | | 3 |
| ejection | N | N | N |
| seat belt | Y | Y | ? |
| | | | |
| | 2006 Ford Five Hundred Ltd, Sedan 4 door | | |

Crash Narrative

Semi tried to make illegal u-turn on interstate from EB to WB lanes. Car going EB ran into and under left side rear of semi. Then teen's SUV rear ended car.

Contributing factors

Fog; semi driver operating vehicle in an erratic/reckless/careless/negligent/aggressive manner

Other factors

-

Reporting Agency: Davenport Police

Teen driver at fault? No

License history:

*License history data omitted for protection of privacy

Criminal charges:

None

Civil litigation:

None

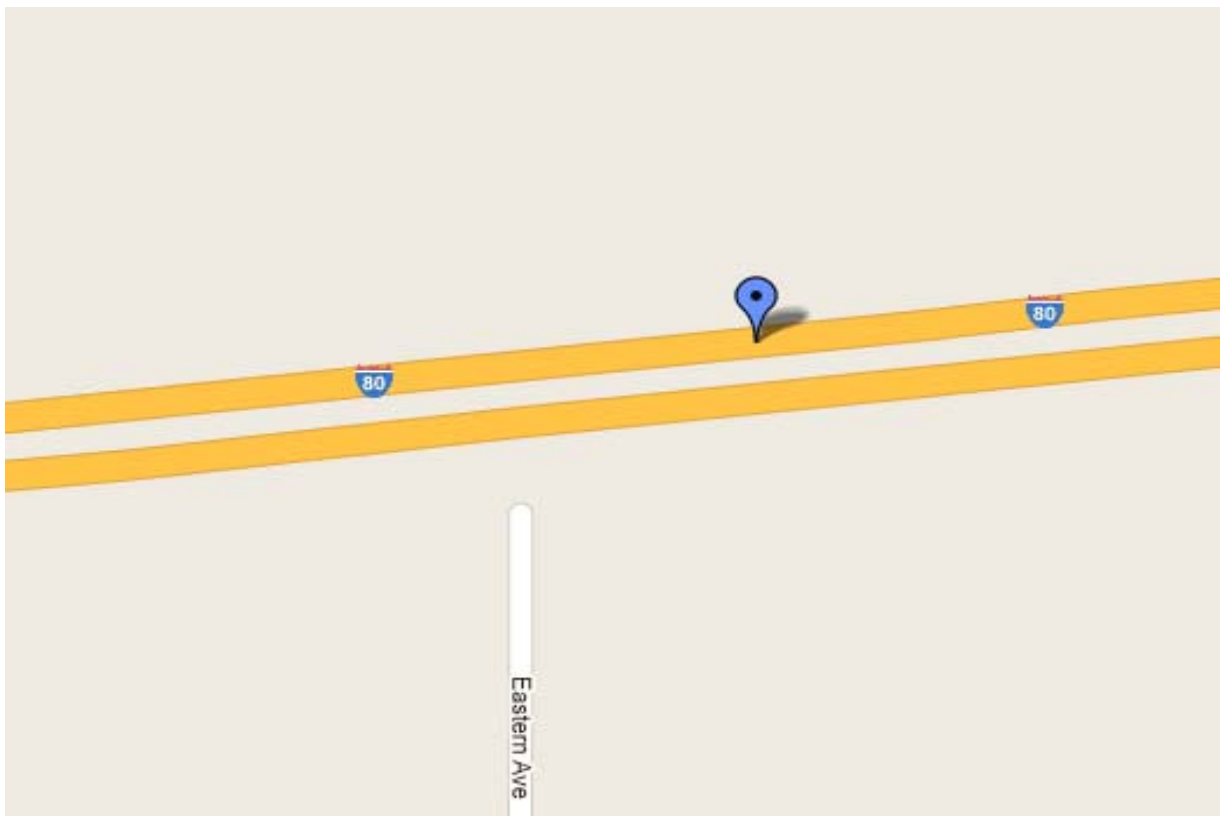

Hwy 71 & Hwy 44, Audubon County
 US Route (2L) /State Route (2L), controlled four-way intersection
 Broadside

| | Teen driver | Front pass. | Rear pass. | Rear pass. | Rear pass. |
|-----------|-------------|-------------|------------|------------|------------|
| age | 17 | | | | |
| gender | M | | | | |
| fatality | | | | | |
| injury | 4 | | | | |
| ejection | N | | | | |
| seat belt | N | | | | |

1997 Chevrolet Monte Carlo LS, Coupe
 Full license 176 days

| | Other driver | Front pass. | Rear pass. | Rear pass. | Rear pass. |
|-----------|--------------|-------------|------------|------------|------------|
| age | 32 | | | | |
| gender | M | | | | |
| fatality | Y | | | | |
| injury | | | | | |
| ejection | N | | | | |
| seat belt | N | | | | |

2004 Harley Davidson Fxdi, Motorcycle

Crash Narrative

Teen (Unit 1) heading EB and motorcyclist (Unit 2) NB. Teen stopped at stop sign but FTY. Motorcyclist was struck by teen's right front of vehicle. Motorcyclist was thrown from motorcycle.

Contributing factors

-

Other factors

-

Reporting Agency: ISP

Teen driver at fault? Yes

License history:

*License history data omitted for protection of privacy

Criminal charges:

Failure to obey stop sign and yield right of way (fine) and failure to wear seat belt (fine)

Civil litigation:

None

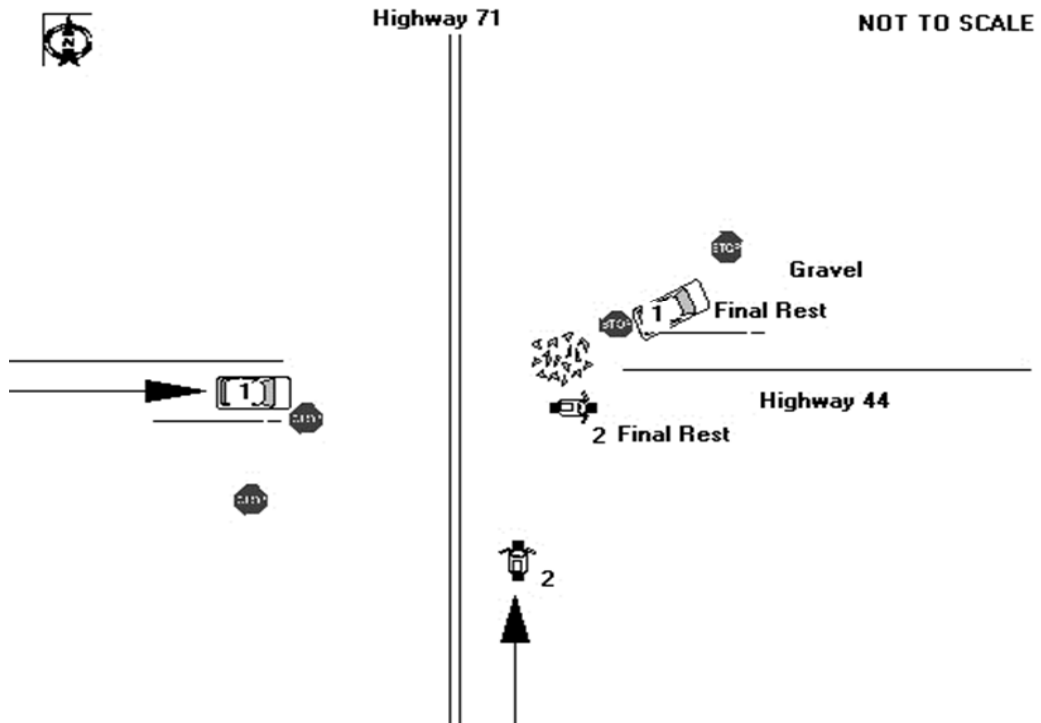

10:17 PM

Friday

May 21, 2010

12

8th St & Division St, Burlington, Des Moines County
Municipal 2L, controlled four-way intersection
Non-collision

| | Teen driver | Front pass. | Rear pass. | Rear pass. | Rear pass. |
|-----------|-------------|-------------|------------|------------|------------|
| age | 19 | | | | |
| gender | M | | | | |
| fatality | | | | | |
| injury | 5 | | | | |
| ejection | N | | | | |
| seat belt | Y | | | | |

2007 Toyota Tundra Double Cab Sr5, Crew pickup
Full license 477 days

Pedestrian
51 years old, female, fatal

Crash Narrative

Teen WB and came to intersection. He made a complete stop and turned south and didn't see pedestrian.

Contributing factors

-

Other factors

-

Reporting Agency: Burlington Police/ISP

Teen driver at fault? Unclear

License history:

*License history data omitted for protection of privacy

Criminal charges:

None

Civil litigation:

None

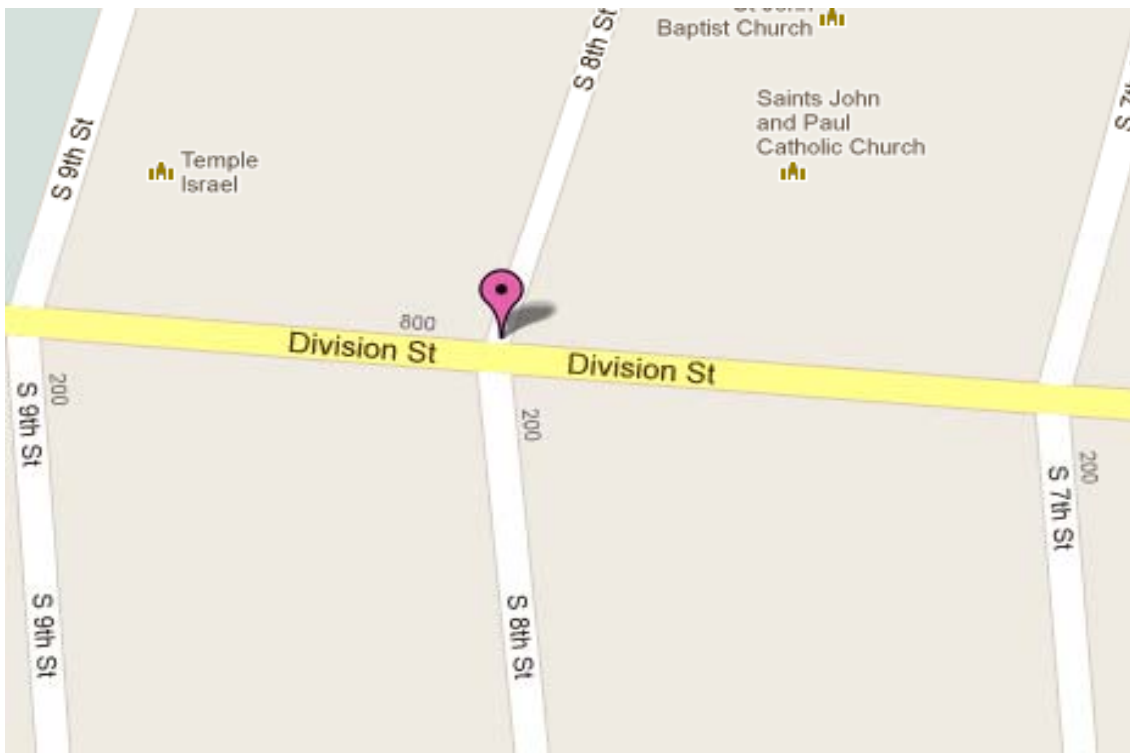

Hwy 10, between 250th Ave & 240th Ave, Buena Vista County

Iowa Route 2L

Rear-end

| | | | | | |
|-----------|-------------|-------------|------------|------------|------------|
| | Teen driver | Front pass. | Rear pass. | Rear pass. | Rear pass. |
| age | 18 | | | | |
| gender | F | | | | |
| fatality | | | | | |
| injury | 4 | | | | |
| ejection | N | | | | |
| seat belt | Y | | | | |

2002 Honda Accord EX, Sedan 4 door

Intermediate* 834 days

*converted to full license at age 18

| | | | | | |
|-----------|--------------|-------------|------------|------------|------------|
| | Other driver | Front pass. | Rear pass. | Rear pass. | Rear pass. |
| age | 50 | | | | |
| gender | M | | | | |
| fatality | Y | | | | |
| injury | | | | | |
| ejection | | | | | |
| seat belt | | | | | |

Bicycle

Crash Narrative

Both teen and bicyclist heading WB. Teen blinded by the sun and rear-ended bicyclist.

Contributing factors

-

Other factors

Driver blinded by the sun

Reporting Agency: Buena Vista County

Teen driver at fault? Unclear

License history:

*License history data omitted for protection of privacy

Criminal charges:

None

Civil litigation:

None

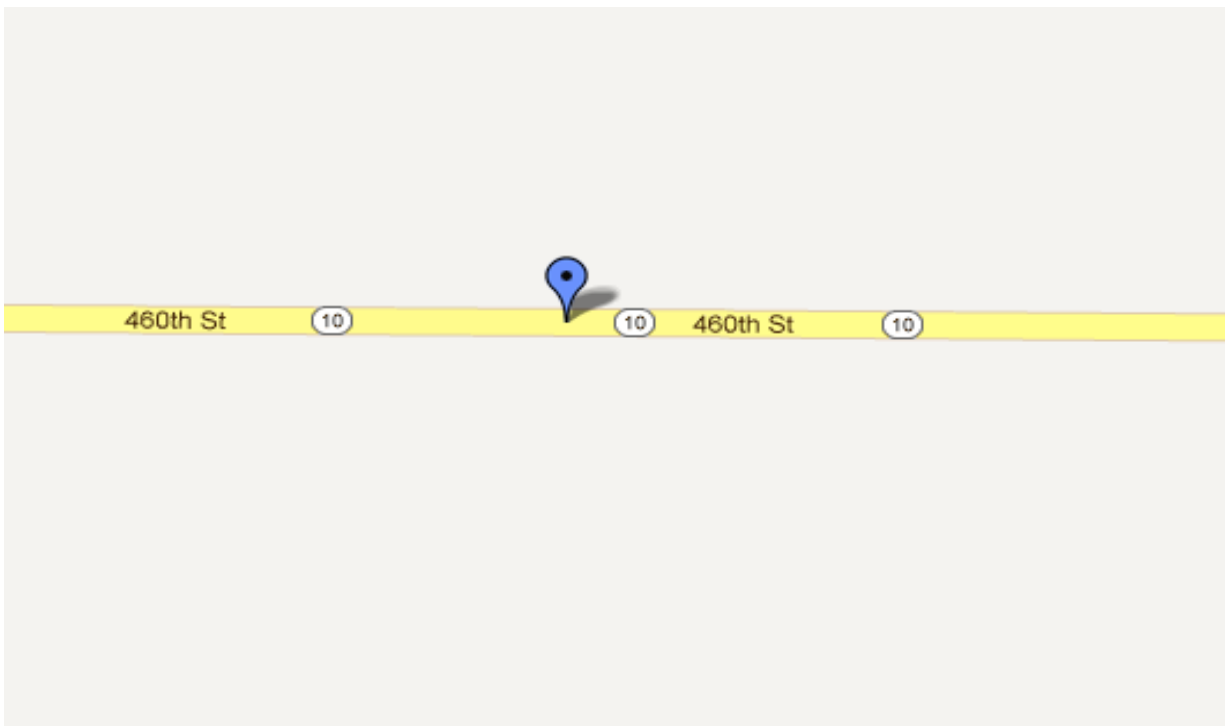

240th Street & Keokuk Ave, Wright County
 Secondary 2L, uncontrolled intersection, gravel
 Broadside

| | Teen driver | Front pass. | Rear pass. | Rear pass. | Rear pass. |
|-----------|-------------|-------------|------------|------------|------------|
| age | 16 | 15 | | | |
| gender | M | M | | | |
| fatality | | Y | | | |
| injury | 2 | | | | |
| ejection | N | N | | | |
| seat belt | Y | N | | | |

2000 Pontiac Grand Prix GTP, Sedan 4 door
 Intermediate 308 days

| | Other driver | Front pass. | Rear pass. | Rear pass. | Rear pass. |
|-----------|--------------|-------------|------------|------------|------------|
| age | 16 | | | | |
| gender | M | | | | |
| fatality | | | | | |
| injury | 3 | | | | |
| ejection | N | | | | |
| seat belt | Y | | | | |

1997 Chrysler Concorde LX/LXI, Sedan 4 door
 Intermediate 225 days

Crash Narrative

Teen (Unit 1) EB and other teen driver (Unit 2) NB. Both vehicles entered uncontrolled intersection. Unit 2 struck Unit 1 in the passenger side door. Unit 1 slid into NE ditch and rolled one time coming to rest on its wheels facing SE. Unit 2 slid into NE ditch facing N on its wheels and did not roll.

Contributing factors

-

Other factors

-

Reporting Agency: ISP

Teen driver at fault? Teen #1: Yes; Teen #2: No

License history:

*License history data omitted for protection of privacy

Criminal charges:

Failure to yield to vehicle on the right.

Civil litigation:

Civil suit filed by mother of deceased passenger against both teen drivers, insurance company. Dismissed w/ prejudice.

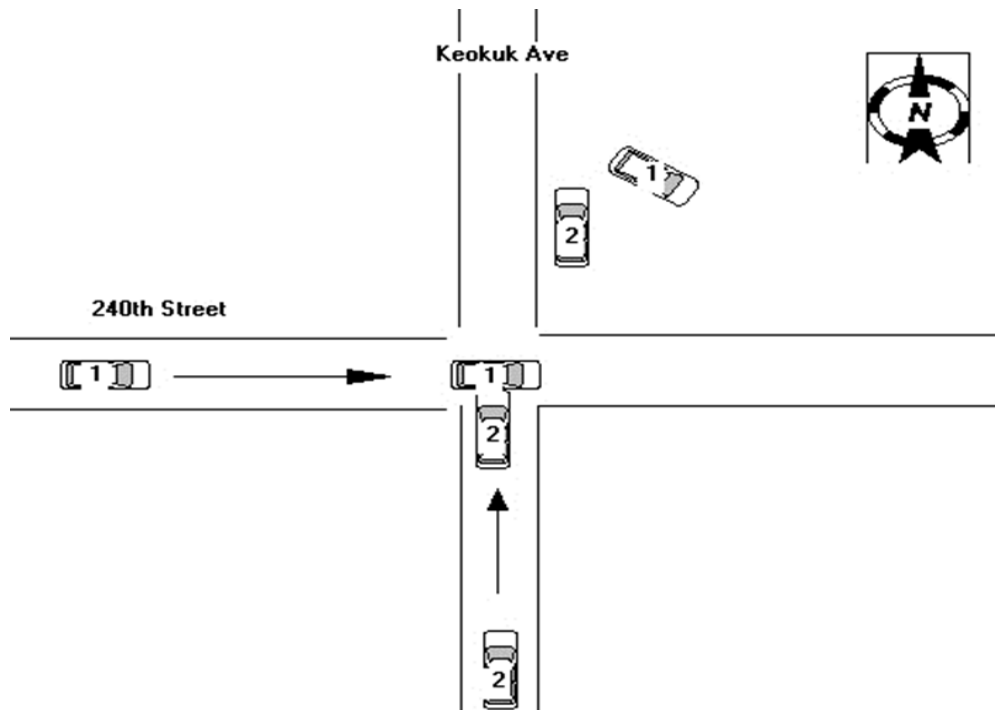

7:55 PM

Sunday

May 23, 2010

15

Pole Line Rd, just south of intersection with 282nd St, Winneshiek County

Secondary 2L

Non-collision

| | Teen driver | Front pass. | Rear pass. | Rear pass. | Rear pass. |
|-----------|-------------|-------------|------------|------------|------------|
| age | 19 | | | | |
| gender | M | | | | |
| fatality | Y | | | | |
| injury | | | | | |
| ejection | Y | | | | |
| seat belt | ? | | | | |

1999 NR

Intermediate* 1203 days

*Converted to full license at age 18

Crash Narrative

Teen EB when he crossed the centerline, swerved and LOC. Vehicle ran off the road to the right and overturned multiple times.

Contributing factors

Ruts/holes/bumps in road; animal in roadway

Other factors

-

Reporting Agency: Winneshiek County

Teen driver at fault? Yes

License history:

*License history data omitted for protection of privacy

Criminal charges:

None

Civil litigation:

None

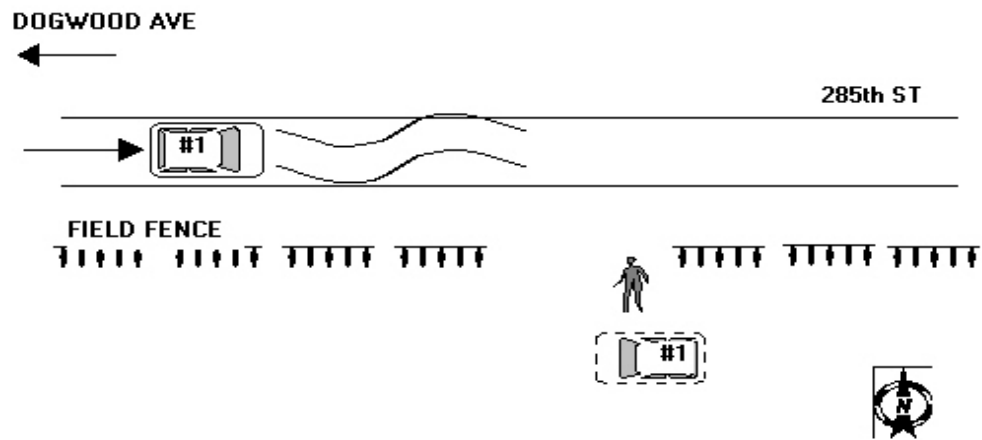

8:16 PM

Monday

July 5, 2010

17

Yankee Avenue, between Co Hwy F44 & Co Hwy F37, Cedar County

Secondary 2L, gravel

Non-collision

| | Teen driver | Front pass. | Rear pass. | Rear pass. | Rear pass. |
|-----------|-------------|-------------|------------|------------|------------|
| age | 17 | | | | |
| gender | F | | | | |
| fatality | Y | | | | |
| injury | | | | | |
| ejection | Y | | | | |
| seat belt | N | | | | |

2000 Mercury Cougar V6, Hatchback 2 door

Full license 292 days

Crash Narrative

Teen was SB when vehicle lost control. Teen entered the west ditch and overcorrected coming back onto the road. The vehicle rolled and came to rest on its top facing east.

Contributing factors

Texting while driving

Other factors

-

Reporting Agency: ISP

Teen driver at fault? Yes

License history:

*License history data omitted for protection of privacy

Criminal charges:

None

Civil litigation:

None

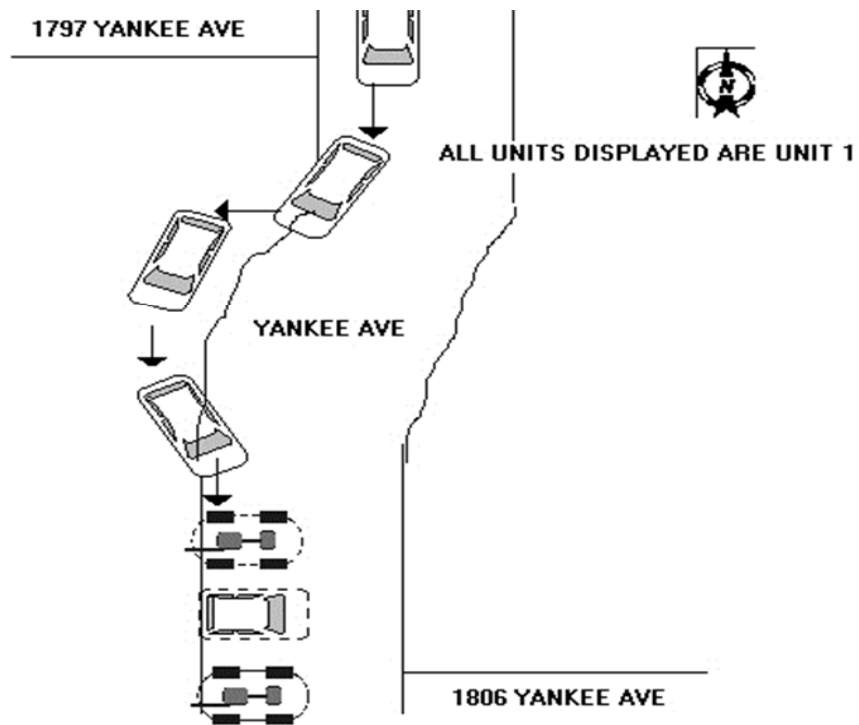

4:17 AM

Tuesday

July 6, 2010

18

NE Bluff Drive, just east of intersection with NE 72nd St, Polk County

Secondary 2L

Non-collision

| | Teen driver | Front pass. | Rear pass. | Rear pass. | Rear pass. |
|-----------|-------------|-------------|------------|------------|------------|
| age | 18 | 17 | 17 | | |
| gender | M | * | * | | |
| fatality | Y | | | | |
| injury | | * | * | | |
| ejection | Y | * | * | | |
| seat belt | N | * | * | | |

1998 Pontia Grand Prix GT, Sedan 4 door

Full license 105 days

*Passenger data unavailable

Crash Narrative

Teen driving WB where he lost control and ran off the road to the right. The vehicle hit the ditch and rolled at least once coming to rest on passenger side.

Contributing factors

Under the influence of alcohol/drugs/medications

Other factors

-

Reporting Agency: Polk County

Teen driver at fault? Yes

License history:

*License history data omitted for protection of privacy

Criminal charges:

None

Civil litigation:

None

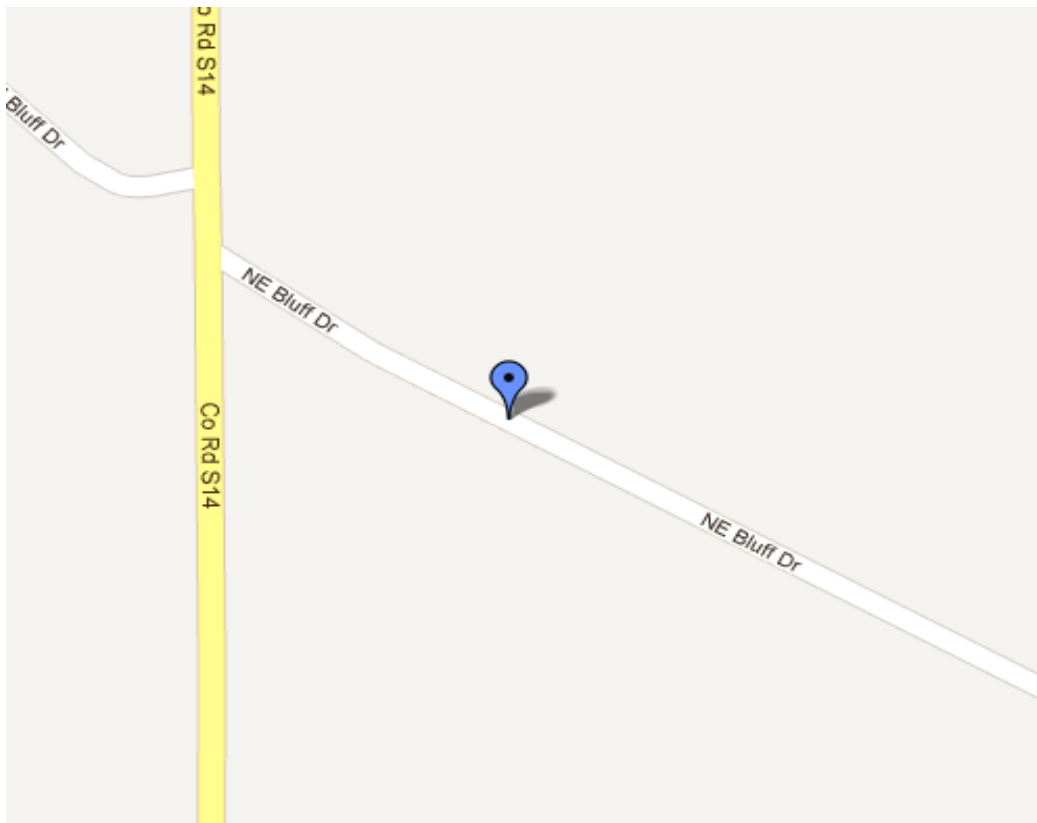

US 65, just north of intersection with Co Rd G76, Warren County

US Route 2L

Head-on

| | Teen driver | Front pass. | Rear pass. | Rear pass. | Rear pass. |
|-----------|-------------|-------------|------------|------------|------------|
| age | 15 | | | | |
| gender | M | | | | |
| fatality | | | | | |
| injury | 2 | | | | |
| ejection | N | | | | |
| seat belt | Y | | | | |

2000 Chevrolet Monte Carlo LS, Coupe
School license 62 days

| | Other driver | Front pass. | Rear pass. | Rear pass. | Rear pass. |
|-----------|--------------|-------------|------------|------------|------------|
| age | 67 | | | | |
| gender | M | | | | |
| fatality | Y | | | | |
| injury | | | | | |
| ejection | N | | | | |
| seat belt | Y | | | | |

2006 Ford Econoline E350 Super Duty, Extended cargo van

Crash Narrative

Teen driver (Unit 1) SB when teen attempted to pass a vehicle on a crest of a slight hill. Teen (Unit 1) attempted to pull back into the southbound lane due to other vehicle (Unit 2) in NB lane when teen struck other vehicle (Unit 2) head-on. Other vehicle came to rest in the east ditch. Teen came to rest in SB lane.

Contributing factors

Vision obscured - hillcrest

Other factors

Reporting Agency: ISP

Teen driver at fault? Yes

License history:

*License history data omitted for protection of privacy

Criminal charges:

Failure to maintain vehicle control (\$625 fine, 200 hr comm. service, probation until 18, 30 days jail in juv. center suspended).

Civil litigation:

None

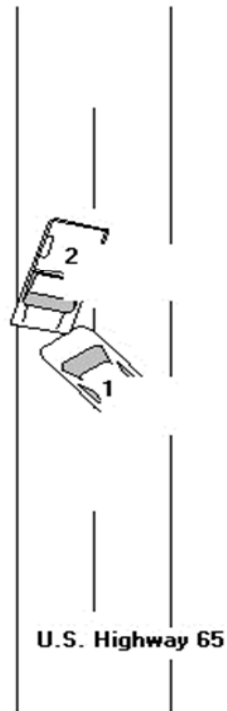

8:35 AM

Tuesday

July 13, 2010

20

Hwy 6, between 245th St & 250th St, Pottawattamie County

US Route 2L

Head-on

| | Teen driver | Front pass. | Rear pass. | Rear pass. | Rear pass. |
|-----------|-------------|-------------|------------|------------|------------|
| age | 17 | 15 | | | |
| gender | F | F | | | |
| fatality | Y | | | | |
| injury | | 3 | | | |
| ejection | N | N | | | |
| seat belt | Y | Y | | | |

2001 Chevrolet Cavalier Cng, Sedan 4 door
Intermediate 365 days

| | Other driver | Front pass. | Rear pass. | Rear pass. | Rear pass. |
|-----------|--------------|-------------|------------|------------|------------|
| age | 70 | | | | |
| gender | M | | | | |
| fatality | | | | | |
| injury | 5 | | | | |
| ejection | N | | | | |
| seat belt | ? | | | | |

2002 Semi-tractor

Crash Narrative

Teen driving WB when vehicle crossed center line and struck rear tires of EB semi-truck.

Contributing factors

-

Other factors

Teen's passenger mentioned the driver was tired but crash report says driver condition was apparently normal

Reporting Agency: Pottawattamie County

Teen driver at fault? Yes

License history:

 *License history data omitted for protection of privacy

Criminal charges:

 None

Civil litigation:

 None

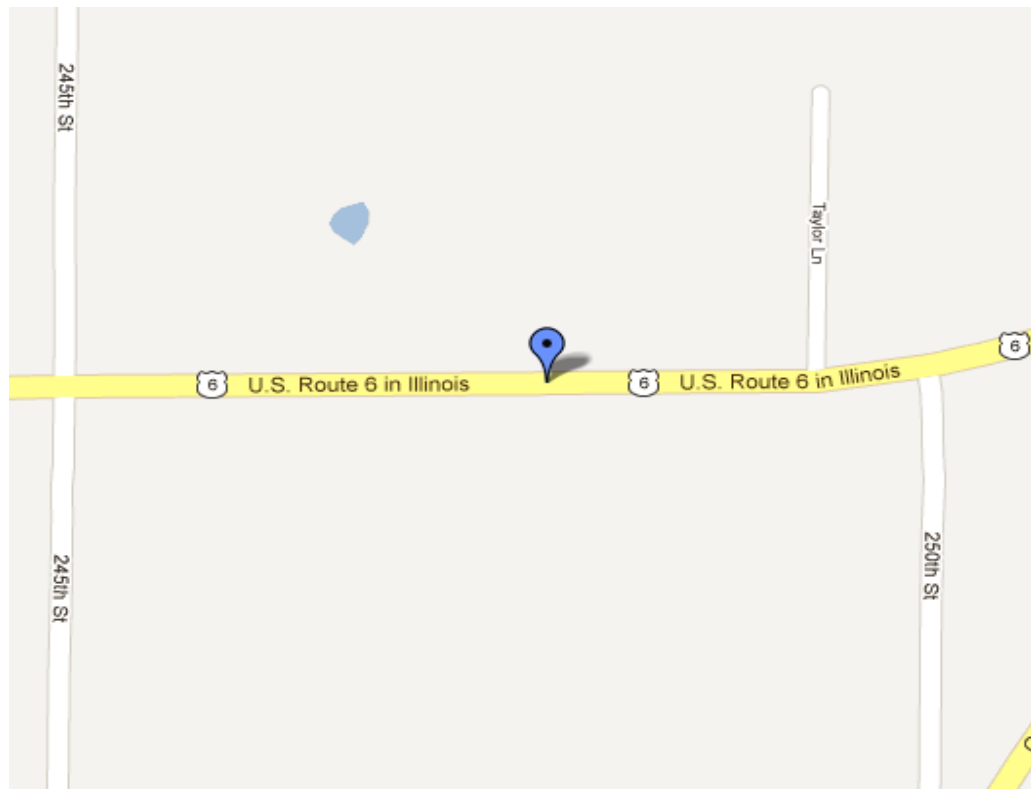

6:36 AM

Sunday

July 18, 2010

21

Hwy S70, between 400th St & 137th Ave, Appanoose County

Secondary 2L

Non-collision

| | Teen driver | Front pass. | Rear pass. | Rear pass. | Rear pass. |
|-----------|-------------|-------------|------------|------------|------------|
| age | 19 | 18 | | | |
| gender | M | M | | | |
| fatality | Y | | | | |
| injury | | 3 | | | |
| ejection | N | N | | | |
| seat belt | N | N | | | |

1997 Dodge Ram, Pickup
 Revoked 31 days

Crash Narrative

Teen was driving WB when he exceeded authorized speeds, failed to make curve and lost control. Teen's vehicle entered south ditch and collided with a tree at the driver's front door.

Contributing factors

Under the influence of alcohol/drugs/medication; Rain

Other factors

-

Reporting Agency: ISP

Teen driver at fault? Yes

License history:

*License history data omitted for protection of privacy

Criminal charges:

None

Civil litigation:

None

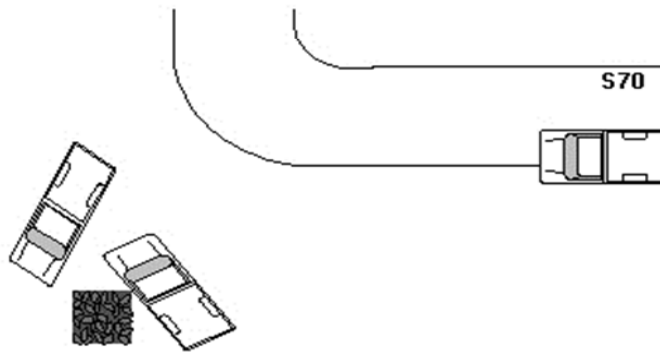

12:00 AM

Tuesday

August 3, 2010

22

Co Hwy W151, between Dove Rd & 215th St, Fayette County

Secondary 2L

Non-collision

| | Teen driver | Front pass. | Rear pass. | Rear pass. | Rear pass. |
|-----------|-------------|-------------|------------|------------|------------|
| age | 19 | | | | |
| gender | F | | | | |
| fatality | Y | | | | |
| injury | | | | | |
| ejection | Y | | | | |
| seat belt | Y | | | | |

2000 Hyundai Tiburon, Coupe
Full license 487 days

Crash Narrative

Teen heading SB and exceeded authorized speeds. LOC and ran off road to the left into a ravine and overturned coming to rest on its roof. Teen's mom reported her missing on Tues 8/3 in the pm. Teen's vehicle was not discovered until Wed 8/4 at approximately 8:26 AM.

Contributing factors

Teen had BAC of 0.092

Other factors

-

Reporting Agency: Fayette County

Teen driver at fault? Yes

License history:

*License history data omitted for protection of privacy

Criminal charges:

None

Civil litigation:

None

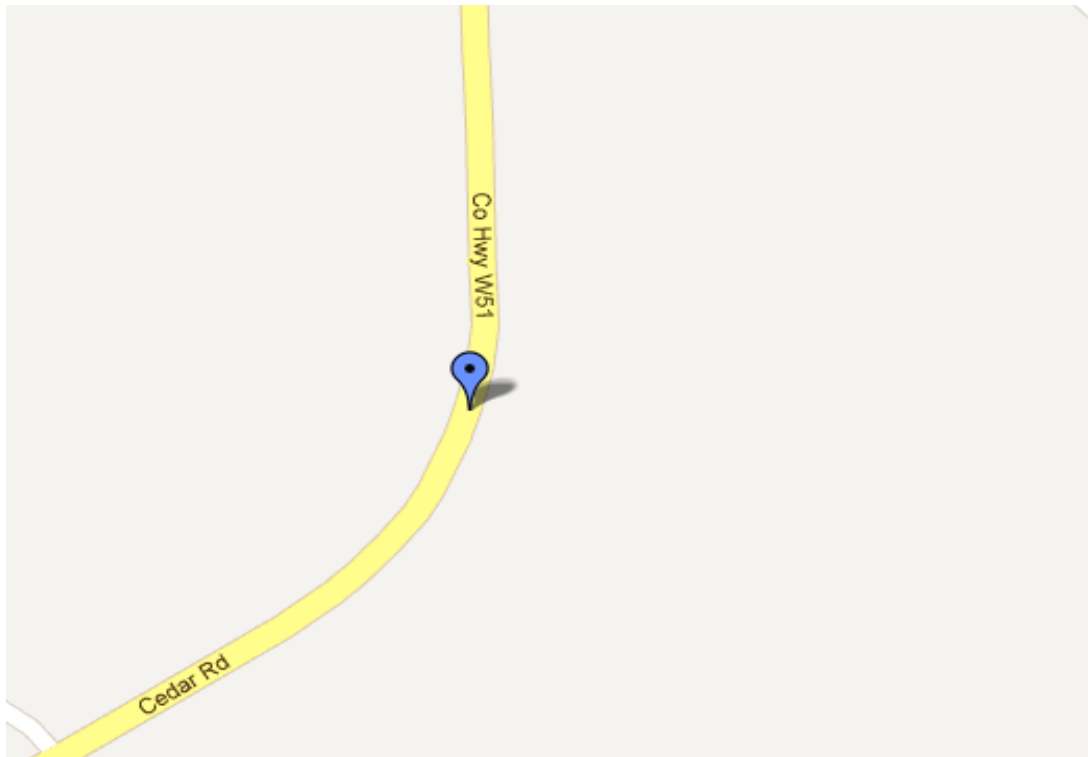

4:40 PM

Saturday

August 7, 2010

23

W Ridgeway Avenue & Lexington Blvd, Cedar Falls, Black Hawk County

Municipal 2L, t-intersection

Non-collision

| | Teen driver | Exterior | Exterior | Rear pass. | Rear pass. |
|-----------|-------------|----------|----------|------------|------------|
| age | 17 | 17 | 17 | | |
| gender | M | M | M | | |
| fatality | | Y | | | |
| injury | 5 | | 3 | | |
| ejection | N | | | | |
| seat belt | N | | | | |



2003 Hyundai Accent GS/GL, Sedan 4 door

Full license

4 days

Crash Narrative

Teen driver SB with victim riding on outside of vehicle on the trunk. Vehicle traveling at low speed (around 15 mph) in mobile home court. Teen passenger fell and suffered a head injury.

Contributing factors

-

Other factors

-

Reporting Agency: Cedar Falls Police

Teen driver at fault? Yes

License history:

*License history data omitted for protection of privacy

Criminal charges:

Involuntary manslaughter (suspended fine, 2 yr probation, 2 yr prison suspended)

Civil litigation:

None

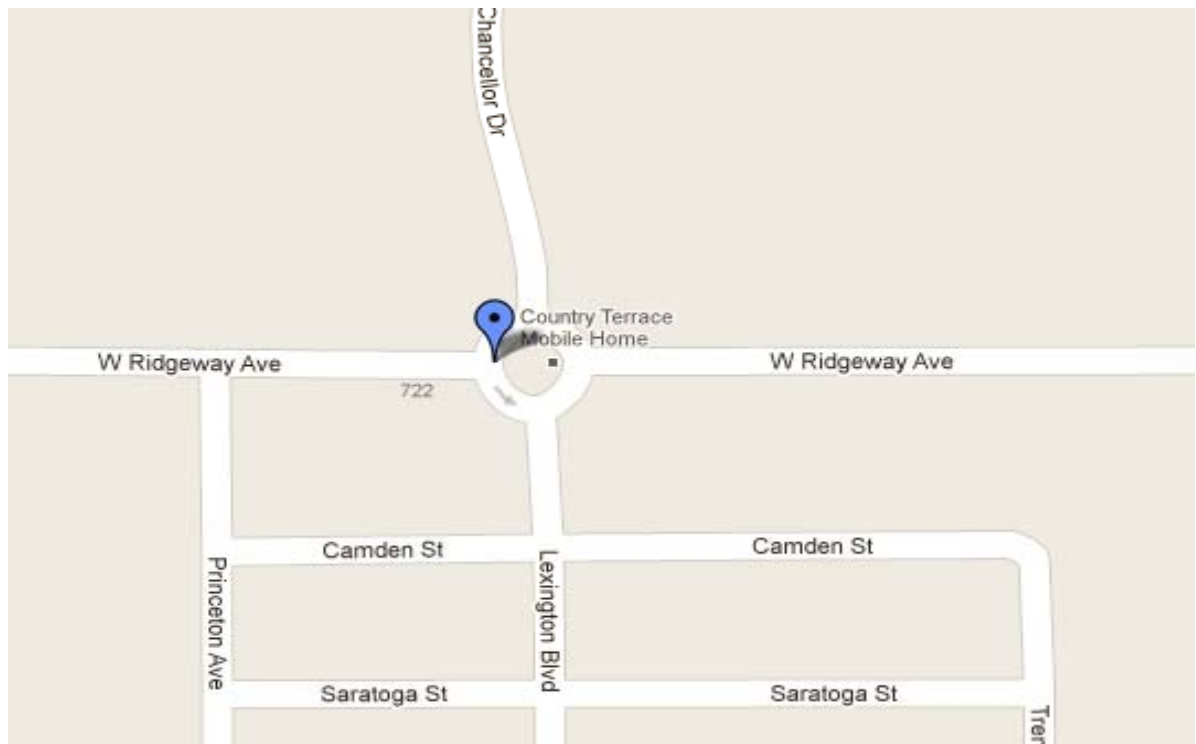

Co Rd C25 & Hwy 71, Buena Vista County
 US Route / Secondary 2L, controlled four-way intersection
 Head-on

| | | | | | | | | |
|-----------|-------------|----|-------------|--|------------|--|------------|--|
| | Teen driver | | Front pass. | | Rear pass. | | Rear pass. | |
| age | 15 | 15 | | | | | | |
| gender | M | M | | | | | | |
| fatality | | | | | | | | |
| injury | 3 | 3 | | | | | | |
| ejection | N | N | | | | | | |
| seat belt | Y | Y | | | | | | |

2000 Dodge Durango, Wagon 4 door
 School license 126 days

| | | |
|-----------|--------------|--|
| | Other driver | |
| age | 60 | |
| gender | M | |
| fatality | | |
| injury | 3 | |
| ejection | N | |
| seat belt | Y | |

2006 Peterbilt Tractor truck

| | | | | |
|-----------|--------------|----|-------------|--|
| | Other driver | | Front pass. | |
| age | 69 | 52 | | |
| gender | M | F | | |
| fatality | | | | |
| injury | 3 | 3 | | |
| ejection | N | N | | |
| seat belt | Y | Y | | |

1987 Mercury Topaz GS, Sedan 4 door

| | | |
|-----------|--------------|--|
| | Other driver | |
| age | 35 | |
| gender | M | |
| fatality | Y | |
| injury | | |
| ejection | N | |
| seat belt | Y | |

1993 Kenworth Construct T800, Tractor truck

Crash Narrative

Teen driver (Unit 1) EB when he stopped at stop sign and pulled out in front of a semi (Unit 2) heading NB. Semi (Unit 2) collided with teen (Unit 1) and threw the teen's vehicle into the path of another car (Unit 3) who was travelling SB. The semi continued NB into the path of the second semi (Unit 4) where they collided head-on.

Contributing factors

-

Other factors

-

Reporting Agency: Buena Vista County

Teen driver at fault? Yes

License history:

***License history data omitted for protection of privacy**

Criminal charges:

Failure to yield upon entering through highway (fine) and Violation of Minor School License (fine)

Civil litigation:

None

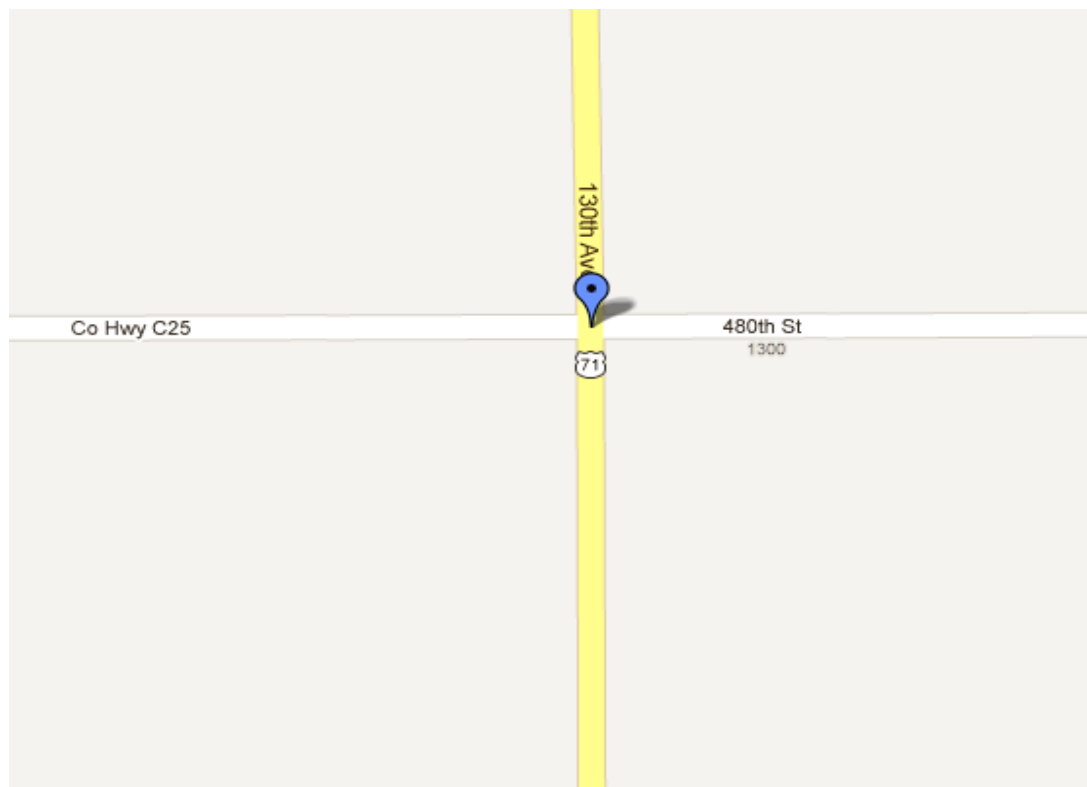

4:00 AM

Wednesday

August 11, 2010

25

NE 54th Ave at Mud Creek, just east of NE 80th St intersection, Polk County

Secondary 2L, overpass

Rear-end

| | Teen driver | Front pass. | Rear pass. | Rear pass. |
|-----------|-------------|-------------|------------|------------|
| age | 17 | * | * | * |
| gender | F | * | * | * |
| fatality | | | | |
| injury | 3 | 5 | 5 | 5 |
| ejection | N | * | * | * |
| seat belt | Y | * | * | * |

1998 Dodge Avenger ES, Pillard Hardtop 2 door
Intermediate 441 days

*Passenger data unavailable

| | Other driver | Front pass. |
|-----------|--------------|-------------|
| age | 16 | * |
| gender | F | * |
| fatality | Y | |
| injury | | 5 |
| ejection | N | * |
| seat belt | ? | * |

2004 Pontiac Grand AM SE, Sedan 4 door
Intermediate 169 days

*Passenger data unavailable

| | Other driver | Front pass. | Rear pass. | Unknown | Unknown |
|-----------|--------------|-------------|------------|---------|---------|
| age | 17 | 18 | 21 | 16 | * |
| gender | F | M | M | F | * |
| fatality | | | | | |
| injury | 4 | 3 | 3 | 3 | 5 |
| ejection | ? | N | ? | N | * |
| seat belt | ? | ? | ? | ? | * |

1998 Dodge Avenger ES, Pillard Hardtop 2 door
Intermediate 158 days

*Passenger data unavailable

Crash Narrative

Three vehicles were travelling EB with a total of 11 people ages 16-21 closely following one another. A flooded creek was rushing over and under the roadway at a depth of at least 18 in. First car tried to stop and fishtailed. Second car hit first, and third car hit second. All three cars were washed off the road and submerged. Teen driver of second vehicle was fatal. Other ten people managed to escape.

Contributing factors

Flooding; Driver of third vehicle had BAC of 0.088

Other factors

-

Reporting Agency: ISP

Teen driver at fault? Unclear

License history:

*License history data omitted for protection of privacy

Criminal charges:

None

Civil litigation:

None

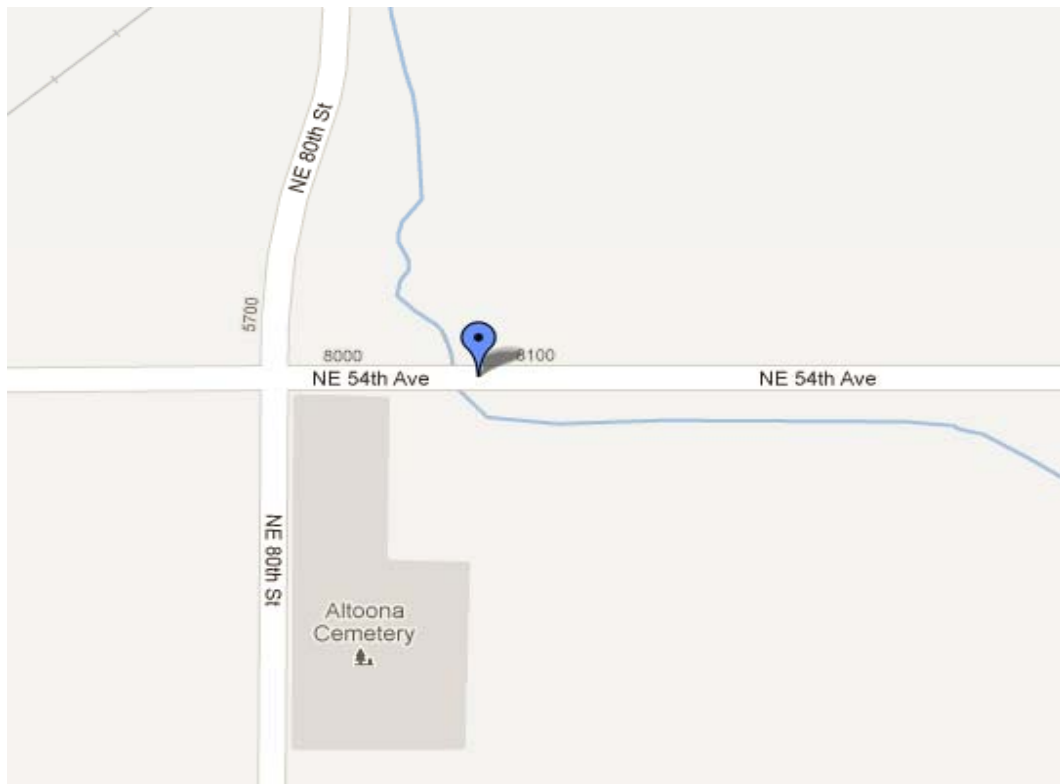

I-80, between W 62nd St S & Hwy F48 W, Jasper County
 Interstate, 2L each direction, divided by grass median
 Broadside

| | Teen driver | Front pass. | Middle left | Middle Right | Back Left | Back Middle | Back Right |
|-----------|-------------|-------------|-------------|--------------|-----------|-------------|------------|
| age | 19 | 30 | 18 | 15 | 20 | 16 | 19 |
| gender | M | M | M | M | M | F | F |
| fatality | | | Y | Y | Y | Y | Y |
| injury | 4 | 4 | | | | | |
| ejection | N | N | Y | Y | Y | Y | Y |
| seat belt | Y | Y | N | N | N | N | N |

2002 Honda Odyssey, Mini van
 Out of state

| | Other driver |
|-----------|--------------|
| age | 49 |
| gender | M |
| fatality | |
| injury | 5 |
| ejection | N |
| seat belt | Y |

2007 Semi (NR)

| | Other driver | Front pass. | Rear pass. |
|-----------|--------------|-------------|------------|
| age | 45 | | 5 |
| gender | M | | M |
| fatality | Y | | Y |
| injury | | | |
| ejection | N | | N |
| seat belt | N | | Y |

2004 Toyota Corolla, Sedan 4 door

Crash Narrative

Teen driver in mini van (Unit 1) was WB on I-80 in the right lane of traffic. Semi truck (Unit 2) was WB in the right lane. Third car (Unit 3) was EB in the right lane. While traveling WB Unit 1 moves to the left lane to pass Unit 2. While passing Unit 2, Unit 1 enters the right lane making contact with Unit 2 striking the left side of Unit 2 with the right side of Unit 1. Unit 1 loses control and veers left entering the median. Unit 1 then exits the median entering the path of EB traffic. As Unit 1 is entering the path of EB, Unit 3 is EB at the same location. The front of Unit 3 strikes the left sliding door of Unit 1. Unit 1 then spins counter clockwise coming to rest partially on the right lane and shoulder of EB traffic facing NE. Unit 3 comes to rest just east of Unit 1 partially on the right lane and outside shoulder of EB traffic facing NE. Unit 2 comes to rest several hundred yards down the interstate on the outside shoulder of WB traffic facing west.

Contributing factors

Driver fell asleep?

Other factors

-

Reporting Agency: ISP

Teen driver at fault? Yes

License history:

*License history data omitted for protection of privacy

Criminal charges:

Improper use of lanes (fine) and failure to maintain control (fine).

Civil litigation:

None

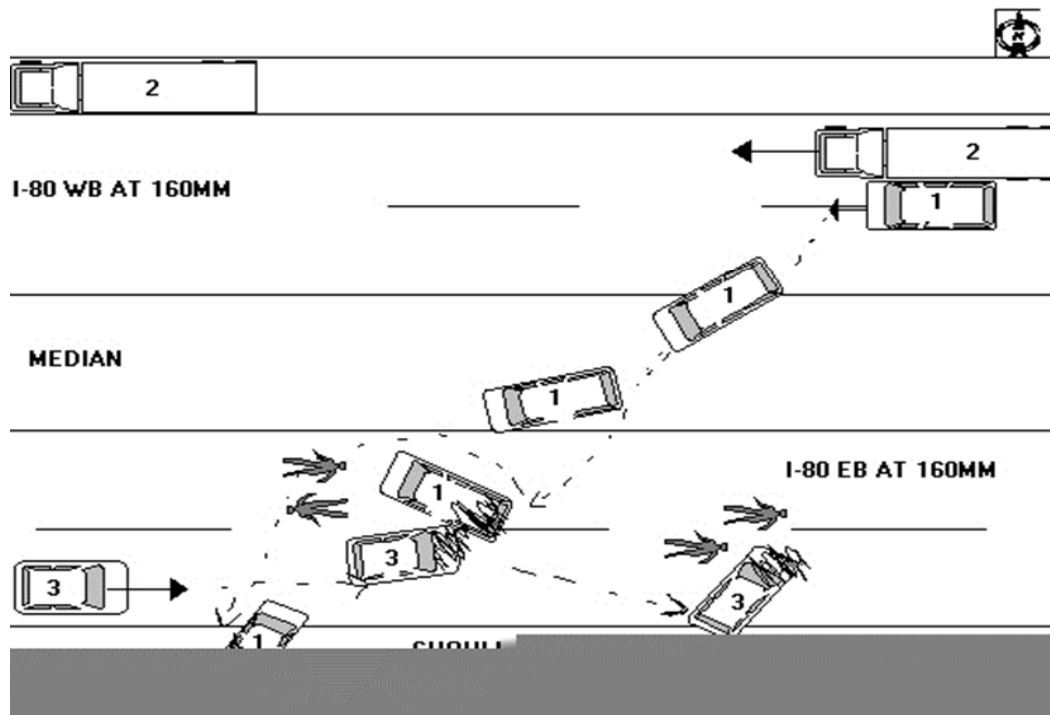

R Ave & 260th Street, Dallas County
Secondary 2L, controlled four-way intersection
Broadside

| | Teen driver | Front pass. | Rear pass. | Rear pass. | Rear pass. |
|-----------|-------------|-------------|------------|------------|------------|
| age | 17 | 19 | 12 | | |
| gender | F | F | F | | |
| fatality | | | Y | | |
| injury | 4 | 3 | | | |
| ejection | N | N | Y | | |
| seat belt | ? | ? | ? | | |

2004 Honda Odyssey, Van
Intermediate 560 days

| | Other driver | Front pass. | Rear pass. | Rear pass. | Rear pass. |
|-----------|--------------|-------------|------------|------------|------------|
| age | 75 | | | | |
| gender | M | | | | |
| fatality | | | | | |
| injury | 5 | | | | |
| ejection | N | | | | |
| seat belt | Y | | | | |

2010 Mercury Mountaineer Premier, Wagon 4 door

Crash Narrative

Teen (Unit 1) was traveling SB and went off the roadway to the right. Other driver (Unit 2) was approaching intersection SB. Teen (Unit 1) failed to yield while making a u-turn into the path of other driver (Unit 2). The point of impact was in the middle of the intersection. Other driver (Unit 2) struck teen (Unit 1) in the middle of the van on driver side. Teen (Unit 1) spun counter clockwise and came to rest half on the NB side of R-16 and half on shoulder of NB R-16. Other driver (Unit 2) spun counter clockwise and came to rest in west ditch of SW corner of R-16 and 260th Street.

Contributing factors

-

Other factors

-

Reporting Agency: ISP

Teen driver at fault? Yes

License history:

*License history data omitted for protection of privacy

Criminal charges:

None

Civil litigation:

None

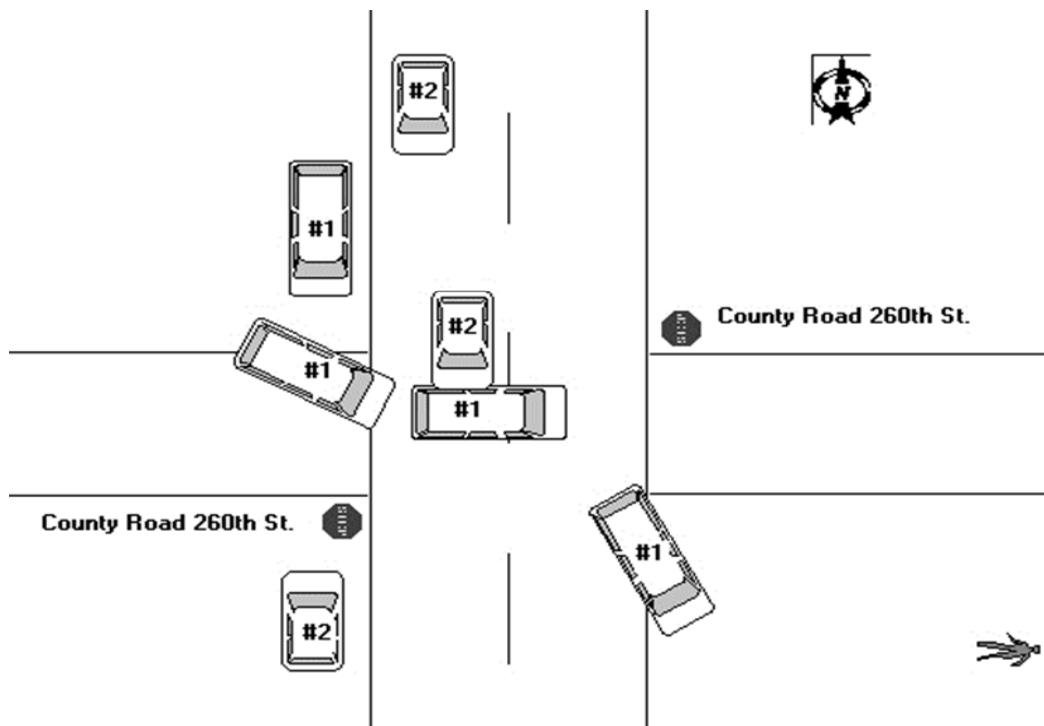

6:44 PM

Tuesday

August 17, 2010

28

300th Street, between Thrush Ave & Union Ave, Audubon County

Secondary 2L, Farm/residential drive, gravel

Head-on

| | Teen driver | Front pass. | Rear pass. | Rear pass. | Rear pass. |
|-----------|-------------|-------------|------------|------------|------------|
| age | 18 | | | | |
| gender | F | | | | |
| fatality | Y | | | | |
| injury | | | | | |
| ejection | N | | | | |
| seat belt | Y | | | | |

1995 Oldsmobile Cutlass Supreme SL, Sedan 4 door
Full license 238 days

| | Other driver | Front pass. | Rear pass. | Rear pass. | Rear pass. |
|-----------|--------------|-------------|------------|------------|------------|
| age | 43 | | | | |
| gender | M | | | | |
| fatality | | | | | |
| injury | 4 | | | | |
| ejection | N | | | | |
| seat belt | Y | | | | |

1999 Ford F250 Super Duty, 4 door ext cab pickup

Crash Narrative

Teen (Unit 1) was EB and other driver (Unit 2) was WB. Vehicles approached at the crest of a hill and made contact head on. Unit 2 started on fire and the driver was able to get out of his vehicle and pulled the teen driver (Unit 1) out of her vehicle which was on fire.

Contributing factors

Vision obscured with hillcrest

Other factors

-

Reporting Agency: ISP

Teen driver at fault? Yes

License history:

*License history data omitted for protection of privacy

Criminal charges:

None

Civil litigation:

None

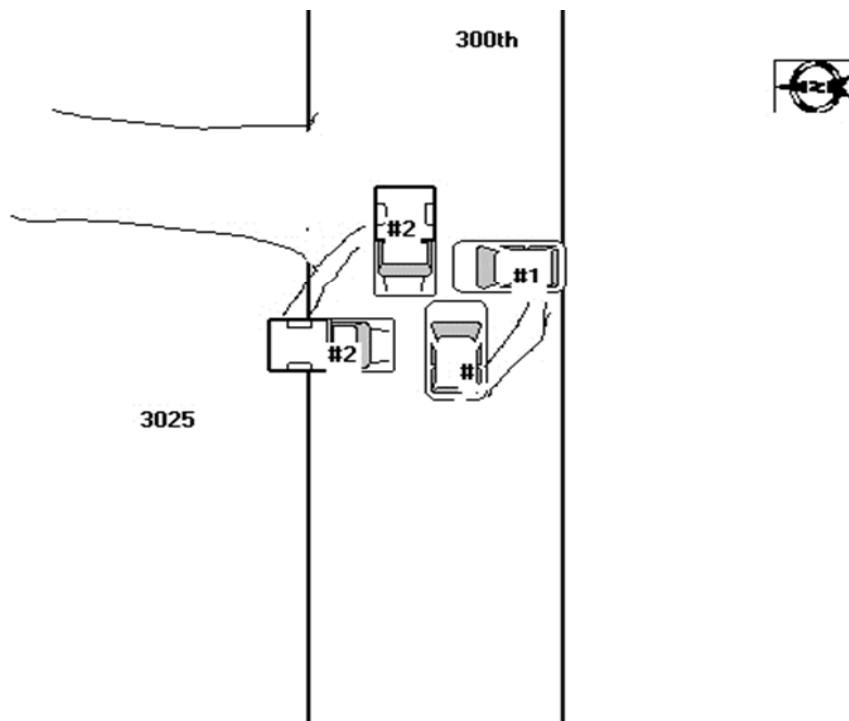

Route 28, 1/2 mile south of IA Hwy 5, Norwalk, Warren County

Iowa Route 2L each direction, separated by raised median

Head-on

| | Teen driver | Front pass. | Rear pass. | Rear pass. | Rear pass. |
|-----------|-------------|-------------|------------|------------|------------|
| age | 18 | 18 | 18 | | |
| gender | M | F | M | | |
| fatality | | Y | | | |
| injury | 2 | | 2 | | |
| ejection | N | N | N | | |
| seat belt | Y | Y | N | | |

1990 Jeep Cherokee Laredo, Wagon 4 door
Full license 186 days

| | Other driver | Front pass. | Rear pass. | Rear pass. | Rear pass. |
|-----------|--------------|-------------|------------|------------|------------|
| age | 62 | | | | |
| gender | F | | | | |
| fatality | | | | | |
| injury | 2 | | | | |
| ejection | N | | | | |
| seat belt | Y | | | | |

2000 Mercury Grand Marquis LS, Sedan 4 door

Crash Narrative

Teen driver (Unit 2) was SB when other driver (Unit 1) was NB. Other driver crossed the raised median to the left and struck teen head-on. Both vehicles came to rest in the NB lanes.

Contributing factors

-

Other factors

None reported - but pictures from google search show road was wet

Reporting Agency: ISP

Teen driver at fault? No

License history:

*License history data omitted for protection of privacy

Criminal charges:

None

Civil litigation:

None

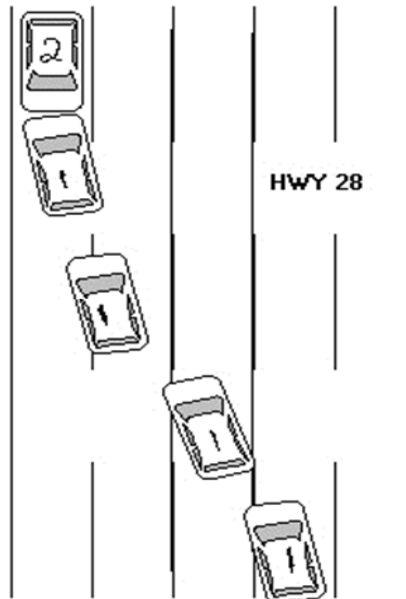

NW 159th St & Hickman Rd, Clive, Dallas County

Municipal 2L each direction, controlled four-way intersection, separated by median
Broadside

| | Teen driver | Front pass. | Rear pass. | Rear pass. | Rear pass. |
|-----------|-------------|-------------|------------|------------|------------|
| age | 19 | | | | |
| gender | M | | | | |
| fatality | | | | | |
| injury | 5 | | | | |
| ejection | N | | | | |
| seat belt | ? | | | | |

2001 Ford F150, 4 door ext cab pickup
Intermediate* 1252 days
*converted to a full license at age 18

| | Other driver | Front pass. | Rear pass. | Rear pass. | Rear pass. |
|-----------|--------------|-------------|------------|------------|------------|
| age | 84 | | | | |
| gender | M | | | | |
| fatality | Y | | | | |
| injury | | | | | |
| ejection | N | | | | |
| seat belt | ? | | | | |

1995 Dodge Grand Caravan SE, Sport van

Crash Narrative

Teen EB when other driver NB. Other driver failed to yield at stop sign. Teen hit other driver's vehicle in the driver's side middle.

Contributing factors

Rain

Other factors

-

Reporting Agency: Clive Police

Teen driver at fault? No

License history:

*License history data omitted for protection of privacy

Criminal charges:

None

Civil litigation:

None

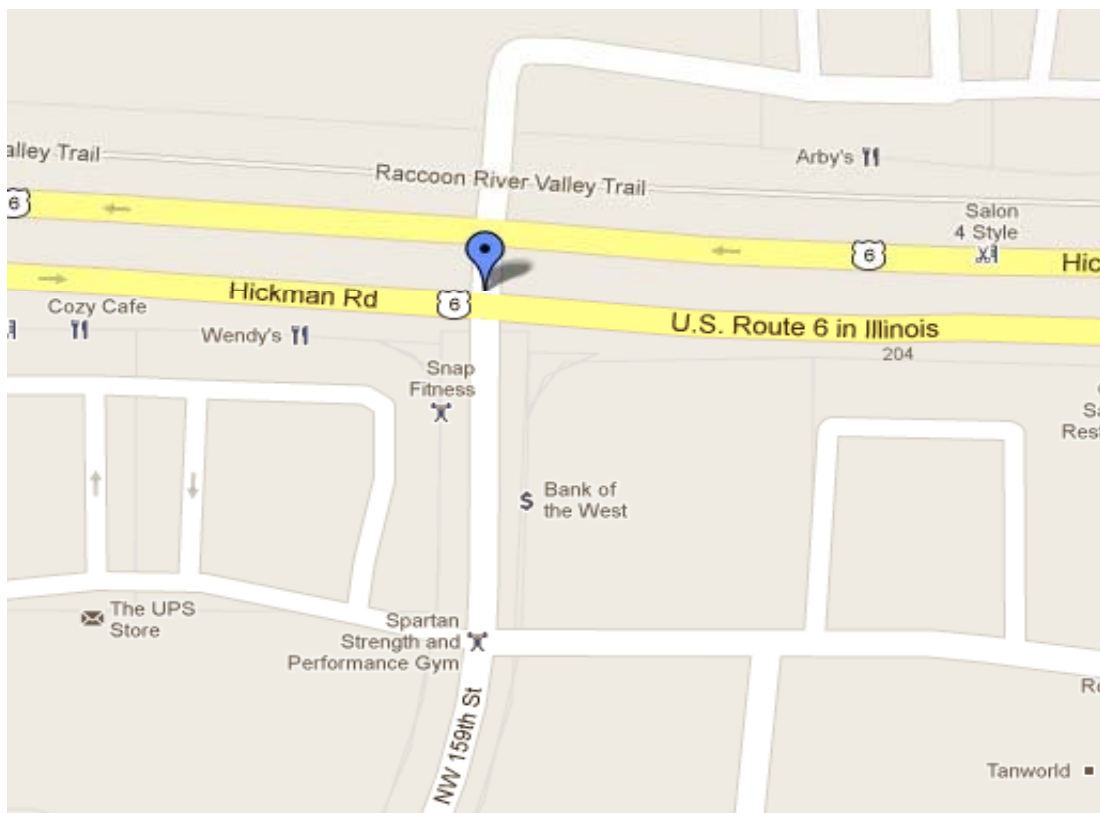

I-80, just west of IA 14 interchange, Jasper County
 Intersection 2L each direction, divided by unnprotected median
 Sideswipe, opposite direction

| | | | | | |
|-----------|-------------|-------------|------------|------------|------------|
| | Teen driver | Front pass. | Rear pass. | Rear pass. | Rear pass. |
| age | 19 | | | | |
| gender | F | | | | |
| fatality | Y | | | | |
| injury | | | | | |
| ejection | N | | | | |
| seat belt | ? | | | | |

1998 Kia Sportage, Wagon 4 door
 Full license 340 days

| | |
|-----------|--------------|
| | Other driver |
| age | 61 |
| gender | M |
| fatality | |
| injury | 5 |
| ejection | N |
| seat belt | Y |

1998 International 8000 Series
 8100, Tractor truck (diesel)

| | | | |
|-----------|--------------|-------------|------------|
| | Other driver | Front pass. | Rear pass. |
| age | 66 | 77 | |
| gender | F | F | |
| fatality | | | |
| injury | 3 | 4 | |
| ejection | N | N | |
| seat belt | Y | Y | |

2009 Honda Odyssey EXL, Sport
 van

Crash Narrative

Teen (Unit 1) was WB on the inside travel line. Semi (Unit 2) was EB on the outside travel lane and van (Unit 3) was EB on the inside lane. Teen (Unit 1) lost control and entered the median to the left and crossed the inside EB travel lane and struck the rear tandums of the semi (Unit 2). Teen's vehicle (Unit 1) exploded into flames upon impact and spun counter-clockwise. Van (Unit 3) was unable to avoid teen (Unit 1) and struck the rear of teen's vehicle. Teen's vehicle (Unit 1) came to rest in the middle of EB lanes. Van (Unit 3) came to rest in the median and semi (Unit 2) entered into the right ditch and then came to rest in the shoulder.

Contributing factors

-

Other factors

-

Reporting Agency: ISP

Teen driver at fault? Yes

License history:

*License history data omitted for protection of privacy

Criminal charges:

None

Civil litigation:

None

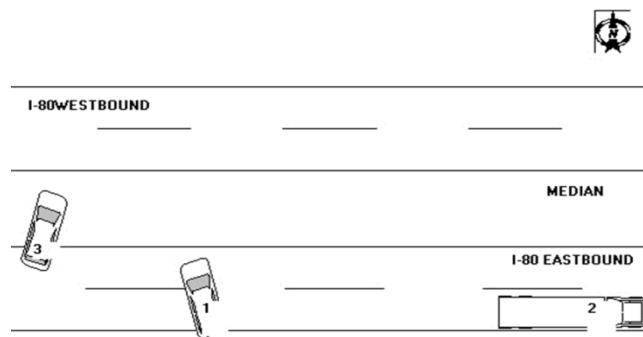
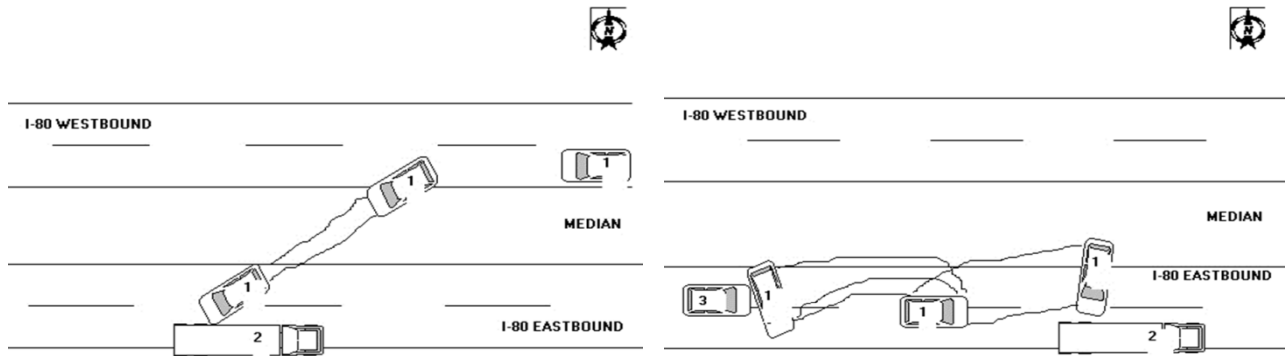

US 218, Brinker Lake, Waterloo, Black Hawk County
US Route 3L each direction, divided median
Non-collision

| | Teen driver | Front pass. | Rear pass. | Rear pass. | Rear pass. |
|-----------|-------------|-------------|------------|------------|------------|
| age | 19 | | | | |
| gender | M | | | | |
| fatality | Y | | | | |
| injury | | | | | |
| ejection | n/a | | | | |
| seat belt | * | | | | |

2004 Kawasaki ZX636B1 Motorcycle
Full license 735 days

*teen wearing helmet

Crash Narrative

Teen on motorcycle NB driving at high speeds while changing lanes. Teen lost control, went off road to the right, under fence, and into lake.

Contributing factors

Exceeded authorized speed

Other factors

-

Reporting Agency: Waterloo Police

Teen driver at fault? Yes

License history:

*License history data omitted for protection of privacy

Criminal charges:

None

Civil litigation:

None

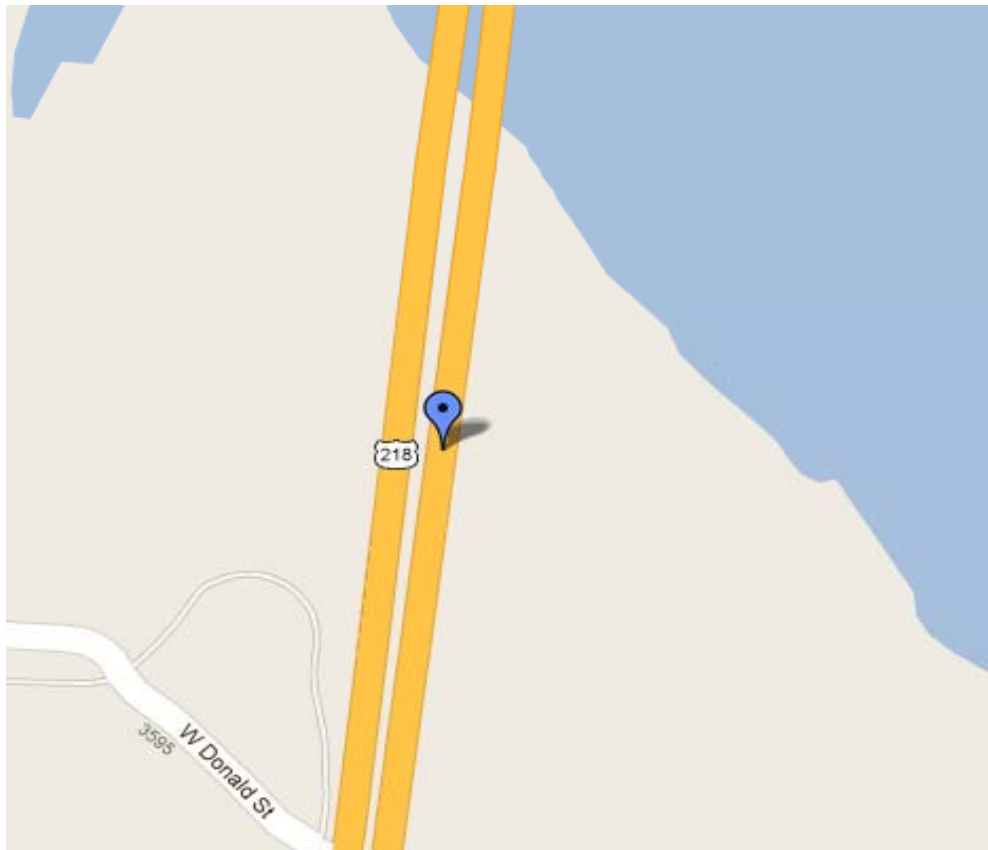

4:00 AM

Monday

September 6, 2010

33

230th Street, between Glass Ave & Foothill Ave, Floyd County

Secondary 2L, gravel, residential driveway

Non-collision

| | Teen driver | Front pass. | Front pass. | Rear pass. | Rear pass. |
|-----------|-------------|-------------|-------------|------------|------------|
| age | 19 | 19 | 21 | | |
| gender | M | M | F | | |
| fatality | | | Y | | |
| injury | 3 | 5 | | | |
| ejection | N | N | Y | | |
| seat belt | N | Y | N | | |

1998 Dodge Ram 1500 Quad, 4 door pickup
 Full license 703 days

Crash Narrative

Teen (Unit 1) entered street from the driveway of a residence at a high rate of speed. Teen lost control and the vehicle left the roadway to left. The front end of the vehicle made contact with the embankment of the south ditch. The vehicle rolled over onto its top where it came to rest facing east.

Contributing factors

Driver had BAC level of 0.243

Other factors

-

Reporting Agency: ISP

Teen driver at fault? Yes

License history:

*License history data omitted for protection of privacy

Criminal charges:

Vehicular homicide/reckless or elude (10 years)

Civil litigation:

None

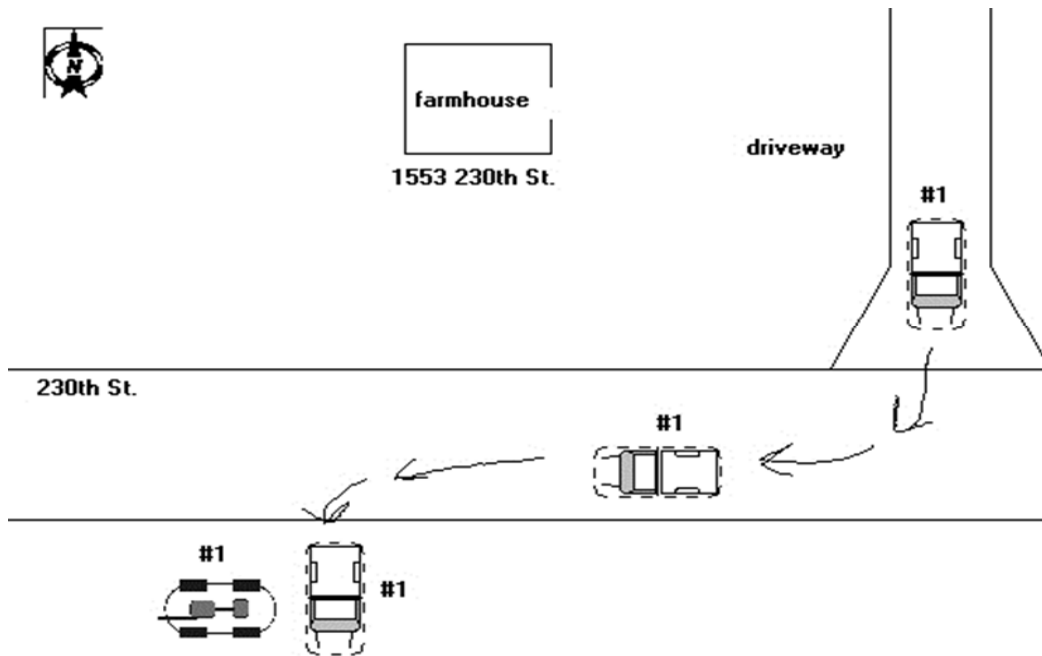

US 65, just south of intersection with US 18, Cerro Gordo County

US Route 2L, separated by grass median
Head-on

| | Teen driver | Front pass. | Rear pass. | Rear pass. | Rear pass. |
|-----------|-------------|-------------|------------|------------|------------|
| age | 18 | 24 | | | |
| gender | F | M | | | |
| fatality | Y | | | | |
| injury | | 2 | | | |
| ejection | N | N | | | |
| seat belt | Y | Y | | | |

2004 Ford FOC, sedan 4 door
Full license 42 days

| | Other driver | Front pass. | Rear pass. | Rear pass. | Rear pass. |
|-----------|--------------|-------------|------------|------------|------------|
| age | 53 | | | | |
| gender | M | | | | |
| fatality | | | | | |
| injury | 3 | | | | |
| ejection | N | | | | |
| seat belt | Y | | | | |

2010 Peterbilt Conventional 365, semi

Crash Narrative

Teen (Unit 1) SB when she lost control and ran off the road to the right. Unit 1 crossed centerline into oncoming lanes and struck NB semi (Unit 2) head-on. Google news picture show Unit 1 overturned.

Contributing factors

-

Other factors

-

Reporting Agency: ISP

Teen driver at fault? Yes

License history:

*License history data omitted for protection of privacy

Criminal charges:

None

Civil litigation:

None

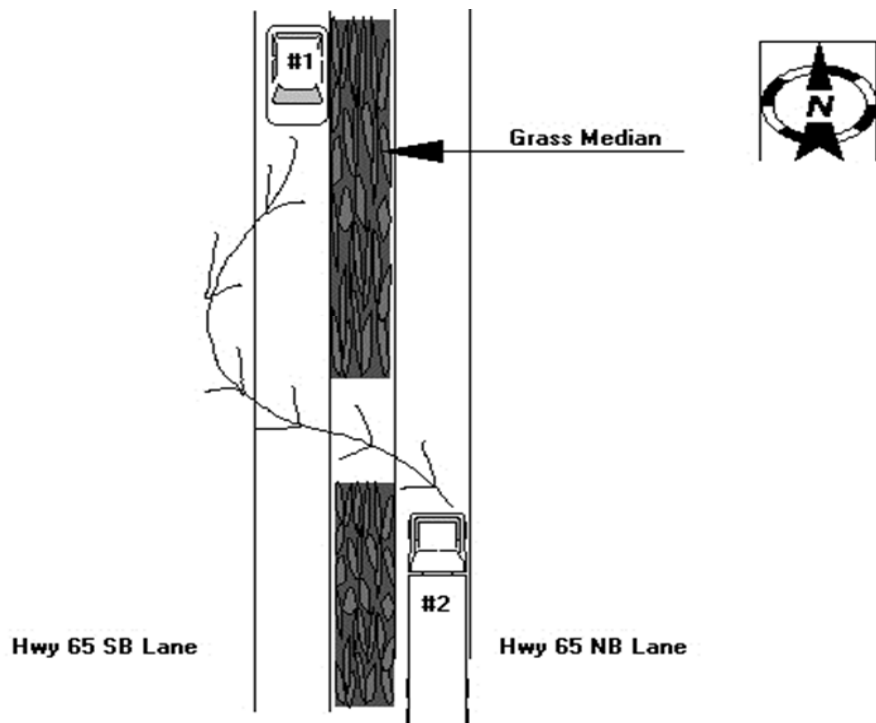

**There is no median on this road

James St & MacKinlay Kantor Dr, Webster City, Hamilton County
 Municipal 2L, controlled four-way intersection
 Broadside

| | | | | | |
|-----------------------------|--------------|-------------|------------|------------|------------|
| | Teen driver | Front pass. | Rear pass. | Rear pass. | Rear pass. |
| age | 19 | | | | |
| gender | M | | | | |
| fatality | | | | | |
| injury | 4 | | | | |
| ejection | N | | | | |
| seat belt | Y | | | | |
| 2004 Chevrolet Venture, van | | | | | |
| | Full license | | 525 days | | |

| | | |
|-------------------------------------|--------------|-------------|
| | Other driver | Front pass. |
| age | 75 | 72 |
| gender | M | F |
| fatality | Y | |
| injury | | 2 |
| ejection | N | N |
| seat belt | Y | Y |
| 1993 Cadillac Deville, sedan 4 door | | |

| | | | |
|--------------------------|--------------|-------------|------------|
| | Other driver | Front pass. | Rear pass. |
| age | 52 | | |
| gender | M | | |
| fatality | | | |
| injury | 5 | | |
| ejection | N | | |
| seat belt | Y | | |
| 1999 Sterling STLG, semi | | | |

Crash Narrative

Other driver (Unit 2) was WB while Unit 3 was stopped at a stop sign facing south waiting for Unit 2 to pass. Teen driver (Unit 1) was NB and failed to stop at a stop sign and struck Unit 2 on the driver's side. The impact of the collision made Unit 2 strike Unit 3. Unit 2 came to rest in the NW ditch and Unit 1 came to rest facing EB.

Contributing factors

-

Other factors

Unit 2's airbags were not deployed

Reporting Agency: ISP

Teen driver at fault? Yes

License history:

 *License history data omitted for protection of privacy

Criminal charges:

 Failure to obey stop sign/signal and yield right of way (fine).

Civil litigation:

 None

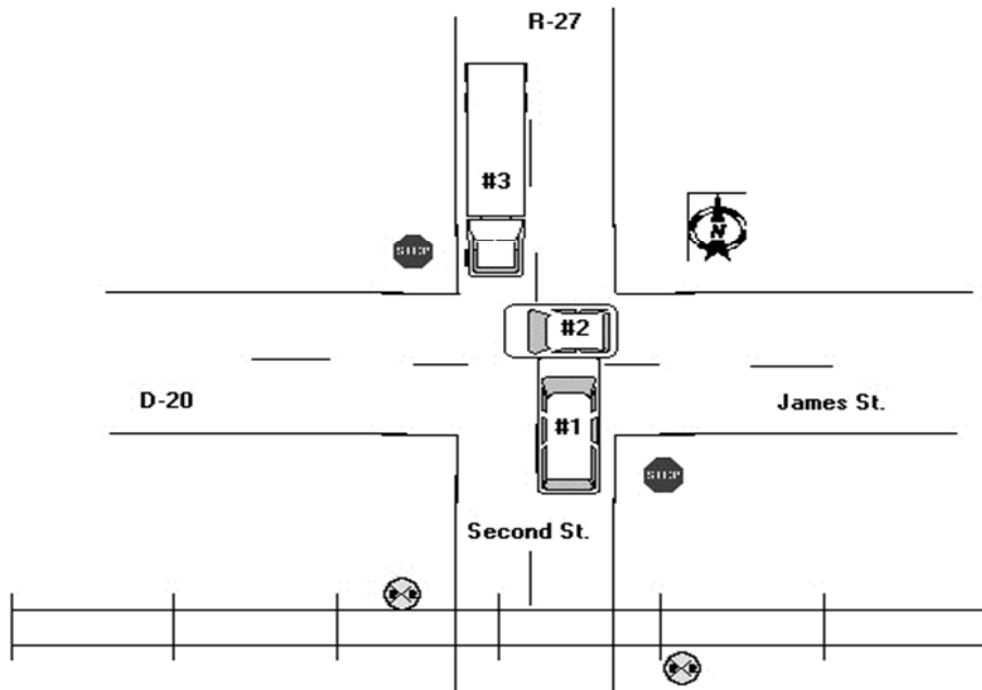

11:55 AM

Thursday

October 7, 2010

36

US Hwys 218/61, just north of the intersection of 320th St, Lee County

US Route 2L each direction, grass median

Non-collision

| | Teen driver | Front pass. | Rear pass. | Rear pass. | Rear pass. |
|-----------|-------------|-------------|------------|------------|------------|
| age | 19 | 23 | 20 | | |
| gender | F | M | M | | |
| fatality | | Y | | | |
| injury | 2 | | 2 | | |
| ejection | N | N | N | | |
| seat belt | Y | Y | N | | |



2003 GMC Yukon XL C1500, Wagon 4 door
Out of State

Crash Narrative

Teen driver NB when it dropped off to the left on the inside shoulder. Teen driver overcorrected pulling back onto highway. As the vehicle came onto the highway, the vehicle slid sideways and rolled several times coming to rest on its right side.

Contributing factors

-

Other factors

-

Reporting Agency: ISP

Teen driver at fault? Yes

License history:

*License history data omitted for protection of privacy

Criminal charges:

None

Civil litigation:

None

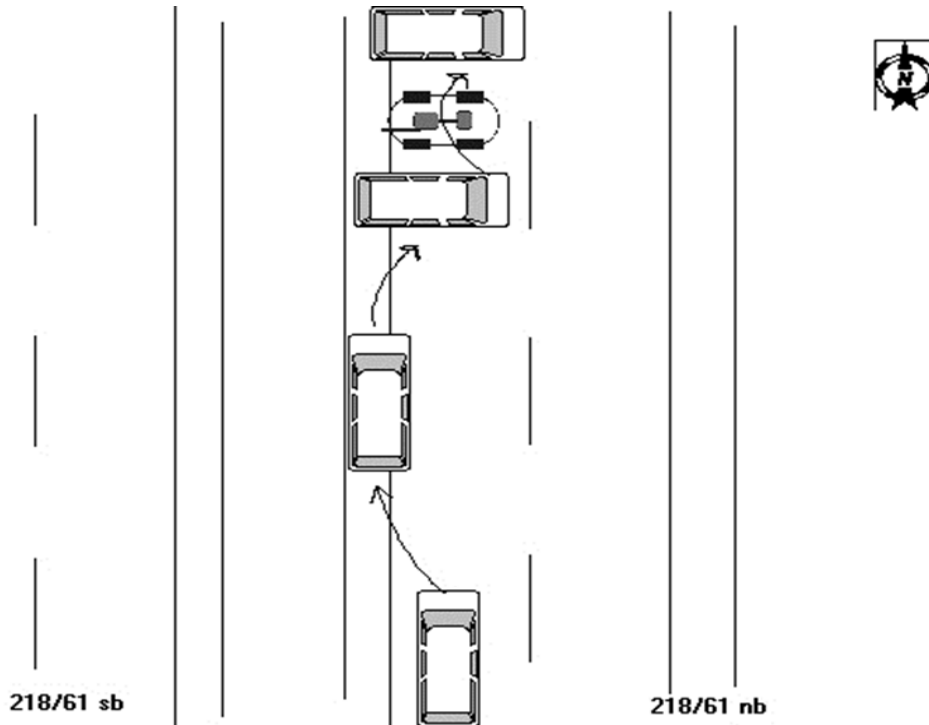

2:56 AM

Saturday

October 16, 2010

37

120th St & US 52, Winneshiek County
Secondary 2L, controlled t-intersection
Non-collision

| | Teen driver | Front pass. | Rear pass. | Rear pass. | Rear pass. |
|-----------|-------------|-------------|------------|------------|------------|
| age | 19 | | | | |
| gender | M | | | | |
| fatality | Y | | | | |
| injury | | | | | |
| ejection | n/a | | | | |
| seat belt | * | | | | |

2002 Yamaha YZFR6L motorcycle
Full license 572 days
*teen did not wear helmet

Crash Narrative

Teen driver failed to stop at stop sign. Law enforcement pursued teen on motorcycle who fled and was traveling at a "very high" rate of speed EB. Teen failed to make a curve, entered ditch to the left, and struck railroad tracks parallel to road. Teen came to rest on the north side of the railroad track and the motorcycle came to rest on the south side of the tracks.

Contributing factors

Teen being pursued by law enforcement at high speed; teen had BAC of 0.184

Other factors

-

Reporting Agency: ISP

Teen driver at fault? Yes

License history:

*License history data omitted for protection of privacy

Criminal charges:

None

Civil litigation:

None

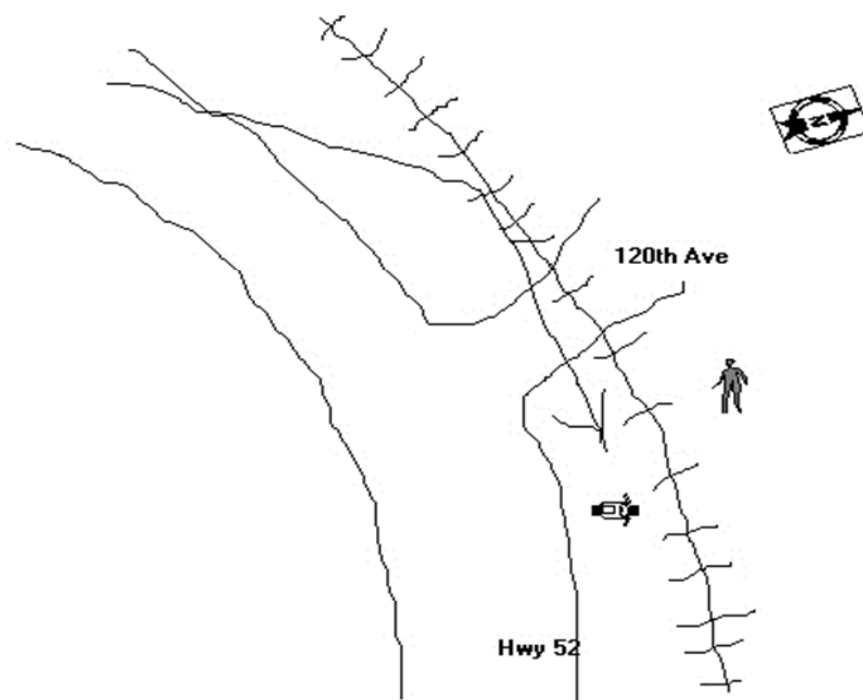

12:19 PM

Wednesday

October 27, 2010

38

Birch Dr just east of intersection with N Illinois Ave, Mason City, Cerro Gordo County
Secondary 2L
Non-collision

| | Teen driver | Front pass. | Rear pass. | Rear pass. | Rear pass. |
|-----------|-------------|-------------|------------|------------|------------|
| age | 17 | 16 | 16 | | |
| gender | M | M | M | | |
| fatality | | Y | | | |
| injury | 2 | | 3 | | |
| ejection | N | N | N | | |
| seat belt | Y | Y | N | | |

1999 Pontiac Grand Prix, 4 door
Intermediate 413 days

Crash Narrative

Teen was EB and exceeded authorized speed when the teen's vehicle ran off the road to the right and struck a tree. The vehicle went down embankment and landed on its roof in river.

Contributing factors

Exceeded authorized speed

Other factors

-

Reporting Agency: Mason City

Teen driver at fault? Yes

License history:

*License history data omitted for protection of privacy

Criminal charges:

Speeding 24/15 (\$625) and failure to maintain control (\$625)

Civil litigation:

Parents of the deceased teen passenger brought suit against the teen driver of the vehicle their son was in as well as the teen driver of another vehicle they allege was racing or chasing and the parents of both teen drivers. Jury trial requested. Motion to append plaintiff's petition set for 5-25-12.

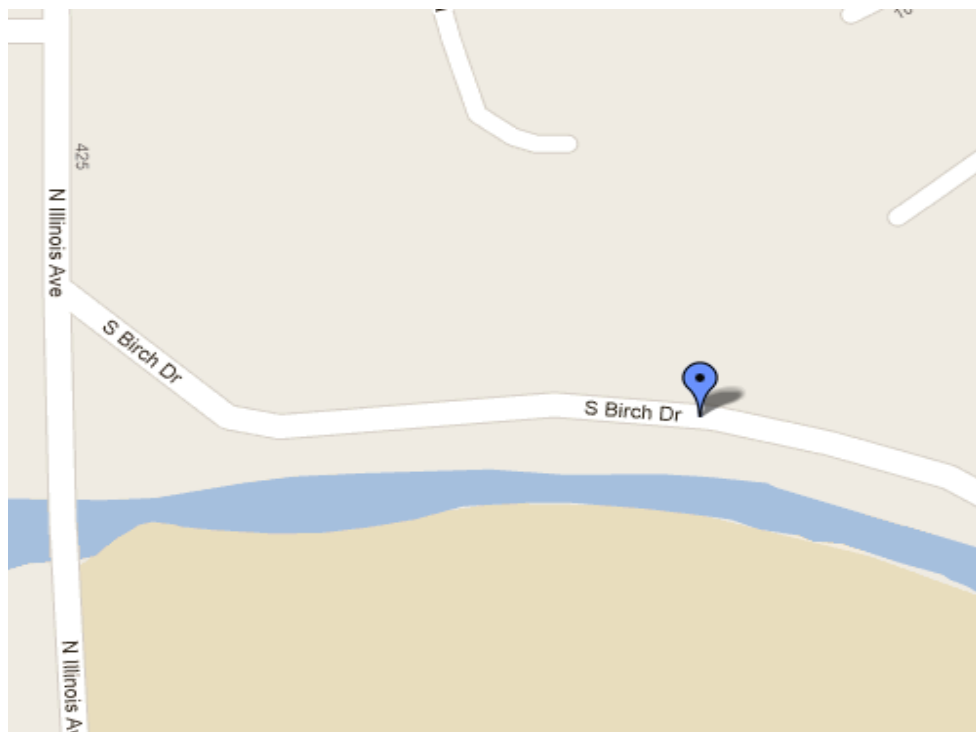

I-29, NE of interchange with I-480, Council Bluffs, Pottawattamie County

Interstate 2L each direction, divided by grass median

Non-collision

| | Teen driver | Front pass. | Rear pass. | Rear pass. | Rear pass. |
|-----------|-------------|-------------|------------|------------|------------|
| age | 19 | | | | |
| gender | F | | | | |
| fatality | Y | | | | |
| injury | | | | | |
| ejection | Y | | | | |
| seat belt | N | | | | |

1995 Toyota Corolla LE/DX, Sedan 4 door
 Full license 87 days

Crash Narrative

Teen heading north when lost control around curve of interstate and ran off road to the right. Her vehicle skidded sideways, rolled down embankment and struck a light pole. Teen was ejection from vehicle which landed on top of her.

Contributing factors

Police officer said speed "appeared" to have been a factor

Other factors

-

Reporting Agency: Council Bluffs

Teen driver at fault? Yes

License history:

*License history data omitted for protection of privacy

Criminal charges:

None

Civil litigation:

None

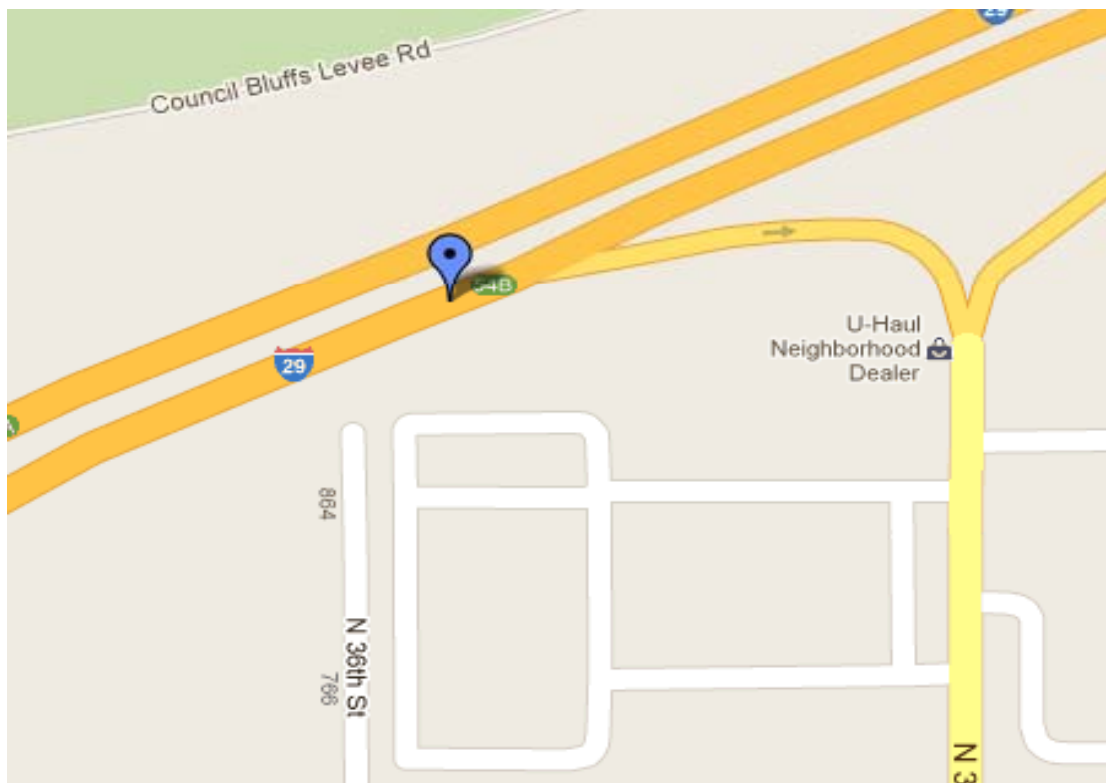

77th St & 24th Ave, Benton County

Secondary 2L, controlled t-intersection, E/W street paved, N street gravel

Rear-end

| | Teen driver | Front pass. | Rear pass. | Rear pass. | Rear pass. |
|-----------|-------------|-------------|------------|------------|------------|
| age | 15 | | | | |
| gender | F | | | | |
| fatality | Y | | | | |
| injury | | | | | |
| ejection | N | | | | |
| seat belt | ? | | | | |

1983 Volkswagen Rabbit LS Custon, Hatchback 4 door
School license 122 days

| | Other driver | Front pass. | Rear pass. | Rear pass. | Rear pass. |
|-----------|--------------|-------------|------------|------------|------------|
| age | 17 | | | | |
| gender | M | | | | |
| fatality | | | | | |
| injury | 4 | | | | |
| ejection | N | | | | |
| seat belt | Y | | | | |

2003 Ford Taurus SE, Sedan 4 door
Intemmediate 666 days

Crash Narrative

Teen #1 was EB and was stopped waiting to turn left onto a gravel road. She was rear-ended by other Teen #2.

Contributing factors

Teen #2 distracted by fallen object

Other factors

-

Reporting Agency: Benton County

Teen driver at fault? Teen #1: No; Teen #2: Yes

License history:

*License history data omitted for protection of privacy

Criminal charges:

None

Civil litigation:

None

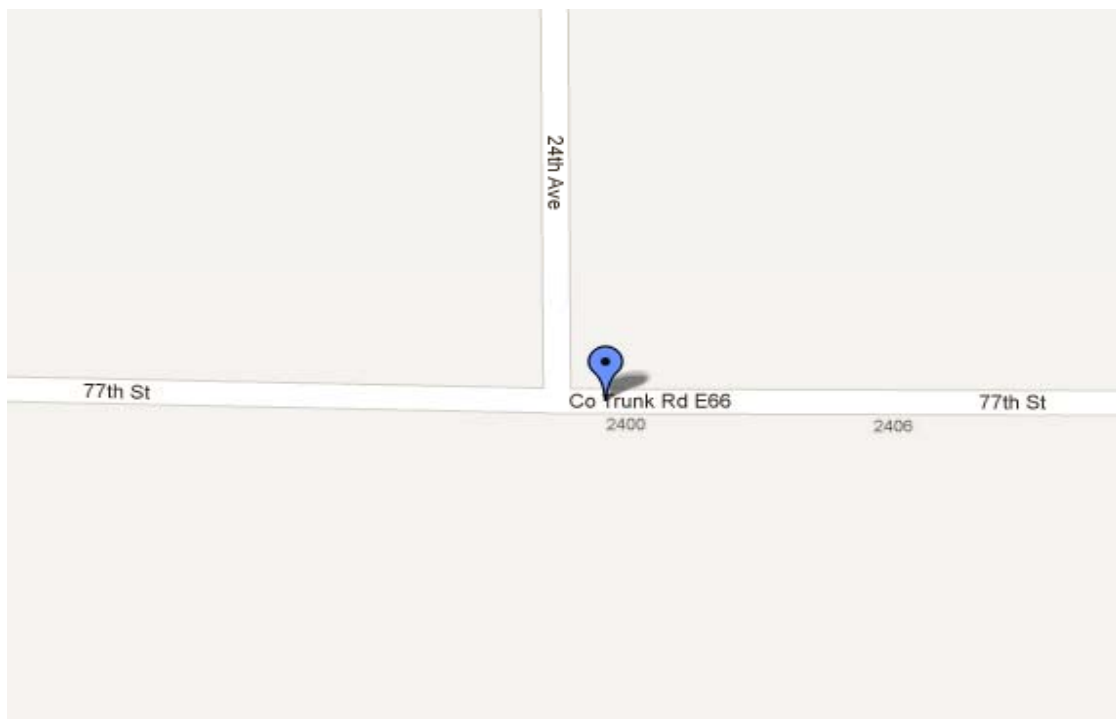

1:40 AM
 Cottage Grove Ave, between Lincolnshire Dr SE & Goblins Gully Dr SE, Cedar Rapids, Linn County
 Monday
 November 8, 2010
 Municipal 2L, hill
 Non-collision

| | Teen driver | Front pass. | Rear pass. | Rear pass. | Rear pass. |
|-----------|-------------|-------------|------------|------------|------------|
| age | 17 | 18 | 17 | 17 | |
| gender | M | F | M | M | |
| fatality | | | | Y | |
| injury | 4 | 4 | 4 | | |
| ejection | N | N | N | N | |
| seat belt | Y | Y | Y | Y | |

1997 Ford Taurus SHO, Sedan 4 door
 Instruction permit 499 days

Crash Narrative

Teen driver SB. LOC at the crest of the hill. Vehicle ran off road to the right, rolled several times, before striking a pole and coming to a rest on its top.

Contributing factors

Teen driver had BAC of 0.066; Exceeded authorized speed; Hill

Other factors

-

Reporting Agency: Cedar Rapids

Teen driver at fault? Yes

License history:

*License history data omitted for protection of privacy

Criminal charges:

vehicular homicide/OWI and vehicular homicide/reckless or elude. Pleaded guilty to involuntary manslaughter (5 yr suspended prison, 3 yrs probation but has violated probation).

Civil litigation:

None

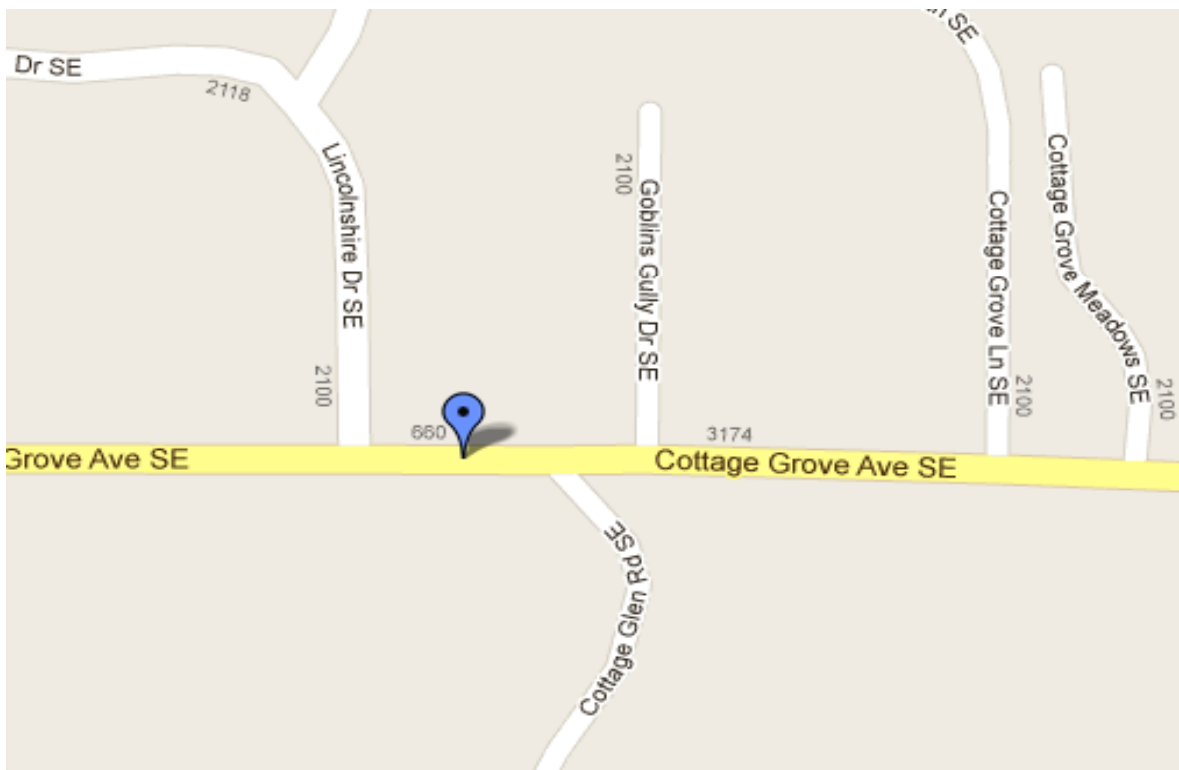

10:00 AM

Thursday

November 18, 2010

42

IA Hwy 415, just north of intersection with NW 66th Ave, Polk County

IA Route 2L in each direction, grass median

Non-collision

| | Teen driver | Front pass. | Rear pass. | Rear pass. | Rear pass. |
|-----------|-------------|-------------|------------|------------|------------|
| age | 18 | 17 | | | |
| gender | M | M | | | |
| fatality | | Y | | | |
| injury | 2 | | | | |
| ejection | N | N | | | |
| seat belt | Y | Y | | | |

1998 Chevrolet Camaro Z28, Convertible

Full license 26 days

Crash Narrative

Teen driver SB traveling at high rate of speed. Teen lost control and ran off the road to the left and overcorrected. The vehicle overturned several times and came to a rest in the median.

Contributing factors

Authorities report teen was traveling at about 100 MPH in a 55.

Other factors

-

Reporting Agency: Polk County

Teen driver at fault? Yes

License history:

*License history data omitted for protection of privacy

Criminal charges:

Vehicular homicide/reckless or elude (5 yrs probation, \$1000 fine)

Civil litigation:

Father of deceased teen passenger filed wrongful death suit against teen driver and his father. TRIAL IS SET FOR 2/18/13

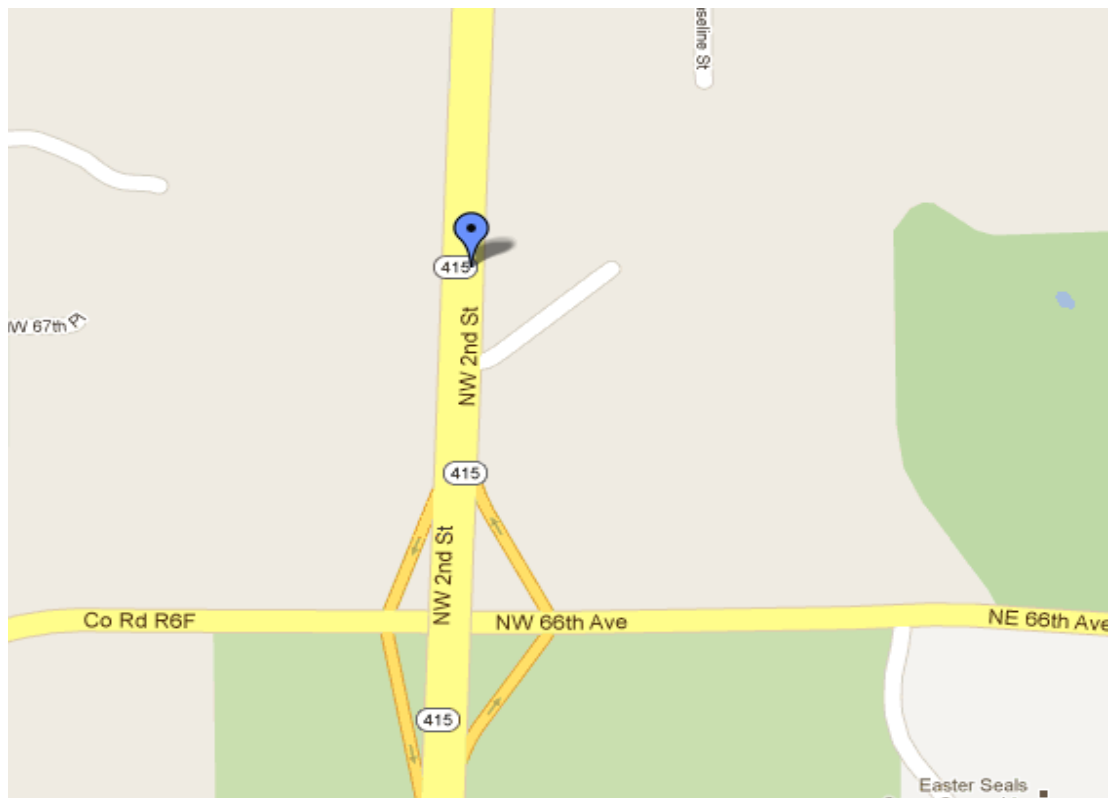

2:00 AM
 Old Highway Rd, just east of intersection with Sundown Road, Centralia, Dubuque County
 Friday
 November 19, 2010
 Secondary 2L
 Non-collision

| | Teen driver | Front pass. | Rear pass. | Rear pass. | Rear pass. |
|-----------|-------------|-------------|------------|------------|------------|
| age | 18 | | | | |
| gender | M | | | | |
| fatality | Y | | | | |
| injury | | | | | |
| ejection | Y | | | | |
| seat belt | Y | | | | |

1996 Chevrolet Cavalier, Coupe
 Intermediate* 664 days
 *Converted to full license at age 18

Crash Narrative

Teen driver traveling at high rate of speed WB when he failed to negotiate curve. He lost control and ran off road to the right and collided with ditch before his vehicle rolled several times.

Contributing factors

Teen had BAC of 0.21; Exceeded authorized speed

Other factors

-

Reporting Agency: Dubuque County

Teen driver at fault? Yes

License history:

*License history data omitted for protection of privacy

Criminal charges:

None

Civil litigation:

None

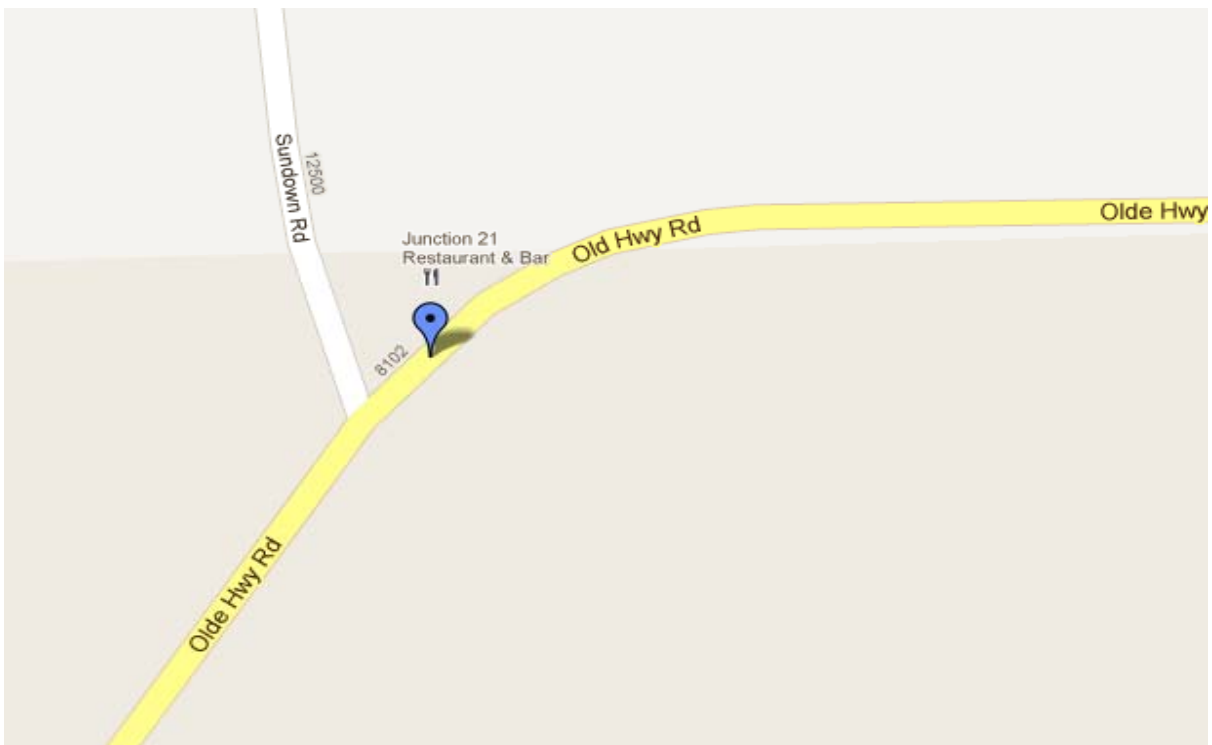

IA 48, between 240th St & 250th St, Montgomery County

Iowa Route 2L

Head-on

| | Teen driver | Front pass. | Rear pass. | Rear pass. | Rear pass. |
|-----------|-------------|-------------|------------|------------|------------|
| age | 18 | | | | |
| gender | F | | | | |
| fatality | | | | | |
| injury | 2 | | | | |
| ejection | N | | | | |
| seat belt | Y | | | | |

2005 Nissan Altima, sedan 4 door
Full license 555 days

| | Other driver | Front pass. | Rear pass. | Rear pass. | Rear pass. |
|-----------|--------------|-------------|------------|------------|------------|
| age | 25 | 5 | 4 | | |
| gender | F | M | M | | |
| fatality | | Y | Y | | |
| injury | 2 | | | | |
| ejection | N | N | N | | |
| seat belt | Y | Y | Y | | |

2001 Kia Spectra, Hatchback 4 door

Crash Narrative

Teen driver (Unit 1) was SB when she passed two vehicles in SB lane in a no-passing zone on a hill. Other driver (Unit 2) was NB when Unit 1 collided head-on with Unit 2 in the NB lane.

Contributing factors

Texting while driving, speeding, passing in a no-passing zone. Teen operating vehicle in an erratic/reckless/careless/negligent/aggressive manner.

Other factors

-

Reporting Agency: ISP

Teen driver at fault? Yes

License history:

*License history data omitted for protection of privacy

Criminal charges:

Two counts of motor vehicle homicide and one count of causing serious injury by motor vehicle

Civil litigation:

None

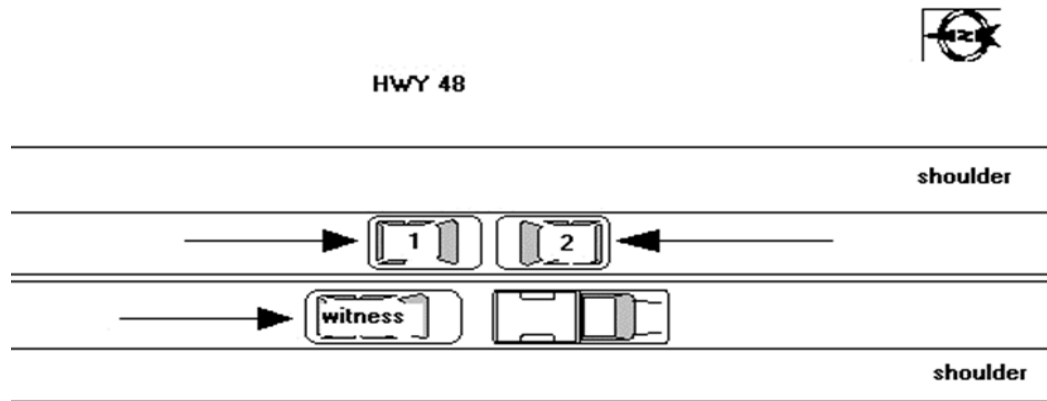

Kimberly Rd/US Hwy 6 & N Marquette Rd, Davenport, Scott County
US Route/Municipal 2L each direction plus turning lanes, controlled four-way intersection
Broadside

| | | | | | |
|-----------|-------------|-------------|------------|------------|------------|
| | Teen driver | Front pass. | Rear pass. | Rear pass. | Rear pass. |
| age | 17 | * | * | | |
| gender | M | * | * | | |
| fatality | | * | * | | |
| injury | 5 | 5 | 5 | | |
| ejection | N | * | * | | |
| seat belt | Y | * | * | | |

2006 car

Instruction permit 103 days

*Passenger data unavailable

| | |
|-----------|--------------|
| | Other driver |
| age | 86 |
| gender | F |
| fatality | Y |
| injury | |
| ejection | N |
| seat belt | Y |

2003 Ford Taurus SE, Sedan 4 door

| | |
|-----------|--------------|
| | Other driver |
| age | 65 |
| gender | F |
| fatality | |
| injury | 5 |
| ejection | N |
| seat belt | Y |

2006 Ford Five Hundred Ltd, Sedan 4 door

Crash Narrative

Second driver FTY at stoplight when he was EB and turning SB. Second driver's vehicle was hit on the driver side middle by the front of teen's SB vehicler. Then front of third NB car made contact with second vehicle.

Contributing factors

-

Other factors

-

Reporting Agency: Davenport Police (?)

Teen driver at fault? No

License history:

*License history data omitted for protection of privacy

Criminal charges:

None

Civil litigation:

None

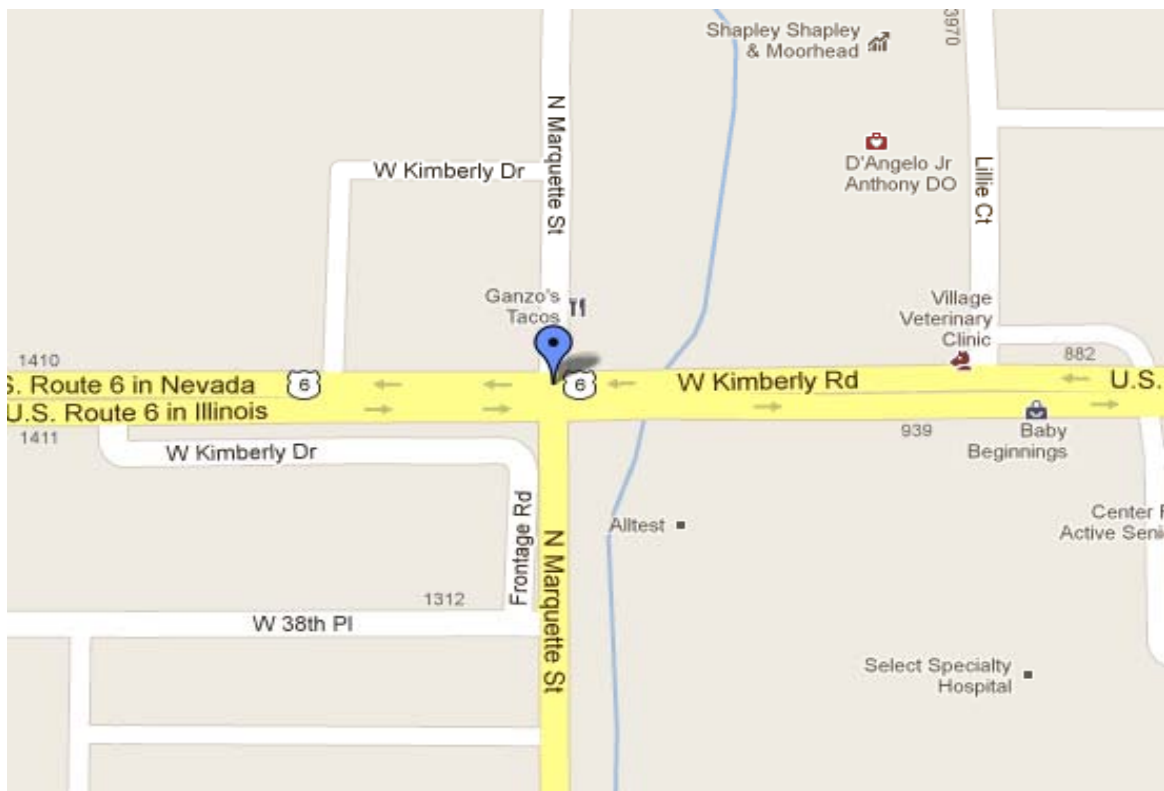

3:30 AM

Sunday

December 5, 2010

46

Midway Dr, between Richland Dr & Progress Ave, Waterloo, Black Hawk County

Municipal 2L

Non-collision

| | Teen driver | Front pass. | Rear pass. | Rear pass. | Rear pass. |
|-----------|-------------|-------------|------------|------------|------------|
| age | 18 | | | | |
| gender | M | | | | |
| fatality | Y | | | | |
| injury | | | | | |
| ejection | N | | | | |
| seat belt | ? | | | | |



2000 Pontiac Grand Prix GT, Sedan 4 door

Full license 506 days

Crash Narrative

Teen EB when he lost control on a curve. Vehicle ran off road to the right and struck a tree head-on and caught fire. Teen was found inside the car and had to be identified by dental records.

Contributing factors

Exceeded authorized speed

Other factors

-

Reporting Agency: Waterloo Police

Teen driver at fault? Yes

License history:

 *License history data omitted for protection of privacy

Criminal charges:

 None

Civil litigation:

 None

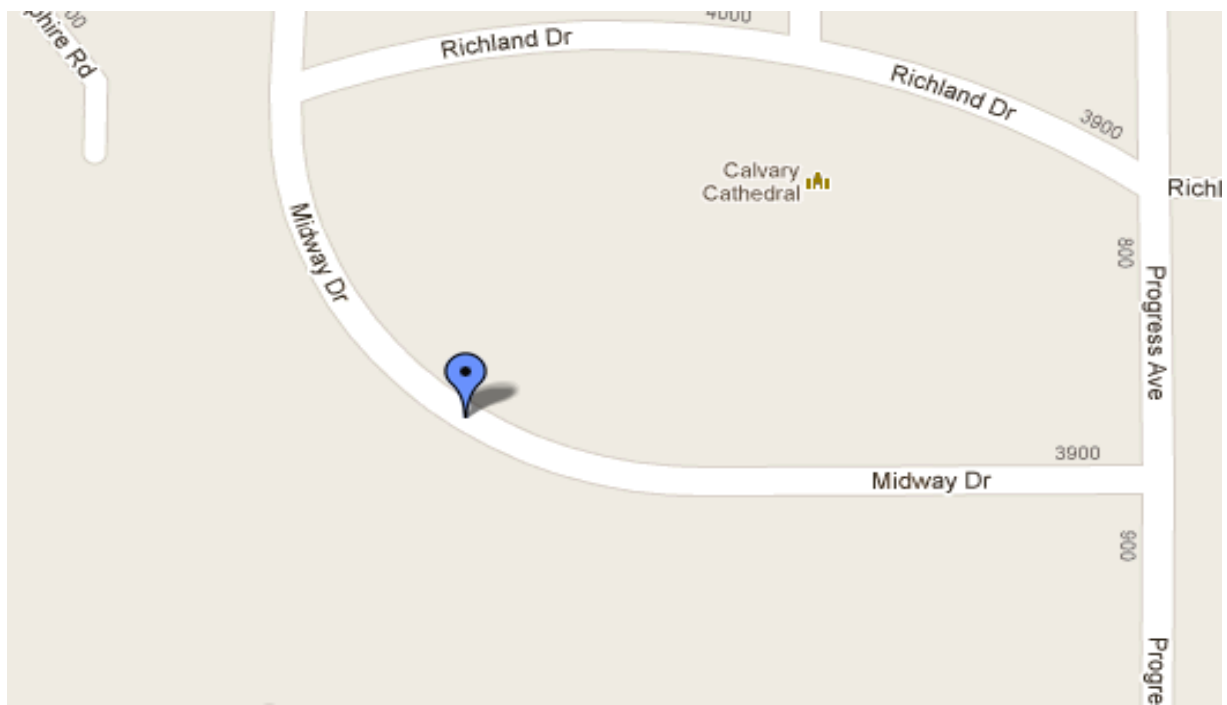

310th St & Yankee Ave, Cedar County

Secondary 2L, controlled four-way intersection, 310th: gravel, Yankee: paved
Broadside

| | Teen driver | Front pass. | Rear pass. | Rear pass. | Rear pass. |
|-----------|-------------|-------------|------------|------------|------------|
| age | 16 | | | | |
| gender | F | | | | |
| fatality | Y | | | | |
| injury | | | | | |
| ejection | N | | | | |
| seat belt | Y | | | | |

1999 Jeep Grand Cherokee Laredo, Wagon 4 door
Intermediate 274 days

| | Other driver | Front pass. | Rear pass. | Rear pass. | Rear pass. |
|-----------|--------------|-------------|------------|------------|------------|
| age | 41 | | | | |
| gender | M | | | | |
| fatality | | | | | |
| injury | 5 | | | | |
| ejection | N | | | | |
| seat belt | Y | | | | |

2003 Ford F250 Super Duty, Pickup pulling a trailer

Crash Narrative

Teen (Unit 1) heading EB when she FTY at stop sign of intersection. Other driver (Unit 2) SB and struck Unit 1 as she entered intersection. Unit 2 struck the left side of Unit 1 and both vehicles came to rest in the SE ditch of intersection.

Contributing factors

Full report said road conditions were normal, apparently clear. But according to google news alerts, the gravel road was "snow and ice packed."

Other factors

-

Reporting Agency: ISP

Teen driver at fault? Yes

License history:

*License history data omitted for protection of privacy

Criminal charges:

None

Civil litigation:

None

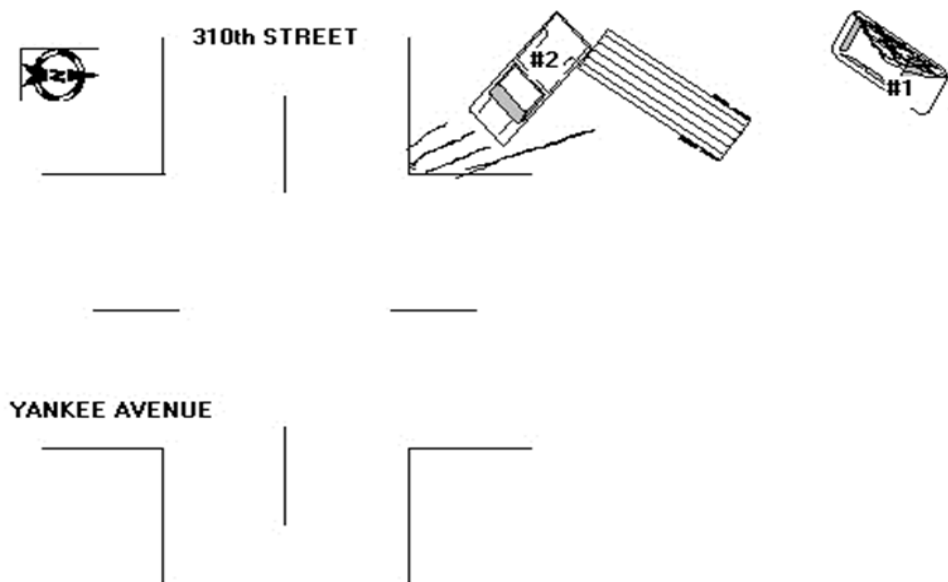

12:00 AM

Sunday

December 5, 2010

48

Co Hwy F17, just east of intersection with W 108th St N, Jasper County

Secondary 2L

Non-collision

| | Teen driver | Front pass. | Rear pass. | Rear pass. | Rear pass. |
|-----------|-------------|-------------|------------|------------|------------|
| age | 17 | | | | |
| gender | M | | | | |
| fatality | Y | | | | |
| injury | | | | | |
| ejection | Y | | | | |
| seat belt | N | | | | |

2007 Chevrolet Colorado, Pickup
Intermediate 391 days

Crash Narrative

Teen driver EB when LOC and ran off road left. Vehicle collided with ditch in t-intersection and the vehicle rolled several times. Vehicle came to rest in north shoulder of Co Hwy F17.

Contributing factors

-

Other factors

-

Reporting Agency: Jasper County

Teen driver at fault? Yes

License history:

*License history data omitted for protection of privacy

Criminal charges:

None

Civil litigation:

None



This page intentionally left blank

Appendix C: 2011 crashes

8:19 PM

Saturday

January 15, 2011

1

La Porte Rd between Locke Ave & Eastone Ave, Waterloo, Blackhawk County

Municipal 2L both directions

Non-collision

| | Teen driver | Front pass. | Rear pass. | Rear pass. | Rear pass. |
|-----------|-------------|-------------|------------|------------|------------|
| age | 16 | | | | |
| gender | F | | | | |
| fatality | | | | | |
| injury | 5 | | | | |
| ejection | N | | | | |
| seat belt | Y | | | | |

1999 Kia Sephia/LS, Sedan 4 door
Intermediate 157 days

53, male, pedestrian
Fatal

Crash Narrative

Teen NB on La Porte Road hit a pedestrian who had been walking in the outside lane of La Porte Rd near Easton Ave. Crash report says no improper action for driver. Pedestrian was not visible (dark clothing).

Contributing factors

It was dark but lighting was present. Pedestrian was not visible (dark clothing).

Other factors

-

Reporting Agency: Waterloo Police

Teen driver at fault? Unclear

License history:

***License history data omitted for protection of privacy**

Criminal charges:

None

Civil litigation:

None

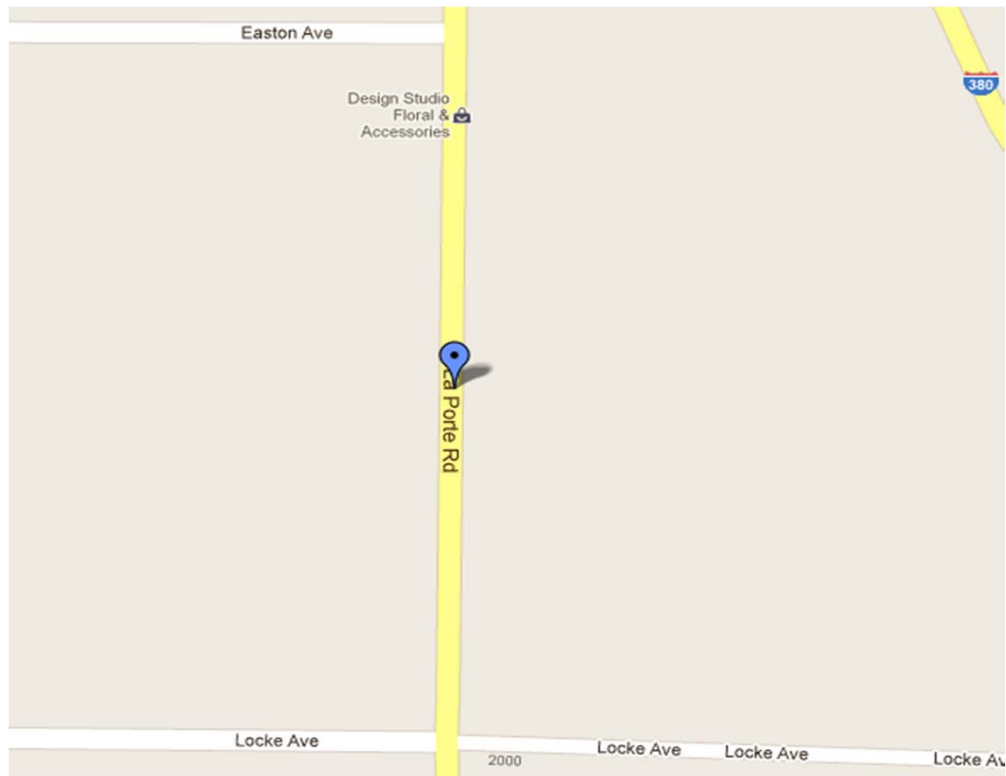

Unk

Saturday

January 29, 2011

2

Utah Street, less than 1/2 mile north of W River Dr, Davenport, Scott County

Municipal 2L

Non-collision

| | Teen driver | Front pass. | Rear pass. | Rear pass. | Rear pass. |
|-----------|-------------|-------------|------------|------------|------------|
| age | 19 | 19 | | | |
| gender | M | M | | | |
| fatality | | Y | | | |
| injury | 2 | | | | |
| ejection | N | N | | | |
| seat belt | Y | Y | | | |

1998 Mercury Mountaineer, Wagon 4 door
Full 568 days

Crash Narrative

Teen SB when vehicle went off left side of the road, crashed into a deep ravine, hit a tree, and landed upside down. Unknown when crash exactly occurred but was reported at about 7:30 a.m.

Contributing factors

Teen had BAC of 0.189, driving too fast for conditions

Other factors

-

Reporting Agency: Davenport Police

Teen driver at fault? Yes

License history:

***License history data omitted for protection of privacy**

Criminal charges:

Charged with homicide by vehicle, operating while intoxicated, failure to have control of vehicle, and failure to have proof of insurance.

Civil litigation:

None

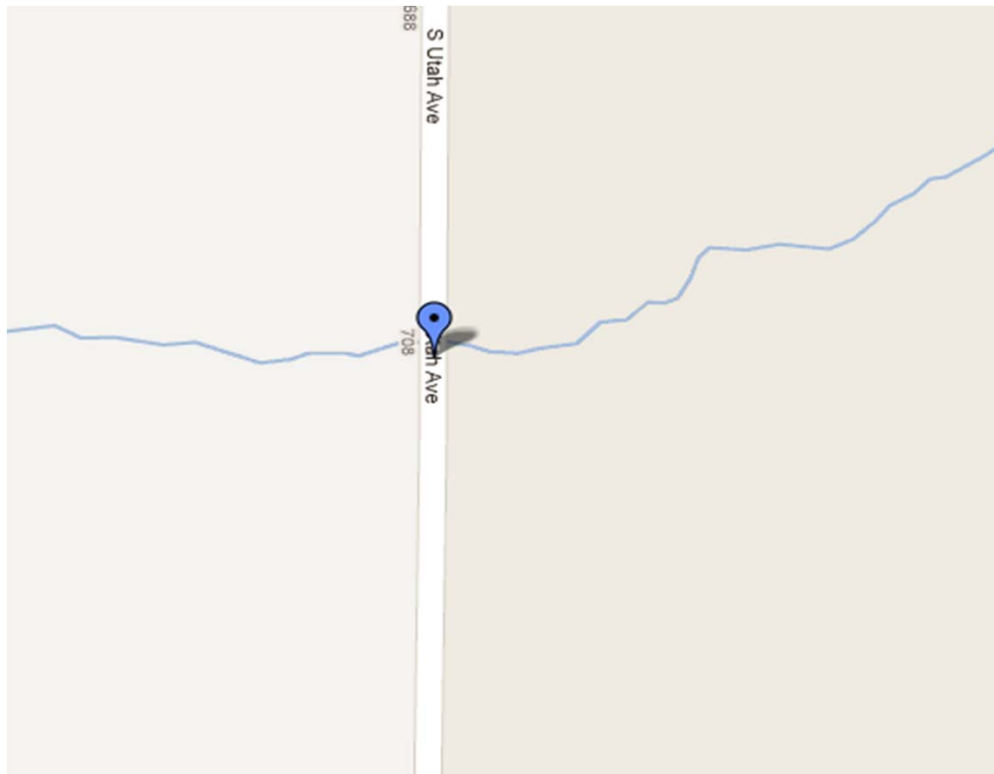

7:15 AM

Friday

February 11, 2011

3

US Hwy 18, just east of intersection with Marsh Ave, Sioux County

US Route 2L

Head-on

| | Teen driver | Front pass. | Rear pass. | Rear pass. | Rear pass. |
|-----------|-------------|-------------|------------|------------|------------|
| age | 17 | | | | |
| gender | F | | | | |
| fatality | Y | | | | |
| injury | | | | | |
| ejection | N | | | | |
| seat belt | Y | | | | |

1995 Oldsmobile 88 Royale, Sedan 4 door
Full 127 days

| | Other driver | Front pass. | Rear pass. | Rear pass. | Rear pass. |
|-----------|--------------|-------------|------------|------------|------------|
| age | 36 | | | | |
| gender | M | | | | |
| fatality | | | | | |
| injury | 5 | | | | |
| ejection | N | | | | |
| seat belt | N | | | | |

2003 Freightliner Conventional Columbia, Tractor truck

Crash Narrative

Teen WB on Hwy. 18. Teen lost control and entered EB lane in front of semi tractor pulling grain trailer. Vehicles struck head on. Major cause listed as swerving/evasive action.

Contributing factors

Road surface conditions (says to see narrative of crash report).

Other factors

-

Reporting Agency: Sioux County Sheriff

Teen driver at fault? Unclear

License history:

*License history data omitted for protection of privacy

Criminal charges:

None

Civil litigation:

None

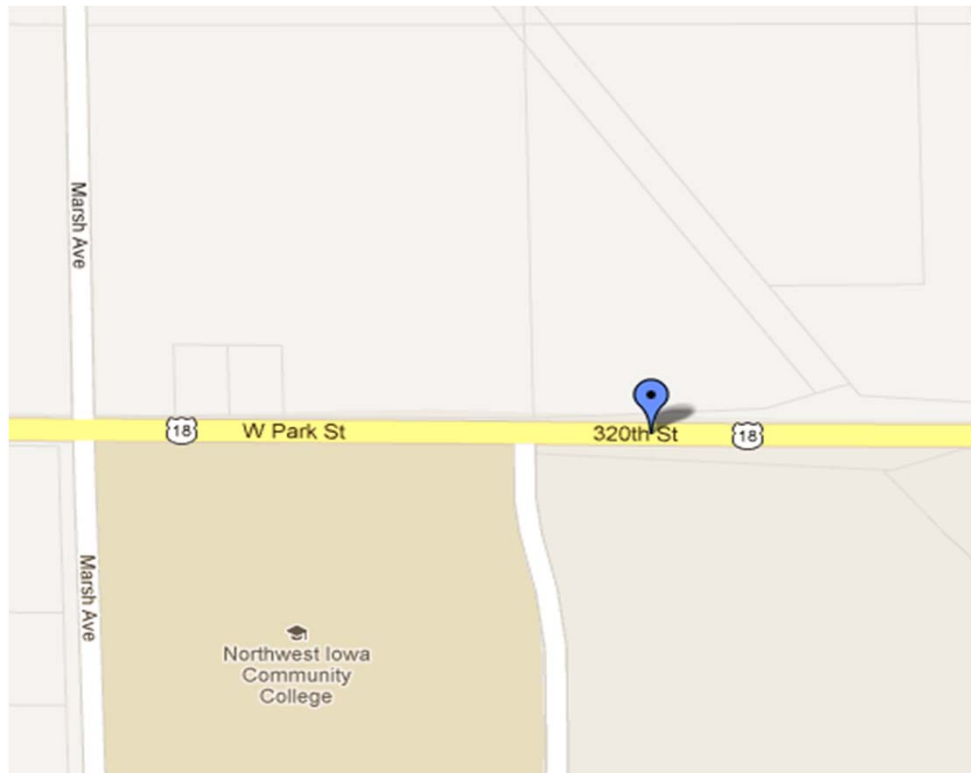

10:28 PM

Monday

February 21, 2011

4

NB I-29, between Carroll Ave & 310th St, Woodbury County
Interstate, 2L in both directions, separated by grass median
Head-on

| | Teen driver | Front pass. | Rear pass. | Rear pass. | Rear pass. |
|-----------|-------------|-------------|------------|------------|------------|
| age | 17 | | | | |
| gender | F | | | | |
| fatality | Y | | | | |
| injury | | | | | |
| ejection | N | | | | |
| seat belt | Y | | | | |

2003 Oldsmobile Alero 4DR
Reinstated Intermediate 52 days

| | Other driver | Front pass. | Rear pass. | Rear pass. | Rear pass. |
|-----------|--------------|-------------|------------|------------|------------|
| age | 23 | | | | |
| gender | M | | | | |
| fatality | | | | | |
| injury | 3 | | | | |
| ejection | N | | | | |
| seat belt | Y | | | | |

2011 Chevrolet SLV pickup with utility trailer

Crash Narrative

Teen (Unit 1) was SB in the NB lanes of I-29. Unit 1 struck a NB pickup pulling a utility trailer (Unit 2) head-on. Both vehicles came to rest in the median.

Contributing factors

Teen had BAC of 0.238

Other factors

-

Reporting Agency: ISP

Teen driver at fault? Yes

License history:

*License history data omitted for protection of privacy

Criminal charges:

None

Civil litigation:

None

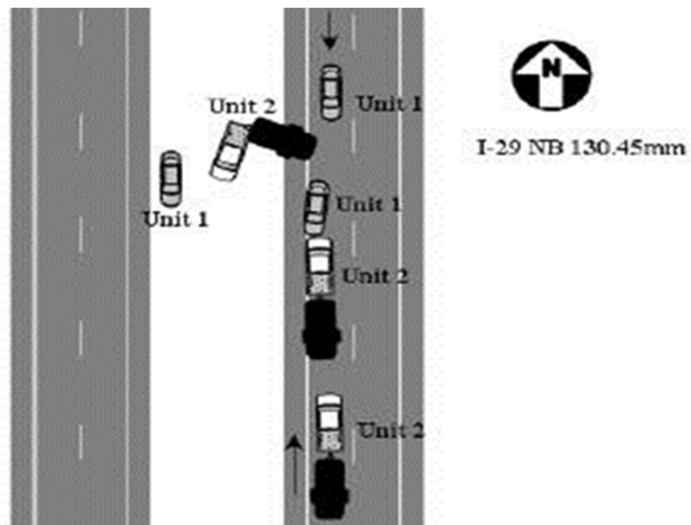

4:40 AM

Thursday

March 17, 2011

5

S 36th Ave W, between W 52nd St S & Maple St, Newton, Jasper County

Secondary 2L, gravel road

Non-collision

| | Teen driver | Front pass. | Rear pass. | Rear pass. | Rear pass. |
|-----------|-------------|-------------|------------|------------|------------|
| age | 18 | 16 | 14 | | |
| gender | M | M | M | | |
| fatality | | Y | Y | | |
| injury | 3 | | | | |
| ejection | N | N | N | | |
| seat belt | N | N | N | | |

1990 Chevrolet C1500, Pickup
No license 92 days

Crash Narrative

Teen was EB on gravel road and lost control, veered into ditch, and rolled over before striking a utility pole. Pole snapped and fell on cab of truck.

Contributing factors

Intoxicated (marijuana and oxycodone)

Other factors

-

Reporting Agency: Jasper County Sheriff

Teen driver at fault? Yes

License history:

 *License history data omitted for protection of privacy

Criminal charges:

 2 cts. involuntary manslaughter (5 yrs prison and fine), driving while suspended (dismissed), and failure to prove security against a liability accident (dismissed).

Civil litigation:

 None

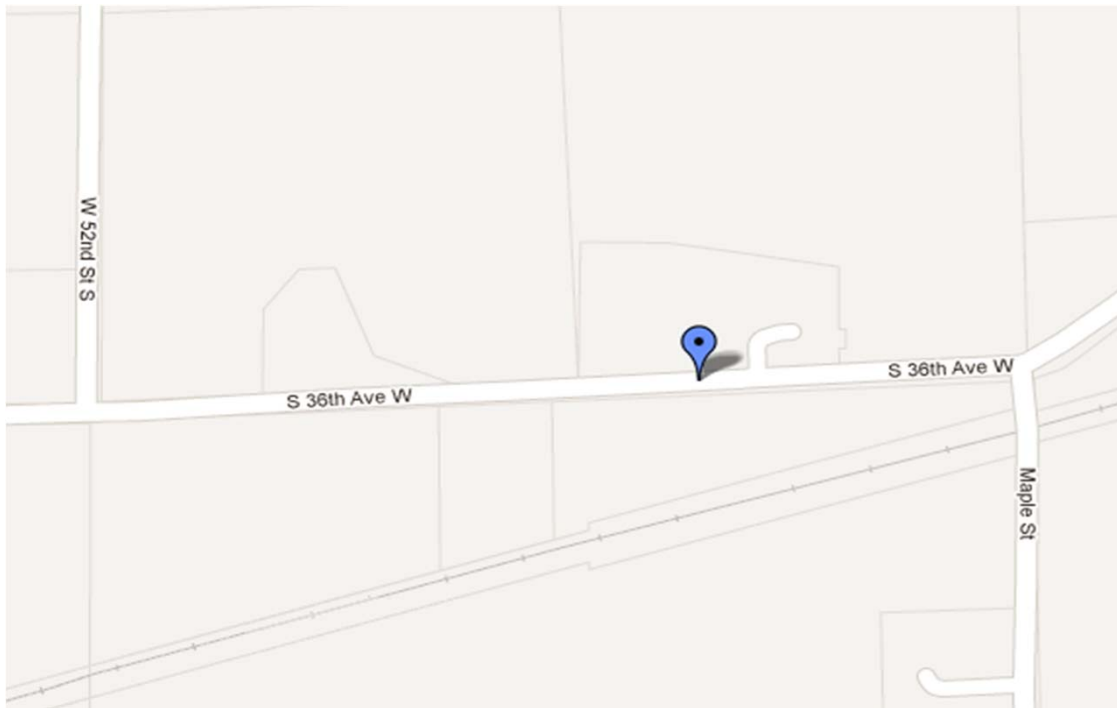

EB I-80 just east of I-235 interchange, Polk County
 Interstate, 3L each direction, divided
 Rear-end

| | Teen driver | Front pass. | Rear pass. | Rear pass. | Rear pass. |
|-----------|-------------|-------------|------------|------------|------------|
| age | 18 | | | | |
| gender | M | | | | |
| fatality | | | | | |
| injury | 3 | | | | |
| ejection | N | | | | |
| seat belt | Y | | | | |

1998 Ford Crown Vic 4DR
 Intermediate* 433 days
 *Converted to full licence at age 18

| | Other driver | Front pass. | Rear pass. | Rear pass. | Rear pass. |
|-----------|--------------|-------------|------------|------------|------------|
| age | 84 | | | | |
| gender | M | | | | |
| fatality | Y | | | | |
| injury | | | | | |
| ejection | N | | | | |
| seat belt | N | | | | |

1999 International Tractor/Trailer

Crash Narrative

Teen (Unit 1) EB on I-80, was stopped on the traveled portion of the roadway next to a non-contact vehicle that was legally parked on the shoulder. EB semi (Unit 2) crested the hill and rear-ended teen. Unit 1 came to rest on the south shoulder. Unit 2 rolled over and left the roadway, coming to rest on its top in the south ditch.

Contributing factors

Hill

Other factors

-

Reporting Agency: ISP

Teen driver at fault? Yes

License history:

*License history data omitted for protection of privacy

Criminal charges:

Stopping on paved part of highway (fined); violation of financial liability - accident (dismissed);

Civil litigation:

None

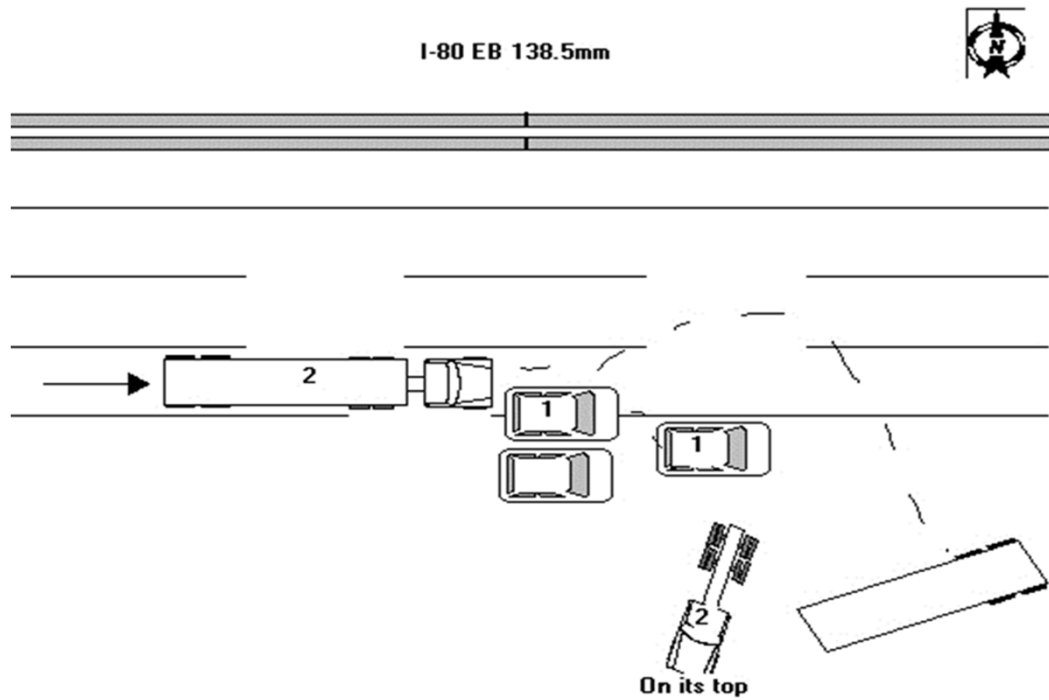

7:30 AM

Thursday

April 7, 2011

7

8th St & 1st Ave, Altoona, Polk County
Municipal multi-lanes, controlled intersection
Broadside

| | | | | | |
|-----------|-------------|--|--|--|--|
| | Teen driver | | | | |
| | Front pass. | | | | |
| | Rear pass. | | | | |
| | Rear pass. | | | | |
| | Rear pass. | | | | |
| age | 19 | | | | |
| gender | M | | | | |
| fatality | | | | | |
| injury | 4 | | | | |
| ejection | N | | | | |
| seat belt | ? | | | | |

2011 Jeep Grand Cherokee Laredo, Wagon 4 c
No license 978 days

| | |
|-----------|--------------|
| | Other driver |
| age | 36 |
| gender | M |
| fatality | Y |
| injury | |
| ejection | N |
| seat belt | Y |

2006 Pontiac Vibe, Hatchback 4 door

| | |
|-----------|--------------|
| | Other driver |
| age | 52 |
| gender | F |
| fatality | |
| injury | 4 |
| ejection | N |
| seat belt | Y |

2006 Chrysler 300c Awd, Sedan 4 door

Crash Narrative

Teen was EB on 8th St in stolen SUV and reportedly speeding at 90 mph. Ran red light and struck the driver side of the Vibe which was was NB on First Ave. Vibe then collided with third vehicle. Teen fled the scene by foot.

Contributing factors

Speed; Under the influence of drugs

Other factors

-

Reporting Agency: Altoona Police

Teen driver at fault? Yes

License history:

*License history data omitted for protection of privacy

Criminal charges:

Entered "Alford" plea for veh. homicide/OWI (10 yr prison) and first-degree theft (25 yr prison).

Civil litigation:

None

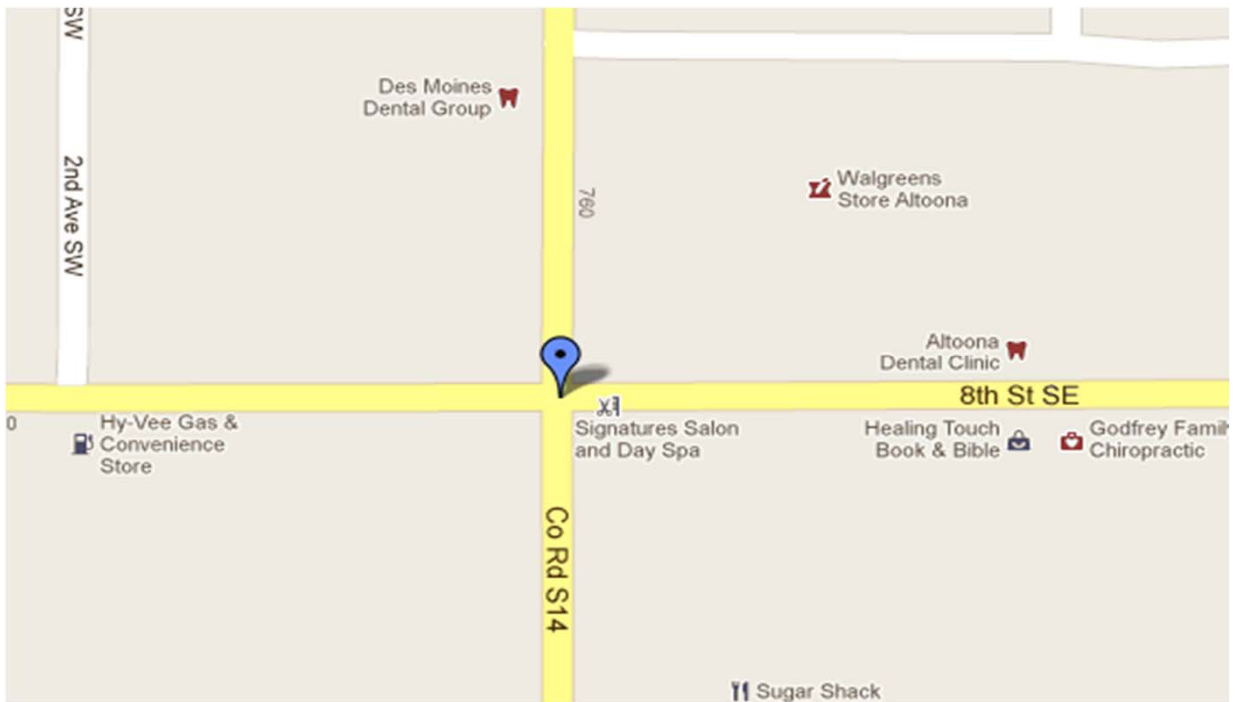

2:55 PM

Saturday

April 30, 2011

8

Raven Ave, between 350th St & Hwy 9, Worth County

Secondary 2L, gravel road

Non-collision

| | Teen driver | Front pass. | Rear pass. | Rear pass. | Rear pass. |
|-----------|-------------|-------------|------------|------------|------------|
| age | 17 | 15 | 15 | 15 | |
| gender | F | F | F | F | |
| fatality | | | | Y | |
| injury | 5 | 5 | 3 | | |
| ejection | N | N | N | Y | |
| seat belt | Y | Y | Y | N | |

1995 Jeep Grand Cherokee, SUV
Intermediate 711 days

Crash Narrative

Teen NB on gravel. Teen crossed the center line, over corrected, and lost control. Vehicle entered the east ditch, rolled and came to rest upright facing south in the east ditch.

Contributing factors

-

Other factors

-

Reporting Agency: ISP

Teen driver at fault? Yes

License history:

*License history data omitted for protection of privacy

Criminal charges:

None

Civil litigation:

None

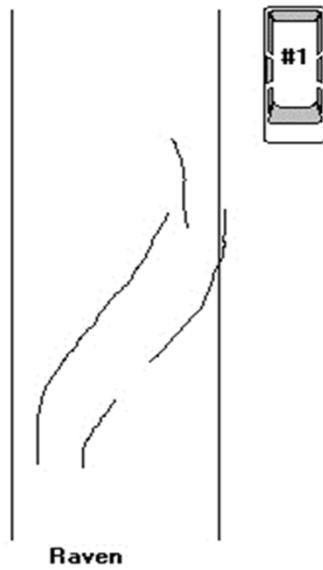

C Ave & Hardin St, Hardin County
Secondary 2L gravel road, uncontrolled 4-way intersection
Broadside

| | Teen driver | Front pass. | Rear pass. | Rear pass. | Rear pass. |
|-----------|-------------|-------------|------------|------------|------------|
| age | 17 | | | | |
| gender | F | | | | |
| fatality | Y | | | | |
| injury | | | | | |
| ejection | Y | | | | |
| seat belt | Y | | | | |

1991 Pontiac Grand Prix
Full 120 days

| | Other driver | Front pass. | Rear pass. | Rear pass. | Rear pass. |
|-----------|--------------|-------------|------------|------------|------------|
| age | 56 | | | | |
| gender | M | | | | |
| fatality | | | | | |
| injury | 3 | | | | |
| ejection | N | | | | |
| seat belt | Y | | | | |

2002 Chevrolet Silverado, Pickup

Crash Narrative

Other driver (Unit 1) SB while teen (Unit 2) eastbound as they both approached an uncontrolled 4-way intersection on a gravel road. Unit 1 collided into driver's door of Unit 2. Both vehicles came to rest in SE ditch facing west. Teen was ejected despite seatbelt use due to severity of the damage sustained to the vehicle.

Contributing factors

Uncontrolled intersection

Other factors

-

Reporting Agency: ISP

Teen driver at fault? No

License history:

*License history data omitted for protection of privacy

Criminal charges:

Other driver charged with failure to yield to vehicle on right (\$1100 fine).

Civil litigation:

None

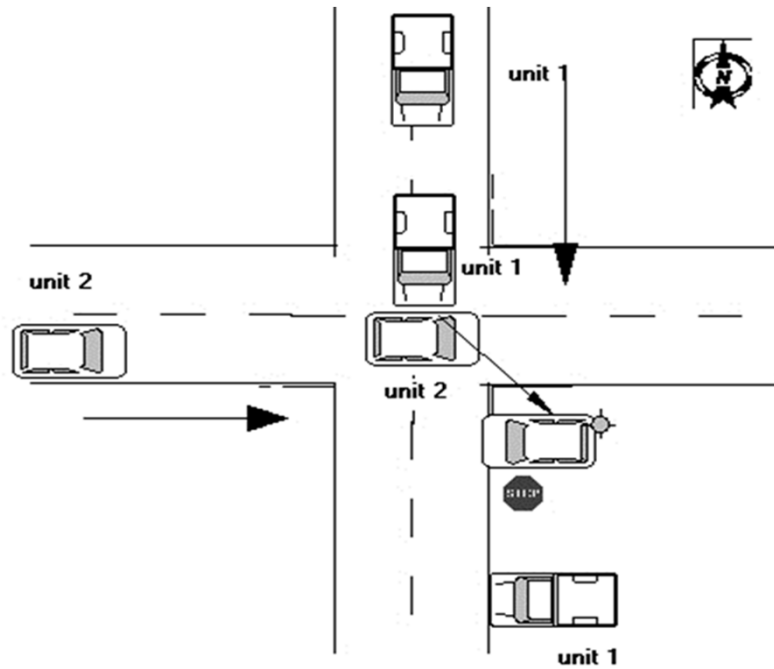

Lincoln Way & Duff Ave, Ames, Blackhawk County
US Route/Municipal 2L both directions, controlled intersection
Head-on

| | Teen driver | Front pass. | Rear pass. | Rear pass. | Rear pass. |
|-----------|-------------|-------------|------------|------------|------------|
| age | 18 | 16 | 14 | | |
| gender | M | M | F | | |
| fatality | | Y | | | |
| injury | 4 | | 2 | | |
| ejection | N | N | N | | |
| seat belt | Y | N | Y | | |

1997 Pontiac Firebird, Hatchback 2 door
No license 352 days

| | Other driver | Front pass. | Rear pass. | Rear pass. | Rear pass. |
|-----------|--------------|-------------|------------|------------|------------|
| age | 38 | | | | |
| gender | M | | | | |
| fatality | | | | | |
| injury | 2 | | | | |
| ejection | N | | | | |
| seat belt | ? | | | | |

1997 Toyota 4Runner LTD, Wagon 4 door

Crash Narrative

Teen EB on Lincoln Way after fleeing from gas station without paying. Police began to pursue vehicle as it accelerated to more than 90 mph. Teen attempted to evade the officer. As teen approach intersection, other driver was WB making a left when teen crashed head-on with other vehicle.

Contributing factors

Speed, reckless driving

Other factors

-

Reporting Agency: ISP

Teen driver at fault? Yes

License history:

*License history data omitted for protection of privacy

Criminal charges:

Teen charged with vehicular homicide, driving under suspension, and theft. Teen pleaded guilty to one count of homicide by reason of eluding police and two counts of serious injury. Sentenced to 15 years in prison.

Civil litigation:

None

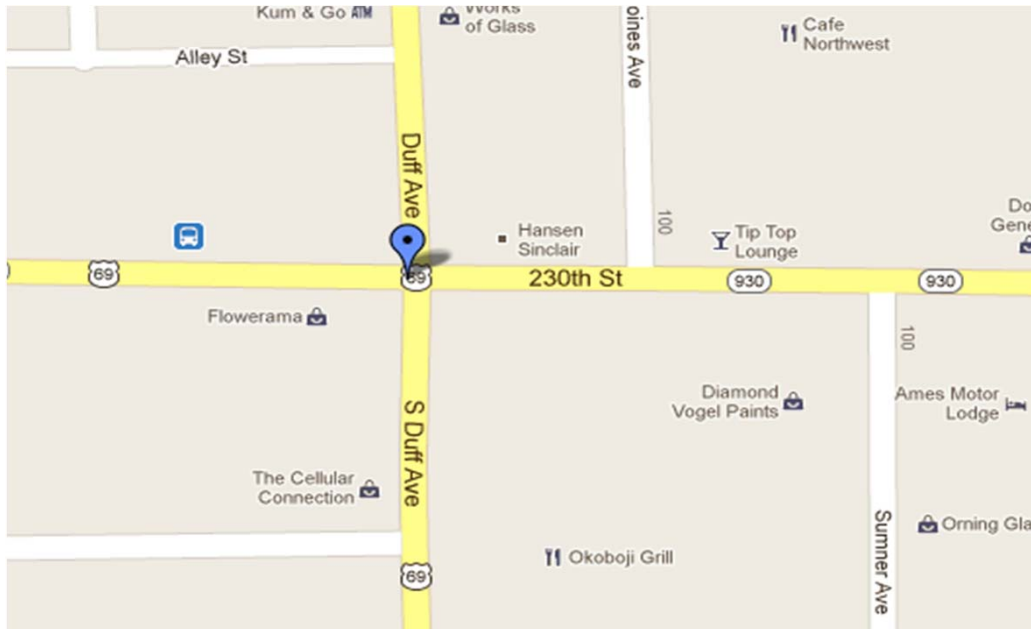

IA Hwy 58 & Viking Rd, Cedar Falls, Blackhawk County

IA Route/Municipal 2L both directions (plus turning lanes), controlled intersection
Non-collision

| | Teen driver | Front pass. | Rear pass. | Rear pass. | Rear pass. |
|-----------|-------------|-------------|------------|------------|------------|
| age | 19 | | | | |
| gender | M | | | | |
| fatality | | | | | |
| injury | 5 | | | | |
| ejection | N | | | | |
| seat belt | Y | | | | |

2002 Chrysler 300M, Sedan 4 door
Full 765 days

| | Other driver | Front pass. | Rear pass. | Rear pass. | Rear pass. |
|-----------|--------------|-------------|------------|------------|------------|
| age | 26 | | | | |
| gender | M | | | | |
| fatality | | | | | |
| injury | 5 | | | | |
| ejection | N | | | | |
| seat belt | Y | | | | |

2005 Jeep Grand Cherokee, Wagon 4 door

57, female, pedestrian
Fatal

Crash Narrative

Pedestrian ran out into street from NE corner of the intersection and thought she could beat traffic.
Pedestrian was hit by two NB vehicles.

Contributing factors

-

Other factors

-

Reporting Agency: Cedar Falls Police

Teen driver at fault? No

License history:

*License history data omitted for protection of privacy

Criminal charges:

None

Civil litigation:

None



12:06 AM

Saturday

May 21, 2011

12

NE 27th Ave, between NE 84th St & Gay Lea Wilson Trail, Altoona, Polk County

Secondary 2L

Non-collision

| | Teen driver | Front pass. | Rear pass. | Rear pass. | Rear pass. |
|-----------|-------------|-------------|------------|------------|------------|
| age | 16 | 15 | 16 | | |
| gender | M | M | M | | |
| fatality | | Y | Y | | |
| injury | 3 | | | | |
| ejection | ? | Y | ? | | |
| seat belt | Y | Y | Y | | |

1991 Chevrolet Camaro RS, Coupe
 Intermediate 149 days

Crash Narrative

Teen WB when he LOC and ran off road to the right. Vehicle struck mailbox and then ran into a tornado-siren pole. The impact tore the vehicle into two separate pices. Vehicle came to a rest in a farm field north of the road.

Contributing factors

Operating vehicle in reckless manner

Other factors

-

Reporting Agency: Polk County Sheriff

Teen driver at fault? Yes

License history:

*License history data omitted for protection of privacy

Criminal charges:

None

Civil litigation:

None

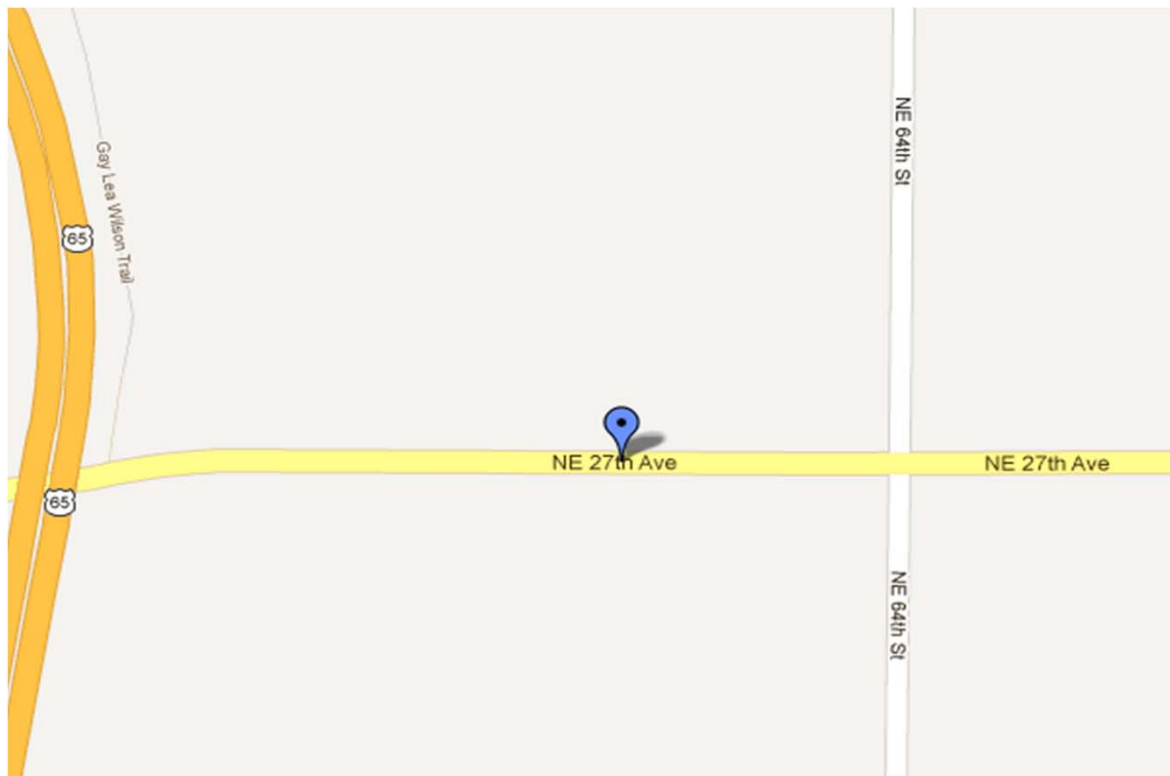

County Hwy M54 & Hwy 10, Buena Vista County
 IA Route/Secondary 2L, controlled intersection
 Broadside

| | Teen driver | Front pass. | Rear pass. | Rear pass. | Rear pass. |
|-----------|-------------|-------------|------------|------------|------------|
| age | 18 | 17 | 18 | 18 | 17 |
| gender | M | M | F | F | F |
| fatality | | | | | Y |
| injury | 3 | 2 | 2 | 2 | |
| ejection | N | N | Y | Y | Y |
| seat belt | Y | Y | N | N | N |

2005 Chrysler Sebring Touring, Sedan 4 door
 Full 537 days

| | Other driver | Front pass. | Rear pass. | Rear pass. | Rear pass. |
|-----------|--------------|-------------|------------|------------|------------|
| age | 36 | | | | |
| gender | M | | | | |
| fatality | | | | | |
| injury | 3 | | | | |
| ejection | N | | | | |
| seat belt | Y | | | | |

1999 Ford Expedition, Wagon 4 door

Crash Narrative

Teen SB when FTY at stop sign and crashed into other EB vehicle. Teen ran off road to the left while other vehicle ran off road to the right. Teen's vehicle overturned.

Contributing factors

-

Other factors

-

Reporting Agency: Buena Vista County

Teen driver at fault? Yes

License history:

*License history data omitted for protection of privacy

Criminal charges:

Media report and driving record says teen was charged with failure to obey stop sign/signal but nothing comes up in search of courts.

Civil litigation:

None

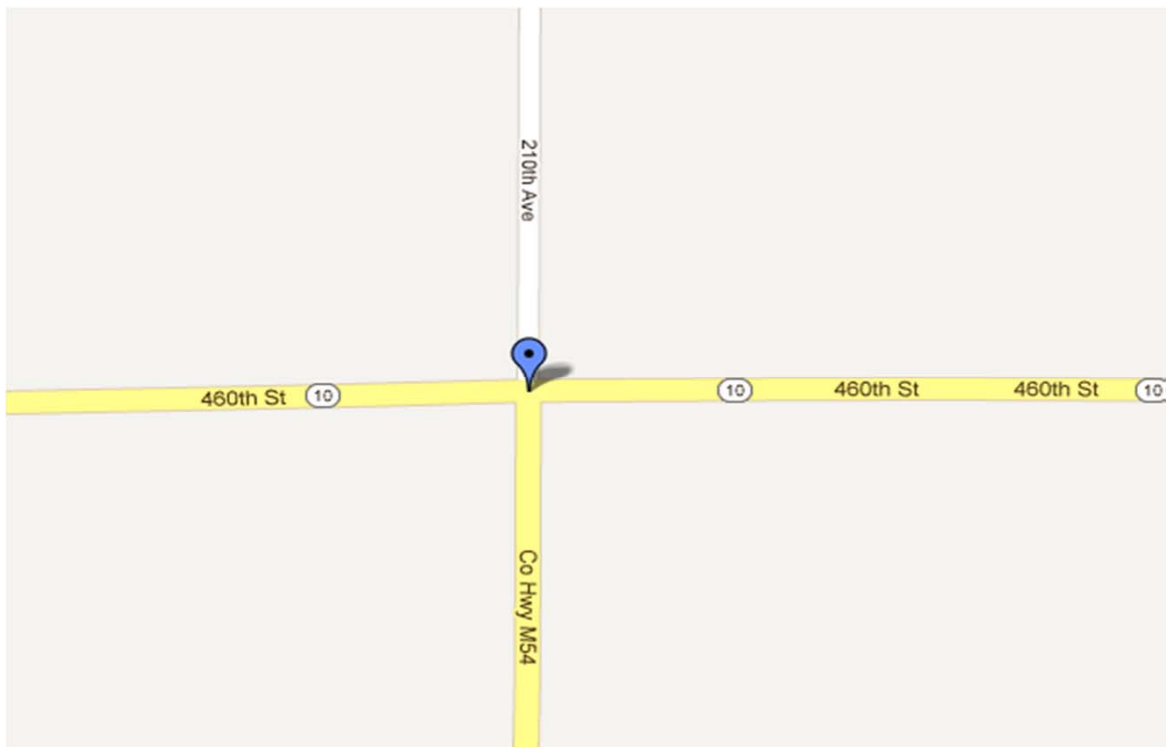

E 125th St N & US 6, Jasper County
Secondary 2L controlled T-intersection
Broadside

| | Teen driver | Front pass. | Rear pass. | Rear pass. | Rear pass. |
|-----------|-------------|-------------|------------|------------|------------|
| age | 18 | | | | |
| gender | F | | | | |
| fatality | Y | | | | |
| injury | | | | | |
| ejection | N | | | | |
| seat belt | Y | | | | |

1997 Chevrolet Lumina LS, Sedan 4 door
Full 377 days

| | Other driver | Front pass. | Rear pass. | Rear pass. | Rear pass. |
|-----------|--------------|-------------|------------|------------|------------|
| age | 44 | | | | |
| gender | M | | | | |
| fatality | | | | | |
| injury | 3 | | | | |
| ejection | N | | | | |
| seat belt | Y | | | | |

2002 Chevrolet Blazer, Wagon 4 door

Crash Narrative

Teen was SB on E 125th St. N and after stopping, pulled out in front of SUV that was WB on Hwy 6. SUV struck teen in driver side door.

Contributing factors

Teen's vision obscured by hillcrest

Other factors

At least three comments on media websites say that this intersection has two blind spots and a hill

Reporting Agency: ISP

Teen driver at fault? Yes

License history:

*License history data omitted for protection of privacy

Criminal charges:

None

Civil litigation:

None

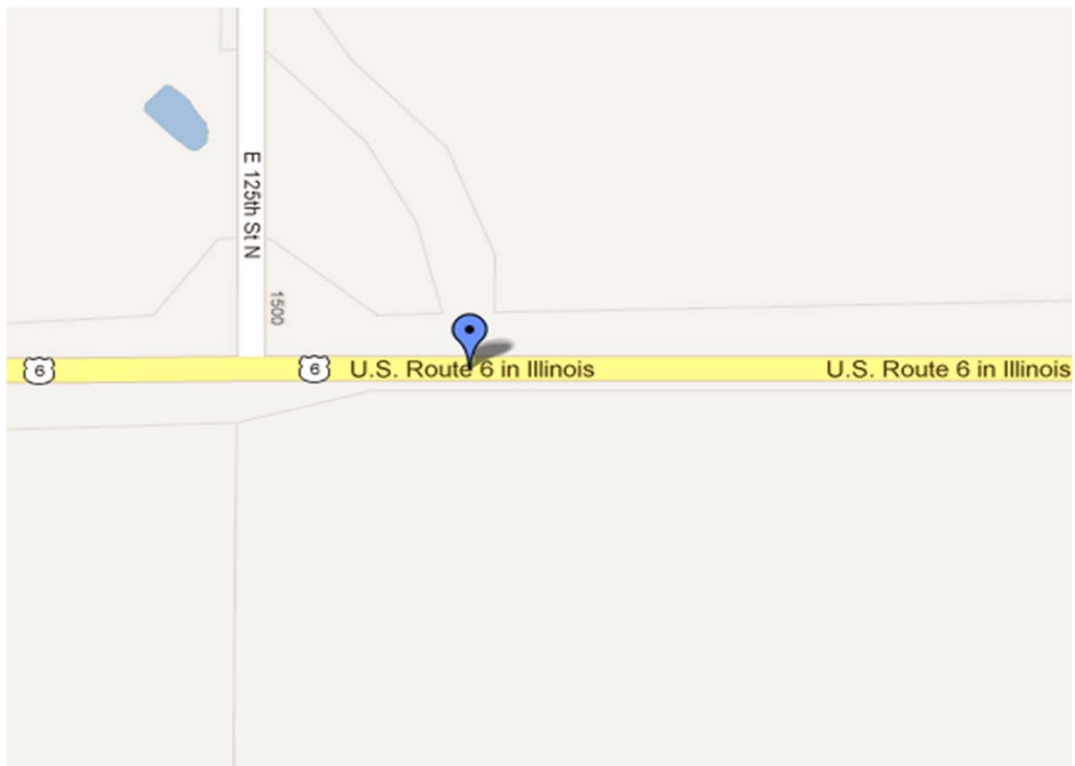

NE 23rd Ave & Oakhill Dr, Des Moines, Polk County
Secondary 2L, controlled y-intersection
Head-on

| | Teen driver | Front pass. | Rear pass. | Rear pass. | Rear pass. |
|-----------|-------------|-------------|------------|------------|------------|
| age | 19 | 19 | | | |
| gender | M | M | | | |
| fatality | Y | | | | |
| injury | | 2 | | | |
| ejection | N | N | | | |
| seat belt | Y | Y | | | |

1995 Acura Integra Special Edition, Hatchback 2 door
Full 501 days

| | Other driver | Front pass. | Rear pass. | Rear pass. | Rear pass. |
|-----------|--------------|-------------|------------|------------|------------|
| age | 45 | | | | |
| gender | M | | | | |
| fatality | | | | | |
| injury | 5 | | | | |
| ejection | N | | | | |
| seat belt | Y | | | | |

2001 AM General Hummer, SUV

Crash Narrative

Teen WB while other vehicle heading EB. Teen's vehicle crossed the centerline while other vehicle swerved, ran off the road to the right but then both vehicles collided head-on.

Contributing factors

Other driver had positive drug test and BAC of 0.001

Other factors

-

Reporting Agency: Polk County Sheriff

Teen driver at fault? Yes

License history:

 *License history data omitted for protection of privacy

Criminal charges:

 None

Civil litigation:

 None

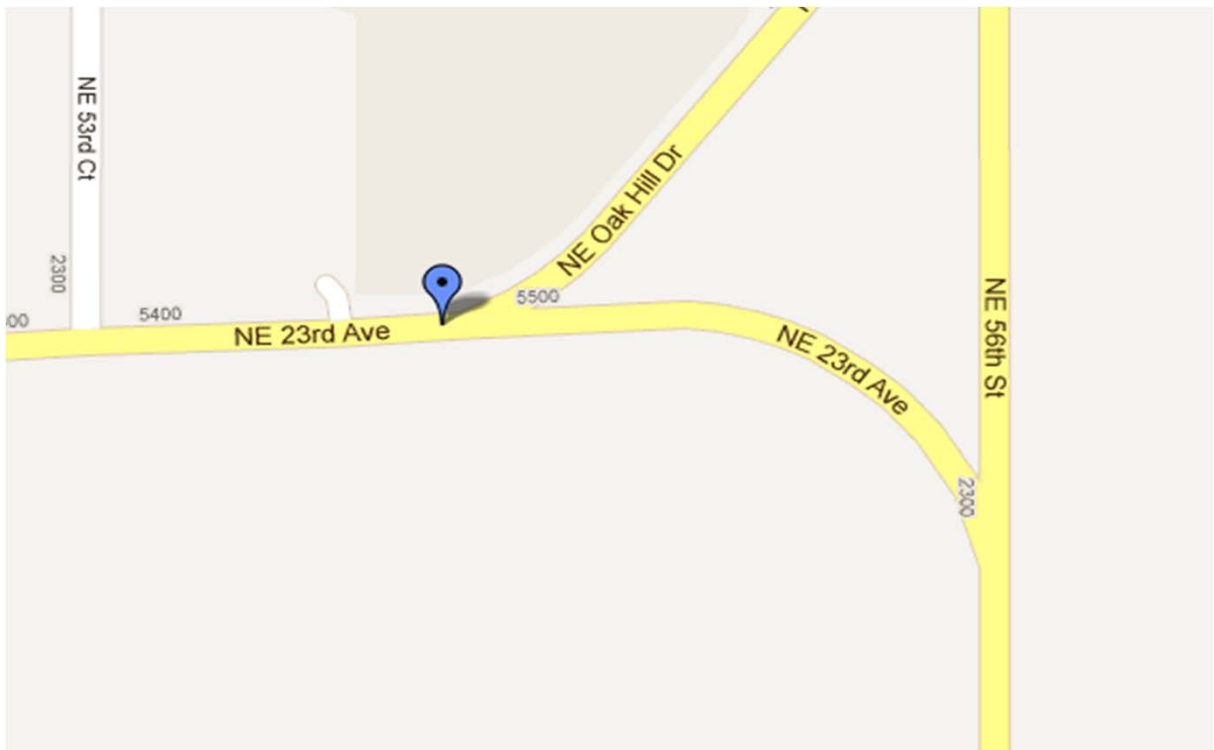

3:20 AM

Thursday

June 9, 2011

16

Walford Rd between Cherry Valley Rd SW & 34th St SW, Linn County

Secondary 2L gravel

Non-collision

| | Teen driver | Front pass. | Rear pass. | Rear pass. | Rear pass. |
|-----------|-------------|-------------|------------|------------|------------|
| age | 19 | 16 | | | |
| gender | M | M | | | |
| fatality | Y | | | | |
| injury | | 3 | | | |
| ejection | N | N | | | |
| seat belt | N | Y | | | |

1998 Audi A4 2.8 Quattro, Sedan 4 door

Class B commercial 8 days

Crash Narrative

Teen was WB, LOC, ran off road to the left, hit embankment, airborne, hit drive, and overturned in ditch coming to a rest on its top. IDOT reports teen was driving on wrong side of road.

Contributing factors

Teen had BAC of 0.184; positive for THC (marijuana); Was composing or reading text message

Other factors

-

Reporting Agency: Linn County Sheriff

Teen driver at fault? Yes

License history:

*License history data omitted for protection of privacy

Criminal charges:

None

Civil litigation:

None

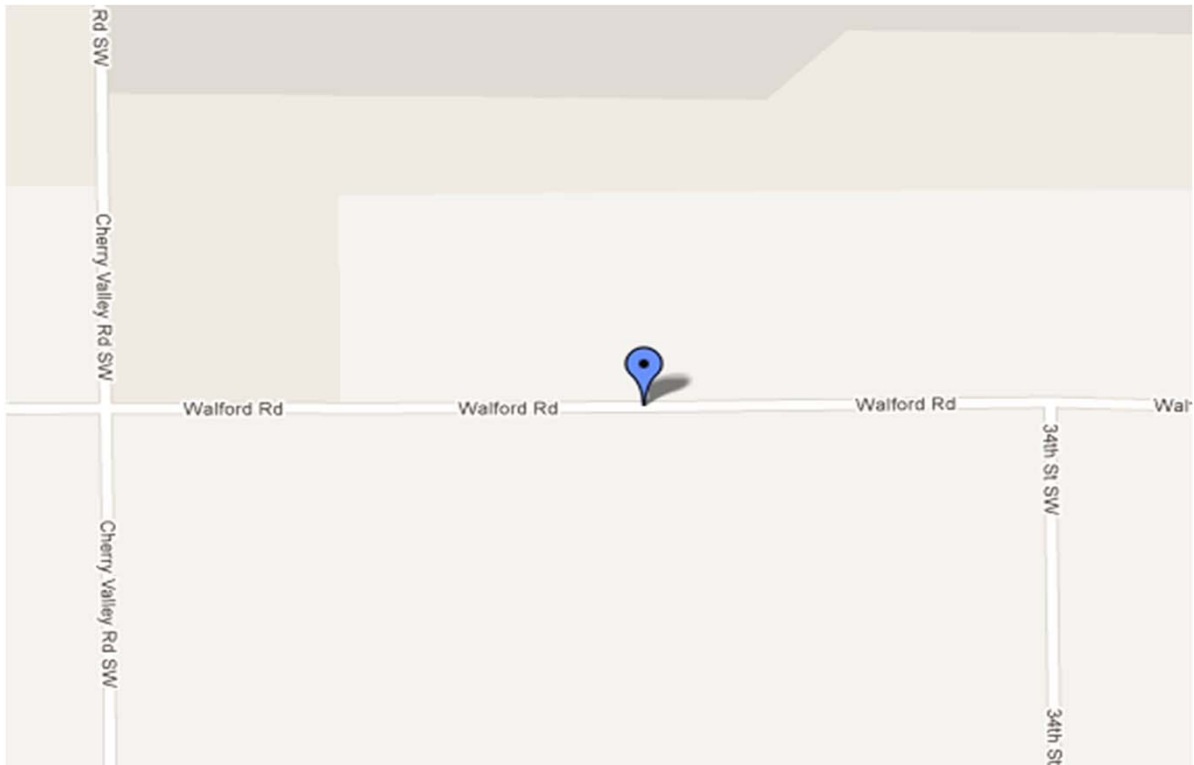

12:34 AM

Monday

July 11, 2011

17

170th St between Granite Ave & Hawthorne Ave, Carroll County

Secondary 2L gravel

Non-collision

| | Teen driver | Front pass. | Rear pass. | Rear pass. | Rear pass. |
|-----------|-------------|-------------|------------|------------|------------|
| age | 19 | 28 | 27 | | |
| gender | F | M | F | | |
| fatality | Y | | | | |
| injury | | 2 | 3 | | |
| ejection | Y | Y | N | | |
| seat belt | Y | N | N | | |

1999 Ford Expedition, Wagon 4 door

Instruction permit 1487 days

Crash Narrative

Teen driver WB when she LOC, ran off road to the right, overcorrected, and overturned multiple times as vehicle entered the north ditch.

Contributing factors

Exceeded authorized speed

Other factors

-

Reporting Agency: Carroll County/ISP

Teen driver at fault? Yes

License history:

*License history data omitted for protection of privacy

Criminal charges:

None

Civil litigation:

None

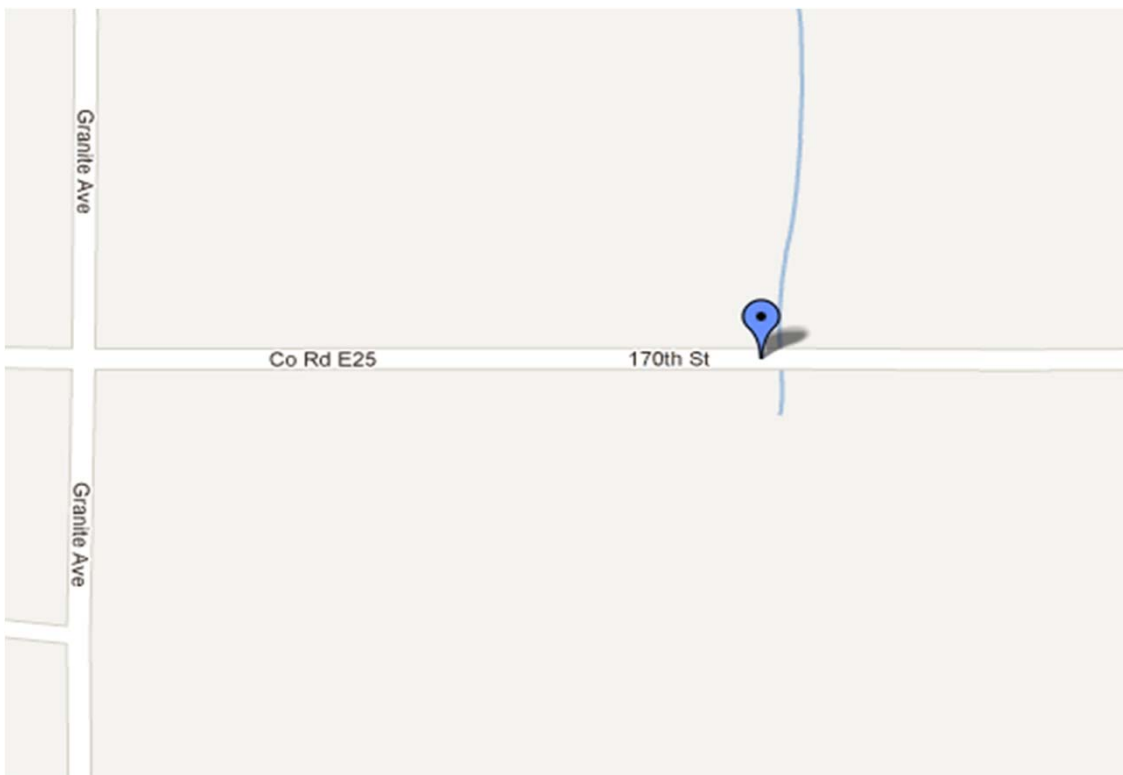

| | Teen driver | Front pass. | Rear pass. | Rear pass. | Rear pass. |
|-----------|-------------|-------------|------------|------------|------------|
| age | 19 | 18 | | | |
| gender | F | F | | | |
| fatality | Y | Y | | | |
| injury | | | | | |
| ejection | N | N | | | |
| seat belt | N | Y | | | |

2003 Mitsubishi Eclipse GTS, Hatchback 2 door
 Full 428 days

| | Other driver | Front pass. | Rear pass. | Rear pass. | Rear pass. | Rear pass. | Rear pass. |
|-----------|--------------|-------------|------------|------------|------------|------------|------------|
| age | 68 | 79 | 52 | 55 | 56 | 35 | 36 |
| gender | M | F | F | F | M | M | F |
| fatality | | | | | | | |
| injury | 5 | 3 | 3 | 3 | 3 | 3 | 3 |
| ejection | N | N | N | N | N | N | N |
| seat belt | Y | ? | ? | ? | ? | ? | ? |

2006 Ford Ecoline, Van

Crash Narrative

Teen SB when veered off road to the right onto the shoulder. Teen overcorrected, crossed the centerline and struck NB airport shuttle van head-on.

Contributing factors

Texting

Other factors

Media reports Old Lincoln Highway is a narrow, two lane paved road that contains many hills and curves. No street lights. Trace amounts of marijuana were found in both teens.

Reporting Agency: Pottawattamie County

Teen driver at fault? Yes

License history:

*License history data omitted for protection of privacy

Criminal charges:

None

Civil litigation:

None

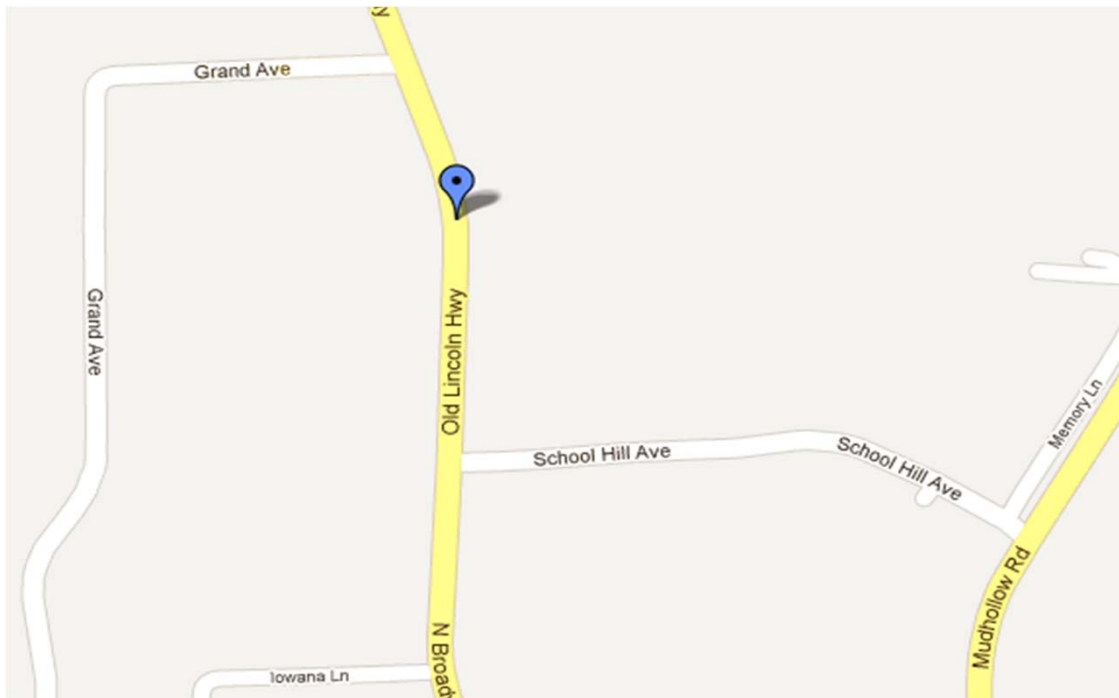

2:50 AM

Saturday

July 23, 2011

19

Co Hwy Z40/400th Ave between 148th St & Co Hwy E50, Clinton County

Secondary 2L, gravel

Non-collision

| | Teen driver | Front pass. | Rear pass. | Rear pass. | Rear pass. |
|-----------|-------------|-------------|------------|------------|------------|
| age | 19 | 19 | 18 | | |
| gender | M | M | F | | |
| fatality | | Y | Y | | |
| injury | 2 | | | | |
| ejection | Y | Y | Y | | |
| seat belt | N | N | N | | |

2001 Pontiac Grand Prix GTP, Sedan 4 door

Class A commercial 266 days

Crash Narrative

Teen SB when vehicle LOC and ran off road to the right into a ditch. Vehicle struck a tree and overturned.

Contributing factors

Driver under the influence of alcohol, refused alcohol test after crash

Other factors

-

Reporting Agency: ISP

Teen driver at fault? Yes

License history:

*License history data omitted for protection of privacy

Criminal charges:

Charged with two counts of vehicular homicide/OWI. Pleaded guilty to two counts of vehicular homicide/reckless or elude and OWI first offense. Sentencing set for May 24.

Civil litigation:

None

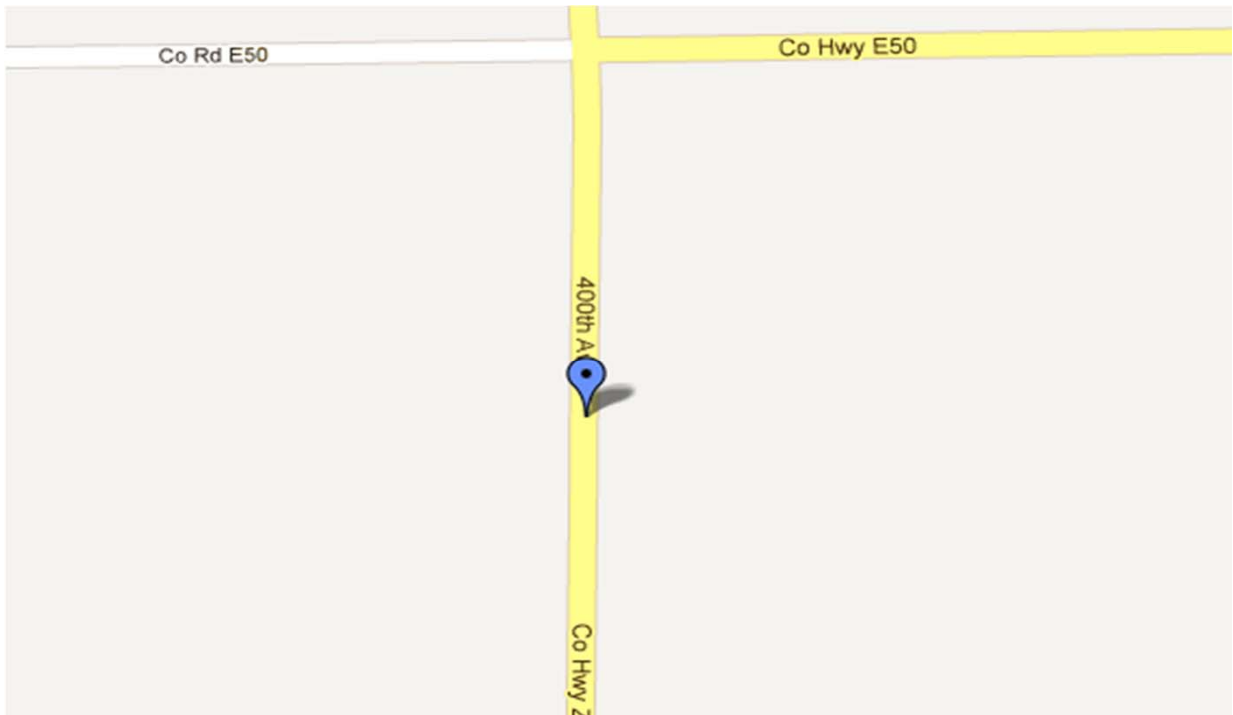

Zeller Ave & Quarry Rd, Marshall County
 Secondary 2L, controlled t-intersection, NB/SB paved, EB gravel
 Sideswipe, opposite direction

| | Teen driver | Front pass. | Rear pass. | Rear pass. | Rear pass. |
|-----------|-------------|-------------|------------|------------|------------|
| age | 16 | | | | |
| gender | M | | | | |
| fatality | Y | | | | |
| injury | | | | | |
| ejection | N | | | | |
| seat belt | N | | | | |

1983 Chevrolet C10, Pickup
 Intermediate 14 days

| | Other driver | Front pass. | Rear pass. | Rear pass. | Rear pass. |
|-----------|--------------|-------------|------------|------------|------------|
| age | 51 | | | | |
| gender | M | | | | |
| fatality | | | | | |
| injury | 5 | | | | |
| ejection | N | | | | |
| seat belt | Y | | | | |

2004 Freightliner Conventional ST120, Tractor truck

Crash Narrative

Teen was EB when FTY at stop sign and pulled NB into SB path of semi. Front of semi struck teen's driver side middle. Came to rest in ditch. Vehicles severed a utility pole according to media.

Contributing factors

-

Other factors

-

Reporting Agency: Marshall County

Teen driver at fault? Yes

License history:

*License history data omitted for protection of privacy

Criminal charges:

None

Civil litigation:

None

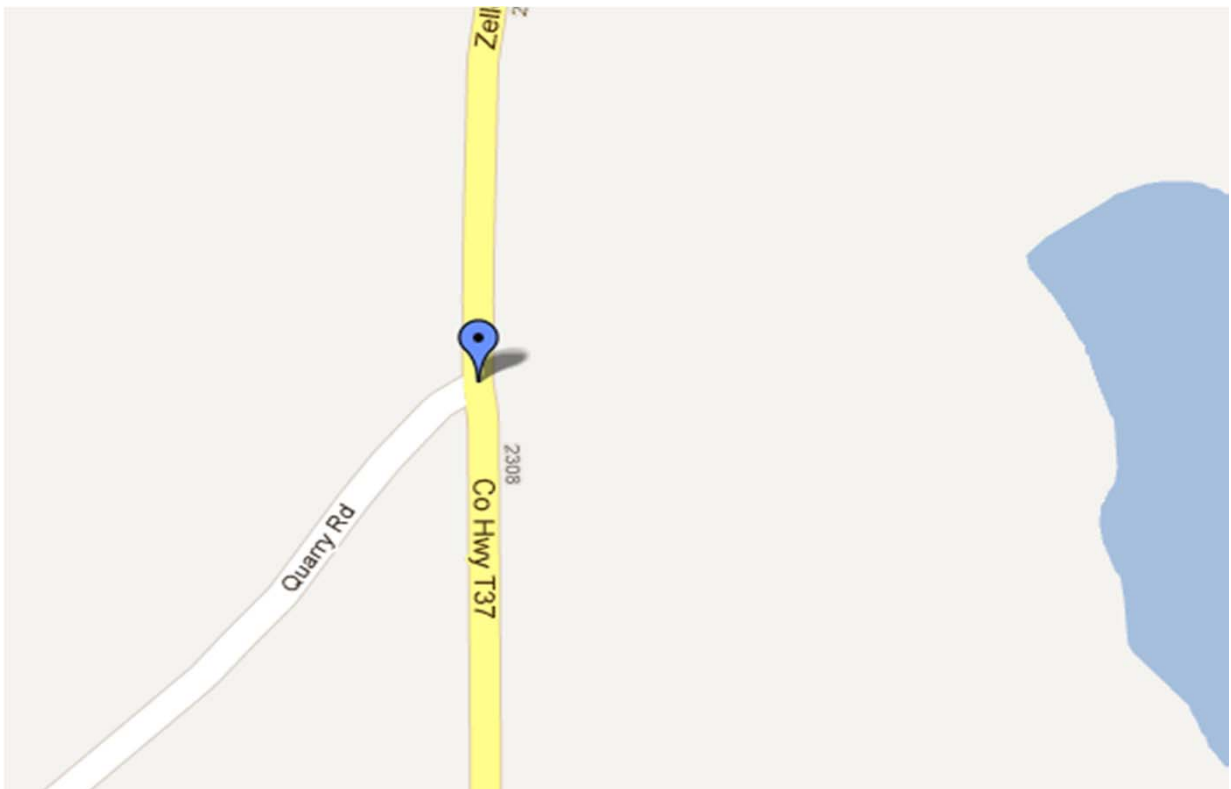

4:25 PM Saturday August 27, 2011 21
 Diagonal Rd just east of intersection with U Ave/Co Rd T55, New Hartford, Butler County
 Secondary 2L gravel
 Non-collision

| | Teen driver | Front pass. | Rear pass. | Rear pass. | Rear pass. |
|-----------|-------------|-------------|------------|------------|------------|
| age | 16 | 15 | 15 | 15 | 15 |
| gender | M | M | M | F | M |
| fatality | | | | | Y |
| injury | 4 | 4 | 4 | 3 | |
| ejection | N | N | N | N | Y |
| seat belt | Y | Y | Y | Y | N |

2001 Mitsubishi Eclipse Spider, Convertible 2 door
 Intermediate 5 days

Crash Narrative

Teen EB when driver LOC and vehicle spun counter-clock wise. Vehicle entered into north ditch and rolled on its top.

Contributing factors

Road changed from pavement to gravel

Other factors

-

Reporting Agency: ISP

Teen driver at fault? Yes

License history:

*License history data omitted for protection of privacy

Criminal charges:

Failure to maintain control

Civil litigation:

None

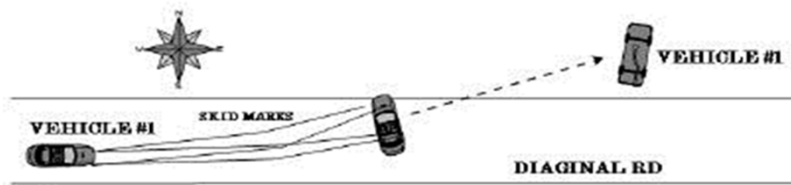

3:00 AM

Sunday

August 28, 2011

22

SE 14th St & Hartford Ave, Des Moines, Polk County
US Route (2L both directions)/Municipal (2L), Four-way controlled intersection
Broadside

| | Teen driver | Front pass. | Rear pass. | Rear pass. | Rear pass. |
|-----------|-------------|-------------|------------|------------|------------|
| age | 17 | 14 | 18 | 20 | |
| gender | F | F | F | M | |
| fatality | Y | | | | |
| injury | | 3 | 3 | 3 | |
| ejection | Y | N | N | Y | |
| seat belt | Y | Y | N | N | |

2002 Ford Explorer, Wagon 4 door
Never licensed

| | Other driver | Front pass. |
|-----------|--------------|-------------|
| age | 21 | 22 |
| gender | M | F |
| fatality | | |
| injury | 3 | 3 |
| ejection | N | N |
| seat belt | ? | ? |

2009 Dodge Charger, Sedan 4 door

| | Other driver |
|-----------|--------------|
| age | 38 |
| gender | * |
| fatality | |
| injury | ? |
| ejection | N |
| seat belt | Y |

2011 Ford F150, 4 door pickup
*Gender data unavailable

Crash Narrative

Teen was EB when other vehicle traveling SB at high rate of speed failed to obey red light at intersection. Other vehicle struck teen on driver side. Teen's vehicle overturned coming to a rest on its side and started on fire.

Contributing factors

Other driver had BAC of 0.175. According to media report, was speeding up to 100 mph.

Other factors

-

Reporting Agency: Des Moines Police

Teen driver at fault? No

License history:

*License history data omitted for protection of privacy

Criminal charges:

Vehicular homicide by OWI (25 yr prison) and four counts of serious injury by motor vehicle/OWI (5 yr each, served concurrently), for 30 yrs total.

Civil litigation:

None

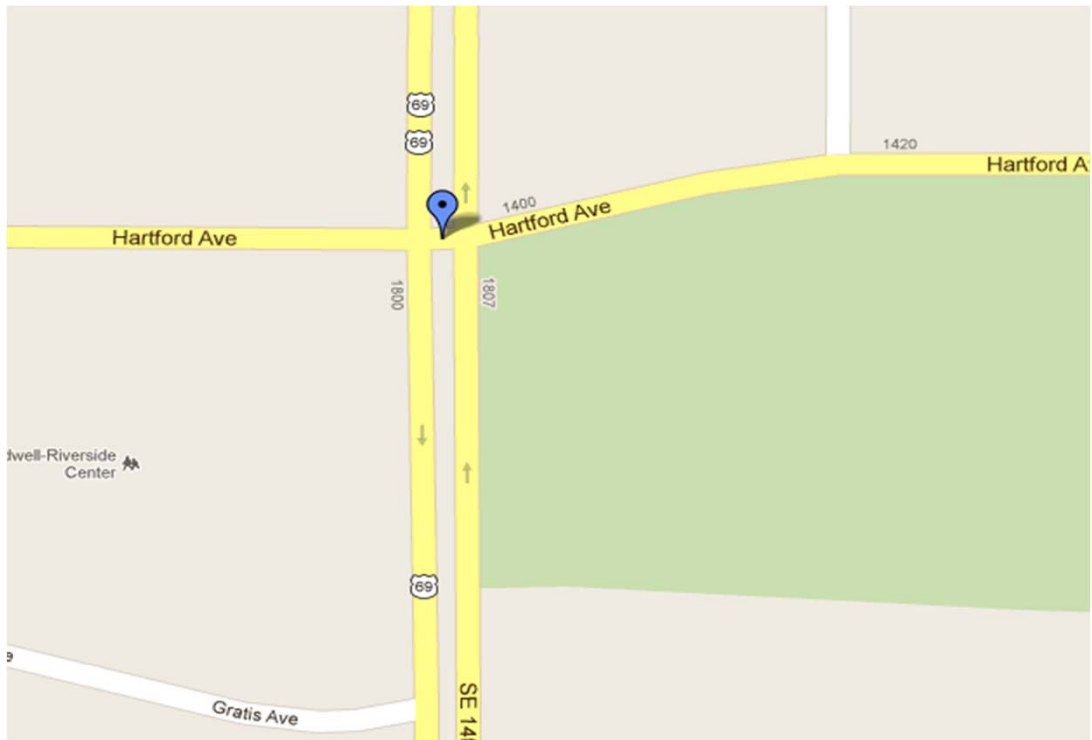

9:26 AM

Tuesday

August 30, 2011

23

Co Hwy F48 between S 28th Ave W & W 16th St S, Jasper County

Secondary 2L bridge/overpass

Non-collision

| | Teen driver | Front pass. | Rear pass. | Rear pass. | Rear pass. |
|-----------|-------------|-------------|------------|------------|------------|
| age | 17 | | | | |
| gender | F | | | | |
| fatality | Y | | | | |
| injury | | | | | |
| ejection | N | | | | |
| seat belt | ? | | | | |

1998 Ford Explorer, Wagon 4 door
Intermediate 367 days

Crash Narrative

Teen EB when failed to negotiate curve. Teen overcorrected, ran off the road to the left, struck bridge rail, and rolled several times. Vehicle came to rest upside down in a creek.

Contributing factors

-

Other factors

-

Reporting Agency: Jasper County Sheriff

Teen driver at fault? Yes

License history:

*License history data omitted for protection of privacy

Criminal charges:

None

Civil litigation:

None

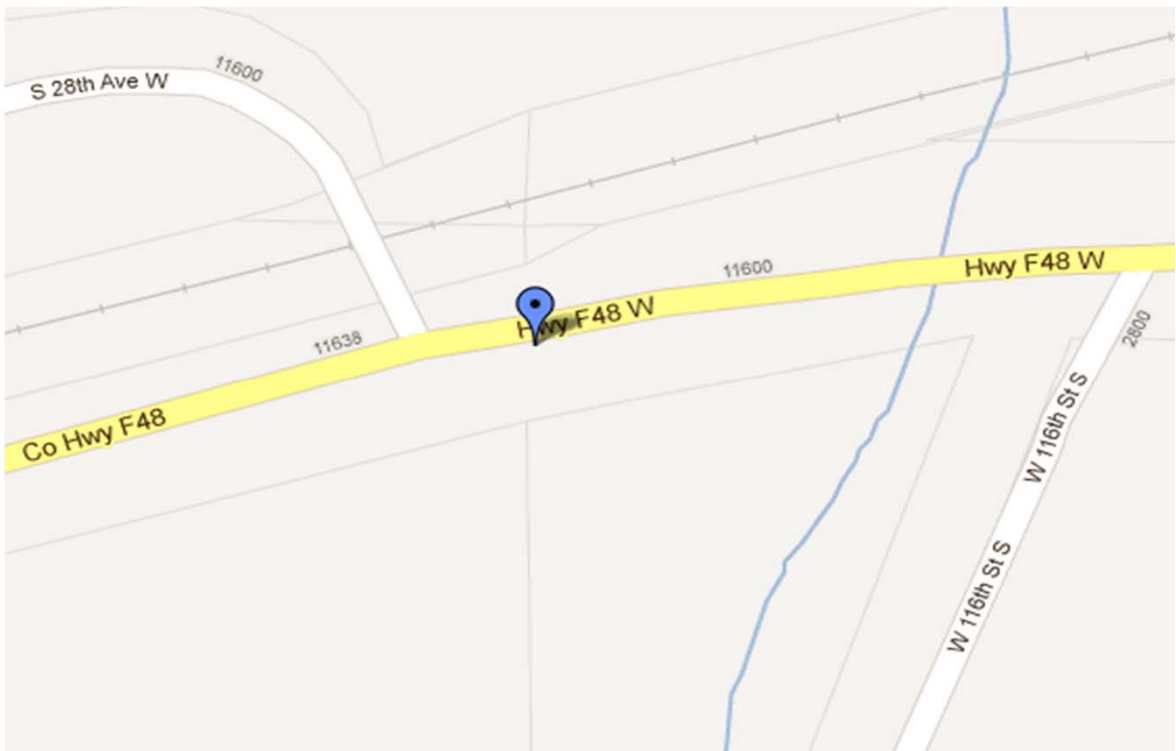

2:00 AM

Sunday

September 18,2011

24

Co Hwy D38/D Ave between 530th St & 540th St, Cherokee County

Secondary 2L

Non-collision

| | Teen driver | Front pass. | Rear pass. | Rear pass. | Rear pass. |
|-----------|-------------|-------------|------------|------------|------------|
| age | 16 | | | | |
| gender | M | | | | |
| fatality | Y | | | | |
| injury | | | | | |
| ejection | Y | | | | |
| seat belt | N | | | | |

2000 Chevrolet Monte Carlo SS, Coupe
 Intermediate 342 days

Crash Narrative

Teen NB and ran off road to the right, crossed the centerline, and ran off road to the right again. The vehicle overturned.

Contributing factors

Exceeded authorized speed

Other factors

-

Reporting Agency: Cherokee County

Teen driver at fault? Yes

License history:

*License history data omitted for protection of privacy

Criminal charges:

None

Civil litigation:

None

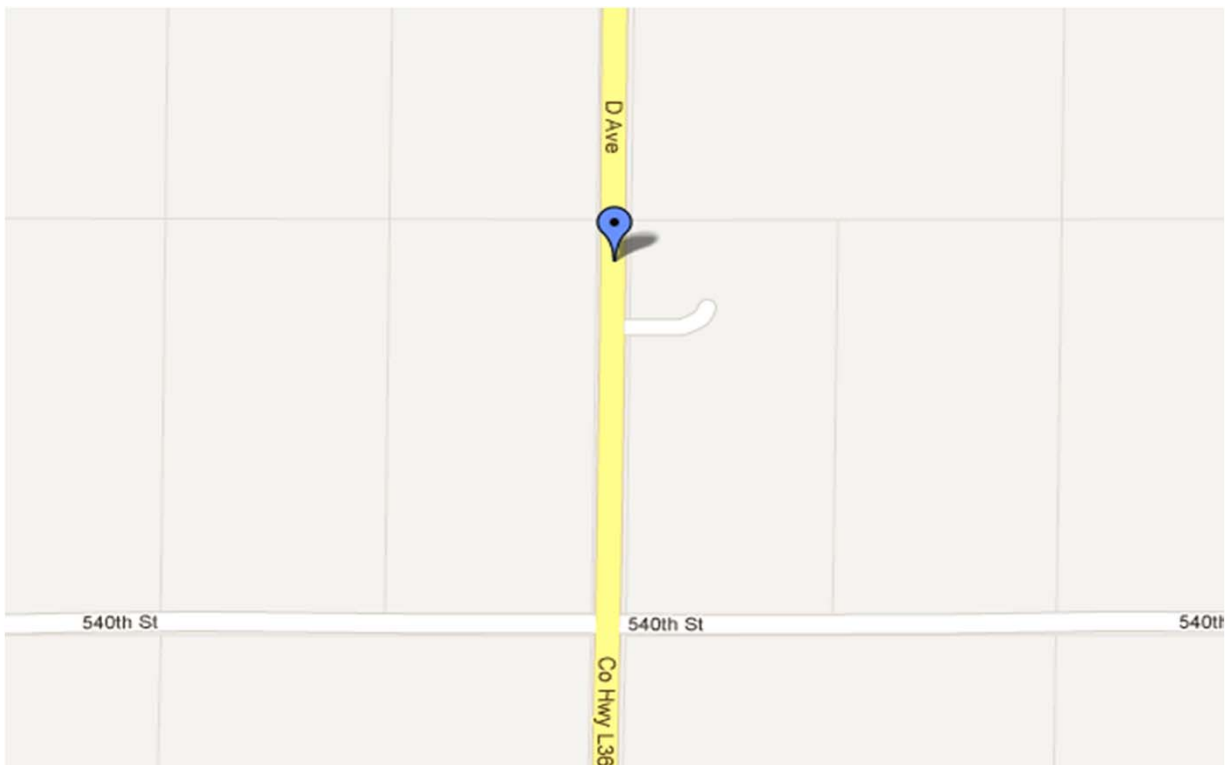

1:30 AM

Saturday

September 24, 2011

25

290th St between US 169 & Co Rd P46, Ringgold County

Secondary 2L, gravel

Non-collision

| | Teen driver | Front pass. | Rear pass. | Rear pass. | Rear pass. |
|-----------|-------------|-------------|------------|------------|------------|
| age | 15 | 15 | | | |
| gender | M | M | | | |
| fatality | Y | | | | |
| injury | | 2 | | | |
| ejection | Y | Y | | | |
| seat belt | N | N | | | |

2004 Pontiac Grand Prix GT, Sedan 4 door

School license 362 days

Crash Narrative

Teen EB while exceeding authorized speed. Ran off road to the left, LOC, and rolled several times.

Contributing factors

"Hill jumping," exceeded authorized speed, reckless driving

Other factors

-

Reporting Agency: Ringgold County

Teen driver at fault? Yes

License history:

*License history data omitted for protection of privacy

Criminal charges:

None

Civil litigation:

None

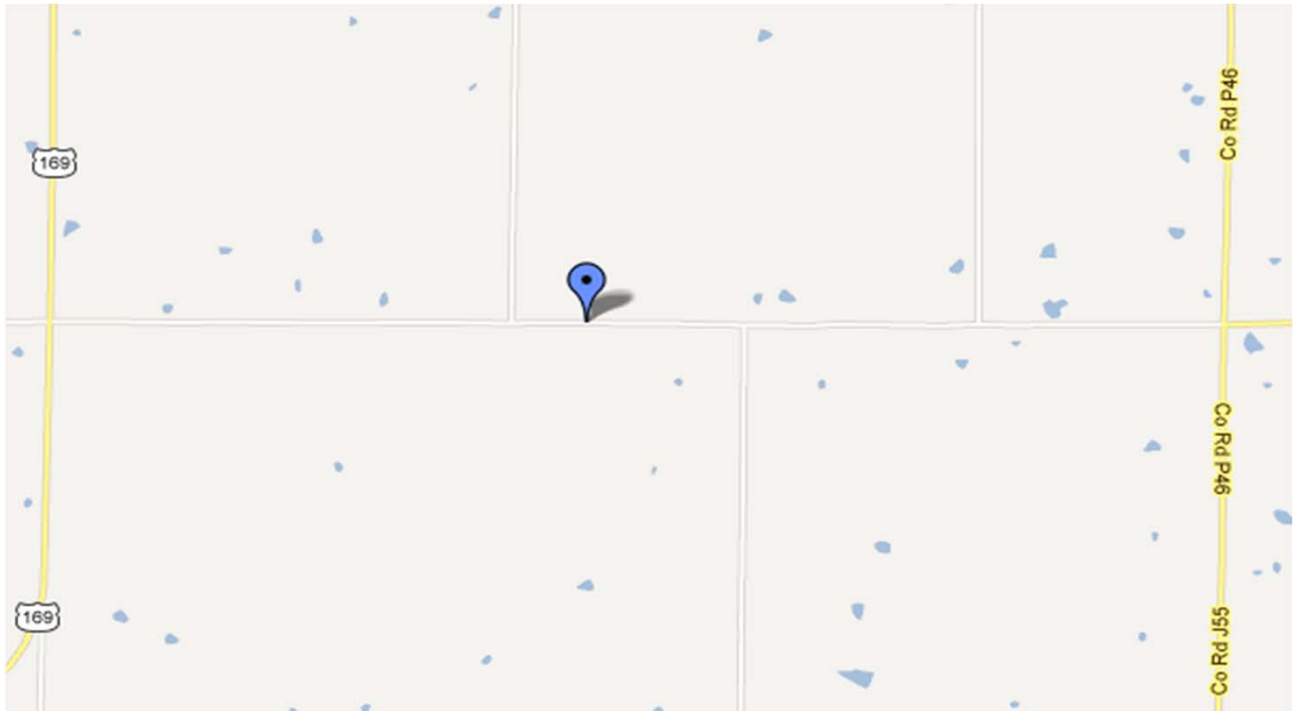

6:08 AM

Monday

September 26, 2011

26

US 67, just south of intersection with 125th St, Clinton County

US Route 2L

Non-collision

| | Teen driver | Front pass. | Rear pass. | Rear pass. | Rear pass. |
|-----------|-------------|-------------|------------|------------|------------|
| age | 17 | | | | |
| gender | M | | | | |
| fatality | Y | | | | |
| injury | | | | | |
| ejection | N | | | | |
| seat belt | N | | | | |

1993 Mazda MX-3, Hatchback
Intermediate 104 days

Crash Narrative

Teen NB and LOC and ran off road to the right. Vehicle slide sideways for 419 feet before striking a tree on the driver's door.

Contributing factors

Wet surface conditions

Other factors

-

Reporting Agency: Clinton County

Teen driver at fault? Yes

License history:

 *License history data omitted for protection of privacy

Criminal charges:

 None

Civil litigation:

 None

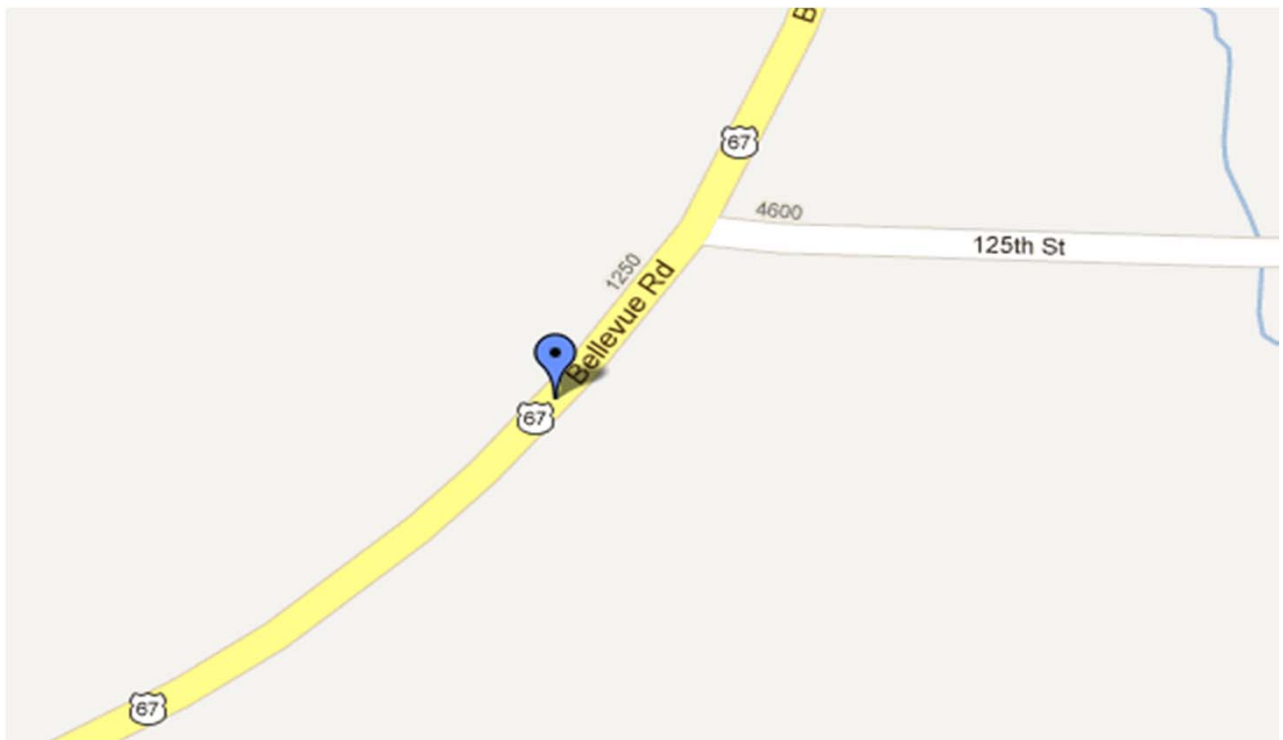

E Sheridan Ave & E 40th St, Des Moines, Polk County
 Municipal 2L, controlled four-way intersection
 Broadside

| | Teen driver | Front pass. | Rear pass. | Rear pass. | Rear pass. |
|-----------|-------------|-------------|------------|------------|------------|
| age | 18 | | | | |
| gender | M | | | | |
| fatality | Y | | | | |
| injury | | | | | |
| ejection | Y | | | | |
| seat belt | Y | | | | |

2008 Motorcycle
 No license

| | Other driver | Front pass. | Rear pass. | Rear pass. | Rear pass. |
|-----------|--------------|-------------|------------|------------|------------|
| age | 73 | | | | |
| gender | F | | | | |
| fatality | | | | | |
| injury | 5 | | | | |
| ejection | N | | | | |
| seat belt | Y | | | | |

1999 Chevrolet Lumina LTZ, Sedan 4 door

Crash Narrative

Teen WB at high rate of speed and FTY at stop sign. Teen struck other NB vehicle. Teen's motorcycle was partly underneath the other vehicle.

Contributing factors

Exceeded authorized speed, operating vehicle in reckless manner

Other factors

-

Reporting Agency: Des Moines Police

Teen driver at fault? Yes

License history:

*License history data omitted for protection of privacy

Criminal charges:

None

Civil litigation:

None

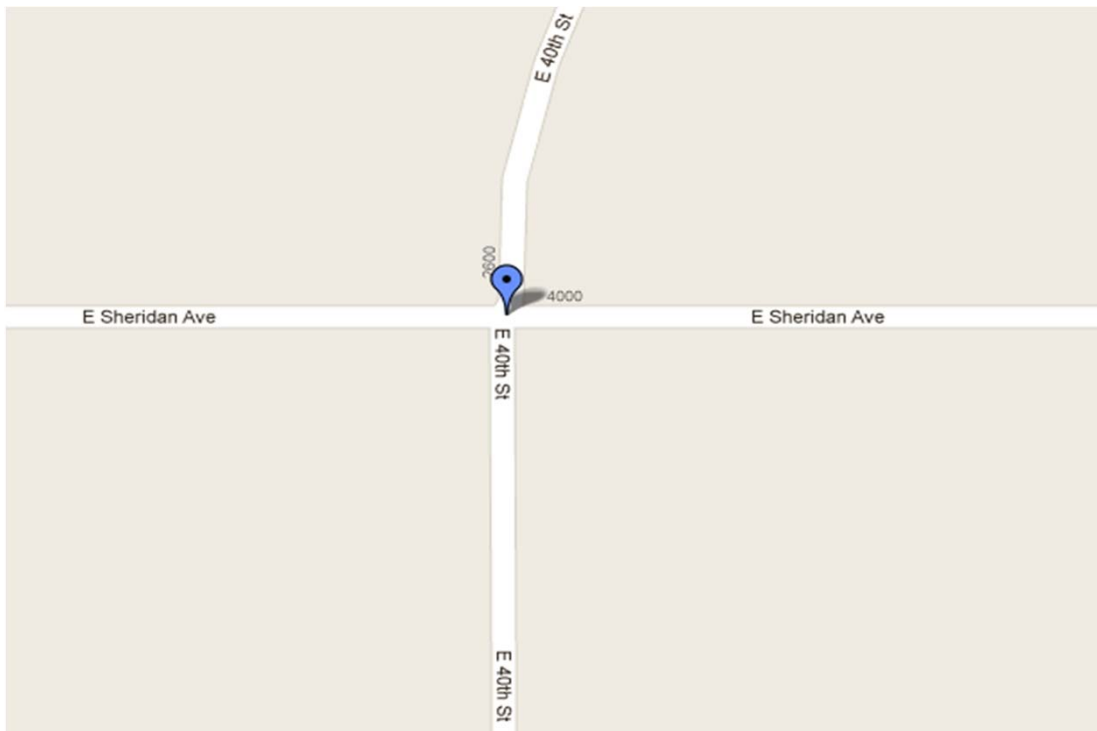

| | Teen driver | Front pass. | Front pass. | Rear pass. | Rear pass. | Rear pass. |
|-----------|-------------|-------------|-------------|------------|------------|------------|
| age | 18 | 15 | 16 | 14 | 14 | 14 |
| gender | M | M | M | F | F | F |
| fatality | | | | Y | | |
| injury | 3 | 3 | 3 | | 2 | 2 |
| ejection | N | N | N | N | N | Y |
| seat belt | Y | Y | Y | Y | Y | Y |

1996 Chevrolet Lumina, Sedan 4 door
Intermediate* 222 days

*Converted to full license at age 18

| | Other driver | Front pass. | Rear pass. | Rear pass. | Rear pass. |
|-----------|--------------|-------------|------------|------------|------------|
| age | 47 | 42 | | | |
| gender | M | F | | | |
| fatality | | | | | |
| injury | 3 | 3 | | | |
| ejection | N | N | | | |
| seat belt | Y | Y | | | |

2010 Honda Odyssey, Van

Crash Narrative

Teen (Unit 1) was EB and other vehicle (Unit 2) was WB. As Unit 1 traveled through the curve, the vehicle drifted to the right and the right side tires dropped off onto the gravel shoulder. The driver over corrected and steered to the left and crossed the center line. The teen in Unit 1 steered to the right attempting to avoid oncoming Unit 2. Unit 2 collided with the left rear side of Unit 1 causing massive damage to the left rear passenger side of Unit 1. Unit 1 came to rest in the north ditch facing east. Unit 2 came to rest facing south on the north shoulder.

Contributing factors

Google news report teen driver traveling at 100 mph. Civil trial alleges reckless driving, excessive speed, and failure to maintain control.

Other factors

Road curved

Reporting Agency: ISP

Teen driver at fault? Yes

License history:

*License history data omitted for protection of privacy

Criminal charges:

None

Civil litigation:

Parents of deceased teen are suing teen driver for reckless operation of a vehicle, driving at an excessive speed and failure to maintain control of the vehicle (Filed on 2/17/12)

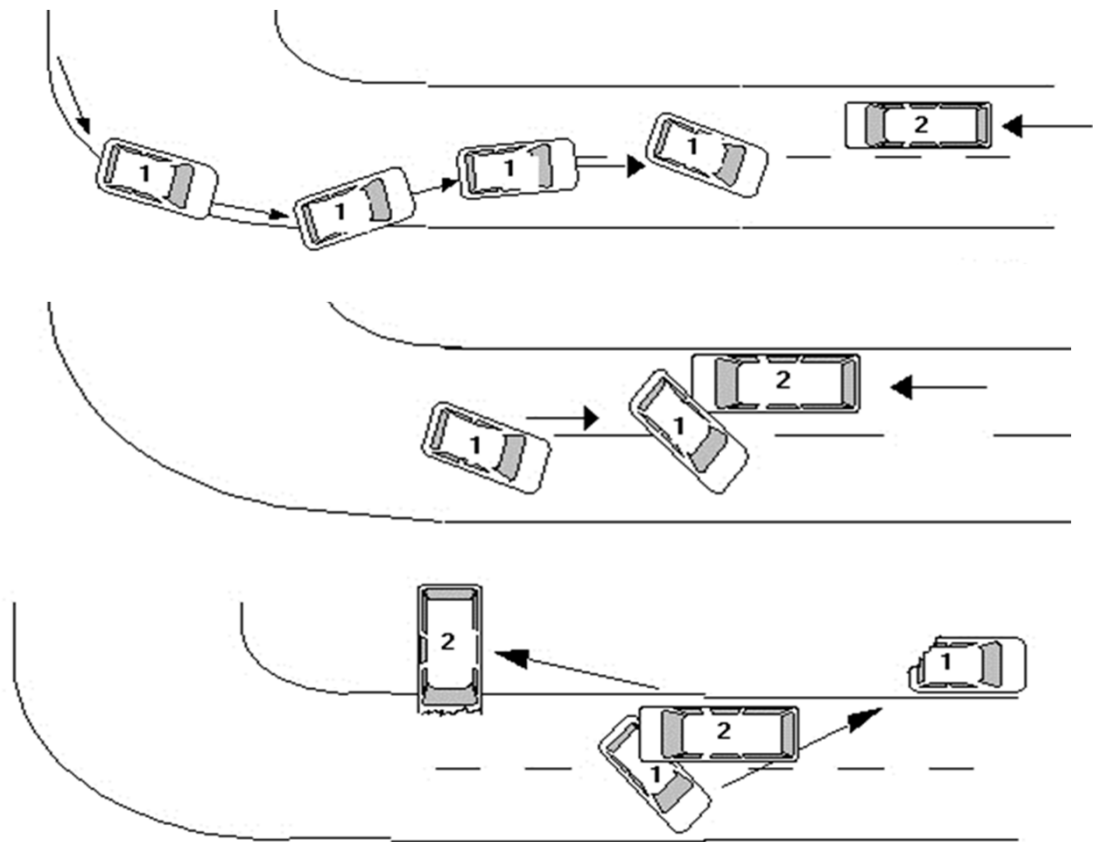

Hwy 6

**Maximum Engagement and
Final Rest**

US Hwy 30 just east of Grimmell Rd intersection, Greene County

US Route 2L

Sideswipe, opposite direction

| | Teen driver | Front pass. | Rear pass. | Rear pass. | Rear pass. |
|-----------|-------------|-------------|------------|------------|------------|
| age | 18 | 20 | | | |
| gender | M | F | | | |
| fatality | Y | | | | |
| injury | | 3 | | | |
| ejection | N | N | | | |
| seat belt | Y | Y | | | |

2006 Ford Taurus, Sedan 4 door
Suspended? 0 days

| | Other driver | Front pass. | Rear pass. | Rear pass. | Rear pass. |
|-----------|--------------|-------------|------------|------------|------------|
| age | 22 | | | | |
| gender | M | | | | |
| fatality | | | | | |
| injury | 5 | | | | |
| ejection | N | | | | |
| seat belt | Y | | | | |

2008 Ford F250, Pickup - police

Crash Narrative

Teen (Unit 1) travelling WB at a high rate of speed. Teen was being pursued by state patrol after being clocked going 92 mph in a 55-mph zone. Unit 1 began operating in a reckless and dangerous manner. Other police pickup (Unit 2) was travelling north on Grimmell St and then east on Hwy 30 to assist with the pursuit. Unit 1 was driving west in EB lane approaching Unit 2. Unit 2 attempted to avoid collision by steering to the south shoulder. As Unit 1 approached Unit 2 it deliberately turned into and struck Unit 2 on the left side of the vehicle. Unit 2 was spun around into the south ditch where it rolled once coming to a stop on its wheels facing SW. Unit 1 continued west in the EB lane and across the WB lane into the north ditch where it came to a rest facing south.

Contributing factors

Speed, BAC of 0.065

Other factors

-

Reporting Agency: ISP

Teen driver at fault? Yes

License history:

*License history data omitted for protection of privacy

Criminal charges:

None

Civil litigation:

None

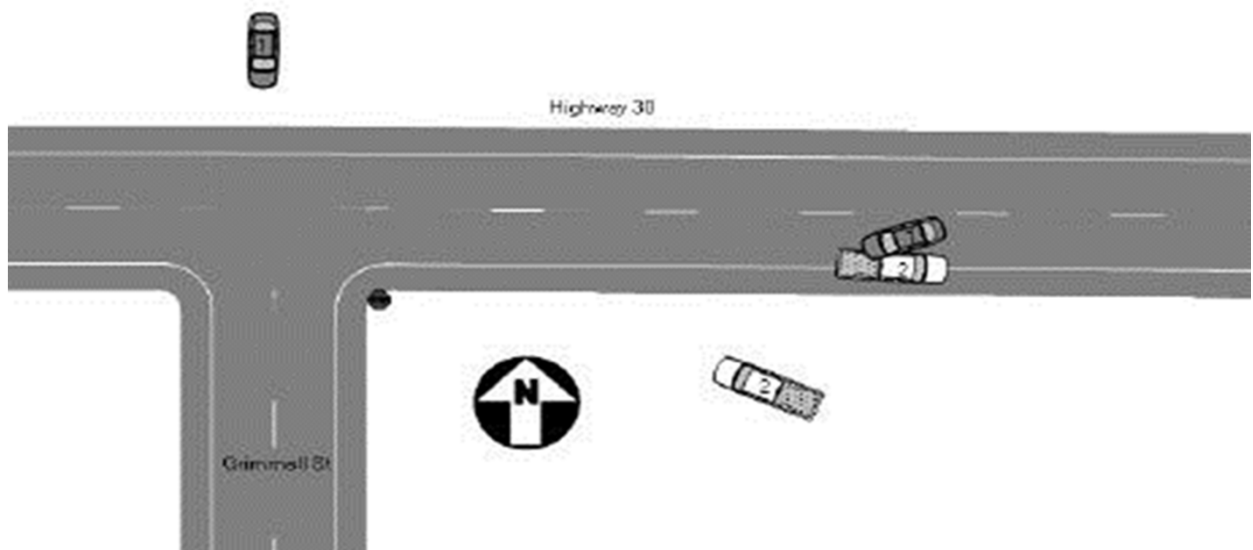

9:15 PM

Wednesday

November 3, 2011

30

245th Ave just south of 200th St, Winneshiek County

Secondary 2L

Non-collision

| | Teen driver | Front pass. | Front pass. | Front pass. | Rear pass. | Rear pass. | Rear pass. |
|-----------|-------------|-------------|-------------|-------------|------------|------------|------------|
| age | 18 | 19 | 18 | 18 | 19 | 19 | 19 |
| gender | M | F | M | F | M | F | F |
| fatality | | | Y | | | | Y |
| injury | 3 | 2 | | 2 | 3 | 2 | |
| ejection | ? | Y | Y | Y | N | Y | Y |
| seat belt | N | N | N | N | N | N | N |

1998 Ford F150, Pickup
Out of State

Crash Narrative

Teen was driving with six other passengers in a pickup truck heading EB. Teen failed to negotiate a curve to the north and entered the east ditch, overturned, and came to final rest on the passenger side in the field to the east.

Contributing factors

-

Other factors

-

Reporting Agency: ISP

Teen driver at fault? Yes

License history:

*License history data omitted for protection of privacy

Criminal charges:

Failure to maintain control (10 days jail)

Civil litigation:

None

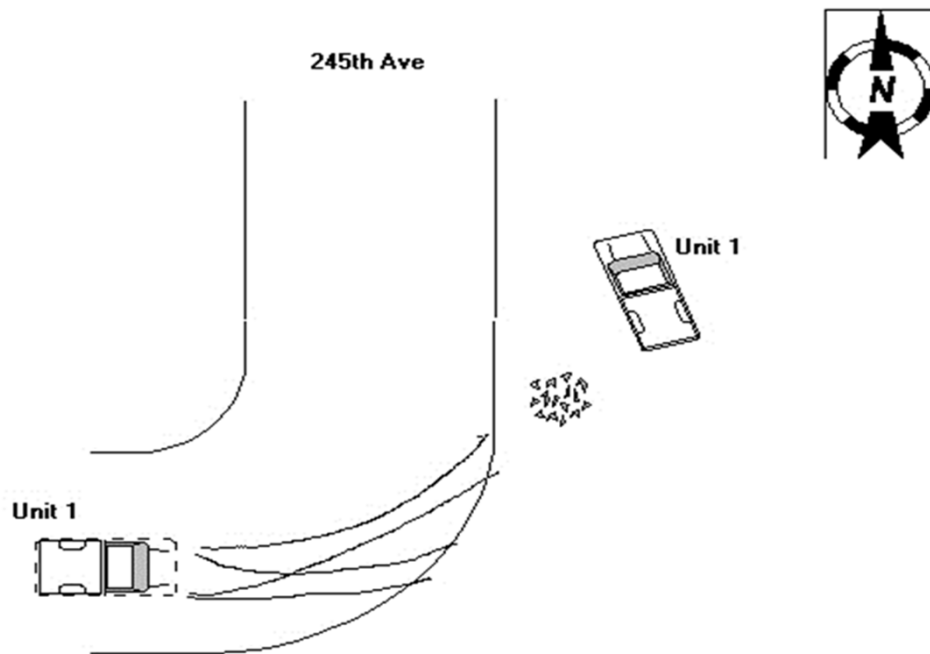

4:02 AM

Saturday

September 17, 2011

31

I St between 3rd Ave & 4th Ave, Iowa City, Johnson County

Municipal 2L

Head-on

| | Teen driver | Front pass. | Rear pass. | Rear pass. | Rear pass. |
|-----------|-------------|-------------|------------|------------|------------|
| age | 19 | 18 | | | |
| gender | M | M | | | |
| fatality | Y | | | | |
| injury | | 2 | | | |
| ejection | N | N | | | |
| seat belt | ? | ? | | | |

1992 Honda Civic DX, Sedan 4 door
"operators license" 65 days

| | Other driver | Front pass. | Rear pass. | Rear pass. | Rear pass. |
|-----------|--------------|-------------|------------|------------|------------|
| age | 0 | | | | |
| gender | 0 | | | | |
| fatality | | | | | |
| injury | | | | | |
| ejection | | | | | |
| seat belt | | | | | |

No one in the vehicle - parked
1998 Oldsmobile Aurora, Sedan 4 door

Crash Narrative

Teen driving WB on I Street at high rate of speed and struck a parked motor vehicle head-on.

Contributing factors

Exceeded authroized speeds (Police told media, not recorded in crash file)

Other factors

-

Reporting Agency: Iowa City Police

Teen driver at fault? Yes

License history:

*License history data omitted for protection of privacy

Criminal charges:

None

Civil litigation:

None

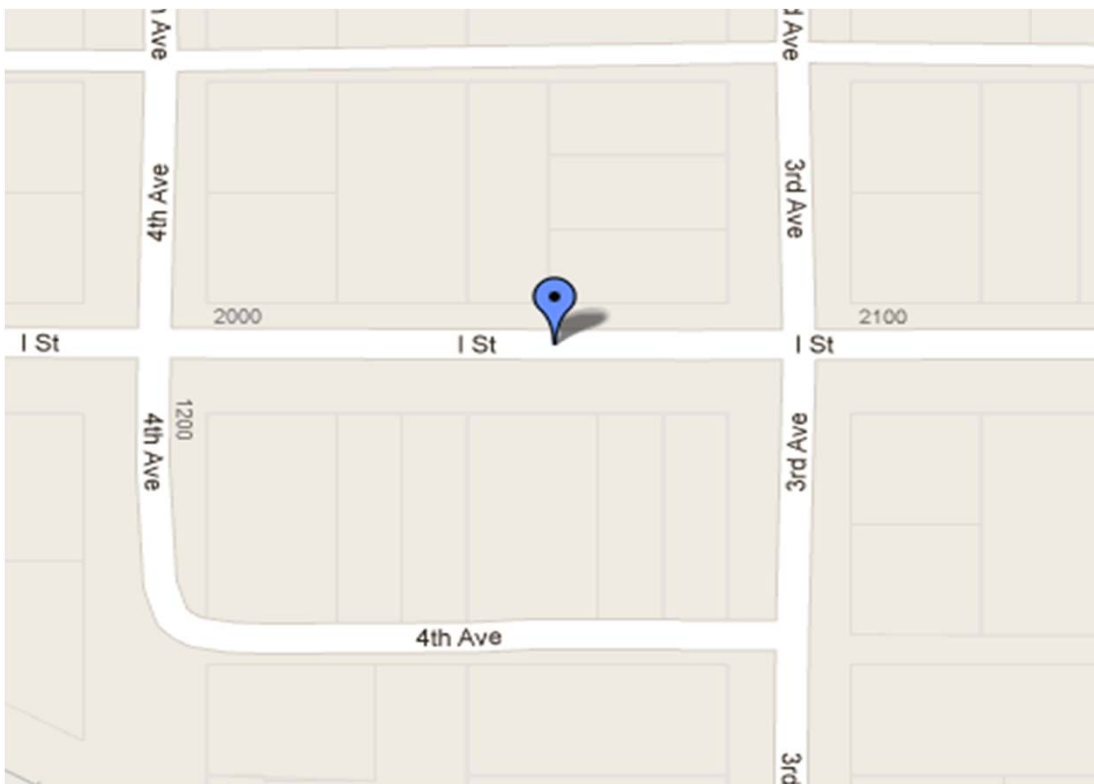

US Hwy 218 EB, between Hickory Ave & Indigo Ave, Mitchell County

US Route 2L

Rear-end

| | Teen driver | Front pass. | Rear pass. | Rear pass. | Rear pass. |
|-----------|-------------|-------------|------------|------------|------------|
| age | 17 | | | | |
| gender | F | | | | |
| fatality | Y | | | | |
| injury | | | | | |
| ejection | N | | | | |
| seat belt | Y | | | | |

2005 Pontiac Bonneville, Sedan 4 door
Intermediate 386 days

| | Other driver | Front pass. | Rear pass. | Rear pass. | Rear pass. |
|-----------|--------------|-------------|------------|------------|------------|
| age | 65 | | | | |
| gender | F | | | | |
| fatality | | | | | |
| injury | 5 | | | | |
| ejection | N | | | | |
| seat belt | Y | | | | |

2006 International School Bus
*21 pxs on school bus (no one injured)

Crash Narrative

A school bus (Unit 1) was traveling EB and came to a stop to let passengers off at the residence. Witnesses report that Unit 1 had its stopsign out and amber lights flashing. Teen (Unit 2) was traveling EB and struck the rear of Unit 1 and came to a rest underneath it.

Contributing factors

Press release from law enforcement reports teen was texting

Other factors

-

Reporting Agency: ISP

Teen driver at fault? Yes

License history:

*License history data omitted for protection of privacy

Criminal charges:

None

Civil litigation:

None

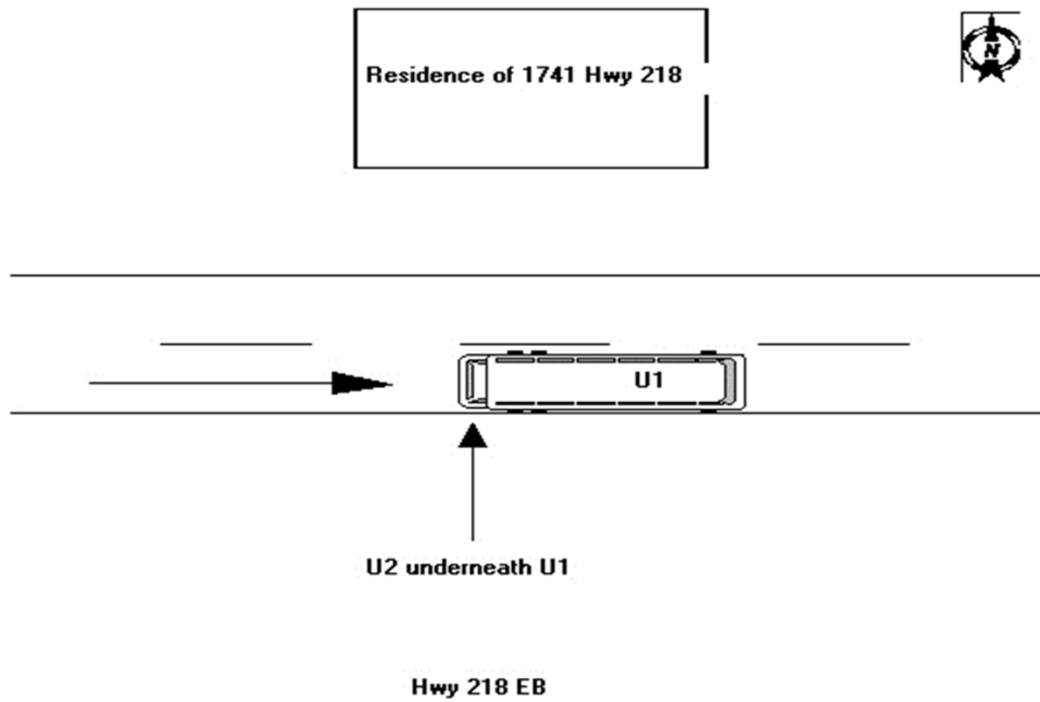

5:18 PM

Tuesday

November 8, 2011

33

290th St between Pembroke Ave & Quinlan Ave, Chickasaw County

Secondary 2L gravel

Non-collision

| | Teen driver | Front pass. | Rear pass. | Rear pass. | Rear pass. |
|-----------|-------------|-------------|------------|------------|------------|
| age | 17 | | | | |
| gender | F | | | | |
| fatality | | | | | |
| injury | 5 | | | | |
| ejection | N | | | | |
| seat belt | ? | | | | |

2004 Chrysler Concorde LXI, Sedan 4 door
No license

56, male, pedestrian
Fatal

Crash Narrative

Teen was EB when she lost control and overcorrected. First event was ran off road to the right and second event was collision with non-motorist (pedestrian on the side of road who was walking his dog). Third event was ran off road to the right again, and fourth was collision with ditch/embankment. Both pedestrian and dog fatal. Teen fled the scene.

Contributing factors

-

Other factors

-

Reporting Agency: 0

Teen driver at fault? Yes

License history:

*License history data omitted for protection of privacy

Criminal charges:

Reckless homicide by vehicle, leaving the scene of a personal injury accident resulting in death, involuntary manslaughter. Set 6/5/12.

Civil litigation:

None

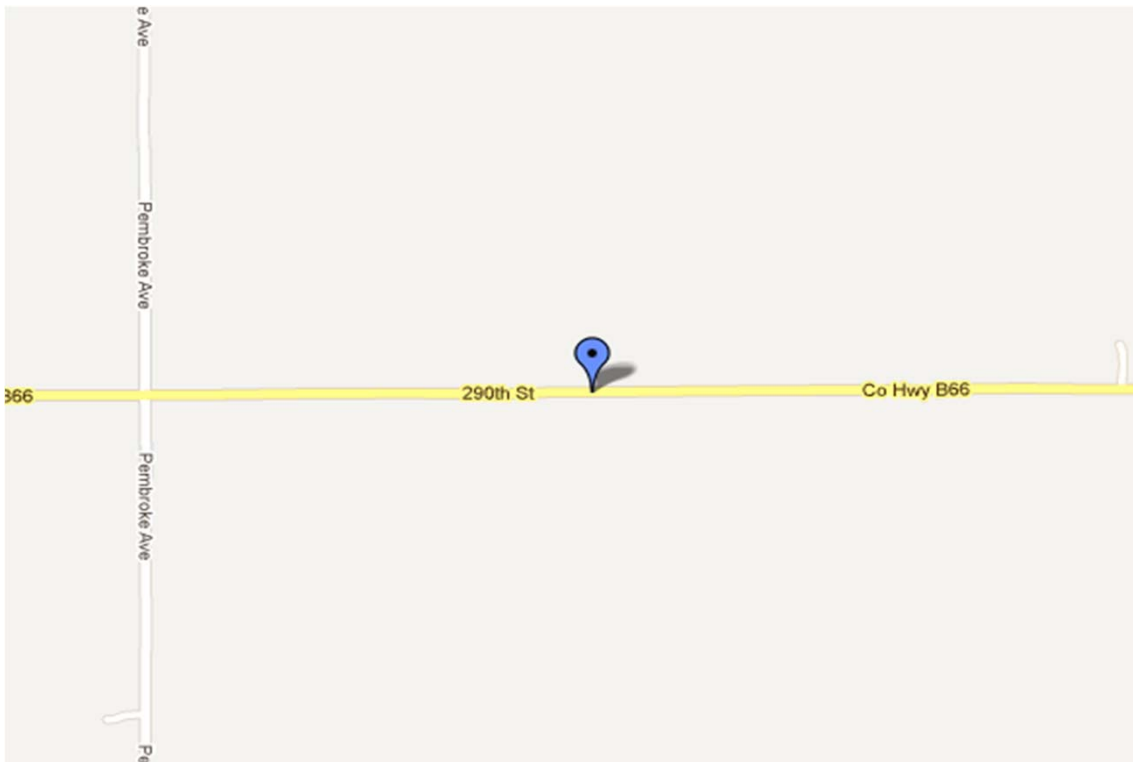

IA Hwy 9 & 430th St, Emmet County
IA Route/Secondary 2L, controlled four-way intersection
Non-collision

| | Teen driver | Front pass. | Rear pass. | Rear pass. | Rear pass. |
|-----------|-------------|-------------|------------|------------|------------|
| age | 19 | | | | |
| gender | M | | | | |
| fatality | Y | | | | |
| injury | | | | | |
| ejection | N | | | | |
| seat belt | Y | | | | |

1998 Buick Skylark Custom, Sedan 4 door
Full 709 days

Crash Narrative

Teen WB when vehicle began to run off road to the left, crossed the centerline, struck the ditch and overturned.

Contributing factors

Fell asleep

Other factors

-

Reporting Agency: 0

Teen driver at fault? Yes

License history:

***License history data omitted for protection of privacy**

Criminal charges:

None

Civil litigation:

None

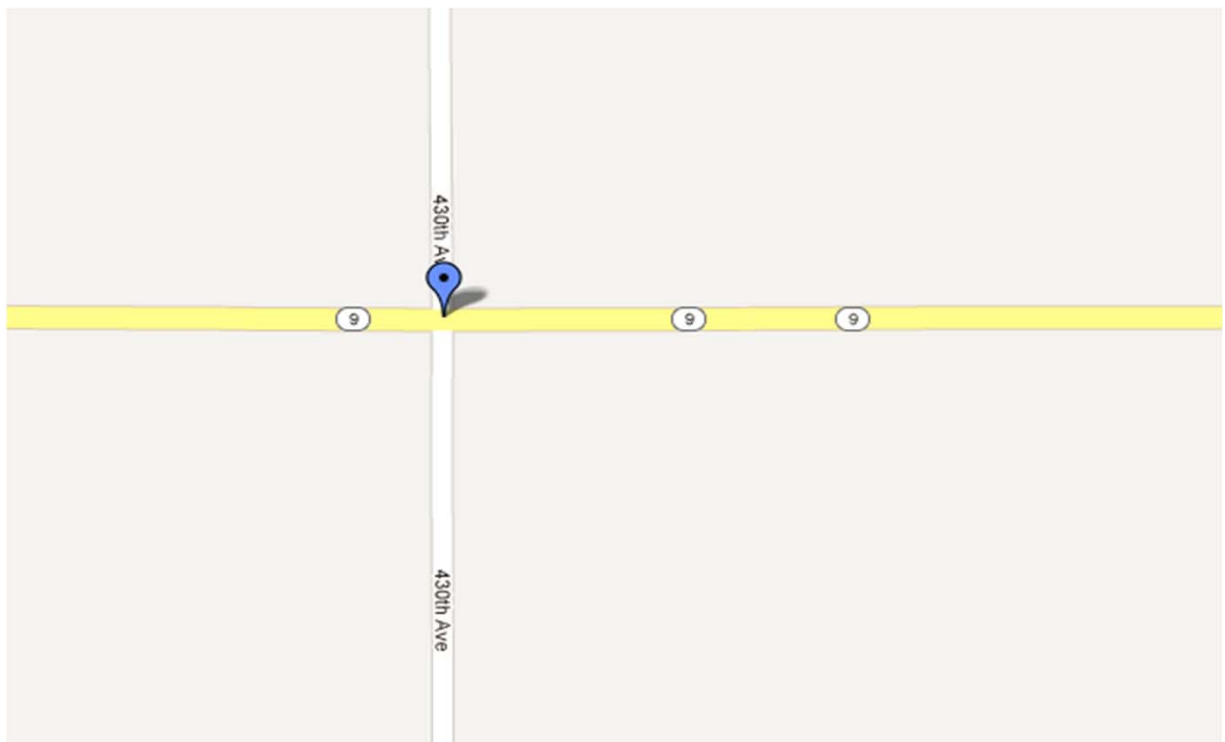

Baxter Ave & 360th St, Webster County
 Secondary 2L, four-way controlled intersection
 Broadside

| | Teen driver | Front pass. | Rear pass. | Rear pass. | Rear pass. |
|-----------|-------------|-------------|------------|------------|------------|
| age | 17 | | | | |
| gender | M | | | | |
| fatality | Y | | | | |
| injury | | | | | |
| ejection | Y | | | | |
| seat belt | N | | | | |

2001 Chrysler Concorde LX, Sedan 4 door
 Intermediate 132 days

| | Other driver | Front pass. | Rear pass. | Rear pass. | Rear pass. |
|-----------|--------------|-------------|------------|------------|------------|
| age | 20 | 25 | | | |
| gender | M | F | | | |
| fatality | | | | | |
| injury | 4 | 3 | | | |
| ejection | N | N | | | |
| seat belt | Y | Y | | | |

2002 Mazda Protégé PR5, Hatchback 4 door

Crash Narrative

Teen SB and ran stop sign and struck by other WB car. Other vehicle's front hit teen's driver's side. Teen's vehicle then collided with ditch while other vehicle ran off road to the left, collided with ditch and rolled onto its top and started on fire.

Contributing factors

-

Other factors

-

Reporting Agency: 0

Teen driver at fault? Yes

License history:

*License history data omitted for protection of privacy

Criminal charges:

None

Civil litigation:

None

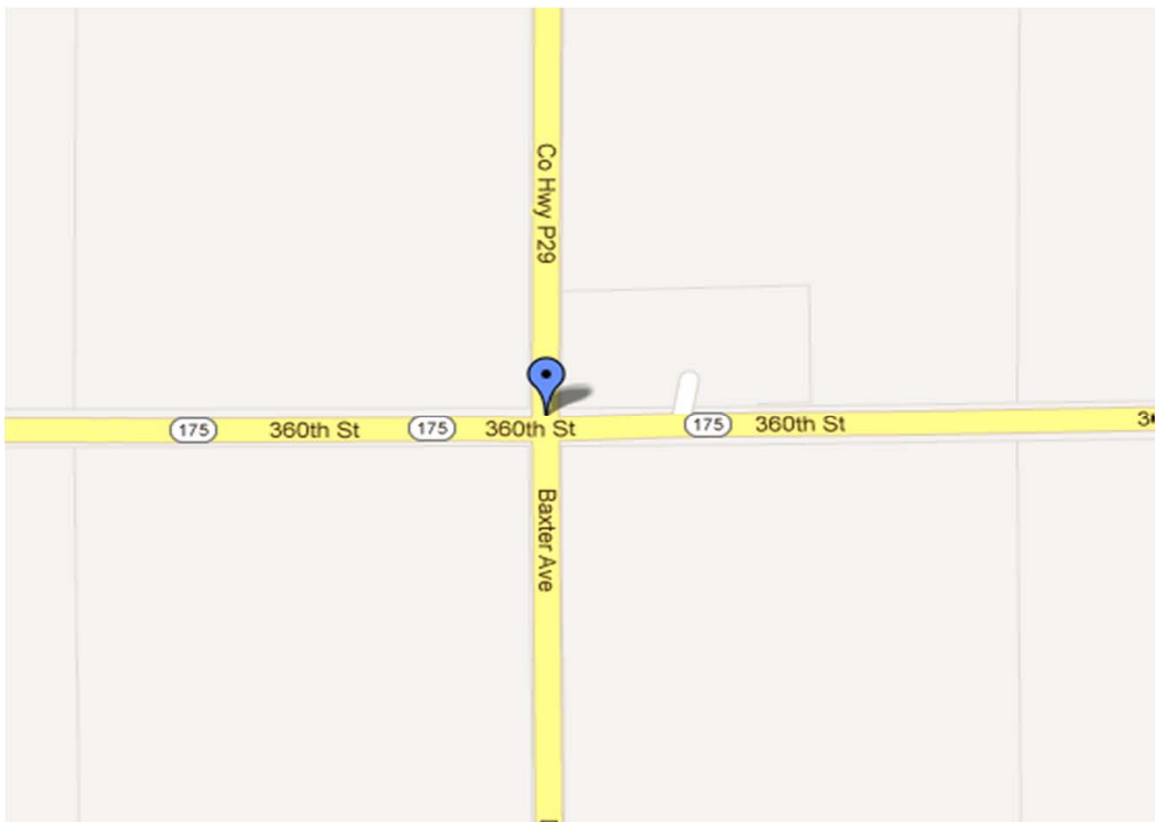

Williston Ave & Hwy 218, Waterloo, Black Hawk County
US (3L, one-way)/Municipal (2L both directions), four-way controlled intersection
Broadside

| | | | | | | | | |
|-----------|---|----|-------------|--|------------|--|------------|--|
| | Teen driver | | Front pass. | | Rear pass. | | Rear pass. | |
| age | 19 | 21 | | | | | | |
| gender | M | F | | | | | | |
| fatality | | | | | | | | |
| injury | 5 | 4 | | | | | | |
| ejection | N | N | | | | | | |
| seat belt | Y | Y | | | | | | |
| | 2003 Ford Explorer, Wagon 4 door Unknown | | | | | | | |

| | | |
|-----------|-----------------------------------|--|
| | Other driver | |
| age | 37 | |
| gender | F | |
| fatality | Y | |
| injury | | |
| ejection | N | |
| seat belt | Y | |
| | 1999 Chevrolet Cavalier/RS, Coupe | |

| | | |
|-----------|-------------------|--|
| | Other driver | |
| age | 28 | |
| gender | F | |
| fatality | | |
| injury | 5 | |
| ejection | N | |
| seat belt | Y | |
| | 1998 Honda Accord | |

Crash Narrative

Teen EB and stopped at intersection. Other vehicle WB and third vehicle SB. Second vehicle ran traffic signal and hit third vehicle in the driver side middle. Third vehicle then hit teen's car.

Contributing factors

Second driver had BAC of 0.074 and third driver had BAC of 0.084

Other factors

-

Reporting Agency: 0

Teen driver at fault? No

License history:

*License history data omitted for protection of privacy

Criminal charges:

None

Civil litigation:

None

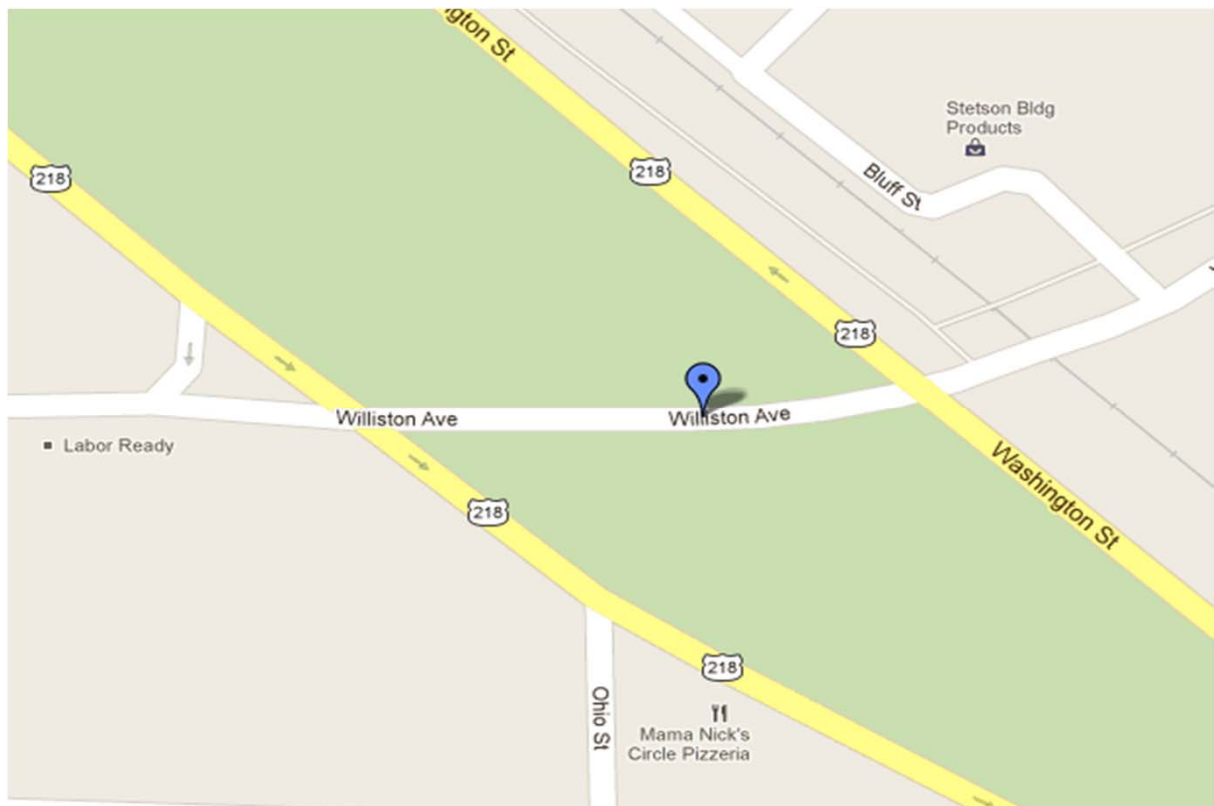

Hwy 61 & W 31st St, Davenport, Scott County
 US Route (4L, one-way)/Municipal (2L), controlled t-intersection
 Rear-end

| | Teen driver | Front pass. | Rear pass. | Rear pass. | Rear pass. |
|--|-------------|-------------|------------|------------|------------|
| age | 18 | | | | |
| gender | M | | | | |
| fatality | | | | | |
| injury | 5 | | | | |
| ejection | N | | | | |
| seat belt | Y | | | | |
| 2001 Lincoln LS, Sedan 4 door Unknown | | | | | |

| | Other driver | Front pass. | Rear pass. | Rear pass. | Rear pass. |
|---------------------------------|--------------|-------------|------------|------------|------------|
| age | 31 | | | | |
| gender | M | | | | |
| fatality | Y | | | | |
| injury | | | | | |
| ejection | Y | | | | |
| seat belt | N | | | | |
| 1997 Honda CBR900RR, Motorcycle | | | | | |

| | Other driver |
|--------------|--------------|
| age | |
| gender | |
| fatality | |
| injury | 5 |
| ejection | |
| seat belt | |
| "Boxy sedan" | |

Crash Narrative

Motorcycle driver and a third unnamed driver were both SB and tried to occupy same lane and collided. Motorcycle overturned, slid a considerable distance, and collided with the rear of teen's vehicle. Witnesses/physical evidence suggested deceased who was on motorcycle was traveling at high speed. Third vehicle, described as a "boxy sedan" did not stop and apparently was not found. Crash data file does not list third vehicle which made initial contact.

Contributing factors

Crash data states driver of motorcycle was emotional (depressed/angry/disturbed), exceeded authorized speed, and lost control.

Other factors

-

Reporting Agency: 0

Teen driver at fault? No

License history:

*License history data omitted for protection of privacy

Criminal charges:

None

Civil litigation:

None

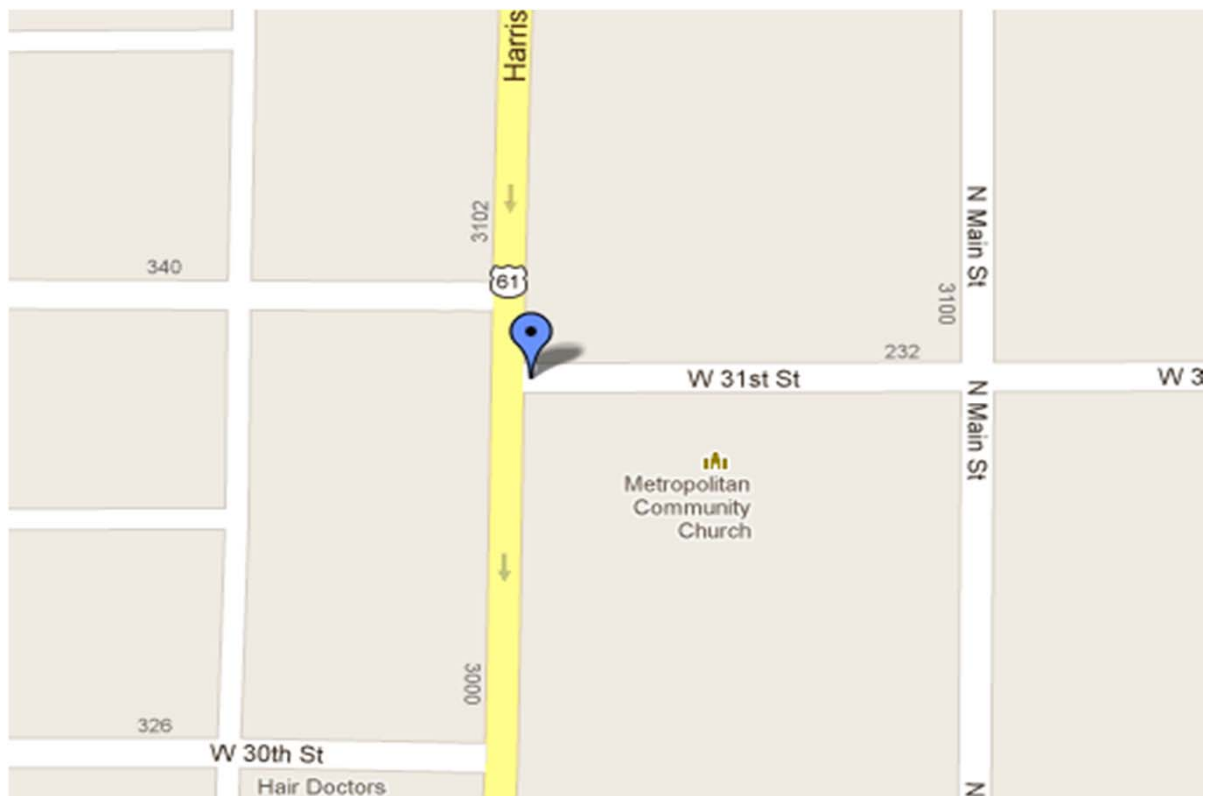

4:00 PM

Sunday

September 11, 2011

38

Co Hwy S56, just north of intersection with 200th St, Hardin County

Secondary 2L

Non-collision

| | Teen driver | Front pass. | Front pass. | Rear pass. | Rear pass. |
|-----------|-------------|-------------|-------------|------------|------------|
| age | 17 | 18 | 19 | 17 | |
| gender | M | M | M | F | |
| fatality | | | Y | | |
| injury | 3 | 3 | | 3 | |
| ejection | N | N | Y | N | |
| seat belt | Y | Y | N | N | |

1996 Dodge Ram 1500, Club cab pickup
Unknown

Crash Narrative

Teen EB and failed to negotiate a curve. Teen swerved, lost control, collided with ditch, and overturned.

Contributing factors

Distracted by passenger

Other factors

-

Reporting Agency: 0

Teen driver at fault? Yes

License history:

 *License history data omitted for protection of privacy

Criminal charges:

 Failure to maintain control (fine \$625)

Civil litigation:

 None

