



U.S. Department of
Transportation

Federal Railroad
Administration

Investigating Technical Challenges and Research Needs Related to Shared Corridors for High-Speed Passenger and Railroad Freight Operations

Office of Research
and Development
Washington, DC 20590



NOTICE

This document is disseminated under the sponsorship of the Department of Transportation in the interest of information exchange. The United States Government assumes no liability for its contents or use thereof. Any opinions, findings and conclusions, or recommendations expressed in this material do not necessarily reflect the views or policies of the United States Government, nor does mention of trade names, commercial products, or organizations imply endorsement by the United States Government. The United States Government assumes no liability for the content or use of the material contained in this document.

NOTICE

The United States Government does not endorse products or manufacturers. Trade or manufacturers' names appear herein solely because they are considered essential to the objective of this report.

REPORT DOCUMENTATION PAGE			<i>Form Approved</i> <i>OMB No. 0704-0188</i>	
Public reporting burden for this collection of information is estimated to average 1 hour per response, including the time for reviewing instructions, searching existing data sources, gathering and maintaining the data needed, and completing and reviewing the collection of information. Send comments regarding this burden estimate or any other aspect of this collection of information, including suggestions for reducing this burden, to Washington Headquarters Services, Directorate for Information Operations and Reports, 1215 Jefferson Davis Highway, Suite 1204, Arlington, VA 22202-4302, and to the Office of Management and Budget, Paperwork Reduction Project (0704-0188), Washington, DC 20503.				
1. AGENCY USE ONLY (Leave blank)		2. REPORT DATE May 2013		3. REPORT TYPE AND DATES COVERED Technical Report
4. TITLE AND SUBTITLE Investigating Technical Challenges and Research Needs Related to Shared Corridors for High-Speed Passenger and Railroad Freight Operations				5. FUNDING NUMBERS
6. AUTHOR(S) M.R. Saat, C.P.L. Barkan				
7. PERFORMING ORGANIZATION NAME(S) AND ADDRESS(ES) University of Illinois at Urbana-Champaign Rail Transportation and Engineering Center –RailTEC Department of Civil and Environmental Engineering 205 N. Mathews Ave Urbana, IL 61801				8. PERFORMING ORGANIZATION REPORT NUMBER DOT/FRA/BAA-2010-1
9. SPONSORING/MONITORING AGENCY NAME(S) AND ADDRESS(ES) U.S. Department of Transportation Federal Railroad Administration Office of Railroad Policy and Development Office of Research and Development Washington, DC 20590				10. SPONSORING/MONITORING AGENCY REPORT NUMBER DOT/FRA/ORD-13/29
11. SUPPLEMENTARY NOTES				
12a. DISTRIBUTION/AVAILABILITY STATEMENT This document is available to the public through the FRA Web site at http://www.fra.dot.gov .				12b. DISTRIBUTION CODE
13. ABSTRACT (Maximum 200 words) The development of both incremental and dedicated high-speed rail lines in the United States poses a number of questions. Despite nearly 50 years of international experience in planning, designing, building and operating high-speed passenger infrastructure and rolling stock, there is a range of problems partially or completely unique to North America. Successful development of expanded higher speed, and new, very high-speed rail, will require careful analysis and, in many cases, research to develop satisfactory solutions. The questions involve a range of engineering, operational, economic, and institutional aspects. This report introduces various technical challenges related to shared high-speed passenger and freight rail corridors, describes an effort to prioritize the challenges, and presents an in-depth literature review of the high-priority challenges to identify existing research and future research needs.				
14. SUBJECT TERMS Shared corridor, high speed rail, heavy axle load freight				15. NUMBER OF PAGES 133
16. PRICE CODE				
17. SECURITY CLASSIFICATION OF REPORT Unclassified	18. SECURITY CLASSIFICATION OF THIS PAGE Unclassified	19. SECURITY CLASSIFICATION OF ABSTRACT Unclassified		20. LIMITATION OF ABSTRACT

METRIC/ENGLISH CONVERSION FACTORS

ENGLISH TO METRIC

METRIC TO ENGLISH

<p>LENGTH (APPROXIMATE)</p> <p>1 inch (in) = 2.5 centimeters (cm)</p> <p>1 foot (ft) = 30 centimeters (cm)</p> <p>1 yard (yd) = 0.9 meter (m)</p> <p>1 mile (mi) = 1.6 kilometers (km)</p>	<p>LENGTH (APPROXIMATE)</p> <p>1 millimeter (mm) = 0.04 inch (in)</p> <p>1 centimeter (cm) = 0.4 inch (in)</p> <p>1 meter (m) = 3.3 feet (ft)</p> <p>1 meter (m) = 1.1 yards (yd)</p> <p>1 kilometer (km) = 0.6 mile (mi)</p>
<p>AREA (APPROXIMATE)</p> <p>1 square inch (sq in, in²) = 6.5 square centimeters (cm²)</p> <p>1 square foot (sq ft, ft²) = 0.09 square meter (m²)</p> <p>1 square yard (sq yd, yd²) = 0.8 square meter (m²)</p> <p>1 square mile (sq mi, mi²) = 2.6 square kilometers (km²)</p> <p>1 acre = 0.4 hectare (he) = 4,000 square meters (m²)</p>	<p>AREA (APPROXIMATE)</p> <p>1 square centimeter (cm²) = 0.16 square inch (sq in, in²)</p> <p>1 square meter (m²) = 1.2 square yards (sq yd, yd²)</p> <p>1 square kilometer (km²) = 0.4 square mile (sq mi, mi²)</p> <p>10,000 square meters (m²) = 1 hectare (ha) = 2.5 acres</p>
<p>MASS - WEIGHT (APPROXIMATE)</p> <p>1 ounce (oz) = 28 grams (gm)</p> <p>1 pound (lb) = 0.45 kilogram (kg)</p> <p>1 short ton = 2,000 pounds (lb) = 0.9 tonne (t)</p>	<p>MASS - WEIGHT (APPROXIMATE)</p> <p>1 gram (gm) = 0.036 ounce (oz)</p> <p>1 kilogram (kg) = 2.2 pounds (lb)</p> <p>1 tonne (t) = 1,000 kilograms (kg) = 1.1 short tons</p>
<p>VOLUME (APPROXIMATE)</p> <p>1 teaspoon (tsp) = 5 milliliters (ml)</p> <p>1 tablespoon (tbsp) = 15 milliliters (ml)</p> <p>1 fluid ounce (fl oz) = 30 milliliters (ml)</p> <p>1 cup (c) = 0.24 liter (l)</p> <p>1 pint (pt) = 0.47 liter (l)</p> <p>1 quart (qt) = 0.96 liter (l)</p> <p>1 gallon (gal) = 3.8 liters (l)</p> <p>1 cubic foot (cu ft, ft³) = 0.03 cubic meter (m³)</p> <p>1 cubic yard (cu yd, yd³) = 0.76 cubic meter (m³)</p>	<p>VOLUME (APPROXIMATE)</p> <p>1 milliliter (ml) = 0.03 fluid ounce (fl oz)</p> <p>1 liter (l) = 2.1 pints (pt)</p> <p>1 liter (l) = 1.06 quarts (qt)</p> <p>1 liter (l) = 0.26 gallon (gal)</p> <p>1 cubic meter (m³) = 36 cubic feet (cu ft, ft³)</p> <p>1 cubic meter (m³) = 1.3 cubic yards (cu yd, yd³)</p>
<p>TEMPERATURE (EXACT)</p> <p>$[(x-32)(5/9)] \text{ } ^\circ\text{F} = y \text{ } ^\circ\text{C}$</p>	<p>TEMPERATURE (EXACT)</p> <p>$[(9/5)y + 32] \text{ } ^\circ\text{C} = x \text{ } ^\circ\text{F}$</p>

QUICK INCH - CENTIMETER LENGTH CONVERSION

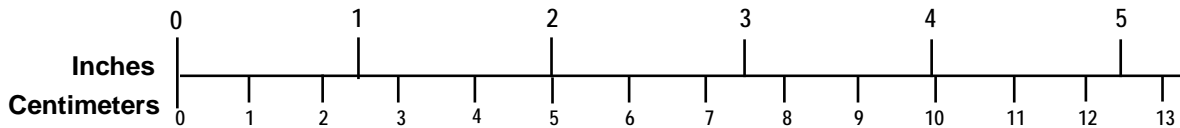

QUICK FAHRENHEIT - CELSIUS TEMPERATURE CONVERSION

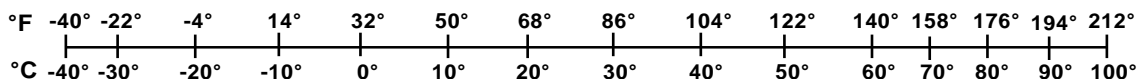

For more exact and or other conversion factors, see NIST Miscellaneous Publication 286, Units of Weights and Measures. Price \$2.50 SD Catalog No. C13 10286

Updated 6/17/98

Contents

Executive Summary	1
1. INTRODUCTION.....	2
1.1 Introduction.....	2
1.2 Description of Technical Challenges	3
1.2.1 Safety	3
1.2.2 Infrastructure and Equipment.....	4
1.2.3 Planning and Operations	6
1.2.4 Economic Challenges.....	7
1.2.5 Institutional Challenges	8
1.3 Research Methodology	9
1.4 Results	10
1.5 Discussions and Conclusions.....	11
1.6 References.....	12
2. EVALUATING AND MITIGATING THE RISK POSED TO HIGHER SPEED PASSENGER TRAINS BY ADJACENT TRACK DERAILMENTS	13
2.1 Introduction.....	13
2.2 Relevant Accidents.....	13
2.3 Example of Shared Rail Corridors With Non-FRA Compliant Vehicles	16
2.4 Adjacent Track Derailment Risk	19
2.4.1 Railroad Accident Models	19
2.4.2 Adjacent Track Derailment Risk Models.....	22
2.5 Risk Mitigation Strategies.....	25
2.5.1 Accident Prevention.....	25
2.5.2 Survivability.....	26
2.6 Discussion and Conclusions	26
2.7 References.....	28
3. HIGHWAY-RAIL GRADE CROSSING SAFETY CHALLENGES FOR SHARED HIGH-SPEED RAIL PASSENGER AND HEAVY AXLE LOAD FREIGHT OPERATIONS IN THE UNITED STATES.....	30
3.1 Introduction.....	30
3.2 Methodology	31
3.3 Regulations, Guidelines, and Standards	31
3.3.1 Consolidation and Closures	31
3.3.2 Sealed Corridors.....	32
3.3.3 Warning/Barrier Systems	32
3.3.4 Train Control Integration	32
3.3.5 Grade Crossing Inspection.....	33
3.4 Crashworthiness of Passenger Train Cars	33
3.5 Grade-Crossing Accident Prediction	34
3.6 Alternative Grade Crossing Warning Strategies	37
3.6.1 Sealed Corridors.....	37
3.6.2 Obstacle Detection	38
3.6.3 Traffic Channelization	39
3.6.4 Low-Cost Level Crossing Warning Devices	40
3.6.5 Emergency Response Management	41

3.6.6. Human Factors and Driver Behavior	42
3.7 Discussion and Conclusions	44
3.8 References.....	48
4. SPECIAL TRACKWORK FOR SHARED HIGH-SPEED RAIL PASSENGER AND HEAVY AXLE LOAD FREIGHT OPERATIONS	52
4.1 Introduction.....	52
4.2 Divergent Design Considerations for HSR and HAL	52
4.3 Flange bearing Technology	53
4.4 Turnout Geometry	56
4.5 Other Innovative Component Designs	60
4.6 Field Instrumentation and Modeling	61
4.7 Discussion and Conclusions	62
4.8 References.....	65
5. BALLASTED TRACK FOR SHARED-USED RAIL CORRIDORS	67
5.1 Introduction.....	67
5.2 Life-Cycle Cost Considerations	68
5.3 Ballast Quality and Modeling	69
5.4 Ballast Flight	72
5.5 Discussion and Conclusions	75
5.6 References.....	76
6. VEHICLE TRACK INTERACTION (VTI) CHARACTERISTICS OF TRACK TRANSITION SECTIONS AND IMPLICATIONS TO SHARED PASSENGER AND FREIGHT RAIL CORRIDOR OPERATIONS	78
6.1 Introduction.....	78
6.2 Track Transition Maintenance Costs.....	79
6.3 Causes of Differential Track Movement.....	79
6.4 Vehicle-Track Interaction (VTI)	80
6.5 Potential Track Transition Solutions	84
6.5.1 Construction of Transition Zones	86
6.5.2 Increase Track Stiffness with Longer Cross-ties.....	86
6.5.3 Hot-Mix Asphalt (HMA) Underlayment	86
6.5.4 Increasing Approach Stiffness at Grade Crossing	87
6.5.5 Approach Slab.....	88
6.5.6 Geotechnical Considerations	88
6.5.7 Rail Seat Pads on Open Deck Bridges and Direct-Fixation Structures.....	89
6.5.8 Reducing Track Stiffness on Ballast Deck Bridges	89
6.6 Discussion and Conclusions	90
6.7 References.....	92
7. CAPACITY AND OPERATING CHALLENGES OF SHARED PASSENGER AND FREIGHT RAIL CORRIDORS	94
7.1 Introduction.....	94
7.2 Capacity Planning.....	94
7.2.1 Modeling	94
7.2.2 Optimization	95
7.3 Scheduling.....	96
7.3.1 Passenger Train Schedules.....	96
7.3.2 Freight Train Schedules	96
7.3.3 Temporal Separation of Traffic Types on Shared Corridors	96
7.4 Train Delay	97

7.4.1 Sources of Delay	97
7.4.2 Delays Due to Heterogeneity	102
7.4.3 Delay Mitigation	103
7.5 Maintenance Planning	109
7.5.1 Integrated Maintenance and Rail Traffic Scheduling	109
7.5.2 Strategic Maintenance Scheduling.....	110
7.5.3 Tactical Maintenance Scheduling	111
7.6 Discussion and Conclusions	112
7.7 References.....	114
8. SUMMARY OF IDENTIFIED RESEARCH NEEDS RELATED TO SHARED HIGH-SPEED RAIL PASSENGER AND FREIGHT TRAIN OPERATIONS.....	117
Appendix A: Prioritized List of Challenges based on Survey Results (sorted by category)	118
Appendix B: Prioritized List of Challenges based on Survey Results (sorted by descending rank).....	120
Abbreviations and Acronyms	121

Illustrations

Figure 1.1	Distribution of participant affiliations.....	9
Figure 2.1	Shared corridor in Denver.	16
Figure 2.2	Cleveland light rail sharing ROW with Norfolk Southern.....	17
Figure 2.3	CTA and CN trains sharing a corridor with 13 ft track center distance.....	18
Figure 2.4	Proposed Caltrain non-FRA compliant EMU equipment.	18
Figure 2.5	Relationship between accident speed and average number of cars derailed in mainline freight derailments with at least one hazardous materials car derailed (Barkan et al. 2003).....	21
Figure 2.6	Frequency and severity graph of Class I mainline freight-train derailments, 2001-2010 (Liu et al. 2012).	22
Figure 2.7	Lateral dispersion of accidents by dataset (English et al. 2007).	23
Figure 2.8	Lateral dispersion probability and speed (English et al. 2007).	24
Figure 2.9	Percent of accidents exceeding a lateral distance as a function of speed (English et al. 2007).....	24
Figure 2.10	Derailed railcar lateral displacement due to embankment.	25
Figure 2.11	Separation by earth berm and ditch.....	26
Figure 3.1	An upgraded crossing in Charlotte, NC (Bien-Aime 2009).....	38
Figure 3.2	Four-quadrant gate configuration for a double-track segment (Hellman and Ngamdung 2009).	39
Figure 3.3	Traffic channelization device in North Carolina (FRA 2010).....	40
Figure 3.4	Highway-rail grade crossing accident contributors (Caird et al. 2002).....	42
Figure 4.1	Example of full flange bearing frog diamond (Clark et al. 2008).....	54
Figure 4.2	Example of one-way low speed partial flange bearing (Clark et al. 2008).	55
Figure 4.3	Maximum vertical wheel force versus train speed for lift frog (Davis et al. 2009). .	56
Figure 4.4	Concept of optimum lateral force for turnout design (Prasad 2011).....	57
Figure 4.5	Comparison of switch geometries (Ossberger and Bishop 2010).	59
Figure 4.6	Gauge-widening switch structure (Wang et al. 2009).	60
Figure 4.7	Hydraulically linked distributed system (Abbot et al. 2010).....	61
Figure 5.1	Schematic representation of the savings in ballast material due to the use of a lower lateral slope for the bituminous sub-ballast solution (Teixeira 2008).....	68
Figure 5.2	The life-cycle assessment inventory stages (Kiani et al. 2007).....	69
Figure 5.3	Life-cycle energy consumption analysis of track beds (Kiani et al. 2007).	69
Figure 5.4	Simple (top) and discrete (bottom) FEM models (Kuo and Hang 2009).	71
Figure 5.5	Pressure coefficient vs. normalized time (Quinn 2008).	73
Figure 5.6	Plot of the normalized wind velocity and normalized pressure values vs. the position of the train wheels over time (Lazaro 2011).....	74
Figure 5.7	Turbulence (circled) is noted right before the arrival of the train (Powrie 2011).	74
Figure 6.1	Vehicle element model with 26 degrees of freedom (Lei and Zhang 2010).	82
Figure 6.2	Methodology for simulation of wheel-rail contact and damage in S&C: (a) simulation of dynamic contact force; (b) calculation of contact stress and contact patch size; (c) simulation of plastic deformation and wear; (d) Summation and smoothing of total profile change (Nicklisch et al. 2009).	83
Figure 6.3	Mesh geometry of numerical model (Smith et al. 2006).....	84
Figure 6.4	Example of HMA bridge approach design (Kerr and Moroney 1993).....	85

Figure 6.5	Transition design implemented at Bates Mill Road crossing (Zarembski and Palese 2005).....	87
Figure 6.6	Slab track transition at TTC (Li and Read 2006).....	89
Figure 6.7	Comparison of track modulus values of different ballast deck bridge tie types (Sasaoka et al. 2005).....	90
Figure 7.1	Example delay-volume curve (number of trains on the x-axis).....	97
Figure 7.2	Average delay versus the ratio of bulk to intermodal trains by (a) conflict and (b) source.....	99
Figure 7.3	Transportation Department Delays (Martland et al. 1994).....	100
Figure 7.4	Causes of delays to trains, 1999–2000 (based on minutes of train delay compared with timetabled journey time).....	101
Figure 7.5	Analysis of delay minute, 2006-2007 (FOC = freight operated company) (Source: Network Rail).....	101
Figure 7.6	Commuter rail delays (Nelson and O’Neil 2000).....	102
Figure 7.7	Freight train delays when adding freight (left) and 110 mph passenger trains (right) to a base case of 24 freight trains per day (Sogin et al. 2011).....	103
Figure 7.8	Impact of slack on system response (Petersen and Taylor 1987).....	107
Figure 7.9	NPV when additional sidings are added to a single-track line (Dingler et al. 2011).....	106
Figure 7.10	NPV when a 2 nd mainline track is added to a single-track line (Dingler et al. 2011).....	106
Figure 7.11	Best allocation of maintenance activities to time window (Higgins 1998).....	112

Tables

Table 1.1	Types of Mixed-Use Rail Corridors	2
Table 2.1	Estimated Accident Rate by FRA Track Class (Anderson and Barkan 2004)	20
Table 2.2	Sensitivity Analysis of the Effect of Train Length on Accident Rate (Schafer and Barkan 2008)	20
Table 3.1	Track Class and Related Maximum Speed	31
Table 3.2	Summary of Federal Regulation Related to Grade-crossing Protection and Closure.....	32
Table 3.3	FRA Grade Crossing Signal System Safety Regulations (Hellman and Ngamdung 2010)	41
Table 3.4	Caird et al. (2002) Summary of Effectiveness and Cost of Countermeasures	43
Table 5.1	Typical Axle Loads (Not Including Locomotives) in Tons.....	67
Table 7.1	Categories of Delays	98
Table 7.2	Hypothetical Annual Payment for “Good” vs. “Poor” Performance (Corridor Traffic, Penn Central Railroad) Baumol 1975)	108

Executive Summary

The development of both incremental and dedicated high-speed rail lines in the United States poses a number of questions. Despite nearly 50 years of international experience in planning, designing, building, and operating high-speed passenger infrastructure and rolling stock, there remains a range of problems partially or completely unique to North America. Successful development of expanded higher speed and new very high-speed rail will require careful analysis and, in many cases, research to develop satisfactory solutions to the many challenges faced. These challenges involve a range of engineering, operational, economic, and institutional factors. The following report (1) discusses the technical challenges associated with shared high-speed passenger and freight rail corridors, (2) describes an effort to prioritize the challenges, and (3) presents an in-depth literature review of specific high-priority challenges to identify existing research and future research needs.

This work was undertaken by the Rail Transportation and Engineering Center (RailTEC) in the Department of Civil and Environmental Engineering at the University of Illinois at Urbana-Champaign (Illinois) and sponsored by the Federal Railroad Administration (FRA) under the Broad Agency Announcement (BAA) Program: Research and Demonstration Projects Supporting the Development of High-Speed and Intercity Passenger Rail Service. The research was led by Rapik Saat, PhD, supported by RailTEC's Director, Professor Christopher Barkan, PhD, and other RailTEC faculty and staff, and involved two graduate research assistants, Brennan Caughron and Sam Sogin, as well as the students enrolled in CEE 598SRC – Shared Rail Corridor in the Spring semester of 2012 at the university. Below is a list of the report's key sections, along with the names of the students who assisted in preparing the initial drafts.

Section 1: Introduction—*Brennan Caughron*

Section 2: Evaluating and Mitigating the Risk Posed to Higher Speed Passenger Trains by Adjacent Track Derailments—*Brennan Caughron and Samuel Sogin*

Section 3: Highway-Rail Grade Crossing Safety Challenges for Shared High-Speed Rail Passenger and Heavy Axle Load Freight Operations in the United States—*Samantha Chadwick and Nanyan Zhou*

Section 4: Special Trackwork for Shared High-Speed Rail Passenger and Heavy Axle Load Freight Operations—*Ryan Kernes and Chris Rapp*

Section 5: Ballasted Track for Shared-Use Rail Corridors—*Francesco Bedini and Tanvi Damani*

Section 6: Vehicle Track Interaction (VTI) Characteristics of Track Transition Sections and Implications to Shared Passenger and Freight Rail Corridor Operations—*Riley Edwards and Zhe Chen*

Section 7: Capacity and Operating Challenges of Shared Passenger and Freight Rail Corridors—*Samuel Sogin, Brennan Caughron, Greg Munden, and Craig Jakobsen*

1. INTRODUCTION

1.1 Introduction

The U.S. Department of Transportation (U.S. DOT) is supporting the development of substantially expanded and improved passenger rail service on a number of intercity corridors connecting communities across the country. These corridor development projects will range from incremental improvement of existing trackage to new, dedicated high-speed rail (HSR) lines. There will be a corresponding range—from extensive sharing of track to partially parallel—in the extent and nature of sharing corridor usage with existing freight and passenger rail lines. Although such mixed-use corridor development and operation is not new, numerous changes in U.S. freight railroad infrastructure, rolling stock, and operating practices have resulted in a variety of new questions about how to safely and effectively accommodate new passenger service while sustaining ongoing rail freight transportation efficiency and growth. Furthermore, regulatory requirements continue to evolve to ensure both the safety and efficiency of freight and passenger rail development.

The U.S. DOT Federal Railroad Administration (FRA) defines three types of mixed-use corridor: shared trackage, shared right-of-way (ROW), and shared corridor (Table 1.1) (Federal Railway Administration, 2003). Each of these has a different, although in some cases related, set of issues that needs to be resolved. The objective of this research is to develop a technology or strategic plan for HSR mixed-use corridors in the United States by doing the following:

1. Identifying and describing shared rail corridor technical challenges
2. Analyzing and prioritizing their importance
3. Identifying previous and ongoing research related to the major technical challenges
4. Identifying knowledge gaps and research needs for the major technical challenges

Table 1.1. Types of Mixed-Use Rail Corridors

Type of Operation	Dedicated Tracks for Different Traffic Types	Concurrent Operation of Freight and Passenger Traffic	Track Center Spacing (ft)
Shared track	No	Varies	n/a
Shared right of way (ROW)	Yes	Yes	< 25 ft
Shared corridor	Yes	Yes	25–200 ft

The nature of the mixed-use corridor issues that need to be addressed varies; it includes, but is not limited to, the following categories:

- *Safety* – operational practices, safety technologies, infrastructure, and rolling stock designs that support very low operational risk of passenger and freight trains on the same corridors
- *Infrastructure and Rolling Stock* – safe, reliable, and effective design of trackage and equipment, and their maintenance

- *Planning and Operations* – capacity and service quality impacts, upgrades to track, train control, and scheduling
- *Economic* – equitable approaches to sharing capital and operating costs for construction and maintenance, maximizing passenger operation profitability without interfering with current and future capacity and quality of freight services
- *Institutional* – regulatory compliance and possible changes, incentive compensation and penalties, liability and accommodation for growth in either passenger or freight

This section reviews the technical issues presented in the safety, infrastructure and rolling stock, planning and operational challenge categories, and identifies the high-priority challenges to be addressed in the remaining sections of this report.

1.2 Description of Technical Challenges

The technical challenges presented here were identified as potential key issues through a preliminary high-level literature review and through discussion and interviews with representatives from both the passenger and freight sides of the industry.

1.2.1 Safety

Loss of shunt problems

Reducing the weight of passenger rail equipment offers a number of benefits, including greater energy efficiency and improved train performance. There is some concern and anecdotal evidence of short, light passenger consists exhibiting shunt reliability problems, particularly with grade crossing circuits. This problem may be related to the buildup of corrosion on wheel treads that would interfere with reliable electrical contact. The relationship between wheel load and wheel tread condition could be investigated as it relates to track circuit shunt reliability.

Barriers

Barriers have several applications to shared corridors. Barriers may be useful to prevent the intrusion of foreign vehicles onto the railway ROW. In areas of high security risk, barriers should be designed to withstand large trucks or other vehicles that would pose a significant risk to train operations. Barriers may also be useful in mitigating the effects of a derailment. By separating tracks with barriers, the paths of derailed equipment may be channeled or controlled in a way that prevents impact with adjacent rail operations.

Highway grade crossings

Implementing higher speed passenger service on existing freight corridors may increase the risk to rail traffic as well as automotive traffic at highway grade crossings. The cost effectiveness of enhanced grade crossing equipment such as median barriers and four quadrant gates should be weighed against the ultimate but often cost prohibitive solution of grade separation.

Pedestrian risk

Trespasser-train accidents may occur with higher frequency on mixed-use corridors because of the inherently higher speed of passenger trains. Fencing off an entire ROW might serve to mitigate some of this risk, but would not guarantee against intrusion. Additional signage, selective use of landscaping features, and dedicated pedestrian paths may help channel potential

trespassers away from tracks. Radar, infrared, and video motion systems also may help detect trespassers on the railroad ROW.

Adjacent track derailments

The consequences of a collision between a passenger train and derailed equipment are greater at higher passenger train speeds. In all three operating scenarios of mixed-use corridors (Table 1.1), there remains a risk of equipment derailing and interfering with passenger rail traffic. A comprehensive analysis of derailment probability could be carried out to understand the effect of track center spacing, equipment standards, and train speeds in mitigating this risk.

Wayside defect detection

For many years, the use of wayside defect detectors has helped reduce the frequency of derailments caused by mechanical component failures. To further mitigate this risk in a mixed-use environment, an intensified deployment of wayside defect detectors could be investigated.

Risk to maintenance of way and train operating employees

Representatives from several freight railroads have expressed concern about the increased risk to railroad personnel working on and around an HSR mixed-use corridor. Faster passenger operations would make it difficult for workers to visually detect and clear out of the way of a train in a timely manner. The additional risk to these personnel could be studied, especially in areas in the United States where high-speed shared track configurations already exist. Track center spacing and train warning technologies could be investigated as possible methods for mitigating this risk.

1.2.2 Infrastructure and Equipment

Slab track

Slab tracks are not widely used on freight lines because the geometry is not adjustable, and the track superstructure is less resilient in the event of a derailment. In addition, the first cost of slab track systems is generally higher than ballasted track. However, in a shared corridor environment where capacity is constrained, slab track may offer the benefit of extra capacity due to lower track occupancy for maintenance purposes. The tradeoff between ballasted and slab track could be investigated for different traffic scenario. In addition, a slab track designed to accommodate both Heavy Axle Load (HAL) and HSR traffic could be developed.

Ballasted track

On a ballasted track system, the track superstructure must be optimized for the combination of freight and passenger traffic. Ties, fastening systems, and ballast must be selected by taking into account the loading characteristics of both train types. On ballasted track with higher track classes, track-surfacing activities may be more frequent to maintain track geometry. Engineering a ballasted track that performs well for HAL and HSR traffic is one potential research area.

Special trackwork

Turnouts with higher diverging speeds may be utilized in order to minimize train delay when entering shared track or when passing from one main track to another. Innovations in turnout geometry and components must be made to accommodate heavy axle as well as high-speed wheel loads. In addition, optimizing the diverging route configuration of mainline turnouts may

better accommodate certain traffic patterns. Rail crossings with asymmetrical traffic may also benefit from premium frog designs with uninterrupted running rails for the predominant route.

Curve superelevation

Curve superelevation is typically set for the predominant traffic speed on a rail line. On freight lines, curves are typically elevated for the balancing speed or slight unbalance of a freight train. Conventional passenger trains may operate at a higher unbalance than freight traffic, but on especially sinuous lines this may lead to numerous speed restrictions that would negatively impact the average speed of a passenger train. With heavy-axle freight operation, changing curve elevation to accommodate passenger trains could potentially impact rail life and increase risk of low rail rollover on curves.

Track stiffness transition zones

Highway grade crossings, bridges, tunnels, and areas featuring special trackwork are locations where the vertical stiffness of the track structure typically increases compared with conventional ballasted track. These stiffness transition zones may be problematic when considering track vehicle interaction and track component lifespan. Engineering transition zones to perform well for both HAL and HSR traffic could be one area of future research.

Track surfacing cycles

Increasing the service speed of passenger traffic requires the track geometry to conform to a higher class of Federal standards. An increase in track class requires tighter geometric tolerances for alignment, cross-level, warp, and gauge, among other criteria. Because geometry degradation is typically driven by the amount of cumulative tonnage over a line, higher track classes will likely require more frequent surfacing operations to maintain track geometry. Any technologies that would reduce the amount of time needed to occupy the track for surfacing could be investigated for application on shared corridors.

Rail wear and defect rate

By increasing superelevation on curves, a railway line can accommodate higher speed traffic for the same degree of curve. Freight traffic traveling at speeds below the balancing speed of the curve will impart higher loads on low curve rails. Increased rail stress can lead to an increased rate of rail defect formation. Rail corrugation and other short wave irregularities can increase dynamic loads on the track structure. In particular, weld geometry can have an impact on higher speed dynamic loads. At higher speeds, these types of defects may have a detrimental effect on passenger ride quality. The impact of weld geometry could be investigated as it relates to ride quality and dynamic track loads.

Wheel and rail profiles

Wheel and rail profiles are typically optimized for a specific traffic type on dedicated freight and passenger lines. Given the different wheel profiles used by freight and passenger rolling stock, there may be need for an optimal rail grinding profile that minimizes rail wear and the rate of rail defect occurrence. In addition, changes to wheel profiles could be made to maximize the lifespan of wheel sets in a shared track-operating environment. An optimization process combined with physical testing could be pursued to develop an ideal wheel rail interaction strategy for shared track operations.

Electrification

North American clearance profiles are dimensionally larger than many others from shared corridors around the world. Electrification of existing freight lines to introduce higher speed passenger trains may be technically possible but would require extensive clearance modifications to existing bridges and tunnels. Additional clearance around messenger wires would likely also be necessary. In electrified territory, track geometry is subject to the additional constraint of contact wire position. The position of a contact wire raised for double stack clearance may dictate new pantograph designs and a general optimization of the current collection system in shared corridor environments.

Tilting equipment

On rail lines where curves restrict the speed of passenger trains, tilting equipment may be used to increase speeds without increasing curve elevation. Active or passive tilting equipment may be used to operate passenger trains at higher, unbalanced elevations. In spite of the enhanced passenger comfort, utilizing tilting equipment does not mitigate the increased rail stresses by operating equipment at higher unbalance speeds through curves. Overall, increases in passenger train speeds may increase stresses on the high rails of curves. Different levels of curve unbalance could be investigated in terms of vehicle dynamics and relation to rail wear.

Level boarding of rolling stock

Station and equipment configurations that allow level boarding are inherently more time efficient than standard low-level boarding equipment. This feature allows for shorter dwell time at stations, thereby improving overall average speed of a schedule and allowing for increased line capacity. High-level platforms are generally not utilized on existing freight lines due to clearance conflicts with freight equipment. Retractable platforms, gauntlet tracks, or rolling stock with retractable walkways are possible methods to allow for level boarding on existing freight lines.

1.2.3 Planning and Operations

Infrastructure upgrade prioritization

In many recent proposals for improved passenger rail service, emphasis has been placed on achieving a higher maximum operating speed rather than higher average speeds. Improvements to lower speed terminal areas, among others, can often yield a greater marginal trip time reduction than an increase in maximum operating speed. Developing a model that prioritizes infrastructure upgrades could help enhance the efficiency of proposed passenger rail projects.

Rail capacity planning

Rail capacity is a function of the level of service expected for all different train types operating on a line. Planning for increases in rail traffic should take into account present, as well as future desired levels of service. Present methods of determining adequate rail capacity include parametric and simulation modeling. More research could be undertaken to more accurately quantify the impact of adding higher speed passenger traffic on existing freight lines. The effects of train performance, speed, and priority could be analyzed with the goal of determining the equivalent capacity consumption for different types of rail traffic.

Maintenance of way scheduling

With the addition of passenger service on a shared track line, the time required for infrastructure maintenance is further constrained. On lines with especially high density and little excess capacity, maintenance activities may take place during night hours when passenger traffic does not typically operate. For areas where this technique is not economical, new maintenance window scheduling strategies could be developed to minimize delay to both passenger and freight traffic while at the same time preserving maintenance productivity.

Train scheduling patterns

Different scheduling scenarios can have a tremendous impact on both the ridership and capital costs of a proposed service. Regional intercity passenger trains typically operate during the day, disproportionately adding more demand for infrastructure during certain time periods. Accommodating this traffic may require extra infrastructure that would otherwise not be needed if the service were scheduled more uniformly throughout the day. Different scheduling patterns could be assessed for their efficiency in utilizing new infrastructure, as well as their impact on delay for both freight and passenger traffic. In addition, grouping train types with more similar performance characteristics—for an example, intermodal and passenger trains—may hold some opportunity for reducing delay. The impact of speed and priority differentials between train types could be investigated as they relate to traffic levels and infrastructure characteristics.

Train schedule reliability

Many contemporary intercity passenger rail services use a fixed percentage of minimum run time applied as slack time to the end terminal to help enhance reliability of train services. Slack time is not typically adjusted for expected rail traffic or even infrastructure characteristics. In addition, distributing slack time to different points in the schedule-based delay statistics could help make for a more robust schedule. Investigating these different methods and developing a model that could be applied to existing and future service would serve to increase the reliability of passenger services.

1.2.4 Economic Challenges

Capacity cost allocation

Some freight railroads are concerned with scenarios where, by accepting passenger rail traffic onto their lines, they forfeit lower cost capacity upgrades and relegate themselves to investing in more expensive capacity upgrades in the future as freight traffic increases. An example of this would be adding a second main track on two sides of a single track tunnel for passenger service, but then adding a second tunnel years later to accommodate additional freight traffic. New frameworks for more equitable allocation of the cost of these capacity upgrades could be developed.

New shared line construction

In some cases around the world, new high-speed lines that otherwise would be dedicated to passenger traffic are being built to accommodate temporally separated freight traffic. The economics of this arrangement could be studied in the context of North America with the end result being a model that considers revenue from passenger and freight operations, capital and maintenance costs, operating concession periods, and operating costs of both freight and passenger services.

Homogenous freight operations

To reduce heterogeneous traffic delay on shared track lines, freight operators could run shorter, higher performance, and more frequent freight trains. However, doing this would be less efficient and would result in increased operating costs for the freight company. In this scenario, the passenger service operator would pay the difference in operating costs to the freight company to allow for more homogenous but inefficient freight trains with passenger traffic during the day while allowing longer, more efficiently powered trains to operate at night. The economics of this type of arrangement could be studied on lines where there is sufficient capacity.

Impact of reduced industry access

Some shared ROW or shared corridor high-speed rail systems would construct new dedicated high-speed service tracks adjacent to existing freight rail lines. Freight railroad representatives have expressed concerns that these types of proposals would isolate half of their available area on either side of the existing lines that could be used for future rail freight traffic development.

1.2.5 Institutional Challenges

Track safety standards

Current FRA track safety standards do not exist for lines where traffic exceeds 200 miles per hour (mph). Although there are no examples of this type of operation in the United States, some proposed HSR services have envisioned speeds as high as 220 mph. Because shared corridors and even shared tracks are likely to be utilized for portions of high-speed routes, the stretches of dedicated new high-speed lines would likely be subject to FRA regulation. The current framework of FRA track safety standards could be expanded to accommodate the higher speeds being proposed by some services.

Passenger equipment safety standards

FRA currently has two categories for passenger car safety standards: Tier I equipment can operate up to 125 mph, while Tier II equipment can operate up to 150 mph. There is currently no provision for equipment with maximum speeds in excess of 150 mph. The maximum speed of trains in many other countries is in excess of 186 mph. Tier III standards under development may allow for passenger trains up to 220 mph on dedicated lines and speeds of up to 125 mph in mixed traffic environments.

Liability and indemnification

When implementing new passenger services onto existing freight lines, the freight company will typically require indemnification from any liability in the new passenger service. In some cases, States have enacted laws that grant the freight carrier the same liability immunity as a State DOT.

Grant agreement structure

Recent government grants aimed at improving passenger rail service have required an agreement with the passenger service provider, freight infrastructure company, and FRA. There has been concern from freight railroads that these types of grant agreements will, in the future, require performance guarantees that would hold the freight railroad liable for further upgrades to meet the performance goals outlined for the new passenger service. If this were the case, the freight

companies would likely not be amenable to allowing new passenger traffic on their networks. New grant frameworks could be developed to ensure that proposed rail passenger services will meet their performance goals in a manner that is agreeable to the freight railroads. Possible solutions might include more lucrative performance incentives for passenger trains that are given proper priority over freight trains and that arrive on time to key stations.

Track usage charges

When designing a new shared track rail corridor, a proper usage fee structure must be developed for both freight and passenger traffic. When operating on freight railroads, Amtrak pays only a fraction of the marginal costs of maintaining the rail infrastructure to passenger train speeds. Compensating freight railroad companies for the full cost of maintaining their infrastructure for passenger traffic may better allow the freight companies to make investments that would improve the quality of service for passenger traffic.

1.3 Research Methodology

There were two main activities undertaken under this project to identify and prioritize shared passenger and freight rail corridor technical challenges. On November 10–11, 2011, a research symposium was held at the University of Illinois involving over 14 industry representatives from the National Railroad Passenger Corporation (Amtrak), the Class I freight railroad CSX, FRA, Illinois Department of Transportation (IDOT), the University of Illinois at Urbana Champaign (UIUC), and the Swedish Royal Institute of Technology (KTH). The symposium facilitated the sharing of research challenges and objectives between industry and government representatives. Academics from KTH also interested in mixed-use corridor technical challenges were able to learn more about developing solutions that would allow for more efficient freight trains on the European rail network. Discussion over the course of the 2-day symposium served as a framework for further discussion with industry experts.

In addition to the symposium, the University of Illinois Rail Transportation and Engineering Center (RailTEC) conducted an industry survey between September 21, 2011, and January 31, 2012. The main objective of the survey was to determine which mixed-use corridor challenges to pursue for in-depth literature reviews. Participation in the survey was solicited from RailTEC’s railway industry contacts via email and at conference events such as the 2011 AREMA Conference and Exposition in Minneapolis, MN. At the end of the survey, there were 24 total participants from the industry sectors illustrated in Figure 1.1.

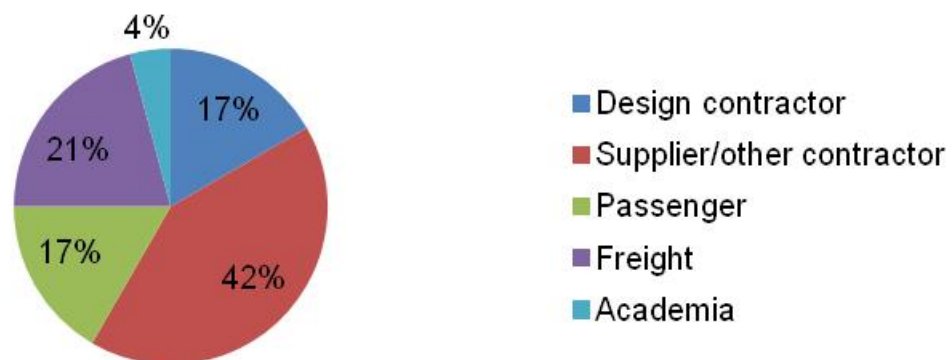

Figure 1.1. Distribution of participant affiliations

Survey participants were permitted to respond to whichever technical challenge categories they felt sufficiently qualified. For each challenge, participants were asked to rate several criteria on a scale of one to five, with one reflecting high importance or potential for improvement and five being the lowest importance or potential for improvement. The following criteria were included in the survey:

- Potential to increase safety
- Potential to increase corridor effectiveness
- Potential to reduce costs
- Research priority
- Overall importance

The overall importance category was included so that participants could boost the rating of a challenge that was not adequately rated by the other criteria. Some criteria were omitted from certain categories as they were deemed irrelevant to some challenges. For example, the potential to increase safety criteria was omitted from the economic challenge category. Final challenge scores were computed by summing the weighted averages of the criteria scores for each challenge. In the final results, a weight factor of 0.5 (twice as important) was selected for the overall importance criteria. In this ranking system, a lower number corresponds with a higher ranked challenge. The challenge list was eventually sorted by increasing scores; it served as a guide for selecting the prioritized list of technical challenges.

In addition to rankings from the survey, each challenge was assessed for its relevance to each of the mixed-use corridor operating scenarios. In discussions with industry participants, it was pointed out that some categories are more relevant to specific mixed-use corridor operating scenarios. For each challenge, the operating configuration relevance was rated as very relevant (high), somewhat relevant (medium), or irrelevant (low). For example, maintenance of way window planning is very relevant to shared track HSR, slightly relevant to shared ROW HSR, and irrelevant to shared corridor HSR.

1.4 Results

After closing the survey, the weighted scores from various participants were used to calculate an average score for each challenge. The top priority challenges were selected primarily from the survey results (Appendices A and B). In each category, challenges with lower scores indicated greater importance. The RailTEC team then used its own domain knowledge as well as information gathered from interviews with industry experts to identify the following top challenges for further analysis in the next phase of the project:

- Adjacent track derailments
- Highway grade crossings
- Special track work
- Optimized ballasted track
- Track stiffness transitions

- Operating challenges and maintenance window scheduling
- Capacity planning methodologies

1.5 Discussions and Conclusions

In summary, top technical challenges requiring further research were identified through a research symposium, industry interviews, and an industry survey. In the safety category, assessing the risk of adjacent track derailments and understanding highway grade crossing risk mitigation were identified as top challenges. In infrastructure, special track work, ballasted track, and track transition optimization were identified as top challenges. In planning and operations, train scheduling, maintenance window scheduling, and capacity planning methodology were identified as top challenges.

The next step of the project was to conduct an extensive literature review for the identified top, high-priority challenges. In this review process, the relevance of the challenges to different types of mixed-use corridors was assessed. In addition, existing research, knowledge gaps, and future research needs in each of the top challenges were identified. The following sections present the literature review of the identified high-priority technical challenges.

1.6 References

Federal Railway Administration. (2003). *Catalog of "Common Use" Rail Corridors*. U.S. Department of Transportation, Washington, DC.

2. EVALUATING AND MITIGATING THE RISK POSED TO HIGHER SPEED PASSENGER TRAINS BY ADJACENT TRACK DERAILMENTS

2.1 Introduction

There are limited options for developing new transportation corridors in many areas of the United States. Environmental and political opposition to new corridors can potentially erode support for projects and cause them to be cancelled. New transit, intercity, and commuter rail projects are looking to construct infrastructure within existing freight rail corridors to reduce costs and environmental impact. Conventional passenger and freight trains have a long history of sharing tracks. Meanwhile, the design of passenger equipment has evolved over time to minimize the risk of injuries and fatalities in a collision with a heavy freight train. Urban rail transit lines have long used non-FRA compliant vehicles. These vehicles do not adhere to the same FRA passenger equipment safety standards that may affect their performance in a collision with a heavy freight consist. These transit lines are mostly built as separate systems without any shared infrastructure with freight trains. However, there are many instances in which a transit line shares a ROW or corridor with a freight line. As with transit, high-speed rail may use non-FRA-compliant vehicles and still share a ROW or corridor with a freight route.

With shared light rail and high-speed corridors, passengers are being exposed to risks inherent in freight railroading. There is a higher likelihood of people being near dangerous goods and being in the wreckage area of a derailed train. In the event of an accident, freight railroads insist on being protected from the liability added by passenger trains on the corridor. Current recommended practice is to have 25 feet (ft) between dedicated freight and passenger tracks (FRA, 2009). There are numerous examples in the United States where a freight railroad has sold a portion of its ROW, with track center spacing less than 25 ft, to a transit agency. Intercity passenger trains travel much faster than a typical urban transit train and have a significantly longer stopping distance. Consequently, freight railroads have adopted a more cautious attitude towards trains traveling faster than 90 mph within close proximity of freight tracks (Doss and Caruso, 2011). While having track centers less than 25 ft may have been acceptable for past transit lines, operating high-speed trains on adjacent tracks may be unacceptable. There may not be enough time for a high-speed passenger train to slow to a stop in the event of a fouled track. To mitigate the risk of these types of accidents, strategies to address both the frequency and severity of accidents should be investigated. Track and rolling stock standards, effective inspection strategies, and signaling systems that enforce stop indications and prevent over-speed conditions can help reduce the likelihood of an adjacent track derailment. In addition, rolling stock safety standards, intrusion detection systems, track spacing, and crash walls can reduce the severity of any incident that may occur.

2.2 Relevant Accidents

This section provides a summary of some adjacent track derailments. National Transportation Safety Board (NTSB) recommendations and accident reports were the primary sources used to identify and describe these incidents. In recent years, there have been a number of incidents that could be classified as adjacent track derailments. It is a derailment of rail vehicles fouling one or more adjacent tracks and potentially threatening the safe operation of rail traffic on those tracks. Three of the adjacent track derailments outlined here involved three trains on multiple main track territory and were the direct result of rear-end collisions involving trains on the same track. The

implementation of a PTC system that enforces stop signals could reduce the likelihood of this type of adjacent track derailment.

1981 – Crewe, VA

On November 28, 1981, a Norfolk and Western freight train, after receiving a clear signal, passed through a misaligned crossover leading into a yard track, sideswiping loaded coal cars, and then striking another freight train on an adjacent main track. Two locomotives and seven cars of the first train were derailed; thirteen cars in the yard were derailed, and nine cars of the train on the adjacent mainline track were derailed. Two crew members received minor injuries (National Transportation Safety Board, 1982).

1987 – Washington, DC

On June 19, 1987, 21 cars of a 135-car, eastbound CSX freight train derailed near the Takoma Park Station and fouled the tracks of the Washington Metropolitan Area Transit Authority (WMATA). An automatic warning of the intrusion was detected after the derailed cars broke through the intrusion detection warning (IDW) chain link fence separating the adjacent freight and metro tracks. This warning was received by the Metro operation control center. On September 5, 1987, 12 cars of a 90-car, eastbound CSX freight train derailed near the Fort Totten Station and fouled the tracks of the WMATA. Two WMATA trains were stopped short of the wreckage by damage to track circuits and an IDW alarm triggered by the severed chain link fence. On September 17, 1987, a CSX freight train struck a piece of heavy construction equipment and deposited debris on adjacent WMATA tracks. The IDW fence was severed, triggering an alarm to the operational control center. In all of these incidents, the NTSB expressed concern about the delay introduced by having the IDW system send an alarm to the control center rather than linking directly to the signal system. By reducing this transmission delay, the probability of a non-FRA compliant metro train striking debris from a freight derailment would be decreased (National Transportation Safety Board, 1987).

1991 – Lugoff, SC

On July 31, 1991, a National Railroad Passenger Corporation (Amtrak) train derailed at milepost S329.6. The derailed passenger cars struck nine hopper cars on an adjacent industry siding. Twelve crewmembers and 53 passengers sustained minor injuries. Twelve passengers suffered serious injuries. Eight passengers were fatally wounded (National Transportation Safety Board, 1993).

1994 – Thedford, NE

On June 8, 1994, an eastbound train passed a restricting-proceed signal near Thedford, NE, and struck a second eastbound train on the same track. The lead locomotive of the striking train derailed and fouled an adjacent track where it was struck by a passing westbound freight train. Two crew members of the striking train were killed and two crew members of the westbound train sustained injuries (National Transportation Safety Board, 1995).

1999 – Bryan, OH

On January 17, 1999, a westbound Consolidated Rail Corporation (Conrail) freight train struck the rear of a preceding westbound train near Bryan, OH. Three locomotives and the first thirteen cars of the striking westbound train derailed. The rear three cars of the struck train also derailed.

The derailed equipment fouled an adjacent main track and was struck by an eastbound train, derailing 16 cars on that train. Two crew members on the striking westbound train were killed (National Transportation Safety Board, 2001).

1999 – Bourbonnais, IL

On March 15, 1999, a southbound National Railroad Passenger Corporation (Amtrak) train struck a loaded semitrailer at a highway grade crossing in Bourbonnais, IL. Two locomotives and 11 of 14 passenger cars were derailed. The derailed equipment collided with two freight cars on an adjacent siding. Eleven people were killed and 122 were injured (National Transportation Safety Board, 2002).

2001 – Pacific, MO

On December 13, 2001, an eastbound train struck the rear of a second stopped eastbound train near Pacific, MO. The rear distributed power unit (DPU) and six cars of the first train fouled an adjacent main line track and were struck by a westbound train. The striking eastbound train derailed 2 lead locomotives and 54 cars. The westbound train derailed three locomotives and five cars. Nine stationary cars on an adjacent siding were also derailed. Four crew members were injured in the incident (National Transportation Safety Board, 2001).

2007 – Littleton, CO

On December 11, 2007, on a curved section of track near Littleton, CO, a string of 25 coal cars derailed from a 106-car Union Pacific (UP) train. The track in this location is owned and maintained by BNSF Railway. The derailed cars spilled coal and wreckage onto the adjacent tracks of a Denver Regional Transit District (RTD) light rail line. The operator of the next RTD train saw the derailment and applied the emergency brake. The light rail train collided into the wreckage at reduced speed and derailed. The train remained upright with no injuries or fatalities.

A separate category of derailment incidents is somewhat related to adjacent track derailments. There have been a number of incidents wherein derailed equipment left the railroad ROW and struck adjacent structures. The risk of this type of scenario might be analyzed and compared with the risk of an adjacent track derailment involving a freight and high-speed passenger train.

1989 – San Bernardino, CA

On May 12, 1989, a Southern Pacific freight train of four leading locomotives and 69 loaded hopper cars derailed at milepost 486.8 in San Bernardino, CA. Seven homes in the area of the derailment were completely destroyed and four were extensively damaged. Two crew members in the front of the train were killed and one received serious injuries. Two crew members in the rear of the train received minor injuries. Two residents in the affected homes were killed and one was seriously injured (National Transportation Safety Board 1990).

1991 – Palatka, FL

On December 17, 1991, a National Railroad Passenger Corporation (Amtrak) train derailed at milepost A697.6 and struck two homes adjacent to the track. Eleven passengers sustained serious injuries and forty-one received minor injuries. Five operating crew members and four on-board service personnel received minor injuries (National Transportation Safety Board 1993).

2003 – Commerce, CA

On June 20, 2003, a string of 31 freight cars were cut off from a train on a siding in Montclair, CA. The air brakes on the cars had been released in preparation for switching moves, causing the cars to roll. The runaway cars proceeded for 28 miles, reaching a calculated maximum speed of greater than 95 mph before derailling in Commerce, CA. Some derailed cars struck nearby residences. Thirteen people sustained minor injuries (National Transportation Safety Board 2003).

2.3 Example of Shared Rail Corridors with Non-FRA Compliant Vehicles

The Denver Regional Transportation District (RTD) Orange line is located adjacent to 11.8 miles of a joint BNSF Railway and UP track. Engineering documents indicate that most of the track is separated by more than 25 ft. In a few locations, freight and light rail tracks are closer than 20 ft. Figure shows a satellite photograph of a bridge embankment near Littleton, CO, where the light rail and freight tracks are separated by 17 ft (Ressor 2003).

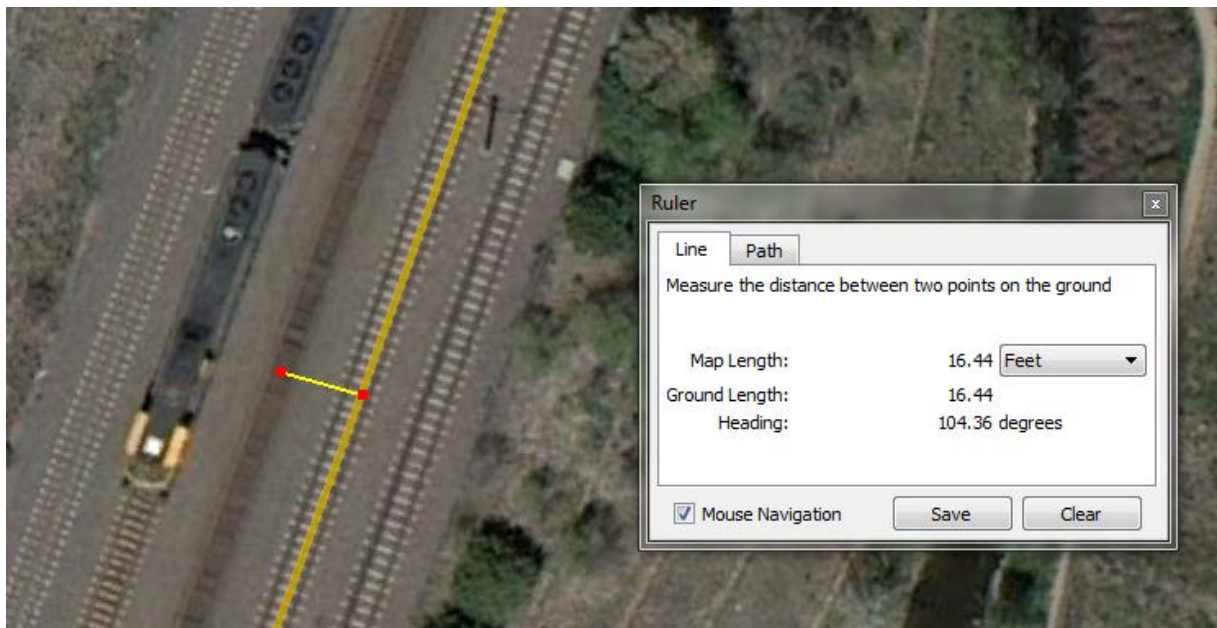

Figure 2.1. Shared corridor in Denver

Similar to the Denver RTD, the Cleveland light rail trains operate alongside CSX and Norfolk Southern at a minimum track center spacing of 20 ft, as seen in Figure 2.2. The Red Line in Cleveland has operated adjacent to this freight line for more than 60 years without any major incident reported (Ressor 2003).



Figure 2.2. Cleveland light rail sharing ROW with Norfolk Southern

The Chicago Transit Authority (CTA) operates four of its lines in a shared corridor configuration and two have significant route miles that are categorized as shared ROW. The CTA Green Line operates alongside Metra and UP freight trains. The freight line has 30 Million Gross Tons (MGT) of traffic and 58 commuter trains that travel up to 70 mph. The Orange Line travels alongside Norfolk Southern, CSX, Canadian National, and the Belt Railway of Chicago. These lines vary from 5 to 20 MGT and speeds of 10–60 mph. The CTA separates all of its shared corridors by chain link fences. If track spacing is within 6 ft of the clearance envelope, the CTA constructs a concrete wall to separate the tracks. The only reported freight rail intrusion onto the transit ROW was a door that fell off a boxcar. The CTA operator of the next affected train was able to stop before striking the debris (Ressor 2003).



Figure 2.3. CTA and CN trains sharing a corridor with 13-foot track center distance

By 2025, Caltrain will phase in partially FRA-compliant vehicles on its commuter rail route between San Francisco and San Jose. These vehicles have received a conditional waiver from 49 CFR 238.203 (static end strength), 238.205 (anti-climbing mechanism), and 238.207 (link between coupling mechanism and car body) after Caltrain studied and demonstrated the benefits of crash energy management (CEM) utilized by the proposed vehicles (Federal Railway Administration, 2010; DiBrito et al. 2011). These trains will share track with conventional Tier I commuter rail equipment, limited freight traffic not temporally separated, and potentially Tier III high-speed rail equipment.



Figure 2.4. Proposed Caltrain non-FRA compliant EMU equipment

The proposed California Rail system from Los Angeles to San Francisco will likely use FRA Tier III equipment on dedicated tracks for most of the route. On several segments, these dedicated tracks will share a corridor or ROW with BNSF Railway or UP. At the extreme ends of the route, where environmental concerns have ruled out a new dedicated line, high-speed trains will instead share track with conventional freight and commuter equipment. The California High-Speed Rail Authority has investigated different methods of protecting against rolling stock and vehicle intrusion, including increasing track center spacing where possible, designing high-speed viaduct piers to withstand derailment impact loads, placing check rails on freight track in high risk areas, and installing physical features such as berms or walls to arrest derailed rolling stock (Parsons Brinckerhoff 2008).

2.4 Adjacent Track Derailment Risk

2.4.1 *Railroad Accident Models*

When considering the risk posed to high-speed passenger trains by derailments of freight trains on adjacent tracks, accurately understanding the likelihood of a freight train derailment is important. Derailments can usually be traced to any combination of track, rolling stock, and operations issues. In the following section, research in those areas is outlined as it pertains to derailment risk reduction. Anderson and Barkan (2004) investigated train accident rates using data from the FRA Office of Railroad Safety. In this analysis, shown in Table 2.1, derailment rates for different track classes were estimated from data collected between 1992 and 2001.

Table 2.1. Estimated Accident Rate by FRA Track Class (Anderson and Barkan 2004)

FRA Track Class	X & 1	2	3	4	5 & 6	Total
Number of Derailments	670	921	1,136	1,522	332	4,600
Number of Derailed Cars	3,708	7,218	10,809	15,045	2,869	39,747
Average Number of Derailed Cars	5.5	7.8	9.5	9.9	8.6	8.6
Average Speed	8.7	17.7	26.3	33.6	37	25.2
Train Mile Percentage	0.3	3.3	12.1	61.8	22.6	100
Freight Train Miles (millions)	13.8	152.0	557.5	2,847.5	1,041.3	4,612.0
Derailments per Million Freight Train Miles (95% confidence interval)	48.54 (±3.67)	6.06 (±0.39)	2.04 (±0.12)	0.53 (±0.03)	0.32 (±0.03)	1.00 (±0.03)

The analysis of this data suggests that upgrading the FRA class of tracks adjacent to passenger operations could potentially reduce the risk of an adjacent track derailment.

Improved train operating practices may also help in reducing the risk of adjacent track derailments. Schafer and Barkan (2008) investigated the effect of train length on derailment rate. Accident causes can be separated into groups that vary relative to rail car miles or train miles. By increasing the average train length, the probability of an accident occurring for each individual train increases due to the increased exposure to car-mile related causes, but total expected number of accidents decreases due to fewer trains being operated. The authors point out that while the total likelihood of accidents may decrease by operating longer trains, the severity of accidents that do occur might increase due to having more cars per train. A summary of these findings is shown in Table 2.2.

Table 2.2. Sensitivity Analysis of the Effect of Train Length on Accident Rate (Schafer and Barkan 2008)

Average Train Length (Cars)	Number of Trains	Probability of Accident for Each Individual Train	Total Expected Number of Accidents
20	1,250	0.00214	2.68
40	625	0.00256	1.60
60	417	0.00298	1.24
80	313	0.00340	1.06
100	250	0.00382	0.96
120	208	0.00424	0.88

25,000 carloads shipped; 2,000 miles

In addition to train length, the operating speed of freight trains affects the severity of a derailment in terms of number of cars derailed. Barkan et al. (2003) showed that the average number of cars derailed in an accident increased linearly with speed. Decreasing freight train speeds may be one way of reducing the severity of any adjacent track derailments.

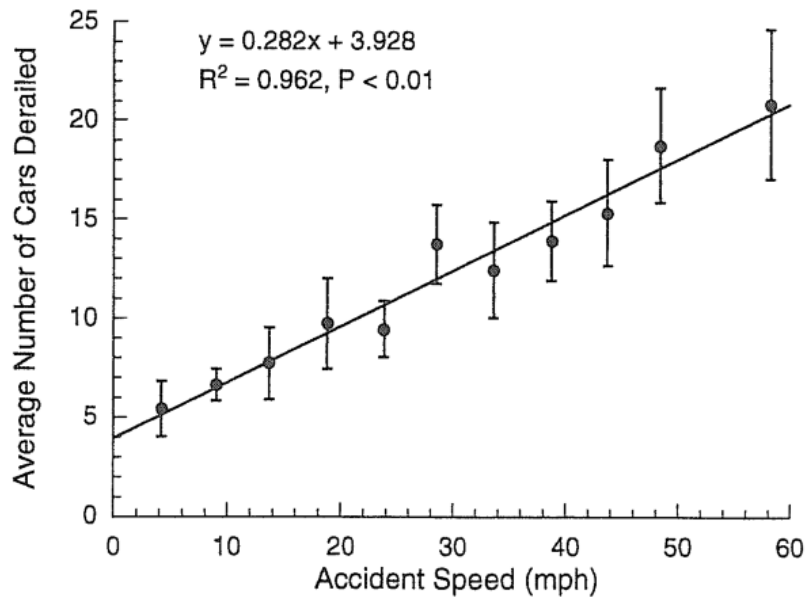

Figure 2.5. Relationship between accident speed and average number of cars derailed in mainline freight derailments with at least one hazardous materials car derailed (Barkan et al. 2003)

Analysis of the FRA train accident database by Liu et al. (2012) shows broken rails as a high frequency and high severity freight train derailment cause in North America (Figure 2.6). Reducing the likelihood of a broken rail derailment could be achieved by increasing the frequency of rail flaw inspection. Jeong et al. (2009) presented a model that predicts the number of rail service defects with different inspection frequencies. Zhou et al. (2007) presents a model for broken rails that takes into account weld defect rate, fatigue rate, the effects of grinding, and the effectiveness of inspection techniques. Zarembski (2008) showed that with increased rail flaw inspection frequency, the likelihood of a broken rail derailment decreases.

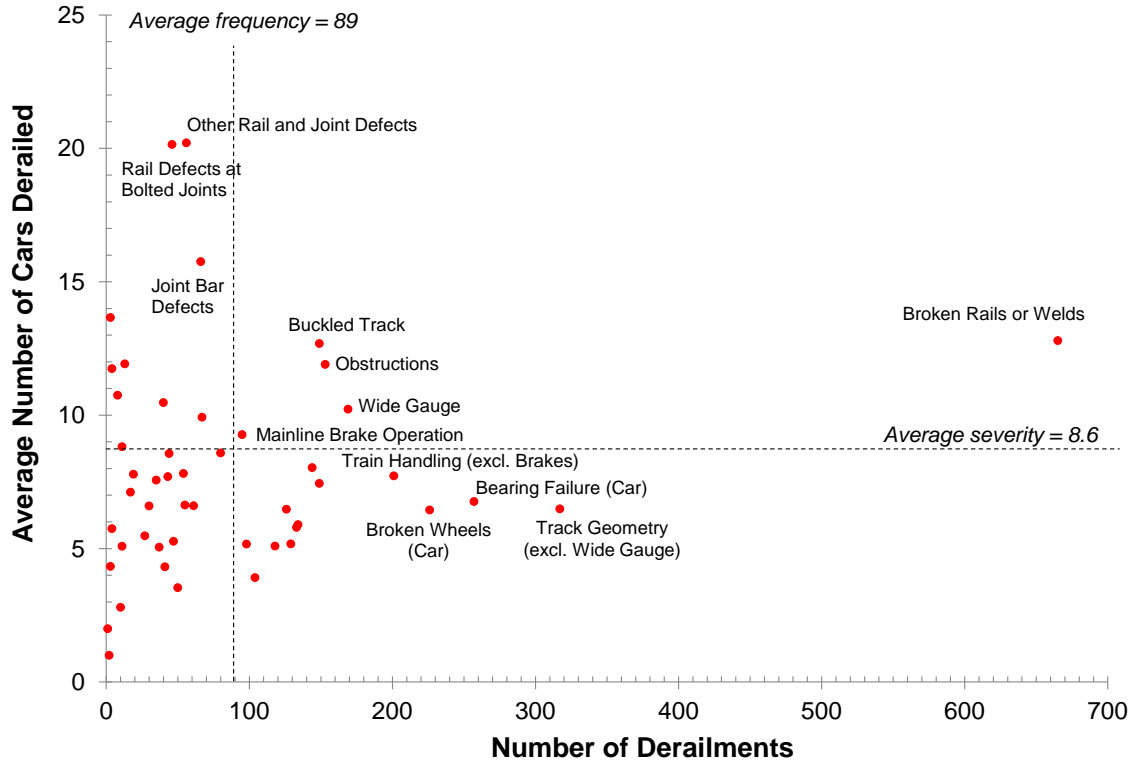

Figure 2.6. Frequency and severity graph of Class I mainline freight-train derailments, 2001–2010 (Liu et al. 2012)

Wayside rolling stock defect detectors have proven successful in reducing the likelihood of derailments. Wayside overheated bearing, dragging equipment, shifted load, and wheel impact detectors are just some examples of technologies that have reduced derailments and other types of accidents. Ouyang et al. (2009) outlined a model that determined optimal locations for deploying different types of detectors on a railway network. The model formulation presented in the paper seeks to maximize the benefit of inspections across a railcar fleet, but the authors point out that the model objective function could be modified to minimize the risk of accidents or derailments. By comparing a baseline detector deployment strategy with an ideal strategy determined by the model, the enhanced benefit of more heavily deployed wayside detectors could be weighed against the cost of other risk reduction strategies.

2.4.2 Adjacent Track Derailment Risk Models

Very little research has been undertaken to quantify the risk of a high-speed passenger train operating next to a freight train in a shared track or shared corridor setting. The primary reason is likely the lack of data on how far railcars and lading travel in the event of a derailment. The NTSB collected data on this between 1978 and 1985 then stopped the practice. Transport Canada estimated lateral displacement of rolling stock from derailment photographs in NTSB reports. The NTSB chooses which accidents they investigate and will usually study only the most severe accidents. To further complicate matters, maximum lateral displacement may refer to maximum displacement of the car-body or the displacement of railcar components such as trucks. A truck spring may travel further in a derailment than an entire car-body. However, a truck spring is not likely to derail a high-speed passenger train. The actual data presented in Figure 2.7 is more

conservative because the underlying data comes from a sample of more severe derailments. Approximately 10 percent of the accidents had a maximum lateral travel of more than 80 to 90 ft.

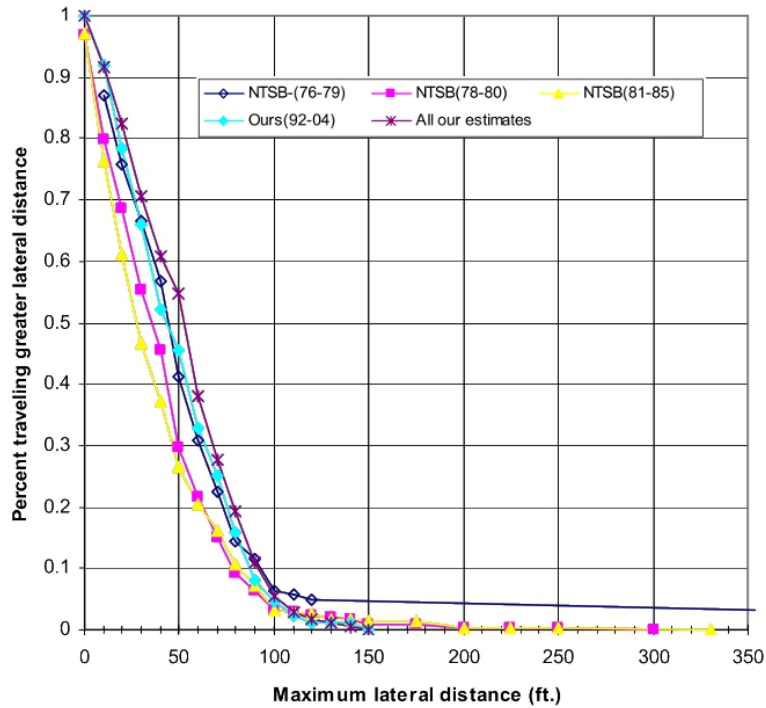

Figure 2.7. Lateral dispersion of accidents by dataset (English et al. 2007)

English et al. (2007) attempted to determine an underlying probability distribution between the speed of the train and the lateral displacement of derailed equipment. Higher derailment speeds have inherently higher kinetic energy and, therefore, may have greater lateral displacement of cars from the track. The authors found that the frequency in the dataset best followed a Gamma Distribution with an R^2 value of 0.5, as shown in Figure 2.8. The peak of the distribution is more pronounced at lower speeds and occurs at a smaller lateral travel distance than would be the case at higher speeds. All resulting distributions are skewed to the right. The authors explained that there are factors other than speed that affect lateral displacement—grade and curvature, for example. In addition, trains that derail on an embankment can roll down the sides.

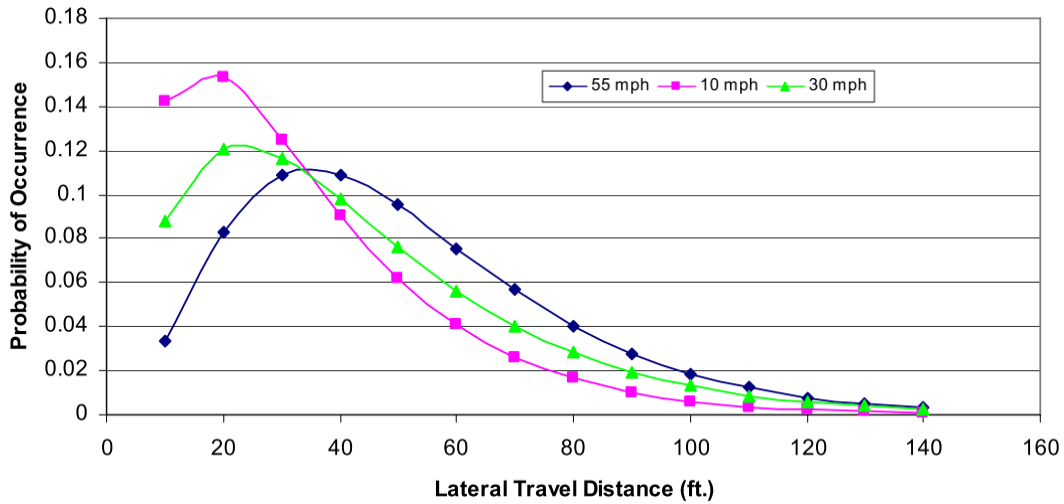

Figure 2.8. Lateral dispersion probability and speed (English et al. 2007)

Lateral travel as a function of speed is plotted in Figure 2.9. The authors reported an R-squared value of 0.175 for the relationship. There is a 50 percent probability of exceeding a 49-foot threshold regardless of the speed of the adjacent track. At 10 mph, 18 percent of the accidents will exceed 49 ft and at 70 mph, 32 percent of the accidents will exceed 49 ft. At speeds up to 48 mph, less than 10 percent of the accidents exceed 82 ft.

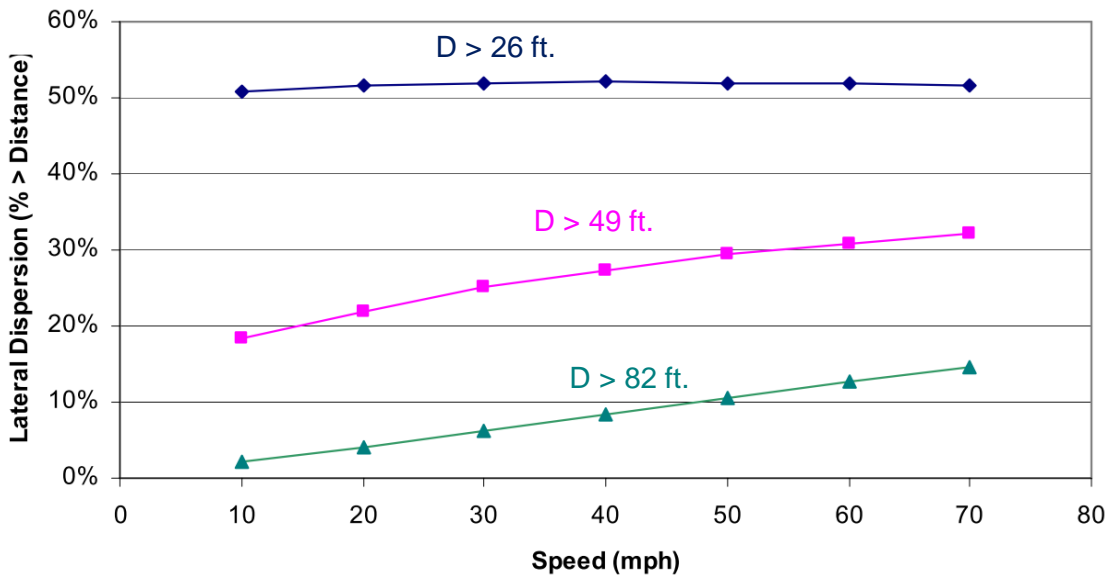

Figure 2.9. Percent of accidents exceeding a lateral distance as a function of speed (English et al. 2007)

2.5 Risk Mitigation Strategies

2.5.1 Accident Prevention

There are numerous methods to reduce the likelihood of a derailment on a freight railroad. One mitigation technique might be to increase the number of wayside defect detectors. Overheated wheel bearings were the third leading cause of derailments in the United States from 2001 to 2010 (Liu et al. 2012). This particular derailment typically derails only 1–3 railcars. Wheel impact load detectors can reduce the frequency of flat wheels and decrease the likelihood of broken wheels. Shifted load detectors can prevent freight lading from fouling catenary and striking rail vehicles on an adjacent passenger line.

In low speed derailments, the installation of checkrails can help keep a derailed train from intruding on adjacent tracks. Improving track quality can prevent many of the track-related derailments such as wide gauge, broken rail, and broken joints. Positive train control can prevent collisions by reducing human factor errors, authority encroachment, speeding, and switch alignment-related causes.

Some design ideas can be implemented to limit derailed railcar displacement. If the corridor is on an embankment or parallel to a slope, placing passenger tracks above the freight tracks will be beneficial. If a freight train derails, railcars are pulled away from the passenger track by gravity, as shown in Figure 2.10. On a tight curve, if the freight line is on the outside of a curve, then an over-speed derailment will result in the cars falling to the outside of the curve and staying clear of the passenger tracks.



Figure 2.10. Derailed railcar lateral displacement due to embankment

2.5.2 Survivability

The most typical method of separating freight and high-speed trains on adjacent but dedicated tracks is using a concrete crash wall, as was planned in the preliminary design of the California High-Speed Rail Project. In the event of a freight or passenger derailment, the concrete wall serves to absorb energy and limit the impact to an adjacent high-speed rail line. If there is enough room, building an earth wall and ditch is an alternative to a concrete barrier, as shown in Figure 2.11. Another proposed solution is to have an intrusion detection warning (IDW) system. If a derailed freight train crossed into the passenger ROW, the derailed rolling stock would break a fence that would in turn change signals on either side of the affected area to a stop indication. In this scenario, passenger trains beyond the next block in either direction would have sufficient time to stop before striking the derailment wreckage. Even with an IDW system, there is still the possibility of a passenger train not being a sufficient distance away to prevent a collision.

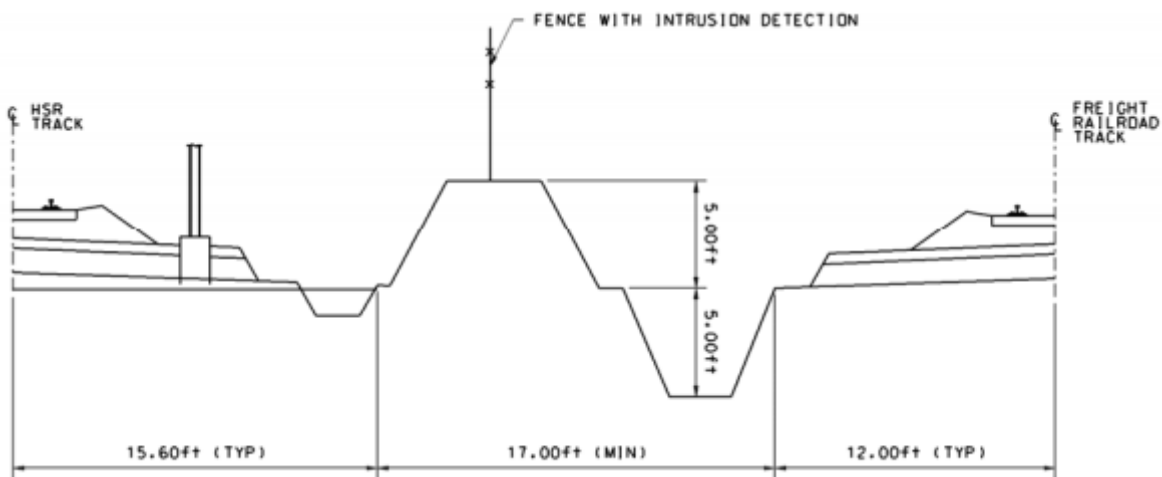

Figure 2.11. Separation by earth berm and ditch

Finally, there might be design improvements to the crashworthiness of the passenger rail vehicles. Innovations in CEM would serve to further mitigate the severity of adjacent track derailments at slow speeds. A high-speed train-set weighing 380 tons and traveling at 300 km/h has 1,319 MJ of kinetic energy. The FRA Tier II rolling stock standards require 8 MJ of kinetic energy absorption in any power car and 3 MJ of absorption at the end of the first trailer car adjacent to the power car. Very high-speed collisions between passenger and freight equipment will likely have catastrophic consequences regardless of CEM improvements.

2.6 Discussion and Conclusions

The United States has a long practice of operating passenger trains and freight trains on the same tracks. As a consequence, the design of the passenger train vehicles has been improved over time. Adjacent track derailments are, however, still an area of concern. UP has agreed to allow the operation of 110 mph passenger trains between Chicago and St. Louis. CSX meanwhile has only agreed to 90 mph passenger trains on the Empire Corridor from New York to Buffalo (Doss and Caruso 2011). All of the mitigation techniques previously discussed apply to this operating scenario. One technique not addressed in Section 2.5 is to temporally separate the traffic types as is practiced in San Diego (Ressor 2003) and in the operating plan of the Caltrain (DiBrito et al.

2011). Passenger train speed in this shared track operating environment cannot exceed 125 mph for FRA Tier I equipment and 150 mph for FRA Tier II equipment. Track class, signal system, and the presence and condition of highway grade crossings could further restrict the maximum passenger train speed in this operating configuration.

The shared corridor and shared ROW configurations between freight and very high-speed passenger trains have a higher risk of adjacent track derailment damage. Shared corridors have less risk than shared ROW because of the greater track center spacing, but the challenges are similar. As is shown by English et al. (2007), derailed rolling stock regularly displaces hundreds of feet laterally from the center line of track. Risk mitigation strategies are the same as in the shared track scenario and are outlined in Section 2.5.

There is significant uncertainty in predicting how far a rail vehicle will travel from its original track in the event of a derailment (English et al. 2007). One of the most popular risk mitigation techniques is to place reinforced concrete walls between the passenger and freight lines. This is currently being suggested at distances less than 25 ft on the California High-Speed Rail plan. There has been little research to correlate the necessary strength of the concrete barrier to the speed of the freight train. An easily severed IDW fence integrated with the signal system has been used to mitigate adjacent track derailment risk with transit operations at lower speeds. A holistic model that assesses derailment risk reduction strategies is needed. This model should be able to calculate the relative risk exposure of different infrastructure and operating configurations for shared track, shared ROW, and shared corridor. Each of the different risk mitigation strategies should be analyzed for cost effectiveness. As an example, increasing the detector density, improving track quality, including a derailment IDW system, and implementing positive train control might prove more cost effective overall than building miles of reinforced concrete crash wall.

2.7 References

- Alexandre J. M. and C. T. Eyquem. (2011). “Shared Use of Railway Corridors by Public Transit Vehicles.” *Proceedings of the ASME/ASCE/IEEE 2011 Joint Rail Conference*. Pueblo, CO.
- Anderson, R. T. and C. P. Barkan. (2004). “Railroad Accident Rates for Use in Transportation Risk Analysis.” *Transportation Research Record*, 88–98.
- Barkan, C. P., C. T. Dick, and R. Anderson. (2003). “Railroad Derailment Factors Affecting Hazardous Materials Transportation Risk.” *Transportation Research Record*, 64–74.
- DiBrito, D. A., R. A. Mayville, R. Doty, and C. Tsao. (2011). “Moving Toward Unrestricted Shared Use: How Caltrain Took the Next Step and What Recent Developments Mean to U.S. Commuter Railroads.” *Transportation Research Record: Journal of the Transportation Research Board*, 2219, 78–87.
- Doss, N. and L. Caruso. (2011, July 27). “CSX CEO Fighting High-Speed Rail.” *Bloomberg News*.
- English, G., G. Higham, M. Bagheri, T. Moynihan, and F. Saccomanno. (2007). *Evaluation of Risk Associated with Stationary Dangerous Goods Railway Cars*. Kingston: Transport Canada.
- Federal Railroad Administration. (2009). *Railroad Workplace Safety; Adjacent-Controlled-Tracks On-Track Safety for Roadway Workers*. Washington, DC. Federal Register.
- Federal Railway Administration. (2010, May 27). Letter to Pinensula Corridor Joint Powers Board. Washington, DC.
- Federal Railway Administration Office of Safety Analysis. (n.d.). Download Data on Demand. http://safetydata.fra.dot.gov/OfficeofSafety/publicsite/on_the_fly_download.aspx?itemno=3.03.
- Joeng, D. and J. Gordon. (2009). “Evaluation of Rail Test Frequencies Using Risk Analysis.” *Proceedings of the 2009 ASME Joint Rail Conference*. Pueblo, CO.
- Liu, X., M.R. Saat, and C.P.L. Barkan. (2012). “Analysis of Major Train Derailment Causes and Their Effect on Accident Rates.” *Transportation Research Record*, in-press.
- National Transportation Safety Board. (1982). *Safety Recommendation R-82-47*. Washington, DC.
- National Transportation Safety Board. (1987). *Safety Recommendation R-87-57*. Washington, DC.
- National Transportation Safety Board. (1990). *Safety Recommendation R-90-18*. Washington, DC.
- National Transportation Safety Board. (1993). *Safety Recommendation R-93-16*. Washington, DC.
- National Transportation Safety Board. (1993). *Safety Recommendation R-93-23*. Washington, DC.
- National Transportation Safety Board. (1995). *Safety Recommendation R-95-35*. Washington, DC.

- National Transportation Safety Board. (2001). *Railroad Accident Brief DCA-02-FR-002*. Washington, DC.
- National Transportation Safety Board. (2001). *Railroad Accident Report Collision Involving Three Consolidated Rail Corporation Freight Trains Operating in Fog on a Double Track Main Line Near Byron, OH January 17, 1999*. Washington, DC.
- National Transportation Safety Board. (2002). *Railroad Accident Report Collision of National Railroad Passenger Corporation (Amtrak) Train 59 with a Loaded Truck-Semitrailer Combination at a Highway/Grade Crossing in Bourbonnais, Illinois March 15, 1999*. Washington, DC.
- National Transportation Safety Board. (2003). *Railroad Accident Brief DCA-03-FR-005*. Washington, DC.
- Ouyang, Y., X. Li, C. P. Barkan, A. Kawprasert, and Y. C. Lai. (2009). Optimal Locations of Railroad Wayside Defect Detection Installations. *Computer-Aided Civil and Infrastructure Engineering*, 309–319.
- Parsons Brinckerhoff. (2008). *Rolling Stock and Vehicle Intrusion Protection for High-Speed Rail and Adjacent Transportation Systems*. California High-Speed Train Project.
- Ressor, R. R. (2003). *Catalog of “Common Use ” Rail Corridors*. Washington, DC. Federal Railroad Administration.
- Schafer, D. H. and C. P. Barkan. (2008). “Relationship between Train Length and Accident Causes and Rates.” *Transportation Research Record*, 73–82.
- Steets, P. and Y. Tse. (1998). “Conrail's Integrated Automated Wayside Inspection.” *Proceedings of the 1998 ASME/IEEE Joint Rail Conference*, 113–125.
- Zarembski, A. M. and J. W. Palese. (2005). “Characterization of Broken Rail Risk for Freight and Passenger Railway Operations.” *Proceedings of the 2005 AREMA Conference*.
- Zhao, J., A. Chan, and M. Burrow. (2007). “Probabilistic Model for Predicting Rail Breaks and Controlling Risk of Derailment.” *Transportation Research Record*, 76–83.

3. HIGHWAY-RAIL GRADE CROSSING SAFETY CHALLENGES FOR SHARED HIGH-SPEED RAIL PASSENGER AND HEAVY AXLE LOAD FREIGHT OPERATIONS IN THE UNITED STATES

3.1 Introduction

In 2010, there were approximately 255,000 highway-rail grade crossings in the United States, of which 52 percent were publicly accessible (FRA, 2012a). All grade crossings are at risk for a collision between a highway vehicle and a train, which can result in casualties, extensive property damage, and even the release of hazardous materials. Though the safety record of rail in the United States compares favorably with other modes of transportation, in the past 20 years, 186 rail passenger fatalities and nearly 15,000 injuries have occurred in passenger train accidents (RITA, 2011). Approximately 25 percent of these passenger rail fatalities involved collisions at highway-rail grade crossings (FRA, 2011b). Additionally, highway grade crossing users currently represent about 30 percent of all rail-related fatalities in the U.S. Grade-crossing collision rates have declined by 80 percent in the past 20 years, but more than 15,000 highway users have been killed over that time period at grade crossings (FRA, 2012b).

The U.S. Department of Transportation is supporting the development of substantially expanded and improved passenger rail service on a number of intercity corridors across the country (FRA, 2012c). These corridor development projects will range from incremental improvement of existing tracks to construction of new, dedicated high-speed rail (HSR) lines. Existing lines could already have freight or passenger rail services, necessitating shared operations. As the interest in shared corridors grows, the risk of interoperating heavy axle load freight and lighter, higher speed passenger trains needs to be understood. One of the most important aspects of this risk involves highway-rail grade crossings.

Many proposed HSR corridors are expected to pass through densely populated areas. This will pose significant challenges since these areas are likely to have many grade crossings. FRA has issued regulations requiring complete grade separation for HSR operations in excess of 125 mph. For higher speed rail (HrSR) operations between 110 and 125 mph, crossings may still be used with extra protections, but this is not recommended.

The most economical approach to eliminating a crossing is arguably to close it; however, communities are often opposed to closing existing grade crossings in their area because of a perceived loss of convenience, as well as concerns about increased emergency service response time and reduced access to schools and other key places. If a crossing cannot be closed, other approaches must be considered. These include grade separation and upgraded warning and protection devices.

The topic of highway-rail grade crossing risk has been extensively researched throughout the years, especially with a view to improving highway safety. Research has also examined the crashworthiness of passenger trains. This paper presents an overview of grade crossing challenges to shared HSR and HAL operations in the United States and offers an in-depth analysis of the relevant research to date. Results from this study are expected to identify principal

technical challenges related to grade crossings in developing HSR systems. This will facilitate the planning, development, construction, and operation of new HSR shared corridors.

3.2 Methodology

Papers published through 2011 relevant to this literature review were found using Google Scholar and a multidatabase search engine at the UIUC Library. Keywords used in the search include highway-rail grade crossings, level crossings, high-speed rail, shared corridors, passenger train crashworthiness, grade crossing human factors, driver human factors, low-cost crossing design, and grade crossing technology. The reference section of each paper was reviewed and other potentially relevant papers were identified. Those contributing to a better understanding of grade crossings, especially as pertains to shared corridor operations, were selected for more detailed analysis.

In the following section, a review of current regulations, guidelines, and standards is provided. This is followed by a review of studies related to HrSR or shared corridor operations addressing crashworthiness of passenger train cars, grade-crossing accident prediction, alternative grade-crossing warning strategies, emergency response management, and human factors. In the discussion section, the relevance of different shared operation types and research needs are presented.

3.3 Regulations, Guidelines, and Standards

Passenger train operations and maximum speeds are regulated by FRA (CFR, 2012). FRA track classes and their related maximum speed greater than 90 mph (145 kph) are shown in Table 3.1.

Table 3.1. Track Class and Related Maximum Speed

Track Class	Maximum Passenger Train Speed
Class 6	110 mph (177 kph)
Class 7	125 mph (201 kph)
Class 8	160 mph (257 kph)
Class 9	200 mph (322 kph)

Grade crossing regulations and guidelines for high-speed corridors can be separated into several parts including consolidation and closures, sealed corridors, warning and barrier systems, train control integration, and grade crossing inspection. Jennings (2009) summarized the State laws for each aspect. FRA also regulates passenger train crashworthiness requirements and emergency management (FRA, 2009c).

3.3.1 Consolidation and Closures

FRA safety regulations require crossings to be grade separated or closed where trains operate at speeds above 125 mph (201 kph) (CFR, 2012). Table 3.2 summarizes the regulation related to grade-crossing protection and closure.

Table 3.2. Summary of Federal Regulation Related to Grade-Crossing Protection and Closure

Maximum Passenger Train Speed	> 79 mph (127 kph)	111–125 mph (179–201 kph)	> 125 mph (201 kph)
Grade Crossing Protection Type	Active	Warning/Barrier with FRA Approval	Grade Separate or Close

3.3.2 Sealed Corridors

A sealed corridor, as defined by the North Carolina DOT, is “an extended rail corridor or segment thereof on which all public at grade crossing are evaluated through an engineering diagnostic process to determine the appropriate level of safety improvement needed to decrease or eliminate violations.” The ideal situation would be to provide complete grade separation. However, for trains operating in the 110–125 mph (177–201 kph) range, grade separation is suggested but not required. Where the line is not grade separated, FRA requires crossings to have approved barrier systems that can prevent highway vehicle incursion on the ROW; obstacle detection systems to alert the train if a vehicle does become stuck on the tracks are recommended. These requirements and appropriate technologies for use in achieving these goals are summarized in FRA’s “Highway-Rail Grade Crossing Guidelines for High-Speed Passenger Rail” (2009a).

3.3.3 Warning/Barrier Systems

Trains can only operate at Class 7 speeds with highway-rail grade crossings under the condition that (1) an FRA-approved warning/barrier system exists, and (2) all elements of that warning/barrier system are functioning (CFR, 2012). The barrier system must be designed to physically prevent the incursion of a motor vehicle into the ROW.

Automatic, active warning devices at crossings (such as flashing lights and gates) provide valuable information to motorists approaching a crossing by indicating the presence or absence of a train. Interconnection and supplementary traffic control, obstacle detection, and remote health monitoring systems can be introduced to enhance the effectiveness of the warning system (FRA 2009a).

Since June of 2005, FRA has provided nationwide regulations on the use of locomotive horns at highway-rail grade crossings (CFR 2012). These regulations require trains to sound the locomotive horn at public highway-rail grade crossings and establish minimum and maximum sound levels for the locomotive horn (Jennings 2009).

3.3.4 Train Control Integration

Positive Train Control (PTC) system implementation is required by FRA (74 FR 35950, 2009). PTC will be required by law on all intercity and commuter passenger lines by December 31,

2015. The industry is required to address highway-rail grade crossing safety in PTC implementation.

3.3.5 Grade Crossing Inspection

A proactive inspection and maintenance cycle for grade crossings is recommended by the American Railway Engineering and Maintenance-of-Way Association (AREMA 2010). The Railroad Safety Improvement Act of 2008 requires updated crossing data to be provided to FRA by October 16, 2010, and then thereafter by September 30 each subsequent year. However, a survey by Liu et al. (2011) found several challenges to implementation of this act. Many States do not have a standard inspection procedure or checklist; additionally, the annual or biannual inspection of all grade crossings cannot be accomplished in some States due to a lack of inspectors.

3.4 Crashworthiness of Passenger Train Cars

A vast body of research has examined the issue of passenger train car crashworthiness. Primarily, this research has focused on American commuter and intercity rail cars traveling at speeds below 100 mph (161 kph). Crashworthiness studies on high-speed rail cars are few and far between, possibly because HSR operators tend to focus on accident prevention rather than crashworthiness.

Simons and Kirkpatrick (1998) developed a Finite Element Model (FEM) of a theoretical generic U.S. high-speed train and then used it to understand the safety risks posed to passengers. The train consist was tested in seven different crash scenarios. For each scenario, the expected number of casualties was predicted based on primary and secondary impact data. This model could be adapted to study the crashworthiness of proposed HrSR and HSR train designs.

A 1998 collision in Portage, IN, between a commuter train and a tractor-trailer carrying steel coils, led to new regulation addressing passenger train structural design. Full-scale collision testing of the new passenger cars was conducted to compare their performance to the pre-1999 car design. Jacobsen et al. (2003) tested the crash performance of the two car designs by colliding them with a steel coil truck to imitate the Portage incident. They found that the 1990's cab car end structure deformed more than 20 inches (50.8 cm) longitudinally, resulting in loss of operator survival space, whereas the new design deformed only 8 inches (20.3 cm), which preserved survival space. Additionally, Martinez et al. (2003) developed a computer model to predict crushing behavior in the cab car. They validated the computer model with the full-scale collision test and found that the model accurately predicted crush patterns. Samavedam and Kasturi (2011) performed the same full-scale test at higher speeds in order to validate their FEM of train collisions. The model closely predicted the overall damage to the locomotive, as well as the intrusion into operator survival space.

In the wake of the 2005 Glendale, CA, collision between a Metrolink commuter train and an SUV in which 11 people were killed, FRA released a report on the safety of push-pull and multiple unit locomotive passenger rail operations (FRA 2006). This report sought to understand the relative crashworthiness of cab-car leading trains (push mode) and conventional locomotive-led trains (pull mode). Analysis of 20 years of data showed that, although locomotive-powered

trains operated in the push mode had a slightly greater number of fatalities and tendency to derail than those operated in pull mode, the differences were not statistically significant.

Also in response to the Glendale collision, Metrolink worked with FRA, the Federal Transit Administration (FTA), and the American Public Transportation Association (APTA) to develop a performance-based technical specification for passenger rail car crashworthiness focused on CEM. This work produced performance specifications for the overall train consist; for its cab and passenger-carrying cars; and for mechanical components such as couplers (Tyrell et al. 2006).

Research resulting from the Glendale and Portage incidents led to the development of CEM trains. These trains are designed to deform in a controlled way during a collision, collapsing unoccupied areas to absorb energy and preserving survival space in the occupied areas. Tyrell and Perlman (2003) compared the crashworthy (or survivable) speeds of CEM and conventional trains in both train-to-train collisions and highway-rail grade crossing collisions. They found that passengers in CEM trains could experience a much higher primary collision speed and survive, even though their secondary impact velocity would be slightly greater than in a conventional train.

3.5 Grade-Crossing Accident Prediction

Many methods of modeling collision likelihood at grade crossings have been developed, mainly with the goal of understanding the risk posed to highway users by freight trains. These models have traditionally been used to decide how funds for highway-rail grade crossing improvements should be allocated. However, these models are equally applicable to passenger train risk.

Faghri and Demetsky (1986) categorized collision likelihood models into two groups: relative formulas and absolute formulas. Relative formulas use crossing data to rank the relative hazards at each crossing, so that improvements can be prioritized from most dangerous to least dangerous crossings. Absolute formulas predict the number of collisions expected to occur at each crossing over a certain time period, allowing for estimation of the number of lives saved by upgrading a crossing. Faghri and Demetsky compared the predictive performance of four absolute formulas and one relative formula. Of these, the New Hampshire, the Peabody-Dimmick, the NCHRP Report 50, and the U.S. DOT models have been most commonly used for grade crossing accident prediction.

The New Hampshire model is a relative formula that can be used to rank the importance of crossing upgrades (Austin and Carson 2002; Faghri and Demetsky 1986). It has been widely used across the country, either in its original form or in various modified forms. Its popularity is due to its ease of use. Analysis has shown that the hazard index ranks crossings similarly to more complex formulas, but it is limited in that it does not predict the expected number of collisions. The hazard index formula is as follows:

$$\text{Hazard Index} = V T P_f \quad (3.1)$$

where:

V = average 24-hour (highway) traffic volume

T = average 24-hour train volume

P_f = protection factor (0.1 for gates; 0.6 for flashing lights; 1.0 for signs only)

The Peabody-Dimmick formula (also called the Bureau of Public Roads formula), developed in 1941, is an absolute formula that predicts the number of accidents at a crossing over a period of 5 years (Austin and Carson 2002; Faghri and Demetsky 1986). The 5-year accident prediction formula is as follows:

$$A_5 = 1.28 \frac{(V^{0.170})(T^{0.151})}{P^{0.171}} + K \quad (3.2)$$

where:

A_5 = expected number of accidents in five years

V = annual average daily traffic (AADT)

T = average daily train traffic

P = protection coefficient

K = additional parameter (smoothing factor)

The NCHRP Report 50 Hazard Index is an absolute formula developed in 1968 by Andrew Voorhees and Associates (Austin and Carson 2002; Faghri and Demetsky 1986). It can be expressed as a formula, but is more commonly determined from a series of charts and tables that allow the user to calculate the expected yearly accident rate. It is dependent on factors such as annual average daily traffic (AADT), number of trains per day, the type of warning device in use, the location of the crossing, and geometric aspects of the crossing.

Today, the most commonly used model is the U.S. DOT Accident Prediction Model (Austin and Carson 2002; Faghri and Demetsky 1986; Ogden and Korve Engineering 2007). First developed in the early 1980s, the formula uses a wide variety of factors, including highway type and train traffic, to predict the expected yearly number of collisions at a crossing. The general expression of the formula is as follows:

$$a = K \times EI \times MT \times DT \times HP \times MS \times HT \times HL \quad (3.3)$$

$$B = \frac{T_0}{T_0+T} (a) + \frac{T}{T_0+T} \left(\frac{N}{T}\right) \quad (3.4)$$

$$A = \begin{cases} 0.7159B & \text{For passive devices} \\ 0.5292B & \text{For flashing lights} \\ 0.4921B & \text{For gates} \end{cases} \quad (3.5)$$

where:

a = initial collision prediction, collisions per year at the crossing
 K = formula constant
 EI = factor for exposure index based on product of highway and train traffic
 MT = factor for number of main tracks
 DT = factor for number of through trains per day during daylight
 HP = factor for highway paved (yes or no)
 MS = factor for maximum timetable speed
 HT = factor for highway type
 HL = factor for number of highway lanes
 B = adjusted accident frequency value
 T_0 = formula weighting factor; = $1.0/(0.05 + a)$
 N = number of observed accidents in T years at a crossing
 A = normalized accident frequency value

A set of tables in Ogden and Korve Engineering (2007) provides each of the factors for crossings with passive controls, flashing lights, and gates. U.S. DOT provided a procedure for using this formula to determine grade crossing upgrade resource allocation (FRA 1987).

Faghri and Demetsky (1986) tested four absolute formulas and found that the U.S. DOT formula most accurately predicted the number of collisions occurring at grade crossings in Virginia for the 5-year period of study. They recommended that the Virginia DOT use the U.S. DOT formula in combination with site visits to evaluate the importance of grade crossing upgrades.

However, there are some concerns about the U.S. DOT model's accuracy. Since it is based on data from the whole country, it may not account for regional differences. As a result, some States have developed specialized formulas using more detailed State-specific data. For example, Benekohal and Elzohairy (2001) examined 10 years of highway-rail grade crossing collisions in Illinois. They found that the U.S. DOT formula only selected 89 of the top 200 grade crossings with collisions for upgrade and did not reliably identify the most dangerous crossings. They developed a regression model, the Illinois Hazard Index, which suggested a higher percentage of crossings with collisions for improvement; unlike other equations, it selected locations with higher crash rates.

Another concern about the accuracy of the U.S. DOT formula is that crossing conditions and warning/protection technologies may have changed since its development. Austin and Carson (2002) showed that the normalizing coefficients used in Equation 3.5, which account for the difference between the model's predicted values and actual observed values, have been steadily reducing in value over time; that is to say, the model's prediction accuracy has declined over time and the normalizing coefficients have been adjusted to compensate. Austin and Carson propose that the formula's accuracy could be improved if it were re-evaluated using present-day data. However, they also consider the complexity of the U.S. DOT's three-part formula to be problematic, since it is difficult to interpret and prioritize the effects of changing various parameters. To address this concern, Austin and Carson developed an alternate model using negative binomial regression. This model identified many of the same significant variables as the U.S. DOT formula, but as it was developed using only collision data at public grade crossings in six States; further testing would have to be conducted to see if the model would be applicable to

all U.S. grade crossings.

Chaudhary et al. (2011) compared the performance of the U.S. DOT Accident Prediction Formula to that of the Transport Canada Accident Model to see which would more effectively identify “hot spots” (high-risk areas) on a network in California. They found that, overall, the U.S. DOT model more closely predicted the yearly number of accidents occurring at a crossing. However, in cases where the crossing had an accident history, the Transport Canada model was more accurate. They suggested adapting the Transport Canada model to U.S. crossing data and using it to rank the most dangerous crossings.

Other models have been developed abroad. South Korea evaluated the effectiveness of the U.S. DOT Accident Prediction Formula for predicting accidents at Korean grade crossings (Oh et al., 2006). After finding that it did not accurately predict collision rates in Korea—because all grade crossings in Korea are equipped with gates, unlike in the United States—they developed a gamma probability model using Korean accident data. Collisions were observed to increase with highway traffic volume, train volume, proximity to commercial areas, distance of train detector from crossing, and time between activation of warning signals and gates.

Mok and Savage (2005) took a different approach to analyzing collision rates at grade crossings. They observed that the number of collisions and fatalities at grade crossings has decreased significantly over the past 30 years, despite an increase in both train and highway traffic. Their analysis showed that approximately 70 percent of the decrease could be attributed to human factors related aspects (such as educational programs like Operation Lifesaver and the requirement of ditch/crossing lights on locomotives), and 30 percent could be attributed to the installation of gates and flashing lights, as well as the closing of some crossings. This result suggests that collision prediction models rightly attribute high importance to the type of crossing warning device in use, but should also consider human factors aspects.

3.6 Alternative Grade Crossing Warning Strategies

Ideally, any rail line operating high-speed or higher speed passenger trains would be completely grade separated. However, due to cost considerations, it is often infeasible to grade separate an entire line. Nelson (2010) summarizes the many strategies currently in use around the world for reducing risk at grade crossings. These include closures and consolidation, upgraded lights and gates, and alternative technologies such as in-pavement flashers. The goal in the United States is to develop a strategy that balances cost with risk reduction.

3.6.1 Sealed Corridors

The sealed corridor was developed as a way to upgrade conventional rail lines to carry higher speed passenger trains. The State of North Carolina was the first to make aggressive use of the sealed corridor concept (Bien-Aime 2009; FRA 2009a, 2009b). The NCDOT Sealed Corridor is part of the Southeast High-Speed Rail (SEHSR) Corridor and initially included 216 grade crossings, 44 of which were private crossings. Between 1987 and 2004, this section experienced 282 collisions that resulted in 74 injuries and 55 fatalities. NCDOT eventually closed and consolidated a number of those grade crossings and upgraded the rest to include self-monitoring four-quadrant gates, long-arm gates, and traffic channelization devices (Figure 3.1).



Figure 3.1. An upgraded crossing in Charlotte, NC (Bien-Aime 2009)

Based on a sharp decrease in the number of grade crossing collisions, NCDOT estimated that 19 lives were saved between 2004 and 2009 as a result of implementing the sealed corridor concept (Bien-Aime 2009; FRA 2009c).

Illinois DOT (IDOT) has been upgrading certain sections of track between Chicago and St. Louis using a sealed corridor approach (Hellman and Ngamdung 2009). The route between Chicago and Springfield, IL, had 311 grade crossings, of which 68 were proposed for closure. However, only 10 crossings were ultimately closed due to strong opposition from impacted communities. Of the remaining crossings, 69 were equipped with 4-quadrant gates and vehicle detection systems. These improvements are required by the Illinois Commerce Commission for trains operating in excess of 79 mph (127 kph).

3.6.2 Obstacle Detection

Glover (2009) summarizes the goal of obstacle detection as “identifying the presence of a vehicle or person on the crossing as the train approaches and communicating this to the train driver in time for him or her to stop before reaching it.” This technology should provide a reliable and cost-effective way of mitigating grade crossing risk. However, the main challenge is that these systems have a short amount of time to react to an intrusion and bring the train to a stop. Glover suggests that there may be only limited reduction in the severity of a collision because the train may still collide with the obstructing highway vehicle. Additionally, there are concerns that these systems could be less reliable than traditional gated crossings; since the devices are fail-safe, an error in the detection system would result in a “false-alarm” closing of the crossing gates. If highway users become accustomed to higher error rates, they may erroneously assume the crossing is out of service when in fact the gates have been activated by the presence of a train. If they attempt to circumvent the gates, a collision could occur.

Hall (2007) suggests that there are benefits to obstacle detection even if the system is not capable of entirely preventing collisions. Advance warning of a track obstruction, especially when combined with crashworthy passenger train designs, could allow the train to decelerate sufficiently to prevent passenger deaths. Additionally, Hall states that obstacle detection systems will have the greatest benefit when information can be communicated directly between the grade crossing and an approaching locomotive (as in PTC or ERTMS).

IDOT and UP use a detection system that consists of an inductive loop embedded in the pavement on either side of a railway track, as shown in Figure 3.2 (A1, A2, B1, B2, C1 and D1 represent the detection circuits). It is capable of detecting the presence of a vehicle within the crossing gates (Hellman and Ngamdung 2009). This system could be integrated with a PTC-equipped train consist.

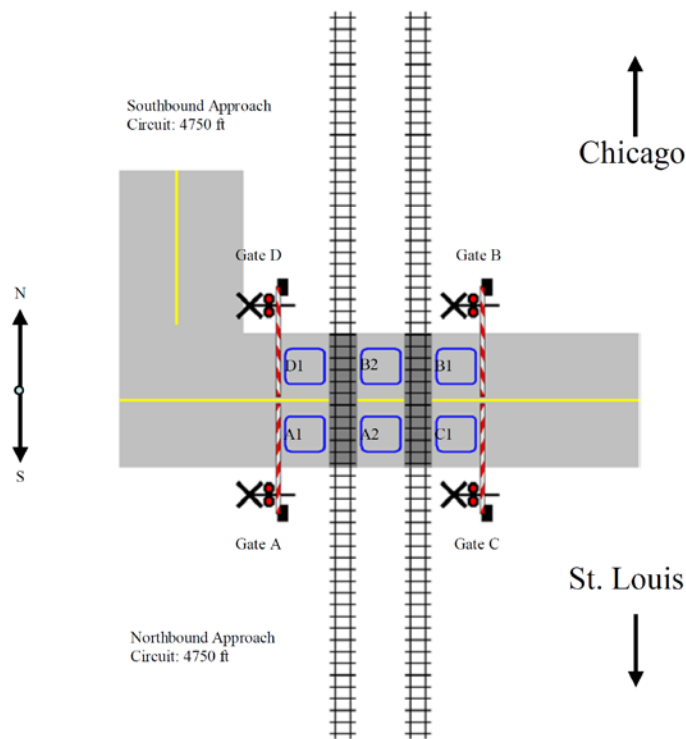

Figure 3.2. Four-quadrant gate configuration for a double-track segment (Hellman and Ngamdung 2009)

The system usually operates in “dynamic” mode, meaning the exit gates function based on the presence of highway vehicles within the grade crossing. However, in the fail-safe condition, it operates in a “timed” mode that closes the exit gates after a specified amount of time. FRA and the Volpe Center conducted tests of this equipment to verify its reliability. They found that the average total delay to five scheduled high-speed passenger roundtrips was approximately 38.5 minutes. They also found that this equipment had a “minimal impact on the frequency and duration of grade crossing malfunctions” (Hellman and Ngamdung 2009).

3.6.3 Traffic Channelization

Traffic channelization devices direct or separate traffic flow. In the context of highway-rail grade

crossings, these devices are intended to prevent drivers from using a grade crossing in an unsafe manner by confining them to controlled lanes (FRA 2010). An example is a raised median, as shown in Figure 3.3.



Figure 3.3. Traffic channelization device in North Carolina (FRA 2010)

Research has suggested that channelization discourages risky driving behavior (e.g., “zig-zagging” past closed gates) around grade crossings (FRA 2010). Several States have already begun to employ channelization in an effort to improve grade crossing safety.

3.6.4 Low-Cost Level Crossing Warning Devices

An emerging trend in grade crossing warning devices is the development of low-cost devices that provide a level of safety comparable to conventional devices. These systems generally cost between 5 and 30 percent the price of conventional technologies and often rely on wireless communications and solar power (FRA 2011a). Wullems (2011) summarizes this state-of-the-art technology and considers its potential for large rural networks such as the Australian railway. Hellman and Ngamdung (2010) presented several low-cost warning devices that satisfy FRA’s minimum performance requirements for grade crossing warning devices (summarized in Table 3.3). They emphasized the importance of reducing annual maintenance costs, not just installation costs.

**Table 3.3. FRA Grade Crossing Signal System Safety Regulations
(Hellman and Ngamdung 2010)**

Section	Description
234.203	All control circuits that affect the safe operation of a highway-rail grade crossing warning system shall operate on the fail-safe principle.
234.205	Operating characteristics of electromagnetic, electronic, or electrical apparatus of each highway-rail crossing warning system shall be maintained in accordance with the limits within which the system is designed to operate.
234.215	A standby source of power shall be provided with sufficient capacity to operate the warning system for a reasonable length of time during a period of primary power interruption.
234.225	A highway-rail grade crossing warning system shall be maintained to activate in accordance with the design of the warning system, but in no event shall it provide less than 20 seconds warning time for the normal operation of through trains before the grade crossing is occupied by rail traffic.
234.227 (a)	Train detection apparatus shall be maintained to detect a train or rail car in any part of a train detection circuit, in accordance with the design of the warning system.
234.275	This requires that grade crossing warning systems, subsystems, or components that are processor based and contain new or novel technology, are required to comply with the safety and risk analysis requirements defined in 236, Subpart H. In this context, new or novel technology specifically refers to designs that do not use conventional track-circuit technology.

Although low-cost level crossing warning devices may be interesting from a cost-efficiency point of view, it is unlikely that any of the devices currently on the market will be used in the United States for high-speed shared corridor applications since none of the devices incorporate gates but instead rely on augmented passive systems (adding lights or advance warnings to areas around crossings). Additionally, there are significant legal concerns stemming from public perception of the devices, fail-safe requirements, and liability to both the public and private sector (Hellman and Ngamdung 2010; Wullems 2011). However, the concept will likely continue to develop and may expand to include gate technology.

3.6.5 Emergency Response Management

Wahle and Beatty (1993) define emergency response management as “the process of preparing for, mitigating, responding to, and recovering from an emergency.” The process of developing an emergency plan is “dynamic,” in that the plan can and should change over time. A comprehensive emergency response management system includes training, conducting drills, testing equipment, and coordinating activities with the community.

The Standard for Rail Transit System Emergency Management (APTA 2004) was developed to establish minimum emergency response management requirements for rail transit systems; these requirements address emergency mitigation, preparedness, response, and recovery. In the mitigation phase, potential risks are identified and minimized. Recommended methods for

accomplishing this are given. The preparedness phase involves developing and documenting emergency procedures, as well as training transit staff and emergency responders. The response phase is when an emergency occurs and the transit agency uses the emergency plan. In the recovery phase, normal service resumes. The agency then evaluates and documents the performance of their emergency response.

3.6.6. Human Factors and Driver Behavior

Understanding driver behavior and identifying human factor causes for accidents at highway grade crossings can help us develop better accident-prevention strategies. Caird et al. (2002) developed a taxonomy of human factor accident contributors to highway-rail grade crossing accidents (Figure 3.4).

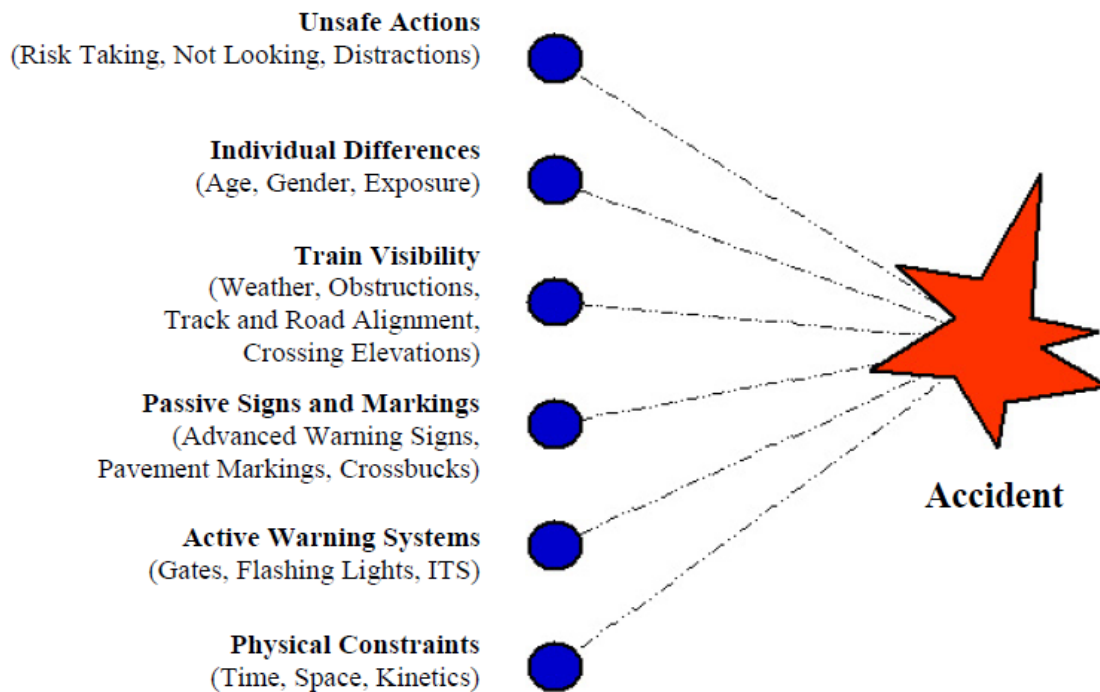

Figure 3.4. Highway-rail grade crossing accident contributors (Caird et al. 2002)

Different people react differently to warning signs at grade crossings. Several studies have been conducted with the goal of identifying the source of this variation (Lenné et al. 2011; Jeng 2005; Tey et al. 2011a, 2011b; Caird et al. 2002). The age group of 26 to 64 accounted for the most fatalities (Caird et al. 2002); however, this age group proportionally drives the most and thus has the greatest exposure (Evans 1991). Different age ranges within this group might have different results. Taylor (2008) stated that 16- to 25-year-old drivers were identified as the group most at risk at grade crossings because they were the most likely to knowingly engage in risky crossing behavior.

In response to warning signs at grade crossings, drivers showed lower compliance rates at passive crossings than at active crossings (Lenné et al. 2011; Tey et al. 2011a, 2011b). Additional warnings, especially the addition of active warning devices, should result in increased crossing compliance. But due to limited budgets, it is impossible to update all passive signs to active

warning systems. Alternative ways of augmenting passive crossings are being studied (Cairney 2003; Tey et al. 2011b; Wullems 2011). Caird et al. (2002) summarized the effectiveness and cost of different countermeasures at grade crossings (Table 3.4).

Table 3.4. Caird et al. (2002) Summary of Effectiveness and Cost of Countermeasures

Countermeasure	Effectiveness	Cost	References
Stop signs at passive crossings	Unknown	\$1.2 to \$2 K (US)	NTSB (1998)
Intersection lighting	52% reduction in nighttime accidents over no lighting	Unknown	Walker and Roberts (1975)
Flashing lights	64% reduction in accidents over crossbucks alone; 84% reduction in injuries over crossbucks; 83% reduction in deaths over crossbucks	\$20 to \$30 K (US) in 1988	Schulte (1975) Morrissey (1980)
Lights and gates (2) + Flashing lights	88% reduction in accidents over crossbucks alone; 93% reduction in injuries over crossbucks; 100% reduction in deaths over crossbucks	\$150 K (US)	NTSB (1998) Schulte (1975) Morrissey (1980)
	44% reduction in accidents over flashing lights alone		Hauer and Persaud (1986)
Median barriers	80% reduction in violations over 2-gate system	\$10 K (US)	Carroll and Haines (2002a)
Long-arm gates (3/4 of roadway covered)	67 to 84% reduction in violations over 2-gate system	Unknown	Carroll and Haines (2002a)
4-quadrant gate systems	82% reduction in violations over 2-gate system	\$125 K (US) more expensive than standard gates; \$250 K (US) more expensive than passive crossing	Carroll and Haines (2002a), Hellman and Carroll (2002)
4-quadrant gate system + median barriers	92% reduction in violations over 2-gate system	\$135 K (US)	Carroll and Haines (2002a)
Crossing closure	100% reduction in violations, accidents, injuries, and deaths	\$15 K (US)	Carroll and Haines (2002a); NTSB (1998)
Photo/video enforcement	34 to 94% reduction in violations	\$40 to \$70 K per installation (US)	Carroll and Haines (2002b)
In-Vehicle Crossing Safety Advisory Warning Systems (ICSAWS)	Unknown	\$5 to \$10 K (US) per crossing + \$50 to \$250 per receiver	NTSB (1998)

Caird et al. (2002) and Sussman and Raslear (2007) also identified the primary reasons for accidents at grade crossings. In general, the reasons can be classified as intentional, distraction, or other (visibility issues or driver confusion) for both passive and active grade crossings.

Accidents at passive crossings may occur because (1) the driver is unaware of the train's arrival due to visibility problems (bad weather), distractions (talking on a cellular phone, talking with passengers), or late detection; (2) the driver does not know the required response to a crossbuck; or (3) the driver incorrectly decides that sufficient time was available to cross after detecting the train, or makes a purposeful attempt to "beat the train."

Reasons for accidents at active crossings might be (1) a lack of sufficient sight distance; (2) the driver willfully violating the traffic control device, as in driving around the gates or attempting to beat the train; (3) driver confusion at railroad crossings that are close to highway intersections; or (4) visibility problems in bad weather.

Three main approaches are commonly used to address these problems. They are referred to as the "Three Es": engineering, education, and enforcement (Sussman and Raslear 2007; Jeng 2005). "Engineering" involves using better devices to alert people to and impede vehicles from wandering onto the grade crossing. "Education" aims at building public awareness of the hazards of train movements. "Enforcement" seeks to enforce compliance with laws at grade crossings. The most prominent educational and outreach effort for grade crossing safety in the United States is Operation Lifesaver (OL). OL's network includes certified volunteer speakers and trained instructors offering free rail safety education programs to school groups, driver education classes, community audiences, commercial drivers, law enforcement officers, and emergency responders (Savage 2006). Proving the program's effectiveness, Mok and Savage (2005) found that the introduction of OL programs in a State results in a 15 percent decrease in the number of grade crossing incidents and a 19 percent decrease in the number of fatalities.

Jeng (2005) drafted an additional section in the New Jersey driver's manual about railroad safety, and then performed an experimental driver's test on the draft section. The drivers who studied the manual with the additional section performed significantly better on the test. The result suggested that an accurate, easy-to-read, and comprehensible driver's manual could improve drivers' response at grade crossings.

In Australia, some educational methods being applied by the National Railway Level Crossing Behavioral Coordination Group include organizing a national workshop, publishing safety Web pages containing relevant information, and producing a communications package consisting of radio and press advertisements (Taylor 2008).

3.7 Discussion and Conclusions

FRA classifies passenger and freight train shared operations into (1) shared track, where passenger and freight trains use the same trackage on single or multiple tracks for all or part of their operation; (2) shared ROW, where passenger and freight trains use separate tracks but with adjacent track centers of 25 ft (7.6 m) or less; and (3) shared corridor, which is similar to shared ROW, but with adjacent track centers of more than 25 ft (7.6 m) but less than 200 ft (61 m) apart

(Resor 2003). In addition, “hybrid” systems exist in which HSR trains operate on dedicated high-speed infrastructure on some sections and conventional infrastructure on others.

In a shared track scenario, adding new HSR passenger services will increase the total rail traffic. Increased rail traffic at a crossing has been linked to an increased number of grade crossing collisions (Austin and Carson 2002; Faghri and Demetsky 1986; Ogden and Korve Engineering 2007). Also, highway users may overestimate the amount of time they have to cross in front of a higher speed train since they are used to interacting with slower conventional rail. It is important to consider upgrading any crossing with an increased number of through trains per day. Highway users must be informed that trains at crossings may have higher closing speeds than expected.

Shared ROW and shared corridor operations have similar challenges. A correlation has been demonstrated between multiple-track territory and higher collision rates (Austin and Carson 2002; Faghri and Demetsky 1986; Ogden and Korve Engineering 2007). At grade crossings with multiple tracks, drivers may check for trains on one track but forget there is another track to check and could be struck by an unexpected train on the second track.

Additionally, shared corridor operations could have very long grade crossings, or multiple grade crossings very close together. Both of these are undesirable from a highway driver’s point of view as they could limit visibility and reduce the driver’s ability to perceive approaching trains.

Shared operations using multiple tracks face the additional risk of experiencing secondary collisions with freight trains on adjacent tracks. An example of this is the Glendale, CA, collision in 2005. In this incident, a passenger train struck an SUV that had been abandoned on the tracks¹. The SUV subsequently became lodged on switch equipment, resulting in the train derailing and jackknifing. The passenger train struck a freight train on an adjacent track as well as the tail end of another passenger train. Thus the shared operating scenario increased the severity of the grade crossing collision.

In a hybrid system, the dedicated and conventional sections would require different considerations. For the dedicated section, cost would be the primary obstacle since all grade crossings would need to be grade separated. For the conventional infrastructure section, grade crossings would not necessarily need to be eliminated provided trains were not operating at more than 125 mph (201 kph). However, they would likely need to be upgraded to quad-gate systems or other advanced grade crossing warning devices.

In addition, hybrid operations could require passenger trains to meet different crashworthiness standards. On a dedicated HSR line, lightweight train sets would be highly desirable, whereas they could pose an unacceptable safety risk when operated on conventional track.

The field of research related to grade crossing safety is vast, as can be seen from this literature review. However, there is room to expand on the existing knowledge base and to explore new techniques for improving safety, especially in the context of shared rail corridor operations.

¹ The Glendale, CA, collision was not technically a grade crossing collision, as the driver of the SUV drove some distance up the track before parking his vehicle. However, the same collision could occur at a grade crossing.

There are several challenges to implementing the Railroad Safety Improvement Act of 2008, as illustrated by the Liu et al. (2011) survey. One important challenge is the timely completion of grade crossing inspections. It may be difficult to reduce the number of operating crossings, which indicates that the workload cannot be reduced. Given that it may also be difficult to increase the number of crossing inspectors due to current economic conditions, one approach to solving this problem may be to improve the efficiency of inspection procedures and techniques. More in-depth research is needed to understand the feasibility of this approach.

In the area of crashworthiness, new research may be conducted to understand the ideal tradeoff between lightweight passenger car design and crashworthiness. Using principles of CEM design should allow engineers to build trains that could work either in hybrid operations or on shared ROWs or shared corridors. In the case of hybrid operations, it would be valuable to study the car designs used abroad—in France, for example. Design of the TGV has been informed by collisions at grade crossings on conventional track, and the TGV's designers' understanding of crashworthiness has developed over time (Cleon et al. 1993, 1996; Jacobsen 2008). In the case of shared ROW and shared corridor operations, it is especially important to determine if it is possible to design trains to withstand collisions such as the Glendale, CA, accident, where jackknifing of the train resulted in side-swiping of a freight train. It may be that improved crashworthiness is insufficient to address this type of accident and that risk reduction strategies should instead focus on accident prevention.

Collision likelihood modeling should continue to develop and evolve. New research may be conducted to understand if the U.S. DOT Accident Prediction Formula needs to be updated to reflect the current state of technology, or if an entirely new formula needs to be developed. Since the formula currently does not account for a sealed corridor differently than it accounts for traditional gated crossings, this would be a critical area to consider as shared corridor usage grows.

Several experiments have been performed on driver response to grade crossing devices, and statistical models have been developed based on analyses of existing crash data, but there is still an absence of a theoretical or behavior-based model of the grade crossing system. Development of such a model could help designers evaluate the effectiveness of new grade crossing systems.

Several current studies and previous research indicate that active systems at crossings provide better performance than passive systems. However, upgrading all passive crossings to active crossings would involve a huge investment. Moreover, collisions at grade crossings with active systems are mainly attributed to driver behavior. Also, collisions occur randomly with significant variations in time and space. Therefore, there is no guarantee that upgrading a grade crossing from passive to active is the best solution for improving safety at crossings. Further in-depth research on the cost-effectiveness of this approach is needed. More aggressive driver education could be a more effective tool for improving safety.

Highway-rail grade crossing risk is a topic that has been researched extensively. The results of these studies have led to significant safety advancements, especially in the areas of crashworthiness, grade crossing design, and driver education. These advancements, combined with increased government oversight, have led to a sharp decrease in the number of grade

crossing-related casualties in the United States. Implementation of high-speed rail passenger services on existing freight rail corridors will likely pose new grade crossing safety concerns or amplify existing ones. This section identified the potential technical challenges, relevant existing research, and future research needed to facilitate the planning, development, construction, and operation of future HSR shared corridors in the United States.

3.8 References

- 74 FR 35950. (2009). Positive Train Control Systems. *Notice of Proposed Rulemaking*. Federal Register 74 (138) 35950-36028.
- American Public Transportation Association (2004). Standard for Rail Transit System Emergency Management. *Manual of Rail Transit Standards and Recommended Practices Volume 4 – Operating Practices*. The American Public Transportation Association. Washington, DC.
- American Railway Engineering and Maintenance-of-Way Association. (2010). Chapter 17 High Speed Rail Systems. *AREMA Manual for Railway Engineering*.
- Austin, R. D. and J. L. Carson. (2002). “An alternative accident prediction model for highway-rail interfaces.” *Accident Analysis & Prevention* 34, 31–42.
- Benekohal, R. F. and Y. M. Elzohairy. (2001). “A New Formula for Prioritizing Railroad Crossings for Safety Improvement.” Proceedings of the Institution of Transportation Engineers Annual Meeting. Chicago, IL.
- Bien-Aime, P. (2009). *North Carolina “Sealed Corridor” Phase I, II, and III Assessment*. Federal Railroad Administration Office of Research and Development, Washington, DC.
- Caird, J. K. (2002). A Human Factors Analysis of Highway-Railway Grade Crossing Accidents in Canada. Transportation Development Centre, Montreal.
- Cairney, P. (2003). *Prospects of improving the conspicuity of trains at passive railway crossings*, CR 217. Australian Transport Safety Bureau, Canberra.
- Carroll, A. A. and M. Haines. (2002a). “North Carolina “sealed corridor” Phase I safety assessment.” *Transportation Safety Board [CD-ROM]*. Transportation Research Board, Washington, DC.
- Carroll, A. A. and M. Haines. (2002b). “The use of photo enforcement at highway-rail grade crossings.” *Transportation Safety Board [CD-ROM]*. Transportation Research Board, Washington, DC.
- Chaudhary, M., A. Hellman, and T. Ngamdung. (2011). *Railroad right of way incident analysis research*. Federal Railroad Administration Office of Railroad Policy and Development, Washington, DC.
- Cleon, L. M., M. Piosson, P. Pastor, V. Tha IV, and P. H. Guardiola. (1993). Résistance passive application au TGV 2N; *Tolérances à la collision des matériels ferroviaires* (French). Revue générale des chemins de fer, HC Editions. Paris, France.
- Cleon, L. M., J. Legait, and M. Villemin (1996). SNCF Structural Crashworthiness Design Strategy: Design Examples of Duplex TGV and XTER Diesel Multiple Unit. Symposium on Rail Vehicle Crashworthiness, Office of Research and Development, Washington, DC.
- Code of Federal Regulations (CFR) (2012). “Transportation.” *Title 49 Code of Federal Regulations*, Part 213-222.
- Evans, L. (1991). *Traffic Safety and the Driver*. Van Nostrand Reinhold, New York.
- Faghri, A. and M. J. Demetsky. (1986). *Evaluation of Methods for Predicting Rail-Highway*

- Crossing Hazards*. Virginia Highway & Transportation Research Council, Charlottesville, VA.
- Federal Railroad Administration (FRA) (1987). *Rail-Highway Crossing Resource Allocation Procedure: User's Guide, 3rd Edition*. Office of Safety Analysis, Washington, DC.
- Federal Railroad Administration (FRA) (2006). *Report to the House and Senate Appropriations Committees: The Safety of Push-Pull and Multiple-Unit Locomotive Passenger Rail Operations*. Office of Railroad Development, Washington, DC.
- Federal Railroad Administration (FRA) (2009a). *Highway-Rail Grade Crossing Guidelines for High-Speed Passenger Rail*. Office of Railroad Development, Washington, DC.
- Federal Railroad Administration (FRA) (2009b). North Carolina Department of Transportation's "Sealed Corridor" Assessment – Phase IV. In: *Research Results*, Washington, DC.
- Federal Railroad Administration (FRA) (2009c). *High-Speed Passenger Rail Safety Strategy*. Office of Railroad Development, Washington, DC.
- Federal Railroad Administration (FRA) (2010). Use of Traffic Channelization Devices at Highway-Rail Grade Crossings. In: *Research Results*, Washington, DC.
- Federal Railway Administration (FRA) (2011a). Low-Cost Warning Device Industry Assessment. In: *Research Results*, Washington, DC.
- Federal Railroad Administration (FRA) (2011b). *Download Accident Data On Demand*. http://safetydata.fra.dot.gov/OfficeofSafety/publicsite/on_the_fly_download.aspx. Accessed March 2011.
- Federal Railroad Administration (FRA) (2012a). *Crossing Inventory by State*. <http://safetydata.fra.dot.gov/OfficeofSafety/publicsite/Query/invtab.aspx>. Accessed Jan 2012.
- Federal Railroad Administration (FRA) (2012b). *Highway/Rail Incidents Summary Tables: Jan 2011–Dec 2011*. <http://safetydata.fra.dot.gov/OfficeofSafety/publicsite/Query/gxrtab.aspx>. Accessed May 2012.
- Federal Railroad Administration (FRA) (2012c). *Chronology of High-Speed Rail Corridors: Designations and Extensions*. Office of Railroad Development, Washington, DC. <http://www.fra.dot.gov/Page/P0140>. Accessed May 2012.
- Glover, J. (2009). "The Level Crossing Conundrum." *Rail Professional* (November), pp. 30–31.
- Hall, S. (2007). "Reducing Risk at Automatically-Operated Level Crossings on Public Roads." In: *IET Seminar on Reducing Risk at the Road Rail Interface*, pp. 1–5, 17.
- Hauer, E. and B. N. Persaud. (1986). "Rail-highway grade crossings: Their safety and the effect of warning devices." In: *Proceedings of the 30th Annual American Association for Automotive Medicine*, Montreal, QC, pp. 247–262.
- Hellman, A. D. and A. A. Carroll. (2002). "Preliminary evaluation of the school street four-quadrant gate highway-railroad grade crossing." *Transportation Research Board, [CD-ROM]*, Washington, DC.
- Hellman, A. D. and T. Ngamdung. (2009). *Illinois High-Speed Rail Four-Quadrant Gate*

- Reliability Assessment*. Federal Railroad Administration Office of Research and Development, Washington, DC.
- Hellman, A. D. and T. Ngamdung. (2010). *Low-Cost Warning Device Industry Assessment*. Federal Railroad Administration Office of Research and Development, Washington, DC.
- Jacobsen, K., D. Tyrell, and B. Perlman. (2003). “Rail Car Impact Tests with Steel Coil: Collision Dynamics.” In: *Proceedings of ASME/IEEE Joint Railroad Conference*.
- Jacobsen, K. M. (2008). “Collision Dynamics Modeling of Crash Energy Management Passenger Rail Equipment.” *M.S. Thesis*. Tufts University, Boston, MA.
- Jeng, O.-J. (2005). *Survey of Driver Perceptions of Railroad and Light Rail Warning Devices/Grade Crossings*. Federal Transit Administration, Washington, DC.
- Jennings, L. S. (2009). *Compilation of State Laws and Regulations Affecting Rail-Highway Grade Crossings, 5th ed.* Jennings Consulting Group, Woodstock, VA.
- Lenné, M. G., C. M. Rudin-Brown, J. Navarro, J. Edquist, M. Trotter, and N. Tomasevic. (2011). “Driver Behaviour at Rail Level Crossings: Responses to Flashing Lights, Traffic Signals and Stop Signs in Simulated Rural Driving.” *Appl Ergon* 42 (4), 548–554.
- Liu R., Z. Huang, and W. Hao. (2011). Potential Issues and Challenges in Implementing the Railroad Safety Improvement Act of 2008 Based on a National Survey, *J. Transp. Saf. Secur.* 3 (4), 252–271.
- Martinez, E., D. Tyrell, and J. Zolock. (2003). “Rail Car Impact Tests with Steel Coil: Car Crush.” In: *Proceedings of ASME/IEEE Joint Railroad Conference*.
- Mok, S. C. and I. Savage. (2005). “Why has safety improved at rail-highway grade crossings?” *Risk Analysis* 25 (4), 867–881.
- Morrissey, J. (1980). *The Effectiveness of Flashing Lights and Flashing Lights with Gates in Reducing Accident Frequency at Public Rail-Highway Crossings 1975–1978: Final Report*. Federal Railroad Administration, Washington, DC.
- National Transportation Safety Board (NTSB) (1998). *Safety study: Safety at passive grade crossings, Volume 1: Analysis (PB98-917004, NTSB/SS-98/02)*. NTSB, Washington, DC.
- Nelson, A. (2010). “Breaking down the barriers to safer crossings.” *International Railway Journal* 50 (5), 45–47.
- Ogden, B. D., Korve Engineering (2007). *Railroad-Highway Grade Crossing Handbook – Revised 2nd Edition*. Office of Safety Design, Federal Highway Administration, Washington, DC.
- Oh, J., S. P. Washington, and D. Nam. (2006). “Accident prediction model for railway-highway interfaces.” *Accident Analysis & Prevention* 38 (2) 346–356.
- Raub, R. (2007). “Examination of Vehicle Crashes Nationally at Highway-Rail Grade Crossings.” *ITE Journal*.
- Research and Innovative Technology Administration (2011). *Table 2–42: Railroad Passenger Safety Data*. U.S. Department of Transportation, Washington, DC.
- Resor, R. R. (2003). *Catalog of “Common Use” Rail Corridors*. Federal Railroad Administration

Office of Research and Development, Washington, DC.

- Samavedam, G. and K. Kasturi. (2011). *Full-Scale Locomotive Dynamic Crash Testing and Correlations: Locomotive Consist Colliding with Steel Coil Truck at Grade Crossing (Test 3)*. Federal Railroad Administration Office of Railroad Policy and Development, Washington, DC.
- Savage, I. (2006). “Does public education improve rail-highway crossing safety?” *Accident Analysis and Prevention* 38 (2), 310–316.
- Schulte, W. R. (1975). “Effectiveness of automatic warning devices in reducing accidents at grade crossings.” *Transportation Research Record* 611, 49–57.
- Simons, J. W. and S. W. Kirkpatrick. (1998). “High-Speed Passenger Train Crashworthiness and Occupant Survivability.” In: *Proceedings of the International Crashworthiness Conference*.
- Sussman, E. D. and T. G. Raslear. (2007). Railroad Human Factors. *Reviews of Human Factors and Ergonomics* 3 (1) 148–189.
- Taylor, K. (2008). “Addressing road user behavioural changes at railway level crossings.” In: *Proceedings of Joint ACRS-Travelsafe National Conference*, pp. 368–375.
- Tey L. S., L. Ferreira, and A. Wallace. (2011a). “Measuring driver responses at railway level crossings.” *Accident Analysis & Prevention*, 43 (6) 2134–2141.
- Tey, L. S., G. Wallis, and L. Ferreira. (2011b). “Using a driving simulator to assess driver compliance at railway level crossings.” In: *Proceedings of the 34th Australasian Transport Research Forum*, Adelaide, Australia.
- Tyrell, D. and A. B. Perlman. (2003). “Evaluation of rail passenger equipment crashworthiness strategies.” *Transportation Research Record* 1825, 8–14.
- Tyrell, D., E. Martinez, K. Severson, K. Jacobsen, D. Parent, M. Priante, A.B. Perlman. (2006). “Overview of a Crash Energy Management Specification for Passenger Rail Equipment.” In: *Proceedings of JRC 2006*.
- Wahle, T. and G. C. Beatty. (1993). *Emergency Management Guide for Business & Industry: A Step-by-Step Approach to Emergency Planning, Response and Recovery for Companies of all Sizes*. Federal Emergency Management Agency, Washington, DC.
- Walker, F.W. and S. E. Roberts. (1975). “Influence of lighting on accident frequency at highway intersections.” *Transportation Research Record* 562, 73–78.
- Wullems, C. (2011). “Towards the adoption of low-cost rail level crossing warning devices in regional areas of Australia: A review of current technologies and reliability issues.” *Saf.Sci.* 49 (8–9), 1059–1073.

4. SPECIAL TRACKWORK FOR SHARED HIGH-SPEED RAIL PASSENGER AND HEAVY AXLE LOAD FREIGHT OPERATIONS

4.1 Introduction

The railroad track structure poses a unique challenge at the location where two tracks intersect. Special trackwork (i.e., turnouts, crossing diamonds and their components) plays a vital role in railway infrastructure by providing route flexibility to trains as they travel across a network. Discontinuities in wheel-rail contact at the running surface and increased stiffness of special trackwork result in high impact loads and dynamic interactions between train wheels and the specialty components that make up turnouts and crossing diamonds (Kassa 2008). Discontinuities in the track are critical because they alter the vertical and lateral stiffness of the track and affect the velocity of the vehicle (Licciardello 2008). As a result of these interactions, a significant amount of damage to the track ensues in the form of plastic deformation, component wear, and rolling contact fatigue (Kassa 2008). Although special trackwork typically consists of only a small portion of route miles on a railway network, problems with turnout and crossing components represent a relatively large percentage of maintenance costs, train delays, and track-related incidents (Ossberger 2010; Weart 2012).

The U.S. DOT is supporting development of a substantially expanded and improved passenger rail service on a number of intercity corridors across the United States (FRA 2012). These corridor development projects will range from incremental improvement of existing tracks to construction of new, dedicated HSR lines. Existing lines could already have freight or passenger rail services, necessitating shared operations. As the interest in shared corridors grows, special trackwork represents a significant challenge due to diverging loading characteristics and design priorities of HAL freight traffic and HSR passenger traffic (Nash 2003).

4.2 Divergent Design Considerations for HSR and HAL

Special trackwork design in North America has progressed with a focus on increased axle loads; the operating speeds have not seen similar growth. Consequently, designs of track components have become stronger, albeit larger, yet the actual geometry of turnouts and other special trackwork has not varied greatly (Abbot et al. 2010). This highlights the unique challenge in North American railway infrastructure of introducing higher speed passenger service, which requires a higher standard for track quality, onto existing track typically experiencing heavy axle freight loads. To meet the track design conditions required for the growth of HSR in North America, the design of the turnout must be reanalyzed. Many other countries, specifically in Europe and Asia, could provide valuable insight into track design for high-speed operation (Rohlmann and Hess 2007; Cao et al. 2011; Haifeng et al. 2011). However, there is still much to be learned about operating on shared track, and the combination of North American freight axle loads and more robust passenger car designs than those generally seen globally on existing high-speed lines contributes to this challenge (Abbot et al. 2010).

Both HAL and HSR types of traffic require special trackwork components that minimize impact loads (Davis et al. 2010). However, notable differences between HAL and HSR in the design requirements and loading conditions have created a variety of challenges related to special trackwork. The primary difference is the priority given to considerations for passenger comfort

and diverging speed. HSR lines require that turnouts and crossings minimize or eliminate the need to slow the train while maintaining passenger safety and comfort (Davis et al. 2010). Increases in diverging speed and rider comfort can be achieved through optimal turnout geometries and the use of movable point frogs (Davis et al. 2010). Another alternative is to orient turnouts so that the direction of high-speed traffic corresponds with the straight movement through the turnout. On the other hand, special trackwork on HAL freight lines are designed to withstand the high tonnage on a specific route while minimizing maintenance (Davis et al. 2010). Because the diverging speed is typically not important on HAL lines, the goal of innovative frog designs for HAL is to eliminate the gap in the running rails on the mainline. This may be achieved through flange bearing frogs or spring frogs.

In addition to design considerations, HSR and HAL operations impose different loading conditions on special trackwork. Impact loads vary significantly with train speed and are the primary cause of track degradation (Remennikov and Kaewunruen 2007). Both HAL and HSR traffic impose impact loads due to irregularities in the track and in the wheels, but the combination of axle load and train speed makes the differences in load magnitude and track damage extremely complex. By definition, loads from HAL freight trains are higher in magnitude and longer in duration than loads from HSR trains. When irregularities incite dynamic interaction between rails and HAL wheels, a dynamic amplification of the load magnitude can occur at higher frequencies. HSR loads have a lower magnitude, but the faster speeds result in a greater amplification of the forces. For example, one study has shown that the wheel-rail contact force in a turnout is approximately 100 percent greater than the static load for trains traveling at 43.5 mph and 200 percent greater at 93.2 mph (Andersson and Dahlberg 2009).

For incremental upgrades to result in a successful HSR system, special trackwork must meet the design requirements necessary to run passenger trains at high speeds while withstanding heavy impact loads from HAL freight cars. This section presents an overview of the issues related to special trackwork for shared corridors and provides an in-depth analysis of the relevant research to date. In the following section, a review of studies related to flange bearing technology, turnout geometry, other innovative component designs, and field instrumentation and modeling is presented. In the discussion section, the relevance of different shared operation types and research needs is addressed.

4.3 Flange bearing Technology

As the demands on the track become more significant due to increasing axle loads and faster train speeds, railroad crossing diamonds will require improvement. The traditional approach to designing crossing diamonds is to create small gaps in the intersecting rails to allow a train to pass through another track without having to separate the grade of the two lines. High impact loads from train wheels are often imparted on the edges of the frog where these gaps occur, which greatly increases wear and reduces the life cycle of these components. High impact forces cause damage to the rail, and the supporting earthwork below a crossing diamond is also negatively affected. In an attempt to mitigate these impacts under increasing axle loads and increase the life cycle of crossing diamond components, Class I railroads have been investigating the use of flange bearing technologies (Clark et al. 2008). The gap in the running surface of the rail is eliminated because the flange of a wheel is used to support the car as it is essentially lifted over the intersecting track.

One type of flange bearing technology is a full flange bearing frog diamond (FBF) as shown in Figure 4.1. In this type, wheels on trains traveling on both tracks at a crossing are ramped up to be supported by the flanges so that intersection occurs at the same level surface for either route (Clark et al. 2008). The elimination of flangeway gaps for both routes mitigates the issue of high impact forces on the crossing diamond components. FRA does, however, have a regulation governing flangeway depth of railroad track components, necessitating the request of a special waiver to make use of this technology. A field installation of an FBF diamond was performed in Shelby, OH, by CSX in 2006. Within the first 22 months of service—after supporting approximately 60 MGT per year since installation—practically no maintenance related to this diamond was required (Clark et al. 2008). Although the speed on both routes had to be reduced to 40 mph, the advantage of this technology is that the relative speed of each route can be the same. Further evaluation of the longer life cycle of this turnout is still being performed. This type of diamond may be beneficial at crossings where the freight and passenger line traffic volumes are similar. Because of the lower speeds required on FBF diamonds, this technology would not be ideal where higher speed operation is desired. Further research may lead to increased speed operation through geometric and material improvements.



Figure 4.1. Example of full flange bearing frog diamond (Clark et al. 2008)

Another popular type of flange bearing technology is the one-way low speed (OWLS) partial flange bearing crossing diamond (Fig. 4.2). This technology was developed in response to the requirement to obtain a waiver from the FRA Track Safety Standards to make use of FBF crossings. In this application, the rail on a line with a large volume of traffic can be left continuous, while an intersecting line with less traffic becomes flange bearing to cross over the mainline. The geometry of an OWLS diamond still requires a gap on the flange bearing track to go over the continuous rail. The lower frequency of impact loadings on this track results in less damage to the frog. An example where this type of crossing could benefit train operation would

be where a lesser-used branch line intersects a busy, high-density mainline. It should be noted that research of flange bearing technology has shown that it does not have a negative effect on freight car or locomotive wheels (Clark et al. 2008). This type of diamond would be ideal in a shared corridor where a given line is predominant in traffic volume over an intersecting line that is operated at lower speeds. The lesser used line would be flange bearing through the diamond, allowing the other to be continuous, benefiting from unrestricted speeds and providing a smooth running surface for passenger comfort.



Figure 4.2. Example of one-way low speed partial flange bearing (Clark et al. 2008)

Flange bearing technology has also been adapted for turnouts through use of a partial flange bearing turnout frog. In this application the rail of a mainline route can remain continuous, while the lesser-used diverging track lifts the train wheels over the mainline rail and is lowered down to continue on the diverging route (Davis et al. 2009). This type of turnout is said to be more effective than a commonly used spring frog because there is no need for the moving parts and additional inspection and lubrication necessary for that type of trackwork (Clark et al. 2008). Because a frog is generally used in an area experiencing high impact loads in more typical designs, elimination of this area can increase the life cycle of the expensive track component.

A test installation on the Facility for Accelerated Service Testing (FAST) at the Transportation Technology Center (TTC) included two different prototypes of partial flange bearing turnout frogs. One of these is called the Lift Frog and is similar to turnouts that the railroad companies are currently purchasing. The Lift Frog is unique because of an increased ramp length in the frog and the presence of a parallel ramp on the guardrail side of the turnout opposite the frog (Davis et al. 2008; Davis et al. 2009). At FAST, this frog has been installed on a turnout on the High Tonnage Loop (HTL), which sees 39-ton axle loads operating at 40 mph. When comparing the results of vertical wheel forces for the Lift Frog with a rail bound manganese (RBM) frog that

was previously installed at this location, the vertical wheel forces experienced by the frog from the mainline traffic have been reduced significantly. Fig. 4.3 shows these forces plotted versus train speed for both frog types, with an approximately 38 percent decrease in force at 40 mph.

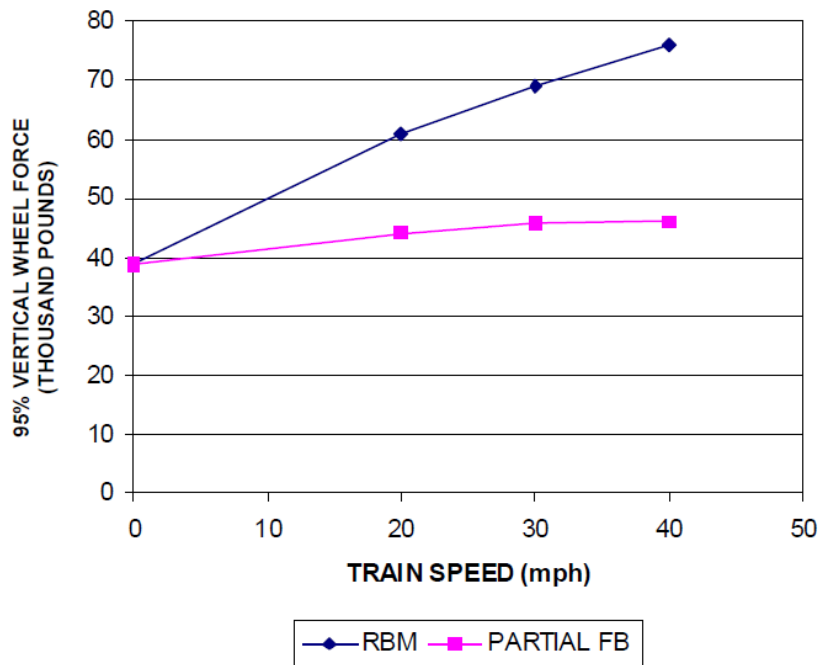

Figure 4.3. Maximum vertical wheel force versus train speed for lift frog (Davis et al. 2009)

A diverging move made over this turnout is limited to 15 mph. Since it is generally the higher operating speeds that produce the increased dynamic impact loads, a reduction of the force from the faster, mainline traffic results in a very positive result. The benefit of reduced forces at this speed is that, unlike with the more commonly used RBM frog, a longer service life is expected for the Lift Frog. In a shared track operation, partial flange bearing turnout frogs such as the Lift Frog could be used where a track diverges into respective freight and passenger routes. It should be noted that in a shared track scenario, the ramps in partial flange bearing turnout frogs must be designed to accommodate a greater variety of wheel flanges. Different types of freight and passenger rolling stock have wheel profiles optimized for their given performance requirements. Accordingly, special trackwork on shared corridors must be designed so that both types of wheel profiles can navigate the gaps in the frog.

4.4 Turnout Geometry

Another aspect of the challenge of operating higher speed passenger trains on existing freight lines is the geometry of the turnouts. The primary influence on the design of the frog angle on a turnout that governs the rate at which two tracks diverge is the desired operating speed through the turnout. Inversely, existing turnouts restrict the increase in speed of train operation through certain sections of track. Turnouts designed for higher speed operation are generally longer in length so as to reduce lateral accelerations and provide a more gradual change of direction. Too rapid of a change in lateral acceleration can cause a phenomenon known as entry “jerk,” which causes passenger discomfort (Abbot et al. 2010). Passenger comfort is a critical factor that has

resulted in adherence to high maintenance standards for high-speed rail. A primary constraint that requires the installation of turnouts capable of high-speed operation into existing track infrastructure is turnout geometry. New turnout designs for existing track must safely carry the dynamic forces resulting from increased speeds (Abbot et al. 2010).

Research is being performed on increasing the operating speed of trains through the diverging route of a turnout while maintaining the same turnout footprint, that is, without changing the basic track infrastructure (Prasad 2011). The goal of the research is to maintain the same locations of the Point of Switch (PS) and Point of Frog (PF) and keep the frog angle as fixed parameters. Redesign of the turnout would occur in the area within the PS and PF. The issue is that a train diverging through a turnout causes high lateral forces as a result of centrifugal action on the car body, and these forces can vary with the geometry of a given turnout. The forces imparted on turnout components are often greater than the designed strengths. To mitigate this, the proposed changes in turnout design should be made to ensure the forces remain within the optimum level (Prasad 2011). Figure 4.4 illustrates various components of a turnout where lateral forces can exceed the optimum force level and thus should be targets for analysis and potential redesign. The ultimate goal of increasing diverging speed through a turnout within the same footprint with reduced lateral forces and accelerations is to improve ride quality and to decrease component wear. Higher diverging speeds can also increase the capacity of a railroad system (Prasad 2011).

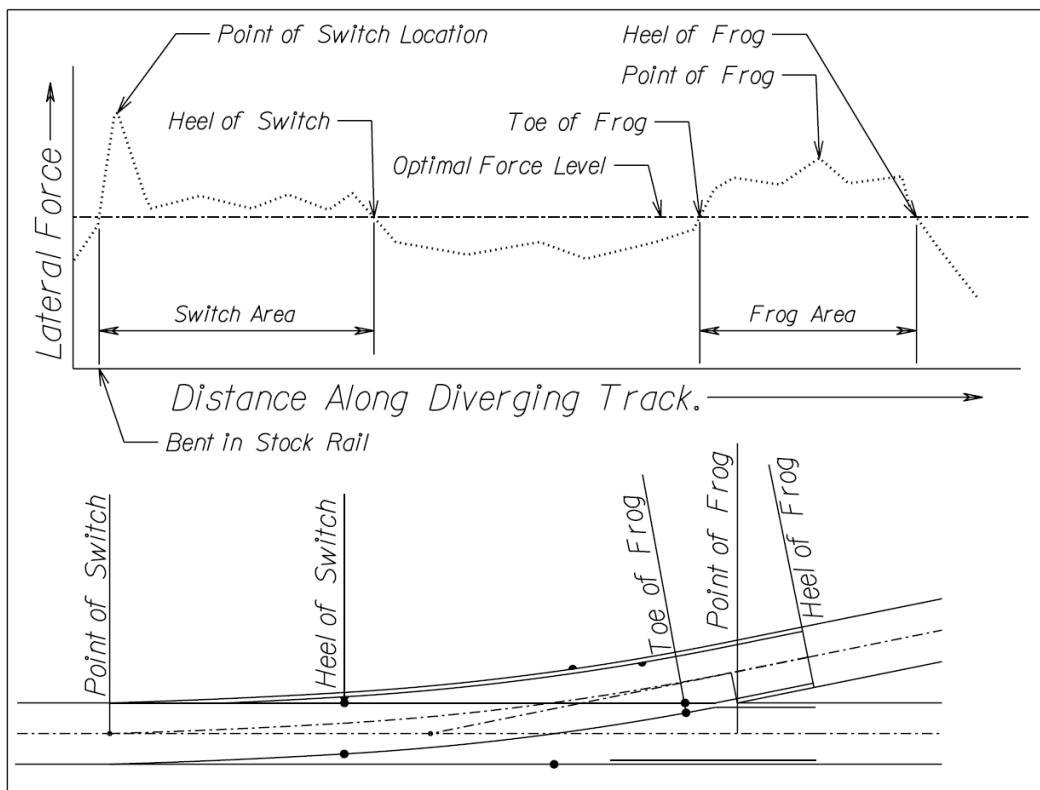

Figure 4.4. Concept of optimum lateral force for turnout design (Prasad 2011)

It is likely that upgrading a single turnout will have no major effect on increasing the capacity of a line. Rather, a greater amount of improvement can come by performing low cost modifications

to several turnouts over a given section of rail line, which would increase the average speed of the trains over that section (Prasad 2011). Increasing average train speed in a shared corridor can mean more operating revenue for freight companies and shorter travel time for passenger trains. Part of the research was to identify the following components and locations in a standard turnout that cause the restriction of speed through special trackwork: the toe of the switch which causes both a kink in the alignment and a change in curvature; the heel of the switch which causes a change in curvature; the toe and heel of the frog which both cause a change in curvature; the gap at the “V” of the crossing where high vertical impacts can occur; and the lack of superelevation in the lead curve on which high centrifugal forces act (Prasad 2011).

The geometry of a turnout has several constraints that can be addressed to satisfy the theoretical desired results of this research. These constraints are the lead distance between the PS and PF, the interlocking footprint of the turnout, the frog angle, and the location of the PS and PF (Prasad 2011). These constraints are considered in this research in order to avoid an extreme case of turnout rehabilitation and because changing any of these geometric values will induce the high cost of changing basic track infrastructure. Modifying existing turnouts for higher diverging speeds will ideally result in higher line capacity, better ride quality and comfort, reduced lateral wheel forces and acceleration, lower rail wear rates, longer service life, and minimum life-cycle cost (LCC) with less interruption of traffic for repair or reconditioning of turnout (Prasad 2011).

Research on optimizing turnout design was furthered through field testing performed by VAE Aketiengesellschaft on turnout responses of a standard AREMA #20 turnout and an optimized #20 turnout for the wheel-rail forces from the leading axle of a train. The optimized turnout is comprised of back-to-back spirals with larger radii entering and leaving the turnout and a smaller radius in the body of the turnout. Use of a larger radius for switch entry for the diverging rail through means of a spiral will allow for a smaller entry angle of a turnout, which can lower lateral forces and acceleration and allow a higher diverging speed (Ossberger and Bishop 2010; Abbot et al. 2010). The result of this optimized design was that while maintaining the same lead length and turnout angle as the standard #20, the optimized turnout saw lateral forces reduced by approximately 40 percent (Prasad, 2011). Operating speeds for this test were 40 mph, which is more representative of freight train operation. Fig. 4.5 shows results from a test of lateral forces produced by a 110-ton coal hopper car traveling at 40 mph through three different turnout types (Ossberger and Bishop 2010). One of the tested turnouts has a larger entry and exit radii, meaning it has been created with spiral transitions into and out of the turnout. From these results it can be seen that this design for the geometry of a turnout can significantly reduce lateral loads from freight train operations.

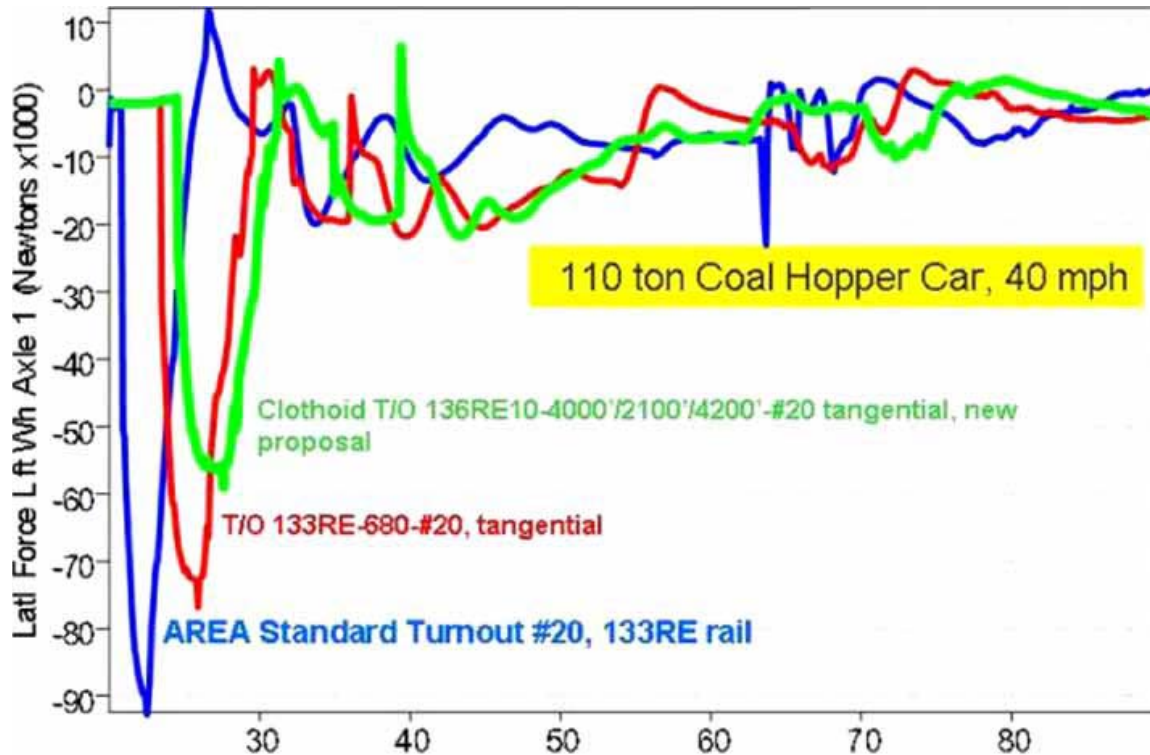

Figure 4.5. Comparison of switch geometries (Ossberger and Bishop 2010)

A similar test was conducted by Butzbacher Weichenbau Gesmmbh (BWG) comparing wheel-rail forces from the leading axle in two high-speed turnouts: one with Kinematic Gauge Optimization (KGO) and one without. KGO is an innovative turnout design where the track gauge is widened at the switch entry area, reducing lateral impact loads (Abbot et al. 2010). It does so by causing the wheels to ride outwards on the taper of the tread, thus steering a train car away from a closed switch point (Abbot et al. 2010). This also allows for the switch rail to be thickened, reducing wear on this component and increasing its life cycle (Wang et al. 2009). This gauge-widening concept is demonstrated in Fig. 4.6. Immediately behind the wheels, an exaggeration of the widened gauge is depicted. It can be seen that the lines of contact between the rail and the wheel tapers have been moved outward relative to the track centerline. This can be compared with where this contact would occur in a normal design where the gauge remains constant through the turnout.

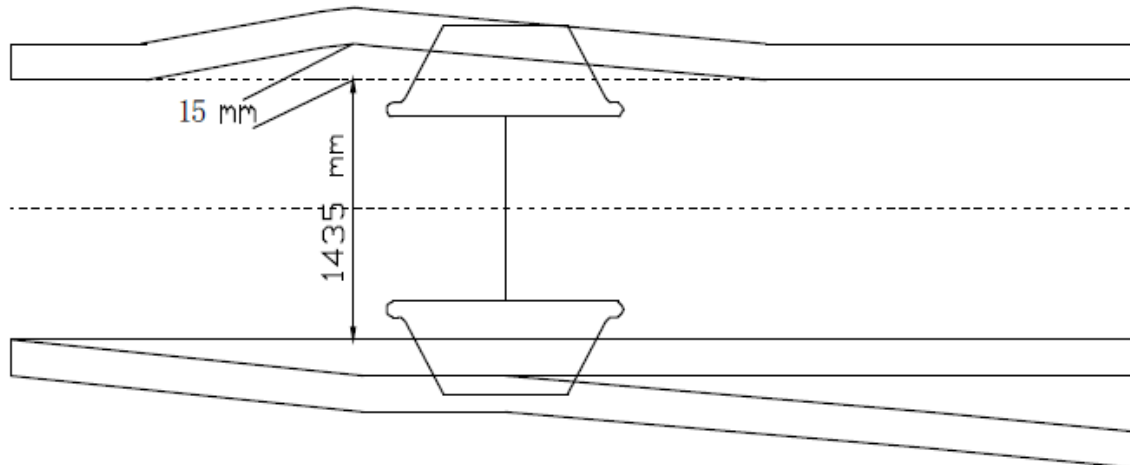

Figure 4.6. Gauge-widening switch structure (Wang et al. 2009)

Operating speeds for this test were 190 mph for the mainline and 140 mph for the diverging route, thus this test was beneficial for understanding the effects of changing internal turnout geometry for high-speed operation. The results from this study also showed a 40 percent decrease in maximum forces for the turnout with KGO, which increases the life of the turnout components (Prasad 2011).

Several design proposals for turnouts have been identified in order to increase the diverging speed within the same interlocking footprint of existing turnouts (Abbot et al., 2010; Prasad, 2011). The first proposal is to reduce the angle for switch entry, reducing the angle of attack and lateral forces and minimizing “jerk” forces that cause passenger discomfort. Designing turnouts with transition curves in components such as the switch rail, lead rail, closure rails, or at points between the P.S. and P.F. can mitigate unbalance forces on the wheelset of a passing train. Increasing the superelevation and reducing cant deficiency in the design for the diverging track of a turnout can allow for higher speed train operation. Making use of KGO technology and creating back-to-back spirals within an optimized turnout design reduces wheel flange contact on the gauge side, minimizing wear. Use of clips and special clamps on the gauge side of the running rail or guard rail can allow for more simplified removal of those significantly worn components, thus decreasing track maintenance time. Future research could focus on designing rolling stock suspension systems that better absorb lateral forces, thereby allowing for greater diverging speeds and increasing passenger comfort.

4.5 Other Innovative Component Designs

Another important aspect of special trackwork is the design of the supporting crossties. For the purposes of heavy freight loads and high-speed operation, concrete crossties are considered to be the most effective material choice. Oftentimes, specially produced long crossties are used in the transition area of a turnout before the two diverging tracks become far enough apart that separate series of crossties can be used. There have been concrete crossties produced with 25 ft or more in length; however, the ability to transport and install these can prove difficult (Abbot et al. 2010). A solution to this is the use of long tie connections that can connect two typical crossties. An advantage to using this type of connection between two smaller crossties is the minimization of

fouling adjacent track through use of the large machinery necessary for installing very long crossties (Abbot et al. 2010).

A design factor in many turnouts is the presence of a switch machine to move the points necessary to maintain operation on the mainline or to make a diverging move. For smaller sized turnouts, a single switch machine is often adequate to provide the power needed to move the necessary components. With the implementation of larger turnouts necessary for high-speed operation, more power is needed to move the longer rail components. To provide a smoother ride for passengers and for safety reasons, it is necessary that the whole point is being moved evenly (Abbot et al. 2010). Currently in some larger turnouts more support locations along the moving point are necessary to successfully “throw” the switch.

High-speed turnouts not only require an adequate number of these supporting locations for proper alignment, but in some cases multiple switch machines are necessary to provide adequate power to do so. For example, for a #45 high-speed turnout, six switch machines are currently necessary to move the switch point, and three more are required if the turnout contains a moveable point frog (Abbot et al. 2010). As a solution, a type of turnout has been successfully used in Europe where multiple slave drive units are connected by hydraulic lines to a primary active unit. This design allows the forces necessary to move the switch point to be applied simultaneously (Abbot et al. 2010). This type of turnout, shown in Fig. 4.7, can make for smoother and safer operation at high speeds.

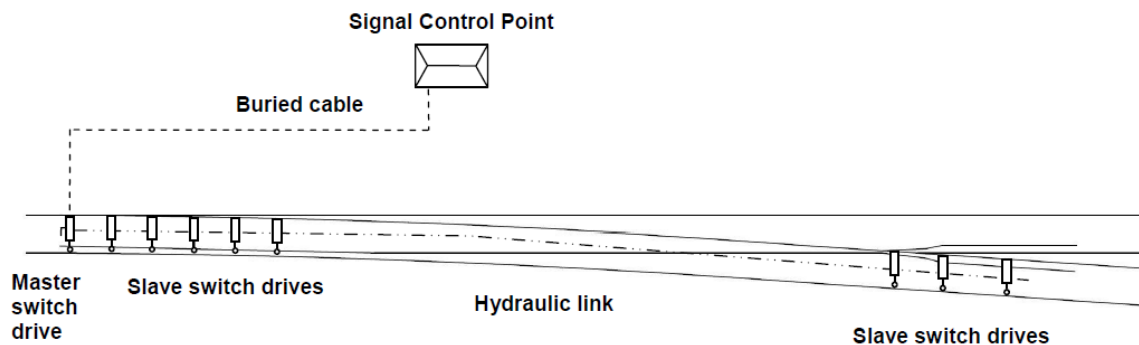

Figure 4.7. Hydraulically linked distributed system (Abbot et al. 2010)

4.6 Field Instrumentation and Modeling

Several research projects are being conducted with the objective of understanding the dynamic interactions of special trackwork through field measurements and finite element modeling. Kassa et al. (2008) instrumented wheelsets to measure vertical and lateral contact forces on the wheels on a test train as it traversed a standard UIC60-760-1:15 turnout. The field data was used to validate two models that predict the vertical and lateral forces with “acceptable” agreement (Kassa et al., 2008). The influence of train speed, train orientation (facing or trailing move), and train route (main or diverging route) was analyzed with data from the field and the results of the model. The train route had the most significant impact on the maximum vertical and lateral contact forces, with the highest forces occurring when a train made a facing move on the diverging route. Contact forces increase with increasing train speed, and the forces increase at a greater rate for the diverging route (Kassa et al., 2008).

Licciardello et al. (2008) measured the vertical and lateral deflections of switch points of a 60 km/h turnout in Italy with displacement transducers. After gathering data from a variety of passing trains that included both freight and high-speed passenger trains, the study concluded that switch point movement does not depend on train type and is more closely linked to the angle of attack of the wheels. It should be noted that the axle loads of the freight traffic in this study were likely not as heavy as those in the United States, resulting in a more homogeneous loading situation. Little influence of the frequency of dynamic interactions on the switch points was detectable in this study.

Wiest et al. (2008) developed a three-dimensional FEM that accounts for elastic-plastic deformation of the frog nose and incorporates shear forces caused by the rolling wheel. Using a quasi-static model, more deformation occurred in a manganese steel frog nose than in a composite steel frog nose. The deformation of the manganese frog led to the reduction of contact forces by 20 percent. Additionally, damage to the frog nose was estimated by locating tensile principal stresses that could result in voids or cracks.

Another model focused on the impact of irregularities and gaps of a #38 turnout with a moveable point frog designed for HSR applications (Cao et al. 2009). Multiple gaps create greater vehicle accelerations than single gaps on the same turnout. Although the conclusions from this paper may seem obvious, the authors highlighted the need to minimize and eliminate gaps on turnouts for high-speed operations with quantitative results to support their argument.

Unfortunately, none of the research studies examined the contrasting traffic, HSR and HAL, which is pertinent to shared corridors in the United States. One study is currently underway at the UIUC to compare impact loads measured on Amtrak's Northeast Corridor (NEC), an example of shared track operation. Initial results from this data show that greater variability exists for HAL freight impact loads than HSR impact loads. The data has not yet been analyzed with respect to train speed. Quantifying the load impacts from both traffic types on special trackwork would significantly contribute to the advancement of the field.

4.7 Discussion and Conclusions

Effective design of special trackwork is necessary to make shared railway systems as efficient as possible. To satisfy the design requirements for special trackwork, railway engineers must understand the various types of shared rail corridors and identify the constraints that are present with each type.

FRA classifies passenger and freight train shared operations into (1) shared track, where passenger and freight trains use the same trackage on single or multiple tracks for all or part of their operation; (2) shared ROW, where passenger and freight trains use separate tracks but with adjacent track centers of 25 ft (7.6 m) or less; and (3) shared corridor, which is similar to shared ROW, but with adjacent track centers of more than 25 ft (7.6 m) but less than 200 ft (61 m) apart (FRA 2003). In addition, "hybrid" systems exist in which HSR trains operate on dedicated, high-speed infrastructure on some sections and conventional infrastructure on others.

Shared track systems pose the most unique challenges for infrastructure design. High-speed operations will require more stringent track geometry and maintenance standards, as the effect of

typical geometry and track component problems can be amplified at such high speeds, causing passenger discomfort and posing a safety concern. For freight traffic, a much more resilient system is desired to mitigate the impact of HALs. For a shared track system, these challenges must be met simultaneously because both types of traffic must be supported by the shared track structure.

For a shared ROW system, it is possible that special trackwork will be required to support both track types when dedicated freight tracks must cross dedicated passenger tracks at grade or vice versa. Since the tracks are spaced so close together, it is unlikely that a diverging move for either track will be grade separated. Consequently, crossings may be required to handle HAL and HSR loading conditions.

In a shared corridor system, the issue of special trackwork is typically not applicable, as track centers for adjacent tracks can be up to 200 ft apart. Dedicated passenger lines should be grade separated when crossing a conventional line.

For a “hybrid” track system, dedicated high-speed rail equipment may operate on conventional rail networks near city centers, but for a majority of the route will operate on a dedicated track. This system creates similar challenges to shared track systems because the special trackwork must be designed to support both HAL and HSR loading conditions. However, on the shared portion of the track, the operating speed of a high-speed train will likely be reduced as it approaches a station. Consequently, there may be little incentive to design special trackwork to accommodate higher speeds.

Many gaps in the current understanding of special trackwork as it relates to shared HAL and HSR operations have resulted in a variety of research needs. After a vigorous review of current research, the primary needs in this field appear to be load-damage correlation, life-cycle cost of upgrades, and material behavior of track components.

The effects of various types of impact and dynamic loads on shared corridors are not fully understood. The damage caused by the different loading characteristics need to be analyzed in order to guide turnout geometry and materials selection. The tradeoffs between running more HAL freight traffic and the desire to increase speed through turnouts should be investigated with regard to the possible accelerated wear they cause (Liu et al. 2011). Current field observations and models can be used to create a damage index that can relate axle load, train speed, and tonnage to deterioration of special trackwork components. This tool could allow track designers to select the appropriate special trackwork in a more complex loading environment than conventional railways and would allow track maintainers to strategically plan maintenance.

Many of the proposed designs and modifications to special trackwork for use in shared corridors are very theoretical in nature, or have seen only a small amount of field testing. A research need in this area is continued field experimentation and implementation of proposed component designs to test track segments. A better understanding of component effectiveness under realistic loading scenarios is necessary to ensure the feasibility of use in mainline service. The development of innovative and modified track components to allow shared corridors to operate efficiently will result in improved track durability, necessitating the reexamination of many of

the regulations for layout and maintenance (Abbot et al. 2010; Xu et al. 2011).

Due to the relatively new concept of running HAL and HSR on shared track, only limited amounts of actual life-cycle data of special trackwork under this type of train operation are available. While new components for shared corridors are designed and installed, close analysis and monitoring of wear and material behavior should be noted to produce detailed life-cycle data for future designs. Little data exists on material research for specific shared corridor applications; however, it would seem that the advancement of materials in the general field of railway engineering could contribute to increased durability of special trackwork components. Research on head hardened crossing materials and heat-treated switch tips could result in turnout components that can achieve higher fatigue strength and receive higher lateral forces (Prasad 2010).

Finally, applications for premium special trackwork such as moveable point frogs and flange bearing frogs should be investigated based on traffic and route characteristics. For some shared rail corridors in the United States, capacity and speed requirements may necessitate the use of moveable point frogs. However, many of the proposed shared corridors are being planned on lower capacity freight routes that could operate efficiently with a more conventional frog. A model based on data from Amtrak's NEC or European countries that operate shared corridors should be developed to help railway engineers understand the optimal thresholds for special trackwork selection.

In conclusion, special trackwork research and design has progressed with a focus on increased axle loads in North America or higher speed in Europe. A review of existing research shows the need for a more pronounced focus on understanding the loading characteristics and design tradeoffs required for shared HAL and HSR operations. Regardless of the strategy to improve its design, special trackwork must provide safety and durability for successful shared rail corridors.

4.8 References

- Abbot, B. C., G. Click, T. Lee, S. Mattson, and K. Ouelette. (2010). "Design Considerations in the Development of a North American High Speed Turnout." Proceedings of the 2010 Joint Rail Conference, Urbana, IL, April.
- Andersson, C. and T. Dahlberg. (1999). "Load Impacts at Railway Turnout Crossing." Proceedings of the 16th IAVSD Symposium, Pretoria, South Africa, August–September.
- Cao, Y., P. Wang, and W. Zhao. (2011). "Dynamic Responses Due to Irregularity of the No. 38 Turnout for High-Speed Railway." Proceedings of the International Conference on Transportation Engineering 2011, Chengdu, China, July.
- Clark, D. C., T. O'Connor, and D. Davis. (2008). "Update on the Use of Flange Bearing Technology in Special Trackwork." AREMA Conference Proceedings. American Railway Engineering and Maintenance-of-way Association (AREMA), Landover, Maryland, September.
- Davis, D. D., X. Shu, R. Jimenez, and T. O'Connor. (2008). "Evaluation of Flange Bearing Frogs for Turnouts." *Technology Digest TD-08-044*. Association of American Railroads, Transportation Technology Center, Inc., Pueblo, CO.
- Davis, D. D., X. Shu, and R. Jimenez. (2009). "Initial Performance Evaluation of Partial Flange Bearing Frogs for Turnouts in Heavy Axle Load Service." *Technology Digest TD-09-031*, Association of American Railroads, Transportation Technology Center, Inc., Pueblo, CO.
- Davis, D. D., J. LoPresti, and S. Kalay. (2010). "Improved Performance Track Components for Heavy Axle Loads and High Speed Rail." Proceedings of the 2010 Joint Rail Conference, Urbana, IL, April.
- Federal Railway Administration. (2003). *Catalog of "Common Use" Rail Corridors*. U.S. Department of Transportation, Washington, DC.
- Federal Railroad Administration (FRA). (2012). Chronology of high-speed rail corridors: Designations and extensions. <http://www.fra.dot.gov/Page/P0140>. Accessed May 2012.
- Haifeng, L., Y. Zhou, and Y. Xu. (2011). "Inspection and analysis of wheelset lateral displacement in high-speed turnout on passenger-dedicated railway line." Proceedings of the 3rd International Conference on Transportation Engineering, Chengdu, China, July.
- Kassa, E. and C. O. Nielsen. (2008). "Dynamic interaction between train and railway turnout: full-scale field test and validation of simulation models" *Vehicle System Dynamics: International Journal of Vehicle Mechanics and Mobility*, 46:S1, pp. 521–534.
- Licciardello, R. V., M. Bruner, G. R. Corazza, E. Cosciotti, Ga. Malavasi, Gi. Malavasi, R. Troisi, and S. Musella. (2008). "Some experience on the dynamics of turnouts due to passing trains," Proceedings of the 8th World Congress on Railway Research, Seoul, South Korea, May.

- Liu, L., Y. Xuan, L. Wang, and J. Lin Sun. (2011). "Theoretical Analysis and Simulation Study on Track Rigidity of Turnout." *Applied Mechanics and Materials*, Vol. 97-98, pp. 235–240.
- Nash, A. (2003). *Best Practices in Shared-Use High-Speed Rail Systems*. MTI Report 02-02, Mineta Transportation Institute, College of Business, San Jose, California, June.
- Ossberger, H. and G. Bishop. (2010). "Life cycle cost-driven innovations for heavy haul turnouts." *Proceedings of the Institution of Mechanical Engineers, Part F: Journal of Rail and Rapid Transit*, September.
- Prasad, A. (2011). Turnout Design: Higher Diverging Speed in The Same Footprint. AREMA Conference Proceedings, American Railway Engineering and Maintenance-of-way Association (AREMA), Landover, Maryland, September.
- Remennikov, A. M. and S. Kaewunruen. (2007). "A review of loading conditions for railway track structures due to train and track vertical interaction." *Structural Control and Health Monitoring*, Vol. 15, pp. 207–234.
- Resor, R. R. (2003). *Catalog of "common use" rail corridors*. Federal Railroad Administration Office of Research and Development, Washington, DC.
- Rohlmann, J. and J. Hess. (2007). "Advanced turnouts for Taiwan's high speed trains." *Railway Gazette International*. April 2007. <http://www.railwaygazette.com/nc/news/single-view/view/advanced-turnouts-for-taiwans-high-speed-trains.html>. Accessed April 2012.
- Wang P., R. Chen, and X. Chen. (2009). "Wheel/rail relationship optimization of switch zone in high-speed railway turnout." Proceedings of the International Conference on Transportation Engineering, Chengdu, China, July.
- Weart, W. (2012). Product update: Special trackwork 2012. *Progressive Railroading*. March 2012. <http://www.progressiverailroading.com/mow/article/Product-update-Special-trackwork-2012--30185>. Accessed April 2012.
- Wiest, M., W. Daves, F. D. Fischer, and H. Ossberger (2008). Deformation and damage of a crossing nose due to wheel passages. *Wear*, Vol. 265, pp. 1431–1438.
- Xu, H., P.Wang, D. Lui, J. Hui Xu, and R. Chen. (2011). Maintenance Technologies Research of High speed Turnout. *Applied Mechanics and Materials*, Vol. 97-98, pp. 114–120.

5. BALLASTED TRACK FOR SHARED-USED RAIL CORRIDORS

5.1 Introduction

Ballast is the layer found between the subgrade and the track superstructure of a typical railroad. One of the main functions of the ballast is to dissipate the high pressures from the railroad ties and to distribute them evenly to the underlying subgrade. Typical values of upper pressure are 200–300 psi (Hay 1982). The subgrade usually receives a pressure ranging from 10 to 20 psi (Hay 1982). In spite of the development of new track support systems such as slab track, ballasted track still plays a vital role in the railroad industry because of the availability of the material, the ease of installation, and the relatively low purchase price. Since the development of railways in the 19th century, the principle of ballasted track structure has not substantially changed (Esveld 2001). A typical railroad built today would not present significant differences in construction layout if compared with a railway built 100 years ago. The best material to provide good durability and resistance to crushing and degradation is crushed stone (Hay 1982), even though it might present signs of exposure to weathering, thus producing the possibility of mud formation (Esveld 2001).

In North America, nearly all railroads in operation are owned and maintained by private freight operators, and the Class I railroads are the main players. Amtrak, although it is considered a Class I railroad, only owns track on the North East Corridor, in Michigan (Porter Kalamazoo), and some track in main stations across the United States. The freight railroad system in the United States is regarded as a very efficient system for transporting goods from one location to another. The freight trains that run across the American continent are trains with typical wheel loads ranging from 33,000 lb to 40,000 lb. Such high wheel loads greatly affect the long-term performance of the track infrastructure. Table 5.1 summarizes the axle loads from different types of rolling stock in North America and Europe.

Table 5.1. Typical Axle Loads (Not Including Locomotives) in Tons

North American		European	
Passenger	Freight	Passenger	Freight
17.5	32–40	13.25–17	12–23.5

To maintain an acceptable track profile, not only does the track superstructure have to be evaluated, but the underlying subgrade has to be assessed for durability and resistance to permanent deformation. In Illinois, for example, the surficial soils present a low bearing capacity and a moderate to high susceptibility to heave and frosting actions. A detailed taxonomy classification should be taken into account from the early planning stages (Johnson 1977).

In a shared ROW scenario, where the ROW of the host railroad has enough room to build an additional track that will be dedicated to passenger operations and is within 25 ft of the existing railroad track, the design loads may be more flexible since no freight would make use of the new track for passenger service. Since passenger trains would be the only type of rolling stock planned, and the top speed is limited by the FRA safety standards because of level crossings and proximity to the freight operated line, the construction cost would still be restricted to levels acceptable for this type of upgrade (Nash 2003).

When the track to be constructed is adjacent to the freight line but more than 25 ft away and less than 200 ft, the passenger track is considered a shared corridor line. The same considerations outlined in the previous case would apply here as well, but the construction cost could be higher since there might be cases where a grade crossing can continue as either an overpass or underpass when crossing the passenger track.

In all shared-used rail corridor scenarios discussed above, the use of ballasted track is still considered to be the most efficient, especially when the supporting formation is natural soil. There are challenges related to the nature of ballast itself as well as its behavior at high speeds. The different load actions from either freight or passenger rolling stock can significantly affect the overall performance of the track structure. In the following sections, literature related to lifecycle cost analysis, the quality and degradation of ballast, and future research needs will be discussed.

5.2 Life-Cycle Cost Considerations

Europe has used conventional high-speed ballasted track structures with an all-granular track bed for a few decades, and this has been successful even though there is a higher maintenance cost associated with it. To reduce this maintenance cost, slab track was adopted. However, the high capital cost for slab track makes it difficult to be cost-beneficial. To reduce the maintenance needs and the cost of installation, Teixeira et al. (2008) discuss the limitations of granular sub-ballast and suggest the use of a bituminous sub-ballast layer (Figure 5.1). This is an ‘intermediate solution’ that enhances the track substructure’s long-term bearing capacity by incorporating stiffer and more durable materials between the subgrade and the ballast layer. However, to avoid excessive ballast deterioration, an increase in the elasticity of the rail-pads might be required to keep track within an optimum overall vertical stiffness (Teixeira 2008).

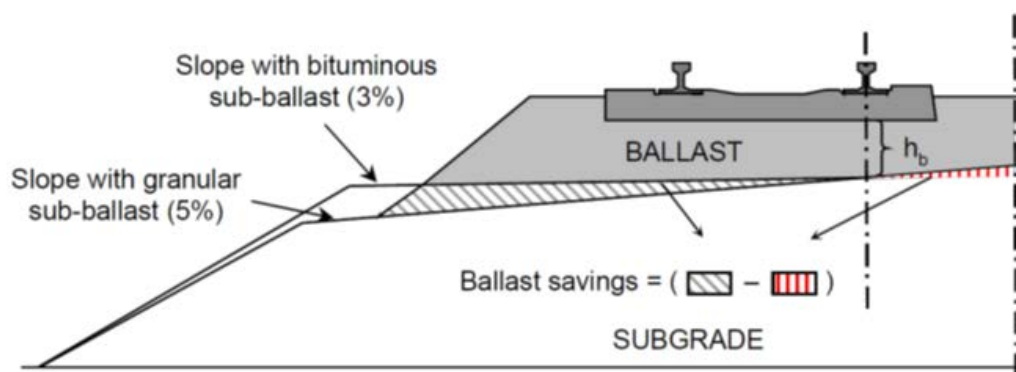

Figure 5.1. Schematic representation of the savings in ballast material due to the use of a lower lateral slope for the bituminous sub-ballast solution (Teixeira 2008)

Kiani et al. (2007) assess the life-cycle environmental impact of different types of track beds (Figure 5.2). Ballasted track is a commonly constructed track structure because of its relatively low initial cost. Although concrete slab track is more expensive, it can have lower LCC. This paper looks at the manufacturing, construction, maintenance, dismantling, and recycling of the track bed components to describe the results of the environmental life-cycle analyses. In addition, this paper compares the life-cycle analyses of energy consumption and carbon dioxide emissions. The limitations of the data available in this paper are also discussed, and some of these include, but are not limited to, insufficient data associated with water pollution and waste generation. The results of this paper (Figure 5.3) show that concrete slab track has no higher environmental burdens than ballast track bed.

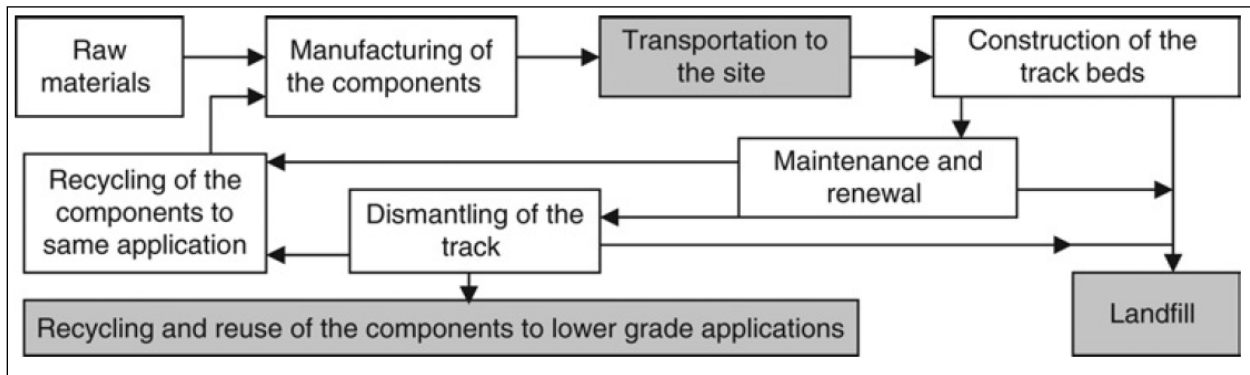

Figure 5.2. The life-cycle assessment inventory stages (Kiani et al. 2007)

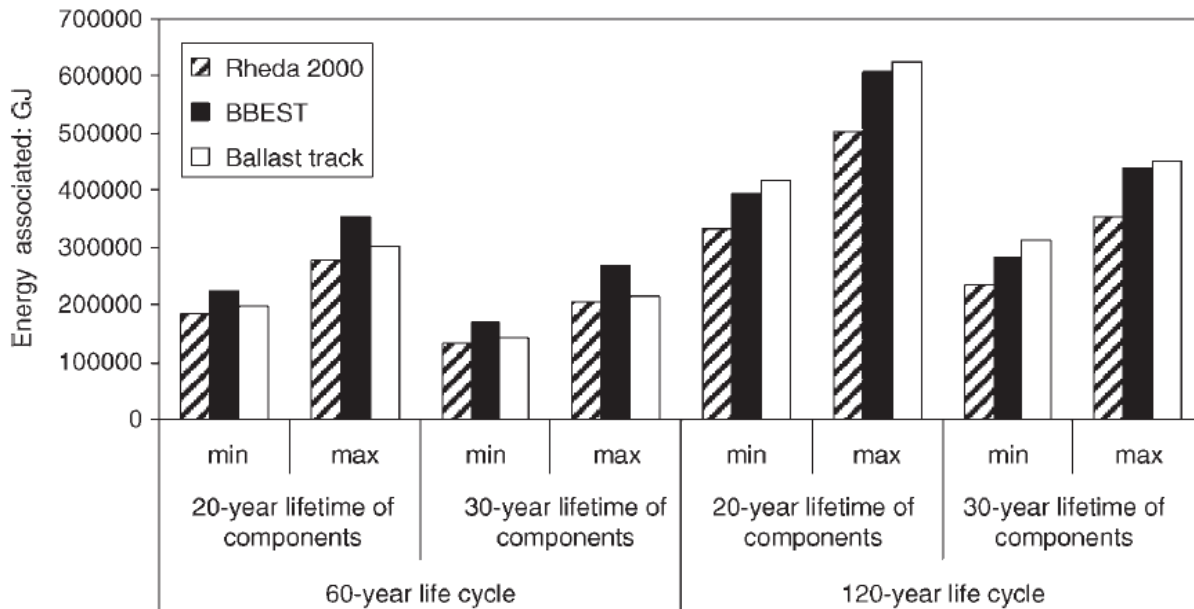

Figure 5.3. Life-cycle energy consumption analysis of track beds (Kiani et al. 2007)

5.3 Ballast Quality and Modeling

Tutumluer et al. (2011) investigated validations in the field for Discrete Element Modeling (DEM) used to characterize the ballast conditions. Maintenance and renewal of track ballast are a significant part of the annual budget allocated to sustaining a railway track system. Ballast layers with large air voids also produced higher permanent deformations under repeated train loading. Therefore, to provide a better evaluation of ballast, it is important to characterize the existing ballast layer, strength, and modulus and deformation behavior. This paper tries to provide some insight into the design of ballasted track so as to improve safety and reliability. Tutumluer et al. (2011) presents field validation results of a realistic DEM railroad ballast model developed at UIUC. Ballast settlement data was collected from FAST for HAL applications at TTC in Pueblo, CO. The DEM model was used to conduct field applications and investigate railroad ballast design and behavior by simulating the quantitative track performance. To do this, it analyzed the particulate nature of aggregate particles and their interaction based on their size and shape. Four 100-foot test sections were constructed in 2010 for the field validation tests. Four different aggregate materials were installed as the new ballast layers on a curve at the TTC FAST test track. To measure the ballast deformation, settlement plates were installed on top of the subgrade in the middle and outside rail locations. The ballast settlement predictions showed sensitivity to aggregate shape and gradation. According to the paper, “the DEM model can be used as a validated tool for engineering ballasted track designs and addressing critical substructure concerns such as those related to variable track stiffness and track transition zones” (Tutumluer 2011).

Burrow et al. (2007) presents research which used falling weight deflectometer (FWD) devices for the dynamic testing of ballasted railway track and the data obtained from these tests were used along with “inverse-analysis” to determine the elastic modulus of the track substructure that is required to build a numeric model of the track. The authors’ findings conclude that the approach outlined in their work would contribute to making the FWD a useful piece of equipment for railway track evaluation.

Anderson et al. (2008) investigated a new technique to assess the rate of ballast damage during triaxial testing under both monotonic and cyclic loading. The paper describes the method of stoneblowing, which is essentially a procedure in which the ties are lifted in pairs and a new layer of gravel is placed under the tie’s bottom surface. The paper found that the ballast density was not altered when maintained by ordinary means of tamper. It appears that this new technique significantly extends the period between maintenance cycles.

Rujikiatkamjorn et al. (2011) reviews the methods that are common in the industry for evaluating degree of ballast fouling. A new parameter was proposed to overcome the limitations of the current practices. This parameter is referred to as the “relative ballast fouling ratio,” which is the ratio between the solid volumes of fouling particles and ballast particles. This method uses a number of categories that are derived from gradation curves from past literature. Comparison of this model with other methods shows that it would better represent the influence of the gradation of fouling materials. It is believed that the described technique could be applied to track evaluation on shared-use corridors in North America.

Kuo and Hang (2009) provide a description with relative results of a FEM using two different approaches in modeling the behavior of ballasted track. The first model treats the ballast as a continuum medium while the second model uses a discrete element approach. Several scenarios have been tested in an attempt to understand the behavior of ballast at increasing speeds. The simplified model shown in Figure 5.4 (top) treats the ballast as a continuum layer connected with springs to the ties. A simplified ballast model that would connect discrete finite elements with contact springs was proposed. The intended goal was to encourage the appropriate selection of analysis model, as well as to shed light on characteristics of a ballasted track. The other model considered was a DEM, as shown in Figure 5.4 (bottom). Here the ballast is treated by discrete elements interacting with one another by means of springs. However, neither of the two models is able to completely characterize the behavior of the ballast. While deflections of the rail are lower than predicted by FEM models, actual deflections observed at the ballast level were found to be greater. Possible explanations for the inconsistencies of the two results are that in one case, the ballast is assumed to behave like a continuum elastic solid so that the classic assumptions of either Bernoulli-Euler beam theory or Timoshenko beam theory can be applied.

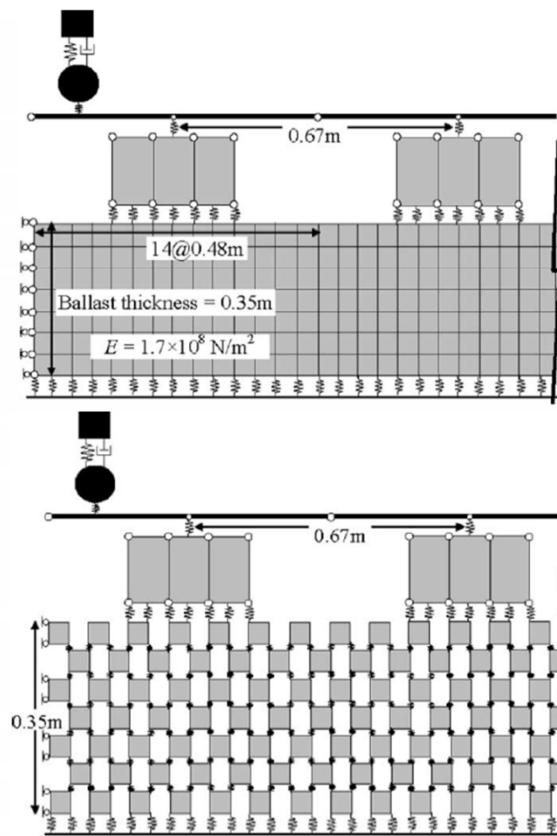

Figure 5.4. Simple (top) and discrete (bottom) FEM models (Kuo and Hang 2009)

Yang et al. (2009) analyzed dynamic stress of a ballasted rail track during the passage of a train. They found a linear relationship between vertical and shear stresses with the speed of the train between 10 percent and 100 percent of the critical speed. When the train reaches the critical speed, the shear stress is about 80 percent greater than “static” shear stress.

Lam et al. (2010) investigated the dynamic behavior of ballast. The authors discussed in detail the mathematical model of the rail-sleeper-ballast system as a Multiple Degree of Freedom (MDOF) system. Many assumptions have to be made to simplify the mathematics involved. The final objective is to derive the differential equation of equilibrium based on the Winkler model combined with the differential equation of motion. The analysis covers several scenarios starting from the case of clean ballast and continuing to scenarios where 90 percent of the ballast material is damaged (i.e., fouled). It is interesting to note that a reduction in the ballast stiffness does not really alter the overall displacement of the ballast itself.

5.4 Ballast Flight

Another issue with the reliability of a ballasted track is related to the flying ballast phenomenon. Quinn (2008) conducted a study to investigate the causes of movement of ballast particles from their position in the roadbed. Damage to the railhead is becoming an increasingly critical issue, especially when the track is used by high-speed trains traveling in excess of 160 km/h. A phenomenon observed in this study was the so-called ballast pitting. It was observed that the railheads had erratic spots likely due to the movement of ballast rocks from the roadbed. Apparently, the rocks would be displaced from their initial position due to the high energy released by the passage of a high-speed train; the energy released would be high enough to cause the moving object to cause permanent damage to the rail. Moreover, voids within the ballast would be created due to the displacement of these particles. The purpose of this study was to determine the pressures under the train at high speeds that would cause the ballast particles to move. A series of observations and measurements were performed on the High-Speed 1 line connecting London to Folkestone. The objective was to determine if the airflow generated by the passing train was sufficiently intense to displace ballast thus initiating the ballast flight. The location selected was a section of the line where trains were known to travel at nearly full speed (300 km/h). Figure 5.5 shows the pressure coefficient variation with respect to a normalized time. The data was corrected for noise interference while taking measurements. It is interesting to note the trailing peak pressure that was not reported in full-scale measurements.

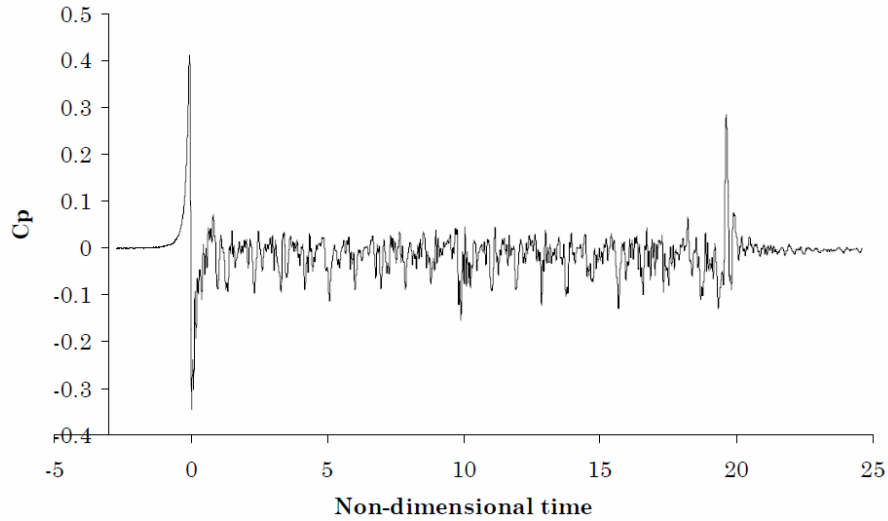

Figure 5.5. Pressure coefficient vs. normalized time (Quinn 2008)

Benigno et al. (2011) analyzed the phenomenon on the Madrid Barcelona high-speed line. A series of Pitot devices were installed on a portion of the high-speed line with the purpose of measuring the pressures induced by the passage of a high-speed train. The results are summarized in Figure 5.6 where the measured values of wind velocity and pressures are normalized. The most important aspect of this plot are the initial and final peaks measured right before the arrival of the train through the point of interest and right after the passage of the trailing locomotive. A similar behavior was noted by Chris Baker of the University of Southampton who conducted a comparable experiment on the HS1 line (Figure 5.7). Baker noted turbulence of the air right before the arrival of the nose of the train. It would be interesting to investigate whether these measured turbulences counteract the gravity force of the ballast particle.

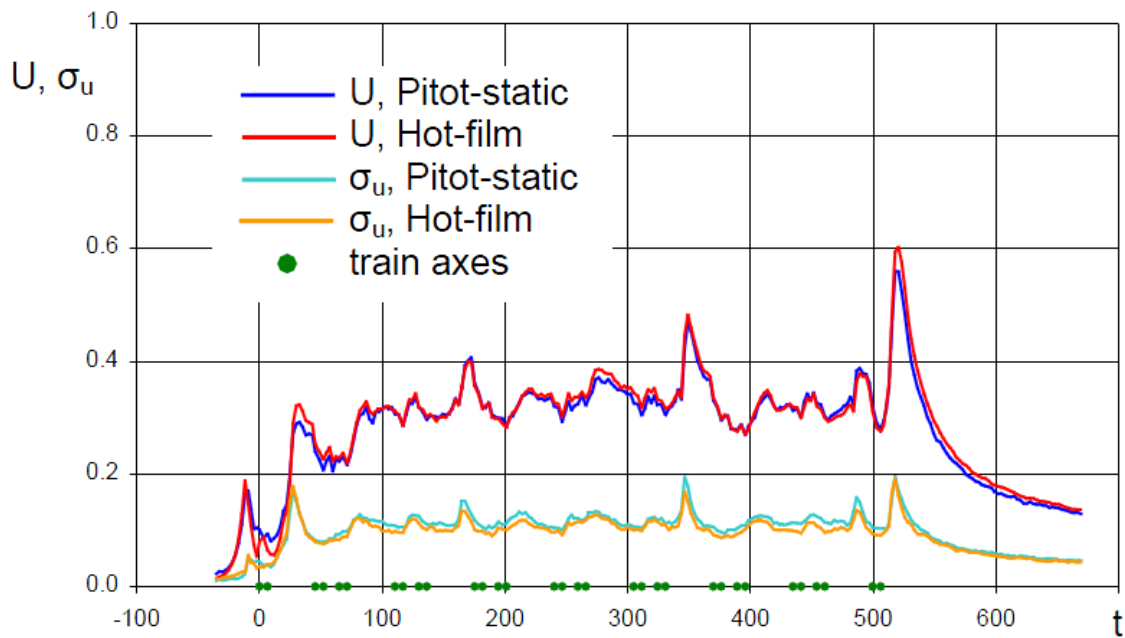

Figure 5.6. Plot of the normalized wind velocity and normalized pressure values vs. the position of the train wheels over time (Lazaro 2011)

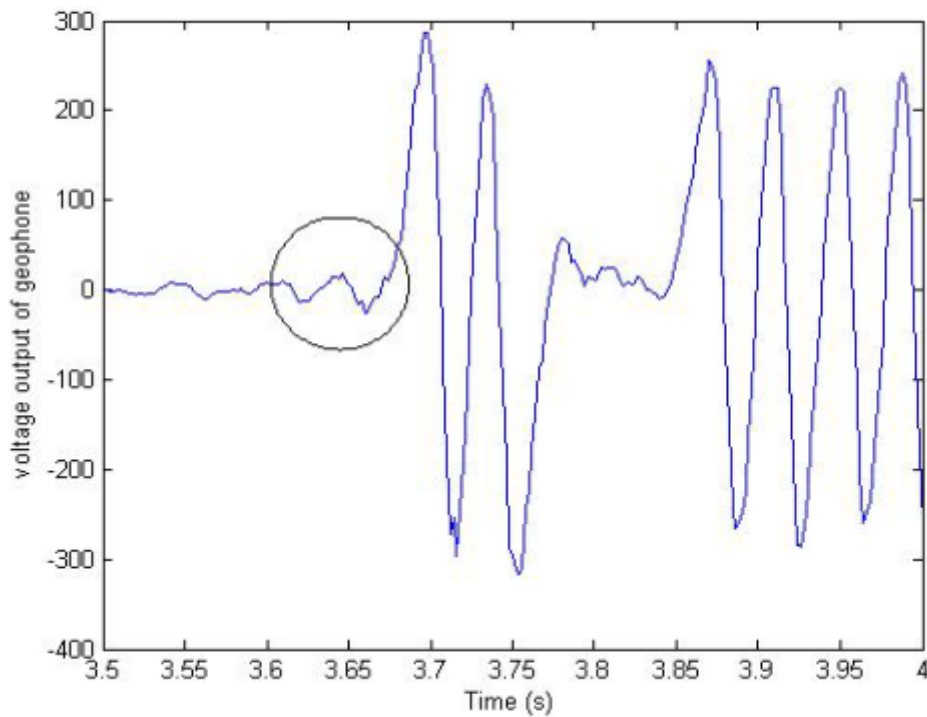

Figure 5.7. Turbulence (circled) is noted right before the arrival of the train (Powrie 2011)

Other studies of the ballast flight phenomenon have been carried out in China and in some European countries. Solutions to the issue include lowering the ballast profile to leave a gap between the rail and the ballast crib. Other solutions include “gluing” the ballast particles immediately surrounding the ties, as well as “bagging” them, as done in Japan. The purpose of lowering the ballast profile is to allow the air that is compressed under the train during its transit to escape through the enlarged gaps between the rail and the ballast, thus reducing the pressure applied at the surface of the ballast. These techniques may lower the probability of the particles being displaced. Kwon et al. (2006) investigated the probability of ballast flight using experimental data collected on a South Korean high-speed line. The results of this research showed that particles located on top of the tie have a 50 percent chance of being picked up by the wind pressures generated by a train traveling at 300 km/h. Bombardier carried out field measurements while certifying the ICE 3 train in Belgium. A computational fluid dynamics simulation was also conducted during the same series of measurements aimed to certify the ICE 3. Sima et al. (2008) used wind tunnel testing of a car-body undercarriage to validate several commercial computation approaches to modeling wind turbulence. By understanding wind flow characteristics, the risks of ballast flight might be more accurately understood. The results of the testing were varied, with some elements of the flow not accurately predicted by any of the models analyzed.

5.5 Discussion and Conclusions

Knowing the costs of construction, operation, and maintenance of the track is important for choosing a certain type of track, and the lifecycle cost takes into account those variables. However, the lifecycle cost analysis for ballasted track is outdated and lacking. This is an area that needs to be expanded on. Further research is needed to fully understand the phenomenon of ballast flight. Although in some instances the issue has been resolved by compacting and lowering the ballast profile, there are still unexplained processes that cause the ballast to be displaced at a sufficiently high speed to make contact with the moving train. The applicability of this phenomenon to North American shared-use corridors is evident. Although the highest allowed speed of a train is 240 km/h (150 mph) on limited portions of the North East Corridor, such speed is considered the minimum speed required to initiate the displacement of resting ballast particles. The scenario could have very serious consequences for future higher speed train operations.

5.6 References

- Anderson, W. F. and P. Fair. (2008). "Behavior of Railroad Ballast under Monotonic and Cyclic Loading." *Journal of Geotechnical & Geoenvironmental Engineering*, Vol. 134, Issue 3, 316–327.
- Baker, C. and H. Hemida. (2011). The Calculation of Train Slipstreams Using Large Eddy Simulation Techniques. World Congress of Railway Research. Lille 2011.
- Burrow, M., A. Chan, and A. Shein. (2007). "Deflectometer based analysis of ballasted railway tracks." *Geotechnical Engineering 160*, July 2007, Issue GE3, 169–177.
- Dahlberg, T. (2006). Handbook of Railway Vehicle Dynamics Chapter 6: Track Issues, Taylor and Francis Group LLC.
- Esvled, C., (2001). Modern Railway Track.
- Hay, W. W. (1982). Railway Engineering, J. Wiley & Sons.
- Indraratna, B., L. Su, and C. Rujikiatkamjorn. (2011). "A New Parameter for Classification and Evaluation of Railway Ballast Fouling." *Canadian Geotechnical Journal*, Vol. 48 Issue 2, 322–326.
- Johnson, W. M. and J. E. McClelland. (1977). Soil Taxonomy: an Overview. Transportation Research Record, Issue n. 642, 2-6.
- Kiani, M., T. Parry, and H. Ceney. (2008). "Environmental life-cycle assessment of railway track beds." *Engineering Sustainability*, Vol. 161 Issue 2, 135–142.
- Kuo, C. M. and C. H. Huang. (2009). "Two Approaches of Finite-Element Modeling of Ballasted Railway Track." *Journal of Geotechnical & Geoenvironmental Engineering*, Vol. 135 Issue 3, 455–458.
- Kwon, H. B. and C. S. Park. (2006). "An experimental study on the relationship between ballast flying phenomenon and strong wind under high speed train." Proceedings of the World Congress on Rail Research, Montreal, Canada.
- Lam, H. F., M. T. Wong, and R. M. Keefe. (2010). "Detection of ballast damage by in situ vibration measurement of sleepers." AIP Conference Proceedings, Vol. 1233 Issue 1, 1648–1653.
- Lazaro, B. J., E. Gonzalez, M. Rodriguez, S. Osma, and I. Jorge. (2011). Characterization and Modeling of Flying Ballast Phenomena in High-speed Train Lines. World Congress of Railway Research. Lille 2011.
- Nash, A. (2003). Best Practices in Shared-Use High Speed Rail Systems. Mineta Transport Institute, San Jose State University.
- Powrie, W. and J. Priest. (2011) "Behavior of Ballasted Track During High Speed Train Passage." PowerPoint presentation. University of Southampton.
http://web.sbe.hw.ac.uk/railday/William_Powrie_U_Southampton_Presentation_150211.pdf.

- Quinn, A. and M. Hayward. (2008). Full Scale Aerodynamic Measurements Underneath a HST. BBA VI International Colloquium on: Bluff Bodies & Aerodynamics & Applications, Milan.
- Sima, M., A. Gurr, and A. Orellano. (2008). Validation of CFD for the flow under a train with 1:7 scale wind tunnel measurements. BBA VI International Colloquium on: Bluff Bodies & Aerodynamics & Applications, Milan.
- Teixeira, P. F., A. Lopez Pita, and P. A. Ferreira. (2010). “New possibilities to reduce track costs on high speed lines using a bituminous sub-ballast material.” *International Journal of Pavement Engineering*, Vol. 11, n. 4, August 2010, pp 301–307.
- Tutumluer, E., Y. Qian, Y. Hashash, J. Ghaboussi. (2011). Field Validated Discrete Element Model for Railroad Ballast, AREMA Conference Proceedings.
- Yang, L. A., W. Powrie, and J. A. Priest. (2009). “Dynamic Stress Analysis of a Ballasted Railway Track Bed during Train Passage.” *Journal of Geotechnical & Geoenvironmental Engineering*, Vol. 135 Issue 5, 680–689.

6. VEHICLE TRACK INTERACTION (VTI) CHARACTERISTICS OF TRACK TRANSITION SECTIONS AND IMPLICATIONS TO SHARED PASSENGER AND FREIGHT RAIL CORRIDOR OPERATIONS

6.1 Introduction

Track transitions are an unavoidable part of the railway infrastructure due to the need to construct railway structures, at-grade crossings, and other structural elements on or beneath the track superstructure. Track transitions occur at locations where there are abrupt changes in the track modulus. Common track transitions are highway-rail grade crossings, tunnel portals, bridge approaches, and special trackwork elements such as crossing diamonds and turnouts. As the track modulus transitions from the comparatively soft natural subgrade to the comparatively stiff turnout, loads imparted into the track structure increase sharply due to increased stiffness, which creates degradation of track geometry. Track modulus values of 10,000 lb/in/in are not uncommon for bridges (Li and Davis 2005). This is compared with track modulus values of 3,000–6,000 lb/in/in on other track (Hay 1982).

Because of these deviations in track geometry, which frequently manifest themselves as profile or cross-level deviations, frequent track maintenance is required in terms of surfacing or other work that mitigates the effect of poor geometry. Track transitions represent one of the highest sources of operating cost expenditures for the entire railway infrastructure because of the frequent surfacing and other remedial actions that are required to maintain track in the operating class for which it was designed. Additionally, track transitions are the cause of frequent “slow orders,” which require railroads to downgrade track classes, resulting in lower operating speeds and reduced capacity.

There are two general approaches to increasing the life cycle of track transitions. One involves a complete overhaul and redesign of the transition, which is typically best for new construction or lines that have redundant tracks that allow one or more lines to be removed from service. The other approach involves in situ improvement of the track transitions—while the track is still in service, but temporarily void of traffic due to a maintenance window. A recent project funded by FRA at UIUC is addressing both of these solutions. Given that many shared corridor projects will be upgrades of existing lines, remedial in situ track transition solutions are the most relevant. One of the primary research questions that must be answered is whether the in situ approaches are equal to the new construction techniques in terms of their effectiveness. Track transitions at bridges may be the most pronounced, compared with other track transition locations that were discussed earlier. This is due to the fact that bridges are typically constructed on piling foundations that are driven to refusal (or near refusal).

This section will review previous and ongoing research efforts aimed at increasing the life cycle of track transitions. These efforts are aimed at mitigating the costs of maintaining track transitions by reducing settlement between the track on the structure and the adjacent track. While many of these efforts were not conducted specifically for the purpose of investigating shared corridor track transitions, the results will be reviewed through the lens of shared-corridor operations. Additionally, existing knowledge gaps and research needs pertaining to shared-corridor track transitions will be identified.

6.2 Track Transition Maintenance Costs

Approximately \$200 million is spent annually on track transition maintenance in the United States (Sasaoka et al. 2005). Based on the Association of American Railroads' (AAR) 2008 Strategic Research Initiatives (SRI) plan (R. Jimenez, personal communication, June 2008), the cost of railway bridge transition repairs is estimated to be \$26 million per year (\$16 million for steel bridges and \$10 million for concrete bridges). One reason the estimate seems very low is that this figure does not take into account the significant cost resulting from slow orders that railroads must impose in problem locations.

One of the primary questions to be addressed through research is how track transition maintenance costs will be affected by HSR and HAL shared-corridor operations. These costs may increase because of mixed traffic for two primary reasons. First, the differing loads from HSR and HAL provide different loading and failure modes that result in diverging life cycles. Track components in the railway superstructure that are sub-optimized for highway and rail loading could result in insufficient attenuation of loads to the track substructure. Second, HSR and HAL require more stringent geometry requirements than HAL alone, thus it is more challenging to keep transitions within safe operating conditions without additional maintenance expenditures.

To address specific research needs and knowledge gaps associated with track transitions for shared corridors, higher-level research is needed. One possible high-level shared-corridor research need involves developing a complete understanding of the loading distributions for varying traffic types on shared corridors. This loading distribution should include both peak and nominal loads and should provide infrastructure designers with a clear understanding of the loads that are being imparted on the railway superstructure. In addition to loading magnitude, the impulse of loads and the amount of load that is attenuated at each interface needs to be understood. This could best be understood through a complete parametric analysis of substructure and superstructure materials and geometry. This analysis will provide a sensitivity analysis of various infrastructure components and will provide methods for lowering the allowable ballast pressure on the base of concrete cross-ties.

6.3 Causes of Differential Track Movement

It is important to determine the causes of differential movement of the railway track in order to evaluate and propose design and mitigation techniques. According to Stark and Tutumluer (2011), the primary causes of differential movement at the railroad bridge-embankment transition can be divided into the following categories: (1) approach and subgrade materials, (2) ballast condition and thickness, (3) approach geometry, (4) approach structure, (5) approach environment, and (6) bridge properties. Stark and Tutumluer (2011) list some of the factors affecting these categories: ballast thickness, condition, stiffness, cross-tie type, type of approach, embankment and foundation soil, degree of compaction, compaction water content of the approach soil, fill height and side slopes, type of approach slab (if any), bridge foundation system, type of abutment, type of bridge support (e.g., concrete versus timber), railroad loading and speed, drainage, weather, and time.

6.4 Vehicle-Track Interaction (VTI)

The interaction between a moving vehicle and the track structure is critical because it impacts the character of the dynamic loading that is applied on the track as well as the ride quality of the vehicle. At railroad transitions, the problem is more complicated because of the possible discontinuity of support condition and potential rail profile irregularity. Based on research done at TTC (Sasaoka 2006), problems at track transition can be categorized into three types:

1. **Differential settlement:** For example, railroad bridges are often built on a deep foundation (e.g., driven piles or auger cast piles) and therefore would not be affected by subgrade settlement. However, bridge approaches consist of different layers of support and typically need to go through a large amount of settlement, depending on the amount of traffic that a given route handles.
2. **Track stiffness:** At railroad transitions, stiffness would abruptly change from one segment to another. On a precast concrete bridge, the track modulus could be as much as two times higher than surrounding track (Li and Davis 2005).
3. **Damping:** Damping qualities in the track structure help to dissipate the energy due to high dynamic loading. Track damping characteristics vary at track transitions. It is important to understand how the change in damping affects track performance by reducing potential damage.

According to Li and Davis (2005), track transition problems, specifically problems at bridge approaches, can be attributed to the following factors:

1. An abrupt change in vertical stiffness of track causes the wheel to experience an equally abrupt change in elevation because of uneven track profile (elevation). Due to the sudden vertical displacement, vertical acceleration increases simultaneously and generates a high dynamic load. After some loading cycles, the elevation change will increase and lead to a higher dynamic loading. The effect of increased loading depends on the direction of the train. When the train is moving from a high stiffness segment to a low stiffness segment, the dynamic loading is applied to the lower stiffness segment and will increase the settlement rate of the track. When the train is moving in reverse direction, the increased dynamic loading is applied on the high-stiffness side. In this case, it will contribute to the problem of rail surface fatigue, tie deterioration, and rail seat pad deterioration. One research need that stems from this issue is identifying which type of traffic (passenger or freight) result in higher damage when transitioning between high and low stiffness track sections and vice versa.
2. At-grade ballasted track may settle more than ballasted track on structures or direct-fixation track. This may introduce an abrupt change in elevation and cause the effect described above. This is especially true when the structure abutment is built in deep pile foundation where settlement is negligible.
3. Settlement of at-grade track can be highly variable and geotechnical issues such as low-strength soil, deficient soil placement and compaction, poor drainage, and erosion can affect subgrade performance. Environmental factors such as wet-dry and freeze-thaw cycle also affect subgrade settlement behavior.

Researchers have been using computational models to simulate vehicle-track interaction and to analyze the effect of vehicle and track parameters on the dynamic behavior of the system. Some models are built for general railroad transition with abrupt stiffness change, and others are built to look specifically into a certain type of transition such as bridge approach or turnout. Frohling et al. (1996) presented a simplified model to qualitatively determine the effect of some vehicle and track conditions on the dynamic loads in the system. This model is representative of one modeling approach that uses generalized springs and dampers to simplify the complicated vehicle-track system and to deduce the equations of motion based on the simplified model. A continuous one-layer support model is used, since it offers a reasonable approximation of the practical discrete support system under low frequency loading. The track structure is also simplified into a linear system with fixed stiffness. The research includes several sets of comparison related to rail geometric irregularity, spatially varying track stiffness, and vehicle damping. Researchers reached the conclusion that the spatial variation of track stiffness itself would not cause any significant changes in vertical vehicle acceleration. The lack of spatial variation would not considerably affect the ride quality of the vehicle, but the dynamic loading on the track would be affected by varying track stiffness.

Plotkin and Davis (2008) came to a similar conclusion. Five different methods were used to evaluate the role of variable track stiffness in causing bridge approach track settlement and adversely affecting ride quality. All of these methods proved that track stiffness changes at bridge ends have no measurable effect on track settlement and ride quality at a bridge approach. Using the model presented in the paper and stress analysis based on GEOTRACK, Plotkin and Davis concluded that track stiffness variation was a major factor contributing to the deterioration of track.

Lei and Zhang (2010) presented their model of the dynamic behavior of track transition in a similar way. Using a finite element method, they established a model for the dynamic analysis of vehicle-track coupling system and deduced the associated stiffness, mass, and damping matrix (Figure 6.1). The model is used to evaluate the influence of train speed, subgrade stiffness, and irregularity angle of track transition. The parameter for the model is based on the Chinese HSR train. The paper, published by Lei and Mao (2004), gives a more detailed description of the algorithm of the model and the deduction of various matrices. The results of the modeling show that both abrupt change in subgrade stiffness and the irregularity angle of track transition have significant influence on the wheel-rail contact force. In addition, they both essentially have no influence on the vertical acceleration of the vehicle, as the suspension system will reduce vibration, which is in agreement with the results of Frohling et al. (1996). The study also concluded that the moving direction of the vehicle has little effect on the dynamic behavior of it.

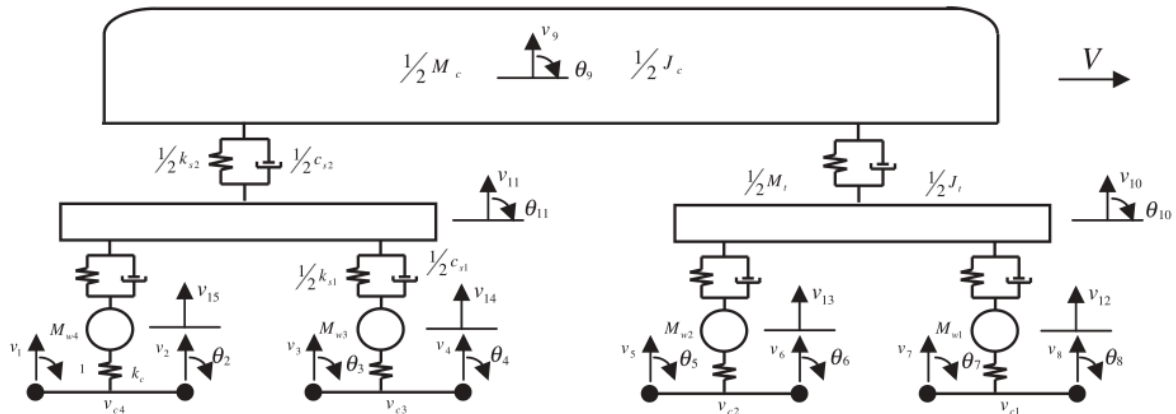

Figure 6.1. Vehicle element model with 26 degrees of freedom (Lei and Zhang 2010)

The models described above are primarily focused on the general case of track transition that includes abrupt stiffness change. However, various differences are observed between types of track transitions including bridge approaches, turnout, and grade crossings. The models need to consider the actual design and geometry of the type of track transition to simulate the performance characteristics of it.

Researchers have conducted extensive work related to the analysis and optimization of railway turnout. Full-scale tests were conducted by Kassa and Nielsen (2008) to validate their models about the dynamic interaction between train and railway turnout. The two models they validated were built with the commercial multibody system software GENSY and CHARMEC's in house software DIFF3D. Traditionally, turnouts were designed to study the quasi-static motion of wheelset, assuming nominal turnout geometry. Unlike the models developed for general track transition with generalized spring and damper, the two models are 3D detailed finite element models that consider the geometry of turnout and dynamic interaction. They are designed to consider low frequency (0–20 Hz) and high frequency (up to 1500 Hz) dynamic interaction respectively. A more detailed description is included in a paper by Kassa et al. (2006). In the field test, the test train passed through the turnout at different speeds in the main and diverging routes and in the facing and trailing move. In comparing the results, good agreement was observed between measured and calculated contact force. Both of them showed increased contact force with higher train speed.

In Nicklisch et al. (2009), a methodology for simulating material degradation at switch and crossing under mixed traffic was presented. In switch and crossing components, common damage mechanisms include wear, accumulated plastic deformation, and rolling contact fatigue. To predict material degradation in these components, all three mechanisms need to be considered. As shown in Figure 6.2, the methodology includes the collaboration of several numerical tools that would be respectively responsible for the simulation of vehicle-track dynamics, wheel-rail interaction, and wear and plasticity calculation. The results will then be summarized and updated into the new model and iterated again. The optimization of switch panel and cross panel designs are discussed, and it is concluded that when the optimized crossing design is combined with reduced track stiffness, the impact loads would be significantly reduced and could potentially reduce the LCC.

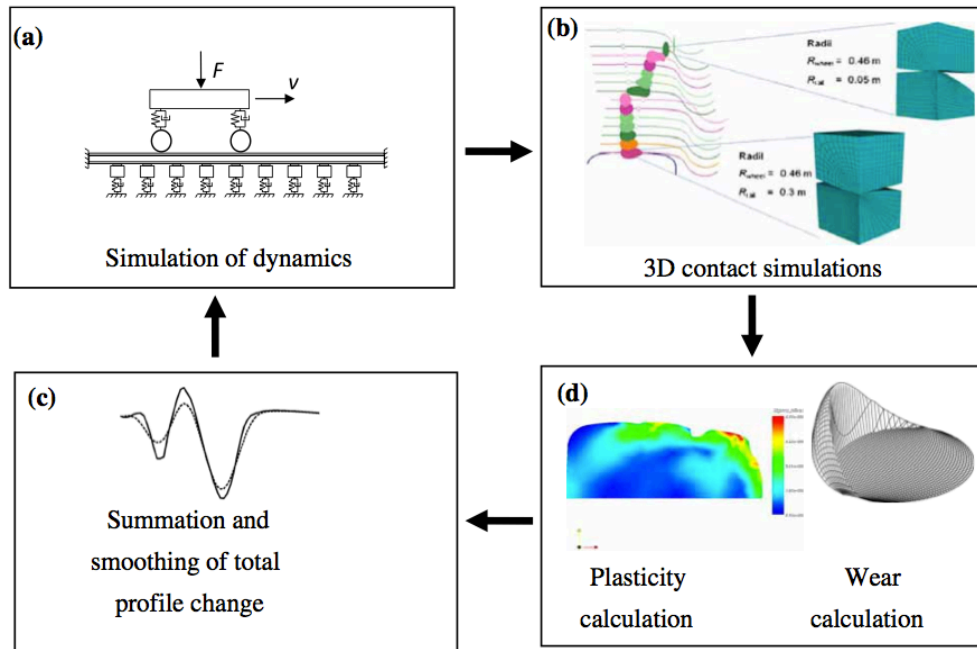

Figure 6.2. Methodology for simulation of wheel-rail contact and damage in S&C: (a) simulation of dynamic contact force; (b) calculation of contact stress and contact patch size; (c) simulation of plastic deformation and wear; (d) Summation and smoothing of total profile change (Nicklisch et al. 2009)

A finite element model specialized for transition zone in railway bridges is presented by Smith et al. (2006). In the model, a bridge geometry representative of a concrete bridge in Europe is considered, as shown in Figure 6.3. Train loading is directly applied on ballast, and a stiff bearing layer is provided under embankment fill. In addition, the absence of crosstie and rail is part of the limitation in this model. While modeling the behavior of a bridge system under the passing of trains, a parametric study is done on the speed of train, the stiffness of ballast and sub-ballast material, and the stiffness of embankment fill. Based on the modeling results, it is observed that (1) with higher train speed, the net horizontal stress in ballast and sub-ballast increases, and (2) the stiffness and ballast have little effect on the calculated vertical deflection in transition zone, but the stiffness of sub-ballast and embankment fill have a more substantial influence.

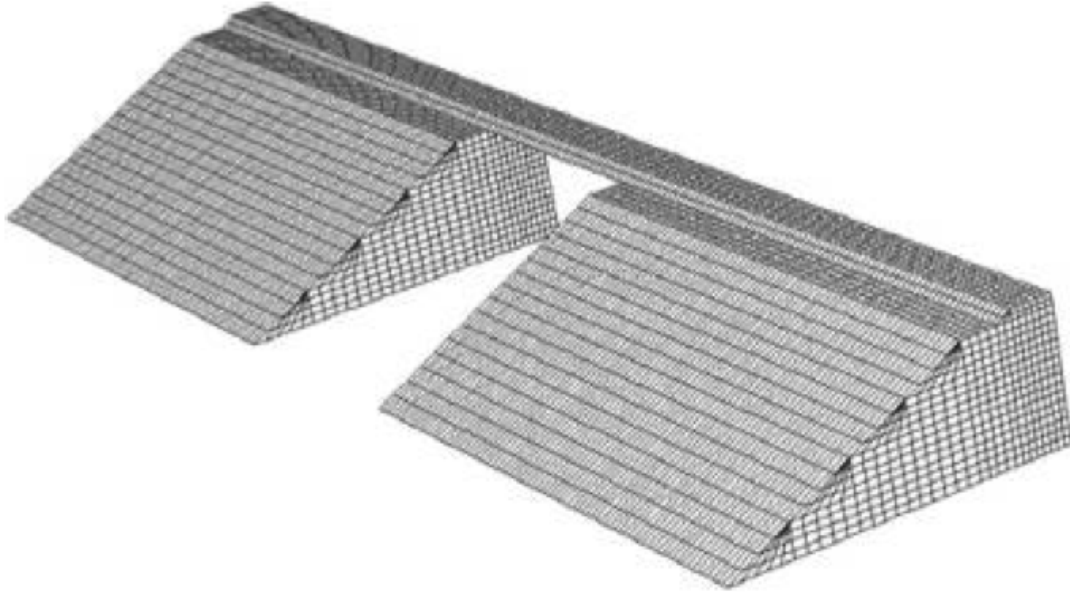

Figure 6.3. Mesh geometry of numerical model (Smith et al. 2006)

6.5 Potential Track Transition Solutions

Kerr and Moroney (1993) concluded that the main principle that should be followed when searching for track transition remedies is as follows: (a) ensure the tracks are designed in such a way that the wheels of the moving train will cause the same vertical rail deflections, or (b) if this is not possible, at least ensure that the vertical deflection does not go through rapid change, to avoid large vertical accelerations of the wheels, which cause large dynamic loading. Point (a) suggests that the track stiffness at different segments of a track transition should be designed to remain the same, which would involve some techniques that apply different types of crosstie (wood or concrete) and rail pad of different stiffness to compensate for the difference in stiffness of other track components.

Track transition remedies can basically be categorized into three groups:

1. Use smooth track stiffness transition to replace the original sections that have abrupt stiffness change.
2. Increase the stiffness of rail-tie structure on the “soft” side in close vicinity of the transition section.
3. Reduce the track stiffness on the “hard” side of track transition.

The importance of a smooth stiffness transition zone has been validated in numerical simulation. Zakeri and Ghorbani (2011) presented their numerical model in Matlab and addressed the dynamic performance of railway track transition zone. The 2D model is built to simulate the dynamic effect when a train passes through the transition zone between ballasted track and slab track. The dynamic effects with and without a smooth transition zone of varying ballast depth are compared. It is concluded that in the absence of a transition zone, the displacement reaches its peak, causing the sudden change of acceleration in a short time and the oscillation of the track; but when smooth transition zone is considered, variations will be distributed along the transition zone and the shock is moderated.

A 2006 survey of track transitions (Li and Read 2006) found many experiments pertaining to improved track transitions. These experiments included the following:

- Use of longer ties and a concrete approach slab by the Metropolitan Atlanta Rapid Transit Authority (MARTA) to transition from ballasted at-grade track to direct-fixation structures.
- Transition from at-grade ballasted track to a direct-fixation structure on a commuter/intercity passenger service railway in the United Kingdom using an approach slab along with vertically adjustable direct-fixation fasteners to allow design tamping of the ballasted approach track.
- Installation of stone columns to strengthen and improve the drainage of a weak bridge approach subgrade on a UP main line.
- Use of a transition grade crossing system designed to smooth the track modulus across the approach to a highway crossing and reduce impact loads at the crossing on New Jersey Transit's Atlantic City line.
- Installation of tie pads on open wood-tie bridge decks having stiffness characteristics designed to match the track modulus of the approach track on Amtrak's NEC and on a Norfolk Southern mainline with freight and intercity passenger service.
- Reducing the track modulus on a UP ballast deck bridge by replacing the existing concrete deck ties with composite (plastic) ties or with concrete ties with a rubber pad cast into the tie bottom.

Following the literature review, a number of representative track transition designs were simulated with the GEOTRACK computer model. GEOTRACK is a well-established and validated model that predicts a quasi-static response of the track to an applied vertical wheel loading. Based on the analysis, some of the most informative results are summarized as follows:

- Matching the rail deflection on direct-fixation track to the deflection of the at-grade ballasted track—through careful design and specification of the direct-fixation fastener vertical stiffness—provides the best possibility for an effective and seamless transition between the two track configurations. However, ballasted track on low-stiffness subgrades also requires strengthening with either a concrete approach slab or hot-mix asphalt (HMA) underlayment to match the direct-fixation track. Otherwise, the pad stiffness of the direct-fixation track would need to be unreasonably low.
- A concrete approach slab placed between the ballast and sub-ballast layers was the most effective technique for increasing ballasted track stiffness. HMA underlayment installed between the ballast and subgrade also produced benefits to low-strength track, but it was not as effective as concrete in increasing the stiffness of track on very low-stiffness subgrades.
- Increasing the subgrade stiffness reduced the differences between concrete slab and HMA layer thicknesses.
- Placing additional rails on the ties of the ballasted track to increase the stiffness of the track panel had modest benefits for low-stiffness subgrades. This condition often exists when bridge guardrails extend past the abutment onto the approach track.

- Other changes to the track superstructure, such as reduced tie spacing, installation of longer ties, or installation of ties with larger cross sections, had an insignificant effect on track modulus or rail deflections and would not be especially effective transition designs.

6.5.1 Construction of Transition Zones

One approach to managing track transition is through the development of transition zones. There are many types of track transition zones. The purpose of a transition zone is to bring a gradual adjustment between the subgrade modulus of the slab track and the ballasted track (Zakeri and Ghorbani 2011). Track reaction to wheel force is related to track stiffness and other factors (Zakeri and Ghorbani 2011). During train movement onto two tracks with different stiffness, there will be an abrupt change in response to existing track in the connection area (Kerr 2003). Based on modeling work by Zakeri and Ghorbani (2011), it was found that loads will be distributed along the transition zone and will moderate the shock. Additionally, they found that in the transition from ballasted track to slab track, the acceleration changes noticeably.

6.5.2 Increase Track Stiffness with Longer Crossties

One of the conventional designs for track transition involves installation of a series of ties of increasing length on the ballasted track side. This method assumes that by increasing the bearing area of a crosstie, the compression is averaged over a larger area and can in turn increase track stiffness. However, Kerr and Moroney (1993) pointed out that the effectiveness of this method depends on whether the ballast under the tie at the two ends is of uniform density. Based on GEOTRACK analysis results, Sussman and Selig (1998) indicate that the use of a longer tie does little to increase the track stiffness, and it would, in fact, be more effective to reduce tie spacing or increase tie cross section.

This method has been implemented by MARTA. In a transition between ballasted at-grade, concrete-tie track and direct-fixation structure, four 10-foot timber ties followed by four 11-foot and four 12-foot timber ties are installed in a 24-inch spacing pattern. A 20-foot long concrete transitional slab is also installed on the ballasted track approach. Simulation results indicate that the variable length design reduced maintenance costs by a factor of three compared with designs that only included the approach slab.

6.5.3 Hot-Mix Asphalt (HMA) Underlayment

A layer of asphalt pavement could be installed in ballasted track as a structural element in the substructure to increase the bearing capacity of subgrade (Figure 6.4). Hot-mix asphalt is the mixture of aggregate and bitumen, and the material property of it could be different according to different component ratio and aggregate size. Typical thickness range of the HMA layer is between 8 and 12 inches, and it can be placed between ballast and sub-ballast or installed directly on subgrade. Field experimentation (Li et al. 2001) has proven that HMA works well when used to strengthen weak subgrade. It should be noted that after the installment of HMA underlayment, the loading capacity is still limited by the strength of nearby layers. Tests on UP Railroad (Li and Davis 2005) concluded that HMA provides little improvement on a subgrade of high bearing capacity, and the settlement observed on bridge approaches are mainly due to settlement in the ballast rather than subgrade.

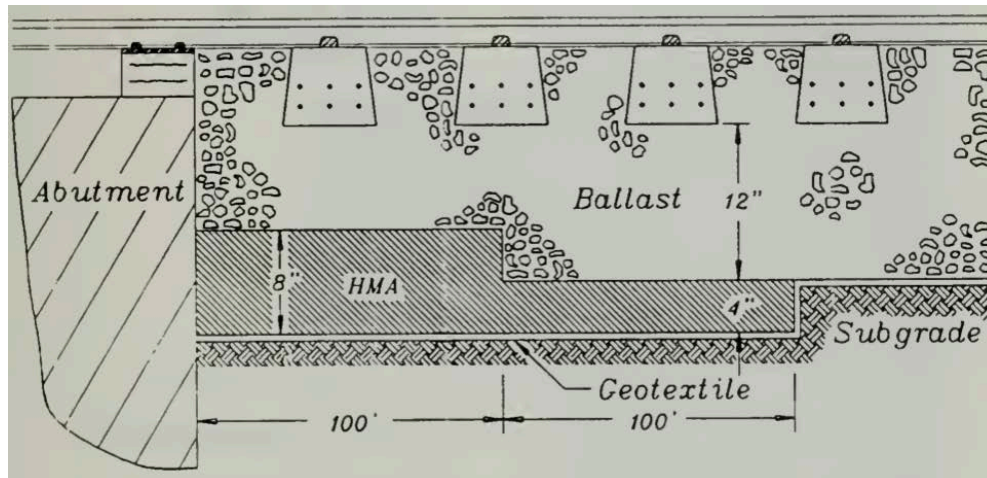

Figure 6.4. Example of HMA bridge approach design (Kerr and Moroney 1993)

6.5.4 Increasing Approach Stiffness at Grade Crossing

To reduce the impact loading at grade crossing, the idea of “smoothing” the transition from normal track to stiffer track and back again was applied by Zarembski and Palese (2005). Based on the idea, a prototype dynamically stable grade-crossing system was designed and tested (Figure 6.5). The resulting transition zone between the standard track and crossing was developed using the following discrete stiffness steps:

1. The parent track with wood ties and cut spikes.
2. The parent track with wood ties and elastic Pandrol system fasteners.
3. A single Premier Concrete Railroad Crossing field panel installed in the center of the track.
4. Full Premier Concrete Railroad Crossing (full set of panels) with maximum stiffness.

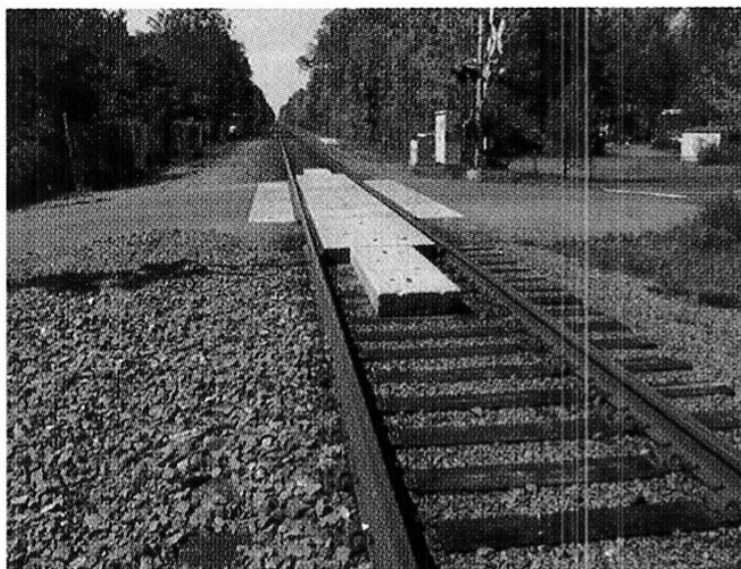

Figure 6.5. Transition design implemented at Bates Mill Road crossing (Zarembski and Palese 2005)

Ride quality data and degradation measures were obtained on the grade crossing, and test results proved the car experienced less vertical acceleration after installation. Minimal degradation was observed after 3½ years. Track modulus tests also revealed a much smoother transition than the preinstallation results. The test results are basically in agreement with the results of modeling analysis based on beam-on-elastic-foundation theory.

6.5.5 Approach Slab

Reinforced concrete slab can be installed as a structural element in the track substructure to increase the stiffness of the track. Approach slabs are often used at transitions to direct-fixation aerial structures and tunnel inverts, and it is also a common highway transition practice. Most slabs are reinforced concrete and are designed either with a taper to gradually increase the stiffness over an approach distance of about 20 feet, or are uniform in thickness but placed at an angle with tapering of the ballast depth to achieve the same ramping effect (Li and Read 2006). Concrete approach slabs have been tested at TTC to provide transition from at-grade concrete-tie track to concrete-slab track (Figure 6.6). Track modulus data showed that the approach slab was over-designed and provided an unnecessary high track modulus at the interface.



Figure 6.6. Slab track transition at TTC (Li and Read 2006)

6.5.6 Geotechnical Considerations

While different measures can be taken to strengthen weak subgrade and reduce differential settlement, it is crucial to optimize subgrade performance. Some geotechnical best practices proposed by Li and Read (2006) are as follows:

- Determining the soil characteristics prior to construction by performing in situ testing.
- Using selected noncohesive soils or applying admixtures to existing soils, if needed, to improve subgrade strength.

- Maintaining optimum moisture content and using correct compaction techniques for the soil type being placed, as well as ensuring adequate compaction when placing soil next to structures such as abutment backwalls.
- Ensuring maximum and uniform soil density by performing adequate soil density testing during construction.
- Removing ruts, crowning or sloping the subgrade surface, and using edge drains at the toe of the ballast section to prevent pocketing of free water in the track granular layer.
- Lowering groundwater levels or installing cut-off layers, if needed, to prevent capillary movement of ground water upward into cohesive soil embankment.
- Allowing for adequate embankment width to accommodate the ballast and sub-ballast depth.
- Allowing for adequate embankment slope angles or the use of benches, retaining walls, or sheet piles for slope stability and control of erosion.

6.5.7 Rail Seat Pads on Open Deck Bridges and Direct-Fixation Structures

As discussed above, one type of track transition remedy involves reducing the track stiffness on the “hard” side of track transition. Elastomeric pads can be used on open deck bridges and direct-fixation structures to reach this goal. The stiffness of these pads should be designed to match the track modulus of the at-grade approach to provide a smooth transition. Kerr and Moroney (1993) have proposed that the spring constant of discrete support pads should be equal to the track modulus on continuous support, modified by the tie spacing. There are two main limitations to this approach. On the direct-fixation structures, other track components are assumed to have infinite stiffness, and, therefore, only pad stiffness affects elastic modulus. Apparently, it is not the case when composite or timber crossties are used on the bridge. In addition, the Kerr-Moroney relationship is derived under static loading and does not consider the effects of dynamic and impact loading. When train speed is relatively low and the dynamic effect between train and track structure is not significant, this relationship may apply. But when high-speed trains are considered, correct bridge pad stiffness should be calculated with more realistic assumptions.

6.5.8 Reducing Track Stiffness on Ballast Deck Bridges

Besides using rail seat pad, other techniques such as replacing concrete tie with composite tie and installing tie pad have also been considered and tested. Different tie materials are used on ballasted deck bridge to compare their performance in reducing track stiffness (Sasaoka et al. 2005). Two methods were tested: (1) replacing concrete ties with composite (i.e., plastic) crossties on bridge deck and (2) installing concrete crossties on the bridge deck with 1-inch-thick rubber pads on the bottom of the ties. Figure 6.7 shows track modulus measured on the bridge and the approach with three types of ties (concrete tie, composite tie, and concrete tie with rubber pads).

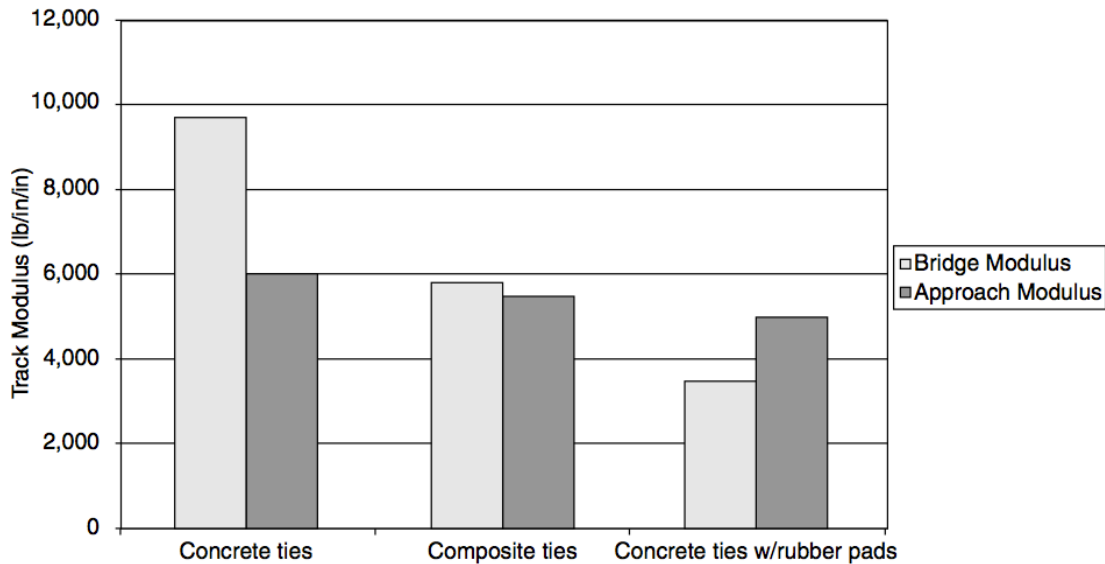

Figure 6.7. Comparison of track modulus values of different ballast deck bridge tie types (Sasaoka et al. 2005)

When compared, both composite tie and concrete tie with rubber pads can successfully reduce the stiffness difference between bridge and approach. The rubber pads reduced the modulus of the bridge by a factor of 2.8. Tests results (Sasaoka 2006) also indicated that rubber pads cast into concrete tie bottom can provide additional damping for the bridge structure, which will be able to dissipate the energy due to impact loading. In addition, the long-term performance of both concrete tie with rubber pad and composite tie are proven as they performed well after 270 MGT.

6.6 Discussion and Conclusions

Different loading demands for both HAL and HSR create divergent design and performance requirements for track transitions. For passenger routes, the importance is placed on rideability and criticality to ensure that trains can operate at maximum authorized track speed. For freight corridors, it is imperative that track transitions be robust to sustain large tonnages and be able to go for long periods of time between track surfacing, given the limitations to obtaining track windows for surfacing operations. According to Tutumluer (2012), surfacing of some track transitions can occur as often as every two weeks. Shared corridors see the worst of both situations—the need to maintain a high ride quality over track transitions and the critical need to avoid surfacing operations due to high levels of track utilization. Many of the track transition settlement mitigation methods mentioned previously have direct applicability to shared corridors due to their ease of implementation and extension of surfacing life cycles.

Research needs related to shared corridors include understanding how differing loading magnitudes and frequencies relate to settlement. There is both a modeling and experimental element to this research question that should be addressed using numerical models and field experimentation. Beyond relating settlement to specific loading types (magnitude and frequency), it is important to understand where settlement occurs within the track structure (i.e., in which layer it occurs). Current research projects are aimed at understanding the location of

settlement—whether it is the ballast, sub-ballast, or the subgrade. It is important to understand the location of settlement to ensure the appropriate remedial action is taken. Additionally, research should be undertaken to develop remedial actions to mitigate differential movement in track, given that most shared corridors will be upgraded lines as opposed to new infrastructure. The cost effectiveness of each solution or method of mitigation should be evaluated using a LCC approach.

Through modeling and experimentation, a significant amount of insight has been gained into the performance of track transitions under dynamic loading conditions. Additionally, modeling and experimentation have allowed for critical analysis of track transition designs, leading to track settlement mitigation approaches. There are many approaches that have been taken to increase the life cycles of track transitions. Some of these include constructing stiffness transition zones, placing elastomeric pads on concrete crossties, and using hot-mix asphalt underlayments.

6.7 References

- Briaud, J., R. W. James, and S. B. Hoffman. (1997). *NCHRP Synthesis 234: Settlement of Bridge Approaches (the Bump at the End of the Bridge)*. Transportation Research Board, National Research Council, Washington, DC.
- Davis, D., D. Otter, D. Li, and S. Singh. (2003). "Bridge Approach Performance in Revenue Service." *Railway Track and Structures*, 99(12), 18–20.
- Frohling, R. D., H. Scheffel, and W. Ebersohn. (1995). "The Vertical Dynamic Response of a Rail Vehicle Caused by Track Stiffness Variations along the Track." *The Dynamics of Vehicles on Roads and on Tracks: Proceedings of 14th IAVSD Symposium (August 21–25, 1995, Ann Arbor, MI)*. International Association for Vehicle Systems Dynamics.
- Frohling, R. D., H. Scheffel, and W. Ebersohn. (1996). "The Vertical Dynamic Response of a Rail Vehicle caused by Track Stiffness Variations along the Track." *Vehicle System Dynamics*, 25(Supplement), 175–187.
- Hay, W. W. (1982). *Railroad Engineering*. John Wiley and Sons.
- Jimenez, R. (1998), Engineer, Transportation Technology Center, Inc. Personal communication, June 2008.
- Kassa, E. and J. C. O. Nielsen. (2008). "Dynamic interaction between train and railway turnout full-scale field test and validation of simulation models." *Vehicle System Dynamics*, 46(Supplement), 521–534.
- Kassa, E., C. Andersson, and J. C. O. Nielsen. (2006). "Simulation of dynamic interaction between train and railway turnout." *Vehicle System Dynamics*, 44(3), 247–258.
- Kerr, A. D. and B. E. Moroney. (1993). "Track transition problems and remedies." *American Railway Engineering Association*. 94(739), 167–298.
- Kerr, A. D. (2003). *Fundamentals of Railway Track Engineering*, Simmons-Boardman Books, Inc.
- Lei, X. Y. and L. J. Mao. (2004). "Dynamic response analyses of vehicle and track coupled system on track transition of conventional high speed railway." *Journal of Sound and Vibration*, 271, 1133–1146.
- Lei, X. and B. Zhang. (2010). "Analyses of dynamic behavior of track transition with finite elements." *Journal of Vibration and Control*, 17(11), 1733–1747.
- Lei, X. and B. Zhang. (2010). "Influence of track stiffness distribution on vehicle and track interactions in track transition." *Proc. ImechE* Vol. 224, Part F: J. Rail and Rapid Transit, 592–604.
- Li, D. and D. Read, (2006). Design of Track Transitions. Transit Cooperative Research Program, Research Results 79, TCRP Project D-7/Task 15.
- Li, D. and D. Davis. (2005). "Transition of Railroad Bridge Approaches." *Journal of Geotechnical and Geoenvironmental Engineering*, 131(11), 1392–1398.

- Li, D., L. Smith, B. Doe, D. Otter, and S. Uppal. (2003). Study of Bridge Approach and Track Transition Degradation – Factors and Mitigation. Federal Railroad Administration Contract DTFR53-01-H-00305.
- Nicklisch, D., E. Kassa, J. Nielsen, M. Ekh, and S. Iwnicki. (2010). “Geometry and stiffness optimization for switches and crossings, and simulation of material degradation.” *Proc. ImechE* Vol. 224, Part F: J. Rail and Rapid Transit, 279–292.
- Plotkin, D. and D. Davis, (2008). Bridge Approaches and Track Stiffness. Final Report, DOT/FRA/ORD-08-01, Federal Railroad Administration.
- Sasaoka, C. D., D. D. Davis, K. Koch, R. P. Reiff, and W. GeMeiner. (2005). Implementing Track Transition Solutions. Technology Digest TD-05-01. Association of American Railroads, Transportation Technology Center, Inc.
- Sasaoka, C. D. (2006). “Track transition designs for heavy-axle-load service.” *Railway Track & Structure*, 102(4), 15–18.
- Smith, M. E., P. E. Bengtsson, and G. Holm. (2006). Three-dimensional analyses of transition zones at railway bridges. *Numerical Methods in Geotechnical Engineering-schweiger (ed.)*, Taylor & Francis Group, London, UK.
- Sussman, T. R. and E. T. Selig. (1998). Track Component Contributions to Track Stiffness. E. T. Selig, Inc. Amherst, MA.
- Tutumluer, E. (2011). Professor in Civil and Environmental Engineering, University of Illinois at Urbana-Champaign. Unpublished Federal Railroad Administration (FRA) proposal document.
- Tutumluer, E. (2012). Professor in Civil and Environmental Engineering, University of Illinois at Urbana-Champaign. Personal email communication.
- Zakeri, J. and V. Ghorbani, (2011). “Investigation on dynamic behavior of railway track in transition zone.” *Journal of Mechanical Science and Technology*, 25(2), 287–292.
- Zarembski, A. M. and J. Palese. (2003). “Transitions eliminate impact at crossings.” *Railway Track & Structure*, 99(8), 28–30.

7. CAPACITY AND OPERATING CHALLENGES OF SHARED PASSENGER AND FREIGHT RAIL CORRIDORS

7.1 Introduction

North American freight railroads are expected to experience increasing capacity constraints across their networks. Long-term freight demand is projected to increase and new passenger services are being proposed to operate over portions of the freight infrastructure. Existing freight corridors can provide ROW for new construction and potentially provide tracks to share with new passenger services. Sharing existing tracks will have the immediate consequence of consuming the available capacity of that corridor. This increase in capacity utilization can lead to scheduling issues, increased train delay, and smaller time windows to maintain infrastructure. Different rail traffic types can have different characteristics in terms of acceleration and braking performance, top speed, priority, and on-time performance sensitivity. These unique characteristics place different demands on the freight infrastructure.

This section includes a literature review and discussion of capacity planning, train scheduling, train delay, and infrastructure maintenance planning as these topics relate to shared rail corridors. The capacity-planning segment includes a discussion of theoretical, parametric, and simulation models and systems optimization. The section on train scheduling outlines the differences between passenger and freight train scheduling and offers examples of temporal mitigation strategies. The section on train delay examines sources of delay and the effects of heterogeneity. In addition, this section discusses delay mitigation techniques on single and double track rail lines. The overall goal of this work is to provide a comprehensive background of shared-corridor capacity and operating challenges from which further research and analysis can be identified.

7.2 Capacity Planning

7.2.1 Modeling

Numerous approaches and tools have been developed to determine rail line capacity. Each of them has its strengths and weaknesses and has been generally designed for a specific application. Railway capacity tools can be categorized into three groups: (1) theoretical, (2) parametric, and (3) simulation. Modeling is a challenge for developing shared corridors because more accurate models require more data. In the context of sharing track with a freight railroad, the freight railroad might be the only party with the knowledge, expertise, and data for modeling the corridor. This asymmetry in knowledge can be a challenge in negotiations over the amount of additional infrastructure required to accommodate the added traffic.

Theoretical

Most theoretical models are based on determining the maximum amount of trains that can pass a bottleneck per unit time. The constraint of this “bottleneck” could be the signal spacing where a blocking-time model could be adapted. The blocking-time model analyzes the route setup time and signal block occupation time to determine the minimum train spacing (Pachl and White, 2004). If the bottleneck is due to a single track section, then it would be more appropriate to use the Poole formula which considers the time for trains to share the single track section (Poole, 1962). Theoretical models are useful for (1) analyzing passenger operations where most train

movements are rigorously planned by a timetable and not by a dispatcher; (2) analyzing a shared-corridor situation where a high or higher speed passenger train shares track with commuter rail traffic; and (3) determining initial estimates of railway line capacity in the beginning stages of the planning process.

Parametric

Parametric models use field or simulated data to generate a model that can predict rail line capacity more quickly than full simulation. Generally, the parametric models handle more inputs than the theoretical models. Krueger (1999) used simulations to develop a parametric model that calculated the delay-volume curve for single-track routes. The model accounted for heterogeneity by using parameters for average speed, speed ratio, and priority. Lai et al. (2012) developed a parametric model based on simulated data of hypothetical single- and double-track lines. Parametric models require less data than simulation models and can provide early estimates of capacity and train delays for corridors that are considering sharing track.

Simulation

Vromans et al. (2006) used simulation to study heterogeneous passenger services and developed measures of heterogeneity. By giving local and long distance trains the same number of station stops, the authors were able to homogenize the train schedule and improve operations. Abril et al. (2008) used simulation to investigate different factors influencing capacity on Spanish rail lines. One of the factors considered was trains operating at two speeds: “normal” and 50 percent of normal on single- and double-track lines. Results showed that on single-track lines, capacity is more affected by the average train speed than the heterogeneity of train speeds. Bronzini and Clarke (1985) investigated North American operations using simulation to develop delay-volume curves for traffic with varying amounts of intermodal and unit trains on a hypothetical single-track line. They found that heterogeneity had caused a measurable increase in train delay. Simulation modeling should be used in the advanced planning stages of a shared track corridor to analyze impacts to the existing and future traffic. The simulation model can then be used to evaluate delay mitigation alternatives.

7.2.2 Optimization

Optimization can be a useful tool when analyzing a corridor. Once the cost and benefits of a set of projects are known, a selection model can choose projects to undertake based on a series of constraints. These models can help develop plans with higher benefit-to-cost ratios. A model by Lai and Barkan (2011) optimized a Class I railroad network and selected links for capacity improvement for a given planning horizon. This model was then adopted to analyze a single passenger rail line (Lai and Shih 2010) and select station locations for additional tracks. This model has been modified to select engineering projects to improve travel times between Nangang and Toucheng in Taiwan (Lai and Huang 2012).

7.3 Scheduling

Freight railroads in the United States are a 24-hour operation. Infrastructure is built to be used every hour of the week. In contrast, passenger railroads generally have traffic concentrated in daylight hours with an increase in intensity during the morning and evening rush hours.

7.3.1 Passenger Train Schedules

The current practice in the United States is to schedule passenger trains very close to their minimum run time. This has the benefit of encouraging the host railroad to preserve the average service speed. Additionally, this incentivizes passengers to arrive at stations before the train shows up. As a consequence of strict schedules, the on-time performance of passenger trains generally deteriorates due to various deviations from the original schedule. Martland et al. (2008) suggest “experienced-based scheduling,” where schedules are created to reflect the current operating performance of the inner-city trains. This will improve the on-time arrival percentage and give the public more realistic expectations about the travel time and punctuality of the passenger trains. The actual travel times under the experienced-based schedule and the original schedule need to be maintained by the host railroad. Additionally, a policy should be in place to specify what happens when a train arrives at a station earlier than suggested by the experienced based schedule (Martland 2008).

7.3.2 Freight Train Schedules

Hallowell and Harker (1998) identify two scheduling strategies that railroads can use: master scheduling and real-time scheduling. Master scheduling is commonly used by European railroads. This involves developing a detailed timetable for scheduled trains and slots for unscheduled trains, and then operating with strict adherence to these schedules. With real-time scheduling, railroads use schedules more as guidelines in making decisions as to how trains should operate. Although North American railroads are becoming more scheduled, most traffic, other than passenger trains, does not conform to a precise schedule. Consequently, to improve operations in North America, research should focus on improving dispatching efficiency.

7.3.3 Temporal Separation of Traffic Types on Shared Corridors

In some cases, the passenger and freight traffic can be separated by time of day. Often, the passenger trains would run in the day and the freight trains would run at night. This strategy has been implemented on some commuter rail corridors such as the West Express in Portland, OR (Leeson 2002). This solution is most effective when freight traffic is light and the passenger trains are not on the corridor for a long period of time. One challenge to implementing this solution is that, often, the existing infrastructure is built for a 24-hour period. There may not be enough capacity to compress the freight service to only nighttime operation. By only allowing freight trains at night, more than 50 percent of the capacity of the line is taken away from the freight railroad. Additionally, the freight railroad may have business obligations requiring it to serve its customers during daylight hours (Bing et al. 2010).

7.4 Train Delay

Train delay can be defined in the following two ways: (1) the difference between the minimum or unopposed travel time and the actual travel time, or (2) the difference between the scheduled and actual travel time (Dingler et al. 2010). Delay can also be categorized by scheduled and unscheduled delays. Scheduled delays are incorporated into the rail line timetable, allowing for a buffer of time to deal with traffic conflicts and station stops. Unscheduled delays are random events that are beyond the railroad's control, such as extreme weather and accidents.

The delay-volume curve is important for analyzing the capacity of a rail line (Figure 7.1). As the number of trains per unit time or traffic volume increases, the delays to the trains will show little change in performance where a line with low capacity utilization is concerned (Normal). Trains will show a moderate increase in delay when the line is well utilized (Saturation). Finally, the delay-volume curve increases exponentially (Congestion) as the traffic on the line approaches its capacity (Abril et al., 2008). An important aspect of the delay-volume curve is that it does not relate a distinct value for the capacity of the rail line. The delay-volume curve will indicate the performance of the trains for certain traffic heterogeneity. There could exist a level of delay where the delay is no longer acceptable for the rail traffic (Sogin et al., 2012a). Passenger railroads may not be comfortable with the reliability of their trains in a saturated or congested network, whereas a freight railroad may be more tolerant of delays. Accordingly, passenger railroads might need to invest more in infrastructure to avoid a saturated or congested network.

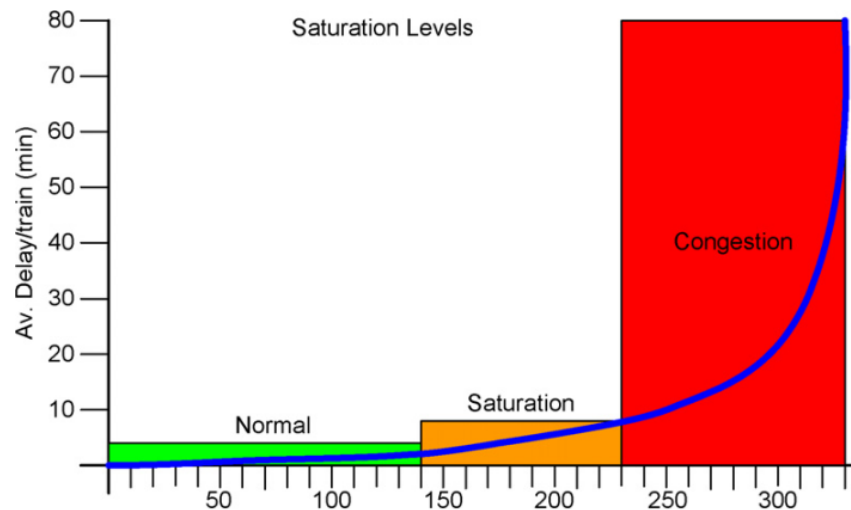

Figure 7.1. Example delay-volume curve (number of trains on the x-axis)

7.4.1 Sources of Delay

Gorman (2009) created a train run-time model from empirical data of eight BNSF subdivisions. He identified meets, passes, and overtakes as the principal causes of delay. Dingler et al. (2010) expanded Gorman's work and used simulation analysis to evaluate delays between intermodal and bulk trains by categorizing delays by the conflict types and the sources, as shown in Table 7.. Identifying the operational sources allowed the authors to determine which delay conflict produces more delay and why that delay is occurring. Meet delays are caused when one

train is delayed due to a conflict with one or more trains in the opposing directions. Delays caused when a train is traveling at a reduced speed were minor and remained relatively constant.

Table 7.1. Categories of Delays

Conflicts	Sources
Meets	Accelerating
Passes	Braking
Line	Reduced Speed
	Stopped

Passes are found not to be a major source of delay on a single track, indicating that speed difference alone is not a significant factor affecting train delay. Delays caused when a train is stopped in a siding for a meet were found to be the leading cause of delay, as shown in Figure 7.2a. Delays when a train is braking and accelerating increase as the percentage of bulk trains in the traffic mix increases, making these delays more dependent on the type of train than on the heterogeneity of the traffic. Delays when a train is stopped are the only source of delay that increases with heterogeneity (Figure 7.2b). Therefore, heterogeneity increases delay by increasing the time trains are stopped waiting on a siding. Dingler et al. (2010) provided two possible explanations for this result. First, at the higher levels of heterogeneity there is greater likelihood that two trains of different priorities will meet, resulting in less efficient meets with more time stopped. Second, higher levels of heterogeneity result in more complex conflicts in which a train is met or passed by more than one train, again resulting in more time stopped. Through the results from their work, Dingler et al. (2010) affirmed that the amount of delay due to heterogeneity is related to the volume and type of traffic on a route. While delay can generally be said to increase exponentially with traffic volume, the specific delay-volume relationship is dependent on the traffic mix on a route. Further, each source of delay has a different trend with regard to traffic mix. This work could be developed to gain insight into a shared track scenario between freight and higher speed passenger trains. Passenger trains can expect to cause more “stop delay” in meets. Mitigation strategies should address this delay type in a single-track line.

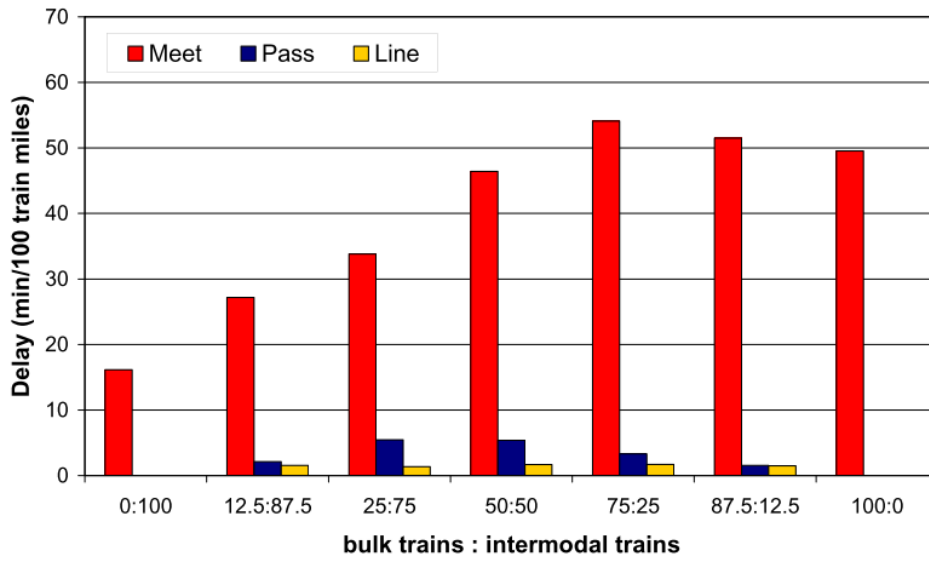

(a)

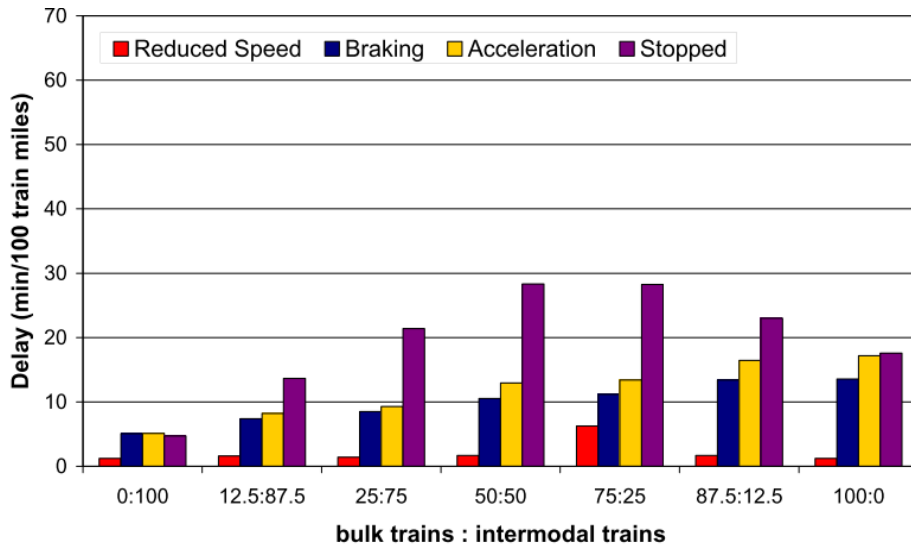

(b)

Figure 7.2. Average delay versus the ratio of bulk to intermodal trains by (a) conflict and (b) source

Martland et al. (1994) analyzed freight railroad transportation department-related delays. The distribution of these delays is shown in Figure 7.3. In this work, train meets were found to be the greatest source of delays at 20 percent. Other categories of delays could be attributed directly to the management of the railroad assets such as yards, crews, and locomotives. Martland et al. (1994) proposed that better management of these assets could lead to better railroad performance.

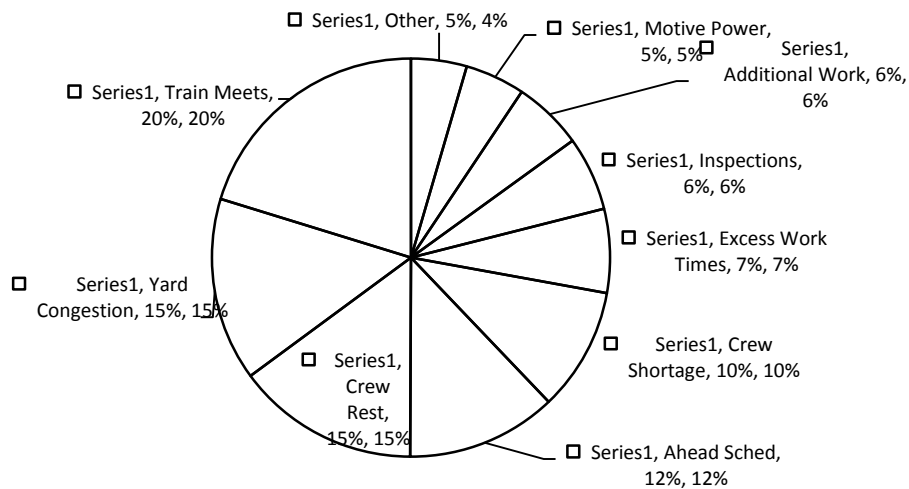

Figure 7.3. Transportation Department Delays (Martland et al. 1994)

Preston et al. (2009) investigated railway practices in the UK. They reported that delays to trains could be attributed to three sources: operator causes, network infrastructure causes, and external causes. Operator causes include train faults, train crews, train operations, station delays, and depot and freight operations. Network infrastructure causes include track faults, power and signal faults, and network operations. External factors include suicides, vandalism, and extreme weather and affect both operator and infrastructure owners. Figure 7.4 shows a breakdown of the causes of train delays from 1999 to 2000. Approximately 50 percent of delays could be attributed to the train operator, 35 percent to the infrastructure owner, and 15 percent to external causes. As shown in Figure 7.5, more recent figures for 2006–2007 indicate that around 40 percent of delay, referred to as primary delay, is directly attributable to the initial impact of the train operator, the infrastructure authority, or external causes. Congestion and other resulting delays, referred to as reactionary or secondary delay, account for the remaining 60 percent. In their study, the biggest single cause of delay from 1999 to 2000 was train faults (23 percent) caused by breakdowns or slow orders due to poor rolling stock. They also found that there was a decrease in the overall average age of rolling stock: 21 years for 2000–2001, 15 years for 2004–2005, and 13 years for 2005–2006. These figures from the UK offer some comparison for, but may not accurately reflect, a North American operating environment.

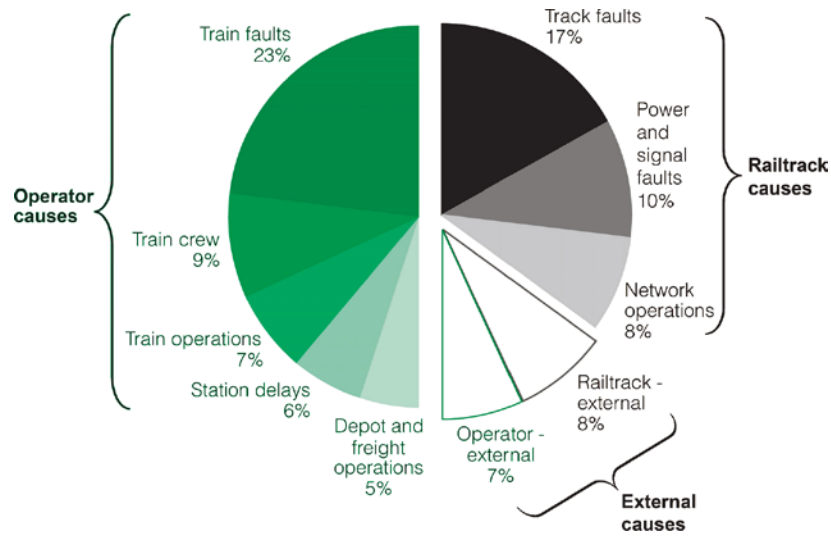

Figure 7.4. Causes of delays to trains, 1999–2000 (based on minutes of train delay compared with timetabled journey time)

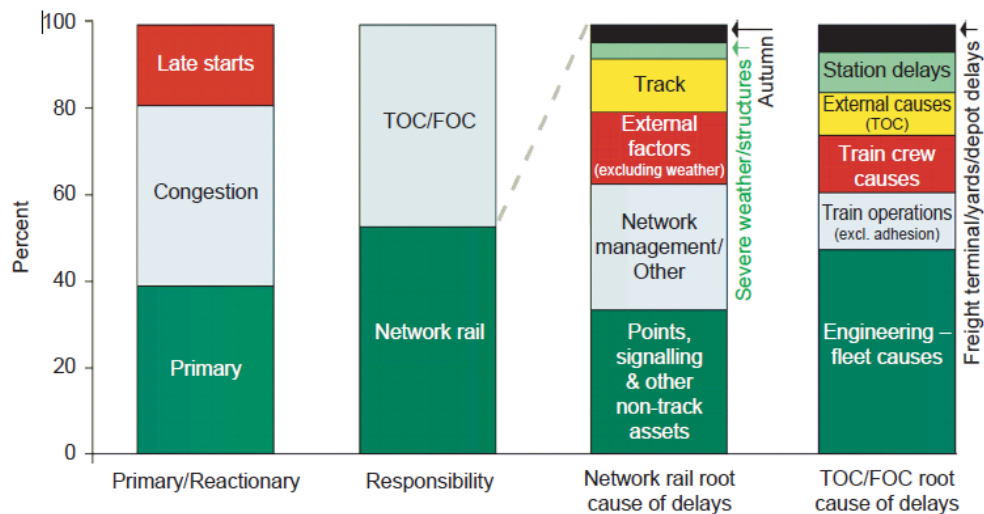

Figure 7.5. Analysis of delay minute, 2006-2007 (FOC = freight operated company) (Source: Network Rail)

Nelson and O’Neil (2000) investigated on-time performance of U.S. commuter railroads. The on-time performance of commuter railroads is expected to be even higher than the on-time performance of intercity trains. Figure 7.6 shows a delay pie chart. Unlike the pie charts presented by Martland and Preston, commuter rail trains are delayed most by construction and maintenance (engineering) activities at a combined 34 percent. Transportation issues only account for 11 percent of the delays. This stark contrast to the freight pie chart from Martland is indicative of the fact that commuter rail is optimized for stricter operations. O’Neil and Nelson (2000) explained that “Cascades Delays” are delays to a train caused by another train and caution that the various commuter agencies classify this delay type differently.

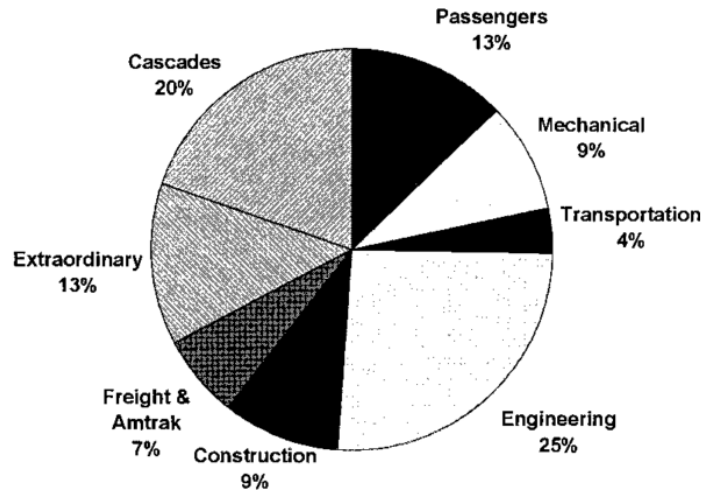

Figure 7.6. Commuter rail delays (Nelson and O’Neil 2000)

On a single-track line, transportation-related delays should be more numerous than other sources. On a double-track line, the railway system components (vehicle, track, and signal reliability) may start to cause a greater proportion of the delays. Proper maintenance activities can help mitigate these types of delays.

7.4.2 Delays Due to Heterogeneity

Railway traffic is considered to be homogeneous if all trains have similar characteristics. A good indicator of homogeneity is when the trains have the same average speed per track segment. Urban metro systems are homogenous systems where all trains have equal running times and stopping patterns. In a shared corridor, one could expect different train types including freight, high-priority freight, commuter, and high-speed passenger trains. Vromans et al. (2006) studied the Dutch rail network and the heterogeneity of its various passenger services. By homogenizing the stopping pattern to have a similar number of stops, they were able to decrease the headway between trains and help mitigate delay propagation (cascading delay).

Abbott (1975) analyzed the interaction of 50 mph freight trains sharing alongside passenger trains traveling at 80 mph, 125 mph, and 150 mph. Abbott only considered one direction of a double-track line—where the passenger trains have absolute priority over freight trains. Abbott reports that freight paths decline from the base (no passenger) scenario by 28 percent, 57 percent, and 71 percent, respectively, and that freight train trip times increase by 33 percent, 58 percent, and 88 percent. However, because the trains all travel in a single direction, no meets between opposing trains occur, only passes (Harrod, 2009).

Harrod (2009) modeled traffic using mathematical integer programming. This paper considered the impact of mixing faster and slower nonconforming trains. The author found that introducing a higher priority faster train would not reduce the total amount of feasible train paths through a single-track network. However, adding a fast high-priority train comes at the cost of higher delays to the slower, lower priority train type. This work assumed that all sidings were long enough for meets to occur without stopping. Trains stopped at sidings when they arrived at the siding earlier than scheduled for a meet. In addition, slower trains stopped at sidings to allow

overtaking by faster trains. Harrod (2009) suggests that all trains stopping for meets would lower the average speeds of his scenarios but not change capacity. Harrod (2009) suggests that incorporating stochastic schedules and stochastic delays are an area for future research.

Sogin et al. (2011) created a hypothetical single-track line and simulated shared-track scenarios with 50 mph freight trains and passenger trains with different maximum speeds of 50 mph, 79 mph, 90 mph, and 110 mph. The base case was a homogenous traffic composition of only freight trains. Passenger trains were then added in pairs to each base case. This procedure was repeated for different numbers of freight trains in the starting base case. In all cases, the marginal delay to the freight trains increased more when adding a high-priority passenger train as opposed to a freight train. In addition, the results showed greater variation in freight train performance when adding passenger trains as opposed to freight trains (Figure 7.7). The authors found little connection between the delay of the freight train and the maximum speed of the passenger train. The authors suggested that the increased passenger train speed had two counteracting effects on freight train delays. The positive factor was that because of their higher speed, passenger trains spent less time on a given network than freight trains, leading to fewer opportunities to conflict with freight traffic. The negative factor was that higher speeds disturbed homogenous freight operations and introduced more complex dispatching resolutions. These complex resolutions caused more delays than simple meets between two trains (Sogin et al. 2011).

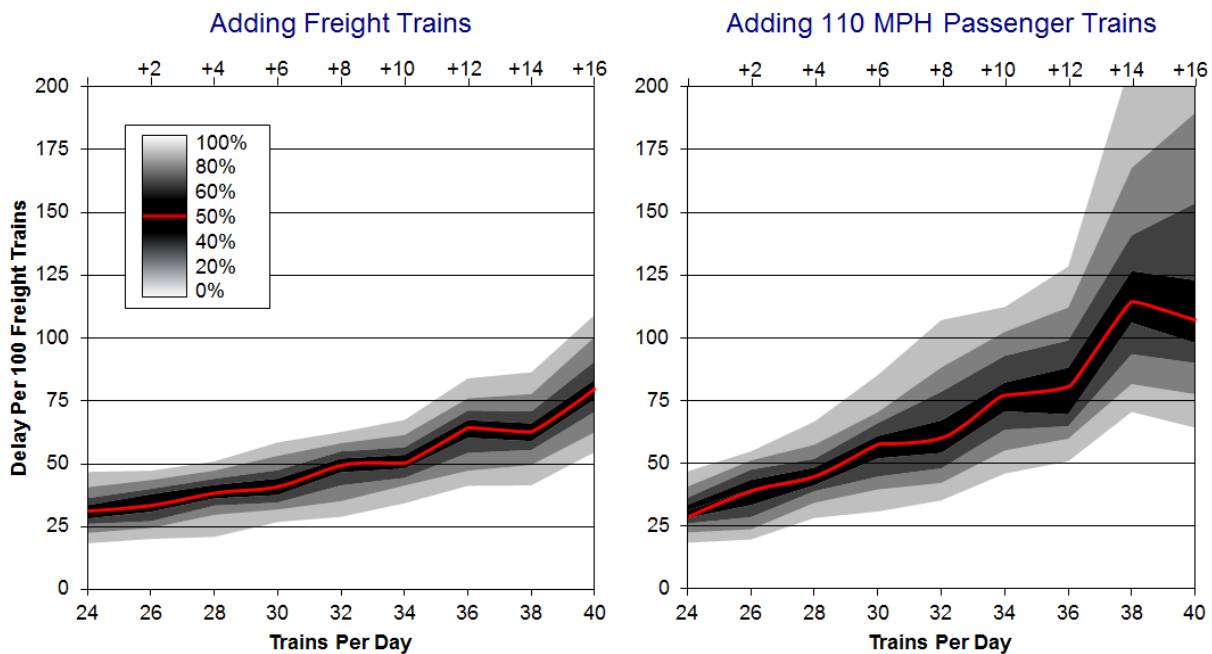

Figure 7.7. Freight train delays when adding freight (left) and 110 mph passenger trains (right) to a base case of 24 freight trains per day (Sogin et al. 2011)

7.4.3 Delay Mitigation

To add traffic to an existing corridor, a host railroad would likely require additional delays caused by passenger traffic to be mitigated through capacity expansion solutions. Two common techniques for delay mitigation are adding additional tracks to the railroad line or changing operations to be more efficient.

Infrastructure Solutions – Single Track Base Case

Preston et al. (2009) point out that delays attributed to infrastructure issues in Europe have risen. They suggest more investment in infrastructure as a possible mitigation strategy. They also point out that railway capacity has been widely assumed to be a key factor in delays—particularly the number and extent of secondary delays. They refer to a study indicating that infrastructure capacity utilizations above 75 percent have a significant effect on delay, with utilizations above 60 percent not recommended outside peak periods.

Petersen and Taylor (1987) state that an effective way to mitigate the delay due to meets is to optimize the locations of the passing sidings. They describe an optimization method for locating passing sidings such that opposing trains are able to pass each other without coming to a full stop, a so-called “flying meet.” They begin by assuming a homogenous traffic mix with known cruising speed and acceleration characteristics. From these train characteristics and information about headways and travel times, they determine the number and location of meets and the length required for each siding. This scenario is solved for the various speeds allowed on the siding and the various cruising speeds. Next, the authors determine the ability of the designed track to resist delay or, when delay occurs, avoid compounding that delay. They refer to this as the “robustness” of the track design. They found that increased length of sidings, as well as “schedule padding,” both contribute to the robustness of track designs. They show that “extra siding length has a strong impact on the ability of the line to recover from unexpected delay (as measured by the system response ratio) for delays in the range of 2 to 8 minutes to a train,” as is shown in

Figure 7.8.

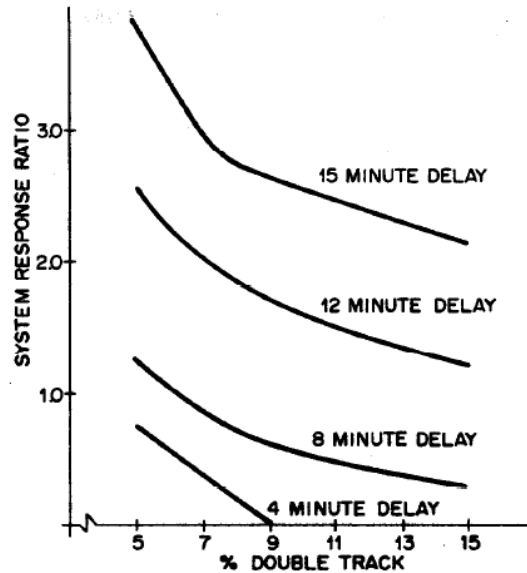

Figure 7.8. Impact of slack on system response (Petersen and Taylor 1987)

Petersen and Taylor (1987) performed a delay analysis by mixing three train types and optimizing siding locations. The three train types were (1) high-speed passenger, (2) express freight, and (3) work trains. Each train type had different frequencies, speeds, and priorities, with passenger trains having the highest priority. Petersen and Taylor (1987) found that with a relatively small amount of double track (13 percent), the passenger trains could achieve levels of delay similar to those of a double-track line. However, according to the authors, “because the freight and work trains must keep clear of the passenger service on the single line, we observe that their performance is relatively poor on this line. Given the enormous capital cost-saving, however, this poor performance for the low priority traffic would appear to be acceptable.” With the shared corridor approach in America, and with freight railroads owning most of the infrastructure, this approach may not be acceptable.

Dingler et al. (2010) determined that stopped delay in meets was the leading cause of delays due to heterogeneity. Dingler et al. suggested that these delays could potentially be eliminated by extending the sidings to prevent the train from having to stop. Building additional sidings allows trains to stop closer to the point of conflict, thereby reducing waiting time. Like intermodal trains, passenger trains operate at higher speed and priorities than other traffic types. Passenger trains could benefit even more from extended sidings by not having to stop for a meet. Extending sidings for freight trains would allow for increased train lengths and give passenger trains more room to have meets without stopping.

Siding construction may not always be economically feasible. Dingler et al. (2011) analyzed the interaction of intermodal and bulk trains with regard to siding construction mitigation strategy. The analysis included the net present value (NPV) of adding sidings (Figure 7.9) and adding a second mainline track (Figure 7.10). Adding sidings was shown to be most beneficial when the line was congested and near capacity. In this case, the delay reductions were the greatest. Additionally, there was greater benefit for the cases with greater heterogeneity. The addition of a second mainline track did not show a positive NPV for the combinations of heterogeneity and

traffic volumes studied. The trend showed an increasing NPV, so it can be assumed that at higher traffic volumes outside the scope of the study, one might begin to see a positive NPV. Passenger trains may be expected to increase delays to freight trains more so than to intermodal trains such that in shared track operations, this type of NPV analysis might show positive results at lower traffic. Additionally, a high cost of delay to passengers may shift the results.

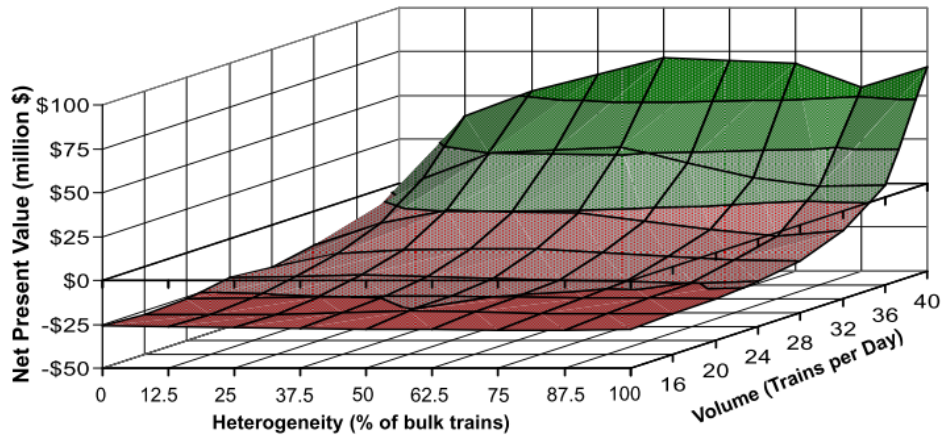

Figure 7.9. NPV when additional sidings are added to a single-track line (Dingler et al. 2011)

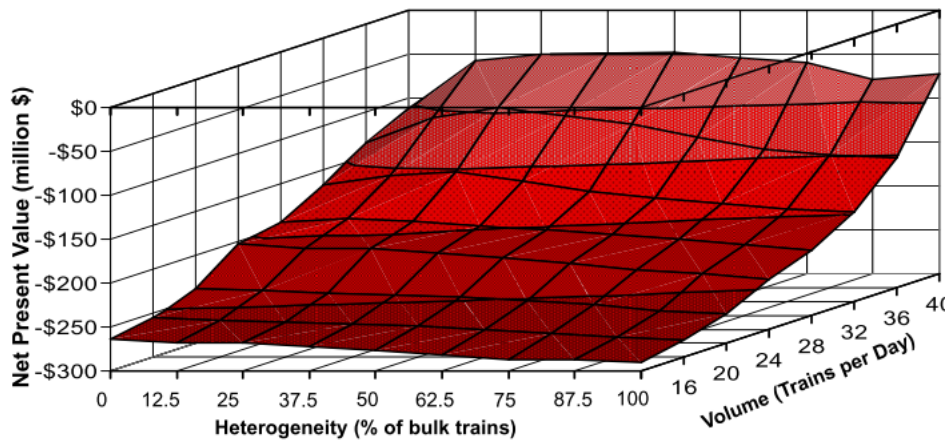

Figure 7.10. NPV when a 2nd mainline track is added to a single-track line (Dingler et al. 2011)

Infrastructure Solutions – Double Track

Two bidirectional mainline tracks should eliminate meet delays from occurring. Sogin et al. (2012) identified large speed differentials as a cause of significant delays in double-track configurations. Most infrastructure solutions for double track are based on allowing the faster high priority train to overtake slower rail traffic on a separate track. At low traffic levels this may be feasible with only two mainline tracks. At higher traffic levels, sidings or additional mainline tracks may be required. In Europe, many shared track lines have passing sidings that enable freight trains to clear off the mainline and allow overtaking by passenger trains. FRA considered

two mainline tracks with passing sidings as a potential track configuration to accommodate both 125 mph passenger trains on freight lines (Abbott 1975). The BNSF line between Chicago and Aurora uses three main tracks to separate intercity, commuter, and freight trains. At higher traffic levels, meet delays might occur on third track such that a fourth track is required to maintain a certain level of service. Most of the NEC between Washington D.C. and New York has four mainline tracks. This allows high-speed intercity trains to pass local commuter trains without delay.

Operating Solutions

Baumol (1975) explains that passenger traffic constituted a very minor source of revenue for most railroads, which resulted in poor service being provided to Amtrak by the operating railroads. Amtrak purchased transportation along a given route from a monopoly supplier, and under the law, did not have the choice to forego operations, even when receiving poor service. In response to the problem, Congress adopted an amendment in 1973 requiring that performance in the following areas be the basis for Amtrak's payments to railroads providing it services: (1) schedule adherence, (2) excessive delay, (3) recovered time, (4) schedule improvement, (5) car cleanliness, (6) equipment operability, and (7) equipment availability. To quantify how the incentives program could affect the passenger revenues of a railroad, Baumol (1975) provided data to show how Penn Central's earnings on its NEC could vary if its performance in a given year was "reasonably good" or "rather poor." Baumol's data represents values valid in 1975 and appears in Table 7.2.

Table 7.2. Hypothetical Annual Payment for “Good” vs. “Poor” Performance (Corridor Traffic, Penn Central Railroad) (Baumol 1975)

TYPE OF PAYMENT	“GOOD” PERFORMANCE CASE		“POOR” PERFORMANCE CASE	
	ASSUMPTION	AMOUNT (MILLIONS OF \$)	ASSUMPTION	AMOUNT (MILLIONS OF \$)
a. SCHEDULE ADHERENCE	90% ON TIME	\$8.4	60% ON TIME	0
b. EXCESSIVE DELAY — RECOVERED TIME	NO DELAY IN EXCESS OF TOLERANCE	0	5 TRAIN MINUTES PER TRAIN EXCESS DELAY	-\$0.9
c. CAR CLEANLINESS	NO VIOLATIONS	0	25% OF CARS IN VIOLATION	-\$2.2
d. EQUIPMENT OPERABILITY	97% OPERABLE	\$0.2	93% OPERABLE	-\$0.2
e. EQUIPMENT AVAILABILITY	87% LOCOMOTIVES 90% CARS	\$1.3	LESS THAN 85% LOCOMOTIVES 88% CARS	0
SUBTOTAL		\$9.9		-\$3.3
f. PAYMENTS UNRELATED TO PERFORMANCE		\$105.0		\$105.0
TOTAL		\$114.9		\$101.7

* ASSUMES 100 TRAINS PER DAY, \$5 PER TRAIN MINUTE PENALTY.
 **ASSUMES ALL ASSIGNED CARS ARE SUBJECT TO OPERATING STANDARDS ARRANGEMENT.

Baumol’s study of the 1973 amendment provides the historical background for why passenger trains are given highest priority. Passenger trains have the highest priority because Amtrak and other passenger companies pay railroads based on how well passenger trains perform on their lines. When considering the elimination of train priorities as a method for reducing delay, the likely reduction that would follow in the quality of performance provided to passenger service should also be considered. Providing poor performance would reduce payments made to railroads. This cost should be compared with the anticipated benefits of decreased delay.

Another mitigation technique suggested by Dingler et al. (2011) is to improve the acceleration performance and top speed of freight trains by adding a locomotive. This may be feasible to implement when there is both traffic congestion and a high percentage of low horsepower to trailing ton trains. In addition, equalizing the priorities between bulk and intermodal may decrease total delays of all trains. Removing the priority constraint from dispatchers can allow dispatchers to achieve an optimal conflict resolution strategy rather than sacrificing the performance of one train type to preserve the other. In the context of a shared track scenario with passenger and freight trains, this may not be compatible with the operating goals of the passenger agency.

Often there are practices across North America to stage trains or change crews on mainline tracks. There are many projects on the BNSF planned to remove trains blocking the mainline to passenger train flow. These projects do not improve theoretical capacity but can allow for greater use of the existing mainline. In Blaine, WA, freight trains queue up on the mainline and block

passenger train flow as they wait for customs inspections. In Everett, WA, departure and receiving tracks are being extended to accept longer freight trains without the tail of the train blocking the mainline. In Galesburg, IL, three additional yard tracks were constructed to accommodate BNSF's longest trains and have these trains refuel and change crews off the adjacent siding and mainline, thereby maintaining the flow of the through traffic. Shared track shared corridors can see immediate benefit by identifying those locations where freight operations block the mainline. Such sidings and yard projects can be cheaper than adding multiple mainline tracks.

7.5 Maintenance Planning

Scheduling railway infrastructure maintenance activities is an important aspect of railway operations planning. The challenge of planning maintenance windows to minimize impact to train delay and maintenance costs is not unique to shared rail corridors. Given passenger rail traffic's sensitivity to delay, complex interactions between different traffic types, and the increased number of stakeholders involved, the problem has potentially greater consequences on shared corridors than on dedicated freight or passenger lines. Preventive renewal maintenance, reactive maintenance, and routine inspection of track, signaling, and structures can consume rail capacity through windows of time where personnel and machinery occupy segments of a rail line. These maintenance windows can cause delay to train operations both on tracks where the activity is occurring and, depending on applicable safety regulations, on tracks adjacent to the activity. For this reason, infrastructure maintenance planning is most relevant to mixed-use corridors with shared track operations, as well as dedicated tracks with shared ROW. These impacts, including delays to rail traffic, can lead to financial penalties to the rail service operator depending on the type of traffic, e.g., bulk, intermodal, manifest, passenger. In addition, maintenance windows that are interrupted by rail traffic can suffer from productivity losses and consequent increases in cost. Finally, determining the optimal schedule for maintenance activities on a rail line can be challenging because maintenance and train delay costs may be realized by different stakeholders and service operators.

7.5.1 Integrated Maintenance and Rail Traffic Scheduling

The amount of coordination between maintenance planning and rail service planning varies in the industry. It is not uncommon for maintenance windows to be scheduled after rail service has already been scheduled on a line. For lower traffic volumes, this planning process may be acceptable as maintenance windows can be shifted to minimize train delay with little disadvantage. For higher traffic volumes, the lack of coordination between railway maintenance and train scheduling is likely to result in an increased number of delays as well as higher maintenance costs. This type of coordinated scheduling may have limited success on lines where many freight trains operate without a schedule. On lines with high volumes of passenger traffic, it is sometimes impossible to schedule maintenance during the hours when trains operate. One solution, such as is practiced on Amtrak's NEC, is to perform maintenance activities during nighttime hours when most traffic does not operate. This greatly reduces the potential for train delay and loss of productivity due to train interference, but may also introduce higher labor costs and safety concerns. In addition, temporally separating both freight traffic and line maintenance from passenger traffic could lead to high levels of freight service delay.

In lines where the temporal separation strategy is not feasible, an integrated train and maintenance schedule planning methodology may be adopted. Albrecht et al. (2010) presented a Problem Space Search (PSS) meta-heuristic for simultaneous scheduling of both maintenance activities and rail traffic. In this formulation, the total amount of delay to rail traffic and maintenance activities was minimized. In addition, the delay experienced by the worst performing train was considered. A case study line, 480 km long, with 50 trains per day, was evaluated over a 24-hour period. When applied to the case study line, the timetables generated by the PSS were found to reduce total delay by 17 percent and maximum train delay by 34 percent. These improvements were relative to a simulated manual schedule, which reflected the sometimes week-long practice of creating timetables on paper or basic software. One limitation of this analysis was that a unit of train delay was considered the same as a unit of maintenance delay. In addition, delays to all trains were evaluated equally. One way of strengthening the results of this work would be to reformulate the objective function of the model to minimize total cost. In this way, the cost of train delay for different traffic types, and the different “delay cost” of maintenance activities, could be accurately considered. In addition, the interaction of maintenance activities and rail traffic on adjacent tracks was not considered in this analysis. The applicability of this work to shared corridors is complicated by the limited ability of rail operations managers to reschedule passenger traffic, as well as the difficulties encountered in scheduling freight traffic at all.

7.5.2 Strategic Maintenance Scheduling

Strategic maintenance planning involves long-term scheduling over months or years to determine the activities of production gangs and inspection systems. In this section, the work outlined mostly considers the maintenance scheduling process as separate and secondary to train scheduling.

Grimes (1995) outlined genetic algorithm and genetic programming techniques for planning track surfacing. Using track surface quality data, segments of track were selected for improvement based on the costs of surfacing, track quality degradation rate, ballast degradation costs, and performance incentives for adhering to track geometry standards. For each time interval, the track surface quality was predicted for both surfaced and nonsurfaced segments, as selected by the decision variables. This approach is limited to surfacing operation scheduling, but the methodology could be part of a higher-level optimization model that both selects and schedules maintenance activities.

Gorman et al. (2010) formulated a model for scheduling maintenance production gangs on a network. The authors’ model minimizes gang labor, equipment, repositioning, and travel costs. Model constraints include number of workdays related to labor agreements, activity precedence relationships, and early start and late finish activity constraints. The authors present both a time-space network model formulation, as well as a job scheduling problem formulation. For both models, the solution methodologies applied exceeded what the authors considered to be an acceptable amount of time. Future work in this area could consider variable gang characteristics, as well as the rescheduling of activities given mechanical, labor, or weather interruptions.

Budai et al. (2006) presented a preventative maintenance scheduling problem (PMSP). In this problem, a set of preventative maintenance activities is scheduled with the objective of

minimizing total maintenance and track possession cost for one network segment. The authors presented a mathematical model for scheduling activities on a 2-year planning horizon with 1-week time intervals. The model takes into account the different activity durations, as well as the ability of activities to be combined. The possession cost of the network segment was dependent on the time period in which an activity could be scheduled. Since the model only considers one network segment, the constraints of limited machinery and personnel must be considered for a case study application of the model. For shared corridor scenarios with high levels of traffic, the bundling of activities, as presented in this analysis, could reduce train delay and maintenance costs. Several Class 1 railroads have already implemented these types of maintenance “blitz” scheduling techniques.

Pouryousef et al. (2010) further developed the PMSP model outlined by Budai to include simultaneous planning of several network segments. The advantage of the modified model is that it allows planners to consider the characteristic maintenance requirements and costs of different segments. The objective function minimizes the sum of track possession costs, maintenance costs, and a penalty cost related to performing work earlier than required. The authors applied the model over a case study HSR line in Iran, comparing the objective function costs of both shared track HSR with conventional traffic and a dedicated HSR. The outcome of this model is largely dependent on the assumed possession cost, which in reality varies depending on train delay.

Peng et al. (2011) presented a strategic maintenance-scheduling model that determines the optimal assignments of production gangs for a set of activities on an entire railroad network. In this analysis, a time-space network was considered with a 1-year planning horizon divided into weeklong time periods. Constraints included time-related (weather) constraints, mutually exclusive (network disruption) constraints, and precedence constraints between activities. The objective function of the model was to minimize travel costs of production gangs moving from project to project. On a strategic level, these travel costs were more variable than the comparatively fixed cost of actually performing maintenance work. The methodology of this work was implemented into the maintenance planning process of a Class 1 railroad. In the context of shared corridors, additional time and network constraints could be added to better manage passenger train delays caused by maintenance activity.

7.5.3 Tactical Maintenance Scheduling

Tactical maintenance planning involves a short-term several day or week planning horizon for scheduling routine inspection and smaller scale reactive maintenance activities. In this section, the work outlined mostly considers the maintenance scheduling process as separate and secondary to train scheduling. Higgins (1998) put forward a model to schedule maintenance activities and crews in an existing rail traffic pattern. The model was intended as a decision support tool for rail operations and maintenance managers. The types of activities included were visual inspection, replacing crossties, replacing rail, rail grinding, ballast cleaning, and track surfacing. The model was formulated as a time-dependent integer programming problem and considered maintenance costs, crew and track availability, work discontinuity, and activity precedence constraints. In this model, the objective function minimizes the weighted sum of expected train and maintenance delays, as well as prioritized activity finishing time. Because the model is time dependent, there are a large number of decision variables. A local search heuristic

technique is used in this case to find a solution. The model was applied to an Australian case study line 302 km long with 45 sidings, comparing a four-day maintenance schedule with one constructed manually by railway planners. The manually constructed schedule had a 7.4 percent worse performance in prioritized maintenance activity finishing time and an 18 percent higher train and maintenance activity delay. Figure 7.11 shows an example of the time-space diagram of the case study line. This maintenance-scheduling model appears to be useful to shared corridors. Higgins included different train types and priorities in the model formulation. In addition, the model optimizes the maintenance schedule for a given rail traffic pattern rather than scheduling both rail traffic and maintenance activities. Higgins’s assumptions follow operating practices in the United States more closely than other work pursued on maintenance scheduling.

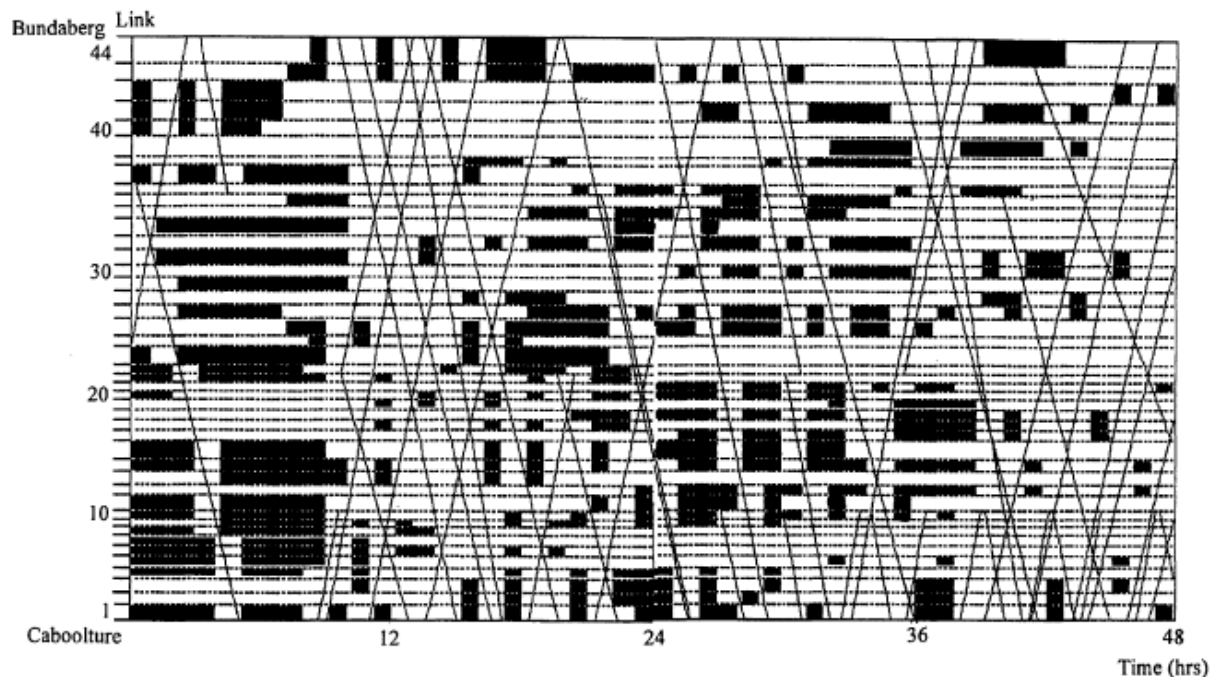

Figure 7.11. Best allocation of maintenance activities to time window (Higgins 1998)

7.6 Discussion and Conclusions

In Europe, heterogeneous operations of freight and passenger trains can be achieved by strict scheduling of the freight trains. In the United States, the flexibility and variability of the freight railroad operation may make this strategy seem unrealistic. A thorough cost-benefit analysis of the business case for a scheduled railroad should be conducted. More simulation work is needed for shared track scenarios as far as temporal separation of the passenger and freight trains is concerned. The work should consider the amount of “buffer time” necessary for a line to transition between types of operations. Additionally, this work should identify which train type must have its headways compressed to achieve this buffer.

The work of Dingler et al. (2010) on delay source was limited by sample size and only considered the average delay of all train types. This work can be expanded by analyzing the delays of the different train types and assigning the type of train causing the delay, in addition to the conflict and source. Finally, this work can be expanded to include bulk, intermodal, and

passenger trains. The traditional solution to mitigating train delay is adding infrastructure. The funding to extend sidings or fully double track a route may not be available all at once. An optimization model could help develop an implementation plan of feasible intermediate infrastructure solutions. These intermediate phases can be built over time as funding becomes available.

A completely integrated methodology for scheduling rail traffic and maintenance activities may not be feasible for some shared rail corridors in the United States. The unscheduled nature of U.S. freight traffic would make it difficult to optimize a combined maintenance and rail traffic schedule for longer time horizons. Ideally, strategic scheduling of maintenance activities should take into account additional time and network constraints to minimize delays to passenger traffic. Optimizing the scheduling of maintenance activities to best fit into an existing traffic pattern on a short-term planning horizon may be the best solution considering the current state of practice.

Future work should address costs of train delay, as well as loss of maintenance productivity. The differing delay costs of various train types should be applied to any scheduling problem. In addition, the delay and productivity effects introduced by safety regulations on adjacent but dedicated HSR track should be considered in scheduling models.

7.7 References

- Abbott, R. K. (1975). Operation of High-Speed Passenger Trains in Rail Freight Corridors. Washington, D.C.
- Abril, M., F. Barber, L. Ingolotti, and M. Salido. (2008). An Assessment of Railway Capacity. *Transportation Research Part E: Logistics and Transportation Review*, 44(5), 774–806.
- Albrecht, A. R., D. M. Pantou, and D. H. Lee. (2010). Rescheduling rail networks with maintenance disruptions using Problem Space Search. *Computers and Operations Research*, 1–10. doi:10.1016/j.cor.2010.09.001.
- Baumol, W. J. (1975). “Payment an Transportation: Passenger in Amtrak’s Innovation Operations.” *The Bell Journal of Economics*, 6(1), 281–298.
- Bing, A. J., E. W. Beshers, M. Chzvez, and D. P. Simpson. (2010). Guidebook for Implementing Passenger Rail Service on Shared Passenger and Freight Corridors. Washington, D.C.
- Budai, G., D. Huisman, and R. Dekker. (2005). “Scheduling preventive railway maintenance activities.” *Journal of the Operational Research Society*, 57(9), 1035–1044. doi:10.1057/palgrave.jors.2602085.
- Dingler, M., A. Koenig, S. L. Sogin, and C. P. L. Barkan. (2010). Determining the Causes of Train Delay. AREMA Annual Conference Proceedings. Orlando.
- Dingler, M., Y.-C.Lai, and C. P. L. Barkan. (2011). Economics of Expanding Capacity on a Single Track Heavy Haul Railway Line. Proceedings of the 2011 International Heavy Haul Association (pp. 1–8). Calgary.
- Gorman, M. F. (2009). Statistical estimation of railroad congestion delay. *Transportation Research Part E: Logistics and Transportation Review*, 45(3), 446–456. doi:10.1016/j.tre.2008.08.004.
- Gorman, M. F. and J. J. Kanet. (2010). “Formulation and solution approaches to the rail maintenance production gang scheduling problem.” *Journal of Transportation Engineering*, (August), 701–708.
- Grimes, C. (1995). Application of genetic techniques to the planning of railway track maintenance work. *Genetic Algorithms in Engineering Systems: Innovations and Applications*, 1995. GALEZIA. First International Conference, (414), 467–472. doi:10.1049/cp:19951093.
- Hallowell, S. F. and P. T. Harker. (1998). Predicting on-time performance in scheduled railroad operations: methodology and application to train scheduling. *Transportation Research Part A: Policy and Practice*, 32(4), 279–295. doi:10.1016/S0965-8564(97)00009-8.
- Harrod, S. (2009). Capacity factors of a mixed speed railway network. *Transportation Research Part E*, 45(5), 830–841. doi:10.1016/j.tre.2009.03.004.
- Higgins, A. (1998). “Scheduling of railway track maintenance activities and crews.” *Journal of the Operational Research Society*, 49(10), 1026–1033.
- Higgins, A. and E. Kozan. (1998). Modeling Train Delays in Urban Networks. *Transportation Science*, 32(4), 346–357. doi:10.1287/trsc.32.4.346.

- Ireland, P., R. Case, J. Fallis, and J. Kuehn. (2003). Perfecting the Scheduled Railway : Model-Driven Operating Plan Development. System (pp. 1–28). Phoenix.
- Krueger, H. (1999). Parametric Modeling in Rail Capacity Planning. Proceedings of the 1999 Winter Simulation Conference (pp. 1194–1200). Phoenix.
- Lai, Y.-C. and C. P. L. Barkan. (2011). “Comprehensive Decision Support Framework for Strategic Railway Capacity Planning.” *Journal of Transportation Engineering*, 137(10), 738–749. doi:10.1061/(ASCE)TE.1943-5436.0000248.
- Lai, Y.-C. and P. Huang. (2012). High Speed Route Improvement Optimizer. Transportation Research Board: 91st Annual Meeting (pp. 1–14). Washington, DC.
- Lai, Y.-C. and M.-C. Shih, (2010). Strategic Capacity Planning Process for Intercity Passenger Rail. Proceedings of the 2010 Joint Rail Conference (pp. 1–7). Urbana.
- Leeson, F. (2002, September 25). “Old Rails Could Carry Commuters in Future.” *The Oregonian*, p. C01. Portland.
- Martland, C. D. (2008). “Improving on-time performance for long-distance passenger trains operating on freight routes.” *Journal of the Transportation Research Forum*, 47(4), 63–80.
- Martland, C. D., P. Little, and J. M. Sussman. (1994). Service Management in the Railroad Industry. Transportation Research Board.
- Mattesson, L. (2007). Railway Capacity and Train Delay Relationships. Critical Infrastructure.
- Nelson, D. and K. O’Neil. (2000). Commuter Rail Service Reliability: On-Time Performance and Causes for Delays. Transportation Research Record: Journal of the Transportation Research Board, 1704(00), 42–50. doi:10.3141/1704-07.
- Pachl, J. and T. White. (2004). Analytical Capacity Management with Blocking Times. Transportation Research Board: 83rd Annual Meeting.
- Peng, F., S. Kang, X. Li, Y. Ouyang, K. Somani, and D. Acharya. (2011). A Heuristic Approach to the Railroad Track Maintenance Scheduling Problem. *Computer-Aided Civil and Infrastructure Engineering*, 26(2), 129–145. doi:10.1111/j.1467-8667.2010.00670.x.
- Petersen, E. and A.J. Taylor. (1987). Design of single-track rail line for high-speed trains. Transportation Research Part A: General, 21(1).
- Poole, E. (1962). Costs – A Tool for Railroad Management.
- Pouryousef, H., P. Teixeira, and J. Sussman, (2010). Track maintenance scheduling and its interactions with operations: Dedicated and mixed high-speed rail (HSR) scenarios.
- Preston, J., G. Wall, R. Batley, J. N. Ibáñez, and J. Shires. (2009). Impact of Delays on Passenger Train Services. Transportation Research Record: Journal of the Transportation Research Board, (2117), 14–23. doi:10.3141/2117-03.
- Sogin, S. L., C. P. L. Barkan, Y.-C. Lai, and M. R. Saat. (2012a). Measuring the Impact of Additional Rail Traffic Using Highway and Railroad Metrics. Proceedings of the 2012 Joint Rail Conference. Philadelphia.

- Sogin, S. L., C. P. L. Barkan, Y.-C. Lai, and M. R. Saat. (2012b). Impact of Passenger Trains in Double Track Networks. Proceedings of the 2012 Joint Rail Conference. Philadelphia.
- Sogin, S. L., Barkan, C. P. L., and Saat, M. R. (2011). Simulating the Effects of Higher Speed Passenger Trains in Single Track Freight Networks. Proceedings of the 2011 Winter Simulation Conference (pp. 3679–3687). Phoenix: IEEE.
doi:10.1109/WSC.2011.6148061.
- Vromans, M. J. C. M., Dekker, R., and Kroon, L. G. (2006). Reliability and heterogeneity of railway services. *European Journal of Operational Research*, 172, 647–665.
doi:10.1016/j.ejor.2004.10.010.

8. SUMMARY OF IDENTIFIED RESEARCH NEEDS RELATED TO SHARED HIGH-SPEED RAIL PASSENGER AND FREIGHT TRAIN OPERATIONS

The following is a list of identified research needs from the literature review presented in Sections 2 to 7:

- Develop a holistic model to assess adjacent derailment risk.
- Evaluate potential adjacent derailment risk reduction strategies (e.g., concrete barrier versus intrusion detection warning).
- Evaluate if the U.S. DOT Grade-Crossing Accident Prediction Formula needs to be updated to reflect the current state of technology and its relevance to shared rail corridor operations.
- Develop a theoretical or behavior-based model to account for driver response to evaluate the effectiveness of grade crossing protection systems.
- Evaluate the cost-effectiveness of different grade crossing protection systems.
- Develop a model to analyze the consequences of various types of impact and dynamic loads on shared corridors, accounting for axle load, train speed, and tonnage, to evaluate deterioration rates of special trackwork and other track structure and sub-structure components.
- Conduct field experimentation of proposed special trackwork component designs for use in shared operations.
- Evaluate premium special trackwork applications such as moveable-point frogs and flange bearing frogs, based on traffic and route characteristics for shared operations.
- Develop understanding of relevance of potential ballast flight risk for high- and higher speed rail services in North America.
- Identify remedial actions to mitigate differential movement in track at transition sections.
- Develop understanding of how differing loading magnitudes and frequencies relate to settlement of specific track structure on shared corridors.
- Conduct a thorough cost-benefit analysis of the business case for a scheduled freight railroad in shared-corridor operations.
- Conduct simulation work to evaluate shared track scenarios with temporal separation of the passenger and freight trains.
- Develop an optimization model to evaluate infrastructure improvement solutions to reduce train delays.
- Develop an optimization model to schedule maintenance activities to best fit into an existing traffic pattern on a short-term planning horizon.
- Evaluate the costs of train delay as well as loss of maintenance productivity.

Appendix A. Prioritized List of Challenges based on Survey Results (sorted by category)

	Challenge Description	Rank	HSR Configuration Relevance		
			Shared Track	Shared ROW	Shared Corridor
IE	Engineering special trackwork , such as turnouts and crossings, that perform well for both HAL and HSR traffic	1	High	Low	Low
IE	Evaluating rail performance under higher speed passenger and heavy axle freight traffic and correlating wear and defect rate with different loading characteristics	2	High	Low	Low
IE	Evaluating the performance of stiffness transition areas such as bridges, highway grade crossings, tunnels, and special trackwork in the context of mixed passenger and freight traffic	3	High	Low	Low
IE	Evaluating the effectiveness of conventional ballasted track for accommodating both HAL and HSR traffic	4	High	Low	Low
PO	Analyzing the effectiveness of different scheduling patterns in reducing heterogeneous traffic delay , including bunching passenger trains with higher priority freight trains	5	High	Low	Low
IE	Developing a better understanding of wheel load characteristics to be expected on shared corridors, including both static and dynamic magnitude, as well as frequency for different types of traffic	6	High	Low	Low
IE	Investigating different techniques for increasing the amount of time between track surfacing operations given the more stringent geometry requirements inherent to higher speed passenger traffic	7	High	Low	Low
IE	Engineering new slab track designs that would accommodate both heavy axle load (HAL) as well as high speed rail (HSR) traffic	8	High	Low	Low
PO	Analyzing different scheduling patterns of maintenance of way (MOW) windows with the goal of reducing train delay in mixed traffic environments	9	High	Medium	Low
IE	Engineering fastening systems that perform well given heterogeneous rail seat load magnitudes and frequencies in a shared track environment	10	High	Low	Low
PO	Developing capacity planning methodologies that factor in present and future traffic, as well as desired level of service	11	High	Low	Low
S	Evaluating an expanded use of wayside defect detection equipment as a method of reducing derailment risk on shared corridors	12	High	High	Medium
IE	Investigating the risk posed to signaling and communications systems by rolling stock electrical interference , characterized by low impedance and extraneous currents in certain frequency ranges	13	High	High	Low
S	Evaluating the use of upgrades such as median barriers, four quadrant or long arm gates, and incursion detection as a way of mitigating risk at highway grade crossings	14	High	Low	Low
S	Developing barrier systems and other strategies to prevent motor vehicle incursion onto shared corridor rights of way (ROW)	15	High	High	Medium
E	Investigating different methods of indemnifying freight railroads from the accident liability added by passenger traffic on existing freight lines	16	High	High	Medium
IE	Evaluating the impact to rail wear and rail defects by operating tilting equipment through curves at higher cant deficiencies than conventional passenger equipment	17	High	Low	Low
IE	Determining the feasibility of electrifying existing freight lines with clearance requirements for double stack intermodal freight equipment	18	High	Low	Low
S	Investigating the causes of loss of track circuit shunt sometimes associated with lighter passenger equipment traveling at faster speeds	19	High	Low	Low
S	Evaluating the effectiveness of the current track safety standards to prevent derailments in adjacent or shared track high speed passenger operating environments	20	High	High	Medium
IE	Developing technologies such as rolling stock or platform extensions that would allow for the use of level boarding equipment on existing freight corridors	21	High	Low	Low
S	Evaluating the increased risk posed by higher speed passenger trains to train operating and maintenance of way (MOW) employees working on or near a shared corridor ROW	22	High	High	Low
PO	Developing computer models that help passenger rail planning agencies determine the most cost effective infrastructure upgrades to achieve a certain trip time improvement	23	High	Low	Low
I	Determining equitable frameworks for allocating the cost of capacity between different track users when the marginal cost of capacity upgrades increases with capacity	24	High	Low	Low
I	Evaluating the economics of constructing new shared lines capable of accommodating temporally separated heavy axle load (HAL) and high speed rail (HSR) traffic	25	High	Low	Low
S	Evaluating the risk posed to higher speed passenger operations by derailments on adjacent or shared freight tracks	26	High	High	Low

PO	Developing new methods of enhancing passenger train schedule reliability , including distributing slack time based on infrastructure configurations and conflicts with other trains rather than a flat percentage of train schedules	27	High	Low	Low
E	Development of passenger equipment safety standards beyond the current maximum Tier II level, allowing for the operation of passenger trains at speeds exceeding 150MPH on dedicated lines while enabling intermixed operation with freight traffic at slower speeds	28	High	Low	Low
I	Evaluating the economic impact of imposing temporal separation of freight and passenger traffic on existing shared lines	29	High	Low	Low
I	Evaluating the life cycle cost of slab track while taking into account the cost of capacity used by maintenance activity	30	High	Low	Low
E	Developing a new track usage fee structure that takes into account the amount of capacity used by a particular train type and priority	31	High	Low	Low
I	Evaluating the economic impact caused by the severing of freight rail industry access by adjacent dedicated passenger tracks	32	High	High	High
E	Finding new frameworks for federal grant agreements that help ensure the quality of the passenger service while protecting freight railroads from investing their own capital for future delay mitigation	33	High	Low	Low
S	Developing fencing systems and other strategies to prevent trespasser incursion onto shared corridor rights of way (ROW)	34	High	High	Medium
S	Developing barrier systems to prevent derailed equipment from fouling adjacent tracks	35	High	High	Medium

Appendix B. Prioritized List of Challenges based on Survey Results (sorted by descending rank)

	Challenge Description	Rank	HSR Configuration Relevance		
			Shared Track	Shared ROW	Shared Corridor
Safety	Evaluating an expanded use of wayside defect detection equipment as a method of reducing derailment risk on shared corridors	12	High	High	Medium
	Evaluating the use of upgrades such as median barriers, four quadrant or long arm gates, and incursion detection as a way of mitigating risk at highway grade crossings	14	High	Low	Low
	Developing barrier systems and other strategies to prevent motor vehicle incursion onto shared corridor rights of way (ROW)	15	High	High	Medium
	Investigating the causes of loss of track circuit shunt sometimes associated with lighter passenger equipment traveling at faster speeds	19	High	Low	Low
	Evaluating the effectiveness of the current track safety standards to prevent derailments in adjacent or shared track high speed passenger operating environments	20	High	High	Medium
	Evaluating the increased risk posed by higher speed passenger trains to train yard and engine (TY&E) and maintenance of way (MOW) employees working on or near a shared corridor ROW	22	High	High	Low
	Evaluating the risk posed to higher speed passenger operations by derailments on adjacent or shared freight tracks	26	High	High	Low
	Developing fencing systems and other strategies to prevent trespasser incursion onto shared corridor rights of way (ROW)	34	High	High	Medium
	Developing barrier systems to prevent derailed equipment from fouling adjacent tracks	35	High	High	Medium
Infrastructure and Equipment	Engineering special trackwork, such as turnouts and crossings, that perform well for both HAL and HSR traffic	1	High	Low	Low
	Evaluating rail performance under higher speed passenger and heavy axle freight traffic and correlating wear and defect rate with different loading characteristics	2	High	Low	Low
	Evaluating the performance of stiffness transition areas such as bridges, highway grade crossings, tunnels, and special trackwork in the context of mixed passenger and freight traffic	3	High	Low	Low
	Evaluating the effectiveness of conventional ballasted track for accommodating both HAL and HSR traffic	4	High	Low	Low
	Developing a better understanding of wheel load characteristics to be expected on shared corridors, including both static and dynamic magnitude, as well as frequency for different types of traffic	6	High	Low	Low
	Investigating different techniques for increasing the amount of time between track surfacing operations given the more stringent geometry requirements inherent to higher speed passenger traffic	7	High	Low	Low
	Engineering new slab track designs that would accommodate both heavy axle load (HAL) as well as high speed rail (HSR) traffic	8	High	Low	Low
	Engineering fastening systems that perform well given heterogeneous rail seat load magnitudes and frequencies in a shared track environment	10	High	Low	Low
	Investigating the risk posed to signaling and communications systems by rolling stock electrical interference, characterized by low impedance and extraneous currents in certain frequency ranges	13	High	High	Low
	Evaluating the impact to rail wear and rail defects by operating tilting equipment through curves at higher cant deficiencies than conventional passenger equipment	17	High	Low	Low
	Determining the feasibility of electrifying existing freight lines with clearance requirements for double stack intermodal freight equipment	18	High	Low	Low
Developing technologies such as rolling stock or platform extensions that would allow for the use of level boarding equipment on existing freight corridors	21	High	Low	Low	
Planning and Ops.	Analyzing the effectiveness of different scheduling patterns in reducing heterogeneous traffic delay, including bunching passenger trains with higher priority freight trains	5	High	Low	Low
	Analyzing different scheduling patterns of maintenance of way (MOW) windows with the goal of reducing train delay in mixed traffic environments	9	High	Medium	Low
	Developing capacity planning methodologies that factor in present and future traffic, as well as desired level of service	11	High	Low	Low
	Developing computer models that help passenger rail planning agencies determine the most cost effective infrastructure upgrades to achieve a certain trip time improvement	23	High	Low	Low
	Developing new methods of enhancing passenger train schedule reliability, including distributing slack time based on infrastructure configurations and conflicts with other trains rather than a flat percentage of train schedules	27	High	Low	Low

Institutional Challenges	Investigating different methods of indemnifying freight railroads from the accident liability added by passenger traffic on existing freight lines	16	High	High	Medium
	Development of passenger equipment safety standards beyond the current maximum Tier II level, allowing for the operation of passenger trains at speeds exceeding 150MPH on dedicated lines while enabling intermixed operation with freight traffic at slower speeds	28	High	Low	Low
	Developing a new track usage fee structure that takes into account the amount of capacity used by a particular train type and priority	31	High	Low	Low
	Finding new frameworks for federal grant agreements that help ensure the quality of the passenger service while protecting freight railroads from investing their own capital for future delay mitigation	33	High	Low	Low
Economic Challenges	Determining equitable frameworks for allocating the cost of capacity between different track users when the marginal cost of capacity upgrades increases with capacity	24	High	Low	Low
	Evaluating the economics of constructing new shared lines capable of accommodating temporally separated heavy axle load (HAL) and high speed rail (HSR) traffic	25	High	Low	Low
	Evaluating the economic impact of imposing temporal separation of freight and passenger traffic on existing shared lines	29	High	Low	Low
	Evaluating the life cycle cost of slab track while taking into account the cost of capacity used by maintenance activity	30	High	Low	Low
	Evaluating the economic impact caused by the severing of freight rail industry access by adjacent dedicated passenger tracks	32	High	High	High

Abbreviations and Acronyms

RailTEC	Rail Transportation and Engineering Center
FRA	Federal Railroad Administration
BAA	Broad Agency Announcement
HSR	High-Speed Rail
ROW	Right-of-Way
HAL	Heavy Axle Load
IDOT	Illinois Department of Transportation
UIUC	University of Illinois at Urbana-Champaign
KTH	Swedish Royal Institute of Technology
NTSB	National Transportation Safety Board
PTC	Positive Train Control
IDW	Intrusion Detection Warning
DPU	Distributed Power Unit
RTD	Regional Transit District
CTA	Chicago Transit Authority
HrSR	Higher Speed Rail
FTA	Federal Transit Authority
APTA	American Public Transportation Association
CEM	Crash Energy Management
AADT	Annual Average Daily Traffic
UP	Union Pacific
FBF	Flange bearing Frog Diamond
OWLS	One-Way Low Speed
FAST	Facility for Accelerated Service Testing
TTC	Transportation Technology Center
HTL	High Tonnage Loop
RBM	Rail Bound Manganese
PS	Point of Switch
PF	Point of Frog

KGO	Kinematic Gauge Optimization
DEM	Discrete Element Modeling
FWD	Falling Weight Deflectometer
FEM	Finite Element Model
MDOF	Multiple Degree of Freedom
HSL	High-Speed Line
AAR	Association of American Railroads
SRI	Strategic Research Initiatives
VTI	Vehicle-Track Interaction
LCC	Life-Cycle Cost
MARTA	Metropolitan Atlanta Rapid Transit Authority
HMA	Hot-Mix Asphalt
FOC	Freight-Operated Company
NPV	Net Present Value
PSS	Problem Space Search
PMSP	Preventative Maintenance Scheduling Problem
U.S. DOT	United States Department of Transportation