

# TECHNOLOGY ALTERNATIVES FOR AN AUTOMATED COLLISION NOTIFICATION SYSTEM, FINAL REPORT

## **NOTE TO READER:**

### **THIS IS A LARGE DOCUMENT**

Due to its large size, this document has been segmented into multiple files. All files separate from this main document file are accessible from links ([blue type](#)) in the [table of contents](#) or the body of the document.



U.S. Department  
of Transportation  
National Highway  
Traffic Safety  
Administration

---

DOT HS 808 288

**August 1994**

**Final Report**

# Technology Alternatives for an Automated Collision Notification System



This publication is distributed by the U.S. Department of Transportation, National Highway Traffic Safety Administration, in the interest of information exchange. The opinions, findings and conclusions expressed in this publication are those of the author(s) and not necessarily those of the Department of Transportation or the National Highway Traffic Safety Administration. The United States Government assumes no liability for its contents or use thereof. If trade or manufacturers' name or products are mentioned, it is because they are considered essential to the object of the publication and should not be construed as an endorsement. The United States Government does not endorse products or manufacturers.

1. Report No. DOT HS 808 288		2. Government Accession No.		3. Recipient's Catalog No.	
4. Title and Subtitle Technology Alternatives for an Automated Collision Notification System Final Report				5. Report Date August 1994,	
				6. Performing Organization Code	
7. Author(s) R.L. Yuan; R.W. Newman; S.E. Young; E.D. Holm; J.S. Lin				8. Performing Organization Report No:	
9. Performing Organization Name and Address The Johns Hopkins University Applied Physics Laboratory Johns Hopkins Road Laurel, MD 20723-6099				10. Work Unit No. (TRAI5)	
				11. Contract or Grant No.	
12. Sponsoring Agency Name and Address Office of Crash Avoidance Research National Highway Traffic Safety Administration 400 Seventh Street, SW. Washington, DC 20590				13. Type of Report and Period Covered Technical Report	
				14. Sponsoring Agency Code NRD-50	
15. supplementary Notes					
16. Abstract  In support of the National Highway Traffic Safety Administration, The Johns Hopkins University Applied Physics Laboratory examined various technologies to assess their suitability for use in an automated collision notification system. Specific technologies for crash sensing, communicating the crash occurrence, and determining the position of a crash are described, as well as technologies for obtaining amplifying information about a crash. Both mature and emerging technologies are considered.					
17. Key Words Automated Collision Notification System, Mayday System, Accelerometers, Wireless Communications Systems, Mobile Communication Systems, Automatic Vehicle Location, Intelligent Vehicle Highway System			16. Distribution Statement This document is available to the public through the National Technical Information Service, Springfield, VA 22161		
19 Security Classif. of this report		20. Security Classif. (of this page)		21. No. of Pages	22. Price

## TABLE OF CONTENTS

Section		Page
	Abstract .....	i
	List of Illustrations ....	vii
	List of Tables .....	ix
	EXECUTIVE SUMMARY .....	ES-P
	ES.1 Sensor Summary .....	ES-1
	ES.2 Communication System Summary.. ..	ES-2
	ES.3 Navigation System Summary.....	ES-4
	ES.4 Conclusion.....	ES-4
1	INTRODUCTION .....	1-1
2	IN-VEHICLE SYSTEM REQUIREMENTS .....	2-1
	2.1 Crash Detection .....	2-1
	2.1.1 Crash Characteristics .....	2-2
	2.1.2 Supplemental Crash Data Requirements .....	2-3
	2.2 Determination of Vehicle Crash Location.. ..	2-3
	2.3 EMS Notification .....	2-4
	2.4 Survivability .....	2-6
	2.5 Commercial Viability .....	2-7
3	SENSOR TECHNOLOGY ALTERNATIVES.....	3-1
	3.1 Methods of Crash Detection .....	3-1
	3.1.1 Deceleration.....	3-1
	3.1.2 Chassis Deformation.....	3-9
	3.2 Supplemental Crash Data .....	3-9
	3.2.1 Crash Dynamics .....	3-9
	3.2.2 Number of Occupants.....	3-10
	3.2.3 Use of Restraints .....	3-11
	3.2.4 Indication of Fire.....	3-12
	3.2.5 Vehicle Weight and Vehicle Type.. ..	3-13
	3.2.6 Age of Occupants .....	3-14
	3.3 Summary and Conclusions .....	3-14
4	COMMUNICATION SYSTEM ALTERNATIVES .....	4-1
	4.1 Geosynchronous Satellite Systems.....	4-1
	4.1.1 MSAT .....	4-3
	4.1.2 INMARSAT .....	4-4

TABLE OF CONTENTS (Continued)

Section		Page
	4.1.3 Omni-TRACS .....	4-4
	4.1.4 Application of GEO Satellite Systems to Automated Crash Notification.....	4-5
4.2	Low Earth Orbit Satellite Systems .....	4-7
	4.2.1 Big LEO Satellite Systems .....	4-8
	4.2.2 Application of Big LEO Satellite Systems to Automated Crash Notification.. .....	4-11
	4.2.3 Little LEO Satellites.. .....	4-13
	4.2.4 Application of Little LEO Satellite Systems to Automated Crash Notification.....	4-14
4.3	Terrestrial Systems .....	4-16
	4.3.1 Cellular Telephone System .....	4-16
	4.3.2 Wireless Local Loop .....	4-18
	4.3.3 Packet Radio.. .....	4-19
	4.3.4 Specialized Mobile Radio.. .....	4-21
	4.3.5 Citizens Band Radio.. .....	4-22
	4.3.6 Land Mobile Radio at 220 MHz.. .....	4-22
	4.3.7 Application of Terrestrial Communication Systems to Automated Crash Notification .....	4-22
4.4	Summary and Conclusions.. .....	4-24
5	NAVIGATION SYSTEM ALTERNATIVES. ....	5-1
	5.1 Satellite-Based Navigation .....	5-1
	5.1.1 Global Positioning System.. .....	5-1
	5.1.2 Mobile Satellite Communication Systems.. .....	5-3
	5.1.3 Satellite Search and Rescue.....	5-3
	5.1.4 Tracking Beacons for Experimental Data Collection .....	5-4
	5.1.5 Application of Satellite-Based Navigation to ACN.. ..	5-4
5.2	Terrestrial-Based Navigation.....	5-5
	5.2.1 Loran-C .....	5-5
	5.2.2 Omega.....	5-5
	5.2.3 Automobile Security System .....	5-6
	5.2.4 Cellular Telephone-Based Systems .....	5-6
	5.2.5 Application of Terrestrial-Based Navigation to ACN .....	5-7
5.3	In-Vehicle Navigation .....	5-7
5.4	Summary and Conclusions .....	5-8

TABLE OF CONTENTS (Continued)

Section		Page
6	SUMMARY AND CONCLUSIONS .....	6-1
	6.1 Sensor Summary .....	6-1
	6.2 Communication System Summary .....	6-2
	6.3 Navigation System Summary .....	6-2
	6.4 Conclusion .....	6-3
<b>Appendix</b>		
A	Bibliography .....	A-1
B	In-Vehicle System Architectures to Minimize False Alarms.. . . . .	B-1
C	Supplemental Crash Data.....	C-1
D	Crash Sensing Using Accelerometers .....	D-1
E	EMS Notification Using Cellular Telephones.....	E-1
F	Navigation Using GPS .....	F-1
G	End-to-End Demonstration .....	G-1
H	List of Acronyms and Abbreviations.....	H-1

## LIST OF ILLUSTRATIONS

Figure		Page
ES-1	Example of Message Clearinghouse Connectivity . . . . .	ES-7
1-1	ACN In-Vehicle Component Functional Block Diagram . . . . .	1-2
2-1	Acceleration Data from Crash Test . . . . .	2-2
2-2	Specific Attenuation of Woodland . . . . .	2-5
3-1	Mechanical Acceleration Switch . . . . .	3-2
3-2	Acceleration Transducer . . . . .	3-2
3-3	Strain Gauge Accelerometer . . . . .	3-4
3-4	Capacitive Accelerometer . . . . .	3-4
3-5	Electrolytic Accelerometer . . . . .	3-5
3-6	Inductive Accelerometer . . . . .	3-6
3-7	Piezoelectric Accelerometer . . . . .	3-6
3-8	Piezoresistive Accelerometer . . . . .	3-7
3-9	Servo/Force Balance Accelerometer . . . . .	3-8
3-10	Potentiometric Accelerometer . . . . .	3-8
4-1	Communication System Overview . . . . .	4-2
4-2	Examples of Current Cellular Telephone Coverage . . . . .	4-17
4-3	Examples of Current Ardis Packet Radio Coverage . . . . .	4-20
4-4	Examples of Wireless Communication Antennas . . . . .	4-26
4-5	EMS Notification Scenario . . . . .	4-28
6-1	Example of Message Clearinghouse Connectivity . . . . .	6-5



## LIST OF TABLES

Table		Page
ES-1	Communications System Summary.....	ES-3
ES-2	Navigation System Summary.....	ES-5
2-1	Possible Crash Notification Message Components.....	2-6
3-1	Comparison of Accelerometers.....	3-3
4-1	GEO Satellite System Summary.....	4-6
4-2	Big LEO Satellite-Based Communication Systems.....	4-12
4-3	Little LEO Satellite System Characteristics.....	4-15
4-4	Terrestrial Communication Options.....	4-23
4-5	Communications System Summary.....	4-25
5-1	Navigation System Summary.....	5-9

## EXECUTIVE SUMMARY

In automobile crashes involving life threatening injuries, time is the most critical factor in saving lives; therefore, rapid response by Emergency Medical Service (EMS) personnel is a necessity. Unfortunately, evidence suggests that many crash victim's medical requirements are not being met due to delays in both crash notification and response. In recognition of this problem, an automated collision notification (ACN) capability has been identified as a critical component of the Emergency Notification and Personal Security user service defined in the National Program Plan for the Intelligent Vehicle Highway System (IVHS). This capability would automatically sense a crash and immediately notify a local EMS dispatcher of its occurrence.

The ACN system can be divided into two segments: the EMS dispatching infrastructure and the in-vehicle equipment. The EMS infrastructure consists of communications and computer processing equipment that is used to receive requests for assistance, deploy units in response to requests, and monitor units' progress. Compatibility of communications equipment between infrastructure and the vehicle is critical issue. The in-vehicle equipment must perform four functions. First, changes in the vehicle's static or dynamic conditions that could have resulted from a crash must be detected. This may require a suite of sensors that is able to measure a variety of parameters including deceleration or damage to the chassis. Second, all the sensor inputs must be constantly monitored to determine whether or not the vehicle has been involved in a crash. Because it is highly undesirable to generate a false alarm, it is necessary to consider as many inputs as possible before issuing a crash notification message. Third, if a serious crash has occurred, vehicle location must be determined. Fourth, crash location data must be transmitted to the local EMS facility.

In support of the National Highway Traffic Safety Administration (NHTSA), The Johns Hopkins University Applied Physics Laboratory (JHU/APL) has examined various crash sensing, communications, and navigation technologies to assess their suitability for use in the in-vehicle component of an ACN system. The results of the assessment are summarized in the following paragraphs.

### ES.1 SENSOR SUMMARY

Devices considered for crash sensing included strain gauges to detect chassis deformation and inertial switches and accelerometers to sense deceleration force. Due to reliability, cost, or inability to measure g forces that could provide supplemental crash data (assists in determining an appropriate EMS response), both strain gauges and inertial switches were not as appropriate for crash sensing as accelerometers. Of the eight accelerometers examined, two types were particularly well suited for ACN, the capacitive

and the piezoresistive micromachined solid state devices. These devices both meet the performance requirements and are expected to be low cost when produced in significant quantities. They are already being used in automobiles to activate air bag systems.

If accelerometers are used to sense crashes, it is possible to determine the change in velocity resulting from the crash, which is the primary indicator of crash severity. In fact, change in velocity can be directly correlated with a specific level of injury. Multiple accelerometers can also be placed in a three-axis array to provide indication of vehicle rollover and direction of impact, which are both considered valuable supplemental crash data. Thus, three accelerometers can provide detection and critical supplemental data in a single low-cost package.

Additional sensors can be added to provide other important supplemental data including number of occupants, use of restraints, and indication of fire. Although many of the sensors themselves are low cost, installation may be expensive. Furthermore, there are still issues concerning data reliability. For example, sensors could be placed in the seats to use body weight as an indicator of occupancy, but this detector could be misled by other objects. To determine if any additional sensors should be added to the vehicle, the value of the supplemental data versus the cost of obtaining that data, both in terms of fiscal impact to the consumer and operational impact on EMS, should be evaluated. Note that incorporating the vehicle identification number into the crash notification' message format would allow an EMS dispatcher to determine the type and weight'of the vehicle, which would help estimate level of injury..

## ES.2                    COMMUNICATION SYSTEM SUMMARY

A number of wireless communication system candidates that could support EMS notification were' considered. These include geosynchronous (GEO) orbit and low earth orbit (LEO) satellites (both voice capable big LEO and data only little LEO satellites), terrestrial (mobile and fixed) voice and data systems in the 220-, 450-, 800-, and 900-MHz band and CB radio. They are summarized in Table ES-1. Taking into account both equipment cost and system coverage, the two leading candidates are data-only little LEO' satellites and the cellular telephone system. Both have reasonably priced mobile communications equipment that provides relatively broad coverage, but there are availability issues. The little LEOs can support crash notification anywhere in the U.S. (also have good foliage penetration capability due to the low operating frequency). However, satellites are not always in view. Several minutes may pass before there is a satellite that can provide a link. Cellular telephone coverage is limited by the number of cell sites constructed. Although cellular telephone service is available to over 95% of the U.S. population, geographic coverage is expected to level off at 65% of the Continental U.S. (CONUS). Other satellite systems can provide continuous coverage but are more expensive.

Table ES-1 Communications System Summary

System	Availability	Cost	Survivability
GEO Satellite	Continuous U.S. Coverage	>\$2500	Multicomponent Systems, Some with Tracking Antennas
Big LEO Satellite	Continuous U.S. Coverage (from more than one satellite)	\$300-\$3500	Single Unit, Quadrafilar Helix, 1/4-Wave Monopole, Dual-mode capable
Little LEO Satellite	U.S. Coverage w/Reduced Availability; Foliage Penetration	<\$200	Single Unit, Whip Antenna
Cellular Telephone	65% of CON-US by 1996	\$50-\$800	Single Unit, 3-dB 'co-linear or 1/4-Wave Monopole Antenna
Land Mobile Radio at 800,900 MHz (Packet Radio and SMR)	Metropolitan, Urban, Suburban (CDPD coverage could be as broad as cellular telephone coverage)	\$300-1500	Single Unit, 1/4-Wave Monopole Antenna
Wireless Local Loop	Rural; Foliage Penetration	\$1506	Single Unit, whip Antenna
Land Mobile Radio at 220 MHz	Metropolitan, Urban, Suburban; Foliage Penetration	\$900-\$1000	Single Unit, Whip Antenna
CB Radio	Fixed and Mobile Monitoring Sites: Foliage Penetration	\$50-\$200	Single Unit, Whip Antenna

CDPD = Cellular Digital Packet Data

SMR = Specialized Mobile Radio

Equally important to the successful operation of an ACN system is the survivability of the in-vehicle communications equipment. It is expected that those systems requiring multiple components dispersed about the vehicle or 'with large or complex (e.g., tracking) antennas will be less survivable than single unit communications terminals with small antennas. Therefore, LEO satellite terminals are not expected to survive crashes as well as a cellular telephone. This is a result of the larger antennas needed to operate at the LEO satellite's low transmission frequencies. Furthermore, there is a variety of low profile antennas available for cellular telephones. Note that big LEO satellites can enhance survivability and availability due to dual-mode capable terminals that permit operation over satellites and cellular telephone.

### ES.3 NAVIGATION SYSTEM SUMMARY

The navigation systems considered fall into three categories: satellite, terrestrial, and dead reckoning. Satellite options included Global Positioning System (GPS), satellite communication systems that provide geolocation services, a satellite search and rescue system called the Global Maritime Distress and Safety System (GMDSS), and the Argos environmental data collection system. Research on terrestrial systems focused on marine navigation (Loran-C. and Omega) and vehicle tracking technology (Lojack, Inc. and cellular telephone based). Dead-reckoning systems considered employed gyros, compasses, and differential odometers. They are summarized in Table ES-2.

High accuracy and update rate distinguish GPS from other options. However, unless the receiver cost is reduced (it is expected to drop significantly in the near future), it is too expensive for an ACN-only application. There are also foliage and terrain blockage issues since GPS must have unobstructed access to multiple satellites. These issues could be addressed by using GPS in combination with dead reckoning. A lower cost but lower accuracy option is either Loran-C or using the geolocation capability of a mobile satellite communication system. These systems provide location accuracy suitable for many crash scenarios. Loran-C also has good foliage penetration due to its low operating frequency, whereas the satellite systems are attractive because of their dual functionality. Due to lower accuracy, problem scenarios include situations where the vehicle -is not visible from the roadway and in areas where ambiguity due to the close proximity of two roads can occur. Note that other IVHS functions will require a navigation capability; therefore, vehicle location will be available in the automobile. However, the data may not be readily accessible if IVHS integration issues are not considered during ACN system development.

### ES.4 CONCLUSION

The results indicate that there exist (or will soon exist) options that can support the crash sensing, EMS notification, and crash location functions. For example, a low-cost system could use a three-axis accelerometer integrated with an 8-bit microcontroller to sense the crash, obtain supplemental crash data (change in velocity, direction of impact, and indication of rollover), and assemble the notification message. A little LEO satellite could be used to transmit the message and determine the crash location. However, delays in EMS response could result from lack of satellite coverage at the crash location and searching by EMS due to inaccuracies in geolocation. Total equipment costs are expected to be under \$500 and perhaps less than \$300.

GPS could be added to the ACN system to improve accuracy and thus decrease search time. In the near future, this would increase system cost by \$200. Cellular telephones could also be used in place of the LEOs. This option offers decreased notification time with no significant change in cost. However, if the crash occurs outside of cellular coverage, no message can be sent.

**Table ES-2 Navigation System Summary**

Option	Coverage	Accuracy	Update Rate	Mobile Equipment Cost
G P S	Mobile Terrain and Foliage Blockage	<100 m	<1 per set	\$400
Mobile Communication Satellites	Same as Communication Coverage	>100 m	Every Transmission	None (Assuming Mobile Terminal is Already in Vehicle)
GMDSS	Global; Foliage Penetration	10 to 20 km 3 to 5 km	Hours	\$200 \$1000
Argos	Global; Foliage Penetration	150 m (Highly Stable Oscillators)	Hours	Specially Built Hardware
Loran-C	CONUS Atlantic and Pacific Oceans; Foliage Penetration	Up to 1 km on Land	>10 sec	\$200400
Omega	Global; Foliage Penetration	>>1 km	> 10 sec	\$30, 000"
Lojack	25-mi <sup>2</sup> Box Centered on 'Police' Cruiser Position; Foliage Penetration	Line of Bearing Available to +/-110	N/A	\$595 (Not Modified for ACN)
Cellular Telephone Based	Same as Cellular	To Within a Cell (Unless Using Specialized Direction Finding Equipment, Then 50 m at 8 km	Every Transmission	None (Assuming Cellular Telephone is Already in Vehicle)
Dead Reckoning	Global; No Blockage Issues	<2% of Distance Traveled	<1 per sec	\$50-5000

\*: Due to the advent of more accurate systems, no pure Omega systems are available. Cost represents Omega hybrids (with GPS).

It is clear that a variety of solutions is possible. What is not clear is which solutions are best. For instance, if a vehicle already has a cellular telephone, is it better to add a sensor/processor unit and a GPS navigation system to the vehicle or should the low-cost LEO satellite based system described above be employed? The answer depends not only on cost but also on the additional utility provided to the individual. If an individual desires to have a highly accurate navigation capability for some, other purpose, the GPS solution would be more attractive. If low-cost messaging were desired, the LEO satellite terminal option could be selected. Because the proper solution depends on the individual, an ACN system design should not be limited, to one technology. Different technologies that can fulfill the functional requirements of crash notification should be available. This will allow the market to make the cost-benefit tradeoff.

To accomplish this, it is desirable for an ACN system to have an open architecture that has standardized component functions and interfaces but does not restrict the specific equipment used to support the function. This implies the following:

- 1.. Standardize interfaces between in-vehicle components.
2. Define a crash notification message format.
3. Modify EMS infrastructure to permit common access.
4. Establish end-to-end technical performance requirements.

Standardization of interfaces between in-vehicle equipment will allow different sensor, navigation, and communication systems to be employed. The key device is the processor that connects to all the component systems. Note that advanced vehicular electronic systems that support engine operation as well as other IVHS functions will drive the need for microprocessors and an electronic bus in automobiles. Therefore, ACN interface standards development may be focused on integration into future automotive electronic systems. The crash notification message format should be defined so that it can convey a variety of data. The content of the message will depend on the sensors available in the vehicle and the method of vehicle crash location. Consideration must also be given to other IVHS functions that have similar data requirements.. The EMS infrastructure must provide a common access point to a wide range of communication systems. To minimize the cost (economically or procedurally) borne by individual counties, message clearinghouses at the state, regional, or national level may have to be established. These clearinghouses could also support other emergency notification and personal security functions as shown in Figure ES-1. Finally, overall system level requirements must be defined so that individual component performance specifications can be determined. For example, upper bounds on overall notification delay will provide a time budget for communication service providers.

By promoting an open architecture, it will be possible to offer private citizens a variety of emergency and security services at low cost that will enhance travel over the nation's roadways.

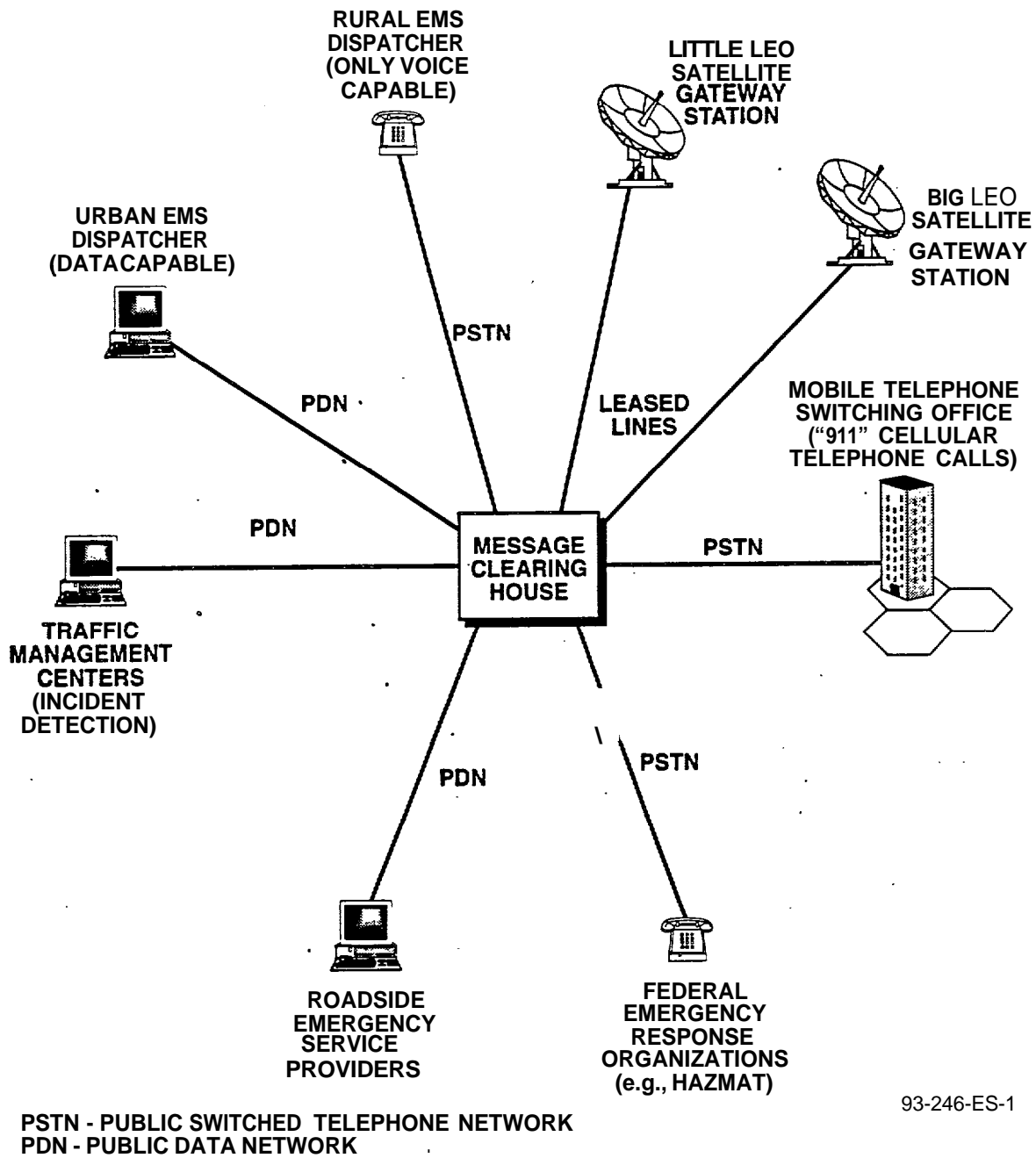

**Figure ES1 Example of Message Clearinghouse Connectivity**



## Section 1

### INTRODUCTION

In automobile crashes involving life threatening injuries, time is the most critical factor in saving lives. Therefore, rapid response by Emergency Medical Service (EMS) personnel is a necessity. Unfortunately, evidence suggests that many crash victim's medical requirements are not being met due to delays in both crash notification and response. This is especially true in rural areas. The Fatal Accident Reporting Service (FARS) data for 1992 indicate that the average time (nationwide) required to notify an EMS dispatcher of an urban crash was 4.85 minutes. In contrast, rural crashes were reported in 8.95 minutes. This large difference in average notification time is a result of low traffic density, which reduces the number of opportunities for assistance by other travelers, and the long distances between telephones from which an emergency call could be made.

The difference in average EMS response times was even greater. Urban response time averaged 6.26 minutes, whereas rural response time averaged 11.47 minutes. Multiple factors contribute to this difference, including longer distances to travel to the scene of a crash and ambiguous crash location information.

In recognition of this problem, an automated collision notification (ACN) capability has been identified as a critical element of the Emergency Notification and Personal Security user service defined in the National Program Plan for the Intelligent Vehicle Highway System (IVHS). This in-vehicle capability would automatically sense a crash and immediately notify a local EMS dispatcher of its occurrence. Not only would crash notification time be minimized, but response times could be reduced since accurate vehicle location would be available.

To implement an ACN system, it is necessary to consider its two components, the EMS dispatching infrastructure and the in-vehicle equipment. The EMS dispatching infrastructure consists of communications and computer processing equipment that is used to receive requests for assistance, deploy units in response to requests, and monitor units' progress. Although the capabilities of this equipment vary from county to county, almost all requests for EMS assistance that are not made by public safety officers are received over the public switched telephone network (PSTN). Therefore, to maintain compatibility, it is desirable that an ACN system use the PSTN when communicating the occurrence and location of a crash. However, this does not imply that the interface between the vehicle and EMS infrastructure must be voice. In fact, given the automated operation of this system, data transmission is a more natural choice.

The in-vehicle equipment must perform the four functions shown in Figure 1-1. First, the equipment must sense changes in the vehicle's static or dynamic conditions

that could have resulted from a crash. The equipment may employ a suite of sensors that is able to measure a variety of parameters, including deceleration or damage to the chassis. The ACN processor constantly monitors all the sensor inputs and decides whether or not the vehicle has been involved in a crash. Since it is highly undesirable to generate a false alarm, it is necessary to consider as many inputs as possible before issuing a crash notification message. If the processor determines that a serious crash has occurred, then it captures the last known location of the vehicle. These data are sent to the communications system for transmission to the local EMS facility. Supplemental crash data that may aid in issuing the appropriate personnel and equipment can also be sent. These data could include an estimate of the magnitude of the crash (and thus provide estimates on occupant injury), the presence of fire, number of occupants in the vehicle, or whether or not the vehicle has rolled. It may be necessary to include sensors specifically designed to measure the data.

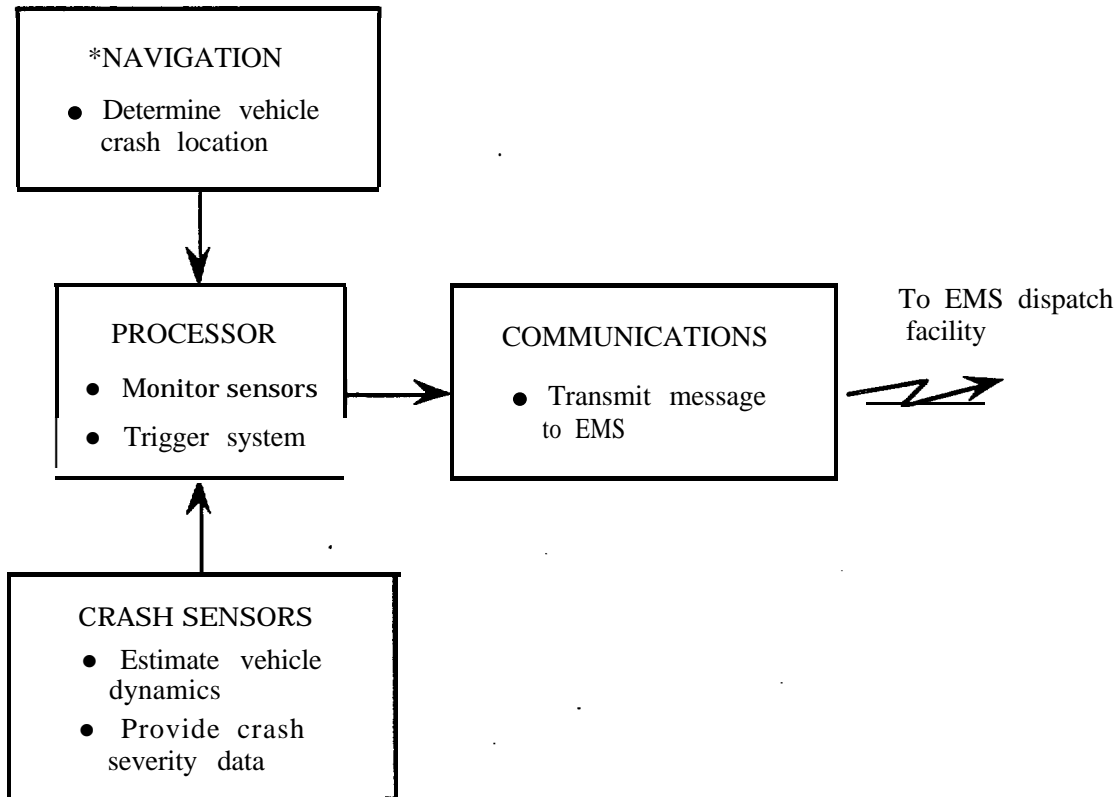

**Figure 1-1 ACN In-Vehicle Component Functional Block Diagram**

Based on the in-vehicle component's functional requirements, it appears that the processor hardware can be developed using readily available microprocessor

technology. Furthermore, there are or will soon be off-the-shelf alternatives that can support crash sensing, communications, and navigation.

In support of the National Highway Traffic Safety Administration (NHTSA), The Johns Hopkins University Applied Physics Laboratory (JHU/APL) is examining various technologies to assess their suitability for use in an ACN system. The purpose of this report is to document the results of this effort. Section 2 discusses high level functional and technical requirements of the ACN in-vehicle component to provide a basis for comparing technology alternatives. Then, specific technologies for crash sensing, communications, and navigation are described, and their relative merits are considered. Section 3 discusses sensor technology that can detect crashes and provide amplifying information. Section 4 describes wireless communication systems that can transfer crash occurrence and location data to the EMS dispatcher. Section 5 summarizes navigation system alternatives that can be used to determine crash location. Also, the appendixes include the results of additional research and testing that further characterizes the performance of several technologies that are readily available today.

## Section 2

### IN-VEHICLE SYSTEM REQUIREMENTS

In this section, requirements for the in-vehicle component of an ACN system are examined, to provide the basis for comparing technology alternatives. The requirements are divided into the following five categories: crash detection, determination of crash location, EMS notification, crash survivability, and commercial -viability. The first three categories correspond to specific in-vehicle functions, whereas the last two categories apply to the complete in-vehicle system. The five requirement categories are discussed below.

#### 2.1 CRASH DETECTION

The first requirement of an ACN system is to reliably detect a vehicle impact that results in serious injury to the occupants. Failure of the ACN system to activate as a result of a collision of this magnitude would severely hinder consumer confidence as well as raise questions of liability. Equally important is the system's false alarm rate. If the system activates under normal driving conditions or in minor collisions, a dispatcher may erroneously commit equipment and manpower, thereby reducing the ability of the EMS to respond to other more serious situations. With a potential for a large number of systems on the road, a seemingly small false alarm rate could have significant implications on the ability to provide emergency medical care. Furthermore, it could result in a loss of confidence in the ACN system by the EMS community. Specifically, due to their experience with false alarm problems in the 911 and automatic medic alert systems (used by people with chronic health problems), the EMS community is hesitant to accept any automatic reporting system unless it demonstrates a low false alarm rate and provides accompanying data to verify the need for EMS.

To design a crash detection system that has an acceptable probability of detection while maintaining a low false alarm rate, it is first necessary to identify a characteristic of a crash that can be used to distinguish an injury-inducing crash occurrence from normal vehicle operations. Then, sensors designed to measure that characteristic can be integrated into a system architecture that provides fail-safe operation. This architecture will also allow the addition of other sensors that provide supplementary information about the crash. The supplementary information can be used to reject false alarms as well as to assist in dispatching EMS personnel and equipment. The following two sections examine crash characteristics and supplementary data, respectively. Appendix B discusses in-vehicle system architectures that can mitigate false alarms.

### 2.1.1 CRASH CHARACTERISTICS .

There are several characteristics of a collision that can be used to detect its occurrence. These include deceleration, of the vehicle and chassis deformation.

Figure 2-1 illustrates the, deceleration forces experienced by a Hyundai Excel during a crash test in which the vehicle struck a solid barrier at a speed. of 30 miles per hour. The deceleration peaks at 40 g and has a magnitude greater than 20 g for more than 50 milliseconds. Since normal accelerations and decelerations of an automobile due to braking and poor road conditions rarely exceed  $\pm 1$  g for more than a few' milliseconds, it is expected that vehicle deceleration can be used to distinguish between a serious collision and normal driving. Furthermore, the magnitude of the crash test data implies that deceleration measurements do not have to be highly accurate. An accuracy of 5 to 10% would suffice. Other constraints associated with a deceleration measuring device include -a 150 g operating range and an oyer-range protection ceiling that exceeds 100 g. Frequency response should be adequate to completely characterize the deceleration over. the entire collision, typically 100 to 200 milliseconds in duration. This calls for a frequency response of 200 Hz or greater. An important advantage of measuring deceleration is that it can be directly linked to a standard measure of crash severity called equivaleni barrier velocity (EBV). EBV is estimated by integrating the deceleration profile over a time period corresponding to the duration of a crash (e.g., 100 to 200 milliseconds). It is possible to relate EBV to expected occupantinjuries. Therefore, EBV can be used to determine when to request EMS assistance. Appendix C discusses efforts to relate EBV and occupant injury.

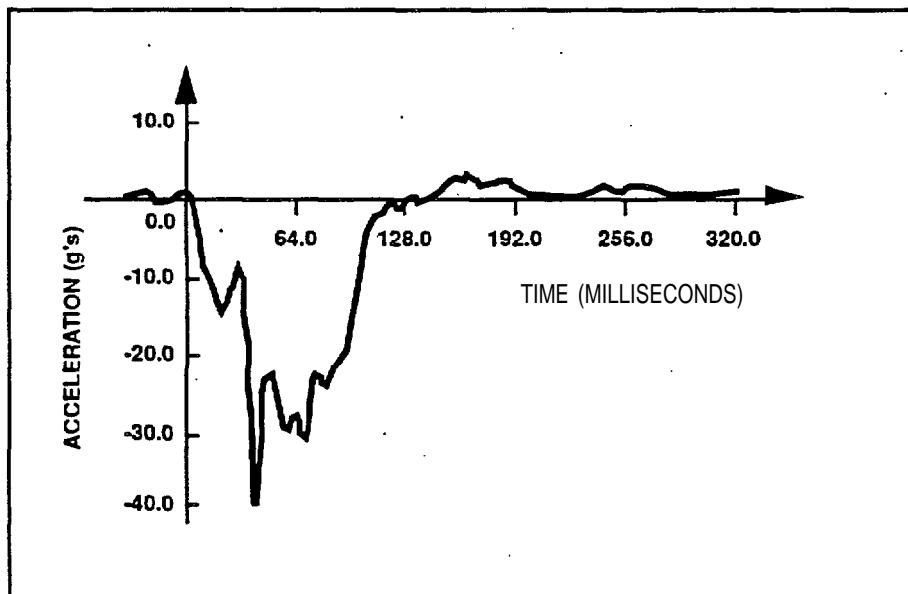

Figure 2-1 Acceleration Data from Crash Test

Chassis deformation occurs in almost every vehicle collision and therefore could be used to detect the occurrence of a crash. However, it is also necessary to estimate the severity of the crash so that the processor can distinguish between a “fender bender” and a serious collision. This could be accomplished by measuring the amount of chassis deformation and correlating the deformation with expected occupant injury. It is not clear if this relationship has been developed well enough to use as a criterion to request EMS assistance.

It may also be technically feasible to detect a crash by listening for a characteristic audible signature generated by chassis deformation, but the processing required for audio signal recognition is computationally intensive. It is not expected to lead to any viable solutions.

### 2.1.2 SUPPLEMENTAL CRASH DATA REQUIREMENTS

Although not required for successful operation of an ACN system, supplemental crash data can enhance system performance by providing additional information about a crash to assist in dispatching EMS resources. Appendix C highlights efforts to determine what data are useful to EMS personnel. The efforts resulted in a set of measurable crash parameters that are listed below in order of priority.

- Crash Severity
- Number of Occupants
- Indication of Rollover
- Use of Restraints (seatbelts and airbags)
- Direction of Impact
- Indication of Fire
- Vehicle Type and Weight
- Occupant's Age

Some of these crash parameters are readily available in automobiles today. For example, transmission of the vehicle identification number (VIN) gives the EMS dispatcher access to vehicle type and weight through the state Department of Motor Vehicles registration. Other parameters require additional sensors to make specific measurements such as fire indication. Interestingly, crash severity data could be obtained from crash detection sensors if these sensors were able to provide an estimate of EBV. Therefore, not only would the crash sensors be used to assist the processor in classifying vehicle dynamics, but the EBV estimate would be passed to the EMS dispatcher.

### 2.2 DETERMINATION OF VEHICLE CRASH LOCATION

Once the in-vehicle processor determines that a crash has occurred, it must obtain vehicle location. The accuracy of the location estimate directly impacts the EMS response time and thus victim survivability.

Successful determination of crash location depends not only upon the accuracy of the location estimating technique but also the availability of the system to

make location estimates. For example, a location technique that is very precise but can only be updated once an hour would not be useful to an ACN system. Issues that influence accuracy of technique include equipment limitations and propagation anomalies (for radio navigation). Issues that influence the availability of estimates include calculation time and operating limitations (asset availability and shadowing in radio navigation systems).

Assuming the crash occurs on or near the roadway (General Estimates System data for 1992 indicate that less than 20% of all crashes resulting in injuries occur off the roadway) and roads are separated by substantial distances (such as in rural areas), the navigation system does not have to be highly accurate. It is possible that errors over 1 km could be tolerated. However, to minimize EMS response time in all scenarios, crash location accuracy should be on the order of 100 meters. In particular, a combination of darkness, inclement weather, terrain, or heavy foliage may make it difficult to determine the vehicle location from the roadway, including hiding visual cues such as marks made by the tires. Also, there may be ambiguities as to which road the crash is located on if roads are close together. (Even 100-meter accuracy may not be enough to determine the side of a highway on which a vehicle is located. This could delay response if EMS units had to travel great distances before they were able to make a U-turn.)

System availability has two primary components: geographic coverage and update rate. For ACN, a geolocation system should be able to operate anywhere in the U.S. Update rate requirements depend upon the time when the crash location is determined. The location estimate should be made as close as possible to the point where the vehicle comes to rest. If the estimate is made before the crash, a high position update rate is necessary. For example, an automobile traveling at 55 miles per hour moves approximately 25 meters in 1 second. Even if vehicle location can be determined precisely, it will be necessary to obtain a location estimate every 4 seconds to meet the 100-meter accuracy requirement. If the position estimate is made after the crash, the frequency of estimate does not have to be as often. Several tens of seconds may elapse before an estimate has to be made. However, since the vehicle is not moving, the effects of terrain and foliage become more significant to radio navigation techniques because shadowing and blockage effects may not change significantly over time.

### 2.3 EMS NOTIFICATION

The communication requirements can be divided into three areas: link availability, link capacity, and signal fidelity. Link availability depends upon the accessibility of the communication system and its geographic coverage. Ideally, a communication system used\* for ACN has enough resources (e.g., channels) to permit immediate dispatcher notification. There should be no significant delays resulting from waiting to access a channel. The system should also be designed to operate anywhere in the U.S., and the impact of propagation effects such as terrain shadowing and foliage blockage should be minimized. For example, Figure 2-2 shows that woodlands tend to attenuate higher frequency transmissions more than low frequency transmissions. Therefore, systems operating on lower frequencies would be expected to provide better geographic coverage in forest covered areas. This is especially important if the vehicle has driven off the roadway. Note that a return link from the EMS dispatcher to the vehicle

should not be required because it does not provide any service to incapacitated occupants of the vehicle. However, if there are any conscious occupants, a dialog could be established that could provide valuable supplemental data to the dispatcher.

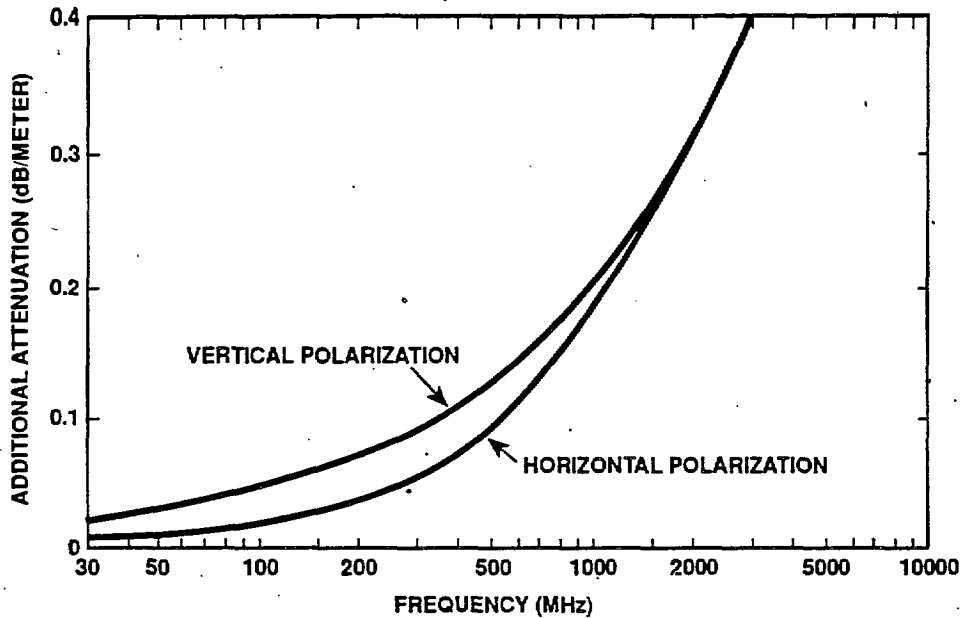

93.246 - 2.2

Figure 2-2 Specific Attenuation of Woodland\*

\*Both transmitter and receiver are below tree tops.

Link capacity requirements are a function of acceptable message delivery time and the size of the message. Although it is desirable to have message delivery times as short as possible, even times as great as a few tens of seconds are satisfactory. The message size depends on the type of information sent by the vehicle. As indicated in Table 2-1, a message containing an identifying header and vehicle location could be as short as 72 bits. Therefore, bit rates can be below 10 bits per second. A message containing a header, 17-digit VIN, several supplemental crash parameters, and vehicle location could be less than 250 bits long. This would require the data link to operate at a few tens of bits per second. Note that no fixed message format has been defined because the type of supplemental crash and vehicle position data has not been established. This suggests that it may be appropriate for ACN systems to use a variable message format that adjusts to the information available in the vehicle. The header identifies the message as a crash notification and indicates what type of data is to follow. For example, the message may contain only position or it may contain position, crash severity, and VIN.



Table 2-1 Possible Crash Notification Message Components (Bits)

Header	8
Location (latitude and longitude in binary format)	64
VIN (ASCII format)	136
Crash Severity	8
Direction of Impact	4
Indication of Rollover (Final Vehicle Orientation)	4
Number of Occupants and Use of Restraints	8
Indication of Fire	1
<hr/>	
Total Number of Bits	233

Signal fidelity or bit error rate (BER) is directly related to message error rate (MER). Suppose 2000 messages are transmitted daily, and one message error per day is acceptable. If a message contains 500 bits, the communication link must provide an average BER no worse than  $10^{-6}$ . Since it is not clear what is an acceptable MER, it is difficult to determine a BER requirement. However, it is possible to make BER arbitrarily low using error detection and correction coding techniques. These techniques sacrifice capacity (assuming a fixed bandwidth constraint) for robustness. Since link capacity demands for an ACN system are expected to be low, it is possible to enhance link performance through coding.

#### 2.4 SURVIVABILITY

Even if all the ACN equipment is functioning properly before a crash, it is operation during and after a crash that is critical. Certain elements of the in-vehicle system must survive. These elements include the processor and communications hardware (including antenna). Furthermore, power must be available long enough to enable message transmission.

Other than a ruggedized equipment chassis design, it is placement of these components in the vehicle that will provide the greatest chance of crash survival. Based on anecdotal evidence, one location that could potentially provide crash protection is directly behind the passenger compartment. The processor, communications modem and power amplifier, and emergency power source could be placed in that location. However, mobile communication systems are not usually located in protected areas; they are positioned for ease of access. Also, it is difficult to protect antennas and cabling. Therefore, systems that have complex antenna systems and multiple components that must be dispersed about the vehicle will have less chance of surviving a crash. Interestingly, the crash detection sensor and navigation hardware does not have to survive a crash as long as the data can be captured by the processor. This places constraints on the navigation system as described in Section 2.2. Also, sensors to detect fire must survive a crash.

COMMERCIAL VIABILITY

An ACN system cannot save any lives if it is not in a vehicle. Assuming there is no Federal mandate requiring automobiles to have an ACN system, this capability will only be available if private citizens decide to purchase the in-vehicle ACN component. They will only purchase the component if it is perceived to provide a benefit at a reasonable cost. Therefore, desirability of the system can be enhanced by either reducing cost or increasing utility. Cost reduction can be addressed through competition in the market place and mass production. To promote competition, the system should be designed with an open architecture; that is, with functions and interfaces defined but no constraints on the design of sensor, navigation, processing, or communications hardware. Use of components that can be readily mass produced will allow component builders to decrease unit costs. Mass production has reduced costs on many of the technology alternatives that are considered in this report. Low equipment cost is critical to market penetration.

Increased utility can be obtained by providing other desirable capabilities using the same equipment. For example, if the navigation and communications components of the ACN system could be used to manually initiate a call for police assistance or for a non-crash related medical emergency or to receive roadside assistance for a mechanical problem such as a flat tire, the benefits of owning an ACN system could outweigh its cost. Low service costs (e.g., cost per minute) help increase the system's utility, but do not impact component costs as discussed in the previous paragraph.

Under the aegis of IVHS many of the components necessary for an ACN system may be offered as part of a standard option package in future automobiles. These components include navigation devices to aid travelers in selecting the most efficient path to their destination or wireless communication Systems that support vehicle-to-traffic management center communications. At that time, there may be little or no additional costs to obtain an ACN capability. However, to maximize the benefits of sharing ACN components with a multitude of other IVHS functions, it is necessary to ensure that the ACN function has been considered during the design of the overall IVHS architecture;

## Section 3

### SENSOR TECHNOLOGY ALTERNATIVES

The primary function of the sensor system is to characterize the vehicle's static or dynamic conditions so that the processor can detect the occurrence of a crash and activate the ACN system. The secondary function of the sensor system is to collect supplemental crash information indicating the severity of the crash so that an appropriate emergency medical response can be dispatched. Critical issues and key technologies that can impact the design of the sensor system are described in this section.

#### 3.1 METHODS OF CRASH DETECTION

Methods of sensing a vehicle crash include measuring the deceleration of the vehicle and detecting the accompanying body deformation. Devices that can support these crash sensing methods are described below.

##### 3.1.1 DECELERATION

Detection of large changes in vehicle velocity in a relatively short time, less than 200 milliseconds, is the method used by Supplemental Restraint System (SRS) manufacturers to deploy airbags. Although the task of airbag deployment is significantly more difficult than that of crash detection (due to time constraints), the instrumentation is similar. The two types of instruments used to detect crashes are electromechanical switches and accelerometers. The distinguishing difference between the two instrument types is that electromechanical switches, or simply inertial switches, provide only a binary indication of acceleration level based on their calibration, whereas accelerometers provide a complete time history of deceleration within the automobile. Inertial switches are the primary instruments employed in SRSs today. Recent advances in micromachining technology are making solid state accelerometers, once too costly for automotive applications, available for mass production. It is predicted that the majority of the airbag manufacturers will convert to these devices within the next few years due to decreased cost as well as increased reliability.

##### 3.1.1.1 Inertial Switches

Inertial switches consist of an inertial mass that must overcome a force to physically activate a switch. The force that must be overcome may be generated by a magnet, spring, chemical bond, etc. An example of such a device is shown in Figure. 3-1. A stainless steel ball is held at one end of a tube by a magnet. On the other end of the tube, there is a mechanical switch. When the vehicle decelerates quickly enough to overcome the

magnetic force, the ball leaves the magnet, rolls down the tube, and impacts the switch to activate the SRS. A variation of this technique uses a spring instead of the magnet. The approximate price range for this unit is \$10 to \$30. The majority of car manufacturers utilize this type of switch to activate air bags. Reliability is achieved by using redundant sensors. Two or three of these sensors are used in a system with some type of voting logic in which a majority of the switches must trigger before the system will activate. Since SRS systems are designed to detect only head-on collisions, additional sensors must be added to the vehicle to detect collisions from different directions.

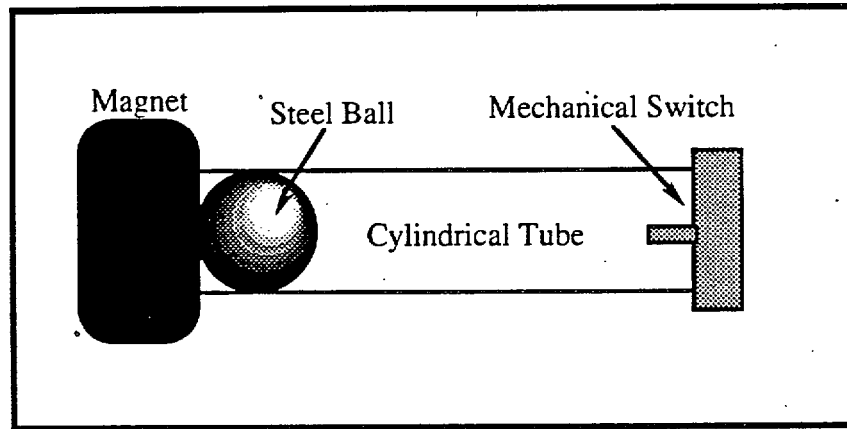

Figure 3-1 Mechanical Acceleration Switch

### 3.1.1.2 Accelerometers

Accelerometers differ from inertial switches in that they provide a continuous reading of acceleration forces rather than a binary decision based on a calibrated threshold. The basic principle common to all acceleration transducers is the use of a seismic mass restrained by a spring, whose motion is damped in a spring-mass system such as shown in Figure 3-2. When the system is accelerated, the mass moves relative to the case of the transducer. When the acceleration is removed, the mass returns to its original position. The spring and damper functions, although represented by a classical spring and dash pot, are typically provided by the structural members of the transducer.

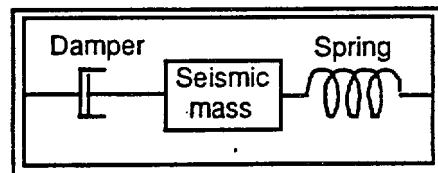

Figure 3-2 Acceleration Transducer

The differences among transducers are the methods of detecting the movement of the mass and the methods of providing spring and damper functions. Common types of accelerometers in use today are as follows:

- Strain-Gauge or Bonded Resistance
- Capacitive
- Electrolytic
- Inductive
- Piezoelectric
- Piezoresistive
- Servo or Force Balance Type
- Potentiometric

Table 3-1 summarizes the relative characteristics of each type of technology. Cross sensitivity is a measure of how well the device can isolate the direction of the acceleration. It is not critical for crash detection, but it's necessary to resolve the direction of impact if used for supplemental crash data.

Table 3-1 Comparison of Accelerometers

Accelerometer Type	Range Limits (g)	Frequency Limits (Hz)	Error Limits (%FS*)	Over-range Protection (g)	Cross Sensitivity (%FS)	cost
Strain Gauge	+/-1 to +/- 500	0 to 2000	1.0	>5 x FS	+/-5.0	Medium
Capacitive	+/-2 to +/-50	0 to 1000	0.2 to 1.0	10,000	+/-1.0	Low
Electrolytic	+/-0.1 to +/-1.0	<1	1.0 to 5.0	300	+/-2.0	Low
Inductive	1 to 120	0 to 325	0.25 to 0.5	1.2 to 5 x FS	0.34	High
Piezoelectric	5 to 100,000	1 to 30,000	0.5	2 to 10 x FS	5.0	Medium
Piezoresistive	2 to 2000	0 to 4000	1.0	2 to 5 x FS	3.0 to 5.0	Low
Servo/Force Balance	0.25 to 0.50	0 to 200	0.02	100	0.2	High
Potentiometric	0 to 50	0 to 500	3 to 5	200	1 to 2	Low

\*FS -Full Scale

The performance requirements for the ACN system stress the reliability and range of the accelerometer over the accuracy due to the magnitude of acceleration forces in an automotive collision.

The following paragraphs provide short explanations of the different technologies employed to produce accelerometers.

a. Strain-Gauge Accelerometer (Figure 3-3)

These devices are composed of a mass and metallic spring element. The spring element utilizes conventional strain gauges, usually in a Wheatstone bridge configuration. When acceleration acts on the mass and deforms the spring, the resulting strain gauge output is proportional to the applied acceleration. Although common and relatively inexpensive, this type of sensor cannot be easily produced in large quantities.

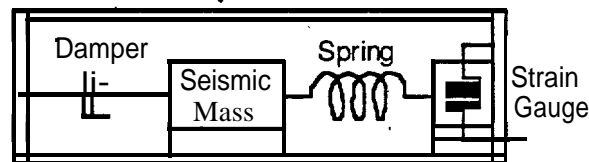

Figure 3-3 Strain Gauge Accelerometer

b. Capacitive Accelerometer (Figure 3-4)

This device has a parallel plate capacitor arrangement in which one plate of the capacitor is free to move with applied stress. During an acceleration, the distance between the movable plate and the fixed plates changes, thus changing the capacitance between the movable and fixed plates. The change in capacitance is directly related to the acceleration. Capacitive accelerometers can be produced using surface micromachining techniques that allow the capacitor and all signal conditioning electronics to be fabricated on a single silicon chip using standard integrated circuit manufacturing techniques.

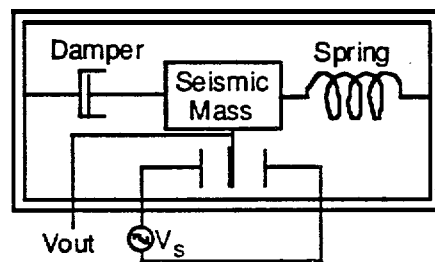

Figure 3-4 Capacitive Accelerometer

c . Electrolytic Accelerometer (Figure 3-5)

An electrolytic liquid is restrained in a curved tube much like that of a common level. Two metal probes, inserted from each end, pass through the liquid and into the bubble. A third probe is fully submerged in the liquid. Changes in acceleration are measured by the movement of the bubble. As long as no net acceleration is acting on the bubble, it remains stationary. If the bubble shifts in one direction or the other due to acceleration, a corresponding difference in resistance is measured. In comparison to the classical accelerometer, the damping function is provided by the viscous liquid, the spring function by a combination of gravity and buoyancy, and the seismic mass by the liquid (not the air bubble). These are simple devices used to measure small slowly varying horizontal accelerations and do not lend themselves to an ACN system.

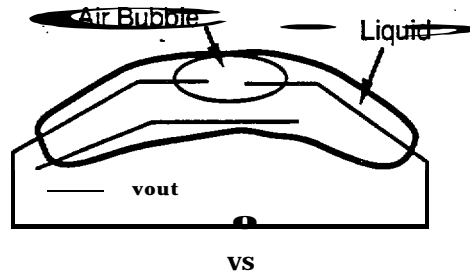

Figure 3-5 Electrolytic Accelerometer .

d. Inductive Accelerometer (Figure 3-6)

A mass is suspended between two iron core inductance coils. The induction coils are part of an alternating current Wheatstone bridge so that, as the mass is displaced due to acceleration, a voltage change proportional to the magnitude of the acceleration is produced. These devices are characterized by good long-term stability, but they cannot be easily produced in large quantities.

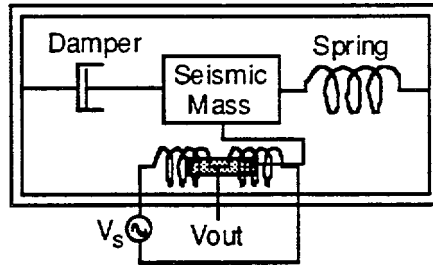

Figure 3-6 Inductive Accelerometer

e. Piezoelectric Accelerometer (Figure 3-7)

These types of accelerometers are used in a wide range of dynamic applications, particularly at high frequencies and where over-ranging is likely. Applications include machinery vibration and shock studies. The properties of a piezo crystal are exploited to produce an accelerometer. When the crystal is deformed by stress due to acceleration, an electrical charge that is proportional to the acceleration appears on the face of the crystal. The main limitation of this technology is the required support circuitry. It does not lend itself easily to mass production, mainly because of difficulties working with piezoelectric material, but also because of the charge amplification device necessary for operation. DC performance with piezoelectric is not applicable since the charge amplifier eventually drains the charge off the crystal. DC performance is not necessary for crash detection but may prove useful for measuring other severity parameters such as vehicle orientation after the crash.

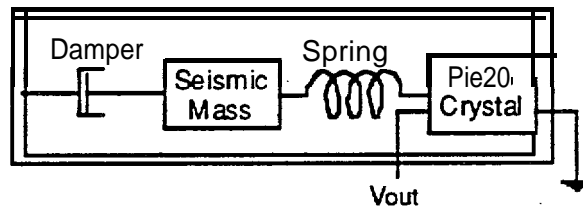

Figure 3-7 Piezoelectric Accelerometer

f. Piezoresistive Accelerometer (Figure 3-8)

These devices, characterized by the ability to operate from DC into the kilohertz region, are similar to piezoelectric, but instead of emitting



charge in response to stress; their resistance changes in proportion to applied stress. They are typically arranged in a Wheatstone bridge configuration. They differ from strain gauge accelerometers in that the material intrinsically changes resistivity with applied stress rather than due to the geometry of the layout of metal traces. These piezoresistive films are typically semiconductor materials that can easily be produced using micromachining technology. There are two primary disadvantages with these devices. First, they must be bulk micromachined, which does not allow the supporting electronics to be placed on the same chip. Second, they are sensitive to temperature.

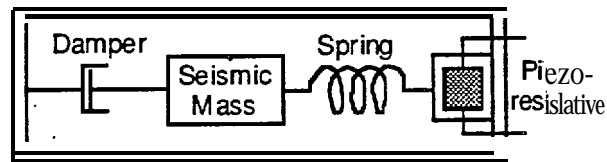

Figure 3-8 Piezoresistive Accelerometer

g. Servo or Force Balance Accelerometer (Figure 3-9)

These types of accelerometers are typically used where accuracy is essential in the low g ranges such as in dead-reckoning navigation systems. "Servo" or "force balance" indicates the design philosophy used to create the accelerometer rather than any particular technology or fabrication method: In such a device, the displacement of the seismic mass is detected by a displacement sensor. The signal from the displacement sensor is used to restore the mass to its original position as well as to obtain a direct measure of the applied acceleration. (In Figure 3-9, a capacitive sensor is used to detect the displacement, and an inductive coil is used to restore the mass to its original position. These are common technologies used in servo designs, but others are possible.) Servo designs are typically found in instrument grade accelerometers.

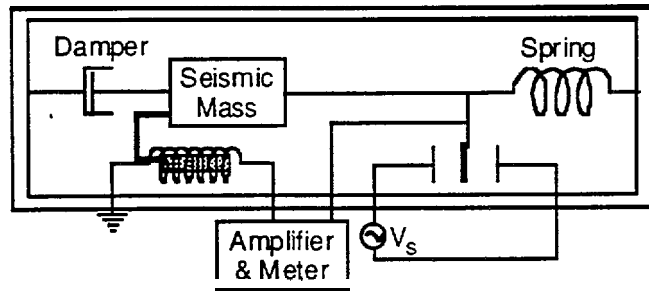

Figure 3-9 Servo/Force Balance Accelerometer

h. Potentiometric Accelerometer (Figure 3-10)

An inertial mass is attached to the wiper arm of a potentiometer. As the mass moves, a voltage divider measures the applied acceleration. Contact resistance and reliability are problems. This type is restricted to low frequency use.

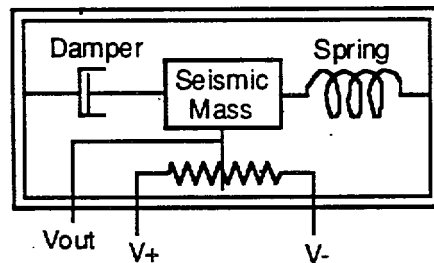

Figure 3-10 Potentiometric Accelerometer

3.1.1.3 Applicability of Deceleration Sensors

Accelerometers are recommended for an ACN system over inertial switches. This is not only due to their ability to completely characterize the forces in a crash but also their increased reliability, testability, reduced size, and reduced cost. Of the eight accelerometer types, the micromachined solid state devices such as the capacitive and piezoresistive accelerometers are the most acceptable candidates from both cost and performance perspectives. Examples of devices that have been introduced into the market include the Analog Devices ADXL50 and the IC Sensors 3145.

### 3.1.2 CHASSIS DEFORMATION

Another method of sensing a crash is to detect deformation of the vehicle's chassis. This is a relatively straightforward method where strain gauges are placed on structural body components such as the frame and bumpers. The gauges are relatively inexpensive, costing less than a dollar when purchased in large quantities. However, strain gauges have many disadvantages, and they are not recommended as a primary sensor to detect impact.

One disadvantage of strain gauges is that multiple sensors would be required. The vehicle could be impacted at one of many locations, and a strain gauge would have to be mounted in the vicinity of the impact to ensure response. Another disadvantage is that strain gauges give only local crash severity information and cannot be readily related to the overall severity of the crash. Strain gauges are also not very durable. They are mounted to the body with adhesives that lose their integrity over time. They also have very thin wires that can be easily broken over the lifetime of operation prior to a crash. These wires also could be broken during a crash, requiring that the gauges be replaced after a crash and increasing the likelihood that data will not be collected throughout the duration of the crash.

Although strain gauges are not suited as primary sensors for collision detection, they may be useful as an arming device for other crash sensors such as accelerometers.

## 3.2 SUPPLEMENTAL CRASH DATA

Listed below are the supplemental crash parameters introduced in Subsection 2.1.2. The following sections investigate available sensor technology to provide the information at a reasonable cost.

- Crash Severity (change in velocity)
- Number of Occupants
- Indication of Rollover
- Use of restraints (seatbelts and airbags)
- Direction of Impact
- Indication of Fire
- Vehicle Type and Weight
- Occupant Age

### 3.2.1 CRASH DYNAMICS

Change in velocity, indication of rollover, and direction of impact are all measures of crash dynamics that can be obtained by an accelerometer. If time series deceleration data are available, it is possible to develop even better estimates of occupant injury by observing the deceleration profile. In the absence of research to determine valid measures based on deceleration profile, velocity change is taken as the measure of crash severity.

### 3.2.1.1 Change in Velocity

The best method of measuring change in velocity- (or EBV), the primary indicator of occupant injury, is integration of an accelerometer output. Other methods, such as monitoring the vehicle speed prior to impact, provide an estimate of change in velocity but are frequently in error because not all of a vehicle's velocity may be dissipated in the collision. Micromachined capacitive and piezoresistive accelerometers, as recommended for crash detection, are sufficient to provide a good indication of velocity change.

### 3.2.1.2 Indication of Rollover

In the event of rollover, specialized rescue equipment could be required. Therefore, an indication of rollover can reduce response times for the special equipment. Rollover can be detected in a number of ways depending on the fidelity of the information desired. For higher precision, the use of a gyroscope to track the orientation of the vehicle with respect to ground for the duration of the crash is necessary. However, gyroscopes are prohibitively expensive.. On the low precision end are simple inexpensive devices such as a mercury switch or a strain gauge attached to the roof of the vehicle that can detect the rollover event or the orientation of the vehicle after the crash but cannot give details on how it transpired. Another method involves the use of an accelerometer oriented in the vertical direction to provide an additional axis of information. This should provide enough information to indicate rollover and final vehicle orientation.

### 3.2.1.3 Direction of Impact

The best method of determining the direction of impact is using a two-dimensional array of accelerometers to determine the \*acceleration vector. The only other viable method of determining direction of impact is the use of strain gauges strategically placed throughout the vehicle to detect chassis deformation. However, this method suffers from high installation costs and poor reliability.

## 3.2.2 NUMBER OF OCCUPANTS

One of the primary factors in determining the appropriate emergency equipment to send to the scene of a crash is the number of people in the vehicle. For example, the number of occupants in a car affects the number of ambulances that should be dispatched. Only the passengers need to be counted since a driver is assumed.. To eliminate the requirement of manually entering passenger count, several sensors can be used to detect passengers, including seat belt monitors, infrared (IR) sensors, and proximity sensors. The costs for these sensors typically are small, but the installation costs must be considered. In addition, some of these sensors are prone to give a false indication of a passenger.

### a. Seat Belt Monitors

Currently, seat belt monitors determine if a clasp is closed. The problem is that although the clasp is closed, it does not necessarily

indicate that someone is occupying the seat. The clasp could be permanently latched close. However, by continuously monitoring each seat belt, the system will be able to determine if a seat belt goes from unclasped to clasped within a predetermined time before the vehicle is started or any time after the vehicle is started. If either of these events occurs, it is very likely the seat is occupied. Unfortunately, the converse 'situation is also a problem; that is, not all occupants fasten their belts. There is no clear solution to this problem.

#### b. Infrared Detectors

IR sensors, without accompanying electronics, cost \$1.00 to \$2.00. One small fixture, mounted near the dome light, can house four IR sensors. Each sensor will monitor one of the four passenger positions in a typical sedan. The driver position will not be monitored. The fixture can include a lens to restrict the field of view for each sensor.

#### c. Proximity Sensors

The simplest form of occupant sensors is either pressure transducers or microswitches embedded in the seats. Although these are inexpensive mechanical devices, they would require the redesign of most car seats and would therefore need to be introduced into new cars rather than backfitted into existing automobiles. They also may interpret objects placed in seats as persons. Capacitive transducers are another alternative, but they are easily fooled by moisture, which can be caused by rain, dew, or a spill. Inductive or magnetic proximity switches are good alternatives. Being solid state devices, they are immune to fatigue failures and contact resistance. One disadvantage of all proximity sensors is that one sensor will be required for each seat, and this will necessitate the additional expense of wiring and insulation.

### 3.2.3 USE OF RESTRAINTS

#### a. Seat Belt Use

Crash statistics clearly indicate that the use of seat belts significantly increases a person's chances of surviving crashes. Therefore, knowledge of occupant seat belt use provides an indication of injury severity. Assuming that a closed seat belt clasp corresponds to a properly restrained passenger, existing seat belt monitors can be used. This information is available at very little additional cost and could be readily implemented in the design of a new vehicle. For vehicles that have only seat belt sensing of the driver's seat, additional sensors will be needed in the passenger seat belt clasps. The expense is small, and the technology is available. Retrofitting a seat belt monitoring system to an existing vehicle would be more difficult, since there is no standard detection system between automobile companies or even from one model

to another. This parameter is meaningful only when used in combination with the number of occupants parameter.

#### b. Air Bag Deployment

Deployment of an air bag indicates that the severity of injury should be less than that normally expected for a given change in velocity. Data indicating the deployment of such devices are easily gained by interfacing with the SRS installed in the vehicle. If the triggering device for an ACN system is integrated into the existing SRS, the data would be immediately available.

### 3.2.4 INDICATION OF FIRE

The detection of a post-crash fire would appear to be critical supplemental data. However, discussions with local fire fighting companies indicated that, in most instances, they arrive on the scene too late to be of any value in fighting the fire. Therefore, detection of a fire is not necessary for deploying fire fighting equipment, but it could be useful in determining whether or not to prepare for burn victims. Note that the FARS and General Estimates System data for 1992 indicate that less than 3% of fatal crashes and 0.2% of non-fatal injury crashes involve fire.

There are several technologies available for detecting fires. They include ionization sensors, visible smoke detection, IR heat sensors, mechanical sensors, and fiber-optic gas sensors.

#### a. Ionization Sensors

These sensors are most often used in industrial environments since they detect the ionization resulting from extreme heat. The lack of smoke or actual flames in industrial accidents is common; therefore, this type of sensor depends only on the heat level. Such sensors are dependable but expensive. The other deficiency of such detectors in an automobile environment is that they can be activated by exhaust fumes.

#### b. Smoke Detectors

Most households have smoke detectors, not fire detectors. The basic principle is that light reflects in smoke. The detector consists of a black chamber with a small opening for smoke to enter. In the chamber, there is a light emitting diode (LED) and a light detector placed so the light detector cannot see the LED. When smoke enters the chamber, light is reflected by the smoke and hence makes the LED visible to the light detector. At this point the smoke detector activates. Although these devices are effective, one problem is their sensitivity to dense fog, particles in the air (such as dust), cigarette smoke, and exhaust fumes.

### c. IR Sensors

IR sensors can be used to detect IR radiation emissions from the surroundings. Such sensors are semiconductor based and therefore are low cost. However, problems exist in discerning engine heat from a fire. If this can be solved, IR sensors may offer a viable means of detecting a fire in an automobile. An additional advantage of an IR sensor is that, if they are used to detect the number of passengers in the vehicle, it may also be possible to employ them as post-crash fire detectors.

### d. Mechanical Switches

The principle of fire detection using a-mechanical switch is based on a depressed spring embedded in wax. When the wax melts, the spring is allowed to relax and create an electrical connection. These sensors offer a relatively simple and reliable method of detecting excessive heat with moderate cost.

### e. Fiber-Optic Sensors

Fiber-optic sensors are now available that can detect many chemicals. Important chemicals to detect include hydrocarbons and carbon monoxide. The former indicates a fuel leak, and the latter suggests a fire. Fiberchem, Inc., Las Vegas, Nevada, is marketing a Digital Hydrocarbon Probe. The sensor operates by detecting changes in the refractive index of a special polymer coating on an optical fiber. The coating is specifically designed to bond with hydrocarbons. The bonding is reversible, so the sensor will correctly read decreasing hydrocarbon concentrations. The cost for these sensors is prohibitively high, over \$1000, but this price includes a large development cost. In large volumes, the cost to manufacture the sensors will decrease drastically, and this option may become feasible.

Based on the discussion of fire sensing technologies: it is clear that there are a number of issues that must be resolved before this capability can be integrated into an ACN system. For example, ionization, smoke, IR, and gas sensors could have a potentially high false alarm rate. Also, any fire sensor would be required to be able to survive a crash because there is usually a time delay between the crash occurrence and the time when a fire becomes detectable. Because there are also questions regarding the utility of a fire indication message, a fire detection system may not be warranted.

## 3.2.5 VEHICLE WEIGHT AND VEHICLE TYPE

Since expected injury severity is a function of vehicle size, make, and model, it would be useful to transmit this information to the EMS dispatcher. Also, estimates of number of occupants could be obtained from vehicle type (e.g.; bus). This data could be input manually by coding the VIN into the in-vehicle processor. If the ACN

-system is installed in a new vehicle, the manufacturer could input this information at the factory. If the ACN system is retrofitted into the vehicle, the VIN could be input at the time of installation. This information would remain resident in the system on an erasable programmable read only memory (EPROM).

### 3.2.6 AGE OF OCCUPANTS

Another parameter that can help estimate injury severity is the age of the occupants. Since this information cannot be measured, the only way it could be incorporated is by manual input to the system. It is not practical for each person to enter this information each time they enter the vehicle. However, it may be useful to make a one-time entry of the ages of the primary users of the vehicle. Obviously, on occasions when other people use the vehicle, the information would not be accurate. The advantages and disadvantages of this procedure should be evaluated further.

### 3.3 SUMMARY AND CONCLUSIONS

This section examined sensors that can be used for both crash sensing and providing supplemental crash data. After a variety of sensor options was considered, it was clear that micromachined solid state accelerometers are the best choice for detecting crashes. Although strain gauges (which would detect crashes by sensing chassis deformation) are inexpensive, many of them would be required to ensure that impacts anywhere on the automobile could be detected. Furthermore, due to thin wires and adhesives (used in mounting), which do not retain their desired properties over time, they are not highly reliable. Inertial switches are a reasonable choice for crash detection. They are currently used by the SRS industry. However, they will be replaced by solid state accelerometers because of their increased reliability and testability, smaller size, and lower cost. Of the eight accelerometers examined, the capacitive and the piezoresistive types best meet the ACN requirements. Appendix D presents the results of laboratory and field testing that were conducted to examine the use of these types of accelerometers in an ACN system. The results lead to the development of a crash detection algorithm.

Another benefit of the solid state accelerometer is its ability to provide supplemental crash data. A suite of three accelerometers oriented along orthogonal axes can provide an estimate of crash severity, a direction of impact, and indication of rollover.

Other than vehicle type and weight which can be sent using the VIN, there are issues associated with obtaining other amplifying crash data. Many of them require the addition of sensors. To determine if any additional sensors should be added to the vehicle, it is necessary to evaluate the value of the supplemental data versus the cost to obtain that data, both in terms of fiscal impact to the consumer and operational impact on EMS.



## Section 4

### COMMUNICATION SYSTEM ALTERNATIVES

This section describes mobile communication alternatives that could be used to support an ACN system. The alternatives are divided into the following categories: geosynchronous orbit (GEO) satellite communication systems, the low earth orbit (LEO) satellite communication systems, and terrestrial communication systems. Specific alternatives that will be discussed in this section are shown in Figure 4-1.

At an altitude of 22,350 miles, a GEO satellite orbits the earth in 24 hours, and therefore can remain fixed over a specific location on the earth. In this way, one satellite can provide constant coverage to as much as one-third of the surface of the earth. LEO satellites (for the purposes of this paper, these include medium earth orbit satellites) are at significantly lower altitudes than GEOs. This causes a satellite to move with respect to a location on the surface of the earth. The time while the satellite is in view from the location is a function of a number of parameters including satellite orbit and the mobile terminal's position. To obtain constant coverage of a particular location on the earth requires a constellation of satellites. These satellites can "hand off" coverage of that location throughout the day. Terrestrial-based systems typically use towers and other means to place antennas as high as possible to provide broad coverage of surrounding areas. Communication range from a single antenna location can be, as great as several tens of miles. To obtain extensive seamless geographic coverage, multiple antenna locations must be employed.

This section is divided into discussions of each of the three communication system categories. For each category, the characteristics of specific alternatives are examined. Then, the advantages and limitations of applying the alternatives to a crash notification system are considered. Emphasis is placed on link availability, survivability, and cost (summarized in tables at the end of each section). Capacity and fidelity are not as critical because the requirements are not as demanding. System architectures that can provide access to EMS dispatch facilities via the PSTN are briefly discussed.

#### 4.9 GEOSYNCHRONOUS SATELLITE SYSTEMS

Although there are many GEO satellite communication systems currently in operation, most provide fixed satellite service to ground stations that support television, trunked telephone calls, etc. Only a few provide any type of service to mobile users.

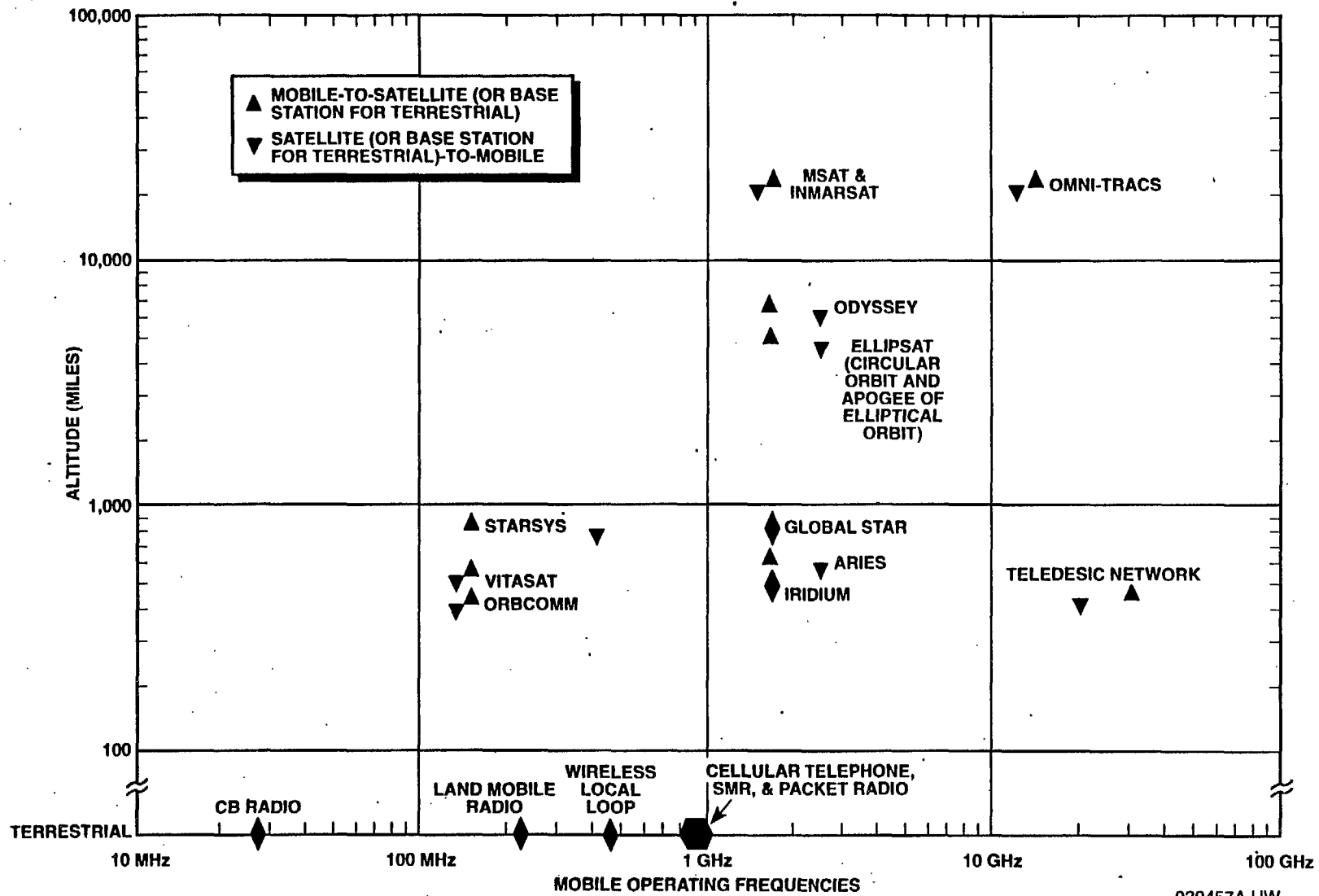

Figure 4-1 Communication System Overview

Systems that provide (or will provide) communications to mobile, terminals include the following:

1. MSAT - American Mobile Satellite Corporation (AMSC)
2. Inmarsat (including the P terminal) - Inmarsat Consortium
3. Omni-TRACS - Qualcomm, Incorporated.

#### 4.1.1 MSAT

During the mid-1980s, 12 organizations applied to the Federal Communications Commission (FCC) to provide mobile satellite services (MSS) in the U.S. In 1988, the FCC directed eight of the applicants to form a consortium to develop a mobile satellite system. The consortium, called AMSC, received a license from the FCC in 1989 to construct and operate three geosynchronous satellites dedicated to MSS. The first satellite, MSAT-1, is scheduled to be launched in early 1995, which will allow AMSC to offer its Skycell Fleet Management service in mid 1995. This service will include voice, facsimile, or data communications between mobiles and their base stations via PSTN or private networks. AMSC estimates that a single satellite will be able to provide this service to 500,000 subscribers (not all simultaneously).

The MSAT satellite communications payload consists of two separate transponder subsystems that receive, amplify, and retransmit 5-kHz bandwidth signals between a mobile terminal and the earth gateway station. The gateway station, currently being built in Reston, VA, provides the interface to the PSTN or private networks. The communications payload also includes an antenna subsystem that can generate six beams that cover North America. Four of the beams serve the contiguous U.S. and Canada, including 200 nmi off both country's coasts. Each beam is designed to roughly service a time zone. The fifth beam covers Alaska and Hawaii, while the sixth beam serves Mexico, Central America, and the Caribbean. These beams allow some frequency reuse, which increases satellite capacity.

It is expected that several terminal types will be developed for communications with MSAT. Westinghouse is considering a mobile terminal design that has dimensions of 12x9x3 inches and weighs 10 pounds. Antenna designs under consideration include a 3-foot high and 5/8-inch diameter omnidirectional antenna or an electronically steered saucer shaped antenna. One option that is expected to be offered in MSAT terminals is a dual mode capability that allows the terminal to use the terrestrial cellular telephone system for voice communications if possible. If it cannot complete the call, the terminal will use MSAT. Also, it permits the terminal to use MSAT when the vehicle has moved out of range of terrestrial cells during a conversation. Only a few seconds of the transmission will be lost during transition from cellular to MSAT. AMSC has signed distribution agreements with many cellular telephone service providers to support dual mode operation.

#### 4.1.2 INMARSAT

In 1976, the International Maritime Organization convened a conference to examine the application of satellite communications to maritime operations. The findings of the conference provided the basis for the formation of a nonprofit consortium of telecommunications companies to implement a satellite system dedicated to maritime communications. This consortium currently includes signatories from over 70 nations. Some of the companies that form the consortium are state-owned, whereas others like the U.S. representative, Comsat, are commercial ventures. Comsat is the largest member of the consortium, owning 25% of the Inmarsat system. When it represents the U.S. as a member of the consortium, Comsat must take direction from the U.S. Government.

Official operations began in February 1982 by the consortium leasing capacity on Comsat General Spacecraft. Currently, global coverage (except the poles) is provided by two MARECS satellites, leased from the European Space Agency (ESA), three Intelsat V satellites, leased from Intelsat, and four Inmarsat-2 satellites. Continued demand has led to a third-generation satellite called Inmarsat-3, which will be able to switch antennas between spot beam and global coverage antennas to increase system flexibility. The first Inmarsat-3 is scheduled to be launched in mid-1995.

There are four terminal types that have been developed to operate with Inmarsat earth coast stations where connections to the PSTN or private networks can be made. Inmarsat-A provides analog voice, telex, facsimile, and high speed data (up to 64 kbps). Inmarsat-B will be the successor to Inmarsat-A. It increases system capacity by replacing analog voice with 16 kbps digital voice. Both types are designed for either land portable or marine operation. Since these terminals require high gain antennas (20 dBi), antenna pointing is critical to their operation. This requires the marine (mobile) version to use a stabilized antenna pedestal. Inmarsat-M is a less capable and lower cost terminal. Services include 4.2-kbps digital voice, low speed data, and facsimile. Terminals are briefcase size and weigh on the order of 25 pounds. A stabilized antenna is necessary for mobile applications. Inmarsat-C is the lowest cost terminal. It is designed for two-way messaging only (600 bps) and has an omnidirectional antenna. The Magnavox MX-1400 Inmarsat-C terminal has an antenna unit that is 10 inches in diameter and 6 inches high and a transceiver unit that is 2.5x8.5x12 inches and weighs only 2.5 pounds, but operation of the terminal also requires a keyboard and display.

There is expected to be a fifth terminal type called the Inmarsat-P. This will be a handheld device capable of continuous operation for 1 hour before the battery requires recharging. It will be used primarily in the land mobile application and will use a new satellite communications system. This system is expected to employ satellites in intermediate circular orbits (i.e., medium earth orbit). The first satellite launch is scheduled for 1998.

#### 4.1.3 OMNI-TRACS

In December 1987, Qualcomm, Inc., filed an application to construct and operate a network of mobile and transportable earth stations that would provide two-way messaging and position reporting for management of commercial vehicle fleets

(primarily interstate trucking companies). The system began operational tests in January 1988 in which a mobile terminal, driven from coast-to-coast, was in constant contact with the hub facility in San Diego, CA. Fully operational commercial services began in August 1989. Currently, there are over 55,000 terminals operating in the U.S. Both dial-in electronic mail (e-mail) type service and open leased lines connections are available through the hub facility.

Service is provided by transponders on the GTE Spacenet GSTAR-I satellite. A pair of transponders is capable of serving between 40,000 and 80,900 users in the Continental U.S. (CONUS). One of the two transponders on the satellite is used for moderate rate (5 to 15 kbs) continuous data stream from the hub to all mobile terminals in the system. Messages are addressed to individual users or groups of users. The second transponder is used for the return link that has data rates available from 55 to 165 kbps. Since Omni-TRACS operates in a portion of the L-band, where mobile transmissions fall under a secondary allocation in the U.S., the signal cannot interfere with primary services and must operate in the presence of interference from those services. Thus, spread spectrum waveform and power and frequency management are critical to link operation.

The mobile terminal has three components: outdoor unit, communication unit, and display unit. The outdoor unit contains an antenna assembly and radio frequency (RF) electronics. This unit is 11 inches in diameter, 7 inches high, and weighs 10 pounds. The antenna has an asymmetric pattern (40 deg elevation and 6 deg azimuth 3-dB beamwidths). It is automatically steered in azimuth and has 19-dBi gain. The outdoor unit is typically mounted on the vehicle's roof and includes a 1.0-watt power amplifier. The communication unit is 4.4x9.22x12.5 inches and weighs 16 pounds. The display unit is 11x7.5x2.75 inches. It consists of a 40-character by four-line display. System features include a panic button that issues a message to the network management center, causing a telephone call to be manually initiated to the appropriate personnel. Delays through the system are on the order of seconds.

#### 4.1.4 APPLICATION OF GEO SATELLITE SYSTEMS TO AUTOMATED CRASH NOTIFICATION

Table 4-1 summarizes the characteristics of the GEO satellite-based mobile communication systems. All systems are capable of transmitting a crash notification message from anywhere in CONUS. Furthermore, all three systems have earth hubs or gateway stations that could be used to route emergency messages over the PSTN. This would require the ground stations to use the crash location data to identify which EMS dispatch facility to alert. The alert could be issued either manually or automatically. Interestingly, Omni-TRACS already has an emergency notification capability. The system automatically identifies emergency messages that arrive at the gateway station. If necessary, a telephone call to a predetermined party can be placed manually.

**Table 4-1 GEO Satellite System Summary**

System	Mobile Operating Frequency (MHz)		Coverage	Terminal		Operational Status	Coast	
	Up	Down		Size	Weight (lb)		Equipment	Service
MSAT	1631.5-1660.5	1530-1559	North America	Small Briefcase	10	Available in Early 1995	\$2500 for Dual Mode Terminal	Voice: \$1.45/min Messaging: 180 Free Messages with monthly service fee
Inmarsat A	1631-1645	1530-1545	Global	Multiple Components	>50 Without Antenna	Currently Available	\$30,000-40,000	Voice: \$6-10 per min
B	1631-1646	1530-1545	Global	Multiple components	>50 Without Antenna	Available in 1994	\$30,000-40,000	Voice: \$7 per min
M	1631-1645	1530-1545	Global	Briefcase	25	Currently Available	\$16,000-25,000	Voice: \$5.60 per min
C	1631-1645	1530-1545	Global	Small Briefcase	2.5	Currently Available	<del>\$4,500-7,000</del>	Data \$1.12 per kbit
Omni-TRACS	14,000-14,500	11,700-12,200	CONUS	Three Units See Text	26 Without Display Unit	Currently Available	<del>\$3,900-4,500</del>	\$0.10/Message \$2.00 for Emergency Message \$10.00 for Panic Button

4-6

By providing a database of EMS dispatch facility telephone numbers and their corresponding coverage areas to an operator at the gateway station, it would be possible to provide crash notification using the existing Omni-TRACS system architecture.

Disadvantages of using GEO satellite systems result from the cost and complexity of communicating with a satellite at an altitude of 22,350 miles. Specifically, to communicate using a GEO satellite drives data link equipment to use a combination of high gain antennas (which require satellite tracking) and high power transmitters/low noise receivers or to sacrifice data rate (assuming channel bandwidth remains fixed). This results in even the least capable data terminal costing several thousand dollars. The high cost would make the ACN in-vehicle equipment too expensive for privately owned automobiles. Some cost savings could be obtained if ACN-specific terminals were developed. A more likely scenario would be the purchase of a GEO satellite terminal for another primary application. Then, it could also be used for ACN by adding sensor and navigation equipment. Some modifications to address survivability issues would be required; however, it may not be possible to address all issues, such as Omni-TRACS tracking antenna. The dual-mode capability of MSAT terminals is an attractive feature for crash notification because it provides redundancy. The terminal will try to establish a link with a terrestrial cellular base station first but can also use MSAT if it is out of range or the cellular equipment is damaged.

In the future, technological advances and consumer demand will significantly reduce terminal cost and size. However, GEO satellites may not play a large role. Both the Inmarsat consortium (studying Inmarsat-P terminal in their Project 21) and AMSC are considering alternatives for handheld terminals that would communicate using LEO or medium earth orbit (MEO) satellites.

#### 4.2 LOW EARTH ORBIT SATELLITE SYSTEMS

There are a number of organizations that are developing LEO satellite systems to provide land-mobile communications to handheld or vehicular terminals located in CONUS or around the globe. The systems can be divided into two categories: the "big" LEOs and the "little" LEOs. The "big" LEOs will support both voice and high speed data. The intent of these systems is to extend mobile telephone service into low population density areas where it is not economical to build and operate terrestrial cellular telephone base stations or into countries that do not have a well developed communication infrastructure. These systems will compete directly with AMSC's MSAT in North America.

The "little" or non-voice, non-geosynchronous (NVNG) LEO satellites are designed to transfer data at low rates only. Thus, they will be used primarily for messaging.

#### 4.2.1 BIG LEO SATELLITE SYSTEMS

There are six big LEO satellite systems that could provide voice and data services to mobile terminals. They are:

1. Iridium. - Motorola
2. Globalstar - Loral Aerospace Corporation and Qualcomm, Inc.
3. Odyssey - TRW
4. Ellipso - Ellipsat Corporation
5. Aries - Constellation Communications, Inc.
6. Teledesic Network - Teledesic Corporation

The first five systems also provide radio determination satellite service (RDSS) that uses the communications resources to geo-locate the mobile terminal. This feature is attractive because it combines the communication and navigation functions. The characteristics of RDSS are discussed in detail in Section 5.1.2.

This section briefly describes the six big LEO satellite systems. Some of the design and operating characteristics of these systems are still undefined. Until the FCC awards licenses to build and launch satellites, the characteristics as well as the schedules will remain in flux. One significant issue delaying the awarding of licenses is the lack of a joint resolution by the FCC-advisory panel that was formed to assign frequencies to the RDSS capable big LEOs. The panel was dissolved in April 1993. Recently, Motorola and Loral/Qualcomm submitted a joint proposal to the FCC for band assignment based on system availability. The FCC is expected to make a ruling on the frequency allocations by January 1995.

##### 4.2.1.1 Iridium

In December 1990, Motorola submitted an application to the FCC for a license to construct and operate a LEO satellite system that provides voice, data, facsimile, and messaging services. In August 1992, the FCC awarded Motorola an experimental license to launch five satellites. The first satellite (under the experimental license) is scheduled to be launched in 1996. Expected operational date for the system is 1998.

The Iridium system uses a constellation of 66 satellites orbiting at an altitude of 500 miles in six near-polar orbits to obtain global coverage. Each satellite can use 48 spot beams to form a continuous overlapping pattern on the earth. Each beam has a 300- to 400 nmi diameter footprint. The beam pattern is fixed relative to the spacecraft but moves rapidly over the earth's surface. Therefore, to provide uninterrupted communications, it is necessary to hand off the mobile terminal to a new beam as the satellite moves over the mobile terminal location. On average, there can be 236 simultaneous users per beam. The contiguous U.S. is covered by 59 beams.

The handheld unit has an omni-directional stub antenna and is capable of operating continuously for 2 hours before requiring battery recharging. Options include a single-mode unit used only for communications over Iridium and a dual-mode unit that attempts to communicate over a terrestrial cellular telephone system before operating on



Iridium. The system supports 4.8-kbps vocoded voice and 2400-baud data. There is a maximum 150-millisecond delay through the system.

#### 4.2.1.2 Globalstar

Loral and Qualcomm are currently awaiting FCC authorization to begin development of their 48-satellite constellation. This constellation will permit Globalstar to offer voice, data, facsimile, and messaging to mobile or fixed users located between 72 degrees north and south latitude. Terminals in CONUS can expect coverage 100% of the time from at least two satellites.

A satellite is capable of supporting up to 2400 circuits simultaneously. The satellite antenna subsystem generates six elliptical spot beams that are aligned with the velocity vector of the satellite. This keeps the mobile user in the same satellite beam for the 10 to 12 minutes the satellite is in view. Together, the beams cover an area the size of CONUS.

To determine which satellite should be used, each mobile terminal has three receivers that continually monitor the signal quality from the satellites in view. Periodically, the gateway station will transmit a pilot tone via the satellites, which the user terminal's three receivers will acquire and retransmit to the gateway via each satellite in view. The gateway station will determine which satellite provides the best performance. This will allow the system to overcome momentary blockages by buildings or other topological obstacles.

There is a variety of terminal types that can be used to communicate over Globalstar, including vehicle mounted, handheld, and RDSS-only. There will also be a dual-mode version that supports terrestrial cellular and Globalstar systems. The terminal size will be "similar to currently proposed digital cellular telephones."

#### 4.2.1.3 Odyssey

TRW filed an application with the FCC in May 1991 to obtain authorization to construct a constellation of 12 MEO satellites. These satellites will support voice, data, and messaging to designated regions of the world. (Thus, ocean coverage may be sacrificed.) These regions will have continuous coverage by at least two satellites.

Since Odyssey is a MEO system, a satellite will remain in view from a particular location for almost 2 hours. Therefore, it is likely that the same satellite will support an entire communication session between mobile and gateway. Few satellite hand-offs will be necessary. There will be two gateway stations in CONUS, one on each coast, that will provide access to the PSTN or private networks.

Each satellite generates 19 beams that divide a satellite's coverage region into a set of continuous cells. Cell diameters are on the order of 497 nmi and can support approximately 2300 voice circuits simultaneously. In the present design, 15 of the 19 beams are low power, and 4 are high to accommodate different user density levels. Low power beams have a 100-voice channel capacity, whereas high power beams will have

approximately 200 voice channels. Delays through the system (including PSTN) are on the order of 100 milliseconds.

The mobile terminal will be a modified version of a cellular telephone handset and will support dual-mode operation. The antennas will be quadrifilar helix design.

#### 4.2.1.4 Ellipso

In November 1990, Ellipsat filed an application with the FCC to provide 4800-bps digital voice communication services via LEO satellites. These satellites will use both a circular and an elliptical orbit. The circular orbit is at an altitude of 4875 miles, whereas the elliptical orbits have a perigee at 325 miles and apogee at 4900 miles. An 18-satellite constellation provides better than 99% availability at all points in CONUS. Initially, Ellipso is tailored to serve 200,000 users. System capacity can be increased with the addition of more satellites.

The satellite communication payload is designed to relay communications between mobile terminals and one of six ground control stations (GCSs) in the U.S. Inter-GCS traffic is provided by the PSTN. Since the waveform matches the proposed digital cellular code division multiple access (CDMA) standard, the same CDMA processing hardware, handsets, and other components can be used for both terrestrial cellular and Ellipso. The only add-ons will be RF and antenna components.

There are several different mobile terminal products offered by Ellipsat. Ellipcell-Plus provides the modem, RF equipment, and antennas to support dual-mode operations. Ellipcell is a unit that can be added to a terrestrial cellular CDMA telephone to convert cellular transmissions to satellite frequencies. Datacell is used for data-only applications.

#### 4.2.1.5 Aries

Constellation Communications filed an application with the FCC in June 1991 to provide voice, high speed data, telex, and facsimile via a constellation of 48 LEO satellites. The constellation will provide continuous coverage (at a 5-degree look angle to the satellite) at the equator and 7.5-degree elevation angle coverage at latitudes greater than 25 degrees.

Transmissions from mobiles are in L-band with a 7-kbps data rate. The S-band downlink to the user terminal is at 110 kbps and is spread to 16.5-MHz bandwidth using a pseudonoise direct sequence. Gateways provide the interface between the Aries system and the PSTN. They are positioned within each service area so that a satellite is always in view of at least one gateway. The exact position of gateways will be determined by the geography and service needs of each region served. Each satellite has a single beam antenna and a peak capacity of 50 channels.

There are two types of user terminals initially planned for the Aries system: one for mobile use and one for a portable unit. The mobile unit consists of three modules. The dashboard module includes a telephone handset and status indicators and

controls. The electronics unit contains the baseband, intermediate frequency (IF) and RF equipment. The antenna unit is mounted on the roof of the vehicle. The portable unit consists of the same three modules but integrated into a single unit.

#### 4.2.1.6 Teledesic Network

In January 1993, Teledesic Corporation (formerly known as Calling Communications) announced its intention to apply to the FCC to construct and operate a satellite-based telephone system. This system is primarily intended to provide integrated multimedia services to fixed terminals including high quality voice, high-rate data, high speed fax, full-motion compressed video, and interactive high-resolution graphics. Thus, it will provide the capabilities of wireline telephone systems but be based in space. It will also be capable of supporting global mobile telephone service. Currently, Teledesic is projecting the system will be operational by 2001.

Each of the 840 satellites in the Teledesic system is a network node that contains a fast-packet switch and is connected to nearby satellites using 60-GHz crosslinks. Each switch determines the routing for each packet autonomously. Fixed cells (53.3-km sided squares) are tracked by each satellite using electrically scanned phased-array antennas. As one satellite moves into view, it uses the same time and frequency resources as the previous satellite. There is no handoff from the terminal point of view. The basic channel rate is 16 kbps (voice driven) but can be aggregated upon demand to create channels up to DS-3 data rates (50 Mbps). To minimize rain attenuation effects in the k-band, terminal-to-satellite look angles must be greater than 40 degrees above the horizon. (This is the reason for the 840-satellite constellation.) End-to-end delay is specified to be no greater than 120 milliseconds. Communication availability is specified to be greater than 99.9% in temperate regions. Each satellite is capable of supporting 90,000 to 100,000 simultaneous two-way conversations with ground terminals (on average).

Fixed terminals with a single channel terminal can use a flat rooftop antenna about 10 centimeters square. Mobile terminals use smaller flat-plate antennas, and handheld terminals use a spherical antenna the size of a tennis ball.

#### 4.2.2 APPLICATION OF BIG LEO SATELLITE SYSTEMS TO AUTOMATED CRASH NOTIFICATION

Table 4-2 summarizes the characteristics of the big LEO satellite-based communication systems. Industry analysts believe that only one or two of the five L/S-band systems will survive the eventual market shakeout. Furthermore, they predict delays in license awards, construction, and launch will push operational dates back by more than a year. Any of these systems that becomes operational will be able to support ACN. They will be able to transmit a crash notification message from anywhere in the U.S. These systems provide near continuous, gapless coverage of CONUS. Geographic coverage may be better than GEOs because the big LEOs will have more than one satellite visible from a specific location. This will provide multiple communication paths that could provide connectivity, therefore decreasing the chances of terrain and foliage blockage.

**Table 4-2 Big LEO Satellite-Based Communication Systems**

	Iridium	Odyssey	Ellipso	Globalstar	Aries	Teledesic Network
Number of Satellites	66	12	14-24	48	48	840
Orbit Altitude (mile)	500	6,400	4900/325	750	635	435
Orbit	Circular	Circular	Elliptical and Circular	Circular	Circular	Circular
<b>Coverage Area</b>	Global	CONUS Offshore U.S. Europe Asia/Pacific	CONUS Offshore U.S.	Global	CONUS Offshore U.S.	Global
<b>Service Markets</b>	Voice, RDSS, Paging, Messaging, Data Transfer	Voice, RDSS, Paging, Messaging, Data Transfer	Voice, RDSS, Paging, Messaging	Voice, RDSS, Paging, Messaging	Voice, RDSS, Paging, Messaging	Voice, Data, Fax, Full Motion Video, Interactive High Resolution Graphics
Voice Cost/Min	\$3.00	\$0.60	\$0.40-0.50	\$0.30	N/A	<\$0.40
User Terminal Types	Handheld Vehicular Transportable	Handheld Vehicular Transportable	Vehicular Transportable	Handheld Vehicular Transportable	Vehicular Transportable	Vehicular Transportable Fixed
Estimated cost	\$3500	\$250-350	\$300-1000	\$750	\$1500	\$500 - 2500
Uplinks (MHz)	1616.5-1626.5	1616.5-1626.5	1616.5-1626.5	1616.5-1626.5	1616.5-1626.5	12.4 MHz Near 30 GHz
Downlinks (MHz)	1616.5-1626.6	2483.5-2500	2483.5-2500	1616.5-1626.5	2483.5-2500	12.4 MHz Near 20 GHz
Projected Operational Date	1998	mid 1996	late 1997	mid 1997	early 1996	2001

Due to the lower altitude of the satellites, high power transmitters and high gain antennas are not necessary. This has allowed a reduction of mobile terminal size and an expected increase in survivability over that of the GEO systems. Also, most of the big LEOs will offer a dual-mode cellular/satellite telephone that provides redundancy.

The disadvantages of the big LEOs stem primarily from cost. The costs are less, on the average, than GEO terminals. However, they are still expensive for the private automobile owner, even when packaged with terrestrial cellular telephone capability. It is not clear if a significant reduction in equipment cost could be obtained if an emergency notification specific terminal were developed.

#### 4.23 LITTLE LEO SATELLITES

There are three NVNG satellite systems discussed in this section. They are Orbcomm, Starsys, and Vitasat. All three systems are expected to become operational in the near future. In addition, there is a variety of systems that are potentially options for ACN. For example, the Leosat Corporation is currently appealing the dismissal of its license application by the FCC. A number of international firms are intending to launch systems that could provide some level of coverage in the U.S. Also, there is a system currently under consideration by the U.S. Department of Defense (DOD) that may be suitable for ACN. This system, called the Combat Survivor Evader Locator (CSEL), is designed to support search and rescue (SAR) activities globally. Other U.S. Government agencies are interested in using the system for two-way messaging.

##### 4.2.3.1 Orbcomm

In February 1990, Orbcomm filed an application with the FCC to construct and operate a satellite-based messaging system. It was granted an experimental license to launch and operate two satellites to begin market development. Orbcomm is currently expecting a license for the full system to be awarded and the launch of the first two satellites in late 1994. These two satellites will provide 10 minutes of service, several times a day to a specific location on earth. The system should be operational by the end of 1995. There are currently four gateway earth stations being constructed.

The 26-LEO satellite constellation at an altitude of 425 miles will provide global coverage. Each satellite has a 60-degree half-power beamwidth that results in a 2500-nmi diameter footprint. As the market grows, an additional eight satellites will be launched. Service availability is a function of simultaneous coverage of both a gateway earth station and the remote terminal by a single satellite. The contiguous U.S. has an average availability rate on the order of 95 percent that results in 72 minutes during every 24 hours when service is unavailable. Outages are frequent, of short duration, and uniformly distributed over time. Estimates of time coverage show that 90 percent of the outages will last for 2 minutes or less.

The mobile terminals are handheld and battery operated and weigh about 16 ounces. Variations of the terminals provide four different services. SecurNet allows a short emergency message to be sent to a user's hub station. Messages are sent until confirmation is received. MapNet provides a tracking capability. DataNet allows

transmission or reception of digital data. VitalNet combines all three services. VitalNet requires a keyboard and a display (which can be handheld). Orbcomm is considering a SecurNet vehicular terminal variant that is designed specifically for the emergency notification function. It would have the capability to send "canned" messages at the push of a button. To minimize equipment costs, some component sharing (including the antenna) with the FM radio is a possibility.

#### 4.2.3.2 **Starsys**

Starsys Global Positioning, Inc. has filed an application with the FCC to construct a constellation of LEO satellites that will be used to provide low rate data and position location services. It anticipates offering these services in mid-1996 with a five- or six-satellite constellation. Recently, Starsys has been conducting link performance demonstrations using the Argos satellite system.

The initial five- or six-satellite constellation at an altitude of 800 miles can provide global coverage. Each satellite has a 3500-mile diameter footprint. Service availability is a function of simultaneous coverage of both a gateway earth station and the remote terminal by a single satellite. There are two earth gateway stations planned, one on each coast of the U.S. This will initially provide an average of one opportunity per hour to communicate between the gateway and a mobile. Each communication opportunity will last several minutes. User data rate will be 1200 bps. Depending upon market demand, the constellation size may be increased up to 24 satellites that will provide near continuous coverage.

Currently, Starsys is projecting three terminal types, a one-way messaging unit, a two-way messaging unit, and a two-way messaging unit with keyboard entry. All three types are handheld. Commercial FM radio antennas can be used for transmission, but an additional antenna is necessary to receive 400-MHz-signals.

#### 4.2.3.3 **Vitasat**

The \$3 million VITA satellite project will provide data communications to relief organizations in developing nations around the world. The system is designed for transferring hundreds of pages of information, not just short messages like the other little LEO systems. The VITA satellites will pass over a region no less than four times a day for 12 minutes each. Fixed ground stations and transportable terminals will be available. VITA satellites is funded primarily by corporations, foundations, and the U.S. Government.

#### 4.2.4 **APPLICATION OF LITTLE LEO SATELLITE SYSTEMS TO AUTOMATED CRASH NOTIFICATION**

Table 4-3 summarizes the characteristics of little LEO satellite systems. The primary advantage of the little LEO systems are low cost and small terminal size. Other than Vitasat, which is not suitable for ACN, these terminals will cost under \$200 for two-way messaging. Limited capability versions will be under \$100. Use of commercial FM radio antennas may also decrease cost.

Table 43 Little LEO Satellite System Characteristics

	Orbcomm (Orbital Communications)	Starsys (Starsys)	Vitasat (VITA)
Number of Satellites	26	5-24	2
Altitude (mi)	425	800	500
Orbit	Circular-Orthogonal	Circular	Circular
Initial Coverage Area	CONUS Offshore Points U.S. Pacific Islands Polar Regions	CONUS Offshore Points	Global
Service Markets	Tracking Messaging Emergency Paging	Tracking Messaging Emergency Paging	Heavy Data Transfer (100 pages+)
User Terminal Types	Handheld Vehicular Transportable Fixed	Handheld Vehicular Transportable Fixed	Transportable Fixed
Estimated Cost	\$30-50 (emergency notification variant)	\$75 (one-way messaging)	\$5000
Uplink Band	148-149.9 MHz	148-149.9 MHz	148-149.9 MHz
Downlink Band	137-138 MHz and 400.075-400.125 MHz for increased position <b>accuracy</b>	400.1-401 MHz	<b>137-138 MHz</b>
Projected Operational Date	1995	1996	Early 1995

A significant disadvantage of these systems is timeliness. Depending on the system, there may be significant periods of time when it will not be possible to communicate because the link geometry will not allow connectivity. Delays can be several minutes in duration. Conversely, these systems should have better foliage penetrating characteristics than the other satellite options because of the low mobile operating frequencies.

From a survivability standpoint, the antenna may be a liability. Because of the low operating frequencies, antennas tend to be larger (such as a commercial FM radio antenna) thus increasing the likelihood of damage in a crash. Orbcomm offers Securnet, which is a service that can send an emergency alert to an earth gateway station. The alert can be initiated by the push of a button or the closure of a switch. As with Omni-TRACS, it would be possible to use the Securnet service for crash notification if the gateway station had a database of EMS dispatch facility telephone numbers and their corresponding coverage areas.

#### 4.3 TERRESTRIAL SYSTEMS

In this section, terrestrial communication systems that provide (or could provide) broad area coverage to vehicular terminals or that have been connected with an emergency notification function are examined. These systems include the cellular telephone system, wireless local, loop, packet radio, specialized mobile radio (SMR), citizens band (CB) radio, and 220-MHz land mobile radio. Other types of wireless communication systems will be available in the near future to support cordless telephone services, tracking, and wireless networks. They will operate in the industrial, scientific, and medical bands (900 MHz and 2.4 and 5.7 GHz) and the personal communication services band (2 GHz). These systems are not considered in this report because they are not expected to provide broad coverage in rural areas, and implementation in the U.S. is not well defined.

##### 4.3.1 CELLULAR TELEPHONE SYSTEM

In the U.S., the current cellular phone system is called the Advanced Mobile Phone System (AMPS). AMPS is specified in EIA/TIA Interim Standards 19 and 20 (IS-19 and IS-20). These standards call for voice transmissions to be 30-kHz wide and use analog FM while the control transmissions used for setup and handoff are binary frequency shift keyed (FSK). Since mobile terminals transmit to a cell base station in the 824- to 849-MHz band and receive in the 869- to 894-MHz band, there are 832 channel pairs that can be assigned to a cellular telephone user. Transmit and receive channels are 45 MHz apart. Typically, there are two cellular providers licensed in each market area (e.g., Baltimore-Washington), which evenly divide the available channels.

The extent of cellular coverage in the U.S. varies from state to state. Figure 4-2 shows a sampling of coverage in four states New Jersey, Virginia, Kansas, and South Dakota. Urban states such as New Jersey have extensive coverage. Also, some more rural states, like Kansas, have fairly broad coverage. In contrast, other rural states, such as



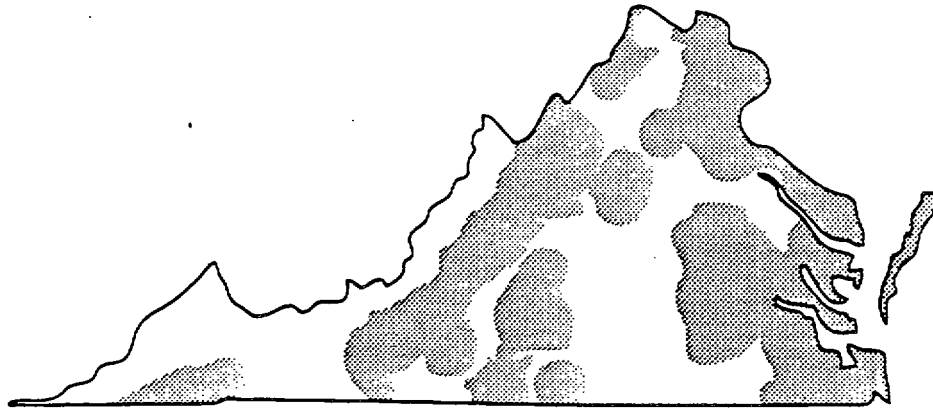

Virginia

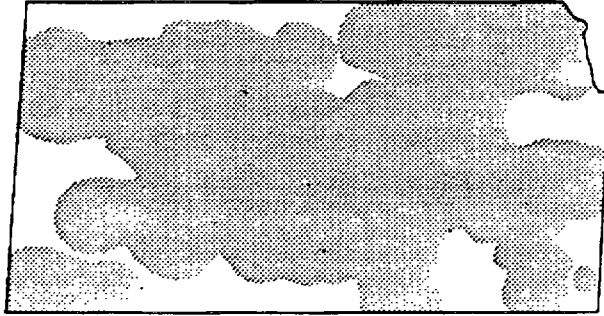

Kansas



New Jersey

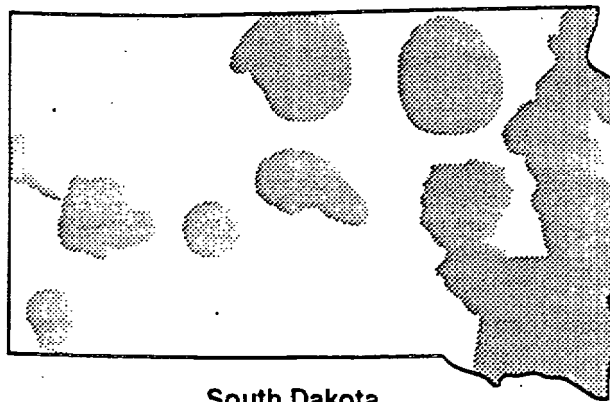

South Dakota

939909 uw

Figure 4-2 Exampks of Current Cellular Telephone Coverage

Virginia and South Dakota, have cellular service clustered primarily along the major interstates and around population centers. Studies conducted by the Cellular Telecommunications Industry Associates indicate that cellular telephone service is available to over 95% of U.S. citizens. However, due to population distribution, actual geographic coverage, is less. AMSC currently estimates geographic coverage of CONUS to be just under 50%. By the end of 1995, they project coverage will have grown to 65% where it will remain into the next century.

There are several proposed systems that would increase system capacity three to ten times. These systems include Narrowband AMPS, time division multiple access (TDMA) (IS-54, 55, and 56), Enhanced TDMA (proposed by Hughes), and CDMA (IS-95). Many cellular providers will soon begin providing dual-mode service; a portion of their band is compatible with AMPS, whereas another portion is allocated to a higher capacity alternative. Users will still be able to use their AMPS phones, but they will also be able to purchase dual-mode phones. The conversion will occur first in large urban areas where demand is near capacity. In rural areas, the conversion to dual mode may not occur for many years.

Although mobile telephone switching offices (MTSOs) are technically capable of routing 911 calls to the appropriate county's EMS dispatching facility by correlating- vehicle location with cell site coverage, many do not. Furthermore, those systems that do attempt to route 911 calls appropriately may still have routing errors because cell-site coverage can overlap county and state borders. Therefore, it may be necessary to establish a state or regional level 911 center in order to route emergency messages to the appropriate destination.

#### 4.3.2 WIRELESS LOCAL LOOP

In December 1992, the first wireless telephone service to fixed users began operation in Quitaque, Texas. The purpose of this system is to reduce the costs associated with installing wire-line infrastructure. In rural settings, high costs are a result of the long distances between users. In urban settings, high costs are a result of limited underground conduit space. Service providers are also allowed to offer mobile telephone service using the channels allocated to wireless local loop as long as they do not degrade service to the fixed users.

The frequencies used by the wireless telephone service providers in Quitaque, Texas were allocated in December 1987 when the FCC created the Basic Exchange Telecommunications Radio Service (BETRS). This service has allocated 94 frequency channels between 454 and 459 MHz. Useful operating ranges are on the order of 30 to 40 miles to fixed users, while mobile users should expect ranges from 20 to 25 miles.

Operation of this system does not include the frequency reuse and automatic handoff features of the cellular telephone system. Therefore, the base station operates at high power to increase range. Mobile users can expect service only from their designated base station, unless they are registered for service by another base station.

Interdigital produces base stations and mobile subscriber units (MSUs). Its next-generation MSU will weigh 7 pounds and will be 8 x 11 x 6 inches. The antenna is a 30-inch whip, which has 5-dB gain.

The current extent of coverage in the U.S. using these systems is not great but it could become integrated into a cellular telephone or other mobile communication system that would further increase coverage in rural areas. Access could be made using a dual-mode telephone.

#### 4.3.3 PACKET RADIO

Packet radio networks provide a two-way messaging service that permits data transfer at lower cost than using cellular telephones. The user terminal breaks the data stream into packets to which addressing information is added. Packets are transmitted through the radio network to base stations that provide an interface to landlines and switching systems. Data are routed through these systems and reassembled at an end-user's location. Transmission times are on the order of seconds.

There are currently two major providers of packet radio networks in the U.S. They are RAM Mobile Data and Ardis. RAM Mobile Data began operation in 1991 and has rapidly increased its coverage to more than 100 metropolitan service areas. In many service areas, RAM has an FCC license for 10 to 30 channels in the 900-MHz SMR band. It is estimated that this system can support 300 to 1000 users per 12.5-kHz channel pair. Ericsson GE builds the Mobidem portable wireless modem that operates with the RAM network. This unit weighs 1 pound and is used with a portable computing device. The modem is capable of transferring data at 8 kbps.

Ardis was started in 1984 to provide messaging service to International Business Machines (IBM) field service representatives. It now offers service in over 400 metropolitan areas. Figure 4-3 shows the coverage of Ardis in New Jersey, Virginia, Kansas, and South Dakota. Transmissions to and from mobile units are in the 800-MHz band. Messages received at a base station are sent directly to, one of two switches (that serve the U.S.) that routes the data to its final destination. Ardis claims that its indoor coverage is superior to other packet radio systems. The mobile unit is the size of two cigarette packages and is used with a portable computing device. It is capable of transferring data at 4800 bps.

A third packet network is currently being deployed by the Cellular Digital Packet Data (CDPD) consortium. This consortium includes most major cellular carriers. It intends to install additional infrastructure at cellular telephone base stations that will allow the transfer of packet data using the cellular telephone channels. Channels that are not carrying voice are used to send data packets. Because packets can be sent on a secondary basis, service costs will be significantly less than standard cellular rates. Coverage area is expected to be nearly extensive as cellular telephone.

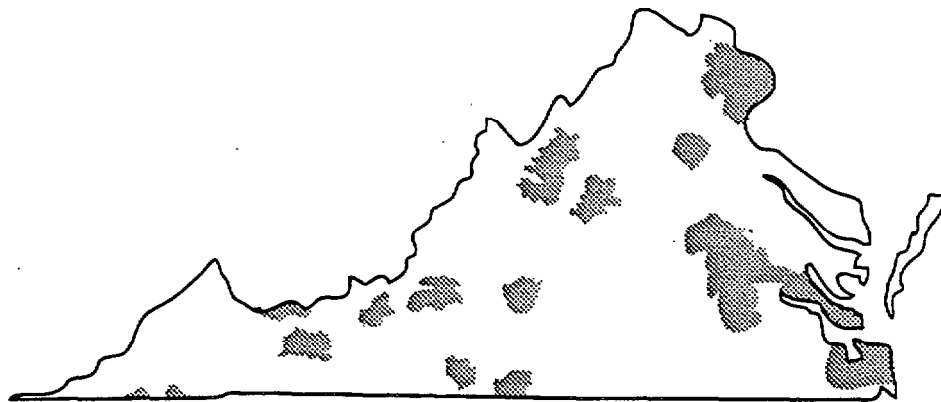

Virginia

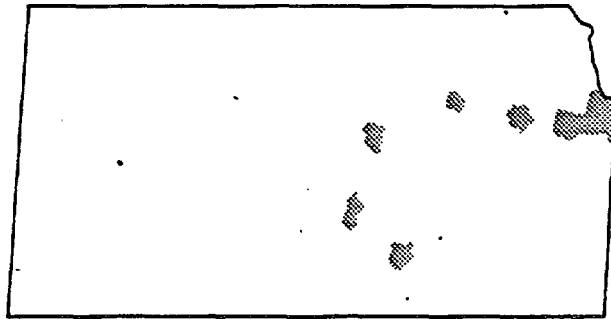

Kansas



New Jersey

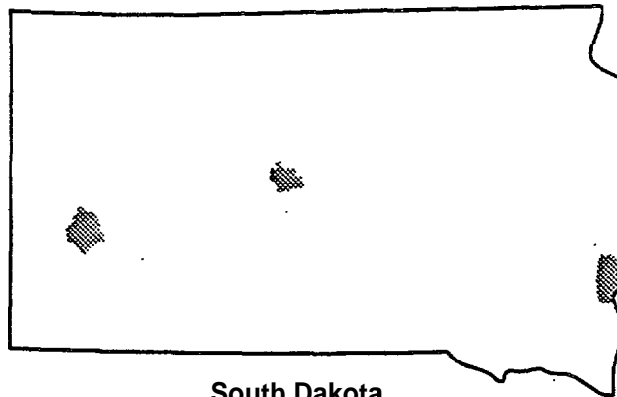

South Dakota

939909.uw

Figure 43 Examples of Current Ardis Packet Radio Coverage

#### 4.3.4 SPECIALIZED -MOBILE RADIO.

Currently, SMR systems are used to support local dispatch services for vehicle fleet operators, field service providers, etc. These systems provide trunked two-way radio that supports 25-kHz wide analog FM voice communications between a dispatcher and mobile units located 30 to 40 miles from an SMR base station. (In a trunked radio system, channels are assigned when a link is desired. A particular user may be able to access any channel in the system. This significantly increases efficient channel use compared to nontrunked systems where channels are always associated with a specific user or group of users. The cellular phone is also a trunking radio.) The dispatcher can connect to the base station using a variety of methods including the PSTN. Much like the wireless local loop, service providers usually have a base station designed to operate at high power from a high location in the region to maximize coverage. Since there is less base station equipment to cover a geographic region, service costs can be significantly less than cellular telephones. However, the systems are not usually designed for automatic handoff that allows mobile users to roam to other base stations.

Typically, an SMR service provider has been allocated 5 to 10 channel pairs in a region. These channels fall into specific segments of the 800 and 900-MHz bands. In the 800-MHz band, mobiles transmit at 806 to 821 MHz, while the base station transmits at 851 to 866 MHz, resulting in 600 channels. Like cellular telephone, channel pairs are 45 MHz apart. Unlike cellular telephones, equipment builders have more latitude in the design of communication equipment, such as protocols. Also, service providers can tailor their services to the specific market. Thus, roaming to other base stations is possible but not necessarily available.

Currently, the SMR industry is experiencing a period of consolidation where many smaller SMR operator licenses are being bought by large regional providers. These providers include Nextel (northeast U.S. and major metropolitan areas), CenCall (northwest and western U.S.) and Dial Page (southeast U.S.). These large regional providers are more easily able to support demand for roaming along major corridors like Interstate I-95 between Washington, DC and Boston, MA They are also able to undertake the task of transitioning to digital systems that will allow data transfer as well as voice. This enhanced SMR (ESMR) capability is just becoming operational.. Nextel's new ESMR system has been designed to provide cellular telephone service also (but not using the existing infrastructure). Thus, a single unit can provide cellular telephone, messaging, text transmission, and paging. With consolidation and increased capability, the SMR industry is moving-towards providing customized mobile communication service.

Note that there is a public safety band that is used by police, EMS, and fire fighters for dispatching. These frequencies are allocated with coordination from the Associated Public-Safety Communications Officers, Inc. (APCO). It is not clear if any of these channels could be made available to an ACN system.

#### 4.3.5 CITIZENS BAND RADIO

The FCC has allocated 40 channels around 27 MHz to CB radios. The channels are spaced 10 kHz apart and support half-duplex, nontrunked amplitude modulated voice communications. Thus, the link performance is highly dependent on the amount of interference competing with the signal on a channel. Local users, the ionosphere (source of interference over skywave), and terrain all impact the intelligibility of the voice signal. In rural areas, where man-made interference could be low, communication ranges exceeding 20 miles may be possible. However, typical ranges are on the order of 5 to 10 miles.

With the tremendous growth of CB radio sales in the decade between 1968 and 1978, a number of U.S. Government agencies examined the use of CB radios in providing contact with local emergency service agencies. This included a 1975 study conducted by NHTSA that led to the development of the National Emergency Action Radio (NEAR) program. This program provided grants to states for the purchase of CB radio equipment, training in the use of CB radios, public information, and data gathering. One key element of a state NEAR program was the regular monitoring of channel 9 (27.065 MHz). Monitoring of channel 9 continues today in many states. For example, in Maryland, State and Toll Facilities Police conduct CB monitoring from police barracks or toll facilities. Furthermore; all State Police cruisers carry a CB radio. Officers in the cruisers monitor channel 9 as a secondary function.

#### 4.3.6 LAND MOBILE RADIO AT 220 MHZ

The FCC is currently distributing regional and national licenses for land mobile radio systems operating in the 220-MHz band. Commercial systems operating in this band will compete with packet radio and 6MRs for wireless communication services in metropolitan areas. Several companies including Uniden and IIMorrow are offering trunked data or voice equipment that can operate in the 5-kHz bandwidth channels and provide SMR-like operation. It is expected that there will be a slight range enhancement over 800- and 900-MHz systems due to the lower frequency band. Links up to 60 miles have been completed.

Along with the commercial allocations are five frequency pairs that have been allotted to the Federal Highway Administration (FHWA) for the next 15 years to support IVHS programs. This includes a nationwide MAYDAY frequency at 221.5525 MHz that can be used for ACN. Since the commercial equipment currently being offered is able to operate on this channel, existing base stations will be able to route calls to EMS. Only a minor software modification is necessary. Guidelines and application for use of these frequencies can be obtained from the FHWA

#### 4.3.7 APPLICATION OF TERRESTRIAL COMMUNICATION SYSTEMS TO AUTOMATED CRASH NOTIFICATION

Table 4-4 summarizes the characteristics of the terrestrial, communication system options. The disadvantage of terrestrial systems is geographic coverage. Even the

**Table 4-4 Terrestrial Communication Options**

Option	Mobile Operating Frequency (MHz)	Coverage	Terminal	
			Type	Equipment cost*
Cellular Telephone	Transmit: 824-849 Receive: 869-894	65% of CONUS by 1996	Handheld, Mobile, Transportable	\$50 - 800
Wireless Local Loop	454-459	Rural (currently very limited)	Mobile, Transportable, Fixed	\$1500 (in large quantities)
Packet Radio	Various Bands in 800- and 900-MHz Region	Metropolitan, Urban (CDPD coverage could be as broad as cellular telephone coverage)	Mobile	\$300 - 1200
SMR	Various Bands in 800- and 900-MHz Region	Metropolitan, Urban, Suburban	Handheld, Mobile	\$700 - 1500
CB	26.9 - 27.4 Monitoring on Channel 9 (27.065 MHz)	Police Monitoring from Both Fixed Sites and Cruisers	Handheld, Mobile, Fixed	\$50 - 200
Land Mobile Radio at 220MHz	220 - 222 Mayday at 221.5525 MHz,	Metropolitan, Urban	Mobile	\$900-1000

\*Equipment costs depend on how much service provider subsidizes consumer.

cellular telephone system, which provides the greatest coverage of the terrestrial communication options, is projected to have gaps in coverage that total up to 35% of CONUS. Most of these systems are focused on supporting commercial applications in metropolitan areas. There is little cost incentive to construct communication infrastructure where there will be little demand. Both CB radio and wireless local loop technologies could extend coverage into rural areas, but infrastructure development is necessary. For CB radio, many more fixed monitoring sites would be required. They could be located so that they fill in cellular telephone coverage gaps, although that would require both a cellular telephone and CB radio in the vehicle. It is not clear whether or not wireless local loop systems will provide telephone service in areas outside the cellular telephone coverage. Installation of these systems usually coincides with the replacement of old analog switching equipment. Therefore, distribution and schedule are difficult to predict. However, broad coverage is not expected soon.

Other than CB radio, costs of mobile equipment used by terrestrial systems depend on the specific service provider. For private automobile owners, equipment costs may not be that great if a service provider feels that ACN will be profitable. It is expected that only the cellular telephone industry and perhaps wireless local loop providers consider the privately-owned automobile market attractive for any type of service.

For antennas without reflectors, size is inversely proportional to operating frequency. Therefore, it is expected that antennas used by systems operating in bands below 800 MHz will have larger, less survivable antennas than those used by cellular telephone, SMRs, and packet radio. For example, a quarter wave monopole antenna used for the cellular telephone is 3 to 4 inches high, whereas the same type of antenna for a 220-MHz land mobile radio is almost 14 inches. CB radios can use whip antennas several feet long. Interestingly, to increase gain at lower elevation angles and thus enhance performance during normal operations, some of these systems employ other types of antennas that can increase antenna size. For instance, the 3-dB colinear antenna used for cellular telephones is more than twice as long as the quarter wave monopole. This antenna is popular because it increases communication range, but the increase in size reduces survivability. Also, since the antenna gain at high elevation angles has been reduced significantly, final vehicle orientation plays a greater role in link availability.

Given the broad coverage, lower cost, and smaller antenna, the cellular telephone system is the most appropriate terrestrial communication system for ACN. However, coverage area is an issue. To address the issue, it is necessary to correlate geographic distributions of crashes with cellular telephone coverage.

#### 4.4 SUMMARY AND CONCLUSIONS

In this section, several different mobile communication systems were examined to determine how well they meet the requirements of an ACN system. Their characteristics are summarized in Table 4-5.



**Table 45 Communications System SUMMARY**

System	Availability	cost	Survivability
GEO Satellites-	Continuous U.S. Coverage	>\$2500	Multicomponent Systems, Some with Tracking Antennas
BigLeo Satellites	Continuous U.S. Coverage (from more than one satellite)	\$300-\$3500	Single Unit, Quadrafilial Helix, 1/4-Wave Monopole, Dual-mode Capable
Little LEO Satellites	U.S. Coverage with Reduced Availability, Foliage Penetration	<\$200	Single Unit, Whip Antenna
Cellular Telephone	65% of CON-US by 1996	\$50-\$800	Single Unit, 3-dB co-linear or 1/4-Wave Monopole Antenna
Land Mobile Radio at 800 and 900 MHz (Packet Radio and SMR)	Metropolitan, Urban, Suburban (CDPD coverage could be as broad as cellular telephone coverage)	\$300-1500	Single Unit, 1/4-Wave Monopole Antenna
Wireless Local Loop	Rural. Foliage Penetration .	\$1500	Single Unit, Whip Antenna
Land Mobile Radio at 220MHz	Metropolitan, Urban, Suburban; Foliage Penetration	\$900-\$1000	Single Unit, Whip Antenna
CB Radio	Fixed and Mobile Monitoring Sites; Foliage Penetration	\$50-\$200	Single Unit, Whip Antenna

Taking into account both cost and coverage, the two leading candidates are the little LEO satellites and the cellular telephone system. Both systems provide low cost equipment and relatively broad coverage, but require sacrifices in availability. The little LEOs do not provide continuous coverage of the U.S. Depending on the number of satellites in the constellation, periods when communications are not possible could last for tens of seconds to tens of minutes. (The opportunity to use various satellites and thus different link geometries could help overcome terrain or foliage blockage.) Conversely, cellular telephone connectivity is rapid as long as the terminal is in a cell. The problem is the cells are designed to cover areas where there is consumer demand such as in population centers and along major highways. Although cellular telephone service is available to 95% of the U.S. population, geographic coverage is projected to reach only 65% of CONUS by 1996. Coverage is expected to remain at this level into the next century. (Appendix E presents a

detailed discussion of cellular telephone system operation and antenna issues and discusses the results of field testing that examined RF propagation in the 800-MHz band.) Other types of satellite systems can address coverage issues but at much greater cost. Other terrestrial systems provide a subset of the coverage offered by cellular telephones.

Although the lower operating frequency of the little LEO satellites provides better foliage propagation, it also implies a larger, less survivable antenna. Figure 4-4 shows different antennas associated with wireless communication systems. In general, the higher frequency systems have smaller antennas..

More survivable (low profile) variants can be found for some systems, such as a flat cellular telephone antenna; however, they may result in degraded performance or greater complexity. A possible avenue for increasing antenna survivability is the use of multiple antennas. The antennas could be positioned in different locations on the vehicle or could automatically be deployed in the event of a crash. This would require the communication system to be able to switch among antennas. Another option is the use of multiple communication systems to provide redundancy. Dual-mode cellular/satellite telephones are already being developed.

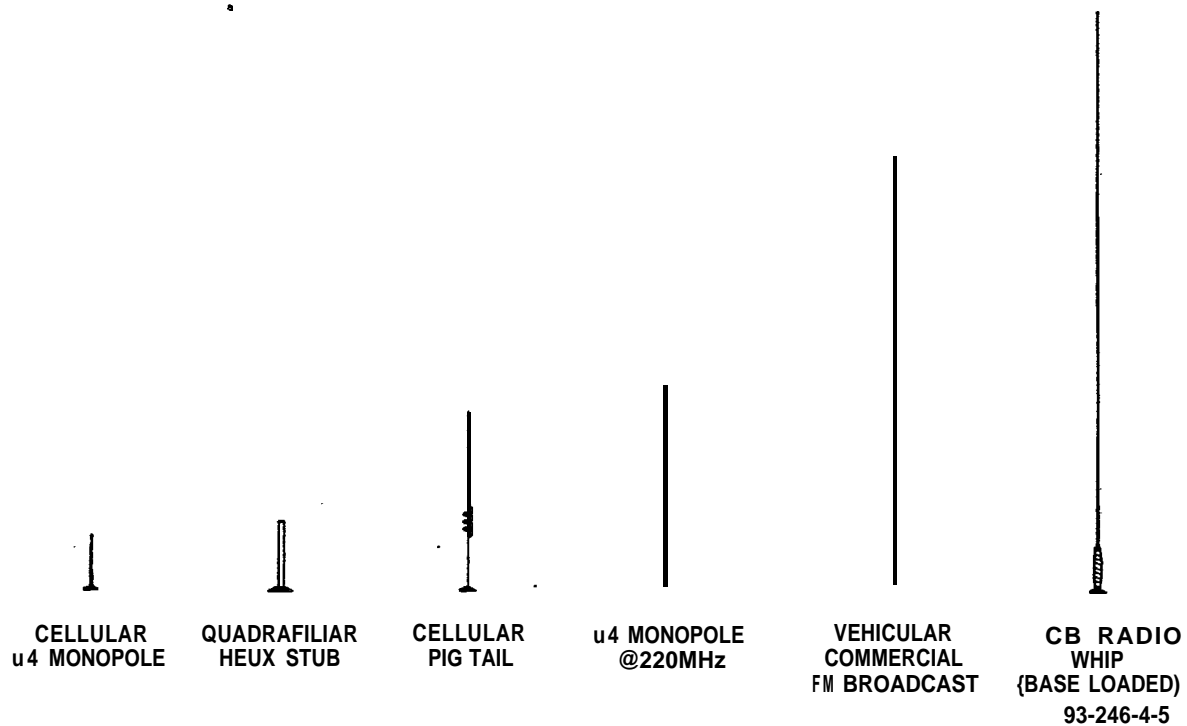

**Figure 4-4 Examples of Wireless Communication Antennas**

Based on the discussion, there does not appear to be any systems that are ideally suited for ACN. Furthermore, it is not clear whether or not private citizens would purchase any of these communication systems for the sole purpose of ACN (assuming it is not Federally mandated). They are more likely to purchase a communication system for business or personal reasons and weigh the benefits of additional features, such as an ACN capability, against the costs. Therefore, in keeping with the desire for an open system architecture, it is proposed that no one system or technology be selected to be the sole EMS notification method. Instead, any wireless communication provider should be able to offer (or could be required to offer) the capability to support ACN. Omni-TRACS and Orbcomm have already determined that there are economic incentives in providing an emergency messaging capability.

This open system approach implies that a standardized message format must be defined. Also, for systems that route messages at a national level (e.g., satellite hubs), access to a database of EMS dispatch facilities and their respective coverage areas must be available. However, if there is a large cost (economically or procedurally) associated with modifying each EMS facility to accept messages directly from national level communication centers (satellite gateway station), it may be more appropriate for a state, regional, or national level message clearinghouse to be established as shown in Figure 4-5. For rural counties that are not expected to have many incidents, a regional or state clearinghouse could provide manual notification using existing PSTN connections. Connections between the clearinghouse and national level communication centers could be made using leased lines.

With this approach, a commercial vehicle fleet operator can obtain an ACN capability using an existing communication and navigation system (and by purchasing a sensor/processor package). Conversely, a private citizen can add a navigation capability and sensor/processor component to his cellular telephone system to support ACN. Communication equipment providers would have to address equipment survivability and the interface with the ACN processor.

To further enhance the incentives for communications providers to support ACN and for consumers to purchase the in-vehicle communication segment, additional capabilities should be available. This includes using the messaging capability to request police and non-crash medical assistance or automobile towing and repair service as outlined in the driver and personal security component of the Emergency Notification and Personal Security user service. Thus, an ACN capability could provide the basis for integration of these emergency services into the overall M-IS architecture.

4-28

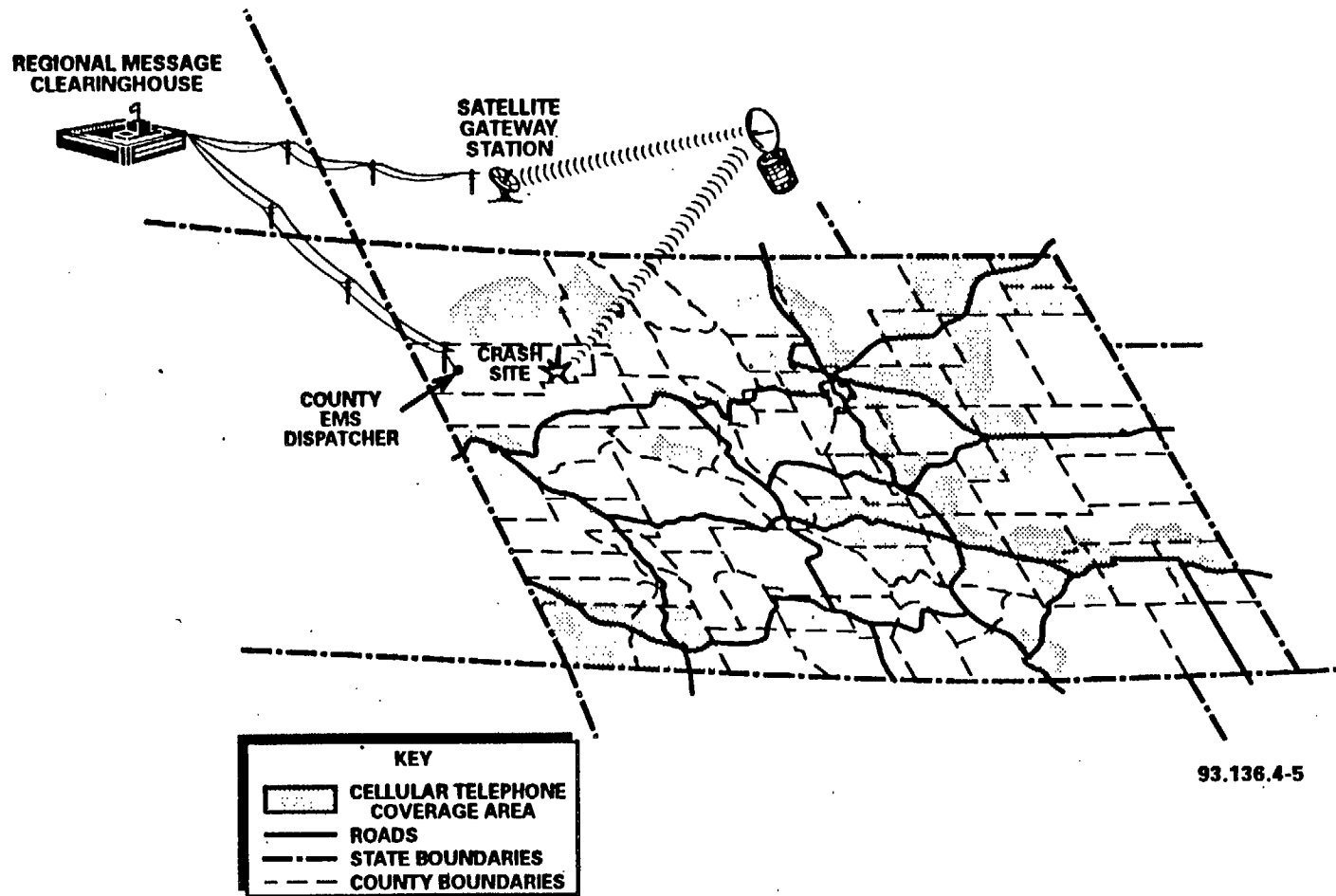

Figure 4-5 EMS Notification Scenario

## **Section 5**

### **NAVIGATION SYSTEM ALTERNATIVES**

This section describes navigation system alternatives that could be used to provide crash location in an ACN system. The alternatives are divided into satellite based, terrestrial based, and in-vehicle. Satellite based navigation consists of the Global Positioning System (GPS), mobile satellite communication systems that can provide geolocation services, a satellite SAR system called the Global Maritime Distress and Safety System (GMDSS), and the Argos environmental data collection satellite system. Terrestrial-based systems either support marine navigation or are oriented towards vehicle tracking. In-vehicle systems include dead reckoning.

#### **5.1 SATELLITE-BASED NAVIGATION**

This section describes characteristics of the GPS and the geolocation services provided by both GEO and LEO satellite communication systems. The communication systems include Omni-TRACS, Iridium, Ellipso, Aries, Odyssey, Globalstar, Orbcomm, and Starsys. Also, the GMDSS and the Argos system are discussed. Although the U.S. Navy's Transit System is an option, it is scheduled to cease operation by 1997. Therefore, it is not considered in this report. Note that using any of the systems except GPS provides dual functionality; that is, one system provides both crash notification and location.

##### **5.1.1 GLOBAL POSITIONING SYSTEM**

NAVSTAR GPS was built and is operated by the U.S. DOD. The constellation consists of 24 satellites in 12-hour orbits at an altitude of 10,898 nmi. The satellites are divided into six orbital planes with four satellites in each plane. The constellation provides global 24-hour coverage.

A GPS receiver uses RF signals from the satellites to determine time and the receiver's three dimensional position (latitude, longitude, and altitude) and velocity. Time and position determinations are based on measurement of the transit time of the RF signals from the satellites. Reception of signals from four satellites allows a receiver to determine time and three-dimensional position. Reception of signals from three satellites and a separate knowledge of altitude allow a user to determine time, latitude, and longitude. Time must always be determined before position can be determined. Velocity can be measured either by differencing position measurements or by measuring the Doppler shifts. With the 24-satellite constellation, there are generally more than 4 satellites in view. However, vehicles in canyons, tunnels, densely forested areas, or

cities may have line-of-sight to one or more satellites blocked. If less than four satellites are visible, a position solution is not possible unless altitude can be determined by some other means. In that case, three satellites are needed.

To obtain high accuracy position estimates it is necessary to be able to receive two navigation signals, one at 1227 MHz and one at 1575 MHz. Measurements from two frequencies allow ionospheric delays to be estimated and corrections made to the signal propagation times. However, the signal at 1227 MHz is modulated with a spread spectrum signal, known as the Precision or P Code (10.23 Mbps), that can be decoded only by military users. The signal at 1575 MHz is modulated with both the P Code and with a Course/Acquisition or C/A Code (1.023 Mbps). Civilian users are able to use only the C/A Code. The DOD intentionally dithers the time position of the C/A Code to degrade a receiver's position accuracy. This "feature" is known as Selective Availability (SA). SA can be turned off to allow better accuracy, but it is usually on. With SA turned on, accuracy is on the order of 100 meters. Single board GPS receivers that can provide 100-meter accuracy are available. Typical antennas include a quadrafilar helix or microstrip.

It is possible to increase accuracy by using a technique called differential GPS. A receiver with a known position determines the error in the signals it receives from each satellite. The corrections necessary to remove the errors are transmitted to receivers with unknown positions. The receivers with unknown positions apply the corrections to produce better estimates of their positions. This technique can remove all errors that are common to both receivers. These errors include the effects of SA, unaccounted satellite clock errors, and most atmospheric effects. The technique works best if the two receivers are in close proximity. Depending on the quality of the receiver and the satellite-to-receiver geometry, accuracy better than 10 meters is possible. There are several commercial ventures planning to transmit differential GPS corrections from FM radio broadcasting stations using an FM subcarrier. Access to the corrections will require users to pay a service fee.

Although GPS is not extensively used in privately owned automobiles, there are vehicle fleets, such as those operated by trucking and delivery companies and police and fire departments, that are using GPS receivers. Most of these systems transmit a vehicle's location back to a central dispatcher where a mapping system displays the locations of the fleet's vehicles. Lower prices will result in increased use by the general public, most likely in conjunction with route guidance systems.

An option that could allow fleet operators to lower the costs of purchasing GPS receivers is a system called Tidget, proposed by the NAVSYS Corporation. Instead of tracking the GPS satellites and calculating a navigation solution, Tidget only digitizes the RF signal. The signal samples can then be sent to a base station, which determines the mobile's position. This decreases the cost of the mobile equipment to under \$100, although there is a cost associated with the base station. If there are many mobiles for each base station, this technique can significantly reduce the overall cost of a positioning system.

The amount of data that must be transmitted is much higher than if only latitude and longitude were sent. The RF spectrum is sampled for 4 milliseconds (2 Msample/sec, 1 bit/sample), resulting in 1 kbyte of data. Transmitting the data at 9600 bps would take just under 1 second.

An additional advantage of Tidget is that the base station can contain maps with elevation information. Using this information, the number of satellites that must be visible is reduced to three. NAVSYS claims that only two satellites are necessary if the locations of roads are taken into account. NAVSYS is currently designing an emergency notification system for vehicles in Colorado. The vehicles would employ the Tidget to obtain position data and the communication link will be provided by cellular telephones.

#### 5.1.2 MOBILE SATELLITE COMMUNICATION SYSTEMS

Almost all the mobile satellite communication systems provide some method of determining position. Depending on the technique, it may be possible to achieve 100 meters accuracy. Those systems that use Doppler tracking, such as Iridium, Aries, Orbcomm, and Starsys, are able to provide on the order of 1- to 2-kilometer accuracy. Starsys has an additional feature that reduces the position error to 100 meters by comparing different signals received over several minute intervals. Doppler tracking usually results in geolocation calculations performed by the earth stations. If the user terminal needs its own position, it is sent over the satellite link. However, Orbcomm, with the use of GPS receivers onboard its satellites, allows the user terminal to calculate its position.

Other systems use techniques that are based on time difference of arrival (TDOA). For example, Omni-TRACS offers a position reporting system called Qualcomm Automatic Satellite Position Reporting (QASPR) that can provide better than 100-ft. accuracy. Terminal' location is estimated using direct ranging from two satellites, GSTAR-1 and GSTAR-4, in combination' with a number of ground stations located throughout the US. Location is calculated at the San Diego, CA hub station.

Ellipse is a hybrid system that uses both time and frequency data for geolocation. The technique, called Geobeacon, was developed by Massachusetts Institute of Technology. Coarse ranging is obtained by TDOA, whereas fine estimates are made using the difference in Doppler shift from signals transmitted from a fixed location and the mobile terminal. Depending on the location and number of satellite relays and the number of samples per unit time, accuracies as low as 100 meters are possible.

Since the communication system must survive the crash, systems that can improve accuracy over time would have additional time to refine position. Dispatch could be based on coarse position estimates. . When more accurate estimates are available, they can be sent to responding units.

#### 5.1.3 SATELLITE SEARCH AND RESCUE

The GMDSS uses two different satellite systems, Inmarsat and the Cospas-Sarsat system. The Inmarsat-E Emergency Position-Indicating Radio-Beacon (EPIRB) terminal is used to communicate distress signals and position location over existing Inmarsat satellites. Position location must be obtained from a device on the ship such as GPS. The Cospas-Sarsat system is the result of an international effort to demonstrate the use of satellites to detect and locate EPIRB emissions. The EPIRBs used in the project had been developed originally to be geolocated by aircraft equipped with only a standard very

high frequency (VHF) radio capable of receiving at 121.5 and 243 MHz. The Doppler shift of the EPIRB transmissions can be used to determine its location when the satellite is in view of both the EPIRB and a local user terminal (ground station designed to operate with these EPIRBs). Due to the low power transmitter, only accuracies on the order of 10 to 20 km are possible. Also, multiple satellite passes are required to obtain unambiguous location fix. For a constellation of five satellites, delays would be no more than 2 hours. In the near future, a more advanced mode of operation will be available. This mode will use a 406-MHz signal that can uniquely identify the source as well as provide amplifying information about the nature of the emergency. Increased power and a more easily generated waveform will allow position to be resolved to within 3 to 5 km.

#### 5.1.4 TRACKING BEACONS FOR EXPERIMENTAL DATA COLLECTION

Argos is a satellite-based data collection system that operates under the supervision of the French space agency, Centre National d'Etudes Spatiales, the National Oceanographic and Atmospheric Administration, and the National Aeronautics and Space Administration. Its primary purpose is gathering worldwide environmental data. Applications include tracking buoys used to monitor ocean currents and collecting data from a JHU/APL-developed bird-borne sensor package. The entire earth is scanned four times a day, and results are available at the Toulouse processing center in less than 6 hours.

Data are transmitted over the satellite repeater, receiving uplinks from sensor systems at the 401.65-MHz band and transmitting to the ground at 137 MHz. Platform location is determined by measurement of signal Doppler shift. Five Doppler measurements during a given pass are sufficient to attempt a location calculation. With very stable oscillators, location accuracy can be on the order of 150 meters. However, it is also possible to average positions over the course of several days to reduce the error to less than 100 meters.

#### 5.1.5 APPLICATION OF SATELLITE-BASED NAVIGATION TO ACN

It is clear that beacon tracking systems used for SAR and environmental monitoring are not able to provide location estimates accurately and timely enough for use by an ACN system. Furthermore, questions of access to these systems remain. The two other methods of geolocation using satellites, GPS, and mobile communication satellites have different advantages. GPS is able to provide 100-meter accuracy with a satisfactory update rate, but currently the unit cost is high. The cost is expected to drop into the \$200 range within the next 2 to 3 years. Blockage of GPS satellites by buildings, terrain, and foliage is also a concern. Techniques like the Tidget can address satellite blockage as well as the cost of GPS, assuming a base station is available to the EMS facility. The increase in the size of crash notification messages would be substantial but would not exceed the capability of most communication systems.

The strength of the mobile communication system geolocation lies in its cost. If a person has purchased a terminal for one of these systems, then at no additional cost, he will be able to obtain position estimates. These estimates can be made with



message transmission. Unfortunately, most of these systems have inaccuracies much greater than 100 meters (although they are acceptable in many cases). Accuracy may increase if the receiver has the capability to correlate multiple location fixes.

## 5.2 TERRESTRIAL-BASED NAVIGATION

This section discusses four systems. Loran-C and Omega are primarily marine navigation systems, Lojack is a vehicle security system. Cellular telephone-based vehicle tracking has a variety of applications including traffic flow monitoring.

### 5.2.1 LORAN-C

The Loran-C navigation system is a hyperbolic position-fixing system that operates at 100 kHz. It was originally developed in the 1940s by the U.S. National Defense Research Center to support all-weather long range precision navigation but it did not begin operation until the late 1950s. The system is composed of 24 transmitting stations (operated by the U.S. Coast Guard) across the U.S. as well as numerous stations around the world that cover the Atlantic and Pacific Oceans. Station locations in the U.S. are not only along the coasts but inland (e.g., Indiana, Nevada, and Oklahoma) to serve inland waterways and aeronautical and land mobile users.

A Loran-C line of position is typically determined in two steps. First, a coarse determination of position is obtained by measuring the difference in time of arrival of synchronized pulsed signals from two stations. Then, a fine indication of position is obtained by measuring the difference in phase of the synchronized 100-kHz carrier signal within the received pulses. Position accuracies are a function of geometry, ground wave propagation, and instrumentation errors in the transmitting and receiving systems. Over seawater, if propagation conditions are close to ideal, accuracies of 100 meters are possible. Due to irregular, inhomogeneous terrain propagation paths, the accuracy of Loran-C over land is poor. Errors can be up to 0.5 mile. Sources of interference that can limit system availability include power line radiation, lightning, and high power VLF communication systems.

In the most recent Federal Radio Navigation Plan, the U.S. Coast Guard is scheduled to discontinue operation of Loran-C in 2015. However, if market penetration of GPS is not as great as expected and the U.S. Government does not provide assurances that GPS will always be available to civilian users (even during national emergencies), operation of Loran-C stations may be extended.

### 5.2.2 OMEGA

Omega is a worldwide radio navigation system capable of providing hyperbolic position fixing by phase comparison of VLF signals. It was developed in the 1960s to satisfy the need for a global, all weather continuous navigation system,

There are eight Omega transmitting stations distributed worldwide. Each station transmits three consecutive 1-second long continuous wave pulses. Each pulse is transmitted at a different frequency (10.2, 11.33, and 13.6 kHz). They are transmitted, in turn, by each station every 10 seconds. These transmissions generate lines of constant phase between any pair of transmitters. Two pairs of transmitters can be used to obtain a position fix. Accuracies are on the order of 1 to 2 kilometers.

The Federal Radio Navigation Plan indicates that support for the Omega system is expected to end in 2005. However, due to large errors in position estimates compared to Loran-C and GPS, it is becoming less commonly used. Therefore, the Omega system may be phased out more rapidly.

### 5.2.3 AUTOMOBILE SECURITY SYSTEM

Lojack, Inc. is currently offering an automobile security system that can determine the location of an automobile if it is stolen. This system is actually a VHF beacon that can be turned on remotely and then tracked by direction finding equipment carried by police cruisers.

When an automobile is reported stolen, the VIN is entered into the state police criminal information network. This causes transmitters located at multiple sites around the state to send an activation signal to the Lojack device in the stolen automobile. Typically, transmitter sites are on towers owned by the state police and can be found along major highways. If the automobile is within range of any transmitter, it will begin transmitting a response that identifies the car to a Lojack receiver. Officers in specially equipped cruisers are guided to the vehicle if it is within a 25 square mile area centered on the cruiser. The special equipment includes a four-element antenna and a Lojack computer that determines a line of bearing to the beacon based on its transmissions at 173.75 MHz. The device in the automobile is chalkboard eraser size.

With a small modification to a Lojack in-vehicle unit, it would be possible to generate a beacon that would support ACN. Some modifications could reduce cost, such as eliminating the receiver that prompts Lojack transmissions. Other modifications include generating a crash notification message and perhaps operating on a different frequency.

### 5.2.4 CELLULAR TELEPHONE-BASED SYSTEMS

Cellular telephone transmissions can be used to determine a vehicle's location. One technique is to determine which cell or sector a vehicle is in using the existing cellular antennas and receivers. The proposed CDPD system will allow this. Unfortunately, a cell is usually too large to provide a useful location for an ACN system.

There is another technique that uses special direction finding antennas. KSI, Inc. has designed a system called the Direction Finding Location System, (DFLS). Signal phases from a three-element antenna array are used to determine a line of bearing to the mobile cellular transmitter. Measurements from two or three sites are needed to

determine a position. (Normally, two are sufficient, but if the mobile is near the line between the two sites, a third site is needed.) The expected bearing accuracy is 0.3 degree. The position accuracy depends on the actual geometry but is expected to be 150 feet at 5 miles. The antenna arrays could be installed at cell sites but would not have to be. Collocation at cell sites is probably the most economical placement. Unfortunately, mobile transmissions are not always received at two or three sites, so some additional locations would need to be instrumented. An estimate for equipping the entire Baltimore-Washington cellular area is between \$7 and \$15 million, depending on the number of callers that must be tracked. An ACN system, with only a few transmissions to track simultaneously, would be at the lower end, whereas a system that could track every caller would be at the higher end.

The advantage of such a system is that it does not require any additional geolocation equipment in the vehicle (other than the cellular telephone), reducing the per user cost. It also provides accurate position within the cellular coverage areas. If cellular telephones were used as the communication links, this system would provide an economical geolocation solution. The location information could also be used for other purposes at a slight cost, thus helping to pay for the infrastructure.

#### 5.2.5 APPLICATION OF TERRESTRIAL-BASED NAVIGATION TO ACN

The terrestrial navigation alternatives break down into the marine navigation systems and the automobile tracking systems. Of the two marine navigation systems, Omega's accuracy is not suitable for ACN. Also, the future operational status of Omega is in doubt. Loran-C has an acceptable accuracy and is currently lower in cost than a GPS receiver. Also, its lower operating frequency would provide better foliage penetration than GPS or the communication satellites.

There are issues associated with both automobile tracking systems. The Lojack system shows the potential for using direction finding equipment to locate automobiles. However, since it is assumed that police cruisers would be used for a beacon based ACN system also, coverage is expected to fluctuate greatly. The overall impact on reducing notification time is unclear. A direction finding network could be established, but it would require a significant investment in infrastructure. A cellular telephone-based tracking system would not have the accuracy required unless there is additional equipment added to the cell site as suggested by KSI.

#### 5.3 IN-VEHICLE NAVIGATION

Dead reckoning has been used as a means of navigation for hundreds, perhaps thousands, of years. Given an initial position, a path of travel can be recorded by noting the direction of travel and the distance traveled. As applied to a modern vehicle, the direction of travel can be determined using a compass or a gyroscope. The distance traveled can be determined using an odometer or wheel revolution counter. Both direction and distance could be obtained using a differential odometer that tracks the distance traveled by each wheel. Dead reckoning does not require any RF signals to be received or transmitted, relying solely on internal sensors.

Electronic compasses can correct for the differences between geographic and magnetic north and can correct for the perturbations in the earth's magnetic field caused by a steel vehicle. Accuracies to 0.5 degree are achievable, which can result in a positional error of 1/10 mile for 11 miles of travel. A company called KVH Industries, Inc. makes such a device for under \$200.

There are several types of gyroscopes including inertial, laser, and one used by Trimbal Navigation called a piezoelectric vibrating beam gyroscope. Gyroscopes must be initialized before use and will drift over time. Because of their adrift, positional errors will increase with distance traveled. They can cost from \$200 to \$100,000 with accuracy varying considerably.

Inertial navigation systems (INS) can be considered a form of dead reckoning. An INS uses gyroscopes and accelerometers to determine the path traveled. Because of the gyroscopes, most INS equipment is quite expensive.

Dead-reckoning systems suffer from two main drawbacks. First, the initial position must be known, and if a gyroscope is used, the initial heading must also be known. Second, their inaccuracies and drifts will cause positional errors to increase as distance is traveled, requiring periodic reinitializations of position and perhaps heading. For these reasons, dead reckoning alone is not sufficient for ACN. However, dead reckoning could be used quite effectively to provide near continuous vehicle location estimates between periodic position updates obtained from another navigation system.

#### 5.4 SUMMARY AND CONCLUSIONS

This section has examined a variety of satellite, terrestrial, and in-vehicle solutions for determining crash location. These are summarized in Table 5-1:

In general, the best accuracy is provided by GPS; however, unless its cost can be reduced through either larger volume of sales, technology, or offloading processing, it is currently too expensive to be considered a general solution for ACN. There are also issues associated with terrain and foliage blockage as described in Appendix F. Other systems, such as mobile communication systems or Loran-C, can provide lower cost but less accurate location estimates. Both Loran-C and little LEO satellite systems will use large antennas that are expected to be more easily damaged in a crash.

The accuracy of some radio navigation systems can be greatly enhanced by using relative navigation. This technique would require the responding EMS unit to carry the same geolocation equipment as the crashed vehicle. Since the equipment in the vehicle and EMS unit experiences the same propagation anomalies, the location estimate errors would be same. This permits the responding unit to align its geolocation to the local propagation conditions and virtually eliminate geolocation errors.

**Table 5-1 Navigation System Summary**

Option	Operating Frequencies	Coverage	Accuracy	Update Rate	Mobile Equipment Cost
GPS	1227 and 1575 MHz	Global	<100 m	<1 per sec	\$400 (\$100 for Tidget)
Mobile Communication Satellites	See Section 4	Same as Communication Coverage	>100 m	Every Transmission	None (assuming mobile terminal is already in vehicle)
GMDSS	121, 243, and 406 MHz	Global	10 to 20 km 3 to 5 km	Hours	\$200 \$1000
Argos	137 and 401 MHz	Global	150 m (Highly Stable Oscillators)	Hours	Specially <b>Built</b> Hardware
Loran-C	100 KHz	CONUS Atlantic and Pacific Oceans	Up to 1 km on land	>10 sec	\$200-400
Omega	10.2, 11.33, and 13.6 KHz	Global	>>1 km	>10 sec	\$30,000*
Lojack	173.75 MHz	25 mi <sup>2</sup> Box Centered on Police Cruiser Position	Line of Bearing Available to ±11°	N/A	\$595 (not modified for ACN)
Cellular Phone Based	824 to 849 MHz	Same as Cellular	To Within a Cell (unless using KS1 system: then 50 m at 8 km)	Every Transmission	None (assuming cellular telephone is already in vehicle)
Dead Reckoning	N/A	Global	<2% of Distance Traveled	<1 per sec	\$50-5000

Due to the advent of more accurate systems, no pure Omega systems are available. Cost represents Omega hybrids (with GPS)

## Section 6

### SUMMARY AND CONCLUSIONS

This document has considered system and technology alternatives for crash sensing, EMS notification, and vehicle location. This section summarizes the results.

#### 6.1 SENSOR SUMMARY

Devices considered for crash sensing included strain gauges to detect chassis deformation and inertial switches and accelerometers to sense deceleration force. Due to reliability, cost, or inability to measure g forces that could provide supplemental crash data, both strain gauges and inertial switches are not as appropriate for crash sensing as accelerometers. Of the eight accelerometers examined, two types are particularly well suited for ACN, the capacitive and the piezoresistive micromachined solid state devices. These devices both meet the performance requirements and are expected to be low cost when produced in significant quantities. They are already being used in automobiles to activate air bag systems.

If accelerometers are used to sense crashes, it is possible to determine the change in velocity resulting from the crash, which is the primary indicator of crash severity. In fact, change in velocity can be directly correlated with a specific level of injury. Multiple accelerometers can also be placed in a three-axis array to provide indication of vehicle rollover and direction of impact, which are both considered valuable supplemental crash data. Thus, three accelerometers can provide detection and critical supplemental data in a single low cost package.

Additional sensors can be added to provide other important supplemental data including number of occupants, use of restraints, and indication of fire. Although many of the sensors themselves are low cost installation may be expensive. Furthermore, there are still issues concerning data reliability. For example, sensors could be placed in the seats to use body weight as an indicator of occupancy, but this detector could be misled by other objects. To determine if any additional sensors should be added to the vehicle, the value of the supplemental data versus the cost of obtaining that data, both in terms of fiscal impact to the consumer and operational impact on EMS, should be evaluated.

## 6.2

### COMMUNICATION SYSTEM SUMMARY

A number of wireless communication system candidates that could support EMS notification were considered. These include GEO and LEO satellites; terrestrial (mobile and fixed) voice and data systems in the 220-, 450-, 800-, and 900-MHz bands; and CB radio. Taking into account both equipment cost and system coverage the two leading candidates are data-only little LEO satellites and the cellular telephone system. Both have reasonably priced mobile communications equipment that provide relatively broad coverage, but there are availability issues. The little LEOs can support crash notification anywhere in the U.S. (also have good foliage penetration capability). However, satellites are not always in view. Several minutes may pass before there is a satellite that can provide a link. Cellular telephone coverage is limited by the number of cell sites constructed. Although cellular telephone service is available to over 95% of the U.S. population, geographic coverage is expected to level off at 65% of CONUS. Other satellite systems can provide continuous coverage but are more expensive.

It is clear that there is no single communication system ideally suited for crash notification. Therefore, it is proposed that no single system be selected to support ACN. Instead, an open system architecture is recommended that allows any wireless communication provider to offer the ACN capability. Then, the market will decide the tradeoff between cost and performance. This will also increase competition, which will reduce overall costs, making ACN available to more users.

## 6.3

### NAVIGATION SYSTEM SUMMARY

The navigation systems considered fall into three categories: satellite, terrestrial, and dead reckoning. Satellite options included GPS and satellite communication systems that provide geolocation services, whereas research on terrestrial systems focused on marine navigation (Loran-C and Omega) and vehicle tracking technology. Dead-reckoning systems considered employed gyros, compasses, and differential odometers.

High accuracy and update rate distinguish GPS from other options. However, unless the receiver cost is reduced (it is expected to drop significantly in the near future), it is too expensive for general consumption by private automobile owners. There are also foliage and terrain blockage issues since GPS must have unobstructed access to multiple satellites. These issues could be addressed by using GPS in combination with dead reckoning. A lower cost but lower accuracy option is either Loran-C or using the geolocation capability of a mobile satellite communication system. These systems provide location accuracy suitable for many crash scenarios. Due to lower accuracy, problem scenarios include situations where the vehicle is not visible from the roadway and in areas where ambiguity due to the close proximity of two roads can occur. The mobile communication system option is particularly attractive because the equipment supports two functions.

CONCLUSION

This report indicates that there exist (or will soon exist) options that can support the crash sensing, EMS notification, and crash location functions. For example, a low-cost system could use a three-axis accelerometer integrated with an 8-bit microcontroller to sense the crash, obtain supplemental crash data (change in velocity, direction of impact, and indication of rollover), and assemble the notification message. A little LEG satellite could be used to transmit the message and determine the crash location. However, delays in EMS response could result from lack of satellite coverage at the crash location and searching by EMS because of inaccuracies in geolocation. Total equipment costs are expected to be under \$500 and perhaps less than \$300.

GPS could be added to the ACN system to improve accuracy and thus decrease search time. In the near future, this would increase system cost by \$200. Cellular telephones could also be used in place of the LEOs. This option offers decreased notification time with no significant change in cost. However, if the crash occurs outside cellular coverage, no message can be sent. Note that a demonstration system that integrates existing technologies (accelerometers, a GPS receiver, and a cellular telephone) was assembled to illustrate system operation. It is briefly described in Appendix G.

It is clear that a variety of solutions is possible. What is not clear is which solutions are best. For instance, if a vehicle already has a cellular phone, is it better to add a sensor/processor unit and a GPS navigation system to the vehicle or should the low-cost LEO satellite-based system described above be employed? The answer depends not only on cost but also on the additional utility provided to the individual. If an individual desires to have a highly accurate navigation capability for some other purpose, the GPS solution would be more attractive. If low-cost messaging were desired, the LEO satellite terminal option could be selected. Since the proper solution depends on the individual, an ACN system design should not be limited to one technology. Different technologies that can fulfill the functional requirements of crash notification should be available. This will allow the market to make the cost-benefit tradeoff.

To accomplish this, it is desirable for an ACN system to have an open architecture that has standardized component functions and interfaces but does not restrict the specific equipment used to support the function. This implies the following needs:

1. Standardize interfaces between in-vehicle components
2. Define a crash notification message format
3. Modify EMS infrastructure to permit common access
4. Establish end-to-end technical performance requirements

Standardization of interfaces between in-vehicle equipment will allow different sensor, navigation, and communication systems to be employed. The key device is the processor that connects to all the component systems. Advanced vehicular electronic systems that support engine operation as well as other M-IS functions will drive the need for microprocessors and an electronic bus in automobiles<sup>1</sup>. Therefore, ACN interface



standards development may be focused on integration into future automotive electronic systems. The crash notification message format should be defined so that it can convey a variety of data. The content of the message will depend on the sensors available in the vehicle and the method of vehicle crash location. Consideration must also be given to other IVHS functions that have similar data requirements. The EMS infrastructure must provide a common access point to a wide range of communication systems. To minimize the cost (economically or procedurally) borne by individual counties,, message clearinghouses at the state, regional, or national level may have to be established. These clearinghouses could also support other emergency notification and personal security functions as shown in Figure 6-1. Finally, overall system level requirements must be defined so that individual component performance specifications can be determined. For example, upper bounds on overall notification delay will provide a time budget for communication service providers.

By promoting an open architecture, it will be possible to offer private citizens a variety of emergency and security services at low cost that will enhance travel over the nation's roadways.

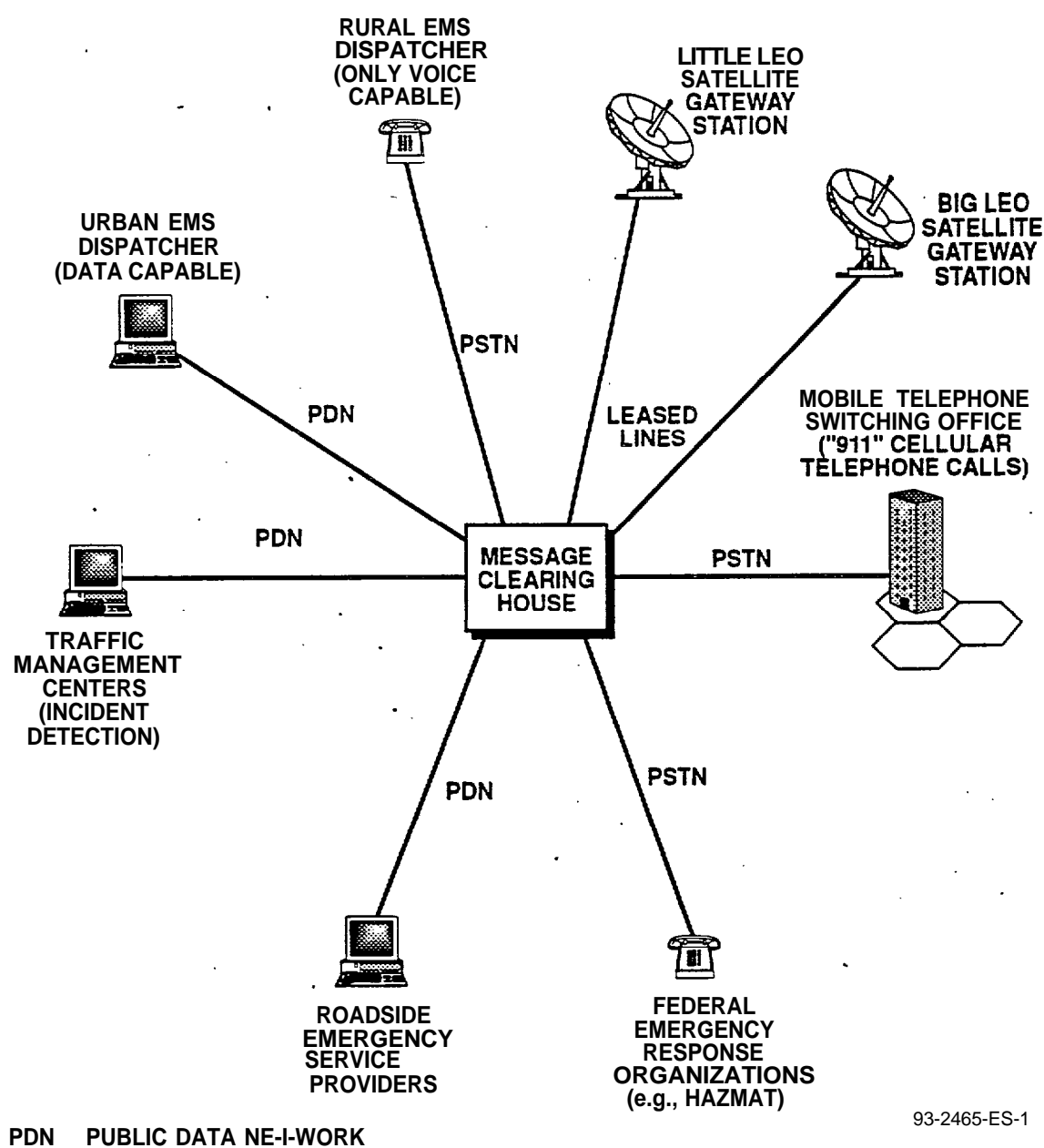

**Figure 6-1 Example of Message Clearinghouse Connectivity**

## Appendix A

### **BIBLIOGRAPHY**

***Aviation Week and Space Technology***, January-November 1993.

Associate Staff Training Program. 1992, "The Automatic Mayday System," JHU/APL, 1992.

"Crash Injury Prediction Model," William L. Carlson, ***Accident Analysis and Prevention***, Volume 11, Pergamon Press Ltd., Great Britain, 1979.

"Effects of Local and \*Skywave Interference on CB Radio Range," National Telecommunications and Information Administration, May 1978.

***Electronics Industry Association Standards for Cellular Telephones.***

***Electronic Surveying and Navigation*** Simo H. Laurila, John Wiley & Sons, 1976.

***Fixed and Mobile Terminal Antennas***, A Kumar, Artech House, 1991.

***Handbook of Transducers for Electronic Measuring Systems***, Harry N. Norton, Prentice-Hall, Inc., Englewood Cliffs, NJ, 1969.

***IEEE Communications Magazine***, November 1991 and October 1992.

***IEEE Spectrum***, March 1984 and August 1985.

***IEEE Transactions on Aerospace and Electronic Systems***, Vol. 29, April 1993.

***IEEE Transactions on Vehicular Technology***, Vol. 40, February 1991..

***Mobile Information Systems***, John Walker, Artech House, 1990,

"National Intelligent Vehicle Highway System Program Plan," Draft.

***Official Cellular Roaming Handbook***, 11th Edition.

***Proceedings of the American Institute of Aeronautics and Astronautics 14th International Communication Satellite Systems Conference and Exhibit***, March 1992.

"Recommendations and Reports of the International Radio Consultative Committee (CCIR) 1992," ***International Telecommunication Union***, Vols. 5 and 8.

“Role of the Citizens Band Radio Service and Travelers Information Stations in Civil Preparedness Emergencies,” System Development Corporation, May 1978.

“VHF-FM Emergency Position Indicating Radio Beacon,” U.S. Department of Transportation, October 1978.

**Space** News, June-August 1994.

**The 1992 World Administrative Radio Conference: Technology and Policy Implications**, U.S. Congress Office of Technology Assessment, May 1993.

**Traffic Safety Facts** 2992, U.S. Department of Transportation, National Highway Traffic Safety Administration, 1992.

**Transducer Handbook, User's Directory of Electrical Transducers**, H.B. Boyle, ISBN 0 7506 1194 4, Butter-worth-Heinemann, 1992.

Product literature and/or discussions with individuals from the following organizations:

Allen Telecomm, Cleveland, OH  
American Mobile Satellite Corporation, Washington, DC  
Analog Devices, Morwood, MA  
Ardis, Lincolnshire, IL  
Associated Public-Safety Communications Officers, Inc., South Daytona, FL  
Audiovox, Long Island, NY  
Bell Atlantic, Bedminster, NJ  
Capacitec, Ayer, MA  
Cellular Business Magazine, Overland Park, KA  
Cellular One, Greenbelt, MD  
Cellular Telecommunication Industry Associates, Washington, DC  
Comsat, Clarksburg, MD  
Dallas Instruments, Inc.; Dallas, TX  
E. F. Johnson, Minneapolis, MN  
Electronics Development Corporation, Columbia, MD  
Enmet, Analytical Instruments, Ann Arbor, MI 48106.  
Etak, Menlo Park, CA  
Federal Communication Commission (Mobile Services Division),  
Washington, DC  
Fiberchem, Inc., Las Vegas, NV  
Fleet Call, Los Angeles, CA  
Fluke Corporation, Evertt, WA  
Garmin, Lenexa, KA  
GEC-Marconi, Holmdel, NJ  
General Motors (Delco Division), Kokomo, IN  
IC Sensors, Milpitas, CA  
IIMorrow, Salem, OR  
Interdigital, King of Prussia, PA  
Kistler Instrument Corporation, Amherst, NY

KSI, Inc., Annadale, VA  
Lojack Corporation, Dedham, MA  
Magnavox Electronic Systems Division, Torrance, CA  
Micrologic, Chatworth, CA.  
Motorola, Schaumburg, IL, Chandler, AZ and Austin, TX  
Murata Erie North America, Smyrna, GA  
Naysys, Colorado Springs, CO  
Nextel, Los Angeles, CA  
Nippon Automation Co., Ltd., Adsens Tech. Inc., La Puente, CA  
Nissan, Gardena, CA  
Omron Electronics, Inc., Schaumburg, IL  
Orbital Sciences Corporation, Fairfax, VA  
Physical Measurement Devices, Melbourne, FL  
Pinpoint Communications, Inc., Dallas, TX  
Qualcomm, Inc., San Diego, CA  
RAM Mobile Data, New York, NY  
Sensotec, Columbus, OH  
Sparton Electronics, Inc., Chicago, IL  
Starsys, Lanham, MD  
Teledesic Corporation, Kirkland, WA  
TRS Communications, Phoenix, MD  
TRW, Redondo Beach, CA  
Uniden, Fort Worth, TX  
United States Coast Guard (Radio Navigation Division), Wash&ton, DC  
Westinghouse, Baltimore, MD .

## **Appendix B**

### **IN-VEHICLE SYSTEM ARCHITECTURES TO MINIMIZE FALSE ALARMS**

To address the issue of false alarms, not only can appropriate thresholds be set for individual sensor systems, but also the system architecture can be designed to minimize the opportunities to generate false alarms. Methods of minimizing false alarm rate are a system arming mechanism, automated detection of faulty sensors, and manual deactivation. These methods attempt to eliminate single point failures that will allow a false crash notification message to be sent. The arming mechanism uses multiple sensors so that no one single sensor is responsible for crash detection. The automated detection of faulty sensors allows the processor to determine if there is improper operation by any single sensor. Manual deactivation allows a user to cancel a request for assistance if a false alarm has occurred. These methods address a straightforward approach to eliminating single point failures. However, through the use of redundant sensors, it is possible to design another level of complexity into the system so that it will not only limit false alarms but also exhibit no loss in capability due to any single point failure.

#### **B.1 ARMING MECHANISM**

Some sensors can be dedicated to arming the ACN system. For example, under normal driving conditions g loads greater than  $\pm 2$  g are not normally encountered. Therefore, the system could be armed only if accelerations greater than  $\pm 2$  g are measured. With the arming sensors, false readings from any other sensors will not cause a false alarm. A similar technique is used in current air bag systems.

#### **B.2 DETECTION OF FAULTY SENSORS**

In addition to the arming system, sensor validation checks must be used to identify faulty sensor readings. A bad sensor reading can be generated by several sources. Therefore the sensors, the wiring and connections, signal conditioning, the power supply, and the data acquisition system must be checked. Both steady state and transient data can be used for sensor validation.

A variety of sensor validation techniques is used to analyze steady state data. The simplest is a limit check. Each sensor will have limitations on valid outputs. Any reading outside these limits clearly indicates a failure in the sensing system. Another technique monitors the sensor for outputs that should not occur given a normal operating environment. For example, if an accelerometer periodically indicates a 10 g deceleration, it is likely that the sensor is not operating correctly. Sensor outputs will also

have a noise level threshold. Wildly varying signals usually do not have any credible physical cause.

The more sophisticated sensor validation techniques, such as analytic redundancy, require greater knowledge about the expected relationships of the various sensors. These relationships may be temporal (high g loadings on multiple accelerometers should occur at the same time); spatial (redundant pairs of accelerometers should give the same acceleration vector), or physical (a 30-g acceleration spike cannot occur in less than 10 milliseconds). These techniques assume that there is overlap in the measurement of some of the parameters. Analytic redundancy techniques can be used to obtain sensor validation without the expense of additional redundant sensors.

The analysis of transient sensor data requires a model of the vehicle and how it responds to inputs. For example, the shape of the measured g-loading curve during a collision can be compared to expected profiles (Figure B-1). A step change in velocity would indicate a sensor failure whereas a ramped change is more compatible with the physics of a crash. These models can be derived either analytically or experimentally.

In actual applications, sensor validation logic is applied in two modes, continuous monitoring and post-crash analysis. By continuously monitoring sensor health, the system can warn the vehicle operator that a sensor system failure has been detected, much like the warning lights now used to indicate air bag or anti-lock brake system failures. After the ACN system has been armed by a detected collision, sensor validation of the crash data is performed before a call for help is initiated. If a hardware failure is identified either no call for assistance will be initiated, or an amended message may be sent, depending on the failure.

#### B.4

One feature that should be included in an ACN system is a manual override that can either deactivate the system before a crash notification message is sent or can send another message to inform a dispatcher that emergency medical services are not required. This would be used in crashes where the occupants are not injured or in instances where the system may have been incorrectly activated and no collision has occurred. The processor must inform the occupants that it is attempting to send a crash notification message. Great care will have to be taken to ensure that this manual deactivation signal is not accidentally initiated during a crash. For example, two switches activated in the proper sequence could be used to ensure that the signal is not sent due to passenger movement and/or vehicle deformations that occur during a crash.

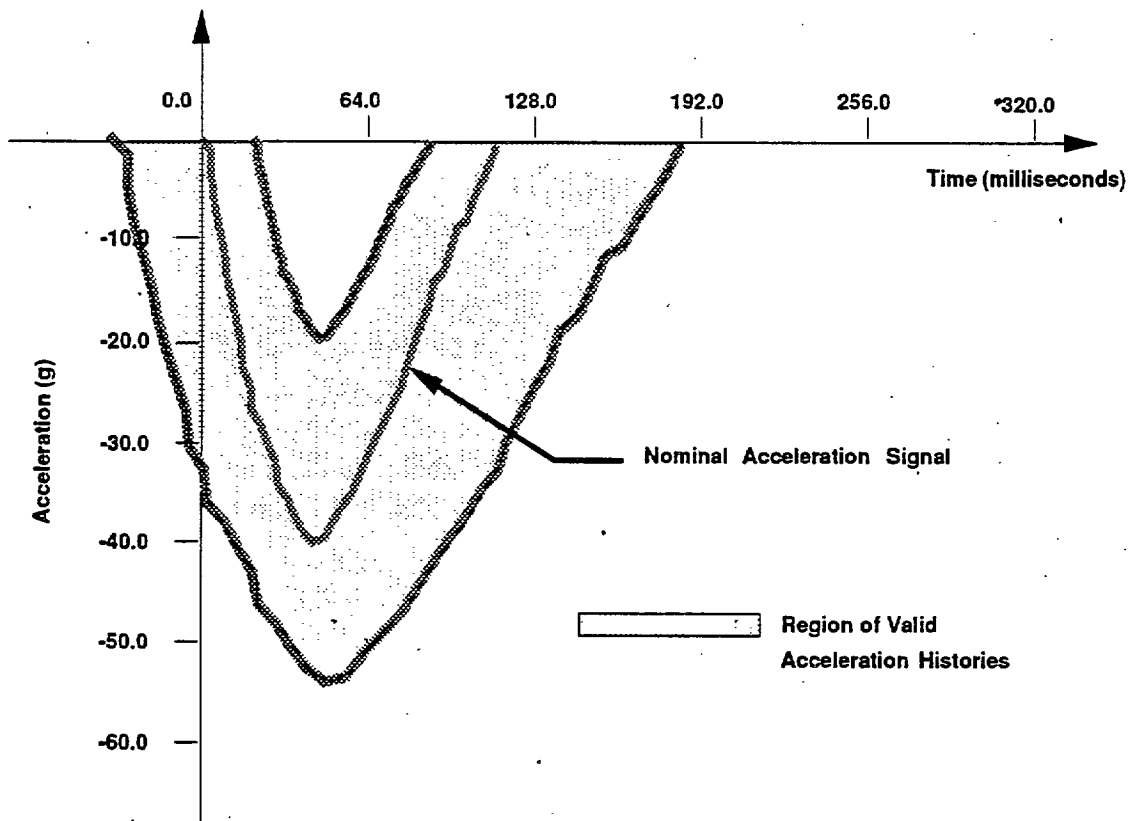

**Figure B-1 Region of Acceptable Measured Acceleration Histories**



## Appendix C

### **SUPPLEMENTAL CRASH DATA**

This appendix summarizes efforts to identify data that should be sent to an EMS dispatcher in addition to vehicle location. Section C.1 examines the correlation between injury severity and crash severity. Then, Section C.2 summarizes discussions with local firefighters and rescue personnel about types of information that are most helpful in dispatching the appropriate resources to the scene of a crash. The outcome of the analysis in these two sections is a list of prioritized crash parameters that should be included in a crash notification message.

#### **C.1 CORRELATION BETWEEN CRASH AND INJURY SEVERITY**

Studies conducted for NHTSA and other automobile safety organizations have correlated measurable vehicle crash parameters with expected occupant injuries. For example, Carlson conducted a study (Reference C-1) in 1980 that provided a comprehensive examination of all possible injuries resulting from a vehicle crash. The crash parameters included in the study were Delta-V (i.e., equivalent barrier velocity), occupant seating (whether driver or passenger), use of restraints (belted or unbelted), age of the occupant, and weight of the vehicle. The parameter being measured was the expected injury level measured in the Abbreviated Injury Scale (AIS). The AIS is a standard injury scale ranging between 0 and 6. It is used to rate severity of injury for trauma victims.

The study conducted by Carlson correlated the measurable parameters stated above to an expected AIS injury level by the use of a linear regression model. The injury model was produced by analyzing reports of crashes. Figures C-1 through C-5 are samples of the regression model he developed to predict the amount of occupant injury. Before reviewing the figures, it should be noted that this information is presented only as a guide to rank the measurable crash parameters. Several problems with the analysis prevent it from being used as an accurate guide to predict occupant injury. Primary among them is that the AIS scale is an ordinal scale, meaning that an injury can be scaled only as an integer value between 0 and 6; a score of 1.4 is not admissible. For this reason, a linear regression model is not a valid way to analyze data. Carlson was quick to point this out in his analysis, adding that the study was meant for a qualitative view at the factors involved in occupant injury rather than quantitative view of predicting injury. The results of his injury prediction model are used to determine the relevance of crash parameters. Other problems with the study result from its age. Since it was conducted in 1980, it does not include the effect of airbags, nor does it reflect the results of recent efforts in vehicle structure design to protect occupants in the event of a crash. The former would add another variable to the equation, and the latter would probably shift the curves to the-right but not meaningfully change their shape.

## Expected AIS vs Delta V for 30 Year Old Restrained Driver

C-2

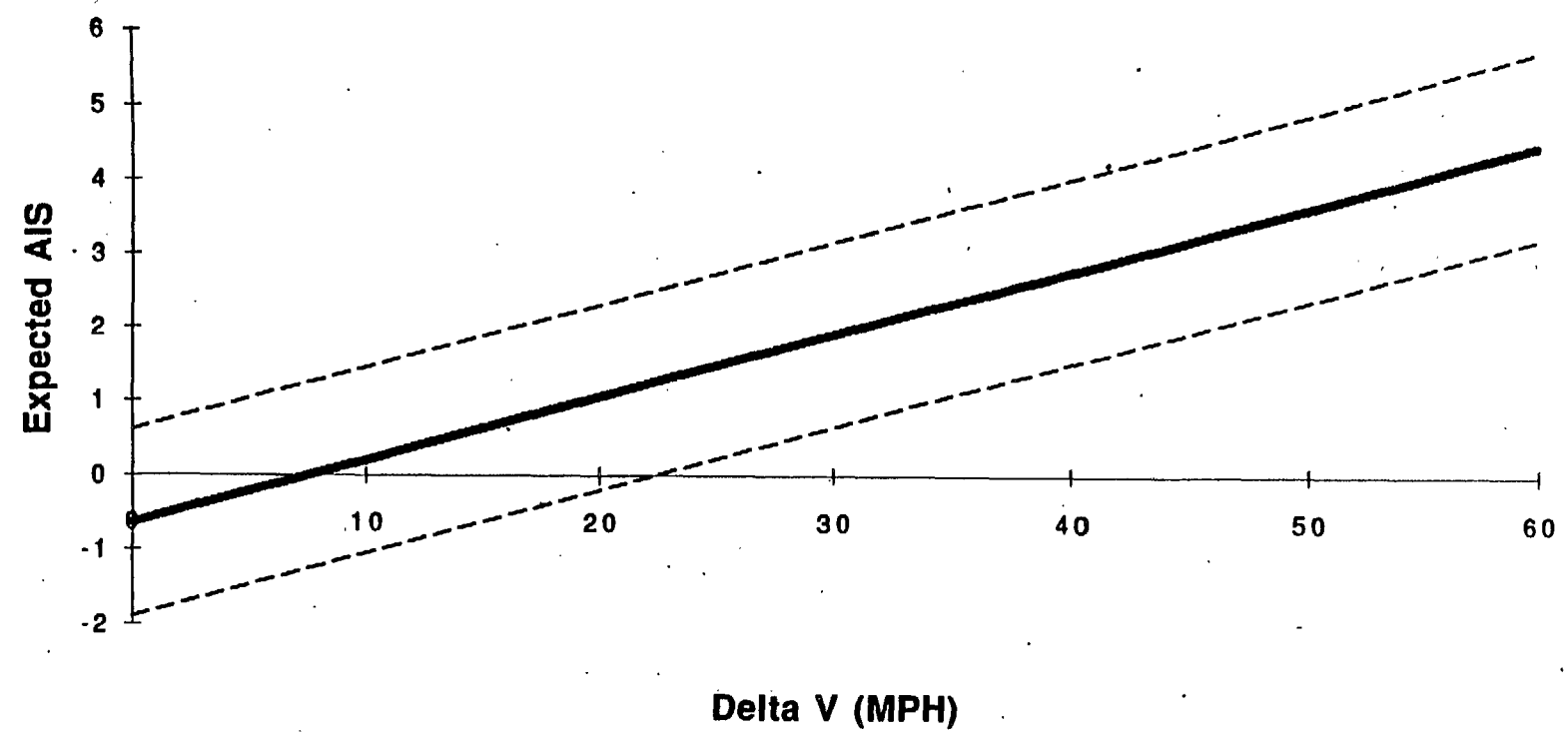

Figure C-1 Expected Injury Severity for a 30 Year Old Restrained Driver in a Frontal Collision

Figure C-1 depicts the expected level of injury for a 30-year-old belted driver in a frontal impact collision as predicted by Carlson's linear regression-model of occupant injury. Delta-V is the most critical factor in determining, or predicting, occupant injury. The plots of the standard deviations (dashed lines) seem to indicate that injury severity can only be predicted to within + or - 1 AIS level with a reasonable level of confidence. However, it must be noted that a linear regression model was used to fit an ordinal scale, and therefore the standard deviation may actually be inflated. Also, the data from which the model was derived were collected by observation after the crash rather than from direct measure and may therefore contain error themselves.

Figure C-2 depicts the change in the regression model as a result of not using a restraint device (seatbelt). The curve shifts nearly one standard deviation above the regression model for a restrained 30-year-old driver. Use of seatbelts proves to be the second most important factor in estimating severity of injury. Other parameters such as seating position, vehicle weight, and age of occupant have significantly less effect in predicting injury. These are shown in Figures C-3, through C-5, respectively. In each, the linear regression model for the specific scenario is plotted alongside the regression model for the 30-year-old restrained driver. In all three cases, the change in the regression model is less than one half of a standard deviation shift.

The vehicle weight category is 'somewhat misleading. Intuition leads to the conclusion that the heavier the vehicle, the safer the occupant in the event of a crash. However, the advantage is gained by the size of the vehicle in comparison to the other vehicles in the crash. The laws of momentum dictate that, in a collision, the heavier vehicle will experience less of a velocity change than the smaller vehicle, thus providing a better chance of survival for its occupants. Also, larger vehicles typically provide greater protection from intrusion of obstacles than smaller vehicles. Figure C-4 indicates that, in a collision, a heavier vehicle does not provide significantly more protection than a lighter vehicle experiencing the same Delta-V.

The conclusions that can be drawn from Carlson's study is that the primary indicator of injury severity in a vehicle collision is the EBV of the impact followed by an indication of the use of seatbelts. Other factors such as the seating position, age of occupant, and vehicle weight, - although elements, do not contribute significantly in predicting the level of injury. Since this study was conducted in 1980 prior to the proliferation of airbags, additional studies would be warranted to determine their affect in predicting injury severity. Also, a current study similar to Carlson's but using current data on late model cars and including the effect of airbags would serve as a basis to calibrate the ACN system.

## Change in AIS for Unrestrained Driver

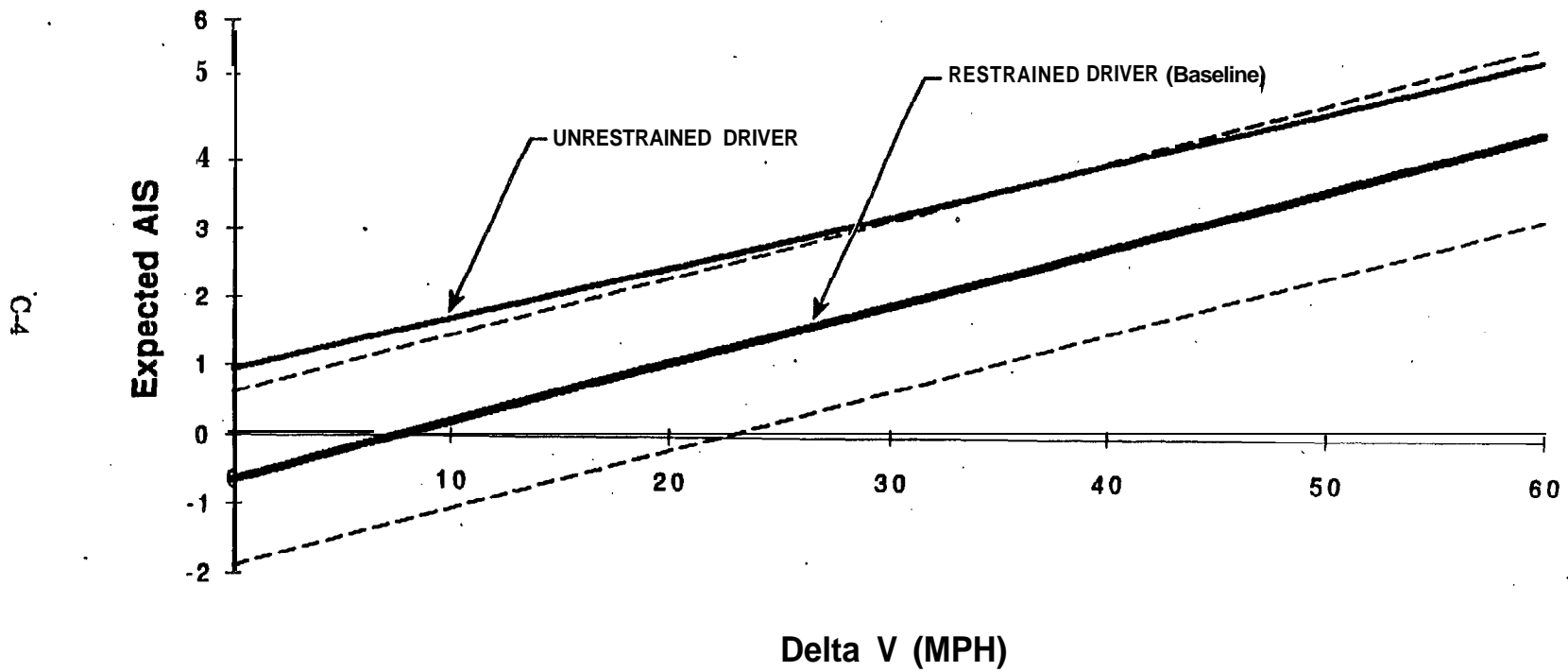
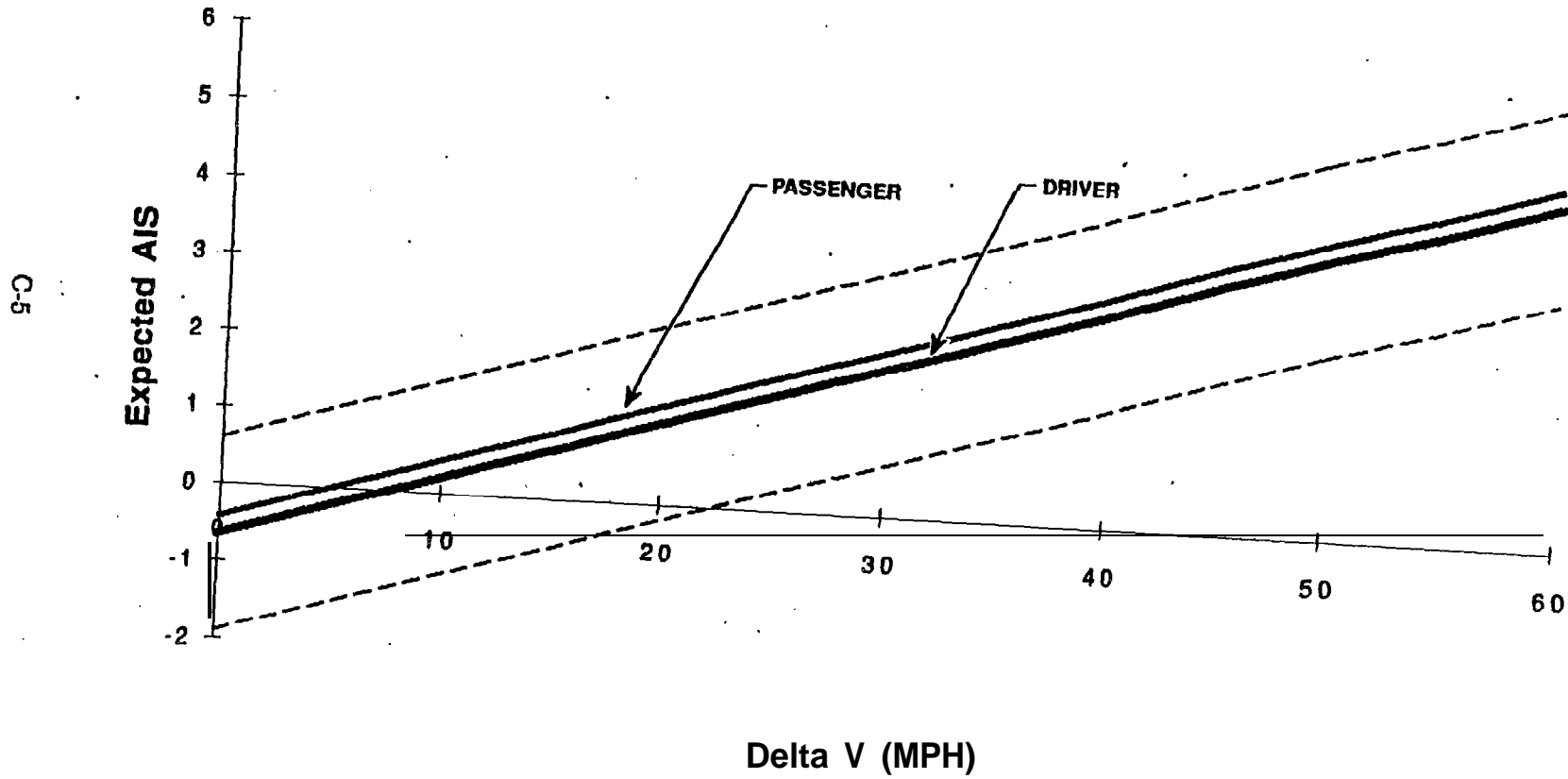

Figure C-2 Change in Expected Injury Severity for an Unrestrained 30 Year Old Driver in a Frontal Collision

### Change in AIS for Passenger



**Figure C-3 Change in Expected Injury Severity for a 30 Year Old Passenger in a Frontal Collision**

## Change in AIS for Heavy Vehicle

C-6

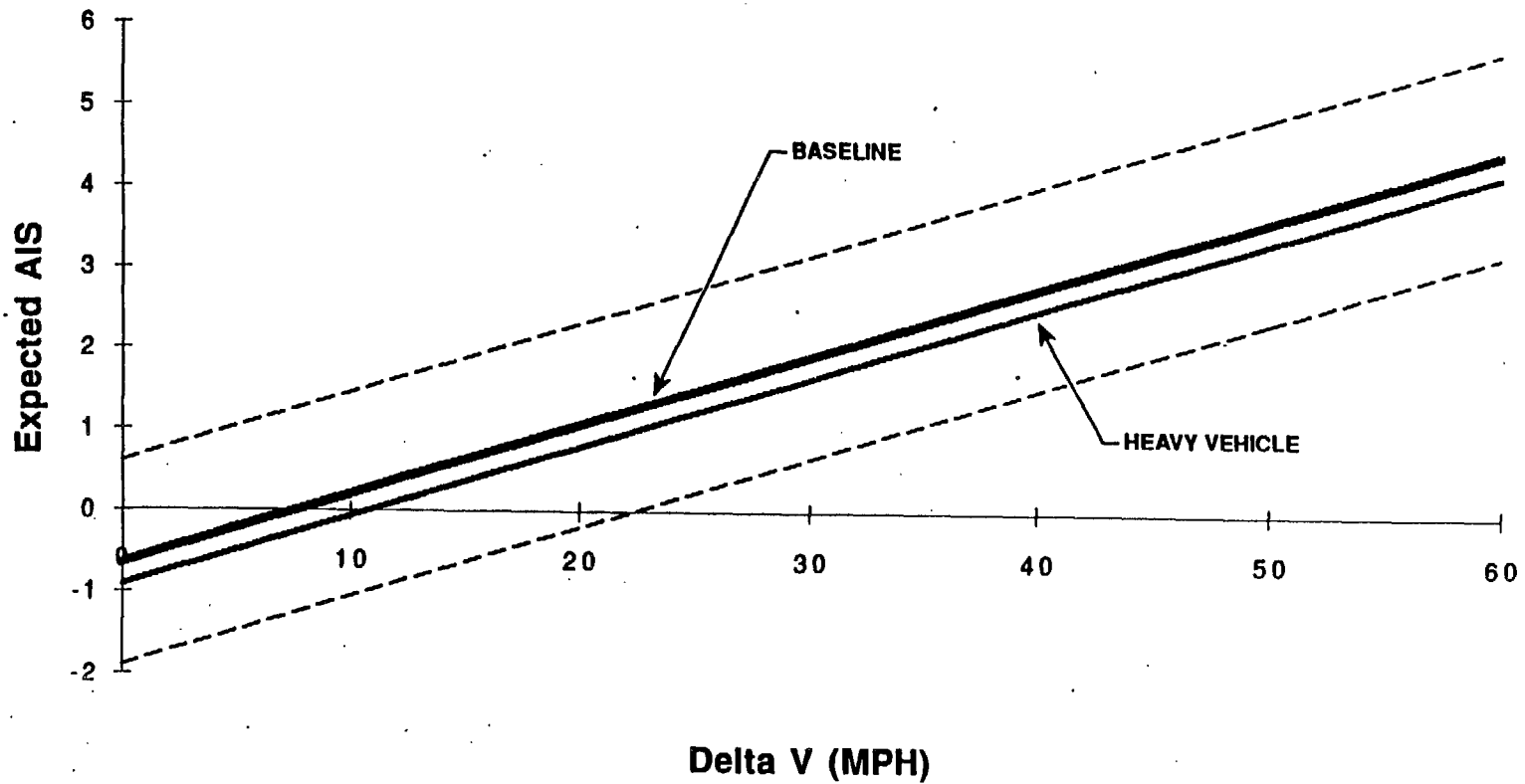

Figure C-4 Change in Expected Injury with a Heavier Vehicle: The second regression line represents the expected level of injury for a 30 year old driver in a heavy weight class vehicle.

## Change in AIS with Age

C-7

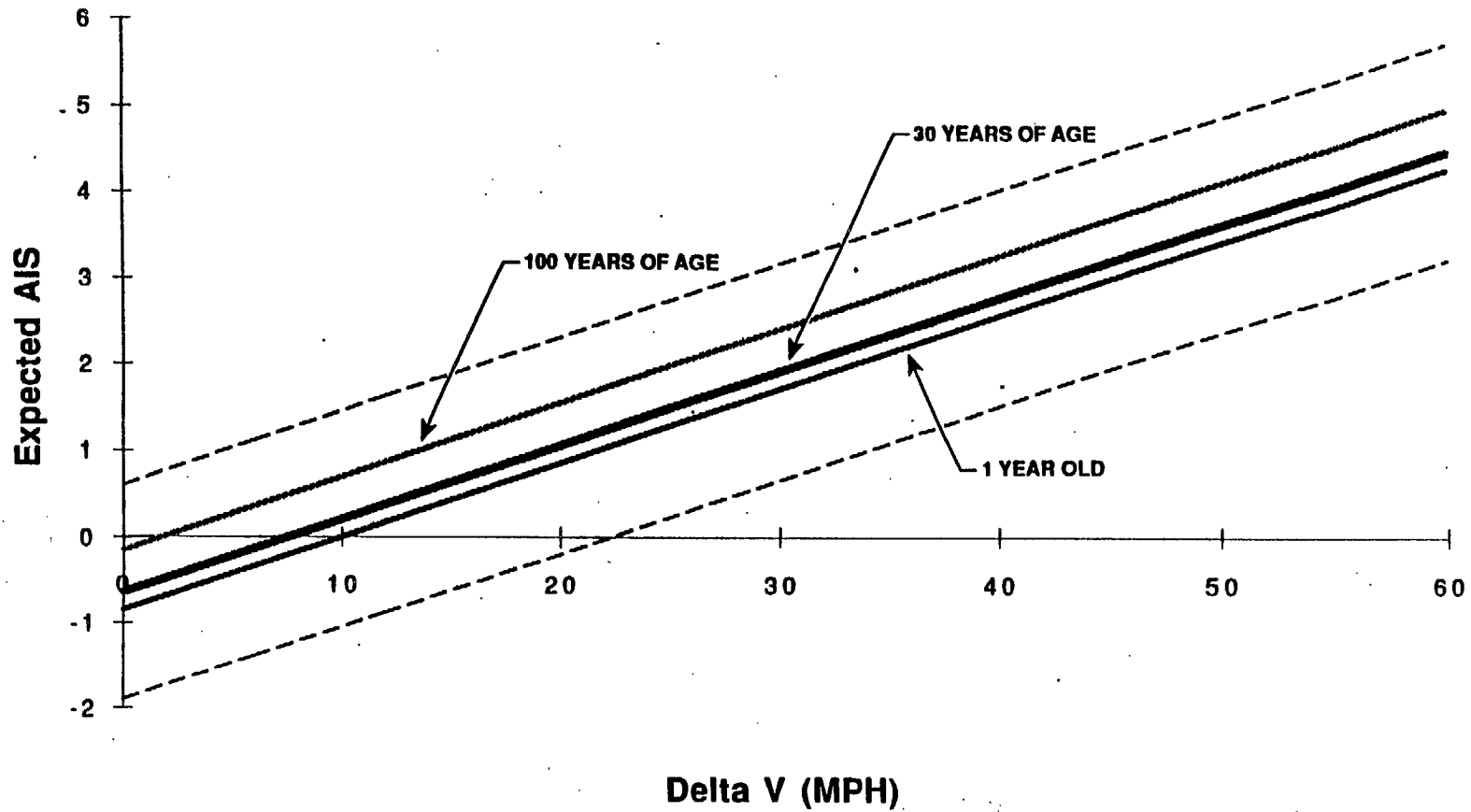

Figure C-5 Range of Expected Injury versus Age for a Frontal Impact

## C.2

### DATA REQUIRED BY EMS PERSONNEL

Discussions with local firefighters and rescue personnel provided additional insight into the relative importance of different types of data that can be reported. Of most concern was the number of people requiring medical attention since it directly impacts the number of ambulances dispatched to the scene. When these personnel were queried about other parameters, such as extent of injury, possibility of fire, and need for specialized rescue equipment, their responses indicated that, at present, rescue personnel receive very little information prior to arriving at the scene of the crash. The following remarks are condensed from discussions with Howard County, Maryland, firefighters and rescue workers. Although it represents only one county's perspective, it reveals problems and concerns shared by many EMS providers.

When a crash is reported in Howard County on a road other than an interstate highway, the first response is to dispatch a police unit to the scene to assess the situation. If the police deem that medical assistance is warranted, they call for either fire, ambulance, or paramedic support. If a crash is reported on an interstate highway, a full rescue team is immediately dispatched, assuming that the crash occurred at highway speeds. The reasons for this approach include lack of information in the original report, the large volume of crash reports, and limited EMS resources. It is rare that enough information is provided by the person reporting a crash to decide on the amount or type of resources to dispatch. The crash reporter is typically a passerby that only observes the aftermath and not the actual crash itself. Without detailed knowledge of the collision, he simply reports the occurrence of a crash at a given location. This, combined with the large number of crash reports, prohibits the dispatch of fire and rescue squads until the severity of the crash is verified. Verification is usually provided by police because they can typically arrive on the scene quickly from patrol routes. However, injury severity is rarely provided when the police are responding to a vehicle crash.

Vehicle rollover is a special case of the crash reporting problem. Rollover crashes are typically more severe and require specialized rescue equipment to extract the victims. This equipment exists only on special units. A typical scenario is that police are dispatched to the scene of a crash and call for an ambulance because the vehicle occupants are injured. The ambulance personnel arrive only to discover that they cannot extract the victims due to structural damage to the vehicle. A special rescue unit must then be dispatched carrying the needed tools (i.e., hydraulic cutters such as the 'Jaws of Life' as well as stabilizing devices in case the vehicle is resting in an unstable position). The firefighters and rescue personnel confirmed the importance of knowing injury severity and indication of rollover since they are primary factors in determining the type of EMS resources needed at the crash scene. It should be noted that in current reporting and dispatching procedures, this information is not available.

Detection of a vehicle fire, although not directly related to occupant injury, is frequently cited as a possible supplemental crash data element. However, discussions with rescue personnel revealed that, although fire is a potential threat, knowledge of a vehicle fire does not significantly alter a rescue unit's procedures. Most rescue vehicles are equipped with extinguishers, and the challenge is to arrive at the scene in time to combat the blaze before it engulfs the occupants.



Overall, the discussions with the firefighters and rescue workers indicated the urgency of knowing the number of people involved in the crash. 'An ambulance can only carry two victims; therefore, an indication of the number of expected victims directly determines the number of ambulances dispatched to the scene. Also, any indication of the extent of occupant injury is better than what is currently available. Vehicle rollover is important since it typically requires special rescue equipment not carried on all rescue vehicles. Lastly, fire detectors do not serve much of a utility since fire does not alter the response of the rescue team but only increases the necessity to arrive at the scene in a timely fashion.

## **REFERENCE**

- C-1. "Crash Injury Prediction Model," William L. Carlson, ***Accident Analysis and Prevention***, Volume 11, Pergamdn Press Ltd., Great Britain, 1979.

## Appendix D

### **CRASH SENSING USING ACCELEROMETERS**

Since solid state micromachined capacitive and piezoresistive accelerometers are primary candidates to support the crash detection function, this appendix describes the results of tests performed to characterize the operation of representative samples of these sensors. Testing included shaker table tests, normal driving characterization, and performance during simulated collision conditions. The test results amplify some of the critical aspects of crash detection and develop the basis of a crash detection algorithm by characterizing the difference between normal driving accelerations (including those caused by such things as hard braking and running over potholes) and accelerations experienced during collisions. The use of accelerometers to determine velocity change is also demonstrated.

#### D.1 ACCELEROMETER EVALUATION

Prior to performing in-vehicle tests, it was necessary to determine the accuracy of the accelerometers. This was accomplished in two stages. First, an accelerometer was placed on a shaker table in the environmental test lab at JHU/APL and tested under various known acceleration levels.

Two series of tests were performed. The first series of tests employed single spike (impulses generated by a half cycle of a sinusoid) accelerations of 15, 30, and 50 g to simulate accelerations that might be experienced during a crash. The second series of tests examined the outputs of the accelerometers during sinusoidal accelerations to determine the repeatability of the measurements from cycle to cycle.

The type of accelerometer tested was an Analog Devices ADXL50. It is a capacitive device constructed on a single monolithic integrated circuit chip. It has a range of +/- 50 g, an internal amplifier that allows the user to adjust sensitivity and 0-g level, and a low pass filter to reduce noise. These accelerometers currently sell for \$85 each, but the cost is anticipated to decrease to \$5. Because the development of the ADXL50 is relatively recent, the accelerometer tested was a preproduction sample.

For the testing, the accelerometer was calibrated to read 0 g at 2.6 volts, -50 g at 0.35 volt, and +50 g at 4.85 volts. It was attached (epoxied) to a specially designed aluminum mounting fixture that provided rigidity during accelerations. The low pass filter bandwidth was set to 1 kHz.

The single spike tests, were designed to simulate the acceleration levels that might be experienced during a crash. Reference D-1 shows the deceleration experienced by a four-door sedan traveling at 35 mph that collides with a concrete barrier. The deceleration peaks at -24 g and has a half-cycle duration of 130 msec. Due to constraints in the travel distance of the shaker table, it was only possible to obtain high g loading for half-cycle times on the order of tens of msec. The actual half cycle times for the tests are as follows: 20 msec for the 15-g spike, 13 msec for the 30-g spike, and 8 msec for the 50-g spike. These conditions are more severe than would be experienced in an actual crash, since they require faster response times from the accelerometer. The measured peak accelerations recorded during the testing are listed in Table D-1. The table indicates that the accelerometer performed satisfactorily.

**Table D-1 Single Spike Peak Accelerations**

Nominal Acceleration (g)	Measured Acceleration (g)	Error (%)
15	16.2	8.0
30	31.0	3.3
50	50.0	0.0

Figures D-1 through D-3 compare the ADXL50 measurements with the measurements made by a high precision (and relatively expensive - \$2000) accelerometer (Piezotronics PCB Series 353) mounted on the shaker table. For the 15-g test shown in Figure D-1, the two accelerometers tracked each other very well. The ADXL50 measured a slightly higher peak than the Piezotronics instrument. Still, the peak error was only 11% from the Piezotronics accelerometer reading of 14.6 g. In the other two tests, the Piezotronics accelerometer saturated at its peak of 20 g. However, below 20 g, the two accelerometers tracked very well. Note that the shaker used to generate the large acceleration pulse has a low amplitude sine wave that precedes the pulse and a slightly higher amplitude overshoot that follows the pulse.

Although the ADXL50 outputs matched the Piezotronics measurements well, there is substantially higher noise levels in the ADXL50 data for all three single spike tests. Characteristics of the noise (peak and root mean square error) for the first 0.04 sec of single spike testing are illustrated in Figure D-4 and listed in Table D-2. Note that the ADXL50 outputs were slightly biased by approximately +0.5 g. This offset was taken into account in the noise characterization.

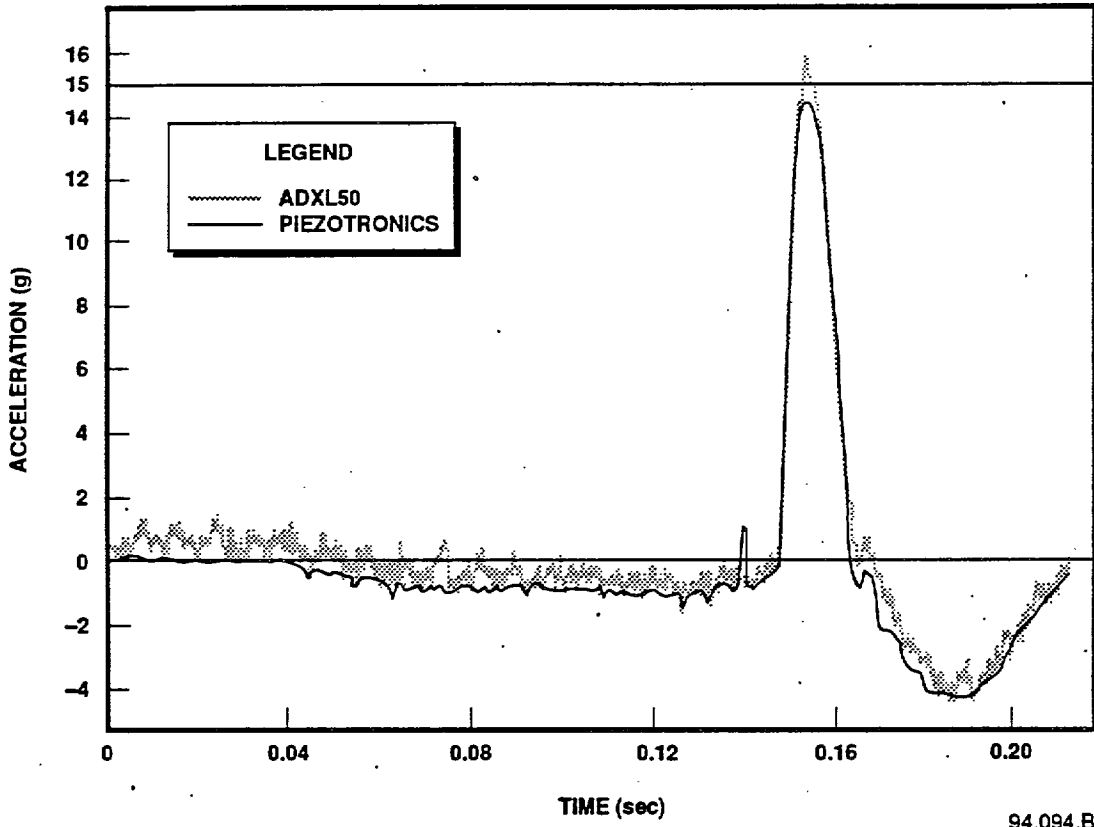

94.094.B-1

Figure D-1 ADXL50 Shaker Test (15 g, Spike)

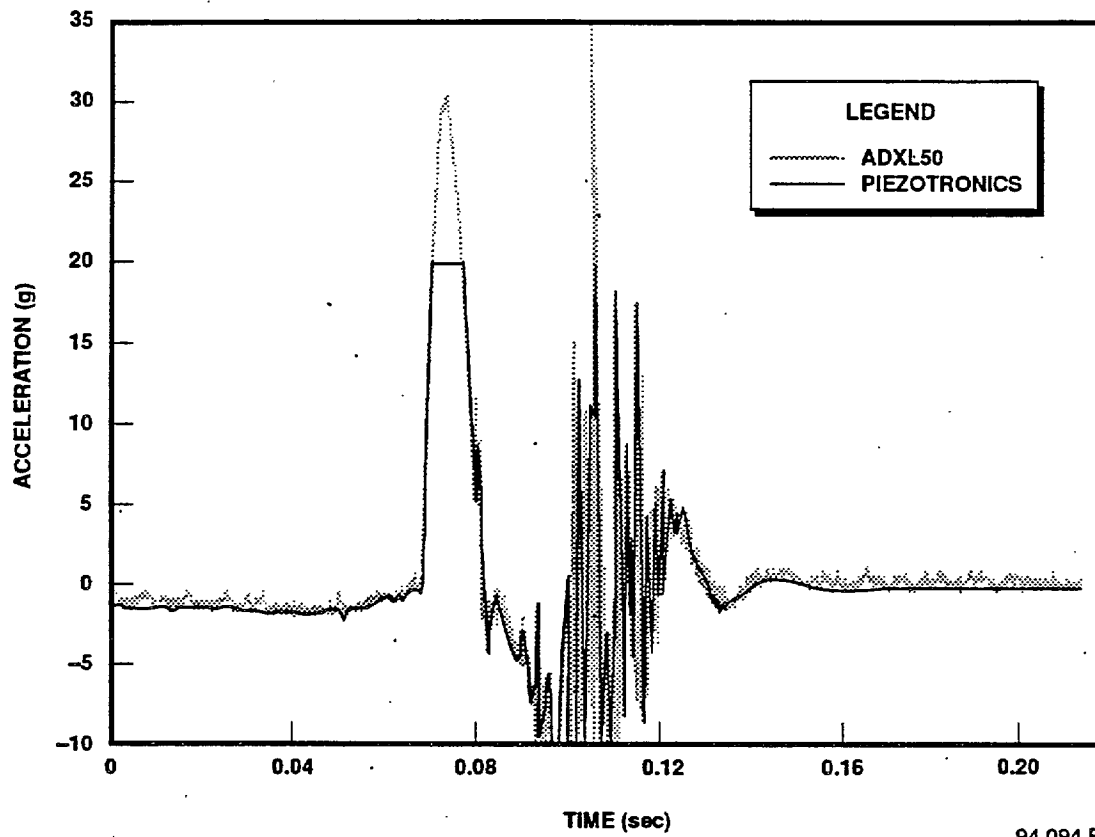

94.094.B-2

Figure D-2 ADXL50 Shaker Test (30 g, Spike)

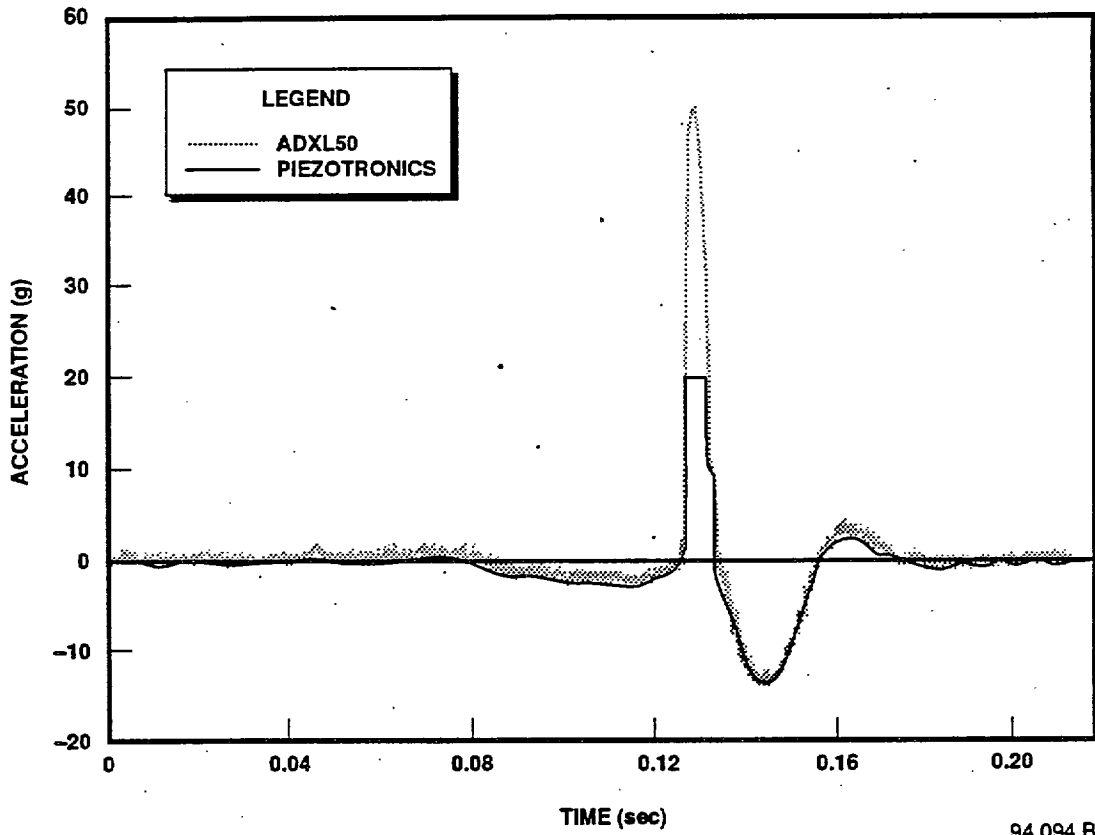

94.094.B-3

Figure D-3 ADXL50 Shaker Test (50 g, Spike)

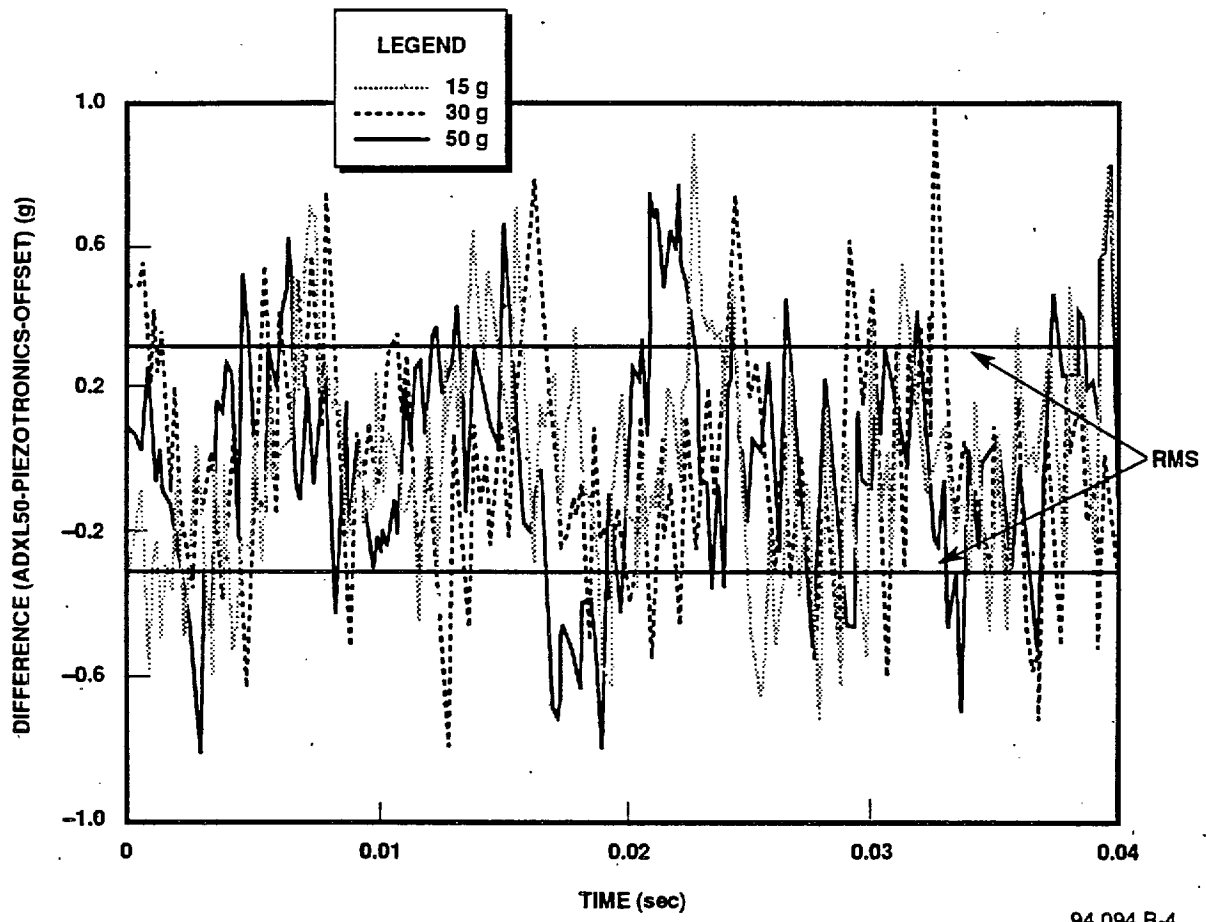

94.094.B-4

Figure D-4 Difference in Accelerometer Readings (ADXL50-Piezotronics-Offset)

**Table D-2 Measured ADXL50 Accelerometer Noise Characteristics**

	<b>15g</b>	<b>30g</b>	<b>50g</b>
Peak Error	0.72	1.06	0.47
RMS Error	0.31	0.32	0.32

The RMS errors are very repeatable and are slightly greater than stated in an application note by Analog Devices (Reference D-21, which predicts an RMS error of 0.21 g. Although the RMS errors are greater than stated in the application note, the peak error is not as great as the predicted value of 1.4 g. Both of these errors can be reduced in the ANC system application, since they are functions of the bandwidth and the bandwidth required for the ANC system is on the order of only 100 Hz. At 100 Hz, the errors will be a quarter of the errors at 1000 Hz (i.e., approximately 0.1 g RMS and 0.3 g peak).

In addition to the simulated spike data, other tests were conducted for 5.0 and 10.0-g sine waves to determine the repeatability of the measurements. The 5.0-g sine data (Figure D-5) measured a positive average peak load of +5.631 +/- 0.0498 (i.e. +/-3.97%) and a negative value of -4.950 +/- 0.0385 g (i.e. +/-3.96%). The average standard deviation for this test is 0.044 g which is well below the published RMS noise level of 0.21 g.

Similar data for the 10.0-g sine wave are presented in Figure D-6. The average positive peak load is 9.744 g +/-0.305 (+/-3.1%) and the negative value is -10.073 +/-0.1817 g (+/-1.8%). The average standard deviation is 0.24 g, which is very close to the published RMS noise level of 0.21 g.

As expected, the standard deviations for both the 5.0-g and 10.0-g tests are close to or less than the published RMS noise. However, it is surprising that, for the 5.0-g test, the average positive peak acceleration is 0.631 g (12%) greater than nominal and for the 10.0-g test it is 0.256 g (2.6%) less than nominal.

In the second stage of the accelerometer evaluation a simple 1-g test was performed on the accelerometers to determine the validity of the factory-specified zero offset and sensitivity (g per volt). Ten accelerometers from three manufacturers were selected for evaluation: four Analog Devices ADXL50, four ICSensors 3140-002, one ICSensors 3140-050, and one Vaisala SCA15. Table D-3 gives the specifications. The 10 accelerometers were tested by rotating the accelerometers at various angles from perpendicular. (Note that if an accelerometer is oriented so that its measurement axis is pointing vertically, it should measure 1 g to account for gravity. By rotating the accelerometer, the output should vary sinusoidally between + and - 1 g.) It was found that the +/-2-g ICSensor accelerometers provided accurate measurements using the published calibration values (see Figure D-7). (The four +/-2-g accelerometers are labeled A, B, C, and D.) The standard deviation from nominal values was only +/-0.030 g. Surprisingly, the standard deviation from nominal for the ICSensor +/-50-g accelerometer was only 0.021 g, which is less than for the +/-2-g accelerometers.



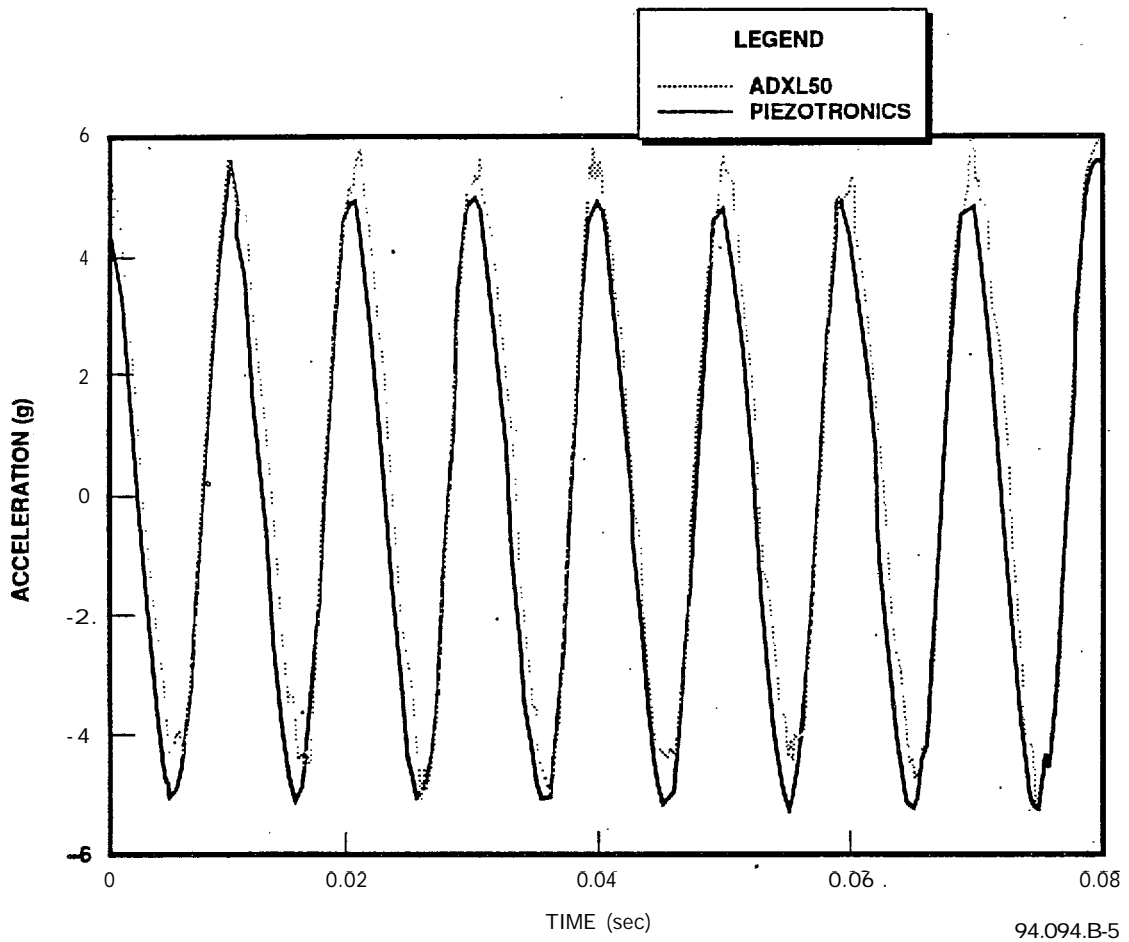

94.094.B-5

**Figure D-5 ADXL50 Shaker Test (5 g, Sine Wave)**

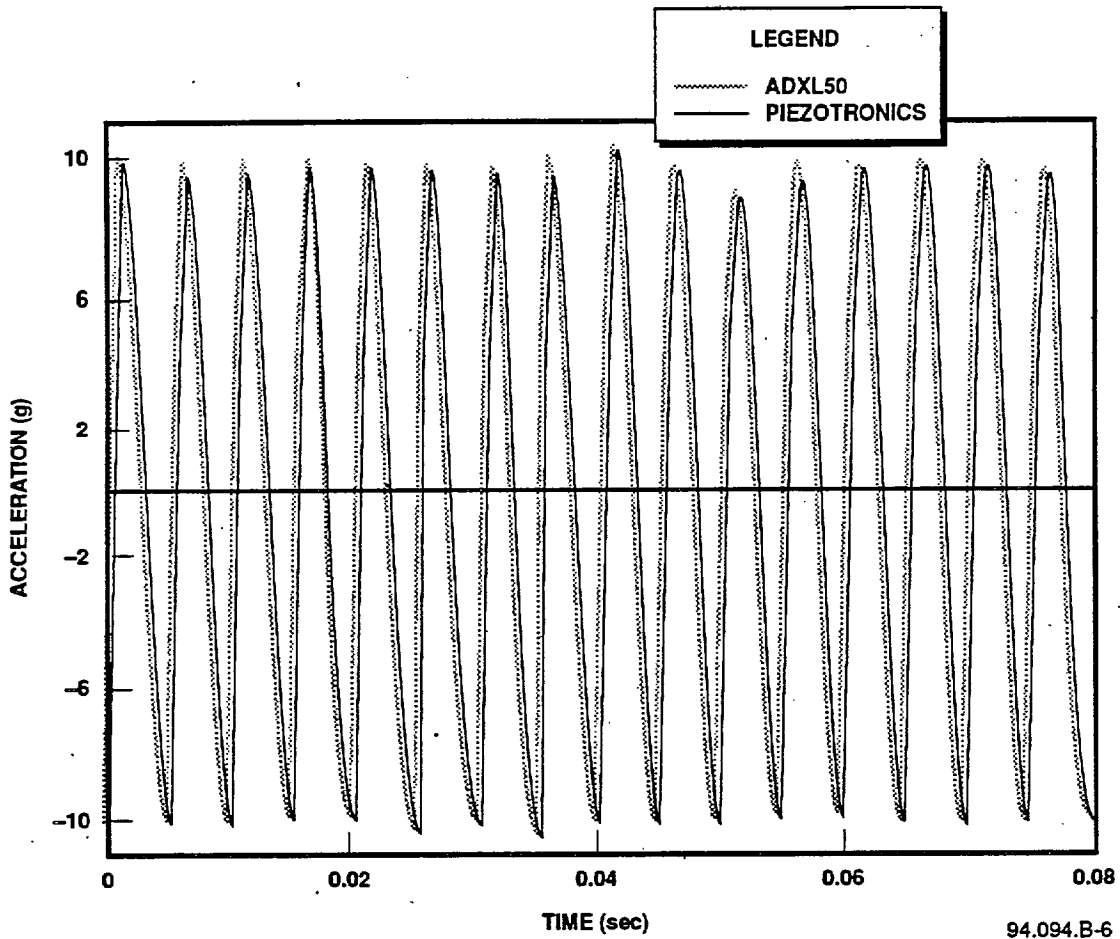
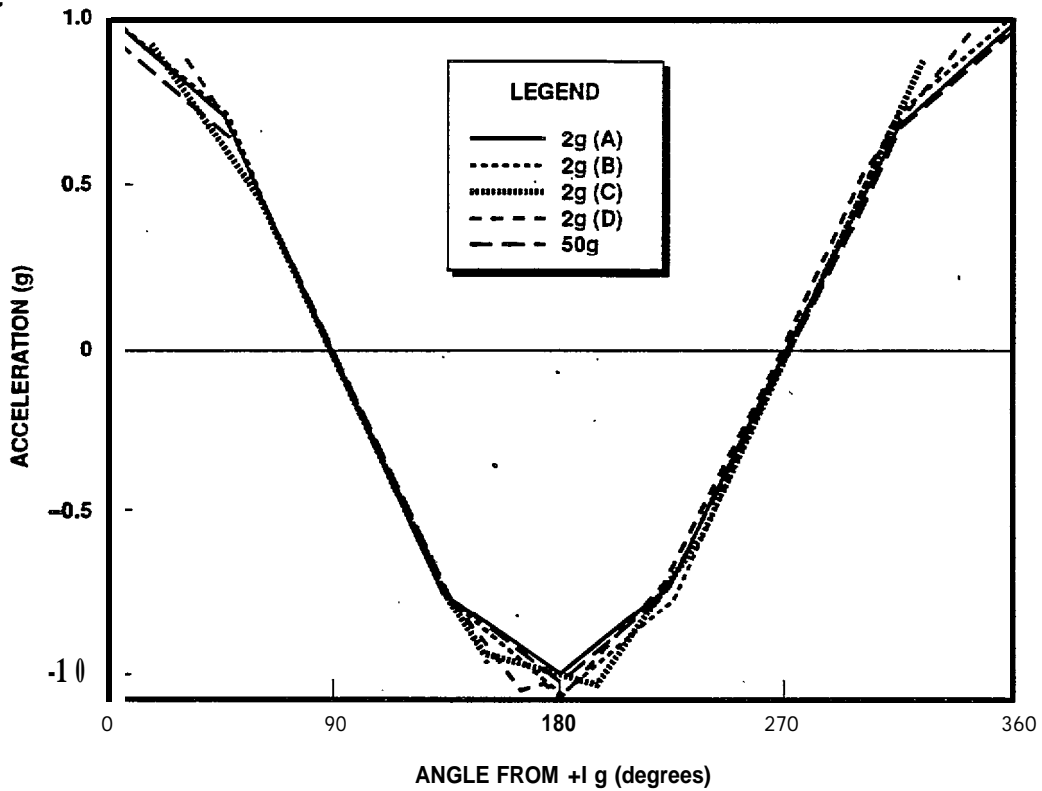

Figure D-6 ADXL50 Shaker Test (10 g, Sine Wave)

Table D-3 Accelerometer Specifications

Vendor	Model	Technology	Range	Unit Price
Analog Devices	ADXL50	Capacitive	±50 g	\$80
Vaisala	SCA15	Capacitive	±15 g	\$275
ICSensors	3140-002*	Piezoresistive	±2 g	\$295
ICSensors	3140-050	Piezoresistive	±50 g	\$230

\*Operating range is insufficient for crash detection; however, it was expected that this type accelerometer would provide higher precision than the 50-g accelerometers and would be necessary for characterization of normal driving.



94.094.5

**Figure D-7 Acceration vs. Angle Test Results for IC Sensors Accelerometers**

Calibrations of the ADXL50 +50-g accelerometers using the vendor-supplied calibration constants (Reference D-2) showed rather large differences from one accelerometer to the next as shown in Figure D-8. (The four accelerometers are labeled A, B, C, and D.) The zero offset is off by as much as 6 g for accelerometer B. This resulted from measuring the accelerometers directly as they came from the vendor without employing a bias resistor to adjust the offset to zero. This implies that accelerometers must be individually calibrated before use. After compensating for the offset, the ADXL50 calibration curves (Figure D-9) produced accurate and consistent results. There was only a  $\pm 0.11g$  variation from the nominal values.

Based on these measurements, it was determined that these types of accelerometers are sufficiently precise and consistent from device to device not only for collision detection but for characterization of normal driving.

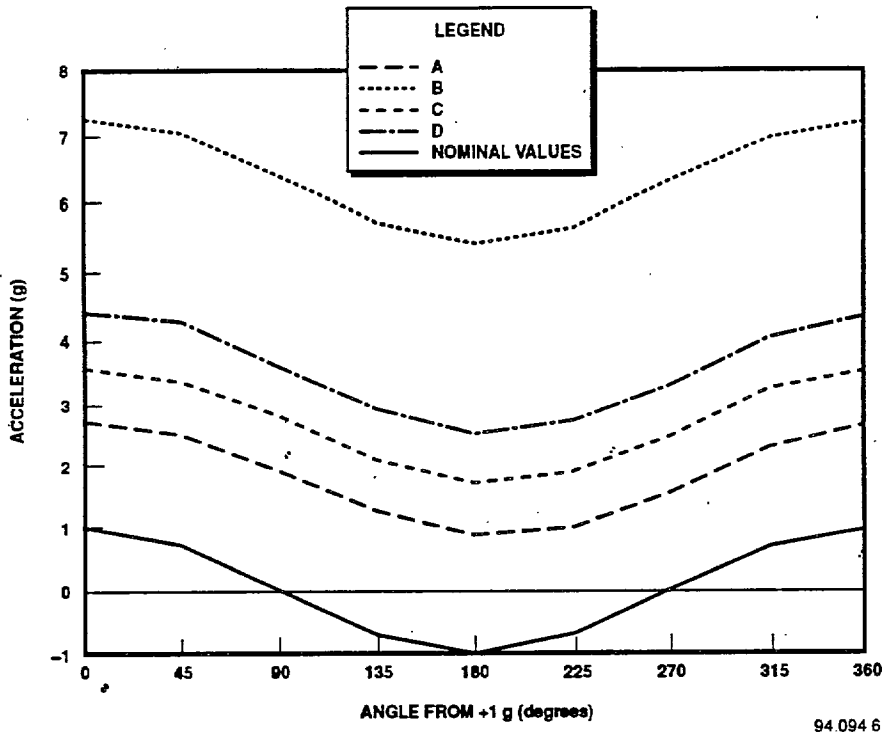

Figure D-8 Acceleration vs. Angle Test Results for Analog Devices ADXL50 Accelerometers

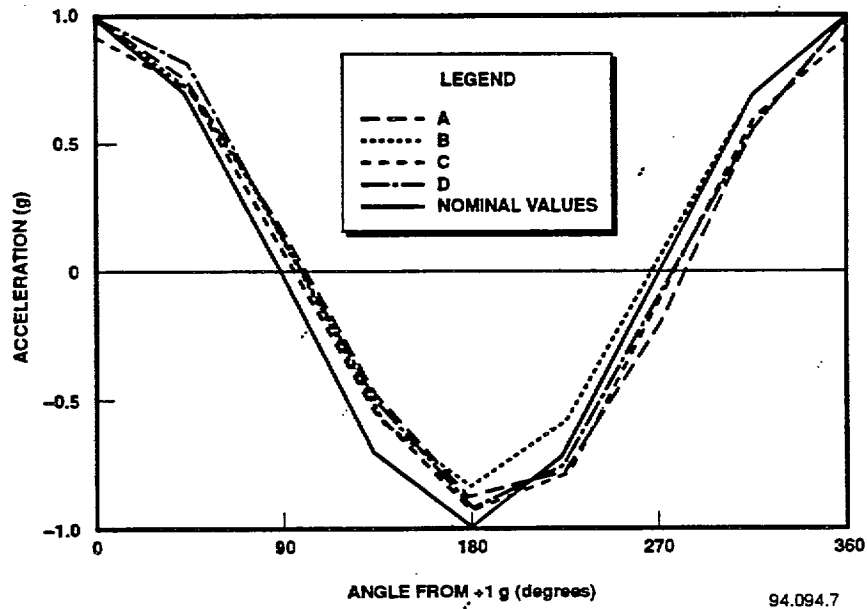

Figure D-9 Calibration of ADXL50 Accelerometers (Calculated Using Vendor Supplied Sensitivity and Measured  $V_0$ )

## D.2 ACCELERATION RESULTING FROM NORMAL DRIVING

To lead to the development of a crash detection algorithm that will distinguish between accelerations generated during normal driving and during a crash, it is necessary to characterize the accelerations experienced during normal driving, including such things as poor pavement conditions, unpaved (dirt or gravel) roads, sharp turns, potholes, speed bumps, hard braking, and striking a curb. This will help to ensure crash detection thresholds are set to minimize false alarms. The objective of this series of tests was to measure accelerations that might be experienced during normal driving. This section describes the test hardware installed in the test vehicle and the results of over-the-road testing. Then, the test data are compared to actual crash test results.

### D.2.1 TEST HARDWARE DESCRIPTION

Figures D-10a through D-10c show the elements of the ACN accelerometer testbed. In an expansion slot of the host PC is a National Instruments PC-LPM-16 data acquisition board containing 16 channels for analog-to-digital conversion. To avoid aliasing problems due to digital sampling, signals from the accelerometers pass through the signal conditioning box where they are electronically filtered. The accelerometers are mounted to a custom aluminum mounting block which provides stability and the correct sensor orientation. Not shown in Figure D-10a is a 1200-W Tripp Lite power supply which converts 12 VDC supplied by the vehicle's electrical system into 120 VAC for use by the host computer and the signal conditioning box. The interfaces between each part of the system are defined below.

The data acquisition card is connected to the signal conditioning box via a 50-pin ribbon cable. The pin assignments for the cable are given in Figure D-11. Of the 50 interface lines, only the 16 analog channels (ACH0 through ACH15), the +5V supply lines, and the grounding pins are used.

The signal conditioning box is a simple card cage accepting standard 44-pin cards. Figure D-12 shows a top view of the box with the cover removed.

The signal conditioning box was built for a previous experiment, but its card cage design allowed for simple reconfiguration, as was done for the ACN application. The anti-aliasing filters were placed directly on the 50-pin interface card, which is normally reserved for patching the 50-pin interface from the data acquisition board through to the back plane of the card cage. The remaining card slots are not used. The anti-aliasing filters consist of 11 second-order low pass Butterworth filters, each with a cutoff frequency of 100 hertz. The 50-pin interface card contains several jumpers to control the routing of the acceleration signals and the application of test signals to the accelerometers. Figure D-13 shows the layout of the card and indicates the jumper assignments. +/-12 volt DC is drawn from the card cage bus; the remaining functions are unused. The Winchester connectors on the front panel of the signal conditioning box are not used.

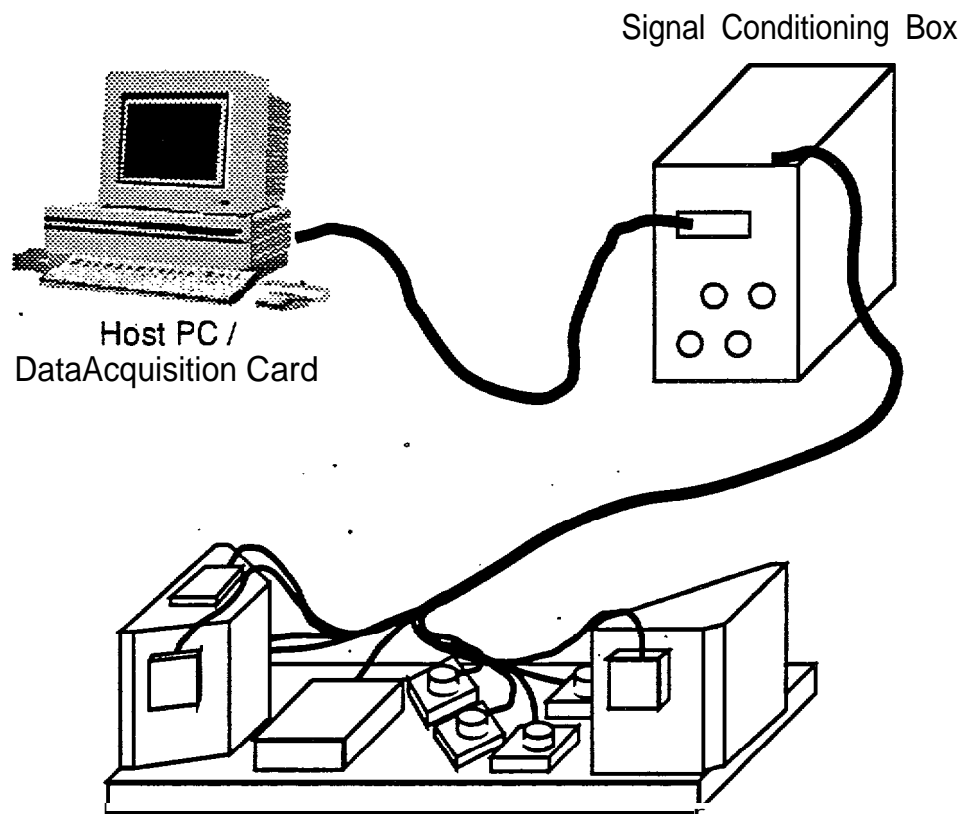

**Figure D-10a ACN Accelerometer Testbed**

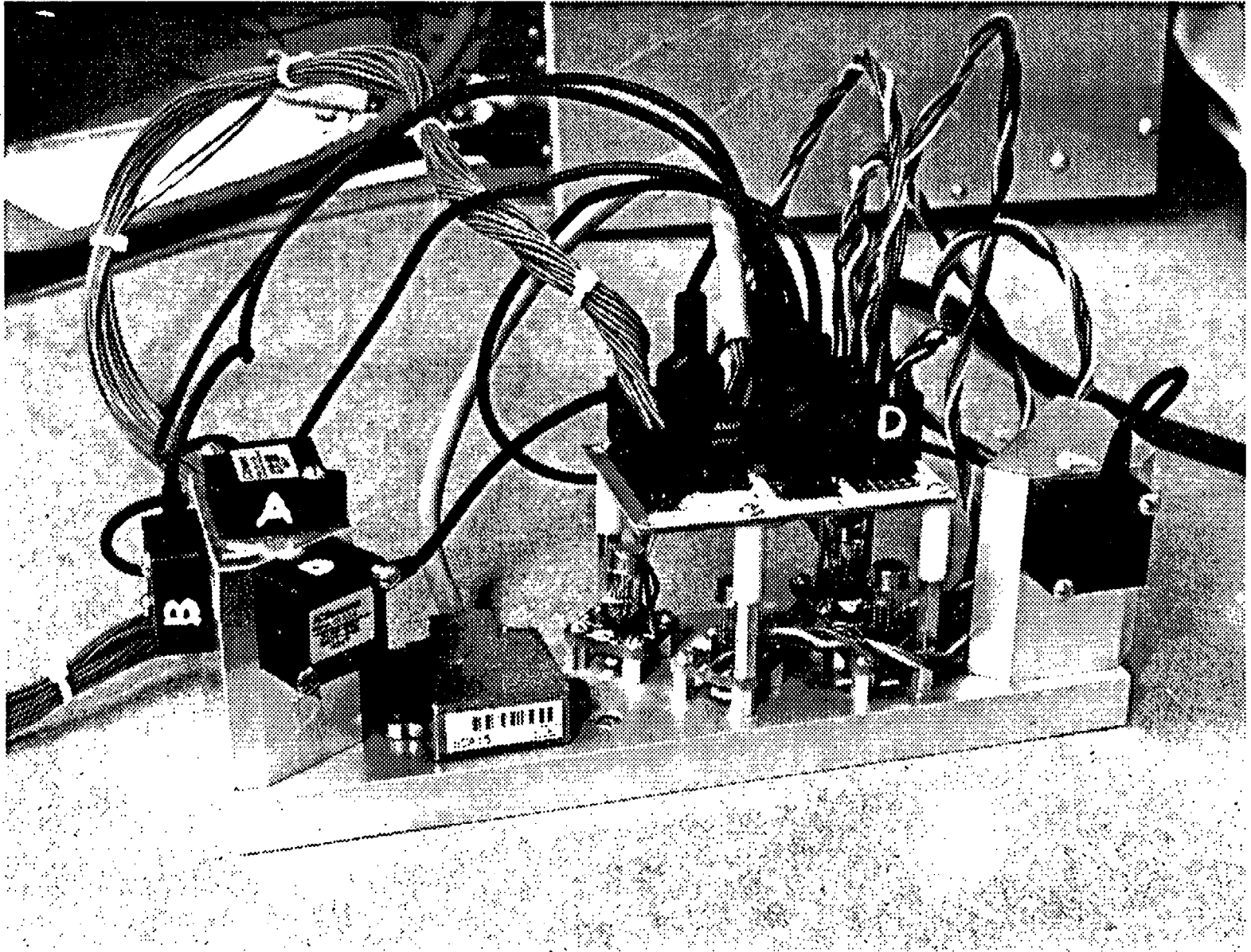

Figure D-10b Accelerometer Suite

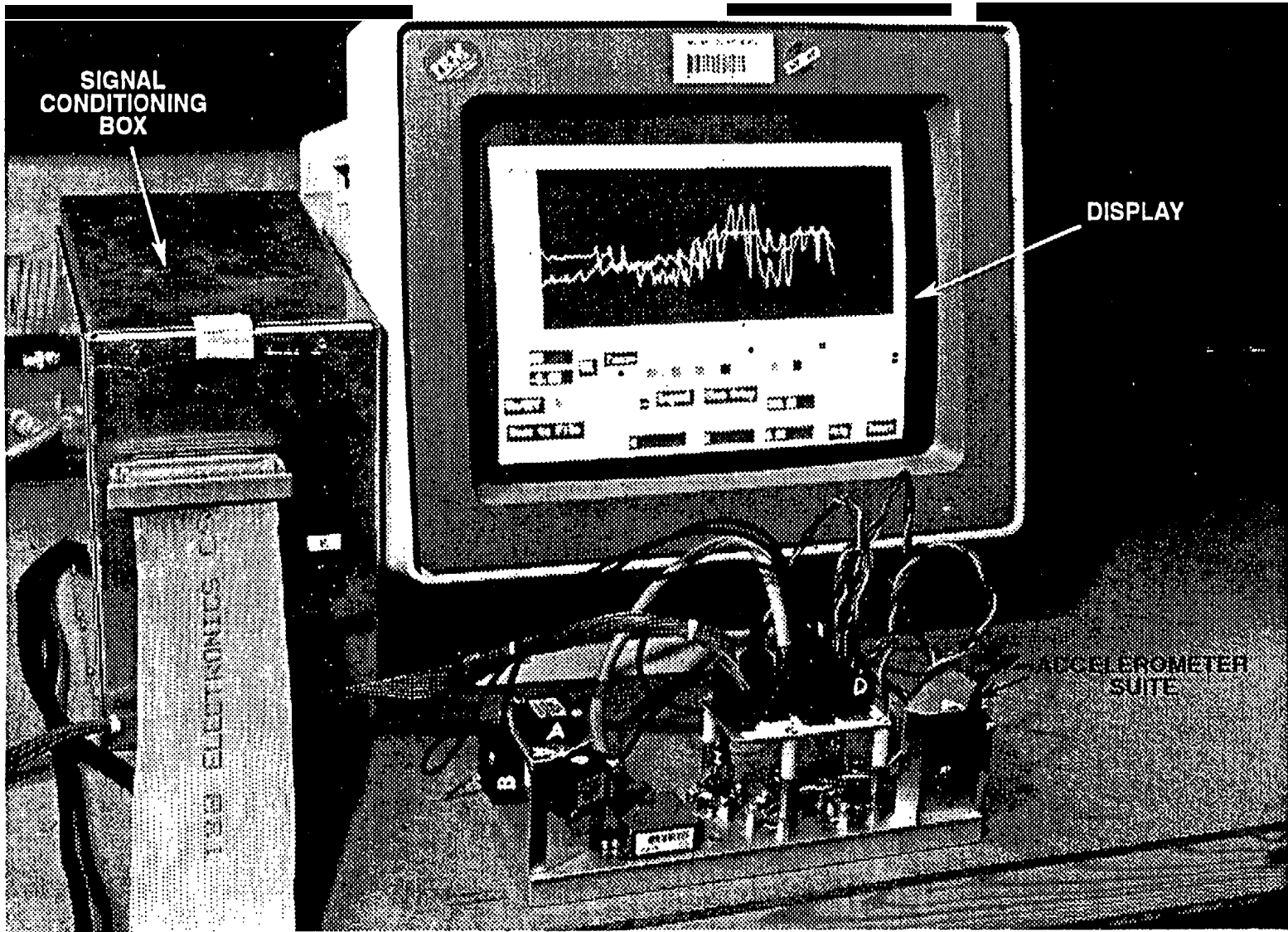
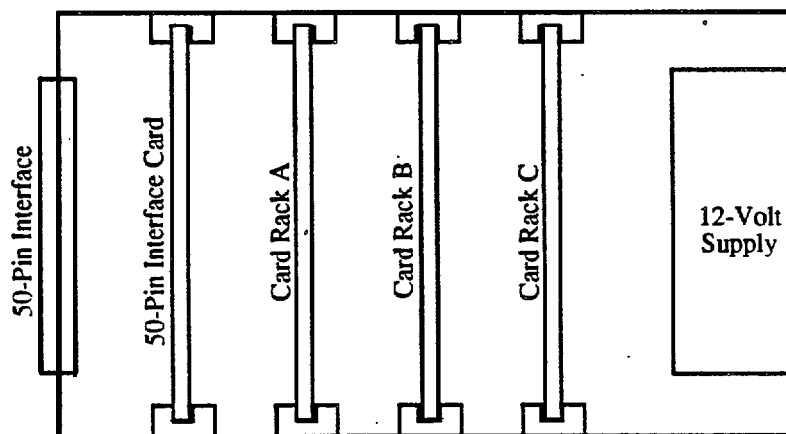

Figure D-10c Accelerometer Test Bed



AIGND	1	2	AIGND
ACH0	3	4	ACH8
ACH1	5	6	ACH9
ACH2	7	8	ACH10
ACH3	9	10	ACH11
ACH4	11	12	ACH12
ACH5	13	14	ACH13
ACH6	15	16	ACH14
ACH7	17	18	ACH15
DGND	19	20	-12v
+12V	21	22	DIN0
DIN1	23	24	DIN2
DIN3	25	26	DIN4
DIN5	27	28	DIN6
DIN7	29	30	DOUT0
DOUT1	31	32	DOUT2
DOUT3	33	34	DOUT4
DOUT5	35	36	DOLJT6
DOUT7	37	38	OUT1
EXTINT	39	40	EXTCONV
OUT0	41	42	GATE0
OUT1	43	44	GATE1
CLK1	45	46	OUT2
GATE2	47	48	CLK2
+5V	49	50	DGND

**Figure D-1 1 Pin Assignments for the 50-pin Cable Connecting the Data Acquisition Card to the Signal Conditioning Box**



**Figure D-12 Top View of Signal Conditioning Box**

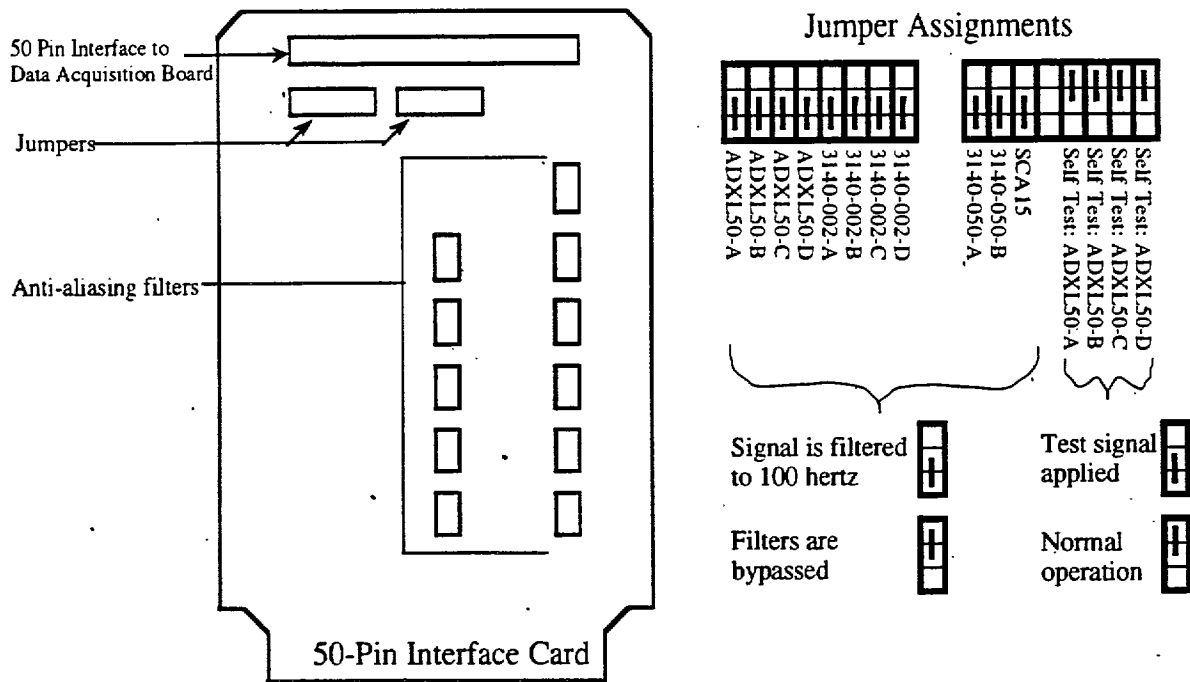
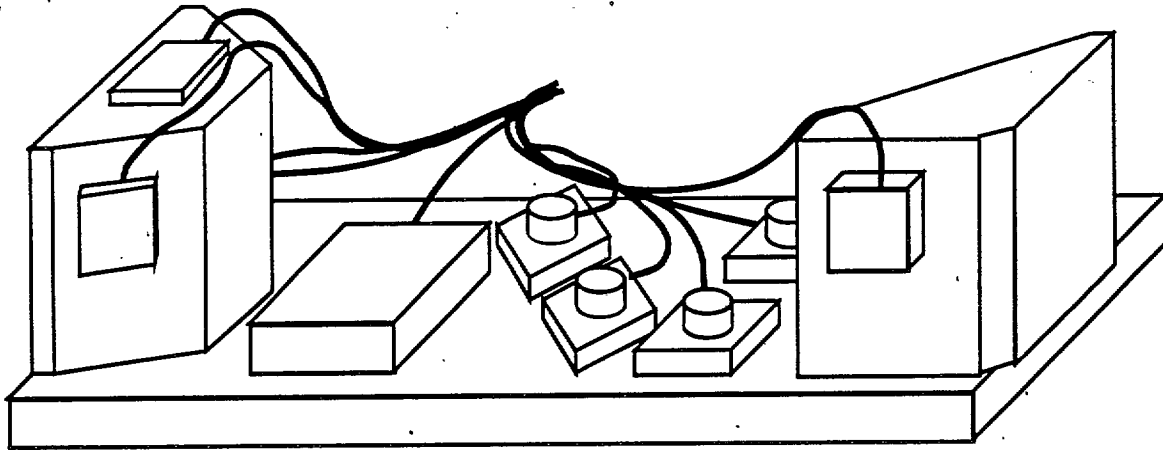

**Figure D-13. 50-Pin Interface Card**

All 10 accelerometers used in the second stage of accelerometer testing are secured to an aluminum mounting block as shown in Figure D-14. The aluminum mounting block was designed not only to provide a solid mounting platform, but also to physically arrange the accelerometers in specific geometrical patterns in order to test sensor validation schemes and directly compare different sensor technologies. Note that the results of these tests are dependent upon a number of factors including the characteristics of the test automobile's suspension, the location of the sensors in the automobile, and the method used to mount the sensors. Furthermore, sensor outputs may experience slight offsets from the expected values (0 g in the forward and transverse directions, -1 g in the vertical direction) due to accelerometer calibration and variations in vehicle attitude and accelerations. However, it is expected that the data collected are representative of the accelerations experienced by a sensor package that would be mounted in a vehicle for crash detection.

Not shown in Figure D-14 is a connection plate that combines all the accelerometer leads to single 26 conductor cable. The layout for the plate is given in Figure D-15.

The first set of accelerometers is composed of the four 50-g Analog Devices ADXL50s which are manufactured using capacitive micromachining technology. They are arranged 45° apart as shown in Figure D-16. The purpose of this configuration is to test two-dimensional validation schemes.



**Figure D-14 Accelerometer Mounting Block**

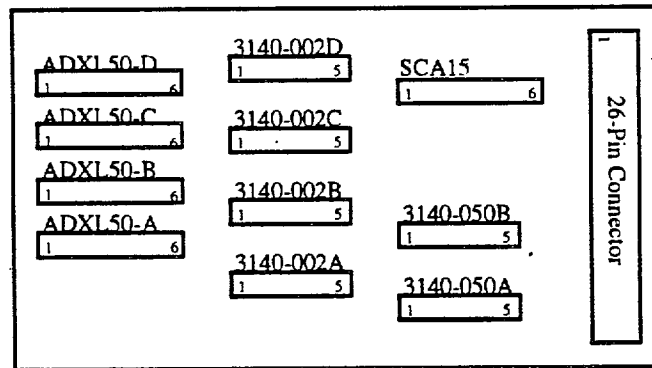

**Figure D-15 Accelerometer Connection Plate**

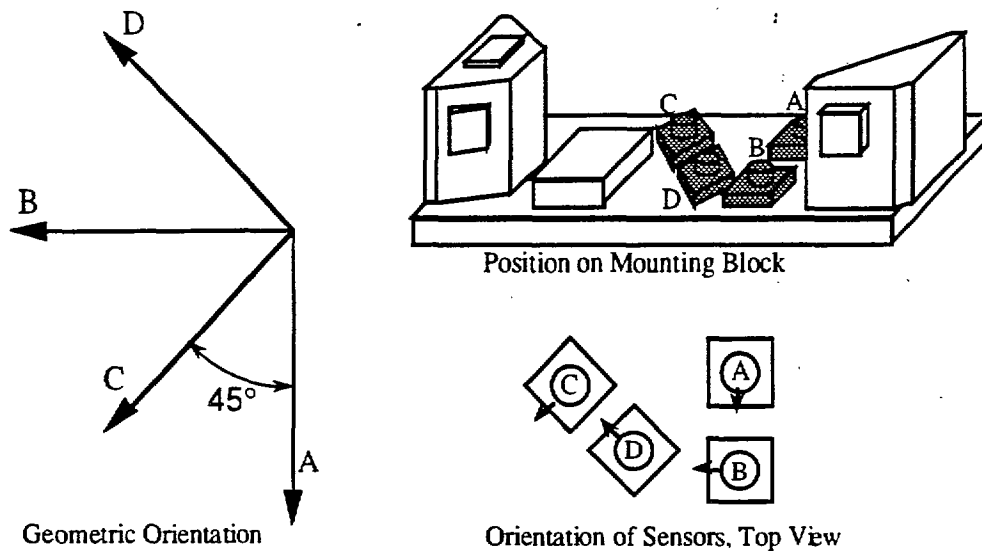

**Figure D-16 ADXL50 Accelerometers, Mounting and Orientation**

The ADXL50 accelerometers are mounted on evaluation boards provided by Analog Devices. The equivalent circuit of the ADXL50 with the evaluation board is shown in Figure D-17. The circuit filters the output with a single-pole, 300-hertz, low-pass filter and scales the signal such that  $\pm 50$  g spans the 0- to 5-volt range. The ADXL50s are unique in that they provide a self-test capability (pin 7). When +5 V is applied to the test pin the sensing element is electrostatically activated to full range. This function can be activated through software using one of the digital outputs of the PC-LPM-16, or from the signal conditioning box by repositioning a jumper.

To the right of the ADXL50s is a single 50-g piezoresistive accelerometer produced by ICSensors. (Originally two sensors were planned for the mounting block, but one failed initially.) The primary purpose of the ICSensor 3140-050 50-g accelerometer is to compare piezoresistive micromachined technology to capacitive micromachined technology used in Analog Devices' ADXL50. The single 3140-050 is oriented in the same direction as the ADXL50-A as shown in Figure D-18.

To the left of the ADXL50s is the Vaisala SCA15 5-g accelerometer. As shown in Figure D-19, the SCA15 is oriented vertically in order to measure a complete three-dimensional acceleration vector in combination with the ADXL50s.

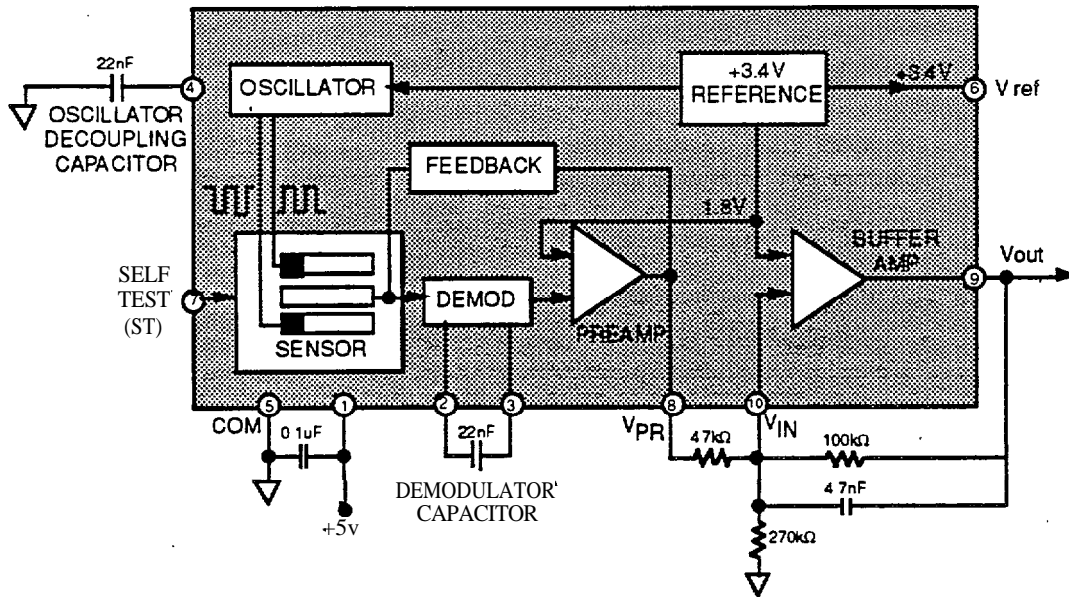

Figure D-17 ADXL50 Evaluation Board Equivalent Circuit

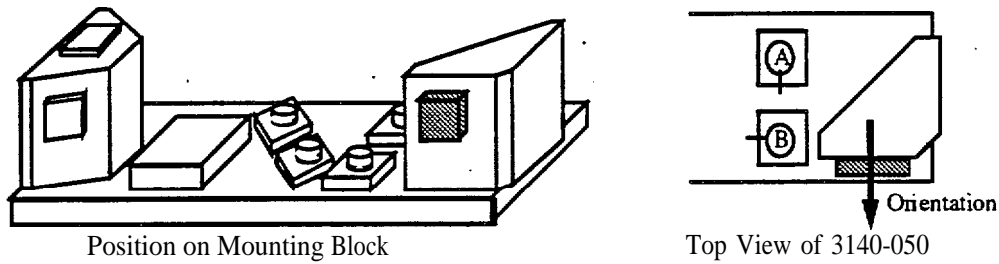

Figure D-18 Location and Orientation of ICSensor 50-g Accelerometer

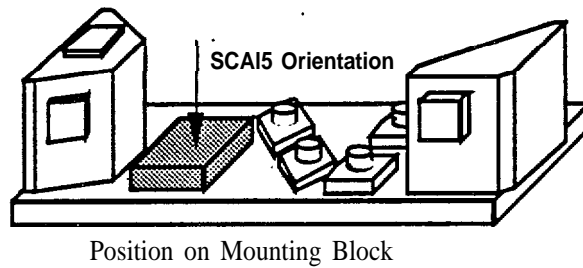
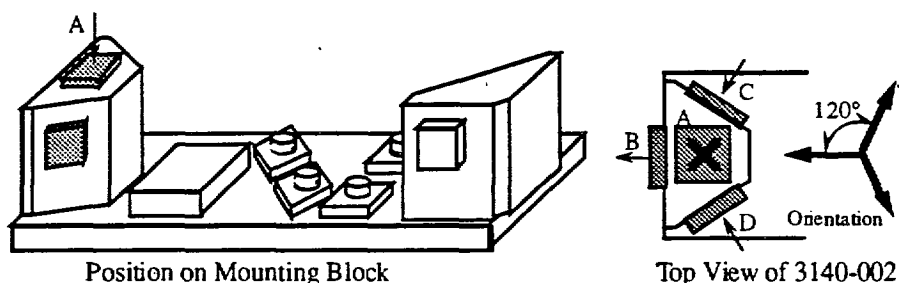

Figure D-19 Position and Orientation of Vaisala SCAI5 5-g Accelerometer

On the far left of the mounting block are four ICSensors 3140-002 accelerometers as shown in Figure D-20. A top view of the mounting block reveals the location and orientation of the four accelerometers. Three accelerometers (B, C, and D) are arranged in a delta (120° apart) in a single plane. The fourth accelerometer (A) is oriented vertically to give a complete 3-D acceleration profile. These 2-g devices are used primarily to characterize road noise since the 50-g accelerometers may not have sufficient resolution.



**Figure D-20 Position and Orientation of ICSensors 3140-002 Accelerometers**

Figure D-21 shows the accelerometer orientations with respect to the vehicle's forward direction of travel (X direction). All of the accelerometers are connected to the signal conditioning box via the accelerometer connection plate and the 26-conductor cable. The pin assignments for connecting to that plate are given in Figure D-22 for the four type of accelerometers used.

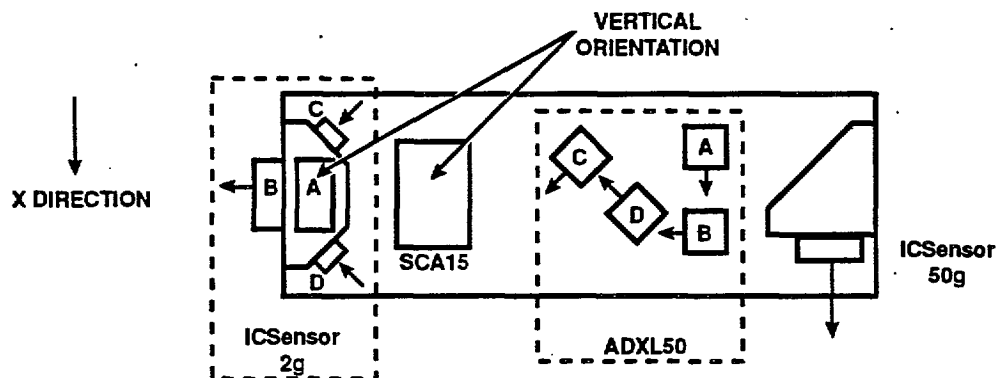

**Accelerometer Orientation**

94.094.D-21

**Figure D-21 Accelerometer Testbed**

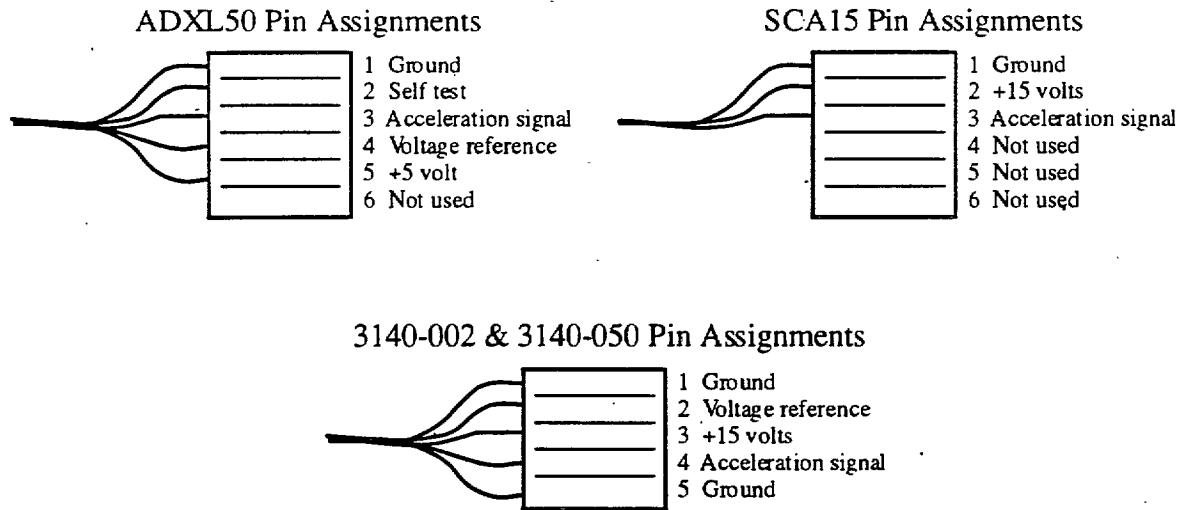

**Figure D-22 Pin Assignments for Connecting with Accelerometer Connection Plate**

## D.2.2 OVER-THE-ROAD TESTING

Figures D-23 and D-24 display the acceleration characteristics of two aspects of normal driving, hard braking and driving on an unpaved road. In Figure D-23, the acceleration profile of a vehicle (in the X direction) which is accelerated slowly (less than 0.2 g) to a speed of 25 mph, and then rapidly stopped by applying the brakes (but without skidding) is shown. The accelerations were measured independently by four sets of accelerometers. The ADXL50 accelerometer (A) and the ICS 50-g accelerometer both measure accelerations in the X direction. Two additional measures of acceleration were obtained by vectorially adding the outputs from ICS accelerometers C and D, and ADXL50 accelerometers C and D. (These accelerometers were mounted at 45° angles to the direction of travel.) All four measured decelerations peaked at approximately -0.5 g, with a variation of approximately -0.05 g. The excellent agreement and small variations verify the accuracy of the accelerometers and demonstrate the ability to vectorially add accelerometer outputs. Interestingly, the two ±50-g accelerometers were accurate enough to give similar results to the more sensitive ±2-g accelerometers. Note that the hard braking did not result in a very large deceleration magnitude.

A number of unpaved roads were traversed to collect representative acceleration data in three axes: the direction of travel (X), the transverse direction (Y), and the vertical direction (Z). Figure D-24 shows a plot of time versus acceleration when traveling over an unpaved road at 30 mph. The road surface is composed of a mixture of dirt and gravel. Due to wear, there are numerous "dips" of a variety of shapes and sizes in the road surface. These dips contribute to accelerations in all three directions. The acceleration parameters are summarized in Table D-4. The frequency of the accelerations appears to be attributable to the interaction of the automobile body and the accelerometer mounting system. Since gravity exerts a 1-g force in the vertical direction, the accelerations in the Z direction are centered on -1.0 g.

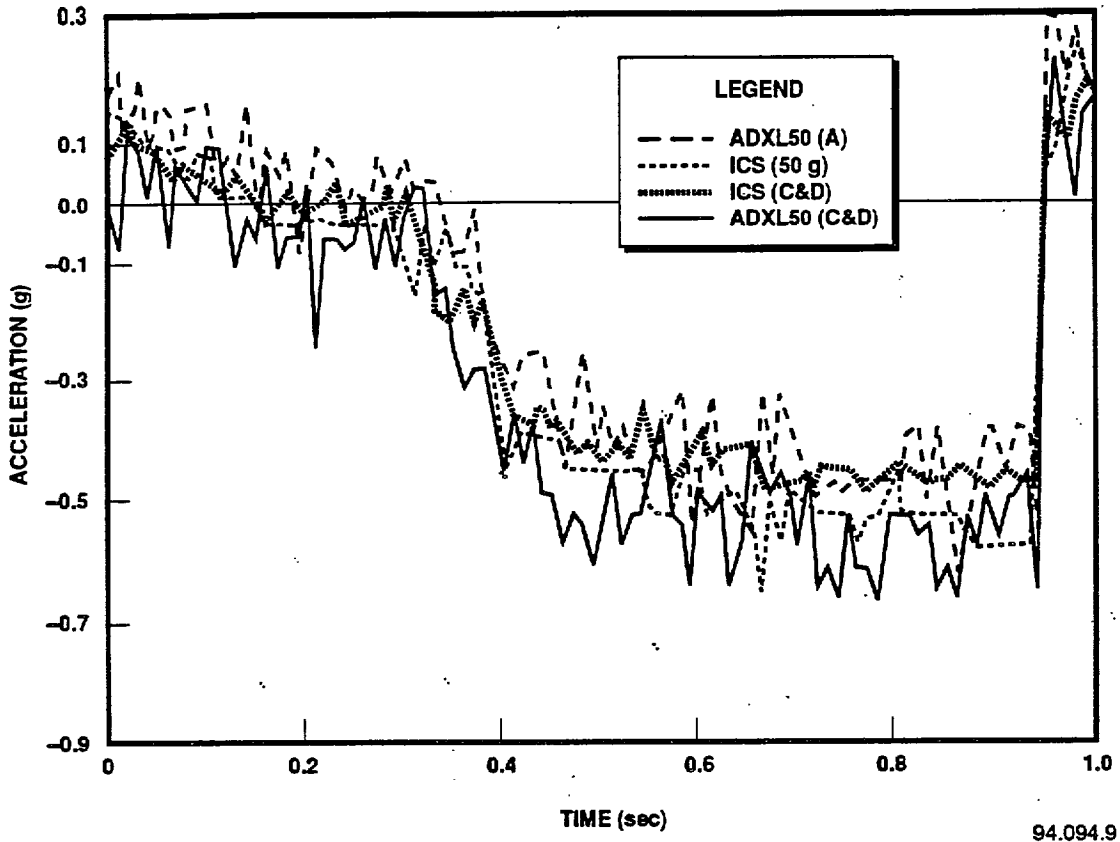

Figure D-23 Measured Acceleration vs. Time (For a Vehicle Which Accelerates, Then Brakes)



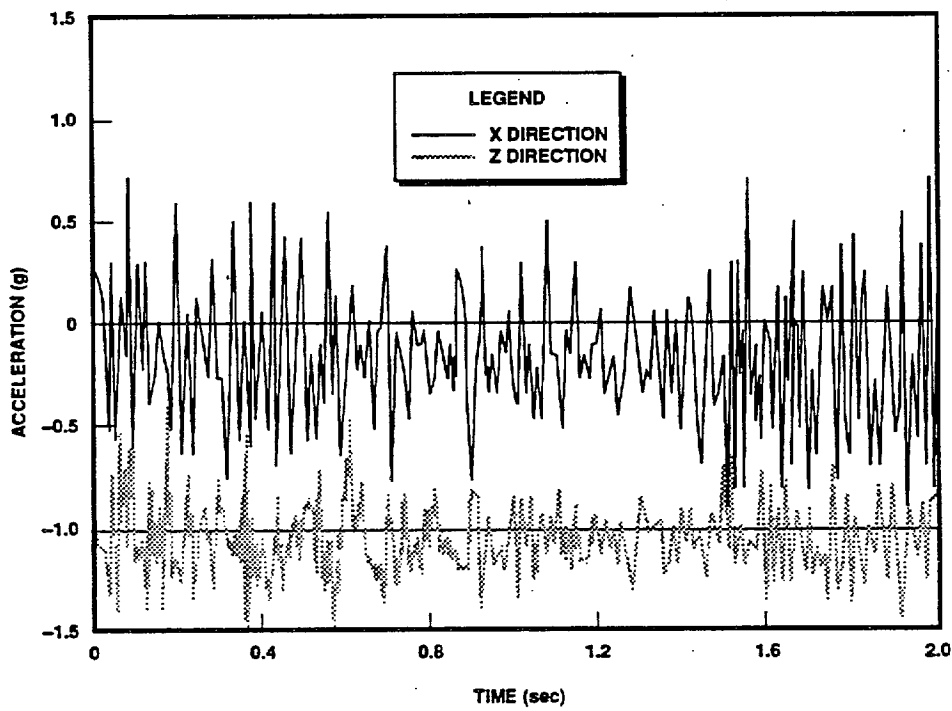
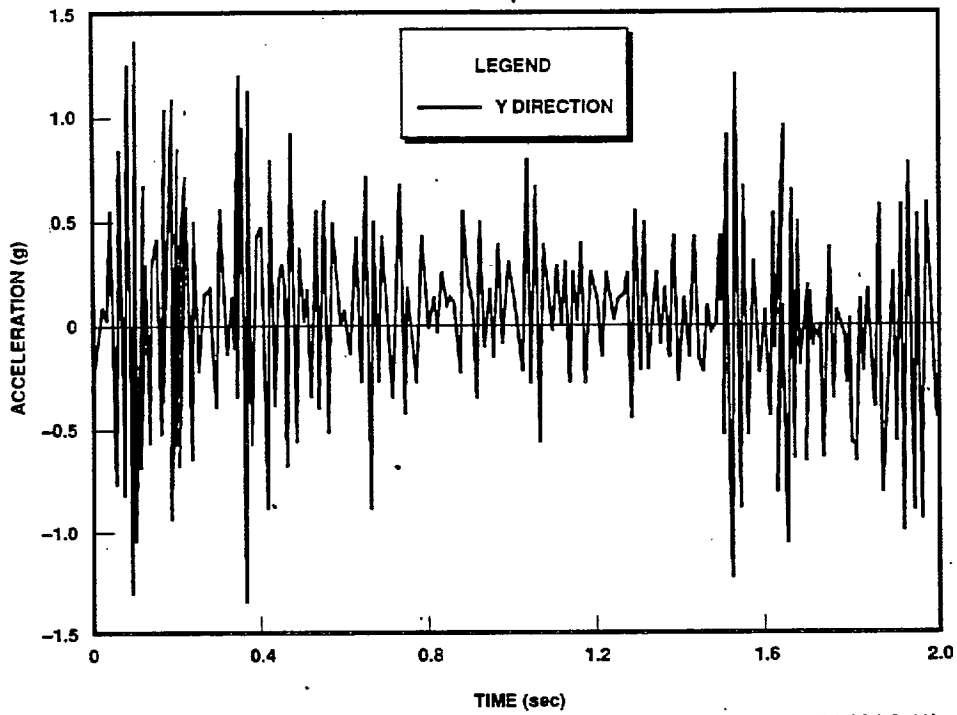

Figure D-24 Measured Vehicle Accelerations (For a Vehicle Driving 30 mph on a Dirt Road)

**Table D4 Summary of Accelerations Experienced During Travel over an Unpaved Road**

Axis	Peak g loading	Standard Deviation
X	0.8	0.32
Y	1.3	0.52
Z	0.6 (referenced to -1.0 g)	0.19

Surprisingly, the greatest accelerations were experienced in the Y direction. After closer examination of the dips in the road, it was found that the dips were distributed such that they tended to cause the vehicle to rock from side to side and thus result in significant accelerations in the Y direction.

Data were also taken for the vehicle driving over a dip in the road (1 inch deep and 1 ft wide) at 45 mph (Figure D-251, over a speed bump (3 inches high and 3 ft wide) at 10 mph (Figure D-261, and off a 6-inch high curb, (Figure D-27). Driving off a curb gave the highest acceleration (approximately 1.5 g), which was in the vertical direction. Note that the test vehicle was decelerating (in the X-direction) during collection of the data displayed in Figures D-25 and D-26.

The final normal driving condition was a series of tight left and right turns. The data are shown in Figure D-28. The initial right turn can be seen in the Y accelerometer around 0.6 sec, followed by a left turn at 1.2 sec, and another right turn at 1.8 sec. Once again, the accelerations are small.

### D.2.3 COMPARISON OF TEST RESULTS WITH CRASH DATA

The acceleration signatures experienced during normal driving events, displayed in Figures D-23 through D-28, are strikingly different from the acceleration signatures associated with a vehicle collision as shown in Figure D-29 (Reference D-21, which shows crash test results for a Hyundai Excel colliding with a pole or wall at various speeds. Under normal driving conditions, accelerations were less than 2 g. However, even for collisions at low speeds (9.5 mph), accelerations reach at least 7 g. The accelerations associated with a vehicle collision are much greater in amplitude than normal driving and generally of greater duration. Note that the difference in deceleration profiles between the 9.6 and 9.5-mph cases is a result of the different paths the pole takes as it slices through the car.

From the collision data in Figure D-29, the duration of the acceleration signature is 80 to 120 msec and not strongly dependent on the velocity at impact. This suggests that an automobile collision could be modeled as a mass-spring system in simple harmonic motion. The mass is the mass of the vehicle. The spring is the energy absorption of the car body during deformation. Since change in vehicle velocity can be obtained by integrating the acceleration, a simple detection scheme would be to integrate the acceleration signature over a short time window, 100 to 200 msec long. If this velocity change exceeds a predefined threshold, then it is determined that a collision has occurred.

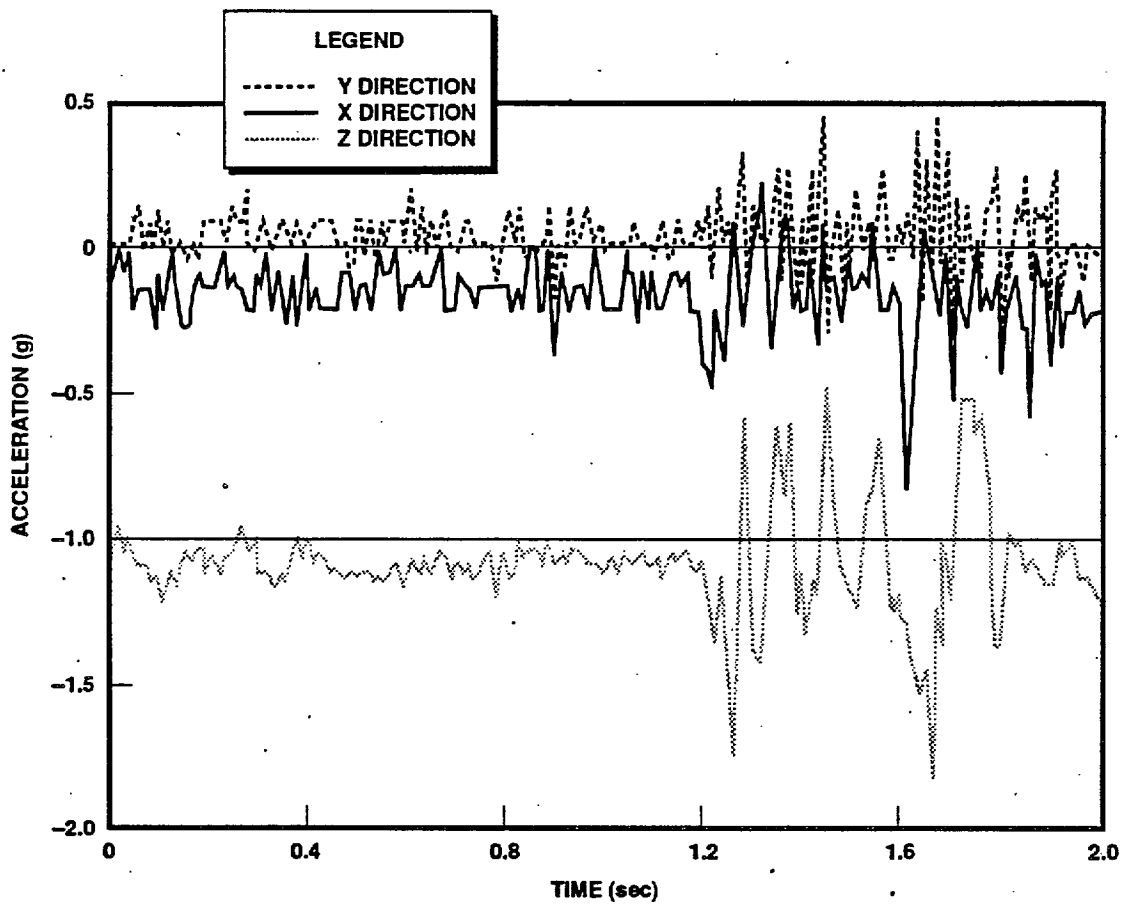

94.094.10

Figure D-25 Measured Vehicle Accelerations (For a Vehicle Driving Over a Dip in the Road at 45 mph)

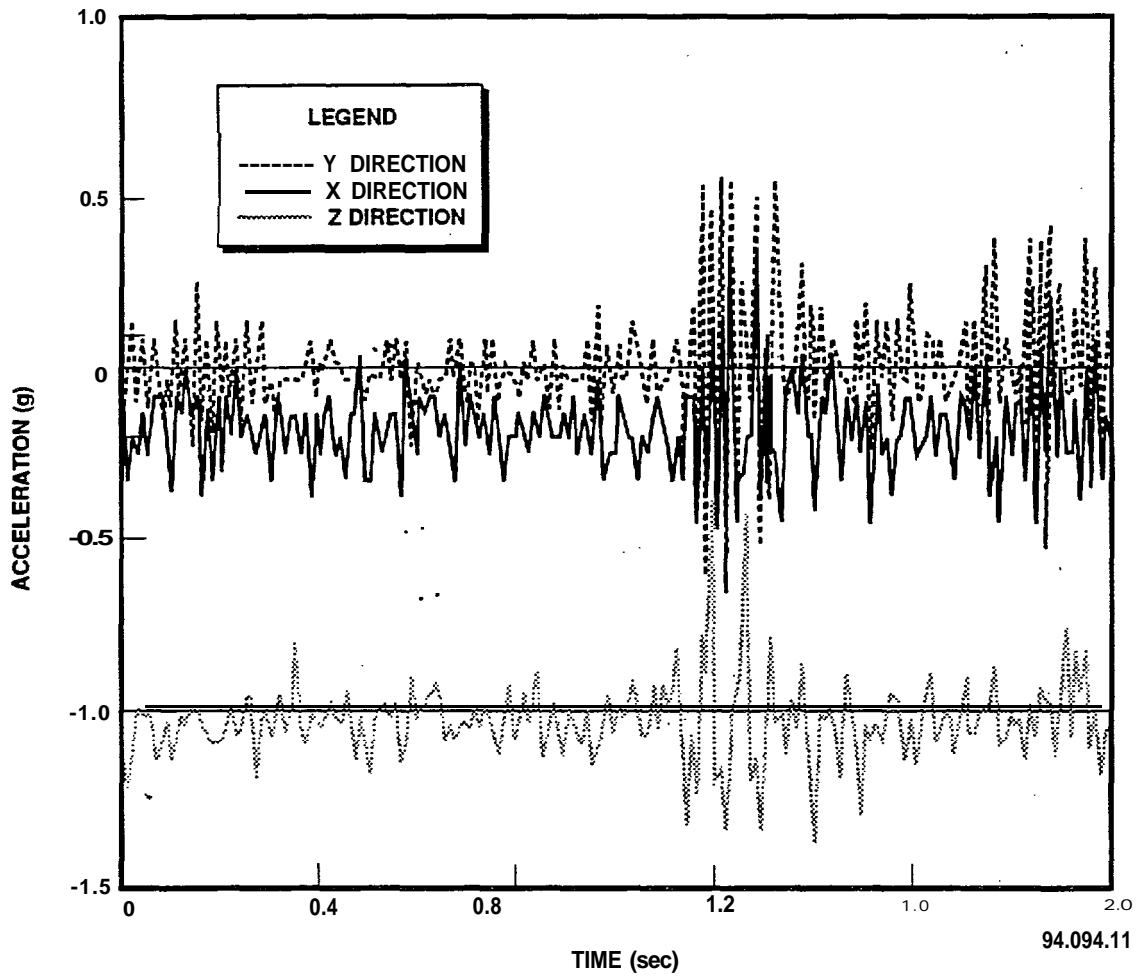

**Figure D-26 Measured Vehicle Accelerations (For a Vehicle Driving Over a Speed Bump)**

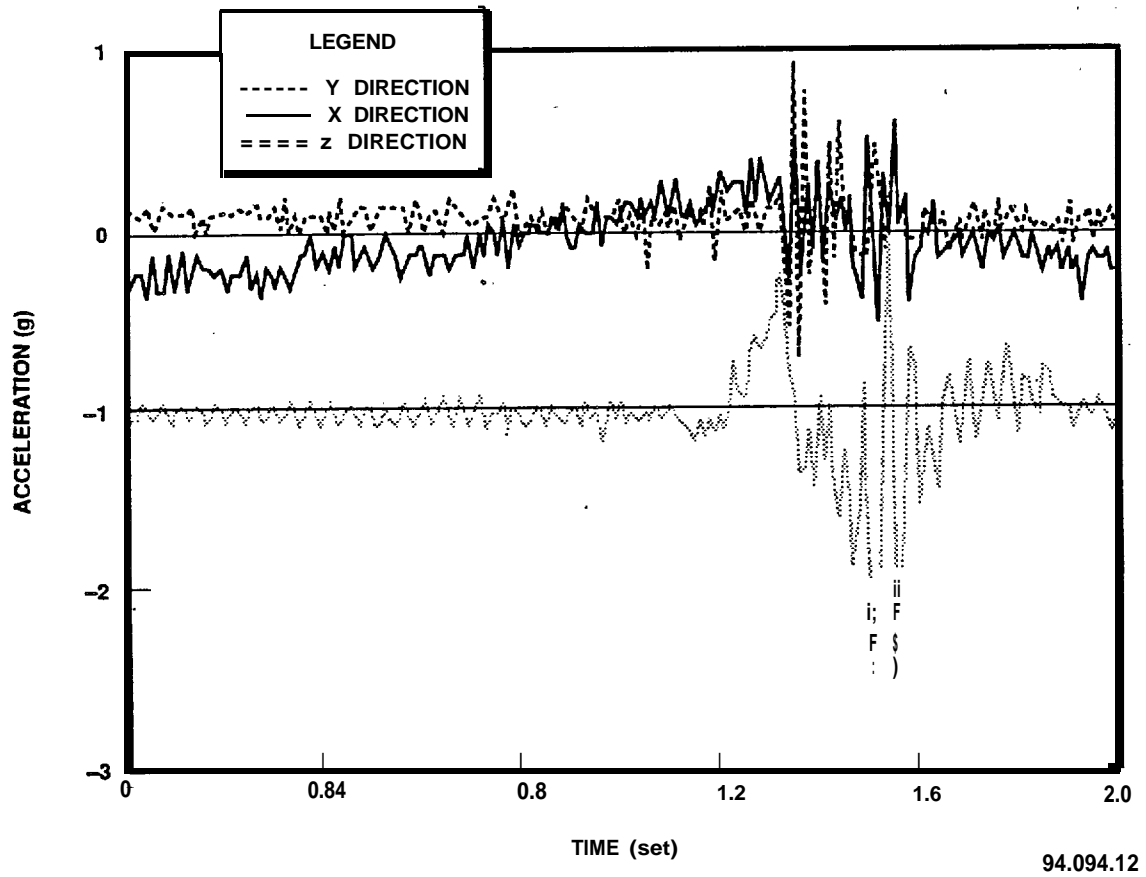

**Figure D-27 Bkssured Vehicle Accelerations (For a Vehicle Driving Off a Curb)**

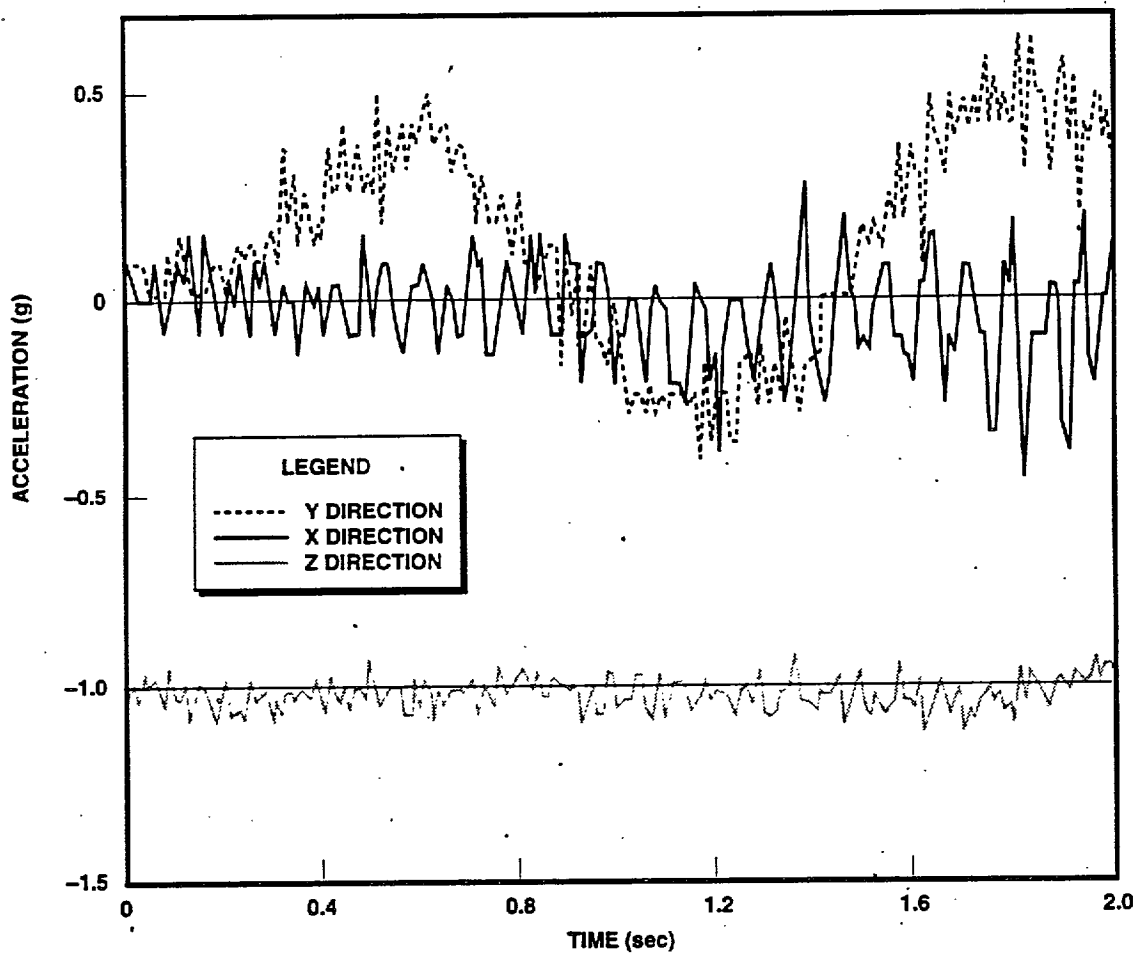

94.094.13

**Figure D-28 Measured Vehicle Accelerations (For a Vehicle Making Sharp Right and Left Turns)**

Integrating the acceleration curves of Figure D-29 and subtracting the result from the initial velocity gives the instantaneous velocity during the collision (Figure D-30). The change in vehicle velocity can then be defined by the difference in instantaneous velocity at the start and end of a specified time interval. Notice that all of the vehicles reach a velocity of zero approximately at the time of peak deceleration. This conforms to the mass spring model. It is interesting to note that most of the vehicles bounce back with a velocity of approximately 3 mph. If the integration window is selected to be greater than 120 msec, then the change in velocity will include bounce back (for the cases in Figure D-30).

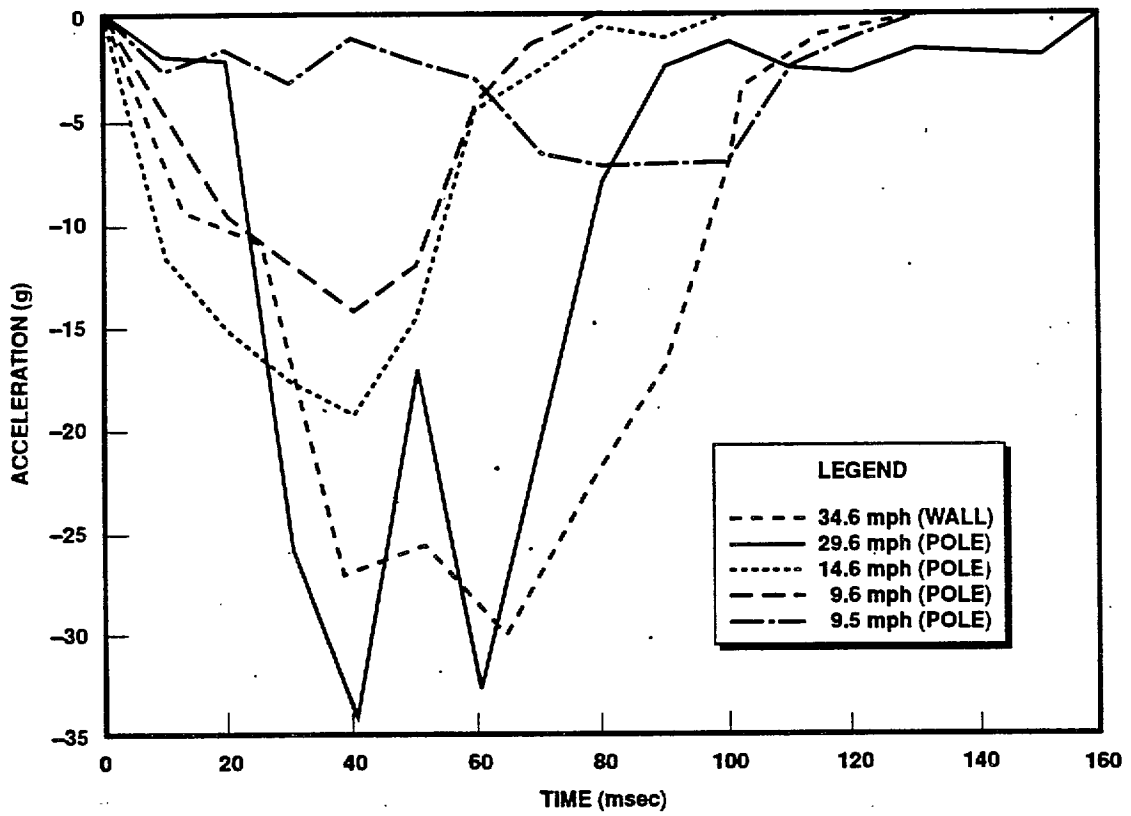

Figure D-29 Measured Deceleration Profiles (Hyundai Excel)

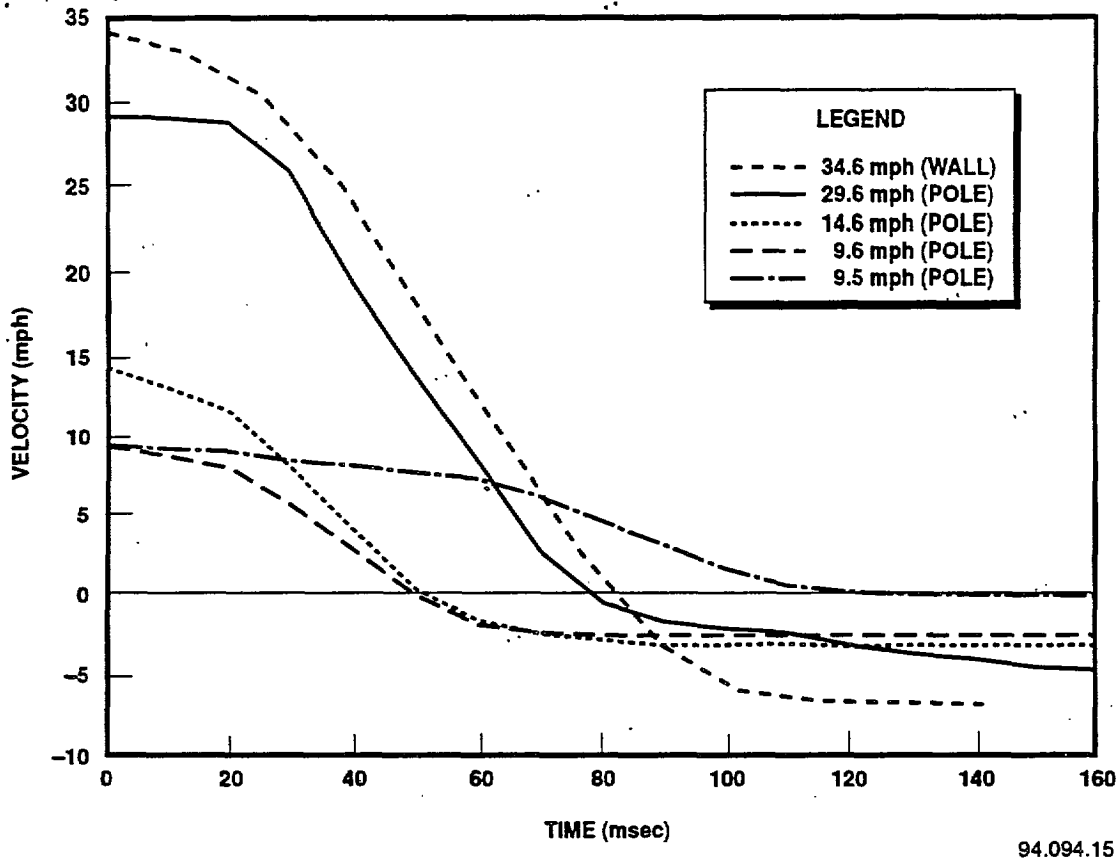

Figure D-30 Calculated Velocity Profiles (Hyundai Excel)

D.3 CRASH SIMULATOR TESTS

To further characterize accelerometers, develop and test crash detection algorithms, and explore sensor validation techniques, a crash simulator was developed that recreates the deceleration forces experienced in a low speed automobile collision. The simulator design is illustrated in Figure D-31.

The accelerometers, mounted to a proof mass, are released at a known height above the foam rubber (which simulates the classic coiled spring). The guide pole keeps the mass oriented correctly, ultimately protecting the accelerometers from damage. The mass is allowed to fall freely until it strikes the foam rubber at the bottom. The variables in the system are the proof mass, the velocity of the proof mass, and the spring constant of the foam rubber.



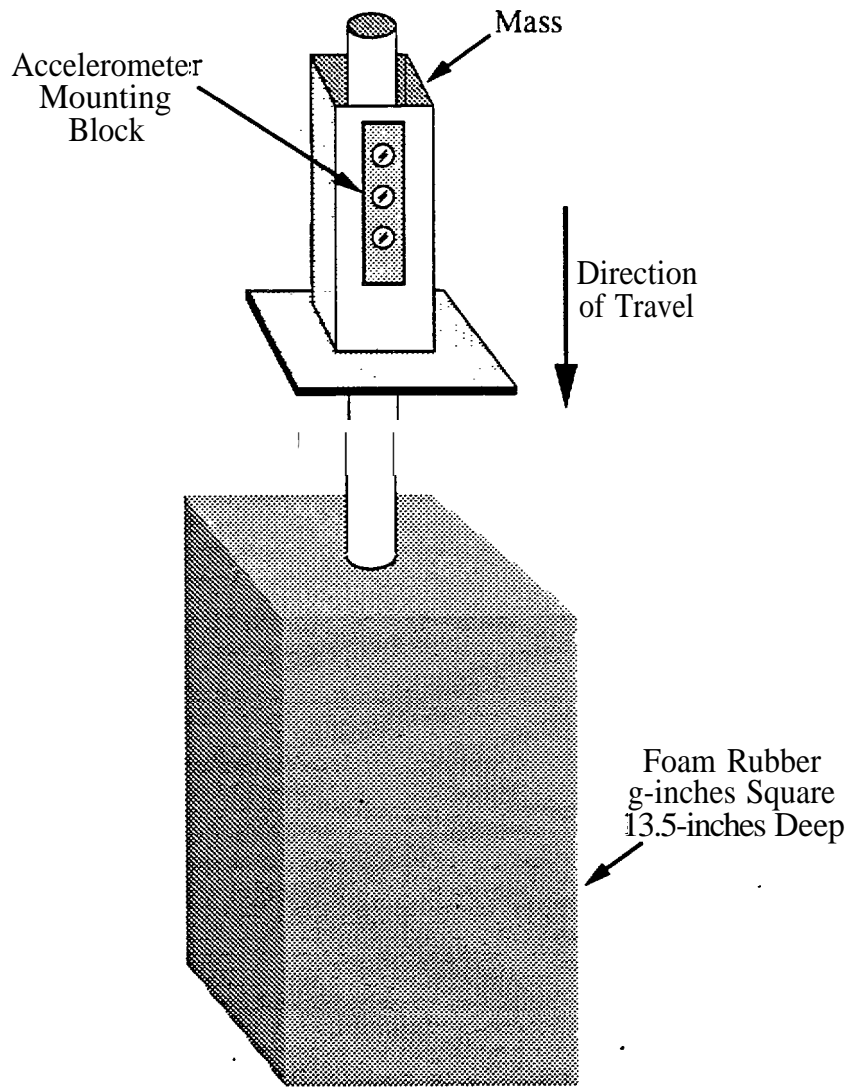

**Figure D-31 Crash Simulator concept Drawing**

The force exerted by the foam rubber on the proof mass is given by  $F = -kx$ . The returning force is characterized by  $F = ma$ . Equating the two equations yields  $ma = -kx$ . Rearranging this and expressing acceleration as a second derivative of the distance yields  $x'' + \frac{k}{m}x = 0$ . This is the equation for simple harmonic motion with the general solution  $x = A\cos(\omega t + \phi)$ , with  $\omega$  equal to  $\sqrt{\frac{k}{m}}$ . The period is therefore equal to  $2\pi\sqrt{\frac{m}{k}}$ .

A common rule of thumb for automobile accidents is that the deceleration forces are dissipated over a period of approximately 100 msec. A typical deceleration profile is shown in Figure D-32. The first 100 msec resembles the first 180 degrees of an inverted cosine wave, adding validity to the spring-mass model of a vehicle collision. Using 100 msec as half a period and applying  $T = 2\pi\sqrt{\frac{m}{k}}$  yields a  $\sqrt{\frac{m}{k}}$  ratio of  $0.1/\pi$  seconds.

The energy associated with a spring is  $\frac{1}{2}kx^2$ , and that for a moving object is  $\frac{1}{2}mv^2$ . All the kinetic energy of a moving vehicle is dissipated in the accident. Modeling the accident as a spring mass system, all the energy is transferred to the spring such that  $\frac{1}{2}kx^2 = \frac{1}{2}mv^2$ . From this a useful ratio is established,  $\frac{x}{v} = \sqrt{\frac{m}{k}}$ , which is interpreted as the amount of vehicle crush per unit of initial vehicle velocity. This ratio was calculated above to be  $0.1/\pi$  sec. Changing the units into a more meaningful measure reveals that in general a vehicle will crush approximately 6 inches for every 10 mph of initial velocity.

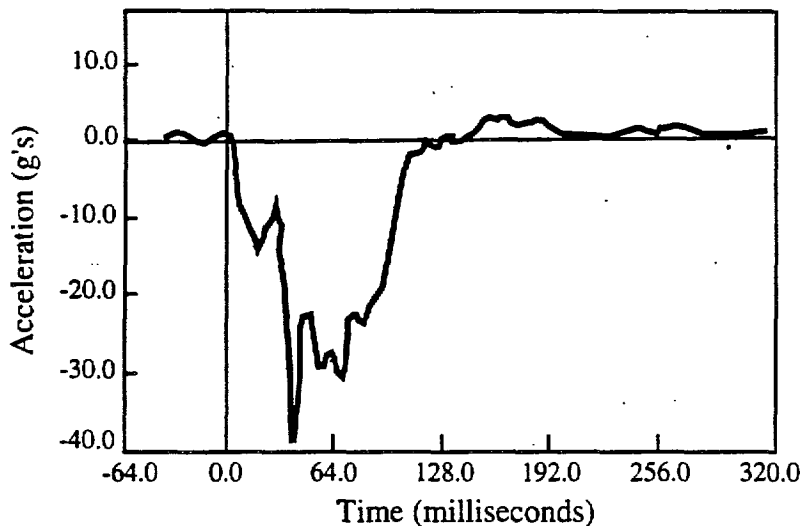
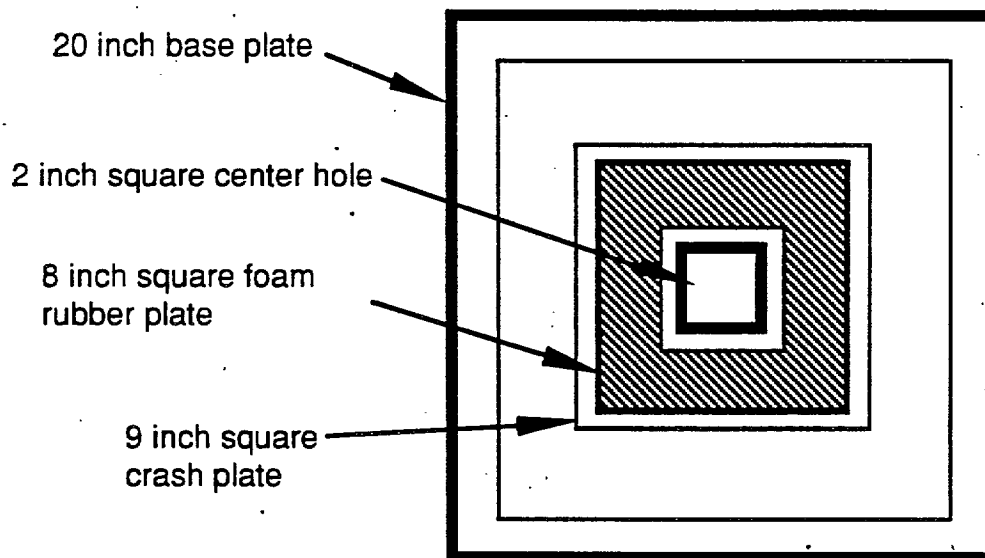

Figure D-32 Acceleration History of 30-mph Collision

The ratio  $\sqrt{\frac{m}{k}}$  is key in developing a crash simulator to test the sensor module of the ACN system. This ratio determines the shape and duration of the deceleration forces acting on the proof mass. For example, an available spring has a measured spring constant of 0.3265 lb/in. This spring would need to be coupled with a mass of 0.128 lb in order to maintain a  $\sqrt{\frac{m}{k}}$  of  $0.1/\pi$  sec.

In the crash simulator (Figure D-33), the proof mass and sensor suite (including mounting block) weigh approximately 10 pounds. To keep the ratio  $\sqrt{\frac{m}{k}}$  equal to  $0.1/\pi$  sec requires a  $k$  of 25.6 lb/in. Since the foam rubber has a measured spring constant per unit area of 0.4 lb/in./in.<sup>2</sup> (for a 2-in. displacement), the area of foam rubber necessary to provide the correct  $k$  is 64 in.<sup>2</sup>. Thus, the crash simulator is constructed with an 8-in. by 8-in. foam rubber mat.



**Figure D-33 Top View of Crash Simulator**

Tests were conducted by dropping the accelerometers from a height of 4 ft above the compressible foam blocks which results in a theoretical contact velocity of approximately 16.1 ft/sec (11.0 mph). The tests indicated that the deceleration profiles generated by the simulator, shown in Figure D-34, resemble those experienced in real collisions (Figure D-29). Notice that from -80 to 0 msec, the instrumentation suite is in free fall. Since the instrumentation and the proof mass in the accelerometers are both being accelerated at +1 g, the difference is 0 g and the accelerometer readings are 0 g. As soon as the instrumentation package impacts the foam, the foam exerts a force slowing down the package. This force (and consequently the deceleration) increases as the foam is compressed. This continues until the velocity reaches zero at the peak deceleration.

Therefore, integrating under the acceleration curves from zero to the peak deceleration gives the velocity change of the instruments.

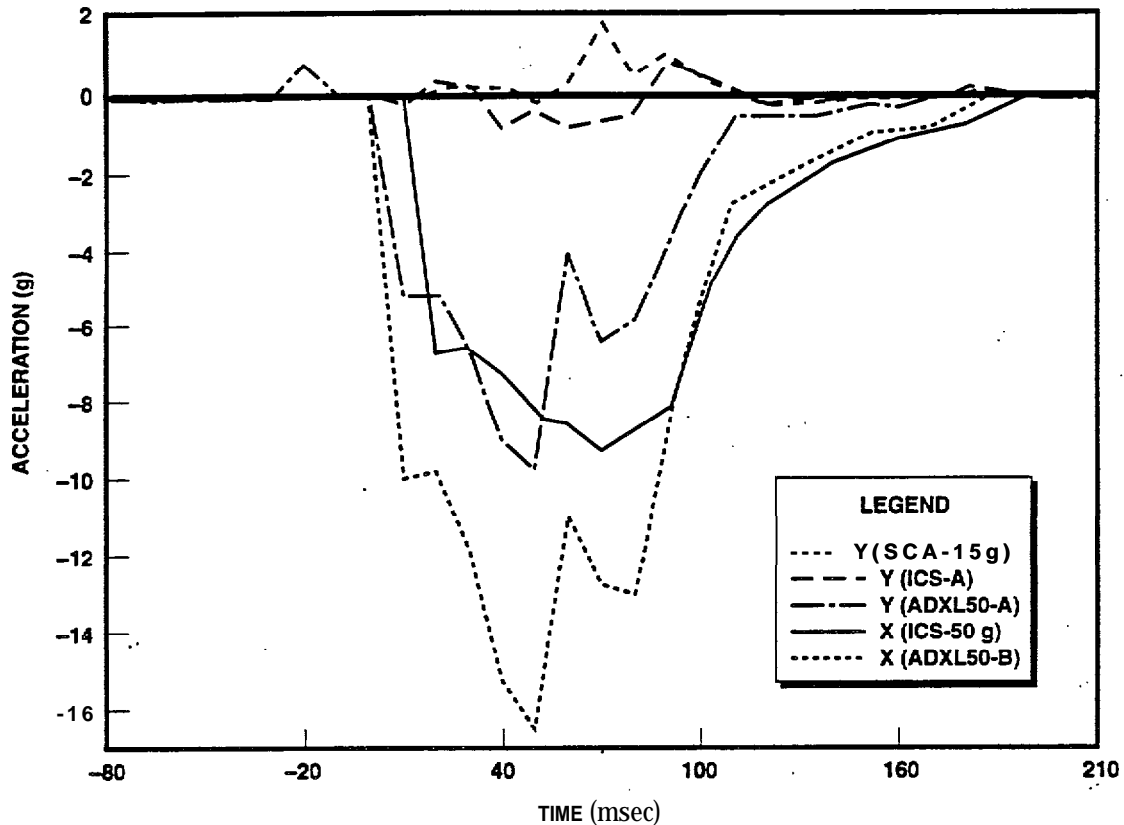

94.094.16

**Figure D34 Crash Simulator Measured Accelerations (4ft Drop)**

As expected, the accelerations in the Y direction (from SCA-15g and ICS-A) were close to zero. (Figure D-34). However, Y direction accelerations measured by ADXL50-A were considerably higher (peaking at -10 g). There was also an inconsistency in the two X direction accelerometers (KS-50g and ADXL50-B), which gave accelerations that were markedly different. The ICS-50g accelerometer peaked at -9.2 g, while the ADXL50-B peak value was nearly -17 g. Integrating under the curves gave velocity changes of 20.5 ft/sec for ADXL50-B, and 15.2 ft/sec for the ICS-50g accelerometer. It appeared that something was wrong with the ADXL50'accelerometer readings since the velocity change should have been approximately 16 ft/sec. An investigation into the problem indicated that the ADXL50 accelerometers were receiving cross talk from the +/-2-g ICS accelerometers. Since these sensors measure very low accelerations, they saturated early in the test. Wires from all the accelerometers were bundled together into a single cable running from the accelerometers to the data acquisition card (approximately 5 ft).

Since these wires are not shielded, induced voltages appeared to be causing the increased values of the ADXL50 accelerometers. This problem was avoided by disconnecting the +/-2-g ICS accelerometers for these tests. However, it appears that the ADXL50 sensors are sensitive to induced voltages and should be connected using shielded cables.

Tests conducted with the +/-2-g ICS sensors disconnected (Figure D-35) show that the ADXL50 and ICS50g accelerometers all give comparable results and an integrated velocity change of approximately 16 ft/sec which agrees well with the predicted value of 16.1 ft/sec. Notice that ADXL50-A now gives accelerations in the Y direction of less than -2 g. Also, the resultant accelerations from ADXL50 accelerometers C and D are the same as measured with the other accelerometers, which verifies again the ability to vectorially combine the outputs of orthogonally oriented accelerometers.

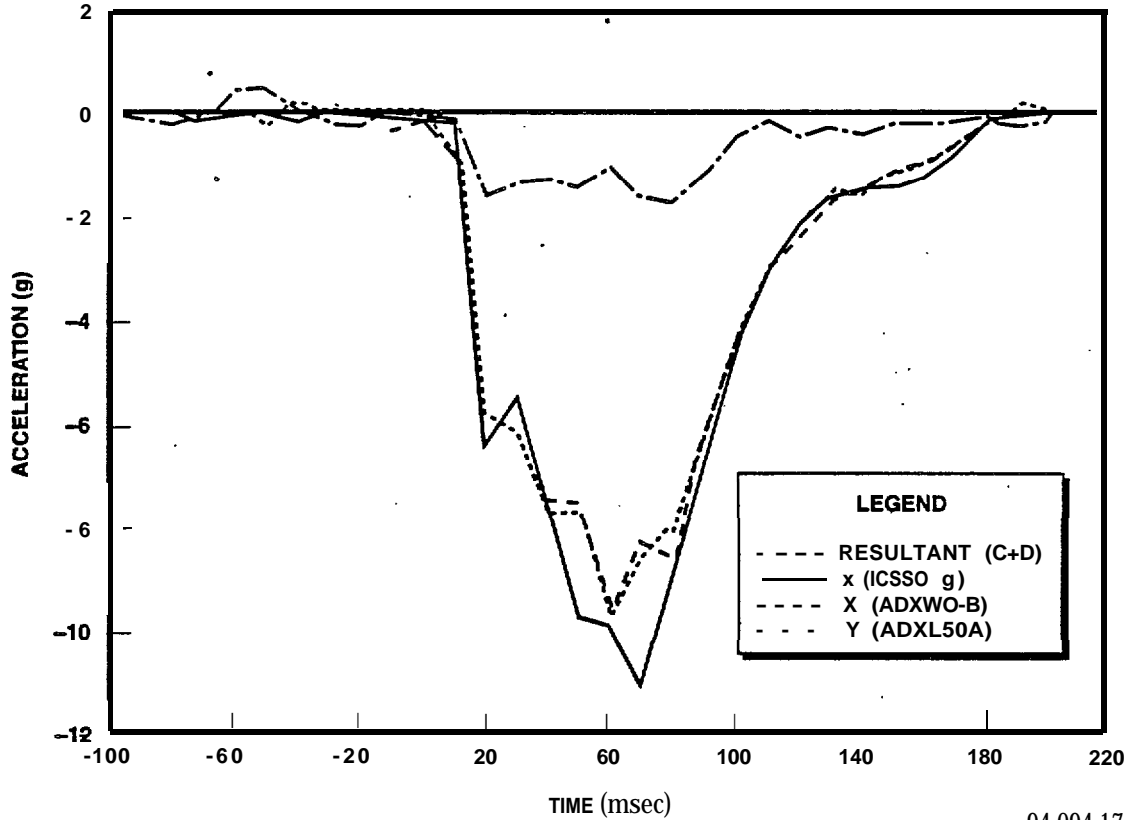

**Figure D-35 Crash Simulator Measured Accelerations [4ft Drop (With ICS 2-g Accelerometers Disconnected)]**

CRASH DETECTION ALGORITHM

Using the crash simulator outputs, a generic algorithm based on velocity change was developed. The algorithm is based on phenomena observed from actual crash test data (Reference D-1). A typical non-rollover automobile collision lasts for approximately 100 to 200 msec with an average deceleration of 10 to 50 g, depending on the velocity at impact. The vehicle does not necessarily come to rest within this time interval, but the largest forces, and therefore most of the damage to vehicle and occupant, occur within the first 200 msec.

For these reasons, the net velocity change within the first 200 msec is a better measure of crash severity than the actual vehicle velocity at impact (Reference D-3). For example, a vehicle moving at 30 mph before impact and moving backward at 10 mph after the first 200 msec (a net velocity change of 40 mph) suffers about as much damage as a 40-mph vehicle that comes to a halt. The net change of velocity over 200 msec is called the Delta-V or equivalent barrier velocity (EBV). The crash detection algorithm is designed to obtain an accurate measurement of EBV. The EBV value is used to determine when a crash has occurred, by making a comparison to a threshold, and then to report on the severity of the crash. To demonstrate the feasibility of developing a crash detection algorithm, only motion in the horizontal plane is considered. Vertical accelerations should also be included in an operational crash detection algorithm.

Figure D-36 shows the effect of accelerations along the x- and y- axes on an accelerometer mounted at an angle  $\theta$  with respect to the x axis. An acceleration,  $a_x$ , along the x axis causes the accelerometer to measure a component,  $a_x \cos \theta$ . Similarly, an acceleration,  $a_y$ , along the y axis causes the accelerometer to measure a component,  $a_y \sin \theta$ . Thus, an arbitrary acceleration with components  $(a_x, a_y)$  will give a total measured acceleration on accelerometer  $i$  of

$$A_i = a_x \cos (\theta_i) + a_y \sin (\theta_i) \quad (D-1)$$

where  $\theta_i$  is the angle of the accelerometer. A similar relation holds for accelerometers  $j$  and  $k$ . Combining the three equations and representing them in matrix form produce Equation D-2.

$$\begin{bmatrix} A_i \\ A_j \\ A_k \end{bmatrix} = \begin{bmatrix} \cos (\theta_i) & \sin (\theta_i) \\ \cos (\theta_j) & \sin (\theta_j) \\ \cos (\theta_k) & \sin (\theta_k) \end{bmatrix} \begin{bmatrix} a_x \\ a_y \end{bmatrix} \quad (D-2)$$

Any two of these equations are sufficient to determine the two unknown acceleration components  $a_x$  and  $a_y$ ; that is, the horizontal acceleration can be determined from any two of the accelerometers. Using a third sensor provides some redundancy for more reliable acceleration measurement. In terms of the theory of linear equations, Equation D-2 is an overdetermined system of the form  $y = Hx$ . If all three accelerometers provide precise measurements, one equation provides redundant information. However, if there are slight errors the system may be inconsistent; that is, there may be no  $x$  such that

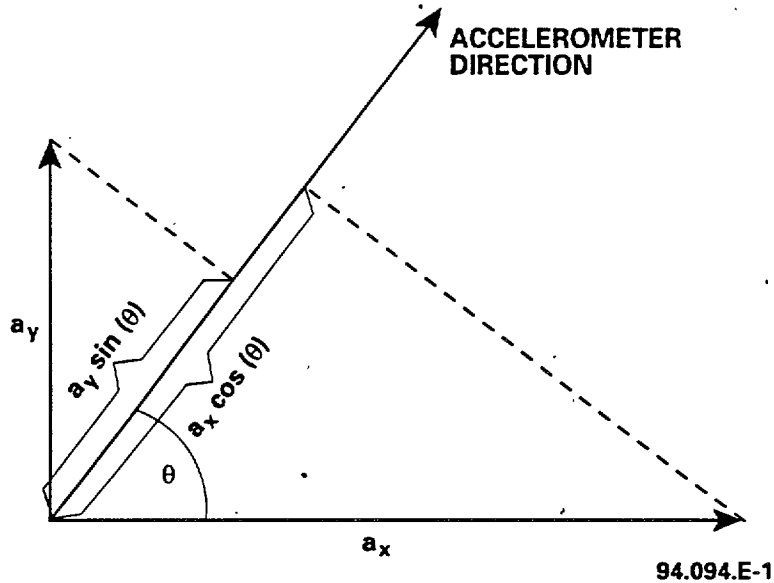

Figure D-36 Effect of Accelerations in X- and Y- Directions on an Accelerometer

$y$  is exactly equal to  $Hx$ . In that case, there is a least squares solution  $\hat{x}$ , such that  $\hat{y} = H\hat{x}$  is as close as possible to  $y$  in the least-squares sense. The least-squares solution is given by  $\hat{x} = (H^T H)^{-1} H^T y$ . In terms of the sensors, a least-squares solution would give the best estimate of the true acceleration vector in the presence of random measurement errors.

Ideally, for each time sample, the acceleration components would be determined, and a time history of  $\vec{A}$  would be maintained. The detection of a collision would then be accomplished by examining this time history to determine if a massive change in velocity has occurred in the last 100 to 200 msec. The vector change in velocity over 200 msec is given by

$$\Delta \vec{v} = \int_{200 \text{ msec}} \vec{A} dt \quad (\text{D-3})$$

The EBV is then the absolute value of this vector  $EBV = |\Delta \vec{v}| = \sqrt{v_x^2 + v_y^2}$ . In practice, it is too time-consuming to perform the least-squares solution of Equation D-2 and calculate EBV on every sample. Instead, a slightly different threshold test is used that can be implemented more efficiently. The modification is described below.

First, let  $K$  denote the complicated matrix expression  $(H^T H)^{-1} H^T$  in the least-squares solution. The matrix  $H$  depends only on the geometry of the sensor array

and is thus constant.  $K$  is therefore also a constant. The least-squares solution to Equation D-2 then can be written as

$$\begin{bmatrix} a_x \\ a_y \end{bmatrix} = \begin{bmatrix} K_{11} & K_{12} & K_{13} \\ K_{21} & K_{22} & K_{23} \end{bmatrix} \begin{bmatrix} A_j \\ A_j \\ A_k \end{bmatrix} \quad (\text{D-4})$$

If this equation is integrated over a 200-msec interval, the left-hand side gives the components  $\Delta v_x$  and  $\Delta v_y$  of the net change in velocity, and the equation becomes:

$$\begin{bmatrix} \Delta v_x \\ \Delta v_y \end{bmatrix} = K \begin{bmatrix} \int A_i dt \\ \int A_j dt \\ \int A_k dt \end{bmatrix} \quad (\text{D-5})$$

Since the data are digitally sampled, the integrals will be approximated by some numerical scheme,  $\int A dt = \sum A \Delta t = (\sum A) \Delta t$ . Whether the approximation is rectangle-rule, trapezoidal-rule, or another method, the common factor ( $\Delta t$ ) can be factored out so that only one multiplication needs to be done at the end. For simplicity, a simple summation is used in the equations below. Thus, Equation D-5 becomes

$$\begin{bmatrix} \Delta v_x \\ \Delta v_y \end{bmatrix} = K \begin{bmatrix} \Delta v_i \\ \Delta v_j \\ \Delta v_k \end{bmatrix} = K \Delta t \begin{bmatrix} \sum A_x \\ \sum A_y \\ \sum A_z \end{bmatrix} \quad (\text{D-6})$$

Instead of the system being triggered by thresholding the system  $\Delta v$ , we are now able to set individual thresholds on the quantities  $\Delta v_i$ ,  $\Delta v_j$ , and  $\Delta v_k$  and avoid the time consuming mathematical steps associated with deriving the system  $\Delta v$ . A threshold for the individual sensors is determined by the geometry of the system, usually anywhere from 50% to 85% of the overall system threshold. If any of the individual  $\Delta v$ 's surpasses its individual thresholds, the system  $\Delta v$  is calculated using least-squares techniques described above. If the system  $\Delta v$  exceeds the system threshold, the ACN system is activated.

The thresholds for the individual  $\Delta v$ 's are entirely dependent on the geometry of the accelerometers. An example is given below. For a system of two accelerometers separated by 90 degrees (Figure D-37), the individual thresholds are determined by the smallest maximum component of acceleration measured by any sensor. (The minimum of the  $\max\{A_i, A_j, \text{ and } A_k\}$  for any acceleration,  $\vec{A}$ .) For this scenario, the



minimum acceleration is measured if the acceleration force,  $\vec{A}$ , is at 45 degrees to the axes of the two accelerometers. For this instance, the acceleration measured by either accelerometer is approximately 0.707 times the absolute magnitude of  $\vec{A}$ .

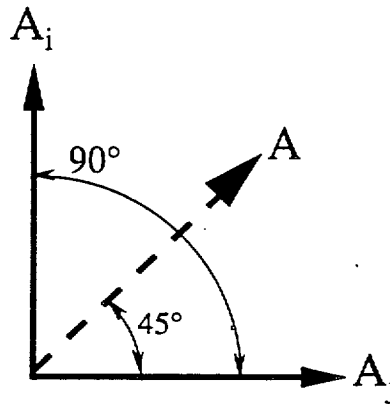

**Figure D-37 System of Two Accelerometers Separated by 90 Degrees**

Two other configurations of interest are three accelerometers arranged 120 degrees apart, and three accelerometers arranged 45 degrees apart. For the 120-degree case, the minimum acceleration read by the array of sensors is when  $\vec{A}$  is 30 degrees from the axes of two sensors, in which case, the acceleration measured would be a  $\cos(30^\circ)$  or approximately 0.866 times the magnitude of  $\vec{A}$ . For the three accelerometers arranged at 45 degrees, the minimum measured acceleration is as shown in Figure D-38 with a factor of the  $\cos(45^\circ)$ , which is approximately 0.707.

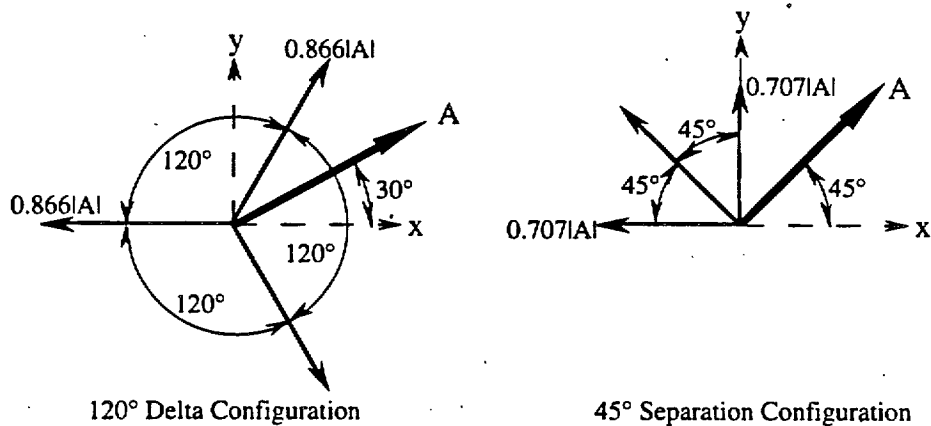

**Figure D-38 Determining Individual Thresholds**

The technique described above will detect an automobile collision, but it may not capture the maximum change in velocity. Figure D-39 illustrates this phenomenon. Initial detection of the collision is based on a minimum threshold  $\Delta v$ . The minimum threshold may be detected early in the accident, but the maximum  $\Delta v$  may not be achieved for several msec.

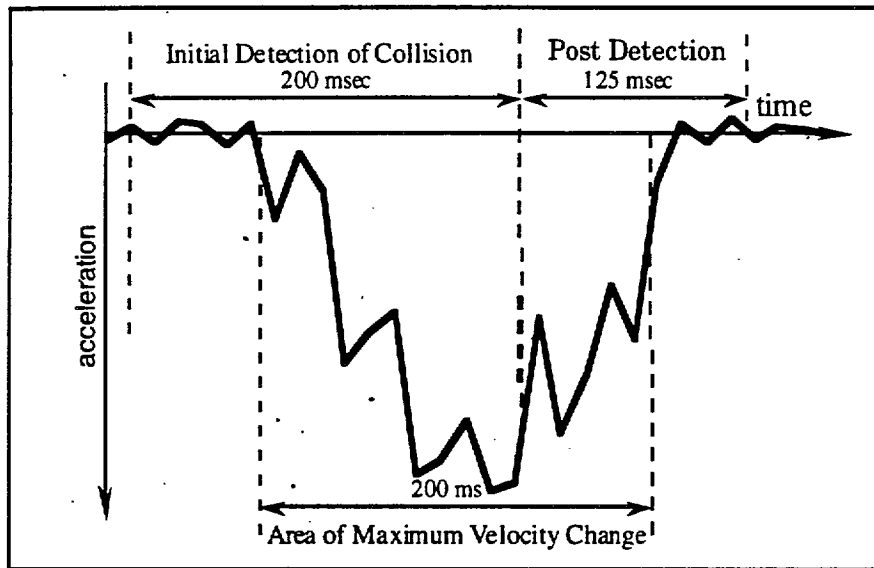

**Figure D-39 Calculation of Maximum Velocity Change for Crash Detection**

A method of combating this problem is to closely monitor the acceleration for several msec after initial detection. The maximum  $\Delta v$  will be captured after monitoring the accident for an additional period of time (125 msec is used in the detection algorithm). Once the maximum is found and the system  $\Delta v$  exceeds the system threshold, the ACN system is activated, and a Mayday message is sent.

The complete computer algorithm for detecting a collision is divided into a three-state machine with functions as shown in Figure D-40.

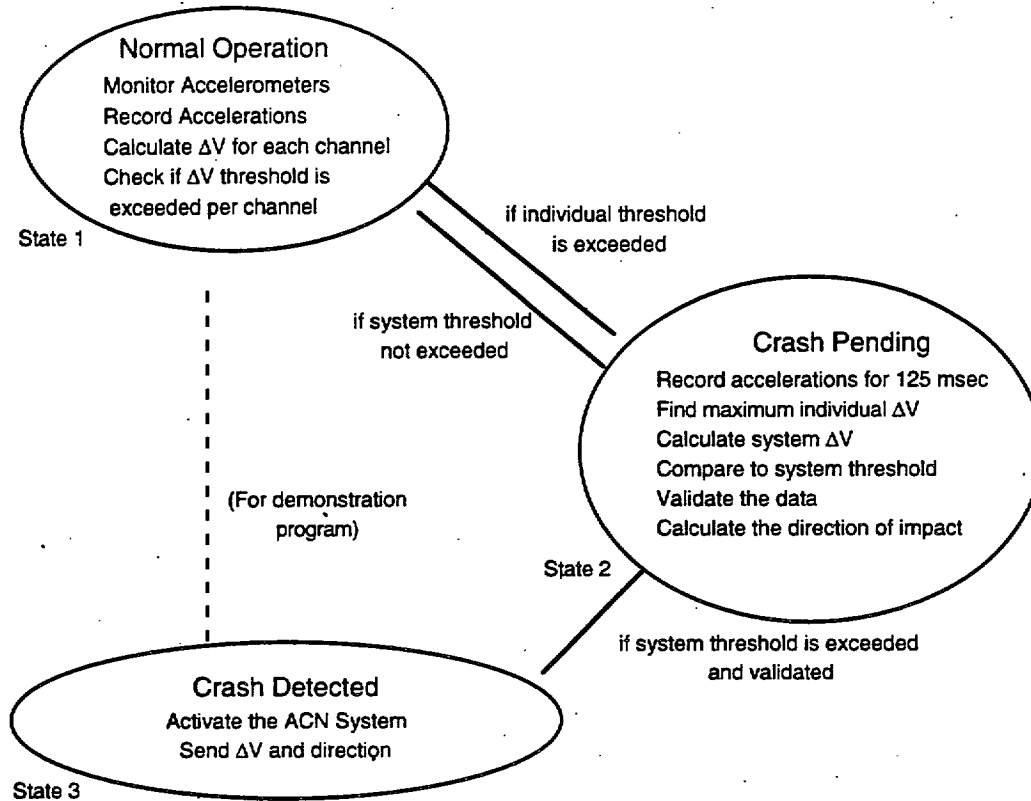

**Figure D-40 State Diagram for Algorithm**

A generic algorithm for crash detector is given below without any further explanation.

Function Call: `has_crash_occurred (Ai, Aj, Ak)`

Inputs:        A<sub>i</sub>, A<sub>j</sub>, A<sub>k</sub>     /\* Acceleration readings           \*/  
 Returns:        1            : Normal Operation  
                2            : Crash Pending  
                3            : Crash has occurred

Global Variables :

`acceleration_history`   /\* a 'circular array' to store acceleration data   \*/  
`individual_Δv`         /\* Δv's for last 200 ms for each channel           \*/  
`index_ah`             /\* index to the array                               \*/  
`system_status`        /\* Either 1,2, or 3 as above                       \*/  
`counter_125ms`        /\* A 125 ms loop counter                           \*/  
`max_delta_v`          /\* maximum Δv                                       \*/  
`direction_of_impact`  /\* direction of impact                               \*/  
`index_mdv`            /\* store the index for the maximum Δv in state 2 \*/

Global Constants :

```
individual_thresholds /* the  $\Delta v$  for any one channel */
system_threshold     /* the  $\Delta v$  for the system */
```

algorithm

```
if system_status = 1
  store  $A_i, A_j, A_k$  in acceleration history
  calculate individual  $\Delta v$ 
  increment index_ah
  if any individual  $\Delta v$ 's > individual_thresholds
    set counter_125ms = 0
    set system_status = 2
    store max individual  $\Delta v$  in max_delta_v
    store (index_ah-1) in index_mdv
    return 2
  else
    return 1
  end

else if system_status = 2
  store  $A_i, A_j, A_k$  in acceleration history
  calculate individual  $\Delta v$ 
  increment index_ah
  increment counter_125ms
  if any individual  $\Delta v$ 's > max_delta_v
    store max individual  $\Delta v$  in max_delta_v
    store (index_ah-1) in index_mdv
  end
  if counter_125ms > 125ms
    calculate maximum system  $\Delta v$ 
    if system  $\Delta v$  > system_threshold
      calculate direction_of_impact
      system_status=3
      return 3
    else
      system_status=1
      return 1
    end
  else
    return 2
  end
else if system_status = 3
  for the demonstration system, reset everything, delay a few seconds and
  return to system_status 1
end
```

This algorithm was tested against simulated crash data to ensure successful crash detection. It was also evaluated under normal driving conditions to demonstrate that the system will not activate under normal but severe driving situations, such as hard braking, cornering, and driving over potholes.

As a demonstration of the 'capability of the crash detection algorithm, the crash simulator was dropped from successively greater distances. Below the 10-mph integrated velocity change threshold, the system recorded data but did not activate the ACN system. When the velocity change exceeded 10 mph, the ACN system was properly activated.

## D.5 SUMMARY

The performance of capacitive and piezoresistive solid state accelerometers were evaluated to determine their suitability to characterize normal driving and to use in an ACN system. Although some pitfalls were identified (calibration, noise susceptibility), both types of accelerometers were found to be sufficiently reliable and accurate to support both functions. Using these two types of accelerometers, a test bed was developed and installed in a vehicle to collect normal driving acceleration data. The most severe accelerations occurred from driving off of a curb and hard braking. However, even in these cases, the maximum measured accelerations tended to be less than 2 g (1 g in the X-Y plane). This low level of acceleration combined with the short duration of the peak accelerations allows normal driving to be distinguished from a collision by using velocity change. An algorithm was developed to measure velocity change using a 200-msec sliding window and multiple accelerometers. Using a 10-mph threshold for crash detection, the algorithm was tested under both normal driving conditions and for a simulated crash. In all test cases, the sensors and the algorithm functioned properly and, therefore, could be used as prototypes for an ACN system. Based on the results of the testing, it can be concluded that, using currently available technology, it is feasible to develop a crash detection system that can support ACN. Additional feasibility efforts should be focused on the use of accelerometers to determine if a vehicle has rolled over and the direction of impact.

## REFERENCES

- D-1. C. A. Markusic, "Final Report of a 1987 Hyundai Excel into a 0" Frontal Pole Barrier in Support of Crash III Damage Algorithm Reformulation," Department of Transportation, National Highway Traffic Safety Administration, DOT HS 807 775, Springfield, VA, June 1991.
- D-2. Charles Kitchin, "Using the ADXL50 in Low G Applications," Application Note, Analog Devices, Norwood, Massachusetts.
- D-3. William L. Carlson, *Accident Analysis and Prevention*, Volume 11, Pergamon Press Ltd., 1979, Great Britain.