



PROCEDURE FOR ANALYSIS AND DESIGN OF WEAVING SECTIONS

VOLUME 2. Users Guide

F I N A L R E P O R T

Federal Highway Administration
Contract DTFH61-82-C-00050

Prepared by

JACK E. LEISCH & ASSOCIATES
Evanston, Illinois

February 1984

FORWORD

This report summarizes the results of a research effort in the development of a procedure for design and analysis of weaving sections on freeways. The technique developed was directed toward improving efficiency and safety in rehabilitation and redesign of congested and outmoded freeways. The technique, utilizing new data, was structured to some extent upon the 1965 HCM procedure, with the objective of presenting a direct, easy-to-use method facilitated by the application of several nomographs. The method is quite different, although utilizing much of the same data, from that developed by the Polytechnic Institute of New York and reported under NCHRP Project 3-15, Weaving Area Operations Study, 1973. The results of the two projects are being analyzed under an independent FHWA research effort for comparison and evaluation, to serve as input in this area, toward development of the new Highway Capacity Manual.

The report is presented in two parts: Volume 1--covering the development and verification of the procedure; and Volume 2--providing a users guide to demonstrate the solution of a variety of weaving problems, encompassing a full spectrum of applications. Volume 2 is also organized and written with the possibility of serving, with appropriate editing and adjustments, as a chapter on Weaving for the Highway Capacity Manual.

1. Report No. FHWA-RD-85/073	2. Government Accession No.	3. Recipient's Catalog No. PB85 184158/AS	
4. Title and Subtitle PROCEDURE FOR ANALYSIS AND DESIGN OF WEAVING SECTIONS Vol. 1. Research Findings and Development of Techniques for Application Vol. 2. Users Guide		5. Report Date December 1983/February 1984	
		6. Performing Organization Code	
7. Author(s) J.E. Leisch and J.P. Leisch		8. Performing Organization Report No.	
9. Performing Organization Name and Address Jack E. Leisch & Associates 1603 Orrington, Suite 1290 Evanston, Illinois 60201		10. Work Unit No. (TRAIS)	
		11. Contract or Grant No. DOTFH61-82-C-00050	
12. Sponsoring Agency Name and Address Office of Research and Development Federal Highway Administration U.S. Department of Transportation Washington, D.C. 20590		13. Type of Report and Period Covered Final Report - 2 Volumes	
		14. Sponsoring Agency Code	
15. Supplementary Notes FHWA Contract Manager: Guido Radelat (HSR-40)			
16. Abstract This research was performed to complete and advance the status of recently developed procedures for analysis and design of weaving sections (known as the Leisch method) and initially published in the 1979 issue of ITE Journal). The objective was to enlarge upon and complete the earlier work through calibration of the method by using data from the BPR Weaving Area Study, NCHRP Project 3-15, and studies of Institute for Research of Pennsylvania State College; also to expand and refine the initial statistical analysis to provide full documentation; as well as to update the nomographs previously developed, including a demonstration of problem solutions for application. The research and development conducted closely verified the previous work, and largely expanded on documentation and application of the procedure. The general framework of the procedure is patterned to some degree upon the 1965 Highway Capacity Manual in order to maintain familiarity and ease of application. This was verified in using the technique, allowing for relatively simple and rapid solutions. The method is applicable to both design and operational analysis situations, and oriented to be in consonance with AASHTO Design Policies. The report is presented in two parts: <u>Volume 1</u> --covering the development and verification of the procedure; and <u>Volume 2</u> --providing a users guide to demonstrate the solution of a variety of weaving problems, encompassing a full spectrum of applications.			
17. Key Words Freeway Design Freeway Operations Freeway Weaving Sections Traffic Weaving Sections Weaving Sections		18. Distribution Statement No Restrictions.	
19. Security Classif. (of this report) Unclassified	20. Security Classif. (of this page) Unclassified	21. No. of Pages Vol.1-- 169 Vol.2-- 74	22. Price



TABLE OF CONTENTS

	<u>Page</u>
Introduction	1
Characteristics and Forms of Weaving Sections	3
Definition of Terms	9
Operational Features and Levels of Service	10
Analysis Techniques	13
Example Problems*	29
Guidelines and Nomographs	57
* <u>Special Note for Use of Guide</u>	29

LIST OF FIGURES

<u>Number</u>		<u>Page</u>
1	Forms of Weaving Sections	5
2	Nomenclature of One-Sided and Two-Sided Weaving Sections	6
3	Variations of One-Sided Weaving Sections	7
4	Configuration of Weaving Sections - Lane Arrangement and Lane Balance	8
5	Nomograph for Design and Analysis of Weaving Sections--One-Sided Configurations	14
6	Nomograph for Design and Analysis of Weaving Sections--Two-Sided Configurations	15
7	Supplementary Nomograph for Speed Calibration--One-Sided Weave	16
8	Supplementary Nomograph for Speed Calibration--Two-Sided Weave	17
9	Nomograph Procedure for Lane-Imbalanced Sections One-Sided Weaving Sections	21
10	Analysis Worksheet Form for 2EN-EX Multiple Weaving Sections	24
11	Analysis Worksheet Form for EN-2EX Multiple Weaving Sections	25

LIST OF TABLES

<u>Number</u>		<u>Page</u>
1	Performance Criteria for Weaving Sections on Freeways	12
2	Use of Nomographs Including Adjunct Procedures for Weaving Sections	27 & 28

USERS GUIDE

For

Analysis and Design of Weaving Sections on Freeways

Introduction

In the design and operation of freeways, weaving sections are formed by closely spaced interchanges or ramps which tend to produce adverse effects on traffic and be a source of facility breakdowns. Weaving is the crossing of traffic streams moving in the same general direction, accomplished by successive merging and diverging. Weaving maneuvers are especially prevalent on urban freeways and must be carefully examined to ensure a reasonably balanced design and a uniform level of service over the length of the freeway.

The process to measure and achieve this is accomplished by harmonizing the performance of: (1) the freeway proper characterized by uninterrupted flow, removed from influence of interchanges; (2) the sections of freeway associated with interchanges involving merging and diverging facilities and their sequence and arrangement; and (3) the weaving sections formed along the freeway. The procedures for (1) and (2) have been set out in other works preparatory for inclusion in the new HCM, while procedures for (3) have been under study on several projects, one of which is presented herein.

Operations on weaving sections are akin to freeway sections with ramps producing merging or diverging maneuvers, and including in some instances their overlapping influence. The weaving section configuration although a form of ramp sequential arrangement, however, is sufficiently distinct to require an independent analysis to bring it into level of service balance with the freeway as a whole.

Drawing upon the development of Volume 1, procedures have been expanded and formulated to assist the user in applying the techniques for solution of a great variety of problems representative of actual conditions. It is intended that the practitioner, by referring to the set of example problems provided in this Volume, will be able to solve most any form of weaving problem present within a freeway corridor.

A special effort has been made and accomplished here in presenting a procedure easy to comprehend and apply in solution of problems. This evolves from the objectives achieved in the development processes in Volume 1, wherein: (a) the procedure was structured to be simple and readily usable; (b) the format maintained a degree of simplicity with the already familiar aspects of the 1965 HCM; (c) the basis for development was predicated on the full set of data available at the time, with statistical applications recognizing data limitations; and (d) the development further utilized analytical modeling and rational formulations to supplement and expand upon portions of findings determined statistically and to fill the gaps in the procedure to provide a broad spectrum for application.

The complete procedure and its ease of application was thus made possible. The technique developed may not always replicate fully the operational characteristics of weaving sections under a variety of conditions; i.e., in all cases produce a high degree of correlation or supposed "accuracy" which may be presumed to exist (if it were possible to identify and measure). The procedure developed for design and operation of weaving sections in conjunction with freeways, however, does provide practical and uniform results, which are considered to be in consonance with analysis results on other elements of the freeway.

Characteristics and Forms of Weaving Sections

Weaving sections which constitute a particular arrangement or sequence of ramps--an entrance ramp followed relatively close by an exit ramp along a highway--require a special procedure in determining quality of operation or level of service. There are several variations of weaving sections which, although somewhat different in form, perform with a degree of similarity. Each can be broken down to a set of operational components which are much the same although interrelated a bit differently. Because of the similarity in the basic operational elements, it has been possible to devise analysis procedures to solve problems associated with all forms of weaving sections using minor variations in the process.

There are four principal means of classifying weaving sections--simple or multiple, and one-sided or two-sided--as shown in Figure 1:

- A. Simple weaving section is a general term for a single weaving segment consisting of two joining roadways followed by two separating roadways.
- B. Multiple weaving section is formed by several ramp junctions in sequence; for example, an entrance ramp followed by two exit ramps, or two entrance ramps followed by a single exit ramp. A multiple weaving section may also be of a mixed variety, such as a right-hand ramp followed successively by a left- and a right-hand ramp.
- C. One-sided weaving section is formed by one right-hand entry followed by a right-hand exit, sometimes referred to as a ramp weave; it is also a form of simple weaving section. In special cases (as along a continuous C-D road) a one-sided weaving section could involve a left-hand entry followed by a left-hand exit.
- D. Two-sided weaving section is formed by a right-hand entry followed by a left-hand exit, or a left-hand entry followed by a right-hand exit.

The major difference between a simple weave and multiple weave is that the first represents a single weaving action, whereas the second produces two overlapping

weaving sections, resulting in a much more complex operation. The difference between a one-sided and a two-sided weave is that the first is simpler, with weaving taking place along one side, while through traffic proceeds along the other side of the section. The second, two-sided section, is much more complex on which weaving traffic completely crosses the path of freeway traffic.

The more detailed arrangement depicting the comparison between a one-sided and two-sided weaving section is illustrated in Figure 2. An important feature noted is the method of measuring the length of weaving section, which is accomplished from a merging tip of 2 feet (between normal edges of traveled way of freeway and entering ramp) to a dimension in vicinity of the diverging point where the dimension between the normal edges of traveled way is equivalent to a lane width, or 12 feet.

Basic forms of one-sided weaving sections are noted in Figure 3, demonstrating three different arrangements applicable to the analysis procedure developed herein. Section A is a case of simple merge (accelerating facility) followed by a normal diverge (decelerating facility), without the use of an auxiliary lane. Section B is a more expansive form of simple weave in which the entrance and the exit are connected by an auxiliary lane, providing continuous lane between the two. The third variation of one-sided weave shown in Section C, entails a C-D (collector-distributor) road which separates all weaving from through traffic.

Further configurations of weaving sections have to do with internal lane arrangement and lane balance. Examples of a variety of patterns which provide different degrees of operational flexibility and extent of lane changing are shown in Figure 4. Lane continuity and lane balance play a primary role in the efficiency and quality of operation. The arrangements shown demonstrate considerable variations in lane configurations and different lane changing maneuvers within the weaving sections. Designs which do not fully provide lane balance (where lane balance has the feature of "one more lane going away"), tend to produce two and possibly three times the number of lane shifts (L.S.) than on fully lane-balanced weaving sections. Those sections with the greater number of lane changes, even if the total number of lanes and weaving volume are the same, would be expected to operate at a lower level of service. The more complex weaving sections should receive individual attention and special analysis to achieve as high an operational quality as feasible, even though much of it would be accomplished by rational deduction.

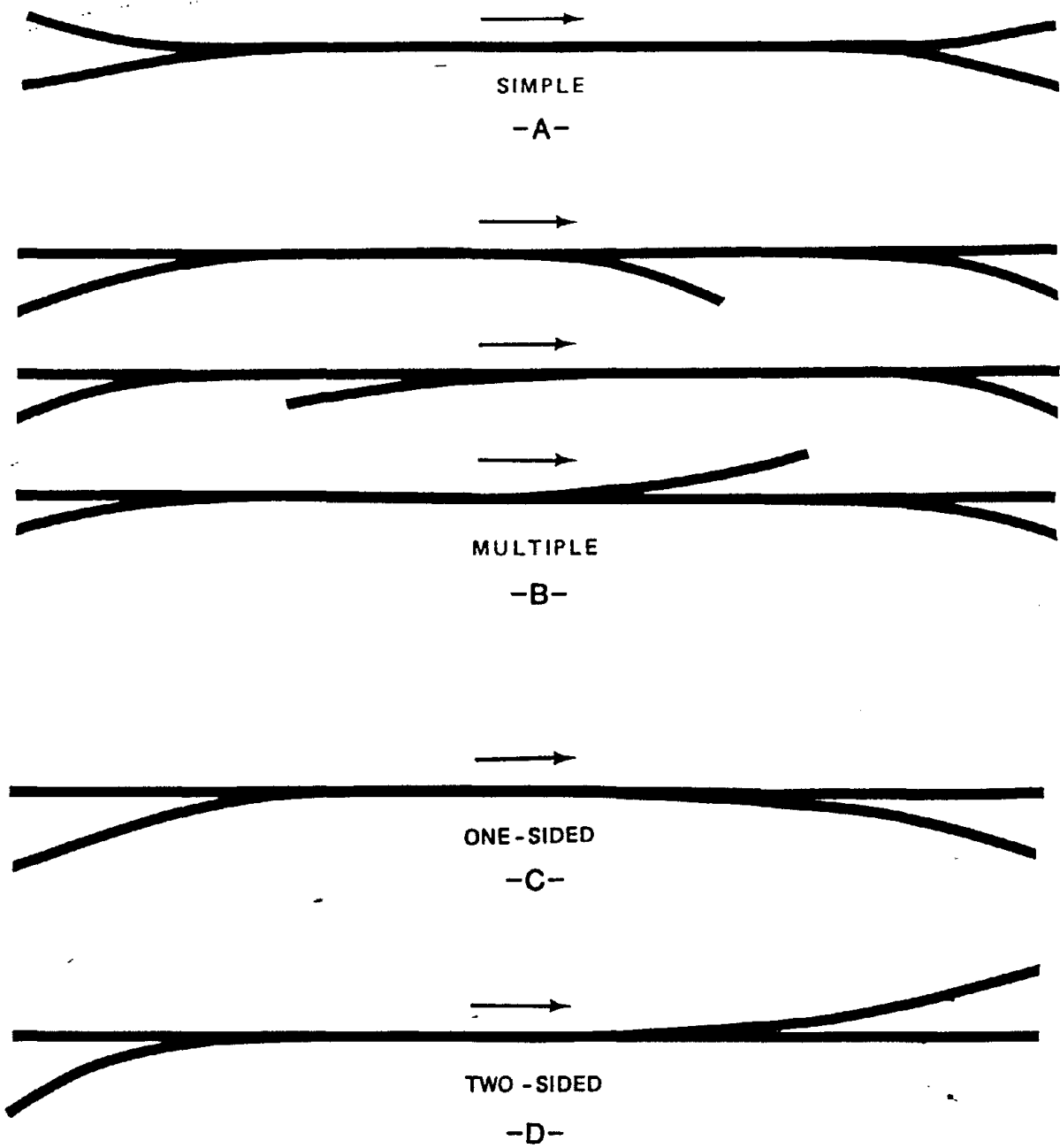

Figure 1. FORMS OF WEAVING SECTIONS

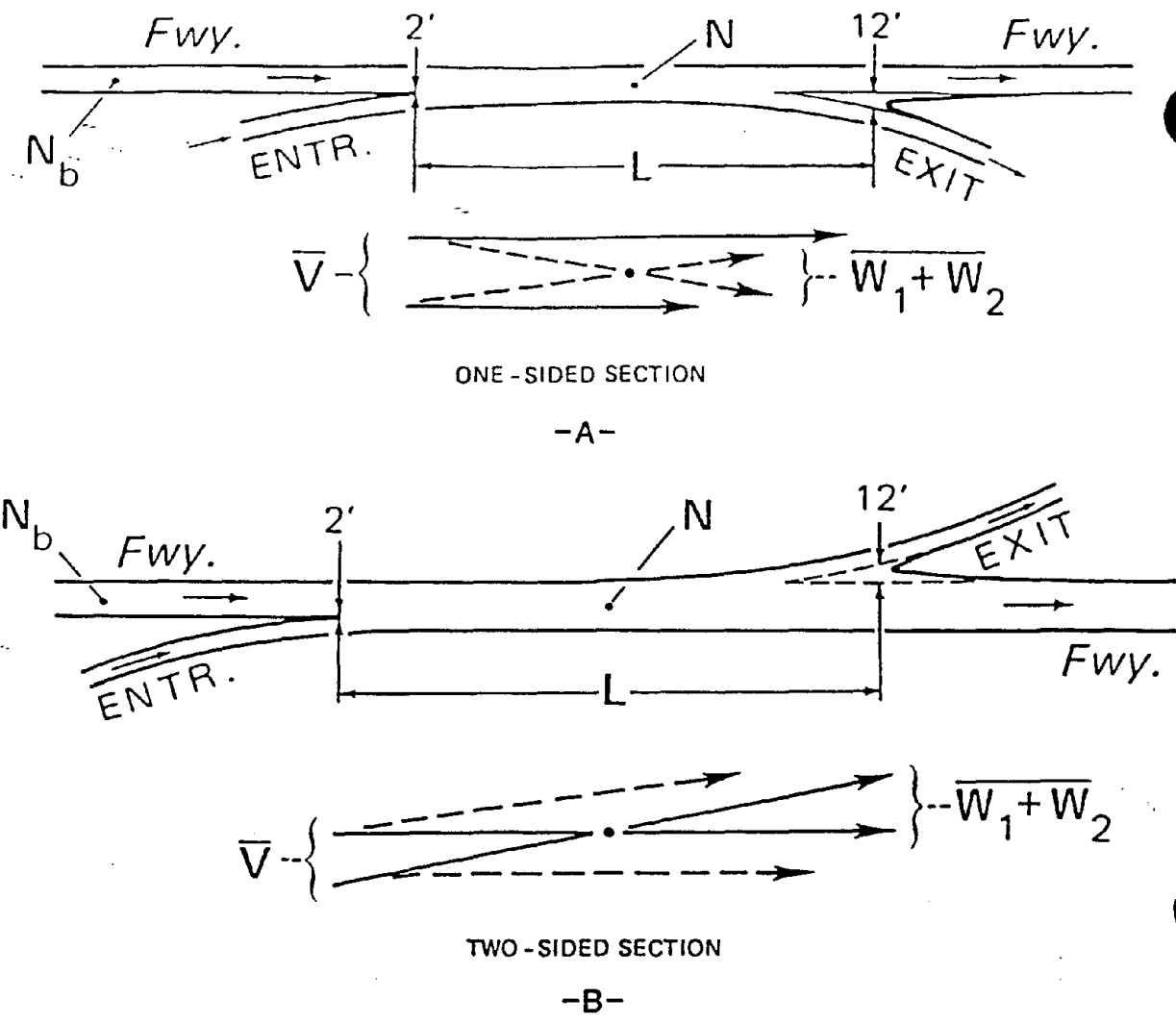

Figure 2. NOMENCLATURE OF ONE-SIDED AND TWO-SIDED WEAVING SECTIONS

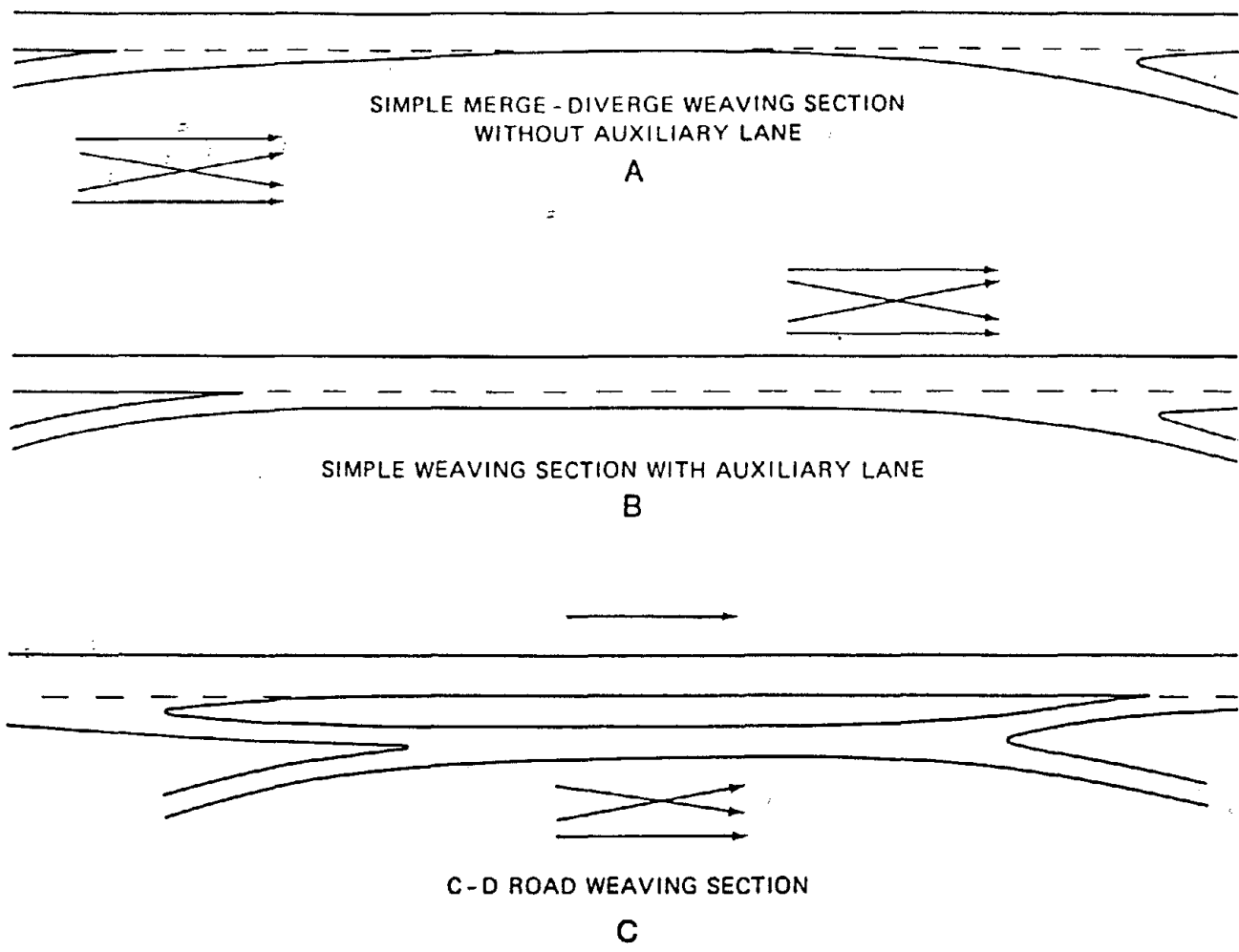
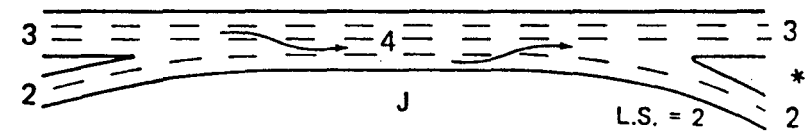
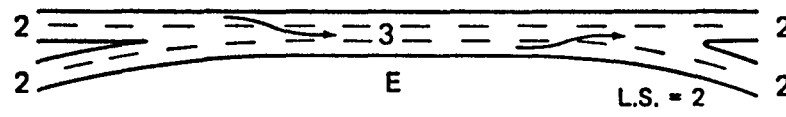
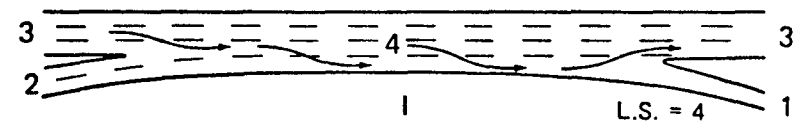
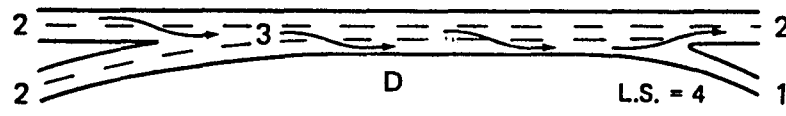
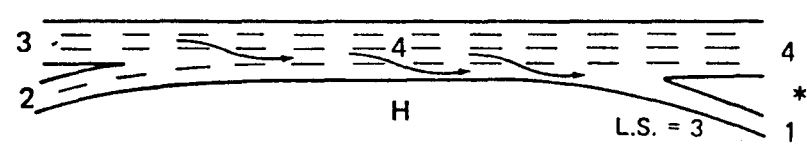
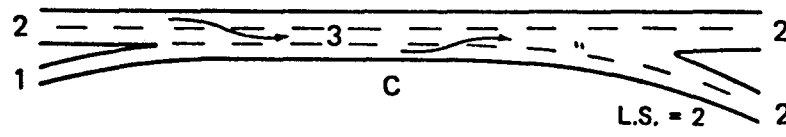
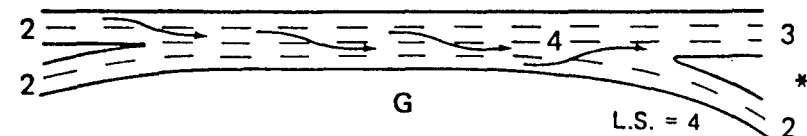
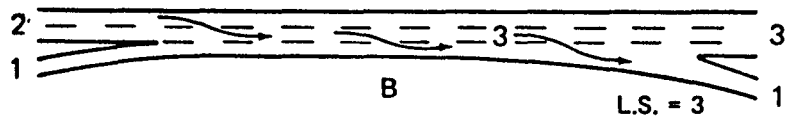
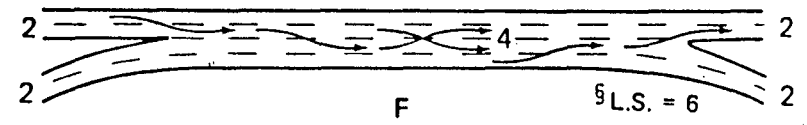
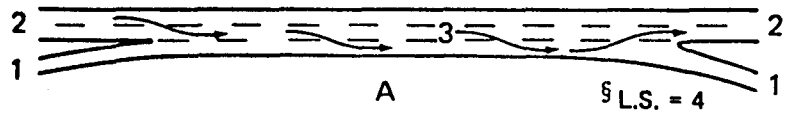

Figure 3. VARIATIONS OF ONE - SIDED WEAVING SECTIONS



* DENOTES LANE BALANCE – OPTIONAL LANE AT EXIT,
i.e., ONE MORE LANE GOING AWAY

§L.S. – POTENTIAL LANE SHIFTS, CONSIDERING MAX. OF
2 LANES INVOLVED ON ANY ONE APPROACH

Figure 4. CONFIGURATION OF WEAVING SECTIONS – LANE ARRANGEMENT AND LANE BALANCE

Definition of Terms

In presentation of the following material, particularly as it relates to general application and specifically to solution of example problems, the nomenclature and principal definition of terms are noted below. To the extent feasible, these are presented so as to match a number of terms already in use in conjunction with the 1965 HCM, AASHTO geometric design policies, and PINY research which has introduced a group of meaningful definitions and notations. Although somewhat of a composite, the terms generally should be familiar, as well as useful and convenient in application of techniques and problem solutions presented.

V_w or W_1+W_2	Total weaving volume	pcph
V_{nw}	Total nonweaving volume	pcph
V	Total volume	pcph
W_2	Smaller weaving volume	pcph
k	Weaving intensity factor	--
SV	Service volume	pcph or pcphpl
S_w	Speed of weaving traffic	mph
S_{nw}	Speed of nonweaving traffic	mph
S	Speed of all traffic (composite)	mph
N_w	Width of traveled way occupied or required for weaving	Number of lanes
N_{nw}	Width of traveled way occupied or required for nonweaving	Number of lanes
N	Width of traveled way of weaving section, total	Number of lanes
N_b	Number of basic lanes on major approach to weaving section	Number of lanes
R	Ratio of smaller weaving to total weaving volume	$W_2 \div (W_1+W_2)$
VR	Ratio of weaving volume to total volume	V_w/V
LOS	Level of Service, designated as A, B, C, D and E; V_w measured by S_w directly with SV as dependent variable; and V measured by SV directly with S as dependent variable.	
PHF	Peak-hour factor: Hourly volume divided by 4 times the 15-min. peak flow within the hour.	

Operationally Balanced Section: Section with weaving traffic operating at or near LOS of nonweaving traffic.

Constrained Section: Section with weaving intermixing with nonweaving traffic, and each tending to operate at different LOS.

Operational Features and Levels of Service

Weaving sections are formed along a highway by merging followed by diverging traffic, with the separation between the points of entering and exiting traffic at sufficiently close intervals to cause a degree of turbulence and intensity of lane changing beyond that experienced with other arrangements or sequences of ramp junctions. The complexity of operation within a weaving section becomes evident, where one element of traffic is destined to pass through the section (nonweaving traffic), while another element of traffic is required at the same time to cross the paths of other vehicles within the section (weaving traffic). Due to stream friction, introduced by weaving traffic and often by intermixing of weaving and nonweaving traffic elements, an impact or adverse effect on the overall operation of such sections occurs along the freeway. To account for or compensate for the possible degeneration in the quality of operation, the weaving section as a distinct component of the freeway should be separately analyzed and adjusted as required with respect to geometrics and traffic pattern.

Weaving performance is fundamentally dependent upon the length and width of the weaving section, as well as on the amount and makeup of weaving and nonweaving traffic. Other geometric and operational features--such as, design speed, lane widths, gradients, proportion of trucks, and potential speeds of entering or exiting traffic as affected by ramp geometry and nearby traffic control devices--all have an effect on weaving section performance. Conversion of traffic volumes to equivalent passenger cars (pcph) is accomplished prior to analysis of the weaving section. The method for doing so is covered in the 1965 HCM and further updated in the new HCM. The model and procedures developed, as well as the demonstration of example problems presented herein, are thus simplified by a common pcph base.

In design or in improvement of operations of weaving sections, an attempt is made to provide the required number of lanes for each traffic component--weaving traffic and nonweaving traffic. Meeting the separate lane requirements works toward providing unconstrained weaving sections or operationally balanced sections, wherein both the weaving and the nonweaving traffic tend to operate at the same level of service. Even so, there is an impact of exiting and entering

traffic upon the flow of traffic on the freeway. Some slow-down in the freeway movement or degradation of quality of operation under such circumstances is evident and is expected; however, such effect for proper design should be minimal and of short duration, allowing the overall freeway flow to recoup and reestablish its quality of operation experienced prior to the diverging or merging junction. This approach is the basis for design and operation of weaving sections, and is reflected in the level of service criteria set out in this report.

Level of service measures (A through E) relating to freeway proper or basic freeway sections, are quantified primarily on the basis of speeds of operation and service volumes (per lane) generated. These provide a general basis for establishing levels of service for weaving sections. Consideration of level of service values utilized for ramp merging and diverging traffic are further taken into account. Also of importance is the peak-hour factor (PHF) which accounts for fluctuations within the hourly volume and permits the higher rates of flow generated during the shorter periods within the hour (normally taken for 15 minutes) to be established and incorporated into the level of service measurement process. The basic service volumes per lane per full hour of operation derived through research on this project are multiplied by a "representative" PHF for each applicable level of service (C through E). This produces numerically lower service volumes (SV) as part of the level of service criteria which, when applied to design-hour or demand volumes (DHV), account for higher rates of flow in evaluation of operation or design.

The performance criteria for weaving sections, defining levels of service in terms of speed and volume measures are shown in Table 1. The weaving traffic element is predicated directly on the average speed of weaving traffic, with the corresponding SV serving as a dependent variable, whereas for the overall weaving section, involving both weaving and nonweaving traffic, SV serves as the independent variable and speed as the dependent variable.

In either case, the two are correlated for purposes of analysis. The speed of weaving, for each level of service, is taken for one-sided weaving sections to be 5 mph less than the speed on the freeway upon approaching or leaving the weaving section. With respect to maximum service volumes (SV) in pcph per lane, the values reflect built-in peak-hour factors as expressed in the third note of Table 1.

TABLE 1

PERFORMANCE CRITERIA FOR WEAVING SECTIONS ON FREEWAYS

A. SPEED MEASURES FOR LEVELS OF SERVICE

LEVEL OF SERVICE	AVERAGE RUNNING SPEED – MPH*		
	FREEWAY PROPER THRU MOVEMENT, APPROACHING AND, FOLLOWING RECOVERY, LEAVING WEAVING SECTION†	ONE-SIDED WEAVING SECTION WEAVING TRAFFIC ONLY	TWO-SIDED WEAVING SECTION WEAVING AND MAJOR ROUTE TRAFFIC
A	55	50	55
B	50	45	50
C	45	40	45
D	40	35	40
E	30	25-30	30

B. VOLUME MEASURES FOR LEVELS OF SERVICE
 APPLICABLE TO ALL TRAFFIC – WEAVING AND NON-WEAVING

LEVEL OF SERVICE	SV – MAXIMUM SERVICE VOLUME – PCPH PER LANE [‡] FOR NUMBER OF BASIC LANES (N _b) ON MAJOR APPROACH ROADWAY		
	<u>N_b = 2</u>	<u>N_b = 3</u>	<u>N_b = 4</u>
A	750	800	850
B	1000	1100	1200
C	1250	1350	1450
D	1550	1600	1650
E	1900	1900	1900

* Either measured or indicative of Space Mean Speed (SMS).

† Values shown (except for "E") are approximately 5 mph less than for fully uninterrupted flow, open highway conditions reported in new HCM Draft, 1983.

‡ Predicated on uniform periods (15-minutes) indicating hourly flow rates based on representative PHF of 0.85, 0.90 and 0.95 for LOS of C, D and E, respectively.

Analysis Techniques

Analysis of weaving sections for design or operations are accomplished by a specific technique developed as part of the overall project. This evolved from the research effort reported in Volume 1, where in accordance with a formulated weaving model, a series of statistical analyses (utilizing data from several sources of traffic operations on weaving sections) in combination with analytical derivations and rational formulations produced a definitive procedure. Direct experience of the researchers in design, construction, and operation of innumerable weaving sections throughout the process of the Interstate System development has provided an additional dimension to the practical considerations of real conditions to be reflected in the final product.

Primary results are presented in the form of two composite graphs, Nomograph 1 shown in Figure 5, and Nomograph 2 shown in Figure 6; these are supplemented for further calibration of speeds, as required, in Nomographs 3 and 4, shown in Figures 7 and 8, respectively. Nomographs 1 and 3 were derived for one-sided and Nomographs 2 and 4 for two-sided weaving sections, due to distinctively different, although somewhat interrelated, operational characteristics of each.

Elements of the general framework of an already long-standing procedure in Chapter 7 of the 1965 HCM, coupled with numerous findings of the NCHRP 3-15 project (PINY report), provided valuable input to further research and development in arriving at the methodology presented herein. The analysis relied primarily on the data of the weaving operations studies, which had to do with the interrelationship of the weaving volume with length of weaving section and the resulting speeds, or, in brief--weaving volume/length/speed relations. Another important element of the model and the procedure derived is the width-volume relations. These two major components have been tied together through the use of the derived k factor, which provided a continuum within the model and the necessary link in development of Nomographs 1 and 2. (The k values, representing the intensity of weaving, were especially derived through a mechanism of "operationally balanced" weaving sections and relating specifically to the composite service volumes within the overall weaving section.) The remainder of the major nomographs account for elements within them of W_2 , V, SV (prescribed LOS), and N. Full analyses and derivations are presented in Volume 1.

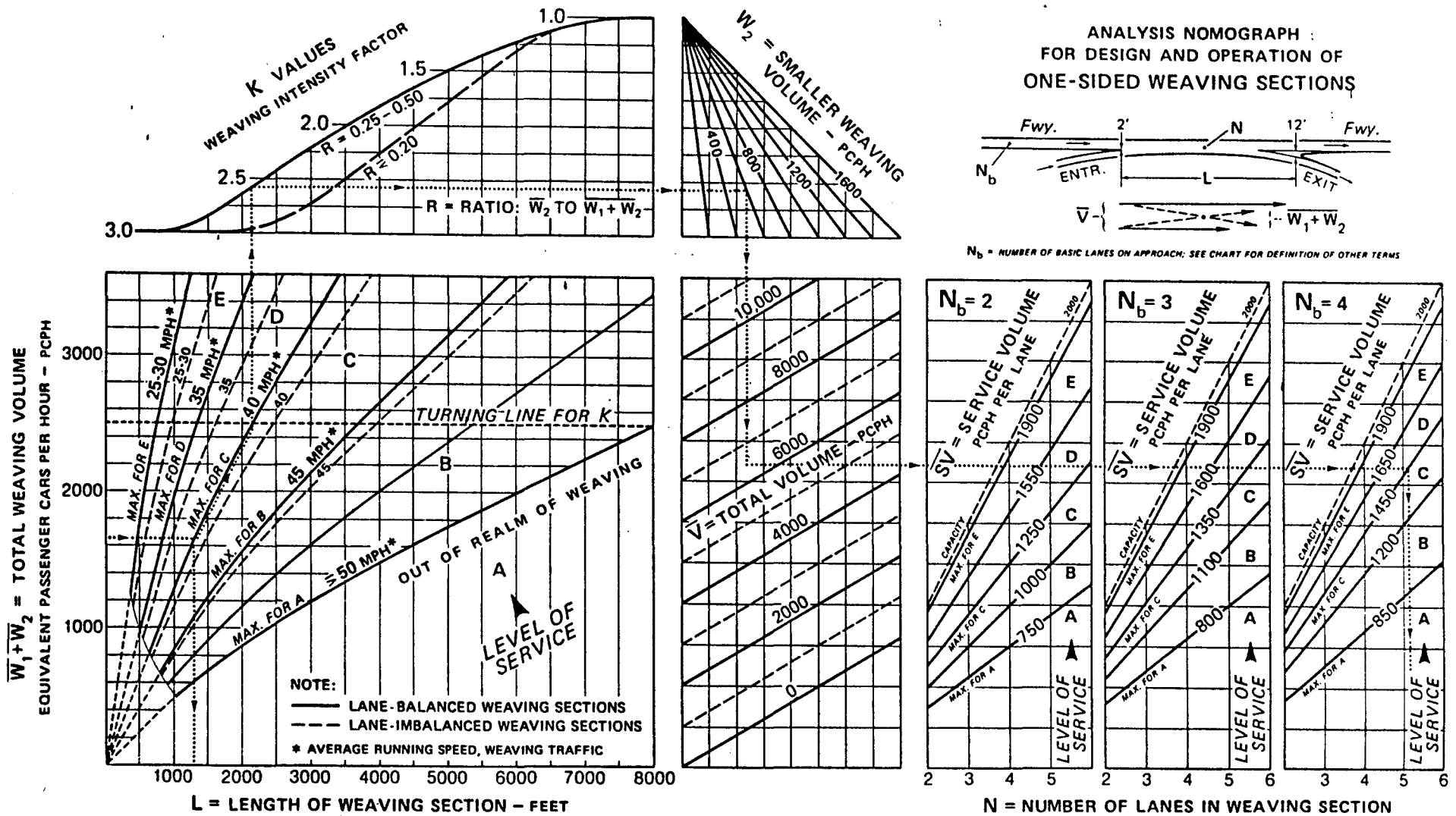

Figure 5. NOMOGRAPH FOR DESIGN AND ANALYSIS OF WEAVING SECTIONS — ONE-SIDED CONFIGURATIONS

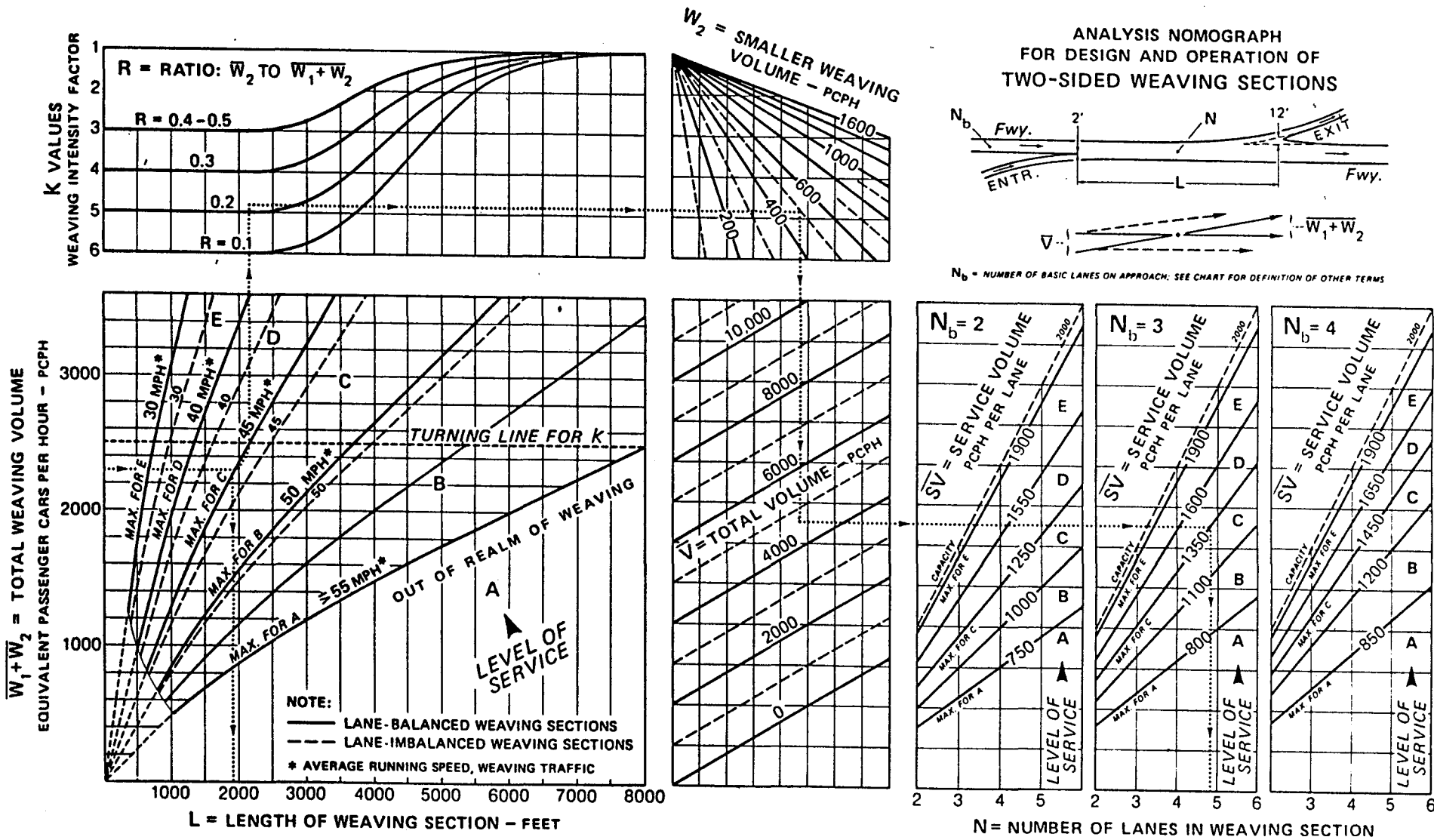
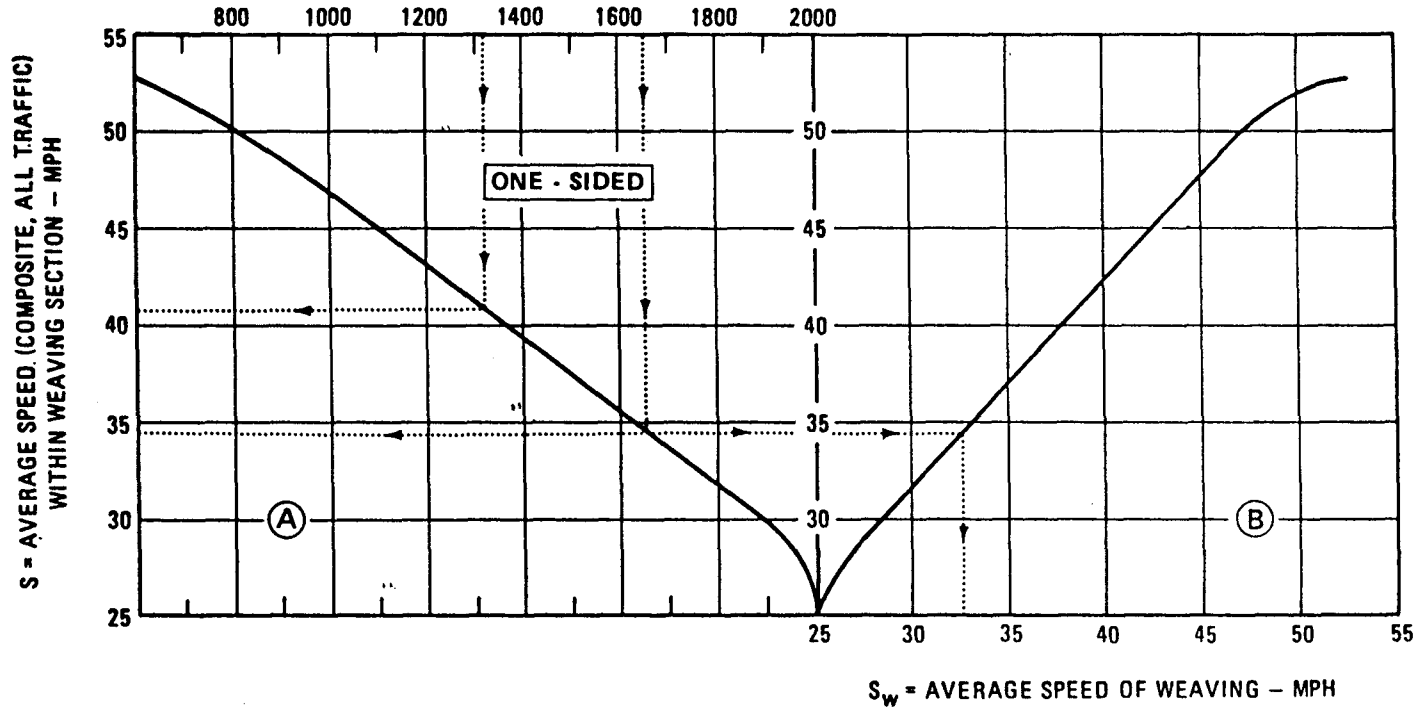

Figure 6. NOMOGRAPH FOR DESIGN AND ANALYSIS OF WEAVING SECTIONS - TWO-SIDED CONFIGURATIONS

SV = SERVICE VOLUME WITHIN WEAVING SECTION - PCPHPL*



INSTRUCTIONS:

1. WHEN LOS OF V IS SAME AS LOS OF V_w , S_w REMAINS THE SAME AND S EQUALS S_w .
2. WHEN V IS WITHIN $\frac{1}{2}$ LOS (\pm) OF V_w , S_w REMAINS THE SAME AND S EQUALS S_w .
3. WHEN V IS ONE OR MORE LOS BETTER THAN THAT OF V_w , S_w REMAINS THE SAME AND S IS READ FROM CHART (A).
4. WHEN V IS ONE OR MORE LOS WORSE THAN THAT OF V_w , S_w IS REDUCED AND BOTH S AND S_w ARE READ FROM CHARTS (A) AND (B).

DO NOT USE
NOMOGRAPH 3

USE
NOMOGRAPH 3

NOTE:

LOS OF V IS THE OVERALL LEVEL OF SERVICE AS A COMPOSITE WITHIN THE WEAVING SECTION, DETERMINED IN THE RIGHT PORTION OF NOMOGRAPH 1.

LOS OF V_w REFERS TO THE LEVEL OF SERVICE OF WEAVING TRAFFIC ELEMENT, DETERMINED IN LEFT PORTION OF NOMOGRAPH 1.

* SV READ FROM INITIAL SOLUTION OF NOMOGRAPH 1.

Figure 7. SUPPLEMENTARY NOMOGRAPH FOR SPEED CALIBRATION - ONE-SIDED WEAVE

NOMOGRAPH 3

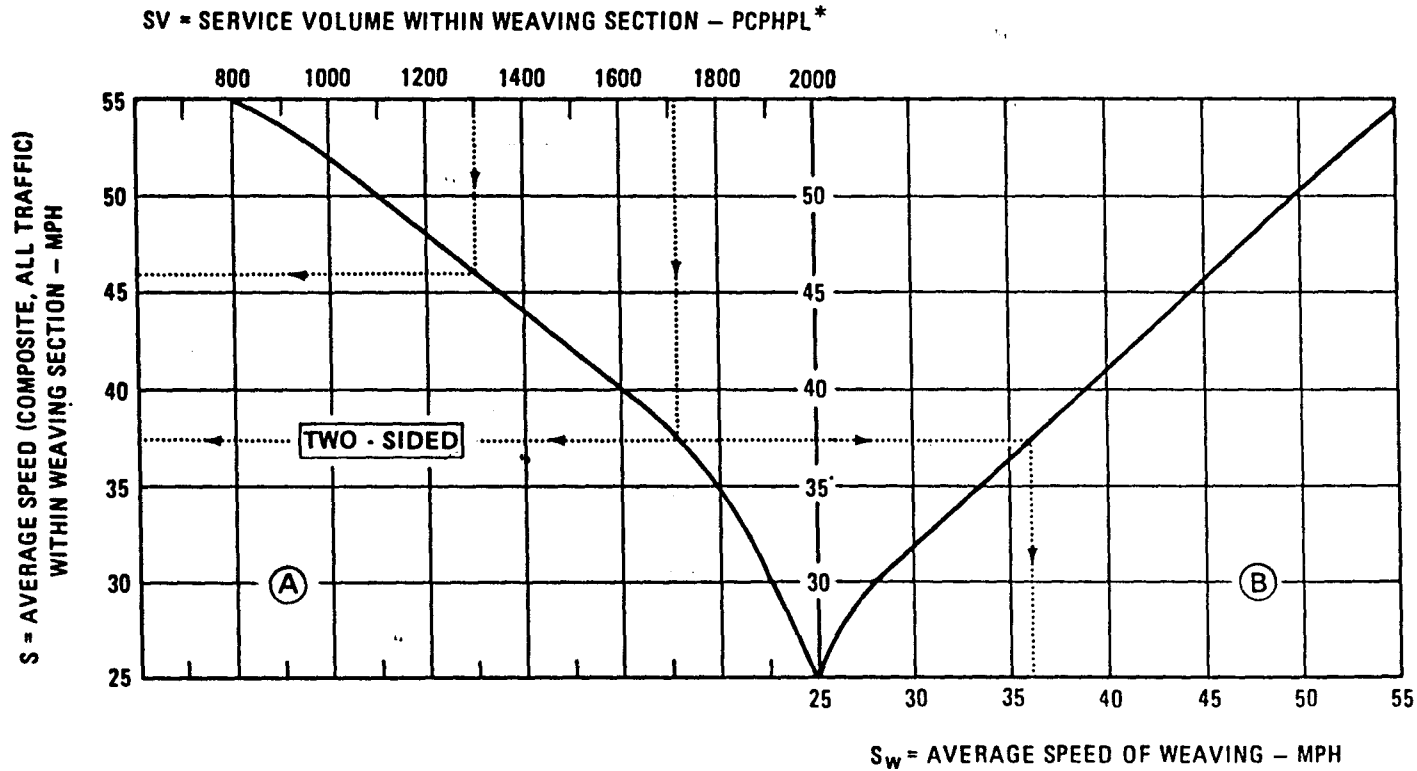

INSTRUCTIONS:

- | | |
|---|-------------------------------------|
| 1. WHEN LOS OF V IS SAME AS LOS OF V _w , S _w REMAINS THE SAME AND S EQUALS S _w . | } DO NOT USE
NOMOGRAPH 4 |
| 2. WHEN V IS AT A <u>BETTER</u> LOS THAN THAT OF V _w , S _w (AND THE SPEED OF FREEWAY THROUGH TRAFFIC) REMAINS THE SAME, AND OVERALL SPEED S IS READ FROM CHART (A). | |
| 3. WHEN V IS AT A <u>WORSE</u> LOS THAN THAT OF V _w , S _w (AND THE SPEED OF FREEWAY THROUGH TRAFFIC) IS REDUCED AND BOTH S AND S _w ARE READ FROM CHARTS (A) AND (B). | } USE NOMOGRAPH 4
CHARTS A AND B |

NOTE:

LOS OF V IS THE OVERALL LEVEL OF SERVICE AS A COMPOSITE WITHIN THE WEAVING SECTION, DETERMINED IN THE RIGHT PORTION OF NOMOGRAPH 2.

LOS OF V_w REFERS TO THE LEVEL OF SERVICE OF WEAVING TRAFFIC ELEMENT, DETERMINED IN LEFT PORTION OF NOMOGRAPH 2.

*SV READ FROM INITIAL SOLUTION OF NOMOGRAPH 2.

Figure 8. SUPPLEMENTARY NOMOGRAPH FOR SPEED CALIBRATION - TWO-SIDED WEAVE

NOMOGRAPH 4

The use of nomographs is further discussed and demonstrated in conjunction with the solution of problem examples. As an introduction, the basic procedure in the use of the major nomographs, Figures 5 and 6, is indicated by dotted projection lines with arrows. Referring to Figure 5, the use for a typical design example of a one-sided weaving section is shown, for which the necessary traffic information is provided, and the solution for length, L , and width, N , is required.

The nomograph is entered on the left with the weaving volume, W_1+W_2 (or V_w) followed by projection to the right, intersecting the desired weaving LOS or speed curve; a vertical drop from this point provides distance $L = 1650$ feet. Returning to first intersection point of V_w with LOS line, an upward projection along the LOS or speed curve is intersected with the horizontal, heavy dashed, "turning line for k ;" from here the solution line is extended vertically to intersect the k values curve, from which a horizontal extension meets the desired W_2 volume. Then a downward turn to total volume, V , from which the line is horizontally projected to the right, intersecting (in this case) the desired LOS = C curve having an SV of 1400 (representing the overall or composite operation of the weaving section), from which a downward extension yields an N of 5.2; this would be rounded to $N = 5$ lanes.

Using the nomograph for analysis of operation rather than design, the procedure is similar except that some of the projections, with respect to L and N are made in reverse order, or in the upward direction. The use of Nomograph 2, Figure 6, for solution of two-sided weaving sections follows basically the same procedure. The dotted projection lines indicate a design procedure in which a solution with $L = 1800$ feet and N of 4.8, or rounded, $N = 5$ lanes was determined for LOS C.

Nomographs 3 and 4, Figures 7 and 8, are supplementary to Nomographs 1 and 2, respectively. The additional nomographs allow for speed calibration where the weaving section is not operationally balanced; i.e., where LOS of weaving movement is different from LOS of the overall weaving section. A specific group of notes and an organized set of instructions on Nomographs 3 and 4 provide the necessary information for their use. The calibration for certain conditions adjusts S_w for a final reading, and provides associated values of overall or composite speed of weaving section, S . Thus, the combination of Nomographs 1 and 3, and combination of Nomographs 2 and 4, provide a full solution.

In order to comply with instructions for application in conjunction with Nomographs 3 and 4, levels of service relating to V_w and V have to be derived to reflect sublevels within a level of service. To establish whether there is one or more levels of service difference between V_w and V , it becomes necessary for analysis purposes (only) to determine what may be termed as fractional levels of service. These may be expressed, for example, as B.4, C.8, D.6 which mean the first is 0.4 into the B band of LOS, the second 0.8 into the C band of LOS, and the third 0.6 into the D band of LOS. These readings, interpolated visually, are demonstrated by intersection points marked by an asterisk on the right-hand portion of Nomograph 1 (or 2) shown on this page, representing a composite LOS for V on the overall weaving section.

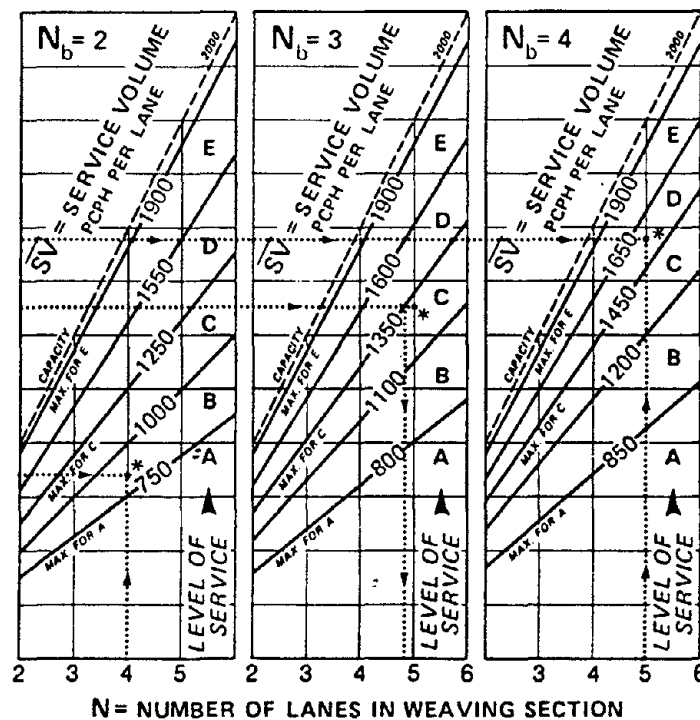

The corresponding service volumes can then be calculated as may be required for further use in conjunction with Nomographs 3 and 4. This would be accomplished* by interpolating between the upper and lower SV within which the point of intersection is formed. For example: for B.4 the corresponding SV (referring to portion of nomograph) is $750 + 0.4 (1000-750) = 850$ pcph per lane; for C.8 the corresponding SV = $1100 + 0.8 (1350-1100) = 1300$ pcph per lane; and for D.6 the corresponding SV = $1450 + 0.6 (1650-1450) = 1570$ pcph per lane.

Fractional levels of service can similarly be found for V_w in the lower left portion of Nomographs 1 and 2. Referring to Nomograph 1, Figure 5, an entry of W_1+W_2 (or V_w) of 1800 and L of 2000 would form an intersection point (visually interpolated at 48 mph, or 2 mph within LOS band of C. This would represent a fractional LOS of 2/5 or 0.4 within LOS C, or LOS C.4. Other fractional values would be similarly established as required.

Another feature in the use of Nomographs 1 and 2 is the special projection movement required in the lower left portion of the nomograph for solution of lane-imbalanced weaving sections. The nomographs have two sets of LOS curves (associated with average speeds)--solid curves for lane-balanced weaving sections and dashed curves for lane-imbalanced weaving sections. Figure 9 shows an enlargement of Nomograph 1 which demonstrates the difference in procedures for lane-balanced and lane-imbalanced sections. The two portions within Figure 9 show the identical portion of the nomograph--on the left to demonstrate the procedure for lane-balanced, and on the right for lane-imbalanced sections.

The lane-balanced procedure has already been described in conjunction with use of Nomographs 1 and 2; however, the initial entries are repeated here in the left diagram for comparative purposes with the lane-imbalanced condition. For the case when V_w and L are given along with traffic information, the procedure in the left diagram shows an entry at point b with $V_w = 2350$ and at point c with $L = 2100$, producing an intersection at a within LOS C and interpolated speed of 40.5 mph; then proceeding along the trend of the series of solid curves upward to "turning line for k " to point d ; from this point the solution line is extended vertically to point e on "k factor" curve, and hence to the right to f and the remainder of the nomograph. This demonstrates a standard procedure for lane-balanced sections.

The solution procedure for the same conditions with $V_w = 2350$ and $L = 2100$ but for a lane-imbalanced situation is shown, by contrast, in the right diagram of Figure 9. Here, entries at n and o are intersected at m (corresponding locationally to point a in previous example). Point m , however, with respect to the dashed set of LOS or speed curves (which represent lane-imbalanced conditions) falls within LOS D band with an interpolated speed of 39 mph. In order to utilize the remaining movements through the nomograph, it is necessary

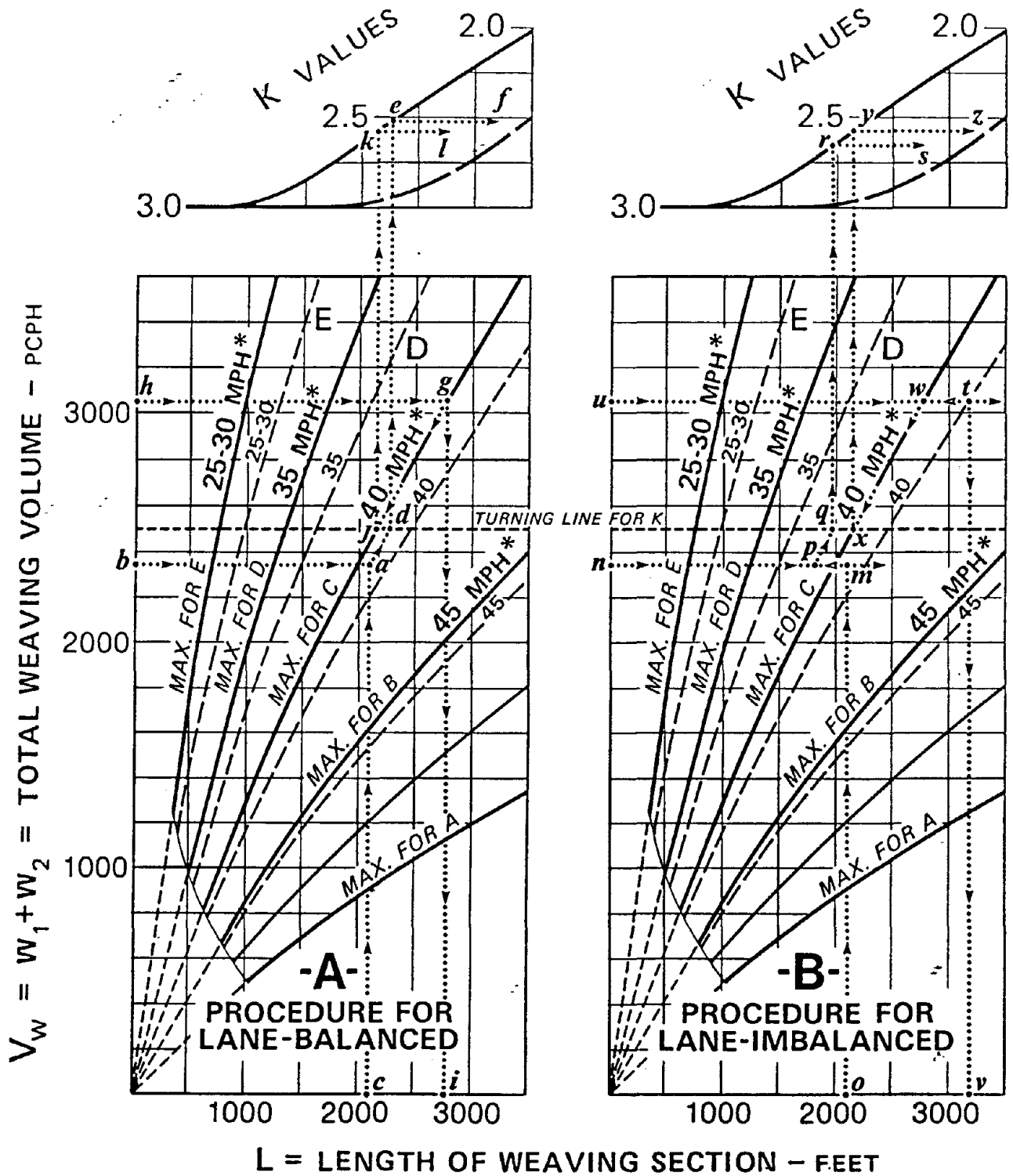

NOTE:

- LANE-BALANCED WEAVING SECTIONS
- - - LANE-IMBALANCED WEAVING SECTIONS
- * AVERAGE RUNNING SPEED, WEAVING TRAFFIC

Figure 9. NOMOGRAPH PROCEDURE FOR LANE-IMBALANCED SECTIONS
ONE-SIDED WEAVING SECTIONS

to shift point m to the left to a comparable position with respect to the solid speed curves. Thus, the lateral shift is made from m to p , which places point p at 39 mph with respect to solid speed curves. The process continues, along the trend of the speed curves to point q and hence to r and s , and through the remainder of the nomograph. The procedure with the lateral shift allows the same overall nomograph to be used properly for both lane-balanced and lane-imbalanced sections.

The second example demonstrates the use of nomographs for design-type problems where V_w and LOS are given, along with pertinent traffic information, in which L and N are to be determined. In this case $V_w = 3050$ and required LOS C. For the lane-balanced condition (left part of figure) the initial entry is made at point h with an extension to point g , an intersection with the LOS C line (speed of 40 mph). Two projections are made from this point: first, downward to read $L = 2800$ at point i ; and second, along the 40-mph curve downward to "turning line for k " at point j . From here an extension is made to point k , and to the right to l ; then beyond through the nomograph.

For the same problem with lane-imbalance (right part of figure) the initial entry is made at point u with a projection to point t , an intersection with the dashed line for LOS C. A downward projection to v indicates an L of 3200; then, returning to point t , a lateral shift is made to point w , a comparable position on the solid 40-mph curve. From here the solution line follows the 40-mph solid curve to point x on the "turning line for k ." From x a vertical extension is made to y , and to the right to z ; then beyond through the nomograph.

Multiple weaving sections (see Figure 1) embody the overlapping of two or more simple weaving sections and hence produce more complex operations. It follows that analyses of multiple weaving sections involve more difficult procedures. The basic principles for simple weaving apply to multiple weaving sections. Before the nomographs can be used, however, it is necessary to determine how to handle any of the overlapping weaving maneuvers which may take place between the two segments (possibly three segments in special cases) of the overall multiple weaving section. The manner in which weaving traffic divides itself between the various segments of a multiple weaving section can only be estimated.

Considerable variation occurs, depending upon geometrics, including lane arrangements and relative spacing of multiple entrances and exits, relative traffic volumes comprising individual weaving maneuvers, truck traffic, signing, and other factors.

Several procedures have been considered and utilized. For clarity of discussion reference is made initially to the upper diagrams of Figures 10 and 11, showing two most common configurations and the pattern of traffic movements therewith. The primary consideration relates to the distribution of weaving volumes between segments 1 and 2, which involve movements 2 and 3 for the 2EN-EX case and movements 2 and 4 for the EN-2EX type of multiple weaving section. Once this is established and the traffic diagram (with its individual movements) for each segment determined, the process involves a separate analysis of each segment by the standard nomograph procedure.

The method in the 1965 HCM utilized a division in the long weave volume in proportion to the length of segments 1 and 2. In the PINY procedure (taken from very limited observations) it is indicated that the long potential weave such as between movements 2 and 3 for the 2EN-EX case (Figure 10) would tend to take place completely in segment 1; and, for the EN-2EX case (Figure 11) the long potential weave between movements 2 and 4 would tend to take place completely in segment 2. This was generally supported by observation of drivers with respect to: "necessity to weave," where most drivers will not weave until they have to; and "presegregation," where drivers enter a weaving section already in lanes appropriate to their desired travel path. This procedure in the PINY report was generally considered to be applicable, except in cases where the two segments are extremely disproportionate and particularly short.

The basic principles expressed in the PINY research are generally adopted in this report; however due to a multitude of variables affecting operations, as innumeraed above, it was rationalized that a small part of the long weave would take place in the other segment. Thus, as an overall analysis procedure, some amount less than all weaving traffic between the first ramp and last ramp would occur in segment 1 of the 2EN-EX type of section, and in segment 2 of the EN-2EX type of section.

ANALYSIS WORKSHEET
 MULTIPLE WEAVING 2EN-EX

PROJECT _____

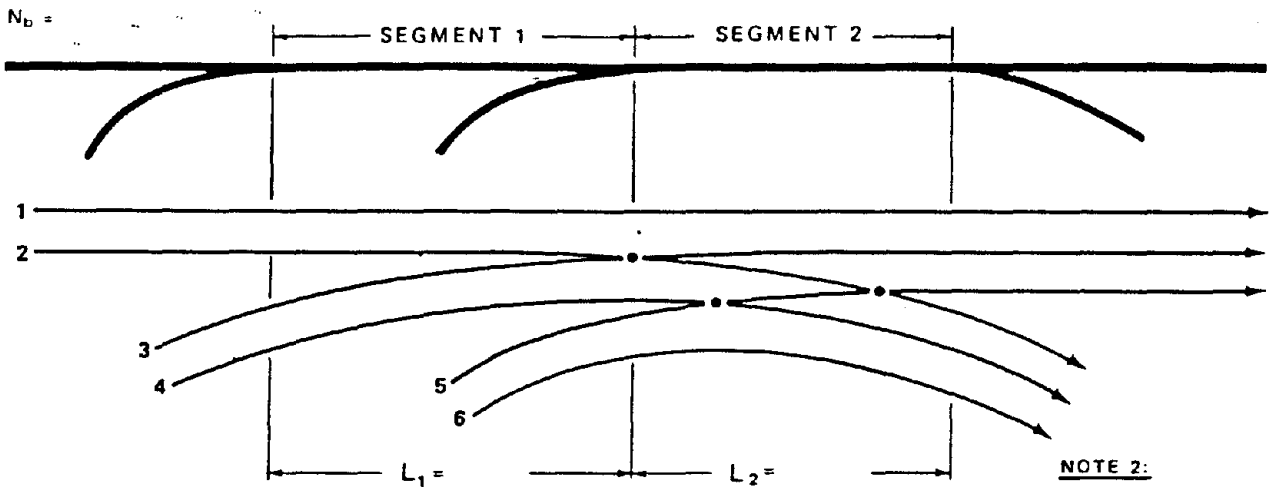

NOTE 2:
 PLACE NUMBER
 OF LANES, EXISTING
 OR SOLVED, ALONG
 UPPER DIAGRAM.

LONG WEAVE - VOL. 2. vs. VOL. 3 (SEE NOTE 1)*

SEGMENT 1

$$\begin{aligned} [2] &= P \times \text{VOL. 2} \\ &= X \quad = \underline{\hspace{2cm}} \\ [3] &= P \times \text{VOL. 3} \\ &= X \quad = \underline{\hspace{2cm}} \end{aligned}$$

SEGMENT 2

$$\begin{aligned} (2) &= (1 - P)(\text{VOL. 2}) \\ &= X \quad = \underline{\hspace{2cm}} \\ (3) &= (1 - P)(\text{VOL. 3}) \\ &= X \quad = \underline{\hspace{2cm}} \end{aligned}$$

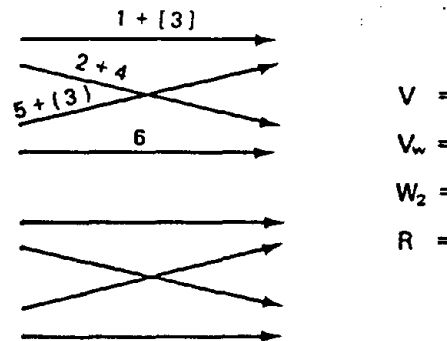
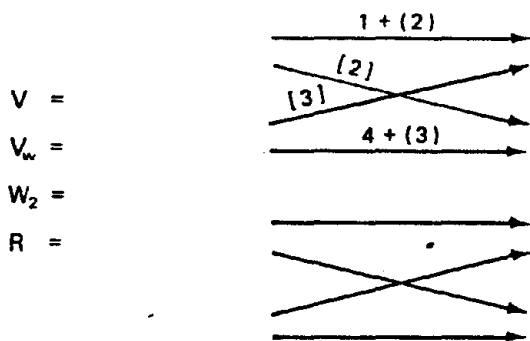

NOTE 3:
 ALL VOLUMES
 IN PCPH. RECORD
 ON DIAGRAM.

COMPUTATIONS

NOTE 1: ALL OF LONG WEAVE TENDS TO TAKE PLACE IN SEGMENT 1, WITH PROPORTION P INCLINED TO APPROACH 1.0; P, HOWEVER, MAY VARY IN INDIVIDUAL CASES. IN DESIGN AND IN GENERAL OPERATIONAL ANALYSIS, NORMALLY USE P = 0.75 IN SEGMENT 1. OTHERWISE, IN MORE DETAILED OPERATIONAL ANALYSIS, FIELD SAMPLING OF TRAFFIC MAY GIVE INDICATION OF P.

Figure 10. ANALYSIS WORKSHEET FORM FOR 2 EN - EX MULTIPLE WEAVING SECTIONS

ANALYSIS WORKSHEET
 MULTIPLE WEAVING EN-2 EX

PROJECT _____

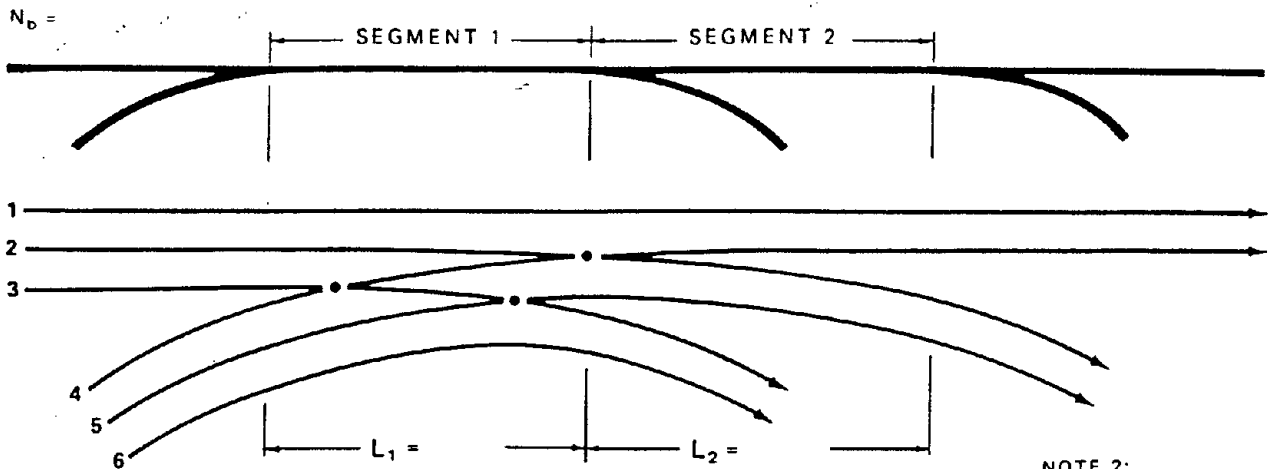

LONG WEAVE - VOL. 2 vs. VOL. 4 (SEE NOTE 1) *

NOTE 2:
 PLACE NUMBER
 OF LANES, EXISTING
 OR SOLVED, ALONG
 UPPER DIAGRAM.

SEGMENT 1:

$$\begin{aligned} (2) &= (1 - P)(\text{VOL. 2}) \\ &= X = \underline{\hspace{2cm}} \\ (4) &= (1 - P)(\text{VOL. 4}) \\ &= X = \underline{\hspace{2cm}} \end{aligned}$$

SEGMENT 2:

$$\begin{aligned} [2] &= P \times \text{VOL. 2} \\ &= X = \underline{\hspace{2cm}} \\ [4] &= P \times \text{VOL. 4} \\ &= X = \underline{\hspace{2cm}} \end{aligned}$$

V =
 V_w =
 W₂ =
 R =

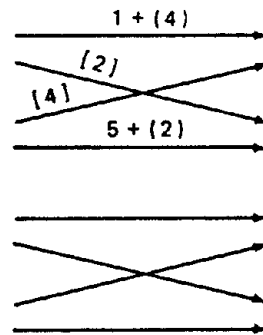
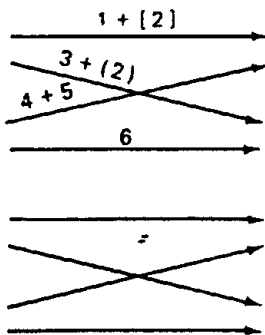

V =
 V_w =
 W₂ =
 R =

COMPUTATIONS:

NOTE 3:
 ALL VOLUMES
 IN PCPH, RECORD
 ON DIAGRAM.

NOTE 1: ALL OF LONG WEAVE TENDS TO TAKE PLACE IN SEGMENT 2, WITH PROPORTION P INCLINED TO APPROACH 1.0; P, HOWEVER, MAY VARY IN INDIVIDUAL CASES. IN DESIGN AND IN GENERAL OPERATIONAL ANALYSIS, NORMALLY USE P = 0.75 IN SEGMENT 2. OTHERWISE, IN MORE DETAILED OPERATIONAL ANALYSIS, FIELD SAMPLING OF TRAFFIC MAY GIVE INDICATION OF P.

Figure 11. ANALYSIS WORKSHEET FORM FOR EN-2 EX MULTIPLE WEAVING SECTIONS

The portion (p) of the long weave, in these segments, was considered to be generally representative at 75 percent, expressed as p of 0.75. This value evolved from a series of test calculations for various combinations of weaving volumes and length of segments for multiple weaving sections, in which all three methods were used. Most logical and more-nearly balanced results were found for the method presented here. The PINY procedure for some cases showed odd or disproportionate distribution of lanes along the total section. In other cases all three methods produced results that were not radically different, particularly after rounding of lane requirements from fractional to whole lanes. This analysis clearly showed the advantage of introducing p to scale down the concentration of the long weave, with recommendation for its application. The problems which follow utilize this approach.

The analysis worksheets of Figures 10 and 11 provide a convenient way of organizing multiple weaving problems. The form allows for a complete record to be made of input data, calculations as required, nomograph readings, and solution results. The form also has the flexibility of varying the proportion p of the long weave, should it be judged appropriate to do so to more closely fit a given set of conditions. A p of 0.75, however, is recommended generally as noted at the bottom of the form.

The above discussion deals with multiple weaving configurations which operate as multiple weaving sections. However, there are instances when such configurations have widely spaced ramps, or sufficiently light traffic, or both, so that a portion within the overall section may be out-of-realm of weaving. In such a case the configuration may be reduced to a simple weaving section. It would be prudent, therefore, to make an initial test to determine whether the overall configuration is indeed a multiple weaving section. The procedure for the test is outlined in Table 2.

To summarize the application of nomographs and analysis procedures for different types of weaving sections and variety of conditions therewith, Table 2 has been prepared to serve as a guide. It provides concise information as an adjunct to the use of nomographs and a reference for solution of problems.

TABLE 2

USE OF NOMOGRAPHS INCLUDING ADJUNCT PROCEDURES
FOR WEAVING SECTIONS

A. FREEWAY SECTIONS

(1) One-Sided Weaving Sections--General:

- Use Nomograph 1, for which general application is demonstrated thereon by dotted solution lines with arrows; followed by Nomograph 3, for which application is indicated thereon by "Instructions," 1 through 4.

(2) Two-Sided Weaving Sections--General:

- Use Nomograph 2, for which application is demonstrated thereon by dotted solution lines with arrows; followed by Nomograph 4, for which application is indicated thereon by "Instructions," 1 through 3.

B. C-D ROADS

- (1) Local Sections provided for individual interchanges, arranged for simple weaving between two ramps; generally use Nomograph 1 only for the C-D road (freeway proper analyzed separately). S_w with corresponding LOS is determined from the lower-left portion of Nomograph 1, provided that sufficient number of lanes is available. Overall speed of weaving section, S , equals S_w . Nomograph 3 should be referred to, however, when the outer flow from one ramp to the other exceeds about 15 percent of V .

- (2) Sections on Continuous or Extended C-D Roads along the freeway serving several interchanges are analyzed in the same manner as freeway weaving sections, utilizing Nomographs 1 and 3, and Nomographs 2 and 4, as noted under A(1) and A(2) above.

C. LANE-BALANCED AND LANE-IMBALANCED WEAVING SECTIONS

- (1) Lane-Balanced Sections as previously defined, refer primarily to exits with provision of "one more lane going away" (i.e., combined number of lanes on freeway and ramp after exit being one more than on freeway preceding the ramp). This case is directly accounted for by the solid curves in the lower-left portion of Nomographs 1 and 2. Direct use of these curves and continuation through the nomographs are demonstrated by dotted solution lines.

- (2) Lane-Imbalanced Sections which normally refer to bifurcations without change in total number of lanes (i.e., the number of lanes on freeway and ramp after exit is the same as on freeway preceding the ramp). This case is accounted for by the dotted speed curves in the lower-left portion of Nomographs 1 and 2--indicating that for the same weaving volume, more length of weaving section is required to maintain level of service; or, for the same length, less weaving traffic can be handled than for the lane-balanced section. In using the lower-left portion of the nomograph and then proceeding upward toward the k curve requires, for the lane-imbalanced section, a jog or lateral shift to the left, from the dotted set of speed curves to the solid set of speed curves. This is necessary to permit the remaining elements of the nomograph to serve equally the lane-balanced and lane-imbalanced sections. The method for handling this situation, in solution of problems, is demonstrated in Figure 9; note that the procedure as shown by the sample solution lines in part A of the figure is direct for lane-balanced sections, and for lane-imbalanced sections it requires an equivalent speed jog to the left (from dotted to solid speed curve set), as shown in part B of the figure.

TABLE 2 (continued)

D. WEAVING SECTIONS AS RELATED TO LANE ARRANGEMENTS

- (1) Configurations with Normal Lane Shifts. Weaving sections with various lane arrangements have an effect on operational quality and speed, a feature closely allied to lane balance. The combination with different configurations produces different amount of lane shifting in the process of weaving. The concept of potential lane shifts is demonstrated in Figure 4. As shown, most of the well designed sections produce 2 to 3 potential lane shifts. Weaving sections with 4 potential lane shifts also may be considered within acceptable limits, in which solutions achieved by the procedures of Nomographs 1 - 4 apply.

- (2) Configurations with Excessive Lane Shifts. Weaving sections requiring 5 and 6 potential lane changes, indicate from examination of limited data, that levels of service and associated speeds, S and S_w , would be lowered 3- to 5-mph below those normally produced by Nomographs 3 and 4. For such conditions as a rational deduction, 3- to 5-mph speed increments should be deducted from the nomograph readings to estimate the final result.

E. MULTIPLE WEAVING SECTIONS

- (1) Test for Multiple Weaving. Ramp junctions in sequence involving two or more overlapping simple weaving configurations should be tested prior to analysis if, in fact, multiple weaving is present (see Figures 10 and 11). The check is made with respect to the portion of the long weave (between first and last ramps) which occurs in segment 1 for ZEN-EX form and in segment 2 for EN-2EX form; if this portion in either case is within realm of weaving, the configuration is analyzed as a multiple weaving section and, if not, as a simple weaving section.

- (2) Distribution of Long Weave:
 - Type ZEN-EX--Portion of weave occurring in segment 1 is normally taken to be three-quarters of movements 2 plus 3, and remainder in segment 2, as shown in Figure 10.

 - Type EN-2EX--Portion of weave occurring in segment 2 is normally taken to be three-quarters of movements 2 plus 4, and remainder in segment 1, as shown in Figure 11.

- (3) Use of Nomographs and Analysis Worksheets. Nomographs 1 - 4 are applied in normal manner to each segment separately in accordance with weaving diagrams formulated per above explanation. Analysis Worksheets, Figures 10 and 11 provide an organized means of evaluating multiple weaving problems.

Example Problems

The following set of problem examples is included to serve as a guide in the application of procedures developed and presented herein. The problems and accompanying solutions have been carefully selected to cover a broad spectrum of weaving situations which may occur in the planning, design and operation of freeway facilities.

The problems are structured so as to provide the user with a sufficiently detailed explanation of the procedure employed. Also, the selected problems are representative of a variety of actual conditions.

The solution of problems normally has been considered in terms of two aspects--design problems and operational analysis problems. Although the situations seem different, in essence the overall solution or end result, by the technique presented here, is much the same or similar.

For design problems, usually the solution involves finding L and N, with an attempt at an operationally balanced section for a given or desired LOS, using Nomographs 1 and 2; should a balanced section not be feasible, a supplementary Nomograph 3 or 4 would be used to calibrate speeds of operation, S_w and S. For operational analysis problems, the solution also involves Nomograph 1 or 2, but since the values of L and N are given, entries for them are made in reverse order, while procedures in Nomograph 3 or 4 are accomplished as before. The final results in this case involve the determination of LOS and speeds for the weaving movement and for the overall weaving section.

Accordingly, the example problems presented are not separated and are handled in the same manner for either condition. A set of 20 problems with solutions follow.

Special Note for Use of Guide

In order to allow for expedient review of these problems and to facilitate the use of this Guide by the user in solving other problems, a complete set of the four nomographs with Table 2, and multiple weaving Forms 1.01 and 1.02, are repeated at the very end of the report, following the example problems.

Problem 1. - The problem to be investigated is a one-sided lane-balanced weaving section formed along the freeway between two interchanges. The design calls for level of service C. The volumes noted have all been converted to equivalent passenger cars per hour (pcph). Referring to the weaving configuration at the upper-right portion of Nomograph 1 in describing the example, the approach freeway volume is 5200 pcph on 4 lanes with 4600 pcph proceeding through and 600 pcph departing at the next exit. At the entrance ramp 1200 pcph are merging, of which 1050 pcph are proceeding on the freeway, and 150 pcph are destined to the next exit. The total volume through the weaving section amounts to 6400 pcph. The problem is to determine the minimum spacing (for weaving) between ramps and the number of lanes required through the weaving section to maintain level of service C operation.

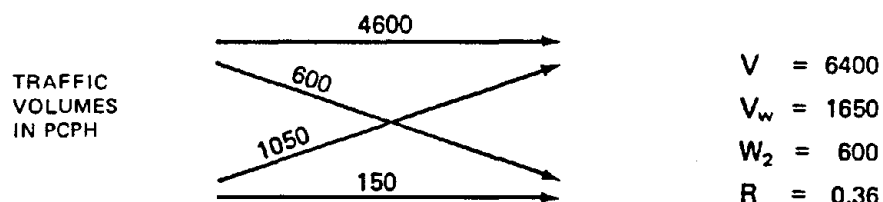

Solution:

Enter Nomograph 1 with a weaving volume of $V_w = W_1 + W_2 = 1050 + 600 = 1650$, proceed right to the 40-mph curve (maximum for C) and turn downward to read a minimum required weaving length of $L = 1300$ feet. (The fine dotted lines with arrows projected through the nomograph show the process in solution.) Then, from the original intersection point proceed along the 40-mph curve to the "turning line for k" and continue upward to intersect the upper k values curve (for $R = 600/1650 = 0.36$); at this point turn right and advance to the smaller weaving volume, W_2 of 600, followed by a downward turn to $V = 6400$; then a horizontal - projection to level of service C line (1450 pcph) for $N_b = 4$ yields, with a downward projection, a total number of lanes, N , of 5.2. A rounding to $N = 5$ is close enough to maintain a balanced section. Referring to Nomograph 3, Instruction 2--the weaving speed would be maintained along with the overall speed, so that $S_w = S = 40$ mph.

Problem 2. In this case a two-sided weaving section is formed by an entering ramp on the right and an exiting ramp on the left as diagrammed in the upper part of Nomograph 2. The existing section is badly congested and is slated for improvement as required in length and width to produce an operationally balanced facility at level of service C. The freeway is planned for 6 basic lanes. The total projected volume in one direction of $V = 4600$ pcph within the weaving section includes 1800 pcph (W_1) proceeding through on the freeway, and 500 pcph (W_2) crossing the freeway from entrance to a lane-balanced exit ramp.

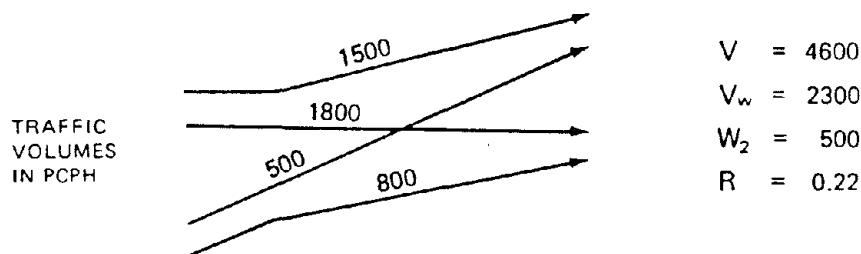

Solution:

Following the solution arrows in Nomograph 2, it is noted that with $W_1 + W_2$, or V_w , of 2300 and level of service C, the spacing between ramps has to be increased to at least $L = 1900$ feet. Proceeding further through the graph with $R = 0.22$, $W_2 = 500$, and a proposed N_b of 3 lanes, the required number of lanes in the weaving section is indicated to be 4.8. A rounding to $N = 5$ lanes would be appropriate, maintaining reasonable balance with possibly a very slight improvement in operation. The resulting SV for 5 lanes approximates 1300 pcphpl which, according to Nomograph 4, Instruction 2 (as shown by the projection lines) yields an overall speed for all traffic in the weaving section of $S = 46$ mph with the weaving movement (and freeway through traffic as part of it) being maintained at $S_w = 45$ mph.

Problem 3. - Determine level of service and associated average speeds for the existing one-sided, lane-balanced weaving section shown in the following sketch.

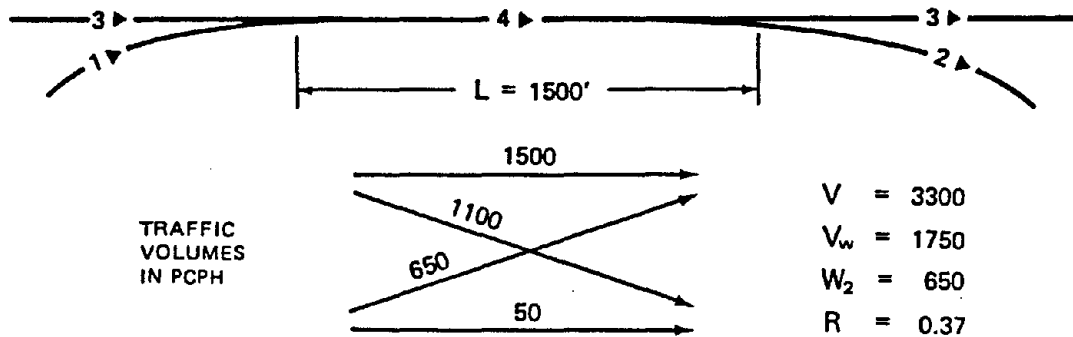

Solution:

Enter Nomograph 1 at bottom left with $V_w = 1750$ and $L = 1500$; read initial $S_w = 41$ mph at LOS C.g, using solid curves for lane-balanced condition. Continue upward from turning line to $k = 0.37$, then to $W_2 = 650$, $V = 3300$, and $N = 4$ within $N_b = 3$ graph; read overall LOS B.g and equivalent $SV = 1050$. Using Nomograph 3, Instruction 3 for speed calibration, determine $S = 46$ mph in Chart A, and $S_w = 41$ mph as per initial reading above. In general terms the overall (composite) weaving section would operate at LOS B, and the weaving movement at LOS C.

Problem 4. An operational analysis is required to determine the level of service and associated speeds on the existing, one-sided weaving section shown in the accompanying sketch. In contrast with Problem 3, the configuration lacks lane balance, but the approach and exit conditions along the freeway in both cases provide favorable operations within LOS B, while similar weaving maneuvers take place in a length of 1500 feet.

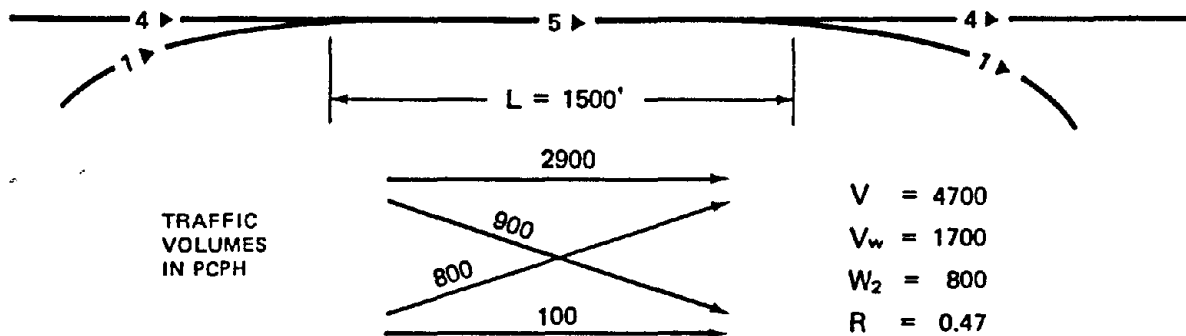

Solution:

Enter Nomograph 1 with $V_w = 1700$ and $L = 1500$; intersect initial $S_w = 40$ mph with associated LOS of C_{max} using the dotted speed curves representing lane-imbalanced condition. In order to continue through the nomograph, it is necessary (according to nomograph structure) to transfer this intersection point laterly to the left to a comparable position with respect to the basic solid speed curves, as per demonstration in Figure 9. Proceed from this point along the trend of the curve to "turning line for k," and then vertically up to the upper k curve (since $R = 0.47$). From this position of $k = 2.6$ proceed in the usual manner using $W_2 = 800$, $V = 4700$, and $N = 5$ within $N_b = 4$ graph; read overall (composite) LOS B_{max} with corresponding $SV = 1200$. Using Nomograph 3, Instruction 3, find $S = 43$ mph for $SV = 1200$ in graph A, while $S_w = 40$ mph reading remains the same as per initial determination in Nomograph 1. Check of ramp entrance and exit operations (not shown) indicates compatible levels of service with the weaving section. In summary, the overall (composite) weaving section and the weaving movement would both operate generally at LOS C with $S = 43$ mph and $S_w = 40$ mph, respectively.

Problem 5. Determine level of service and associated average speeds for the existing one-sided weaving section, without lane balance, shown in the following sketch.

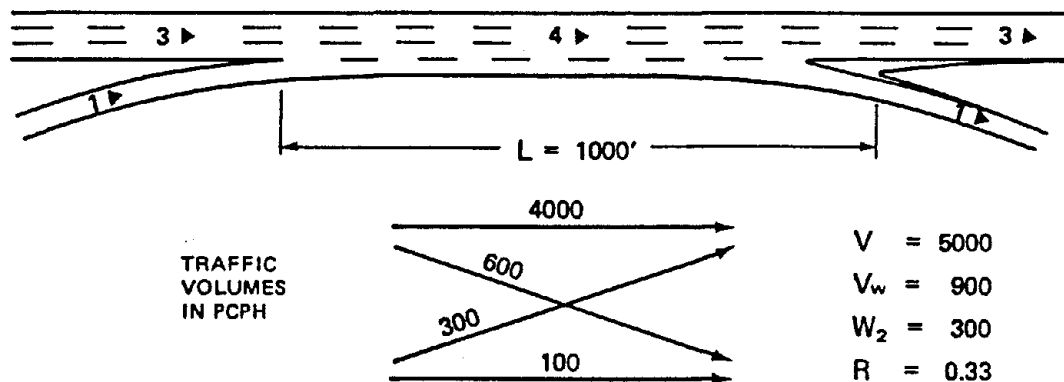

Solution:

Enter Nomograph 1 with $V_w = 900$ and $L = 1000$. Using dotted curve, since section is lane-imbalanced, read initial LOS of slightly over B, or C.2, indicating preliminary reading of $S_w = 44$ mph. Continue through nomograph using $R = 0.33$, $W_2 = 300$, $V = 5000$ and $N = 4$ preceded by N_b of 3; read LOS of nearly D, or C.9, and corresponding $SV = 1325$. Then using Nomograph 3, Instruction 4, with $SV = 1325$, find $S = 41$ mph and $S_w = 39$ mph*, which are equivalent to overall LOS C.8 and weaving LOS D.2.

A check of ramp entrance and exit levels of service shows favorable operation. The portion of freeway downstream of the weaving section, however, indicates a slightly lower level of service. The volume of 4300 pcph on 3 freeway lanes produces 1430 pcphpl which, according to Table 1, is equivalent to a freeway LOS D.3 and an average speed after the influence of the exit ramp of about 43 mph.

Apparently there is some constraint or pressure upon the weaving maneuver by non-weaving traffic (as indicated by initial analysis in Nomograph 1 and by supplementary check of freeway traffic leaving the weaving section. Despite nominal intermix of weaving and nonweaving traffic, the final results (per Nomograph 3 calibration) are sufficiently close to consider the combined operation, and individual movements, at the limit of LOS C and an average speed of 40 mph.

* These resulting speeds as determined above are in conformance with the same weaving example as that in Problem 2, page 202, of TR Circular 212, solved by the PINY procedure.

General statement for Problems 6, 7 and 8.--An existing freeway within the outskirts of an urban area is to be improved to accommodate increased traffic due to system reorientation and concentrated development projected along the corridor. Design studies produced several alternatives for consideration. As part of performing "capacity" analysis using projected future traffic, the existing configuration (Problem 6) has been included for comparison in the evaluation; it consists of a simple merge-diverge section formed by a standard entrance ramp followed by a normal exit ramp, with tapered speed-change lanes and no auxiliary lane within the weaving section as depicted in Figure 3-A. The second alternative (Problem 7) utilizes an auxiliary lane between the entering and exiting ramps as shown in Figure 3-B. The third alternative (Problem 8) incorporates a section of C-D road as in Figure 3-C. The projected traffic in conjunction with weaving is to be accommodated at LOS D and preferably LOS C. For convenience of demonstrating the problem solutions, all traffic volumes have been adjusted for the effect of trucks and grades to pcph preparatory to using the nomographs. The presentation of this three-part overall problem emphasizes the sensitivity of geometric changes and indicates the visual aspects of the use of nomographs in quickly analyzing alternative plans.

(Individual Problem Examples Follow on Succeeding Pages.)

Problem 6. The skeletonized plan, including the number of lanes, length of weaving and projected traffic for the various movements, is shown in the accompanying sketch. The problem is to determine if the projected traffic can be accommodated. If so, at what level of service and associated speeds of weaving and overall traffic within the weaving section?

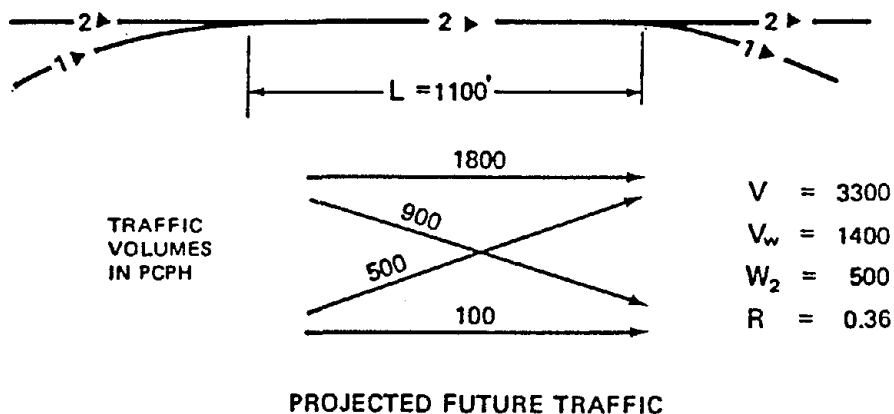

Solution:

Enter Nomograph 1 at the lower left and bottom with $V_w = 1400$ and $L = 1100$, and locate intersection at 40 mph (initial reading of S_w). Project along the 40-mph line to k turning line and then upward to the k value curve (considering $R = 0.36$) from there continue right to $W_2 = 500$, down to $V = 3300$, right to $N_b = 2$ portion of graph and intersect $N = 2$ at $SV = 1900$ (representing V). The latter value indicates a highly constrained section with overall operation of weaving section approaching capacity. In Nomograph 3, Instruction 4, enter with $SV = 1900$ and read overall (composite) speed of weaving section, $S = 30$ mph in Chart A, and corresponding weaving speed, $S_w = 28$ mph in Chart B, indicating operation limited to LOS E (capacity). Extremely poor conditions would prevail if this configuration were to be maintained in the future.

Problem 7. -A minimum improvement is represented in this case by merely adding an auxiliary lane within the weaving section between the ramp terminals and reconstructing the facility to a modern standard, including a 2-lane exit. The weaving section assumes the following configuration.

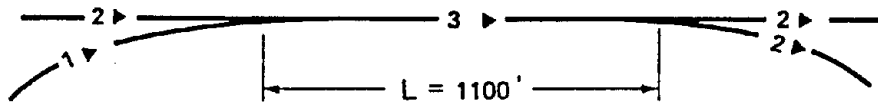

TRAFFIC DIAGRAM
SAME AS IN PROBLEM 6

Solution:

Proceed through Nomograph 1 in the same manner as in Problem 6, except that the horizontal projection from $V = 3300$ to $N_b = 2$ zone is intersected with $N = 3$. This yields for the overall section an SV of about 1325, just within LOS D. Instruction 2 of Nomograph 3 applies, so that the initial reading of $S_w = 40$ mph remains the same and the overall speed equals S_w , or 40 mph. The result is sufficiently close to a balanced section, with operation considered at the limit of LOS C, with $S_w = S = 40$ mph.

Problem 8. A more elaborate improvement, emphasizing greater freedom of operation on the freeway is presented in this case by separating the weaving movement from the freeway. The accompanying sketch demonstrates the plan.

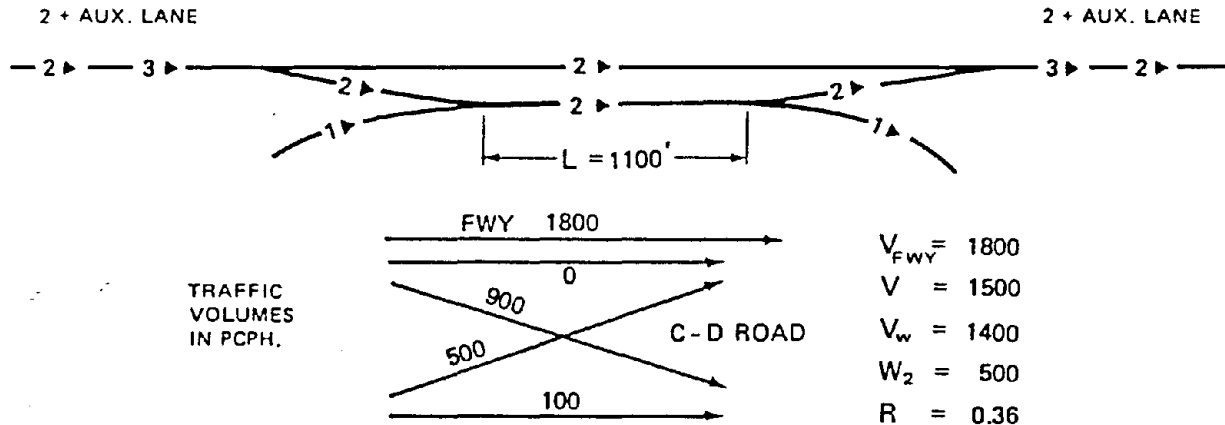

Solution:

Proceed through Nomograph 1 in the same manner as before, except that the downward projection of $W_2 = 500$ is intersected with $V = 1500$ (C-D road traffic only); then, project to the right (within $N_b = 2$ zone) to intersect with $N = 2$, which yields an SV of about 1250. In the case of a local C-D road weaving section, Nomograph 3 normally is not used as indicated previously; thus, S_w with corresponding LOS is determined by the lower-left portion of Nomograph 1, which yields on the C-D road an S_w of 40 mph and corresponding LOS C. The through movement on the main line, $1800/2 = 900$ pcph per lane, indicates operation on the freeway proper at LOS B at an average speed of about 55 mph.

Problem 9. -An existing 6-lane urban freeway with a 50-foot median, in need of considerable maintenance and safety improvements, along with anticipated traffic growth, is slated for reconstruction. Preliminary design studies indicate utilizing for the most part the existing location in plan and profile, providing a continuous additional lane for each direction in the median, pavement strengthening, and modernizing exits and entrances. Of particular concern is a weaving section along the freeway shown in the accompanying sketch prior to construction. As a first step in the analysis and design process determine the operational condition of the existing facility--Case A.

CASE A - INITIAL (EXISTING) CONDITION

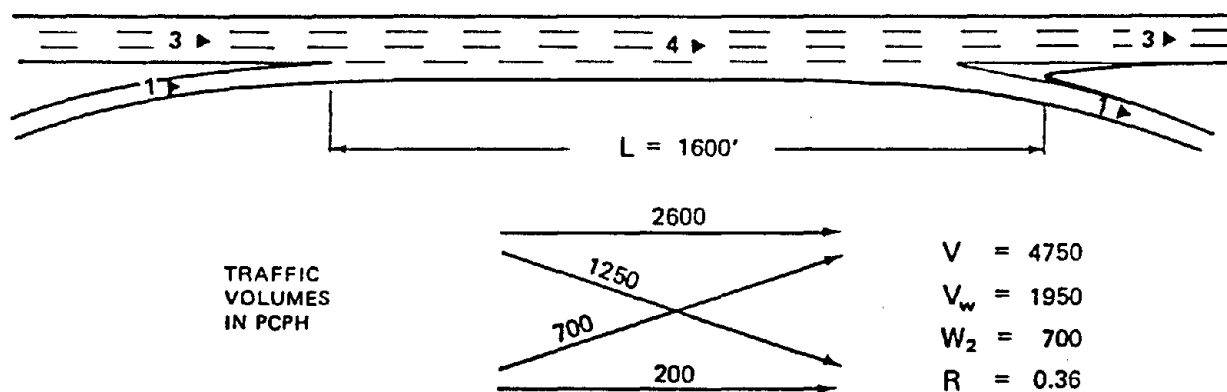

During construction one lane is to be closed on the median side, providing 3 lanes within the weaving section and 2 lanes approaching and leaving the section--Case B. Determine whether it is feasible to handle the indicated traffic during construction and, if so, at what level of service and associated speeds. The condition is depicted in the following sketch.

CASE B - CONSTRUCTION STAGE, ONE LANE CLOSED

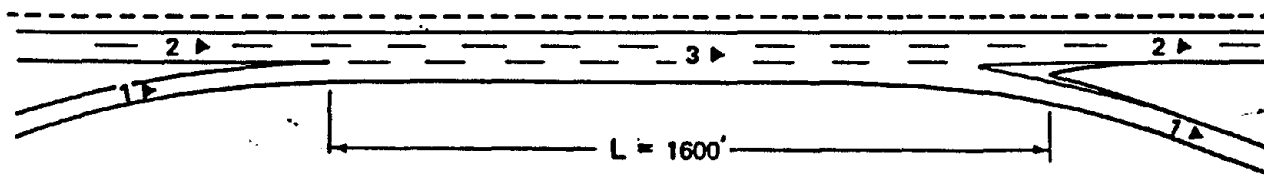

TRAFFIC AS SHOWN FOR CASE A

Problem 9. -- (continued)

Upon completion of construction, the freeway will consist of 4 basic lanes with a 5-lane weaving section and a 2-lane exit at the far ramp--Case C. Determine the level of service and associated speeds of the reconstructed section upon opening the freeway to full operation. The reconstructed facility is shown in the following sketch. Also check future operation for the assumption that traffic will increase uniformly within the pattern by 50 percent.

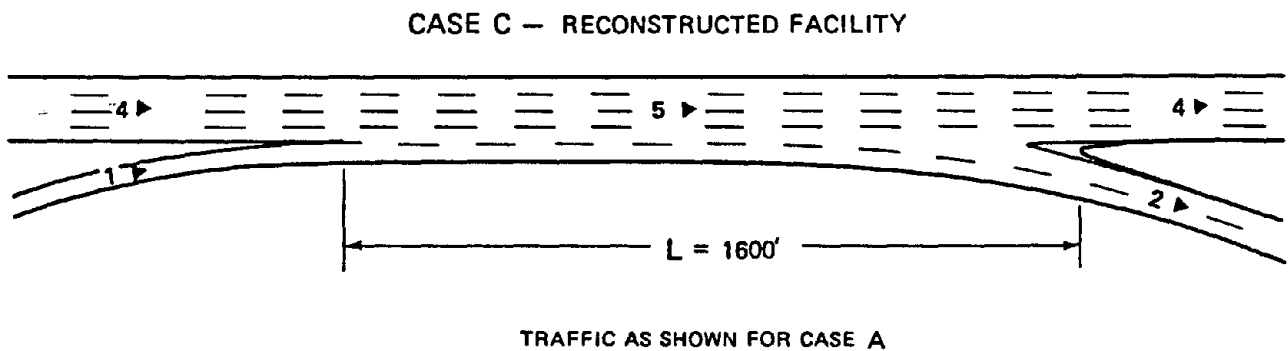

Solution:

Case A (Existing condition). Enter Nomograph 1 with $V_w = 1950$ and $L = 1600$. At intersection relative to dotted speed curves (lane-imbalanced condition) find initial $S_w = 38$ mph with corresponding LOS D.4. Shift horizontally a comparable increment to left (as described in Figure 9-B) and proceed in conventional manner through nomograph using $R = 0.36$, $W_2 = 700$, $V = 4750$, and $N = 4$ within $N_b = 3$ zone; read LOS D.5 with corresponding $SV = 1475$. Referring to Nomograph 3, Instruction 1 (since LOS of $V \approx$ LOS V_w) $S_w = S = 38$ mph, corresponding to LOS D. Check of ramp entrance and exit indicates operation of each within LOS D.

Case B (Reduced cross section). Proceed through Nomograph 1 in identical manner as for Case A except that the terminal reading is made for $N_b = 2$ and $N = 3$; read LOS E_{max} and $SV = 1900$. Using Nomograph 3, Instruction 4, with $SV = 1900$, find $S = 30$ mph and $S_w = 28$ mph, corresponding to LOS E_{max} . Check of ramp entrance and exit indicates operation in the range of LOS D to E.

Problem 9. (Solution continued)

Case C (Widened cross section). Enter Nomograph 1 with $V_w = 1950$ and $L = 1600$; use solid speed curves directly (lane-balanced condition) and read initial $S_w = 40$ mph and corresponding LOS C_{max} . Continue through nomograph with $R = 0.36$, $W_2 = 700$, $V = 4750$, and $N = 5$ within $N_b = 4$ zone, locate $SV = 1150$ with corresponding LOS of B.g. Using Nomograph 3, Instruction 3, with $SV = 1150$, find $S = 44$ mph and weaving speed as initially read of $S_w = 40$ mph. Thus, the overall (composite) weaving section will operate near LOS B and weaving movement at LOS C. Check of ramp entrance and exit indicates operation in the range of LOS B to C.

In checking the design for a uniform increase of traffic movements by 50 percent in the future, Nomograph 1 indicates a near operationally balanced design within LOS E at a speed of approximately $S_w = S = 34$ mph.

Problem 10. - An existing 3-lane freeway in one direction having a 1500-foot long one-sided weaving section is to be upgraded to 4-basic lanes. Projected one-directional traffic volumes in pcph are: through on freeway, 3600; exiting at second ramp, 1500; entering at first ramp, 900 (producing a weaving volume of 2400); and an outer flow between the ramps of 100. An alternative solution to be considered is to remove the existing ramp and provide via a new interchange an exit ramp about 1/2 mile farther downstream, producing an improved weaving section of 4000 feet.

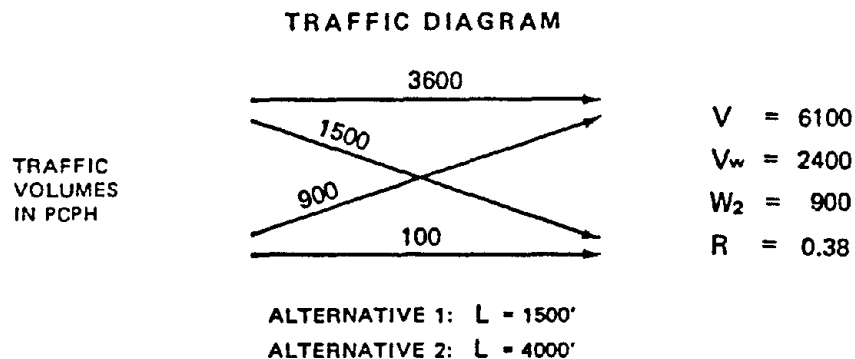

Determine the number of lanes required in each case, considering lane balance, to satisfy a design of the overall freeway weaving section at not less than level of service C operation; include level of service and average speed of weaving traffic, and the resulting average speed of traffic on the overall weaving section.

(Solution Follows on Next Page)

Problem 10. (continued)

Solution:

Alternative 1. Enter Nomograph 1 with $V_w = 2400$ and $L = 1500$; read initial $S_w = 37$ mph and corresponding LOS D.7. Continue through nomograph using upper k curve ($R = 0.38$), $W_2 = 900$, $V = 6100$ and LOS C ($SV = 1350$) for $N_b = 4$. Find $N = 5.4$; round to $N = 6$ lanes with corresponding LOS C.4, and SV of 1300. For further calibration, using Nomograph 3, Instruction 3, determine $S = 42$ mph in Chart A, and $S_w = 37$ mph as initially established in Nomograph 1. Thus, for Alternative 1, LOS C at $S = 42$ mph is satisfied, while the weaving movement operates at $S_w = 37$ mph corresponding to LOS D. The number of lanes required for this solution is shown as follows:

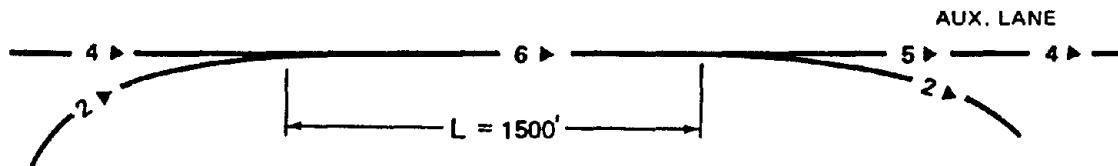

ALTERNATIVE 1

Alternative 2. Enter Nomograph 1 with $V_w = 2400$ and $L = 4000$; read initial $S_w = 46$ mph and corresponding LOS B.8. Continue through remaining nomograph as before and find $N = 4.7$ for LOS C and $N_b = 4$; round to $N = 5$ with corresponding LOS C and SV of 1350. For further calibration, using Nomograph 3, Instruction 4, determine $S = 41$ mph and $S_w = 38$ mph. Thus, completed solution provides, for all practical purposes, the same quality of operation as Alternative 1, but with one less lane. For the overall (composite) weaving section $S = 41$ mph at LOS C is indicated, while the weaving movement operates at $S_w = 38$ mph corresponding to LOS D. The number of lanes required for Alternative 2 is shown as follows.

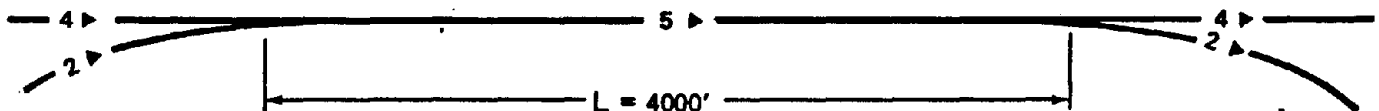

ALTERNATIVE 2

Problem 11. - Alternative designs are being considered for a 6-lane high-type freeway in a rural area on which it is intended to maintain a level of service B. For one design it would result in a one-sided weaving section while the other would create two-sided weaving. The alternative arrangements under study, including the volume and pattern of traffic, are shown below. The analysis requires the determination of respective lengths of weaving sections, lane arrangements, and resulting speeds of operation.

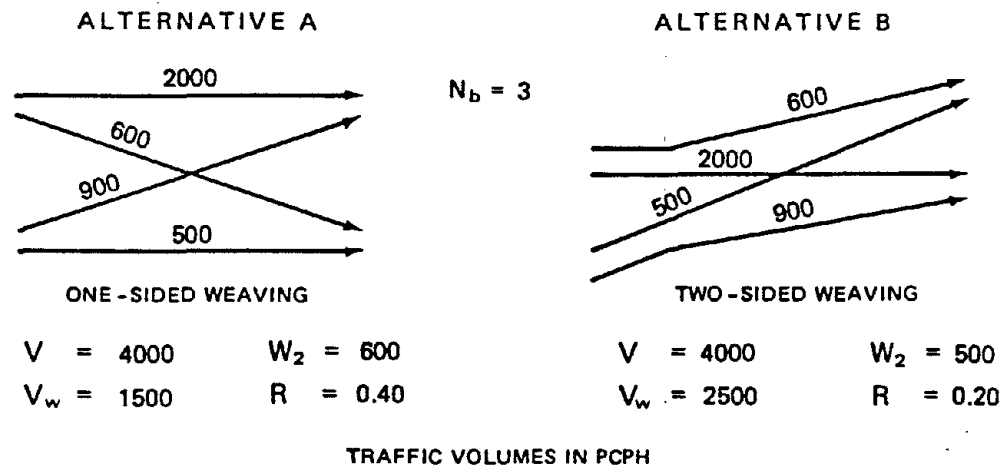

Solution:

Alternative A. Using Nomograph 1 find $L = 1900$ feet for V_w of 1500 pcph and LOS B curve (45 mph). Proceed through nomograph to $R = 0.40$, $W_2 = 600$, $V = 4000$ and LOS B line for $N_b = 3$; read $N = 4.2$ lanes. Round back to a whole number of $N = 4$ lanes. Referring to Nomograph 3, Instruction 2, the resulting average speeds are $S_w = 45$ mph (as previously read at lower left of Nomograph 1) and $S = 45$ mph. Pertinent dimensions are shown as follows (note lane balance has been provided).

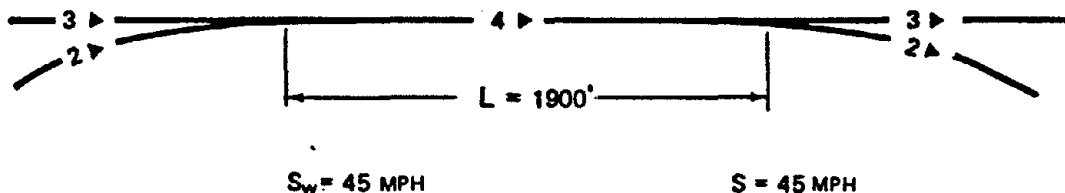

Problem 11. (Solution continued)

Alternative B. Using Nomograph 2 find $L = 3700$ feet for V_w of 2500 pcph and LOS B curve (50 mph). Proceed through nomograph to $R = 0.20$, $W_2 = 500$, $V = 4000$ and LOS B line for $N_b = 3$; read $N = 5.0$. Using 5 lanes, the section is fully balanced at LOS B, which obviates the use of Nomograph 4. The following dimensions are produced (note provision of lane balance and need to continue auxiliary lane on freeway forward beyond the weaving section).

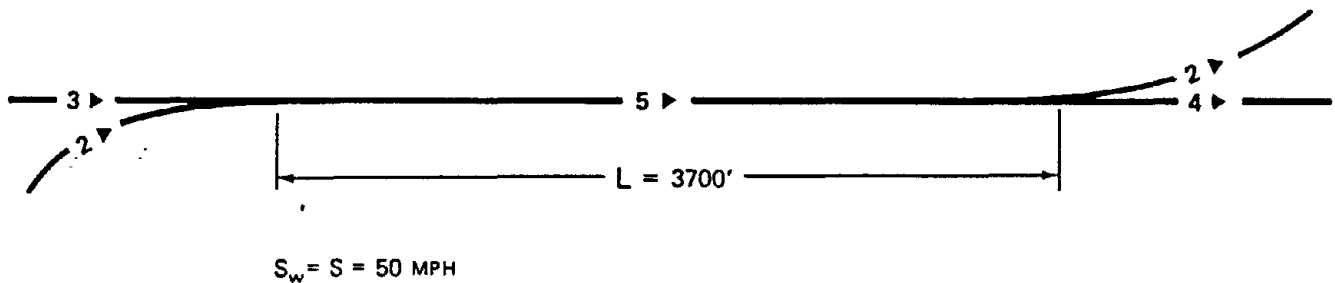

Summary Although the basic volume and pattern of traffic entering and leaving the weaving section is the same in each alternative, the dimensional features differ materially. The two-sided section in this case, due to the makeup of a larger weaving volume, in conjunction with inherently more stringent requirements of two-sided weaving, requires greater length and width of section, with an extra auxiliary lane carried forward which would be terminated appropriately on the right as a lane drop on the freeway or a lane drop via the next ramp exit. The comparative dimensions for a two-sided weaving section as a general case are not necessarily more critical. There are situations for certain combinations of volumes and patterns of traffic where the reverse may be true. The problem example does demonstrate the difference which frequently exists.

Problem 12. - A diamond-type interchange is to be located on a modern freeway downstream from a fully directional, freeway-to-freeway interchange as shown in the accompanying diagram. For the traffic movements indicated, what distance is required between the merging end and the exit nose (C to D) to take the intervening freeway section out-of-realm of weaving? Assuming this can be accomplished, a level of service B is to be maintained on the freeway; in which case the number of lanes required and the approximate average speed for this section are to be determined.

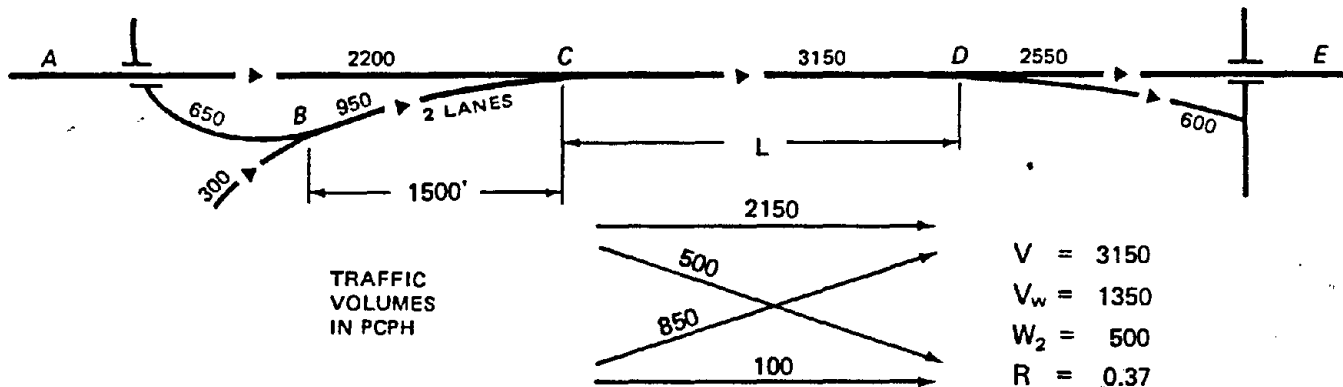

Solution:

As a prelude to the problem solution, it is of interest to note that upon examination of the two-interchange complex and its configuration that a variety of possible weaving situations could arise. Depending on the following conditions--volume and pattern of traffic, distances between merging and diverging points, B, C and D, and number and arrangement of lanes--the configuration may function as a multiple weaving section, a simple weaving section, or as a freeway uninterrupted-flow condition with spaced out entrances and exits. A preliminary analysis of the double (2-lane) ramp entry from the major interchange (section B-C) indicates that it is out-of-realm of weaving. Further, an appropriate elongation between interchanges, of what otherwise could constitute a major weave along the freeway (C to D), can provide a no-weaving situation for the overall plan.

Problem 12. (Solution continued)

Proceeding with the solution, Nomograph 1 is used to determine the required distance along the freeway (section C-D), where V_w of 1350 pcph shows operation to be out-of-realm of weaving at 3500 feet. At this or greater distance between the ramps allows the intervening section between the ramps to be analyzed as a free-flow highway section, for which the number of lanes required is calculated by the uninterrupted-flow relationship of V/SV . A maximum SV of 1150 pcphpl for LOS B is designated at approximately 55 mph for freeway operation in the draft of the new HCM. Accordingly, the number of lanes on the section is calculated to be, $N = 3150/1150 = 2.7$ or, rounded, $N = 3$. Further analysis indicates the following lane arrangement for the overall facility.

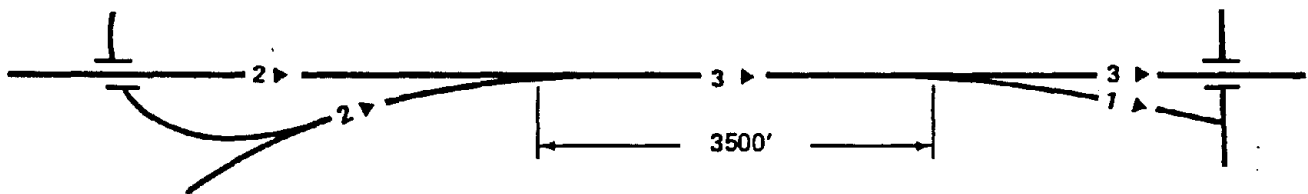

Problem 13. - Determine the level of service and speeds of operation on the following weaving section formed by right-hand ramps between two interchanges.

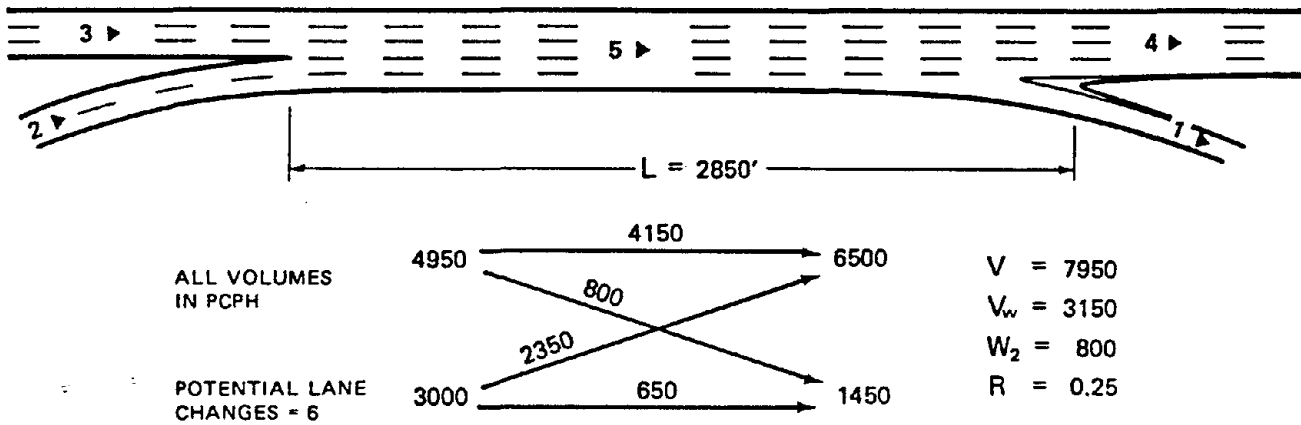

Solution:

Enter Nomograph 1 with $V_w = 3150$ and $L = 2850$, and locate an initial S_w of 38 mph at LOS D.4 with respect to dotted curves for lane-imbalanced condition. Transfer $S_w = 38$ to left along "turning line for k" to a position between solid curves comparable to 38 mph before proceeding upward to k (see special application in Figure 9-B). Continue through nomograph with $R = 0.25$, $W_2 = 800$ and $V = 7950$; then, project horizon-tally to $N = 5$ within $N_b = 3$ zone, and read $SV = 1870$ at LOS E.g. Using Nomograph 3, Instruction 4, with $SV = 1870$, find $S = 30$ mph and $S_w = 28$ mph, indicating operation at this point of analysis to be at LOS E_{max}. Ramp entrance and exit levels of service were evaluated (analysis not shown) to check for possible constraints. The single-lane exit at the far end of the weaving section would operate at or slightly beyond ramp exit capacity, which is apt to impact on the speeds derived above. Also, since the weaving section generates a potential number of 6-lane shifts, average speeds of operation are considered to be lowered by 5 mph (according to special condition D(2) in Table 2); thus, with final adjustment, overall speed $\underline{S} = 30 - 5 = \underline{25 \text{ mph}}$, and weaving speed $\underline{S_w} = 28 - 5 = \underline{23 \text{ mph}}$, producing LOS E/F.

This problem demonstrates that under some circumstances a variety of constraints and impacts such as those brought about by the level of service of the ramp merge and diverge, the level of service of freeway downstream, and the lane configuration in the overall makeup of the weaving section as reflected in potential lane shifts, may cause operational conditions difficult to predict.

Problem 14. - What improvement in operation could be expected on the weaving section in Problem 13 if the design is altered to provide lane balance, accomplished by adding an extra (second) lane to the ramp exit; number of lanes on all other elements would be retained. The adjusted arrangement is shown below.

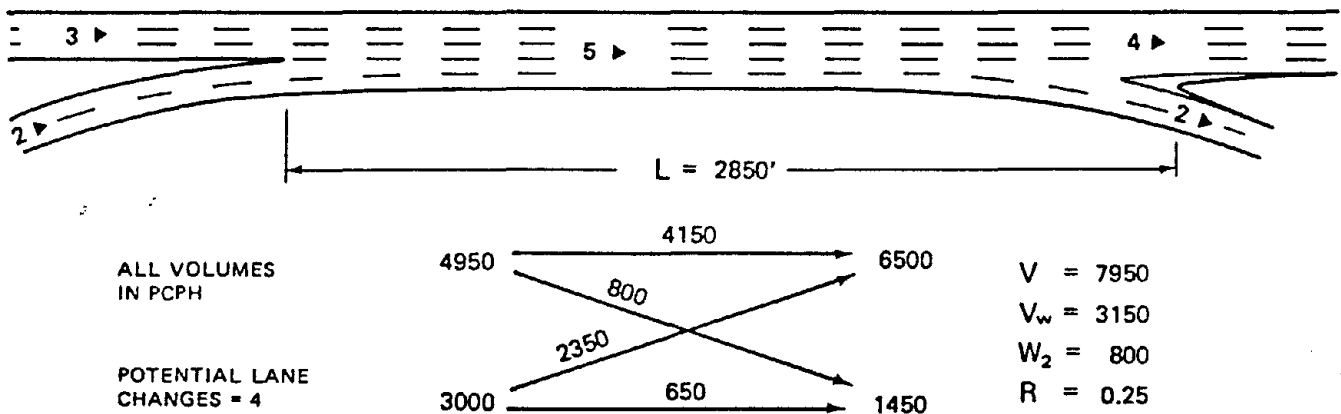

Solution:

Since this configuration reduces the number of potential lane shifts to 4 and mitigates the constraint at the exit, the solution is accomplished by the direct use of Nomographs 1 and 3. As before, enter Nomograph 1 with $V_w = 3150$ and $L = 2850$, except that in this case the intersection point is made with respect to solid curves for the lane-balanced condition; locate an initial S_w of 40 mph at equivalent LOS C_{max} . Continue through the nomograph with $R = 0.25$, $W_2 = 800$, $V = 7950$, and $N = 5$ within $N_b = 3$ graph; read $SV = 1840$ at LOS E.g. Using Nomograph 3, Instruction 4, with an entry of $SV = 1840$, find $S = 31$ mph and $S_w = 29$ mph, indicating overall operation approaching LOS E_{max} . The predicted operational improvement in this example can be significant when compared with the arrangement of the previous problem in which low, critical speeds subject to intermittent time intervals of stop-and-go traffic would be evident.

Problem 15. - A section of modern freeway including two successive entrances followed by an exit, with indicated ramp spacing and traffic volumes (pcph), is under design as illustrated below. Although the overall configuration has a general form of a multiple weaving section, it is to be established first whether it is a simple or a multiple section; then, for level of service B operation, determine the number of lanes required and if the length or lengths of weaving section are adequate.

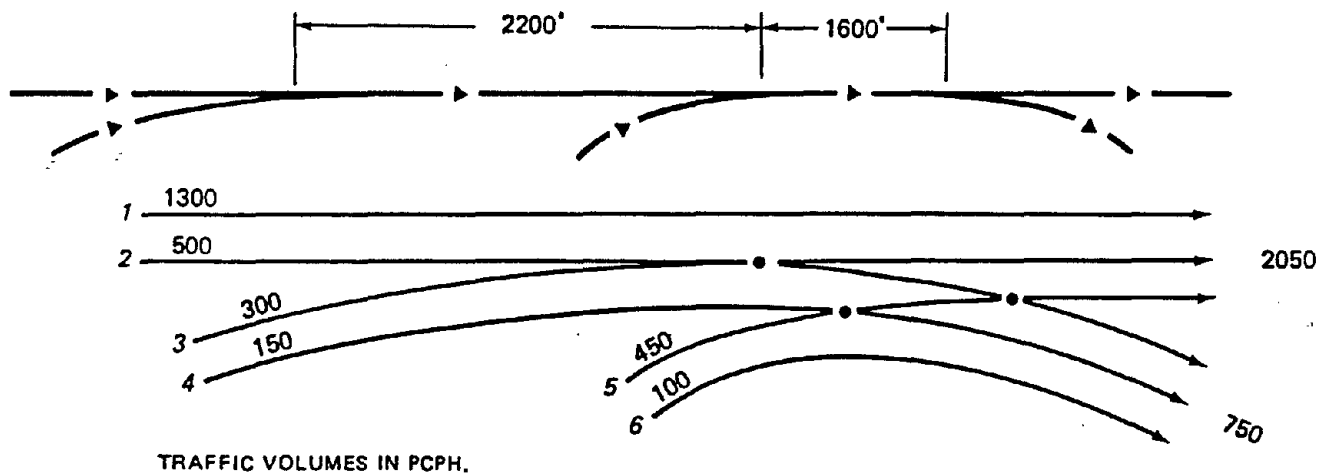

Solution:

A standard check for a multiple weaving section of the 2EN-EX form is made by determining the amount of weaving that would take place in the first segment with relation to the out-of-realm of weaving limit (see Section E(1), Table 2). Weaving in the first segment, as described in Section E(2), Table 2, would normally be 0.75 of (Vol. 2 + Vol. 3), or 0.75 (800) = 600 pcph. For a length of 2200 feet, the movement is out-of-realm of weaving, according to Nomograph 1, which places the solution into a simple weaving section involving the primary weave only of the second segment. The weaving diagram for the second segment then resolves to be as follows.

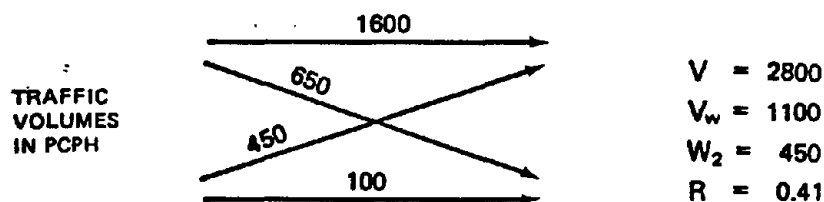

Problem 15. (Solution continued)

Using Nomograph 1 for a simple weaving section with $V_w = 1100$ and $L = 1600$ feet, read LOS B.8 (47 mph); follow trend of speed curves to turning line k, then continue to $R = 0.41$, $W_2 = 450$, $V = 2800$, and LOS B line for $N_b = 2$, read $N = 3.1$; round to $N = 3$, corresponding to LOS B.2 and SV of 1050. Refer to Nomograph 3, Instruction 2, which verifies $S_w = 47$ mph and also indicates that $S = 47$ mph. The remaining elements of the highway within the range diagrammed would operate as uninterrupted flow at LOS B and SV of 1150 pcph, producing average overall speeds upward of 55 mph (according to the new HCM). At the extreme right of the configuration the higher speed would be achieved, at some distance beyond the ramp exit, after the through flow has recovered from the influence of the weaving section. The number of lanes, utilizing a lane-balanced condition would be as shown below. Although not included herein, in all cases LOS of ramp merges and diverges would be checked in completing the solution.

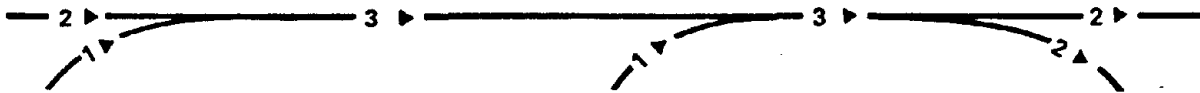

Problem 16. - A section of modern freeway including two successive entrances followed by an exit (2EN-EX configuration) is under design as indicated in the accompanying figure. The design-hourly volumes shown have been converted to equivalent passenger vehicles (pcph) accounting for the effect of trucks and grades. The traffic diagram is arranged to demonstrate the pattern of weaving. A preliminary level of service analysis along the facility has been accomplished and a basic number of lanes determined to be $N_b = 3$. Operation at level of service C is to be provided.

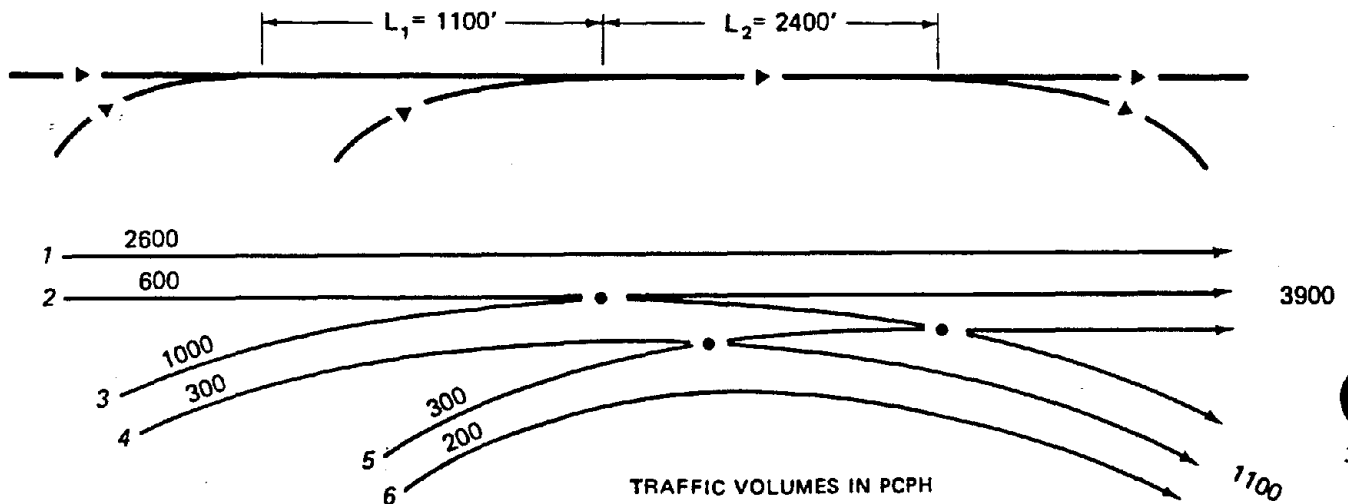

Determine the following features: whether simple or multiple weaving is present; whether the length or lengths of weaving section are adequate; and, the number of lanes required on the various elements, incorporating the feature of lane balance.

Solution:

The problem constitutes a potential multiple weaving section of the type 2EN-EX. The first step in the analysis is a check to determine whether the configuration is indeed a multiple weaving section. If so, the analysis proceeds on the basis of a multiple section; if not, it is analyzed as a simple weaving section. The procedure for the test is provided in Section E(1) Table 2, and as demonstrated in the previous problem.

Problem 16. (Solution continued)

In segment 1, using a length of 1100 feet and a weaving volume of 0.75 times the sum of movements 2 and 3, indicates operation to be to the left of the limiting curve in the lower part of Nomograph 1, or within the realm of weaving. The configuration, therefore, represents a multiple weaving section, and is thus analyzed in accordance with the analysis worksheet of Figure 10 for a multiple weaving section of the form 2EN-EX. The computations in the lower part of the form utilize Nomograph 1 for the initial weaving volume-length effects and width requirements for both segments, while Nomograph 3 is used to calibrate and finalize average overall and weaving speeds, along with levels of service of each. The level of service C is satisfied as a composite throughout the facility, and generally for weaving traffic ($S = 42$ mph for both segments, and $S_w = 42$ and 39 mph for segments 1 and 2 respectively). In both segments, $N = 4$ conforms to required operation. As a whole, the number of lanes fit into proper sequence and provide lane balance. The details and results of the analysis are shown on the following worksheet.

ANALYSIS WORKSHEET
MULTIPLE WEAVING 2EN-EX

PROJECT PROBLEM 16

12-8-83

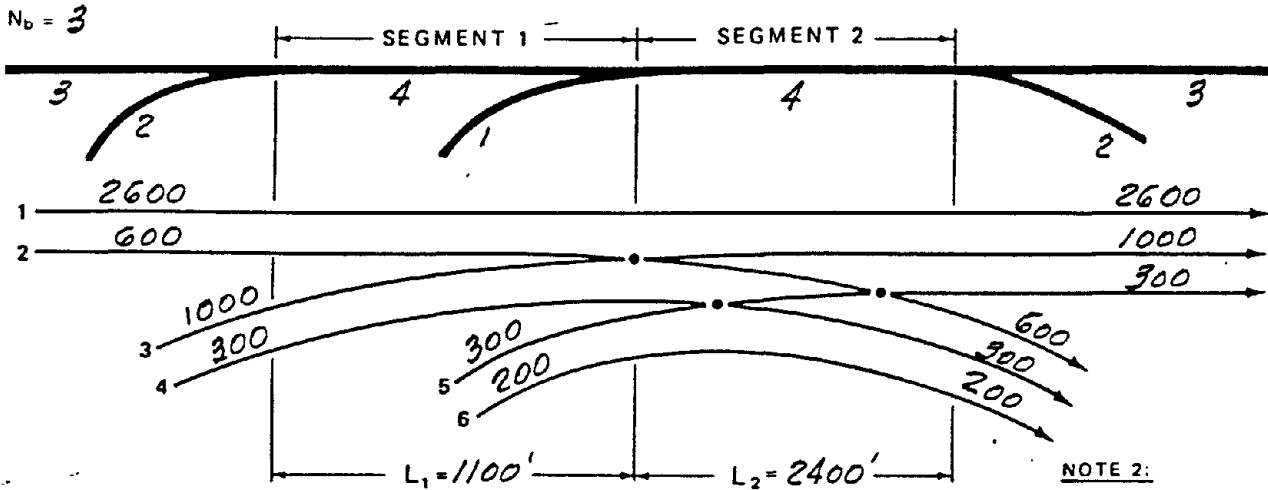

LONG WEAVE - VOL 2. vs. VOL. 3 (SEE NOTE 1)*

NOTE 2:
PLACE NUMBER OF LANES, EXISTING OR SOLVED, ALONG UPPER DIAGRAM.

SEGMENT 1

$$\begin{aligned} [2] &= P \times \text{VOL. 2} \\ &= 0.75 \times 600 = \underline{450} \\ [3] &= P \times \text{VOL. 3} \\ &= 0.75 \times 1000 = \underline{750} \end{aligned}$$

SEGMENT 2

$$\begin{aligned} (2) &= (1 - P)(\text{VOL. 2}) \\ &= 0.25 \times 600 = \underline{150} \\ (3) &= (1 - P)(\text{VOL. 3}) \\ &= 0.25 \times 1000 = \underline{250} \end{aligned}$$

$V = 4500$
 $V_w = 1200$
 $W_2 = 450$
 $R = 0.38$

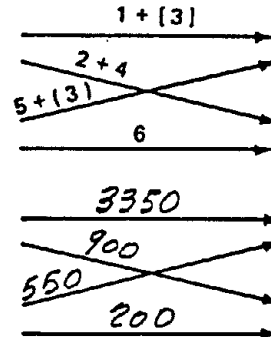
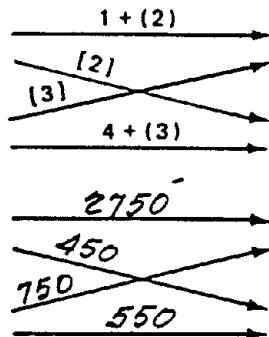

$V = 5000$
 $V_w = 1450$
 $W_2 = 550$
 $R = 0.38$

COMPUTATIONS

NOTE 3:
ALL VOLUMES IN PCPH. RECORD ON DIAGRAM.

NOMOGRAPH 1:
 V_w initial LOS C,8 ($S_w = 42$)
 $N = 3.8$, LOS Cmax, Round to
 $N = 4$, LOS C,8, $SV = 1300$

NOMOGRAPH 1:
 V_w initial LOS B,6 ($S_w = 47$)
 $N = 3.8$, LOS C, Round to
 $N = 4$, LOS C,8, $SV = 1300$

NOMOGRAPH 3, Instr. 2:
 $S = 42$ mph, LOS C
 $S_w = 42$ mph, LOS C
 $N = 4$ } RESULT

NOMOGRAPH 3, Instr. 4:
 $S = 42$ mph, LOS C
 $S_w = 39$ mph, LOS C-
 $N = 4$ } RESULT

*NOTE 1: ALL OF LONG WEAVE TENDS TO TAKE PLACE IN SEGMENT 1, WITH PROPORTION P INCLINED TO APPROACH 1.0; P, HOWEVER, MAY VARY IN INDIVIDUAL CASES. IN DESIGN AND IN GENERAL OPERATIONAL ANALYSIS, NORMALLY USE $P = 0.75$ IN SEGMENT 1. OTHERWISE, IN MORE DETAILED OPERATIONAL ANALYSIS, FIELD SAMPLING OF TRAFFIC MOVEMENTS MAY GIVE INDICATION OF P.

Problem 17. - A multiple weaving configuration of the EN-2EX variety, along the same freeway as in the previous problem with segments of 2400 feet and 1200 feet, respectively, is to be tested for level of service C operation, including the determination of the numbers of lanes required. Design-hourly volumes, expressed in pcph, and the pattern of movements are shown in the accompanying figure.

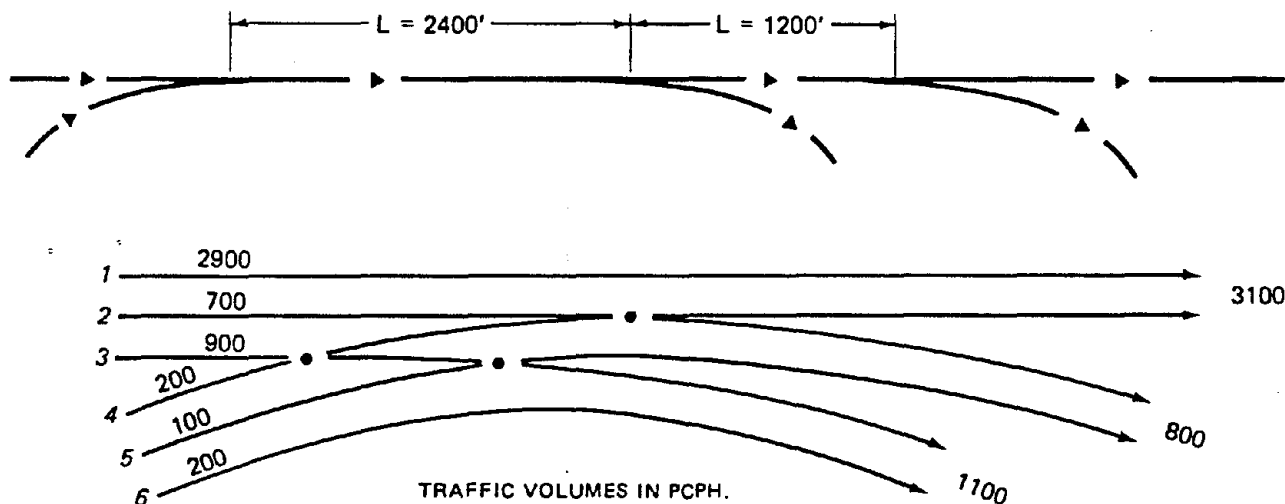

Preliminary analysis indicated the one-directional basic lanes of $N_b = 3$, and verified that the configuration constitutes multiple weaving, according to the standard test. The analysis and design, therefore, is to be predicated on a multiple weaving section of the EN-2EX form, providing the necessary details for the overall solution including a lane-balanced design.

Solution:

The solution is advanced in accordance with the analysis worksheet of Figure 11. The computations in the lower part of the form which follow utilize Nomograph 1 for initial weaving volume-length effects and width requirements, while Nomograph 3 is used to calibrate and finalize average overall and weaving speeds, along with levels of service of each segment. The solution indicates that the level of service C is satisfied as a composite throughout the facility, except for weaving traffic element which falls just short of LOS C in segment 2. The details and results of the analysis are shown on the following worksheet.

12-8-83

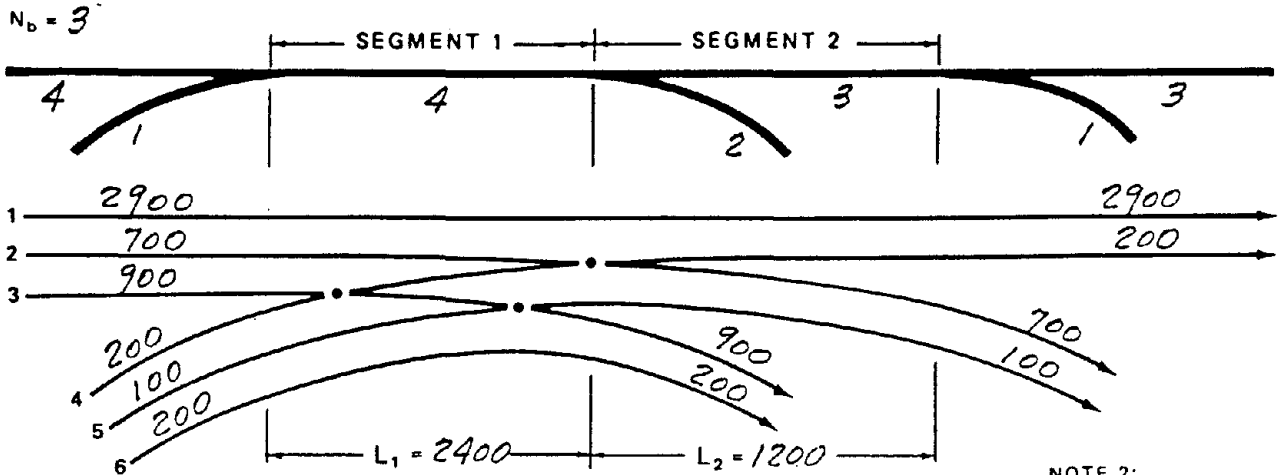

LONG WEAVE - VOL. 2 vs. VOL. 4 (SEE NOTE 1)*

NOTE 2:
PLACE NUMBER OF LANES, EXISTING OR SOLVED, ALONG UPPER DIAGRAM.

SEGMENT 1:

$$\begin{aligned} (2) &= (1 - P)(\text{VOL. 2}) \\ &= 0.25 \times 700 = \underline{175} \\ (4) &= (1 - P)(\text{VOL. 4}) \\ &= 0.25 \times 200 = \underline{50} \end{aligned}$$

SEGMENT 2:

$$\begin{aligned} (2) &= P \times \text{VOL. 2} \\ &= 0.75 \times 700 = \underline{525} \\ (4) &= P \times \text{VOL. 4} \\ &= 0.75 \times 200 = \underline{150} \end{aligned}$$

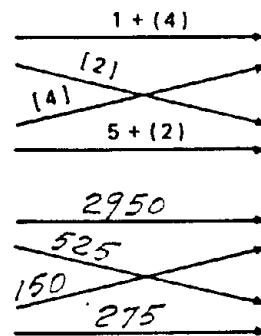
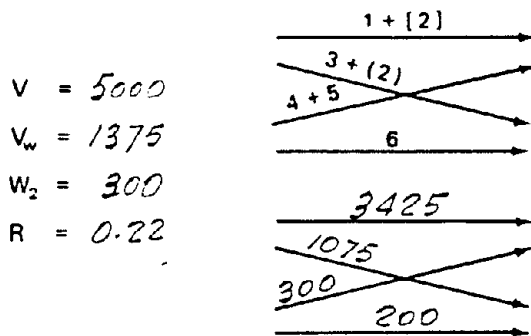

NOTE 3:
ALL VOLUMES IN PCPH, RECORD ON DIAGRAM.

COMPUTATIONS:

NOMOGRAPH 1:
 V_w initial LOS B.6 ($SW = 47.5$)
 $N = 3.8$, LOS C_{max}, Round to
 $N = 4$, LOS C.8, $SV = 1300$

NOMOGRAPH 1:
 V_w initial LOS B.4 ($SW = 48$)
 $N = 3.0$, LOS C_{max}.
 $SV = 1350$

NOMOGRAPH 3, Instr. 4:
 $S = 42$ mph, LOS C
 $SW = 39$ mph, LOS C-
 $N = 4$ } RESULT

NOMOGRAPH 3, Instr. 4:
 $S = 40$ mph, LOS C
 $SW = 38$ mph, LOS D
 $N = 3$ } RESULT

*NOTE 1: ALL OF LONG WEAVE TENDS TO TAKE PLACE IN SEGMENT 2, WITH PROPORTION P INCLINED TO APPROACH 1.0: P, HOWEVER, MAY VARY IN INDIVIDUAL CASES. IN DESIGN AND IN GENERAL OPERATIONAL ANALYSIS, NORMALLY USE $P = 0.75$ IN SEGMENT 2. OTHERWISE, IN MORE DETAILED OPERATIONAL ANALYSIS, FIELD SAMPLING OF TRAFFIC MOVEMENTS MAY GIVE INDICATION OF P.

Problem 18. - A section of modern freeway including two successive entrances followed by two successive exits (2EN-2EX), comprising a 3-segment multiple weaving configuration, is under design as indicated in the accompanying figure. Length of segments provided are 1200, 2400 and 1200 feet, respectively. The design-hourly volumes (in pcph) are shown for the various elements of the facility. Individual movements comprising the pattern from which weaving movements can be determined are discussed in conjunction with the solution of the problem. A preliminary analysis of the facility indicates a basic number of lanes to be $N_b = 3$ in each direction. Operation at level of service C is to be provided.

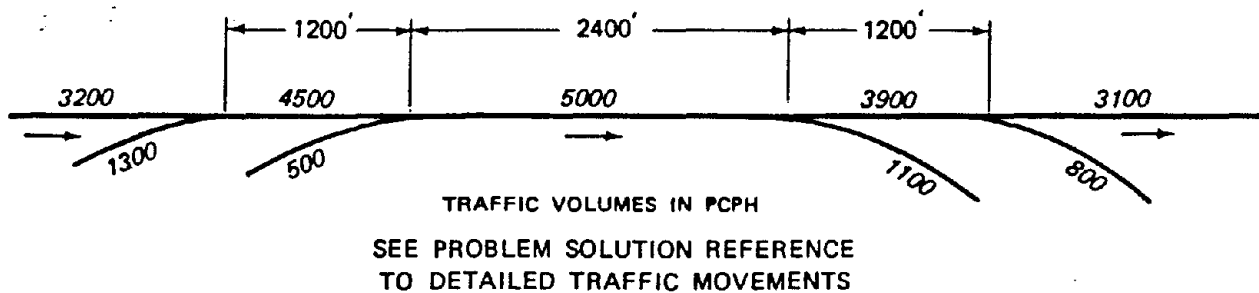

Determine: whether 3-segment multiple, 2-segment multiple, or simple weaving is present; whether the length or lengths of weaving sections are adequate; and the number of lanes required on the various elements, incorporating the features of lane balance.

Problem 18 (Continued)

Solution:

Multiple weaving section configurations of more than two segments are analyzed by a rational technique of breaking down the overall section into overlapping 2-segment sections. For a potential 3-segment section, the separation process involves two overlapping 2-segment weaves as shown below.

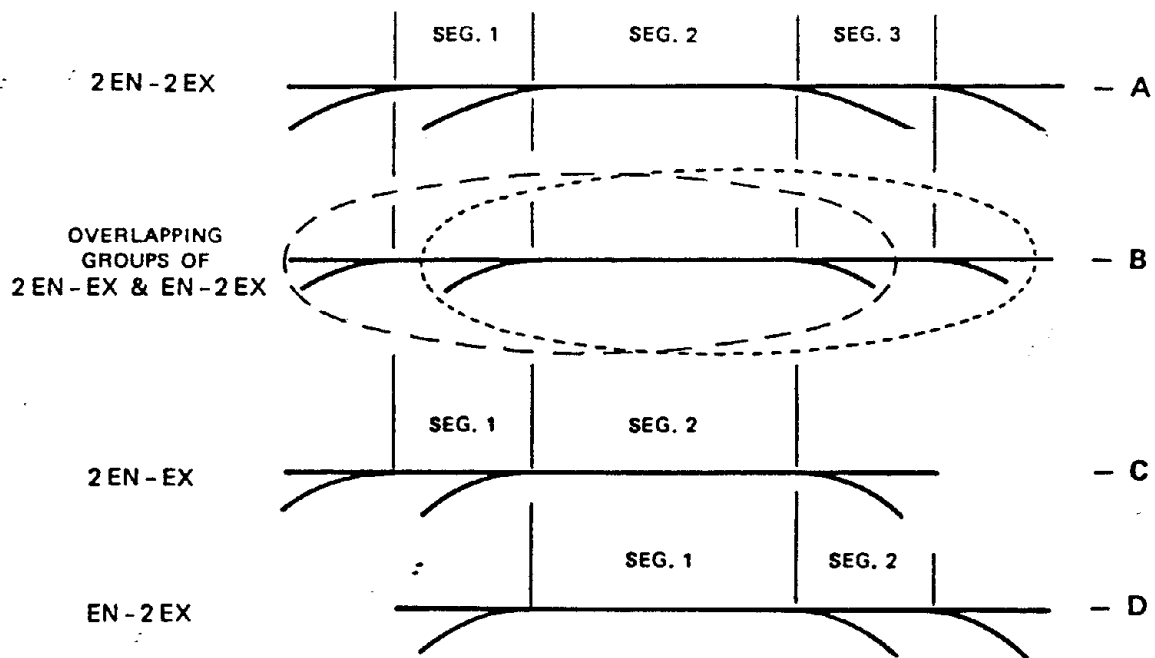

After the indicated separation each 2-segment section, C and D above, is analyzed independently--in this case, as 2EN-EX and EN-2EX sections, following the standard procedure previously described and utilized in problems 16 and 17. The test for each (for C and for D) is first applied to determine if it constitutes a multiple or simple weaving. If both involve multiple weaving, standard analysis worksheets (Figures 10 and 11) are utilized to solve Section C and Section D. The two sections are then rejoined and the results of the overlapping portion are harmonized, as required, to produce an overall continuous solution.

Problem 18. (Continued)

The facility presented in the problem statement for this example is actually a combination of Problems 16 and 17 and their solutions, each representing and being identical, respectively, to the separated Sections C and D noted above. Thus, the final solution involves merely the rejoining of the sections of Problems 16 and 17 results as follows:

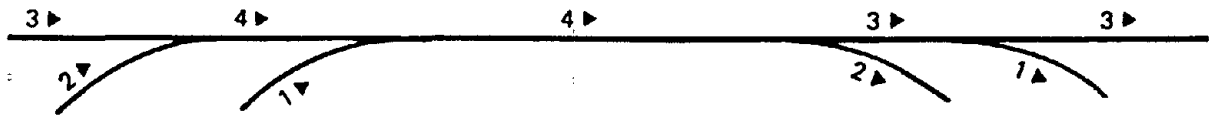

In this case the two rejoined sections required no adjustments in solution results, producing an overall harmonuous geometry. (This may not always be so, in which case the overall section would be adjusted through the overlap to provide an appropriate balance in number of lanes or segment lengths.)

Although a specific problem is not presented for a multiple weaving section of 2 or 3 segments involving left-hand ramps intermixed with right-hand ramps (as may be the case along a continuous C-D road), the procedure is the same as for Problems 16, 17 and 18, except that both Nomographs 1 and 2 would be utilized.

Problem 19. An urban freeway with continuous one-way frontage roads is being designed with diamond interchanges utilizing slip ramps between freeway and frontage road, for the condition shown in the accompanying figure. Determine the length L_f and width N (and N' if wider than N) required to accommodate the indicated traffic.

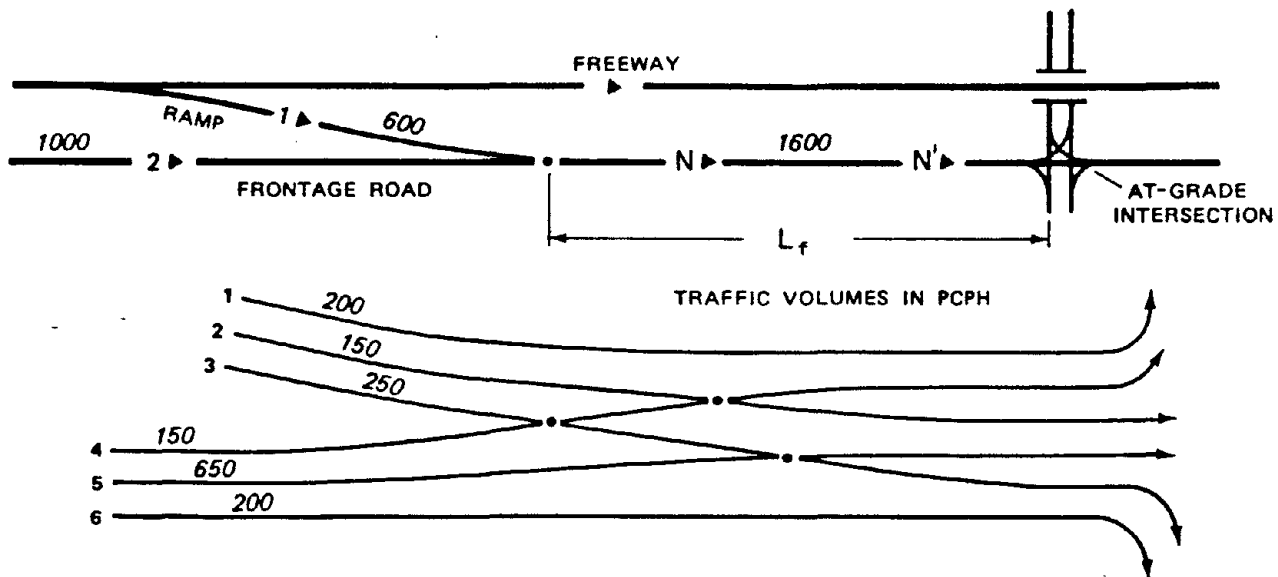

WEAVING MOVEMENT: RAMP + FRONTAGE ROAD

$$V_w = (2 + 3) + (4 + 5) \\ = 400 + 800 = 1200 \text{ pcph}$$

Solution:

Since no specific research or data are available for this prevalent condition associated with freeways, a rational method to solve the problem is utilized, deduced from general observation and operational experience. The technique employs the sum of three dimensions during a representative peak hour, where $L_f = L_w + L_s + L_q$ as structured in the following diagram. The first element, L_w , involves the distance required for the traffic weaving between the ramp and frontage road (in this problem, as shown above, $V_w = 1200$ pcph from which--according to appropriate weaving speed and SV--both L and N can be determined. The second length, L_s , is that required for the complete weave to come to a stop, considering its speed, before reaching the end of the queue of stopped vehicles in advance of the intersection. The third length, L_q , is the average distance per signal cycle occupied by queued vehicles produced by operation of the intersection.

Problem 19: (Continued)

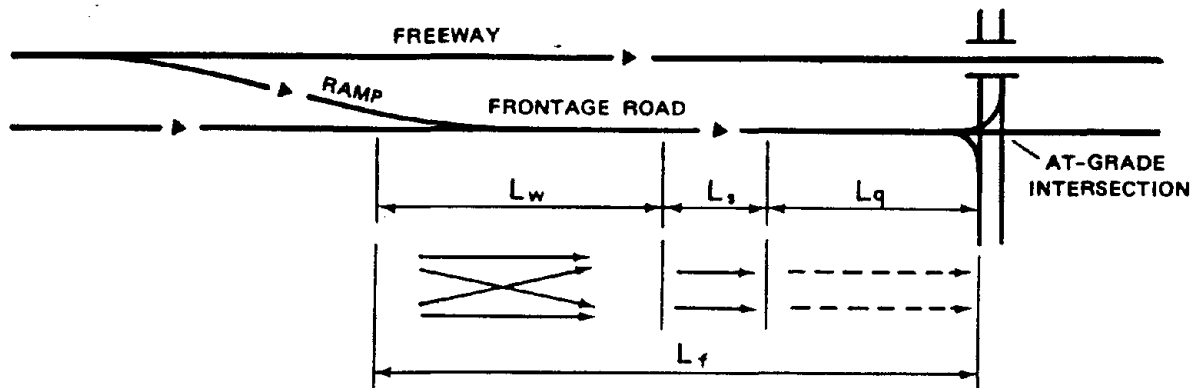

The weaving maneuver, unlike that along a freeway or C-D road, takes place on the frontage road at a variable speed, after which the traffic alternately must come to a stop at the end of an appropriate queue of the intersection. The three length elements are logically quantified in the following manner, considering that the configuration for the condition described does not lend itself to a specific level of service but to an acceptable and appropriate operational situation.

The speeds of ramp and frontage road upon merging and beginning of weaving are considered well represented by 40 mph in urban areas. Since the weaving maneuver is faced by a queue of standing vehicles, the variable speed of weaving is assumed to be accomplished by the time the speed is reduced to about 15 mph followed by a deceleration to a stop at the queue end. Accordingly, the average speed of weaving over distance L_w may be approximated at 25 mph, which is used in Nomograph 1 to determine distance L_w . In this case for V_w of 1200 pcph it is found to be 300 feet.

Length L_s , according to AASHTO design policy, is equivalent to a stopping distance of 80 feet from a speed of 15 mph. The average length of queue is dependent upon the design and operation of the at-grade intersection. Although the analysis of the intersection is not shown here, for the resulting N' of 4 lanes on the approach, an L_q of 320 feet was determined. Thus, the distance between ramp junction and intersection is $L_f = 300 + 80 + 320 = 700$ feet.*

* Dimension of L_f is frequently smaller than demonstrated (as a minimum), due to less stringent traffic requirements.

Problem 19: (Continued)

Using Nomograph 1 with values of $V_w = 1200$, $S_w = 25$ mph, resulting $k = 3$, $W_2 = 400$, $V = 1600$, and an assumed value of $SV = 800$, N closely approximates 3 lanes. (An SV of 800 pcph per lane is taken to be representative of uninterrupted flow operation on portions of non-access controlled facilities.)

The following plan is the result of this analysis.

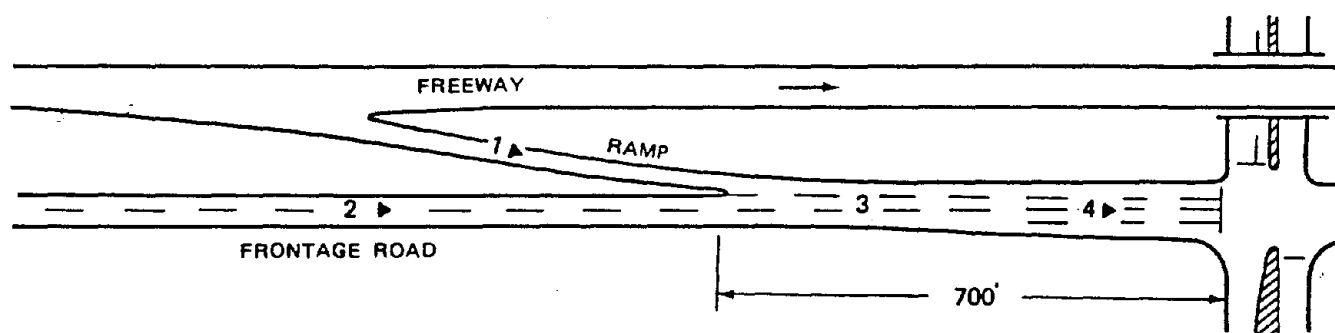

Problem 20. For the same basic configuration of freeway, ramp and frontage road for the urban condition in Problem 19 (in which L_f of 700 feet was established), determine the length, L_f , required between ramp junction and intersection if the facility is located in a rural area. Assume identical traffic pattern and the need for 320 feet at the intersection for queuing.

Solution:

The method is the same as for Problem 19, except that higher speeds on ramp and frontage road, and thus of weaving traffic, must be accounted for in the solution. In rural areas the speed at the beginning of the weave is taken to be representative at 50 mph and at the completion of the weave at 20 mph, for which an approximate average weaving speed is equivalent to 35 mph. For $V_w = 1200$ pcph and a weaving speed of 35 mph, Nomograph 1 indicates $L_w = 660$. Stopping distance from 20 mph is equal to $L_s = 120$ feet. Thus, $L_f = 660 + 120 + 320 = 1100$ feet.*

* Dimension of L_f is frequently smaller than demonstrated (as a minimum), due to less stringent traffic requirements.

TABLE 2
USE OF NOMOGRAPHS INCLUDING ADJUNCT PROCEDURES
FOR WEAVING SECTIONS

A. FREEWAY SECTIONS

(1) One-Sided Weaving Sections--General:

- Use Nomograph 1, for which general application is demonstrated thereon by dotted solution lines with arrows; followed by Nomograph 3, for which application is indicated thereon by "Instructions," 1 through 4.

(2) Two-Sided Weaving Sections--General:

- Use Nomograph 2, for which application is demonstrated thereon by dotted solution lines with arrows; followed by Nomograph 4, for which application is indicated thereon by "Instructions," 1 through 3.

B. C-D ROADS

- (1) Local Sections provided for individual interchanges, arranged for simple weaving between two ramps; generally use Nomograph 1 only for the C-D road (freeway proper analyzed separately). S_w with corresponding LOS is determined from the lower-left portion of Nomograph 1, provided that sufficient number of lanes is available. Overall speed of weaving section, S , equals S_w . Nomograph 3 should be referred to, however, when the outer flow from one ramp to the other exceeds about 15 percent of V .
- (2) Sections on Continuous or Extended C-D Roads along the freeway serving several interchanges are analyzed in the same manner as freeway weaving sections, utilizing Nomographs 1 and 3, and Nomographs 2 and 4, as noted under A(1) and A(2) above.

C. LANE-BALANCED AND LANE-IMBALANCED WEAVING SECTIONS

- (1) Lane-Balanced Sections as previously defined, refer primarily to exits with provision of "one more lane going away" (i.e., combined number of lanes on freeway and ramp after exit being one more than on freeway preceding the ramp). This case is directly accounted for by the solid curves in the lower-left portion of Nomographs 1 and 2. Direct use of these curves and continuation through the nomographs are demonstrated by dotted solution lines.
- (2) Lane-Imbalanced Sections which normally refer to bifurcations without change in total number of lanes (i.e., the number of lanes on freeway and ramp after exit is the same as on freeway preceding the ramp). This case is accounted for by the dotted speed curves in the lower-left portion of Nomographs 1 and 2--indicating that for the same weaving volume, more length of weaving section is required to maintain level of service; or, for the same length, less weaving traffic can be handled than for the lane-balanced section. In using the lower-left portion of the nomograph and then proceeding upward toward the k curve requires, for the lane-imbalanced section, a jog or lateral shift to the left, from the dotted set of speed curves to the solid set of speed curves. This is necessary to permit the remaining elements of the nomograph to serve equally the lane-balanced and lane-imbalanced sections. The method for handling this situation, in solution of problems, is demonstrated in Figure 9; note that the procedure as shown by the sample solution lines in part A of the figure is direct for lane-balanced sections, and for lane-imbalanced sections it requires an equivalent speed jog to the left (from dotted to solid speed curve set), as shown in part B of the figure.

TABLE 2 (continued)

D. WEAVING SECTIONS AS RELATED TO LANE ARRANGEMENTS

- (1) Configurations with Normal Lane Shifts. Weaving sections with various lane arrangements have an effect on operational quality and speed, a feature closely allied to lane balance. The combination with different configurations produces different amount of lane shifting in the process of weaving. The concept of potential lane shifts is demonstrated in Figure 4. As shown, most of the well designed sections produce 2 to 3 potential lane shifts. Weaving sections with 4 potential lane shifts also may be considered within acceptable limits, in which solutions achieved by the procedures of Nomographs 1 - 4 apply.
- (2) Configurations with Excessive Lane Shifts. Weaving sections requiring 5 and 6 potential lane changes, indicate from examination of limited data, that levels of service and associated speeds, S and S_w , would be lowered 3- to 5-mph below those normally produced by Nomographs 3 and 4. For such conditions as a rational deduction, 3- to 5-mph speed increments should be deducted from the nomograph readings to estimate the final result.

E. MULTIPLE WEAVING SECTIONS

- (1) Test for Multiple Weaving. Ramp junctions in sequence involving two or more overlapping simple weaving configurations should be tested prior to analysis if, in fact, multiple weaving is present (see Figures 10 and 11). The check is made with respect to the portion of the long weave (between first and last ramps) which occurs in segment 1 for 2EN-EX form and in segment 2 for EN-2EX form; if this portion in either case is within realm of weaving, the configuration is analyzed as a multiple weaving section and, if not, as a simple weaving section.
- (2) Distribution of Long Weave:
 - Type 2EN-EX--Portion of weave occurring in segment 1 is normally taken to be three-quarters of movements 2 plus 3, and remainder in segment 2, as shown in Figure 10.
 - Type EN-2EX--Portion of weave occurring in segment 2 is normally taken to be three-quarters of movements 2 plus 4, and remainder in segment 1, as shown in Figure 11.
- (3) Use of Nomographs and Analysis Worksheets. Nomographs 1 - 4 are applied in normal manner to each segment separately in accordance with weaving diagrams formulated per above explanation. Analysis Worksheets, Figures 10 and 11 provide an organized means of evaluating multiple weaving problems.

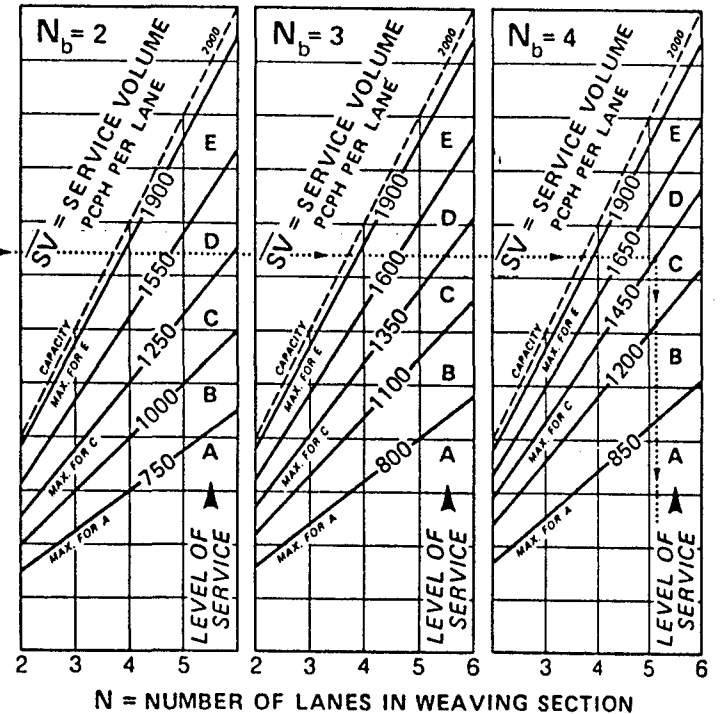
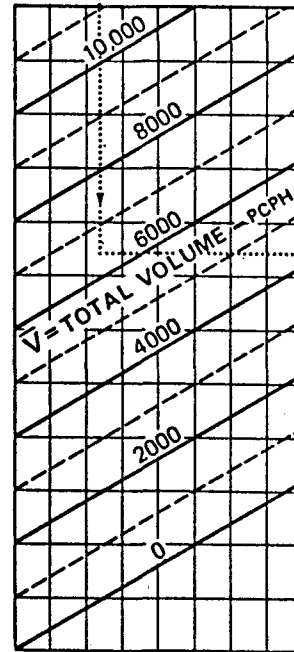
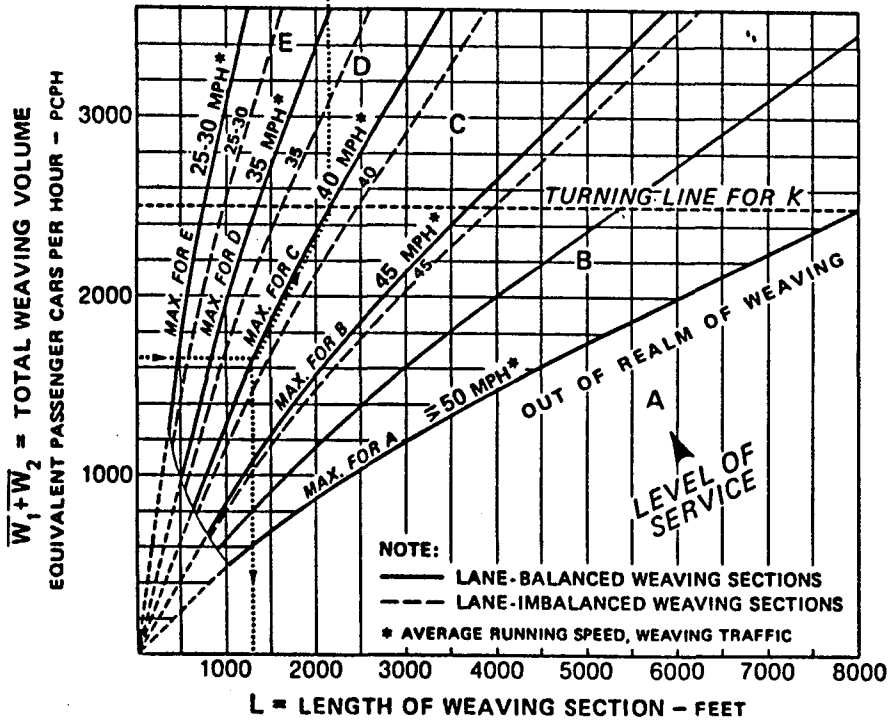
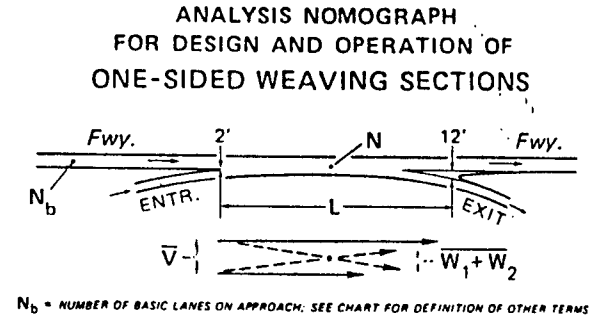
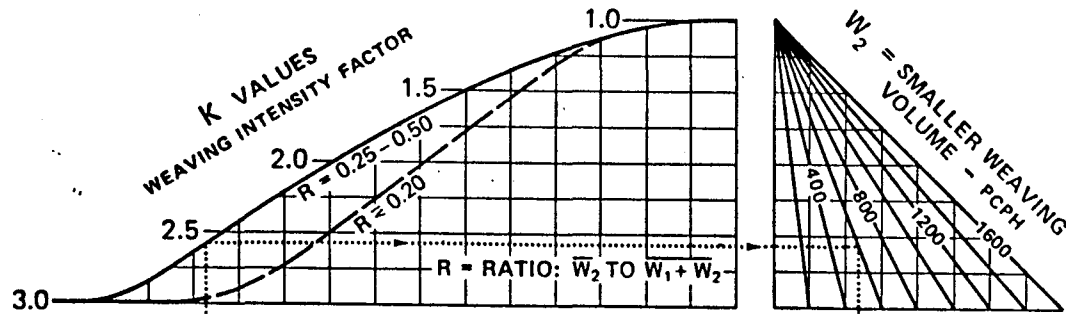

NOMOGRAPH FOR DESIGN AND ANALYSIS OF WEAVING SECTIONS - ONE-SIDED CONFIGURATIONS

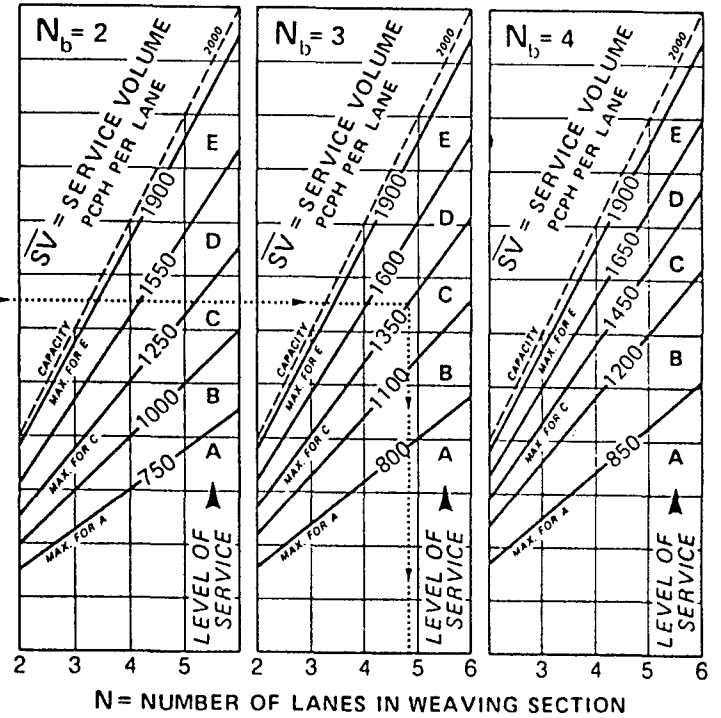
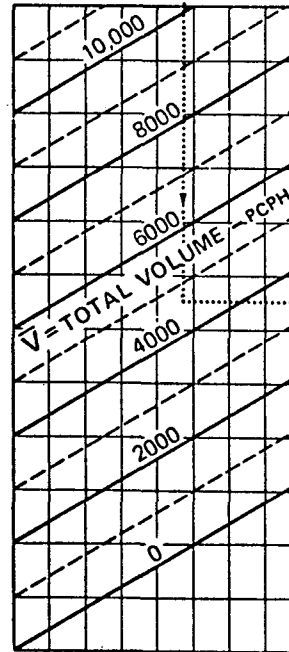
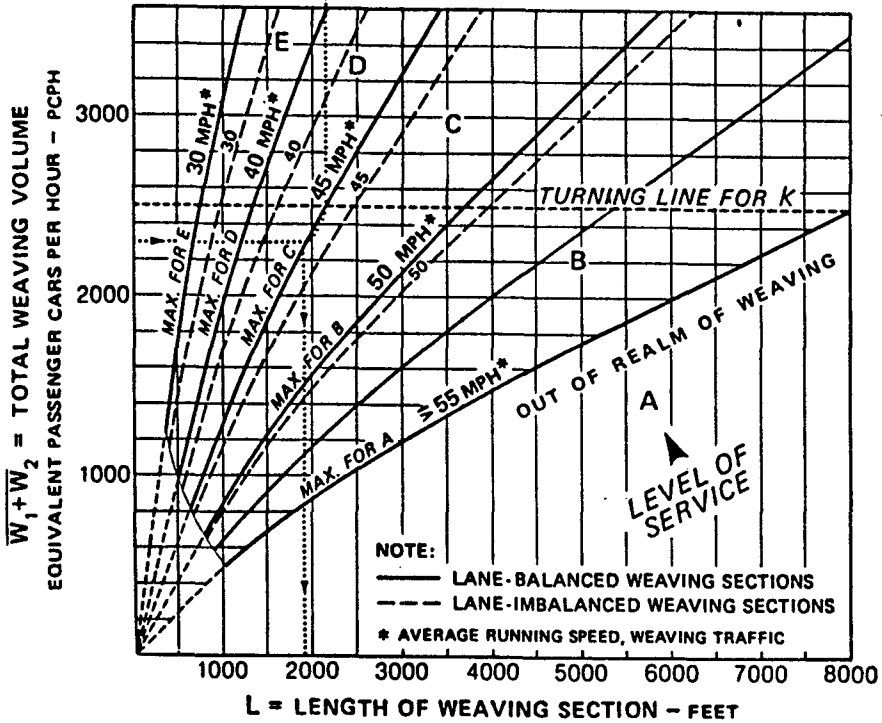
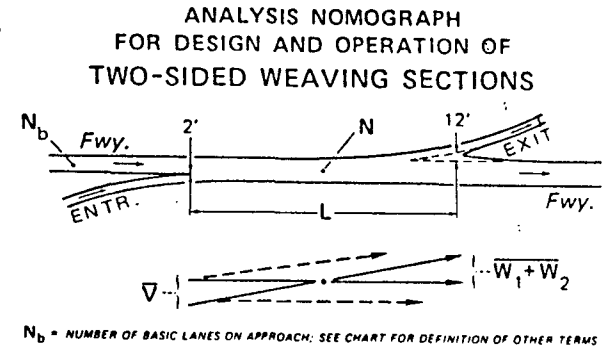
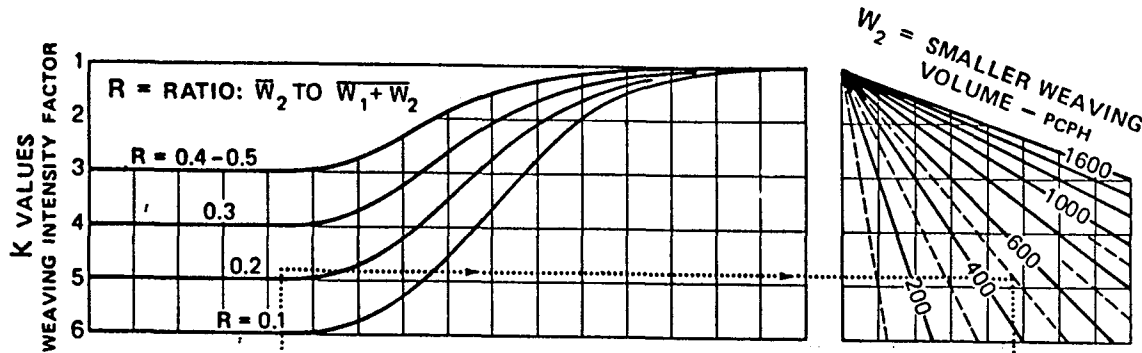

NOMOGRAPH FOR DESIGN AND ANALYSIS OF WEAVING SECTIONS - TWO-SIDED CONFIGURATIONS

SV = SERVICE VOLUME WITHIN WEAVING SECTION - PCPHPL*

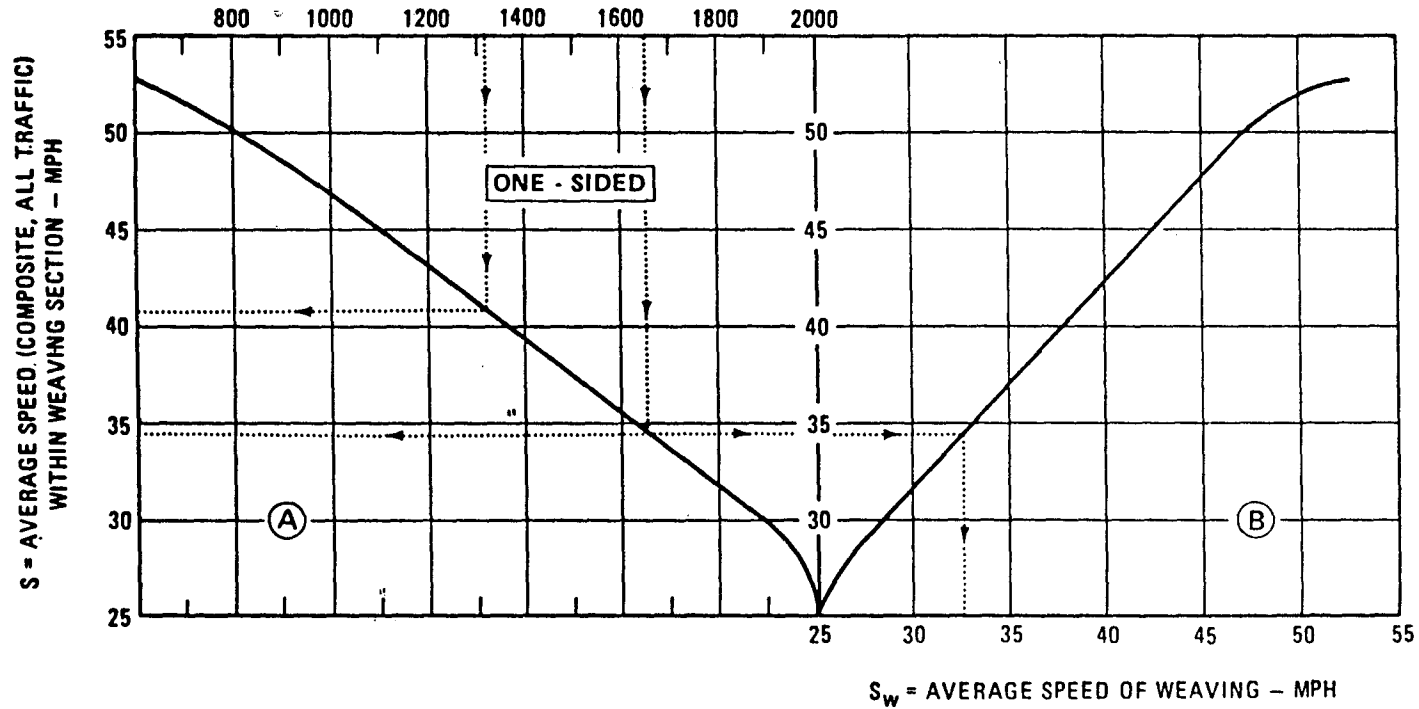

INSTRUCTIONS:

- | | |
|--|-----------------------------|
| 1. WHEN LOS OF V IS SAME AS LOS OF V_w , S_w REMAINS THE SAME AND S EQUALS S_w . | } DO NOT USE
NOMOGRAPH 3 |
| 2. WHEN V IS WITHIN $\frac{1}{2}$ LOS (\pm) OF V_w , S_w REMAINS THE SAME AND S EQUALS S_w . | |
| 3. WHEN V IS ONE OR MORE LOS <u>BETTER</u> THAN THAT OF V_w , S_w REMAINS THE SAME AND S IS READ FROM CHART (A). | } USE
NOMOGRAPH 3 |
| 4. WHEN V IS ONE OR MORE LOS <u>WORSE</u> THAN THAT OF V_w , S_w IS REDUCED AND BOTH S AND S_w ARE READ FROM CHARTS (A) AND (B). | |

NOTE:

LOS OF V IS THE OVERALL LEVEL OF SERVICE AS A COMPOSITE WITHIN THE WEAVING SECTION, DETERMINED IN THE RIGHT PORTION OF NOMOGRAPH 1.

LOS OF V_w REFERS TO THE LEVEL OF SERVICE OF WEAVING TRAFFIC ELEMENT, DETERMINED IN LEFT PORTION OF NOMOGRAPH 1.

* SV READ FROM INITIAL SOLUTION OF NOMOGRAPH 1.

SUPPLEMENTARY NOMOGRAPH FOR SPEED CALIBRATION - ONE-SIDED WEAVE

NOMOGRAPH 3

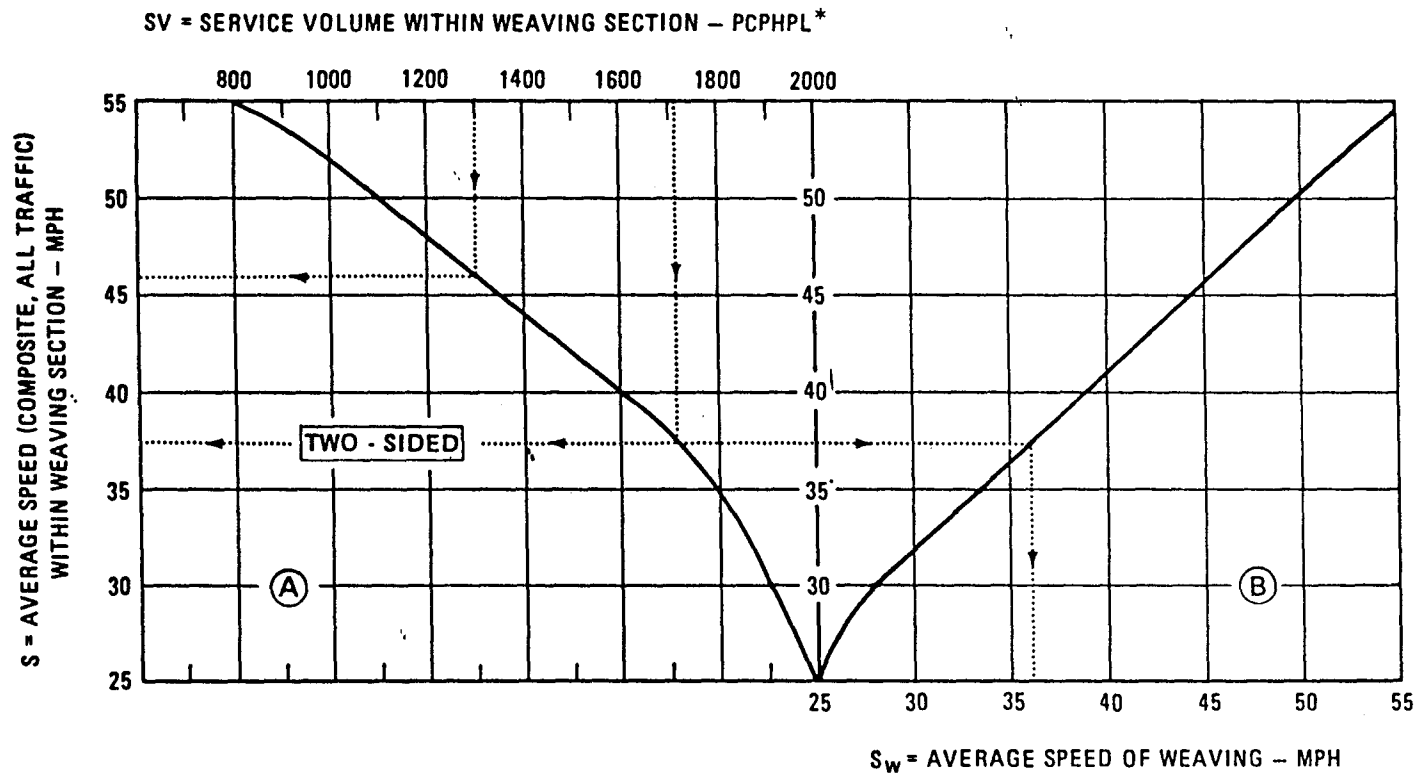
**INSTRUCTIONS:**

- | | |
|---|-------------------------------------|
| 1. WHEN LOS OF V IS SAME AS LOS OF V _w , S _w REMAINS THE SAME AND S EQUALS S _w . | } DO NOT USE
NOMOGRAPH 4 |
| 2. WHEN V IS AT A <u>BETTER</u> LOS THAN THAT OF V _w , S _w (AND THE SPEED OF FREEWAY THROUGH TRAFFIC) REMAINS THE SAME, AND OVERALL SPEED S IS READ FROM CHART (A). | |
| 3. WHEN V IS AT A <u>WORSE</u> LOS THAN THAT OF V _w , S _w (AND THE SPEED OF FREEWAY THROUGH TRAFFIC) IS REDUCED AND BOTH S AND S _w ARE READ FROM CHARTS (A) AND (B). | } USE NOMOGRAPH 4
CHARTS A AND B |

NOTE:

LOS OF V IS THE OVERALL LEVEL OF SERVICE AS A COMPOSITE WITHIN THE WEAVING SECTION, DETERMINED IN THE RIGHT PORTION OF NOMOGRAPH 2.

LOS OF V_w REFERS TO THE LEVEL OF SERVICE OF WEAVING TRAFFIC ELEMENT, DETERMINED IN LEFT PORTION OF NOMOGRAPH 2.

*SV READ FROM INITIAL SOLUTION OF NOMOGRAPH 2.

SUPPLEMENTARY NOMOGRAPH FOR SPEED CALIBRATION - TWO-SIDED WEAVE

NOMOGRAPH 4



ANALYSIS WORKSHEET
 MULTIPLE WEAVING 2 EN - EX

PROJECT _____

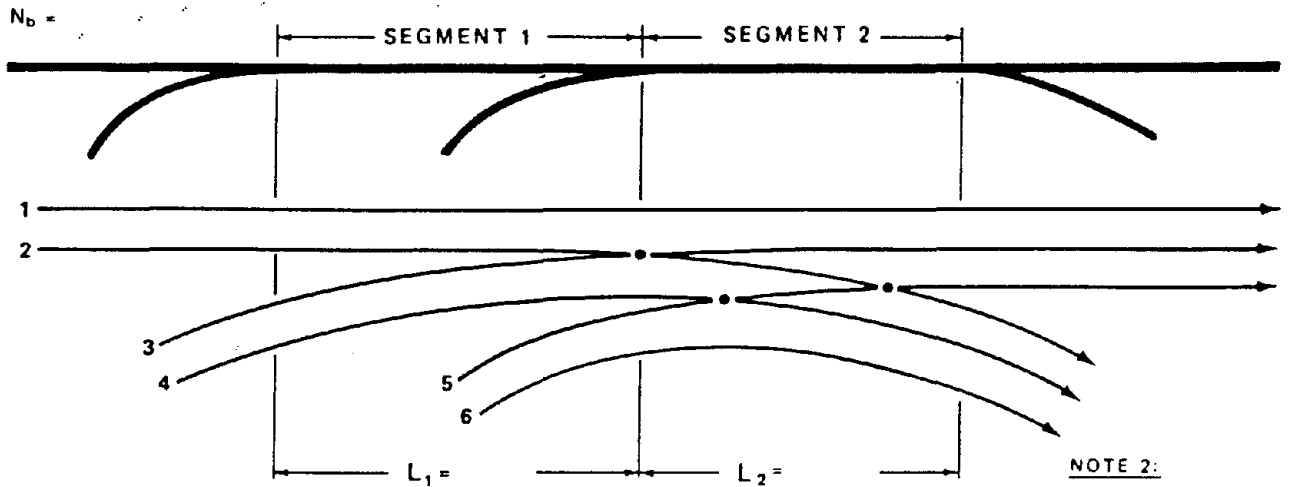

NOTE 2:
 PLACE NUMBER OF LANES, EXISTING OR SOLVED, ALONG UPPER DIAGRAM.

LONG WEAVE - VOL 2. vs. VOL. 3 (SEE NOTE 1)*

SEGMENT 1

$$\begin{aligned} [2] &= P \times \text{VOL. 2} \\ &= X \quad = \text{_____} \\ [3] &= P \times \text{VOL. 3} \\ &= X \quad = \text{_____} \end{aligned}$$

SEGMENT 2

$$\begin{aligned} (2) &= (1 - P) (\text{VOL. 2}) \\ &= X \quad = \text{_____} \\ (3) &= (1 - P) (\text{VOL. 3}) \\ &= X \quad = \text{_____} \end{aligned}$$

V =
 V_w =
 W₂ =
 R =

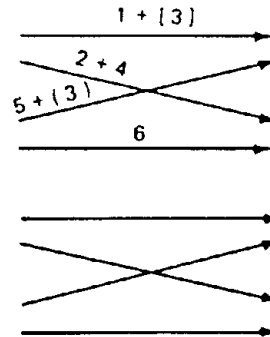
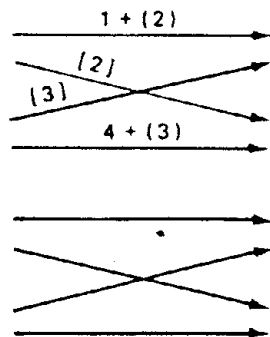

V =
 V_w =
 W₂ =
 R =

NOTE 3:
 ALL VOLUMES IN PCPH. RECORD ON DIAGRAM.

COMPUTATIONS

NOTE 1: ALL OF LONG WEAVE TENDS TO TAKE PLACE IN SEGMENT 1, WITH PROPORTION P INCLINED TO APPROACH 1.0; P, HOWEVER, MAY VARY IN INDIVIDUAL CASES. IN DESIGN AND IN GENERAL OPERATIONAL ANALYSIS, NORMALLY USE P = 0.75 IN SEGMENT 1. OTHERWISE, IN MORE DETAILED OPERATIONAL ANALYSIS, FIELD SAMPLING OF TRAFFIC MAY GIVE INDICATION OF P.



ANALYSIS WORKSHEET
 MULTIPLE WEAVING EN-2EX

PROJECT _____

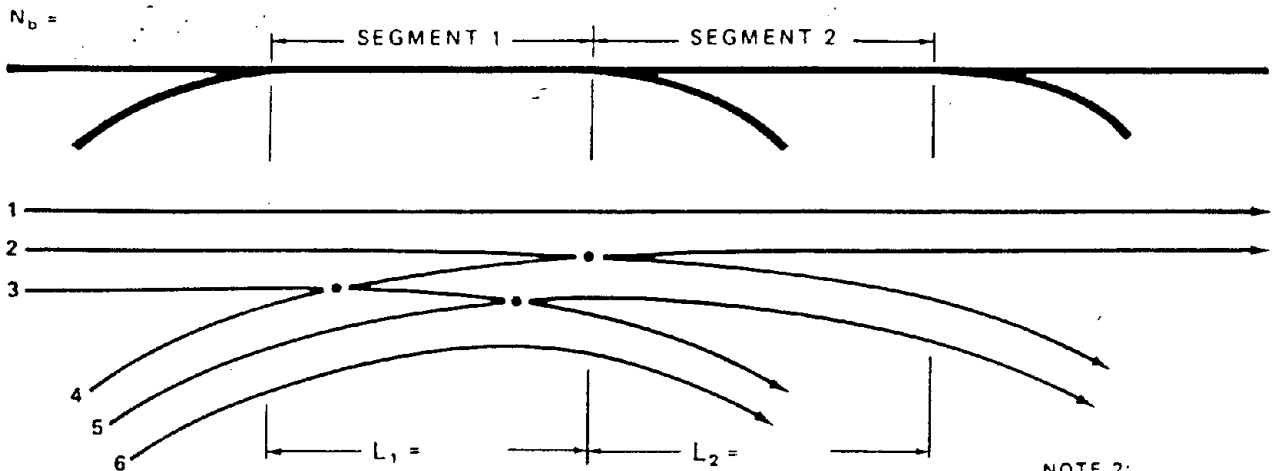

LONG WEAVE - VOL. 2 vs. VOL. 4 (SEE NOTE 1) *

NOTE 2:
 PLACE NUMBER
 OF LANES, EXISTING
 OR SOLVED, ALONG
 UPPER DIAGRAM.

SEGMENT 1:

$$\begin{aligned} (2) &= (1 - P)(VOL. 2) \\ &= X \quad = \underline{\hspace{2cm}} \\ (4) &= (1 - P)(VOL. 4) \\ &= X \quad = \underline{\hspace{2cm}} \end{aligned}$$

SEGMENT 2:

$$\begin{aligned} (2) &= P \times VOL. 2 \\ &= X \quad = \underline{\hspace{2cm}} \\ (4) &= P \times VOL. 4 \\ &= X \quad = \underline{\hspace{2cm}} \end{aligned}$$

V =
 V_w =
 W₂ =
 R =

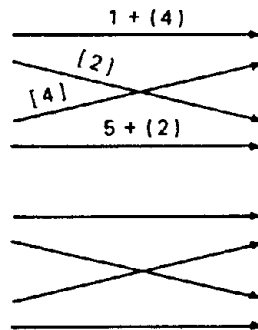
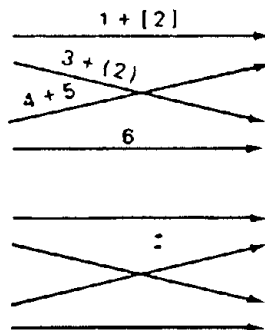

V =
 V_w =
 W₂ =
 R =

COMPUTATIONS:

NOTE 3:
 ALL VOLUMES
 IN PCPH, RECORD
 ON DIAGRAM.

NOTE 1: ALL OF LONG WEAVE TENDS TO TAKE PLACE IN SEGMENT 2, WITH PROPORTION P INCLINED TO APPROACH 1.0; P, HOWEVER, MAY VARY IN INDIVIDUAL CASES. IN DESIGN AND IN GENERAL OPERATIONAL ANALYSIS, NORMALLY USE P = 0.75 IN SEGMENT 2. OTHERWISE, IN MORE DETAILED OPERATIONAL ANALYSIS, FIELD SAMPLING OF TRAFFIC MAY GIVE INDICATION OF P.

71

