

Technical Report Documentation Page

1. Report No. FHWA/TX-12/0-6432-1		2. Government Accession No.		3. Recipient's Catalog No.	
4. Title and Subtitle Low Cost Wireless Network Camera Sensors for Traffic Monitoring				5. Report Date Published: July 2012	
				6. Performing Organization Code	
7. Author(s) Yan Huang and Bill P. Buckles				8. Performing Organization Report No. 0-6432-1	
9. Performing Organization Name and Address University of North Texas Department of Computer Science and Engineering College of Engineering University of North Texas Denton, Texas 76203-1366				10. Work Unit No. (TRAIS)	
				11. Contract or Grant No. 0-6432	
12. Sponsoring Agency Name and Address Texas Department of Transportation Research and Technology Implementation Office P.O. Box 5080 Austin, TX 78763-5080				13. Type of Report and Period Covered Technical Report Sept. 1, 2009-Aug. 31, 2011	
				14. Sponsoring Agency Code	
15. Supplementary Notes Project performed in cooperation with the Texas Department of Transportation and the Federal Highway Administration. Project: Low Cost Network Camera Sensors for Traffic Monitoring URL:					
16. Abstract Many freeways and arterials in major cities in Texas are presently equipped with video detection cameras to collect data and help in traffic/incident management. In this study, carefully controlled experiments determined the throughput and output quality of various communication configurations. Configurations entailed antennas at several cost levels and it was determined that the least expensive antennas were adequate only for one-hop systems. Via a survey to which 20 districts responded, incidents, volume, and speed were found to be the functionalities most in demand for autonomous surveillance systems. Most systems are monitored by human operators. An alternative to operator-based video monitoring is video analytics. An autonomous traffic monitoring system from a vendor was tested. A demonstration surveillance system was developed and delivered to TxDOT.					
17. Key Words Wireless communication; Traffic cameras; Surveillance software; Network configurations				18. Distribution Statement No restrictions. This document is available to the public through the National Technical Information Service, Alexandria, Virginia 22312; <a href="http://www.ntis.gov">www.ntis.gov</a> .	
19. Security Classif. (of report) Unclassified	20. Security Classif. (of this page) Unclassified	21. No. of pages 222		22. Price	



# **LOW COST WIRELESS NETWORK CAMERA SENSORS FOR TRAFFIC MONITORING**

by

Yan Huang, Ph.D.

and

Bill P. Buckles, Ph.D.

Report: 0-6432-1

Project: 0-6432

Project Title: Low Cost Network Camera Sensors for Traffic Monitoring

Performed in cooperation with the  
Texas Department of Transportation  
and the  
Federal Highway Administration

Published: July 2012

University of North Texas  
Department of Computer Science and Engineering  
College of Engineering  
University of North Texas  
Denton, Texas 76203-1366



## **Disclaimers**

**Author's Disclaimer:** The contents of this report reflect the views of the authors, who are responsible for the facts and the accuracy of the data presented herein. The contents do not necessarily reflect the official view or policies of the Federal Highway Administration or the Texas Department of Transportation (TxDOT). This report does not constitute a standard, specification, or regulation.

**Patent Disclaimer:** There was no invention or discovery conceived or first actually reduced to practice in the course of or under this contract, including any art, method, process, machine manufacture, design or composition of matter, or any new useful improvement thereof, or any variety of plant, which is or may be patentable under the patent laws of the United States of America or any foreign country.

Notice: The United States Government and the State of Texas do not endorse products or manufacturers. If trade or manufacturers' names appear herein, it is solely because they are considered essential to the object of this report.

### **Engineering Disclaimer**

NOT INTENDED FOR CONSTRUCTION, BIDDING, OR PERMIT PURPOSES.

The researcher in charge of this project was Yan Huang.

## **Acknowledgments**

This project was conducted in cooperation with the Texas Department of Transportation (TxDOT). Project members extend thanks to the TxDOT project director Frank Phillips, program coordinator Wade O'Dell, and to members of the Project Management Committee (PMC) including Joseph Hunt, Valerie Taylor, Heath Bozeman, Leo Ramirez, Robert Packert, and Sandra Kaderka.

# Table of Contents

<b>Chapter 1. Research Method Overview.....</b>	<b>1</b>
<b>Chapter 2. Literature Review and Background.....</b>	<b>3</b>
2.1 Surveillance Procedural Methods: State of the Art .....	3
2.1.1 Video Analytics .....	3
2.1.2 Communications .....	6
2.2 Existing Surveillance Technologies.....	15
2.2.1 Video Camera and VIP .....	15
2.3 Case Studies.....	18
2.4 Application Scenarios.....	23
2.4.1 Intersection Control .....	23
2.4.2 Tunnel Surveillance .....	23
2.4.3 Work Zones Surveillance.....	24
2.4.4 Dilemma Zones Protection .....	24
2.5 Conclusions.....	24
<b>Chapter 3. Survey of Texas Practice .....</b>	<b>27</b>
3.1 Introduction.....	27
3.1.1 Equipment Preference .....	29
3.1.2 Other Sensors .....	34
3.2 Surveillance Applications and Functionalities .....	35
3.2.1 Application Scenarios .....	35
3.2.2 System Configuration .....	38
3.3 Cost Analysis .....	39
3.4 Conclusions.....	39
<b>Chapter 4. Equipment Survey .....</b>	<b>43</b>
4.1 Introduction.....	43
4.2 Camera Parameters .....	43
4.2.1 Explanations of Parameters.....	43
4.2.2 Parameters Value Selection .....	45
4.3 Camera Survey.....	46
4.3.1 Analog Cameras.....	46

4.3.2 Network Camera .....	52
4.4 Parameters for Wireless Equipment .....	73
4.4.1 Parameter Value Selection .....	74
4.5 Wireless Equipment Survey.....	74
4.5.1 2.4 GHz .....	74
4.5.2 4.9 GHz .....	82
4.5.3 5 GHz.....	83
4.5.4 900 MHz .....	95
4.5.5 Others.....	98
4.6 Equipment Selection Guidelines.....	112
4.6.1 Situation Definition.....	113
4.6.2 Camera Selection .....	114
4.6.3 Bandwidth Calculation for Data Transmission (Honovich 2008) .....	115
4.6.4 Wireless Equipment Selection .....	116
4.6.5 System Analysis and Cost Control .....	119
<b>Chapter 5. System Development.....</b>	<b>121</b>
5.1 Considerations for Deployment of Wireless Devices.....	121
5.1.1 Architecture of Wireless Network .....	121
5.1.2 Antenna Pattern.....	123
5.1.3 Fresnel Zone.....	124
5.1.4 Frequency Conformance and Interference.....	125
5.2 Site Investigation .....	125
5.3 System Development .....	128
5.3.1 PTP 54300 Configuration .....	128
5.3.2 NanoStation M5 Configuration.....	130
5.3.3 Rocket M5 Configuration .....	136
5.3.4 Performance Comparison of Wireless Devices .....	137
5.3.5 Camera .....	142
5.4 System Monitoring .....	143
5.4.1 Video.....	143
5.4.2 Wireless Communication.....	144
<b>Chapter 6. Video Analytics .....</b>	<b>147</b>



6.1 Traffic Surveillance Video Analytics Survey .....	147
6.1.1 Typical Scenarios .....	147
6.1.2 Generic System Configuration .....	149
6.1.3 Selection Guidelines .....	151
6.2 TxDOT Video Analytics Demonstration System .....	158
6.2.1 Baseline Requirements .....	158
6.2.2 System Components .....	161
6.2.3 Usage Guidelines .....	170
6.3 Performance Evaluation .....	174
6.3.1 Phase One, System Stabilization .....	175
6.3.2 Phase Two, Live Traffic .....	181
<b>Chapter 7. Conclusions and Recommendations.....</b>	<b>189</b>
7.1 Communications Equipment .....	189
7.2 Video Analytics (VA) .....	190
<b>References .....</b>	<b>193</b>
<b>Appendix A: System Devices.....</b>	<b>197</b>
<b>Appendix B: Testing Devices .....</b>	<b>199</b>
<b>Appendix C: Development Platform and Software .....</b>	<b>203</b>



## List of Figures

Figure 1 VA Components .....	3
Figure 2 Video Analytics Module.....	4
Figure 3 Communication Module.....	7
Figure 4 Wireless Camera Configuration .....	14
Figure 5 Infrastructure-connected Camera Configuration .....	14
Figure 6 Cellular-connected Camera Configuration.....	15
Figure 7 Typical CCTV Station (Leader 2005).....	20
Figure 8 Function Diagram of CCTV Station (Leader 2005).....	20
Figure 9 System Architecture (Leader 2005).....	21
Figure 10 Final Wireless Network (Leader 2005).....	21
Figure 11 System Architecture (Zhang et al. 2008).....	23
Figure 12 Survey Coverage .....	27
Figure 13 Surveillance System Components .....	28
Figure 14 Video Cameras in Use .....	29
Figure 15 Manufacturers of Wireless Equipment in Use.....	32
Figure 16 Sensor Usage Based on Number of Installations .....	35
Figure 17 Video Camera Installations .....	36
Figure 18 Greatest Distance between TMC and a Video Camera .....	36
Figure 19 Importance Weighting of Detection Functions .....	37
Figure 20 Importance of Events to Detect .....	38
Figure 21 Usage of Wireline and Wireless Communication .....	38
Figure 22 Components of Cost Analysis .....	39
Figure 23 Roadblocks to System Expansion .....	39
Figure 24 Costs Tradeoffs between Loops and VIVDS .....	40
Figure 25 Practical Issues Relevant to System Design.....	113
Figure 26 Loss in Wireless Transmission.....	119
Figure 27 Scenarios of Single-Hop Transmission .....	121
Figure 28 Scenario of Linear-Chain Transmission.....	123
Figure 29 An Example of Antenna Pattern.....	124
Figure 30 An Example of Fresnel Zone.....	125
Figure 31 Profiles Obtained from LINKPlanner .....	127

Figure 32 An Antenna Alignment Tool .....	132
Figure 33 Channel Usage in the Test Bed .....	133
Figure 34 Signal Strength and Noise Floor Changes by Channel Width .....	135
Figure 35 Influence of Output Power on Signal Strength and Noise Floor .....	135
Figure 36 Influence of Output Power on Throughput for NanoStation M5 .....	136
Figure 37 Influence of Output Power on Throughput for Rocket M5 .....	137
Figure 38 20-min uteThroughput Plot for (a) Motorola PTP54300; (b) NanoStation M5; (c) RocketDish .....	139
Figure 39 MPEG-4 Settings of Camera Axis 213PTZ .....	143
Figure 40 General Image Settings of Camera Axis 213PTZ .....	143
Figure 41 Snapshots of Traffic Monitoring Video .....	144
Figure 42 Data Rate in Diagnostic Plotter .....	145
Figure 43 Throughput Change in a Day .....	145
Figure 44 Signal Strength .....	146
Figure 45 Typical Scenarios .....	148
Figure 46 Generic System Configuration .....	151
Figure 47 Typical Road Structure and Camera Location .....	159
Figure 48 Camera Perspective from Different Viewing Angles.....	159
Figure 49 General System Framework .....	162
Figure 50 System Framework Flow-Chart .....	163
Figure 51 Motion Correspondence .....	165
Figure 52 Trajectory Analysis .....	166
Figure 53 Vanishing Points-based Camera Calibration.....	166
Figure 54 Functional Architecture of Video Analytics Processor .....	169
Figure 55 System Setup with On-site Processor.....	170
Figure 56 Settings for Camera .....	171
Figure 57 Settings for Road Structure .....	172
Figure 58 Parameters for Speed Estimation and Incident Detection .....	173
Figure 59 Visualization for Traffic Data .....	174
Figure 60 Intermediate Results .....	176
Figure 61 Speed Estimation Evaluation UPDATE.....	177
Figure 62 Volume Estimation Results for Direction 1 UPDATE.....	177
Figure 63 Illustration of Side Occlusion of Two Rightmost Lanes .....	178

Figure 64 Detection of a Stopped Vehicle.....	178
Figure 65 Initialization Tableau (a) Camera Configuration Tab (b) Vehicles within the Frame Boundary Defined in (a) Are Successfully Detected.....	180
Figure 66 Alarm Scene: (a) Video Frame Boundaries Configured for Video Clip 2; (b) Stopped Vehicle Detected.....	181
Figure 67 TxDOT Road Structure Settings for Four Testing Videos (a) for May 09, 2011; (b) for May 17, 2011; (c) for May 20, 2011; (d) for Video with Stopped Car .....	183
Figure 68 Overlay Configured for (a) May 09, 2011; (b) May 17, 2011; (c) May 20, 2011; (d) Video with Stopped Car .....	184
Figure 69 Speed Estimation Comparison for (a) May 09, 2011; (b) May 17, 2011; (c) May 20, 2011 with Light Rain.....	186
Figure 70 Count Estimation Comparison for (a) May 09, 2011; (b) May 17, 2011; (c) May 20, 2011 with Light Rain; (d) for May 20, 2011 with Heavy Rain.....	188



## List of Tables

Table 1 Comparison of Wireless Technology .....	12
Table 2 System Cost (Zhang et al. 2008).....	22
Table 3 Comparison of Camera Models .....	30
Table 4 Common Operating Ranges of Video Cameras in Use .....	31
Table 5 Comparison of Wireless Equipment in Use.....	33
Table 6 Commonalities across Wireless Communication Options.....	34
Table 7 Approximate Compression Ratios.....	116
Table 8 Geographic Information of Test Bed.....	126
Table 9 Relationship of MCS Index and Data Rate.....	134
Table 10 Performance Comparison of Wireless Devices .....	138
Table 11 Throughput Comparison Based on 20-minute Duration.....	138
Table 12 One-hop Wireless Transmission Comparison Based on Perceived Video Quality .....	140
Table 13 Two-hop Wireless Transmission Comparison for Motorola and NanoStation .....	141
Table 14 Throughput Degrade Comparison for Two-hop NanoStation .....	141
Table 15 Summaries of Traffic Data Collected and Most Events Detected by Existing Products.....	149
Table 16 Video Analytics Products .....	153
Table 17 Levels of Service .....	161
Table 18 Traffic Data Collected from Abacus Compared with the Ground Truth.....	180
Table 19 Characteristics of Test Videos .....	182
Table 20 Important Parameters for Abacus Setup .....	184
Table 21 Incident Detection Performance from Both Abacus and TxDOT Systems .....	188





## Executive Summary

Within the last decade, we have seen tremendous technological advances in sensors, networking, and processing that not only make the connection between the physical world and cyber-informatics world possible, but also make such connections much more affordable. We investigated how these new technologies can be used in the Texas transportation systems to improve the cost-effectiveness, accuracy, and timeliness of data collection.

Many freeways and arterials in major cities in Texas are presently equipped with video detection cameras to collect data and help in traffic/incident management. With the proliferation of less-expensive cameras and the ability to link them via a Wi-Fi network to form a network of sensors, the Texas Department of Transportation (TxDOT) could feasibly use these relatively low-cost technologies in traffic surveillance, at a lower cost than the commercial off-the-shelf traffic surveillance systems.

An alternative to operator-based video monitoring is video analytics. With video analytics, the information processing is ideally performed at a remote site and only alarms are returned to the central location. Employing video analytics on-site at a traffic management center is also feasible. Either provides the promise of increased safety and system coverage while reducing costs and staffing requirements. While a number of vendors now have this technology available, it has not been tested in typical situations with respect to typical TxDOT needs, and no guidelines exist for when and where installations may be appropriate.

Although existing information infrastructures are in place throughout Texas, some districts have much more comprehensive coverage than the others. For those areas with extensive infrastructure, the challenge lies in integrating the new data acquisition technologies into the existing systems and synthesize the information provided by both systems to provide a unified interface and service to the user without incurring substantial capital expenses and extensive maintenance effort.

In this study, carefully controlled experiments determined the throughput and output quality of various communication configurations. Configurations entailed antennas at several cost levels and it was determined that the least expensive antennas were adequate only for one-hop systems. Via a survey to which 20 districts responded, incidents, volume, and speed were found to be the functionalities most in demand for autonomous surveillance systems. Therefore, both a commercial system and a team-developed demonstration system were tested. Following are some of the findings:

- Communication
  - Single-hop configurations (sensor to backbone) can use inexpensive antennas with little loss of throughput or quality.
  - Multi-hop configurations require antennas with stable (small variation) throughput.
  - In single-camera configurations, antennas across a broad cost range are adequate; multiple camera systems will require further study.

- Autonomous surveillance systems
  - Precise calibration and operator-controlled camera movement are competitive goals.
  - Specialized expertise is required for development.
  - Camera placement (perspective) is very important; placement near the shoulder of the roadway with a height of less than 60 feet diminishes occlusion and facilitates self-calibration.
  - If bandwidth is not an issue, placing autonomous surveillance processing at the Traffic Management Center is as effective as placing it adjacent to the camera.
  - It would be cost-effective for TxDOT to develop and deploy its own freeway-oriented video analytics system if 20 or more installations are anticipated.

# Chapter 1. Research Method Overview

The research project was divided into tasks according to the following list:

- Literature survey
- Survey of Texas practice
- Equipment survey
- System development
- Video analytics
- Validation
- Documentation

The literature and background review included a very broad review of technical papers, patents, books, and research reports on issues including traffic monitoring, infrastructure design, and equipment. Much of the literature is online (particularly state reports) and is cited within this document as web sites with date of last access. The remaining literature is in the *References* section.

The survey of Texas practice was performed via a lengthy survey to which 20 districts responded. The survey determined such data as the following:

- Existence of a local Traffic Management Center (TMC)
- Number and manufacturers of cameras deployed
- Status of wireless deployment and the manufacturer of any equipment
- The relative importance of various autonomous surveillance functions
- Distance to the most remote surveillance site

The system development used two sites. One was on the campus of the University of North Texas (UNT), which afforded an opportunity to install and reconfigure communication devices. The configuration included an embedded camera. The second site included an operational traffic camera for which access was provided by DalTrans, a Dallas-area intelligent traffic system. The traffic surveillance software was placed at a TMC substation; the video was intercepted from a fiber backbone several miles from the camera site.

The technique of video analytics (VA) was investigated by examining a version of Abacus loaned by Iteris, Inc. Additionally, a demonstration system with a more limited functionality was implemented and installed on a weather-hardened processor.

Validation was performed by separate experiments over the communications configuration and the VA systems. Well-designed experiments for one-hop and two-hop communication systems measured throughput and video quality at the receiving end. The controlled variables included:

- Frequency;
- Channel width; and
- Power.

Validation of the VA component was conducted in two phases. The development phase used video taken from overpasses with a probe car, which allowed gauging the accuracy of speed. The live traffic phase used three long time periods (3 hours each) plus a video supplied by Iteris. For the latter phase, truth data was acquired manually for volume and a microwave vehicle detector (MVD) that was mounted adjacent to the camera. Quality of the output was compared for the following elements:

- Traffic volume
- Vehicle speed
- Stopped vehicles (false positives and false negatives)

## Chapter 2. Literature Review and Background

### 2.1 Surveillance Procedural Methods: State of the Art

Intelligent transportation systems (ITS) have been improving with the incorporation of multiple technologies into vehicles, roadways, highways, tunnels, and bridges. Such technologies include image processing, pattern recognition, electronics, and communication. These have been employed for monitoring traffic conditions, reducing congestion, enhancing mobility, and increasing safety. Vision-based technology is a state-of-the-art approach with the advantages of easy maintenance, real-time visualization, and high flexibility compared with other technologies, which makes it one of the most popular ITS techniques for traffic control.

In general, a video-based ITS (also called as video detection and monitoring system) consists of two major components as shown in Figure 1: a video analytics module and a communication module. The video analytics module utilizes image processing and pattern recognition techniques to convert and analyze raw video data, deriving valuable traffic data and signaling commands that are used to monitor, control, and improve traffic condition.

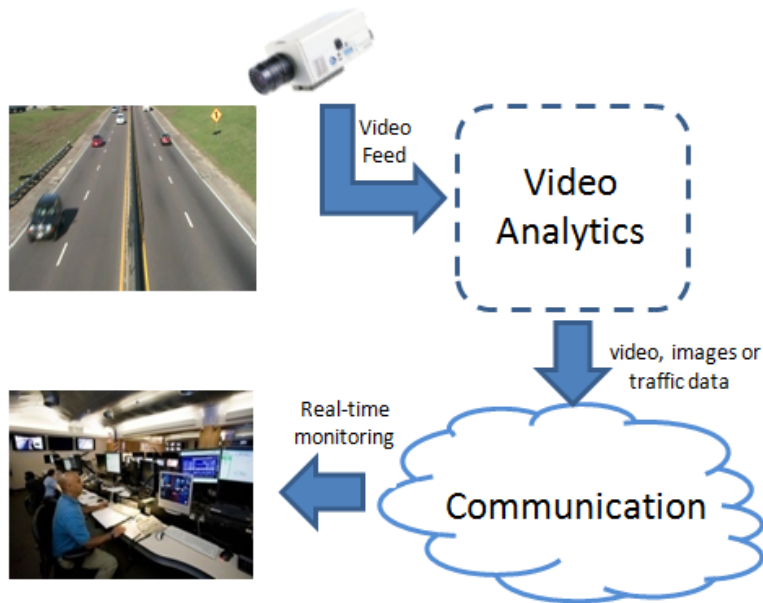

*Figure 1 VA Components*

#### 2.1.1 Video Analytics

The video analytics module takes raw video as input and has four main parts as depicted in Figure 2: pre-processing, event detection, data collection, and post-collection processing.

### Pre-processing

The pre-processing includes foreground and background extraction, shadow removal, and calibration. Detecting the object of interest from complex backgrounds is an important process also called object detection. In real traffic applications, objects appearing on the freeway, arterials, bridges, and in tunnels mostly consist of moving or stopped vehicles, debris, and moving or stopped pedestrians. A complex and continuously changing background challenges a video analytics system and hinders the easy extraction of objects. It is essential for an ITS to recognize and identify accurately many different objects.

Shadow removal is another issue that proves to be a major source of error in detection and classification. In particular, the shadows of large trucks prevent smaller, adjacent vehicles from being detected successfully.

Calibration consists of both camera calibration and image calibration. In real-time traffic applications, the process is more difficult than usual. Perspective effects cause vehicle geometry features such as length, width, and height to vary. In other words, the different positions at which cameras are installed give different perception angles for each lane. Thus, it is very important to calibrate the camera and allow the computer to perceive the traffic situation in more accurately given the calibration parameters. Image calibration means, in part, manual configuration for detection zones. However, manual calibration cannot be applied to most video PTZ (pan, tilt, zoom) cameras because PTZ cameras change positions, making the predefined configuration inoperable. Another approach is to automatically distinguish lanes and detect width and length of each lane with a non-calibrated camera<sup>1</sup>.

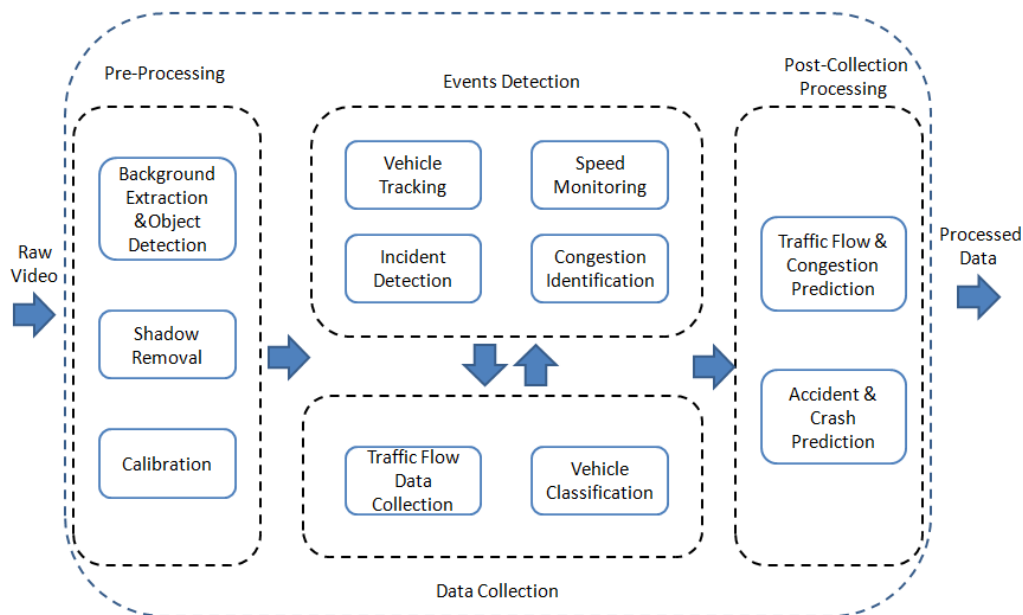

Figure 2 Video Analytics Module

<sup>1</sup> See website [http://www.westernsystems-inc.com/communication\\_casestudy1.htm](http://www.westernsystems-inc.com/communication_casestudy1.htm).

Thus, raw video data needs to be pre-processed to improve image quality and prepare it for further processing.

### *Data Collection*

Traffic flow data is among the most important information collected. This data is the basis for computing indicators for traffic conditions such as congestion level, crash potential, and incident probability. Traffic flow data includes volume counts, vehicle speed, and lane occupancy. Often traffic flow data is detected in multi-lane configurations using loop detectors, radar technology, or digital image processing.

Another useful component of traffic data often collected is vehicle classification. Classification can give a better perspective on traffic patterns. The literature describes many image processing approaches focusing on classifying vehicles into only two classes: cars and non-cars. Meanwhile, extant vision sensors approach the problem by classifying based on length. However, with the diversity of vehicles on the road today, it is both necessary and useful to classify them into many more types such as car, truck, van truck, van, minivan, motorcycle, and bicycle<sup>2</sup>.

### *Events Detection*

Event detection is one of key components of any video analytics system. Generally, it includes vehicle detection and tracking, congestion identification, and incident detection, such as wrong-way drivers, fast and slow drivers, stopped vehicles, and pedestrians.

Traffic congestion identification is a real-time task requiring an ITS to make rapid decisions based on available traffic data from all sorts of sensors such as cameras, loop detectors, and so on. First, the quality of the traffic flow data should be improved via preprocessing because congestion identification depends on such flow data. Second, the time consumption and computational complexity of congestion identification algorithms should be limited to a specified level because event detection is a real-time task and doesn't allow much time delay. Finally, accuracy of congestion identification is the most important factor in evaluating system performance. These three factors should be kept in mind when designing a comprehensive and efficient real-time congestion identification scheme (Cherkassky et al. 2002).

In addition to events detected by speed monitoring, fire/smoke detection in tunnels and accident recognition are other examples of anomalous incidents that can be detected. Traditional fire/smoke detection approaches are typically based on detecting the presence of certain particles that fire and smoke generate. The disadvantages are that the fire/smoke cannot be detected immediately and the approach is not applicable in open spaces. Vision-based approaches make it possible to detect fire/smoke in open spaces in a more timely fashion (Zhang et al. 2008). Anomalous incident detection solutions follow two major directions. The first group of solutions identifies accident or anomalous incidents when the data collected is similar to those data collected in past accidents or anomalous incidents—also known as positive recognition. The second group of approaches detects outliers of normal conditions and is known as negative identification.

---

<sup>2</sup> See website [http://www.westernsystems-inc.com/communication\\_casestudy1.htm](http://www.westernsystems-inc.com/communication_casestudy1.htm).

### *Vehicle Tracking*

The objective of vehicle tracking is to provide the trajectory of a moving vehicle over time by locating its position in every frame of the video. The tasks of vehicle tracking can be accomplished with two major steps: object detection and correspondence establishment.

For each vehicle successfully detected and tracked, data is collected. Speed is the most important factor; it assists in detecting other events such as stopped vehicles, wrong-way or opposite direction driver, pedestrians, over- or under-speed driver, and so on. Traditionally, radar technology is used to realize vehicle speed monitoring or detection. However, radar has two major disadvantages for this task: 1) a radar sensor can track only one vehicle at any time, and 2) cosine errors can result from the incorrect direction of the radar gun as well as errors caused by shadowing and radio-frequency interference. Thus, researchers have begun to apply vision-based approaches to speed detection, which entails tracking.

### *Post-collection Processing*

Post-collection processing of traffic flow data and incidents assists an ITS by identifying and predicting congestion and traffic incidents. In other words, it provides real-time and short-term predictions of when and where incidents and congestion are likely to occur. It is achieved through the combination of network modeling, traffic flow simulation, statistical regression and prediction methodologies, and archived and real-time traffic sensor information.

Traffic flow and congestion prediction is an essential task for intelligent transportation planning and traffic control, because reallocating traffic resources beforehand is ideal. Weather and environment data is also an informative indicator for accident and crash prediction.

### **2.1.2 Communications**

As shown in Figure 3, the communication module is responsible for transmitting processed data to the TMC using a wireline or wireless network. The wireline networks include telephone networks, cable television, Internet access, and fiber-optical communication. The wireless networks include personal area, local area, metropolitan, wide area, and state and national networks, all categorized based on the ranges and coverage.



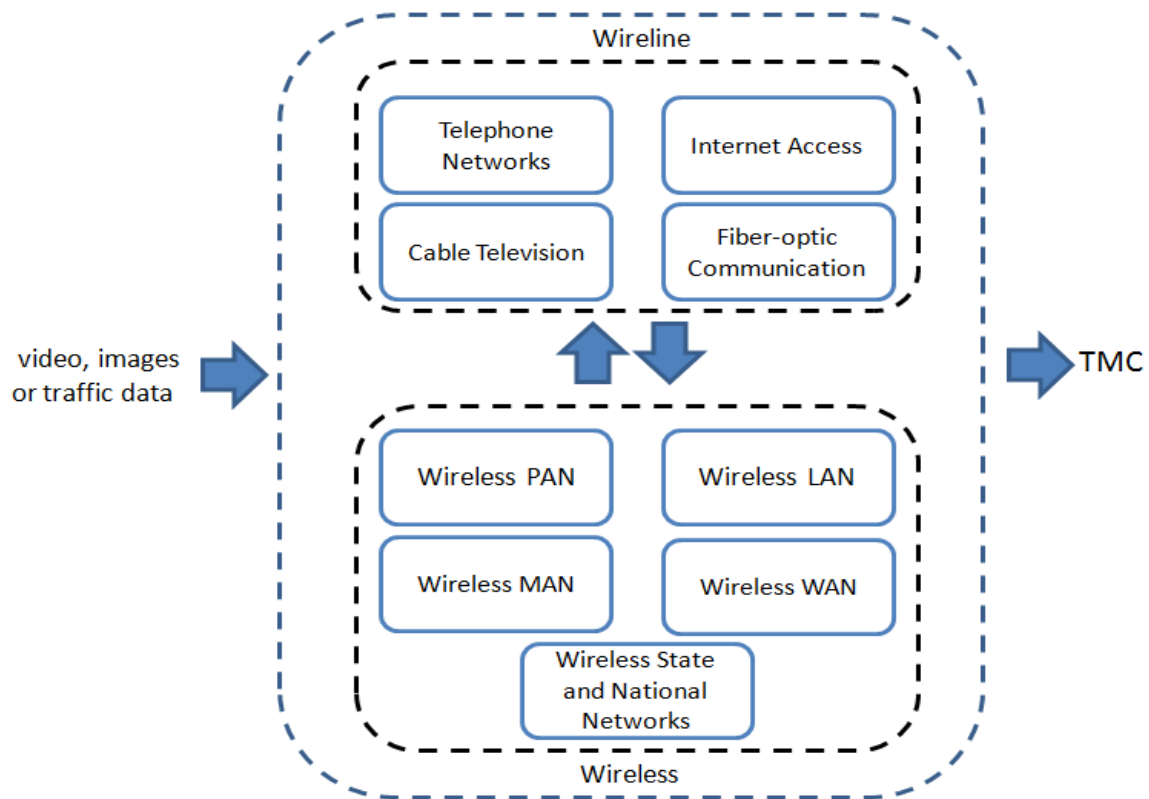

*Figure 3 Communication Module*

### *Wireline Communication*

Telephone networks and the Internet typically use twisted pair cable. Twisted pair cable can be categorized by the number of pairs per meter. Of the eight categories (CAT1–CAT7 and CAT5E), CAT3 and CAT5 are most widely utilized. CAT3 is used in telephone services and 10 Base-T Ethernet and CAT5 is usually used in 10/100 Base-T networks.

Coaxial cable was originally used to provide communications in video incident management system and now it is mostly replaced by fiber optics. It is still commonly used in linking closed-circuit television (CCTV) cameras and monitors and video switchers. (If a CCTV camera has a fiber optic transceiver, fiber optics is also used).

The transmission of fiber optics takes the form of light impulses. Fiber strands are typically divided into two classes: single mode and multimode. The former is designed to transmit a single ray of light and can carry a signal a longer distance (40 to 60 miles) than multimode fiber. The latter is used for transmission of multiple rays concurrently and the transmission distance is less than 15,000 feet.

### *Wireless Communication*<sup>3</sup>

A wireless communication network interconnects nodes without the use of wire. Wireless communication networks are implemented with various types of remote information transmission systems, which use radio waves (point-to-point, spread spectrum radio, and two-way radio), and electromagnetic waves. Wireless communication technologies are classified into five categories based on range: WPAN, WLAN, WMAN, wide area networks, and state and national networks.

#### **WPAN**

A wireless personal area network (WPAN) generally has a range of 8 inches to 30 feet and can reach 300 feet with high power. It interconnects devices within a relatively small area, generally within reach of a person.

Bluetooth provides a WPAN for interconnecting a headset to a laptop. It operates in the unlicensed 2.4 GHz industrial, scientific, and medical (ISM) frequency band, which is a wireless frequency hopping spread spectrum (FHSS) technology for transferring data at very short ranges. The data rates can be as low as 1Mbps on small chips designed to sell for \$5 or less. Because the range is comparatively short, local data wirelessly transmitted via Bluetooth would then be transferred to a repeater or remote management center by wireline communication technologies such as Ethernet or T1 line.

ZigBee is a specification for a suite of high level communication protocols using small, low-power digital radios based on the IEEE 802.15.4-2003 standard for WPANs. One use is wireless headphones connecting with cell phones via short-range radio. The technology defined by the ZigBee specification is intended to be simpler and less expensive than other WPANs. ZigBee is targeted at radio frequency applications that require a low data rate, long battery life and secure networking.

The Infrared Data Association (IrDA) defines physical specifications communications protocol standards for the short-range exchange of data over infrared light. IrDA has established a standard for wireless communications that uses infrared light ( $0.003\text{--}4 \times 10^{14}\text{Hz}$ ) and can produce data rates of 4 Mbps at low power within a range between 8 inches to 3 feet. It can provide 75 kbps over roughly 300 feet at higher power. It is limited to line-of-sight communication within a room as infrared light is not able to go penetrate obstacles such as walls. This technology has been in use for communications between various personal devices such as personal digital assistants (PDAs) and laptops. This technology is inexpensive.

Ultra-wideband (UWB) is a radio technology that can be used at very low energy levels for short-range high-bandwidth communications by using a large portion of the radio spectrum. The frequency is from 3.1 to 10.6 GHz. The speed is between 40 Mbps and over 1000 Mbps and the range is from 3 to 30 feet. It is designed to avoid interfering with other devices or equipment licensed to use the same spectrum. UWB can also be designed to use more power and therefore compete with WLAN, although considered a WPAN technology. It is a candidate technology for WMAN due to its capability to solve the problem of the last mile of transmission to home.

---

<sup>3</sup> See website [http://en.wikipedia.org/wiki/Wireless\\_network#Wireless\\_PAN](http://en.wikipedia.org/wiki/Wireless_network#Wireless_PAN).

## **WLAN**

A wireless local area network (WLAN) uses radio instead of wire to transmit data back and forth between computers in the same network. It is standardized under the IEEE 802.11 series.

Wi-Fi, short for wireless fidelity, is a wireless LAN technology. Wi-Fi systems require no license. They have standards developed by IEEE, and most comply with IEEE 802.11 standards. 802.11b and 802.11g have a frequency of 2.4 GHz, but the former has a slower speed of 11 Mbps while the latter has a speed of 54 Mbps; 802.11a has 5 GHz frequency and 54 Mbps speed (Hwang et al. 2006). As a variation of a Wi-Fi network, mesh Wi-Fi is usually used in corridor and metropolitan areas, as will be described later. Each device can be regarded as a relay node by other devices. If some nodes in the network are disabled or overloaded, communications of other nodes can bypass these nodes by finding another way to transmit signals. A Wi-Fi wireless router costs between \$20 and \$120 and must be connected to an Internet access point such as DSL or cable.

Fixed wireless data is a type of wireless data network used to connect two or more buildings in order to extend or share the network bandwidth without physically wiring the buildings together. It is also known as point-to-point radio systems when used to transfer information and data between fixed locations through licensed or unlicensed frequencies. Microware, one of the point-to-point radio systems, utilizes a licensed frequency approved by the FCC (Federal Communications Commission) to connect fixed locations.

Dedicated short range communications (DSRC) lies within the family of IEEE 802.11 standards and has been designated 802.11p. DSRCs are one-way or two-way short- to medium-range wireless channels specifically designed for communication between vehicles and a corresponding set of protocols and standards. The FCC allocated 75 MHz of the U.S. spectrum in the 5.9 GHz band for DSRC to be used in ITS. DSRCs have seven channels and data rates that are generally within the range of 6 to 27 Mbps. The communication range could be 1,000 meters or less. Data rates vary depending on the performance envelopes for different applications.

## **WMAN**

A wireless metropolitan area network (WMAN) connects several WLANs. WMAN solutions to be discussed include 1G, 2G, 2.5G, and 3G generation voice and data services. These include analog, cellular personal communication services (PCS), wireless internet service providers (WISPs), Wi-Fi Mesh, WiMAX, and Flash-OFDM.

The Integrated Digital Enhanced Network (iDEN) is a mobile telecommunications technology developed by Motorola. Compared with analog cellular and two-way radio systems, iDEN places more users in a given spectral space by using speech compression and time division multiple access (TDMA). iDEN is one of the most widely used wireless systems in the United States. A distinguishing feature of Nextel's iDEN service is direct phone-to-phone communications. The phone does not have to communicate via a base station.

The Global System for Mobile Communications (GSM) is a wideband TDMA communications technology that handles video and data. Cellular network and mobile phones can be connected to it by searching for cells in the immediate vicinity. A GSM

network has five different cell sizes: macro, micro, pico, femto, and umbrella cells. The coverage area of each cell varies according to the implementation environment. A distinguishing feature of GSM is each user must have a Subscriber Identify Module (SIM) smart card. GSM networks operate in a number of different frequency ranges. Most 2G GSM networks operate in the 900 MHz or 1800 MHz bands.

General packet radio service (GPRS) is a packet-oriented mobile data service with data rates of 56–114 Kbit/s. The service is available to users of the 2G cellular communication systems global system for mobile communications. GPRS is intended for data communication and aims to provide users high capacity internet access. GPRS uses TDMA for modulation and must work with GSM. The range of GPRS is 7–8 miles and with external antenna or amplifier the transmission distance can easily be doubled. Monthly cost for GPRS is approximately \$20–\$80.

Wi-Fi Mesh is a wide area, high-speed broadband, IP network built up from Wi-Fi base stations that adhere to IEEE 802.11 (a, b, g, or i). The Wi-Fi Mesh can cover hundreds of square miles. It has a high degree of redundancy with self-organizing and self-healing capabilities. A Wi-Fi Mesh can cover a construction site, campus, a metropolitan area, or even wider region.

Serial Wi-Fi involves daisy-chaining Wi-Fi units and thus communicates in hops along point-to-point connections. Serial Wi-Fi can provide communication over distance of 2.5 miles to 30 miles. A typical serial Wi-Fi deployment would be a multi-hop system involving telephone poles with antennas spaced up to 3 miles apart. An 8-hop system would have over 500 Kbp/s of bandwidth at the most distant node. Serial Wi-Fi is much cheaper than optical fiber because it uses commercial-off-the-shelf technology. Installation costs appear to be an order of magnitude cheaper than optical fiber. Thus, in the long term, it could be a cost-effective option.

WiMAX is the term used to refer to WMANs, which are based on IEEE standard 802.16. WiMAX may cover a larger area than Wi-Fi. It uses a different transmission mechanism than Wi-Fi. The installation of WiMAX devices does not require line-of-sight. The bandwidth of WiMAX can be divided into multiple channels to transmit signals efficiently. Based on the IEEE 802.16e standard, WiMAX has a frequency of 2.5 GHz. Based on 802.16-2004, it has a frequency of 3.5 GHz and 5.8 GHz. The 2.5 GHz and 3.5 GHz transmissions need licenses, yet 5.8 GHz does not (Hwang et al. 2006).

### **Wireless Wide Area Networks**

The spread spectrum radio frequency communication is also used in communication systems and makes use of more than one radio frequency for security reasons. It either transmits signals with the frequencies simultaneously, or uses one at a time and changes to another at specific intervals. Two-way radio can transmit and receive signals concurrently using different frequencies. The transmission media of a free space optics (FSO) system is laser and the limitation of the coverage range is 3 air miles.

### **Wireless State and National Networks**

Satellite communication uses a space-based artificial satellite for telecommunications. Modern communications satellites use a variety of orbits, including geostationary orbits,

molniya orbits, other elliptical orbits, and low earth orbits. Satellite communication's communication capabilities range from narrow to broadband and thus satellite is able to communicate everything from data to voice to television images.

### *Wireless Technology Comparison*

In order to choose a cost-effective wireless option for traffic transportation, the coverage, data rates, operation, and equipment cost should be compared for all available wireless communication options. Several wireless technologies are listed in Table 1.

**Table 1 Comparison of Wireless Technology**

<b>Technology</b>	<b>Distance</b>	<b>Data Rates</b>	<b>Frequency</b>	<b>Operation Cost</b>	<b>Equipment Cost</b>	<b>Comments</b>
Bluetooth	35 feet	1 Mbps	2.4 GHz	\$0	\$0	Built into home and business electronics
IrDA	8 inches to 3 feet	4 Mbps	0.003–4x 4 <sup>14</sup>	\$0	\$0	Built into home and business electronics
Wi-Fi (IEEE 802.11a)	100 feet outdoors; 50 feet indoors	54 Mbps	5 GHz	\$0–\$50/month	\$225–\$1500/router	Will fall back to 48, 36, 24, 18, 12, 9, or 6 Mbps
Wi-Fi (IEEE 802.11b)	300 feet outdoors; 150 feet indoors	11 Mbps	2.4 GHz	\$0–\$50/month	\$20–\$120/router	No comments
Wi-Fi (IEEE 802.11g)	300 feet outdoors; 150 feet indoors	54 Mbps	2.4 GHz	\$0–\$50/month	\$20–\$120/router	Will fall back to 5.5, 2, or 1 Mbps
Wi-Fi (IEEE 802.11n)d	600 feet outdoors; 300 feet indoors	600 Mbps	5 GHz/2.4 GHz	\$0–\$50/month	\$120/router	No comments
Integrated Digital Enhanced Network (iDEN)	City and nationwide	20 kbps	800–900 MHz	\$20/month	\$60–\$70	No comments
Global System for Mobile Communication (GSM)	City and nationwide	9.6 kbps	450, 800, 1900 MHz for different U.S. systems	NA	NA	No comments
General Packet Radio Service (GPRS)	City and nationwide; 7–8 miles from base station; can double with antenna or amplifier	14.4 kbps to 115.2 kbps	900, 1800, 1900 MHz	\$25–\$80/month	\$75–\$100/air card	No comments
Wi-Fi Mesh	City, corridor, site	Max based on Wi-Fi bit rates	2.4/5 GHz	NA	NA	Equipment and software commercially available and being deployed in many U.S.

Technology	Distance	Data Rates	Frequency	Operation Cost	Equipment Cost	Comments
						cities
WiMAX	30 miles at low frequencies; 4–6 miles typical	40 Mbps typical	2–11 GHz	NA	NA	Similar system deployed in Santa Clara, CA
Spread spectrum radio frequency communication	Basic technology that can cover corridors or areas of varying sizes including WANs	Depends on radio and many factors	Depends on radio and many factors	Depends	Depends	No comments
Satellite communication—narrow band	Country or hemisphere	2.4 kbps–28.8 kbps	Varies	\$2.30–\$11.30/month	\$500–\$5,000	A large number of satellite data service providers
Satellite communication—broadband	Country or hemisphere	64 kbps–256 kbps	Varies	\$100–\$500/month	\$500–\$5,000	A large number of satellite data service providers

*Technologies Identification According to System Configuration (Chiu et al. 2005)*

Prior to identifying a feasible and cost-effective wireless communication technology, a system configuration must be designed. Three configurations are possible. In configuration 1, depicted in Figure 4 Wireless Camera Configuration, the data are transmitted directly to the TMC wirelessly. This is especially useful when the system serves a remote place with no existing traffic infrastructure. In configuration 2, given in Figure 5, the data are transmitted from cameras to the cabinet and then an existing wireline communication technology is used to transfer the data to the TMC. For configuration 3, shown in Figure 6 Cellular-connected Camera Configuration, the data are sent to the center using cellular technology such as GPRS and iDEN. In order to choose a cost-effective solution, it is necessary to decide which system configuration is feasible, which means the possible system configuration should capitalize on utilizing existing communication infrastructure according to different application scenarios.



*Figure 4 Wireless Camera Configuration*

In the first configuration, long-range transmission from thousands of feet to miles is needed and line-of-sight is required. Considering the data rate requirement in different applications, the wireless communication options are spread spectrum and microwave-based technologies.



*Figure 5 Infrastructure-connected Camera Configuration*

In the second configuration, short-range communication (hundreds of feet) is needed. The prevalent wireless technology for this configuration is based on the IEEE 802.11x standard.



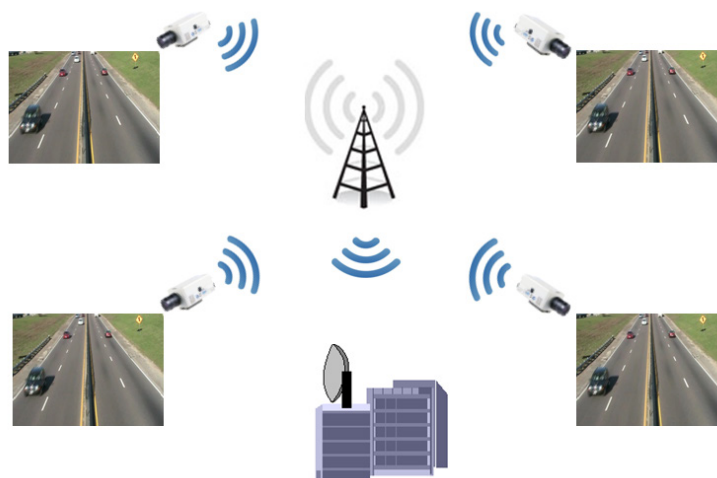

*Figure 6 Cellular-connected Camera Configuration*

In the third configuration, the data are transmitted from the cameras to the TMC through a wireless services provider's base station. The possible options for this configuration could be 2.5G technologies—GPRS (GSM-based), EDGE (GSM-based), 1xRTT (CDMA-based)—or 3G technologies—1XV-DO (CDMA2000 based) and UMTS (WCDMA).

## **2.2 Existing Surveillance Technologies**

An increasing number of surveillance products on the market utilize cameras and machine vision sensors in a large scale to assist intelligent traffic monitoring, analysis, and control.

### **2.2.1 Video Camera and VIP**

#### *Camera*

Cameras have two important measurements: light sensitivity and display resolution. Light sensitivity indicates the amount of light necessary for a recognizable image and display resolution defines the number of lines that compose an image from the camera. Based on the color and spectral coverage of images, cameras can be divided into three categories: monochrome, color, and infrared cameras. Monochrome cameras can function with only 0.13 FC while color cameras require at least 0.8 FC (Neudorff et al. 2003), where FC (foot-candle) is usually used as a unit to define luminance in photography. Note that color cameras provide more information, such as vehicle color, than monochrome cameras.

Although digital cameras are widely applied in transportation currently, previously analog cameras were prevalent. Analog cameras always utilize CCD (Charge Coupled Device) sensors that can be classified as interline CCD and frame CCD. Frame CCD is more sensitive than interline CCD (Neudorff et al. 2003), and for strong light sources, the former sensor produces more prominent vertical lines in images. Another type of analog camera uses CMOS (Complementary Metal Oxide Semiconductor) sensors.

IP cameras are one sort of CCTV camera having an IP interface for connection with Ethernets. This type of video equipment can use standard Ethernet communications backbones directly and requires fewer wires compared with analog cameras.

The lens is one of most significant components of a camera. Focal length is an important parameter for the lens. Focal length refers to the distance between the lens and imager. If the focal length is great, the camera can take images with smaller angle of view but provide more details of objects far away; if small, the images obtained have wider angles of view.

#### *Accessories*

Transportation surveillance cameras usually have PTZ functions—pan (P) refers to movement of the camera from left to right, tilt (T) is movement up and down, and zoom (Z) is near/far. To fulfill pan and tilt (P&T) functions, two types of equipment work are available: dome enclosed systems and external P&T systems. The former has a wider motion range and is more difficult for drivers to detect.

To protect camera systems, environmental enclosure is also necessary. This enclosure can be atmospheric vented enclosure, which costs less, or a self-contained, sealed enclosure (Neudorff et al. 2003).

#### *Coding*

A digital camera system, in addition to the camera itself, requires a device known as the codec, which is a combination of coder and decoder. The following paragraph is a brief introduction of codec approaches.

**H.261 codecs** use the H.261 standard to code audio and video. This standard was originally designed for video conferencing. To transmit signals coded by H.261, POTS (Plain Old Telephone Service) or T-1 circuits are used. **DS-3 codecs** were formerly used in distance learning. Signals coded by DS-3 coders are usually sent via DS-3 services. **JPEG** (Joint Photographic Group Experts) and **Motion JPEG (MJPEG)** are popular in photograph compression. On the decoder side, the receiving photos are decoded and played at a sufficient rate to allow viewing video motion. POTS, broadband copper, fiber optics, spread spectrum radio, and CDPD (Cellular Digital Packet Data) services are approaches for transmission of signals coded by JPEG. **MPEG** (Moving Picture Experts Group) is widely utilized in audio and video compression and transmission, and comes in six versions: MPEG-1, MPEG-2, MPEG-3, MPEG-4, MPEG-7, and MPEG-21. Current surveillance systems use primarily MPEG-2 and MPEG-4 standards. MPEG-2 is usually used in television systems and DVD, while MPEG-4 is the standard for multimedia transmission over the web and has a higher compression rate than MPEG-2.

#### *Video Image Processor (Mimbela and Klein 2007, Klein et al. 2006)*

A video image processor (VIP) system, also known as a machine vision processor (MVP) system, is usually composed of camera(s), microprocessor (for digitizing, compression, and processing functions), and software to interpret images in order to provide traffic data. Therefore, these systems sometimes can also serve as surveillance cameras (Hourdakakis et al. 2005). On the market are some VIP products that have a processor but

not an integrated camera. Chapter 6 provides a schematic of the camera-side and center-side components of a typical wireless system for an existing VIP-based traffic monitoring system.

For the data collected by a machine vision processor, a communication component is needed for transmission to a central site such as a TMC. The capabilities of the communication component mainly consist of data compression, alarms, video/images, and interfaces to link the MVP with different types of communication networks such as direct line, telephone lines, fiber networks, wireless communication, and so on.

In actual applications, a sensor network consisting of a large number of cameras and processors is necessary. A typical installation consists of several machine vision processor boards (possibly serving different types of applications) that are integrated into a standard rack.

Remote camera control and processor reconfiguration are possible with the management software installed at the center side (TMC). Management software makes it possible to remotely execute a complete camera set-up, modify detection zones, and check the results on-screen. Other software applications of data management and analysis are designed in particular for visualizing statistical data and incident alarms transmitted from camera side (traffic field) to center side (TMC). All traffic data, including events and alarms, are stored in the database for management and analysis. Management software can also provide an interface for monitoring and reporting application. Monitoring includes event visualization, documentation of event status, pre- and post-image sequences, all event information, and an incident video. For reporting applications, a database is required to generate data summaries or event reports as exportable graphs or tables. More advanced analysis functions might be available such as map visualization, map zoom tools, a central map image where the status of each camera can be verified, and event alerts. The latter may incorporate a visual indication on the central map image for the camera at which the event or alarm occurred. Generally, management and analysis software associated with different products have basic features in common but vary with respect to specialized functionalities.

VIP has three tracking method categories: tripline, closed-loop tracking, and data association tracking. Tripline tracking is the more commonly utilized. Tripline-related products include Solo Terra and Solo Pro from Autoscope, Traficon VIP, Iteris Vantage Edge2 processors (Mimbela and Klein 2007), and others. The principal idea of tripline is to predefine zones within the field of view of camera. When vehicles are detected in a zone, traffic measurements are taken. Surface-based and grid-based technologies are used in this tracking approach. The former technology makes use of characteristics' edges within the image while the latter is based on categorizing squares on a grid. Closed-loop tracking is a variant of tripline tracking that can detect vehicles' larger areas and provide information such as lane-to-lane actions of vehicles. Data association tracking can track a specific vehicle or a collection of vehicles.

Much research has been conducted on the evaluation of existing VIP systems. For example, a report from the Federal Highway Administration (FHWA) (Rhodes et al., 2006) compares Autoscope (version 8.10), Peek UniTrak (version 2), and Iteris Vantage (Camera CAM-RZ3) on the basis of performance on comprehensive tests. Prevedouros et

al. (3006) compare Autoscope, VisioPad, VIP/I, Vantage, and Video Track with respect to incident detection performance. Weather and environment such as wind, rain, snow, fog, and a day/night switch are vital factors influencing the performances of machine vision system configuration. Reports (Cherkassky 2002, Zhang 2008) have compared weather and environment influence among popular machine vision systems such as Autoscope, Iteris Vantage, and others.<sup>4</sup> Chapter 6 contains basic information for a number of VIP products.

## 2.3 Case Studies

- The Michigan Department of Transportation (MDOT) contracted with AVD Technologies to transmit real-time images to a monitoring center using a Wi-Fi network (Chiu et al. 2005).
- The Korean Highway Corporation selected Wi-Fi Mesh-based Strix systems<sup>5</sup> to construct a testbed for wireless data transmission between Korea's two largest cities—Seoul and Pusan. The test bed is located on the Kyungbu highway at a 31-kilometer (19 mile) stretch between Pangyo and Osan. The system enabled the wireless delivery of video surveillance and voice streamed to and from public safety and commuter vehicles. It is capable of streaming megapixel video across four wireless hops at 180 kilometers per hour.
- Motorola's Canopy broadband wireless solution—wi4, which is based on WiMAX technology<sup>6</sup> helps to provide the Nevada DOT a cost-effective way to monitor road conditions at the crossroads of interstate 80 and State Highway 93. It is geographically the same size as New Jersey and a wireless broadband data system supports a network of digital video cameras along a 200-mile stretch of I-80. The video network consists of seven mountaintop installations of backhaul units, access points, and subscriber modules that support five video cameras positioned at remote weather stations at mountain passes. In addition to remote weather station data, the DOT TMC also has a view of real-time road conditions.

Oakland County, located northwest of Detroit, Michigan, also chose the WiMAX-based wireless technology wi4 solution<sup>7</sup> in order to operate their adaptive traffic signal system more efficiently with reduced costs. The pilot program covers 4 miles of roadway and more than 15 signalized intersections. The wi4 solution features 10 and 20 Mbps backhaul modules and point-to-multipoint technology capable of delivering high speed connectivity in line-of-sight (LOS), non-line-of-sight (NLOS), near-line-of-sight (nLOS).

---

<sup>4</sup> See website [http://www.westernsystems-inc.com/communication\\_casestudy1.htm](http://www.westernsystems-inc.com/communication_casestudy1.htm).

<sup>5</sup> See <http://www.strixsystems.com/press/Koreas-intelligent-highway-infrastructure.asp>.

<sup>6</sup> See website <http://www.motorola.com/content.jsp?globalObjectId=8688>.

<sup>7</sup> See website [http://southwesternwireless.com/downloads/case\\_studies/cs\\_road-comm-oakland-county.pdf](http://southwesternwireless.com/downloads/case_studies/cs_road-comm-oakland-county.pdf).

- Some wireless services provided by companies are used in video surveillance systems. CDPD is one of data services commonly utilized in AMPS mobile phones. Hourdakis et al. (2005) and Lou (2005) used this service in their systems. A promising wireless transmission method, GPRS, can convert the data in a wireless network to an internet package. The ideal speed of GPRS is 171.2 Kbps.
- The city of Colorado Springs chose Microwave Data System (MDS) spread spectrum radios<sup>8</sup> at many of its intersection controllers to reduce costs for communication in traffic management and high network infrastructure. Their MDS transceivers were chosen for use at over 200 sites in the network. The transceivers use advanced spread spectrum technology and operate at 900 MHz frequencies. The system contains a remote network of upgraded intersection controllers, weather stations, video cameras, loop detectors, and carbon monoxide monitors, from which critical information is collected and forwarded to Colorado Springs Traffic Control Center. Another city division, the Colorado Springs Water Department, also installed MDS radios. Zero monthly fees and free licenses are two cost benefits of MDS radio. An experimental system in the Duluth Transportation Operations and Communications Center (TOCC) Network System (Cherkassky 2002) uses a 2.4 GHz spread spectrum radio link to transmit digitized video from highway cameras to the control center.
- To update its traffic signal system, after comparisons with leased telecommunication services, the city of Irving, Texas, decided to make use of a wireless infrastructure based on 5.8 GHz, 24/23 GHz, and 18 GHz. The instruments utilizing 5.8 GHz microwave are compliant with the IEEE 802.16 standard and manage the transmission of data and video from CCTV cameras. The communications backbone, which connects five major systems, utilizes licensed 18–24 GHz two-way microwave.

A typical CCTV station in the field and its diagram are illustrated in Figure 7 and Figure 8, respectively. As shown in Figure 7, the power supply of a station is located in the cabinet, which provides power for the CCTV camera, PTZ module with camera, and power-communication module. VIP and PTZ signals from camera are sent to a communication module through CAT-5 cable. The CCTV video can be converted to IP format using a built-in codec at the camera. In addition, the communication module can also offer an Ethernet connection for a wireless antenna system.

---

<sup>8</sup> See website [http://www.westernsystems-inc.com/communication\\_casestudy1.htm](http://www.westernsystems-inc.com/communication_casestudy1.htm).

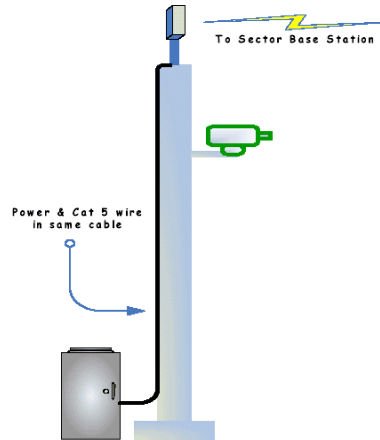

Figure 7 Typical CCTV Station (Leader 2005)

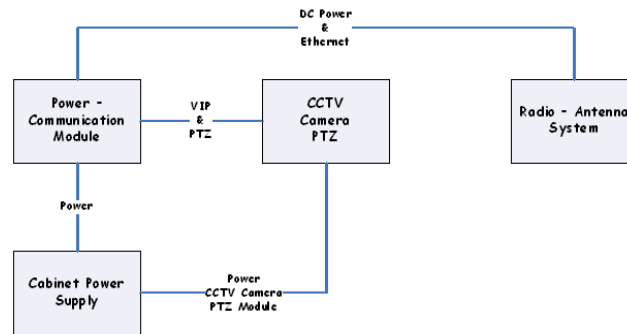

Figure 8 Function Diagram of CCTV Station (Leader 2005)

- Portable detection and surveillance systems can play an important role in scenarios such as construction sites. However, few off-the-shelf products can provide both temporary and reliable functions. Therefore, Hourdakis et al. from the University of Minnesota studied this problem and developed an applicable detection and surveillance system (Hourdakis et al. 2005).

Through thorough investigation and comparison, the researchers decided to use MV (machine vision) sensors to obtain traffic measurements. When MV sensors work with proper equipment, e.g., lens and correct settings, they can also be used as surveillance cameras. The outputs of the MV sensors used in this system are RS-485 signals. To transmit them through wireless networks, these signals must be converted to Ethernet packets via converters.

A small form-factor PC is used in the field to encode and store videos. This computer is equipped with a video capture board and applications to encode and record video in MPEG-4 format. Because the video capture board has one input channel on and four CCTV outputs, a four-to-one quad processor is added to translate the four video signals into one. The stored video files on this PC can be downloaded by a supervising station through an FTP connection and real-time video can be transmitted using a streaming application. The architecture of this system is displayed in Figure 9.

Figure 10 depicts the final physical configuration. To provide sufficient bandwidth for data and video transmission, this system uses TSUNAMI, produced by the company Proxim. The wireless link is 20 Mbps and the frequency is 5.4 GHz. This network is compliant with IEEE 802.16 and utilizes a frequency hopping protocol.

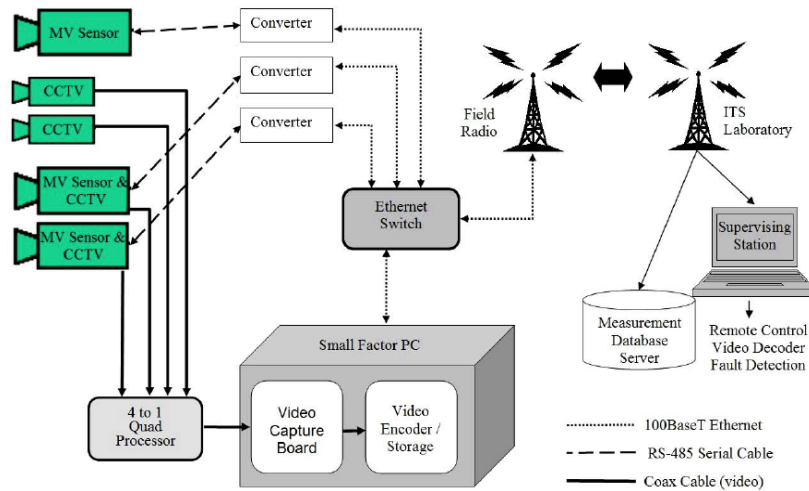

Figure 9 System Architecture (Leader 2005)

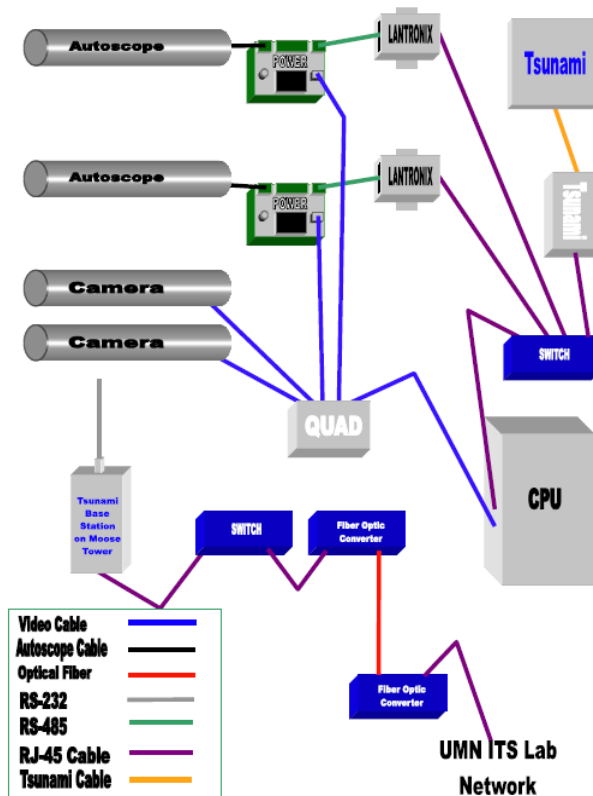

Figure 10 Final Wireless Network (Leader 2005)

- The North Central Texas Council of Governments (NCTCOG) is coordinating the Regional Data and Video Communication System (RDVCS). The RDVCS is an effort to create a regional network to exchange data and video. The city of Irving was connected to the RDVCS via wireless Ethernet because of the lack of fiber routes around the city. Tsunami 480 wireless fast Ethernet bridge was used as a representative vendor for this wireless connection. This product provides a 480 Mbps full-duplex link and has a range up to 20 miles. Using a wireless connection, the city of Irving will connect to TransVISION Satellite 3 (over 4 miles away), which in turn connects to various RDVCS backbone switches allowing transmission of data and video. The city of Irving has 12 cameras and video from the cameras is available for simultaneous viewing throughout the region.
- Zhang et al. researched a cost-effective traffic data collection system based on the iDEN mobile telecommunication network. The cost-effective data collection system for 170 Caltrans controllers is based on TCP/IP communication over existing low-cost mobile communication networks and Motorola iDEN mobile handsets. Each handset can deliver data fetched from a signal controller at a period of 200 ms continuously over 95% of the time. One set of data collection devices cost less than \$100 and monthly cost can be as low as \$10. Detailed cost information is listed in Table 2.

**Table 2 System Cost (Zhang et al. 2008)**

Item	Cost	Description
iDEN265	~\$30 each without contract	One cell phone for one master controller with one power supply
RS232 Cable	~\$15 each	
Power Supply	~\$15 each	
Installation	Simply put into the cabinet No extra device required	
Resetting circuit	Optional, <\$10	A simple circuit for resetting the cell phone when there is a failure in embedded software
Nextel® Service:	\$10/month with static IP	2007 cost figure

As shown in Figure 11, the moderately priced Motorola iDEN series phones are used as remote data modems. The phones feature a standard RS232 serial port, the iDEN wireless data connection support and Global Positioning System (GPS) support. The iDEN wireless network serves as a cost-effective and reliable communication link for the system. The channel capacity limit is 9.6Kbp/s. This data rate is adequate for the traffic application and the service contract pricing for this network is superior to other available rate plans.



In order to achieve high data rates and reliable communications, high level control protocols were developed. An adaptive flow control protocol was employed in order to maintain a data link channel with variable but highly reliable capacity on top of the TCP/IP over the iDEN network.

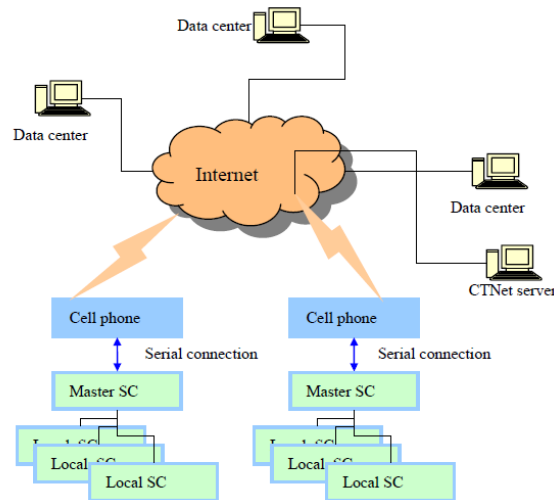

Figure 11 System Architecture (Zhang et al. 2008)

## 2.4 Application Scenarios

Camera surveillance systems are widely applied in many scenarios including intersection control, tunnel surveillance, highway management, arterial traffic monitoring, dilemma zone protection, temporary and work zone detection, and other scenarios.

### 2.4.1 Intersection Control

A number of intersection control systems are applications of video imaging vehicle detection systems (VIVDSs). Nearly 10% of the intersections in Texas use VIVDSs (Bonneson and Abbas 2002). Because of the uniqueness of each intersection, several details should be given attention: occlusion of camera view caused by vehicles, camera stability, sun glare and reflection, image size, illuminance, headlight glare, shadows, and so on.

### 2.4.2 Tunnel Surveillance

Schwabach et al. (2005) introduce VITUS-1, which automatically detects alarm events in tunnels and stores incident video. Tunnels have no variation of brightness due to weather or alternation of day and night. As illustrated in Schwabach et al. (2005), other factors may affect the effectiveness of tunnel surveillance systems, including effects of the wall or deficiency of light. One of the requirements for a tunnel surveillance system is response time. It must be short to provide enough time for travelers to evacuate as tunnels have limited emergency exits (especially long tunnels). Much research and testing has been conducted on tunnel scenarios. Prevedouros et al. (2006) invited Autoscope, Citilog,

and Traficon to install their respective VIP devices for testing of incident detection capabilities in tunnels.

### **2.4.3 Work Zones Surveillance**

To reduce incidents at work zones, video surveillance systems should have full functionality compared to permanent system. However, these systems have different characteristics compared to the most common freeway monitoring systems (Lou 2005). Such systems must be portable, which means they are easy to deploy and uninstall, and require as little wiring as possible. They should not interfere with operations at work zones; they should provide timely information for drivers passing through. When the construction is finished, such systems have no further purpose.

### **2.4.4 Dilemma Zones Protection**

A dilemma zone is the area before a stop line at which drivers may take different actions (abruptly stop or pass through the intersection by speeding up). The “dilemma” typically occurs when a signal light at an intersection changes to yellow. To evaluate the performance of current video systems serving dilemma zones, Middleton et al. (Middleton et al. 2008) studied VIVDS used for that purpose.

## **2.5 Conclusions**

Previous sections discussed most aspects of vision-based traffic surveillance systems. This included available video analytics functionalities, communication options (wireless options in particular), existing surveillance technologies (video cameras and machine vision processors), three different system configurations, case studies of typical current technologies applied in vision-based traffic surveillance systems, and, finally, application scenarios in which vision-based surveillance systems are highly valued.

Cost-effective system design has always been an important topic for traffic monitoring system deployment. Given all the information in the previous sections, the basic system requirements are clearly the principal guide in designing a cost-effective system. With the basic requirements, we can narrow the possible choices. Following is a list of the basic requirements of vision-based surveillance systems.

- Video cameras: the necessary video quality, compression option and rate, weather and environment durability and cost.
- Video analytics: the basic and necessary functionalities such as data collection and event detection, visualization for data collected and events detected and corresponding data load for transmission.
- Wireless communication: the appropriate choice of range and coverage, transmission speed, equipment and operation cost, life cycle cost, and risk of available technologies.
- Realistic system design and deployment: the consideration and utilization of existing traffic monitoring infrastructure.

The concept of life cycle cost and risk is important because technologies develop faster than expected. The advent of new technologies causes previous technologies to be outdated, entailing an upgrading or replacement cost.

With the knowledge of basic requirements, resource availability, comparisons of cost-effective technologies, and a comprehensive and forward-looking design, implementing a vision-based surveillance system would be an easy task.



## Chapter 3. Survey of Texas Practice

### 3.1 Introduction

A comprehensive understanding of current practice regarding camera-based surveillance and wireless communication is necessary prior to recommending effective configurations. Of the 25 districts in the TxDOT system surveyed, 20 responded, providing data on current practice and experience. In Figure 12, districts contributing to this report are indicated with a red marker. Obviously, the response was excellent and the coverage is adequate for us to present reliable and comprehensive information relevant to the major components of current surveillance systems in Texas.

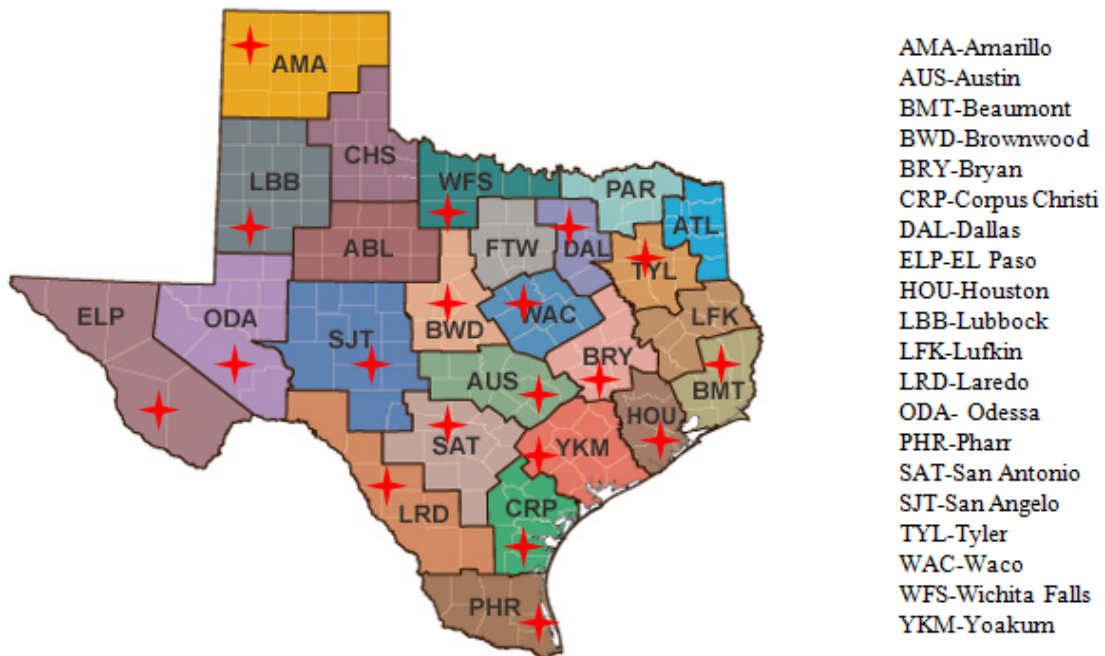

*Figure 12 Survey Coverage*

Generally, as illustrated in Figure 13, traffic surveillance systems consist principally of hardware and software components. Hardware includes video cameras and communication systems; software components include video analytics to process streaming video in order to collect statistical data and detect events automatically without manual intervention. Video cameras and video analytics can be integrated into one unit by embedding the analytics processing at the camera side. Communication systems can be wireline, wireless, or a combination of wireline and wireless connectivity.

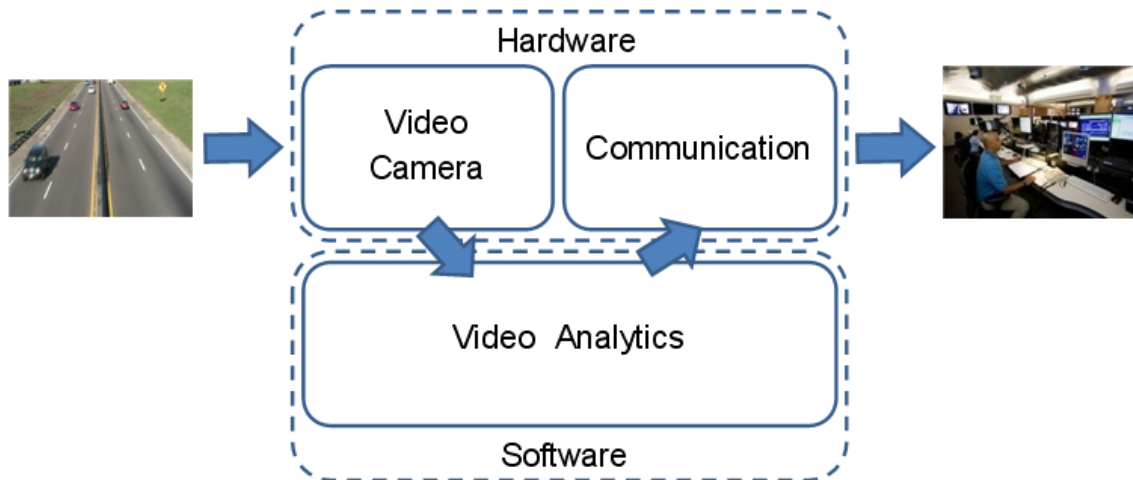

*Figure 13 Surveillance System Components*

Four steps were necessary to conduct the survey: (1) design a survey instrument; (2) engage in two rounds of reviews of the instrument by TxDOT personnel, each followed by modification by the team with the assistance of the project director; (3) distribute and collect the survey with the assistance of the project director; and (4) analyze the responses using graphs, lists, and simple statistical measures.

From comprehensive analysis of data collected from 20 districts, the following types of information are available:

- Types of corridors that are under surveillance: freeway or arterials
- The transmission distances between TMCs and surveillance cameras
- Types of video cameras that are widely employed in TxDOT surveillance systems
- The basic capability and specification requirements for video cameras in use
- The most cost-effective video camera model currently in use
- The popularity of wireless technology in traffic video surveillance system
- Types of wireless technology used in traffic surveillance system
- The basic range (possible maximal transmission distance), frequency, and data transmission rate requirements based on practical needs
- The most cost-effective wireless technology currently employed
- Types of sensors other than video cameras used in the surveillance systems
- The functionalities desired by TxDOT district personnel of camera-based surveillance systems
- The greatest barrier for expanding surveillance systems
- Possible approaches to improve the cost effectiveness of a traffic surveillance system

First, equipment preference as expressed by survey respondents are discussed, including video camera and communication technologies. Second, application scenarios, video camera coverage, video analytics functionalities, and system configurations are also covered. Cost analysis is discussed later on. Finally, a conclusion in the last section presents the comprehensive summary of the knowledge obtained by analyzing the survey.

### 3.1.1 Equipment Preference

The design of a surveillance system includes the choices of video camera and communication technologies. In this section, the choices that have led to existing TxDOT systems are summarized.

#### *Video Camera*

Video cameras from eight manufacturers are used in the surveillance systems of the 20 responding districts in Texas. These include makes from Cohu, Pelco, IndigoVision, Axis, Iteris, Vicon, American Dynamics, and Sony. Cohu is the most popular manufacturer with 64% usage among the eight manufacturers, as depicted in Figure 14.

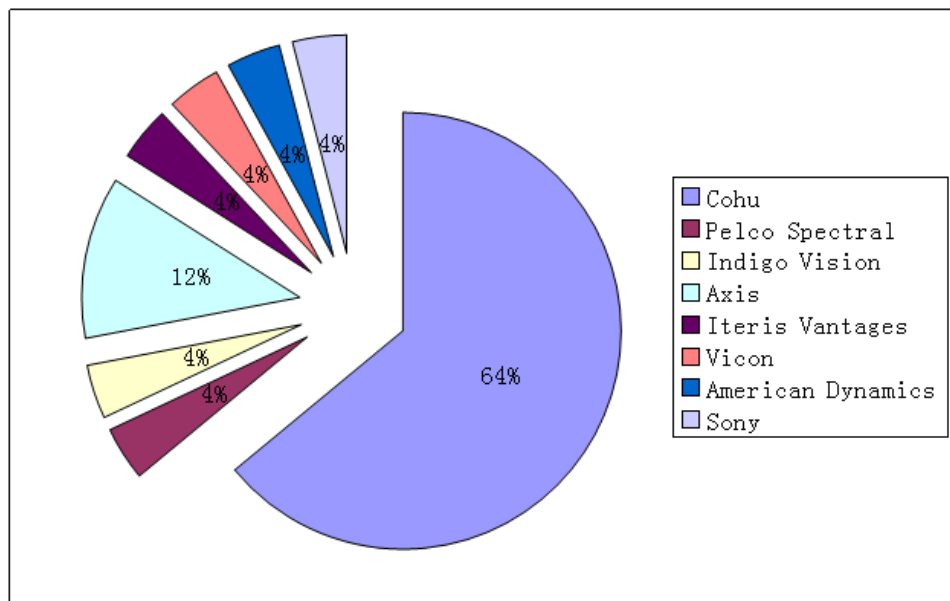

*Figure 14 Video Cameras in Use*

More important than the manufacturer, however, is the basic capability and specifications of the chosen video cameras. Table 3 compares the basic specifications of the different models employed in current systems. Some models are no longer marketed. For this and other reasons, some model specification information is not provided. Thus, the seven video cameras, including different models of the same make, in the comparison are the Cohu 3950, 3920, and 3960, Axis 213 PTZ, Pelco Spectral III, Iteris Vantage RZ4C, and indigoVision. While sufficient data is provided for the Cohu make, which enjoys a 64% share of usage, information for the 3850 series is not currently available.

**Table 3 Comparison of Camera Models**

<b>Features/Models</b>	<b>Cohu 3950</b>	<b>Cohu 3920</b>	<b>Cohu 3960</b>	<b>Axis 213 PTZ</b>	<b>Pelco Spectral III</b>	<b>Iteris Vantage RZ4C</b>	<b>Indigo Vision 9000</b>
<b>Color/Mono</b>	Color/Mono	Color/Mono	Color/Mono	Color/Mono	Color/Mono	Color/Mono	Color/Mono
<b>Focal length (mm)</b>	3.60–82.8	3.4–119	3.4–119	3.5–91	3.6–82.8	N/A	3.4–119
<b>Resolution (TV lines)</b>	470 Lines	540	540	704 x 576 (effective pixels)	>470	768 x 494 (effective pixels)	>540
<b>Day/Night</b>	D/N	D/N	D/N	D/N	D/N	D/N	D/N
<b>Optical Zoom</b>	23X	35X	35X	26X	23X	N/A	18X, 35X, 36X
<b>Compression</b>	N/A	N/A	N/A	MJPEG/MPEG-4	D/N	N/A	H.264
<b>Power Consumption (Watts)</b>	50	104	54	13	N/A	N/A	24
<b>PT</b>	P(360°), T(-90° - +40°)	P(360°), T(-90° - +5°)	P(360°), T(-90° - +90°)	P(340°), T(-10° - +90°)	P(340°), T(-2° - +90°)	N/A	P(360°), T(-2° - +90°)
<b>Operation Temperature (°F)</b>	-40 to 131	-29.2 to 131	-29.2 to 165	-41 to 104	-60 to 140	-31 to 140	-4 to 140
<b>Enclosure/Protection Standard</b>	IP67	IP67	Positioner: IP66 Camera: IP67	N/A	IP66	IP67	IP67
<b>Interface</b>	RS422/485	RS232/422	RS232/422	RJ45, RS232 from connection module	RJ45	2.4 GHz wireless operation	RS232, RJ45
<b>Cost</b>	N/A	N/A	N/A	1,498.95	1415	N/A	N/A



A study of the data in Table 3 yields the summary depicted in Table 4, which indicates the operating ranges met by all or nearly all cameras.

**Table 4 Common Operating Ranges of Video Cameras in Use**

<b>Specification</b>	<b>Description</b>
Day/Night	Day and night traffic monitoring are both very important, which requires the camera to be able to function in both Day and Night Mode.
Color/Mono	It should be possible for the video camera to switch between color and mono both day and night, if possible automatically.
Focal length (mm)	3.4–82.2 is focal length range all systems cover
Resolution	No less than 470 horizontal lines
Optical Zoom	18–36X
Compression	Preferably, video compression is embedded within the video camera; JPEG, MPEG, and H264 could be the options.
Power (watts)	Within the range of [13,104]
PT	P(360°)/P(340), T(-90° - +40°) Pan Tilt functionality is a must for video surveillance.
Operation Temperature (°F)	Basic range should be within [-4,122].
Enclosure/Protection Standard	IP66, IP67
Interface	Options are RS232/422/485, RJ45.
Cost	N/A

### *Communication*

Wireline communication technologies used in the 20 districts included T1, telephone lines, DSL, fiber optics, MPEG-4 over IP, ISDN lines, JPEG/MPEG2 digital encoding over SONET, digital encoding over ISDN, MPEG-4 over IP, and others. While wireline communication technologies were solicited in the survey, wireless communication technologies are the focus of this study.

Based on survey responses, most districts utilize wireless technologies in some capacity and more detailed discussion is contained in the following sections.

As Figure 15 illustrates, Encom is the most popular wireless equipment manufacturer and is used in eight districts for video data transmission. Motorola and GE ranked second, being the preference of three districts.

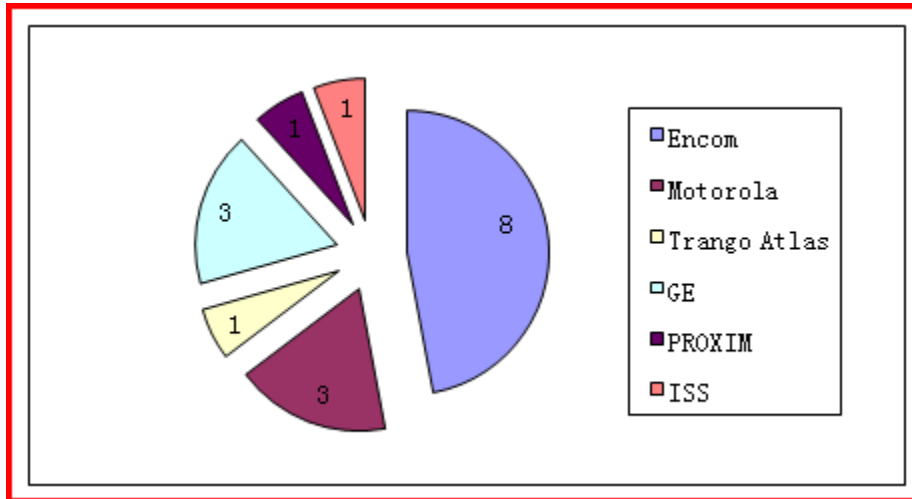

*Figure 15 Manufacturers of Wireless Equipment in Use*

The detailed comparisons of the various wireless equipment options in Table 5 yield the summary depicted in Table 6. This summary is particularly valuable in selecting future system configurations that are compatible with present deployed technologies.

**Table 5 Comparison of Wireless Equipment in Use**

Features/ Models	Encom			Proxim	GE MDS			Trango	ISS		Motorola		
	5200	Comm- pak BB49	Comm- pak BB58	GX200	9810	InetII -900	Trans Net 900	Atlas Series	EIS G4	EIS X2	PTP 58600	PTP300	2400BH RF20
<b>Data Rates</b>	1200 baud to 115 kbps	54 Mbps	54 Mbps	100 Mbps	19.2 Kbps	512 Kbps -1 Mbps	115.2 kbps	45 Mbps	24 Gbps	45 Mbps	150 Mbps	54 Mbps	20
<b>Range</b>	60 miles	60 miles	60 miles	20 miles	long	15-20 miles	30 miles	6-20 miles	76m	N/A	124 miles	155 miles	35 miles
<b>Frequency</b>	900 MHz	4.9 GHz	5.8 GHz	5.8 GHz	900 MHz	900 MHz	900 MHz	5.8 GHz	2.4 GHz	900 MHz	5.8 GHz	5.4/5.8 GHz	2.4 GHz
<b>Interface</b>	RS232/ 485	802.11 a/b/g	802.11 a	RJ-45	N/A	802.3, RJ-45	RS23 2/485	RJ45, 802.3	N/A	NA	RJ-45, 802.3	RJ-45, 802.3	802.3
<b>Price</b>	1500- 2000	1500- 2000	1500- 2000	N/A	1580	2400	1100	N/A	N/A	N/A	N/A	N/A	1489

**Table 6 Commonalities across Wireless Communication Options**

<b>Features</b>	<b>Descriptions</b>
Data Rates	Min=115 kps, Max=24 Gbps, most in the 10–60 Mbps range. There are three different levels of data rates in magnitudes of Kbps, Mbps, and Gbps. However, taking into consideration video transmission, the basic data rates for video transmission should be within the range of [20 Mbps, 150 Mbps].
Range	Min=15 miles, Max=155 miles, most on the order of 50 miles. The transmission range of majority is between [15 and 155 miles] (limits); a radar-based short-range transmission range less than 100 meters is not included, with the preference being long range based transmission.
Frequency	Lowest=900 Mhz, many in the ITS reserved band (5.8 Ghz).
Interface	IEEE 802.x protocol dominates. Possible physical interface options are RS232/485 and RJ45, and possible compliant protocol options are 802.3,802.11.
Price	Low=\$1100, High=\$2400, Median=\$1500.

Generally, cellular networks based transmission has comparatively lower data rates with cost reduction. Because only three districts did take advantage of cellular network for video data transmission, cellular network based wireless technologies have great potential to help improve the cost-effectiveness of wireless communication equipment.

### **3.1.2 Other Sensors**

Apart from video cameras, other sensors are in use such as loops, radar vehicle detectors (RVDs), toll tag readers, and video imaging. A comparison of the percentage of usage among these four sensors is shown in Figure 16. Loops are still the most widely deployed with 71% of usage. VIVDS ranks second with 18% of usage as measured by number of installations. Toll tag readers are the least frequently employed, no doubt due to the absence of significant mileage of tolled freeways in many districts. In summary, the survey responses indicate that loops are the first choice among all sensor choices, excluding video cameras.

"  
"  
"

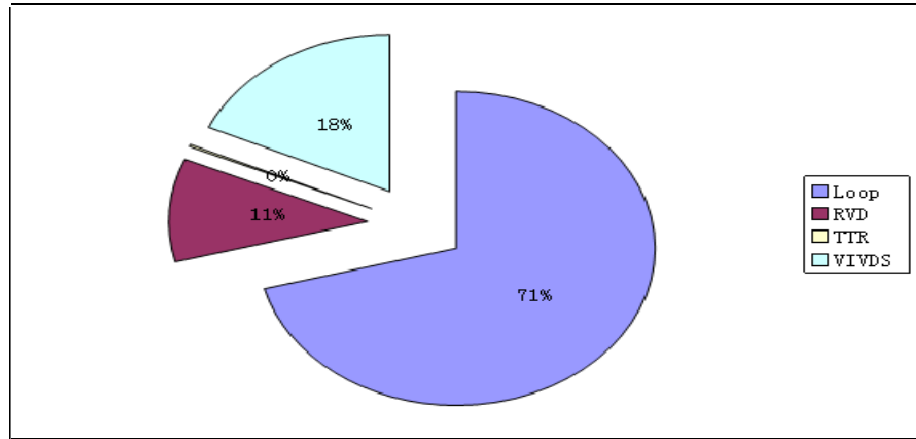

*Figure 16 Sensor Usage Based on Number of Installations*

## **3.2 Surveillance Applications and Functionalities**

### **3.2.1 Application Scenarios**

To determine configurations for future use of video analytics in wireless networks, we must first understand the present application scenarios within TxDOT districts. One survey question addressed the issue of whether the district manages roadways other than freeways that are not on the TxDOT ITS communication backbone. Based on the survey, most of districts (14 out of 20) manage only freeways and only a few manage arterials.

#### *Video Camera Deployment*

The total number of video cameras employed in each district is shown in Figure 17. Only 5 districts—Houston, Austin, Dallas, San Antonio, and El Paso—have deployed more than 100 video cameras. This low deployment indicates great opportunity for expansion of video camera coverage; video cameras have not been taken full advantage of on a large scale in many regions.

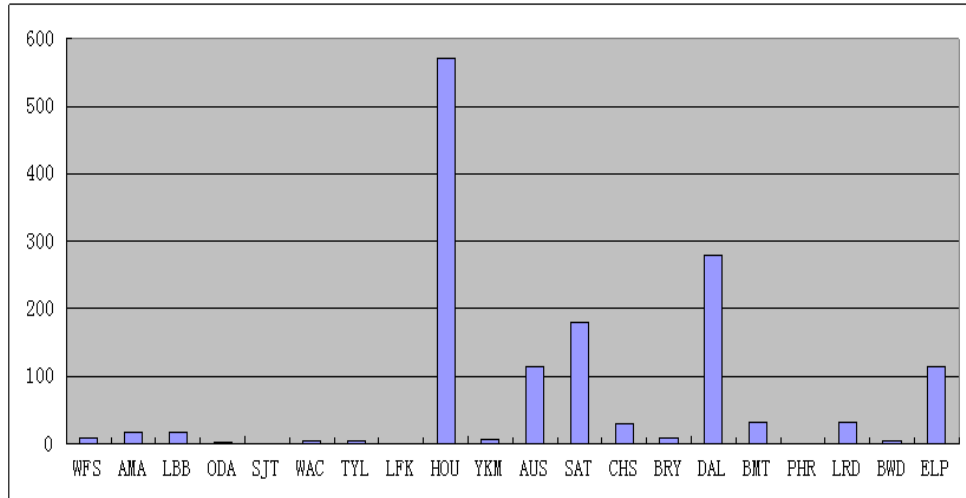

Figure 17 Video Camera Installations

One factor in deciding the range the wireless communication technology should have, an issue is the distance across regions currently covered. As illustrated in Figure 18, for 13 districts the greatest distance between the TMC and a video camera is between 10 and 100 miles. This distance is probably a reasonable basic range that should be noted for future expansion.

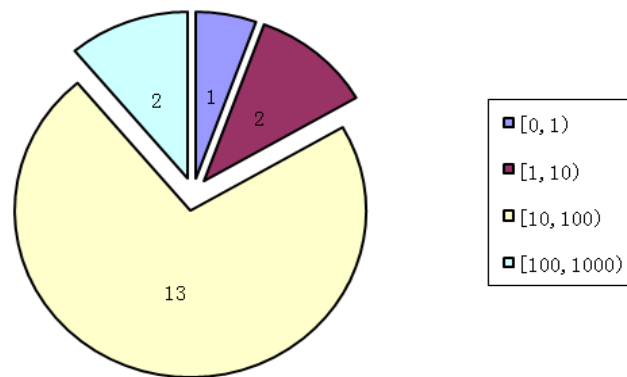
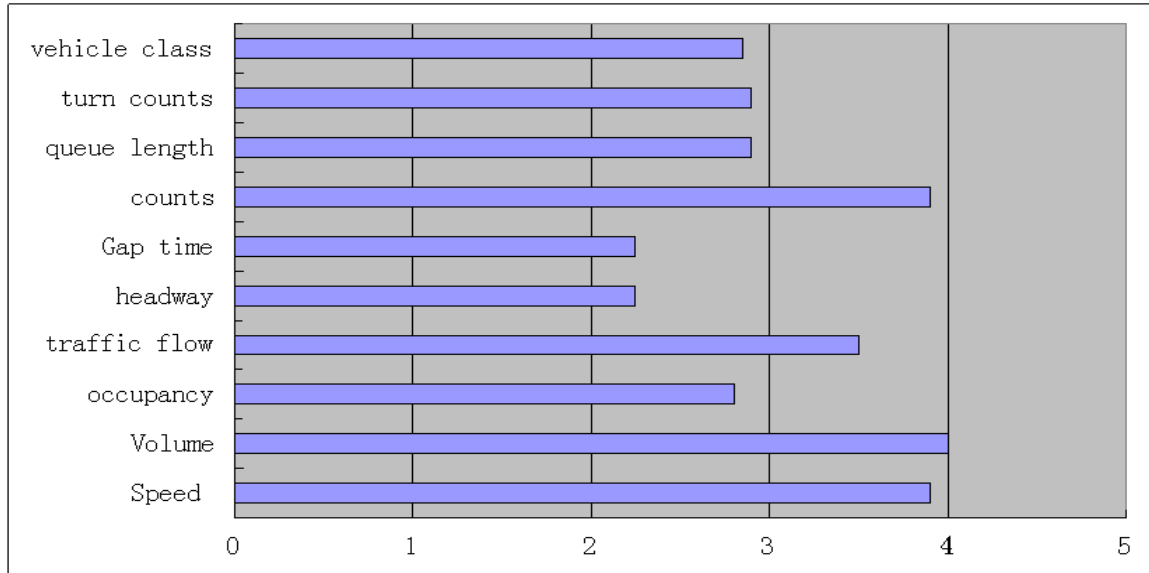

Figure 18 Greatest Distance between TMC and a Video Camera

### Video Analytics Functionalities

Video analytic functions consist of data collection and measurement components. Measurable statistics include vehicle class, turn counts, queue length, counts, gap time, headway, traffic flow, occupancy, volume, and speed. Importance weights for each type of measure were assigned by survey responders. Statistical results were calculated by averaging the rating values among all districts with a 5 indicating the most important functionalities and a 1 indicating the least important. Figure 19 shows the raw results from averaging. Should we group the categories subjectively into classes such as high (very important), normal (necessary), and low (least important), it is clear that the

important data to collect are volume, counts, speed, and traffic flow; necessary data to collect are vehicle class, turn counts, queue length, and occupancy; the least important data to collect are gap time and headway.



*Figure 19 Importance Weighting of Detection Functions*

In the same way, detectable events such as abnormal lane change count, accident, fire/smoke, slow/fast driver, pedestrian, roadway debris, stalled vehicle, wrong-way driver, and congestion were assigned importance weights and summarized by averaging. Again, a 5 indicated the most important events to be detected and a 1 indicated the least important. Using the responses detectable events were subjectively grouped into three categories of decreasing importance – high (very important), normal (necessary), and low (least important). From the raw data averages shown in Figure 20, the important events to detect are congestion and accident; necessary events to detect are wrong-way driver, stalled vehicle, roadway debris, fire/smoke, pedestrian, and abnormal lane change count; the least important event to detect is slow/fast driver.

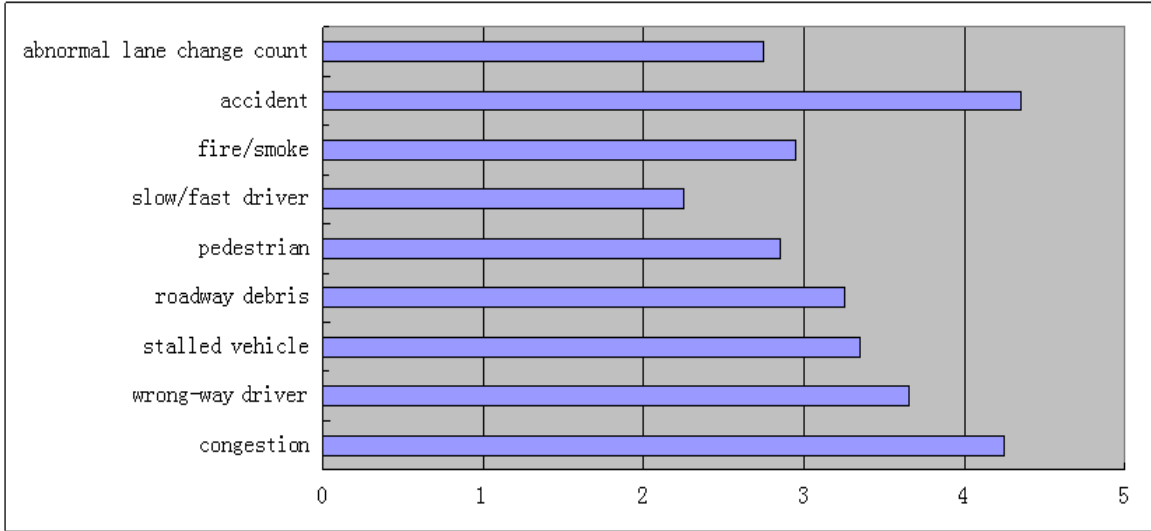

Figure 20 Importance of Events to Detect

### 3.2.2 System Configuration

Nineteen districts indicated their communication technologies. As shown in Figure 21, four districts have only wireline-based communication systems; four districts have only wireless-based communication systems; and the majority has both. When both exist, as they do in 11 districts, the systems are presumably interconnected in some fashion. In summary, 15 out of 19 districts (19 indicating communications technologies) have an existing wireline communication system. In considering wireless communication, we wish to take full advantage of existing wireline communication systems in designing a new cost-effective video surveillance system.

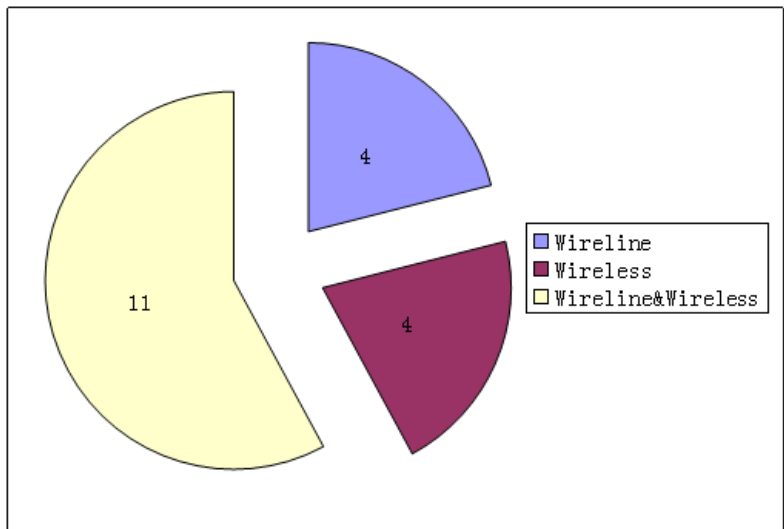

Figure 21 Usage of Wireline and Wireless Communication



### 3.3 Cost Analysis

The survey was not designed to gather extensive cost data, as collecting it would be an onerous task for the responders. Yet the objective of designing cost-effective wireless solutions demands the calculation of cost. Figure 22 shows that the major cost components include equipment installation, monthly service, system maintenance, and system cycle risk.

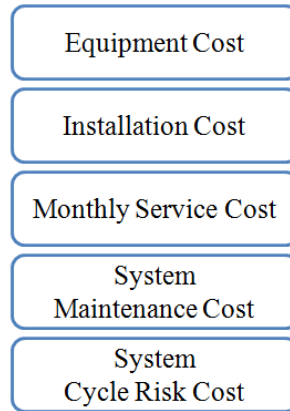

Figure 22 Components of Cost Analysis

In order to reduce system cost, it is helpful to know the obstacles to system expansion. For the survey, we rolled equipment and installation costs into one. As seen in Figure 23, in decreasing order, the barriers to expansion are installation costs, maintenance costs, and recurring utility costs. It is interesting to note that lack of need does not register very highly.

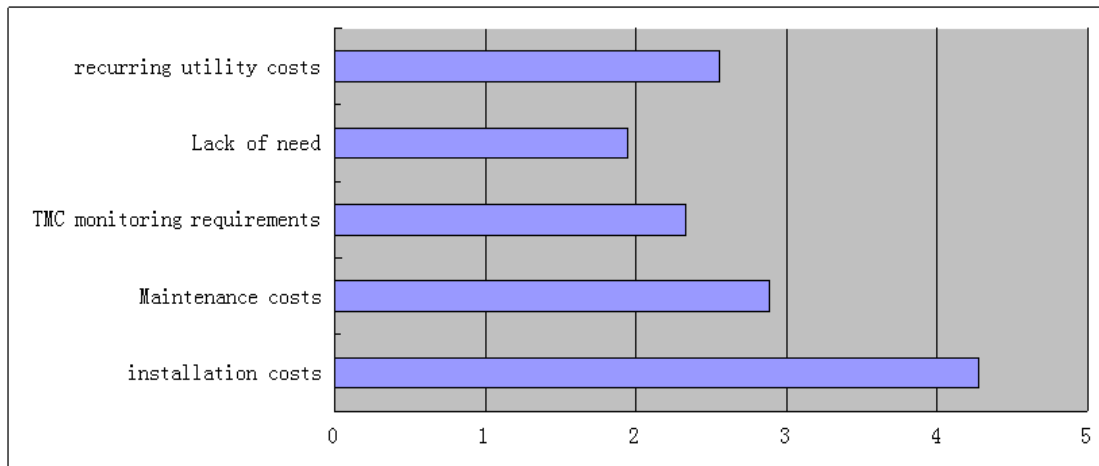

Figure 23 Roadblocks to System Expansion

### 3.4 Conclusions

After comprehensive analysis of the surveys, we acquired much useful information that we can apply in designing a cost-effective, wireless video surveillance system. Following are some of the most useful observations.

1. Most districts manage only freeways.
2. The camera manufacturer in the greatest use is Cohu.
3. Most districts have developed wireless system and about the same percentage will consider wireless communication in future expansions.
4. The greatest transmission distance between TMC and a surveillance camera is between 10 and 100 miles.
5. Other than video cameras, loops are the most widely deployed sensor considering the set loop, RVD, TTR, and VIVDS.
6. Volume, speed, and counts are the statistical data with highest preference.
7. Accidents and congestion are the event detection capabilities more greatly preferred.
8. Installation costs are the greatest barrier to expanding surveillance coverage.

The overall conclusion is that room exists to expand current systems, cost is the most important criterion in expansion, existing communication systems technologically support wireless communication, and the regional distribution of present systems are within the reach of wireless system. With respect to there being room for expansion and VIVDS being a cost-effective approach, we point to previous TxDOT research from 2002. Note that the application scenario studied was intersections. Nevertheless, we believe the results are credible in other applications.

In Figure 24, cameras are shown to be the most cost-effective for intersections requiring 12 or more cameras regardless of the lifespan of the loop technology employed.

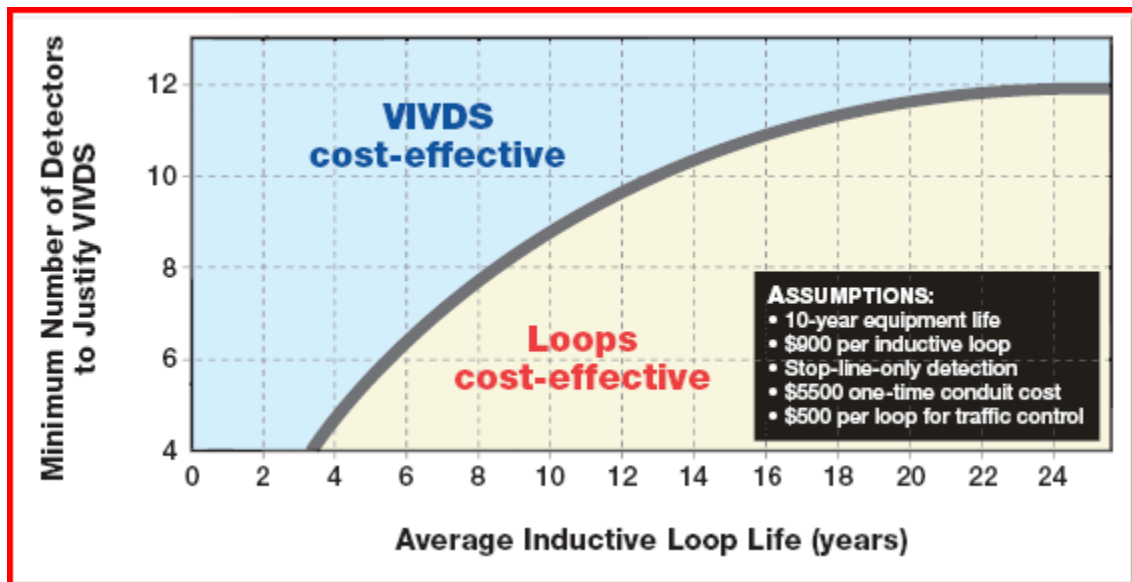

Figure 24 Costs Tradeoffs between Loops and VIVDS

Our next steps are to acquire the current status of each utilized technology and equipment component, explore new technologies, and make a comprehensive comparison. The objective is to determine a cost-effective wireless traffic video surveillance system. The principal criterion is system cost reduction. In choosing an economical configuration of video camera, the basic specification requirements determined from the survey will be considered. Additional considerations are reducing the data transmission load, thus reducing the cost of wireless equipment and the number of staff needed to monitor traffic video. One approach might be to incorporate video analytics and transmit processed traffic data most of the time instead of streaming video.



## Chapter 4. Equipment Survey

### 4.1 Introduction

Currently, a wide range of equipment is available for satisfying ITS needs and the price trend is downward. This trend suggests transportation monitoring in the future may cost less, offer greater functionality, or both. Provided here is a survey of camera and wireless devices that are already or soon will be used in transportation surveillance systems. Of the many products for wireless monitoring, however, not all are suited for transportation applications. This survey is organized as follows: clarification of the requirements, setting the parameters, and finally information on candidate products.

### 4.2 Camera Parameters

Cameras inherit different technologies and provide different functions. Yet they share several parameters that lead into our equipment survey. In the following subsections, we outline important camera parameters and explain their significance.

#### 4.2.1 Explanations of Parameters

**Imager.** The imagers of cameras used in traffic monitoring are most often 1/4 inch in diameter. Two types of sensors can be utilized in transportation field but in different situations: 1) a charge coupled device (CCD) is the prevailing format of camera sensors on the market and has better sensitivity but higher price, and 2) a complementary metal oxide semiconductor (CMOS), in comparison with a CCD sensor, has faster read-out capability and lower power consumption.

The scanning techniques, usually known as interlaced and progressive scanning technologies, are also critical in obtaining high quality images. In interlaced scanning, only odd lines or even lines of images are refreshed during one scan. This technique can reduce the transmission bandwidth requirements. With respect to the progressive technique, the entire frame is sent to the viewer after each scan. The viewer obtains more detailed pictures of high speed objects in place of the twittering images obtained from interlaced scanning.<sup>9</sup>

**Focal Length.** Focal length is the distance between the center of the lens and the imager. The greater the focal length, the greater the image of distant objects. However, the angle of view is narrower.

**Angle of View.** Angle of view refers to the extent, described by angle, of the scene captured by a camera system. The two types of angles of view are horizontal and vertical. Datasheets of many products provide only the former. The relationship between angle of view and focal length has been indicated above.

**Resolution.** Both analog and digital cameras have the parameter known as resolution although they may use different measurements. Practically the two may be interchanged via a conversion formula.

---

<sup>9</sup> See technical guide at [http://www.axis.com/products/video/about\\_networkvideo/image\\_scanning.htm](http://www.axis.com/products/video/about_networkvideo/image_scanning.htm), accessed Mar. 4, 2011.

For resolution of analog cameras, TV lines from the television industry are used. Traditional television has three formats: NTSC (National Television System Committee), PAL (phase alternate line), and SECAM (sequential color with memory). In this document, we discuss only the NTSC format which is used in North America. This format has 480 lines and a 60Hz refresh rate. Because video in NTSC format can be digitized, we can also express the resolution in pixels. The finest resolution of NTSC is D1 (720 × 480) but 4CIF (704 × 480) is the most frequently used resolution<sup>10</sup>.

A digital camera has some components in common with an analog camera, such as an optical system. It also is able to provide NTSC resolution. Additionally, digital cameras may provide resolution choices other than that of the TV industry. Such cameras may have VGA (640 × 480) resolution, which is commonly used in network cameras with resolution of just under a megapixel. Megapixel cameras can provide images having more details. Of course, more bandwidth is needed to transmit the images.

**Minimum Illumination.** Minimum illumination indicates the minimal amount of light needed to make an image recognizable. The unit of minimum illumination is lux. Although many manufactures provide this parameter, there is not a standardized measuring process for it.

**Pan/Tilt/Zoom.** In surveillance systems, most cameras have PTZ functions. Pan represents left and right movement; tilt refers to up and down movement; and zoom allows magnification of distant objects to obtain more details.

Digital camera systems have two kinds of zoom: optical and digital. Optical zoom actually changes the focal length. Thus, the imager captures larger images of fewer, more distant objects or smaller images of more objects with the same resolution. Digital zoom is not a real zoom. It only enlarges a portion of the image up the original image size. Using this process, image quality is lost.

**Compression.** For network cameras, compression is employed before transmission. It is particularly significant for video or image wireless communications. Constrained by various factors, wireless communications cannot supply the same bandwidth and distance as some wired systems (such as fiber systems). Accordingly, given bandwidth, compression is necessary to achieve quality. For video, most products support MJPEG, MPEG-4, or H.264 standards. The size of a video file processed by H.264 may be up to 50% smaller than a file using MPEG-4, and 20% of the size of an MJPEG video file, without sacrificing quality<sup>11</sup>. Therefore, H.264 is more effective but needs a more powerful processor.

**Protection.** Manufacturers of outdoor cameras provide housing for protection purposes. Some housings are directly integrated with the camera but some are not and need to be ordered separately.

---

<sup>10</sup> See technical guide at [http://www.axis.com/products/video/about\\_networkvideo/resolution.htm](http://www.axis.com/products/video/about_networkvideo/resolution.htm), accessed Feb. 15, 2010.

<sup>11</sup> See technical guide at [http://www.axis.com/products/video/about\\_networkvideo/compression\\_formats.htm](http://www.axis.com/products/video/about_networkvideo/compression_formats.htm), accessed Mar. 1, 2010.

Most products use an IP code (international protection rating) to define the protection level<sup>12</sup>. The format of the code is IPXX where “XX” are digits. The first digit is the protection rating against solid objects and the second is the level against moisture. The greater the digit value, the higher the protection level. For example, a camera with IP 66 protection means its enclosure can prevent dust from entering and has the capability withstand water jets from all directions. Some products also use the NEMA (National Electrical Manufacturers Association) standard. For example, NEMA 4 is used to characterize indoor/outdoor enclosure which can protect equipment from dust, rain, snow, hose water, and other hazards.

#### 4.2.2 Parameters Value Selection

To narrow the candidate camera choices for traffic monitoring, we provide parameter choices below. The choices are based on camera specifications for TxDOT transportation surveillance applications.<sup>13</sup> However, in order for the survey to remain relatively comprehensive, our choices are less restrictive than the specifications.

Camera and Lens:

- Imager: 1/4 in. CCD
- Resolution: minimum of 460 horizontal TV lines by 350 vertical TV lines or 640×480 pixels
- Focal Length:  $\geq 70\text{mm}$
- Zoom: optical zoom  $\geq 18\text{X}$ ; digital zoom  $\geq 4\text{X}$
- Angle of View:  $\geq 40^\circ$
- Day/Night function: to permit night surveillance, the camera must have the day/night function and the illumination of the camera must meet this requirement. Different manufacturers use different methods to measure sensitivity in various conditions, and use different processes to measure this parameter. Consequently, it is difficult to compare products simply based on the sensitivity parameter. Nevertheless, we place this parameter in the list as a reference.

Pan and Tilt:

- Angle:  $\geq 90^\circ$  vertical movement,  $\geq 340^\circ$  horizontal movement
- Speed: pan---> $80^\circ/\text{second}$ ; tilt---> $70^\circ/\text{second}$

Environment:

- IP66 / NEMA 4

Operating Temperature of Camera:  $-20^\circ\text{C}$  to  $+50^\circ\text{C}$  ( $-4^\circ\text{F}$  to  $-122^\circ\text{F}$ )

---

<sup>12</sup> See website [http://en.wikipedia.org/wiki/IP\\_Code](http://en.wikipedia.org/wiki/IP_Code), accessed Feb. 24, 2010.

<sup>13</sup> See TxDOT website [http://ftp.dot.state.tx.us/pub/txdot-info/ftw/dfw\\_connector/cda/book2/17-1.pdf](http://ftp.dot.state.tx.us/pub/txdot-info/ftw/dfw_connector/cda/book2/17-1.pdf) and Georgia DOT website <http://www.itsga.org/Knowledgebase/NAV01-050%20%28Rev%207.0%29%20936%2001-26-05.pdf>.

### 4.3 Camera Survey

In the following subsections, we categorize cameras as either analog or network cameras. In each group, cameras are ordered by decreasing price of camera with housing.

Most products here meet the requirements listed above. If not, we indicate it in comments. Prices include camera cost and housing cost (if needed), which are in dollars.

#### 4.3.1 Analog Cameras

Manufacturer: **COHU**  
Product: 3960  
Format: 1/4 in. Sony Ex-View HAD  
Focal Length (mm): 3.4 mm to 119 mm ( $\pm 15\%$ )  
Zoom: 35X optical /12X digital  
Angle of View: 56° to 1.7°  
Resolution: 540 HTVL; 400 VTVL  
Minimum Illumination: (F1.4 @ 50IRE, Progressive Scan Mode) 0.1 fc (1.0 lx) @ 1/60 shutter (color mode); 0.01 fc (0.10 lx) @ 1/4 shutter (color mode); 0.005 fc (0.05 lx) @ 1/2 shutter (color mode); 0.001 fc (0.01 lx) @ 1/4 shutter (mono mode)  
P/T: Pan Range: 360° continuous; Pan Speed: (preset) max 120°/sec (manual) 0.1° to >80°/sec; Tilt Range: -90° to +90°; Tilt Speed: (preset) max 120°/sec(manual)0.1° to >40°/sec  
Compression: N/A  
Temperature: -29.2° to 165°F (-34° to 74°C)  
Protection: Camera IP-67/NEMA-4X/ASTM-B117; Positioner IP-66/NEMA-4X/ASTM-B117  
Camera Cost: 4,845.00  
Housing Cost: 0.00  
Comments: Wiper optional  
Website: <http://www.cohu-cameras.com>

Manufacturer: **COHU**  
Product: 3920  
Format: 1/4 in. Sony Ex-View HAD  
Focal Length (mm): 3.4 mm to 119 mm ( $\pm 15\%$ )  
Zoom: 35X optical/12X digital  
Angle of View: 56° to 1.7°



Resolution: 540 HTVL; 400 VTVL  
Minimum Illumination: (F1.4 @ 50IRE, Progressive Scan Mode) 0.1 fc (1.0 lx) @ 1/60 shutter (color mode); 0.01 fc (0.10 lx) @ 1/4 shutter (color mode); 0.005 fc (0.05 lx) @ 1/2 shutter (color mode); 0.001 fc (0.01 lx) @ 1/4 shutter (mono mode)  
P/T: Pan Range: 360° continuous; Pan Speed: (preset) max 250°/sec (manual) 0.1° to >80°/sec; Tilt Range: -90° to +5°; Tilt Speed: (preset) max 120°/sec (manual) 0.1° to >40°/sec  
Compression: N/A  
Temperature: -29.2° to 131°F (-34° to 55°C)  
Protection: IP-67 / NEMA 4X / ASTM-B117  
Camera Cost: 3,594.00  
Housing Cost: 0.00  
Comments:  
Website: <http://www.cohu-cameras.com>

Manufacturer: **Pelco**  
Product: ESPRIT (ES30C/ES31C)(35X)  
Format: 1/4 in. EXview HAD CCD  
Focal Length (mm): 3.4–119 mm  
Zoom: 35X optical, 12X digital  
Angle of View: 55.8° at 3.4 mm wide zoom; 1.7° at 119 mm telephoto zoom  
Resolution: 35X: >540HTVL  
Minimum Illumination: 0.55 lux at 1/60 sec shutter (color); 0.063 lux at 1/4 sec shutter (color); 0.00018 lux at 1/2 sec shutter (B-W)  
P/T: Pan Range: 360° continuous Speed: 0.1° to 40°/sec (manual) 100°/sec (turbo & preset); Tilt Range: +33° to -83° Speed: 0.1° to 20°/sec (manual) 30°/sec (preset)  
Compression: N/A  
Temperature: -50° to 122°F (-45° to 50°C)  
Protection: NEMA Type 4X and IP66 standards  
Camera Cost: (ES30CBW35-5W) (standard) 2,588.00; (ES31CBW35-5W) (with wiper) 2,728.00  
Housing Cost: 0.00  
Comments: Tilt speed is low; Suggested model: ES30CBW35-5W/ES31CBW35-5W; Analog camera

Website: <http://www.pelco.com>

Manufacturer: **Vicon Industries Inc.**

Product: SVFT-PRS23

Format: Color (Day/Night with Wide Dynamic Range) NTSC/PAL

Focal Length (mm):

Zoom: 23X optical/12X digital

Angle of View:

Resolution: 540 TV lines

Minimum Illumination:

P/T: Pan Range: 360° Speed: 0.1 to 360°/sec; Tilt Range -2.5° to 92.5°

Speed: 0.1 to 150°/sec

Compression:

Temperature: 14° F (-10° C) to 140° F (60° C)

Protection: IP67

Camera Cost: 2,645.00

Housing Cost: 0.00

Comments: Video can be transmitted through coaxial cable; Vicon also provides the option of interface boards for TCP/IP transmission; lowest maintained temperature is just 14° F (-10° C)

Website: <http://www.vicon-cctv.com/>

Manufacturer: **Pelco**

Product: ESPRIT (ES30C/ES31C)(22X)

Format: 1/4 in. EXview HAD CCD

Focal Length (mm): 4–88 mm

Zoom: 22X optical, 10X digital

Angle of View: 47.3° at 4.0 mm wide zoom; 2.2° at 88 mm telephoto zoom

Resolution: >470HTVL (NTSC)

Minimum Illumination: 0.02 lux at 1/2 sec shutter

P/T: Pan Range: 360° continuous Speed: 0.1° to 40°/sec (manual) 100°/sec (turbo & preset); Tilt Range: +33° to -83° Speed: 0.1° to 20°/sec (manual) 30°/sec (preset)

Compression: N/A

Temperature: -50° to 122°F (-45° to 50°C)  
Protection: NEMA Type 4X and IP66 standards  
Camera Cost: (ES30C22-5W) (Standard) 2,357.00 (ES31C22-5W) (With wiper) 2,479.00  
Housing Cost: 0.00  
Comments: Tilt speed is low; Suggested model: ES30C22-5W/ES31C22-5W; Analog camera; Color, LowLight camera  
Website: <http://www.pelco.com>

Manufacturer: **Pelco**  
Product: ESPRIT (ES30C/ES31C)(24X)  
Format: 1/4 in. CCD  
Focal Length (mm): 3.8–91.2 mm  
Zoom: 24X optical, 10X digital  
Angle of View: 50.7° at 3.8 mm wide zoom; 2.3° at 91.2 mm telephoto zoom  
Resolution: >520HTVL  
Minimum Illumination: 0.005 lux at 1/2 sec shutter (color); 0.015 lux at 1/60 sec shutter (B-W); 0.0005 lux at 1/2 sec shutter (B-W)  
P/T: Pan Range: 360° continuous Speed: 0.1° to 40°/sec (manual) 100°/sec (turbo & preset); Tilt Range: +33° to –83° Speed: 0.1° to 20°/sec (manual) 30°/sec (preset)

Compression: N/A  
Temperature: -50° to 122°F (-45° to 50°C)  
Protection: NEMA Type 4X and IP66 standards  
Camera Cost: (ES30CBW24-5W) (Standard) 2,251.00 (ES31CBW24-5W) (With wiper) 2,373.00  
Housing Cost: 0.00  
Comments: Tilt speed is low; Suggested model: ES30CBW24-5W/ES31CBW24-5W; Analog camera  
Website: <http://www.pelco.com>

Manufacturer: **Pelco**  
Product: Spectra IV SE(35X)  
Format: 1/4 in. EXview HAD  
Focal Length (mm): 3.4–119 mm

Zoom: 35X optical, 12X digital  
Angle of View: 55.8° at 3.4 mm wide zoom; 1.7° at 119 mm telephoto zoom  
Resolution: >540 HTVL  
Minimum Illumination: Maximum Sensitivity at 35 IRE NTSC/EIA 0.55 lux at 1/60 sec (color); 0.018 lux at 1/2 sec (color); 0.00018 lux at 1/2 sec (B-W)  
P/T: Pan Range:360° continuous, Speed: 0.1° to 80°/sec (manual), 150°/sec (Turbo), 400°/sec (preset); Tilt Range: +2° to -92° Speed: 0.1° to 40°/sec (manual),200°/sec(preset)  
Compression: N/A  
Temperature: -50°F (-45°C) to 122°F (50°C) for outdoor model  
Protection: Meets NEMA Type 4X, IP66  
Camera Cost: 2,254.00  
Housing Cost: 0.00  
Comments: Suggested model: (35X) SD435-PG-E0/SD435-PG-E1; Analog camera  
Website: <http://www.pelco.com>

Manufacturer: **Pelco**  
Product: Spectra IV SE (27X)  
Format: 1/4 in. EXview HAD  
Focal Length (mm): 3.4–91.8 mm  
Zoom: 27X optical, 12X digital  
Angle of View: 55.8° at 3.4 mm wide zoom; 2.3° at 91.8 mm telephoto zoom  
Resolution: >540 HTVL  
Minimum Illumination: Maximum Sensitivity at 35 IRE NTSC/EIA 0.55 lux at 1/60 sec (color); 0.018 lux at 1/2 sec (color); 0.00018 lux at 1/2 sec (B-W)  
P/T: Pan Range: 360° continuous, Speed: 0.1° to 80°/sec (manual), 150°/sec (Turbo), 400°/sec (preset); Tilt Range: +2° to -92° Speed: 0.1° to 40°/sec (manual), 200°/sec(preset)  
Compression: N/A  
Temperature: -50°F (-45°C) to 122°F (50°C) for outdoor model  
Protection: Meets NEMA Type 4X, IP66  
Camera Cost: 1,836.00  
Housing Cost: 0.00  
Comments: Suggested model: SD427-PG-E0/SD427-PG-E1; Analog camera

Website: <http://www.pelco.com>

Manufacturer: **Elmo**

Product: ESD-380DR PTZ Camera

Format: Progressive 1/4 in. CCD

Focal Length (mm): 3.6–82.8 mm

Zoom: 23X optical/1x–12x variable

Angle of View:

Resolution: NTSC: 480 TV lines

Minimum Illumination: 0.01 lux, 0 lux (IR illuminator)

P/T: Pan: 360° endless; Tilt:-10° to 190°; P&T Preset Speed: 5° to 400°/sec; P&T Manual Speed: 1° to 90°/sec

Compression: N/A

Temperature: -30°C to 45°C (-22°F to 113°F)

Protection: IP66

Camera Cost: 1,595.00

Housing Cost: 0.00

Comments: Controller Interface: RS-485

Website: <http://www.elmoussa.com>

Manufacturer: **Pelco**

Product: Pelco Spectra IV SL

Format: 1/4 in. progressive scan CCD

Focal Length (mm): 3.6–82.8 mm (f1.6)

Zoom: 23X optical, 12X digital

Angle of View: 54° at 3.6 mm wide zoom; 2.5° at 82.8 mm telephoto zoom

Resolution: 540 HTVL

Minimum Illumination: Maximum Sensitivity at 35 IRE NTSC/EIA: 0.65 lux at 1/60 sec (color), 0.15 lux at 1/60 sec (B-W)

P/T: Pan Range: 360° continuous, Speed: 0.1° to 80°/sec (manual), 400°/sec(preset); Tilt Range: +2° to -92° Speed 0.1° to 40°/sec (manual), 200°/sec(preset)

Compression: N/A

Temperature: -50°F (-45°C) to 122°F (50°C) for outdoor model

Protection: NEMA Type 4X, IP66  
Camera Cost: 1,178.00  
Housing Cost: 0.00  
Comments: Suggested model: SD423-PG-E0/ SD423-PG-E1; Analog camera  
Website: <http://www.pelco.com>

Manufacturer: **Iteris**  
Product: Vantage RZ4  
Format: CCD  
Focal Length (mm):  
Zoom:  
Angle of View: 5.4° wide to 50.7° wide  
Resolution: 470 TV lines  
Minimum Illumination: 0.1lux  
P/T: N/A  
Compression: N/A  
Temperature: -31° F to +140° F (-35° C to +60° C)  
Protection: IP67  
Camera Cost: 1,000.00  
Housing Cost: 0.00  
Comments: No PTZ functions; Analog camera  
Website: <http://www.iteris.com/>

#### **4.3.2 Network Camera**

Manufacturer: **COHU**  
Product: 3980  
Format: 1/4 in. Sony Ex-View HAD  
Focal Length (mm): 3.4 mm to 119 mm (±15%)  
Zoom: 35X optical and 12X digital  
Angle of View: 56° to 1.7° (±15%)  
Resolution: Camera Resolution: Typical 540 HTVL, 400 VTVL; Video Resolution: 640 x 480 (VGA), 640 x 240 (2CIF), 320 x 240 (CIF)

Minimum Illumination: (F1.4 @ 50IRE, Progressive Scan Mode) 0.1 fc (1.0 lx) @ 1/60 shutter (color mode); 0.01 fc (0.10 lx) @ 1/4 shutter (color mode); 0.005 fc (0.05 lx) @ 1/2 shutter (color mode); 0.001 fc (0.01 lx) @ 1/4 shutter (mono mode)

P/T: Pan Range: 360° continuous; Pan Speed: max 120°/sec (preset) 0.1° to >80°/sec (manual); Tilt Range: -90° to +90°; Tilt Speed max 120°/sec: ( preset) 0.1° to >40°/sec(manual)

Compression: MPEG 4

Temperature: Standard: -29.2° to 131°F (-34° to 55°C)

Protection: Camera: IP-67/NEMA-4X/ASTM-B117; Positioner: IP-66/NEMA-4X/ASTM-B117

Camera Cost: 6,770.00

Housing Cost: 0.00

Comments: IP camera

Website: <http://www.cohu-cameras.com>

Manufacturer: **COHU**

Product: 3960HD

Format: Ex-View ICX445AKA Progressive Scan

Focal Length (mm): 4.7 mm to 86.4 mm

Zoom: 18X optical zoom

Angle of View: 54° to 3.25

Resolution: Sensor Effective Resolution: 1280(H) x 720(V); Image Resolution: 720p, D1, VGA, CIF

Minimum Illumination: 1.7 Lux (0.17 fc) @ 1/60 shutter, color; 0.1 Lux (0.01 fc) @ 1/60 shutter, mono

P/T: Pan Range: 360° continuous; Pan Speed: max 120°/sec(preset) 0.1° to 80°/sec(manual); Tilt Range: -90° to +90°; Tilt Speed: max 120°/sec(preset) 0.1° to 40°/sec(manual)

Compression: H.264 & MJPEG

Temperature: -29.2° to 165°F (-34° to 74°C)

Protection: Camera IP-67/NEMA-4X/ASTM-B117; Positioner IP-66/NEMA-4X/ASTM-B117

Camera Cost: -6,500.00

Housing Cost: 0.00

Comments: New product, available soon; IP camera

Website: <http://www.cohu-cameras.com>

Manufacturer: **COHU**  
Product: 3940  
Format: 1/4 in. Sony Ex-View HAD  
Focal Length (mm): 3.4 mm to 119 mm ( $\pm 15\%$ )  
Zoom: 35X optical and 12X digital  
Angle of View:  $56^\circ$  to  $1.7^\circ$  ( $\pm 15\%$ )  
Resolution: Camera Resolution: Typical 540 HTVL, 400 VTVL; Video Resolution: 640 x 480 (VGA), 640 x 240 (2CIF), 320 x 240 (CIF)  
Minimum Illumination: (F1.4 @ 50IRE, Progressive Scan Mode) 0.1 fc (1.0 lx) @ 1/60 shutter (color mode); 0.01 fc (0.10 lx) @ 1/4 shutter (color mode); 0.005 fc (0.05 lx) @ 1/2 shutter (color mode); 0.001 fc (0.01 lx) @ 1/4 shutter (mono mode)  
P/T: Pan Range:  $360^\circ$  continuous; Pan Speed: max  $250^\circ/\text{sec}$  (preset)  $0.1^\circ$  to  $>80^\circ/\text{sec}$  (manual); Tilt Range:  $-90^\circ$  to  $+5^\circ$ ; Tilt Speed : max  $120^\circ/\text{sec}$ (preset)  $0.1^\circ$  to  $>40^\circ/\text{sec}$ (manual)  
Compression: MPEG 4  
Temperature:  $-29.2$  to  $122^\circ$  F ( $-34$  to  $50^\circ$  C)  
Protection: IP-67 / NEMA 4X / ASTM-B117  
Camera Cost: 5,180.00  
Housing Cost: 0.00  
Comments: IP camera  
Website: <http://www.cohu-cameras.com>

Manufacturer: **Indigo Vision**  
Product: 9000 PTZ IP Dome Camera (36X)  
Format: 1/4 in. Sony ExView HAD  
Focal Length (mm): 3.4 mm to 122.4 mm, F1.6 to F4.5  
Zoom: 36x optical; 12x digital  
Angle of View:  $1.7^\circ$  to  $57.8^\circ$   
Resolution: Camera resolution:  $>540$  TVL; Video resolution: 704X480  
Minimum Illumination: (NTSC, F1.6, 50 IRE): 0.1 lx at 1/4 sec (color); 0.01 lx at 1/4 sec (mono)  
P/T: Pan Range:  $360^\circ$  continuous; Tilt Range:  $-2^\circ$  to  $+90^\circ$ ; P&T Speed:  $0.001^\circ/\text{s}$  to  $360^\circ/\text{s}$ ; Preset move speed:  $200^\circ/\text{s}$   
Compression: Full frame rate H.264  
Temperature:  $-4^\circ$  to  $122^\circ$ F ( $-20^\circ$  to  $50^\circ$ C)



Protection: IP67  
Camera Cost: 3,576.00  
Housing Cost: 0.00  
Comments: IP camera  
Website: <http://www.indigovision.com>

Manufacturer: **Indigo Vision**  
Product: 9000 PTZ IP Dome Camera (35X)  
Format: 1/4 in. Sony ExView HAD  
Focal Length (mm): 3.4 mm to 119 mm, F1.4 to F4.2  
Zoom: 35x optical; 12x digital  
Angle of View: 1.7° to 55.8°  
Resolution: Camera resolution: >540 TVL; Video resolution: 704X480  
Minimum Illumination: Interlace mode, NTSC, F1.4, 35 IRE: 0.05 lx at 1/4s (color); 0.01 lx at 1/4s (mono). Progressive mode, figures are doubled  
P/T: Pan Range: 360° continuous; Tilt Range: -2° to +90°; P&T Speed: 0.001°/s to 360°/s; Preset move speed: 200°/s  
Compression: Full frame rate H.264  
Temperature: -4° to 122°F (-20° to 50°C)  
Protection: IP67  
Camera Cost: 3,576.00  
Housing Cost: 0.00  
Comments: IP camera  
Website: <http://www.indigovision.com>

Manufacturer: **Indigo Vision**  
Product: 9000 PTZ IP Dome Camera (18X)  
Format: 1/4 in. Sony ExView HAD  
Focal Length (mm): 4.1 mm to 73.8 mm, F1.4 to F3.0  
Zoom: 18x optical; 12x digital  
Angle of View: 2.8° to 48°  
Resolution: Camera resolution: >540 TVL; Video resolution: 704X480

Minimum Illumination: NTSC, F1.4, 50 IRE: 0.07 lx at 1/4 sec (color); 0.01 lx at 1/4 sec (mono)

P/T: Pan Range: 360° continuous; Tilt Range: -2° to +90°; P&T Speed: 0.001°/s to 360°/s; Preset move speed: 200°/s

Compression: Full frame rate H.264

Temperature: -4° to 122°F (-20° to 50°C)

Protection: IP67

Camera Cost: 3,386.00

Housing Cost: 0.00

Comments: IP camera

Website: <http://www.indigovision.com>

Manufacturer: **JVC**

Product: VN-V686WPBU

Format: 1/4 in. IT CCD

Focal Length (mm): 3.43 mm to 122 mm

Zoom: 36x optical/32x digital

Angle of View:

Resolution: 640x480, 320x240

Minimum Illumination: Color: 1.0 lx (50%, AGC SUPER) 0.5 lx (25%, AGC SUPER); B&W: 0.08 lx (50%, AGC SUPER) 0.04 lx (25%, AGC SUPER)

P/T: Pan: 360° endless; Tilt: -5° to 185°; Pan/Tilt speed: 0.04° to 400°/sec

Compression: MJPEG & MPEG-4

Temperature: -40°C to 50°C /14°F to 122°F

Protection: IP66

Camera Cost: 3,299.00

Housing Cost: 0.00

Comments: Outdoor IP camera; POE

Website: <http://pro.jvc.com>

Manufacturer: **Axis**

Product: Q6032-E

Format: 1/4 in. ExView HAD Progressive Scan CCD

Focal Length (mm): 3.4–119 mm  
Zoom: 35x optical/12x digital  
Angle of View: 1.7°–55.8°  
Resolution: 704x480 to 176x120  
Minimum Illumination: Color: 0.5 lux at 30 IRE; B/W: 0.008 lux at 30 IRE  
P/T: Pan: 360° endless; Tilt: 220°; P&T Speed 0.05 – 450°/s  
Compression: H.264/MJPEG  
Temperature: -40 °C to 50 °C (-40 °F to 122 °F)  
Protection: IP66  
Camera Cost: 2,992.00  
Housing Cost: 0.00  
Comments: Network camera; High Power over Ethernet; H.264 compression  
Website: <http://www.axis.com>

Manufacturer: **Axis**  
Product: 233D  
Format: 1/4 in. ExView HAD Progressive scan CCD  
Focal Length (mm): 3.4–119 mm, F1.4–4.2  
Zoom: 35x optical/12x digital  
Angle of View: 1.73°–55.8°  
Resolution: 704x480 - 176x120  
Minimum Illumination: Color: 0.5 lux at 30 IRE; B/W: 0.008 lux at 30 IRE  
P/T: Pan Range: 360° endless; Tilt Range 180°; P&T Speed: 0.05 – 450°/s  
Compression: MPEG-4, MJPEG  
Temperature: -5 to -45 °C; with housing can work at -40 to 50 °C (-40 to 122 °F)  
Protection: Can work with IP66 housing  
Camera Cost: 2,336.00  
Housing Cost: model 25733: 608.00  
Comments: Network camera; Need housing for outdoor usage  
Website: <http://www.axis.com>

Manufacturer: **Bosch**  
Product: AutoDome 300 Series (36x)  
Format: 1/4 in. Exview HAD CCD  
Focal Length (mm): 3.4–122.4 mm  
Zoom: 36x optical/12x digital  
Angle of View: 1.7° to 57.8°  
Resolution: 540 HTVL  
Minimum Illumination: Day -- SensUp Off: 0.66 lx at 30IRE SensUp On(15x): 0.033 lx at 30IRE; Night -- SensUp Off: 0.166 lx at 30IRE SensUp On(15x): 0.0065 lx at 30IRE  
P/T: Pan Range: 360° continuous Pan Preposition Speed:360°/sec; Tilt Range:18° above horizon; Tilt Preposition Speed: 100°/s; P&T manual Speed: 0.1°/s-120°/s  
Compression: IP operation (MPEG-4)  
Temperature: -40°C to 50°C (-40°F to 122°F)  
Protection: IP66  
Camera Cost: 2,797.00  
Housing Cost: 0.00  
Comments: Optional hybrid analog/IP operation; Suggested modle:VG4-324-ECE1P  
Website: <http://www.boschsecurity.us/en-us/>

Manufacturer: **American Dynamics**  
Product: VideoEdge IP SpeedDome(ADVEIPSD35N)  
Format: Interline transfer 1/4 in. CCD array  
Focal Length (mm): 3.4 to 119 mm  
Zoom: 35x optical/12x digital  
Angle of View: 55.8 (H)  
Resolution: Camera resolution 540HTVL; Video resolution 320 x 240 to 704 x 480 (NTSC)  
Minimum Illumination: 0.24 lux (Color); 0.028 lux (Color with 1/4 sec open shutter);0.021 lux (B/W IR Mode);0.00041 lux (B/W IR Mode with 1/2 sec open shutter)  
P/T: Pan: 360° continuous; tilt: 110°; P&T manual speed: 0.25°–100°/sec; Pan preset speed: 360°/sec; T preset speed:220/sec

Compression: H.264, MJPEG, MPEG-4 and Active Content Compression (ACC) technology  
Temperature: -10°C to 50°C (14°F to 122°F); with environmental housing: -40°C to 50°C (-40°F to 122°F)  
Protection: Can work with NEMA 4, IP66 housing  
Camera Cost: 2,216.00  
Housing Cost: ADVESDHOC (pendant, clear)/ADVESDHOS (pendant, smoke): 565.00  
Comments: IP camera; PoE; Supports H.264, MJPEG, MPEG-4 and Active Content Compression (ACC) technology; need to order housing separately  
Website: <http://americandynamics.net>

Manufacturer: **Panasonic**  
Product: WV-NW964  
Format: 1/4-type interline transfer CCD  
Focal Length (mm): 3.8 mm–114 mm  
Zoom: 30x optical/ 10x digital  
Angle of View: H: 1.9°–52.0°, V: 1.4°–40.0°  
Resolution: VGA (640 x 480) / QVGA (320 x 240)  
Minimum Illumination: Color (30IRE): 0.5 lux (Sens up: OFF), 0.02 lux (Sens up: 32x) at F1.4; B/W (10IRE): 0.04 lux (Sens up: OFF), 0.0013 lux (Sens up: 32x) at F1.4  
P/T: Panning: 360° endless, 0.065°/s–120°/s (manual), 400°/s (preset); tilting: -5°–185°, 0.065°/s–120°/s (manual), 400°/s (preset)  
Compression: MPEG-4 and JPEG dual streaming  
Temperature: -40 °C–+50 °C (-40 °F–122 °F) (Heater ON)  
Protection: IP66  
Camera Cost: 2,741.00  
Housing Cost: 0.00  
Comments:  
Website: <http://www.panasonic.com/>

Manufacturer: **Axis**  
Product: 232D+  
Format: 1/4 in. Exview HAD CCD

Focal Length (mm): 4.1 mm to 73.8 mm (F1. 4–3.0)  
 Zoom: 18x optical/12x digital  
 Angle of View: 2.8°–48°  
 Resolution: 160x120 to 704x576  
 Minimum Illumination: Color: 0.3 lux at 30IRE; B/W: 0.005 lux at 30IRE  
 P/T: Pan Range: 360° endless; Tilt Range: 0°-90° (± 3°) P&T Speed: 360°/sec  
 Compression: MPEG-4, MJPEG  
 Temperature: 50–50 °C (410–122 °F); with housing can work at -20 to 50 °C (-4 to 122 °F)  
 Protection: Can work with IP66 housing  
 Camera Cost: 1,870.00  
 Housing Cost: model 25733: 608.00  
 Comments: Network camera; Need housing for outdoor usage  
 Website: <http://www.axis.com>

**Manufacturer: Bosch**  
**Product: AutoDome 300 Series (26x)**  
**Format: 1/4 in. Exview HAD CCD**  
**Focal Length (mm): 3.5–91.0 mm**  
**Zoom: 26x optical/12x digital**  
**Angle of View: 2.3° to 55°**  
**Resolution: 470 HTVL**  
**Minimum Illumination: Day -- SensUp Off: 0.5 lx at 30IRE SensUp On(15x): 0.0052 lx at 30IRE; Night -- SensUp Off: 0.10 lx at 30IRE SensUp On(15x): 0.0013 lx at 30IRE**  
**P/T: Pan Range: 360° continuous Pan Preposition Speed:360°/sec; Tilt Range:18° above horizon; Tilt Preposition Speed: 100°/s; P&T manual Speed: 0.1°/s-120°/s**  
**Compression: IP operation (MPEG-4)**  
**Temperature: -40°C to 50°C (-40°F to 122°F)**  
**Protection: IP66**  
**Camera Cost: 2,466.00**  
**Housing Cost: 0.00**

Comments: Optional hybrid analog/IP operation; Suggested model: VG4-323-ECE1P

Website: <http://www.boschsecurity.us/en-us/>

Manufacturer: **Bosch**

Product: AutoDome 300 Series (18x)

Format: 1/4 in. Exview HAD CCD

Focal Length (mm): 4.1–73.8 mm, F1.4 to F3.0

Zoom: 18x optical/12x digital

Angle of View: 2.7° to 48°

Resolution: 470 HTVL

Minimum Illumination: Day -- SensUp Off: 0.4 lx at 30IRE SensUp On(15x): 0.0041 lx at 30IRE; Night -- SensUp Off: 0.05 lx at 30IRE SensUp On(15x): 0.0007 lx at 30IRE

P/T: Pan Range: 360° continuous Pan Preposition Speed: 360°/sec;  
Tilt Range: 18° above horizon; Tilt Preposition Speed: 100°/s; P&T manual Speed: 0.1°/s-120°/s

Compression: IP operation (MPEG-4)

Temperature: -40°C to 50°C (-40°F to 122°F)

Protection: IP66

Camera Cost: 2,372.00

Housing Cost: 0.00

Comments: Optional hybrid analog/IP operation; Suggested model: VG4-322-ECE1P

Website: <http://www.boschsecurity.us/en-us/>

Manufacturer: **CP Technologies**

Product: FCS-4200(Level One)

Format: 1/4 in. Exview HAD CCD

Focal Length (mm): 3.4–122.4 mm/F1.6–4.5

Zoom: 36x optical/12x digital

Angle of View: 57.8°–1.7°

Resolution: 704x480 pixels at 30 fps (NTSC)

Minimum Illumination: 1.4Lux/F1.6 Color; 0.01Lux/F1.6 Monochrome

P/T: Pan range: 360° continuous Pan Speed: 0.1–240°/Sec; Tilt range: 0°–90° Manual Tilt Speed 0.1–120°/Sec; P&T preset speed: 240°/Sec

Compression: MPEG-4/MJPEG

Temperature: -20°C–50°C

Protection: Indoor/Outdoor use; IP66 water-proof

Camera Cost: 2,235.00

Housing Cost: 0.00

Comments: Work with POS-4001 outdoor High Power PoE Splitter (12V)

Website: <http://www.cptechusa.com>

Manufacturer: **Inscape Data**

Product: NVC3000 (NVC3026)

Format: 1/4 in. Sony Exview HAD CCD

Focal Length (mm): 3.5–91.0 mm

Zoom: Optical 26X; Digital 12X

Angle of View: 80° to 4°

Resolution: D1(704x480), CIF (352x240), QCIF (176 x 144) Max 704 x 480 (NTSC)

Minimum Illumination: Normal mode: 0.7Lux (50IRE); Night (B/W) Mode: 0.01Lux (ICR On)

P/T: Pan Range: 360° Endless, Manual Speed: 100°–200°/sec, Preset Speed: Max 350° /sec; Tilt range: 0°–90°, Manual Speed 100°–200°/sec, Preset Speed Max 250° /sec

Compression: JPEG & MPEG-4

Temperature: -40°C–60°C (-40°F–140°F)

Protection: IP66

Camera Cost: 2,157.25

Housing Cost: 0.00

Comments: Simultaneous IP and CCTV Video

Website: <http://www.inscapedata.com>

Manufacturer: **CP Technologies**

Product: FCS-4100(Level One)

Format: 1/4 in. Exview HAD CCD



Focal Length (mm): 3.5–91 mm/F1.6–3.8  
Zoom: 26x optical/12x digital  
Angle of View: 54.2° –2.2°  
Resolution: 704x480 pixels at 30 fps (NTSC)  
Minimum Illumination: 1.0Lux/F1.6 Color; 0.01Lux/F1.6 Monochrome  
P/T: Pan range: 360° continuous Pan Speed: 0.1–240°/Sec; Tilt range: 0°–90° Manual Tilt Speed 0.1–120°/Sec; P&T preset speed: 240°/Sec  
Compression: MPEG-4/MJPEG  
Temperature: -20°C–50°C  
Protection: Indoor/Outdoor use; IP66 water-proof  
Camera Cost: 2,026.00  
Housing Cost: 0.00  
Comments: Work with POS-4001 outdoor High Power PoE Splitter (12V)  
Website: <http://www.cptechusa.com>

Manufacturer: **Sony**  
Product: SNC-RZ50N  
Format: 1/4-type Super HAD CCD  
Focal Length (mm): f=3.5 to 91.0 mm  
Zoom: 26x optical, 12x digital  
Angle of View: 1.7 °to 42.0°  
Resolution: 640 x 480; 320 x 240; 160 x 120 (JPEG/MPEG-4/H.264)  
Minimum Illumination: Color: 2.2 lx (50IRE F1.6 AGC ON); B/W: 0.3 lx (50IRE)  
P/T: Pan: -170° to +170° speed 300°/s; Tilt: -90° to +25° speed 300°/s  
Compression: JPEG/MPEG-4 Dual, H.264  
Temperature: 32 °F to 104 °F (0 °C to 40 °C)  
Protection:  
Camera Cost: 1,148.00  
Housing Cost: UNIONS7C1/UNIONS7T1 (pendant mount, clear/tinted):424.00,  
UNIOPS7C1/UNIOPS7T1(pressurized, pendant mount, clear/tinted): 875.00,  
UNIOR7C1/UNIOR7T1(Vandal resistant, pendant mount, clear/tinted): 539.00  
Comments: IP camera; Indoor camera; Need housing for outdoor usage  
Website: <http://pro.sony.com/bbsc/home.do>

Manufacturer: **Vivotek**  
Product: SD7313  
Format: SONY 1/4 in. EXview HAD CCD sensor in D1 resolution  
Focal Length (mm):  $f = 3.4\text{--}119$  mm  
Zoom: 35x optical  
Angle of View:  $1.7^\circ\text{--}55.8^\circ$   
Resolution: 704x480  
Minimum Illumination: 0.05 Lux / F1.4 (Color), 0.01 Lux / F1.4 (B/W)  
P/T: Pan range:  $360^\circ$  continuous Pan Speed:  $0.1^\circ\text{--}300^\circ/\text{sec}$ ; Tilt range:  $0^\circ\text{--}90^\circ$  Tilt Speed  $0.1^\circ\text{--}120^\circ/\text{sec}$   
Compression: MJPEG & MPEG-4  
Temperature:  $-20\text{--}60$  °C ( $-4\text{--}140$  °F)  
Protection: IP66  
Camera Cost: 2,011.00  
Housing Cost: 0.00  
Comments:  
Website: <http://www.vivotek.com>

Manufacturer: **Axis**  
Product: 213 PTZ  
Format: 1/4" Interlaced CCD  
Focal Length (mm): 3.5–91 mm, F1.6– F4.0  
Zoom: 26x optical/12x digital  
Angle of View:  $1.7^\circ\text{--}47^\circ$   
Resolution: 160x90 to 704x576  
Minimum Illumination: Color mode: 1 lux, F1.6; IR mode: 0.1 lux, F1.6; using built-in IR light in complete darkness up to 3 m (9.8ft)  
P/T: Pan Range:  $\pm 170^\circ$  Speed:  $10\text{--}90^\circ/\text{sec}$ ; Tilt Range:  $-10^\circ$  to  $+90^\circ$  Speed:  $1\text{--}70^\circ/\text{sec}$   
Compression: MPEG-4, MJPEG  
Temperature:  $50\text{--}40$  °C ( $410\text{--}104^\circ\text{F}$ ); with housing can work at  $-40$  to  $38$  °C ( $-40$  to  $100$  °F)  
Protection: Can work with IP66 housing

Camera Cost: 1,402.00  
Housing Cost: Model 25733: 608.00  
Comments: Network camera; Need housing for outdoor usage  
Website: <http://www.axis.com>

Manufacturer: **SAMSUNG Electronics**  
Product: SNC-C7478  
Format: 1/4 in. Ex-View HAD Progressive Scan CCD  
Focal Length (mm): 3.4–122.4 mm  
Zoom: 36x Optical, 12x Digital  
Angle of View: 57.8°(H) x 43.35°(V)  
Resolution: Camera resolution (Color) 540HTVL (B/W) 570. Video resolution D1: 720x480; VGA 640x480; CIF NTSC: 352x240  
Minimum Illumination: Color: 0.84Lux with Sens-up off at 30IRE, 0.0131Lux with 64 times Sens-up at 30IRE; B/W: 0.09Lux with Sens-up off at 30IRE, 0.0014Lux with 64 times Sens-up at 30IRE;  
P/T: Pan: 0°–360° (Endless); Tilt: 180°; P&T Speed: 0.05°–360°/s (manual), 360°/s (preset)  
Compression: MPEG-4 & MJPEG Dual  
Temperature: -49°F–+122°F / -45°C–+50°C  
Protection: Vandal Proof/ Weather Proof  
Camera Cost: 1,943.00  
Housing Cost: 0.00  
Comments:  
Website: <http://www.samsung-security.com>

Manufacturer: **ACTi**  
Product: CAM-6610  
Format: 1/4 in. EXviewHAD CCD  
Focal Length (mm): 4.1–73.8 mm  
Zoom: 18x optical/X1–X12 variable digital  
Angle of View: 48°–2.8°  
Resolution: Horizontal: 530 TVL

Minimum Illumination: 0.1 Lux (F1.4, 1/4s (NTSC) or 1/3s (PAL)); 0.01 Lux (F1.4, 1/1s (NTSC) or 1/1s (PAL), IR ON)  
P/T: Pan: 360° Continuous; Tilt: -10°–100° (190° in Image Flip mode); preset P&T speed 5°–400°/sec; manual P&T speed 1°–90°/sec  
Compression: MPEG-4 ASP compliant  
Temperature: -45 °C–50 °C (-49 °F–122 °F)  
Protection: IP66  
Camera Cost: 1,905.00  
Housing Cost: 0.00  
Comments: CAM-6600 Series also have 23X and 35X models  
Website: <http://www.acti.com>

Manufacturer: **Canon**  
Product: VB-C60  
Format: 1/4 in. Progressive Scan CCD  
Focal Length (mm): 3.4–136.0 mm  
Zoom: 40x Optical/4X Digital  
Angle of View: 55.8° (W)–1.5 (T)  
Resolution: 640 x 480, 320 x 240, 160 x 120  
Minimum Illumination: (Normal use) Day mode: 0.7lux (F1.6, color, 1/30 sec.); Night mode: 0.2lux (F1.6, monochrome, 1/30 sec.)  
P/T: pan: 340° (±170°); tilt: 115°; P&T speed: 150°/sec  
Compression: JPEG /MJPEG/ MPEG-4  
Temperature: -10–50°  
Protection: Can work with IP66 or IPX4 (selectable) housing  
Camera Cost: 1,456.00  
Housing Cost: A-ODW5C (wall mount, clear, 5 in.): 326.00, A-ODW5CS (wall mount, clear, sunshield 5 in.):411.00  
Comments: Indoor model, need housing for outdoor usage  
Website: <http://www.usa.canon.com>

Manufacturer: **CP Technologies**  
Product: FCS-4000 (Level One)  
Format: 1/4 in. Exview HAD CCD

Focal Length (mm): 4.0–72 mm/F1.4–3.0  
Zoom: 18x optical/12x digital  
Angle of View: 48°–2.8°  
Resolution: 704x480 pixels at 30 fps (NTSC)  
Minimum Illumination: 0.7 Lux/F1.4 Color; 0.01Lux/F1.4 Monochrome  
P/T: Pan range: 360° continuous Pan Speed: 0.1–240°/Sec; Tilt range: 0°–90° Manual Tilt Speed 0.1–120°/Sec; P&T preset speed: 240°/Sec  
Compression: MPEG-4/MJPEG  
Temperature: -20°C–50°C  
Protection: Indoor/Outdoor use; IP66 water-proof  
Camera Cost: 1,852.00  
Housing Cost: 0.00  
Comments: Work with POS-4001 outdoor High Power PoE Splitter (12V)  
Website: <http://www.cptechusa.com>

Manufacturer: **Axis**  
Product: 214 PTZ  
Format: 1/4 in. ExView HAD CCD  
Focal Length (mm): 4.1–73.8 mm, F1.3–3.0  
Zoom: 18x optical/12x digital  
Angle of View: 2.7°–48°  
Resolution: 160x120 to 704x576  
Minimum Illumination: Color mode: 0.3 lux at F1.4, 30IRE; Black/white mode: 0.005 lux at F1.4, 30IRE  
P/T: Pan Range: ±170° Speed: 100°/sec; Tilt Range: -30° to +90°  
Speed: 90°/sec  
Compression: MPEG-4, MJPEG  
Temperature: 00–45 °C (320–113 °F); with housing can work at -40 to 38 °C (-40 to 100 °F)  
Protection: Can work with IP66 housing  
Camera Cost: 1,215.00  
Housing Cost: Model 25733: 608.00  
Comments: Network camera; Need housing for outdoor usage  
Website: <http://www.axis.com>

**Manufacturer:** Canon  
**Product:** VB-C50iR  
**Format:** 1/4 in. CCD (primary color filter)  
**Focal Length (mm):** 3.5 mm to 91.0 mm  
**Zoom:** 26x Optical/12x Digital  
**Angle of View:**  
**Resolution:** 160 x 120, 320 x 240, 640 x 480  
**Minimum Illumination:** Normal mode: 1 Lux (at 1/30 sec.); Night Mode: 0 lux  
**P/T:** Pan: 340 degrees; Tilt: 120 degrees  
**Compression:** JPEG & MJPEG  
**Temperature:** 00–40°C  
**Protection:** Can work with IP66 or IPX4 (selectable) housing  
**Camera Cost:** 1,333.00  
**Housing Cost:** A-ODW5C (wall mount, clear, 5 in.): 326.00, A-ODW5CS (wall mount, clear, sunshield 5 in.): 411.00  
**Comments:** Indoor model, need housing for outdoor usage  
**Website:** <http://www.usa.canon.com>

**Manufacturer:** PiXORD  
**Product:** P-463  
**Format:** ExView HAD CCD, 1/4 in. Interline Transfer CCD  
**Focal Length (mm):** 3.8–95 mm  
**Zoom:** 25X optical, no digital zoom  
**Angle of View:** Wide: 39.2° (V) 51.9° (H)  
**Resolution:** Full D1 (4SIF): 720 x 480; SIF: 352 x 240; QSIF: 176 x 112;  
**Minimum Illumination:** Mono: 0.01 Lux at F1.6; Color: 0.1 Lux at F1.6  
**P/T:** Pan: 360° Continuous; Tilt: -5°–+95°; preset P&T speed: 1°/s–255°/s; manual P&T speed: 0.18°–180° / sec  
**Compression:** MPEG-4 Simple Profile (SP) / MJPEG, Dual codec  
**Temperature:** -10°C–+50°C (14–122 °F)  
**Protection:**  
**Camera Cost:** 1,472.00  
**Housing Cost:** P-2652(IP68, wall mount): 239.00

Comments: No digital zoom declared; Dome camera, need housing  
Website: <http://www.pixord.com>

Manufacturer: **Panasonic**  
Product: WV-NS202A  
Format: 1/4-type interline transfer CCD  
Focal Length (mm): 3.79 mm–83.4 mm  
Zoom: 22X optical/10X digital  
Angle of View: H: 2.6°–51.7°, V: 2.0°–39.9°  
Resolution: VGA (640x480) / QVGA(320x240)  
Minimum Illumination: Color (30 IRE): 0.7 lux (Sens up: OFF), 0.02 lux (Sens up: 32x) at F1.6; B/W (10 IRE): 0.5 lux (Sens up: OFF), 0.015 lux (Sens up: 32x) at F1.6  
P/T: Panning: 0°–350°, 1°/s–100°/s(manual), 300°/s (preset); tilting: –30°–90°, 1°/s–100°/s(manual), 100°/s (preset)  
Compression: MPEG-4/JPEG  
Temperature: –10 °C–+50 °C (14 °F–122 °F)  
Protection: Indoor model  
Camera Cost: 978.00  
Housing Cost: PODV7CWNS(Outdoor Vandal Resistant, clear, wall mount) 551.00  
Comments: Simple Day-Night function (No IR cut filter moving); Indoor model  
Website: <http://www.panasonic.com/>

Manufacturer: **PiXORD**  
Product: P-465  
Format: 1/4 in. Interline Transfer CCD  
Focal Length (mm): 3.6 mm–126 mm  
Zoom: 35x optical  
Angle-of-View: Wide: 41.6°(V) 53.8°(H)  
Resolution: Full D1 (4SIF): 720 x 480; SIF: 352 x 240; QSIF: 176 x 112;  
Minimum Illumination: Color: 0.1 Lux at F1.6; Mono: 0.01 Lux at F1.6  
P/T: Pan: 360° Continuous; Tilt: –6°–+96°; preset P&T speed: 1°/s–255°/s; manual P&T speed: 0.15°/s–120°/s

Compression: MPEG-4 Simple Profile (SP) / MJPEG, Dual codec  
Temperature: -40°C—+50°C (-40 –122 °F)  
Protection: IP 66  
Camera Cost: 1,509.00  
Housing Cost: 0.00  
Comments: No digital zoom declared  
Website: <http://www.pixord.com>

Manufacturer: **Advanced Technology**  
Product: IPSD518S  
Format: 1/4 in., SONY Super HAD CCD  
Focal Length (mm): 4.1 mm–73.8 mm  
Zoom: 18X optical/ 12X digital  
Angle of View: 48°–2.7°  
Resolution: D1 (NTSC: 720 x 480), 640 x 480, 320 x 240, 160 x 120  
Minimum Illumination: Color 0.7 Lux; B/W 0.05 Lux; Slow-shutter 0.01 Lux  
P/T: Pan: 360°; tilt:-10°—+90°; P&T max speed: 380°/sec  
Compression: MPEG-4  
Temperature:  
Protection: Can work with IP66 housing  
Camera Cost: 1,237.00  
Housing Cost: DH304-OC: 170.00  
Comments: Network Camera; need order housing separately  
Website: <http://www.atvideo.com>

Manufacturer: **Vivotek**  
Product: SD7151  
Format: SONY 1/4 in. progressive scan CCD sensor in VGA resolution  
Focal Length (mm): 4.1–73.8 mm  
Zoom: 18x optical  
Angle of View: 2.8°–48° (horizontal)  
Resolution: 640x480



Minimum Illumination: 1.61 Lux (F1.4, 1/30s), 0.38 Lux (F1.4, 1/30s, without IR-cut filter)

P/T: Pan range: 360° Pan Speed: 0.1°–300°/sec; Tilt range: 0°–90° Tilt Speed 0.1°–120°/sec

Compression: MJPEG & MPEG-4

Temperature: -20–60 °C (-4–140 °F)

Protection: IP66

Camera Cost: 1,365.00

Housing Cost: 0.00

Comments: No digital zoom declared

Website: <http://www.vivotek.com>

Manufacturer: **Sony**

Product: SNC-RZ25N

Format: 1/4 in. type ExwaveHAD CCD

Focal Length (mm): f=4.1 mm to 73.8 mm

Zoom: 18x optical, 12x digital

Angle of View:

Resolution: 640 x 480, 480 x 360, 384 x 288, 320 x 240, 256 x 192, 160 x 120

Minimum Illumination: Color: 0.7 lx (AGC ON F1.4 50IRE); B/W: 0.06 lx (AGC ON)

P/T: Pan:-170 to +170°; Tilt: -90° to +30°

Compression: JPEG/MPEG-4 Selectable

Temperature: 0 °C to + 40 °C (32 °F to 104 °F)

Protection:

Camera Cost: 768.00

Housing Cost: UNIONL7C2 (Pendant mount, clear):366.00, UNIORL7C2 (vandal resistant, pendant mount, Clear Lower Dome):477.00

Comments: IP camera; Built-in Web Server - View and control using standard web browsers; Indoor camera; need housing for outdoor usage

Website: <http://pro.sony.com/bbsc/home.do>

Manufacturer: **Toshiba**

Product: IK-WB21A

Format: 1/4 in. interline transfer SuperCCD  
Focal Length (mm): f=4.0 mm to 88.0 mm  
Zoom: 22x optical  
Angle of View:  
Resolution: SXVGA (1280 x 960), VGA (640 x 480) default, QVGA (320 x 240), QQVGA (160 x 120)  
Minimum Illumination: 0.13 lux @ F1.6 at AGC High  
P/T: Pan range: -175° to +175° Pan Speed: 300°/second; Tilt range: -90° to 30° Tilt Speed 200°/sec  
Compression: JPEG & MJPEG  
Temperature: 14° F to 104° F (-10° C to 40° C)  
Protection:  
Camera Cost: 862.00  
Housing Cost: FB-3610-92-HB-C (Environmental Dome): 277.00  
Comments: Indoor, need housing for outdoor usage; high resolution; no digital zoom declared; compression method: JPEG & MJPEG  
Website: <http://www.toshibasecurity.com>

Manufacturer: **CNB**  
Product: ISS2765NW/ISS2765PW  
Format: 1/4 in. Interlace IT CCD  
Focal Length (mm):  
Zoom: 27x optical/ 10X digital  
Angle of View:  
Resolution: D1 (704 x 480), CIF (352 x 240)  
Minimum Illumination: 1.0Lux (color), 0.5Lux (BW), 0.001Lux (DSS 128FLD) 30IRE  
P/T: Panning: 360°; tilting: 90°; P&T speed: Manual: 1°-360°/sec; Preset: 360°/sec; Swing: 1°-180°/sec  
Compression: MJPEG / MPEG-4 / H.264  
Temperature: -30°C-50°C  
Protection: IP66  
Camera Cost: 612.00  
Housing Cost: 0.00

Comments:

Website: <http://www.cnbtec.com>

#### 4.4 Parameters for Wireless Equipment

**Frequency.** The transmission frequency is the cycles per second of the radio waves. Not all frequency bands are free. Licenses for frequency require both time and a recurring cost. However, licensed frequencies have less interference. Currently, 900 MHz, 2.4 GHz, and 5.8 GHz are the commonly used license-exempt frequencies. The 4.9 GHz public safety frequency is reserved for ITS and other municipal services.

**Data Rate and Bandwidth.** Data rate is the speed in bits per second that data is transmitted across the communication pathway. Given a frequency range, bandwidth is the value obtained, in hertz, by subtracting the lowest frequency from highest frequency. It is restricted by both the transmitter and communication medium (Stallings 2005). Given a fixed error rate, the greater the bandwidth, the greater the data rate, but the more expensive the equipment. Based on Hartley's law, the largest data rate under ideal condition is associated with the bandwidth as measured in hertz. So in the digital world, bandwidth is also a term used to refer to the data rate in bits per second.

**Standard.** At present, most Wi-Fi devices employ the standards IEEE802.11a/b/g and 802.11n (a new amendment issued in October 2009). The 802.11a standard is compatible with 5 GHz and allows a maximum data rate of 54 Mbps; 802.11b operates at 2.4 GHz with 11 Mbps at most; 802.11g also uses 2.4 GHz as its functioning frequency with the data rate no larger than 54 Mbps. When the 802.11n standard appears, the data rate in Wi-Fi systems will rise to 300 Mbps and function in both the 5 GHz and 2.4 GHz frequencies.

Additionally, there are WiMAX devices on the wireless equipment market. Some of them function in licensed frequencies and some do not. The standards upon which WiMAX devices are based are 802.16d and 802.16e.

**Transmit Power/Receive Sensitivity.** Transmit power is the power emitted by wireless devices. It is always defined in dBm units (decibel in milliwatts), which can be converted from mW units (milliwatts). Receiver sensitivity is the minimum power that can be sensed by the wireless receiver and achieve an acceptable connection for certain performance.

**Antenna.** The antenna is the device transferring energy from an electrical format to an electromagnetic format and sending electromagnetic signals into the transmission medium, or vice versa. An antenna can implement both transmission and reception tasks.

To describe distribution of radiation around an antenna, one uses the polar coordinate system. In this graphic description, the length from antenna to a point represents the amount of power. The angle of the line connecting the antenna and the point on the polar axis indicates the physical location. On the basis of a radiation pattern, beamwidth refers to the angle within which the power transmitted is no less than half of the maximum power radiated.

Antenna gain (Stallings 2005) is the ratio of the power in a given direction to the power in any direction using an ideal omni antenna. Increase of antenna gain does not mean the

enhancement of total power, but relates to power augmentation in a particular direction. In other words, an antenna increases the power in one direction at the expense of decreasing the power in other directions. Because the FCC sets power constraints for license-free usage, one cannot increase the communication power arbitrarily. Therefore, taking antenna gain into account is important when choosing a wireless device.

**Channel.** A channel is a path from transmitter to receiver. The maximum data rate over a channel is called the channel capacity.

**Protection.** The typical protection standards for wireless devices are the IP code and NEMA rating. For detailed information, please refer to the protection description in camera section.

**Types.** Because of various practical needs, wireless networks are arranged in different architectures: Point-to-Point (PTP), Point-to-Multipoint (PTMP), and mesh network.

An individual wireless device can function as an access point, station, or CPE (customer premises equipment). An access point bridges between the wireless network and wired network (Geier 2004). Station is not a well-defined term. Some manufacturers use it to refer to a client node that communicates with an access point wirelessly but some companies sell their base station and subscriber products to implement PTMP communication systems. It is a terminal on the customer side.

#### 4.4.1 Parameter Value Selection

**Frequency.** The choices are license-exempt frequencies such as 900 MHz, 2.4 GHz, and 5.8 GHz, or the public safety frequency 4.9 GHz.

**Coverage and Data Rate.** Although coverage and data rate are vital to selecting the proper wireless equipment, practically one cannot rely on the parameter values posted by manufacturers. One reason is that coverage and data rates are greatly affected by the environment such as buildings or trees between transmitters and receivers. The antennas used and many other factors can also affect performance. Additionally, some companies prefer not to put this information in the product datasheets. Therefore, we do not prescribe thresholds. However, we do include the coverage and data rate in the descriptions below if they are available.

Operating Temperature: -20°C to +50°C (-4°F to 122°F)

### 4.5 Wireless Equipment Survey

In this section, products are categorized by their frequencies: 2.4 GHz, 4.9 GHz, 5 GHz, 900 MHz, and mixed frequencies (within one model or model series). In each group, the products are ordered from highest price to lowest price. Prices do not include antenna and accessories. Each is expressed in dollars.

#### 4.5.1 2.4 GHz

Manufacturer:	Trango
Product:	M2400S
Frequency:	24000–2483 MHz

Coverage: Standard Integrated Antenna (Each End): 15 Miles; Standard AP Antenna and SU w/Grid Antenna: 25 Miles  
Data Rate: Up to 5 Mbps  
Standard:  
Power/Sensitivity: Output Power: +23 dBm Max Setting, +10 dBm Min Setting;  
Sensitivity: -90 dBm typical  
Antenna: Access point: Integrated 13 dBi, optional 12 dBi or 17 dBi antenna; Subscriber: Integrated 15 dBi, optional 24 dBi  
Channels: 8 channels, 10 MHz channel size  
Enclosure: All-weather, powder coated, cast aluminum with Polycarbonate  
Environment: -40° to 60° C (-40 to 140°F)  
Cost: Base Station: 1,993.00; Subscriber: 713.00  
Comments: PTMP (Base station support up to 128 sub unit)  
Website: <http://www.trangobroadband.com>

Manufacturer: **Alvarion**  
Product: BreezeMAX Wi<sup>2</sup>/BreezeACCESS Wi<sup>2</sup>  
Frequency: 802.11b/g: 2.4–2.4835 GHz  
Coverage:  
Data Rate: 802.11g: 6, 9, 11, 12, 18, 24, 36, 48, 54 Mbps; 802.11b: 1, 2, 5.5, 11 Mbps  
Standard: 802.11b/g  
Power/Sensitivity: 802.11g Tx: 20 dbm with 6 Mbps to 18 dbm with 54 Mbps, Rx:-95 dbm with 6 Mbps to -70 dbm with 54 Mbps; 802.11b Tx: 20 dbm with 1 Mbps to 11 Mbps, Rx:-111 dbm with 1 Mbps to -91 with 11 Mbps  
Antenna: 2 x 8 dBi Omni directional (2.4–2.5 GHz)  
Channels: Maximum Channels: FCC/IC: 1–11  
Enclosure:  
Environment: -40 to 60°C (-40 to 140°F)  
Cost: ALVR-Wi2-ODU-b/g (Wi-Fi 802.11 b/g outdoor Access Point) 1,860  
Comments: mesh  
Website: <http://www.alvarion.com>

**Manufacturer:** **Encom**  
**Product:** Commpak BB24  
**Frequency:** 2.4 GHz  
**Coverage:** Up to 60miles  
**Data Rate:** Up to 54 Mbps  
**Standard:** 802.11 b/g or eMax Proprietary protocol  
**Power/Sensitivity:** Transmit power: 28 dB, 700 mW; Receive signal: 1 Mbps -97 dBm to 54 Mbps -74 dBm  
**Antenna:** Integrated antenna (23 dBi) or external Omni, Yagi and Panel antennas  
**Channels:** 5 MHz, 10 MHz and 20 MHz channels  
**Enclosure:** IP67  
**Environment:** -30°C to +60°C (-22 to 140°F)  
**Cost:** 1,750.00  
**Comments:** Access point and station  
**Website:** <http://www.encomwireless.com>

**Manufacturer:** **Alvarion**  
**Product:** BreezeNET DS.11  
**Frequency:** 2.4 GHz  
**Coverage:** Up to 25 km (15 miles)  
**Data Rate:** 11/5.5/2/1 Mbps  
**Standard:** IEEE 802.11b  
**Power/Sensitivity:** Sensitivity: 11 Mbps -85 dBm; 5.5 Mbps -88 dBm; 2 Mbps -90 dBm; 1 Mbps -93 dBm; Output power: -4, -2, 4, 6, 12, 14, 20, 24 (dBm)  
**Antenna:** Integrated Antenna: Flat Panel 16 dBi, 20° Vertical /Horizontal; or external  
**Channels:** 1–11  
**Enclosure:**  
**Environment:** Outdoor unit: - 40°C to 55°C (-40 to 122°F)/ Indoor unit: 0°C to 40°C (-32 to 104°F)

Cost: 1,395.00  
Comments: PTP & PTMP  
Website: <http://www.alvarion.com>

Manufacturer: **Inscape Data**  
Product: AirEther AB54E Pro  
Frequency: 2.412–2.462 GHz  
Coverage:  
Data Rate: IEEE802.11b: 1/2/5.5/11 Mbps; IEEE802.11g:  
6/9/12/18/24/36/48/54 Mbps; Super g: up to 108 Mbps  
Standard: IEEE 802.11b/g  
Power/Sensitivity: Transmit Power 28 dBm max; Sensitivity 802.11b -85 dbm@  
11 Mbps to -94 dBm@ 1 mbps, 802.11g -91 dbm@ 6 Mbps to -70  
dBm@ 108 Mbps

Antenna: N-Female  
Channels: 11  
Enclosure: IP68  
Environment: -22°F to +158°F (-30°C to +70°C)  
Cost: 549.99  
Comments: Access point with bridge, repeater, client features  
Website: <http://www.inscapedata.com>

Manufacturer: **Tranzeo wireless**  
Product: TR-6019  
Frequency: 2401 MHz to 2483.5 MHz  
Coverage:  
Data Rate: 802.11b: 5.5/11 Mbps, 2 Mbps, 1 Mbps; 802.11g: 48/54 Mbps,  
24/36 Mbps, 12/18 Mbps, 6/9 Mbps  
Standard: 802.11 b/g  
Power/Sensitivity: Output Power: +23 dbm max; Sensitivity: 802.11b: -85 dbm @ 11  
Mbps, -90 dbm @ 1 Mbps; 802.11g: -72 dbm @ 54 Mbps, -  
89 dbm @ 6 Mbps  
Antenna: 19 dBi Panel (internal)

Channels:  
Enclosure:  
Environment: -65°C to +60°C (-85 to 140°F)  
Cost: 356.00  
Comments: Access Point, a PTP bridge, or a Client Adapter (CPE).  
Website: <http://www.tranzeo.com>

Manufacturer: **Tranzeo wireless**  
Product: TR-CPQ-19  
Frequency: 2400–2483.5 MHz  
Coverage: 10miles  
Data Rate: 802.11b: 5.5/11 Mbps, 2 Mbps, 1 Mbps; 802.11g: 48/54 Mbps, 24/36 Mbps, 12/18 Mbps, 6/9 Mbps BPSK  
Standard: 802.11b/g  
Power/Sensitivity: Transmit Power: 23 dBm max; Sensitivity: 802.11a: -85 dbm @ 11 Mbps, -90 dbm @ 1 Mbps, 802.11g: -72 dbm @ 54 Mbps, -89 dbm @ 6 Mbps  
Antenna: 19 dBi Panel (internal)

Channels:  
Enclosure:  
Environment: -65°C to +60°C (-85 to 140°F)  
Cost: 301.00  
Comments: Client Adapter (CPE)  
Website: <http://www.tranzeo.com>

Manufacturer: **Teletronics**  
Product: TT2400  
Frequency: 2.4 GHz  
Coverage:  
Data Rate: up to 54 Mbps  
Standard: IEEE 802.11b/g  
Power/Sensitivity: Transmit Power: IEEE 802.11b: 23 dbm (+/- 1.5dB)@



to  
Mbps

1/2/5.5/11 Mbps, IEEE 802.11g: 20 dbm (+/- 1.5dB) @ 54 Mbps  
23 dbm (+/- 1.5dB) @ 6 Mbps; Sensitivity: IEEE 802.11g 54

<= -72 dbm to 6 Mbps <= -89 dbm, IEEE 802.11b 11 Mbps: <=-  
88 dbm to 1 Mbps: <= -95 dbm

Antenna: N-type Female  
Channels: Total of 3 Non-Overlapping Channels  
Enclosure:  
Environment: -40 to 70 °C (-40 to 158°F)  
Cost: 220.00  
Comments: AP/Bridge/CPE  
Website: <http://www.teletronics.com>

Manufacturer: **Ubiquiti**  
Product: NanoStation M2  
Frequency: 2412 MHz–2462 MHz  
Coverage: 15km  
Data Rate: 150 Mbps  
Standard: 802.11b/g/n/airmax  
Power/Sensitivity: Output Power: 802.11b/g: 28 dBm @1–24 Mbps to 24 dBm @  
54 Mbps, 802.11n/Airmax: 28 dBm to 22 dbm; Sensitivity:  
802.11b/g: -97 dBm @ 1–24 Mbps to -75 dBm @ 54 Mbps,  
802.11n/Airmax: -96 dBm to -75 dbm

Antenna: 10.4–11.2 dBi  
Channels:  
Enclosure: Outdoor UV Stabalized Plastic  
Environment: -30°C to +80°C (-22 to 176°F)  
Cost: 89.95  
Comments: WIRELESS CPE; 2 X 10/100 Ethernet Interface  
Website: <http://www.ubnt.com>

Manufacturer: **Teletronics**

Product: EZStation2  
Frequency: 2.412 GHz–2.4835 GHz  
Coverage:  
Data Rate: 802.11b (11 Mbps, 5.5 Mbps, 2 Mbps, 1 Mbps); 802.11g (54 Mbps, 48 Mbps, 36 Mbps, 24 Mbps, 18 Mbps, 12 Mbps, 9 Mbps, 6 Mbps)  
Standard: 802.11b/g  
Power/Sensitivity: Transmit Power: 26±1.5 dbm@802.11b, 20±1.5 dbm@802.11g; Sensitivity: 802.11b -80 dBm, 802.11g -68 dBm  
Antenna: 15 dBi patch antenna  
Channels: 2.412–2.462 GHz (11 Channels)  
Enclosure:  
Environment: -40 to 70 °C (-40 to 158°F)  
Cost: 89.00  
Comments: AP Client Router, AP Router, AP Bridge, Repeater  
Website: <http://www.teletronics.com>

Manufacturer: **Ubiquiti**  
Product: Rocket M2  
Frequency: 2412 MHz–2462 MHz  
Coverage: 50km  
Data Rate: 150 Mbps  
Standard: 802.11b/g/n/airmax  
Power/Sensitivity: Output Power: 802.11b/g: 28 dBm @ 1–24 Mbps to 24 dBm @ 54 Mbps, 802.11n/Airmax: 28 dBm to 22 dbm; Sensitivity: 802.11b/g: -97 dBm @ 1–24 Mbps to -75 dBm @ 54 Mbps, 802.11n/Airmax: -96 dBm to -75 dbm  
Antenna: External Antenna: AirMax Sector 2G-16-90(16.0–17.0 dBi); AirMax Sector 2G-15-120(15.0–16.0 dBi)  
Channels:  
Enclosure: Outdoor UV Stabalized Plastic  
Environment: -30°C to 75°C (-22 to 167°F)

Cost: 89.00  
 Comments: PTP; 2 X 10/100 Ethernet Interface  
 Website: <http://www.ubnt.com>

**Manufacturer: Ubiquiti**  
 Product: Bullet M2  
 Frequency: 2412–2462 MHz  
 Coverage: 50km  
 Data Rate: 100 Mbps  
 Standard: 802.11b/g/n  
 Power/Sensitivity: Output Power: 802.11b/g: 28 dBm @ 6–24 Mbps to 23 dBm @ 54 Mbps, 802.11n: 28 dBm to 22 dbm; Sensitivity: 802.11b/g: -83 dBm @ 24 Mbps to -75 dBm @ 54 Mbps, 802.11n/Airmax: -96 dBm to -74 dbm

Antenna: Any antenna like grid antenna and sector antenna  
 Channels:  
 Enclosure: Outdoor UV Stabalized Plastic  
 Environment: -40°C to 80°C (-40 to 176°F)  
 Cost: 79.00  
 Comments: PTP; 1 X 10/100 Ethernet Interface  
 Website: <http://www.ubnt.com>

**Manufacturer: Deliberant**  
 Product: Deliberant CPE 2  
 Frequency: 2.3 GHz–2.5 GHz (Country dependent)  
 Coverage:  
 Data Rate: 802.11g: 54 / 48 / 36 / 24 / 12 / 9 / 6 Mbps; 802.11b: 11 / 5.5 / 2 / 1 Mbps  
 Standard: 802.11 b/g  
 Power/Sensitivity: RF output power: Up to 27 dBm (Adjustable); Receiver Sensitivity: 802.11g: -93 +/- 2 dbm @ 6 Mbps, -75 +/- 2 dbm @ 54 Mbps; 802.11b: -96 +/- 2 dbm @ 1 Mbps, -90 +/- 2 dbm @ 11 Mbps  
 Antenna: Software selectable—14 dBi Integrated Panel or N-connector for

custom antenna application

Channels:  
Enclosure: IP67  
Environment: -25°C–65°C (-13 to 149°F)  
Cost: 76.00  
Comments: Client Bridge/Client/Router/WDS/CPE  
Website: <http://www.deliberant.com>

#### 4.5.2 4.9 GHz

Manufacturer: **Trango**  
Product: ATLAS 4900-INT22  
Frequency: 4.9 GHz Public Safety Band  
Coverage: 5 Mbps: 20 miles; 45 Mbps: 3 miles  
Data Rate: up to 45 Mbps  
Standard:  
Power/Sensitivity: Sensitivity: -71 dBm (54 Mbits) to -90 dBm (6 Mbits)  
Antenna: Integrated, 22 dBi  
Channels:  
Enclosure: NEMA 4  
Environment: -40° to 60° C (-40° to 140° F)  
Cost: 5,195.00  
Comments: PTP  
Website: <http://www.trangobroadband.com>

Manufacturer: **Encom**  
Product: Commpak BB49  
Frequency: 4.9 GHz licensed public safety frequency band  
Coverage: Up to 60miles  
Data Rate: Up to 54 Mbps  
Standard: 802.11 a/b/g or eMax Proprietary protocol  
Power/Sensitivity: Transmit power: 28 dB, 700 mW; Receive signal: 1 Mbps -97 dBm to 54 Mbps -74 dBm

Antenna: Integrated antenna (23 dBi) or external Omni, Yagi and Panel antennas  
Channels: 5 MHz, 10 MHz and 20 MHz channels  
Enclosure: IP67  
Environment: -30°C to +60°C (-22 to 140°F)  
Cost: 1,800.00  
Comments: Access point and station  
Website: <http://www.encomwireless.com>

#### 4.5.3 5 GHz

Manufacturer: **Motorola**  
Product: PTP 58600  
Frequency: 5.470 GHz–5.725 GHz, 5.725 GHz–5.850 GHz  
Coverage: LOS range 124 mi (200 km); NLOS range 5 mi (8 km); nLOS range 20 mi (32 km)  
Data Rate: full: 5 MHz Channel – Up to 40 Mbps /10 MHz Channel – Up to 84 Mbps /15 MHz Channel – Up to 126 Mbps/30 MHz Channel – Up to 300 Mbps lite: 10 MHz Channel – Up to 42 Mbps /15 MHz Channel – Up to 63 Mbps/30 MHz Channel – Up to 150 Mbps  
Standard:  
Power/Sensitivity: Transmit Power: Varies with modulation mode and settings up to 25 dBm; Sensitivity: varying between -98 dBm and -58 dBm  
Antenna: Integrated flat plate 23 dBi / 7°or External  
Channels: Configurable to 5, 10, 15, or 30 MHz  
Enclosure:  
Environment: -40°C to +60°C (-40 to 140°F)  
Cost: 15,995(Lite)/19,995(Full)  
Comments: PTP; non-line-of-sight, line-of-sight, near-line- of- sight  
Website: <http://www.motorola.com>

Manufacturer: **Motorola**  
Product: PTP 58500  
Frequency: 5.725 GHz–5.875 GHz; 5.470 GHz–5.725 GHz

Coverage: LOS range 155 mi (250 km), NLOS range 6 mi (10 km), nLOS range 25 mi (40 km)

Data Rate: full: 5 MHz Channel – Up to 35 Mbps /10 MHz Channel – Up to 70 Mbps /15 MHz Channel – Up to 105 Mbps  
lite: 5 MHz Channel – Up to 17 Mbps /10 MHz Channel – Up to 35 Mbps /15 MHz Channel – Up to 52 Mbps

Standard:

Power/Sensitivity: Transmit Power: Varies with modulation mode and settings from 18 dBm to 27 dBm; Sensitivity: varying between -94 dBm and -69 dBm

Antenna: Integrated flat plate 23 dBi / 8° or External

Channels: Configurable to 5, 10, or 15 MHz

Enclosure:

Environment: -40°C to +60°C (-40 to 140°F)

Cost: 9,995 (Lite); 13,995 (Full)

Comments: PTP Bridge; NLOS, nLOS, and LOS

Website: <http://www.motorola.com>

Manufacturer: **Proxim**

Product: MP-8150

Frequency: 5.8 GHz

Coverage: up to 43 miles (70km)

Data Rate: High Throughput mode (6.5–300 Mbps); legacy mode (6 Mbps–54 Mbps)

Standard:

Power/Sensitivity: Transmit Power: 18 dbm; Sensitivity: (40 MHz) -87 dbm, -71 dbm, -69 dbm, (20 MHz) -93 dbm, -75 dbm, -71 dbm

Antenna: 21 dBi Integrated antenna

Channels: 40 MHz, 20 MHz (10 MHz and 5 MHz are available by firmware upgrade)

Enclosure: IP67

Environment: -40° to 60°C (-40 to 140°F)

Cost: Base station: 8,999; Subscriber: 1,799  
Comments: PTMP; non-line-of-sight  
Website: <http://www.proxim.com>

Manufacturer: **Motorola**  
Product: PTP 58300  
Frequency: 5.725 GHz–5.875 GHz, 5.470 GHz–5.725 GHz  
Coverage: LOS: Up to 155 miles (250 km) / NLOS: 6 mi (10 km) / nLOS: 25 mi (40 km)  
Data Rate: LOS: up to 50 Mbps over 6 miles (10 km)  
Standard:  
Power/Sensitivity: Transmit Power: Varies with modulation mode and settings from 18 dBm to 27 dBm; Sensitivity: varying between -94 dBm and -69 dBm  
Antenna: Integrated flat plate 23 dBi /8° or External  
Channels: Configurable to 5, 10, or 15 MHz  
Enclosure:  
Environment: -40°C to +60°C (-40 to 140°F)  
Cost: 5,995.00  
Comments: PTP Bridge; NLOS, nLOS, and LOS  
Website: <http://www.motorola.com>

Manufacturer: **Airspan**  
Product: MicroMAXd  
Frequency: in both licensed (700 MHz, 1.5 GHz, 3.3 GHz, 3.5, 3.7 GHz, 4.9 GHz) and unlicensed (5.1, 5.4 GHz, 5.8 GHz, 5.9 GHz) bands  
Coverage:  
Data Rate:  
Standard: IEEE802.16-2004  
Power/Sensitivity: +27 dbm  
Antenna:  
Channels: 10 MHz, 5 MHz, 3.5 MHz, 1.75 MHz  
Enclosure:

Environment:

Cost: light version: 5,000, full version: 9,000

Comments: Base Station

Website: <http://www.airspan.com>

Manufacturer: **Alvarion**

Product: BreezeNET B100 (BU/RB-B100D-5.8 and BU/RB-B100-5.8)

Frequency: 5.7250–5.875 GHz

Coverage:

Data Rate: Up to 73 Mbps

Standard:

Power/Sensitivity: Up to 21 dBm

Antenna: 21 dBi integrated antenna, 23 or 28 dBi external antenna

Channels: 10, 20, and 40 MHz channels

Enclosure:

Environment: Outdoor unit: - 40°C to 55°C (-40 to 122°F) / Indoor unit: 0°C to 40°C (-32 to 104°F)

Cost: 3,995 (BU/RB-B100D-5.8 and BU/RB-B100-5.8)

Comments: PTP

Website: <http://www.alvarion.com>

Manufacturer: **Ruckus**

Product: ZoneFlex 7731

Frequency: 5.15–5.85 GHz

Coverage: LOS: Up to 190 Mbps at 1.5 km/1 mi; Up to 165 Mbps at 3 km/2 mi; Up to 100 Mbps at 5 km/3 mi; Up to 50 Mbps at 10 km/6 mi; 15km maximum range

Data Rate: 802.11n: 6.5 Mbps–130 Mbps (20 MHz) / 6.5 Mbps–270 Mbps (40 MHz); 802.11a: up to 54 Mbps

Standard: 802.11a/n

Power/Sensitivity: Transmit Power: 22 dBm

Antenna: Internal 14 dBi directional antenna & two external

Channels: 20 MHz and/or 40 MHz



Enclosure: IP-65  
Environment: -40°C to 65° C (-40°F to 149°F)  
Cost: 2,398/pair  
Comments: PTP  
Website: <http://www.ruckuswireless.com>

Manufacturer: **Alvarion**  
Product: BreezeNET B28 (BU/RB-B28D-5.8 and BU/RB-B28-5.8)  
Frequency: 5.7250–5.875 GHz  
Coverage:  
Data Rate: Up to 28 Mbps  
Standard:  
Power/Sensitivity: Up to 21 dBm  
Antenna: 21 dBi integrated antenna; 23 and 28 dBi external antenna  
Channels: 10, 20, and 40 MHz channels  
Enclosure:  
Environment: Outdoor unit: - 40°C to 55°C (-40 to 122°F) / Indoor unit: 0°C to 40°C (-32 to 104°F)  
Cost: 1,995 (BU/RB-B28D-5.8 and BU/RB-B28-5.8)  
Comments: PTP  
Website: <http://www.alvarion.com>

Manufacturer: **Trango**  
Product: Access5830  
Frequency: 5725 MHz to 5850 MHz  
Coverage: Up to 18-mile range with external antenna  
Data Rate: 10 Mbps  
Standard:  
Power/Sensitivity: Sensitivity: 1600 byte packets: -83 dBm, 64 byte packets: -87 dBm  
Antenna: Integrated patch: 14 dBi; External Antenna: 16 dBi or 12 dBi  
Channels: 6 non-overlapping channels  
Enclosure: NEMA 4  
Environment: -40° to 60° C (-40 to 140°F)

Cost: Base Station: 1,993.00; Subscriber Unit: 786  
Comments: PTMP/wireless base station (Supports up to 500 subscribers per AP)  
Website: <http://www.trangobroadband.com>

Manufacturer: **Motorola**  
Product: 5750APDD  
Frequency: 5725–5850 MHz  
Coverage: 2 mi (3.2 km)  
Data Rate: 14 Mbps Maximum  
Standard:  
Power/Sensitivity: Sensitivity: -86 dB  
Antenna: 7 dB antenna gain  
Channels: 20 MHz; 6 channels  
Enclosure:  
Environment: -40° C to +55° C (-40° F to +131° F)  
Cost: 1,895.00  
Comments: Access point; Not on Motorola company website now  
Website: <http://www.motorola.com>

Manufacturer: **Encom**  
Product: Commpak BB58  
Frequency: 5.8 GHz  
Coverage: Up to 60 miles  
Data Rate: Up to 54 Mbps  
Standard: 802.11 a or eMax Proprietary protocol  
Power/Sensitivity: Transmit power: 28 dB, 700 mW; Receive signal: 1 Mbps -97 dBm to 54 Mbps -74 dBm  
Antenna: Integrated antenna (23 dBi) or external Omni, Yagi, and Panel antennas  
Channels: 5 MHz, 10 MHz, and 20 MHz channels  
Enclosure: IP67  
Environment: -30°C to +60°C (-22 to 140°F)

Cost: 1,750.00  
Comments: Access point and station  
Website: <http://www.encomwireless.com>

Manufacturer: **Tranzeo wireless**  
Product: TR-WMX-58-pBS pico Base Station  
Frequency: 5.725 to 5.875 GHz  
Coverage:  
Data Rate:  
Standard: IEEE 802.16-2004  
Power/Sensitivity: Output Power: 17 dBm; Sensitivity: -89 dBm (BPSK1/2) -72 dbm (64 QAM 2/3)  
Antenna: Selection of Omni and Sector Antennas  
Channels: 10 MHz  
Enclosure: IP67 weathertight  
Environment: -35°C to +50°C (-31 to 122°F)  
Cost: 1,600.00  
Comments: WiMAX Base Station; LOS, NLOS PTMP Cellular Architecture  
Website: <http://www.tranzeo.com>

Manufacturer: **AIRAYA**  
Product: AI108-4958-OSU (Outdoor subscriber unit)  
Frequency: 5.25–5.35, 5.47–5.72, or 5.725–5.85 GHz  
Coverage: Up to 2.5 miles in multipoint mode  
Data Rate: up to 35 Mbps  
Standard: 802.11a  
Power/Sensitivity: Tx: 0 and 21 dBm; Rx: -71 to -85 dBm  
Antenna: integrated 23 dBi antenna  
Channels: 5.25–5.35 GHz: 4 x 20 MHz, 2 x 40 MHz; 5.47–5.72 GHz: 11 x 20 MHz; 5.725–5.850 GHz: 5 x 20 MHz, 2 x 40 MHz  
Enclosure:  
Environment:  
Cost: 1,399.00

Comments: outdoor subscriber

Website: <https://secure.airaya.com>

Manufacturer: **Alvarion**

Product: BreezeNET B14 (BU/RB-B14D-5.8 and BU/RB-B14-5.8)

Frequency: 5.7250–5.875 GHz

Coverage:

Data Rate: Up to 14 Mbps

Standard:

Power/Sensitivity: Up to 21 dBm

Antenna: 16 dBi integrated antenna or 24 dBi external antenna

Channels: 10 and 20 MHz channels

Enclosure:

Environment: Outdoor unit: -40°C to 55°C (-40 to 122°F) / Indoor unit: 0°C to 40°C (-32 to 104°F)

Cost: 1,195(BU/RB-B14D-5.8 and BU/RB-B14-5.8)

Comments: PTP

Website: <http://www.alvarion.com>

Manufacturer: **Motorola**

Product: 5750SMDD

Frequency: 5.725 to 5.850 GHz

Coverage: 2 miles (3.2 km), 10 miles (16 km) with reflector

Data Rate: 14 Mbps (1 mile)

Standard:

Power/Sensitivity: Sensitivity: -86 dbm

Antenna: 7 dBi

Channels: 20 MHz; 6 channels

Enclosure:

Environment: -40° C to +55° C (-40 to 131°F)

Cost: 895.00

Comments: Access point; Not on Motorola company website now

Website: <http://www.motorola.com>

Manufacturer: **Inscape Data**  
Product: AirEther BR108  
Frequency: 5.15–5.85 GHz  
Coverage:  
Data Rate: IEEE802.11a: 6/12/18/24/36/48/54/108 Mbps  
Standard: IEEE 802.11a  
Power/Sensitivity: Transmit Power: 23 dBm; Receiver Sensitivity: -88 @ 6 Mbps to  
-64 @ 108 Mbps  
Antenna: N-Female  
Channels: 13  
Enclosure: IP68  
Environment: -22°F to +158°F (-30°C to +70°C)  
Cost: 617.68  
Comments: PTP or PTMP; Tri-Band  
Website: <http://www.inscapedata.com>

Manufacturer: **Tranzeo wireless**  
Product: TR-5PLUS-24  
Frequency: 5170 MHz to 5805 MHz  
Coverage:  
Data Rate: up to 54 Mbps  
Standard: 802.11a  
Power/Sensitivity: Transmit Power: +23 dbm; Sensitivity: -76 dbm @ 54 Mbps  
Antenna: 24 dBi Panel (internal)  
Channels:  
Enclosure:  
Environment: -65°C to +60°C (-85 to 140°F)  
Cost: 357.00  
Comments: Access Point (AP) / PTP / Customer Premise  
Equipment (CPE)  
Website: <http://www.tranzeo.com>

Manufacturer: **Teletronics**  
Product: TT5800  
Frequency: 5.7250–5.850 GHz  
Coverage:  
Data Rate: 54, 48, 36, 24, 18, 12, 9, and 6 Mbps  
Standard: IEEE 802.11a  
Power/Sensitivity: Output Power: 23 dBm (+/- 1.5dB) @ 6/9/12/18/24 Mbps 0–18 dBm @ 54 Mbps; Sensitivity: -90 dBm <=6 Mbps, -72 dBm <=54 Mbps  
Antenna: N-type Female  
Channels: 5 Channels  
Enclosure: Silver Powder Coated Cast Aluminum  
Environment: -40 to 70 °C (-40 to 158°F)  
Cost: 245.00  
Comments: AP/Bridge/CPE  
Website: <http://www.teletronics.com>

Manufacturer: **E-ZY.NET**  
Product: EZ-Bridge-LT5  
Frequency: 5 GHz  
Coverage: 3miles  
Data Rate: real world throughput up to 25 Mbps  
Standard: 802.11g/b  
Power/Sensitivity: Transmit power: 802.11g: 50, 100mW, 802.11b: 100, 150, 200, 250mW; Sensitivity: 802.11g: -73 +2 dbm @ 54 Mbps, 802.11b: -84 + 2 dbm @ 11 Mbps  
Antenna: 14 dBi Panel Antenna  
Channels: 11 channels  
Enclosure:  
Environment: -30°C to 50°C (-22°F to 122°F)  
Cost: 230.00  
Comments: PTP Bridge, Access Point, Client  
Website: <http://www.e-zy.net>

Manufacturer: **Compex**  
Product: MMJ543LVA-P26 (MIMO Junior)  
Frequency: 5.45–5.85 GHz  
Coverage:  
Data Rate: up to 300 Mbps  
Standard: IEEE 802.11a/n  
Power/Sensitivity: 400mW (26 dbm)  
Antenna: 13 dBi directional dual-polarization  
Channels:  
Enclosure: Outdoor  
Environment: -20°C to 70°C (-4 to 158°F)  
Cost: 89.95  
Comments: Station/Station WDS/AP/AP WDS/Repeater WDS  
Website: <http://www.cpx.com>

Manufacturer: **Ubiquiti**  
Product: NanoStation M5  
Frequency: 5745 MHz–5825 MHz  
Coverage: 15km  
Data Rate: 150 Mbps  
Standard: 802.11a/n  
Power/Sensitivity: Output Power: 802.11a: 27 dBm @ 6–24 Mbps to 22 dBm @  
54 Mbps, 802.11n: 27 dBm to 21 dbm; Sensitivity: 802.11a: -94  
dBm @ 6–24 Mbps to -75 dBm @ 54 Mbps, 802.11n: -96 dBm to  
–  
75 dbm  
Antenna: 14.6–16.1 dBi  
Channels:  
Enclosure: Outdoor UV Stabalized Plastic  
Environment: -30°C to +80°C (-22 to 176°F)  
Cost: 89.95  
Comments: WIRELESS CPE; 2 X 10/100 Ethernet Interface

Website: <http://www.ubnt.com>

Manufacturer: **Ubiquiti**  
Product: Rocket M5  
Frequency: 5470 MHz–5825 MHz  
Coverage: 50km  
Data Rate: 150 Mbps  
Standard: 802.11 a/n  
Power/Sensitivity: Output Power: 802.11a: 27 dBm @ 6–24 Mbps to 22 dBm @ 54 Mbps, 802.11n: 27 dBm to 21 dbm; Sensitivity: 802.11a: -94 dBm @ 6–24 Mbps to -75 dBm @ 54 Mbps, 802.11n: -96 dBm to – 75 dbm  
Antenna: External Antenna: AirMax Sector 5G-17-90(16.1–17.1 dBi); AirMax Sector 5G-16-120(15.0–16.0 dBi); AirMax Sector 5G-20-90(19.4–20.3 dBi); AirMax Sector 5G-19-120(18.6-19.1); RocketDish5G-34(32.1–34.2 dBi)  
Channels:  
Enclosure: Outdoor UV Stabalized Plastic  
Environment: -30°C to 75°C (-22 to 167°F)  
Cost: 89.00  
Comments: PTP; 1 X 10/100 Ethernet Interface  
Website: <http://www.ubnt.com>

Manufacturer: **Ubiquiti**  
Product: Bullet M5  
Frequency: 5470 MHz–5825 MHz  
Coverage: 50km  
Data Rate: 100 Mbps  
Standard: 802.11 a/n  
Power/Sensitivity: Output Power: 802.11a: 25 dBm @ 1–24 Mbps to 20 dBm @ 54 Mbps, 802.11n: 25 dBm to 19 dBm; Sensitivity: 802.11a: -83 dBm @ 24 Mbps to -75 dBm @ 54 Mbps, 802.11n: -96 dBm to – 74 dbm



Antenna: Any antenna like grid antenna and sector antenna  
Channels:  
Enclosure: Outdoor UV Stabilized Plastic  
Environment: -40°C to 80°C (-40 to 176°F)  
Cost: 79.00  
Comments: PTP; 1 X 10/100 Ethernet Interface  
Website: <http://www.ubnt.com>

#### **4.5.4 900 MHz**

Manufacturer: **GE**  
Product: MDS Inetii-900 900 MHz  
Frequency: 902–928 MHz ISM band  
Coverage: Range (512 Kbps) Up to 20 miles (fixed), and Up to 3 miles (mobile); Range (1 Mbps) Up to 15 miles  
Data Rate: 1 Mbps/512 Kbps  
Standard:  
Power/Sensitivity: 100mW to 1W (20 to 30 dBm); Sensitivity: 512 Kbps -97 dBm, 1 Mbps -92 dBm  
Antenna: External  
Channels:  
Enclosure: die cast aluminum  
Environment: -30°C to +60°C (-22 to 140°F)  
Cost: 2,400.00  
Comments: transceiver  
Website: <http://www.gedigitalenergy.com>

Manufacturer: **Trango**  
Product: M900S  
Frequency: 9020–928 MHz  
Coverage: Up to 20 miles LOS  
Data Rate: 3 Mbps  
Standard:

Power/Sensitivity: Output Power: +26 dBm Max Setting, -4 dBm Min Setting;  
Sensitivity: -90 dBm typical  
Antenna: Integrated 10 dBi & external antenna  
Channels: 4 non-overlapping, 6 MHz  
Enclosure: All-weather, powder coated, cast aluminum with polycarbonate radome  
Environment: -40° to 60° C (-40 to 140°F)  
Cost: Base Station: 1,993.00; Subscriber: 713.00  
Comments: PTMP (Base station support up to 126 sub unit); LOS & Non-line-of-sight  
Website: <http://www.trangobroadband.com>

Manufacturer: **GE**  
Product: MDS TransNet 900 MHz  
Frequency: 902–928 MHz ISM band  
Coverage: Up to 30 miles  
Data Rate: 115.2 kbps  
Standard:  
Power/Sensitivity: 100 mW to 1W (20 to 30 dBm); Sensitivity -105 dBm  
Antenna: External  
Channels:  
Enclosure:  
Environment: -40° C to +70° C (-40 to 158°F)  
Cost: 1,100.00  
Comments: PTMP: Master/Remote/Repeater Extension  
Website: <http://www.gedigitalenergy.com>

Manufacturer: **Hana Wireless**  
Product: HW9  
Frequency: 902–928 MHz ISM Band  
Coverage: Distances up to 15 Miles LOS  
Data Rate: Real Data Rates of 25 Mbps+  
Standard:

Power/Sensitivity: Sensitivity: -93 dbm  
Antenna: 13 dBi Integrated Antenna  
Channels: 5/10/20 MHz Wide Channels  
Enclosure: UV Stabilized Radome  
Environment:  
Cost: 379.00  
Comments: Multi-Point or PTP  
Website: <http://www.hanawireless.com>

Manufacturer: **Tranzeo wireless**  
Product: TR-902-11  
Frequency: 902 MHz to 928 MHz  
Coverage: up to 4 miles with 2 to 3 Mbps  
Data Rate: 802.11b: up to 11 Mbps/ 802.11g: up to 54 Mbps  
Standard: 802.11b/g  
Power/Sensitivity: Transmit Power: +25 dbm mean, +29 dbm peak; Sensitivity:  
802.11b: -83 dbm @ 11 Mbps to -92 dbm @ 1 Mbps, 802.11g: -  
67 dbm @ 54 Mbps to -87 dbm @ 6 Mbps  
Antenna: 11 dBi  
Channels:  
Enclosure:  
Environment: -55°C to +60°C (-67 to 140°F)  
Cost: 370.00  
Comments: AP/PtP/CPE  
Website: <http://www.tranzeo.com>

Manufacturer: **Teletronics**  
Product: TT 900  
Frequency: 902–928 MHz  
Coverage:  
Data Rate: 54, 48, 36, 24, 18, 12, 11, 9, 6, 5.5, and 1 Mbps  
Standard: IEEE 802.11b/g  
Power/Sensitivity: Transmit Power: 23 dBm (+/- 1.5dB) @ 1–24 Mbps, 22 dBm @ 36

Mbps, 21 dBm @ 48 Mbps, 20 dBm @ 54 Mbps; Sensitivity: -92 dBm @ 6 Mbps, -72 dBm @ 54 Mbps

Antenna: N-type Female  
Channels: 2 Channels: 913, 918 MHz  
Enclosure: NEMA 4 Enclosure  
Environment: -40 to 70 °C (-40 to 158°F)  
Cost: 289.00  
Comments: AP/Bridge  
Website: <http://www.teletronics.com>

#### 4.5.5 Others

Manufacturer: **Alvarion**  
Product: BreezeNET B300  
Frequency: 4.90–5.9 GHz  
Coverage:  
Data Rate: Up to 250 Mbps  
Standard:  
Power/Sensitivity: Up to 18 dBm  
Antenna: 23 dBi (integrated antenna) or 23 and 28 dBi external antenna  
Channels: 5, 10, 20, and 40 MHz channels  
Enclosure:  
Environment: Outdoor units: -40°C to 60°C (-40 to 140°F)/ Indoor unit: 0°C to 40°C (-32 to 104°F)  
Cost: 7,995.00  
Comments: PTP  
Website: <http://www.alvarion.com>

Manufacturer: **Alvarion**  
Product: BreezeACCESS VL  
Frequency: 902–927 MHz, 4.9–5.1 GHz, 5.15–5.35 GHz, 5.47–5.725 GHz, 5.725–5.875 GHz/4.9–5.875 GHz (SU-L)  
Coverage: SU: up to 30 km (LOS)/ SU-L: up to 12 km (LOS) /SU-Video: up

	to 30 km (LOS)
Data Rate:	SU(5.8 GHz) SU-3 and SU-3L: 3 Mbps, SU-6 and SU-6L: 6 Mbps, SU-12L: 12 Mbps, SU-54: 54 Mbps, SU-Video: 8 Mbps uplink and 2 Mbps downlink; 900 MHz SU: 3 Mbps( upgradable to 8 Mbps)
Standard:	
Power/Sensitivity:	Max input power (at ant. port) -48 dBm typical; Max output power (at antenna port) AU: -10 dBm to 21 dBm, AU (900 MHz): -10 dBm to 27 dBm; SU: -10 dBm to 21 dBm, SU (900 MHz): -10 dBm to 27 dBm, SU-L: -9 dBm to 18 dBm
Antenna:	Integrated antenna: (SU) 20 dBi (19 dBi in 4.9–5.1 GHz band), (SU-L) 17 dBi AU: 16 dBi sector 60° vertical, 16 dBi sector 90° vertical, 15 dBi sector 120° vertical, 8 dBi Omni horizontal
Channels:	AU/SU: 5 MHz (900 MHz), 10 MHz, 20 MHz; SU-L: 20 MHz, 10 MHz
Enclosure:	
Environment:	Outdoor unit: - 40°C to 55°C (-40 to 122°F)/ Indoor unit: 0°C to 40°C (-32 to 104°F)
Cost:	5.8 GHz Access Point: 5,245(AU-E-SA-5.8-VL); 5,595(AU-D-SA-5.8-120-VL/AU-D-SA-5.8-90-VL); 2,595(AUS-E-SA-5.8-VL) 5.8 GHz Subscriber: 649(SU-3); 799(SU-6); 999(SU-Video); 1199 (SU-54) 900 MHz Access Point: 2,495(AUS-E-SA-900-VL) 900 MHz Subscriber: 649(SU)
Comments:	PTMP; AU stands for access unit; SU stands for subscriber unit; SU-L is light version for subscriber unit; SU-Video is used in video transmission.
Website:	<a href="http://www.alvarion.com">http://www.alvarion.com</a>
Manufacturer:	<b>Cisco</b>
Product:	Aironet 1524SB
Frequency:	2.401 to 2.473 GHz; 5.725 to 5.850 GHz

Coverage:

Data Rate: 802.11a: 54, 48, 36, 24, 18, 12, 9, 6 Mbps; 802.11b: 11, 5.5, 2, 1 Mbps; 802.11g: 54, 48, 36, 24, 18, 12, 9, 6 Mbps

Standard: 802.11a/b/g

Power/Sensitivity: Rx sensitivity 802.11a 5.0 GHz: -91 dBm @ 6 Mbps to -73 dBm @ 54 Mbps; 802.11b: -96 dBm @ 1 Mbps to -92 dBm @ 11 Mbps; 802.11g with MRC: -96 dBm @ 1 Mbps to -80 dBm @ 54 Mbps TX max. Power: 28 dBm

Antenna: 3 external antennas

Channels: 2.401 to 2.473 GHz: 11 channels; 5.725 to 5.850 GHz: 5 channels

Enclosure: IP67/NEMA Type 4X

Environment: -40 to 55°C (-40 to 131°F)

Cost: 3,230.95

Comments: Access Point (Secure Wireless Mesh); suggested model: AIR-LAP1524SB-A-K9

Website: <http://www.cisco.com>

Manufacturer: **Proxim**

Product: MeshMAX 3500

Frequency: 3.40–3.6 GHz for WiMAX/5.150–5.85 GHz and 2.4120–2.472 for Mesh and Wi-Fi

Coverage:

Data Rate: up to 54 Mbps

Standard: 802.11 a/b/g & IEEE 802.16e

Power/Sensitivity: Transmit Power: 3.5 GHz: +21 dbm, 5 GHz: +18 dbm, 2.4 GHz: +20 dbm

Antenna: Must order separately

Channels: 3.5 MHz and 7 MHz for WiMAX radio, 20 MHz for mesh backhaul and Wi-Fi access

Enclosure:

Environment: -33° to 60°C (-27.4 to 140°F)

Cost: Base Station: 2,749/ Subscriber: 1,549

Comments: WiMAX subscriber and Wi-Fi Access Point

Website: <http://www.proxim.com>

Manufacturer: **Proxim**

Product: MeshMAX 5054

Frequency: 5.15–6.08 GHz for unlicensed WiMAX/5.150–6.08 GHz and 2.4120–2.472 for Mesh and Wi-Fi

Coverage:

Data Rate: up to 54 Mbps

Standard: 802.11 a/b/g & IEEE 802.16e

Power/Sensitivity: Transmit Power: 5 GHz: +18 dbm, 2.4 GHz: +20 dbm

Antenna: Three external (two for 5 GHz and one for 2.4 GHz)

Channels: 5 MHz, 10 MHz and 20 MHz for WiMAX radio, 20 MHz for mesh backhaul and Wi-Fi access

Enclosure:

Environment: -35° to 60°C (-31 to 140°F)

Cost: MeshMAX 5054WM:2,749; MeshMAX 5054W: 1,549

Comments: WiMAX 5 GHz subscriber and Wi-Fi Mesh Access Point

Website: <http://www.proxim.com>

Manufacturer: **Cisco**

Product: Aironet 1522AG

Frequency: 5 GHz, 4.9 GHz, 2.4 GHz

Coverage:

Data Rate: 802.11a: 54, 48, 36, 24, 18, 12, 9, 6 Mbps; 802.11b: 11, 5.5, 2, 1 Mbps; 802.11g: 54, 48, 36, 24, 18, 12, 9, 6 Mbps  
4.9 GHz: 5 MHz: 13.5, 12, 9, 6, 4.5, 3, 2.25, 1.5 Mbps; 10 MHz: 27, 24, 18, 12, 9, 6, 4.5, 3 Mbps; 20 MHz: 54, 48, 36, 24, 18, 12, 9, 6 Mbps

Standard: 802.11a and 802.11b/g dual radio

Power/Sensitivity: Rx sensitivity 802.11a 5.0 GHz: -91 dBm @ 6 Mbps to -73 dBm @ 54 Mbps; 802.11b: -96 dBm @ 1 Mbps to -92 dBm @ 11 Mbps; 802.11g with MRC: -96 dBm @ 1 Mbps to -80 dBm @ 54 Mbps; 4.9 GHz, 20 MHz: -89 dBm @ 6 Mbps to -74 dBm

@ 54 Mbps Tx max. Power: 2.4 GHz/ 5 GHz 28 dBm;  
4.9 GHz 20 dBm

Antenna: 3 external antennas

Channels: 2.401 to 2.473 GHz: 11 channels; 4.940 to 4.990 GHz: 5 MHz—10 channels, 10 MHz—5 channels, 20 MHz—2 channels; 5.250 to 5.850 GHz: 16 channels (excludes channel 120, 124, 128)

Enclosure: IP68/NEMA Type 4X

Environment: -40 to 55°C (-40 to 131°F)

Cost: 2,699.99

Comments: Access Point (Secure Wireless Mesh)

Website: <http://www.cisco.com>

Manufacturer: **Neteon**

Product: BAT54-F

Frequency: 2 x independent: each 2.4 GHz and 5 GHz: 2400–2483 and 5170–5810 MHz

Coverage: Up to 20 km with external antenna

Data Rate: up to 54 Mbps according to IEEE 802.11g/a/h; up to 11 Mbps for IEEE 802.11b

Standard: IEEE 802.11a/b/g/h/i

Power/Sensitivity: Transmit Power: 2.4 GHz 802.11b: +19 dbm @ 1 and 2 Mbps, +19 dbm @ 5.5 and 11 Mbps, 2,4 GHz 802.11g: +19 dBm @ 6 Mbps, +14 dBm @ 54 Mbps, 5 GHz 802.11a/h: +18 dBm @ 6 Mbps, +12 dBm @ 54 Mbps with TPC and DFS;  
Sensitivity: 2.4 GHz 802.11b: -87 dBm @ 11 Mbps, -94 dBm @ 1 Mbps; 2.4 GHz 802.11g: -87 dBm @ 6 Mbps, -70 dBm @ 54 Mbps; 5 GHz 802.11a/h: -87 dBm @ 6 Mbps, -67 dBm @ 54 Mbps

Antenna: External

Channels:

Enclosure: IP57

Environment: -20° to +50°C (-4 to 122°F)

Cost: 2,565.00



Comments: AP/Router with Dual band  
Website: <http://www.neteon.net>

Manufacturer: **Proxim**  
Product: ORiNOCO AP-4000MR-LR  
Frequency: 802.11b/g: 2.412 to 2.462 GHz; 802.11a:5.745 to 5.85 GHz  
Coverage:  
Data Rate: 802.11b:1, 2, 5.5, 11 Mbps; 802.11a/g: 6, 9, 12, 18, 24, 36, 48, 54 Mbps  
Standard: 802.11a/b/g  
Power/Sensitivity: Transmit Power: +24 dBm for 802.11b, +24 dBm for 802.11g and 802.11a  
Antenna: Two external (2.4 GHz and 5 GHz)  
Channels:  
Enclosure: IP65  
Environment: -35° to 60°C (-31 to 140°F)  
Cost: 2,499.00  
Comments: Mesh Access Point  
Website: <http://www.proxim.com>

Manufacturer: **Proxim**  
Product: Tsunami MP.11 2454-R/5054-R/5054-R-LR  
Frequency: 2454-R: 2.4–2.4835 GHz; 5054-R: 5.25–5.35 GHz, 5.47–5.725 GHz, 5.725–5.850 GHz; 5054-R-LR: 5.725–5.850 GHz  
Coverage: 5054-R-LR version provides extended range up to 20 miles  
Data Rate: 54, 48, 36, 24, 18, 12, 9, 6, 4.5, 3, 2.25, 1.5 Mbps  
Standard: capabilities of the IEEE 802.16e  
Power/Sensitivity:  
Antenna: 5054-R Subscriber Unit with Integrated 23 dBi antenna; 5054-R-LR Subscriber Unit for extended range with Integrated 23 dBi antenna; 2454-R Subscriber Unit with Integrated 18 dBi antenna;  
or external  
Channels: 2454-R: 13 channels; 5054-R: 5.25–5.35 GHz (15 channels), 5.47–

GHz (46 channels), 5.725–5.850 GHz (21 channels); 5054-R-LR: 21 channels

Enclosure:

Environment: -33° to 60°C (-27.4 to 140°F)

Cost: 2454-R Base Station: 1,999 / Subscriber: 1,199  
5054-R Base Station: 1,999 / Subscriber: 1,199 (with antenna)  
999 (without antenna)  
5054-R-LR Base Station: 2,299 / Subscriber: 1,399 (with 23 dBi antenna) 1,199 (without antenna)

Comments: PTMP

Website: <http://www.proxim.com>

Manufacturer: **Proxim**

Product: ORiNOCO AP-4000MR

Frequency: 802.11b/g: 2.412 to 2.472 GHz; 802.11a: 5.15 to 5.25 GHz, 5.25 to 5.35 GHz, 5.47 to 5.725 GHz, 5.85 to 6.08 GHz;

Coverage:

Data Rate: 802.11b:1, 2, 5.5, 11 Mbps; 802.11a/g: 6, 9, 12, 18, 24, 36, 48, 54 Mbps

Standard: 802.11a/b/g

Power/Sensitivity: Transmit Power: +20 dBm for 802.11b, +18 dBm for 802.11g and 802.11a

Antenna: Two external (2.4 GHz and 5 GHz )

Channels:

Enclosure: IP65

Environment: -40° to 60°C (-40 to 140°F)

Cost: 1,999.00

Comments: Mesh Access Point

Website: <http://www.proxim.com>

Manufacturer: **Meru**

Product: OAP180

Frequency: 802.11a: 5.180–5.240 GHz 4 channels; 5.260–5.320 GHz 4

channels; 5.745–5.825 GHz 5 channels / 802.11b/g: 2.4 GHz–2.4835 GHz

Coverage:

Data Rate: 802.11b: 11, 5.5, 2 and 1 Mbps; 802.11a: 54, 48, 36, 24, 18, 12, 9, and 6 Mbps; 802.11g: 54, 48, 36, 24, 18, 12, 11, 9, 6, 5.5, 2, 1 Mbps

Standard: Dual radios enable simultaneous support of 802.11a and 802.11b/g

Power/Sensitivity: Transmit Power: 802.11b/g: +20 dBm (100 mW) nominal, 802.11a: +18 dBm (65 mW) nominal; Sensitivity: 802.11 a -71 dBm at 54 Mbps to -89 dBm at 6 Mbps, 802.11b -90 dBm at 11 Mbps to -96 dBm at 1 Mbps, 802.11g -73 dBm at 54 Mbps to -91 dBm at 6 Mbps

Antenna: External

Channels: 802.11a: 13 channels; 802.11b/g: 11 channels

Enclosure: IP65 / NEMA 4 enclosure with sealed connectors

Environment: -40° to 60° C (-40 to 140°F)

Cost: 1,995.00

Comments: Access Point

Website: <http://www.merunetworks.com>

Manufacturer: **Moxa**

Product: AWK-6222

Frequency: 2.412 to 2.462 GHz/5.18 to 5.24 GHz

Coverage:

Data Rate: 802.11b: 1, 2, 5.5, 11 Mbps; 802.11a/g: 6, 9, 12, 18, 24, 36, 48, 54 Mbps

Standard: IEEE 802.11a/g/b for Wireless LAN; IEEE 802.11i Wireless Security

Power/Sensitivity: Transmit Power: 802.11b: 23±1.5 dBm @ 1 to 11 Mbps, 802.11g: 18±1.5 dBm @ 6 to 24 Mbps to 15±1.5 dBm @ 54 Mbps, 802.11a: 20±1.5 dBm @ 6 to 24 Mbps to 17±1.5 dBm @ 54 Mbps; Sensitivity: 802.11b: -97 dBm @ 1 Mbps to -90 dBm @ 11 Mbps, 802.11g: -93 dBm @ 6 Mbps to -74 dBm @ 54 Mbps, 802.11a: -

90 dBm @ 6 Mbps to -74 dBm @ 54 Mbps  
Antenna: 5 dBi, 2.4 GHz omni-directional antenna and External  
Channels: 2.412 to 2.462 GHz (11 channels) /5.18 to 5.24 GHz (4 channels)  
Enclosure: Metal, IP68 protection  
Environment: -40 to 75°C (-40 to 167°F)  
Cost: 1,899.00  
Comments: AP/Bridge/Client  
Website: <http://www.moxa.com>

Manufacturer: **AIRAYA**  
Product: AI108-4958-BSU (Base station)  
Frequency: 4.94–4.99, 5.25–5.35, 5.47–5.72, or 5.725–5.85 GHz  
Coverage: Up to 2.5 miles in multipoint mode  
Data Rate: up to 42 Mbps  
Standard:  
Power/Sensitivity: Tx: 0 and 21 dBm; Rx: -71 to -85 dBm  
Antenna: 60/90 degree sector (17 dBi), 120 degree sector (16 dBi), 360 degree  
Omni (10 dBi) options  
Channels: 5.25–5.35 GHz: 4 x 20 MHz, 2 x 40 MHz; 5.47–5.72 GHz: 11 x 20 MHz; 5.725–5.850 GHz: 5 x 20 MHz, 2 x 40 MHz  
Enclosure:  
Environment:  
Cost: 1,599.00  
Comments: each base station includes an indoor signal/power injector, and an outdoor radio  
Website: <https://secure.airaya.com>

Manufacturer: **Neteon**  
Product: BAT 54 Rail  
Frequency: Two independent radio modules, each 2.4 GHz and 5 GHz: 2400–2483,5 MHz (ISM) and 5150–5750 MHz  
Coverage: Up to 20km with external antenna

Data Rate: up to 54 Mbps according to IEEE 802.11g/a/h; up to 11 Mbps for IEEE 802.11b

Standard: IEEE 802.11a/b/g/h/i

Power/Sensitivity: Sensitivity: 2.4 GHz 802.11b: -87 dbm @ 11 Mbps, -94 dbm @ 1 Mbps; 2.4 GHz 802.11g: -87 dbm @ 6 Mbps, -70 dbm @ 54 Mbps; 5 GHz 802.11a/h: -87 dbm @ 6 Mbps, -67 dbm @ 54 Mbps

Transmit Power: 802.11b: +19 dbm @ 1 and 2 Mbps, +19 dbm @ 5.5 and 11 Mbps; 802.11g: +19 dbm @ 6 Mbps, +14 dbm @ 54 Mbps; 802.11a/h: +18 dbm @ 6 Mbps, +12 dbm @ 5 4 Mbps with TPC and DFS

Antenna: External

Channels:

Enclosure: IP40-housing

Environment: -20° to +50°C (-4 to 122°F)

Cost: 1,400.00

Comments: Rail mounted; Dual band access point/client

Website: <http://www.neteon.net>

Manufacturer: **Moxa**

Product: AWK-4121

Frequency: 2.412 to 2.462 GHz, 5.18 to 5.24 GHz

Coverage: Long-distance data transmission over 10 km

Data Rate: 802.11b: 1, 2, 5.5, 11 Mbps; 802.11a/g: 6, 9, 12, 18, 24, 36, 48, 54 Mbps

Standard: IEEE 802.11a/g/b for Wireless LAN; IEEE 802.11i Wireless Security

Power/Sensitivity: Transmit Power (V1.2): 802.11b: 23±1.5 dBm @ 1 to 11 Mbps, 802.11g: 18±1.5 dBm @ 6 to 24 Mbps to 15±1.5 dBm @ 54 Mbps, 802.11a: 20±1.5 dBm @ 6 to 24 Mbps to 17±1.5 dBm @ 54 Mbps; Sensitivity(V1.2): 802.11b: -97 dBm @ 1 Mbps to -90 dBm @ 11 Mbps, 802.11g: -93 dBm @ 6 Mbps to -74 dBm @ 54 Mbps, 802.11a: -90 dBm @ 6 Mbps to -74 dBm @ 54 Mbps

Antenna: Default Antenna 5 dBi, 2.4 GHz omni-directional antenna and external antenna  
Channels: 2.412 to 2.462 GHz (11 channels), 5.18 to 5.24 GHz (4 channels)  
Enclosure: Metal, IP67 protection  
Environment: -40 to 75°C (-40 to 167°F)  
Cost: 1,249.00  
Comments: AP/Bridge/Client  
Website: <http://www.moxa.com>

Manufacturer: **D-Link**  
Product: DWL-7700AP  
Frequency: 2.4 GHz to 2.4835 GHz 5.725 GHz to 5.850 GHz  
Coverage: Outdoors: 367ft (112m) @ 54 Mbps/ 820ft (250m) @ 18 Mbps/  
1640ft (500m) @ 6 Mbps  
Data Rate: For 802.11a/g: 54, 48, 36, 24, 18, 12, 9 and 6 Mbps; For 802.11b:  
11, 5.5, 2, and 1 Mbps  
Standard: 802.11a/b/g  
Power/Sensitivity: Transmit Output Power for 802.11a: up to + 100mW (20 dbm);  
for 802.11b: + 200mW (23 dbm); For 802.11g: + 200mW  
(23 dbm)  
Receiver Sensitivity: For 802.11a: -85 dbm @ 6 Mbps to -68 dbm  
@ 54 Mbps; For 802.11b: -94 dbm @ 1 Mbps to -85 dbm @  
11 Mbps; For 802.11g: -95 dbm @ 1 Mbps to -72 dbm @ 54  
Mbps

Antenna: 5 dBi Gain Diversity Dualband Dipole Antenna  
Channels:  
Enclosure: Built-in Heater with Temperature Sensor  
Environment: -40°C to 60°C (-40 to 140°F)  
Cost: 929.99  
Comments: Access Point/ WDS with AP/WDS/Bridge (No AP Broadcasting)  
Website: <http://www.dlink.com/default.aspx>

Manufacturer: **D-Link**

Product: DAP-3520  
 Frequency: 2.4 GHz to 2.4835 GHz, 5.15 GHz to 5.25 GHz and 5.725 GHz to 5.85 GHz  
 Coverage:  
 Data Rate: up to 300 Mbps  
 Standard: IEEE 802.11a/b/g/n  
 Power/Sensitivity: Maximum Transmit Output Power: 17 dBm @ 2.4 GHz; 16 dBm @ 5 GHz  
 Antenna: 8 dBi at 2.4 GHz; 10 dBi at 5 GHz  
 Channels:  
 Enclosure: IP65  
 Environment: -20°C to 60°C (-4 to 140°F)  
 Cost: 659.99  
 Comments: Access Point (AP)/ WDS with AP/ WDS/ Wireless Client  
 Website: <http://www.dlink.com/default.aspx>

Manufacturer: **EnGenius**  
 Product: EOR7550  
 Frequency: 802.11a: 5.15–5.35 GHz, 5.47–5.725 GHz, 5.725–5.825 GHz;  
 802.11b/g/n: 2.400 to 2.484 GHz  
 Coverage:  
 Data Rate: IEEE802.11a/g/n up to 54 Mbps; IEEE802.11b up to 11 Mbps  
 Standard: 802.11a/g/n  
 Power/Sensitivity: Receive sensitivity: 802.11a: -92 dbm @ 6 Mbps to -73 dbm @ 54 Mbps, 802.11g: -94 dBm @ 6 Mbps to -74 dBm @ 54Mbps, 802.11b: -97 dBm @ 1 Mbps to -92 dBm @ 11 Mbps, 802.11n: -

91

dBm @ MCS8 to -74 dBm @ MCS15  
 Transmit power: (Radio 1)802.11a 28 dbm @ 6–24 Mbp to 22 dbm @ 54 Mbps, 802.11g 28 dbm @ 6–24 Mbp to 24 dbm @ 54 Mbps, 802.11b 28 dbm @ 1–11 Mbps  
 (Radio 2)802.11g/n 19 dbm @ 6–24 Mbp to 16 dbm @ 54 Mbps, 802.11b 18 dbm @ 1–11 Mbps

Antenna: Integral Omni Antenna or external antenna  
Channels: 12 non-overlapping channels  
Enclosure: IP-65  
Environment: -20°C to 70°C (-4 to 158°F)  
Cost: 159.99  
Comments:  
Website: <http://www.ingeniustech.com>

Manufacturer: **Deliberant**  
Product: AP Solo  
Frequency: 4.9 GHz–5.85 GHz (Country dependent)/2.4 GHz–2.497 GHz  
(Country dependent)  
Coverage:  
Data Rate: 802.11a: 54 / 48 / 36 / 24 / 12 / 9 / 6 Mbps; 802.11g: 54 / 48 / 36 /  
24 / 12 / 9 / 6 Mbps; 802.11b: 11 / 5.5 / 2 / 1 Mbps  
Standard: 802.11a, 802.11b, 802.11g  
Power/Sensitivity: RF output power: Up to 24 dBm - Adjustable; Tx sensitivity:  
802.11a: -93 +/- 2 dbm @ 6 Mbps, -74 +/- 2 dbm @ 54 Mbps;  
802.11b: -99 +/- 2 dbm @ 1 Mbps, -90 +/- 2 dbm @ 11 Mbps;  
802.11g: -93 +/- 2 dbm @ 6 Mbps, -75 +/- 2 dbm @ 54 Mbps

Antenna: External  
Channels:  
Enclosure: Rugged Cast Aluminum IP67  
Environment: -30°C–60°C (-22 to 140°F)  
Cost: 159.95  
Comments: AP/AP Client/WDS (Wireless Repeater, PTP, PTMP)/  
AP Router/AP Client Router  
Website: <http://www.deliberant.com>

Manufacturer: **Teletronics**  
Product: EZStation5  
Frequency: 5.03 GHz–5.85 GHz, 4.9 GHz Public Safety Spectrums  
Coverage:



Data Rate:	54, 48, 36, 24, 18, 12, 9, and 6 Mbps
Standard:	802.11a
Power/Sensitivity:	Transmit Power: 26 dbm (+/-1.5dB)@6/9/12/18/24 Mbps, 20 dbm (+/-1.5dB)@54 Mbps; Sensitivity: -90 dBm ---- ≤ 6 Mbps, -70 dBm --- ≤ 54 Mbps
Antenna:	12 dBi/19 dBi (optional) patch antenna
Channels:	
Enclosure:	
Environment:	-20°C to 70°C (-4 to 158°F)
Cost:	118.00
Comments:	Access Point/ Client/Repeater/Gateway
Website:	<a href="http://www.teletronics.com">http://www.teletronics.com</a>
Manufacturer:	<b>Deliberant</b>
Product:	Deliberant CPE 5
Frequency:	4.9 GHz–5.85 GHz (Country dependent)
Coverage:	
Data Rate:	802.11a: 54 / 48 / 36 / 24 / 12 / 9 / 6 Mbps
Standard:	802.11a
Power/Sensitivity:	RF output power: Up to 22 dBm - Adjustable; Receiver Sensitivity: -93 +/- 2 dbm @ 6 Mbps, -74 +/- 2 dbm @54 Mbps
Antenna:	Software selectable—18 dBi Integrated Panel or N-connector for custom antenna application
Channels:	
Enclosure:	IP68
Environment:	-30°C to 60°C (-22 to 140°F)
Cost:	86.00
Comments:	
Website:	<a href="http://www.deliberant.com">http://www.deliberant.com</a>

Few devices for wireless connection are made available by communications providers. Before choosing such devices, check the network coverage in the installation area. Among others, these devices include the following:

- U301 USB Device (Sprint): easy to plug in USB port; supports 3G/4G mode. Regular price: \$299.99; current price from Sprint (based on fulfilling requirements): \$0.00.
- Sierra Wireless W801 Mobile Hotspot (Sprint): supports 3G/4G mode. Regular price: \$349.99; current price from Sprint based on some requirements: \$99.99.
- EUROTECH ZyWAN cellular router: provides link to CDMA, EVDO, GSM/GPRS, 3G, and iDEN. Price: \$815.
- MiFi™2200 Intelligent Mobile Hotspot (Verizon): supports Mobile Broadband provided by Verizon. Retail price: \$99.99; current price from Verizon (based on some requirements): \$49.99.
- webConnect™ USB Laptop Stick (T-Mobile): laptop USB; supports 3G. Retail price: \$129.99; current price from T-Mobile (based on some requirements): \$19.99.
- AT&T USBConnect Lightning (AT&T): USB; supports 3G. No-commitment price: \$249.99; current price from AT&T (based on fulfilling requirements): \$0.00.

## **4.6 Equipment Selection Guidelines**

Designing a cost-effective system requires a practical understanding of each system component. For traffic surveillance systems, the major components are the camera and communications equipment. The following subsections describe factors that should be considered when selecting and installing a wireless surveillance system.

Figure 25 depicts the decision sequence recommended for addressing the issues. The number preceding each step refers to the subsection below in which the key points that should be considered are discussed.

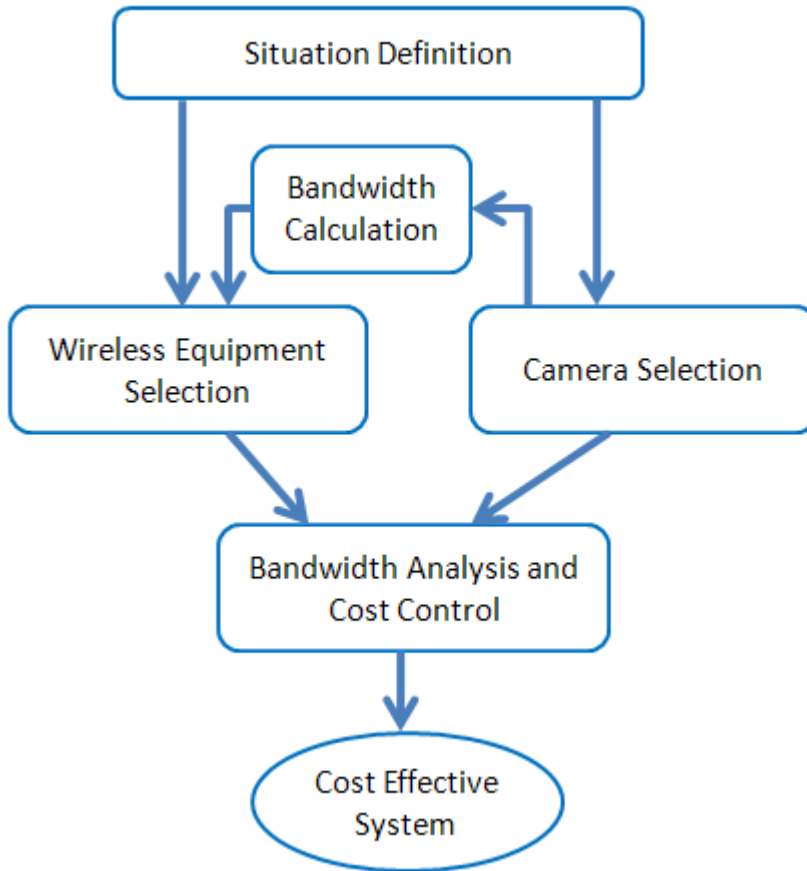

*Figure 25 Practical Issues Relevant to System Design*

#### **4.6.1 Situation Definition**

At the outset, a definition of the situation at which deployment will occur is necessary. Situation description involves a number of aspects:

- The environmental condition of system deployment location such as ground flatness, general height information, and distribution density for buildings, trees, or other obstructions.
- The number of sites that will be monitored and number of video cameras needed.
- The topological relationship between different sites/video cameras and the likely configurations: PTP, PTMP, or Mesh.
- The distance between the TMC and the farthest site/video camera, considering utilization of existing infrastructure.
- The existing wireless network deployment for the site, especially noting the ambient wireless signal strengths at different frequencies (approximation of interference between signals).

- The level of service needed, such as streaming video 24 hours a day, video only during certain time intervals, or incident alarms that require confirmation.

Without a definition of the situation in terms of aspects discussed above, it is difficult to assess practical issues such as approximating signal attenuation due to interference, calculation of video bandwidth requirements, choice of type of wireless equipment (PTP/PTMP/Mesh), estimation of the number of hops needed, and so on.

#### 4.6.2 Camera Selection

**Analog and Network Camera.** The merits of analog vs. network cameras, especially IP cameras, generate much argument that revolves around both cost and technology.

An IP camera has several pros: the output video is digitalized; compression components are located in the camera; an in-camera web server provides direct network access and makes web-based application easier; PTZ functions and video transmission need just one Ethernet cable—some products even utilize PoE (power over Ethernet) technology to provide power to the camera through the Ethernet cable; and most megapixel cameras are IP cameras, which can be used in places requiring high quality video such as casino and law enforcement sites. For an analog camera, the cost of the camera itself may be lower and have better compatibility with the existing analog camera systems.

One of the most discussed disadvantages of an IP camera is its higher cost. However, some experts argue, if the whole system cost (including cost of wiring, transmitting, storing, encoding, etc.) is taken into account, the IP system might not actually cost more. Axis, one network camera manufacturer, compares IP and analog camera systems, and draws the conclusion that although the IP camera is more expensive, the total system cost is less.

One significant problem of analog cameras is transmission security. Analog video has no encryption when transmitted through coaxial cable. Thus, it is easily tapped.<sup>14</sup> When it comes to wireless transmission, the analog signal is also unencrypted, which makes unauthorized access possible. But a network camera does not have such problem. It uses standard IEEE 802.11 with built-in encryption.

With the development of technology and marketing, the network camera has caught up with the analog camera. In some aspects it even supersedes its counterpart. Currently, it is widely used in various applications: bank, industrial, transportation, retail, and home monitoring. More and more analog camera manufacturers, such as COHU and Pelco, are developing their own network edition. Axis even anticipates “the analog will still be around in 10 years but only for smaller projects and replacement of existing systems” and “all major players” will “focus on IP in the next 5 to 7 years.”<sup>15</sup>

**Protection/Housing.** Clearly, traffic surveillance cameras should be able to perform well under adverse conditions. Beyond the basic protection from moisture, heat, and cold,

---

<sup>14</sup> See website [http://www.axis.com/files/feature\\_articles/ar\\_10reasons\\_34954\\_en\\_0903\\_lo.pdf](http://www.axis.com/files/feature_articles/ar_10reasons_34954_en_0903_lo.pdf), accessed Feb. 11, 2010.

<sup>15</sup> See website [http://ipvideomarket.info/report/ip\\_vs\\_cctv](http://ipvideomarket.info/report/ip_vs_cctv), accessed May 24, 2010.

other needs may arise based on the local situation. For example, in some parts of Texas dust is a serious problem.

**Video Codecs.**<sup>16</sup> As stated, wireless traffic surveillance system must employ codecs (compression/decompression) for effective real-time monitoring. In the market, most network cameras incorporate compression standards such as MJPEG, MPEG-4, or H.264. Additional compression techniques are available, such as JPEG2000, MJPEG-1, MJPEG-2, H.261, and H.263, as well as others. However, the more advanced the compression technology, the more processing power required.

#### 4.6.3 Bandwidth Calculation for Data Transmission (Honovich 2008)

It is intuitive that bandwidth will be predominantly consumed by the uplink direction from the camera to the network. The network operator has to allocate a portion of the bandwidth to the downlink direction from the network to the camera. The downlink bandwidth is used to control the camera's pan, tilt, zoom, and other functions. Thus both downlink and uplink bandwidth should be considered when purchasing wireless equipment.

Because traffic surveillance requires little downlink bandwidth capacity, only the uplink bandwidth calculation is discussed in detail via the following formulae:

$$\text{Bandwidth (Mbps)} = (\text{Frame\_Size (KB)} \times \text{Frame\_Rate} \times \text{Camera\_Count} \times 8 / 1024) \times (1 + \text{Overhead}) \quad (\text{Eq. 4-1})$$

where Overhead is normally taken to be 0.05;

Camera\_Count refers to the number of cameras;

b stands for bit while B stands for byte;

Frame\_Rate is the number of frames displayed or transmitted per second. Normally, it is 30, 15, or 10.

For Frame\_Size, use Equation 4-2:

$$\text{Frame\_Size (KB)} = (\text{Pixel\_Width} \times \text{Pixel\_Height} \times \text{Bit\_Depth}) / 8 / 1024 \times \text{Compression\_Ratio} \quad (\text{Eq. 4-2})$$

where Pixel\_Width and Pixel\_Height express the resolution of the video;

Bit\_Depth is the number of bits required to describe one pixel in an image. The larger the bit depth, the more colors that can be represented;

Compression\_Ratio is the ratio of the size of compressed file to that of uncompressed version of the same image. Compression techniques such as MJPEG, MPEG-4, and H.264 are only for digitalized video; should compression of an analog signal before transmission be desirable, the signal must be converted to digital at the source.

Practically, the value of the variable Compression\_Ratio is dependent on certain factors beyond the compression protocol employed:

---

<sup>16</sup> See website <http://jmcgowan.com/avialgo.html>.

(1) Video quality requirement—compression incurs loss of data and the more data discarded the lower the video quality. A greater compression ratio will be at a cost of video quality, and different applications lead to different video quality requirements. Because quality requirements are set manually by an operator, Compression\_Ratio will be within a range instead of a fixed value.

(2) Motion effects—for all compression techniques except MPEG, the motion content affects the compression ratio; a greater level of motion lowers the compression ratio. This is because reference frames are inserted that internal frames refer to indicate “no change here.” The more motion there is, the less useful reference frames become. Thus, the compression ratio, for a fixed quality requirement, will change dynamically.

(3) Camera resolution—the higher the resolution of the camera, the greater the data redundancy; this affords more opportunities to reduce redundancy; thus, a greater compression ratio is obtained.

Given the discussion above, the ranges for the variable Compression\_Ratio in Table 7 must be treated as approximate. The exact ratio is dependent on application needs (user compression quality selection and resolution selection) and scene motion. What’s more, because MJPEG, MPEG-4, and H.264 are the three most popular video compression techniques embedded in current traffic cameras, Compression\_Ratio values are only listed for these three techniques. To practically approximate the bandwidth needed, the lower bound of the ratio is recommended in order to guarantee sufficient margin.

**Table 7 Approximate Compression Ratios**

<b>Video Compression</b>	<b>Ratio Range</b>
MJPG	10:1–20:1
MPEG-4	25:1–50:1
H.264	50:1–100:1

#### **4.6.4 Wireless Equipment Selection**

In some cases, an 11 Mbps wireless system yields only 5.5 Mbps for streaming video. Furthermore, common environmental conditions can reduce the bandwidth to 2.75 Mbps. In practice, the bandwidth is always much less than the theoretical bandwidth. Normally, usable bandwidth is in the range of 30–70% of theoretical bandwidth. For example (Honovich 2008), 500 Mbps is the practical bandwidth for a 1 Gigabit Ethernet, 55–60 Mbps for a 100 Mbps Fast Ethernet, 6–7 Mbps for a 10 Mb Ethernet, and 12–25 Mbps for a Wi-Fi 802.11g 54 Mb.

In practice, the performance of wireless communication is dependent on the system location, environmental conditions, and even the weather. Thus, practical bandwidth capacity should be calculated by taking the factors mentioned above into consideration. To estimate the actual performance within an acceptable margin is of the great

importance. Achieving full utilization of the capability of the chosen wireless technology is necessary for a cost-effective solution.

**PTP, PTMP, Mesh.** Different architectures (PTP, PTMP, and mesh networks) might be preferred in different situations. If cameras are aligned almost in a line, PTP is apparently the best choice. PTMP or mesh networks might be the options when cameras are sparsely distributed. As with other equipment options, the network architecture might be obvious once the situation definition is given. At least, the situation will assist in narrowing the options.

**Signal Propagation Factors.**<sup>17</sup> Line-of-sight performance of wireless equipment is limited due to the curvature of the earth. Obstructions may exist in the path between transmitters and receivers. Moreover, under normal atmospheric conditions, radio waves do not propagate in a straight line due to the atmospheric refraction; the height of poles or towers for antenna or wireless equipment is often dictated by pre-existing structures or partially constrained by environmental reality. Pre-existing structures are normally intended for reuse. With respect to the environment, local geography or ordinances may limit the transmitter or receiver height. Even if new structures can be erected, the height must be reasonable because greater height incurs greater wind load, which is particularly significant if poles are considered for equipment mounting. In order to maximize practical wireless performance and minimize the limitations at the same time, the Fresnel zone clearance and height calculation of transmitters and receiver configuration are used.

The Fresnel zone is a long ellipsoid that stretches between two antennas. If a significant portion of the Fresnel zone is obstructed, the signal strength at the receiver will be greatly attenuated. At least 60% of the first Fresnel zone should be clear of any obstructions so that the radio wave propagation will behave as if it is in “free space.” Taking into account the Fresnel Zone clearance and the possible height options for both transmitter and receiver antennas, the maximal data range can be approximated.

**Interference.** Given the proliferation of wireless technologies, finding locations not already covered by a wireless networks, except for remote sites, is difficult. Frequency interference is another possible “signal loss” that should be avoided or minimized. Thus, interference should be considered when choosing candidate wireless equipment and specifically in choosing the frequency band employed.

**Loss.**<sup>18</sup> Radio waves propagate first from the transmitter via cable to the transmit antenna, second through an open free space (possibly obstructed by buildings and trees), next to the receiver antenna, and finally to the receivers via cable. Signal strength is greatly attenuated due to the loss in this propagation sequence. Free space loss (FSL) and obstacle absorption loss (OAL) are the two major causes of loss. FSL occurs when the signal spreads out in space. The loss is theoretically proportional to both the square of the distance and the square of signal frequency. OAL is due to tree leaves, water, and other obstructions. Quantifying the signal attenuation from obstacle absorption is difficult but the loss is to some extent dependent on the operation frequency. Moreover, the cable connecting the radio equipment and antennas will also cause a small signal loss. Poor

---

<sup>17</sup> See website <http://wndw.net/pdf/wndw2-en/ch02-physics.pdf>.

<sup>18</sup> See website <http://www.afar.net/tutorials/>.

weather condition will increase the free space loss and obstacle absorption loss because water absorbs radio waves at certain frequencies. Generally the losses are dependent on the location at which the system is deployed (e.g., whether there are tall buildings and trees between antennas), on the range of the system, on the frequency of the carrier wave, and on the weather conditions. Estimation of possible loss in different scenarios is quite necessary and useful in choosing the most effective wireless equipment.

**Allowable Loss Calculation.**<sup>19</sup> Practical comparisons of wireless equipment choices should include allowable loss. However, signal attenuation due to FSL, OAL, and frequency interference is dependent on the operational frequency employed. The allowable loss calculation scheme described here is only useful in comparing wireless technologies having the same operation frequencies. If comparison across equipment choices having different operation frequencies is necessary, some extra calculations to make them comparable will be needed because path loss (FSL and OAL) for equipment with different frequencies will not be the same. Generally, system location is dictated a priori for any system design, the choice of antenna height is inflexible, and weather conditions are variable. Thus, given the same bandwidth, the more the allowable loss, the more coverage the wireless equipment is able to provide. Conversely, given the same coverage the greater the bandwidth that can be delivered.

Figure 26 depicts the points at which loss of signal occurs (FSL and OAL). When no external antenna is required, cable loss can be ignored. The following calculation of allowable loss does consider the cable loss.

$$\text{Allowable Loss}_{AB} = \text{TransPower}_A - \text{CableLoss}_A + \text{AntennaGain}_A + \text{AntennaGain}_B - \text{ReceiveSensitivity}_B \quad (\text{Eq. 4-3})$$

---

<sup>19</sup> See website <http://www.afar.net/tutorials/>.



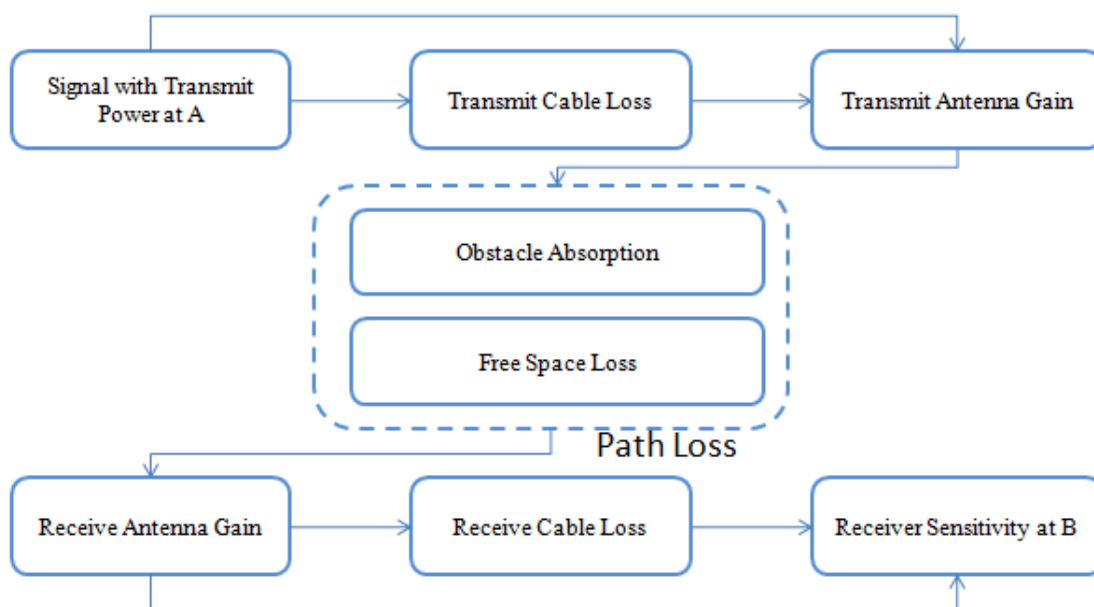

*Figure 26 Loss in Wireless Transmission*

In a previous subsection, the calculation of video bandwidth requirements is explained. Based on the video bandwidth requirement, receiver sensitivity can be determined for each wireless component and then the allowable loss of different wireless component choices is easily compared.

Assume the bandwidth for data transmission is known after selecting level of service and camera. This bandwidth requirement is the minimum value that any candidate wireless equipment should provide. Of course, a margin of error should be included in order to assume a reliable transmission channel because unpredictable weather and fluctuations of system component performance can definitely reduce further the practical bandwidth.

#### **4.6.5 System Analysis and Cost Control**

Recall the requirement of bandwidth capability calculated using equations (4-1) and (4-2), the approximate minimal allowable loss (including margin) during radio propagation calculated in equation (4-3), and the chosen type of wireless equipment (PTP/PTMP/Mesh). A list of candidate wireless equipment can now be easily compiled. By fully utilizing the capability of each system component and minimizing the overall cost at the same time, a cost-effective system can be finalized with respect to the actual requirements derived from the deployment situation definition.



## Chapter 5. System Development

After surveying the literature, Texas practice, and off-the-shelf equipment in the market, we designed and set up wireless transmission systems with ten wireless devices and one camera. This report describes system development for the UNT-developed TxDOT demonstration system. It is organized as follows: firstly, we describe our considerations in setting up systems; secondly, the steps we followed in building the systems are described, namely site investigation, installation, configuration, testing, and monitoring. In addition, Appendix A lists information concerning the hardware and software that was used.

### 5.1 Considerations for Deployment of Wireless Devices

The first step in setting up a wireless system is to determine the architecture based on practical conditions. Then the Fresnel zone of the link path, the antenna pattern, and the radio frequency must be considered. We discuss each in detail in the following section.

#### 5.1.1 Architecture of Wireless Network

There are several typical wireless network topologies, such as mesh, star, tree, and line. For video or data transmission along a highway, the structure is typically linear. In this specific context, we further divide configurations of wireless networks into two categories: single-hop point-to-point structure, and linear chain connection.

##### *Single-Hop Transmission*

Single-hop transmission is mainly used over short-distances with no or few obstructions (Figure 27). It is typically applicable where the video or data sources are near the TMC, the backbone access point is near the camera or data processor, or there are difficulties in connecting devices in the field with wired stations.

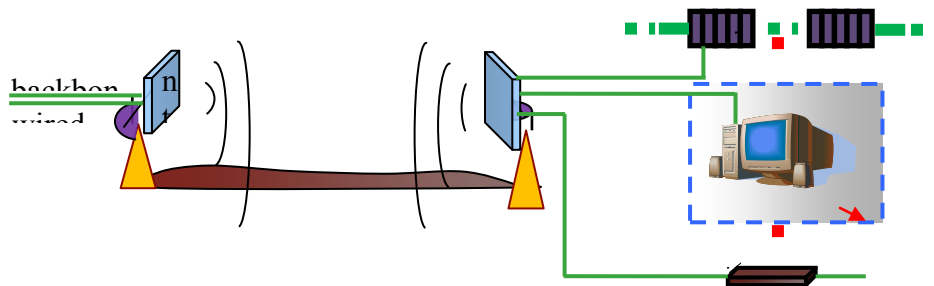

Figure 27 Scenarios of Single-Hop Transmission

Signal attenuation affects the transmission quality and distance choice. Even if a wireless link is in line-of-sight, signal losses between transmitter and receiver may occur. Reasons include free-space loss, cable loss, and absorption. Generally the majority of loss comes from the free-space loss.

### Free-Space Loss

Free-space loss is the loss between actual performance and the ideal vacuum transmission of a wireless signal. It greatly depends on the frequency of the radio and the link distance. The formula to calculate free-space loss is as follows<sup>20</sup>:

$$\text{Free - space loss} = 20\log_{10}f + 20\log_{10}s + 36.58 \quad (\text{Eq. 5-1})$$

where  $f$  is the frequency in Hertz,  $s$  is the distance in miles between the two ends of the link, and the unit of free-space loss is dB.

### Fade Margin

To determine the capability of the device in handling the losses, one value called fade margin can be used.

Fade margin is the difference between received signal strength and the minimum strength which can be captured by the receiver. This parameter indicates the reliability of a link. It can be obtained using the following formula:

$$\text{Fade margin} = P_{Tx} + G_{Tx} - CL_{Tx} - S_{Rx} + G_{Rx} - CL_{Rx} - FL \quad (\text{Eq. 5-2})$$

where  $P_{Tx}$  is the transmission power,  $G_{Tx}$  and  $G_{Rx}$  are the antenna gains of transmitter and receiver respectively,  $CL_{Tx}$  is the cable loss from the wireless transmission equipment to the transmission antenna,  $CL_{Rx}$  is the cable loss from the wireless receiving equipment to the receiving antenna,  $S_{Rx}$  is sensitivity of a receiver whose value is usually negative, and  $FL$  is the free-space loss.

The larger the fade margin is, the more reliable the wireless link and the better the performance.

### Throughput Estimation

For a single-hop wireless transmission, the formula to estimate the throughput, taking into account retransmission and timeout influences (Madsen et al. 2009), is as follows:

Throughput =

$$\min \left( \frac{W}{T_{RTT}}, \frac{1}{T_{RTT} \sqrt{\frac{2nR_{PER}}{3} + T_0} \min \left( 1, 3 \sqrt{\frac{3nR_{PER}}{8}} \right) R_{PER} (1 + 32R_{PER}^2)} \right) \quad (\text{Eq. 5-3})$$

where  $W$  is the maximum congestion window size;

$T_{RTT}$  is the Round Trip Time (RTT);

$n$  is the number of packets which are acknowledged by a single ACK;

$R_{PER}$  is the packet error rate;

$T_0$  is the average timeout duration and does not include retransmission time.

<sup>20</sup> See website [http://en.wikipedia.org/wiki/Free-space\\_path\\_loss](http://en.wikipedia.org/wiki/Free-space_path_loss), accessed Nov. 20, 2010.

### Linear-Chain Transmission

A linear-chain configuration is utilized not only in long-distance transmission but also under conditions where large obstructions are on the link path.

Although line-of-sight is not a necessary factor for wireless transmission, engineers always account for it. Signal under line-of-sight condition are stronger and more reliable. When there are obstacles blocking the link path, one possible solution is to use a linear chain configuration. For example, in Figure 28(a), antenna 4 can hardly receive video or data from antenna 1. If we add antenna 2 and 3, then 1 2, 3 and 4 are two line-of-sight links. Data can be transmitted between antenna 1 and 4.

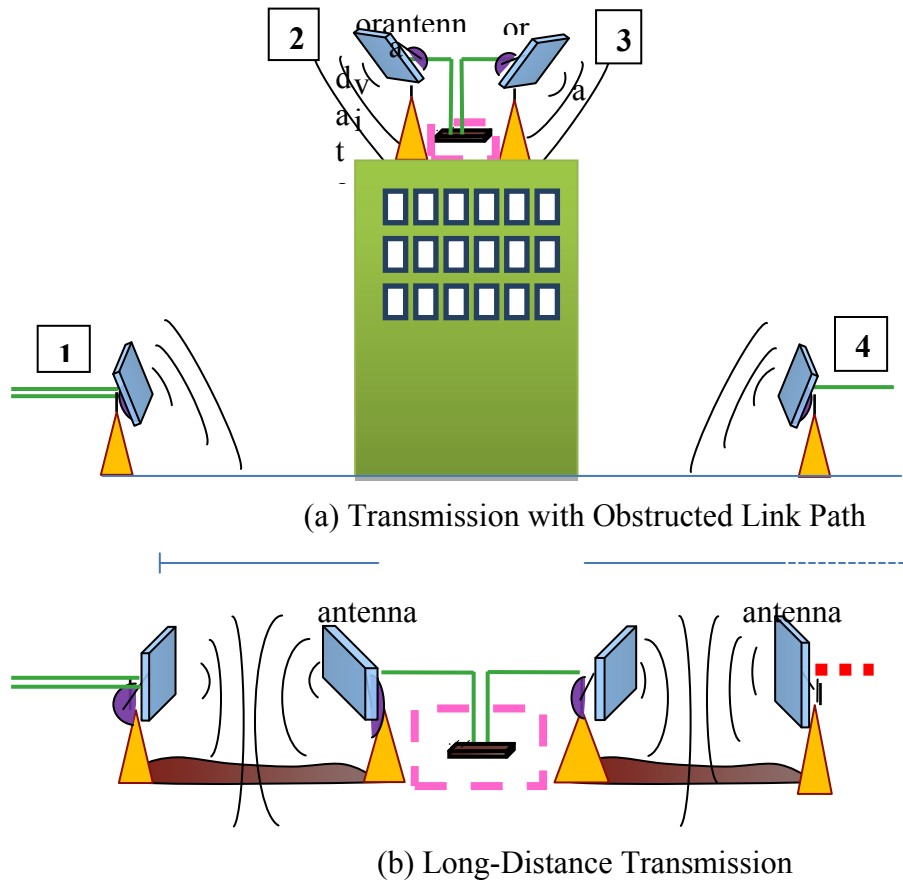

Figure 28 Scenario of Linear-Chain Transmission

Additionally, linear chain structures can be used in long-distance transmission as shown in Figure 28(b). However, this structure may result in significant delays if the number of hops is large.

#### 5.1.2 Antenna Pattern

An antenna pattern is a graphic description of antenna's signal spatial distribution. Based on different usages, antennas may take various forms and use different mechanisms. Examples are dipole, yagi, patch, sector antenna, etc. Different antennas have different

antenna patterns. For patch array antenna, an example of its pattern is depicted in Figure 29.<sup>21</sup>

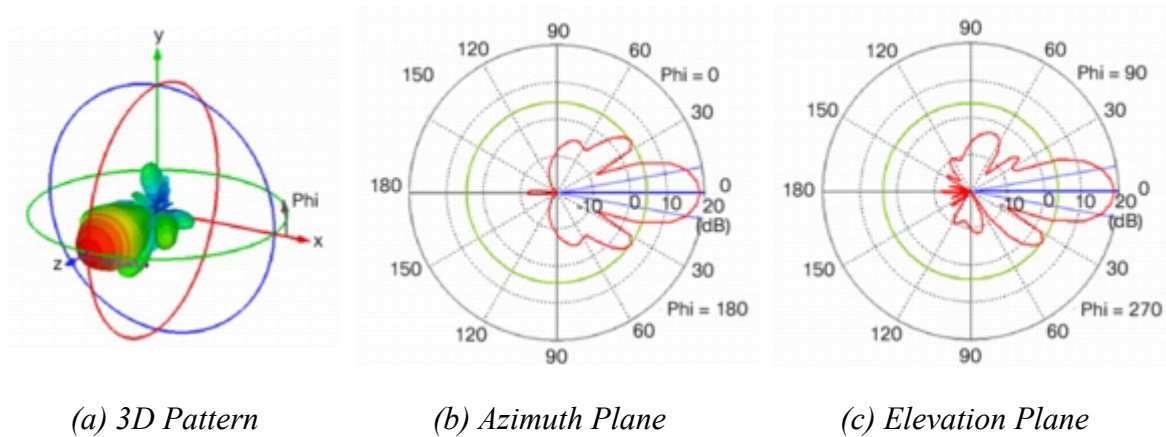

Figure 29 An Example of Antenna Pattern

As shown in Figure 29(a), the radiation energy on z axis has the highest value, which tells us the best position of a peer antenna when aligned. Figure 29(b) and (c) illustrates the sliced view of 3D antenna pattern through the x-z plane and y-z plane, respectively. In this case, (b) is called azimuth plane and (c) is elevation plane. Both of them are in polar coordinates. If an engineer knows the antenna pattern before setting up a wireless system, a better understanding of antenna alignment is obtainable.

### 5.1.3 Fresnel Zone

Fresnel zones define regions in which a particular phase difference is produced by obstructions.<sup>22</sup> Figure 30 shows an example of a Fresnel zone. The most important one is the first Fresnel zone occupying the most transmission power. The formula to calculate radius of this zone at any point between two termini is the following:

$$R = \sqrt{\frac{c}{f} * \frac{s1*s2}{s1+s2}}, \quad (\text{Eq. 5-4})$$

where c is velocity of wave in meters/second,

f is the frequency in Herz,

s1 and s2 are distances in meters from the chosen point to each terminus.

Theoretically, it is not necessary to have this zone totally obstruction free. Only when the size of the object or part of the object in this zone is larger than 40% of the radius of the zone is the reduction effect significant (Freeman 1997).

<sup>21</sup> See website

[http://www.cisco.com/en/US/prod/collateral/wireless/ps7183/ps469/prod\\_white\\_paper0900aecd806a1a3e.html](http://www.cisco.com/en/US/prod/collateral/wireless/ps7183/ps469/prod_white_paper0900aecd806a1a3e.html), accessed Nov. 20, 2010.

<sup>22</sup> See website [http://radiomobile.pe1mew.nl/?Calculations:Propagation\\_calculation:Fresnel\\_zones](http://radiomobile.pe1mew.nl/?Calculations:Propagation_calculation:Fresnel_zones), accessed June 20, 2010.

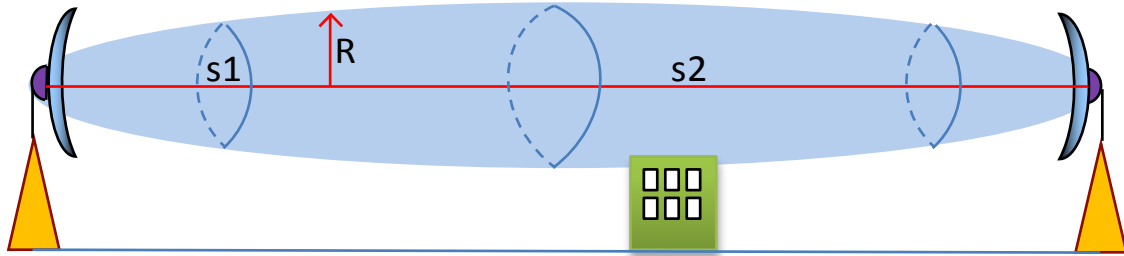

Figure 30 An Example of Fresnel Zone

#### 5.1.4 Frequency Conformance and Interference

The transmission frequency is the number of cycles per second of the radio waves. It is the reciprocal of the wavelength. Not all frequency bands are cost free. Licenses for non-free frequencies require both time and a recurring cost. However, licensed frequencies have less interference. Currently, 900 MHz, 2.4 GHz, and 5.8 GHz are the commonly used license-exempt frequencies. The 4.9 GHz public safety frequency is reserved for ITS and other municipal services. Even for license-free frequencies, their usage is subject to regulations that vary in different countries. These principles include the following considerations: which wireless devices can be used in a country; which frequencies are license-free; what is the highest output power under specific conditions; in practical usage what is the relationship between antenna gain, channel width, and output power; what are the obligations of wireless network configuration, etc. In the U.S., the FCC is responsible for regulating radio spectrum usage. For detailed information, please consult resources concerning relevant codes. One such code is the Electronic Code of Federal Regulations.<sup>23</sup> Fortunately, manufacturers usually take care to assure frequency conformance to the regulations in each country, which makes operation of wireless devices much easier for end users. However, users have to check conformance themselves if an external antenna to be used is not integrated with a radio by the manufacturer.

License-exempt frequencies charge no fees for usage. However, if too many devices are in operation with similar frequencies in an area, there are significant interferences. Thus, checking the frequency usage at planned installation sites is essential. One may use a tool, such as AirView,<sup>24</sup> which is provided by Ubiquiti Networks. When setting up the system, avoid setting the device to operate over crowded channels.

## 5.2 Site Investigation

Because long distance transmissions are needed in transportation and because environmental factors may influence transmission quality, site investigation is necessary before setting up a wireless system. The input for site investigation is the geographic information of the intended locations. The main information acquired from site

<sup>23</sup> See website

[http://ecfr.gpoaccess.gov/cgi/t/text/textidx?c=ecfr&sid=1143b55e16daf5dce6d225ad4dc6514a&tpl=/ecfrbrowse/Title47/47cfr15\\_main\\_02.tpl](http://ecfr.gpoaccess.gov/cgi/t/text/textidx?c=ecfr&sid=1143b55e16daf5dce6d225ad4dc6514a&tpl=/ecfrbrowse/Title47/47cfr15_main_02.tpl), accessed Nov. 20, 2010.

<sup>24</sup> See website <http://ubnt.com/airview/downloads>, accessed May 5, 2010.

investigation is distance between antenna pairs, terrain overview, possible obstructions on the link path, and minimum antenna height at each terminus.

For our configuration tests, we selected three sites on the UNT campus: two in Discovery Park (DP), which is about 3 miles from the main campus, and the other one on the roof of the EESAT building on the main campus. One DP site is on a weather station, and the other is on the roof of the DP building. They are approximately 0.5 miles apart. The roof of EESAT has two poles. The geographic information of these three places is shown in Table 8.

**Table 8 Geographic Information of Test Bed**

<b>Location</b>	<b>DP Building</b>	<b>EESAT (Pole 1)</b>	<b>EESAT (Pole 2)</b>	<b>DP Weather Station</b>
Longitude	-97.15195 (-97° 9' 7.0194")	-97.15111 (-97° 9' 3.996")	-97.15109 (-97° 9' 3.9234")	-97.14997 (97° 8' 59.8914")
Latitude	33.25355 (33° 15' 12.7794")	33.21429 (33° 12' 51.4434")	33.21428 (33° 12' 51.408")	33.25690 (33° 15' 24.84")
Elevation	228.3m/749ft	226m/741.5ft	226m/741.5ft	221m/725.1 ft
Above Ground Level	15.2m/50ft	16m/52.5ft	15.5m/50.9ft	10m/32.8ft
Azimuth	358.97° (From EESAT to DP Building)		181.26°(From DP Weather Station to EESAT)	
Distance	4.365 km (2.712 miles)		4.739 km (2.945 miles)	

Our testing configurations had two link configurations. One was a one-hop link from the EESAT to the DP building; the other was a two-hop linear link consisting of a link from the DP weather station to the EESAT and then to the DP building. The former configuration is used to compare performances of different wireless devices and the latter is for testing characteristics of a linear multi-hop configuration.

Engineers have tools to survey sites virtually before visiting the field. For instance, we initially used Radio Mobile, which is easily downloaded, as is the terrain data.<sup>25</sup> In the end, however, we analyzed the propagation path with Motorola PTP LINKPlanner,<sup>26</sup> which is a more user-friendly and functionally capable tool. Although this tool is designed for estimating the performance of Motorola products, it is also a useful source for obtaining transmission path information for other products. It has an interface with

<sup>25</sup> Radio Mobile is downloadable from [http://www.g3tvu.co.uk/Radio\\_Mobile\\_Setup.zip](http://www.g3tvu.co.uk/Radio_Mobile_Setup.zip), and the terrain data from <http://www2.jpl.nasa.gov/srtm/>.

<sup>26</sup> See website <http://motorola.wirelessbroadbandsupport.com/software/ptp/>, accessed Nov. 29, 2010.



Google Earth,<sup>27</sup> which provides a bird's-eye view of the transmission path. After inputting location data into PTP LINKPlanner and selecting frequency and regulation, we obtained profiles as shown in Figure 31.

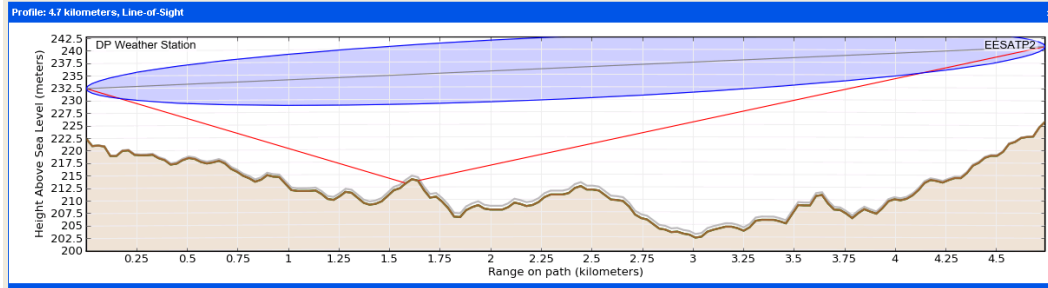

(a) DP Weather Station to EESAT

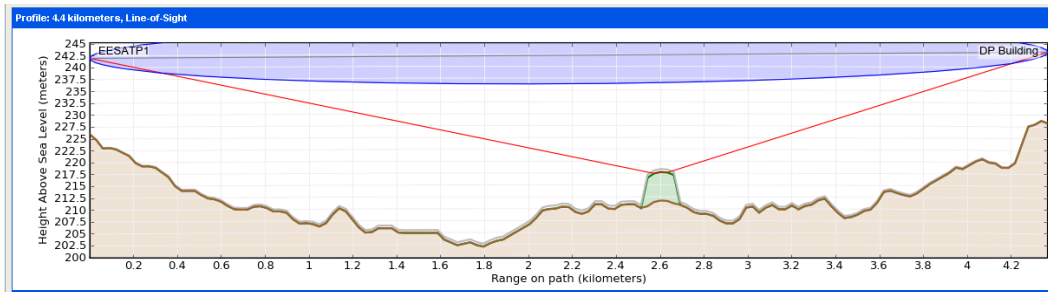

(b) EESAT to DP Building

Figure 31 Profiles Obtained from LINKPlanner

In Figure 31, the brown line outlines the contour of the terrain between two link nodes; the red lines connect antennas and the largest obstacle on the path; the blue shadowed region indicates the Fresnel zone; the green part is an obstacle above ground level. When checking the link, we need to pay special attention to Fresnel zone clearance, especially at high points between two paired antennas.

PTP LINKPlanner allows for mapping the link as an overlay on Google Earth.<sup>28</sup> With the help of map view, we can determine what objects may obstruct the path of communication, especially at the three points where a link is most inclined to be blocked. The obstructions may have a great influence on excess path loss. However, an on-site survey of link paths is essential and cannot be totally replaced by planning tools. An on-site survey is necessary to obtain the height of the obstructions, identify unknown blockages, and determine feasibility of the antenna height. In our test configuration, although there are buildings at three high points on the link path from the EESAT to DP building, they are not in the first Fresnel zone and exert little effect on transmission.

<sup>27</sup> See website <http://earth.google.com/>, accessed July 1, 2010.

<sup>28</sup> See website <http://earth.google.com/>, accessed July 1, 2010.

## 5.3 System Development

Between the EESAT building and DP building, we developed three separate links with the Motorola PTP 54300,<sup>29</sup> the NanoStation M5<sup>30</sup> and the Rocket M5<sup>31</sup> (+ Rocket Dish<sup>32</sup>). In the first stage, we configured, installed, tested, and compared the performances of these devices. Once the one-hop characteristics were investigated, we extended the system by developing a two-hop linear system with the NanoStation M5 and a two-hop linear system with Motorola PTP58300 and Motorola PTP54300. This latter configuration consists of two links: one is from the DP Weather Station to the EESAT building (pole 2), and the other from the EESAT building (pole 1) to the DP building. Price information of equipment can be obtained from the equipment survey that begins on page 74.

### 5.3.1 PTP 54300 Configuration

**Configuration Prior to Installation.** Before installing wireless devices, we need to access the device's parameter interface and enter the pre-installation configuration. For the Motorola PTP 54300, the default IP address is 169.254.1.1 for the master unit and 169.254.1.2 for the slave unit. If the IP address of wireless equipment is unknown, we can reset it to the default one. One connects to the wireless device using its IP address. Then, using the interface, we can validate the license key which assures the link compliance to regulations of a certain country; update the firmware if necessary; change the IP address; set the MAC address of a peer node or link name to define a link pair; identify the working mode for each device; prescribe the output power whose value should not be greater than the maximum value defined in LINKPlanner; set the channel width which should be the same for devices at each end of the link; set link symmetry on the master unit; and enable audio tone if engineers wish to use this tone to tune the antenna, and others.

#### *Antenna Alignment*

As illustrated in the antenna pattern section, the power of the wireless signal emanating from an antenna forms a distribution pattern in the space. To achieve the best transmission result, it is essential to align the antennas carefully. Here we describe two stages to do so: theoretical calculation and practical alignment.

---

<sup>29</sup> See website

<http://www.motorola.com/web/Business/Products/Wireless%20Networks/Wireless%20Broadband%20Networks/Point-to-Point/PTP%20300%20Series/WNS%20PTP%20300%20SS%20Updt%20072910%20r1.pdf>, accessed Nov. 20, 2010.

<sup>30</sup> See website <http://www.ubnt.com/nanostationm>, accessed May 5, 2010.

<sup>31</sup> See website <http://ubnt.com/rocketm>, accessed Nov. 20, 2010.

<sup>32</sup> see website

<http://www.motorola.com/web/Business/Products/Wireless%20Networks/Wireless%20Broadband%20Networks/Point-to-Point/PTP%20300%20Series/WNS%20PTP%20300%20SS%20Updt%20072910%20r1.pdf>, accessed Nov. 20, 2010

Based on the geography of the sites, we can compute the azimuth and tilt angles of each antenna in the link. The FCC provides an online tool<sup>33</sup> to calculate the azimuth angle. The tilt angle can be estimated by a simple triangle transformation.

In the practical installation stage, with the help of the compass and angle scale on the antenna, we can determine roughly the azimuth and tilt angle. Next we need to perform fine adjustments: fix the slave antenna and tune the master unit; fix the master antenna and move its counterpart. Repeat these steps several times until the signal strength achieves the largest one. If the audio aid on the device is enabled, engineers can roughly judge the communication quality by listening to the tone. When the tone is stable with a high pitch, the quality is good. Otherwise it is not good and may need more alignment.

### *Important Parameters and Settings*

#### **Frequency**

Motorola PTP 54300 has several options of for spectrum management. In places where radar avoidance is not required, fixed frequency and intelligent dynamic frequency selection (i-DFS) are two choices. If radar avoidance is required, engineers may choose dynamic frequency selection (DFS) or DFS with i-DFS. For instance, at our test site there is a weather radar working at 5640 MHz. We chose DFS with i-DFS method. The DFS scheme changes the frequency only when interferences by radar are detected. The DFS with i-DFS can not only avoid radar spectrum but select channel with the least interference automatically as well. We learned that DFS with i-DFS causes improper functioning for about 60–120 seconds each time the device switches frequency. So the threshold for frequency hopping is quite important. We decided to use the default value: 85 dbm in the testing system.

Users can control the frequency not only by setting the spectrum management mode but also by modifying the lower center frequency. The choices in this setting are 5478, 5480, and 5482 MHz. For a 10 MHz channel width, the subsequent center frequency is increased by 5 MHz, starting from the user-selected lower center frequency (there is an overlap between adjacent channels). Through this parameter, engineers can change the center frequency of channels deployed. The final center frequency is chosen by the device based-on the practical conditions. In our tests, the lower center frequency is 5480 MHz.

After setting the channel management mode and lower center frequency, the Motorola PTP 54300 can autonomously select the frequency.

#### **Transmission Symmetry**

On the basis of practical requirements, users can choose 1:3, 3:1, or 1:1 symmetry schemes if the channel width is larger than 5 MHz. The main task of this wireless network is to transmit the video or data back from the field, which requires much more bandwidth from the video collection side to the receiving side than the reverse direction. For testing, we set link symmetry to 3:1. This setting allows the data rate to be about

---

<sup>33</sup> <http://www.fcc.gov/mb/audio/bickel/distance.html> (accessed Nov. 20, 2010).

three times greater transmitting from field than the reverse direction. That is, more bandwidth is used for transmitting information (videos) back from the field than for sending commands to the field.

### **Data Rate**

If dual payload mode is enabled, 12 coding techniques are available, from 64QAM (Quadrature Amplitude Modulation) with 0.83 code rate to BPSK (Binary Phase Shift Keying) with 0.5 code rate. The devices automatically select a coding scheme and decide the data rate suitable for current circumstances. With the help of LINKPlanner, the estimated total data rate for our test configuration is 23.16 Mpbs (5.68 Mbps and 17.48 Mbps in each direction). In practice, we obtain an average speed of 19.43 Mbps (4.83 Mbps and 14.6 Mbps in each direction).

### **Channel Width**

There are three options for channel width: 5, 10, and 15 MHz. As indicated in LINKPlanner, the 5 MHz channel width allows very low throughput. There was no large difference in throughput for channel widths of 15 MHz or 10 MHz. Because the narrower the channel width, the less influence noise exerts on signal, we made the channel width 10 MHz.

### **Output Power**

Based on the above channel width, the maximum output power suggested by LINKPlanner is 3 dbm. This parameter is limited by the FCC regulations. The user should set output power equal to or lower than this value. The throughput will decrease accordingly in the testing conditions if we decrease the output power. Therefore, we set output power to 3 dbm in the testing system.

### **Disarming the Device**

After finishing alignment and setting up a wireless link, the device should be disarmed to allow automatic modulation to take effect, disable the alignment tone, enable the programmed hopping scheme, and allow a higher data rate to come into operation. In the “Installation” tab on the device web interface, there is a “Disarm Installation Agent” button to disarm the unit. This can also be done automatically after link is set up following a lapse of 24 hours.

Note: The PTP58300 was set up following the same configuration steps for PTP54300 described above. Because the PTP58300 (from the DP Weather Station to the EESAT building [pole 2]) and PTP54300 (from the EESAT building [pole 1] to the DP building) operate in different frequency ranges, some of the settings must differ. For example, the maximum output power suggested by LINKPlanner is 27 dbm instead of 3 dbm.

## **5.3.2 NanoStation M5 Configuration**

Although Motorola PTP54300 works well for our scenario, a goal of the project is to test other low-cost wireless transmission systems. Consequently, we can recommend cost-effective systems with tradeoffs between quality and system expense. NanoStation M5 is

a product having low cost and good quality. In one test configuration, we used it to establish a one-hop system and a two-hop linear system.

### *Configuration Prior to Installation*

Like the PTP54300, the NanoStation M5 also requires pre-configuration leading up to installation. The main settings to be attended to are IP address, wireless mode, SSID, frequency, channel width, and output power.

When the unit is connected for the first time, the default IP address is 192.168.1.20, and default user name and password both are “ubnt.” Users can change these items after successful connection.

The wireless mode defines the role of a unit in a wireless network; the four modes are Access Point (AP), AP WDS (Wireless Distribution System), Station, and Station WDS. The device that is functioning as a subscriber is set to be a station while the device that bridges the wireless network and wired network is an access point. AP WDS and Station WDS are used in a wireless distribution system. The user guide is online.<sup>34</sup> They are transparent on Layer 2 of an OSI network model. In our test configuration, the device on the EESAT roof acts as a station and the one on the DP roof is set to be an AP.

The Service Set Identifier (SSID) is the name of a link. Equipment on both sides of a link should have the same SSID. Users can also specify the AP MAC address at the station side to create a communication pair.

Using the tool provided by Ubiquiti Networks,<sup>35</sup> one can investigate the best frequency at a certain location and set this frequency at the AP side. The working frequency can be modified after a link is set up. For detailed information, please refer to the “Important Parameters and Settings” part of this document.

Channel width and output power can also be changed after a system is established. The channel width should be the same on both sides at the pre-establishment stage. Output power should be sufficient to allow the two devices to communicate with each other.

Antenna alignment is similar to that described for the PTP 54300. However, the NanoStation M5 does not have an indication tone to aid antenna alignment. The alternative is the tool in the system interface provided by Ubiquiti. This tool reports signal strength in real time. Thus, engineers can align the antenna at the position at which the device achieves the greatest signal strength. Figure 32 provides an example of an alignment tool.

---

<sup>34</sup> [http://ubnt.com/wiki/AirOS\\_5.2](http://ubnt.com/wiki/AirOS_5.2) accessed Dec. 10, 2010.

<sup>35</sup> See website <http://www.ubnt.com/nanostationm>, accessed May 5, 2010.

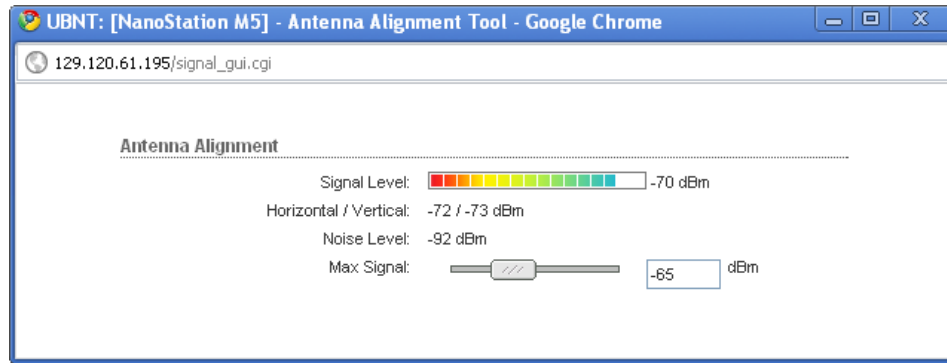

*Figure 32 An Antenna Alignment Tool*

The antenna gain of this device is 16 dBi. The vertical and horizontal polarizations are 41 and 43 degrees, respectively. We did not use a kit to adjust the tilt angle of the antennas. We adjusted the heights of the antennas to be as equal as possible under the line-of-sight conditions.

*Important Parameters and Settings.*

**Frequency**

The frequency of the NanoStation M5 for the test configuration is in the 5470 MHz–5825 MHz band. The goal in this section is to choose an appropriate frequency to minimize the interference with other wireless systems.

Using the AirView<sup>36</sup> software provided by Ubiquiti Networks, we can analyze the frequency usage at each site. In Figure 33, the vertical axis indicates the usage of each channel measured in percentages. The usage values show the occupancy rate, which takes into account quantity and energy level of wireless links in that channel. The horizontal axis is the frequency channel ranging from 5735 to 5815 MHz.

---

<sup>36</sup> See website <http://ubnt.com/airview/downloads>, accessed May 5, 2010.



(a) From device in DP Building

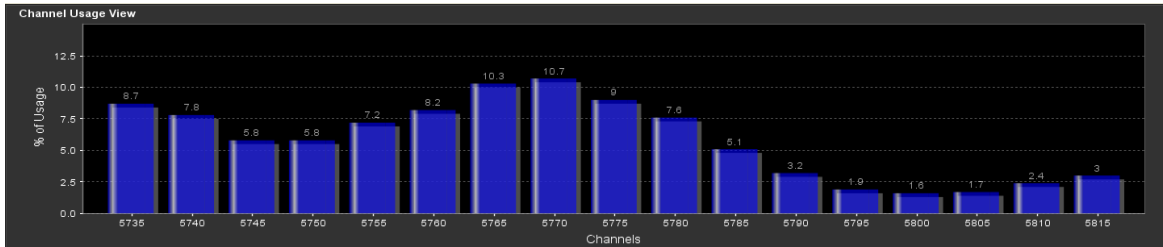

(b) From device in EESAT

*Figure 33 Channel Usage in the Test Bed*

From Figure 33(a), we can see channel 154 (5770 MHz) has the highest usage, and frequencies on each side of this channel have lower usage. And in Figure 33(b), the usage has a similar distribution. The rule of thumb for choosing a channel is to select the one with the least interference on both sites. In our test configuration, we set the channel to be 160 (5800 MHz).

### Data Rate

This product uses the 802.11a/n standard. For wireless products with standard IEEE 802.11n, the data rate is usually expressed with the MCS (Modulation and Coding Scheme) index, which represents different combinations of the number of streams, modulation method, and coding rate. So for different channel widths, the same MCS index refers to different data rates. Table 9 shows their relationship.

MCS0 and MCS8 use the BPSK (Binary Phase Shift Keying) modulation method; MCS1-2 and MCS9-10 use the QPSK (Quadrature Phase Shift Keying) modulation algorithm; MCS3-4 and MCS11-12 are based on 16-QAM (Quadrature Amplitude Modulation), while MCS5-7 and MCS13-15 are on 64-QAM.

**Table 9 Relationship of MCS Index and Data Rate**

MCS Index	Data Rate (Mbps)			
			10 MHz	5 MHz
0	13.5	6.5	3.25	1.625
1	27	13	6.5	3.25
2	40.5	19.5	9.75	4.875
3	54	26	13	6.5
4	81	39	19.5	9.75
5	108	52	26	13
6	121.5	58.5	29.25	14.625
7	135/150	65	32.5	16.25
8	27	13	6.5	3.25
9	54	26	13	6.5
10	81	39	19.5	9.75
11	108	52	26	13
12	162	78	39	19.5
13	216	104	52	26
14	243	117	58.5	29.25
15	270/300	130	65	32.5

Fortunately, extensive experiments are not necessary to determine a sufficient data rate. The wireless equipment chooses the data rate automatically to cater to current conditions if the engineer checks the *Automatic* box in the unit interface.

**Channel Width**

Channel width may be likened to the diameter of a pipe. The wider the channel width, the higher the throughput may be for the same MCS index value when the link is not saturated. However, we must consider another factor when we choose the channel width: the signal strength. From Figure 34, we see the signal strength changes according to variation of channel width. Signal strength of -80 dBm or better is suggested for a reliable link. The noise floor indicates the noise level that can be used in the SNR (Signal-to-Noise Ratio) calculation. The larger the gap between signal strength and noise floor, the larger the margin of the link. From experience, a 20 dbm or larger deviation between signal strength and noise floor works well. Therefore, we chose 10 MHz as the channel width for testing.



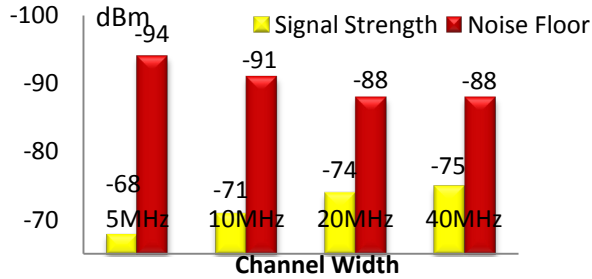

Figure 34 Signal Strength and Noise Floor Changes by Channel Width

### Output Power

We investigated the influence of output power on signal strength, noise floor, and overall throughput. Here, we set MCS index at 15 in each test and chose to change data rate automatically. Figure 35 gives the alterations of signal strength and noise floor with respect to output power changes. With the enhancement of output power, the noise floor remains almost the same for the same channel width, while signal strength increases. From Figure 35 we see throughput rises with increase of output power. Consequently, output power is set as the maximum 26 dbm in the test system.

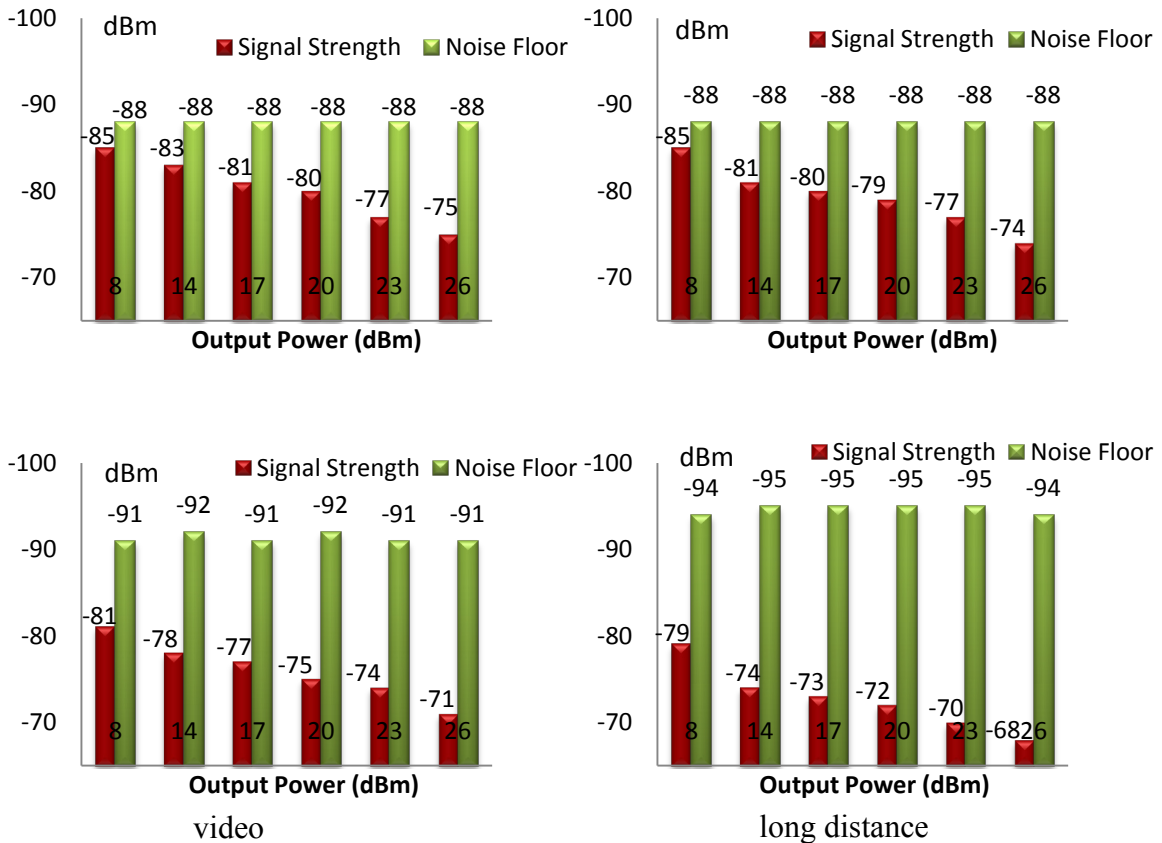

Figure 35 Influence of Output Power on Signal Strength and Noise Floor

Figure 36 depicts the relationship between output power and throughput in the test configuration.

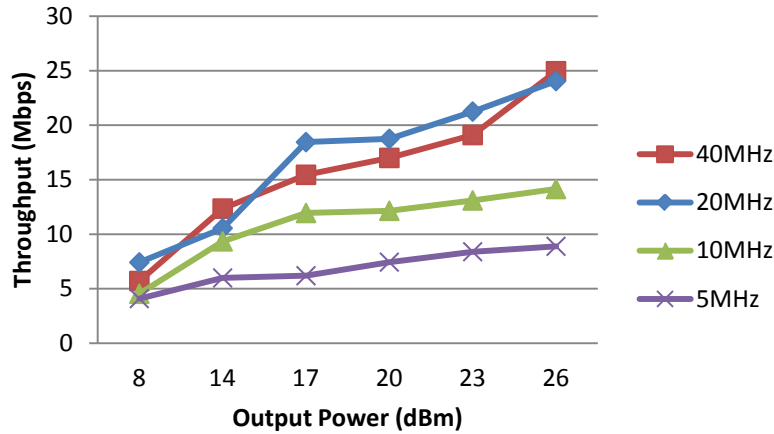

Figure 36 Influence of Output Power on Throughput for NanoStation M5

Note: both pairs of the NanoStation M5 are set up in the fashion described above. In order to diminish interference the frequency of the first pair (from the DP Weather Station to the EESAT building [pole 2]) is set to be 5240Hz.

### 5.3.3 Rocket M5 Configuration

The Rocket M5 can function with such antennas as AirMax sectors and Rocket Dish (both are products of Ubiquiti Networks) to provide higher throughput and cover longer distances. Additionally, the Rocket M5 itself has a larger memory than the NanoStation M5. Therefore, it can be used in circumstances in which a more powerful but cost-effective system is required.

Pre-configuration prior to installation for the Rocket M5 is similar to the NanoStation M5. But for antenna alignment, the RocketDish5G-30 is more difficult than the NanoStation M5 because the former has a higher antenna gain (30 dBi) than the latter (16 dBi). The beamwidth of RocketDish5G-30 is just 5 degrees while NanoStation M5 has a more than 40-degree beamwidth. Thus, this procedure should be implemented with care. When tuning the antenna, we can adjust it up or down, turn it left or right, and tilt it upward or downward. However, it should not be rotated.

#### Frequency and Channel Width

As indicated in AirView for channel usage, there were interferences near our test bed and the channel width should not be too broad. Here we set our frequency to be 5805 with 20 MHz as the channel width.

#### Output Power

Because our link is of short distance, it is not necessary to set the output power to the maximum. Figure 37 illustrates that as the output power increases the throughput remains at almost the same level.

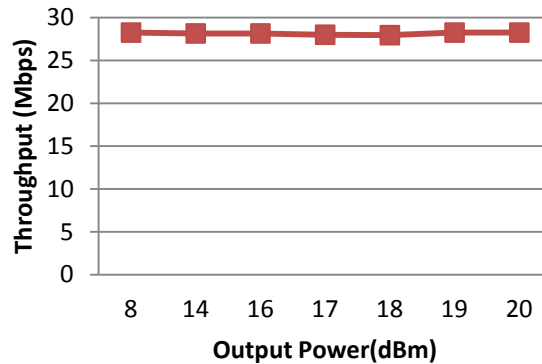

Figure 37 Influence of Output Power on Throughput for Rocket M5

Here we set the output power to be the minimum value, 8 dbm.

### 5.3.4 Performance Comparison of Wireless Devices

Note: comparisons of wireless devices were performed over two time periods using different channels obtained from AirView. The frequencies of the devices were adjusted as necessary.

**One-hop Transmission.** Data rate is the nominal speed in bits per second at which data is transmitted across the communication pathway. Data refers to not only the user information but network information as well. The term throughput refers to the transmission speed of real user data. This parameter is the crucial measurement by which to judge a wireless system. Besides link throughput, perceived video quality and throughput stability were also measured for comparison.

**Throughput (as tested in first time period).** After we set up the three links—with Motorola PTP54300, NanoStation M5, and Rocket M5, respectively—we used Jperf<sup>37</sup> to test their throughput. Jperf is a graphical edition of Iperf. Information on Iperf may be found online<sup>38</sup>. It is a popular Java application to measure the throughput of a network using the TCP or UDP protocol. The specifications of the test laptop are in Appendix B. In each test, two experiment replications are performed. The final result in Table 10 is the average of the two experiments.

<sup>37</sup> See website <http://code.google.com/p/xjperf/>, accessed Nov. 29, 2010.

<sup>38</sup> <http://en.wikipedia.org/wiki/Iperf> (accessed Sept. 10, 2010) and <http://www.noc.ucf.edu/Tools/Iperf/> (accessed June 2, 2010).

**Table 10 Performance Comparison of Wireless Devices**

<b>Products</b>	<b>Frequency (MHz)</b>	<b>Channel Width (MHz)</b>	<b>Output Power (dBm)</b>	<b>Throughput from EESAT to DP (Mbps)</b>	<b>Throughput from DP to EESAT (Mbps)</b>
Motorola PTP 54300	5480	10	3	14.6	4.83
NanoStation M5	5800	10	26	14.5	15.1
Rocket M5+ RocketDish5G-30	5805	20	8	27.8	28.8

As the table indicates, the NanoStation M5 and Rocket M5+ RocketDish5G-30 have competitive performances in terms of link throughput. They should be candidates to construct cost-effective wireless systems. The Motorola PTP 54300 we used is not the best in this series. It may achieve better performance if the license was upgraded. It also provides several unique functions such as intelligent channel selection, transmission symmetry, alignment tone aid, and system monitoring, which are missing in the NanoStation M5 and Rocket M5.

**Throughput stability (as tested in second time period).** Table 11 presents a throughput stability comparison based on 20-minute duration for three separate single-hop wireless devices. Because our focus is on throughput stability we analyzed only one direction throughput. Figure 38 illustrates that the single-hop link from Motorola PTP543000 is the most stable and the single-hop link from NanoStation M5 is the least stable.

**Table 11 Throughput Comparison Based on 20-minute Duration**

<b>Products</b>	<b>Frequency (MHz)</b>	<b>Channel Width (MHz)</b>	<b>Output Power (dBm)</b>	<b>Average Throughput from EESAT to DP (Mbps)</b>	<b>Throughput Variance from EESAT to DP (Mbps)</b>
Motorola PTP 54300	5480	10	3	14.6	0.067
NanoStation M5	5805	10	26	14.7	1.12
Rocket M5+ RocketDish5G-30	5245	20	17	29	0.57

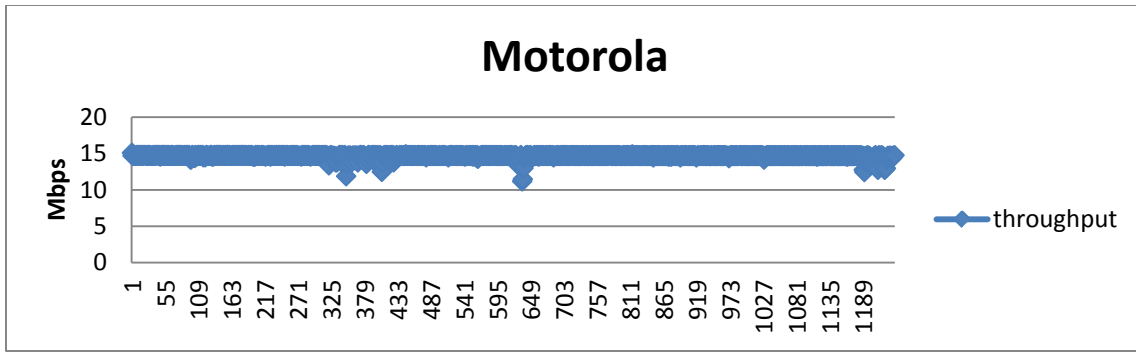

(a)

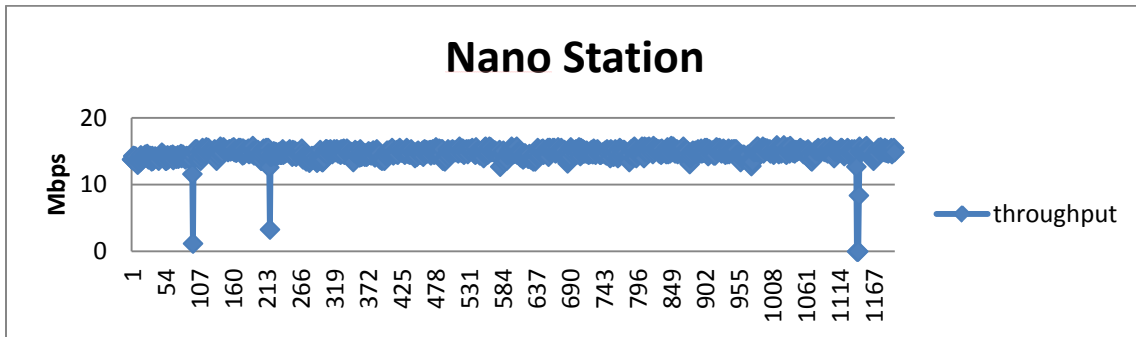

(b)

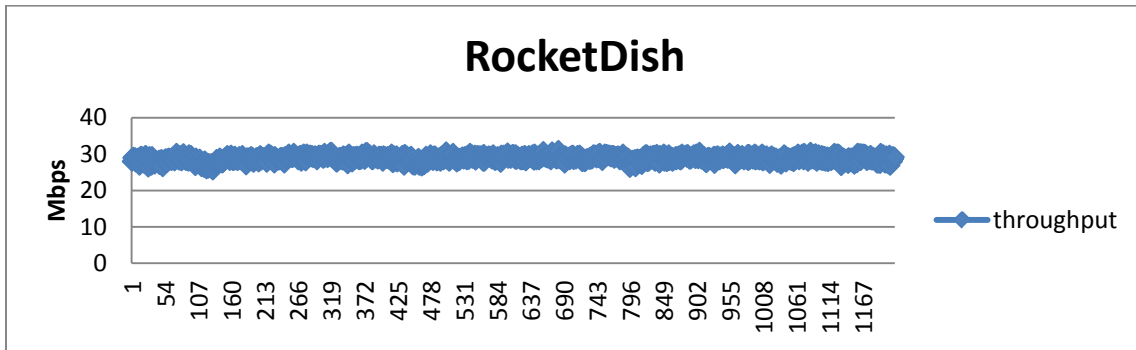

(c)

Figure 38 20-min uteThroughput Plot for (a) Motorola PTP54300; (b) NanoStation M5; (c) RocketDish

**Perceived video quality (as tested in second time period).** EvalVid, a public wireless transmission evaluation tool available online, is utilized for comparing three separate links with the Motorola PTP 54300, the NanoStation M5, and the Rocket M5(+ Rocket Dish) according to the perceived video quality. Average delay, accumulated jitter, and video quality loss (PSNR) are used for comparison in Table 12.

**Table 12 One-hop Wireless Transmission Comparison Based on Perceived Video Quality**

Products	Frequency (MHz)	Channel Width (MHz)	Output Power (dBm)	Average Delay(s)	Accumulative Jitters(s)	Image Quality PSNR Loss
Motorola PTP 54300	5480	10	3	0.033298	0.00130	0%
NanoStation M5	5805	10	26	0.033304	0.00133	0%
Rocket M5+ RocketDish5G-30	5245	20	17	0.033305	0.00091	0%

**Two-hop transmission (tested in time period 2).** For two-hop transmission comparison, we utilized link throughput for measurement.

As shown in Table 13, the two-hop Motorola link has better throughput performance. As was discussed previously in the single-hop transmission comparison, the Motorola PTP54300 has much less throughput variance compared with NanoStation M5. We tried to decrease the throughput variance of NanoStationM5 pair from ESSAT to DP building by narrowing the bandwidth from 10 MHz to 5 MHz. As presented in Table 14, when the single-hop transmission throughput is more stable, the throughput degrade due to two-hop configuration is much less. Throughput degrade is calculated by the following formula.

$$\text{ThroughputDegrade} = \frac{\text{throughput\_linkAC} - \min(\text{throughput\_linkAB}, \text{throughput\_linkBC})}{\min(\text{throughput\_linkAB}, \text{throughput\_linkBC})}$$

**Table 13 Two-hop Wireless Transmission Comparison for Motorola and NanoStation**

Products	From Field to ESSAT				From ESSAT to DP				From Field to DP
	Frequency (MHz)	Channel Width (MHz)	Output Power (dBm)	One-Hop Throughput (Mbps)	Frequency (MHz)	Channel Width (MHz)	Output Power (dBm)	One-Hop Throughput (Mbps)	Two-Hop Throughput (Mbps)
Motorola	5480	10	3	14.7	5800	10	27	14.7	14.1
Nano Station M5	5240	10	26	17.7	5805	10	26	14.1	11.5

**Table 14 Throughput Degrade Comparison for Two-hop NanoStation**

Products	From Field to ESSAT (Link_AB)	From ESSAT to DP (Link_BC)					From Field to DP (Link_AC)	
	One-Hop Throughput (Mbps)	Frequency (MHz)	Channel Width (MHz)	Output Power (dBm)	One-Hop Throughput (Mbps)	Throughput Variance (Mbps)	Two-Hop Throughput (Mbps)	Throughput Degrade
<b>Nano Station M5</b>	17.7	5805	10	26	14.1	0.49	11.5	-18.4%
<b>Nano Station M5</b>	17.7	5805	5	26	8.4	0.06	8.0	-4.8%

### 5.3.5 Camera

Because we chose an IP camera for which the output can be directly transmitted through the Internet without conversion equipment, the wiring is quite simple. Power is supplied through a power cord. An Ethernet cable can connect the camera and wireless equipment directly without a switch (if the wireless equipment has an extra Ethernet interface) or through a switch.

Proper camera settings are important because they not only provide the operator with acceptable quality for live video but also conserve the limited communication bandwidth.

The first significant setting is the compression method. The method chosen must achieve satisfactory quality for the given bandwidth. Most IP camera products support motion MJPEG, MPEG-4, H.264 standards, or a combination. The size of a video file processed by H.264 may be up to 50% smaller than a file using MPEG-4, and an 80% smaller video file can be produced by MJPEG without sacrificing quality.<sup>39</sup> But generally, cameras supporting H.264 are more expensive and there are fewer product choices in the current market. Cameras with the MPEG-4 codec are good compromises. The Axis 213PTZ<sup>40</sup>, which we tested, is a cost-efficient IP camera with MPEG-4 and MJPEG codecs.

The Axis 213PTZ supplies a web interface within which to set parameters. In the “Setup” page, there is an “MPEG-4” setting page under “Advanced” in the “Video & Image” category, as displayed in Figure 39. “Video object type” has two options: “simple” and “advanced simple.” The former uses the H.263 coding method. H.263 has a lower compression rate but video in this format can be viewed through QuickTime. The latter option takes advantage of MPEG-4 part 2 and it can function with AMC (AXIS Media Control) in IE, an ActiveX component developed by AXIS. To conserve bandwidth, we set the type as “advanced simple.”

Intra-coded frame (I-frame) and predicted frame (P-frame) are two frame types in compressed video. An I-frame is independent of content from other frames when decoded. P-frames are decompressed in reference to previous frames. A video with a larger number of P-frames has a greater compression rate. So we chose an IP structure with both I-frames and P-frames. The length of the GOV (group of video object plane) is set to 8, which means that for seven P-frames there is an I-frame.

Additionally, due to the limitation of wireless capacity in practical usage, we constrained the maximum bit rate to 1500 kbps.

---

<sup>39</sup> See website [http://www.axis.com/products/video/about\\_networkvideo/compression\\_formats.htm](http://www.axis.com/products/video/about_networkvideo/compression_formats.htm), accessed June 4, 2010.

<sup>40</sup> See website [http://www.axis.com/files/datasheet/ds\\_213ptz\\_33081\\_en\\_0909\\_lo.pdf](http://www.axis.com/files/datasheet/ds_213ptz_33081_en_0909_lo.pdf), accessed April 20, 2010.



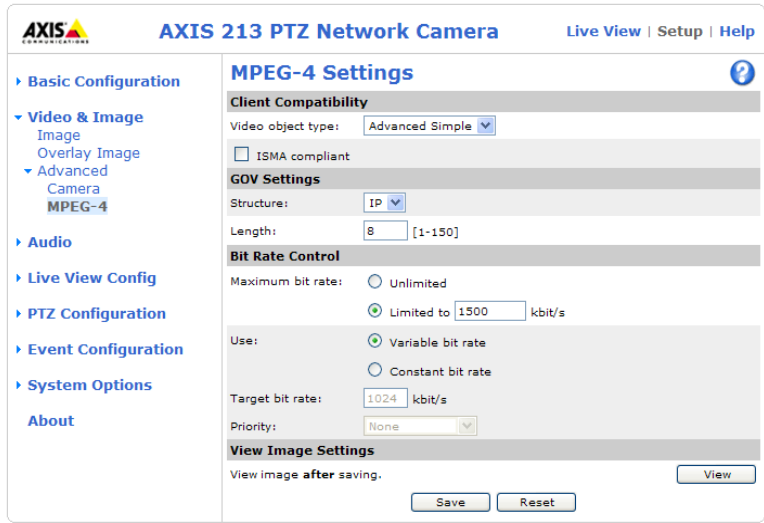

Figure 39 MPEG-4 Settings of Camera Axis 213PTZ

In a general image setting, we set the resolution to be 1CIF (352 x 240) and compression level to be 30. In practice, 15 frames/second is acceptable for video fluency. Therefore, we limit maximum frame rate to be 15 frames/second for each viewer (Figure 40).

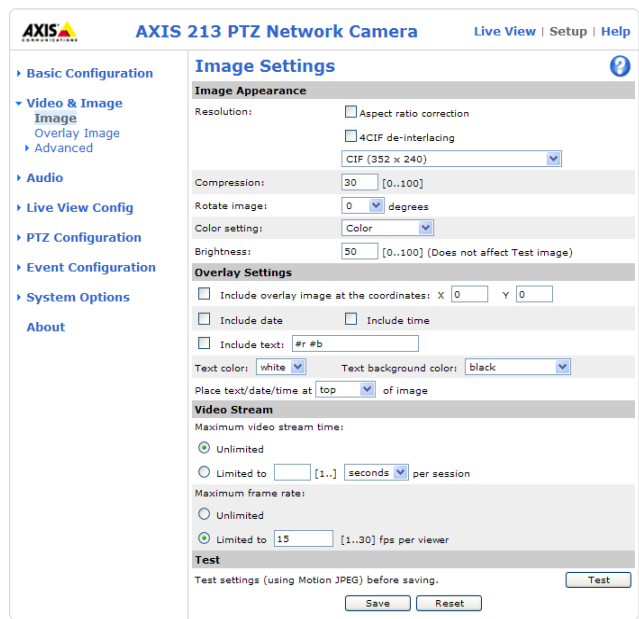

Figure 40 General Image Settings of Camera Axis 213PTZ

## 5.4 System Monitoring

### 5.4.1 Video

Using the wireless and camera settings introduced above, we can obtain smooth traffic videos in real time. With the AMC component (a recommended ActiveX component used

to view videos and control cameras) in IE, the PTZ response is so quick that we can change pan/tilt angle and zoom in /out instantly.

Figure 41 provides some snapshots of traffic monitoring video of the deployed system. Even though we have to install the camera around 90 meters (300 feet) away the road due to lack of better location, we can still have clear view of cars and traffic signs.



(a)



(b)



(c)



(d)

*Figure 41 Snapshots of Traffic Monitoring Video*

#### **5.4.2 Wireless Communication**

To judge the communication quality of this system, we not only checked its throughput, throughput stability, and perceived video quality, but also used tools to monitor the system over time.

The Motorola PTP54300 provides the *Diagnostic Plotter* to monitor the link (Figure 42).

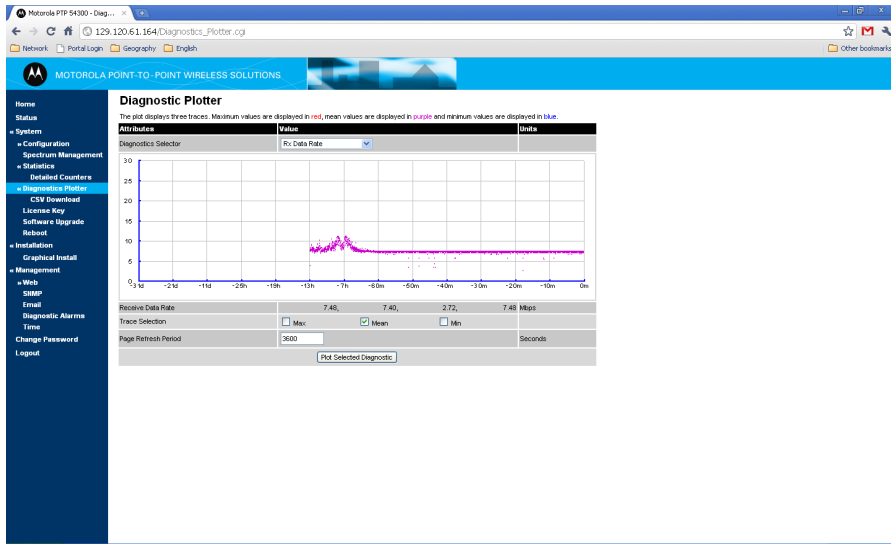

Figure 42 Data Rate in Diagnostic Plotter

For Ubiquiti devices, we used a tool called The Dude<sup>41</sup> to monitor the performance of wireless devices. The wireless equipment we used supports SNMP (Simple Network Management Protocol), which is a protocol typically applied in network monitoring. Through SNMP, The Dude gets such real-time transmission parameters as signal strength, transmitted packages and bytes, working data rate, etc. The Dude can also demonstrate those data by charts in hour, day, week, or year scale. Figure 43 and Figure 44 provide some example images of The Dude.

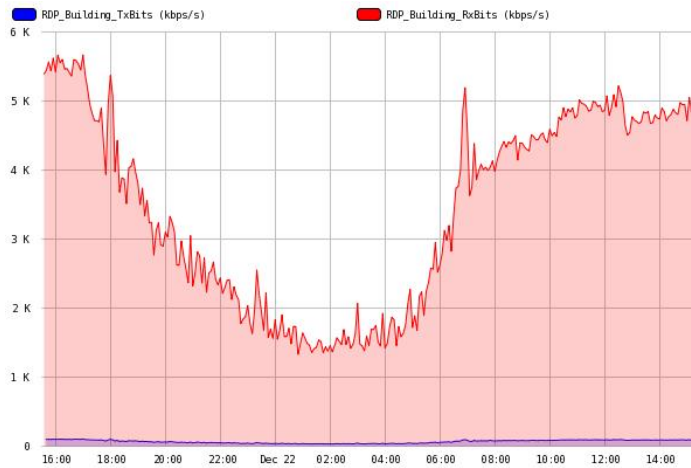
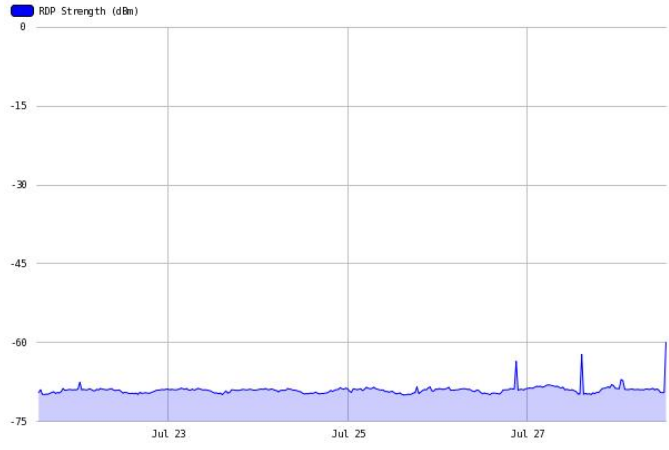

Figure 43 Throughput Change in a Day

<sup>41</sup> See website <http://www.mikrotik.com/thedude.php>, accessed June 3, 2010.



*Figure 44 Signal Strength*

## Chapter 6. Video Analytics

Video analytics (VA), as applied to traffic monitoring, operates autonomously to collect statistics and generate alerts when incidents occur. Such capabilities promise to extend the radius of a TMC's surveillance region while keeping equipment costs low and adding very little to the operational costs. This chapter aims to inform TxDOT engineers by providing (1) a survey of the existing VA products for traffic surveillance, (2) data on one such product—Abacus from Iteris, and (3) insight into the software architecture of a typical roadside VA system. The latter is achieved in the context of a TxDOT demonstration system that has been developed by UNT. The configuration of the demonstration system allows it to collect statistics and report a small class of traffic anomalies.

The report is organized as follows: firstly we survey currently existing video analytics products; secondly we describe the components, design, and usage of the TxDOT demonstration system. This includes how such a system could be integrated within existing surveillance systems as well as the functionality it might provide. Later on we report preliminary performance evaluation results for the TxDOT demonstration system and Abacus (an existing video analytics product). Finally, we provide recommendations and discuss the forthcoming evaluation phase.

### 6.1 Traffic Surveillance Video Analytics Survey

A number of video analytics products are marketed for ITS. Narrowing the choices from the products on the market requires taking into consideration three factors: (1) the scenarios to which the products are to be applied and the necessary traffic data to be collected for each; (2) the system configurations that are possible, particularly with respect to communication; (3) the minimal performance requirements, taking into consideration all necessary aspects such as data transmission and system configuration.

To make a wise choice regarding VA products, criteria must be established and a comparison of existing products must be conducted. Based on the three factors listed, we provide data and discussion in the following three subsections that will be helpful in framing the problem of product selection.

#### 6.1.1 Typical Scenarios

Figure 45 illustrates the four typical scenarios that current VA products target: urban arterials, tunnels, freeways, and bridges. Different scenarios require the same basic processing functionalities, but may have different high-level functionalities, as delineated in

Table 15. For urban arterials, vehicle presence detection is one of the basic functions required. Some products perform only intersection control so that vehicle presence detection is the only function available. Other products not only assist in intersection control but also collect traffic data and detect incidents. Such products could serve for intersection control, freeway monitoring, or bridge monitoring. Traffic data produced by VA includes speed, volume, density, headway, occupancy, and so on. Incident detection, another high-level functionality, covers congestion, pedestrians, stopped vehicles, and fast/slow drivers. For the tunnel scenario, fire and smoke detection is required above all other incidents.

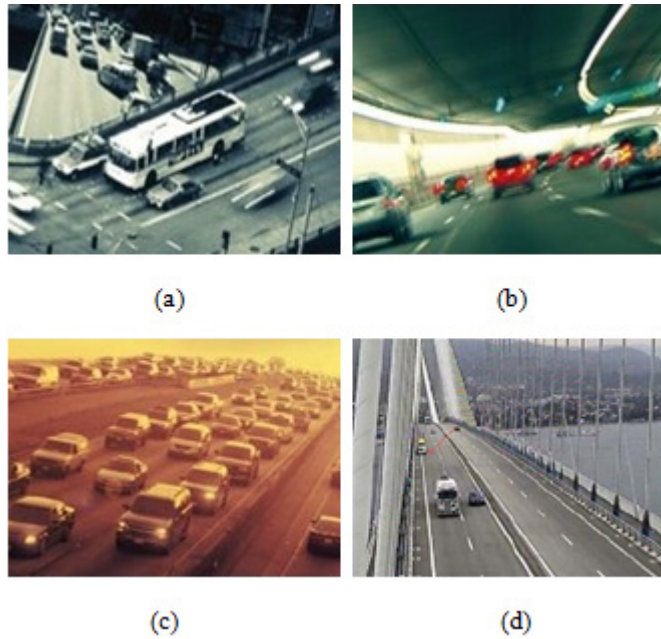

*Figure 45 Typical Scenarios*

**Table 15 Summaries of Traffic Data Collected and Most Events Detected by Existing Products**

<b>Traffic Data and Monitoring</b>	
Speed	Speed of individual vehicles
Volume	The number of vehicles per time unit per lane
Occupancy	The average number of vehicles per lane
Traffic Flow	Total number of vehicles summed over all directions
Density	The density of vehicles per lane
Headway	Distance between vehicles
Gap time	Time distance between vehicles
Counts	Number of vehicles passing over a detection zone
Queue length	The length of the queue formed by waiting vehicles
Turn counts	The number of turns occurring at intersections
<b>Automatic Event Detection</b>	
Congestion	Congestion level
Stopped vehicles	Vehicles stopped roadside
Slow/fast drivers	Speed not within nominal bounds
Wrong-way drivers	Wrong way
Pedestrians	Pedestrians on roadway
Debris	Trash or fallen objects
Fire/smoke	Fire or smoke in tunnel
Accident Recognition	Recognition of vehicle collision
<b>System Technical Alarms</b>	
Image Quality	Image quality is not sufficient for viewing or processing
Camera Movement	Camera's instability affects the quality of video output
Video Failure	No video output
PTZ out of home	PTZ camera is not focusing on right scene

### **6.1.2 Generic System Configuration**

Two types of traffic surveillance system configuration are available: an onsite system with processors deployed on-site and a centralized system with a processor in the TMC. A centralized system with wireless communication is not preferred because it will result in a heavy bandwidth burden in order to transmit videos. Figure 46 is a schematic of the camera-side and TMC-side components of a typical wireless system for traffic monitoring.

The component labeled “machine vision processor” (at top of Figure 46) is vital to a traffic monitoring system. It plays an important role in intelligently processing traffic video and providing either a compressed video stream (MPEG2 or MPEG-4) or statistical data with incident alarms. There are two major types of machine vision processors. One is a single board processor and the other is a camera with an imbedded processor. For the

data collected by a machine vision processor, a communication component is needed for transmission to a central site such as a TMC.

The communication component links the machine vision processor with a variety of communication networks such as direct line, telephone lines, fiber networks, and wireless communication.

Remote camera control and processor reconfiguration are possible with the management software installed at the center side (TMC). Management software makes it possible to remotely execute a complete camera set-up, modify detection zones, and check the results on-screen. Other software applications of data management and analysis are designed in particular for visualizing statistical data and incident alarms transmitted from camera side (traffic field) to center side (TMC). Traffic data, events, and alarms are typically stored in a relational database by the software for management and analysis. Management software can also provide an interface for monitoring and reporting applications. Monitoring includes event visualization, documentation of event status, pre- and post-event image sequences, all event information, and an incident video. For reporting applications, a database is required to generate data summaries or event reports as exportable graphs or tables. More advanced analysis functions might be available such as map tree visualization, map zoom tool, a central map image where the status of each camera can be verified. The latter may incorporate a visual indication on the central map for the camera at which the event or alarm occurred. Generally, management and analysis software associated with different products have basic features in common but vary with respect to specialized functionalities.



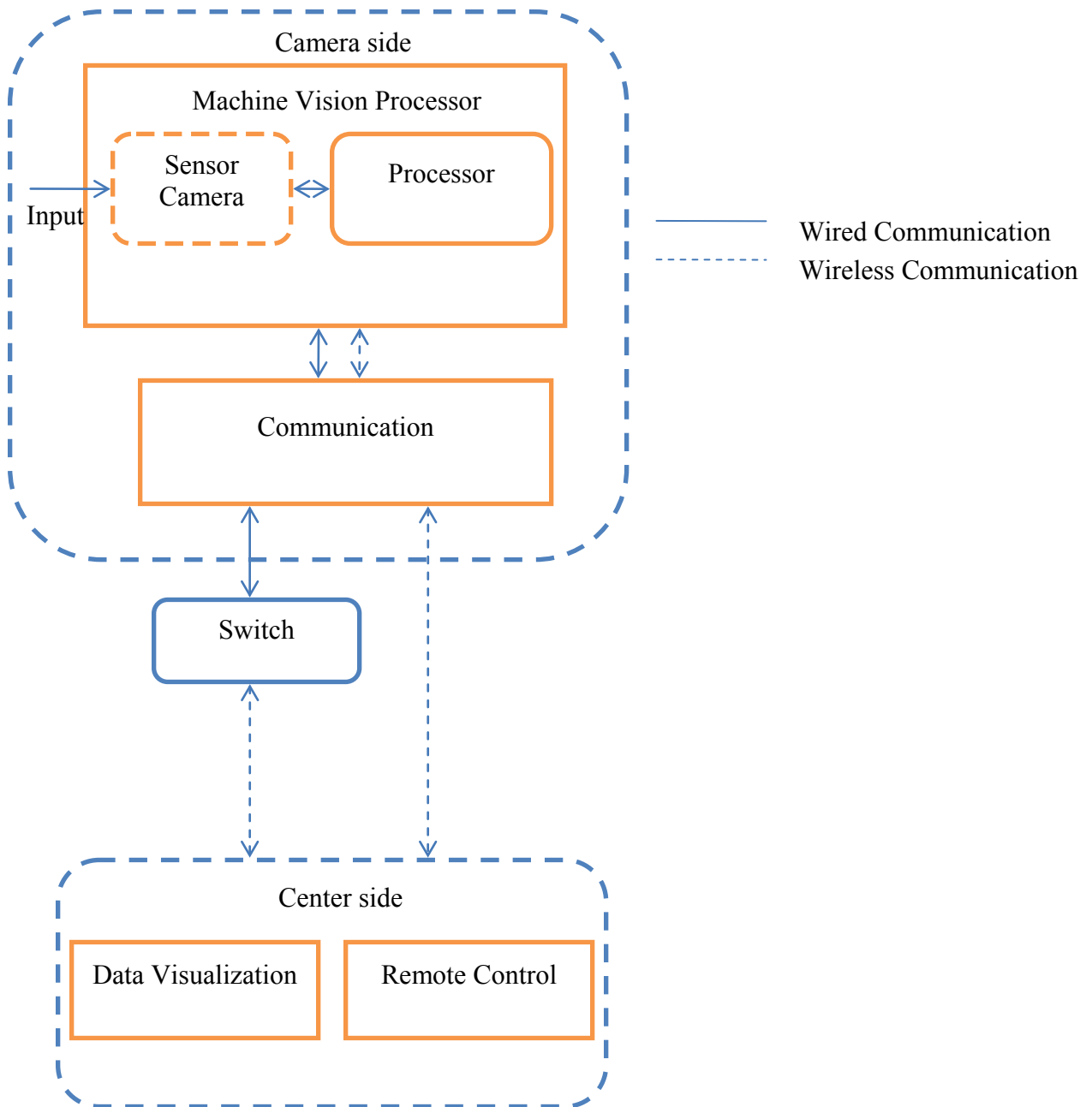

Figure 46 Generic System Configuration

### 6.1.3 Selection Guidelines

Table 16 summarizes video analytics products compared across five aspects: application, object classification, data aggregation, events detected, and video compression. Products from one company are grouped with the same color. A total of 10 companies are listed in the table.

In order to find the right solution at low cost, it is necessary to verify what the real needs are for traffic monitoring and management in the deployment context. Intuitively, the more processing functions a product has, the better it is. However, this concept is not

helpful in practical terms because of the tradeoff between the size of data to be transmitted and the cost of wireless equipment with the required bandwidth capability. Thus a comprehensive cost-effective solution should be chosen based on this tradeoff.

**Table 16 Video Analytics Products**

	<b>Product</b>	<b>Applications</b>	<b>Object Classification</b>	<b>Data Aggregation</b>	<b>Events Detection</b>	<b>Video Compression</b>	<b>Specifications</b>
1	Autoscope Solo Terra	Arterials, freeway, tunnel, and bridges	Vehicle classification	Speed, volume, occupancy	Stopped vehicle, debris, wrong-way driver detection, fire/smoke detection, pedestrian and slow moving vehicles detection	MPEG-4	15 W, 85–265 VAC, 50–60 Hz
2	Autoscope RackVison Terra	Arterials, freeway, tunnel, and bridges	Vehicle classification	Speed, volume, occupancy	Stopped vehicle, debris, wrong-way driver detection, fire/smoke detection, pedestrian and slow moving vehicles detection	MPEG-4	12–24VDC, 11 W maximum, 12VDC,11W,900mA; 24 VDC: 11W, 500mA
3	Autoscope RackVison System One	Arterials, freeway, and bridges	Vehicle classification	Speed, volume, occupancy	Vehicle detection	N/A	12 W maximum, 110–240 VAC,0.098A; 10 VDC, 0.81A, 30 VDC, 0.36A
4	Autoscope Phoenix	Arterials	N/A	N/A	Vehicle detection	N/A	12–24 VDC, 11W maximum, 12VDC, 6W, 500mA; 24 VDC,7W,290 mA
5	Autoscope Solo ProII	Arterials, freeway, tunnel, and bridges	Vehicle classification	Volume, speed, occupancy, density, headway, traffic counts	Incident detection, vehicle detection	Wavelet codec	RS170/NTSC: 24VAC 60 Hz; CCIR/PAL: 24 VAC 50Hz, 10–28 VDC, 17 watts with heater on (25 watts

	<b>Product</b>	<b>Applications</b>	<b>Object Classification</b>	<b>Data Aggregation</b>	<b>Events Detection</b>	<b>Video Compression</b>	<b>Specifications</b>
							with optional video compression module)
6	Vantage Edge 2	Arterials, freeway, tunnel, and bridges	Vehicle classification	Traffic count, speed, occupancy	Bicycle detection, slow moving or wrong way motion detection, vehicle detection, highway congestion	N/A	12 or 24 VDC, 7 W maximum; 12VDC-490mA; 24VDC-280mA
7	VersiCam	Arterials	N/A	Traffic count, speed, occupancy	Vehicle detection	N/A	48VDC 22W typical; 100–240 VAC 50/60 Hz, 0.7A
8	VersiCam Wireless	Arterials	N/A	Traffic count, speed, occupancy	Vehicle detection	N/A	N/A
9	Abacus (no zone configuration)	Arterials , freeway, tunnel, and bridges	Vehicle classification	Volume, speed, Occupancy, vehicle counts of different class	Stopped vehicle detection, roadway debris detection, wrong way driver detection, fire/smoke detection	N/A	N/A
10	VIP/I	Arterials, freeway, and tunnel	N/A	Traffic flow, occupancy	Stopped vehicle detection, queue detection, speed drop, sudden speed variation, smoke/fog, video failure, wrong way driver	N/A	5VDC (600mA) to 26VDC (200mA)

	Product	Applications	Object Classification	Data Aggregation	Events Detection	Video Compression	Specifications
11	VIP/D	Arterials, freeway	N/A	Volume, speed, gap time, head way, occupancy per lane, zone occupancy concentration, average length, confidence level, traffic flow	Wrong-way driver, sudden speed variations, image quality	N/A	5VDC (600mA) to 26VDC(200mA)
12	VIP/P	Arterials	N/A	Counts, queue length measurement	Presence of vehicle approaching or waiting at the intersection	N/A	5VDC (600mA) to 26VDC (200mA)
13	VIP/T	Arterials, freeway, tunnel, and bridges	Vehicle classification	Traffic flow speed, zone occupancy, volume (count), average speed per lane, gap time, density, headway, confidence level	Vehicle presence, stopped vehicle, inverse direction, pedestrian, speed drop, traffic congestion, underspeed, fallen object, smoke, technical alarms, bad video, camera movement, PTZ out of home	MPEG-4, pre- and post-image sequences of incident	N/A
14	TrafiCam Xstream	Arterials	N/A	N/A	Vehicle presence detection	MPEG-4	N/A
15	TrafiCam Collect-R	Arterials, freeway	Vehicle classification	Volume, speed, occupancy, traffic flow and zone occupancy, distinguish five	N/A	N/A	Suitable for stand-alone solar-powered installation

	<b>Product</b>	<b>Applications</b>	<b>Object Classification</b>	<b>Data Aggregation</b>	<b>Events Detection</b>	<b>Video Compression</b>	<b>Specifications</b>
				levels of service			
16	TrafiCam	Arterials	N/A	N/A	Vehicle presence detection	N/A	115mA,10VDC, 1.2W; 55mA, 25VDC, 1.4W
17	Agilent N9385A (Self Calibration)	Arterials, freeway	Vehicle classification	Traffic count, average speed, occupancy	N/A	N/A	Input: Vdc 10–15 V, 30 W
18	Eagle Vision	Arterials	N/A	N/A	Vehicle presence detection	N/A	24VDC, 13W maximum
19	XCam-I	Arterials, freeway, and bridges	N/A	N/A	Trajectory and tracking-based topped vehicle detection, traffic slow and congestion detection, fluid traffic and congested traffic discrimination	Pre- and post-image sequences of incident, incident video clip	12/24 V AC/DC, 3W maximal
20	XCam-p	Arterials	N/A	N/A	Trajectory and tracking-based vehicle presence detection	Available	12/24 V AC/DC, 3W maximum
21	XCam-ng	Arterials	N/A	Queue length measurement, static occupancy	Trajectory and tracking-based vehicle presence detection, grid detection	Available	12/24 V AC/DC, 3W maximum
22	GridSmart (no zone creation)	Arterials	Vehicle classification	Speed, turn counts	Vehicles, pedestrians, golf carts, bicycles, emergency vehicles detection, incident	N/A	120–240VAC, 30Watts (control unit), 48VDC(camera)

	<b>Product</b>	<b>Applications</b>	<b>Object Classification</b>	<b>Data Aggregation</b>	<b>Events Detection</b>	<b>Video Compression</b>	<b>Specifications</b>
					identification		
23	Kapsch VR-2 (no zone creation)	Freeway and tunnels	N/A	N/A	Accident recognition, obstacle detection, wrong-way driver detection, traffic jam detection	N/A	N/A
24	Video Trak IQ	Arterials	N/A	N/A	Vehicle presence detection	MPEG-4	540mA, 12V, 6.5W; 290mA, 24V, 7.0W; 10–26 VDC
25	Uni Trak 2	Arterials	N/A	N/A	Vehicle presence detection	N/A	10.8–30V

## 6.2 TxDOT Video Analytics Demonstration System

In this section the baseline requirements for the TxDOT video analytics demonstration system are introduced. As the system is a demonstration, the software is not intended for all-weather, all-illumination conditions; thus, the baseline requirements circumscribe the nominal operating environment. System components and usage guidelines are also included to assist in understanding the system.

### 6.2.1 Baseline Requirements

The baseline requirements for the TxDOT video analytics demonstration system entail external factors, functionalities, and levels of service. The requirements can assist in deciding whether deploying the video analytics demonstration in a specific highway site can achieve optimal performance. The requirements also provide essential guidance when choosing between different levels of service in accordance with available network bandwidth capability.

#### *External Factors*

##### **Highway Road Structure**

In general, most roads, particularly freeways, conform to a uniform standard. A typical structure is illustrated in Figure 47. As shown in Figure 47(b) and (d), most highways are bidirectional (d1: oncoming traffic, d2: departing traffic) and the road segment between the camera and the dashed line is both straight and flat. The TxDOT video analytics demonstration system performs as expected if the observed highway segment is typical as shown in Figure 47(b) and (d). Generally, we want to be able to monitor traffic in both directions. However, performance and coverage are trade-offs. When many lanes are under observation, the lanes far from the camera will have occlusion. Thus, we suggest the four lanes as the maximum number to observe. When the total number of lanes exceeds this limit, we suggest deploying two cameras, one to monitor the traffic of each direction.

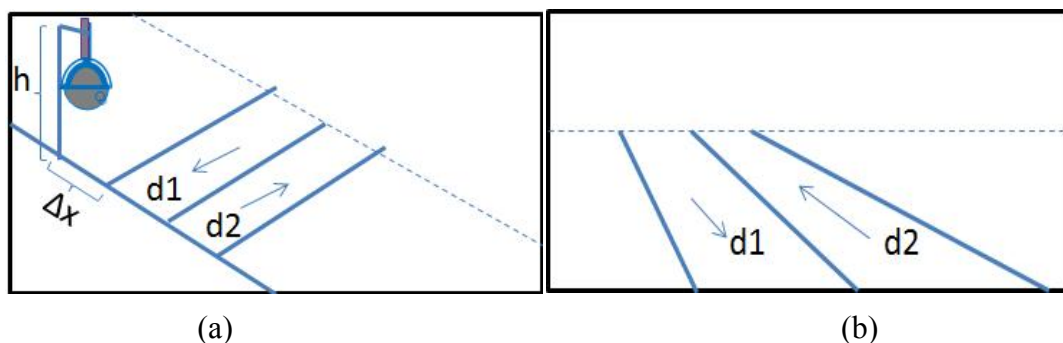



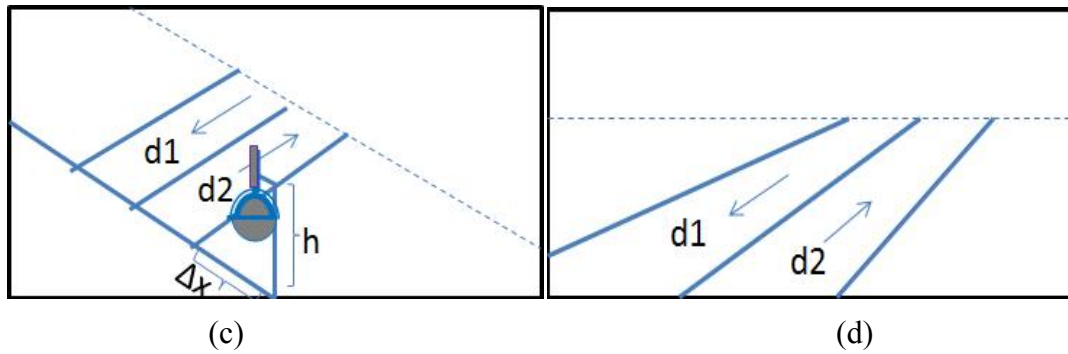

Figure 47 Typical Road Structure and Camera Location

Figure 47 (a) and (c) illustrate the typical practical camera location relative to the road; (b) and (d) show, respectively, the road structure captured in the camera view.

### Camera Perspective

Camera calibration is the process of estimating camera parameters so that pixel points in camera coordinates can be mapped into real-world coordinates. The camera parameters include the camera perspective such as height, tilt angle, and pan angle. Automatic vanishing-point-based camera calibration is used in the TxDOT video analytics demonstration system. In order to achieve acceptable accuracy for camera calibration, the camera perspective is preferred to be one of the typical views shown in Figure 48(a) and (c). The height of the camera should be sufficient so that the camera captures a high-angle view such that the vertical occlusion is minimized. Moreover, the horizontal distance from the camera to the road surface,  $\Delta x$ , should be reasonable so that horizontal occlusion is also minimized. In Figure 48, both poor and reasonable camera perspectives from different viewing angles are illustrated.



Figure 48 Camera Perspective from Different Viewing Angles

Figure 48(a) shows the camera perspective with low angle because of camera height is not adequate; (b) shows the far view perspective with with excessive  $\Delta x$ ; and (c) presents the ideal camera perspective.

### Other Necessary Constraints

Even when the camera is installed at a location with an ideal perspective, challenges still exist. Visibility changes occur due to lighting conditions caused by day-night transition and various weather conditions such as sun, clouds, heavy rain, fog, and snow.

Before discussing the tolerance of the TxDOT video analytics demonstration system to visibility conditions, we introduce the two basic phases: initialization phase and steady-state phase. During the initialization phase, the background must be estimated quickly, followed by autonomous camera calibration and detection zone generation. During the steady-state phase, with the camera now calibrated and detection zones ready, the system collects traffic data and detects events.

During the initialization phase, free-flow traffic is preferred for achieving an accurate background estimation. Background estimation is possible only when background information is the most prevalent value at each pixel location. Normal lighting is preferred for autonomous camera calibration. The most important step is to estimate perpendicular vanishing points based on detected car edges. The visibility available during daylight is always better than the visibility at night. Extreme weather conditions hinder accurate calibration. Therefore, the system should initialize itself under conditions of free-flowing traffic and normal weather conditions during daytime. Fortunately, during the steady-state phase, the system functions with fewer restrictions but performance degrades as visibility deteriorates. In general, vision-based video analytics techniques are sensitive to image visibility; accordingly, the better the visibility, the better the TxDOT demonstration system will perform.

### *Functionalities*

The available functionalities are part of the baseline requirements. Familiarity with the functionality assists users in deciding whether the system satisfies the functional requirements for their particular application scenario. In general functionalities can be categorized into data collection and event detection, which varies with respect to different application scenarios. The proposed functionalities for the TxDOT video analytics demonstration system are listed in the following paragraphs.

#### **Data Collection**

Traffic data collected includes vehicle counts and average speed aggregated over specified time granularity. The data are collected for each lane. How often traffic data is updated can be redefined by the user and the default granularity is one minute.

#### **Event Detection**

Stopped vehicles will be detected as an event. The incident of a car stopping is one of the most important signs of accidents or emergencies requiring immediate response and action. However, only vehicles that have stopped for a specified time (defined by users) will be detected in order not to flag vehicles stopped by law enforcement or drivers making adjustments.

### *Levels of Service*

Transmission of streaming video challenges the capability of network bandwidth. The levels of service, by our definition, are driven by bandwidth requirements. The four levels of service, corresponding to increasing bandwidth requirements, are described in Table 17.

**Table 17 Levels of Service**

<b>Level</b>	<b>Description</b>
1	Video analysis (traffic data collection and event detection) will be processed in the camera site; Traffic data and alarms will be transmitted to TMC
2	Video analysis (traffic data collection and event detection) will be processed in the camera site; Traffic data, alarms together with image sequence or video clip will be transmitted to TMC and streaming video will be transmitted into TMC via request
3	Video analysis (traffic data collection and event detection) will be processed in the camera site; Traffic data, alarms together with image sequence or video clip will be transmitted to TMC
4	Streaming Video will be transmitted into TMC all the time; and video analysis (traffic data collection and event detection) will be processed in TMC

### **6.2.2 System Components**

Before discussing the details of components of the TxDOT video analytics demonstration system, we wish to introduce them in a more general way. This introduction will provide better insight into the manner in which the system could be upgraded or simplified.

#### *Video Analytics General System Framework*

As illustrated in Figure 49, the general system framework consists of four major components: pre-processing, event detection, data collection, and post-processing. Pre-processing is basically low-level image processing, from which primitive elements useful for higher-level video understanding are obtained. For example, background estimation and foreground detection are the most basic computations of a video analytics system. Event detection and data collection, which provide intermediate understanding of a traffic scene, are obtained through the primitive elements. The difference between event detection and data collection is that event detection focuses on interesting events resulting from motion such as vehicle fire, a vehicle being tracked, and vehicle stalled in congestion; data collection emphasizes static characteristics of vehicles such as vehicle size and shape or traffic data indicating traffic conditions (including average speed as well as counts). The post-processing component attempts to understand the traffic scene at a higher level compared to event detection and data collection. Post-processing establishes such understanding using knowledge accumulated over a given period of time.

In Figure 49, the sub-components indicated by solid lines are provided in the TxDOT video analytics demonstration system and the sub-components in dashed lines are not available but the system could be extended to include them.

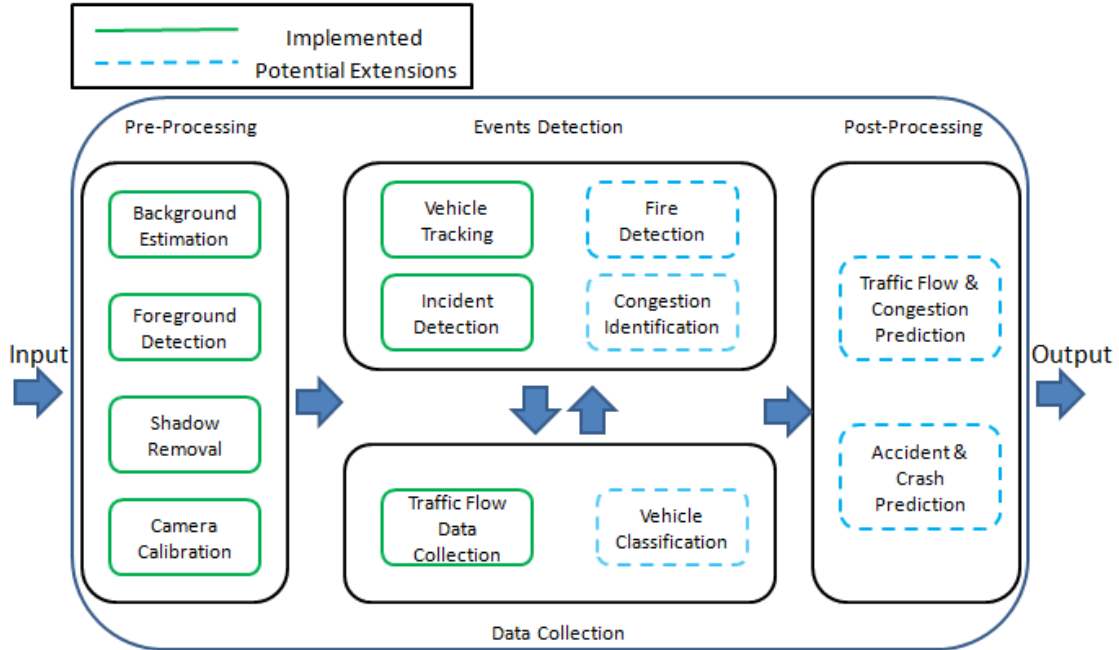

Figure 49 General System Framework

#### System Framework Flowchart

Given the general discussion above of the video analytic system, we wish now to introduce the system framework with a flowchart and detailed explanations of each component.

As shown in Figure 50, the input is streaming video in the form of consecutive frames. The output is traffic data (speed and counts) and incident detected (stopped vehicles). The details of the intermediate steps and components are discussed in the following paragraphs.

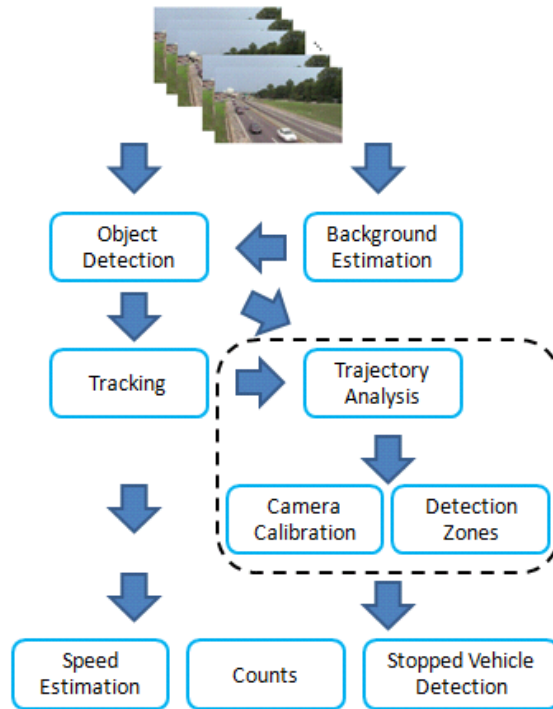

Figure 50 System Framework Flow-Chart

### Background Estimation

A sequence of intensity values is acquired by taking the intensity value of each location from a sequence of consecutive frames. The intensity value that appears most often is assumed to comprise the background. A temporal median filter (G. Zhang et al. 2007) is applied over a sequence of consecutive frames sampled in temporal rate  $r_t$  in order to estimate the background image. The lighting condition changes slowly throughout the day, however. Thus, it is necessary to reestablish the background periodically, such as every hour ( $T_{bgr}=60$  minutes). It should be mentioned that during the initialization phase, a faster background estimation is performed within 30 seconds.

### Object Detection

With an estimated background from a sequence of consecutive frames, the foreground is detected (i.e., the vehicles) by subtracting the background from each frame. Using the difference image, we apply thresholding with a parameter  $t_d$ . In other words, we locate pixel for which the difference is larger than  $t_d$ .

Because the background is estimated over a short time period, any sudden change of illumination affects the result of subtracting the current new frame and estimated background image. Automatic gain control (AGC)<sup>42</sup> is basically a form of amplification in which the camera will automatically boost the image received so that objects are seen more clearly. When the lighting condition drops below a certain level, the camera will

<sup>42</sup> See website [http://en.wikipedia.org/wiki/Automatic\\_gain\\_control](http://en.wikipedia.org/wiki/Automatic_gain_control).

begin to boost the signal to compensate. Besides the passing of clouds, AGC is the most frequent cause for unexpected sudden illumination changes.

Gamma correction controls the overall brightness of an image. Images that are not properly corrected can look either bleached out or too dark. Thus, in order to deal with sudden illumination changes, gamma correction<sup>43</sup> is applied to balance the illumination from frame to frame. In this way, it is assured that the brightness of the background image is similar to each incoming frame. The foreground is detectable in a much more robust way. There is another illumination issue. The sun causes objects/vehicles to cast shadows at certain times of the day. As the sun climbs/descends, the lengths of shadows change. The existence of shadow affects the description of the foreground objects. Thus, we adapted the real-time shadow removal technique proposed in Xiao et al. (2007) directly on the foreground detected in the previous step.

### Tracking

We calculate the center of mass to serve as a representative of each object/vehicle detected. This allows a more general approach for feature-based tracking. Here we formulate the problem of object tracking as a motion correspondence problem (Veenman 2007) or, more generally, an assignment problem (Kuhn 1955). Any approaches used should be able to deal with entering and exiting (initiation and termination of tracking), false points (due to errors in detection) and missing points (due to occlusions). Given a sequence of  $n$  frames denoted by  $F_{t1}, F_{t2}, \dots, F_{tn}$ , we assume that every object is represented as a point (center of mass). Therefore, each frame  $F_{tk}$  has a set of points. The aim is to develop one-to-one object assignments for consecutive  $n$  frames ( $n \geq 2$ ) such that proximate uniformity and smooth motion constraints are best preserved. The larger the number of consecutive frames  $n$ , the more we need to take into consideration the computation efficiency. Because motion constancy can only be reflected over a minimum of three frames, we assign a value of 3 to  $n$ . As illustrated in Figure 51, the motion of two objects is captured in three consecutive frames:  $F_{tk-1}, F_{tk}$ , and  $F_{tk+1}$ . Both objects are moving in the directions indicated by the arrows. Tracking of these two moving objects can be interpreted as establishing frame-to-frame matchings. Three objects, one from each of the three consecutive frames, must be put in correspondence. As in Figure 51, tracking of the two objects is illustrated as matchings in solid and dashed lines, respectively. The Hungarian algorithm (Kuhn 1955) is a classical method for the “assignment problem” such as the 2-D matching of assigning persons to tasks. We generalized the classical 2-D Hungarian algorithm to an  $n$ -D Hungarian and actually applied a 3-D Hungarian algorithm to solve the tracking problem described above. Initiation and termination of tracking was incorporated; detection errors and occlusions are also handled by logical reasoning. Objects will not match unless proximal uniformity is satisfied and the motion is smooth. Tracking is initialized to tolerate absent points due to occlusion using a Kalman filter<sup>44</sup> to predict the location of a missed object for a limited number of frames.

---

<sup>43</sup> See website [http://www.cgsd.com/papers/gamma\\_intro.html](http://www.cgsd.com/papers/gamma_intro.html).

<sup>44</sup> See website [http://en.wikipedia.org/wiki/Kalman\\_filter](http://en.wikipedia.org/wiki/Kalman_filter).

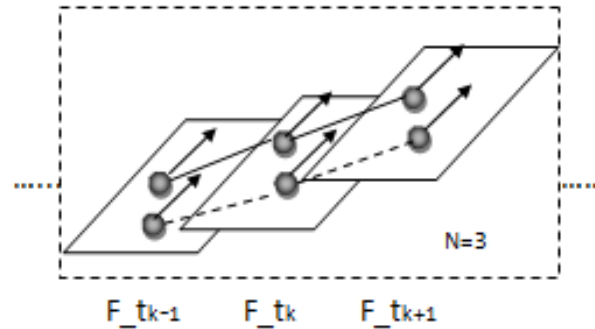

Figure 51 Motion Correspondence

### Trajectory Analysis

The center of mass is used to represent objects/vehicles as a sequence of points—the trajectory is obtained through object/vehicle tracking. During the initialization phase, objects/vehicles are tracked and a large number of trajectories are collected. This enables derivation of higher-level knowledge through trajectory analysis. In the context of traffic surveillance, the aim of trajectory analysis is to model the traffic scene in order to obtain the road structure (spatial knowledge) and to learn the motion pattern (spatio-temporal knowledge) of objects/vehicles travelling on the road. One focus is to learn the road structure and to estimate the parallel vanishing point as shown in Figure 52 and Figure 53, respectively.

In order to learn road structure we adapted the unsupervised dominant-set based clustering technique (Pavan and Pelillo 2007) to hierarchically cluster trajectories collected in the initialization phase into  $K$  dominant sets. Practically,  $K$  is known a priori. Figure 52 illustrates a set of trajectories that are clustered into two dominant sets. Each cluster represents one highway lane (one sketched via a solid line and the other via a dashed line). From each dominant set of trajectories we derive one representative trajectory by median filtering—eliminating most of the noise. Parallel lines in the real world appear to converge to a point—the vanishing point in the image plane. We consider trajectories of vehicles to be parallel to one another in the real world with the assumption that most vehicles maintain lane discipline. Unavoidably the trajectories, even after filtering, are somewhat noisy. Thus, we adapted the Levenberg-Marquardt optimization algorithm<sup>45</sup> for the parallel vanishing point estimation. As shown in Figure 53, the parallel vanishing point  $V_{\text{par}}(u_0, v_0)$  is circled in green.

<sup>45</sup> See website [http://cobweb.ecn.purdue.edu/~kak/courses-i-teach/ECE661.08/homework/HW5\\_LM\\_handout.pdf](http://cobweb.ecn.purdue.edu/~kak/courses-i-teach/ECE661.08/homework/HW5_LM_handout.pdf).

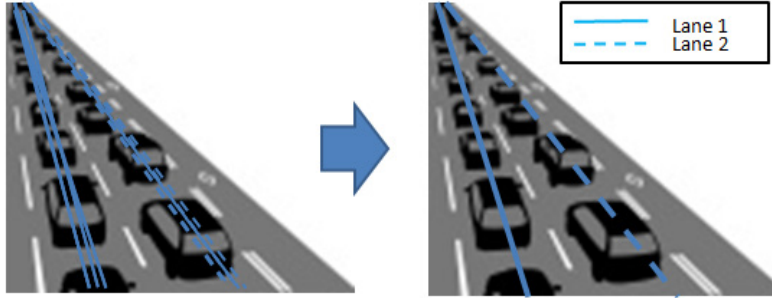

Figure 52 Trajectory Analysis

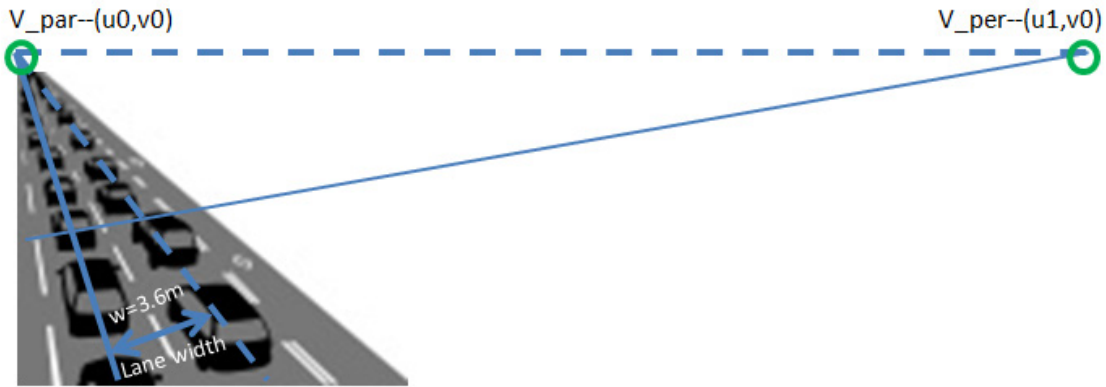

Figure 53 Vanishing Points-based Camera Calibration

### Camera Calibration

Similar to the parallel vanishing point, the perpendicular vanishing point is a point of convergence. It must be constructed from lines perpendicular to the highway lanes. Based on the assumption that the road is not inclined, i.e., on the plane  $z=0$  in the real-world coordinates, the vanishing-point-based camera calibration (Schoepflin and Dailey, 2003) considers the two vanishing points constructed from two pairs of parallel lines. The second pair must be perpendicular to the first pair in the real world. We refer to the vanishing point computed from the traffic lanes as  $V_{\text{par}}(u_0, v_0)$ . The second, from lines perpendicular to the traffic lanes, is referred to as vanishing point  $V_{\text{per}}(u_1, v_0)$ . For the conditions just described (i.e.,  $z=0$ ), the two vanishing points lie on the line  $y=v_0$  in the image plane. With the assumption that the horizontal edges of vehicles are approximately perpendicular to the highway lane, we collect a set of several perpendicular lines. This is accomplished by detecting the leading edges of vehicles using the Canny edge detection (Canny, 1986) followed by utilizing the Hough transform (Duda and Hart, 1972). In the image plane, the intersection of every perpendicular line and line  $y=v_0$  gives one candidate for  $V_{\text{per}} = (u_{1_i}, v_0)$ . The perpendicular vanishing point candidates spread along line  $y=v_0$  are expected to be quite noisy. Under some circumstances, it is customary to apply the Levenberg-Marquardt optimization algorithm. We chose a simpler approach. We take x-coordinate of all the perpendicular point candidates  $\{u_{1_1}, u_{1_2}, \dots, u_{1_N}\}$  ( $N$  is the number of candidate perpendicular lines). Values falling outside  $\pm 2$  standard deviations are discarded and the remaining ones are averaged for the final  $V_{\text{per}}$  estimation.



In addition to  $V_{\text{par}}(u_0, v_0)$  and  $V_{\text{per}}(u_1, v_0)$ , a real-world distance between any two points or between any two parallel lines in the image plane is needed for estimating the following camera parameters:  $f$  (focal length), pan angle, tilt angle, and  $h$  (the height of the camera). The FHWA reported<sup>46</sup> that every state strictly follows highway lane width standards; thus, we are able to utilize this information as a known value (together with  $V_{\text{par}}$  and  $V_{\text{per}}$ ) prior to calibrating the camera. This is explained in equations (6-1)–(6-4).

$$f = \sqrt{-(v_0 * v_0 + u_0 * u_1)} \quad (\text{Eq. 6 - 1})$$

$$\text{tilt} = \tan^{-1} \left( -\frac{v_0}{f} \right) \quad (\text{Eq. 6 - 2})$$

$$\text{pan} = \tan^{-1} \left( -\frac{u_0 * \cos(\text{tilt})}{f} \right) \quad (\text{Eq. 6 - 3})$$

$$h = \frac{f * a * \sin(\text{tilt})}{\cos(\text{pan})}, a = \frac{w}{\Delta} \quad (\text{Eq. 6 - 4})$$

In equation (6-4),  $a$  is scale factor relating distance in image coordinates to distance in real-world coordinates; and here the scale factor  $a$  is calculated as the ratio of lane width  $w$  ( $w = 3.6m$  by default) and the real-world distance between two neighboring lanes.

### Speed Estimation

With the camera calibrated, any point in the image plane can be mapped/transformed to the plane  $z=0$  in the real-world coordinates. In other words, the real-world distance of any two points in the image could be calculated easily. Assume that it takes  $\Delta t$  seconds for one vehicle to travel in the image plane from point  $(p_u, p_v)$  to point  $(c_u, c_v)$  and these two points are mapped to  $(p_x, p_y, 0)$  and  $(c_x, c_y, 0)$  in real-world coordinates as described in equations (6-5)–(6-8). The average speed (in miles per hour) of the vehicle can be calculated using equations (6-9)–(6-10).

$$p_x = \frac{h * p_u * \sec(\text{tilt})}{p_v + f * \tan(\text{tilt})} \quad (\text{Eq. 6 - 5})$$

$$p_y = \frac{h * (f - p_v * \tan(\text{tilt}))}{(p_v + f * \tan(\text{tilt}))} \quad (\text{Eq. 6 - 6})$$

$$c_x = \frac{h * c_u * \sec(\text{tilt})}{c_v + f * \tan(\text{tilt})} \quad (\text{Eq. 6 - 7})$$

$$c_y = \frac{h * (f - c_v * \tan(\text{tilt}))}{(c_v + f * \tan(\text{tilt}))} \quad (\text{Eq. 6 - 8})$$

$$\Delta d = \sqrt{(p_x - c_x)^2 + (p_y - c_y)^2} \quad (\text{Eq. 6 - 9})$$

<sup>46</sup> See website <http://www.fhwa.dot.gov/policyinformation/statistics/2008/hm39.cfm>.

$$v = \frac{\Delta d * 0.621 * 3.6}{\Delta t} \quad (\text{Eq. 6 – 10})$$

### Counts

As mentioned earlier, detection zones are automatically generated utilizing the results of trajectory clustering. Detection zones are necessary for accurately counting the objects/vehicles. A detection zone has two states: occupied (O) and unoccupied (U). Transition from state O to state U indicates that a moving object/vehicle has just passed the detection zone. The number of O→U transitions captured is equal to the number of objects/vehicles that have passed.

### Stopped Vehicle Detection

We store the trajectories of moving objects/vehicles that have not yet exited the scene and delete them after they exit. Normally, it does not take long for an object to exit the scene. Objects/vehicles that remain at the same place in the scene longer than 1–2 seconds are associated with a stopped-car tracker. The stopped-car tracker keeps a record of how long the vehicle has stopped and of the location. It is also designed to tolerate missed detections of the stopped vehicle over time; in other words, it has the ability to recognize the stopped vehicle when it reappears again at the same location. If the vehicle remains stationary for more than  $T_s$  seconds, an alarm is triggered and sent to the TMC for response. An operator can set any reasonable value for  $T_s$  according to needs. ( $T_s$  is set to be 10 seconds by default.)

### *Hardware Setup*

#### Processor

A roadside streaming-video analytics traffic surveillance system requires the processor to be weather-hardened and computationally powerful. With these two requirements in mind, we decided to use the Logic Supply Extreme Environment PT-9WC1 Core2 Fanless backbone<sup>47</sup> as the processor. With respect to extreme environments, the PT-9WC1 has the ability to withstand extended temperatures between -40 °C–70 °C and is resilient to shock and vibration. With respect to computation power, it has a 2.26 GHz Intel Core2 Duo P8400 CPU and 2GB DDR2 wide-temperature memory in a ruggedized and fanless enclosure; it is pre-installed with Ubuntu 10.04 OS.

#### Pre-configuration

Before integrating the video analytics processor with the existing network, we need to assign a valid IP address for the processor so that via an Ethernet cable it can be connected and made accessible within the network.

Figure 54 illustrates the three major components for the network-connected video analytics processor: core computation unit, web server, and database server.

---

<sup>47</sup> See website [http://www.logicsupply.com/products/pt\\_9wc1](http://www.logicsupply.com/products/pt_9wc1).

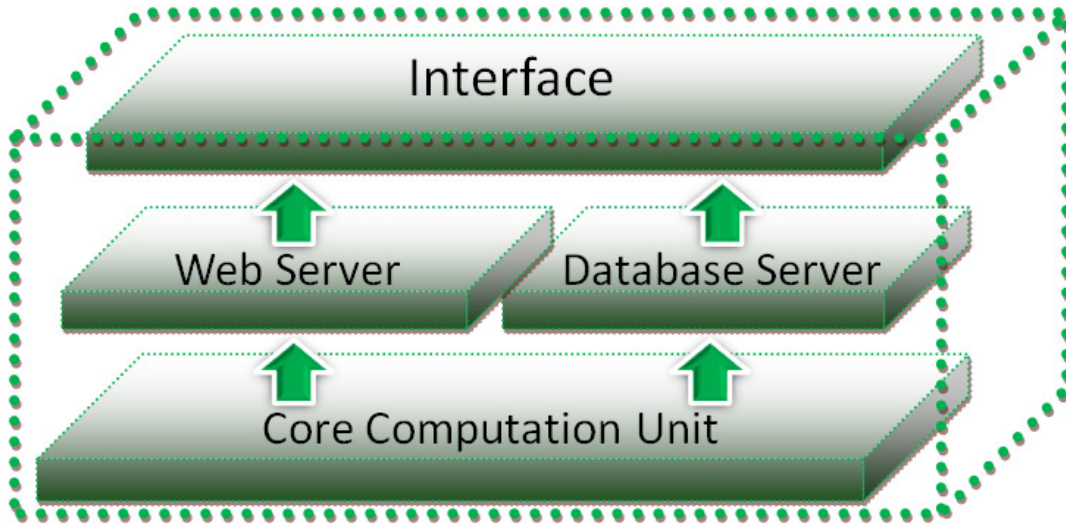

*Figure 54 Functional Architecture of Video Analytics Processor*

The database server and web server cooperate to store and visualize data provided through a web-based interface to the user. The interface bridges the communication gap between the operators in the TMC and the data from the on-site processor. The core computation unit is mainly developed in C/C++ with utilization of several open source libraries. One library is OpenCV with FFmpeg enabled and MYSQL++, which must be pre-installed and configured correctly for the processor. Also, the web server Apache with a PHP processor module and database management server MySQL must be installed.

- OpenCV (<http://opencv.willowgarage.com/wiki/>)

OpenCV (Open Source Computer Vision) is a library of programming functions aimed at real-time computer vision. It is free for both academic and commercial use under the open source BSD license.

- FFmpeg (<http://www.ffmpeg.org/> )

FFmpeg is a complete, cross-platform solution for handling multimedia data such as recording, converting, and streaming audio and video. It also has functions for manipulating video. The most notable library component of FFmpeg is the libavcodec—an audio/video codec library. OpenCV depends on it to encode and decode streaming videos. The latest version is FFmpeg 0.6. FFmpeg should be installed prior to OpenCV so that OpenCV can be installed with the FFmpeg functionalities enabled.

- MySQL++ (<http://www.ffmpeg.org/> )

MySQL++ is a powerful C++ library wrapper for MySQL's C API. Its purpose is to simplify database queries by adapting C++ standard template libraries such as STL containers.

- Web Server Apache (<http://httpd.apache.org/>)

Apache is possibly the most popular Linux-based web server application in use. It also has the ability to process PHP script.

- Database Management Server MySQL (<http://www.mysql.com/>)

MySQL is a relational database management system that runs as a server providing multi-user access to a number of databases. It is utilized in the TxDOT video analytics demonstration system in order to record the collected traffic and incident data as the output from the system. Moreover, MySQL is also a popular database choice for use in web applications.

### Setup

Assuming that a wireless network between the traffic monitoring site and Traffic Management Center is already established, the processor installed with the TxDOT video analytics can be easily integrated with the existing traffic management communication system via network interconnection equipment such as a network router or switch. As shown in Figure 55, the remote processor (the green box) is connected into the existing wireless network via an on-site network switch. Similarly the processor can also be connected to the network via a network switch in the TMC if installation of the processor on-site is not a favorable option.

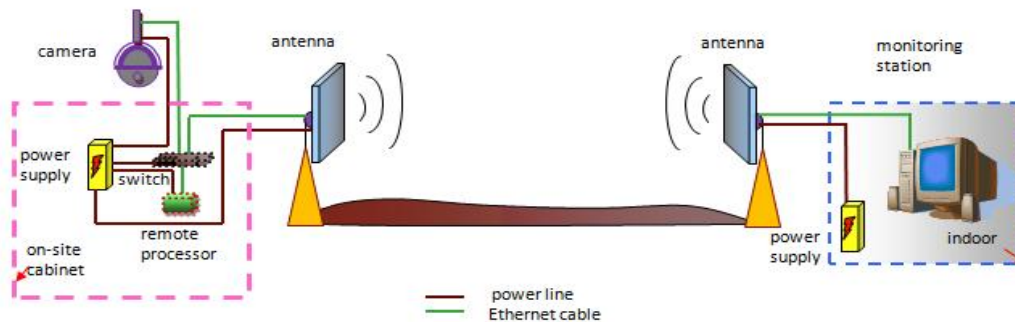

Figure 55 System Setup with On-site Processor

### Interface

The web-based interface is a necessity because it plays an important role in bridging the communication gap between the user and the remote processor on which the TxDOT video analytics demonstration system is installed. As a user-friendly interface, it provides a convenient interface for users to remotely configure and launch the video analytics system. It also enables visualization of traffic data in graphical form. Therefore, functionally, it consists of two major components: remote configuration and data visualization. In the following section more details are given.

### 6.2.3 Usage Guidelines

In this section we provide usage instructions for remote access, remote configuration, and data visualization. Potential customizations of the processor's functions are described.

## Remote Access and Configuration

Just as the video analytics processor should be assigned a valid IP address, the desktop temporarily used for testing and developing is also assigned an IP. An HTTP protocol allows access to the interface of the video analytics processor via the IP. Through the interface, users can edit the camera settings camera and the road structure view captured by the camera. The user can change the frequency at which the traffic data is updated and, of course, launch or stop execution of video analytics.

### Settings

The settings tableau is an important interface component. It is accessed before the video analytics is launched. One must set the URL link necessary for accessing snapshots or video from the camera. (Each camera model has its own rules for providing access.) Additionally, it provides a screen tableau on which to specify the road structure and the information required for the video analytics units to perform optimally. As shown in Figure 56, video input may originate from an IP camera or a stored video clip. (The latter is effective for testing.)

- IP Camera

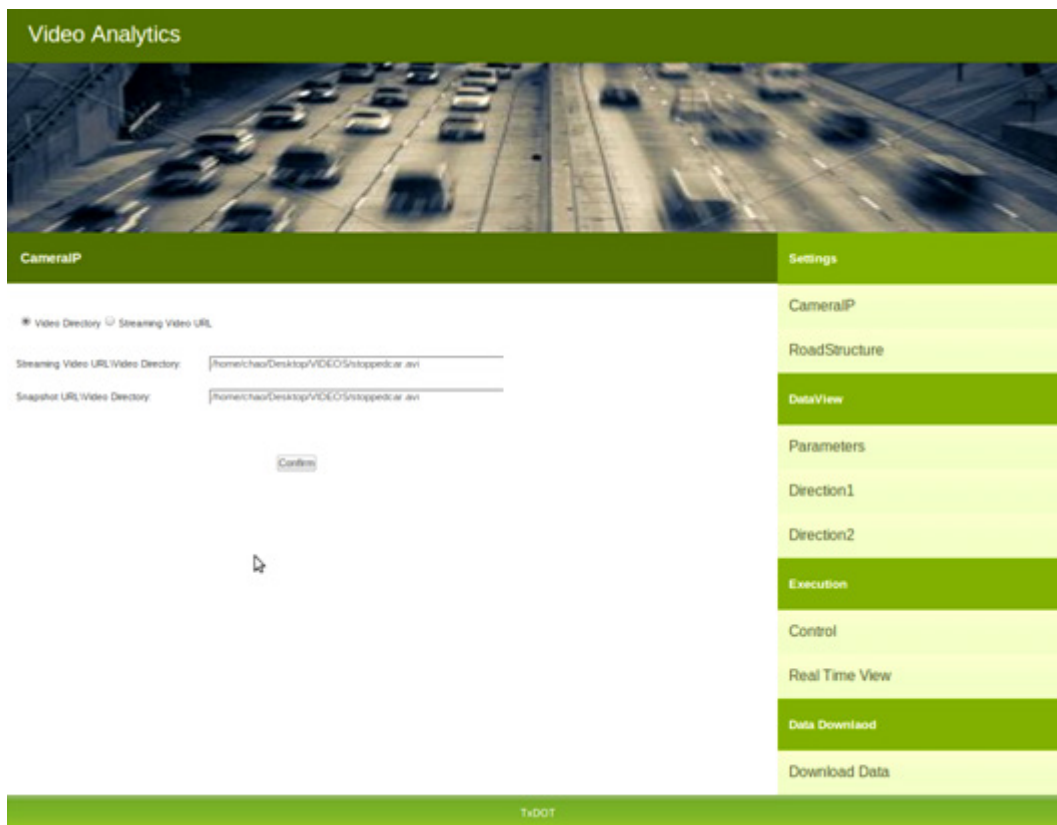

Figure 56 Settings for Camera

- Road Structure

Figure 57 depicts the tableau for describing the road structure. Several inputs based on human observation are required:

- D1: the number of lanes in Direction 1 (oncoming traffic)
- D2: the number of lanes in Direction 2 (departing traffic)
- Lane Width: the real-world distance between two neighboring lane center lines
- Perpendicular Angle: slope angle of lines perpendicular to the traffic lanes in real-world coordinates<sup>48</sup> (the range is -180 to 180 degrees)
- Top Ratio (default: 0), Bottom Ratio (default: 1), Left Ratio (default: 0) and Right Ratio (default: 1): parameters for defining the boundary of the region of interest (ROI) (normally, the user avoids processing the distant objects by setting the top ratio to 0.5, allowing only the lower half of the image to be processed).

Vehicle views may be needed to determine the perpendicular angle; a “refresh snapshot” button requests a new static image if the current image is not informative enough. Check Yes or No for “Remove Shadow” to determine whether the current view has shadows.

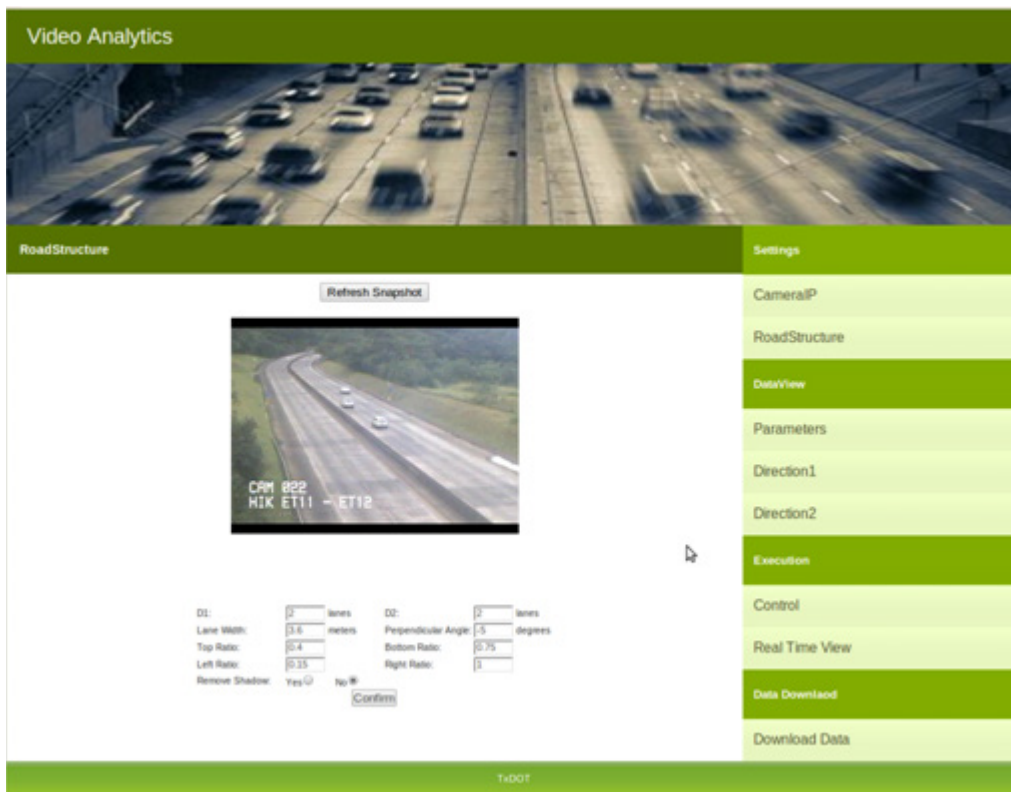

Figure 57 Settings for Road Structure

<sup>48</sup> Wind shields on oncoming vehicles can be used to gauge the perpendicular direction.

## Data Visualization

### DataView

- Parameters

Before launching the core computation unit of the video analytics unit, parameters for traffic data collection and stopped vehicle detection must be established. For example, how often should statistics be updated? How long must a vehicle be stopped before it is treated as an incident? Who will receive the emergency warning email whenever an incident is detected? The appropriate fields for data entry are shown in Figure 58.

The screenshot shows a web interface for configuring video analytics. At the top, there is a header 'Video Analytics' and a video feed of a multi-lane highway with cars. Below the video feed is a 'Parameters' section with the following fields:

- Speed/Volume:** A sub-section header.
- Update Every:** A text input field containing '5' followed by the unit 'minutes'.
- Stopped Vehicle Detection:** A sub-section header.
- Stop Duration Longer than:** A text input field containing '25' followed by the unit 'seconds'.
- Incident Email Recipient:** A text input field containing 'realmyloving@gmail.com'.
- Confirm:** A button located below the email recipient field.

On the right side of the interface is a vertical navigation menu with the following items:

- Settings
- CameraIP
- RoadStructure
- DataView
- Parameters
- Direction1
- Direction2
- Execution
- Control
- Real Time View
- Data Download
- Download Data

At the bottom of the interface, there is a small text label 'TxDOT'.

*Figure 58 Parameters for Speed Estimation and Incident Detection*

- Direction1/Direction2

Visualization of average speed and counts for Direction 1 and Direction 2 are displayed separately. Illustrated in Figure 59 are speed and counts, which are updated each minute.



Figure 59 Visualization for Traffic Data

### Execution

#### Control

- Start/End Program

Processing can be started and ended by clicking corresponding buttons.

- Real-Time View

Real-time views provide the operator with real-time visuals whenever an incident is detected. This step permits the operator to validate the detection.

#### Data Download

The collected traffic data can also be downloaded, including incident reports, by clicking Data Download.

Note: please refer to TxDOT Demo User Manual for detailed instructions on using the TxDOT demonstration system.

## 6.3 Performance Evaluation

Performance evaluation experiments were performed in two phases for which the TxDOT video analytics demonstration system was deployed. The first phase, system refinement, focused on short video clips taken from a bridge at I35E, exit 466B, overlooking the freeway. We arranged a probe vehicle to drive past at a constant speed of 55 mph.



Experiments in phase one, the system stabilization phase, played a major role in optimizing the core processing algorithms of the TxDOT demonstration system. Experiments in phase two, the live traffic phase, were designed to evaluate the performance with respect to traffic data collection (speed estimation and vehicle counts) and incident detection (stopped car detection).

### **6.3.1 Phase One, System Stabilization**

#### *Testing Setup*

Two traffic video clips were used for preliminary performance evaluation. One four-minute video clip (clip 1) was taken from a bridge at I35E, exit 466B, overlooking the interstate. During the four minutes we arranged a probe vehicle to drive past at a constant speed of 55 mph; the other video clip (clip 2) is distributed as a demonstration of Abacus. Clip 2 is 10 minutes long. In our experiments, video clip 1 is used for camera calibration/speed and volume estimation; video clip 2 is used to evaluate only stopped-car detection because ground truth for speed is not available.

#### *TxDOT Video Analytics System*

A visualization of the intermediate results from the TxDOT video analytics system is shown in Figure 60. In video clip 1, the camera has a good but not ideal perspective because there is occlusion of vehicles in rightmost two lanes due to the limited camera height. (Recall that video clip 1 was taken from a bridge.)

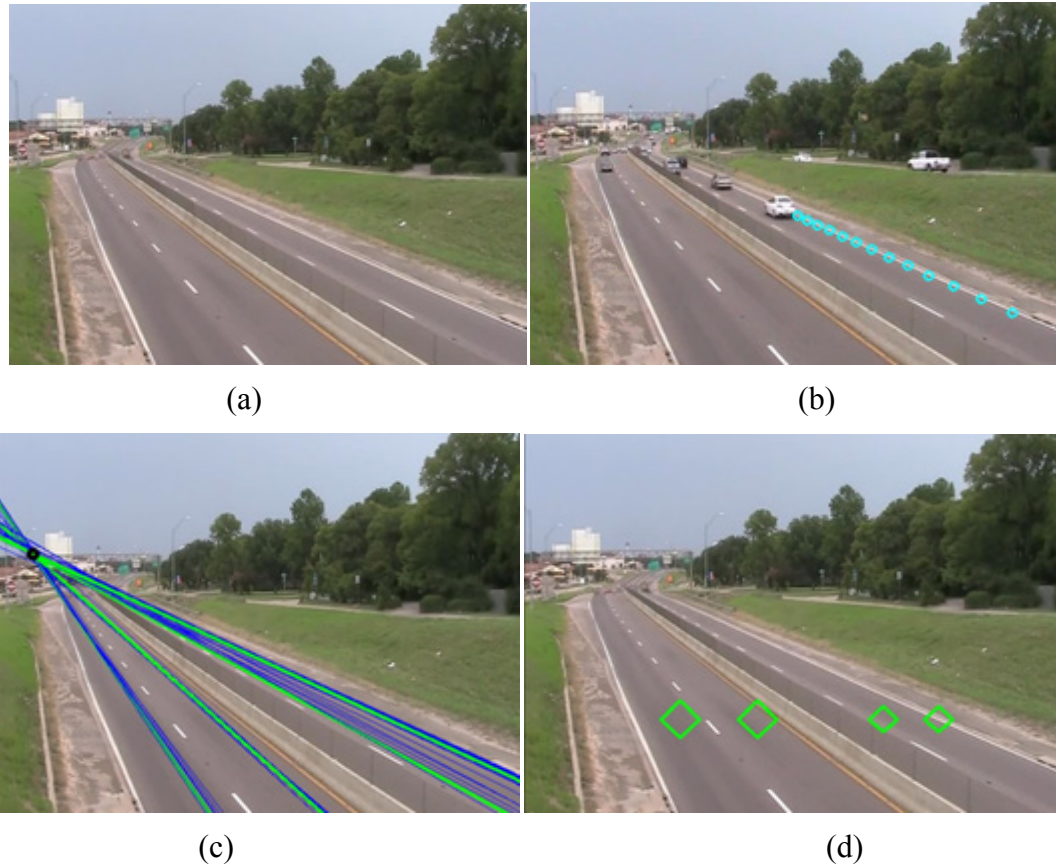

*Figure 60 Intermediate Results*

Figure 60(a) shows the background estimated during the initialization phase; (b) shows the trajectory for one vehicle being tracked; (c) depicts the dominant paths learned from clustering collected trajectories; and (d) presents the automatically generated detection zones.

### **Camera Calibration/Speed Estimation**

Highways, even interstates, do not offer ideal, straight, horizontal terrain. Thus, it is difficult to obtain accurate camera tilt and pan angles or the vertical distance between the camera and highway surface. Without a priori camera parameters, the accuracy of calibration is best reflected in the accuracy at which vehicle speed is estimated (given accurate vehicle tracking). Speed estimation is dependent only on camera calibration and tracking. Based on the probe vehicle moving at a constant speed of 55 mph, we approximated the speed of four other vehicles that traveled in the same lane as the probe car. In order to minimize trajectory noise, manually traced trajectories of the five vehicles were created. These were for use alongside automatically extracted tracks. We estimated the speed utilizing both manually and automatically extracted trajectory sets.

In the initialization phase, camera parameters (camera height, focal length, tilt angle, and pan angle) were estimated. They are obtained using parallel and perpendicular vanishing points and road structure. Based on the camera parameters estimated in the initialization phase, the speed estimation was obtained for the five vehicles using, separately,

trajectories automatically extracted and those manually extracted. The results are shown in the Figure 61. Compared to the GT (ground truth) of speed, one can see that speed estimation based on both trajectory sets are accurate with maximal error of 2.6% and 2.5%, respectively. The low error rates for either trajectory set indicate that not only is the camera well-calibrated and but also speed is accurately estimated. However, in reality, tracking in some environments may be noisy.

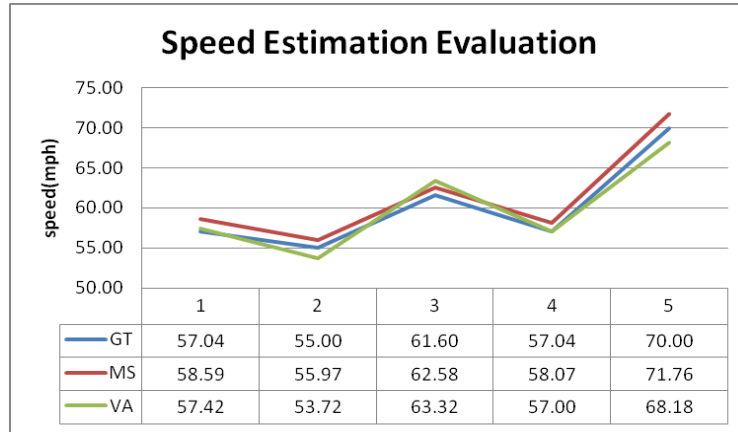
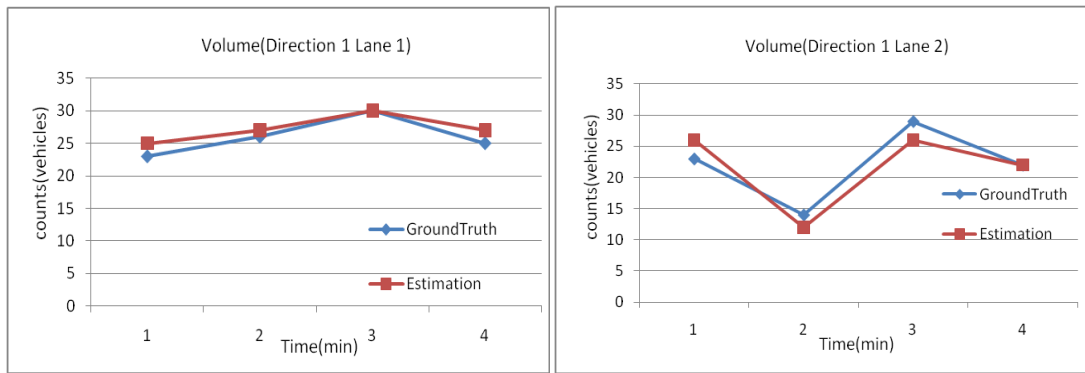

Figure 61 Speed Estimation Evaluation

### Volume Estimation

It is easier to acquire ground truth for volume. One can manually count the number of passing vehicles for a given time interval (one minute in our experiments). As shown in Figure 62, the traffic volume for four periods is estimated for each lane. However, results are shown for only the two leftmost lanes (Direction 1). The reason is that the median barrier affects detection of vehicles traveling in the two rightmost lanes (Figure 63). The zones generated for the rightmost lanes (Direction 2) are shifted as was illustrated in Figure 60. The results for Direction 1 indicate that traffic volume estimation using the TxDOT video analytics system is acceptable and has an approximate error rate of 3.6%.



(a)

(b)

Figure 62 Volume Estimation Results for Direction 1



*Figure 63 Illustration of Side Occlusion of Two Rightmost Lanes*

### **Stopped Vehicle Detection**

In video clip 2, only one vehicle pulled to the shoulder and stopped for approximately 35 seconds. For stopped vehicle detection, a parameter for stop duration toleration needs to be entered to prevent notification of vehicles stopped momentarily. We entered a stop duration tolerance of 10 seconds. The stopped vehicle was successfully detected just at the 10-second mark. The scene is illustrated in Figure 64. The stopped vehicle continued to be detected for approximately 34–35 seconds when it left the scene. No redundant incident detection warnings were generated and sent to the simulated TMC.



*Figure 64 Detection of a Stopped Vehicle*

### *Abacus*

Iteris, Inc.'s Abacus™ is one video analytics product on the market. It uses a unique blend of artificial intelligence and video detection algorithms to allow either fixed or PTZ cameras to be used for data collection and incident detection. The system tracks all vehicles as they move through the camera's field of view (FOV). As a result, all information is captured and incidents can be detected by identifying anomalous driving behaviors without the need for virtual or detection zone configurations. The functionality of this version of Abacus is described in the paragraphs below.

### **Traffic Data Collection**

The traffic data collection capabilities are designed to provide a continuous feed of data similar to other technologies. In this way, a single camera can be used for both surveillance and data collection while at the same time monitoring for incidents. The default reporting period of data collection is 60 seconds. Information is provided in the form of a universal XML schema. Each camera can collect data from up to two directions of traffic. The data collected includes volume (reported in vehicles per minute), speed (reported as the average vehicle speed during the reporting interval), occupancy (reported as a percentage), classification (reported as the number of vehicles for each classification group), and traffic incident detection.

### **Traffic Incident Detection**

The Abacus system is designed to continuously monitor video feeds for incidents. Abacus can act as a digital video recorder to record incidents or work with existing digital video recorder units to provide notification of an event. These notifications can be provided by means of e-mail or an SMS text message. The types of incidents which can be detected for immediate notification are stopped vehicle detection, roadway debris detection, wrong way driver detection, and fire or smoke detection.

### *Experiments*

The version of Abacus used in the phase one experiments is Abacus Highway v1.2.3709.277BO BETA. The detailed installation and user manual is accessible online<sup>49</sup>. We also used video clip 1 and clip 2 as testing datasets to evaluate the accuracy of speed/volume estimation and stopped vehicle detection. The system must be initialized for streaming video or video clip input. The details of configuration are not included here. However, it is worth noting that parameters must be tuned for best performance. An initialization tableau is illustrated in Figure 65.

---

<sup>49</sup> See website

<http://www.interprovincial.com/files/manuals/iteris/Abacus%20Installation%20and%20User%20Manual.pdf>.

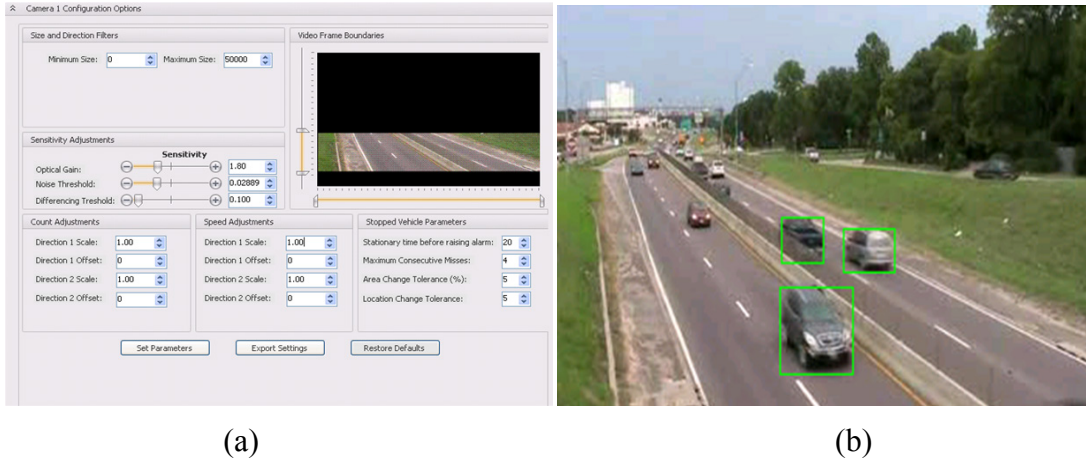

Figure 65 Initialization Tableau (a) Camera Configuration Tab (b) Vehicles within the Frame Boundary Defined in (a) Are Successfully Detected

### Speed/Volume Estimation

As noted in the previous section, the perspective of video clip 1 is not ideal. Occlusions exist for vehicles in the rightmost two lanes; thus, we utilized traffic data collected for Direction 1 (oncoming traffic) to evaluate the Abacus. Note that video clip 1 is only 4 minutes long. Speed estimation by Abacus improves if it observes traffic for a longer period. To partially compensate, we ran video clip 1 repeatedly for 20 minutes. The comparison between Abacus and ground truth is given in Table 18.

Table 18 Traffic Data Collected from Abacus Compared with the Ground Truth

GroundTruth	Direction 1	Abacus	Direction 1(mph)
Average Counts(vehicles)	202	Average Counts(vehicles)	167
Average Speed(mph)	60.3	Average Speed(mph)	70.2

### Traffic Incident Detection

As shown in Figure 65, four parameters relate to stopped vehicle detection: 1) stationary time prior to raising an alarm—20 seconds by default; 2) maximum consecutive misses (the maximal number of consecutive frames the candidate stopped vehicles can be misdeteched)—4 frames by default; 3) area change tolerance (the tolerance for the change of the size of candidate stopped vehicles)—5% by default; and 4) location change tolerance (the tolerance for the change of the location of candidate stopped vehicles)—5% by default. Video clip 2 was utilized to evaluate the stopped vehicle detection function. All parameters including those four for the stopped vehicle detection were kept intact except the video frame boundaries. The boundaries are specified as shown in Figure 66(a). Most vehicles are detected successfully. The clip was run repeatedly because Abacus needs initialization time. Nevertheless, the stopped vehicle was not detected well enough. It was detected successfully for a short period of time as it slowed down before stopping. A stopped vehicle incident was not triggered. The default stationary time before raising an alarm is 20 seconds. The stationary time before raising an alarm was changed to less than 6 seconds (the actual stationary time is 35 seconds).

The alarm scene is shown in Figure 66. However, parameters *maximum consecutive misses*, *area change tolerance*, and *location change tolerance* did not affect the detection of the stopped vehicles. We had only the single test case. More intensive testing with more data must be done before a valid judgment can be given.

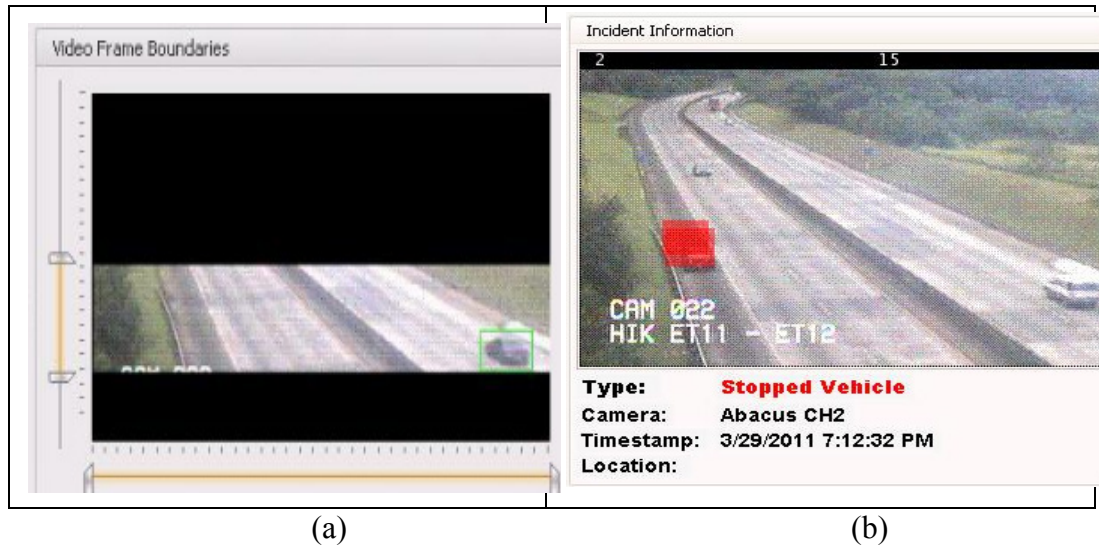



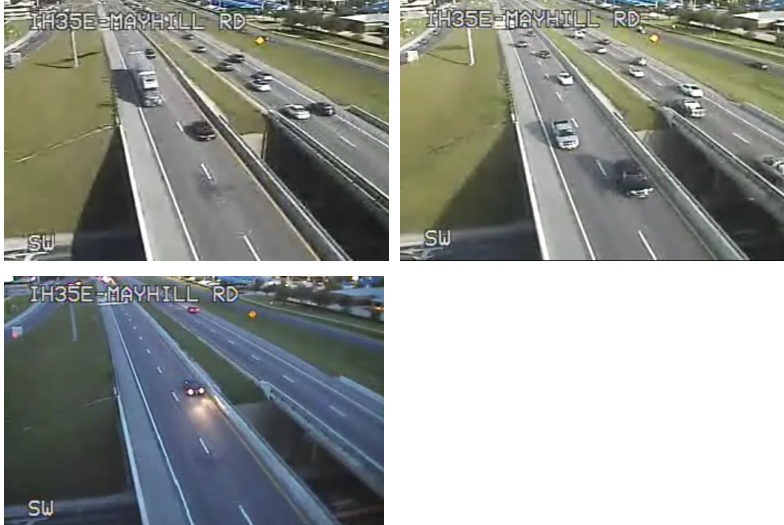

Figure 66 Alarm Scene: (a) Video Frame Boundaries Configured for Video Clip 2; (b) Stopped Vehicle Detected

### 6.3.2 Phase Two, Live Traffic

#### Testing Setup

Courtesy of DalTrans, we were given direct access to the traffic camera at Mayhill and I35E. Four time periods having different characteristics were chosen for evaluation. These four and the Iteris-provided stopped vehicle video are described in Table 19. While we had access to an MVD (microwave vehicle detector), for greater accuracy we acquired vehicle counts manually. Speed, volume, and stopped vehicles statistics were collected. We compared systems based on traffic data collected for only one direction (the direction closer to the camera).

**Table 19 Characteristics of Test Videos**

Date	Time Period	Characteristics
May 09, 2011	17:06 PM–21:16 PM	 <p>Normal lighting without apparent shadows and night vision</p>
May 17, 2011	17:38 PM–21:58 PM	 <p>Begin with apparent short shadows, long weak shadows, and night vision</p>
May 20, 2011	12:37 PM–15:47 PM	 <p>Light rain and heavy rain</p>
From Iteris	daytime	 <p>Normal condition with a stopped vehicle</p>



### Configuration Setup

For the TxDOT demo system, the usage parameters as defined for the experiments are shown in Figure 67. For Abacus, the ROIs for each time period are shown in Figure 68. In Figure 68(a) and (d), the ROI includes the shoulder in order to detect stopped vehicles. The important Abacus parameter settings are shown in Table 20.



D1:	<input type="text" value="2"/> lanes	D2:	<input type="text" value="2"/> lanes
Lane Width:	<input type="text" value="3.6"/> meters	Perpendicular Angle:	<input type="text" value="-10"/> degrees
Top Ratio:	<input type="text" value="0.4"/>	Bottom Ratio:	<input type="text" value="0.8"/>
Left Ratio:	<input type="text" value="0.3"/>	Right Ratio:	<input type="text" value="1"/>
Remove Shadow:	Yes <input checked="" type="radio"/> No <input type="radio"/>		

(a)

D1:	<input type="text" value="2"/> lanes	D2:	<input type="text" value="2"/> lanes
Lane Width:	<input type="text" value="3.6"/> meters	Perpendicular Angle:	<input type="text" value="-16"/> degrees
Top Ratio:	<input type="text" value="0.4"/>	Bottom Ratio:	<input type="text" value="0.8"/>
Left Ratio:	<input type="text" value="0.15"/>	Right Ratio:	<input type="text" value="1"/>
Remove Shadow:	Yes <input checked="" type="radio"/> No <input type="radio"/>		

(b)



D1:	<input type="text" value="2"/> lanes	D2:	<input type="text" value="2"/> lanes
Lane Width:	<input type="text" value="3.6"/> meters	Perpendicular Angle:	<input type="text" value="4"/> degrees
Top Ratio:	<input type="text" value="0.35"/>	Bottom Ratio:	<input type="text" value="1"/>
Left Ratio:	<input type="text" value="0"/>	Right Ratio:	<input type="text" value="0.6"/>
Remove Shadow:	Yes <input type="radio"/> No <input checked="" type="radio"/>		

(c)

D1:	<input type="text" value="2"/> lanes	D2:	<input type="text" value="2"/> lanes
Lane Width:	<input type="text" value="3.6"/> meters	Perpendicular Angle:	<input type="text" value="-5"/> degrees
Top Ratio:	<input type="text" value="0.4"/>	Bottom Ratio:	<input type="text" value="0.75"/>
Left Ratio:	<input type="text" value="0.15"/>	Right Ratio:	<input type="text" value="1"/>
Remove Shadow:	Yes <input type="radio"/> No <input checked="" type="radio"/>		

(d)

Figure 67 TxDOT Road Structure Settings for Four Testing Videos (a) for May 09, 2011; (b) for May 17, 2011; (c) for May 20, 2011; (d) for Video with Stopped Car

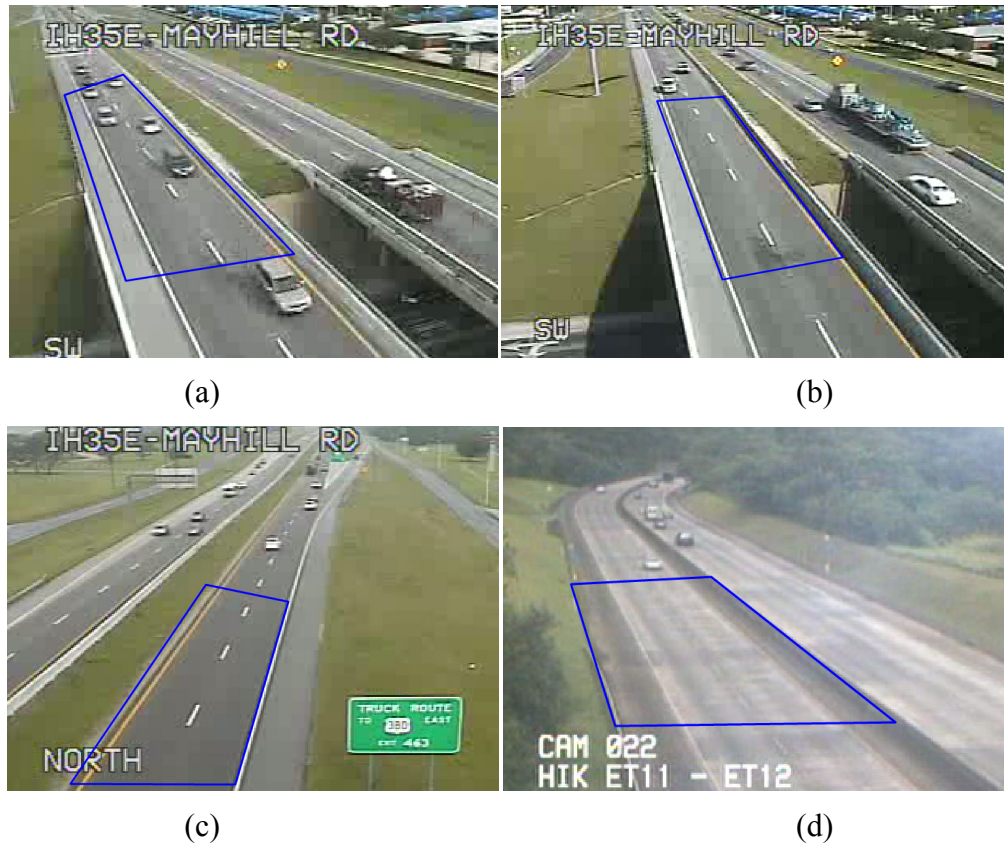

Figure 68 Overlay Configured for (a) May 09, 2011; (b) May 17, 2011; (c) May 20, 2011; (d) Video with Stopped Car

**Table 20 Important Parameters for Abacus Setup**

	<b>Detection Sensitivity</b>	<b>Top Boundary</b>	<b>Bottom Boundary</b>	<b>Left Boundary</b>	<b>Right Boundary</b>
May 09, 2011	1.8	96	192	53	352
May 17, 2011	3	96	192	106	352
May 20, 2011	1.8	84	240	0	211
Stopped car	2	96	200	53	352

### Comparison

Comparisons in the live traffic phase is on the basis of speed, volume (count), and incident detection.

- **Speed:** For each of the cases (time periods) in the first three rows of Table 19, there is a companion comparison chart in Figure 69(a) through (c). In each chart, the detector response is the data returned by the MVD. TxDOT refers to the demo system. The tail of Figure 69(b) shows fluctuations after 9:00 p.m. This is the nighttime sub-segment. The TxDOT system does not incorporate specific algorithmic methods for analyzing low ambient light conditions.

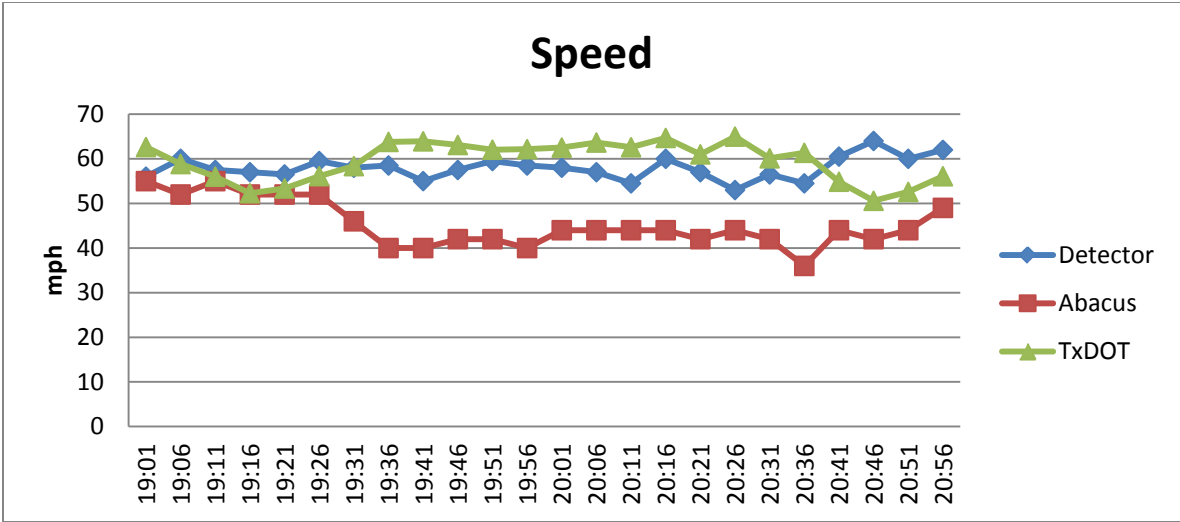

(a)

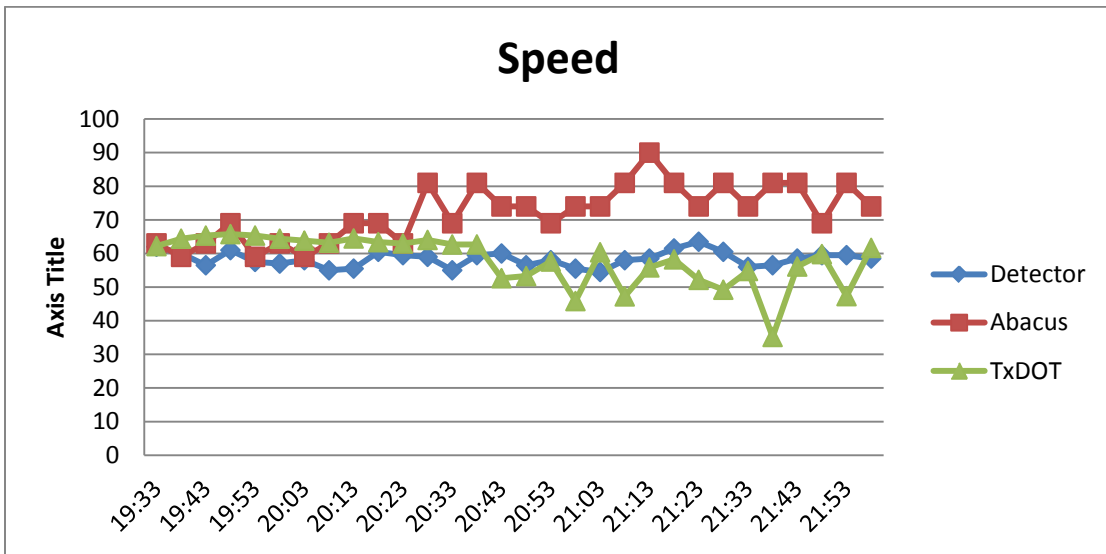

(b)

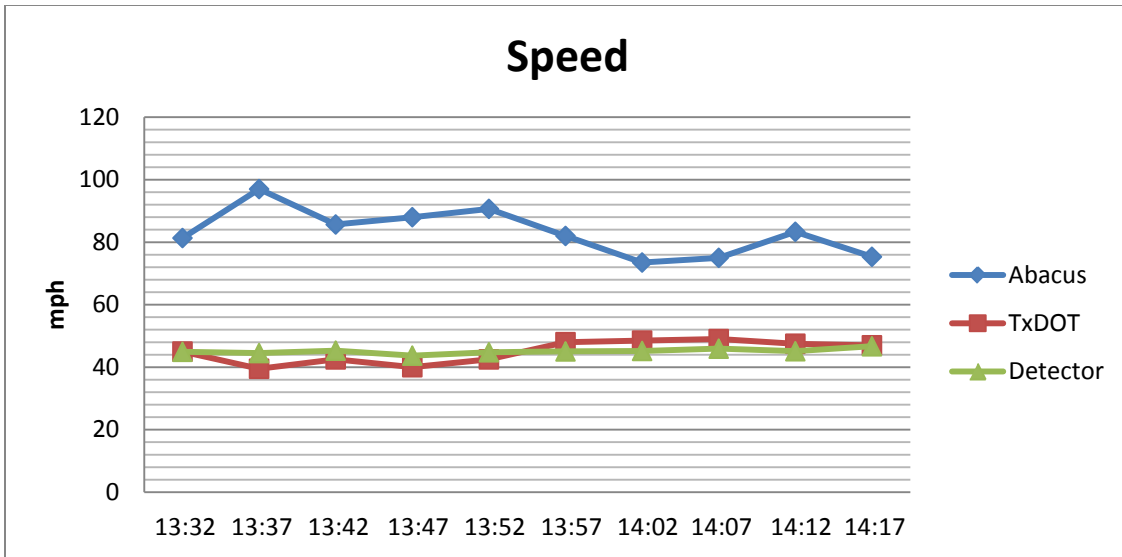

(c)

Figure 69 Speed Estimation Comparison for (a) May 09, 2011; (b) May 17, 2011; (c) May 20, 2011 with Light Rain

- Count: For each of the cases (time periods) in the first three rows of Table 19, there is a companion comparison chart in Figure 70(a) through (d). In each chart, the ground truth response is the data determined by manual counting. TxDOT refers to the demo system. The rainy subsequence of the third time period is separated into a separate chart, Figure 70(d).

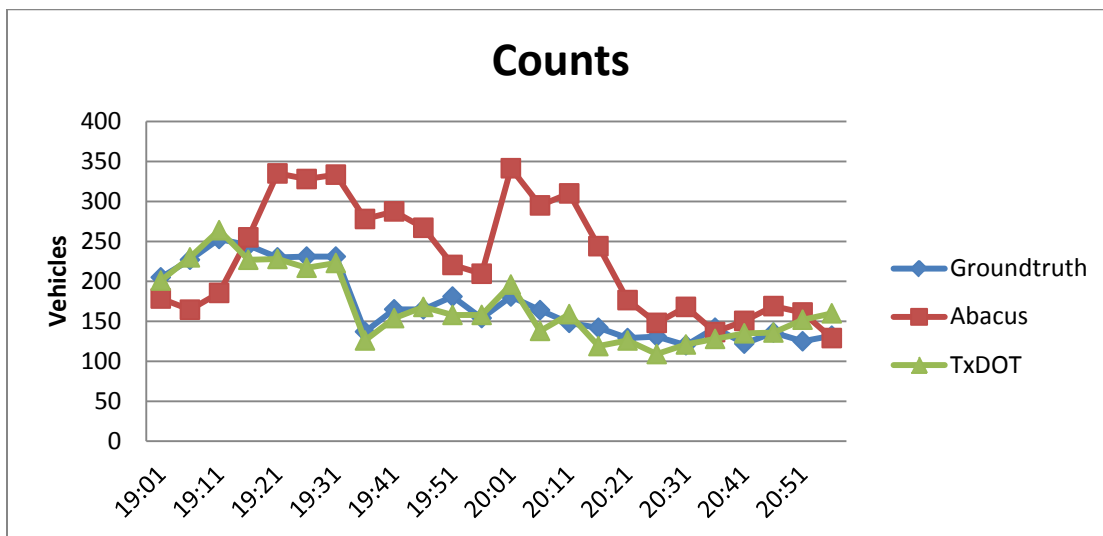

(a)

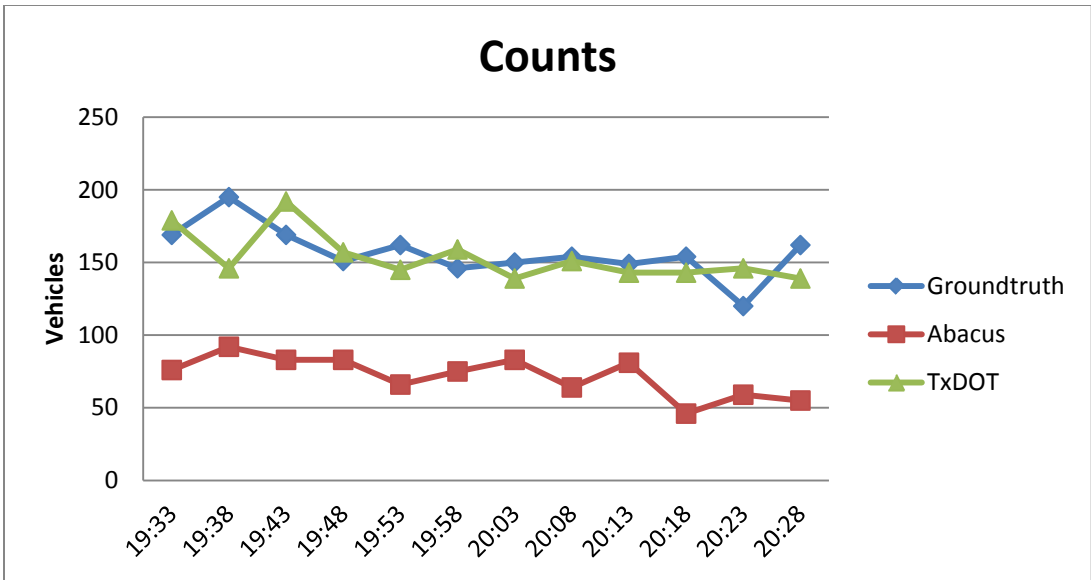

(b)

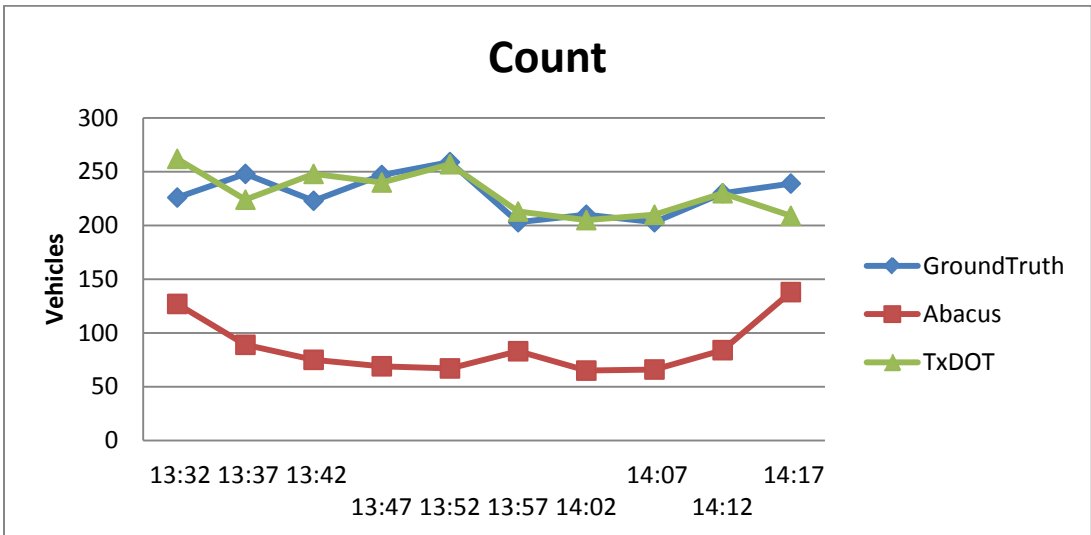

(c)

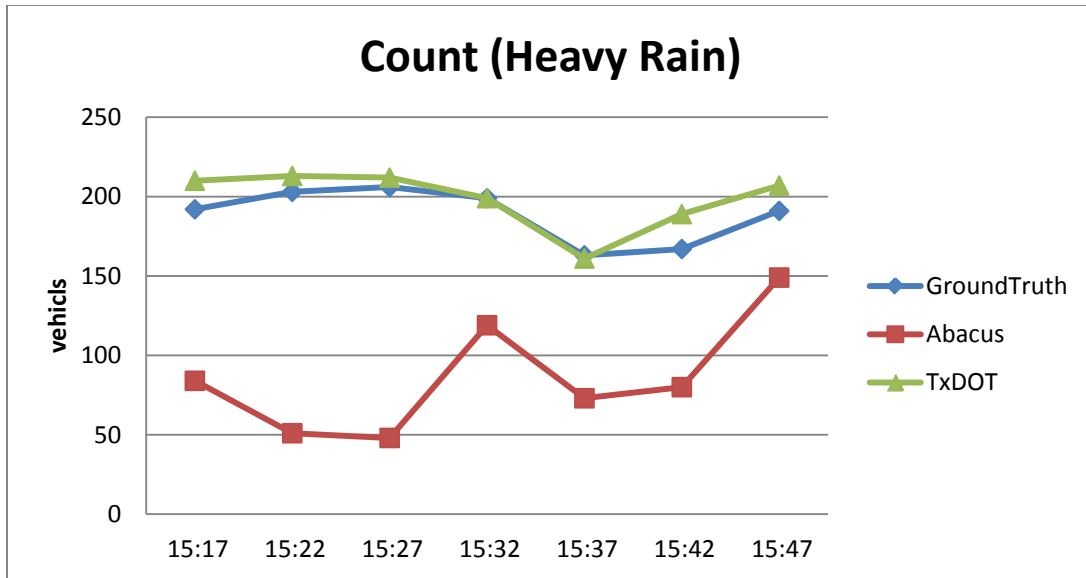

(d)

Figure 70 Count Estimation Comparison for (a) May 09, 2011; (b) May 17, 2011; (c) May 20, 2011 with Light Rain; (d) for May 20, 2011 with Heavy Rain

- Incident detection: The only implemented incident detection algorithm was for stopped vehicle. The functionality of both Abacus and the TxDOT demonstration system included detection. While stopped vehicle is the most common incident, it is relatively rare. Across the four time periods characterized in Table 19, only the last contains a stopped vehicle. As shown in Table 21, the two systems behaved identically, with no false positives or false negatives.

**Table 21 Incident Detection Performance from Both Abacus and TxDOT Systems**

Date	Location	Time Period	Events/Accuracy	False Alarm
May 09, 2011	Mayhill@I-35	17:06 PM–21:16 PM	0/100%	0
May 17, 2011	Mayhill@I-35	17:38 PM–21:58 PM	0/100%	0
May 20, 2011	Mayhill@I-35	12:37 PM–15:47 PM	0/100%	0
From Iteris	N/A	daytime	1/100%	0

## Chapter 7. Conclusions and Recommendations

A study was conducted to determine the feasibility of extending the range of traffic monitoring systems using low-cost communications and autonomous cameras. For communications, three sets of antennas were investigated: a very low-cost radio (Ubiquiti Nanostation M5), a low-cost radio (Ubiquiti Rocket Dish), and the Motorola PTP300 series. For cameras, we used an Axis 213 PTZ supplied by TranStar in Houston and a Cohu supplied by DalTrans in Dallas.

To evaluate autonomous operation, we used a commercial video analytics product, Abacus Highway Product, marketed by Iteris. In addition, a demonstration system was developed and delivered to TxDOT. Both had the functionality of self-calibration, speed/volume detection, and stopped vehicle identification. The TxDOT demonstration system was restricted to operation under nominal lighting conditions and is capable of self-calibration for straight, flat roadways. Both systems performed satisfactorily.

### 7.1 Communications Equipment

In the area of wireless communications, we made several observations regarding both bandwidth and antennas. With respect to bandwidth, the following was determined:

For single-camera configurations, all tested antennas tested were adequate as determined by video quality metrics.

This observation may not hold for multiple-camera configurations.

We conclude the following for antennas:

Single-hop configurations (sensor to backbone) can use inexpensive antennas.

We found no essential differences in operational quality, regardless of antenna quality, if the video could be transported to the network backbone in a single hop. It may be noted that we were not, within the confines of this study, capable of investigating the durability of the antennas or survivability to extreme events. Additionally, we noted this:

Multi-hop configurations require antennas with stable (small variation) throughput.

While relatively high numbers of drop-outs did not precipitate drastic reductions in throughput in single-hop configurations, when combined in two-hop configurations, the throughput diminished by half. While this occurrence was consistently observed, direct experimentation was not possible. Drop-outs are random, non-controllable events that cannot be replicated from one experiment repetition to the next.

## 7.2 Video Analytics (VA)

The communications choices represent the primary means to control equipment and maintenance costs. Autonomous monitoring, the role of video analytics, is an option that controls operational cost. Deploying VA reduces the need for attention by human operators.

Our conclusions include the following.

Precise calibration and operator-controlled camera movement are competitive goals.

Camera calibration is computationally expensive. Also, even if “self-calibrating,” the software will not operate properly without some input from the operator. (Perhaps this function is in place to ascertain whether the result is reasonable.) If the camera is moved by a human operator, the calibration process must be repeated.

A number of commercial products are on the market; Iteris’s Abacus was selected for testing as part of the study. Should a unique system be developed for TxDOT, this should be noted:

Specialized expertise is required for development.

The development of a VA system for traffic monitoring requires knowledge of image processing, computer vision, projective geometry pattern recognition, and artificial intelligence.

A VA system may be placed camera-side or TMC-side.

If bandwidth is not an issue, placing VA processing at the TMC is as effective as placing it in the field.

The input to the VA system is video. The quality of the video is important. If good quality video is available at the TMC (and it generally is), then the system operation is equal to a road-side installation. Furthermore, the costs of housing, weather hardening, and field maintenance is less.

Camera placement (perspective) is crucial.

Near or over the roadway at a height of 40 to 60 feet is ideal. The farther the camera is from the road, the greater becomes the problem of occlusion. Vehicle counts become less accurate. The height of the camera affects the perceived size of the vehicles and ultimately makes calibration more difficult.

TxDOT has the option of purchasing an existing autonomous surveillance system or developing its own in-house.



It would be cost-effective for TxDOT to develop and deploy its own freeway-oriented VA system.

Admittedly, this conclusion is dependent on the number of installations that are anticipated. Not counting maintenance in the years following installation, the breakeven point likely occurs with approximately 12 installations.



## References

- Sheldon Leader. Federal Highway Administration Report. Report No. FHWA-HOP-04-034. Telecommunications Handbook for Transportation Professionals (The Basics of Telecommunications). 2004.
- John Hourdakakis, Ted Morris, Panos Michalopoulos, Kyle Wood. Center for Transportation Studies (University of Minnesota) Report. Report No. CTS 05-07. Advanced Portable Wireless Measurement and Observation Station (Final Report). 2005.
- Louis G. Neudorff, Jeffrey E. Randall, Robert Reiss, Robert Gordon. Federal Highway Administration Report. Report No. FHWA-OP-04-003. Freeway Management and Operations Handbook . 2003 (partially updated 2006).
- Mimi Hwang, James Kemp, Eva Lerner-Lam, Nancy Neuerburg, Paula Okunieff; edited by John Schiavone. Federal Transit Administration Report. Report No. FTA-NJ-26-7062-06.1. Advanced Public Transportation Systems: State of the Art Update 2006.
- Mimbela, Luz Elena Y; Klein, Lawrence A. Submitted to: Federal Highway Administration's (FHWA) Intelligent Transportation Systems Program Office. A Summary of Vehicle Detection and Surveillance Technologies used in Intelligent Transportation Systems –Updated August 2007.
- Lawrence A. Klein, Milton K. Mills, David R.P. Gibson. Federal Highway Administration Turner-Fairbank Highway Research Center. Traffic Detector Handbook: Third Edition—Volume I. 2006.
- H Schwabach, M. Harrer, W. Holzmann, H. Bischof, G. Fernández Domínguez, M. Nölle, R. Pflugfelder, B. Strobl, A. Tacke, A. Walzl. 12th World Congress on Intelligent Transport Systems. Video Based Image Analysis for Tunnel Safety - VITUS-1: A Tunnel Video Surveillance and Traffic Control System. 2005.
- Panos D. Prevedouros, Xiaojin (Jerry) Ji , Konstantinos Papandreou , Pantelis Kopelias , Vily Vegiri. Freeway Operations and High-Occupancy Vehicle Systems, Transportation Research Record: Journal of the Transportation Research Board. Video Incident Detection Tests in Freeway Tunnels. 2006.
- James Z. Lou. Intelligent Transportation Systems and Vehicle-Highway Automation, Transportation Research Record: Journal of the Transportation Research Board. Network and Communication Design of a Work Zone Intelligent Transportation System. 2005.
- Avery Rhodes, Ed Smaglik, Darcy Bullock. Federal Highway Administration Report. Report No. FHWA/IN/JTRP-2005/30. Vendor Comparison of Video Detection Systems. 2006.

- Dan Middleton, Eun Sug Park, Ryan Longmire, and Hassan Charara. TxDOT Report. Report No. FHWA/TX-09/0-5774-1. Improve Current Design of Video Imaging Detection Systems Used for Dilemma Zone Protection. 2008.
- Yi-Chang Chiu, Haitham Logman, Mo-Ning Chiu, Analsoni Sunkara, Carl Haas. Guidebook for Selecting Cost-Effective Wireless Communication Technologies for Intelligent Transportation Systems. October 2003, Revised March 2005.
- Document for the North Central Texas Council of Governments (NCTCOG) Regional Data and Video Communications System (RDVCS). Report No. RDVCS-AAS-1.0.1. NCTCOG Regional Data and Video Communication System Agencies Assessment Summary. 2006.
- James Bonneson and Montasir Abbas. Report No. FHWA/TX-03/4285-2. Intersection Video Detection Manual. 2002.
- Prevedouros, Panos D, Ji, Xiaojin, Papandreou, Konstantinos, Kopelias, Pantelis, Vegiri, Vily Video Incident Detection Tests in Freeway Tunnels, Transportation Research Record: Journal of the Transportation Research Board, Issue No.1959, pp 130–139, 2006.
- Jun-Wei Hsieh, Shih-Hao Yu, Chen Yung-Sheng and Wen-Fong Hu, Automatic Traffic Surveillance System for Vehicle Tracking and Classification, IEEE TRANSACTIONS ON INTELLIGENT TRANSPORTATION SYSTEM, VOL.7,NO.2,JUNE 2006.
- Magy Kandil and May Salama, A NEW HYBRID ALGORITHM FOR FIRE VISION RECOGNITION, EUROCON 09.IEEE, pp:1460–1466, May, 2009.
- Zhanquan Sun and Yinglong Wang, Traffic congestion identification by combining PCA with higher-order Boltzmann machine, Neural Computation and Application 2009, pp:417–422, VOL.18, NO.5, June, 2009.
- T. Thomas and E.C. van Berkum, Detection of incidents and events in urban networks, IET Intelligent Transport Systems, VOL.3, Iss. 2, pp: 198–205, July 2008.
- William A. Hyman, Jim Zeitlin, Harley Radin, Shawn Snellgrove and Edward Page, Use of Wireless Technology for Field Applications, Report NO. SD2005-03, July 31, 2006.
- Vladimir Cherkassky, Xuhao He and Prakash Balasubramanian, Wireless Transmission of Image and Video Data, April 2002, ReportNo. MN/RC-2002-24, April 2002.
- Liping Zhang, Meng Li, Peter Lau, Wei-Bin Zhang and Kai Leung, A Cost-effective Traffic Data Collection System Based on the iDEN Mobile Telecommunication Network, Report No. UCB-ITS-PWP-2008-5, October 2008.

- Roger L. Freeman, *Radio System Design for Telecommunications*, Wiley-Interscience, 1997.
- T.K. Madsen, J. Groenbaek, J. Figueiras, H.P. Schwefel, *Modelling Chain for Throughput Estimation in Wireless Networks*, Vehicular Technology Conference, IEEE 69th, April 2009.
- Guohui Zhang, Ryan P. Avery and Yin Hai Wang, "Video-Based Vehicle Detection and Classification System for Real-Time Traffic Data Collection Using Uncalibrated Video Cameras," *Transportation Research Board: Journal of the Transportation Research Board*, No.1993, Transportation Research Board of the National Academics, Washington, D.C., 2007, pp. 138–147.
- Mei Xiao, Chong-Zhao Han and Lei Zhang, "Moving Shadow Detection and Removal for Traffic Sequences," *International Journal of Automation and Computing*, 04(1), 38–46, January 2007.
- Veenman, C.J., Reinders, M.J.T., and Backer, E., "Resolving motion correspondence for densely moving points," *IEEE Transactions on Pattern Analysis and Machine Intelligence*, vol. 23, issue 1, pp. 54, August, 2007.
- Harold W. Kuhn, "The Hungarian method for the assignment problem," *Naval Research Logistics Quarterly*, 2:83–97, 1955. (Kuhn's original publication)
- Marcello Pavan and Marcello Pelillo, "Dominant Sets and Pairwise Clustering," *IEEE Transaction on Pattern Analysis and Machine Intelligence*, vol. 29, no. 1, January 2007.
- Todd N.Schoepflin and Daniel J.Dailey, "Dynamic Camera Calibration of Roadside Traffic Management Cameras for Vehicle Speed Estimation," *IEEE on Intelligent Transportation System*, Vol. 4, No. 2, pp. 90–98, June 2003.
- Canny, J., A Computational Approach To Edge Detection, *IEEE Trans. Pattern Analysis and Machine Intelligence*, 8(6):679–698, 1986.
- Duda, R. O. and P. E. Hart, "Use of the Hough Transformation to Detect Lines and Curves in Pictures," *Comm. ACM*, Vol. 15, pp. 11–15, January, 1972.



## Appendix A: System Devices

The following devices are those used in the test systems.

### Wireless Devices

- **Nanostation M5** (<http://ubnt.com/airview/downloads>, accessed May 5, 2010)

Manufacturer: Ubiquiti Networks

Frequency: 5470 MHz–5825 MHz

Coverage: up to 15km (9 miles)

Data Rate: up to 150 Mbps

Standard: 802.11a/n

Power/Sensitivity: Tx Power: 802.11a: 27 dBm @ 6–24 Mbps to 22 dBm @ 54 Mbps, 802.11n: 27 dBm @ MCS 0 to 21 dbm @ MCS 15;  
Sensitivity: 802.11a: -94 dBm @ 6–24 Mbps to -75 dBm @ 54 Mbps, 802.11n: -96 dBm @ MCS0 to -75 dbm @ MCS15

Antenna: 14.6–16.1 dBi

Enclosure: Outdoor UV Stabalized Plastic

Environment: -30° to +80°C (-22 to 176°F)

- **Rocket M5** (<http://ubnt.com/rocketm>, accessed Nov. 20,2010) + **RocketDish5G-30** (<http://ubnt.com/rocketdish> , accessed Nov. 20, 2010)

Manufacturer: Ubiquiti Networks

Frequency: 5470 MHz–5825 MHz

Coverage: up to 50km (31miles)

Data Rate: up to 150 Mbps

Standard: 802.11a/n

Power/Sensitivity: Tx Power: 802.11a: 27 dBm @ 6–24 Mbps to 22 dBm @ 54 Mbps, 802.11n: 27 dBm @ MCS 0 to 21 dbm @ MCS 15;  
Sensitivity: 802.11a: -94 dBm @ 6–24 Mbps to -75 dBm @ 54 Mbps, 802.11n: -96 dBm @ MCS0 to -75 dbm @ MCS15

Antenna: 28.0–30.25 dBi (RocketDish**5G-30**)

Enclosure: Outdoor UV Stabalized Plastic

Environment: -30° to +75°C (-22 to 167°F)

To judge the performance of cost-effective testing wireless system, we also set up a system composed by Motorola PTP 54300 which have been used in the other TxDOT project and obtained good feedbacks.

➤ **PTP 54300 (Part Number: WB3151BB)**

(<http://www.motorola.com/web/Business/Products/Wireless%20Networks/Wireless%20Broadband%20Networks/Point-to-Point/PTP%20300%20Series/WNS%20PTP%20300%20SS%20Upt%20072910%20r1.pdf>, accessed Nov. 20, 2010)

Manufacturer: Motorola

Frequency: 5470 MHz–5725 MHz

Coverage: up to 250 km (155 miles); in optional LOS up to 10km (6 miles)

Data Rate: (standard) 5 MHz: up to 13 Mbps; 10 MHz: up to 25 Mbps;  
15 MHz: up to 25 Mbps

(LOS) 5 MHz: up to 18 Mbps; 10 MHz: up to 35 Mbps; 15 MHz: up to 50 Mbps

Power/Sensitivity: Transmission power: -18 dBm to 27 dBm;

Receiving sensitivity: -94 dBm to -69 dBm

Antenna: 23 dBi

Environment: -40° to +60°C (-40° to +140°F)

## **Camera**

➤ **Axis 213 PTZ** ([http://www.axis.com/files/datasheet/ds\\_213ptz\\_33081\\_en\\_0909\\_lo.pdf](http://www.axis.com/files/datasheet/ds_213ptz_33081_en_0909_lo.pdf) , accessed April 20, 2010)

Name: 213 PTZ ([http://www.axis.com/products/cam\\_213/](http://www.axis.com/products/cam_213/), accessed May 5, 2010)+Housing 25733

Manufacturer: Axis

Format: 1/4" Interlaced CCD

Focal Length (mm): 3.5–91 mm, F1.6–F4.0

Zoom: 26x optical/12x digital

Angle of View: 1.7°–47°

Resolution: 160x90 to 704x576

Minimum Illumination: Color mode: 1 lux, F1.6; IR mode: 0.1 lux, F1.6; using built-in IR light in complete darkness up to 3 m (9.8ft)



## Appendix B: Testing Devices

### Hardware

#### ✓ Laptop1

Manufacturer: Dell

CPU: Intel Core2 Duo CPU @1.4 GHz 795 MHz

RAM: 2.00GB

Network: Broadcom 440x 10/100 Integrated Controller

#### ✓ Laptop2

Manufacturer: Dell

CPU: Intel CPU T2050 @1.60 GHz 798 MHz

RAM: 0.99GB

Network: Broadcom 440x 10/100 Integrated Controller

### Software

#### ✓ LINKPlanner

Developer: Motorola™

Version: 2.3.10

Usage in the project: Site investigation and performance estimation for Motorola products

Link: <http://motorola.wirelessbroadbandsupport.com/software/ptp/index.php>, accessed Nov. 29, 2010

Screenshot:

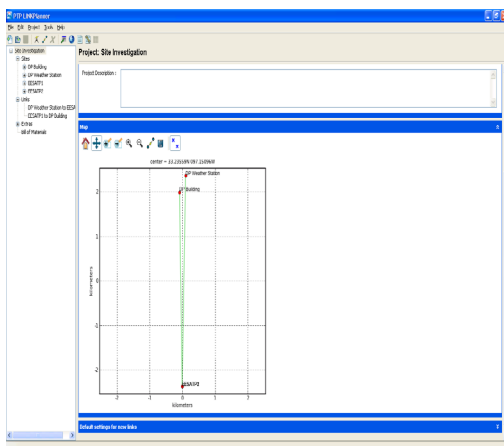

## ✓ Google Earth

Developer: Google™

Version: 5.2.1.1588

Usage in the project: Site investigation

Link: <http://www.google.com/earth/index.html>, accessed July 1, 2010

Screenshot:

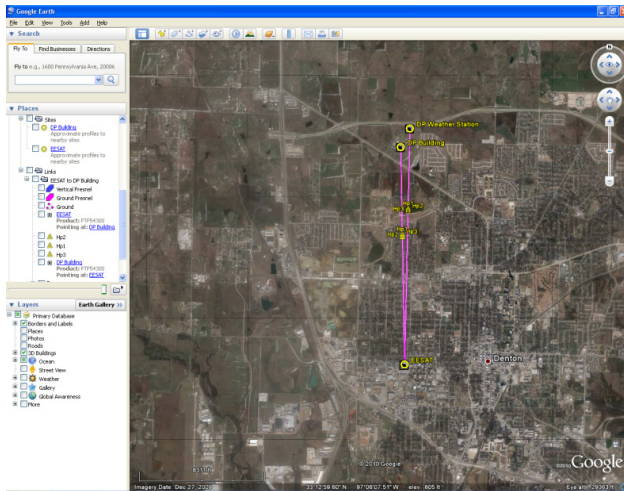

## ✓ Jperf

Developer: Nicolas Richasse

Version: 2.02

Usage in the project: Throughput Testing

Link: <http://code.google.com/p/xjperf/>, accessed Nov. 29, 2010

Screenshot:

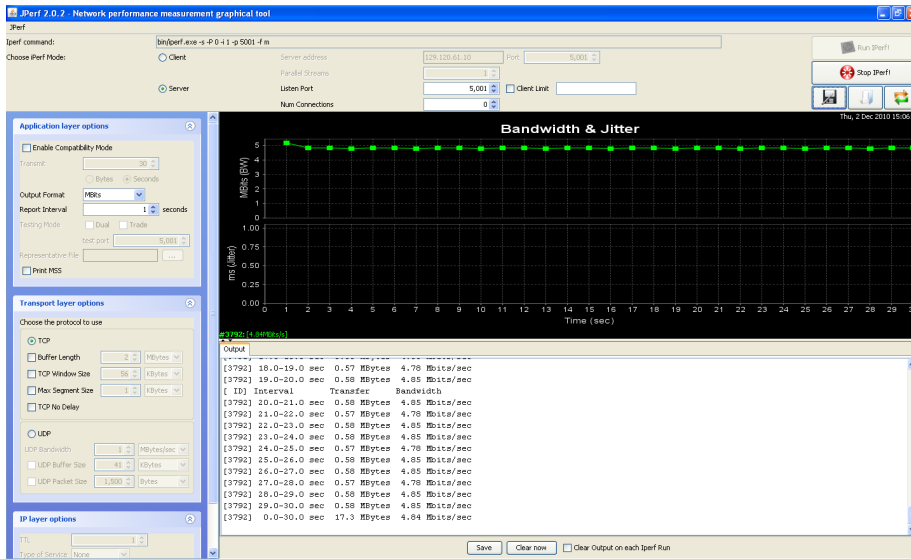

✓ **The Dude**

Developer: MikroTik™

Version: 3.6

Usage in the project: Network Monitoring

Link: <http://www.mikrotik.com/thedude.php>, accessed June 3, 2010

Screenshot:

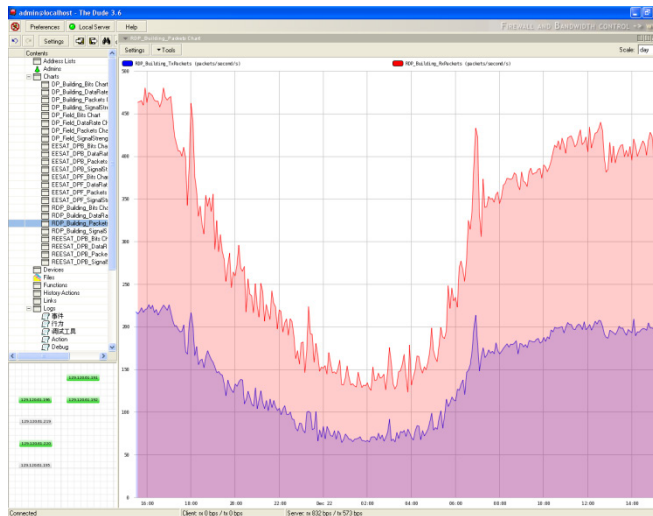



# Appendix C: Development Platform and Software

## Development Platform

The following desktop computer is used for basic development and implementation for the video analytics system.

➤ Desktop

Manufacturer: Dell

CPU: Intel Core2 Duo CPU @ 3 GHz 2.99 GHz

RAM: 3.00GB

Open Source Dependencies: OpenCV (<http://opencv.willowgarage.com/wiki/>), FFmpeg (<http://www.ffmpeg.org/>), MySQL++ (<http://www.ffmpeg.org/>), Apache (<http://httpd.apache.org/>) and MySQL (<http://www.mysql.com/>)

## Software

➤ Abacus

(<http://www.interprovincial.com/files/manuals/iteris/Abacus%20Installation%20and%20User%20Manual.pdf>)

Developer: Iteris's Abacus™

Version: v1.2.3709.277BO BETA

Usage in the project: Video Analytics Product Reference

User Manual Available Online:

<http://www.interprovincial.com/files/manuals/iteris/Abacus%20Installation%20and%20User%20Manual.pdf>

Screenshot:

