

**Report No. CDOT-2012-3
Final Report**



HYDRAULIC EFFICIENCY OF GRATE AND CURB-OPENING INLETS UNDER CLOGGING EFFECT

**James C.Y. Guo, Principle Investigator
Ken MacKenzie, Project Manager**

April 2012

**COLORADO DEPARTMENT OF TRANSPORTATION
DTD APPLIED RESEARCH AND INNOVATION BRANCH**

The contents of this report reflect the views of the author(s), who is(are) responsible for the facts and accuracy of the data presented herein. The contents do not necessarily reflect the official views of the Colorado Department of Transportation or the Federal Highway Administration. This report does not constitute a standard, specification, or regulation.

1. Report No. CDOT-2012-3	2. Government Accession No.	3. Recipient's Catalog No.	
4. Title and Subtitle HYDRAULIC EFFICIENCY OF GRATE AND CURB-OPENING INLETS UNDER CLOGGING EFFECT		5. Report Date April 2012	
		6. Performing Organization Code	
7. Author(s) James C.Y. Guo and Ken MacKenzie		8. Performing Organization Report No. CDOT-2012-3	
9. Performing Organizations University of Colorado Denver and Urban Drainage and Flood Control District, Denver, Colorado		10. Work Unit No. (TRAIS)	
		11. Contract or Grant No. 105.81	
12. Sponsoring Agency Name and Address Colorado Department of Transportation - Research 4201 E. Arkansas Ave. Denver, CO 80222		13. Type of Report and Period Covered	
		14. Sponsoring Agency Code	
15. Supplementary Notes Prepared in cooperation with the US Department of Transportation, Federal Highway Administration			
16. Abstract The goal of this project is to investigate the hydraulic efficiencies of Type 13 (bar inlets), Type 16 (vane inlets), and Type R (curb-opening inlets) for street and roadway drainage. Although these inlets have been widely used in many metropolitan areas, the design empirical formulas and coefficients have not been verified. In this study, a flume was constructed in the laboratory to simulate street gutter flows ranging from 6 to 18 inch of flow depths. Type 13, 16, and curb-opening inlet models were built using a 1/3 scale to investigate the depth-flow relations under both on-grade and in-sump conditions. It was found that the flow interception capacity for a sump inlet is determined by either weir or orifice hydraulics, whichever is less for the given flow depth. Two new splash-velocity curves were developed to model the street gutter flow around a Type 13 or 16 inlet on a grade. In this study, a decay-based clogging factor was developed and recommended for the design of a series of inlets. The clogging effect shall be applied to the effective wetted length for an inlet that operates like a weir, or to the effective opening area for an inlet that operates like an orifice in a sump.			
17. Implementation A new chapter of Inlet and Sewer Designs was introduced to the CDOT Hydraulic Design Manual. This design procedure has been coded into the design tool: UDINLET (MS Spread Sheet Model). Visit WWW.UDFCD.org to download.			
19. Keywords bar grate inlets, vane grate inlets, curb-opening inlets, combination inlets, decay-based clogging effects		18. Distribution Statement No restrictions. This document is available to the public through the National Technical Information Service www.ntis.gov or CDOT's Research Report website http://www.coloradodot.info/programs/research/pdfs	
19. Security Classif. (of this report) Unclassified	20. Security Classif. (of this page) Unclassified	21. No. of Pages 90	22. Price

ACKNOWLEDGEMENTS

The authors gratefully acknowledge the Colorado Department of Transportation's financial support during the course of this study. The authors would also like to extend their deep appreciation to the members of the Colorado Department of Transportation Research Study Panel including Amanullah Mommandi (Project Development Branch), Mr. Alfred Gross (R-1 Hydraulics), Mr. Stuart Gardner (R-3 Hydraulics), Aziz Khan (Applied Research and Innovative Branch) and Jake Kononov (Applied Research and Innovative Branch) for their technical assistance, guidance, and review of this document.

HYDRAULIC EFFICIENCY OF GRATE AND CURB-OPENING INLETS UNDER CLOGGING EFFECT

James C. Y. Guo, Principle Investigator
and
Ken MacKenzie, Project Manager

Report No CDOT-2012-3

Prepared for
Colorado Department of Transportation
Applied Research and Innovation Branch

Prepared by
University of Colorado Denver
and
Urban Drainage and Flood Control District

April 2012

TABLE OF CONTENTS

1.0 INTRODUCTION	1
1.1 Objectives	1
2.0 LITERATURE REVIEW	3
3.0 LABORATORY STREET MODEL	5
3.1 Testing Equipment and Model Scaling.....	5
3.2 Cases of Street Flow Conditions Tested	7
3.3 Model Inlet Construction	10
4.0 MODEL OPERATION AND TESTING PROCEDURE.....	20
4.1 Data Collection	23
5.0 INLET CLOGGING	24
6.0 STREET HYDRAULICS	26
7.0 ON-GRADE GRATE INLET.....	28
8.0 ON-GRADE CURB-OPENING (TYPE R) INLET	32
9.0 IN-SUMP GRATE INLET	34
10.0 IN-SUMP CURB-OPENING INLET.....	37
11.0 COMBINATION INLET IN SUMP	40
12.0 CONCLUSIONS AND RECOMMENDATIONS	42
13.0 REFERENCES	43
APPENDIX A: USDCM GRATE INLET SCHEMATICS	45
APPENDIX B: ON-GRADE TEST DATA	49
APPENDIX C: SUMP TEST DATA	60
APPENDIX D: INLET CONSTRUCTION DRAWINGS.....	63
APPENDIX E: ADDITIONAL PARAMETERS	68
APPENDIX F: CALCULATED EFFICIENCY.....	78

LIST OF FIGURES

Figure 2.1	Dimensions of Grate and Curb-Opening Inlets	3
Figure 3.1	Laboratory Layout of Model Street and Inlet.....	5
Figure 3.2	Flume Cross-Section Sketch (prototype scale).....	6
Figure 3.3	Curb Inlet Gutter Panel During Fabrication (Type R)	11
Figure 3.4	Combination Inlet Gutter Panel During Fabrication (Type 13 and 16 grates)	11
Figure 3.5	Type 13 Grate Photograph.....	12
Figure 3.6	Type 16 Grate During Fabrication	12
Figure 3.7	Single No. 13 Combination Photograph.....	13
Figure 3.8	Double No. 13 Combination Photograph	13
Figure 3.9	Triple No. 13 Combination Photograph	13
Figure 3.10	Single No. 13 Combination with 4-in. Curb Opening Photograph	14
Figure 3.11	Single No. 13 Combination with Grate Only Photograph.....	14
Figure 3.12	Single No. 13 Curb Opening Only Photograph.....	14
Figure 3.13	Single No. 13 Combination Debris Test One Photograph	15
Figure 3.14	Single No. 13 Combination Debris Test Two Photograph.....	15
Figure 3.15	Single No. 16 Combination Photograph.....	15
Figure 3.16	Double No. 16 Combination Photograph	16
Figure 3.17	Triple No. 16 Combination Photograph	16
Figure 3.18	Single No. 16 with 4-in. Curb Opening Photograph	16
Figure 3.19	Single No. 16 Grate Only Photograph.....	17
Figure 3.20	Single No. 16 Combination Debris Test One Photograph	17
Figure 3.21	Single No. 16 Combination Debris Test Two Photograph.....	17
Figure 3.22	R5 Curb Inlet Photograph.....	18
Figure 3.23	R9 Curb Inlet Photograph.....	18
Figure 3.24	R12 Curb Inlet Photograph.....	18
Figure 3.25	R15 Curb Inlet Photograph.....	19
Figure 3.26	R5 with 4-in. Curb Opening Photograph.....	19
Figure 3.27	R5 with Safety Bar Photograph.....	19
Figure 4.1	Laboratory Layout for Street-Inlet Study	20
Figure 4.2	Data Collection Cart (looking upstream)	22
Figure 5.1	Decay of Inlet Clogging Percentage.....	24
Figure 5.2	Decay of Debris Amount on Grates	24
Figure 6.1	Illustration of Street Flow.....	26
Figure 7.1	Splash-Over Flow Over Type 13 Grate.....	28
Figure 7.2	Predicted vs. Observed Efficiency for Type 13 Combination.....	30
Figure 7.3	Predicted vs. Observed Efficiency for Type 16 Combination.....	31
Figure 8.1	Predicted vs. Observed Efficiency for Type R Inlet.....	33
Figure 9.1	Comparison Between Observed and Predicted Data for Type 13 Bar Grate	35
Figure 9.2	Comparison Between Observed and Predicted Data for Type 16 Vane Grate.....	36
Figure 10.1	Horizontal Throat for Type 13 and Type 16 Combo.....	37
Figure 10.2	Comparison Between Observed and Predicted Data for 3-ft Curb Opening.....	38
Figure 10.3	Comparison Between Observed and Predicted Data for 5-ft Curb Opening.....	39
Figure 11.1	Observed and Predicted Flow Interception for Type 13 Combination.....	41
Figure 11.2	Observed and Predicted Flow Interception for Type 16 Combination.....	41

LIST OF TABLES

Table 2.1	Dimensions of Various Types of Inlets Used in This Study.....	3
Table 2.2	Summary of FHWA Model Characteristics.....	4
Table 3.1	Prototype Dimension	6
Table 3.2	Scaling Ratios for Geometry, Kinematics and Dynamics	7
Table 3.3	Test Matrix for 0.33-ft Prototype Flow Depth.....	8
Table 3.4	Test Matrix for 0.5-ft Prototype Flow Depth.....	9
Table 3.5	Test Matrix for 1-ft Prototype Flow Depth.....	10
Table 3.6	Additional Sump Tests (prototype scale)	10
Table 4.1	Discharge Measurement-Instrument Ranges	21
Table 4.2	Empirically-Derived Weir Parameters.....	22
Table 5.1	Clogging Factors for Inlet Design	25
Table 7.1	Coefficients for Estimating Splash-Over Velocity	29
Table 7.2	Sample On-Grade Test Data	30
Table 8.1	New Coefficients for Curb-Opening Inlet Derived in This Study.....	32
Table 9.1	Grate Coefficients for Grate Inlet in Sump.....	34
Table 9.2	Sample Sump Test Data.....	35
Table 10.1	Coefficients for Curb-Opening Inlet.....	38

1.0 INTRODUCTION

As recommended for urban street drainage design by the Colorado Department of Transportation (CDOT) and the Urban Drainage and Flood Control District (UDFCD), Type R curb-opening inlets, Type 13 steel-bar grates, and Type 16 vane grates have been widely installed in the Denver metropolitan area (UDFCD 2001, CDOT 2004). These inlets have not been sufficiently tested for their hydraulic efficiency in flow interception. Current design practices are based upon the empirical formulas documented in “*Hydraulic Engineering Circular 22 (HEC22)*” (FHWA 2001). Although HEC 22 covers the general types of bar and vane inlets, it provides no specific guidance for these three inlets recommended by the UDFCD and CDOT.

A task committee was established to conduct the research study to evaluate the hydraulic efficiency of Type 13, Type 16, and Type R inlets, including a 1/3 scaled street model built at the Hydraulic Laboratory in the Colorado State University (CSU), data analyses and modifications on the design methods performed in the Department of Civil Engineering, U of Colorado Denver, and a new chapter of street hydraulics and inlet sizing prepared for CDOT and UDFCD drainage design manuals.

It was concluded that the HEC22 design procedures and formula can fairly represent the hydraulic performance of these three inlets. However, the design parameters used in the empirical formulas must be revised to agree with the laboratory data.

1.1 Objectives

Storm runoff is conveyed through the drainage network that consists of streets, gutters, inlets, storm sewer pipes, and treatment facilities. Design methods for grate and curb-opening inlets presented in the Chapter of Street Inlet and Sewer in the Urban Storm Design Criteria Manual (*USDCM 2001*) generally follow the HEC 22 procedures. Uncertainties in sizing Type 13, 16, and R inlets lie in the empirical parameters associated with orifice and weir flows. In this study, improvements to current design methods are discussed as follows:

- (1) Although the bar-grate inlets specified in *HEC 22* are similar to, but not exactly the same as, Type 13 grates, subtle differences exist in the flow area due to the grate’s geometry can result in miscalculations of hydraulic performances.
- (2) The vane grate specified in *HEC 22* has a different inclined angle from the Type 16 vane grate. A new set of empirical parameters needs to be developed from the laboratory data.
- (3) A Type R inlet has an inlet depression greater than what is described in *HEC 22* and capable of capturing more flow.
- (4) A combination inlet, that is formed by a grate and a curb-opening inlet used together, presents a complicated hydraulic condition. Guidance provided in the *USDCM 2001* is to ignore the curb-opening inlet or the inlet efficiency is solely determined based on the grate capacity. Some degree of conservatism is provided when determining efficiency in this manner, but

performance of the combination inlet may be under-predicted when flow submerges the grate portion.

(5) Current practice suggests that an inlet be firstly sized without clogging and then its unclogged capacity be reduced by 50% due to clogging. For instance, a 15-ft inlet suggested by the non-clogging design procedure will become a 30-ft inlet. Over the years, this procedure has linearly doubled the number of inlets and results in street inlets excessively long. In this study, the HEC 22 design procedure is modified with a decay-based clogging approach.

Hydraulics of street flow may or may not be uniform in any given situation, and the assumption of uniform flow may not be entirely valid. The relevance of uniform flow in analysis of the test data will be examined.

2.0 LITERATURE REVIEW

As shown in Figure 2.1, an inlet grate is formed by steel bars and often placed horizontally within the gutter width in the street. A curb-opening inlet is installed vertically on the curb face. In comparison, curb-opening inlets are less susceptible to debris clogging than grate inlets. A combination inlet is formed by a set of grates and curb-opening units. An on-grade inlet is placed on a continuous sloping street while an in-sump inlet is placed in a low point. No matter where the inlet is installed, the flow interception depends on the inlet's length and width as indicated in Table 2.1.

Table 2.1 Dimensions of Various Types of Inlets Used in This Study

Grate Dimension	Type 13 Bar Grate	Type 16 Vane Grate	Type R 5-ft Curb-opening	Type 13/16 3-ft Curb-opening	Type 13 Combo	Type 16 Combo
Grate Length in ft	3.27	3.27	5.0	3.0	3.27	3.27
Grate Width in ft	1.87	1.87			1.87	1.87
Curb Opening Height in ft			0.50	0.50	0.50	0.50
Curb Opening Horizontal Throat Width in ft				0.44	0.44	0.4
Steel Bar Width in ft	0.14				0.14	
Vane angle in degrees		45°				45°



(a) grate inlet



(b) curb opening inlet



(c) combination inlet

Figure 2.1 Dimensions of Grate and Curb-Opening Inlets

HEC 22 procedures were developed, in part, from a FHWA report titled “*Bicycle-Safe Grate Inlets Study*.” Ultimately, it was that FHWA study that provided data for development of the inlet equations provided in *HEC 22* and used in the *USDCM 2001*. Volume 1 of the FHWA study titled “*Hydraulic and Safety Characteristics of Selected Grate Inlets on Continuous Grades*” (FHWA, 1977) describes the model built and the testing methods used. Table 2.2 provides a summary of physical characteristics of the FHWA model.

Table 2.2 Summary of FHWA Model Characteristics

Feature	FHWA
Scale (prototype : model)	1:1
Gutter section width (ft)	2
Street section width (ft)	6
Street section length (ft)	60
Approach section length (ft)	None
Curb height (ft)	None
Longitudinal slopes (%)	0.5 – 13
Cross slopes (%)	2 - 6.25
Maximum flow (cubic feet per second (cfs))	5.6
Manning's roughness	0.016 - 0.017
Surface material	3/4-in. PermaPly® (fiberglass)
Inflow control	vertical sluice gate
Inflow measurement	Orifice-Venturi meter
Outflow measurement	weir / J-hook gage
Flow type (uniform or non-uniform)	Uniform
Inlet length (ft)	2 – 4
Gutter cross slope type	Uniform
Maximum depth of flow (ft)	0.45

A total of eleven grate inlets were tested for structural integrity and bicycle safety characteristics in the FHWA study. Of these, seven were tested hydraulically. A total of 1,680 tests were carried out at the U. S. Bureau of Reclamation (USBR) Hydraulic Laboratory. Efforts were made to separately measure the gutter-captured flow within the gutter width and the side-captured flow from the traffic lanes. Grate efficiency was defined as the ratio of captured flow to total street flow.

3.0 LABORATORY STREET MODEL

Testing was performed on three different types of curb and grate inlet from January 2006 through November 2008. Emphasis was placed on collection of curb depth and flow data to facilitate completion of research objectives. Two basic street drainage conditions were tested in this study for a total of 318 tests. First was a sump condition, in which all of the street flow was captured by the inlets. Second was an on-grade condition, in which only a portion of the total street flow was captured and the rest of the flow bypassed the inlets. All three inlets (Type 13, Type 16, and Type R) were tested in the sump and on-grade conditions at three depths.

3.1 Testing Equipment and Model Scaling

Model construction and testing was performed at the CSU. A photograph of the laboratory 1/3 scaled street and inlet model is presented in Figure 3.1. The model consisted of a head-box to supply water, a flume section containing the street and inlets, supporting pumps, piping, several flow-measurement devices, a tail-box to capture returning flow, and the supporting superstructure.

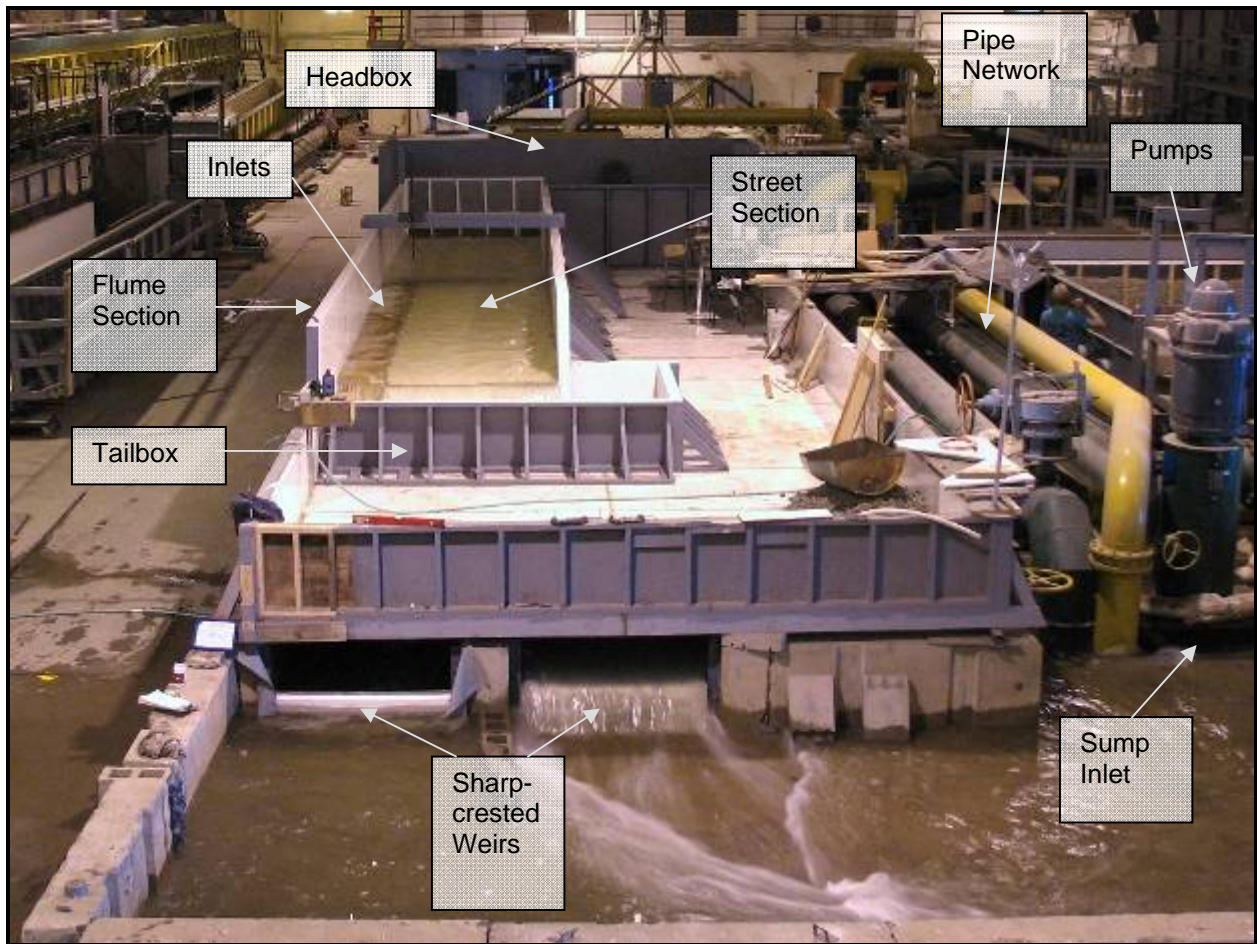

Figure 3.1 Laboratory Layout of Model Street and Inlet

Contained within the flume section were the model street and inlet components. Sufficient laboratory space allowed for construction of a flume that is shaped with two traffic lanes, a gutter panel, and a sidewalk as presented in Figure 3.2. The street section was constructed as a 2-by-4 in. tubular steel framework and decked with 1/8-in. thick sheet steel. Slope adjustment was achieved by the use of eight scissor jacks placed under the street section, and adjustment ranged from 0.5% to 4% longitudinally and from 1% to 2% laterally. Upstream of the street section, an approach section was constructed to allow flow to stabilize after exiting the headbox. A diffuser screen was installed at the junction between the headbox and the approach section to minimize turbulence and to distribute flow evenly across the width of the model. The long horizontal approach section provided stabilized flow. Prototype dimensions and characteristics are presented in Table 3.1, which can be directly compared to Table 2.1 for the FHWA model.

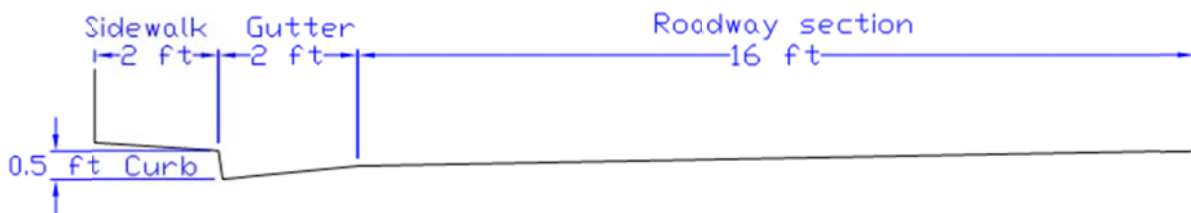

Figure 3.2 Flume Cross-Section Sketch (prototype scale)

Table 3.1 Prototype Dimensions

Feature	Prototype design
Scale (prototype : model)	3:1
Gutter section width (ft)	2
Street section width (ft)	16
Street section length (ft)	63
Approach section length (ft)	42
Curb height (ft)	0.5
Longitudinal slopes (%)	0.5 - 4
Cross slopes (%)	1 - 2
Maximum flow (cfs)	Over 100
Manning's roughness	0.015
Surface material	1/80-in. steel plate
Inflow control	butterfly valve / diffuser screen
Inflow measurement	electro-magnetic flow meter or differential pressure meter
Outflow measurement	weir / point gage
Flow type (uniform or non-uniform)	Varies
Inlet length (ft)	3.3 - 9.9
Gutter cross slope type	composite
Maximum depth of flow (ft)	1

A Froude number based laboratory model was chosen for this study. Table 3.2 provides scaling ratios used in the model. The length scaling ratio was determined to be 3 in prototype to 1 in model. A similar study performed at The Johns Hopkins University identified the minimum reliable scale to be 3 to 1 based on correlation of laboratory and field test data (Li, 1956).

Table 3.2 Scaling Ratios for Geometry, Kinematics and Dynamics

Geometry	Scale Ratios
Length, width, and depth (L_r)	3.00
All slopes	1.00
Kinematics	Scale Ratios
Velocity (V_r)	1.73
Discharge (Q_r)	15.62
Dynamics	Scale Ratios
Fluid density	1.00
Manning's roughness (n_r)	1.20

An analysis of Manning's roughness coefficient was conducted for the model street section to create a surface with the scaled roughness of asphalt. Roughness was established by adding coarse sand to industrial enamel paint (at about 15% by weight), and painting the street section. An average value of 0.013 was determined for the laboratory model, which corresponds to a prototype value of 0.015 (the mean value for asphalt).

3.2 Cases of Street Flow Conditions Tested

A test matrix was developed to organize the variation of parameters through three inlet types, two lateral slopes, four longitudinal slopes, three flow depths, and several inlet lengths. Type 13 and 16 combination inlets were configured to 3.3-, 6.6-, and 9.9-ft prototype lengths. Type R curb inlets were configured to 5-, 9-, 12-, and 15-ft prototype lengths. Required flow depths were provided by the UDFCD and consisted of 0.33-, 0.5-, and 1-ft depths at the prototype scale. Rationale for selection of these depths was based on curb height. A depth of 0.33 ft is below a standard 0.5-ft curb, a depth of 0.5 ft is at the curb height, and a depth of 1 ft is above the standard 0.5-ft curb. A total of 318 independent tests resulted from variation of these parameters, and each test matrix is presented in Tables 3.3 through 3.6 by depth of flow. At the request of the UDFCD, twelve additional sump tests and twenty additional debris tests were performed beyond the original 286 tests. Additional debris tests were performed at 4% longitudinal and 1% cross slope to provide data for combination inlets of varying lengths. They were performed for type 1 (flat – 50% coverage) and type 2 (3d – 25% coverage) debris. Additional sump condition tests were performed to provide two additional depths for the Type 13 and 16 combination inlets. Table 3.6 provides a list of these additional sump tests. Tabular versions of each test matrix were developed with test identification (ID) numbers for organizing the results and are presented in Appendices B and C. In the tabular version, each unique slope

and inlet configuration was given an ID number (1 through 286), with additional sump tests AT1 through AT12 and additional debris tests AT287 through AT305. Each inlet was tested under two basic conditions. First was the sump condition, where the inlet was placed such that all the flow was captured and none of the flow was bypassed. Roadway cross slope was a constant 1% with no longitudinal slope. Second was an on-grade condition, where some of the flow was captured by the inlets and the remainder was bypassed off the road section. Both the longitudinal and cross slope were varied for the on-grade condition, for a total of six slope configurations ranging from 0.5% to 4% longitudinal and 1% to 2% lateral.

Table 3.3 Test Matrix for 0.33-ft Prototype Flow Depth

	Flow Depth = 0.33 ft							TOTAL:
	SUMP TEST	ON-GRADE TEST						
Longitudinal Slope	0.00%	0.50%	0.50%	2.00%	2.00%	4.00%	4.00%	
Cross Slope	1.00%	1.00%	2.00%	1.00%	2.00%	1.00%	2.00%	
Single No. 13	1	1	1	1	1	1	1	7
Single No. 13 - Debris Test One			1		1		1	3
Single No. 13 - Debris Test Two			1		1	1	1	4
Double No. 13 - Debris Test One						1		1
Double No. 13 - Debris Test Two						1		1
Triple No. 13 - Debris Test One						1		1
Triple No. 13 - Debris Test Two						1		1
Double No. 13	1	1	1	1	1	1	1	7
Triple No. 13	1	1	1	1	1	1	1	7
Single No. 16	1	1	1	1	1	1	1	7
Single No. 16 - Debris Test One			1		1	1	1	4
Single No. 16 - Debris Test Two			1		1		1	3
Double No. 16 - Debris Test One						1		1
Double No. 16 - Debris Test Two						1		1
Triple No. 16 - Debris Test One						1		1
Triple No. 16 - Debris Test Two						1		1
Double No. 16	1	1	1	1	1	1	1	7
Triple No. 16	1	1	1	1	1	1	1	7
5-ft Type R (R5)	1	1	1	1	1	1	1	7
9-ft Type R (R9)	1	1	1	1	1	1	1	7
12-ft Type R (R12)	1	1	1	1	1	1	1	7
15-ft Type R (R15)	1	1	1	1	1	1	1	7
TOTAL:	10	10	14	10	14	20	14	92

No. 13 – Type 13; No. 16 – Type 16

Table 3.4 Test Matrix for 0.5-ft Prototype Flow Depth

	Flow Depth = 0.5 ft							TOTAL:
	SUMP TEST	ON-GRADE TEST						
	Longitudinal Slope	0.00%	0.50%	0.50%	2.00%	2.00%	4.00%	
Cross Slope	1.00%	1.00%	2.00%	1.00%	2.00%	1.00%	2.00%	
Single No. 13	1	1	1	1	1	1	1	7
Single No. 13 - Debris Test One			1		1		1	3
Single No. 13 - Debris Test Two			1		1	1	1	4
Double No. 13 - Debris Test One						1		1
Double No. 13 - Debris Test Two						1		1
Triple No. 13 - Debris Test One						1		1
Triple No. 13 - Debris Test Two						1		1
Single No. 13 - Curb Opening Only	1		1		1		1	4
Single No. 13 - Grate Only	1		1		1		1	4
Single No. 13 - Grate & 4-in. Curb Opening	1		1		1		1	4
Double No. 13	1	1	1	1	1	1	1	7
Triple No. 13	1	1	1	1	1	1	1	7
Single No. 16	1	1	1	1	1	1	1	7
Single No. 16 - Debris Test One			1		1	1	1	4
Single No. 16 - Debris Test Two			1		1		1	3
Double No. 16 - Debris Test One						1		1
Double No. 16 - Debris Test Two						1		1
Triple No. 16 - Debris Test One						1		1
Triple No. 16 - Debris Test Two						1		1
Single No. 16 - Grate Only	1		1		1		1	4
Single No. 16 - Grate & 4-in. Curb Opening	1		1		1		1	4
Double No. 16	1	1	1	1	1	1	1	7
Triple No. 16	1	1	1	1	1	1	1	7
5-ft Type R (R5)	1	1	1	1	1	1	1	7
5-ft Type R (R5) - Horizontal Safety Bar	1		1		1		1	4
5-ft Type R (R5) - 4-in. Curb Opening	1		1		1		1	4
9-ft Type R (R9)	1	1	1	1	1	1	1	7
12-ft Type R (R12)	1	1	1	1	1	1	1	7
15-ft Type R (R15)	1	1	1	1	1	1	1	7
TOTAL:	17	10	21	10	21	20	21	120

No. 13 – Type 13; No. 16 – Type 16

Table 3.5 Test Matrix for 1-ft Prototype Flow Depth

	Flow Depth = 1 ft								TOTAL:
	SUMP TEST	ON GRADE TEST							
Longitudinal Slope	0.00%	0.50%	0.50%	2.00%	2.00%	4.00%	4.00%		
Cross Slope	1.00%	1.00%	2.00%	1.00%	2.00%	1.00%	2.00%		
Single No. 13	1	1	1	1	1	1	1	1	7
Single No. 13 - Curb Opening Only	1		1		1		1		4
Single No. 13 - Grate Only	1		1		1		1		4
Single No. 13 - Grate & 4-in. Curb Opening	1		1		1		1		4
Double No. 13	1	1	1	1	1	1	1	1	7
Triple No. 13	1	1	1	1	1	1	1	1	7
Single No. 16	1	1	1	1	1	1	1	1	7
Single No. 16 - Grate Only	1		1		1		1		4
Single No. 16 - Grate & 4-in. Curb Opening	1		1		1		1		4
Double No. 16	1	1	1	1	1	1	1	1	7
Triple No. 16	1	1	1	1	1	1	1	1	7
5-ft Type R	1	1	1	1	1	1	1	1	7
5-ft Type R - 4-in. Curb Opening	1		1		1		1		4
9-ft Type R	1	1	1	1	1	1	1	1	7
12-ft Type R	1	1	1	1	1	1	1	1	7
15-ft Type R	1	1	1	1	1	1	1	1	7
TOTAL:	16	10	16	10	16	10	16	16	94

No. 13 – Type 13; No. 16 – Type 16

Table 3.6 Additional Sump Tests (prototype scale)

	Flow Depth = 0.75 ft	Flow Depth = 1.5 ft	TOTAL:
	Longitudinal Slope	0.00%	
Cross Slope	1.00%	1.00%	
Single No. 13	1	1	2
Double No. 13	1	1	2
Triple No. 13	1	1	2
Single No. 16	1	1	2
Double No. 16	1	1	2
Triple No. 16	1	1	2
TOTAL:	6	6	12

No. 13 – Type 13; No. 16 – Type 16

3.3 Model Inlet Construction

Curb and gutter sections were fabricated from 1/8-in. thick sheet metal, and construction is shown in Figures 3.3 and 3.4. Removable gutter sections for both the Type R curb inlet and the Type 13 and 16 combination inlets allowed the inlet length to be adjusted. Modular construction methods were utilized to facilitate exchanging curb inlets with combination inlets, which

simplified reconfiguration of the model. Construction drawings of each inlet type are presented in Appendix D.



Figure 3.3 Curb Inlet Gutter Panel During Fabrication (Type R)

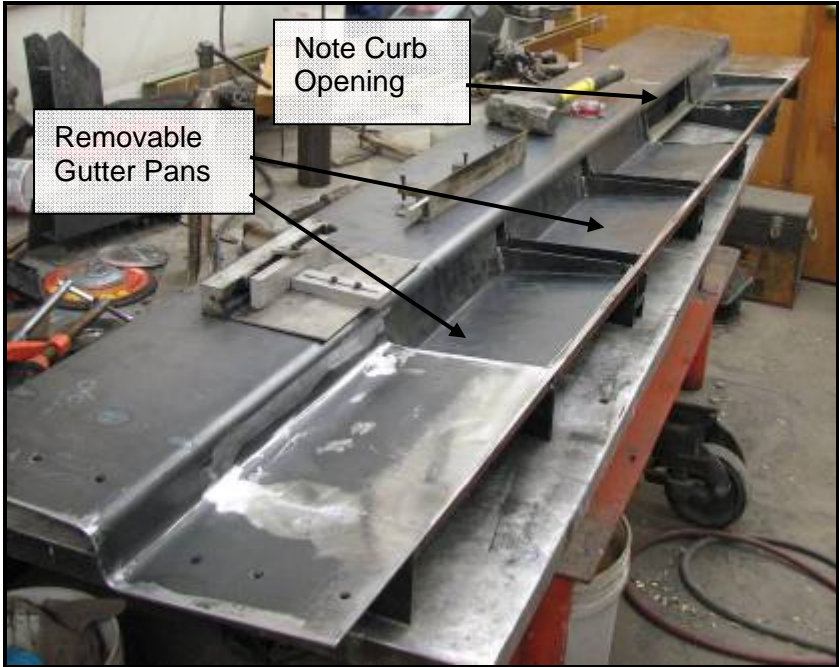

Figure 3.4 Combination Inlet Gutter Panel During Fabrication (Type 13 and 16 grates)

Solid Plexiglas was milled to produce the Type 13 grate shown in Figure 3.5. Copper pipe and brass bar stock were used to fabricate the Type 16 grate shown in Figure 3.6. Curved vanes on the Type 16 grate were constructed of copper pipe. Transitions from the gutter cross slope to the inlet cross slope were built into the gutter panels. As a result of the need for variable opening lengths in each inlet type, the gutter panels were built as modular elements which could be removed and relocated within the gutter panel framework. Modeling clay was used to smooth-out any irregularities in the curb, gutter, and inlet surfaces.



Figure 3.5 Type 13 Grate Photograph



Figure 3.6 Type 16 Grate During Fabrication

Type 13 and 16 inlets were used in a combination inlet configuration, in which there was a curb opening in addition to the grate. The Type R inlet is only a curb opening, which differed from the curb opening used in the combination inlet configuration. The model incorporated depressed gutters in which the invert of the curb inlet was lower than the bottom of the gutter flow line.

With reference to the figures presented previously, the curb inlet portion of the combination inlet is most similar to the vertical throat type, whereas the Type R curb inlet is most similar to the inclined throat type. There were several other configurations in which the flow area of the inlet was reduced in some way: the curb portion of a combination inlet was reduced to a “4-in.” height, the curb portion of a combination inlet was blocked-off completely, the grate portion of a combination inlet was obstructed with debris, the grate portion of a combination inlet was blocked-off completely, or a horizontal safety bar was used across the Type R inlet. The photographs provided in Figures 3.7 through 3.27 illustrate the inlet types and configurations.

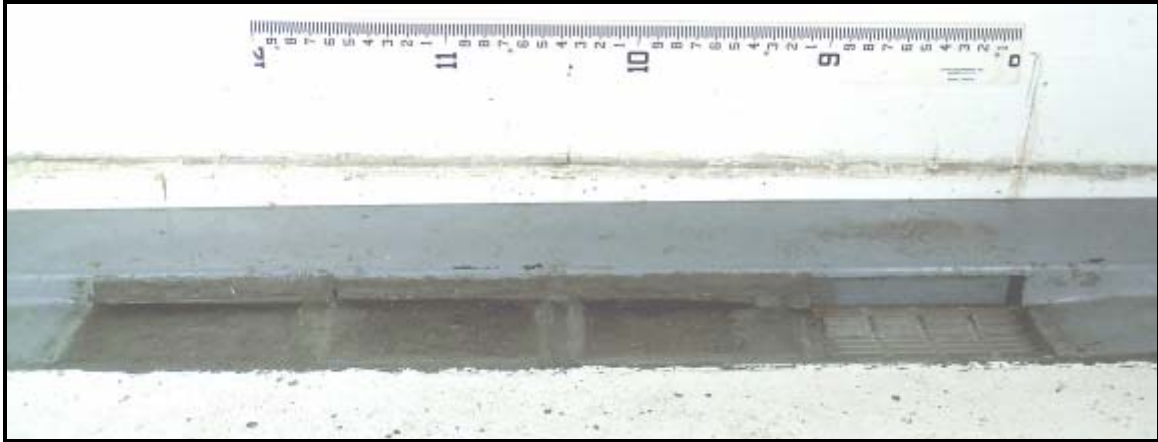

Figure 3.7 Single No. 13 Combination Photograph

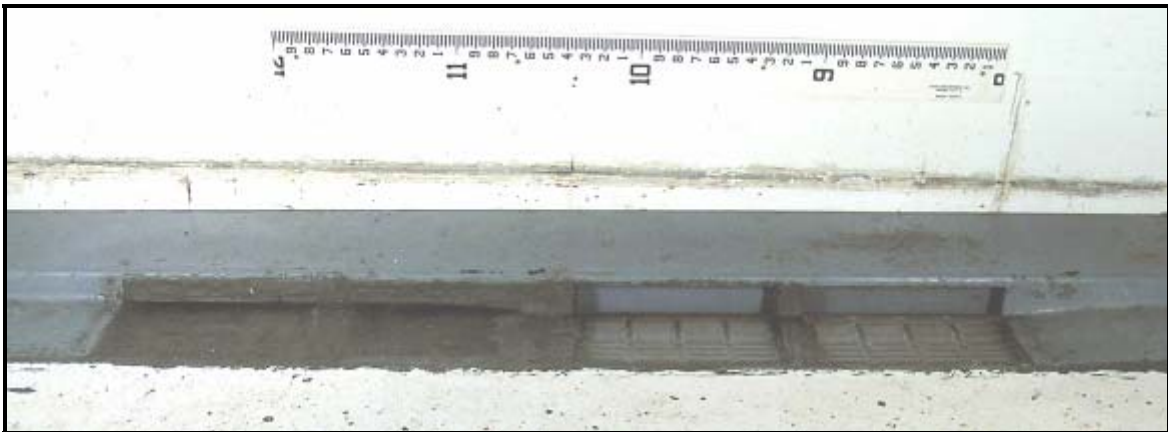

Figure 3.8 Double No. 13 Combination Photograph



Figure 3.9 Triple No. 13 Combination Photograph

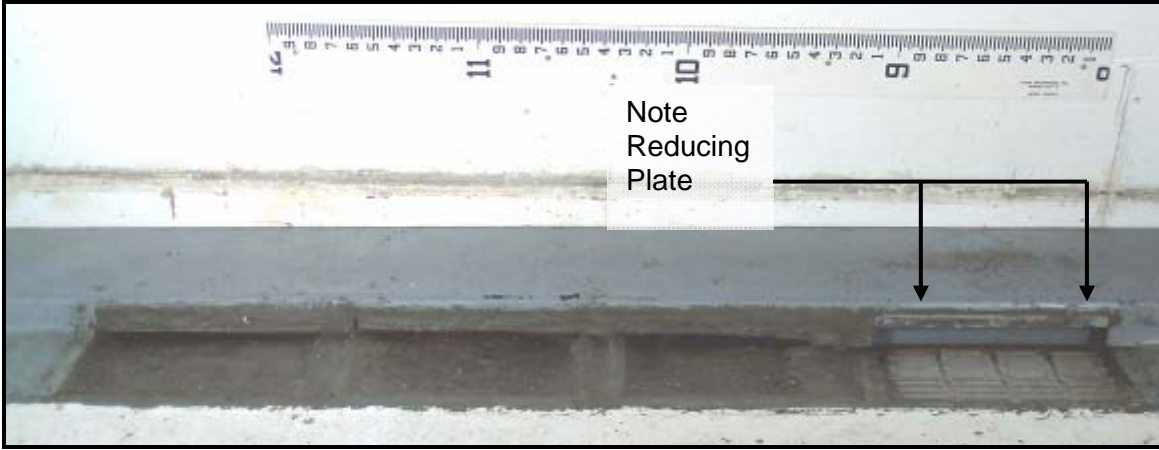

Figure 3.10 Single No. 13 Combination with 4-in. Curb Opening Photograph



Figure 3.11 Single No. 13 Combination with Grate Only Photograph



Figure 3.12 Single No. 13 Curb Opening Only Photograph



Figure 3.13 Single No. 13 Combination Debris Test One Photograph

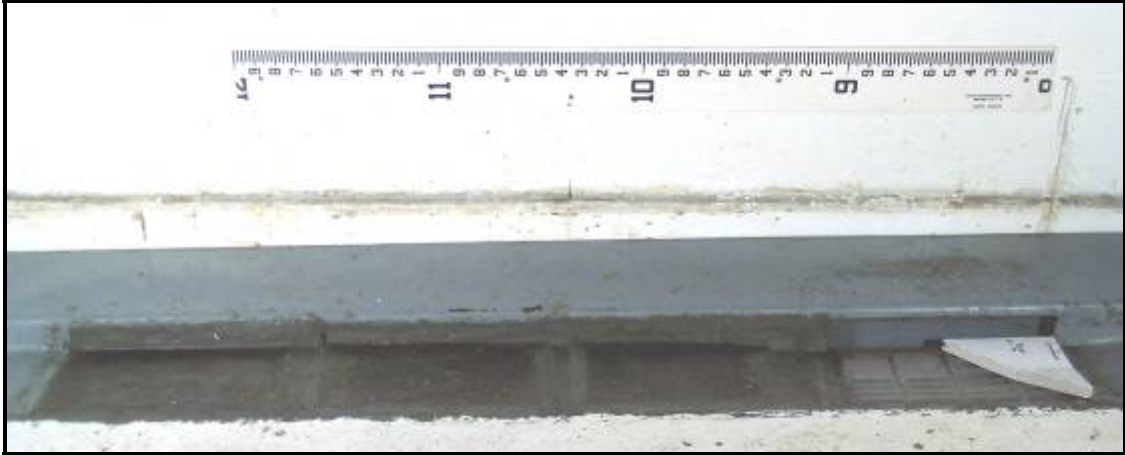

Figure 3.14 Single No. 13 Combination Debris Test Two Photograph



Figure 3.15 Single No. 16 Combination Photograph

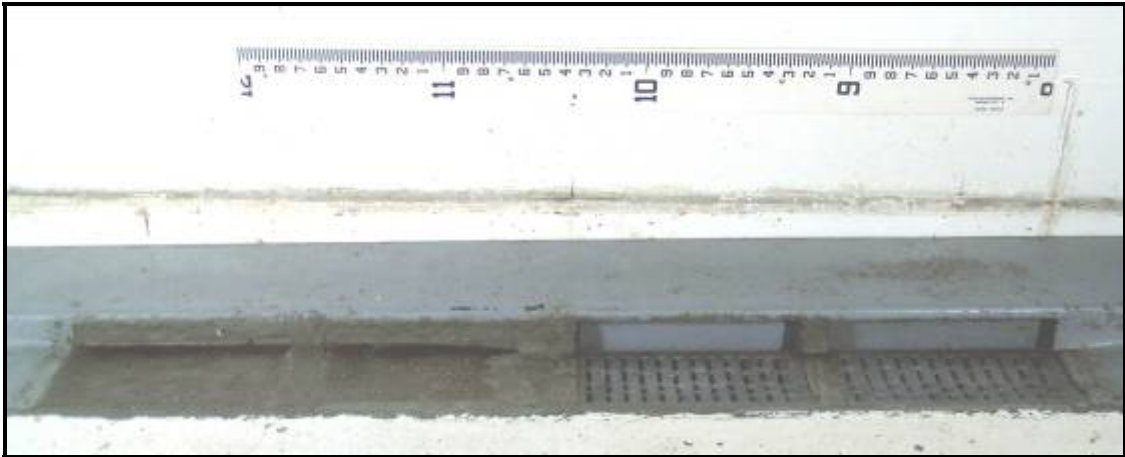

Figure 3.16 Double No. 16 Combination Photograph

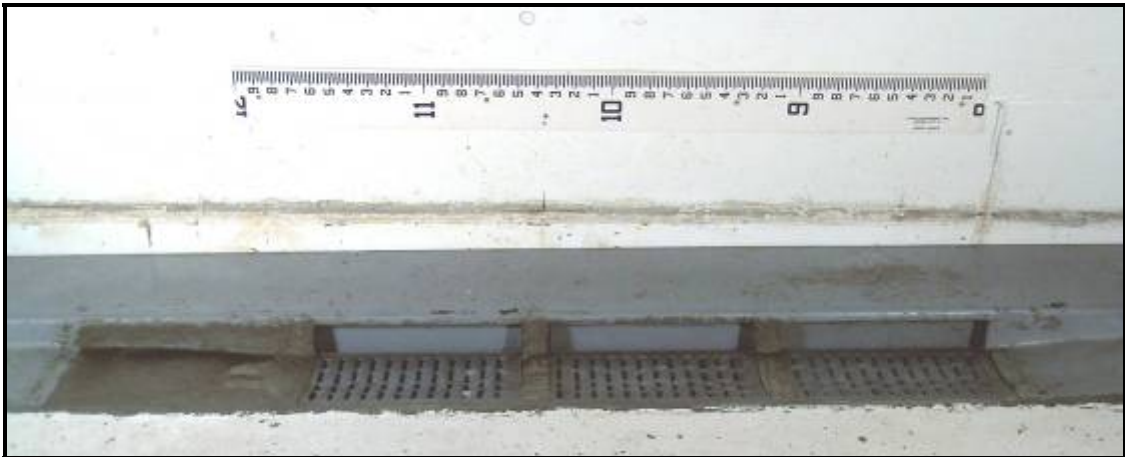

Figure 3.17 Triple No. 16 Combination Photograph

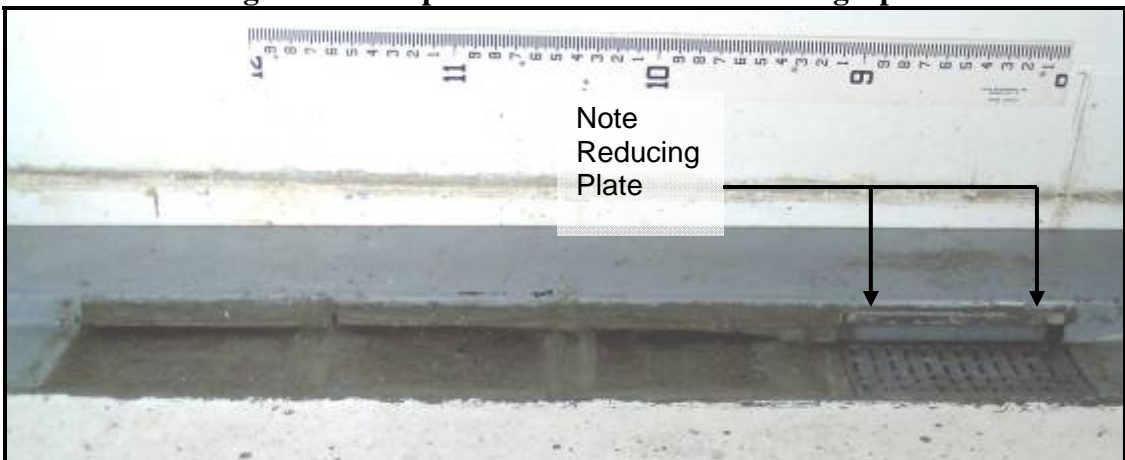

Figure 3.18 Single No. 16 with 4-in. Curb Opening Photograph

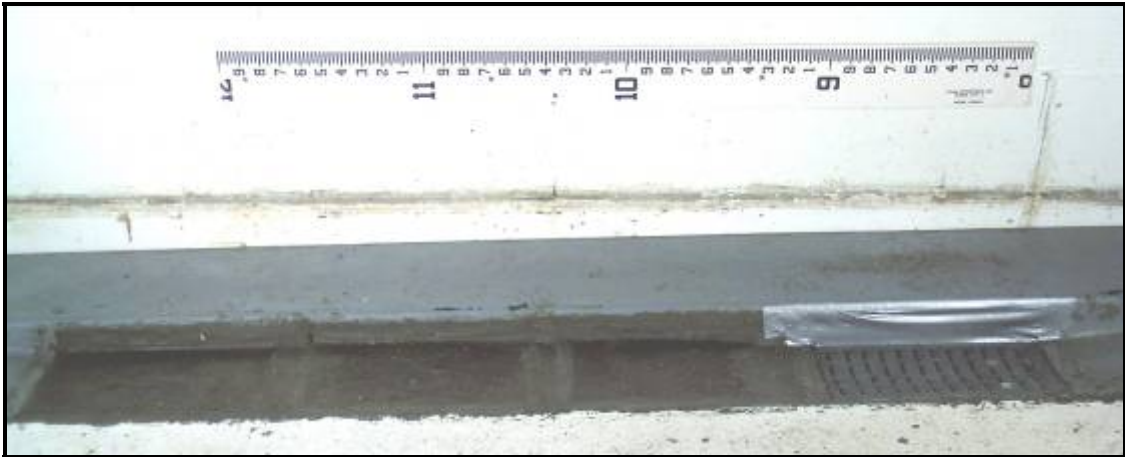

Figure 3.19 Single No. 16 Grate Only Photograph



Figure 3.20 Single No. 16 Combination Debris Test One Photograph



Figure 3.21 Single No. 16 Combination Debris Test Two Photograph



Figure 3.22 R5 Curb Inlet Photograph



Figure 3.23 R9 Curb Inlet Photograph



Figure 3.24 R12 Curb Inlet Photograph



Figure 3.25 R15 Curb Inlet Photograph

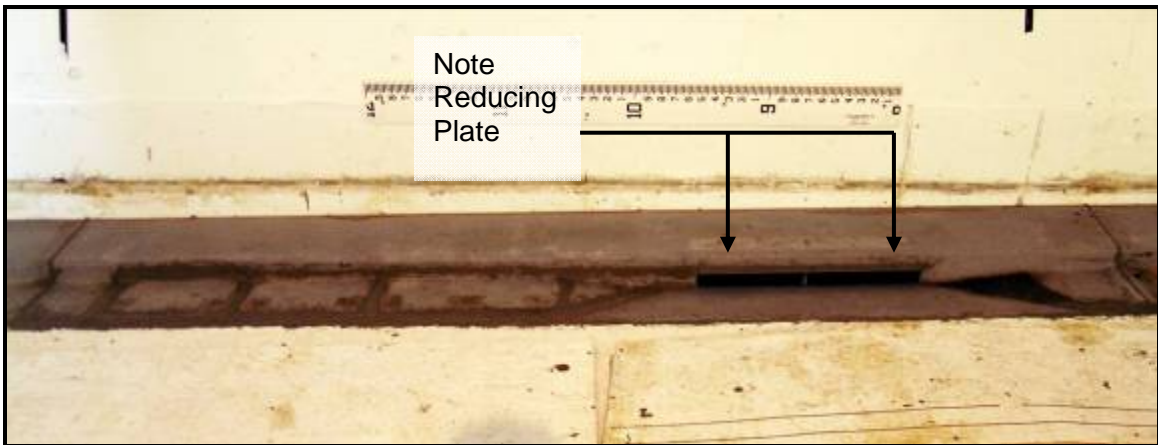

Figure 3.26 R5 with 4-in. Curb Opening Photograph

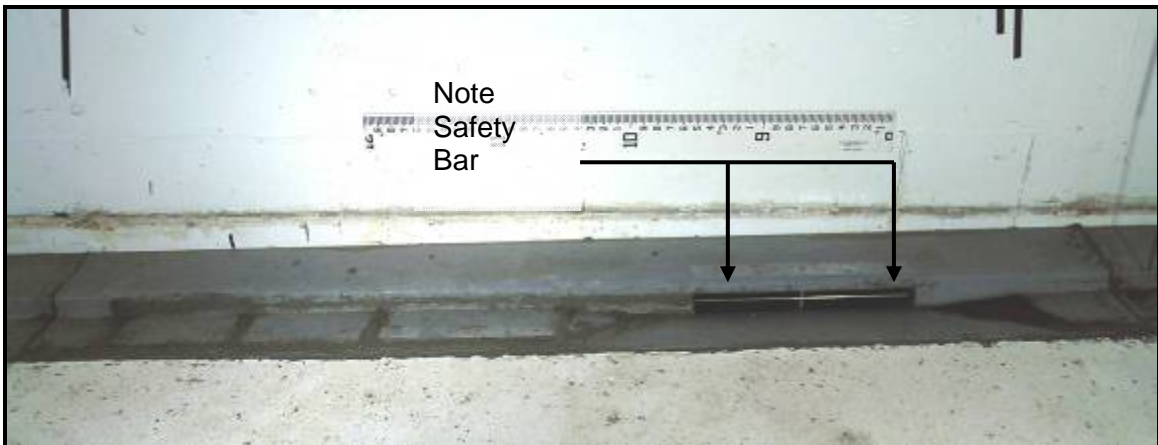

Figure 3.27 R5 with Safety Bar Photograph

4.0 MODEL OPERATION AND TESTING PROCEDURE

A headbox was used to supply water to the model, a flume section contained the street and inlet components, and a tailbox was used to catch flow that bypassed the inlets. Figure 4.1 provides a sketch of the entire model. Water flowed from the inlet valve to the headbox, through the flume section, then exits into the tailbox. Two pumps fed water to the headbox through a network of large pipes and valves. A 40-horsepower (hp) pump was used for the 0.33-ft and 0.50-ft prototype-scale depths, and a 75-hp pump was used for the 1-ft prototype-scale flow depth. Both pumps drew water from a sump located beneath the laboratory floor, which was approximately 1 acre ft in volume. Lined channels below the flume conveyed flow away from the tailbox and back into the sump.

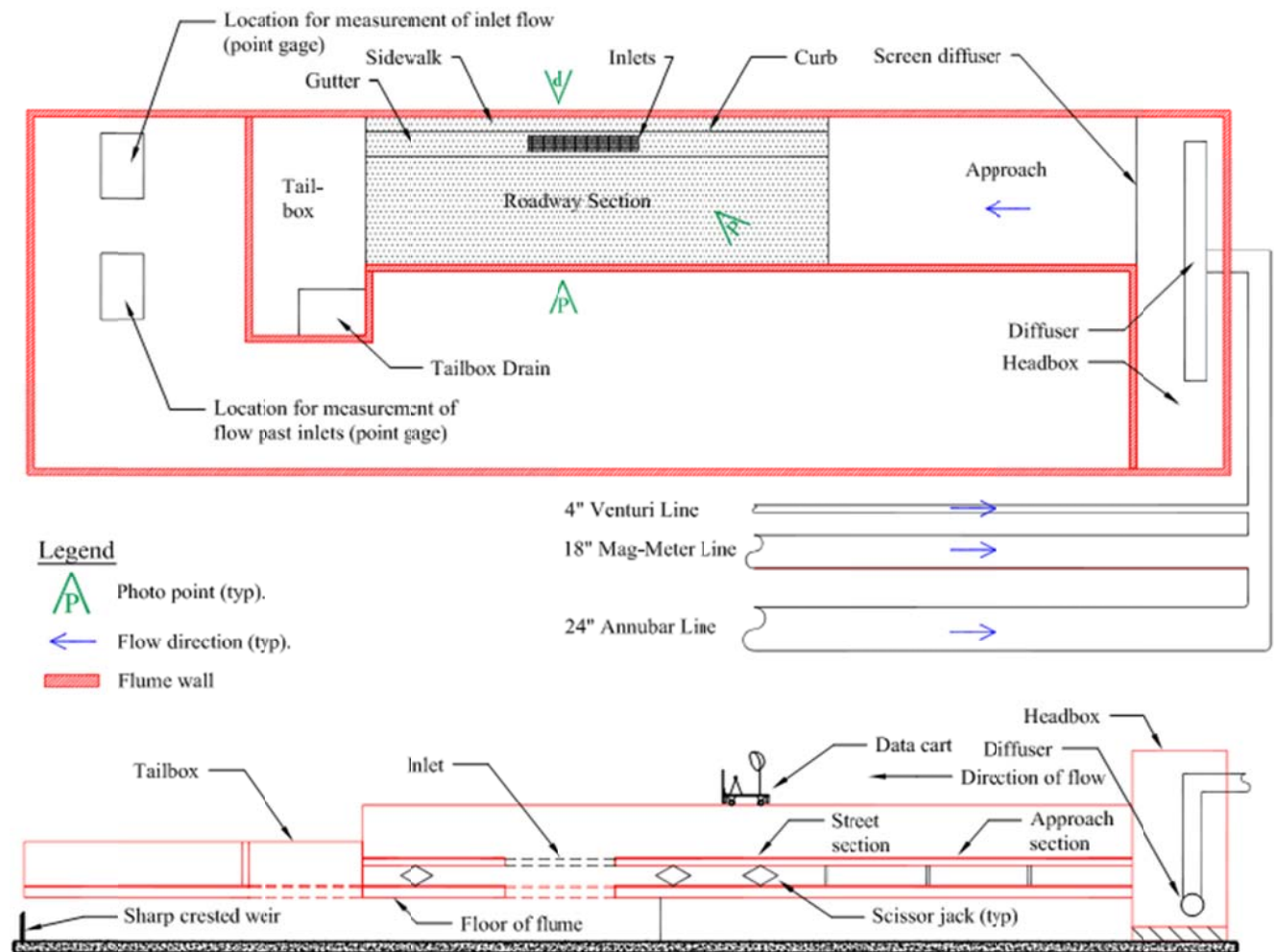

Figure 4.1 Laboratory Layout for Street-Inlet Study

Flow entering and exiting the model was measured as part of the data-collection process. Flow entered the model headbox through pipes as pressurized flow. Measurement-instrument selection for inflow was based on the anticipated flow required for each test, and the associated pump and pipelines used. Two instruments were used: 1) a differential pressure meter (annubar) manufactured by the Rosemount division of the Emerson Process Management Company, and 2) an electro-magnetic flow meter (mag meter) manufactured by the Endress and Hauser Company. Table 4.1 summarizes flow-measurement characteristics of each instrument.

Table 4.1 Discharge Measurement-Instrument Ranges

Instrument Type	Flow Range (cfs)	Pipeline	Pump	Accuracy
mag meter	0.13 - 10	18 in.	40 hp	0.5%
annubar	6.5 - 15	24 in.	75 hp	2.5%

Outflow from the model flume section was either conveyed through the inlets or bypassed off the road section. In either case, the flow passed through an opening in the tailbox of the flume and into channels below. Flow exiting the channels was measured by either a rectangular weir for bypassed flow or V-notch sharp-crested weir for inlet captured flow. Both weirs were constructed in accordance with published specifications (Bos, 1989; USBR, 2001). Calibration was performed for each weir prior to testing of the model. Rating equations in the form of Eq 4.1 were developed by regression analysis of depth-flow data over the expected operating range of each weir. Coefficients and exponents used in these equations are given in Table 4.2. For slope configurations greater than 0.5% longitudinal, the tailwater depth was noted to rise significantly in the tailbox of the model. When this occurred the weirs were raised and recalibrated:

$$Q = aH^b \quad (4.1)$$

where:

- Q = discharge (cfs);
- a = coefficient of discharge;
- H = head above the weir crest (ft); and
- b = depth exponent.

Table 4.2 Empirically-Derived Weir Parameters

Slopes	V-notch Weir	Rectangular Sharp-crested Weir
4% and 2%; 4% and 1%; 2% and 2%; 2% and 1%	$a = 2.64$ $b = 2.50$ $R^2 = 0.999$	$a = 15.78$ $b = 1.58$ $R^2 = 0.999$
0.5% and 1%; 0.5% and 2%	$a = 2.52$ $b = 2.45$ $R^2 = 0.999$	$a = 13.5$ $b = 1.35$ $R^2 = 0.999$

Flow depth required for each test was measured at the same location roughly 5 prototype feet upstream of the first inlet. This location was chosen to be free of surface curvature from flow being drawn into the inlets, free of ripples generated from the upstream approach transition, and served as a control section to establish the depth and adjust the flow into the model for each test. Depth of flow was measured using a point gage with ± 0.001 ft accuracy, which was mounted on a data-collection cart designed to slide along the model and perform other water-surface measurements as well. Figure 4.2 provides a photograph of the data-collection cart. A camera tripod was mounted on the data-collection cart providing one of the three photograph points: 1) an elevated oblique view from the data-collection cart, 2) a view laterally opposite from the inlets, and 3) a plan view from directly above the inlets.

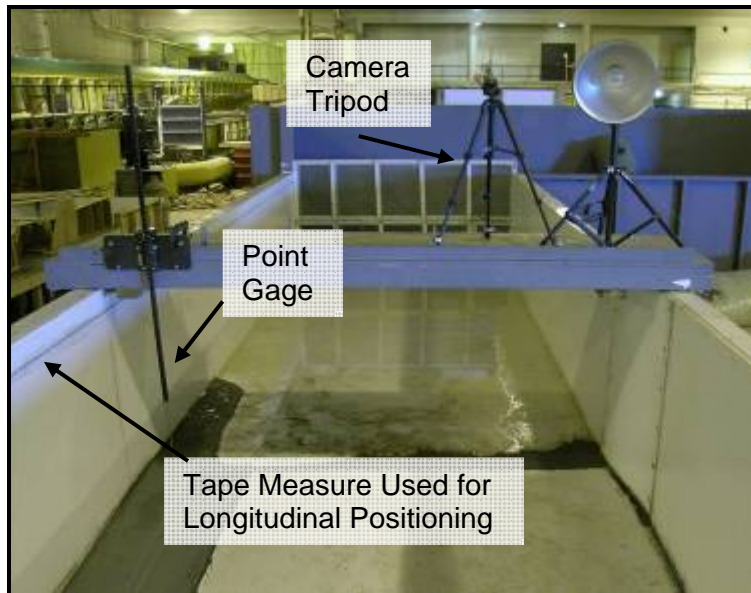

Figure 4.2 Data Collection Cart (looking upstream)

Following a standardized testing procedure assured consistency and facilitated data collection by multiple technicians. Prior to testing, the street slope and inlet type were configured. The flow depth was then set on the point gage and the flow into the model was adjusted to contact the point gage. Technicians waited approximately 10 minutes once the target depth was achieved for flow conditions to stabilize. Outflow measurement point gages were checked periodically

during this time until the readings stabilized. Test conditions were then checked and recorded on the data sheet. If the slope and inlet configurations did not change for a subsequent test, a new depth was set on the point gage and the flow adjusted accordingly. If a new slope or inlet configuration was required, the pumps were shut off and the model was reconfigured. If the spread of water did not cover the street section for any given test, the extent of flow was recorded to provide a top width at every longitudinal station. A fixed measuring tape was used to determine longitudinal stations along the flume. Lateral positions across the flume were determined with a measuring tape affixed to the data-collection cart. Both tapes were graduated in tenths of a foot and had ± 0.01 ft accuracy.

Data collection was documented by completing a data sheet for each test, taking still photographs, and shooting short videos. The data-collection sheet used for all testing is presented in Appendix E. Data collection was comprised of the following information: date, operator name, water temperature, test ID number, start and end times, slope configuration, inlet configuration, discharge and measurement devices used, depth of flow, extent of flow, and flow characteristics. Flow characteristics consisted of any general observations that the operator recorded for a particular test. Typical observations included the condition of flow around the inlets (if waves emanated or splashing occurred), and if possible an approximation of flow percentage passing through each inlet was made.

Several measures were taken to maintain data quality. After the testing procedures described above were followed, data were entered into the database by the operator, and then checked by another person for accuracy with the original data sheets. A survey of the model was performed every time the model inlet type was changed. This confirmed that the model was not shifting or settling, and that the slope was accurate to within allowable limits of 0.05% for longitudinal and cross slopes.

4.1 Data Collection

A 1/3-scale model of a two-lane street section was constructed in the laboratory. Variations in street longitudinal slope, cross slope, inlet length, and flow depth were accomplished to provide data on captured inlet flow and bypassed street flow. In addition, the spread of flow was measured along the street section. Surface roughness of the prototype was designed to be 0.015, which is the mean value for asphalt. Inflow to the model was measured using either a magnetic flow meter or a differential pressure meter. Outflow from the model was measured using sharp-crested weirs for captured inlet flow and bypassed street flow. Photographs were taken and video recordings were made to facilitate later inspection of flow conditions in the model. From the collected test data, qualitative and quantitative observations will be made for determination of efficiency for each inlet. The complete test data set is presented in Appendices B and C, where it is organized by: test ID number, inlet configuration, slopes, flow depth, total flow, efficiency, top width of flow at the upstream control section, and top width of flow downstream of the inlets.

In addition to the laboratory tests, field observations of inlet performance were also conducted during storm events. The records of photos and video clips provide a basis to analyze clogging effects on a single inlet and a series of inlets.

5.0 INLET CLOGGING

The operation of an Inlet in Figure 5.1 is subject to the clogging due to urban debris that is varied with respect to location and season. To be conservative, a clogging factor of 50% is recommended for a single grate and 10% for a single curb-opening inlet.

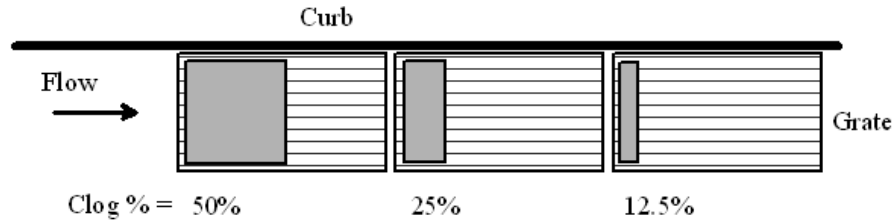

Figure 5.1 Decay of Inlet Clogging Percentage

For an inlet with multiple units as shown in Figure 5.1, it is observed that the clogging effect decays from the front to the last inlet unit as shown in Figure 5.2. As recommended, the clogging factor, Clog%, decays as the number of inlet units increases (Guo 2006).



Figure 5.2 Decay of Debris Amount on Grates

As a result, the clogging factor for multiple inlets in serial is equal to the total clogging percentage divided by the number of inlet units as (Guo 2000c):

$$C_g = \frac{1}{N} (C + eC + e^2C + e^3C + \dots + e^{N-1}C) = \frac{C}{N} \sum_{i=1}^{i=N} e^{i-1} \quad (5.1)$$

in which C_g = multiple-unit clogging factor, C = single-unit clogging factor, e = decay ratio less than unity, and N = number of inlets. Table 5.1 is the comparison between the observed and recommended clogging factors using $e = 0.25$ for curb opening inlet and $e = 0.5$ for grate inlet.

Table 5.1 Clogging Factors for Inlet Design

Number of Unit	Curb Opening Inlet		Grate Inlet	
	Observed	Predicted with e=0.25	Observed	Predicted with e=0.5
1.00	0.12	0.12	0.50	0.50
2.00	0.08	0.08	0.35	0.38
3.00	0.05	0.05	0.25	0.29
4.00	0.03	0.04	0.20	0.23

The interception capability of an on-grade inlet is proportional to the inlet wetted length, and an in-sump inlet is proportional to the inlet opening area. Therefore, the effective length of an on-grade inlet is calculated as:

$$L_e = (1 - C_g)L \quad (5.2)$$

in which L = total wetted length, C_g = clogging percentage selected for the number of inlet units, and L_e = effective (unclogged) length. Similarly, the effective opening area of an in-sump inlet is calculated as:

$$A_e = (1 - C_g)A \quad (5.3)$$

in which A = total opening area, and A_e = unclogged opening area.

6.0 STREET HYDRAULICS

Figure 6.1 illustrates a typical street gutter cross section. Storm water flow carried in a street gutter can be divided into *gutter flow* and *side flow*. The gutter flow is the amount of flow carried within the gutter width, W , and the side flow is the amount of flow carried by the water spread, T_x , encroaching into the traffic lanes.

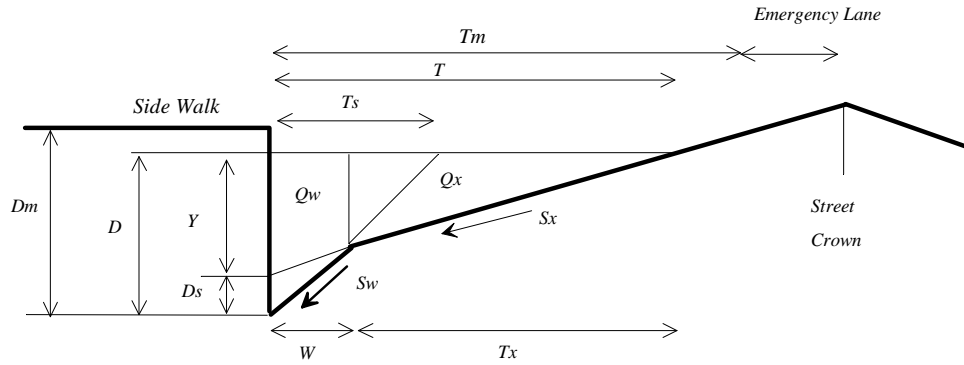

Figure 6.1 Illustration of Street Flow

In practice, a depression of 2 inches is often introduced at street curb in order to increase the gutter conveyance capacity. As a result, the transverse slope across the gutter width is:

$$S_w = S_x + \frac{D_s}{W} \quad (6.1)$$

in which S_w = gutter cross slope in ft/ft, W = gutter width of 2 feet, D_s = gutter depression of 2 inches, S_x = street transverse slope. The water depth at the curb face, D , is the sum of the flow depth, Y , and gutter depression, D_s , as illustrated in Figure 6.1.

$$D = Y + D_s \quad (6.2)$$

The corresponding water spread for the water depth, D , in the gutter is

$$T_s = \frac{D}{S_w} \quad (6.3)$$

For convenience, the total water spread, T , is divided into gutter-flow width, W , and side-flow width, T_x , that can be calculated as:

$$T_x = \frac{D - D_s}{S_x} \quad (6.4)$$

Applying the open channel flow theory to the gutter and side flow yields:

$$Q_x = \frac{0.56}{n} S_x^{1.67} T_x^{2.67} \sqrt{S_o} \quad (6.5)$$

$$Q_w = \frac{0.56}{n} S_w^{1.67} [T_s^{2.67} - (T_s - W)^{2.67}] \sqrt{S_o} \quad (6.6)$$

in which Q_x = side flow in cfs, Q_w = gutter flow in cfs within gutter width, W = gutter width which is usually 2 feet wide, T_s = water spread in feet for water depth, D in feet, in the gutter, and n = surface roughness coefficient of 0.016. The total flow, Q_s in cfs, on the street is the sum as:

$$Q_s = Q_x + Q_w \quad (6.7)$$

The flow cross sectional area in sq feet for a composite street is calculated as:

$$A = \frac{YT + WD_s}{2} \quad (6.8)$$

The average cross sectional flow velocity, V in fps, is calculated as:

$$V = \frac{Q_s}{A} \quad (6.9)$$

7.0 ON-GRADE GRATE INLET

Storm water carried in a street gutter is divided into the gutter flow that is carried within the gutter width, and the side flow that is spread into the traffic lanes. The ratios of the flow distribution on the street area calculated as:

$$E_w = \frac{Q_w}{Q_s} \quad (7.1)$$

$$E_x = \frac{Q_x}{Q_s} = 1 - E_w \quad (7.2)$$

in which E_w = ratio of gutter flow, Q_w , to total street flow, Q_s , and E_x = ratio of side flow, Q_x , to street flow. The capacity of an on-grade grate is estimated by the interception percentage. For the side flow, the interception percentage, R_x , is estimated as:

$$R_x = \frac{1}{\left(1 + \frac{0.15V^{1.8}}{S_x L_e^{2.3}}\right)} \quad (7.3)$$

For the gutter flow, the interception percentage, R_f , depends on the flow splash-over velocity that can be empirically estimated as:

$$V_o = \alpha + \beta L_e - \gamma L_e^2 + \eta L_e^3 \quad (7.4)$$

The coefficients, α , β , γ , ζ are defined in Table 7.1. It is noted that the coefficients for Type 13 and Type 14 grates are derived using the data collected in this study.



Figure 7.1 Splash-Over Flow Over Type 13 Grate

Table 7.1 Coefficients for Estimating Splash-Over Velocity

Type of Grate	α	β	γ	η
Type 13 Bar Grate or Combo*	0	0.583	0.030	0.0001
Type 16 Vane Grate or Combo*	0	0.815	0.074	0.0024
Bar P-1-7/8	2.22	4.03	0.65	0.06
Bar P-1-7/8-4	0.74	2.44	0.27	0.02
Bar P-1-1/8	1.76	3.12	0.45	0.03
45° Bar	0.99	2.64	0.36	0.03
30° Bar	0.51	2.34	0.20	0.01
Reticuline	0.28	2.28	0.18	0.01

* derived from the 1/3 scaled laboratory model

The ratio of gutter flow captured by the inlet is expressed as:

$$R_f = 1.0 - 0.09(V - V_o) \quad \text{if } V > V_o; \text{ otherwise } R_f = 1.0 \quad (7.5)$$

where R_f = ratio of gutter flow captured, V = cross-sectional flow velocity in Eq 6.9, and V_o = splash-over velocity in fps. As a result, the interception capacity for the grate inlet is equal to

$$Q_i = R_f Q_w + R_x Q_x = (R_f E_w + R_x E_x) Q \quad (7.6)$$

Where Q_i = interception capacity in cfs. The hydraulic efficiency for an inlet on grade is defined as:

$$E = \frac{Q_i}{Q_s} \quad (7.7)$$

The carry-over flow, Q_{co} , is the difference between Q_s and Q_i as:

$$Q_{co} = Q_s - Q_i \quad (7.8)$$

Table 7.2 presents a sample of data collected for the model Type 13 grate placed on a continuous grade. It was found that the HEC 22 method tends to over-predict the capacity of Type 13 grate by an average of 10%. Applying the multiple regression analyses to the data collected from Type 13 grate and Type 13 combination inlet, a set of new coefficients, α , β , γ , ζ , was derived as presented in Table 7.1. Figures 7.2 and 7.3 present good agreement between the observed and predicted hydraulic efficiency using the above design procedure.

Table 7.2 Sample On-Grade Test Data

Test ID Number	Configuration	Longitudinal Slope (%)	Cross Slope (%)	Flow Depth (ft)	Prototype Total Flow (cfs)	Efficiency (%)	Top Width at Control (ft)	Top Width Downstream of Inlets (ft)
56	Triple No. 13	0.5	1	0.333	4.4	82.1	15.8	9.0
57	Triple No. 13	0.5	1	0.501	20.6	43.2	18.2	18.2
58	Triple No. 13	0.5	1	0.999	126.6	22.7	18.2	18.2
59	Double No. 13	0.5	1	0.333	4.7	73.3	16.0	10.7
60	Double No. 13	0.5	1	0.501	22.6	35.9	18.2	18.2
61	Double No. 13	0.5	1	0.999	127.8	16.2	18.2	18.2
62	Single No. 13	0.5	1	0.333	4.8	61.3	16.0	15.8
63	Single No. 13	0.5	1	0.501	26.2	23.8	18.2	18.2
64	Single No. 13	0.5	1	0.999	126.4	9.9	18.2	18.2

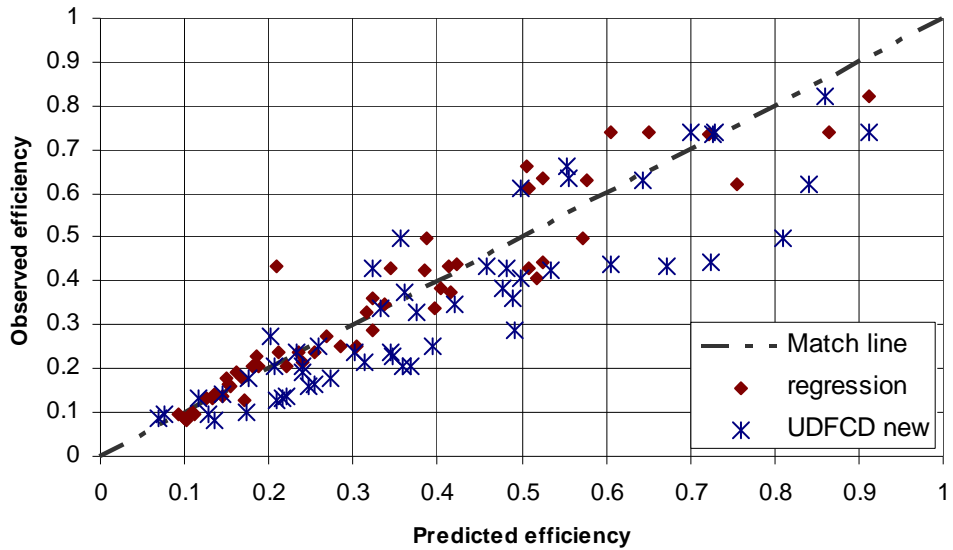

Figure 7.2 Predicted vs. Observed Efficiency for Type 13 Combination Inlet

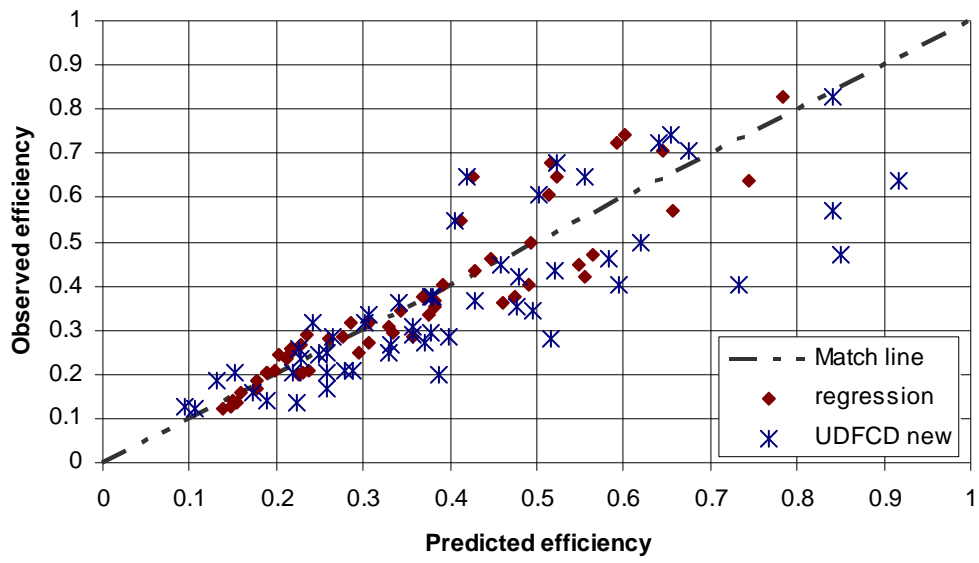

Figure 7.3 Predicted vs. Observed Efficiency for Type 16 Combination Inlet

8.0 ON-GRADE CURB-OPENING (TYPE R) INLET

To install a curb opening inlet on a continuous grade, the required curb opening length, L_t , for a complete interception of the design storm runoff, Q_s , on the street is computed by:

$$L_T = NQ^a S_L^b \left(\frac{1}{nS_e} \right)^c \quad (8.1)$$

$$S_e = S_x + S_w E_w \quad (8.2)$$

in which L_t = required length for a 100% runoff interception, S_o = street longitudinal slope, n = Manning's roughness of 0.016, and S_e = equivalent transverse street slope. The analysis of the laboratory data collected in this study leads to a new set of coefficients for Eq 8.1. Table 8.1 presents the improvement to HEC22 procedures.

Table 8.1 New Coefficients for Curb-Opening Inlet Derived in This Study

Coefficients in Eq 8.1	N	a	b	c	n
Recommended by HEC 22	0.60	0.42	0.30	0.60	0.016
Newly derived in this study	0.38	0.51	0.06	0.46	0.016

Substituting the new coefficients into Eq 8.1 yields:

$$L_t = 0.38Q^{0.51} S_o^{0.06} \left(\frac{1}{nS_e} \right)^{0.46} \quad (8.3)$$

The curb-opening inlet shall have a length less than, but close to, L_t . The interception capacity of a curb-opening inlet is calculated as:

$$Q_i = Q \left[1 - \left(1 - \frac{L_e}{L_t} \right)^{1.80} \right] \quad (8.4)$$

in which Q_i = inlet capacity, and L_e = effective length of curb opening inlet. For the Type R inlet, the HEC 22 method was modified with new coefficients in Eq 8.3. The comparison between observed and predicted hydraulic efficiency is presented in Figure 8.1.

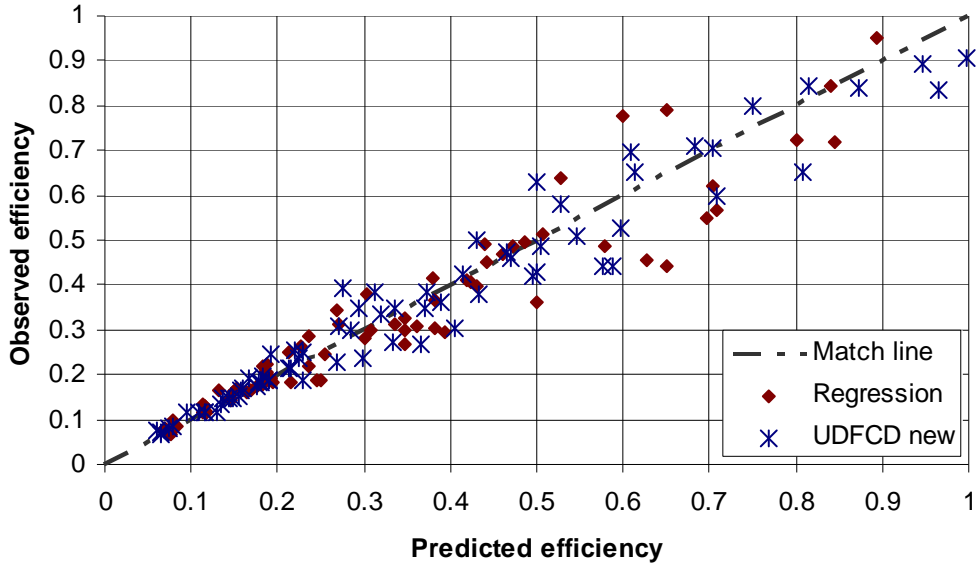

Figure 8.1 Predicted vs. Observed Efficiency for Type R Inlet

9.0 IN-SUMP GRATE INLET

As reported (Guo, MacKenzie and Mommandi, 2008), the flow through a sump inlet is varied with respect to the water depth on the grate and continuously changes from weir flow, through mixing flow, to orifice flow when the water becomes deep enough. A grate is formed by steel bars or vanes. Therefore, the original formulas for orifice and weir flows are modified with weir length or area opening ratios as:

$$Q_w = N_w C_w (2W_g + L_e) D^{3/2} \quad \text{for weir flow through grate} \quad (9.1)$$

$$Q_o = N_o C_o W_g L_e \sqrt{2gD} \quad \text{for orifice flow through grate} \quad (9.2)$$

Where Q_w = weir flow in cfs, Q_o = orifice flow in cfs, W_g =grate width in feet, L_e =effective grate length in feet, D =water depth in feet on street curb, N_w = weir length opening ratio after subtracting steel bar's width, N_o = orifice areal opening ratio, C_w = weir discharge coefficient, and C_o = orifice discharge coefficient. The transient process between weir and orifice flows is termed mixing flow that is modeled as:

$$Q_m = C_m \sqrt{Q_w Q_o} \quad \text{for mixing flow} \quad (9.3)$$

Where Q_m = mixing flow in cfs and C_m = mixing flow coefficient. In practice, for the given water depth, it is suggested that the interception capacity for the in-sump grate be the smallest among the weir, orifice, and mixing flows as:

$$Q_i = \min(Q_w, Q_m, Q_o) \quad (9.4)$$

The recommended coefficients, C_w , C_m , and C_o are listed in Table 9.1 as:

Grate Inlet	N_w	C_w	N_o	C_o	C_m
Type 13 Bar Grate	0.55	2.73	0.44	0.57	0.97
Type 16 Vane Grate	0.62	2.38	0.32	0.61	0.97

Table 9.1 Grate Coefficients for Grate Inlet in Sump

A tabular sample of the sump test data is presented as Table 9.2. All of the flow into the model was captured by the inlets in the sump test condition. The entire sump test data set is included as Appendix C.

Table 9.2 Sample Sump Test Data

Test ID Number	Configuration	Longitudinal Slope (%)	Cross Slope (%)	Flow Depth (ft)	Prototype Flow (cfs)
1	Triple No. 13	0	1	0.333	2.5
2	Triple No. 13	0	1	0.501	8.6
3	Triple No. 13	0	1	0.999	42.2
4	Double No. 13	0	1	0.333	2.3
5	Double No. 13	0	1	0.501	7.8
6	Double No. 13	0	1	0.999	27.1
7	Single No. 13	0	1	0.333	2.0
8	Single No. 13	0	1	0.501	5.9
9	Single No. 13	0	1	0.999	15.3

The test data comparing with the HEC 22 procedure and UDINLET computer model are plotted in Figures 9.1 and 9.2 for increasing flow depth for the three inlets tested.

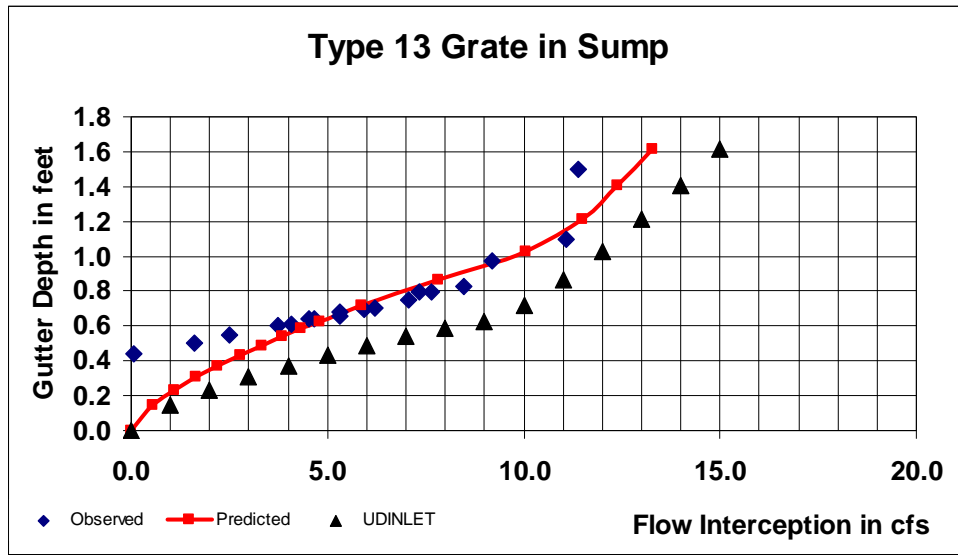

Figure 9.1 Comparison Between Observed and Predicted Data for Type 13 Bar Grate

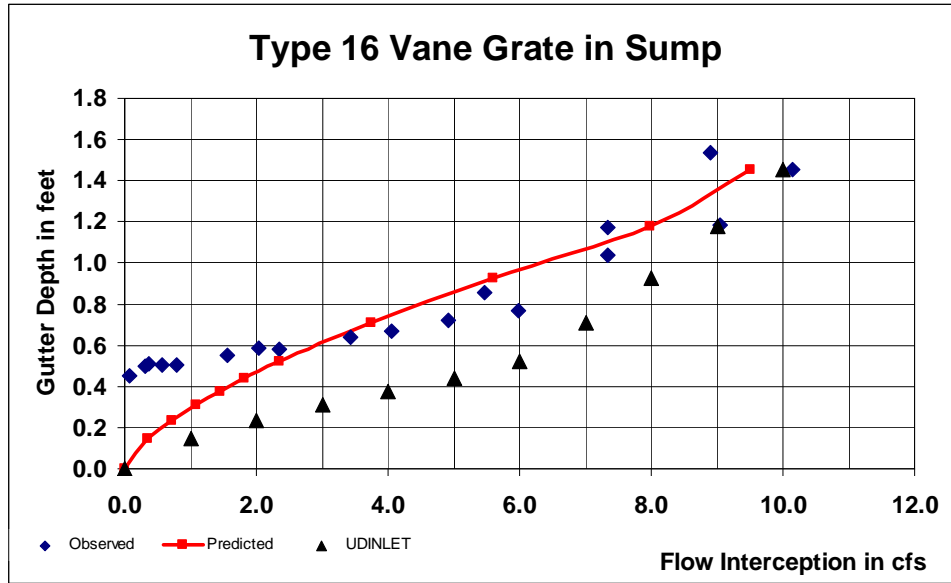

Figure 9.2. Comparison Between Observed and Predicted Data for Type 16 Vane Grate

10.0 IN-SUMP CURB-OPENING INLET

Like a grate inlet, a curb-opening inlet operates like weir, orifice, or mixing flow. The capacity of a 5-ft Type R Inlet is estimated based on its curb opening geometry as:

$$Q_w = C_w N_w L_e D^{3/2} \quad \text{for weir flow through curb opening} \quad (10.1)$$

$$Q_o = C_o N_o (L_e H_c) \sqrt{2g(D - 0.5H_c)} \quad \text{for orifice flow through curb opening } (D > H_c) \quad (10.2)$$

Where H_c = height of curb-opening inlet. As illustrated in Figure 10.1, the capacity of a 3-ft curb opening inlet associated with a Type 13 or 16 Combo Inlet is estimated based on its horizontal throat opening geometry as:

$$Q_w = C_w N_w L_e D^{3/2} \quad \text{for weir flow through curb opening} \quad (10.3)$$

$$Q_o = C_o N_o (L_e H_w) \sqrt{2gD} \quad \text{for orifice flow through throat} \quad (10.4)$$

Where H_w = horizontal throat width as shown in Figure 10.1. The standard throat width is 0.44 foot for Type 13 and 16 Combo Inlets.

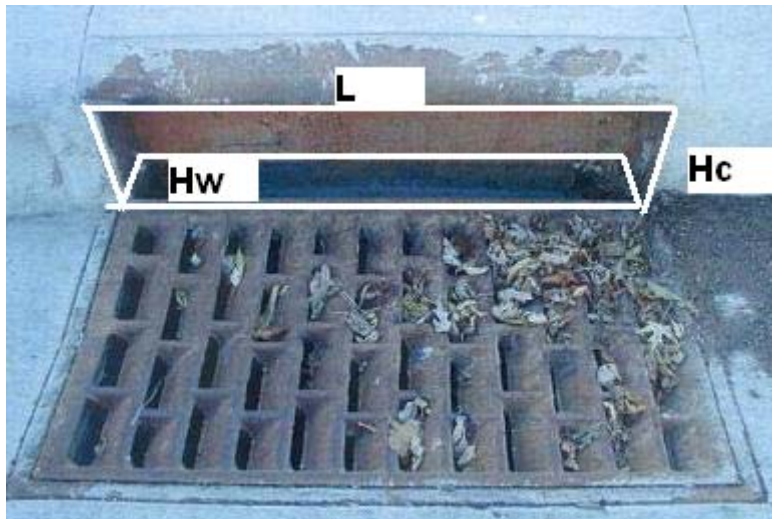

Figure 10.1 Horizontal Throat for Type 13 and Type 16 Combo

The transient process between weir and orifice flows is termed mixing flow that is modeled as:

$$Q_m = C_m \sqrt{Q_w Q_o} \quad \text{for mixing flow through curb opening} \quad (10.5)$$

Where Q_m = mixing flow and C_m = mixing flow coefficient. In practice, for the given water depth, it is suggested that the interception capacity of the curb-opening inlet be the smallest among the weir, orifice, and mixing flows as:

$$Q_i = \min(Q_w, Q_m, Q_o) \quad (10.6)$$

With the flow data collected from the laboratory model, regression analyses were conducted to produce the best fitted empirical coefficients in Eq's 10.1 through 10.6. Results are presented in Table 10.1.

Curb-opening Inlet	N_w	C_w	N_o	C_o	C_m
3-ft Curb Opening Inlet	1.0	2.59	1.0	0.67	0.90
5-ft Curb Opening Inlet	1.0	3.55	1.0	0.67	0.73

Table 10.1 Coefficients for Curb-Opening Inlet

Figures 10.2 and 10.3 present the performance curves for 3-ft and 5-ft curb opening inlets. A curb opening acts like a side weir. The data reveal that a curb opening is a more efficient weir than the grate because both 3-ft and 5-ft curb opening have a higher value for C_w . In comparison, the HEC-22 procedure overestimates the capacity of a curb-opening inlet when water depth is shallow, and then becomes underestimating when water depth exceeds 7 inches. On the contrary, the proposed new equation agrees with the observed well.

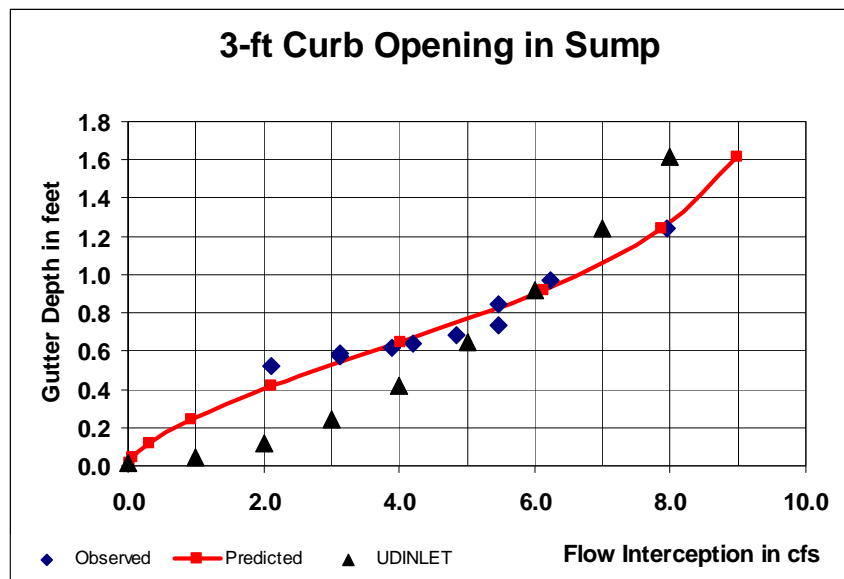

Figure 10.2 Comparison Between Observed and Predicted Data for 3-ft Curb Opening

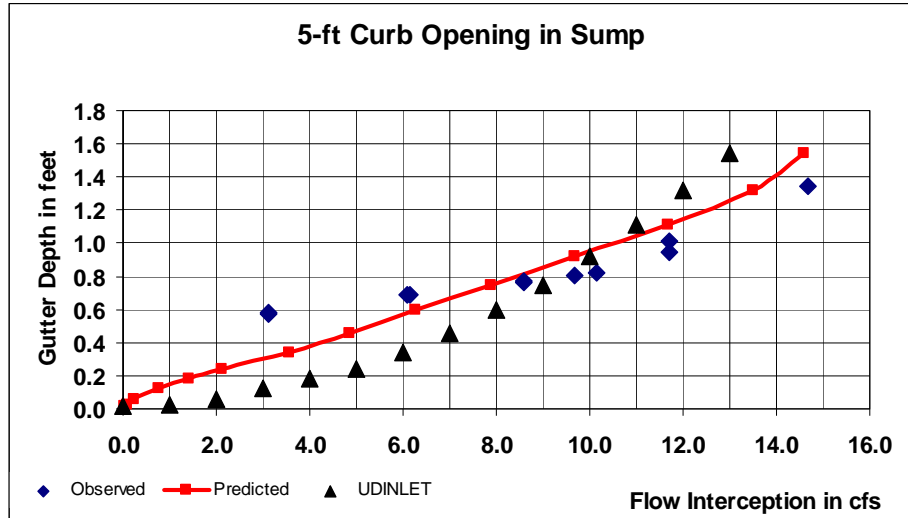

Figure 10.3 Comparison Between Observed and Predicted Data for 5-ft Curb Opening

11.0 COMBINATION INLET IN SUMP

A combination inlet consists of a horizontal grate placed in the gutter and a vertical curb opening inlet on the curb face. The advantage to adopt a combination inlet is to reduce the risk of being completely clogged by debris. For instance, if the grate becomes clogged, the curb opening remains functional or vice versa. When water flows through a combination inlet, the grate intercepts the shallow flow. As a result, the curb opening will not function until the grate is submerged. Different approaches were developed to size a combination inlet. For instance, it has been recommended that the capacity of a combination inlet be the larger interception between the grate and the curb opening or a reduction on the algebraic sum of the total interception (Guo 1999). However, no clear recommendation has ever been made or verified for such a capacity reduction. In practice, the street flow is first intercepted by a grate as if the curb opening did not exist, and then the remaining flow is applied to the curb opening inlet as if the grate did not exist (USWDCM 2001). Nevertheless, the hydraulics of a combination inlet remains unclear even though hundreds of combination inlets have been installed in metro areas every year. In this study, a new approach was formulated to model the interception capacity of a combination inlet. It is suggested that a reduction factor be applied to the algebraic sum of the total interception as:

$$Q_t = Q_g + Q_c - K\sqrt{Q_g Q_c} \quad (11.1)$$

Where Q_t = interception capacity for combination inlet, Q_g = interception for grate, Q_c = interception for curb opening, and K = reduction factor.

Combination 13 inlet is composed of a horizontal bar grate and a 3-ft long curb opening. Similarly, Combination 16 inlet was formed with a vane grate and 3-ft long curb opening. Having collected several sets of data, the least square method was set up to minimize the squared errors using the reduction factor, K . It was found that $K=0.37$ for Combination 13 inlet as shown in Figure 11.1, and $K=0.21$ for Combination 16 inlet as shown in Figure 11.2. A higher reduction factor implies that the higher interference between the grate and the curb opening. For instance, the vane grate is more susceptible to inundation because of its low area-open ratio. As a result, the vane grate is more likely to operate under high water depths or both the vane grate and its curb opening can constructively function together. On the contrary, a bar grate in the Combination 13 inlet can intercept the majority of the gutter flow. Its curb opening is therefore not fully utilized until the bar grate is submerged under an overwhelming inflow. The HEC22 procedure assumes that the grate and curb opening can independently work. As a result, it consistently overestimates the capacity of a combination inlet. In this study, a capacity reduction is introduced to Eq 11.1. Of course, the value of K is a lumped, average parameter representing the range of observed water depths in the laboratory. During the model tests, it was observed that when the grate surface area is subject to a shallow water flow, the curb opening intercepted the flow at its two low corners, or it did not behave as a side weir to collect the flow along its full length. Under a deep water flow, the vortex circulation dominates the flow pattern. As a result, the central portion of the curb opening seems to more actively draw water into the inlet box. Although Eq 11.1 appears simple for use, it best represents the range of the observed data.

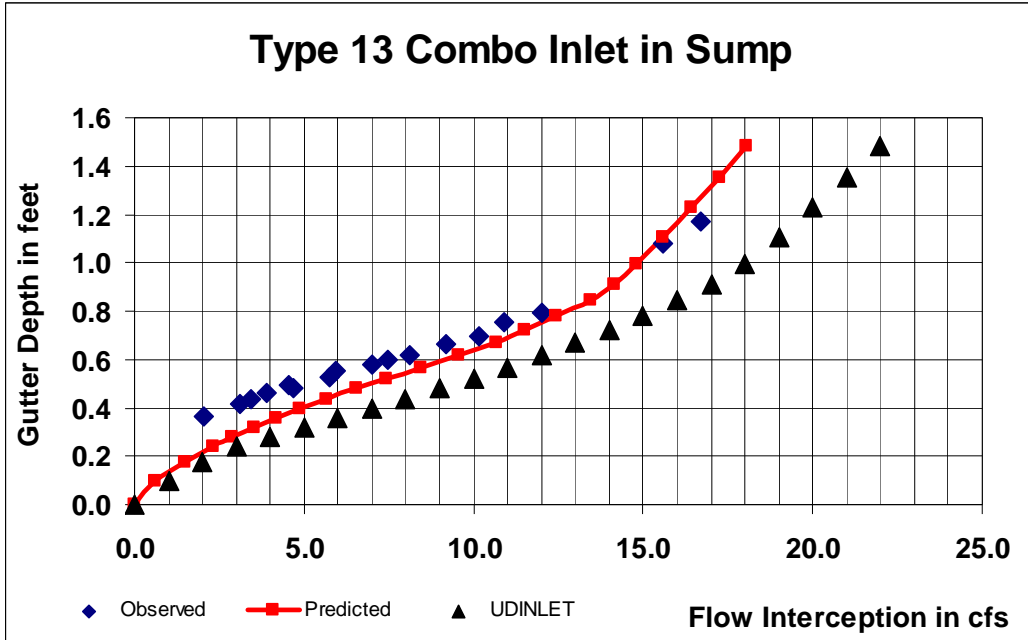

Figure 11.1 Observed and Predicted Flow Interception for Type 13 Combination Inlet

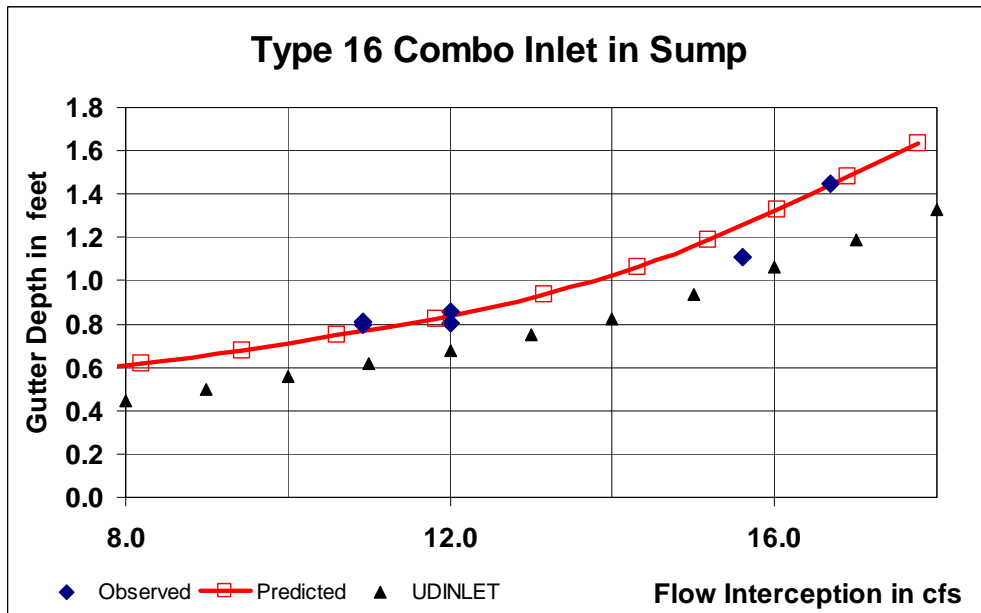

Figure 11.2 Observed and Predicted Flow Interception for Type 16 Combination Inlet

12.0 CONCLUSIONS AND RECOMMENDATIONS

As illustrated in *USDCM 2001*, the current state-of-the-art methods in determining the inlet efficiency for Type 13, 16, and R inlets have not been sufficiently verified. In this study, physically-meaningful test conditions that are likely to be encountered in the field were reproduced in the laboratory. The data collected and analyzed provided considerable insight to understand the performance of the Type 13, 16, and R inlets under varying hydraulic conditions.

It was found that agreement with observed test data was generally poor with a hydraulic efficiency over-predicted by an average of 20% for the Type 13 and 16 inlets and under-predicted by an average of 7% for the Type R inlet. Methods given in the *USDCM 2001* have been improved by developing a new set of splash-over velocity coefficients for the Type 13 and 16 combination inlets. This was done by calibrating the HEC 22 formula outlined in the *USDCM 2001*. A third-order polynomial regression was then fitted to the calculated splash-over velocity data to provide updated coefficients. The splash-over velocity coefficients are reflective of the combination inlet performance, not the grate-only inlet performance, and provide a considerable improvement when comparing with the observed data. Similarly, the existing HEC-22 formula for Type R inlet is improved by the regression analysis using the observed data. The form of the original equation was preserved, and the overall fit to the observed efficiency data was improved considerably with efficiency errors averaging 3.8%.

A comparison of on-grade hydraulic efficiency was conducted among a combination inlet, a grate-only inlet, and a curb-only inlet for single Type 13 and 16 configurations. An average difference of 3% efficiency was observed when the combination and the grate-only inlets were compared, and an average difference of 12% efficiency was observed when the combination and curb-only inlets were compared.

Vane grate was invented to be safe for bicycles and to be efficient for flow interception. The laboratory data indicate that the interception capacity of a sump vane grate is only 75 to 80% of a bar grate in sump. The width of inclined vanes significantly reduces the area and width opening ratios. As a result, the efficiency of a vane grate is substantially compromised by its safety. In comparison, a combination inlet with a bar grate has a higher reduction factor than that using a vane grate.

All cases investigated in the laboratory were conducted under no clogging condition. As recommended, a decay-based clogging factor is applied to the grate area when the grate operates as an orifice or to the wetted perimeter when the grate operates as a weir (Guo 2000C, 2006). The clogging decay coefficients are 0.5 for grate inlet and 0.25 for curb-opening inlet.

Lastly, the relevance of uniform flow in the model was examined by repeating the analysis with the observed test data adjusted to conditions of uniform flow. An average difference in hydraulic efficiency is approximately 3%, for all inlets under uniform or non-uniform flow conditions in the model. As a result, it is concluded that the impact of the uniformity of the street flow immediately upstream of the inlet is negligible.

13.0 REFERENCES

- Agrawal, S.K., Henry, J.J., and Mayer, W.E., (1977). "Measurement of Hydroplaning Potential", Final Report to Pennsylvania Department of Transportation, Report No. FHWA-PA-72-6.
- Bos, M. G. (1989). Discharge Measurement Structures. Third Edition revised, The Netherlands: Institute for Land Reclamation and Improvement.
- Chaudhry, M. H. (2008). Open Channel Flow. Second Edition, New York, NY: Springer.
- CDOT (2004). "Hydraulic Design Criteria for Highways", Hydraulic Division, Colorado Department of Transportation (CDOT), Denver, Colorado.
- Comport, B.C., Thornton C. I., and Cox A., (2009). "Hydraulic Capacity of Grate and Curb Inlets for Urban Storm Drainage", Engineering Research Center, Colorado State University, Ft. Collins, Colorado.
- Federal Highway Administration (2001). Hydraulic Engineering Circular No. 22, Second Edition, Urban Drainage Design Manual. Publication FHWA-NHI-01-021, Springfield, VA: U. S. National Technical Information Service.
- Federal Highway Administration (1977). Hydraulic and Safety Characteristics of Selected Grate Inlets on Continuous Grades, Vol 1. Publication FHWA-RD-77-24, Springfield, VA: U. S. National Technical Information Service.
- Guo, James C.Y. and McKenzie, K, and Mommandi, A. (2008) "Sump Inlet Hydraulics", ASCE J. of Hydraulic Engineering, Vol 135, No 1, Nov.
- Guo, James C.Y. (2006). "Decay-based Clogging Factor for Curb Inlet Design", Vol 132, No. 11, ASCE J. of Hydraulic Engineering, November.
- Guo, James C.Y. (2000a). "Street Storm Water Conveyance Capacity," ASCE J. of Irrigation and Drainage Engineering, Vol 126, No 2, Mar/Apr,
- Guo, James C.Y. (2000b). "Street Storm Water Storage Capacity", J. of Water Environment Research, Vol 27, No 6., Sept./Oct.
- Guo, James C.Y. (2000c). "Design of Grate Inlets with a Clogging Factor," Advances in Environmental Research, Vol 4, Elsevier Science, Ireland.
- Guo, James C.Y. (1999). "Sand Recovery for Highway Drainage Designs," ASCE J. of Drainage and Irrigation Engineering, Vol 125, No 6, Nov.
- Guo, James C.Y. (1998). "Risk-cost Approach to Interim Drainage Structure Designs," ASCE J. of Water Resources Planning and Management, Vol 124, No 6, Nov/Dec.

Li, W. H. (1956). Design of Storm-Water Inlets. The Johns Hopkins University, Baltimore, MD.

U. S. Bureau of Reclamation (2001). Water Measurement Manual. Third Edition, U. S. Department of the Interior, Denver, CO.

UDFCD (2001). Urban Storm Drainage Criteria Design Manual, Volumes 1 and 2, Urban Drainage and Flood Control District, Denver, CO.

APPENDIX A: USDCM GRATE INLET SCHEMATICS

APPENDIX B: ON-GRADE TEST DATA

On-Grade Test Results

All three inlets (Types 13, 16, and R) were tested in the on-grade condition at various slopes.

Table B-1 0.5% and 1% On-Grade Test Data

Test ID Number	Configuration	Longitudinal Slope (%)	Cross Slope (%)	Flow Depth (ft)	Prototype Total Flow (cfs)	Efficiency (%)	Top Width at Control (ft)	Top Width Down-stream of Inlets (ft)
44	15-ft Type R (R15)0.5		1	0.333	4.4	89.3	16.0	10.2
45	15-ft Type R (R15)0.5		1	0.501	20.3	50.8	17.5	16.0
46	15-ft Type R (R15)0.5		1	0.999	128.8	23.6	18.2	18.2
47	12-ft Type R (R12)0.5		1	0.333	3.9	84.0	16.0	10.0
48	12-ft Type R (R12)0.5		1	0.501	21.8	37.9	18.2	18.2
49	12-ft Type R (R12)0.5		1	0.999	126.3	19.5	18.2	18.2
50	9-ft Type R (R9) 0.5		1	0.333	4.2	70.4	16.0	12.0
51	9-ft Type R (R9) 0.5		1	0.501	21.5	34.8	18.2	18.2
52	9-ft Type R (R9) 0.5		1	0.999	127.8	14.5	18.2	18.2
53	5-ft Type R (R5) 0.5		1	0.333	4.4	50.0	16.0	15.6
54	5-ft Type R (R5) 0.5		1	0.501	22.3	24.5	18.2	18.2
55	5-ft Type R (R5) 0.5		1	0.999	125.5	8.3	18.2	18.2
56	Triple No. 13	0.5	1	0.333	4.4	82.1	15.8	9.0
57	Triple No. 13	0.5	1	0.501	20.6	43.2	18.2	18.2
58	Triple No. 13	0.5	1	0.999	126.6	22.7	18.2	18.2
59	Double No. 13	0.5	1	0.333	4.7	73.3	16.0	10.7
60	Double No. 13	0.5	1	0.501	22.6	35.9	18.2	18.2
61	Double No. 13	0.5	1	0.999	127.8	16.2	18.2	18.2
62	Single No. 13	0.5	1	0.333	4.8	61.3	16.0	15.8
63	Single No. 13	0.5	1	0.501	26.2	23.8	18.2	18.2
64	Single No. 13	0.5	1	0.999	126.4	9.9	18.2	18.2
65	Single No. 16	0.5	1	0.333	5.1	60.6	16.0	15.8
66	Single No. 16	0.5	1	0.501	21.4	28.5	18.2	18.2
67	Single No. 16	0.5	1	0.999	126.9	13.5	18.2	18.2
68	Double No. 16	0.5	1	0.333	5.3	70.6	17.0	12.8
69	Double No. 16	0.5	1	0.501	23.2	34.2	18.2	18.2
70	Double No. 16	0.5	1	0.999	124.7	20.9	18.2	18.2
71	Triple No. 16	0.5	1	0.333	4.5	82.8	15.7	9.0
72	Triple No. 16	0.5	1	0.501	23.7	40.1	18.2	18.2
73	Triple No. 16	0.5	1	0.999	125.8	26.9	18.2	18.2

Table B-2 0.5% and 2% On-Grade Test Data

Test ID	Number Configuration	Longitudinal Slope (%)	Cross Slope (%)	Flow Depth (ft)	Prototype Total Flow (cfs)	Efficiency (%)	Top	Top
							Width at Control (ft)	Width of Inlets (ft)
74	Triple No. 16	0.5	2	0.333	3.4	63.6	14.0	13.6
75	Triple No. 16	0.5	2	0.501	11.2	47.2	18.2	13.8
76	Triple No. 16	0.5	2	0.999	93.8	28.2	18.2	18.2
77	Double No. 16	0.5	2	0.333	3.3	57.1	14.0	13.4
78	Double No. 16	0.5	2	0.501	11.2	40.3	18.2	14
79	Double No. 16	0.5	2	0.999	94.5	19.8	18.2	18.2
80	Single No. 16	0.5	2	0.333	3.7	50.0	14.0	13.6
81	Single No. 16	0.5	2	0.501	11.5	35.1	18.2	14
82	Single No. 16	0.5	2	0.999	95.6	17.0	18.2	18.2
83	Single No. 16, Grate only	0.5	2	0.501	11.4	35.6	18.2	13.9
84	Single No. 16, Grate only	0.5	2	0.999	94.3	14.9	18.2	18.2
85	Single No. 16, grate and 4-in. opening	0.5	2	0.501	11.2	34.7	18.2	14
86	Single No. 16, grate and 4-in. opening	0.5	2	0.999	95.4	16.2	18.2	18.2
87	Single No. 16, Debris Test 1	0.5	2	0.333	3.4	50.0	14.0	13.4
88	Single No. 16, Debris Test one	0.5	2	0.501	10.9	34.3	18.2	13.9
89	Single No. 16, Debris Test two	0.5	2	0.333	3.3	47.6	14.0	13.6
90	Single No. 16, Debris Test two	0.5	2	0.501	10.9	32.9	18.2	13.9
91	Single No. 13	0.5	2	0.333	3.0	63.2	12.0	13.4
92	Single No. 13	0.5	2	0.501	10.1	38.5	18.2	18.2
93	Single No. 13	0.5	2	0.999	95.1	13.1	18.2	18.2
94	Single No. 13, Debris Test one	0.5	2	0.333	3.7	45.8	14.0	13.6
95	Single No. 13, Debris Test one	0.5	2	0.501	11.8	32.9	18.2	14
96	Single No. 13, Debris Test two	0.5	2	0.333	3.4	54.5	14.0	13.5
97	Single No. 13, Debris Test two	0.5	2	0.501	12.0	33.8	14.0	13.7
98	Single No. 13, Grate only	0.5	2	0.501	10.4	34.3	18.2	13.9
99	Single No. 13, Grate only	0.5	2	0.999	93.2	11.0	18.2	18.2
100	Single No. 13, Grate and 4-in. Opening	0.5	2	0.501	11.2	34.7	18.2	13.9
101	Single No. 13, Grate and 4-in. Opening	0.5	2	0.999	94.3	12.7	18.2	18.2
102	Single No. 13, Curb opening only	0.5	2	0.501	11.2	23.6	18.2	14
103	Single No. 13, Curb opening only	0.5	2	0.999	94.3	7.1	18.2	18.2
104	Double No. 13	0.5	2	0.333	3.3	61.9	14.0	13.3
105	Double No. 13	0.5	2	0.501	11.2	44.4	18.2	18.2
106	Double No. 13	0.5	2	0.999	98.2	20.5	18.2	18.2
107	Triple No. 13	0.5	2	0.333	3.6	73.9	14.0	13.3
108	Triple No. 13	0.5	2	0.501	13.4	50.0	18.2	18.2
109	Triple No. 13	0.5	2	0.999	108.3	43.3	18.2	18.2
110	5-ft Type R (R5)	0.5	2	0.333	3.0	57.9	14.0	13.3
111	5-ft Type R (R5)	0.5	2	0.501	11.1	39.4	18.2	13.8
112	5-ft Type R (R5)	0.5	2	0.999	93.2	11.7	18.2	18.2
113	5-in. Type R (R5), w/ 4-in. Curb Opening	0.5	2	0.501	11.2	38.9	18.2	13.8

Test ID Number	Configuration	Longitudinal Slope (%)	Cross Flow Slope (%)	Flow Depth (ft)	Prototype		Top Width at Control (ft)	Top Width Down- stream of Inlets (ft)
					Total Flow (cfs)	Efficiency (%)		
114	5-in. Type R (R5), w/ 4-in. Curb Opening	0.5	2	0.999	94.3	9.8	18.2	18.2
115	5-ft Type R (R5), w/Horizontal Safety Bar	0.5	2	0.501	11.1	39.4	18.2	13.8
116	9-ft Type R (R9)	0.5	2	0.333	3.1	65.0	14.0	13.1
117	9-ft Type R (R9)	0.5	2	0.501	11.2	47.2	18.2	13.7
118	9-ft Type R (R9)	0.5	2	0.999	93.8	19.3	18.2	18.2
119	12-ft Type R (R12)	0.5	2	0.333	2.8	83.3	14.0	13.1
120	12-ft Type R (R12)	0.5	2	0.501	10.9	52.9	18.2	13.7
121	12-ft Type R (R12)	0.5	2	0.999	93.8	25.4	18.2	18.2
122	15-ft Type R (R15)	0.5	2	0.333	3.3	90.5	14.0	13
123	15-ft Type R (R15)	0.5	2	0.501	10.9	60.0	18.2	13.6
124	15-ft Type R (R15)	0.5	2	0.999	94.3	30.7	18.2	18.2

Table B-3 2% and 1% On-Grade Test Data

Test ID Number	Configuration	Longitudinal Slope (%)	Cross Slope (%)	Flow Depth (ft)	Prototype Total Flow (cfs)	Efficiency (%)	Top Width at Control (ft)	Top Width Down-stream of Inlets (ft)
125	15-ft Type R (R15)	2	1	0.333	14.8	44.2	18.2	16
126	15-ft Type R (R15)	2	1	0.501	33.5	30.2	18.2	18.2
127	15-ft Type R (R15)	2	1	0.999	178.5	17.6	18.2	18.2
128	12-ft Type R (R12)	2	1	0.333	13.4	43.0	18.2	16
129	12-ft Type R (R12)	2	1	0.501	32.9	27.0	18.2	18.2
130	12-ft Type R (R12)	2	1	0.999	176.1	14.7	18.2	18.2
131	9-ft Type R (R9)	2	1	0.333	13.4	36.0	18.2	16
132	9-ft Type R (R9)	2	1	0.501	29.6	22.6	18.2	18.2
133	9-ft Type R (R9)	2	1	0.999	173.0	11.4	18.2	18.2
134	5-ft Type R (R9)	2	1	0.333	13.1	25.0	18.2	16
135	5-ft Type R (R9)	2	1	0.501	28.4	16.5	18.2	18.2
136	5-ft Type R (R9)	2	1	0.999	179.0	7.6	18.2	18.2
137	Triple No. 16	2	1	0.333	13.2	44.7	18.2	16
138	Triple No. 16	2	1	0.501	39.9	30.9	18.2	18.2
139	Triple No. 16	2	1	0.999	155.1	23.6	18.2	18.2
140	Double No. 16	2	1	0.333	14.7	36.2	18.2	16
141	Double No. 16	2	1	0.501	32.7	27.1	18.2	18.2
142	Double No. 16	2	1	0.999	177.1	18.7	18.2	18.2
143	Single No. 16	2	1	0.333	15.3	28.6	18.2	16
144	Single No. 16	2	1	0.501	34.0	20.6	18.2	18.2
145	Single No. 16	2	1	0.999	176.6	12.3	18.2	18.2
146	Single No. 13	2	1	0.333	15.9	27.5	18.2	16
147	Single No. 13	2	1	0.501	33.7	20.4	18.2	18.2
148	Single No. 13	2	1	0.999	166.6	9.4	18.2	18.2
149	Double No. 13	2	1	0.333	14.3	33.7	18.2	16
150	Double No. 13	2	1	0.501	33.7	23.6	18.2	18.2
151	Double No. 13	2	1	0.999	176.6	13.3	18.2	18.2
152	Triple No. 13	2	1	0.333	13.1	42.9	18.2	16
153	Triple No. 13	2	1	0.501	31.0	28.6	18.2	18.2
154	Triple No. 13	2	1	0.999	177.7	17.7	18.2	18.2

Table B-4 2% and 2% On-Grade Test Data

Test ID	Number Configuration	Longitudinal Slope (%)	Cross Slope (%)	Flow Depth (ft)	Prototype Total Flow (cfs)	Efficiency (%)	Top	Top
							Width	Down-
							Width	stream
							at	of
							Control	Inlets
							(ft)	(ft)
155	Triple No. 13	2	2	0.333	7.8	74.0	16.0	8.3
156	Triple No. 13	2	2	0.501	22.1	43.7	18.2	18.2
157	Triple No. 13	2	2	0.999	163.2	19.1	18.2	18.2
158	Double No. 13	2	2	0.333	8.1	63.5	16.0	8.3
159	Double No. 13	2	2	0.501	23.4	34.7	18.2	18.2
160	Double No. 13	2	2	0.999	161.3	14.3	18.2	18.2
161	Single No. 13	2	2	0.333	7.8	50.0	14.8	9
162	Single No. 13	2	2	0.501	24.8	23.9	18.2	18.2
163	Single No. 13	2	2	0.999	155.9	8.9	18.2	18.2
164	Single No. 13, Debris Test one	2	2	0.333	7.3	40.4	14.0	8.3
165	Single No. 13, Debris Test one	2	2	0.501	24.0	17.5	18.2	18.2
166	Single No. 13, Debris Test two	2	2	0.333	7.2	47.8	14.0	8.3
167	Single No. 13, Debris Test two	2	2	0.501	24.0	19.5	18.2	18.2
168	Single No. 13, Grate Only	2	2	0.501	23.2	19.5	18.2	18.2
169	Single No. 13, Grate Only	2	2	0.999	154.3	6.6	18.2	18.2
170	Single No. 13, Grate and 4-in. Opening	2	2	0.501	22.3	25.2	18.2	15.8
171	Single No. 13, Grate and 4-in. Opening	2	2	0.999	164.1	8.2	18.2	18.2
172	Single No. 13, Curb opening only	2	2	0.501	24.2	9.7	18.2	18.2
173	Single No. 13, Curb opening only	2	2	0.999	155.9	3.7	18.2	18.2
174	Single No. 16	2	2	0.333	7.9	54.9	14.0	8.6
175	Single No. 16	2	2	0.501	22.3	31.5	18.2	15.6
176	Single No. 16	2	2	0.999	162.9	12.6	18.2	18.2
177	Single No. 16, Grate only	2	2	0.501	22.9	27.2	18.2	15.7
178	Single No. 16, Grate only	2	2	0.999	162.9	10.3	18.2	18.2
179	Single No. 16, Grate and 4-in. Opening	2	2	0.501	22.3	28.7	18.2	18.2
180	Single No. 16, Grate and 4-in. Opening	2	2	0.999	164.1	11.5	18.2	18.2
181	Single No. 16, Debris Test one	2	2	0.333	8.1	53.8	14.0	8.9
182	Single No. 16, Debris Test one	2	2	0.501	24.0	27.3	18.2	18.2
183	Single No. 16, Debris Test two	2	2	0.333	8.4	51.9	14.0	8.9
184	Single No. 16, Debris Test two	2	2	0.501	24.9	25.6	18.2	18.2
185	Double No. 16	2	2	0.333	7.9	64.7	14.0	8.3
186	Double No. 16	2	2	0.501	23.7	36.8	18.2	18.2
187	Double No. 16	2	2	0.999	163.7	20.3	18.2	18.2
188	Triple No. 16	2	2	0.333	8.4	72.2	14.0	8.3
189	Triple No. 16	2	2	0.501	22.6	46.2	18.2	18.2
190	Triple No. 16	2	2	0.999	162.9	25.7	18.2	18.2
191	5-ft Type R (R5)	2	2	0.333	7.3	38.3	17.8	11.3
192	5-ft Type R (R5)	2	2	0.501	22.9	18.4	18.2	18.2
193	5-ft Type R (R5)	2	2	0.999	166.0	7.1	18.2	18.2
194	5-ft Type R (R5), w/ 4-in. Curb Opening	2	2	0.999	166.8	5.4	18.2	18.2

Test ID Number	Configuration	Longitudinal Slope (%)	Cross Slope (%)	Flow Depth (ft)	Total Flow (cfs)	Prototype Efficiency (%)	Top	Top
							Width at Control (ft)	Down- stream of Inlets (ft)
195	5-ft Type R (R5), w/ 4-in. Curb Opening	2	2	0.501	22.8	18.5	18.2	18.2
196	5-ft Type R (R5), w/Horizontal Safety Bar	2	2	0.501	23.1	18.2	18.2	18.2
197	9-ft Type R (R9)	2	2	0.333	6.2	65.0	11.0	6.8
198	9-ft Type R (R9)	2	2	0.501	21.8	33.6	18.2	14.3
199	9-ft Type R (R9)	2	2	0.999	166.0	11.6	18.2	18.2
200	12-ft Type R (R12)	2	2	0.333	7.5	70.8	14.0	9.8
201	12-ft Type R (R12)	2	2	0.501	21.7	42.4	18.2	15.8
202	12-ft Type R (R12)	2	2	0.999	166.8	15.2	18.2	18.2
203	15-ft Type R (R15)	2	2	0.333	7.0	84.4	14.0	8.3
204	15-ft Type R (R15)	2	2	0.501	21.5	48.6	18.2	15.8
205	15-ft Type R (R15)	2	2	0.999	166.8	18.8	18.2	18.2

Table B-5 4% and 1% On-Grade Test Data

Test ID Number	Configuration	Longitudinal Slope (%)	Cross Slope (%)	Flow Depth (ft)	Prototype Total Flow (cfs)	Efficiency (%)	Top Width at Control (ft)	Top Width Down-stream of Inlets (ft)
206	15-ft Type R (R15)	4	1	0.333	13.1	44.0	18.2	16
207	15-ft Type R (R15)	4	1	0.501	38.3	26.8	18.2	18.2
208	15-ft Type R (R15)	4	1	0.999	143.4	18.6	18.2	18.2
209	12-ft Type R (R12)	4	1	0.333	12.6	42.0	18.2	16
210	12-ft Type R (R12)	4	1	0.501	38.3	23.6	18.2	18.2
211	12-ft Type R (R12)	4	1	0.999	152.9	14.9	18.2	18.2
212	9-ft Type R (R9)	4	1	0.333	13.9	34.8	18.2	16
213	9-ft Type R (R9)	4	1	0.501	38.2	18.8	18.2	18.2
214	9-ft Type R (R9)	4	1	0.999	141.5	11.7	18.2	18.2
215	5-ft Type R (R5)	4	1	0.333	13.7	21.6	18.2	16
216	5-ft Type R (R5)	4	1	0.501	38.2	11.4	18.2	18.2
217	5-ft Type R (R5)	4	1	0.999	140.3	6.9	18.2	18.2
218	Triple No. 16	4	1	0.333	12.6	42.0	18.2	16
219	Triple No. 16	4	1	0.501	38.2	29.4	18.2	18.2
220	Triple No. 16	4	1	0.999	145.7	24.8	18.2	18.2
221	Double No. 16	4	1	0.333	13.2	37.6	18.2	16
222	Double No. 16	4	1	0.501	36.6	25.1	18.2	18.2
223	Double No. 16	4	1	0.999	145.0	20.4	18.2	18.2
224	Single No. 16	4	1	0.333	13.1	33.3	18.2	16
225	Single No. 16	4	1	0.501	37.9	20.2	18.2	18.2
226	Single No. 16	4	1	0.999	141.2	14.0	18.2	18.2
227	Single No. 13	4	1	0.333	12.9	25.3	18.2	16
228	Single No. 13	4	1	0.501	37.7	12.8	18.2	18.2
229	Single No. 13	4	1	0.999	142.6	8.4	18.2	18.2
230	Double No. 13	4	1	0.333	13.2	37.6	18.2	16
231	Double No. 13	4	1	0.501	36.6	21.3	18.2	18.2
232	Double No. 13	4	1	0.999	138.7	13.5	18.2	18.2
233	Triple No. 13	4	1	0.333	12.6	40.7	18.2	16
234	Triple No. 13	4	1	0.501	38.2	24.9	18.2	18.2
235	Triple No. 13	4	1	0.999	146.8	17.9	18.2	18.2

Table B-6 4% and 2% On-Grade Test Data

Test ID	Number Configuration	Longitudinal Slope (%)	Cross Slope (%)	Flow Depth (ft)	Prototype Total Flow (cfs)	Efficiency (%)	Top	Top
							Width at Control (ft)	Down-stream of Inlets (ft)
236	Triple No. 13	4	2	0.333	8.4	74.1	15.5	7.7
237	Triple No. 13	4	2	0.501	25.7	42.4	18.2	14.3
238	Triple No. 13	4	2	0.999	128.6	20.5	18.2	18.2
239	Double No. 13	4	2	0.333	8.3	66.0	15.5	7.8
240	Double No. 13	4	2	0.501	26.0	32.9	18.2	14.3
241	Double No. 13	4	2	0.999	127.8	15.9	18.2	18.2
242	Single No. 13	4	2	0.333	9.0	43.1	15.5	7.7
243	Single No. 13	4	2	0.501	27.3	20.6	18.2	13.7
244	Single No. 13	4	2	0.999	129.7	9.5	18.2	18.2
245	Single No. 13, Debris Test one	4	2	0.333	8.6	34.5	16.0	8.6
246	Single No. 13, Debris Test one	4	2	0.501	26.5	15.9	17.5	14.3
247	Single No. 13, Debris Test two	4	2	0.333	8.4	40.7	16.0	8
248	Single No. 13, Debris Test two	4	2	0.501	27.1	16.7	18.2	14.3
249	Single No. 13, Curb opening only	4	2	0.501	26.5	9.4	18.2	14.3
250	Single No. 13, Curb opening only	4	2	0.999	119.2	4.7	18.2	18.2
251	Single No. 13, Grate Only	4	2	0.501	21.8	19.3	18.2	9.8
252	Single No. 13, Grate Only	4	2	0.999	117.7	6.5	18.2	18.2
253	Single No. 13, Grate and 4-in. Opening	4	2	0.501	24.5	21.7	18.2	14.3
254	Single No. 13, Grate and 4-in. Opening	4	2	0.999	113.3	9.9	18.2	18.2
255	Single No. 16, Grate and 4-in. Opening	4	2	0.501	28.2	31.5	18.2	14.3
256	Single No. 16, Grate and 4-in. Opening	4	2	0.999	123.1	15.3	18.2	18.2
257	Single No. 16, Grate only	4	2	0.501	30.4	28.7	18.2	12.8
258	Single No. 16, Grate only	4	2	0.999	133.4	12.7	18.2	18.2
259	Single No. 16, Debris Test one	4	2	0.333	8.1	55.8	18.2	7.4
260	Single No. 16, Debris Test one	4	2	0.501	26.5	25.9	18.2	14.3
261	Single No. 16, Debris Test two	4	2	0.333	8.1	48.1	18.2	8
262	Single No. 16, Debris Test two	4	2	0.501	26.8	17.4	18.2	14.3
263	Single No. 16	4	2	0.333	7.5	64.6	14.6	7.8
264	Single No. 16	4	2	0.501	28.1	31.7	18.2	14.3
265	Single No. 16	4	2	0.999	129.4	15.7	18.2	18.2
266	Double No. 16	4	2	0.333	8.7	67.9	14.6	7.8
267	Double No. 16	4	2	0.501	26.5	37.6	18.2	14.3
268	Double No. 16	4	2	0.999	130.9	24.6	18.2	18.2
269	Triple No. 16	4	2	0.333	8.4	74.1	14.6	7.7
270	Triple No. 16	4	2	0.501	25.7	43.6	18.2	14.3
271	Triple No. 16	4	2	0.999	127.8	29.0	18.2	18.2
272	5-ft Type R (R5)	4	2	0.333	8.1	34.6	16.0	8.6
273	5-ft Type R (R5)	4	2	0.501	26.7	17.0	18.2	14.3
274	5-ft Type R (R5)	4	2	0.999	118.9	7.9	18.2	18.2
275	5-ft Type R (R5), w/ 4-in. Curb Opening	4	2	0.501	27.4	16.5	18.2	14.3

Test ID Number	Configuration	Longitudinal Slope (%)	Cross Slope (%)	Flow Depth (ft)	Prototype		Top Width at Control (ft)	Down- stream of Inlets (ft)
					Total Flow (cfs)	Efficiency (%)		
276	5-ft Type R (R5), w/ 4-in. Curb Opening	4	2	0.999	128.6	6.2	18.2	18.2
277	5-ft Type R (R5), w/Horizontal Safety Bar	4	2	0.501	26.7	16.4	18.2	14.3
278	9-ft Type R (R9)	4	2	0.333	7.9	62.7	16.0	8.6
279	9-ft Type R (R9)	4	2	0.501	25.9	30.1	18.2	14.3
280	9-ft Type R (R9)	4	2	0.999	117.7	13.2	18.2	18.2
281	12-ft Type R (R12)	4	2	0.333	8.7	69.6	16.0	8
282	12-ft Type R (R12)	4	2	0.501	25.3	38.3	18.2	14.3
283	12-ft Type R (R12)	4	2	0.999	113.8	18.2	18.2	18.2
284	15-ft Type R (R15)	4	2	0.333	7.8	80.0	16.0	7.7
285	15-ft Type R (R15)	4	2	0.501	23.4	46.0	18.2	14.3
286	15-ft Type R (R15)	4	2	0.999	123.1	21.3	18.2	18.2

Table B-7 Additional Debris Tests (4% and 1% on-grade)

Test ID Number*	Configuration**	Longitudinal Slope (%)	Cross Slope (%)	Flow Depth (ft)	Prototype Total Flow (cfs)	Efficiency (%)	Top Width at Control (ft)	Top Width Down-stream of Inlets (ft)
AT287	Single No. 13 - 25% flat	4	1	0.333	14.50	21.51	18.2	16.0
AT288	Single No. 13 - 25% flat	4	1	0.501	38.03	11.48	18.2	18.2
AT291	Double No. 13 - 25% flat	4	1	0.333	14.65	27.66	18.2	16.0
AT293	Double No. 13 - 25% flat	4	1	0.501	38.81	18.88	18.2	18.2
AT303	Triple No. 13 - 25% flat	4	1	0.333	14.34	40.22	18.2	16.0
AT306	Triple No. 13 - 25% flat	4	1	0.501	37.57	24.90	18.2	18.2
245	Single No. 13 - 50% flat	4	1	0.333	8.57	34.55	18.2	16.0
246	Single No. 13 - 50% flat	4	1	0.501	26.50	15.88	18.2	18.2
AT295	Double No. 13 - 50% flat	4	1	0.333	14.50	33.33	18.2	16.0
AT297	Double No. 13 - 50% flat	4	1	0.501	38.35	17.48	18.2	18.2
AT300	Triple No. 13 - 50% flat	4	1	0.333	14.65	39.36	18.2	16.0
AT301	Triple No. 13 - 50% flat	4	1	0.501	38.03	24.59	18.2	18.2
261	Single No. 16 - 25% 3d	4	1	0.333	8.11	48.08	18.2	16.0
262	Single No. 16 - 25% 3d	4	1	0.501	26.81	17.44	18.2	18.2
AT296	Double No. 16 - 25% 3d	4	1	0.333	14.34	34.78	18.2	16.0
AT298	Double No. 16 - 25% 3d	4	1	0.501	38.03	16.39	18.2	18.2
AT299	Triple No. 16 - 25% 3d	4	1	0.333	14.65	36.17	18.2	16.0
AT302	Triple No. 16 - 25% 3d	4	1	0.501	37.88	21.40	18.2	18.2
AT289	Single No. 16 - 50% 3d	4	1	0.333	14.19	27.47	18.2	16.0
AT290	Single No. 16 - 50% 3d	4	1	0.501	38.03	11.89	18.2	18.2
AT292	Double No. 16 - 50% 3d	4	1	0.333	14.65	34.04	18.2	16.0
AT294	Double No. 16 - 50% 3d	4	1	0.501	38.50	16.60	18.2	18.2
AT304	Triple No. 16 - 50% 3d	4	1	0.333	14.34	35.87	18.2	16.0
AT305	Triple No. 16 - 50% 3d	4	1	0.501	37.72	20.66	18.2	18.2

*AT – additional test

**flat – type 1 debris; 3d – type 2 debris

APPENDIX C: SUMP TEST DATA

Sump Test Data

All three inlets (Types 13, 16, and R) were tested in the sump condition.

Table C-1 Sump Test Data

Test ID Number	Configuration	Longitudinal Slope (%)	Cross Slope (%)	Flow Depth (ft)	Prototype Flow (cfs)
1	Triple No. 13	0	1	0.333	2.5
2	Triple No. 13	0	1	0.501	8.6
3	Triple No. 13	0	1	0.999	42.2
4	Double No. 13	0	1	0.333	2.3
5	Double No. 13	0	1	0.501	7.8
6	Double No. 13	0	1	0.999	27.1
7	Single No. 13	0	1	0.333	2.0
8	Single No. 13	0	1	0.501	5.9
9	Single No. 13	0	1	0.999	15.3
10	Single No. 13, Curb opening only	0	1	0.501	5.1
11	Single No. 13, Curb opening only	0	1	0.999	6.1
12	Single No. 13, Grate only	0	1	0.501	10.3
13	Single No. 13, Grate only	0	1	0.999	11.4
14	Single No. 13, w/ 4-in. opening	0	1	0.501	5.8
15	Single No. 13, w/ 4-in. opening	0	1	0.999	15.1
16	Single No. 16, Grate only	0	1	0.501	3.6
17	Single No. 16, Grate only	0	1	0.999	13.7
18	Single No. 16, w/ 4-in. opening	0	1	0.501	5.5
19	Single No. 16, w/ 4-in. opening	0	1	0.999	7.5
20	Single No. 16	0	1	0.333	2.3
21	Single No. 16	0	1	0.501	6.2
22	Single No. 16	0	1	0.999	13.9
23	Double No. 16	0	1	0.333	2.5
24	Double No. 16	0	1	0.501	7.6
25	Double No. 16	0	1	0.999	26.5
26	Triple No. 16	0	1	0.333	2.8
27	Triple No. 16	0	1	0.501	8.4
28	Triple No. 16	0	1	0.999	37.4
29	5-ft Type R (R5)	0	1	0.333	2.2
30	5-ft Type R (R5)	0	1	0.501	7.3
31	5-ft Type R (R5)	0	1	0.999	12.6
32	5-ft Type R (R5), w/ 4-in. Curb Opening	0	1	0.501	6.4
33	5-ft Type R (R5), w/ 4-in. Curb Opening	0	1	0.999	8.9
34	5-ft Type R (R5), Horizontal Safety Bar	0	1	0.501	7.3
35	9-ft Type R (R9)	0	1	0.333	2.5
36	9-ft Type R (R9)	0	1	0.501	8.7
37	9-ft Type R (R9)	0	1	0.999	24.2
38	12-ft Type R (R12)	0	1	0.333	2.8
39	12-ft Type R (R12)	0	1	0.501	10.0
40	12-ft Type R (R12)	0	1	0.999	32.9
41	15-ft Type R (R15)	0	1	0.333	2.8
42	15-ft Type R (R15)	0	1	0.501	10.1
43	15-ft Type R (R15)	0	1	0.999	42.1

For the additional sump tests only the Type 13 and 16 were tested at two additional flow depths (0.75 and 1.5 ft).

Table C-2 Additional Sump Test Data

Test ID Number	Configuration	Longitudinal Slope (%)	Cross Slope (%)	Flow Depth (ft)	Prototype Flow (cfs)
AT1	Triple No. 16	0	1	0.75	21.8
AT2	Triple No. 16	0	1	1.5	52.7
AT3	Double No. 16	0	1	0.75	17.9
AT4	Double No. 16	0	1	1.5	33.8
AT5	Single No. 16	0	1	0.75	10.9
AT6	Single No. 16	0	1	1.5	17.6
AT7	Single No. 13	0	1	0.75	11.5
AT8	Single No. 13	0	1	1.5	19.2
AT9	Double No. 13	0	1	0.75	16.7
AT10	Double No. 13	0	1	1.5	40.1
AT11	Triple No. 13	0	1	0.75	20.3
AT12	Triple No. 13	0	1	1.5	59.4

APPENDIX D: INLET CONSTRUCTION DRAWINGS

Inlet Drawings

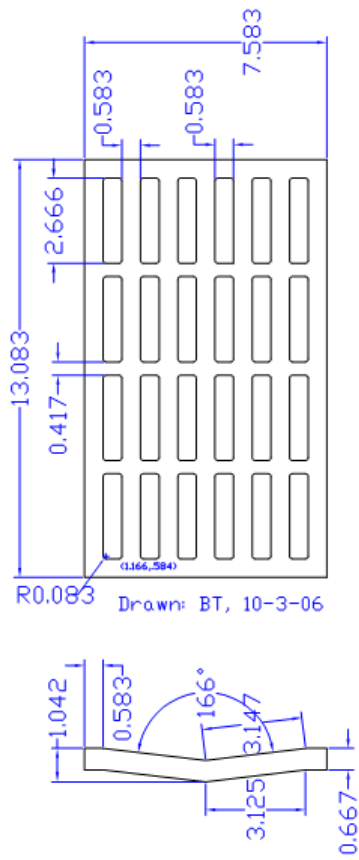
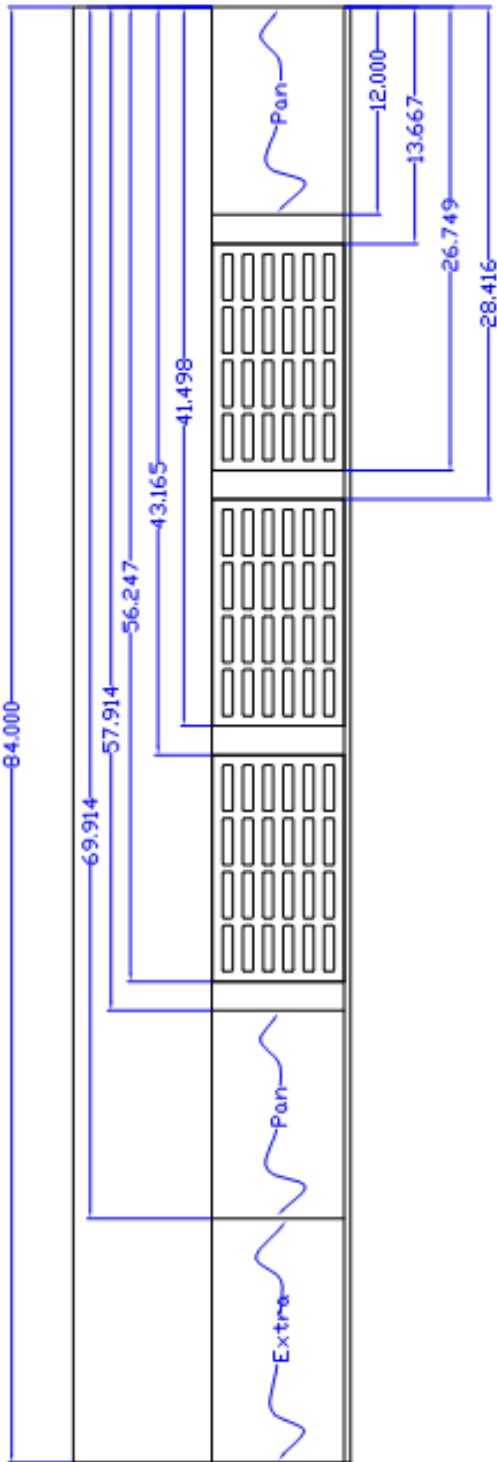

(a)

(b)

Figure D-1 Type 13 Inlet Specifications

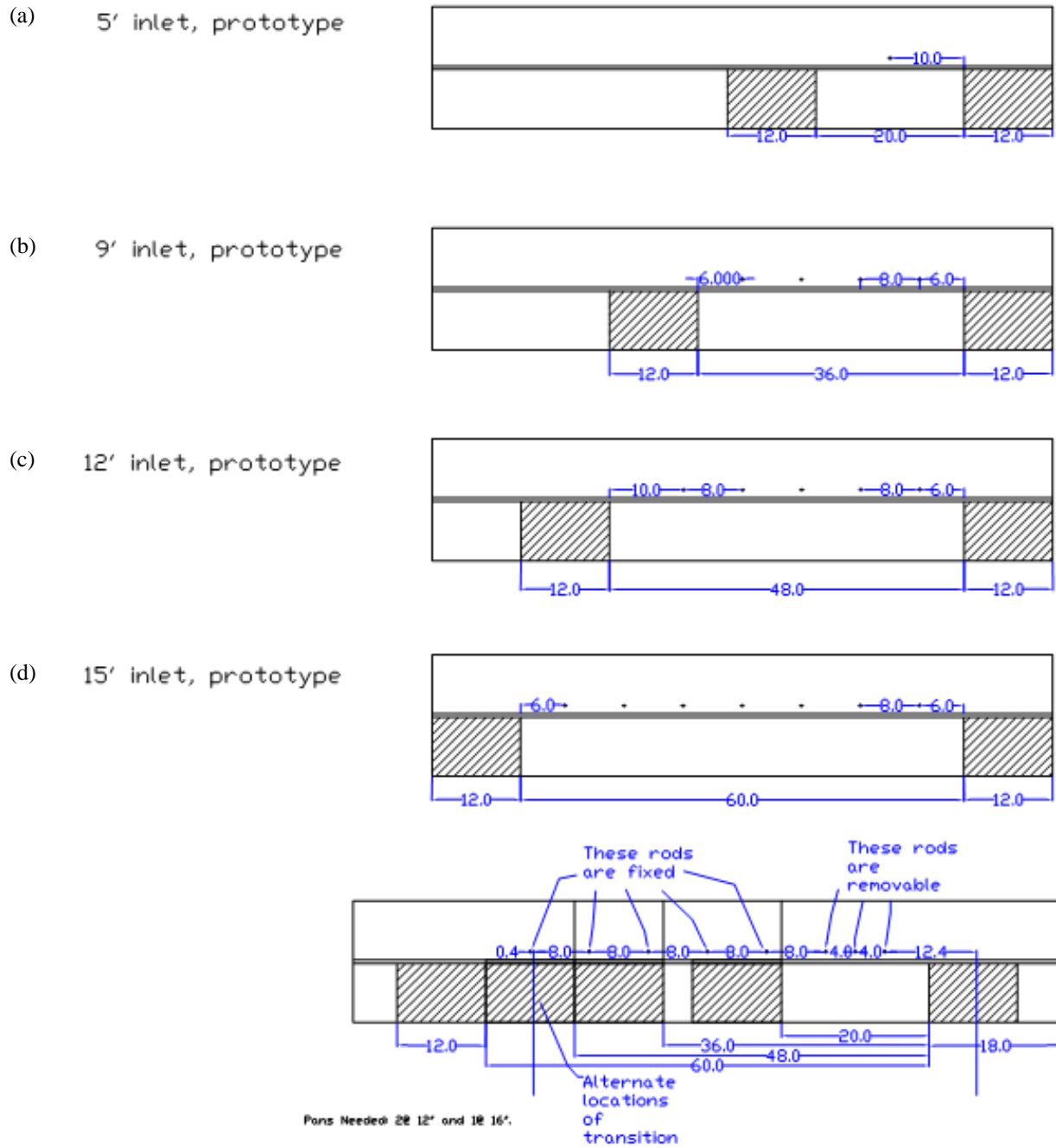
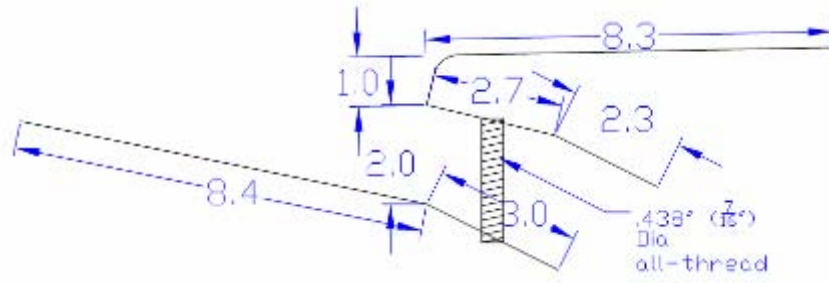
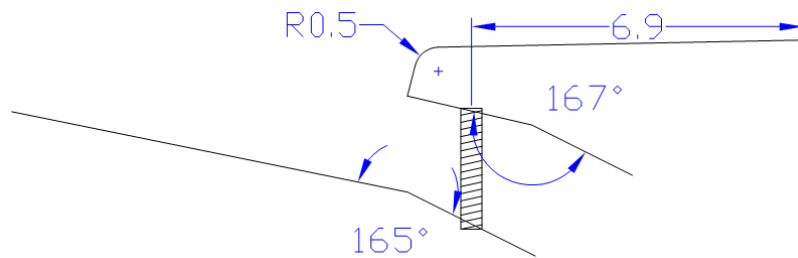

Figure D-3 Type R Inlet Specifications (plan view)



(a)



(b)

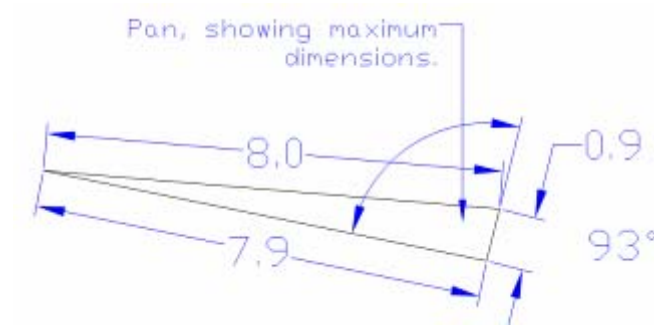

(c)

Figure D-4 Type R Inlet Specifications (profile view)

APPENDIX E: ADDITIONAL PARAMETERS

Additional Parameters Used in Regressions and UDFCD Methods

From the collected test data, several parameters such as top width (Tw), cross sectional flow area (A), wetted perimeter (Wp), critical depth ($depth$), Froude number (Fr), Manning's roughness coefficient (n), and flow velocity ($velocity$) were determined at the prototype scale and are given here for use by the UDFCD in data analysis. These are organized by the inlet type used and are given for all the on-grade tests.

Table E-1 Additional Parameters for the Type 13 Inlet Tests

Test	<i>depth</i> (ft)	<i>Tw</i> (ft)	<i>A</i> (ft²)	<i>Wp</i> (ft)	<i>Fr</i>	<i>n</i>	<i>velocity</i> (ft/s)
62	0.111	16	1.92	16.23	1.28	0.0124	2.517
63	0.167	18.15	5.18	18.65	1.67	0.0109	5.056
64	0.333	20.165	15.48	21.675	1.64	0.0126	8.167
91	0.111	12	1.42	12.22	1.07	0.0172	2.086
92	0.167	18.15	3.92	18.5	0.98	0.0207	2.585
93	0.333	20.165	14.2	21.525	1.41	0.0170	6.696
94	0.111	12	1.42	12.22	1.35	0.0136	2.635
95	0.167	18.15	3.92	18.5	1.15	0.0177	3.022
96	0.111	12	1.42	12.22	1.24	0.0148	2.415
97	0.167	18.15	3.92	18.5	1.16	0.0175	3.062
98	0.167	18.15	3.92	18.5	1.01	0.0201	2.664
99	0.333	20.165	14.2	21.525	1.38	0.0174	6.565
100	0.167	18.15	3.92	18.5	1.09	0.0187	2.863
101	0.333	20.165	14.2	21.525	1.39	0.0172	6.641
102	0.167	18.15	3.92	18.5	1.09	0.0187	2.863
103	0.333	20.165	14.2	21.525	1.39	0.0172	6.641
146	0.111	18.15	2.14	18.39	3.81	0.0071	7.430
147	0.167	18.15	5.18	18.65	2.14	0.0145	6.500
148	0.333	20.165	15.48	21.675	2.17	0.0164	10.765
161	0.111	16	1.79	16.22	2.29	0.0124	4.354
162	0.167	18.15	3.92	18.5	2.40	0.0132	6.323
163	0.333	20.165	14.2	21.525	2.31	0.0162	10.977
164	0.111	16	1.79	16.22	2.16	0.0132	4.093
165	0.167	18.15	3.92	18.5	2.32	0.0136	6.124
166	0.111	16	1.79	16.22	2.11	0.0134	4.006
167	0.167	18.15	3.92	18.5	2.32	0.0136	6.124
168	0.167	18.15	3.92	18.5	2.25	0.0140	5.925
169	0.333	20.165	14.2	21.525	2.28	0.0163	10.868
170	0.167	18.15	3.92	18.5	2.16	0.0146	5.686
171	0.333	20.165	14.2	21.525	2.43	0.0153	11.559
172	0.167	18.15	3.92	18.5	2.34	0.0135	6.164
173	0.333	20.165	14.2	21.525	2.31	0.0162	10.977
227	0.111	18.15	2.14	18.39	3.10	0.0119	6.046
228	0.167	18.15	5.18	18.65	2.40	0.0177	7.282
229	0.333	20.165	15.48	21.675	1.85	0.0262	9.214
242	0.111	15.5	1.79	16.72	2.62	0.0139	5.051
243	0.167	18.15	3.92	18.5	2.64	0.0159	6.959
244	0.333	20.165	14.2	21.525	1.92	0.0259	9.133
245	0.111	15.5	1.79	16.72	2.48	0.0147	4.790

Test	depth (ft)	<i>T_w</i> (ft)	<i>A</i> (ft²)	<i>W_p</i> (ft)	<i>Fr</i>	<i>n</i>	velocity (ft/s)
246	0.167	18.15	3.92	18.5	2.56	0.0164	6.760
247	0.111	15.5	1.79	16.72	2.44	0.0150	4.703
248	0.167	18.15	3.92	18.5	2.62	0.0160	6.919
249	0.167	18.15	3.92	18.5	2.56	0.0164	6.760
250	0.333	20.165	14.2	21.525	1.76	0.0282	8.398
251	0.167	18.15	3.92	18.5	2.11	0.0199	5.567
252	0.333	20.165	14.2	21.525	1.74	0.0286	8.288
253	0.167	18.15	3.92	18.5	2.37	0.0178	6.243
254	0.333	20.165	14.2	21.525	1.68	0.0296	7.981
59	0.111	16	1.92	16.23	1.24	0.0128	2.436
60	0.167	18.15	5.18	18.65	1.44	0.0126	4.363
61	0.333	20.165	15.48	21.675	1.66	0.0125	8.257
104	0.111	12	1.42	12.22	1.18	0.0156	2.305
105	0.167	18.15	3.92	18.5	1.09	0.0187	2.863
106	0.333	20.165	14.2	21.525	1.45	0.0165	6.916
149	0.111	18.15	2.14	18.39	3.44	0.0079	6.701
150	0.167	18.15	5.18	18.65	2.14	0.0145	6.500
151	0.333	20.165	15.48	21.675	2.29	0.0155	11.409
158	0.111	16	1.79	16.22	2.39	0.0119	4.528
159	0.167	18.15	3.92	18.5	2.26	0.0139	5.965
160	0.333	20.165	14.2	21.525	2.39	0.0156	11.362
230	0.111	18.15	2.14	18.39	3.18	0.0116	6.191
231	0.167	18.15	5.18	18.65	2.33	0.0182	7.072
232	0.333	20.165	15.48	21.675	1.80	0.0270	8.962
239	0.111	15.5	1.79	16.72	2.39	0.0153	4.615
240	0.167	18.15	3.92	18.5	2.52	0.0167	6.641
241	0.333	20.165	14.2	21.525	1.89	0.0263	9.002
56	0.111	16	1.92	16.23	1.16	0.0137	2.273
57	0.167	18.15	5.18	18.65	1.31	0.0138	3.972
58	0.333	20.165	15.48	21.675	1.64	0.0126	8.177
107	0.111	12	1.42	12.22	1.29	0.0142	2.525
108	0.167	18.15	3.92	18.5	1.30	0.0157	3.420
109	0.333	20.165	14.2	21.525	1.60	0.0150	7.629
152	0.111	18.15	2.14	18.39	3.14	0.0086	6.119
153	0.167	18.15	5.18	18.65	1.98	0.0157	5.988
154	0.333	20.165	15.48	21.675	2.31	0.0154	11.480
155	0.111	16	1.79	16.22	2.29	0.0124	4.354
156	0.167	18.15	3.92	18.5	2.14	0.0147	5.647
157	0.333	20.165	14.2	21.525	2.41	0.0154	11.493
233	0.111	18.15	2.14	18.39	3.03	0.0122	5.900
234	0.167	18.15	5.18	18.65	2.43	0.0175	7.373
235	0.333	20.165	15.48	21.675	1.91	0.0255	9.486
236	0.111	15.5	1.79	16.72	2.44	0.0150	4.703
237	0.167	18.15	3.92	18.5	2.49	0.0169	6.561
238	0.333	20.165	14.2	21.525	1.90	0.0261	9.056
AT287	0.111	18.15	2.14	18.39	3.48	0.0106	6.774

Test	<i>depth</i> (ft)	<i>T_w</i> (ft)	<i>A</i> (ft²)	<i>W_p</i> (ft)	<i>Fr</i>	<i>n</i>	<i>velocity</i> (ft/s)
AT288	0.167	18.15	5.18	18.65	2.42	0.0175	7.343
AT291	0.111	18.15	2.14	18.39	3.51	0.0105	6.847
AT293	0.167	18.15	5.18	18.65	2.47	0.0172	7.493
AT303	0.111	18.15	2.14	18.39	3.44	0.0108	6.701
AT306	0.167	18.15	5.18	18.65	2.39	0.0178	7.252
AT295	0.111	18.15	2.14	18.39	3.48	0.0106	6.774
AT297	0.167	18.15	5.18	18.65	2.44	0.0174	7.403
AT300	0.111	18.15	2.14	18.39	3.51	0.0105	6.847
AT301	0.167	18.15	5.18	18.65	2.42	0.0175	7.343

Table E-2 Additional Parameters for the Type 16 Inlet Tests

Test	depth (ft)	<i>T_w</i> (ft)	<i>A</i> (ft²)	<i>W_p</i> (ft)	<i>Fr</i>	<i>n</i>	velocity (ft/s)
65	0.111	17	1.88	17.22	1.45	0.0108	2.736
66	0.167	18.15	5.18	18.65	1.36	0.0133	4.123
67	0.333	20.165	15.48	21.675	1.65	0.0126	8.197
80	0.111	12	1.42	12.22	1.35	0.0136	2.635
81	0.167	18.15	3.92	18.5	1.12	0.0182	2.943
82	0.333	20.165	14.2	21.525	1.41	0.0170	6.729
83	0.167	18.15	3.92	18.5	1.10	0.0184	2.903
84	0.333	20.165	14.2	21.525	1.39	0.0172	6.641
85	0.167	18.15	3.92	18.5	1.09	0.0187	2.863
86	0.333	20.165	14.2	21.525	1.41	0.0170	6.718
87	0.111	12	1.42	12.22	1.24	0.0148	2.415
88	0.167	18.15	3.92	18.5	1.06	0.0192	2.784
89	0.111	12	1.42	12.22	1.18	0.0156	2.305
90	0.167	18.15	3.92	18.5	1.06	0.0192	2.784
143	0.111	18.15	2.14	18.39	3.66	0.0074	7.138
144	0.167	18.15	5.18	18.65	2.16	0.0143	6.560
145	0.333	20.165	15.48	21.675	2.29	0.0155	11.409
174	0.111	14	1.6	14.22	2.59	0.0110	4.969
175	0.167	18.15	3.92	18.5	2.16	0.0146	5.686
176	0.333	20.165	14.2	21.525	2.41	0.0155	11.471
177	0.167	18.15	3.92	18.5	2.22	0.0142	5.846
178	0.333	20.165	14.2	21.525	2.41	0.0155	11.471
179	0.167	18.15	3.92	18.5	2.16	0.0146	5.686
180	0.333	20.165	14.2	21.525	2.43	0.0153	11.559
181	0.111	14	1.6	14.22	2.64	0.0108	5.066
182	0.167	18.15	3.92	18.5	2.32	0.0136	6.124
183	0.111	14	1.6	14.22	2.74	0.0104	5.261
184	0.167	18.15	3.92	18.5	2.41	0.0131	6.362
224	0.111	18.15	2.14	18.39	3.14	0.0118	6.119
225	0.167	18.15	5.18	18.65	2.41	0.0176	7.313
226	0.333	20.165	15.48	21.675	1.83	0.0265	9.123
255	0.167	18.15	3.92	18.5	2.73	0.0149	7.198
256	0.333	20.165	14.2	21.525	1.82	0.0264	8.672
257	0.167	18.15	3.92	18.5	2.94	0.0139	7.754
258	0.333	20.165	14.2	21.525	1.97	0.0244	9.397
259	0.111	14.6	1.66	14.82	2.55	0.0144	4.883
260	0.167	18.15	3.92	18.5	2.56	0.0159	6.760
261	0.111	14.6	1.66	14.82	2.55	0.0144	4.883
262	0.167	18.15	3.92	18.5	2.59	0.0157	6.840
263	0.111	14.6	1.66	14.82	2.36	0.0161	4.507
264	0.167	18.15	3.92	18.5	2.71	0.0155	7.158
265	0.333	20.165	14.2	21.525	1.91	0.0260	9.111
68	0.111	17	1.88	17.22	1.49	0.0105	2.819
69	0.167	18.15	5.18	18.65	1.48	0.0123	4.484

Test	depth (ft)	<i>T_w</i> (ft)	<i>A</i> (ft²)	<i>W_p</i> (ft)	<i>Fr</i>	<i>n</i>	velocity (ft/s)
70	0.333	20.165	15.48	21.675	1.62	0.0128	8.056
77	0.111	12	1.42	12.22	1.18	0.0156	2.305
78	0.167	18.15	3.92	18.5	1.09	0.0187	2.863
79	0.333	20.165	14.2	21.525	1.40	0.0172	6.652
140	0.111	18.15	2.14	18.39	3.51	0.0077	6.847
141	0.167	18.15	5.18	18.65	2.08	0.0149	6.319
142	0.333	20.165	15.48	21.675	2.30	0.0154	11.439
185	0.111	14	1.6	14.22	2.59	0.0110	4.969
186	0.167	18.15	3.92	18.5	2.29	0.0138	6.044
187	0.333	20.165	14.2	21.525	2.42	0.0154	11.526
221	0.111	18.15	2.14	18.39	3.18	0.0116	6.191
222	0.167	18.15	5.18	18.65	2.33	0.0182	7.072
223	0.333	20.165	15.48	21.675	1.88	0.0258	9.365
266	0.111	14.6	1.66	14.82	2.75	0.0138	5.259
267	0.167	18.15	3.92	18.5	2.56	0.0164	6.760
268	0.333	20.165	14.2	21.525	1.94	0.0257	9.221
71	0.111	17	1.88	17.22	1.27	0.0123	2.405
72	0.167	18.15	5.18	18.65	1.51	0.0120	4.574
73	0.333	20.165	15.48	21.675	1.63	0.0127	8.126
74	0.111	12	1.42	12.22	1.24	0.0148	2.415
75	0.167	18.15	3.92	18.5	1.09	0.0187	2.863
76	0.333	20.165	14.2	21.525	1.39	0.0173	6.608
137	0.111	18.15	2.14	18.39	3.18	0.0085	6.191
138	0.167	18.15	5.18	18.65	2.54	0.0122	7.704
139	0.333	20.165	15.48	21.675	2.02	0.0176	10.019
188	0.111	14	1.6	14.22	2.74	0.0104	5.261
189	0.167	18.15	3.92	18.5	2.19	0.0144	5.766
190	0.333	20.165	14.2	21.525	2.41	0.0155	11.471
218	0.111	18.15	2.14	18.39	3.03	0.0122	5.900
219	0.167	18.15	5.18	18.65	2.43	0.0175	7.373
220	0.333	20.165	15.48	21.675	1.89	0.0257	9.415
269	0.111	14.6	1.66	14.82	2.65	0.0143	5.071
270	0.167	18.15	3.92	18.5	2.49	0.0169	6.561
271	0.333	20.165	14.2	21.525	1.89	0.0263	9.002
AT296	0.111	18.15	2.14	18.39	3.44	0.0108	6.701
AT298	0.167	18.15	5.18	18.65	2.42	0.0175	7.343
AT299	0.111	18.15	2.14	18.39	3.51	0.0105	6.847
AT302	0.167	18.15	5.18	18.65	2.41	0.0176	7.313
AT289	0.111	18.15	2.14	18.39	3.40	0.0109	6.629
AT290	0.167	18.15	5.18	18.65	2.42	0.0175	7.343
AT292	0.111	18.15	2.14	18.39	3.51	0.0105	6.847
AT294	0.167	18.15	5.18	18.65	2.45	0.0173	7.433
AT304	0.111	18.15	2.14	18.39	3.44	0.0108	6.701
AT305	0.167	18.15	5.18	18.65	2.40	0.0177	7.282
AT303	0.111	18.15	2.14	18.39	3.44	0.0108	6.701
AT306	0.167	18.15	5.18	18.65	2.39	0.0178	7.252

Test	<i>depth</i> (ft)	<i>T_w</i> (ft)	<i>A</i> (ft²)	<i>W_p</i> (ft)	<i>Fr</i>	<i>n</i>	<i>velocity</i> (ft/s)
AT295	0.111	18.15	2.14	18.39	3.48	0.0106	6.774
AT297	0.167	18.15	5.18	18.65	2.44	0.0174	7.403
AT300	0.111	18.15	2.14	18.39	3.51	0.0105	6.847
AT301	0.167	18.15	5.18	18.65	2.42	0.0175	7.343

Table E-3 Additional Parameters for the Type R Inlet Tests

Test	depth (ft)	<i>T_w</i> (ft)	<i>A</i> (ft²)	<i>W_p</i> (ft)	<i>Fr</i>	<i>n</i>	velocity (ft/s)
44	0.111	16.000	1.92	1.809	1.16	0.0137	2.273
45	0.167	17.500	4.96	4.793	1.35	0.0139	4.086
46	0.333	20.165	15.48	15.147	1.67	0.0124	8.318
47	0.111	16.000	1.92	1.809	1.03	0.0153	2.030
48	0.167	18.150	5.18	5.013	1.39	0.0131	4.213
49	0.333	20.165	15.48	15.147	1.64	0.0127	8.157
50	0.111	16.000	1.92	1.809	1.12	0.0142	2.192
51	0.167	18.150	5.18	5.013	1.37	0.0132	4.153
52	0.333	20.165	15.48	15.147	1.66	0.0125	8.257
53	0.111	16.000	1.92	1.809	1.16	0.0137	2.273
54	0.167	18.150	5.18	5.013	1.42	0.0128	4.303
55	0.333	20.165	15.48	15.147	1.63	0.0127	8.106
122	0.111	14.000	1.6	1.489	1.07	0.0172	2.046
123	0.167	18.150	3.92	3.753	1.06	0.0192	2.784
124	0.333	20.165	14.2	13.867	1.39	0.0172	6.641
119	0.111	14.000	1.6	1.489	0.91	0.0200	1.754
120	0.167	18.150	3.92	3.753	1.06	0.0192	2.784
121	0.333	20.165	14.2	13.867	1.39	0.0173	6.608
116	0.111	14.000	1.6	1.489	1.02	0.0180	1.949
117	0.167	18.150	3.92	3.753	1.09	0.0187	2.863
118	0.333	20.165	14.2	13.867	1.39	0.0173	6.608
110	0.111	14.000	1.6	1.489	0.96	0.0190	1.851
111	0.167	18.150	3.92	3.753	1.07	0.0190	2.823
112	0.333	20.165	14.2	13.867	1.38	0.0174	6.565
113	0.167	18.150	3.92	3.753	1.09	0.0187	2.863
114	0.333	20.165	14.2	13.867	1.39	0.0172	6.641
115	0.167	18.150	3.92	3.753	1.07	0.0190	2.823
125	0.111	18.150	2.14	2.029	3.55	0.0076	6.920
126	0.167	18.150	5.18	5.013	2.13	0.0145	6.470
127	0.333	20.165	15.48	15.147	2.32	0.0153	11.530
128	0.111	18.150	2.14	2.029	3.21	0.0084	6.264
129	0.167	18.150	5.18	5.013	2.09	0.0148	6.350
130	0.333	20.165	15.48	15.147	2.29	0.0155	11.379
131	0.111	18.150	2.14	2.029	3.21	0.0084	6.264
132	0.167	18.150	5.18	5.013	1.89	0.0164	5.718
133	0.333	20.165	15.48	15.147	2.25	0.0158	11.177
134	0.111	18.150	2.14	2.029	3.14	0.0086	6.119
135	0.167	18.150	5.18	5.013	1.81	0.0172	5.477
136	0.333	20.165	15.48	15.147	2.33	0.0153	11.560
203	0.111	14.000	1.6	1.489	2.29	0.0124	4.384
204	0.167	18.150	3.92	3.753	2.08	0.0152	5.488
205	0.333	20.165	14.2	13.867	2.47	0.0151	11.746
200	0.111	14.000	1.6	1.489	2.44	0.0117	4.676
201	0.167	18.150	3.92	3.753	2.10	0.0150	5.527

Test	depth (ft)	<i>T_w</i> (ft)	<i>A</i> (ft²)	<i>W_p</i> (ft)	<i>Fr</i>	<i>n</i>	velocity (ft/s)
202	0.333	20.165	14.2	13.867	2.47	0.0151	11.746
197	0.111	11.000	1.34	1.229	2.35	0.0122	4.653
198	0.167	18.150	3.92	3.753	2.11	0.0149	5.567
199	0.333	20.165	14.2	13.867	2.46	0.0152	11.691
191	0.111	17.800	1.95	1.839	2.00	0.0141	3.757
192	0.167	18.150	3.92	3.753	2.22	0.0142	5.846
193	0.333	20.165	14.2	13.867	2.46	0.0152	11.691
194	0.333	20.165	14.2	13.867	2.47	0.0151	11.746
195	0.167	18.150	3.92	3.753	2.20	0.0143	5.806
196	0.167	18.150	3.92	3.753	2.23	0.0141	5.885
206	0.111	18.150	2.14	2.029	3.14	0.0118	6.119
207	0.167	18.150	5.18	5.013	2.44	0.0174	7.403
208	0.333	20.165	15.48	15.147	1.86	0.0261	9.264
209	0.111	18.150	2.14	2.029	3.03	0.0122	5.900
210	0.167	18.150	5.18	5.013	2.44	0.0174	7.403
211	0.333	20.165	15.48	15.147	1.99	0.0245	9.878
212	0.111	18.150	2.14	2.029	3.33	0.0111	6.483
213	0.167	18.150	5.18	5.013	2.43	0.0175	7.373
214	0.333	20.165	15.48	15.147	1.84	0.0264	9.143
215	0.111	18.150	2.14	2.029	3.29	0.0112	6.410
216	0.167	18.150	5.18	5.013	2.43	0.0175	7.373
217	0.333	20.165	15.48	15.147	1.82	0.0267	9.063
284	0.111	16.000	1.79	1.679	2.29	0.0165	4.354
285	0.167	18.150	3.92	3.753	2.26	0.0186	5.965
286	0.333	20.165	14.2	13.867	1.82	0.0273	8.672
281	0.111	16.000	1.79	1.679	2.57	0.0147	4.877
282	0.167	18.150	3.92	3.753	2.44	0.0172	6.442
283	0.333	20.165	14.2	13.867	1.68	0.0295	8.014
278	0.111	16.000	1.79	1.679	2.34	0.0162	4.441
279	0.167	18.150	3.92	3.753	2.50	0.0168	6.601
280	0.333	20.165	14.2	13.867	1.74	0.0286	8.288
272	0.111	16.000	1.79	1.679	2.39	0.0159	4.528
273	0.167	18.150	3.92	3.753	2.58	0.0163	6.800
274	0.333	20.165	14.2	13.867	1.76	0.0283	8.376
275	0.167	18.15	3.92	3.753	2.65	0.0159	6.999
276	0.333	20.165	14.2	13.867	1.90	0.0261	9.056
277	0.167	18.15	3.92	3.753	2.58	0.0163	6.800
AT302	0.167	18.15	5.18	18.65	2.41	0.0176	7.313
AT289	0.111	18.15	2.14	18.39	3.40	0.0109	6.629
AT290	0.167	18.15	5.18	18.65	2.42	0.0175	7.343
AT292	0.111	18.15	2.14	18.39	3.51	0.0105	6.847
AT294	0.167	18.15	5.18	18.65	2.45	0.0173	7.433
AT304	0.111	18.15	2.14	18.39	3.44	0.0108	6.701
AT305	0.167	18.15	5.18	18.65	2.40	0.0177	7.282
AT303	0.111	18.15	2.14	18.39	3.44	0.0108	6.701
AT306	0.167	18.15	5.18	18.65	2.39	0.0178	7.252

Test	<i>depth</i> (ft)	<i>T_w</i> (ft)	<i>A</i> (ft²)	<i>W_p</i> (ft)	<i>Fr</i>	<i>n</i>	<i>velocity</i> (ft/s)
AT295	0.111	18.15	2.14	18.39	3.48	0.0106	6.774
AT297	0.167	18.15	5.18	18.65	2.44	0.0174	7.403
AT300	0.111	18.15	2.14	18.39	3.51	0.0105	6.847
AT301	0.167	18.15	5.18	18.65	2.42	0.0175	7.343

APPENDIX F: CALCULATED EFFICIENCY

Efficiency Determined From Regression Equations and Improved UDFCD Methods

Table F-1 Type 13 Combination Inlet Calculated Efficiency

Test	Depth (ft)	Grates	Flow (cfs)	Efficiency		
				Observed	Regression	UDFCD New
62	0.333	1	4.83	0.61	0.51	0.50
63	0.501	1	26.19	0.24	0.21	0.30
64	0.999	1	126.42	0.10	0.11	0.17
91	0.333	1	2.96	0.63	0.58	0.64
92	0.501	1	10.13	0.38	0.40	0.48
93	0.999	1	95.09	0.13	0.13	0.22
146	0.333	1	15.90	0.27	0.27	0.20
147	0.501	1	33.67	0.20	0.18	0.24
148	0.999	1	166.64	0.09	0.09	0.08
161	0.333	1	7.79	0.50	0.39	0.36
162	0.501	1	24.78	0.24	0.23	0.23
163	0.999	1	155.88	0.09	0.10	0.07
227	0.333	1	12.94	0.25	0.30	0.26
228	0.501	1	37.72	0.13	0.17	0.21
229	0.999	1	142.63	0.08	0.10	0.13
242	0.333	1	9.04	0.43	0.34	0.32
243	0.501	1	27.28	0.21	0.22	0.21
244	0.999	1	129.69	0.09	0.11	0.13
59	0.333	2	4.68	0.73	0.72	0.73
60	0.501	2	22.60	0.36	0.32	0.49
61	0.999	2	127.82	0.16	0.15	0.25
104	0.333	2	3.27	0.62	0.75	0.84
105	0.501	2	11.22	0.44	0.53	0.72
106	0.999	2	98.20	0.20	0.18	0.36
149	0.333	2	14.34	0.34	0.40	0.33
150	0.501	2	33.67	0.24	0.25	0.34
151	0.999	2	176.61	0.13	0.12	0.12
158	0.333	2	8.11	0.63	0.53	0.56
159	0.501	2	23.38	0.35	0.34	0.42
160	0.999	2	161.34	0.14	0.13	0.14
230	0.333	2	13.25	0.38	0.42	0.36
231	0.501	2	36.63	0.21	0.24	0.31
232	0.999	2	138.73	0.13	0.14	0.22
239	0.333	2	8.26	0.66	0.51	0.55
240	0.501	2	26.03	0.33	0.32	0.38
241	0.999	2	127.82	0.16	0.15	0.25
56	0.333	3	4.36	0.82	0.91	0.86
57	0.501	3	20.58	0.43	0.41	0.67
58	0.999	3	126.57	0.23	0.18	0.35
107	0.333	3	3.59	0.74	0.87	0.91
108	0.501	3	13.41	0.50	0.57	0.81
109	0.999	3	108.34	0.43	0.21	0.46

Test	Depth (ft)	Grates	Flow (cfs)	Efficiency		
				Observed	Regression	UDFCD New
152	0.333	3	13.09	0.43	0.51	0.48
153	0.501	3	31.02	0.29	0.32	0.49
154	0.999	3	177.70	0.18	0.15	0.17
155	0.333	3	7.79	0.74	0.65	0.73
156	0.501	3	22.13	0.44	0.42	0.61
157	0.999	3	163.21	0.19	0.16	0.24
233	0.333	3	12.63	0.41	0.52	0.50
234	0.501	3	38.19	0.25	0.28	0.39
235	0.999	3	146.84	0.18	0.17	0.27
236	0.333	3	8.42	0.74	0.61	0.70
237	0.501	3	25.72	0.42	0.38	0.53
238	0.999	3	128.60	0.20	0.19	0.37

Table F-2 Type 16 Combination Inlet Calculated Efficiency

Test	Depth (ft)	Grates	Flow (cfs)	Efficiency		
				Observed	Regression	UDFCD New
65	0.333	1	5.14	0.61	0.51	0.56
66	0.501	1	21.36	0.28	0.28	0.39
67	0.999	1	126.89	0.14	0.16	0.25
80	0.333	1	3.74	0.50	0.49	0.63
81	0.501	1	11.54	0.35	0.38	0.40
82	0.999	1	95.55	0.17	0.18	0.20
143	0.333	1	15.28	0.29	0.36	0.40
144	0.501	1	33.98	0.21	0.24	0.27
145	0.999	1	176.61	0.12	0.14	0.07
174	0.333	1	7.95	0.55	0.41	0.46
175	0.501	1	22.29	0.31	0.31	0.29
176	0.999	1	162.89	0.13	0.15	0.06
224	0.333	1	13.09	0.33	0.38	0.33
225	0.501	1	37.88	0.20	0.23	0.18
226	0.999	1	141.23	0.14	0.15	-0.08
263	0.333	1	7.48	0.65	0.43	0.37
264	0.501	1	28.06	0.32	0.29	0.21
265	0.999	1	129.38	0.16	0.16	-0.05
68	0.333	2	5.30	0.71	0.65	0.78
69	0.501	2	23.23	0.34	0.34	0.58
70	0.999	2	124.70	0.21	0.20	0.34
77	0.333	2	3.27	0.57	0.66	0.84
78	0.501	2	11.22	0.40	0.49	0.73
79	0.999	2	94.46	0.20	0.23	0.37
140	0.333	2	14.65	0.36	0.46	0.59
141	0.501	2	32.73	0.27	0.31	0.38
142	0.999	2	177.08	0.19	0.18	0.13
185	0.333	2	7.95	0.65	0.52	0.69
186	0.501	2	23.69	0.37	0.38	0.47
187	0.999	2	163.67	0.20	0.19	0.15
221	0.333	2	13.25	0.38	0.48	0.48
222	0.501	2	36.63	0.25	0.29	0.26
223	0.999	2	144.97	0.20	0.19	-0.04
266	0.333	2	8.73	0.68	0.52	0.57
267	0.501	2	26.50	0.38	0.37	0.35
268	0.999	2	130.94	0.25	0.20	0.01
71	0.333	3	4.52	0.83	0.78	0.89
72	0.501	3	23.69	0.40	0.39	0.73
73	0.999	3	125.80	0.27	0.23	0.45
74	0.333	3	3.43	0.64	0.74	0.92
75	0.501	3	11.22	0.47	0.56	0.86
76	0.999	3	93.84	0.28	0.26	0.53
137	0.333	3	13.25	0.45	0.55	0.74
138	0.501	3	39.91	0.31	0.33	0.49

Test	Depth (ft)	Grates	Flow (cfs)	Efficiency		
				Observed	Regression	UDFCD New
139	0.999	3	155.10	0.24	0.21	0.19
188	0.333	3	8.42	0.72	0.59	0.83
189	0.501	3	22.60	0.46	0.45	0.64
190	0.999	3	162.89	0.26	0.22	0.25
218	0.333	3	12.63	0.42	0.56	0.61
219	0.501	3	38.19	0.29	0.33	0.35
220	0.999	3	145.75	0.25	0.22	0.01
269	0.333	3	8.42	0.74	0.60	0.72
270	0.501	3	25.72	0.44	0.43	0.50
271	0.999	3	127.82	0.29	0.24	0.08

Table F-3: Type R Inlet Calculated Efficiency

Test	Depth (ft)	Length (ft)	Flow (cfs)	Efficiency		
				Observed	Regression	UDFCD New
44	0.333	15	4.36	0.89	0.95	0.95
45	0.501	15	20.26	0.51	0.51	0.55
46	0.999	15	128.76	0.24	0.22	0.22
47	0.333	12	3.90	0.84	0.84	0.87
48	0.501	12	21.82	0.38	0.41	0.43
49	0.999	12	126.26	0.20	0.18	0.18
50	0.333	9	4.21	0.70	0.62	0.70
51	0.501	9	21.51	0.35	0.32	0.34
52	0.999	9	127.82	0.15	0.14	0.14
53	0.333	5	4.36	0.50	0.36	0.43
54	0.501	5	22.29	0.24	0.19	0.19
55	0.999	5	125.48	0.08	0.08	0.08
122	0.333	15	3.27	0.90	1.00	1.00
123	0.501	15	10.91	0.60	0.78	0.71
124	0.999	15	94.31	0.31	0.30	0.27
119	0.333	12	2.81	0.83	1.00	0.96
120	0.501	12	10.91	0.53	0.64	0.60
121	0.999	12	93.84	0.25	0.25	0.22
116	0.333	9	3.12	0.65	0.79	0.81
117	0.501	9	11.22	0.47	0.49	0.46
118	0.999	9	93.84	0.19	0.19	0.17
110	0.333	5	2.96	0.58	0.49	0.53
111	0.501	5	11.07	0.39	0.29	0.28
112	0.999	5	93.22	0.12	0.11	0.09
125	0.333	15	14.81	0.44	0.45	0.58
126	0.501	15	33.51	0.30	0.38	0.40
127	0.999	15	178.48	0.18	0.18	0.18
128	0.333	12	13.41	0.43	0.40	0.50
129	0.501	12	32.89	0.27	0.31	0.33
130	0.999	12	176.14	0.15	0.15	0.14
131	0.333	9	13.41	0.36	0.31	0.39
132	0.501	9	29.62	0.23	0.26	0.27
133	0.999	9	173.03	0.11	0.11	0.11
134	0.333	5	13.09	0.25	0.19	0.23
135	0.501	5	28.37	0.16	0.16	0.16
136	0.999	5	178.95	0.08	0.07	0.06
203	0.333	15	7.01	0.84	0.72	0.82
204	0.501	15	21.51	0.49	0.50	0.50
205	0.999	15	166.79	0.19	0.20	0.19
200	0.333	12	7.48	0.71	0.57	0.68
201	0.501	12	21.67	0.42	0.40	0.42
202	0.999	12	166.79	0.15	0.17	0.15
197	0.333	9	6.24	0.65	0.44	0.61
198	0.501	9	21.82	0.34	0.31	0.32

Test	Depth (ft)	Length (ft)	Flow (cfs)	Efficiency		
				Observed	Regression	UDFCD New
199	0.999	9	166.01	0.12	0.13	0.12
191	0.333	5	7.33	0.38	0.30	0.31
192	0.501	5	22.91	0.18	0.18	0.18
193	0.999	5	166.01	0.07	0.08	0.07
206	0.333	15	13.09	0.44	0.49	0.59
207	0.501	15	38.35	0.27	0.35	0.37
208	0.999	15	143.41	0.19	0.20	0.19
209	0.333	12	12.63	0.42	0.41	0.50
210	0.501	12	38.35	0.24	0.28	0.30
211	0.999	12	152.92	0.15	0.16	0.15
212	0.333	9	13.87	0.35	0.30	0.37
213	0.501	9	38.19	0.19	0.22	0.23
214	0.999	9	141.54	0.12	0.13	0.12
215	0.333	5	13.72	0.22	0.18	0.22
216	0.501	5	38.19	0.11	0.13	0.13
217	0.999	5	140.29	0.07	0.08	0.07
284	0.333	15	7.79	0.80	0.72	0.75
285	0.501	15	23.38	0.46	0.47	0.47
286	0.999	15	123.15	0.21	0.25	0.21
281	0.333	12	8.73	0.70	0.55	0.61
282	0.501	12	25.25	0.38	0.37	0.37
283	0.999	12	113.79	0.18	0.22	0.18
278	0.333	9	7.95	0.63	0.45	0.50
279	0.501	9	25.88	0.30	0.28	0.28
280	0.999	9	117.69	0.13	0.16	0.13
272	0.333	5	8.11	0.35	0.27	0.29
273	0.501	5	26.66	0.17	0.16	0.16
274	0.999	5	118.94	0.08	0.10	0.07