

Martin O'Malley, *Governor*
Anthony G. Brown, *Lt. Governor*



Beverley K. Swaim-Staley, *Secretary*
Melinda B. Peters, *Administrator*

MARYLAND DEPARTMENT OF TRANSPORTATION

STATE HIGHWAY ADMINISTRATION

RESEARCH REPORT

LONG-TERM BED DEGRADATION IN MARYLAND STREAMS (PHASE 2): BLUE RIDGE AND WESTERN PIEDMONT PROVINCES

ARTHUR C. PAROLA, JR., PHD
RIVERINE SYSTEMS, LLC

WARD L. OBERHOLTZER, PE
LANDSTUDIES, INC.

AND

DAVID W. BLACK, PE
RK&K

Project Number SP109B4K
FINAL REPORT

March 2012

The contents of this report reflect the views of the author who is responsible for the facts and the accuracy of the data presented herein. The contents do not necessarily reflect the official views or policies of the Maryland State Highway Administration. This report does not constitute a standard, specification, or regulation.

Technical Report Documentation Page

1. Report No. MD-12-SP109B4K	2. Government Accession No.	3. Recipient's Catalog No.	
4. Title and Subtitle Long-Term Bed Degradation in Maryland Streams (Phase 2): Blue Ridge and Western Piedmont Provinces	5. Report Date March 2012		6. Performing Organization Code
	8. Performing Organization Report No.		
7. Author/s Arthur C. Parola, Jr., PhD, Ward L. Oberholtzer, PE, and David Black, PE	10. Work Unit No. (TRAIS)		
9. Performing Organization Name and Address RK&K 81 Mosher Street Baltimore, MD 21217	11. Contract or Grant No. SP109B4K		
	13. Type of Report and Period Covered Final Report		
12. Sponsoring Organization Name and Address Maryland State Highway Administration Office of Policy & Research 707 North Calvert Street Baltimore MD 21202	14. Sponsoring Agency Code (7120) STMD - MDOT/SHA		
	15. Supplementary Notes		
16. Abstract <p>Estimation of potential long-term down-cutting of the stream bed is necessary for evaluation and design of bridges for scour and culverts for fish passage. The purpose of this study has been to improve predictions of this potential long-term bed degradation (LTBD) in Maryland streams through the measurement and analysis of stream bed and waterway structure survey data and bridge plans. Long-term bed degradation was defined as the vertical change in the channel profile other than that caused by local or contraction scour. A total of 30 sites—23 bridges, 2 culverts, 2 utility crossings, 2 embankment walls, and 1 concrete ford—in Frederick, Carroll, and Montgomery counties were selected for data collection. Drainage areas of these sites in the Blue Ridge and Piedmont physiographic provinces ranged from 1.7-25.9 mi². At each sampling site, the vertical drop at the outlet of the structure was measured with a pocket rod and a hand level. These rapid measurements were conducted where a step, a series of steps, a steep section, or a riprap-protected streambed was at the outlet of a culvert or a bridge with a paved or riprap-protected invert or downstream apron. Six factors that may influence a site's risk of LTBD in the three western Maryland provinces were also investigated. These include (1) the valley slope, (2) the effective floodplain width, (3) discharge, (4) downstream channel entrenchment, (5) bed material size, and (6) downstream grade controls. The possibility of developing regional relations between watershed area and LTBD was evaluated for each physiographic province, but the data was inconclusive. Three relations between LTBD and five of the risk factors were examined: LTBD and valley slope; LTBD and an index combining Factors 1-4; and LTBD and an index combining Factors 1-5. A comparison of the resulting equations revealed that valley slope was as good a predictor of the susceptibility of a site to LTBD as the two indices that required additional data and considered more parameters. The relation between valley slope and LTBD was recommended to estimate LTBD for streams with slopes of less than 0.027 ft/ft. The relation will not apply, however, to structures located in deep deposits of sediment created by backwater from dams or other structures or to structures located in streams with evidence of active channel degradation. The development of rate relationships for LTBD was also considered, but the number of available structure plans was insufficient to develop a rate relation. Future research on LTBD in Maryland should include the development of a method to include the effectiveness of downstream bed controls in limiting degradation, and the development of a rate relation should be explored further.</p>			
17. Key Words Long Term Bed Degradation, Channel Incision, Entrenchment, Bridge Scour, Culvert, Maryland Streams	18. Distribution Statement: No restrictions This document is available from the Research Division upon request.		
19. Security Classification (of this report) None	20. Security Classification (of this page) None	21. No. Of Pages 28	22. Price

CONTENTS

List of Figures and Tables.....	ii
Glossary and Abbreviations.....	iii
Executive Summary.....	v
1 Introduction.....	1
2 Study Area.....	2
3 Methods.....	2
3.1 Site Selection.....	2
3.2 Data Collection.....	4
3.3 Data Reduction and Analysis.....	12
4 Results.....	14
5 Application.....	23
6 Conclusions and Recommendations.....	25
References.....	28

FIGURES AND TABLES

Figures

Figure 3.1	Sample site locations. Bold lines represent physiographic province boundaries	7
Figure 3.2	Distribution of sampling sites according to watershed drainage area and physiographic province.	7
Figure 3.3	Typical bed profile of a culvert with downstream bed degradation and a scour pool.....	9
Figure 3.4	LTBD: uniform degradation and single step downstream.	9
Figure 3.5	LTBD: uniform degradation.....	10
Figure 3.6	LTBD with scour: single step downstream.	11
Figure 4.1	Variation of LTBD with drainage area for each physiographic province.	14
Figure 4.2	LTBD as a function of impervious area.	15
Figure 4.3	LTBD as a function of valley slope.....	16
Figure 4.4	Conservative upper limit of LTBD as a function of τ_o	18
Figure 4.5	LTBD as a function of the bed mobility index.....	18
Figure 4.6	Grade control features identified in Blue Ridge and western Piedmont streams.	20
Figure 4.7	Variation of LTBD with structure's age.....	21
Figure 4.8	Comparison of residual LTBD values and observed LTBD for the Piedmont data.	23
Figure 4.9	Comparison of predicted LTBD values and observed LTBD for the Blue Ridge data.	23

Photographs

Photo 4.1	LTBD measured at the culvert outlet of Site 45.....	16
Photo 4.2	LTBD measured downstream of bridge at Site 50.	17
Photo 4.3	Boulder armor at Site 29.	19
Photo 4.4	Bedrock exposed in streambed downstream of Site 49.....	20
Photo 4.5	Step in channel profile composed of weakly cemented gravel downstream of Site 36.....	22

Tables

Table 3.1	Long-Term Bed Degradation Estimates and Site Characteristics	5
Table 3.2	Factors That Influence LTBD	8

GLOSSARY AND ABBREVIATIONS

Variables

A_{ch}	Pre-degradation channel area..... (Eq. 6, 7)
BMI	Bed mobility index = τ_o/τ_c (Eq. 9)
D₅₀	Median size of the bed material (ft)..... (Eq. 10)
DA	Drainage area (mi ²)
LTBD	Long-term bed degradation (ft). The vertical change in the channel profile other than that caused by local or contraction scour..... (Eq. 3, 11, 12, 13, 14)
n_{ch}	Manning <i>n</i> estimated for the channel (Eq. 6)
n_{fp}	Composite Manning <i>n</i> estimated for the effective floodplain width (Eq. 4)
P_{ch}	Pre-degradation channel wetted perimeter (Eq. 6)
Q₁₀₀	The 100-year recurrence interval peak flow (cfs)..... (Eq. 5, 6)
Q_{ch}	Top-of-bank flow in the pre-degradation channel (cfs)..... (Eq. 5)
Q_{fp100}	100-year peak flow on the floodplain..... (Eq. 4, 5)
S_{ch}	Channel slope (ft/ft)
S_g	Specific weight of the sediment..... (Eq. 10)
S_v	Valley slope (ft/ft) (Eq. 1, 4, 11, 12, 15)
W_{bed}	Width of the channel measured at the toe of the banks (ft) (Eq. 7, 8)
W_{fp}	Effective floodplain width (ft)..... (Eq. 4)
W_{toB}	Width of channel measured at the level of the top of the lowest banks (ft) (Eq. 7, 8)
Y₁₀₀	Flood flow depth (ft) for Q ₁₀₀ (Eq. 1, 2)
Y_{ch}	Depth of channel for the top-of-bank flow (ft)..... (Eq. 3)
Y_{chp}	Depth of pre-degradation channel for the top-of-bank flow (ft)..... (Eq. 2, 3, 7, 8)
Y_{fp100}	Flood flow depth (ft) on the floodplain for Q ₁₀₀ (Eq. 1, 2, and 4)
γ	Unit weight of water (62.4 pcf) (Eq. 1, 10)
τ_c	Boundary shear stress required to mobilize the native bed material (psf)..... (Eq. 2, 9, 10)
τ_o	Boundary shear stress index (psf)..... (Eq. 1, 9, 13)

Units of Measure

cfs	Cubic feet per second
ft	Feet
mi²	Square miles
pcf	Pounds per cubic foot
psf	Pounds per square foot

EXECUTIVE SUMMARY

Estimation of potential long-term down-cutting of the stream bed is necessary for evaluation and design of bridges for scour and culverts for fish passage. Equations for estimating this potential long-term bed degradation (LTBD) were developed from field data collected in Maryland streams in Frederick, Carroll, and Montgomery counties. The conservative upper limit curve that describes LTBD as a function of valley slope (S_v) was given as

$$\text{LTBD (ft)} = 3 \text{ ft for } S_v < 0.01 \text{ ft/ft} \quad (11)$$

$$\text{LTBD (ft)} = -11300 (S_v)^2 + 615 (S_v) - 2.0 \text{ for } 0.01 \text{ ft/ft} < S_v < 0.027 \text{ ft/ft} \quad (12)$$

These equations can be used as a general guide for the prediction of long-term bed degradation in streams that have all of the following characteristics:

1. Valley slopes of less than 0.027 ft/ft.
2. Drainage areas from 1.7-25.9 mi².
3. A majority of their watershed drainage area in the Blue Ridge physiographic province of Washington and Frederick counties or the western part of the Piedmont physiographic region in Frederick, Carroll, and Montgomery counties
4. Impervious area of less than 16 percent of the contributing watershed's surface area.

Until further study has been completed, the research team recommends that use of these equations be limited to sites not located in deep deposits of sediment created by backwater from dams or other structures or in streams with evidence of active channel degradation. For stream channel networks already experiencing significant degradation or at structures located in thick dam deposits, the value of LTBD may be substantially greater than those given in this study.

A thorough examination of the site and downstream valley should be made to determine whether either of these conditions applies to the site being evaluated. Indicators of bed degradation problems may include perched culverts, exposed utility crossings, exposed bridge foundations, and/or channel headcuts. A search of historical documents should be made to determine the location of historic mill dams or other dams that may have caused deep and extensive backwater deposits. Evidence of backwater deposits include exposure of clay in the streambed, no evidence of gravel at the base of eroding stream banks, banks greater than 4 ft composed completely of fine-grained sediment. Neither Eq. 11 and 12 nor any other equations derived in this study should be used to predict LTBD for

1. Structures located in channels with ongoing degradation problems.
2. Structures located in the backwater deposit of a dam.
3. Locations where other structures may have been or may be removed during the life of the structure being evaluated.

In such cases, an LTBD assessment should be completed in accordance with the procedures in Chapter 14 of Maryland's *Hydrology and Hydraulics Manual* [1].

A channel should be evaluated as follows for signs of active channel degradation within approximately 1000 ft upstream and downstream of the structure location:

1. Examine records of the site including bridge inspection reports and reports from sewer line authorities and other utility companies that may have pipeline crossings. A step in the channel profile at any of these structures is an indication of an existing bed degradation problem.
2. Examine bridges that cross the channel upstream and downstream of the site for exposed foundations or other signs of bed degradation.
3. Examine the channel bed for signs of ongoing bed degradation problems.

If any of these evaluations indicate that the channel is degrading, or if the valley slope is greater than 0.027 ft/ft, then the LTBD equations should not be used. Instead, the techniques recommended in Chapter 14 of Maryland's *Hydrology and Hydraulics Manual* [1] should be used to evaluate bed degradation potential.

If the channel shows no evidence either of existing degradation problems in the stream system or of a deep deposit of sediment created by backwater from a dam or other structure, then the LTBD equations may be used as follows for Blue Ridge and western Piedmont sites with valley slopes less than 0.027 ft/ft and drainages areas from 1.7-25.9 mi²:

1. Compute the valley slope, S_v , from a USGS 7.5-minute topographic map. For most sites, the contour lines directly upstream and downstream of the structure location should be used to compute the slope as follows:

$$S_v = (\text{distance between contours}) / (\text{contour interval}) \quad (15)$$

At sites where the downstream contour is immediately downstream of the structure, the slope should be calculated using the two contour lines downstream of the site. Where the structure is located directly upstream of the confluence with a much larger stream, the slope upstream of the site should be averaged with the slope of the larger, receiving stream's valley.

2. Use Eq. 11 and 12 from this study to estimate LTBD.

The LTBD values computed by Eq. 11 and 12 are likely to be conservative for most sites to which they are applicable. Engineers should consider other site-specific factors not included in the development of Eq. 11 and 12. Two factors that could be used to reduce the values obtained in Eq. 11 and 12 are bed controls and the time required for the full potential for LTBD to be realized. Bed controls such as durable bedrock and large immobile bed material may limit degradation. Unlike other forms of localized scour that can obtain their maximum values under a single flood event, the full potential LTBD is realized over multiple flood events extending over time periods of a few years to decades. The long-term nature of LTBD allows time for the degradation to be observed during bridge inspections and for countermeasures to then be installed.

Engineers should also consider other site-specific factors that may increase the potential for LTBD beyond those predicted by Eq. 11 and 12. In particular, structures founded on sediment deposits upstream of existing dams that may be removed during the life of the structure have the potential to experience much larger values of LTBD than those predicted by Eq. 11 and 12. Man-made structures, such as culverts and utility crossings, may also provide downstream grade control that once removed may cause degradation upstream beyond those values predicted by Eq. 11 and 12. This is particularly the case if these man-made controls or structures are founded on soils formed from sediments trapped upstream of historic milldams. The final depth of LTBD used for the placement of structure foundations should be determined using Eq. 11 and 12 and the additional site-specific information.

Long-Term Bed Degradation in Maryland Streams (Phase 2): Blue Ridge and Western Piedmont Provinces

1.0 INTRODUCTION

Federal and Maryland state standards and policies require that bridge foundations be evaluated and designed to resist worst-case conditions of scour and channel instability that may occur over the service life of a bridge. Recently implemented policies also require that crossings accommodate passage of aquatic organisms. An important component of the evaluation and design processes is the estimation of long-term changes in stream bed elevations which may occur due to down-cutting of the stream bed (degradation) or raising of the bed by deposition of sediment (aggradation).

Existing guidelines for assessing potential long-term bed degradation in Maryland streams [1] require expertise that may not be available and/or field studies that, depending on the project budgets, may be cost prohibitive, especially for replacement of county structures. The morphological techniques recommended by these guidelines also lack verification data and may lead to overly conservative estimates, unnecessarily large foundation depths, and consequently, significantly higher costs. For this reason, the Structure Hydraulics and Hydrology Division initiated a study to improve predictions of long-term bed degradation in Maryland streams. Due to funding limitations, the study is being completed in phases. Phase 1 [2], which examined long-term bed degradation (LTBD) in Western Maryland streams, was completed in March 2011. The present study, Phase 2, was limited to Frederick, Carroll, and Montgomery counties. The remaining parts of Maryland will be studied as funding becomes available.

The Phase 2 study had five primary objectives:

1. Continue development of a database of field measurements of LTBD in Maryland streams.
2. Define the range of degradation depths to be expected in streams of the non-urbanized (low impervious ground cover) regions of Frederick, Carroll, and Montgomery counties. These counties lie in the Blue Ridge physiographic province and the western Piedmont.
3. Quantify risk factors identified in the Phase 1 study that may influence a site's risk (likelihood and magnitude) of LTBD.
4. Develop quantitative relations between the identified factors and measured long-term bed degradation.
5. Evaluate the possibility of developing a regional relation for LTBD by physiographic province.

The database and the relations between risk factors and LTBD may serve as a basis for decisions related both to design and planning projects involving foundations for waterway crossings, depth of utility crossings, culvert replacements requiring fish passage, and mitigation projects involving stream restoration and/or stream stability. In foundation designs, the database would establish a baseline for evaluating reasonable values of degradation, and thus it will save significant structure costs. Where the potential for bed degradation is high, LTBD data may indicate deeper foundations are needed to prevent structure failure or continuous remediation of the substructure unit. In other locations, the LTBD data may provide assurance that shallower foundation depths are appropriate. In the planning phase, the database could support quick decisions on the type and size of

the structures needed for stream crossings in small watersheds. A reliable estimate of this degradation rate could indicate the need to propose a bridge rather than a culvert: assuming the culvert invert needs to be designed well below the expected long-term bed degradation, a culvert would be less practical than a bridge in locations where degradation is predicted to be more than 30% of the culvert diameter. Thus, the database could result in a more accurate consolidated transportation program cost in the planning phase. It would also be of great help to all counties that lack resources to perform detailed stream morphology studies on their waterway crossing projects.

2.0 STUDY AREA

The study examined LTBD in three Maryland counties: Frederick, Carroll, and Montgomery. These counties lie in the Blue Ridge physiographic province, the Lowland section of the Piedmont, and a portion of the Upland section of the Piedmont. Land use transitions from mostly rural farmland and low-density residential with scattered urban areas in the western portion of the Piedmont to urban and high-density residential on the eastern edge of the Piedmont.

The Blue Ridge province of Maryland consists of a series of mostly parallel ridges and valleys formed from folded, fractured, and eroded rock. Two high, discontinuous ridges—Catoctin Mountain in the east and South Mountain in the west—border a valley containing minor dissected ridges [3]. The major ridges are composed of quartzite that is highly resistant to weathering and erosion. The broad valley is floored with gneiss and volcanic rock [3]. Most of the central and southern parts of the Blue Ridge province are dissected and drained by the headwaters of Catoctin Creek. The northern part of the province is dissected by smaller streams that join to form larger streams that have eroded through the main ridges to the east or west and flow into streams of the adjacent physiographic provinces.

East of Catoctin Mountain is the Piedmont Plateau province, which rises gradually from east to west. The western part of the Piedmont is primarily rolling plains underlain by moderately to slightly metamorphosed volcanic rocks and diverse igneous and metamorphic rocks such as phyllite, slate, and marble. The rocks underlying Frederick Valley, along the Monocacy River, are Cambrian and Ordovician limestones and dolomites [3].

The drainage patterns in the entire Piedmont are heavily influenced by the geologic structure and resistance of the mostly metamorphic and igneous rock. East of Frederick Valley, two ridges run from northeast to southwest: the Dug Hill Ridge and Pars Ridge [4]. The Potomac River forms the southern border of the Frederick Valley. West of Dug Hill and Pars ridges, the streams of Frederick County and northwestern Carroll County flow mainly west into the Monocacy River, which flows mainly south to its confluence with the Potomac River. East of the ridges, the Patuxent River and other major stream of the eastern Piedmont generally flow southeast to the Chesapeake Bay.

3.0 METHODS

3.1 Site Selection

Initial Screening

Several sources of information were requested from Frederick, Carroll, and Montgomery counties to identify an initial set of sampling sites:

- Bridge inspection reports
- Phases I and II of Item 113 bridge inspection ratings
- Inspection reports for bridges or culverts known to have aquatic organism blockages
- Utility line surveys
- Plan sheets for box culverts and bridges

The reports and surveys were reviewed to identify any citations of foundation exposure or undermining, fish passage barriers, or exposure of utility crossing protection, any of which would indicate that the channel bed near a culvert or bridge had degraded, and therefore, LTBD would probably be measureable. All structures where any of these problems had been cited were considered for field evaluation.

Plan sheets for box culverts were requested because they usually provide the elevation of the culvert outlet invert, the elevation of the downstream channel, and the depth to which the culvert may have been countersunk relative to the downstream channel. Construction drawings for new or replacement bridges may provide normal water surface elevations or stream profiles through the bridge. This plan information provides an accurate reference from which to measure changes in bed elevation. All box culverts and bridges for which plans were available were considered for field evaluation.

Finally, sites for which reports or plans were not available were considered for field evaluation if bed degradation had been observed by research team members or county engineers. A total of approximately 80 sites in Frederick, Carroll, and Montgomery counties were considered during this initial screening process. Each of these sites was then identified on Google Earth, and impervious area of their watersheds was visually estimated. Because streams in watersheds with significant impervious area may undergo rapid morphological change [5], watersheds that appeared to have more than 10 percent impervious area were excluded. Most of the excluded sites were in the eastern regions of Carroll and Montgomery counties and in cities such as Frederick. The remaining sites were all selected for field evaluation.

Field Identification

The sites selected for additional evaluation were identified on USGS 7.5-minute topographic quadrangle maps for reference in the field. An initial field visit was then made to each site to evaluate them for final selection, and other sites visited during the field reconnaissance were added to the sample. The research team conducted a windshield survey along all state roads and most county roads. The research team estimates that they viewed more than 90 percent of the bridges and culverts over streams with drainage areas between about 1 and 30 mi² on the Maryland state highway system and 80 percent of the structures on county roads.

During the windshield survey, the field team looked for structures with vertical drops at the outlet as an indication of LTBD. When a vertical drop was observed, the location was identified on the topographic maps and Google Earth to visually estimate drainage area and impervious area of the watershed. These locations were selected for addition to the sample if their estimated drainage areas were between about 1 and 50 mi² and watershed impervious area appeared to be less than 10 percent.

Rapid measurements (see Section 3.2) were also taken at each site during this field investigation. Even though some of the collected data was not used because some sites were ultimately excluded from the final sample, collecting data during the initial field visit was more efficient than making a second visit to every sample site to collect the data.

Final Site Selection

Following the field investigation, the watershed boundaries of each sample site were delineated using 30-meter national elevation data [6] in the web-based version of GISHydro [7], and their surface drainage areas and impervious areas were estimated. Because the watersheds of several of the sites were found to have impervious areas of 11 to 16 percent, and their exclusion would have reduced the sample size significantly, only those sites where impervious area exceeded 16 percent were excluded from the final sample.

A total of 30 sites—23 bridges, 2 culverts, 2 utility crossings, 2 embankment walls, and 1 concrete ford—were selected for inclusion in the final sample. Data collected from four Blue Ridge sites in the Phase 1 study also were included, which increased the sample size to 34 sites (Table 3.1 and Figure 3.1). Drainage areas of sites in the Blue Ridge province ranged from 1.7–11.3 mi², and drainage areas of sites in the Piedmont province ranged from 2.3–25.9 mi² (Figure 3.2).

3.2 Data Collection

The primary focus of the field data collection effort was to obtain measurements of LTBD and other parameters listed in Table 3.1. This data provided the information necessary to examine the relation between watershed area and LTBD in both physiographic regions. The field data in combination with readily available mapping data was also sufficient to examine the relation between LTBD and factors identified in the Phase 1 study that may influence a site's risk (likelihood and magnitude) of LTBD.

Factors that influence LTBD were determined in the Phase I report to include those that influence the boundary shear stress on the channel bed and those that influence the mobility and transport of the bed material (Table 3.2). The risk factors that affect the boundary shear stress on the channel bed can be related using the uniform flow equation for wide channels

$$\tau_o = \gamma Y_{ch} S_{ch}$$

where τ_o is the boundary shear stress on the channel, γ is unit weight of water (62.4 pcf), Y_{ch} is the flow depth, and S_{ch} is the channel slope.

Risk factors that affect the resistance of coarse bed material to mobilization and transport can be expressed in terms of a critical shear stress:

$$\tau_c = 0.04 (S_g - 1) \gamma D_{50}$$

where S_g is the specific weight of the sediment, γ is unit weight of water (62.4 pcf), and D_{50} is the estimated median size of the bed material.

Table 3.1. Long-Term Bed Degradation Estimates and Site Characteristics

(This page is formatted to fit on 11 x 17-inch paper.)

Sample No.*	Structure No.	Yr Built/Modified	Structure	Reference	County	Physiographic Province	Stream Crossing	Route	Estimated LTBD (ft)	Bed Control	D ₅₀ (mm)	Y _{ch} (ft)	W _{top} (ft)	W _{bed} (ft)	DA (mi ²)
16	11/07		Bridge	Existing stream bed	Washington	BR	Israel Creek	Keep Tryst Rd	4.0		64	Not measured	Not measured	Not measured	13.1
17	07/19		Culvert	Culvert outlet invert	Washington	BR	Little Antietam Creek	Hells Delight	6.0		64	Not measured	Not measured	Not measured	1.5
18	07/11		Culvert	Culvert outlet invert	Washington	BR	Little Antietam Creek	Pleasant Valley Rd	2.0		128	Not measured	Not measured	Not measured	1.6
19	21072	1959	Culvert	Culvert outlet invert	Washington	BR	Trib of Little Antietam Creek	MD 67	6.0		16	Not measured	Not measured	Not measured	2.3
27			Sewer line	Top of sewer line	Frederick	BR	Turkey Creek	CO 37	2.7	Cobble armor	64	4.0	11	24	1.7
28	F05-07	2002	Bridge	Top of foundation	Frederick	BR	Friends Creek	CO 22	3.5	Boulder armor	44	4.7	34	50	11.3
29			Wall	Top of foundation	Frederick	BR	Owens Creek	MD 550	5.9	Boulder armor	206	7.5	45	32	11.1
30	10381X0		Wall	Top of foundation	Frederick	BR	Trib to C&O Canal	MD 180	3.0	Boulder armor	26	8.0	17	10	1.8
31	10090		Bridge	Top of foundation	Frederick	BR	Little Catocin Creek	MD 464	3.0	Boulder armor	35	4.7	45	34	8.6
32	10058	1941	Bridge	Weep holes in abutment	Frederick	BR	Little Catocin Creek	MD 79	2.6	Bedrock	39	4.5	50	28	5.9
33	CL-402	1940	Bridge	Top of foundation	Carroll	PM	South Branch Gunpower Falls	CO 206	1.5	Boulder armor	Railroad ballast	3.5	38	28	15.2
34			Bridge	Top of foundation	Carroll	PM	Piney Run	MD 32	1.8	Dam	84.5	4.0	49	36	11.5
35	CL-383	1960	Bridge	Top of foundation	Carroll	PM	Muphy Run	CO 172	1.2	Weakly cemented gravel	31	3.0	30	26	3
36	6036	1937	Bridge	Top of foundation and waterline in plans	Carroll	PM	East Branch North Branch Patapsco River	MD 482	0.0	Weakly cemented gravel	34	3.0	31	26	2.8
37	CL-359	1972	Bridge	Top of foundation	Carroll	PM	East Branch North Branch Patapsco River	CO 459	1.6	Cobble armor	79	4.1	48	29	19.7
38	CL-208	1987	Bridge	Top of foundation	Carroll	PM	Alloway Creek	CO 6	1.0	Dam	22	5.9	54	43	24.6
39			Bridge	Weep holes in abutment	Carroll	PM	East Branch North Branch Patapsco River	CO 465	1.5	Cobble armor	62	3.0	37	28	20.6
40	CL-340X	1960	Bridge	Top of foundation	Carroll	PM	Middle Run	CO 539	1.2	Culvert invert	60	4.0	19	11	2.3
41	CL-324	1941	Bridge	Top of foundation	Carroll	PM	Morgan Run	CO 545	2.0	Bedrock	54	5.5	69	62	25.9
42	CL-210	1963	Bridge	Abutment protection pavement	Carroll	PM	Alloway Creek	CO 4	0.0	Bedrock	78	2.3	59	27	22.5
43	CL-211	1988	Bridge	Exposed concrete line on abandoned downstream pier	Carroll	PM	Alloway Creek	CO 2	2.7	Bedrock	46	5.6	67	39	21.8
44			Sewer line	Sewer line	Frederick	PM	Big Hunting Creek	MD 77	2.8	Boulder armor	144	6.0	48	24	9.8
45	F15-22P	2009	Culvert	Culvert outlet apron	Frederick	PM	Little Owens Creek	CO 30	3.0	Boulder armor	55	6.2	33	17	4.2
46			Ford	Drop at concrete ford	Frederick	PM	Flat Run	Sewer Plant Rd	0.7	Bedrock	23.5	4.2	67	33	11.6
47	F07-06	1909	Bridge	Top of foundation	Frederick	PM	Bush Creek	CO 373	3.0	Weakly cemented gravel	23	5.6	34	27	22
48	F07-05	1982	Bridge	Weep holes in abutment	Frederick	PM	Bush Creek	CO 368	2.0	Bedrock	19	4.3	45	40	21.5
49	F11-10P	2007	Culvert	Culvert Invert	Frederick	PM	Israel Creek	CO 474	0.0	Bedrock	25	3.0	40	35	9.5
50			Bridge	Paved invert	Frederick/Carroll	PM	Sams Creek	MD 31	4.1	Bedrock	48	11.0	62	22	7.6
51	6012	1972	Bridge	Bridge plans low cord	Frederick/Carroll	PM	Sams Creek	MD 75	0.0	Ford	57	3.0	32	28	18.3
52	15036		Bridge	Weep holes in abutment	Montgomery	PM	Little Bennett Creek	I-270	2.5	Bedrock	Weakly cemented gravel	4.3	54	34	14.3
53	M0138		Bridge	Abutment foundation	Montgomery	PM	Bucklodge Branch	CO 259	2.7	Bedrock	30	4.5	47	24	8.5
54	M0164	1930	Bridge	Top of foundation	Montgomery	PM	Unnamed Trib	CO 253	1.2	Bedrock	34	4.0	44	38	2.5
55	M0039		Bridge	Top of foundation	Montgomery	PM	Trib to Horsepen Branch	CO 2603	1.3	Clay	Clayey soil	4.5	28	11	3.5
56	M0028		Bridge	Top of foundation	Montgomery	PM	Hooker Branch	CO 264	2.6	Boulder armor	28	4.4	34	16	2.9

Cont'd.

Table 3.1. Long-Term Bed Degradation Estimates and Site Characteristics (Continued)

(This page is formatted to fit on 11 x 17-inch paper.)

Sample No.*	V _s (ft/ft)	W _{fb} (ft)	n _{ch}	n _{fb}	Y _{chD} (ft)	A _{ch}	P _{ch}	Q _{ch} (cfs)	Q ₁₀₀ (cfs)	Y _{m100} (ft)	τ _c (psf)	τ _o (psf)	BMI	Land Use Coverage	Soil Coverage	Forested Area (%)	Urban Area (%)	Impervious Area (%)
16	0.0260	50		0.07					5150	7.7	0.86	12.5	14.4	2002 MD/DE	STATSGO	58	14.1	3.7
17	0.0566	50		0.10					1330	3.4	0.86	11.8	13.7	2002 MD/DE	STATSGO	57.1	15.9	4.1
18	0.0478	70		0.10					1390	3.0	1.73	8.8	5.1	2002 MD/DE	STATSGO	58.4	15.9	4.1
19	0.0256	40		0.10					1020	4.1	0.22	6.6	30.7	2002 MD/DE	STATSGO	45.9	12.2	3.3
27	0.0262	128	0.04	0.10	1.3	23	20	149	1660	2.6	0.86	6.4	7.4	2010 MOP	SSURGO	98.4	0.3	1.5
28	0.0149	90	0.04	0.10	1.2	50	44	249	5450	8.0	0.59	8.5	14.3	1970s USGS	SSURGO	63	1.5	0.9
29	0.0206	50	0.06	0.10	1.6	62	42	285	5330	10.1	2.78	15.1	5.4	2010 MOP	SSURGO	81	3.2	1.9
30	0.0200	22	0.06	0.07	5.0	68	24	486	1780	6.0	0.35	13.7	38.9	2010 MOP	SSURGO	46.4	11.8	7.3
31	0.0058	94	0.04	0.07	1.7	67	43	258	4810	7.7	0.47	3.4	7.2	2010 MOP	SSURGO	22.9	11.1	4.7
32	0.0116	107	0.04	0.07	1.9	74	43	429	3820	4.8	0.53	4.9	9.3	2010 MOP	SSURGO	21.6	9	3.9
33	0.0046	56	0.04	0.07	2.0	66	37	244	5420	12.2	0.00	4.0	0.00	2010 MOP	SSURGO	21.1	13.7	5.9
34	0.0074	177	0.04	0.07	2.2	93	47	474	9260	7.2	1.14	4.4	3.8	2010 MOP	SSURGO	24.1	30.6	10.9
35	0.0101	222	0.04	0.10	1.8	50	32	257	3310	3.8	0.42	3.5	8.4	2010 MOP	SSURGO	11.9	41.4	15.6
36	0.0052	318	0.04	0.07	3.0	85	34	416	1800	1.9	0.46	1.6	3.4	2010 MOP	SSURGO	14.9	23.4	9.5
37	0.0054	148	0.04	0.10	2.5	96	43	444	6270	8.6	1.07	3.7	3.5	2010 MOP	SSURGO	25.3	22	8.9
38	0.0034	271	0.04	0.07	4.9	238	58	1317	6950	5.4	0.30	2.2	7.4	1970s USGS	SSURGO	4.5	2.3	1.2
39	0.0038	93	0.04	0.10	1.5	49	35	137	6460	13.3	0.84	3.5	4.1	2010 MOP	SSURGO	26.3	21.8	8.8
40	0.0111	124	0.04	0.07	2.8	42	21	264	2650	3.6	0.81	4.5	5.5	2010 MOP	SSURGO	20.9	35.4	11.8
41	0.0080	111	0.04	0.10	3.5	229	73	1652	8610	10.1	0.73	6.8	9.3	2010 MOP	SSURGO	35.3	18.2	6.5
42	0.0044	180	0.04	0.07	2.3	96	47	383	6540	6.8	1.05	2.5	2.4	1970s USGS	SSURGO	3.9	2.5	1.2
43	0.0044	171	0.04	0.07	2.9	154	59	723	6370	6.6	0.62	2.6	4.2	1970s USGS	SSURGO	4.1	2.6	1.3
44	0.0188	81	0.06	0.07	3.2	115	42	760	4880	5.6	1.95	10.3	5.3	2010 MOP	SSURGO	85.7	4.9	2.6
45	0.0164	38	0.06	0.07	3.2	79	31	466	2600	6.1	0.74	9.6	12.9	2010 MOP	SSURGO	86.5	1.8	3.0
46	0.0028	210	0.04	0.07	3.5	175	57	730	5900	6.4	0.32	1.7	5.4	1970s USGS	SSURGO	14.4	3.8	3.4
47	0.0033	121	0.04	0.07	2.6	80	36	293	10,700	12.8	0.31	3.2	10.2	2010 MOP	SSURGO	29.3	30.7	11.7
48	0.0033	89	0.04	0.07	2.3	98	47	341	10,600	15.3	0.26	3.6	14.1	2010 MOP	SSURGO	29.7	30.8	11.8
49	0.0062	1011	0.04	0.07	3.0	113	44	622	4450	1.6	0.34	1.8	5.3	2010 MOP	SSURGO	25.3	7.3	2.8
50	0.0082	130	0.04	0.07	6.9	289	56	2860	2860	0.0	0.65	3.5	5.4	2010 MOP	SSURGO	21.3	16.8	5.6
51	0.0036	196	0.04	0.07	3.0	90	36	373	4840	5.6	0.77	2.0	2.5	2010 MOP	SSURGO	69.0	10.3	4.4
52	0.0055	102	0.04	0.07	1.8	79	48	306	6370	8.8	0.00	3.6	0.00	2010 MOP	SSURGO	50.3	10.2	5.2
53	0.0063	120	0.04	0.10	1.8	63	39	259	4690	7.9	0.41	3.8	9.3	2010 MOP	SSURGO	35.3	3.5	2.2
54	0.0059	59	0.04	0.10	2.8	113	46	590	2200	6.7	0.46	3.5	7.6	2002 MOP	SSURGO	28.6	8.7	6.8
55	0.0033	396	0.04	0.10	3.2	61	26	235	2700	3.3	0.00	1.3	0.00	2010 MOP	SSURGO	40.4	0.0	1.0
56	0.0109	48	0.04	0.10	1.8	45	28	234	3180	9.1	0.38	7.4	19.5	2010 MOP	SSURGO	34.8	35.5	14.2

Note: Parameters denoted by symbols/abbreviations are defined in the glossary. Forested, urban, and impervious areas were obtained from GIS Hydro [7].

* Site numbering for Phase 2 (Sites 27–56) continues from Phase 1 (Sites 1–26). Data for sites 16–19 were collected in 2009 for the Phase 1 study.

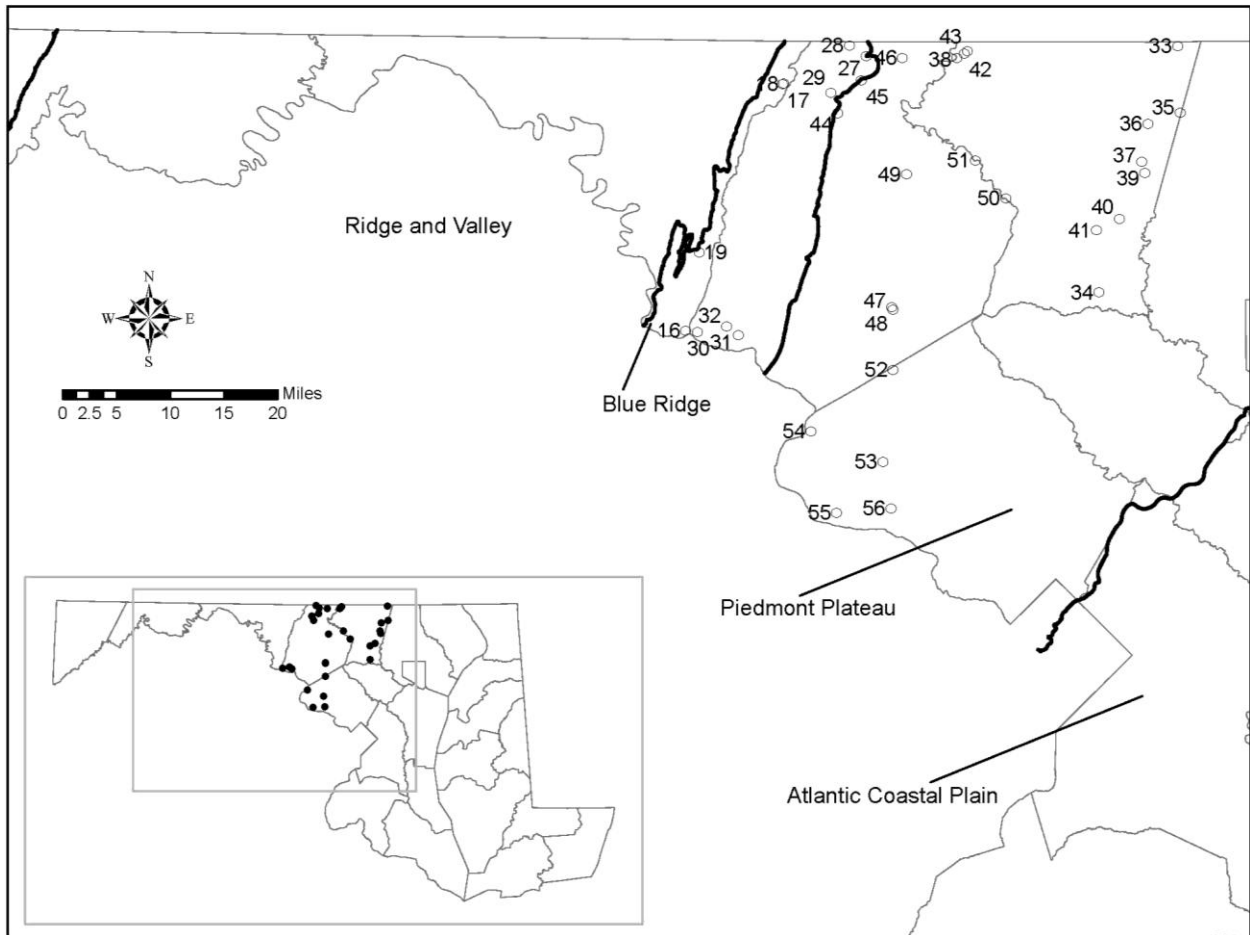

Figure 3.1. Sample site locations. Bold lines represent physiographic province boundaries.

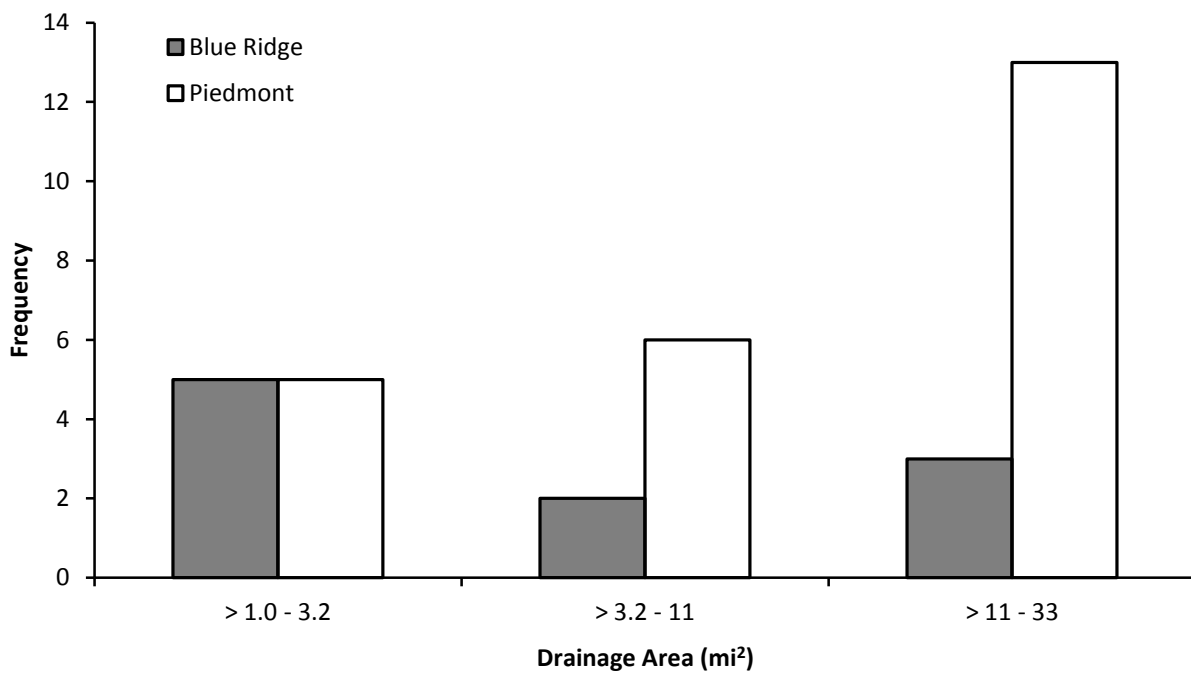

Figure 3.2. Distribution of sampling sites according to watershed drainage area and physiographic province.

Table 3.2. Factors That Influence LTBD

	Hydraulic Parameter	Risk Factors	Increased Risk	Reduced Risk
Channel boundary stress	Channel slope	1. Valley slope	Steep valley slope	Mild valley slope
		[6a. (See below) Proximity of downstream durable grade controls]	No durable downstream grade control points to limit slope change. Removal of a dam, culvert or other downstream structure that had caused aggradation prior to the installation of the sampling site's structure.	Durable grade control point or points that limit slope change
	Depth of flow in the channel	2. Effective downstream floodplain width	Constriction of downstream floodplain by obstruction, walls, or an embankment	No constriction of downstream floodplain by obstruction, walls, or an embankment
		3. 100-yr return interval discharge	Increased 100-yr discharge	Decreased 100-yr discharge
	4. Top-of-bank channel dimensions	Downstream channelization including widening, and deepening	Lack of obvious channelization; often associated with natural valley geometry, such as a narrow, meandering valley, that limits potential channel reconfiguration	
Resistance to stress	Bed material	5. Bed material median size	Size small relative to bed stresses	Size large relative to bed stresses
		6b. Downstream proximity and depth of bedrock below channel bed	Lack of durable downstream bed control including degradation of bedrock	Durable downstream bed control including bedrock

Field Measurements

Bed Profile

Long-term bed degradation was defined as the vertical change in the channel profile other than that caused by local or contraction scour. Scour and LTBD were distinguished based on their effect on the bed morphology and associated bed profile. Local and contraction scour result in the formation of pools with extents limited to the region of the bed beneath and immediately downstream of the structure. Scour holes appear as sags in the channel profile. LTBD is a more extensive lowering of the bed profile that can be represented as a decrease in riffle crest elevations over time. The main observable morphological indicator of LTBD is an increase in the distance between the low-flow water surface and the top of the bank along the entire reach over which LTBD has occurred. LTBD progresses from downstream to upstream and is halted by fixed-bed sections of channel. Where a portion of the bed is fixed, such as a culvert invert, paved bridge invert, or riprap-protected bed, an abrupt change in bed elevation and bank height occurs at the transition from upstream fixed-bed reach to the downstream reach that has undergone LTBD. The abrupt change in the streambed often occurs as a step or series of steps in the bed profile.

Based on this interpretation of scour and LTBD, the research team used the low-flow water surface, which represented the approximate elevation of riffle crests, as the demarcation between scour and LTBD when measuring vertical drops at structures. At each sampling site, LTBD was measured with a pocket rod and a hand level. Scour was considered to extend below the water surface to the streambed, with a maximum scour depth represented by the maximum pool depth (Figure 3.3). LTBD was considered to be the vertical drop from an approximated pre-degradation channel bed elevation to the existing low-flow water surface. The approximation of the pre-degradation channel bed was based on whether the channel bed was fixed (utility crossings, paved bridge inverts, riprap protected sections of streambed, and culverts that were not countersunk) or not fixed.

Before about 1975, Maryland culverts were constructed such that the outlet invert was set approximately at the bed elevation of the channel. In culverts constructed after 1975, the inlets may have been countersunk below the streambed to support fish passage. At the two sample sites where culverts were constructed after 1975, bankline tree roots upstream of the culverts were at the same elevation as the invert. This indicated that the culverts had been constructed less than 1 ft below the pre-degradation streambed. Therefore, the beds at all culverts in the sample were fixed.

At fixed-bed sites, the pre-degradation channel bed elevation was assumed to be the same as the existing channel bed elevation at the structure (Figures 3.3 and 3.4). LTBD was measured as the vertical drop in the water surface at the downstream step (Figure 3.4). Where multiple downstream steps were observed, such as where partial failure and displacement of riprap downstream formed a series of two or more drops in the channel profile, the cumulative vertical drop over all of the steps was measured (Figure 3.3).

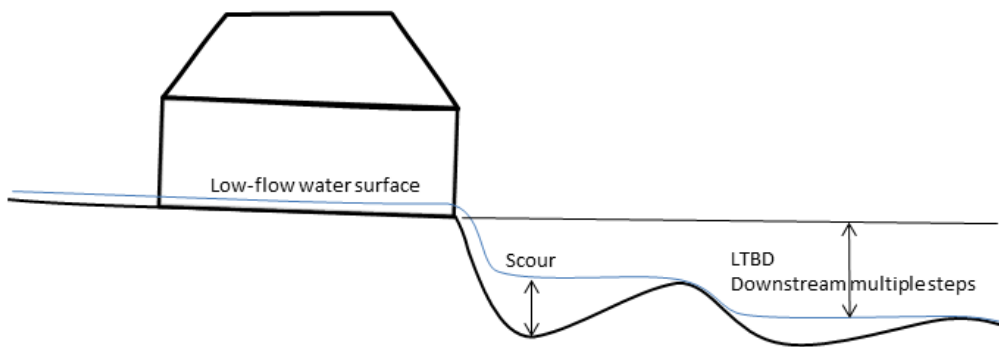

Figure 3.3. Typical bed profile of a culvert with downstream bed degradation and a scour pool.

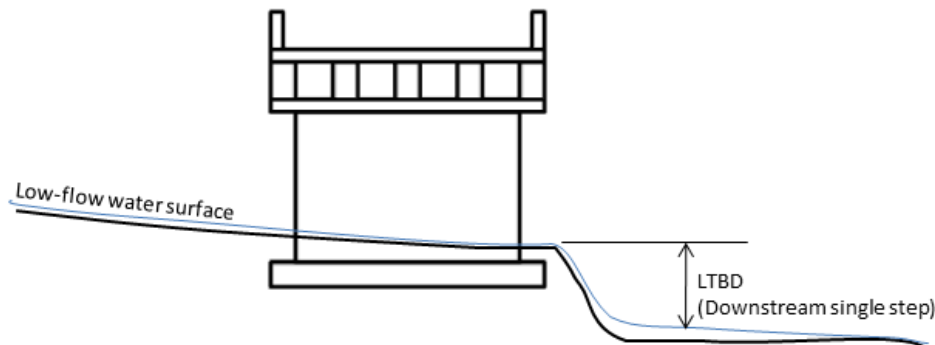

Figure 3.4. LTBD: uniform degradation and single step downstream.

LTBD was estimated at two utility line crossings: one on Turkey Creek and a second immediately upstream of a bridge on Big Hunting Creek. At Turkey Creek, the channel bed and bank had eroded away from the now-exposed cast iron pipe. The research team considered the drop from the top of the pipe to the existing streambed to be the LTBD that occurred since the placement of the pipe. At Big Hunting Creek, a concrete casing was poured around the pipe for protection. Although the protection was failing, the pipe and the protection were providing grade control that prevented upstream migration of a headcut in cobble and boulder bed material. The LTBD observed at the utility crossing was approximately the same as that observed at the footing of the paved embankment under the bridge immediately downstream of the pipe, which suggested that the LTBD at the bridge had progressed upstream to the pipe. The research team considered the step in the profile at the utility crossing to be the LTBD that occurred since the construction of the protection.

At bridge locations where the bed was not fixed, with the exception of Site 51, three main indicators were considered in approximating the pre-degradation channel bed elevation: the top surface of the footings; the elevation of weep holes used to drain the backfill of abutment walls; and the top-of-bank elevation downstream of the structure. Because plans for some bridges showed that the top surface of the foundation was at or within approximately 1 ft of the pre-degradation channel bed, all bridge foundations were assumed to have been constructed within approximately 1 ft of the pre-degradation channel bed unless other indicators suggested otherwise. The top of the stream bank and the weep holes in bridge abutments provide upper bounds because weep holes are generally placed higher than the streambed to allow for free drainage and because the stream probably would have had a depth greater than 1 ft. Depending on the indicators at each site where the bed was not fixed, LTBD was measured as the distance from the low-flow water surface to the exposed top surface of foundations or weep holes (Figures 3.5 and 3.6).

At Site 51, field indicators were compared to the bridge plans, which provided a channel cross section showing the elevation of the streambed and low flow water surface elevation within the bridge opening. The water surface elevation on the plans was assumed to be a close approximation of the pre-degradation riffle crest elevation near the bridge. At this site, the distance from the water surface to the downstream beam low cord was measured and compared to the same difference on the plan sheets. The change in the distance between the low flow water surface to the low cord was used as the estimate of LTBD.

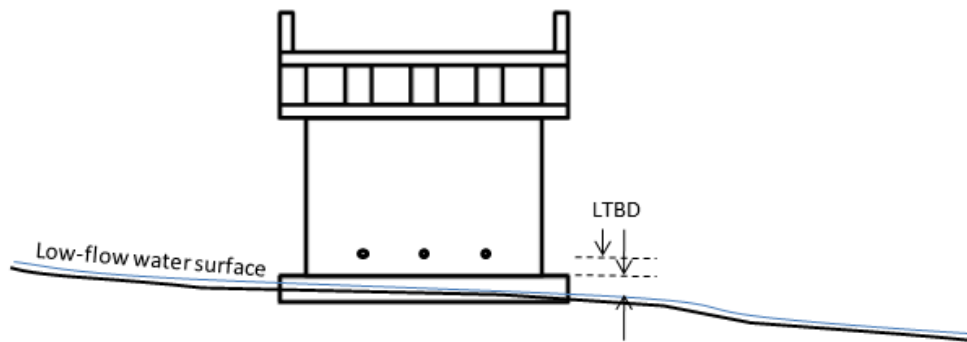

Figure 3.5. LTBD: uniform degradation.

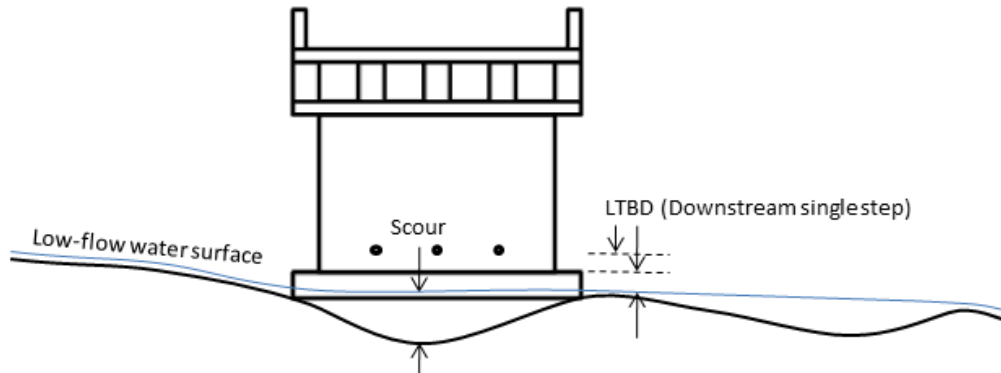

Figure 3.6. LTBD with scour: single step downstream.

Channel Dimensions

Downstream of each sampling site, the channel base width, top width, and depth were measured to approximate trapezoidal channel geometry. These measurements were made to evaluate the entrenchment of the channel with respect to the extensive flat of the valley bottom that may be inundated during a 100-year recurrence interval flood.

Bed Material Gradation

The surface particle-size distribution was estimated using standard pebble counting techniques [8] in a riffle. The riffle was selected to represent the bed material transported through the site. Colluvial deposits and/or artificial material used to armor the streambed were avoided unless they composed most of the streambed. At two sites, no particles were sampled: at one, a large supply of railroad ballast had recently been deposited, and at the other, the bed was composed of cohesive bed material. Sampled riffles were located downstream of the sampling sites except in a few cases where pebble counts were taken upstream because the stream emptied into the backwater of a shallow lake or the downstream bed was armored with coarse colluvial material. A minimum of 100 particles per riffle were sampled. A grid of at least five transects was established over the riffle, and at least 10 particles were sampled per transect. Individual measurements of each particle's intermediate axis were recorded.

Downstream Bed Controls and Grade Controls

In-channel features that would either limit rapid degradation of the bed (“bed controls”) or were controlling the slope of the low-flow water surface (“grade controls”) were identified if they could be located within approximately 1000 ft of the sampling site’s structure. These controls consisted primarily of bedrock in the streambed, boulder and cobble in the streambed, or dams.

Remote Measurements

Valley slope and effective floodplain width were estimated for each site as follows:

1. Valley slope. The valley slope, S_v , was estimated from contour lines shown on USGS 7.5-minute topographic maps. For most of the sites, the change in elevation between contours was divided by the distance between the contour lines directly

upstream and downstream of the structure location. At sites where the downstream contour was immediately downstream of the structure, using the above method would have resulted in the estimated slope being biased heavily in the upstream direction. For those instances, the slope was calculated using the two contour lines downstream of the site. At four locations, the structure was located directly upstream of the confluence with a much larger stream. At these locations, the slope upstream of the site was averaged with the slope of the larger, receiving stream's valley.

2. Effective 100-yr floodplain width, W_{fp} (the same variable referred to as "effective valley width" in Phase 1). Valley constrictions or sharp bends that could create backwater during 100-yr recurrence interval floods were identified from 7.5-minute USGS topographic maps, field observations of floodplain obstructions and channelization, and recent aerial photographs obtained from Google Earth. The effective floodplain width was estimated from the smallest width of the floodplain unobstructed by embankments or structures or, where channelization was evident, from the width of the widened and deepened channel.

3.3 Data Reduction and Analysis

Impervious Area

The variation of LTBD with percent impervious area was examined for both provinces using the GIS land use coverages and methods provided in GISHydro [7].

Valley Slope

The variation of observed LTBD with valley slope was examined for each physiographic region. The data was then compared to the conservative upper limit curve developed for the Phase 1 data from western Maryland that describes the observed LTBD as a function of valley slope (S_v).

Estimates of 100-Year Peak Discharges

Each site's 100-year recurrence interval peak discharge was obtained from the web-based version of GISHydro [7] using the Fixed Region equations [9]. Watershed runoff characteristics were based on STATSGO soils data [10] and either 2002 or 2010 Maryland land use data [7] for watersheds located entirely within Maryland or 1970s USGS land use data [7] for watersheds that extended into Pennsylvania.

Estimates of Median Bed Particle Sizes

Gradation analysis of the pebble count data was conducted to determine the median size (D_{50}) of the sampled bed material at each site.

Channel Boundary Shear Stress Index

A channel boundary shear stress index (τ_o) was developed to examine the combined effect of valley slope, valley confinement, channel incision, and the potential discharge that could be

produced by each sample site drainage area (Table 3.1). The estimation of τ_o used here is different than that included in the Phase 1 report because it includes the effect of the pre-degradation channel geometry and flow capacity. The τ_o (psf) was defined as

$$\tau_o = \gamma Y_{100} S_v \quad (1)$$

where γ is unit weight of water (62.4 pcf), S_v is the valley slope (ft/ft), and Y_{100} is the depth (ft) of the 100-year peak discharge in the pre-degradation channel. Calculation of the channel boundary shear stress index required an estimate of Y_{100} as

$$Y_{100} = Y_{chp} + Y_{fp100} \quad (2)$$

where Y_{chp} is the pre-degradation channel depth (ft), and Y_{fp100} is the average depth of the 100-year peak discharge (ft) on the floodplain. The pre-degradation channel depth was approximated as

$$Y_{chp} = Y_{ch} - LTBD \quad (3)$$

where Y_{ch} is the measured existing channel depth.

Y_{fp100} was approximated as

$$Y_{fp100} = [(Q_{fp100} n_{fp}) / (1.49 W_{fp} S_v^{0.5})]^{0.6} \quad (4)$$

where Q_{fp100} is the 100-year peak discharge on the floodplain, W_{fp} is the effective floodplain width (ft), and n_{fp} is the composite Manning n estimated for the effective floodplain width. One value of n representative of the roughness of the effective floodplain width downstream of the structure was used at each site. The parameter Q_{fp100} was estimated as

$$Q_{fp100} = Q_{100} - Q_{ch} \quad (5)$$

where Q_{100} is the 100-year peak discharge, and Q_{ch} is the top-of-bank flow in the pre-degradation channel, estimated as

$$Q_{ch} = (1.49/n_{ch}) A_{ch} (A_{ch}/P_{ch})^{0.667} S_v^{0.5} \quad (6)$$

where n_{ch} is the Manning channel roughness, A_{ch} is the pre-degradation channel area, and P_{ch} is the pre-degradation channel wetted perimeter. The parameter n_{ch} was selected as 0.04 for gravel- and small-cobble-bed streams and 0.06 for large-cobble- and boulder-bed streams. The parameters A_{ch} and P_{ch} were estimated as

$$A_{ch} = Y_{chp} (W_{tob} \text{ and } W_{bed})/2 \quad (7)$$

$$P_{ch} = 2 Y_{chp} + (W_{tob} \text{ and } W_{bed})/2 \quad (8)$$

where W_{tob} and W_{bed} are the measured channel top width and bed width, respectively.

Bed Mobility Index (BMI)

A bed mobility index was developed to examine the combined effect of τ_o and sediment size on LTBD for data. The bed mobility index was defined as

$$\text{BMI} = \tau_o / \tau_c \quad (9)$$

where τ_c is the boundary shear stress required to mobilize the native bed material and is defined as

$$\tau_c = 0.04 (S_g - 1) \gamma D_{50} \quad (10)$$

where S_g is the specific weight of the sediment, γ is unit weight of water (62.4 pcf), and D_{50} is the estimated median size of the bed material. Calculation of a BMI for each sample site required an estimate of τ_c from Eq. 10 for each site. Therefore, an estimate of the specific weight of the bed material and an estimate of bed material grain size at each site was required. A constant specific weight of 2.65 was used for all bed materials. The BMI for each site was computed from the estimate of τ_c and an estimate of τ_o from Eq. 1.

A plot of LTBD as a function of BMI was then developed and examined for trends in the maximum observed LTBD with BMI.

4.0 RESULTS

The possibility of developing regional relations between watershed area and LTBD was evaluated for each physiographic province, and three relations between LTBD and five of the six quantified risk factors (Table 3.2) were examined: LTBD and valley slope; LTBD and an index combining Factors 1-4; and LTBD and an index combining Factors 1-5.

LTBD Regional Relation

Maximum and minimum values of LTBD in the Blue Ridge were higher than those in the Piedmont, which suggests that rates of LTBD differ between the two provinces. Although the datasets are too small to draw a reliable conclusion about a relationship between LTBD and drainage area in each region, the data do not suggest even a weak correlation between the two variables (Figure 4.1).

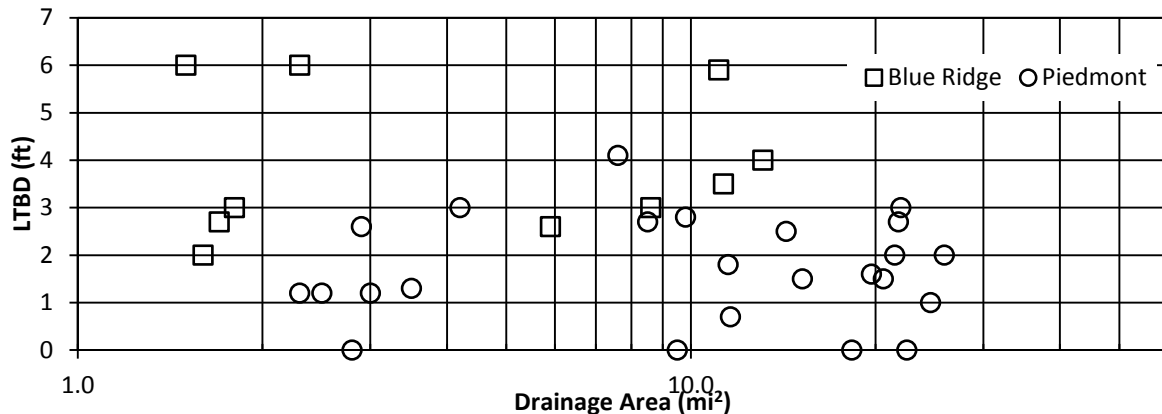

Figure 4.1. Variation of LTBD with drainage area for each physiographic province.

Impervious Area

Impervious area varied from 0.9 percent to 7.3 percent in the Blue Ridge and from 1.0 percent to 15.6 percent in the Piedmont. The effect of impervious area was examined to determine whether use of sample sites with imperviousness of between 10 percent and 16 percent would introduce another factor that would influence LTBD. The variation of LTBD (Figure 4.2) indicates that impervious area has no correlation with LTBD for Piedmont streams with watershed imperviousness of 0 percent to 16 percent.

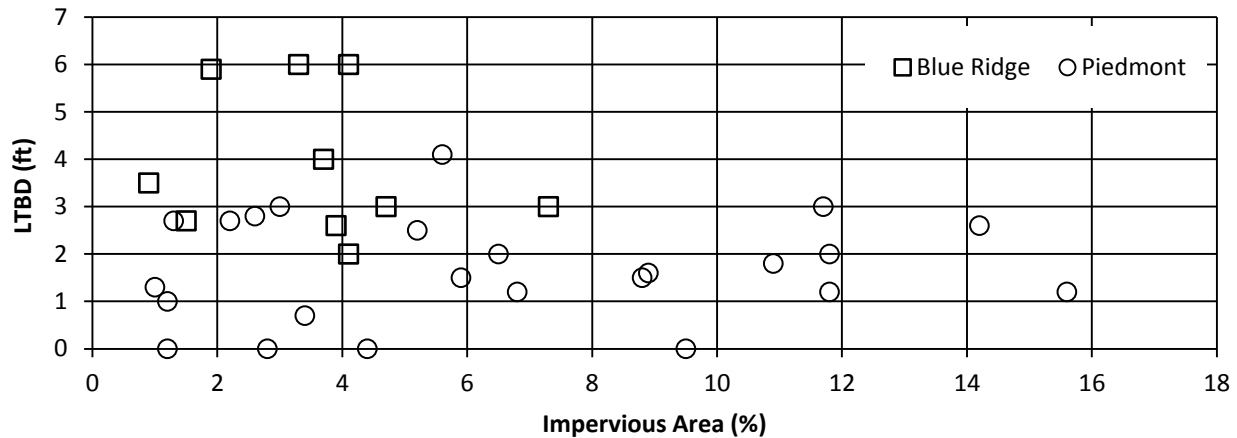

Figure 4.2. LTBD as a function of impervious area.

Valley Slope

Valley slopes in the Blue Ridge were steeper than those in the Piedmont. Maximum values of LTBD increased in the Blue Ridge in the range of slopes from 0.01 to 0.02. This trend of increased maximum LTBD with slope in the Blue Ridge is similar to that found in the same range of valley slopes in Phase 1 study sites in western Maryland. The conservative upper limit curve that described the LTBD observed at Phase 1 sites as a function of valley slope (S_v) was given as

$$\text{LTBD (ft)} = 3 \text{ ft for } S_v < 0.01 \text{ ft/ft} \quad (11)$$

$$\text{LTBD (ft)} = -11300 (S_v)^2 + 615 (S_v) - 2.0 \text{ for } 0.01 \text{ ft/ft} < S_v < 0.027 \text{ ft/ft} \quad (12)$$

This curve also bounds the data from Phase 2 Blue Ridge sites. The Phase 2 sites with slopes in the range of 0.01 to 0.027 ft/ft lie on or slightly below the curve (Figure 4.3), and all four of the Phase 1 data points included in this plot were below the curve. Where valley slopes were greater than 0.027 ft/ft, the dataset for slopes above 0.027 ft/ft is too small to be conclusive.

Data from the Piedmont do not indicate an increase in maximum observed LTBD with slope. One reason for this lack of correlation may be the similarity of the slopes in the sample: few stream reaches in the western Piedmont with watershed areas greater than 1 mi² have slopes that exceed 0.012 ft/ft. The two sample points (44 and 45) (Photo 4.1) where the valley slope exceeds 0.012 ft/ft in the Piedmont are located near the base of Catocin Mountain and within 1 mile of the Blue Ridge Physiographic region border.

Eq. 11 and 12 that describe a conservative upper limit curve for the western Maryland data provide an upper bound for all of the Phase 2 Piedmont data except for Site 50 (Photo 4.2). This site is

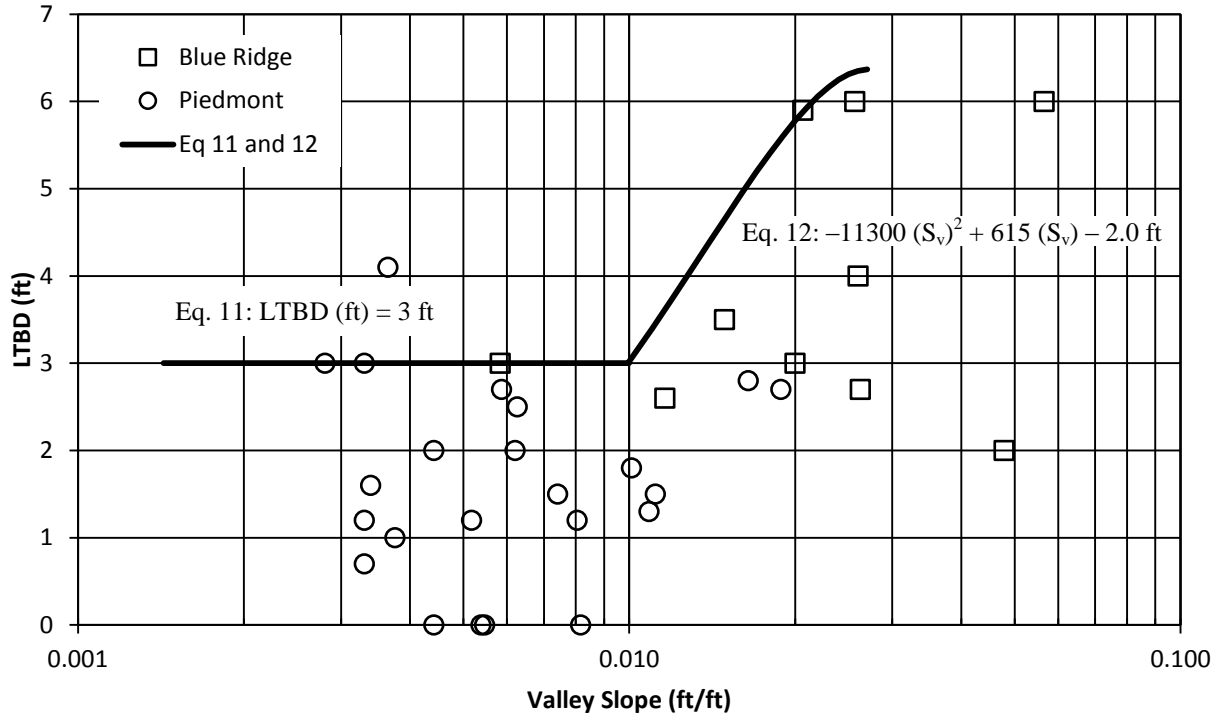

Figure 4.3. LTBD as a function of valley slope.



Photo 4.1. LTBD measured at the culvert outlet of Site 45.



Photo 4.2. LTBD measured downstream of bridge at Site 50.

different than other sites because the bridge at this location was founded on the sediment deposit of a milldam that is now breached. The breached dam is located approximately 570 ft downstream of the bridge where LTBD was measured. The dam height was estimated to be approximately 8 ft over the current water level. This sample site illustrates that Eq. 11 does not provide a conservative upper limit curve for sites located on sediment deposits formed in the backwater of dams or other structures that previously caused aggradation of the valley with fine sediment. Removal of these structures may cause LTBD to be significantly larger than at other sites in the same region.

LTBD versus Channel Boundary Shear Stress Index

Data from the Blue Ridge and the Piedmont show an increase in LTBD with the channel boundary shear stress index, τ_o . A conservative upper limit curve (Figure 4.4) that describes the LTBD as a function of τ_o for all sites in the Blue Ridge and Piedmont except for Site 50 is

$$\text{LTBD} = 4.21 \text{ Log}_{10} (\tau_o) + 0.910 \quad (13)$$

This equation was developed for channel boundary shear stress indices of 1.3 psf to 15.1 psf. As described earlier, Site 50 is different than other sites because the bridge at this location was founded on the sediment deposit of a milldam that is now breached. Eq. 13 does not provide a conservative upper limit curve for sites located on sediment deposits formed in the backwater of dams or other structures. Where these structures are breached or removed, LTBD may be significantly larger than predicted by Eq. 13.

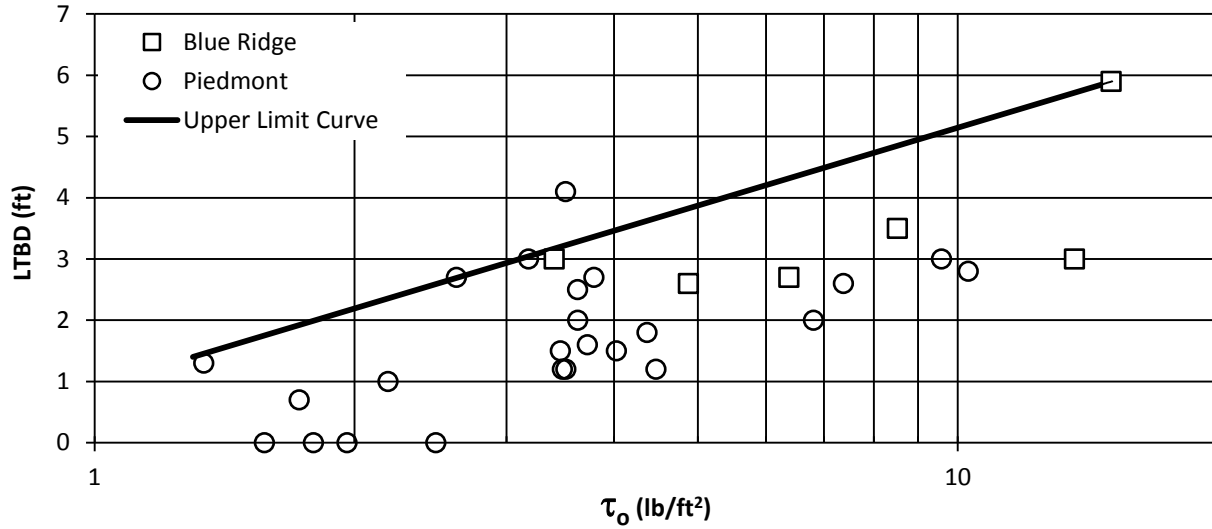

Figure 4.4. Conservative upper limit of LTBD as a function of τ_o .

Bed Mobility Index versus LTBD

Data from the Blue Ridge and Piedmont indicate that BMI is not a good index to predict the observed LTBD (Figure 4.5). One reason for the lack of correlation of LTBD with BMI is the dependence of BMI on the measured D_{50} at each site. As channels degrade vertically, they tend to erode into larger bed material; therefore at some sites, the measured bed material may be larger than it would have been prior to channel degradation. At several sites, the bed was armored with material that was substantially larger than the material in the channel banks that may represent the characteristics of the bed prior to channel degradation (Photo 4.3).

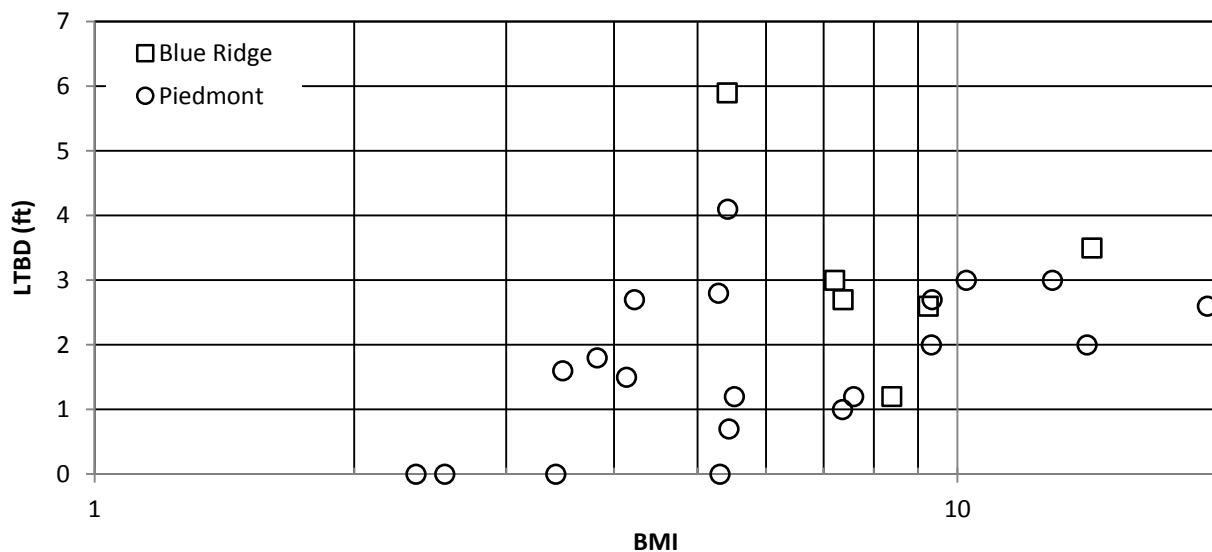

Figure 4.5. LTBD as a function of the bed mobility index.



Photo 4.3. Boulder armor at Site 29.

Bed Controls

Three forms of downstream bed control were identified in the Blue Ridge: bedrock, boulder-armored reaches, and cobble-armored reaches. The most frequent control identified (Figure 4.6) was a boulder-armored reach (4 sites). Bedrock exposure in the channel bed and a cobble riffle were identified as controls in the other two sites of the Blue Ridge.

In the Piedmont, several potential forms of downstream bed control were identified:

- The most frequent apparent form of bed control (42 percent) in the Piedmont was bedrock exposure (Photo 4.4). **Bedrock exposure** was typically but not always observed in stream reaches along the edge of valleys near the base of hillsides. Unlike bedrock steps that formed bed controls in highly resistant bedrock observed in western Maryland, fractured and weathered bedrock was most commonly observed in pools, shallow runs, or riffles with drops as small as 0.1 ft. The low-flow water surface slope was rarely controlled by exposed bedrock. Instead, it was controlled by cobble or gravel riffles. Because the fractured and weathered bedrock does not form the highest points in the channel profile during low flow, it may or may not be controlling the stream grade.
- **Boulder-armored reaches** that provided downstream bed control were observed at 17 percent (4 sites) of the Piedmont sites. The boulder reaches were typically formed of colluvial material or rubble from bed or bank protection or milldam breaches.

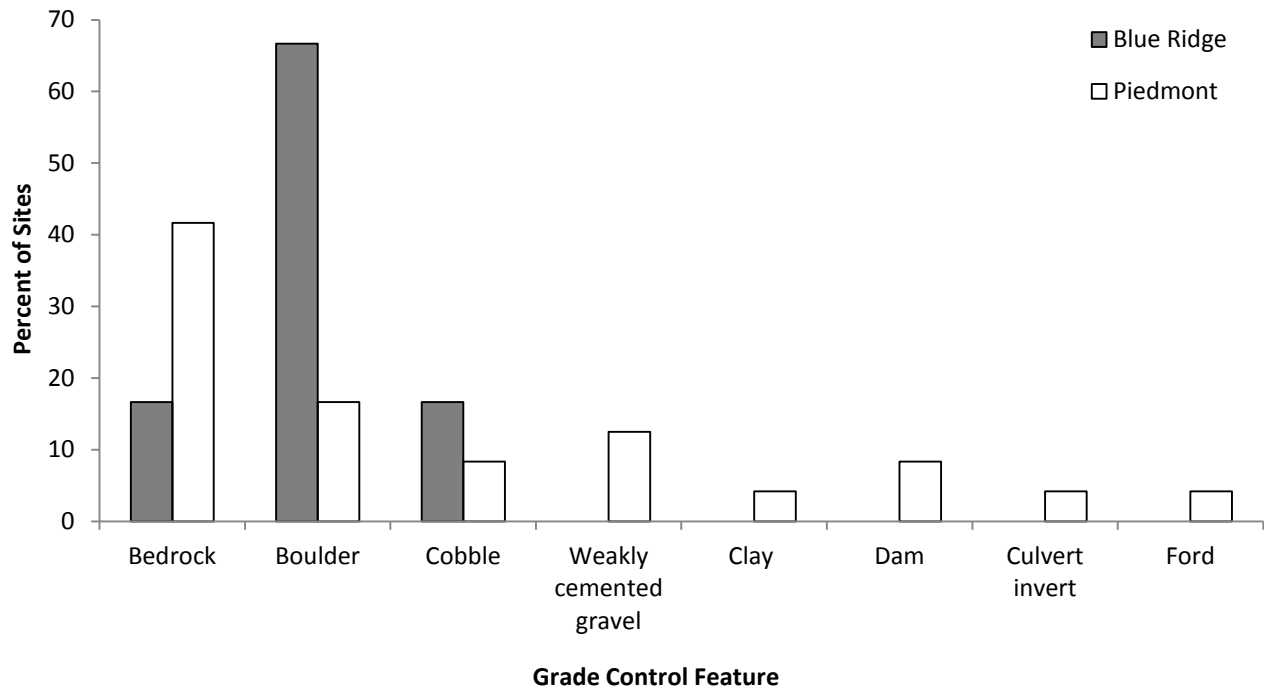

Figure 4.6. Grade control features identified in Blue Ridge and western Piedmont streams.



Photo 4.4. Bedrock exposed in streambed downstream of Site 49.

- **Cobble-armored reaches** that provided bed control were observed at 8 percent (2 sites) of Piedmont sites.
- **Weakly cemented gravel layers** (Photo 4.5) form bed control at 13 percent (3 sites) of Piedmont sites. Small steps formed by the erosion of the gravel layers migrate upstream as headcuts, and they represent a gradual upstream progression of bed degradation.
- **A thick deposit of clay** was observed at Site 55 in a small tributary to the Potomac River. No bed control features were observed within 1000 ft downstream of the site.
- **Two dams, a culvert invert, and a ford** were identified as downstream controls at the remaining four sites in the Piedmont.

A means of incorporating the present bed controls into the assessment of observed LTBD has not yet been identified, particularly in cases when the features may have become exposed or developed as bed degradation has occurred. For example, the fractured bedrock that was identified at several sites was not exposed above the low-flow water surface; therefore, it may have degraded at the same rate as the rest of the channel profile. Additional effort needs to be focused on determining the role of bedrock exposure in controlling the bed profile.

Structure Age versus LTBD

The relationship between the age of the structure and LTBD was examined (Figure 4.7) with the intent of developing a relation between site parameters and the rate of LTBD. For replacement structures, the date of completion for the replaced structure was used to compute the age. The research team could confirm the age of only 17 structures. The data for these structures does not indicate a correlation of LTBD with age, as shown in Figure 4.7. Given this result and the small number of observations, the team did not pursue development of a rate relation. The data set is inadequate to develop a reliable rate relationship.

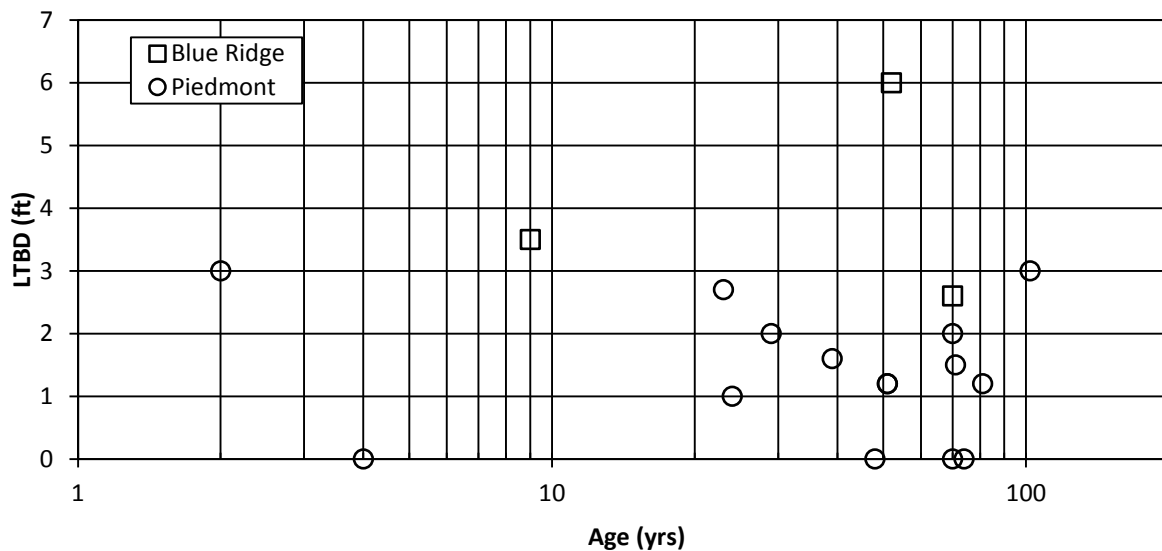

Figure 4.7. Variation of LTBD with structure’s age.



Photo 4.5. Step in channel profile composed of weakly cemented gravel downstream of Site 36.

Comparison of LTBD Equations

Observed values of LTBD were compared to those predicted by the use of S_v -based equations (Eq. 11 and 12) and the τ_o -based equation (Eq. 13). The residuals were defined as

$$\text{Residual LTBD} = \text{Observed LTBD} - \text{Predicted LTBD} \quad (14)$$

Residuals were computed and plotted for all of the Piedmont site samples except Site 50 (Figure 4.8), which was excluded because none of the equations represents the specific conditions at that site. Linear regression was used to develop a relation between the residuals for Eq. 11 and 12 and Eq. 13. Eq. 11 and 12 provide a better estimate of LTBD for observed LTBD values greater than about 1.8 ft. For observed LTBD of less than 1.8 ft, the residuals for Eq. 13 are smaller than those for Eq. 11 and 12, but the maximum difference in residual regression lines is less than 0.7 ft. This means that use of the more data-intensive Eq. 13 would only be expected to provide an estimate 0.7 ft lower than Eq. 11 & 12 in conditions where LTBD is anticipated to be low. Low values of LTBD can be expected at S_v less than 0.0055. For S_v greater than 0.0055, Eq. 11 and 12 provide a better estimate than Eq. 13.

Regression of Blue Ridge data residuals for Eq. 11 and 12 and Eq. 13 indicate that Eq. 13 provides a marginally better estimate of LTBD by about 0.23 ft to 0.52 ft over the range of S_v from 0.01 to 0.027 ft/ft (Figure 4.9).

Given the simplicity of using S_v obtained from topographic maps and the lack of substantial improvement in the prediction of observed LTBD values by Eq. 13, Eq. 11 and 12 are recommended for use in assessing LTBD on Piedmont and Blue Ridge streams with slopes of less than 0.027 ft/ft.

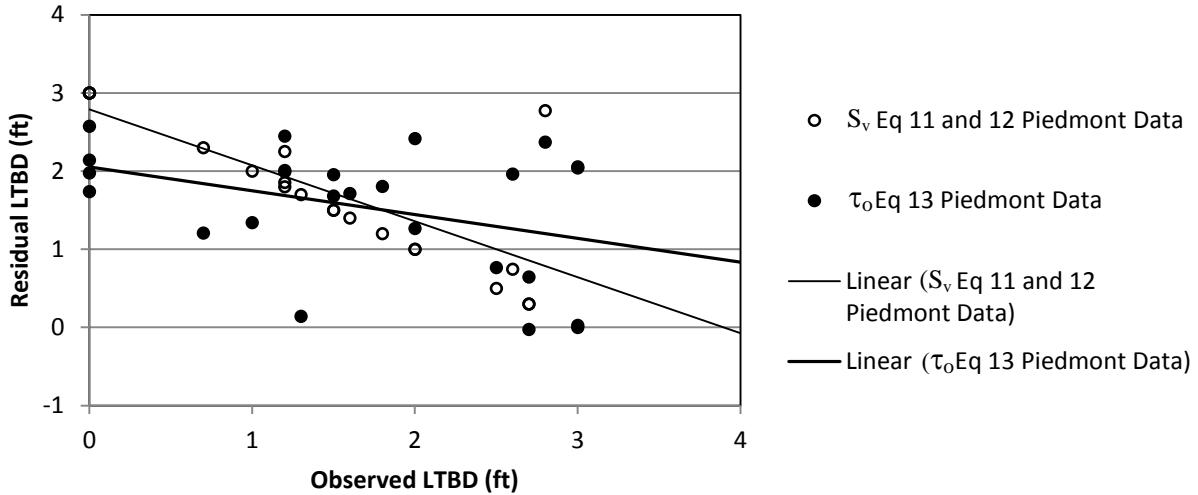

Figure 4.8. Comparison of residual LTBD values and observed LTBD for the Piedmont data.

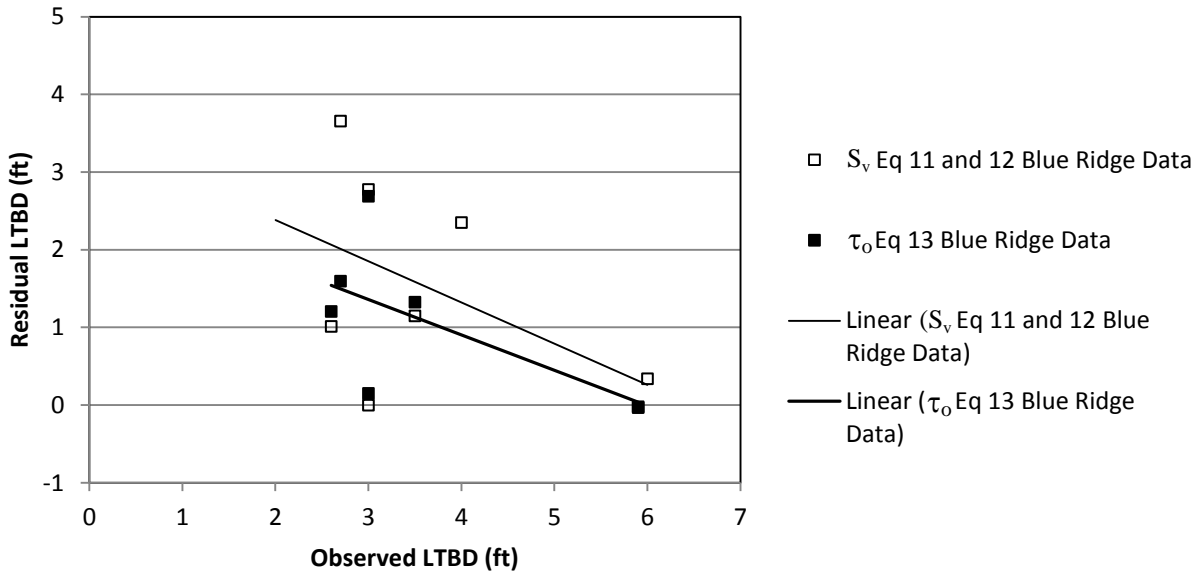

Figure 4.9. Comparison of predicted LTBD values and observed LTBD for the Blue Ridge data.

5.0 APPLICATION

The equations developed from field data in this study can be used as a general guide for the prediction of long-term bed degradation in the Blue Ridge physiographic province of Washington and Frederick counties and the western part of the Piedmont physiographic region in Frederick, Carroll, and Montgomery counties. The equations can be used for streams with slopes of less than

0.027 ft/ft and drainage areas from 1.7-25.9 mi². **Until further study has been completed, however, the research team recommends that use of these equations be limited to sites not located in deep deposits of sediment created by backwater from dams or other structures or in streams with evidence of active channel degradation.** The value of LTBD may be substantially greater than those given in this study for stream channel networks already experiencing significant LTBD or at structures located in thick dam deposits.

A thorough examination of the site and downstream valley should be made to determine whether either of these conditions applies to the site being evaluated. Indicators of bed degradation problems may include perched culverts, exposed utility crossings, exposed bridge foundations, and/or channel headcuts. A search of historical documents should be made to determine the location of historic mill dams or other dams that may have caused deep and extensive backwater deposits. Evidence of backwater deposits include exposure of clay in the streambed, no evidence of gravel at the base of eroding stream banks, banks greater than 4 ft composed completely of fine-grained sediment. Neither Eq. 11 and 12 nor Eq. 13 should be used to predict LTBD for

1. Structures located in channels with ongoing degradation problems
2. Structures located in the backwater deposit of a dam
3. Locations where other structures may have been or may be removed during the life of the structure being evaluated.

In such cases, an LTBD assessment should be completed in accordance with the procedures in Chapter 14 of Maryland's *Hydrology and Hydraulics Manual* [1].

The effects of large impervious areas and other land use modifications associated with urbanization were not examined extensively in this study. Imperviousness was less than 16 percent in the watersheds contributing flow to the Piedmont sites. Therefore, the equations developed in this study should be applied only to streams where less than 16 percent of the contributing watershed's surface area is impervious.

A channel should be evaluated as follows for signs of active channel degradation within approximately 1000 ft upstream and downstream of the structure location:

1. Examine records of the site including bridge inspection reports and reports from sewer line authorities and other utility companies that may have pipeline crossings. A step in the channel profile at any of these structures is an indication of an existing bed degradation problem.
2. Examine bridges that cross the channel upstream and downstream of the site for exposed foundations or other signs of bed degradation.
3. Examine the channel bed for signs of ongoing bed degradation problems.

If any of these evaluations indicate that the channel is degrading, or if the valley slope is greater than 0.027 ft/ft, then the LTBD equations should not be used. Instead, the techniques recommended in Chapter 14 of Maryland's *Hydrology and Hydraulics Manual* [1] should be used to evaluate bed degradation potential.

If the channel shows no evidence either of existing degradation problems in the stream system or of a deep deposit of sediment created by backwater from a dam or other structure, then the LTBD equations may be used as follows for Blue Ridge and western Piedmont sites with valley slopes less than 0.027 ft/ft and drainages areas from 1.7-25.9 mi²:

3. Compute the valley slope, S_v , from a USGS 7.5-minute topographic map. For most sites, the contour lines directly upstream and downstream of the structure location should be used to compute the slope as follows:

$$S_v = (\text{distance between contours}) / (\text{contour interval}) \quad (15)$$

At sites where the downstream contour is immediately downstream of the structure, the slope should be calculated using the two contour lines downstream of the site. Where the structure is located directly upstream of the confluence with a much larger stream, the slope upstream of the site should be averaged with the slope of the larger, receiving stream's valley.

4. Use Eq. 11 and 12 from this study to estimate LTBD.

The LTBD values computed by Eq. 11 and 12 are likely to be conservative for most sites to which they are applicable. Engineers should consider other site-specific factors not included in the development of Eq. 11 and 12. Two factors that could be used to reduce the values obtained in Eq. 11 and 12 are bed controls and the time required for the full potential for LTBD to be realized. Bed controls such as durable bedrock and large immobile bed material may limit degradation. Unlike other forms of localized scour that can obtain their maximum values under a single flood event, the full potential LTBD is realized over multiple flood events extending over time periods of a few years to decades. The long-term nature of LTBD allows time for the degradation to be observed during bridge inspections and for countermeasures to then be installed.

Engineers should also consider other site-specific factors that may increase the potential for LTBD beyond those predicted by Eq. 11 and 12. In particular, structures founded on sediment deposits upstream of existing dams that may be removed during the life of the structure have the potential to experience much larger values of LTBD than those predicted by Eq. 11 and 12. Man-made structures, such as culverts and utility crossings, may also provide downstream grade control that once removed may cause degradation upstream beyond those values predicted by Eq. 11 and 12. This is particularly the case if these man-made controls or structures are founded on soils formed from sediments trapped upstream of historic milldams. The final depth of LTBD used for the placement of structure foundations should be determined using Eq. 11 and 12 and the additional site-specific information.

6.0 CONCLUSIONS AND RECOMMENDATIONS

Field Data Collection

A database of 30 field measurements of LTBD was developed for Frederick, Carroll, and Montgomery counties. These measurements were adequate for the intended purpose of providing a range of LTBD observed in the three counties. Two important sources of error in these measurements should be addressed in future studies:

1. Precise pre-degradation reference elevations were available to estimate LTBD at only a few of the bridge sites. Pre-degradation reference elevations at the rest of the sites were approximated as the top surface of the foundations, or they were approximated as the existing bed protection elevation. These approximations resulted in an underestimation of LTBD. Locating bridge sites where degradation is measurable and bridge plans with streambed reference elevations are available would remedy this situation. A more efficient means of locating sites that have both measurable degradation and plans with stream bed reference elevations is needed.
2. Consideration needs to be given to the fact that the measurements may not represent the maximum degradation that may have occurred. The estimates of LTBD developed in this study were based on a single set of bed profile measurements. In some locations, the bed may have degraded, and subsequent deposition may have changed the channel profile such that the measured LTBD is less than the maximum that may have occurred during the life of the structure. This problem is envisioned to be most significant at bridge sites on lower-sloped streams and least significant downstream of culverts on higher-sloped streams.

The effects of entrenchment were included in this study by adding the effects of the estimated pre-degradation channel geometry on the index shear stress. The research team found that inclusion of this effect did not significantly improve the prediction of LTBD over that of the relation developed for slope. The research team recommends that future phases continue to collect the same channel geometry data, as the effect may be more significant in other regions.

The research team examined the utility of including bed resistance in predictions of LTBD through the development of a bed mobility index (BMI). The effects were incorporated through the use of a threshold shear stress that was based on the measured median size of the bed material. The research team found a poor correlation of BMI with LTBD for the data of both regions of this study. The research team recommends that future phases continue to collect the same bed material data, as the effect may be more significant in other regions.

The research team located bed controls at most sites; whether or how these bed controls were controlling the profile of the channel to limit LTBD, however, was unclear. Highly weathered and fractured bedrock was present near the low-flow water surface (within 1 ft) and in the base of pools at multiple locations; however, bedrock rarely controlled the low-flow water surface slope, indicating that coarse material downstream may be controlling the channel profile. A method for incorporating the effects of weak near-surface bedrock and coarse material needs to be developed to quantify their role in LTBD.

Remedial activities employed after flood events may conceal LTBD where structures were damaged. Soon after severe flood events and before maintenance crews can repair structures, a team of SHA engineers should obtain rapid measurements at damaged structures. The most severe cases of channel degradation are likely to endanger structures, and they are repaired as soon as possible after floods recede. For this reason, the most severe degradation may not have been measured in this study. Measurements by SHA engineers after floods may exceed those of this study.

Regional Relations

The possibility of developing regional relations between drainage area and LTBD was evaluated for each physiographic province. The data for the Blue Ridge and Piedmont provinces did not indicate strong trends in the variation of LTBD with drainage area. Development of regional relations based solely on drainage area was not pursued in this study.

LTBD Risk Factors

The variation of LTBD was examined with respect to five of the six risk factors: (1) the valley slope, (2) the effective floodplain width, (3) discharge, (4) downstream channel entrenchment, and (5) bed material size. Three relations between LTBD and these factors were examined: LTBD and valley slope; LTBD and an index combining Factors 1-4 (boundary shear stress index); and LTBD and an index combining Factors 1-5 (bed mobility index). A comparison of the resulting equations revealed that valley slope was as good a predictor of the susceptibility of a site to LTBD as the two indices that required additional data and considered more parameters. The relations between valley slope and LTBD were recommended to estimate LTBD for streams with slopes of less than 0.027 ft/ft and drainage areas from 1.7-25.9 mi².

The analysis and development of indices include parameters for one of the two factors not measured in Phase 1: downstream channel entrenchment. The fieldwork did include the identification of bed controls, but additional field data would be required to develop parameters and indices that would capture the influence of bed controls. The next phase of LTBD research should include the development of a method to include the effectiveness of downstream bed controls in limiting degradation.

Rate of LTBD

The number of available structure plans was insufficient to develop a rate relation. The development of a rate relation should be explored further in future phases of this research. The lack of success in obtaining plans during the time period of each study and the lack of plans for each individual study area for each phase does not provide sufficient data for the evaluation of the rate of degradation. Although data from any one region has been insufficient, the composite data from regions with similar degradation causes and values of LTBD may be grouped in future research to provide sufficient data for an analysis of degradation rates.

ACKNOWLEDGEMENTS

Andrzej (“Andy”) J. Kosicki, MS, PE, Chief, Structure Hydrology and Hydraulics Division, Maryland State Highway Administration Office of Structures, and Stanley R. Davis, PE, Independent Consultant Engineer, developed the concept for this research project. Mr. Kosicki provided valuable comments and suggestions that improved this report.

Jeremy Mondock, PE, Senior Project Manager, Structure Hydrology and Hydraulics Division, Maryland State Highway Administration Office of Structures, was the project manager for SHA and provided valuable comments on the project plan and final report.

Clayton Mastin, Riverine Systems engineer, assisted in the field data collection and data analysis.

Michael Croasdaile, Riverine Systems geomorphologist, assisted in the data collection and data analysis.

Chandra Hansen, Technical Editor at Riverine Systems, edited sections of the report.

Seyed A. Saadat, PE, Associate Water Resources Engineer at RK&K, was the consultant project manager.

Krista Greer, PE, Water Resources Engineer with RK&K, conducted the analysis of land use, watershed parameters, and flows for the sample sites of this study. She also assisted in field data collection.

Kelly Collins-Lindow, MS, PE, Water Resources Engineer with RK&K, assisted in the data collection and data analysis.

Dorianne Shivers, Water Resources Engineer with RK&K, assisted in the data collection and data analysis.

The following individuals from Carroll and Frederick counties graciously provided information on sample sites: Kendall M. Stoner, Project Engineer, Bureau of Engineering, Carroll County Government; and Jason Stick, Floodplain Management Specialist, Bureau of Resource Management, Carroll County Government.

REFERENCES

1. Parola AC and Hansen C. 2007. Chapter 14: stream morphology. In Hydrology and Hydraulics Manual. SHA Office of Structures, Structure Hydrology and Hydraulics Division, Maryland Department of Transportation. Available at http://www.gishydro.umd.edu/sha_soft.htm, accessed Sep2011.
2. Parola AC, Oberholtzer WL, and Black D. 2011. Long-term bed degradation in western Maryland streams. Technical report MD-11-SP909B4G, Maryland State Highway Administration, Baltimore, MD. 20 pp.
3. Maryland Geological Survey. 2009. A brief description of the geology of Maryland. Available at <http://www.mgs.md.gov/esic/brochures/mdgeology.html>, accessed Sep2011.
4. Stose AJ and Stose GW. 1946. The physical features of Carroll County and Frederick County. Maryland Department of Geology, Mines, and Water Resources, Baltimore, MD.
5. Schueler T. 1995. Environmental land planning series: site planning for urban stream protection. Prepared by the Metropolitan Washington Council of Governments and the Center for Watershed Protection, Silver Spring, MD.
6. US Geological Survey (USGS). 2006. National elevation dataset. Available at <http://ned.usgs.gov/>, accessed Sep2010.
7. University of Maryland Department of Civil and Environmental Engineering and Maryland State Highway Administration (UMD and SHA). 2010. GISHydro: A GIS-based hydrologic modeling tool. Available at <http://www.gishydro.umd.edu/>, accessed Sep2011.
8. Bunte, K. and S.R. Abt. 2001. Sampling surface and subsurface particle-size distributions in wadable gravel- and cobble-bed streams for analyses in sediment transport, hydraulics, and streambed monitoring. Gen. Tech. Rep. RMRS-GTR-74. US Department of Agriculture, Forest Service, Rocky Mountain Research Station, Ft. Collins, CO, 428 pp.
9. Moglen G, Thomas WO, and Cuneo CG. 2006. Evaluation of alternative statistical methods for estimating frequency of peak flows in Maryland. Final report (SP907C4B), Maryland Department of Transportation, Hanover, MD. 78 pp.
10. US Department of Agriculture Natural Resources Conservation Service (USDA NRCS). 2006. US General Soil Map (STATSGO2). Available at <http://soils.usda.gov/survey/geography/statsgo/>, accessed Sep2011.