

Field Testing and Evaluation of a Demonstration Timber Bridge

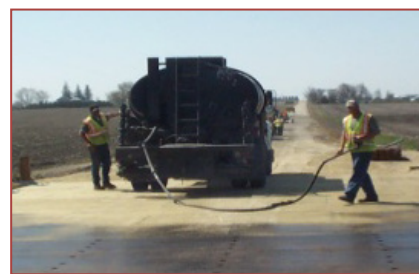

Final Report
February 2012



IOWA STATE UNIVERSITY
Institute for Transportation

Sponsored by
Iowa Highway Research Board
(IHRB Project TR-604)
Iowa Department of Transportation
(InTrans Project 08-343)

About the BEC

The mission of the Bridge Engineering Center is to conduct research on bridge technologies to help bridge designers/owners design, build, and maintain long-lasting bridges.

Disclaimer Notice

The contents of this report reflect the views of the authors, who are responsible for the facts and the accuracy of the information presented herein. The opinions, findings and conclusions expressed in this publication are those of the authors and not necessarily those of the sponsors.

The sponsors assume no liability for the contents or use of the information contained in this document. This report does not constitute a standard, specification, or regulation.

The sponsors do not endorse products or manufacturers. Trademarks or manufacturers' names appear in this report only because they are considered essential to the objective of the document.

Non-Discrimination Statement

Iowa State University does not discriminate on the basis of race, color, age, religion, national origin, sexual orientation, gender identity, sex, marital status, disability, or status as a U.S. veteran. Inquiries can be directed to the Director of Equal Opportunity and Diversity, (515) 294-7612.

Iowa Department of Transportation Statements

Federal and state laws prohibit employment and/or public accommodation discrimination on the basis of age, color, creed, disability, gender identity, national origin, pregnancy, race, religion, sex, sexual orientation or veteran's status. If you believe you have been discriminated against, please contact the Iowa Civil Rights Commission at 800-457-4416 or Iowa Department of Transportation's affirmative action officer. If you need accommodations because of a disability to access the Iowa Department of Transportation's services, contact the agency's affirmative action officer at 800-262-0003.

The preparation of this (report, document, etc.) was financed in part through funds provided by the Iowa Department of Transportation through its "Agreement for the Management of Research Conducted by Iowa State University for the Iowa Department of Transportation," and its amendments.

The opinions, findings, and conclusions expressed in this publication are those of the authors and not necessarily those of the Iowa Department of Transportation.

Technical Report Documentation Page

1. Report No. IHRB Project TR-604		2. Government Accession No.		3. Recipient's Catalog No.	
4. Title and Subtitle Field Testing and Evaluation of a Demonstration Timber Bridge				5. Report Date February 2012	
				6. Performing Organization Code	
7. Author(s) Travis Hosteng, Brent Phares, and Michael Ritter				8. Performing Organization Report No. InTrans Project 08-343	
9. Performing Organization Name and Address Bridge Engineering Center Iowa State University 2711 South Loop Drive, Suite 4700 Ames, IA 50010-8664				10. Work Unit No. (TRAIS)	
				11. Contract or Grant No.	
12. Sponsoring Organization Name and Address Iowa Highway Research Board Iowa Department of Transportation 800 Lincoln Way Ames, IA 50010				13. Type of Report and Period Covered Final Report	
				14. Sponsoring Agency Code	
15. Supplementary Notes Visit www.intrans.iastate.edu for color PDFs of this and other research reports.					
16. Abstract <p>Asphalt wearing surfaces are commonly used on timber bridges with transverse glued-laminated deck panel systems to help protect the timber components. However, poor performance of these asphalt wearing surfaces in the past has resulted in repeated repair and increased maintenance costs.</p> <p>This report describes the field demonstration and testing of a newly-constructed, glued-laminated timber girder bridge. Previous field work revealed that differential panel deflections in the glued-laminated deck were one significant factor resulting in the premature failure of the asphalt wearing surfaces on these bridges. In addition, laboratory work subsequent to the field testing attempted to address the problematic asphalt cracking common in transverse glued-laminated panel decks by testing several deck joint connection alternatives.</p> <p>The field demonstration project described in this report showcases the retrofit detail that was determined to provide the best field performance. The project was a cooperative effort between the Bridge Engineering Center (BEC) at Iowa State University and the United States Department of Agriculture (USDA) Forest Service Forest Products Laboratory (FPL).</p>					
17. Key Words asphalt wearing surface—glued-laminated timber—timber girder bridge—wearing surfaces				18. Distribution Statement No restrictions.	
19. Security Classification (of this report) Unclassified.		20. Security Classification (of this page) Unclassified.		21. No. of Pages 46	22. Price NA

FIELD TESTING AND EVALUATION OF A DEMONSTRATION TIMBER BRIDGE

**Final Report
February 2012**

Co-Principal Investigators

Travis Hosteng
Bridge Research Engineer
Bridge Engineering Center, Iowa State University

Brent Phares
Director
Bridge Engineering Center, Iowa State University

Michael Ritter
Assistant Director, Wood Products Research
United States Department of Agriculture
Forest Service Forest Products Laboratory

Authors

Travis Hosteng, Brent Phares, and Michael Ritter

Sponsored by
the Iowa Highway Research Board
(IHRB Project TR-604)

Preparation of this report was financed in part
through funds provided by the Iowa Department of Transportation
through its research management agreement with the
Institute for Transportation
(InTrans Project 08-343)

A report from
Bridge Engineering Center
Iowa State University
2711 South Loop Drive, Suite 4700
Ames, IA 50010-8664
Phone: 515-294-8103
Fax: 515-294-0467
www.intrans.iastate.edu

TABLE OF CONTENTS

ACKNOWLEDGMENTS	vii
EXECUTIVE SUMMARY	ix
1. GENERAL.....	1
1.1 Introduction.....	1
1.2 Research Objectives.....	1
1.3 Project Scope	2
2. SUMMARY OF PRECEEDING WORK.....	3
2.1 Field Test Results - 2004	3
2.2 Laboratory Test Results - 2006.....	5
3. DEMONSTRATION BRIDGE	8
3.1 Design	8
3.2 Construction.....	12
4. TEST AND EVALUATION METHODOLOGY	14
5. TEST AND EVALUATION RESULTS	21
5.1 Inspection.....	21
5.2 Live Load Test Results	23
6. SUMMARY AND CONCLUSIONS	31
7. RECOMMENDATIONS.....	33
REFERENCES	34

LIST OF FIGURES

Figure 2.1. Wearing surface deterioration resulting from cupped deck panels	4
Figure 2.2. Erected laboratory bridge	5
Figure 2.3. Maximum differential panel deflection for the laboratory bridge alternatives	6
Figure 2.4. Plywood layout on the laboratory bridge	6
Figure 3.1. Completed demonstration bridge in service	8
Figure 3.2. Superstructure layout, demonstration bridge.....	9
Figure 3.3. Deck panel and lag screw layout, both spans	10
Figure 3.4. Cross section of demonstration bridge, Span 1	10
Figure 3.5. Plan layout of plywood on demonstration bridge, Span 1.....	11
Figure 3.6. Typical screw pattern for plywood attachment to timber deck	12
Figure 3.7. Construction of the demonstration bridge in Delaware County, Iowa.....	13
Figure 4.1. Typical instrumentation setup	15
Figure 4.2. Instrumentation layout, demonstration bridge test 2009	16
Figure 4.3. Instrumentation layout, demonstration bridge test 2010	17
Figure 4.4. Instrumentation layout near supports, demonstration bridge 2010	18
Figure 4.5. Load cases for demonstration bridge 2009 testing (looking north).....	19
Figure 4.6. Load cases for demonstration bridge 2010 testing (looking north).....	20
Figure 5.1. Transverse cracking evident one month post construction on Span 2.....	21
Figure 5.2. Transverse cracking two months post construction.....	22
Figure 5.3. Transverse cracking, Span 1, one year post construction.....	22
Figure 5.4. Peak girder deflections for Load Cases 1 through 5, 2009 data	23
Figure 5.5. Span 1 midspan girder strains, 2009.....	24
Figure 5.6. Span 2 midspan girder strains, 2009.....	25
Figure 5.7. Top and bottom girder strains, Span 1, G6, 2010.....	26
Figure 5.8. Comparison of differential panel deflections for Span 1 and Span 2, 2009 data	27
Figure 5.9. PJ6 differential panel deflection comparison, 2009-2010.....	28
Figure 5.10. PJ5, LC 6, differential panel deflections between G3 and G4	29
Figure 5.11. PJ4, LC 6, differential panel deflections between G3 and G4	29
Figure 5.12. Global displacement of gage clusters, Detail A and B	30

LIST OF TABLES

Table 2.1. Effective span for transverse glued-laminated deck panels.....	3
Table 2.2. Correlation between global girder deflection and wearing surface performance	4

ACKNOWLEDGMENTS

This research project was sponsored by the Iowa Department of Transportation and the Iowa Highway Research Board. The authors would like to thank the technical advisory committee for their input and effort on the project. The authors would like to thank Delaware County for their input and assistance both during construction and during the testing of the structure. The authors would also like to thank Peter Moreau for his help with drafting computer-aided design (CAD) drawings and reducing test data.

EXECUTIVE SUMMARY

Asphalt wearing surfaces on timber bridges are designed not only to protect the timber deck components from vehicular wear and tear, but also to provide a moisture barrier and protect the deck from the elements. However, premature failure and/or degradation of the wearing surface have been common problems associated with glued-laminated timber girder bridges with transverse glued-laminated decks.

This failure/degradation of the wearing surface can result in the accelerated deterioration of the timber beneath due to water infiltration, and often incorrectly implies structural inadequacy.

The primary objective of the research summarized in this report was to construct and test a demonstration timber bridge utilizing new design details developed to reduce the magnitude of the asphalt wearing surface deterioration to acceptable levels and therefore increase the durability of the entire bridge system.

In support of this objective, lessons learned from previous bridge field tests, along with details developed during laboratory testing, were applied to a field demonstration bridge.

Previous load tests conducted on glued-laminated timber bridges with asphalt wearing surfaces found that the bridges with the most significant amount of wearing surface deterioration had two characteristics in common: 1) average to moderate relative deflections between adjacent glued-laminated deck panels and 2) cupped deck panels resulting from differences in moisture content between the top and bottom of the deck panels.

Subsequent laboratory testing of a full-scale glued-laminated timber bridge concluded that relative deck panel deflections could be reduced by means of physical connection at the deck panel joints. Various connection details were investigated, including steel dowels, glass-fiber dowels, a steel plate placed at mid-panel depth, and a plywood overlay.

It was concluded that, based on the test results and the constructability of all of the alternatives considered, the plywood overlay was the most viable option.

Given the findings of the field and laboratory testing, there was a need to test the plywood overlay alternative on a structure with an asphalt wearing surface to determine if this alternative had an impact on the deterioration of the asphalt.

The bridge specifically designed for this project consists of two 38 ft simple spans; each span consists of six glued-laminated timber girders and 5 1/8 in. by 4 ft transverse glued-laminated timber deck panels lag screwed to the girders.

Span 1, the south span, has a layer of 3/4 in. treated plywood screwed directly to the deck panels; Span 2, the north span, was not covered with plywood and would be used as a control. The decks of both spans were overlaid with asphalt.

Inspection of the wearing surface one month following bridge construction noted transverse cracking at the deck panel joints on Span 2 with less noticeable cracks on Span 1 over the deck panel joints. However, cracking over the plywood joints was also observed in Span 1.

Global girder deflection measurements from 2009 indicate that the global response of the structure was as expected. The peak tensile strain in the girders measured during the 2009 and 2010 tests was approximately 250 microstrain (0.45 ksi), well below the design bending stress (calculated based on HS20 truck) of approximately 2.2 ksi.

Wearing surface inspection in 2010 noted that the cracking at the panel joints on Span 2 were becoming more prevalent; cracking on Span 1 was now evident at both the transverse and longitudinal plywood joints, as well as at the transverse deck panel joints.

Differential panel deflection data measured in both 2009 and 2010 indicated two things: 1) differential panel deflections were within the recommended limit of 0.10 in. and 2) slightly larger differential panel deflections were evident on Span 1 than on Span 2, which was opposite of what was expected.

1. GENERAL

1.1 Introduction

The Bridge Engineering Center (BEC) at Iowa State University (ISU), in cooperation with the United States Department of Agriculture (USDA) Forest Products Laboratory (FPL), has completed research in the recent past on glued-laminated timber girder bridges, specifically related to improving the performance and deterioration characteristics of the deck and asphalt wearing surface (Hosteng et al. 2005, Wipf et al. 2005).

Numerous timber bridges with problematic asphalt wearing surfaces were field tested in previous work (Hosteng et al. 2005). Subsequently, a laboratory investigation was conducted that resulted in the development of design modifications for reducing or eliminating differential panel deflections in bridges with glued-laminated girders and transverse glued-laminated decks (Wipf et al. 2005).

In an attempt to improve the performance of asphalt wearing surfaces on timber bridges, research was funded and supported by the National Center for Wood Transportation Structures (NCWTS), a national center housed at Iowa State University in partnership with the FPL, the Federal Highway Administration (FHWA), and the National Parks Service (NPS).

This research involves the demonstration of construction practices developed to improve the performance of new and existing glued-laminated timber bridges. Specifically, a demonstration timber bridge was constructed to test various design, rehabilitation, and construction alternatives.

The design alternative developed in the laboratory research (Wipf et al. 2005), a plywood overlay alternative, was the first alternative to be evaluated on the demonstration bridge and is the focus of this report.

Summarized in this report are the results of two years of inspection and load testing of the demonstration bridge. Initial inspection and load testing was conducted in the summer of 2009 and a follow-up inspection and testing were conducted in the summer of 2010.

1.2 Research Objectives

The objectives of this study include the following:

- Evaluate the effectiveness of the plywood overlay alternative at reducing differential panel deflections
- Evaluate the effect of the plywood overlay alternative on the global response of the structure
- Evaluate the performance of the plywood overlay alternative at reducing or eliminating the deterioration of the asphalt wearing surface

1.3 Project Scope

To satisfy the research objectives, the project scope includes the following post-bridge construction tasks:

- Inspect the asphalt wearing surface for visual signs of distress and note locations
- Evaluate the performance of the wearing surface of Span 1, the span with the plywood deck overlay alternative, compared to the performance of Span 2, the control
- Evaluate the global deflection performance of both spans compared to design
- Evaluate the deflection performance of the transverse deck panels

2. SUMMARY OF PRECEEDING WORK

2.1 2004 Field Test Results

Inspection and test results from the work conducted in 2003-2004 by the BEC (Hosteng et al. 2005) indicated that asphalt wearing surface deterioration is very prevalent, but the presence and severity of the deterioration tends to vary from bridge to bridge.

Of the bridges tested, those with the most severe asphalt wearing surface deterioration were found to have several characteristics in common that may relate to wearing surface degradation, including repeated and/or large differential panel deflections, glued-laminated deck panels with physical conditions showing deterioration, and relatively large global girder deflection.

Field test data suggested that the repetitive relative movement of adjacent deck panels, as well as the actual magnitude of the relative displacements, were both significant factors affecting the condition of the asphalt wearing surface. Measured differential panel deflection magnitudes ranged from negligible to as much as 0.18 in. Differential panel deflection is a quantity that is not directly addressed in any code or specification; however, the Timber Bridge Manual (Ritter 1990) does recommend limiting differential deflections to 0.10 in. and presents a table (Table 2.1 in this report), that recommends maximum girder spacing based on the thickness and stiffness of the glued-laminated deck panel.

Table 2.1. Effective span for transverse glued-laminated deck panels

		Approximate maximum deck span (in.)		
		t = 5 in. or t = 5 1/8 in.	t = 6 3/4 in.	t = 8 1/2 in. or t = 8 3/4 in.
E' (lb/in.²) *	E' (lb/in.²) *			
1,300,000	1,082,900	50	68	91
1,400,000	1,166,200	51	70	94
1,500,000	1,249,500	53	72	95
1,700,000	1,416,100	56	75	99
1,800,000	1,499,400	57	76	101

*E' = EC_M = 0.833E

Field data from the 2004 study ranged from negligible to up to twice the 0.1 in. recommended by the Timber Bridge Manual (Ritter 1990) to eliminate asphalt cracking. Furthermore, the bridges with the largest differential deflections also had comparatively worse asphalt wearing surface performance.

The physical condition of the transverse glued-laminated deck panels were also found to likely impact and even compound the deterioration of the asphalt wearing surface in some cases. In general, the most severe wearing surface deterioration was found on bridges that had cupped deck panels. Figure 2.1 illustrates one case of significant deck panel cupping and the subsequent effect on wearing surface condition (Hosteng et al. 2005).



Figure 2.1. Wearing surface deterioration resulting from cupped deck panels

The cupping of the deck panels is believed to be a result of insufficient panel-to-girder connections combined with significant moisture content gradients between the top and bottom surfaces of the deck panel. Although bridges with flat, uncupped deck panels had wearing surface deterioration that was less severe than those with cupped panels, in most cases, the deterioration was significant nonetheless. Lastly, of the bridges tested, those with the best-performing asphalt wearing surfaces were also found to have lower global midspan girder deflections as shown in Table 2.2.

Table 2.2. Correlation between global girder deflection and wearing surface performance

Bridge	Experimental n-values $D=L/n$	Wearing Surface Condition Rating*
Lost Creek	2032	9
Camp Creek	1380	7
Badger Creek	1150	9
Russellville	750	5
Chambers County	675	6
Wittson	600	5
Butler County	560	2
Erfurth	520	4

*Rating Scale: 1-severe; 5-moderate; 9-minor

Deck and/or wearing surface deterioration may decrease as bridge stiffness increases; however, it is also recognized that a more stringent deflection criteria would result in structural members that provide more strength than is necessary from a structural capacity perspective.

The cost associated with members that provide more capacity than necessary may not be warranted as a short-term solution to the problem, but, given the significant costs associated with the rehabilitation of bridge overlays, research may be warranted into the long-term cost-effectiveness of these types of structural modifications.

2.2 2006 Laboratory Test Results

Shortly after the above-mentioned field testing, a laboratory investigation was conducted that involved the design, construction, testing, and evaluation of a full-scale glued-laminated timber bridge at the ISU Structures Laboratory (Wipf et al. 2005) (see Figure 2.2).



Figure 2.2. Erected laboratory bridge

The laboratory bridge consisted of glued-laminated timber girders and a transverse glued-laminated timber deck and was used to evaluate several different panel-to-panel connection alternatives that were developed to minimize relative panel deflection.

Loading of the structure was performed using hydraulic actuators loaded in 1,000 lb increments up to 16,000 lbs each, which is half of an axle load of the HS-20 design truck, located adjacent to a panel joint. Figure 2.3 shows the maximum differential panel displacements calculated for each alternative investigated with the left-most “Control” bar indicating no special joint treatment.

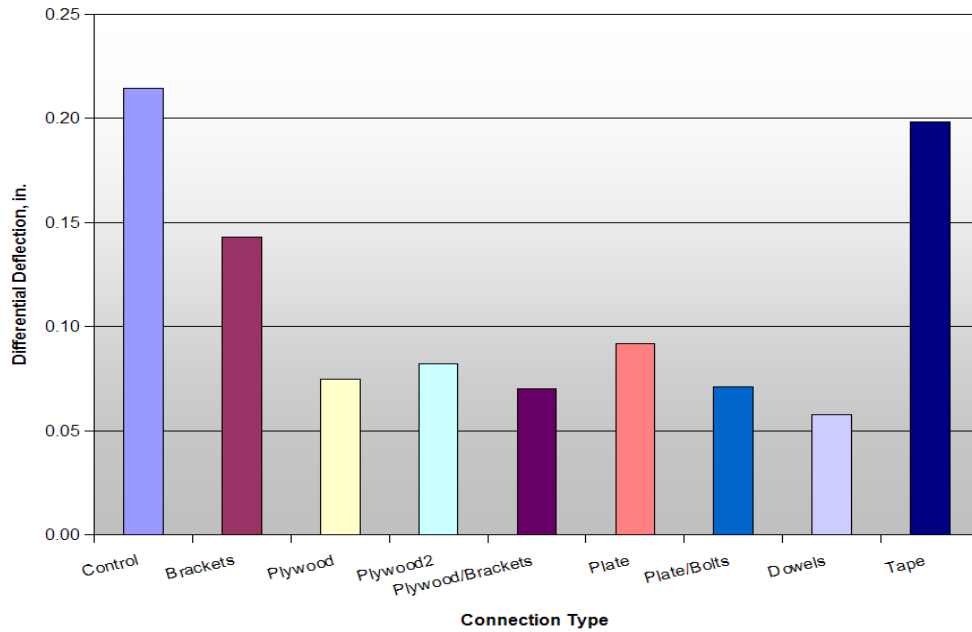

Figure 2.3. Maximum differential panel deflection for the laboratory bridge alternatives

Based on Figure 2.3, the most promising deck modification (based on both performance and ease of construction) involves adding a layer of treated tongue and groove plywood on top of the timber deck surface prior to placement of the wearing surface, as illustrated conceptually in Figure 2.4.

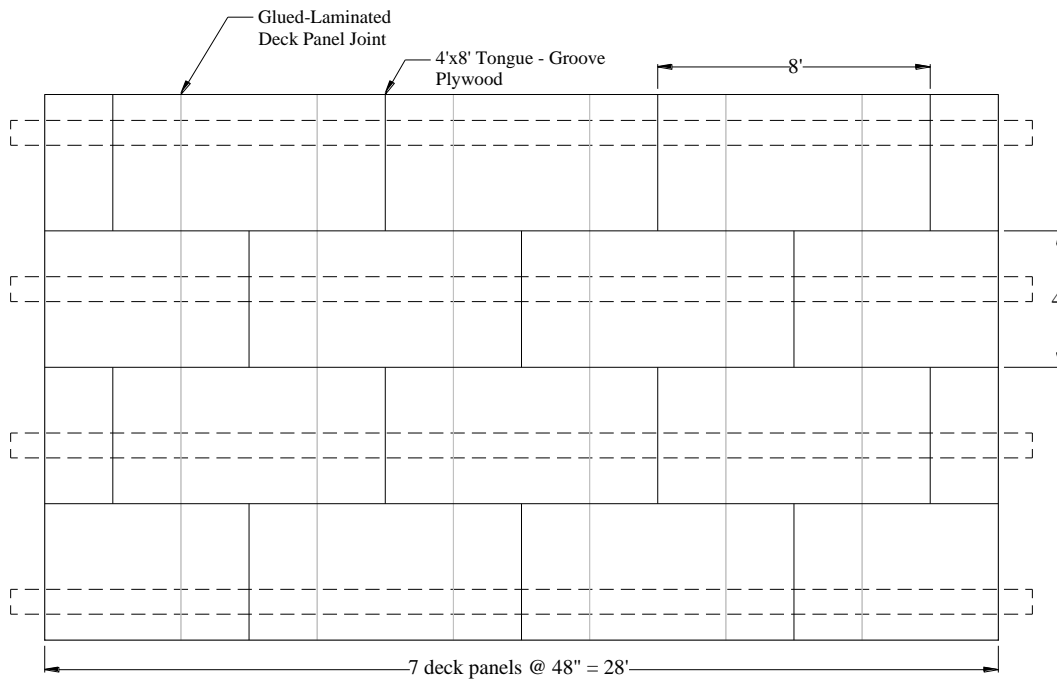

Figure 2.4. Plywood layout on the laboratory bridge

Differential panel deflection data from the plywood overlay alternative is presented in Figure 2.3 as the data bar labeled Plywood. Compared to the control, the plywood overlay alternative reduced the differential panel deflections by more than 50 percent. In addition, this alternative is less expensive and a more construction-friendly alternative compared to the dowels alternative.

Following the completion of the laboratory evaluation, the BEC designed a full-scale glued-laminated timber girder bridge that would be the field test-bed for the details developed in the laboratory. The bridge was constructed in the summer of 2009 in Delaware County, Iowa on a substructure designed by the Delaware County Engineer. The design details and results of the first segment of this testing and investigation on this demonstration bridge are presented in the following chapters.

3. DEMONSTRATION BRIDGE

3.1 Design

Design of the demonstration bridge superstructure was completed following the Timber Bridges: Design, Construction, Inspection and Maintenance manual (Ritter 1990) and the American Association of State Highway and Transportation Officials (AASHTO) Load and Resistance Factor Design (LRFD) Bridge Design Specifications (AASHTO 1998) in supplement. The design live loading considered during design was the HS 20-44 vehicle.

As mentioned previously, the demonstration bridge is a two-span, glued-laminated, timber girder bridge (see Figure 3.1).



Figure 3.1. Completed demonstration bridge in service

Both spans consist of six 38 ft long glued-laminated timber girders simply supported on 5 ft centers. The girders are Southern Yellow Pine (SYP), combination symbol 24F-V3, 10 1/2 in. by 31 5/8 in., with 3/4 in. of camber at midspan.

Figure 3.2 illustrates a plan view of the completed structure. Precast concrete abutment and pier caps provide 9 in. of girder bearing. Transverse glued-laminated timber deck panels are lag screwed to the girders as shown in Figure 3.3. Each span consists of two 3 ft by 5 1/8 in. thick deck panels and eight 4 ft by 5 1/8 in. thick deck panels, all made of SYP combination symbol Number 49. Figure 3.4 illustrates a cross section of Span 1; Span 2 is identical only without plywood on the deck panels.

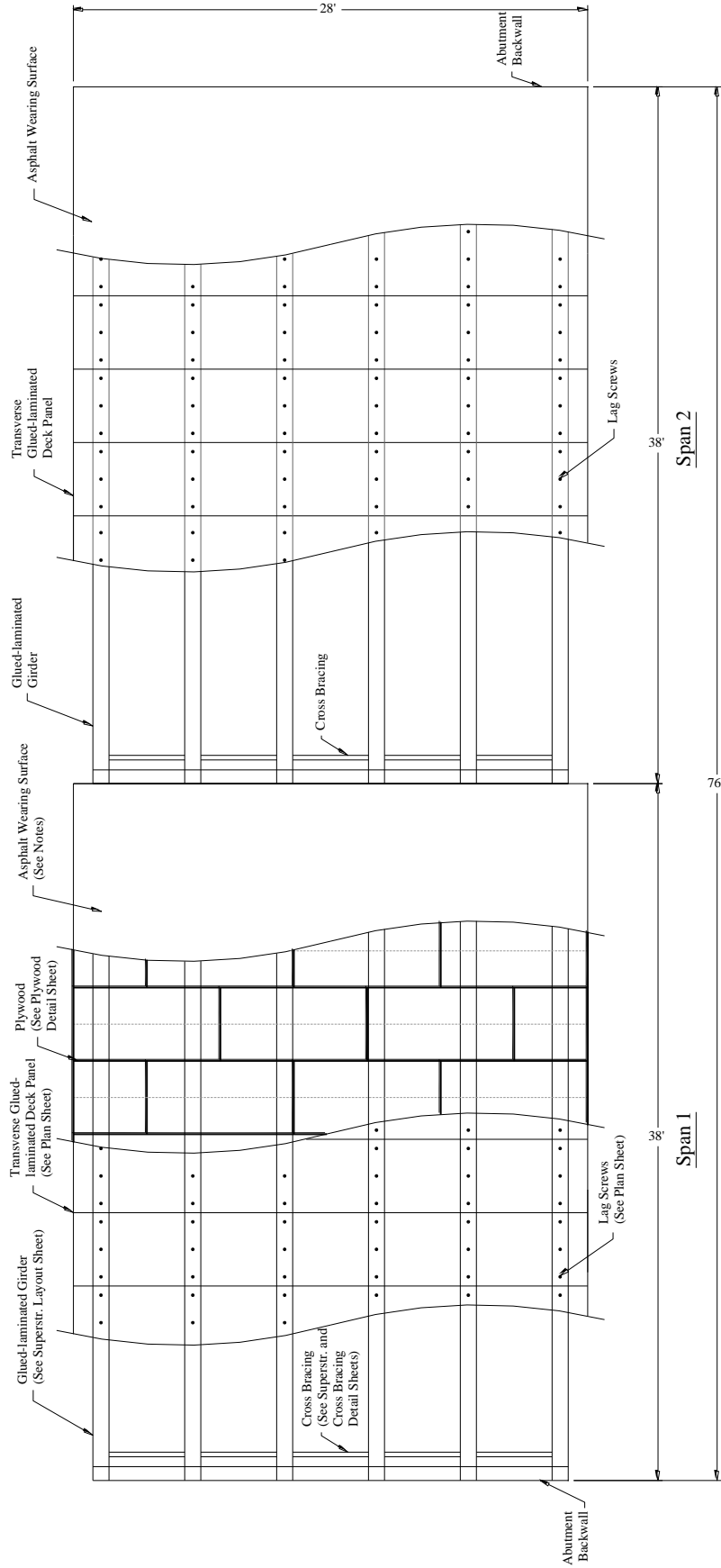

Overall Superstructure Layout
 (Guardrail omitted for clarity, see Guardrail Detail Sheets)

Figure 3.2. Superstructure layout, demonstration bridge

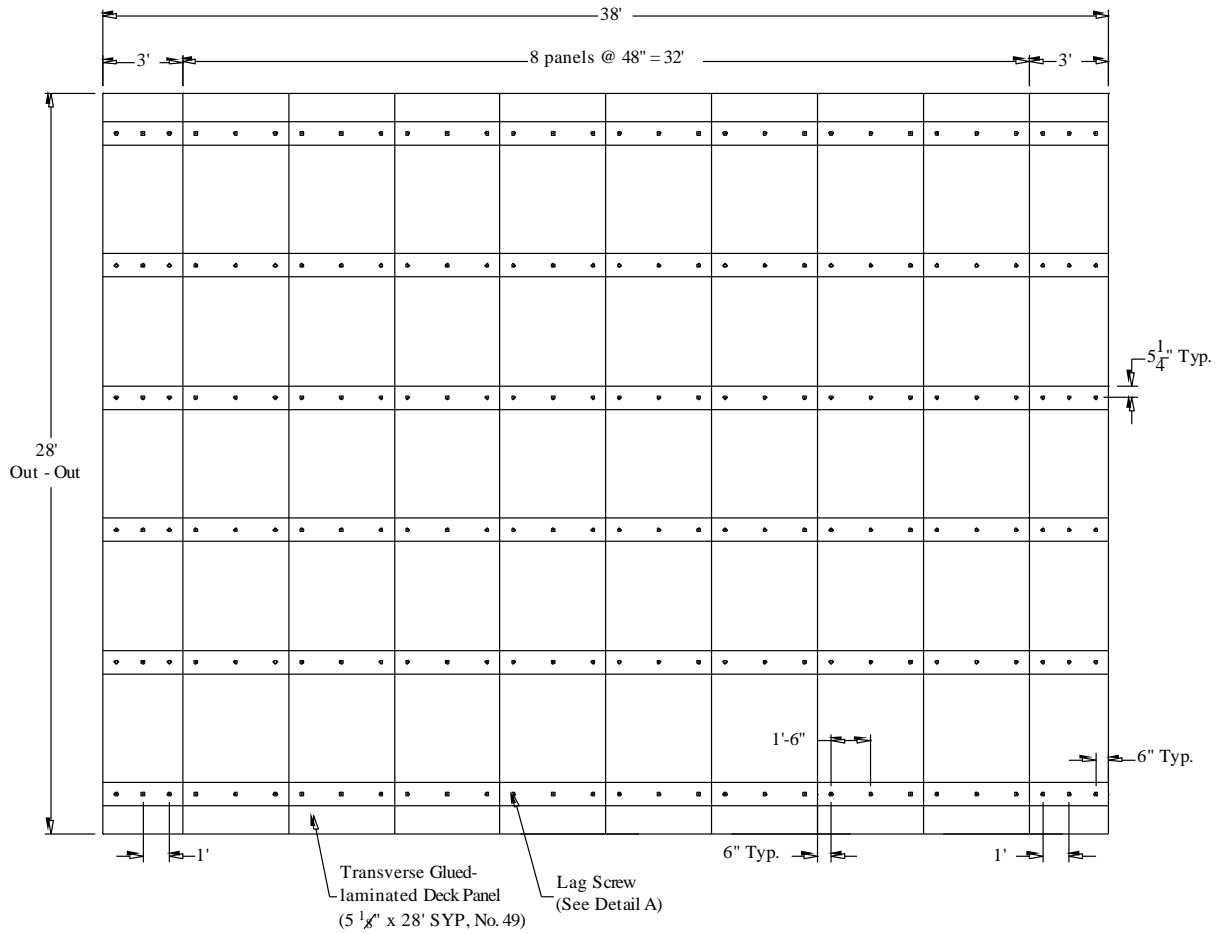

Figure 3.3. Deck panel and lag screw layout, both spans

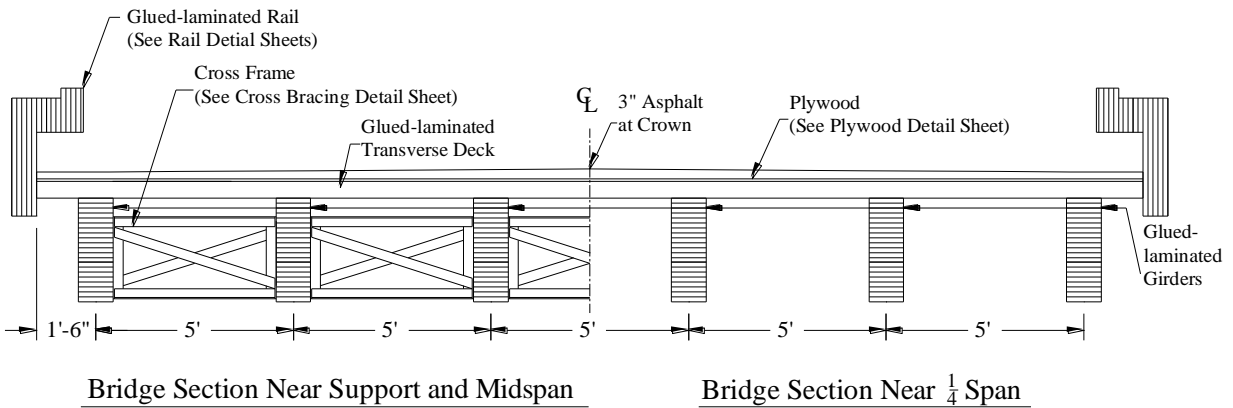

Figure 3.4. Cross section of demonstration bridge, Span 1

Note the plywood overlay alternative that was developed and tested in the laboratory had the plywood orientated with the long side of the plywood sheet running parallel with the span of the

bridge. However, during design of the demonstration bridge, the research team decided to change the orientation of the plywood by rotating the sheets 90 degrees as shown in Figure 3.5.

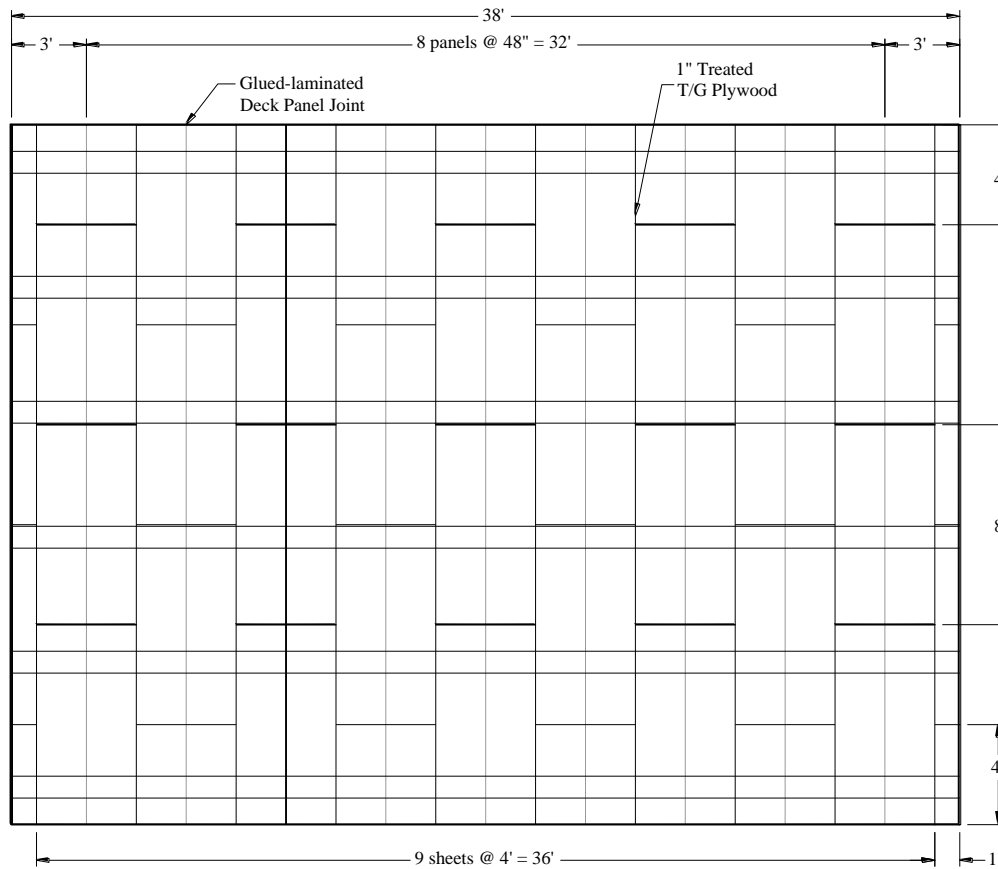

Figure 3.5. Plan layout of plywood on demonstration bridge, Span 1

In addition, the plywood used on the demonstration bridge was NOT tongue and groove as used on the laboratory bridge because tongue and groove was not available in the correct thickness of treated plywood (3/4 in. plywood was used on the laboratory bridge and 1 in. plywood was specified by the research team for the demonstration bridge).

There are currently no codes, standards, or specifications that recommend or provide guidelines for the pattern of screws for attaching plywood to a timber bridge deck; therefore, recommendations were taken from guidelines typically used on the installation of roof sheathing and used as a baseline.

The final pattern of screws utilized to affix the plywood to the deck is illustrated in Figure 3.6. To allow for a level deck surface after placement of the plywood, the Span 1 girder bearings were designed 1 in. lower in elevation than the Span 2 girder bearings. A glued-laminated timber guardrail was designed for this structure, and the county engineer specified a steel approach rail for the structure.

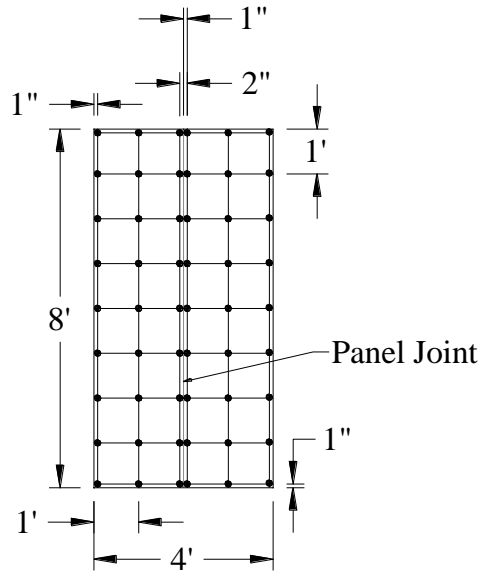

Figure 3.6. Typical screw pattern for plywood attachment to timber deck

3.2 Construction

Construction of the demonstration bridge began in early spring of 2009. As mentioned previously, Delaware County provided the design of the pier and abutments and the BEC provided the design of the superstructure.

The substructure consisted of concrete abutment caps on steel H-piles and a concrete pier on steel H-piles. Figure 3.7a shows the casting of the south abutment cap, pier, and H-pile for the north abutment (with the photo taken looking south).

Once the pier and abutments were constructed, the glued-laminated girders were erected one span at a time. The girders were connected to the abutment and piers with steel angles, thru-bolts, and a neoprene bearing pad.

Figure 3.7b shows the placement of the girders on the south span bearings. Steel cross-bracing provided the lateral support for the girders at the supports and at midspan and were assembled prior to being installed between the girders.

Once the girders were erected, anchored, and braced, the transverse glued-laminated deck panels were set in place and connected to the girders. Connection of the deck panels to the girders was provided by three lag screws per panel per girder, in field-drilled, countersunk holes. Figures 3.7c and 3.7d illustrate the installation and attachment of the transverse deck panels to the girders.



a. Construction of abutments and pier



b. Erection of south span girders



c. Deck panel placement

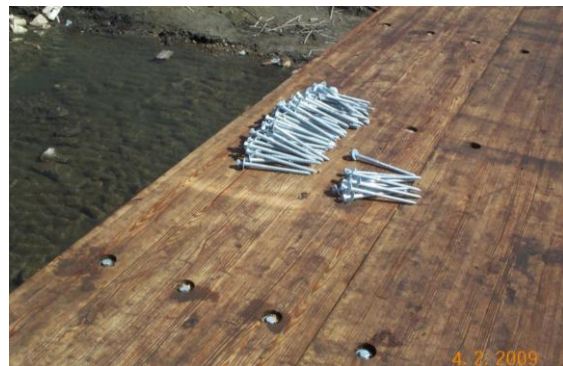

d. Deck panel connection to girders



e. Plywood and guardrail posts installed



f. Asphalt binder



g. Placement of asphalt wearing course



h. Completed demonstration bridge

Figure 3.7. Construction of the demonstration bridge in Delaware County, Iowa

Following the installation of the glued-laminated timber deck panels, the plywood sheathing was attached to Span 1. As noted previously, Span 1 was designed so that the elevation of the top of the deck panels would be 1 in. lower than the top of the deck panels on Span 2; this elevation difference accounted for the thickness of the plywood sheathing and resulted in an even bridge surface at the joint between Spans 1 and 2.

Following the placement of the plywood overlay alternative, the timber guardrail posts were installed on the entire structure. The rails were left off of the bridge temporarily to facilitate easier placement of the asphalt wearing surface (see Figure 3.7e).

4. TEST AND EVALUATION METHODOLOGY

Field tests in 2009 included installing deflection transducers and strain transducers at midspan of both spans, as illustrated in Figure 4.1.



Figure 4.1. Typical instrumentation setup

Figure 4.2 shows the location of displacement and strain transducers for the 2009 test on Spans 1 and 2, along with the direction of travel for the test truck (south for all 2009 tests).

Figure 4.3 shows the location of displacement and strain transducers for the 2010 test on Spans 1 and 2. The direction of travel for the test truck during the 2010 test was opposite for each span (i.e., the truck traveled north when testing Span 1 and south when testing Span 2).

In 2009, global girder deflections were measured at midspan of each girder on both spans; however, global deflection of the girders was not recorded during the 2010 testing as the focus of testing was shifted to the performance of the deck panels.

Differential panel deflections were determined in both 2009 and 2010. In 2009, differential deflections were recorded only at panel joints. In 2010, several of the panel joints instrumented in 2009 were instrumented again to check for any changes in behavior over the course of a year. Differential deflections were also calculated at girder/panel connections and at the mid-width of several panels where a plywood joint was present (see Figure 4.4).

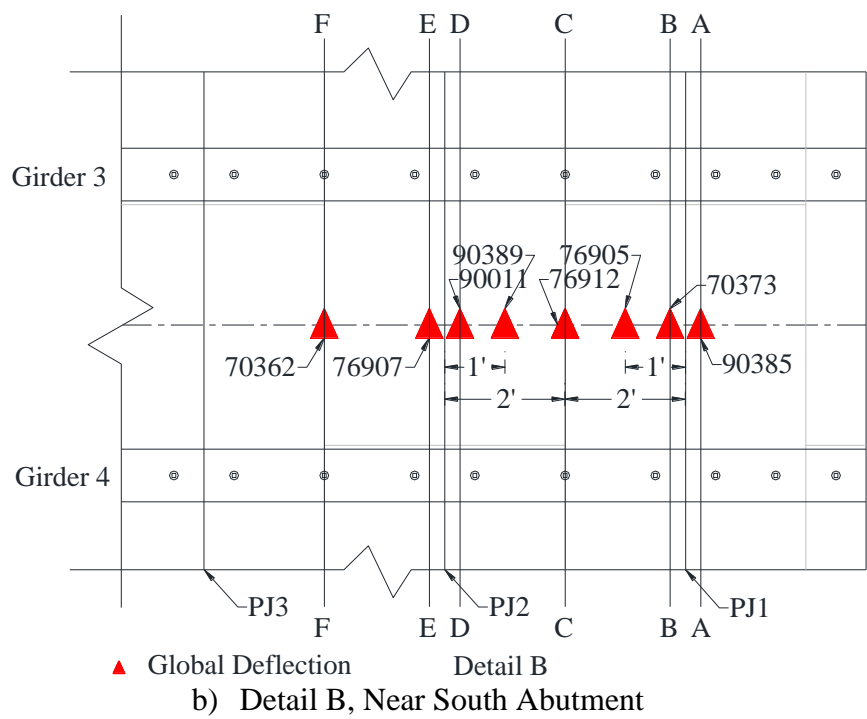
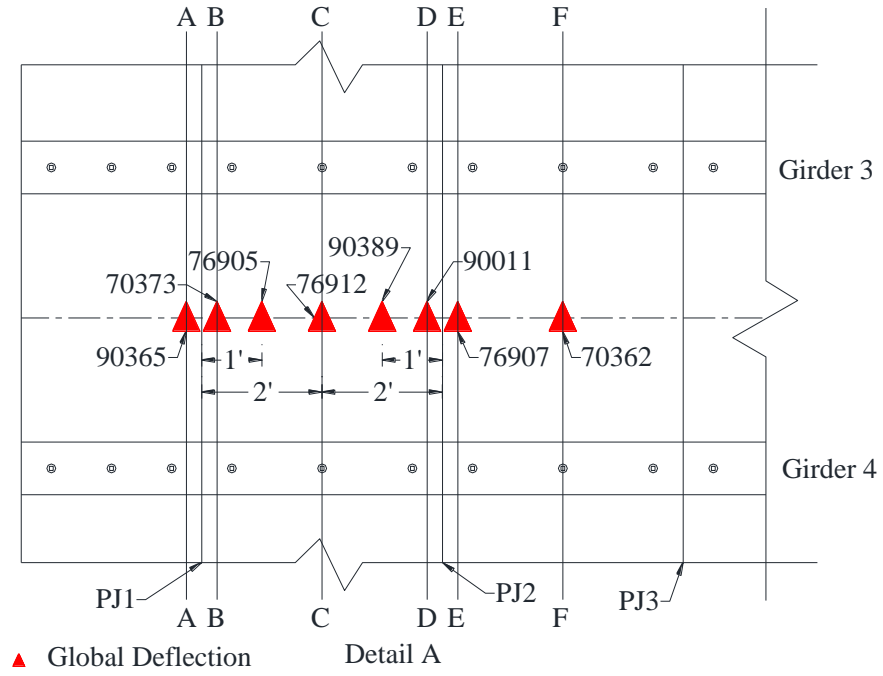

Figure 4.4. Instrumentation layout near supports, demonstration bridge 2010

Strains were recorded at the top and bottom of each girder at midspan of both spans in 2009. For the 2010 testing, the number of girders instrumented was reduced to two per span (girders G4 and G6), such that the 2009 and 2010 data could be directly compared.

In all cases, one strain transducer was installed on the bottom of the girder and one approximately 3 in. below the top of the girder. Note that herein all global deflections and panel deflections relative to the girders are negative values as they are a measurement of downward deflection. Differential panel deflections are denoted as positive given they are only a magnitude value and direction has no significance.

During live load testing, the bridge was loaded with a tandem axle dump truck with a total weight of 49,860 lbs and 52,320 lbs in 2009 and 2010, respectively. For all tests and all load cases, the load truck traveled across the bridge at a crawl speed. See Figure 4.5 for the positioning of the load truck in 2009 and Figure 4.6 for the positioning in 2010.

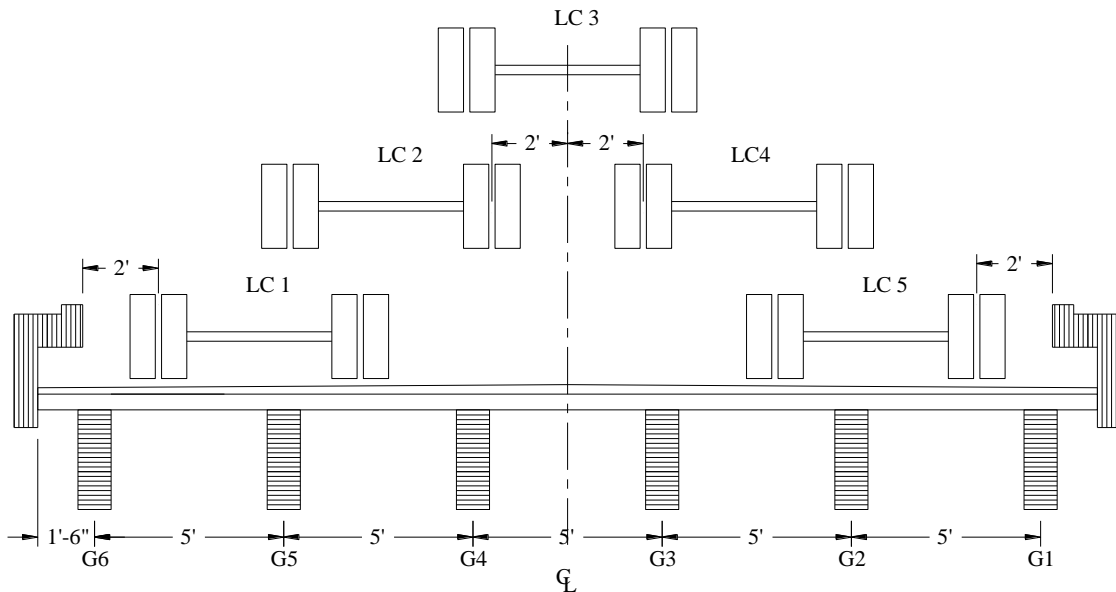

Figure 4.5. Load cases for demonstration bridge 2009 testing (looking north)

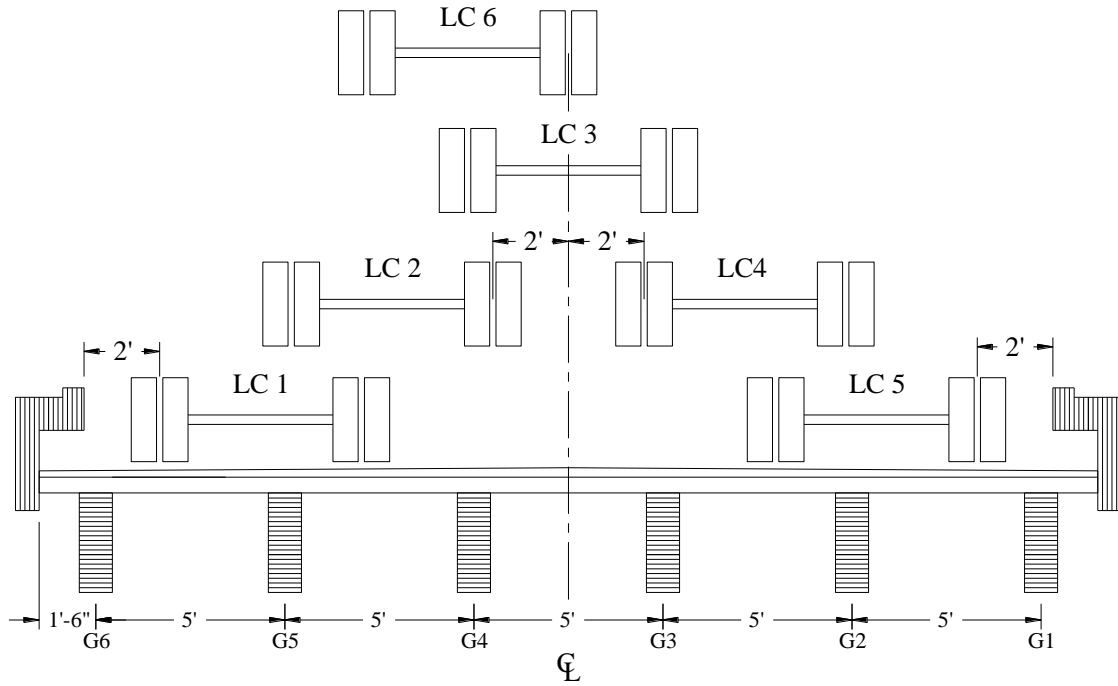

Figure 4.6. Load cases for demonstration bridge 2010 testing (looking north)

5. TEST AND EVALUATION RESULTS

5.1 Inspection

5.1.1 One Month Post-Construction

Approximately one month after construction of the demonstration bridge, the research team visually inspected and load tested the structure. Visual inspection of the substructure and superstructure components indicated that all components were in excellent condition.

Girder bearings showed no signs of rotation; the deck panels were seated firmly on the top of the girders; and no signs of distress or deterioration were found in the hardware or timber members.

Inspection of the wearing surface one month following construction of the bridge noted transverse cracking at the deck panel joints on Span 2, as illustrated in Figure 5.1, and less noticeable cracks on Span 1 over the deck panel joints. However, cracking over the plywood joints was also observed in Span 1.

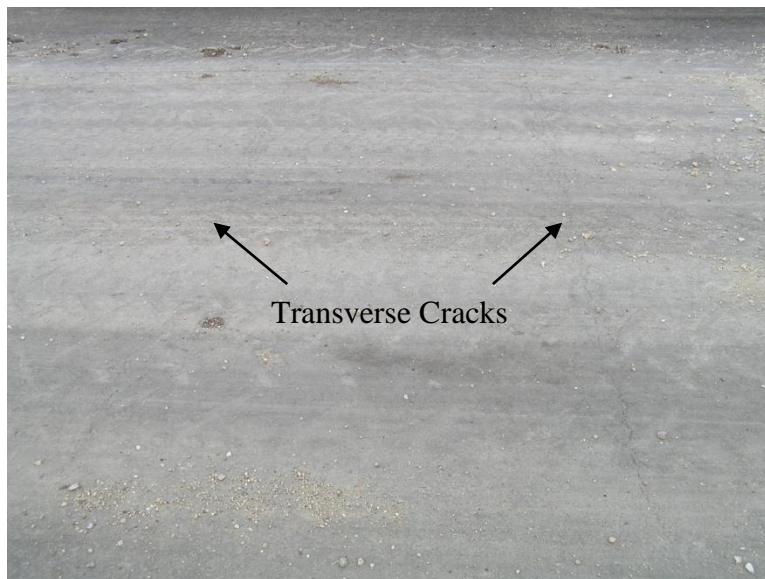

Figure 5.1. Transverse cracking evident one month post construction on Span 2

5.1.2 Two Months Post-Construction

One month after the initial inspection and testing, a follow-up inspection was completed. The substructure and superstructure were, again, in excellent condition and unchanged. The wearing surface condition was unchanged as well, with the exception of one observation. On Span 1, additional minor cracking in the wearing surface was noted at the deck panel joints, in addition to the cracking at the transverse plywood joints noted a month earlier, as shown in Figure 5.2.



a. Span 1



b. Span 2

Figure 5.2. Transverse cracking two months post construction

5.1.3 One Year Post-Construction

Approximately one year after construction of the demonstration bridge, the research team conducted a second visual inspection and load test on the structure. Visual inspection of the substructure and superstructure components again indicated that these components were in excellent condition. Inspection of the asphalt wearing surface revealed cracking of the wearing surface at the deck panel joints on Span 2 (no plywood); on Span 1 (with plywood), visible cracking was evident at the transverse plywood joints as well as at the panel joints (see Figure 5.3).



Figure 5.3. Transverse cracking, Span 1, one year post construction

5.2 Live Load Test Results

5.2.1 2009 Global Deflections

In general, global girder deflection results from 2009 indicate that the global response of the structure satisfies the design criteria even when normalized to consider the difference in weight between the test vehicle and the design vehicle.

For the truck located near the guardrails, such as Load Cases 1 and 5, the maximum girder deflection was approximately 0.37 in. at the exterior girder nearest the load. For Load Case 3 with the load centered transversely on the structure, the maximum girder deflection was approximately 0.28 in. at an interior girder.

Using the global girder deflections to approximate the distribution of loads, a comparison of symmetric load cases (i.e., Load Cases 1 and 5 and Load Cases 2 and 4) indicated that the transverse load distribution was also symmetric for both spans, as expected (see Figure 5.4).

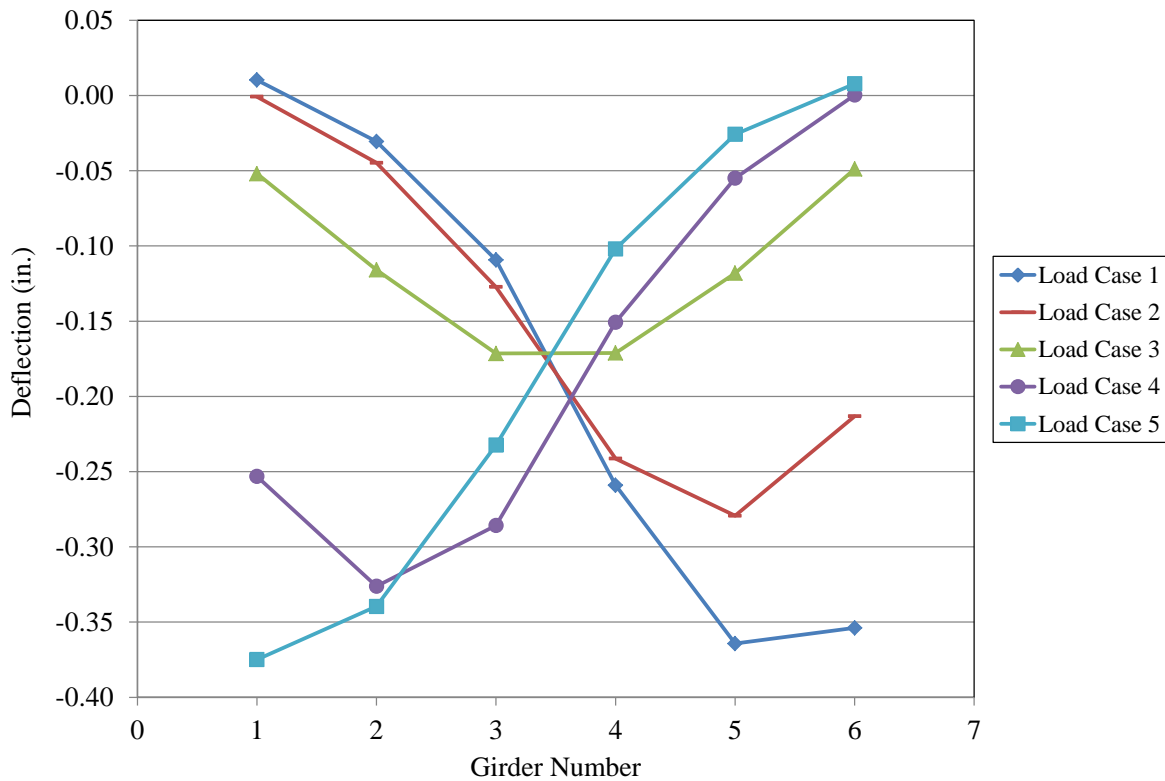

Figure 5.4. Peak girder deflections for Load Cases 1 through 5, 2009 data

5.2.2 2009 and 2010 Girder Strains

The peak tensile strain in the girders for both the 2009 and 2010 tests was approximately 250 microstrain, which corresponds to a stress of approximately 0.45 ksi, assuming a modulus of

elasticity of 1800 ksi for the glued-laminated timber girders. This is well below the design bending stress of approximately 2.2 ksi for an HS20 truck.

These peak strains typically occurred in the exterior girders when the load truck was positioned near the curb on either side. With the load truck centered on the bridge (Load Case 3 in Figure 4.5 and 4.6), the transverse distribution of strain was symmetric and resulted in peak strains at the center girders of approximately 175 microstrain as illustrated in Figures 5.5 and 5.6.

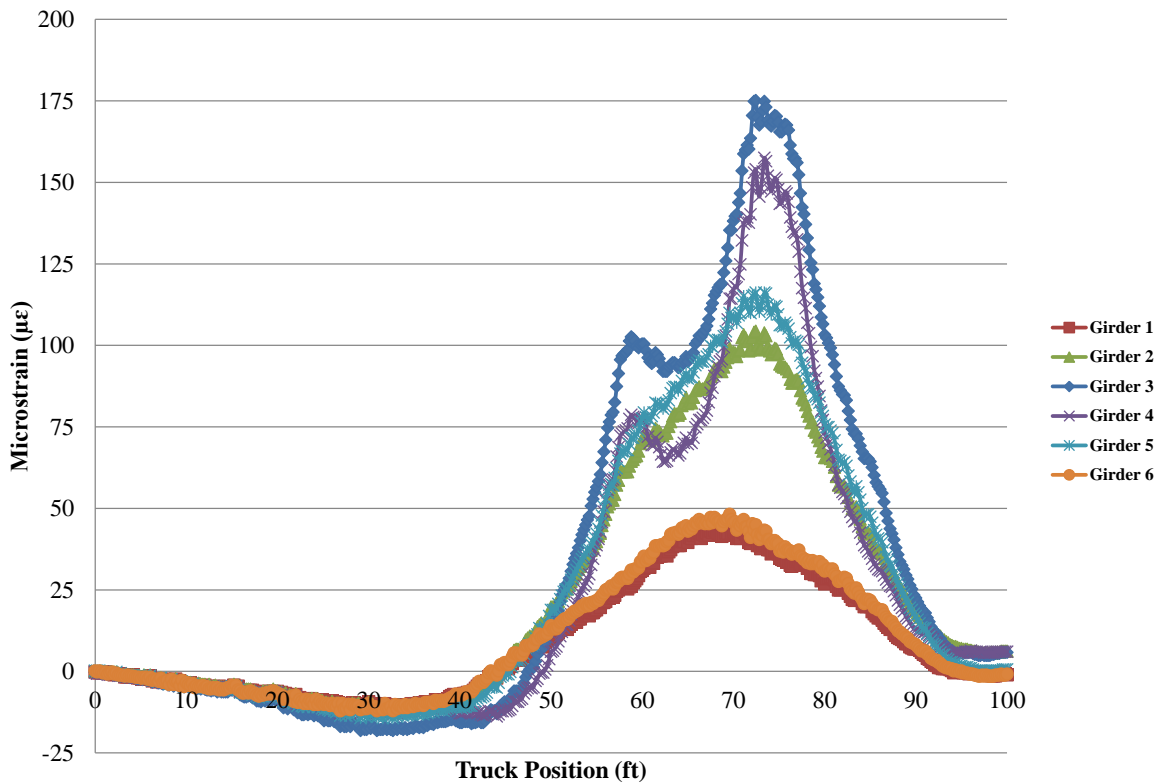

Figure 5.5. Span 1 midspan girder strains, 2009

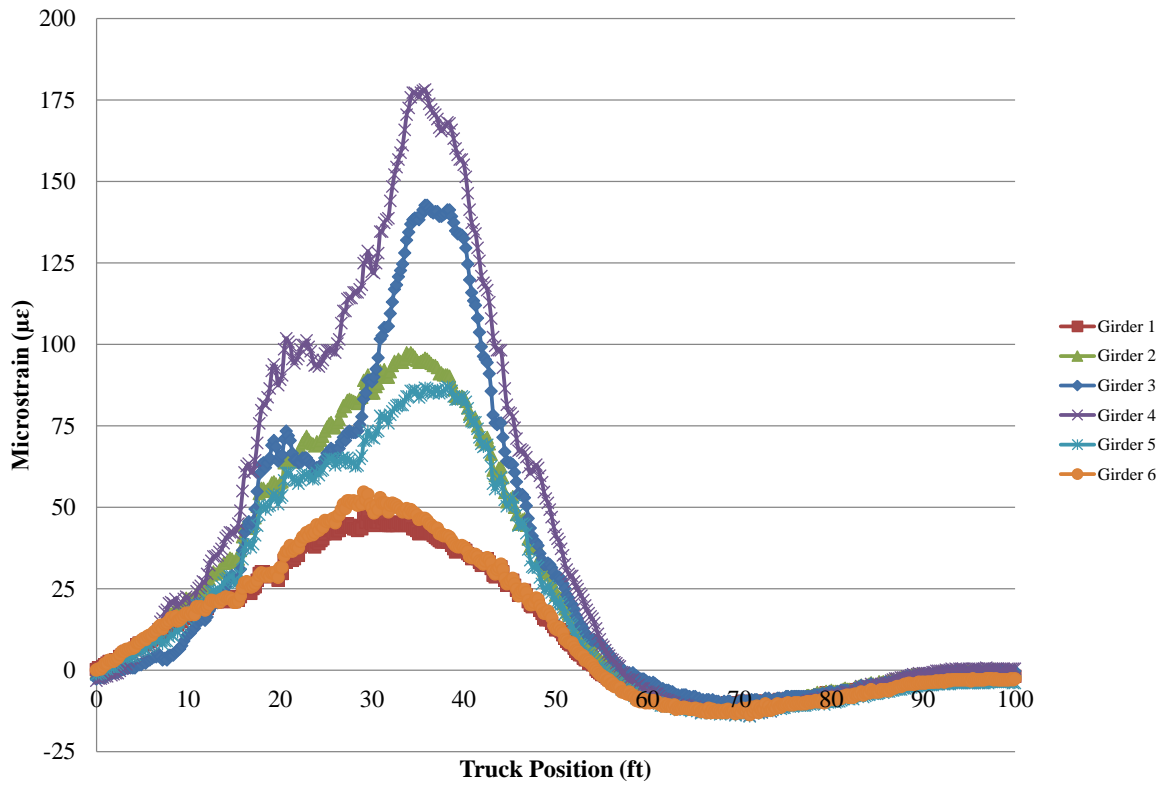

Figure 5.6. Span 2 midspan girder strains, 2009

A comparison of the top and bottom strain from a girder under the load truck for any given load case indicates that the transverse deck panels and the girders did not act compositely as expected; see Figure 5.7 for a typical strain plot from 2010.

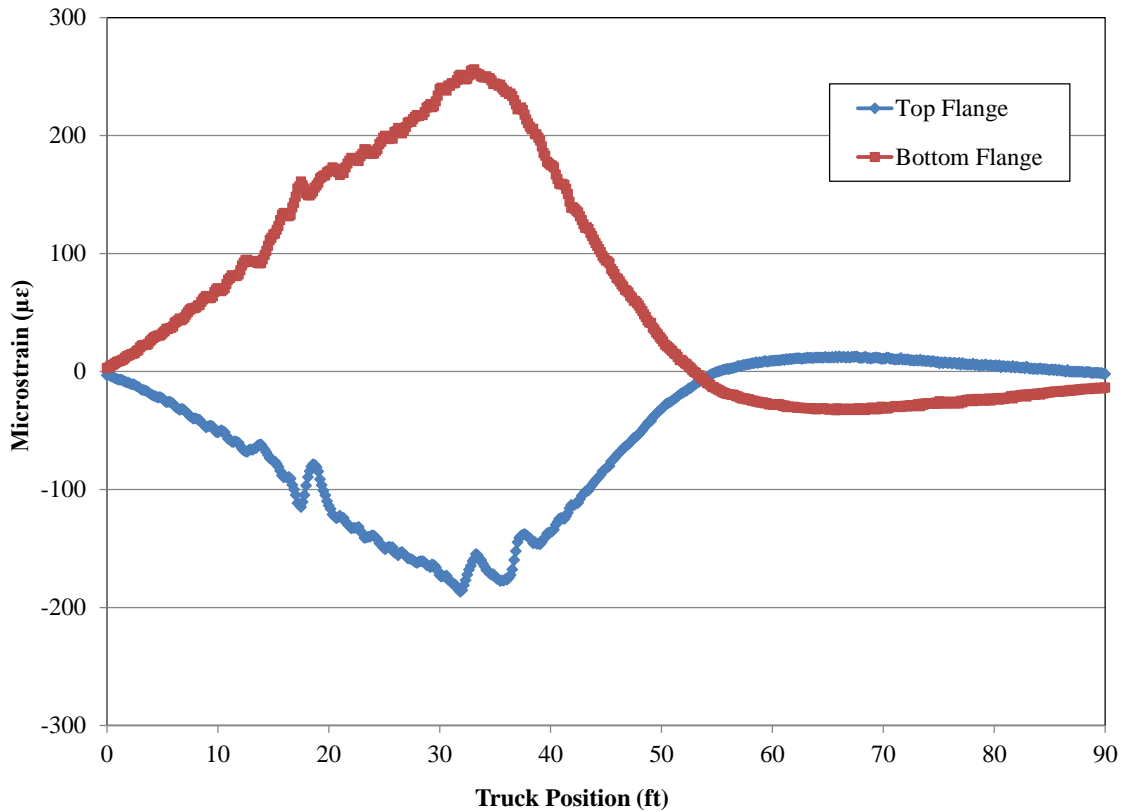

Figure 5.7. Top and bottom girder strains, Span 1, G6, 2010

5.2.3 2009 Differential Panel Deflections

Differential panel deflections were determined at two locations on each span in 2009 (refer to Figure 4.2). One location was centered between the two mid-width girders at panel joint PJ6 and the other location was centered between the exterior two girders on the west side of the structure at PJ6.

Data reduction after the 2009 testing revealed that the deflection data from displacement transducer 70370 on Span 2, located between the two center girders, was erratic and unreliable. This limited the amount of useful data available to the location between the exterior two girders.

The differential panel deflection data calculated from this location on Span 1 (plywood) and Span 2 for Load Case 1 (which was the worst case scenario with a wheel line directly over the instrument location) are illustrated in Figure 5.8.

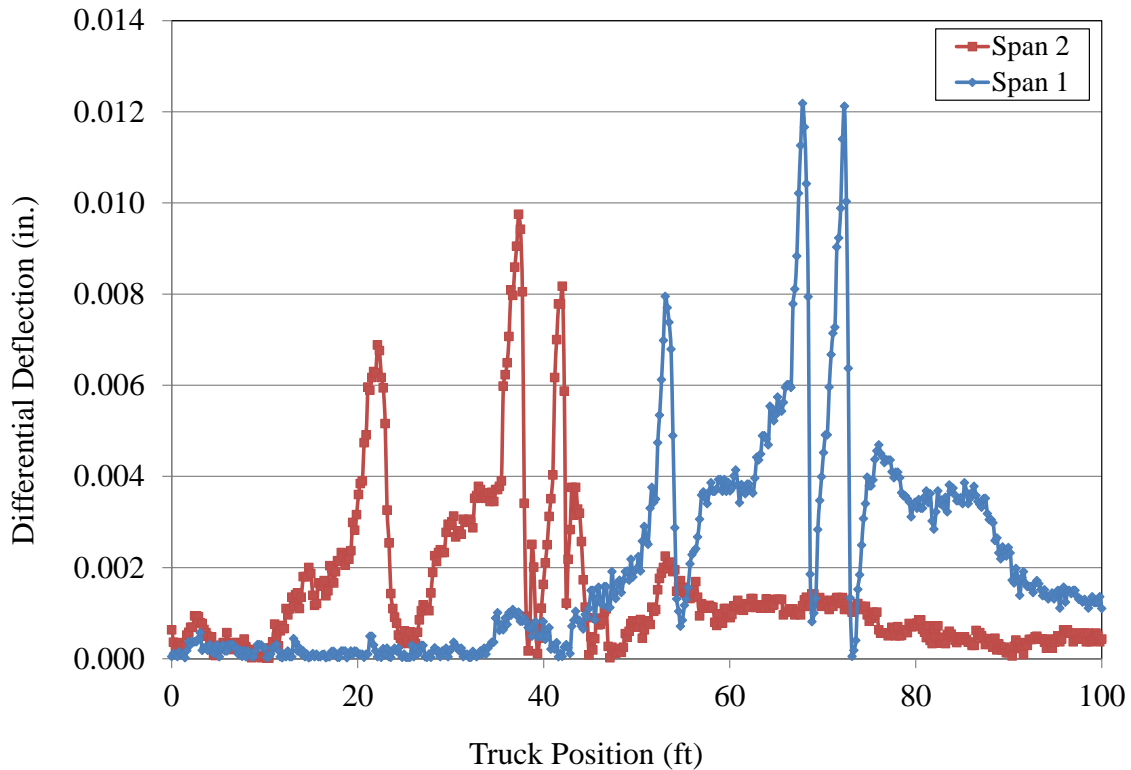

Figure 5.8. Comparison of differential panel deflections for Span 1 and Span 2, 2009 data

The data in Figure 5.8 indicate larger differential panel deflections on Span 1, the span with plywood, compared to Span 2, the span without plywood. This same observed behavior is evident in the other load cases, as well, and may be a result of the following factors: 1) the difference in the location of the measurement of the relative deflection longitudinally with respect to load direction on the two spans, 2) changes made to the plywood orientation, or 3) other factors or a combination of these factors.

5.2.4 2010 Panel Deflections, Global and Differential

In 2010, much of the focus of the test was directed toward obtaining a better understanding of the differential panel performance. To investigate the potential change in differential panel deflection performance over time, differential panel deflection was again recorded midway between the two center girders on Span 1 at panel joint PJ6, as was done in 2009.

Figure 5.9 shows the differential panel deflection data from 2009 and 2010 for location PJ6 (which was midway between the middle girders). The data suggest that some reduction in the differential panel deflection magnitude has taken place over the one-year time period. However, with the cracking of the asphalt wearing surface still prevalent, the significance of this decrease is unknown.

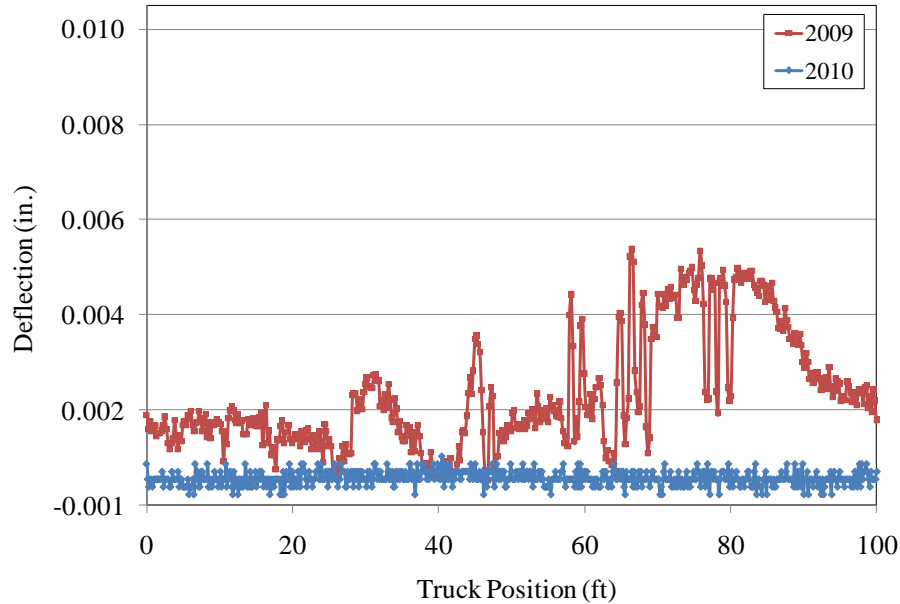

Figure 5.9. PJ6 differential panel deflection comparison, 2009-2010

The focus from here is on data from the 2010 load testing, only, with specific interest directed toward Load Case 6 and the gages located between girders G3 and G4 (Figures 4.4a, 4.4b, and 4.6) directly under a wheel line. In general, differential panel deflections were small in magnitude and quite similar for both spans.

Figure 5.10 shows the differential panel deflections between G3 and G4 at PJ5 for LC 6 and indicates that the differential panel deflections for the demonstration bridge are well below the suggested limit of 0.10 in. However, with the deflection magnitudes of Span 1 and Span 2 being so similar, it also suggests that the plywood on Span 1 has little influence on the magnitude of the differential panel deflections. Similar findings were found at panel joint PJ4, as shown Figure 5.11.

In an attempt to better assess the displacement characteristics of the transverse deck panels, a cluster of gages was installed across two panel joints (PJ1 and PJ2) near the abutments of each span (Figure 4.4). Each triangle in Figure 4.4 represents a location where global displacement of the deck panel was recorded. Differential panel deflections were then calculated by finding the difference between two adjacent displacements, where relevant.

Overall, the performance of the deck panels near the abutment on both spans was very similar, even with the presence of the plywood on Span 1. Differential panel deflections calculated at PJ1 and PJ2 are similar in magnitude for both spans for LC6; similar results were found at these locations for the other load cases as well. Furthermore, if the displacements of each gage of the cluster are plotted for various positions of the truck for both tests, significant similarities are evident.

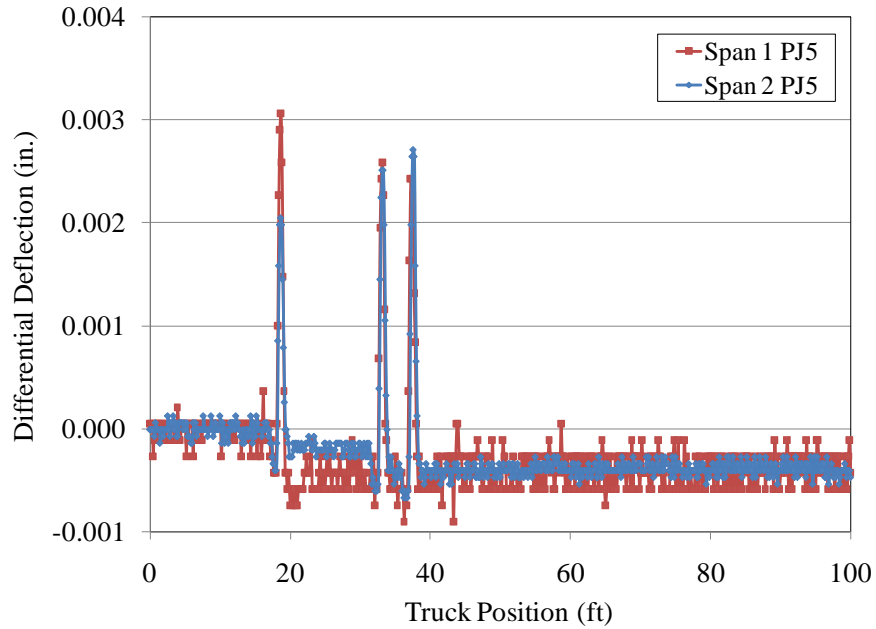

Figure 5.10. PJ5, LC 6, differential panel deflections between G3 and G4

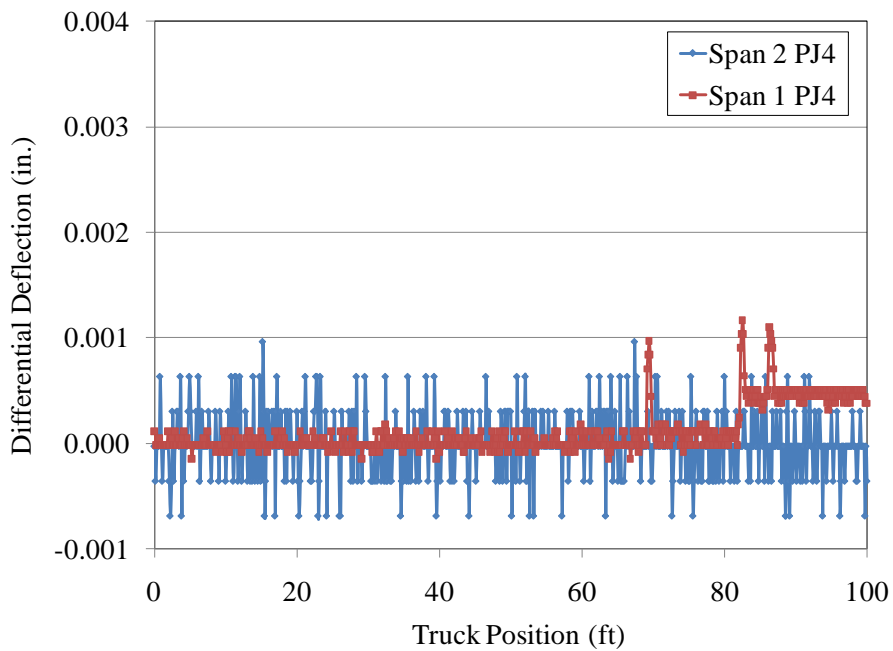
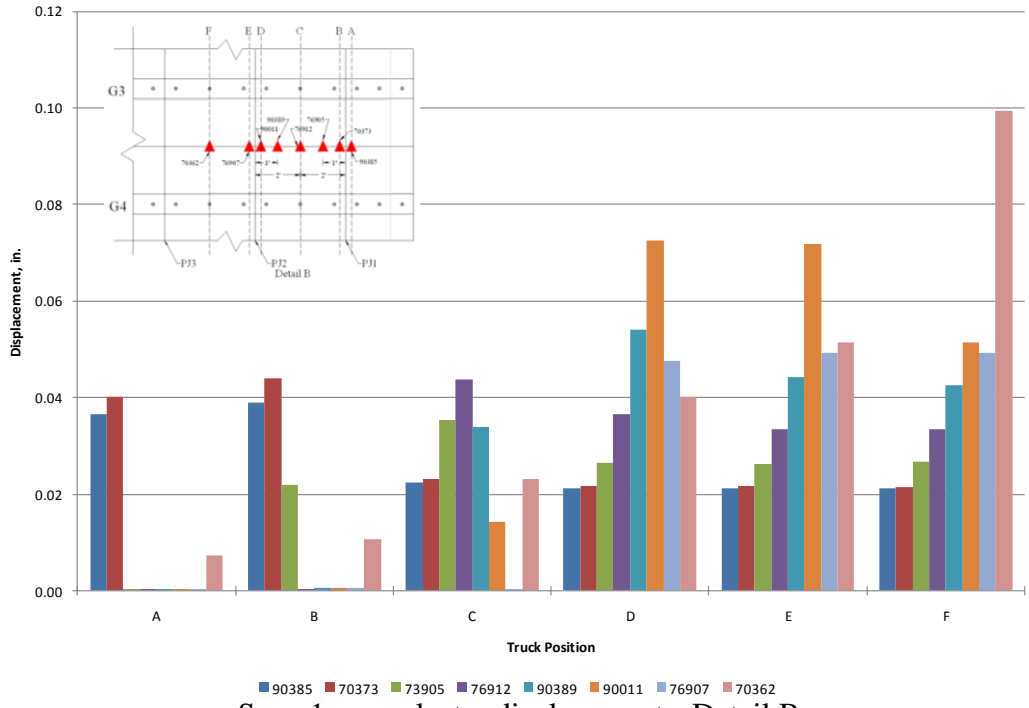
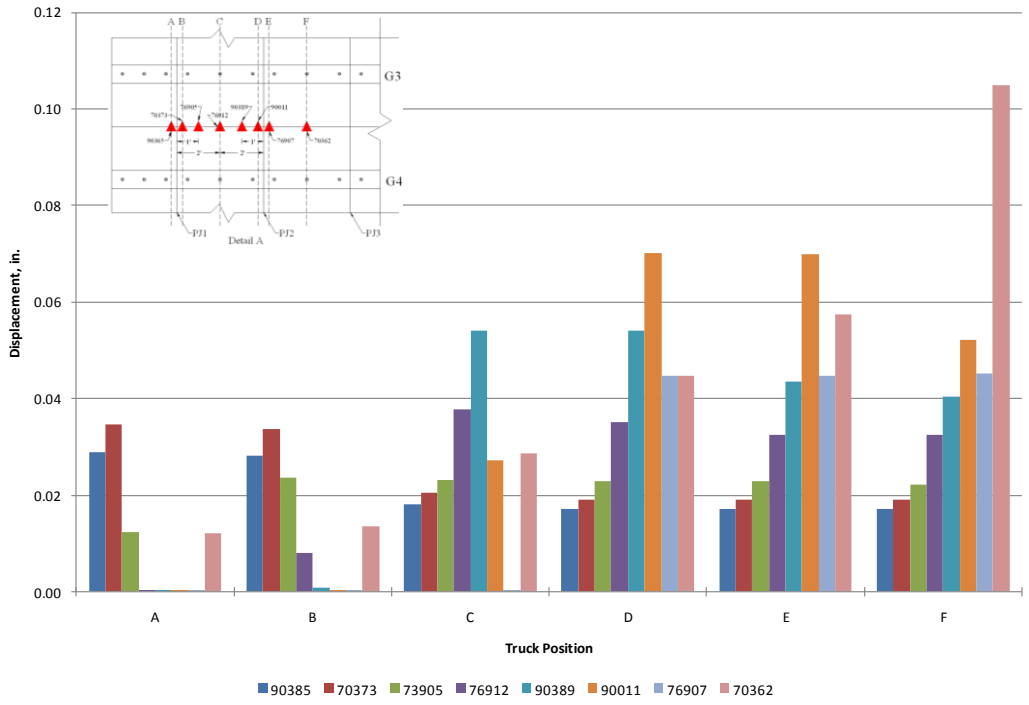

Figure 5.11. PJ4, LC 6, differential panel deflections between G3 and G4

Figure 5.12 shows the global displacements measured at each gage in the cluster for each of the six locations (A-F) detailed in Figure 4.4. Figure 5.12a represents Span 1 and Figure 5.12b represents Span 2.



a. Span 1 gage cluster displacements, Detail B



b. Span 2 gage cluster displacements, Detail A

Figure 5.12. Global displacement of gage clusters, Detail A and B

Moving left to right across both graphs in Figure 5.12 provides a snapshot of the displacement of the cluster of gages as the load truck travels across the section. Not only is the pattern of the displacements similar for both spans at each location of the truck, but the magnitudes are similar as well. There appears to be little to no influence on the global panel deflection or the differential panel joint deflections from the presence of the plywood.

6. SUMMARY AND CONCLUSIONS

Previous field test results by the BEC in 2004 suggested that differential panel deflections were one potential cause of the premature cracking and deterioration of the asphalt wearing surfaces typically found on glued-laminated timber girder bridges. Of the bridges tested and inspected, in the majority of the cases it was found that those bridges that tested with relatively small differential panel deflections also had asphalt wearing surfaces with the least amount of deterioration.

Subsequently, a laboratory research project was conducted on a full scale glued-laminated timber girder bridge to develop decking alternatives that would reduce or minimize the magnitude of differential panel deflections. The decking alternative developed in the laboratory testing that performed the best was the use of plywood decking over the glued-laminated deck. This alternative was then implemented on a field demonstration bridge constructed by Delaware County and the BEC to investigate its effectiveness on a bridge with an asphalt wearing surface.

Preliminary field load test results from a few short months after the bridge being placed in service indicated that the plywood decking alternative on Span 1 did not reduce the magnitude of differential panel deflections compared to the control span, Span 2.

Inspections of the asphalt wearing surface several months later indicated transverse cracking in the asphalt directly above the deck panel joints on both spans, as well as along the transverse plywood joints.

One year post-construction, cracking appears to be slightly more evident than the previous year, but no new cracking has developed and the increase in deterioration is minimal. Differences in the style and orientation of the plywood on the demonstration bridge from that used in the laboratory project are potential factors, along with asphalt mix design, among others, contributing to the observed behaviors.

7. RECOMMENDATIONS

This research is ongoing and the research team is looking into the following areas in hopes of improving the effectiveness and long term use of asphalt wearing surfaces on glued-laminated timber deck bridges:

1. Perform follow-up field tests on the bridge to better assess and understand the performance
2. Consider reorienting the plywood to mimic what was tested on the laboratory bridge
3. If available, utilize tongue and groove treated plywood
4. Design an asphalt deck overlay mix design, and/or asphalt overlay “system,” that is optimum for this application

Currently, work is being completed on the redesign and evaluation of the asphalt mix design being used, and other asphalt overlay “systems” are being developed for implementation and evaluation this spring.

REFERENCES

- AASHTO. *LRFD Bridge Design Specifications*. Washington, DC: American Association of State Highway and Transportation Officials, 1998.
- Hosteng, T. K., T. J. Wipf, B. M. Phares, M. A. Ritter, and D. Wood. Live Load Deflection of Glued-Laminated Timber Girder Bridges. *Transportation Research Record: Journal of the Transportation Research Board, No. 1928*, Transportation Research Board of the National Academies, Washington, DC, 2005, pp. 174-182.
- Ritter, M. A. *Timber Bridges: Design, Construction, Inspection and Maintenance*. Washington, DC: U.S. Department of Agriculture, Forest Service, Engineering Staff, 1990.
- Ritter, M. A. and S. R. Duwadi, *Accomplishments for Wood Transportation Structures Based on a National Research Needs Assessment*, General Technical Report FPL-GTR_105, U.S. Department of Agriculture, Forest Service, Forest Products Laboratory, 1998.
- Wipf, T. J.; Phares, B. M.; Hosteng, T. K.; Ritter, M. A.; Wood, D. *Laboratory Evaluation of Design Details for Minimizing Differential Panel Deflection on Glued-Laminated Timber Bridges*. Ames, IA: Iowa State University, Bridge Engineering Center. 2005.

