

2011

# Procurement Procedures and Specifications for Performance Measure Capable Traffic Infrastructure Data Collection Systems

Christopher M. Day  
*Purdue University, cmday@purdue.edu*

Thomas M. Brennan Jr.  
*Purdue University - Main Campus, tmbrenna@purdue.edu*

Joseph M. Ernst  
*jernst@purdue.edu*

Jim Sturdevant  
*INDOT, jsturdevant@indot.in.gov*

Darcy M. Bullock  
*Purdue, darcy@purdue.edu*

---

## Recommended Citation

Day, C. M., T. M. Brennan, J. M. Ernst, J. Sturdevant, and D. M. Bullock. *Procurement Procedures and Specifications for Performance Measure Capable Traffic Infrastructure Data Collection Systems*. Publication FHWA/IN/JTRP-2011/18. Joint Transportation Research Program, Indiana Department of Transportation and Purdue University, West Lafayette, Indiana, 2011. doi: 10.5703/1288284314642

# JOINT TRANSPORTATION RESEARCH PROGRAM

INDIANA DEPARTMENT OF TRANSPORTATION  
AND PURDUE UNIVERSITY



## PROCUREMENT PROCEDURES AND SPECIFICATIONS FOR PERFORMANCE MEASURE CAPABLE TRAFFIC INFRASTRUCTURE DATA COLLECTION SYSTEMS

**Christopher M. Day**  
Sr. Research Scientist  
School of Civil Engineering  
Purdue University

**Thomas M. Brennan, Jr.**  
Sr. Research Scientist  
School of Civil Engineering  
Purdue University

**Joseph M. Ernst**  
Graduate Assistant  
School of Civil Engineering  
Purdue University

**James R. Sturdevant**  
Traffic Systems Engineer  
Indiana Department of Transportation

**Darcy M. Bullock**  
Professor of Civil Engineering  
Purdue University  
*Corresponding Author*

SPR-3409  
Report Number: FHWA/IN/JTRP-2011/18  
DOI: 10.5703/1288284314642

This page intentionally left blank.

## **RECOMMENDED CITATION**

Day, C. M., T. M. Brennan, J. M. Ernst, J. R. Sturdevant, D. M. Bullock. *Procurement Procedures and Specifications for Performance Measure Capable Traffic Infrastructure Data Collection Systems*. Publication FHWA/IN/JTRP-2011/18. Joint Transportation Research Program, Indiana Department of Transportation and Purdue University, West Lafayette, Indiana, 2011. DOI: 10.5703/1288284314642

## **CORRESPONDING AUTHOR**

Darcy M. Bullock  
School of Civil Engineering  
Purdue University  
(765) 494-2226  
darcy@purdue.edu

## **JOINT TRANSPORTATION RESEARCH PROGRAM**

The Joint Transportation Research Program serves as a vehicle for INDOT collaboration with higher education institutions and industry in Indiana to facilitate innovation that results in continuous improvement in the planning, design, construction, operation, management and economic efficiency of the Indiana transportation infrastructure.  
[https://engineering.purdue.edu/JTRP/index\\_html](https://engineering.purdue.edu/JTRP/index_html)

Published reports of the Joint Transportation Research Program are available at: <http://docs.lib.purdue.edu/jtrp/>

## **NOTICE**

The contents of this report reflect the views of the authors, who are responsible for the facts and the accuracy of the data presented herein. The contents do not necessarily reflect the official views and policies of the Indiana Department of Transportation or the Federal Highway Administration. The report does not constitute a standard, specification or regulation.

This page intentionally left blank.

1. Report No. FHWA/IN/JTRP-2011/18		2. Government Accession No.		3. Recipient's Catalog No.	
4. Title and Subtitle Procurement Procedures and Specifications for Performance Measure Capable Traffic Infrastructure Data Collection Systems				5. Report Date 2012	
				6. Performing Organization Code	
7. Author(s) Christopher M. Day, Thomas M. Brennan, Joseph M. Ernst, James R. Sturdevant, and Darcy M. Bullock				8. Performing Organization Report No. FHWA/IN/JTRP-2011/18	
9. Performing Organization Name and Address Joint Transportation Research Program Purdue University 550 Stadium Mall Drive West Lafayette, IN 47907-2051				10. Work Unit No.	
				11. Contract or Grant No. SPR-3409	
12. Sponsoring Agency Name and Address Indiana Department of Transportation State Office Building 100 North Senate Avenue Indianapolis, IN 46204				13. Type of Report and Period Covered  Final Report	
				14. Sponsoring Agency Code	
15. Supplementary Notes Prepared in cooperation with the Indiana Department of Transportation and Federal Highway Administration.					
<p><b>16. Abstract</b></p> <p>Traffic signal systems represent a substantial component of the highway transportation network in the United States. It is challenging for most agencies to find engineering resources to properly update signal policies and timing plans to accommodate changing traffic demands. Upgrading existing systems can achieve incremental benefits, but do not address the fundamental problem that information about system performance is not communicated to the agency in a meaningful or systematic way. This project developed a collaborative pilot deployment partnership between a large public agency, university, and commercial equipment manufacturers to define an architecture for a centralized traffic signal management system that can be used on a large geographic scale by both maintenance and technical services staff. This architecture leverages wireless IP communications to integrate performance measures into a database environment and a performance measure dashboard.</p> <p>In addition to this architecture, several uses of high resolution signal controller event data are presented. An extended discussion of a visualization technique called the "Purdue Coordination Diagram" is presented, which enables new methods for visualizing and assessing 24-hour corridor operations without field visits or searching through hours of recorded video. A new methodology for using data from peer intersections to estimate fundamental traffic flow characteristics is proposed. In this methodology, phase status from an upstream intersection is fused with downstream detector status to obtain link travel time and platoon dispersion characteristics. Finally, this data is integrated into an optimization engine for determining cycle length, phase sequence, and offsets.</p>					
17. Key Words  Traffic signals, traffic signal timing, traffic signal optimization, traffic signal architecture, performance measures			18. Distribution Statement  No restrictions. This document is available to the public through the National Technical Information Service, Springfield, VA 22161		
19. Security Classif. (of this report)  Unclassified		20. Security Classif. (of this page)  Unclassified		21. No. of Pages  20	22. Price

This page intentionally left blank.

## EXECUTIVE SUMMARY

# PROCUREMENT PROCEDURES AND SPECIFICATIONS FOR PERFORMANCE MEASURE CAPABLE TRAFFIC INFRASTRUCTURE DATA COLLECTION SYSTEMS

### Introduction

Traffic signal systems represent a substantial component of the highway transportation network in the United States. Unfortunately, most agencies struggle to meet the challenge of finding enough resources to properly update signal policies and timing plans to accommodate changing traffic demands. The traffic engineering community has been aware of system under-performance for several years, but most proposed solutions have been too expensive or not well enough understood to see widespread implementation. Incremental system upgrades can return some benefits, but the more fundamental problem that they do not address is that system performance information is not measured or reported in any meaningful or systematic manner.

This project continues the INDOT-Purdue traffic signal systems research program, bringing previous findings closer to the deployment and implementation stage by taking on the major hurdles to system wide traffic signal performance measures. The problem of establishing data communication in a geographically distributed signal system is addressed, and methodologies for systematizing, processing, and making use of the data are explored.

### Findings

This project developed a collaborative pilot deployment partnership between INDOT, Purdue University, and three commercial equipment manufacturers. One outcome of the collaboration has been the creation of a standard specification for traffic signal event data, which is nearing completion.

This project led to a paper defining an architecture for a centralized traffic signal management system that can be used on a

large geographic scale by both maintenance and technical services staff. This architecture leverages wireless IP communications to integrate performance measures into a database environment and a performance measure dashboard. Adoption of this architecture in the INDOT network breaks a 40-year traffic industry “tradition” that remote data collection is infeasible for widespread deployment for a highly distributed system.

In addition to this architecture, several uses of high resolution signal controller event data are explored. An extended discussion of a visualization technique called the “Purdue Coordination Diagram” is presented, which enables new methods for visualizing and assessing 24-hour corridor operations without field visits or searching through hours of recorded video. A paper explaining the educational value of this visualization tool received the 2011 Exceptional Paper Award from the Traffic Signal Systems committee of the Transportation Research Board.

Additionally, a new methodology for using data from peer intersections to estimate fundamental traffic flow characteristics is proposed. In this methodology, phase status from an upstream intersection is fused with downstream detector status to obtain link travel time and platoon dispersion characteristics. This methodology can replace otherwise extensive manual observations otherwise needed to obtain the information. Lastly, the signal event data is integrated into an optimization engine for determining cycle length, phase sequence, and offsets.

### Implementation Recommendations

This project successfully developed a performance measure dashboard for use by agency technical and maintenance personnel. At the time of the conclusion of the project, INDOT traffic engineers were able to retrieve performance measures from approximately 70 traffic signals in corridors in Indianapolis, Noblesville, Merrillville, Fort Wayne, and Martinsville.

It is recommended that INDOT continue to deploy data collection enabled traffic signal controllers throughout its highway network as scheduled equipment change outs take place. The current database configuration for harvesting and storing data is expected to be able to serve the agency until such time as industry provides a product that can meet INDOT’s system-wide needs.



## CONTENTS

EXECUTIVE SUMMARY .....	i
LIST OF TABLES.....	
LIST OF FIGURES .....	iii
CHAPTER 1. INTRODUCTION.....	1
CHAPTER 2. PROBLEM STATEMENT.....	1
CHAPTER 3. OBJECTIVE .....	1
CHAPTER 4. SUMMARY OF PROJECT ACCOMPLISHMENTS.....	2
CHAPTER 5. IMPLEMENTATION OF PROJECT RESULTS.....	3
CHAPTER 6. SUMMARY OF FINDINGS .....	5
6.1 Communications Architecture for Geographically Distributed Signal Systems.....	5
6.2 Data Reduction Procedures .....	6
6.3 Visual Education Tools for Coordinated System Operation.....	7
6.4 Analysis of Peer Intersection Data for Arterial Traffic Signal Coordination Decisions.....	9
6.5 Using Field Data to Improve Model Accuracy.....	11
6.6 Optimization.....	11
CHAPTER 7. CONCLUSION AND SUMMARY OF IMPACT .....	12
Appendix A. Architecture for Active Management of Geographically Distributed Signal Systems .....	13
Appendix B. Data Reduction Procedures for Traffic Signal Systems Performance Measures .....	13
Appendix C. Visual Education Tools to Illustrate Coordinated System Operation .....	13
Appendix D. Analysis of Peer Intersection Data for Arterial Traffic Signal Coordination Decisions .....	14
Appendix E. Using Field Data to Improve Model Accuracy .....	14
Appendix F. Optimization of Offsets and Cycle Length Using High Resolution Signal Event Data .....	14
REFERENCES.....	14

## LIST OF FIGURES

Figure 2.1 Workflow for traffic signal systems operations, including two feedback (FB) loops (2).	2
Figure 6.1 Growth of data collection-enabled traffic signals in Indiana.	3
Figure 6.2 Remote data collection architecture.	3
Figure 6.3 Prototype performance measure dashboard.	4
Figure 6.4 Partial prototype database diagram showing the relationship between tables used to define and calculate performance measures.	4
Figure 6.5 Example Purdue Coordination Diagrams.	5
Figure 6.6 Vehicle movement on a link between two non-coordinated intersections.	6
Figure 6.7 Vehicle flow profile determined from upstream-downstream methodology.	7
Figure 6.8 Percentage on green by intersection.	8
Figure 6.9 Cumulative frequency diagrams of probe vehicle travel time (minutes).	9
Figure 6.10 Measured and modeled platoons.	9
Figure 6.11 Example model results from 16 coordinated links on SR 37, March 12, 2011, 1400-1600.	10
Figure 6.12 Box-whisker plots of link speeds inferred from travel time data. Parameters shown for model goodness-of-fit accepted at the 90% confidence level.	11
Figure 6.13 Box-whisker plots of link dispersion parameters. Parameters shown for model goodness-of-fit accepted at the 90% confidence level.	11
Figure 6.14 View of prototype software for arterial timing plan optimization.	12
Figure 6.15 Comparison of algorithm results for the SR 37 test network. The box-whisker plots show distributions from 20 runs per cycle length for the GA and hybrid-GA algorithms, and 1000 runs for Monte Carlo simulation.	13

## CHAPTER 1. INTRODUCTION

Traffic signal systems represent a substantial component of the highway transportation network in the United States. The National Transportation Operations Coalition (NTOC) in their 2007 *Traffic Signal Report Card* (1) noted that nationally 5 to 10 percent of all traffic delay is caused by improper traffic signal timings along major roadways. In 2007, the National Report Card score for overall traffic signal systems operations was a D.

Upgraded intersection controllers, communication, detection equipment, closed loop systems, and/or central systems can provide modest improvements. However, there are more significant improvement opportunities for traffic operations and agency manpower efficiency by i) defining active management practices based upon sound performance measures, and ii) implementing alternative traffic signal architectures that go beyond traditional closed loop and central system models.

This project was initiated to implement active management performance measures using an emerging IP based communication architecture. This report is structured as an executive summary of the project objectives and findings, with detailed findings outlined in a series of appendices. Four of those appendices correspond to technical papers that have been developed over the course of this project documenting the incremental research findings and are in various stages of publication in the technical literature:

- D.M. Bullock, C.M. Day, T.M. Brennan, J.R. Sturdevant, and J.S. Wasson. "Architecture for Active Management of Geographically Distributed Signal Systems." *ITE Journal*, Vol. 81, No. 5, pp. 20-24, May 2011.
- T.M. Brennan, C.M. Day, J.R. Sturdevant, and D.M. Bullock. "Visual Education Tools to Illustrate Coordinated System Operation." *Transportation Research Record*, Paper No. 11-0590, accepted for publication, in press<sup>1</sup>.
- C.M. Day, T.M. Brennan, H. Premachandra, J.R. Sturdevant, and D.M. Bullock. "Analysis of Peer Intersection Data for Arterial Traffic Signal Coordination Decisions." *Transportation Research Record*, Paper No. 11-0037, accepted for publication, in press.
- C.M. Day and D.M. Bullock. "Using Field Data to Improve Model Accuracy: Application of the Robertson Dispersion Model to High-Resolution Signal Event Data." Submitted to *Transportation Research Record* August 1, 2011, Paper No. 12-0061, under review.

In addition to the four above documents, two white papers were prepared to summarize additional findings for inclusion in this report.

- A. M. Ernst, C.M. Day, and D.M. Bullock. "Data Reduction Procedures for Traffic Signal Systems Performance Measures." Working paper, SPR-3409, Joint Transportation Research Program, August 2011.

---

<sup>1</sup>This paper received the exceptional paper award from the Traffic Signal Systems Committee of the Transportation Research Board in January 2011.

- C.M. Day and D.M. Bullock. "Optimization of Offsets and Cycle Length Using High Resolution Signal Event Data." Working paper, SPR-3409, Joint Transportation Research Program, August 2011.

## CHAPTER 2. PROBLEM STATEMENT

The current state of the practice for traffic signal systems operations is represented by the diagram of the work flow in Figure 2.1 (2). In Step I, agencies usually establish policies or objectives of some sort, formally or informally, that guides the work. In Step II, traffic data is obtained through manual field counts. This data is then keyed into a software model where signal control policies are determined in Steps III-IV. This is usually an iterative process (feedback loop "FB1") where the design engineer works with the software to compare alternative timing plan options before deciding what to send to the field. Upon deployment in the field (Step V), signal timing plans are usually evaluated by observations from the field (Step VI). Typically, the post-deployment feedback loop ("FB2") is limited to initial deployment, rather than the full design life of the signal policy.

Because of the lack of post-deployment data, agencies retune signals and carry out maintenance activity at signals on arbitrary schedules, or in response to user complaints (which are often difficult to verify). These activities require considerable effort to coordinate field visits. Most systems are only optimized for typical working hours of engineering staff, meaning that late evenings, early mornings, and weekends are not always served by the best policy or timing plan.

Deploying performance measures in a signal system is an emerging possibility with the development of new data collection technology, and cheaper computing and communications equipment. However, there is little understanding of how to deploy a geographically distributed data collection system in the context of traffic signal systems. Current "central systems" are based on the assumption that agencies needing this type of management capability are geographically condensed (such as cities), where it is feasible to establish direct wired connections to all of the intersections in the system. Additionally, at the time of the inception of this project, there was no vendor with a system that was capable of developing signal performance measures from high resolution event data.

## CHAPTER 3. OBJECTIVE

The objective of SPR-3409 is to develop a collaborative pilot deployment partnership between INDOT, Purdue, and traffic signal equipment vendors to define an architecture for a central traffic signal management system that can be used statewide by both the maintenance and technical services staff.

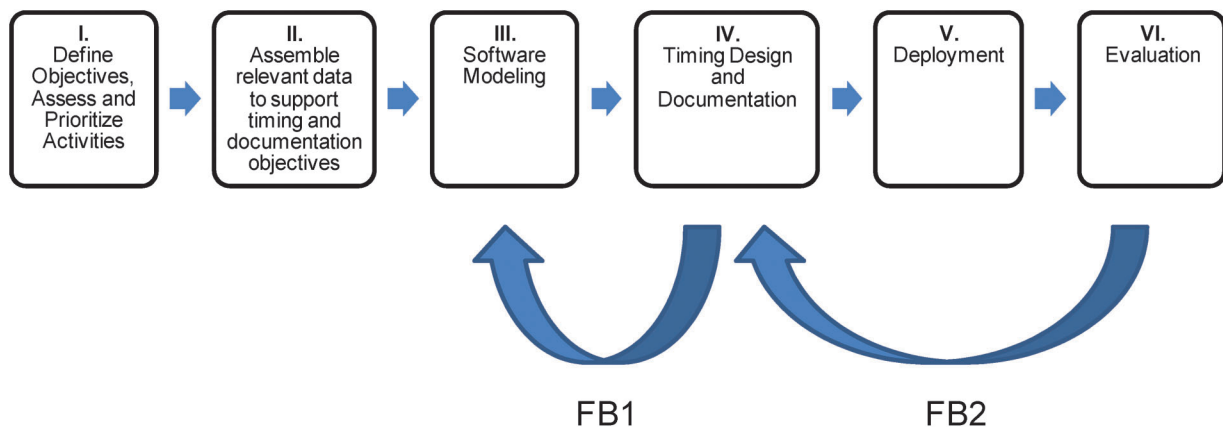

Figure 2.1 Workflow for traffic signal systems operations, including two feedback (FB) loops (2).

#### CHAPTER 4. SUMMARY OF PROJECT ACCOMPLISHMENTS

In the two-year project timeline, this project serves as a mechanism for facilitating collaboration between INDOT, Purdue, and vendors to implement high-resolution data collection in traffic signal controllers.

The accomplishments of SPR-3409 are summarized below.

- *Data management and processing.* An emphasis of SPR-3409 was in developing appropriate procedures for obtaining and processing high resolution signal event data. An architecture for deploying the technology throughout a geographically disperse system such as INDOT's network was formalized during this project. The architecture was proposed to the signal system community in a journal article that is included in Appendix A. Procedures for using the raw data to establish signal systems performance measures were researched and are documented in Appendix B.
- *Dashboard development.* A prototype dashboard website was developed during SPR-3409 and is currently available for use by traffic engineers. Dashboard development necessitated the development and optimization of database queries to swiftly retrieve the performance measures. This is discussed in Appendix B. The use of high resolution data to understand signal coordination was documented in a technical paper that received an award at the 2011 Transportation Research Board conference. This paper is presented in Appendix C.
- *Vendor coordination.* Continued dialog with signal equipment vendors in SPR-3409 led to the development of a collaborative specification for the high resolution event data format. An experimental NTCIP node was established by INDOT for use in developing a more standardized protocol for future streamlining of the data collection process.
- *Optimization algorithm development.* Procedures for developing quantitative measures of traffic characteristics for system optimization were investigated (results in Appendix C and Appendix D). These methods enable direct measurement of traffic characteristics related to corridor progression, which are usually conjectured by models (including both optimization software and most adaptive control systems). A framework for optimization of signal timing plans based on high resolution data was

investigated, and an algorithm for optimization of cycle length, offsets, and phase sequence was identified. Preliminary results of this research are presented in Appendix E.

- *Central Systems.* During SPR-3409, the research team focused its efforts toward system procurement on working with signal vendors to better implement high resolution event data and performance measures in traffic engineering products, in order to better understand how data would be managed in a large system such as INDOT. During the project lifetime, RFPs for high resolution data collection enabled Advanced Traffic Management Systems (ATMSs) emerged in Elkhart County and the City of Lafayette; these projects were deployed during the course of SPR-3409. Other agencies in the US, such as Morgantown, WV have begun to implement such systems.

At the time that this report was written, the data requirements of a very large, multiple-vendor agency are not yet fully addressed by current industry central system products. ATMS systems are currently intended for one vendor's product only; with existing systems, INDOT would have to maintain several ATMS licenses to integrate its entire signal network. In order for INDOT to maintain a competitive bidding environment for equipment, it is recommended to continue the present practice of documenting equipment requirements in an INDOT approved materials list, so that any vendor wanting to sell product to INDOT needs only to meet the published requirements to submit bids. New software licensing structures might be needed to integrate multiple vendor products into a central management system.

The lessons learned in development of data management procedures in SPR-3409 are likely to promote development of more advanced systems, and the continuing partnership between INDOT and Purdue will continue to expand the existing INDOT data management system and expand it to fully integrate and manage traffic signal assets in the state of Indiana.

In summary, this project succeeded in achieving its objective of continuing vendor collaboration to define high resolution data and integrate it into existing signal systems, and to use this data with optimization

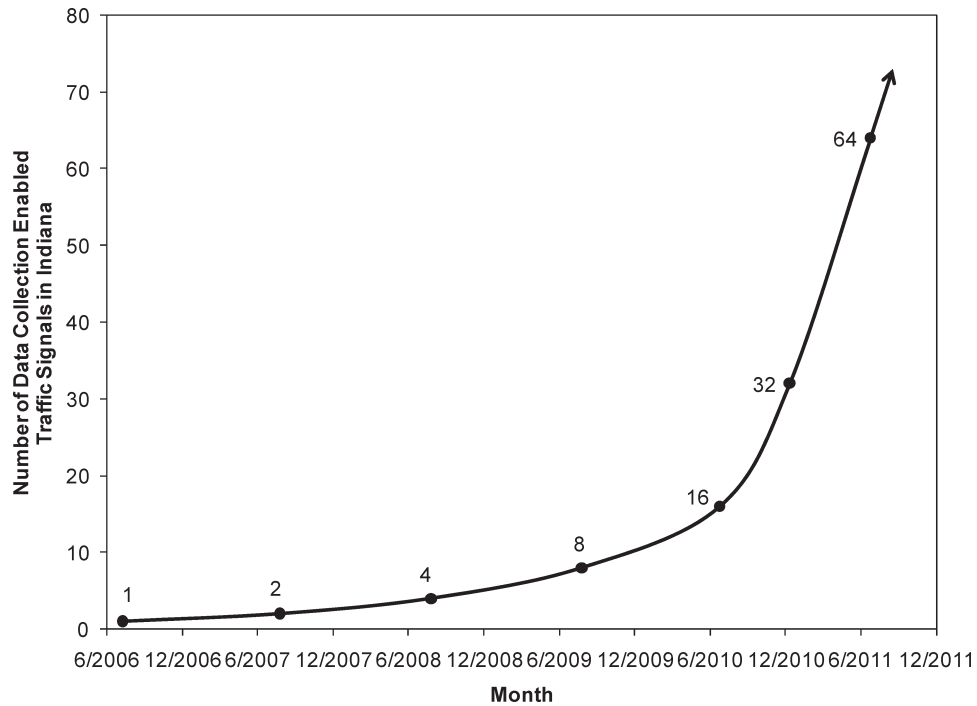

Figure 6.1 Growth of data collection-enabled traffic signals in Indiana.

processes. The findings presented in the rest of this report contribute to the state of the practice and will lead to improved operations of signal systems in Indiana.

## CHAPTER 5. IMPLEMENTATION OF PROJECT RESULTS

Figure 6.1 shows the growth of the number of signals in the INDOT network where data-collection enabled signal controllers are located. The first deployment of a controller with an experimental data collector was in the summer of 2006 at SR 32 and SR 37 (3). Approximately one year later, the second such controller was installed

at the neighboring intersection of SR 37 and Pleasant St.. By July 2008, the system had grown to incorporate four intersections along SR 37, which had grown to eight intersections by July 2009, which was the extent of the system at the beginning of SPR-3409. During SPR-3409, the number of deployed signals has doubled twice, as the US 31, SR 37 South, US 36, and SR 30 systems have been integrated into the system. The data reduction procedures have made the exponential growth of signal data sustainable, as discussed further in Appendix B. As a result of research in SPR-3409, performance measures from nearly 70 signals may now be retrieved through the prototype dashboard.

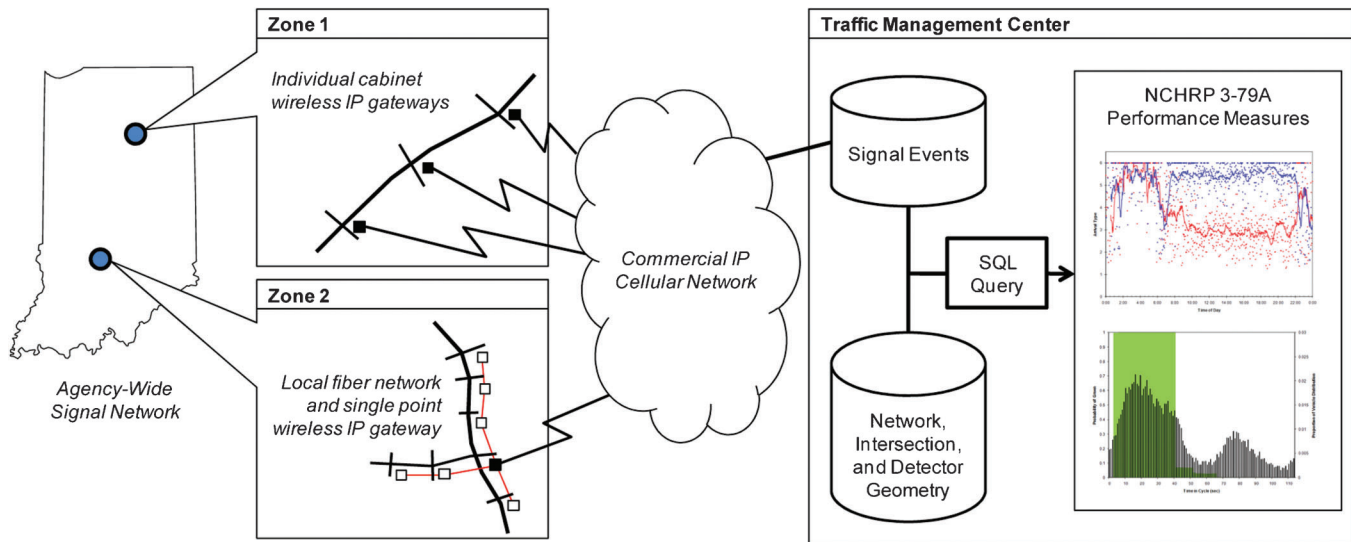

Figure 6.2 Remote data collection architecture.

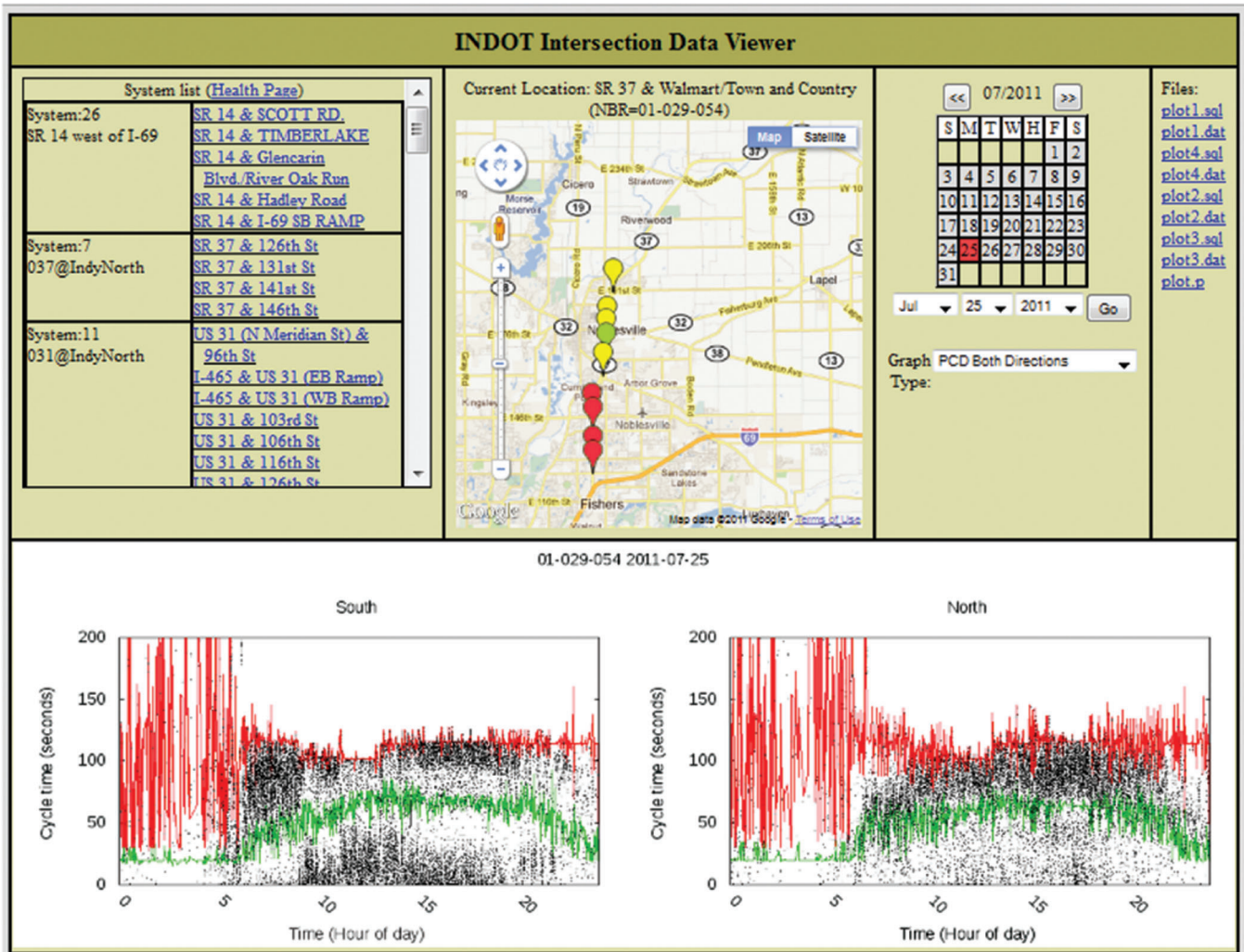

Figure 6.3 Prototype performance measure dashboard.

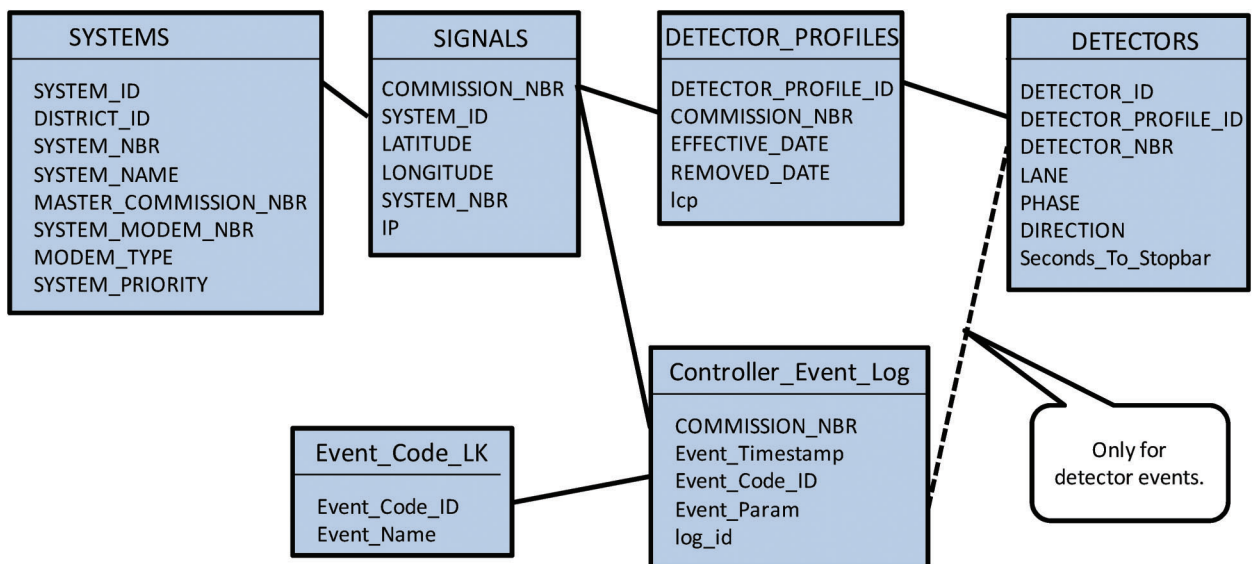
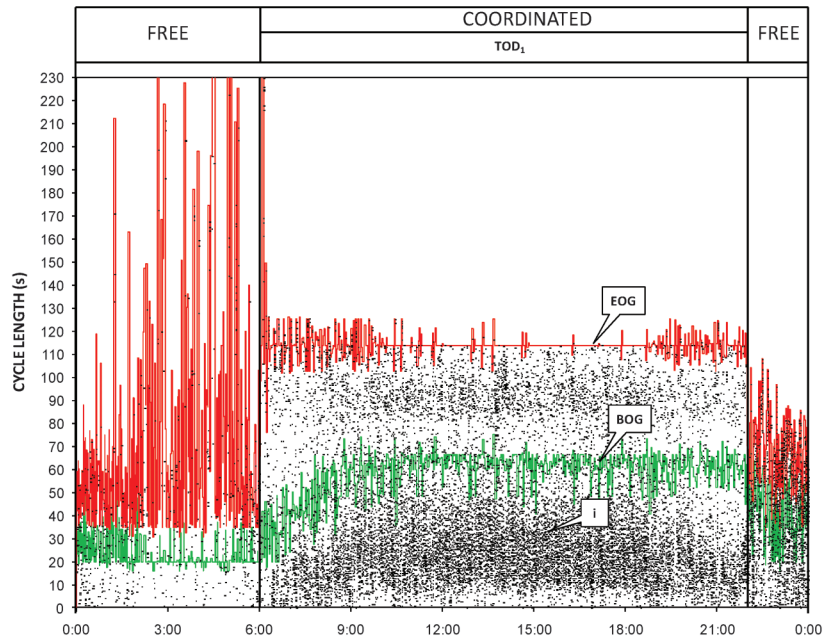
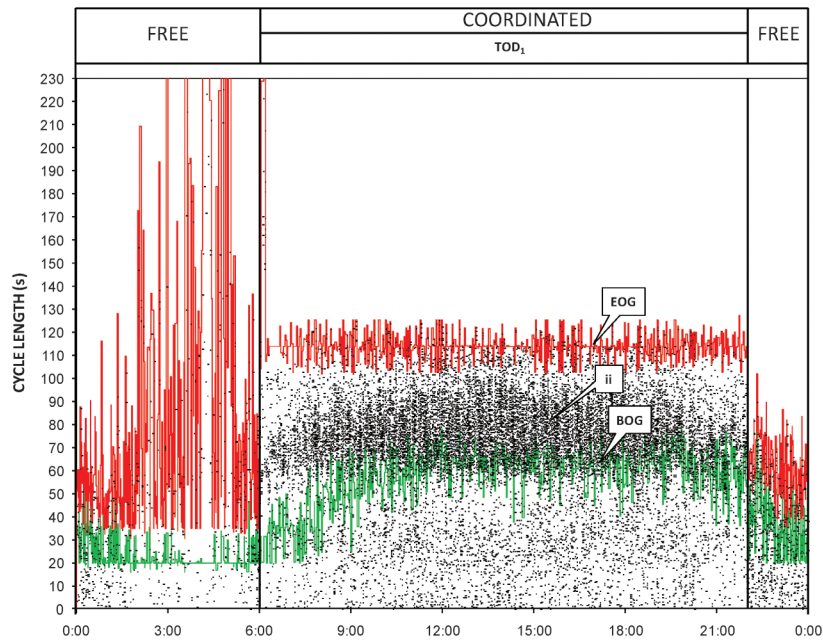

Figure 6.4 Partial prototype database diagram showing the relationship between tables used to define and calculate performance measures.



a) Poor vehicle progression before offset adjustments, Saturday, June 5<sup>th</sup>, 2010.



b) Improved vehicle progression after offset adjustments, Saturday, June 12<sup>th</sup>, 2010.

Figure 6.5 Example Purdue Coordination Diagrams.

## CHAPTER 6. SUMMARY OF FINDINGS

### 6.1 Communications Architecture for Geographically Distributed Signal Systems

Part of the challenge in deploying active traffic management solutions such as signal performance

measures is the establishment of communications with field equipment. Historically, high technology systems have been limited to cities where the equipment is distributed in a geographically condensed cluster, where direct wire communications are possible (or, more recently, where it is feasible to extend wireless coverage through distribution of routers). Systems where there

are relatively long distances between deployed units are not considered in this perspective, yet such distributions are common in many agencies.

In this study, a scalable statewide center-field communications architecture was developed, and is illustrated in Figure 6.2. This architecture leverages the commercial IP cellular network to retrieve data from the field, taking advantage of relatively low costs of bandwidth and installation. This architecture requires the installation of a wireless IP gateway at each point, or can integrate existing field communication equipment, such as installed fiber interconnects, to deploy data collection at clusters of equipment. The bandwidth requirements for collecting compressed data are found to be relatively light, with an example corridor of eight intersections requiring approximately 9 MB per 24-hour data set, or 270 MB per month, which is well below typical wireless provider data usage caps (typically 2-5 GB per month).

This architecture is becoming the backbone of data collection capabilities of the INDOT signal system, replacing the existing dial-up connections as well as

providing the capability of harvesting high-resolution event data. As mentioned earlier, the system is proving to be scalable to grow rapidly, with the number of online intersections doubling roughly every 6 months since the beginning of 2010 (see Figure 6.1).

Further detailed discussion of the architecture is provided in Appendix A.

## 6.2 Data Reduction Procedures

Two deliverables for SPR-3409 include the production of a performance measure dashboard linking to a signal event database, and the documentation of the database structure behind the dashboard. This information is provided in the working paper attached to this report as Appendix B.

A view of the prototype dashboard is shown in Figure 1.4. This dashboard uses an embedded map system view to locate intersections in the system; the user is then able to specify which date and what performance measure for which data is to be generated. In the

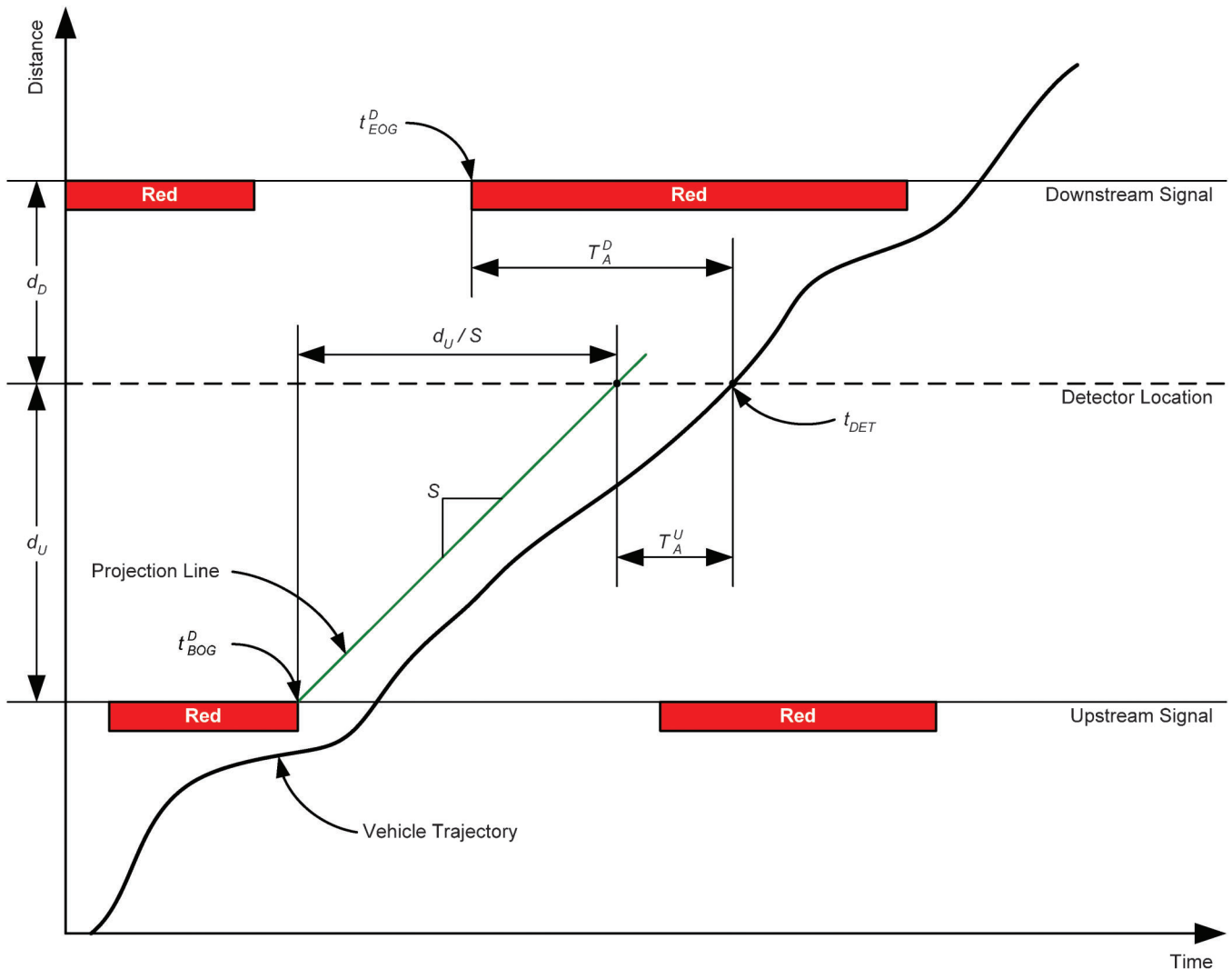

Figure 6.6 Vehicle movement on a link between two non-coordinated intersections.



example plot, coordination diagrams are shown for the northbound and southbound coordinated phases at the intersection of SR 37 and Town and Country Blvd.

The working paper in Appendix A mainly focuses on the database schema used to develop the performance measures used in the dashboard. In SPR-3409, the existing INDOT database used for signal systems management was used as the backbone of the dashboard. Figure 6.4 illustrates the subset of tables in the signal systems database used for performance measures. A series of SQL queries were written to transform the raw data in the “Controller\_Event\_Log” table and configuration information contained in the other tables into performance measures. In addition to creating these queries, several administrative tweaks were made to the database in order to improve its performance at storing the increasing amount of data from a growing network of data collection enabled signal controllers. These are also documented in further detail in Appendix A.

### 6.3 Visual Education Tools for Coordinated System Operation

The emphasis of SPR-3409 was on deployment of performance measures developed in prior studies

(3,4,5,6,7,8). It was desirable to develop material that would improve understanding of the performance measures; in particular, a visualization tool called the “Purdue Coordination Diagram” (PCD) was considered particularly promising to assist engineers in assessing link coordination at a glance for a given time period. The PCD is a powerful tool because it enables the engineer to view data that normally must be observed in the field, either directly or by examination of live and/or recorded video; both of these are labor-intensive operations, and assessment of progression quality by visual inspection of live intersection operations is open to considerable interpretation (9).

Figure 6.5 shows two example PCDs to illustrate the utility of the diagram. The two PCDs are for the same coordinated approach on two separate days from before retiming (Figure 6.5a) and after retiming (Figure 6.5b). The “dots” in the two plots each represent a detected vehicle arrival time. The vertical position represents the time in the cycle that the vehicle arrived, while the horizontal position represents the time of day. Superimposed on the dots is a record of the phase green and red times. Moving vertically from the x-axis upward, the timeline begins at the previous end of green (EOG); the signal is thus in a *red* state until

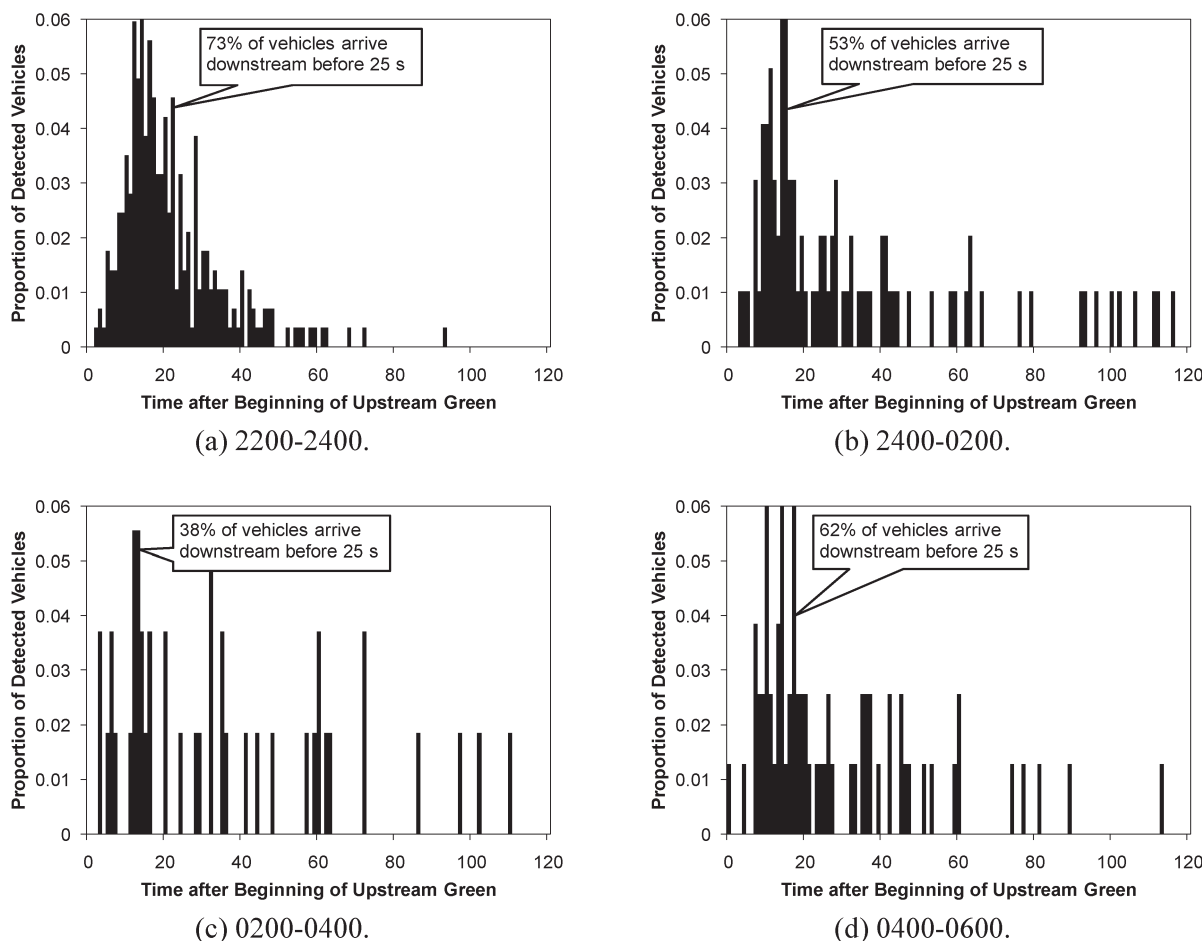
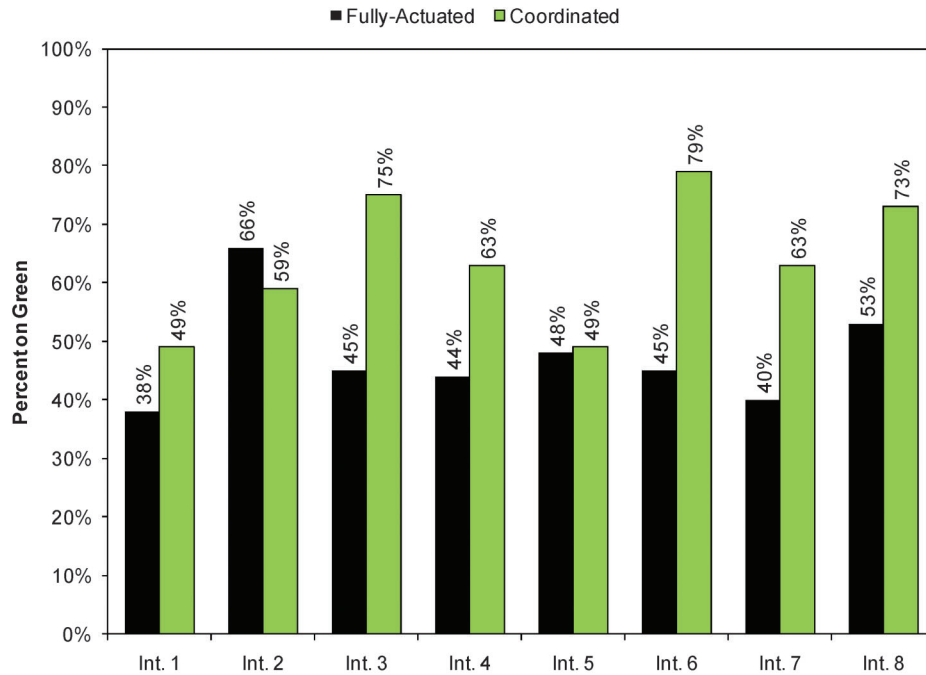

Figure 6.7 Vehicle flow profile determined from upstream-downstream methodology.

reaching the beginning of green (BOG), as shown by the callouts in the plots. Vehicles plotted in the space below the BOG line represent arrivals in red. The area above the BOG line represents arrivals in green. Finally, the topmost line is the EOG, where the timeline wraps back around to the x-axis again.

In Figure 6.5a, the vast majority of vehicles are shown to arrive during red, as indicated by callout “i”. This represents a poor offset, which is causing vehicles to arrive while the signal is red. After making an adjustment to the offset, we are able to consider the impact on the phase by viewing the PCD in Figure 6.5b. Here, the



(a) Northbound.

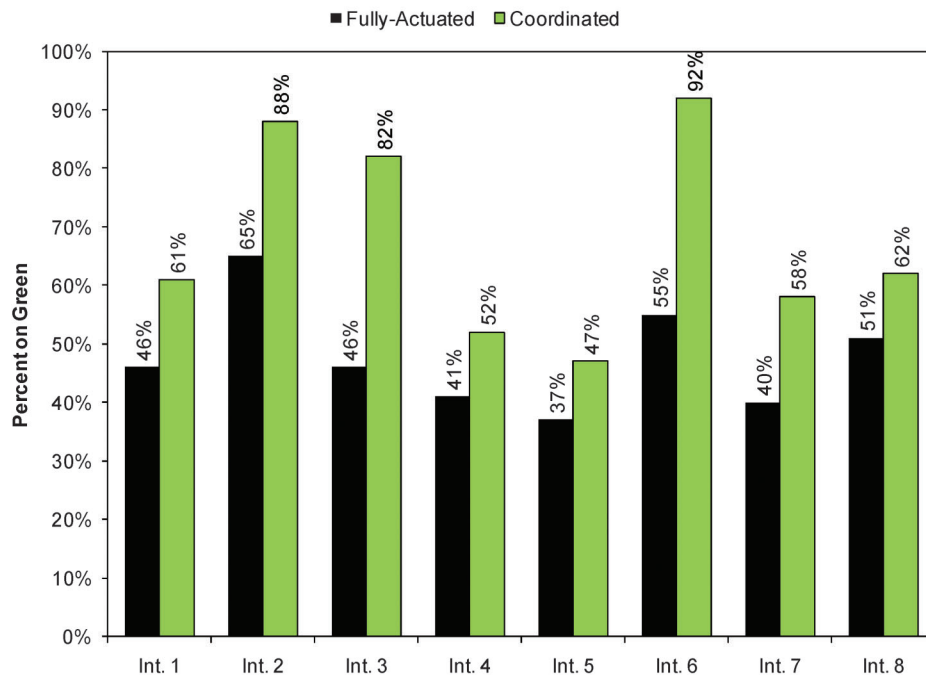

(b) Southbound.

Figure 6.8 Percentage on green by intersection.

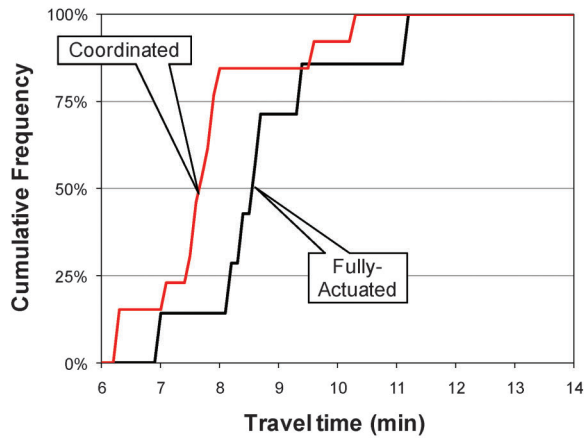

(a) Southbound, Case A to Case C.

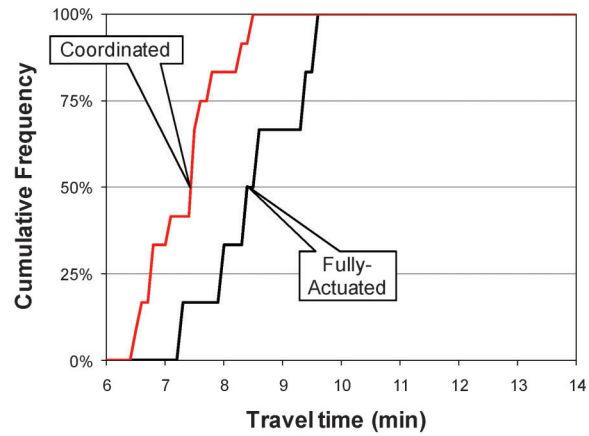

(b) Northbound, Case C to Case A.

Figure 6.9 Cumulative frequency diagrams of probe vehicle travel time (minutes).

arrivals have been shifted into green, as shown by callout “i”. This is a very basic example of a dramatic change that can be quickly visualized by the PCD; the paper reprint included in Appendix C shows example PCDs from a variety of situations encountered in coordinated operations. This paper was selected for the 2011 Exceptional Paper Award by the Traffic Signal Systems Committee of the Transportation Research Board.

#### 6.4 Analysis of Peer Intersection Data for Arterial Traffic Signal Coordination Decisions

One new way in which the use of high resolution signal event data was explored in SPR-3409 was the fusion of data between multiple “peer” intersections to analyze operations along their shared links. The first application of this methodology was to infer likely benefits from coordinating traffic signals at the adjacent intersections. At present, the decision to coordinate adjacent signals is based on rules of thumb

(e.g., one mile is considered a threshold upper bound link distance), or analysis of link volumes compared to distances, or using traffic flow models.

In SPR-3409, a methodology for analyzing incoming traffic flow using high resolution signal event data was developed. The model is illustrated in Figure 6.6. Essentially, the upstream beginning of green time is projected forward in time to a downstream detector (which would be the *upstream* detector of the next intersection). By subtracting the upstream beginning of green time (plus a baseline travel time) from the detector arrival times, it is possible to develop a platoon profile by aggregating the data across successive cycles.

Figure 6.7 shows four separate profiles for a link during four overnight two-hour time periods. Despite the fact that the two neighboring intersections were *not running in coordination* during this time period (*i.e.*, they did not run a common cycle length), it is still possible to develop a platoon profile by using the methodology, as shown in Figure 6.7a. Between 2200-2400, 73% of

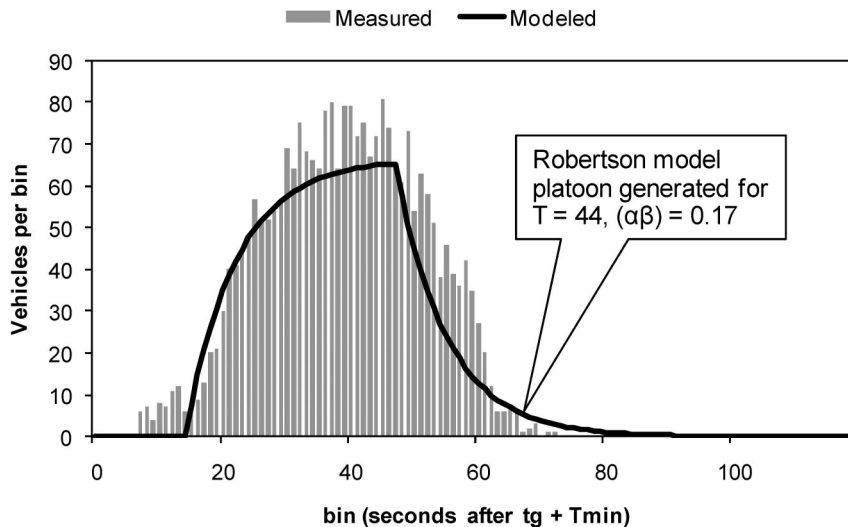

Figure 6.10 Measured and modeled platoons.

vehicles are estimated to arrive in platoons that could potentially be coordinated. As the volumes decrease overnight, the platoons gradually disappear, as shown in Figure 6.7a, Figure 6.7c, and Figure 6.7d.

Based upon this analysis, it was determined that the coordination plan on SR 37 in Noblesville, IN should be extended until 2400; previously, coordination ended at 2200 based on a “rule of thumb” type of assumption that traffic diminished after that time to the point where there was no benefit to coordinating the signals.

By implementing this change, the percent of arrivals on green increased substantially on nearly all approaches in the corridor, as shown in Figure 6.8. The impact was to save travelers on SR 37 over 1 minute of travel time in both directions, as shown in Figure 6.9 (corresponding to a 11% reduction compared to the baseline travel time over an approximately 6-mile section).

Additional details of the methodology are provided in Appendix D.

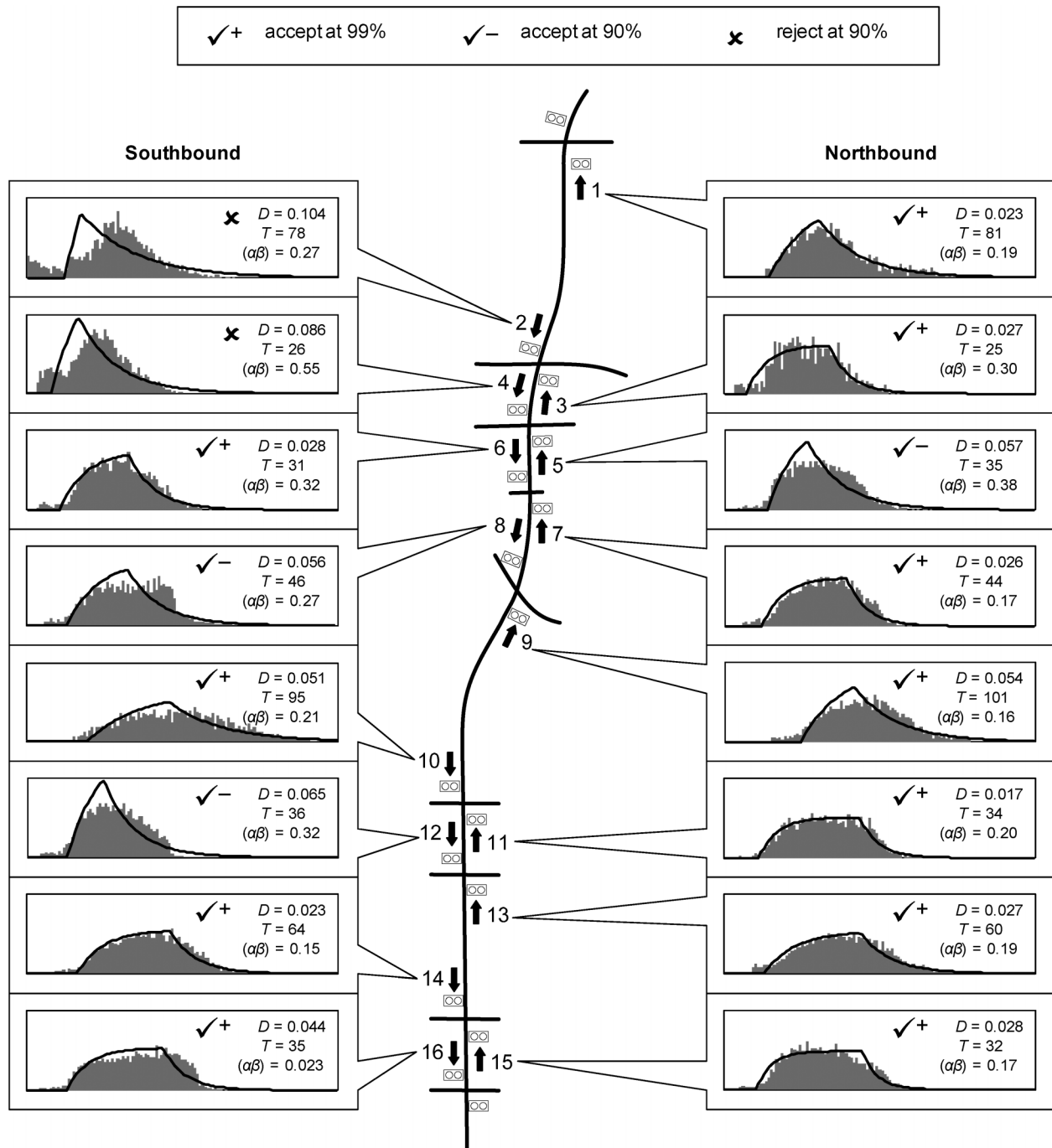

Figure 6.11 Example model results from 16 coordinated links on SR 37, March 12, 2011, 1400-1600.

### 6.5 Using Field Data to Improve Model Accuracy

The peer intersection data methodology described in the previous section was extended by applying the Robertson platoon dispersion model to quantify the characteristics of the platoons, and measure how those characteristics changed over time. The objective of obtaining this information was to develop a set of parameters to use for timing plan optimization; the same parameters are vital to adaptive control and other applications. For example, recent work by Bonneson et al. (10,11) has proposed integrating platoon characteristics into the HCM to analyze traffic performance on urban streets. A real-time implementation of the methodology would make dependent models self-calibrating. Because the method could be fully automated, the level of effort to obtain the platoon characteristics is substantially reduced from manual observations.

Figure 6.10 shows an example of how a modeled platoon is matched to a measured platoon. A nonparametric statistical method is used to compare the two distributions and determine their similarity to a specified confidence level (90% and 99% thresholds are considered in this study). An exhaustive search is

used to find the set of parameters having the best statistical fit. Figure 6.11 illustrates the use of the matching algorithm across nine intersections on SR 37 in Noblesville, IN, and the use of the statistical fit as a filter on whether to accept or reject the model parameters. A month's worth of data was used to develop a statistical distribution of parameters, with very tight distributions for link travel time (and speed, which can be derived from it) and wider distributions for the dispersion parameter. Figure 6.12 and Figure 6.13 respectively present the resulting data for link speeds and platoon dispersion.

Details of the methodology are presented in Appendix E.

### 6.6 Optimization

One of the deliverables of SPR-3409 was to establish a methodology for optimizing cycle length. This was first envisioned as an extension of the previously developed methodology for offset optimization, with mathematical scaling and translating of the shape functions related to the vehicle arrival distributions. Although the prior initial investigation of this methodology had some

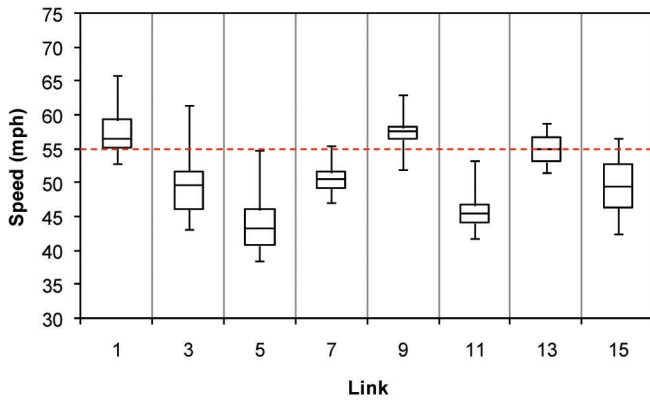

(a) Northbound links.

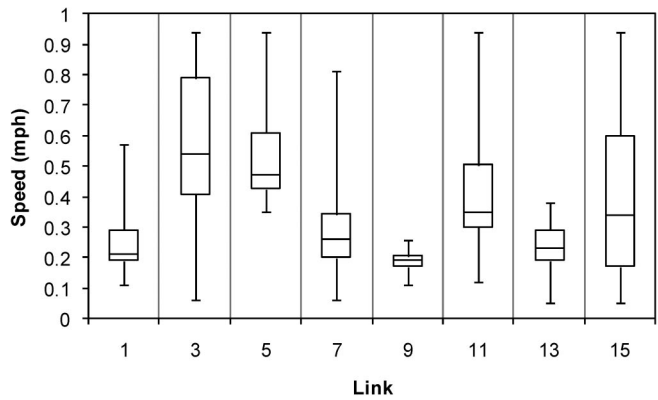

(a) Northbound links.

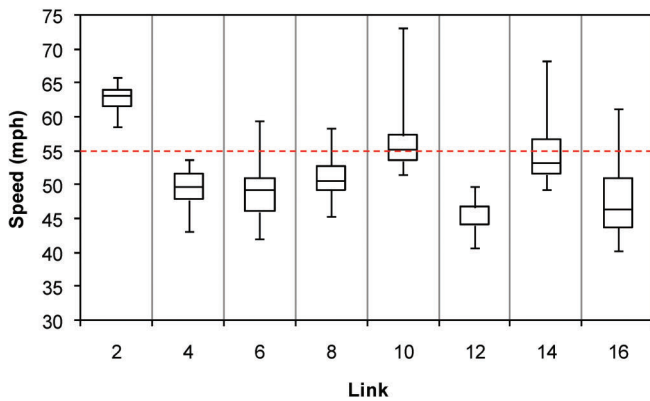

(b) Southbound links.

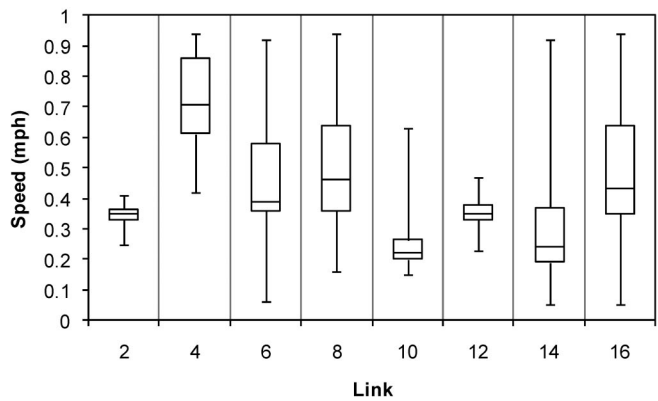

(b) Southbound links.

Figure 6.12 Box-whisker plots of link speeds inferred from travel time data. Parameters shown for model goodness-of-fit accepted at the 90% confidence level.

Figure 6.13 Box-whisker plots of link dispersion parameters. Parameters shown for model goodness-of-fit accepted at the 90% confidence level.

promise (12), subsequent experiments during SPR-3409 did not demonstrate that platoon profiles for a trial cycle length could be accurately predicted by simple mathematical transformations of observed platoons under another cycle length. Furthermore, this methodology could not model changes to phase sequence, which was also desired.

A different approach was taken, namely the fusion of high resolution signal event data with an optimization program. For this purpose, a model called “Traffic Signal Model 3409” (TSM 3409) was created, based on the TRANSYT macroscopic model. The model uses a series of link definitions that are based on volume, travel time, and dispersion parameters obtained directly from signal event data. A screenshot of the program is provided in Figure 6.14. This shows the model output for a particular scenario for SR 37 in Noblesville, IN.

Three algorithms for optimizing offsets and phase sequence for a given cycle length were developed. These included a genetic algorithm, and two “hybrid” algorithms that combined the genetic algorithm with an offset optimization subroutine (either hill climbing or link pivoting (13)). A range of feasible cycle lengths for SR 37 was swept through to determine the impact of cycle length and to see if it was possible to discover a

resonant cycle. The results of the cycle length sweep are shown in Figure 6.15. This plot shows box-whisker plots from outcomes of the three algorithms compared to a Monte Carlo simulation (random parameter selection) for a distribution of alternative parameter starting points. The vertical axis, performance index, is equal to delay, plus the number of stops converted to delay.

The results of the study show that, at least for the study network considered here, delay tends to gradually increase with cycle length, regardless of which algorithm is used. A “resonant” cycle length, or a minimum point somewhere in the middle of the range, does not appear to emerge. Of the three algorithms tested, the two hybrid genetic algorithms performed about equally, and better than genetic algorithms alone. With regard to the SPR 3409 objectives, this research successfully identified a methodology for optimizing cycle length and offsets for a signalized corridor based upon field data.

## CHAPTER 7. CONCLUSION AND SUMMARY OF IMPACT

The high resolution data collection architecture and subsequent processing of that raw data into meaningful

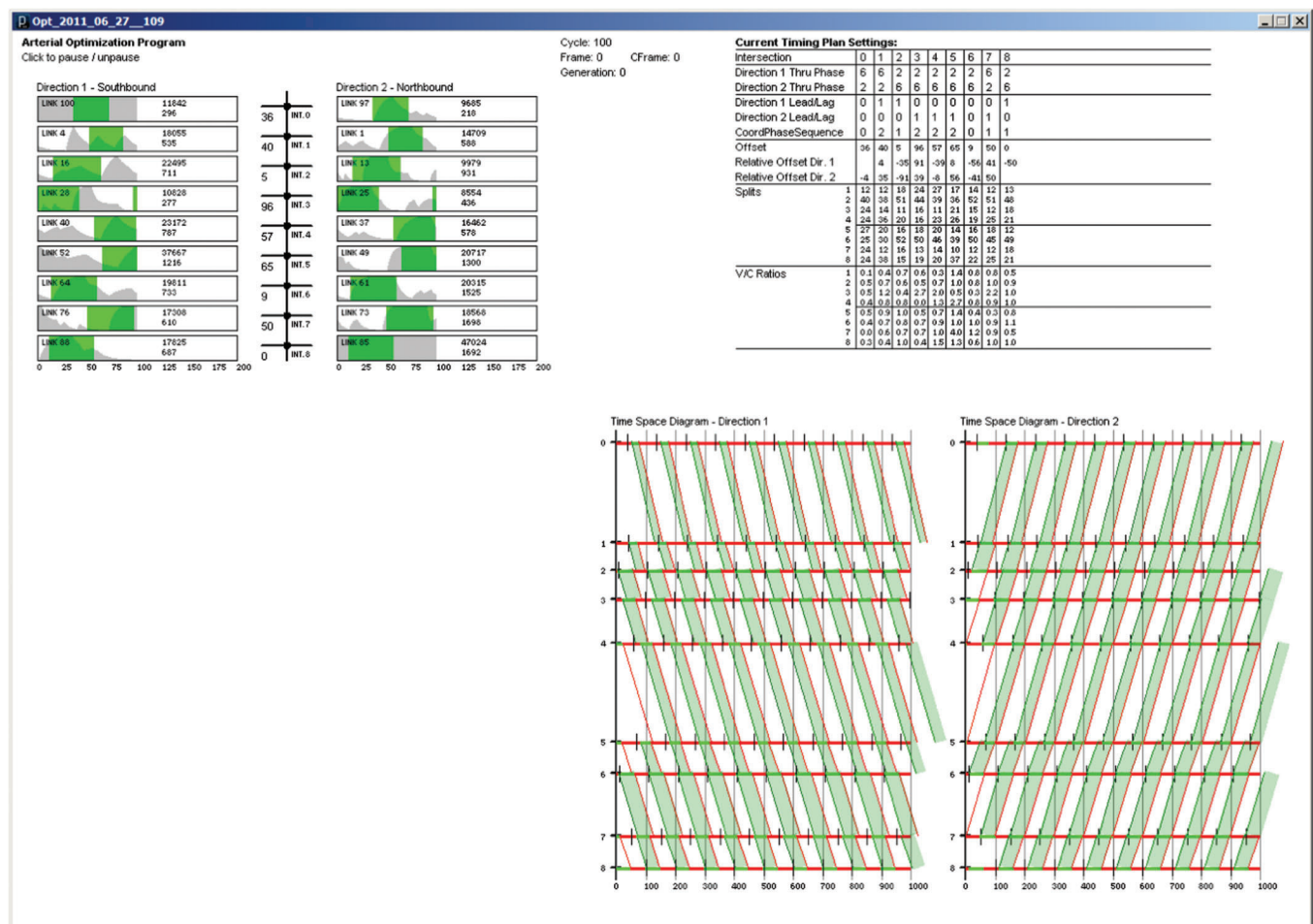

Figure 6.14 View of prototype software for arterial timing plan optimization.

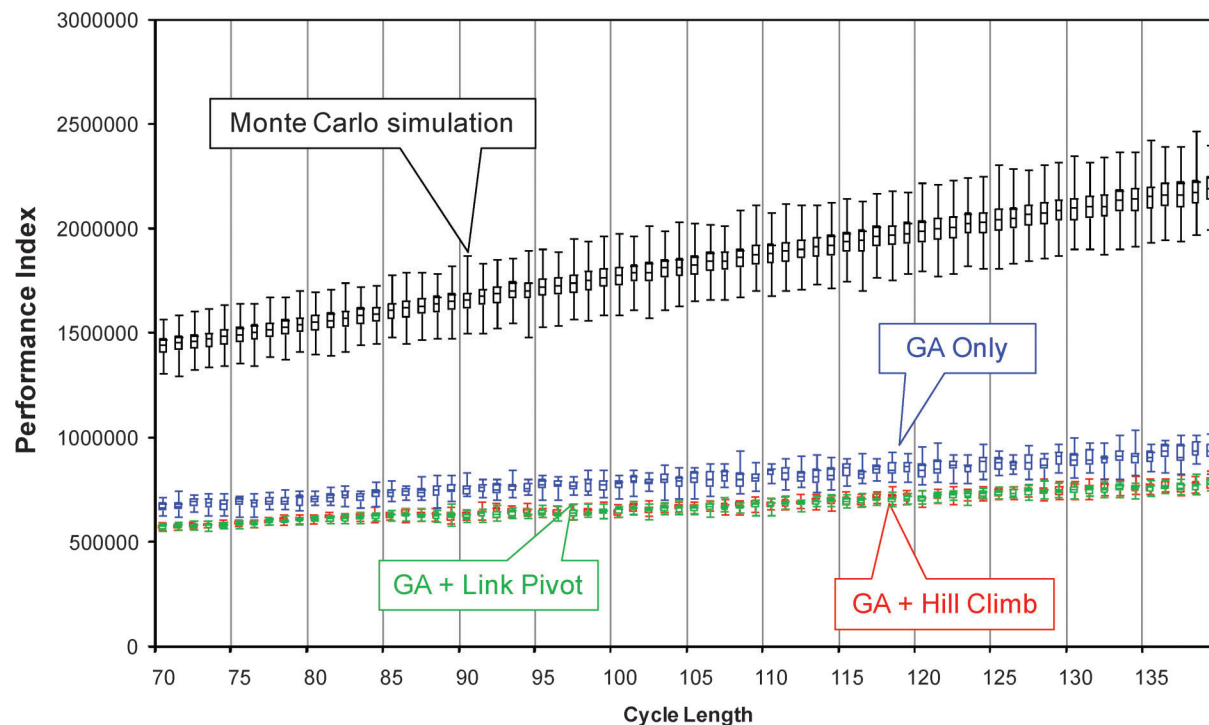

Figure 6.15 Comparison of algorithm results for the SR 37 test network. The box-whisker plots show distributions from 20 runs per cycle length for the GA and hybrid-GA algorithms, and 1000 runs for Monte Carlo simulation.

performance measures was a major contribution resulting from this project. The architecture was proposed to the signal system community in a journal article that is included in Appendix A. Procedures for using the raw data to establish signal systems performance measures are documented in Appendix B. Commercial vendors have now begun to embrace this new architecture and are working to implement performance measure tabulation. A critical component of vendor collaboration is the development of a shared specification for high resolution data. This specification is currently nearing a “1.0” version.

The first two deployments of contracted performance measure-capable ATMS systems in the US were in Lafayette, IN and Elkhart County, IN during the Spring and Fall of 2011, respectively. This architecture is gaining traction outside of Indiana, with a deployment scheduled for Morgantown, WV in Fall 2011.

High resolution data enables new methods for visualizing and assessing 24-hour corridor operations without field visits or searching through hours of recorded video (Appendix C). The new architecture for data collection opens up opportunities to develop new optimization techniques for estimating fundamental traffic flow characteristics (Appendix D and Appendix E) and analytically computing recommended traffic signal offsets, phase sequence, and cycle length (Appendix F).

#### APPENDIX A. ARCHITECTURE FOR ACTIVE MANAGEMENT OF GEOGRAPHICALLY DISTRIBUTED SIGNAL SYSTEMS

D.M. Bullock, C.M. Day, T.M. Brennan, J.R. Sturdevant, and J.S. Wasson. “Architecture for Active Management of Geographically Distributed Signal Systems.” *ITE Journal*, Vol. 81, No. 5, pp. 20-24, May 2011.

#### APPENDIX B. DATA REDUCTION PROCEDURES FOR TRAFFIC SIGNAL SYSTEMS PERFORMANCE MEASURES

J. M. Ernst, C.M. Day, and D.M. Bullock. “Data Reduction Procedures for Traffic Signal Systems Performance Measures.” Working paper, SPR-3409, Joint Transportation Research Program, August 2011.  
<http://docs.lib.purdue.edu/cgi/viewcontent.cgi?filename=5&article=2970&context=jtrp&type=additional>

#### APPENDIX C. VISUAL EDUCATION TOOLS TO ILLUSTRATE COORDINATED SYSTEM OPERATION

T.M. Brennan, C.M. Day, J.R. Sturdevant, and D.M. Bullock. “Visual Education Tools to Illustrate Coordinated System Operation.” *Transportation Research Record*, Paper No. 11-0590, accepted for publication, in press.  
 \*Received Exceptional Paper Award, Traffic Signal Systems Committee, Transportation Research Board, January 24, 2011.

## APPENDIX D. ANALYSIS OF PEER INTERSECTION DATA FOR ARTERIAL TRAFFIC SIGNAL COORDINATION DECISIONS

C.M. Day, T.M. Brennan, H. Premachandra, J.R. Sturdevant, and D.M. Bullock. "Analysis of Peer Intersection Data for Arterial Traffic Signal Coordination Decisions." *Transportation Research Record*, Paper No. 11-0037, accepted for publication, in press.

## APPENDIX E. USING FIELD DATA TO IMPROVE MODEL ACCURACY

C.M. Day and D.M. Bullock. "Using Field Data to Improve Model Accuracy: Application of the Robertson Dispersion Model to High-Resolution Signal Event Data." Submitted to *Transportation Research Record* August 1, 2011, Paper No. 12-0061, under review.

## APPENDIX F. OPTIMIZATION OF OFFSETS AND CYCLE LENGTH USING HIGH RESOLUTION SIGNAL EVENT DATA

C.M. Day and D.M. Bullock. "Optimization of Offsets and Cycle Length Using High Resolution Signal Event Data." Working paper, SPR-3409, Joint Transportation Research Program, August 2011.  
<http://docs.lib.purdue.edu/cgi/viewcontent.cgi?filename=9&article=2970&context=jtrp&type=additional>

## REFERENCES

1. *National Traffic Signal Report Card – Technical Report*. National Transportation Operations Coalition, Washington, DC, 2007.
2. Day, C.M. and D.M. Bullock. *Arterial Performance Measures, Volume 1: Performance Based Management of Arterial Traffic Signal Systems*. Final Report, NCHRP 3-79A, Transportation Research Board, Washington, DC. In production, expected 2011.
3. Smaglik, E.J., A. Sharma, D.M. Bullock, J.R. Sturdevant, and G. Duncan, "Event-Based Data Collection for Generating Actuated Controller Performance Measures." In *Transportation Research Record No. 2035*, Transportation Research Board of the National Academies, Washington, DC, pp. 97–106, 2007.
4. Day, C.M., E.J. Smaglik, D.M. Bullock, and J.R. Sturdevant, *Real-Time Arterial Traffic Signal Performance Measures*, Report No. FHWA/IN/JTRP-2008/9, Joint Transportation Research Program, Purdue University, 2008.
5. Day, C.M., R. Haseman, H. Premachandra, T.M. Brennan, J. Wasson, J.R. Sturdevant, and D.M. Bullock. "Evaluation of Arterial Signal Coordination: Methodologies for Visualizing High-Resolution Event Data and Measuring Travel Time." *Transportation Research Record No. 2192*, Transportation Research Board of the National Academies, Washington, DC, pp. 37–49, 2010.
6. Day, C.M., J.R. Sturdevant, and D.M. Bullock. "Outcome Oriented Performance Measures for Management of Signalized Arterial Capacity." *Transportation Research Record No. 2192*, Transportation Research Board of the National Academies, Washington, DC, pp. 24–36, 2010.
7. Day, C.M., D.M. Bullock, and J.R. Sturdevant, "Cycle Length Performance Measures: Revisiting and Extending Fundamentals," *Transportation Research Record No. 2128*, Transportation Research Board of the National Academies, Washington, DC, pp. 48–57, 2009.
8. Day, C.M., E.J. Smaglik, D.M. Bullock, and J.R. Sturdevant. "Quantitative Evaluation of Fully Actuated Versus Non-Actuated Coordinated Phases." *Transportation Research Record No. 2080*, Transportation Research Board of the National Academies, Washington, DC, pp. 8–21, 2008.
9. Eidson, W.C. and D.M. Bullock. "Analysis of Arrival Type Estimation Procedures." In *Transportation Research Record No. 1776*, Transportation Research Board of the National Academies, Washington, DC, pp. 123–127, 2001.
10. Bonneson, J.A., M.P. Pratt, and M.A. Vanderhey. *Predicting the Performance of Automobile Traffic on Urban Streets*. Final Report, NCHRP 3-79, Transportation Research Board, 2008.
11. Bonneson, J.A., M.P. Pratt, and M.A. Vanderhey. "Predicting Arrival Flow Profiles and Platoon Dispersion for Urban Street Segments." In *Transportation Research Record No. 2173*, Transportation Research Board of the National Academies, Washington, DC, pp. 28–35, 2010.
12. Day, C.M. *Performance Based Management of Arterial Traffic Signal Systems*. PhD Thesis, Purdue University, 2010.
13. Day, C.M. and D.M. Bullock. "Computational Efficiency of Alternative Arterial Offset Optimization Algorithms." *Transportation Research Record*, Paper No. 11-0181, accepted for publication, in press.