

J. E. Bolluyt, V. B. Kau, L. F. Greimann

Performance of Strip Seals in Iowa Bridges, Pilot Study

January 2001

Sponsored by the
Iowa Department of Transportation
and the Iowa Highway Research Board

FINAL REPORT

Iowa Highway Research Board
Project TR-437



report

College of Engineering

Iowa State University

The opinions, findings, and conclusions expressed in this publication are those of the authors and not necessarily those of the Iowa Highway Research Board or the Iowa Department of Transportation.

J. E. Bolluyt, V. B. Kau, L. F. Greimann

Performance of Strip Seals in Iowa Bridges, Pilot Study

**Sponsored by the
Iowa Department of Transportation
and the Iowa Highway Research Board**

FINAL REPORT

**Iowa Highway Research Board
Project TR-437**

College of Engineering

Iowa State University

ABSTRACT

A pilot study was conducted on the premature failures of neoprene strip seals in expansion joints in Iowa bridges. In a relatively large number of bridges, strip seals have pulled out of the steel extrusions or otherwise failed well before the expected life span of the seal. The most serious consequence of a strip-seal failure is damage to the bridge substructure due to salt, water, and debris interacting with the substructure.

A literature review was performed. Manufacturers' specifications and recommendations, practices in the states bordering Iowa, and Iowa DOT design and installation guidelines were reviewed. Discussions were held with bridge contractors and the installation of a strip seal system was observed. Iowa DOT bridge databases were analyzed. A national survey was conducted on the use and performance of strip seals.

With guidance from the Iowa DOT, twelve in-service bridges with strip-seal expansion joints were selected for detailed investigation. Effective bridge temperatures and corresponding expansion-joint openings were measured, DOT inspection reports were reviewed, and likely cause(s) of premature failures of strip seals were proposed.

All of the seals used in the twelve bridges that had the most serious failures were in concrete girder bridges. Experimental results show that for a majority of these serious failures, the joint opening at 0° F predicted by the Iowa DOT design equations, the joint opening at 0° F extrapolated from the experimental data, or both, are larger than the movement rating of the strip seal specified on the bridge plans. Other likely causes of premature failures of seals in the twelve bridges include debris and ice in the seal cavity, a large skew and the corresponding decrease in the movement rating of the seal, improper installation, and improper setting of the initial gap.

TABLE OF CONTENTS

	<u>Page</u>
1. INTRODUCTION	1
1.1. Background	1
1.2. Objectives	2
1.3. Overview and	2
2. LITERATURE REVIEW	5
2.1. Coefficients of Expansion and Contraction (α values)	5
2.1.1. Concrete	5
2.1.2. Steel	11
2.2. Effective Bridge Temperature	12
2.3. Movement Characteristics	15
2.4. Creep and Shrinkage of Concrete	17
2.4.1. Creep	17
2.4.2. Shrinkage	20
2.5. Vertical Wheel Loading on Expansion Joints	23
2.6. Miscellaneous Topics	25
2.6.1. Drainage of Expansion Joints	25
2.6.2. Field Evaluations and General Recommendations	26
3. DESIGN OF STRIP SEAL EXPANSION JOINT SYSTEMS	29
3.1. Manufacturers' Recommendations	29
3.1.1. Manufacturers' Recommendations Related to Design	30
3.1.2. Manufacturers' Recommendations Related to Materials	30
3.2. Practices in States Bordering Iowa	32
3.2.1. Design Considerations and Requirements in Neighboring States	33
3.2.2. Material Requirements in Neighboring States	37
3.3. Design Practices in Iowa	41
3.4. Review of Iowa DOT Design Guidelines for Strip Seal Systems	43

4. FABRICATION AND INSTALLATION OF STRIP SEAL SYSTEMS	51
4.1. Manufacturers' Recommendations	51
4.1.1. Manufacturers' Recommendations for Fabrication	51
4.1.2. Manufacturers' Recommendations for Installation	52
4.2. Practices in States Bordering Iowa	57
4.3. Fabrication and Installation Practices in Iowa	57
5. DATABASE ANALYSIS AND SURVEY OF STATE DOTS	49
5.1. Overview	79
5.2. Analysis Based on Iowa DOT Databases	79
5.3. Survey of State Departments of Transportation	84
6. EXPERIMENTAL INVESTIGATION OF SELECTED BRIDGES	91
6.1. Overview	91
6.2. Experimental Program	91
6.2.1. Bridge Selection	91
6.2.2. Instrumentation	93
6.2.3. Data Collection	96
6.3. Experimental Results	98
6.3.1. Bridge 1: 0781.1R218 (FHWA 606200)	99
6.3.2. Bridge 2: 0781.1L218 (FHWA 606210)	106
6.3.3. Bridge 3: 0996.0R218 (FHWA 601235)	110
6.3.4. Bridge 4: 0996.0L218 (FHWA 601240)	115
6.3.5. Bridge 5: 0787.7A218 (FHWA 601575)	120
6.3.6. Bridge 6: 0784.8S218 (FHWA 605800)	125
6.3.7. Bridge 7: 8561.5L030 (FHWA 607795)	130
6.3.8. Bridge 8: 7776.8L065 (FHWA 606800)	133
6.3.9. Bridge 9: 6485.3L030 (FHWA 601620)	136
6.3.10. Bridge 10: 6402.0S014 (FHWA 007911)	140
6.3.11. Bridge 11: 6403.6L014 (FHWA 035431)	145
6.3.12. Bridge 12: 6481.9L030 (FHWA 601895)	150

6.4. Summary of the Experimental Results	153
6.4.1. Experimental α -Values Versus Design α -Values	153
6.4.2. Apparent Causes of Poor Strip Seal Performance	155
7. RECOMMENDATIONS.....	159
7.1. Recommendations for Design, Installation, and Maintenance Procedures	159
7.1.1. Bridge Temperature Ranges for Design	159
7.1.2. Bridge Temperature for Setting the Gaps	159
7.1.3. Selection of Strip Seal Size and Specifications for Gap Settings	160
7.1.4. End Detail	161
7.1.5. Leak Test After the Installation Process	162
7.1.6. Specifications for the Design and Installation of Strip Seal Systems	162
7.1.7. Cleaning of Expansion Joints	163
7.2. Related Recommendations	164
7.2.1. Inclusion of Additional Information in Iowa DOT Databases	164
7.2.2. Further Research	164
8. SUMMARY AND CONCLUSION	169
8.1. Summary	169
8.2. Conclusions	170
9. ACKNOWLEDGEMENTS	173
10. REFERENCES	175
APPENDIX A: THERMOCOUPLE LOCATION TEST DATA.....	179

1. INTRODUCTION

1.1 Background

Expansion joints are used in bridges to allow expansion and contraction of the bridge superstructure due to temperature changes. In order to prevent salt, water and debris from passing through the expansion joint opening and reaching the bridge substructure, a seal or trough is required in the expansion joint opening. A strip-seal expansion joint device is one alternative for this function. It consists of a pair of steel retainer rails (steel extrusions), a polychloroprene (neoprene) gland and lubricant/adhesive material to facilitate the installation of the gland and to seal the gland in the extrusions.

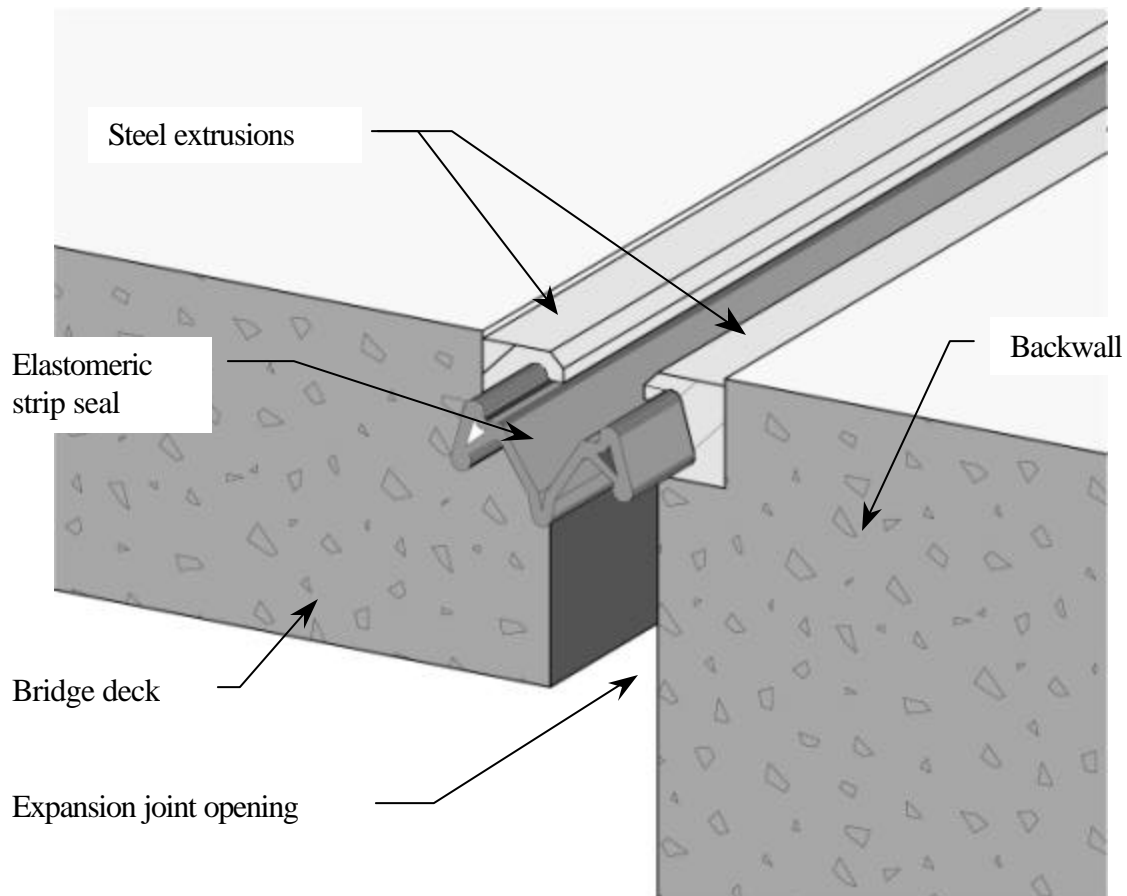

Figure 1.1 Typical strip-seal expansion joint device

According to a manufacturer's representative, the expected service life of a strip seal (neoprene gland) is fifteen to twenty years. In Iowa however, a significant number of strip seals have failed prematurely, which for purposes of this report will mean failure in less than five years. In these premature failures, the strip seal either tears or pulls out from the extrusions relatively soon after the bridge construction is completed. The most serious consequence of a strip-seal failure is damage to the bridge substructure due to salt, water and debris interacting with the substructure, which can result in large costs to repair or replace portions of the damaged bridge.

1.2 Objectives

A number of possible causes for premature strip-seal failures have been proposed including thermal movement different than that predicted, incorrect setting of the expansion joint opening during construction, and wheel loads transmitted to the seal by debris and ice in the joint. The main objective of this research project was to investigate these and other possible causes of the premature failures of strip seals in Iowa bridges.

1.3 Overview and Scope

To accomplish the research objective, existing information was assembled and analyzed and detailed investigations of the strip-seal expansion joints on twelve Iowa bridges were carried out. A number of tasks were performed as part of this investigative process.

A comprehensive literature search was conducted. Sources listed by the Transportation Research Information Services (TRIS) were obtained. International literature

and sources not covered by TRIS were sought by using TRANSPORT, the CD-ROM database available from Transportation Research Information. Service [1].

Design criteria, recommended installation procedures, sample specifications, and supporting test data were obtained from various manufacturers of strip-seal expansion joint systems. A national survey of state departments of transportation (DOTs) was conducted to obtain information about the use and performance of strip-seal expansion joint systems outside of Iowa. Design and installation practices and specifications used in states surrounding Iowa were obtained.

Databases maintained by the Iowa DOT were used to try to identify factors that effect the performance of strip seals. The design procedures used by the Iowa DOT for sizing the seal and for determining the expansion joint gap settings to be specified on the bridge plans were reviewed. Construction procedures used in setting the expansion joint gaps and installing the seal were observed and also discussed with contractor representatives.

Twelve Iowa bridges with strip-seal expansion joints were instrumented with thermocouples and representative bridge temperatures and corresponding expansion joint openings were obtained over an eight-month period (December of 1999 to July of 2000). The experimental work included determining the movements of the bridge structure caused by temperature change, correlating the bridge movements to thermocouple readings and comparing the measured expansion joint openings to the theoretical design values. Inspection reports for the twelve bridges were reviewed and incorporated in the analysis of the performance of the strip-seal systems in the twelve bridges.

2. LITERATURE REVIEW

A comprehensive literature review was conducted using TRANSPORT (CD-ROM database) [1]. TRANSPORT provides complete resources of the three leading transportation research organizations: the Road Transport Research Program of the Organization for Economic Co-operation and Development (OECD); the Transportation Research Board (TRB) of the National Academy of Science; and the European Conference of Ministers of Transport (ECMT). This section reviews and summarizes the experiences and research studies found in the literature that are related to the performances of strip-seal expansion joint systems in bridges.

2.1 Coefficients of Expansion and Contraction (α -values)

Temperature changes will induce thermal expansion and contraction of bridge materials. Relative movements of bridge components resulting from such temperature changes are a function of the coefficient of thermal expansion and contraction, or α -value, of the bridge material. The α -value of a mixture such as concrete can be determined by the combined effects of the α -values of its components.

2.1.1 Concrete [2, 3, 4, 5, 6]

Concrete is made by mixing cement, coarse aggregates, fine aggregates and water. The factors which influence the thermal properties of concrete include: richness of mix, type of cement paste, characteristics of aggregates, water-cement ratio, age, temperature and cycles between high and low temperatures [3]. A previous investigation conducted by Emanuel [3] has shown that the α -value of concrete can range from 4.0×10^{-6} in./in./° F at

60°F to 6.5×10^{-6} in./in./°F at 150° F. The same trend was observed for both saturated and partially dry samples. According to Emanuel and Hulsey [3], the approximate α -value of a concrete mixture can be determined using Equation 2.1 and 2.2:

$$\alpha_C = f_T(f_M f_A \beta_P \alpha_S + \beta_{FA} \alpha_{FA} + \beta_{CA} \alpha_{CA}) \quad (2.1)$$

$$\beta_P + \beta_{FA} + \beta_{CA} = 1.0 \quad (2.2)$$

where,

α_C = thermal coefficient of linear expansion for concrete,

α_{CA} = thermal coefficient of linear expansion for coarse aggregates (Table 2.1),

α_{FA} = thermal coefficient of linear expansion for fine aggregates (Table 2.1),

f_T = correction factor for exposure condition (1.0 for controlled environment; 0.86 for outside exposure),

f_M = correction factor for moisture content (Figure 2.1),

f_A = correction factor for age (Figure 2.2),

β_P = proportion by volume of paste,

α_S = thermal coefficient of cement paste, 6.0×10^{-6} in./in./° F,

β_{FA} = proportion by volume of fine aggregate, and

β_{CA} = proportion by volume of coarse aggregate.

Table 2.1 Average coefficient of linear expansion of rocks (adapted from [3])

Type of Rock or Mineral	Average Coefficient (10^{-6} in./in./°F)
Quartzite, silica shale, cherts	6.1 – 6.9
Sandstone	5.8 – 6.7
Quartz, sands, pebbles	5.6 – 6.9
Clay, mica shales	5.3 – 6.1
Granites, gneisses	3.6 – 4.7
Syenites, feldspathic prophyry diorites, andesite, phonolite gabbros, diabase, basalt	3.1 – 4.4
Dense, crystalline, porous limestone	1.9 – 3.3
Pure calcite	2.2 – 3.6
Marbles	2.2 – 3.9
Dolomites, magnesites	3.9 – 5.6

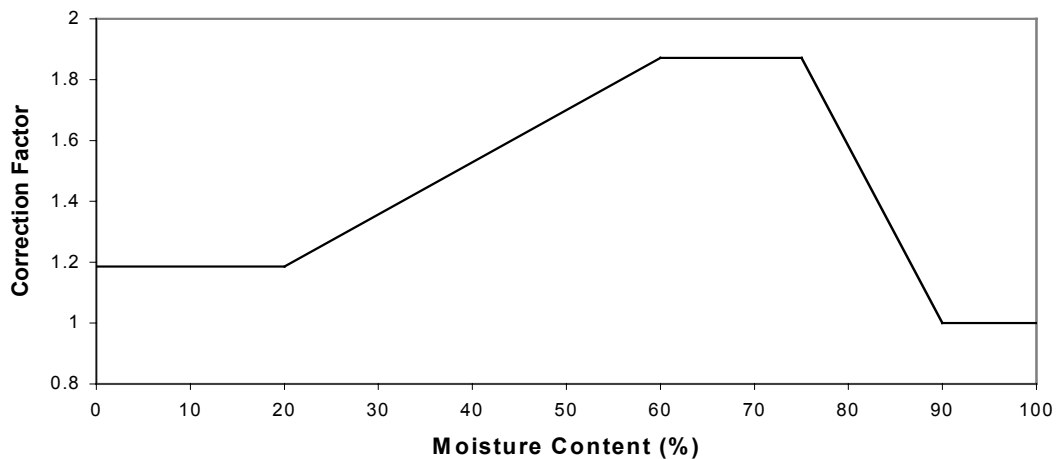
Figure 2.1 Correction Factor for f_M (adapted from [3])

These researchers stated that the aggregates occupy approximately 70% to 80% of the volume of the concrete. If the actual aggregate volume is not known, aggregates can be assumed to occupy 75% of the total volume with 30% of that aggregate volume considered as fine aggregates. Emanuel and Hulsey concluded that: (i) the α -value of concrete is

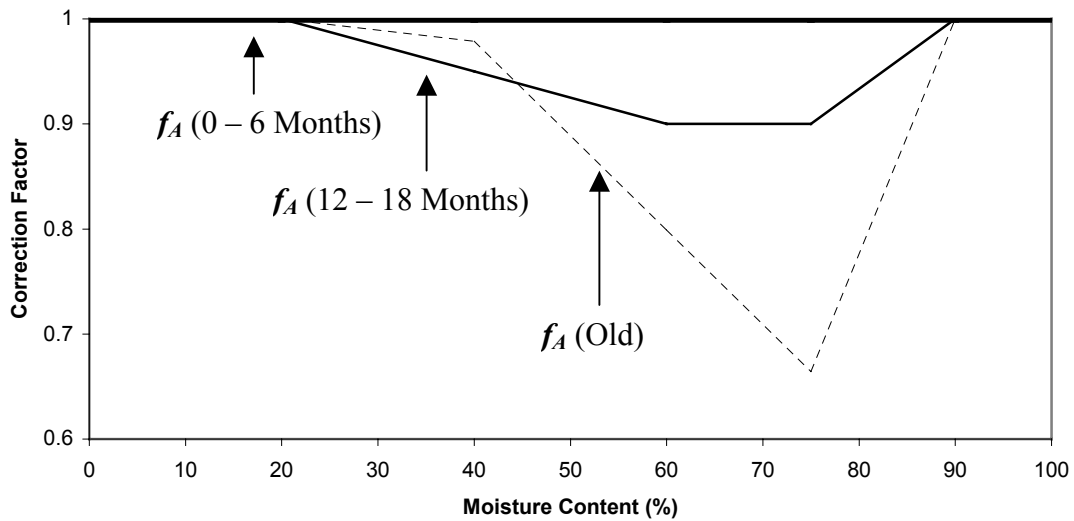

Figure 2.2 Correction Factor for f_A (adapted from [3])

dependent upon the volumetric weighted average of the ingredients, (ii) the α -value of concrete is the least at the saturated condition, is slightly higher at the oven-dry condition, and is the highest at a partially dry condition (about 15% higher than for the saturated condition), (iii) the α -value of concrete increases with the richness of the mix and decreases with repeated temperature variations, and (iv) an increase in the amount of aggregate will decrease the moisture effect on the α -value of concrete.

ACI 209R [2] states that within a temperature range of 32° F to 140° F, the α -value of a concrete mixture can be determined from Equation 2.3 as long as the moisture content of the sample remains constant. For thermal movements of highway bridges, lower bound and upper bound values of 4.7×10^{-6} in./in./° F and 6.5×10^{-6} in./in./° F for α_c can be used [2].

$$\alpha_c = \alpha_{mc} + 1.72 \times 10^{-6} + 0.72\alpha_a \quad (2.3)$$

where,

α_{mc} = α -value based on the degree of saturation (values listed in Table 2.2), and

α_a = average α -value of the coarse and fine aggregates (values listed in Table 2.3)

Table 2.2 Suggested values for α_{mc} (adapted from [2])

Concrete member environmental condition	Degree of saturation	α_{mc} (10^{-6} in./in./° F)
Immersed structures, high humidity condition	Saturated	0
Mass concrete pours, thick walls, beams, columns and slabs, particularly where surface is sealed	Between partially saturated and saturated	0.72
External slab, walls, beams, columns and roofs allowed to dry out or internal walls, columns slabs, not sealed (e.g. by mosaic or tiling) and where under floor heating or central heating exists	Partially saturated decreasing with time to the dryer condition	0.83 – 1.11

Table 2.3 α -values of different aggregate types by (adapted from [2])

Aggregate type	α_a (10^{-6} in./in./° F)
Basalt	3.6
Chert	6.6
Dolerite	3.8
Granite	3.8
Limestone	3.1
Marble	4.6
Quartz	6.2
Quartzite	5.7
Sandstone	5.2
Siliceous	4.6

With the temperature of concrete below 32° F, the α -value of concrete decreases due to the effect of ice formation [5]. In addition, the α -value of concrete does not behave linearly at high temperatures and can be as high as 18.2×10^{-6} in./in./° F above 800° F [5].

Neville [5] concluded that the method of curing the concrete would alter the coefficient of thermal expansion. Table 2.4 summarizes the coefficients of thermal expansion for concrete made with various aggregates and curing methods (all of the concrete mixes had the same cement to sand ratio of 1:6). Other α -values for different types of aggregate and other expressions for estimating the α -value of concrete have been proposed by various authors. For further information, refer to [7, 8 and 4].

Table 2.4 Concrete mixes: 1:6 cement to sand ratio, various aggregates (adapted from [5])

Type of aggregate	Linear coefficient of thermal expansion (10^{-6} in./in./° F)		
	Air-cured	Water-cured	Air-cured and wetted
Gravel	7.3	6.8	6.5
Granite	5.3	4.8	4.3
Quartzite	7.1	6.8	6.5
Dolerite	5.3	4.7	4.4
Sandstone	6.5	5.6	4.8
Limestone	4.1	3.4	3.3
Portland stone	4.1	3.4	3.6
Blastfurnace slag	5.9	5.1	4.9
Expanded slag	6.7	5.1	4.7

In 1998, Ng [6] conducted a series of tests to determine the α -values of concrete specimens obtained from in-service bridge decks. For the 100% dry condition and temperature range from 40° F to 190° F, the α -value for all the specimens was between 3.9×10^{-6} in./in./° F and 6.0×10^{-6} in./in./° F. A majority of the specimens had an α -value between 5.0×10^{-6} in./in./° F and 6.0×10^{-6} in./in./° F. In the lower temperature range of 40° F to 140° F, the α -values were about 5% lower than those in the temperature range of 140° F to 190° F. In the 100% saturated condition, the measured α -values were 5% to 10% lower than they were for the 100% dry condition.

2.1.2 Steel

According to the Manual of Steel Construction [9], the average α -value of structural steel with the temperature between 70° F and 100° F is 6.5×10^{-6} in./in./° F. For temperatures from 100° F to 1200° F, Equation 2.4 can be used:

$$\alpha = (6.1 + 0.0019t) \times 10^{-6} \text{ in./in./}^\circ\text{F} \quad (2.4)$$

where,

α = coefficient of thermal expansion and contraction of steel, and

t = temperature in degrees Fahrenheit.

Lee [8] specified some α -values for different types of steel commonly used in bridge construction (Table 2.4):

Table 2.4 α -values of steels (adapted from [8])

Material	α-values (10^{-6} in./in./° F)
Structural steel	6.6
Corrosion resisting steel	6.0
Stainless steel: austenitic	10.0
Stainless steel: ferritic	5.6
Cast carbon steel	6.1 – 6.9
Cast alloy steel	6.1 – 10.0

The American Association of State Highway and Transportation Officials (AASHTO) Load and Resistance Factor Design (LRFD) Bridge Design Specifications [7] specifies an α -value of 6.5×10^{-6} in./in./° F for use in determining thermal expansion and contraction movements of steel components.

2.2 Effective Bridge Temperature

The total thermal movements of a bridge superstructure are related to the selected temperature range. The temperature of a bridge superstructure is dependent on the shade temperature, solar radiation and the material type of the structure. AASHTO [7] suggests that for concrete girder bridges, temperature ranges of 80° F and 70° F for cold and moderate climate zones, respectively, can be used to predict the thermal movements due to temperature variations. For steel girder bridges, temperature ranges of 150° F and 120° F for cold and moderate zones, respectively, can be used.

Construction Technologies Laboratories (CTL) [10] developed empirical equations for the maximum and minimum effective bridge temperatures for concrete girder bridges and steel girder bridges. These equations relate the effective bridge temperature to shade temperature and solar radiation. For a concrete girder bridge, the relationships are:

$$T_{\min(\text{eff})} = 1.00T_{\min(\text{shade})} + 9^{\circ}F \quad (2.5)$$

$$T_{\max(\text{eff})} = 0.97T_{\max(\text{shade})} - 3^{\circ}F + \Delta T_{\text{solar}} \quad (2.6)$$

For a steel girder bridge, the relationships are:

$$T_{\min(\text{eff})} = 1.04T_{\min(\text{shade})} + 3^{\circ}F \quad (2.7)$$

$$T_{\max(\text{eff})} = 1.09T_{\max(\text{shade})} - 3^{\circ}F + \Delta T_{\text{solar}} \quad (2.8)$$

where,

$T_{min(eff)}$ = minimum effective bridge temperature,

$T_{max(eff)}$ = maximum effective bridge temperature,

$T_{min(shade)}$ = minimum shade temperature,

$T_{max(shade)}$ = maximum shade temperature, and

ΔT_{solar} = uniform temperature change from direct radiation based on girder type and bridge location.

For Iowa, ΔT_{solar} is equal to 13° F for concrete bridges and 9° F for steel girder bridges [10].

CTL recommended that temperature data from the American Society of Heating, Refrigeration and Air-Conditioning Engineers (ASHRAE) [11] be used for the maximum and minimum shade temperatures, which are outdoor air temperatures based on a 99% confidence interval that is expected to be exceeded for approximately 30 hours per year.

In a study on concrete integral abutment bridges being conducted at Iowa State University (ISU) [12], experimental data that was obtained for a bridge located in Guthrie County and a second bridge that was located in Story County were used to verify the validity of the Equations 2.5 to 2.8. The recorded temperatures in the Guthrie County and Story County bridges revealed that, over a 21-month period from July of 1998 to April of 2000, the recorded minimum shade temperatures were -25° F and -16° F for the Guthrie County bridge and Story County bridge, respectively. The maximum shade temperatures recorded were 93° F for the Guthrie County bridge and 96° F for the Story County bridge. The ranges of effective bridge temperatures recorded in Guthrie and Story bridges were 113° F and

115° F, respectively. Based on the temperature data from the integral abutment studies conducted at ISU [12], Equations 2.5 to 2.8 were acceptable for converting shade temperature to an effective bridge temperature.

The ISU integral abutment study [12] suggests that the temperature data from the National Oceanic and Atmospheric Administration (NOAA) be used instead of ASHRAE for predicting the maximum and minimum shade temperatures and, hence, the maximum and minimum effective bridge temperatures. According to that ISU study, the range of shade temperature recorded at the Des Moines International Airport by the NOAA – Climatic Diagnostics Center over a thirty-year period was 132° (from -24° F to 108° F). Using Equations 2.5 to 2.8 and the shade temperatures from Table 2.5, the computed ranges of effective bridge temperatures for concrete girder bridges and steel girder bridges in Des Moines is 130° F and 146° F, respectively.

Table 2.5 Temperature data (1961 – 1990) for various locations in Iowa [12]*

Location	Minimum shade temperature (°F)	Maximum shade temperature (°F)
Burlington	-23	101
Cedar Rapids	-28	104
Des Moines	-24	108
Dubuque	-28	101
Mason City	-30	104
Ottumwa	-23	105
Sioux City	-26	108
Waterloo	-34	105

**Based on National Oceanic and Atmospheric Administration (NOAA) temperature data*

The authors of this report on strip-seal performance selected software published by NOAA [13] (based on recorded shade temperatures from 1948 to 1997) to verify the acceptability of the shade temperature extremes in Des Moines, Iowa, suggested in [12].

Table 2.6 shows the probabilities of temperature extremes for six months at the Des Moines International Airport. Based on the probabilities from the software, the temperature range suggested in the ISU integral abutment study [12] is appropriate. The minimum shade temperature (-24° F) has a probability of occurrence of approximately 8.4% in January and the maximum shade temperature (108° F) has a probability of occurrence of approximately 2.7% in July.

Table 2.6 Probabilities* of air temperature extremes versus month [13]

Month	Low (° F)					High (° F)			
	-35	-30	-25	-20	-15	100	105	110	115
December	0.0	0.1	0.6	2.7	7.2	-	-	-	-
January	0.6	2.6	6.2	17.2	35.4	-	-	-	-
February	0.1	0.3	1.6	4.5	13.4	-	-	-	-
June	-	-	-	-	-	16.4	2.4	0.0	0.0
July	-	-	-	-	-	30.8	6.0	0.5	0.0
August	-	-	-	-	-	26.0	5.6	0.6	0.0

* Probabilities are displayed in percentage

2.3 Movement Characteristics

Temperature changes can induce large thermal forces and cause thermal movements. The thermal movements can be divided into two parts: movements caused by the daily temperature cycle and movements caused by the annual temperature cycle. The thermal movements are often erratic rather than continuous and smooth because of the slip-stick action introduced by frictional forces of bridge bearings. The change in length, ΔL , of a bridge component caused by temperature changes can be estimated using Equation 2.9:

$$\Delta L = \alpha \Delta T L \quad (2.9)$$

where,

α = coefficient of thermal expansion and contraction,

ΔT = effective temperature change, and

L = expansion length.

Frictional forces resist any movements until the internal forces caused by temperature changes are adequate to overcome the static friction; then a sudden step-like movement will occur. The movement will then stop until the internal forces caused by temperature change is again adequate to overcome the static frictional force. These erratic movements are more severe in steel girder bridges than in concrete girder bridges because of the higher thermal conductivity of steel and the huge thermal mass of concrete girder bridges [14].

The thermal movement that is caused by the annual temperature cycle is considerably larger than that caused by the daily temperature cycle. Concrete girder bridges will experience smaller annual movements because the huge thermal mass resists short duration temperature extremes [14].

Thermal movements are also dependent on bridge geometry. In straight bridges, the thermal movements induced by temperature changes usually only need to be considered as a longitudinal effect. However, in skewed and curved bridges the thermal effects are not as simple. Field observations have shown that thermal movements of curved bridges are neither tangential nor are they on the chord. In some cases the magnitude of the radial component of movement is similar to the chord or tangential movement. If a curved bridge is taken as a line element, theoretical calculations show that the movement at free supports will be on the chord from the fixed support location, but observed evidence has shown that the movements

often do not obey this simplistic relation. Field observations have also shown that in some cases skewed bridges produce both longitudinal and transverse movements [14].

2.4 Creep and Shrinkage of Concrete

Many concrete properties (strength, stiffness, volume, etc.) change gradually over time. Such time dependent properties of concrete are influenced by many factors, in particular the conditions at the time of placement of the fresh concrete and the environment that surrounds it throughout its service life. It is difficult to predict the exact effect of all of these conditions, but crude estimates can be made of the trends and changes in behavior. The two most obvious changes in concrete after placement are creep and shrinkage.

2.4.1 Creep

Creep of concrete is an increase in deformation with time due to an applied load. This effect is evident in prestressed concrete beams. Creep in concrete is associated with the change of strain over time in the regions of beams and columns subjected to sustained compressive stresses. Generally speaking, creep is dependent on the water content of the fresh concrete; the type of cement and aggregate used; the ambient conditions at placement which include air temperature, humidity, and wind velocity; the amount of reinforcement used in the concrete; the curing procedure; the volume to surface area ratio; the magnitude and duration of the compressive stresses; the compressive strength of the concrete; the age of the concrete when the sustained load is applied [15]. These effects can be approximated by Equations 2.10 to 2.13 [7]:

$$\varepsilon_{CR} = \Psi \varepsilon_{ci} \quad (2.10)$$

$$k_f = \frac{1}{0.67 + \frac{f'_c}{9}} \quad (2.11)$$

$$\Psi = 3.5k_c k_f \left(1.58 - \frac{H}{120}\right) t_i^{-0.118} \left\{ \frac{(t-t_i)^{0.6}}{10 + (t-t_i)^{0.6}} \right\} \quad (2.12)$$

$$k_c = \frac{\frac{t}{26e^{0.36(V/S)} + t}}{45 + t} * \left\{ \frac{1.80 + 1.77e^{-0.54(V/S)}}{2.587} \right\} \quad (2.13)$$

where,

ε_{CR} = creep strain,

ε_{ci} = instantaneous elastic compressive strain,

Ψ = creep coefficient,

k_c = factor for the effect of the volume-to-surface area ratio of the component,

k_f = factor for the effect of concrete strength,

t = maturity of concrete (days),

t_i = age of concrete when load is initially applied (days), and

V/S = volume to surface area ratio of component (in.).

A simpler equation was presented in a book published in 1998 by Hurst [16] to estimate the long term (30-year) specific creep strain in concrete:

$$\varepsilon = \frac{\phi}{E_{cmt}} \quad (2.14)$$

where,

ε = creep strain per unit stress,

ϕ = creep coefficient specified in Table 2.8, and

E_{cmt} = modulus of elasticity of the concrete over the long term.

Table 2.8 Creep coefficients (adapted from [16])

Age at transfer (days)	Notional size 2 A_c/u^*					
	50mm (1.97in.)	150mm (5.91in.)	600mm (23.62in.)	50mm (1.97in.)	150mm (5.91in.)	600mm (23.62in.)
	Dry atmospheric conditions (relative humidity 50%)			Humid atmospheric conditions (relative humidity 80%)		
1	5.5	4.6	3.7	3.6	3.2	2.9
7	3.9	3.1	2.6	2.6	2.3	2.0
28	3.0	2.5	2.0	1.9	1.7	1.5
90	2.4	2.0	1.6	1.5	1.4	1.2
365	1.8	1.5	1.2	1.1	1.0	1.0

* A_c is the cross-sectional area and u the perimeter of the concrete member

AASHTO [7] specified a creep strain of 200 $\mu\varepsilon$ for 28-day concrete and 500 $\mu\varepsilon$ for 1-year concrete. Due to insufficient experimental data, AASHTO allows ACI 209R [2] to be used for creep estimation. Many authors have suggested alternative methods to predict creep of concrete. For further information, see References [2, 17, 4, 5, 18 and 19].

2.4.2 Shrinkage

According to Barker and Puckett [15], shrinkage of concrete is the decrease in volume under constant temperature due to loss of moisture after concrete has hardened. Shrinkage of concrete is dependent on water content of the fresh concrete; the type of cement and aggregate; the ambient conditions at placement which include air temperature, humidity and wind velocity; the amount of reinforcement used in the concrete; the curing procedure;

the volume to surface area ratio [15]. As specified in AASHTO Load and Resistance Factor Design (LRFD) Bridge Design Specifications [7], for moist cured concrete devoid of shrinkage-prone aggregates, the strain due to shrinkage may be evaluated from Equations 2.15 and 2.16:

$$\varepsilon_{sh} = -k_s k_h \left(\frac{t}{35+t} \right) 0.51 * 10^{-3} \quad (2.15)$$

$$k_s = \frac{\frac{t}{26e^{0.36(V/S)} + t} * \left[\frac{1064 - 94(V/S)}{923} \right]}{45+t} \quad (2.16)$$

where,

ε_{sh} = strain due to shrinkage,

k_h = humidity factor specified in Table 2.9 and Figure 2.3,

t = curing time (day), and

k_s = size factor.

Table 2.9 Factor k_h for relative humidity (Adapted from [7])

Average ambient relative humidity (%)	k_h
40	1.43
50	1.29
60	1.14
70	1.00
80	0.86
90	0.43
100	0.00

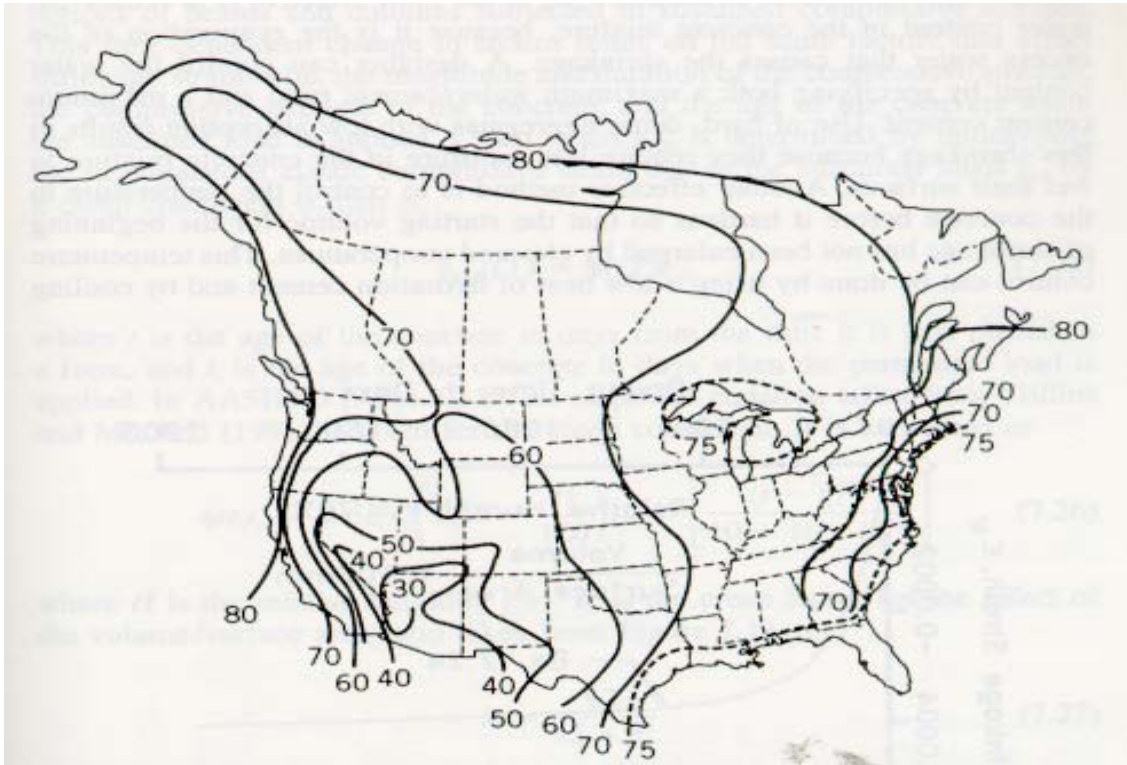

Figure 2.3 Annual average ambient relative humidity in % (Adapted from [7])

If the moist-cured concrete is exposed to drying before five days of curing have elapsed, the shrinkage of concrete from Equation 2.15 should be increased by 20% [7]. For steam-cured concrete devoid of shrinkage-prone aggregates, Equation 2.17 should be used:

$$\varepsilon_{sh} = -k_s k_h \left(\frac{t}{55 + t} \right) 0.56 * 10^{-3} \quad (2.17)$$

In an article published in June 1979 by Zia, Preston, et. al., [19], a similar procedure for estimating the shrinkage strain of concrete as a function of relative humidity and the volume to surface area ratio was developed (Equation 2.18):

$$\varepsilon_{sh} = 8.2 * 10^{-6} \left(1 - 0.06 \frac{V}{S} \right) (100 - RH) \quad (2.18)$$

where,

V/S = volume to surface area ratio (in.) and

RH = relative Humidity (Figure 2.3).

Neville [5] divided concrete shrinkage into two parts: autogenous shrinkage and drying shrinkage. Continued hydration, when a supply of water is present, leads to temporary expansion. When no moisture movement to or from the cement paste is allowed, water will be withdrawn from the capillary pores by the hydration of the hitherto unhydrated cement (known as self-desiccation). Autogenous shrinkage occurs in the interior of a concrete mass. The contraction of the cement paste is restrained by the rigid skeleton of the already hydrated cement paste and also by the aggregate particles. This shrinkage of concrete is an order of magnitude smaller than in cement paste. Although autogenous shrinkage is three-dimensional, it is usually expressed as a linear strain. Typical values are about $40 \mu\epsilon$ at the age of one month and $100 \mu\epsilon$ after five years.

The second part of concrete shrinkage is drying shrinkage. This kind of shrinkage is caused by the withdrawal of water from concrete stored in unsaturated air. Since there are other strains that could take place in concrete (e.g elastic shortening and steel relaxation), a lump sum of $1500 \mu\epsilon$ after a year is reasonable for use in prestressed concrete design [19]. There are other articles that discuss shrinkage of concrete and factors that influence this time dependent effect. For further information, refer to References [2, 17, 16, 4, 5, 18 and 19].

2.5 Vertical Wheel Loading on Expansion Joints

The Watson Bowman Acme Corporation (WBA) is the largest strip-seal supplier in Iowa. This corporation sponsored an impact load test of strip-seal expansion joint systems [20]. The test was performed using a pseudo wheel load of 8 kips. AASHTO [7] specifies that a rear axle load of 32 kips and a front axle load of 8 kips should be used for any vehicular load design and a dynamic load allowance should be applied for designing vehicular loads on bridge deck joints. According to AASHTO, the static effects of the design truck or tandem, other than braking and centrifugal force, shall be increased by 75% for the dynamic load allowance.

A study on modular expansion joints by the Washington Department of Transportation [21] showed that the vertical wheel load transmitted to a modular expansion joint system by a truck travelling at 55 mph was increased 30 to 40 percent over the static load. So, for a truck travelling at 55 mph, a 16-kip static load would become, effectively, a 21-to-22-kip load due to dynamic effects. The Washington DOT study recommended that a vertical wheel load of 24.7 kips (110 kN) should be used in designing expansion joints.

In a study of the relationships between pavement roughness and dynamic loading [22], a relationship between the dynamic wheel load on an expansion joint and static wheel load was developed (Equation 2.19):

$$P = P_s I_c \quad (2.19)$$

where,

P = dynamic vertical wheel load,

P_s = static wheel load, and

I_c = dynamic amplification factor (Figure 2.4).

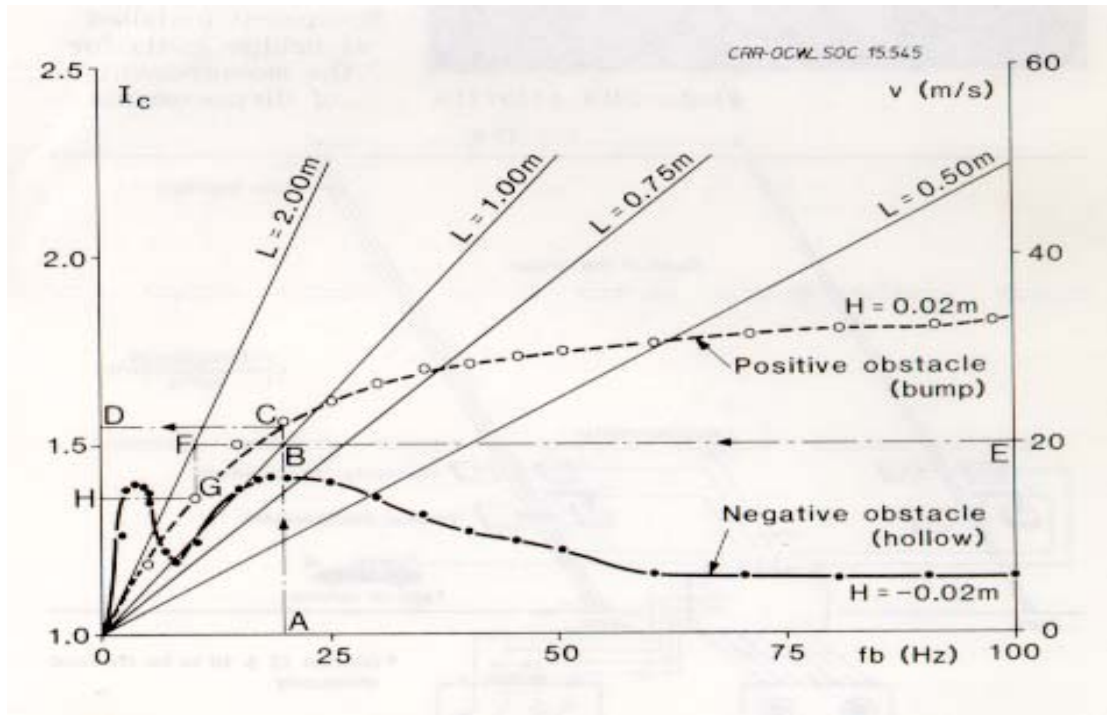

Figure 2.4 Determination of dynamic amplification factor (adapted from [22])

To illustrate the use of this equation and Figure 2.4, suppose that a truck with a rear wheel load of 8 kips traveling at a speed of 45mph (20m/s at point E in Figure 2.4) passes over a positive obstacle or bump in the road. The bump appears to be a sinusoidal unevenness having a height of 0.79 in. ($H = .02$ m in the figure) and a length of 3.3 ft (line $L = 1.00$ m in the figure). Following the path from E (speed) to B (intersection with length of unevenness line), then vertically to C (intersection with height of positive obstacle curve), and finally to D (dynamic amplification axis), the dynamic amplification factor is found to be 1.56. Then from Equation 2.19, the effective vertical wheel load exerted on the bump is

equal to 1.56 times 8 kips or 12.5 kips. Although Equation 2.19 was developed for a smooth sinusoidal approximation and limited experimental data is available to support this equation, it could be used as a guide for predicting actual vehicle wheel load exerted on a strip-seal expansion joint.

2.6 Miscellaneous Topics

There is wide variation in the procedures used by various agencies for the design and specification of strip-seal expansion joint systems. Also, there are variations in these joint systems from manufacturer to manufacturer (see Chapter 3). This makes determining best practices that can be universally applied more difficult. However, some experienced engineers have suggested the following practices to improve the performance of strip seals.

2.6.1 Drainage of Expansion Joints

In a study of bridge deck expansion joints by Dahir and Mellott [23], observations showed that in many cases the lack of deck drainage maintenance, primarily not cleaning out the debris, contributed to less than satisfactory performance and poor ratings. Gupta [24] stated that according to the American Society of Civil Engineers (ASCE) and Water Pollution Control Federation, a water velocity of 2 ft/s would be sufficient to move a 15.0-mm-diameter organic or 2.0-mm-diameter sand particle. To determine the actual flow velocity in an open channel, Chezy and Darcy-Weisbach's equation has proven to be the most reliable in practice [24]:

$$V = \frac{1.486}{n} R^{\frac{2}{3}} S^{\frac{1}{2}} \quad (2.20)$$

where,

V = mean velocity (ft/s),

R = hydraulic radius (ft),

S = slope of energy line, which is equal to channel bottom for uniform flow, and

n = manning's roughness coefficient.

Strip-seal expansion joints form an approximately triangular open channel, therefore

$$R = \frac{Gd}{2\sqrt{\frac{G^2}{4} + d^2}} \quad (2.21)$$

where,

G = expansion gap opening (in.) and

d = depth of surface of roadway to bottom of strip seal (in.)

The slope required to attain a flow velocity of 2 ft/s can be calculated from Equations 2.20 and 2.21.

2.6.2 Field Evaluations and General Recommendations

Strip-seal expansion joint systems have been used in Pennsylvania and their performance has ranged from fair to quite good [23]. A study of the performance of expansion joints by the Pennsylvania DOT revealed that 76% of the expansion joints were either completely open or leaking. Some of the problems included debris accumulation, leakage, and noise under traffic. The study also observed that many skewed joints with acute

angles between 30 and 70 degrees had buckling or folding of the neoprene gland and subsequent damage caused by snow plows and truck traffic.

A Minnesota DOT [25] study revealed that 55% of the 2,271 expansion joints investigated exhibited leakage. The study also revealed that the dirt and debris that is trapped in an expansion joint can cause disintegration of the gland.

The Michigan DOT conducted a study [23] to determine the allowable movement ratings of various proprietary bridge deck expansion joint systems with various skew angles. The Michigan DOT researchers concluded that for the majority of the expansion joints evaluated, “As the angle of crossing becomes more severe, the total perpendicular movement a system can adequately provide decreases due to the inability of the system to fully extend to its maximum recommended perpendicular width, or fully close to its minimum recommended perpendicular width, or both.”

A study conducted by Weisgerber, et. al. [26], concluded that the performance of strip seals was better than that of compression seals or modular seals. A significant weakness of the strip-seal system is that it is difficult to repair. Observations showed that the water tightness of a strip seal strongly degenerates with age. Repair of failed components should be done before substantial damage occurs to the bridge substructure.

According to Monroe [27], the strip-seal system presents only a small recess to traffic. There are some general principals suggested by Monroe that hold true for any successful expansion joint installation regardless of the sealing system employed:

- There should be a method of controlling deflection as traffic passes over the joint.
- The joint should be placed at a high point so that water does not pond over the joint, but drains away from the seal.

- Dimensions of the joint opening should be no larger than necessary to meet requirements for movement.
- Where possible, 90° turns and joint intersections should be avoided. A straight line joint is easiest to properly seal.
- To simplify joint maintenance, the joint seal should be exposed at the surface.

According to Van Lund [28], factors that should be considered in the design and installation of strip-seal systems include creep and shrinkage of the concrete, the construction sequence used for the bridge, construction tolerances specified for the range, the range of bridge temperature to be accommodated, the type of bridge bearings used, direction(s) of permitted movement of bridge components, the skew angle(s) of the bridge, and external restraints on bridge movement. In order to provide a reasonable ride and minimize impact loading and hazard to motorcyclists, the maximum preferred expansion joint opening in the direction of traffic is 4 in. For ease of installation of the gland (for field installation), the minimum installation width is usually 1.5 in.

3. DESIGN OF STRIP SEAL EXPANSION JOINT SYSTEMS

3.1 Manufacturers' Recommendations

The two largest manufacturers of strip seal expansion joint systems in the U. S. are Watson Bowman Acme Corporation, Amherst, New York and The D. S. Brown Company, North Baltimore, Ohio. Of the 39 state departments of transportation that responded to the survey that was part of this project (see Section 5.3) and used strip seal systems for bridge expansion joints, 38 of the 39 listed at least one of these two companies as strip seal system suppliers and 32 of the 39 listed both. The nearest competitor to the two, according to the survey, is R. J. Watson, Inc., East Amherst, New York. R. J. Watson strip seal systems have been used in 10 of the 39 states. The vast majority of such systems used in Iowa in recent years have been manufactured by Watson Bowman Acme.

Other companies that may have supplied strip seal systems in Iowa (and other states) in the past include Acme, General Tire, and Lewis Engineering Company (LENCO). Acme was bought by Watson Bowman in the mid-1980s. General Tire went through major corporate changes in the mid 1980s and stopped making their strip seal systems about that time. Lewis Engineering Company (LENCO) stopped supplying their own systems (very similar to the Acme systems) in late 1993 after relatively poor results in pullout tests conducted by the Minnesota DOT. LENCO subsequently supplied D. S. Brown Company products and was purchased by D. S. Brown in 1997.

For these reasons, recommendations provided by manufacturers on the design, materials, fabrication, and installation of strip seal systems will concentrate on literature available from Watson Bowman Acme (WBA) and The D. S. Brown Company (DSB) [29,

30, 31]. The material presented is based on sample or suggested specifications and installation instructions available from the two companies and information provided by company representatives. This section will summarize manufacturers' literature related to design and materials. Section 4.1 will cover manufacturers' recommendations for fabrication and installation. These divisions are for purposes of this report only and do not necessarily correspond to the way the information is presented in the manufacturers' literature.

3.1.1 Manufacturers' Recommendations Related to Design

The WBA specification includes the type of design loading for the joint (e.g., HS-20 truck loading and impact in accordance with AASHTO requirements). It specifies that the device shall accommodate the movements indicated on the contract drawings. It also includes the general design requirement that the device shall seal the deck surface, gutters, curbs, and walls as shown on the plans and prevent water seeping through the joint area, and states that any seeping is cause for rejection of the joint installation. The DSB literature that was obtained did not include any similar basic design requirements.

The WBA literature specifies that the rails must be anchored to the structure according to specifications and/or contract drawings. It specifies that the anchorage shall provide a minimum of 0.75 sq. in. of bolt or anchor area per lineal foot of joint (minimum ½-in. diameter hardware at 6 in. o. c. both sides of joint).

3.1.2 Manufacturers' Recommendations Related to Materials

The WBA specification states that the expansion joint system shall be of the type and at the location(s) shown on the plans. It requires the contractor to state at the pre-construction conference the manufacturer and type of system to be installed. It requires that the anchorages as well as the expansion joint device be supplied by the manufacturer. It also

requires that the manufacturer (i.e., fabricator) be pre-qualified with a five-year history of successful product manufacture and have AISC Category III shop approval.

Both the WBA and DSB literature specifies that the steel retainer rails must be “one-piece construction” or “monolithic.” That is, the final cross section shall not be built up from multiple cross-sectional elements. WBA specifies A588 weathering steel for the rails and adds that the steel elements must be designed such that they securely lock the gland. WBA also specifies that the rails must have a minimum thickness of $\frac{1}{4}$ in. as measured from the top of the cavity to the top surface of the rail. DSB specifies A36 or A588 steel and adds that the steel must be manufactured domestically, certified, and traceable.

The WBA literature specifies that the rails must have a machined seal retainer cavity and excludes from consideration multiple component welded shapes (i.e., those made up of multiple cross-sectional elements) and rolled shapes which are bent or crimped to form the final shape. DSB produces both a hot-rolled/machined series (SSPA and SSCM rails in which the cavity is machined) and a hot-rolled-only series (SSA2, SSE2, and SSCM2 rails in which the cavity is formed during the rolling process and is not machined).

The WBA literature specifies that the gland must be continuous, non-reinforced polychloroprene (neoprene). It states that the shape “shall promote self-removal of foreign material during normal joint operation.” According to a manufacturer’s representative, this can be interpreted to mean it should minimize the debris-collecting volume and, as it opens and closes, should not trap debris and prevent it from being moved out by natural forces such as wind and water. DSB literature requires that the seal shall be an extruded synthetic rubber with virgin polychloroprene as the only polymer. It states that the gland shall be shipped

from the factory as one continuous piece and that any molded shop splices for horizontal and vertical turns can be done only with the approval of the expansion joint system manufacturer.

Both WBA and DBS literature specify the required physical properties of the neoprene (see Table 3.1). Both require the same ASTM test methods, test parameters, and test values for tensile strength, elongation, ozone resistance, heat aging effects, oil swell effects, low temperature stiffening, and compression set. For Durometer A Hardness by ASTM 2240 (modified), DSB requires 60 ± 5 , WBA requires 55 ± 5 . DBA also includes a low temperature requirement (not brittle) by ASTM D-746. WBA specifies that the bonding material (lubricant/adhesive) shall be a one part moisture curing polyurethane and hydrocarbon solvent mixture meeting the requirements of ASTM-4070-81.

3.2 Practices in States Bordering Iowa

In addition to reviewing manufacturers' recommendations for the use of their products, the authors also obtained information about the specification and use of strip seal systems from the states surrounding Iowa (Illinois, Kansas, Minnesota, Missouri, Nebraska, South Dakota, and Wisconsin). This information was obtained from specifications published by the various state DOTs [32, 33, 34, 35, 36, 37, 38] and through e-mail exchanges. This section will summarize the information thus obtained from those states related to design and materials for strip seal systems. Section 4.2 will summarize information from those states concerning the fabrication and installation of such systems.

Table 3.1 Typical physical property requirements for polychloroprene seal material^a

Physical Property	ASTM Test Method	Requirements
Tensile Strength, min., psi	D-412	2000
Elongation @ break, min., %	D-412	250
Hardness, Type A durometer, points	D-2240 Modified	55 ± 5 ^b
Oven aging, 70h @ 212° F Tensile strength, max. % loss Elongation, max. % loss Hardness, Type A durometer, points change	D-573	20 max 20 max 0 to +10
Oil Swell, ASTM Oil No. 3, 70h @ 212° F Weight change, max. %	D-471	45
Ozone resistance 20% strain, 300 pphm in air 70h @ 104° F	D-1149 Modified	no cracks
Low temperature stiffening, 7 days @ 14° F ^c Hardness, Type A durometer, points change	D-2240	0 to +15
Compression Set, 70h @ 212° F max.	D-395 method B (modified)	40%

^a Taken from “WABO Strip Seal Specification” [29].

^b D. S. Brown specifies 60 ± 5

^c D. S. Brown includes a “Not brittle” requirement by ASTM D-746

3.2.1 Design Considerations and Requirements in Neighboring States

Design considerations and requirements for the use of strip seals in states bordering on Iowa are summarized in Tables 3.2, 3.3, and 3.4. Table 3.2 summarizes the factors applied by each state DOT in determining the expected movements at expansion joints, Table 3.3 lists the size limitations applied by each state, and Table 3.4 describes how the ends of strip seal systems (at barrier walls, railings, etc.) are typically detailed.

In the survey of state departments of transportation conducted in October of 1999 (see Section 5.3), Illinois, Missouri, and Nebraska indicated that they had no standard design procedures or written standards for the installation of strip seal systems, though some information about current practices was obtained from those states. Missouri and Illinois

Table 3.2 Predicted movement at expansion joints specified by states bordering Iowa

State	Factors applied to predict movement
Illinois	Temperature movements only; -30° F to +130° F and α -value = 0.0000065/° F for both steel and concrete.
Kansas	AASHTO recommendations for cold climate: 150° F range (-30° F to 120° F) for steel with α -value = 0.0000065/° F; 80° F range (+5° F to 85° F) for concrete with α -value = 0.000006/° F).
Minnesota	Temperature movements only; -30° F to +120° F; α -values = 0.0000065/° F for steel, 0.0000055/° F for concrete.
Missouri	For concrete structures, α -value = 0.000006/° F; from base temperature of 60° F, rise = 50° F, fall = 70° F, range = 120° F For steel structures, α -value = 0.0000065/° F; from base temperature of 60° F, rise = 60° F, fall = 80° F, range = 140° F.
Nebraska	For temperature movement, 130° F range for steel only, 110° F range for concrete deck on steel girders, 90° F range for concrete only; α -value for concrete = 0.0000060/° F; α -value for steel = 0.0000065/° F; AASHTO shrinkage factor (0.0002)
South Dakota	AASHTO recommendations for cold climate (see Kansas).
Wisconsin	AASHTO recommendations for cold climate (see Kansas). Add 0.0003 ft/ft for shrinkage. Add 0.5 in. for superstructure movement.

Table 3.3 Size limits for strip seals specified by states bordering Iowa

State	Size limits on strip seals
Illinois	(No information available)
Kansas	Movements in 2 in. to 4 in. (50 mm to 100 mm) range. Substantial factor of safety should be provided: specify seal that will accommodate a minimum movement of 4 in. (100 mm). Skews > 30° require 50% oversized strip seal.
Minnesota	Movements up to 4 in. (100 mm)
Missouri	For movements from 2 in. to 4 in. (50 mm to 100 mm) if skew \leq 45°. (Use flat plates on curved structures and skews > 45°.) Racking must not exceed 1.5 in. (75 mm) for either rise or fall movements. Minimum joint width = 0.5 in.
Nebraska	Movements from 3 in. to 4 in. (50 mm to 100 mm)
South Dakota	Movements up to 4 in. (100 mm)
Wisconsin	Movements up to 5 in. (125 mm). Use 4 in. (100 mm) seal as a minimum. Use a 5 or 6 in. (125 or 150 mm) seal for skews > 30°.

indicated they were in the process of developing written standards. Illinois indicated that, in the mean time, they were relying largely on manufacturers' recommendations in the application of strip seal systems.

Table 3.4 End details for strip seal systems used by states bordering Iowa

State	Typical end details
Illinois	Manufacturers' recommendations (60 degree upturns at ends typical)
Kansas	Seals extended through barrier rail where possible, 6 in. (150 mm) beyond outside of rail. (Open gutter or riprap on berms used for overflow.)
Minnesota	Two-step upturn (30 degrees for 2 in. (50 mm), then 60 degrees) – see Figure 3.1.
Missouri	Seals extended through barrier rail at least 3 in. (75 mm) beyond face of barrier. (Protective coatings applied to structural components subject to drainage or fiberglass drainage system provided for overflow.)
Nebraska	Ends turned up
South Dakota	Upturn (1:4 slope) at bent locations. Downturn (-1:4 slope) at abutments. (Standard trough detail to handle drainage.)
Wisconsin	Two-step upturn (see Minnesota).

Several states use the AASHTO recommended values for cold climates for predicting temperature movement or a slight variation of those recommended values (see Table 3.2).

Only Nebraska and Wisconsin seem to include a specific calculation for including the effects of shrinkage and creep. Wisconsin includes an allowance for superstructure movement.

Most states use strip seals for movements in the 2-in. to 4-in. range (see Table 3.3). Kansas DOT policy is not to provide expansion devices on steel bridges up to 300 ft (90 m) in length and concrete bridges up to 500 ft (150 m) in length because of the maintenance problems associated with such devices. If a strip seal system is used, the Kansas DOT

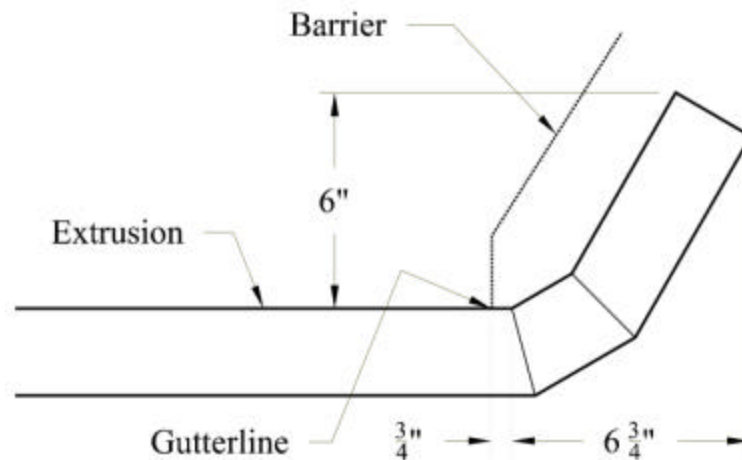

Figure 3.1 A two-step upturn end detail used in Minnesota and Wisconsin. Adopted by Iowa in 2000.

requires that the strip seal system be carried through the rails where possible and extended 150 mm (6 in.) beyond the outside of the rail to help clean the seal of debris. Overflow drainage may be handled by an open gutter or riprap protection on the berms. The Kansas DOT requires that gap settings corresponding to various temperatures be shown on the plans, including the gap for the reference temperature of 15° C (59° F). Because of the difficulty of accurately predicting bridge movements, however, the Kansas DOT states that incorporating a substantial factor of safety is essential (because of creep/shrinkage, moisture content, abutment rotation, etc.). Kansas, therefore, requires that the specified strip seal will accommodate a movement of at least 4 in. (100 mm), even if the predicted movement is less. For skews above 30 degrees, the seal is to be 50% oversized.

Kansas, Missouri, and South Dakota use end details that are intended to help keep the strip seal clear of debris. Kansas and Missouri require the strip seal system be run straight

out through the barrier wall or railing (typically at a slight downward slope because of the roadway contour). South Dakota uses an angled downturn (-1:4 slope) at abutments and an angled upturn (1:4 slope) at bents. Drainage systems are typically used for handling the overflow from the seal ends. Missouri also allows the option of using a protective coating on all the structural elements likely to be exposed to the overflow from the seal ends.

3.2.2 Material Requirements in Neighboring States

Specifications that pertain to the materials that are used in strip seal systems in states that border on Iowa are summarized in Tables 3.5, 3.6, and 3.7. Table 3.5 summarizes the extrusion materials acceptable in each of the states, Table 3.6 the elastomeric seal materials allowed, and Table 3.7 the lubricant/adhesive requirements.

According to the survey of state DOTs (Section 5.3), all of the states listed in Tables 3.2-3.7 have used expansion joint devices manufactured by The D. S. Brown Company. All except Wisconsin have used devices manufactured by Watson Bowman Acme. Kansas, Minnesota, Missouri, and South Dakota have used strip seals from Lewis Engineering Company. Kansas, Missouri, and Wisconsin have used seals from R. J. Watson and Missouri and Nebraska has used General Tire seals.

Table 3.5 Extrusion material requirements specified by states bordering Iowa

State	Extrusion (rail) material(s)
Illinois	As recommended by manufacturer
Kansas	ASTM A36 steel
Minnesota	Type A as manufactured by Watson Bowman Acme Corp. or Steelflex SSA2 Series by the D. S. Brown Company or approved equal.
Missouri	D. S. Brown SSPA, Watson Bowman Acme Type P, or equivalent. Others allowed for rehabilitation work.
Nebraska	ASTM A 709/A 709 M, Grade 36, Grade 50, or Grade 50W
South Dakota	ASTM A36, A242, or A588 steel.
Wisconsin	ASTM A36, A242, or A588 steel

Table 3.6 Seal material requirements specified by states bordering Iowa

State	Seal material
Illinois	As recommended by manufacturer
Kansas	Polychloroprene (Neoprene) conforming to ASTM D2628 or ASTM D2000 (250% elongation); continuous across bridge
Minnesota	Unreinforced neoprene ¼ in, thick (7/32 in. minimum); Watson Bowman Acme SE Series, D. S. Brown A2R series, or approved equal
Missouri	Single layer gland
Nebraska	Polychloroprene meeting requirements of Nebraska DOT Specifications Table 730.01; continuous across bridge (no splicing unless called for in plans).
South Dakota	Polychloroprene (Neoprene) conforming to ASTM D2628 but without recovery test; continuous across bridge (no splices permitted).
Wisconsin	Neoprene, no splicing permitted

The *Kansas DOT Special Provision to the Standard Specification, 1990 Edition*, defines a Type I, Type II, and Type III Strip Seal Assembly. The system described as Type I consists of a pair of metal extrusions with anchors and a neoprene seal like the strip seals that are the subject of this report. That *Special Provision* permitted the use of ASTM A36, A242, or A588 steel or ASTM B221 aluminum to be used for the extrusions for Type I systems. In the *Kansas DOT Design Manual, Version 7/99*, however, only ASTM A36 steel is allowed for the rails; weathering steel and aluminum are not allowed. This *Design Manual* specifies that a Type I Strip Seal be used for joints when the skew is less than or equal to 30 degrees. For skews greater than 30 degrees, it specifies that a 50 per cent oversized Type I Strip Seal be used. If there is not a Type I available that meets this oversize requirement, then a Type II or modular expansion joint system must be used (a device or assembly which consists “of separate units or elastomer and metal or integrally molded components under heat and pressure and anchored to the bridge by bolts or studs”).

Table 3.7 Lubricant/adhesive/sealant materials specified by states bordering Iowa

State	Lubricant/adhesive material
Illinois	As recommended by manufacturer
Kansas	As recommended by manufacturer
Minnesota	Shall conform to ASTM D4070; Delastibond 1520 (D. S. Brown), Prima-Lub (Watson Bowman Acme), Lube Plus 4070 (The Spray Cure Co.), Neoprene Adhesive D 4070-81 (Pacific Polymers Inc.) or approved equal.
Missouri	(No information obtained)
Nebraska	As recommended by manufacturer
South Dakota	High solids lubricant/adhesive as recommended by manufacturer of extrusions and conforming to ASTM D4070.
Wisconsin	High solids content

Minnesota specifications include requirements for the physical and chemical properties of the neoprene gland. They specify that one foot of seal material from each lot be submitted for testing if required by the project engineer and require the contractor to furnish certified test results from the manufacturer attesting to the physical and chemical properties of the expansion joint devices. If the skew is between 15 and 50 degrees, short lengths of backer bar are welded at regular intervals to the back of one or both rails to make the addition of snow plow fingers possible.

The specifications of the Nebraska Department of Roads includes a table listing the material property requirements for the polychloroprene seal. The ASTM tests and test results required are nearly identical to those given in the literature from Watson Bowman Acme and D. S. Brown. Nebraska and D. S. Brown require a Type A durometer hardness of 60 ± 5 , Watson Bowman Acme requires 55 ± 5 . D. S. Brown and Watson Bowman Acme specify a low temperature stiffening requirement, Nebraska does not.

The South Dakota DOT permits the use of A36, A242, or A588 steel for the rails. The small steel plates welded to the bottoms of the rails for purposes of mounting the rails to the formwork, however, are to be of A36 steel and the concrete anchors are to be Type A Steel Studs (Figure 3.2). South Dakota requires that, before installation, the shop plans of the proposed strip seal showing the fixed dimensions, thickness of the seal, and dimensions pertinent to the fit of the seal in the extrusion be submitted to and approved by the engineer.

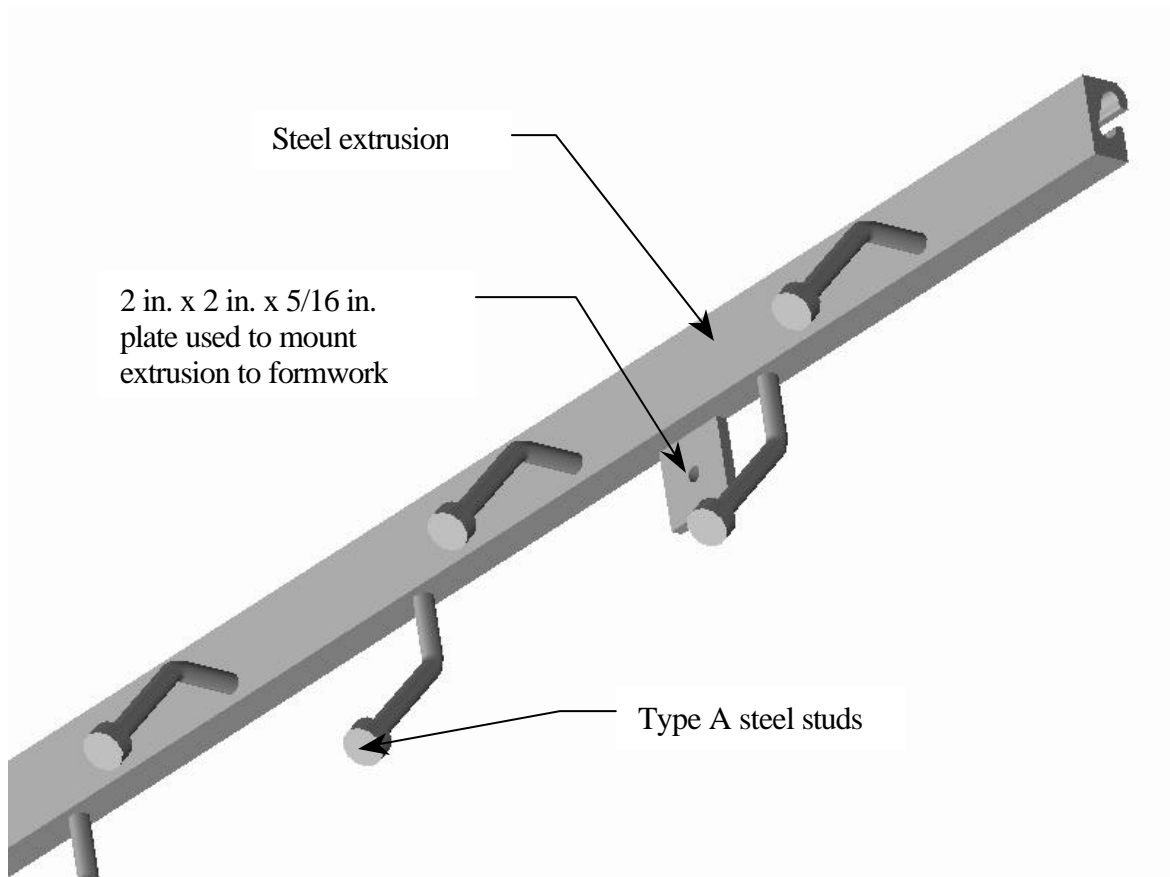

Figure 3.2 Typical configuration of steel extrusions as used in South Dakota.

3.3 Design Practices in Iowa

This section will summarize the Iowa DOT requirements related to design and materials for strip seal systems. The Iowa DOT requires that the strip seal expansion device be designed considering the skew angle of the bridge and the expansion length that the joint must accommodate [39]. The Iowa DOT literature lists systems that will accommodate from 2 in. to 5 in. of movement (movement perpendicular to the joint opening and based on manufacturer's recommendations). A study done by the Michigan DOT [40] on allowable movements for products manufactured by Watson Bowman Acme Corporation and The D. S. Brown Company is used for in-house designs of strip seal expansion joint systems used in Iowa. The Michigan study showed a significant change and variance in movement ratings for strip seals when the skew angle was larger than 30 degrees. The Iowa DOT in-house design guide therefore does not allow specifying a system for skew angles greater than 30 degrees for which such test data is not available.

For the thermal movement of steel bridges, the Iowa DOT uses a temperature range of -30° F to 120° F and an α -value of $0.0000065/^{\circ}$ F. For the thermal movement of concrete bridges, a temperature range of 0° F to 100° F and an α -value of $0.000006/^{\circ}$ F are used. In addition, an allowance for shrinkage of 0.0002 in./in. is used for concrete bridges. Though the 0.0002 value is referred to as "an allowance for shrinkage" in the guidelines, it is probably intended to include the effects of creep (e.g., in prestressed concrete girders) and other factors as well as shrinkage. According to the guidelines, the shrinkage is assumed to occur after the extrusions are installed. The designer is therefore to include both thermal expansion and shrinkage factors for sizing the seal (i.e., to predict the long-term maximum gap). But only the coefficient of thermal expansion is to be used to determine the

perpendicular joint settings for 10° F, 50° F, and 90° F to be tabulated on the bridge plans (i.e., the gap before shrinkage has occurred).

The Iowa DOT design standards require that the contractor submit shop drawings of the expansion devices showing layout, material to be used, and provisions for holding the devices during placement of concrete. The end detail used in Iowa is a one-step or two-step angled upturn. The two-angled version is shown in Figure 3.1, the one-step version in Figure 3.3. The minimum grade of structural steel to be used for the extrusions is ASTM A36, though in recent years most steel extrusions used in Iowa have been ASTM A588. The neoprene gland is to conform to the requirements of ASTM D-2628 modified to exclude recovery tests and compression set. The gland is to be placed as one continuous piece from end to end of the steel extrusions.

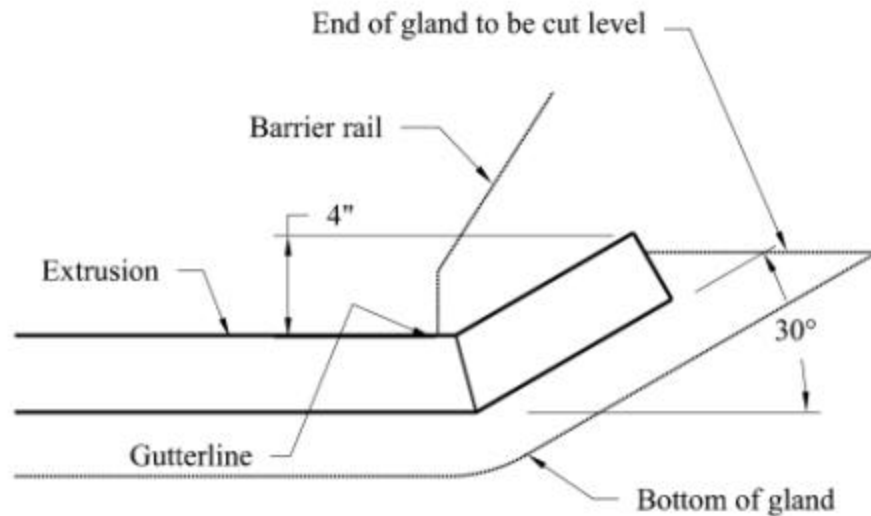

Figure 3.3 The one-step upturn end detail used in Iowa.

3.4 Review of Iowa DOT Design Guidelines for Strip Seal Systems

Two examples will be used to illustrate and analyze the recommended procedure used in-house by the Iowa DOT for the “Design of Strip Seal Expansion Device (10/20/95).” [39]. The Iowa DOT guidelines make use of the results of a series of tests on strip seal systems conducted by the Michigan DOT [40]. The test values for the Watson Bowman Acme (WBA) 300- and 400-series seals given in [40] are shown in Table 3.8. In the Michigan DOT testing, the extrusions are first set to a given skew and the gap is set to the manufacturer’s recommended movement midpoint (e.g., for the WBA 300- and 400-series glands, 1.5 in. and 2 in., respectively). At this starting gap, the gland is allowed to attain a “relaxed” condition; i.e., one with no perceivable racking stresses (see Figure 3.4). The movement ratings in Table 3.8 are based on twice the lesser of the “successful” opening and closing movements from this relaxed middle position. “Successful” means that the displacement from the “relaxed” middle position could be attained without an observed “physical material distortion, buckling, or excessive shear” [40].

Table 3.8 Experimentally determined movement capabilities (in.) parallel to centerline of roadway of evaluated joint systems vs. angle of crossing (from [40])

Joint System	*Angle of Crossing						
	90°	80°	70°	60°	50°	40°	30°
Watson Bowman Acme SE300	3.0	3.0	3.2	3.5	3.8	3.4	2.8
Watson Bowman Acme SE400	4.0	4.1	4.3	4.4	3.7	2.8	2.6

*Angle of crossing = 90° – skew angle

The first example follows the procedure as shown in Example 2 in [39] for concrete girder bridges but, for additional simplicity, assumes a skew angle of 0 degrees rather than 30 degrees. The example also assumes an expansion length of 400 ft rather than 350 ft.

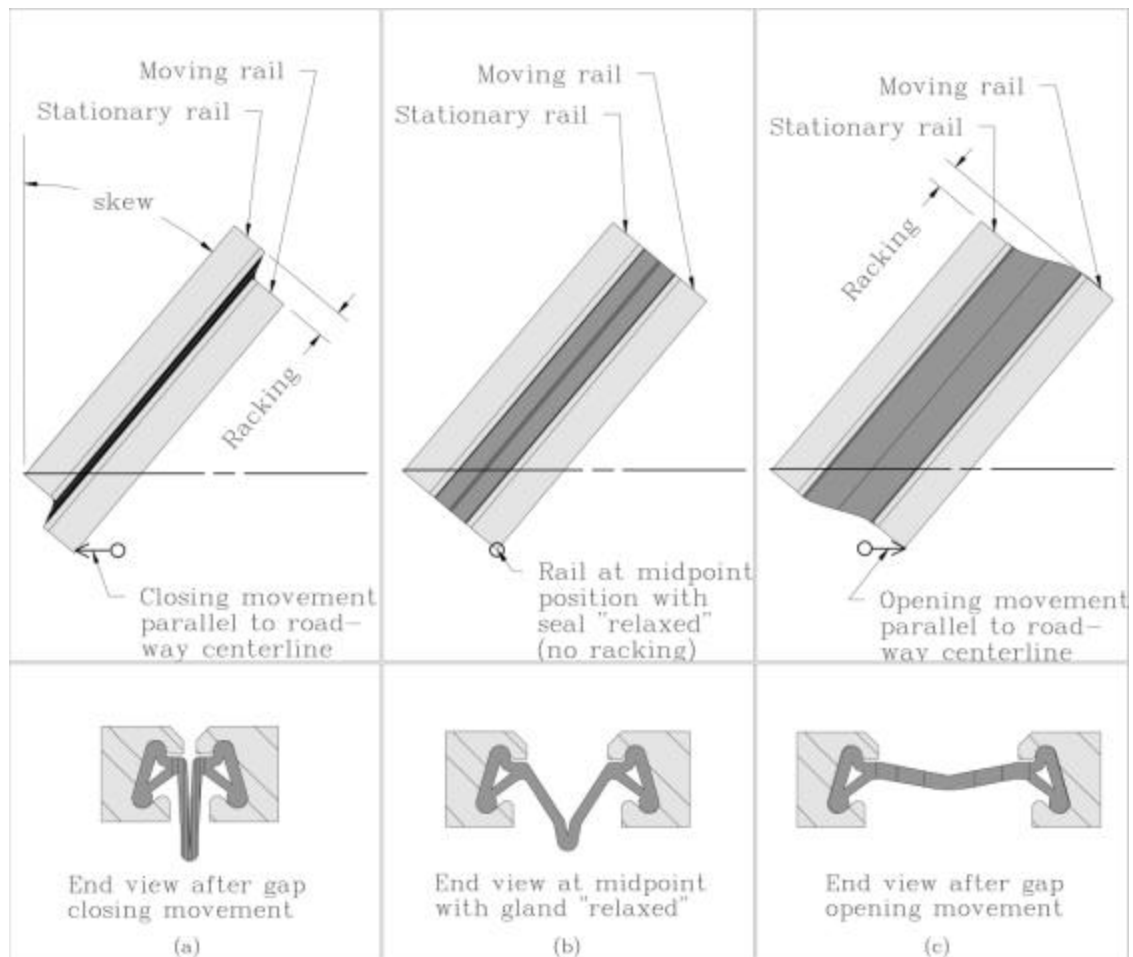

FIGURE 3.4 For large skew angles, movement includes a significant racking component which decreases the effective movement range of the neoprene gland.

The predicted maximum movement from Example 1 is compared to the movements predicted by the design factors used by states bordering Iowa as summarized in Table 3.2. The second example duplicates and then analyzes Example 2 in [39] using the skew angle of 30 degrees and the expansion length of 350 ft given in that Iowa DOT design guide example.

EXAMPLE 1. Concrete girder bridge, expansion length = 400 ft, skew angle = 0 degrees.

Determine the required movement, ΔL , parallel to the centerline of the roadway. For concrete girder bridges, the Iowa DOT guidelines assume a temperature range of 0°F to 100°F, an α -value of 0.000006/°F, and an allowance for shrinkage of 0.0002. Therefore

$$\Delta L = 0.000006/\text{° F} (100\text{° F}) 400 \text{ ft} (12 \text{ in./ft}) + (0.0002) 400 \text{ ft} (12 \text{ in./ft}) \quad (3.1)$$

$$\Delta L = 2.88 \text{ in.} + 0.96 \text{ in.} = 3.84 \text{ in.} \quad (3.2)$$

Of the 3.84 in. of total predicted long-term movement, 2.88 in. is required for thermal movement and 0.96 in. is required for shrinkage.

For a total movement of 3.84 in., a WBA 400-series seal is selected (4 in. movement rating at 0 degrees skew).

Once the gland size is selected, the Iowa DOT guidelines state “the designer should calculate the perpendicular joint settings for 10°, 50°, and 90° F. The Iowa DOT guidelines apparently assume that 1) the shrinkage value should not be included in the gap setting calculations and 2) the effects of shrinkage should not have any influence on the approach used to determine the initial gap settings. As the guidelines illustrate, the gap setting at 50°F is first calculated by assuming a minimum gap of 0.25 in. and adding to that the midpoint of the gland. The midpoint of a gland is simply half of the movement rating of the gland, which for a WBA SE400 gland would be 4 in./2. The gap setting at 50° F is therefore given by

$$\text{Gap setting @ } 50\text{° F} = 0.25 \text{ in.} + 4 \text{ in./2} = 2.25 \text{ in}$$

From this gap setting for 50° F, the predicted gaps at 100° F and 0° F (i.e., the gaps at the assumed temperature extremes) would be

$$\text{Gap @ 100° F} = 2.25 \text{ in.} - 0.000006/^{\circ} \text{ F (50° F) } 400 \text{ ft (12 in./ft)} = 0.81 \text{ in.}$$

$$\text{Gap @ 0° F} = 2.25 \text{ in.} + 0.000006/^{\circ} \text{ F (50° F) } 400 \text{ ft (12 in./ft)} = 3.69 \text{ in.}$$

These short-term minimum and maximum gaps (i.e., the gaps at the assumed temperature extremes and before any of the assumed shrinkage has occurred) are illustrated in Figure 3.5(a). The gap variation due to thermal effects only is 2.88 in. (Equations 3.1 and 3.2). The maximum short-term gap is 3.69 in., which is less than the 4 in. maximum opening rating for the SE400 gland.

The long-term minimum and maximum gaps (i.e., the gaps at the assumed temperature extremes of 0° F and 100° F and after the assumed shrinkage has occurred) corresponding to these short-term minimum and maximum gaps can be calculated as

$$\text{Minimum long-term gap} = 0.81 \text{ in.} + (0.0002) 400 \text{ ft (12 in./ft)} = 1.77 \text{ in.}$$

$$\text{Maximum long-term gap} = 3.69 \text{ in.} + (0.0002) 400 \text{ ft (12 in./ft)} = 4.65 \text{ in.}$$

These long-term minimum and maximum gaps are illustrated in Figure 3.5(b). The gap variation due to thermal effects is still 2.88 in. However, because of shrinkage effects, the maximum gap (i.e., the gap at 0° F) is now 4.65 in., which is considerably larger than the 4 in. maximum opening rating for the SE400 gland.

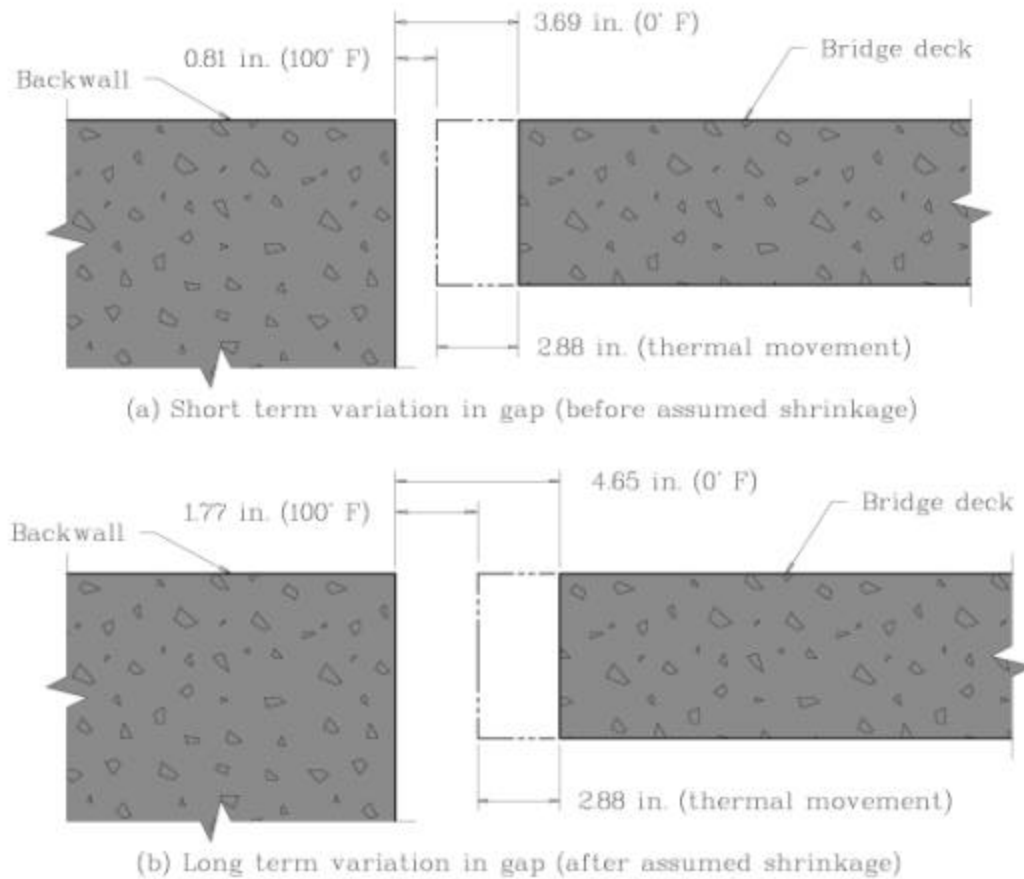

Figure 3.5 Predicted gap variation with and without the effects of shrinkage

Table 3.9 lists the design values, including α -value, temperature range, and concrete shrinkage and creep factor used by the Iowa DOT and the DOTs of the eight states that border on Iowa (from Table 3.2). Table 3.9 also lists the predicted maximum movement determined by the given design values from each state DOT and the seal size that would be specified based on the predicted maximum movement for the Example 1 bridge (expansion length of 400 ft and no skew).

Table 3.9 Comparison of maximum movements predicted by the Iowa DOT design equations and by the design factors and values used in states bordering Iowa

State	a-value (/° F)	Temperature range	Creep/ shrinkage	Predicted movement (in.)	Seal size specified (in.)
Iowa	0.000006	100° F	0.0002	4.65	5
Illinois	0.0000065	160° F	none	4.99	5
Kansas	0.000006	80° F	none	2.30	4*
Minnesota	0.0000055	150° F	none	3.96	4
Missouri	0.000006	120° F	none	3.46	4
Nebraska	0.000006	110° F	0.0002	3.55	4
South Dakota	0.000006	80° F	none	2.30	3
Wisconsin	0.000006	80° F	0.0003	4.24**	5

* Seal with rating of at least 4 in. is used even if the predicted movement is considerably less

** Wisconsin specifies an allowance of 0.5 in. for superstructure movement

EXAMPLE 2. Concrete bridge, expansion length = 350 ft, skew = 30 degrees (from [39]).

Following Example 2 in [39],

$$\Delta L = 350 \text{ ft} (0.000006/^{\circ}\text{F}) (100^{\circ}\text{F}) (12 \text{ in./ft}) + 350 \text{ ft} (0.0002) (12 \text{ in./ft}) \quad (3.3)$$

$$\Delta L = 2.52 \text{ in.} + 0.84 \text{ in.} = 3.36 \text{ in.} \quad (3.4)$$

For a skew angle of 30 degrees, movement perpendicular to the joint, Δ_{\perp} , is then

$$\Delta_{\perp} = (2.52 \text{ in.} + 0.84 \text{ in.}) (\cos 30^{\circ}) = 2.18 \text{ in.} + 0.73 \text{ in.} = 2.91 \text{ in.} \quad (3.5)$$

Following Example 2 in [39], an SE300 gland is selected. The gap setting at 50°F is then determined by assuming a minimum gap of 0.25 in. and adding to that the midpoint of the nominal gland size, 3 in./2 for the SE300 gland.

$$\text{Gap setting @ } 50^{\circ}\text{F} = 0.25 \text{ in.} + 3 \text{ in./2} = 1.75 \text{ in.}$$

From this gap setting at 50°F, the predicted gaps at 100°F and 0°F (i.e., the gaps at the assumed temperature extremes) would be

$$\text{@ } 100^{\circ}\text{F} = 1.75 \text{ in.} - (\cos 30^{\circ}) (350 \text{ ft}) (0.000006/^{\circ}\text{F}) (50^{\circ}) (12 \text{ in./ft}) = 0.66 \text{ in.}$$

$$\text{@ } 0^{\circ}\text{F} = 1.75 \text{ in.} + (\cos 30^{\circ}) (350 \text{ ft}) (0.000006/^{\circ}\text{F}) (50^{\circ}) (12 \text{ in./ft}) = 2.84 \text{ in.}$$

The gap variation due to thermal effects only is 2.18 in. (Equation 3.5). The maximum short-term gap is 2.84 in. and the maximum short-term movement parallel to centerline of the roadway is given by

$$\Delta L = 2.84 \text{ in.} / (\cos 30^{\circ}) = 3.28 \text{ in.}$$

which is less than the 3.5 in. movement rating for the SE300 gland at a skew angle of 30 degrees (see Table 3.8).

The long-term minimum and maximum gaps (at the assumed temperature extremes and after the assumed shrinkage has occurred) corresponding to these short-term minimum and maximum gaps can be calculated as

$$\text{Minimum long-term gap} = 0.66 \text{ in.} + (\cos 30^\circ) (350 \text{ ft}) (0.0002) (12 \text{ in./ft}) = 1.39 \text{ in.}$$

$$\text{Maximum long-term gap} = 2.84 \text{ in.} + (\cos 30^\circ) (350 \text{ ft}) (0.0002) (12 \text{ in./ft}) = 3.57 \text{ in.}$$

The gap variation due to thermal effects is still 2.18 in. However, because of shrinkage effects, the gap at 0°F is now 3.57 in., which corresponds to a maximum movement parallel to the centerline of the roadway of

$$\Delta L \text{ (long-term)} = 3.57 \text{ in.}/(\cos 30^\circ) = 4.12 \text{ in.}$$

which is significantly larger than the 3.5 in. maximum movement rating for the SE300 gland at a skew angle of 30 degrees (Table 3.8).

4. FABRICATION AND INSTALLATION OF STRIP SEAL SYSTEMS

4.1 Manufacturers' Recommendations

This section will describe the fabrication and installation recommendations of manufacturers of strip seal systems. For the reasons given in Section 3.1, the discussion will only reference materials from Watson Bowman Acme (WBA) and The D. S. Brown Company (DSB) [29, 30, 31]. The information presented is based on communications with company and fabricator representatives in addition to the company literature.

4.1.1 Manufacturers' Recommendations for Fabrication

The WBA strip seal specification allows for either shop assembly or field assembly of rail sections (rail sections with the required anchorages and/or finishes – see Figure 3.2) and seal. (Field assembly is by far the most common in Iowa – see Section 4.3). WBA specifies that the contractor shall submit shop drawings for the fabrication and assembly after the award of the contract. If the length of the required expansion joint system or stage construction requires installation in sections, the WBA specification requires that appropriate ends shall be beveled by the manufacturer (fabricator) to allow for field welding.

The DSB specification also requires shop drawings for fabrication of the system, including all dimensions, anchorages, welding procedures, and other appropriate data. It requires that the fabricator be certified under AISC Category I and that all welding be done according to state specifications or AWS D-1.5. All surfaces that will not be embedded in concrete are to be treated according to state specifications. If painting of the rails is required, backer rod is to be placed in the cavities before painting. The rail sections are to be shipped in maximum lengths of 18 feet unless otherwise required by contract drawings or field conditions. The rails are to be banded together to form matching pairs and identified clearly

as to intended location. A representative of The D. S. Brown Company said that the steel extrusions are typically paired up in opposing sections and banded or bolted together for shipment to the construction site because the rails are typically fabricated for field splicing at grade breaks, crowns, or stage points. DSB literature states that the neoprene gland is to be shipped concurrently with the rails and also identified clearly as to intended location.

4.1.2 Manufacturers' Recommendations for Installation

The WBA specification requires that the device shall be accurately set and securely supported at correct grade, elevation, and joint opening. It states that, immediately prior to installation (i.e., embedment of the device and anchorages), the system shall be inspected by the engineer for proper alignment, complete bond between the gland and retainers, and proper stud placement and effectiveness. "Complete bond between the gland and retainers" implies the neoprene gland is already installed in the rails before the deck or deck overlay is placed, but this is atypical. According to a WBA representative, the seal is installed after the rails are permanently fixed about 90% of the time. The WBA specifications say that unnecessary bends or kinks in the rails shall be cause for rejection.

The WBA literature states that if there is a minimal time delay (less than 2 months) between the installation of the two rails, the seals can be left out of the assemblies when they leave the fabrication shop. For longer delays between the installation of the two rails, the first rail can be installed with a temporary seal in place.

For setting the expansion gap opening between rails, WBA states the structure temperature shall be based on surface temperatures of the concrete and/or steel taken with a surface thermometer. The average of two temperatures of the underside of the concrete slab at either end of the superstructure element adjacent to the expansion joint (i.e., at two

locations not in the vicinity of larger masses such as abutments or piers) should be used.

Alternatively, WBA suggests drilling a 1/4-in. hole 3 in. into the concrete slab, filling the hole with water, and using a probe thermometer. The temperature thus determined should be used to determine the gap that corresponds to the proper ambient temperature dimension shown on the shop drawings. (Though the WBA material mentions determining the surface temperature of the steel structure, it does not suggest how this be done or if it should be used alone or in combination with concrete slab temperatures in determining the gap setting.)

The WBA literature states that the gap setting adjustment is to be accomplished using prestressing devices. These are devices furnished by the manufacturer or fabricator for positioning one or both steel extrusions before the concrete is placed. These devices should be removed after completing all bolted and welded connections of the rails to superstructure or formwork and before placing the concrete. Devices on top of the joint may remain if they will not interfere with concrete placement (see Figure 4.1 for an illustration of such a device as used by the Kansas DOT). The WBA specifications also state that care should be taken to achieve proper compaction of concrete around the positioned rails.

WBA specifies that all metal surfaces that will contact the neoprene gland shall be blast cleaned (Steel Structures Painting Council Surface Preparation No. 6 (SSPC-SP6) – Commercial Blast Cleaning to clean quality C SA 2 or better). Cleaned surfaces shall be protected from rusting until the actual installation of the gland. . WBA recommends that the lubricant/adhesive not be applied to surfaces under 40 degrees F. because a film of moisture is likely to form on the cavity surfaces and prevent a good bond and seal between the rail and the neoprene gland.

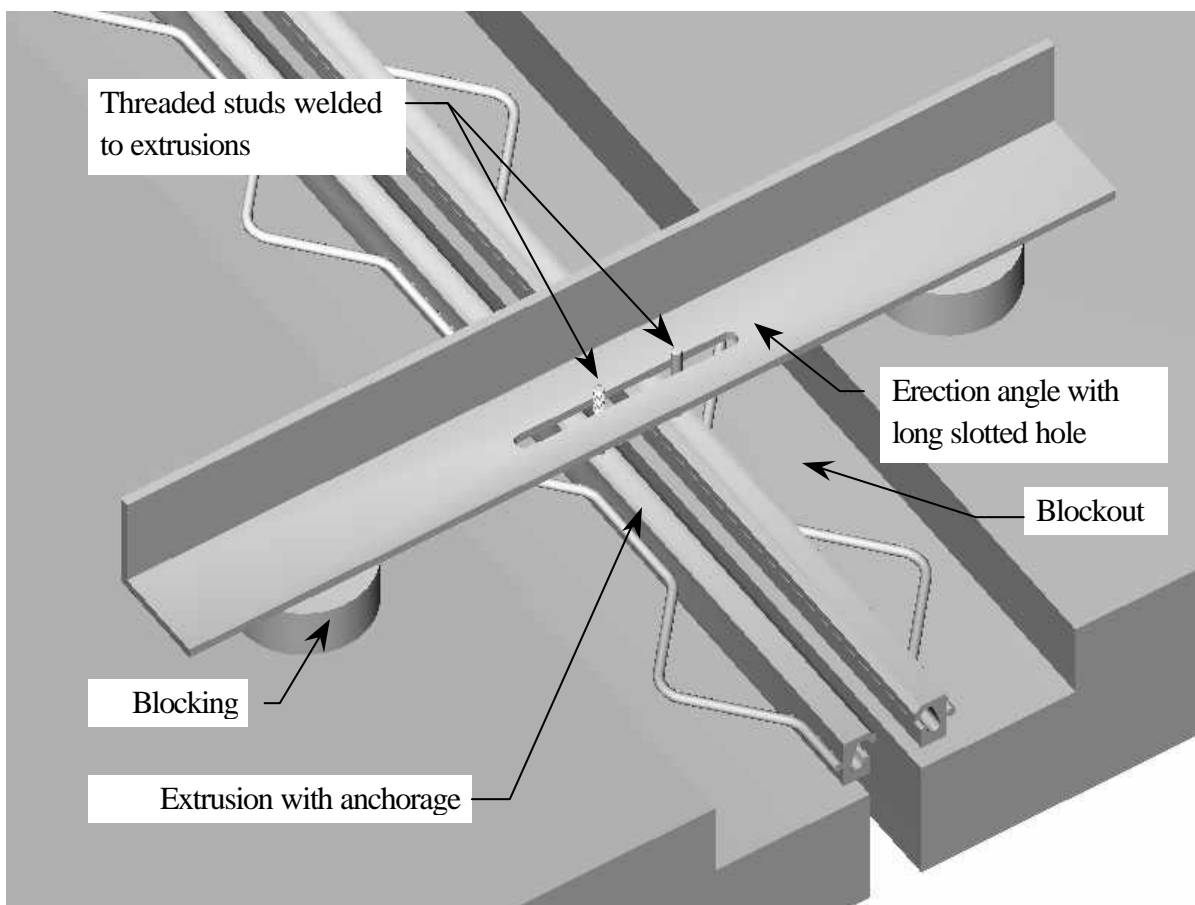

Figure 4.1 Computer model of extrusions positioned in blockouts using an erection angle

WBA specifies that the gland shall be installed in a continuous length across the entire roadway. The minimum width of the gap for field installation is 1.5 in. For proper fit and ease of installation, dirt, spatter, or standing water shall be removed from the cavity using brush, scraper, or compressed air prior to actual installation. The cavity and seal lug should be wiped with an approved solvent (e.g., toluene). Prima-Lub (lubricant/adhesive) should then be applied liberally by brush to the full perimeter of the steel extrusion cavity (of both rails). Installation instructions provided by WBA suggest the lubricant/adhesive be applied in approximately 5-foot increments to avoid possible premature setting problems if installation goes slower than anticipated. The WBA instructions list and/or illustrate the

following installation steps (for each section of gland and pair of rails; see Figure 4.2 for the WBA illustrations of the installation steps):

1. Clean cavity of debris
2. Wipe seal lug and steel cavity with solvent
3. Liberally coat the entire cavity with Prima-Lub adhesive
4. Fold gland in middle and push into joint opening until the lower ears of the lugs seat themselves in the lower portions of the cavities in the two rails
5. Coat the upper lug of the seal with Prima-Lub adhesive
6. Insert seal lug into cavity using WABAC installation tools (Part #B-923 – see Figure 4.3) using care not to pinch the seal lug against the steel extrusion, but to tuck the lug into the cavity.

The figures shown with the installation instructions illustrate the use of the lever action of the installation tool against the opposing rail to press incremental lengths of the upper ear of the lug into the rail cavity (for the section with the lubricant/adhesive applied). The WBA instructions recommend that the installer inspect the overall seal installation to insure that the seal has been properly installed and locked in the extrusion cavity. Any portion of the seal not seated properly should be corrected at once. The WBA literature states that after the lubricant/adhesive has had adequate time to cure, a watertight integrity test shall be performed.

The D. S. Brown literature states that the recommended means for aligning and setting the expansion joint system to grade shall be explicitly set forth in the shop drawings. The contractor shall strictly follow the manufacturer's recommendations for setting the joint

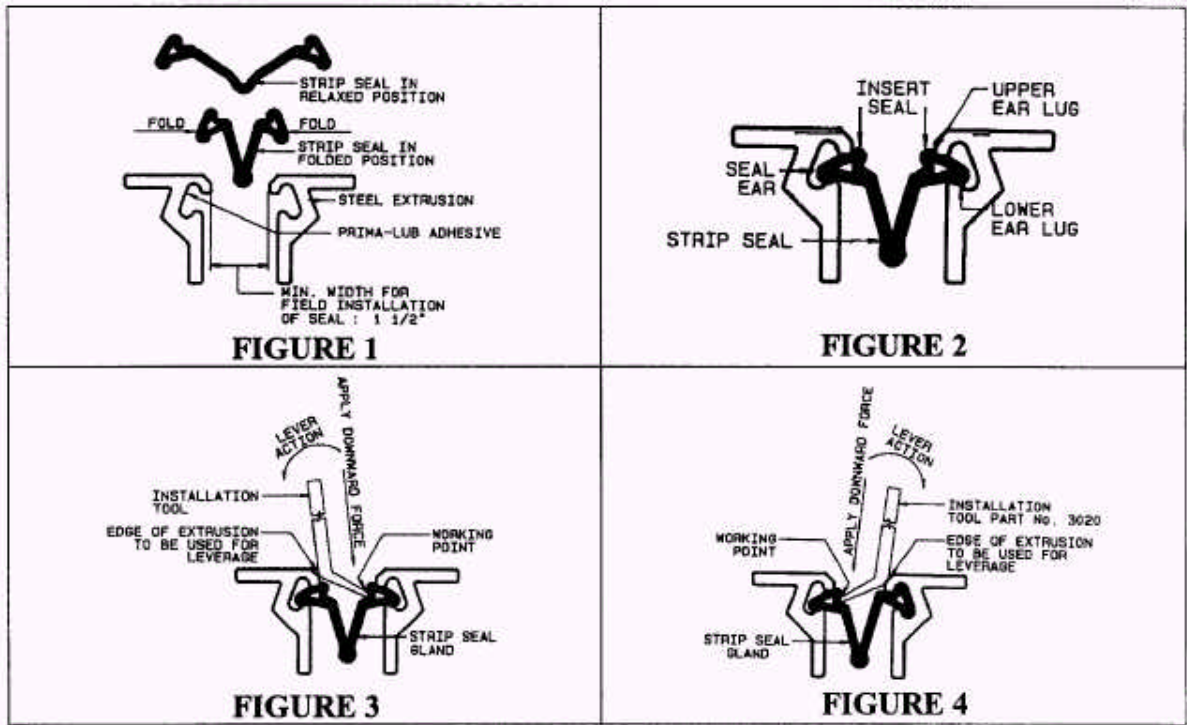

Figure 4. 2 Figures from Watson Bowman Acme to illustrate the seal installation steps

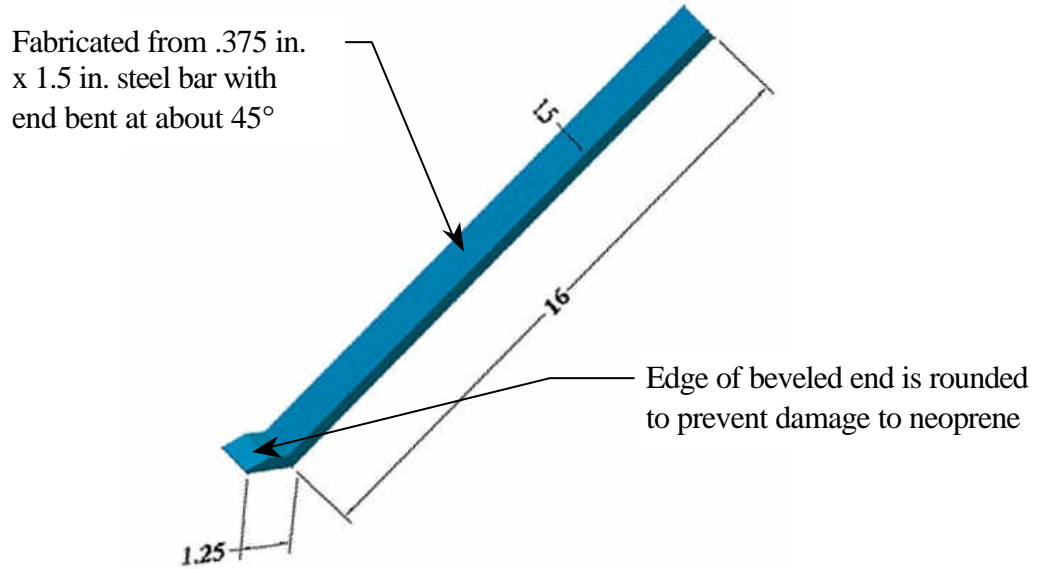

Figure 4.3 Installation tool similar to that available from Watson Bowman Acme

and the contractor shall install the gland in the field. The DSB literature requires that a manufacturer's representative be present at the initial installation of a strip seal expansion joint. Subsequent times the manufacturer's representative need not be present unless required by the resident-in-charge engineer (at cost to the contractor). The DSB literature states that polyurethane backer rod shall be placed in the cavity prior to pouring concrete and shall remain in the cavity until the final concrete pour has been made. A company representative said that DSB does not currently make a tool for installation of the gland and said that a bent bar with a dulled edge or crow-bar works as well as anything.

4.2 Practices in States Bordering Iowa

This section will summarize the information obtained from Illinois, Kansas, Minnesota, Missouri, Nebraska, South Dakota, and Wisconsin related to the fabrication and installation of strip seal systems in bridge expansion joints. As for the information given in Section 3.2, the information in this section was obtained from written standards of the various state DOTs [32, 33, 34, 35, 36, 37, 38] and through e-mail exchanges.

Fabrication considerations and requirements for the use of strip seal systems in states bordering on Iowa are summarized in Table 4.7. Specifications for the installation of strip seal expansion joint systems, including installation of both the extrusions and the neoprene seal, are summarized in Table 4.8.

4.3 Fabrication and Installation Practices in Iowa

The fabricator who has supplied the vast majority of strip seal expansion joint systems in Iowa in recent years is Hi-way Products, Inc. of Ida Grove, Iowa. Based on

Table 4.7 Typical fabrication requirements for strip seal extrusions

Illinois	As recommended by manufacturer.
Kansas	Anchorage system as detailed on the shop drawings. No paint if extrusion is to be embedded in elastomeric concrete; paint all of extrusion except grip (cavity) if to be embedded in regular concrete.
Minnesota	If rail is pre-galvanized, fabricator shall 1) provide sections not less than 10 ft long; 2) provide anchorage within 9 in. of each end of each section; 3) bevel abutting ends ¼ in. on 3 edges and de-burr; 4) prepare surfaces for welding; 5) groove weld sections on 3 sides; 6) grind weld smooth; 6) repair welded surfaces; 7) install protective filler material in gland groove before storage or transport if gland is not installed in shop.
Missouri	¾ -in. diameter x 8-in. welded shear connector studs welded alternately high and low at 9 in. centers on P-type joint armor for new construction.
Nebraska	All exposed surfaces of the extrusions shall be painted with a primer unless weathering steel is used. Alternatively, steel extrusions may be galvanized. Extrusions may be one piece or multiple pieces welded or bonded so as to produce a tight seal.
South Dakota	½-in. diameter x 6-in. concrete anchors welded alternately to inner face and bottom face of extrusion. 2-in. x 2-in. x 5/16-in. plates with bolt holes welded on edge to bottom face of extrusion for fixing extrusion to formwork. Extrusions and anything welded to them are to be galvanized. Field splices are permitted, but no welds are permitted in the internal section of the extrusion. Weld details are to be shown on shop plans and approved by the engineer. If welded splices are used subsequent to galvanizing, the weld details and surface repair procedures are to be included with the shop plans.
Wisconsin	5/8-in. diameter x 6 3/8-in. studs welded to bottom inner edge of extrusion on 6-in. centers and alternately bent up and down after welding or specially fabricated anchors. One field splice permitted in extrusions. Extrusions shall be sand blasted and hot dip galvanized after fabrication. Extrusions shall be straightened after fabrication but before shipment. Fabricator shall provide means of keeping extrusions clean and smooth prior to installation of gland.

information obtained from Hi-way Products, the typical fabrication sequence for strip seal expansion joint systems used in Iowa is as follows. Hi-way Products obtains the basic components, rails in 20-ft lengths (typically A588 steel in recent years), neoprene glands, and lubricant adhesive (Prima-Lub) from the Watson Bowman Acme Corporation. They cut the

Table 4.8 Installation requirements for extrusions and seal

Illinois	As recommended by manufacturer.
Kansas	Lubricant shall be applied in accordance with manufacturer's recommendation. Manufacturer of expansion device shall have a qualified technical service representative on the project to supervise installation and shall review the fabrication of the armoring. A butt joint shall occur at each break in the pavement cross slope or a unit of device shall be bent to conform to break in cross slope. If to be installed in sections, shop drawings shall show sequence.
Minnesota	Protective filler material shall be removed and neoprene to steel contact areas cleaned of all dirt, oil, grease, and other contaminants before installing neoprene gland. Contact areas shall be lightly sandblasted so as to roughen but not damage galvanized surface. Lubricant adhesive is to be applied to both neoprene and steel contact areas. Installation is to be with tools recommended by manufacturer (use of other tools prohibited).
Missouri	Gap to be set using 1/2-in. diameter machine bolt through both rails at about 18-in. centers using two hex nuts (see Figure 4.4). Gap to be set within 2 hours of placement of concrete. 2-in. gap at 60° F.
Nebraska	Contractor shall provide setting or installation plans for Engineer's approval. Installation shall be in accordance with manufacturer's instructions and recommendations. Seals shall be installed on a properly prepared surface. Installed seals shall be protected against damage from equipment by placing wooden planks along the seals or other suitable means.
South Dakota	Gap is to be at least 1.5 in. at 90° F. (for ease of installation of gland). Installation of neoprene seal shall be as recommended by manufacturer and approved by Engineer. Neoprene surfaces shall be roughened with wire brush before application of lubricant/adhesive. Installation may be either before or after extrusions are concreted into slab. Extrusions shall be dry, clean, free from dirt, grease and contaminants at time of installation of gland. Supplier shall submit detailed gland installation procedure with shop plans. Gland shall extend minimum of 6 in. beyond each end of extrusions.
Wisconsin	Set gap to 1.75 in. when expansion length ≤ 230 ft. If expansion length > 230 feet, table shall be prepared for gap settings for 85° F., 40° F. and -5° F. Sand blast clean extrusions before coating with lubricant adhesive.

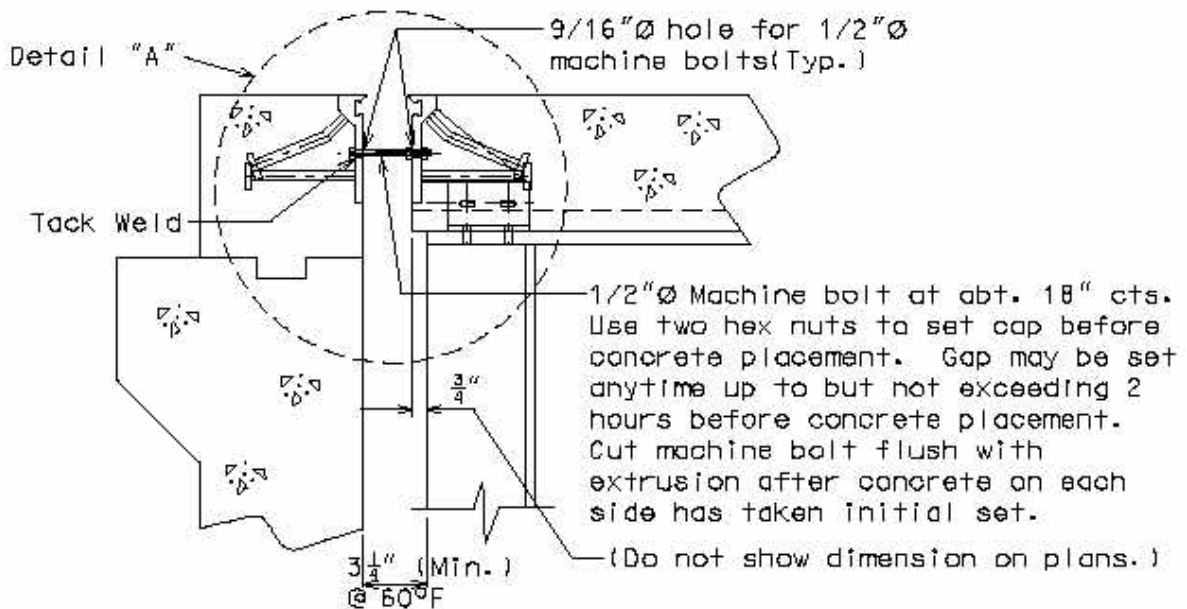

Figure 4.4 Mechanism used in Missouri for setting the gap with P-type extrusions

rails to appropriate lengths and create vertical and horizontal turns in rail sections for curb/barrier ends and skew ends, respectively. They bevel the ends of sections that are to be field welded and weld on anchorages specified in the bridge plans (Figure 4.5). They also weld on bolts or brackets specified by the contractor for use in attaching to bridge formwork or positioning devices. They then have the rail sections pickled and galvanized by a subcontracting shop. Once the rail sections are galvanized, they are shipped to the bridge contractor along with neoprene gland material and lubricant/adhesive.

In order to obtain detailed information about the use and installation of strip seal joints from the contractor's perspective, the authors met with representatives from four contractors who frequently do work for the Iowa DOT. On April 28, 2000, representatives from United Construction (Mike Jeffries), Cramer and Associates (Robert Cramer), Peterson Contractors (Kevin Steffen), and Jensen Construction (Randy Freel) met with representatives

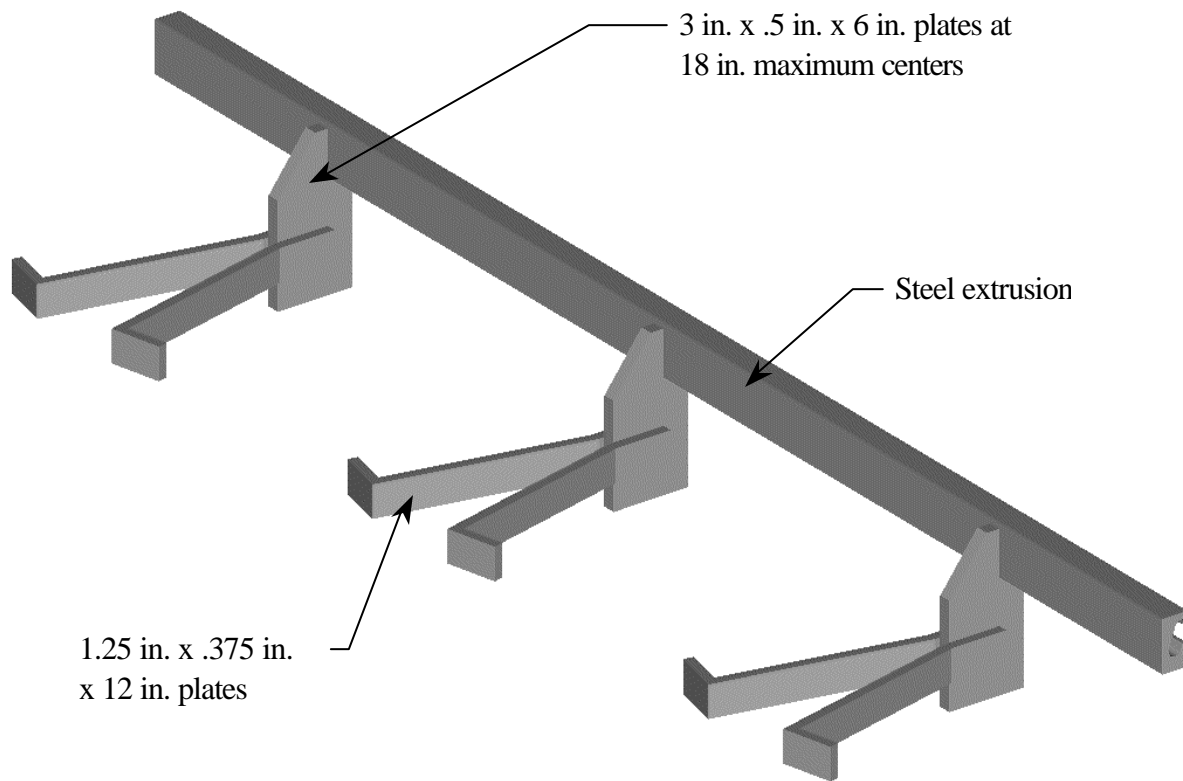

Figure 4.5 Model of the extrusion with anchorages of the type used in Iowa

from the DOT, the FHWA, and the authors to discuss strip seals. As a follow-up to that discussion, two of the authors observed, over several months, the steps in the installation of strip seal systems in the east-bound bridge of Iowa Highway 5 over Iowa Highway 28 (just south of Des Moines, Iowa) being constructed by Cramer and Associates. The following description of the fabrication and installation process for new bridge construction is based on that initial group discussion, construction observations, and subsequent conversations with construction and Iowa DOT personnel and material suppliers.

Contractors obtain the steel rails for the strip seal system from a supplier/fabricator (e.g., Hiway Products of Jefferson, IA). As delivered to the construction site (Figure 4.6), the

rails have been cut to appropriate lengths, typically 10-16 ft. Steel anchors as per design specifications and formwork attachment mechanisms specified by the contractor (e.g., threaded studs or clip angles) have been welded to the rail sections, and the rails with attachments have been pickled and hot-dip galvanized. The fabricator has also constructed an appropriate number of gutter sections, each of which has a short section of rail mitered and welded at an upturned angle to a longer length of rail as per design specifications. An upturned end is the standard detail in Iowa (Figures 3.1 and 3.3).

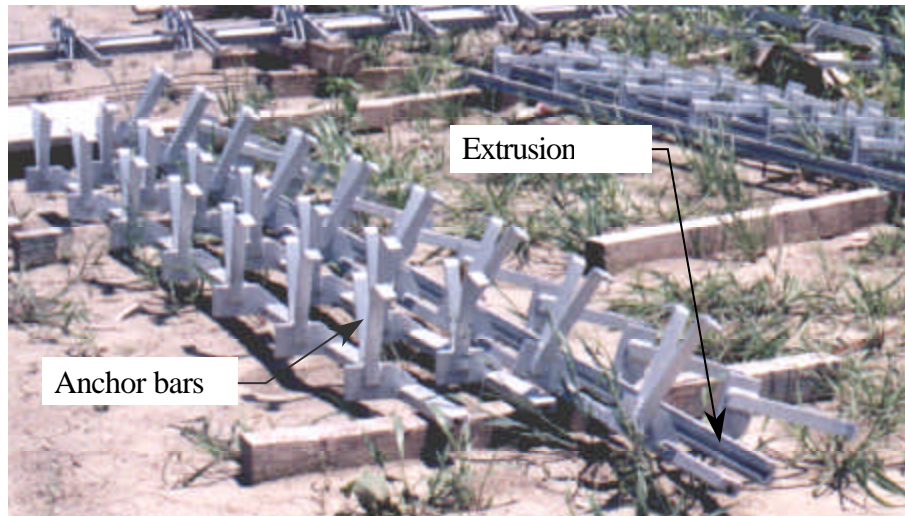

Figure 4. 6 Extrusions with anchorages stacked at construction site

None of the Iowa contractors contacted obtained strip seal systems already assembled; i.e., with a pair of monolithic gutter-to-gutter rails and neoprene seal already installed. Much of the manufacturers' literature, however, makes this sound like the preferred and/or most common approach. According to one manufacturer's representative, however, about 90% of strip seal systems they provide are assembled on site, which is consistent with the practice in Iowa. Fabricating and assembling an entire strip seal system

in the shop makes initial quality control easier, but transporting, handling, and installing the typically long and flexible assembled unit that results, without damaging it, is a major challenge.

The rail sections are then welded together as necessary on site. For example, on the IA Highway 5 bridge, the rails at either end of the deck were installed first (there were no intermediate joints in this bridge). Starting at one side of the bridge, a gutter section (rail section with upturn – see Figure 3.3) was positioned and attached to the deck formwork with temporary bolts (Figure 4.7). A second section was then positioned adjacent to the first, bolted to the formwork, and welded to the first across the top, back (deck side), and bottom of the rail. Additional rail sections were positioned and welded in a similar fashion to complete the rails at either end of the deck (Figure 4.8).

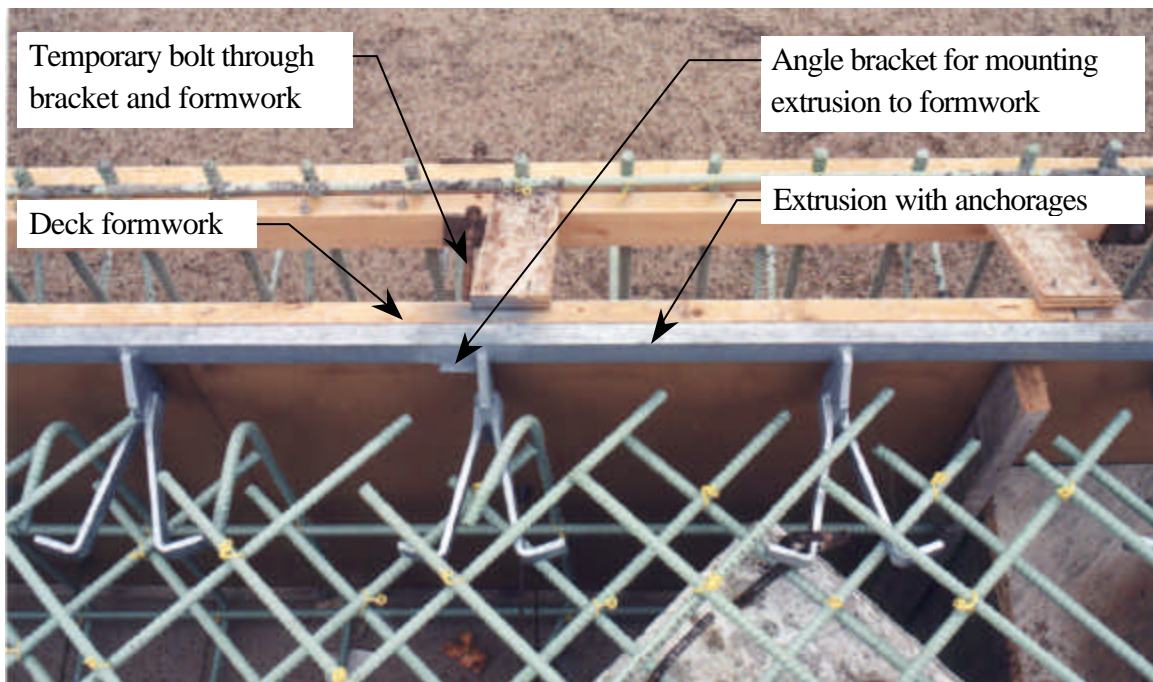

Figure 4.7 Rail section with anchorages positioned and bolted to deck formwork

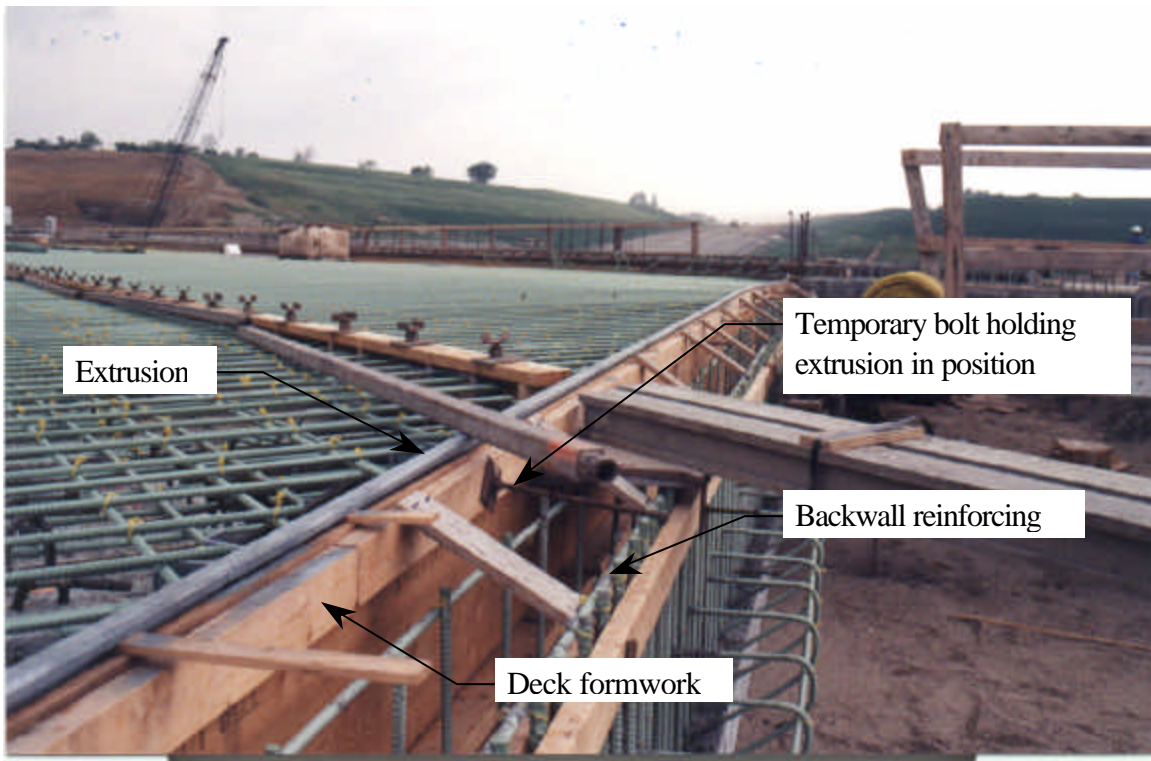

Figure 4.8 Extrusion at one end of deck installed from gutter to gutter

On this particular bridge, the total length of rail supplied did not quite match the length of the formwork – the ridge had a large skew – so a short piece of rail (3 to 4 in. long) had to be obtained and used as a filler for each of the two rails of the two joint systems. Also, the fabricator had welded threaded studs to the top of the rails for use in positioning devices typically used for rehabilitation work rather than new construction (Figure 4.9). The contractor therefore cut these studs off and welded small angle brackets to the bottom surface of the rail (Figures 4.7 and 4.10). Once the sections are all positioned and the welding is completed, the welds are ground flush and a spray-on galvanizing is applied to the welded areas. For the IA Highway 5 bridge, galvanizing paint was also applied to the angle brackets and short filler pieces of rail.

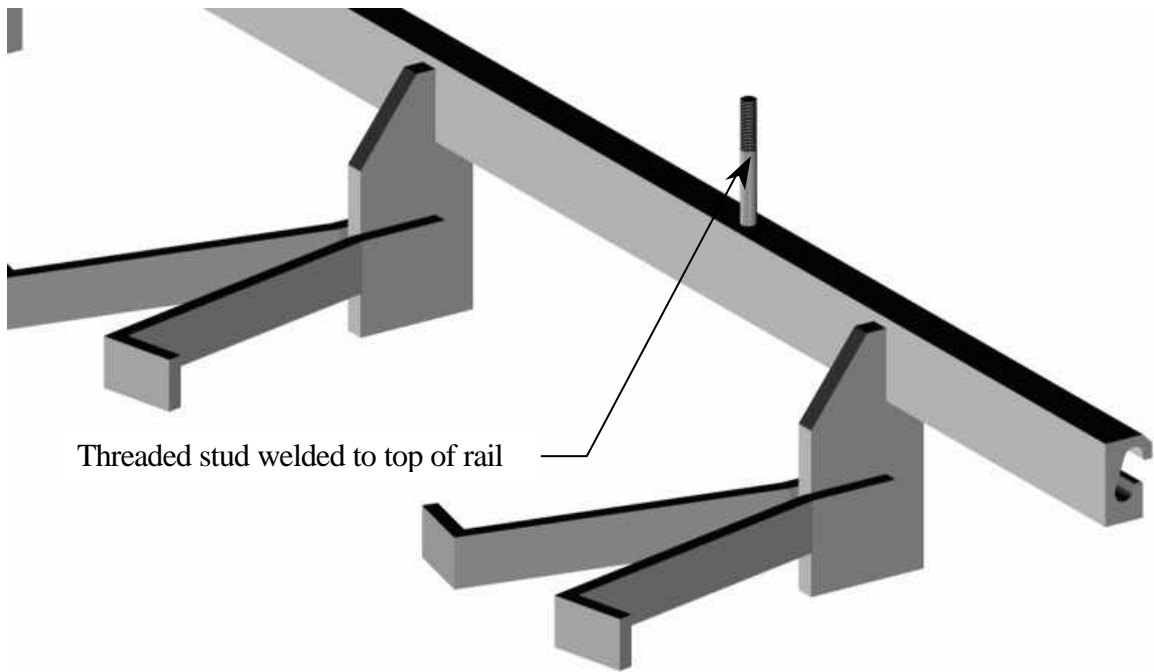

Figure 4.9 Threaded studs are one mechanism used to hold rails in position (see Figure 4.1)

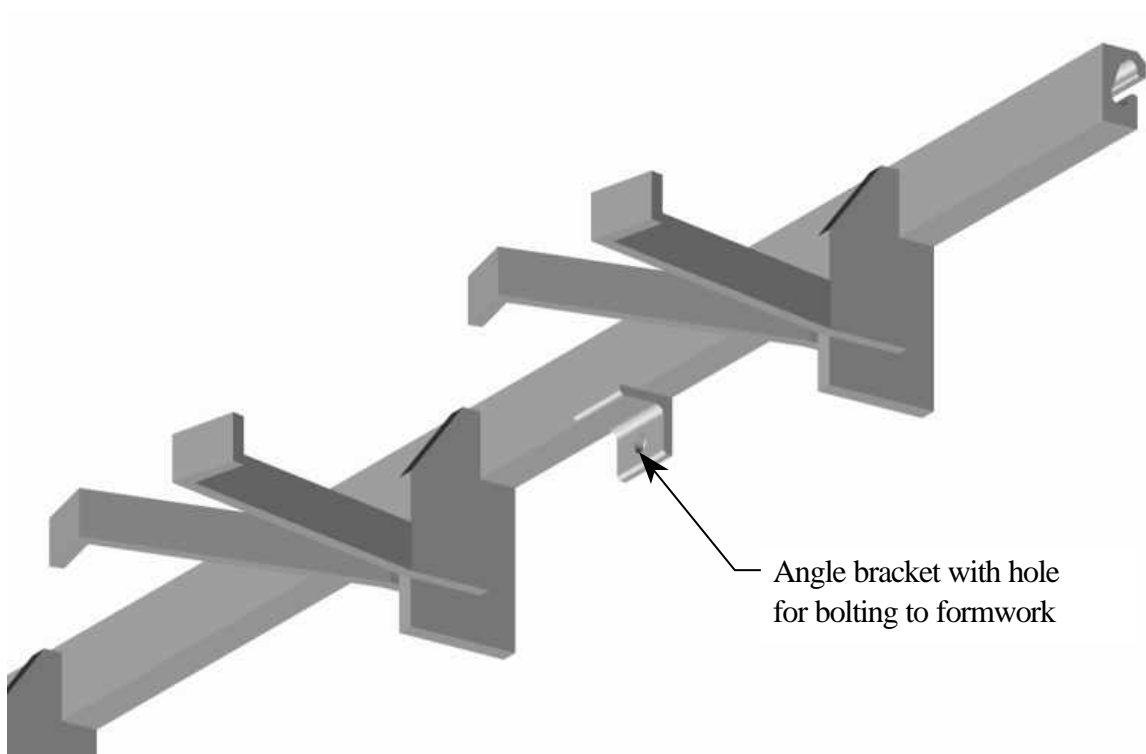

Figure 4.10 Model of extrusion with angle bracket for mounting welded to bottom surface

On the Highway 5 bridge on the day the deck was cast, the cavity of the west rail was filled with a sacrificial filler (cylindrical pieces of foam or backer rod wedged into the cavity) to keep out concrete and debris during concrete placement and other construction operations (Figure 4.11). The cavity of the east rail was open on the day the north half of the deck was placed (Figure 4.12). Tape is also sometimes used to seal the cavity against concrete and debris. A clean, smooth rail cavity is essential for the efficient installation and ultimate effectiveness of the neoprene seal. Protecting the cavity with a sacrificial filler, tape, or other means can save considerable labor later required to clean out a contaminated cavity. And a contaminated cavity that is not cleaned out can make the efficient and effective installation of the neoprene seal impossible.

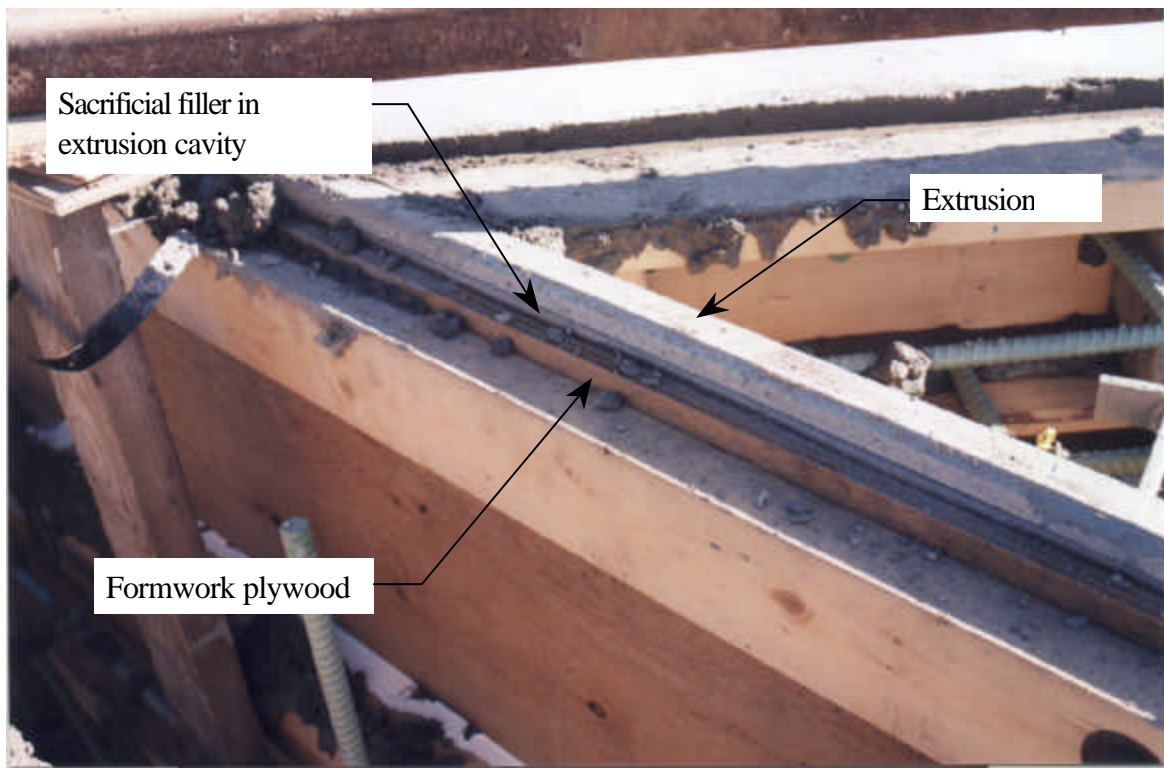

Figure 4.11 Foam backer rod was used to protect the cavity of the west side deck extrusion

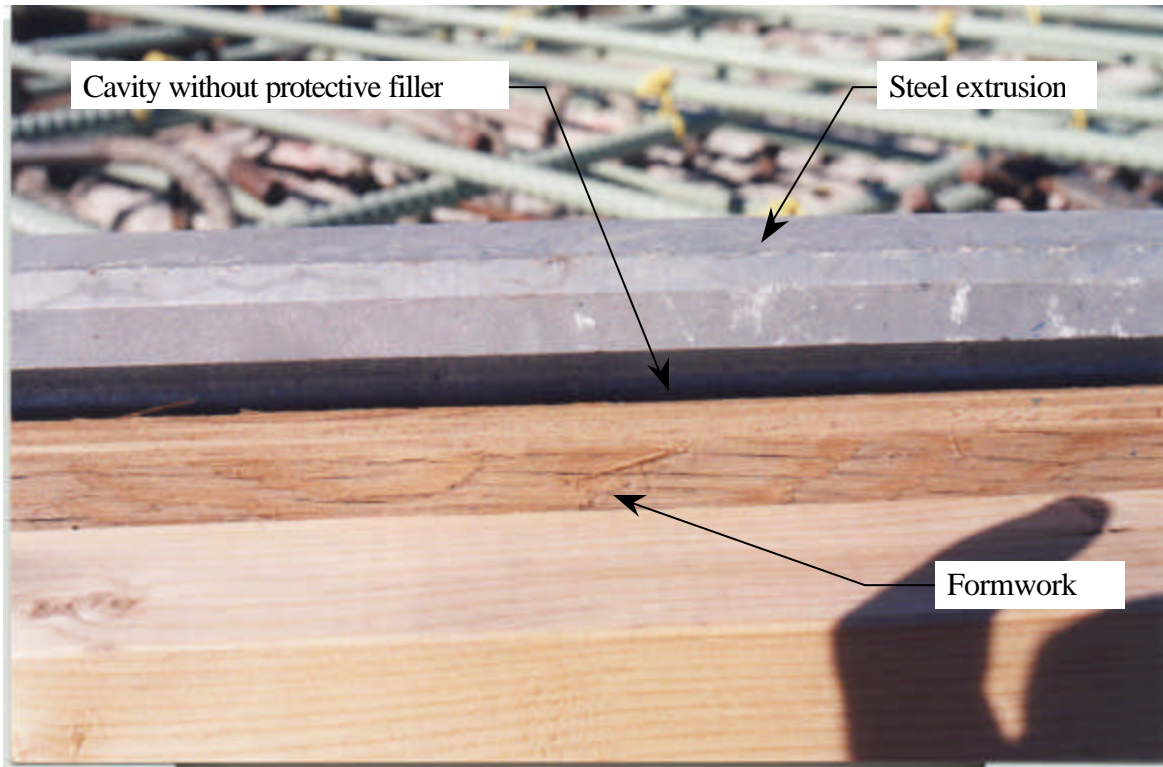

Figure 4.12 No sacrificial filler was present in the cavity on the east end of the deck

Sometime after the deck rails are installed, the deck is poured and the anchorages and bottom and deck-side of the rail are encased in concrete (Figure 4.13). After adequate curing time for the deck concrete (usually about a week), the deck formwork is stripped and forming of the backwalls begins. Once the formwork for the backwalls is complete, the rail sections on the backwall sides are positioned, attached to the backwall formwork, and welded together in a manner like that used for the rails on the deck side of the expansion joint. There is very limited space available between the deck and backwall formwork for connecting the rails to the formwork. On the Highway 5 bridge, small angle brackets with short bolts were welded to the bottom of the rail sections for this purpose (Figures 4.7 and 4.10).

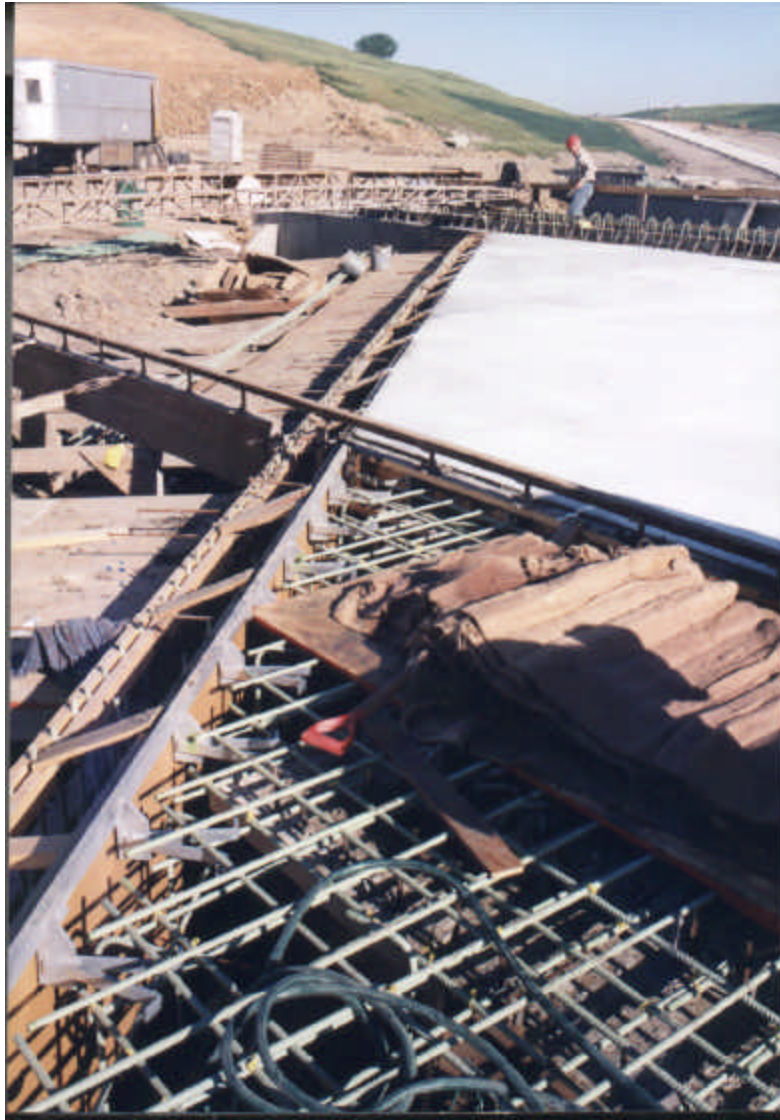

Figure 4.13 North portion of extrusion embedded in concrete

To create a uniform gap between the rails during the casting of the backwalls, a gap size is first selected (the top edge of the backwall formwork has enough play to allow adequate adjustment for this purpose). To maintain the selected gap, small steel plates are placed across the gap and tack welded to both rails (Figures 4.14 and 4.15). The gap is selected based on the gap-versus-temperature values given in the design specifications. For

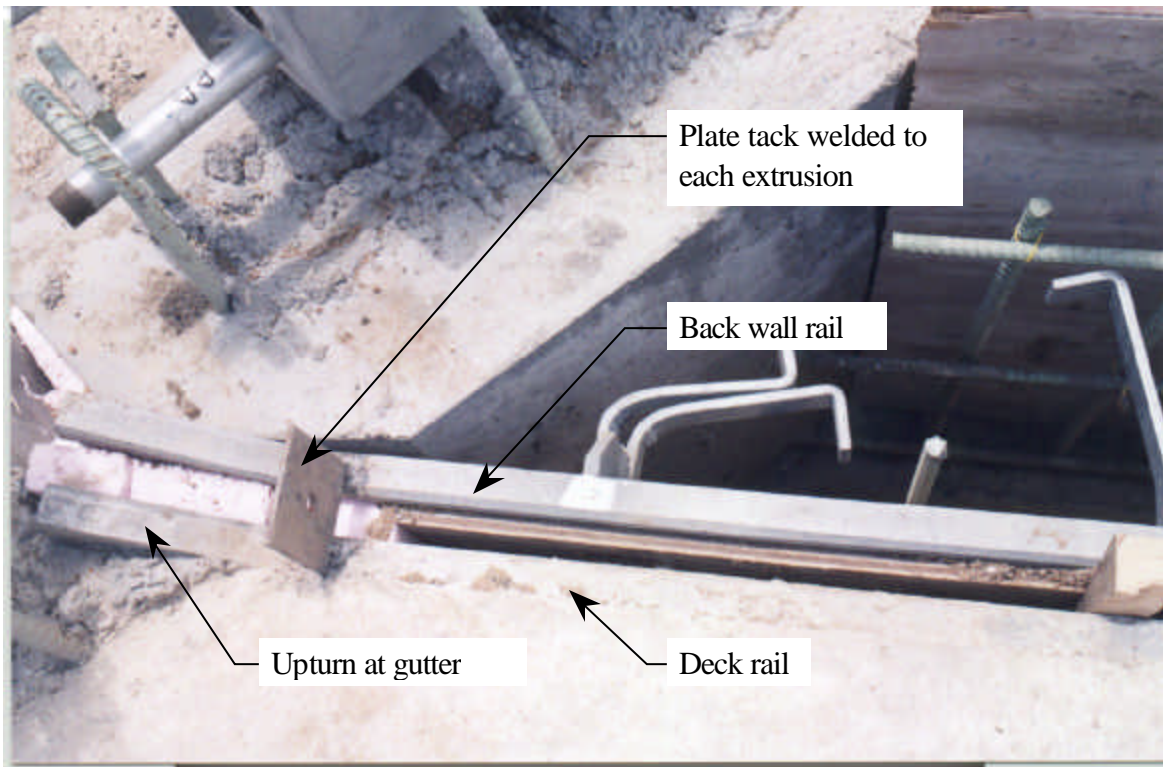

Figure 4.14 Small plates are tack welded to either extrusion to maintain gap

the temperature value, an estimate is made of the temperature expected to occur when the concrete is going to be placed based on the most recent weather forecasts. In actual practice in Iowa at present, the temperature used is typically an air temperature estimate as opposed to a bridge temperature estimate.

Sometime after the backwall rails are in place, the backwalls are cast and the anchorages and bottom and backwall faces of the rails are encased in concrete. Using the technique of plates across the gap that are tack welded to each rail (Figure 4.14), the gap setting cannot easily be changed. On the day the west backwall was poured on the IA Highway 5 bridge, the sky remained overcast longer than the weather service predicted. The air temperature at the time of concrete placement was therefore not quite as warm (by 5 to 10 degrees) as had been assumed in setting the gap opening.

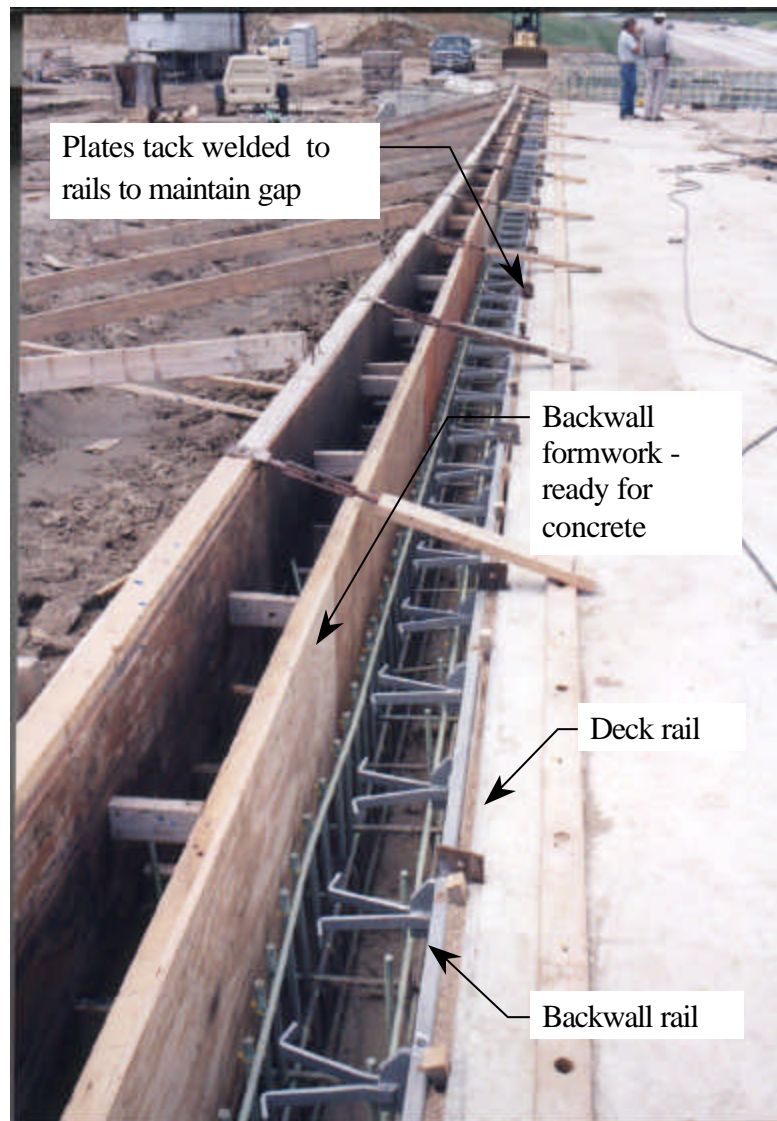

Figure 4.15 West backwall formed and ready for concrete

For intermediate joints in new construction, the gap between the rails is generally set during the forming. Both rails are fixed to the formwork and typically both are tack welded to horizontal bars or plates that are positioned to maintain alignment during casting. Multiple deck sections are then cast in a continuous pour, unless design requirements and/or the size of the bridge require multiple pours. As for setting the gap opening at the abutments, an

“educated guess” is made as to the temperature that is likely to occur when the deck is cast. And, as at the backwall joint, the gap cannot be easily changed once it has been set.

After the deck and backwall or deck sections are cast, embedding the two rail anchorages, and the forms have been stripped, the neoprene seal is installed in one piece from gutter to gutter (Figure 4.15). Before the actual installation of the neoprene seal, the cavities in the metal extrusions are cleaned as necessary to ensure that the strip seal will fit into the recesses properly. Cleaning the cavity can be difficult, especially if concrete has run over the rail and entered the cavity. That is the primary reason some contractors use a sacrificial filler in the recess or tape over the cavity to prevent dirt, concrete, and debris from fouling the cavities.



Figure 4.16 Seal is installed in one piece from end to end

Tools for efficiently cleaning the cavity do not seem to be readily available. Since the temperature is typically warm during construction, the gap between the pair of rails is typically small (2 in. or less) and provides little room to work (Figure 4.17). Even when the gap is larger, it is practically impossible to see into the upper portion of the cavity without mirrors or other special optical equipment. Cleaning of much of the cavity must therefore be

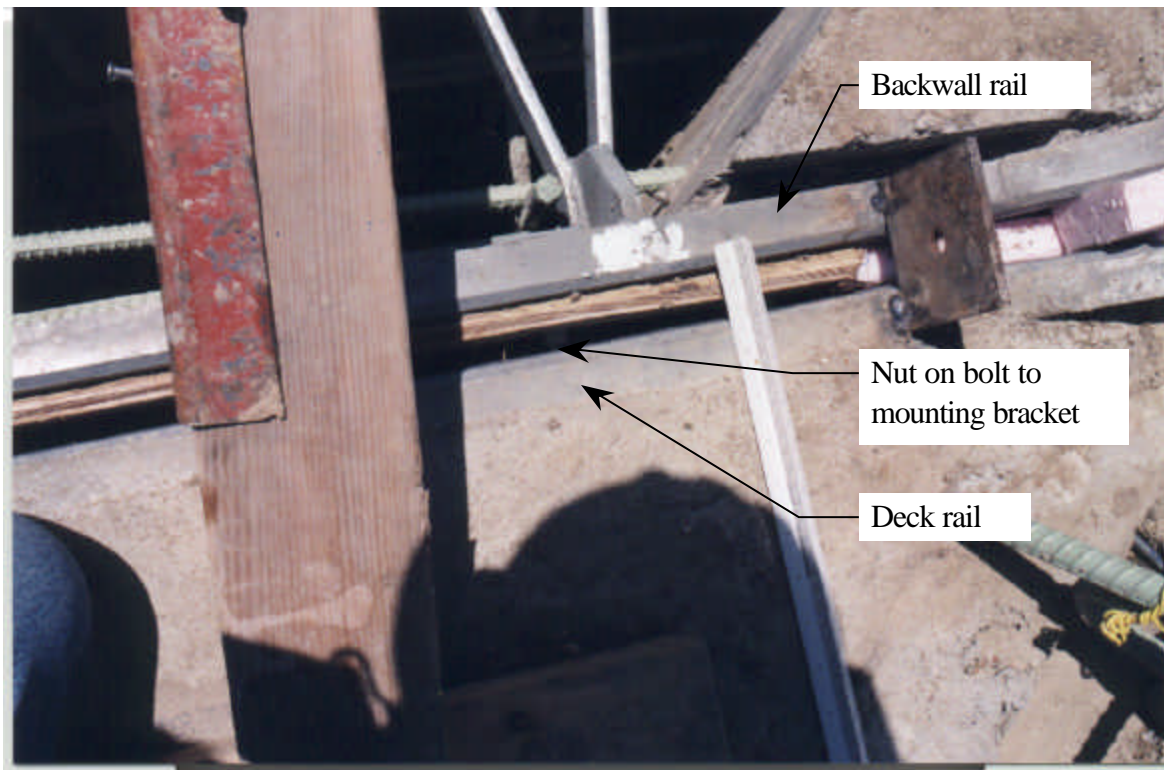

Figure 4.17 There is typically little room to work between the pair of extrusions

done by feel rather than by sight. Kevin Steffen of Peterson Construction said he uses a piece of heavy wire bent into a “J-hook” to clean the upper portion of the cavity. He runs the upturned end along the upper cavity to feel for debris and uses it to try to scrape off any debris so detected. A foreman for Cramer and Associates said that after using a tool to scrape from end-to-end of the rail and blowing out the rail cavities with an air hose, he

(carefully) runs a bare finger along the cavity to feel for any remaining debris. He said such care is worth it because any debris in the cavity during the installation of the neoprene seal can cause installation difficulties and/or may result in an ineffective seal. For the Highway 5 bridge, the installers used a pry bar and a bar with a hooked end to clean the lower and upper cavity space, respectively. They then blew out the cavities with an air hose two times and also blew debris away from the installation area. The cavities and neoprene seal were not cleaned with toluene or anything similar (see Section 4.1.2) and there were no directions to do so on the can of lubricant/adhesive being used.

To install the neoprene seals on the IA Highway 5 bridge the seal was first cut to length and then folded in the middle with the lugs up. Then the bottom “V” was pushed into the expansion joint opening with a metal bar (e.g., a pry bar or seal installation tool) such that the lugs were resting flat on top of the extrusions (Figures 4.16 and 4.18). Next, lubricant/adhesive was applied to the seal lugs with a paint brush. The seal was then pushed further down into the expansion joint opening until the two outer ears of the lugs caught on the opposing rail cavities (Figure 4.2). Then two installers, one working on each side of the joint and each with a pair of prying tools, forced the upper ears of the lugs into each rail cavity. The prying action to push the upper ears into the cavity was done in alternating fashion with the pair of tools and in increments of 2 to 3 in. The installers said the best test of whether or not the upper ear was completely seated was the appearance of the seal. They said there was generally no particular sound or feel when the upper ear became fully engaged. The lubricant/adhesive was applied 3 to 5 ft ahead of the installers (Figure 4.18).



Figure 4.18 Installation requires working in small increments

It took a crew of five about an hour and a half to clean the two cavities and do other installation preparation and then about another one-and-one-half hours to install the seal from gutter to gutter (Figure 4.19). The installers commented on how well the installation had gone and said it is not always that way. The temperature was ideal (about 65° F.) – the adhesive did not dry too quickly and the gap size was adequate. The installers said that any debris in the cavity can cause problems as can excess lubricant/adhesive. They said that too much lubricant/adhesive tends to push the seal lugs back out of the extrusion cavities.

One of the authors, Mr. V. Kau, made a visual inspection of the installed seal as the installation was nearing completion and noticed one small area (1 to 2 in. long) where the seal was not quite seated completely (one had to look closely to see it). The installers easily corrected this situation. (Had the weather been warmer such that the lubricant/adhesive was setting up faster, this may not have been the case.)

Contractors report that sometimes the installation of the neoprene seal goes very smoothly and sometimes it is terribly frustrating. In warm weather, the lubricant/adhesive

sets up faster and installers must be careful not to apply the lubricant too far ahead of those pressing the seal into place. In hot weather when the deck is close to the maximum expansion and the gaps are near minimum, installation can be difficult if not impossible. Too little or too much lubricant/adhesive can make it difficult to press the seal into the cavities. Any debris left in the cavity can prevent the seal from seating correctly and may require



Figure 4.19 Installation of seal complete at east end

pulling some of the seal back out to correct the problem. Installation can also be difficult on skewed bridges at the gutters if the rail must turn “out of skew” – neoprene seals do not readily conform to that kind of turn.

The installers for Creamer and Associates used a paint brush to apply the lubricant/adhesive as suggested by the manufacturer (Section 4.1.2). Kevin Steffen of Peterson Contractors said that swiping the lubricant/adhesive on with a rubber-gloved hand was one of most effective ways for ensuring adequate coverage of the neoprene seal lugs. Using this technique, the entire lug is covered with the material, top and bottom. For the technique used on the Highway 5 bridge, only the top and a little bit of the sides of the lug were covered (Figures 4.16 and 4.18). Some contractors said that the typical response of manufacturers to installation or seal retention (seal pullout) problems is to “use more lubricant/adhesive.” Some also said that some workers do not understand the importance of the lubricant/adhesive and perhaps do not understand that it is not just a lubricant but an effective adhesive/sealant as well (i.e., in the words of one contractor, “Crisco is not an acceptable substitute”).

Some workers also do not understand the correct way of inserting the seal into the rails (though the assumption seems to be that everyone does). On one of the instrumented bridges, according to Iowa DOT personnel, the installers inserted the seal at one end and pulled the seal through the rail cavities using vise grips to pull the seal along. This resulted in considerable damage to the end being pulled. Fortunately, the seal was pulled through far enough such that the damaged portion could be cut off. Contractors said seal systems obtained from suppliers do not come with installation instructions or specifications. The contractors assumed such materials would be available upon request, but they thought

suppliers just assumed contractors had been doing such things for a long time and did not need such information.

Contractors were generally not happy with the tools provided by manufacturers for pressing the seal into the extrusion recesses. Kevin Steffen (Peterson Contractors) obtained one manufacturer-supplied tool several years ago that he thought worked very well, but in general, ordinary crow-bars, pry bars, and similar tools seemed to work best. Typically, such prying tools were used to press the upper lug into the upper recess using the opposing rail as a pivot point (see the Watson Bowman Acme illustrations in Figure 4.2).

For rehabilitation work, Cramer Associates uses a technique that does allow some adjustment of the gap if blockouts are used in the process. Horizontal brackets (perhaps supplied by the rail manufacturer) are used to span the blockouts and joint opening and are attached to the pavement outside of the blockouts (Figure 4.1). The rails are then attached to these brackets to hold them in position. If threaded studs temporarily welded to the tops of the rails are used to make the rail-to-bracket connections and the brackets have slotted holes, then some adjustment may be possible right up to the time of placing the blockout fill material. In other rehabilitation work, the new rails may simply be welded to the tops of the existing rails before an overlay is applied. In this case, the “new” gaps are simply repeats of the gaps set in the original construction (although some adjustment is theoretically possible).

5. DATABASE ANALYSIS AND SURVEY OF STATE DOTs

5.1 Overview

Access to the Structures Inventory and Appraisal database (BASEREC) and the Supplemental Structures Inventory database (SSI) was provided by the Iowa DOT for use by the ISU research team for this project. These databases were used to investigate the performance of strip-seal expansion joint systems in Iowa. The databases were analyzed to search for factors, such as traffic volume and skew angle, that might be related to premature failures in such systems. In addition, a national survey was conducted to obtain information from other states about their experiences with strip-seal expansion joints.

5.2 Analysis Based on Iowa DOT Databases

Iowa DOT personnel inspect the condition of in-service bridges at least once every two years. There are three general types of bridge inspection: intensive inspections, field inspections, and inspections classified as “other”.

As part of an intensive inspection, ratings are assigned to the strip-seal expansion joints and gap measurements and the shade temperature at the bridge location are recorded in an inspection report. The joint ratings and other selected information from the inspection report are also recorded in the databases maintained by the Iowa DOT. Basic information including the location of the bridge, facility carried, main structure type and the year built is recorded in the BASEREC database. Ratings assigned to the expansion joints are recorded in the SSI database. However, if a strip seal is replaced, the replacement information is not recorded in either database. Therefore, the actual age of the seal in a particular expansion joint is not necessarily known from these databases.

Information from these databases was used to produce the histograms that are shown later in this chapter. Only end deck joint ratings (ratings that represent the condition for the expansion joint devices installed between the bridge deck and abutment backwall) were included in the plotted data. Intermediate deck joint ratings (ratings for expansion joint devices between two deck sections) were not included. Interpretations of the strip-seal expansion joint ratings used by the Iowa DOT are summarized in Table 5.1:

Table 5.1 Interpretations of Iowa DOT strip-seal expansion joint ratings

Rating	Condition
5	Complete or serious failure
6	Some tearing or pulling out
7	Satisfactory condition
8	In good condition but filled with debris
9	Brand new or in excellent condition

Though the Iowa DOT ratings apply to the condition of the entire expansion joint system, premature failures in Iowa are generally failures of the neoprene seal. Hereafter, therefore, the term “strip seal” will generally be used rather than “strip-seal expansion joint system” in connection with failure analysis. The condition of the end deck joint strip seals in Iowa bridges is summarized in Figure 5.1. End deck joints are those between the bridge deck and the abutment backwall. Intermediate deck joints (those between two bridge deck sections) are not included in Figure 5.1. Based on the information in the two databases and assuming a rating of 5 or 6 represents significant to complete failure, approximately 17% of the total number of end deck joint strip seals have failed.

Using information in the databases, three factors were investigated as possible causes of the premature failure of strip seals: skew angle of the bridge deck, average daily traffic

volume (ADT) and a deduced “age” of the strip seal. The “age” of the strip seal was obtained by comparing the database items of year built, reconstruction year, resurfacing year and remodel year. The ISU researchers assumed that the strip seal (and expansion joint) was new on the date that any of these events occurred and, therefore, used the most recent of such events to calculate the “age” of the strip seal.

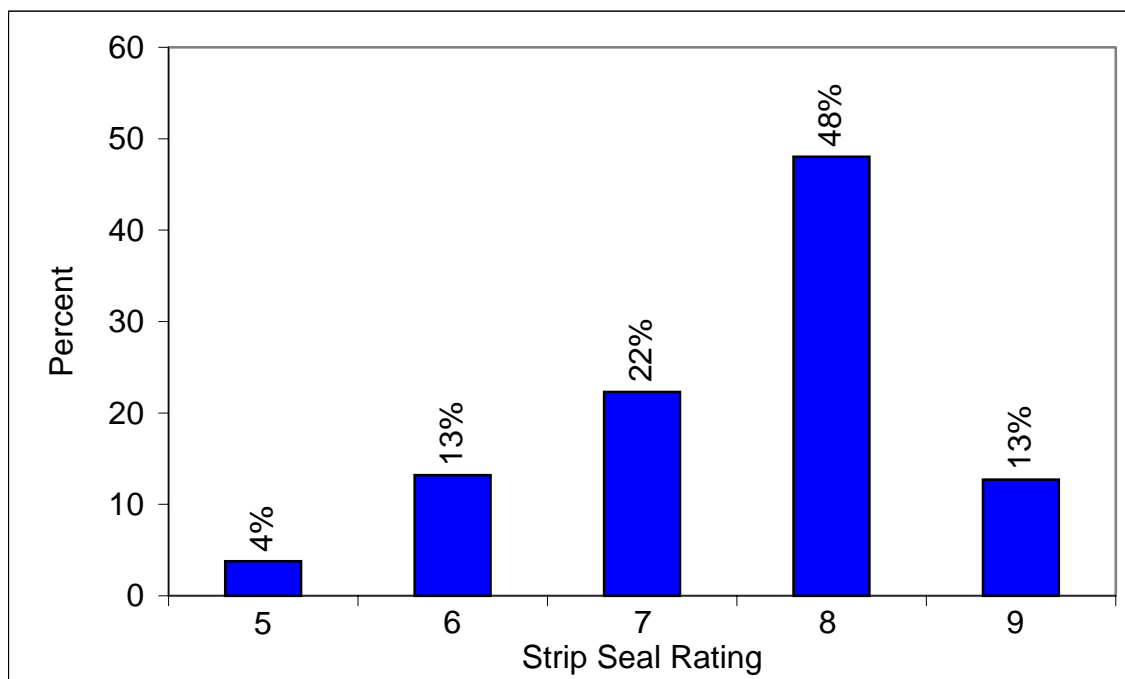

Figure 5.1 – Ratings of the end deck joint strip seals in Iowa bridges

Figure 5.2 shows the distributions of ratings as a function of skew angle of the bridge deck. As shown in Figure 5.2, the combined percentage of strip-seal expansion joints with a rating of 5 or 6 increases slightly as the range of the skew angle of the bridge deck increases from 0°-15° to 35°-45°, but the evidence is not sufficient to draw any firm conclusion.

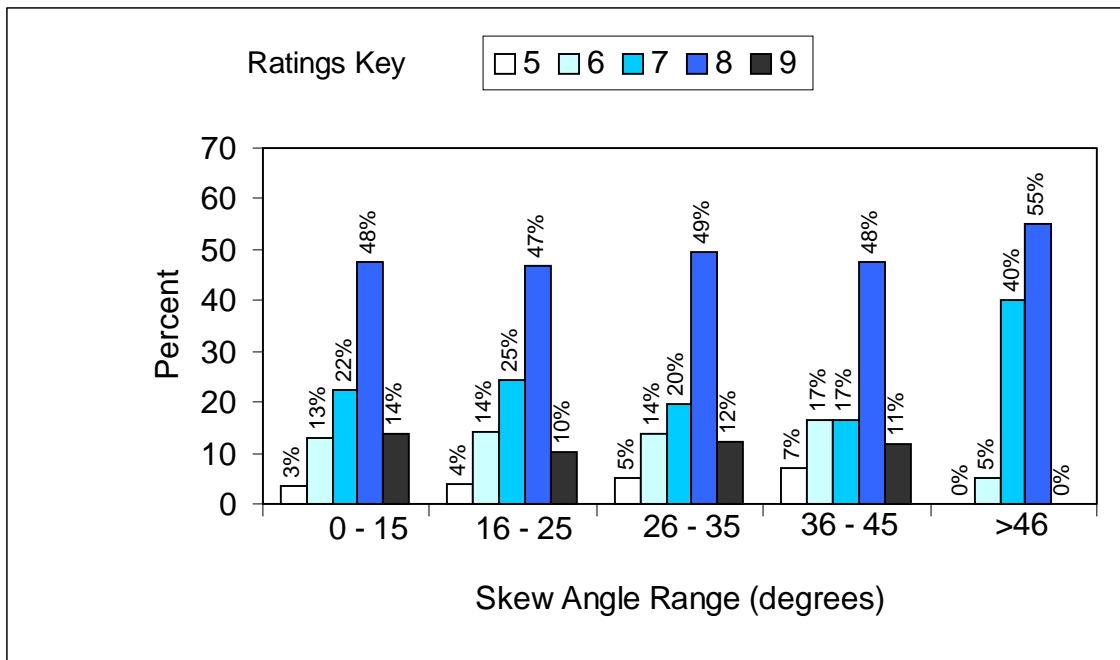

Figure 5.2 End deck joint strip seal rating versus skew angle of bridge

Figure 5.3 shows the distributions of the ratings of the strip-seal expansion joints as a function of the average daily traffic (ADT) volume. As shown in Figure 5.3, there is no evidence of a correlation between the rating of a strip-seal expansion joint and the average daily traffic volume.

As stated in Section 1.1, the expected service life of a strip seal is fifteen to twenty years. Somewhat arbitrarily, therefore, only the strip seals with an “age” of 30 years or less are included in the plot shown in Figure 5.4. That figure shows the distributions of ratings of strip seals as a function of “age.” Figure 5.4 suggests no evidence of a correlation between the rating of a strip seal and the “age” of the strip seal.

Though large skew angles and large traffic volumes might be expected to adversely effect the service life of strip seals, information in the Iowa DOT databases does not seem to

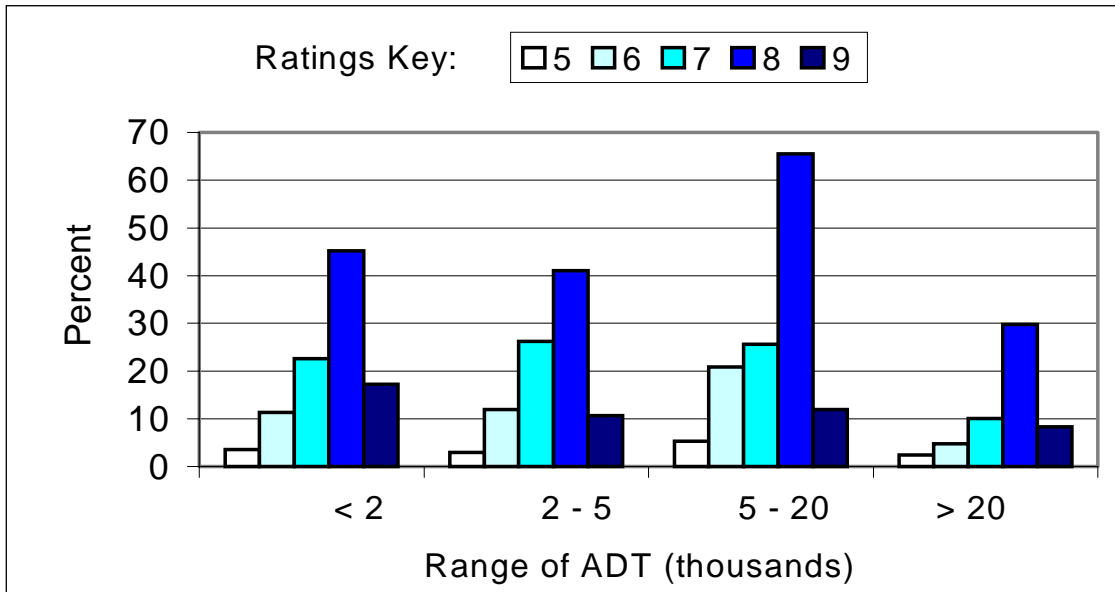

Figure 5.3 End deck joint strip-seal rating versus Average Daily Traffic (ADT)

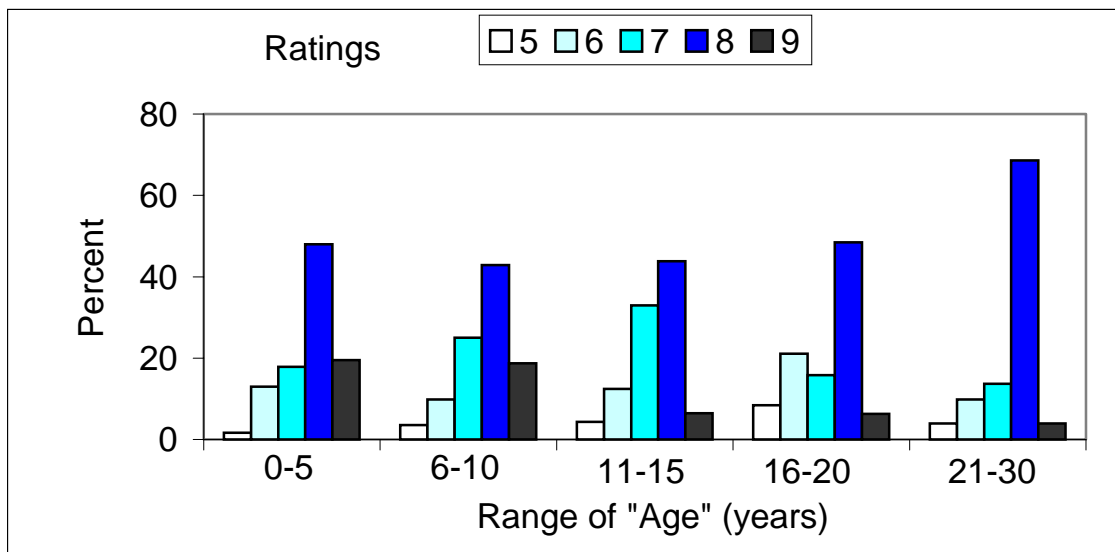

Figure 5.4 End deck joint strip-seal rating versus "age" of seal

support any such conclusions. And in any case, any such conclusions would be open to question because the actual age of a given strip seal, which is critical in determining whether or not failure is considered "premature," is not necessarily known from the databases.

Perhaps many of the strip seals with higher ratings (ratings of 8 or 9) are seals that have been replaced within the last several years, but this information is not recorded in either of the databases nor in the inspection reports. Therefore, no conclusions could be reached based on the review of the database information related to strip seals provided by the Iowa DOT.

5.3 Survey of State Departments of Transportation

To obtain information about the experiences with strip-seal expansion joints of other states, a questionnaire was mailed to all the departments of transportation of all the states (except Iowa) and Puerto Rico. The questionnaire gathered information about frequency of use, success/failure rate, likely causes of premature failure, brands of seals used, and design, installation, and maintenance procedures. The questionnaire is shown in Figure 5.5. Of the 50 questionnaires mailed, 40 were completed and returned. The results from these 40 responses are summarized in Tables 5.2, 5.3, and 5.4.

In only one of the 40 states that responded are strip seals not used (Maryland – see Table 5.2). (For purposes of this discussion, Puerto Rico will be included as a state.) Of the 40, the largest users are Minnesota, Ohio, Pennsylvania, Tennessee, and Texas (each with more than 1200 expansion joints with strip seals).

For the questionnaire, premature failure was defined as failure in less than 5 years. According to a manufacturer's representative, normal expected service life is 15 to 20 years. Of the 37 states that responded to Question 3, about half (19) have relatively few premature failures (0-5%), but 10 are in the 6-10% range and 8 are at 11% and above of premature failures. Respondents from three states (Alaska, Mississippi, and Puerto Rico) indicated they have premature failure rates exceeding 40%.

Strip Seal Questionnaire F99A - Civil and Construction Engineering, Iowa State University

Respondent's Name: _____ Phone Number: _____ Email: _____

(For the following questions, please check all that apply.)

0. Would you like a copy of the final report from this study?

Yes No

1. Are strip seals (see illustration enclosed) used in any of the bridge expansion joints in your state?

Yes No (If NO, please stop and return this form)

2. Approximately how many bridge expansion joints that use strip seals are there in your state?

0 – 200 201 – 400 401 – 800 801 – 1200 More than 1200

3. Strip seals are normally expected to last 15-20 years. Approximately what percent of the strip seals that have been used in your state have failed (pulled out/torn off) “prematurely” (say, < 5 years)?

0% - 5% 6% - 10% 11% - 20% 21% - 40% >40%

4. If a significant number (> 5%) of “premature” strip seal failures have occurred in your state, do you have an opinion as to the most common cause of such “premature” failures?

Wheel loads transmitted to the seal by debris or ice that has accumulated in the joint

Structural thermal movement different than that used in design

Incorrectly sized strip seal

Incorrect setting of the expansion joint opening during construction

Failure of the lubricant/adhesive used to install the strip seal

Inadequate design and/or manufacturing tolerances of the strip seal components

Deterioration due to chemical interactions

Other (please specify) _____

No opinion

5. Which manufacturers provide strip seals for use in your state?

Watson Bowman Acme The D.S. Brown company General Tire

Lewis Engineering Company R.J. Watson Other (please specify) _____

6. Does your state have any regular maintenance program specifically for expansion joints using strip seals?

Yes No (If YES, please describe briefly on the back of this sheet)

7. Does your state DOT have standard design procedures for strip seal?

Yes No

8. What is the maximum designed expansion joint opening for which your state DOT uses strip seals? _____ in.

9. Does your state DOT have written standards for the installation (including end treatment) of strip seals?

Yes No

10. If the answer to questions 7 and/or 9 is YES, from whom can we obtain the written standards for design and/or construction procedures for strip seals?

Name: _____ Phone Number: _____ Email: _____

Address: _____ City: _____ State: _____ Zip: _____

Figure 5.5 Strip Seal questionnaire sent to the DOTs of all the states (except Iowa)

Table 5.2 Responses to questions about the use and failure rates of strip seals

STATE (respondents in bold)	1. Strip seals used in your state?		2. Approximately how many bridge expansion joints use strip seals in your state?					3. Approximately what percent fail prematurely?				
	YES	NO	0 to 200	201 to 400	401 to 800	801 to 1200	>1200	0 to 5%	6 to 10%	11 to 20%	21 to 40%	>40%
ALASKA	1		1									1
ARIZONA	1			1					1			
ARKANSAS	1		1						1			
CALIFORNIA	1					1			1			
COLORADO	1			1					1			
DELAWARE	1		1						1			
GEORGIA	1				1				1			
HAWAII	1		1						1			
IDAHO	1		1							1		
ILLINOIS	1		1									
KANSAS	1				1				1			
LOUISIANA	1			1					1			
MAINE	1		1						1			
MARYLAND		1										
MASSACHUSETTS	1				1				1			
MINNESOTA	1						1			1		
MISSISSIPPI	1		1									1
MISSOURI	1		1						1			
MONTANA	1			1						1		
NEBRASKA	1				1							
NEVADA	1			1						1		
NEW HAMPSHIRE	1		1							1		
NEW JERSEY	1			1							1	
NEW MEXICO	1					1			1			
NEW YORK	1			1						1		
NORTH CAROLINA	1		1						1			
NORTH DAKOTA	1		1								1	
OHIO	1						1		1			
OREGON	1		1								1	
PENNSYLVANIA	1						1		1			
PUERTO RICO	1				1							1
RHODE ISLAND	1		1								1	
SOUTH DAKOTA	1			1						1		
TENNESSEE	1						1		1			
TEXAS	1							1		1		
UTAH	1			1						1		
VERMONT	1		1							1		
VIRGINIA	1							1				
WISCONSIN	1				1						1	
WYOMING	1		1						1			
TOTALS	39	1	16	9	6	2	5	19	10	4	1	3

Table 5.3 Responses about causes of premature failure of strip seals

STATE (respondents in bold)	4. Do you have an opinioin as to the most common cause of "premature" failures?								
	Wheel loads	Thermal movement	Incorrect sizing	Incorrect setting	Lubricant/adhesive	Manufac. tolerances	ical interactions	Other	No opinion
ALASKA	1			1					
ARIZONA									
ARKANSAS									
CALIFORNIA									
COLORADO	1								
DELAWARE	1								
GEORGIA								1	
HAWAII									
IDAHO	1			1					
ILLINOIS									
KANSAS			1	1				1	
LOUISIANA									
MAINE								1	
MARYLAND									
MASSACHUSETTS									
MINNESOTA	1	1		1		1		1	
MISSISSIPPI									1
MISSOURI	1	1	1						
MONTANA	1	1		1					
NEBRASKA			1					1	
NEVADA	1	1		1					
NEW HAMPSHIRE	1								
NEW JERSEY	1						1		
NEW MEXICO									
NEW YORK				1		1			
NORTH CAROLINA									
NORTH DAKOTA	1							1	
OHIO	1							1	
OREGON								1	
PENNSYLVANIA									1
PUERTO RICO				1				1	
RHODE ISLAND	1							1	
SOUTH DAKOTA	1				1				
TENNESSEE									
TEXAS	1								
UTAH	1			1	1				
VERMONT	1								
VIRGINIA									
WISCONSIN	1			1		1		1	
WYOMING									
TOTALS	18	4	3	10	2	3	1	11	2

The fourth question asked for opinions about possible causes of premature failures of strip seals. Seven specific causes were listed for selection along with an “Other (please specify)” category and a “No opinion” option (see Figure 5.5 and Table 5.3). Of the 22 respondents who had an opinion as to the most common cause(s) of premature failure of strip seals, 18 selected “wheel loads transferred to the seal by debris or ice that had accumulated in the joint” (Table 5.3). Ten of the respondents thought a most common cause was incorrect setting of the expansion joint opening during construction. Also, of the 22, 18 indicated more than one “most common cause” and in several cases specifically noted that they thought failure was often caused by a combination of factors.

Several suspected or known causes not listed on the questionnaire were specified by respondents in the “other” category. One was creep in prestressed beams (Wisconsin). A second was the setting/hardening of the adhesive before installation is completed, especially when the weather is warm and a small gap leaves little room to work (Rhode Island). A third was a snow plow blade matching the skew angle of the bridge and catching and damaging the expansion joint and/or seal (Ohio and Nebraska). A fourth was poor quality of the elastomeric gland (Minnesota). A fifth was improper installation (Georgia and North Dakota).

Of the manufacturers of strip seals, Watson Bowman Acme Corporation (WBA), Amherst, New York, and The D. S. Brown Company (DSB), North Baltimore, Ohio, are by far the most common suppliers. Both WBA and DSB strip seals have been used in 35 of the 39 states that responded and use strip seals (Table 5.4). The next most common supplier is R. J. Watson (RJW), Inc., East Amherst, New York, which has supplied strip-seal systems to 10 of the 39 responding states. Though General Tire (GT) and Lewis Engineering Company

Table 5.4 Responses about manufacturers, maintenance, design, and installation per

STATE (respondents in bold)	5. Which manufacturers provide strip seals for use in your state?						6. Regular maintenance program?		7. Standard design procedures?		8. Max. opening?	9. Written installation standards?	
	WBA	DSB	GT	LEC	RJW	Other	YES	NO	YES	NO		YES	NO
ALASKA	1							1		1			1
ARIZONA	1	1						1		1		4	1
ARKANSAS	1	1		1				1	1		2.5@60	1	
CALIFORNIA	1	1						1	1			4	1
COLORADO	1	1						1	1			4	1
DELAWARE	1	1						1		1		4	1
GEORGIA	1	1						1		1		4	1
HAWAII	1	1						1	1	1		4	1
IDAHO	1	1					1		1		4 (5)	manu.	
ILLINOIS	1	1						1		1			1
KANSAS	1	1		1	1			1	1			4	1
LOUISIANA	1	1				1		1	1			4	1
MAINE	1	1			1		1	1	1		3.5	1	
MARYLAND													
MASSACHUSETTS	1	1					1	1	1		6		1
MINNESOTA	1	1		1				1	1			4	1
MISSISSIPPI	1	1	1					1		1			1
MISSOURI	1	1	1	1	1	1	1			1		4	1
MONTANA	1	1			1			1	1			4	1
NEBRASKA	1	1	1					1		1		4	1
NEVADA	1	1			1			1		1		4	1
NEW HAMPSHIRE	1	1			1			1		1		3	1
NEW JERSEY		1			1			1		1		1	1
NEW MEXICO	1	1			1			1	1			2.5	1
NEW YORK	1	1			1	1		1	1			3	1
NORTH CAROLINA		1						1		1		3.5	1
NORTH DAKOTA	1			1				1		1		4	1
OHIO	1	1						1	1			5	1
OREGON	1	1						1	1			4	manu.
PENNSYLVANIA	1	1					1		1			5	1
PUERTO RICO	1	1						1		1		6	1
RHODE ISLAND	1	1			1			1	1		man rec.	1	
SOUTH DAKOTA	1	1		1				1	1			4	1
TENNESSEE	1	1				1		1	1			4	1
TEXAS	1	1						1		1		5	1
UTAH	1	1				1		1		1		5	1
VERMONT	1	1						1		1			1
VIRGINIA								1		1		3.5	1
WISCONSIN		1		1				1	1			5	1
WYOMING	1							1		1		4	1
TOTALS	35	35	3	7	10	5	5	36	19	20		20	17

(LEC) products have been used in several states in the past (perhaps including Iowa), both are no longer available (see Section 3.1).

Only 5 of 39 respondents have any kind of regular maintenance program for strip-seal expansion joints (Table 5.4). Idaho, Maine, and Pennsylvania include a yearly cleaning and flushing in their maintenance plans (though the Idaho respondent said the cleaning doesn't always get done). Missouri maintenance practice is to wash out the expansion joints twice year when the bridge decks are flushed. The respondent from Massachusetts wrote "If joints are cleaned on a regular basis, our failure rate is close to 0%. If the joints are not cleaned, the failure rate is about 5%." All five states with some kind of maintenance program reported a premature failure rate in the 0-5% range for strip-seal expansion joints.

About half of the respondents indicated that they have state DOT design procedures for strip-seal systems and about half indicated they did not have such written design procedures (Table 5.4). The same was true for written installation standards. A majority of state DOTs (19 of 35 responses) limit the use of strip seals to expansion joints with a maximum predicted opening of 4 in. Five states allow an opening up to 5 in. and 2 states permit 6-in. maximums. Six states restrict the maximum joint opening to something less than 4 in.

6. EXPERIMENTAL INVESTIGATION OF SELECTED BRIDGES

6.1 Overview

Twelve bridges were instrumented in five counties within Iowa: Story County, Polk County, Marshall County, Black Hawk County and Bremer County. Most of the twelve bridges that were instrumented had had premature failures of the strip seals, in some cases slight failure, and in other cases major failure. For those bridges, Iowa DOT bridge inspectors had reported that some of the strip seals were pulled out from the metal extrusions, torn apart, or both pulled out and torn apart. As part of the investigation of these twelve bridges, inspection records were reviewed and, for those bridges for which they were still available, construction records as well.

The primary goals of the field instrumentation were to record the gap openings at the expansion joints and corresponding representative bridge temperatures, determine the experimental α -values of the bridges, and compare the experimental results with values predicted by and used in the Iowa DOT design equations. For eleven of the twelve bridges, two thermocouples were installed to measure bridge temperatures. For one of the twelve bridges (a steel-girder bridge), twenty thermocouples were installed. Vernier calipers were used to measure the gap openings of the expansion joints.

6.2 Experimental Program

6.2.1 Bridge Selection

Selection of the twelve bridges was based on information in databases provided by the Iowa DOT and recommendations provided by the Office of Bridge Maintenance and

Inspection of the Iowa DOT. A brief summary of descriptive data for the twelve instrumented bridges is listed in Table 6.1.

Table 6.1 Data summary for the twelve instrumented bridges

Pilot Study Bridge ID	FHWA number	Iowa DOT Maintenance number	Iowa County	Structural length (ft)	Girder material	Year built	Average Daily Traffic	Skew angle (°)
1	606200	0781.1R218	Black Hawk	1317	Concrete	1991	23,700	6
2	606210	0781.1L218	Black Hawk	1333	Concrete	1991	23,700	4
3	601235	0996.0R218	Bremer	679	Concrete	1993	12,600	0
4	601240	0996.0L218	Bremer	679	Concrete	1993	12,600	0
5	601575	0787.7A218	Black Hawk	620.7	Concrete	1995	810	30
6	605800	0784.8S218	Black Hawk	755.9	Concrete	1989	23,500	20
7	607795	8561.5L030	Story	302.8	Concrete	1997	6,100	37
8	606800	7776.8L065	Polk	615.2	Concrete	1997	9,700	0
9	601620*	6485.3L030	Marshall	275.9	Steel	1995	3,170	0
10	007911	6402.0S014	Marshall	861.9	Concrete	1985	12,600	5
11	035431	6403.6L014	Marshall	475.1	Steel	1987	6,800	15
12	601895	6481.9L030	Marshall	230	Concrete	1996	5,900	45

**Instrumented with twenty thermocouples*

Bridges are identified by both a Federal Highway Administration (FHWA) number and a Maintenance number by the Iowa DOT. The Maintenance number of a bridge is a combination of the county identification number, the last three digits of the mile posting, a letter designation, and the highway number. Mile posting increases from south to north and from east to west. For example, for the bridge maintenance number 0781.1R218 identifies a bridge that is located in Black Hawk County (county ID 07), is at the mile post number of 181.1, is in the northbound lane (R is for the Right and L the Left bridge of a four-lane road, A represents an Approach bridge such as an exit ramp), and carries traffic of US Highway 218. For purposes of this study, a Pilot Study Bridge Identification number was also given to each of the twelve bridges.

All the bridges are located within the State of Iowa, with one located east of Nevada in Story County, one located east of Des Moines in Polk County, four located in or near Marshalltown in Marshall County, four located in Waterloo in Black Hawk County, and two located north of Waterloo in Bremer County. Of the twelve bridges, two are steel-girder bridges and ten are prestressed concrete-girder bridges.

6.2.2 Instrumentation

To determine the locations for the thermocouples, temperature data from a separate field study of concrete, integral-abutment bridges in Guthrie County and Story County [12] was analyzed. In that study, a bridge in Guthrie County north of Panora, Iowa was instrumented with forty-seven thermocouples. Comparisons were made between the coefficients of correlation of the temperature readings from each thermocouple and the displacements of the abutments (see Appendix A). The results of those comparisons showed that two of the better locations for obtaining a representative concrete-girder bridge temperature, T_b , are at the inside upper flanges of the outside girders near the middle of an end span as shown in Figure 6.1 (the best ten locations and the corresponding coefficients of correlation are presented in Appendix A). The representative bridge temperature is the average of the readings from all the thermocouples installed on a bridge. Based on these results from the integral abutment study, thermocouples for the concrete-girder bridges in this investigation were installed on the inside sloping portion of the upper flanges of the two exterior girders at the middle of an end span (Figure 6.1). The thermocouples were embedded about one inch into the upper flanges of the girders and at about half the distance between the face of the web and the edge of the flange.

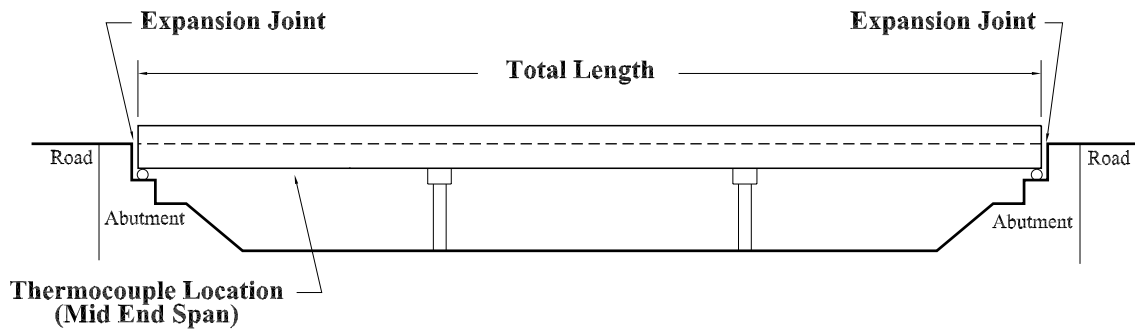

(a) Elevation view (not to scale)

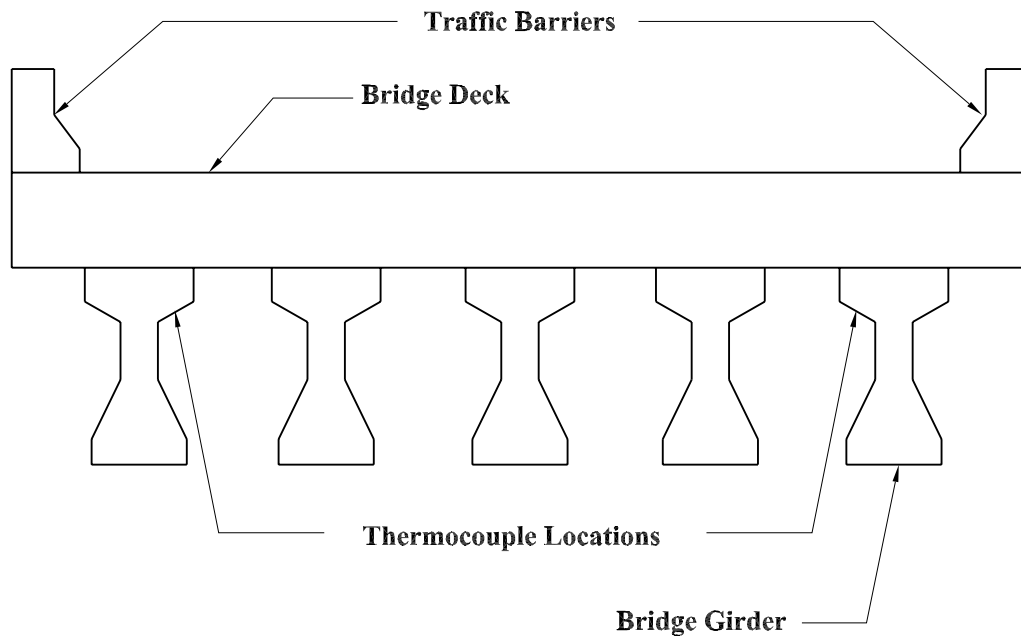

(b) Cross-sectional view (not to scale)

Figure 6.1 Thermocouple locations for concrete-girder bridges

The integral abutment bridge studies did not provide information about the best location for determining T_b for steel-girder bridges. Therefore, one of the steel-girder bridges in this study (Bridge 9, Maintenance Number 6485.3L030) was instrumented with twenty thermocouples. Eighteen of the thermocouples were installed on the girders in nine groups in one of the end spans as shown in Figure 6.2 and two were installed in the deck

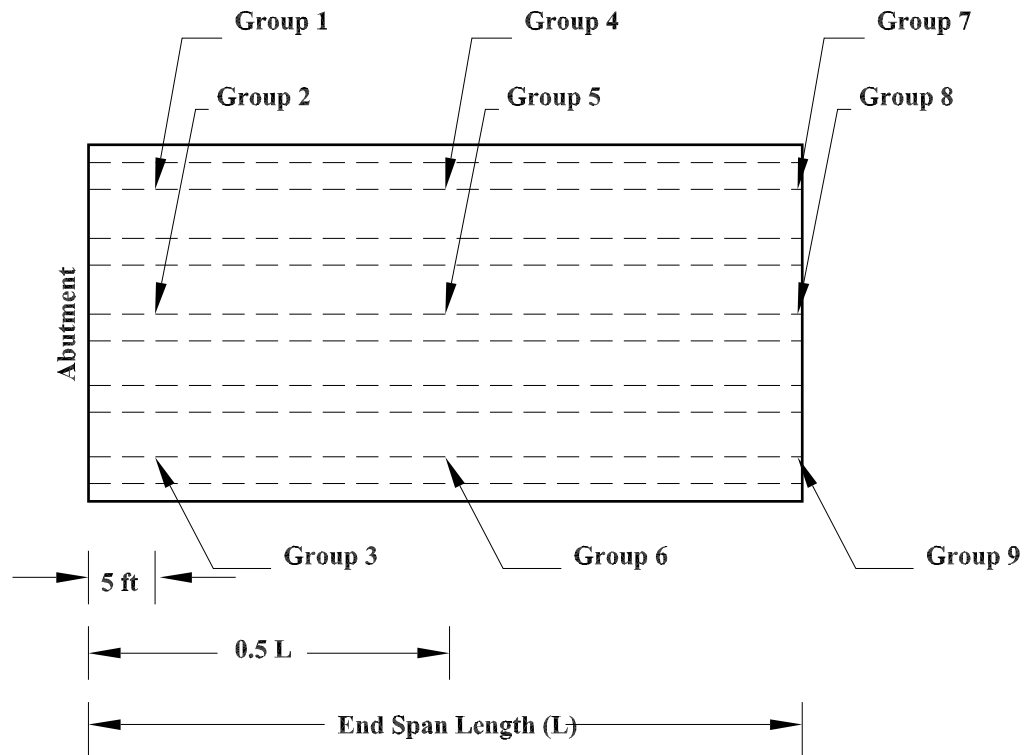

(a) Plan view (not to scale)

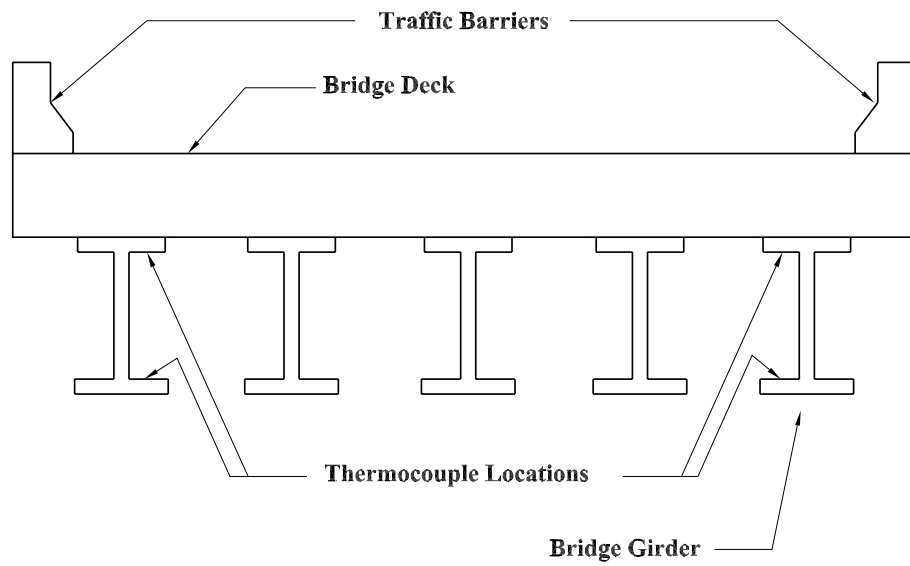

(b) Cross-sectional view (not to scale)

Figure 6.2 Thermocouple locations on steel-girder Bridge 9 (6485.3L030)

slab. Each of the nine groups in Figure 6.2(a) consisted of two thermocouples, one on the upper flange and one on the lower flange as shown in Figure 6.2(b).

Linear regression analysis was used on the twenty thermocouple readings and gap openings recorded from December of 1999 to July of 2000 for Bridge 9 (6485.3L030). The coefficients of correlation for each of the eighteen thermocouples installed on the steel girders of Bridge 9 are shown in Appendix A. The results showed that the best of the twenty locations for obtaining the representative bridge temperature would have been on the inside of the top flange of the north outside girder near the pier. The two thermocouple locations selected for the second steel-girder bridge, Bridge 11 (6403.6L014) were on the insides of the top flanges of the two outside girders in an end span (similar to the two locations used for all the concrete-girder bridges). These two locations correspond to the fifth and tenth best correlation coefficients (R-squared values of 0.9616 and 0.9304) for measured gap opening versus thermocouple reading for Bridge 9 (6485.3L030).

6.2.3 Data Collection

Five types of data were recorded during data collection: thermocouple readings, shade temperature at the bridge location, expansion joint openings, time of day, and sky conditions. Shade temperature was measured using a thermocouple and the thermocouple reader. Data was collected in as large a variety of temperatures and sky conditions as was practical. Sky conditions are considered important because of the heating effects of direct sunlight on portions of the bridge.

Regardless of the skew angle, the gap openings were measured perpendicular to the steel extrusions (see Figure 6.3) at approximately one foot in from each gutter line at each end of an expansion joint.. Each gap was measured twice using a vernier calipers. If the

difference between the two successive measurements was more than 0.01 in., a third measurement was taken. The average of the two measurements within the 0.01 in. variation was recorded on the data sheet.

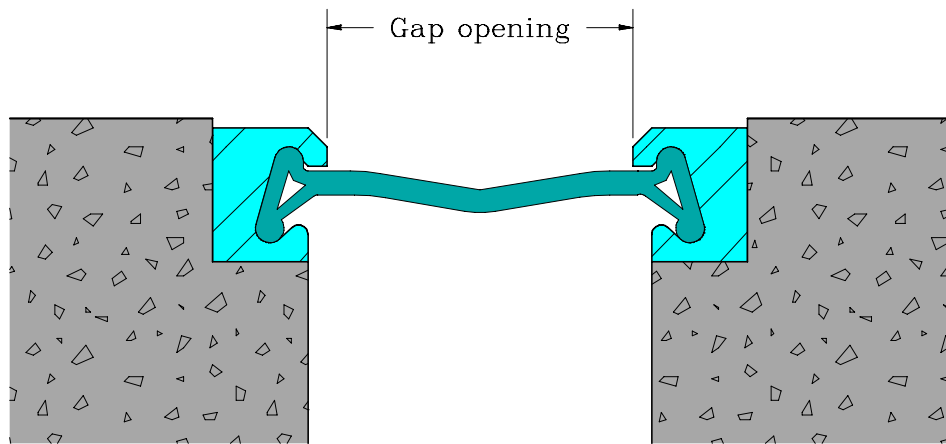

Figure 6.3 Measured expansion joint opening

Thermal movements of bridges follow both an annual cycle and a daily cycle. To obtain sample daily cycles, multiple readings within a single day were taken for the four instrumented bridges (two steel-girder bridges and two concrete-girder bridges) in or near Marshalltown, Iowa and the six bridges (all concrete-girder bridges) located in the Waterloo, Iowa area. The earliest set of data was taken before sunrise and the last set of data was taken shortly after sunset. These multiple sets of daily cycle data were obtained in both January and July of 2000. The results of analyses of daily cycle data did not seem meaningful, however, and therefore they are not included in this report.

To obtain data for the annual cycle, data was taken at least once a month from December of 1999 to August of 2000 for the bridges that were located in or near

Marshalltown, Nevada or Des Moines, Iowa and at least once every two months from December of 1999 to July of 2000 for the six bridges located in the Waterloo, Iowa area. A summary of the data collection schedule is shown in Table 6.2:

Table 6.2 Data sets* collected and collecting schedule for the twelve instrumented bridges

Month	Six bridges in Black Hawk and Bremer counties	Four bridges in Marshall county	One bridge in Story County	One bridge in Polk County
Dec. of 1999	1	1	1	1
Jan. of 2000	2	3	1	1
Feb. of 2000	None	1	1	1
Mar. of 2000	1	1	1	1
Apr. of 2000	None	1	1	1
May of 2000	1	1	1	1
Jun. Of 2000	None	1	1	1
Jul. of 2000	2	3	1	1

* Each data set included all the thermocouple readings and gap readings for each bridge

In addition to the data collected, a leak test was conducted on each of the strip-seal expansion joints of the twelve bridges. The leak test was performed by filling the expansion gap near each gutter with water and checking for leakage underneath the expansion joint. The strip seals for the twelve bridges were also given a rating by the ISU investigators using the rating interpretations that were shown in Table 3.1. Based on inspection records, a rating of 7 often indicated some leaking, sometimes very limited pullout, but a seal that was still generally performing its function.

6.3 Experimental Results

In this section, the results of the experimental program for each of the twelve bridges are summarized. Summaries include a brief description of the bridge, strip-seal ratings and

related data from inspection records, results from the instrumentation program, comparisons of the measured behavior to that predicted by Iowa DOT design equations, and conclusions that might be drawn from the information.

In the discussion to follow, strip-seal expansion joints and the corresponding gaps are labeled from the near abutment to the far abutment (“near” corresponds to the direction of decreasing mile post values, i.e., south or west; “far” corresponds to the direction of increasing mile post values). For example, for a bridge with four strip-seal expansion joints, G1 corresponds to the joint (or gap or seal) at the near abutment, G2 corresponds to the first joint from the near abutment, G3 corresponds to the second joint from the near abutment, and G4 corresponds to the joint at the far abutment. Also, the abbreviation LG represents the left gutter (looking towards the far abutment) and RG represents the right gutter (again, looking towards the far abutment). The effective bridge temperature, T_b , is defined as the average of the two thermocouple readings (see Section 6.2.2).

6.3.1 Bridge 1: 0781.1R218 (FHWA 606200)

Bridge 1 is a three-lane, eighteen-span prestressed concrete-girder bridge that carries northbound traffic of US 218 across 4th Street, 5th Street, 6th Street and West Park Avenue in the city of Waterloo, Iowa. The bridge was constructed in 1991. The estimated Average Daily Traffic (ADT) was 18,300 in 1993, 19,300 in 1996 and 23,100 in 1999. The bridge has three expansion joints with strip seals, one near the middle and one at each abutment, and expansion lengths of 313.5 ft, 686 ft, and 313.5 ft for joints G1, G2, and G3, respectively.

The first intensive inspection was performed in 1995 and serious problems were observed in the strip seal G2. The 1995 Iowa DOT inspection record for G2 noted “4 ft area in right gutter the strip seal is pulled loose from extrusions and leaking water and debris to

bridge seat at pier #9". The ratings for the G1 and G3 strip seals remained at 9 (as they would have been in 1991, "brand new" – see Table 3.1) but the rating for the G2 strip seal dropped from 9 in 1991 to 6 in 1995. In 1997 and 1999, routine inspections were performed instead of intensive inspections, so the strip-seal expansion joints were not rated.

Replacement of the failed strip seal at G2 was requested in 1995. In 1998, a strip seal of the proper size for the intermediate expansion joint was requested. In response, the Iowa DOT bridge engineer requested measurements in cold weather to determine the maximum joint opening. A maximum joint opening that was too large might have required replacing the entire expansion joint at pier #9.

In July 2000, a field investigation of the strip seals was performed as part of this study. At G1, no sign of damage or pull out was observed but slight leakage was observed at the right gutter. At G2, most of the strip seal was pulled out from one and sometimes both of the extrusions (Figure 6.4). At G3, portions of the strip seal were pulled out. Strip seals at G1, G2 and G3 were assigned a rating of 7, 5 and 6, respectively, by the ISU investigators.

The air temperature and approximate gap openings were determined as part of the Iowa DOT intensive inspections and the ISU investigation, and are summarized in Table 6.4. The Iowa DOT inspection reports include gap measurements at both gutters and the roadway centerline for each joint; i.e., three measurements for each joint. Obtaining centerline measurements as part of this experimental work was not practical for the ISU investigators because of bridge traffic. Therefore, only the measurements near each gutter taken by Iowa DOT inspectors and ISU investigators are included in the table.

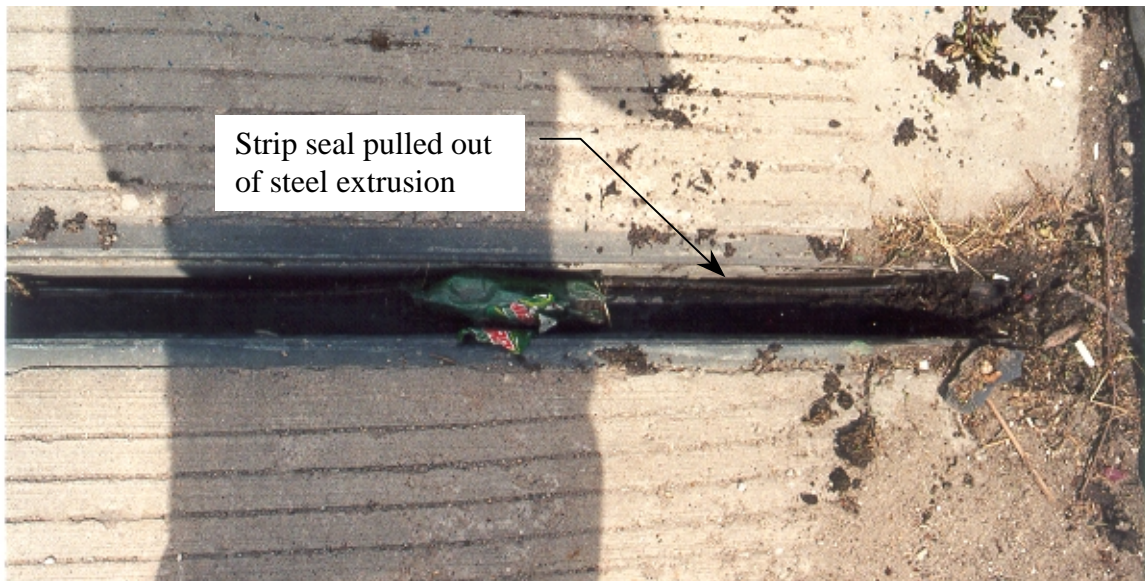

Figure 6.4 Strip seal at G2 for Bridge 1 (0781.1R218)

Table 6.3 Gap openings and ratings for Bridge 1 (0781.1R218)

Year	Ratings			Gap Opening (in.)						Temp. (°F)
				G1		G2		G3		
	G1	G2	G3	LG	RG	LG	RG	LG	RG	
1991	9	9	9	-	-	-	-	-	-	-
1995	9	6	9	2 1/4	2 3/8	4 1/2	4 1/4	2	2 1/8	50
2000*	7	5	6	1.57	1.50	2.96	3.09	1.4	1.78	72

* Inspection by ISU investigators

The experimental gap opening and temperature data gathered for each bridge as described in Section 6.2.3 was analyzed. The plots of the relationships between the gap opening, G , at each of the three expansion joints G1, G2, and G3, and T_b (the representative bridge temperature – see Section 6.3) for Bridge 1, are shown in Figure 6.5. For this report, G is defined as the average of the two gap openings measured near each gutter of an expansion joint. The best-fit linear equations relating average gap opening, G , to representative bridge temperature, T_b , for each of the three joints G1, G2, and G3 are plotted

on the chart and are also given in equation form at the top of Figure 6.5. Though no temperatures very near 0° F were recorded during this investigation, the linear plots are extended back to 0° F as a dashed line to show the gaps that could be expected at the minimum temperatures assumed in the Iowa DOT design procedure for concrete-girder bridges (Section 3.3).

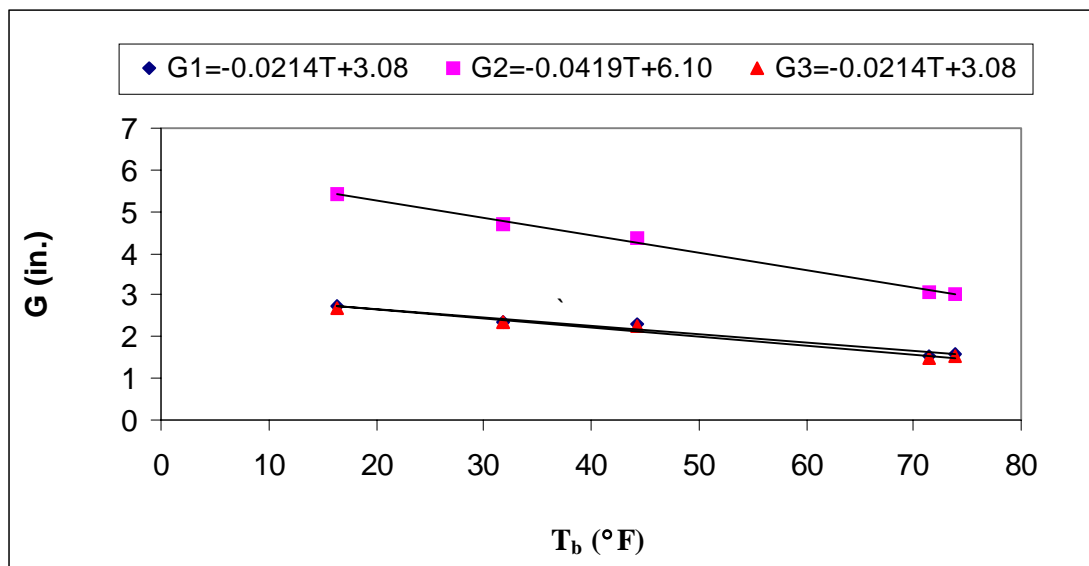

Figure 6.5 Gap openings vs. bridge temperature for Bridge 1 (0781.1R218)

According to the design equations for expansion joints obtained from the Iowa DOT [39], both temperature effects and concrete shrinkage are to be included in the sizing of seals for concrete-girder bridges (see Section 3.3). From the plans for Bridge 1 (0781.1R218), the size of the strip seal to be used for both G1 (near abutment) and G3 (far abutment) is 4 in., and for G2 (intermediate expansion joint), 5 in. The gap settings specified on the bridge plans are given in Table 6.4.

Table 6.4 The gap settings specified on the plans for Bridge 1 (0781.1R218)

Setting temperature (° F)	Specified G1 setting (in.)	Specified G2 Setting (in.)	Specified G3 setting (in.)
90	15/16	1/2	15/16
50	1 7/8	2 1/2	1 7/8
10	2 13/16	4 1/2	2 13/16

From the gap setting at the middle temperature of 50° F (Table 6.4), and using the Iowa DOT design values given in Section 3.3, the procedure illustrated in Section 3.4, and the expansion length of 686 ft, the expansion joint opening for G2 at 0° F, without including the effects of concrete shrinkage (i.e., the short-term gap), is

$$G2 = (2 \frac{1}{2}) + [(0.000006 \times 50) \times (686 \times 12)] \times \cos(6^\circ) = 4.96 \text{ in.}$$

The predicted expansion joint opening for G2 at 0° F, including the concrete shrinkage factor (i.e., the long-term gap), is

$$G2 = 4.96 + [0.0002 \times (686 \times 12)] \times \cos(6^\circ) = 6.60 \text{ in.}$$

Similar calculations for the short-term and long-term expansion joint openings at 0° F for G1 and G3 produce the values of 3.00 in. and 3.75 in., respectively.

From the experimental data, the gap openings at 0° F using the regression equations are 3.08 in., 6.10 in., and 3.08 in. for G1, G2 and G3, respectively (the y-intercepts from the equations shown in Figure 6.5). These predicted gaps and the short-term and long-term gaps predicted by the Iowa DOT design equations are summarized in Table 6.5. The size of the

strip seal specified on the plans for each joint and the most recent rating (1995) of each strip seal from Iowa DOT inspections are also included.

Table 6.5 Various predicted expansion joint gaps for Bridge 1 (0781.1R218)

	G1 (in.)	G2 (in.)	G3 (in.)
Gap setting at 50° F specified on plans	1 7/8	2 1/2	1 7/8
DOT predicted short-term gap at 0° F	3.00	4.96	3.00
DOT predicted long-term gap at 0° F	3.75	6.60	3.75
Experimental gap at 0° F (extrapolated)	3.08	6.10	3.08
Size of strip seal specified on plans	4 in.	5 in.	4 in.
Latest rating from inspection records**	9	6	9

**1995

For G2, the long-term gap predicted by the Iowa DOT design equations is 6.60 in. The gap at 0° F extrapolated from the experimental data would be 6.10 in. (see Figure 6.5). Both are considerably larger than the 5-in. size of the seal specified for that joint on the bridge plans. At low temperatures, the seal would have been subjected to considerable tension and would have been exposed to more wheel loadings. Seal G2 has almost completely pulled out. For G1 and G3, the gaps at 0° F extrapolated from the experimental data (3.08 in. for both) are considerably smaller than the size of the seal specified for those two joints (4 in.). These seals (G1 and G3) have performed better than Seal G2.

The calculations or factors, such as for creep or shrinkage (see Example 1 in Section 3.4), used to predict the gaps and the initial gap settings and corresponding temperatures were not found in the bridge records. The construction records do indicate the deck was poured on April 2 of 1991 and the temperature extremes were 42° F and 63° F. Assuming the bridge temperature averaged about 60° F during the pour and no shrinkage or creep

occurred, the initial gap at 60° F would have had to be set at about 3.5 in., instead of the 2 in. specified, for the long-term gap at 0° F to be 6.1 in.

The thermocouple and gap measurement data were also used to determine experimental α -values for the twelve bridges. In determining the experimental α -value for the annual cycle, only the first set of data in a day was used if multiple sets of readings were taken. The relationship between the change in bridge length, ΔL , normalized by the total length of the bridge, L , and the representative bridge temperature, T_b , for Bridge 1 is shown in Figure 6.6. For this report, the change in bridge length, ΔL , was approximated as the sum of the changes in the gap measurements; e.g., for Bridge 1

$$\Delta L = \Delta G1 + \Delta G2 + \Delta G3$$

where $\Delta G1$ is the change in the average gap measurement at joint G1, and similarly for $\Delta G2$ and $\Delta G3$. The total length of the bridge, L , is the sum of the expansion lengths; e.g., for Bridge 1

$$L = L1 + L2 + L3 = 313.5 \text{ ft} + 686 \text{ ft} + 313.5 \text{ ft} = 1313 \text{ ft}$$

The slope of the best fit line is the experimental α -value for the bridge. The square of the coefficient of correlation, R^2 , is also given in the figure.

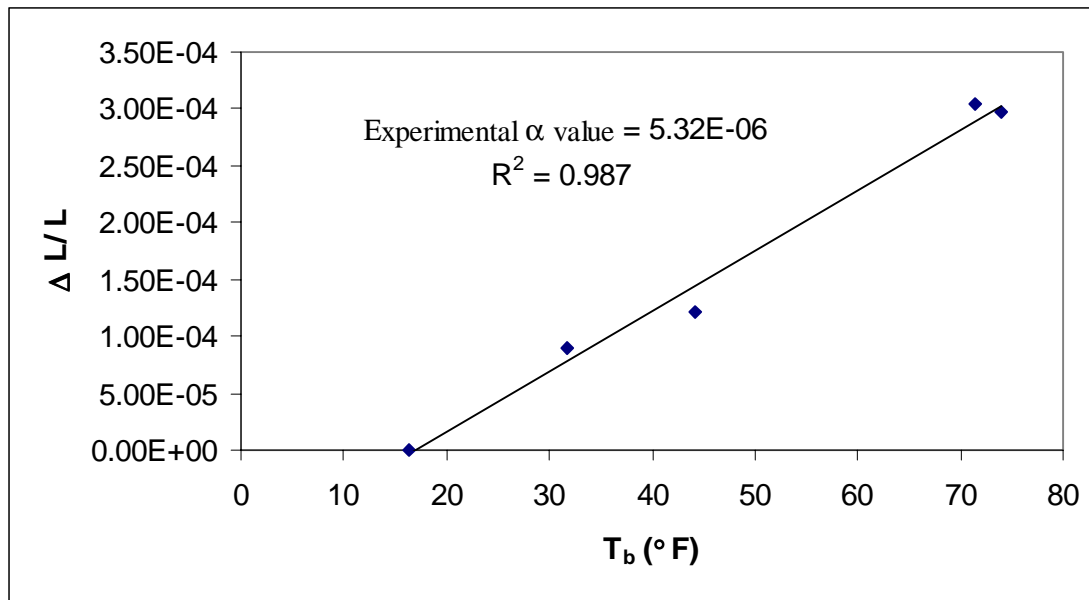

Figure 6.6 The experimental α -value for Bridge 1 (0781.1R218)

6.3.2 Bridge 2: 0781.1L218 (FHWA 606210)

Bridge 2 is the “twin” of Bridge 1 (Section 6.3.2). The bridge has three expansion joints with strip seals, one near the middle and one at each abutment, and expansion lengths of 313.6 ft, 694.9 ft, and 313.6 ft for G1, G2 and G3, respectively. The first intensive inspection was performed in 1995 and serious problems were observed in the strip seal at G2. The 1995 Iowa DOT inspection record for G2 noted “the left gutter has 3 ft section that has been pulled out of the anchor”. The ratings for the G1 and G3 strip seals remained at 9 (same as when they were installed in 1991) but the rating of the G2 strip seal dropped from 9 in 1991 to 6 in 1995. In 1997 and 1999, routine inspections were performed instead of intensive inspections, so the expansion joints were not rated.

Replacement of the failed strip seal at G2 was requested in 1995. In 1998, a strip seal of the proper size for the intermediate expansion joint was requested. In response, the Iowa

DOT bridge engineer requested measurements in cold weather to determine the maximum joint opening.

In July of 2000, a field investigation of the strip seals was performed as part of this study. At G1, portions of the strip seal were pulled out and considerable leaking was observed at the left gutter. At G2, most of the strip seal was pulled out from the steel extrusions (Figure 6.7). At G3, small portions of the strip seals were pulled out, the seal was slightly torn and considerable leaking was observed at the left gutter. Strip seals at G1, G2 and G3 were assigned a rating of 6, 5 and 7, respectively, by the ISU investigators.

In a manner similar to that used for Bridge 1 (see Section 6.3.1), air temperatures and approximate gap openings were determined as part of the Iowa DOT intensive inspections and the ISU investigation and are summarized in Table 6.6. Plots of the relationships between the gap openings and representative bridge temperatures are shown in Figure 6.8. Predicted gaps at 0° F, specified strip seal sizes, and the most recent DOT inspection ratings are summarized in Table 6.7. The plot used to determine the experimental α -value for Bridge 2 is shown in Figure 6.9. Refer to Section 6.3.1 for the process used to produce Figures 6.8 and 6.9, and Tables 6.6 and 6.7.

Table 6.6 Gap openings and ratings for Bridge 2 (0781.1R218)

Year	Ratings			Gap Opening (in.)						Temp. (° F)
				G1		G2		G3		
	G1	G2	G3	LG	RG	LG	RG	LG	RG	
1991	9	9	9	-	-	-	-	-	-	-
1995	9	6	9	2 1/8	2 1/4	3 3/4	3 1/2	2 1/4	2 1/8	50
2000*	6	5	7	1.42	1.57	2.24	2.17	1.87	1.34	73

* Inspection by ISU Investigators



Figure 6.7 Strip seal at G2 for Bridge 2 (0781.1L218)

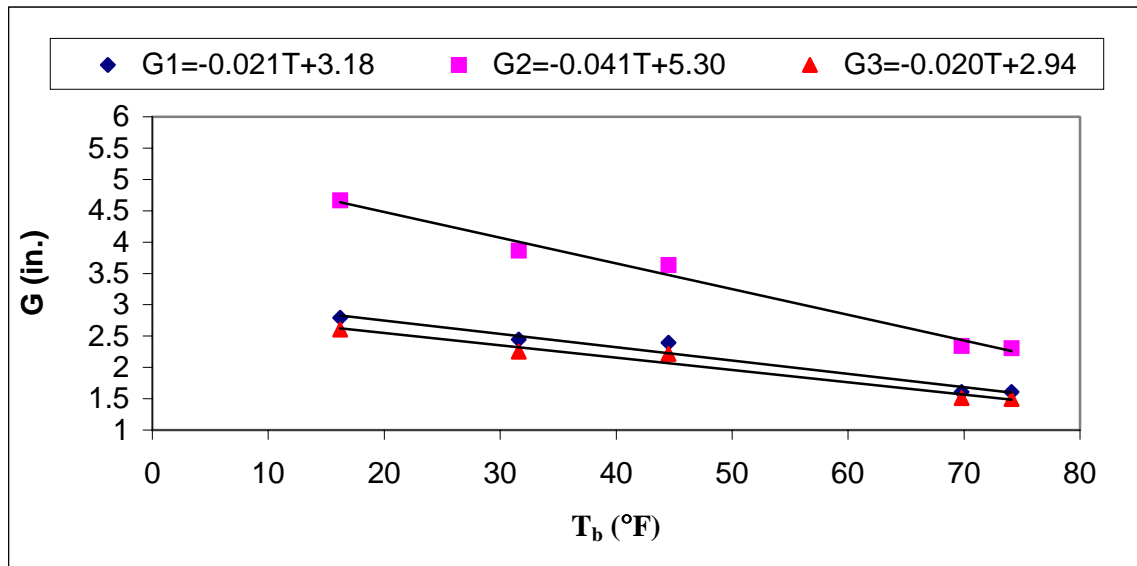
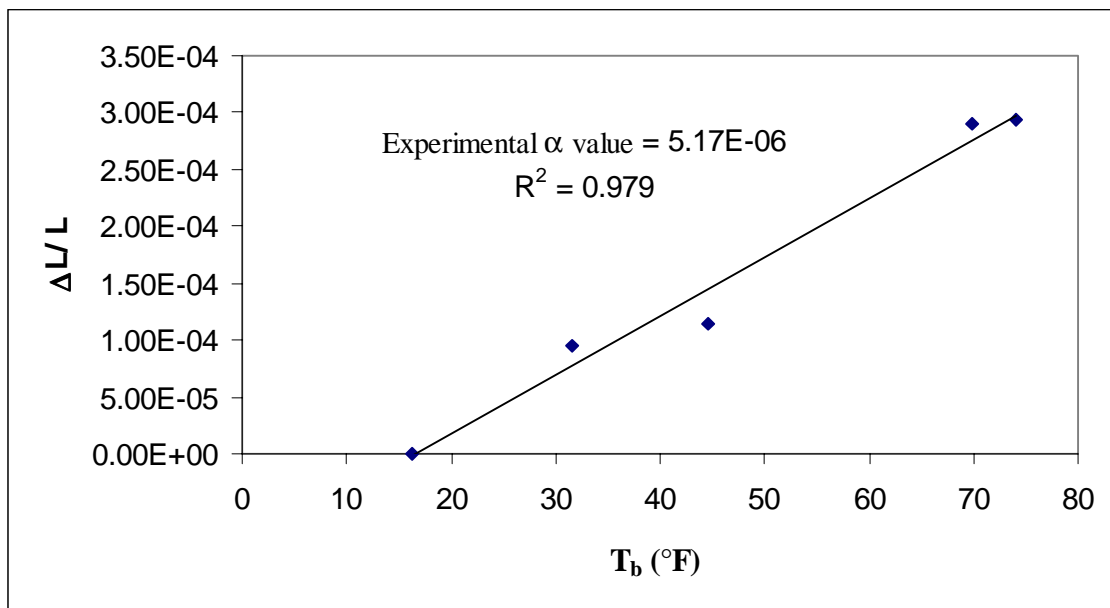

Figure 6.8 Gap openings vs. bridge temperature for Bridge 2 (0781.1L218)

Table 6.7 Various predicted expansion joint gaps for Bridge 2 (0781.1L218)

	G1 (in.)	G2 (in.)	G3 (in.)
Gap setting at 50° F specified on plans	1 7/8	2 1/2	1 7/8
DOT predicted short-term gap at 0° F	3.00	5.00	3.00
DOT predicted long-term gap at 0° F	3.75	6.66	3.75
Experimental gap at 0° F (extrapolated)	3.18	5.30	2.94
Size of strip seal specified on plans	4 in.	5 in.	4 in.
Latest rating from inspection records**	9	6	9

**1995

Figure 6.9 The experimental α -value for Bridge 2 (0781.1L218)

From Table 6.7, the gaps at 0° F predicted by the Iowa DOT design equations are 3.75 in., 6.66 in., and 3.75 in. for G1, G2, and G3, respectively (see Sections 3.3. and 6.3.1). The gaps at 0° F extrapolated from the experimental data are 3.18 in., 5.30 in., and 2.94 in. for G1, G2, and G3, respectively (see Figure 6.8 and Table 6.8). For G2, the gap openings at 0° F predicted by the DOT design equations (6.66 in.) and extrapolated from the experimental data (5.30 in.) are significantly larger than the 5-in. size of the seal specified for

that joint on the bridge plans. As for Bridge 1 (Section 6.3.1), the “twin” of Bridge 2, the seal at G2 would have been subjected to considerable tension and would have been exposed to more wheel loadings at low temperatures. Seal G2 has almost completely failed (pulled out - see Figure 6.7. For G1 and G3, the gaps at 0° F extrapolated from the experimental data (3.18 in. and 2.94 in. for G1 and G3, respectively) are considerably smaller than the size of the seal specified for those two joints (4 in.). Note, however, that at -15° F (see Section 2.2) gaps at G1 and G3 would be considerably closer to the seal rating. Seals G1 and G3 have performed better than Seal G2.

6.3.3 Bridge 3: 0996.0R218 (FHWA 601235)

Bridge 3 is a two-lane, seven-span prestressed concrete-girder bridge with galvanized steel intermediate diaphragms that carries northbound traffic of US 218 across the Cedar River north of Waterloo, Iowa. It was built in 1993. The estimated Average Daily Traffic (ADT) was 6,800 in 1993, 7,000 in 1994 and 7,300 in 1996. The bridge has four expansion joints with strip seals, and expansion lengths of 95.75 ft, 241.3 ft, 241.2 ft, and 96.52 ft for G1, G2, G3 and G4, respectively.

The initial inspection was performed in 1994 and problems were observed in the strip seals at G2, G3 and G4. The 1994 Iowa DOT inspection records for G4 noted “joint material is failing”. For G2, the Iowa DOT inspection records noted “The strip seal rubber in the joint over pier #5 has torn and pulled loose from its anchor allowing water and debris onto Pier #5 bridge seat. The rating of the strip seal at G1 dropped from 9 (new) in 1993 to 8 in 1994. Ratings of the strip seals at G2 and G3 dropped from 9 to 5 and the rating of the strip seal at G4 dropped from 9 to 6. Replacement of the failed strip seals was requested in 1995.

A second inspection was performed in 1996 and problems were observed in all four strip seals. The 1996 Iowa DOT inspection records for both end deck joints (G1 and G4) noted “Some of the material is ripped or torn loose”. For both G2 and G3, Iowa DOT inspection records noted “material is pulled out or torn on both, also debris in both”. The rating of the strip seal at G1 dropped from 8 (1994) to 6 (1996). Ratings of the strip seals G2 and G3 improved from 5 to 6 (though no evidence was found that the seal was replaced or repaired between 1994 and 1996). The rating of the seal at G4 remained at 6.

In July of 2000, a field investigation of the strip seals was performed as part of this study. Some parts of the strip seal at G1 were pulled out. At G2 and G3, most of the seal was either torn or pulled out along one or both edges (Figures 6.10 and 6.11). At G4, a large piece of the neoprene seal is completely pulled out (Figure 6.12). Strip seals at G1, G2, G3 and G4 were all assigned a rating of 5 by the ISU investigators.

Similar to Bridge 1 (see Section 6.3.1), inspection ratings for Bridge 3 are summarized in Table 6.8, gap openings versus representative bridge temperature are plotted in Figure 6.13, predicted behavior is summarized in Table 6.9, and the experimental α -value plot is shown in Figure 6.14.

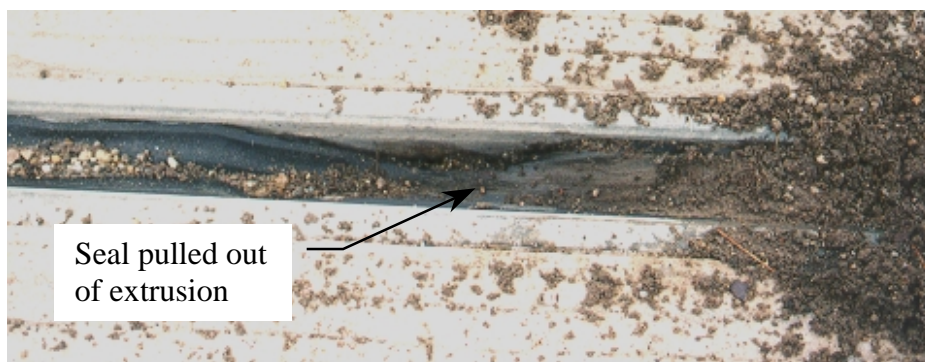

Figure 6.10 Strip seal at G2 for Bridge 3 (0996.0R218)

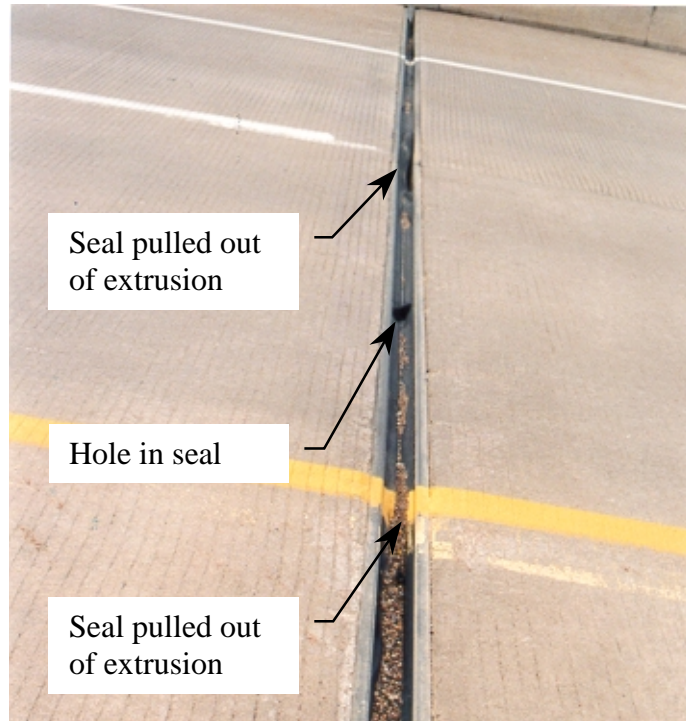

Figure 6.11 Strip seal at G3 for Bridge 3 (0996.0R218)

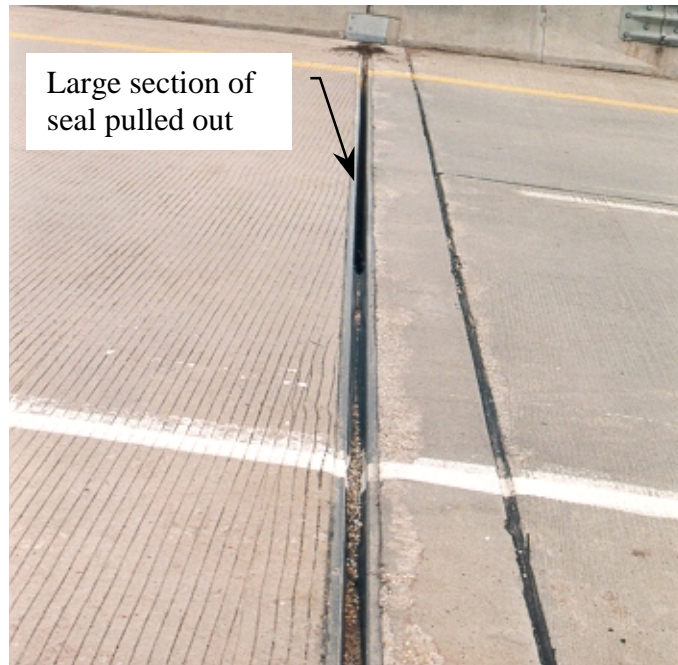

Figure 6.12 Strip seal at G4 for Bridge 3 (0996.0R218)

Table 6.8 Gap openings and ratings for Bridge 3 (0996.0R218)

Year	Rating				Gap Openings (in.)								Temp (°F)
					G1		G2		G3		G4		
	G1	G2	G3	G4	LG	RG	LG	RG	LG	RG	LG	RG	
1993	9	9	9	9	-	-	-	-	-	-	-	-	-
1994	8	5	5	6	2	2 1/4	3 1/4	3 1/4	3 3/8	3 1/4	2 1/4	2 1/4	25°F
1996	6	6	5	6	2	2	2 3/8	2 1/2	2 1/2	2 1/4	2	2	75°F
2000*	5	5	5	5	2.21	2.06	2.51	2.47	2.54	2.41	2.34	2.27	73°F

- Inspection by ISU investigators

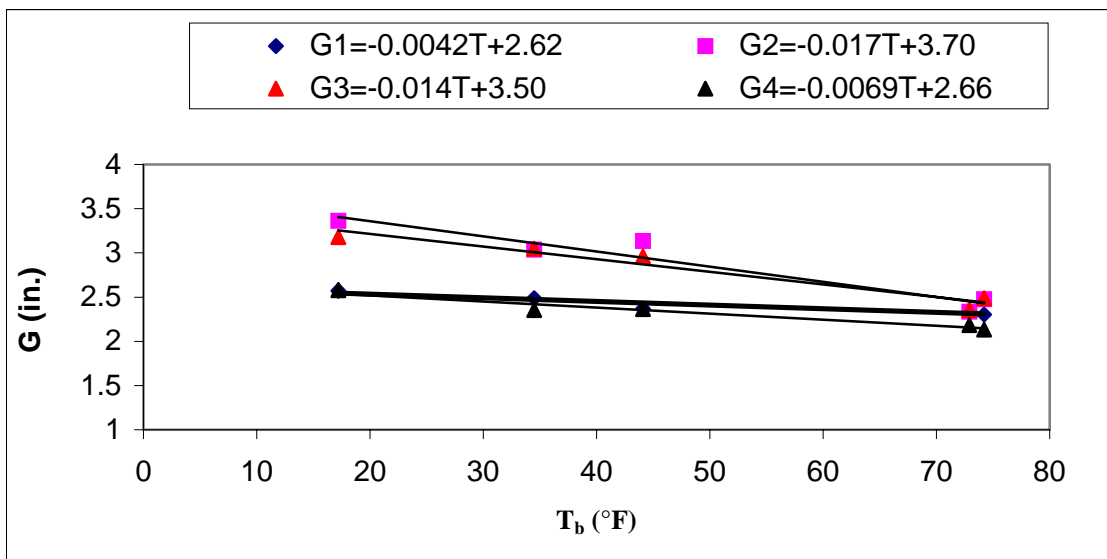

Figure 6.13 Gap openings vs. bridge temperature for Bridge 3 (0996.0R218)

Table 6.9 Various predicted expansion joint gaps for Bridge 3 (0996.0R218)

	G1 (in.)	G2 (in.)	G3 (in.)	G4 (in.)
Gap setting at 50° F specified on plans	2	2	2	2
DOT predicted short-term gap at 0° F	2.34	2.87	2.87	2.35
DOT predicted long-term gap at 0° F	2.57	3.45	3.45	2.58
Experimental gap at 0° F (extrapolated)	2.62	3.70	3.50	2.66
Size of strip seal specified on plans	3 in.	3 in.	3 in.	3 in.
Latest rating from inspection records**	6	6	5	6

**1996

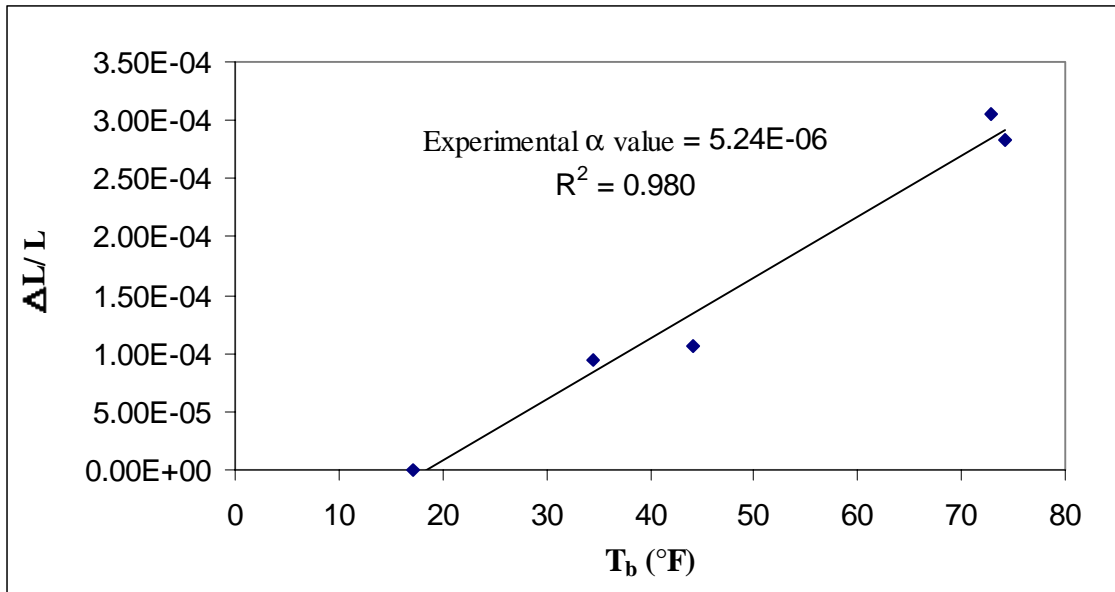

Figure 6.14 The experimental α -value for Bridge 3 (0996.0R218)

All four seals have largely failed (see Figures 6.10, 6.11 and 6.12). The gap at 0° F predicted by the DOT design equations for G2 and G3 is 3.45 in. The gaps at 0° F extrapolated from the experimental data for G2 and G3 are 3.70 in. and 3.50 in., respectively.

In the construction diary for Bridge 3 for 10/19/1992, there is the note “Several employees are working on chipping out concrete that got into the extruded joints.” For 10/20/1992, there is the note “Work continues on cleaning concrete out of the extruded joints so that the neoprene glands can be installed.” For 10/21/1992, the entry says “Work continues on cleaning up the expansion joints” and for 10/23/1992, “Several employees are installing the neoprene glands.” According to Iowa DOT personnel, most, and perhaps all, of the seals on this bridge and Bridge 4 were installed by pulling them through the extrusion cavities from end to end using vise grips and a come-along (Section 4.3). The vise grips damaged the end being pulled, but the seals were long enough that the damaged ends could

be cut off cleanly. During a later stage of construction, material from the tires of construction vehicles using the bridge was deposited on the bridge and settled in the seal cavities. Construction traffic over the debris-filled joints then caused damage to several of the seals on the two bridges. Iowa DOT personnel required the contractors to lay steel plates over the joints to protect the seals from further damage. One or more of the damaged seals in the two bridges may have been replaced before the bridges were open to normal traffic. Which seals, if any, were replaced could not be determined.

6.3.4 Bridge 4: 0996.0L218 (FHWA 601240)

Bridge 4 is the “twin” of Bridge 3. The bridge has four expansion joints with strip seals and expansion lengths of 95.75 ft, 241.3 ft, 241.2 ft, and 96.52 ft for G1, G2, G3 and G4, respectively. The initial inspection was performed in 1994 and problems were observed in the strip seals at G2 and G3. For G2 and G3, the Iowa DOT inspection records noted “damage or leaking over pier #2 left lane, joint material pulled out of anchor, and left metal guard on handrail at joint over pier #2 missing”. The 1994 Iowa DOT inspection records for G4 noted “right leaking”. From 1993 to 1994, the rating of the strip seal at G1 dropped from 9 to 8, the ratings of the strip seals at G2 and G3 dropped from 9 to 5, and the rating of the strip seal at G4 dropped from 9 to 7. Replacement of the failed strip seals was requested by Iowa DOT inspectors in 1995.

A second inspection was performed in 1996. The 1996 Iowa DOT inspection records for G1 and G4 noted “strip seals are choked with sand/debris”. For G2 and G3, the Iowa DOT inspection records noted “some debris on all deck joints, the curb plates at near deck joint on right and pier #5 deck joint are loose, the kick plate at pier #2 on left is missing, material is pulled out of both”. The rating of the strip seal at G1 was 8 in 1994 and dropped

to 7 in 1996. The ratings of the seals at G2 and G3 remained the same at 6 as did the rating of the seal at G4 at 7.

In July of 2000, a field investigation of the strip seals was performed as part of this study. At G1, the seal had started to pull out at two locations. The rest of the seal was filled with debris. At G2, large portions of the seal were pulled out (Figure 6.15). At G3 and G4, most of the seals were pulled out (Figure 6.16). Strip seals at G1, G2, G3 and G4 were assigned a rating of 7, 6, 5 and 5, respectively, by the ISU investigators.

Inspection data for Bridge 4 is summarized in Table 6.10, gap openings versus representative bridge temperature are plotted in Figure 6.17, predicted behavior is summarized in Table 6.11, and the experimental α -value plot for Bridge 4 is shown in Figure 6.18. Refer to Section 6.3.1 for the process used to produce Figures 6.17 and 6.18 and Tables 6.10 and 6.11.



Figure 6.15 Strip seal at G2 for Bridge 4 (0996.0L218)

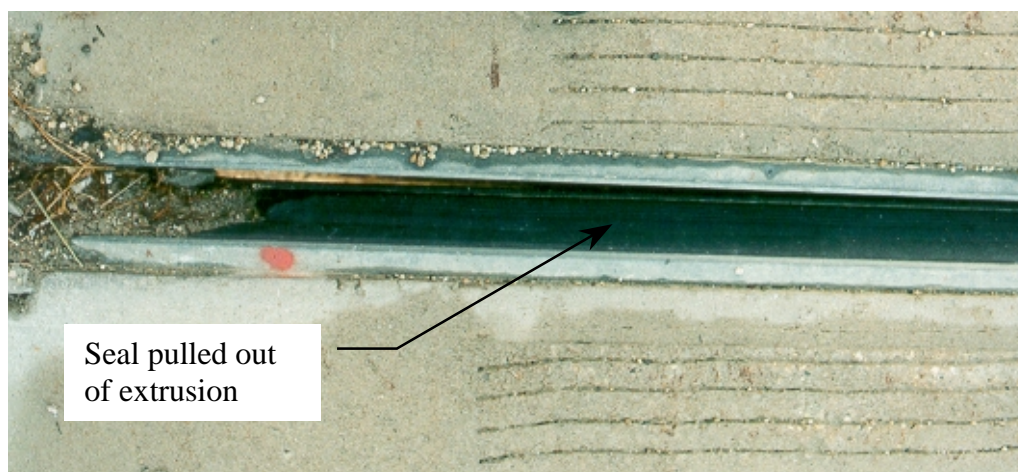

Figure 6.16 Strip seal at G3 for Bridge 4 (0996.0L218)

Table 6.10 Gap openings and ratings for Bridge 4 (0996.0L218)

Year	Ratings				Gap Openings								Temp. (°F)
					G1		G2		G3		G4		
	G1	G2	G3	G4	LG	RG	LG	RG	LG	RG	LG	RG	
1993	9	9	9	9	-	-	-	-	-	-	-	-	-
1994	8	6	6	7	2 1/2	2 3/8	3 3/8	3 3/8	3 3/8	3 1/4	2 1/2	2 1/2	25
1996	7	6	6	7	2	2	2 1/2	2 1/2	2 1/2	2 1/2	2	2 1/4	75
2000*	7	6	5	5	2.35	2.77	2.76	2.58	2.88	2.69	2.26	2.17	74

* Inspection by ISU investigators

The two intermediate seals (at G2 and G3) have almost completely failed (see Figures 6.15 and 6.16). Ignoring concrete shrinkage, the gap at 0° F predicted by the Iowa DOT design equations for G2 and G3 is 2.87 in. Including shrinkage, the DOT predicted gap at these two joints is 3.45 in. The gaps at 0° F extrapolated from the experimental data for G2 and G3 are 3.71 in. and 3.60 in., respectively. As for Bridge 3, the 3-in. size of strip seal for G2 and G3 specified on the bridge plans is smaller than the predicted long-term gap openings, including the effects of concrete creep and shrinkage. At low temperatures, the seals at G2 and G3 would have been subjected to tension and more wheel loadings.

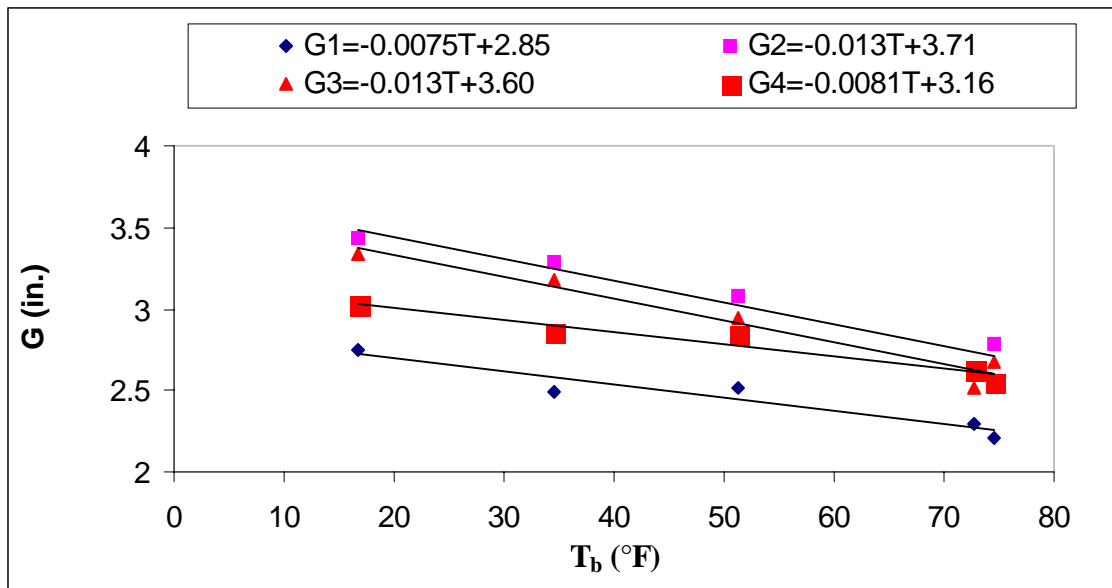

Figure 6.17 Gap openings vs. bridge temperature for Bridge 4 (0996.0L218)

Table 6.11 Various predicted expansion joint gaps for Bridge 4 (0996.0L218)

	G1 (in.)	G2 (in.)	G3 (in.)	G4 (in.)
Gap setting at 50° F specified on plans	2	2	2	2
DOT predicted short-term gap at 0° F	2.34	2.87	2.87	2.35
DOT predicted long-term gap at 0° F	2.57	3.45	3.45	2.58
Experimental gap at 0° F (extrapolated)	2.85	3.71	3.60	3.16
Size of strip seal specified on plans	3 in.	3 in.	3 in.	3 in.
Latest rating from inspection records**	7	6	6	7

**1996

The extrapolated experimental gap at 0° F for G4 (3.16 in.) also exceeds the specified 3-in. strip seal size. This may have contributed significantly to the poor performance of the seal at G4. For G1 the extrapolated experimental gap at 0° F (2.85 in.) does not exceed the specified size of the strip seal (3 in.). However, according to NOAA, there is a 6.2% chance for the shade temperature to be lower than -25°F in January (see Section 2.2 and Table 2.6).

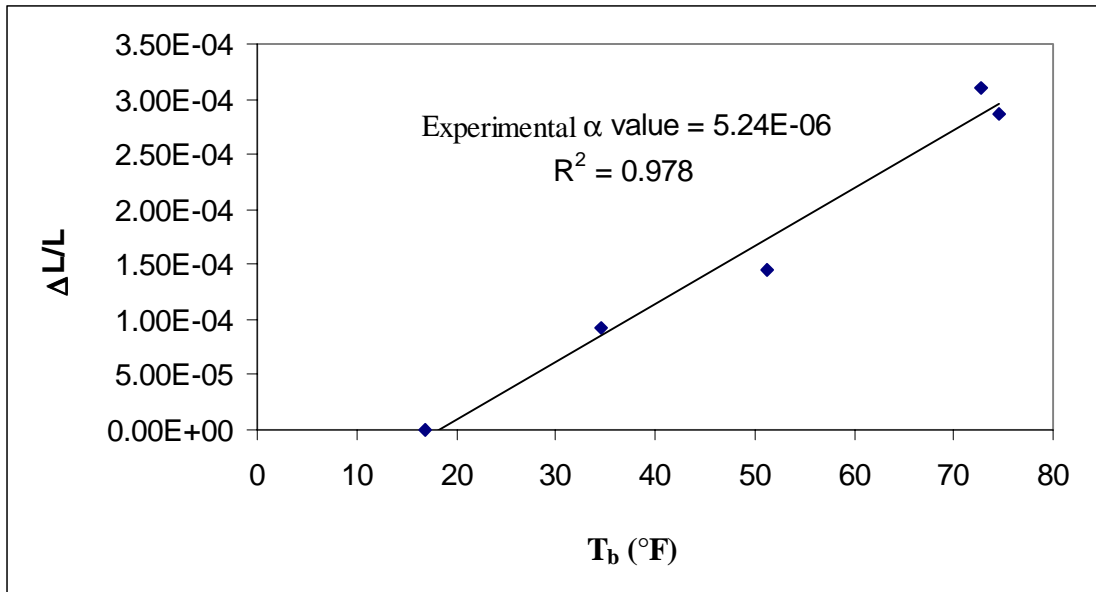

Figure 6.18 The experimental α -value for Bridge 4 (0996.0L218)At a shade

temperature of -25°F and corresponding bridge temperature of about -15°F , the gap at G1 exceeds 3 in. (see Section 6.3.1 for predicted gap opening calculations).

In the construction diary for Bridge 4, notations indicate that contractor employees spent all or part of three days “cleaning concrete out of the extruded joints so that the neoprene glands can be installed.” As for Bridge 3, DOT personnel reported that some or all of the seals on this bridge were installed by pulling them through the extrusion cavities from end to end using vise grips (see Sections 4.3 and 6.3.3). What effect this had on the distribution and effectiveness of the lubricant/adhesive used or on the integrity of the neoprene seal can not be determined. Also, as for Bridge 3, damage was done to some of the seals by construction traffic travelling over construction-debris-filled joints during later stages of the project (see Section 6.3.3). One or more of the seals in Bridges 3 and 4 may have been replaced before the bridges were opened to normal traffic. As for Bridge 3, which,

if any, seals were replaced could not be determined. What effect, if any, this sequence of events had on the performance of the strip seals is not clear.

6.3.5 Bridge 5: 0787.7A218 (FHWA 601575)

Bridge 5 is a one-lane, six-span prestressed concrete-girder bridge with galvanized steel intermediate diaphragms that carries Ramp A traffic of southbound US 218 across Lincoln Street in Waterloo, Iowa. It was built in 1995. The estimated Average Daily Traffic (ADT) was 400 in 1995. The bridge has two expansion joints with strip seal, one at each abutment and expansion lengths of 303.3 ft and 317.1 ft for G1 and G2, respectively. The skew angle is 42.0 degrees at G1, 27.6 degrees at the fixed pier near the middle of the bridge, and 12.5 degrees at G2.

The first intensive inspection was performed in 1998 and problems were observed in the strip seals at G1 and G2. The 1998 Iowa DOT inspection records noted “about 1 ft of material is broken out at about centerline on the near abutment”. The ratings of strip seals at G1 and G2 dropped from 9 in 1995 to 7 in February of 1998. Replacement of the broken strip seal had been requested in November of 1999.

In July of 2000, a field investigation of the strip seals was performed as part of this study. At G1, a hole in the seal near the centerline of the roadway was observed (Figure 6.19). The hole was roughly elliptical, had irregular and jagged edges, and was approximately 1-ft long. A piece of neoprene that would have largely filled the hole was found below the bridge by the ISU investigators. At an earlier visit in December of 1999, several types of metal road debris (Figure 6.20) were observed in the expansion joint openings and on the roadway. At G2, severe leaking was observed at the right gutter but no

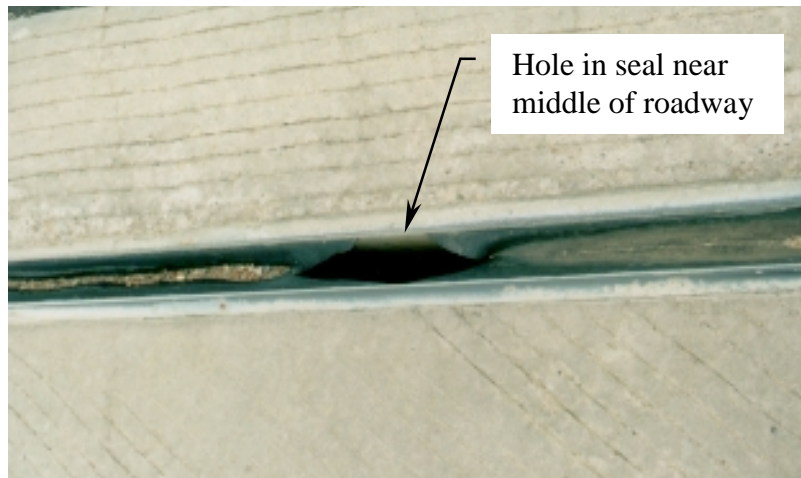

Figure 6.19 Strip seal at G1 for Bridge 5 (0787.7A218)



Figure 6.20 Road debris found on Bridge 5 (0787.7A218)

sign of leaking was observed at the left gutter. The strip seals at G1 and G2 were assigned a rating of 6 and 7, respectively, by the ISU investigators.

As for Bridge 1 (see Section 6.3.1), air temperatures and approximate gap openings that were determined as part of the Iowa DOT intensive inspections and the ISU investigation

are summarized in Table 6.12. The plots of the relationships between the gap openings and representative bridge temperature are shown in Figure 6.21. Predicted gaps at 0° F, specified strip seal sizes, and the most recent DOT inspection ratings are summarized in Table 6.13. The plot used to determine the experimental α -value for Bridge 5 is shown in Figure 6.22. Refer to Section 6.3.1 for the process used to produce Figures 6.21 and 6.22 and Tables 6.13.

Table 6.12 Gap openings and ratings for Bridge 5 (0787.7A218)

Year	Ratings		Gap Openings				Temp. (°F)
			G1		G2		
	G1	G2	LG	RG	LG	RG	
1995	9	9	-	-	-	-	-
1997	7	7	2 3/4	3	3 1/4	3 1/4	30
2000*	6	7	2.30	2.19	2.36	2.46	77

* Inspection by ISU investigators

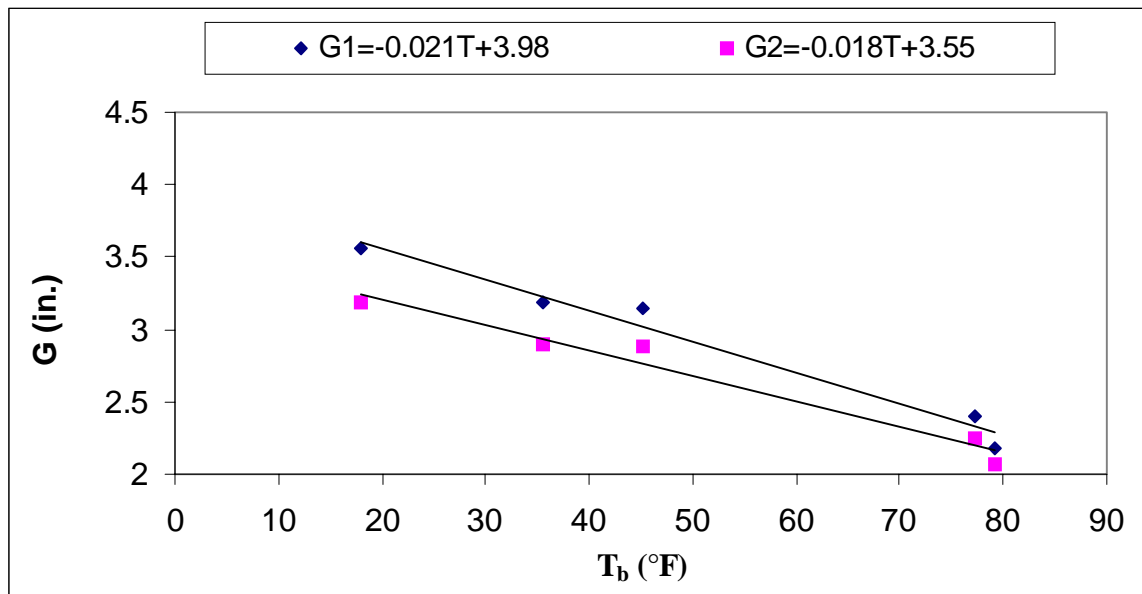
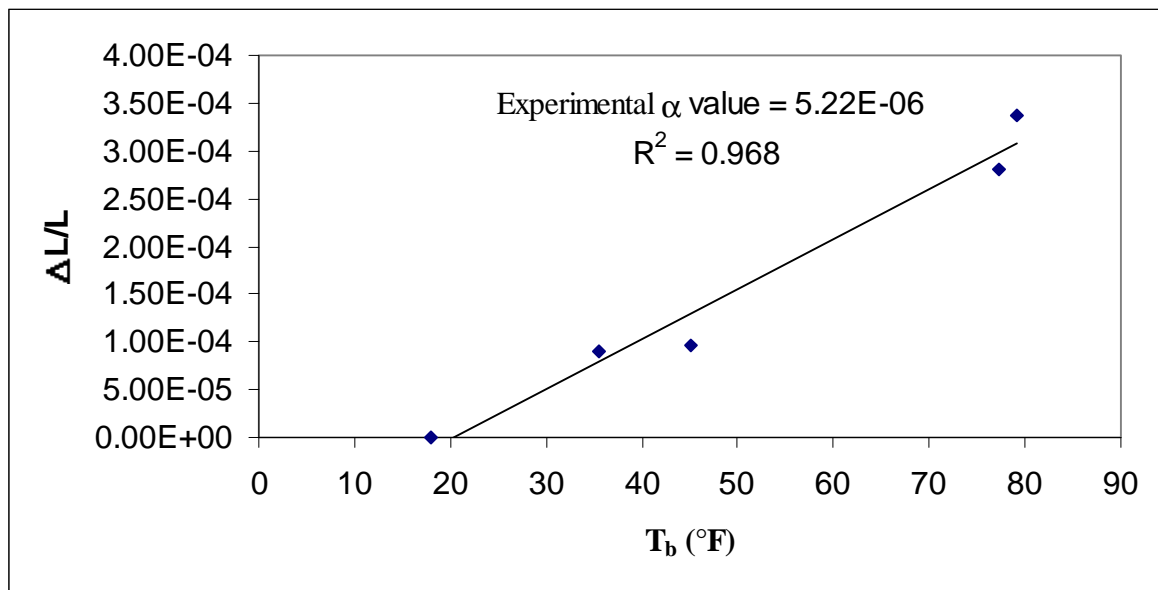

Figure 6.21 Gap opening vs. bridge temperature for Bridge 5 (0787.7A218)

Table 6.13 Various predicted expansion joint gaps for Bridge 5 (0787.7A218)

	G1 (in.)	G2 (in.)
Gap setting at 50° F specified on plans	2 1/2	2 1/2
DOT predicted short-term gap at 0° F	3.45	3.49
DOT predicted long-term gap at 0° F	4.08	4.15
Experimental gap at 0° F (extrapolated)	3.98	3.55
Size of strip seal specified on plans	4 in.	4 in.
Movement rating at 42° skew (G1) [40]	2.6 in.	-
Latest rating from inspection records**	7	7

**1997

Figure 6.22 The experimental α -value for Bridge 5 (0787.7A218)

From Table 6.13, the short-term (ignoring any concrete creep or shrinkage) gaps for G1 and G2 at 0° F predicted by the Iowa DOT design equations are 3.45 in. and 3.49 in., respectively, and the predicted long-term gaps at 0° F are 4.08 in. and 4.15 in., respectively (see Sections 3.3. and 6.3.1). The specified size for both seals was 4 in. The gap openings for G1 and G2 at 0° F extrapolated from the experimental data are 3.98 in. and 3.55, respectively, both smaller than the strip-seal size specified.

At G1, however, the skew angle is 42 degrees. Based on research done by the Michigan DOT [40], such a large skew angle has a detrimental effect on the movement capacity of strip seals (see Sections 2.6.2 and 3.4). For a skew of 42 degrees, the Michigan DOT study referenced in the Iowa DOT design guide [39] gives a movement rating perpendicular to the steel extrusion of about 2.6 in. ($\cos 42^\circ \times 3.5$ in. interpolated from Table 3.8) for a Watson Bowman Acme 4-in. seal. This movement rating is considerably less than the movement rating of 4 in. for a skew angle of 0 degrees.

The strip seal at G1 was likely installed at a temperature of about 70° F (from the construction records, the high temperature was 79° F and the low was 58° F on the day the seals were installed). At the time of installation, the existing gap would represent the “relaxed” condition of the seal; i.e., the condition with no evidence of racking stresses as defined in the Michigan DOT study. From this starting relaxed condition, the long-term opening movement, $\Delta G1$, predicted by the Iowa DOT design equations for both temperature and shrinkage effects would be

$$\Delta G1 = [(303.3 \times 12) \times (0.000006 \times 70 + 0.0002)] \times \cos(42^\circ) = 1.68 \text{ in.}$$

From the Michigan DOT study, the opening movement capacity (perpendicular to the extrusions) for a Watson Bowman Acme 4-in. seal for a skew angle of 42 degrees is about 1.3 in. (total movement rating of 2.6 in./2). This is considerably smaller than the predicted opening movement of 1.68 in. (or 1.53 in. if the experimental α -value of 0.00000522 from Figure 6.22 is used instead of 0.000006). From the Michigan DOT study, when the opening

movement exceeds the rated capacity, the seal typically ripples and then portions of it invert upward. The areas that have inverted are then subject to damage by traffic, especially snowplows. The shape of the piece of neoprene found below the bridge seems consistent with this kind of failure. There were few if any signs of pullout at G1.

At G2, the skew angle (12.5 degrees) does not significantly reduce the movement capacity and the extrapolated experimental gap opening of 3.55 in. at 0° F is smaller than the size of the seal specified (4 in.). Even at lower temperatures (refer to Table 2.6 for probabilities of temperature extremes vs. month), the gap opening at G2 should not exceed the size of the seal. However, the left gutter at G2 is at the low end of the super-elevated roadway and therefore tends to collect much debris. According to Iowa DOT personnel, runoff also tends to flow over the upturned end of the seal at the left gutter during heavy rains or rapid snowmelt. Any wind from the north or west then blows the overflow back onto the bridge substructure.

6.3.6 Bridge 6: 0784.8S218 (FHWA 605800)

Bridge 6 is a six-lane, eight-span prestressed concrete-girder bridge that carries the southbound traffic of US 218 across Quarry Lake in Waterloo, Iowa. It was built in 1989. The estimated Average Daily Traffic (ADT) was 12,700 in 1989, 13,000 in 1991, 18,700 in 1993, 19,500 in 1995 and 22,900 in 1997. The bridge has three expansion joints with strip seals, a skew angle of 20 degrees, and expansion lengths of 182.3 ft., 364 ft. and 182.3 ft. for G1, G2 and G3, respectively.

In the inspections of 1991, serious problems were observed at the strip seal at G2. The Iowa DOT inspection records noted “neoprene gland is pulling out of steel extrusion and right cover plate broken off”. From 1989 to 1991, the rating of the strip seals at G1 and G3

dropped from 9 to 8 and the rating of the strip seal at G2 dropped from 9 to 6. In the 1993 inspections, the ratings of the strip seals at G1, G2, and G3 remained the same at 8, 6, and 8, respectively. The 1993 inspection records noted for G2 “some displacement of neoprene gland at pier #4 and #5 of southbound”. In the inspection records of 1995, problems were observed in the strip seals at G1 and G3. The 1995 inspection records for G1 and G3 noted “loose material on south bound on left” and for G2 noted “material pulled out at pier #4 of south bound, and the curb plate is missing from the right end of the joint at pier #4”. The ratings of the strip seals of G1 and G3 dropped from 8 in June of 1993 to 7 in October of 1995. The rating of the strip seal at G2 remained the same at 6. Limited inspections were performed in October of 1997, and the inspection records noted “strip seal deck joints are choked with sand and debris. Strip seal over pier #4 of south bound lane has pulled loose for about 36 ft. Strip seal over near abutment on south bound lane has pulled loose for about 6 ft”. In 1999, limited inspections were again performed and the inspection records noted “about 36 ft of strip seal deck joint are loose ...”. Replacement of the broken strip seals had been requested in November of 1991.

In July of 2000, a field investigation of the strip seals was performed as part of this study. At G1, portions of the seal were pulled out from the steel extrusions (Figure 6.23). At G2, most of the seal was pulled out from the steel extrusions (Figure 6.24). At G3, there was no immediate leaking during the leak test, but staining on the backwall due to leakage was observed. Strip seals at G1, G2 and G3 were rated as 6, 5 and 7, respectively. Inspection data for Bridge 6 are summarized in Table 6.14, gap openings versus representative bridge temperature are plotted in Figure 6.25, predicted behavior is

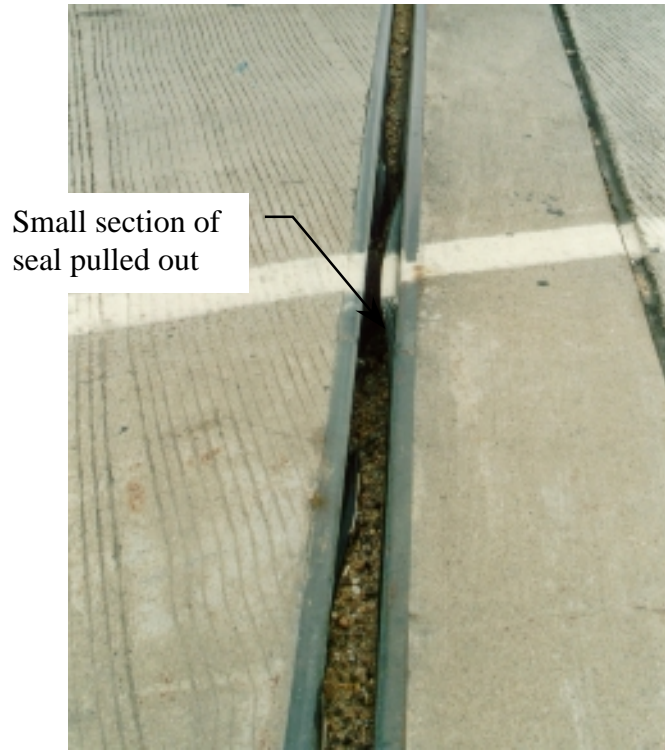

Figure 6.23 Strip seal at G1 of Bridge 6 (0784.8S218)

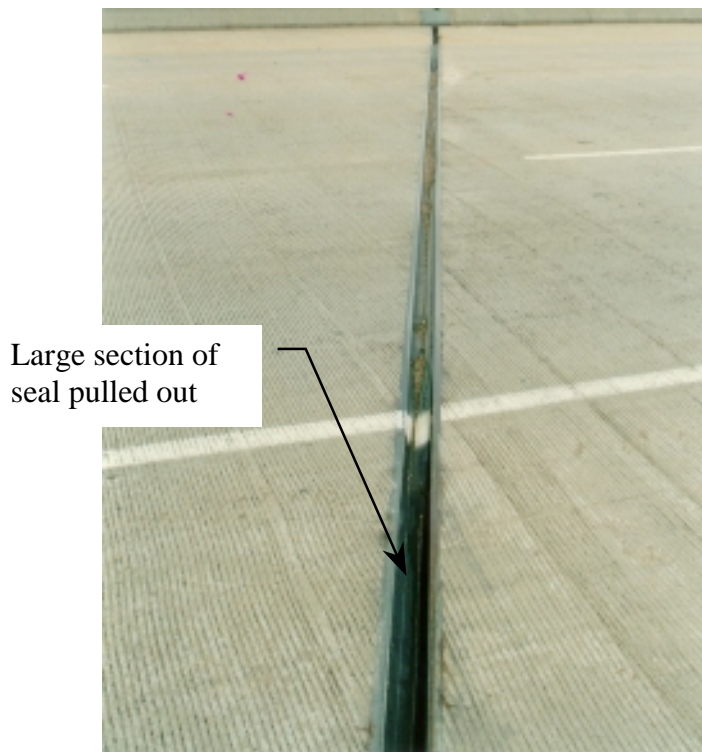

Figure 6.24 Strip seal at G2 of Bridge 6 (0784.8S218)

summarized in Table 6.15, and the experimental α plot is shown in Figure 6.26. Refer to Section 6.3.1 for the process used to produce Figures 6.25 and 6.26 and Tables 6.14 and 6.15.

Table 6.14 Gap openings and ratings for Bridge 6 (0784.8S218)

Year	Rating			Gap Openings						Temp. (°F)
				G1		G2		G3		
	G1	G2	G3	LG	RG	LG	RG	LG	RG	
1989	9	9	9	-	-	-	-	-	-	-
1991	8	6	8	1 3/4	1 3/4	2 1/2	2 1/2	1 1/2	1 1/2	75
1993	8	6	8	1 3/4	1 3/4	2 5/8	2 1/2	1 1/2	1 1/2	75
1995	7	6	7	2 1/4	2 3/8	3 3/8	3 3/8	2	2	60
2000*	6	5	7	1.67	1.91	2.61	2.50	1.64	1.44	75

* Inspection by ISU investigators

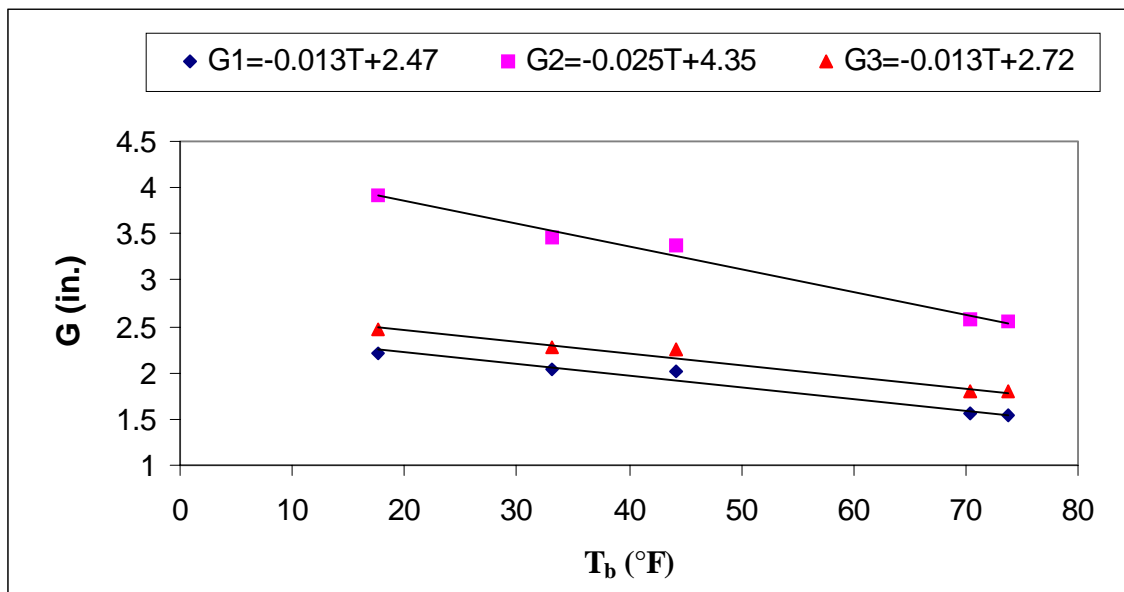
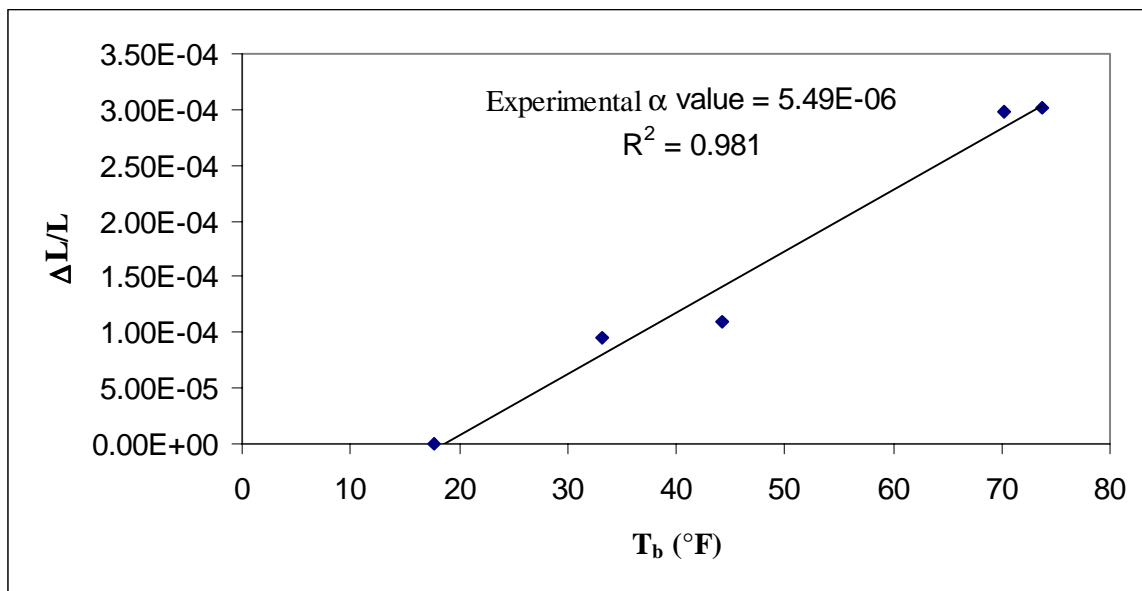

Figure 6.25 Gap openings vs. bridge temperature for Bridge 6 (0784.8S218)

Table 6.15 Various predicted expansion joint gaps for Bridge 6 (0784.8S218)

	G1 (in.)	G2 (in.)	G3 (in.)
Gap setting at 50° F specified on plans	1 1/2	2 1/4	1 1/2
DOT predicted short-term gap at 0° F	2.12	3.56	2.12
DOT predicted long-term gap at 0° F	2.53	4.43	2.53
Experimental gap at 0° F (extrapolated)	2.47	4.35	2.72
Size of strip seal specified on plans	2 in.	4 in.	2 in.
Latest rating from inspection records**	7	6	7

**1995

Figure 6.26 The experimental α -value for Bridge 6 (0784.8S218)

From Table 6.15, the long-term gaps at 0° F predicted by the Iowa DOT design equations for G1, G2, and G3 are 2.53 in., 4.43 in., and 2.53 in., respectively. The gaps at 0° F that were extrapolated from the experimental data are 2.47 in., 4.35 in., and 2.72 in., respectively. These gaps are all larger than the corresponding seal sizes of 2 in., 4 in., and 2 in. specified for G1, G2, and G2, respectively. Some pullout has occurred at G1, most of the seal at G2 has pulled out, and leaking is occurring at G3. Even the short-term gap of

2.12 in. predicted by the Iowa DOT design equations for G1 and G3 is larger than the strip seal specified for those joints. The gap setting specified on the plans for G1 and G3 at 10° F is 2 in.

6.3.7 Bridge 7: 8561.5L030 (FHWA 607795)

Bridge 7 is a two-lane, three-span prestressed concrete-girder bridge that carries westbound traffic of US 30 across East Indian Creek east of Nevada, Iowa. It was built in 1997. No average daily traffic data for this bridge was available. The bridge has two expansion joints with strip seals, one at each abutment, a skew angle of 37 degrees, and an expansion length of 151.5 ft for both G1 and G2.

The initial Iowa DOT inspection was performed in 1998 and the strip seals at G1 and G2 were in good condition – both were given a rating of 9. In June of 2000, a field investigation of the strip seals was performed as part of this study. No sign of damage or pullout was observed but slight leakage was observed for the strip seal at G1 and considerable leakage was observed at G2 (Figure 6.27). Both strip seals were assigned a rating of 7 by the ISU investigators.

Inspections data for Bridge 7 is summarized in Table 6.16, relationships between the gap openings and representative bridge temperature are plotted in Figure 6.28, predicted behavior is summarized in Table 6.17, and the experimental α -value for Bridge 7 is shown in Figure 6.29. Refer to Section 6.3.1 for the process used to produce Figures 6.28 and 6.29 and Tables 6.16 and 6.17.

From Table 6.17, the gaps at 0° F extrapolated from the experimental data (2.48 in.) and predicted by the Iowa DOT design equations (2.41 in. and 2.43 in. for G1 and G2,



Figure 6.27 Backwall below left gutter at G2 of Bridge 7 (8561.5L030)

Table 6.16 Gap openings and ratings for Bridge 7 (8561.5L030)

Year	Ratings		Gap Openings				Temp. (°F)
			G1		G2		
	G1	G2	LG	RG	LG	RG	
1995	9	9	-	-	-	-	-
1997	9	9	2	2	1 7/8	1 3/4	40
2000*	7	7	1.80	1.87	1.71	1.67	70

* Inspection by ISU investigators

respectively) are all well within the movement rating of a 3-in. Watson Bowman Acme seal at a 37 degree skew ($\cos 37^\circ \times 3.7$ in. interpolated from Table 3.8 = 2.93 in.). Both seals seem to be performing reasonably well.

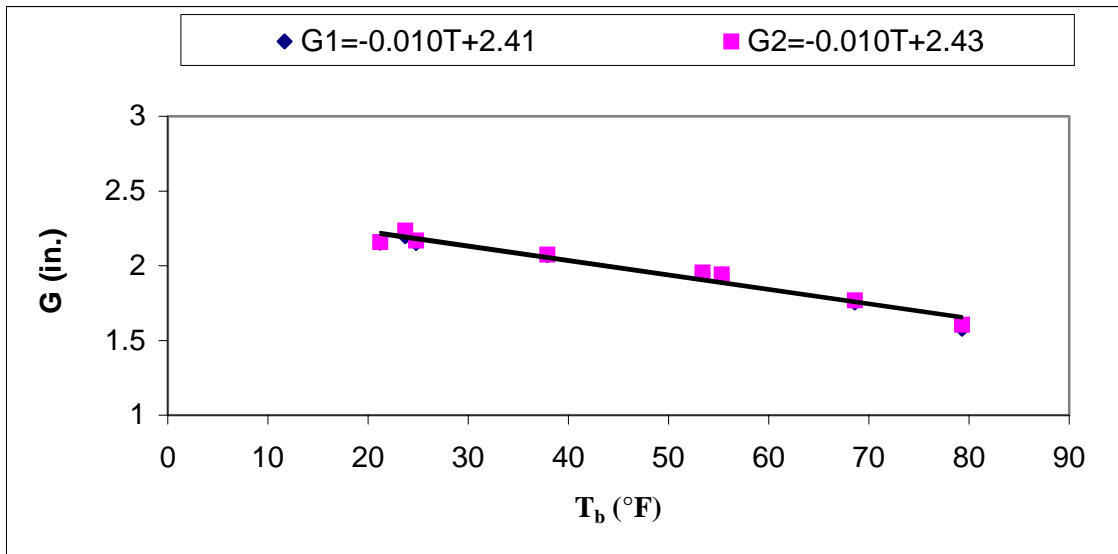

Figure 6.28 Gap opening vs. bridge temperature for Bridge 7 (8561.5L030)

Table 6.17 Various predicted expansion joint gaps for Bridge 7 (8561.5L030)

	G1 (in.)	G2 (in.)
Gap setting at 50°F specified on plans	1 3/4	1 3/4
DOT predicted short-term gap at 0°F	2.19	2.19
DOT predicted long-term gap at 0°F	2.48	2.48
Experimental gap at 0°F (extrapolated)	2.41	2.43
Size of strip seal specified on plans	3 in.	3 in.
Movement rating at 37° skew [40]	2.93 in.	2.93
Latest rating from inspection records**	9	9

**1997

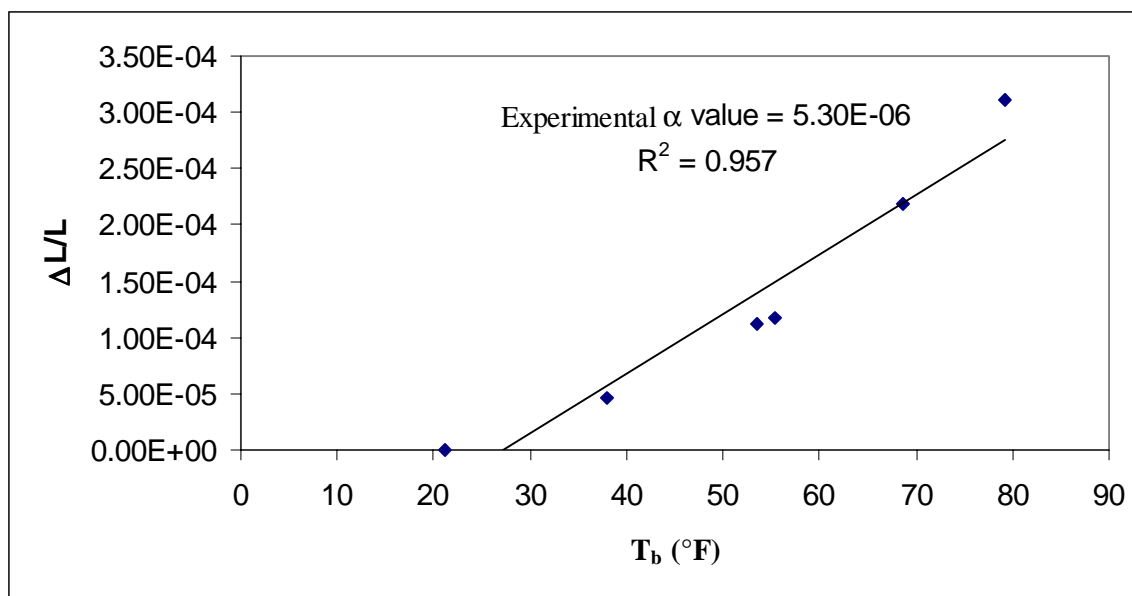

Figure 6.29 The experimental α -value for Bridge 7 (8561.5L030)

6.3.8 Bridge 8: 7776.8L065 (FHWA 606800)

Bridge 8 is a three-lane, seven-span, bulb-tee, prestressed concrete girder bridge that carries southbound traffic of US 65 across the Des Moines River southeast of Des Moines, Iowa. The bridge was built in 1997. The estimated Average Daily Traffic (ADT) was 9,300 in 1997. The bridge has four expansion joints with strip seals, one at each of the abutments and two at intermediate expansion joints. The expansion lengths are 129.8 ft, 327.5 ft, 327.5 ft and 129.8 ft for G1, G2, G3 and G4, respectively.

The initial Iowa DOT inspection was performed in 1999 and the strip seals at G1, G2 and G3 were in good condition and were rated 9. The strip seal at G4 was rated 8. In June of 2000, a field investigation of the strip seals was performed by the ISU investigators. All the joints were filled with debris, and debris was mounded over the seals at most of the gutters. At G1, no obvious leaking was observed below the joint during the leak test, but both ends of

the seal were cut off short and near vertical rather than horizontal as called for on the bridge plans (see Figure 3.3). The vertical cut allows water to flow over the ends of the seals to the substructure. At G2, G3, and G4, this same problem was observed (see Figure 6.30). The strip seals at G1, G2, G3 and G4 were all given a rating of 7 by the ISU investigators because of the seal end detailing.

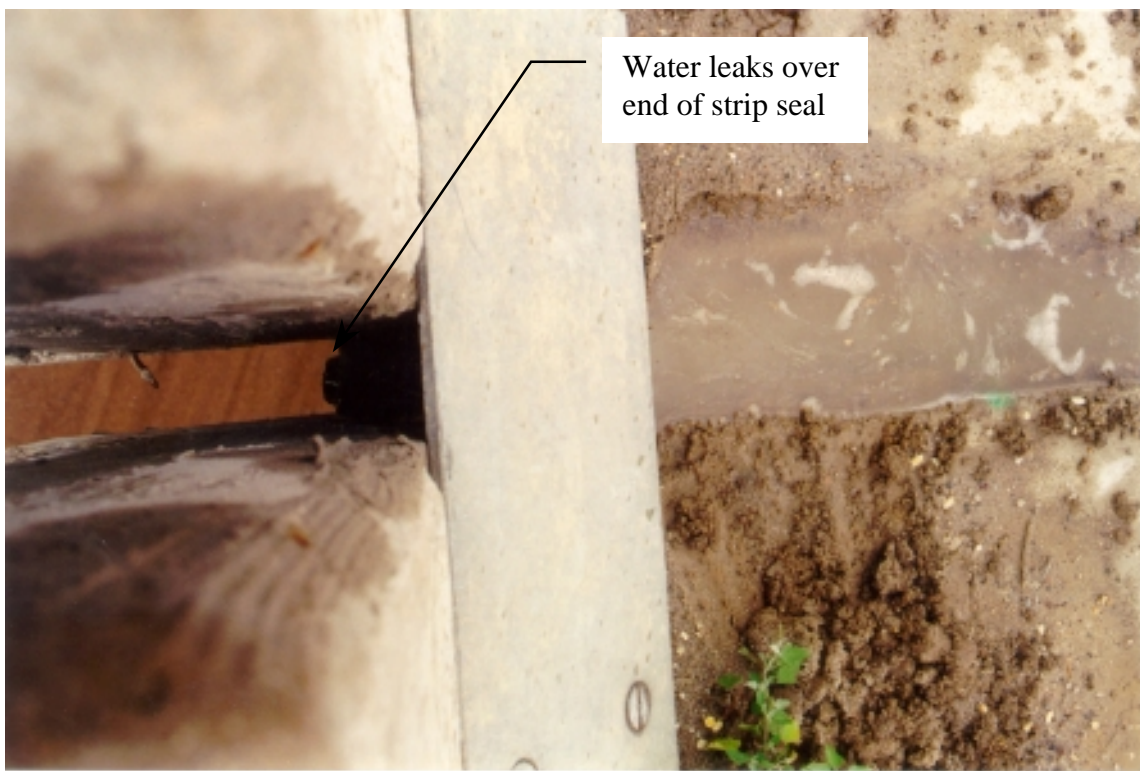

Figure 6.30 Strip seal at G3 for Bridge 8 (7776.8L065)

Inspection data for Bridge 8 is summarized in Table 6.18. Gap openings versus representative bridge temperature are plotted in Figure 6.31. Predicted gaps at 0° F, specified strip seal sizes, and the most recent DOT inspection ratings are summarized in Table 6.19.

The experimental α -value is plotted in Figure 6.32. Refer to Section 6.3.1 for the process used to produce Figures 6.31 and 6.32, and Tables 6.18 and 6.19.

Table 6.18 Gap openings and ratings for Bridge 8 (7776.8L065)

Year	Ratings				Gap Openings								Temp (°F)	
					G1		G2		G3		G4			
	G1	G2	G3	G4	LG	RG	LG	RG	LG	RG	LG	RG		
1997	9	9	9	9	-	-	-	-	-	-	-	-	-	-
1999	9	9	9	8	2 7/16	2 1/2	2 7/8	2 5/8	2 3/16	2	2	1 15/16	60	
2000*	7	7	7	7	2.32	2.15	2.63	2.44	1.93	1.69	1.90	1.85	70	

* Inspection by ISU investigators

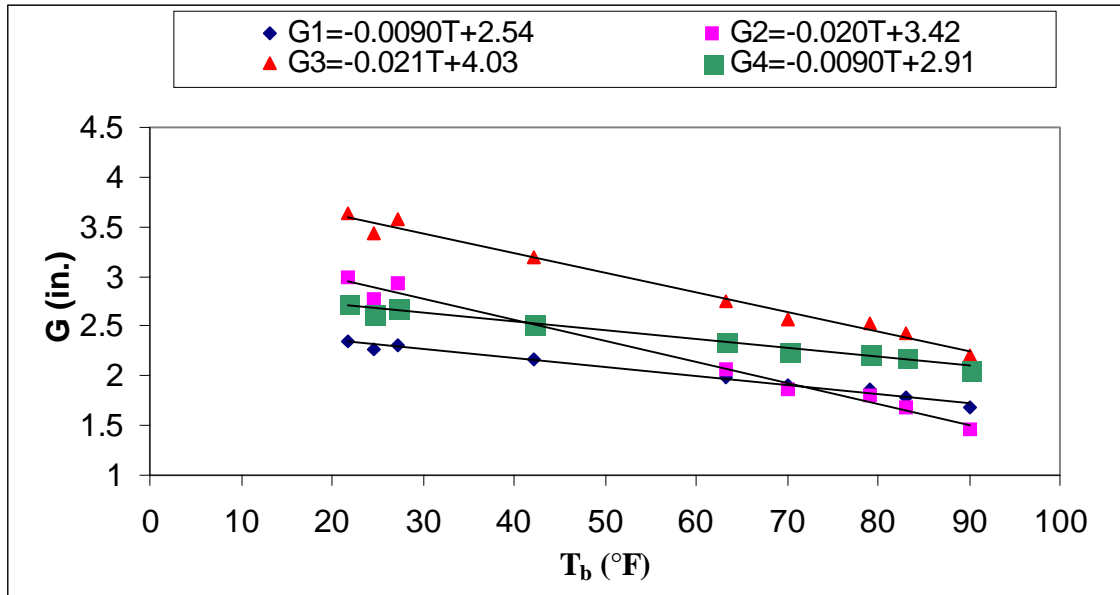

Figure 6.31 Gap opening vs. bridge temperature for Bridge 8 (7776.8L065)

Table 6.19 Various predicted expansion joint gaps for Bridge 8 (7776.8L065)

	G1 (in.)	G2 (in.)	G3 (in.)	G4 (in.)
Gap setting at 50° F specified on plans	2 1/4	2 1/4	2 1/4	2 1/4
DOT predicted short-term gap at 0° F	2.76	3.53	3.53	2.76
DOT predicted long-term gap at 0° F	3.07	4.31	4.31	3.07
Experimental gap at 0°F (extrapolated)	2.54	3.42	4.03	2.91
Size of strip seal specified on plans	4 in.	4 in.	4 in.	4 in.
Latest rating from inspection records**	9	9	9	8

**1999

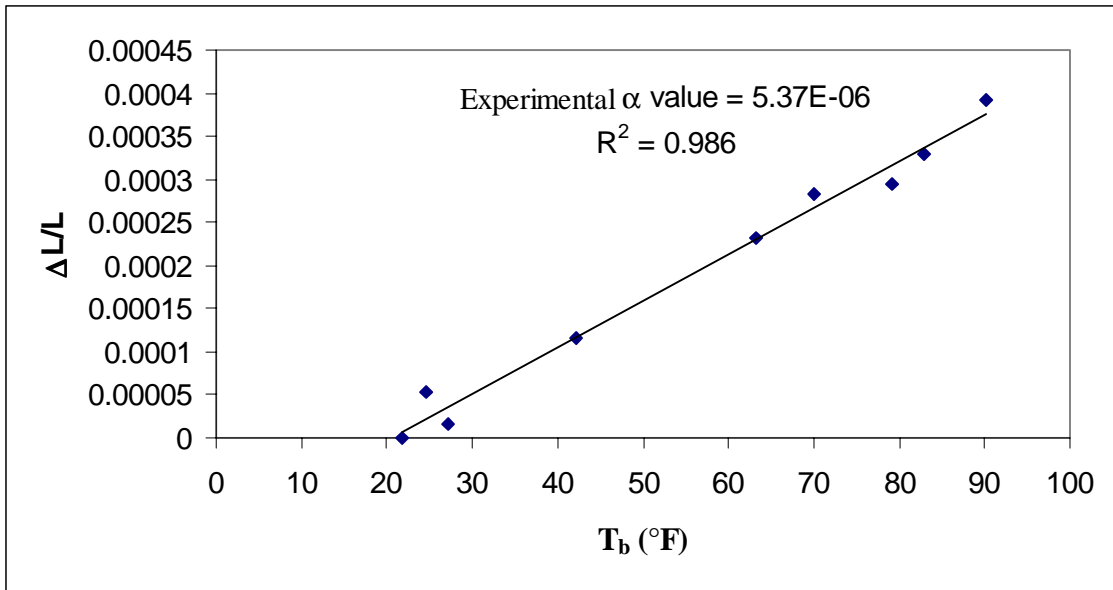

Figure 6.32 The experimental α -value for Bridge 8 (7776.8L065)

From Table 6.19, the gap openings at 0° F for G1 and G4 predicted by the DOT equations (3.07 in. for both) and extrapolated from the experimental data (2.91 in. and 2.54 in., respectively) are well within the size of the strip seal specified on the plans (4 in.). The long-term tap of 4.31 in. predicted by the DOT equations and the experimentally extrapolated gap of 3.42 in. at 0° F for G2 are on either side of the specified seal size. The DOT predicted (4.31 in.) and experimentally extrapolated (4.03 in.) gaps at G3 are both larger than the specified seal size of 4 in. The seals all seem to be performing well except for the overflow leakage allowed by the end detailing. However, the seals have only been in service for about three years

6.3.9 Bridge 9: 6485.3L030 (FHWA 601620)

Bridge 9 is a two-lane, three-span continuous steel-girder bridge built in 1995 that carries westbound traffic of US Highway 30 across IA 14 in Marshalltown, Iowa. The superstructure was constructed with A-588 weathering steel. The estimated Average Daily

Traffic (ADT) was 3,280 in 1996 and 3,170 in 1997. The bridge has two expansion joints, one at each abutment. One of the two piers is a fixed pier (pier #2, the east pier); i.e., the pier and girders are keyed together to prevent large relative translation. The resulting expansion lengths are 200 ft and 71.8 ft for G1 and G2, respectively.

The initial inspection was done in 1997 and problems were observed in the strip seals at both abutments. The 1997 inspection records noted “water is leaking in opening behind the curb plate next to the outside edge of the joint steel extrusion in both gutters. Water then continues to run down the backwall and onto the bridge seat, especially in the right gutter which is the low side of the super-elevated horizontal curve on the structure.” The ratings of the strip seals at G1 and G2 dropped from 9 in 1995 to 6 in November of 1997.

In June of 2000, a field investigation of the strip seals was done by the ISU investigators. No sign of damage or pullout of the seal was observed but leakage was observed for the strip seal at the near abutment (only in the right gutter, shown in Figure 6.33). There was no sign of leakage for the strip seal at G2. The strip seals at G1 and G2 were assigned a rating of 7 and 8, respectively, by the ISU investigators.

Data for Bridge 9 from the Iowa DOT inspections and the ISU investigation are summarized in Table 6.20. Plots of the relationships between the gap openings and representative bridge temperature are shown in Figure 6.34. Predicted gaps at -30°F (minimum temperature used by the Iowa DOT for steel-girder bridges – see Section 3.3), specified strip seal sizes, and the most recent DOT inspection ratings are summarized in Table 6.21. For steel-girder bridges, no concrete shrinkage is included in the calculations for sizing the neoprene seals in the Iowa DOT design equations. The plot used to determine the experimental α -value for Bridge 9 is

shown in Figure 6.35 (see Section 6.3.1 for the process used to produce these figures and tables).

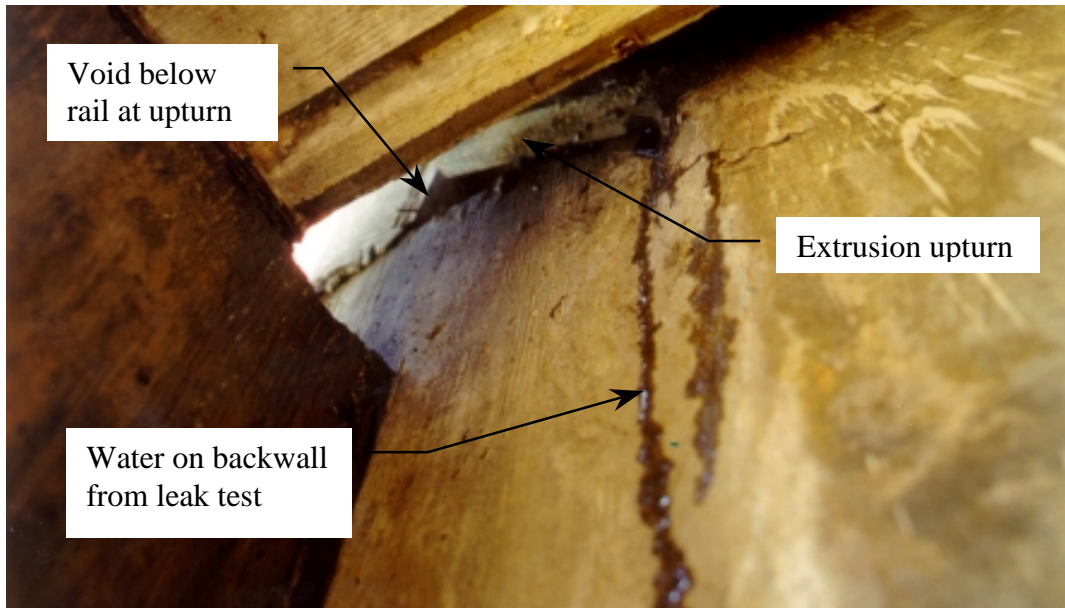

Figure 6.33 Leaking below the right gutter at G1 of Bridge 9 (6485.3L030)

Table 6.20 Gap openings and ratings for Bridge 9 (6485.3L030)

Year	Ratings		Gap Opening (in.)				Temp. (°F)
			G1		G2		
	G1	G2	LG	RG	LG	RG	
1995	9	9	-	-	-	-	-
1997	6	6	2 3/4	2 7/8	3	3 1/8	40
2000*	7	8	2.76	2.48	2.38	2.41	72

* Inspection by ISU investigators

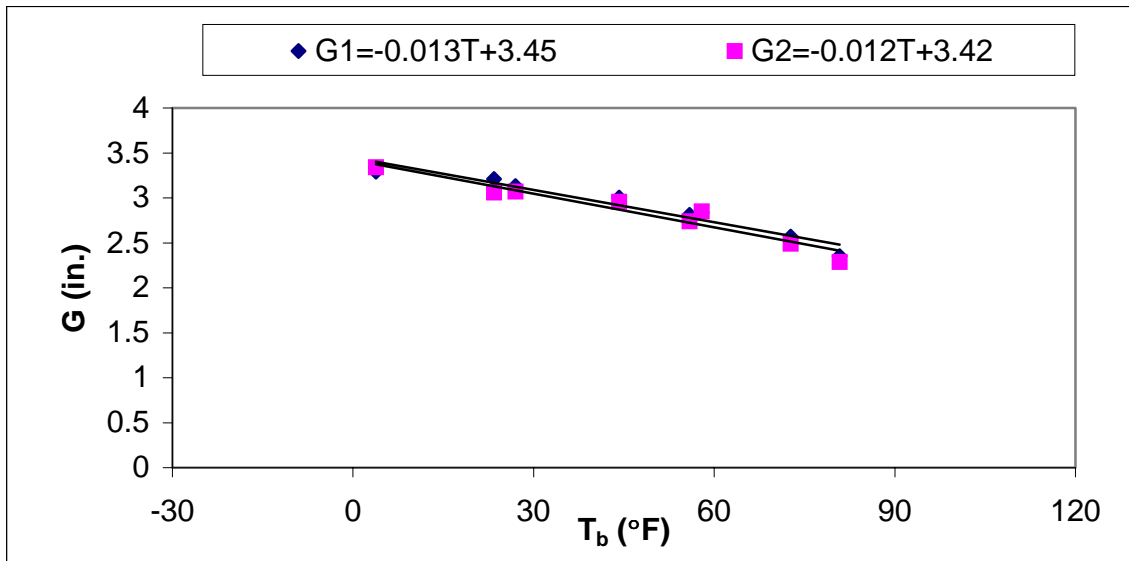

Figure 6.34 Gap opening vs. representative bridge temperature for Bridge 9 (6485.3L030)

Table 6.21 Various predicted expansion joint gaps for Bridge 9 (6485.3L030)

	G1 (in.)	G2 (in.)
Gap setting at 50°F specified on plans	2 1/4	2
DOT predicted gap at -30°F	3.50	2.45
Experimental gap at -30°F (extrapolated)	3.81	3.81
Size of strip seal specified on plans	4 in.	4 in.
Latest rating from inspection records**	6	6

**1997

From Table 6.21, the gaps at 0° F predicted by the Iowa DOT design equations are 3.50 in. and 2.45 in. for G1 and G2, respectively (see Sections 3.3. and 6.3.1). The gap at 0° F that was extrapolated from the experimental data is, coincidentally, 3.81 in. for both G1 and G2, even though both the gap settings and expansion lengths for the two joints are different because of the fixed east pier. Both experimental values are larger than those predicted by the design equations, perhaps because the gaps set during construction were larger than those called for on the plans. Note, however, that both values are still smaller than the seal size specified for the joints and the seals did not pull out.

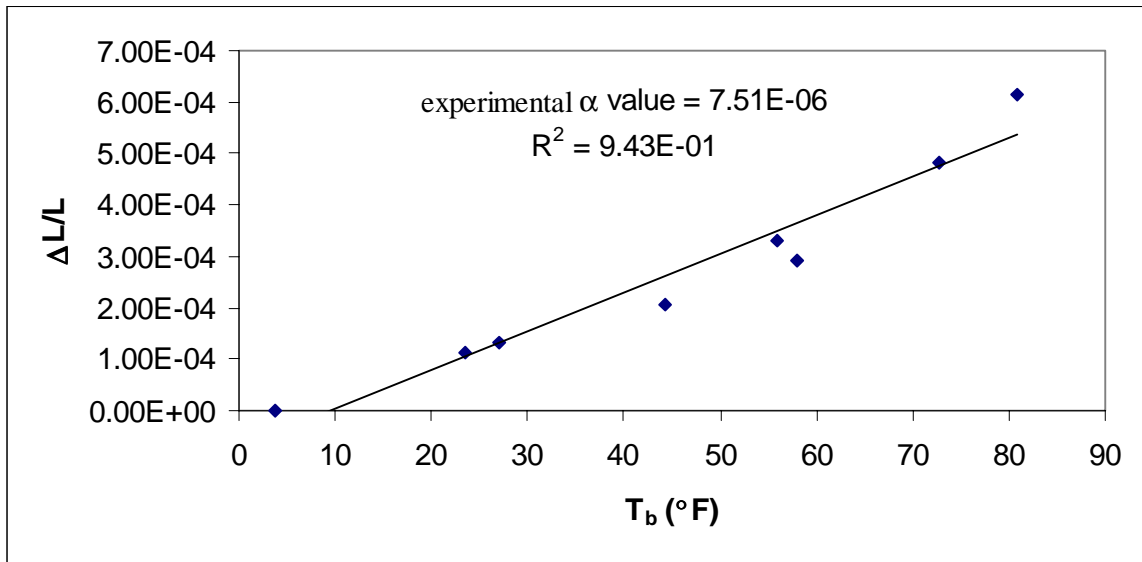

Figure 6.35 The experimental α -value for Bridge 9 (6485.3L030)

Though both expansion joints were filled with debris, the seals seemed to be functioning well except at the end details, especially at the right gutter at the near abutment (G1). This gutter is on the low side of the super-elevated horizontal curve of the bridge. At that location during the leak test (Section 6.2.3), water leaked immediately around the rail upturn (see Figure 6.33). At that location (and the other three rail upturns), the blockout around the upturn was not formed so that the upturn would be encased in concrete as shown on the bridge plans. Instead it was formed in such a way that a void was left below the rail upturn as can be seen in Figure 6.33. Water at the gutter can therefore flow around the rail upturns, down through the void, and then down the backwall.

6.3.10 Bridge 10: 6402.0S014 (FHWA 007911)

Bridge 10 is a four-lane, ten-span prestressed concrete-girder bridge that was built in 1985 and carries both northbound and southbound traffic on IA 14 across the Union Pacific Railroad in Marshalltown. The estimated ADT was 23,600 in 1984, 11,700 in 1985, 9,430 in

1986 and 1987, 18,700 in 1993, 19,500 in 1995 and 22,900 in 1997. The bridge has four expansion joints with strip seals, one at each abutment and one at each of two intermediate deck joints. The expansion lengths for G1, G2, G3, and G4 are 144.0 ft, 324.4 ft, 262.6 ft, and 129.0 ft, respectively.

In the inspection of 1987, serious problems were observed and all the strip seals were rated 6. In the 1993 inspection, the strip seals at G1, G2, G3, and G4 were rated 7, 6, 6, and 9. Presumably, one or more of the seals was replaced between 1987 and 1993, but no record was found to confirm which, if any, were replaced. The 1993 inspection report for G2 and G3 noted “deck joints over piers #3 and #7 in the right gutter are in need of repair” and “Neoprene gland pulled loose from the steel extrusion in the right gutter of pier #3, small opening in right gutter – joint material not continuous between pier #7 and sidewalk”. In June of 2000, a field investigation of the strip seals was performed as part of this study. At G1, portions of the strip seal were torn through near the center of the roadway (Figure 6.36). The G2 strip seal at the east lane was pulled out (Figure 6.37). For G3, the strip seal was pulled out at several locations (Figure 6.38). No sign of pullout was observed at G4. All of the joints were filled with debris except where the seals were pulled out allowing the debris to fall through the joint. The strip seals at G1, G2, G3 and G4 were assigned a rating of 6, 5, 6 and 7, respectively, by the ISU investigators.

Inspection data for Bridge 10 is summarized in Table 6.22, gap openings versus representative bridge temperature are plotted in Figure 6.39, predicted behavior is summarized in Table 6.23, and the experimental α -value is plotted in Figure 6.40 (see Section 6.3.1 for the process used to produce these figures and tables).



Figure 6.36 Strip seal at G1 for Bridge 10 (6402.0S014)

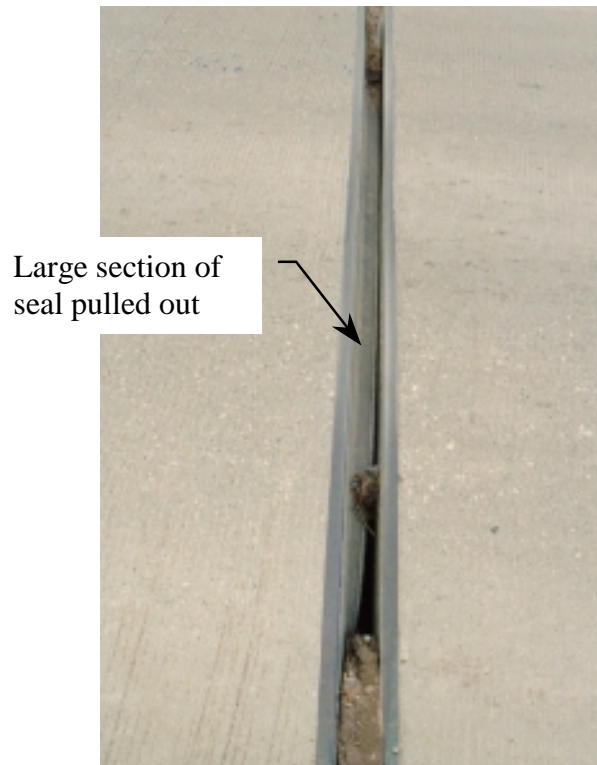

Figure 6.37 Strip seal at G2 for Bridge 10 (6402.0S014)

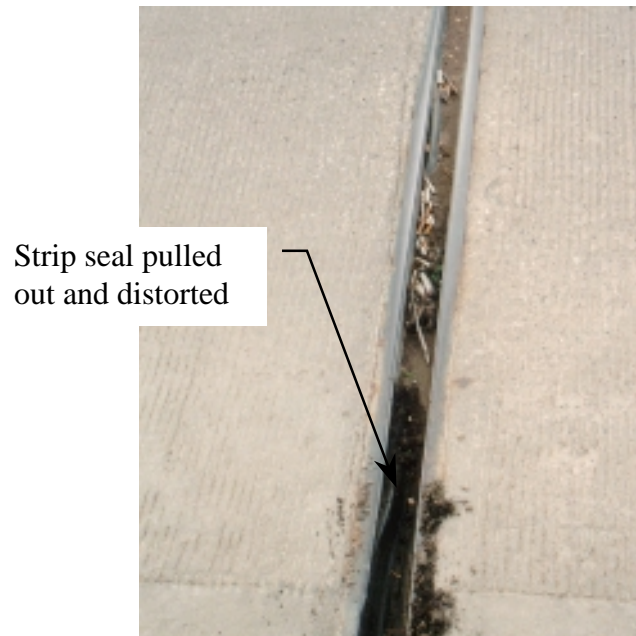

Figure 6.38 Strip seal at G3 for Bridge 10 (6402.0S014)

Table 6.22 Gap openings and ratings for Bridge 10 (6402.0S014)

Year	Ratings				Gap Openings								Temp. (°F)
					G1		G2		G3		G4		
	G1	G2	G3	G4	LG	RG	LG	RG	LG	RG	LG	RG	
1985	9	9	9	9	-	-	-	-	-	-	-	-	-
1987	6	6	6	6	2 5/8	2 1/2	3 5/16	3 3/8	3 1/8	3 1/8	2 3/8	2 1/2	35
1993	7	6	6	9	2 1/2	2 1/2	3 1/4	3 1/4	3 1/16	3	2 1/4	2 3/8	35
2000*	6	5	6	7	1.93	2.17	2.79	2.61	2.29	2.37	2.16	2.17	73

* Inspection by ISU investigators

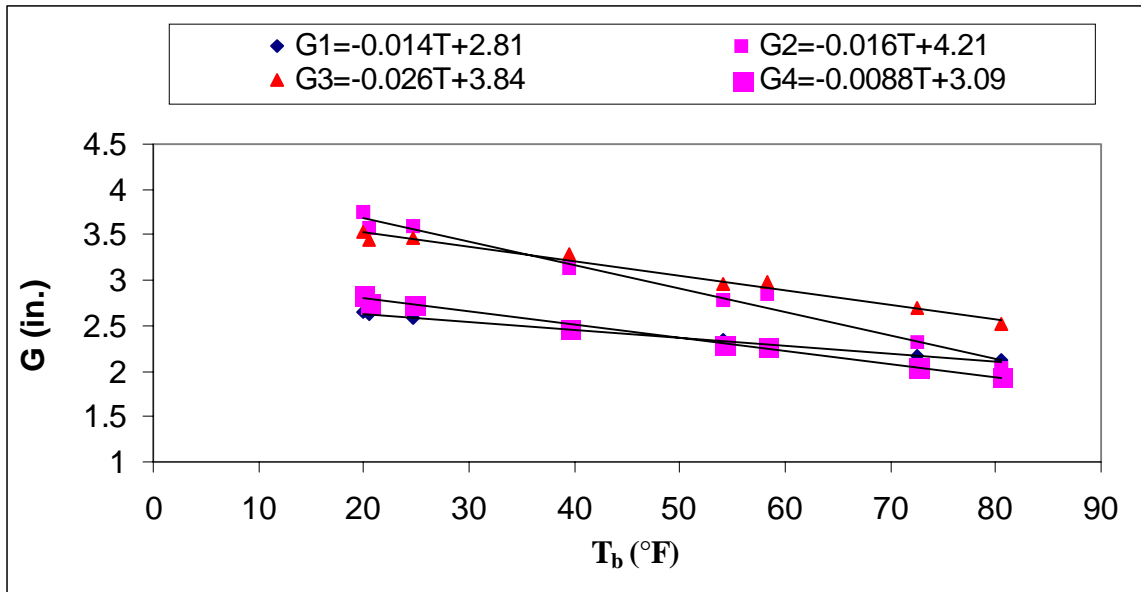

Figure 6.39 Gap openings vs. bridge temperature for Bridge 10 (6402.0S014)

Table 6.23 Various predicted expansion joint gaps for Bridge 10 (6402.0S014)

	G1 (in.)	G2 (in.)	G3 (in.)	G4 (in.)
Gap setting at 50° F specified on plans	2 1/2	2 1/2	2 1/2	2 1/2
DOT predicted short-term gap at 0° F	3.02	3.65	3.55	2.96
DOT predicted long-term gap at 0° F	3.36	4.42	4.25	3.27
Experimental gap at 0° F (extrapolated)	2.81	4.21	3.84	3.09
Size of strip seal specified on plans	4 in.	4 in.	4 in.	4 in.
Latest rating from inspection records**	7	6	6	9

**1993

From Table 6.23, the long-term gap openings at 0° F predicted by the Iowa DOT design equations for G2 and G3 (4.42 in. and 4.25 in., respectively) exceed the strip seal size specified on the bridge plans (4 in.). The extrapolated experimental gap opening at 0° F for G2 (4.21 in.) also exceeds the specified seal size. At G3, the extrapolated experimental gap opening at 0° F (3.84 in.) is slightly smaller than the specified seal size. But at temperatures

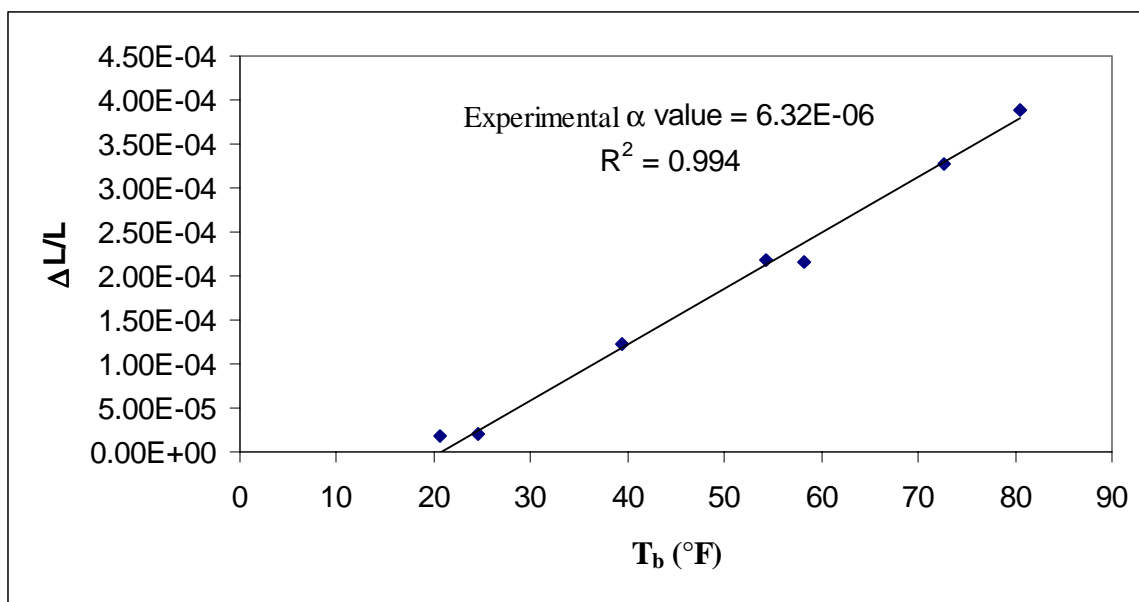

Figure 6.40 The experimental α -value for Bridge 10 (6402.OS014)

near -15°F (see Section 2.2), the extrapolated gap at G3 would exceed the specified seal size. The seals at G2 and G3 have performed poorly, primarily due to pullout of the seals.

For G1 and G4, the DOT predicted gaps at 0°F (3.36 in. and 3.27 in., respectively) and extrapolated experimental gaps at 0°F (3.09 in. and 2.81 in., respectively) are all considerably smaller than the specified strip seal size (4 in.). Seals at G1 and G4 have performed better than those at G2 and G3.

6.3.11 Bridge 11: 6403.6L014 (FHWA 035431)

Bridge 11 is a two-lane, four-span continuous welded steel-girder. The bridge was built in 1987 and carries the southbound traffic of IA 14 across the Iowa River at the north edge of Marshalltown. The estimated Average Daily Traffic (ADT) was 5,720 in 1986, 5,950 in 1987, 6,430 in 1989, 6,600 in 1991, 6,200 in 1993, and 6,500 in 1995 and 1997. The bridge has a skew angle of 15 degrees, two expansion joints with strip seals, one at each

abutment, and the middle pier is a fixed pier. The resulting expansion lengths for G1 and G2 are 269.5 ft and 204 ft, respectively.

In the inspection of November 1988, the strip seals at G1 and G2 were rated 8. In the June of 1989 inspection, the ratings of the strip seals G1 and G2 remained the same. In 1991 and 1993, routine inspections were done, so neither ratings of strip seals nor measurements of expansion joint openings are available. In the inspection of 1995, records show that the ratings of strip seals at G1 and G2 remained at 8. The inspection report noted for G2 that “left steel curb plate is missing”. Routine inspections were performed again in 1997 and 1999, so no ratings and measurements of expansion joint opening are available.

In June of 2000, a field investigation was performed by the ISU investigation team. Both seals were largely filled with debris, especially at the gutters. At G1, slight bulges in the seal were observed, which might suggest the beginnings of pullout. At G2, the end of the seal at the right gutter was pulled out slightly. The end of the seal at the left gutter was cut off too short which allowed water to flow over the end and down the backwall during the leak test (Figure 6.41). The strip seals at G1 and G2 were both assigned a rating of 7 by the ISU investigators.

Inspection data for Bridge 11 is summarized in Table 6.24, gap openings versus representative bridge temperature are plotted in Figure 6.42, predicted gaps at -30° F (see Section 3.3 for temperature ranges used in Iowa), specified strip seal sizes, and the most recent Iowa DOT inspection ratings are summarized in Table 6.25. No concrete shrinkage is included in the Iowa DOT recommended design procedure for sizing the neoprene seals for steel-girder bridges. The experimental α -value for Bridge 11 is plotted in Figure 6.43. See Section 6.3.1 for the process used in producing these figures and tables.



Figure 6.41 Leakage observed underneath G2 for Bridge 11 (6403.6L014)

Table 6.24 Gap openings and ratings for Bridge 11 (6403.6L014)

Year	Ratings		Gap Openings				Temp. (°F)
			G1		G2		
	G1	G2	LG	RG	LG	RG	
1987	9	9	-	-	-	-	-
1988	8	8	2 1/8	1 7/8	1 7/8	2 1/16	70
1989	8	8	2 1/8	2 1/8	2	2	65
1995	8	8	2 1/4	2 3/8	2	2	45
2000*	7	7	1.44	1.36	1.55	1.52	74

* Inspection by ISU investigators

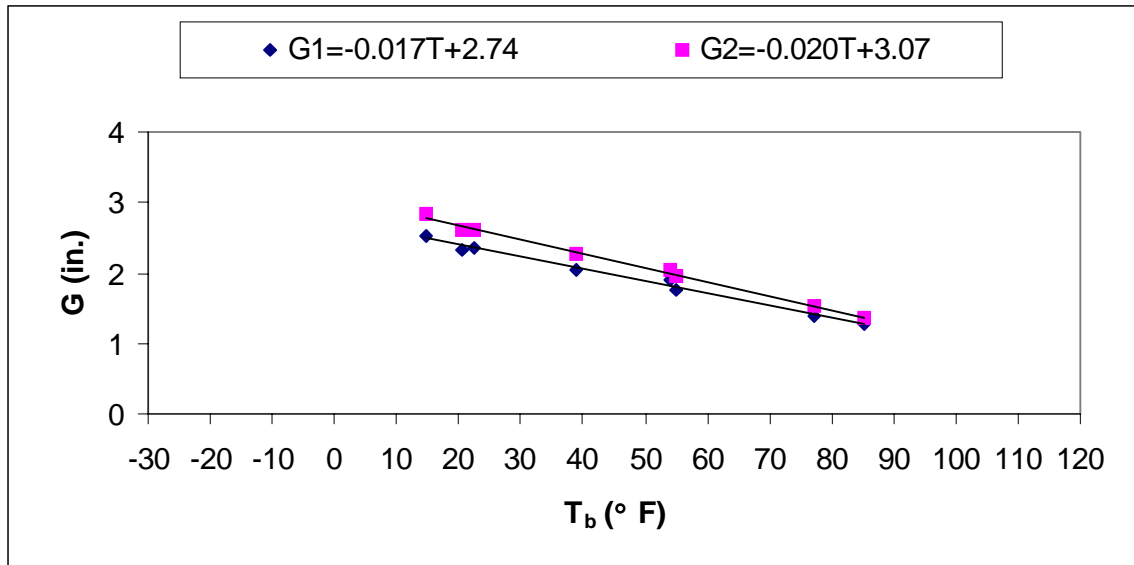

Figure 6.42 Gap opening vs. bridge temperature for Bridge 11 (6403.6L014)

Table 6.25 Various predicted expansion joint gaps for Bridge 11 (6403.6L014)

	G1 (in.)	G2 (in.)
Gap setting at 50° F specified on plans	2 1/16	1 5/8
DOT predicted short-term gap at -30° F	3.74	2.90
Experimental gap at -30° F (extrapolated)	3.25	3.67
Size of strip seal specified on plans	4 in.	4 in.
Latest rating from inspection records**	8	8

**1995

From Table 6.25, the gaps for G1 and G2 at -30° F predicted by the Iowa DOT design equations are 3.74 in. and 2.90 in., respectively (see Sections .3 and 6.3.1). The gaps at -30° F extrapolated from the experimental data are 3.25 in. and 3.67 in. for G1 and G2, respectively. The DOT predicted and experimental values are very close (within 2%) for G1 and fairly close (within 12%) for G2. One possible cause for the larger variation in the values for G2 is that an incorrect gap setting may have been used at G2. The relatively small gap setting of 1 5/8 in. specified at 50° F for G2 would correspond to a gap less than 1.5 in.

for any temperature above about 60° F. Though the construction records for this bridge are no longer available, it is probable that the concrete placement for the bridge took place when the temperature was higher than 60° F. A gap of 1.5 in. is considered the minimum gap width necessary for the installation of the neoprene seal. A gap of 1.5 in. or more is also desirable for typical forming and rail installation techniques. Therefore, it is possible, perhaps likely, that a contractor would not set a gap of less than 1.5 in. even if the gap setting table on the bridge plans called for it. (South Dakota requires that the gap be at least 1.5 in. at 90° F to make installation of the seal practical – see Table 4.8).

Though both expansion joints were filled with debris, the seals seemed to be functioning well (Iowa DOT rating of 8 for both) except at the end details of the far abutment. The seal at the left gutter of G2 is cut off too short and cut off near vertical rather than horizontal as called for on the bridge plans. Virtually all of the seals in the experimental

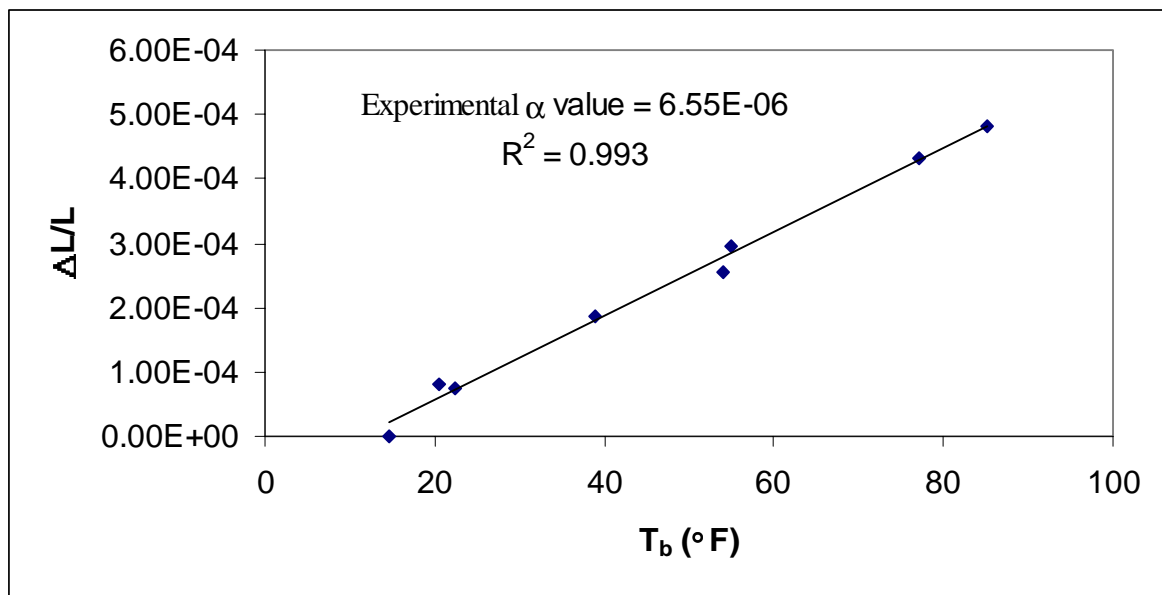

Figure 6.43 The experimental α -value for Bridge 11 (6403.6L014)

bridges were cut off near vertical even though the standard Iowa DOT detail indicates that the seal ends are to be cut off horizontally in an attempt to ensure that water does not leak over the ends of the seals – see Figure 3.3. On Bridge 11, the seal at the right gutter is slightly pulled out, or perhaps was never completely installed – installation at the angled upturns is especially problematic because there is little room to work and pressing lugs in the rail cavities around an angle is difficult.

6.3.12 Bridge 12: 6481.9L030 (FHWA 601895)

Bridge 12 is a two-lane, three-span prestressed concrete-girder bridge built in 1996 that carries westbound traffic of US 30 across Ramp B (to IA Avenue) and is located west of Marshalltown. The estimated Average Daily Traffic (ADT) was 5,700 in 1997. The bridge has a skew angle of 45 degrees, two expansion joints, one at each abutment, and expansion lengths of 109 ft and 114 ft for G1 and G2, respectively.

The initial inspection was done in 1997 and the inspection records for G1 (near abutment) noted “the curb joint opening at the wings have some dirt and concrete caught in them (viewed from the wing side). The opening over the roadway is impacted with gravel and dirt concentrated mostly at the gutters. The strip seal at the barrier rails was cut short and not installed according to plan. The neoprene gland at the near left is big enough but is out of the steel extrusion. The strip seal should be repaired and installed according to plan. Clean curb joint openings”. The ratings of the strip seals at both G1 and G2 dropped from 9 in 1996 to 6 in December 1997. A routine inspection was performed in 1999, so the strip-seal expansion joints were not rated, but replacement of the failed (at the ends) strip seals was requested in January 1999.

From the field investigation performed by the ISU investigators in June of 2000, the seal at the right gutter of G1 was pulled out from the end to about 6 in. beyond the curb plate. At one of the splices between two sections of the G1 deck-side rail, the ends of the two sections were out of alignment by about a quarter of an inch. There was no sign that pullout of the seal was initiating at this location, however. At G2, leakage was observed at the left gutter. The left gutter of G1 and right gutter of G2 were filled with debris. The strip seals at G1 and G2 were assigned a rating of 6 and 7, respectively, by the ISU investigators.

Similar to Bridge 1 (see Section 6.3.1), inspection summaries for Bridge 12 are given in Table 6.26. Gap openings versus representative bridge temperature are plotted in Figure 6.44. Predicted behavior is summarized in Table 6.27. The table includes the movement rating for a Watson Bowman Acme 3-in. seal used in a bridge with a skew based on the Michigan DOT study [40] which is referenced in the Iowa DOT design guidelines (see Sections 3.3 and 3.4). The movement rating of 2.55 in. is smaller than the nominal seal size because of the racking effects that occur in bridges with a large skew (see Figure 3.4). The experimental α -value plot for Bridge 12 is shown in Figure 6.45. See Section 6.3.1 for the process used in producing Figures 6.44 and 6.45 and Table 6.27.

Table 6.26 Gap openings and ratings for Bridge 12 (6481.9L030)

Year	Ratings		Gap Openings				Temp. (°F)
			G1		G2		
	G1	G2	LG	RG	LG	RG	
1996	9	9	-	-	-	-	-
1997	6	6	2 1/8	2 1/4	1 7/8	2	35
2000*	6	7	2.04	2.20	1.61	1.75	77

* Inspection by ISU investigators

From Table 6.27, the gaps at 0° F predicted by the Iowa DOT design equations are 1.96 in. and 1.98 in. for G1 and G2, respectively (see Sections 3.3 and 6.3.1). The gaps at

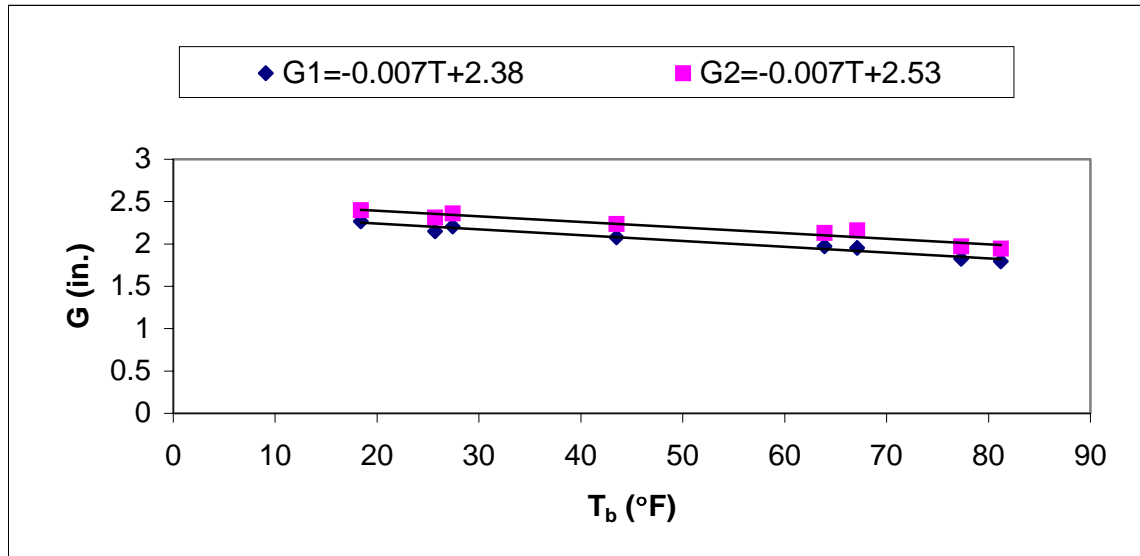

Figure 6.44 Gap opening vs. bridge temperature for Bridge 12 (6481.9L030)

Table 6.27 Various predicted expansion joint gaps for Bridge 12 (6481.9L030)

	G1 (in.)	G2 (in.)
Gap setting at 50° F specified on plans	1 1/2	1 1/2
DOT predicted short-term gap at 0° F	1.78	1.79
DOT predicted long-term gap at 0° F	1.96	1.98
Experimental gap at 0° F (extrapolated)	2.38	2.53
Size of strip seal specified on plans	3 in.	3 in.
Movement rating of seal at 45° skew [40]	2.55 in.	2.55 in.
Latest rating from inspection records**	6	6

**1997

0° F extrapolated from the experimental data are 2.38 in. and 2.53 in. for G1 and G2, respectively. Both experimental values are larger than those predicted by the design equations. Both sets of values are slightly smaller than the movement rating of 2.55 in. for a 3-in. seal used at a 45-degree skew. The seals were fairly free of debris except near the left

gutter of G1 and right gutter of G2. The seals seemed to be functioning well except at the right gutter of the near abutment (G1) where the seal was pulled out at the end and at the left

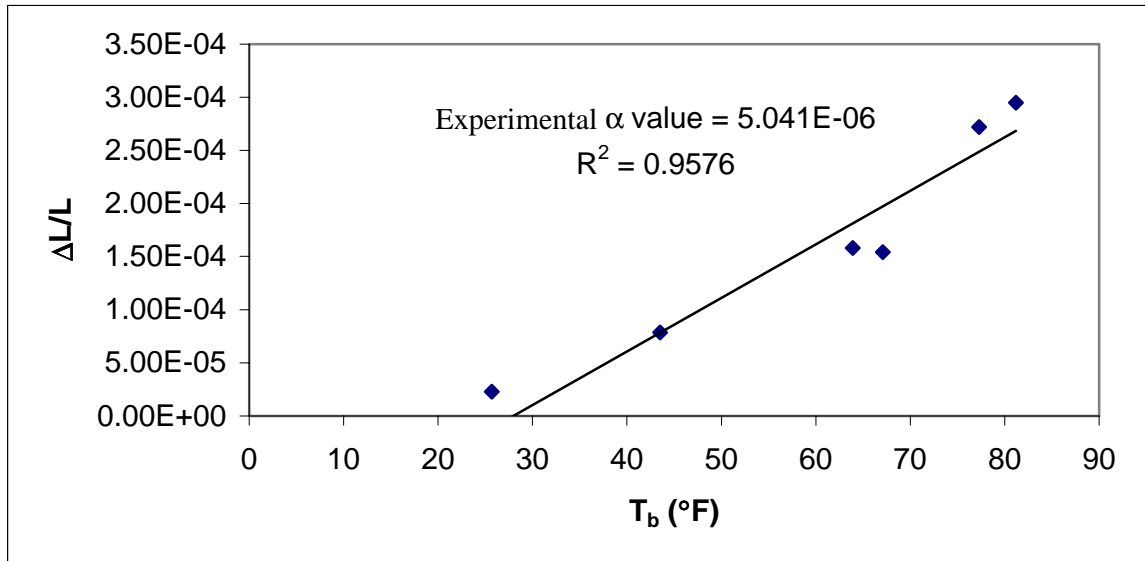

Figure 6.45 The experimental α -value for Bridge 12 (6481.9L030)

gutter of the far abutment where the seal was leaking. These end problems may be due to improper installation at the angled upturns or detrimental racking effects at the angled upturns corresponding to the bridge skew. The Michigan DOT study on skew effects [40] focused on straight sections of rail with no upturns or downturns. No other test data was found that indicated the effects of racking forces at typical Iowa end details.

6.4 Summary of the Experimental Results

6.4.1 Experimental α -values Versus Design α -values

Table 6.28 summarizes the experimental α -values (annual cycle) and the corresponding squares of the correlation coefficients (R-squared values) for each of the twelve bridges. Based on the collected data, the average experimental α -value for the ten

concrete-girder bridges is 5.6×10^{-6} in./in./° F, which is reasonably close to the α -value for concrete bridges used by the Iowa DOT. For expansion joint design, the Iowa DOT uses 6.0×10^{-6} in./in./° F (Section 3.3) for concrete-girder bridges, which is slightly conservative compared to the average experimental value.

Table 6.28 – Experimental α -values (annual cycle) for each of the twelve bridges

Pilot Study Bridge ID	Iowa DOT Maintenance Number	Girder material	Experimental α -value (10^{-6} in./in./° F)	R-squared value
1	0781.1R218	Concrete	5.32	0.987
2	0781.1L218	Concrete	5.17	0.979
3	0996.0R218	Concrete	5.24	0.980
4	0996.0L218	Concrete	5.24	0.978
5	0787.7A218	Concrete	5.22	0.968
6	0784.8S218	Concrete	5.49	0.981
7	8561.5L030	Concrete	5.30	0.957
8	7776.8L065	Concrete	5.37	0.986
9	6485.3L030	Steel	7.51	0.943
10	6402.0S014	Concrete	6.32	0.994
11	6403.6L014	Steel	6.55	0.993
12	6481.9L030	Concrete	5.04	0.957

The average experimental α -value for the two steel-girder bridges is 7.0×10^{-6} in./in./° F. The α -value of 7.51×10^{-6} in./in./° F for Bridge 9 is likely not a good value, however. The shape of the extrusion used for that bridge was a D. S. Brown rolled shape rather than a Watson Bowman Acme extrusion as was used for all the other bridges in the experimental program. In hindsight, the tools used to measure the joint openings (see Section 6.2.3) may not have given consistent gap measurements with that extrusion geometry to produce a reasonable determination of the α -value. The experimental α -value resulting from the field data analysis for Bridge 11, 6.55×10^{-6} in./in./° F is very close to the α -value used by the Iowa DOT for steel bridges, 6.5×10^{-6} in./in./° F.

6.4.2 Apparent Causes of Poor Strip-seal Performance

Table 6.29 presents a summary of what seem to have been the primary causes of the poor performance of the strip-seal expansion joints used in the twelve instrumented bridges. The table includes the most recent Iowa DOT rating of each expansion joint, the ISU rating of each strip seal, and an indication of the apparent primary cause(s) of poor performance for each seal. Of the thirty-five strip seals used in the twelve bridges, ten of the seals were given a rating of 5 by the ISU investigators, eight were given a rating of 6, sixteen were given a rating of 7, and one was given a rating of 8. The discussion to follow will be based on the ISU ratings since they are the most recent.

Under “Causes of failure and/or poor performance” in Table 6.29, “Gap > seal rating” means that the gap between the extrusions at low temperatures was larger than the movement rating of the seal. A “gap > seal rating” may have happened if more shrinkage and/or creep occurred than that assumed during the sizing of the seal (see Section 3.4), initial gaps were set too large during the construction of the bridge, and/or the bridge reached lower temperatures than those that were assumed for design. For fifteen of the thirty-one expansion joints in the ten concrete-girder bridges, the long-term gap opening at 0°F predicted by the Iowa DOT design equations exceeds the movement rating of the strip seal specified on the bridge plans. For twelve of the expansion joints in the concrete-girder bridges, the gap opening at 0° F extrapolated from the experimental data exceeds the movement rating of the specified strip seal. Also, it is likely that concrete-girder bridge temperatures in Iowa reach significantly below 0° F at times which would result in even larger gap openings.

Table 6.29 Likely causes of poor performance of strip seals in the twelve bridges

Pilot study bridge ID	Pilot study joint ID	Ratings		Causes of failure and /or poor performance					
		DOT	ISU	Gap > seal rating	Debris in joint	Large skew angle	Improper installation	Improper setting of gap	Age
1	G1	9	7						
	G2	6	5	x	x				
	G3	9	6						
2	G1	9	6						
	G2	6	5	x	x				
	G3	9	7						
3	G1	6	5				x		
	G2	6	5	x	x		x		
	G3	5	5	x	x		x		
	G4	6	5				x		
4	G1	7	7	x	x		x		
	G2	6	6	x	x		x		
	G3	6	5	x	x		x		
	G4	7	5	x	x		x		
5	G1	7	6	x		x			
	G2	7	7						
6	G1	7	6	x	x				
	G2	6	5	x	x				
	G3	7	7	x	x				
7	G1	9	7						
	G2	9	7						
8	G1	9	7				x		
	G2	9	7				x		
	G3	9	7				x		
	G4	9	7				x		
9	G1	6	7				x		
	G2	6	8				x		
10	G1	7	6						x
	G2	6	5	x	x				x
	G3	6	6	x	x				x
	G4	9	7						x
11	G1	8	7						x
	G2	8	7				x		x
12	G1	6	6	x		x	x	x	
	G2	6	7	x		x	x	x	

A gap larger than the seal movement rating makes the seal especially susceptible to wheel loads transmitted through debris and ice in the joint depression (see Section 7.2.2). Therefore, when the “Gap > seal rating” column is checked, the “Debris in joint” column is usually checked as well. Based on pullout tests of seals [20], a gap moderately larger than the seal rating would not likely cause pullout (or tearing or other damage), if there were no debris or ice in the joint.

“Large skew angle” is checked when the racking effects and reduced movement rating corresponding to a large skew angle were likely a primary cause of failure. For joints at small skew angles, the movement rating is the nominal size of the gland, but at skew angles of 30 degrees or more, the movement rating will be smaller than the nominal size of the gland (see Sections 3.3 and 3.4).

“Improper installation” refers to such things as pulling seals in from end to end, failure to encase upturned ends in concrete, or cutting ends of seals off short and/or closer to vertical rather than horizontal. “Improper setting of gap” is checked if there is evidence to suggest that the initial gap was set larger than called for on the plans, and therefore contributed to the “Gap > seal rating” problem. “Age” is checked if there was no major failure of the seal but slowly deteriorating performance is most likely a result of the age of the seal approaching the normal 15-20 year life span of neoprene seals. For many of the seals, failure or poor performance was likely caused by a combination of these factors. For some of the seals with low ratings, no cause is checked because there was no strong evidence to suggest a primary cause of failure.

For eight of the ten seals that were given a rating of 5 by the ISU investigators, joint openings at low temperatures larger than the movement rating of the seal, in combination

with wheel loadings, is likely to have been the major cause of the seal failure (typically substantial to nearly complete pullout of one or both lugs of the seal). Improper installation may have played a major or minor role in the failure of as many as six of the seals that were given a rating of 5. "Age" is likely a factor for one of the ten.

"Gap > seal size" was also probably the primary cause of the poor performance of five of the eight seals that were given a rating of 6 (failure was typically substantial pullout). "Large skew angle" was likely a factor for three of the seals with a rating of 6, "Improper installation" for two of the eight, and "Improper setting of gap" for one of the eight. For two of the eight with an ISU rating of 6, there was no apparent primary cause(s) of failure.

Seals with a rating of 7 are still functioning reasonably well but are allowing some leakage or have very small areas that are pulled out or torn (typically at an end of the seal). For the sixteen seals that were given a rating of 7, "Gap > seal size" likely contributed to decreased performance for three, "Debris in joint" for two, "Large skew angle" for one, "Improper installation" for eight, "Improper setting of gap" for one, and "Age" for three. For five of the sixteen seals with an ISU rating of 7, there was no apparent primary cause(s) of decreased performance.

7. RECOMMENDATIONS

7.1 Recommendations for Design, Installation, and Maintenance Procedures

Based on the information gathered for this study, the authors believe that implementing the recommendations in Sections 7.1.1 through 7.1.7 would significantly decrease the number of premature failures of strip seals.

7.1.1 Bridge Temperature Ranges for Design

A larger temperature range should be used for the design of concrete-girder bridges. As discussed in Section 2.2, a shade temperature range of 132° F (from -24° F to 108° F) suggested in another ISU study [12] seems appropriate. Using Equations 2.5 and 2.6, computed minimum and maximum effective concrete bridge temperatures are -15° F and 115° F, respectively. An effective temperature range from -15° F to 115° F for concrete-girder bridges would be conservative to accommodate movements induced by thermal effects.

For steel-girder bridges, using Equations 2.7 and 2.8 proposed by CTL and minimum and maximum shade temperatures suggested in [12] (-24° F to 108° F), the computed minimum and maximum effective bridge temperatures are -22° F and 124° F, respectively. Therefore, the effective bridge temperature range of 150° F (-30° F to 120° F) currently used by the Iowa DOT for steel-girder bridges seems reasonable.

7.1.2 Bridge Temperature for Setting the Gaps

The expansion joint gap to be set is a function of the bridge temperature at the time of placing the concrete for the backwall or deck slab. Using the shade temperature at the bridge location and the local weather forecast is reasonable for predicting the bridge temperature at

the time of concrete placement. However, if concrete placement is to take place on a sunny day, the equations provided by CTL [10] to convert shade temperature to effective bridge temperature suggest that 13° F and 9° F should be added to the measured shade temperature for concrete-girder bridges and steel-girder bridges, respectively.

Based on discussions with Iowa contractors and observations of the construction of the expansion joints for a bridge (Section 4.3), the setting of the gap at an expansion joint begins at least several hours before the concrete is placed. The bridge temperature at the time of concrete placement can be estimated, but not known with certainty at the time the gap is set. However, if the selected effective bridge temperature ranges are conservative and, for concrete-girder bridges, the shrinkage factor is included in expansion joint design, the effective bridge temperature at the setting of the expansion gap openings need only be reasonably close, say within $\pm 10^\circ$ F.

7.1.3 Selection of Strip Seal Size and Specification of Gap Settings

For concrete-girder bridges, a minimum effective bridge temperature of -15° F along with the currently specified shrinkage (and creep) factor of 0.0002 should be used for computing the long-term, maximum gap and for selecting a strip seal to accommodate that gap. The effects of shrinkage on the long-term gap should be considered in determining the gap settings specified on the bridge plans, so that the long-term gap does not exceed the movement rating of the selected strip seal (see Section 3.4). The joint opening at the maximum effective bridge temperature of 115° F, without including the shrinkage effects, should be computed to ensure that the minimum gap opening is not less than the minimum required gap opening specified by the manufacturer of the seal system. In general, because of all the design, construction, and material variables that effect bridge movement, selection

of strip seals based on the computed movement ratings should be conservative. For example, if the computed movement is close to 3 in. (say within 20%), a 4-in. strip seal should be specified instead of a 3-in. seal. For steel-girder bridges, the current Iowa DOT practice for determining joint opening requirements seems appropriate.

7.1.4 End Detail

The “one-step,” upturned end detail that is illustrated in Figure 3.3. and that has been used by the Iowa DOT requires the end of the gland to be cut level. The purpose of the specified horizontal cut is to keep the “bottom” of the gland above the elevation of the gutterline in order to prevent water from running over the end of the gland.

The actual procedure used by the bridge contractors is to cut the end perpendicular to the longitudinal axis of the gland. This practice has resulted in water leakage onto the beams and piers. In addition to the perpendicular cut, sometimes the gland is cut short of the end of the steel extrusions, which makes the leakage worse.

The Iowa DOT has recently revised the end detail to that shown in Figure 3.1. This will allow the gland to be cut off perpendicular to its longitudinal axis and still prevent leakage.

The end details shown in Figures 3.1 and 3.3 result in the accumulation of water, salt, and debris in the strip seal depression, especially at the gutters, and, at best, permits only partial removal of such accumulation by natural forces. Therefore, even minor leaks that develop will result in much of the accumulated water and dissolved minerals reaching the bridge substructure (minor as well as major leaks were common in the twelve bridges investigated for this report – see Section 6.3). If proper drainage for the strip seal depression is provided, most of the water and salt and much of the debris collected in the expansion joint

may be drained away with little to none likely to leak to the substructure, even if minor leaks in the seal develop.

A different end detail, such as that used in Kansas, Missouri, and South Dakota (Section 3.2.1 and Table 3.4) should be considered to provide drainage for the strip seal expansion joints. The effectiveness of different end details, especially in cold weather, should be investigated. The drainage details must prevent any collected water, salt, and debris from reaching any component of the substructure of the bridge.

7.1.5 Leak Test after the Installation Process

Because any expansion joint leakage may cause severe problems in the bridge substructure, a leak test of each strip seal expansion joint is recommended (see Watson-Bowman-Acme recommendations in Section 4.1.2). A simple leak test can be done (after the lubricant/adhesive has had adequate time to cure) by pouring water in the space above the seal and, after a specified time (e.g., 12 or 24 hours), checking underneath the seal for any leakage. If leakage is observed, the contractor may be required to properly fix the leak if possible or otherwise replace the seal.

7.1.6 Specifications for the Design and Installation of Strip Seal Systems

To help ensure consistently good design and proper installation of strip seal expansion joint systems, a more complete specification for such design and installation should be developed. A complete and conservative design specification for selecting strip seals and predicting gap openings for both short-term (without shrinkage) and long-term (including shrinkage, creep, etc.) joint openings for concrete-girder bridges should be included. The specifications could also provide guidelines to contractors for determining an appropriate gap setting temperature. DOT inspection of the rail positioning and enclosure,

gap setting, and strip seal installation should be part of the specification. A leak test should also be specified.

7.1.7 Cleaning of Expansion Joints

One of the most likely major contributors to the premature failures of strip seals in Iowa bridges is the wheel loads transferred to the strip seals through the debris that builds up in the expansion joint gap. Data from the twelve instrumented bridges suggests that this is especially true when the gap opening is large relative to the seal size (see Section 6.3). If the gap is kept relatively clear of debris, the wheel loads transmitted to the strip seal can be minimized or eliminated. By reducing the wheel loads transmitted to the seal, pullout or tearing caused by wheel loadings can be reduced or eliminated.

Perhaps a first step is to determine how rapidly joints accumulate debris, which is likely a function of time of year, winter probably by far the worst in this respect. A few of the twelve instrumented bridges in which the gaps have been the largest might be the best test cases for a cost/benefit analysis of cleaning out the joints. If a time table for cleaning out the joints could be devised that would keep the joints relatively free of debris, it could then be determined if clean joints prevent pullout of seals, even if the gaps are sometimes wider than the seal size, such as for Bridges 1 and 2 (see Section 6.3). Unfortunately, the gaps are widest, the debris accumulation is the worst, and ice formation is an added problem in the season when cleaning out the joints is most unpleasant and problematic.

7.2 Related Recommendations

7.2.1 Inclusion of Additional Information in Iowa DOT Databases

To provide data for future evaluations of the performance of strips seals, more of the information from the design, installation, and inspection processes should be maintained in a readily available bridge record. The calculations for the gap openings specified on the bridge plans and for the selection of the strip seals should be presented to the Iowa DOT and maintained as part of this record. Construction data, including the type and size of strip seal, the estimated bridge temperature and corresponding gap setting at the time of concrete placement, and results of a leak test should be included in the computer databases. More information from the inspection reports, including the historical record of the joint ratings, should also be included in the databases. If a strip seal is replaced or repaired, a record of the replacement or repair should be recorded. By keeping such information in one of the databases, factors that cause the premature failure of strip seals in the future can be more readily identified and analyzed (see Section 5.2).

7.2.2 Further Research

Further studies on the performance of strip seals in Iowa bridges could be done. As suggested in Section 7.1.7, the rate of accumulation of debris in joints could be determined, particularly in those joints in which pullout or tearing has been a serious or recurring problem. Effective and economical methods of cleaning out the joints could be sought and evaluated. The experiences of Kansas, Missouri, and South Dakota with alternative end details that provide some drainage for the joint and make the strip seal depression easier to clean out could be investigated in detail.

Testing could be performed to understand the nature and effects of wheel loads on strip seal expansion joints. One report on the testing of the effects of vertical impact loading on strip seals was found in the literature search for this report [20]. The loading method used in that test probably does not reasonably reflect the effects of wheel loads moving against the rail and pinching the debris between the wheel, rail, and that part of the seal near the rail. This pinching kind of loading would likely tend to pry the seal out of the rail cavity, just as similar “loading” with a prybar is used to pry the seal into the rail cavity during installation (see Figures 4.2 and 7.1). This prying action from the wheels through the debris in the joint is likely most severe when the size of the joint opening is close to (or beyond) the size rating of the seal. Under this condition, the seal membrane is nearly horizontal and any debris or ice in the joint is more likely to settle close to the rails.

The effects of the racking movement of bridges with large skews could be investigated for the end detail currently used in Iowa. The Michigan DOT study [40] that is used as the source for part of the Iowa DOT design guidelines [39] does not include the effects of racking due to large skews at an angled upturn end detail. The effects of racking are quite likely more detrimental to seal performance at such an end detail than they are for the straight sections of rail used in the Michigan DOT study (see Sections 6.3.5, 6.3.7, and 6.3.12). The results of the Michigan study for skews greater than 30 degrees should also be checked for situations where the installation of the seal occurs when the gap is at other than the midpoint of the seal (the midpoint is a gap of 1.5 in. for a WBA 3 in. seal or 2 in. for a WBA 4 in. seal).

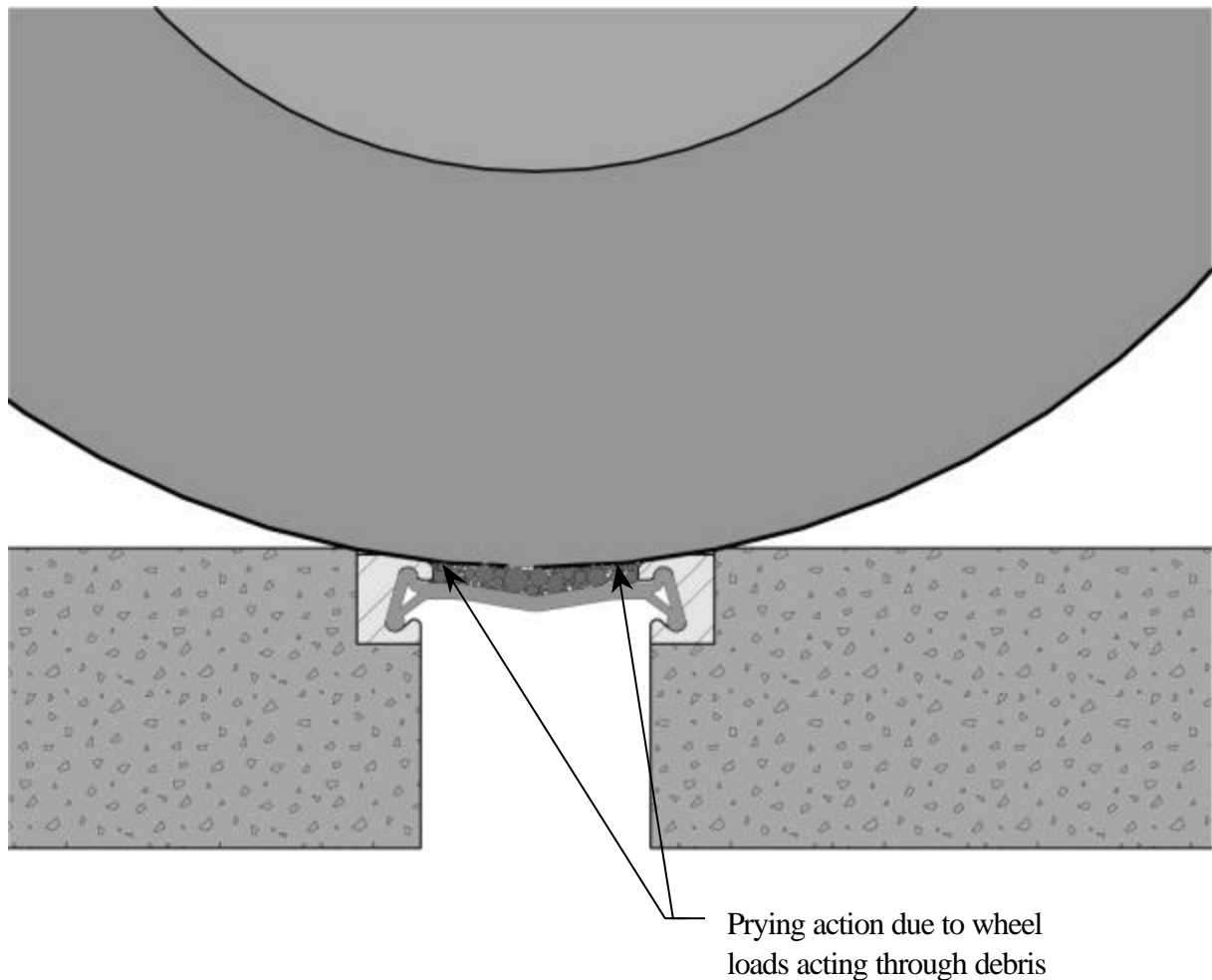

Figure 7.1 Interaction of wheel, seal, and debris when gap is near seal rating

Concrete shrinkage (and creep) should be tracked over a period of two or three years for several new concrete-girder bridges. Based on data from the instrumented bridges, and assuming initial gaps were set near those specified on the bridge plans, the shrinkage value currently used in the Iowa DOT guidelines for concrete-girder bridges, 0.0002, seems conservative in some cases (see, for example, Bridges 1 and 2 in Sections 6.3.1 and 6.3.2), unconservative in others (Bridges 3 and 4 in Sections 6.3.3 and 6.3.4). But since the initial

gap settings and corresponding bridge temperatures are not part of the record for these bridges, the amount of shrinkage and/or creep that actually occurred can not be determined.

8. SUMMARY AND CONCLUSIONS

8.1 Summary

A pilot study was conducted on the premature failures of strip seals in Iowa bridges. A literature review was performed on previous work pertaining to bridge expansion joints. Information on topics related to strip-seal expansion joints was summarized. Manufacturers' specifications and recommendations related to the use, design, fabrication, and installation of strip-seal expansion devices were reviewed. Current practices regarding strip-seal expansion devices in the states bordering Iowa were reviewed and summarized. Current Iowa DOT design and installation guidelines were reviewed. Discussions were held with bridge contractors who do work for the Iowa DOT. With the cooperation of one of the contractors, the installation of a strip-seal expansion joint system was observed. Iowa DOT databases containing information about bridges with strip-seal expansion joints were analyzed. A national survey was conducted to obtain experiences and opinions from other state departments of transportation on the use and performance of strip seals.

With guidance from the Office of Bridge Maintenance and Inspection of the Iowa DOT, twelve in-service bridges with strip-seal expansion joints were selected for detailed investigation. The twelve bridges were instrumented with thermocouples and, over an eight-month period, effective bridge temperatures and corresponding expansion joint openings were determined. The expansion joint openings were correlated to an effective bridge temperature to obtain equations for expansion joint gaps. Inspection reports of the twelve instrumented bridges were also reviewed and summarized. Based on the experimental data, the inspection records and construction records, conversations with Iowa DOT personnel,

and first-hand observations, the likely cause(s) of premature failures of strip seals in the twelve bridges were then proposed.

All of the seals used in the twelve bridges that failed seriously were in concrete girder bridges. Experimental results show that for a majority of these serious failures, the joint opening at 0° F predicted by the Iowa DOT design equations, the joint opening at 0° F extrapolated from the experimental data, or both, were larger than the movement rating of the strip seal specified on the bridge plans. One possible explanation is differences between the amount of concrete shrinkage and/or creep assumed for design and the amount that actually occurred. Other likely causes of premature failures of seals in the twelve bridges include wheel loads transferred through the debris and ice in the seal cavity, a large skew and the corresponding decrease in the movement rating of a seal, improper installation of one or more of the expansion joint components, and improper setting of the initial gap.

Based on the experimental data, the coefficients of thermal expansion recommended in the Iowa DOT design guidelines for estimating the thermal movements for both steel and concrete girder bridges seem appropriate. The 0.0002 in./in. shrinkage factor recommended in the guidelines also seems appropriate. Based on a study of integral-abutment bridges by other ISU researchers and literature from the Construction Technologies Laboratory and the National Oceanic and Atmospheric Administration, the recommended 0° F to 100° F effective bridge temperature range for concrete girder bridges is not conservative.

8.2 Conclusions

The importance of strip-seal expansion joints as a bridge component should be re-emphasized, because large maintenance costs can result if the expansion joint seal fails. A

more complete history of the design, installation, and performance of strip seals in the Iowa DOT databases would be helpful in future evaluation of any future premature failures.

Design equations used by the Iowa DOT should be reviewed and be made more conservative to accommodate more thermal movement for concrete girder bridges. The effects of concrete shrinkage and/or creep on the long-term expansion joint openings should be considered in determining the gap settings specified on the bridge plans. A redesign of the current Iowa DOT strip-seal expansion joint end detail should be considered to improve the drainage of the joints and minimize leak potential and problems associated with leakage. Requiring a leak test after the installation of each seal should be considered. A more complete specification for strip-seal expansion joint design and installation should be developed to help decrease the occurrence of premature seal failures in Iowa bridges. The transfer of wheel loads through debris to the strip seal and the cost versus benefits of cleaning the debris from strip-seal expansion joints should be investigated.

9. ACKNOWLEDGMENTS

The study presented in this report was sponsored by the Iowa Department of transportation and the Iowa Highway Research Board under Iowa DOT Project TR-437. The authors wish to extend sincere thanks to the numerous personnel of the Iowa DOT for their cooperation and support in this effort. Special thanks are extended to the following individuals at the Iowa DOT:

- Bruce Brakke (Maintenance Bridge Engineer)
- Tim Dunlay (Assistant Maintenance Bridge Engineer)
- Dave Jensen (Bridge Management System and Special Programs)
- Dean Bierwagen (Methods Engineer)
- Wayne Sunday (Construction)

Thanks also to many others at the Iowa DOT for their help and cooperation including Ahmad Abu-Hawash, Olya Arjmand, Bill Staebler, Elvin Hebner, John Haggren, Gerry Lund, Mark Callahan, George Feazell, and Steve Timmerman.

The authors are also grateful to the following contractors for their time and cooperation: Robert Cramer of Robert Cramer and Associates, Randy Freeland of Jensen Construction, Mike Jeffries of United Construction, and Kevin Steffen of Peterson Contractors. Special thanks go to Robert Cramer, Dan Cramer, and Bob Pfler (Robert Cramer and Associates) for their cooperation on the construction observation portion of the project.

Sincere thanks also go to Ed Bechstein of the Watson Bowman Acme Corporation, Tom Lewis of the D. S. Brown Company, and Shawn Cadwell of Hi-way Products (Ida Grove, Iowa) for valuable assistance.

For providing materials and answering numerous questions, thanks to Salah Khayyat of the Illinois DOT, Richard Mesloh of the Kansas DOT, Mark Spafford of the Minnesota DOT, Kent Nelson of the Missouri DOT, O. Bumanis of the Nebraska DOT, Tom Gilsrud of the South Dakota DOT, and Stan Woods of the Wisconsin DOT.

And lastly, thanks to Robert Abendroth of ISU for valuable advice as project consultant.

10. REFERENCES

1. Transportation Research Information Service, "TRANSPORT CD-ROM," 1995.
2. American Concrete Institute (ACI), "Prediction of Creep, Shrinkage, and Temperature Effects in Concrete Structures," ACI 209-98, ACI Committee 209 Report, 1998.
3. Emanuel, Jack H., Hulsey J. Leroy. "Prediction of the Thermal Coefficient of Expansion of Concrete." *ACI Journal* 74 (April 1977): 149 – 155.
4. Mindess, S., Young, J.F. Concrete. Englewood Cliffs, New Jersey: Prentice-Hall Inc., 1981.
5. Neville, A.M. Properties of Concrete. New York City, New York: John Wiley & Sons, Inc., 1996.
6. Ng, W.C. Thermal Expansion and Contraction of Concrete. M.S. creative component project, Iowa State University, Ames, Iowa, 1999.
7. American Association of State Highway and Transportation Officials (AASHTO). AASHTO LRFD Bridge Design Specifications. First Ed. Washington D.C., 1994.
8. Lee, David J. Bridge Bearings and Expansion Joints. 2nd Ed. London: Chapman & Hall, 1994.
9. American Institute of Steel Construction Inc (AISC). "Load & Resistance Factor Design." Manual of Steel Construction V.1. Second Ed. 1995.
10. Oesterle, Ralph G., et al. "Jointless and Integral Abutment Bridges Summary Report – Draft Final Report." Construction Technology Laboratories, Inc. Skokie, Illinois., 1999.
11. ASHRAE, "Fundamentals Handbook," American Society of Heating, Refrigerating, and Air-Conditioning Engineers, New York, NY, 1993.
12. Greimann, L., Abendroth, R. "Field Testing of Integral Abutments," Iowa DOT Research Project, HR-399.
13. National Climatic Data Center. "Probabilities of Temperature Extremes in the USA. Version 1." CD – ROM. Asheville, North Carolina. February 1999.
14. Roeder, Charles W., Moorty, Shashi. "Thermal Movements in Bridges." Transportation Research Record 1290 (1991): 135 – 143.

15. Barker, Richard M., and Puckett Jay A. Design of Highway Bridges. Toronto: John Wiley & Sons, Inc., 1997.
16. Hurst, M.K. Prestressed Concrete Design. 2nd Ed. New York: E & FN Spon, 1998.
17. Gilbert, R.I. Time Effects in Concrete Structures. New York: Elsevier, 1988.
18. Smerda, Zdenek., and Kristek, Vladimir. Creep and Shrinkage of Concrete Elements and Structures. New York: Elsevier Science Publishing Company, Inc. 1988.
19. Zia, Paul., Preston H. Kent., etc. "Estimating Prestress Losses." Concrete International (June 1979) : 32 – 38.
20. Watson Bowman Associates Inc. "Impact Testing of Wabo Strip Seal Model SC-400," Getzville, New York, December 1978.
21. Roeder, Charles W. Field Measurements of Dynamic Wheel Loads on Modular Expansion Joints. Seattle, Washington: Washington State Transportation Center (TRAC), April 1995.
22. Clauwaert, C. "A Study of Expansion Joints and Buried Joints for bridges in Belgium." Second World Congress on Joint Sealing and Bearing Systems for Concrete Structures V.2: Sponsored by American Concrete Institute (ACI). September 28 – October 2 1986. Ed. Patricia Kost. San Antonio, Texas.
23. Dahir, Sabir H., Mellott, Dale B. "Bridge Deck Expansion Joints." Transportation Research Record 1118 (1987): 16 – 24.
24. Gupta, Ram S. Hydrology & Hydraulic Systems. Prospect Heights, Illinois: Waveland Press, Inc., 1995.
25. Hill, James J., Shirole, Arunprakash M. "Bridge Joint Systems – A Performance Evaluation." Transportation Research Record 990 (1984): 1 – 4.
26. Watiez, G. "A Guide to the Criteria Used for the Development, Improvement, and Selection of Expansion Joints." Second World Congress on Joint Sealing and Bearing Systems for Concrete Structures V.2: Sponsored by American Concrete Institute (ACI). September 28 – October 2 1986. Ed. Patricia Kost. San Antonio, Texas.
27. Monroe, David C. "Waterproofing Concrete Decks Requires a Systems Approach." Public Works September (1991): 40 – 42.

28. Van Lund, J.A. (1991), "Bridge Deck Joints in Washington State." Joint Sealing and Bearing Systems for Concrete Structures Vol.1, (pp. 371-393). Detroit, Michigan: American Concrete Institute.
29. Watson Bowman Acme Corporation. Wabo Strip Seal Installation. Amherst, New York: Watson Bowman Acme Corporation, 1999.
30. Watson Bowman Acme Corporation. Wabo Strip Seal Specification. Amherst, New York: Watson Bowman Acme Corporation, 1999.
31. The D. S. Brown Company. Steelflex Strip Seal Expansion Joint Systems. North Baltimore, Ohio: The D. S. Brown Company, 1997.
32. Kansas Department of Transportation. Special Provision to the Standard Specification, 1990 Edition. Topeka, Kansas: Kansas Department of Transportation, 1990.
33. Kansas Department of Transportation. Design Manual, Version 7/99, Volume III. Topeka, Kansas: Kansas Department of Transportation, 1999.
34. Minnesota Department of Transportation. Bridge CADD Standards and Special Provisions. Roseville, Minnesota: Minnesota Department of Transportation, 1999.
35. Missouri Department of Transportation. Bridge Design Manual. Springfield, Missouri: Missouri Department of Transportation, 2000.
36. Nebraska Department of Roads. Standard Specification for Highway Construction. Lincoln, Nebraska: Nebraska Department of Roads, 2000.
37. South Dakota Department of Transportation. South Dakota Bridge Design Manual. Pierre, South Dakota: South Dakota Department of Transportation, 1998.
38. Wisconsin Department of Transportation. Highway Structures, Standard Details. Madison, Wisconsin: Wisconsin Department of Transportation, 1999.
39. Meyer, Ron. Bridge and Structures Electronic Design Manual. Iowa DOT, August 1995.
40. Bashore, F. J., A. W. Price, and D. E. Branch. Determination of Allowable Movement Ratings for Various proprietary Bridge Deck Expansion Joint Devices at Various Skew Angles. Michigan Department of Transportation, Lansing, Michigan, 1980.

41. Iowa Department of Transportation. "Bridge Data." Bridge Maintenance Department. CD – ROM. July 2000.

APPENDIX A. THERMOCOUPLE LOCATION TESTING DATA

Only two thermocouples were placed on each of the ten concrete girder bridges in this study. To determine the best placement for the thermocouples, temperature data from a separate field study of a concrete integral abutment bridge in Guthrie County [12] was analyzed. The Guthrie County bridge was instrumented with forty-seven thermocouples. Displacements due to temperature variation versus thermocouple readings over the twenty-one-month period were recorded (ending April 2000). Linear regression analysis was used and the coefficient of correlation for the change in length of the bridge deck, ΔL , versus the temperature change, ΔT , for each thermocouple was calculated. The ten highest coefficients of correlation (squared) and the corresponding thermocouple location codes are listed in Table A.1. Interpretations of those ten thermocouple location codes are given in Table A.2. As a result of this analysis, the thermocouples for the ten concrete girder bridges were placed at approximately the middle of an end span on the inside top flange of the two exterior girders (see Figures 6.1(a) and 6.1(b)). These two locations correspond to the first and third thermocouple listings in Tables A.1 and A.2.

To obtain similar thermocouple location guidelines for steel girder bridges, one of the two steel girder bridges that were part of the experimental work (Bridge 9, Maintenance number 6485.3L030) was instrumented with twenty thermocouples (Section 6.2.2 and Figures 6.2(a) and 6.2(b)). Gap measurements and thermocouple readings were recorded. Linear regression analysis was again used and the coefficient of correlation for the change in length of the bridge deck, ΔL , versus the temperature change, ΔT , for each thermocouple was determined. The ten highest coefficients of correlation (squared) and the corresponding

Table A.1 Coefficients of correlation for Guthrie County bridge

Thermocouple code	Square of coefficient of correlation (R-squared)
TCMSWT	0.996
TCNWT	0.995
TCMSET	0.995
TCMSCW	0.994
TCSCT	0.994
TCNCT	0.994
TCNEB	0.994
TCNCB	0.994
TCMSWB	0.993
TCSWS	0.993

Table A.2 Interpretations of thermocouple codes for Guthrie County bridge

Thermocouple code	Thermocouple location
TCMSWT*	Middle of south end span (pier), west girder, top flange
TCNWT	End of north end span (abutment), west girder, top flange
TCMSET*	Middle of south end span (pier), east girder, top flange
TCMSCW	Middle of south end span (pier), center girder, web
TCSCT	End of south end span (pier), center girder, top flange
TCNCT	End of north end span (abutment), center girder, top flange
TCNEB	End of north end span (abutment), east girder, bottom flange
TCNCB	End of north end span (abutment), center girder, bottom flange
TCMSWB	Middle of south end span (pier), west girder, bottom flange
TCSWS	End of south end span (abutment), west girder, web

**Selected locations for representative bridge temperature*

thermocouple location codes for the steel girder bridge are listed in Table A.3.

Interpretations of those ten thermocouple location codes are given in Table A.4. . The two thermocouple locations used for the second steel girder bridge in this pilot study (Bridge 11, Maintenance number 6403.6L014) correspond to the fifth and tenth thermocouple listings in Tables A.3 and A.4 (Figures 6.2(a) and 6.2(b)).

Table A.3 Coefficients of correlation for Bridge 9 (6485.3L030)

Thermocouple code	Square of coefficient of correlation (R-squared)
ENT	0.9695
WMT	0.9694
WNT	0.9673
MMT	0.9662
MNT*	0.9616
ENB	0.9500
EST	0.9388
WNB	0.9329
WST	0.9308
MST*	0.9304

* Thermocouple locations used for steel girder Bridge 11

Table A.4 Interpretations of thermocouple codes for Bridge 9 (6485.3L030)

Thermocouple code	Thermocouple location
ENT	East end (pier), north girder, top flange
WMT	West end (abutment), middle girder, top flange
WNT	West end (abutment), north girder, top flange
MMT	Mid-span, middle girder, top flange
MNT*	Mid-span, north girder, top flange
ENB	East end (pier), north girder, bottom flange
EST	East end (pier), south girder, top flange
WNB	West end (abutment), north girder, bottom flange
WST	West end (abutment), south girder, top flange
MST*	Mid-span, south girder, top flange

All thermocouples were installed in west end span of Bridge 9 (6485.3L030)