Interim Guide for Optimum **JOINT PERFORMANCE** of Concrete Pavements



Technical Report Documentation Page

1. Report No.	2. Government Accession No.	3. Recipient's Catalog No.	
4. Title and Subtitle <i>Interim Guide for Optimum Joint Performance of Concrete Pavements</i>		5. Report Date September 2011	
		6. Performing Organization Code	
7. Author(s) Peter Taylor, Robert Otto Rasmussen, Helga Torres, Gary Fick, Dale Harrington, Tom Cackler		8. Performing Organization Report No.	
9. Performing Organization Name and Address Institute for Transportation Iowa State University 2711 South Loop Drive, Suite 4700 Ames, IA 50010-8664		10. Work Unit No. (TRAIS)	
		11. Contract or Grant No.	
12. Sponsoring Organization Name and Address TPF-5(224) Transportation Pooled Fund with FHWA and state departments of transportation of Indiana, Iowa, Michigan, Minnesota, New York, South Dakota, and Wisconsin		13. Type of Report and Period Covered	
		14. Sponsoring Agency Code	
15. Supplementary Notes			
16. Abstract The purpose of this guide is to help practitioners understand how to optimize concrete pavement joint performance through the identification, mitigation, and prevention of joint deterioration. It summarizes current knowledge from research and practice to help practitioners access the latest knowledge and implement proven techniques. Emphasizing that water is the common factor in most premature joint deterioration, this guide describes various types of joint deterioration that can occur. Some distresses are caused by improper joint detailing or construction, and others can be attributed to inadequate materials or proportioning. D cracking is a form of joint distress that results from the use of poor-quality aggregates. A particular focus in this guide is joint distress due to freeze-thaw action. Numerous factors are at play in the occurrence of this distress, including the increased use of a variety of deicing chemicals and application strategies. Finally, this guide provides recommendations for minimizing the potential for joint deterioration, along with recommendations for mitigation practices to slow or stop the progress of joint deterioration.			
17. Key Words Concrete pavement, portland cement concrete, concrete pavement joints		18. Distribution Statement No restrictions.	
19. Security Classification (of this report) Unclassified.	20. Security Classification (of this page) Unclassified.	21. No. of Pages 26	22. Price

Interim Guide for Optimum JOINT PERFORMANCE of Concrete Pavements

About This Guide

The purpose of this guide is to help practitioners understand how to optimize concrete pavement joint performance through the identification, mitigation, and prevention of joint deterioration.

While the majority of concrete pavements are not affected by premature joint deterioration, the problem is common enough to have triggered research efforts to identify both causes and preventative measures. Current projects include a Federal Highway Administration (FHWA) Transportation Pooled Fund Study TPF 5(224): Investigation of Jointed Plain Concrete Pavement Deterioration at Joints and the Potential Contribution of Deicing Chemicals. With the Iowa Department of Transportation (DOT) as the lead state, TPF-5(224) is a collaborative effort among the CP Tech Center, Michigan Technological University, and Purdue University and sponsored by the state departments of transportation in Indiana, Iowa, Michigan, Minnesota, New York, South Dakota, and Wisconsin. Its goals include investigating the mechanisms of joint deterioration, understanding joint damage due to deicing chemicals, and developing prevention and mitigation methods. Other research efforts include work at state departments of transportation in Iowa, Michigan, Minnesota, and South Dakota, to name a few.

In recent months, the National Concrete Pavement Technology Center (CP Tech Center) at Iowa State University has been assisting the industry in these efforts. The CP Tech Center is synthesizing and supplementing research performed to date, using data and photographs provided by local authorities in multiple states, numerous

visits and investigations at sites (mostly in Iowa, Minnesota, Wisconsin, and Michigan), as well as laboratory testing. As a result of all these efforts, knowledge about the causes of joint deterioration is growing significantly.

Instead of waiting for “all the answers” to questions that still remain, the CP Tech Center has developed this interim guide under TPF 5(224) to help practitioners access the latest knowledge and implement proven techniques for identifying, mitigating, and reducing the risk of premature joint deterioration.

Acknowledgments

The authors appreciate the support of the FHWA and state DOTs in Indiana, Iowa, Michigan, Minnesota, New York, South Dakota, and Wisconsin whose sponsorship of TPF 5(224) has made it possible to develop this interim guide. They would also like to acknowledge the contributions of numerous organizations and individuals referenced herein, particularly Purdue University, Michigan Tech University, and the cities of Ankeny, Iowa, and West Des Moines, Iowa.

Authors

Peter Taylor, National Concrete Pavement Technology Center, Iowa State University
 Robert Otto Rasmussen, The Transtec Group, Inc.
 Helga Torres, The Transtec Group, Inc.
 Gary Fick, Trinity Construction Management Services
 Dale Harrington, Snyder and Associates
 Tom Cackler, National Concrete Pavement Technology Center, Iowa State University

For More Information

For technical assistance regarding cement-based concrete paving, contact the CP Tech Center:

Tom Cackler, Director
 Sabrina Shields-Cook, Managing Editor
 National Concrete Pavement Technology Center
 Institute for Transportation
 Iowa State University Research Park
 2711 S. Loop Drive, Suite 4700
 Ames, IA 50010-8664
 515-294-7124
 shieldsc@iastate.edu
 www.cptechcenter.org/

Disclaimers

Neither Iowa State University nor this document's authors, editors, designers, illustrators, distributors, or technical advisors make any representations or warranties, expressed or implied, as to the accuracy of information herein and disclaim liability for any inaccuracies.

Iowa State University does not discriminate on the basis of race, color, age, religion, national origin, sexual orientation, gender identity, sex, marital status, disability, genetic testing, or status as a U.S. veteran. Inquiries can be directed to the Director of Equal Opportunity and Diversity, Iowa State University, 3680 Beardshear Hall, 515-294-7612.

Contents

Executive Summary.....	1
1 Why Now – What’s New?	1
2 Types and Mechanisms of Joint Deterioration	2
2.1 Mechanical Damage	2
2.2 Early-Age Drying Damage	2
2.3 D Cracking.....	2
2.4 Frost Damage	3
2.4.1 Shadowing	4
2.4.2 Incremental Cracking.....	4
2.4.3 Bottom-Up Moisture.....	5
2.4.4 Discussion of Frost Damage Failure Mechanism	6
2.5 Summary of Joint Deterioration Mechanisms.....	7
3 Joint Deterioration Investigation.....	9
3.1 Design and Construction	9
3.2 Field Indicators	9
3.2.1 Mechanical Damage and Early-Age Drying.....	9
3.2.2 D Cracking.....	10
3.2.3 Shadowing	10
3.2.4 Incremental Cracking.....	10
3.2.5 Bottom-Up Moisture.....	10
3.2.6 Drainage.....	10
3.3 Sampling and Testing	10
4 Preventing Joint Deterioration in New Pavements and Overlays	11
4.1 Adequate Air-Void System	11
4.2 Reduced Concrete Permeability	12
4.2.1 Low w/cm ratio.....	12
4.2.2 Appropriate Use of SCMs.....	12
4.2.3 Well Graded Aggregates.....	12
4.2.4 Curing	12
4.2.5 Penetrating Sealers.....	13
4.3 Drainage of the Pavement System	13
4.4 Sawing and Sealing Joints	14
4.4.1 Sawing Joints	14
4.4.2 Sealing Joints	14
4.5 Durable Aggregates.....	15
4.6 Summary.....	15

5 Maintenance Activities to Reduce Joint Deterioration Risk 16

- 5.1 Routine Maintenance 16
 - 5.1.1 Joint Cleaning and Sealing 16
 - 5.1.2 Surface Drainage 16
 - 5.1.3 Subsurface Drainage 16
- 5.2 Winter Maintenance 17

6 Treatment of Pavements with Joint Deterioration..... 18

- 6.1 Concrete Surface Sealers 18
- 6.2 Partial-Depth Repairs..... 18
- 6.3 Full-Depth Repairs / Slab Replacement 19
- 6.4 Overlays 20
- 6.5 Reconstruction 20

7 References 21

Figures

Figure 1. Incompressibles causing mechanical damage, which can lead to further distress	2
Figure 2. Raveling due to poor sawing practice (Source: Iowa Department of Transportation)	2
Figure 3. Early-age drying stresses (left) and resulting horizontal cracking and delamination spalling (right) due to high moisture loss during placement (2)	3
Figure 4. Example of delamination spalling (Source: Washington State)	3
Figure 5. D cracking of low severity (left) and high severity (right) (Source: The Transtec Group).....	3
Figure 6. Evolution of joint deterioration from shadowing (left) to high severity (right)	4
Figure 7. Typical saturated foundations under a shadowed section (Source: Snyder and Associates).....	4
Figure 8. Secondary ettringite deposits in air voids (Source: American Engineering Testing, Inc.)	4
Figure 9. Typical incremental cracking: Note (left to right) the crack parallel to the already patched face, the signs of water passing through the crack, and the exposed aggregate remaining in the concrete .	5
Figure 10. Coarse aggregate exposed by damage to the paste	5
Figure 11. Shallow joint damage	5
Figure 12. Three cores illustrating progression of distress from bottom-up moisture	6
Figure 13. Water flow through joints from a high water table (bottom-up moisture); note staining on surface.....	6
Figure 14. Schematic of poor joint sealant leading to saturation (3).....	6
Figure 15. Saturated soils due to inadequate drainage and roadside irrigation (left) leading to joints showing frost damage (right) (Source [left]: Snyder and Associates)	6
Figure 16. Typical slivers from freezing and thawing cycles	7
Figure 17. Shadowing at the joints, which is commonly followed by loss of material	7
Figure 18. Top-down joint distress, with vertical edges and shallow depth.....	8
Figure 19 Joint deterioration evident below the joint sealant	8
Figure 20. Deterioration due to D cracking	8
Figure 21. Deterioration due to bottom-up moisture	8
Figure 22. Joint deterioration due to raveling from improper saw-cut procedures	8
Figure 23. Damage starting at joint intersections	9
Figure 24. Coring at deteriorated joints to help identify causes of failure.....	10
Figure 25. Example of a poorly draining pavement	13
Figure 26. Definition of the sawing window (9)	14
Figure 27. Different degrees of joint raveling caused by sawing (9).....	14
Figure 28. Using temporary joint spacers to protect and minimize damage due to early entry sawing (Source: Husqvarna)	14
Figure 29. Evidence of saturation within joint beneath seal (Source: Purdue).....	15
Figure 30. Joint filled with hot pour sealant (Source: The Transtec Group).....	15
Figure 31. Failing transverse joint associated with poor drainage at gutter	16

Figure 32. Typical components of an edge drain system (Source: NHI 131008) (16) 16

Figure 33. Subdrain retrofit operation including clean out (The Transtec Group) 17

Figure 34. Example of effective drainage of unsealed joints 17

Figure 35. Signage to help avoid salting of new pavement 17

Figure 36. Typical forms of damage that require different repair approaches..... 18

Figure 37. Delineation of spalled area for partial-depth repair (top) and a completed patch (bottom)
 (Source [bottom]: The Transtec Group) 18

Figure 38. Schematic of a partial-depth repair 19

Figure 39. Steps to conducting a proper partial-depth repair (Source: Snyder and Associates)..... 19

Figure 40. Full-depth patching 19

Executive Summary

Users of this guide will learn why joint deterioration occurs, how to address deterioration that may already be evident, and how to prevent it from occurring on future projects.

Emphasizing that water is the common factor in most premature joint deterioration, this guide describes various types of joint deterioration that can occur. Some distresses are caused by improper joint detailing or construction, and others can be attributed to inadequate materials or proportioning. D cracking is a form of joint distress that results from the use of poor-quality aggregates.

A particular focus in this guide is joint distress due to freeze-thaw action. Numerous factors are at play in the occurrence of this distress, including the increased use of a variety of deicing chemicals and application strategies.

Finally, this guide provides recommendations for minimizing the potential for joint deterioration, along with recommendations for mitigation practices to slow or stop the progress of joint deterioration.

1 Why Now – What’s New?

Concrete pavements are constructed with joints for both functional and aesthetic reasons; joints accommodate concrete shrinkage, and they control the location of cracks. Joint performance will vary from project to project and from joint to joint. Given the variety of concrete pavement design alternatives, construction scenarios, and materials and climate factors, this is to be expected.

While the majority of concrete pavements are not affected by premature joint deterioration, the problem has been reported in several states, particularly in the northern United States. Pavements affected include state highways, county roads, city streets, and parking lots.

The question of why premature joint deterioration is happening now is frequently raised, particularly because none of the mechanisms that appear to contribute to the problem is new to concrete technology. It is likely that the deterioration is a result of a combination of many factors:

- The lowering of air contents in order to increase concrete strength at minimal cost.
- A further reduction of air content due to losses during the paving process. There is a perception that this

tendency is greater when using some of the newer air entraining admixtures (AEAs), particularly in comparison to more conventional AEAs. Work is underway to investigate this further.

- Joints that are saturated with trapped water.
- Increased water-cementitious materials (w/cm) ratios to reduce cost and improve placement, while still achieving minimum strength.
- Mixtures containing supplementary cementitious materials (SCMs) that are known to be more sensitive to poor curing.
- The common practice of not curing the freshly exposed concrete within the saw-cut faces.
- Construction that is being pushed further into the cold season. The result is reduced concrete strengths achieved before the concrete is exposed to freezing conditions.
- Deferred or inadequate joint maintenance due to reduced budgets.

It is common to observe sections of a roadway experiencing joint deterioration in the immediate vicinity of other sections that are in excellent condition. It appears that even small differences between concrete batches or in construction-related activities lead to differences in joint performance. For example, hand-placed sections are more prone to distress than slipformed sections in the same roadway, possibly because water is added to improve workability of the hand-placed sections.

While all of these factors are important, quite possibly the final straw is related to de-icing practices:

Pavement owners are becoming increasingly aggressive in their deicing activities, with the goal of improving safety. In addition to using greater quantities of salt, alternatives to sodium chloride (NaCl) such as calcium chloride (CaCl₂) and magnesium chloride (MgCl₂) are now being used. Unfortunately, these alternatives have been shown to increase the saturation of the concrete at a saw cut, which is likely a contributor to the observed joint deterioration. This last point is supported by the fact that distress is often more severe at intersections where salting is more rigorous for safety reasons.

Since owners may be reluctant to reverse the more aggressive trends in deicing activities, concrete pavements may have to be engineered to resist this added stress.

2 Types and Mechanisms of Joint Deterioration

No single mechanism can account for all reported occurrences of joint deterioration. Contributors can include mechanical damage, early-age damage, D cracking, and frost, or freeze-thaw, damage, each of which is summarized below. Particular emphasis is given to frost damage due to its prevalence and severity and the shortage of printed guidance on the subject compared to mechanical damage, early-age damage, and D cracking.

2.1 Mechanical Damage

Spalling due to mechanical damage is typically found at the surface and will rarely extend through the depth of the slab. Mechanical-related joint damage can often be attributed to stresses caused by incompressible materials (sand, rocks, other debris) trapped in the joint (see Figure 1).

Raveling of a saw cut is caused by aggregate particles being dislodged during sawing, typically because the concrete strength is too low when sawing occurs. This is common when the shoe on an early-entry saw is not functioning properly, or when conventional sawing is started too early (Figure 2).

It is possible that the concrete at the bottom of the saw cut can become damaged during early-entry sawing or from conventional sawing using machines with worn bearings or an inappropriate blade. Erosion and/or a zone of micro-cracking is possible. Either can lead to subsequent trapping of water and thus to damage from frost action.

Traffic loading has been considered as a mechanical cause of joint deterioration, but the shear stresses imposed

at the edges of saw cuts by wheel loads are low. Unless construction traffic is allowed on a pavement a few hours after placement, loading is unlikely to be a significant contributor.

2.2 Early-Age Drying Damage

One potential mechanism for joint deterioration begins with adverse conditions during concrete placement; the related joint damage may not become evident until years later. As reported by McCullough et al., drying from high evaporation rates during placement (1) results in large differences in moisture content through the depth of the concrete slab. Differences in slab moisture may lead to stresses that are high enough to cause fine horizontal cracks (delamination). In areas where these horizontal cracks intersect vertical cracks or joints, concrete material can break free, and “flat bottom” or delamination spalling can occur. The severity and timing of delamination spalling varies with the severity of moisture loss at an early age, along with traffic and climate factors. This process is illustrated in Figure 3 and the result is shown in Figure 4.

To prevent joint deterioration caused by early-age drying damage, an effort should be made to minimize rapid moisture loss during placement. Better curing techniques can decrease evaporation rates. Often, this is all that is required; however, in more extreme environments, night paving may be warranted.

2.3 D Cracking

D cracking is a type of joint deterioration caused by expansive freezing of water trapped inside some types of aggregate particles. The damage normally starts near joints and forms a characteristic crack pattern (Figure 5). The



Figure 1. Incompressibles causing mechanical damage, which can lead to further distress



Figure 2. Raveling due to poor sawing practice (Source: Iowa Department of Transportation)

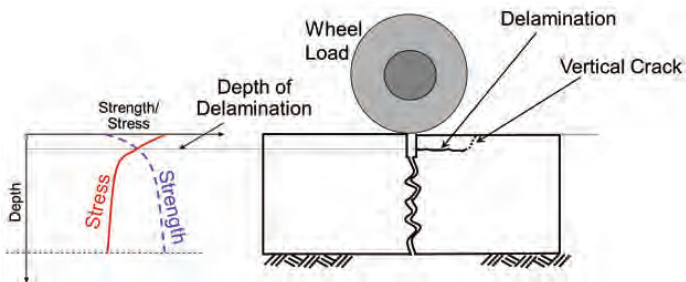

Figure 3. Early-age drying stresses (left) and resulting horizontal cracking and delamination spalling (right) due to high moisture loss during placement (2)

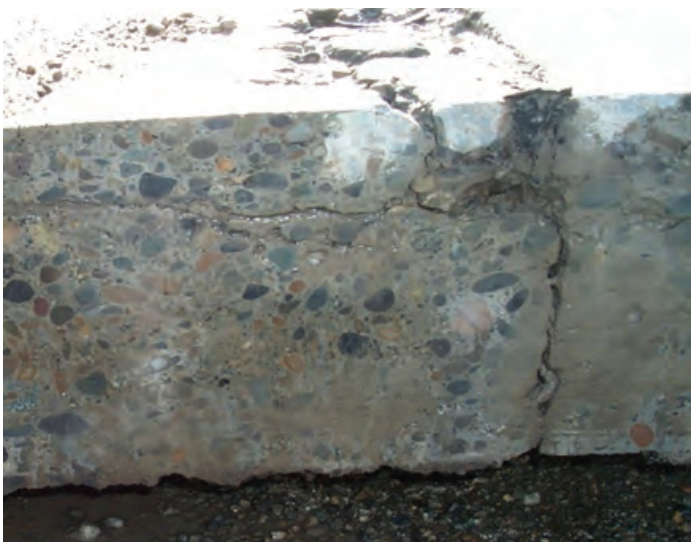

Figure 4. Example of delamination spalling (Source: Washington State)

damage is generally worse at the bottom of a slab than at the top. D cracking can compromise the integrity of a pavement, and as long as freeze-thaw cycles continue, the distress cannot be stopped.

D cracking can be prevented by choosing aggregates that are not susceptible to freeze-thaw deterioration. Alternatively, where marginal aggregates must be used, reducing the maximum aggregate size has been found to be beneficial. Improving drainage to reduce the potential for saturation of the concrete aggregates can have a marginal benefit.

2.4 Frost Damage

Joint deterioration due to freeze-thaw damage within the concrete is termed “frost” damage in this guide. This is different from D cracking because frost damage occurs in the paste and not the aggregates. Frost damage is partially due to expansion of water in the capillaries of the concrete as it freezes. This may cause fine cracks to occur as deep as several inches into the concrete. Cycles of freezing and thawing open these cracks, and as a result the concrete continues to deteriorate.

Common characteristics of or practices on pavements with frost-damaged joints include the following:

- Pavement saturated for long periods, regardless of the source of water.
- Pavement with marginal air-void systems (total air content, spacing factors, and specific surface).
- The use of significant quantities and/or potentially aggressive deicing salts.
- Secondary ettringite growth that fills the air-void system under saturated conditions.



Figure 5. D cracking of low severity (left) and high severity (right) (Source: The Transtec Group)

The distress is typically observed in several forms: shadowing, incremental cracking, and moisture-related damage from the bottom up.

2.4.1 Shadowing

Joint deterioration from frost damage is sometimes first observed as shadowing or darkening of a zone a few inches on either side of a joint. This effect is the result of a fine network of microcracks that develop near and parallel to the joint. The cracks trap water, which lead to the darker color. Over time, the concrete begins to crumble, and significant loss of material may occur. This evolution is shown in Figure 6.

In most cases where shadowing is observed, the system is not well drained (Figure 7). Furthermore, the air-void systems of concrete near afflicted joints are often marginal or deficient. If petrographic examination is conducted on cores, it is common to observe evidence of secondary ettringite deposition in the air voids (Figure 8). This indicates abundant water within the concrete, although the exact mechanisms and effects of this ettringite deposition are still not resolved.

2.4.2 Incremental Cracking

Joint deterioration due to frost action can also be seen as parallel cracks that form at approximately one-inch increments starting from the joint face (Figure 9). The concrete between the crack and the free face is normally sound, as is the remaining concrete next to the crack.



Figure 7. Typical saturated foundations under a shadowed section (Source: Snyder and Associates)

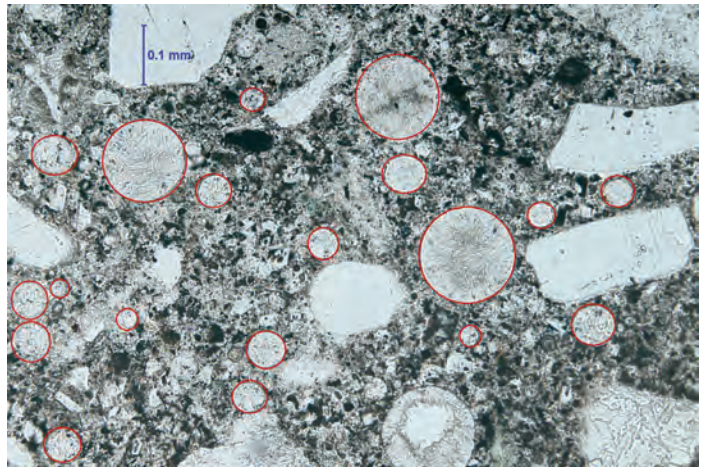

Figure 8. Secondary ettringite deposits in air voids (Source: American Engineering Testing, Inc.)



Figure 6. Evolution of joint deterioration from shadowing (left) to high severity (right)

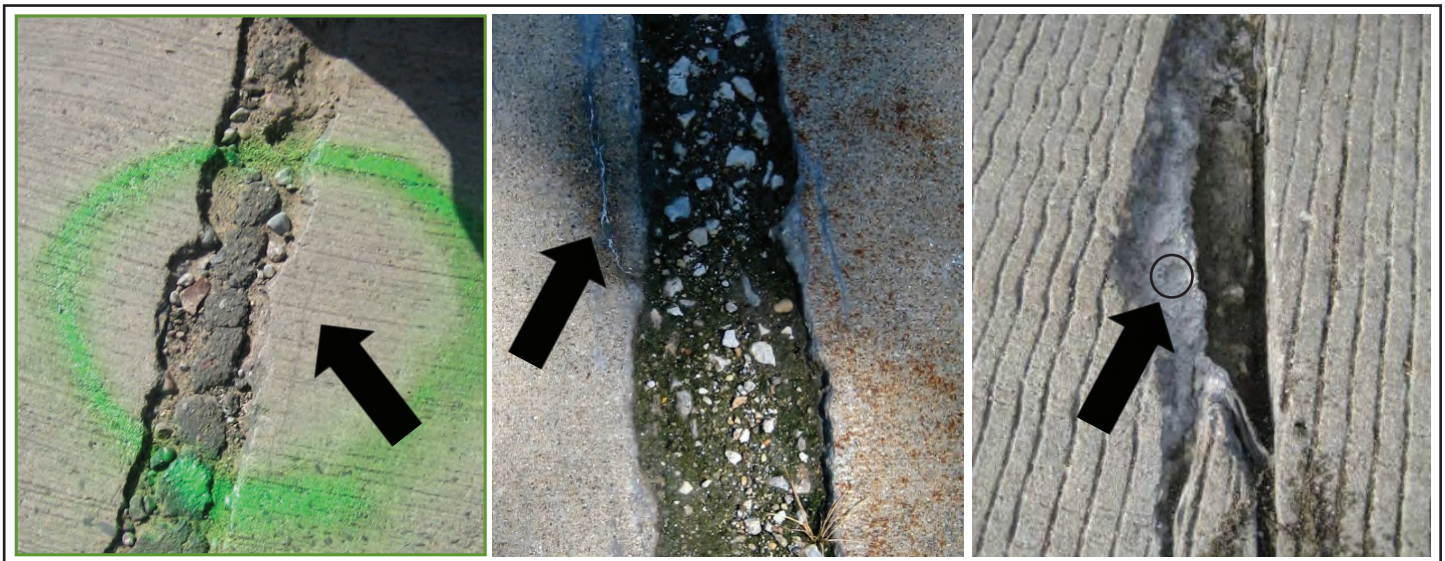

Figure 9. Typical incremental cracking: Note (left to right) the crack parallel to the already patched face, the signs of water passing through the crack, and the exposed aggregate remaining in the concrete

The coarse aggregate still embedded in the concrete is often free of adhering mortar on the exposed face (Figure 10). This indicates a mechanism that is attacking the paste alone.

When a joint is patched or filled, it is common to observe new cracks that form an inch or so beyond the boundaries of the repair. Furthermore, signs of water coming out of the crack are also common, often in the form of staining and carbonate deposits.

If drainage of the support system is adequate, frost damage is normally top-down, and generally does not extend beyond the bottom of the saw cut (Figure 11). In this case, the joint is often filled with loose aggregate.

2.4.3 Bottom-Up Moisture

Another form of frost damage can occur when the pavement is placed on a non-draining base and/or when the water table is above the bottom of the slab. In this case, the top of the pavement may appear to be in reasonable condition, but coring reveals concrete that has been seriously damaged in the joint. Figure 12 illustrates the progression of this phenomenon. Interestingly, the damage is more pronounced in the saw-cut than in the crack, presumably because a significant amount of water can collect in the saw-cut while cracks tend to be tight. Figure 13 illustrates the site where these cores were extracted, showing the clear signs of abundant water flow.



Figure 10. Coarse aggregate exposed by damage to the paste



Figure 11. Shallow joint damage

2.4.4 Discussion of Frost Damage Failure Mechanism

Water is the common factor in most premature joint deterioration. Water can be present in a pavement system for a variety of reasons including inadequate surface or subsurface drainage, or because it is trapped behind a seal above an uncracked joint. Weiss and Nantung have modeled how a joint face can be saturated when a seal fails to prevent water ingress (3). This is illustrated in Figure 14. Figure 15 illustrates how inadequate subsurface drainage can be a contributor, especially when coupled with excessive roadside irrigation.



Figure 12. Three cores illustrating progression of distress from bottom-up moisture



Figure 13. Water flow through joints from a high water table (bottom-up moisture); note staining on surface

Frost damage is caused by expansion of water in the capillaries of the concrete as it freezes. Typically, this causes fine cracks to occur parallel to the exposed surface, and up to several inches into the concrete. Traditionally freeze-thaw damaged concrete appears as small slivers (Figure 16), with the size governed by the depth of water penetration. Damage is normally progressive with continued freeze-thaw cycles.

Weiss has shown that increasing the saturation of a concrete sample will decrease its ability to resist freezing because there is more water in the system than can be accommodated when freezing occurs (4). Concrete that is less than 85 percent saturated can survive, while saturation greater than this will likely result in damage.

Deicing salts can aggravate frost damage. Based on findings by Weiss, the primary driver behind this acceleration is likely the increased saturation due to the tendency of some salts (most notably magnesium chloride $[MgCl_2]$ and calcium chloride $[CaCl_2]$) to retain water (4).

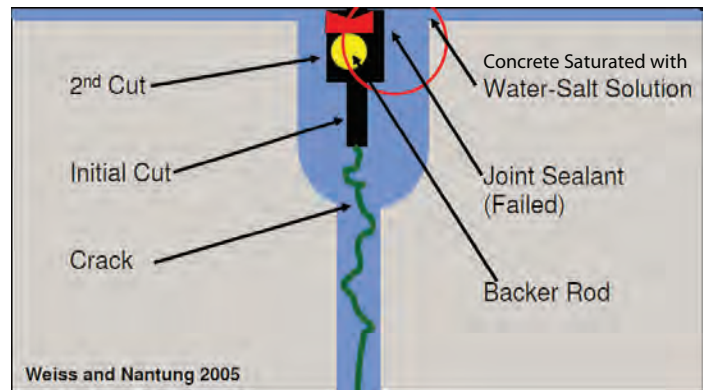

Figure 14. Schematic of poor joint sealant leading to saturation (3)



Figure 15. Saturated soils due to inadequate drainage and roadside irrigation (left) leading to joints showing frost damage (right) (Source [left]: Snyder and Associates)

Additional mechanisms may also include expansion of crystallizing salts as water evaporates and/or solutions freeze.

The chemical decomposition of calcium silicate hydrate in contact with some salts (magnesium chloride [MgCl₂]) is also possible; however, this is a relatively slow process and may not be a significant contributor compared to other effects (5).

There are two primary strategies for preventing or reducing frost damage to concrete joints: optimizing air entrainment and reducing concrete permeability. A third strategy—limiting the use of deicing salts—may be impractical.

Air entrainment. Concrete is provided with deliberately entrained small air bubbles that provide pressure relief for expanding water when it freezes. It is therefore important to ensure that the concrete has an adequate air-void system.

A spacing factor of 0.008 in. should provide satisfactory performance; however, work is continuing to establish whether this value is sufficient for concrete that is saturated for extended periods.

Low permeability. It is recommended that the permeability of concrete be low, particularly if it is likely to be wet for extended periods. Reducing permeability can be achieved by the following:

- Limiting the maximum w/cm ratio to below 0.45. Ideally, the w/cm ratio should be close to 0.40, as long as the pavement can be constructed satisfactorily.
- When possible, using appropriate supplementary cementitious materials at appropriate dosages.
- Implementing rigorous curing techniques, including expedited application.
- Potential use of surface or impregnating sealants. Work continues to quantify the specific benefits and limitations of this approach.

2.5 Summary of Joint Deterioration Mechanisms

Basic forms of joint deterioration are shown in Figure 17 through Figure 22. Following are the critical factors:

- Water has to be prevented from saturating the concrete.
 - Water penetrating from the top surface must be prevented from ponding in the joint.
 - Water must be prevented from penetrating from the base.
 - Permeability of the concrete should be as low as practically feasible.
- The air-void system in the in-place concrete must be adequate.



Figure 16. Typical slivers from freezing and thawing cycles



Figure 17. Shadowing at the joints, which is commonly followed by loss of material



Figure 18. Top-down joint distress, with vertical edges and shallow depth



Figure 21. Deterioration due to bottom-up moisture



Figure 19 Joint deterioration evident below the joint sealant

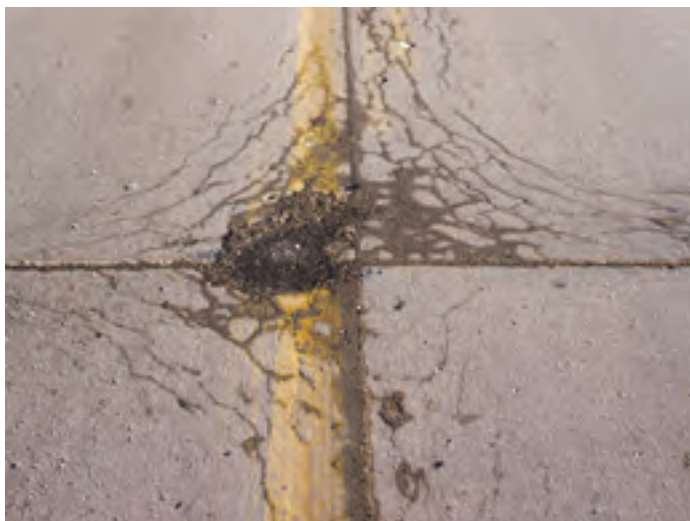

Figure 20. Deterioration due to D cracking



Figure 22. Joint deterioration due to raveling from improper saw-cut procedures

3 Joint Deterioration Investigation

Before mitigation or preventive measures can be identified, it is important to assess the form, amount, and probable causes behind the pavement joint damage (6). Questions to be addressed are the following:

- Are saturation and salting likely to be issues?
- What is the quality of the concrete with respect to its ability to resist severe conditions?
- Are there differences between distressed and nearby non-distressed pavements that may flag potential causes?

To help assess the causes, it is best to begin by collecting information about the design and construction of the pavement. A field review can then be conducted and, in many cases, complemented by sampling and testing of the pavement. Together, these steps will yield significant insight about the probable joint deterioration mechanisms.

3.1 Design and Construction

When possible, historical information about the pavement should be collected. Specific information that can be helpful includes the following:

- Design details
 - Foundation system including aggregate gradation
 - Drainage system
 - Design life
 - Specified mixture parameters (air, w/cm ratio)
- Construction information
 - Weather
 - State of the foundation system
 - Compaction of the subbase as the result of construction equipment
 - Equipment used (paver type, sawing technique)
 - As-built mixture parameters
 - Records of problems encountered
- Operation and maintenance information
 - Pavement age
 - Salting practices
 - Joint sealing
 - Sealant maintenance
 - Historical pavement condition data (structural and functional)
 - Drainage conditions (subsurface and surface)

3.2 Field Indicators

Prior to making a decision about the best repair approach, two questions must be answered:

1. Is the distress at the top, bottom, or all the way through the slab?
2. Will damage continue to develop after the repair has been completed?

The first question can only be reliably addressed by coring since nondestructive methods cannot reliably identify voids inside a joint.

The second question is more complex. The short answer is that if water can be trapped adjacent to a marginal concrete mixture, damage will indeed continue to develop.

3.2.1 Mechanical Damage and Early-Age Drying

Both of these distresses occur early in the life of a pavement, so the root causes can no longer be mitigated. Often, however, damage caused by these early-age mechanisms provides places for water to collect and thus becomes a starting point for frost damage. For example, it is common to see distress starting at intersections of longitudinal and transverse saw cuts (Figure 23). It is likely that some “bruising” of the concrete at the joints can become a zone where water is trapped, thus accelerating subsequent frost damage.



Figure 23. Damage starting at joint intersections

3.2.2 D Cracking

D cracking is typified by crack patterns parallel to saw cuts extending several inches from the joint (Figure 5 and Figure 21) after about 20 years. The damage is normally caused by moisture migrating from the bottom up and leaves behind loose, unbound material.

Damage is progressive, meaning that repairs will likely fail unless they can straddle the loose material.

That said, experience with overlays of D-cracked pavements is varied. If quantities of water become trapped in the unbound rubble, freezing will cause ice lenses that can significantly affect the overlay's structural performance and its ride quality.

3.2.3 Shadowing

Pavements that have exhibited shadowing are often found to be damaged through about one-third the depth of the slab.

To mitigate the source of the distress, repairs may have to include retrofitting a drainage system. Penetrating sealers may slow the rate of damage but only if applied early enough. It has been reported that reduction of salt brine application rates on shadowed roadways can reduce the rate of deterioration.

3.2.4 Incremental Cracking

Typically, incremental cracking is seen in systems that have some form of cut-off layer in the foundation. Distress is typically top down, meaning that partial depth repairs are an option.

Filling the voids with asphaltic materials does not appear to help because new cracking appears outside the patch (Figure 9). It is likely that an intimate bond is required between the repair material and the existing concrete to prevent the entrapment of water between them.

3.2.5 Bottom-Up Moisture

Distress can be caused by the presence of moisture near the bottom of the slab. Because such damage is likely to be progressive, long-lasting repairs are feasible only if adequate support drainage is provided.

3.2.6 Drainage

During the field investigation, it should be noted if distress is related to surface drainage. For example, is damage more pronounced to one side of the lane (i.e., adjacent to the shoulder) or possibly confined to the edge drains?

It should also be noted if, after a rain event, the joints are drying faster than the slab or vice versa. Observations in cleanouts and catch pits can indicate whether the sub-drains are flowing.

3.3 Sampling and Testing

Field-testing via coring may be conducted to further characterize joint deterioration and identify its possible causes (Figure 24).

Cores can provide information about where the damage is occurring. If necessary, cores can also be sent to a laboratory for petrographic examination to assess the following:

- The quality of the air void system.
- The w/cm ratio.
- D cracking.
- Whether salts are being deposited.
- Other distress mechanisms.

Ideally, cores should be extracted from several locations:

- Over a distressed area of a joint.
- Over the same joint, but at the end of the distressed area in an attempt to identify damage early in its development.
- In the slab, a few inches from the joint, in order to characterize the concrete near the joint.
- At the center of the slab, to assess variability in the mixture and placement.
- From a nearby section that is not exhibiting distress in order to determine why one section is distressed and the other is not.



Figure 24. Coring at deteriorated joints to help identify causes of failure

4 Preventing Joint Deterioration in New Pavements and Overlays

While not all the causes of joint deterioration are known, the following approaches can still be recommended as a means of reducing risk. These recommendations are based on research findings to date and address the fundamental damage mechanisms discussed in this guide. Decisions about which recommendations are implemented and how they are implemented should be based on industry best practices and local needs.

These recommendations are targeted at three primary areas:

1. Prevent moisture remaining in contact with the joint face.
2. Reduce permeability of the concrete as a preventive measure against the ingress of moisture.
3. Provide an adequate air-void system within the concrete paste.

4.1 Adequate Air-Void System

Freeze-thaw durability is primarily affected by the environment (wet freezing conditions) and the air-void system of the concrete. An air-void system consisting of many small, closely spaced voids is a common means of providing protection against freeze-thaw damage.

An adequate air void system is vital. Air void systems can be affected by varying the composition of concrete constituents, placing techniques, and finishing activities.

At right is an excerpt of a Special Provision used by the Michigan Department of Transportation for local agencies. It is considered to be an example of appropriate measures that should be taken for achieving an adequate air void system:

For concrete that is exposed to deicing chemicals or high water saturation (which is considered “severe exposure”), PCA Bulletin EB001.15 recommends a minimum of 5 percent to 8 percent air content in the in-place concrete to prevent damage (7). In addition, a spacing factor equal to or below 0.008 in. (0.2 mm) is recommended, along with a specific surface area of air voids equal to or greater than 600 in²/in. (24 mm²/mm). Sutter has reported that these values are still appropriate based on recent laboratory work (8).

Test procedures to determine air content in fresh concrete include the pressure method (ASTM C 231 /

Air entrainment

Air entrainment shall be accomplished by addition of an approved air entraining agent. Air content as determined by ASTM C 231 or ASTM C 173, shall be determined on each day of production as early and as frequently as necessary until the air content is consistently acceptable. Acceptance testing for air content shall be on the grade ahead of the placement operation.

Paver placement

The target air content of the in-place finished plastic concrete is 6.0%. During production acceptance will be at the point of acceptance sampled ahead of the paver, the target value referred to as the Acceptance Air Content (AAC). The AAC will be determined by the air loss actually experienced during transportation, consolidation and placement of the concrete. The difference between the as-produced concrete in front of the paver and the in-place air content will be considered the air loss. The AAC for the project will be 6.0% plus an amount equal to the air loss.

To establish the initial target AAC on the first day of paving, the first load shall be tested at the plant. For up to the first ten loads, the AAC measured prior to placement shall be at least 8.0% and no more than 12.0%.** After initial testing at the plant at least two sample sets shall be tested to determine the actual air loss during placement. A set shall consist of two samples of concrete from the same batch, one taken at the point of discharge and the other from the in-place concrete behind the paver. The air loss from the two sets shall be averaged and added to 6.0% to establish the AAC (rounded to the next higher 0.5%). The project acceptance air tests shall be taken prior to placement and shall be within the range of the AAC plus 2.0% or minus 1.0%.

After the AAC has been established it shall be verified and/or adjusted through daily checks of the air loss through the paver. The loss through the paver shall be checked twice daily. A Revised AAC shall be established if the average air loss from two consecutive tests deviates by more than 0.5% from the current accepted air loss.

Hand placed concrete

The air content for non slip form paving shall be 7.0% plus 1.5% or minus 1.0% at point of placement.

Excerpt of a Special Provision, Michigan Department of Transportation
**Note: other agencies limit the maximum air content to 8 or 10%

AASHTO T 152), volumetric method (ASTM C 173 / AASHTO T 196), and the gravimetric method (ASTM C 138 / AASHTO T 121). The spacing factor and the specific surface can be determined in hardened concrete by microscopical measurements (ASTM C 457)

The air content should be checked in samples taken in front of paver, and periodically from behind the paver to quantify how much air is lost during placing.

Concrete performance can be assessed in the laboratory (during design stage) using ASTM C 666/AASHTO T 161.

4.2 Reduced Concrete Permeability

The permeability of a concrete mixture determines how easily moisture can infiltrate the paste structure of the concrete. A lower permeability is desirable to slow the rate at which concrete will become saturated.

Recent work led by the South Dakota Department of Transportation includes recommendations to achieve durable, dense, and impermeable concretes that withstand the deleterious effects of deicing chemicals (5) and prevent or reduce joint deterioration caused by water saturation at the joints. Recommendations include the following:

1. Low w/cm ratio.
2. Appropriate use of SCMs.
3. Well graded aggregates.
4. Improved curing.
5. Application of penetrating sealers.

4.2.1 Low w/cm ratio

The permeability of a concrete mixture is primarily governed by the amount of water in the concrete at the time of mixing. Permeability will decrease as less water is used. The w/cm ratio should not exceed 0.45; ideally, the w/cm ratio should be between 0.37 and 0.42.

There are a number of ways to achieve lower w/cm ratios while retaining satisfactory workability including:

- Using SCMs in appropriate dosages.
- Using water-reducing admixtures.
- Using aggregate systems with a good gradation.
- Entraining air.
- Controlling concrete temperature.
- If water is added to a ready-mix truck at the point of delivery, taking care to ensure that the maximum w/cm ratio is not exceeded.

4.2.2 Appropriate Use of SCMs

Replacement of some portland cement with SCMs in well-cured concrete has multiple benefits ranging from improved workability to reduced permeability of the hardened concrete. Typical replacement rates with SCMs are 15 percent to 35 percent depending on the chemistry of the system. Commonly used SCMs include Class C fly ash, Class F fly ash, and ground granulated blast furnace slag (GGBFS).

Setting times for concrete may be retarded when SCMs are used, especially in cool weather conditions, which can cause difficulty in sawing joints before random cracking occurs. Therefore, use caution when using SCMs during periods of extended cool weather until it can be determined that the strength gain of the mix is compatible with the sawing plan.

More information is available in the *Integrated Materials and Construction Practices for Concrete Pavement* (9).

4.2.3 Well Graded Aggregates

The use of well graded aggregates helps to make mixtures more workable, which in turn means that less water is required to achieve the same workability, allowing use of a lower w/cm ratio. In addition, better workability will mean better consolidation of the mixture, also improving (reducing) permeability.

Recent work to develop an FAA guide specification for construction of concrete airfield pavements highlights the benefits of utilizing well-graded aggregate combinations, and explains the disadvantages of gap-graded combinations as listed on the following page (10). All the benefits listed for well graded aggregate combinations are likely to improve joint performance.

4.2.4 Curing

Curing is the practice of ensuring that the concrete is moist and warm enough to promote hydration. The most common means of curing pavements is to apply curing compound.

When properly applied, a curing compound slows the loss of moisture from the pavement to the atmosphere. This allows for improved hydration, which in turn decreases the permeability of the concrete. Improper curing will result in a loss of moisture, which leads to larger capillary voids in the pavement structure and higher permeability.

It is recommended that curing compound be applied to the inside faces of saw cuts, in addition to the pavement

surface, shortly after sawing. Although applying curing compound to the internal sawed faces is not common practice, it is especially important to ensure that the quality of concrete exposed inside the joint is as good as that on the surface of the slab.

4.2.5 Penetrating Sealers

An additional approach to improving impermeability of concrete is to apply penetrating sealers to reduce the rate of ingress of water into the concrete. Surface sealants may be applied to the concrete inside concrete joints, along the joint faces. With respect to specific sealants, the following has been demonstrated from recent research:

- Siloxane-based materials have a proven history of reducing permeability of concrete systems. They have to be replaced periodically—approximately every 5 to 7 years (5).
- Other sealant types are being investigated (4).

4.3 Drainage of the Pavement System

It is clear that moisture trapped in the joint is a significant factor in the distress observed. Design, construction, and maintenance practices must all ensure that water is allowed to depart the joint. This means that subsurface drainage should be designed to facilitate water away from the concrete slab, and surface drainage should be designed to quickly shed water from a pavement surface. This may be achieved through combinations of the following activities:

- Provide stable and drainable base layers (evidence of the lack of this is shown in Figure 25). It should be noted that because the amount of water that penetrates



Figure 25. Example of a poorly draining pavement

a joint is small, very high permeability rates are not required in the base, which improves its stability.

- Avoid bathtub designs that trap water under the pavement.
- Provide underdrain systems, particularly in urban environments where it is not possible to drain the pavement structure to an open ditch.
- Detail sufficient cross-slopes and profile grade lines that facilitate water to the edge of pavement or gutter where applicable.
- Avoid low spots that can hold water for extended periods (“birdbaths”).
- Avoid saw-cut details that can become reservoirs for trapped water.

Well graded aggregates

Concrete mixtures produced with well graded, dense aggregate matrix tend to

- Reduce the water demand.
- Reduce the cementitious material demand.
- Reduce the shrinkage potential.
- Improved workability.
- Require minimal finishing.
- Consolidate without segregation.
- Enhance strength and long-term performance.

Gap-graded aggregates

Concrete mixtures produced with a gap-graded aggregate combination may

- Segregate easily.
- Contain higher amounts of fines.
- Require more water.
- Require more cementitious material to meet strength requirements.
- Increase susceptibility to shrinkage.
- Limit long-term performance.

(Source: FAA [10])

4.4 Sawing and Sealing Joints

4.4.1 Sawing Joints

There is window to saw contraction joints in new concrete pavements (Figure 26) (2,9,11). The window begins when concrete strength is sufficient for sawing without excessive raveling along the cut. The window ends when random cracking starts to occur. The risk of random cracking increases as joint sawing is delayed.

Sawing too early can cause the saw blade to break or pull aggregate particles free from the pavement surfaces along the cut. The resulting jagged, rough edges are termed raveling. Some raveling is acceptable, especially where a second saw-cut would be made for a joint sealant. If the raveling is too severe, it will affect the appearance and/or the ability to maintain the joint. Figure 27 shows different degrees of raveling.

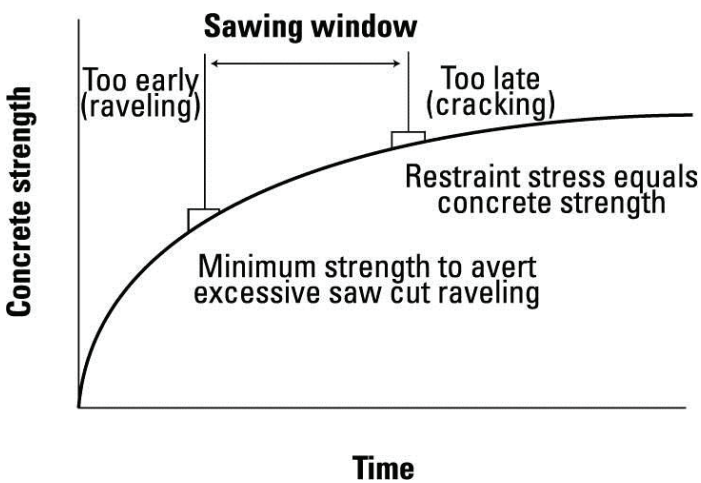

Figure 26. Definition of the sawing window (9)

a) No raveling—sawed later in the window



b) Moderate raveling—sawed early in the window



c) Unacceptable raveling—sawed too early



Figure 27. Different degrees of joint raveling caused by sawing (9)

When using early-entry saws, it is recommended that temporary spacers be inserted where cuts intersect existing cuts, in order to prevent corner damage and the subsequent risk of other joint deterioration mechanisms (Figure 28).

There is evidence that some mechanical damage (or bruising) may be incurred around the sides of the saw cut, particularly if bearings on the sawing equipment are loose and/or inappropriate saw blades are used. Microcracking can result, which can provide a place for water to be trapped and thus as an initiation point for further damage. While this mechanism is still being investigated, it is good practice to ensure that sawing equipment is well maintained for use.

Water can be trapped in a joint where longitudinal joints are sawed to a depth of $T/3$ and transverse contraction joints sawed to a shallower depth, particularly using early entry saws. This scenario results in a void in the longitudinal joint that can trap water with no means of egress. Consideration may be given to requiring sawing of transverse joints at the same depth as longitudinal joints or fully filling the joints as discussed below.

4.4.2 Sealing Joints

The purpose of sealing joints is to minimize infiltration of surface water, deicing solution, and incompressible material (11).

Excess water can contribute to subgrade or base softening, erosion, and pumping of subgrade or base fines over time with the associated loss of structural support.



Figure 28. Using temporary joint spacers to protect and minimize damage due to early entry sawing (Source: Husqvarna)

However, there have been numerous examples of pavements exhibiting premature joint deterioration where water has been trapped in the joint, particularly below a seal in a tight or uncracked joint, as illustrated in Figure 29.

It is critical that water be prevented from ponding at the sawn surface. Alternative approaches to consider include:

- Apply and maintain sealants in accordance with industry best practices (11).
- Saw contraction joints as narrow as practical and leave all joints unsealed.
- Fill the saw kerf with a hot poured material (Figure 30).

These activities will not address water penetrating from below the pavement, which can only be remedied by providing adequate drainage.

The effectiveness of a joint seal can be lost when it tears (cohesive failure) or loses bond with the edges of the joint face (adhesive failure) (12). Premature joint seal failure can be the result of poor quality materials or installation practices.

However, during the life of a pavement, intrusion of dirt, debris, and water into the pavement joints is inevitable. Joint failure may be accelerated by excess joint movement and/or poor quality slab support (13).

4.5 Durable Aggregates

Aggregates should be prequalified for resistance to D cracking. D cracking is generally a regional problem since it is inherent to aggregates extracted from certain geological formations. Screening aggregate sources is therefore an effective tool.

Past performance in the field is the best indicator of the quality of an aggregate source.

Aggregates not having a service record can be tested in the laboratory, and several methods are available (9). One method is ASTM C 1646, which proscribes a standard mixture that can be tested in a freeze-thaw method. Alternatively, the rapid pressure release method or the Iowa pore index test can be considered.

4.6 Summary

In summary, new concrete pavements must be specified to be of adequate quality:



Figure 29. Evidence of saturation within joint beneath seal (Source: Purdue)



Figure 30. Joint filled with hot pour sealant (Source: The Transtec Group)

- Air content, in place, greater than 5 percent.
- Maximum w/cm ratio of 0.45, preferably 0.40.
- Appropriate amounts of SCMs.
- Durable aggregates.
- Thorough curing (not optional), preferably including coverage of the saw cut faces.
- Joints that can dry out periodically.

5 Maintenance Activities to Reduce Joint Deterioration Risk

5.1 Routine Maintenance

5.1.1 Joint Cleaning and Sealing

It is recommended that joints be resealed in existing pavements only when they were originally sealed during construction. Proper selection should consider the environment, cost, performance, joint type, and joint spacing. Resealing joints is most effective when the joints are not severely deteriorated and when resealing is combined with other maintenance activities such as joint repairs and grinding (14).

Typically, sealants have to be replaced every 8 to 10 years. Sealants are either placed in a liquid form or are preformed and inserted into the joint reservoir. Sealants installed in a liquid form depend on long-term adhesion to the joint face for successful sealing.

Several factors regarding concrete material or sealant installation technique can affect joint seal performance:

- Silicone sealants are known to have poor adhesion to concrete containing dolomitic limestone. A primer application to the sealant reservoir walls will help ensure that the silicone adheres.
- Chemical solvents used to clean the joint reservoir may be detrimental. Solvents can carry contaminants into pores and surface voids on the reservoir faces that will inhibit bonding of the new sealant.
- For cleaning joints, the air stream must be free of oil. Many modern compressors automatically insert oil into the air hoses to lubricate air-powered tools. New hoses or an oil and moisture trap prevents contamination of the joint face from oil in the compressor or air hoses.

The process for resealing transverse joints involves removing the old seal, joint refacing, reservoir cleaning, backer rod installation, and new sealant installation. For more specific information on joint resealing, consult the ACPA's Technical Bulletin TB012P (11) and the *Concrete Pavement Preservation Workshop Reference Manual* (14).

5.1.2 Surface Drainage

Maintenance activities to enhance surface drainage include cleaning drainage structure grates/drains (to prevent clogging from roadway debris, ice, or snow), grinding to increase the cross-slope, and resealing joints.

If there are water accumulation problems due to inadequate surface drainage, such as inadequate cross slope (Figure 31), then grinding to increase the cross slope is a possible solution. Resealing joints is another possible solution to minimize infiltration where surface drainage cannot be easily remedied.

5.1.3 Subsurface Drainage

Proper maintenance of drainage systems is critical. This includes both regular inspection and cleaning. Maintenance of edge drains involves flushing the system, and cleaning and replacing outlets. Figure 32 shows the typical components of edge drain systems, which include a trench filled with filter-graded aggregate wrapped with a geotextile, longitudinal (perforated) pipe, and outlet (non-perforated) pipe (15).

If the existing pavement is beginning to show signs of joint deterioration and a subsurface drainage system is not present, then potential sources of excess water should be identified. Common sources include landscaped islands/shoulders with irrigation systems, shallow ditches, or high



Figure 31. Failing transverse joint associated with poor drainage at gutter

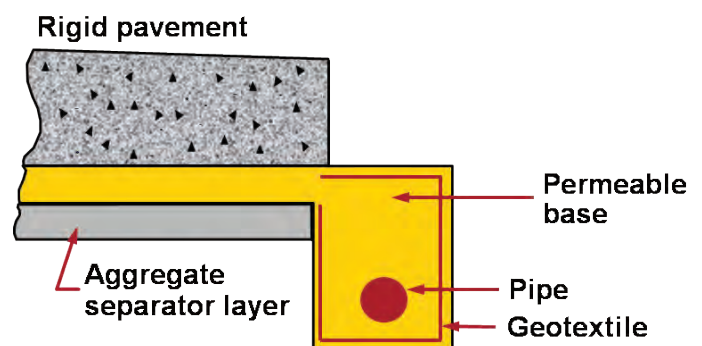

Figure 32. Typical components of an edge drain system (Source: NHI 131008) (16)

groundwater tables. If a source of excess water is identified and cannot otherwise be mitigated, edge drain retrofit can be considered. A retrofit is shown in Figure 33. It should be noted that this process requires careful project evaluation, design, installation, and maintenance. The presence of existing utilities can be particularly problematic during the retrofit process. Retrofitting edge drains is not recommended for sections exhibiting severe joint deterioration. More guidance on this topic can be found in the *Concrete Pavement Preservation Workshop Reference Manual* (14).

One technique to determine if there are drainage issues is to observe the pavement surface immediately after a rain event, noting whether the joints or the rest of the slab dries first. Figure 34 shows a pavement with unsealed joints after measurable rain. It can be observed that the water is effectively exiting the system and the joints are drying before the rest of the slab. This pavement is in good condition after 10 years in service.

If the joints remain wet and the rest of the slab dries, this is an indication that water is not effectively leaving the system and further investigation is necessary to identify measures, such as joint sealing or drainage improvements, to prevent joint deterioration.



Figure 33. Subdrain retrofit operation including clean out (The Transtec Group)



Figure 34. Example of effective drainage of unsealed joints

5.2 Winter Maintenance

Winter maintenance activities to remove snow and ice on highway pavements include sanding, snow plowing, and application of anti-icing or deicing solutions.

A recently completed Transportation Pooled Fund Study TPF 5(042) (8), led by South Dakota DOT investigated the effect of commonly used anti-icing and deicing solutions on concrete pavements. The study concluded that concentrated brines of magnesium chloride ($MgCl_2$) and calcium chloride ($CaCl_2$) have the most deleterious effects on concrete samples. It was also found that deicer concentrations have an impact on the rate/amount of distresses, and that concrete surface sealants are effective at slowing the ingress of chemicals into the concrete. Following are the main recommendations from this study:

- Use less deicing chemicals (the lowest possible concentration levels).
- Use sodium chloride ($NaCl$) brines whenever possible.
- Use concrete sealants and concrete mixture designs incorporating SCMs to slow deicer ingress.

An additional recommendation from Transportation Pooled Fund TPF 5(042) (5) is to employ a minimum 30-day or one-winter “drying period” before applying deicing chemicals to new concrete (Figure 35).



Figure 35. Signage to help avoid salting of new pavement

6 Treatment of Pavements with Joint Deterioration

Several techniques may help mitigate joint deterioration. Selection of the technique is primarily governed by the following:

- The extent of the damage.
- Whether the damage is developing from the top or the bottom or has progressed through the full depth of the slab (Figure 36).
- The number of joints that are distressed.

6.1 Concrete Surface Sealers

As with new pavements, surface sealants may be applied to the faces of and near existing joints to reduce ingress of water and deicing solutions into the concrete. Very early indications from a test section in Michigan indicate that such a treatment is helpful. At present, there is little guidance available on when such materials should be applied or how to specify them. Work is continuing to develop more specific guidance.

6.2 Partial-Depth Repairs

Partial-depth repairs are defined as the removal of small, shallow areas of deteriorated concrete that are then replaced with a cementitious repair material (14). Partial depth repairs are not recommended when the main cause of joint deterioration is D cracking or other material-related distress, or where damage is more than one-third to one-half the depth of the slab.

Partial depth repair techniques and milling equipment have improved over the last few years. Figure 37 illustrates a joint before and after repair.

Typically, repairs that are less than 6 ft long are more labor-intensive and use hand-removal methods, whereas larger repairs utilize milling to speed up the repair.

A typical schematic of a joint repair is illustrated in Figure 38.

The steps for a successful repair are illustrated in Figure 39:



Figure 37. Delineation of spalled area for partial-depth repair (top) and a completed patch (bottom) (Source [bottom]: The Transtec Group)

1. Removing deteriorated joint material by clipping (jackhammer or milling).
2. Sandblasting to remove loose material.
3. Air blasting to remove loose material.
4. Installation of compressible insert in crack.
5. Application of bonding agent.
6. Placement of repair material.
7. Screeding and finishing.
8. Curing.

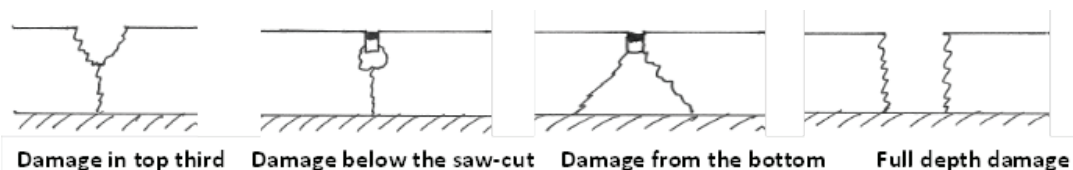

Figure 36. Typical forms of damage that require different repair approaches

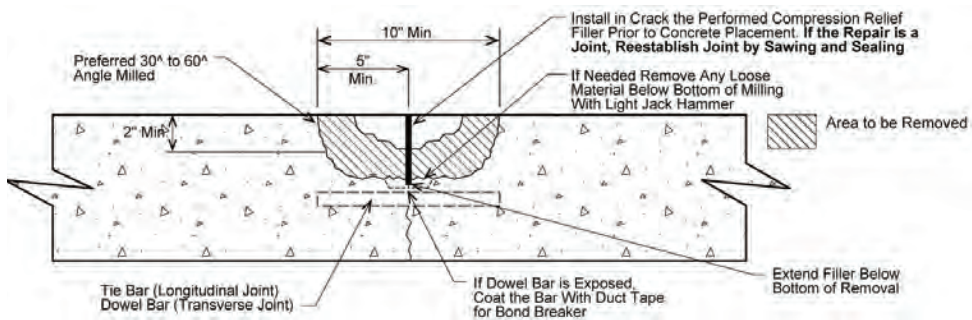

Figure 38. Schematic of a partial-depth repair

A new, detailed guide for partial-depth repairs for concrete pavements will be available from the National Concrete Pavement Technology Center in the fall 2011. Other references include the *Concrete Pavement Field Reference: Preservation and Repair* manual (20), and the *Concrete Pavement Preservation Workshop Reference Manual* (14).

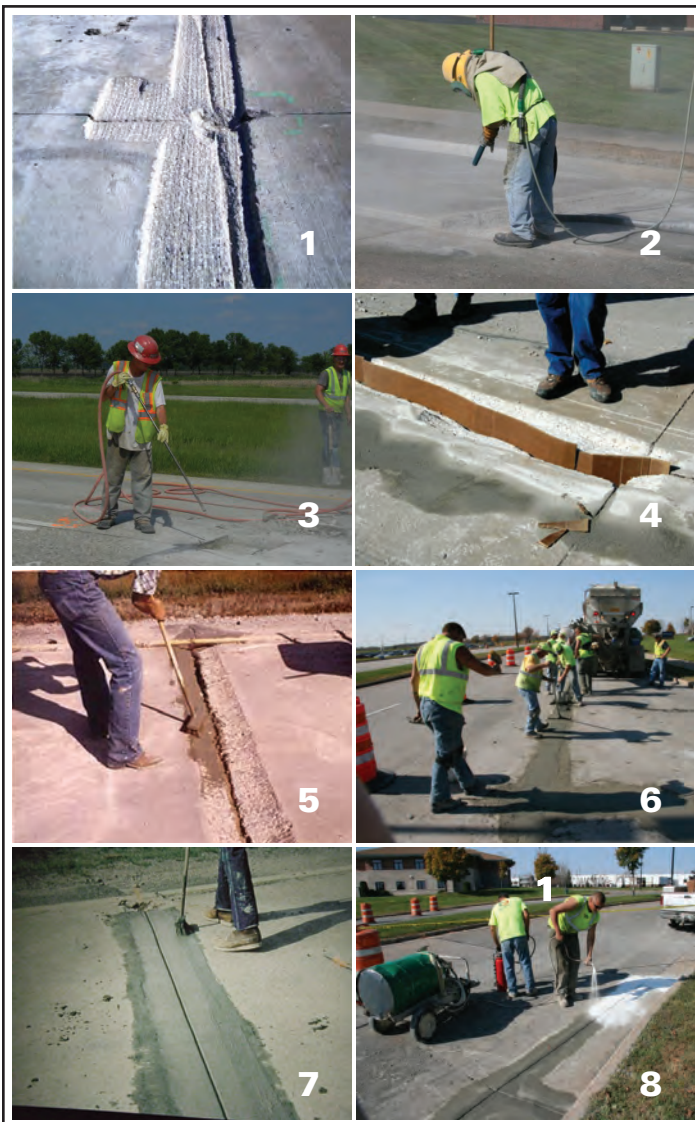

Figure 39. Steps to conducting a proper partial-depth repair (Source: Snyder and Associates)

6.3 Full-Depth Repairs / Slab Replacement

In cases where deterioration has occurred through more than one-third the depth of the pavement, a full-depth repair is required. Shown in Figure 40, a full-depth repair is defined as a cast-in-place concrete repair that extends through the full thickness of the existing concrete slab.

Like partial-depth repairs, full-depth repairs are not recommended when the principal cause of joint deterioration is D cracking. The following are considerations when evaluating the viability of full-depth joint repairs:

- Full-depth repairs are effective if deterioration is limited to the joints or cracks.
- Full-depth repairs are effective if the deterioration is not widespread over the entire project length; otherwise, a structural overlay or reconstruction is more suited.
- Long-lasting full-depth repairs are dependent upon many items, including appropriate project selection, effective load transfer design, and effective construction procedures.
- Diamond grinding should be considered after the repairs are made to produce a smooth-riding surface.



Figure 40. Full-depth patching

If every joint requires repair, economics may demonstrate that an overlay or replacement is more effective than full-depth repairs.

Other references include the *Pavement Preservation Workshop Reference Manual* (14), *Concrete Pavement Field Reference: Preservation and Repair* manual (17), and *Concrete Pavement Rehabilitation—Guide for Full-Depth Repairs* (18).

6.4 Overlays

Asphalt overlays may not perform well in some cases because continued deterioration under the overlay will reflect through the overlay, reducing ride quality. However, concrete overlays may be a viable option.

Items to consider when assessing the suitability of an overlay include the severity and extent of joint deteriora-

tion, risk of continued deterioration under the overlay, pre-overlay repairs required to prevent reflective cracking, design life, and related costs.

Partial-depth repairs may be required to address damage before bonded or unbonded overlays are placed.

More guidance on this topic is available in the CP Tech Center Guide to Concrete Overlays (19).

Additional guidance on the use of concrete overlays for the repair of concrete pavements exhibiting joint deterioration is being developed at the CP Tech Center.

6.5 Reconstruction

Pavements exhibiting severe joint deterioration throughout the entire length of the section and at a majority of the joints are more suited for reconstruction.

7 References

1. McCullough, B. Frank, et al., *Evaluation of the Performance of Texas Pavements made with Different Coarse Aggregates*, Texas DOT Report 7-3925-1, 2000.
 2. Ruiz, Mauricio, et al., *Computer-Based Guidelines For Concrete Pavements Volume III-Technical Appendices*, FHWA Report FHWA-HRT-04-127, 2005.
 3. Yang, Z., Weiss, J., Olek J., and Nantung, T., "Assessing Damage, Sorptivity, Air Content, and Strength of PCCP in Indiana," Presentation at 8th Intl. Conference on Concrete Pavements, 2005.
 4. Spragg, E., et al., "Damage is Seen in Transverse and Longitudinal Joints in Pavements," Presentation on the Joint Deterioration Pooled Fund Study, National Concrete Consortium, Indianapolis, Indiana, 26 April 2011.
 5. Sutter, Lawrence, et al., *The Deleterious Chemical Effects of Concentrated Deicing Solutions on Portland Cement Concrete*, Final Report, South Dakota Department of Transportation, SD2002-01-F, 2008.
 6. Sutter, L., et. al., *The Deleterious Chemical Effects of Concentrated Deicing Solutions on Portland Cement Concrete – Implementation Guide*, South Dakota Department of Transportation, SD2002-01-G, April 2008.
 7. Kosmatka, S.H. and Wilson, M.L., *Design and Control of Concrete Mixtures, 15th Edition*, PCA Bulletin EB001.15, 2011.
 8. Peterson, K.W., et. al, *Impact of Hydrated Cement Paste Quality and Entrained Air-Void System on the Durability of Concrete: Final Report*, Michigan Department of Transportation, Report No. RC-1552, June 30, 2011.
 9. Taylor, Peter, et al., *Integrated Materials and Construction Practices for Concrete Pavement: A State-of-the-Practice Manual*, FHWA Report FHWA-HIF-07-004, 2007.
 10. Tayabji, S., et al., *Supplemental Report for Proposed Specification for Construction of Concrete Airfield Pavement*, Innovative Pavement Research Foundation, Report IPRF-01-G-002-04-1A, 2007.
 11. American Concrete Pavement Association, "Joint and Crack Sealing and Repair for Concrete Pavements," Technical Bulletin TB012P, 1993.
 12. Michigan Department of Transportation, *Scoping Manual*, Chapter 5, 2005.
 13. Minnesota Department of Transportation, *Maintenance Manual*, Chapter 3.
 14. Smith, Kurt, et al., *Concrete Pavement Preservation Workshop Reference Manual*, National Concrete Pavement Technology Center, Iowa State University, 2008.
 15. Christopher, Barry, *Maintenance of Highway Edgedrains*, National Cooperative Highway Research Program Synthesis 285, 2000.
 16. Federal Highway Administration, *Techniques for Pavement Rehabilitation*, FHWA-NHI 131008, 1998.
 17. American Concrete Pavement Association, *Concrete Pavement Field Reference: Preservation and Repair*, Publication EB239P, 2006.
 18. Correa, A., and Wong, B., *Concrete Pavement Rehabilitation—Guide for Full-Depth Repairs*, Federal Highway Administration Report, 2003.
 19. Harrington, et al., *Guide to Concrete Overlays*, Second Edition, National Concrete Pavement Technology Center, Iowa State University, 2008.
- For information about obtaining any of these references, contact the National Concrete Pavement Technology Center, or visit www.cptechcenter.org.

