

Handbook of Simplified Practice for Traffic Studies

Sponsored by the
Iowa Department of Transportation
and Iowa Highway Research Board

Iowa DOT Project TR-455



GLOSSARY OF TERMS

Calibration: The act of checking or adjusting (by comparison with a standard) the accuracy of a measuring instrument.

Obstruction: Any object that blocks a driver's sight line of approaching conflicting vehicles.

School route plan: A map showing the school, nearby streets, existing traffic controls, and the suggested school route for children to follow.

Sight distance: The maximum distance of unobstructed vision in a horizontal or vertical plane from within an automobile located at any given point on a roadway.

Horizontal sight distance: The driver's vision may be limited by buildings, hedges, vehicles, trees, bushes, tall crops, walls, fences, etc.

Vertical sight distance: The driver's vision may be limited by the vertical curvature of the roadway.

Sight triangles: Specified areas along intersection approach legs and across their included corners.

Approach sight triangle: A sight triangle that provides the driver of a vehicle approaching an intersection, a clear unobstructed view of any approaching conflicting vehicles.

Departure sight triangle: A sight triangle that provides sufficient sight distance for a stopped vehicle on a minor road to depart from the intersection and enter or cross the major road.

Speeding: Exceeding the posted speed limit or driving too fast for conditions.

Speed percentiles: A tool used to determine effective and adequate speed limits.

50th percentile of speed: Median speed of the observed data set.

85th percentile of speed: Speed at which 85% of the observed vehicles are traveling at or below.

Traffic control device (TCD): Signs, signals, markings, and devices placed on, over, or adjacent to a street or highway by an authority of a public body having jurisdiction to regulate, warn, or guide traffic.

Traffic volume: Amount of traffic that travels any given roadway during any given time period.

Average daily traffic (ADT): The total volume during a given time period (in whole days), greater than one day and less than one year, divided by the number of days in that time period.

Annual average daily traffic (AADT): A general unit of measure for traffic, which represents the annual average traffic per day.

DEV: Daily entering volume.

Off-peak flow traffic: A time period during any given day when the traffic volume is normally the least.

Peak-flow traffic: A time period during any given day when the traffic volume is normally the heaviest. Peak-flow traffic may last up to two hours in some locations and is normally for the a.m. commute to work and the p.m. commute home from work.

COMMONLY USED ACRONYMS

AASHTO:	American Association of State Highway and Transportation Officials
CTRE:	Center for Transportation Research and Education
DOT:	Department of Transportation
FHWA:	Federal Highway Administration
ITE:	Institute of Transportation Engineers
ITSDS:	Iowa Traffic Safety Data Service
MUTCD:	<i>Manual on Uniform Traffic Control Devices</i>
NCHRP:	National Cooperative Highway Research Program
TEAP:	Traffic Engineering Assistance Program
TRB:	Transportation Research Board

Handbook of Simplified Practice for Traffic Studies

Iowa DOT Project TR-455
CTRE Project 01-80
November 2002

Principal Investigator
Duane Smith

Graduate Research Assistant
Jeff McIntyre

Editor
Mark Anderson-Wilk

Illustrator
Sarah Moreau

Center for Transportation Research and Education
Iowa State University
2901 South Loop Drive, Suite 3100
Ames, Iowa 50010-8632
Telephone: 515-294-8103
Fax: 515-294-0467
www.ctre.iastate.edu

Preparation of this report was financed in part through funds provided by the Iowa Department of Transportation through its research management agreement with the Center for Transportation Research and Education.

The opinions, findings, and conclusions expressed in this publication are those of the authors and not necessarily those of the Iowa Department of Transportation or the Iowa Highway Research Board.

CTRE's mission is to develop and implement innovative methods, materials, and technologies for improving transportation efficiency, safety, and reliability while improving the learning environment of students, faculty, and staff in transportation-related fields.

Contents

Glossary of Terms inside front cover

1. Introduction

Background	1.1
Objectives	1.1
Contributions and Acknowledgments	1.2
Identified Common Traffic Studies	1.2

Traffic Studies:

2. Spot Speed

Introduction	2.1
Speed Percentiles and How to Use Them	2.2
Stopwatch Method	2.4
Radar Meter Method	2.11
Pneumatic Road Tube Method	2.17
Contracting for a Spot Speed Study	2.21
References	2.24

3. Traffic Volume Counts

Introduction	3.1
Using Count Period to Determine Study Method	3.1
Manual Count Method	3.2
Automatic Count Method	3.9
Examples of Traffic Volume Count Studies	3.12
Contracting Out for a Traffic Volume Count Study	3.14
References	3.17

4. Sight Distance

Introduction	4.1
Intersection Sight Distance	4.1
Sight Distance Study Methods	4.4
Uncontrolled Intersections	4.5
Intersections with Stop Sign Control	4.12
Stopping Sight Distance	4.18
Contracting Out for a Sight Distance Study	4.23
References	4.26

5. Crash Analysis

Introduction	5.1
Key Steps to a Crash Analysis Study	5.1
Example Crash Analysis Study	5.10
Contracting Out for a Crash Analysis Study	5.18
References	5.21

6. School Zone Program

Introduction 6.1
Responsibility for the Safety of School Pedestrians 6.2
Key Steps to a School Zone Program 6.2
Example School Zone Program Study 6.13
Contracting Out for a School Zone Program Study 6.16
References 6.19

7. Appendixes:

A. Spot Speed Study Data Forms 7.1
B. Traffic Volume Count Intersection Tally Sheet..... 7.5
C. Sight Distance Diagram Form..... 7.6
D. Crash Analysis Field Observation Report, Software Instructions, and Guidelines .. 7.7
E. Project Work Order (Contracting Out)..... 7.45

1



Introduction

BACKGROUND

The Iowa Highway Research Board has identified the development of a simplified handbook of transportation studies as a high priority for the state of Iowa. The Center for Transportation Research and Education (CTRE) at Iowa State University was chosen to develop such a handbook.

A well-executed, well-documented study is critical in the decision-making process for many transportation-related projects and in reporting to elected officials and members of the community. As more research is conducted in the area of transportation, study procedures in many cases have become more complex. It is often difficult for local jurisdictions with limited staff, training, experience, and time availability to perform these studies.

The most commonly used publication for traffic studies is geared toward transportation professionals and professional engineers. That defining document, *Manual of Transportation Studies* (Institute of Transportation Engineers, 2000), is over 500 pages and includes several dozen types of transportation studies. Many of the transportation studies described in the manual are rarely (if ever) used by local jurisdictions. Further, those studies that are frequently used are at times very complex and possibly very costly to perform exactly as described. Local jurisdictions without the staff expertise to understand and apply the manual's various studies have a need for a simplified handbook of procedures to perform common traffic studies themselves or properly define a scope of work to hire a consultant to perform the studies.

This handbook describes simplified procedures that are easy to apply and are written for all potential users (civil engineers and traffic engineers, public works managers, city managers and attorneys, and the general public).

OBJECTIVES

This handbook has two primary objectives: The first objective is to develop a handbook of traffic studies that is convenient for Iowa jurisdictions to use in assessing traffic issues. The second objective is to develop a series of boilerplate scopes of work that local jurisdictions can use to hire outside consulting firms to perform traffic studies.

CONTRIBUTIONS AND ACKNOWLEDGMENTS

One of the initial steps taken with this manual was the formation of an advisory committee to provide technical guidance and expertise to CTRE staff who developed the handbook. The advisory committee is listed below alphabetically:

Steve Akes, Warren County
Greg Benedict, City of Mason City
Tim Crouch, Iowa Department of Transportation
Jim George, Dallas County
Neil Hawkins, Howard R. Green Company
Randy Krauel, City of Carroll
Duane Smith, Iowa State University

The advisory committee defined the studies that are most common at the local jurisdiction level and that would provide the biggest benefits if presented in a handbook of simplified practice. In several periodic meetings, members of this voluntary committee offered insights and recommendations for content, presentation, and applicability of the procedures described.

The study team would also like to thank the Iowa Highway Research Board for sponsoring this important project.

IDENTIFIED COMMON TRAFFIC STUDIES

This handbook is organized into chapters, one chapter for each of the studies presented:

- Spot Speed
- Traffic Volume Counts
- Sight Distance
- Crash Analysis
- School Zone Program

Each chapter includes an introduction to the study type, step-by-step instructions for each common method of conducting the study, real-world examples, a model project work order for contracting out, and references.

Appendixes provide additional resources and blank data-collection forms and project work orders that can be used or modified by local jurisdictions.

2

Spot Speed

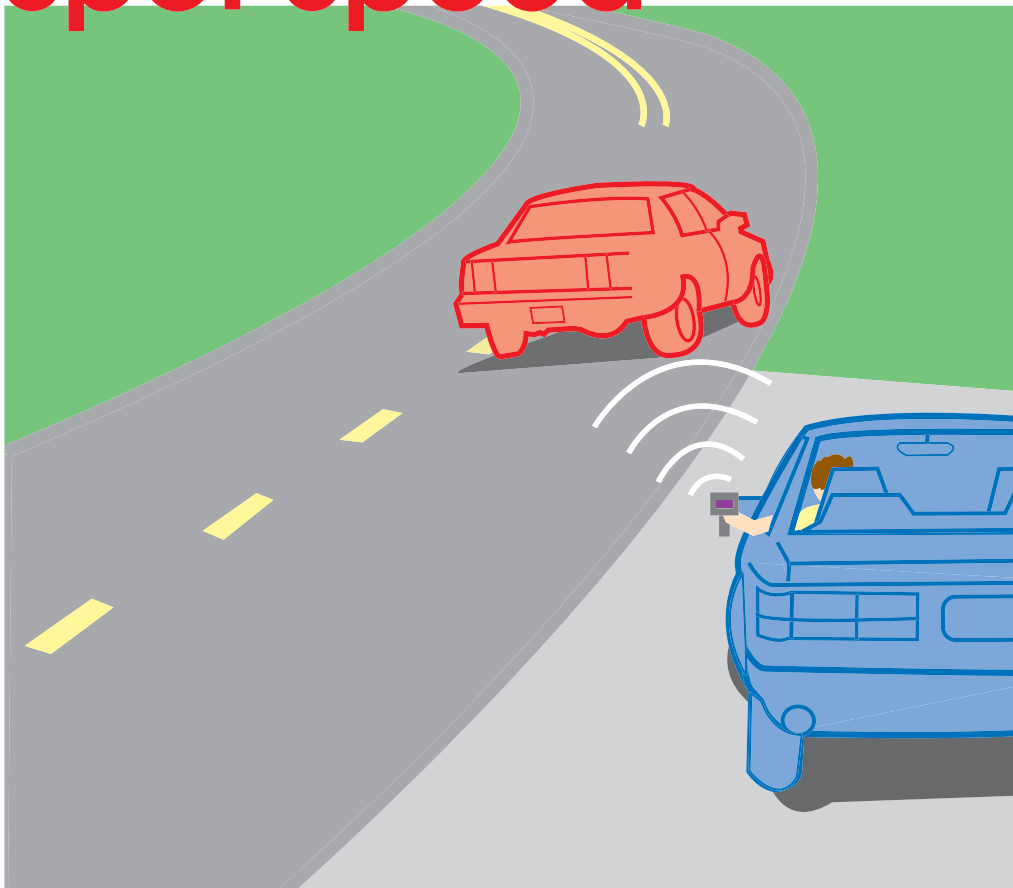

Spot Speed

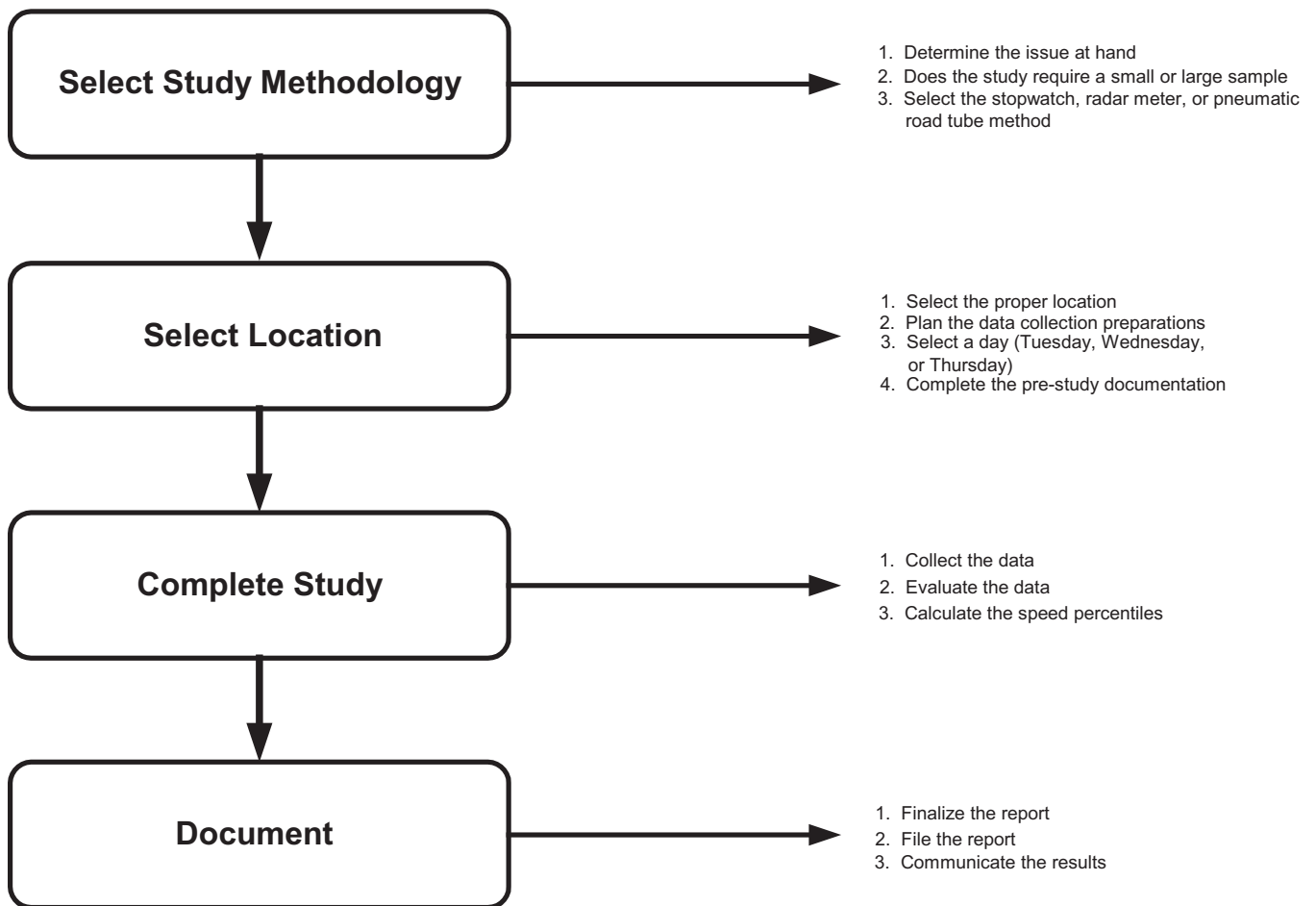

INTRODUCTION

Speed is an important transportation consideration because it relates to safety, time, comfort, convenience, and economics. Spot speed studies are used to determine the speed distribution of a traffic stream at a specific location. The data gathered in spot speed studies are used to determine vehicle speed percentiles, which are useful in making many speed-related decisions. Spot speed data have a number of safety applications, including the following (Robertson 1994):

1. Determining existing traffic operations and evaluation of traffic control devices
 - a. Evaluating and determining proper speed limits
 - b. Determining the 50th and 85th speed percentiles (explained below)
 - c. Evaluating and determining proper advisory speeds
 - d. Establishing the limits of no-passing zones
 - e. Determining the proper placements of traffic control signs and markings
 - f. Setting appropriate traffic signal timing
2. Establishing roadway design elements
 - a. Evaluating and determining proper intersection sight distance (for more information refer to Chapter 4 in this handbook)
 - b. Evaluating and determining proper passing sight distance (for more information refer to Chapter 3 in the *AASHTO Green Book*)
 - c. Evaluating and determining proper stopping sight distance (for more information refer to Chapter 4 in this handbook)
3. Assessing roadway safety questions
 - a. Evaluating and verifying speeding problems
 - b. Assessing speed as a contributor to vehicle crashes
 - c. Investigating input from the public or other officials
4. Monitoring traffic speed trends by systematic ongoing speed studies
5. Measuring effectiveness of traffic control devices or traffic programs, including signs and markings, traffic operational changes, and speed enforcement programs

For a spot speed study at a selected location, a sample size of at least 50 and preferably 100 vehicles is usually obtained (Ewing 1999). Traffic counts during a Monday morning or a Friday peak period may show exceptionally high volumes and are not normally used in the analysis; therefore, counts are usually conducted on a Tuesday, Wednesday, and Thursday. Spot speed data are gathered using one of three methods: (1) stopwatch method, (2) radar meter method, or (3) pneumatic road tube method. These methods are described in this chapter in order from least

expensive to most expensive. The stopwatch method is the least expensive and least accurate of the methods.

SPEED PERCENTILES AND HOW TO USE THEM

Speed percentiles are tools used to determine effective and adequate speed limits. The two speed percentiles most important to understand are the 50th and the 85th percentiles. The 50th percentile is the median speed of the observed data set. This percentile represents the speed at which half of the observed vehicles are below and half of the observed vehicles are above. The 50th percentile of speed represents the average speed of the traffic stream. The 85th percentile is the speed at which 85% of the observed vehicles are traveling at or below. This percentile is used in evaluating/recommending posted speed limits based on the assumption that 85% of the drivers are traveling at a speed they perceive to be safe (Homburger et al. 1996). In other words, the 85th percentile of speed is normally assumed to be the highest safe speed for a roadway section.

Weather conditions may affect speed percentiles. For example, observed speeds may be slower in rainy or snowy conditions.

A frequency distribution table is a convenient way to determine speed percentiles. An example is given in Table 2.1. The frequency of vehicles is the number of vehicles recorded at each speed. The cumulative frequency is the total of each of the numbers (frequencies) added together row by row from lower to higher speed. The fourth column is a running percentage of the cumulative frequency.

Table 2.1. Example Frequency Distribution Table

Speed (mph)	Frequency of Vehicles	Cumulative Frequency	Cumulative Percent	Speed Percentile
15	1	1	1%	
18	2	3	3%	
21	6	9	9%	
24	12	21	21%	
27	13	23	23%	50th
30	20	54	54%	
33	18	72	72%	85th
36	14	86	86%	
39	6	92	92%	

42	6	98	98%	
45	1	99	99%	
48	1	100	100%	

The 50th and 85th speed percentiles are determined from the cumulative percent column. For the example data in Table 2.1, the 50th percentile falls between 27 and 30 mph and the 85th percentile falls between 33 and 36 mph. The calculation of speed percentiles is easier if a sample size of 100 vehicles is collected. When the sample size equals 100 vehicles, the cumulative frequency and cumulative percent are the same.

As can be observed from Table 2.1, the exact 50% and 85% (50th and 85th percentiles) are not found in the cumulative percent column. To reach these exact percentages, a calculation is completed using percentages and speeds from the distribution table. Shown below is the equation for calculating speed percentiles:

$$S_D = \frac{P_D - P_{\min}}{P_{\max} - P_{\min}}(S_{\max} - S_{\min}) + S_{\min} , \quad (2.1)$$

where S_D = speed at P_D , P_D = percentile desired, P_{\max} = higher cumulative percent, P_{\min} = lower cumulative percent, S_{\max} = higher speed, and S_{\min} = lower speed.

Example speed percentile calculations follow, using the example frequency distribution table in Table 2.1. The 50th percentile of speed ($P_D = 50\%$) falls between 27 and 30 mph (see Table 2.1), so $S_{\max} = 30$ mph and $S_{\min} = 27$ mph. The higher cumulative percent (P_{\max}) is 54%, and the lower cumulative percent (P_{\min}) is 23%. Therefore, to find S_D at $P_D = 50\%$,

$$S_D = \frac{50\% - 23\%}{54\% - 23\%}(30 \text{ mph} - 27 \text{ mph}) + 27 \text{ mph} = 29.6 \text{ mph.}$$

The 85th percentile of speed ($P_D = 85\%$) falls between 33 and 36 mph (see Table 2.1), so $S_{\max} = 36$ mph and $S_{\min} = 33$ mph. The higher cumulative percent (P_{\max}) is 86%, and the lower cumulative percent (P_{\min}) is 72%. To find S_D at P_D in this case (85th percentile of speed),

$$S_D = \frac{85\% - 72\%}{86\% - 72\%}(36 \text{ mph} - 33 \text{ mph}) + 33 \text{ mph} = 35.8 \text{ mph.}$$

(1) STOPWATCH METHOD

The stopwatch method can be used to successfully complete a spot speed study using a small sample size taken over a relatively short period of time. The stopwatch method is a quick and inexpensive method for collecting speed data.

Preparation Checklist for a Stopwatch Spot Speed Study

When preparing for a spot speed study using a stopwatch, use the checklist in Table 2.2. The checklist may be modified or expanded as necessary.

Table 2.2. Stopwatch Spot Speed Study Preparation Checklist

Step	√ When Complete	Notes
Obtain stopwatch		
Obtain backup stopwatch		
Obtain 50–100 foot tape		
Obtain data collection forms		
Obtain hardhat and safety vest		
Obtain brightly colored reference posts		
Select time and day		
Contact local law enforcement		
Other:		

If an agency does not possess the equipment necessary to complete a spot speed study using a stopwatch, it may be obtained from the Iowa DOT, another jurisdiction, or a responsible consulting firm.

Key Steps to a Stopwatch Spot Speed Study

A stopwatch spot speed study includes five key steps:

1. Obtain appropriate study length.
2. Select proper location and layout.
3. Record observations on stopwatch spot speed study data form.
4. Calculate vehicle speeds.
5. Generate frequency distribution table and determine speed percentiles.

Obtain Appropriate Study Length

The study length is important because it is used in the calculation of vehicle speeds. Table 2.3 provides recommended study lengths, which are based on the average speed of the traffic stream. Using these recommended study lengths makes speed calculations straightforward and less confusing. If these lengths are not appropriate, another length can be used assuming it is long enough for reliable observer reaction times.

Table 2.3. Recommended Spot Speed Study Lengths

Traffic Stream Average Speed	Recommended Study Length (feet)
Below 25 mph	88
25–40 mph	176
Above 40 mph	264

Select Proper Location and Layout

Figure 2.1 illustrates a typical layout for conducting a spot speed study using a stopwatch. When selecting a location and layout, care must be exercised so that the observer can clearly see any vertical reference posts. The observer should be positioned higher than the study area and be looking down. The position could be on a bridge or a roadway back slope. The observer should use reference points to aid in collecting the elapsed time it takes a vehicle to travel through the study area. The reference point to start timing may be a brightly colored vertical post. The reference point to end timing may be a tree or a signpost in the observer's sight line. An accurate sketch of the site should be documented, including number of lanes, position of observer, and description of reference points (see Figure 2.1 for an example).

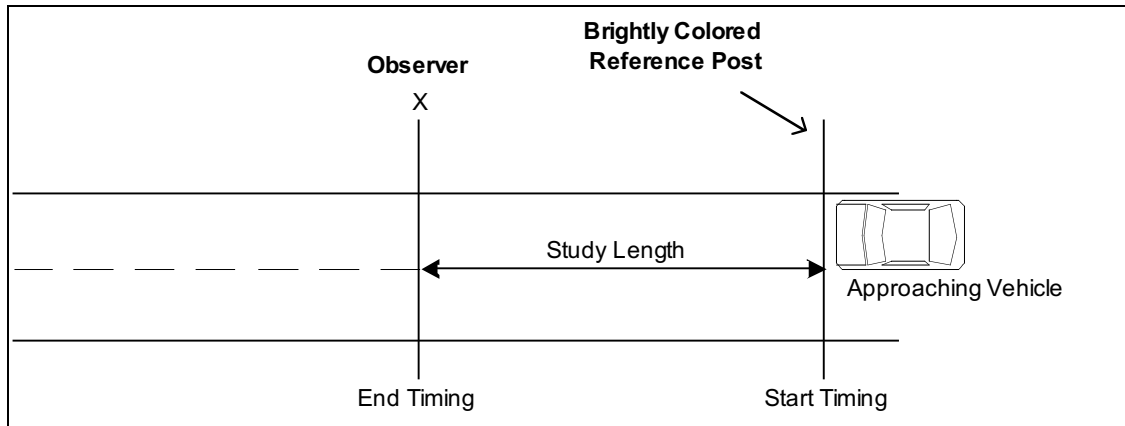

Figure 2.1. Stopwatch Spot Speed Study Layout

Record Observations on Stopwatch Spot Speed Data Form

On the stopwatch spot speed data form (a blank form is provided in Appendix A.1), the observer records the date, location, posted speed limit, weather conditions, start time, end time, and down time. As the front wheels of a vehicle (or only the lead vehicle in a group) cross a mark or pavement crack at the beginning of the predetermined study length, the observer starts the stopwatch. The watch is stopped when the vehicle’s front wheels pass a reference line in front of the observer. A slash is recorded on the data form corresponding to the elapsed time observed.

Calculate Vehicle Speeds

To calculate vehicle speed, use the predetermined study length and the elapsed time it took the vehicle to move through the course (as recorded on the stopwatch data form) in the following formula (Robertson 1994):

$$V = \frac{D}{1.47T}, \tag{2.2}$$

where V = spot speed (mph), D = length (feet), and T = elapsed time (seconds). In the equation, 1.47 is a constant that converts units of feet per second into miles per hour. For example, if the spot speed study length is 100 feet and the motorist’s elapsed time is 2.5 seconds, the motorist is traveling at

$$\frac{100 \text{ feet}}{1.47(2.5 \text{ seconds})} = 27 \text{ mph.}$$

Generate Frequency Distribution Table and Determine Speed Percentiles

Determine the 50th and 85th speed percentiles using a frequency distribution table and calculations as described earlier.

Example Stopwatch Spot Speed Study

The city of Cottonwood Glen received a complaint of afternoon traffic speeding in a residential area. The city suspected this was related to students leaving a nearby high school. The first action taken by the city was to quantify the facts by conducting a spot speed study. The city decided to use the stopwatch method because of their limited resources.

A location was selected near the intersection of 4th Street and University Avenue, approximately two blocks from the high school and where the city had received multiple speeding complaints from residents. The posted speed limit is 30 mph. The study was conducted on a Wednesday and started at 3:00 p.m. The time was selected to correspond to the period when most high school students leave the school. The study continued until a sample size of 100 vehicles was measured. The study length of 176 feet was used because the posted speed limit is between 25 and 40 mph, as shown in Table 2.3. The study layout is illustrated in Figure 2.2.

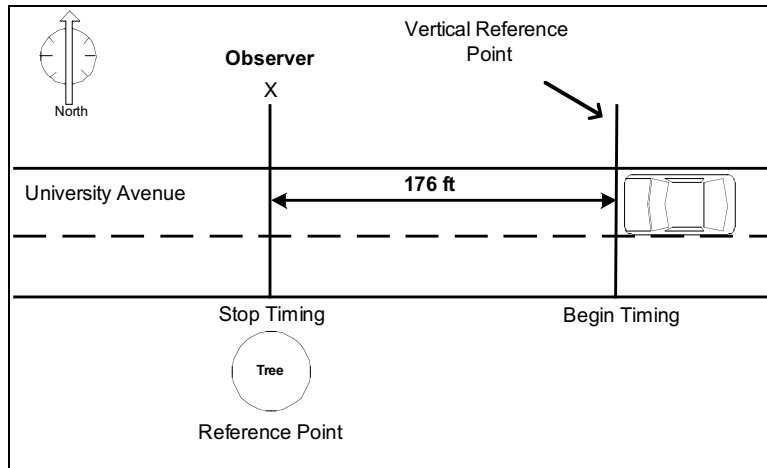

Figure 2.2. Example Stopwatch Spot Speed Study Layout

The vertical reference point is the “begin timing” reference. A tree is the “stop timing” reference point. This vertical reference point helps with the accuracy of timing by providing a line-of-sight to aid the observer. The results of the study are shown in Figure 2.3 (data form) and Table 2.4 (distribution table). Figure 2.3 shows elapsed time in predetermined 0.2-second intervals (Robertson 1994).

The study shows that the 50th percentile or median speed falls between 27.2 and 28.9 mph, and the 85th percentile of speed falls between 33.3 and 35.2 mph. Equation 2.1 is used to find the exact speeds for the 50th and 85th percentiles of speed. For the 50th percentile of speed, $P_D = 50\%$, $P_{\max} = 54\%$, $P_{\min} = 41\%$, $S_{\max} = 28.9$ mph, and $S_{\min} = 27.2$ mph, so

$$S_D = \frac{50\% - 41\%}{54\% - 41\%} (28.9 \text{ mph} - 27.2 \text{ mph}) + 27.2 \text{ mph} = 28.4 \text{ mph.}$$

For the 85th percentile of speed, $P_D = 85\%$, $P_{\max} = 92\%$, $P_{\min} = 83\%$, $S_{\max} = 35.2$ mph, and $S_{\min} = 33.3$ mph, so

$$S_D = \frac{85\% - 83\%}{92\% - 83\%} (35.2 \text{ mph} - 33.3 \text{ mph}) + 33 \text{ mph} = 33.4 \text{ mph.}$$

Date: MM/DD/YY				Start Time: 1500				
Name: John Doe				End Time: 1545				
Location: 4th Street and University Avenue				Down Time: N.A.				
Speed Limit: 30 mph				Weather: Clear				
Seconds	mph for 176 feet	Passenger Vehicles		Buses		Trucks		Total
		Record	No.	Record	No.	Record	No.	
1.0	120.0							
1.2	100.0							
1.4	85.7							
1.6	75.5							
1.8	66.6							
2.0	60.0							
2.2	54.5							
2.4	50.0							
2.6	46.1							
2.8	42.8		1					1
3.0	40.0		1					1
3.2	37.5		6					6
3.4	35.2		9					9
3.6	33.3		8				2	10
3.8	31.5		8				2	10
4.0	30.0		6				3	9
4.2	28.9		10		3			13
4.4	27.2		9				2	11
4.6	26.1		7				2	9
4.8	25.0		7				1	8
5.0	24.0		4		1		2	7
5.2	23.0		1					1
5.4	22.2		2				1	2
5.6	21.4		3					3
5.8	20.6							
6.0	20.0							
6.2	19.3							
6.4	18.7							
6.6	18.1							
6.8	17.6							
7.0	17.1							
Total								100

Figure 2.3. Example Stopwatch Spot Speed Study Data Form

Table 2.4. Example Stopwatch Spot Speed Study Distribution Table

Speed (mph)	Frequency of Vehicles	Cumulative Frequency	Cumulative Percent	Speed Percentile
21.4	3	3	3%	
22.2	2	5	5%	
23	1	6	6%	
24	7	13	13%	
25	8	21	21%	
26.1	9	30	30%	
27.2	11	41	41%	50th
28.9	13	54	54%	
30	9	63	63%	
31.5	10	73	73%	
33.3	10	83	83%	85th
35.2	9	92	92%	
37.5	6	98	98%	
40	1	99	99%	
42.8	1	100	100%	

A 5-mph rule of thumb is sometimes used to determine whether the 85th percentile of speed is too high compared to the posted speed limit. If the 85th percentile of speed is 5 mph or more above the posted speed limit, the situation should be evaluated. In this case, the 85th percentile of speed was 3.4 mph above the posted speed limit, so speeding may not have been an issue. If the 85th percentile of speed would have been 5 mph or more above the posted speed limit, the following actions could have been considered:

- Adjust the posted speed limit.
- Increase speeding enforcement.
- Initiate traffic calming measures.
- Conduct public awareness efforts.

(2) RADAR METER METHOD

A radar meter is a commonly used device for directly measuring speeds in spot speed studies (see Figure 2.4). This device may be hand-held, mounted in a vehicle, or mounted on a tripod. The effective measuring distance for radar meters ranges from 200 feet up to 2 miles (Parma 2001). A radar meter requires line-of-sight to accurately measure speed and is easily operated by one person. If traffic is heavy or the sampling strategy is complex, two radar units may be needed.



Figure 2.4. Radar Meter

Different sized vehicles and the detection of the observation vehicle may affect radar readings (Currin 2001). Large vehicles such as trucks and buses send the strongest return signal to the radar meters and as a result smaller vehicles may not be detected. If there is a presence of large vehicles, the observer may need to record the speeds of vehicles that are alone. Also, some vehicles are equipped with radar detectors to warn them that a radar unit is operating in their vicinity. Drivers will slow down when warned by a detector. It is not unusual for other drivers to slow down also. This slowing will affect the study results. The radar unit may be turned off while not in use so radar detectors cannot detect it.

Radar Meter Spot Speed Study Preparation Checklist

When preparing for a spot speed study using a radar meter, use the checklist in Table 2.5. The checklist may be modified or expanded as necessary.

Table 2.5. Radar Meter Spot Speed Study Preparation Checklist

Step	√ When Complete	Notes
Obtain radar meter		
Read instructions and safety directions for the radar meter		
Obtain backup battery		
Obtain tripod to support radar meter		
Create data collection forms		
Obtain hardhat and safety vest		
Select time and day		
Contact local law enforcement		
Other:		

Because of its cost, a radar meter may be the most difficult piece of equipment for an agency to obtain. A radar meter can be purchased, or one may be obtained (rented or borrowed) from a local law enforcement agency.

Key Steps to a Radar Meter Spot Speed Study

A radar meter spot speed study includes four key steps:

1. Select proper location and placement of radar meter.
2. Determine an appropriate selection strategy.
3. Record observations on radar meter spot speed study data form.
4. Generate frequency distribution table and determine speed percentiles.

Select Proper Location and Placement of Radar Meter

Proper placement of the radar meter at the study area is critical. The positioning of the radar unit is determined by the capabilities of the radar unit (as listed in the users' manual). The unit should also be concealed from the view of motorists. Effective ranges may be up to 2 miles, but as the distance increases the effectiveness decreases (Robertson 1994). The least accurate position,

which often results in no readings at all, is obtained when the meter is aimed at a 90-degree angle to the roadway centerline (Homburger et al. 1996). An accurate sketch of the site should be documented, including number of lanes, position of observer, and description of reference points.

Determine an Appropriate Selection Strategy

Except for studies conducted under low-volume conditions, it is impossible to obtain a radar measurement for every vehicle. For peak flow analysis, speeds are measured during the peak period. For assessing general speed trends or for setting speed limits, off-peak measurements are more appropriate.

The selection of the target vehicle that represents the vehicle population under study is also important. A good question to ask is, “What type or types of vehicles are of concern—cars, trucks, buses, or others?” Typically cars, station wagons, pickup and panel trucks, and motorcycles are classified as passenger cars. Other trucks and buses are classified as trucks. School buses and farm equipment may be recorded separately. When the target vehicle is defined, a selection strategy is developed to provide a random sample. A random sample will reduce the tendency to select the vehicles that stand out. For example, the observer could obtain a speed reading from every fourth vehicle or every tenth vehicle.

Record Observations on Radar Meter Spot Speed Data Form

On the radar meter spot speed data form (a blank form is provided in Appendix A.2), the observer records the date, location, posted speed limit, weather conditions, start time, end time, and down time. A slash is recorded on the data form corresponding to speed observed for each selected vehicle (or only the lead vehicle in a group) under the appropriate vehicle-type classification.

Generate Frequency Distribution Table and Determine Speed Percentiles

Determine the 50th and 85th speed percentiles using a frequency distribution table and calculations as described earlier.

Example Radar Meter Spot Speed Study

The city of McIntyre noticed a high number of traffic crashes in the morning along Main Street. The city decided to conduct a spot speed study to see how vehicle speeds compared to the posted speed limit. The police department offered their radar meter to be used and so the city decided to use the radar meter method to conduct the spot speed study. The city determined they would not need assistance from local law enforcement personnel. The study was conducted from within a vehicle, so a hardhat and safety vest were not required.

The city decided to conduct the study near the corner of 6th Street and Main Street, the intersection where a larger number of the crashes were occurring. The posted speed limit on Main Street is 35 mph. The study was conducted on a Thursday, from 7:00 a.m. to 7:25 a.m. The time period was chosen to capture morning commutes to the local high school and to work. A sample size of 100 was recorded. The study layout is illustrated in Figure 2.5. The observer used a tree to conceal the observation vehicle from the target vehicles. The results of the study are shown in Figure 2.6 (data form) and Table 2.6 (distribution table).

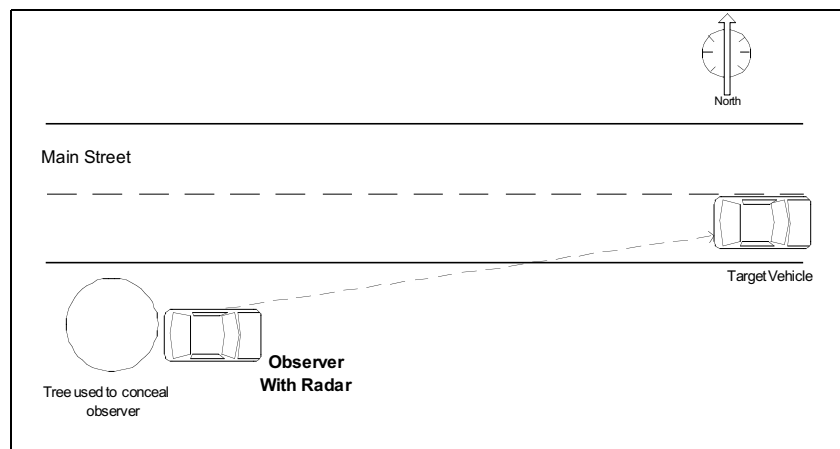

Figure 2.5. Example Radar Meter Spot Speed Study Layout

Date: MM/DD/YY			Start Time: 0700				
Name: John Doe			End Time: 0725				
Location: 6th Street and Main Street			Down Time: N.A.				
Speed Limit: 35 mph			Weather: Clear				
Speed	Passenger Vehicles		Buses		Trucks		Total
	Record	No.	Record	No.	Record	No.	
15							
16							
17							
18							
19							
20							
21		2					2
22						1	1
23		1				2	3
24		4					4
25		1					1
26		3					3
27		2				1	3
28		2					2
29	 	5		2			7
30		2				1	3
31		3					3
32	 	5					5
33		3					3
34		3		1		1	5
35	 	6				2	8
36	 	6					6
37	 	6				2	8
38		4					4
39	 	6					6
40		4					4
41	 	5				2	7
42		3					3
43		2					2
44		4					4
45		2					2
46							
47		1					1
48							
49							
50							
Total							100

Figure 2.6. Example Radar Meter Spot Speed Study Data Form

Table 2.6. Example Radar Meter Spot Speed Distribution Table

Speed (mph)	Frequency of Vehicles	Cumulative Frequency	Cumulative Percent	Speed Percentile
21	2	2	2%	
22	1	3	3%	
23	3	6	6%	
24	4	10	10%	
25	1	11	11%	
26	3	14	14%	
27	3	17	17%	
28	2	19	19%	
29	7	26	26%	
30	3	29	29%	
31	3	32	32%	
32	5	37	37%	
33	3	40	40%	
34	5	45	45%	50th
35	8	53	53%	
36	6	59	59%	
37	8	67	67%	
38	4	71	71%	
39	6	77	77%	
40	4	81	81%	85th
41	7	88	88%	
42	3	91	91%	
43	2	93	93%	
44	4	97	97%	
45	2	99	99%	
47	1	100	100%	

The study shows the 50th percentile or median speed was between 34 and 35 mph, and the 85th percentile of speed was between 40 and 41 mph. Equation 2.1 is used to find the exact speeds for the 50th percentile of speed and the 85th percentile of speed. For the 50th percentile of speed, $P_D = 50\%$, $P_{\max} = 53\%$, $P_{\min} = 45\%$, $S_{\max} = 35$ mph, and $S_{\min} = 34$ mph, so

$$S_D = \frac{50\% - 45\%}{53\% - 45\%} (35 \text{ mph} - 34 \text{ mph}) + 34 \text{ mph} = 34.6 \text{ mph.}$$

For the 85th percentile of speed, $P_D = 85\%$, $P_{\max} = 88\%$, $P_{\min} = 81\%$, $S_{\max} = 41$ mph, and $S_{\min} = 40$ mph, so

$$S_D = \frac{85\% - 81\%}{88\% - 81\%}(41 \text{ mph} - 40 \text{ mph}) + 40 \text{ mph} = 40.6 \text{ mph}.$$

A 5-mph rule of thumb is sometimes used to determine whether the 85 percentile of speed is too high compared to the posted speed limit. If the 85th percentile of speed is 5 mph or more above the posted speed limit, the situation should be evaluated. In this case, the 85th percentile of speed was 5.6 mph above the posted speed limit, so speeding may be an issue. This situation should be considered for further evaluation. The following actions may be considered:

- Adjust the posted speed limit.
- Increase speeding enforcement.
- Initiate traffic calming measures.
- Conduct public awareness efforts.

Information on contracting for a spot speed study, including a project work order using the city of McIntyre example, is provided near the end of this chapter.

(3) PNEUMATIC ROAD TUBE METHOD

The pneumatic road tube method is normally used for longer data collection time periods than those of either the stopwatch or radar meter method. Using this method, pneumatic tubes are placed in the travel lanes (see Figure 2.7) and are connected to recorders located at the side of the road (see Figure 2.8).



Figure 2.7. Pneumatic Road Tubes

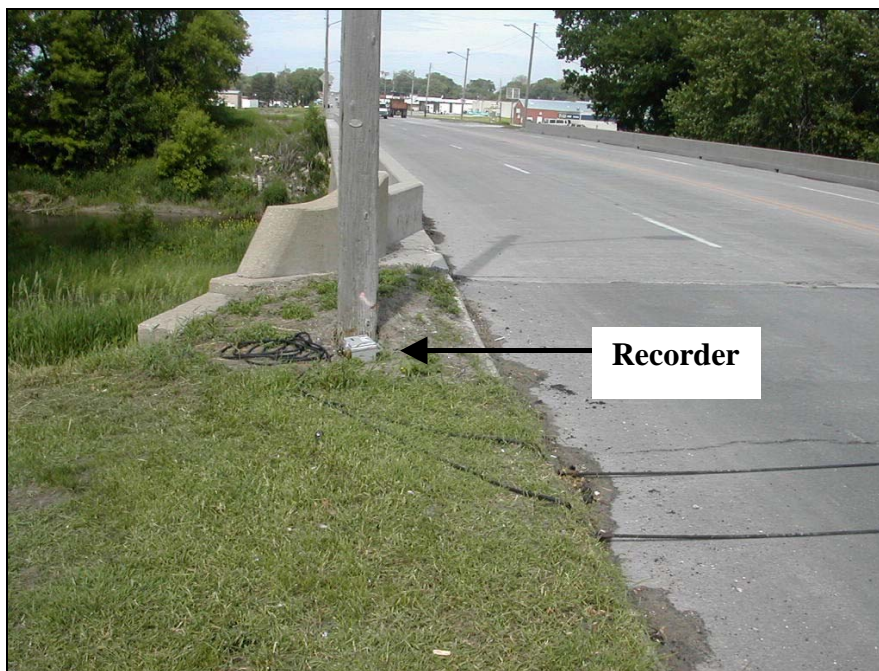

Figure 2.8. Road Tubes and Recorder

The automatic recorders are capable of storing large amounts of individual vehicle data or even larger amounts of vehicle classification data. The collected data are downloaded from the recorder to a laptop computer or portable floppy disk drive in the field, or via telephone modem to a centrally located computer.

Pneumatic Road Tube Spot Speed Study Preparation Checklist

When preparing for a spot speed study using pneumatic road tubes, use the checklist in Table 2.7. The checklist may be modified or expanded as necessary.

Table 2.7. Pneumatic Road Tube Spot Speed Study Preparation Checklist

Step	√ When Complete	Notes
Obtain equipment		
Read users' manual		
Obtain measuring tape for spacing tubes		
Obtain software		
Obtain scissors for trimming tubes		
Select method for attaching tubes to the roadways		
Obtain recorders		
Obtain new batteries for recorders		
Obtain hardhat and safety vest		
Select time and day		
Select location		
Involve corresponding jurisdiction to provide traffic control		
Other:		

Pneumatic road tube spot speed studies require specialized equipment and knowledge of how to maintain the equipment. Few jurisdictions have the equipment to adequately complete this study; most jurisdictions require assistance from the Iowa DOT or a consulting firm. Information on contracting for a spot speed study, including a project work order example, is provided near the end of this chapter.

Key Steps to a Pneumatic Road Tube Spot Speed Study

A pneumatic road tube spot speed study includes four key steps (Robertson 1994):

1. Perform necessary office preparations.
2. Deploy and calibrate data collection equipment.
3. Check data and retrieve equipment.
4. Generate frequency distribution table and determine speed percentiles.

Perform Necessary Office Preparations

During office preparations, coordinate all data collection activities with appropriate state and local officials, including transportation, traffic, and law enforcement agencies. For example, you may coordinate with state or local officials in obtaining traffic control for the deployment and recovery of equipment. The field team must be briefed on the data collection process to ensure that all observers are collecting the same type of data. The team should assemble and inspect all tools, supplies, and equipment. Each piece of equipment should be tested in advance of using.

Deploy and Calibrate Data Collection Equipment

The road tubes are prepared on the roadside to minimize the time each traffic lane is closed. Workers then place the road tubes across the lanes. The location of the tubes should be outside the influence of other factors such as an intersection, major access points, etc. The separation of the pneumatic tubes should be 2–15 feet. For the specific spacing of the pneumatic tubes refer to the users' manual. Traffic control should be provided to protect the crew. After placing, the crew should make sure that the tubes are functioning properly. Finally, the crew can secure the road tubes to the pavement. To avoid theft, the recorder should be secured.

Check Data and Retrieve Equipment

The accuracy of the equipment in measuring the speeds of the traffic stream should be checked. The recorder first measures the elapsed time it takes the vehicle to pass over the tubes. Then this time interval is converted to the corresponding spot speed. The elapsed time can be checked with a stopwatch. The crew can adjust the recorder until the correct speeds are being recorded. It is advisable to check the function and accuracy of the equipment at least once during every 24-hour data collection period. When the data collection period has ended, the recorded data should be checked again for accuracy. Crews recover data collection equipment by reversing the process they used to deploy it.

Generate Frequency Distribution Table and Determine Speed Percentiles

Determine the 50th and 85th speed percentiles using a frequency distribution table and calculations as described earlier.

CONTRACTING FOR A SPOT SPEED STUDY

Information Gathering

Before a jurisdiction contacts an engineering consulting firm to perform a spot speed study, a variety of information may need to be collected. Any available information may aid the consulting firm in adequately completing the study. The following is a list of possible information that an engineering consulting firm may request:

- written description of the issue at hand
- map of posted speed limits in the area
- preliminary speed studies
- proposed future land use changes
- documented citizen input
- location map
- appropriate contact persons
- any other relevant information

The following project work order may assist local governments in contracting to an engineering firm. The example project work contains information from the radar method example (a blank form is provided in Appendix E).

Project Work Order: Spot Speed Study

Referenced Agreement

This work order is part of an agreement between KWB Consulting and the city of McIntyre for municipal engineering services.

Project Location Description

This work involves conducting a spot speed study near the location of 6th Street and Main Street in McIntyre. A map depicting the location is attached.

Obligation of the City/County

The city shall provide the following items to the consultant: map of post speed limits, preliminary spot speed studies, and list of important contacts.

Scope of Consultant Services

This work includes gathering and evaluating spot speed data. The 85th percentile of speed will be calculated along with recommendations for improvement of the study area if needed.

Schedule

Field meeting date:	_____
Estimated date of preliminary deliverable:	_____
Estimated date of final deliverable:	_____

Compensation

Labor cost	\$ _____
Direct expenses	\$ _____
Subcontractor cost	\$ _____
Overhead	\$ _____
Maximum payable	\$ _____

Authorization

_____ City of McIntyre City/County	_____ KWB Consulting Contractor
_____ City/County Administrator	_____ Project Manager's Name/Title
_____ Signature	_____ Signature
_____ Date	_____ Date

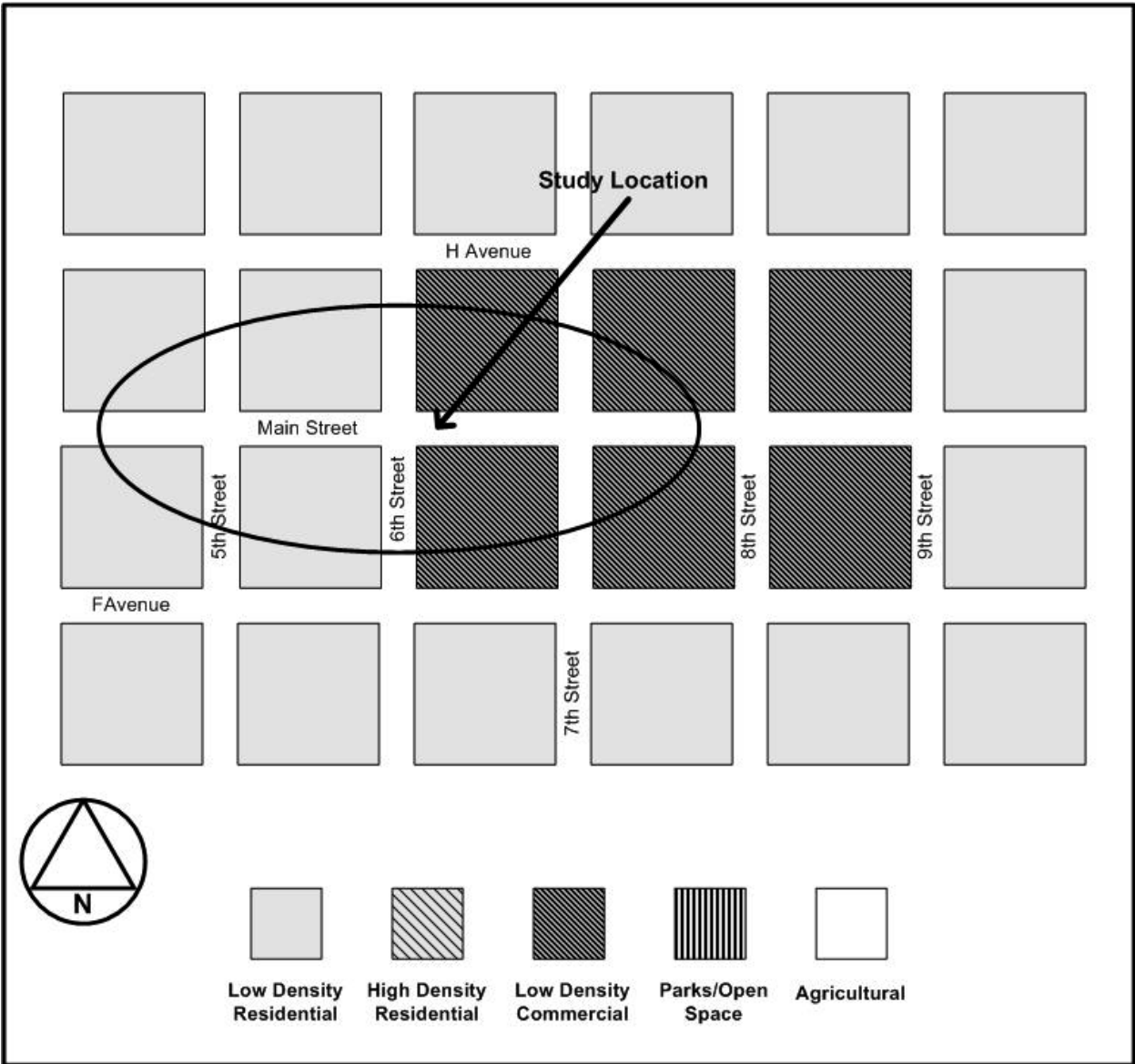

REFERENCES

- AASHTO. 2001. *A Policy on Geometric Design of Highways and Streets (Green Book)*. 4th ed. Washington, D.C.: American Association of State Highway and Transportation Officials.
- Currin, T. R. 2001. Spot Speed Study. In *Introduction to Traffic Engineering: A Manual for Data Collection and Analysis*, ed. B. Stenquist. Stamford, Conn.: Wadsworth Group, pp. 4–12.
- Ewing, R. 1999. Traffic Calming Impacts. In *Traffic Calming: State and Practice*. Washington, D.C.: Institute of Transportation Engineers, pp. 99–126.
- Homburger, W. S., J. W. Hall, R. C. Loutzenheiser, and W. R. Reilly. 1996. Spot Speed Studies. In *Fundamentals of Traffic Engineering*. Berkeley: Institute of Transportation Studies, University of California, Berkeley, pp. 6.1–6.9.
- Parma, K. 2001. *Survey of Speed Zoning Practices: An Informational Report*. Washington, D.C.: Institute of Transportation Engineers.
- Robertson, H. D. 1994. Spot Speed Studies. In *Manual of Transportation Engineering Studies*, ed. H. D. Robertson, J. E. Hummer, D. C. Nelson. Englewood Cliffs, N.J.: Prentice Hall, Inc., pp. 33–51.

Traffic **3**

Volume

Counts

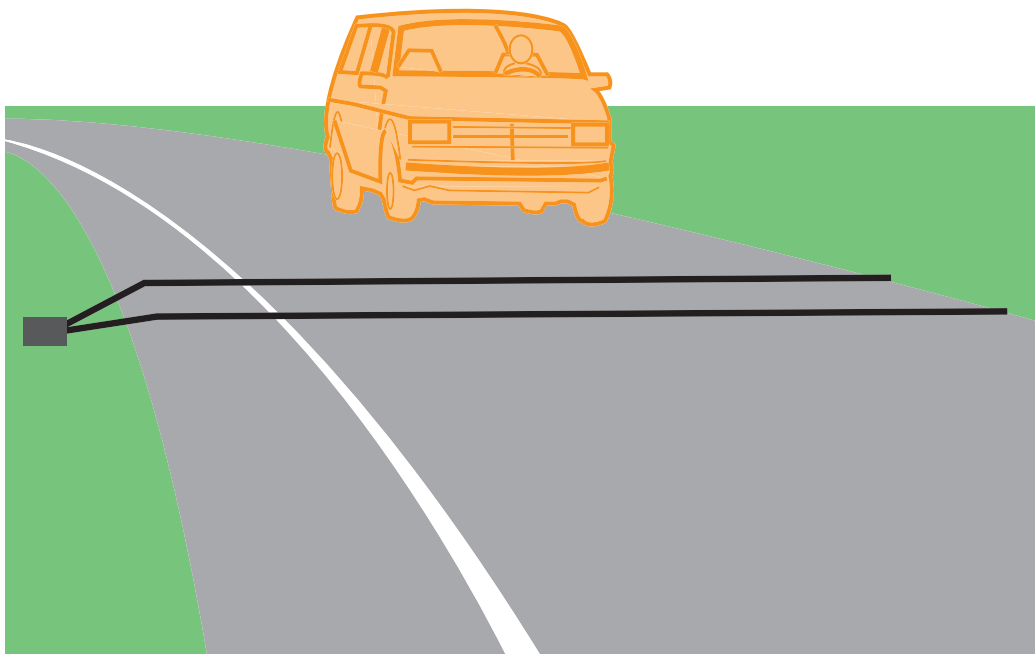

Traffic Volume Counts

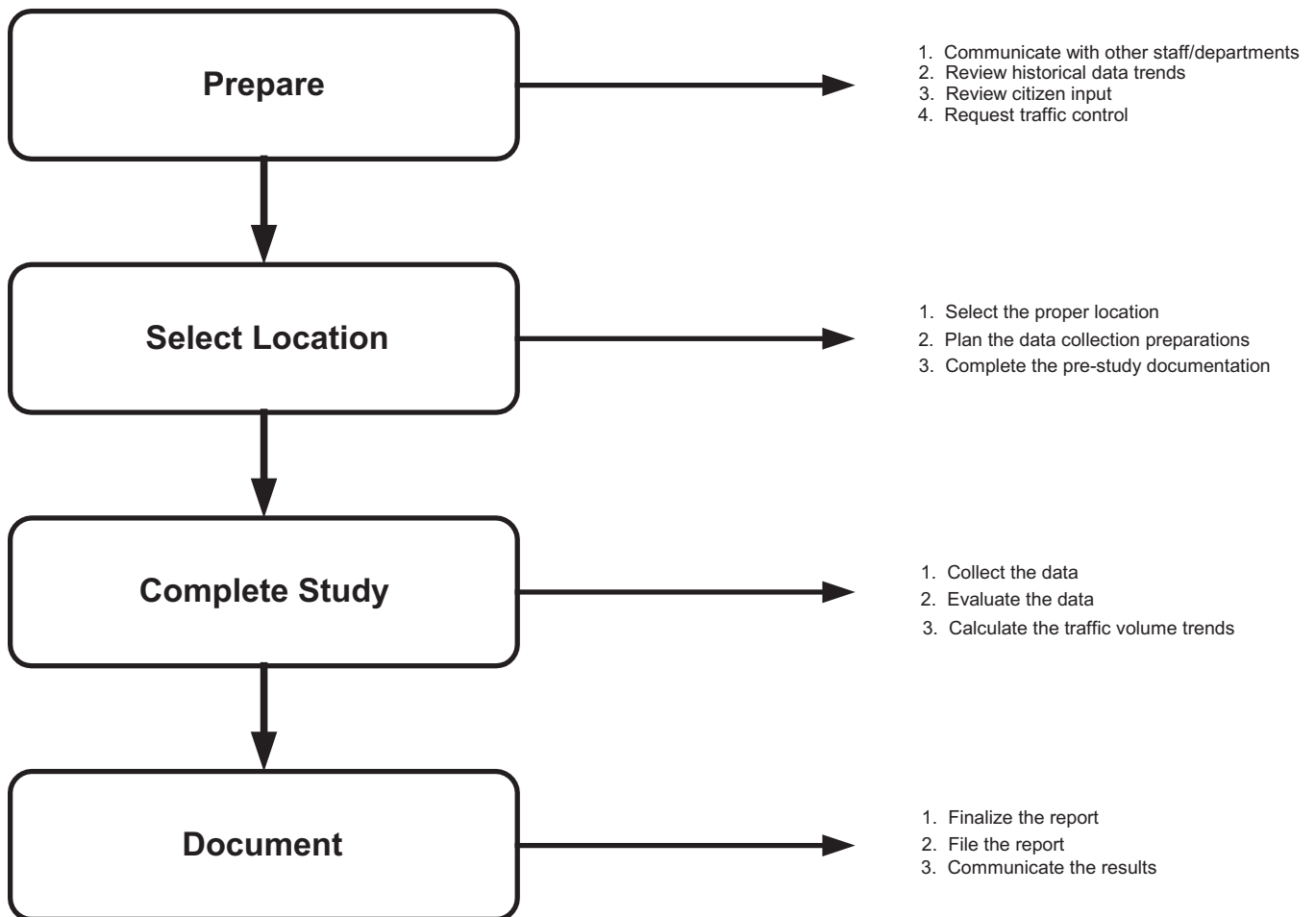

INTRODUCTION

Traffic volume studies are conducted to determine the number, movements, and classifications of roadway vehicles at a given location. These data can help identify critical flow time periods, determine the influence of large vehicles or pedestrians on vehicular traffic flow, or document traffic volume trends. The length of the sampling period depends on the type of count being taken and the intended use of the data recorded. For example, an intersection count may be conducted during the peak flow period. If so, manual count with 15-minute intervals could be used to obtain the traffic volume data.

USING COUNT PERIOD TO DETERMINE STUDY METHOD

Two methods are available for conducting traffic volume counts: (1) manual and (2) automatic. Manual counts are typically used to gather data for determination of vehicle classification, turning movements, direction of travel, pedestrian movements, or vehicle occupancy. Automatic counts are typically used to gather data for determination of vehicle hourly patterns, daily or seasonal variations and growth trends, or annual traffic estimates.

The selection of study method should be determined using the count period. The count period should be representative of the time of day, day of month, and month of year for the study area. For example, counts at a summer resort would not be taken in January. The count period should avoid special event or compromising weather conditions (Sharma 1994). Count periods may range from 5 minutes to 1 year. Typical count periods are 15 minutes or 2 hours for peak periods, 4 hours for morning and afternoon peaks, 6 hours for morning, midday, and afternoon peaks, and 12 hours for daytime periods (Robertson 1994). For example, if you were conducting a 2-hour peak period count, eight 15-minute counts would be required.

The study methods for short duration counts are described in this chapter in order from least expensive (manual) to most expensive (automatic), assuming the user is starting with no equipment.

(1) MANUAL COUNT METHOD

Most applications of manual counts require small samples of data at any given location. Manual counts are sometimes used when the effort and expense of automated equipment are not justified. Manual counts are necessary when automatic equipment is not available.

Manual counts are typically used for periods of less than a day. Normal intervals for a manual count are 5, 10, or 15 minutes. Traffic counts during a Monday morning rush hour and a Friday evening rush hour may show exceptionally high volumes and are not normally used in analysis; therefore, counts are usually conducted on a Tuesday, Wednesday, or Thursday.

Manual Count Recording Methods

Manual counts are recorded using one of three methods: tally sheets, mechanical counting boards, or electronic counting boards.

Tally Sheets

Recording data onto tally sheets is the simplest means of conducting manual counts. The data can be recorded with a tick mark on a pre-prepared field form. A watch or stopwatch is necessary to measure the desired count interval. A blank traffic volume count intersection tally sheet is provided in Appendix B.

Mechanical Counting Boards

Mechanical count boards consist of counters mounted on a board that record each direction of travel. Common counts include pedestrian, bicycle, vehicle classification, and traffic volume counts. Typical counters are push button devices with three to five registers. Each button represents a different stratification of type of vehicle or pedestrian being counted. The limited number of buttons on the counter can restrict the number of classifications that can be counted on a given board. A watch or a stopwatch is also necessary with this method to measure the desired count interval. See Figure 3.1 for an example mechanical counting board.

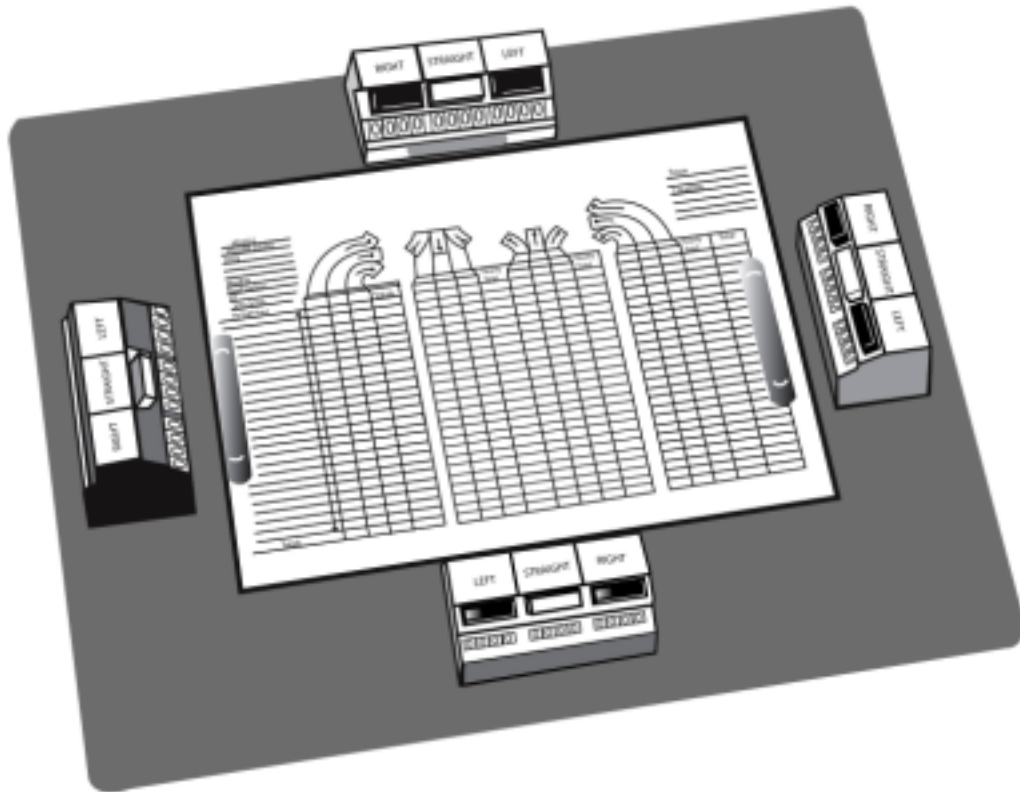

Figure 3.1. Mechanical Counting Board

Electronic Counting Boards

Electronic counting boards are battery-operated, hand-held devices used in collecting traffic count data. They are similar to mechanical counting boards, but with some important differences. Electronic counting boards are lighter, more compact, and easier to handle. They have an internal clock that automatically separates the data by time interval. Special functions include automatic data reduction and summary. The data can also be downloaded to a computer, which saves time. See Figure 3.2 for an example electronic counting board.

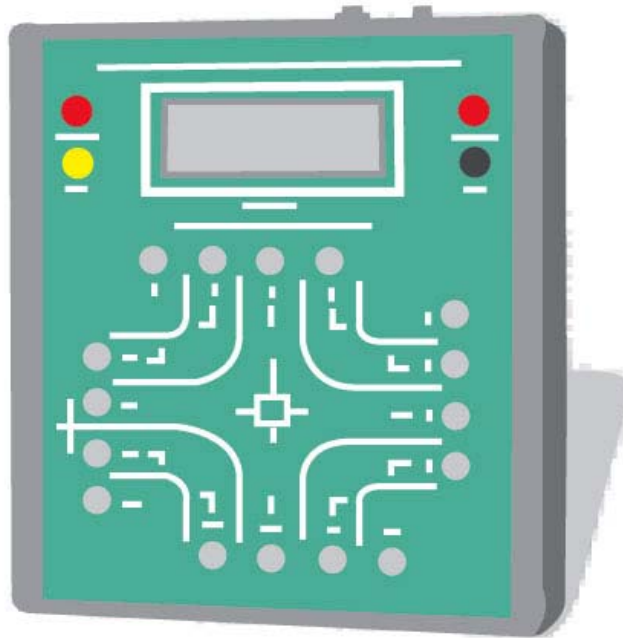

Figure 3.2. Electronic Counting Board

Manual Count Study Preparation Checklist

When preparing for a manual count study, use the checklist in Table 3.1. This checklist may be modified or expanded as necessary.

Table 3.1. Manual Count Study Preparation Checklist

Step	√ When Complete	Notes
Obtain tally sheet or counting board		
Obtain watch		
Obtain hardhat and safety vest		
Select location		
Select time and day		
Determine availability of recorders		
Contact other jurisdictions/schools		
Contact adjacent residents/businesses		
Other:		

If an agency does not possess the equipment necessary to complete a manual count study, it may be obtained from the Iowa DOT, another jurisdiction, or a responsible consulting firm.

Personnel Involved in a Manual Count Study

The size of the data collection team depends on the length of the counting period, the type of count being performed, the number of lanes or crosswalks being observed, and the volume level of traffic (Robertson 1994). The number of personnel needed also depends on the study data needed. For example, one observer can record certain types of vehicles while another counts total volumes.

Observers conducting manual traffic counts must be trained on the study purpose. To avoid fatigue, observers must be relieved periodically. Every 2 hours observers should take a 10 to 15 minute break.

Key Steps to a Manual Count Study

A manual count study includes three key steps:

1. Perform necessary office preparations.
2. Select proper observer location.
3. Label data sheets and record observations.

Perform Necessary Office Preparations

Office preparations start with a review of the purpose of the manual count. This type of information will help determine the type of equipment to use, the field procedures to follow, and the number of observers required. For example, an intersection with multiple approach lanes may require electronic counting boards and multiple observers.

Select Proper Observer Location

Observers must be positioned where they have a clear view of the traffic. Observers should be positioned away from the edge of the roadway. If observers are positioned above ground level and clear of obstructions they usually have the best vantage point. Visual contact must be maintained if there are multiple observers at a site. If views are unobstructed, observers may count from inside a vehicle.

Label Data Forms and Record Observations

Manual counts may produce a large number of data forms; therefore, the data forms should be carefully labeled and organized. On each tally sheet (a blank tally sheet is provided in Appendix B), the observer should record the location, time and date of observation, and weather conditions. Follow the data recording methods discussed earlier.

Example Manual Count Study

Smith City was considering a land use change on one of its city blocks. The proposal was to remove four houses and construct an apartment complex (see Figure 3.3). This proposed land use change would affect traffic volume. The city wanted to document the traffic volumes at the closest intersection during the peak flow period of the day. The study was conducted at the intersection of 7th Street and Delaware Avenue, an uncontrolled intersection. The time period chosen, 7:00 a.m. to 9:00 a.m., included the morning peak flow.

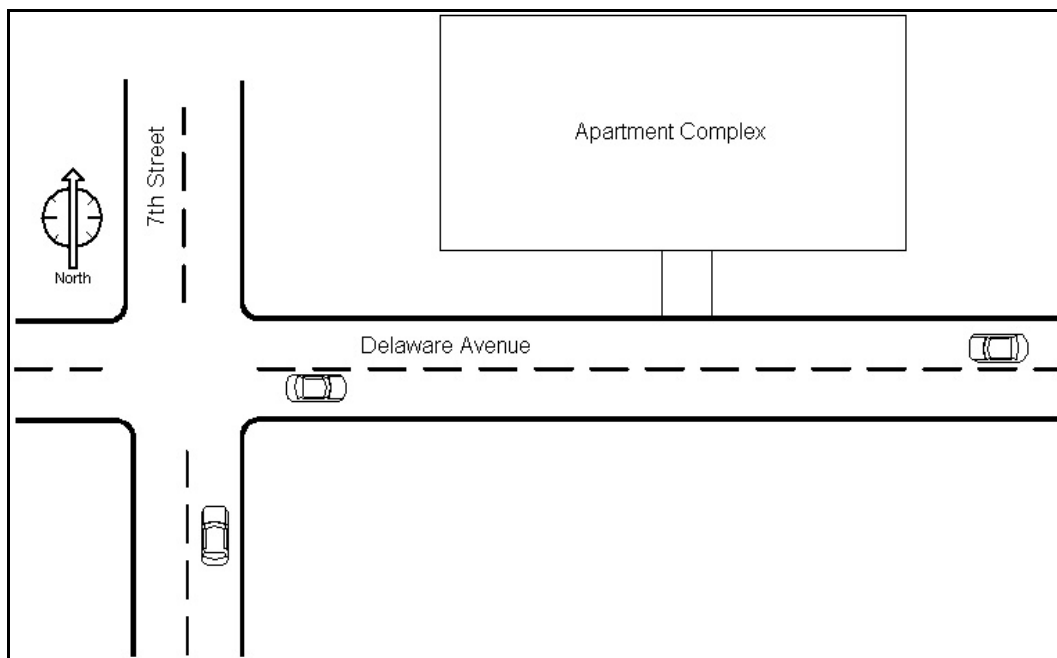

Figure 3.3. Example Proposed Apartment Complex and Intersection

The city decided to conduct a manual traffic count using the tally sheet method because they did not have access to a mechanical or electronic counting board. The example tally sheet in Figure 3.4 shows one 15-minute count. There were 71 westbound vehicles on Delaware Avenue. If you multiply this number by eight (eight 15-minute periods in a 2-hour peak flow), you arrive at 586 vehicles during the peak flow. Typically 2-hour peak flow counts would be conducted once in the morning and once in the afternoon.

If an apartment complex is introduced, another study may need to be conducted. The apartment complex could increase the traffic volume. If the traffic volume is increased, there may be a need for new traffic control. The initial study provides a baseline count that can be used in a traffic impact analysis or a traffic control device evaluation. *The Manual on Uniform Traffic Control Devices* provides current standards on traffic control device warrants.

Information on contracting for a traffic volume count study, including a project work order using the Smith City example, is provided near the end of this chapter.

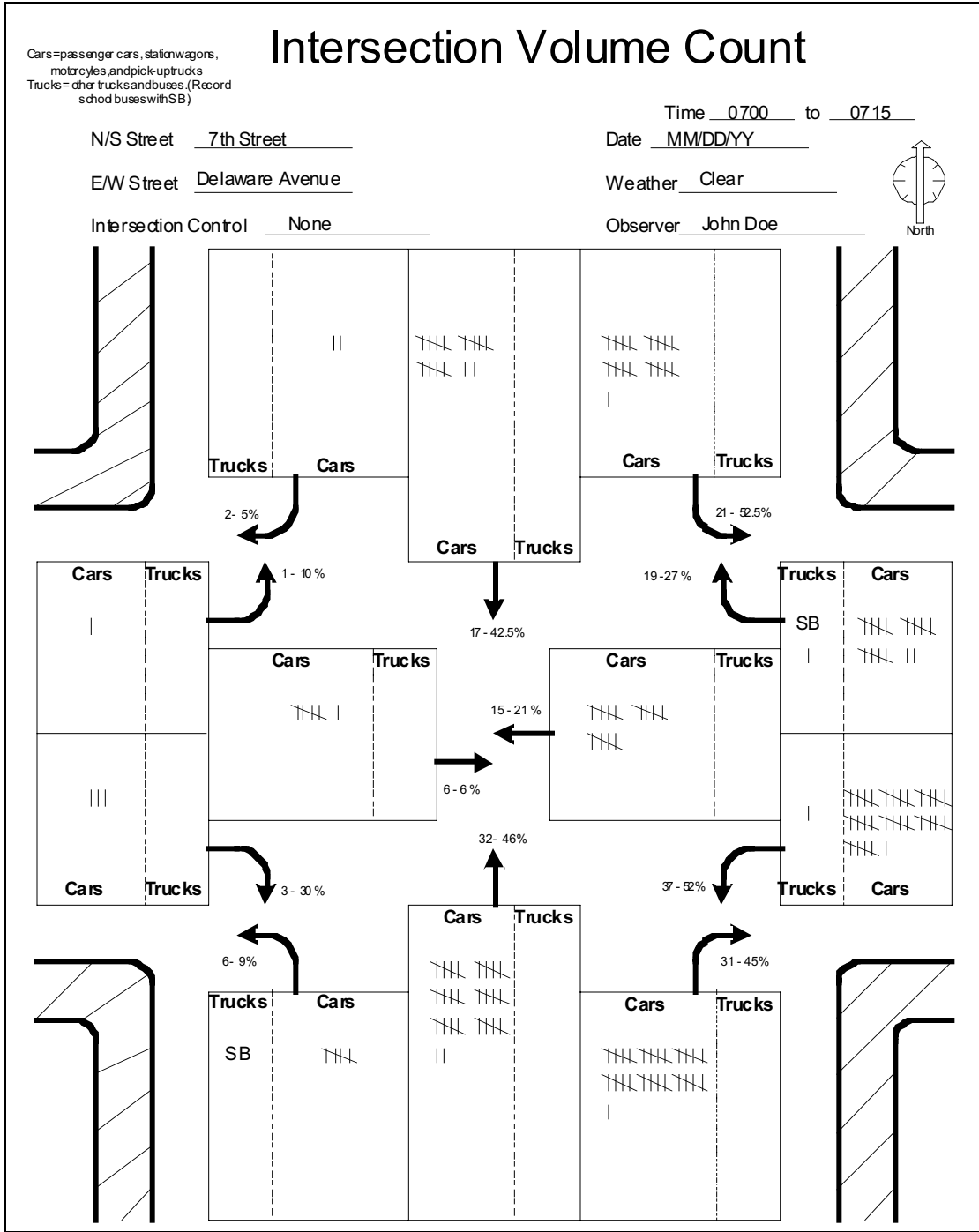

Figure 3.4. Example Manual Intersection Volume Count Tally Sheet

(2) AUTOMATIC COUNT METHOD

The automatic count method provides a means for gathering large amounts of traffic data. Automatic counts are usually taken in 1-hour intervals for each 24-hour period. The counts may extend for a week, month, or year. When the counts are recorded for each 24-hour time period, the peak flow period can be identified.

Automatic Count Recording Methods

Automatic counts are recorded using one of three methods: portable counters, permanent counters, and videotape.

Portable Counters

Portable counting is a form of manual observation. Portable counters serve the same purpose as manual counts but with automatic counting equipment. The period of data collection using this method is usually longer than when using manual counts. The portable counter method is mainly used for 24-hour counts. Pneumatic road tubes are used to conduct this method of automatic counts (see Figure 3.5). Specific information pertaining to pneumatic road tubes can be found in the users' manual.

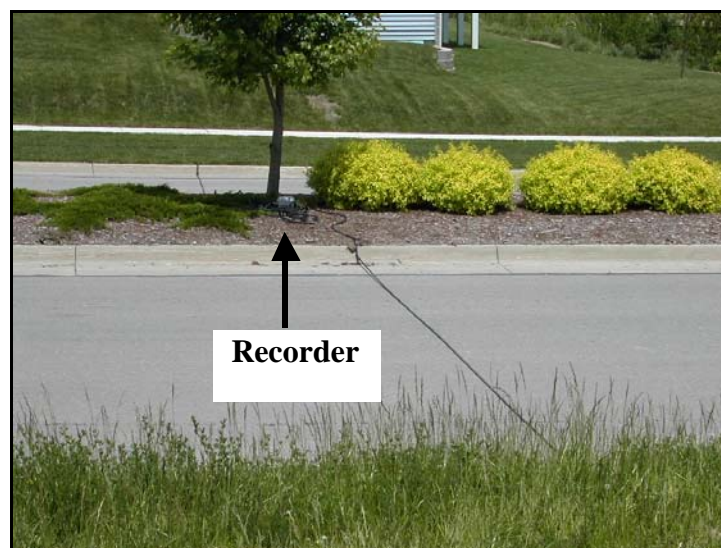

Figure 3.5. Pneumatic Road Tube and Recorder

Permanent Counters

Permanent counters are used when long-term counts are to be conducted. The counts could be performed every day for a year or more. The data collected may be used to monitor and evaluate traffic volumes and trends over a long period of time. Permanent counters are not a cost-effective option in most situations. Few jurisdictions have access to this equipment.

Videotape

Observers can record count data by videotaping traffic. Traffic volumes can be counted by viewing videotapes recorded with a camera at a collection site. A digital clock in the video image can prove useful in noting time intervals. Videotaping is not a cost-effective option in most situations. Few small jurisdictions have access to this equipment.

Automatic Count Study Preparation Checklist

When preparing for an automatic count study, use the checklist in Table 3.2. This checklist may be modified or expanded as necessary.

Table 3.2. Automatic Count Study Preparation Checklist

Step	√ When Complete	Notes
Obtain equipment		
Read users' manual		
Obtain measuring tape for spacing tubes		
Obtain software		
Obtain scissors for trimming tubes		
Select method for attaching tubes to the roadways		
Obtain recorders		
Obtain new batteries for recorders		
Obtain hardhat and safety vest		
Select time and day		
Select location		
Involve corresponding jurisdiction to provide traffic control		
Notify the jurisdiction's roadway sweeper (to avoid potential damage to road tubes)		
Other:		

Note: Replace road tube equipment with video recorder and videotapes if applicable.

Automatic count studies require specialized equipment and knowledge of how to maintain the equipment. Few jurisdictions have the equipment to adequately complete this study; most jurisdictions require assistance from the Iowa Department of Transportation or an engineering consulting firm. Information on contracting out for a traffic volume count study, including a project work order example, is provided near the end of this chapter.

Key Steps to an Automatic Count Study

An automatic count study includes three key steps (Robertson 1994):

1. Perform necessary office preparations.
2. Deploy and calibrate data collection equipment.
3. Check data and retrieve equipment.

Perform Necessary Office Preparations

During office preparations, coordinate all data collection activities with appropriate state and local officials, including transportation, traffic, and law enforcement agencies. For example, you may coordinate with state or local officials in obtaining traffic control for the deployment and recovery of equipment. The field team must be briefed on the data collection process to ensure that all observers are collecting the same data type. The team should assemble and inspect all tools, supplies, and equipment. Each piece of equipment should be tested.

Deploy and Calibrate Data Collection Equipment

The portable counter method using pneumatic road tubes is described here since the other methods are not cost-effective for jurisdictions in most automatic count study situations. The road tubes are prepared on the roadside to minimize the time each traffic lane is closed. Workers then place the road tubes across the lanes. The location of the tubes should be outside the influence of other factors such as an intersection, major access points, etc. Traffic control should be provided to protect the crew. After placing, the crew should make sure that the tubes are functioning properly. Finally, the crew can secure the road tubes to the pavement. To avoid theft, the recorder may also be secured.

Check Data and Retrieve Equipment

When the data collection period has ended, the recorded data are checked for accuracy. Crews recover data collection equipment by reversing the process they used to deploy it.

EXAMPLES OF TRAFFIC VOLUME COUNT STUDIES

Intersection Counts

Intersection counts are used for timing traffic signals, designing channelization, planning turn prohibitions, computing capacity, analyzing high crash intersections, and evaluating congestion (Homburger et al. 1996). The manual count method is usually used to conduct an intersection count. A single observer can complete an intersection count only in very light traffic conditions.

The intersection count classification scheme must be understood by all observers before the count can begin. Each intersection has 12 possible movements (see Figure 3.6). The intersection movements are through, left turn, and right turn. The observer records the intersection movement for each vehicle that enters the intersection.

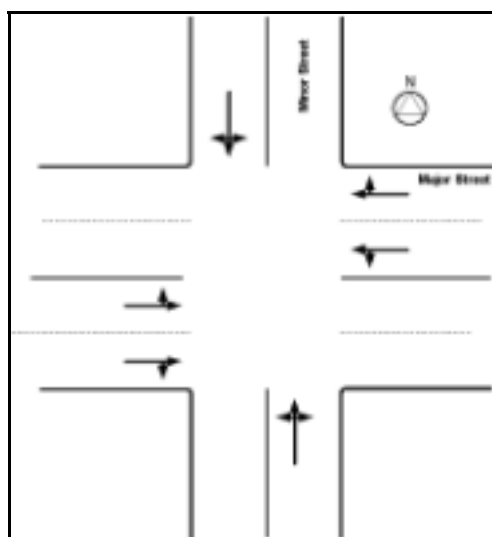

Figure 3.6. Intersection Movements

Pedestrian Counts

Pedestrian count data are used frequently in planning applications. Pedestrian counts are used to evaluate sidewalk and crosswalk needs, to justify pedestrian signals, and to time traffic signals. Pedestrian counts may be taken at intersection crosswalks, midblock crossings, or along sidewalks.

When pedestrians are tallied, those 12 years or older are customarily classified as adults (Robertson 1994). Persons of grade school age or younger are classified as children. The observer records the direction of each pedestrian crossing the roadway.

Vehicle Classification Counts

Vehicle classification counts are used in establishing structural and geometric design criteria, computing expected highway user revenue, and computing capacity. If a high percentage of heavy trucks exists or if the vehicle mix at the crash site is suspected as contributing to the crash problem, then classification counts should be conducted.

Typically cars, station wagons, pickup and panel trucks, and motorcycles are classified as passenger cars. Other trucks and buses are classified as trucks. School buses and farm equipment may be recorded separately. The observer records the classification of the vehicles and the vehicles' direction of travel at the intersection.

Average Daily Traffic and Annual Average Daily Traffic Counts

Average daily traffic (ADT) counts represent a 24-hour count at any specified location. These counts are obtained by placing an automatic counter at the analysis location for a 24-hour period. Accuracy of the ADT data depends on the count being performed during typical roadway, weather, and traffic demand conditions. Local levels of government will typically conduct this type of count.

Annual average daily traffic (AADT) counts represent the average 24-hour traffic volume at a given location averaged over a full 365-day year. AADT volume counts have the following uses:

- measuring or evaluating the present demand for service by the roadway or facility
- developing the major or arterial roadway system
- locating areas where new facilities or improvements to existing facilities are needed
- programming capital improvements

CONTRACTING FOR A TRAFFIC VOLUME COUNT STUDY

Information Gathering

Before a jurisdiction contacts an engineering consulting firm to perform a traffic volume count study, a variety of information may need to be collected. Any information may aid the consulting firm in adequately completing the study. The following is a list of possible information that an engineering consulting firm may request:

- issue at hand
- historic volume counts
- existing zoning
- proposed future land use changes
- traffic impact statements if available
- citizen input
- location map
- appropriate contact persons
- any other relevant information

The following project work order may assist local governments in contracting to an engineering firm. The example project work order contains information from the manual count method example (a blank form is provided in Appendix E).

Project Work Order: Traffic Volume Count Study

Referenced Agreement

This work order is part of an agreement between McIntyre and Associates and the city of Smith City for municipal engineering services.

Project Location Description

This work involves conducting a volume count study around the location of 7th Street and Delaware Avenue. A map depicting the location is attached.

Obligation of the City/County

The city shall provide the following items to the consultant: historic traffic volume counts, traffic volume trends, existing zoning of the study area, proposed future land use changes, and a list of important contacts.

Scope of Consultant Services

This work involves an intersection traffic volume count. The traffic volume count should include all vehicular movements, vehicle classification, and a pedestrian count.

Schedule

Field meeting date:	_____
Estimated date of preliminary deliverable:	_____
Estimated date of final deliverable:	_____

Compensation

Labor cost	\$ _____
Direct expenses	\$ _____
Subcontractor cost	\$ _____
Overhead	\$ _____
Maximum payable	\$ _____

Authorization

City of Smith City City/County	McIntyre and Associates Contractor
_____ City/County Administrator	_____ Project Manager's Name/Title
_____ Signature	_____ Signature
_____ Date	_____ Date

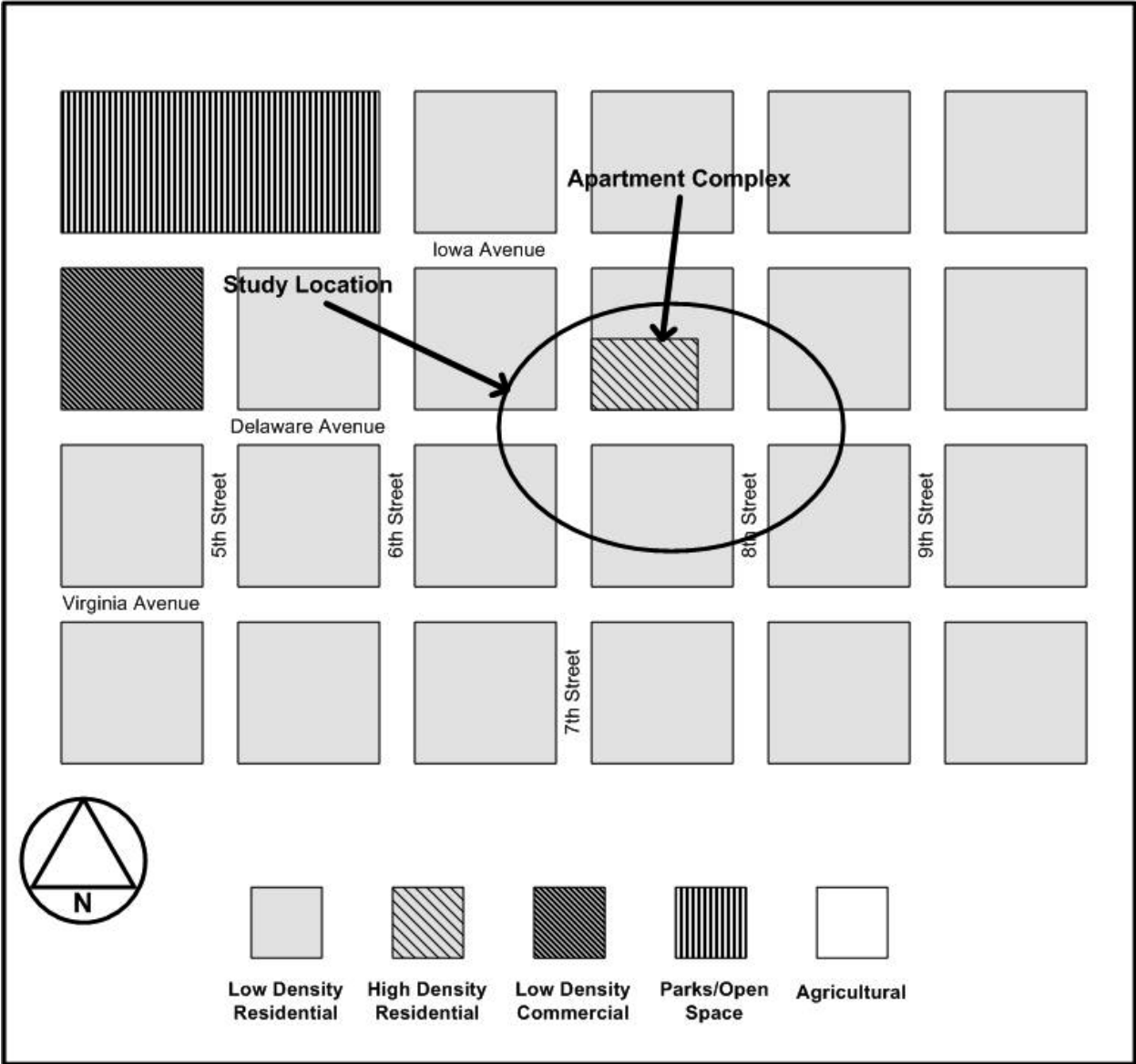

REFERENCES

- Currin, T. R. 2001. Turning Movement Counts. In *Introduction to Traffic Engineering: A Manual for Data Collection and Analysis*, ed. B. Stenquist. Stamford, Conn.: Wadsworth Group, pp. 13–23.
- Homburger, W. S., J. W. Hall, R. C. Loutzenheiser, and W. R. Reilly. 1996. Volume Studies and Characteristics. In *Fundamentals of Traffic Engineering*. Berkeley: Institute of Transportation Studies, University of California, Berkeley, pp. 5.1–5.6.
- FHWA. 2001. *Manual on Uniform Traffic Control Devices: Millennium Edition*. Washington, D.C.: Federal Highway Administration, U.S. Department of Transportation.
- Robertson, H. D. 1994. Volume Studies. In *Manual of Transportation Engineering Studies*, ed. H. D. Robertson, J. E. Hummer, and D. C. Nelson. Englewood Cliffs, N.J.: Prentice Hall, Inc., pp. 6–31.
- Sharma, S. C. 1994. Seasonal Traffic Counts for a Precise Estimation of AADT. *ITE Journal*, Vol. 64, No. 9, pp. 34–41.

4

Sight Distance

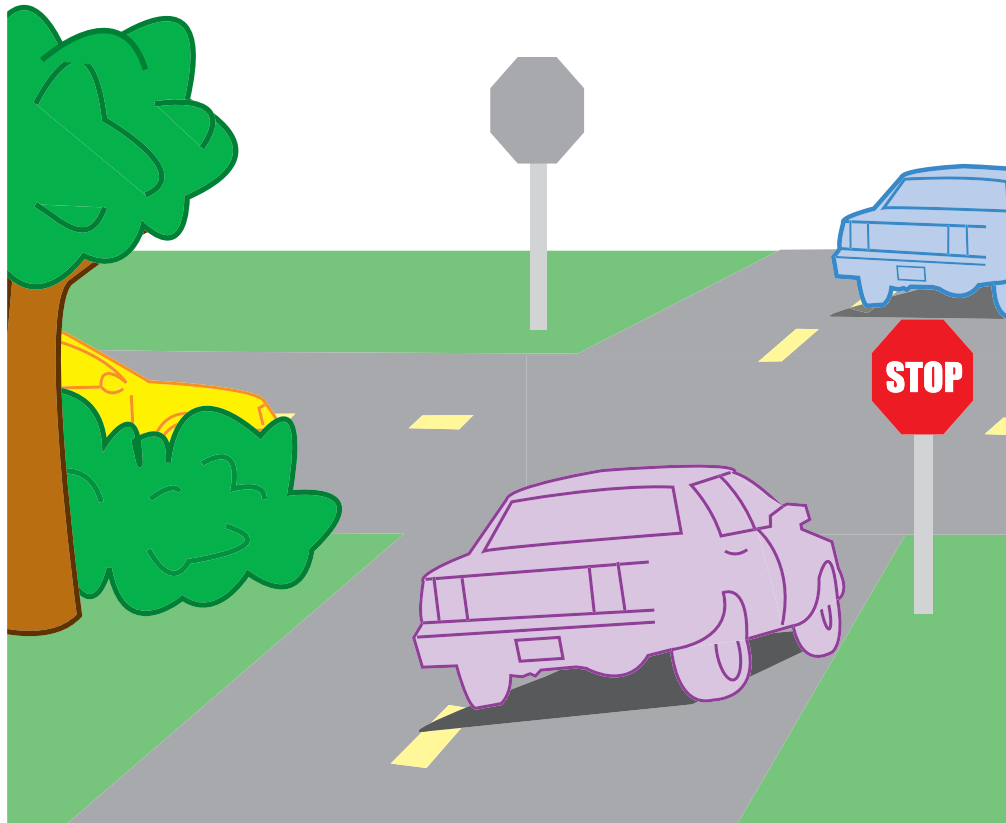

Sight Distance

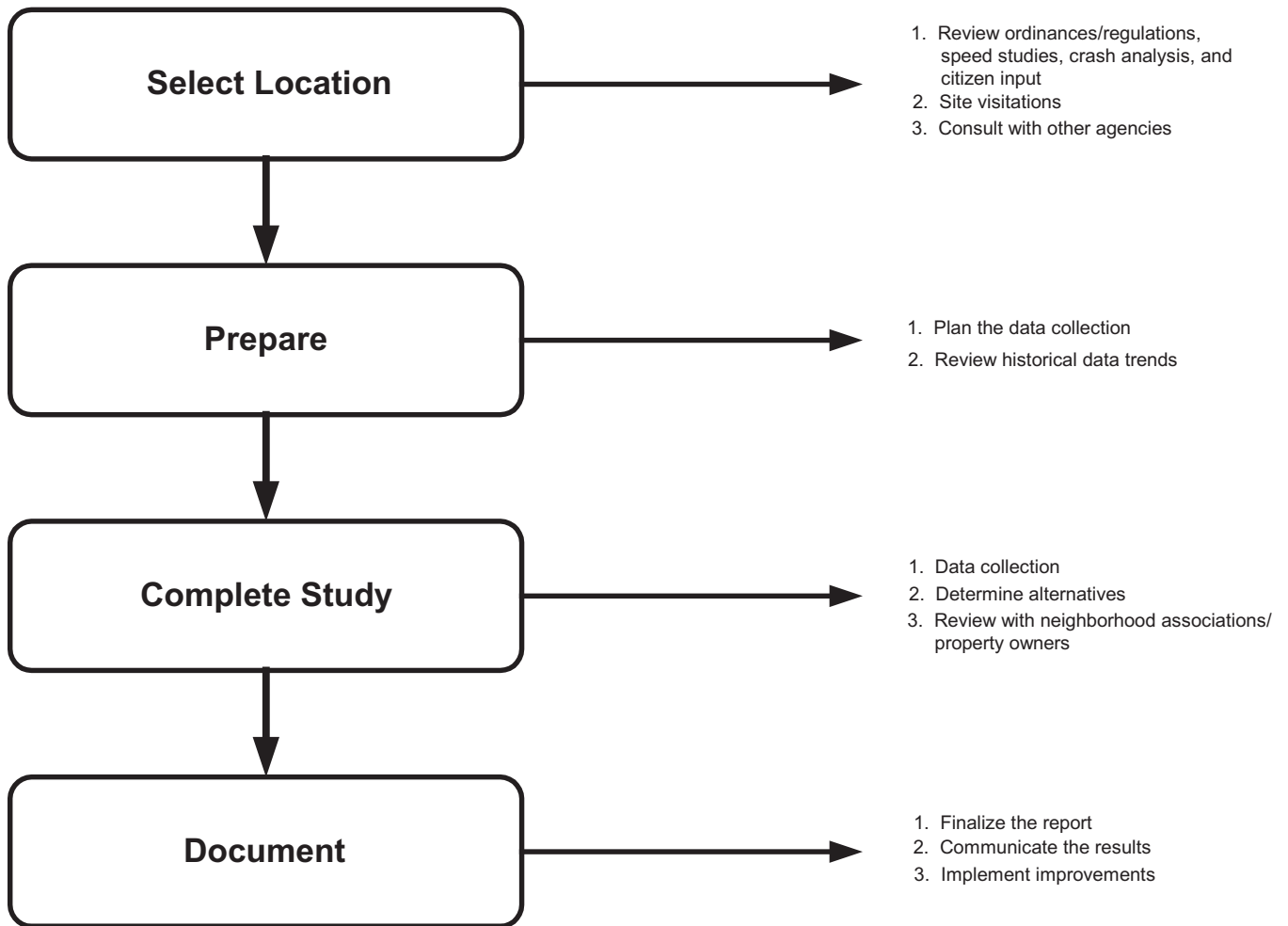

INTRODUCTION

Sight distance is the length of roadway visible to a driver. The three types of sight distance common in roadway design are intersection sight distance, stopping sight distance, and passing sight distance. This handbook will not discuss passing sight distance because it primarily occurs in rural settings and this handbook generally addresses urban areas. (Information on passing sight distance can be found in Chapter 3 of the AASHTO *Green Book* and in the CTRE *Iowa Traffic Control Devices and Pavement Markings* manual.)

INTERSECTION SIGHT DISTANCE

The driver of a vehicle approaching or departing from an intersection should have an unobstructed view of the intersection, including any traffic control devices, and sufficient lengths along the intersecting highway to permit the driver to anticipate and avoid potential collisions (Maze and Plazak 2000). These unobstructed views form triangular areas known as sight triangles.

A typical intersection is divided into areas between each leg known as quadrants. There may be three quadrants, such as for a “T” intersection, or four, such as for a four-legged intersection. Sight triangles are the specified areas along an intersection’s approach legs and across the included corners (see Figures 4.1 and 4.2 for an illustration). These areas should be clear of obstructions that might block a driver’s view of conflicting vehicles or pedestrians. The two types of sight triangles are approach sight triangles and departure sight triangles (AASHTO, *Green Book*, 2001).

Approach Sight Triangles

Approach sight triangles provide the driver of a vehicle approaching an intersection an unobstructed view of any conflicting vehicles or pedestrians. These triangular areas should be large enough that drivers can see approaching vehicles and pedestrians in sufficient time to slow or stop and avoid a crash. Approach sight triangles are illustrated in Figure 4.1.

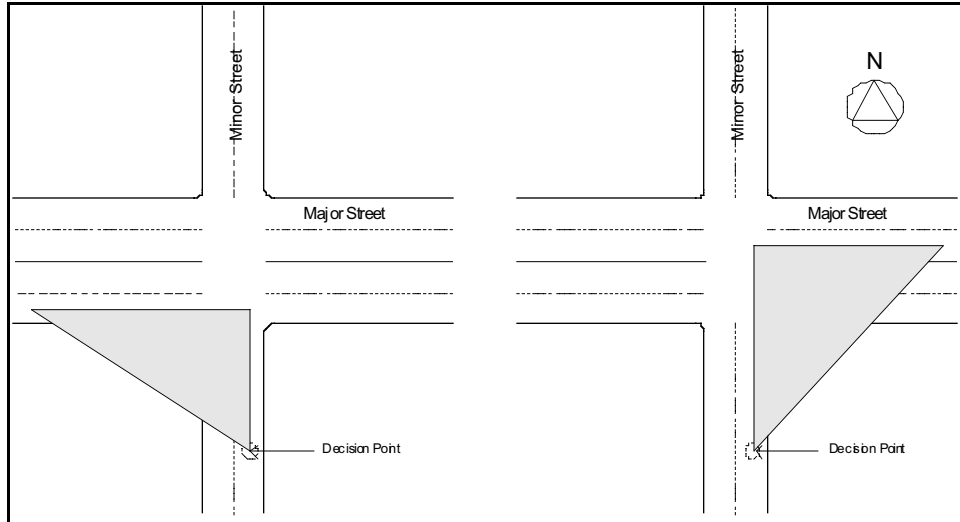

Figure 4.1. Approach Sight Triangles

Departure Sight Triangles

Departure sight triangles provide adequate sight distance for a stopped driver on a minor roadway to depart from the intersection and enter or cross the major roadway. These sight triangles should be provided in each quadrant of a controlled intersection. Departure sight triangles are illustrated in Figure 4.2.

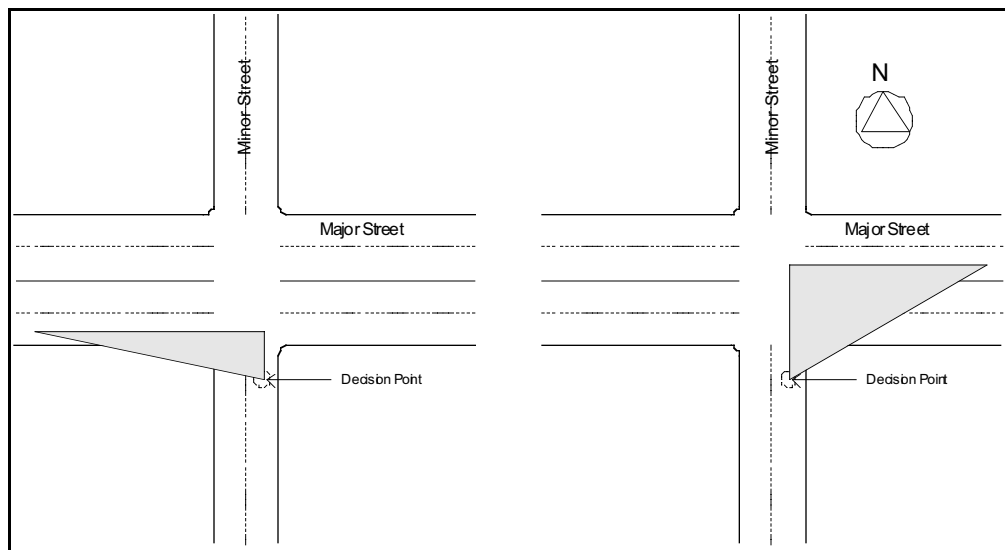

Figure 4.2. Departure Sight Triangles

Obstructions within Sight Triangles

To determine whether an object is a sight obstruction, consider both the horizontal and vertical alignment of both roadways, as well as the height and position of the object (AASHTO, *Green Book*). For passenger vehicles, it is assumed that the driver's eye height is 3.5 feet and the height of an approaching vehicle is 4.25 feet above the roadway surface, as illustrated in Figure 4.3. At the decision point, as shown in Figure 4.3, the driver's eye height is used for measurement.

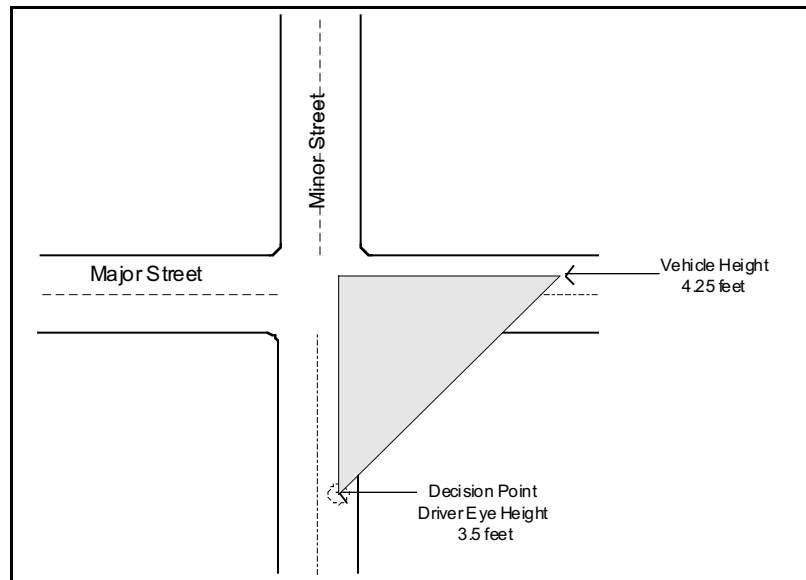

Figure 4.3. Heights Pertaining to Sight Triangles

Any object within the sight triangle that would obstruct the driver's view of an approaching vehicle (4.25 feet in height) should be removed or modified or appropriate traffic control devices should be installed as per the *Manual on Uniform Traffic Control Devices*. Obstructions within sight triangles could be buildings, vehicles, hedges, trees, bushes, tall crops, walls, fences, etc. Figure 4.4 shows a clear sight triangle and an obstructed sight triangle.

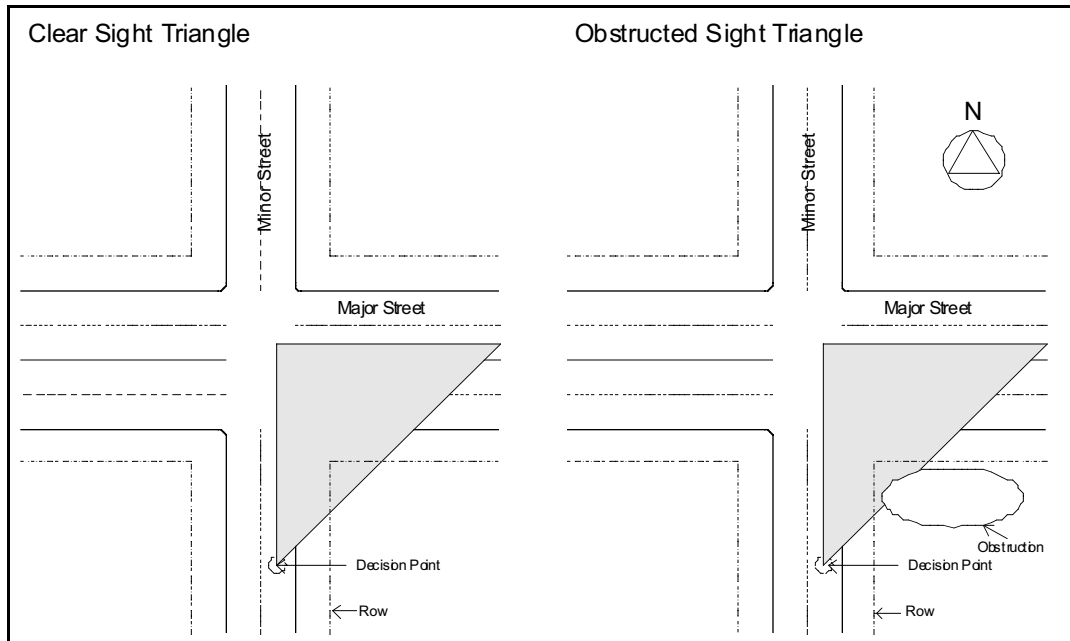

Figure 4.4. Clear versus Obstructed Sight Triangles

SIGHT DISTANCE STUDY METHODS

Different types of traffic control require different sight distances. For example, intersections with no control require adequate distance for the approaching vehicle to identify any conflicts in or approaching the intersection before entering. An approach sight triangle is used for this analysis. However, intersections with stop or yield control require drivers to stop or yield at the intersection, check for approaching vehicles in the intersection, and then depart. A departure sight triangle is used for this analysis.

Sight Distance Study Preparation Checklist

When preparing for an intersection sight distance study, use the checklist in Table 4.1. The checklist may be modified or expanded as necessary.

Table 4.1. Sight Distance Study Preparation Checklist

Step	√ When Complete	Notes
Obtain target and sighting rods		
Obtain measuring wheel		
Obtain hardhat and safety vest		
Obtain sight distance diagram form		
Select time and day		
Determine availability of observers		
Contact corresponding jurisdiction(s)		
Other:		

If an agency does not possess the equipment necessary to complete a sight distance study, it may be obtained from the Iowa DOT, another jurisdiction, or a responsible consulting firm. A blank sight distance diagram form is located in Appendix C. Information on contracting for a sight distance study, including a project work order example, is provided near the end of this chapter.

UNCONTROLLED INTERSECTIONS

For uncontrolled intersections, the drivers of both approaching vehicles should be able to see conflicting vehicles in adequate time to stop or slow to avoid a crash. The required sight distance for safe operation at an uncontrolled intersection is directly related to the vehicle speeds and the distances traveled during perception, reaction, and braking time. Table 4.2 lists the minimum recommended sight distances for specific design speeds. For example, if a vehicle is traveling 20 mph, a sight distance of 90 feet is the minimum recommended stopping sight distance.

Table 4.2. Minimum Recommended Sight Distances

Vehicle Speed (mph)	Stopping Sight Distance (feet)
15	70
20	90
25	115
30	140
35	165
40	195
45	220
50	245
55	285

Note: Distances are from the 2001 AASHTO *Green Book* and 2001 AASHTO *Little Green Book*. Distances may change in future versions.

Key Steps to a Sight Distance Study at an Uncontrolled Intersection

A sight distance study at an uncontrolled intersection includes four key steps:

1. Determine the minimum recommended sight distance.
2. Obtain or construct sighting and target rods.
3. Measure current sight distances and record observations.
4. Perform sight distance analysis.

Determine the Minimum Recommended Stopping Sight Distance

Determine the minimum sight distance for the posted or operating speed at the intersecting roadway (see Table 4.2).

Obtain or Construct Sighting and Target Rods

Sighting and target rods are illustrated in Figure 4.5. The target rod can be constructed out of 2-inch by 0.75-inch wood. The target rod should be 4.25 feet tall to represent the vehicle height and be painted fluorescent orange on both the top portion and bottom 2 feet of the rod. The bottom 2-foot portion represents the object height for measuring stopping sight distance. (This will be further explained later in the stopping sight distance section.) The sighting rod should be 3.5 feet tall to represent the driver's eye height. The sighting rod can be constructed out of the same type of wood but should be painted flat black. The sighting rod and target rod are used in measuring sight distance.



Figure 4.5. Sighting Rod (left) and Target Rod (right)

Measure Current Sight Distances and Record Observations

Sight distance measurements should be gathered for all legs of the uncontrolled intersection. Traffic approaching from both the left and right should be considered for measurements. On the sight distance intersection diagram (a blank diagram form is provided in Appendix C), the observer records the date and time, posted or operating speed, site location, and weather conditions. The measuring process is represented in Figure 4.6 and described below.

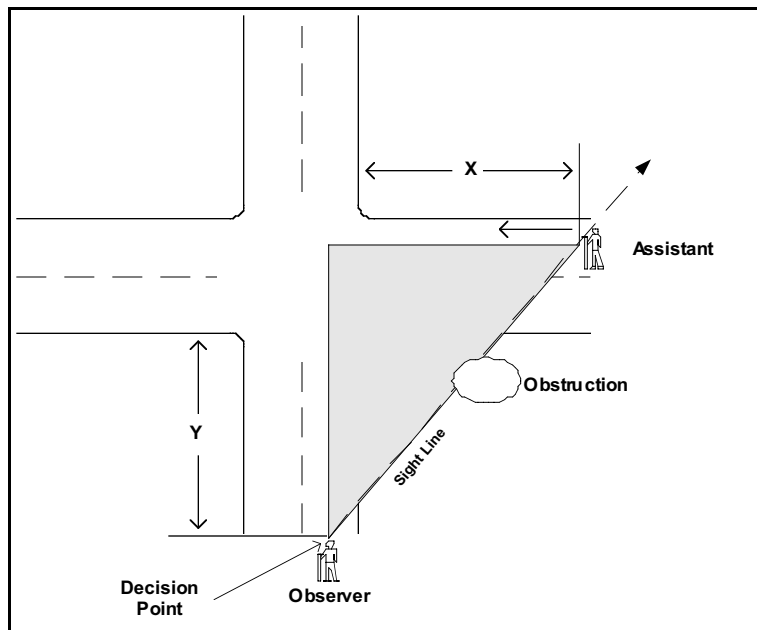

Figure 4.6. Sight Distance Measurement at Uncontrolled Intersection

The observer holds the sighting rod, and the assistant holds the target rod. They position themselves on two intersecting approaches at the appropriate stopping sight distances taken from Table 4.2. These are the X and Y dimensions. The observer represents the approaching vehicle and is located at the decision point. The observer uses the 3.5-foot sighting rod, which represents the driver's eye height. The assistant represents the intersecting vehicle. The assistant uses the 4.25-foot target rod, which represents the height of the approaching vehicle. The observer sights from the top of the sighting rod to the target rod.

If the target rod is visible, the approach sight triangle for the intersection is appropriate. If the top of the target rod is not visible, the assistant holding the target rod should walk toward the intersection along the centerline of the intersecting lane until the observer can see the target rod. When the target rod is visible, the position should be marked and the distance to the intersection should be measured along the centerline of the roadway. This is the X dimension.

Perform Sight Distance Analysis

The analysis of intersection sight distance consists of comparing the recommended sight distance to the measured sight distance. The measured sight distance should be equal to or greater than the recommended stopping sight distance. If the measured sight distance is less than the recommended sight distance, some mitigation may be required. Some mitigation measures are as follows:

- Remove/modify obstruction.
- Reduce speeds.
- Install traffic control devices (if warranted by the MUTCD).

Example Sight Distance Study at an Uncontrolled Intersection

The city of Cottonwood Glen noticed an increase of crashes at the intersection of 6th Street and Phoenix Avenue. The city suspected that the crash problem may be related to sight distance. The problem seemed to be centered around vehicles traveling northbound at the intersection. Cottonwood Glen decided to conduct a sight distance study at the intersection to see whether that was a contributing factor.

The intersection of 6th Street and Phoenix Avenue has no traffic control. The posted speed limit for both of the roadways is 25 mph. Cottonwood Glen referred to Table 4.2 for the recommended

sight distance for this situation: 115 feet for both roadways. Cottonwood Glen conducted the study on a Tuesday at 2:00 p.m. under clear weather conditions. The study was conducted early afternoon to avoid heavy traffic volumes. City staff measured the sight distance for the eastbound and westbound approaches.

Figure 4.7 shows that the measured sight distance on the west approach is 140 feet. The recommended stopping sight distance for this approach is 115 feet. This tells us that the measured sight distance satisfies the minimum recommended. No sight distance related improvements need to be considered on the west approach.

Figure 4.8 shows that the measured sight distance on the east approach is 100 feet. The recommended stopping sight distance for this approach is 115 feet. This tells us that the measured sight distance does not satisfy the minimum recommended. The stopping sight distance diagram shows that there is an obstruction limiting the sight distance, located outside of the right-of-way. In this situation, the property owner should be contacted for cooperation in eliminating, modifying, or moving the obstruction. If they are unwilling to cooperate, other mitigation measures should be considered.

Date	MM/DD/YY
Time of Day	1400
Posted Speed Limit or 85% for Major Roadway ($X(R)$)	25 mph
Posted Speed Limit or 85% for Minor Roadway (Y)	25 mph
Traffic Controls Present	No Control
Intersection Maneuver	N.A.
Weather	Clear
Horizontal Curve	N
Vertical Curve	N

Major Roadway Width	40 feet
No. of Lanes	2
Minor Roadway Width	30 feet
No. of Lanes	2

Y Stopping Distance	115 feet
$X(R)$ Recommended	115 feet
$X(M)$ Measured	140 feet

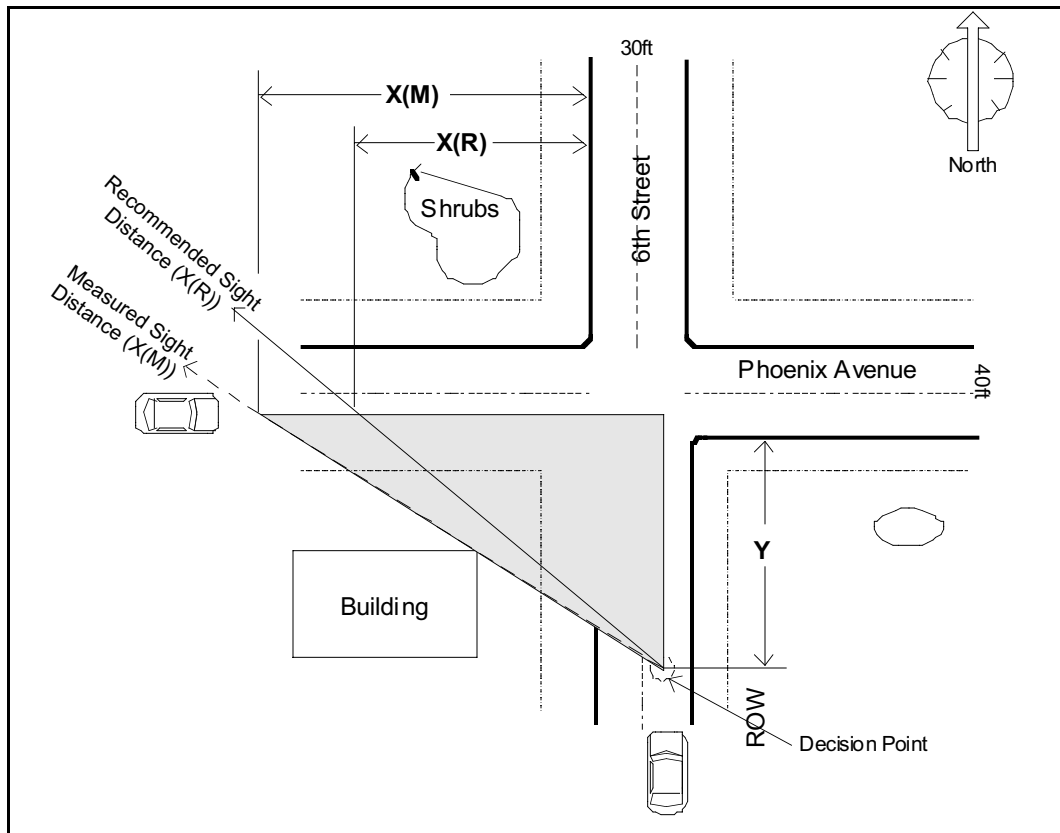

Conclusion: $X(M) > X(R)$. The measured sight distance was 140 feet, which is more than the recommended sight distance of 115 feet. Sight distance on the west approach is adequate.

Figure 4.7. 6th Street and Phoenix Avenue, West Approach

Date	MM/DD/YY
Time of Day	1400
Posted Speed Limit or 85% for Major Roadway ($X(R)$)	25 mph
Posted Speed Limit or 85% for Minor Roadway (Y)	25 mph
Traffic Controls Present	No Control
Intersection Maneuver	N.A.
Weather	Clear
Horizontal Curve	N
Vertical Curve	N

Major Roadway Width	40 feet
No. of Lanes	2
Minor Roadway Width	30 feet
No. of Lanes	2

Y Stopping Distance	115 feet
$X(R)$ Recommended	115 feet
$X(M)$ Measured	100 feet

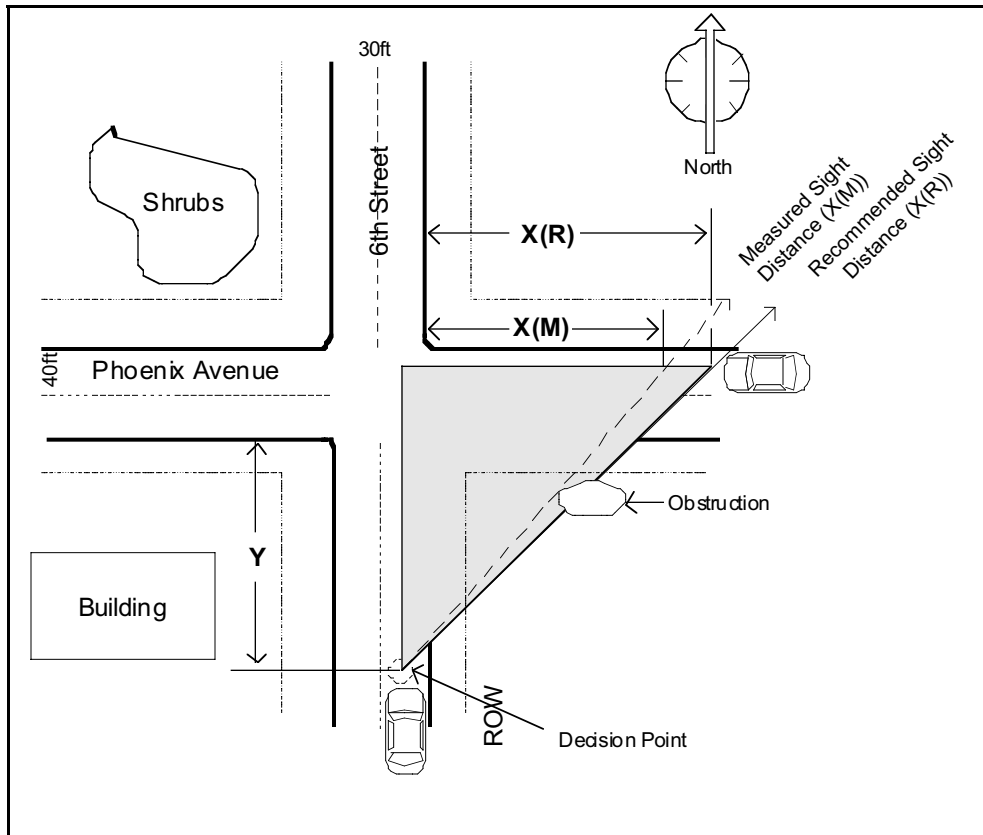

Conclusion: $X(M) < X(R)$. The measured sight distance was 100 feet, which is less than the recommended sight distance of 115 feet. There is an obstruction limiting sight distance and it is outside of the right-of-way.

Figure 4.8. 6th Street and Phoenix Avenue, East Approach

INTERSECTIONS WITH STOP SIGN CONTROL

Vehicles stopped at an at-grade intersection must have sufficient sight distance to permit a safe departure. At intersections with stop sign or yield control, close attention should be given to departure sight triangles.

Vehicle Maneuvers at Intersections with Stop Sign Control

Three maneuvers can be completed for vehicles stopped at an intersection: crossing maneuver, left-turn maneuver, and right-turn maneuver. See Figure 4.9.

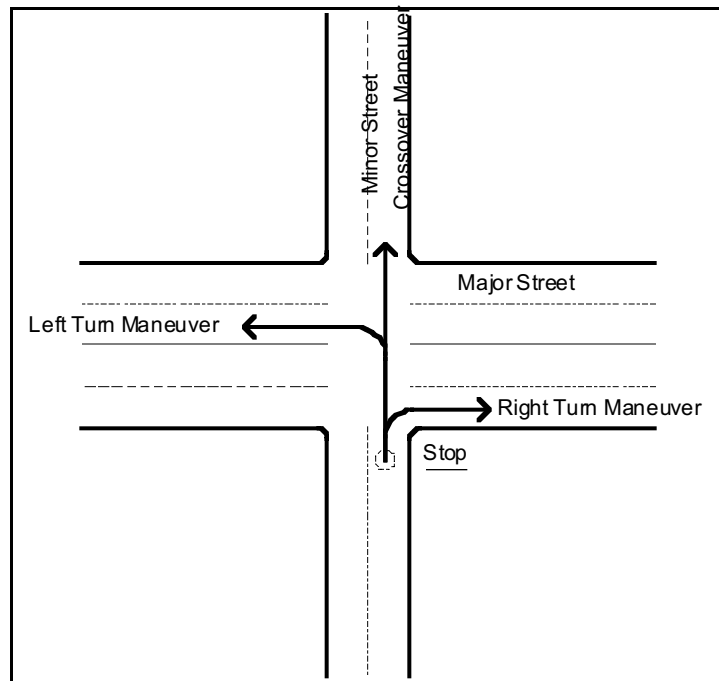

Figure 4.9. Three Maneuvers at an Intersection with Stop Sign Control

Crossing Maneuver from the Minor Roadway

When a driver is completing a crossing maneuver, there must be sufficient sight distance in both directions available to cross the intersecting roadway and avoid approaching traffic. The sight distance required for this maneuver is based on the distance approaching vehicles will travel on

the major road during the time period it takes a stopped vehicle to clear the intersection. Table 4.3 lists the recommended sight distances for this maneuver based on design speeds.

Turning Left from the Minor Roadway

The left-turn maneuver requires first clearing the traffic on the left, then entering the traffic stream on the right. The required sight distance for this maneuver is affected by the amount of time it takes the stopped vehicle to turn left clearing traffic and reach average running speed without affecting the speed of the approaching vehicle. Table 4.3 lists the recommended sight distances for this maneuver based on design speeds.

Turning Right from the Minor Roadway

The right turn maneuver must have sufficient sight distance to permit entrance onto the intersecting roadway and then accelerate to the posted speed limit without being overtaken by approaching vehicles. Table 4.3 lists the minimum recommended sight distances for this maneuver based on design speeds.

Table 4.3. Minimum Recommended Sight Distances Based on Vehicle Maneuver

Vehicle Speed (mph)	Stopping Sight Distance for Left-Turn Maneuver (feet)	Stopping Sight Distance for Crossover and Right-Turn Maneuvers (feet)
15	170	145
20	225	195
25	280	240
30	335	290
35	390	335
40	445	385
45	500	430
50	555	480
55	610	530

Note: Distances are from the 2001 AASTHO *Green Book* and are for two-lane roadways. Distances may change in future versions.

Key Steps to a Sight Distance Study at an Intersection with Stop Control

A sight distance study at an intersection with stop control includes four key steps:

1. Determine the minimum recommended sight distance.
2. Obtain or construct sighting and target rods.
3. Measure current sight distances and record observations.
4. Perform sight distance analysis.

Determine the Minimum Recommended Sight Distances

Determine the minimum sight distance for each maneuver and speed (see Table 4.3).

Obtain or Construct Sighting and Target Rods

Sighting and target rods are illustrated in Figure 4.5. The target rod can be constructed from 2-inch by 0.75-inch wood. The target rod should be 4.25 feet tall to represent the vehicle height and be painted fluorescent orange on both the top portion and bottom 2 feet of the rod. The bottom 2-foot portion represents the object height for measuring stopping sight distance. The sighting rod should be 3.5 feet tall to represent the driver's eye height. The sighting rod can be constructed from the same type of wood but should be painted flat black. The sighting rod and target rod are used in measuring sight distance.

Measure Current Sight Distances and Record Observations

On the sight distance intersection diagram (a blank diagram form is provided in Appendix C), the observer records the date and time, posted or operating speed site location, and weather conditions.

The observer with the sighting rod stands at the center of the approaching lane and 10 feet back from the stop bar or aligned with the stop sign. The observer's eyes should be at the top of the sighting rod.

The assistant walks away from the observer along the intersecting roadway toward approaching traffic. The assistant should stop periodically and place the target rod on the pavement for sighting by the observer. This process should continue until the top of the target rod can no longer be seen. The point where the target rod disappears is the maximum sight distance along that leg and should be recorded from the observer's sight.

Perform Sight Distance Analysis

The analysis of intersection sight distance consists of comparing the recommended sight distance to the measured available sight distance. The comparison of the actual distances should be performed with consideration to the greater of the 85th percentile of speed or the posted speed limit. If the measured sight distance is less than the recommended sight distance some mitigation may be required. Some mitigation measures are as follows:

- Remove/modify obstruction.
- Reduce speed.
- Install traffic control devices (if warranted by the MUTCD).

Example Sight Distance Study at an Intersection with Stop Sign Control

The city of Cottonwood Glen was changing the speed limit on one of their arterial streets from 25 to 30 mph. This change required the city to conduct an intersection sight distance study. The only intersection in question was the T-intersection of Ross Road and 13th Street. The east approach for both left- and right-turn maneuvers need to be studied. The city obtained recommended sight distances from Table 4.3: 335 feet for a right-turn maneuver and 290 feet for a left-turn maneuver.

The study was conducted on a Wednesday at 2:00 pm at the intersection of Ross Road and 13th Street. Because of the need for adequate sight distance for both left- and right-turn maneuvers, two separate sight distance measurements were made.

Figure 4.10 shows the measurement that was conducted for the right-turn maneuver. The measured sight distance for this maneuver is 350 feet. The minimum recommended sight distance is 335 feet for 30 mph. This shows that there is adequate sight distance for a right-turn maneuver from the side road, 13th Street.

Figure 4.11 shows the measurement that was conducted for a left-turn maneuver. The measured sight distance for this maneuver is 300 feet. The minimum recommended sight distance is 290 for 30 mph. This shows that there is adequate sight distance for a left-turn maneuver.

Date	MM/DD/YY
Time of Day	1400
Posted Speed Limit or 85% for Major Roadway ($X(R)$)	30 mph
Traffic Controls Present	Stop
Intersection Maneuver	Right Turn
Weather	Clear
Horizontal Curve	N
Vertical Curve	N

Major Roadway Width	40 feet
No. of Lanes	2
Minor Roadway Width	30 feet
No. of Lanes	2

Y Stopping Distance	N.A.
$X(R)$ Recommended	290 feet
$X(M)$ Measured	300 feet

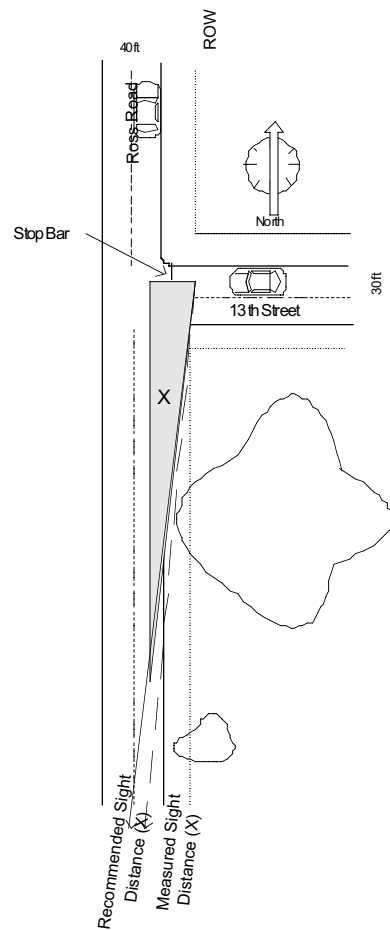

Conclusion: $X(M) > X(R)$. The measured sight distance was 300 feet, which is more than the recommended sight distance of 290 feet. Sight distance for a right-turn maneuver is adequate.

Figure 4.10. Ross Road and 13th Street, Right-Turn Maneuver

Date	MM/DD/YY
Time of Day	1400
Posted Speed Limit or 85% for Major Roadway ($X(R)$)	30 mph
Traffic Controls Present	Stop
Intersection Maneuver	Left Turn
Weather	Clear
Horizontal Curve	N
Vertical Curve	N

Major Roadway Width	40 feet
No. of Lanes	2
Minor Roadway Width	30 feet
No. of Lanes	2

Y Stopping Distance	N.A.
$X(R)$ Recommended	335 feet
$X(M)$ Measured	350 feet

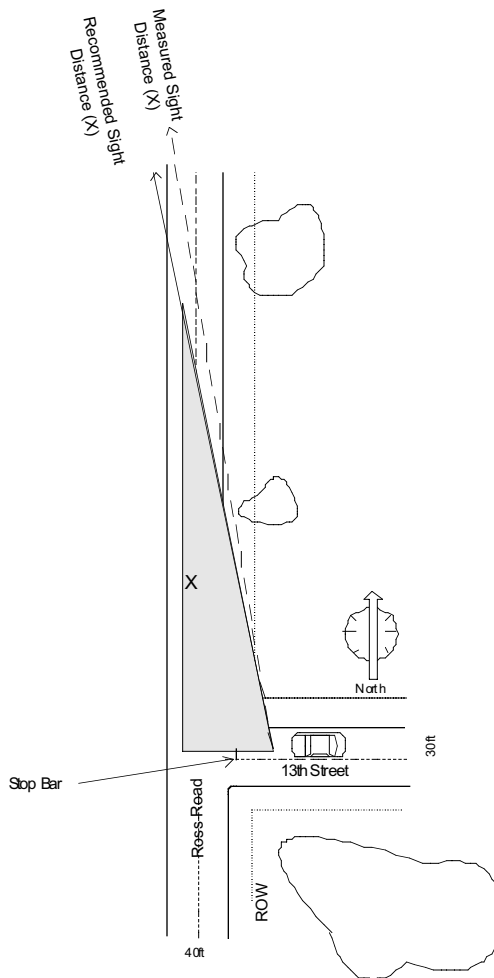

Conclusion: $X(M) > X(R)$. The measured sight distance was 350 feet, which is more than the recommended sight distance of 335 feet. Sight distance for a left-turn maneuver is adequate.

Figure 4.11. Ross Road and 13th Street, Left-Turn Maneuver

STOPPING SIGHT DISTANCE

To allow drivers to perceive, react, and safely stop, a minimum stopping sight distance must be available. Stopping sight distance is defined as the sum of two distances (AASHTO, *Green Book*):

1. *Reaction distance*—the distance traveled by the vehicle from the instant the driver sees an object necessitating a stop to the instant the brakes are applied; plus
2. *Braking distance*—the distance traveled by the vehicle from the instant brake application begins to the instant when the vehicle has come to complete stop.

The reaction distance is based on the reaction time of the driver and the speed of the vehicle. The braking distance is dependent upon the vehicle speed and the coefficient of friction between the tires and roadway.

Table 4.4 lists minimum recommended stopping sight distances based on design speed and the sum of reaction distance and braking distance. At 25 mph, for example, 91.9 feet are needed for reaction distance and 60 feet are needed for braking distance. When these numbers are added, the total distance is 151.9 feet. For performance purposes this figure has been rounded up to 155 feet.

Table 4.4. Minimum Required Stopping Sight Distances

Vehicle Speed (mph)	Reaction Distance (feet)	Braking Distance (feet)	Summed Distance (feet)	Stopping Sight Distance (feet)
15	55.1	21.6	76.7	80
20	73.5	38.4	111.9	115
25	91.9	60.0	151.9	155
30	110.3	86.0	196.7	200
35	128.6	117.6	246.2	250
40	147.0	153.6	300.6	305
45	165.4	194.4	359.8	360
50	183.8	240.0	423.8	425
55	202.1	290.3	492.4	495

Note: Distances are from the 2001 AASHTO *Green Book* and are for dry conditions. Distances may change in future versions.

For stopping distance calculations, the height of the driver's eye is 3.5 feet above the roadway and the object height is 2 feet above the roadway surface, as illustrated in Figure 4.12. The 2-foot object height represents an object that the driver of an approaching vehicle would want to avoid. One element to consider for stopping sight distance is vertical curvature of the roadway. On straight roadway sections, the obstruction that blocks the driver's vision of the roadway ahead is the vertical curvature of the road surface. As the vertical curvature increases, stopping sight distance also increases.

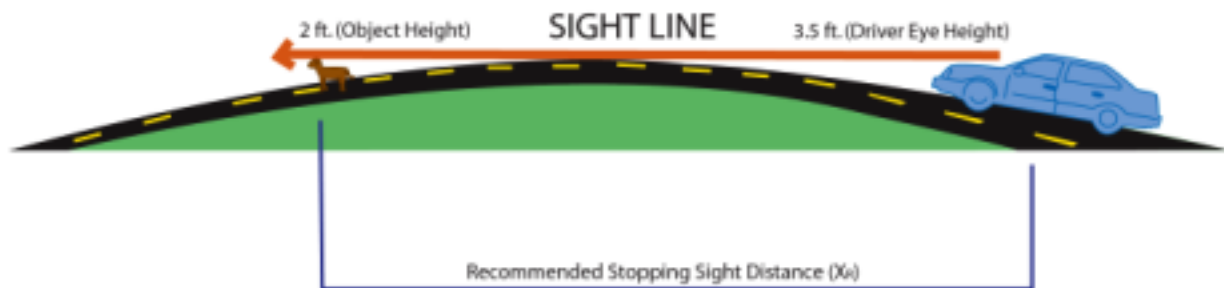

Figure 4.12. Heights Pertaining to Stopping Sight Distance

Key Steps to a Stopping Sight Distance Study

A stopping sight distance study includes four key steps:

1. Determine the minimum recommended stopping sight distance.
2. Obtain or construct sighting and target rods.
3. Measure current sight distances and record observations.
4. Perform sight distance analysis.

Determine the Minimum Recommended Stopping Sight Distance

Determine the minimum stopping sight distance for the posted speed limit (see Table 4.4).

Obtain or Construct Sighting and Target Rods

The target rod can be constructed from 2-inch by 0.75-inch wood. The target rod is 4.25 feet tall to represent the vehicle height and be painted fluorescent orange on both the top portion and bottom 2 feet of the rod. The bottom 2-foot portion of the target rod is the height for conducting

stopping sight distance. The 2-foot height is representative of an object that involves risk to drivers and can be recognized in time to stop before reaching it (AASHTO, *Green Book*).

The sighting rod is 3.5 feet tall to represent the driver's eye height. The sighting rod can be constructed from the same type of wood but should be painted flat black.

Measure Current Sight Distances and Record Observations

On the sight distance diagram (a blank diagram form is provided in Appendix C), the observer records the date and time, posted or operating speed, site location, and weather conditions.

Standing at a pre-determined location along the road, the observer should sight from the top of the sighting rod while the assistant moves away in the direction of travel. The assistant stops when the bottom 2-foot portion of the target rod is no longer visible. This is the distance at which a 2-foot tall object can no longer be seen by an approaching driver. The distance from the disappearing point to the observer is measured and recorded.

Perform Sight Distance Analysis

The analysis of stopping sight distance consists of comparing the recommended sight distance to the measured sight distance. The measured stopping sight distance should be greater than the recommended stopping distance. On a horizontal curved roadway, a sight obstruction may be due to the curve or to physical features outside of the roadway. On a straight roadway, the sight obstruction will be due to the vertical curvature of the roadway alone.

Example Stopping Sight Distance Study

The city of Cottonwood Glen may be undergoing new development near an established housing district, currently including multiple families and many with children. The proposed development is a new city park and is proposed to be directly across the roadway from the housing area. There is no established traffic control and no crosswalks in the area. At public meetings, parents have voiced concern about the safety of their children crossing the roadway to the park. This roadway does have a vertical curve, which may affect the stopping sight distance.

The city of Cottonwood Glen conducted the study on a Thursday at 10:00 a.m. on Washington Avenue. The posted speed limit on this roadway is 25 mph. The recommended stopping sight distance from Table 4.4 is 155 feet.

The results of the study show that the measured stopping sight distance was 245 feet (see Figures 4.13 and 4.14). There is adequate stopping sight distance at the study location. However, if the stopping sight distance would not have been adequate, the following actions could have been considered:

- Install traffic control device(s).
- Establish no-passing zones.
- Conduct public awareness efforts.
- Install a barrier between the park and street to prohibit mid-block crossings.
- Provide input into the developmental planning of the park.

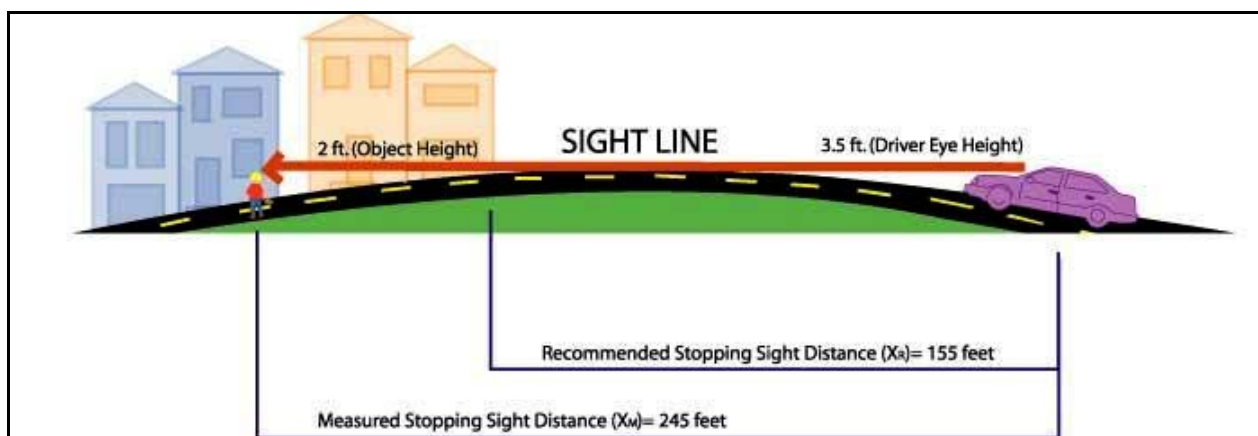
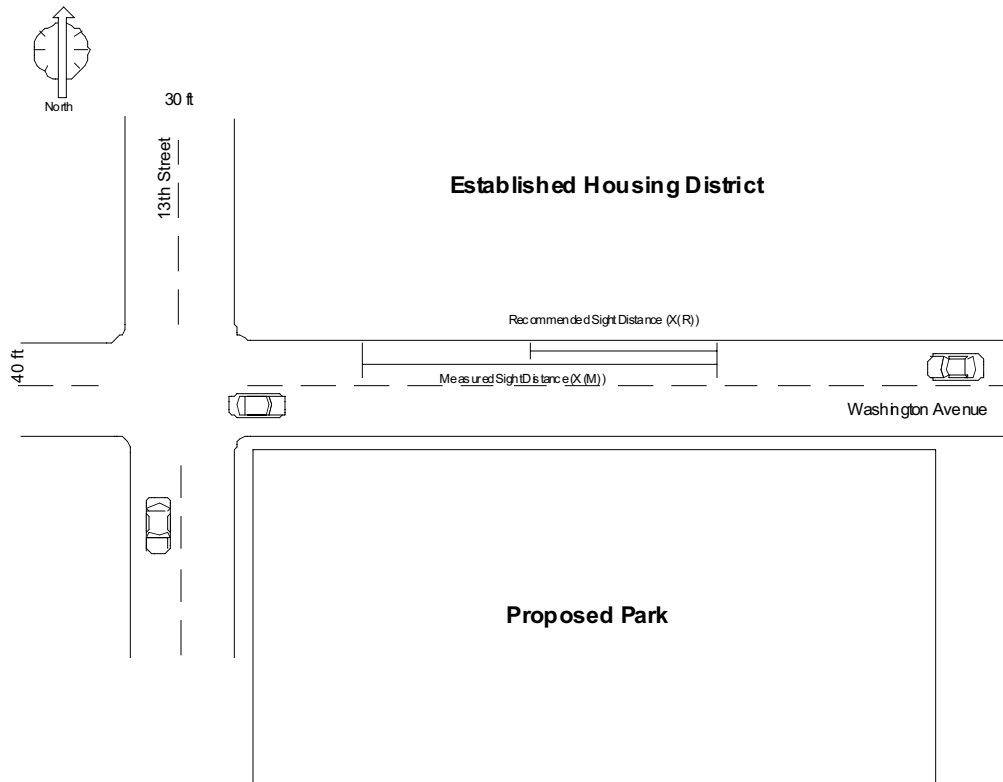

Figure 4.13. Washington Avenue and 13th Street Stopping Sight Distance

Date	MM/DD/YY
Time of Day	1000
Speed (Posted or 85%)	25 mph
Traffic Controls Present	No Control
Intersection Maneuver	N.A.
Weather	Clear
Horizontal Curve	N
Vertical Curve	Y

Major Roadway Width	40 feet
No. of Lanes	2
Minor Roadway Width	N.A.
No. of Lanes	N.A.

Y Stopping Distance	N.A.
X(R) Recommended	155 feet
X(M) Measured	245 feet



Conclusion: $X(M) > X(R)$. The measured sight distance is 245 feet, which is more than the recommended sight distance of 155 feet. Sight distance for this section of roadway is adequate.

Figure 4.14. Washington Avenue and 13th Street Sight Distance Diagram

CONTRACTING FOR A SIGHT DISTANCE STUDY

Information Gathering

Before a jurisdiction contacts an engineering consulting firm to perform a sight distance study, a variety of information may need to be collected. The following is a list of possible information that an engineering consulting firm may request:

- issue at hand
- existing traffic control devices
- conditions map/existing photographs, etc.
- right-of-way information
- roadway geometry
- roadway classifications
- crash history
- posted speed limits in and around study area
- preliminary speed studies
- citizen input
- location map
- appropriate contact persons
- any other relevant information

The following project work order may assist local government in contracting to an engineering firm. The example project work order contains information from the stopping sight distance example (a blank form is provided in Appendix E).

Project Work Order: Sight Distance Study

Referenced Agreement

This work order is part of an agreement between Mattson and Associates and the city of Cottonwood Glen for municipal engineering services.

Project Location Description

This work involves conducting a stopping sight distance study around the location of Washington Avenue and 13th Street. A map depicting the location is attached.

Obligation of the City/County

The city shall provide the following items to the consultant: existing traffic control, volumes, right-of-way information, roadway geometry, posted speed limits, crash history and a list of important contacts.

Scope of Consultant Services

This work includes obtaining and evaluating sight distance measurements on the east side of the proposed driveway for the apartment complex.

Schedule

Field meeting date:	_____
Estimated date of preliminary deliverable:	_____
Estimated date of final deliverable:	_____

Compensation

Labor cost	\$
Direct expenses	\$
Subcontractor cost	\$ _____
Overhead	\$ _____
Maximum payable	\$

Authorization

<u>City of Cottonwood Glen</u> City/County	<u>Mattson and Associates</u> Contractor
_____	_____
City/County Administrator	Project Manager's Name/Title
_____	_____
Signature	Signature
_____	_____
Date	Date

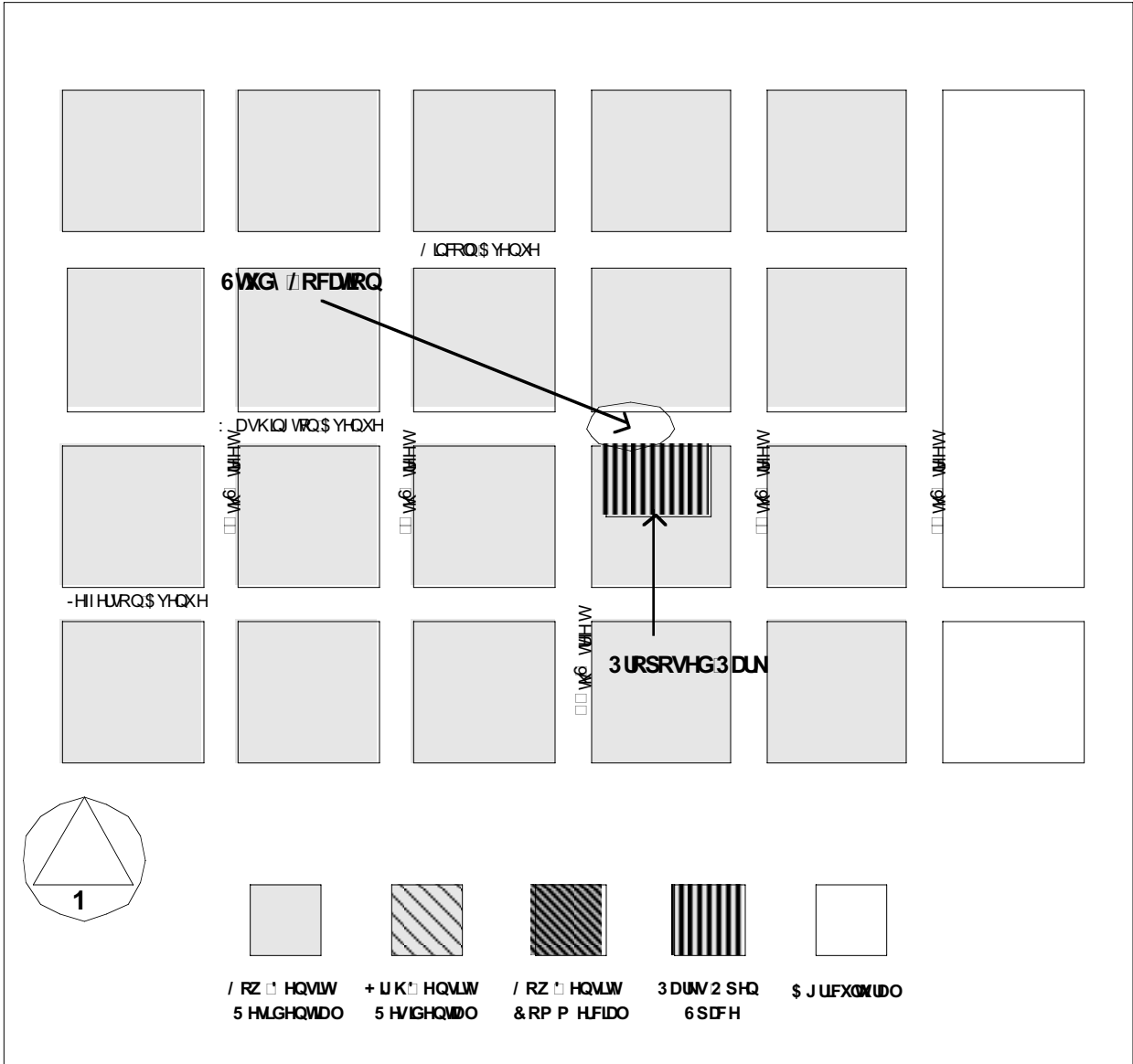

REFERENCES

- AASHTO. 2001. *Guidelines for Geometric Design of Very Low Volume Local Roads (Little Green Book)*. Washington, D.C.: American Association of State Highway and Transportation Officials.
- AASHTO. 2001. *A Policy on Geometric Design of Highways and Streets (Green Book)*. 4th ed. Washington D.C.: American Association of State Highway and Transportation Officials.
- CTRE. 2001. *Iowa Traffic Control Devices and Pavement Markings: A Manual for Cities and Counties*. Ames, Iowa: Center for Transportation Research and Education, Iowa State University.
- Maze, T., and D. Plazak. 2000. *Access Management Handbook: Balancing the Demands on Our Roadways*. Ames, Iowa: Center for Transportation Research and Education, Iowa State University.

Crash Analysis

5

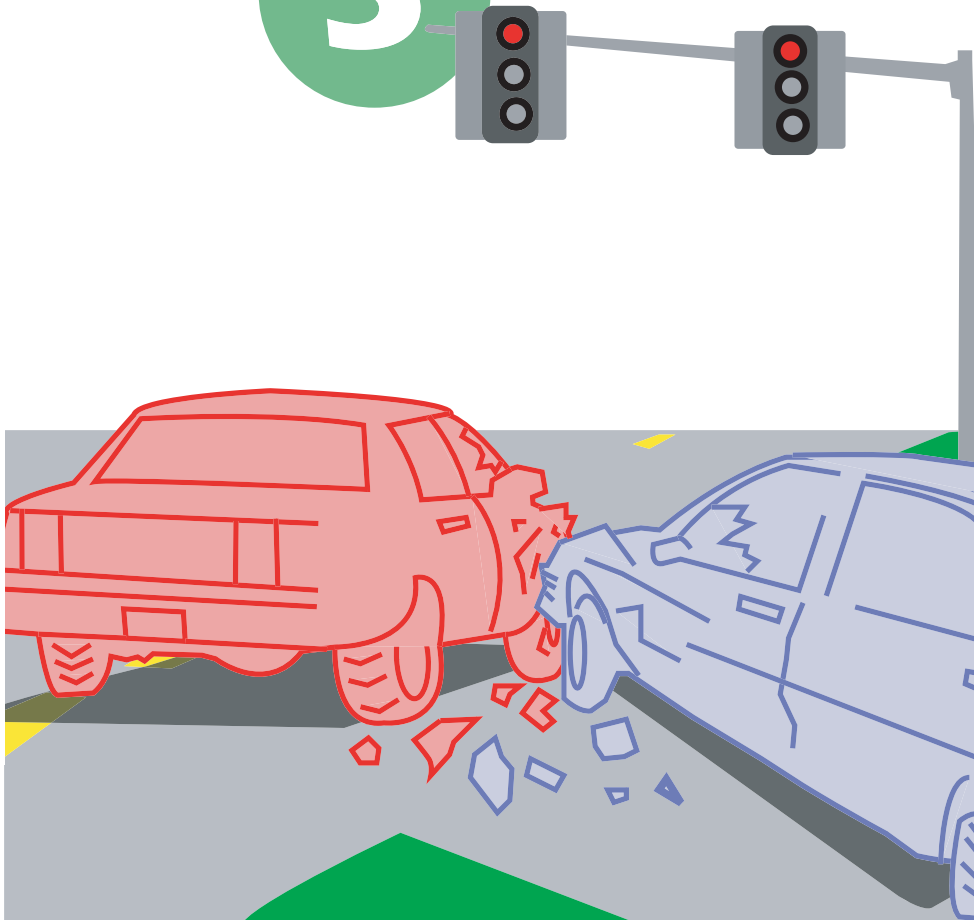

Crash Analysis

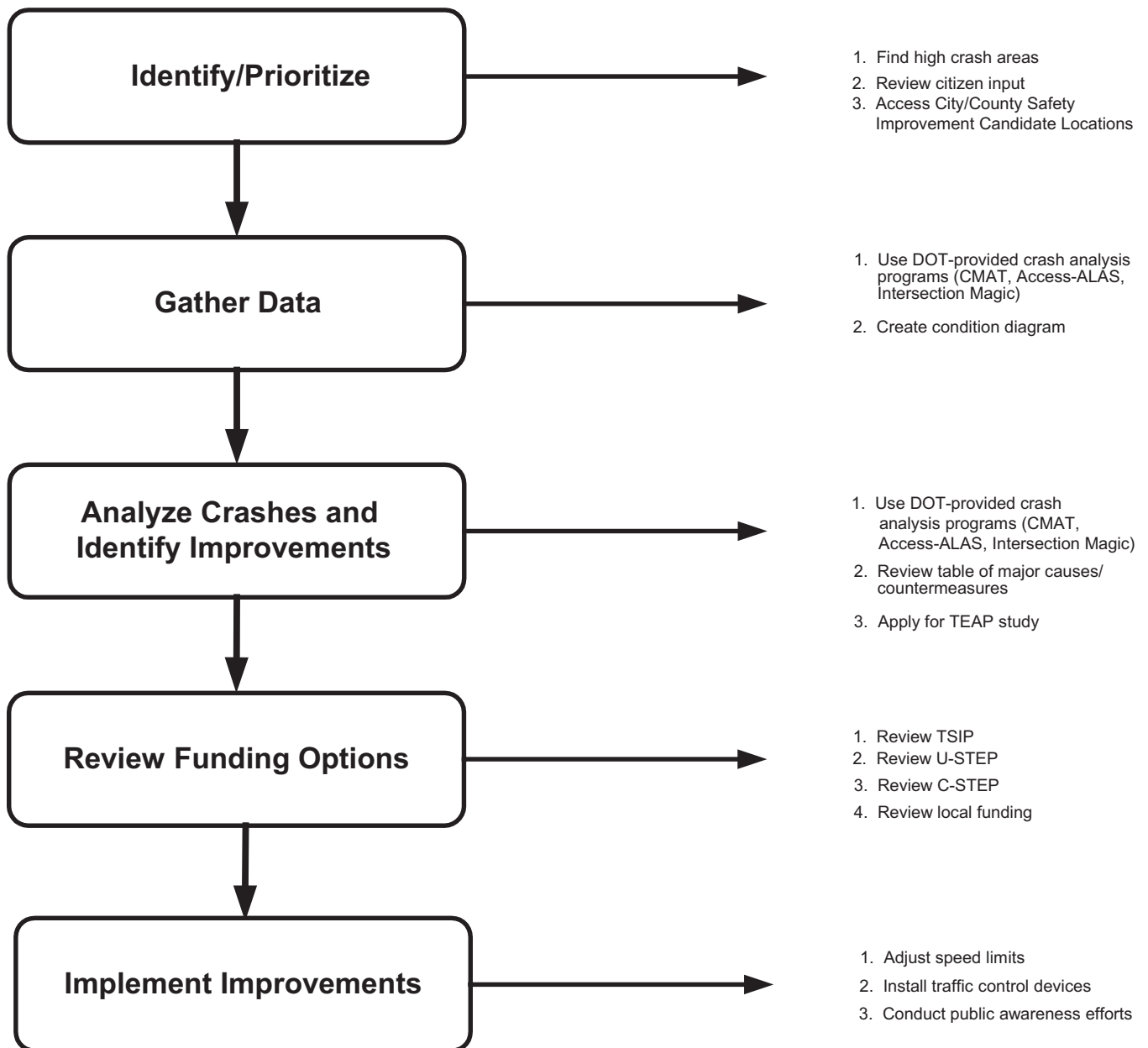

INTRODUCTION

Crashes are rare events. A typical intersection experiences less than one crash per million vehicles that navigate the intersection. Crashes occur because of various factors including the driver, vehicle, roadway, and environment. The primary source of crash data is the local law enforcement agencies. Local law enforcement agencies are usually an excellent source for current conditions at a particular crash location.

Crash data are used to help understand why crashes occur, to help identify high-crash locations, to aid in the choice of safety programs or countermeasures, and to assist evaluations of countermeasure effectiveness (Robertson 1994). The main purpose of crash analysis is to improve safety by identifying crash patterns, mitigating crash severity, and reducing the number of crashes by adopting suitable countermeasures.

KEY STEPS TO A CRASH ANALYSIS STUDY

A crash analysis study includes six key steps:

1. Identify the locations that are candidates for improvement.
2. Quantify the main crash trend(s) at a particular location.
3. Determine the source of the problem(s).
4. Evaluate types of improvements to address the crash problem(s).
5. Obtain an expert opinion about safety improvement(s).
6. Obtain funding to implement a safety improvement.

Identify the Locations That Are Candidates for Improvement

The Iowa Department of Transportation (Iowa DOT) Office of Traffic and Safety has developed a website to assist jurisdictions in identifying locations within their jurisdiction that are candidates for safety improvement. Please refer to www.dot.state.ia.us/crashanalysis/.

The first place to navigate on the website is the City or County (as appropriate) Safety Improvement Candidate Locations (SICL) link. See Figure 5.1. An individual can select their jurisdiction from a list of all cities or counties in Iowa having a candidate location. Once a city or county is selected, the intersections, links and nodes with the highest ranking of crashes, crash rates, and crash severity for that jurisdiction are listed.



Figure 5.1. Iowa DOT SICL Link Listings

The same website also provides a list of the top 200 Safety Improvement Candidate Locations (SICL) within Iowa as shown above. This link provides the same information as listed above but for the top 200 intersections of concern within the state.

Quantify the Main Safety Concern(s) at a Particular Location

The main safety problem(s) at a given location can be quantified a few ways:

- Refer to the Iowa DOT's lists of safety improvement candidate locations.
- Obtain and use crash data and analysis programs from the Iowa DOT.
- Consult the Iowa Traffic Safety Data Service.
- Calculate the crash rate for an intersection.

Refer to the Iowa DOT's Lists of Safety Improvement Candidate Locations

The Iowa DOT Office of Traffic and Safety's City or County (as appropriate) Safety Improvement Candidate Locations (SICL) listings (www.dot.state.ia.us/crashanalysis/) provide each location's statewide rank and crashes by year for a five-year period. Locations that do not meet minimum criteria are not included in the listings. The minimum criteria are at least one fatal crash, four injury crashes, or eight total crashes in the most recent five-year analysis period. The locations are ranked according to a composite of the number of crashes, the severity of the crashes, and the crash rate per traffic volume. SICL listing also provides a breakdown of crashes at each location by crash severity and injury severity.

Obtain and Use Crash Data and Analysis Programs from the Iowa DOT

Free of charge, the Iowa DOT Office of Traffic and Safety will provide statewide crash data, programs to query and print crash data, and training to use their computer programs (see also Appendix D.2). The computer programs are Access-ALAS (accident location and analysis system) and Crash Mapping and Analysis Tool (CMAT). See Figure 5.2. These two programs are available as a set. To find information about obtaining these programs, refer to www.dot.state.ia.us/crashanalysis/. The most currently available crash data can be viewed within these programs. Every year the Iowa DOT Office of Traffic and Safety distributes the new crash data to the jurisdictions that have the programs.

Table of Contents	
Crash Analysis Tools	
Access-ALAS - Iowa's Microsoft® Access-based Accident Location and Analysis System	
Intersection Magic - Vendor-developed collision diagramming software, configured to work with Iowa crash data	
SAVER - Iowa's new set of Safety Analysis, Visualization, and Exploration Resources...Anticipated release soon (August 2002?)	
Crash Analysis Tools Training	
Access-ALAS Training - provided free of charge by a training consultant	
Intersection Magic - no free training, instead a manual has been written for Iowa's system	
SAVER Training - coming soon (August?)	
Data Requests	
If you have a data request, please fill out the Data Request Form. Please be advised that data requests are not necessarily answered in the order they are received nor are they necessarily answered directly by the Iowa Department of Transportation, Highway Division, Engineering Bureau, Office of Traffic and Safety. Your request may be forwarded to a more appropriate agency. Finally, please be advised that request complexity directly influences timeliness of response.	

Figure 5.2. Iowa DOT Crash Analysis Tools Information

CMAT is used to view crash locations on a map and select the crashes needed for further analysis. An individual can enter CMAT, zoom to an intersection, select the crashes needed for analysis, and export them to Access-ALAS. The crash data is then queried and printed from Access-ALAS. A step-by-step process is given in Appendix D.2. Once the data are active in Access-ALAS, an individual can find the number of crashes for the predetermined study period.

Consult the Iowa Traffic Safety Data Service

The Center for Transportation Research and Education (CTRE) also offers a service to jurisdictions called the Iowa Traffic Safety Data Service (ITSDS). ITSDS provides timely access to crash analyses and reports from many safety and geographic information systems tools developed by the Iowa DOT and CTRE in recent years. ITSDS facilitates decision-making, effective presentation of information, and education. The ITSDS is not available to all requestors and is not meant to relieve all traffic data users from performing their own analyses. Rather, it fills the large gap between what data users can get for themselves and what can be obtained by experts with the best software and hardware. An example of crash mapping produced by ITSDS is shown in Figure 5.3. For more information, visit the ITSDS website at www.ctre.iastate.edu/itsds/.

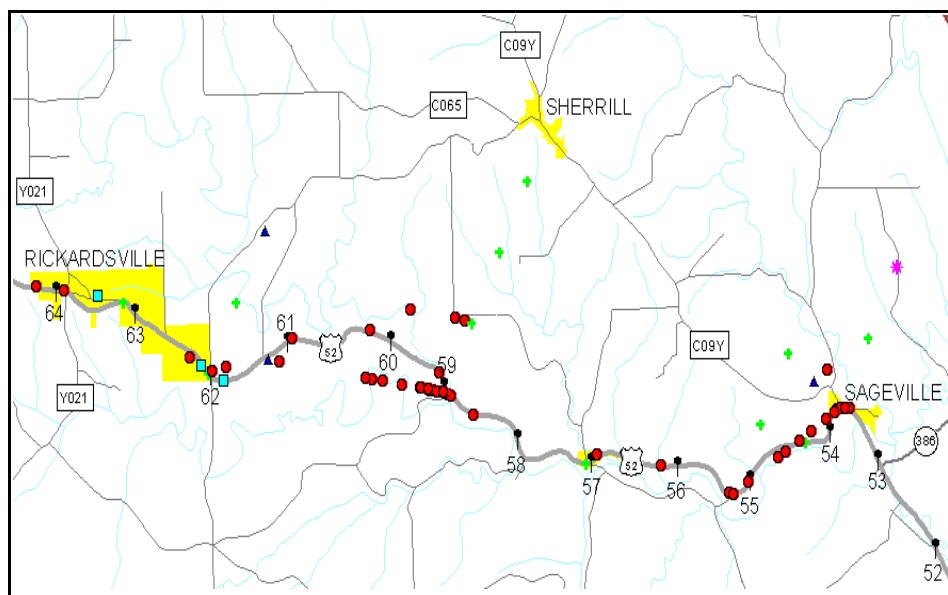

Figure 5.3. Example Crash Mapping Produced by ITSDS

Calculate the Crash Rate for an Intersection

Finally, a jurisdiction can calculate the crash rate for an intersection and compare the rate to statewide averages as shown in Table 5.1 (Iowa DOT 1989).

Table 5.1. Iowa Statewide Average Crash Rates by Daily Entering Volume

	Rural					Municipal				
	1-999 DEV	1,000-2,499 DEV	2,500-4,999 DEV	5,000-9,999 DEV	10,000+ DEV	1-2,499 DEV	2,500-4,999 DEV	5,000-9,999 DEV	10,000-24,999 DEV	25,000+ DEV
Average crash rate per million entering vehicles	2.1	1.2	0.9	0.7	0.7	1.3	1.0	0.7	0.8	1.0

Note: DEV = daily entering volume.

To calculate the crash rate for an intersection, the following data are needed: the number of crashes at the intersection for the time period of the study (found using the computer programs as described above), the number of years in the study, and the annual average daily traffic (AADT) for each leg of the intersection. To develop a crash trend, it is recommended to collect three to five years of crash data.

To obtain the AADT for your intersection, you may have to perform a traffic volume count study as described in Chapter 3 of this handbook. The AADT is sum of the two-way traffic counts for all the intersection’s legs, factored to account for the day of the week and the month of the year. In order to calculate the AADT for an intersection, a jurisdiction may conduct pneumatic road tube counts for all legs or 8 hours of intersection volume counts. These counts are typically conducted between 7:00 a.m. and 11:00 a.m. and between 2:00 p.m. to 6:00 p.m. Once a jurisdiction has obtained these volumes, they may contact the Iowa DOT Office of Transportation Data for assistance in using factors to calculate AADT.

The Iowa DOT provides the AADT for some legs of intersections at www.mmsp.dot.state.ia.us/trans_data/traffic/aadtpdf.html. A jurisdiction can enter this website, click on their city or county and an AADT map will appear. It is on this map that a jurisdiction may find the AADTs that are needed to calculate the crash rate.

When using AADT to calculate crash rates, use the following equation (Iowa DOT 1989):

$$Ri = \frac{2 * C * 1,000,000}{\sum AADTs * Y * 365}, \quad (5.1)$$

where Ri = crash rate per million entering vehicles, C = number of crashes, and Y = number of years analyzed. For example, at the intersection of 4th Street and Main Street, a total of fifteen crashes occurred in five years. The two-way AADTs for the legs of the intersection were 4,000, 4,000, 1,000, and 1,000. The sum of these AADTs equals 10,000 vehicles. The crash rate per million entering vehicles is as follows:

$$Ri = \frac{2 * 15 \text{ crashes} * 1,000,000}{10,000 \text{ vehicles} * 5 \text{ years} * 365 \text{ days}} = 1.64 \text{ crashes per million entering vehicles.}$$

The calculation shows that there were 1.64 crashes for every million vehicles that entered the intersection of 4th Street and Main Street during the given five year period. The statewide average crash rate for this type of intersection is 0.8 crashes per million entering vehicles. That indicates the crash rate at this intersection is approximately twice as high as the statewide average and the intersection should be considered for further analysis. A crash may be higher than the state average but not significantly different.

Determine the Source of the Problem(s)

The source of the problem may be identified in different ways, including using Access-ALAS and Intersection Magic software programs and completing a crash analysis observation report.

Access-ALAS provides a major crash cause summary, a day/time and accident rate summary, a surface and light condition summary, and details for all crashes. See Appendix D.2 or go to www.dot.state.ia.us/crashanalysis/ for more information.

Also, free of charge, the Iowa DOT will provide another program—Intersection Magic—for crash analysis purposes. To find detailed information about obtaining this program, go to www.dot.state.ia.us/crashanalysis/. Intersection Magic is a Microsoft Windows based PC application for crash analysis. Intersection Magic is a node-based application that generates collision diagrams. Starting in the year 2000, crash data were recorded by real coordinates. Because of this, at this point in time, Intersection Magic cannot analyze data more current than 1999. Intersection Magic requires intersection node numbers locate crashes. The intersection node numbers may be obtained within the CMAT program. Use the crash data selection process described in Appendix D.3 to select the node numbers and then use Intersection Magic to create a collision diagram. See Figure 5.10.

A jurisdiction may also fill out a crash analysis field observation report (a form is provided in Appendix D.1; FHWA 1991). The report includes a checklist relating to physical and operational characteristics. A jurisdiction may wish to fill out the observation form and then compare the results to those from the crash analysis programs. This may highlight consistencies between the conditions of the particular location and the type of major causes of the crashes.

Evaluate Types of Improvements to Address the Crash Problem(s)

Once a safety concern is identified, a jurisdiction can begin to evaluate possible countermeasures. Table 5.2 provides a list of possible countermeasures for safety concerns relating to pedestrians, speed, and sight distance (Ogden 1996, SEMCOG 1998, NCHRP 2000). Additional information is provided in Appendix D.4 (FHWA 1991).

Table 5.2. Major Safety Concern Causes and Countermeasures

Major Cause	Possible Countermeasures
Ran traffic signal	Remove signal sight obstructions Post "Signal Ahead" warning signs Install/replace signal visors and back plates Add signal back plates Install advance flasher signs Install (additional) 12-inch signal lenses Upgrade signalization Review warrants/consider removing signal Synchronize adjacent signals
Ran stop sign	Remove sign sight obstructions Install larger signs Install "Stop"/"Yield Ahead" signs Construct rumble strips in pavement Review warrants/consider removing sign Replace "Stop" with "Yield" sign, if feasible Place flashing beacons overhead or on "Stop" sign Place red flags on "Stop" sign Place "Stop" signs on both sides of road
Failed to yield right-of-way to pedestrian	Add stop bars/crosswalks Post "Ped Xing"/"Advance Xing" signs Place advance pavement messages Add/improve lighting Post "School Xing"/"Advance Xing" signs Use crossing guards near schools Reroute pedestrians to safer crossing Signalize pedestrian crossing Install barrier curbing Add pedestrian refuge islands Post "No Right Turn on Red" sign, if at intersection
Exceeded speed limit	Post/reduce speed limit Increase traffic/speed enforcement Install traffic-calming measures: refer to www.ite.org Install larger signs Install flashing beacons on signs
Turned improperly	Prohibit turns Signalize intersection Reduce speed limit Install raised median Install left turn bays Widen approaches to handle turn lanes Improve signing and pavement markings
Vision was obscured	Eliminate parking Remove obstructions from sight triangles Close/relocate driveways near intersections Signalize intersection Install intersection warning signs

Obtain an Expert Opinion about Safety Improvements

Jurisdictions in Iowa may receive an expert opinion about a safety improvement by applying for a Traffic Engineering Assistance Program (TEAP) study through the Iowa DOT. The intent of this program is to offer traffic engineering assistance to local governments for improvements in traffic safety and operations including high crash locations, confusing intersections, school pedestrian routes, railroad crossings, and truck routes.

Obtaining Funding to Implement a Safety Improvement

The Iowa DOT offers three funding programs to assist jurisdictions with safety improvements. The programs are the Traffic Safety Improvement Program (TSIP), the Urban-State Traffic Engineering Program (U-STEP), and the County-State Traffic Engineering Program (C-STEP). These programs are described below. Additional detailed information about the current status of the funding can be found in the Iowa DOT Funding Guide at www.dot.state.ia.us/fundguid.htm.

Traffic Safety Improvement Program

The intent of the TSIP program is to offer funding for traffic safety improvements or studies on public roads under county, city, or state jurisdiction. Funding per project cannot exceed \$500,000. TSIP provides Traffic Safety Funds (TSF) on an annual basis to projects with the greatest safety benefit/project cost ratio.

Urban-State Traffic Engineering Program

The intent of the U-STEP program is to offer construction funding to solve traffic operation and safety problems on primary roads in Iowa cities. Funding per project cannot exceed \$200,000 for spot improvements and \$400,000 for linear improvements. Linear improvements are those that span for two or more intersections. The city must engineer and administer the project, and the project costs are split, 45% city and 55% state.

County-State Traffic Engineering Program

The intent of the C-STEP program is to offer construction funding to solve traffic operation and safety problems on primary roads outside incorporated cities. The county must engineer and administer the project. Funding cannot exceed \$200,000 for spot improvements (those limited to one location). Construction costs are split, 45% county and 55% state. Funding breakdowns for linear improvements are described in the Iowa DOT funding guide at www.dot.state.ia.us/fundguid.htm.

EXAMPLE CRASH ANALYSIS STUDY

The city of Carroll needed a crash analysis conducted at a high-volume intersection (US 30 and Grant Road) that had numerous vehicular crashes in the recent past (see Figure 5.4). The city decided to analyze the crash data for a five-year period.

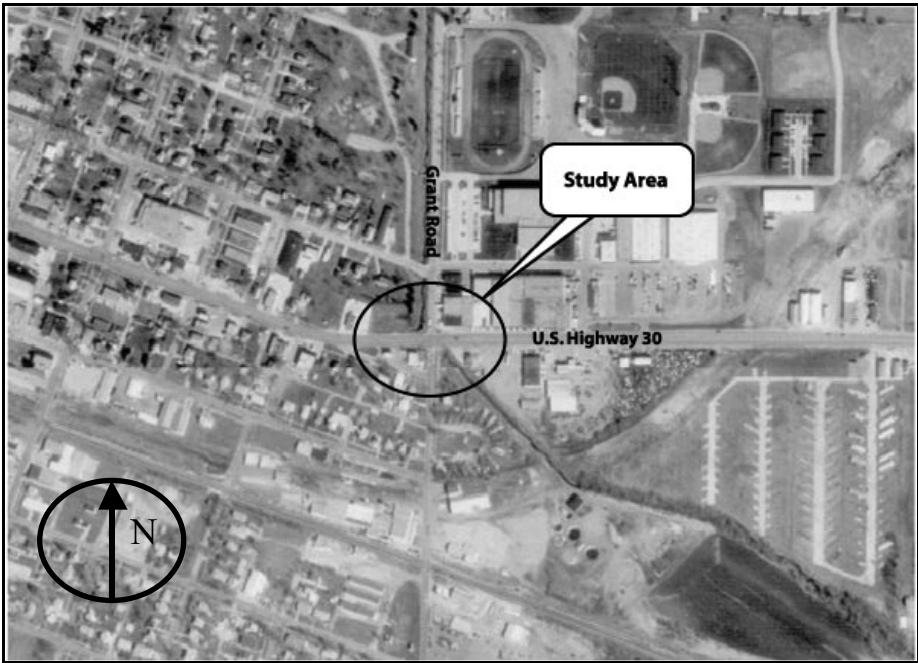

Figure 5.4. Example Crash Analysis Intersection (US 30 and Grant Road, Carroll)

Carroll opened the Access-ALAS program and selected Carroll County from the database. They then located the intersection of US 30 and Grant Road within the CMAT program and selected the crashes at the subject intersection. The data were then exported to Access-ALAS.

Once the data were in Access-ALAS, they could be broken down and specified into three summaries: (1) major cause summary, (2) day/time and accident rate summary, and (3) surface and light condition summary. A listing of all crashes was also available. The city printed out the three Access-ALAS data summaries as shown in Figures 5.5, 5.6, and 5.7.

Instructions for this entire process are given in Appendix D.2.

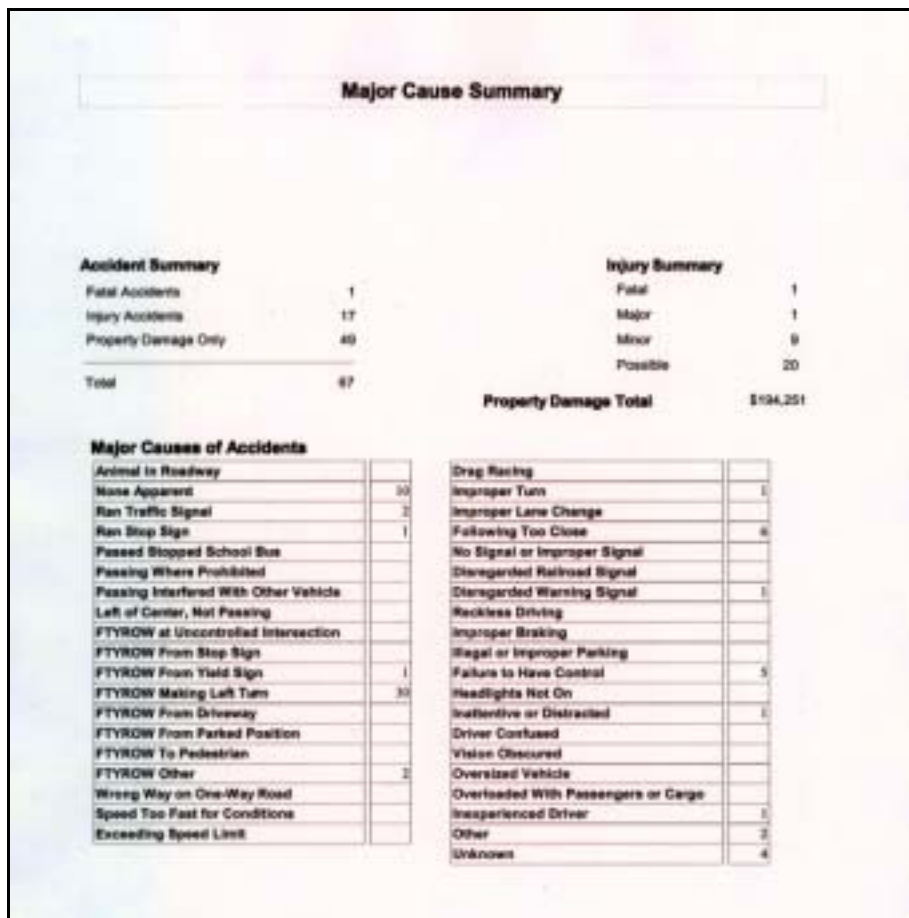

Figure 5.5. Example Major Cause Summary (Access-ALAS)

Day/Time and Accident Rate Summary

Accidents by Time Of Day and Day of Week *

Weekday	0:00	2:00	4:00	6:00	8:00	10:00	12:00	14:00	16:00	18:00	20:00	22:00	24:00	Total
Unknown														0
Sunday											1			1
Monday						1				4	1	1		7
Tuesday						1			3	1	2			7
Wednesday						1	2	3	3		1	2		12
Thursday		1				5		1	3	5				15
Friday					1	2	1	2	2	1			1	10
Saturday					1		2	3	2	2	2	1	1	14
All Days		1			2	10	5	9	13	13	7	4	2	66

* (Accidents with no time recorded are not included.)

Figure 5.6. Example Day/Time and Accident Rate Summary (Access-ALAS)

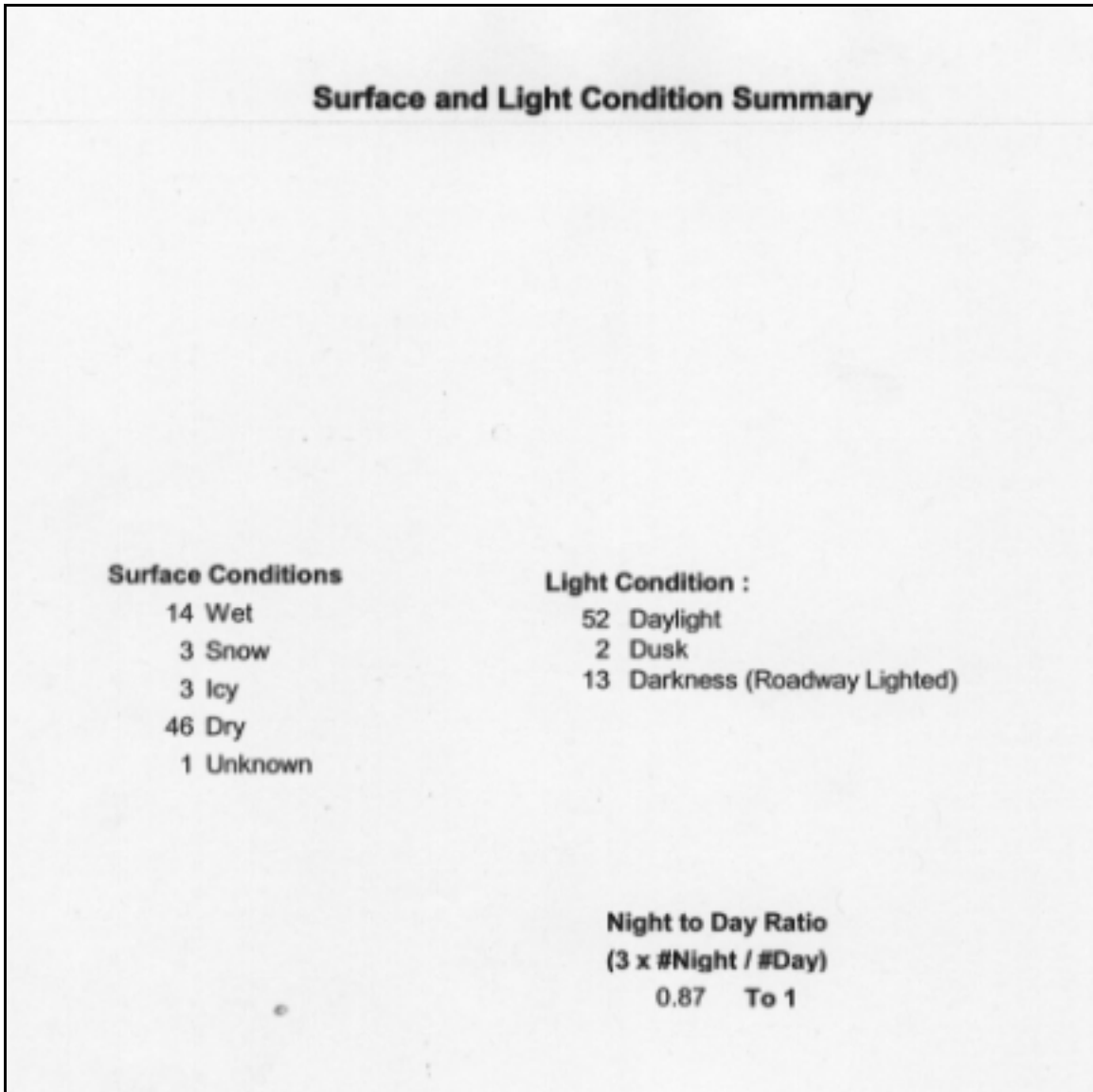

Figure 5.7. Example Surface and Light Condition Summary (Access-ALAS)

As illustrated in Figure 5.5, there were 67 intersection-related vehicular in the five-year period of the study. Failure to yield to the right-of-way while making a left turn accounts for 30 of the vehicular crashes at the intersection.

The data may also be exported to Microsoft Excel (not provided by the Iowa DOT) for further analysis (see Figures 5.8–5.10). The annual number of crashes is shown in Figure 5.10.

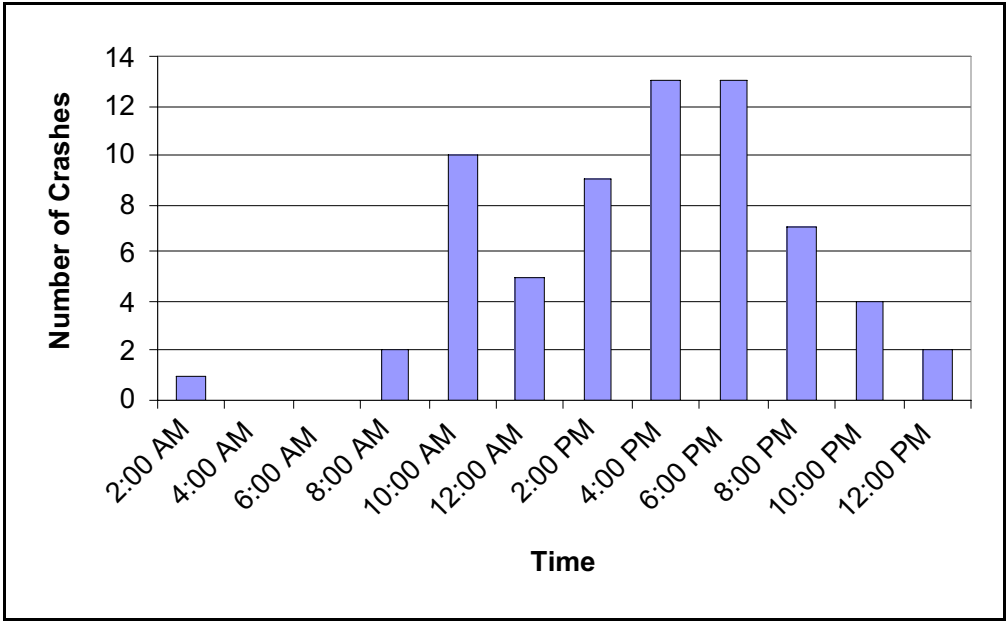

Figure 5.8. Example Crash Count by Time of Day (Microsoft Excel)

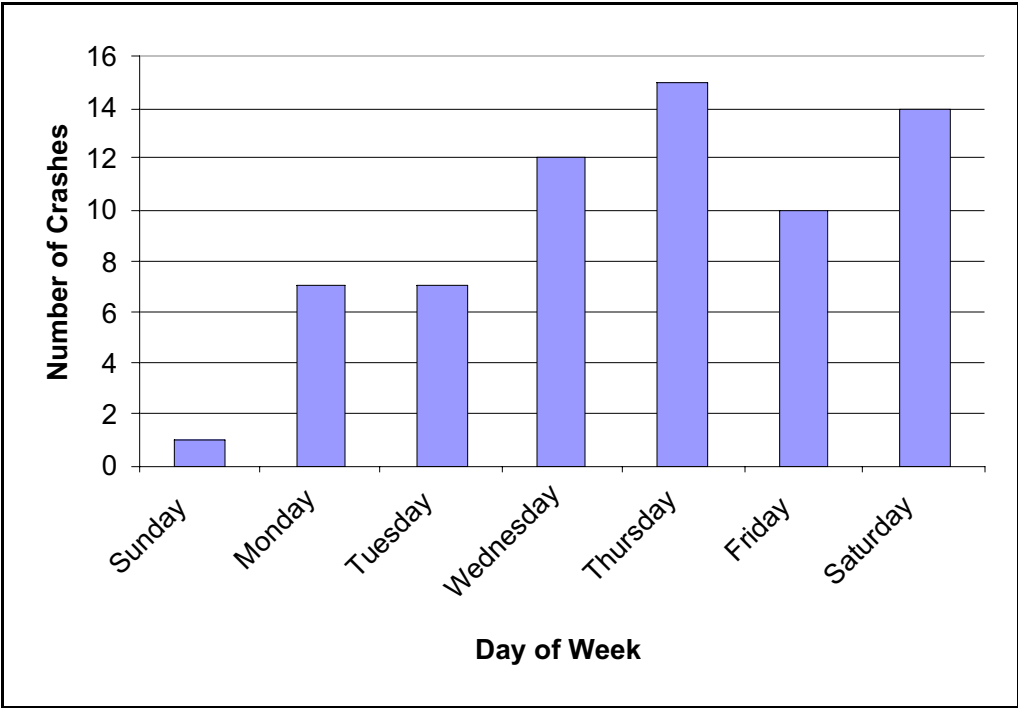

Figure 5.9. Example Crash Count by Day of Week (Microsoft Excel)

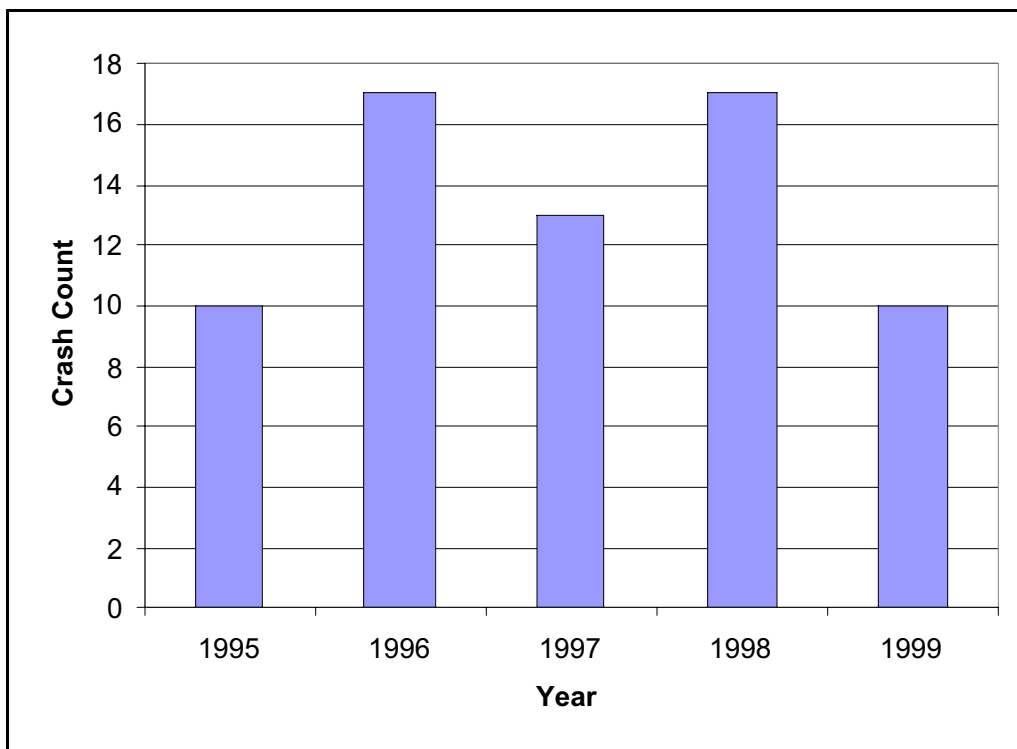

Figure 5.10. Example Crash Count by Year (Microsoft Excel)

The Access-ALAS analysis shows that most crashes occurred in the daylight under dry conditions. The major cause of crashes at the intersection of US 30 and Grant Road was failing to yield to the right-of-way left turning. Half of the crashes occurred on the days of Wednesday, Thursday, and Friday between 4:00 p.m. and 6:00 p.m.

In order to better visualize the types of crashes within the intersection, the city needed a collision diagram. Collision diagrams may be constructed within the program Intersection Magic. The node number for the intersection is needed to run Intersection Magic. CMAT can be used to obtain the node number. The node number is used in Intersection Magic to obtain a collision diagram of all crashes at the intersection of US 30 and Grant Road during the five-year time period. See Figure 5.11. Instructions for this process are provided in Appendix D.3.

The intersection of US 30 and Grant Road was ranked 21st on the Iowa DOT's list of statewide candidate locations for safety improvements. At the time period of the study, the intersection has a leading left-turn phase for eastbound to northbound traffic. From the Access-ALAS queries,

left-turn crashes on the US 30 approaches may be identified as the predominate crash type. Vehicles making left turns from US 30 onto Grant Road may have limited sight distance. Some of the possible countermeasures to reduce these types of crashes are as follows:

- Split-phase the signal operation for the US 30 movements.
- Construct left-turn bays with or without raised medians.
- Re-time the traffic signal.

Information on contracting for a crash analysis study, including a project work order using the city of Carroll example, is provided near the end of this chapter.

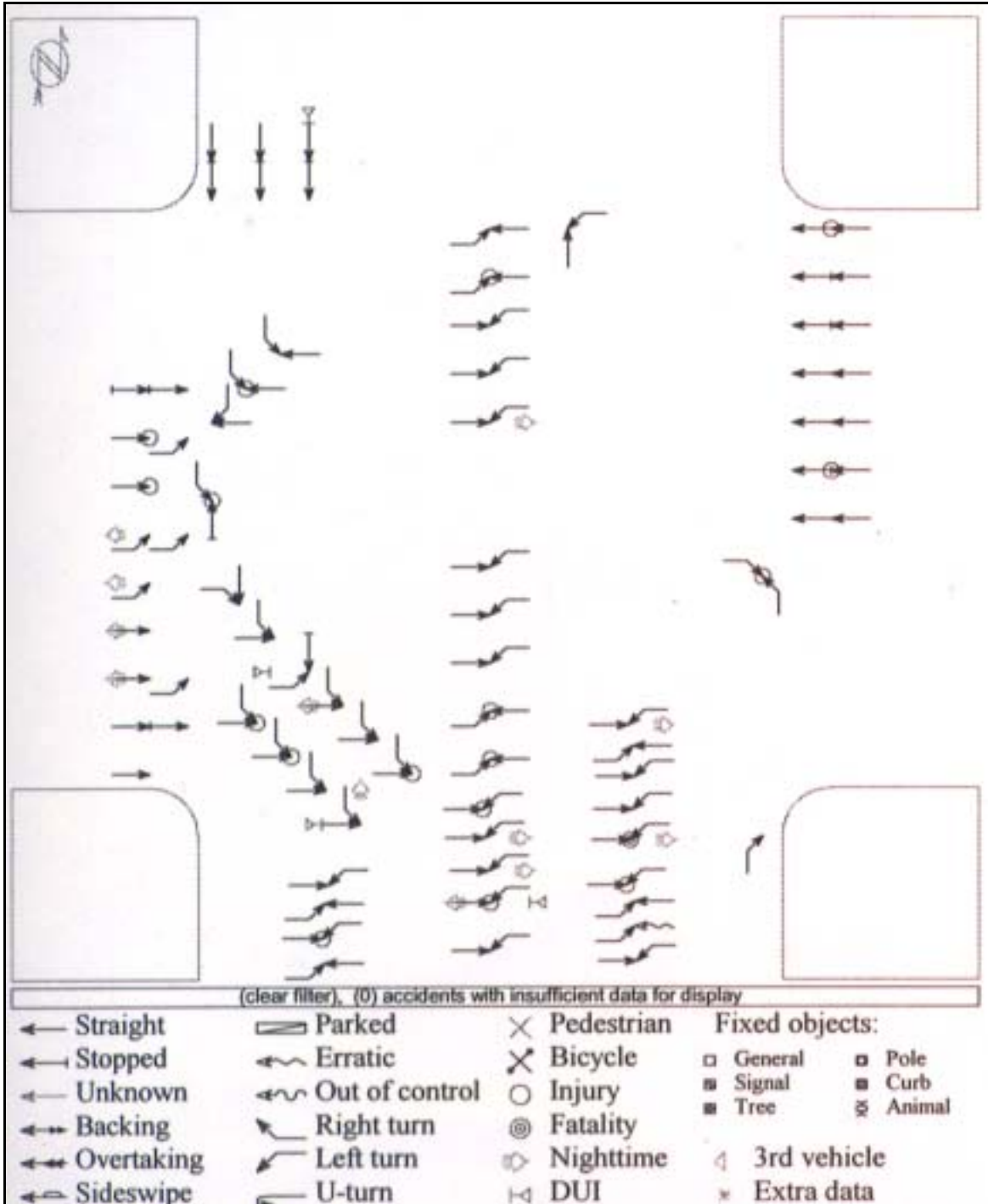

Figure 5.11. US 30 and Grant Road Collision Diagram (Carroll, IA)
(Intersection Magic)

CONTRACTING FOR A CRASH ANALYSIS STUDY

Information Gathering

Before a jurisdiction contacts an engineering consulting firm to perform a crash analysis study, a variety of information may need to be collected. Any information may aid the consulting firm in adequately completing the study. The following is a list of possible information that an engineering consulting firm may request:

- issue at hand
- crash history
- traffic volumes
- sight distances
- right-of-way information
- roadway geometry
- roadway classifications
- posted speed limits in and around study area
- preliminary speed studies
- citizen input
- location map
- appropriate contact persons
- any other relevant information

The following project work order may assist local governments in contracting to an engineering firm. The example project work order contains information from the city of Carroll example (a blank form is provided in Appendix E).

Project Work Order: Crash Analysis Study

Referenced Agreement

This work order is part of an agreement between Smith Consulting and the city of Carroll for municipal engineering services.

Project Location Description

This work involves conducting a crash analysis study at the intersection of Highway US 30 and Grant Road. A map depicting the location is attached.

Obligation of the City/County

The city shall provide the following items to the consultant: historic traffic volumes, current traffic volumes, posted speed limits, available sight distances, crash history, roadway geometry, roadway classification, and a list of important contacts.

Scope of Consultant Services

This work includes gathering and analyzing crash data. Crash mitigation recommendations will also be required, if needed.

Schedule

Field meeting date:	_____
Estimated date of preliminary deliverable:	_____
Estimated date of final deliverable:	_____

Compensation

Labor cost	\$
Direct expenses	\$
Subcontractor cost	\$ _____
Overhead	\$ _____
Maximum payable	\$

Authorization

<u>City of Carroll</u> City/County	<u>Smith Consulting</u> Contractor
_____	_____
City/County Administrator	Project Manager's Name/Title
_____	_____
Signature	Signature
_____	_____
Date	Date

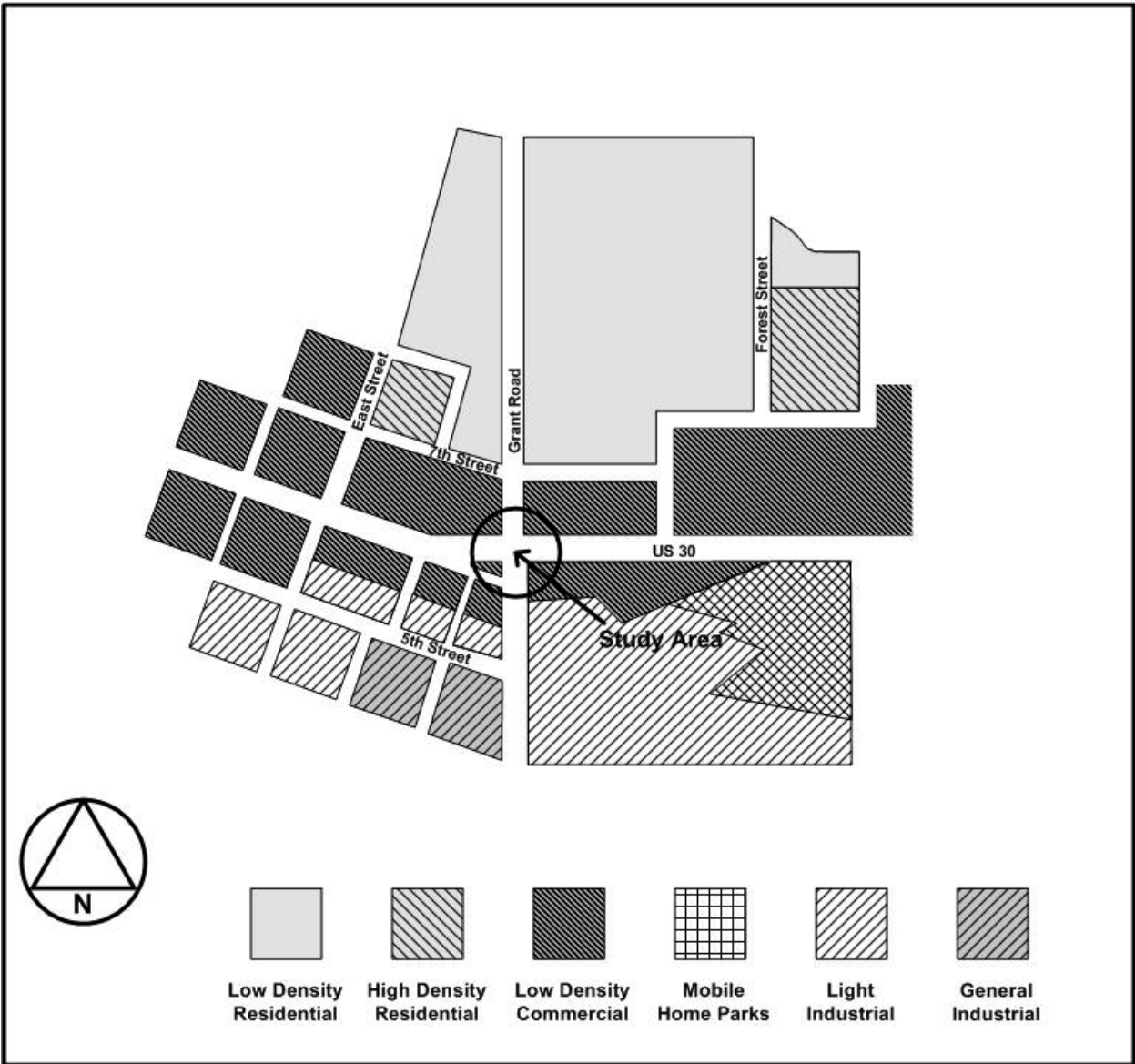

REFERENCES

- NCHRP. 2000. *Accident Mitigation Guide for Congested Rural Two-Lane Highways*. National Cooperative Highway Research Program Report 440. Washington D.C.: Transportation Research Board, National Research Council.
- FHWA. 1991. *Highway Safety Engineering Studies*. NHI Course No. 38031. Washington, D.C.: Federal Highway Administration, U.S. Department of Transportation, pp. 15–17, 61–72.
- Iowa DOT. 1989. *Accident and Related Data for Rural and Municipal Intersections in Iowa*. Ames, Iowa: Iowa Department of Transportation. Iowa.
- Iowa DOT. 2000. *Hazard Elimination Safety (HES): US 30/Grant Road, Carroll, Iowa*. Carroll, Iowa: BRW, Inc., pp. 3–24.
- Ogden, K. W. 1996. Development of Countermeasures. In *Safer Roads: A Guide to Road Safety Engineering*. Aldershot, England: Avebury Technical, pp. 135–150.
- Robertson, H. D. 1994. Traffic Accident Studies, In *Manual of Transportation Engineering Studies*, ed. H. D. Robertson, J. E. Hummer, and D. C. Nelson. Englewood Cliffs, N.J.: Prentice Hall, Inc., pp. 191–218.
- SEMCOG. 1998. *Traffic Safety Manual*. Detroit: Southeast Michigan Council of Government.

School Zone Program

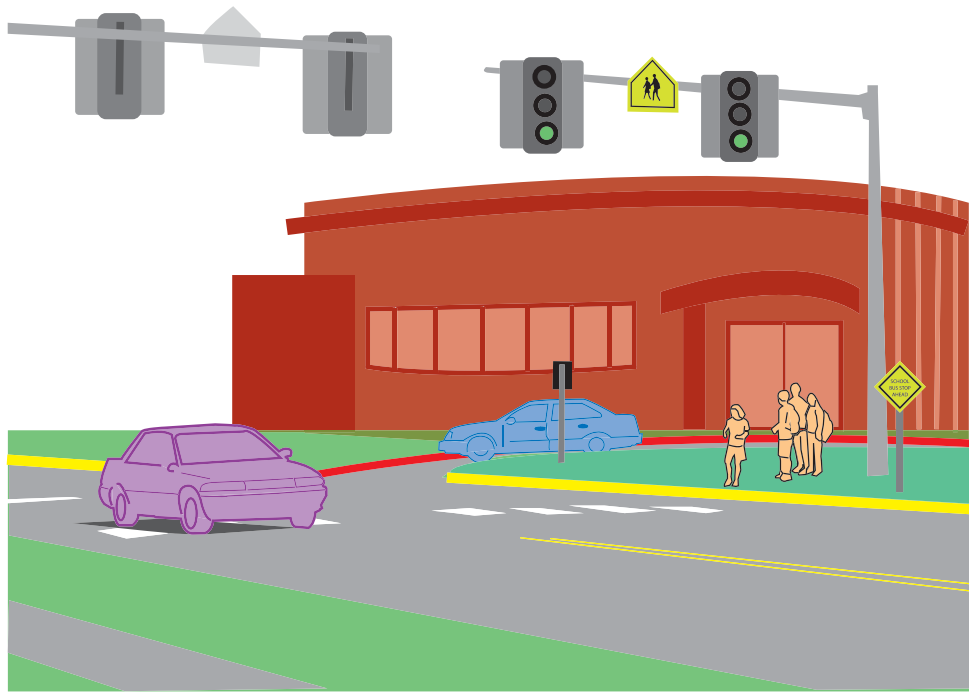

School Zone Program

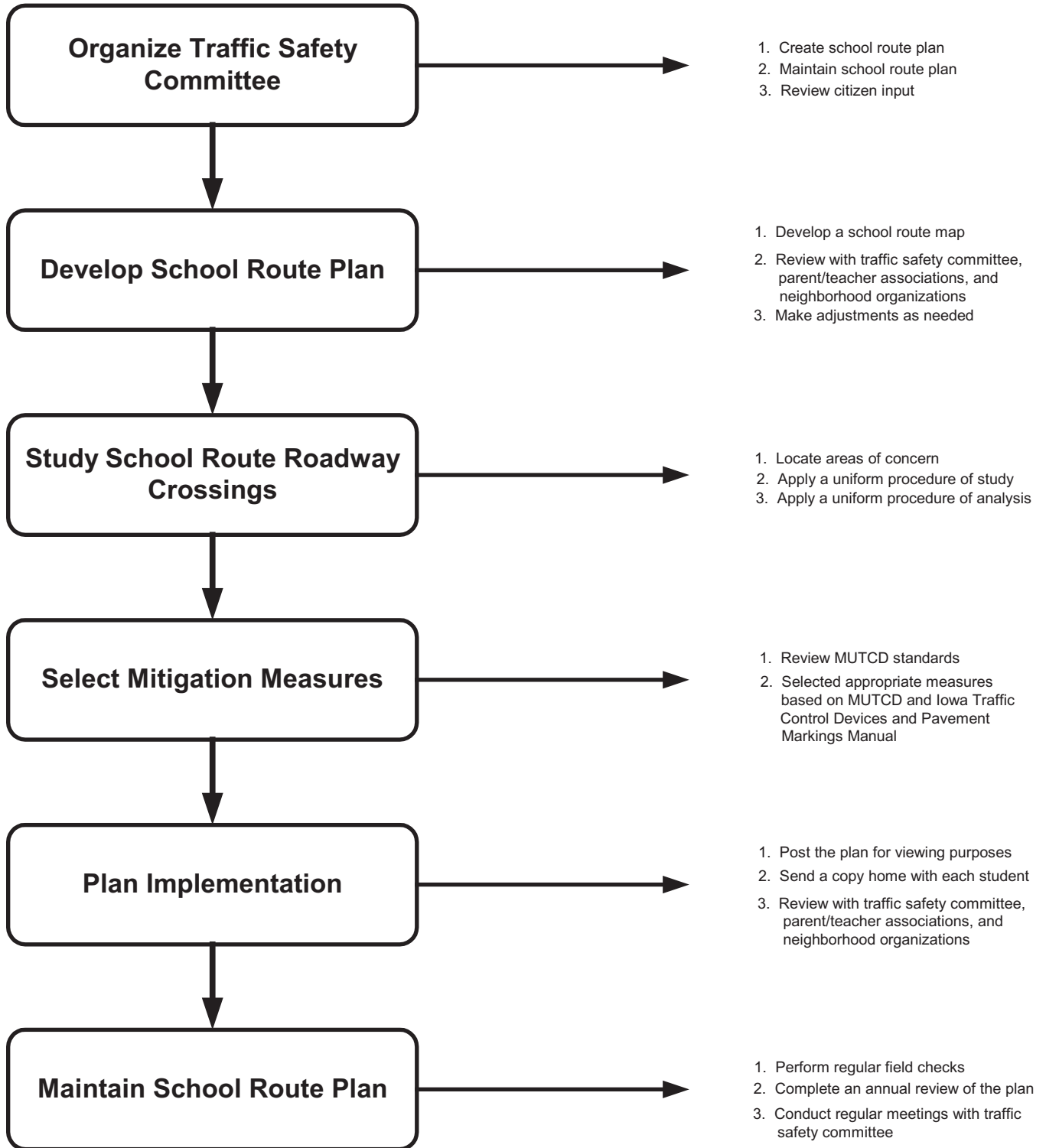

INTRODUCTION

School zone safety is one of the most pressing, controversial, and emotional concerns that elected officials, traffic engineers, city staff, school officials, and enforcement agencies are faced with. Pedestrian and bicycle safety depends upon public understanding of accepted methods for traffic control. This understanding becomes extremely important in a school zone. School children and motorists cannot be expected to navigate safely in school zones unless they understand the need for traffic control devices and how these controls function for their mutual benefit.

The following facts may be considered in the developmental stages of a school zone program (MUTCD 2001):

- Analysis shows that at many locations school crossing controls requested by parents, teachers, and other citizens are unnecessary and costly and tend to lessen the respect for controls that are warranted.
- Pedestrian safety depends in large measure upon public understanding of accepted methods for efficient traffic control.
- Non-uniform procedures and devices cause confusion among pedestrians and vehicle operators, prompt wrong decisions, and can contribute to accidents.
- The type of school area traffic control used, either warning or regulatory, must be related to the volume and speed of traffic, roadway width, and the number of children crossing.

Note that the school zone program described here does not serve to select the device or solution for a particular situation. Instead, a procedure is outlined for logical selection of locations where school zone safety concerns exist. Engineering judgment is applied to the process of selecting a uniform approach.

RESPONSIBILITY FOR THE SAFETY OF SCHOOL PEDESTRIANS

The responsibility to provide safe walking and biking conditions and to develop self-reliance and safe habits among children is shared by parents, school authorities, government agencies, and the children themselves. Parents hold the basic responsibility of their children walking and biking to and from school. School and traffic officials work to provide the appropriate traffic control devices. Without the full cooperation of the parents, the program may not be successful. Parents are obligated to understand traffic regulations and control measures and to make sure their children also understand them (Des Moines Safety Council 1997). By their example, parents are the greatest influence in their child's development of safe and self-reliant actions.

KEY STEPS TO A SCHOOL ZONE PROGRAM

Development of a school zone program includes six key steps (ITE 1988):

1. Organize a traffic safety committee.
2. Develop a school route plan.
3. Configure the school site.
4. Consider other relevant elements.
5. Select mitigation measures (not within the scope of the handbook).
6. Distribute and maintain school route plan.

Organize a Traffic Safety Committee

The traffic safety committee is a key tool to aid in the development and maintenance of a school zone safety program. The traffic safety committee should be composed of government and school board officials who have the authority, interest, and ability to get things accomplished. A jurisdiction's traffic engineer, the chief of police, and school representatives should be official members. The manager of the local safety council, the presidents of parent-teacher associations (PTAs), and representatives of other interested organizations can also serve on the committee.

The duties of the committee are to guide and coordinate all activities connected with the school zone safety program. These activities may include the following (ITE 1988):

- Establish policies and procedures within the program.
- Develop a school route map.
- Review and approve the various phases of the school traffic safety program.
- Review and handle complaints and requests from citizens.
- Establish priorities on projects to administer.
- Promote good public relations.
- Take immediate action to correct emergency school traffic safety concerns.

Develop a School Route Plan

The school traffic safety committee should take the lead to develop a suggested school route plan for schools serving elementary and kindergarten students. Many kinds of existing information may be necessary to develop the plan. The school principal, the PTA, or any organized citizen group involved in public safety may provide information pertaining to the following items:

- student walking areas
- safety patrol and/or crossing guard locations
- locations of concern
- school hours

The school route plan should include a map that shows the following (see Figure 6.1; ITE 1988):

- the school
- nearby roadways
- existing traffic control devices
- the suggested school route for children to follow

The following criteria may be considered when developing a school route plan (ITE 1988):

- The school route plan should be designed to provide maximum protection to the children at a minimum cost to the taxpayer.
- School route plans should be designed to take advantage of existing of traffic control devices.
- School children should be thoroughly instructed by the schools and parents on the purpose and proper use of the school rout plan. Each child should be provided with a copy of the map showing the school route plan.

The ideal uses and functions of the school route plan map are as follows (Bismark 1986):

- to guide children and avoid roadside and intersection hazards
- to provide for the most effective use of protective measures such as traffic control signals, stop signs, pavement markings, and sidewalks
- to minimize the number of crossings on major traffic roadways
- to maximize the use of existing sidewalks and roadways that have wide smooth shoulders
- to choose roadway crossings with adequate sight distance
- to provide a basis for engineering studies of school related traffic control devices
- to indicate priorities for sidewalk construction

Configure the School Site

Figure 6.2 is an example school site configuration. This site was reconstructed some years after the initial construction was completed. The purpose of the reconstruction was to provide a higher level of safety. The school site was designed to separate staff and visitor parking (bottom left) from the student drop off and pickup area (top left). As shown, the arterial roadway (off the school site) in front of the school is designed for student drop off and pickup. The only parking that is allowed in the access driveway on the school site is for school buses (bottom right) and handicapped individuals (top right). There is a wide sidewalk between the school building and the access driveway to allow students to move freely.

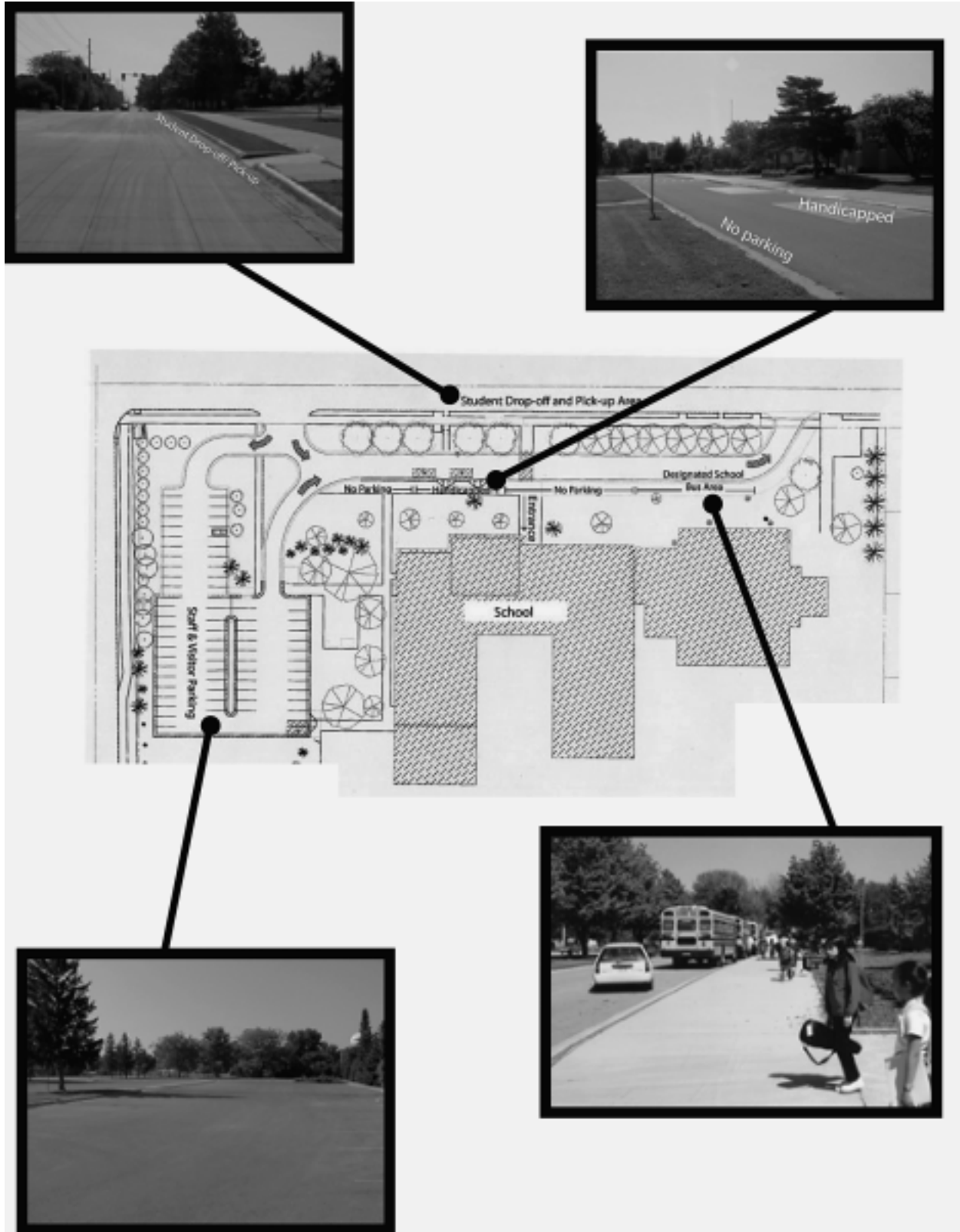

Figure 6.2. Example School Site Configuration

Consider Other Relevant Elements

A school zone safety program may also consider the following relevant elements:

- school bus operations
- school crossings where concerns have been expressed
- appropriate traffic control devices or assistance measures

School Bus Operations

The safe and efficient management of bus transportation of students is a critical element of a school zone safety program. Although school buses are not involved in a large number of traffic crashes, they are important because of their size, limited maneuvering characteristics, and the site restriction they create.

It is important to establish school bus routes that provides safe, efficient, and economical transportation of students. Bus stops should be designed to provide the safest location for stopping the bus and loading or unloading students. This includes the bus stop(s) located at/on a school site. A safe sight distance of approaching vehicles is one of the critical elements of providing a safe bus stop. Children need this critical sight distance for crossing the street safely.

The following information may be helpful in establishing school bus routing (Missouri Safety Center 1996):

- the location of students' residences
- the grade and age of students to be transported
- the type and condition of roads
- the standard of service required
- the funds available for transportation service
- the general safety of all routes in relation to hazards such as hills, intersections, railroad crossings, bridges, sharp curves, and obstructions to sight distance
- the safety of loading/unloading stops in relation to visibility of approaching vehicles
- the walking distance to the bus stop in relation to the age of the student

School Crossings Where Concerns Have Been Expressed

During the development of the school route plan, a school route may cross a major roadway. By applying a uniform procedure of study and analysis to each crossing, it is possible to make

recommendations and assign priorities for the application of traffic control devices or other measures.

For information regarding the procedure for making field studies for an analysis at a location where concerns have been expressed, refer to *A Program for School Crossing Protection* (ITE 1988). The recommended procedure for study is based on the following assumptions:

- Alternating gaps and blockades are formed in the vehicular traffic stream in a pattern related to each location. This requires an analysis of the concerns at each location.
- Pedestrians will wait a reasonable time for an adequate gap in traffic before crossing a roadway.

Appropriate Traffic Control or Assistance Measures

There are several specific standard guidelines and warrants for the application of signs, markings, and signals that would ordinarily be installed on roadways near school sites. To obtain these detailed guidelines, refer to Part 7 (Traffic Controls for School Areas) of the *Manual for Uniform Traffic Control Devices* (MUTCD 2001). Some example traffic control devices and assistance measures are given here. Note: the decision to use a particular device at a particular location should be made on the basis of an engineering study.

Signs. Uniformity of the physical characteristics of signs is critical in school areas.

Consequently, the removal of any nonstandard signs should carry a high priority. Signs that are associated with school areas include “School Crossing,” “School Bus Stop Ahead,” “School Speed Limits,” “End of School Zone,” and “Flashing Yellow Breakers” signs. See Figure 6.3.



Figure 6.3. School Site Signs

Markings. Markings have definite and important functions in a proper school area traffic control plan. Markings may be used to supplement the regulations and warnings provided by other devices such as traffic signs or signals. Markings can also be used on their own to produce results that cannot be obtained from any other device. See Figure 6.4.



Figure 6.4. School Site Markings

Crosswalks. Crosswalks are marked when there is a need for increased visibility and designation of the crossing area. Crosswalks are typically marked at the following locations:

- school crossings approved by the local agency, governing body, safety commission, school principal, etc.
- arterial crossing manned by adult crossing guards
- signalized intersections equipped with pedestrian signals
- crossing on recommended school route plan
- crossings at two-way and four-way stop intersections
- intersection crossings with unusual geometric design where the pedestrian or bike path is confusing and could lead to potential conflict

See Figure 6.5.



Figure 6.5. Marked Crosswalk

Traffic Signals. Standard traffic signals may be warranted at established school crossings where there is a need to create adequate gaps in vehicular traffic for pedestrian and bike crossings. The patterns of adequate vehicular gaps in the traffic stream are unique to each crossing and form the basis for determining the proper control device or technique. See Figure 6.6.



Figure 6.6. Signalized Crosswalk

Crossing Supervision. Many school crossings involve traffic situations problematic to young pedestrians despite the proper application of traditional traffic control devices. In these cases, adult crossing guards, police officers, or student patrol may supervise school crossings. See Figures 6.7 and 6.8.



Figure 6.7. Student Patrol



Figure 6.8. Adult Crossing Guard

Distribute and Maintain School Route Plan

Once the school route plan has been developed, it is distributed to users and maintained by school authorities.

School Route Plan Distribution

The school route plan should be transmitted to the agency responsible for traffic control in a given jurisdiction for final approval. Upon approval, the school should post a copy where everybody can view it. Instructions should be given on general pedestrian safety rules, and on of the use the plan. A copy of the plan should be sent home with each student so that parents can assist in identifying and explaining the correct route to school for their children.

School Route Plan Maintenance

Regular field checks by school authorities should be undertaken to make sure that students are following recommended routes to school. Lack of compliance with the plan should be investigated to determine if corrective measures or a plan revision is required.

The school route plan is reviewed annually to determine whether revisions are necessary due to changes in school district boundaries, new sidewalk construction, installation of new traffic control devices, or other factors that affect pedestrian and bike safety. Along with changes, necessary revisions should also be made on the map that displays sidewalk location, intersection traffic controls, and school-related traffic controls.

EXAMPLE SCHOOL ZONE PROGRAM STUDY

The city of Scottsville's elementary school is considering developing a school zone safety program. Concern has been expressed at PTA meetings about the overall safety of children walking or biking to and from school. Currently there is not a school route plan in place. Consequently, Scottsville Elementary School has decided to implement a school zone safety program.

Scottsville Elementary School organized the Scottsdale Elementary School Traffic Safety Committee. The goal of the committee was to develop a school route plan. Along with the

development of this plan, the committee desires to handle public input positively and to promote good public relations.

The committee developed a school route map depicting the school, roadways, existing traffic control devices, and a suggested route for children to follow walking or biking to and from school. During the process of developing the school route map, the committee identified two intersections of concern, as illustrated in Figure 6.9. These were also the areas that the PTA had expressed concerned with. The committee desires to evaluate the traffic conditions at these locations.

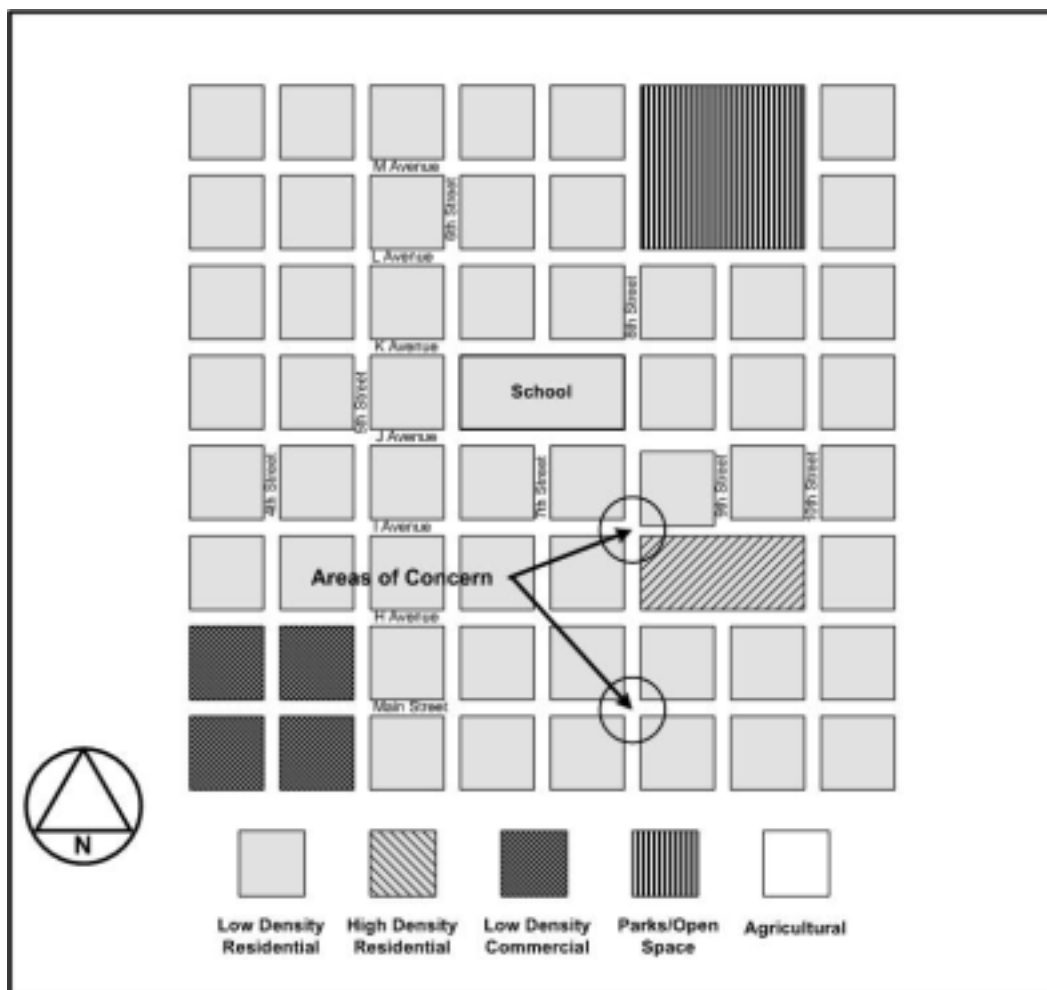

Figure 6.9. Example School Zone Map

The committee met with the local law enforcement and city traffic engineering officials to present the school route map. The main concern of the committee was the crash history and

speeding in this area. The local law enforcement officials replied that the only concern they had was at the intersection of Main Street and 8th Street. There had been complaints from citizens about speeding and there was an existing crash history at that intersection.

The committee presented the school route map to the city administrator for Scottsville and requested assistance in conducting initial traffic studies.

The city conducted preliminary spot speed studies (as explained in Chapter 2 of this handbook) at both of the intersections. The city calculated the 85th percentile of speed for both intersections. The city found that at the intersection of I Avenue and 8th Street the 85th percentile of speed was 1 mph below the posted speed limit. At the intersection of Main Street and 8th Street the 85th percentile of speed was 7 mph over the posted speed limit. A 5-mph rule of thumb is sometimes used to determine whether the 85th percentile of speed is high compared to the posted speed limit. If the 85th percentile of speed is 5 mph or more above the posted speed limit, the situation should be evaluated. In this case, the 85th percentile of speed was 7 mph above the posted speed limit, so speeding may be an issue. This intersection should be considered for further speeding evaluation. Several actions may be considered as described in Chapter 2 of this handbook.

The city also conducted preliminary 15-minute traffic volume counts at both intersections (as described in Chapter 3 of this handbook). The city conducted the volume counts and compared the results with historic traffic volume counts. The 15-minute counts were consistent with the historic traffic counts.

The city staff used a measuring wheel, a target rod, and sighting rod (as shown in Chapter 4 of this handbook) to conduct an intersection sight distance study at both intersections. The results of the study showed the sight distance at both intersections was adequate.

At this point, the city decided the school route plan could not continue without further assistance because of possible safety issues within the school route area. The city wishes to have a consulting engineering firm analyze the traffic conditions within the area included within the school route map. Information on contracting for a school zone safety program study, including a project work order using the Scottsville example, follows.

CONTRACTING FOR A SCHOOL ZONE PROGRAM STUDY

Information Gathering

Before a jurisdiction contacts an engineering consulting firm to perform a school zone study, a variety of information may need to be collected. Any information provided may aid the consulting firm in adequately completing their analysis. The following is a list of possible information that an engineering consulting firm may use:

- issue at hand
- crash history
- preliminary speed studies
- traffic volumes
- sight distances
- documentation from PTAs
- traffic control devices
- roadway classifications
- posted speed limits in and around study area
- school hours
- list of regularly scheduled events
- student demographics
- school site map
- school bus operations/schedules
- pedestrian access ways
- citizen input
- location map
- appropriate contact persons
- any other relevant information

The following project work order may assist local governments in contracting to an engineering firm. The example project work order contains information comes from the school zone example (a blank form is presented in Appendix E).

Project Work Order: School Zone Program Study

Referenced Agreement

This work order is part of an agreement between McIntyre Engineering and the city of Scottsville for municipal traffic engineering services.

Project Location Description

This work involves conducting a school zone safety study around the location of Scottsville Elementary School. A map depicting the location is attached.

Obligation of the City/County

The city shall provide the following items to the consultant: traffic volume counts, traffic volume projections, right-of-way information, truck route information, student population and address, and school hours.

Scope of Consultant Services

This work scope includes the completion of a traffic and pedestrian and bike operations study. Traffic volume counts, speed studies, sight distance measurements, and crash analysis are also included. This work involves data collection and evaluation of existing traffic control devices within the study area.

Schedule

Field meeting date: _____
Estimated date of preliminary deliverable: _____
Estimated date of final deliverable: _____

Compensation

Labor cost \$ _____
Direct expenses \$ _____
Subcontractor cost \$ _____
Overhead \$ _____
Maximum payable \$ _____

Authorization

_____ City of Scottsville City/County	_____ McIntyre Engineering Contractor
_____ City/County Administrator	_____ Project Manager's Name/Title
_____ Signature	_____ Signature
_____ Date	_____ Date

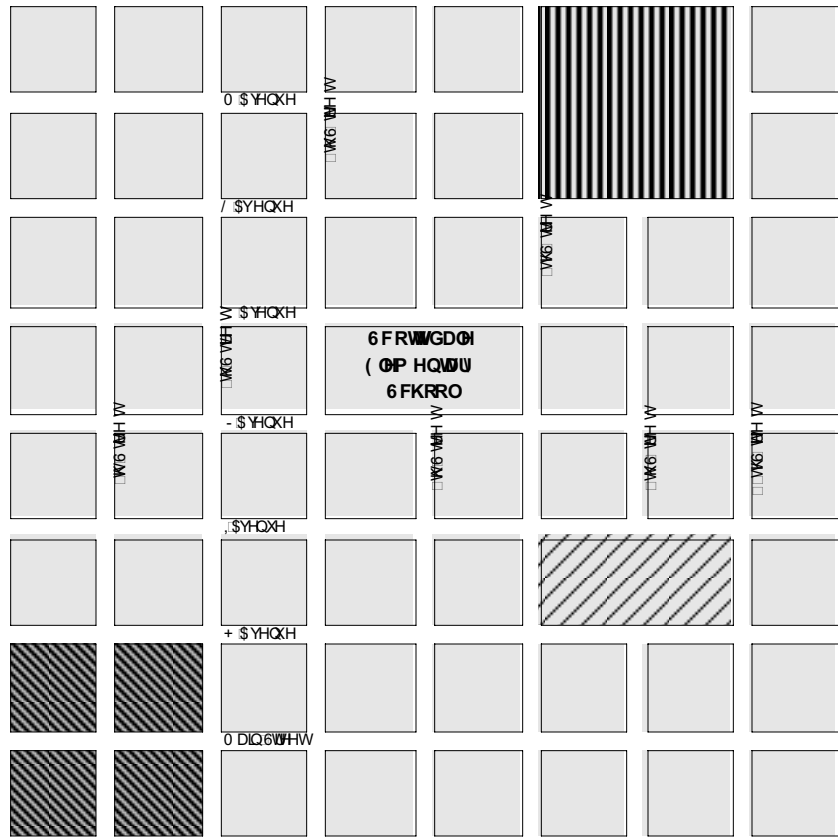
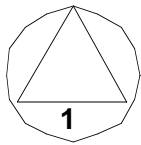

/ RZ □ HQVW
5 HMLGHQWDO

+ U K □ HQVW
5 H/IGHQWDO

/ RZ □ HQVW
&RP P HFLDO

3 DUV 2 SHQ
6 SDFH

\$ J UFXQWDO

REFERENCES

- Benjamin Design Collaborative. 2000. *School Site Configuration*. Ames, Iowa: Benjamin Design Collaborative.
- Bismark. 1986. *School Crossing Studies*. Bismark, N.D.: Bismark.
- Des Moines Safety Council. 1997. *Manual for School Crossing Control*. Des Moines, Iowa.
- FHWA. 2001. Part 7: Traffic Controls for School Areas. In *Manual on Uniform Traffic Control Devices: Millennium Edition*. Washington, D.C.: Federal Highway Administration, U.S. Department of Transportation.
- ITE. 1988. *A Program for School Crossing Protection*. Washington D.C.: Institute of Transportation Engineers.
- Missouri Safety Center. 1996. *School Transportation and Traffic Safety*. Jefferson City, Mo.: Missouri Department of Transportation, pp. 53–61.

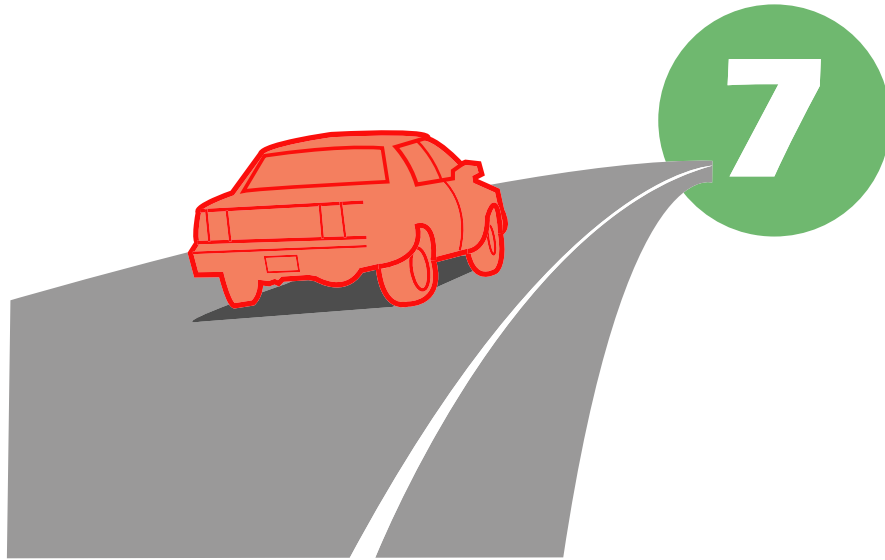

Appendixes

Appendixes

Appendix A: Spot Speed Study Data Forms

A.1. Stopwatch Spot Speed Study Data Forms

A.2. Radar Meter Spot Speed Study Data Form

Appendix B: Traffic Volume Count Intersection Tally Sheet

Appendix C: Sight Distance Diagram Form

Appendix D: Crash Analysis Field Observation Report, Software Instructions, and Guidelines

D.1. Field Observation Report

D.2. Access-ALAS/CMAT Instructions

D.3. Intersection Magic Instructions

D.4. Guidelines for Identifying Data Needs and Studies

Appendix E: Project Work Order (Contracting Out)

APPENDIX A: SPOT SPEED STUDY DATA FORMS

A.1. Stopwatch Spot Speed Study Data Form

Date: _____		Start Time: _____	
Name: _____		End Time: _____	
Location: _____		Down Time: _____	
Speed Limit: _____		Weather: _____	

Seconds	mph for — feet	Passenger Vehicles		Buses		Trucks		Total
		Record	No.	Record	No.	Record	No.	
1.0								
1.2								
1.4								
1.6								
1.8								
2.0								
2.2								
2.4								
2.6								
2.8								
3.0								
3.2								
3.4								
3.6								
3.8								
4.0								
4.2								
4.4								
4.6								
4.8								
5.0								
5.2								
5.4								
5.6								
5.8								
6.0								
6.2								
6.4								
6.6								
6.8								
7.0								
Total								

Stopwatch Spot Speed Study Data Form for 88 Feet

Date: _____		Start Time: _____						
Name: _____		End Time: _____						
Location: _____		Down Time: _____						
Speed Limit: _____		Weather: _____						
Seconds	mph for 88 feet	Passenger Vehicles		Buses		Trucks		Total
		Record	No.	Record	No.	Record	No.	
1.0	60.0							
1.2	50.0							
1.4	42.8							
1.6	37.5							
1.8	33.3							
2.0	30.0							
2.2	27.2							
2.4	25.0							
2.6	23.0							
2.8	21.4							
3.0	20.0							
3.2	18.7							
3.4	17.6							
3.6	16.6							
3.8	15.7							
4.0	15.0							
4.2	14.2							
4.4	13.6							
4.6	13.0							
4.8	12.5							
5.0	12.0							
5.2	11.5							
5.4	11.1							
5.6	10.7							
5.8	10.3							
6.0	10.0							
6.2	9.6							
6.4	9.3							
6.6	9.0							
6.8	8.7							
7.0	8.5							
Total								

Stopwatch Spot Speed Study Data Form for 176 Feet

Date: _____		Start Time: _____						
Name: _____		End Time: _____						
Location: _____		Down Time: _____						
Speed Limit: _____		Weather: _____						
Seconds	mph for 176 feet	Passenger Vehicles		Buses		Trucks		Total
		Record	No.	Record	No.	Record	No.	
1.0	120.0							
1.2	100.0							
1.4	85.7							
1.6	75.5							
1.8	66.6							
2.0	60.0							
2.2	54.5							
2.4	50.0							
2.6	46.1							
2.8	42.8							
3.0	40.0							
3.2	37.5							
3.4	35.2							
3.6	33.3							
3.8	31.5							
4.0	30.0							
4.2	28.9							
4.4	27.2							
4.6	26.1							
4.8	25.0							
5.0	24.0							
5.2	23.0							
5.4	22.2							
5.6	21.4							
5.8	20.6							
6.0	20.0							
6.2	19.3							
6.4	18.7							
6.6	18.1							
6.8	17.6							
7.0	17.1							
Total								

A.2. Radar Meter Spot Speed Study Data Form

Date: _____			Start Time: _____				
Name: _____			End Time: _____				
Location: _____			Down Time: _____				
Speed Limit: _____			Weather: _____				
Speed	Passenger Vehicles		Buses		Trucks		Total
	Record	No.	Record	No.	Record	No.	
15							
16							
17							
18							
19							
20							
21							
22							
23							
24							
25							
26							
27							
28							
29							
30							
31							
32							
33							
34							
35							
36							
37							
38							
39							
40							
41							
42							
43							
44							
45							
46							
47							
48							
49							
50							
Total							

APPENDIX B: TRAFFIC VOLUME COUNT INTERSECTION TALLY SHEET

Intersection Volume Count

Cars=passenger cars, station wagons, motorcycles, and pick-up trucks
 Trucks=other trucks and buses. (Record school buses with SB.)

N/S Street _____
 E/W Street _____
 Intersection Control _____

Time _____ to _____
 Date _____
 Weather _____ 
 Observer _____

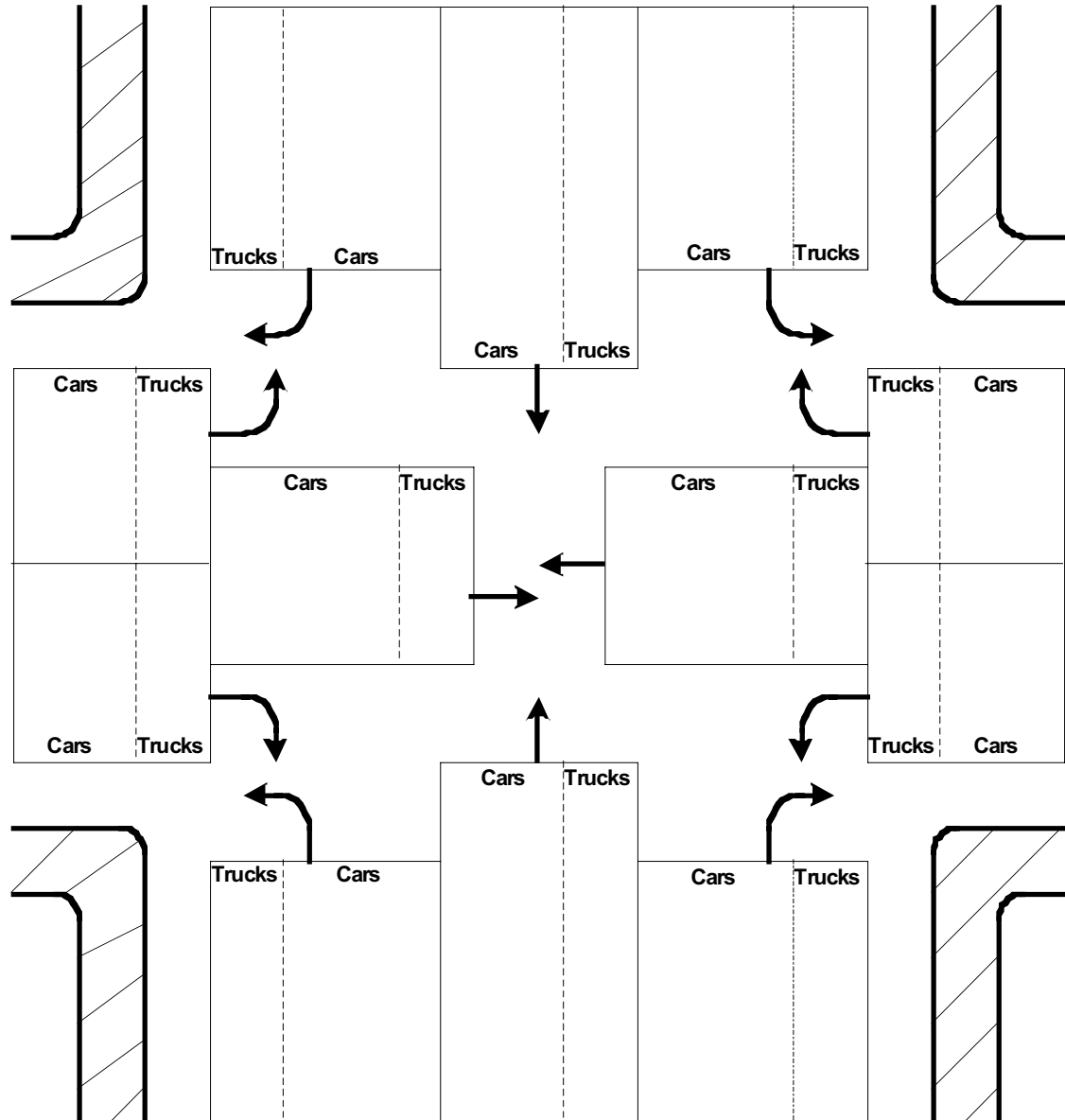

APPENDIX C: SIGHT DISTANCE DIAGRAM FORM

Date	
Time of Day	
Speed (Posted or 85%)	
Traffic Controls Present	
Intersection Maneuver	
Weather	
Horizontal Curve	Y or N
Vertical Curve	Y or N

Major Roadway Width	
No. of Lanes	
Minor Roadway Width	
No. of Lanes	

Y Stopping Distance	
X(R) Recommended	
X(M) Measured	

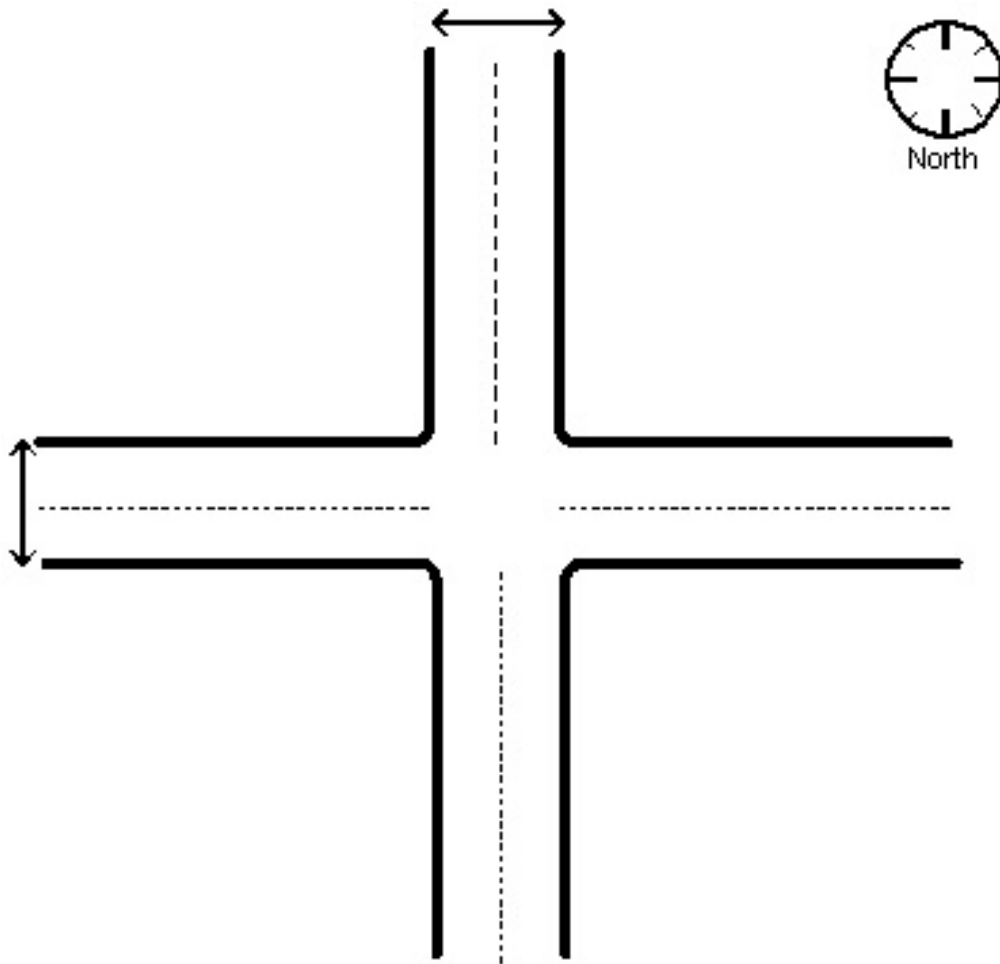

Conclusion: _____

APPENDIX D: CRASH ANALYSIS FIELD OBSERVATION REPORT, SOFTWARE INSTRUCTIONS, AND GUIDELINES

D.1. Field Observation Report

A crash analysis field observation report (from the Federal Highway Administration, 1991) appears on the following three pages.

FIELD OBSERVATION REPORT

Location _____ Date _____

Observer _____ Time _____

PART I - PHYSICAL CHECKLIST

	No	Yes	Comments
1. Are there sight distance obstructions to: a. Traffic control devices? b. Intersections and driveways? c. Turning or oncoming vehicles?	___	___	_____
2. Does parking affect: a. Sight distance? b. Through or turning vehicle paths?	___	___	_____
3. Is horizontal alignment inadequate?	___	___	_____
4. Is vertical alignment inadequate?	___	___	_____
5. Is pavement width or the number of lanes inadequate?	___	___	_____
6. Are intersection or driveway radii too short?	___	___	_____
7. Are there problems with driveways such as: a. Inadequate design? b. Location near major intersection? c. Too many driveways?	___	___	_____
8. Is channelization inadequate for: a. Reducing conflict points? b. Separating traffic flows or defining movements?	___	___	_____
9. Should pedestrian crosswalks be: a. Added? b. Relocated or repainted?	___	___	_____
10. Are there problems with traffic signs such as: a. Inadequate or improper message? b. Too many signs? c. Placement or size?	___	___	_____
11. Are there problems with traffic signals such as: a. Timing? b. Number of signal heads? c. Placement or size?	___	___	_____
12. Are there problems with pavement markings such as: a. Vehicle paths not clearly marked? b. Location of the markings?	___	___	_____
13. Do posted speed limits appear to be too high or too low for conditions?	___	___	_____
14. Does the pavement condition (potholes, irregular surface, etc.) appear to contribute to safety problems?	___	___	_____
15. Is roadway lighting inadequate?	___	___	_____
16. Are there tire skid marks on the pavement?	___	___	_____
17. Is there evidence of vehicle accidents such as scar marks on trees, utility poles, embankments, or other objects?	___	___	_____
18. Is there an abundance of vehicle accident debris such as small pieces of crushed glass, plastic, etc., along the shoulder or in the median area?	___	___	_____

FIELD OBSERVATION REPORT (CONTINUED)

PART II - OPERATIONAL CHECKLIST

	No	Yes	Comments
1. Do obstructions block the driver's view of opposing or conflicting vehicles?	—	—	
2. Do drivers have trouble finding the correct path through the location?	—	—	
3. Is there any indication of driver confusion about routes, street names, or other guidance information?	—	—	
4. Do steep grades create large speed differences?	—	—	
5. Are pavement surface conditions creating erratic driver movements?	—	—	
6. Does the presence of existing driveways contribute to erratic driver movements?	—	—	
7. Is excessive vehicle delay creating unsafe risk taking by motorists?	—	—	
8. Are there large speed differences between vehicles:			
a. Traveling through the location?	—	—	
b. Turning at driveways or intersections?	—	—	
9. Do drivers respond incorrectly to:			
a. Signals?	—	—	
b. Signs or other traffic control devices?	—	—	
c. Turning lanes?	—	—	
10. Are problems being caused by the volume of:			
a. Through traffic?	—	—	
b. Turning traffic?	—	—	
11. Do pedestrian movements create conflicts?	—	—	
12. Do bicycle movements create conflicts?	—	—	
13. Is there considerable weaving or lane changing by drivers at the location?	—	—	
14. Are there violations of parking at the location?	—	—	
15. Are there violations of other traffic control devices or regulations such as:			
a. Running red light?	—	—	
b. Failing to stop or yield the right-of-way?	—	—	
c. Speed limits?	—	—	
d. Right-turn-on-red?	—	—	
e. Other?	—	—	
16. Are there traffic flow problems or traffic conflict patterns associated with turning vehicles?	—	—	
17. Are there any other unusual traffic flow problems or traffic conflict patterns?	—	—	
18. Does inadequate lighting cause drivers to slow down or create erratic maneuvers?	—	—	

FIELD OBSERVATION REPORT (CONTINUED)

PART III - SKETCH OF LOCATION

Instructions: In the space below, draw a free hand sketch of the location and identify areas with considerable vehicle accident debris and mark the paths of any obvious high-risk movements.

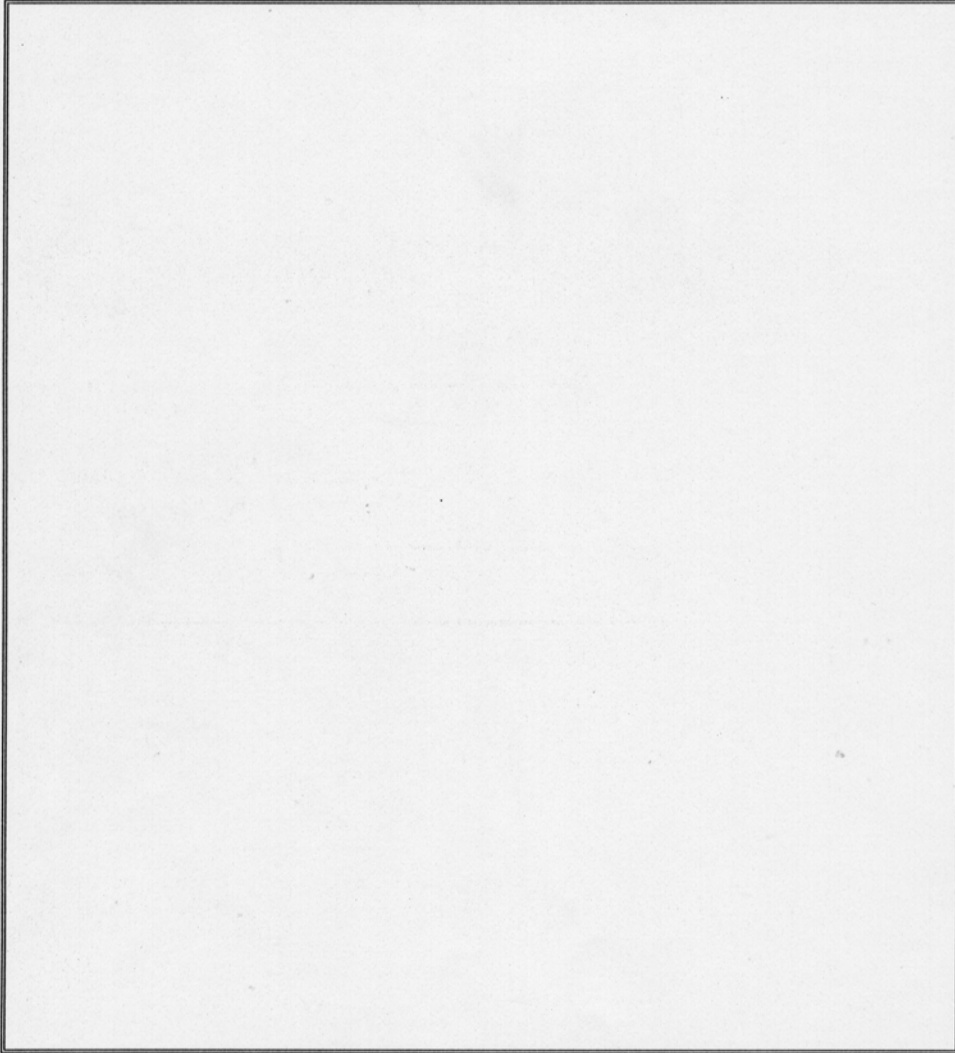

D.2. Access-ALAS/CMAT Instructions

A crash analysis can be performed using Access-ALAS (accident location and analysis system) and Crash Mapping Analysis Tool (CMAT) software packages (available to jurisdictions from the Iowa DOT upon request). If these programs are not currently installed on your PC, follow the installation directions, then proceed with the analysis as follows.

First, open Access-ALAS.

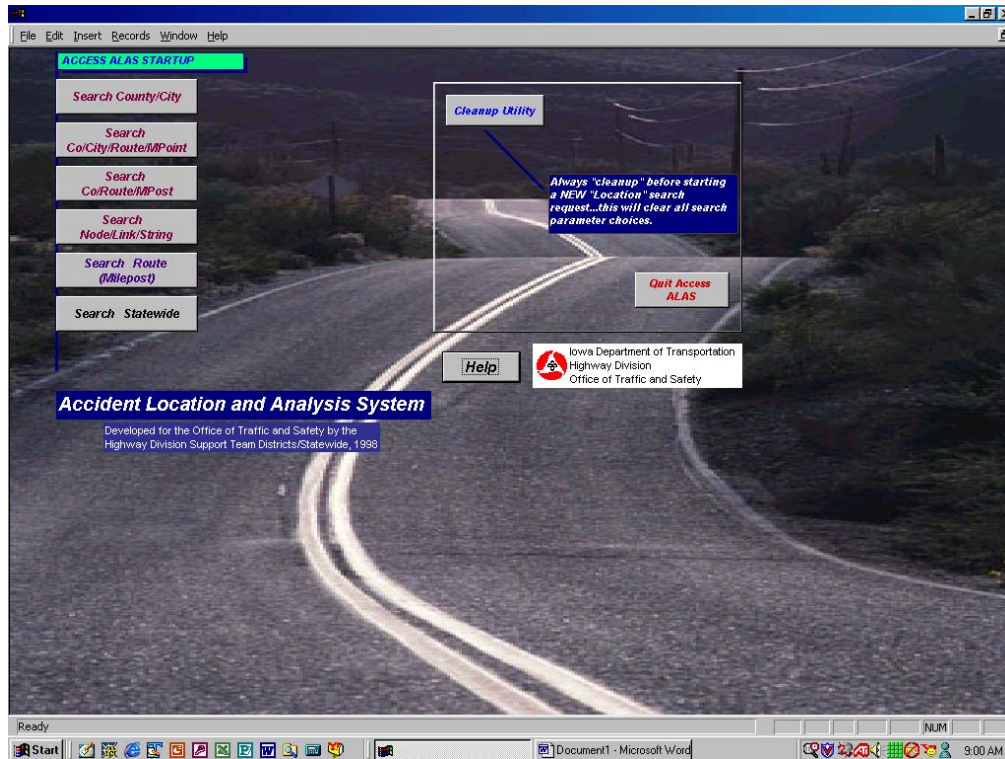

Click the “Help” icon. This will bring you to the next screen.

Click the “Re-Link” icon. This will bring up a new menu.

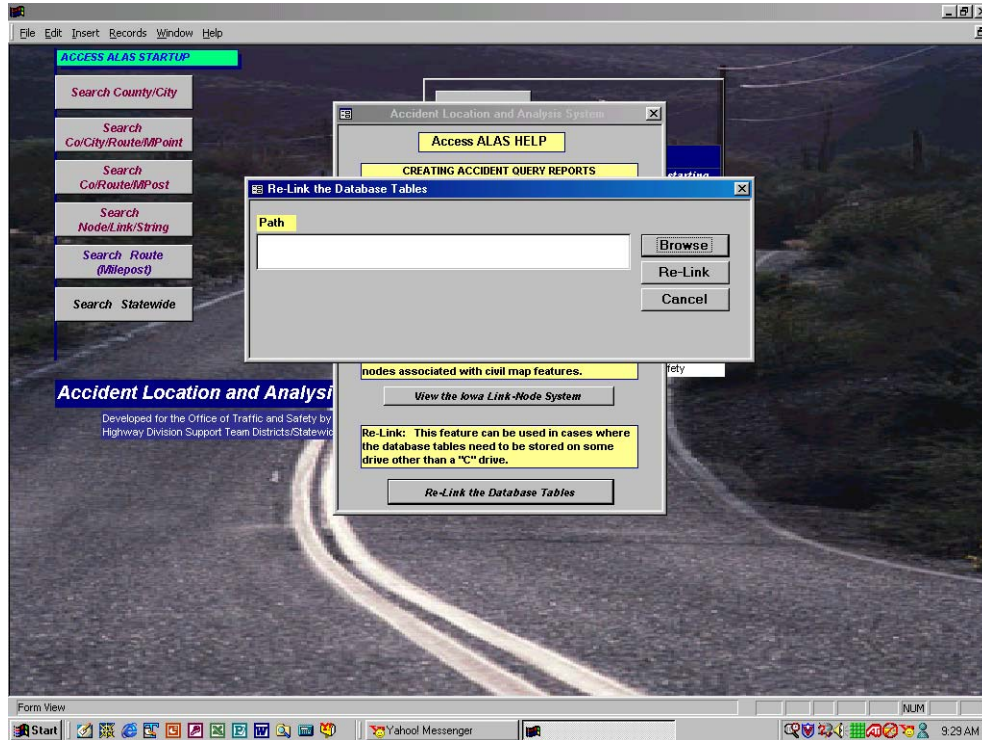

At this menu, click “Browse.” And select the C:/Drive, as shown below (the C:/Drive is where the crash data file is installed).

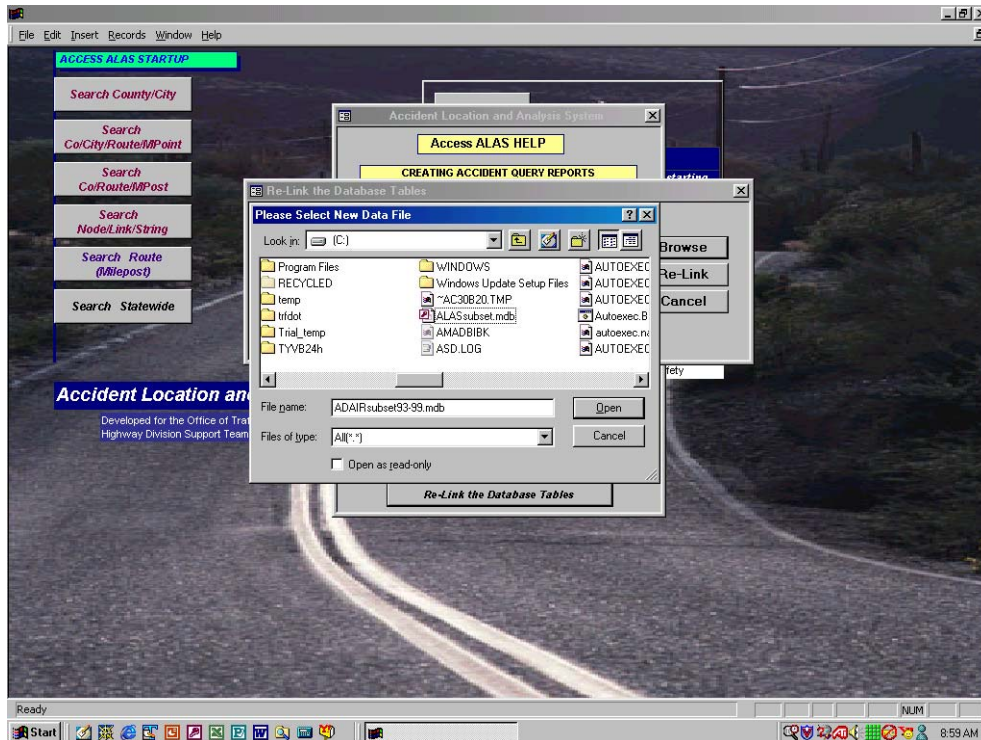

Once the C:/Drive is selected, find and double-click the ALAS Subset.mdb crash data file. A new menu should appear.

Click the “Re-Link” button. A message should appear saying the re-linking was successful.

Close the message window and re-link window. At this point you may choose to use either Access-ALAS (for link-node searches) or CMAT (for map based searches).

Before entering CMAT, minimize (do not exit) Access-ALAS.

Open CMAT by double-clicking the CMAT icon on the desktop. The screen below is the first screen that appears.

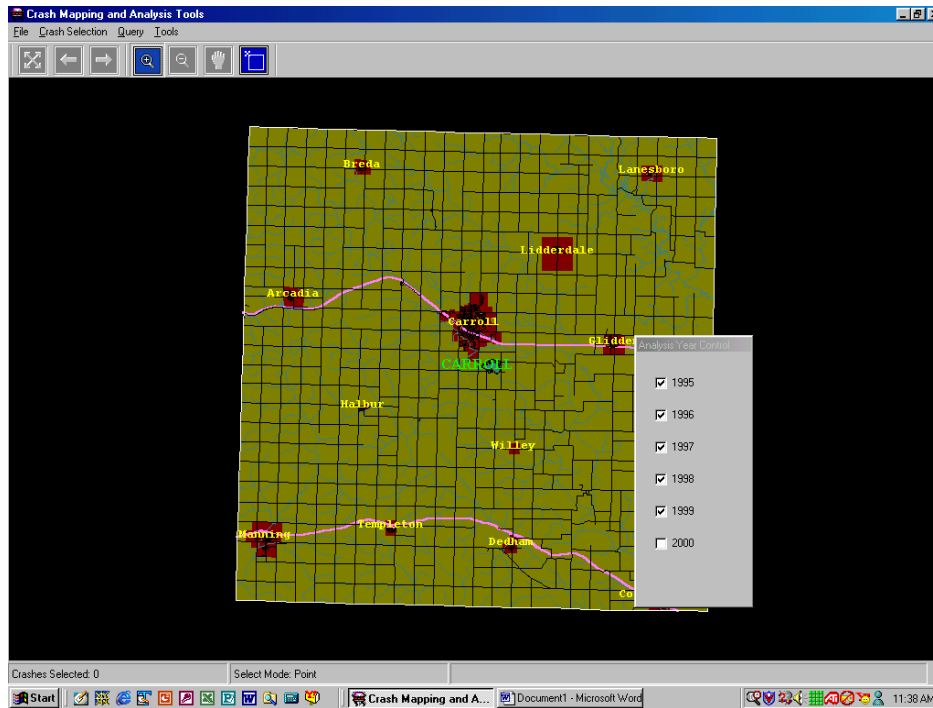

You can turn off any of the years of data not needed for your analysis by clicking on them.

Once you have selected the years for your query, select the “Crash Selection” menu.

In the dropdown menu, select “Spatial Selection Settings.” This will allow you to modify the size of your analysis area.

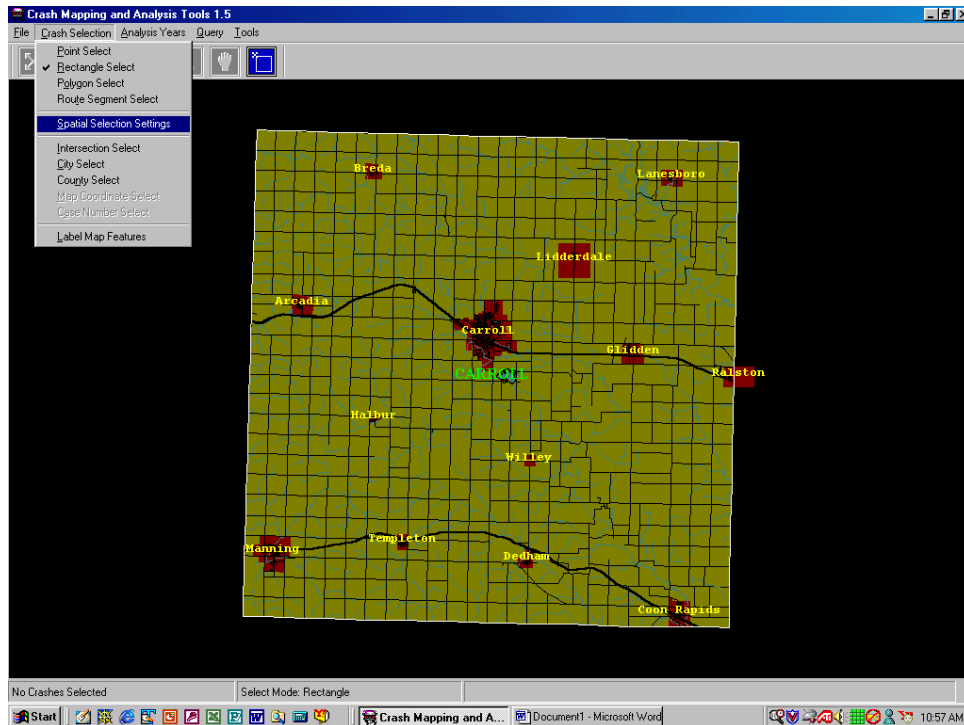

When “Spatial Selection Settings” is selected, the following screen appears.

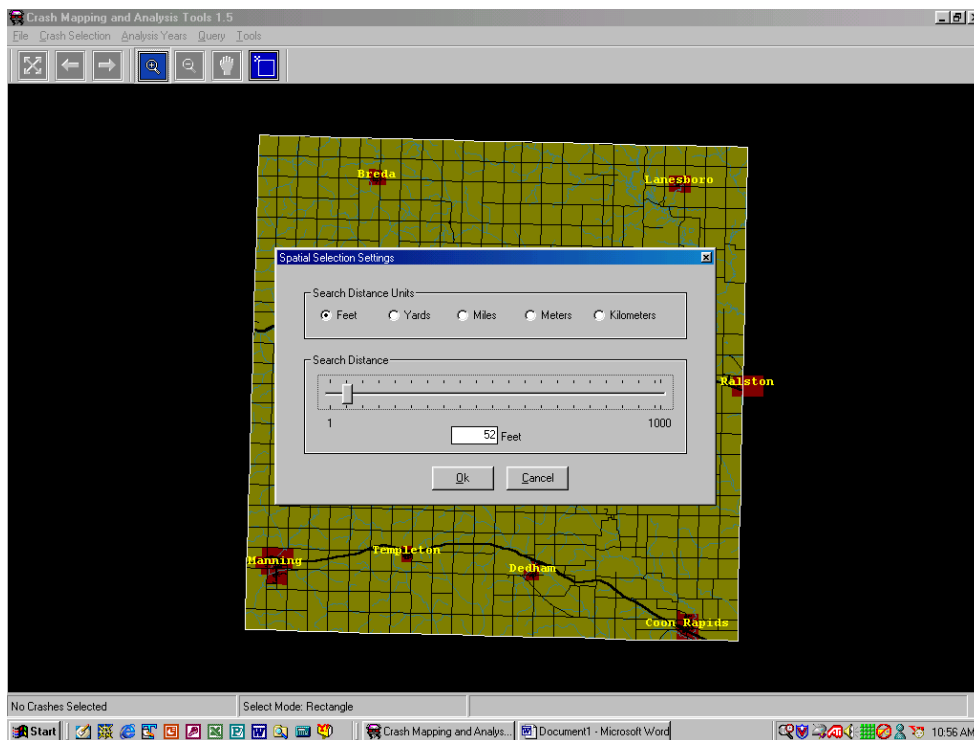

This is where you select the size of your analysis area. Choose the desired unit of length and then move the bar from left to right using the mouse until the size of your analysis area is adequate.

Click on the “Crash Selection” menu again, and the same dropdown menu will appear.

In the dropdown menu, click on “Intersection Select.”

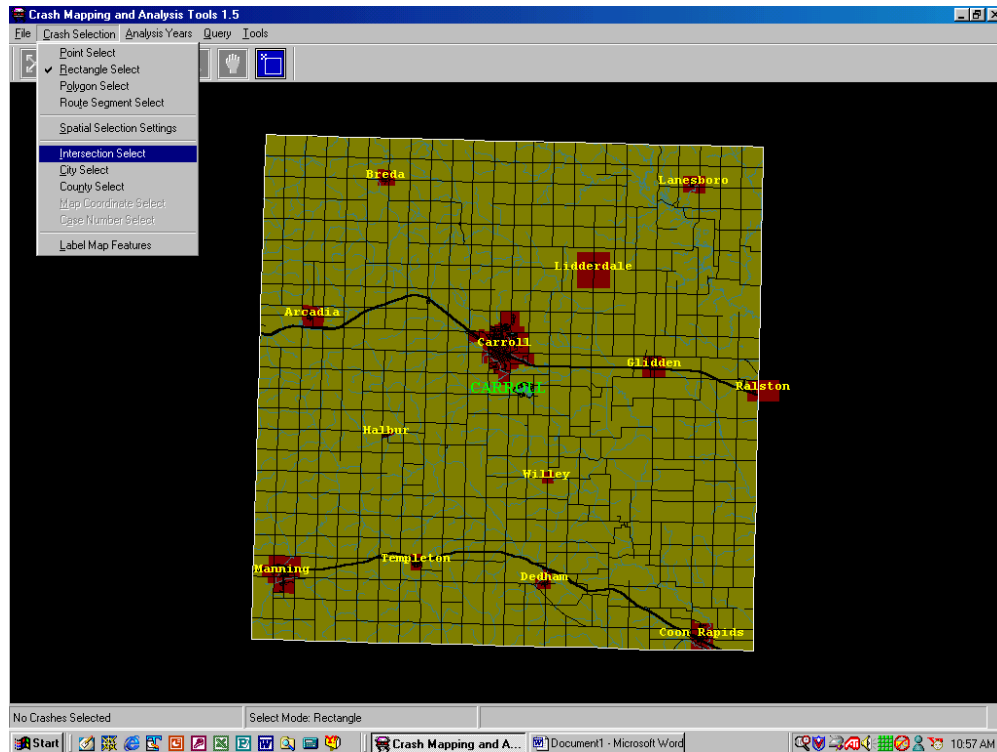

This will take you to any intersection of choice within a county. Select the two intersecting roads.

You have two options for selecting the two intersecting roads:

- 1) Simply use the pick list for the first road, then go to the 2nd window and use the pick list for the second road.
- 2) Make a selection from each pick list item box (County, City, Road Class, Road Name) in the first window and (Road Class, Road Name) in the second window.

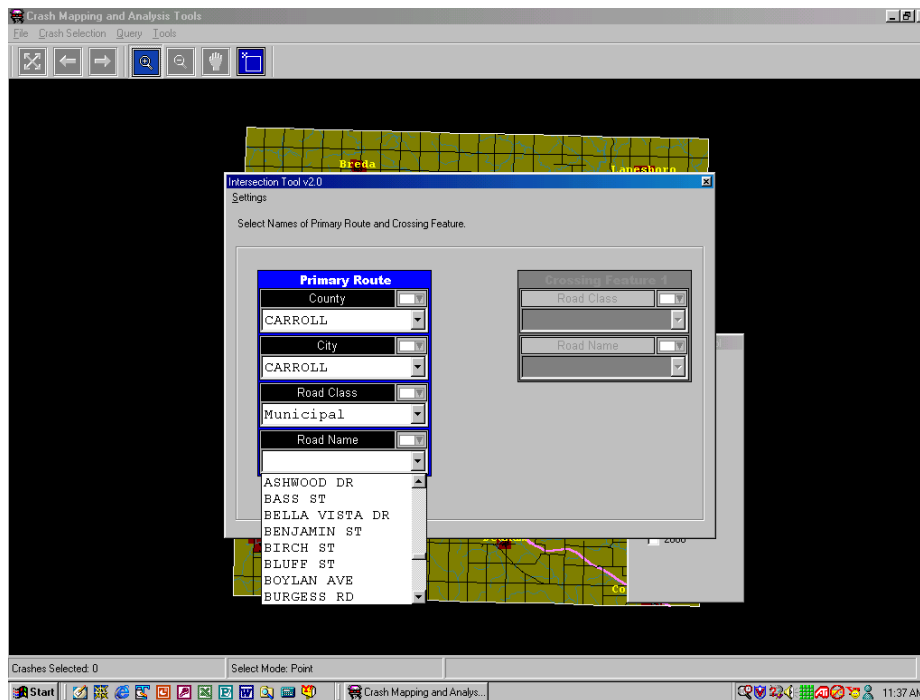

Once the two intersecting roads are selected, a screen similar to this with a circle around the intersection in it will appear. Every crash that occurred within the circular area during the given time period will be selected.

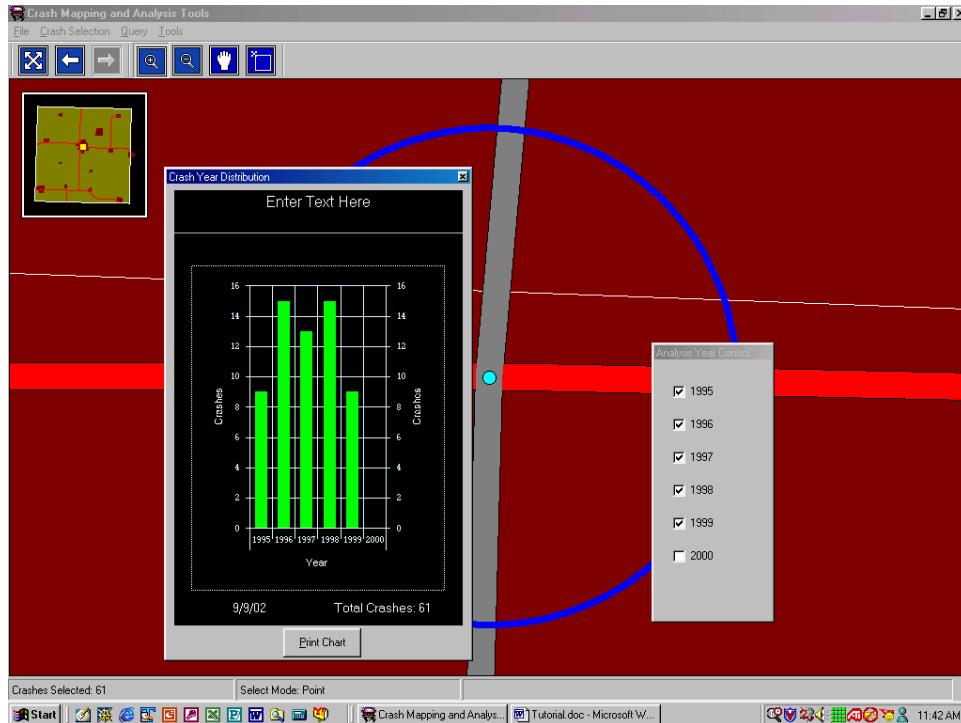

Now, select the “Query” menu, and a dropdown menu will appear.

Note: The map with the selected crashes can be printed.

In the dropdown menu, click on “Export Query to Access ALAS.”

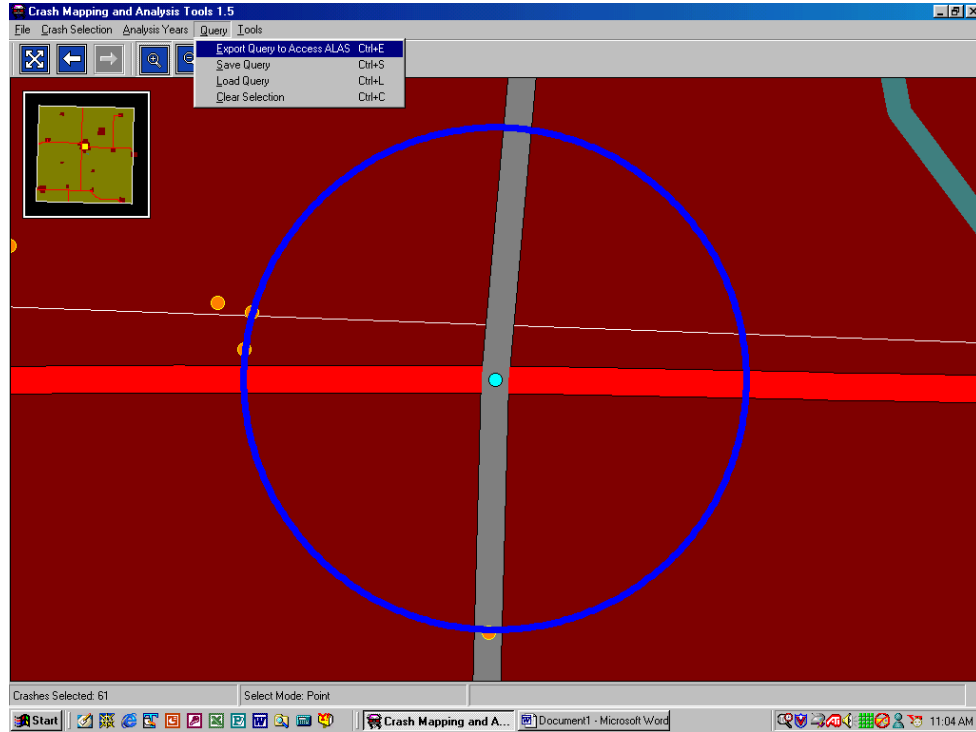

The data you have selected within CMAT will now be active in Access ALAS.

Maximize Access-ALAS.

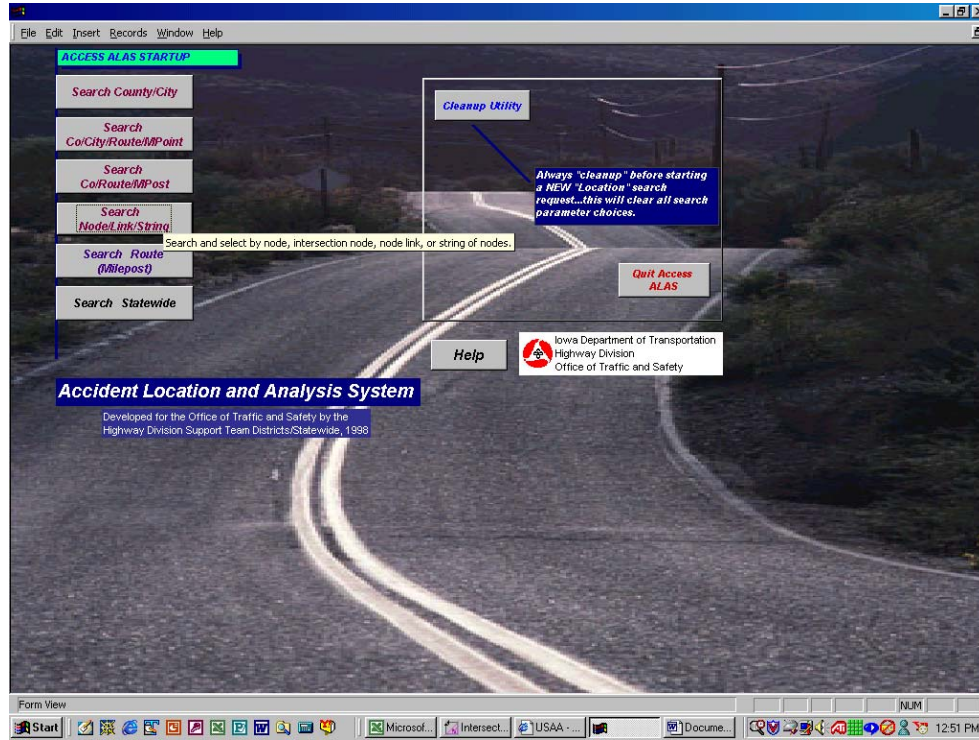

At the left hand side click on “Search County/City.” This will bring you to a new screen.

Click on "Jump to Report."

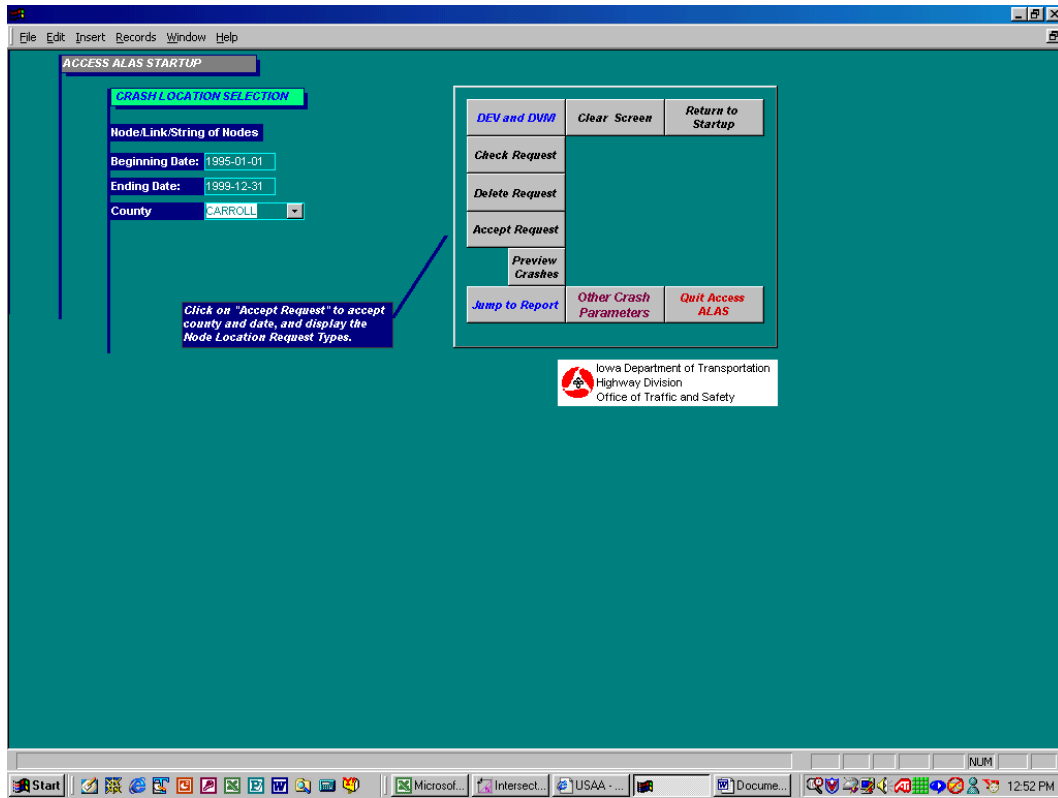

The following screen should appear, and you can now choose your print options. You want to click on the print icon for “Major Cause,” Day/Time Matrix,” and “Surface Light.” “Major Cause” will summarize what the major causes of the accidents were. “Day/Time Matrix” will summarize when the accidents occurred. “Surface Light” will summarize what the surface and light conditions were for the accidents.

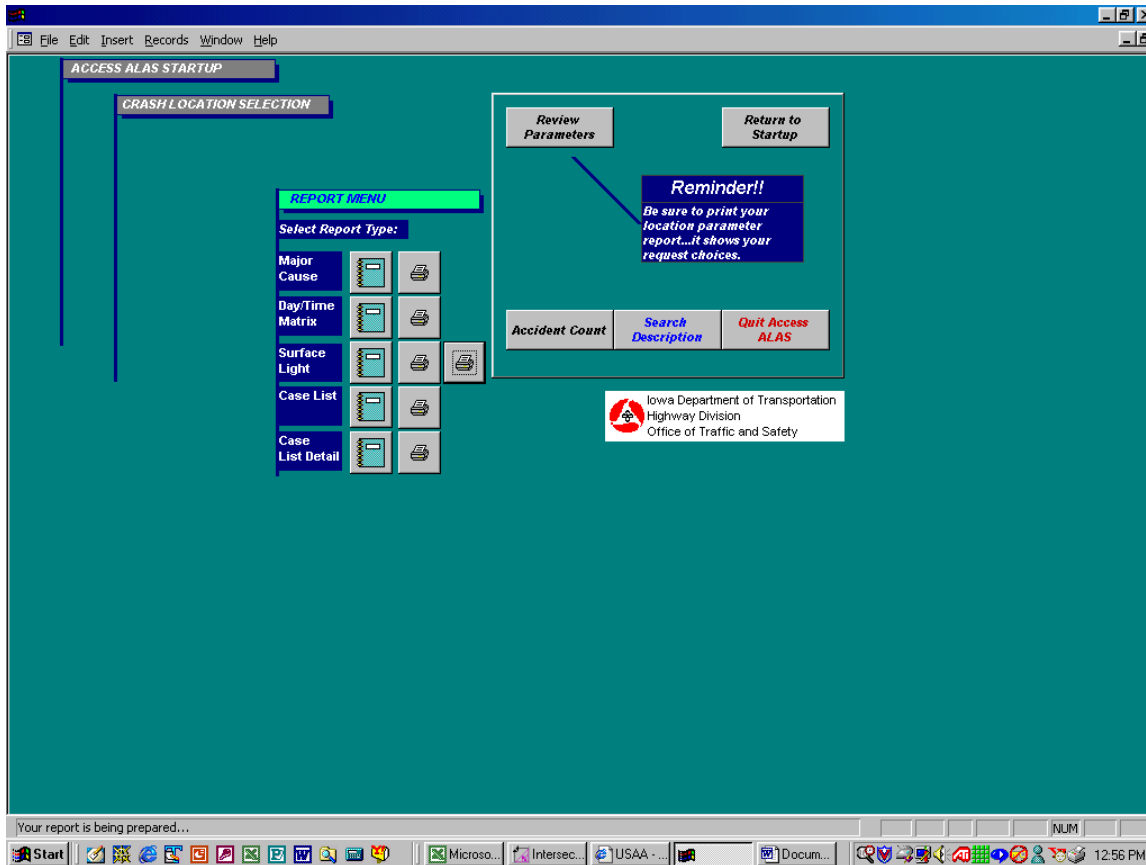

After the crash analysis reports have been printed to meet your needs, exit the programs.

Note: Click the “Accident Count” button before printing to verify that the number of crashes is the same as the CMAT Total.

In the dropdown menu, select “Spatial Selection Settings.” This will allow you to modify the size of your study area.

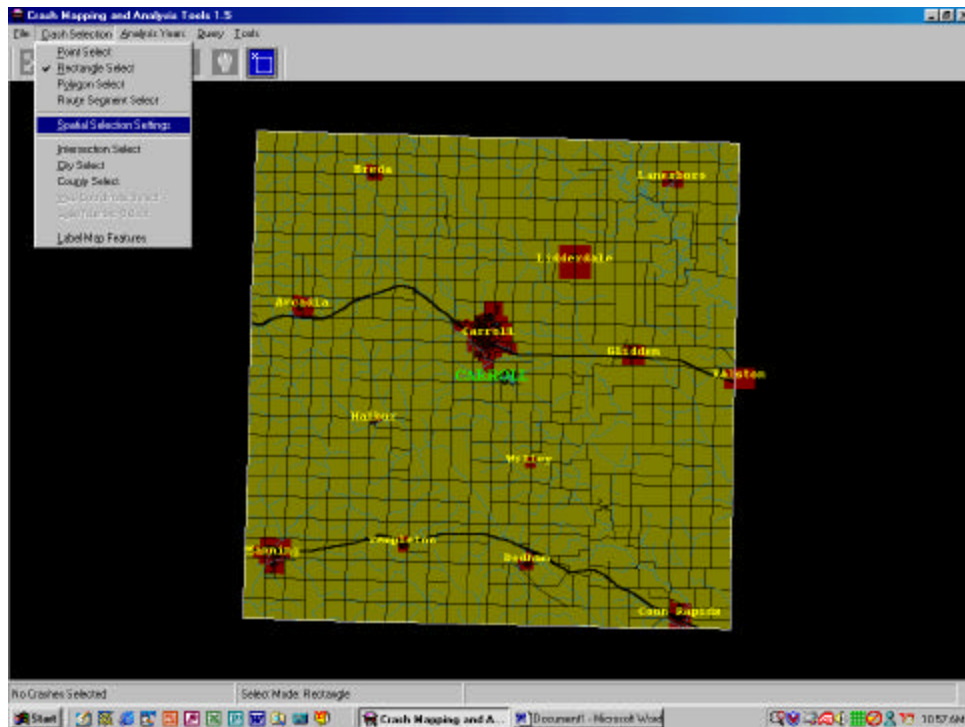

When “Spatial Selection Settings” is selected, the following screen appears.

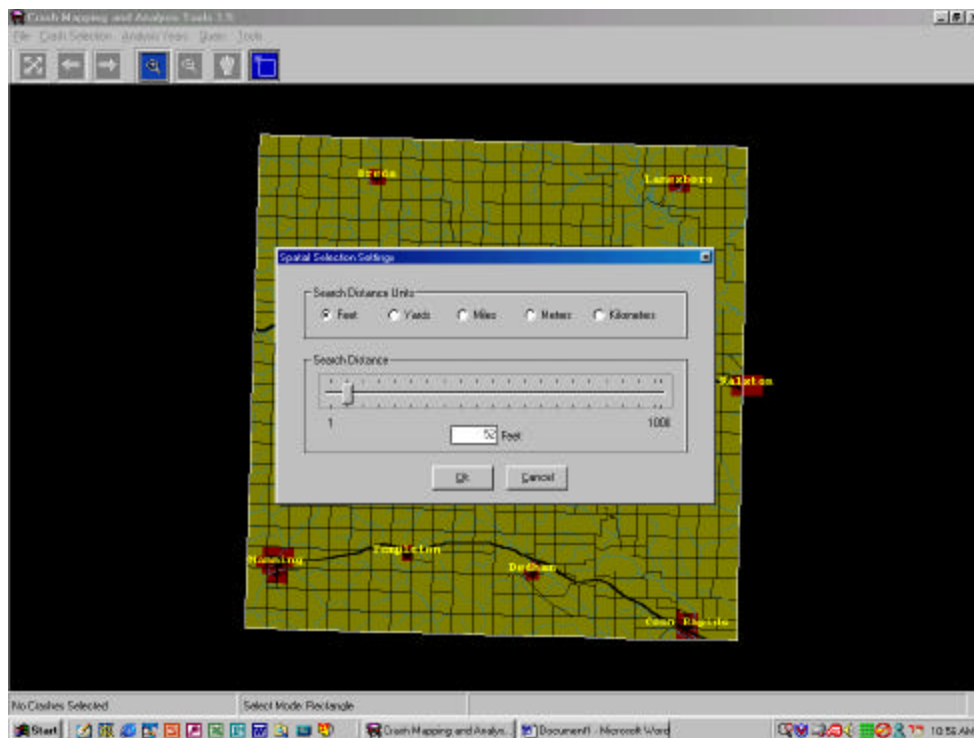

This is where you select the size of your study area. Choose unit of length and then move the bar from right to left using the mouse until the size of your study area is adequate for the purpose of the study.

Once this step is completed, click on “Crash Selection” again, and the same dropdown menu will appear.

In the dropdown menu, click on “Intersection Select.”

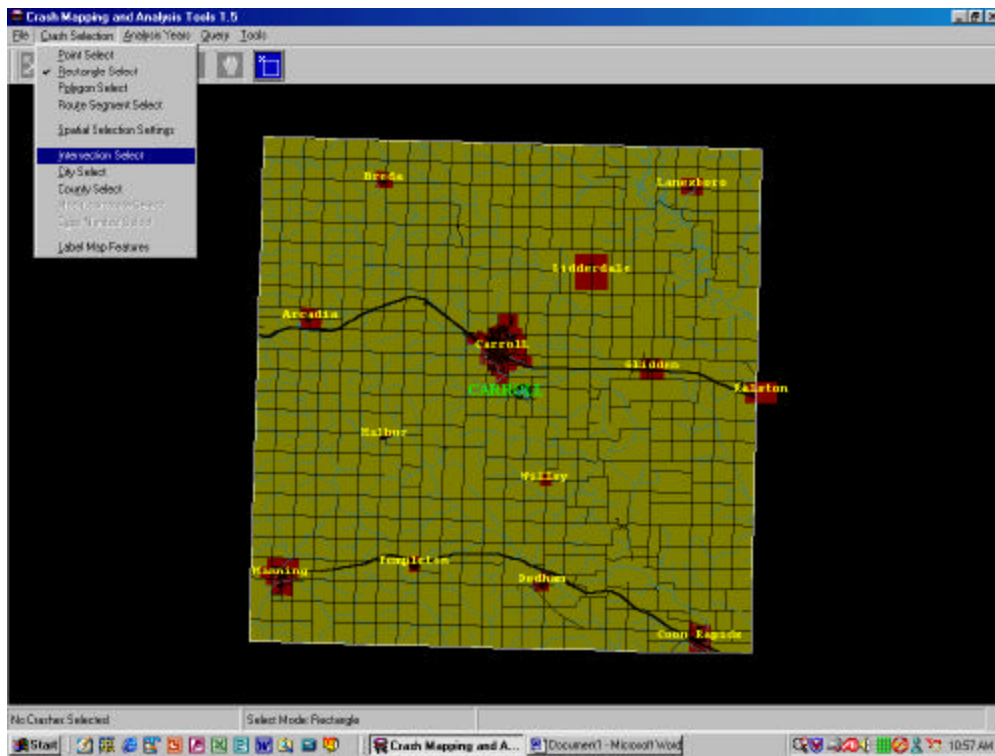

This will take you to any intersection of choice within your county. Type in the two intersecting roads.

Once the two intersecting roads are typed in, a screen similar to this with the intersection in it will appear. Every crash that occurred within the circular area during the given time period will be selected.

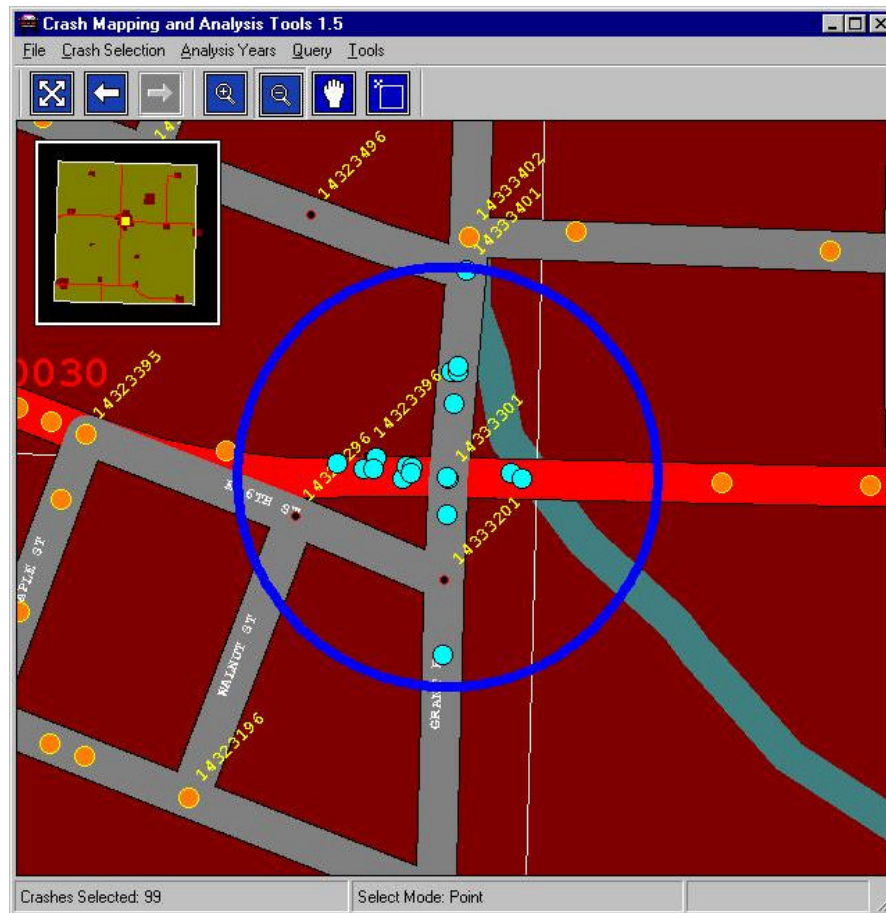

When the intersection is selected, the intersection node number will appear in the background layer of the intersection. Record the intersection node number and exit CMAT.

Enter Intersection Magic. The following screen will appear.

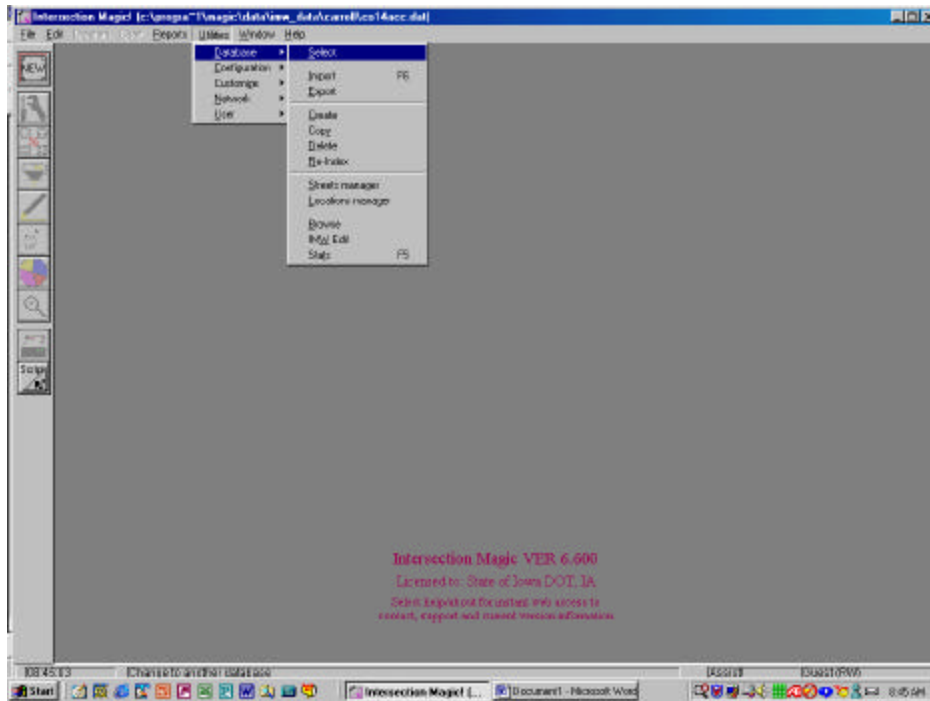

Click on “Utilities” to get a drop down menu. When the menu appears, click on “Database” and then click on “Select” from the next menu. The following menu will appear.

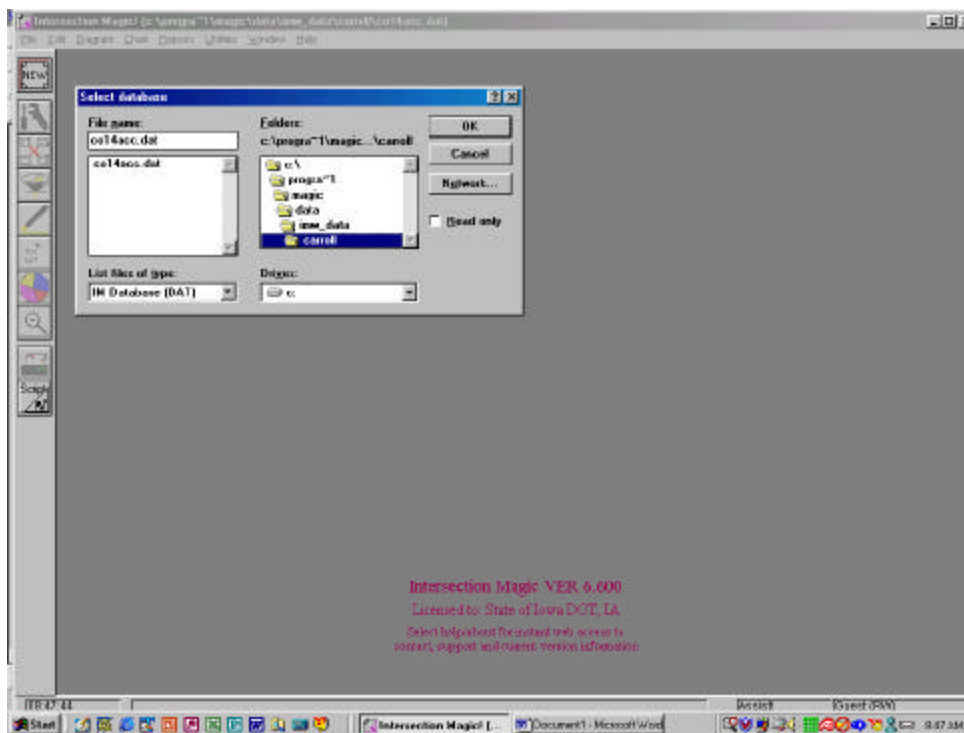

You want to select the folder where you installed the Intersection Magic crash data. In this case, click on the “C” directory” to get another list. Now click “Progra“1.”

Another menu will appear. Click on “Magic.” From the next list, choose “Data” and then “imw_data.” This gives you the county list. From the county list, you want to choose, for example, “Carroll” and then click “OK.” Once the above steps are completed, you get the following blank screen again.

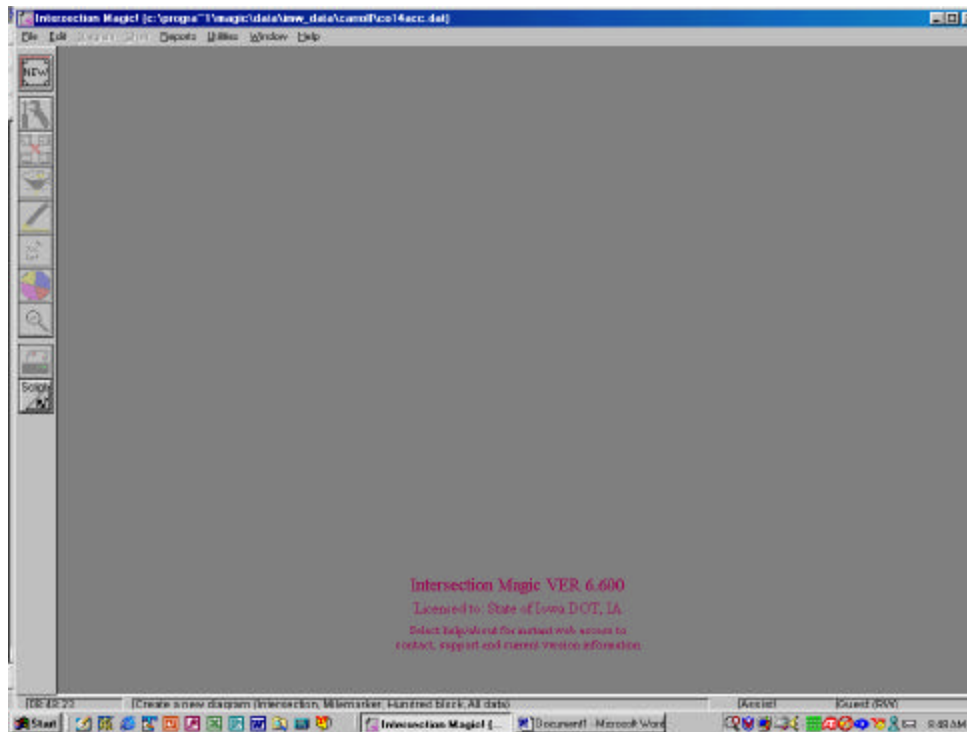

At this point, select “New” from the left-hand side of the screen. This allows you to construct a new diagram.

The bottom dialogue box should appear. In this box, click on the “#” symbol and then enter the last six digits of your node number. After this is completed, click “OK.” That box will disappear.

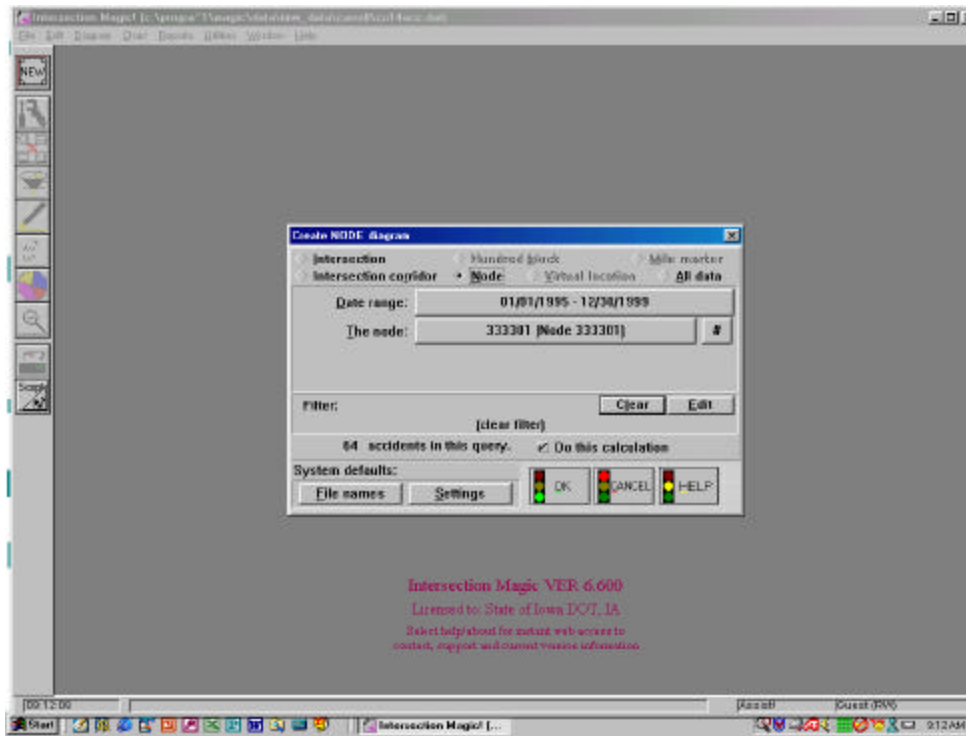

Click “OK” on the bottom box again, and Intersection Magic will construct a collision diagram as shown below.

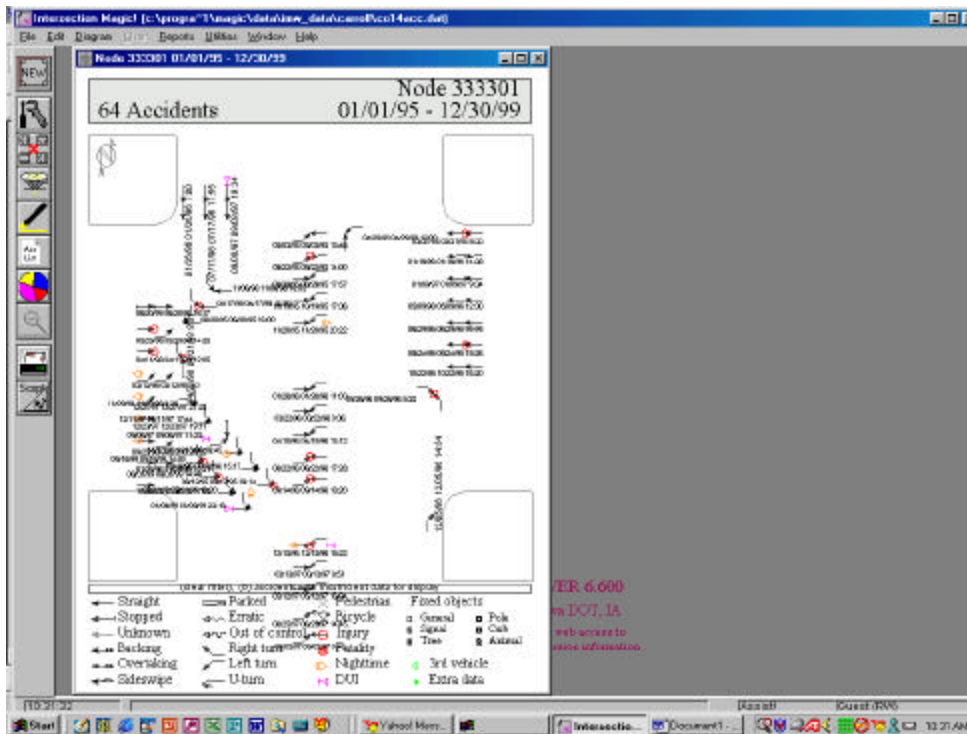

The collision diagram tells you the total number of crashes at the top. At the bottom is a legend with specific details to help you determine what the crashes are on the diagram.

The collision diagram may be printed out before you exit the program.

D.4. Guidelines for Identifying Data Needs and Studies

Guidelines for identifying data needs and studies (from the Federal Highway Administration, 1991) appear on the following pages.

Table 4. Guidelines for identifying data needs and appropriate engineering studies.

Accident Pattern	Possible Causes	Data Needs	Procedures to be Performed
Left-turn head-on collisions	Large volume of left-turns	Volume data Vehicle conflicts Roadway Inventory Signal timing and phasing Travel time and delay data	Volume Study Traffic Conflict Study Roadway Inventory Study Capacity Study Travel Time and Delay Study
	Restricted sight distance	Roadway Inventory Sight distance characteristics Speed characteristics	Roadway Inventory Study Sight Distance Study Spot Speed Study
	Too short amber phase	Speed characteristics Volume data Roadway inventory Signal timing and phasing	Spot Speed Study Volume Study Roadway Inventory Study Capacity Study
	Absence of special left-turning phase	Volume data Roadway inventory Signal timing and phasing Delay data	Volume Study Roadway Inventory Study Capacity Study Travel Time and Delay Study
	Excessive speed on approaches	Speed characteristics	Spot Speed Study
Rear-end collisions at unsignalized intersections	Drivers not aware of intersection	Roadway inventory Sight distance characteristics Speed characteristics	Roadway Inventory Study Sight Distance Study Spot Speed Study
	Slippery surface	Pavement skid resistance characteristics Conflicts resulting from slippery surface	Skid Resistance Study Weather-Related Study Traffic Conflict Study

Table 4. Guidelines for identifying data needs and appropriate engineering studies (Continued).

Accident Pattern	Possible Causes	Data Needs	Procedures to be Performed
Rear-end collisions at unsignalized intersections	Large number of turning vehicles	Volume data Roadway Inventory Conflict data	Volume Study Roadway Inventory Study Traffic Conflict Study
	Inadequate roadway lighting	Roadway inventory Volume data Data on existing lighting	Roadway Inventory Study Volume Study Highway Lighting Study
	Excessive speed on approaches	Speed characteristics	Spot Speed Study
	Lack of adequate gaps	Roadway inventory Volume data Gap data	Roadway Inventory Study Volume Study Gap Study
	Crossing pedestrians	Pedestrian volumes Pedestrian/vehicle conflicts Signal inventory	Volume Study Pedestrian Study Roadway Inventory Study
Rear-end collisions at signalized intersections	Slippery surface	Pavement skid resistance characteristics Conflicts resulting from slippery surface	Skid Resistance Study Weather-Related Study Traffic Conflict Study
	Large number of turning vehicles	Volume data Roadway inventory Conflict data Travel time and delay data	Volume Study Roadway Inventory Study Traffic Conflict Study Delay Study
	Poor visibility of signals	Roadway Inventory Signal review Traffic conflicts	Roadway Inventory Study Traffic Control Device Study Traffic Conflict Study

Table 4. Guidelines for identifying data needs and appropriate engineering studies (Continued).

Accident Pattern	Possible Causes	Data Needs	Procedures to be Performed
Rear-end collisions at signalized intersections	Inadequate signal timing	Roadway inventory Signal timing plans Volume data Travel time and delay data	Roadway Inventory Study Intersection Capacity Study Travel Time and Delay Study
	Unwarranted signal	Roadway inventory Volume data	Roadway Inventory Study Volume Study
	Inadequate roadway lighting	Roadway inventory Volume data Data on existing lighting	Roadway Inventory Study Volume Study Highway Lighting Study
	Excessive speed on approaches	Speed characteristics	Spot Speed Study
Right-angle collisions at signalized intersections	Crossing pedestrians	Pedestrian volumes Pedestrian/vehicle conflicts Signal inventory	Volume Study Pedestrian Study Roadway Inventory Study
	Restricted sight distance	Roadway inventory Sight distance characteristics Travel speed information	Roadway Inventory Study Sight Distance Study Spot Speed Study
Right-angle collisions at signalized intersections	Excessive speed on approaches	Speed characteristics	Spot Speed Study
	Poor visibility of signals	Roadway inventory Signal review Traffic conflicts	Roadway Inventory Study Traffic Control Device Study Traffic Conflict Study

Table 4. Guidelines for identifying data needs and appropriate engineering studies (Continued).

Accident Pattern	Possible Causes	Data Needs	Procedures to be Performed
Right-angle collisions at signalized intersections	Inadequate signal timing	Roadway inventory Signal timing plans Volume data Delay data	Roadway Inventory Study Volume Study Intersection Capacity Study Travel Time and Delay Study
	Inadequate roadway lighting	Roadway inventory Volume data Data on existing lighting	Highway Lighting Study Roadway Inventory Study Volume Study
	Intersection advance warning signs.	Roadway inventory Speed characteristics Traffic conflicts	Roadway Inventory Study Spot Speed Study Traffic Conflict Study
	Large total intersection volume	Volume data Roadway inventory	Volume Study Intersection Capacity Study
Right-angle collisions at unsignalized intersections	Restricted sight distance	Roadway inventory Sight distance characteristics Speed characteristics	Roadway Inventory Study Sight Distance Study Spot Speed Study
	Large total intersection volume	Volume data Roadway inventory Delay data	Volume Study Intersection Capacity Study Traffic Control Device Study Travel Time and Delay Study
	Excessive speed on approaches	Speed characteristics	Spot Speed Study
	Inadequate roadway lighting	Roadway inventory Volume data Data on existing lighting	Roadway Inventory Study Volume Study Highway Lighting Study

Table 4. Guidelines for identifying data needs and appropriate engineering studies (Continued).

Accident Pattern	Possible Causes	Data Needs	Procedures to be Performed
Right-angle collisions at unsignalized intersections	Intersection advance warning signs	Roadway inventory Speed characteristics Traffic conflicts	Roadway Inventory Study Spot Speed Study Traffic Conflict Study
	Inadequate traffic control devices	Roadway inventory Volume data Traffic control device adherence	Roadway Inventory Study Volume Study Traffic Control Device Study
Pedestrian-vehicle collisions	Restricted sight distance	Roadway inventory Speed characteristics Sight distance characteristics	Roadway Inventory Study Spot Speed Study Sight Distance Study
	Inadequate protection for pedestrians	Pedestrian volumes Safe crossing gaps Roadway inventory Speed characteristics	Volume Study Gap Study School Crossing Study Roadway Inventory Study Spot Speed Study
	School crossing area	Pedestrian volumes Safe crossing gaps Roadway inventory Speed characteristics	Volume Study Gap Study School Crossing Study Roadway Inventory Study Spot Speed Study
	Inadequate signals	Pedestrian volumes Pedestrian/vehicle conflicts Roadway inventory	Volume Study Pedestrian Study Roadway Inventory Study
	Inadequate signal phasing	Pedestrian volumes Vehicle volumes Roadway inventory Pedestrian/vehicle conflicts	Volume Study Roadway Inventory Study Pedestrian Study

Table 4. Guidelines for identifying data needs and appropriate engineering studies (Continued).

Accident Pattern	Possible Causes	Data Needs	Procedures to be Performed
Pedestrian-vehicle collisions	Driver had inadequate warning of frequent mid-block crossings	Pedestrian/vehicle conflict Speed characteristics Pedestrian volumes Roadway inventory	Pedestrian Study Spot Speed Study Volume Study Roadway Inventory Study
	Inadequate pavement markings	Roadway inventory Traffic conflicts	Roadway Inventory Study Traffic Control Device Study Traffic Conflict Study
	Inadequate gaps at unsignalized intersections	Roadway inventory Volume data Gap data Speed characteristics Pedestrian/vehicle conflicts	Roadway Inventory Study Volume Study Gap Study Spot Speed Study Pedestrian Study
	Inadequate roadway lighting	Roadway inventory Volume data Data on existing lighting	Roadway Inventory Study Volume Study Highway Lighting Study
Run-off-road collisions	Excessive vehicle speed	Speed characteristics	Spot Speed Study
	Slippery pavement	Skid resistance characteristics Conflicts resulting from slippery surface	Skid Resistance Study Weather-Related Study Traffic Conflict Study
	Roadway design inadequate for traffic conditions	Roadway inventory Speed characteristics Sight distance characteristics	Roadway Inventory Study Spot Speed Study Sight Distance Study
	Poor delineation	Roadway inventory Erratic maneuvers	Roadway Inventory Study Traffic Conflict Study

Table 4. Guidelines for identifying data needs and appropriate engineering studies (Continued).

Accident Pattern	Possible Causes	Data Needs	Procedures to be Performed
Run-off-road collisions	Inadequate roadway lighting	Roadway inventory Volume data Data on existing lighting	Roadway Inventory Study Volume Study Highway Lighting Study
	Inadequate shoulder	Roadway inventory Erratic maneuvers	Roadway Inventory Study Traffic Conflict Study
	Improper channelization	Roadway inventory Erratic maneuvers	Roadway Inventory Study Traffic Conflict Study
	Inadequate pavement maintenance	Pavement roughness characteristics	Roadway Serviceability Study
	Poor visibility	Fog data	Weather-Related Study
	Excessive speed along roadway	Speed characteristics	Spot Speed Study
Fixed-object collisions	Obstructions in or too close to roadway	Roadway inventory Erratic maneuvers	Roadway Inventory Study
	Inadequate roadway lighting	Roadway inventory Volume data Data on existing lighting	Roadway Inventory Study Volume Study Highway Lighting Study
	Inadequate pavement marking	Roadway inventory Erratic maneuvers	Roadway Inventory Study Traffic Control Device Study Traffic Conflict Study
	Inadequate signs, delineators and guard-rails	Roadway inventory Erratic maneuvers	Roadway Inventory Study Traffic Conflict Study

Table 4. Guidelines for identifying data needs and appropriate engineering studies (Continued).

Accident Pattern	Possible Causes	Data Needs	Procedures to be Performed
Fixed-object collisions	Inadequate roadway design	Roadway inventory Speed characteristics Sight distance characteristics	Roadway Inventory Study Spot Speed Study Sight Distance Study
	Slippery surface	Skid resistance characteristics Conflicts resulting from slippery surface	Skid Resistance Study Weather-Related Study Traffic Conflict Study
	Excessive vehicle speed	Speed characteristics	Spot Speed Study
Collisions with parked or parking vehicles	Improper pavement marking	Roadway inventory	Roadway Inventory Study Traffic Control Device Study
	Improper parking clearance at driveways	Roadway inventory	Roadway Inventory Study
	Angle parking	Roadway inventory Traffic conflicts	Roadway Inventory Study Traffic Conflict Study
	Excessive vehicle speed	Speed characteristics	Spot Speed Study
	Illegal parking	Roadway inventory	Roadway Inventory Study
	Improper parking	Roadway inventory	Roadway Inventory Study
	Large parking turnover	Roadway inventory Traffic conflicts	Roadway Inventory Study Traffic Conflict Study
Sideswipe or head-on collisions	Inadequate roadway design	Roadway inventory Speed characteristics Sight distance characteristics	Roadway Inventory Study Spot Speed Study Sight Distance Study

Table 4. Guidelines for identifying data needs and appropriate engineering studies (Continued).

Accident Pattern	Possible Causes	Data Needs	Procedures to be Performed
Sideswipe or head-on collisions	Improper road maintenance	Pavement roughness characteristics	Roadway Serviceability Study
	Inadequate shoulders	Roadway inventory Traffic conflicts	Roadway Inventory Study Traffic Conflict Study
	Excessive vehicle speed	Speed characteristics	Spot Speed Study
	Inadequate pavement marking	Roadway inventory Traffic conflicts	Roadway Inventory Study Traffic Conflict Study Traffic Control Device Study
	Inadequate channelization	Roadway inventory Traffic conflicts	Roadway Inventory Study Traffic Conflict Study
	Inadequate signing	Roadway inventory Traffic conflicts	Roadway Inventory Study Traffic Conflict Study
Driveway-related collisions	Left-turning vehicles	Volume data Traffic conflicts Roadway inventory	Volume Study Traffic Conflict Study Roadway Inventory Study
	Improperly located driveway	Roadway inventory Volume data Traffic conflicts	Roadway Inventory Study Volume Study Traffic Conflict Study
	Right-turning vehicles	Volume data Roadway inventory Traffic conflicts	Volume Study Roadway Inventory Study Traffic Conflict Study

Table 4. Guidelines for identifying data needs and appropriate engineering studies (Continued).

Accident Pattern	Possible Causes	Data Needs	Procedures to be Performed
Driveway-related collisions	Large volume of through traffic	Volume data Speed data Gap data Travel time and delay data Roadway inventory	Volume study Spot Speed Study Gap Study Travel Time and Delay Study Roadway Inventory Study
	Restricted sight distance	Roadway inventory Speed characteristics Sight distance characteristics	Roadway Inventory Study Spot Speed Study Sight Distance Study
	Inadequate roadway lighting	Roadway inventory Volume data Data on existing lighting	Roadway Inventory Study Volume Study Highway Lighting Study
	Excessive speeds on approaches	Speed characteristics	Spot Speed Study
Train-vehicle accidents	Restricted sight distance	Roadway inventory Speed characteristics Sight distance characteristics Railroad data	Roadway Inventory Study Weather-Related Study Highway Lighting Study
	Poor visibility	Roadway inventory Fog data Lighting data	Roadway Inventory Study Weather-Related Study Highway Lighting Study
	Excessive speeds on approaches	Speed characteristics	Spot Speed Study
	Improper traffic signal pre-emption timing	Roadway Inventory	Roadway Inventory Study Volume Study Railroad Crossing Study

Table 4. Guidelines for identifying data needs and appropriate engineering studies (Continued).

Accident Pattern	Possible Causes	Data Needs	Procedures to be Performed
Train-vehicle accidents	Inadequate pavement markings	Roadway inventory	Roadway Inventory Study Railroad Crossing Study Traffic Control Device Study
	Slippery surface	Skid resistance characteristics Conflicts related to slippery surface	Skid Resistance Study Weather-Related Study
	Improper pre-emption timing of RR signals or gates	Speed data Sight distance characteristics Roadway inventory Railroad data	Spot Speed Study Sight Distance Study Roadway Inventory Study Railroad Crossing Study
	Rough crossing surface	Roadway inventory Traffic conflicts	Roadway Inventory Study Traffic Conflict Study
	Sharp crossing angle	Roadway inventory Speed data Sight distance characteristics Railroad data	Roadway Inventory Study Spot Speed Study Sight Distance Study Railroad Crossing Study
Wet pavement accidents	Slippery pavement	Skid resistance characteristics Conflicts resulting from slippery surface	Skid Resistance Study Weather-Related Study
	Inadequate drainage; Inadequate pavement markings	Field review notes Roadway inventory data Traffic conflict data	Safety Performance Study Roadway Inventory Study Traffic Conflict Study

Table 4. Guidelines for identifying data needs and appropriate engineering studies (Continued).

Accident Pattern	Possible Causes	Data Needs	Procedures to be Performed
Night accidents	Poor visibility or lighting	Roadway inventory Volume data Data on existing lighting Traffic conflicts	Roadway Inventory Study Volume Study Highway Lighting Study Traffic Conflict Study
	Poor sign quality; Inadequate channelization or delineation	Field review notes Roadway inventory data Traffic conflict data	Safety Performance Study Roadway Inventory Study Traffic Conflict Study

APPENDIX E: PROJECT WORK ORDER (CONTRACTING OUT)

Referenced Agreement

This work order is part of an agreement between _____ and _____ for municipal engineering services.

Project Location Description

A map depicting the location is attached.

Obligation of the City/County

The city/county shall provide the following items to the consultant: _____

Scope of Consultant Services

Schedule

Field meeting date:	_____
Estimated date of preliminary deliverable:	_____
Estimated date of final deliverable:	_____

Compensation

Labor cost	\$ _____
Direct expenses	\$ _____
Subcontractor cost	\$ _____
Overhead	\$ _____
Maximum payable	\$ _____

Authorization

_____	_____
City/County	Contractor
_____	_____
City/County Administrator	Project Manager's Name/Title
_____	_____
Signature	Signature
_____	_____
Date	Date