

1. Report No. FHWA/TX-11/0-6402-P1		2. Government Accession No.		3. Recipient's Catalog No.	
4. Title and Subtitle TRAFFIC SIGNAL OPERATIONS HANDBOOK, Second Edition				5. Report Date July 2011 Resubmitted: August 2011 Published: October 2011	
				6. Performing Organization Code	
7. Author(s) J. Bonneson, S. Sunkari, M. Pratt, and P. Songchitruksa				8. Performing Organization Report No. Product 0-6402-P1	
9. Performing Organization Name and Address Texas Transportation Institute The Texas A&M University System College Station, Texas 77843-3135				10. Work Unit No. (TRAIS)	
				11. Contract or Grant No. Project 0-6402	
12. Sponsoring Agency Name and Address Texas Department of Transportation Research and Technology Implementation Office P.O. Box 5080 Austin, Texas 78763-5080				13. Type of Report and Period Covered Product: September 2009 - August 2011	
				14. Sponsoring Agency Code	
15. Supplementary Notes Project performed in cooperation with the Texas Department of Transportation and the Federal Highway Administration. Project Title: Development of Pedestrian Safety-Based Warrants for Protected or Protected-Permissive Left-Turn Control URL: http://tti.tamu.edu/documents/0-6402-P1.pdf					
16. Abstract This handbook provides guidelines for timing traffic control signals at intersections that operate in isolation or as part of a coordinated signal system. The guidelines are intended to describe best practices, as identified through interviews with engineers and technicians, and to identify conditions where alternative practices are equally workable. The handbook is intended to make resource investment in signal timing maintenance cost-effective and signal operation more consistent on an area-wide basis. It is likely to be most useful to engineers that desire quick-response methods for maintaining or improving the operation of existing signalized intersections. The second edition of the handbook includes new material focused on pedestrian safety at signalized intersections. One element of the new material is presented as guidelines for determining whether protected left-turn operation is appropriate based on consideration of pedestrian-vehicle crashes and vehicle delay. A second element is presented as guidelines for determining whether an exclusive pedestrian phase is needed. A third element is presented as a new appendix that describes alternative pedestrian treatments that can improve pedestrian safety at signalized intersections.					
17. Key Words Signalized Intersections, Intersection Design, Intersection Performance			18. Distribution Statement No restrictions. This document is available to the public through NTIS: National Technical Information Service Alexandria, Virginia 22312 http://www.ntis.gov		
19. Security Classif.(of this report) Unclassified		20. Security Classif.(of this page) Unclassified		21. No. of Pages 180	22. Price

TRAFFIC SIGNAL OPERATIONS HANDBOOK, Second Edition

by

J. Bonneson, P.E.
Senior Research Engineer
Texas Transportation Institute

S. Sunkari, P.E.
Research Engineer
Texas Transportation Institute

M. Pratt, P.E.
Assistant Research Engineer
Texas Transportation Institute

and

P. Songchitruksa, P.E.
Associate Research Engineer
Texas Transportation Institute

Product 0-6402-P1

Project 0-6402

Project Title: Development of Pedestrian Safety-Based Warrants for Protected or
Protected-Permissive Left-Turn Control

Performed in cooperation with the
Texas Department of Transportation
and the
Federal Highway Administration

July 2011

Resubmitted: August 2011

Published: October 2011

TEXAS TRANSPORTATION INSTITUTE
The Texas A&M University System
College Station, Texas 77843-3135

DISCLAIMER

The contents of this report reflect the views of the authors, who are responsible for the facts and the accuracy of the data published herein. The contents do not necessarily reflect the official view or policies of the Federal Highway Administration (FHWA) and/or the Texas Department of Transportation (TxDOT). This report does not constitute a standard, specification, or regulation. It is not intended for construction, bidding, or permit purposes. The engineer in charge of the project was James Bonneson, P.E. #67178.

NOTICE

The United States Government and the State of Texas do not endorse products or manufacturers. Trade or manufacturers' names appear herein solely because they are considered essential to the object of this report.

ACKNOWLEDGMENTS

This research project was sponsored by the Texas Department of Transportation and the Federal Highway Administration. The research was conducted by Dr. James Bonneson, Mr. Srinivasa Sunkari, Mr. Michael Pratt, and Dr. Praprut Songchitruksa. All four researchers are with the Texas Transportation Institute.

The researchers acknowledge the support and guidance provided by the Project Monitoring Committee:

- Mr. Adam Chodkiewicz, Project Director (TxDOT, Traffic Operations Division).
- Mr. James Bailey (TxDOT, Waco District).
- Mr. Scott Cunningham (TxDOT, Austin District).
- Mr. John Gianotti (TxDOT, San Antonio District).
- Mr. Jianming Ma (TxDOT, Traffic Operations Division).
- Ms. Wendy Simmons (TxDOT, Tyler District).
- Mr. Wade Odell, Research Engineer (TxDOT, Research and Technology Implementation Office).

The researchers also acknowledge the assistance provided by the Project Monitoring Committee for TxDOT Project 0-5629 that led to the first edition of this handbook:

- Mr. Larry Colclasure, Program Coordinator (TxDOT, Waco District).
- Mr. Henry Wickes, Project Director (TxDOT, Traffic Operations Division).
- Mr. Don Baker (TxDOT, Traffic Operations Division).
- Mr. Adam Chodkiewicz (TxDOT, Traffic Operations Division).
- Mr. David Danz (TxDOT, Traffic Operations Division).
- Mr. Gordon Harkey (TxDOT, Brownwood District).
- Mr. Derryl Skinnell (TxDOT, Traffic Operations Division).
- Mr. Dexter Turner (TxDOT, Corpus Christi District).
- Mr. Wade Odell, Research Engineer (TxDOT, Research and Technology Implementation Office).

The researchers would like to acknowledge the insight and advice provided by Mr. Kirk Barnes and Mr. Nader Ayoub during the development of several report chapters and appendices. Also, the researchers would like to recognize the contribution of Dr. Karl Zimmerman. He provided early direction in this document's development and led the effort to assemble, organize, and interpret the survey of agency signal timing practice. Finally, the researchers would like to acknowledge the contribution of Dr. Kay Fitzpatrick to this project. Dr. Fitzpatrick provided direction in the development of the pedestrian safety-related guidelines.

TABLE OF CONTENTS

	Page
LIST OF FIGURES	ix
LIST OF TABLES	x
CHAPTER 1. INTRODUCTION	1-1
HANDBOOK OVERVIEW	1-1
SIGNAL TIMING OVERVIEW	1-3
REFERENCES	1-5
CHAPTER 2. SIGNAL CONTROLLER TIMING	2-1
OVERVIEW	2-1
CONCEPTS	2-3
PROCEDURE	2-8
GUIDELINES	2-12
REFERENCES	2-24
CHAPTER 3. SIGNAL COORDINATION TIMING	3-1
OVERVIEW	3-1
CONCEPTS	3-4
PROCEDURE	3-9
GUIDELINES	3-12
REFERENCES	3-28
CHAPTER 4. BIBLIOGRAPHY	4-1
APPENDIX A. SIGNAL PHASING AND OPERATION	A-1
OVERVIEW	A-1
CONCEPTS	A-2
GUIDELINES	A-8
REFERENCES	A-18
APPENDIX B. ADVANCED SIGNAL TIMING SETTINGS	B-1
OVERVIEW	B-1
CONCEPTS	B-3
GUIDELINES	B-11
REFERENCES	B-22

TABLE OF CONTENTS (continued)

	Page
APPENDIX C. DETECTION DESIGN AND OPERATION	C-1
OVERVIEW	C-1
CONCEPTS	C-3
GUIDELINES	C-7
REFERENCES	C-22
APPENDIX D. DIAMOND INTERCHANGE PHASING, TIMING, AND DESIGN ..	D-1
OVERVIEW	D-1
CONCEPTS	D-3
GUIDELINES	D-14
REFERENCES	D-28
APPENDIX E. ALTERNATIVE PEDESTRIAN TREATMENTS	E-1
OVERVIEW	E-1
CONCEPTS	E-3
GUIDELINES	E-4
REFERENCES	E-11

LIST OF FIGURES

Figure	Page
2-1	Intersection Traffic Movements and Numbering Scheme 2-4
2-2	Dual-Ring Structure with Illustrative Movement Assignments 2-4
2-3	Intervals That Define the Duration of an Actuated Phase 2-5
2-4	Sample Condition Diagram 2-10
2-5	Relationship between Passage Time and Maximum Allowable Headway 2-20
3-1	Coupling Index for Signalized Segments 3-13
3-2	Application of Coupling Index to Form Separate Signal Systems 3-14
3-3	Initial Layout of Street and Timing for First Intersection 3-18
3-4	Initial Layout of Timing for the Remaining Intersections 3-19
3-5	Completed Time-Space Diagram 3-20
3-6	Example Intersection Used to Illustrate Timing Plan Development 3-23
3-7	Through-Vehicle Equivalents for Permissive Left-Turn Vehicles 3-25
A-1	Illustrative Lag-Lag and Permissive-Only Phasing A-3
A-2	Illustrative Lead-Lead and Right-Turn Phasing A-4
A-3	Illustrative Lead-Lag and Split Phasing A-4
A-4	Demonstration of Yellow Trap with Lead-Lag Phasing A-5
A-5	Dallas Phasing to Eliminate Yellow Trap A-6
A-6	Guidelines for Determining Left-Turn Operational Mode A-9
B-1	Factors That Define the Initial Interval Duration B-4
B-2	Factors That Define the Extension Time Limit for Gap Reduction B-5
B-3	Rail Preemption Settings B-8
C-1	Indecision Zone Boundaries on a Typical Intersection Approach C-4
C-2	Distance to the Beginning and End of the Indecision Zone C-5
C-3	Left-Turn and Through Movement Detection Designs C-9
C-4	Right-Turn Movement Detection Designs C-11
C-5	Illustrative Optimal Camera Location and Field of View C-14
C-6	Illustrative Stop Line Detection Zone Layout Using Video Detection C-20
C-7	Alternative Detection Modes C-21
D-1	Alternative Diamond Interchange Configurations D-2
D-2	Interchange Traffic Patterns D-5
D-3	Interchange Traffic Movements and Numbering Scheme D-6
D-4	Three-Phase Sequence D-7
D-5	Four-Phase Sequence D-8
D-6	Separate Intersection Phase Sequence D-10
D-7	Two-Phase Sequence D-11
D-8	Detector Layout for the Texas Diamond Controller D-12
D-9	Conditional Service with the Three-Phase Sequence D-14
D-10	Detection Layout for a Signalized Diamond Interchange D-22
D-11	VIVDS Camera Layout for a Typical Diamond Interchange D-26
D-12	Typical Video Detector Hardware Layout for a Texas Diamond Controller D-26
E-1	Example Intersection Used to Illustrate Pedestrian Treatment Evaluation E-6

LIST OF TABLES

Table	Page
2-1 Data Used to Establish Signal Timing	2-9
2-2 Factors Considered When Establishing the Minimum Green Setting	2-13
2-3 Minimum Green Setting Needed to Satisfy Driver Expectancy	2-14
2-4 Minimum Green Setting Needed to Satisfy Queue Clearance	2-14
2-5 Typical Range of Maximum Green Settings	2-15
2-6 Yellow Change and Red Clearance Interval Duration	2-17
2-7 Passage Time for Stop Line Presence Detection	2-21
2-8 Pedestrian Walk Interval Duration	2-23
2-9 Pedestrian Clearance Time	2-23
3-1 Performance Measures for Evaluating Signal Systems	3-3
3-2 Typical System Cycle Lengths	3-16
3-3 Phase Split Calculation Worksheet	3-24
A-1 Sample Pedestrian Safety Worksheet	A-11
B-1 Primary Influence of Selected Advanced Controller Settings	B-2
B-2 Added Initial Setting	B-12
B-3 Maximum Initial Setting	B-13
B-4 Passage Time for Stop Line Presence Detection	B-14
B-5 Gap Reduction Settings	B-15
B-6 Minimum Gap for Presence Detection	B-16
B-7 Shortest Passage Time and Minimum Gap for Single Advance Detector	B-16
C-1 Detection Design Terminology	C-2
C-2 Typical Use of Various Detection Unit Technologies	C-3
C-3 Layout and Settings for High-Speed Detection Design	C-12
C-4 Minimum Camera Height to Reduce Adjacent-Lane Occlusion	C-16
C-5 Guidance for Locating Detection Zones and Individual Detectors	C-19
C-6 Stop Line Detection Zone Length for VIVDS Applications	C-19
D-1 Texas Diamond Controller Detector Layout and Function	D-13
D-2 Guidelines for Selection of Diamond Interchange Phasing	D-16
D-3 Minimum Green Setting for a Three-Phase Sequence	D-17
D-4 Minimum Green Setting for a Four-Phase Sequence	D-18
D-5 Maximum Green Setting for a Three-Phase Sequence	D-20
D-6 Layout and Settings for Low-Speed Detection with Three-Phase Sequence	D-22
D-7 Layout and Settings for Low-Speed Detection with Four-Phase Sequence	D-23
D-8 Layout and Settings for High-Speed Detection with Three-Phase Sequence	D-24
D-9 Layout and Settings for High-Speed Detection with Four-Phase Sequence	D-25
D-10 Typical Video Detector Switching for a Texas Diamond Controller	D-27
E-1 Treatments for Improving Pedestrian Safety at Intersections	E-2
E-2 Sample Pedestrian Treatment Evaluation Worksheet	E-5

CHAPTER 1. INTRODUCTION

The maintenance of safe and efficient signal timing is an important part of the transportation agency's responsibility to the motoring public, especially as the price of fuel continues to rise and the value of time increases. Signal timing improvements have consistently demonstrated up to \$40 of road-user benefit for every \$1 invested by the transportation agency (*1*). Signal timing improvements in large metropolitan areas are key to congestion mitigation activities and attainment of acceptable emission levels. Poorly timed signals have been shown to increase the frequency and severity of crashes.

This chapter provides an introduction to the traffic signal timing process. The process involves a series of steps that yield an effective signal timing plan for a signalized intersection or interchange. Subsequent chapters in this document provide a detailed description of the signal timing process as well as guidelines for using key signal controller settings. Additional guidelines are provided in the appendices.

This chapter consists of two parts. The first part provides an overview of this document, the *Traffic Signal Operations Handbook*. The second part provides an overview of basic signal timing objectives.

HANDBOOK OVERVIEW

The conventional approach to signal timing involves a process of data collection, evaluation, installation, and field-tuning. The evaluation is often based on the use of a signal timing software product to develop signal timings that yield the “optimal” traffic operation. One drawback to using the conventional approach is that the software product often requires a large amount of traffic volume, geometry, speed, and controller data. Another drawback is that the optimal signal timing plan must be converted into equivalent controller settings before it can be installed in the field. A third drawback is that the installed timing plan must be fine-tuned in the field to account for factors not considered by the signal timing software product. Because of these drawbacks, the conventional approach is perceived by some as being time-consuming and expensive.

In recognition of the aforementioned drawbacks, a quick-response approach to signal timing has evolved. This approach focuses on the use of practical techniques for developing effective timing plans on a limited budget. These techniques may not yield timing plans that are as efficient as those developed using a signal timing software product, but they require less data and less development time. Because of these lower resource requirements, many agencies are more likely to use a quick-response approach at more frequent intervals than the conventional approach. Arguably, agencies that use the quick-response approach to refine signal timings every one or two years will provide better traffic service over time than those agencies that use complex software products to develop optimal timings once every five or more years.

Objectives and Scope

The objectives of this *Handbook* are:

- To promote uniformity in signal timing and signal design.
- To identify signal timing adjustments that can be implemented quickly.
- To provide guidelines for selecting effective signal timing plans.

In other words, the *Handbook* is intended to make resource investment in signal timing maintenance cost-effective and signal operation more consistent on an area-wide basis. Through its implementation, the *Handbook* will promote the safe and efficient operation of signalized intersections.

The *Handbook* is focused on the provision of guidelines for timing traffic control signals at intersections that operate in isolation or as part of a coordinated signal system. The guidelines are intended to describe best practices, as identified through interviews with TxDOT engineers and technicians, and to identify conditions where alternative practices are equally workable.

In general, the *Handbook* provides guidelines for the selection of signal timing settings that have been demonstrated to provide safe and efficient operation under specified conditions. The guidelines are controller-neutral to the extent possible so that they can be used with a larger number of controller products. To this end, the *Handbook* does not provide step-by-step procedures for programming specific traffic signal controllers because these procedures can vary from controller to controller and can change with controller firmware updates.

This *Handbook* will be most useful to those individuals who desire quick-response methods for maintaining or improving the operation of existing signalized intersections. Hence, the main body of the *Handbook* focuses on the use of common signal timing settings to develop signal timing plans for isolated intersections and intersections in coordinated signal systems.

The guidelines in the *Handbook* are based on rules-of-thumb and look-up tables. This approach helps readers find information quickly and easily.

Signalization elements that influence traffic operation, but require a modification to the intersection's physical design to adjust, are partially covered in this *Handbook*. This approach is taken because changes to the intersection's physical design are often associated with a higher cost and lengthy lead time for construction. Hence, these changes are not considered quick-response techniques. Regardless, the appendices include guidelines for selected signalization elements that require design modifications (e.g., detection layout, phase sequence selection, etc.) because of their close relationship to signal timing.

The subject of signalized intersection design, operation, and timing is too broad to be adequately covered in one document. Topics that are not addressed in this *Handbook* include

Documents that provide guidelines for intersection design are identified in Chapter 4: Bibliography.

intersection geometric design, signal display design, and signal warrants. However, documents that address these topics are identified in the bibliography in Chapter 4.

Audience

The *Handbook* is written for engineers and technicians who are responsible for the day-to-day timing or operation of traffic signals. The user of the *Handbook* is assumed to have a working knowledge of traffic signal equipment and the authority to make, or recommend, changes to the operation of this equipment.

Organization

The *Handbook* consists of two main chapters and five appendices. The two chapters focus on signal timing adjustments for signalized intersections. The appendices address signal design options, advanced controller settings, diamond interchange signalization, and pedestrian treatments.

Each chapter and appendix has the same main headings. The initial section is titled “Overview.” It introduces the topics addressed in the chapter or appendix.

<u>Chapter Organization</u>	<u>Appendix Organization</u>
Overview	Overview
Concepts	Concepts
Procedure	--
Guidelines	Guidelines

The second section is titled “Concepts.” It summarizes the basic concepts associated with the topic of the chapter and establishes a vocabulary for interpreting the subsequent guidelines.

Chapters 2 and 3 each have a “Procedure” section that describes the sequence of steps followed in the development of a signal timing plan. The discussion associated with a step often refers to relevant guidance information that is provided in the “Guidelines” section.

The last section in each chapter and appendix is titled “Guidelines.” This section provides guidelines for selecting effective signal settings or making some signal design choices. These guidelines are based on information that has been shown through practice or research to provide effective signal operation. To the extent possible, the guidelines have been developed to minimize the amount of data needed for their use. They have also been cast as rules-of-thumb or look-up tables in an effort to minimize the time needed to obtain effective settings or design values.

SIGNAL TIMING OVERVIEW

The primary purpose of a traffic signal is to assign the right-of-way to intersecting traffic streams for the purpose of ensuring that all streams are served safely and without excessive delay. A properly designed and timed signalized intersection will minimize fuel consumption, delay, and stops without having an adverse effect on safety. Travelers will realize one or more of the following benefits at intersections where the traffic signal is needed, properly designed, and well timed (2):

- Orderly movement of traffic.
- Increase in the traffic-carrying capacity of the intersection.
- Reduction in the frequency and severity of certain types of crashes (e.g., right-angle crashes).
- Progressed traffic when traveling in a coordinated signal system.
- Interruption of heavy traffic flow to provide safe opportunities for minor movements to cross.

Need for Signalization

The benefits to travelers at an intersection are likely to be realized only when the signal is truly needed. The *Texas Manual on Uniform Traffic Control Devices (TMUTCD)* indicates that the “need” for a traffic signal is based on an engineering study of traffic, roadway, and other conditions (3). One element of this study is an evaluation of the relevant signal warrants listed in the *TMUTCD*. The engineering study must show that, in addition to the satisfaction of one or more warrants, that the signal will improve the overall operation and/or safety of the intersection (3). Useful guidelines for conducting this study are provided in *NCHRP Report 457: Evaluating Intersection Improvements: An Engineering Study Guide* (4).

Based on the aforementioned *TMUTCD* guidance, the engineering study should include an evaluation of the proposed signals’ operational impact. An important element of this evaluation is the development of a reasonable signal phasing and timing plan for the proposed signal. The guidelines in this *Handbook* can be used to assist with the development of this plan.

The need for a traffic signal is based on an engineering study. The guidelines in this *Handbook* may be useful during this study.

Relationship between Signal Timing and Intersection Design

The degree to which signal timing can improve intersection operation is based partly on the intersection’s design. A poorly designed intersection may be difficult to signalize in a manner that yields a safe and efficient operation. Key intersection design elements that can influence intersection safety and operation when signalized include:

- Number of lanes provided for each movement.
- Length of turn bays.
- Presence of additional through lanes in the vicinity of the intersection.
- Location of detectors.
- Use of left-turn phasing.

Each traffic movement should have an adequate number of lanes to ensure that it requires no more than its “fair” share of the signal cycle. In general, one lane is needed for every 300 to 500 veh/h served by the associated traffic movement during peak traffic periods.

It is essential that turn bays, when provided, are of adequate length. Queues that spill back from the bay into the adjacent through lane will cause a significant reduction in the capacity of the

through movement. Other geometric features like additional through lanes can also have a significant positive impact on intersection capacity, provided that they are relatively long.

Detectors that are of inadequate length can lead to occasional premature phase termination and require unserved vehicles to wait an additional signal cycle. Advance detectors that are not properly located can unnecessarily extend the green and increase the frequency of phase termination by extension to the maximum limit (i.e., max-out). A left-turn phase can separate left-turning and opposing traffic streams in time and, thereby, reduce left-turn delays or related crashes.

The quality of the signal timing plan is directly tied to the adequacy of the intersection design. In some situations, achieving the objective of safe and efficient intersection operation may require changes to the intersection design. Guidelines are provided in Appendices A and C for the design of phase sequence and detection layout, respectively. Useful guidelines for the design of through lanes and turn bays are provided in the *Urban Intersection Design Guide* (5).

REFERENCES

1. Sunkari, S. "The Benefits of Retiming Traffic Signals." *ITE Journal*. Institute of Transportation Engineers, Washington, D.C., April 2004, pp. 26–29.
2. *Manual on Uniform Traffic Control Devices*. U.S. Department of Transportation, Washington, D.C., December 2003.
3. *Texas Manual on Uniform Traffic Control Devices*. Texas Department of Transportation, Austin, Texas, 2006.
4. Bonneson, J., and M. Fontaine. *NCHRP Report 457: Evaluating Intersection Improvements: An Engineering Study Guide*. Transportation Research Board, National Research Council, Washington, D.C., 2001.
5. Fitzpatrick, K., M.D. Wooldridge, and J.D. Blaschke. *Urban Intersection Design Guide*. Report No. FHWA/TX-05/0-4365-P2. Texas Department of Transportation, Austin, Texas, February 2005.

CHAPTER 2. SIGNAL CONTROLLER TIMING

This chapter provides guidelines for basic traffic signal timing. These guidelines are applicable to most actuated, non-coordinated intersections. Additional guidelines for coordinated intersections are provided in Chapter 3. Guidelines for using advanced signal timing features are provided in Appendix B.

The guidelines in this chapter are based on the assumption that the signal phasing is established and the detection system has been installed. If changes to the signal phasing are being considered, then the guidelines in Appendix A – Signal Phasing and Operation should be consulted. Similarly, if changes to the detection layout are being considered, then the guidelines in Appendix C – Detection Design and Operation should be consulted. If the intersection is part of a diamond interchange, then the guidelines in Appendix D – Diamond Interchange Phasing, Timing, and Design should be consulted.

This chapter consists of four parts. The first part provides an overview of the objectives of signal timing. The second part summarizes the basic signal timing concepts and establishes a vocabulary. The third part describes a signal timing procedure that is intended to yield safe and efficient intersection operation. The fourth part provides guidelines for the selection of values for key signal timing settings.

OVERVIEW

This part of the chapter provides an overview of the objectives of signal controller timing. The discussion is intended to highlight the influence of signal timing on traffic efficiency and safety. It describes the benefits derived from maintenance of timing and identifies the various performance measures that can be used to quantify these benefits.

Signal Timing Objectives

A primary objective when establishing a signal timing plan is to provide safe and efficient service to all intersection travelers. Achieving this objective requires a plan that accommodates fluctuations in volume over the course of the day, week, and year. A good plan will minimize road-user costs while consistently serving each traffic movement in a reasonably equitable manner and without causing any one movement to incur an unacceptable level of service. Because of changes in travel demand pattern over time, the signal timing plan should be periodically updated to maintain intersection safety and efficiency. Periodic retiming of traffic signals has been shown to yield road-user benefits that typically exceed the cost of the retiming by as much as a 40 to 1 ratio (1).

Periodic retiming of traffic signals has been shown to yield road-user benefits that typically exceed the cost of the retiming by as much as a 40 to 1 ratio.

An intersection's signal timing plan can be described by the collective set of settings that describe the manner in which the controller allocates cycle time to each conflicting traffic movement. Most signal controllers have numerous settings that allow its operation to be tailored to the conditions present at a specific intersection. The settings used (and their values) are often based on consideration of the desired phase sequence and available detection layout. For traffic actuated operation, key settings include: minimum green, maximum green, yellow change interval, red clearance interval, passage time, walk interval, and pedestrian change interval. Additional settings are available and are used by some agencies under specific situations.

In general, controller settings that directly influence the green interval duration have the greatest impact on traffic efficiency. Increasing a movement's green duration will reduce its delay and the number of vehicles that stop. However, an increase in one movement's green interval generally comes at the expense of increased delay and stops to another movement. Thus, a good signal timing plan will provide the most equitable balance in green time allocation based on consideration of the efficiency of all intersecting traffic movements.

The yellow change interval is intended to provide for safe termination of the green interval. The safety benefit of this interval is likely to be realized when its duration is consistent with the needs of drivers approaching the intersection at the onset of the yellow indication. This need relates to the driver's ability to perceive the yellow indication and gauge their ability to stop prior to the stop line as well as the time needed to clear the intersection. The driver's decision to stop or continue is influenced by several factors, most notably speed. Appropriately timed yellow change intervals have been shown to reduce intersection crashes (2).

Appropriately timed yellow change intervals have been shown to reduce intersection crashes.

Performance Measures

Performance measures are used to quantify the degree to which an intersection or roadway provides safe and efficient service to travelers. For this reason, the measures typically used are meaningful to travelers and can be quantified through field measurement.

The measures used to quantify intersection efficiency include delay, stop rate, and travel speed. The *Highway Capacity Manual* provides procedures for quantifying these measures for a given signal timing plan (3).

Level-of-service is defined in terms of delay. Operation is typically considered acceptable when the average delay is less than 35 s/veh.

Expected crash frequency is the most appropriate measure for quantifying intersection safety. The intersection's average crash frequency, based on crash data from a period of three or more years, can provide a reasonable estimate of this measure. It can be compared to the average crash frequency computed for similar intersections to gauge whether the subject intersection has an excessive crash frequency. Signalization factors that have been found to reduce intersection crashes are identified in the *Desktop Reference for Crash Reduction Factors* (4).

CONCEPTS

This part of the chapter explains basic signal timing concepts and establishes a vocabulary. Topics addressed include types of signal control, ring-and-barrier structure, and controller settings.

Types of Traffic Signal Control

In general, a controller will operate as pretimed or actuated. Pretimed control consists of a fixed sequence of phases that are displayed in repetitive order. The duration of each phase is fixed. Actuated control consists of a defined phase sequence wherein the presentation of each phase is typically dependent on whether the associated traffic movement has submitted a call for service through a detector. The green interval duration is determined by the traffic demand information obtained from the detector, subject to preset minimum and maximum limits.

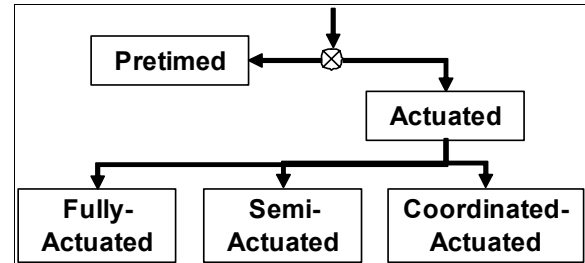

The operation of an actuated controller can be described as fully-actuated, semi-actuated, or coordinated-actuated. Fully-actuated control implies that all phases are actuated and all intersection traffic movements are detected. The sequence and duration of each phase is determined by traffic demand.

Semi-actuated control uses actuated phases to serve the minor movements at an intersection. Only the minor movements have detection. The phases associated with the major-road through movements are operated as “non-actuated.” The controller is programmed to dwell with the non-actuated phases displaying green for at least a specified minimum duration. The sequence and duration of each actuated phase is determined by traffic demand.

Coordinated-actuated control is a variation of semi-actuated operation. The minor movement phases are actuated and the major-road through movement phases are non-actuated. The controller’s force-off settings are used to ensure that the non-actuated phases are served at the appropriate time during the signal cycle such that progression for the major-road through movement is maintained.

Phase Sequence

Figure 2-1 illustrates typical vehicle and pedestrian traffic movements at a four-leg intersection. Three vehicular traffic movements and one pedestrian traffic movement are shown for each intersection approach. Each movement is assigned a unique number, or a number and letter combination. The letter “R” denotes a right-turn movement and “P” denotes a pedestrian movement.

Modern actuated controllers implement signal phasing using a dual-ring structure that allows for the concurrent presentation of a green indication to two phases. Each phase serves one or more movements that do not conflict with each other or those of the concurrent phase. The assignment

of movements to phases will vary in practice, depending on the desired phase sequence and the movements that are present at the intersection.

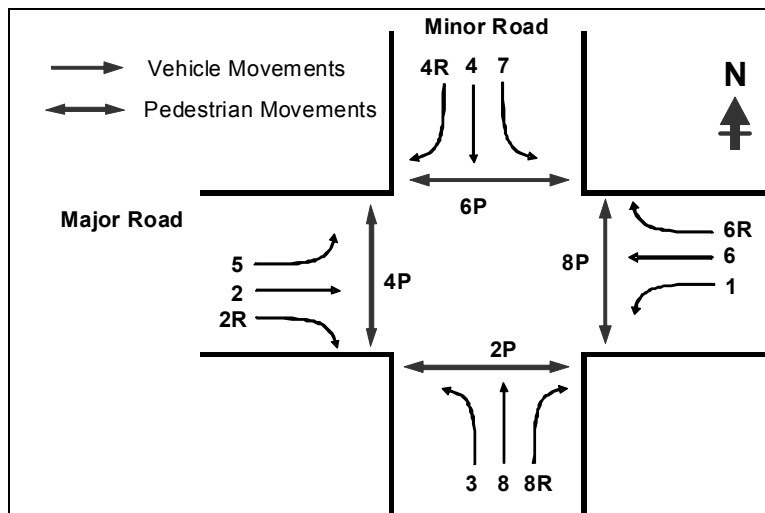

Figure 2-1. Intersection Traffic Movements and Numbering Scheme.

The dual-ring structure is shown in Figure 2-2. It is more efficient than the single-ring structure because it allows the controller to adapt phase duration and sequence to the needs of the individual movements. The dual-ring structure is typically used with eight phases; however, more phases are available for complex signal phasing. The symbol “Φ” shown in this figure represents the word “phase,” and the number following the symbol represents the phase number.

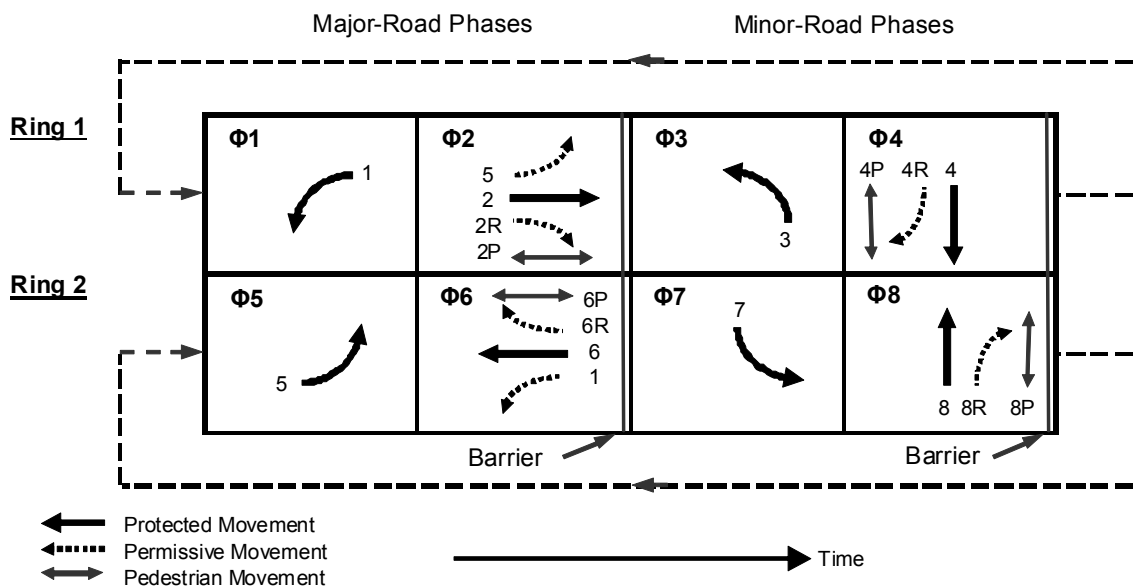

Figure 2-2. Dual-Ring Structure with Illustrative Movement Assignments.

Also shown in Figure 2-2 are the traffic movements typically assigned to each of the eight phases. These assignments are illustrative, but they are also frequently used in practice. Each left-turn movement is assigned to an exclusive phase. During this phase, the left-turn movement is “protected” such that it receives a green arrow indication. Each through, right-turn, and pedestrian movement combination is also assigned to an exclusive phase. The dashed arrows indicate turn movements that are served in a “permissive” manner such that the turn can be completed only after yielding the right-of-way to conflicting protected movements. Alternative phase sequences and left-turn operating modes are described in Appendix A.

Phase Settings

This section describes the controller settings that influence the duration of an actuated phase. The settings addressed include minimum green, maximum green, yellow change interval, red clearance interval, phase recall, and passage time.

Minimum Green

The minimum green setting defines the least amount of time that a green signal indication will be displayed for a movement. It is shown in Figure 2-3 as it relates to the yellow change and red clearance intervals and the controller timers. The timers shown include the minimum green timer and the passage time timer. The lines sloped downward in the figure represent a timer timing down as time passes. Once the minimum green timer reaches zero, the green extension period begins. Once the passage time timer reaches zero, the phase terminates by gap-out. The passage time timer is reset and restarts its countdown each time a detector actuation is received. Nine actuations are shown to occur in the figure.

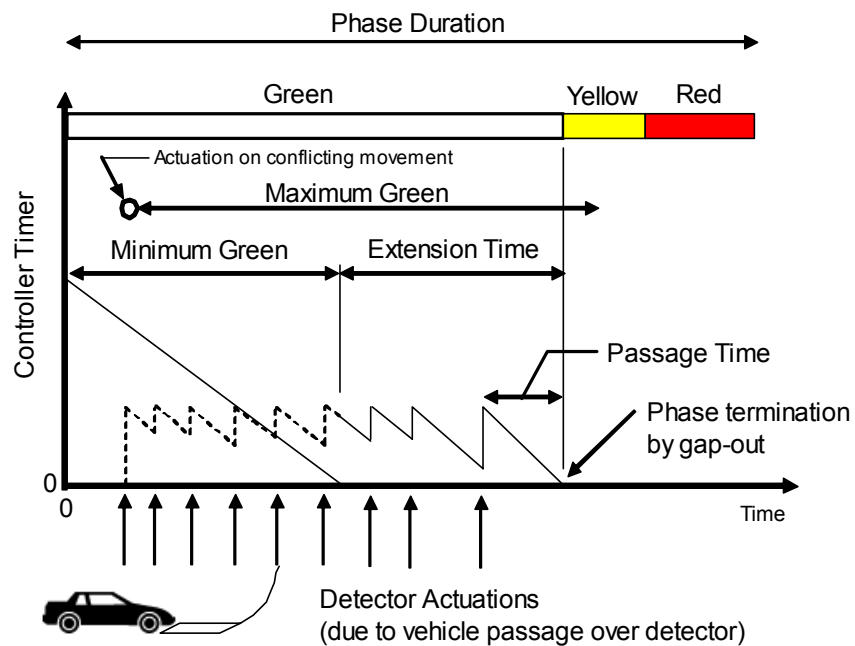

Figure 2-3. Intervals That Define the Duration of an Actuated Phase.

Maximum Green

The maximum green setting represents the maximum amount of time that a green signal indication can be displayed in the presence of conflicting demand. Most modern controllers provide a second maximum green setting that can be invoked by external input or by time of day.

The normal failure mode of a detector is to place a continuous call for service. Thus, when a detector fails, the assigned phase will time to its maximum green limit.

Yellow Change Interval

The yellow change interval is intended to alert a driver to the impending presentation of a red indication. This interval should have a duration in the range of 3 to 6 s, with longer values in this range used for approaches with higher speeds (5).

Red Clearance Interval

The red clearance interval is optional. If not used, its value is 0 s. Non-zero values are used to allow a brief period of time to elapse following the yellow indication and during which the signal heads associated with the ending phase and all conflicting phases display a red indication. The *TMUTCD* advises that the red clearance interval should not exceed 6 s (5).

Phase Recall Mode

Recall causes the controller to place a call for a specified phase each time the controller is servicing a conflicting phase. There are four types of recalls: minimum recall, maximum recall, pedestrian recall, and soft recall. Applying the minimum recall setting causes the controller to place a continuous call for vehicle service on the phase and then services the phase until its green interval exceeds the minimum green time. The phase can be extended if actuations are received.

Maximum recall causes the controller to place a continuous call for the vehicle service on the phase. It results in the presentation of the green indication for its maximum duration every cycle.

If maximum recall is invoked for all phases, then an equivalent pretimed operation is achieved where each phase times to its maximum green limit.

Pedestrian recall causes the controller to place a continuous call for pedestrian service on the phase. After the pedestrian phase is served, additional vehicle actuations can extend the green indication.

Soft recall causes the controller to place a call for vehicle service on the phase but only in the absence of a call on any conflicting phases. When the phase is displaying its green indication, the controller serves the phase until the green interval exceeds the minimum green time. The phase can be extended if actuations are received.

Passage Time

Passage time is the maximum amount of time a vehicle actuation can extend the green interval when green is displayed. The passage timer starts to time from the instant the vehicle actuation is removed. A subsequent actuation will reset the passage timer. When the passage timer reaches the passage time limit and there is an actuation on a conflicting phase, the phase will terminate by gap-out, as shown in Figure 2-3.

Vehicle Detection

The vehicle detection system is used to monitor vehicle activity on the intersection approaches and to allocate cycle time in a manner that is sensitive to need among the conflicting movements. The detection design for a given traffic movement is described by: (1) the physical layout of the detectors in each traffic lane serving the movement, and (2) the detector and controller settings that are paired with the layout. Guidelines for establishing an effective detector layout are provided in Appendix C. Key detector settings are described in the next section.

Detector Settings

Modern signal controllers have several settings that can be used to modify the vehicle actuations received from the detectors for the purpose of improving intersection safety or efficiency. Traditionally, this functionality was available only in the detector amplifier unit that

The delay, extend, call, or queue settings are available in the controller and in the detector unit. If used, they are typically set in the controller and not in the detector unit.

served as an interface between the inductive loop detector and the signal controller. However, modern controllers also support call-modifying features. The settings described in this section are available in most modern controllers; they include: delay, extend, call, and queue.

Delay

The delay setting is used to delay the presentation of a vehicle actuation to the controller. Specifically, the actuation is not made available to the controller until the delay timer expires and the actuation channel input is still active (i.e., the detection zone is still occupied). Once the actuation is made available to the controller, it is continued for as long as the channel input is active.

Extend

The extend setting is used to extend the duration of an actuation, as presented to the controller. The extension timer begins the instant the detector channel input is inactive. The actuation is presented to the controller immediately and retained until the actuation is removed and the extension timer times out. Thus, an actuation that is 1 s in duration at the channel input can be extended to 3 s if the extend setting is set to 2 s.

Call

The call setting allows the controller to receive actuations only when it is not timing a green interval. Actuations received during the green interval are ignored.

Queue

A detector can be configured as a queue service detector to effectively extend the green interval until the queue is served, at which time it is deactivated until the start of the next conflicting phase. This setting is sometimes used with detection designs that include one or more advance detectors and stop line detection.

The queue setting, in combination with an advance detection design, can improve intersection efficiency by eliminating unnecessary green extensions by the stop line detector.

It deactivates the stop line detection during the green interval after the queue has cleared. The advance detectors are then used to ensure safe phase termination. The queue setting is available in most modern controllers (e.g., as Special Detector Mode 4 in the Eagle controller).

Pedestrian Settings

There are two key pedestrian settings: walk interval and pedestrian change interval. The walk interval begins at the start of the green when the pedestrian signal displays a WALK indication. The pedestrian change interval follows the walk interval. During this interval, a flashing DON'T WALK indication (and possibly a trailing solid DON'T WALK indication) is presented.

PROCEDURE

This part of the chapter describes a procedure for developing a signal timing plan for a non-coordinated intersection. The procedure consists of a series of steps that describe the decisions and calculations that need to be made to produce a timing plan that will yield safe and efficient intersection operation. The steps include:

1. Collect data.
2. Assess degree of saturation.
3. Determine controller settings.
4. Install, evaluate, and refine.

Desirably, the decisions made and calculations completed in these steps are based on field data or first-hand observation of traffic operation at the subject intersection.

Step 1. Collect Data

During this step, data are needed that describe conditions at the intersection during the designated traffic period (e.g., evening peak hour) or periods. These data are listed in Table 2-1.

Table 2-1. Data Used to Establish Signal Timing.

Category	Data
Lane assignment	<ul style="list-style-type: none"> ● Number of left-turn, through, and right-turn lanes on each approach ● Lane use: exclusive or shared
Detector data	<ul style="list-style-type: none"> ● Length of each detector in each lane ● Distance between each detector and the stop line
Approach description	<ul style="list-style-type: none"> ● Speed limit (85th percentile speed is preferred, if it can be obtained or estimated) ● Grade
Left-turn mode	<ul style="list-style-type: none"> ● Permissive, protected-permissive, or protected left-turn operation by approach
Signal phase data	<ul style="list-style-type: none"> ● Yellow change and red clearance interval duration ● Minimum and maximum green settings ● Passage time setting ● Phase recall mode
Phase sequence	<ul style="list-style-type: none"> ● Ring diagram showing phase sequence (e.g., no left-turn phase, leading left-turn, split)
Traffic volume ¹	<ul style="list-style-type: none"> ● Turn movement counts for representative morning peak, evening peak, and off-peak traffic periods; volumes may be estimated if actual counts are not available

Note:

1 - Traffic volume is needed to assess degree of saturation or evaluate a signal timing plan in terms of its impact on intersection performance.

As noted in Table 2-1 for Approach Description, the 85th percentile speed is preferred over speed limit because it is a more accurate indication of traffic conditions. Speed limit is not representative of the 85th percentile speed on some roads. Traffic volume is not required to determine the basic signal settings for an actuated, non-coordinated intersection. However, it is needed if the analyst desires to assess degree of saturation or evaluate a signal timing plan in terms of its impact on intersection performance.

The 85th percentile speed is a more accurate indication of traffic conditions than speed limit. Actual speeds are not always consistent with the speed limit.

The data listed in Table 2-1 can be recorded during a site survey. The survey data should be recorded on a condition diagram. An illustrative condition diagram is shown in Figure 2-4. A blank diagram is provided at the end of this chapter.

Step 2. Assess Degree of Saturation

The decisions made when developing the signal timing plan are highly dependent on whether the intersection is under- or over-saturated during the traffic period. Signal timing strategies for under-saturated intersections may not be the same as those for over-saturated intersections. Strategies for timing under-saturated intersections are based on minimizing delay and providing for safe phase termination. In contrast, strategies for over-saturated intersections are based on queue management and throughput maximization. The addition of traffic lanes and lengthening of turn bays are logical solutions for alleviating over-saturated conditions, although they are not always available. The following discussion assumes that these solutions have been considered and that signal timing strategies for mitigating the adverse effects of over-saturation are sought.

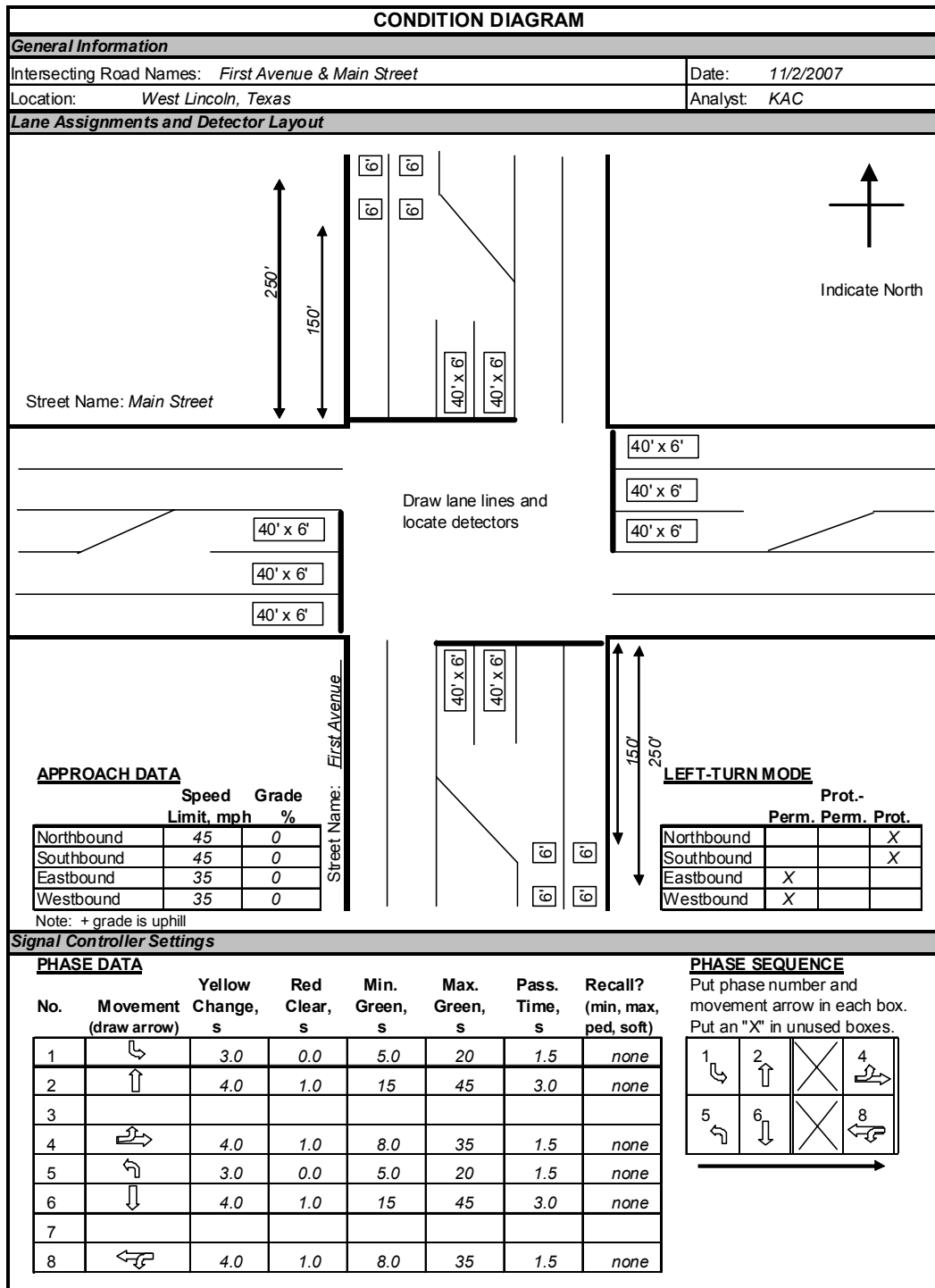

Figure 2-4. Sample Condition Diagram.

During this step, the degree of saturation (i.e., volume-to-capacity ratio) should be quantified for each intersection signal phase during the designated traffic period. Alternatively, queue length and cycle failures can be observed in the field during the designated traffic period. The objective

of this evaluation is to determine the number of phases that are over-saturated (i.e., has a recurring overflow queue during the traffic period or a volume-to-capacity ratio greater than 1.0) and whether it results in bay overflow or spillback into an upstream intersection.

If only a few signal phases are experiencing over-saturation, a timing plan that minimizes overall delay may provide a useful starting point. However, this plan should be “tuned” (i.e., phase splits adjusted slightly) such that the over-saturation is eliminated or reduced to the point that it does not cause overflow or spillback. This plan may need to have some time-of-day sensitivity if different phases are over-saturated at different times.

If many phases are experiencing over-saturation during the traffic period, then a queue management timing plan that allocates cycle time in a manner that minimizes the disruption caused by spillback and overflow may be appropriate. This plan may be initially based on a minimum-delay timing plan, but it must be tuned such that queues are formed only in the least damaging locations. Moreover, the maximum green settings during these periods should be reduced (relative to their under-saturated values) to yield a more nearly pretimed operation at a reasonably short cycle length.

Under certain specific conditions, a longer cycle length may alleviate over-saturated conditions. Consider an intersection where the following conditions exist: (1) two over-saturated phases exist, (2) they are the two major-road through movement phases, (3) the major-road left-turn bays do not overflow, and (4) the minor-road queues do not adversely impact upstream intersections. At this intersection, a longer cycle length will increase capacity and may lessen the degree to which the through movement phases are over-saturated. However, the larger cycle length should be part of a minimum-delay timing plan that has been tuned such that any queues that form are in the least damaging locations.

Step 3. Determine Controller Settings

During this step, the controller settings are determined based on consideration of the data collected in Step 1. The settings that are determined can vary but are likely to include minimum green, maximum green, yellow change interval, red clearance interval, walk interval, pedestrian change interval, and passage time. These settings were defined in the previous part of this chapter. The tasks typically undertaken during this step include:

1. Determine yellow change and red clearance intervals.
2. Determine pedestrian intervals.
3. Determine minimum green setting.
4. Determine maximum green setting.
5. Determine passage time setting.

Guidelines are provided in the next part of this chapter to assist the analyst in making the determinations associated with each task. Guidelines for determining signal phase sequence are provided in Appendix A. Guidelines for using advanced signal timing settings are described in Appendix B. Guidelines for designing the detection layout are provided in Appendix C.

There are several software products and spreadsheets available that automate many of the signal timing tasks. Most of these products can be obtained from the Center for Microcomputers in Transportation (McTrans) at the University of Florida (<http://mctrans.ce.ufl.edu/>). If traffic volume data are provided, then several of these products can also be used to evaluate the proposed controller settings in terms of their expected impact on intersection efficiency.

Step 4. Install, Evaluate, and Refine

The last step in signal timing plan development relates to the implementation and field verification of the proposed controller settings. This step consists of the following five tasks:

1. Install the settings in the signal controller.
2. Put the settings in operation during an off-peak period, and observe traffic behavior.
3. Refine the settings if so indicated.
4. Put the settings in operation during the intended period, and observe traffic behavior.
5. Refine the settings if so indicated.

The goal of the two refinement tasks is to make small changes in the settings, such that intersection safety or efficiency is further improved.

GUIDELINES

This part of the chapter provides guidelines for selecting basic signal timing settings for non-coordinated intersections. The information provided is based on established practices and techniques that have been shown to provide safe and efficient intersection operation. The guidelines address actuated phase settings, detector settings, and pedestrian settings.

Guidelines for Actuated Phase Settings

This section describes guidelines for determining the duration of the various settings associated with an actuated phase. These settings include:

- Minimum green.
- Maximum green.
- Yellow change and red clearance intervals.
- Phase recall mode.
- Passage time.

The guidelines address typical intersection geometry and detection designs. However, they can be extended to atypical configurations with some care.

Minimum Green

The minimum green setting is intended to ensure that each green interval that is displayed is sufficiently long as to allow the waiting queue enough time to perceive and react to the green indication (i.e., satisfy driver expectancy). When stop line detection is not provided, the minimum green must also be sufficiently long as to allow vehicles queued between the stop line and the nearest detector to clear the intersection. The minimum green setting may also need to be sufficiently long as to accommodate pedestrians that desire to cross in a direction parallel to the traffic movement receiving the green indication. These considerations are shown in Table 2-2, as are the conditions for which each consideration may apply.

Table 2-2. Factors Considered When Establishing the Minimum Green Setting.

Phase	Stop Line Detection?	Pedestrian Button?	Considered in Establishing Minimum Green?		
			Driver Expectancy	Ped. Crossing Time	Queue Clearance ²
Through	Yes	Yes	Yes	No	No
		No	Yes	Possibly ¹	No
	No	Yes	Yes	No	Yes
		No	Yes	Possibly ¹	Yes
Left-turn	Yes	not applicable	Yes	not applicable	No

Notes:

- 1 - If no pedestrians are expected to cross, then pedestrian crossing time does not need to be considered when establishing the minimum green setting. Otherwise, pedestrian crossing time should be considered.
- 2 - Settings are only applicable to phases that have one or more advance detectors, no stop line detection, and the variable initial feature is not used.

To illustrate the use of Table 2-2, consider a through movement with stop line detection and a pedestrian push button at the intersection of two major roads. Table 2-2 indicates that the minimum green setting should be based only on consideration of driver expectancy. However, if a pedestrian call button is not provided (and pedestrians are expected to cross the road at this intersection), then the minimum green setting should be based on consideration of both driver expectancy and pedestrian crossing time.

The remainder of this subsection describes a procedure for estimating the minimum green setting duration needed to satisfy each of the three considerations identified in Table 2-2. The minimum green setting needed for each of these considerations is quantified when it is applicable to the subject phase. Then, the minimum green setting is equal to the larger of the applicable values. This relationship is described in Equation 1.

$$G_{min} = \text{Larger of: } [G_e, G_q, G_p] \quad (1)$$

where,

G_{min} = minimum green setting, s.

G_e = minimum green setting needed to satisfy driver expectation, s.

G_q = minimum green setting needed to satisfy queue clearance time, s.

G_p = minimum green setting needed to satisfy pedestrian crossing time, s.

Minimum Green Setting to Satisfy Driver Expectancy. The minimum green setting ranges listed in Table 2-3 are considered to satisfy driver expectancy. Shorter values in each range are used to provide a “snappy” intersection operation. Larger values in each range are often used for phases associated with: (1) exceptionally wide intersections (as measured in the subject direction of travel), (2) traffic movements with a significant number of large trucks, or (3) higher speed conditions.

Table 2-3. Minimum Green Setting Needed to Satisfy Driver Expectancy.

Phase	Intersection Approach Type	Minimum Green (G_e), s
Through	Major-road approach	8 to 15
	Minor-road approach	5 to 10
Left-turn	All	5 to 8

Minimum Green Setting for Queue Clearance. The selection of minimum green setting may also be influenced by detector location and controller operation. This subsection addresses the situation where a phase has one or more advance detectors and no stop line detection. If this detection design is present and the controller’s variable initial feature is not used, then a minimum green duration is needed to clear the vehicles queued between the stop line and advance detector (the variable initial feature is described in Appendix B). The duration of this interval is specified in Table 2-4. If the distance between the stop line and nearest upstream detector exceeds 150 ft, then the variable initial feature should be used.

Table 2-4. Minimum Green Setting Needed to Satisfy Queue Clearance.

Distance between Stop Line and Nearest Upstream Detector, ft	Minimum Green (G_q), s ^{1,2}
0 to 25	5
26 to 50	7
51 to 75	9
76 to 100	11
101 to 125	13
126 to 150	15

Notes:

- Settings are only applicable to phases that have one or more advance detectors, no stop line detection, and the variable initial feature is not used.
- Minimum green needed to satisfy queue clearance, $G_q = 3 + 2n$ (in seconds); where, n = number of vehicles between stop line and nearest upstream detector in one lane ($= D_d / 25$), and D_d = distance between the stop line and the downstream edge of the nearest upstream detector (in feet).

Minimum Green Setting for Pedestrian Crossing Time. The minimum green duration should satisfy pedestrian crossing needs for those through phases that are not associated with a pedestrian push button and for which a pedestrian demand is known to exist. Under these conditions, the minimum green setting can be computed using Equation 2.

$$\text{where,} \quad G_p = W + PCI \quad (2)$$

W = walk interval duration, s.

PCI = pedestrian change interval duration, s.

Guidelines for determining the walk and pedestrian change interval durations are provided in a subsequent section.

Maximum Green

The maximum green setting is intended to limit the green interval duration such that the delay to conflicting movements is not excessive. Its value should exceed the average queue service time and, thereby, allow the phase to accommodate cycle-to-cycle peaks in volume. Frequent phase termination by gap-out (as opposed to max-out) during non-peak periods is an indication of a properly chosen maximum green setting. Typical values of this setting are listed in Table 2-5.

Table 2-5. Typical Range of Maximum Green Settings.

Phase	Condition	Maximum Green Setting, s
Through	Major approach (speed limit exceeds 40 mph)	40 to 70
	Major approach (speed limit is 40 mph or less)	30 to 60
	Minor approach, or low-volume approach	20 to 40
Left-turn	All	15 to 30

If traffic volume data are available, the following rules-of-thumb can be used to estimate the maximum green setting G_{max} for a given through or left-turn phase.

- The maximum green setting for the through phase serving a major-road approach can be estimated as equal in seconds to one-tenth of the phase's peak-period volume V (when expressed in vehicles per hour per lane), but no less than 30 s.
- The maximum green setting for the through phase serving a minor-road approach can be estimated as equal in seconds to one-tenth of the phase's peak-period volume (when expressed in vehicles per hour per lane), but no less than 20 s.

Major-Road Through Phase:

$G_{max, thru} = \text{Larger of: } (30, G_{min, thru} + 10, 0.1 \times V)$
where, V = peak-period volume per lane.

Minor-Road Through Phase:

$G_{max, thru} = \text{Larger of: } (20, G_{min, thru} + 10, 0.1 \times V)$

Left-Turn Movement Phase:

$G_{max, left} = \text{Larger of: } (15, G_{min, left} + 10, 0.5 \times G_{max, thru})$

- The maximum green setting for a left-turn phase should equal one-half that used for the phase serving the adjacent through movement, but no less than 15 s.
- The maximum green setting should exceed the minimum green setting by 10 s or more to allow sufficient flexibility in the phase timing to accommodate volume peaks.

Consider a major-road approach with a through volume of 550 veh/h/ln and a left-turn volume of 100 veh/h/ln. It has a left-turn phase and a through phase. The minor-road approach has a total volume of 100 veh/h/ln and only one phase for all movements. The minimum green setting is 8 s. The maximum green setting for the phase serving the major-road through movement should be 55 s (= larger of: [30, 8 +10, 0.1 ×550]). The maximum green setting for the phase serving the major-road left-turn movement should be 28 s (= larger of: [15, 8 +10, 0.5 ×55]). The maximum green setting for the minor-road phase should be 20 s (= larger of: [20, 8 +10, 0.1 ×100]).

Yellow Change and Red Clearance Intervals

The phase change period is intended to provide a safe transition between two conflicting phases. It consists of a yellow change interval and, optionally, a red clearance interval. The yellow change interval is intended to warn drivers of the impending change in right-of-way assignment. The red clearance interval is used when it is determined that there is some benefit to providing additional time before conflicting movements receive a green indication.

The Institute of Transportation Engineers (ITE) (6) offers the following equation for computing the phase change period:

$$CP = t + \frac{1.47 v}{2(a + 32.2 g)} + \frac{W + L}{1.47 v} \quad (3)$$

where,

CP = change period (yellow change plus red clearance intervals), s.

t = perception-reaction time (use 1 s), s.

v = approach speed, mph.

a = deceleration rate (use 10 ft/s²).

g = approach grade, uphill grade is positive (= percent grade / 100), ft/ft.

W = width of intersection, ft.

L = length of design vehicle (use 20 ft).

Approach Speed. When applying Equation 3 to through movement phases, the approach speed used is either the 85th percentile speed or the posted speed limit. The determination of which speed to use should be based on agency policy. Regardless of which speed term is used, it should be used consistently for all intersections.

<u>Through Movement Approach Speed</u>	<u>Left-Turn Movement Approach Speed</u>
25 to 34 mph	25 mph
35 to 44	30
45 to 54	35
55 to 64	40
65 to 74	45

When applying Equation 3 to left-turn movement phases, the speed used should reflect that of the vehicles turning left. This speed is typically slower than that of the adjacent through vehicles because left-turning drivers slow to reach a comfortable turning speed. The left-turn movement approach speed can be estimated as the average of the through movement approach speed and the left-turn speed (a typical left-turn speed is 20 mph).

Intersection Width. The width of the intersection W should be measured from the near-side stop line to the far edge of the last conflicting traffic lane along the subject vehicle travel path. For through movement phases that serve significant pedestrian volume, this width may be increased to include the width of the pedestrian crosswalk on the far side of the intersection.

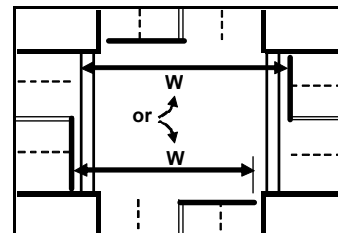

The travel path for a left turn is curved but it can be approximated as a straight line when estimating W for a left-turn phase.

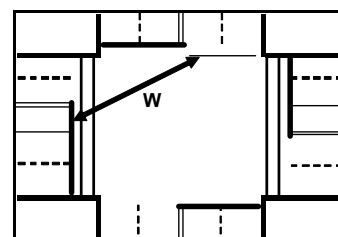

Yellow Change Interval. Column 2 of Table 2-6 lists the yellow change interval for a level grade. It is computed using the first two terms in Equation 3.

Table 2-6. Yellow Change and Red Clearance Interval Duration.

Approach Speed, mph	Yellow Change Interval (Y), s	Width of Intersection, ft					
		50	70	90	110	130	150
		Red Clearance Interval (R_c), s					
25	3.0 ^a	1.9	2.5	3.0	3.5	4.1	4.6
30	3.2	1.6	2.0	2.5	3.0	3.4	3.9
35	3.6	1.4	1.8	2.1	2.5	2.9	3.3
40	3.9	1.2	1.5	1.9	2.2	2.6	2.9
45	4.3	1.1	1.4	1.7	2.0	2.3	2.6
50	4.7	1.0	1.2	1.5	1.8	2.0	2.3
55	5.0	0.9	1.1	1.4	1.6	1.9	2.1
60	5.0 ^b	1.2	1.4	1.7	1.9	2.1	2.3
65	5.0 ^b	1.5	1.7	1.9	2.1	2.3	2.6
70	5.0 ^b	1.8	2.0	2.2	2.4	2.6	2.8

Notes:

a - Yellow change interval is adjusted upward to 3 s.

b - Yellow change interval is adjusted downward to 5 s. The computed time in excess of 5 s is added to the red clearance interval.

For approach speeds of 60 mph or more, the computed time in excess of 5 s is added to the red clearance interval. This adjustment is made in recognition of the disrespect some drivers have shown for notably long change intervals. This shift of time from the yellow to the red clearance

interval may increase the number of drivers that do not have adequate time during the yellow interval to reach the stop line (although they will still be able to safely clear the intersection during the red clearance interval). This factor should be considered when establishing the duration of the “grace” period associated with the enforcement of red-light violations.

The yellow change interval Y values in Table 2-6 are based on a negligible approach grade. They should be increased by 0.1 s for every 1 percent of downgrade.

Increase Y by 0.1 s for each 1% downgrade.
Decrease Y by 0.1 s for each 1% upgrade.

Similarly, they should be decreased by 0.1 s for every 1 percent of upgrade. To illustrate, consider an approach with 30 mph approach speed, 70 ft intersection width, and 4 percent downgrade. The estimated yellow interval is 3.6 s ($= 3.2 + 0.1 \times 4$).

Red Clearance Interval. Columns 3 through 8 of Table 2-6 list the red clearance interval R_c durations for a range of intersection widths and approach speeds. It is computed using the last term of Equation 3.

If a red clearance interval is used, it should not exceed 6 s.

Phase Recall Mode

The phase recall mode is sometimes used to achieve specific control objectives for selected phases. Guidelines describing the use of this mode are provided in this subsection.

Minimum Recall. The recall setting is sometimes set to minimum recall for the major-road through movement phases (usually phases 2 and 6) at a non-coordinated intersection with a low-volume minor road and no detection for the major-road through phases. This use ensures that the major-road through phases will receive the green indication at the earliest possible time

At major-minor intersections:

- Use **Minimum Recall** for the major-road through phases if they do *not* have detection.
- Use **Soft Recall** for the major-road through phases if they have detection.

in the cycle and that they will dwell in green when demand for the conflicting phases is low. This setting is typically used when detection is *not* provided for the major-road through phases.

Maximum Recall. There are two applications for maximum recall. One application stems from a desire to use the actuated controller to yield an equivalent pretimed operation. This application requires all phases to be set for maximum recall. The maximum green settings used for this application should equal the green interval durations for the optimal pretimed timing plan.

A second application is considered when vehicle detection is out-of-service or not present. Using maximum recall ensures that, in the absence of detection, the phase serves the associated movement.

Regardless of the application, maximum recall can result in inefficient operation during low volume conditions (e.g., during nighttimes and weekends) and should be used only when necessary.

Pedestrian Recall. Pedestrian recall is used for phases that have a high probability of pedestrian demand every cycle. This application should be implemented sparingly because it can result in inefficient vehicle operation.

Soft Recall. Soft recall is sometimes used for the major-road through movement phases (usually phases 2 and 6) at non-coordinated intersections. This use ensures that the major-road through phases will dwell in green when demand for the conflicting phases is low. This setting is typically used when detection is provided for the major-road through phases.

Passage Time

The appropriate passage time used for a particular signal phase is dependent on many considerations, including: number of detection zones per lane, location of each detection zone, detection zone length, detection call memory (i.e., locking or nonlocking), detection mode (i.e., pulse or presence), and approach speed. Ideally, the detection design is established and the passage time determined such that the “detection system” provides efficient queue service and, for high-speed approaches, safe phase termination. Detection design procedures that reflect these considerations are described in Appendix C.

The guidelines in this section are based on the following detector design elements:

- Nonlocking controller memory is used.
- Presence-mode detection is used.
- Gap reduction is not used.
- A single source of detection is provided at the stop line for the subject signal phase.

This list describes elements associated with the most common detection design applications. Designs using multiple sources of detection are described in Appendix C. Designs that use the gap reduction feature with a single 6-ft loop detector located at a distance upstream of the stop line (and no detection at the stop line) are described in Appendix B.

The single source of detection noted in the previous list could consist of one long detector loop at the stop line or a series of 6-ft loops that are closely spaced and operate together as one long zone of detection near the stop line. This type of detection design is typically used to ensure queue clearance.

Passage time defines the maximum allowable time separation between vehicle calls that can occur without gapping out the phase. When only one traffic lane is served during the phase, this maximum time separation equals the maximum allowable headway (MAH) between vehicles. Although this relationship does not directly hold when several lanes are being served, the term “MAH” is still used, and it is understood that the “headway” in reference represents the time interval between calls (and not necessarily the time between vehicles in the same lane). Figure 2-5 illustrates

the relationship between passage time and MAH for presence-mode detection. This relationship is quantified using Equation 4.

$$PT = MAH - \frac{L_v + L_d}{1.47 v_a} \quad (4)$$

where,

PT = passage time, s.

MAH = maximum allowable headway, s.

v_a = average approach speed ($= 0.88 \times v_{85}$), mph.

v_{85} = 85th percentile approach speed, mph.

L_v = detected length of vehicle (use 17 ft).

L_d = length of detection zone, ft.

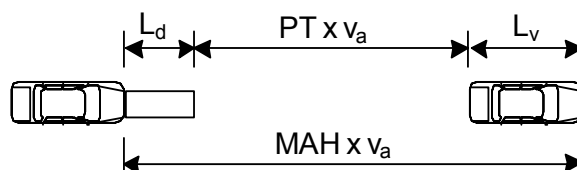

Figure 2-5. Relationship between Passage Time and Maximum Allowable Headway.

Equation 4 is derived for presence-mode detection. This mode tends to provide more reliable intersection operation than pulse-mode detection and is described more fully in Appendix C. If pulse-mode detection is used, then the passage time is equal to the MAH.

The duration of the passage time setting should be based on the following three, somewhat contradictory, goals (7):

- *Ensure queue clearance.* The passage time should not be so *small* that the resulting MAH causes the phase to have frequent premature gap-outs (i.e., a gap-out that occurs before the queue is fully served). A premature gap-out will leave a portion of the stopped queue unserved and, thereby, lead to increased delays and possible queue spillback.
- *Satisfy driver expectancy.* The passage time should not be so *large* that the green is extended unnecessarily after the queue has cleared. Waiting drivers in conflicting phases will become anxious and may come to disrespect the signal indication.
- *Reduce max-out frequency.* The passage time should not be so *large* that the resulting MAH causes the phase to have frequent max-outs. A long MAH would allow even light traffic volume to extend the green to max-out. Waiting drivers in higher-volume conflicting phases may be unfairly delayed.

Experience indicates that a MAH of 3 s provides the best compromise between the aforementioned goals when the controller's gap reduction feature is not used. Passage time settings to be used with the gap reduction feature are described in Appendix B.

Inductive Loop Detection. The passage time for stop line detection is provided in Table 2-7. If detection zone length can be adjusted, a longer detection zone is generally preferred because it is more efficient at identifying when the queue has cleared (8).

With a 40-ft loop detection at the stop line, estimate passage time (PT) as:

$$PT = (85^{\text{th}} \text{ percentile speed in mph})/20$$

Table 2-7. Passage Time for Stop Line Presence Detection.

Maximum Allowable Headway, s	Detection Zone Length, ft	85 th Percentile Speed, mph				
		20	25	30	35	40
		Passage Time (PT), s ¹				
3	20	1.5	2.0	2.0	2.0	2.5
	40	1.0	1.0	1.5	1.5	2.0
	60	0.0	0.5	1.0	1.5	1.5
	80	0.0	0.0	0.5	1.0	1.0

Note:

1 - Passage times shown are applicable to inductive loop detection. Use 0.0 s for video image vehicle detection.

For left-turn movements from an exclusive left-turn lane, the 85th percentile speed will typically be about 20 mph. Similarly, for right-turn movements from an exclusive right-turn lane, the 85th percentile speed will typically be about 20 mph.

The passage time obtained from Table 2-7 may be increased by up to 1 s if the approach is on a steep upgrade, there is a large percentage of heavy vehicles, or both.

Video Detection. If a video image vehicle detection system (VIVDS) is used to provide detection, then the passage time should be set to 0 s and the effective length of the video detection zone increased such that the MAH is

3 s (9). In general, this approach yields a video detection zone with a length equal to about three times the approach speed (in mph). This topic is discussed in more detail in Appendix C.

With VIVDS, use a passage time of 0 s and a stop line detection zone length (L_d) of: L_d in ft = 3 x (85th percentile speed in mph).

Guidelines for Detector Settings

This section provides guidelines for selecting the detector settings that are available in the signal controller. The settings addressed include detector delay and call. Other settings exist (e.g., extend and queue) and are typically designed to work with advance detection for safe phase termination. These settings are discussed in Appendix C.

Delay

Delay is sometimes used with stop line, presence-mode detection for turn movements from exclusive lanes. For right-turn lane detection, delay should be considered when the capacity for right-turn-on-red (RTOR) exceeds the right-turn volume or a conflicting movement is on recall. If RTOR capacity is limited, then delay may only serve to degrade intersection efficiency by further delaying right-turn vehicles. The delay setting should range from 8 to 14 s, with the larger values used when a higher speed or conflicting volume exists on the intersecting road (7).

If the major road uses recall, consider using 8 to 14 s delay for the detectors monitoring the minor-road right-turn movement.

If the left-turn movement is protected-permissive, then the delay setting should be considered for the left-turn lane detection. The delay value used should range from 5 to 12 s, with the larger values used when a higher speed or volume exists on the opposing approach (7).

Call

This setting passes calls to the controller only during yellow and red intervals. It is disabled during green and, thereby, does not allow calls received during the green interval to extend the phase. This setting is typically used when a single advance detector is used without stop line detection and there are one or more driveways between the advance detector and the stop line. In this situation, a second detector is located near the stop line to detect vehicles that enter the approach from the driveway. The call setting is used with this detector to ensure that driveway traffic is served under low-volume conditions, without unnecessarily extending the phase during the green interval.

Guidelines for Pedestrian Settings

This section provides guidelines for determining the duration of the walk and pedestrian change intervals.

Walk Interval

The walk interval gives pedestrians adequate time to perceive the WALK indication and depart the curb before the pedestrian change interval begins. The *TMUTCD* indicates that the minimum walk duration should be at least 7 s, but indicates that a duration as low as 4 s may be used if pedestrian volume is low or pedestrian behavior does not justify the need for 7 s (5). Consideration should be given to longer walk duration in school zones and areas with large numbers of elderly pedestrians. Table 2-8 summarizes the walk interval durations based on guidance provided in the *TMUTCD* (5) and the *Traffic Control Devices Handbook* (10).

Table 2-8. Pedestrian Walk Interval Duration.

Conditions	Walk Interval Duration (<i>W</i>), s
High pedestrian volume areas (e.g., school, central business district, etc.)	10 to 15
Typical pedestrian volume and longer cycle length	7 to 10
Typical pedestrian volume and shorter cycle length	7
Negligible pedestrian volume	4

Pedestrian Change Interval

Pedestrian clearance time must follow the walk interval. It should allow a pedestrian crossing in the crosswalk to leave the curb (or shoulder) and walk at a normal rate to at least the far side of the traveled way, or to a median of sufficient width for pedestrians to wait (5).

Pedestrian Walking Speed. The *TMUTCD* (5) recommends a walking speed value of 4.0 ft/s. However, the *Pedestrian Facilities User Guide* (11) recommends a maximum walking speed of 3.5 ft/s. This guide also suggests that a slower walking speed should be used in areas where there is a heavy concentration of elderly pedestrians or children.

Pedestrian Clearance Time. The pedestrian clearance time is computed as the crossing distance divided by the walking speed. Crossing distance is typically measured from curb to curb along the crosswalk. Clearance time can be obtained from Table 2-9 for typical pedestrian crossing distances and walking speeds.

Table 2-9. Pedestrian Clearance Time.

Pedestrian Crossing Distance, ft	Walking Speed, ft/s		
	3.0	3.5	4.0
	Pedestrian Clearance Time (<i>PCT</i>), s ¹		
20	7	6	5
25	8	7	6
30	10	9	8
35	12	10	9
40	13	11	10
45	15	13	11
50	17	14	13
60	20	17	15
70	23	20	18
80	27	23	20
90	30	26	23
100	33	29	25

Note:

1 - Clearance times computed as $PCT = D_c / v_p$, where D_c = pedestrian crossing distance (in feet) and v_p = pedestrian walking speed (in feet per second).

Pedestrian Change Interval Duration.

The *TMUTCD* indicates that the pedestrian clearance time can be provided during: (1) the pedestrian change interval during which a flashing DON'T WALK indication is displayed, and (2) a second interval that times concurrent with the vehicular yellow change and red clearance intervals and displays either a flashing or solid DON'T WALK (5). This practice minimizes the impact of pedestrian service on phase duration and allows the phase to be responsive to vehicular demand. Following this guidance, the pedestrian change interval duration is computed using Equation 5.

A portion of the pedestrian clearance time can occur during the yellow change and red clearance intervals.

$$PCI = PCT - (Y + R_c) \quad (5)$$

where,

PCI = pedestrian change interval duration, s.

PCT = pedestrian clearance time, s.

Y = yellow change interval, s.

R_c = red clearance interval, s.

Special Cases. If permissive or protected-permissive left-turn operation is used and vehicular volume is low enough that the phase ends after timing the pedestrian walk and change intervals, then the pedestrian change interval from Equation 5 may cause some conflict between pedestrians and left-turning vehicles that are clearing the intersection following the permissive portion of the phase. A similar conflict can occur if permissive or protected-permissive left-turn operation is used with the rest-in-walk mode. If either of these conditions can occur when pedestrians are present, then the pedestrian change interval PCI should equal the pedestrian clearance time PCT .

Controller Implementation. The National Electrical Manufacturers Association (NEMA) standard provides for a solid DON'T WALK during the second interval (which times concurrent with the vehicular yellow change and red clearance intervals). However, some controllers have the capability to display a flashing DON'T WALK during the second interval, if desired. For example, either mode can be selected with the Eagle controller in its Pedestrian Times display (i.e., Extended Pedestrian Clear [EXT PCL], "0" for solid display, and "1" for flashing display during the second interval).

Preemption. It is desirable to provide the pedestrian change interval duration computed using Equation 5 during a preemption timing sequence. However, the *TMUTCD* permits shortening this interval if necessary (5). Additional guidance on the duration of the pedestrian change interval at rail-highway grade crossings is provided in Appendix B.

REFERENCES

1. Sunkari, S. "The Benefits of Retiming Traffic Signals." *ITE Journal*. Institute of Transportation Engineers, Washington, D.C., April 2004, pp. 26–29.

2. Retting, R.A., J.F. Chapline, and A.F. Williams. "Changes in Crash Risk Following Retiming of Traffic Signal Change Intervals." *Accident Analysis & Prevention*. Vol. 34. Pergamon Press, Elsevier Science Ltd., 2002.
3. *Highway Capacity Manual 2000*. 4th ed. Transportation Research Board, Washington, D.C., 2000.
4. Bahar, G., M. Maurice, R. Wolff, and P. Park. *Desktop Reference for Crash Reduction Factors*. FHWA-SA-07-015. Federal Highway Administration, Washington, D.C., September 2007.
5. *Texas Manual on Uniform Traffic Control Devices*. Texas Department of Transportation, Austin, Texas, 2006.
6. Technical Council Task Force 4TF-1 (B. Thompson, Chair). *Determining Vehicle Signal Change and Clearance Intervals*. Institute of Transportation Engineers, Washington, D.C., August 1994.
7. Bonneson, J.A., and P.T. McCoy. *Manual of Traffic Detector Design, 2nd Edition*. Institute of Transportation Engineers, Washington, D.C., May 2005.
8. Lin, F.B. "Optimal Timing Settings and Detector Lengths of Presence Mode Full-Actuated Control." *Transportation Research Record 1010*. Transportation Research Board, National Research Council, Washington, D.C., 1985.
9. Bonneson, J.A., and M. Abbas. *Intersection Video Detection Manual*. Report FHWA/TX-03/4285-2. Texas Department of Transportation, Austin, Texas, September 2002.
10. *Traffic Control Devices Handbook*. J.L. Pline editor. Institute of Transportation Engineers, Washington, D.C., 2001.
11. Zegeer, C.V., C. Seiderman, P. Lagerway, M. Cynecki, M. Ronkin, and R. Schneider. *Pedestrian Facilities User Guide – Providing Safety and Mobility*. Report No. FHWA-RD-01-102. U.S. Department of Transportation, Federal Highway Administration, Washington, D.C., 2002.

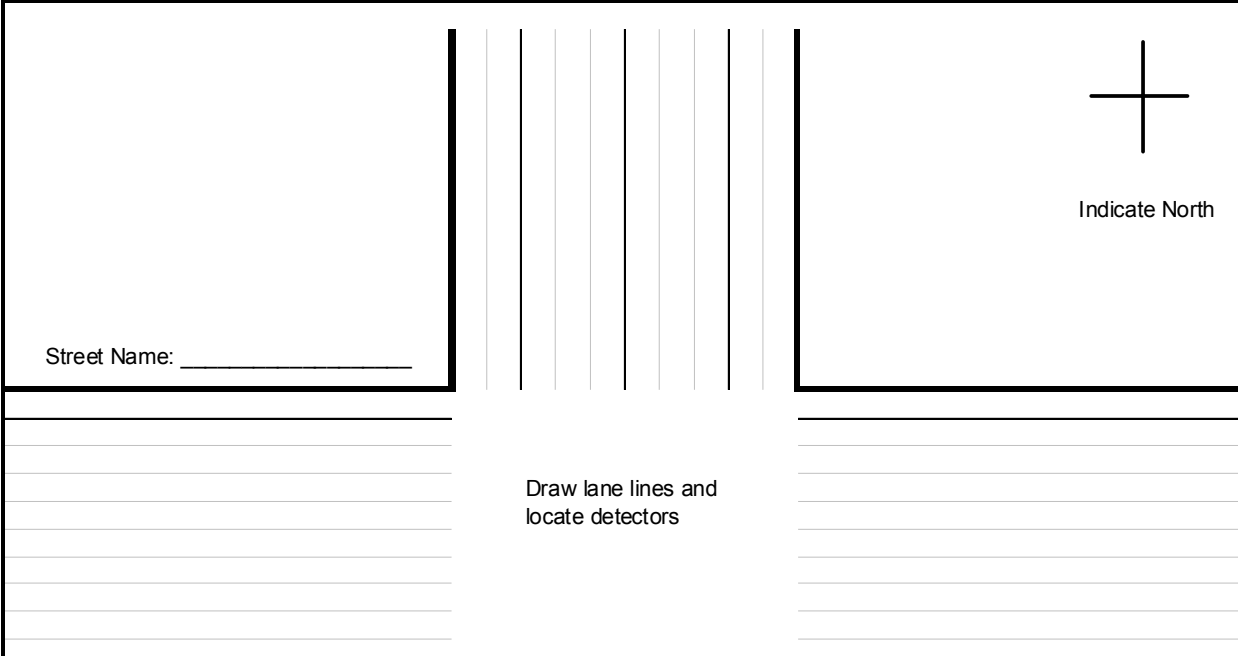
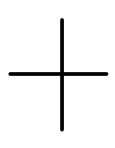
CONDITION DIAGRAM																																																																																	
General Information																																																																																	
Intersecting Road Names:	Date:																																																																																
Location:	Analyst:																																																																																
Lane Assignments and Detector Layout																																																																																	
Street Name: _____	 <p style="text-align: center;">Draw lane lines and locate detectors</p>	 <p>Indicate North</p>																																																																															
<p>APPROACH DATA</p> <table border="1" style="width: 100%; border-collapse: collapse;"> <thead> <tr> <th></th> <th style="text-align: center;">Speed Limit, mph</th> <th style="text-align: center;">Grade %</th> </tr> </thead> <tbody> <tr><td>Northbound</td><td></td><td></td></tr> <tr><td>Southbound</td><td></td><td></td></tr> <tr><td>Eastbound</td><td></td><td></td></tr> <tr><td>Westbound</td><td></td><td></td></tr> </tbody> </table> <p style="font-size: small;">Note: + grade is uphill</p>		Speed Limit, mph	Grade %	Northbound			Southbound			Eastbound			Westbound			Street Name:	<p>LEFT-TURN MODE</p> <table border="1" style="width: 100%; border-collapse: collapse;"> <thead> <tr> <th></th> <th style="text-align: center;">Prot.- Perm.</th> <th style="text-align: center;">Perm.</th> <th style="text-align: center;">Prot.</th> </tr> </thead> <tbody> <tr><td>Northbound</td><td></td><td></td><td></td></tr> <tr><td>Southbound</td><td></td><td></td><td></td></tr> <tr><td>Eastbound</td><td></td><td></td><td></td></tr> <tr><td>Westbound</td><td></td><td></td><td></td></tr> </tbody> </table>		Prot.- Perm.	Perm.	Prot.	Northbound				Southbound				Eastbound				Westbound																																															
	Speed Limit, mph	Grade %																																																																															
Northbound																																																																																	
Southbound																																																																																	
Eastbound																																																																																	
Westbound																																																																																	
	Prot.- Perm.	Perm.	Prot.																																																																														
Northbound																																																																																	
Southbound																																																																																	
Eastbound																																																																																	
Westbound																																																																																	
Signal Controller Settings																																																																																	
<p>PHASE DATA</p> <table border="1" style="width: 100%; border-collapse: collapse;"> <thead> <tr> <th>No.</th> <th>Movement (draw arrow)</th> <th>Yellow Change, s</th> <th>Red Clear, s</th> <th>Min. Green, s</th> <th>Max. Green, s</th> <th>Pass. Time, s</th> <th>Recall? (min, max, ped, soft)</th> </tr> </thead> <tbody> <tr><td>1</td><td></td><td></td><td></td><td></td><td></td><td></td><td></td></tr> <tr><td>2</td><td></td><td></td><td></td><td></td><td></td><td></td><td></td></tr> <tr><td>3</td><td></td><td></td><td></td><td></td><td></td><td></td><td></td></tr> <tr><td>4</td><td></td><td></td><td></td><td></td><td></td><td></td><td></td></tr> <tr><td>5</td><td></td><td></td><td></td><td></td><td></td><td></td><td></td></tr> <tr><td>6</td><td></td><td></td><td></td><td></td><td></td><td></td><td></td></tr> <tr><td>7</td><td></td><td></td><td></td><td></td><td></td><td></td><td></td></tr> <tr><td>8</td><td></td><td></td><td></td><td></td><td></td><td></td><td></td></tr> </tbody> </table>	No.	Movement (draw arrow)	Yellow Change, s	Red Clear, s	Min. Green, s	Max. Green, s	Pass. Time, s	Recall? (min, max, ped, soft)	1								2								3								4								5								6								7								8								<p>PHASE SEQUENCE</p> <p>Put phase number and movement arrow in each box. Put an "X" in unused boxes.</p> <table border="1" style="width: 100%; border-collapse: collapse;"> <tbody> <tr><td style="width: 25%; height: 20px;"></td><td style="width: 25%; height: 20px;"></td><td style="width: 25%; height: 20px;"></td><td style="width: 25%; height: 20px;"></td></tr> <tr><td style="width: 25%; height: 20px;"></td><td style="width: 25%; height: 20px;"></td><td style="width: 25%; height: 20px;"></td><td style="width: 25%; height: 20px;"></td></tr> </tbody> </table> <p style="text-align: center;">→</p>								
No.	Movement (draw arrow)	Yellow Change, s	Red Clear, s	Min. Green, s	Max. Green, s	Pass. Time, s	Recall? (min, max, ped, soft)																																																																										
1																																																																																	
2																																																																																	
3																																																																																	
4																																																																																	
5																																																																																	
6																																																																																	
7																																																																																	
8																																																																																	

CHAPTER 3. SIGNAL COORDINATION TIMING

This chapter provides guidelines for establishing timing plans for signal coordination. These guidelines are applicable to coordinated signal systems that operate on a time-of-day or traffic-responsive basis. Guidelines for basic traffic signal timing settings are provided in Chapter 2. Guidelines for using advanced signal timing features are provided in Appendix B.

The guidelines in this chapter are based on the assumption that the signal phasing is established and the detection system has been installed. If changes to the signal phasing are being considered, then the guidelines in Appendix A – Signal Phasing and Operation should be consulted. Similarly, if changes to the detection layout are being considered, then the guidelines in Appendix C – Detection Design and Operation should be consulted. If the intersection is part of a diamond interchange, then the guidelines in Appendix D – Diamond Interchange Phasing, Timing, and Design should be consulted.

This chapter consists of four parts. The first part provides an overview of the objectives of signal coordination. The second part summarizes signal coordination timing concepts and establishes a vocabulary. The third part describes the signal timing plan development procedure. The last part provides guidelines for selecting key elements of the timing plan for a coordinated signal system.

OVERVIEW

This part of the chapter provides an overview of the objectives of signal coordination. The discussion is intended to highlight the influence of signal timing on traffic efficiency and safety. It describes the benefits derived from maintenance of timing and identifies the various performance measures that can be used to quantify these benefits.

Signal Coordination Objectives

A primary objective when establishing a signal coordination timing plan is to provide for the smooth flow of traffic along the street or highway such that mobility is enhanced and fuel consumption is minimized. Achieving this objective requires a timing plan that minimizes

A previous statewide signal retiming project in Texas reduced fuel consumption by more than 13 percent with a benefit-cost ratio of 32 to 1 (1).

road-user costs while giving priority to the coordinated traffic movements. Because of changes in travel demand over time, the signal timing plan should be periodically updated to maintain intersection safety and efficiency. The practice of periodic signal retiming has been shown to yield significant road-user benefits. In fact, the Traffic Light Synchronization program implemented in Texas in the 1990s showed a benefit-cost ratio of 32:1 for signal coordination improvements (1).

A signal system consists of the controller units associated with each intersection along a street or within a network of streets. Signal coordination is achieved by adjusting these controller

units in a manner to provide a green indication at adjacent intersections in accordance with a specified time schedule for the purpose of permitting the smooth flow of traffic along the street at a planned speed. Coordination is achieved by defining a common cycle length for all controller units and, at each intersection, specifying intervals within the cycle during which each phase may be served. Coordination requires the designation of one phase per ring as the coordinated phase, where all coordinated phases are part of the same concurrency group. Unlike the other phases, the coordinated phase is guaranteed to display the green indication for a designated portion of the cycle.

Most signal controllers have numerous settings that allow their operation to be tailored to the conditions present at the intersection and within the signal system. The typical coordination-related settings include cycle length, offset, force mode, coordination mode, transition mode, and phase splits. The use of these settings is the subject of discussion in this chapter. Other basic timing settings that are relevant to coordinated operation include minimum green, maximum green, walk interval, pedestrian change interval, passage time, yellow change interval, and red clearance interval. These basic settings are discussed in Chapter 2.

The goal of signal coordination timing is to maximize the number of vehicles that can travel through the signal system with the fewest stops. For under-saturated conditions, this goal is typically achieved by maximizing the duration of the coordinated phases and maximizing the capacity of the non-coordinated phases (by adding a turn bay, allowing right-turn-on-red, or adding permissive operation to protected left-turn phasing). For over-saturated conditions, this goal is typically achieved by adjusting timing to minimize the adverse impact of queues. These adjustments may include reducing the cycle length, reallocating phase time, or decreasing the relative offset between adjacent signals.

The goal of signal coordination timing is to maximize throughput and minimize stops.

The relationship between signal coordination and safety is not as well documented as it is for efficiency. One study reported a 38 percent reduction in intersection crashes following improvements to signal coordination (2). Another study found a 6.7 percent reduction in the intersection crash rate after the signals were coordinated (3). A third study found that red-light-related violations are 85 percent less frequent at intersection approaches that are coordinated (4). In general, all of these benefits are likely due to the fact that the coordinated phases are associated with fewer stops and lower delay than would otherwise be incurred in a group of intersections that are not coordinated.

Effective signal coordination can reduce red-light violations and may prevent some crashes.

Performance Measures

Performance measures are used to quantify the degree to which the signal system provides efficient traffic service. The measures traditionally used to quantify system efficiency can vary, depending on whether the system is

The choice of which performance measures to consider depends on whether the system is over- or under-saturated.

operating in under-saturated or over-saturated conditions. If the system is under-saturated, then different measures may be used to evaluate traffic operation during peak and off-peak periods.

Typical performance measures are listed in Table 3-1. Most of these measures are available as output from a variety of signal timing software products (e.g., HCS, PASSER II, Synchro, TRANSYT-7F, SimTraffic, CORSIM).

Table 3-1. Performance Measures for Evaluating Signal Systems.

Traffic Volume Condition	Traffic Period	Useful Performance Measures
Under-saturated	Peak	<ul style="list-style-type: none"> ● Average travel speed for movements served by coordinated phases ● Average stop rate for movements served by coordinated phases ● Bandwidth efficiency and attainability ● Queue storage ratio by movement (based on maximum-back-of-queue)
	Off-peak	<ul style="list-style-type: none"> ● Total delay for all vehicles served by the system
Over-saturated	Peak and off-peak	<ul style="list-style-type: none"> ● Number of street segments with spillback ● Duration of over-saturation ● Total travel time for all vehicles served by the system

For under-saturated conditions, the performance measures often considered for peak periods focus on the efficiency of the traffic movements served by the coordinated phases (i.e., typically the through movements). Several measures are listed in Table 3-1 for this situation.

Bandwidth efficiency and attainability are two measures that are used to describe the quality of the signal coordination timing plan. They are computed from a time-space diagram that represents the signal timing relationship between each intersection within the signal system. Guidelines for computing efficiency and attainability are described in the PASSER II User's Manual (5).

Queue storage ratio represents the ratio of the maximum-back-of-queue length to the available storage space. The storage space for a turn movement equals the turn bay length. The storage space for a through movement equals the length of the segment. Queues that exceed the available storage have a ratio in excess of 1.0 and the potential for significant delay due to spillback.

For off-peak periods during under-saturated conditions, an inbound or outbound dominant traffic pattern is typically not evident in traffic flowing through the signal system. In this situation, performance is often measured in terms of total delay to all vehicles served by the system. This measure gives preference in the timing plan to high-volume traffic movements.

For over-saturated conditions, the more useful performance measures are those that indicate the extent of over-saturation in terms of how far it has extended throughout the signal system and how long it will last. Three measures are listed in Table 3-1 for this situation. Given the unsteady nature of over-saturated conditions, these measures are most accurately quantified by software products that are described as microscopic traffic simulation models, such as VISSIM, SimTraffic, or CORSIM.

CONCEPTS

This part of the chapter explains signal coordination timing concepts and establishes a vocabulary. Topics addressed include degree of saturation, coordination potential, number of timing plans, and signal settings.

Under-Saturated vs. Over-Saturated Conditions

The development of a signal timing plan for a given traffic period is strongly influenced by the traffic conditions present during this period. These conditions are broadly categorized as under-saturated and over-saturated. This characterization can be used to describe a specific signal phase, the intersection, or the signal system.

The determination of which saturation category best describes a given traffic period is based on whether a queue is present at the end of the phase (i.e., an overflow queue). A signal phase that has a recurring overflow queue during the traffic period is referred to as over-saturated; otherwise, it is referred to as under-saturated. Similarly, an intersection that has a recurring overflow queue for all signal phases during the traffic period is referred to as over-saturated; otherwise, it is referred to as under-saturated. A similar statement can be made regarding the intersections that comprise a signal system.

An over-saturated phase will have an overflow queue at the end of the phase.

An over-saturated intersection will have an overflow queue at the end of all phases.

If one or more signal phases are over-saturated but the intersection is not over-saturated, then it is likely that the phase splits can be adjusted to better allocate cycle time. On the other hand, an intersection that is over-saturated is likely to require an increase in capacity to alleviate the condition. In some situations, an over-saturated phase at one intersection can spill back into an upstream intersection and cause one or more phases at that intersection to become over-saturated. If this occurs, a mixture of timing adjustments and capacity improvements at the affected intersections may be needed to improve traffic operation.

Coordination Potential

A fundamental question that is raised when defining a signal system is, “What intersections should be included in the system?” The answer to this question depends on a variety of considerations related to traffic volume, segment length, speed, access point activity, cycle length, and signal system infrastructure. Considerations of traffic volume and segment length can be combined using a coupling index (6, 7). Equation 6 can be used to compute this index.

$$CI = \frac{V}{L} \quad (6)$$

where,

CI = coupling index.

V = two-way volume on the major street, veh/h.

L = segment length (measured between the center of the subject intersection and the center of the adjacent signalized intersection), ft.

Orcutt (6) indicates that coordination is desirable for segments with volume and length combinations that yield a coupling index in excess of 0.5. Segments with an index between 0.3 and 0.5 may benefit from coordination.

It is desirable to coordinate signals when the segment has a coupling index of 0.5 or more.

When the coupling index is used to determine which intersections to include in a signal system, it is computed for all candidate street segments for a common traffic period (e.g., morning peak). Adjacent segments that have an index of 0.5 or more are considered for grouping in the signal system. The consistency of directional traffic demand along the segments during the subject traffic period should also be considered when determining which signals to include in the system.

Number of Timing Plans

A signal timing plan is defined as a unique combination of phase splits, offset, and cycle length. Phase sequence can also be part of the plan. Most controller units can accommodate 16 or more plans, any of which can be selected by time of day, external input, or in a traffic responsive manner.

The variation in daily traffic volume at most intersections typically dictates the need for separate timing plans for different periods of the day. The typical minimum number of plans used is three, with one plan each for the morning peak, evening peak, and off-peak periods. For some signal systems, separate midday and nighttime plans are substituted for the off-peak plan. Plans for weekend traffic and for special events are sometimes used.

A signal timing plan is typically needed for the morning peak, evening peak, and off-peak periods.

System Settings

This section describes the controller settings that define the operation of the signal when it is part of a signal system. The settings addressed include cycle length, offset, phase sequence, force mode, transition mode, and coordination mode.

Cycle Length

Cycle length is defined as the total time to complete one sequence of signalization to all movements at an intersection. For an intersection with coordinated-actuated control, the cycle length is most easily measured as the time between two successive terminations of a given coordinated phase. For an intersection with pretimed control, the cycle length is measured as the time between two successive starts (or terminations) of any given phase.

Signals that are part of a signal system typically have the same system cycle length. However, some lower-volume signalized intersections may operate at a cycle length that is one-half the system value.

The optimum cycle length for a given signal system will depend on its traffic volume, speed, intersection capacity, intersection phase sequence, and segment length. Analytic techniques that consider all of these factors

typically reveal that the optimal cycle length for minor arterial streets and grid networks is in the range of 60 to 120 s. This range increases to 90 to 150 s for major arterial streets.

Typical Cycle Length Ranges
 Minor arterial streets: 60 to 120 s
 Major arterial streets: 90 to 150 s

Offset

The offset for a signalized intersection is defined as the time difference between the intersection reference point and that of the system master. The intersection reference point is typically specified to occur at the planned start (or end) of the green interval for the first coordinated phase. The “first coordinated phase” is the coordinated phase that occurs first (of all coordinated phases) for a given phase sequence and splits.

Offset Objectives. The objective in selecting an offset for an under-saturated intersection is to provide a timely green indication for the platoon associated with the progressed movement. If there are queued

vehicles in the lanes serving the progressed movement at the onset of green, then the offset should be set such that the green interval starts before the progressed movement arrives by an amount that is sufficient for the initial queue to clear before the platoon arrives.

Offset Objectives
 Under-saturated: good progression
 Over-saturated: maximum throughput

The objective in selecting an offset for an over-saturated intersection is to minimize the adverse effect of bay overflow and spillback. In fact, other signal timing and capacity improvements are more effective than offset at achieving this goal. Regardless, an offset that facilitates throughput (i.e., progression away from the over-saturated intersection) should be sought when over-saturation is present.

Early-Return-to-Green. As previously noted, the presentation of the green indication prior to the planned arrival of the progressed platoon is an effective strategy when there is a recurring initial queue. However, when there is no initial queue, this early-return-to-green can encourage drivers to increase speed (beyond the planned progression speed) only to have them unnecessarily stop at a subsequent intersection. Early-return-to-green is particularly problematic with coordinated-actuated operation because the duration of the non-coordinated phases will likely vary from cycle to cycle and cause the amount of early-return-to-green to vary randomly each cycle and from intersection to intersection. This random variation makes it difficult for drivers to develop an expectation of signal behavior and also increases the stop rate. Timing strategies are described in this chapter to minimize early-return-to-green.

Phase Sequence

The phase sequence used at an intersection describes the order by which the individual phases are presented. At least one phase is assigned to each intersection approach. A second phase is often assigned to the left-turn movement on an approach when conditions indicate there will be an operational or safety benefit. Right-turn movements and pedestrian movements may occasionally be assigned to a phase. The typical types of phasing used at signalized intersections are described in Appendix A. Also provided in this appendix are guidelines indicating when a phase should be provided for the exclusive use of a turn movement.

Force Mode

The force mode is a controller-specific setting for coordinated-actuated operation. It is set to “fixed” or “floating.” The controller calculates the phase force-off point for each non-coordinated phase based on the force mode and the phase splits. Research indicates that the fixed mode provides more efficient operation than the floating mode by: (1) providing the possibility of reallocating time among the non-coordinated phases when needed, and (2) minimizing the potential for early-return-to-green (8).

The two force modes operate in effectively the same manner if there is only one non-coordinated phase per ring. If there are two or more non-coordinated phases per ring, then the duration of the second and subsequent phases are influenced in the manner described in the next two paragraphs.

Fixed Mode. When set to the fixed mode, each non-coordinated phase has its force-off point set at a fixed time in the cycle, relative to time zero on the system master. This operation allows unused split time to revert to the following phase. The force-off point for each phase is set at the time of timing plan implementation and applies to every cycle that occurs while the plan is in place.

Floating Mode. When set to the floating mode, each non-coordinated phase has its force-off point set at the split time after the phase first becomes active and, thus, varies from cycle to cycle. This operation can increase the frequency and duration of early-return-to-green, especially if the non-coordinated phases have a low volume-to-capacity ratio.

Transition Mode

When a new timing plan is invoked, the controller goes through a transition from the previous plan to the new plan. There are several methods by which the transition can occur. The two more commonly used methods are described in the following paragraphs.

Short-Way. With this mode, the controller reaches the desired new state by

Each timing plan transition causes delay, so limit the number of plan transitions.

Short-way mode spreads the delay to all movements.

Dwell mode concentrates the delay on the non-coordinated phases.

incrementally reducing the split times for some phases and increasing the split times for other phases during successive signal cycles. The offset also undergoes incremental changes from the old to the new value during the successive cycles. The controller algorithm determines which phases are to be changed and the amount of change to make each cycle. The advantage of this mode is that the signal continues to cycle and serve each movement. The disadvantage is that it typically takes two to four cycles to complete the transition. The algorithm logic for this mode typically varies slightly among controller manufacturers.

Dwell. With this mode, the controller dwells at the intersection offset reference point until the timing plan is synchronized with the system master. This reference point is typically the start (or end) of green for the first coordinated phase. The advantage of this method is that it takes one signal cycle to complete the transition. The disadvantage of this mode is that it can cause excessive delay to the non-coordinated phases (8). Some controller manufacturers allow specification of a maximum dwell time to limit this delay; however, its use requires this mode to use several cycles to complete the transition.

Coordination Mode

The coordination mode is a controller-specific setting. It describes the manner in which the coordinated phases are terminated for the purpose of serving calls on the non-coordinated phases. One commonly used mode will allow any call for service that is received prior to the yield point to terminate the coordinated phase at the yield point. In more complicated variations of this mode, a sliding “window” (i.e., permissive period) approach is used to sequentially allow service only to the “next” non-coordinated phase, with the benefit that additional green is provided to the end of the coordinated phase if there are no calls for service on the next phase. These modes are not standardized in the controller industry and vary widely among controller products.

Phase Settings

This section describes the controller settings that influence the duration of a signal phase. The settings addressed include phase splits, dynamic splits, and maximum green. A discussion of minimum green, yellow change interval, red clearance interval, phase recall, and passage time is provided in Chapter 2.

Phase Splits

A phase split equals the sum of the green, yellow change, and red clearance intervals for the subject phase. The rationale for determining the green interval duration varies among agencies. In general, it is based on an evaluation of the intersection movements and corresponding phase sequence. The green interval for the non-coordinated phases is typically based on an estimate of the time needed to serve their average traffic flow rate, with some additional time provided to accommodate demand that randomly exceeds the average rate. All remaining green time in the cycle is then allocated to the coordinated phase. In practice, the phase splits are often obtained from a signal timing software product that models signal systems and determines the most efficient split values based on specified performance measures.

Dynamic Splits Feature

The dynamic splits feature allows the controller to adjust the phase splits on a cycle-by-cycle basis. In general, the controller monitors all non-coordinated phases and notes how each phase terminates each cycle (i.e., force-off or gap-out). If a phase terminates by force-off for two consecutive cycles, then it is flagged as a candidate to have its split increased. If a phase terminates by gap-out with more than 1 s left before force-off, then it is flagged as a candidate to have its split decreased. At the end of each cycle, splits for the flagged non-coordinated phases are adjusted slightly (typically, in 1-s intervals) by taking time from one phase and giving it to another.

The dynamic split feature is disabled if a phase is operating on maximum recall, either as programmed by the user or as a consequence of a failed detector. Dynamic splits are constrained by the minimum green setting. This feature can be activated by time of day.

The advantage of the dynamic splits feature is that the controller can adapt to unexpected changes in demand and provide better service when there are only a few timing plans implemented by time of day (9). This feature is not standardized in the controller industry and varies among controller products.

Maximum Green

The maximum green setting is described in Chapter 2. It is available to constrain each signal phase in coordinated-actuated operation. However, this setting is somewhat redundant to the force-off settings and has the potential to be disruptive to traffic progression if it is set too short.

PROCEDURE

This part of the chapter describes a procedure for developing a signal timing plan for a coordinated signal system. The procedure consists of a series of steps that describe the decisions and calculations that need to be made to produce a timing plan that will yield safe and efficient operation. The steps include:

1. Collect data.
2. Determine coordination potential.
3. Assess degree of saturation.
4. Determine controller settings.
5. Install, evaluate, and refine.

Desirably, the decisions made and calculations completed in these steps are based on field data or first-hand observation of traffic operation at the subject intersection.

Step 1. Collect Data

During this step, data are needed to describe conditions at the intersections being considered for inclusion in a signal system. A list of desirable intersection data was provided previously in Table 2-1 of Chapter 2. It is recognized that this list of data is extensive but, if collected, it is likely to provide the best indication of existing operating conditions and yield the best new timing plan. Of the data listed in this table, the following data should be considered as essential:

Essential data are identified in the two bullet lists in this section and should be collected during a site visit.

- Lane assignments by intersection.
- Yellow change interval and red clearance interval for all phases by intersection.
- Minimum green setting for all phases by intersection.
- Phase sequence by intersection.
- Turn movement counts by intersection if over-saturated.

The existence of over-saturated phases or over-saturated intersections should be determined during a site visit. This visit should take place during the subject time period (e.g., morning peak). If there are no over-saturated conditions, then turn movement counts are considered desirable (but not essential). If counts are not available, the analyst will need to estimate the phase splits for each intersection based on his or her familiarity with its operation. Also, if counts are not available, then software products that require volume as input cannot be used to develop optimized timing plans.

Segment data that are also considered essential include:

- Distance between signalized intersections.
- Speed limit.

The average mid-segment running speed is considered desirable. If data from a speed study are not available to compute this average, then it should be estimated based on the speed limit and the analyst's familiarity with the street system. Data describing mid-segment access point activity and potential segment bottlenecks are desirable.

Step 2. Determine Coordination Potential

During this step, the coupling index should be computed for each segment for the subject time period. These indices should be plotted on a map of the street system and used to identify logical groupings of signalized intersections. A separate signal system should be established for each group of intersections. Guidelines for implementing this step are

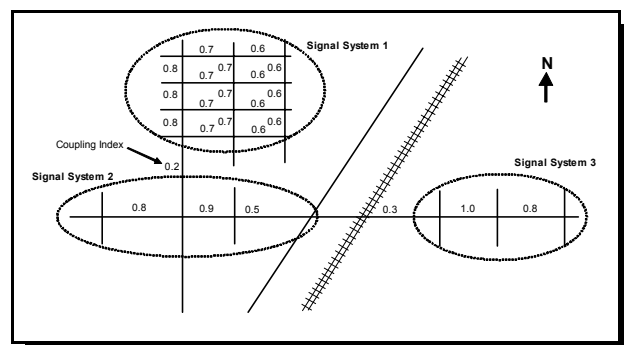

provided in the next part of this chapter in the section titled Guidelines for Determining Coordination Potential.

Step 3. Assess Degree of Saturation

During this step, the presence of over-saturation should be assessed for each phase and intersection. As defined in the previous part of this chapter, saturation can be identified by the presence of an overflow queue at the end of the green indication. The objective of this evaluation is to determine the number of movements that are over-saturated (if any) and whether they result in bay overflow or spillback into an upstream intersection.

If only one phase is experiencing over-saturation, a timing plan that minimizes overall delay may provide a useful starting point. However, this plan should be “tuned” (i.e., phase splits adjusted slightly) such that the over-saturation is eliminated or reduced to the point that it does not cause overflow or spillback.

If many conflicting movements are experiencing over-saturation during a common time period, then a queue management timing plan that allocates cycle time in a manner that minimizes the disruption caused by spillback and overflow may be appropriate. This plan may be initially based on a minimum-delay timing plan, but it must be tuned such that queues are formed only in the least damaging locations and that traffic is progressed *away* from the over-saturated intersections.

Step 4. Determine Controller Settings

During this step, the controller settings are determined based on consideration of the information obtained in the previous steps. The settings that are determined during this step can vary but are likely to include force mode, coordination mode, cycle length, phase splits, and offsets. These settings were defined in the previous part of this chapter. The tasks typically undertaken during this step include:

1. Determine force mode and coordination mode.
2. Determine cycle length.
3. Determine phase splits.
4. Determine offsets.

Guidelines are provided in the next part of this chapter to assist the analyst in making the determinations associated with each task. Guidelines for determining values for minimum green, yellow change interval, red clearance interval, walk interval, pedestrian change interval, and passage time are provided in Chapter 2. Guidelines for determining signal phase sequence are provided in Appendix A. There is also some discussion of phase sequence in the Guidelines part of this chapter. Guidelines for using advanced signal timing settings are described in Appendix B. Guidelines for designing the detection layout are provided in Appendix C.

There are several software products and spreadsheets available that automate many of the signal timing tasks. Most of these products can be obtained from the Center for Microcomputers in

Transportation (McTrans) at the University of Florida (<http://mctrans.ce.ufl.edu/>). If traffic volume data are provided, then several of these products can also be used to evaluate the proposed controller settings in terms of their expected impact on intersection efficiency.

Step 5. Install, Evaluate, and Refine

The last step in signal timing plan development relates to the implementation and field verification of the proposed controller settings. This step consists of the following five tasks:

1. Install the settings in the signal controller.
2. Put the settings in operation during an off-peak period, and observe traffic behavior.
3. Refine the settings if so indicated.
4. Put the settings in operation during the intended period, and observe traffic behavior.
5. Refine the settings if so indicated.

The goal of the two refinement tasks is to make small changes in the settings, such that overall system safety or efficiency is improved.

During Task 2, it may be useful to set all phases to maximum recall for a period of time sufficient to confirm that the intended minimum progression band is provided.

GUIDELINES

This part of the chapter provides guidelines for selecting key elements of the timing plan for a coordinated signal system. The information provided is based on established practices and techniques that have been shown to provide safe and efficient system operation. The guidelines address coordination potential, number of timing plans, system settings, and phase settings.

Guidelines for Determining Coordination Potential

This section provides guidelines for identifying street segments that have some potential to benefit from coordination. The objective of these guidelines is to identify signals that will operate in an efficient manner if grouped together in a signal system. The evaluation is specific to a given traffic period (e.g., morning peak). It should be repeated for each traffic period of interest. Different signal groupings may be identified during different traffic periods and should be accommodated in the signal timing plans to the extent possible.

Coupling Index Calculation

As a first step, the coupling index should be computed for each street segment for the traffic period of interest. The coupling index for a segment can be estimated using Figure 3-1. The following guidelines are offered for interpreting the index values:

A coupling index of 0.5 or more indicates the potential for significant benefit from signal coordination.

- 0.3 or less: *unlikely* benefit from coordination.
- 0.3 to 0.5: segment likely to benefit if mid-segment access point activity is low and turn bays are provided on the major-street at each signalized intersection.
- 0.5 or more: *likely* benefit from coordination.

Experience in using this index indicates that segments shorter than 2600 ft will typically be coordinated, and those longer than 5300 ft will not typically be coordinated.

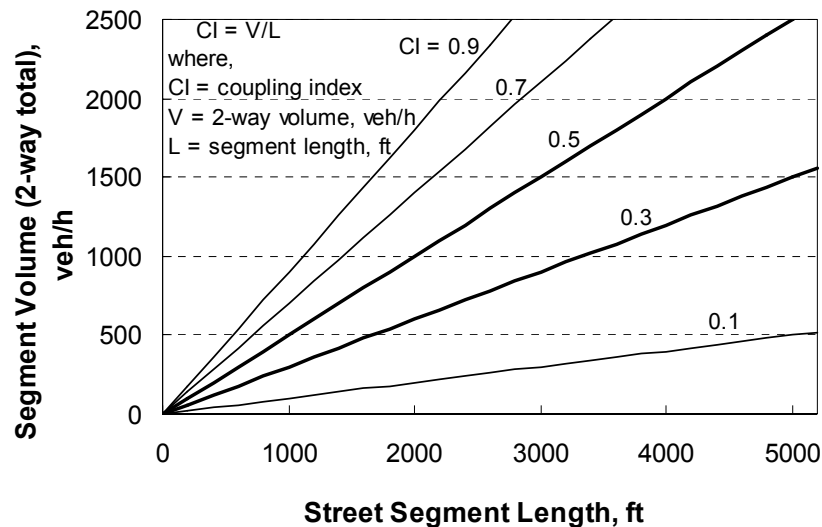

Figure 3-1. Coupling Index for Signalized Segments.

Index Evaluation Procedure

To facilitate an examination of the computed indices, they should be plotted on a map of the street system being evaluated. Logical signal system groupings will be identified by collections of segments with high index values. The boundary between each system will be identified by a segment with a low index value. When an intersection is common to two systems, the coupling index can be used to prioritize the assignment of the signal to a particular system.

Figure 3-2 illustrates the mapping concept for an urban area with a downtown grid street network and an east-west arterial street that is bisected by a railroad line. The numbers shown represent the computed indices. The three signal systems formed include all signals with a coupling index of 0.5 or more. The railroad line forms a logical boundary segment for Systems 2 and 3.

Two other factors should be considered when forming signal systems. They are:

- Adjacent segments with similar directional traffic volume levels should be grouped.
- Crossing arterial streets with high index values on both streets and significant traffic volume should be used to define a system boundary.

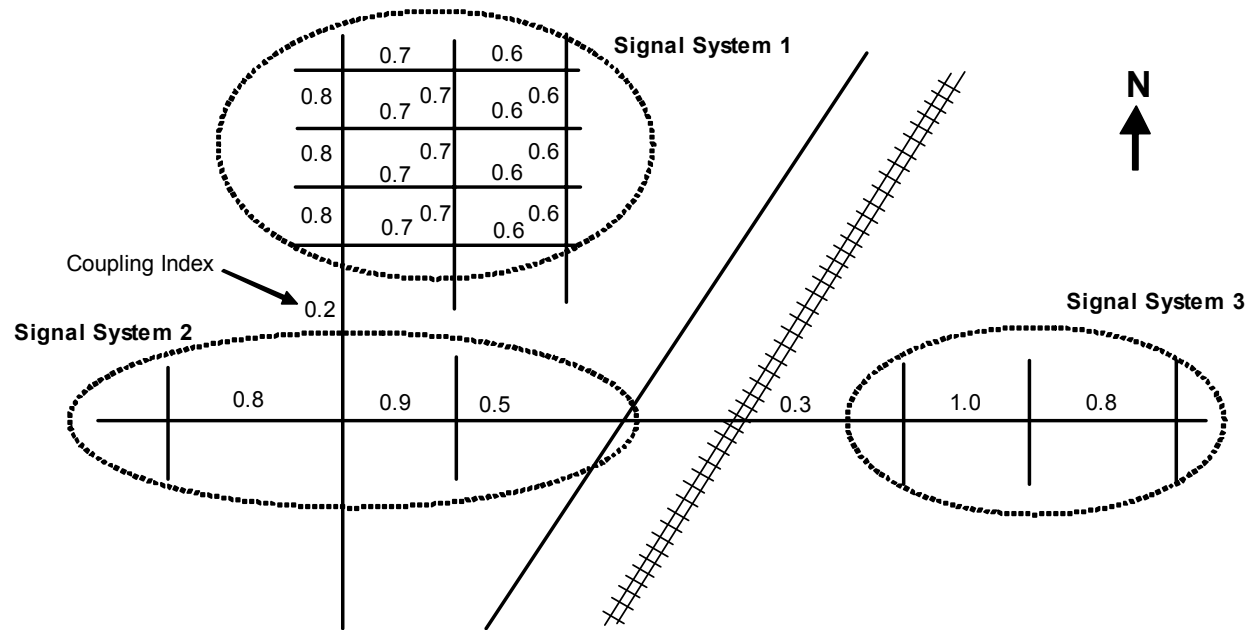

Figure 3-2. Application of Coupling Index to Form Separate Signal Systems.

Considerations of Signal System Size

In general, small to moderate sized signal systems (i.e., 30 intersections or less) tend to be easier to manage and maintain. Large systems require considerable resources to develop, install, and maintain the signal timing plans. Also, they will often present a greater challenge in finding an optimal timing plan. Finally, with large systems, there is a significant increase in infrastructure associated with each signal added to a system and a corresponding increase in exposure to system performance degradation when any one element fails.

Guidelines for Determining Number of Timing Plans

A timing plan needs to be defined whenever a change in phase splits, offset, or cycle length is needed. Such changes are often justified by changes in traffic volume that occur during the course of the day and, sometimes, by the day of week. As a minimum, one timing plan should be developed for each of the following periods:

Eighty percent of signal systems operated by TxDOT include at least three plans.

- Morning peak.
- Evening peak.
- Off-peak.

Additional plans may be needed for noon peak or weekend traffic periods.

Guidelines for Timing Plan Transition

A timing plan should be implemented *before* the start of the traffic demand period for which it was developed, especially if the subject traffic period is a peak period. If a plan is implemented after the start of a peak period, it may cause significant disruption to traffic flow.

There are some inefficiencies with the transition from one plan to another that suggest that a plan should be allowed to operate for a minimum time to achieve a break-even point between the delay caused by transition and the delay saved by the new plan. As a rule-of-thumb, the minimum time a plan should operate should be the larger of 15 minutes or 10 times the travel time through the signal system (6). This rule is most applicable to traffic-responsive timing plan implementation.

Guidelines for System Settings

This section provides guidelines for selecting key controller settings that define the operation of a signal when it is part of a signal system. The settings addressed include:

- Cycle length.
- Offset.
- Phase sequence.
- Force mode.
- Transition mode.
- Coordination mode.

Cycle Length

The cycle length used in the signal timing plan often represents a compromise value based on consideration of capacity, queue length, and progression quality. These considerations include:

- Longer cycle lengths increase capacity; however, the increase in capacity is only about 1 percent for a 10-s increase in cycle length.
- Shorter cycle lengths reduce delay, *provided* that the cycle length is not so short that there is inadequate capacity.
- Longer cycle lengths increase queue length.
- Longer cycle lengths tend to be more conducive to finding a two-way progression solution.

Operational Considerations. If the intersection is under-saturated, then preference is often given to having it operate at its minimum-delay cycle length. This cycle length is typically in the range of 60 to 150 s. If a phase or an intersection is over-saturated, then priority should be given to using a shorter cycle for the purpose of minimizing queue spillback, turn bay overflow, or both.

For under-saturated intersections, use a minimum-delay cycle length.

For over-saturated intersections, use a shorter cycle length to minimize spillback.

Bandwidth Considerations. Progression along the segments that comprise the signal system is easier to achieve as the cycle-length-to-travel-time ratio R_c approaches 2, 4, or 6. This ratio is computed using Equation 7.

$$R_c = 1.47 \frac{C S}{L} \quad (7)$$

where,

R_c = cycle-length-to-travel-time ratio.

C = cycle length, s.

S = progression speed, mph.

L = segment length (measured between the center of the subject intersection and the center of the adjacent signalized intersection), ft.

Typical Cycle Lengths. Table 3-2 identifies typical system cycle lengths for various combinations of segment length, street class, and left-turn phasing. These cycle lengths reflect consideration of the aforementioned ratio as well as minimum-delay and queue length. The segment length used in this table represents an average of all the segments that comprise the signal system. If resources are available to collect traffic volume data, then a software product designed to develop optimal timing plans for signal systems should be used instead of the guidance in Table 3-2.

Table 3-2. Typical System Cycle Lengths.

Average Segment Length, ft ¹	Cycle Length by Street Class and Left-Turn Phasing, s ²					
	Major Arterial Street			Minor Arterial Street or Grid Network		
	No Left-Turn Phases	Left-Turn Phases on One Street	Left-Turn Phases on Both Streets	No Left-Turn Phases	Left-Turn Phases on One Street	Left-Turn Phases on Both Streets
250				50	50	50
500				60	90	100
1000				50	90	120
1500	90	120	150	60	80	120
2000	100	120	140	80	90	100
2500	90	140	150	100	100	120
3000	90	100	160			
3500	100	120	120			
4000	110	120	140			
4500	120	120	150			
5000	140	140	150			

Notes:

1 - Average length based on all street segments in the signal system.

2 - Selected left-turn phasing column should describe the phase sequence at the high-volume intersections in the system.

Double Cycle. Some low-volume intersections that are part of the signal system may benefit by operating at one-half the system cycle length. However, if this shorter cycle is used, it should not have an adverse effect on progression quality. Double-cycle operation should be considered at an intersection when one or more of the following conditions are present for the subject traffic period:

Lower-volume intersections may operate more efficiently if they are operated at one-half of the system cycle length.

- The minor movements are characterized as having low volume.
- The left-turn bays on the major street are short and would frequently overflow if the intersection is operated at the system cycle length.
- The cross street does not have left-turn phasing.
- The system cycle length is at least 100 s.

Offset

A controller's offset is specified for each timing plan. Its value has a significant effect on the operation of the signal system. During under-saturated conditions, a plan with effective offsets will provide smooth progression for the coordinated movements.

During over-saturated conditions, a plan with effective offsets will minimize the adverse effects of spillback by: (1) queueing traffic at less damaging locations on the street system (e.g., side streets, longer segments, etc.), and (2) progressing traffic away from the over-saturated intersections (as opposed to trying to progress traffic through them).

Any adjustment to one or more offsets should reflect consideration of progression throughout the signal system. A change in the offset at any one intersection is likely to impact the quality of progression at the subject intersection as well as at the upstream and downstream intersections.

The most effective means of finding optimal offsets is to use a software product developed for this purpose. The use of a software product is particularly appropriate if one or more intersections are over-saturated.

The most effective means of finding good offsets is to use a software product such as PASSER II, Synchro, or TRANSYT-7F.

For under-saturated conditions, effective offsets for two-way progression can be determined using the Kell Method of time-space diagram development, as described by Henry (7). This method is appealing because it can be applied to any signal system, regardless of the variation in segment length or phase splits among intersections. The description of this method is provided in the following paragraphs.

Offsets from Manually Constructed Time-Space Diagram. The Kell Method is sufficiently general that it can be used to determine an effective combination of cycle length and offsets, based only on phase split percentages and segment length. However, the description provided in this subsection assumes that the phase split durations are known (in seconds) and the cycle length is known. Thus, the analyst is only seeking the optimal offsets. The steps are:

1. Prepare a scale drawing with distance on the x-axis and time on the y-axis. The signalized intersections that comprise the signal system should be located across the x-axis. Draw vertical lines at each intersection. This drawing is shown in Figure 3-3.

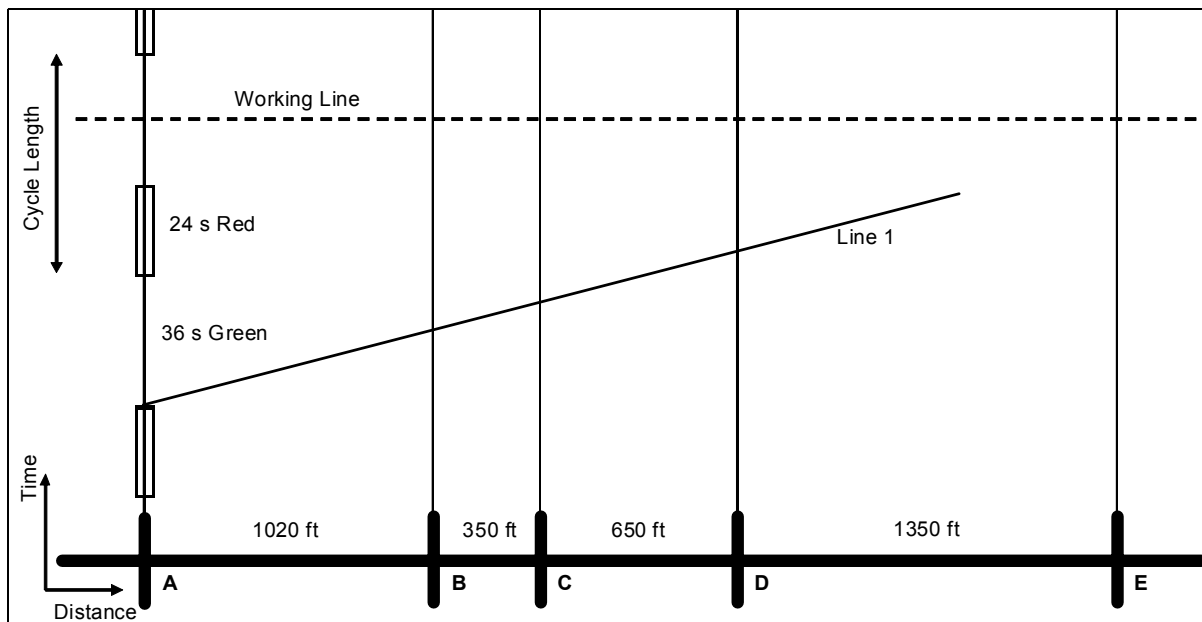

Figure 3-3. Initial Layout of Street and Timing for First Intersection.

2. Draw several cycles on the scale drawing at the first intersection (i.e., Intersection A). A rectangle is used to represent the sum of the non-coordinated phase durations plus the change period associated with the coordinated phase. This time is labeled as “Red” on the drawing and has a duration of 24 s. The remaining time in the cycle represents “Green” for the coordinated phase.

Two complete cycles are shown in Figure 3-3 for Intersection A. In this cycle, the coordinated phases for both travel directions (i.e., phases 2 and 6) are shown to start and stop at the same time. This common start time may not always be the case when there are left-turn phases serving the adjacent left-turn movements.

3. Draw a horizontal working line on the drawing. This line must go through the middle of a Green period or the middle of a Red period (either one can be selected).
4. Draw a line that slopes upward through the beginning of the green period. The slope should equal one-third to one-half of the cycle length per 1000 ft for streets with close signal spacing (e.g., a central business district). Alternatively, it should equal one-fourth of the cycle per 1000 ft for streets with moderate to long segments (e.g., arterial streets). This line represents the leading edge of the progression band for the eastbound travel direction (i.e., Phase 2). It is shown as Line 1 in Figure 3-3.

5. Draw several cycles for the next intersection in the subject direction of travel. Either the green period or the red period must be centered on the working line. The period chosen to be centered is the one that causes the beginning of a green period to come closest to the sloped line (i.e., Line 1). This step is illustrated in Figure 3-4.

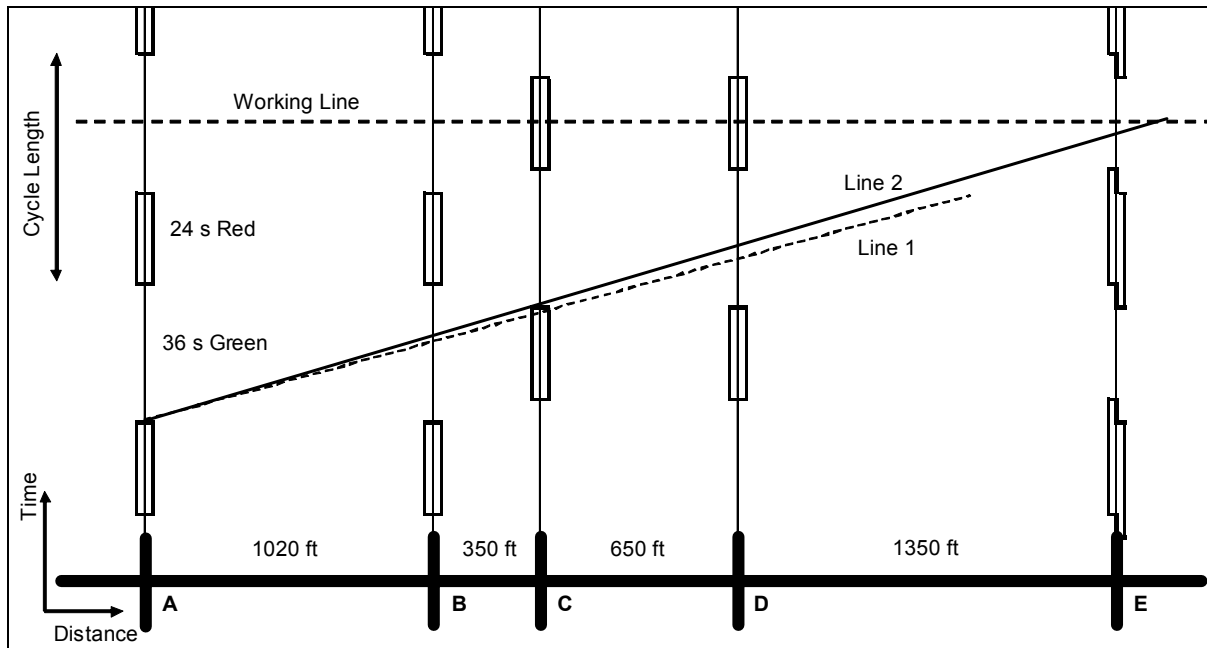

Figure 3-4. Initial Layout of Timing for the Remaining Intersections.

6. Repeat Step 5 for each subsequent intersection. If necessary, the sloped line can be adjusted slightly such that it clears the end of a red period. This adjustment is shown as Line 2 in Figure 3-4. Note that Intersection E has lag-lead left-turn phasing, with eastbound left-turn Phase 5 lagging and westbound left-turn Phase 1 leading (travel from A to E is eastbound).
7. When the layout of the signal timing is completed for the last intersection, the line becomes the leading edge of the progression band. A parallel line is drawn such that it intersects all signals in the green period and just touches the start of one or more of the red periods. This line represents the end of the progression band. In Figure 3-5, this line is shown to intersect the red period of Intersection B and to yield a 14-s eastbound progression band.
8. The through band for the westbound direction is constructed in a similar manner by identifying the leading edge of the westbound progression band as a sloped line that just touches the end of the red period at one or more intersections. The trailing edge is parallel to the leading edge and touches the start of one or more of the red periods. Figure 3-5 indicates this step yields a 14-s westbound progression band.

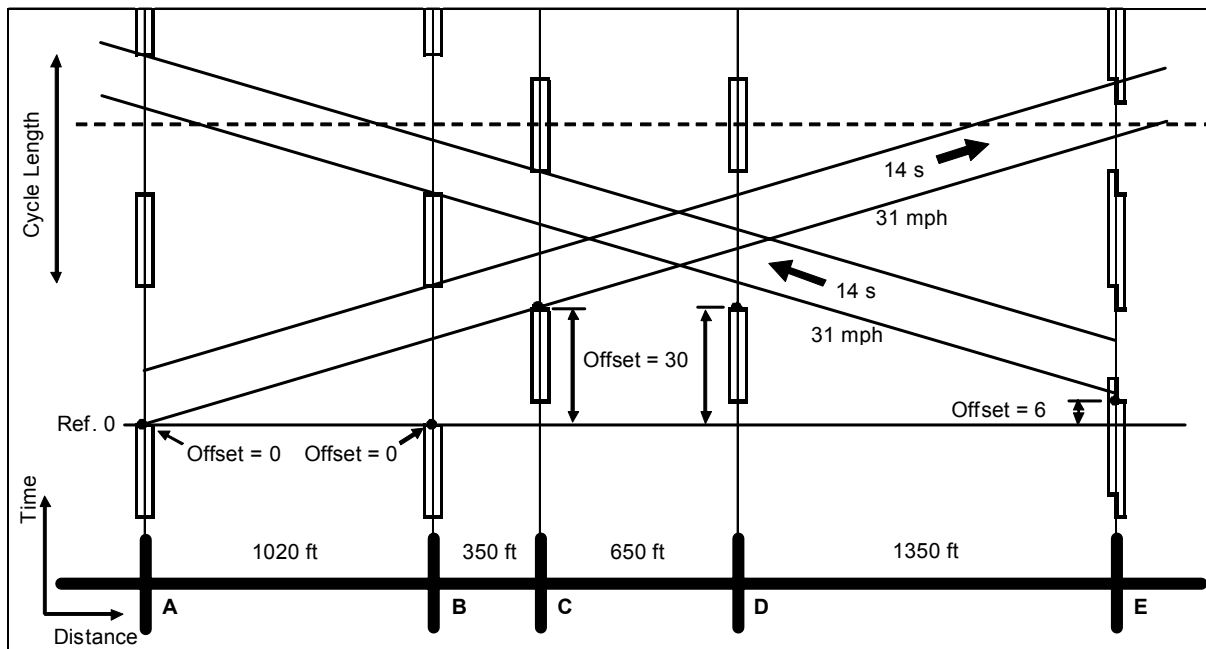

Figure 3-5. Completed Time-Space Diagram.

9. The offsets to the start of green (or end of green) are computed by referencing them to the system master time. For Figure 3-5, the system master time is 0 s and is coincident with the start of green at Intersection A. A horizontal line is drawn through this reference time. The offset for each of the remaining intersections is determined by scaling the vertical distance from the horizontal line to the start of green for the first coordinated phase (i.e., phase 2 or 6). If the offset exceeds the cycle length, then an amount equal to the cycle length is subtracted from it (i.e., all offsets should range in value from 0 s to [cycle length - 1]).

Adjustments to Accommodate an Initial Queue. The offsets derived from the Kell Method do not reflect consideration of the presence of queued vehicles at green onset in the lanes served by the coordinated phase. These queued vehicles originate from side streets and mid-segment access points. Two options are available to account for these queues in the signal timing. For the first option, the *slope* of the line drawn from intersection to intersection (representing the leading edge of the progression band) is adjusted such that the green interval starts before the arrival of the band at the subject intersection. The second option is to increase slightly the split for the coordinated phase at the subject intersection and re-center it on the working line. The time difference between the start of green and the leading edge of the band should be equal to the estimated discharge time of the average initial queue (i.e., based on 2 s per queued vehicle per lane).

Phase Sequence

When left-turn phasing is required for the major-street left-turn movements at intersections in a signal system, the use of lead-

Lead-lag left-turn phasing can improve the quality of progression, but it may need to be placed on maximum recall.

lag left-turn phasing can improve the quality of traffic progression, relative to that obtained with lead-lead or lag-lag left-turn phasing. This benefit was demonstrated in Figure 3-5 where the use of lead-lag phasing at Intersection E is found to increase the width of the progression band by 6 s.

The decision as to whether there is a benefit from the use of lead-lag phasing should be based on the evaluation of a time-space diagram, or through the use of a software product that can evaluate left-turn phase options at each intersection in a coordinated signal system.

Lead-Lag Reversal by Time of Day. If traffic flow on the street has a dominant flow direction that reverses by time of day, then it may be necessary to switch the leading and lagging left-turn phases by time of day. Phase sequence changes of this nature are supported by most modern controllers and can be incorporated in time-of-day timing plans. If the phase sequence is switched in this manner, then traffic behavior should be monitored during the initial stages of plan implementation to ensure that drivers are responding safely to the change in signal operation.

Use of Maximum Recall. As shown in Figure 3-5, the eastbound platoon arrives partially during the lagging left-turn phase at Intersection E. It is important to progression quality that this portion of the lagging left-turn phase occurs each cycle. For this reason, agencies often use the maximum recall setting for the lagging left-turn phase (6). This setting can be changed by time of day to accommodate a change in phase sequence. It should be noted that use of maximum recall prevents the use of the dynamic-splits feature.

Protected-Permissive Left-Turn Mode. If the left-turn phases on the major-street operate in the protected-permissive mode, then some caution should be exercised when lead-lag phasing is used. There is a potential safety issue associated with the termination of the permissive portion of the leading left-turn phase. This issue is described in Appendix A as the “yellow trap.” Techniques are identified in Appendix A for minimizing safety issues associated with the yellow trap.

Turn Bay Overflow. The presence of left-turn queues in the inside through lanes can be disruptive to progression quality. This problem occurs when the left-turn bay is not long enough to store the left-turn queue. The best solutions include increasing the turn bay length or adding an additional lane in the turn bay. However, if these solutions are not available, then the associated left-turn phase should lead, or time concurrently with, the phase serving the adjacent through movement.

Force Mode

Fixed Mode. The fixed force mode provides more efficient operation than the floating mode when there are multiple non-coordinated phases (8). One benefit of the fixed mode is the automatic reallocation of unused time from “early” non-coordinated phases to “later” non-coordinated phases in response to demand variation. A second benefit of the fixed mode is that it can minimize the frequency and duration of early-return-to-green.

Fixed force mode will typically provide more efficient operation than the floating mode.

Floating Mode. The floating force mode may be useful when the minor traffic movements have low volume and the extra time (i.e., via early-return-to-green) allocated to the coordinated phases is beneficial.

Transition Mode

This subsection provides guidelines for selecting the plan transition mode. Regardless of which mode is selected, it should be applied consistently to all intersections in the signal system.

Short Cycle Length. When the cycle length is short, the transition mode has little impact on delay and, hence, any transition mode can be used with similar results (6). However, if the minor traffic movements have low volume, then the dwell mode should be given first consideration.

Long Cycle Length. Plan transition causes delay. The amount of delay incurred increases with cycle length. The various transition modes available tend to distribute this delay over time and among traffic movements differently (but they do not eliminate it). The short-way mode tends to increase delay to all phases proportionately, but takes two to four signal cycles to complete the transition. The dwell mode significantly increases the delay to the non-coordinated phases but takes only one cycle to transition. If lengthy queues for movements served by the non-coordinated phases will be disruptive, then the short-way mode should be given first consideration.

Minor Movement Volume	1 st Choice Transition Mode	
	Short Cycle	Long Cycle
Low	Dwell	Short-way
High	Dwell or Short-way	Short-way

Coordination Mode

Coordination modes vary widely by controller manufacturer and should be carefully evaluated before being implemented. However, the following considerations are offered regarding the choice of coordination mode for a given intersection:

- If pedestrian demand is significant, then consider a mode that allows the coordinated phase to dwell in the WALK indication.
- If volume on the cross street is light, then consider a mode that yields only to the “next” phase during the permissive yield period and sequentially considers only the “next” phase during each subsequent non-coordinated phase. This operation is sometimes referred to as a “controlled yield.” It will tend to extend the green for the coordinated phase and minimize the potential for early-return-to-green.

Additional guidelines for selecting (and setting) the appropriate coordination mode in a Naztec or an Eagle controller are provided by Sunkari et al. (8).

Guidelines for Phase Settings

This section describes guidelines for determining selected settings associated with a phase at a coordinated traffic signal. These settings include:

- Phase splits.
- Dynamic splits.
- Maximum green.

The guidelines in this section address typical intersection geometry and detection designs. However, they can be extended to atypical configurations with some care.

Phase Splits

In practice, the most effective phase splits are often obtained from a signal timing software product that is used to model the signal system and determine the most efficient split values for each intersection. This practice is especially appropriate for over-saturated conditions. In contrast, “manual” procedures are available for estimating phase splits for under-saturated conditions (6, 7).

A procedure for phase split estimation is described in the remainder of this subsection. It is based on the following assumptions: (1) one or more left-turn lanes are provided when left-turn phasing is used, (2) both left-turn movements on a given street are protected when left-turn phasing is used, and (3) phases 2 and 6 are the coordinated phases. Other procedures should be considered when these assumptions are not appropriate.

The procedure for determining phase splits is described in terms of a calculation worksheet. This worksheet is shown in Table 3-3. A blank version of the worksheet is provided at the end of the chapter. An example is used to explain the procedure. The example intersection geometry and traffic volumes (in veh/h) are illustrated in Figure 3-6. The east-west street has protected left-turn phasing, but the north-south street does not have protected left-turn phasing.

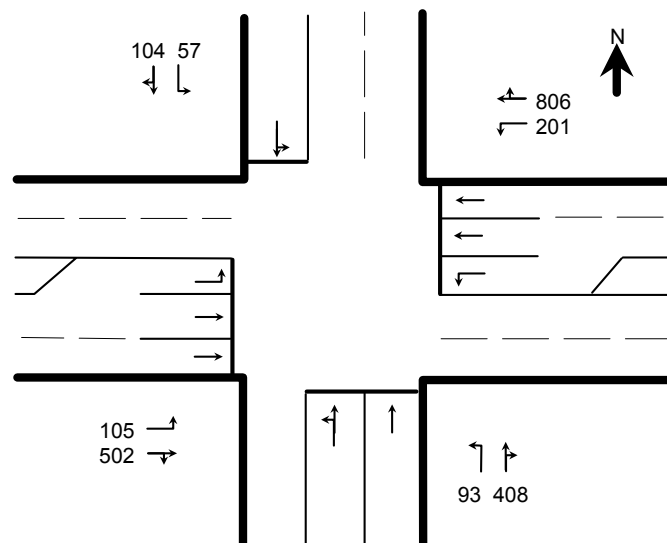

Figure 3-6. Example Intersection Used to Illustrate Timing Plan Development.

Table 3-3. Phase Split Calculation Worksheet.

Phase Split Calculation Worksheet								
General Information								
Location: <u>Main St. & Peach Tree Drive</u>			Cycle Length (C), s: <u>100</u>		Analysis Period: _____ to _____			
Volume and Lane Geometry Input								
Approach:	Eastbound		Westbound		Northbound		Southbound	
Movement, No.: {see note 1}	LT, 5	TH+RT, 2	LT, 1	TH+RT, 6	LT, 3	TH+RT, 8	LT, 7	TH+RT, 4
Volume (v_i), veh/h $i = 1, 2, 3, \dots 8$	105	502	201	806	93	408	57	104
Lanes (n_i)	1	2	1	2	0	2	0	1
Change Period and Minimum Green								
Yellow + red clearance (Y_i), s	5	5	5	5	--	5	--	5
Minimum green ($G_{m,i}$), s	8	10	8	10	--	16	--	16
Phase Sequence - Permissive	LT & TH in Same Phase (prot TH & perm LT)				LT & TH in Same Phase (prot TH & perm LT)			
Opposing Volume ($v_{o,i}$), veh/h	$v_6 =$		$v_2 =$		$v_4 =$ 104		$v_8 =$ 408	
LT equivalency ($E_{L,i}$) (Fig. 3-7)		1.0		1.0	1.5	1.0	2.1	1.0
Sneakers (S_i), veh/h [=5400/C]		0.0		0.0	54	0.0	54	0.0
Adjusted volume (v_i^*) [= $E_{L,i}(v_i - S_i) \geq 0.0$]					59	408	6	104
Without Bay								
Lane volume without bay ($v_{n,i}$) {see note 2}						233		110
Average Green ($G_{a,i}$), s [= larger of: ($v_{n,i} C/1800/0.85$, $G_{m,i}$)]						16		16
Phase split (T_i), s {see note 3}						21		21
With Bay								
Lane volume with bay ($v_{n,i}$) [= v_i^* / n_i], veh/h/ln								
Average Green ($G_{a,i}$), s [= larger of: ($v_{n,i} C/1800/0.85$, $G_{m,i}$)]								
Phase split (T_i), s {see note 4}								
Phase Sequence - Protected	LT Phase & TH Phase				LT Phase & TH Phase			
Lane volume with bay ($v_{n,i}$) [= v_i / n_i], veh/h/ln	105	251	201	403				
Average Green ($G_{a,i}$), s [= larger of: ($v_{n,i} C/1800/0.85$, $G_{m,i}$)]	8	16	13	26				
Phase split (T_i), s {see note 5}	13	26	18	31				
Phase Splits								
Phase split (T_i), s {see note 6}	13	61	18	66	--	21	--	21

Notes:

- 1 - Numbers follow NEMA movement-based phase numbering system (LT = left-turn, TH = through, RT = right-turn).
- 2 - The lane volume for the through movement equals the larger of $v_{n,app}$ or v_{th}^* , with $v_{n,app} = (v_{th}^* + v_{l,i}^*) / n_{th}$ where, v_{th}^* ($v_{l,i}^*$) = adjusted volume for through (left) movement on subject approach; and n_{th} = number of through lanes on the subject approach.
- 3 - Phase split is the same for both approaches on the same street. It equals the larger of the G+Y for the two approaches (e.g., $T_2 = T_6 =$ larger of [$G_{a2} + Y_2$, $G_{a6} + Y_6$]).
- 4 - Phase split is the same for both approaches on the same street. It equals the larger of the G+Y for the left-turn and through movements on the two approaches (e.g., $T_2 = T_6 =$ larger of [$G_{a1} + Y_1$, $G_{a2} + Y_2$, $G_{a5} + Y_5$, $G_{a6} + Y_6$]).
- 5 - Phase split for a left-turn phase equals the sum of its average green and change period. Through phase split is computed as:
 $T_2 =$ larger of [$G_{a1} + Y_1 + G_{a2} + Y_2$, $G_{a5} + Y_5 + G_{a6} + Y_6$] - T_1 $T_6 =$ larger of [$G_{a1} + Y_1 + G_{a2} + Y_2$, $G_{a5} + Y_5 + G_{a6} + Y_6$] - T_5
 $T_4 =$ larger of [$G_{a3} + Y_3 + G_{a4} + Y_4$, $G_{a7} + Y_7 + G_{a8} + Y_8$] - T_3 $T_8 =$ larger of [$G_{a3} + Y_3 + G_{a4} + Y_4$, $G_{a7} + Y_7 + G_{a8} + Y_8$] - T_7
- 6 - Phase splits for phases 1, 5, 3, 4, 7, and 8 are read from the rows above based on the phasing used and bay presence. Phase split for phase 2 is computed as $T_2 = C - T_1 - T_3 - T_4$. Phase split for phase 6 is computed as $T_6 = C - T_5 - T_7 - T_8$.

Step 1. Input Data. Initially, the movement volumes and lane counts are entered in the Volume and Lane Geometry Input section of the worksheet. The right-turn volume is combined with the through movement volume. Similarly, any exclusive right-turn lanes would be included in the count of through lanes for a given approach. Also entered in the spreadsheet during this step are the signal timing data. These data include the cycle length, change period, and minimum green setting. The change period represents the sum of the yellow change interval and the red clearance interval.

Step 2. Compute Adjusted Movement Volumes. The Phase Sequence section of the table is completed next. This section is divided into two main parts, depending on the type of left-turn phasing provided. Each street is considered separately. The first part is completed when a street has permissive-only left-turn operation. The second part is completed when a street has protected or protected-permissive left-turn phasing. The first part requires the calculation of adjusted volumes to account for the effect of permissive left-turn activity. These calculations are described in this step.

For the example application, the first part of the Phase Sequence section is completed for the north-south street because it has permissive left-turn operation. The opposing volumes for both the northbound and southbound left-turn movements are entered in the first row in the Phase Sequence section. This information is combined with that in the next three rows to convert the left-turn volume into an adjusted volume that represents “equivalent” through vehicles. The left-turn equivalence factor E_L is obtained from Figure 3-7. Values for this factor are based on information provided in Appendix C of Chapter 16 in the *Highway Capacity Manual (10)*.

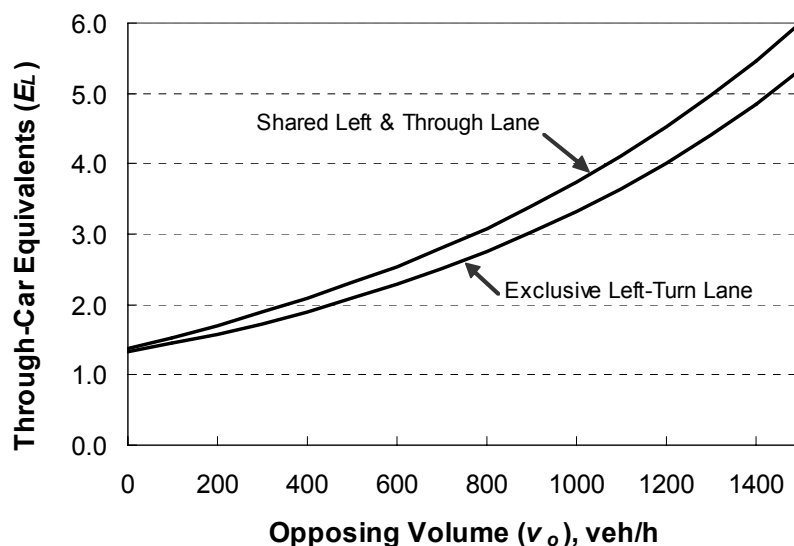

Figure 3-7. Through-Vehicle Equivalents for Permissive Left-Turn Vehicles.

The northbound left-turn movement shares a lane with the northbound through movement and is opposed by 104 southbound vehicles per hour. Figure 3-7 indicates that these conditions result in a left-turn equivalency factor of 1.5. This factor is used, along with the number of vehicles that clear at the end of the through phase (i.e., sneakers), to determine the “adjusted” left-turn

volume. For the northbound left-turn movement, the adjusted volume is computed as 59 veh/h ($= 1.5[93 - 54]$). For through movements, the adjusted volume is equal to the actual through movement volume (i.e., no adjustment is needed).

Step 3. Compute Lane Volumes. The lane volume is computed for each movement during this step. For approaches without a left-turn phase or bay, the lane volume is computed as the larger of: (1) the total adjusted approach volume divided by the number of through lanes, or (2) the adjusted left-turn volume. This calculation is explained in Footnote 2 to Table 3-3.

For approaches without a left-turn phase but with a bay, the lane volume is computed as the adjusted volume divided by the number of lanes.

For approaches with a left-turn phase and bay, the lane volume is computed as the unadjusted movement volume divided by the number of lanes.

The northbound and southbound approaches both have shared lanes; therefore, the provision in Footnote 2 applies to each approach. The lane volume for the northbound approach is computed as 233 veh/h/ln ($= [59 + 408]/2$).

The eastbound and westbound approaches both have a protected left-turn phase and bay; therefore, the lane volumes are computed as the movement volume divided by the number of lanes. For example, the lane volume for the eastbound through movement is 251 veh/h/ln ($= 502/2$).

Step 4. Compute Average Green. The average green interval duration is computed using the equation shown in the worksheet. This equation is based on a saturation flow rate of 1800 veh/h/ln and a target volume-to-capacity ratio of 0.85. The resulting green duration should be adequate for nearly 90 percent of the signal cycles. Longer green intervals can be used, but they will take time from the coordinated phases, and they are more likely to result in early-return-to-green. The computed green duration should equal or exceed the minimum green setting.

For the northbound phase, the average green is computed as 15 s ($= 233 \times 100/1800/0.85$). This value is less than the minimum green setting of 16 s, so an average green of 16 s is used for this phase in subsequent steps.

Step 5. Compute Isolated Phase Splits. The calculation of isolated phase split is dependent on the use of a left-turn phase and the presence of a left-turn bay. Footnote 3 describes the procedure for approaches without a left-turn phase or bay. Footnote 4 describes the procedure for approaches without a left-turn phase but with a bay. Finally, Footnote 5 describes the procedure for approaches with a protected left-turn phase and bay.

For the eastbound and westbound approaches, the isolated left-turn phase splits are set equal to their respective average green plus change period. Thus, the isolated eastbound left-turn phase split is 13 s ($= 8 + 5$). Footnote 5 indicates that the isolated eastbound through phase split is computed as 26 s ($= \text{larger of } [13 + 5 + 16 + 5, 8 + 5 + 26 + 5] - 18$).

Step 6. Compute Phase Splits. The previous step computed phase splits as if each phase was isolated (i.e., independent of the coordination plan). These computed splits can be directly assigned to phases 1, 3, 4, 5, 7, and 8. Phases 2 and 6 are coordinated phases and must be adjusted such that they receive any surplus time in the cycle. This calculation is explained in Footnote 6. If the computed phase split for either coordinated phase is less than that computed in Step 5, then it will not have sufficient capacity to serve the coordinated movement. In this case, the cycle length should be increased, the minimum green for one or more non-coordinated phases reduced, left-turn phasing added, or additional traffic lanes (or bays) installed at the intersection.

The eastbound through phase is a coordinated phase. As indicated in Footnote 6, its duration is computed as 61 s (= 100 - 18 - 0 - 21).

Dynamic Splits Feature

There is limited guidance on the use of the dynamic split feature. Research indicates that this feature can benefit traffic operation when the following conditions occur (9):

Dynamic splits can provide some operational benefit when volume varies somewhat unpredictably over time.

- Left-turn phases lead the through phases.
- Weekly or monthly traffic volume variations are significant and somewhat random such that the creation of special signal timing plans for these periods is impractical or impossible.

The first condition recognizes that lead-lag phasing on the major-street is often associated with maximum recall to ensure good progression quality. However, the use of maximum recall disables the dynamic split feature.

The dynamic split feature may also be helpful when resource constraints limit the frequency with which timing plans can be updated. This feature can be used to minimize the adverse impact of these constraints on signal operation by allowing the controller to adapt the plan to long-term changes in demand patterns and, thereby, postpone the need for a major plan update activity.

Maximum Green

The maximum green setting is redundant to the force-off setting and generally not needed for coordinated-actuated operation. To ensure that the maximum green setting does not terminate a phase by max-out, it should be inhibited for both rings during coordinated operation. It should be noted that the “inhibit maximum termination” setting does not inhibit the timing of the maximum green (just its ability to terminate the phase). Thus, the maximum recall mode will extend the green interval (if invoked), regardless of whether the inhibit setting is or is not invoked.

Inhibit maximum green termination during coordinated operation.

REFERENCES

1. Fambro, D.B, S.M. Sangineni, C.A. Lopez, S.R. Sunkari, and R.T. Barnes. *Benefits of the Texas Traffic Light Synchronization Grant Program II: Volume I*. Report No. 3010-1F. Texas Transportation Institute, The Texas A&M University System, College Station, Texas, 1995.
2. Parsonson, P.S., and J.M. Thomas, Jr. "Atlanta's Traffic-Responsive Computerized Traffic Control System." *ITE Journal*. Institute of Transportation Engineers, Washington, D.C., July 1978, pp. 29–40.
3. Rakha, H., A. Medina, H. Sin, F. Dion, M. Van Aerde, and J. Jeng. "Traffic Signal Coordination across Jurisdictional Boundaries." *Transportation Research Record 1727*. Transportation Research Board, National Research Council, Washington, D.C., 2000, pp. 42–51.
4. Shinar, D., M. Bourla, and L. Kaufman. "Synchronization of Traffic Signals as a Means of Reducing Red-Light Running." *Human Factors, Vol. 46, No. 2*. Human Factors and Ergonomics Society, 2004, pp. 367–372.
5. Chang, E.C.P., and C.J. Messer. *Arterial Signal Timing Optimization Using PASSER II-90. Program User's Manual*. Report No. FHWA/TX-90/467-2F. Texas Department of Transportation, Austin, Texas, 1991.
6. Orcutt, F. *The Traffic Signal Book*. Prentice-Hall, Inc., Englewood Cliffs, New Jersey, 1993.
7. Henry, R.D. *Signal Timing on a Shoestring*. Report No. FHWA-HOP-07-006. Federal Highway Administration, Washington, D.C., March 2005.
8. Sunkari, S., R. Engelbrecht, and K. Balke. *Evaluation of Advance Coordination Features in Traffic Signal Controllers*. Report No. FHWA/TX-05/0-4657-1. Texas Department of Transportation, Austin, Texas, 2004.
9. Engelbrecht, R., S. Venglar, and Z. Tian. *Research Report on Improving Diamond Interchange Operations Using Advanced Controller Features*. Report No. FHWA/TX-02/0-4158-1. Texas Department of Transportation, Austin, Texas, 2001.
10. *Highway Capacity Manual 2000*. 4th ed. Transportation Research Board, Washington, D.C., 2000.

Phase Split Calculation Worksheet								
General Information								
Location: _____			Cycle Length (C), s: _____			Analysis Period: _____ to _____		
Volume and Lane Geometry Input								
Approach:	Eastbound		Westbound		Northbound		Southbound	
Movement, No.: {see note 1}	LT, 5	TH+RT, 2	LT, 1	TH+RT, 6	LT, 3	TH+RT, 8	LT, 7	TH+RT, 4
Volume (v_i), veh/h $i = 1, 2, 3, \dots, 8$								
Lanes (n_i)								
Change Period and Minimum Green								
Yellow + red clearance (Y_i), s								
Minimum green ($G_{m,i}$), s								
Phase Sequence - Permissive	LT & TH in Same Phase (prot TH & perm LT)				LT & TH in Same Phase (prot TH & perm LT)			
Opposing Volume ($v_{o,i}$), veh/h	$v_6 =$		$v_2 =$		$v_4 =$		$v_8 =$	
LT equivalency ($E_{L,i}$) (Fig. 3-7)		1.0		1.0		1.0		1.0
Sneakers (S_i), veh/h [=5400/C]		0.0		0.0		0.0		0.0
Adjusted volume (v_i^*) [= $E_L (v_i - S_i) \geq 0.0$]								
Without Bay								
Lane volume without bay ($v_{n,i}$) {see note 2}								
Average Green ($G_{a,i}$), s [= larger of: ($v_{n,i} C/1800/0.85$, $G_{m,i}$)]								
Phase split (T_i), s {see note 3}								
With Bay								
Lane volume with bay ($v_{n,i}$) [= v_i^*/n_i], veh/h/ln								
Average Green ($G_{a,i}$), s [= larger of: ($v_{n,i} C/1800/0.85$, $G_{m,i}$)]								
Phase split (T_i), s {see note 4}								
Phase Sequence - Protected	LT Phase & TH Phase				LT Phase & TH Phase			
Lane volume with bay ($v_{n,i}$) [= v_i/n_i], veh/h/ln								
Average Green ($G_{a,i}$), s [= larger of: ($v_{n,i} C/1800/0.85$, $G_{m,i}$)]								
Phase split (T_i), s {see note 5}								
Phase Splits								
Phase split (T_i), s {see note 6}								

Notes:

- 1 - Numbers follow NEMA movement-based phase numbering system (LT = left-turn, TH = through, RT = right-turn).
- 2 - The lane volume for the through movement equals the larger of $v_{n,app}$ or v_{th}^* ; with $v_{n,app} = (v_{th}^* + v_{lt}^*)/n_{th}$ where, v_{th}^* (v_{lt}^*) = adjusted volume for through (left) movement on subject approach; and n_{th} = number of through lanes on the subject approach.
- 3 - Phase split is the same for both approaches on the same street. It equals the larger of the G+Y for the two approaches (e.g., $T_2 = T_6 =$ larger of [$G_{a2} + Y_2$, $G_{a6} + Y_6$]).
- 4 - Phase split is the same for both approaches on the same street. It equals the larger of the G+Y for the left-turn and through movements on the two approaches (e.g., $T_2 = T_6 =$ larger of [$G_{a1} + Y_1$, $G_{a2} + Y_2$, $G_{a5} + Y_5$, $G_{a6} + Y_6$]).
- 5 - Phase split for a left-turn phase equals the sum of its average green and change period. Through phase split is computed as:
 $T_2 =$ larger of [$G_{a1} + Y_1 + G_{a2} + Y_2$, $G_{a5} + Y_5 + G_{a6} + Y_6$] - T_1 $T_6 =$ larger of [$G_{a1} + Y_1 + G_{a2} + Y_2$, $G_{a5} + Y_5 + G_{a6} + Y_6$] - T_5
 $T_4 =$ larger of [$G_{a3} + Y_3 + G_{a4} + Y_4$, $G_{a7} + Y_7 + G_{a8} + Y_8$] - T_3 $T_8 =$ larger of [$G_{a3} + Y_3 + G_{a4} + Y_4$, $G_{a7} + Y_7 + G_{a8} + Y_8$] - T_7
- 6 - Phase splits for phases 1, 5, 3, 4, 7, and 8 are read from the rows above based on the phasing used and bay presence. Phase split for phase 2 is computed as $T_2 = C - T_1 - T_3 - T_4$. Phase split for phase 6 is computed as $T_6 = C - T_5 - T_7 - T_8$.

CHAPTER 4. BIBLIOGRAPHY

The documents identified in this chapter provide useful guidance related to signalized intersection (or interchange) design and operation. They are listed herein because they provide information to supplement the signal timing guidance provided in the *Handbook*. The reader should consult these documents when issues beyond signal operation need to be addressed.

TRAFFIC SIGNALS (COMPREHENSIVE)

Rodegerdts, L.A., B. Nevers, B. Robinson, J. Ringert, P. Koonce, J. Bansen, T. Nguyen, J. McGill, D. Stewart, J. Suggett, T. Neuman, N. Antonucci, K. Hardy, and K. Courage. *Signalized Intersections: Informational Guide*. Report FHWA-HRT-04-091. Federal Highway Administration, U.S. Department of Transportation, Washington, D.C., 2004. (<http://www.tfhrc.gov/safety/pubs/04091/index.htm>).

Traffic Control Devices Handbook. J.L. Pline editor. Institute of Transportation Engineers, Washington, D.C., 2001.

Robertson, H., J.E. Hummer, and D.C. Nelson. *Manual of Transportation Engineering Studies*. Institute of Transportation Engineers, Washington, D.C., 2000.

Traffic Signals Manual. Texas Department of Transportation, Austin, Texas, December 1999.

Kell, J.H., and I.J. Fullerton. *Manual of Traffic Signal Design. 2nd Edition*. Institute of Transportation Engineers, Washington, D.C., 1998.

TRAFFIC SIGNAL JUSTIFICATION

Hawkins, H.G. *Traffic Signal Warrants: Guidelines for Conducting a Traffic Signal Warrant Analysis*. 2nd Edition. Texas Department of Transportation, Austin, Texas, March 2008. (<http://tti.tamu.edu/documents/0-4701-P2.pdf>).

Texas Manual on Uniform Traffic Control Devices. Texas Department of Transportation, Austin, Texas, 2006.

Bonneson, J., and M. Fontaine. *NCHRP Report 457: Evaluating Intersection Improvements: An Engineering Study Guide*. Transportation Research Board, National Research Council, Washington, D.C., 2001. (<http://tcd.tamu.edu/Documents/Products.htm>).

SIGNALIZED INTERSECTION DESIGN

Roadway Design Manual. Texas Department of Transportation, Austin, Texas, July 2006.

Fitzpatrick, K., M.D. Wooldridge, and J.D. Blaschke. *Urban Intersection Design Guide*. Report No. FHWA/TX-05/0-4365-P2. Texas Department of Transportation, Austin, Texas, February 2005. (<http://tti.tamu.edu/documents/0-4365-P2.pdf>).

Bonneson, J., and M.M. Abbas. *Intersection Video Detection Manual*. Report No. FHWA/TX-03/4285-2. Texas Department of Transportation, Austin, Texas, September 2002. (<http://tti.tamu.edu/documents/4285-2.pdf>).

TRAFFIC SIGNAL TIMING

Koonce, P., L. Rodegerdts, K. Lee, S. Quayle, S. Beard, C. Braud, J. Bonneson, P. Tarnoff, and T. Urbanik. *Traffic Signal Timing Manual*. Report No. FHWA-HOP-08-024. Federal Highway Administration, U.S. Department of Transportation, Washington, D.C., June 2008. (<http://www.signaltiming.com>).

Henry, R.D. *Signal Timing on a Shoestring*. Report No. FHWA-HOP-07-006. Federal Highway Administration, U.S. Department of Transportation, Washington, D.C., March 2005. (http://ops.fhwa.dot.gov/publications/signal_timing/00_index.htm).

Engelbrecht, R.J., K.N. Balke, S.R. Sunkari, and S.P. Venglar. *Engineering Solutions to Improving Operations and Safety at Signalized Intersections near Railroad Grade Crossings with Active Devices*. Report No. FHWA/TX-06/0-4265-1. Texas Department of Transportation, Austin, Texas, September 2005. (<http://tti.tamu.edu/documents/0-4265-1.pdf>).

Sunkari, S., R. Engelbrecht, and K. Balke. *Evaluation of Advance Coordination Features in Traffic Signal Controllers*. Report No. FHWA/TX-05/0-4657-1. Texas Department of Transportation, Austin, Texas, 2004. (<http://tti.tamu.edu/documents/0-4657-1.pdf>).

Highway Capacity Manual 2000. 4th ed. Transportation Research Board, Washington, D.C., 2000.

Orcutt, F. *The Traffic Signal Book*. Prentice-Hall, Inc., Englewood Cliffs, New Jersey, 1993.

INTERCHANGE SIGNAL TIMING AND DESIGN

Engelbrecht, R.J., S.P. Venglar, and Z. Tian. *Research Report on Improving Diamond Interchange Operations Using Advanced Controller Features*. Report No. FHWA/TX-02/4158-1. Texas Department of Transportation, Austin, Texas, October 2001. (<http://tti.tamu.edu/documents/4158-1.pdf>).

Sunkari, S.R., and T. Urbanik, III. *Signal Design Manual for Diamond Interchanges*. Report No. FHWA/TX-01/1439-6. Texas Department of Transportation, Austin, Texas, September 2000. (<http://tti.tamu.edu/documents/1439-6.pdf>).

APPENDIX A. SIGNAL PHASING AND OPERATION

This appendix provides guidelines for the signal phase sequence selection process. These guidelines are applicable to most signalized intersections. Additional information about signal phasing and operation is provided in Chapters 2 and 3.

The information in this appendix may be useful if the signal phase sequence can be changed at the subject intersection. Guidelines for establishing phase settings are provided in Chapters 2 and 3. If changes to the detection layout are being considered, then the guidelines in Appendix C – Detection Design and Operation should be consulted. If the intersection is part of a diamond interchange, then the guidelines in Appendix D – Diamond Interchange Phasing, Timing, and Design should be consulted. A change in phase sequence may also be accompanied by the addition of a turn bay or a change in signal display. In this case, guidelines for determining the appropriate signal head arrangement and location can be found in the *TMUTCD (I)*.

This appendix consists of three parts. The first part provides an overview of the objectives of signal phase sequence selection. The second part summarizes the basic signal phasing concepts and establishes a vocabulary. The last part provides guidelines for determining the appropriate signal phasing for the subject intersection.

OVERVIEW

An intersection's phase sequence describes the predetermined order by which phases are displayed and the assigned traffic movements are served. In this context, a traffic movement may be a vehicle or a pedestrian. The phase sequence used at an intersection is based on consideration of traffic movement volume, approach lane assignments, and coordination timing (if relevant). The simplest phase sequence provides concurrent service to all traffic movements on opposing approaches of the same road (i.e., left-turning vehicles are required to yield to the opposing through vehicles). More complicated phase sequences occur when one or more turn movements are provided an exclusive phase.

The objective in selecting a signal phase sequence is to provide the most efficient overall intersection operation while ensuring that no movement incurs unreasonable delay or excessive crash risk. It is often achieved when the number of phases used at an intersection is kept to a minimum. It typically results in there being one phase for each through movement and a second phase for any turn movement that does not have adequate opportunity to filter through conflicting traffic in a permissive manner.

Phase Sequence Objective
Selected sequence should:

- provide efficient overall operation; and
- allow no movement to incur unreasonable delay or excessive crash risk.

The efficiency of an intersection is directly impacted by its signal phasing. For example, provision of an exclusive phase for a left-turn movement will reduce the delay incurred by the associated left-turning vehicles. However, this phase generally comes at the expense of increased

delay to other traffic movements. It also tends to increase the cycle length and reduce intersection capacity. Hence, the benefit to the movement receiving the turn phase must outweigh the disbenefit to all other movements combined.

CONCEPTS

This part of the appendix explains the basic signal phasing and operation concepts and establishes a vocabulary. Topics addressed include left-turn operational mode, left-turn phasing, right-turn phasing, and pedestrian phasing.

Left-Turn Operational Mode

There are three operational modes for the turn movements at an intersection. The names used to describe these modes refer to the manner in which the turn movement is served by the controller. The three modes are:

- Permissive.
- Protected.
- Protected-permissive.

Each of these modes is illustrated in the next section in the context of common phase sequences.

The permissive mode requires turning drivers to yield to conflicting traffic streams before completing the turn. Permissive left-turning drivers yield to oncoming vehicles and pedestrians. Permissive right-turning drivers yield to pedestrians. The efficiency of this mode is dependent on the availability of gaps in the conflicting streams. An exclusive turn lane may be provided with this mode, but it is not required. The permissive turn movement is typically presented with a circular green indication (although some agencies use other indications, such as a flashing yellow arrow).

The protected mode allows turning drivers to travel through the intersection while all conflicting movements are required to stop. This mode provides for efficient turn movement service; however, the addition of a turn phase typically results in increased delay to the other movements. An exclusive turn lane is typically provided with this mode. The turn phase is indicated by a green arrow signal indication.

The protected-permissive mode represents a combination of the permissive and protected modes. Turning drivers have the right-of-way during the exclusive phase. They can also complete the turn “permissively” when the adjacent through movement receives its circular green indication. This mode provides for efficient turn movement service, often without causing a significant increase in the delay to other movements.

Left-Turn Phasing

This section describes the sequence of service provided to left-turn movements, relative to the other intersection movements. The typical sequence options include:

- Permissive-only (i.e., no left-turn phase).
- Leading left turn.
- Lagging left turn.
- Split.

Permissive-Only Phasing

The permissive-only option is used when the left-turn operates in the permissive mode. A left-turn phase is not provided with this option. An illustrative implementation of permissive-only phasing for left- and right-turning traffic is shown in Figure A-1 for the minor road.

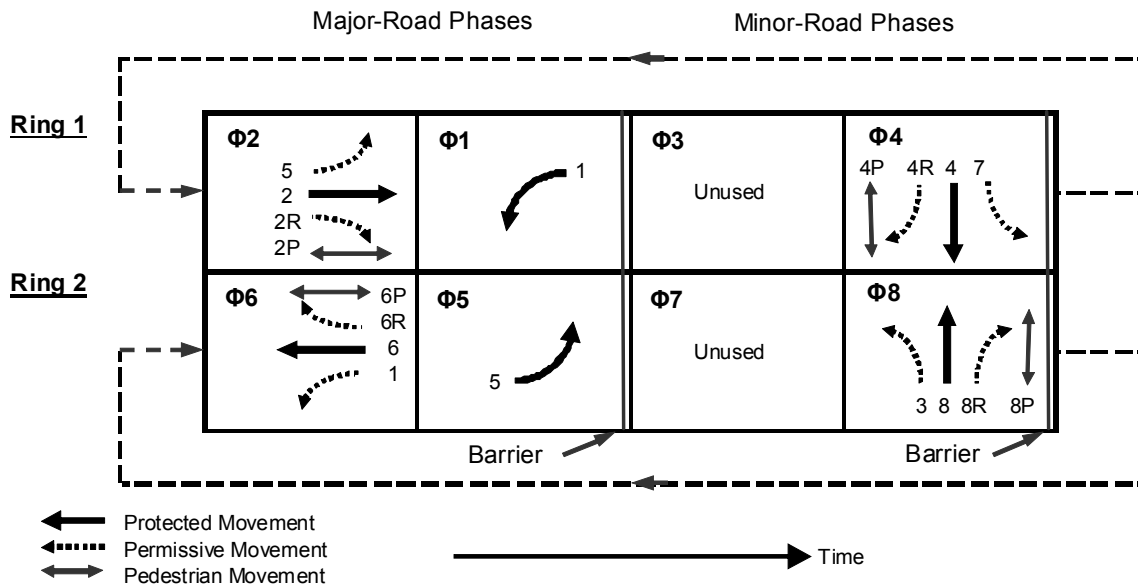

Figure A-1. Illustrative Lag-Lag and Permissive-Only Phasing.

Leading or Lagging Left-Turn Phasing

Phase Sequence. Leading, lagging, or split phasing is used when the left-turn operates in the protected or protected-permissive mode. The terms leading and lagging indicate the order in which the left-turn phase is presented, relative to the conflicting through movement. Leading left-turn phasing is shown in Figure A-2 for both left-turn movements on both the major and minor roads (the “Overlap A” shown is explained in a later section). Lagging left-turn phasing is shown in Figure A-1 for both left-turn movements on the major road. A mix of leading and lagging phasing (called lead-lag) is shown in Figure A-3 for the left-turn movements on the major road.

Yellow Trap. If the protected-permissive mode is used with lead-lag or lag-lag phasing, then the yellow trap (or left-turn trap) problem may occur for one or both of the left-turn movements. This problem stems from the potential conflict between left-turn vehicles and oncoming vehicles at

the end of the adjacent through phase. Of the two through movement phases serving the subject road, the trap is associated with the first through movement phase to terminate and occurs during this phase's yellow change interval. The left-turn driver seeking a gap in oncoming traffic during the through phase first sees the yellow ball indication, then incorrectly assumes that the oncoming traffic also sees a yellow indication; the driver then turns across the oncoming traffic stream without regard to the availability of a safe gap.

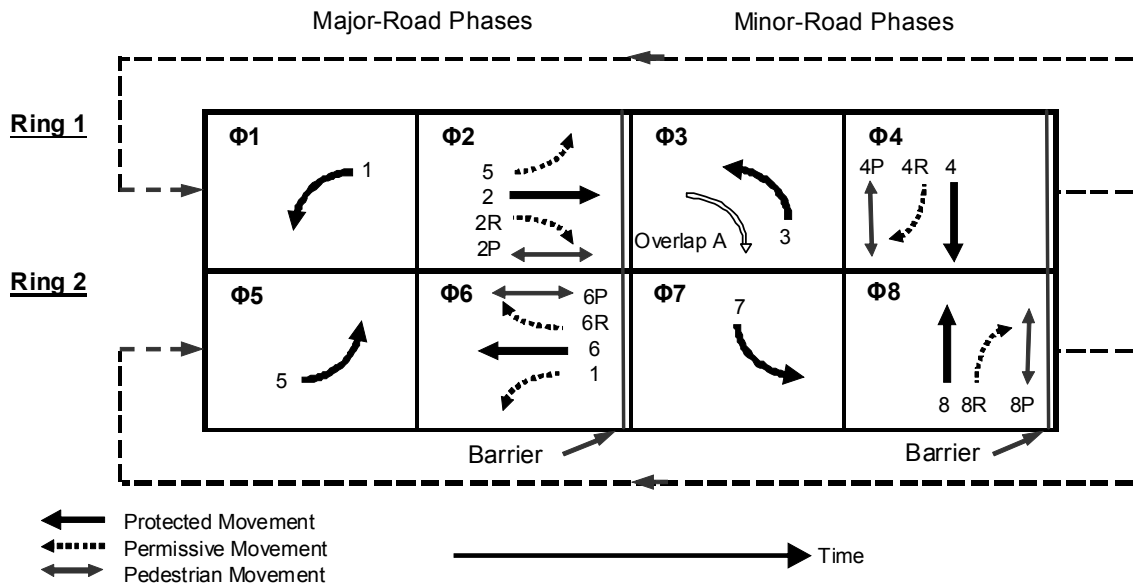

Figure A-2. Illustrative Lead-Lead and Right-Turn Phasing.

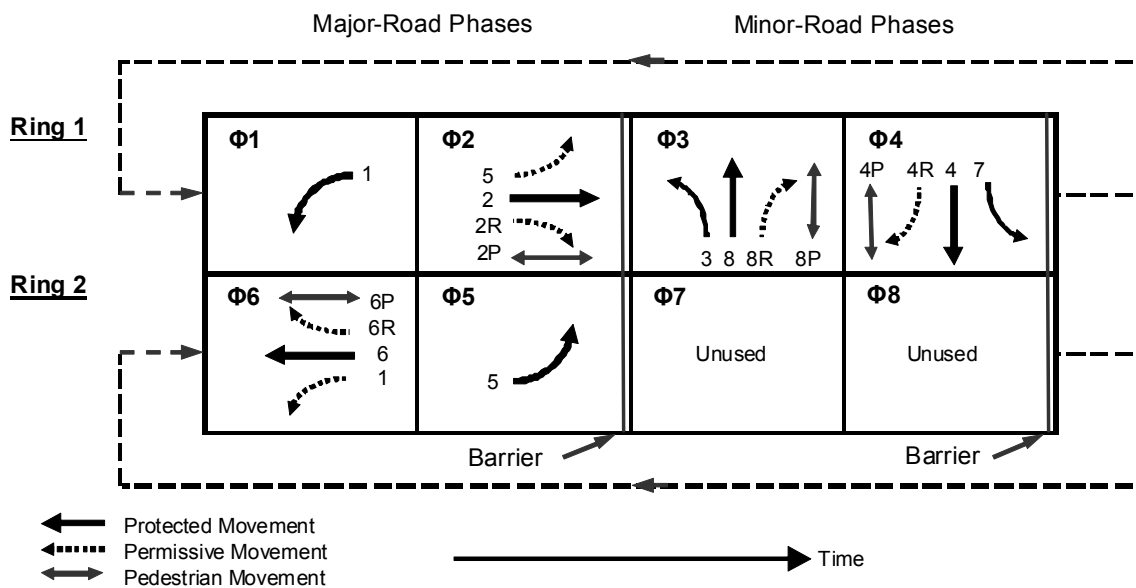

Figure A-3. Illustrative Lead-Lag and Split Phasing.

The yellow trap is illustrated in Figure A-4. During Stage 1, the southbound and northbound left-turn movements are operated in the permissive mode during their respective through phases. During Stage 2, the southbound left-turn and through signal heads display a yellow change interval. However, the northbound left-turn and through heads continue to display a green indication. This condition can create a yellow trap for the southbound left-turn driver if he or she assumes that northbound drivers are also viewing a yellow indication and preparing to stop. Following this incorrect assumption, the southbound left-turn driver attempts to complete the left-turn maneuver even though he or she is exposed to oncoming traffic.

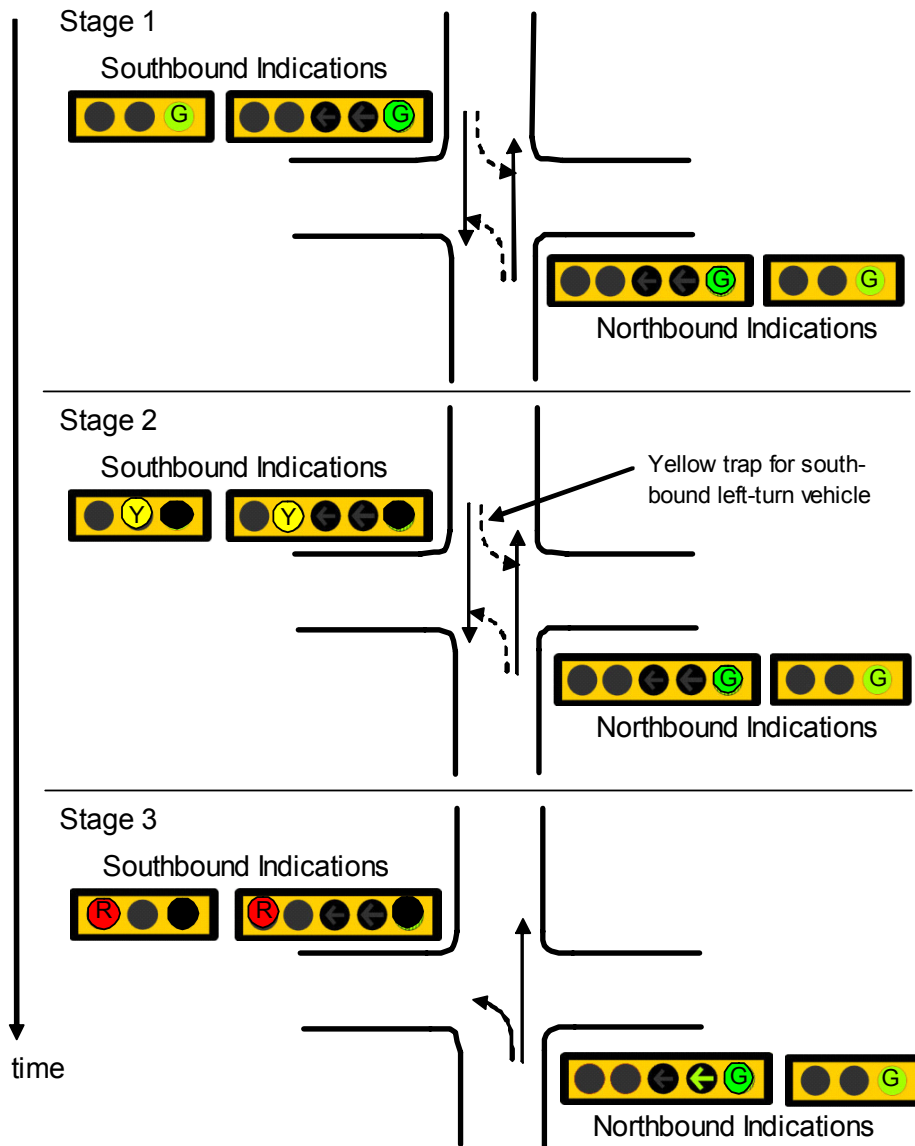

Figure A-4. Demonstration of Yellow Trap with Lead-Lag Phasing.

Dallas Phasing. One technique to avoid the yellow trap is to use a phase sequence called “Dallas Phasing” (2). The left-turn green, yellow, and red ball indications are assigned to a controller overlap that is associated with the adjacent *and opposing* through movement phases. The left-turn green and yellow arrow indications are assigned to the left-turn phase output. The left-turn signal head uses louvers on the yellow and green ball indications to prevent through movement drivers from viewing the left-turn display. The louvered signal head is referred to as the “Dallas Display.” With this display, both left-turn phases can operate in the protected-permissive mode, and the trap is avoided.

The Dallas Phasing operation is shown in Figure A-5 as an alternative Stage 2 for the sequence shown in Figure A-4. In Figure A-4, the yellow trap was noted to occur during Stage 2. However, when Dallas Phasing is used, a louvered green ball indication is maintained for the left-turning driver during this stage. This driver will not be motivated to make a hasty (and incorrect) assumption about the need to clear the intersection because he or she will not be facing a yellow indication. Similar operation is obtained using the flashing-yellow-arrow feature in some controllers along with a flashing-yellow-arrow left-turn signal display.

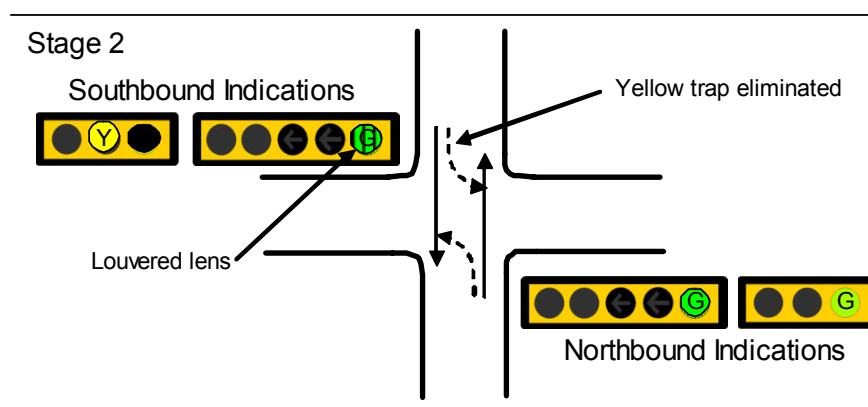

Figure A-5. Dallas Phasing to Eliminate Yellow Trap.

Split Phasing

Split phasing describes a phase sequence where one phase serves all movements on one approach and a second phase serves all movements on the other approach. Split phasing requires that all approach movements simultaneously receive a green indication. Split phasing is shown in Figure A-3 for the minor road; other variations may be used depending on the treatment of the pedestrian movements. A split phase typically uses the protected mode for the left-turn movement (as shown in Figure A-3) and the adjacent pedestrian movement. Additional details of various split phasing options are described in *Signalized Intersections: Informational Guide* (2).

Right-Turn Phasing

In general, the right-turn movement is served concurrently during the adjacent through movement phase. If the adjacent pedestrian movement is also served concurrently, then the

right-turn operates in a permissive mode and must yield to pedestrian traffic. There may be additional right-turning opportunities during other phases, if right-turn-on-red is a legal maneuver. Hence, right-turn capacity is influenced by the through phase duration, pedestrian volume, and right-turn-on-red opportunities.

Right-turn phasing is used to increase right-turn capacity. One option is to provide a right-turn phase that exclusively serves one or more right-turn movements. This option is rarely implemented and only when the operational or safety benefits are shown to outweigh the adverse impact to the efficiency of the other intersection movements. More commonly, the needed right-turn capacity is obtained by providing a right-turn phase concurrently with the phase serving the nearside (or complementary) left-turn movement on the crossroad. A controller overlap is used for this purpose to ensure proper conflict monitor operation. This technique is shown in Figure A-2 where overlap A is associated with Phase 3 and used to serve the right-turn movement (i.e., 2R).

For those intersection approaches where the through movement phase concurrently serves a pedestrian movement, a protected-permissive mode can be used to serve the right-turn movement. This mode is shown in Figure A-2 for movement 2R. It would be implemented with a five-section head for the right-turn movement. The green, yellow, and red ball indications would be associated with those of the adjacent through movement phase. The green and yellow arrow indications would be associated with those of the complementary left-turn movement using a controller overlap.

Pedestrian Phasing

Pedestrian movements are typically served concurrently with the adjacent through movement phase. However, this type of phasing puts pedestrians in conflict with right-turning vehicles and left-turning vehicles that operate in a permissive mode. When the extent of conflict indicates that alternative pedestrian phasing is needed, there are three options to consider:

- Leading pedestrian walk.
- Lagging pedestrian walk.
- Exclusive pedestrian phase.

In the leading pedestrian walk (or leading pedestrian interval) option, the pedestrian walk interval starts a few seconds before the adjacent through movement phase. This option allows pedestrians to establish a presence in the crosswalk and, thereby, reduces conflicts with turning vehicles. It is available in most of the newer signal controllers.

In the lagging pedestrian walk option, the pedestrian walk interval starts several seconds after the adjacent through movement phase. This option allows a waiting right-turn queue to clear before the pedestrian WALK indication is presented and, thereby, reduces conflicts with right-turning vehicles. It is available in most of the newer signal controllers.

In the exclusive pedestrian phase option, an additional phase is required for the exclusive use of all pedestrians. This additional phase is configured such that no vehicular movements are served concurrently with pedestrian traffic. During this phase, pedestrians can cross any of the intersection

legs and may even be allowed to cross the intersection in a diagonal path. The disadvantage of this option is that it significantly reduces the vehicular capacity of the intersection.

GUIDELINES

This part of the appendix provides guidelines for determining the appropriate phase sequence and operational mode. The information provided is based on established practices and techniques that have been shown to provide safe and efficient system operation. The guidelines address left-turn operational mode, left-turn phase sequence, right-turn operational mode, and pedestrian phasing.

Guidelines for Determining Left-Turn Operational Mode

Guidelines are provided in this section for selecting the left-turn mode. The modes addressed include:

- Permissive.
- Protected.
- Protected-permissive.

The first subsection describes comprehensive guidelines that address a wide range of operational and safety considerations. These conditions include speed, driver sight distance, vehicle volume, vehicle delay, and left-turn-related crashes. These guidelines should always be considered.

The second subsection describes guidelines for selecting the left-turn mode based on pedestrian safety considerations. These guidelines should be applied if the pedestrian-vehicle crash experience for a given crosswalk is susceptible to improvement by a protected left-turn operation. More generally, they should be considered whenever pedestrians are present at an intersection.

Comprehensive Guidelines

There are many factors that need to be considered when determining whether a left-turn phase will improve the operation or safety of an intersection. The key factors include:

- Left-turn and opposing through volumes.
- Number of opposing through lanes.
- Cycle length.
- Speed of opposing traffic.
- Sight distance.
- Crash history.

The flowchart shown in Figure A-6 can be used to assist in the determination of whether a left-turn phase is needed for a given left-turn movement and whether the operational mode should be protected or protected-permissive. These guidelines were derived from a variety of sources (3, 4, 5). The criteria used to determine the appropriate operational mode are explicitly identified in the various boxes of the flow chart.

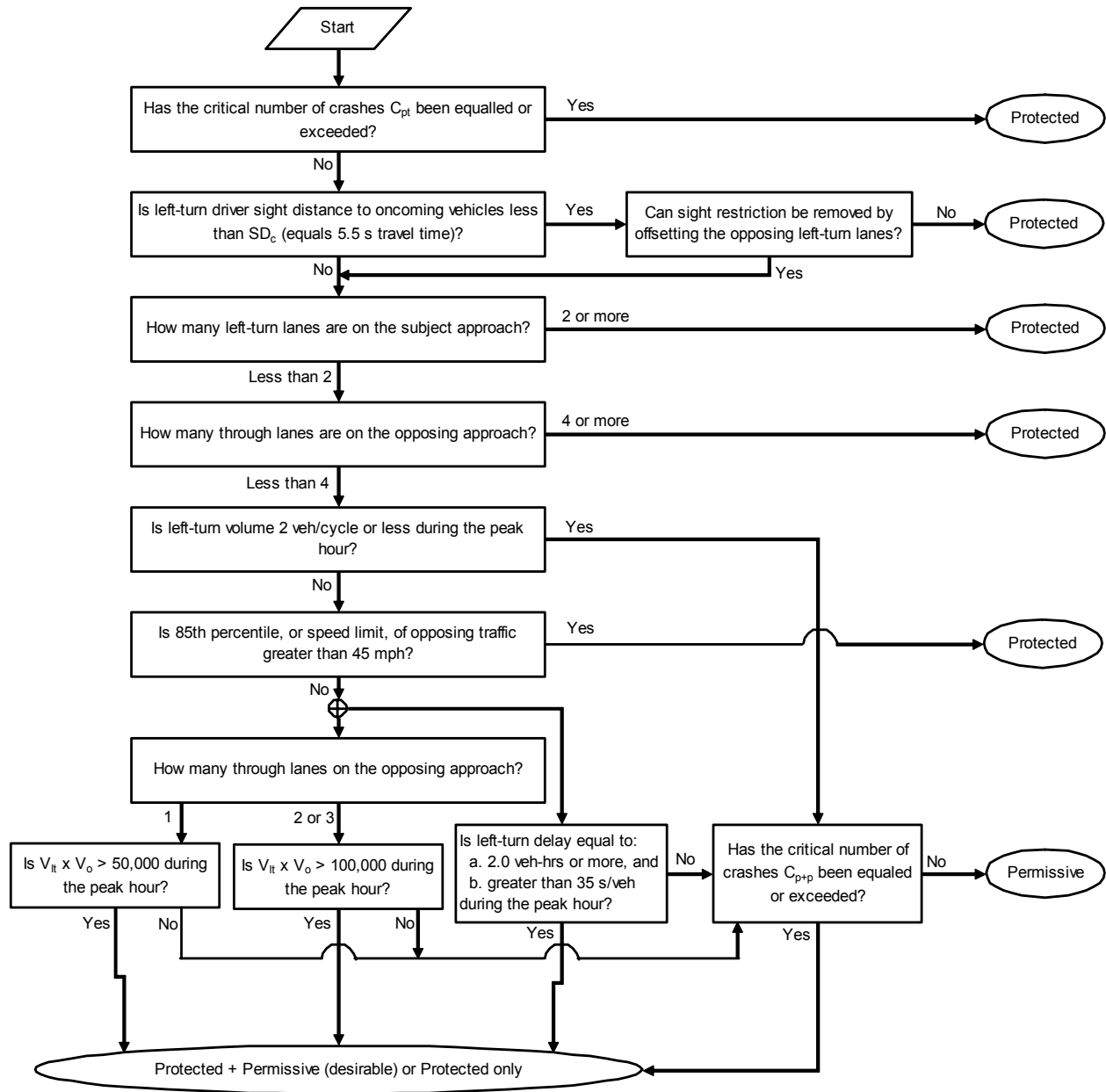

Number of Left-Turn Movements on Subject Road	Period during which Crashes are Considered (years)	Critical Left-Turn-Related Crash Count	
		When Considering Protected-only, C_{pt} (crashes/period)	When Considering Prot.+Perm, C_{p+p} (crashes/period)
One	1	6	4
One	2	11	6
One	3	14	7
Both	1	11	6
Both	2	18	9
Both	3	26	13

Oncoming Traffic Speed Limit (mph)	Minimum Sight Distance to Oncoming Vehicles, SD_c (ft)
25	200
30	240
35	280
40	320
45	360
50	400
55	440
60	480

Variables

V_{lt} = left-turn volume on the subject approach, veh/h

V_o = through plus right-turn volume on the approach opposing the subject left-turn movement, veh/h

Figure A-6. Guidelines for Determining Left-Turn Operational Mode.

The critical left-turn-related crash counts identified in Figure A-6 are based on an underlying average crash frequency and a random distribution of crashes about this average. The underlying average crash frequencies are 1.3 crashes/yr and 3.0 crashes/yr for protected-permissive and protected-only left-turn phasing, respectively. If the reported crash count for an existing permissive operation exceeds the cited critical value, then it is likely that the subject intersection has an average left-turn crash frequency that exceeds the aforementioned average (confidence level is 95 percent). In this situation, a more restrictive operational mode would likely improve the safety of the left-turn maneuver.

The flowchart has two alternative paths following the check of opposing traffic speed. One path requires knowledge of left-turn delay; the other requires knowledge of the left-turn and opposing through volumes. The left-turn delay referenced in the flowchart is the delay incurred when no left-turn phase is provided (i.e., the left-turn movement operates in the permissive mode).

Intent. Figure A-6 is constructed to recommend the least restrictive left-turn operational mode possible. It is also intended to provide a uniform procedure for the evaluation of left-turn phasing for the purpose of promoting consistency in left-turn phase application.

One Approach at a Time. Use of Figure A-6 requires the separate evaluation of each left-turn movement. If one left-turn movement requires a left-turn phase, but the opposing left-turn movement does not require a phase, then only one left-turn phase should be provided. Unnecessary left-turn phases are likely to degrade the overall safety and efficiency of the intersection.

Determine the left-turn mode for each approach separately.

Check it Out: If one approach needs a left-turn phase, do not assume that the other approach also needs a left-turn phase.

Number of Left-Turn Lanes. Figure A-6 is based on the following assumptions. If the protected mode is used, then one or more exclusive left-turn lanes will be provided. If the protected-permissive mode is used, then one or more exclusive left-turn lanes will be provided (unless lead-lag phasing is provided, in which case the left-turn movement can share a lane with the adjacent through movement). If the permissive mode is used, then the left-turn movement is served by an exclusive lane or by a shared lane.

Pedestrian Safety-Based Guidelines

This subsection describes the guidelines for determining left-turn mode based on pedestrian safety considerations. These guidelines consist of a sequence of evaluation steps. The results of each step are recorded in a worksheet. An example worksheet is provided in Table A-1. A blank version of the worksheet is provided at the end of the appendix. The guidelines are applicable to any signalized intersection, including the signalized intersections at an interchange.

Table A-1. Sample Pedestrian Safety Worksheet.

Left-Turn Operational Mode Based on Pedestrian Safety								
General Information								
Location: <u>Main St. & Peach Tree Drive</u>					Analysis Period: <u>12:00 pm</u> to <u>1:00 pm</u>			
Intersection legs (N_L): <u>4</u>								
Volume Data								
Approach:	Eastbound		Westbound		Northbound		Southbound	
Movement, No.: {see note 1}	LT, 5	TH+RT, 2	LT, 1	TH+RT, 6	LT, 3	TH+RT, 8	LT, 7	TH+RT, 4
Volume (v_i), veh/h $i = 1, 2, 3, \dots 8$	105	502	201	806	93	408	57	104
Crosswalk crossing the...		South leg		North leg		East leg		West leg
Pedestrian volume ($v_{ped,i}$), p/h		400		400		400		400
Total entering volume (v_i), [$= \sum v_i$] veh/h: <u>2276</u>								
Volume Combination Check								
Enter volume for each conflicting left-turn movement for which a left-turn phase is being considered or currently exists.								
Conflicting left-turn movement		Westbd.		Eastbd.		Southbd.		Northbd.
Conf. left-turn volume (v_{LT}), veh/h		$v_{LT,1} = 201$		$v_{LT,5} = 105$		$v_{LT,7} = na^2$		$v_{LT,3} = na^2$
Product (v_p) [$= v_{LT} \times v_{ped}$], p-veh/h		80,400		42,000		0		0
Use figure below. Enter "Yes" if product and entering volume intersect in region indicating consider prot. mode or prot.-perm. mode; otherwise, enter "No." Consider protected or protected-permissive mode for conflicting left turn if "Yes" is entered.								
Results from volume check		No		No				
<p style="text-align: center;">Figure A. Three-Leg Intersection.</p>					<p style="text-align: center;">Figure B. Four-Leg Intersection.</p>			
Crash Experience Check								
Approach:	Eastbound		Westbound		Northbound		Southbound	
Movement, No.: {see note 1}	LT, 5	TH+RT, 2	LT, 1	TH+RT, 6	LT, 3	TH+RT, 8	LT, 7	TH+RT, 4
Enter number of reported left-turn-related pedestrian-vehicle crashes associated with each crosswalk during a three-year period.								
Crosswalk crossing the...		South leg		North leg		East leg		West leg
Crash frequency (N), cr/3 yrs		0		4		na		na
Enter "Yes" if four or more crashes; otherwise, enter "No." Consider protected mode for conflicting left turn if "Yes" is entered.								
Conflicting left-turn movement		Westbd.		Eastbd.		Southbd.		Northbd.
Results from crash check		No		Yes				
Recommendation³								
Determination: <u>Consider protected mode for eastbound left turn, further evaluation needed for westbound left turn.</u>								

Notes:

- 1 - Numbers follow NEMA movement-based phase numbering system (LT = left-turn, TH = through, RT = right-turn).
- 2 - na: not applicable. Left-turn protection not present and not being considered for this crosswalk.
- 3 - This worksheet focuses on volume and crash history. It does not address cycle length, speed, or sight distance. These factors may also need to be considered when determining the appropriate left-turn mode.

The worksheet in Table A-1 contains sample data that are used to illustrate the evaluation process. The worksheet is designed to document the evaluation of one one-hour analysis period for the specified combination of left-turn and pedestrian volumes at the intersection. Additional sheets would be completed if additional analysis periods or volume combinations are to be evaluated.

Step 1. Collect Data. Data needed for the evaluation are gathered during this step. They include vehicular volume, pedestrian volume, and crash history. Pedestrian volume and crash history are gathered for the crosswalks of interest. The pedestrian volume for a given crosswalk includes pedestrians traveling in both directions along the crosswalk (i.e., it is a two-way volume).

The pedestrian volume for a given crosswalk is recorded on the worksheet in the column that corresponds to the through movement that is served concurrently with the pedestrians in the subject crosswalk. For example, the pedestrians traveling in the crosswalk across the south leg of an intersection are served concurrently with the eastbound through vehicles, so the pedestrian volume for this crosswalk would be recorded in the same column as the eastbound through (and right-turn) vehicle volume.

The vehicle volume for each movement is added to determine the total volume of vehicles entering the intersection during the analysis period. This sum is recorded in the last row of the Volume Data section.

The number of reported left-turn-related pedestrian-vehicle crashes during a recent three-year period is recorded in the Crash Experience Check section. This number is separately recorded for each crosswalk.

Step 2. Identify Crosswalk and Left-Turn Movement Pairs of Interest. The crosswalks of interest are identified in this step. All crosswalks being considered for protection from their conflicting left-turn movement are “of interest.” A crosswalk is “protected” from its conflicting left-turn movement if this movement is served by a protected left-turn phase or a protected-permissive left-turn phase. For each crosswalk of interest, record its conflicting left-turn volume in the Volume Combination Check section of the worksheet.

For the example intersection in Table A-1, the crosswalk crossing the south leg is conflicted by the westbound left-turn movement (i.e., it is permissive). However, left-turn protection is being considered for it due to the high westbound left-turn volume. This volume is recorded as the conflicting left-turn volume in the *eastbound* through (and right-turn) column because the pedestrian signal heads that control this crosswalk time with the eastbound through movement. For similar reasons, left-turn protection is being considered for the crosswalk crossing the north leg. The crosswalks crossing the east and west legs are not being considered for left-turn protection. So, no conflicting left-turn volume is recorded for these crosswalks.

Step 3. Compute Volume Product for Pairs of Interest. For each crosswalk of interest, the product of the conflicting left-turn volume and pedestrian volume is computed. Each product is recorded in the Volume Combination Check section.

Step 4. Determine Left-Turn Mode Based on Volume Combination. One of the two figures in the middle of Table A-1 is used to determine the appropriate left-turn mode for each left-turn movement of interest. The total entering volume determined in Step 1 and the volume product determined in Step 3 are used with the appropriate figure to make this determination. Specifically, a vertical line is visualized extending upward from the x-axis value associated with the total entering volume. Similarly, a horizontal line is visualized extending to the right from the y-axis value associated with the volume product. The appropriate left-turn mode is identified by the point on the figure where these two lines intersect.

If the point of intersection is located in the region labeled “Consider Protected Mode” or “Consider Protected Mode or Protected-Permissive Mode with Leading Left-Turn Phase,” then the reduction in pedestrian-vehicle crash costs is very likely to offset any increase in delay costs as a result of the identified left-turn operation.

If the point of intersection is located in the region labeled “Consider Site-Specific Evaluation,” then the reduction in pedestrian-vehicle crash costs may be sufficient to offset any increase in delay costs. However, the answer to the question of whether the proposed left-turn operation results in a net benefit will depend on other signal timing and geometric factors. The analyst is encouraged to conduct a site-specific evaluation that considers all relevant factors in the determination of the appropriate left-turn mode.

If the point of intersection is located in the region labeled “Consider Permissive Mode with Pedestrian Treatments,” then the reduction in pedestrian-vehicle crash costs is very unlikely to offset any increase in delay costs as a result of the identified left-turn operation. However, less restrictive treatments for improving pedestrian safety should be considered. Guidelines provided in Appendix E can be used to evaluate some treatments of this type.

The determination made in this step applies to the subject analysis period. If multiple periods are evaluated and the determination made for each period varies (e.g., protected mode is appropriate for the peak period but not any of the other hours), then implementation of the treatment by time of day should be considered when feasible.

Figure B is used for the example intersection in Table A-1. For the eastbound approach, the subject crosswalk is on the south leg of the intersection, and its conflicting left-turn movement comes from the westbound approach. The point of intersection is found for an entering volume of 2276 veh/h and a volume product of 80,400 p-veh/h. The guidance associated with this point is “Consider site-specific evaluation.” Thus, a more detailed examination is needed to determine whether a phase is needed for the westbound left-turn movement. A similar conclusion is reached for the eastbound left-turn movement.

Step 5. Determine Left-Turn Mode Based on Crash Experience. For each crosswalk, the number of reported left-turn-related pedestrian-vehicle crashes is evaluated to determine if protected left-turn operation is appropriate for the conflicting left-turn movement. Each crosswalk is independently evaluated in this manner. If there are four or more crashes associated with a given

crosswalk during a recent three-year period, then “Yes” is recorded in the corresponding column, and protected left-turn operation is appropriate for the conflicting left-turn movement.

Step 6. Assess Findings and Make Recommendation. The last row of the worksheet is used to record the results of the evaluation in the form of a recommendation for the left-turn mode for each intersection approach. The determinations from the Volume Combination Check section and the Crash Experience Check section are used for this purpose. For the example intersection in Table A-1, the crash experience associated with the crosswalk on the north leg of the intersection satisfies the crash experience check, so a protected left-turn mode is appropriate for the conflicting, eastbound left-turn movement.

Guidelines for Determining Left-Turn Phase Sequence

This section provides guidelines for determining the most appropriate phase sequence when left-turn phasing is used. These guidelines include a summary of the advantages of lead-lead, lag-lag, lead-lag, and split left-turn phasing. A more detailed discussion of the advantages of alternative phase sequences is provided in Chapter 13 of the *Traffic Engineering Handbook (5)*.

For typical intersections, research indicates that lead-lead, lag-lag, and lead-lag phasing provide about the same operational efficiency and safety. Split phasing tends to be less efficient than the other sequences at typical intersections. Thus, the choice between lead-lead, lag-lag, and lead-lag is often based on agency preference or identified benefits to signal coordination. Lag-lag and split phasing are sometimes beneficial at intersections with atypical geometric configurations or volume conditions. These points are explained in subsequent paragraphs.

Split phasing increases delay relative to other phase sequences.

Lead-Lead Left-Turn Phasing

The most commonly used left-turn phase sequence is the lead-lead sequence, which has both opposing left-turn phases starting at the same time. The advantages of this phasing option are:

Lead-lead phasing is commonly used.

It works well when the left-turn storage is insufficient during peak periods.

- It is consistent with driver expectation such that drivers react quickly to the leading green arrow indication.
- It minimizes conflicts between left-turn and through vehicles on opposing approaches by clearing left-turn vehicles first and, thereby, reducing the number of left-turn drivers that must find safe gaps.
- It minimizes conflicts between left-turn and through movements on the same approach when the left-turn volume exceeds its available storage length.

Lag-Lag Left-Turn Phasing

This left-turn phase sequence has both opposing left-turn phases ending at the same time. The advantages of the lag-lag phasing option are:

- It ensures that both adjacent through phases start at the same time—a characteristic that is particularly amenable to efficient signal coordination with pretimed control.
- If used with the protected-permissive mode, it minimizes presentation of the left-turn phase during low-volume conditions by clearing left-turn vehicles during the initial through phase.
- If used with the protected-permissive mode for the major road as part of a coordinated signal system, then it reduces delay to major-road left-turn movements by serving them soon after arrival.

The yellow trap problem is created when lag-lag phasing is used for opposing left-turn movements, and the left-turn phases operate in the protected-permissive mode. Techniques for alleviating this problem are described later in this section.

Lag-lag phasing combined with the protected-permissive mode can create a yellow trap problem.

The aforementioned advantages of lagging phasing are realized, and the yellow trap is avoided, at the following special intersection configurations:

- At “T” intersections.
- At the intersection of a two-way street and a one-way street (e.g., frontage road intersection).

At each of the aforementioned intersection configurations, there is only one left-turn movement on the two opposing approaches, so the yellow trap is avoided.

Lead-Lag Left-Turn Phasing

The lead-lag left-turn phase sequence is sometimes used to accommodate through movement progression in a coordinated signal system. The aforementioned yellow trap may occur if the leading left-turn movement operates in the protected-permissive mode and the two through movement phases time concurrently during a portion of the cycle. Techniques for alleviating this problem are described later in this section. This sequence may also be used at intersections where the leading left-turn movement is not provided an exclusive storage bay (or a bay is provided but it does not have adequate storage).

Lead-lag phasing can be used to improve coordination bandwidth.

Split Phasing

Split phasing refers to the sequential service of opposing intersection approaches in two phases. All movements on one approach are served in the first phase, and all movements

Split phasing should be used at a given intersection only when analysis shows that it would improve safety or efficiency.

on the other approach are served in the second phase. This phasing is typically less efficient than lead-lead, lead-lag, or lag-lag left-turn phasing. It often increases the cycle length, or if the cycle length is fixed, it reduces the time available to the intersecting road. Split phasing may be helpful if any of the following conditions are present (2):

- There is a need to serve left-turns from the opposing approaches, but sufficient width is not available to ensure their adequate separation in the middle of the intersection if served concurrently.
- On at least one approach, the left-turn lane-volume is sufficient to justify a left-turn phase and is about equal to its adjacent through lane-volume during most hours of the day (“lane-volume” represents the movement volume divided by the number of lanes serving it).
- The width of the road is constrained such that an approach lane is shared by the through and left-turn movements yet the left-turn volume is sufficient to justify a left-turn phase and bay.
- Crash history indicates an unusually large number of side-swipe or head-on crashes in the middle of the intersection that involve left-turning vehicles.

Techniques to Avoid the Yellow Trap

The yellow-trap problem can be alleviated by using one of the following techniques:

- Use the protected mode for both left-turn movements.
- Use Dallas Phasing or flashing-yellow-arrow operation for both left-turn signal heads and protected-permissive mode for both left-turn movements.
- For lag-lag left-turn phasing and the protected-permissive mode, use controller settings to ensure that the two phases serving the adjacent through movements terminate simultaneously.

The yellow trap can also occur when the protected-permissive mode is used with lead-lead phasing when the crossroad volume is very low and there is some left-turn volume on the major road. Since this volume combination is not common, the yellow trap is not frequently encountered with lead-lead phasing. If it does exist, the trap can be avoided by programming the controller unit to disable the major-road left-turn actuations during the major-road through green indications or to have it switch the left-turn actuations to the adjacent through phases during the green interval (6).

Guidelines for Determining Right-Turn Operational Mode

Justification for Right-Turn Protection

The right-turn phasing addressed in this section uses the phase serving the nearside (i.e., complementary) left-turn movement on the crossroad to control the subject right-turn movement. All of the following conditions should be satisfied before using this type of right-turn phasing:

- The subject right-turn movement is served by one or more exclusive right-turn lanes.
- The right-turn volume is high (i.e., 300 veh/h or more).
- A left-turn phase is provided for the complementary left-turn movement.
- U-turns from the complementary left-turn are prohibited.

Determination of Operational Mode

If the through movement phase for the subject intersection approach serves a pedestrian movement, then the right-turn phasing should operate in the protected-permissive mode. The permissive right-turn operation would occur during the adjacent through movement phase. The protected right-turn operation would occur during the complementary left-turn phase.

If the through movement phase for the subject intersection approach does not serve a pedestrian movement, then the right-turn phasing should operate in the protected-only mode during both the adjacent through movement phase and the complementary left-turn phase. A controller overlap that is associated with both phases is used to provide this sequence.

Guidelines for Determining Pedestrian Phasing

This section provides guidelines for the following pedestrian phasing options:

- Leading pedestrian walk.
- Lagging pedestrian walk.
- Exclusive pedestrian phase.

The leading pedestrian walk (or leading pedestrian interval) is applicable to intersections where there are significant pedestrian-vehicle conflicts (7). The lagging pedestrian walk is applicable to intersections where there is: (1) a high right-turn volume, and (2) either an exclusive right-turn lane (or lanes) exists or the two intersecting roads have one-way traffic (7).

An exclusive pedestrian phase is applicable at intersections that have a high pedestrian volume and experience significant pedestrian-vehicle conflict (e.g., the central business district of larger cities). Consider the use of an exclusive pedestrian phase if one or more of the following conditions are satisfied (8):

1. The intersection experiences a high volume of pedestrians (3000 per hour for an 8-h period),
2. There is a combination of moderate volume of pedestrians (2000 per hour for 8 h) with high turning-vehicle volumes (30 percent of the total),
3. There is moderate pedestrian volume with high pedestrian-vehicle collisions (three collisions over the past 3 years),
4. There is moderate pedestrian volume with 25 percent of pedestrians who desire to cross diagonally, or
5. The intersection geometry is unusual (e.g., highly skewed, five or six legs).

Condition 4 is applicable only if a diagonal pedestrian movement is being considered for the exclusive pedestrian phase.

This treatment has been found to reduce pedestrian crashes by 50 percent in some downtown locations (9).

If an exclusive pedestrian phase is used, steps should be taken to minimize its adverse impact to vehicular capacity and signal coordination. If a diagonal pedestrian movement is provided, then the diagonal path will typically be the longest path and dictate the duration of the pedestrian clearance time. A time-of-day operation should be used to implement the exclusive pedestrian phase such that it is provided only during those hours that justify its operation.

REFERENCES

1. *Texas Manual on Uniform Traffic Control Devices*. Texas Department of Transportation, Austin, Texas, 2006.
2. Rodegerdts, L.A., B. Nevers, B. Robinson, J. Ringert, P. Koonce, J. Bansen, T. Nguyen, J. McGill, D. Stewart, J. Suggett, T. Neuman, N. Antonucci, K. Hardy, and K. Courage. *Signalized Intersections: Informational Guide*. Report FHWA-HRT-04-091. Federal Highway Administration, Washington, D.C., 2004.
3. Kell, J.H., and I.J. Fullerton. *Manual of Traffic Signal Design. 2nd Edition*. Institute of Transportation Engineers, Washington, D.C., 1998.
4. Orcutt, F. *The Traffic Signal Book*. Prentice-Hall, Inc., Englewood Cliffs, New Jersey, 1993.
5. *Traffic Engineering Handbook*. 5th Edition. J.L. Pline editor. Institute of Transportation Engineers, Washington, D.C., 1999.
6. *Traffic Control Devices Handbook*. J.L. Pline editor. Institute of Transportation Engineers, Washington, D.C., 2001.
7. Lalani, N. *Alternative Treatments for At-Grade Pedestrian Crossings*. Institute of Transportation Engineers, Washington, D.C., 2001.
8. Kattan, L., S. Acharjee, and R. Tay. "Pedestrian Scramble Operations: Pilot Study in Calgary, Alberta, Canada." *Transportation Research Record 2140*. Transportation Research Board, Washington, D.C., 2009, pp. 79–84.
9. Zegeer, C., K. Opiela, and M. Cynecki. *Pedestrian Signalization Alternatives*. Report FHWA/RD-83/102. Federal Highway Administration, Washington, D.C., 1983.

Left-Turn Operational Mode Based on Pedestrian Safety								
General Information								
Location: _____					Analysis Period: _____ to _____			
Intersection legs (N_L): _____								
Volume Data								
Approach:	Eastbound		Westbound		Northbound		Southbound	
Movement, No.: {see note 1}	LT, 5	TH+RT, 2	LT, 1	TH+RT, 6	LT, 3	TH+RT, 8	LT, 7	TH+RT, 4
Volume (v_i), veh/h $i = 1, 2, 3, \dots 8$								
Crosswalk crossing the...		South leg		North leg		East leg		West leg
Pedestrian volume ($v_{ped,i}$), p/h								
Total entering volume (v_t), [$= \sum v_i$] veh/h: _____								
Volume Combination Check								
Enter volume for each conflicting left-turn movement for which a left-turn phase is being considered or currently exists.								
Conflicting left-turn movement		Westbd.		Eastbd.		Southbd.		Northbd.
Conf. left-turn volume (v_{LT}), veh/h		$v_{LT,1}$		$v_{LT,5}$		$v_{LT,7}$		$v_{LT,3}$
Product (v_p) [$= v_{LT} \times v_{ped}$], p-veh/h								
Use figure below. Enter "Yes" if product and entering volume intersect in region indicating consider prot. mode or prot.-perm. mode; otherwise, enter "No." Consider protected or protected-permissive mode for conflicting left turn if "Yes" is entered.								
Results from volume check								
<div style="display: flex; justify-content: space-around;"> <div style="width: 45%;"> <p>Figure A. Three-Leg Intersection.</p> </div> <div style="width: 45%;"> <p>Figure B. Four-Leg Intersection.</p> </div> </div>								
Crash Experience Check								
Approach:	Eastbound		Westbound		Northbound		Southbound	
Movement, No.: {see note 1}	LT, 5	TH+RT, 2	LT, 1	TH+RT, 6	LT, 3	TH+RT, 8	LT, 7	TH+RT, 4
Enter number of reported left-turn-related pedestrian-vehicle crashes associated with each crosswalk during a three-year period.								
Crosswalk crossing the...		South leg		North leg		East leg		West leg
Crash frequency (N), cr/3 yrs								
Enter "Yes" if four or more crashes; otherwise, enter "No." Consider protected mode for conflicting left turn if "Yes" is entered.								
Conflicting left-turn movement		Westbd.		Eastbd.		Southbd.		Northbd.
Results from crash check								
Recommendation ³								
Determination: _____								

Notes:

- 1 - Numbers follow NEMA movement-based phase numbering system (LT = left-turn, TH = through, RT = right-turn).
- 2 - na: not applicable. Left-turn protection not present and not being considered for this crosswalk.
- 3 - This worksheet focuses on volume and crash history. It does not address cycle length, speed, or sight distance. These factors may also need to be considered when determining the appropriate left-turn mode.

APPENDIX B. ADVANCED SIGNAL TIMING SETTINGS

This appendix provides guidelines for the selection and use of specialized signal timing settings in an actuated controller. Some of these settings have application in unique situations and, as such, are used less frequently than those described in Chapters 2 or 3. Other settings are used in their “default” mode at typical intersections but, under specific conditions, can be used in other modes to improve intersection safety, efficiency, or both.

The information in this appendix may be useful when traffic or geometric conditions at a given intersection are unusual and the operation of the intersection can be improved by the use of one or more advanced settings in the controller unit. Guidelines for establishing basic controller settings for typical intersections are provided in Chapters 2 and 3. If changes to the signal phasing are being considered, then the guidelines in Appendix A – Signal Phasing and Operation should be considered. If changes to the detection layout are being considered, then the guidelines in Appendix C – Detection Design and Operation should be consulted. If the intersection is part of a diamond interchange, then the guidelines in Appendix D – Diamond Interchange Phasing, Timing, and Design should be consulted.

This appendix consists of three parts. The first part provides an overview of the role of advanced signal timing settings. The second part summarizes the advanced signal timing concepts and establishes a vocabulary. The last part provides guidelines for determining the appropriate advanced signal timing settings for the subject intersection.

OVERVIEW

Modern traffic-actuated signal controllers have numerous features that can be selectively used to improve the signal operation at some intersections. Some of these features are common to all signal controllers. The most widely used features are described in the *National Transportation Communications for ITS Protocol 1202 (1)*. This appendix describes many of the more useful advanced controller features that are present in the controllers that meet the TxDOT traffic signal controller specifications (2).

This appendix is intended to provide guidance on the best use of selected advanced settings that can improve safety, operation, or both when special traffic or geometric conditions are present. These settings are often used in combination with the basic controller settings to tailor the controller operation to the conditions present at an intersection. Table B-1 lists the settings that are discussed in this appendix. It also provides an indication as to whether a setting is intended primarily to improve safety or operation.

Advanced signal timing settings are often used when traffic or geometric conditions are unusual.

The settings listed in Table B-1 are often used when traffic or geometric conditions are unusual. As such, it is difficult to make broad statements about where or when each setting should

be used and how it should be adjusted. Hence, this appendix is focused on providing: (1) a description of the setting and its function in the Concepts part, (2) guidance on reasonable settings and adjustments when such guidance is available in the reference literature, and (3) where guidance is not available from the literature, provide information that describes situations where the settings have been used successfully.

Table B-1. Primary Influence of Selected Advanced Controller Settings.

Controller Feature	Setting	Primary Influence of Setting	
		Operations	Safety
Dynamic maximum green	Dynamic max limit	Yes	
	Dynamic max step		
Variable initial	Added initial	Yes	
	Maximum initial		
Gap reduction	Time before reduction	Yes	
	Time to reduce		
	Minimum gap		
Phase-sequence-related settings	Conditional service	Yes	
	Simultaneous gap-out		Yes, if used with advance detection
	Dual entry	Yes	
Rail preemption	Priority status		Yes
	Preempt delay		
	Preempt memory		
	Preempt minimum green		
	Preempt minimum walk		
	Preempt pedestrian change		
	Track clear phases		
	Track green		
	Dwell phases		
	Minimum dwell period		
	Exit phases		

As with any guidelines, and particularly with the guidelines described in this appendix, judgment should be used in selecting the appropriate advanced settings for a specific location. After installation, intersection operation should be monitored to ensure that the intended operation is achieved and that neither safety nor efficiency has been adversely impacted.

Finally, it should be noted that there are many other features available in most modern controllers and that they may also be used to achieve similar objectives. To the extent that resources allow, the engineer should become familiar with these features and investigate their applicability to unusual conditions or situations that indicate the need for innovative solutions.

CONCEPTS

This part of the appendix explains the basic function of various advanced controller features. Topics addressed include dynamic maximum green, variable initial, gap reduction, conditional service, simultaneous gap-out, dual entry, and various rail preemption settings.

Dynamic Maximum Green Settings

The dynamic maximum green feature allows the controller to adjust the maximum green setting in response to detected traffic conditions. When traffic volume is heavy such that the phase frequently terminates by extension to its maximum limit (i.e., it maxes out), this feature allows the controller to automatically increase the maximum green limit for the subsequent cycle. Likewise, when traffic volume subsides such that the phase no longer maxes out, the controller automatically decreases the maximum green limit for the subsequent cycle.

The dynamic maximum feature changes the maximum green limit in real-time to better serve unpredictable surges in traffic.

The dynamic maximum green feature is set on a phase-by-phase basis. It is invoked through the specification of nonzero values for each of its two settings. These settings are described in the next two subsections.

Dynamic Max Limit

The dynamic-max-limit setting is used to specify one of two boundaries within which the controller can vary the green interval. If the dynamic max limit is shorter than the maximum green setting, then the dynamic max limit represents the lower bound on the green interval duration, and the maximum green setting represents the upper bound. If the dynamic max limit is longer than the maximum green setting, then the dynamic max limit represents the upper bound, and the maximum green setting represents the lower bound. The default value for this setting is 0 s.

Dynamic Max Step

The dynamic-max-step setting is used to specify the amount of time added (or subtracted) from the maximum green limit each time the controller determines that an adjustment is needed. The need to increase the maximum green limit is identified by the controller when the phase maxes out for two consecutive cycles and each successive max-out thereafter. For each cycle that this need is identified, the maximum green limit is increased by an amount equal to the dynamic max step.

The need to decrease the maximum green limit is identified by the controller when the phase gaps out for two consecutive cycles and each successive gap-out thereafter. For each cycle that this need is identified, the maximum green limit is decreased by an amount equal to the dynamic max step. The default value for this setting is 0 s.

Variable Initial Settings

The variable initial feature is typically used to ensure that all vehicles queued between the stop line and the nearest upstream detector are served before the phase is terminated. Queued vehicles positioned further upstream will be detected and will extend the green by an amount sufficient to allow them to be served. This feature allows the minimum displayed green to exceed the minimum green setting. It is applicable when there are one or more advance detectors and no stop line detection.

The variable initial feature adjusts the minimum green limit based on a real-time estimate of arrivals during red or yellow.

Variable initial timing is achieved by programming the following controller settings: minimum green, added initial, and maximum initial. However, some controllers include additional settings (e.g., actuations before the initial green is increased) to refine the variable initial operation. Other controllers are also noted to use different names for the same settings (e.g., some controllers use a “minimum initial setting” instead of a “minimum green setting”).

The variable initial feature is set on a phase-by-phase basis. It is invoked through the specification of nonzero values for each of its two settings. These settings are described in the next two subsections and are shown in Figure B-1.

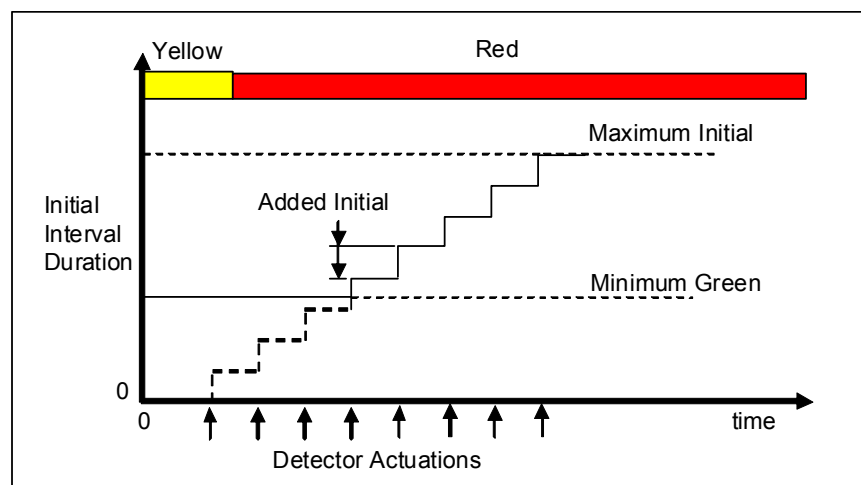

Figure B-1. Factors That Define the Initial Interval Duration.

Added Initial

The added initial setting represents the amount by which the variable initial time period is increased (from 0 s) with each vehicle actuation received during the yellow and red intervals associated with the subject phase. The default value for this setting is 0 s.

Maximum Initial

The maximum initial setting represents the upper limit on the duration of the variable initial timing period. The default value for this setting is 0 s. It is noted that the minimum duration for the initial timing period is equal to the minimum green setting.

Gap Reduction Settings

The gap reduction feature is used to reduce the green extension time limit as the green interval duration increases. For the first few seconds of green, the extension time limit is set equal to the passage time setting (which is set at a relatively large value to ensure that the end of queue can be detected with a high degree of certainty). Then, after a specified time, the extension time limit is reduced to a value slightly less than the passage time. This limit is reduced for a specified time period, and the search for the end of queue continues. If the end of queue has not been found by the end of the reduction period, the extension time limit reaches a specified lower value, and the search for the end of queue continues.

Use of the gap reduction feature for a high-volume movement can provide reasonable queue clearance for this movement while reducing the delay to waiting movements.

Gap reduction functionality is achieved by programming the following controller settings: time before reduction, time to reduce, and minimum gap. However, some controllers include additional settings (e.g., number of cars waiting before reduction) to refine the gap reduction operation. Other controllers are also noted to use different names for the same settings (e.g., some controllers use a “maximum gap setting” instead of the “passage time setting”).

Gap reduction is set on a phase-by-phase basis. It is invoked through the specification of nonzero values for each of its three settings. These settings are described in the next two subsections and are shown in Figure B-2.

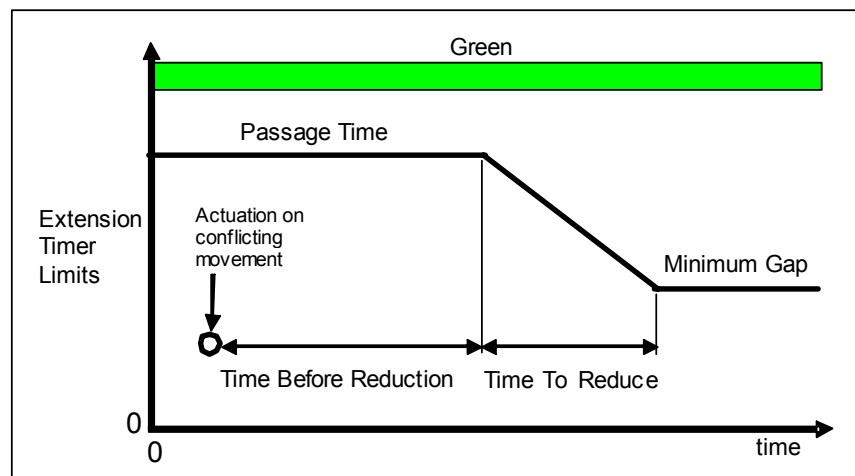

Figure B-2. Factors That Define the Extension Time Limit for Gap Reduction.

Time Before Reduction

The time-before-reduction setting defines the initial portion of the green interval before the extension time limit is reduced from the passage time setting. A timer is used to time the time-before-reduction period. This period starts when there are one or more calls for a conflicting phase (or phases), and the timer continues to time as long as the conflicting call is sustained. It resets if all calls are dropped. When the timer reaches the end of the time-before-reduction period, the controller reduces the extension time limit. The default value for this setting is 0 s.

Time To Reduce

The time-to-reduce setting defines the portion of the green interval during which the extension timer limit is reduced. This time period immediately follows the time-before-reduction period. As this time period is timed, the extension timer limit is reduced in a linear manner such that the timer limit just equals the minimum gap at the same time that the time-to-reduce period ends. The default value for this setting is 0 s.

Minimum Gap

The minimum gap setting defines the extension timer limit during the unexpired portion of the green interval that follows the time-to-reduce period. The default value for this setting is equal to the passage time setting.

Phase-Sequence-Related Settings

This section describes three controller settings that influence the sequence of phase presentation. They include conditional service, simultaneous gap-out, and dual entry.

Conditional Service

Conditional service allows a specified phase to be serviced twice during the same cycle. This phase is served both before and again after the conflicting phase that pairs with it on the same ring and on the same side of the barrier. For example, a conditionally served phase 1 would be served before and after phase 2.

Conditional service is typically used to let the controller serve the left-turn phase twice during the signal cycle.

If this feature is enabled, the conditional phase will be served a second time under the following circumstances (as described in terms of a traditional dual ring structure with left-turn phase 1 being the conditional phase):

- There is a call for service on conditional phase 1, and a concurrent phase (i.e., phases 5 or 6) is timing.
- There is a call for service on the other side of the barrier (i.e., phases 3, 4, 7, or 8).
- The paired phase 2 is prepared to terminate due to gap-out or max-out.

- There is sufficient time remaining in the active concurrent phase (5 or 6) to time the minimum green time of the conditional phase before the concurrent phase reaches its maximum green limit.

The conditional service mode is set on a phase-by-phase basis and applies to dual-ring operation. The feature is either “on” or “off” for each phase. The default condition is to not allow the phase to be conditionally served (i.e., it is “off”). In some controllers, the conditionally served phase operates as “non-actuated.”

Simultaneous Gap-Out

Simultaneous gap-out is a feature that impacts the manner in which phases are terminated in order to cross the barrier to service a conflicting call. When this feature is active, it requires the phase in each ring to reach a point of mutual agreement on the ability to terminate before a conflicting call on the other side of the barrier can be served. The two phases do not need to agree on the reason for termination (i.e., one could be ready to terminate by gap-out, and the other could be ready to terminate by max-out). If one phase is able to terminate because it has gapped out, but the other phase is not able to terminate, then the gapped-out phase will reset its extension timer and restart the process of timing down to gap-out.

Simultaneous gap-out encourages the active phase in each ring to simultaneously find a gap in traffic before they let the controller serve crossroad traffic.

If the simultaneous gap-out feature is not active, then each phase is allowed to reach a point of termination independently. The phases are retained as active until both phases have reached this point. If the extension timer for a phase times down to gap-out, then it is not reset, and the phase remains committed to terminate until the other phase is also committed to terminate.

The gap-out mode is set on a phase-by-phase basis and applies to dual-ring operation. The feature is either “on” or “off” for each phase. The typical default condition is to have simultaneous gap-out active (i.e., it is “on”).

Dual Entry

The dual entry feature is used in dual-ring operation to specify whether a phase is activated (green) even though it has not received a call for service. If set to single entry operation, a phase is activated only if it receives a call for service. If set to dual entry operation, an uncalled phase can be activated if a concurrent phase receives a call for service. For example, phases 4 and 8 are active and a call for service is received on phase 2, but no calls are placed for its concurrent phases (i.e., phases 5 and 6). With single entry set for phases 5 and 6, phase 2 would be the only phase activated. However, with dual entry set for phase 6, it would become active concurrently with phase 2. This feature can provide

Dual entry is often used to ensure that an important phase displays green every cycle.

an operational benefit to the movements served by the phases set for dual entry by ensuring their receipt of a green indication each cycle.

The entry mode is set on a phase-by-phase basis and applies to dual-ring operation. The feature is set to either “dual” or “single” for each phase. The default condition is to have single entry.

Rail Preemption Settings

This section describes the settings used in modern signal controllers for rail preemption. These settings are used to define the signal phase sequence and duration when a call for rail preemption is received by the controller. These settings apply to all preempt routines supported by the controller. They are presented in order of occurrence during the timing of a preempt phase sequence. This sequence is shown in Figure B-3 for typical preemption sequences.

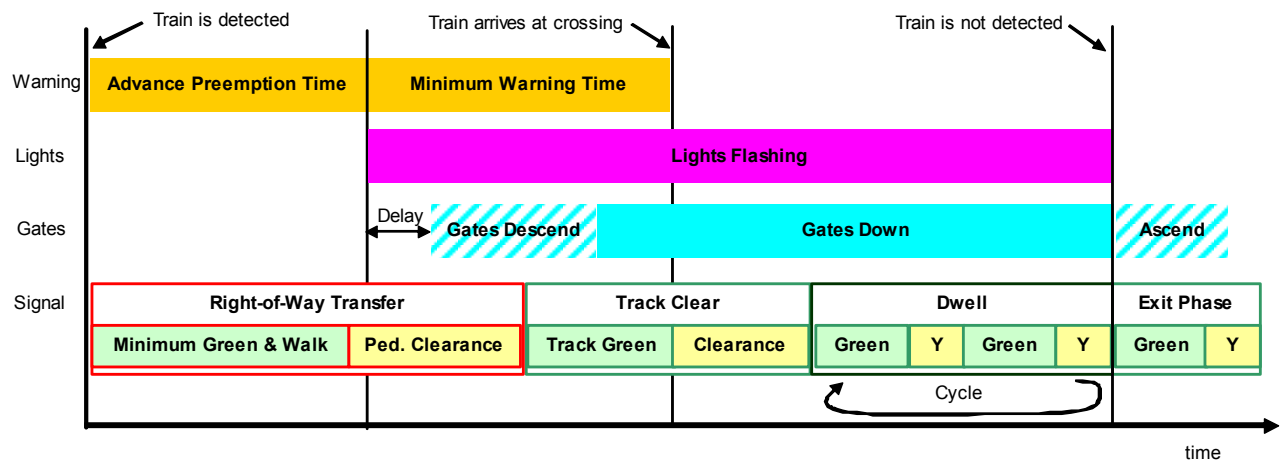

Figure B-3. Rail Preemption Settings.

Priority Status

Most modern controllers support several preempt routines to provide priority to specialized, short-term traffic events (e.g., train, emergency vehicle, transit, etc.). In those rare instances where two or more events occur simultaneously and priority requests are received by the controller for both events, the controller defers to the specified preempt priority status to resolve the conflict. Rail preempt requests are always given the highest priority. By default, Preempt 1 has the highest priority and is used for rail preemption.

Rail preempt should be the highest priority preemption routine.

Preempt Delay

This setting defines the time lag that is intended to occur between the preempt detector actuation and the time the call for preempt is placed in the controller. The detector actuation must be sustained for the duration of the delay interval before the call is placed and the controller responds. Preempt memory (described next) can be used to ensure that a detector actuation is sustained for the duration of the delay period. The default value for this setting is typically 0 s.

Preempt Memory

This setting determines whether a detector actuation is retained after it is received and regardless of whether the detector is subsequently deactivated. The following rules apply to the operation of this feature:

Preempt memory is typically kept in its default, “on” (or locking) state to ensure that a preempt is called every time a train arrives.

1. If memory is “on” (or locking) and the preempt delay equals 0 s, the call for preempt is placed as soon as the actuation is received, and the preempt sequence is activated for its minimum duration.
2. If memory is “on” (or locking) and the preempt delay exceeds 0 s, the call for preempt is placed after the delay period times, and the preempt sequence is activated for its minimum duration.
3. If memory is “off” (or nonlocking) and the preempt delay equals 0 s, then the controller operates the same as for Rule 1.
4. If memory is “off” (or nonlocking) and the preempt delay exceeds 0 s, then:
 - a. If the detector actuation is sustained for the duration of the delay period, then the controller operates the same as for Rule 2.
 - b. If the detector actuation is *not* sustained for the duration of the delay period, then the actuation is ignored, and the preempt sequence is not called.

The default value for this setting is typically “memory on” (i.e., locking).

Preempt Minimum Green and Minimum Walk

The preempt minimum green setting defines the minimum length of the green interval associated with the phase that is active just before the controller transitions to the preempt sequence. This setting may be shorter than the minimum green setting associated with the phase. Typical default values range from 2 to 10 s.

The preempt minimum walk setting defines the minimum length of the walk interval associated with the phase that is active just before the controller transitions to the preempt sequence. This setting may be shorter than the pedestrian walk interval associated with the phase. Typical default values range from 2 to 4 s. It is noted that some controllers use one setting to establish both the preempt minimum green and the minimum walk duration.

Preempt Pedestrian Change

The preempt pedestrian change interval defines the minimum length of time provided for pedestrian clearance, following the walk interval, when the phase is terminated by a preempt request. During the preempt pedestrian change interval, the flashing DON'T WALK indication is presented. The duration of this interval is dictated by consideration of pedestrian volume, pedestrian crossing distance, frequency of preempt events, and the advance warning time provided by the railroad agency. Some agencies use the yellow change and red clearance intervals to satisfy a portion of the pedestrian clearance time requirements.

Track Clear Phases

The track clear phase (or phases) displays a green indication while timing the track green interval. These phases are specified by using a controller input. Each phase identified for this input corresponds to a phase that serves vehicles queued on the approach that is crossed by the railroad tracks. Only one phase per ring is specified as a track clear phase.

Track Green

The track green setting defines the duration of the green indication for any phase (or phases) specified to be concurrently active during the track green interval. This duration is set at a value sufficient to allow vehicles on the intersection approach to be clear of the railroad tracks prior to the train's arrival.

Dwell Phases

The dwell period follows the track clear phase and continues until the minimum dwell period has expired and the call for preempt is no longer present. In typical applications, the controller cycles through each of the phases that are not in conflict with the railroad crossing. These phases are specified by using a controller input.

Minimum Dwell Period

The minimum dwell period defines the shortest duration of the dwell period.

Exit Phases

The exit period follows the dwell period and transitions the controller from the preempt sequence to the normal phase sequence. The phases that are active during the exit period are specified by using a controller input. Only one phase per ring is specified as an exit phase. In many cases, the exit phases would serve those movements that were held while the train was occupying the crossing (i.e., the track clear phases).

GUIDELINES

This part of the appendix provides guidelines for determining (1) whether to use an advance signal timing feature, and (2) if it is used, reasonable values for the associated settings. The information provided is based on established practices and techniques that have been shown to provide safe and efficient signal operation. The guidelines address dynamic maximum green, variable initial, gap reduction, conditional service, simultaneous gap-out, dual entry, and rail preemption.

Guidelines for Dynamic Maximum Green Settings

This section describes guidelines for using the dynamic maximum green feature. This feature is likely to offer the most benefit on the high-volume, low-speed approaches to an isolated intersection that experience frequent max-outs during peak traffic demand periods.

Dynamic maximum may be most appropriate for low-speed, isolated intersection approaches that experience unpredictable surges in traffic volume.

Its use on high-speed approaches may not be appropriate because it is likely to increase the frequency of max-out and compromise the safety benefits of advance detection for indecision zone protection.

The dynamic maximum feature has the ability to adapt to unexpected increases in demand that could be the result of special events or incidents. It can be used without the need for detailed knowledge of the extent and duration of unexpected surges in traffic demand. However, if a change in traffic demand is predictable, other controller features may be more appropriate for addressing problems related to frequent max-out.

The dynamic maximum feature is disabled when the phase is repeatedly extended to maximum, as may be set in the controller (using maximum recall) or the result of a failed detector.

Dynamic Max Limit

Guidance by Engelbrecht et al. (3) indicates that the dynamic max limit should be set to a value that is larger than that of the maximum green setting. Its value should be set sufficiently large that it can accommodate the “design” peak in traffic demand without creating damaging queues on other approaches. A practical upper limit for the dynamic max limit is 70 s. Values in excess of this amount may cause conflicting movements to incur unacceptable delay.

Dynamic Max Step

Engelbrecht et al. (3) recommend keeping the dynamic max step setting relatively short to ensure a balance between the responsiveness of the phase and overall intersection efficiency. They indicate that a dynamic max step size of 5 or 10 s will be sufficient in most cases.

Guidelines for Variable Initial Settings

This section describes guidelines for using the variable initial feature available in most controllers. This feature is most applicable when a phase has one or more advance loop detectors and no stop line detection (i.e., the phase is on recall or uses locking detection memory). This feature is rarely used with video image vehicle detection systems.

The variable initial feature may be most helpful when the phase has advance loop detection and no stop line detection.

The guidelines in this section are developed for phases serving through movements.

Minimum Green

When the variable initial feature is used, the minimum green setting should equal the “Minimum Green Needed to Satisfy Driver Expectancy,” as listed in Table 2-3 of Chapter 2. A range of minimum green values is provided in each row of this table. For variable initial applications, values at the lower end of the range provided in Table 2-3 should be used for the minimum green setting.

Added Initial

The added initial setting values listed in Table B-2 should be used for typical applications. These values are dependent on the number of advance detectors associated with the phase. For example, if a through movement is served by two lanes and each lane has three advance detectors, then the phase serving this movement has six advance detectors ($= 2 \times 3$).

Table B-2. Added Initial Setting.

Number of Advance Detectors ¹	Added Initial, s/actuation	
	Minimum	Desirable
1	2.0	2.5
2	1.3	1.5
3	0.8	1.0
4	0.6	0.8
5	0.5	0.6
6 or more	0.4	0.5

Note:

1 - Total number of advance detectors associated with the subject phase.

The minimum values listed in Table B-2 may be more appropriate for phases serving through and right-turn movements where right-turn-on-red is significant. The minimum values are also appropriate for phases serving movements that have relatively even lane utilization.

The desirable added initial values in Table B-2 may be more appropriate for phases serving through and right-turn movements where right-turn-on-red is not allowed or has negligible right-turn-on-red volume. The desirable values are also appropriate for phases serving movements that have notably unequal lane utilization.

Maximum Initial

The maximum initial setting depends on the distance between the stop line and the nearest upstream detector. It should have sufficient duration to clear the vehicles that can queue within this distance. Values that satisfy this criterion are listed in Table B-3. The maximum initial setting should exceed the minimum green setting by one or more increments of added initial.

Rule-of-Thumb:

$$\text{Max. Initial (in sec)} = \text{Distance (in ft)} / 10$$

Table B-3. Maximum Initial Setting.

Distance between Stop Line and Nearest Upstream Detector, ft	Maximum Initial, s ^{1,2}
151 to 175	17
176 to 200	19
201 to 225	21
226 to 250	23
251 to 275	25
276 to 300	27
301 to 325	29
326 to 350	31

Notes:

- 1 - Settings are only applicable to phases that have one or more advance detectors and no stop line detection.
- 2 - Minimum green needed to satisfy queue clearance, $G_q = 3 + 2n$ (in seconds); where, n = number of vehicles between stop line and nearest upstream detector in one lane ($= D_d / 25$), and D_d = distance between the stop line and the downstream edge of the nearest upstream detector (in feet).

Guidelines for Gap Reduction Settings

This section describes guidelines for using the gap reduction feature to improve intersection efficiency. The intent of using this feature is to be generous in extending the phase initially when vehicles are starting up and later, when platoons are arriving. But, at some point, there is a transition to a more conservative (i.e., shorter) green extension limit such that the green is extended only for the densest platoons. This transition recognizes that the delay for vehicles waiting on a conflicting phase is becoming lengthy.

The guidelines in this section are developed for phases serving through movements. However, gap reduction may also be helpful when used with any phase that typically serves a significant volume of heavy vehicles. In this application, a longer green extension limit at the start

of the phase ensures that the heavy vehicles have sufficient time to accelerate through the intersection without causing the phase to gap-out prematurely.

Applications

Stop Line Detection. The gap reduction feature is most effective when used with a phase serving the major road through traffic movement and for which only stop line detection is provided (i.e., low-speed approaches). It can minimize the frequency of premature gap-out (i.e., phase termination before the queue is cleared) without causing minor movements to incur excessive delay.

The gap reduction feature can be effective when used with the major-road through phase and stop line detection.

Single Advance Detector. Some agencies that use inductive loop detectors avoid the use of stop line detection for through movements because of the higher maintenance costs associated with detection near the stop line. They also recognize that there is some inefficiency with stop line detection because it continues to extend the green indication after the vehicle clears the stop line. These agencies prefer to use a single advance detector located about 2 to 4 s in travel time upstream of the stop line. Gap reduction can be used with this design to improve intersection efficiency.

Advance Detection for Indecision Zone Protection. When advance detection is used to provide green extension for safe phase termination, the passage time is precisely defined by the indecision zone location, and the gap reduction feature should not be used. Effective advance detection designs for this application, and corresponding passage times, are identified in Appendix C.

Passage Time

When the gap reduction feature is used with stop line presence mode detection, the passage time setting should be selected from Table B-4. The values in this table are based on a maximum allowable headway of 4 s.

Table B-4. Passage Time for Stop Line Presence Detection.

Maximum Allowable Headway, s	Detection Zone Length, ft	85 th Percentile Speed, mph				
		25	30	35	40	45
		Passage Time (PT), s ¹				
4	20	3.0	3.0	3.0	3.5	3.5
	40	2.0	2.5	2.5	3.0	3.0
	60	1.5	2.0	2.5	2.5	2.5
	80	1.0	1.5	2.0	2.0	2.5

Note:

1 - Passage time values are computed using Equation 4 in Chapter 2.

When the gap reduction feature is used with a single advance detector (operating in presence mode), the passage time setting should equal 3.5 s. Presence-mode detection (as described in Appendix C) tends to provide more reliable intersection operation than pulse-mode detection. However, if pulse-mode detection is used with a single advance detector, then the passage time should equal 4 s.

The passage time obtained from Table B-4 (or the guidance in the previous paragraph) may be increased by up to 1 s if the approach is on a steep upgrade, there is a large percentage of heavy vehicles, or both.

Time Before Reduction

The time-before-reduction setting should equal the minimum green setting or, if variable initial is used, it should equal the maximum initial setting. Regardless, a practical minimum value for the time-before-reduction setting is 10 s. This guidance is illustrated in Table B-5.

Table B-5. Gap Reduction Settings.

Minimum Green Setting, s	Time Before Reduction, s ¹	Maximum Green Setting, s										
		20	25	30	35	40	45	50	55	60	65	70
		Time To Reduce, s										
5	10	8	10	13	15	18	20	23	25	28	30	33
10	10	5	8	10	13	15	18	20	23	25	28	30
15	15	n.a.	5	8	10	13	15	18	20	23	25	28
20	20	n.a.	n.a.	5	8	10	13	15	18	20	23	25

Notes:

1 - Time before reduction is 10 s or more in length.

n.a. - Gap reduction is not applicable to this combination of minimum and maximum green settings.

Time To Reduce

The time-to-reduce setting should be set to equal one half of the difference between the maximum and minimum green settings (4). This guidance is illustrated in Table B-5.

Minimum Gap

The minimum gap setting should be based on a maximum allowable headway of 2 s. Desirable values of minimum gap for presence-mode detection are listed in Table B-6. Presence-mode detection tends to provide more reliable intersection operation than pulse-mode detection. However, if pulse-mode detection is used, then the minimum gap is equal to 2 s.

The minimum gap obtained from Table B-6 may be increased by up to 1 s if the approach is on a steep upgrade, there is a large percentage of heavy vehicles, or both.

Table B-6. Minimum Gap for Presence Detection.

Maximum Allowable Headway, s	Detection Zone Length, ft	85 th Percentile Speed, mph									
		25	30	35	40	45	50	55	60	65	70
		Minimum Gap, s ¹									
2	6	1.5	1.5	1.5	1.5	1.5	1.5	1.5	1.5	1.5	1.5
	20	1.0	1.0	1.0	1.5	1.5	1.5	1.5	1.5	1.5	1.5
	40	0.0	0.5	0.5	1.0	1.0	1.0	1.0	1.5	1.5	1.5
	60	0.0	0.0	0.5	0.5	0.5	1.0	1.0	1.0	1.0	1.0
	80	0.0	0.0	0.0	0.0	0.5	0.5	0.5	1.0	1.0	1.0

Note:

1 - Minimum gap values are computed using Equation 4 in Chapter 2.

Minimum Gap and Passage Time Check

If a single advance detector is used, the green extension limit (as dictated by the passage time and minimum gap) should be checked to ensure that the detector is not too distant from the stop line for efficient operation. This check can be performed by comparing the passage time and the minimum gap being used with the value listed in Table B-7.

If a single advance detector is used, do not let the passage time or minimum gap get so short that motorists are caught between the detector and stop line at yellow onset.

Table B-7. Shortest Passage Time and Minimum Gap for Single Advance Detector.

Distance between Stop Line and Nearest Upstream Detector, ft	85 th Percentile Speed, mph									
	25	30	35	40	45	50	55	60	65	70
	Shortest Passage Time and Minimum Gap, s ^{1,2}									
0 to 150	2.0	2.0	2.0	2.0	2.0	2.0	2.0	2.0	2.0	2.0
175	2.7	2.0	2.0	2.0	2.0	2.0	2.0	2.0	2.0	2.0
200	3.5	2.5	2.0	2.0	2.0	2.0	2.0	2.0	2.0	2.0
225	4.2	3.2	2.4	2.0	2.0	2.0	2.0	2.0	2.0	2.0
250	5.0	3.8	3.0	2.4	2.0	2.0	2.0	2.0	2.0	2.0
275	5.8	4.5	3.5	2.9	2.3	2.0	2.0	2.0	2.0	2.0
300	6.5	5.1	4.1	3.3	2.7	2.3	2.0	2.0	2.0	2.0
325	7.3	5.8	4.6	3.8	3.2	2.7	2.2	2.0	2.0	2.0
350	8.1	6.4	5.2	4.3	3.6	3.0	2.6	2.2	2.0	2.0

Notes:

1 - Computed as $PT_{min} = \text{Larger of } [2.0, (D_d - L_d - L_v) / (1.47 v_a) - 2.0]$, where D_d = distance between the stop line and the leading edge of the nearest upstream detector (in feet), L_d = length of detection zone (in feet), L_v = detected length of vehicle (use 17 ft), v_a = average approach speed ($= 0.88 \times v_{85}$) (in miles per hour), and v_{85} = 85th percentile speed (in miles per hour).

2 - Phase operation is less efficient if passage time exceeds 3.5 s (as identified by the shaded table cells).

If the passage time or minimum gap is less than the value from Table B-7, then the detector is too far back and one or two vehicles could get caught in front of the stop line when the phase gaps out. If detector relocation is not a viable option, then the passage time, minimum gap, or both should be increased to equal the value listed in Table B-7. If, as a result of this adjustment, the minimum gap equals the passage time, then the gap reduction feature should not be used. The disadvantage of increasing the passage time or minimum gap in this manner is that phase efficiency will be reduced because the green will occasionally be extended by randomly arriving vehicles.

Guidelines for Phase-Sequence-Related Settings

This section provides guidelines for three phase-sequence-related settings; they include: conditional service, simultaneous gap-out, and dual entry.

Conditional Service

Conditional service is typically allowed for one or more left-turn phases. It has been found to provide some operational benefit when the left-turn phase leads the opposing through movement and the left-turn volume is heavier than that of the opposing through movement. Examples where a conditionally served left-turn phase may be useful include:

Conditional service for a left-turn phase can significantly reduce delay for specific traffic conditions and phase sequences.

- The left-turn bay is short, relative to the left-turn volume, and it frequently overflows before the end of the adjacent through phase's green interval.
- The directional split on an arterial street is extreme such that traffic volume in one direction is very dominant (possibly due to a special event).
- The left-turn traffic arrives at different times in the cycle (possibly due to an upstream signal, such as the upstream ramp terminal at a diamond interchange).

Conditional service is typically not used when the left-turn mode is protected-permissive because it can create a yellow trap (as described in Appendix A). It is also avoided if the phase serving the opposing through movement is coordinated *and* the platoon typically arrives late in its green interval. In fact, some controllers do not allow the use of conditional service when the controller is operating in the coordinated mode.

The use of the conditional service feature at a signalized diamond interchange is described in Appendix D.

The conditional service feature may significantly degrade intersection operation if the left-turn detector is prone to frequent failure.

Simultaneous Gap-Out

Simultaneous gap-out ensures that the active phase in each ring is in agreement about the ability to terminate their respective phases before crossing the barrier. In this manner, the frequency of phase termination by gap-out is increased. Phase termination by gap-out implies that the queue has been served and, if advance detection is used, that the indecision zone is clear. Thus, use of this feature provides both safety and efficiency benefits. This feature is typically enabled by default. It should not be disabled unless the analysis of site-specific conditions indicates that such action will improve operation and safety.

Simultaneous gap-out benefits safety and efficiency and should always be used.

Dual Entry

The dual entry feature can provide operational benefits when it is set “on” for the phases serving high-volume traffic movements. Typically, the high-volume movements are the through movements. Therefore, at typical intersections, dual entry should be set “on” for the phases serving through movements (and “off” for the phases that exclusively serve left-turn movements).

Dual entry provides efficiency benefits and should be enabled for the phases serving the through movements.

Guidelines for Rail Preemption Settings

It is important that the engineer have a thorough understanding of the principles and concepts of rail preemption before designing, timing, and operating a traffic signal with rail preemption. The engineer also needs to be familiar with the following items:

- The preemption functionality and programming of the signal controller.
- The special users (e.g., school buses, transit vehicles, heavy vehicles, hazardous cargo vehicles, emergency vehicles, and pedestrians) of the intersection.
- The types of trains (e.g., typical train speed, length, cargo) that use the crossing.

Section 8D.07 of the *TMUTCD* states “if a highway-rail grade crossing is equipped with a flashing-light signal system and is located within 200 ft of an intersection or midblock location controlled by a traffic control signal, the traffic control signal should be provided with preemption...” (5). It also states that “coordination with the flashing-light signal system, queue detection, or other alternatives should be considered for traffic control signals located farther than 200 ft from the highway-rail grade crossing” (5). The guidelines in this section describe settings for rail preemption. Guidance from other documents should be sought when considering queue detection, coordination, or other alternatives.

The *TxDOT 2003 Guide for Determining Time Requirements for Traffic Signal Preemption at Highway-Rail Grade Crossings*, also known as the Preemption Worksheet, should be used to design the preemption timing plan for intersections near railroad grade crossings with active devices.

This worksheet is accompanied by an Instructions document to assist with the completion of the Preemption Worksheet. Both documents are available from TxDOT's Traffic Operations Division. Additional guidance and information related to this worksheet are provided by Engelbrecht et al. (6).

This section summarizes the guidance and information provided in Appendix F of the report cited in Reference 6. This guidance and information can be used with the aforementioned Instructions document to complete the Preemption Worksheet.

Priority Status

In general, the rail preemption routine should be assigned to Preempt 1 and assigned the highest priority. However, at intersections where an upstream gate is used to prevent vehicles from crossing the tracks, two preempt routines are sometimes used (6). Situations where two preempts are used are described in the following paragraphs.

Ensure Track Clearance. In this application, Preempt 2 is initially activated to terminate the active phases and then enter the track clear phase. The gate closure circuit associated with the grade crossing warning equipment is then used to place a call for preemption on Preempt 1. This preempt routine is programmed to time the track clear phase and the dwell phases. This two-preempt application ensures that the track clear phase times *after* the gate is down.

Fail-Safe Operation. In this application, Preempt 2 is used to invoke a red-flash operation in the event that the preempt detector actuation is a consequence of failed circuitry. Preempt 1 is programmed to provide the desired preempt sequence. The maximum duration setting for Preempt 1 is set at a reasonable maximum time period for normal train operation. Preempt 2 (a lower priority preempt) is also connected to the same preempt relay circuitry as Preempt 1 and receives the same detector actuation. However, this preempt is programmed to operate the traffic signals in the all-red flashing mode, without any maximum duration being set. A 5-s preempt delay should be entered for Preempt 2 to ensure that Preempt 1 is given priority. With this configuration, if the preempt detector actuation is due to circuit failure, then Preempt 1 will transition to Preempt 2 (all-red flash) after the maximum duration times out. In all-red flash mode, all traffic movements will be provided a nominal opportunity to traverse the intersection, which should limit driver frustration and possible disregard of the signal indications.

Preempt Delay

In general, the preempt delay feature should be set to 0 s (i.e., not used) at most crossings. However, it may be needed at crossings where train warning time values provided from the railroad are highly varied (e.g., at crossings where switching operations occur on adjacent tracks, or where a single track circuit is used for multiple roadway crossings) (6).

Preempt delay may be needed when train warning time values are highly variable due to rail switching operations.

Preempt Memory

The preempt memory feature should be operated with the memory active (or locked) so that a call for preempt is served even if the actuation is dropped. This mode of operation provides a fail-safe type of operation. Potential reasons for not using the memory-active mode include (6):

- The crossing is susceptible to phantom preempt calls.
- A lower level of preempt is used to provide non-vital advance preemption.
- The crossing contains multiple tracks requiring the use of multiple preempts.

Preempt Minimum Green and Minimum Walk

If the railroad provides sufficient train warning time, the preempt minimum green and minimum walk settings should not be set to less than 2 s. A value less than 2 s may be used if needed to satisfy minimum warning time requirements (6).

Preempt Pedestrian Change

In general, the preempt pedestrian change setting should equal the pedestrian change interval (PCI) duration used for normal controller operation. Guidelines for estimating the pedestrian change interval are provided in Chapter 2.

In some situations, the available train warning time is less than the required maximum preemption time. In this situation, one option is to reduce the preempt pedestrian change such that the warning time and maximum preemption time are equal. The calculation of maximum preemption time is described in the Instruction document and can be found in Box 29 of the Preemption Worksheet.

Section 4D.13 of the *TMUTCD* permits shortening (i.e., truncation) or complete omission of the pedestrian walk interval, the pedestrian change interval, or both (5). When this option is considered, the total truncation exposure (TTE) should be evaluated. The TTE is an indication of the total time that pedestrians experience a truncated (or omitted) interval during the typical day. Engelbrecht et al. (6) recommend that truncation or omission only be considered when the TTE is less than 30 p-s/d (pedestrian-seconds per day). The TTE is computed using the following equations:

$$TTE = \text{Sum of } TE \text{ for each phase serving pedestrians} \quad (8)$$

$$TE = \frac{n P}{2 C} \left(PCI^2 - t_{PCT}^2 \right) \quad (9)$$

where,

TE = truncation exposure for a given phase, p-s/d.

n = number of preemption events per day.

P = average number of pedestrians crossing per phase (of those serving pedestrians), p.

C = average cycle length, s.

PCI = pedestrian change interval duration, s.
 t_{PCT} = proposed reduced pedestrian change time, s.

Track Clear Phases

The track clear phases represent the phases that control the approach movements where vehicles could be potentially stored across the railroad tracks. These phases must be identified in the controller. A green indication should always be provided for the track clear phases. Use of flashing red or flashing yellow indications is not recommended for the track clear phases. All non-track clear phases should display a red indication when the track clear phases are timing.

Track Green

The minimum duration of the track green interval is equal to the computed queue clearance time. This time is measured from the start of the track clear phase to the point in time where the design vehicle accelerates from a stopped position in front of the tracks to a point where it just clears the tracks. This time is calculated as part of the Preemption Worksheet and can be found in Box 25.

To avoid a preemption trap (when not using dual preemption for advance gate clearance), a good rule-of-thumb is to provide a track green time equal to the expected advance preemption time plus 15 s (6). This trap-prevention green time is calculated as part of the Preemption Worksheet and can be found in Box 44.

A desirable track green time is that time that satisfies both the trap-prevention green time and the time needed to clear a significant portion of the clear storage distance. This desirable track green time is calculated as part of the Preemption Worksheet and can be found in Box 51.

Dwell Phases

All phases that serve movements that do not cross the tracks should be allowed to operate in sequence (as defined by the ring structure) during the dwell period. This approach will minimize queues and quicken the return to normal operation after the preempt routine ends. Phases that cross the tracks should not be allowed to cycle during the preemption event because this may lead to driver confusion, increase the potential for collisions, and waste cycle time (6).

Signal operation in flash mode is not recommended during the dwell period.

Minimum Dwell Period

The minimum dwell period should equal or exceed the minimum time needed to serve the longest dwell period phase.

Exit Phases

The exit phases represent the phase or phases that are activated when the dwell period is terminated and the call for preemption has been removed. Typically, the exit phases are the same as those phases served during the track clearance interval.

REFERENCES

1. *National Transportation Communications for ITS Protocol: Object Definitions for Actuated Traffic Signal Controller (ASC) Units – 1202*. National Electrical Manufacturers Association, Rosslyn, Virginia, January 2005.
2. *Departmental Specification TO-4048: Full Actuated Solid State Controller Unit (TS-2) with Diamond, TBC, Preempt, and Closed Loop Operation; and Base-Mounted TS-2 Cabinet Assembly*. Traffic Operations Division, Texas Department of Transportation, Austin, Texas, February 2003.
3. Engelbrecht, R.J., S.P. Venglar, and Z. Tian. *Research Report on Improving Diamond Interchange Operations Using Advanced Controller Features*. Report No. FHWA/TX-02/4158-1. Texas Department of Transportation, Austin, Texas, October 2001.
4. *UDOT Procedural Update – Timing of Traffic Signals*. Traffic Operations Center, Utah Department of Transportation, Ogden, Utah, April 15, 2004.
5. *Texas Manual on Uniform Traffic Control Devices*. Texas Department of Transportation, Austin, Texas, 2006.
6. Engelbrecht, R.J., K.N. Balke, S.R. Sunkari, and S.P. Venglar. *Engineering Solutions to Improving Operations and Safety at Signalized Intersections near Railroad Grade Crossings with Active Devices*. Report No. FHWA/TX-06/0-4265-1. Texas Department of Transportation, Austin, Texas, September 2005.

APPENDIX C. DETECTION DESIGN AND OPERATION

This appendix provides guidelines for the design and operation of the detection system for actuated traffic movements at a signalized intersection. These guidelines have been developed to complement the signal timing guidelines provided in Chapters 2 and 3.

The information in this appendix will be most useful when detection design for a traffic movement is newly installed or is being changed to improve intersection safety or operation. Guidelines for establishing basic controller settings for typical detection designs are provided in Chapters 2 and 3. If changes to signal phasing are being considered, then the guidelines in Appendix A – Signal Phasing and Operation should be considered. If volume-density controller features are being considered, then the guidelines in Appendix B – Advanced Signal Timing Settings should be consulted. If the intersection is part of a diamond interchange, then the guidelines in Appendix D – Diamond Interchange Phasing, Timing, and Design should be consulted.

This appendix consists of three parts. The first part provides an overview of detection design. The second part reviews detection design objectives and detection-related controller settings. The last part provides guidelines for determining the appropriate detection layout and controller settings for individual traffic movements.

OVERVIEW

This part of the appendix provides an overview of detection design and operation. Alternative detector layouts are reviewed in the first section. Then, some terms are established to ensure clarity of the discussion in subsequent sections. Finally, the various types of detection devices used at signalized intersections are identified.

Alternative Detector Layouts

The detector layout (i.e., location and arrangement of individual detectors) can have a significant effect on intersection safety and efficiency. One or more detectors can be placed just upstream of the intersection and used to extend the green to vehicles on the intersection approach. Research indicates that, at higher speeds, advance detection can be used to safely terminate a phase and reduce the frequency of rear-end crashes (1).

Advance detection can provide safety benefits at any high-speed intersection.

Stop line detection is a very effective means of ensuring that a waiting queue is given the time it needs to clear the intersection. This type of detection allows the controller to be responsive to the presence of waiting vehicles and to minimize the percentage of cycles that end unnecessarily before the queue has been cleared.

Stop line detection can provide efficiency benefits by monitoring queue presence and ending the phase when the queue clears.

In general, stop line detection is commonly used for all signal-controlled traffic movements. Advance detection is often combined with the stop line detection for through movements when these movements are considered to have a high speed.

Terminology

The detection design for a given traffic movement includes two elements. The first element consists of the determination of the appropriate controller passage time, delay, and extend settings. The second element consists of the determination of: (1) the length of the stop line detection zone (if provided), and (2) the number and location of each advance detector (if provided). The passage time, delay, extend, and other detection-related settings are described in more detail in Chapter 2. Terms used to describe a detection design are identified in Table C-1.

Table C-1. Detection Design Terminology.

Term	Definition
Detection zone	A length of roadway within which vehicle presence is detected. A detection zone can consist of one 6-ft inductive loop detector, a series of 6-ft loop detectors wired together, one long loop detector, or a length of roadway monitored by any non-intrusive detection device (e.g., video, microwave, etc.).
Long-loop detection	A detection zone that is 10 ft or more in length. The reference to “loop” in this phrase stems from the historic usage of inductive loop detectors to detect a length of roadway. However, in this document, it is more broadly applied to include any detection device that can be used to monitor a long detection zone.
Detection unit	An electronic device that outputs a digital logic signal indicating the presence of a vehicle in the detection zone. The detection unit technology varies with the type of detector (e.g., inductive loop, video, microwave, magnetic, etc.). For traffic signal applications, the detection unit output is assigned to a detector channel input on the signal controller.
Actuation	The output from the detection unit as a result of detected vehicle presence.
Call	The controller’s registration of a request for service on a specific phase. The presence of a call for service is established by the signal controller. A call can be triggered by an actuation from a vehicle detection unit, a pedestrian detector, or through a controller function (e.g., via the max recall mode). When triggered by a vehicle detection unit, the call’s start and end time can be equal to that of the actuation from the detection unit, or it can be modified using the controller’s detector settings (e.g., delay, extend, call, queue, etc.). These settings are described in Chapter 2.

Scope

There are a wide variety of detection units used for vehicle detection at signalized intersections. The inductive loop detector (coupled with an amplifier) and the video image vehicle detection system (VIVDS) typically account for almost all routine detector applications at intersections. Microwave detectors and radar detectors are occasionally used for special situations. In fact, the use of radar detectors to monitor high-speed approaches is increasing due to recent advancements in radar technology and reductions in the cost of this technology.

The use of selected detection units is identified in Table C-2. This table indicates the percentage of intersections using a specified type of detection unit. The percentages listed in column 2 represent the findings from a nationwide survey of 108 city, county, and state agencies that was conducted in 2004 (2). The percentages in column 3 represent the findings from a 2007 survey of TxDOT engineers (3). Most TxDOT districts tend to use one type of detection technology (i.e., mostly VIVDS or mostly inductive loops) within their district.

Table C-2. Typical Use of Various Detection Unit Technologies.

Detection Unit	Percent of Intersections Using a Specified Type of Detection Unit	
	National Survey (2004)	TxDOT (2007)
Inductive loop and amplifier	49%	40%
Video image vehicle detection system	37%	59%
Microwave	11%	0.8%
Other	3%	0.2%

The concepts and guidance in this appendix focus on inductive loop detection and VIVDS. This focus is based on the widespread use of these two detection-unit types at signalized intersections, as indicated in Table C-2. Information about other detection-unit types and guidance on their application is provided in the *Traffic Detector Handbook* (4).

The focus of this appendix is on inductive loop detection and VIVDS design.

CONCEPTS

This part of the appendix presents an overview of vehicle detection concepts. Initially, the indecision zone is described, as it relates to detection design. Then, the objectives of detection design are reviewed. Finally, an overview of the controller and detector settings often used in detection design is provided.

Indecision Zone

At the onset of the yellow indication, most drivers make a decision to stop or continue based on their speed and the distance to the intersection. Research indicates that each driver is fairly consistent in his or her decision for a given speed and distance. However, as a group, they do not always reach the same decision for the same speed and distance. As a result, drivers within a few seconds travel time of the intersection at the onset of the yellow indication are collectively characterized as indecisive about their ability to stop. This behavior yields a zone of indecision in advance of the stop line wherein some drivers may proceed and others may stop. It occurs every signal cycle, just after the onset of the yellow indication and regardless of the yellow duration. The location of this zone is shown in Figure C-1.

Rear-end crashes can occur when vehicles are in the indecision zone at the onset of the yellow indication.

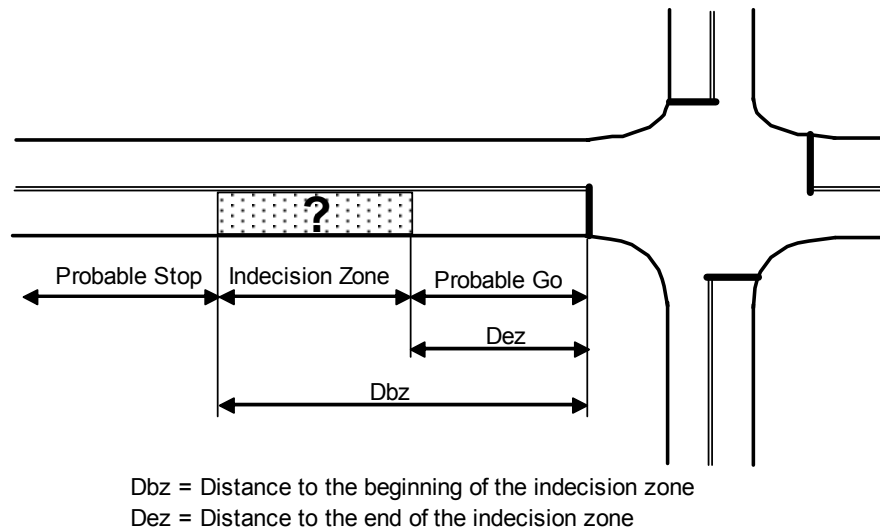

Figure C-1. Indecision Zone Boundaries on a Typical Intersection Approach.

The indecision zone is sometimes incorrectly referred to as the dilemma zone. Both zones exist at the onset of the yellow indication and are located in advance of the stop line, but the similarities end at this point. The dilemma zone is a zone wherein drivers have neither sufficient time remaining in the yellow interval to reach the intersection stop line at the current speed nor sufficient distance to stop before reaching the stop line. Thus, the dilemma zone is a consequence of a speed that is too fast (or a reaction time that is too slow) for the yellow duration. This zone typically exists for those drivers who exceed the speed used to determine the yellow interval.

The indecision zone location has been defined in several ways. Some researchers have defined it in terms of distance from the stop line (5, 6). They define the beginning of the zone as the distance beyond which 90 percent of all drivers would stop if presented a yellow indication. They define the end of the zone as the distance within which only 10 percent of all drivers would stop. The distance to the beginning of the zone recommended by Zegeer and Deen (6) corresponds to about 5 s in travel time. The distance recommended by ITE increases exponentially with speed, ranging from 4.2 to 5.2 s in travel time, with the larger values corresponding to higher speeds (5).

Vehicles in the dilemma zone at yellow onset may end up running the red light.

This zone exists mostly for those vehicles traveling at a speed in excess of that used to determine the yellow duration.

Another definition of the indecision zone boundaries is based on observed travel time to the stop line. Chang et al. (7) found that drivers less than 2 s from the stop line would almost always continue through the intersection.

A third definition of the beginning of the indecision zone is based on safe stopping sight distance (SSD). A method for computing this distance is described in Chapter 3 of the following document: *A Policy on the Geometric Design of Highways and Streets* (8).

The indecision zone boundaries obtained by these three definitions are compared in Figure C-2. The boundaries based on distance typically have an exponential relationship. Those based on travel time have a linear relationship. Based on the trends shown in the figure, the beginning and end of the indecision zone tend to be about 5.5 s and 2.5 s, respectively, in travel time from the stop line. These times equate to about the 90th and 10th percentile drivers, respectively.

The indecision zone starts at about 5.5 s in travel time from the stop line. It ends at about 2.5 s in travel time.

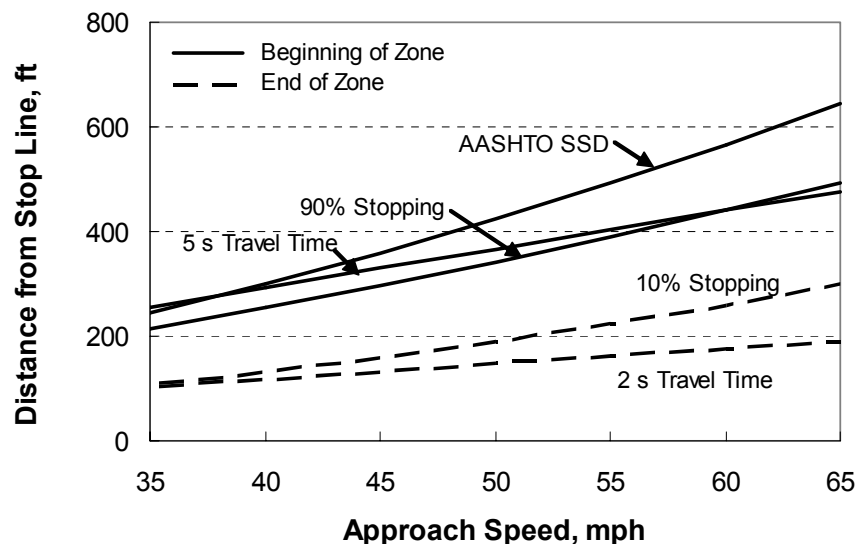

Figure C-2. Distance to the Beginning and End of the Indecision Zone.

Detection Design Objectives

There are three objectives of detection design; they are:

1. Ensure that the presence of waiting traffic is made known to the controller (unless the phase is on recall).
2. Ensure the traffic queue is served each phase.
3. Provide a safe termination of the green interval for high-speed movements by minimizing the chance of vehicles being in the indecision zone at the onset of the yellow indication.

The “queue” referred to in the second objective represents the vehicles present at the start of the green indication and any vehicles that join this queue while it discharges during the green indication.

The first two objectives focus on intersection efficiency. They are often most effectively achieved by using detectors located just in advance of, or at, the stop line (i.e., stop line detection). However, they can also be achieved by using only advance detection and selected controller settings.

The third objective focuses on intersection safety and specifically addresses the potential for a rear-end crash as a result of phase termination on high-speed approaches. It is achieved by using an advance detector located at the beginning of the indecision zone and, often, additional advance detectors located within the zone. The location of these detectors can vary, depending on the detection technology used as well as intersection approach speed.

Detection-Related Control Settings

Controller Memory

Controller memory refers to the controller's ability to remember (i.e., retain) a detector actuation. One of two modes can be used: nonlocking or locking. This mode is set in the controller for each of its detector channel inputs. It dictates whether an actuation received during the red interval (and optionally, the yellow interval) is retained until the assigned phase is served by the controller. All actuations received during the green interval are treated as nonlocking by the controller. The nonlocking mode is typically the default mode.

In the nonlocking mode, an actuation received from a detector is not retained by the controller after the actuation is dropped by the detection unit. The controller recognizes the actuation only during the time that it is held

Nonlocking memory is most appropriate for phases that are served by stop line detection.

present by the detection unit. In this manner, the actuation indicates to the controller that a vehicle is present in the detection zone and the controller converts this actuation into a call for service. This mode is typically used for phases that are served by stop line detection. It allows permissive movements (such as right-turn-on-red) to be completed without invoking a phase change. In doing so, it improves efficiency by minimizing the cycle time needed to serve minor movement phases.

In the locking mode, the first actuation received from a detector during the red interval is used by the controller to trigger a continuous call for service. This call is retained until the assigned phase is serviced, regardless of

Locking memory is most appropriate for phases that are: (1) served by advance detection only and (2) not in recall.

whether any vehicles are actually waiting to be served. This mode is typically used for the major-road through movement phases associated with a low percentage of turning vehicles (as may be found in rural areas). One advantage of using this mode is that it can eliminate the need for stop line detection, provided that advance detection is used and that this detection is designed to ensure efficient queue service.

Locking mode operation may also be useful when a stop line detector is not functioning properly (i.e., missing some actuations) or when through vehicles are consistently stopping beyond the stop line detector.

Detection Mode

Detection mode influences the duration of the actuation submitted to the controller by the detection unit. One of two modes can be used: presence or pulse. This mode is set in the detection unit. Presence mode is typically the default mode. It tends to provide more reliable intersection operation than pulse mode.

In the presence mode, the actuation starts with the arrival of the vehicle to the detection zone and ends when the vehicle leaves the detection zone. Thus, the time duration of the actuation depends on the vehicle length, detection zone length, and vehicle speed. Its duration can also be modified by delay or extend settings in the detection unit or the controller. However, the delay and extend settings in the controller are more commonly used than those in the detection unit.

Presence detection mode is typically used with stop line detection and nonlocking memory.

The presence mode is typically used with long-loop detection located at the stop line. In this application, the associated detector channel in the controller is set to operate in the nonlocking mode. The combination of presence mode operation and long-loop detection typically results in the need for a small passage time value. This characteristic is desirable because it tends to result in more efficient queue service.

In the pulse mode, the actuation starts and ends with the arrival of the vehicle to the detector (actually, the actuation is a short “on” pulse of 0.10 to 0.15 s). This mode is not used as often as presence mode for intersection control because the short “on” pulse is sometimes missed by the controller. However, the pulse mode has been used in the past for phases that have one or more advance detectors, no stop line detection, and the associated detector channel operates in the locking mode.

Pulse detection mode is rarely used for intersection traffic control signal applications.

GUIDELINES

This part of the appendix provides guidelines for establishing the detection design for vehicular traffic at a signalized intersection. The information provided is based on established practices and techniques that have been shown to provide safe and efficient intersection operation. The guidelines address the detector layout and timing for both low- and high-speed traffic movements. Guidelines are separately provided for inductive loop detection and for VIVDS. Guidelines for establishing the controller settings associated with these detection designs are provided in Chapter 2.

Guidelines for Loop Detection Layout for Low-Speed Movements

This section describes guidelines for designing the detection for low-speed traffic movements. In this regard, a low-speed movement is one that has an 85th percentile approach speed of 40 mph or less. The

objectives of a low-speed design are to: (1) ensure that the presence of waiting traffic is made known to the controller, and (2) ensure the traffic queue is served each phase. Due to the lower speed, indecision zone protection is not incorporated in this design, and advance detection is not used.

A low-speed design can accommodate a movement with an 85th percentile speed of 40 mph or less.

Design guidelines are separately described in this section for through, left-turn, and right-turn traffic movements. They were developed to provide efficient operation; however, other designs may be developed that provide equally efficient operation.

The guidelines in this section focus on stop line detection. A single advance detector is sometimes used (with volume-density features) instead of stop line detection to achieve the aforementioned objectives.

Guidelines for using a single advance detector in this manner are provided in Appendix B.

The guidelines in this section focus on **stop line detection**.

Through Movements

The detection design for a typical low-speed through movement is shown at the top of Figure C-3. This design is used for lanes exclusive to the through movement and for lanes that are shared by through and turn movements. It has the following characteristics:

- A detection zone is located at the stop line.
- The detector unit is operating in the presence mode.
- Nonlocking memory is used for the associated detector channel in the controller.
- Recall is not necessary for the phase to which the detector is assigned.
- Gap reduction and variable initial controller settings are not used.

The key element of this design is the determination of detection zone length. The optimal length represents a trade-off in the desire to avoid both premature gap-out and excessive extension of green. Research indicates that the ideal length of the stop line detection zone is about 80 ft (9). This length allows the passage time setting to be small such that the design is very efficient in detecting the end of queue while minimizing the chance of a premature gap-out. On the other hand, the installation and maintenance of an 80-ft detector is often cost-prohibitive, and detectors of a shorter length are used.

For through movements, the stop line detection zone length should be at least 20 ft and, desirably, 80 ft for busy intersections.

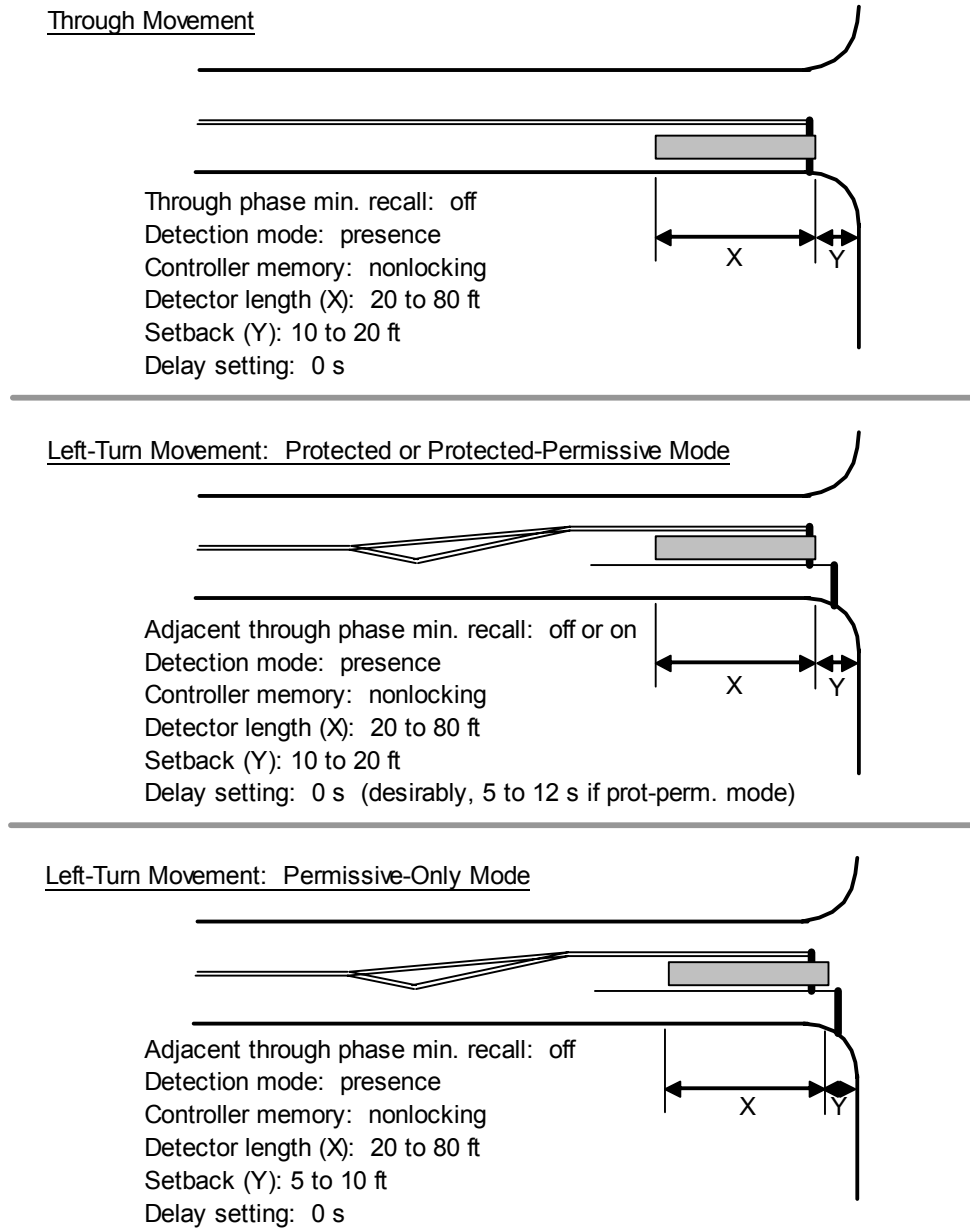

Figure C-3. Left-Turn and Through Movement Detection Designs.

The following guidelines should be used to determine the appropriate length of the stop line detection zone:

- The detection zone should not be smaller than 20 ft. Desirably, it would be 80 ft long.
- Detection zones nearer to 80 ft should be used at higher-volume intersections.
- The zone should be positioned such that a queued vehicle cannot stop between its trailing edge and the crossroad.

- The zone should consist of one long inductive loop or a series of evenly spaced 6-ft loops. Other detection units that can provide the equivalent length of detection can also be used.

A commonly used stop line detection zone length is 40 ft. This length represents a practical compromise between the operational benefits and detector maintenance costs, both of which increase with detection zone length.

Most stop line detection zones that use inductive loops are 40 ft in length.

Left-Turn Movements

The guidelines in this subsection can be used to design the left-turn movement detection when this movement has an exclusive lane (or lanes). In general, the detection design for a left-turn movement operating in a protected or protected-permissive mode should follow the guidelines offered for through movements. This design is shown in the middle of Figure C-3.

If the left-turn movement operates in the protected-permissive mode, then the delay setting can be used with the left-turn detector to minimize unnecessary calls to the left-turn phase. The delay value used should range from 5 to 12 s, with the larger values used when a higher speed or volume exists on the opposing approach.

If the left-turn movement operates in the permissive-only mode and the through movement phases are not on recall, then it may be desirable to extend the stop line detection zone beyond the stop line. This extension is intended to minimize the potential for stranding a turning vehicle in the intersection at the end of the phase. This design is shown at the bottom of Figure C-3.

Right-Turn Movements

The guidelines in this subsection can be used to design the right-turn movement detection when this movement has an exclusive lane (or lanes). In general, the detection design for a protected or protected-permissive right-turn movement should follow the guidelines offered for left-turn movements.

If the right-turn movement operates in the protected-only mode and right-turn-on-red (RTOR) is allowed, then the delay setting can be used with the right-turn detector to minimize unnecessary calls to the right-turn phase. The delay value used should range from 8 to 14 s, with the larger values used when a higher speed or volume exists on the intersecting road. If RTOR is not allowed, the delay setting should be 0 s. This design is shown at the top of Figure C-4.

If the right-turn movement operates in the protected-permissive mode and RTOR is allowed, then the delay setting can be used with the right-turn detector to minimize unnecessary calls to the right-turn phase. The delay value used should range from 8 to 14 s, with the larger values used when a higher speed or volume exists on the intersecting road. If RTOR is not allowed, the delay setting should be based on the average time a right-turn vehicle waits for a gap in the conflicting pedestrian stream plus 7 s. This design is shown at the top of Figure C-4.

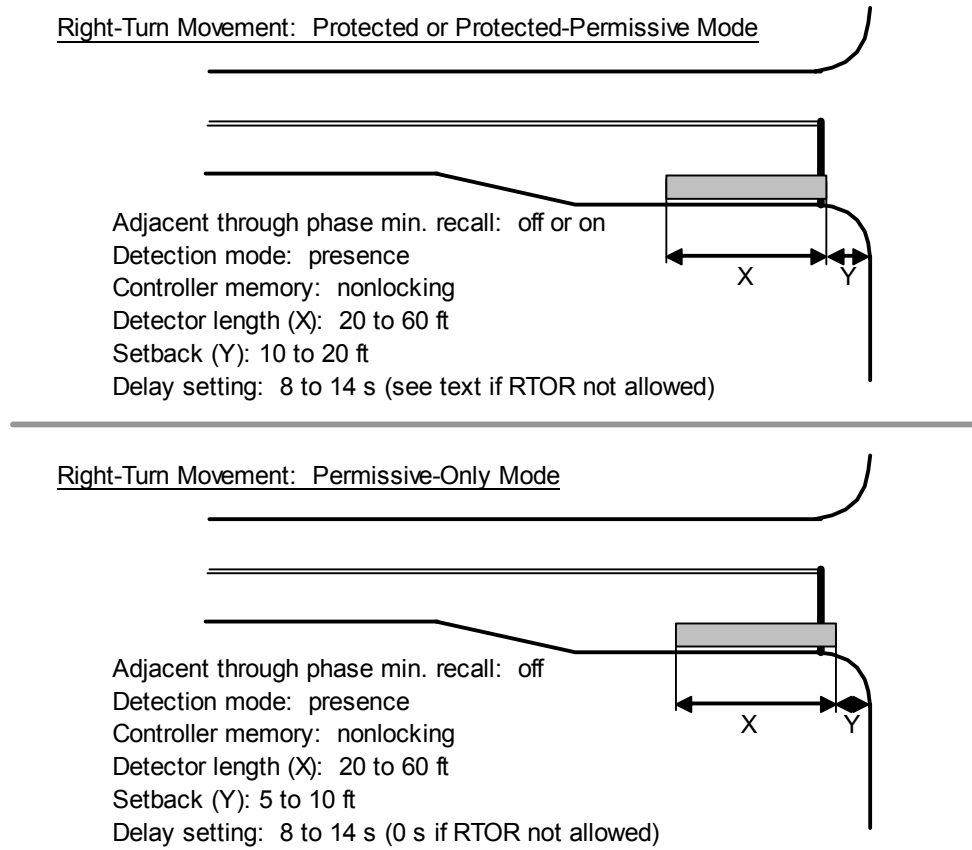

Figure C-4. Right-Turn Movement Detection Designs.

If the right-turn movement operates in the permissive-only mode, the through movement phases are not on recall, and RTOR is allowed; then the delay setting can be used with the right-turn detector to minimize calls to the adjacent through phase. The delay value used should range from 8 to 14 s, with the larger values used when a higher speed or volume exists on the intersecting road. This design is shown at the bottom of Figure C-4. If RTOR is not allowed, then the delay value should be 0 s. This detector is assigned to the phase serving the adjacent through movement.

Guidelines for Loop Detection Layout for High-Speed Through Movements

This section describes recommended detection designs for high-speed through traffic movements. In this regard, a high-speed movement is one that has an 85th percentile approach speed of 45 mph or more. The recommended designs were developed to satisfy the following objectives: (1) ensure that the presence of waiting traffic is made known to the controller, (2) ensure that the traffic queue is served each phase, and (3) provide a safe phase termination by minimizing the chance of a driver being in his or her indecision zone at the onset of the yellow indication.

A high-speed design can accommodate a movement with an 85th percentile speed of 45 mph or more.

The guidelines provided herein will produce safe and efficient operation; however, other designs may be developed that provide equally safe and efficient operation. Gap reduction is not used with the designs described in this section.

The recommended controller settings for the high-speed detection design are listed in Table C-3. Three design options are specified in the table. All three designs are based on the same detection layout, for a given 85th percentile speed. The attributes of each option are summarized in the following three subsections.

Table C-3. Layout and Settings for High-Speed Detection Design.

Category	85 th Percentile Speed, mph	Design Element	Design Values by Detection Option		
			Option 1	Option 2	Option 3
Detection layout	70	Distance from the stop line to the upstream edge of the advance detector, ft (Note: The number of distances listed indicates the number of advance detectors. All advance detectors are 6 ft in length)	600, 475, 350		
	65		540, 430, 320		
	60		475, 375, 275		
	55		415, 320, 225		
	50		350, 220		
	45		330, 210		
	45 to 70	Stop line detection zone length, ft	40	Not used	40
	45 to 70	Advance detection lead-ins wired to channel separate from stop line detection	Yes	Not used	No
Controller settings	70	Passage (extension) time, s	1.4 to 2.0	1.4 to 2.0	1.0 to 1.2
	65		1.6 to 2.0	1.6 to 2.0	1.0 to 1.2
	60		1.6 to 2.0	1.6 to 2.0	1.0 to 1.2
	55		1.4 to 2.0	1.4 to 2.0	1.0 to 1.2
	50		2.0	2.0	1.4 to 1.6
	45		2.0	2.0	1.4 to 1.6
	45 to 70	Detection mode	Presence	Presence	Presence
	45 to 70	Controller memory	Nonlocking	Varies ²	Nonlocking
	45 to 70	Stop line detection channel extend setting, s	2.0 ¹	Not used	0.0
	45 to 70	Stop line detection operation (deactivated or continuously active) ³	Deactivated after gap-out	Not used	Continuously active

Notes:

- 1 - The stop line detection is assigned to a separate channel from the advance detection.
- 2 - Use locking memory when the two intersecting roads have about the same traffic volume. Use nonlocking memory and minimum recall for the subject phase when it serves the major-road through movement and the major road serves significantly more vehicles than the minor road.
- 3 - Stop line detection operation is deactivated if it is disconnected after its detector channel extend timer times out. It is reconnected after the green interval terminates (see Special Detector, Operation Mode 4 in Eagle controller).

Option 1 – Advance Detection and Queue Service Stop Line Detection

This option represents the design with the most detectors, but it is also likely to offer the best combination of safety and efficiency. It is appropriate when stop line detection is provided, its lead-in wire is separate from the lead-in wire used for the advance detection, and both wires are associated with a separate controller channel (each channel being assigned to the subject phase).

With Option 1, the stop line detection operation is deactivated following the first gap-out. This operation is enabled using the controller's queue setting. The extend time setting associated with the stop line detection has a value equal to the passage time.

Option 2 – Advance Detection Only

This design operates without stop line detection. It provides a level of safety equivalent to that of Option 1; however, intersection delay will likely be slightly higher with this option due to occasional premature phase termination. The decision not to provide stop line detection is typically based on practical considerations relating to the cost of maintaining stop line detection.

Two variations of this option are available because stop line detection is not used. The first variation has the controller memory set to locking. The second variation has the memory set to nonlocking and recall set to minimum. The first variation is most appropriate when the intersecting roadways have about the same traffic volume. The second variation is used when the subject phase serves the major-road through movement, and the major road serves significantly more vehicles than the minor road.

Option 3 – Advance Detection and Continuous Stop Line Detection

This option does not provide as high a level of safety or efficiency as provided by Options 1 or 2. It should only be used when the lead-in wire for the stop line detection is the same as for the advance detection (if separate lead-in wires are provided, then Option 1 should be used).

The passage times listed in Table C-3 should provide acceptable operation. They are shorter than those used for Options 1 and 2 to limit the frequency of max-out while providing as much indecision zone coverage as possible. The extend-time setting associated with the stop line detection has a value of 0.0 s.

Detection-Control System

Zimmerman and Bonneson (10) developed for TxDOT a detection and control system for providing indecision zone protection. The system overcomes several limitations associated with multiple advance detector systems (such as those listed in Table C-3). This system (referred to as the Detection-Control System) uses a two-loop speed trap located 800 to 1000 ft upstream of the intersection to

The Detection-Control System provides the most effective advance detection and includes truck priority.

intelligently forecast the best time to end the signal phase considering the presence of vehicles in the indecision zone (with priority given to trucks) and the delay to waiting vehicles.

An evaluation of the before-after data indicated that the Detection-Control System was able to reduce delay by 14 percent, stop frequency by 9 percent, red-light violations by 58 percent, heavy-vehicle red-light violations by 80 percent, and severe crash frequency by 39 percent (10). These reductions were relative to a multiple advance detector system representing the “before” condition.

The Detection-Control System logic is implemented by Naztec, Inc., in a TS-2 controller suitable for a TS-2 Type 1 cabinet.

Guidelines for Video Detection Design

This section addresses several important VIVDS design elements. These elements include camera location and field-of-view calibration. Design considerations include the camera’s height, offset, distance from the stop line, pitch angle (relative to a horizontal plane), and lens focal length. The first three considerations refer to camera location, and the last two considerations refer to the field-of-view calibration. The information presented in this section is based largely on the guidelines provided in the *Intersection Video Detection Manual* (11).

Camera Location

An optimal camera location is one that maximizes detection accuracy. As such, an optimal location is one that provides a stable, unobstructed view of each traffic lane on the intersection approach. The view must include the stop line and extend back along the approach for a distance equal to that needed for the desired detection layout. An example of an optimal camera location is identified by the letter “A” in Figure C-5a. Its field of view is shown in Figure C-5b.

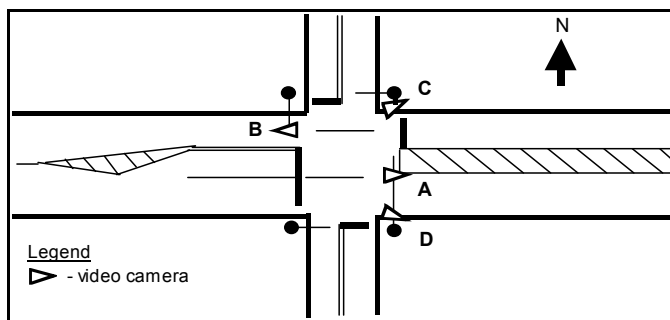

a. Optimal Camera Locations.

b. Optimal Field of View.

Figure C-5. Illustrative Optimal Camera Location and Field of View.

Camera Offset. When mast arms are used to support the signal heads, the optimal camera offset is approximately in the center of the approach being monitored. This location can vary slightly, depending on whether the approach being monitored has a left-turn bay. If it has a left-turn bay, the preferred camera location is over the lane line separating the left-turn bay and the adjacent (oncoming) through lane. This location is shown as point “A” in Figure C-5a, as applied to the eastbound approach. If the approach does not have a left-turn bay, the preferred location is centered on the approach lanes, as shown by location “B” for the westbound approach.

When mast arms are available, the optimal camera location is near the center of the approach being monitored.

When span wire is used to support the signal heads, a right- or left-side camera mount is usually needed. The choice between a right-side or a left-side mount is dependent on the phase sequence used to control the subject approach. For approaches without a left-turn phase, the camera is typically mounted on the right-side, far corner of the intersection (i.e., “D” in Figure C-5a).

For approaches with a left-turn phase and bay, location “D” is problematic because the projected outline of a tall through vehicle can extend into the left-turn bay and unnecessarily call the left-turn phase. To avoid this problem, the camera is mounted on the left-side, far corner of the intersection (i.e., “C” in Figure C-5a). This location minimizes false calls for service to the left-turn phase; any false calls for the through phase by a tall left-turn vehicle would have limited impact because through vehicles are present during most cycles. A 10-s delay (or directional detection) should be used for the left-turn detection zone to prevent unnecessary calls by departing vehicles.

Camera Height. The minimum camera height needed to reduce adjacent-lane occlusion is obtained from Table C-4. Interpolation between cell values is appropriate for offsets intermediate to the values listed. A minimum height of 20 ft is recommended in recognition of the dirt, spray, and mist that can collect on the camera lens at lower heights. Camera locations that require a camera height in excess of 42 ft should be avoided.

The camera should be located at least 20 ft above the roadway, preferably 25 to 35 ft.

The trends in Table C-4 indicate that a camera mounted on a mast arm in the center of the approach is associated with the lowest minimum height. This minimum increases with offset and is particularly large for cameras located on the left side of the approach.

The underlined values in Table C-4 correspond to typical lateral offsets for the associated number of lanes *when* the camera is mounted within 10 ft of the edge of traveled way. For example, a camera mounted on the right side of a single-lane approach (with one left-turn bay) is likely to have an offset of about 15 ft, which corresponds to a minimum camera height of 20 ft. A camera mounted on the left side of this same approach is likely to have an offset of about 25 ft and require a minimum height of 21 ft.

Table C-4. Minimum Camera Height to Reduce Adjacent-Lane Occlusion.

Camera Location	Lateral Offset, ft ¹	No Left-Turn Lanes			One Left-Turn Lane			Two Left-Turn Lanes		
		Through+Right Lanes ²			Through+Right Lanes ²			Through+Right Lanes ²		
		1	2	3	1	2	3	1	2	3
Minimum Camera Height and Typical Camera Mount, ft ^{3,4}										
Left side of approach	-65			<u>P,R 38</u>			<u>P,R,L42</u>			
	-55		<u>P,R 35</u>	<u>P 30</u>		<u>P,R 39</u>				
	-45		<u>P 27</u>		<u>P,R 36</u>	<u>P 32</u>		<u>P,R,L41</u>		
	-35	<u>P 24</u>	<u>P 20</u>		<u>P 29</u>			<u>P 33</u>		
	-25	<u>P 20</u>			<u>P 21</u>					
	-15	<u>P 20</u>						M 20	M 20	M 20
	-5				M 20	M 20	M 20	M 20	M 20	M 20
Center	0	M 20	M 20	M 20	M 20	M 20	M 20	M 20	M 20	M 20
Right side of approach	5	<u>P 20</u>	M 20	M 20	M 20	M 20	M 20	M 20	M 20	M 20
	15	<u>P 20</u>	<u>P 20</u>	<u>P 20</u>	<u>P 20</u>	<u>P 20</u>	M 23	<u>P 20</u>	M 20	M 20
	25	<u>P 20</u>	<u>P 20</u>	<u>P 20</u>	<u>P 21</u>	<u>P 26</u>	<u>P 30</u>	<u>P 20</u>	<u>P 21</u>	<u>P 26</u>
	35		<u>P 20</u>	<u>P 20</u>	<u>P 29</u>	<u>P 33</u>	<u>P,R 38</u>	<u>P 24</u>	<u>P 29</u>	<u>P 33</u>
	45								<u>P,R 36</u>	<u>P,R,L41</u>

Notes:

- 1 - Lateral offset of camera measured from the center of the approach traffic lanes (including turn lanes).
- 2 - Total number of through and right-turn lanes on the approach.
- 3 - Underlined values in each column correspond to typical lateral offsets when the camera is mounted within 10 ft of the edge of traveled way.
- 4 - Camera mounting hardware and maximum camera mounting height supported by the hardware:
 M – mast arm (24 ft maximum).
 P – strain pole (34 ft maximum).
 P,R – camera on 5-ft riser on top of strain pole (39 ft maximum).
 P,R,L – camera on 5-ft riser on luminaire arm attached to the top of strain pole (41 ft maximum).

Research indicates that increasing camera height tends to improve accuracy, provided that there is no camera motion. Data indicate that a camera height of 34 ft or more may be associated with above-average errors due to camera motion when mounted on typical luminaire or mast arm poles (11).

Field-of-View Calibration

Calibration of the camera field of view is based on a one-time adjustment to the camera pitch angle and the lens focal length. An optimal field of view is one that has the stop line parallel to the bottom edge of the view and in the bottom one-third of this view. The optimal view should include all approach traffic lanes and one departing traffic lane if the median is narrow or nonexistent. The focal length would be adjusted such that the approach width, as measured at the stop line, equates to about 90 percent of the horizontal width of the view. Finally, the view must exclude the horizon. An example of an optimal field of view is shown in Figure C-5b.

An optimal field of view has the stop line parallel to the bottom edge of the view and in the bottom one-third of this view.

The optimal field of view is not achievable for some right-side and most left-side camera offsets. In these situations, the approach width may not be parallel to the bottom of the view, and it may not equal 90 percent of the horizontal width of the view. Nevertheless, the field of view should always be adjusted to maximize the approach width at the stop line. Practical minimum widths are 40 and 60 percent for left-side and right-side camera offsets, respectively.

Adjustments to Minimize Sun Glare.

Two camera adjustments are available to minimize the harmful effects of sun glare on detection accuracy. In some instances, glare can be blocked by adjusting the visor on the camera housing. If this adjustment does not eliminate the problem, then the camera pitch angle can be increased such that the horizon is excluded from the field of view. A minimum pitch angle of about 3 degrees (from horizontal) should be provided in all cases.

Use a visor or tilt the camera to avoid glare from the sun in the dawn or dusk periods.

Adjustments to Minimize Glare from Lighting. The camera field of view should be established to avoid inclusion of objects that are brightly lit in the evening hours, especially those that flash or vary in intensity. These sources can include luminaires, signal heads, billboard lights, and commercial signs. The light from these sources can cause the camera to reduce its sensitivity (by closing its iris), which results in reduced detection accuracy. If these sources are located near a detection zone, they can trigger unnecessary calls.

If the pitch angle or focal length cannot be adjusted to avoid glare and brightly lit objects, then alternative camera locations should be considered. If such locations cannot be found, then careful detection zone positioning can minimize the effect of light sources on detection accuracy.

On-Site Performance Checks

Return Visit to Verify Operation. In the days following the VIVDS installation, the engineer or technician should return to the intersection and reevaluate the VIVDS performance. The purpose of the visit is to verify that the intersection is operating in an acceptable manner and that the VIVDS detectors are detecting vehicles with reasonable accuracy. In general, operation and accuracy should be checked at midday and during the late afternoon, nighttime, and early morning hours. In most cases, each time period is checked during a separate return visit.

Maintenance. A periodic check (e.g., every six months) of the camera field of view and detection layout is encouraged. During this check, the engineer or technician should: (1) verify that the detection zones are still in the proper location relative to the traffic lanes, (2) assess the impact of seasonal changes in the sun's position on detection accuracy, (3) verify that the VIVDS is using the latest software version and upgrade it if needed, and (4) check that the camera lens does not have moisture or dirt buildup (and clean the lens if needed).

Application of VIVDS to High-Speed Movements

VIVDS detection accuracy degrades with increasing distance between the detection zone and camera. It is minimized to some degree by increased camera height, but it is not eliminated. This degradation is most notable during the nighttime hours (12). These issues cast some doubt on the ability of VIVDS to provide reliable advance detection for high-speed traffic movements because this type of detection requires precise knowledge of individual vehicle presence at specific locations on the intersection approach.

Recent research by Middleton et al. (13) indicates that the use of VIVDS for advance detection has an adverse effect on intersection efficiency. The researchers also suggested a possible adverse effect on safety because an observed tendency for VIVDS advance detection to frequently extend the green to its maximum limit (i.e., max-out). It is noted that the VIVDS studied by these researchers used one camera for stop line detection and a second camera (located on the near-side mast arm) to provide the advance detection.

Until the aforementioned VIVDS issues are resolved, inductive loop detectors should be given first consideration for the detection of high-speed movements.

Detection systems other than VIVDS may be better suited to advance detection for high-speed movements.

Guidelines for Video Detection Layout for Low-Speed Movements

This section describes guidelines for detection zone layout and operation for low-speed traffic movements. In this regard, a low-speed movement is one that has an 85th percentile approach speed of 40 mph or less. The objectives of a low-speed design are to: (1) ensure that the presence of waiting traffic is made known to the controller, and (2) ensure the traffic queue is served each phase. The VIVDS camera is assumed to be located on a pole or mast arm at the intersection.

The guidelines described in this section are applicable to through, left-turn, and right-turn traffic movements. They were developed to provide efficient operation; however, other designs may be developed that provide equally efficient operation.

Detection Zone Location

Like inductive loops, VIVDS detectors can be placed within a lane or across several lanes. They can be placed at the stop line or several hundred feet in advance of it. The VIVDS product manuals offer some guidance for locating a VIVDS detection zone and the detectors that comprise it. These guidelines are summarized in Table C-5.

Table C-5. Guidance for Locating Detection Zones and Individual Detectors.

Guideline	Rationale
Stop line detection zone typically consists of several detectors extending back from the stop line.	Reliable queue service typically requires monitoring a length of pavement 80 ft or more in advance of the stop line.
Put one detection zone downstream of the stop line if drivers tend to stop beyond the stop line.	Supplemental detection can be used to ensure that vehicles stopped beyond the stop line are served.
Avoid having one long detector straddle a pavement marking.	Slight camera motion (due to wind) can move the detection zone relative to the marking and trigger unneeded detections.
The individual detector length should approximately equal that of the average passenger car.	Maximize sensitivity by correlating the number of image pixels monitored with the size of the vehicle being detected.

The recommended stop line detection zone lengths are listed in Table C-6. The recommended lengths require a 0-s controller passage time. This design should result in lower delay than that realized by longer passage times or shorter detection zone lengths.

With VIVDS, use a passage time of 0 s and a stop line detection zone length (L_d) of: L_d in ft = 3 x (85th percentile speed in mph). (See also Table C-6.)

Table C-6. Stop Line Detection Zone Length for VIVDS Applications.

85 th Percentile Speed, mph	Distance between Camera and Stop Line, ft ¹	Camera Height, ft					
		20	24	28	32	36	40
		Stop Line Detection Zone Length, ft ²					
20	50	55	55	55	60	60	60
	100	45	45	50	50	55	55
	150	30	35	40	45	45	50
25	50	75	75	75	80	80	80
	100	60	65	70	70	70	75
	150	50	55	60	65	65	70
30	50	95	95	95	95	100	100
	100	80	85	90	90	90	95
	150	70	75	80	85	85	90
35	50	115	115	115	115	120	120
	100	100	105	110	110	110	115
	150	90	95	100	105	105	105
40	50	130	135	135	135	135	140
	100	120	125	125	130	130	130
	150	110	115	120	120	125	125

Notes:

- 1 - Distance between the camera and the stop line, as measured parallel to the direction of travel.
- 2 - Lengths shown are based on a passage time setting of 0 s.

Figure C-6 illustrates the location of detection zones on an intersection approach with a camera mounted on the mast arm. Each zone is shown to consist of a series of rectangular detectors. Detectors are located beyond the stop line to enhance vehicle detection during nighttime hours. These detectors are positioned to detect the headlights of vehicles stopped behind the stop line.

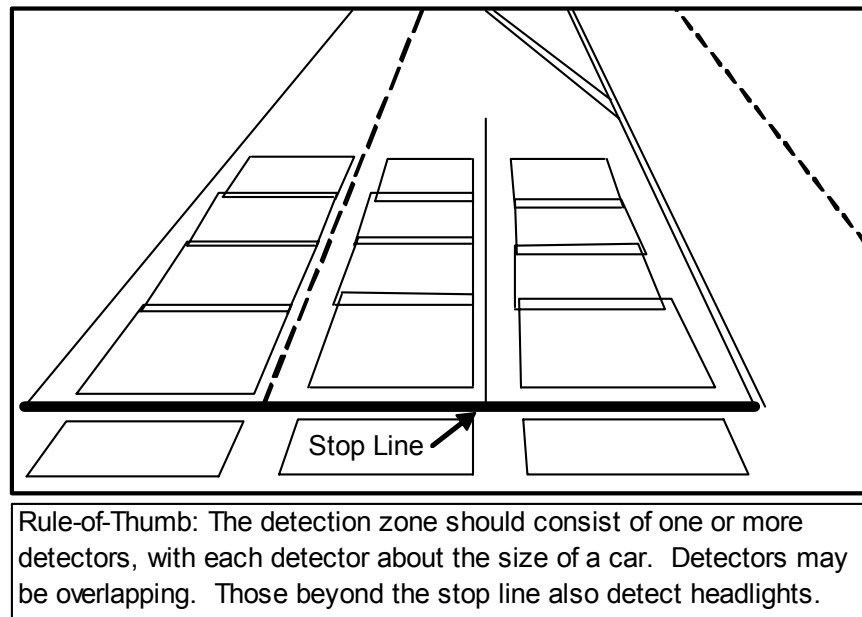

Figure C-6. Illustrative Stop Line Detection Zone Layout Using Video Detection.

Detection Mode

One benefit of a VIVDS is the large number of detection zones that can be used and the limitless ways in which they can be combined and configured to control the intersection. Both pulse-mode and presence-mode detectors can be used, where the latter can have any desired length. In addition, VIVDS detectors can be set to detect only those vehicles traveling in one direction (i.e., directional detectors). They can also be linked to each other using Boolean functions (i.e., AND, OR). The use of these features is shown in Figure C-7. The detector labeled “delay” in this figure is described in the next section.

Figure C-7 is an idealized illustration of alternative detection modes. The approach shown has presence-mode stop line detection in each of the through and left-turn lanes. The left-turn lane uses two parallel detection zones for improved selectivity and sensitivity. Specifically, the right-side camera offset raises the possibility of an unneeded call from a tall vehicle in the adjacent through lane. The AND linkage for the two left-turn detection zones minimizes this problem. Also, for some VIVDS products, the use of two detectors in the same lane improves detection sensitivity. If obtaining reliable detection for protected-only left-turn phases is problematic, then locking memory can be used for the left-turn phase.

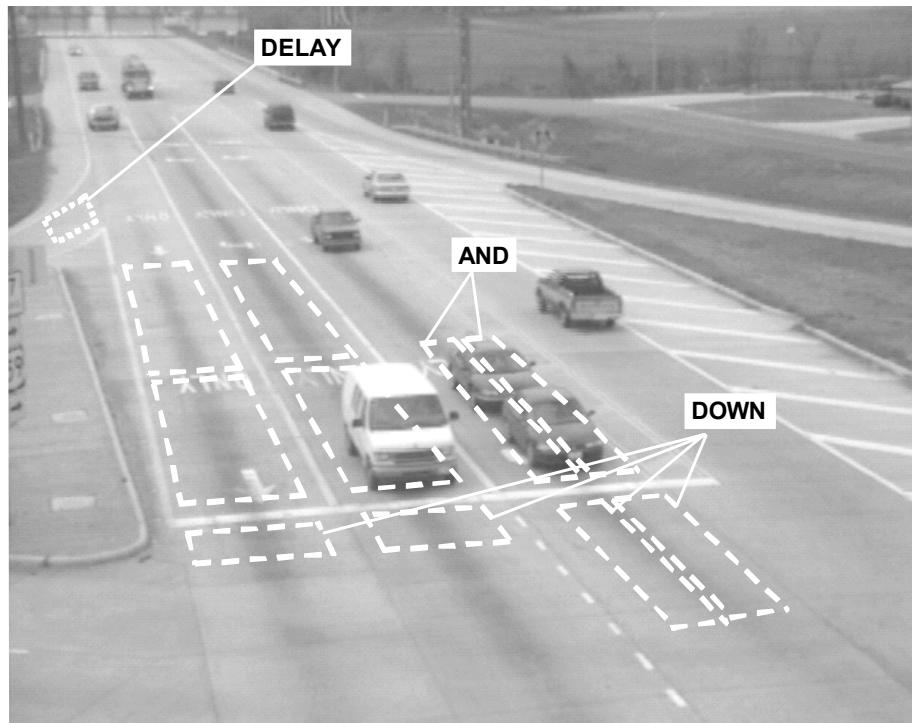

Figure C-7. Alternative Detection Modes.

The intersection approach shown in Figure C-7 is skewed from 90 degrees, which results in a large distance between the stop line and the crossroad. This setback distance is especially significant for the left-turn movements. In anticipation of left-turn drivers creeping past the stop line while waiting for a green indication, additional detectors are located beyond the stop line. However, they are directional detectors (as denoted by the word DOWN), such that they prevent crossing vehicles from triggering an unneeded call. The detectors located beyond the stop line in the through lanes are also directional detectors. They are used to enhance vehicle detection during nighttime hours.

Detector Settings

Video detectors have delay and extend settings that can be used to screen calls or add time to their duration, as may be needed by the detection design. These settings are identical in performance and purpose to those available with inductive loop amplifiers. The use of the delay setting is shown in Figure C-7. The detector in the right-turn lane is used as a queue detector to trigger a call to the through movement in the event that the right-turning drivers cannot find adequate gaps in traffic. The delay setting is set to about 2 s, such that a turning vehicle does not trigger a call unless it is stopped in queue.

The delay setting is also used to reduce the frequency of unneeded calls. Specifically, a few seconds of delay is often set on the detectors in the stop line detection zone of each minor-road approach. This setting offers two benefits. First, it eliminates false calls to the minor-road phases

by major-road vehicle headlights (such as when a major-road vehicle makes a right turn and its headlights sweep across the minor-road stop line detection zone). Second, it eliminates false calls to the minor-road phases by tall major-road vehicles (i.e., when tall vehicles cross the view of the minor-road camera and momentarily project their image onto the minor-road stop line detection zones).

The delay setting is also appropriate for the detectors in the left-turn bay when monitored by a left-side-mounted camera. This delay setting will screen unneeded calls for the left-turn phase that are placed by a tall through vehicle traveling away from the intersection or by headlights from the adjacent through movement. A 10-s delay setting should be sufficient to prevent these calls.

REFERENCES

1. Wu, C-S., C.E. Lee, R.B. Machemehl, and J. Williams. "Effects of Multiple-Point Detectors on Delay and Accidents." *Transportation Research Record 881*. National Research Council, Washington, D.C., 1982, pp. 1–9.
2. ITE Committee TENC-103-02. *Using Existing Loops at Signalized Intersections for Traffic Counts: An ITE Informational Report*. No. IR-122. Institute of Transportation Engineers, Washington, D.C., 2008.
3. Zimmerman, K., J. Bonneson, M. Pratt, and S. Sunkari. "Technical Memorandum No. 2: Summary of Signal Timing Interviews with District Traffic Personnel." TxDOT Project 0-5629. Texas Transportation Institute, The Texas A&M University System, College Station, Texas, June 2007.
4. Klein, L., M. Mills, and D. Gibson. *Traffic Detector Handbook: Third Edition*. Report No. FHWA-HRT-06-108. Federal Highway Administration, Turner-Fairbank Highway Research Center, McLean, Virginia, October 2006.
5. ITE Technical Committee 18 (P.S. Parsonson, Chair). "Small-Area Detection at Intersection Approaches." *Traffic Engineering*. Institute of Transportation Engineers, Washington, D.C., February 1974, pp. 8–17.
6. Zegeer, C.V., and R.C. Deen. "Green-Extension Systems at High-Speed Intersections." *ITE Journal*. Institute of Transportation Engineers, Washington, D.C., November 1978, pp. 19–24.
7. Chang, M.S., C.J. Messer, and A.J. Santiago. "Timing Traffic Signal Change Intervals Based on Driver Behavior." *Transportation Research Record No. 1027*. Transportation Research Board, National Research Council, Washington, D.C., 1985, pp. 20–30.
8. *A Policy on Geometric Design of Highways and Streets*. American Association of State and Highway Transportation Officials, Washington, D.C., 2004.

9. Lin, F.B. “Optimal Timing Settings and Detector Lengths of Presence Mode Full-Actuated Control.” *Transportation Research Record No. 1010*. Transportation Research Board, National Research Council, Washington, D.C., 1985, pp. 37–45.
10. Zimmerman, K., and J.A. Bonneson. “In-Service Evaluation of the Detection-Control System for Isolated High-Speed Intersections.” *Transportation Research Record 1978*. Transportation Research Board, Washington, D.C., 2006, pp. 34–41.
11. Bonneson, J., and M.M. Abbas. *Intersection Video Detection Manual*. Report No. FHWA/TX-03/4285-2. Texas Department of Transportation, Austin, Texas, September 2002.
12. Rhodes, A., K. Jennings, and D. Bullock. “Consistency of Video Detection Activation and Deactivation Times between Day and Night Periods.” *Journal of Transportation Engineering*. American Association of Civil Engineers, Reston, Virginia, September 2007.
13. Middleton, D., E.S. Park, H. Charara, and R. Longmire. “Evidence of Unacceptable Video Detector Performance for Dilemma Zone Protection.” Paper No. 08-2617. Presented at the Annual Meeting of the Transportation Research Board, Washington, D.C., January 2008.

APPENDIX D. DIAMOND INTERCHANGE PHASING, TIMING, AND DESIGN

This appendix provides guidelines for establishing the signal phase sequence, timing, and detection design for a signalized diamond interchange. The focus of this appendix is on the signalization elements that are unique to diamond interchanges such that the guidance provided in previous chapters and appendices does not directly apply.

The topic of signalized interchange operation is complex, due partly to the wide variety of interchange configurations in use and their influence on signal phase sequence selection. Nevertheless, interchanges in Texas tend to have a diamond configuration and often include frontage roads. The Texas Diamond Controller is used by TxDOT at these interchanges to provide consistent diamond interchange operation. The Texas Diamond Controller is a standard, fully actuated traffic signal controller that includes supplemental software to adapt the dual-ring structure to interchange operation. A single Texas Diamond Controller can provide efficient, coordinated service along the surface street at a diamond interchange. The Texas Diamond Controller software allows the choice of four phase sequence alternatives (i.e., three phase, four phase, separate intersection, and two phase) to accommodate a wide range of interchange sizes and volume levels.

The guidelines in this appendix are focused on the Texas Diamond Controller and the phase sequences that it supports. The guidelines address the use of this controller at interchanges that operate in isolation of other signalized intersections and that serve one-way frontage roads. Guidance on the coordination of a signalized diamond interchange with adjacent signalized intersections is provided by Chaudhary and Chu (*1*).

This appendix consists of three parts. The first part provides an overview of diamond interchange signal operation and performance measures. The second part summarizes basic interchange signal phasing, timing, and detection design concepts and establishes a vocabulary. The last part provides guidelines for the selection of an effective phase sequence, controller settings, and detector layout for a signalized diamond interchange.

OVERVIEW

Diamond interchange operation has become increasingly complicated in recent years. Heavy traffic volumes and complicated traffic patterns are placing more and more emphasis on increasing the efficiency of interchange operation. The effective signal control of a diamond interchange can minimize traffic backups on off-ramps, alleviate congestion on freeways, and reduce travel time along the surface streets.

This part of the appendix provides an overview of the objectives of diamond interchange operation. The discussion is intended to highlight the influence of signal timing on traffic efficiency. It describes the benefits derived from maintenance of timing and identifies the various performance measures that can be used to quantify these benefits.

Diamond Interchange Timing Objectives

Diamond interchanges are characterized by two intersections where interchanging traffic from the freeway intersects with the arterial street, as illustrated in Figure D-1a. When frontage roads are present, the ramps combine with the frontage road in advance of the arterial street. This configuration is illustrated in Figure D-1b. It is characterized as a “full” diamond because it has a frontage road (or ramp) approach leg and a frontage road (or ramp) departure leg at both intersections. Variations of the traditional full diamond interchange configuration are shown in Figures D-1c and D-1d.

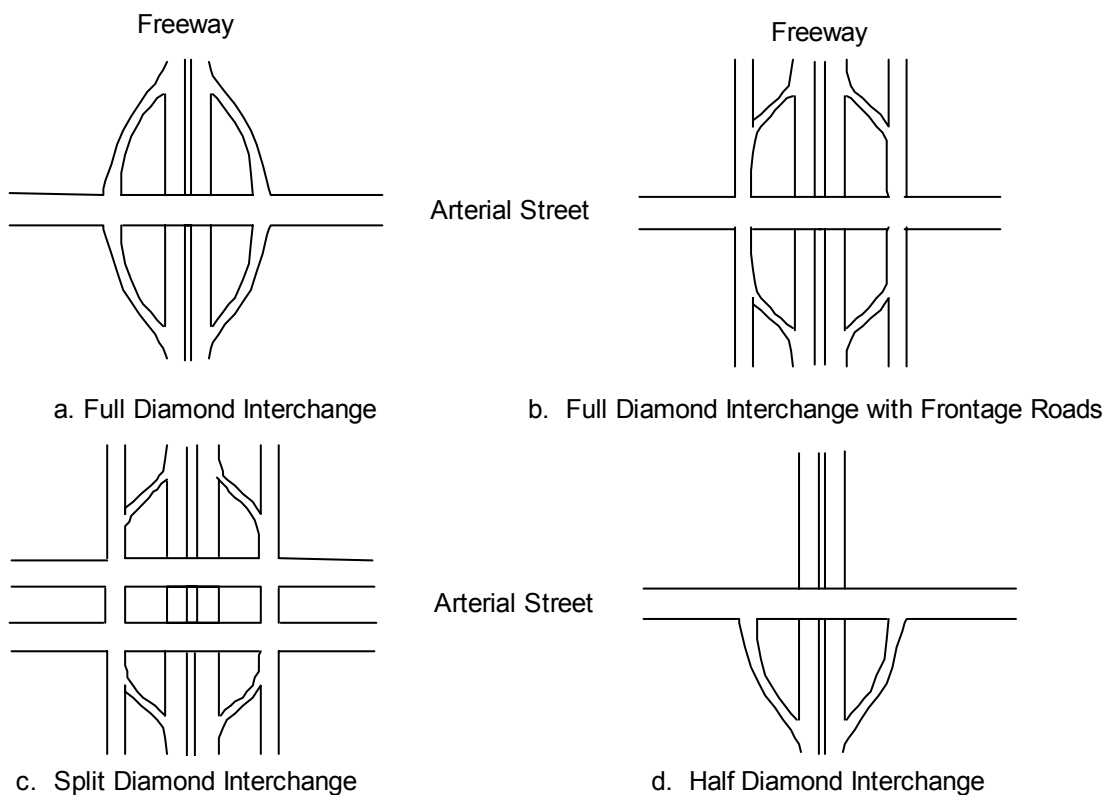

Figure D-1. Alternative Diamond Interchange Configurations.

The primary objective of diamond interchange signalization is to provide a safe and efficient operation for all persons traveling through the interchange. Traffic operation at one intersection will typically have an impact on traffic operation at the other intersection. Therefore, the signal timing plan for a diamond interchange should be designed to treat the two intersections (and the street between them) as a traffic signal system.

Achievement of the primary objective is sometimes challenging when the freeway and the arterial street are operated by different transportation agencies. In many instances, a city will operate the arterial street and has a goal of optimizing traffic progression along the street. The state

will operate the freeway and has a goal of avoiding situations where exit ramp traffic spills back onto the freeway. Techniques for achieving these goals through interchange signalization are sometimes in conflict if pursued independently. However, their optimum balance is often realized when the interchange's signalization is designed to treat the interchange and its adjacent arterial intersections as part of a traffic signal system.

Performance Measures

Performance measures used to assess the efficiency of interchange operation are similar to those used for signalized intersections. The typical measures include delay, queue length, stop rate, travel speed, progression efficiency, and attainability. The last three of these measures describe the quality of progression provided along the arterial street between the two intersections.

One performance measure that is particularly useful when evaluating diamond interchange operation is storage ratio (2). This ratio is computed as the number of vehicles in queue between the two intersections divided by the available storage space. The "number of queued vehicles" represents the maximum number of vehicles that queue each signal cycle, as averaged over the analysis period. A storage ratio in excess of 0.8 indicates the potential for spillback from one intersection to another.

Interchange performance can be quantified by field observation or through the use of various signal timing software products. Of particular note is the PASSER III software product that was developed specifically for the evaluation of signalized diamond interchange operation (2).

PASSER III software is an effective tool for evaluating (and optimizing) the performance of a signalized diamond interchange.

CONCEPTS

The development of an operational strategy for a diamond interchange requires an understanding of its unique operating characteristics. An "operational strategy" represents the phase sequence and timing-related settings implemented in the interchange signal controller. The operational strategy used at an interchange needs to reflect consideration of the relationship between interchange geometry, traffic patterns, traffic volume, signal phasing, and signal timing. These concepts are discussed more fully in this part of the appendix. Topics addressed include: interchange spacing, interchange traffic demand patterns, phase sequence, phase settings, detection design, and pedestrian settings.

Interchange Spacing

Interchange spacing is a critical consideration in the development of an effective operational strategy. It is defined as the distance between the stop line at the two intersections, as measured in a specified direction of travel along the arterial street. From an operational perspective, interchange spacing is categorized as narrow (i.e., less than 400 ft), intermediate (i.e., 400 to 800 ft), and wide (i.e., more than 800 ft).

Interchanges with narrow spacing are characterized by a smaller storage space along the arterial between the frontage roads. Narrow interchanges require an operational strategy that avoids having vehicles stopped within the interchange. On the other hand, a range of phase sequences and timings are available for wide interchanges because they can store vehicles within the interchange. Regardless of the strategy selected, the storage ratio should not exceed 0.8, and the upstream intersection signalization should not restrict arterial street traffic flow such that the phases serving outbound traffic at the downstream intersection are underutilized.

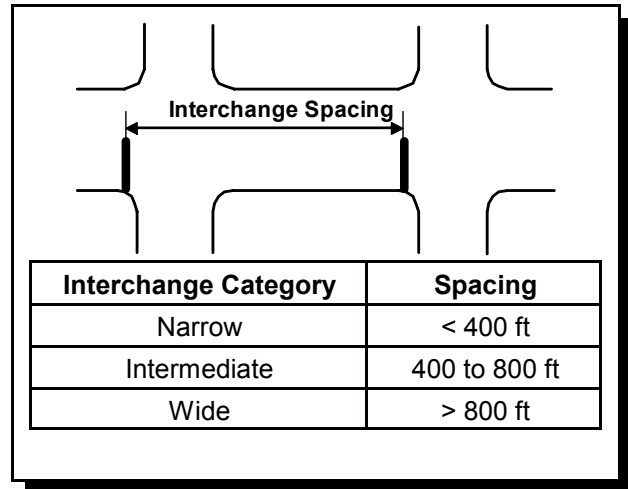

Interchange Traffic Patterns

In addition to interchange spacing, the interchange's traffic pattern also has a significant impact on the development of an effective signalization plan. An interchange's traffic pattern is characterized by the degree of balance in both the frontage road (or ramp) traffic volume and the arterial street traffic volume. Typical traffic patterns are shown in Figure D-2.

Frontage road traffic demand patterns are shown in Figure D-2a. When frontage road volumes are balanced (i.e., both frontage roads have similar traffic volume levels), some signalization plans are more efficient than others. However, when these volumes are unbalanced, still other plans may be more effective. Internal left-turn and arterial through traffic volume patterns have a similar influence on the selection of a signalization plan. These patterns are shown in Figures D-2b and D-2c, respectively. Due to the daily variability in traffic patterns at most interchanges, phase sequence and timing are often changed on a time-of-day basis to provide the most effective plan for the traffic pattern that occurs during each time period.

Types of Traffic Signal Control

There are two types of traffic control that have been used for diamond interchanges. Traditionally, an electro-mechanical controller was used to provide pretimed control. However, with the development of solid-state controllers, fully-actuated control has provided a viable replacement for pretimed control. The first generation of solid-state controllers had only eight phases and did not provide the flexibility needed to implement the more complicated diamond interchange strategies. The subsequent development of 16-phase controllers has made it possible to operate the diamond interchange with a wide range of interchange spacings and traffic patterns.

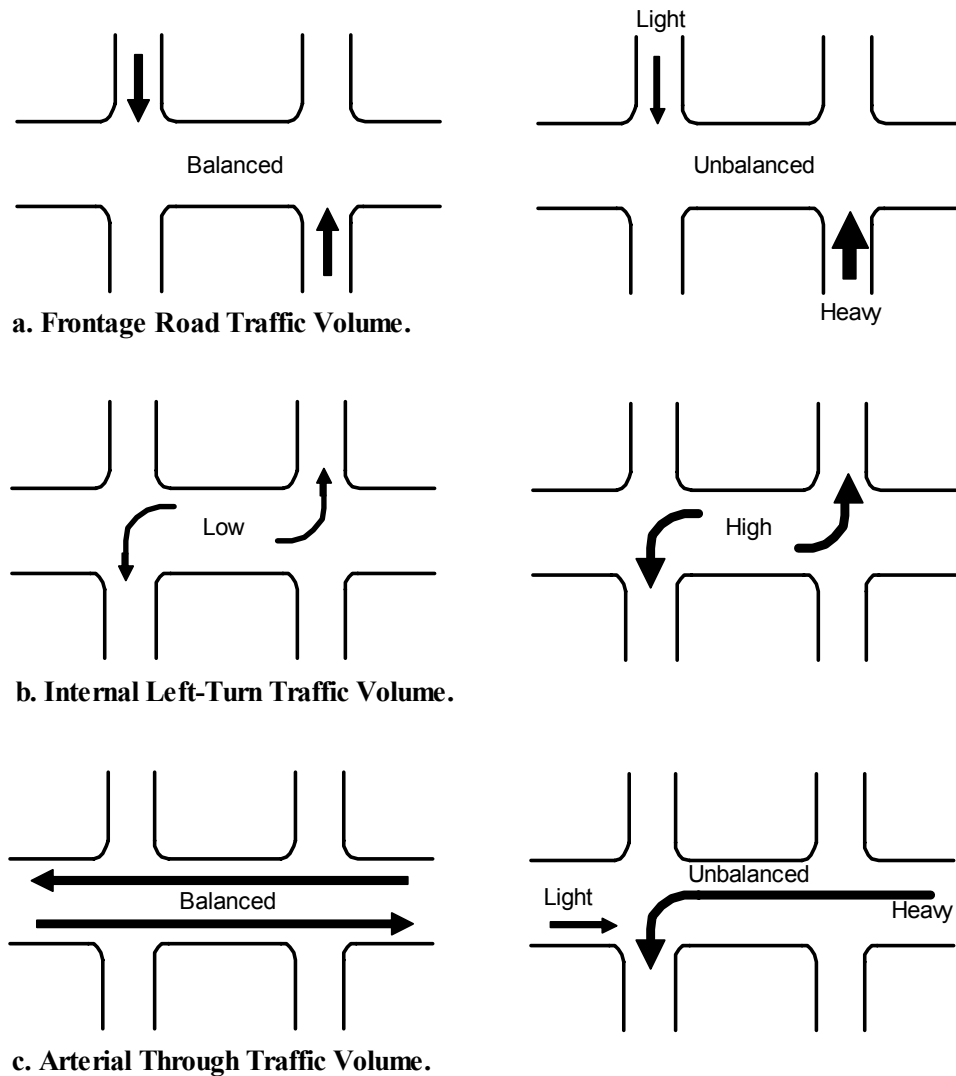

Figure D-2. Interchange Traffic Patterns.

A diamond interchange can be controlled using one or two controllers. If one controller is used, it is a dual-ring controller where each ring is designated to serve the movements at one intersection. This technique allows the signal controller to operate as fully actuated while maintaining traffic progression between the two intersections.

A single controller is typically used to operate a diamond interchange.

If two controllers are used, then one controller is assigned to each intersection and they are coordinated using an external synchronization input. This configuration has the advantage of allowing a larger set of operational strategies to be implemented. However, the use of two controllers requires a thorough understanding of the external coordination equipment. It also requires the provision of additional detector inputs and overlap outputs.

Phase Sequence

The quality of service provided by a diamond interchange is heavily dependent on the compatibility between the phase sequence, interchange spacing, and traffic pattern. Four phase sequences are typically used at diamond interchanges. They are referred to by the following names:

- Three-phase sequence.
- Four-phase sequence.
- Separate intersection sequence.
- Two-phase sequence.

In addition to these four sequences, engineers sometimes use a special sequence (i.e., a non-diamond mode) to operate diamond interchanges. This section briefly describes the aforementioned phase sequence alternatives.

Related to the discussion of interchange phase sequence is the assignment of phases to interchange traffic movements. Each signal phase is assigned to serve one or more movements. A convention has been established that relates the movements to the phases. It is described in a subsequent section. Regardless, it is useful at this point to identify the traffic movements at a diamond interchange. They are typically numbered from 1 through 8, as shown in Figure D-3. The movements served by each phase are indicated using arrows pointing in the direction of traffic flow and are referenced to either the “left” or the “right” intersection.

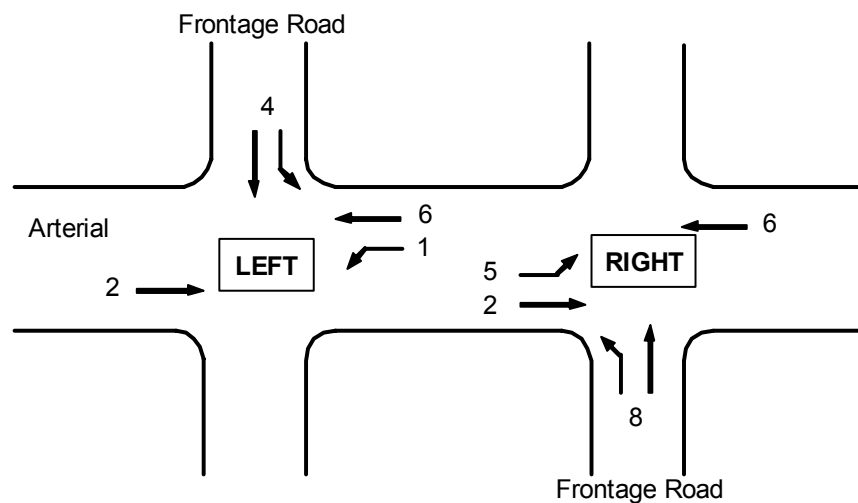

Figure D-3. Interchange Traffic Movements and Numbering Scheme.

Three-Phase Sequence

The three-phase sequence treats the interchange as two separate intersections, with each intersection having three phases (i.e., an

The three-phase sequence is most effective at wide interchanges with balanced, high-volume arterial through movements.

external arterial phase, a frontage road phase, and an internal arterial phase). This sequence is shown in Figure D-4. The three-phase sequence is characterized by the two external arterial phases (i.e., phase 2 at the left intersection and phase 6 at the right intersection) that start simultaneously. The traffic movements served by these phases are also indicated in Figure D-4 using movement arrows. Also indicated is its association with either the “left” or “right” intersection. The physical location of the corresponding traffic movement at the interchange is identified in Figure D-3.

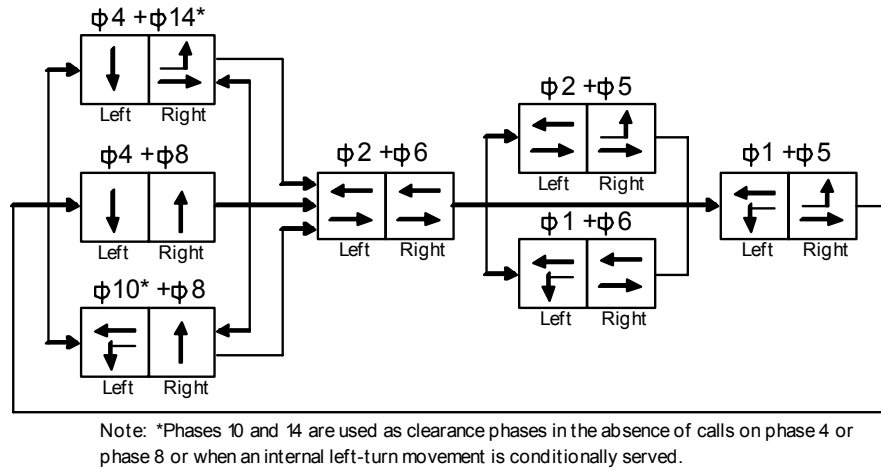

a. Phase Sequence.

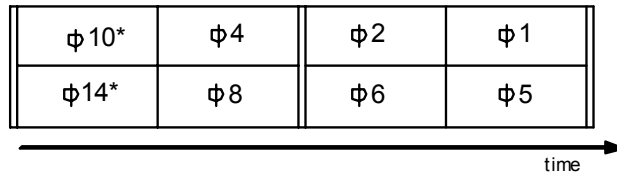

b. Controller Ring Structure.

Figure D-4. Three-Phase Sequence.

The external arterial phases are followed by the two internal left-turn phases (i.e., phase 1 at the left intersection and phase 5 at the right intersection). These phases usually end simultaneously. The internal movements are also served during phase 10 and phase 14 under certain circumstances.

The two frontage road phases (i.e., phase 4 at the left intersection and phase 8 at the right intersection) usually start and end simultaneously. However, if there is demand on only one frontage road phase, then this phase will operate with a compatible internal left-turn phase. For example, if there is demand for phase 4, but no demand for phase 8, then phase 4 and phase 14 will be called. This sequence is very effective at clearing frontage road traffic from the interior of the interchange.

The three-phase sequence has the following characteristics:

- Arterial through traffic typically has good progression through the interchange and with adjacent signalized intersections on the arterial street.
- Adequate storage between intersections is needed when serving phases 4 and 8.
- Frontage road traffic volumes should be reasonably balanced.

Four-Phase Sequence

The four-phase sequence treats the interchange as a single intersection with four external approaches, and with each approach served by a separate phase. This sequence is shown in Figure D-5. The external arterial approaches are served by phase 2 or phase 6. The frontage road approaches are served by phase 4 or phase 8. The four external approach phases influence the duration of the two phases that serve the internal approaches. Each of the four external approach phases can operate as fully actuated. Two fixed-length transition intervals are often used with the four-phase sequence to maximize interchange throughput. These transition intervals use phase 12 to serve the left-side frontage road approach and phase 16 to serve the right-side frontage road approach.

The four-phase sequence is most effective at narrow interchanges with high-volume internal left-turn movements.

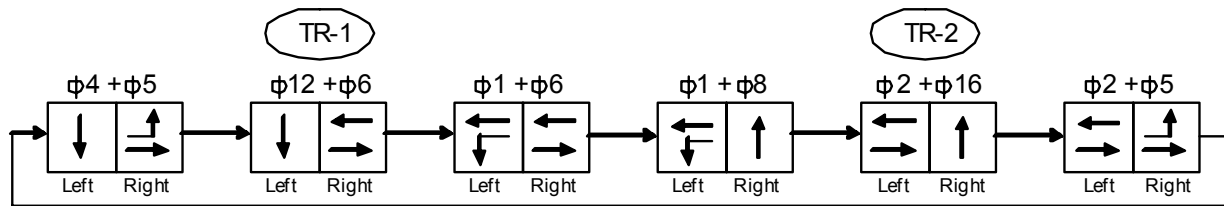

Note: *Phases 12 and 16 are used to provide a short transition interval during which the frontage road phase at one intersection and the external arterial phase at the other intersection are active at the same time.

a. Phase Sequence.

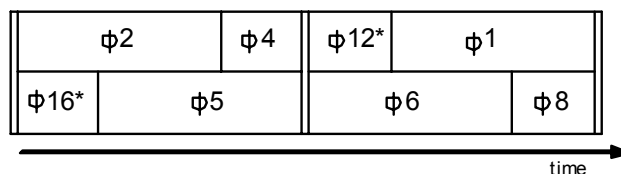

b. Controller Ring Structure.

Figure D-5. Four-Phase Sequence.

As shown in Figure D-5a, the four-phase sequence starts with phases 4 and 5. This phase pair is followed by the two phases that comprise the first transition interval (i.e., TR-1). The movements served during this interval (i.e., movements 4 and 6) conflict with each other; however, the duration of this interval is fixed at a value that is just shorter than the travel time between

intersections. In this manner, the transition interval ends movement 4 just as movement 6 arrives at the left-side intersection, and the conflict is avoided.

The first transition interval is followed by phase 1 at the left-side intersection and phase 6 at the right-side intersection. This phase pair provides an interval during which the arterial through movement 6 is progressed through the interchange. Phases 1 and 8 follow phases 1 and 6. The interval associated with this phase pair serves to clear the internal approach serving movement 6 at the left-side intersections.

The second transition interval (i.e., TR-2) follows phases 1 and 8. This interval serves movements 2 and 8). Like the first transition interval, the second transition interval has a fixed duration that is equal to the interchange travel time. This transition interval is followed by phases 2 and 5. This phase pair provides good progression for arterial through movement 2.

The four-phase sequence has the following characteristics:

- Arterial traffic movements have progression through the interchange but tend to be limited in their ability to be coordinated with adjacent intersections along the arterial street.
- Phases serving the external approaches are fully actuated.
- The duration of the phases serving the external approaches can vary each cycle and, thereby, minimize the potential for queue spillback onto the freeway or into an adjacent intersection.
- Phases serving the internal movements always clear the interior of the interchange such that the adequacy of internal storage space is not an issue.
- The two transition intervals improve throughput during high-volume conditions. However, they can be inefficient during low-volume conditions.

Separate Intersection Sequence

The separate intersection sequence assigns one ring to control each intersection. Coordination between the two intersections is achieved by specifying a common cycle length and a fixed offset between the coordinated phase at each intersection (i.e., in each ring). This offset is generally referred to as ring lag. This use of the separate intersection sequence typically provides good progression for only one of the two arterial through movements. The separate intersection sequence is shown in Figure D-6.

The separate intersection phase sequence is most effective at wide interchanges with unbalanced traffic movements.

As shown in Figure D-6a, each intersection of the interchange has the three phases. However, each intersection is controlled by a separate ring. Ring lag is used to maintain the coordination between the two rings. The separate intersection sequence provides some of the flexibility that was traditionally afforded when two controllers were used to control the interchange.

The separate intersection sequence is typically used to provide coordination for the two intersections. However, each ring can be allowed to time independently of the other ring if desired. In this manner, it is possible to operate the two intersections in an isolated, non-coordinated manner.

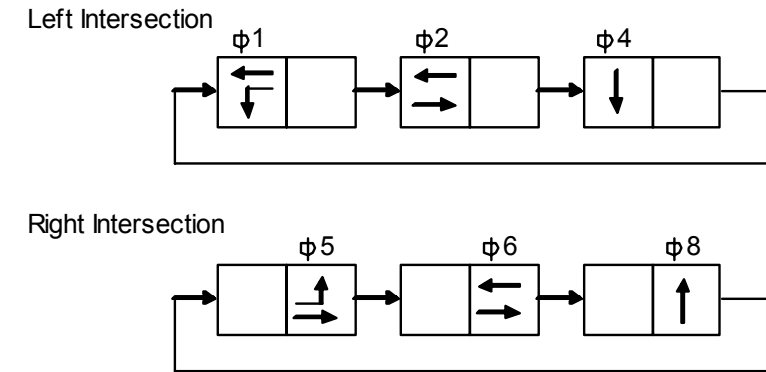

a. Phase Sequence.

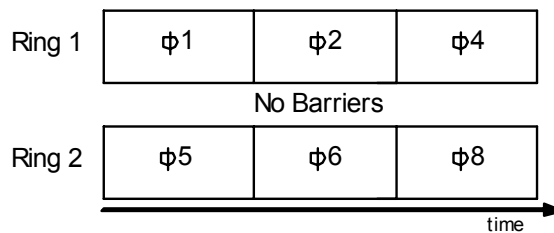

b. Controller Ring Structure.

Figure D-6. Separate Intersection Phase Sequence.

Two-Phase Sequence

The two-phase sequence is typically used in downtown areas having one-way streets and short spacing between intersections. It is also used at low-volume intersections in small towns. The two-phase sequence is applicable when the protected-permissive mode is used for the phases serving the internal left-turn movements. This sequence is shown in Figure D-7.

The two-phase sequence is most effective at interchanges with low-volume internal left-turn movements.

The two-phase sequence is achieved by omitting the internal left-turn phases (i.e., phases 1 and 5) from the separate intersection sequence. The associated left-turn movements are then served in a permissive manner while this sequence is operational. The two-phase sequence is typically invoked during low-volume periods of the day by using special functions within the controller. When used in this manner, it can reduce unnecessary delay to the arterial and frontage road traffic.

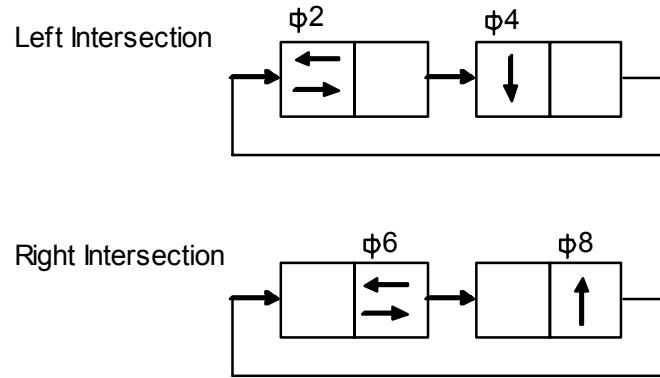

a. Phase Sequence.

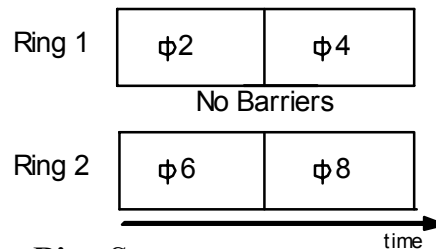

b. Controller Ring Structure.

Figure D-7. Two-Phase Sequence.

Non-Diamond Mode

The diamond mode is used to refer to the use of a two-phase, three-phase, four-phase, or separate intersection sequence, as implemented in a Texas Diamond Controller. If a single controller is used to control an interchange and the diamond mode is not used, then the controller is said to be operating in a non-diamond mode. This mode is used when the diamond-mode phases are unable to serve existing traffic patterns in a satisfactory manner. In the non-diamond mode, the engineer specifies the desired phase sequence by defining the ring structure and phase assignments. This mode offers the flexibility of a two-controller operation while eliminating the need to maintain external synchronization between the two controllers. If the non-diamond mode is used, the interchange cannot be set to automatically revert to the diamond mode on a time-of-day basis.

Detection Design

This section describes the detection design for an interchange that is controlled by a Texas Diamond Controller. The effective operation of this controller requires the installation of detectors at the locations identified in Figure D-8. The rectangular-shaped detectors are 40 ft in length. They

are located at the stop line. In contrast, the detectors that are square represent advance detectors that are located a specified distance upstream of the stop line.

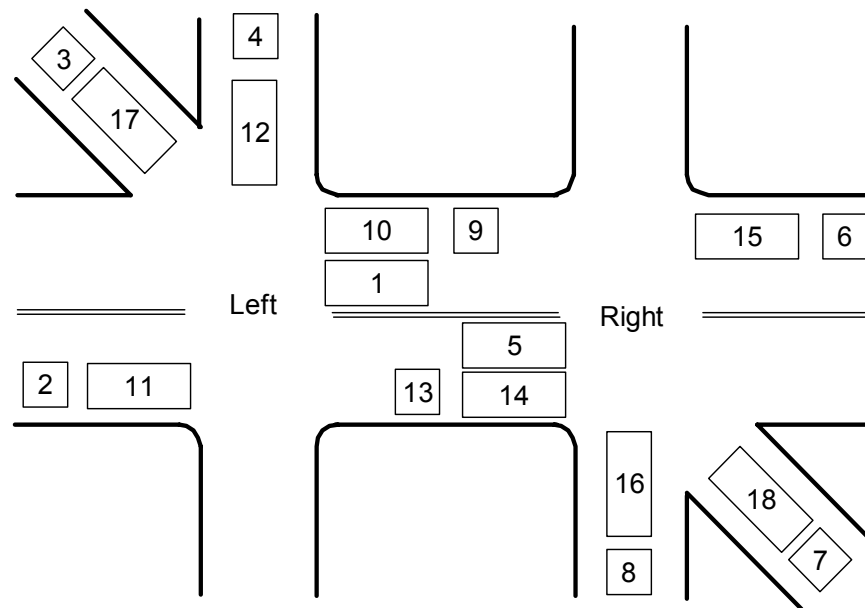

Figure D-8. Detector Layout for the Texas Diamond Controller.

The function of the detectors is preset in the Texas Diamond Controller logic. The function of each detector as well as its location, size, and settings are provided in Table D-1. This table is used in combination with Figure D-8 to define the detector layout and design.

Column 7 of Table D-1 indicates that detectors 2, 3, 4, 6, 7, and 8 (i.e., the advance detectors) have a 2-s delay setting programmed in the controller. This delay is active only during the red indication for the phase that serves the associated movement or approach. Similarly, stop line detectors 11, 12, 15, 16, 17, and 18 serve as “queue” detectors. They are active during the red indication and during the start of the green interval. They become inactive during the green interval following the first occurrence of a 0.2-s gap between detections.

Conditional Service

Conditional service is a feature available in most modern controllers and is applicable to diamond interchanges when using the three-phase sequence. Figure D-9 illustrates the ring structure and display sequence when using conditional service with the three-phase sequence. This figure is the same as shown previously in Figure D-4; however, some of the linkages in Figure D-9a for phases 4, 8, 10, and 14 are deleted to illustrate the path followed when conditional service is provided.

Table D-1. Texas Diamond Controller Detector Layout and Function.

Phase	Detector Channel Assignment	Detector Location	Detection Length, ft ¹	Detector Function		Special Controller Settings ²
				Extend?	Call?	
Φ1	1	Stop line	40	✓	✓	--
Φ2	2	Advance	6	✓	--	2.0 s delay
	11	Stop line	40	✓	✓	Inactive after a 0.2 s gap
Φ3	3	Advance	6	✓	--	2.0 s delay
	17	Stop line	40	✓	✓	Inactive after a 0.2 s gap
Φ4	4	Advance	6	✓	--	2.0 s delay
	12	Stop line	40	✓	✓	Inactive after a 0.2 s gap
Φ5	5	Stop line	40	✓	✓	--
Φ6	6	Advance	6	✓	--	2.0 s delay
	15	Stop line	40	✓	✓	Inactive after a 0.2 s gap
Φ7	7	Advance	6	✓	--	2.0 s delay
	18	Stop line	40	✓	✓	Inactive after a 0.2 s gap
Φ8	8	Advance	6	✓	--	2.0 s delay
	16	Stop line	40	✓	✓	Inactive after a 0.2 s gap
Overlap A (Φ1 + Φ2)	9	Advance	6	✓	--	Extends Φ2
	10	Stop line	40	✓	✓	Calls Φ6, extends Φ2
Overlap B (Φ5 + Φ6)	13	Advance	6	✓	--	Extends Φ6
	14	Stop line	40	✓	✓	Calls Φ2, extends Φ6

Notes:

"--": not used.

1 - Detection length of 40 ft may consist of one long detector or a series of short detectors evenly spaced to provide a continuous call for a passenger car as it traverses the 40-ft detection zone length.

2 - All detectors operate in the presence mode and use nonlocking memory. The special settings shown are preset in the Texas Diamond Controller logic.

Conditional service allows the controller to step back to an earlier phase in the ring if certain conditions are met. These conditions are:

- One of the frontage road phases terminates by gap-out.
- There is a call on the internal left-turn phase in the same ring as the frontage road phase.
- There is sufficient time to service the minimum green for the internal left-turn phase before the non-terminating frontage road phase reaches its maximum limit.
- The controller is not operating in a coordination mode.

For example, consider that a point in the cycle is reached where phase 4 has gapped out and there is a call for service on phase 1. Phase 8 has not gapped out yet, and the time remaining in this phase (before the maximum green limit) exceeds the minimum green setting for phase 10. At this point in time, the controller will “conditionally” serve phase 10 with phase 8. This sequence is

shown in Figure D-9a using the thick bold lines to highlight the phase linkages followed by the controller.

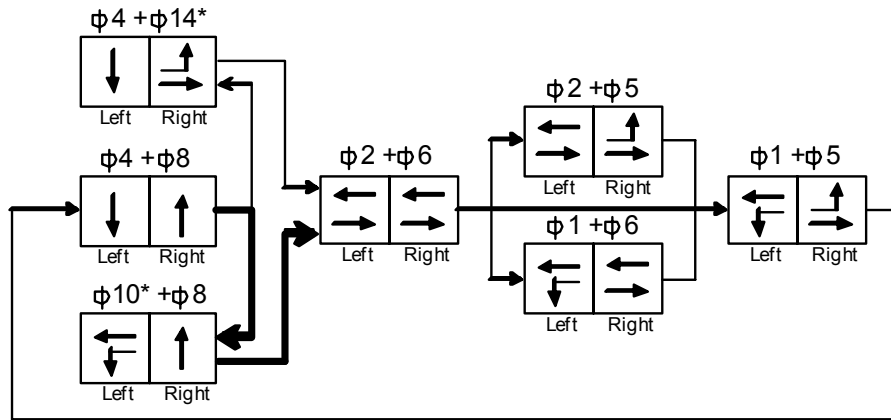

Note: *Phases 10 and 14 are used as clearance phases in the absence of calls on phase 4 or phase 8 or when an internal left-turn movement is conditionally served.

a. Phase Sequence.

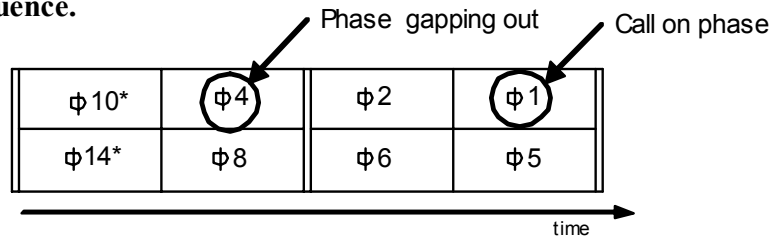

b. Controller Ring Structure.

Figure D-9. Conditional Service with the Three-Phase Sequence.

The typical sequence of phases is disrupted when conditional service is used. With a typical three-phase sequence, the frontage road phases start at the same time and end at the same time. The internal left-turn phases lag the opposing through movement phases. Conditional service changes this sequence by terminating one frontage road phase before the other and replacing it by an internal left-turn phase. Thus, conditional service results in one internal left-turn phase being serviced twice during the same cycle.

GUIDELINES

This part of the appendix provides guidelines for establishing the phase sequence, timing, or detection layout for a signalized diamond interchange. Guidelines for these topics, as they relate to signalized intersections, are provided in other chapters and appendices. The focus of these guidelines are those sequences, settings, or layouts that are unique to the isolated diamond interchange. Guidance on the coordination of signalized diamond interchanges with adjacent signalized intersections is provided by Chaudhary and Chu (1).

Selection of Phase Sequence

Phase sequence selection is critical to the efficient operation of a diamond interchange. The phase sequences typically used at a diamond interchange include:

- Three-phase sequence.
- Four-phase sequence.
- Separate intersection sequence.
- Two-phase sequence.

Table D-2 identifies typical phase sequences that are used for various spacing and traffic patterns. To illustrate the use of Table D-2, consider an interchange with a spacing of 500 ft, a balanced arterial through traffic pattern, a balanced frontage road traffic pattern, and low internal left-turn volume. Table D-2 indicates that a three-phase sequence is typically used at interchanges with these characteristics. However, the second footnote to the table cautions that this sequence should only be used if adequate storage is available to the internal left-turn movements. The first table footnote indicates that a two-phase sequence is sometimes used in this situation—provided that the left-turn phases can be operated in the protected-permissive mode.

The choice of phase sequence for an interchange may be varied by time of day to accommodate the changes in traffic volume during the typical day. The Texas Diamond Controller supports time-of-day switching between the three-phase, four-phase, and separate intersection sequences. *If time-of-day switching among sequences is used, some care should be taken to confirm that drivers are not confused by it and that the anticipated operational benefits are realized.*

Several trends are apparent by inspection of Table D-2. For interchanges with narrow spacing, the four-phase sequence is typically used because it minimizes the need for internal storage. Under moderate- to high-volume conditions, the four-phase sequence is efficient because of its use of transition intervals.

The three-phase sequence is typically used at interchanges with a spacing of 400 ft or more, especially when the arterial through pattern is balanced or the frontage road traffic pattern is balanced. It provides good progression for the arterial through traffic movement. The three-phase sequence typically has the arterial phases and the frontage road phases starting and ending together. Hence, interchange operation is very efficient when these volumes are balanced.

Both the three-phase and the separate intersection phase sequences are viable at interchanges that are wider than 800 ft. In general, preference should be given to the three-phase sequence over the separate intersection sequence when this choice is offered in the table. In fact, the separate intersection mode is rarely used in Texas for a variety of reasons. If it is being considered for a specific location, a detailed study of the interchange should be undertaken and the separate intersection sequence used only if the findings confirm that it is the most appropriate sequence.

Table D-2. Guidelines for Selection of Diamond Interchange Phasing.

Interchange Spacing	Arterial Through Traffic Volume	Frontage Road Traffic Pattern	Internal Left-Turn Traffic Volume	Typical Phase Sequence
Less than 400 ft (narrow)	Unbalanced	Balanced	Low ¹	Four
			High	
		Unbalanced	Low ¹	
			High	
	Balanced	Balanced	Low ¹	Four or three ²
			High	Four
		Unbalanced	Low ¹	Four or three ²
			High	Four
Between 400 and 800 ft (intermediate)	Unbalanced	Balanced	Low ¹	Three ²
			High	Three ² or separate
		Unbalanced	Low ¹	Separate
			High	
	Balanced	Balanced	Low ¹	Three ²
			High	
		Unbalanced	Low ¹	Separate
			High	Three ² or separate
More than 800 ft (wide)	Unbalanced	Balanced	Low ¹	Three
			High	Separate
		Unbalanced	Low ¹	Separate
			High	
	Balanced	Balanced	Low ¹	Three
			High	
		Unbalanced	Low ¹	Separate
			High	

Notes:

1 - Two-phase sequence is sometimes used when the internal left-turn volume is low.

2 - Three-phase sequence is used only if adequate internal storage is available.

Guidelines for Actuated Phase Settings

Phase settings have a significant impact on interchange operation. Guidelines for selecting many of the basic settings are described in Chapter 2. This section focuses on phase settings that are specific to diamond interchange operation as well as the basic settings that are uniquely used at a diamond interchange.

This section provides guidance in the selection of phase settings for the three-phase, four-phase, and separate intersection sequences. It should be noted that settings for phases 10 and 14 must be entered in the traffic signal controller if conditional service is used with the three-phase sequence. Similarly, settings for phases 12 and 16 must be provided when the four-phase sequence is used.

Minimum Green

With a couple of exceptions, the minimum green setting for interchange phases should be based on consideration of driver expectancy and pedestrian crossing time. Guidelines for selecting minimum green settings based on these considerations are provided in Chapter 2. The exceptions are described in the following paragraphs.

Three-Phase Sequence. The minimum green settings for phases 1, 4, 5, 8, 10, and 14 in a three-phase sequence are based on consideration of driver expectancy and, if appropriate, pedestrian crossing time. Table 2-2 in Chapter 2 provides guidelines for selecting the appropriate minimum green values for these phases.

The minimum green setting for phases 2 and 6 is based on the need to ensure that an arterial through vehicle has sufficient time to travel from one intersection to the other before the overlap phase serving the downstream through (and left-turn) movements ends. Guidelines provided by Venglar et al. (2) can be used to estimate this travel time as a function of interchange spacing. This relationship is shown in Table D-3.

Table D-3. Minimum Green Setting for a Three-Phase Sequence.

Interchange Spacing, ft	Travel Time (T), s ¹	Minimum Green for Phase 1, s				Minimum Green for Phase 5, s			
		5	6	7	8	5	6	7	8
		Minimum Green for Phase 2 ($G_{min,2}$), s ²				Minimum Green for Phase 6 ($G_{min,6}$), s ³			
400	15	5	5	5	5	5	5	5	5
450	16	6	5	5	5	6	5	5	5
500	17	7	6	5	5	7	6	5	5
550	18	8	7	6	5	8	7	6	5
600	19	9	8	7	6	9	8	7	6
650	20	10	9	8	7	10	9	8	7
700	21	11	10	9	8	11	10	9	8
750	22	12	11	10	9	12	11	10	9
800	24	14	13	12	11	14	13	12	11
850	25	15	14	13	12	15	14	13	12
900	26	16	15	14	13	16	15	14	13
950	27	17	16	15	14	17	16	15	14
1000	28	18	17	16	15	18	17	16	15

Notes:

- 1 - Travel time is computed using the procedure described by Venglar et al. (2).
- 2 - $G_{min,2} = T - (Y_2 + Rc_2) - G_{min,1}$; where, T = travel time, Y_2 = yellow interval for phase 2, Rc_2 = red clearance interval for phase 2, and $G_{min,1}$ = minimum green for phase 1 (all values in seconds). $Y_2 + Rc_2$ is assumed to equal 5 s.
- 3 - $G_{min,6} = T - (Y_6 + Rc_6) - G_{min,5}$; where, T = travel time, Y_6 = yellow interval for phase 6, Rc_6 = red clearance interval for phase 6, and $G_{min,5}$ = minimum green for phase 5 (all values in seconds). $Y_6 + Rc_6$ is assumed to equal 5 s.

Table D-3 lists the minimum green setting for phase 2 and phase 6 in columns 3 through 6 and 7 through 10, respectively. The values listed are computed using the equations provided in the table footnotes. They are based on an assumed change period duration of 5 s. If the change period is significantly different than 5 s, then the equations in the footnotes should be used to compute the minimum green setting.

The minimum green values listed in Table D-3 ensure that an arterial through vehicle has sufficient time to travel through the interchange. The actual minimum green value used for phase 2 or phase 6 should also reflect consideration of the minimum green duration needed to satisfy driver expectancy and, if appropriate, pedestrian crossing time. Table 2-2 in Chapter 2 provides guidelines for selecting the appropriate minimum green values for these considerations.

To illustrate the use of Table D-3, consider an interchange with 500 ft spacing and a three-phase sequence. The minimum green setting for phase 1 is 5 s, and the change period for all phases is 5 s. Table D-3 indicates that the minimum green setting for phase 2 should be 7 s. Consideration of driver expectancy and pedestrian crossing time may require a larger value.

Four-Phase Sequence. When the four-phase sequence is used at an interchange, the minimum green setting for phases 2, 4, 6, 8, 12, and 16 is based on the travel time from one intersection to the other. Table D-4 lists minimum green settings for these phases.

Table D-4. Minimum Green Setting for a Four-Phase Sequence.

Interchange Spacing, ft	Travel Time (T), s ¹	Minimum Green for Phases 2 and 6, s ^{2,3}	Minimum Green for Phases 4 and 8, s ^{4,5}	Minimum Green for Phases 12 and 16, s ^{6,7}
100	7	9	5	2
150	9	12	6	2
200	10	15	7	3
250	11	17	8	4
300	12	20	9	5
350	13	22	10	6
400	15	24	12	8

Notes:

- 1 - Travel time is computed using the procedure described by Venglar et al. (2).
- 2 - $G_{min,2} = 2 \times T - (Y_8 + Rc_8)$; where, T = travel time, Y_8 = yellow interval for phase 8, and Rc_8 = red clearance interval for phase 8 (all values in seconds). $Y_8 + Rc_8$ is assumed to equal 5 s.
- 3 - $G_{min,6} = 2 \times T - (Y_4 + Rc_4)$; where, T = travel time, Y_4 = yellow interval for phase 4, and Rc_4 = red clearance interval for phase 4 (all values in seconds). $Y_4 + Rc_4$ is assumed to equal 5 s.
- 4 - $G_{min,4} = T - (Y_2 + Rc_2 - 2.0)$; where, T = travel time, Y_2 = yellow interval for phase 2, and Rc_2 = red clearance interval for phase 2 (all values in seconds). $Y_2 + Rc_2$ is assumed to equal 5 s.
- 5 - $G_{min,8} = T - (Y_6 + Rc_6 - 2.0)$; where, T = travel time, Y_6 = yellow interval for phase 6, and Rc_6 = red clearance interval for phase 6 (all values in seconds). $Y_6 + Rc_6$ is assumed to equal 5 s.
- 6 - $G_{min,12} = T - (Y_4 + Rc_4) - 2.0$; where, T = travel time, Y_4 = yellow interval for phase 4, and Rc_4 = red clearance interval for phase 4 (all values in seconds). $Y_4 + Rc_4$ is assumed to equal 5 s.
- 7 - $G_{min,16} = T - (Y_8 + Rc_8) - 2.0$; where, T = travel time, Y_8 = yellow interval for phase 8, and Rc_8 = red clearance interval for phase 8 (all values in seconds). $Y_8 + Rc_8$ is assumed to equal 5 s.

The values listed in Table D-4 are computed using the equations provided in the table footnotes. They are based on an assumed change period duration of 5 s. If the change period is significantly different than 5 s, then the equations in the footnotes should be used to compute the minimum green settings.

The values listed in Table D-4 provide sufficient time to avoid having a vehicle caught on an internal approach at the end of phases 1, 2, 5, or 6. The minimum green value used for phases 2, 4, 6, 8, 12, and 16 should also reflect consideration of the minimum green duration needed to satisfy driver expectancy. If appropriate, phases 2, 4, 6, and 8 should also reflect consideration of pedestrian crossing time. Table 2-2 in Chapter 2 provides guidelines for selecting the appropriate minimum green values for these considerations.

To illustrate the use of Table D-4, consider an interchange with 200 ft spacing and a four-phase sequence. The change period for all phases is 5 s. Table D-4 indicates that the minimum green setting for phases 2 and 6 should be 15 s. Consideration of driver expectancy and pedestrian crossing time may require a larger value.

Maximum Green

With a couple of exceptions, the maximum green setting for interchange phases should be based on consideration of volume and speed. Guidelines for selecting maximum green settings based on these considerations are provided in Chapter 2. The exceptions that are applicable to interchange operation are described in the following paragraphs.

Three-Phase Sequence. The maximum green settings for phases 1 and 5 in a three-phase sequence are based on consideration of the time required to clear the internal approaches. These two phases should not have a green interval longer than the interchange travel time. If the green interval exceeds the interchange travel time, it will prevent the entry of “new” vehicles to the internal approaches.

The maximum green settings for phases 4 and 8 are based on consideration of the time required to fill the associated internal approach with queued vehicles. Once the phase has extended for a sufficient time to fill the internal approach, there is no reason to allow the phase to continue to display a green indication.

Table D-5 lists maximum green settings for phases 1, 4, 5, and 8. The values listed are computed using the equations provided in the table footnotes. The parameters used in these equations are also identified in the footnotes. If different parameters are preferred, then the equations in the footnotes should be used to compute the maximum green settings.

The maximum green values listed in Table D-5 satisfy the considerations stated at the start of this subsection. The values cited for phases 4 and 8 represent an upper limit on the maximum green used. Consideration of other factors (as described in Chapter 2) may justify the use of a shorter maximum green value.

Table D-5. Maximum Green Setting for a Three-Phase Sequence.

Interchange Spacing (<i>S</i>), ft	Travel Time (<i>T</i>), s ¹	Maximum Green for Phases 1 and 5, s ²	Maximum Green for Phases 4 and 8, s ³
400	15	15	34
450	16	16	38
500	17	17	42
550	18	18	46
600	19	19	50
650	20	20	54
700	21	21	58
750	22	22	62
800	24	24	66
850	25	25	70
900	26	26	74
950	27	27	78
1000	28	28	82

Notes:

1 - Travel time is computed using the procedure described by Venglar et al. (2).

2 - $G_{max,1} = G_{max,5} = T$; where, T = travel time (all values in seconds).

3 - $G_{max,4} = G_{max,8} = (S/L_q) \times h + 2.0$; where, S = interchange spacing (in feet), L_q = length of a traffic lane occupied by a stopped vehicle (use 25 ft/veh), and h = saturation headway (use 2 s/veh).

To illustrate the use of Table D-5, consider an interchange with 500 ft spacing and a three-phase sequence. Column 3 of the table indicates that the maximum green setting for phase 1 should be 17 s. Column 4 indicates that the maximum green setting for phase 4 should be 42 s.

The maximum green setting for phases 10 and 14 should equal the corresponding minimum green setting. This action ensures that phases 10 and 14 provide a green interval with a duration equal to the minimum green setting for each cycle in which they are activated.

Maximum green setting:
Phase 10 max. green = Phase 10 min. green
Phase 14 max. green = Phase 14 min. green

Four-Phase Sequence. The maximum green settings for phases 12 and 16 in a four-phase sequence are based on consideration of the time required to travel the length of the interchange. The maximum green setting for these two phases should equal the corresponding minimum green setting, as specified in Table D-4. This action ensures that phases 12 and 16 provide a green interval with a duration equal to the minimum green setting for each cycle.

Maximum green setting:
Phase 12 max. green = Phase 12 min. green
Phase 16 max. green = Phase 16 min. green

Phase Recall Mode

The three-phase sequence is characterized by having good progression for the arterial through movements. To ensure this progression is provided each cycle, the minimum recall mode should be set for the phases serving the arterial through movements (i.e., phases 2 and 6).

Use of minimum recall mode:

- Three-phase: Phases 2 and 6
- Four-phase: Phase 2 or 6

At an interchange served by a four-phase sequence, the external movements dictate the duration of the phases serving the internal traffic movements. However, the two arterial through movement phases do not operate together during the four-phase sequence. Hence, if both the arterial phases have the minimum recall mode set, the signal controller continuously cycles through the entire phase sequence, regardless of whether there is any traffic volume. Therefore, if recall is used, it should only be set for the phase serving the heavier volume arterial through movement (i.e., phase 2 or 6).

Guidelines for Loop Detection Layout for Low-Speed Movements

This section provides guidelines for locating detectors for low-speed interchange traffic movements. A low-speed traffic movement is defined as a movement with an 85th percentile approach speed of 40 mph or less. The objectives of detection design for low-speed movements are to: (1) ensure that the presence of waiting traffic is made known to the controller, and (2) ensure the traffic queue is served each phase. Additional guidance on detection layout at intersections is provided in Appendix C.

Both stop line and advance detectors are used for low-speed interchange traffic movements. Regardless of the phase sequence used, the stop line detection is located near the stop line and is designed to provide a 40-ft detection zone. Advance detectors are 6 ft in length, and their location is based on consideration of the 85th percentile approach speed and the phase sequence. The location of the advance detectors is described in the following subsections.

Three-Phase Sequence

The location of each detector for low-speed movements at an interchange with a three-phase sequence is shown in Figure D-10. This figure also indicates the detector channel to which each detector is assigned. Table D-6 provides guidelines for the advance detector location and passage time setting for the various phases that may serve a low-speed movement.

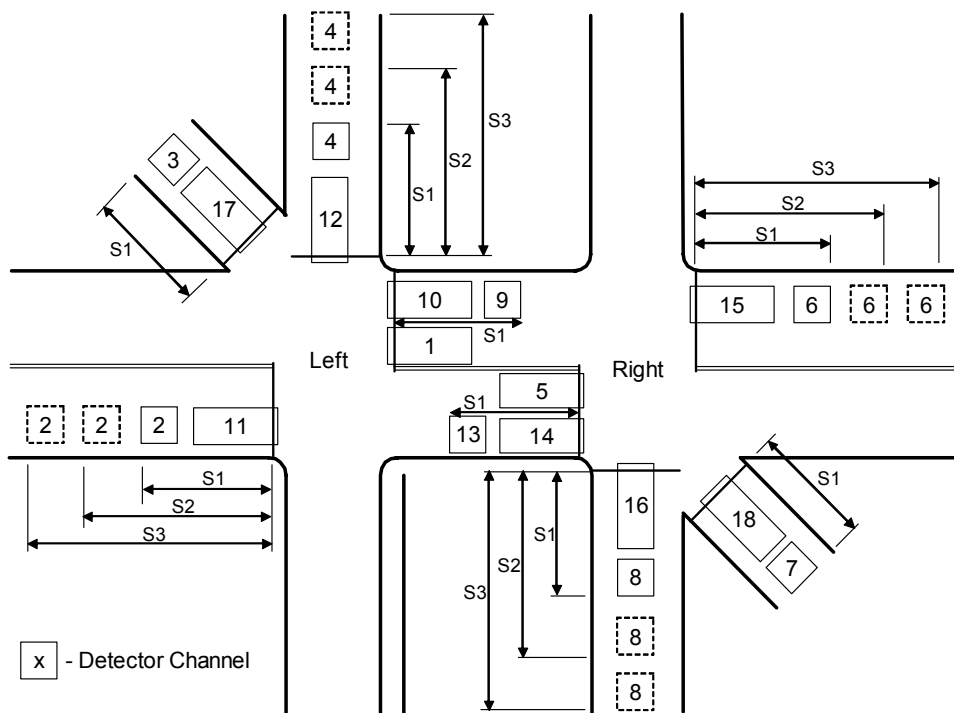

Figure D-10. Detection Layout for a Signalized Diamond Interchange.

Table D-6. Layout and Settings for Low-Speed Detection with Three-Phase Sequence.

85 th Percentile Speed, mph	Phases 1, 2, 5, and 6 ^{1,2}		Frontage Road Phases 4 and 8 ^{1,2}	
	Advance Detector Distance (SI), ft	Passage Time (PT), s	Advance Detector Distance (SI), ft	Passage Time (PT), s
30	100	2.0 to 3.0	100	2.0 to 3.0
35	135	2.0 to 3.0	135	2.0 to 3.0
40	170	2.0 to 3.0	170	2.0 to 3.0

Notes:

- 1 - Advance detector distance is measured from the stop line to the upstream edge of the advance detector.
- 2 - Advance detection lead-ins are wired to a channel separate from that used for stop line detection (see Figure D-10).

Four-Phase Sequence

The advance detection design for phases 1, 2, 5, and 6 at an interchange with a four-phase sequence is the same as that for a three-phase sequence. In contrast, a different criterion is used to establish the advance detector locations for the frontage road phases. These detectors are located such that a transition interval occurs between the time the frontage road phase gaps out and its yellow indication is presented. By placing the advance detector at the proper upstream location, the last frontage road vehicle will have just arrived to the stop line at the time the yellow indication is presented to it. The advance detector locations that satisfy this criterion are listed in Table D-7. The

calculations are keyed to the 85th percentile speed but recognize that the travel time for a frontage road vehicle traveling at the 15th percentile speed will control the advance detector location.

Table D-7. Layout and Settings for Low-Speed Detection with Four-Phase Sequence.

85 th Percentile Speed, mph	Phases 1, 2, 5, and 6 ^{1,2}		Frontage Road Phases 4 and 8 ^{1,2}				Passage Time (PT), s
	Advance Detector Distance (SI), ft	Passage Time (PT), s	Interchange Spacing, ft				
			100	200	300	400	
			Advance Detector Distance (SI), ft ^{3,4,5}				
30	100	2.0 to 3.0	260	355	435	510	2.0 to 3.0
35	135	2.0 to 3.0	305	415	505	595	2.0 to 3.0
40	170	2.0 to 3.0	350	475	575	680	2.0 to 3.0

Notes:

- 1 - Advance detector distance is measured from the stop line to the upstream edge of the advance detector.
- 2 - Advance detection lead-ins are wired to a channel separate from that used for stop line detection (see Figure D-10).
- 3 - $SI_4 = [PT_4 + (Y_5 + Rc_5) + T - 2.0 - (Y_4 + Rc_4)] \times [1.13 v_{85}] \leq 700$ ft; where, SI_4 = detector distance for phase 4, PT_4 = passage time for phase 4, Y_5 = yellow interval for phase 5, Rc_5 = red clearance interval for phase 5, T = travel time, Y_4 = yellow interval for phase 4, Rc_4 = red clearance interval for phase 4, and v_{85} = 85th percentile speed (speed in mph, all other values in seconds). $Y + Rc$ is assumed to equal 5 s.
- 4 - $SI_8 = [PT_8 + (Y_1 + Rc_1) + T - 2.0 - (Y_8 + Rc_8)] \times [1.13 v_{85}] \leq 700$ ft; where, SI_8 = detector distance for phase 8, PT_8 = passage time for phase 8, Y_1 = yellow interval for phase 1, Rc_1 = red clearance interval for phase 1, T = travel time, Y_8 = yellow interval for phase 8, Rc_8 = red clearance interval for phase 8, and v_{85} = 85th percentile speed (speed in mph, all other values in seconds). $Y + Rc$ is assumed to equal 5 s.
- 5 - Travel time is computed using the procedure described by Venglar et al. (2).

The advance detector distances listed in Table D-7 are based on an assumed change period of 5 s and a passage time of 2.5 s. If other values are more appropriate, then the equations in the table footnote should be used to compute the advance detector distance. The values computed from these equations can yield distances that are relatively large for higher speeds. Such distances are often impractical from the standpoint of detector installation cost. In recognition of this practical limitation, the computed distances are limited to 700 ft. This restriction on the maximum advance detector distance will reduce the efficiency of the transition interval, but only by a small amount.

Separate Intersection Sequence

The guidelines in Table D-6 describing advance detector placement for an interchange with a three-phase sequence are also applicable to low-speed movements at interchanges with a separate intersection sequence.

Guidelines for Loop Detection Layout for High-Speed Movements

This section describes the loop detection layout for high-speed movements at an interchange. In this regard, a high-speed movement is one that has an 85th percentile approach speed of 45 mph or more. The objectives of detection design for high-speed movements are to: (1) ensure that the presence of waiting traffic is made known to the controller, (2) ensure the traffic queue is served

each phase, and (3) provide a safe phase termination by minimizing the chance of a driver being in his or her indecision zone at the onset of the yellow indication. As discussed in Appendix C, detection systems other than video image vehicle detection system may be better suited to advance detection for high-speed movements.

The stop line detection layout for high-speed movements is the same as that used for low-speed traffic movements. Specifically, the stop line detection is located near the stop line and is designed to provide a 40-ft detection zone. The location of the advance detectors is described in the following subsections.

Three-Phase Sequence

The location of each detector for high-speed movements at an interchange with a three-phase sequence are shown in Figure D-10. This figure also indicates the detector channel to which each detector is assigned. Table D-8 provides guidelines for the advance detector location and passage time setting for the various high-speed approaches to the interchange.

Table D-8. Layout and Settings for High-Speed Detection with Three-Phase Sequence.

85 th Percentile Speed, mph	Phases 1, 2, 5, and 6 ^{1,2}				Frontage Road Phases 4 and 8 ^{1,2}			
	Advance Detector Distance, ft			Passage Time (PT), s	Advance Detector Distance (S1), ft			Passage Time (PT), s
	S1	S2	S3		S1	S2	S3	
45	210	330	not used	2.0	210	330	not used	2.0
50	220	350	not used	2.0	220	350	not used	2.0
55	225	320	415	1.4 to 2.0	225	320	415	1.4 to 2.0
60	275	375	475	1.6 to 2.0	275	375	475	1.6 to 2.0
65	320	430	540	1.6 to 2.0	320	430	540	1.6 to 2.0
70	350	475	600	1.4 to 2.0	350	475	600	1.4 to 2.0

Notes:

- 1 - Advance detector distance is measured from the stop line to the upstream edge of the advance detector.
- 2 - Advance detection lead-ins are wired to a channel separate from that used for stop line detection (see Figure D-10).

Four-Phase Sequence

The advance detection design for phases 1, 2, 5, and 6 at an interchange with a four-phase sequence is the same as for an interchange with a three-phase sequence. As described previously, the detectors for phases 4 and 8 are located using a different criterion. Specifically, these detectors are located such that the last frontage road vehicle will have just arrived to the stop line at the time the yellow indication is presented. The advance detector locations that satisfy this criterion are listed in Table D-9.

The advance detector distances listed in Table D-9 are based on an assumed change period of 5 s and a passage time of 2.5 s. If other values are considered to be more appropriate, then the

equations in the table footnote should be used to compute the advance detector distance. As a practical limitation, the computed distances are limited to 700 ft. This restriction on the maximum advance detector distance will reduce the efficiency of the transition interval, but only by a small amount.

Table D-9. Layout and Settings for High-Speed Detection with Four-Phase Sequence.

85 th Percentile Speed, mph	Phases 1, 2, 5, and 6 ^{1,2}				Frontage Road Phases 4 and 8 ^{1,2}				
	Advance Detector Distance, ft			Passage Time (PT), s	Interchange Spacing, ft				Passage Time (PT), s
	S1	S2	S3		100	200	300	400	
					Advance Detector Distance (SI), ft ^{3,4,5}				
45	210	330	not used	2.0	390	535	650	700	2.0 to 3.0
50	220	350	not used	2.0	435	590	700	700	2.0 to 3.0
55	225	320	415	1.4 to 2.0	480	650	700	700	2.0 to 3.0
60	275	375	475	1.6 to 2.0	520	700	700	700	2.0 to 3.0
65	320	430	540	1.6 to 2.0	565	700	700	700	2.0 to 3.0
70	350	475	600	1.4 to 2.0	610	700	700	700	2.0 to 3.0

Notes:

- 1 - Advance detector distance is measured from the stop line to the upstream edge of the advance detector.
- 2 - Advance detection lead-ins are wired to a channel separate from that used for stop line detection (see Figure D-10).
- 3 - $SI_4 = [PT_4 + (Y_5 + Rc_5) + T - 2.0 - (Y_4 + Rc_4)] \times [1.13 v_{85}] \leq 700$ ft; where, SI_4 = detector distance for phase 4, PT_4 = passage time for phase 4, Y_5 = yellow interval for phase 5, Rc_5 = red clearance interval for phase 5, T = travel time, Y_4 = yellow interval for phase 4, Rc_4 = red clearance interval for phase 4, and v_{85} = 85th percentile speed (speed in mph, all other values in seconds). $Y + Rc$ is assumed to equal 5 s.
- 4 - $SI_8 = [PT_8 + (Y_1 + Rc_1) + T - 2.0 - (Y_8 + Rc_8)] \times [1.13 v_{85}] \leq 700$ ft; where, SI_8 = detector distance for phase 8, PT_8 = passage time for phase 8, Y_1 = yellow interval for phase 1, Rc_1 = red clearance interval for phase 1, T = travel time, Y_8 = yellow interval for phase 8, Rc_8 = red clearance interval for phase 8, and v_{85} = 85th percentile speed (speed in mph, all other values in seconds). $Y + Rc$ is assumed to equal 5 s.
- 5 - Travel time is computed using the procedure described by Venglar et al. (2).

Separate Intersection Sequence

The guidelines in Table D-8 describing advance detector placement for an interchange with a three-phase sequence are also applicable to high-speed movements at interchanges with a separate intersection sequence.

Guidelines for Configuration of Video Detection Outputs

When a VIVDS is used at an interchange, a total of six cameras are typically used to provide the necessary detection. The location of these cameras is illustrated in Figure D-11. When the VIVDS is housed in the detector rack, its detector outputs do not necessarily align with the predefined detector inputs needed for the Texas Diamond Controller. As a result, the detector outputs must be switched in the controller to obtain the appropriate detector channel assignment (shown previously in Table D-1).

Table D-10. Typical Video Detector Switching for a Texas Diamond Controller.

Camera Number	Detector Output Number	Phase Number	Assigned Detector Channel
C1	1	$\Phi 1$	1
	2		not used
C2	3	$\Phi 2$	11
	4		2
C5	5	$\Phi 5$	5
	6		not used
C6	7	$\Phi 6$	15
	8		6
C1 extension module	9	Overlap A ($\Phi 1 + \Phi 2$)	10
	10		9
C5 extension module	13	Overlap B ($\Phi 5 + \Phi 6$)	14
	14		13
C3	21	$\Phi 4$	12
	22		4
C4	23	$\Phi 8$	16
	24		8

Guidelines for Detector Settings

Delay can be used with the stop line detectors at an interchange to allow traffic turning right or left an opportunity to turn without activating the detector and placing a call on the phase. If an arterial phase is on recall, 8 to 14 s of delay may be used for the detector that serves the right-turn movement on the frontage road. Larger values in this range are used when a higher speed or conflicting volume exists on the intersecting road.

If the internal left-turn movement operates in the protected-permissive mode and the opposing arterial through phase is on recall, a delay of 5 to 12 s may be used for the detector in the left-turn lane. Larger values in this range are used when a higher speed or volume exists on the opposing approach.

If the delay setting is used, it should be programmed in the controller and not in the detector. Delay programmed in the controller is only applied when the associated phase is displaying a yellow or red indication. Additional guidance regarding the use of the delay setting is provided in Chapter 2.

In the Texas Diamond Controller, a 2-s delay is preset in the controller for advance detectors 2, 4, 6, and 8. This delay setting minimizes the potential for a phase to be called by vehicles passing over an advance detector. This result is desired because the stop line detection is provided for the purpose of calling a phase.

Guidelines for Use of Conditional Service

Conditional service can be implemented at a diamond interchange when the following criteria are met:

1. Three-phase sequence is used, and
2. The absolute difference between the average green interval duration of the two frontage road phases exceeds 10 to 12 s (3).

The conditionally served left-turn phase should also have a short minimum green value of 5 to 8 s. This short value will increase the probability that conditional service will be enabled. A short minimum green will also reduce the negative impact of the conditional service on other phases.

The decision to allow conditional service for the left-turn phases should be dictated by consideration of frontage road traffic volume, rather than the volume of the conditionally served phase. This approach is more likely to minimize overall interchange delay. The conditionally served phases should operate in a non-actuated manner (i.e., the minimum green and the maximum green values should be the same or very similar).

Conditional service takes advantage of unbalanced frontage road traffic volumes and keeps the interior of the diamond interchange clear of stopped vehicles. However, if the frontage road volumes are only slightly unbalanced, conditional service may increase the delay to the arterial through movements if it continues to extend the frontage road phase after the frontage road queue is served. The operation of conditional service should always be observed in the field after its implementation to ensure that it is providing the intended operation.

REFERENCES

1. Chaudhary, N., and C-L. Chu. *Guidelines for Timing and Coordinating Diamond Interchanges with Adjacent Traffic Signals*. Report No. TX-00/4913-2. Texas Department of Transportation, Austin, Texas, November 2000.
2. Venglar, S., P. Koonce, and T. Urbanik, II. *PASSER III-98: Application and User's Guide*. Texas Transportation Institute, The Texas A&M University System, College Station, Texas, 1998.
3. Engelbrecht, R., S. Venglar, and Z. Tian. *Research Report on Improving Diamond Interchange Operations Using Advanced Controller Features*. Report No. FHWA/TX-02/0-4158-1. Texas Department of Transportation, Austin, Texas, 2001.

APPENDIX E. ALTERNATIVE PEDESTRIAN TREATMENTS

This appendix provides guidelines for evaluating alternative treatments intended to improve pedestrian safety at a signalized intersection. The guidelines focus on changes to the signal timing or operation that have been found to reduce left-turn-related pedestrian-vehicle crashes.

One viable treatment at some intersections is the use of a protected or protected-permissive left-turn operational mode. This treatment effectively separates in time the pedestrian and left-turning vehicle movements and reduces related conflicts. Guidelines for assessing whether this mode is appropriate for a given left-turn movement are provided in Appendix A.

This appendix consists of three parts. The first part provides an overview of some common pedestrian treatments for signalized intersections. The second part reviews some basic signal timing concepts related to pedestrian accommodation at intersections. The last part provides guidelines for determining the appropriate pedestrian treatment for a given intersection.

OVERVIEW

Pedestrian-vehicle crashes are a serious concern because they are typically severe and often fatal. These crashes are relatively frequent at signalized intersections because the signalization concentrates pedestrian flows temporally, and the crosswalk concentrates them spatially. Signalization is often used to separate the pedestrian and vehicle flows that cross at right angles. However, it is not often used to separate turning vehicles and pedestrians. In fact, it is rarely used to fully separate pedestrian and vehicle traffic flows with an exclusive pedestrian phase.

Engineers have used various treatments to improve pedestrian safety at signalized intersections. Several treatments that address left-turn-related pedestrian-vehicle conflicts are described in Table E-1. This table identifies the safety objectives of each treatment and some issues associated with its implementation. Unfortunately, for many of these treatments, there is limited quantitative information about their effect on pedestrian safety.

The first five treatments identified in Table E-1 are addressed in other locations in this document, as noted in the table. In most cases, guidelines are provided in these other locations for determining whether the treatment is appropriate and how to effectively implement it. Guidelines for evaluating and implementing the last four treatments are provided in this appendix.

Table E-1. Treatments for Improving Pedestrian Safety at Intersections.

Treatment	Objective	Issues
Treatments Based on Conversion from Permissive Mode		
Provide protected-permissive mode (addressed in Appendix A)	Reduce the number of left-turn vehicles that turn during the permissive period by providing a protected arrow indication.	Permissive period presents opportunity for some pedestrian-vehicle conflicts. If used with lagging left-turn phase sequence, safety problems associated with the yellow trap may occur.
Provide protected left-turn mode (addressed in Appendix A)	Separate vehicles and pedestrians on problem approach by providing each a separate time in cycle to be served.	Left-turn phase may increase pedestrian waiting time and decrease their compliance with the pedestrian signal.
Treatments Used in Conjunction with Permissive Mode		
Provide leading pedestrian interval (addressed in Appendix A)	Provide a small amount of time (say, 3 s) to allow pedestrians to start crossing before displaying green ball.	Increases delay to vehicles. May require the use of accessible pedestrian signals to provide crossing cues to visually impaired pedestrians.
Provide exclusive pedestrian phase (addressed in Appendix A)	Separate vehicles and pedestrians at intersection by providing each a separate time in cycle to be served.	Significant delay and waiting time may result if used at large intersections. May require the use of accessible pedestrian signals to provide crossing cues to visually impaired pedestrians.
Provide pedestrian clear interval entirely during green (addressed in Chapter 2)	Some agencies time a portion of the pedestrian clearance time during the yellow change and red clearance intervals to reduce delay.	Increases delay to vehicles. May only provide pedestrian safety benefit if used with a protected left-turn mode or with permissive omit when ped. is detected.
Add turning vehicle warning signs and markings	Add "Pedestrians Watch for Turning Vehicles" signs and/or markings to remind pedestrians to look for turning vehicles.	Markings tend to wear away when used in typical crosswalk locations.
Prohibit pedestrian crossing	Redirect pedestrians to alternative crosswalks or crossing locations.	May shift safety problem to another intersection. May cause negative public reaction unless it is part of a larger traffic management strategy.
Reduce signal cycle length	Reduce pedestrian delay and related illegal crossing frequency.	May reduce intersection capacity and cause oversaturated vehicle movements.
Reduce crossing distance	Reduce pedestrian exposure to conflict by reducing the crossing distance.	Will increase vehicle delay if treatment results in reduced lane width or number of lanes. May reduce vehicle delay by reducing the pedestrian clearance time.
Invoke pedestrian recall	Ensures a WALK indication is presented each cycle, ensures adequate crossing time, and promotes legal crossings.	If treatment increases phase duration beyond vehicle-optimal levels then it is likely to increase vehicle delay.
Increase walk interval duration (without increasing cycle length)	Provides extra time for pedestrians to detect the start of the crossing time and time for large groups to depart the curb.	If treatment increases phase duration beyond vehicle-optimal levels then it is likely to increase vehicle delay.

CONCEPTS

This section explains selected signal timing concepts and establishes a vocabulary. Topics addressed include cycle length, pedestrian recall, walk interval, and “legal pedestrian.”

Cycle Length

Cycle length is defined as the total time to complete one sequence of signalization to all movements at an intersection. For an intersection with coordinated-actuated control, the cycle length is most easily measured as the time between two successive terminations of a given coordinated phase. For an intersection with pretimed control, the cycle length is measured as the time between two successive starts (or terminations) of any given phase.

An intersection with fully-actuated operation does not have a predetermined cycle length. The time between two successive terminations of the major-street through phase can be used to measure a cycle length. However, this value is likely to vary each time it is measured due to random fluctuations in traffic demand. The average of the cycle lengths measured during the analysis period can be used for the purpose of evaluating the operation of a fully-actuated intersection.

Pedestrian Recall Mode

Recall causes the controller to place a call for a specified phase each time the controller is servicing a conflicting phase. There are four types of recalls: minimum recall, maximum recall, pedestrian recall, and soft recall. When pedestrian recall is activated, the phase will time the walk and pedestrian clear intervals in sequence. After these intervals have timed out, additional vehicle actuations can extend the green indication if they are present.

Walk and Pedestrian Change Intervals

There are two key pedestrian settings: walk interval and pedestrian change interval. The walk interval begins at the start of the green when the pedestrian signal displays a WALK indication. The pedestrian change interval follows the walk interval. During this interval, a flashing DON'T WALK indication (and possibly a trailing steady DON'T WALK indication) is presented.

Legal Pedestrian

For the guidelines described in this appendix, a legal pedestrian is considered to be a pedestrian that: (1) enters the crosswalk area during the WALK indication, (2) attempts to enter the crosswalk area during the WALK indication but is prevented from doing so by a turning vehicle, or (3) is present to cross during the WALK indication but the pedestrian density is so great that the crossing is delayed until the flashing DON'T WALK is displayed.

GUIDELINES

This section provides guidelines for evaluating several alternative pedestrian treatments. The treatments are intended to reduce left-turn-related pedestrian-vehicle conflicts and crashes at signalized intersections. The treatments considered are identified in the following list:

- Reduce signal cycle length.
- Reduce crossing distance.
- Invoke pedestrian recall.
- Increase walk interval duration.

The guidelines provided in this part of the appendix take the form of an evaluation procedure that consists of six steps. Application of the procedure produces an estimate of the expected road-user crash costs and delay costs. The input variables associated with this procedure provide the necessary information to evaluate each of the aforementioned treatments.

In general, the evaluation procedure is used to evaluate the “existing” condition, and through a second application, it is used to evaluate one or more proposed treatments. The change in road-user cost associated with a treatment is computed by subtracting the cost associated with the existing condition from that for the proposed treatment. A negative value for this change in cost represents a reduction in road-user costs (i.e., the treatment provides a net benefit to road users), and the treatment should be considered for implementation.

The procedure considers intersection delay and crash frequency in the calculation of road-user cost. The delay cost is based on the value of travel time and reflects the delay to *all* vehicles traveling through the intersection. This approach recognizes that many signal-related pedestrian treatments for a crosswalk can change the signal operation and indirectly impact the service provided to most vehicles entering the intersection.

The procedure for evaluating alternative pedestrian treatments is described as a six-step process that uses a worksheet to document the results. This worksheet is shown in Table E-2. A blank version of the worksheet is provided at the end of the appendix. An example is used to explain the procedure. It is described in the discussion provided for each of the six steps. The example intersection geometry and traffic volumes (in veh/h) are illustrated in Figure E-1. The east-west street and the north-south street have permissive left-turn phasing. All crosswalks have a pedestrian volume of 400 p/h. The phase settings and crosswalk geometry are shown in Table E-2.

The example intersection has coordinated-actuated control with signal coordination provided along the east-west street. The eastbound and westbound through phases are coordinated. The other phases have actuated operation. The cycle length is 100 s.

Table E-2. Sample Pedestrian Treatment Evaluation Worksheet.

Pedestrian Treatment Evaluation Worksheet									
General Information									
Location: <u>Main St. & Peach Tree Drive</u>						Analysis Period: _____ to _____			
Approach:		Eastbound		Westbound		Northbound		Southbound	
Cycle length (C_s), s <u>100</u>	Left-turn mode	<input checked="" type="checkbox"/> Permissive <input type="checkbox"/> Prot.-perm. <input type="checkbox"/> Protected		<input checked="" type="checkbox"/> Permissive <input type="checkbox"/> Prot.-perm. <input type="checkbox"/> Protected		<input checked="" type="checkbox"/> Permissive <input type="checkbox"/> Prot.-perm. <input type="checkbox"/> Protected		<input checked="" type="checkbox"/> Permissive <input type="checkbox"/> Prot.-perm. <input type="checkbox"/> Protected	
	Phase sequence	<input checked="" type="checkbox"/> Not applicable <input type="checkbox"/> Leading <input type="checkbox"/> Lagging		<input checked="" type="checkbox"/> Not applicable <input type="checkbox"/> Leading <input type="checkbox"/> Lagging		<input checked="" type="checkbox"/> Not applicable <input type="checkbox"/> Leading <input type="checkbox"/> Lagging		<input checked="" type="checkbox"/> Not applicable <input type="checkbox"/> Leading <input type="checkbox"/> Lagging	
Volume Input									
Approach:		Eastbound		Westbound		Northbound		Southbound	
Movement, No.: {see note 1}		LT, 5	TH+RT, 2	LT, 1	TH+RT, 6	LT, 3	TH+RT, 8	LT, 7	TH+RT, 4
Vehicle volume, veh/h		105	502	201	806	93	408	57	104
Crosswalk crossing the...			South leg		North leg		East leg		West leg
Pedestrian volume, p/h			400		400		400		400
Phase Settings									
Walk interval duration, s			7.0		7.0		7.0		7.0
Pedestrian recall?			No		No		No		No
Crosswalk Geometry									
Crosswalk length, ft			30		30		70		70
Median width along crosswalk, ft			0		0		12		12
Analysis Results									
Annual ped.-veh. crashes during analysis period, cr/yr				0.1074		Cost of left-turn-related ped.-veh. crash, \$/cr		214,050	
Annual crash cost, \$/yr				23,000					
Intersection delay during analysis period, s/veh				5.0					
Annual vehicle delay during analysis period, h/yr				1154		Value of travel time, \$/h		17.70	
Annual delay cost, \$/yr				20,400					
Annual road-user cost, \$/yr				43,400					
Supplemental Calculations									
Conflicting left-turn volume, veh/h			$V_{LT,1} = 201$		$V_{LT,5} = 105$		$V_{LT,7} = 57$		$V_{LT,3} = 93$
Conflicting left-turn mode			Perm.		Perm.		Perm.		Perm.
Conf. left-turn phase sequence			Not app.		Not app.		Not app.		Not app.
Veh. travel time to conflict area, s			0.8		0.8		2.1		2.1
Prob. WALK indication is displayed			1.00		1.00		1.00		1.00
Pedestrian delay, s/p			39.6		39.6		39.6		39.6
Cross-street volume, veh/h			662		662		1614		1614
Prob. of legal crossing			0.69		0.69		0.77		0.77
Legal ped. volume, p/h			276		276		307		307
Illegal ped. volume, p/h			124		124		93		93
Conf. with legal peds., conf/h			4.5		3.3		4.7		5.8
Conf. with illegal peds., conf/h			6.8		3.3		1.5		2.6
Total conflicts, conf/h			11.3		6.6		6.2		8.4
Annual conflicts during analysis period, conf/yr			4107		2407		2253		3074
Annual crashes during analysis period, cr/yr			0.0370		0.0218		0.0206		0.0280

Note:

1 - Numbers follow NEMA movement-based phase numbering system (LT = left-turn, TH = through, RT = right-turn).

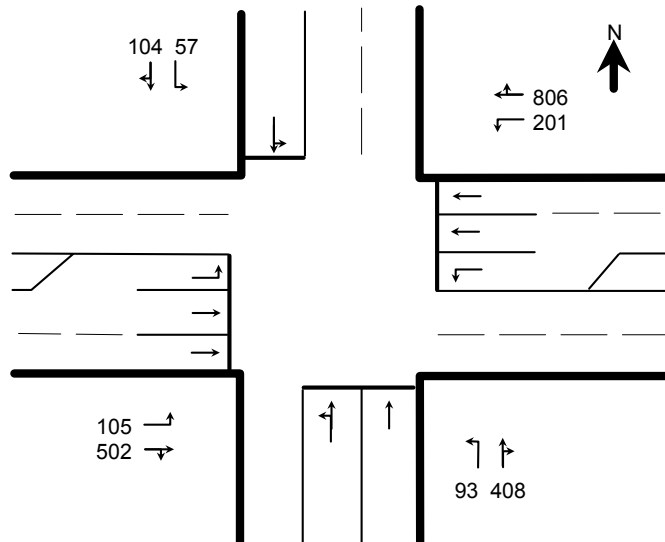

Figure E-1. Example Intersection Used to Illustrate Pedestrian Treatment Evaluation.

Step 1. Gather Data

Data needed for the evaluation are gathered during this step. They include analysis period, left-turn mode, phase sequence, vehicular volume, pedestrian volume, walk interval duration, pedestrian recall setting, crosswalk length, and median width. These data are recorded on the worksheet in one of the following sections: General Information, Volume Input, Phase Settings, or Crosswalk Geometry.

The analysis period is one hour. It will typically coincide with the hour of peak pedestrian demand during the typical day of week. Additional hours of the day can also be evaluated if desired.

The vehicular volume and pedestrian volume are obtained for the analysis period (or periods) of interest and recorded in the Volume Input section of the worksheet. The vehicular volume is recorded for the left-turn, through, and right-turn movements on each intersection approach. The pedestrian volume for each crosswalk is also recorded. The pedestrian volume for a given crosswalk includes pedestrians traveling in both directions along the crosswalk (i.e., it is a two-way volume).

The pedestrian volume for a given crosswalk is recorded on the worksheet in the column that corresponds to the through movement that is served concurrently with the pedestrians in the subject crosswalk. For example, the pedestrians traveling in the crosswalk across the south leg of an intersection are served concurrently with the eastbound through vehicles, so the pedestrian volume for this crosswalk would be recorded in the same column as the eastbound through (and right-turn) vehicle volume.

The walk interval duration is recorded on the worksheet in the same column as the crosswalk that it serves. For example, the walk interval duration for the crosswalk served with the eastbound through movement would be recorded in the same column as the eastbound through (and right-turn) vehicle volume. This walk interval is presented concurrently with the eastbound through green indication. The value recorded in the worksheet should reflect the average duration of the displayed WALK indication, which may exceed the walk interval setting if the phase operates with rest-in-walk enabled. A 7-s duration is shown in Table E-2 for each of the four crosswalks.

If a through phase is actuated, then the pedestrian recall mode can be used for the phase serving the crosswalk (and the concurrent through movement). However, most actuated through phases have a pedestrian push button to provide pedestrian detection, and pedestrian recall is not used. If pretimed control is used, then the pedestrian recall mode is set to “Yes” to indicate that the WALK indication times during every phase. For the example intersection in Table E-2, pedestrian recall is not used for any of the through phases.

The length of the crosswalk is measured from the outside face-of-curb to the outside face-of-curb along the crosswalk. If a curb is not present, then the crosswalk is measured to the near edge of the pedestrian holding area. The measured length includes the width of any median that is provided along the crossed street, including any left-turn lanes that may be located in the median. For the example intersection, the crosswalks associated with the eastbound and westbound through movements (i.e., the crosswalks across the south and north legs) are 30 ft long. The crosswalks associated with the northbound and southbound through movements are 70 ft long.

Step 2. Identify Conflicting Left-Turn Movements

The left-turn volume that conflicts with each crosswalk is identified in this step. It is recorded in the first row of the section titled Supplemental Calculations. A crosswalk’s conflicting left-turn movement follows a path that (1) starts from the street that is parallel to the crosswalk and (2) ends by crossing the subject crosswalk. For the example intersection in Table E-2, the westbound left-turn movement conflicts with the crosswalk crossing the south leg. The westbound left-turn volume is recorded as the conflicting left-turn volume in the *eastbound* through (and right-turn) column because the pedestrian signal heads that control this crosswalk time with the eastbound through movement.

The mode and phase sequence associated with each of the conflicting left-turn movements is also identified. This information is recorded in the second and third rows of the section titled Supplemental Calculations. For the example intersection, all left-turn movements have permissive operation. For this reason, the question about phase sequence is not applicable.

Step 3. Compute Pedestrian-Vehicle Crash Frequency

This step consists of a series of calculations. The equations for these calculations are presented in the order that they are used to evaluate one crosswalk. The calculations are repeated for the other crosswalks of interest at the intersection. The values obtained from using these equations

are recorded on the worksheet, in the section titled Supplemental Calculations. These values for the example intersection are shown in Table E-2.

The vehicle travel time to the conflict area is based on a 20-ft/s vehicle turn speed. This time is computed using the following equation:

$$t = \left(\frac{L_{cw}}{2} + \frac{W_m}{2} \right) \frac{1}{20} \quad (10)$$

where,

- t = vehicle travel time to conflict area, s.
- L_{cw} = crosswalk length (curb to curb), ft.
- W_m = median width (inclusive of any left-turn bay that may be present), ft.

The probability that the WALK indication is displayed is 1.0 if the control is pretimed or if the phase is actuated and pedestrian recall is used. If the phase is actuated and pedestrian recall is not used, then the probability is computed using the following equation:

$$p_p = 1 - e^{(-v_{ped,t}/3600) P_b C} \quad (11)$$

where,

- p_p = probability that the WALK indication is displayed.
- $v_{ped,t}$ = pedestrian volume in the crosswalk (walking in either direction), p/h.
- P_b = probability of a pedestrian pressing the detector button (= 0.66).
- C = cycle length, s.

The pedestrian delay is computed using the following equation from Chapter 18 of the *Highway Capacity Manual (1)*.

$$d_p = \frac{(C - g_{ped})^2}{2 C} \quad (12)$$

where,

- d_p = pedestrian delay due to signal, s/p.
- g_{ped} = pedestrian service time (= $Walk + 4.0$), s.
- $Walk$ = walk interval duration, s.

The cross-street volume v_c represents the vehicle volume that crosses the subject crosswalk. If the crosswalk crosses a street serving two-way traffic, then the cross-street volume represents the sum of traffic from both travel directions. This volume can be estimated as the sum of the left-turn, through, and right-turn movements on the cross-street approaches to the intersection.

The volume of legal pedestrians is computed using the following equation.

$$v_{ped,L} = v_{ped,t} (p_p)^{0.310} \left(\frac{e^{1.32 - 0.020 d_p + 1.493 v_c/3600}}{1 + e^{1.32 - 0.020 d_p + 1.493 v_c/3600}} \right) \quad (13)$$

where,

- $v_{ped,L}$ = legal pedestrian volume in the crosswalk (walking in either direction), p/h.

$v_{ped,t}$ = pedestrian volume in the crosswalk (walking in either direction), p/h.
 v_c = conflicting (cross street) vehicular traffic volume (both directions), veh/h.

The volume of illegal pedestrians is computed using the following equation.

$$v_{ped,I} = v_{ped,t} - v_{ped,L} \quad (14)$$

where,

$v_{ped,I}$ = illegal pedestrian volume in the crosswalk (walking in either direction), p/h.

The frequency of conflict between legal pedestrians and left-turn vehicles is computed using the following equation.

$$N_{co,L} = (v_{lt})^{0.444} (v_{ped,L})^{0.756} e^{-6.13 + 0.144t^2 + 0.0094C - 0.630I_{lead}} \quad (15)$$

where,

$N_{co,L}$ = frequency of pedestrian-vehicle conflicts involving legal pedestrians, conflicts/h.

v_{lt} = conflicting left-turn volume, veh/h.

I_{lead} = indicator variable for leading left-turn phase (= 1.0 if leading, 0.0 otherwise).

The frequency of conflict between illegal pedestrians and left-turn vehicles is computed using the following equation.

$$N_{co,I} = (v_{lt})^{1.134} (v_{ped,I})^{0.266} e^{-5.38} \quad (16)$$

where,

$N_{co,I}$ = frequency of pedestrian-vehicle conflicts involving illegal pedestrians, conflicts/h.

The total number of pedestrian-vehicle conflicts is computed using the following equation.

$$N_{co} = N_{co,I} + N_{co,L} \quad (17)$$

where,

N_{co} = frequency of pedestrian-vehicle conflicts, conflicts/h.

The annual number of conflicts during the analysis period is computed using the following equation.

$$n_{co} = 365 N_{co} \quad (18)$$

where,

n_{co} = annual number of pedestrian-vehicle conflicts, conflicts/yr.

The annual number of crashes during the analysis period is computed using the following equation.

$$n_{cr} = 365 \frac{0.92 N_{co,L} + 0.89 N_{co,I}}{100,000} \quad (19)$$

where,

n_{cr} = annual number of pedestrian-vehicle crashes, cr/yr.

Step 4. Compute Annual Crash Costs

The road-user costs associated with crashes are computed in this step. The results are recorded on the worksheet in the section titled Analysis Results. The crash costs represent left-turn-related pedestrian-vehicle crashes.

The annual crash cost is computed using the following equation.

$$c_{cr} = 214,050 n_{cr} \quad (20)$$

where,

c_{cr} = annual crash cost in 2009 dollars, \$/yr.

The constant “214,050” in this equation represents the average cost of a left-turn-related pedestrian-vehicle crash. It consists of two cost components. One component is the human capital cost of \$88,597 and a non-human-capital cost of \$125,453. The human capital costs represent monetary losses associated with medical care, vehicle damage, legal fees, and lost wages. Non-human-capital costs reflect the crash’s impact to the person’s quality of life.

These crash costs represent 2009 dollars. If crash costs for another year are required, the recommended procedure is to multiply the cost component by the appropriate price index ratio. For human capital costs, the ratio equals the “Consumer Price Index for all urban customers” for the year of interest divided by the index for 2009 (i.e., 214.537). For non-human-capital costs, the ratio equals the “Employment Cost Index (not seasonally adjusted) for total compensation for private industry (all workers)” for the year of interest divided by the index for December 2009 (i.e., 110.2).

Step 5. Compute Annual Delay Costs

The road-user costs associated with motorist delay are computed in this step. The results are recorded on the worksheet in the section titled Analysis Results.

Intersection delay is an input to this evaluation procedure. It represents the weighted average delay to all intersecting movements, where the weighting factor used is the volume of the respective traffic movement. It can be obtained using the signalized intersection analysis methodology described in the *Highway Capacity Manual (I)*. This methodology is recommended because it estimates control delay for a wide range of signal timing designs, signal coordination conditions, geometrics, and pedestrian-related influences. Software products that provide control delay estimates and have a similar sensitivity to a wide range of conditions can also be used for this purpose.

The annual delay cost is computed using the following equation.

$$c_d = 17.70 \frac{365}{3600} d_I \sum v_i \quad (21)$$

where,

c_d = annual delay cost in 2009 dollars, \$/yr.

d_I = intersection delay, s/veh.;

v_i = vehicle volume for movement i ($i = 1, 2, 3, \dots, 8$), veh/h.

The constant “17.70” in this equation represents the average value of travel time. It is in 2009 dollars. If the value of time for another year is required, the recommended procedure is to multiply this value by the price index ratio. This ratio equals the “Consumer Price Index for all urban customers” for the year of interest divided by the index for 2009 (i.e., 214.537).

Step 6. Compute Annual Road-User Costs

The annual road-user cost is computed as the sum of the annual crash cost and the annual delay cost. It represents an annual cost for the analysis period. A similar evaluation can be conducted for each of the 24 hours in the typical day and the results totaled to yield an estimate of total annual road-user cost.

Treatment Evaluation Process

To evaluate a proposed treatment (or treatment combination), the calculations in Steps 1 to 6 are repeated with the appropriate input values changed to reflect the treatment’s application. This approach yields an annual road-user cost for the existing condition and for the proposed condition. The change in road-user cost is computed by subtracting the cost associated with the proposed condition from that for the existing condition. A negative value for this change is considered a net benefit to road users and the treatment should be considered for implementation.

The determination made by this process will apply to the subject analysis period. If multiple periods are evaluated and the determination made for each period varies (e.g., protected mode is appropriate for the peak period but not any of the other hours), then implementation of the treatment by time of day should be considered when feasible.

This process is illustrated by example. Consider the example intersection in Table E-2. The annual road-user cost is \$43,400/yr for existing conditions. Protected left-turn operation (with a leading left-turn phase sequence) is proposed for the eastbound and westbound left-turn movements. The methodology in the *Highway Capacity Manual* is used to evaluate intersection operation and compute intersection delay. This evaluation indicates that the time in the cycle can be reallocated to accommodate the left-turn phases without increasing the 100-s cycle length. However, the intersection delay increases to 6.0 s/veh. Steps 1 to 6 are used to evaluate the proposed change, and an annual road-user cost of \$41,900/yr is computed. The change in road-user costs is computed as \$-1500 (= 41,900 - 43,400). It is a negative value, so it represents a net benefit to persons traveling through the intersection during the analysis period. Thus, the proposed change should be considered for implementation. Other hours of the day can be evaluated to determine if the proposed change should be implemented on a time-of-day basis.

REFERENCES

1. *Highway Capacity Manual*. 4th ed. Transportation Research Board, Washington, D.C., 2000.

Pedestrian Treatment Evaluation Worksheet									
General Information									
Location: _____					Analysis Period: _____ to _____				
Approach:		Eastbound		Westbound		Northbound		Southbound	
Cycle length (C _s), s _____	Left-turn mode	<input type="checkbox"/> Permissive <input type="checkbox"/> Prot.-perm. <input type="checkbox"/> Protected	<input type="checkbox"/> Permissive <input type="checkbox"/> Prot.-perm. <input type="checkbox"/> Protected	<input type="checkbox"/> Permissive <input type="checkbox"/> Prot.-perm. <input type="checkbox"/> Protected	<input type="checkbox"/> Permissive <input type="checkbox"/> Prot.-perm. <input type="checkbox"/> Protected	<input type="checkbox"/> Permissive <input type="checkbox"/> Prot.-perm. <input type="checkbox"/> Protected	<input type="checkbox"/> Permissive <input type="checkbox"/> Prot.-perm. <input type="checkbox"/> Protected	<input type="checkbox"/> Permissive <input type="checkbox"/> Prot.-perm. <input type="checkbox"/> Protected	<input type="checkbox"/> Permissive <input type="checkbox"/> Prot.-perm. <input type="checkbox"/> Protected
	Phase sequence	<input type="checkbox"/> Not applicable <input type="checkbox"/> Leading <input type="checkbox"/> Lagging	<input type="checkbox"/> Not applicable <input type="checkbox"/> Leading <input type="checkbox"/> Lagging	<input type="checkbox"/> Not applicable <input type="checkbox"/> Leading <input type="checkbox"/> Lagging	<input type="checkbox"/> Not applicable <input type="checkbox"/> Leading <input type="checkbox"/> Lagging	<input type="checkbox"/> Not applicable <input type="checkbox"/> Leading <input type="checkbox"/> Lagging	<input type="checkbox"/> Not applicable <input type="checkbox"/> Leading <input type="checkbox"/> Lagging	<input type="checkbox"/> Not applicable <input type="checkbox"/> Leading <input type="checkbox"/> Lagging	<input type="checkbox"/> Not applicable <input type="checkbox"/> Leading <input type="checkbox"/> Lagging
Volume Input									
Approach:		Eastbound		Westbound		Northbound		Southbound	
Movement, No.: {see note 1}		LT, 5	TH+RT, 2	LT, 1	TH+RT, 6	LT, 3	TH+RT, 8	LT, 7	TH+RT, 4
Vehicle volume, veh/h									
Crosswalk crossing the...			South leg		North leg		East leg		West leg
Pedestrian volume, p/h									
Phase Settings									
Walk interval duration, s									
Pedestrian recall?									
Crosswalk Geometry									
Crosswalk length, ft									
Median width along crosswalk, ft									
Analysis Results									
Annual ped.-veh. crashes during analysis period, cr/yr				Cost of left-turn-related ped.-veh. crash, \$/cr				214,050	
Annual crash cost, \$/yr									
Intersection delay during analysis period, s/veh									
Annual vehicle delay during analysis period, h/yr				Value of travel time, \$/h				17.70	
Annual delay cost, \$/yr									
Annual road-user cost, \$/yr									
Supplemental Calculations									
Conflicting left-turn volume, veh/h			V _{LT,1} =		V _{LT,5} =		V _{LT,7} =		V _{LT,3} =
Conflicting left-turn mode									
Conf. left-turn phase sequence									
Veh. travel time to conflict area, s									
Prob. WALK indication is displayed									
Pedestrian delay, s/p									
Cross-street volume, veh/h									
Prob. of legal crossing									
Legal ped. volume, p/h									
Illegal ped. volume, p/h									
Conf. with legal peds., conf/h									
Conf. with illegal peds., conf/h									
Total conflicts, conf/h									
Annual conflicts during analysis period, conf/yr									
Annual crashes during analysis period, cr/yr									

Note:

1 - Numbers follow NEMA movement-based phase numbering system (LT = left-turn, TH = through, RT = right-turn).