

Report of the Workshop on Intelligent Compaction for Soils and HMA

ER08-01

April 2-4, 2008

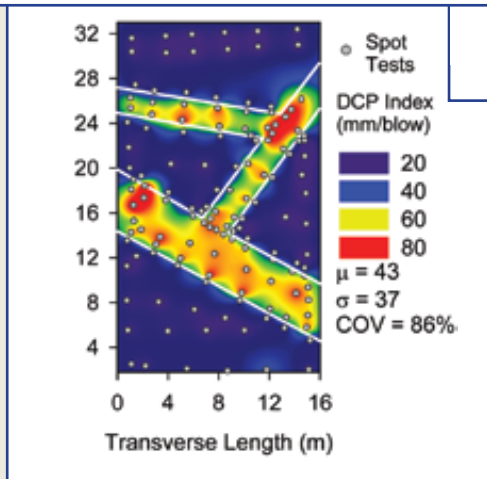
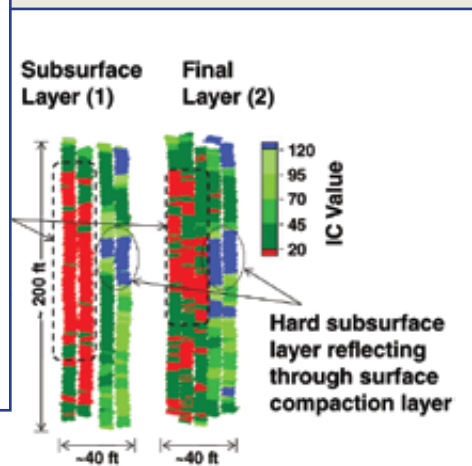
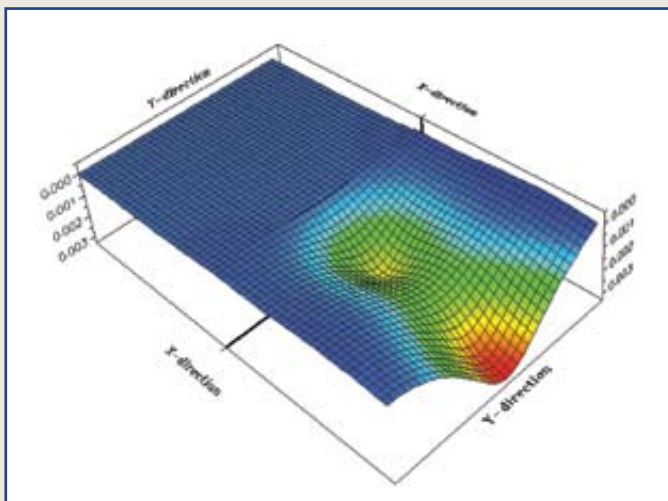

Disclaimer Notice

The contents of this report reflect the views of the authors, who are responsible for the facts and the accuracy of the information presented herein. The opinions, findings and conclusions expressed in this publication are those of the authors and not necessarily those of the sponsors.

The sponsors assume no liability for the contents or use of the information contained in this document. This report does not constitute a standard, specification, or regulation.

The sponsors do not endorse products or manufacturers. Trademarks or manufacturers' names appear in this report only because they are considered essential to the objective of the document.

Non-Discrimination Statement

Iowa State University does not discriminate on the basis of race, color, age, religion, national origin, sexual orientation, gender identity, sex, marital status, disability, or status as a U.S. veteran. Inquiries can be directed to the Director of Equal Opportunity and Diversity, (515) 294-7612.

Federal and state laws prohibit employment and/or public accommodation discrimination on the basis of age, color, creed, disability, gender identity, national origin, pregnancy, race, religion, sex, sexual orientation or veteran's status. If you believe you have been discriminated against, please contact the Iowa Civil Rights Commission at 800-457-4416 or Iowa Department of Transportation's affirmative action officer. If you need accommodations because of a disability to access the Iowa Department of Transportation's services, contact the agency's affirmative action officer at 800-262-0003.

**Report of the
Workshop on Intelligent Compaction for Soils and HMA**

April 2–4, 2008

**David J. White, Ph.D.
Associate Professor of Civil Engineering
Earthworks Engineering Research Center Director
2711 South Loop Drive, Suite 4700
Ames, Iowa 50010
515-294-1892
djwhite@iastate.edu**

**Sponsored by the Iowa Department of Transportation
and the Earthworks Engineering Research Center at Iowa State University**

Table of Contents

Preface	vii
Acknowledgments	ix
Abbreviations	xi
Executive Summary	xiii
Introduction	1
The Challenge	1
IC Workshop Vision.....	1
Background.....	1
Intelligent Compaction.....	1
Mechanistic Based In Situ Testing for QC/QA.....	3
Data Visualization and Management	6
Specifications	7
Current Intelligent Compaction Research Projects.....	7
Presentations	9
Intelligent Compaction for Soils and Aggregate—David White	11
Intelligent Compaction (IC) for Hot Mix Asphalt (HMA)—Lee Gallivan.....	23
Automated Technologies in Construction—Dan Streett	31
Earthworks Engineering Research Center—David White.....	35
Intelligent Compaction at Mn/DOT—Glenn Engstrom, Craig Collison, Art Bolland..	37
European Experience with ICS—François Chaignon	47
Intelligent Compaction for Soil and Asphalt—Dean Potts	55
Asphalt Manager Intelligent Compaction—Chris Connolly	59
Intelligent Compaction for Soils & HMA—Stan Rakowski	71
Evaluation of Highway Subgrade Strength with Acceleration Wave of the Vibration Roller—Stan Rakowski	79
Intelligent Compaction: GPS-based Compaction Control—Kirby Carpenter	83
Intelligent Compaction—Khalil Maalouf	89
Intelligent Compaction: Where we are at and where we need to be—Brett Stanton	91
Facilitator Report / Discussion—Tom Cackler, Ed Engle, Heath Gieselman, Lisa Rold, Douglas Townes, David White	95
Breakout Sessions	99
IC for Soils and Aggregate 1—Heath Gieselman (Facilitator), Pavana Vennapusa (Recorder).....	99
Knowledge Gaps	99
Equipment Advancements	99

Educational/Technology Transfer	99
Standards/Specifications and Guidelines	100
General.....	100
IC for Soils and Aggregate 2—Ed Engle (Facilitator), John Puls (Recorder)	100
Knowledge Gaps.....	100
Equipment Advancements	101
Educational/Technology Transfer	101
Standards/Specifications and Guidelines	102
General.....	102
IC for Soils and Aggregate 3 – Ed Engle (Facilitator), Pavana Vennapusa (Recorder) ...	102
Knowledge Gaps.....	102
Equipment Advancements	103
Educational/Technology Transfer	103
Standards/Specifications and Guidelines	104
IC for HMA 1—Tom Cackler (Facilitator), David White (Recorder)	104
Knowledge Gaps.....	104
Equipment Advancements	105
Educational/Technology Transfer	105
Standards/Specifications and Guidelines	105
General.....	106
IC for HMA 2—Lisa Rold (Facilitator), Paul Weigand (Recorder)	109
Educational/Technology Transfer	109
General.....	109
IC for HMA 3—Tom Cackler (Facilitator), David White (Recorder)	111
Knowledge Gaps.....	111
Equipment Advancements	111
Educational/Technology Transfer	111
Standards/Specifications and Guidelines	111
General.....	112
IC for HMA 4—Lisa Rold (Facilitator), Paul Weigand (Recorder)	113
Knowledge Gaps.....	113
Educational/Technology Transfer	113
General.....	113
Implementation Strategies 1—Douglas Townes (Facilitator), John Puls (Recorder)	114
Knowledge Gaps.....	114
Equipment Advancements	115
Educational/Technology Transfer	115
Standards/Specifications and Guidelines	115
General.....	116
Implementation Strategies 2—Heath Gieselman (Facilitator), Jerod Gross (Recorder)	116
Knowledge Gaps.....	116
Equipment Advancements	117
Educational/Technology Transfer	117
Standards/Specifications and Guidelines	117

Facilitator Report—Summary.....	118
IC for Soils and Aggregate.....	118
Knowledge Gaps.....	118
Equipment Advancements	118
Education/Technology Transfer.....	118
Standards/Specifications and Guidelines:	119
IC for HMA.....	119
Knowledge Gaps.....	119
Equipment Advancements	119
Education/Technology Transfer.....	120
Standards/Specifications and Guidelines	120
Implementation Strategies	120
Knowledge Gaps.....	120
Equipment Advancements	120
Education/Technology Transfer	121
Standards/Specifications and Guidelines	121
Panel Discussion.....	122
Reaction to Breakout Sessions.....	122
New Perspectives.....	122
Specifications	122
Technology Development	123
Group Exercise to Identify Implementation Strategies.....	124
Contractor Perspective	124
Manufacturer Perspective	124
State Agency Perspective	125
Outcomes.....	126
Next Steps.....	127
Appendices.....	130
Appendix A: Workshop Agenda.....	130
Appendix B: Workshop Attendees	132

Preface

This document summarizes the discussion and findings of a workshop on intelligent compaction for soils and hot-mix asphalt held in West Des Moines, Iowa, on April 2–4, 2008. The objective of the meeting was to provide a collaborative exchange of ideas for developing research initiatives that accelerate implementation of intelligent compaction (IC) technologies for soil, aggregates, and hot mix asphalt. Technical presentations, working breakout sessions, a panel discussion, and a group implementation strategy session comprised the workshop activities. About 100 attendees representing state departments of transportation, Federal Highway Administration, contractors, equipment manufacturers, and researchers participated in the workshop.

Acknowledgments

The Earthworks Engineering Research Center (EERC) at Iowa State University of Science and Technology (ISU) gratefully acknowledges the Iowa Department of Transportation (Iowa DOT) for its sponsorship of this workshop. Travel support for most state DOT participants and support for the development of this report were made possible by the Iowa DOT.

The EERC also sincerely thanks the following individuals for their support of this workshop:

Planning Committee

Sandra Larson (Chair), Iowa Department of Transportation
John Adam, Iowa Department of Transportation
Tom Cackler, National Concrete Pavement Technology Center, Iowa State University
Carol Culver, Iowa Department of Transportation
Mark Dunn, Iowa Department of Transportation
Ed Engle, Iowa Department of Transportation
Heath Gieselman, Earthworks Engineering Research Center, Iowa State University
Max Grogg, Federal Highway Administration
Greg Kinser, Des Moines Asphalt
Mike Kvach, Asphalt Paving Association of Iowa
Kent Nicholson, Iowa Department of Transportation
Sharon Prochnow, National Concrete Pavement Technology Center, Iowa State University
Lisa Rold, Federal Highway Administration
John Smythe, Iowa Department of Transportation
David White, Earthworks Engineering Research Center, Iowa State University

Workshop Presenters and Panel Discussion Participants

Art Bolland, Minnesota Department of Transportation
Kirby Carpenter, Texana Machinery
François Chaigon, COLAS
Chris Connolly, Bomag Americas
Glenn Engstrom, Minnesota Department of Transportation
Lee Gallivan, Federal Highway Administration
Khalil Maalouf, Volvo Construction Equipment
Dwayne McAninch, McAninch Corp.
Dean Potts, Caterpillar Global Paving
Stan Rakowski, Sakai America
Brett Stanton, Payne & Dolan, Inc.
Dan Street, New York State Department of Transportation
David White, Earthworks Engineering Research Center, Iowa State University

Breakout Session Facilitators and Recorders

Tom Cackler, National Concrete Pavement Technology Center, Iowa State University
Heath Gieselman, Earthworks Engineering Research Center, Iowa State University
Jerod Gross, Snyder & Associates
John Puls, Iowa State University
Lisa Rold, Federal Highway Administration
Douglas Townes, Federal Highway Administration
Pavana Vennapusa, Iowa State University
David White, Earthworks Engineering Research Center
Paul Wiegand, National Concrete Pavement Technology Center, Iowa State University

Workshop Moderators

Sandra Larson, Iowa Department of Transportation
Max Grogg, Federal Highway Administration
Mike Kvach, Asphalt Paving Association of Iowa

Abbreviations

γ_d	=	dry unit weight
AMG	=	automated machine guidance
CBR	=	California bearing ratio
CCV	=	Sakai compaction control value; Caterpillar compaction value
CIV	=	Clegg impact value
CMV	=	compaction meter value
DCP	=	dynamic cone penetrometer
DOT	=	Department of Transportation
DTM	=	digital terrain model
EED	=	electronic engineering data
E_{LWD}	=	light weight deflectometer elastic modulus
E_{PLT}	=	plate load test elastic modulus
E_{SSG}	=	soil stiffness gauge elastic modulus
E_{vib}	=	BOMAG roller vibration modulus
FHWA	=	Federal Highway Administration
FWD	=	falling weight deflectometer
GPS	=	global positioning system
HMA	=	hot mix asphalt
IC	=	intelligent compaction
K	=	hydraulic conductivity
K_s	=	case/ammann roller stiffness
LWD	=	light weight deflectometer
MDP	=	Caterpillar machine drive power
RMV	=	resonant meter values
TDM	=	theoretical maximum density

Executive Summary

The objective of this workshop was to provide a collaborative exchange of ideas for developing research and educational initiatives that accelerate implementation of intelligent compaction (IC) technologies for soil, aggregates, and hot mix asphalt that will lead to conclusive and measurable improvements within five years. Several key strategies were identified and are documented in this report. Technical presentation slides, notes from the working breakout sessions, a summary of the panel discussion, and a summary of the group implementation strategy session are reported herein. A road map for implementation that identifies several key research and training focal areas is summarized at the end of this report.

Following several technical presentations, nine breakout sessions were conducted covering three topic areas: “IC for Soils and Aggregate,” “IC for HMA,” and “Implementation Strategies.” Each group was asked to address their topic around the following questions:

- What are the existing knowledge gaps?
- What equipment advancements are needed?
- What educational/technology transfer needs exist?
- What standards/specifications and guidelines need to be developed?

Based on a detailed review of the results from this session, there were two levels of analysis of the results: (1) prioritized results for each topic area, and (2) a cross-cutting top 10 list of key research needs. The top 10 research needs are summarized in Table 2 from the report, replicated below.

Table 2. Summary of main IC technology research needs

Top 10 IC Technology Research Needs

1. Correlation studies (cohesive, stabilized, granular, HMA, etc.) (136)
2. Education/training materials and programs (112)
3. Moisture content (influence + measurement) (61)
4. Integrated design + real-time data transfer (57)
5. Case histories + demos + benefit + successes (48)
6. Engineering parameter to measure (density, modulus, stiffness, core mat temperature) (47)
7. Addressing non-uniformity (34)
8. Establishing QC/QA framework - statistically significant (28)
9. Measurement influence depth (19)
10. Promoting good geotechnical practices (13)

A panel discussion was carried out to reflect on the outcomes determined from the breakout sessions and what was learned from the workshop that may have changed perspectives on IC technology. The discussion points were divided into four categories:

- Reaction to breakout sessions
- New perspectives
- Specifications
- Technology developments

Each of these categories was summarized and condensed to four common themes. These themes are summarized in Table 3 of the report, which is replicated below.

Table 3. Summary of common themes from panel discussion

Common Themes from Panel Discussion Session
1. High level of interest from the state DOTs in further studying opportunities to implement IC.
2. Implementation strategies need to build on existing information and past research.
3. Specifications for IC and in situ testing should not restrict manufacturer/equipment developer innovations.
4. Contractor and state DOT field personnel and engineers need educational materials for IC and in situ QC/QA testing.

Following the panel discussion, the audience was given instructions to break up into groups to further brainstorm implementation strategies. A list of the three common strategies was derived from this exercise. The common strategies are summarized in Table 4 of the report, shown here.

Table 4. Summary of common themes from the group implementation strategy session

Common Themes from Group Implementation Strategy Session
1. Develop IC training and certification program.
2. Demonstrate benefits of IC through demonstration projects.
3. Promote partnership as key strategy to implementation.

At the conclusion of the workshop a discussion centered on understanding where we are and where we are going as a lead-in to developing a road map for implementation of IC technologies. Key points from the discussion are summarized in Table 5 of the report, shown on the following page.

To move from the current practice and knowledge base, several key strategies were considered and are listed in Table 6 of the report, shown on the following page.

Table 5. Summary of key points

Where we are:	Where we are going:
<ul style="list-style-type: none"> • Lack widely accepted IC specifications in U.S. • Need education/training materials • Innovative IC and in situ testing equipment • IC technologies provide documented benefits (smooth drum - granular) • Great potential and some limited successes for cohesive and HMA • Poor database development for IC projects and case histories • Human IC network initiated • Increasing acceptance/GPS infrastructure for stakeless grading/machine guidance • “Don’t know what we don’t know” 	<ul style="list-style-type: none"> • Standardized and credible IC specifications inclusive of various IC measurement systems • Widespread implementation of IC technologies • High quality database of correlations • Several documented successes for cohesive/stabilized/granular/HMA • Better understanding of roadway performance - what are key parameters? • Innovative new sensor systems and intelligent solutions • Integrated and compatible 3D electronic plans with improved processes, efficiency and performance • Real-time wireless data sharing • Enhanced archival and visualization software • Improved analytical models of machine-ground interactions

Table 6. Strategies for moving forward

Strategies for Moving Forward
<ul style="list-style-type: none"> • Participate in partnerships for IC research and information exchange regionally and nationally • Be an advocate for IC implementation • Contribute to problem statement development for NCHRP, TRB, FHWA, AASHTO, ASCE Committees • Participate in IC conferences/studies and the annual EERC Workshop • Participate on EERC Scientific and Policy Advisory Council (35 members) – IC and other issues • Stay connected: Subscribe to EERC Technical Bulletins, Tech Transfer Summaries, Technical Reports, Educational Videos, etc. (www.intelligentcompaction.com). • Develop a comprehensive and strategic IC road map for research and educational/technology transfer

Results from the workshop provided significant information to outline the road map which can serve as a starting point for further discussions and assessment. Additional steps beyond peer reviewing the research/educational elements of the road map will be required to create an integrated research management plan, establish a schedule, and identify organizations, contractors, and equipment manufacturers that want to partner and leverage funding/equipment and human resources to move the program forward.

Introduction

The Challenge

When it comes to addressing the nation's infrastructure construction challenges, investment in new research and innovative technologies, changing policy and creating educational programs, and developing sustainable and environmentally-friendly practices are needed^{1, 2, 3}. Although it lacks headline grabbing drama, improvements to earthwork operations and technologies potentially offer a significant return on investment. This is because whether it's highways, levees/dams, railways, airfields, underground tunnels, waterways, etc. all civil infrastructure projects are composed of, or supported by, soil and rock—the world's most abundant construction material. Unfortunately, many of the current problems with highway systems are attributed to unstable and non-uniform ground conditions. Intelligent compaction (IC) is one technology that could address compaction and non-uniformity problems for earth materials and hot mix asphalt (HMA). Roller-integrated global position system (GPS) documentation capabilities (i.e. mapping) provide new opportunities for providing 100 percent coverage information and documenting non-uniformity of compacted materials. To date, only a few research/demonstration projects have been completed, and no widely accepted specifications are available for the United States. To benefit from IC technologies, a comprehensive and strategic plan for research and educational/technology transfer activities is needed.

IC Workshop Vision

The objective of the IC workshop was to provide a collaborative exchange of ideas for developing research and educational initiatives that accelerate implementation of IC technologies for soil, aggregates, and hot mix asphalt that will lead to conclusive and measurable improvements within five years. Several key strategies were identified and are documented in this report. Technical presentation slides, notes from the working breakout sessions, a summary of the panel discussion, and a summary of the group implementation strategy session are reported herein. A road map for implementation that identifies several key research and training focal areas is summarized at the end of this report. As a lead-in, a brief review of intelligent compaction technologies, specifications, and in situ testing is described.

Background

Intelligent Compaction

Intelligent compaction (IC) technologies consist of machine-integrated sensors and control systems that provide a record of machine-ground interaction. With feedback control and adjustment of vibration amplitude and/or frequency and/or speed during the compaction process, the technology is referred to as intelligent compaction. Without the vibration feedback control system the technology is commonly referred to as continuous compaction control (CCC).

¹ *Geological and Geotechnical Engineering in the New Millennium: Opportunities for Research and Technological Innovation* (2006). By National Research Council (U.S.), National Research Council.

² John O'Doherty (2007). *At The Crossroads: Preserving Our Highway Investment*, National Center for Pavement Preservation at Michigan State University.

³ Report Card for America's Infrastructure (<http://www.asce.org/reportcard/2005/index.cfm>)

The machine-ground interaction measurements provide an indication of ground stiffness/strength and to some extent degree of compaction. Most of the IC/CCC technologies are vibratory-based systems applied to single drum self-propelled smooth drum rollers. IC/CCC technologies have also been applied to vibratory double drum asphalt compactors and self-propelled padfoot compactors. CCC vibratory roller systems have been used in Europe for more than 20 years. During this period the technologies have evolved to include a variety of different measurement techniques and GPS-based documentation systems. Most of the research documented in the literature deals with CCC applications for granular materials. More recently, non-vibratory (static) rollers have been outfitted with machine-integrated systems that provide measurement values based on machine drive power. This approach is being developed primarily for use in non-granular materials. Other IC measurements systems are also in development, and it is expected that these technologies will continue to improve and find applications to a wider range of earth materials and field conditions.

There are at least six IC/CCC systems/parameters: omega value, compaction meter value (CMV), stiffness (k_s), vibration modulus (E_{vib}), compaction control value (CCV), and machine drive power (MDP). The measurement parameters are well defined in the literature^{4, 5, 6, 7, 8}. Figure 1 shows several of the manufacturer smooth drum vibratory compactors for soils and corresponding data visualization and management software displays.



Figure 1. Smooth drum compaction monitoring systems for soil and aggregate.

⁴ Kröber, W., Floss, E., Wallrath, W. (2001). "Dynamic soil stiffness as quality criterion for soil compaction," Geotechnics for Roads, Rail Tracks and Earth Structures, A.A.Balkema Publishers, Lisse /Abingdon/ Exton (Pa) /Tokyo, 189-199.

⁵ Thurner, H. and Sandström, Å. (1980). "A new device for instant compaction control." Proc., Intl. Conf. on Compaction, Vol. II, 611-614, Paris.

⁶ Andereg R., and Kaufmann, K. (2004). "Intelligent compaction with vibratory rollers - feedback control systems in automatic compaction and compaction control," Transportation Research Record No. 1868, *Journal of the Transportation Research Board*, National Academy Press, 124-134.

⁷ Scherocman, J., Rakowski, S., and Uchiyama, K. (2007). "Intelligent compaction, does it exist?" 2007 Canadian Technical Asphalt Association (CTAA) Conference, Victoria, BC, July.

⁸ White, D.J, Jaselskis, E., Schaefer, V., and Cackler, E. (2005). "Real-time compaction monitoring in cohesive soils from machine response." Transportation Research Record No. 1936, National Academy Press, 173-180.

Transportation agencies and contractors are beginning to investigate applications for the IC/CCC technologies as part of field demonstrations and a limited number of projects for which the technology has been specified⁹. Expectations are that the IC/CCC systems will (1) improve construction efficiency, (2) streamline quality management programs of earthwork and asphalt projects, (3) better link quality acceptance parameters and documentation with pavement design, and (4) improve the performance of compacted materials^{10, 11, 12}.

Mechanistic Based In Situ Testing for QC/QA

Traditional quality control and assurance (QC/QA) programs are typically fulfilled by performing in situ tests that provide information about the state or performance of the compacted materials. Soil dry density and moisture content are the most common measurements for acceptance for earth materials. Similarly, core samples and nuclear density testing are the predominant field quality assurance tests for hot mix asphalt. IC/CCC measurement values can be empirically related to density but generally requires an independent measure of moisture content and multiple regression analysis, particularly for cohesive soils¹³. In situ measurements of mechanistic parameters (e.g., elastic modulus, strength, etc.) are now being considered with growing interest as an alternative to traditional moisture/density control. One advantage of linking IC/CCC measurement values to mechanistic parameters is that it provides a link to performance-based specifications and input/verification for mechanistic pavement design.

Relationships between IC/CCC measurement values and in situ compaction measurements are influenced by operating conditions of the compactors¹⁴ (e.g., roller size, vibration amplitude and frequency, and velocity) and material conditions (e.g., soil type, moisture content, lift thickness, underlying layer stiffness, asphalt temperature)^{7, 15}. Recent studies have demonstrated empirical relationships, and limitations thereof, between the various IC/CCC measurements values and conventional in situ spot test measurements for soil materials^{16, 17}.

⁹ White, D.J, Thompson, M., Vennapusa, P. (2007). "Field Validation of Intelligent Compaction Monitoring Technology for Unbound Materials," Mn/DOT Report No. MN/RC 2007-10, Iowa State University, Ames, IA.

¹⁰ Briaud, J. L., Seo, J. (2003). *Intelligent Compaction: Overview and Research Needs*, Texas A&M University.

¹¹ Petersen, D., Siekmeier, J., Nelson, C., Peterson, R. (2006). "Intelligent soil compaction – technology, results and a roadmap toward widespread use." Transportation Research Record No. 1975, *Journal of the Transportation Research Board*, National Academy Press, 81–88.

¹² Thompson, M., and White, D. (2007). "Field calibration and spatial analysis of compaction monitoring technology measurements." Transportation Research Record No. 2004, : *Journal of the Transportation Research Board*, National Academy Press, 69–79.

¹³ Thompson, M., and White, D. (2008). "Estimating compaction of cohesive soils from machine drive power." *Journal of Geotechnical and Geoenvironmental Engineering*, ASCE, (in press)

¹⁴ Adam, D., and Kopf, F. (2004). "Operational devices for compaction optimization and quality control (Continuous Compaction Control & Light Falling Weight Device)." Proc., of the Intl. Seminar on Geotechnics in Pavement and Railway Design and Construction, December, Athens, Greece (Invited paper), 97–106.

¹⁵ White, D., and Thompson, M. (2008). "Relationships between in situ and roller-integrated compaction measurements for granular soils." *Journal of Geotechnical and Geoenvironmental Engineering*, ASCE (in press).

¹⁶ White, D.J, Thompson, M., Vennapusa, P. (2007). "Field study of compaction monitoring systems: self-propelled non-vibratory 825G and vibratory smooth drum CS-533 E rollers," Final Report, Center of Transportation Research and Education, Iowa State University, Ames, Iowa.

¹⁷ White, D., Vennapusa, P., Gieselman, H. (2008). "Roller-integrated compaction monitoring technology: Field evaluation, spatial visualization, and specifications." Proc., 12th Intl. Conf. of Intl. Assoc. for Computer Methods and Advances in Geomechanics (IACMAG), 1–6 October, Goa, India.

Because the relationships are influenced by roller operations, soil type, and stratigraphy underlying the soil being compacted, several factors should be considered during calibration. Figure 2 shows a simple example comparing IC measurement values to various in situ spot test measurements. Regression coefficient values (r) range from 0.5 to 0.9, indicating fair to good correlations. Improvements to these correlations are expected with improved understanding of the measurement influence depth of the rollers and various in situ testing devices. Figure 3 illustrates differences between measurement influence depths for rollers and various in situ spot test measurements⁹. One of the challenges with correlating in situ spot test measurements with IC measurement values is that the roller measurements values are an average or integrated value over the width of the drum up to depths equal to one meter and greater.

With the implementation of IC/CCC technologies, several new in situ compaction measurement devices have been developed and investigated. Figure 4 shows many of the in situ measurement devices that are being evaluated as an alternative to traditional density testing. Several recent research reports provide comparison measurements between the new devices and conventional measurements. However, very little has been done to link the IC measurement values analytically to in situ test measurements or to develop statistically reliable sampling and analysis plans.

Measuring soil density and moisture content, albeit relatively laborious and time-consuming using traditional techniques, provides information that can be easily understood and related to laboratory test results. But while density and moisture content are broadly accepted measures of compaction, the physical properties are not necessarily direct measures of performance. Some of the emerging testing technologies now focus on measurement of the in situ mechanistic properties of soil, namely strength and modulus, such as the dynamic cone penetrometer

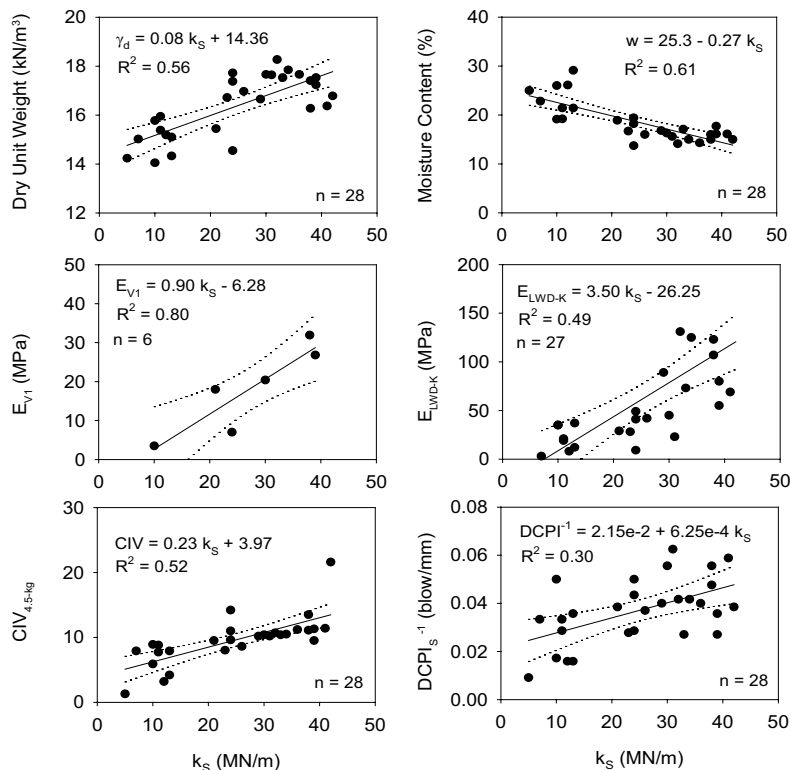

Figure 2. Relationships between k_s and in situ compaction measurements—subgrade material.

(DCP), the Clegg impact tester, the soil stiffness gauge (SSG), the light weight deflectometer (LWD), dirt seismic pavement analyzer (D-SPA), etc. These tools are now being studied and in a few cases implemented into quality control and assurance programs with particular emphasis on characterizing pavement layers and subgrade for mechanistic-empirical (M-E) pavement design.

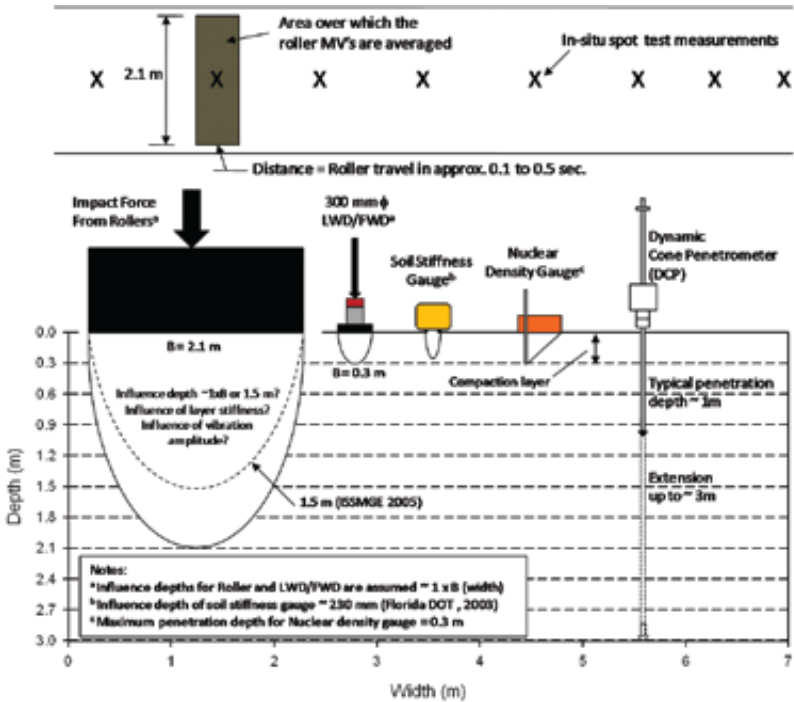

Figure 3. Measurement influence depth comparison for rollers and in situ test devices.



Figure 4. Various in situ compaction equipment for field QC/QA.

Data Visualization and Management

IC/CCC technology provides the opportunity to collect and evaluate information for 100 percent of the project area, but it can also produce large data files that create analysis, visualization, transfer, and archival challenges. Thus, approaches for managing the data need to be developed. IC measurement values referenced to GPS coordinates are spatially referenced, which can be useful for targeting QA testing and signaling to the contractor where additional rolling or rework is needed. Figure 5 shows an example data set for visualization and analysis for CMV data overlaid with in situ measurement values. This approach has the advantage of linking IC and in situ test measurements with electronic plans¹⁸.

IC data output files have various formats that include *.xls, *.txt, *.csv, and *.dbf file types. Memory required for data storage will vary with the file type. For a section with plan dimensions of approximately 250 meters by 10 meters with compaction performed in five roller lanes, the memory required for single point data (assigned to one location across the drum) is approximately one to two megabytes for *.xls, *.txt, *.csv, and *.dbf file formats. The total memory required for creating a geodatabase for a project might be on the order of one to two gigabits.

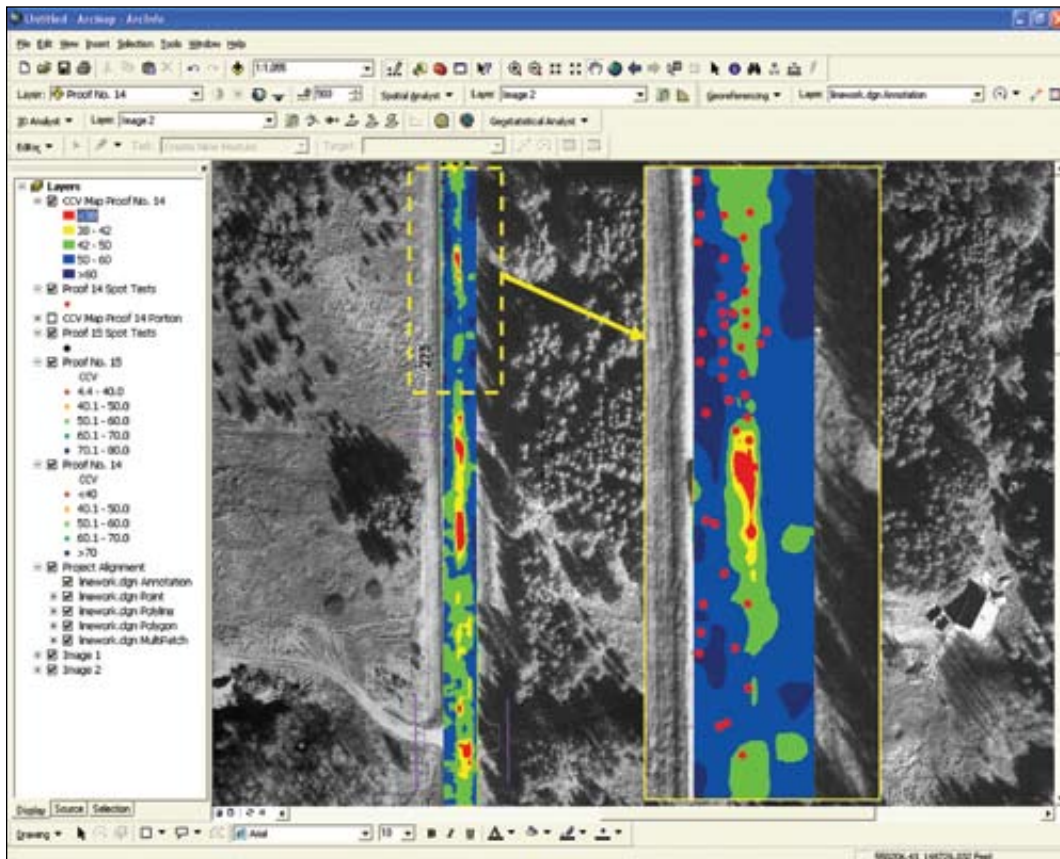

Figure 5. GIS data management approach.

¹⁸ White, D., Thompson, M., Vennapusa, P., and Siekmeier, J. (2008). "Implementing intelligent compaction specifications on Minnesota TH 64: Synopsis of measurement values, data management, and geostatistical analysis." Transportation Research Record: *Journal of the Transportation Research Board*, National Academy Press (in press).

Univariate statistics (e.g. mean and standard deviation) of IC measurement values alone do not characterize the spatial variability and specifically do not address the issue of uniformity from a spatial viewpoint¹⁹. Two data sets with identical distributions of the data (having similar mean, standard deviation, etc), can have significantly different spatial characteristics. This issue has not been addressed adequately in current specifications and will require new research to investigate the impact of non-uniformity on pavement performance.

Specifications

Specifications developed for use of CCC generally provide requirements on the equipment size, requirements for documentation of the machine sensor measurements and GPS mapping, machine operations (including speed and amplitude), and quality control compaction requirements. Table 1 lists some of the key attributes for specifications identified in the literature⁹.

Current Intelligent Compaction Research Projects

Currently, there are two national studies underway to evaluate vibration-based IC and CCC systems—National Cooperative Highway Research Program (NCHRP) 21-09 and FHWA IC pooled fund study 954.

The NCHRP Study has the objectives of determining the reliability of intelligent compaction systems and to developing recommended construction specifications for the application of intelligent compaction systems in soils and aggregate base materials.

The FWHA study includes evaluation of asphalt rollers in addition to soil and aggregate. The emphasis of this study is centered on accelerating the development of IC QC/QA specifications, developing an experienced and knowledgeable IC expertise base within the participating DOTs, and identifying needed improvements and research for IC equipment and QC/QA field-testing equipment. A website has been established for this project (www.intelligentcompaction.com/).

In addition to these national level studies, a few states have conducted demonstration projects. Minnesota DOT (Mn/DOT) has implemented IC on several projects recently and has a detailed website dedicated to intelligent compaction (www.dot.state.mn.us/materials/researchic.html).

¹⁹ Vennapusa, P., White, D.J. (2008). "Geostatistical analysis for spatially referenced roller-integrated compaction measurements," *Journal of Geotechnical and Geoenvironmental Engineering*, ASCE (in review, submitted July 2008).

Table 1. Summary of intelligent compaction specifications

	Equipment	Field size	Location Specs	Documentation	Compaction Specs	Speed	Freq.
Mn/DOT (2006 TH 64)*	Smooth drum or padfoot vibratory roller (25,000 lbs.)	300 ft x 32 ft (minimum at base). Max 4 ft. thick.	One calibration/control strip per type or source of grading material	Compaction, stiffness, moisture, QC activities, and corrective actions (weekly report)	90% of the stiffness measurements must be at 90% of the compaction target value.	Same during calibration and production compaction	
ISSMGE	Roller chosen by experience	100 m by the width of the site	Homogenous, even surface. Track overlap \leq 10% drum width.	Rolling pattern, sequence of compaction and measuring passes; amplitude, speed, dynamic measuring values, frequency, jump operation, and corresponding locations	Correlation coefficient \geq 0.7. Minimum value \geq 95% of Ev1, and mean should be \geq 105% (or \geq 100% during jump mode). Dynamic measuring values should be lower than the specified minimum for \leq 10% of the track. Measured minimum should be \geq 80% of the specified minimum. Standard deviation (of the mean) must be \leq 20% in one pass.	Constant 2–6 km/h (\pm 0.2 km/h)	Constant (\pm 2 Hz)
Earthworks (Austria)	Vibrating roller compactors with rubber wheels and smooth drums suggested	100 m long by the width of the site	No inhomogeneities close to surface (materials or water content). Track overlap \leq 10% drum width.	Compaction run plan, sequence of compaction and measurement runs, velocity, amplitude, frequency, speed, dynamic measuring values, jump operation, and corresponding locations	Correlation coefficient \geq 0.7. Minimum value \geq 95% of Ev1, and median should be \geq 105% (or \geq 100% during jump mode). Dynamic measuring values should be lower than the specified minimum for \leq 10% of the track. Measured minimum should be \geq 80% of the set minimum. Measured maximum in a run cannot exceed the set maximum (150% of the determined minimum). Standard deviation (of the median) must be \leq 20% in one pass.	Constant 2–6 km/h (\pm 0.2 km/h)	Constant (\pm 2 Hz)
Research Society for Road and Traffic (Germany)	Self-propelled rollers with rubber tire drive are preferred; towed vibratory rollers with towing vehicle are suitable.	Each calibration area must cover at least 3 partial fields ~20 m. long	Level and free of puddles. Similar soil type, water content, layer thickness, and bearing capacity of support layers. Track overlap \leq 10% machine width.	Dynamic measuring value; frequency; speed; jump operation; amplitude; distance; time of measurement; roller type; soil type; water content; layer thickness; date, time, file name, or registration number; weather conditions; position of test tracks and rolling direction; absolute height or application position; local conditions and embankments in marginal areas; machine parameters; and perceived deviations	The correlation coefficient resulting from a regression analysis must be \geq 0.7. Individual area units (the width of the roller drum) must have a dynamic measuring value within 10% of adjacent area to be suitable for calibration.	Constant	
Vägverket (Sweden)	Vibratory or oscillating single-drum roller. Min. linear load 15–30 kN. Roller-mounted compaction meter optional.	Thickness of largest layer 0.2–0.6 m.	Layer shall be homogenous and non-frozen. Protective layers $<$ 0.5 m may be compacted with sub-base.	—	Bearing capacity or degree of compaction requirements may be met. Mean of compaction values for two inspection points \geq 89% for sub-base under roadbase and for protective layers over 0.5 m thick; mean should be \geq 90% for roadbases. Required mean for two bearing capacity ratios varies depending on layer type.	Constant 2.5–4.0 km/h	—

* Note: The 2007 Mn/DOT intelligent compaction projects will implement new/revised specifications for granular and cohesive materials including a light weight deflectometer (LWD) quality compaction pilot specification.

Presentations

The following is a list of the technical presentations delivered at the workshop. The slides follow.

1. Intelligent Compaction for Soils and Aggregate—David White
2. Intelligent Compaction (IC) for Hot Mix Asphalt (HMA)—Lee Gallivan
3. Automated Technologies in Construction—Dan Streett
4. Earthworks Engineering Research Center—David White
5. Intelligent Compaction at Mn/DOT—Glenn Engstrom, Craig Collison, and Art Bolland
6. European Experience with ICS—François Chaignon
7. Intelligent Compaction for Soil and Asphalt—Dean Potts
8. Asphalt Manager Intelligent Compaction—Chris Connolly
9. Intelligent Compaction for Soils & HMA—Stan Rakowski
10. Evaluation of Highway Subgrade Strength with Acceleration Wave of the Vibration Roller—Stan Rakowski
11. Intelligent Compaction: GPS-based Compaction Control—Kirby Carpenter
12. Intelligent Compaction—Khalil Maalouf
13. Intelligent Compaction: Where we are at and where we need to be—Brett Stanton
14. Facilitator Report / Discussion—Tom Cackler, Ed Engle, Heath Gieselman, Lisa Rold, Douglas Townes, David White

Intelligent Compaction for Soils and Aggregate

David White

IOWA STATE UNIVERSITY
Civil, Construction & Environmental Engineering

Intelligent Compaction For Soils and Aggregate

Intelligent Compaction for Soils and HMA Workshop
West Des Moines, Iowa
April 2-4, 2008

David J. White, Ph.D.
Associate Professor
djwhite@iastate.edu



Dream it, Design it, Build it. www.ccee.engineering.iastate.edu

Outline

- Theory/Technology
- Specifications
- Why Important?
- Factors that Affect IC-MVs
- Correlation Studies
- Case histories

Technology



Caterpillar:
CMV, RMV, MDP

Dynapac:
CMV, Bouncing Value

Bomag: E_{VIB}

Sakai: CCV

Case/Ammann: k_s

IC Measurement Values

Manufacturer	Roller-Integrated Measurement Features	Feedback Control
Ammann	$k_s = \frac{1}{\rho} \left(\frac{F}{A_s} - \frac{m \cdot \omega^2 \cdot \delta}{A_s} \right)$	Adjusts amplitude and frequency
Bomag	$k_s = \frac{1}{\rho} \left(\frac{F}{A_s} - \frac{m \cdot \omega^2 \cdot \delta}{A_s} \right)$ where $\delta = \frac{1}{\omega} \left(\frac{F}{A_s} - \frac{m \cdot \omega^2 \cdot \delta}{A_s} \right)$	Adjusts amplitude and direction on the drum
Caterpillar	Geodynam CMV = $C \left(\frac{\Delta k_s}{A_s} \right)$ Geodynam RMV = $\frac{\Delta k_s}{A_s}$ $\Delta k_s = F_s - \rho \omega^2 \left(\text{mass} + \frac{\rho}{g} \right) - (\text{net} + \delta)$	Adjusts amplitude based on RMV
Dynapac	Geodynam CMV = $C \left(\frac{\Delta k_s}{A_s} \right)$ Bouncing Value = $\frac{\Delta k_s}{A_s}$	Adjusts amplitude based on bouncing value
Sakai	CCV = $\left[\frac{\Delta k_{s1} + \Delta k_{s2} + \Delta k_{s3} + \Delta k_{s4}}{\Delta k_{s1} + \Delta k_{s2}} \right] \cdot 100$	No

Influence of Drum Operating Mode

Drum motion	Interaction drum-soil	operating condition	soil contact force	application of OGC	soil stiffness	roller speed	drum amplitude
periodic	continuous contact	CONT. CONTACT		yes	low	fast	small
		PARTIAL UPLIFT		yes	↑	↑	↓
	DOUBLE JUMP		yes				
	ROCKING MOTION		no	↓	↓	↓	
stochastic	non-periodic force of contact	CHAOTIC MOTION		no	high	slow	large

Summary of operating modes (from Adam and Kopf 2004)

Influence of Drum Operating Mode

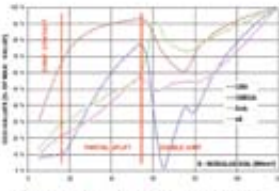
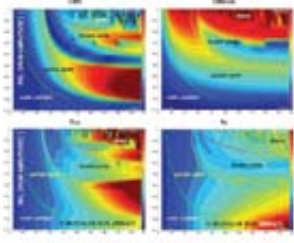
Influence of drum operating condition on roller MV's relative to soil stiffness

Roller MV variation with soil modulus and drum vibration amplitude

(results of numerical simulations, from Adam and Kopf 2004)

Intelligent Compaction for Soils and Aggregate

David White

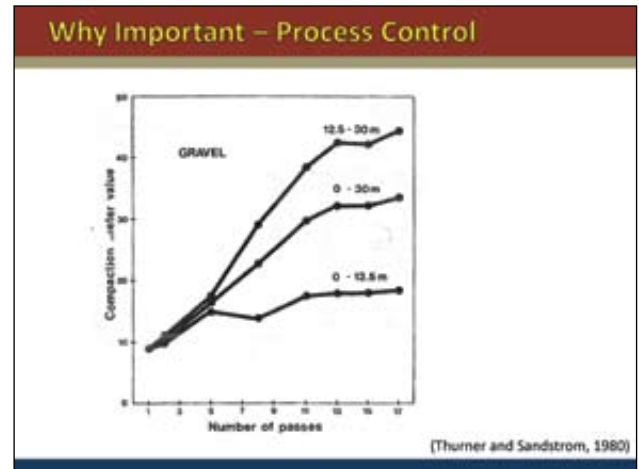
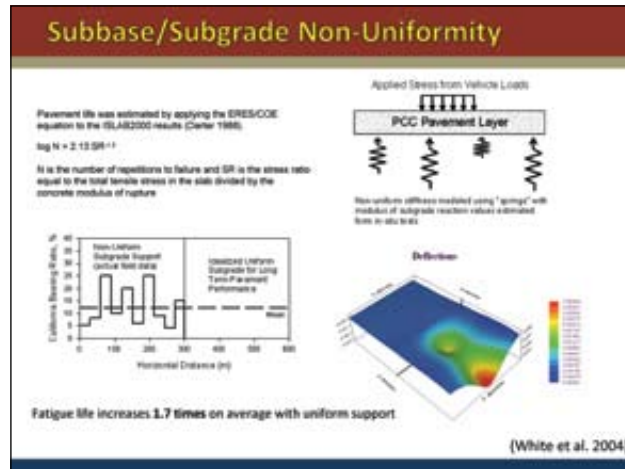
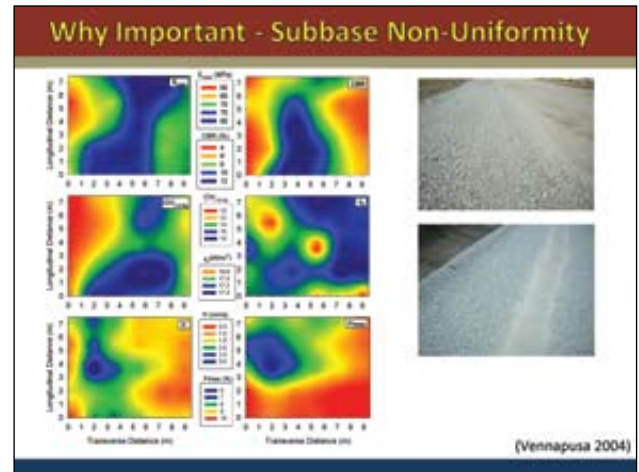
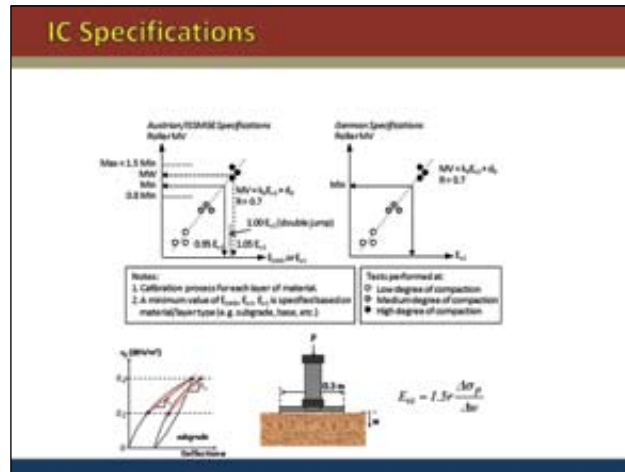

- ### Factors Affecting IC - MVs
- Vibration Amplitude/Frequency
 - Operating Speed
 - Roller Size
 - Soil Type
 - Soil Stratigraphy
 - In-situ Moisture Content

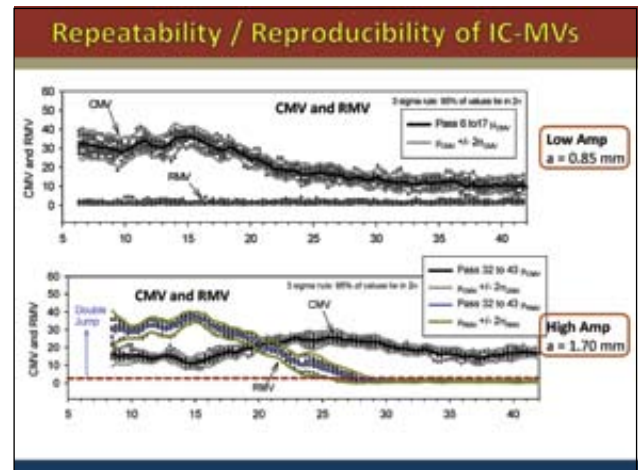

Intelligent Compaction for Soils and Aggregate

David White

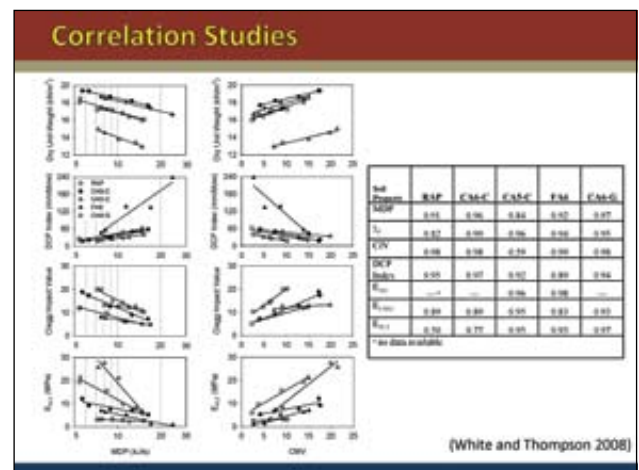
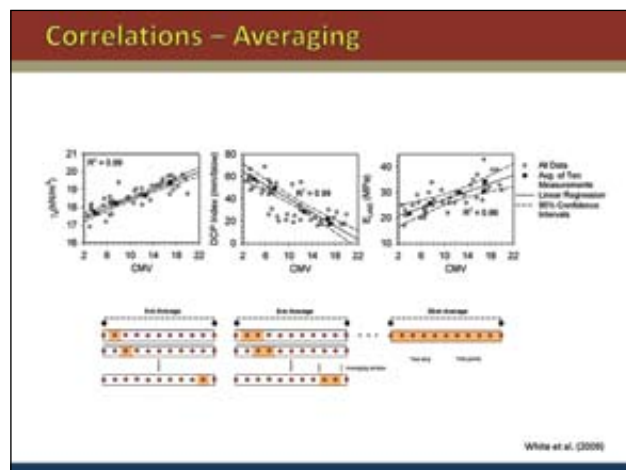
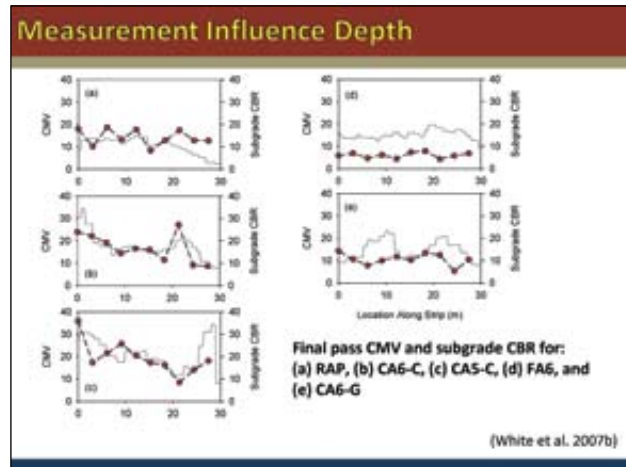
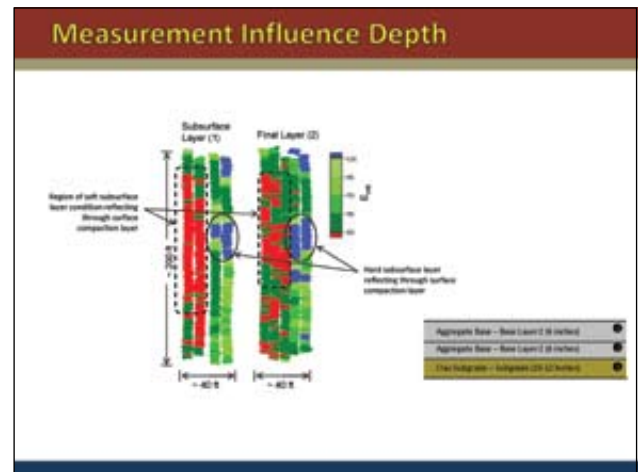
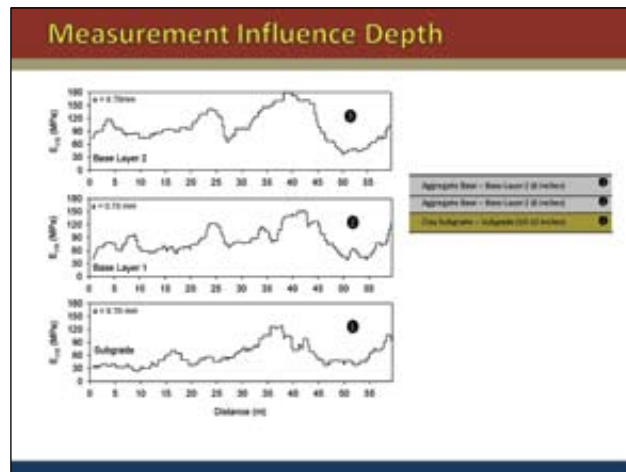

Intelligent Compaction for Soils and Aggregate

David White

Regression Relationships

Relationship	Statistical Data	Relationship	Statistical Data
IC-TV vs. k_v	$k_v = 0.0001 \cdot IC-TV + 0.0001$ $R^2 = 0.99$	IC-TV vs. k_v	$k_v = 0.0001 \cdot IC-TV + 0.0001$ $R^2 = 0.99$
IC-TV vs. E_{max}	$E_{max} = 0.0001 \cdot IC-TV + 0.0001$ $R^2 = 0.99$	IC-TV vs. E_{max}	$E_{max} = 0.0001 \cdot IC-TV + 0.0001$ $R^2 = 0.99$
IC-TV vs. OCV	$OCV = 0.0001 \cdot IC-TV + 0.0001$ $R^2 = 0.99$	IC-TV vs. OCV	$OCV = 0.0001 \cdot IC-TV + 0.0001$ $R^2 = 0.99$
IC-TV vs. CMV	$CMV = 0.0001 \cdot IC-TV + 0.0001$ $R^2 = 0.99$	IC-TV vs. CMV	$CMV = 0.0001 \cdot IC-TV + 0.0001$ $R^2 = 0.99$

(White et al. 2009)

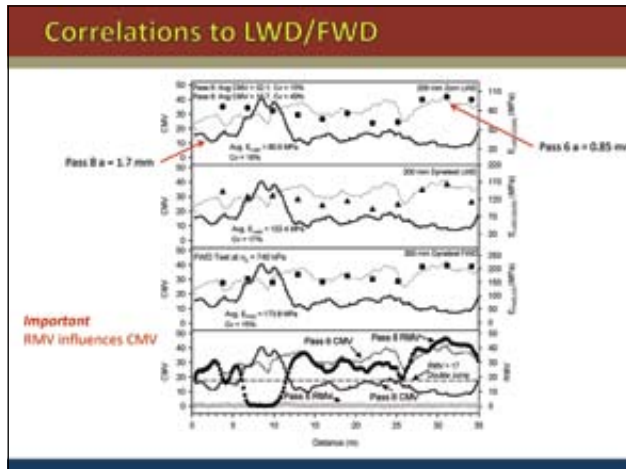
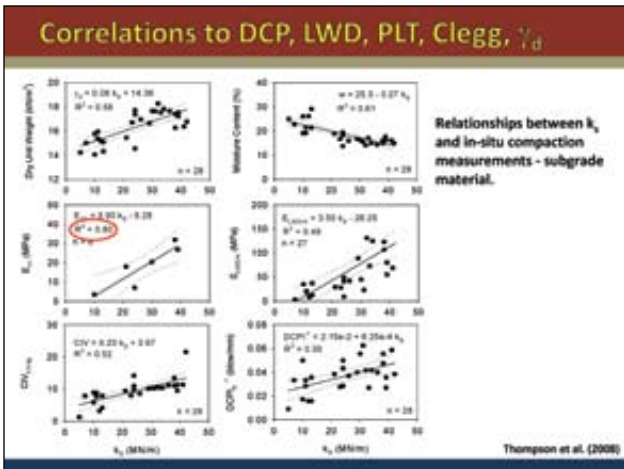
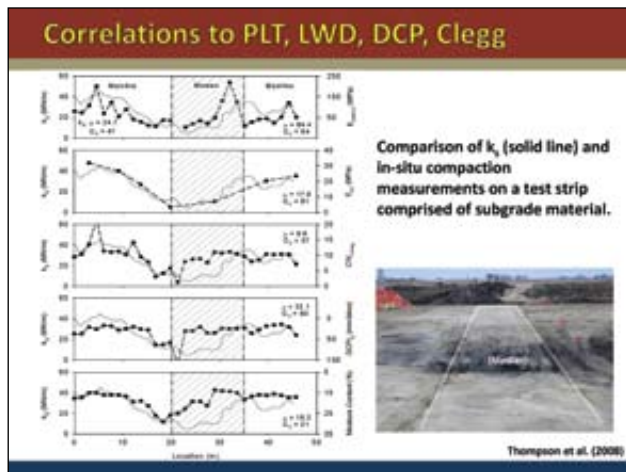

Case History

TH 64 Reconstruction Project Akeley, MN

- ### Project Summary
- TH 64 Widening and Reconstruction Project – 10 km
 - First earthwork project in US with IC technology implementation
 - Some Main Features of Specifications
 - **Control Strips:** 100 m x 10 m plan size – Compacted until no significant increase in CMV is noticed with additional pass and IC target values (IC-TV's) are established.
 - **Moisture Content:** 65% to 95% of standard Proctor optimum.
 - **Acceptance Specifications:**
 - 90% of IC measurement values \geq 90% of IC-TV
 - If significant portion of grade $>$ 130% of IC-TV, the IC-TV will be re-evaluated

Intelligent Compaction for Soils and Aggregate

David White

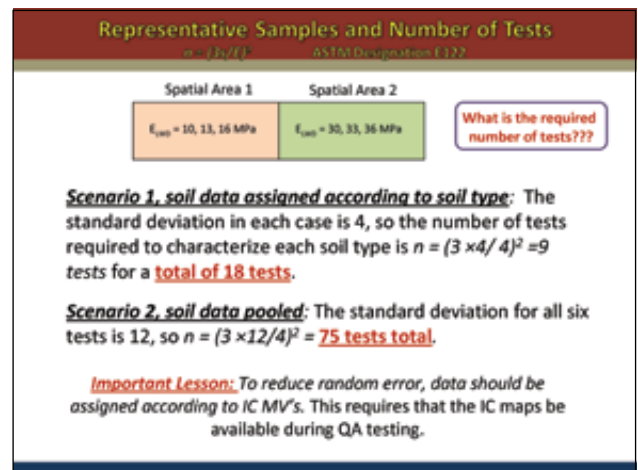
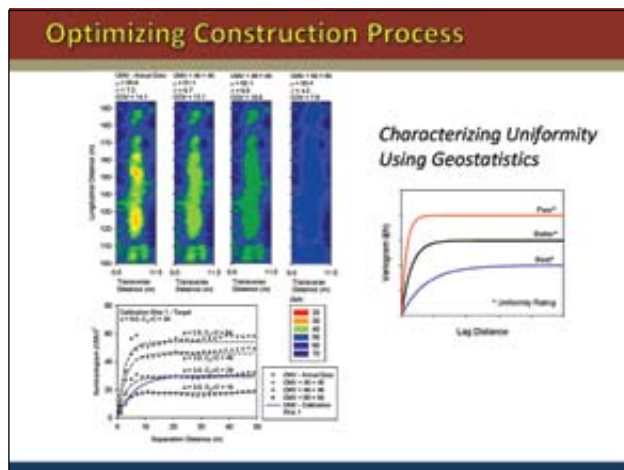
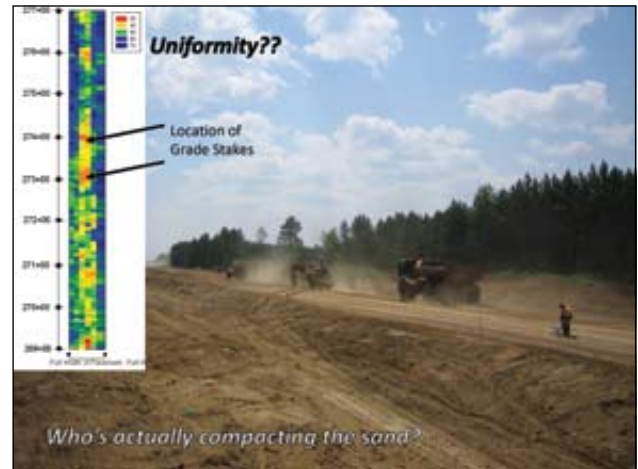
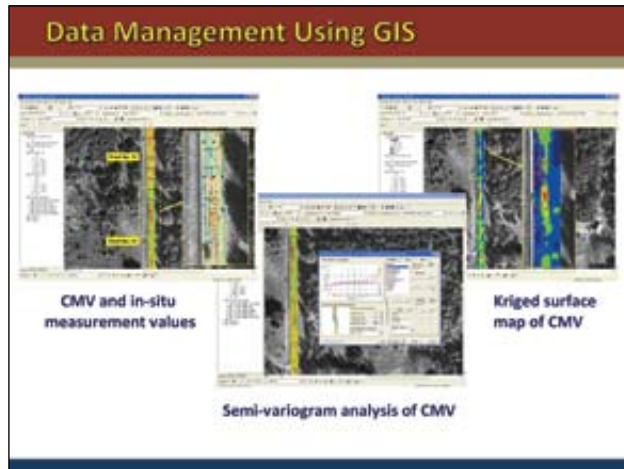
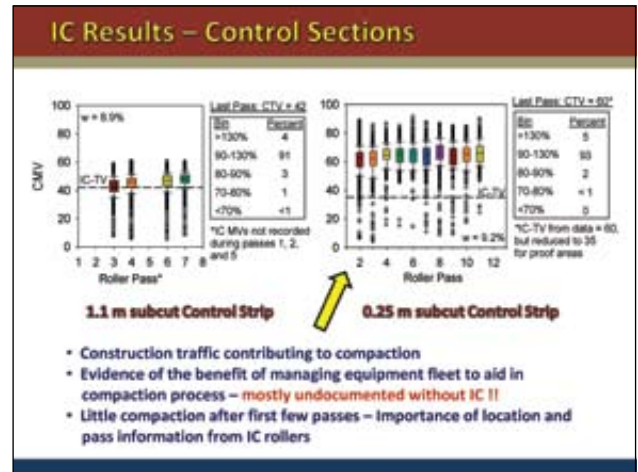

Intelligent Compaction for Soils and Aggregate

David White

Lessons Learned

- ✓ **Construction traffic** contributing to compaction – well observed with 100% coverage of IC data
- ✓ Little compaction after first few passes – Importance of **compaction history** from IC rollers
- ✓ CMV and in-situ test results are correlated at the project scale
- ✓ Scatter in relationships between IC and in-situ measurements – differences in **measurement influence depth**
- ✓ **GIS** can be used for effective data managing and archiving
- ✓ **Geostatistics** can help improve process control
- ✓ **IC MV can be used to reduce # QA tests!**

Case History

US 60 Project Bigelow, MN



Construction



Test Strip Construction and Testing



Comparison Test Results

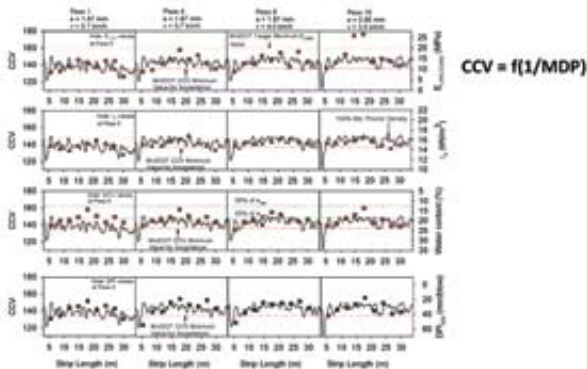

Simple and Multiple Regression Analysis

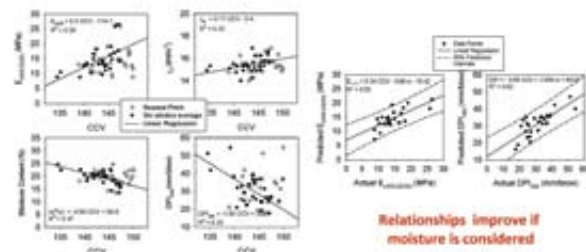

Need to **average** data over a test strip for multiple passes to get narrow prediction limits

Intelligent Compaction for Soils and Aggregate

David White

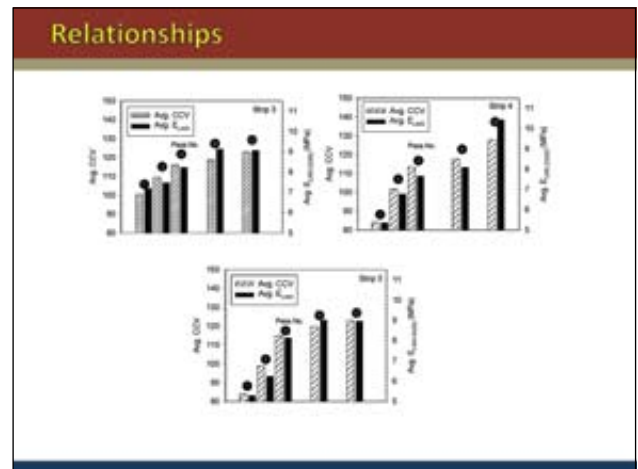
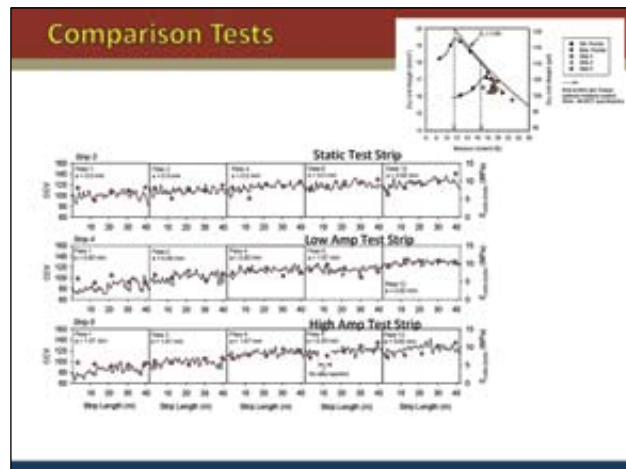
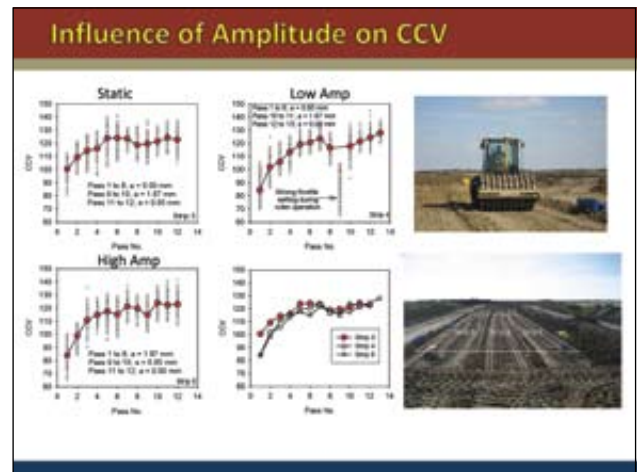
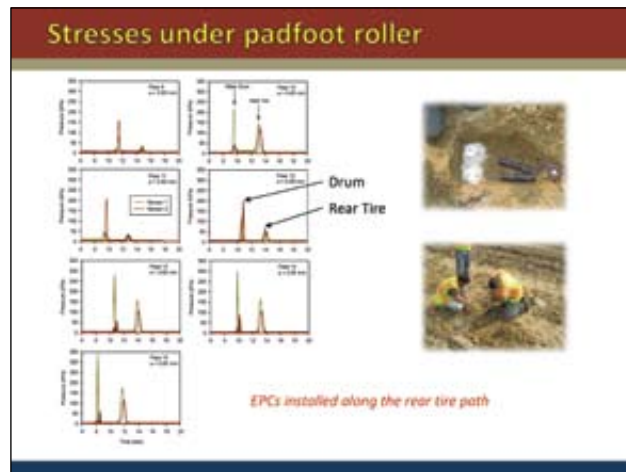

- ### Lessons Learned
- ✓ MDP – sensitive to surficial soil properties
 - ✓ Loaded scrapers used in compaction operations
 - ✓ **Moisture** – important parameter to include in correlation analysis
 - ✓ Amplitude did not influence the MDP values for soils wet of optimum moisture content

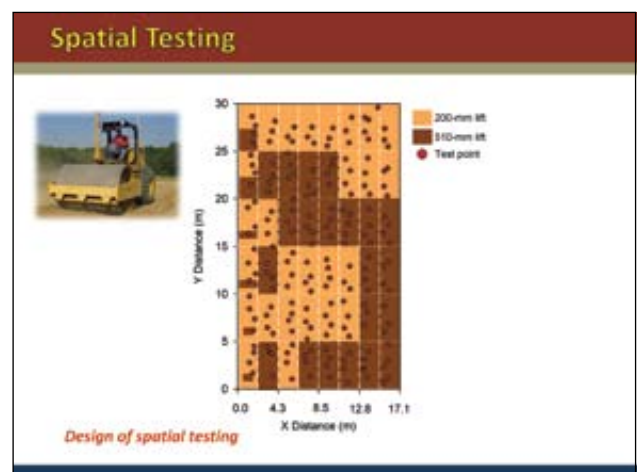

Intelligent Compaction for Soils and Aggregate

David White

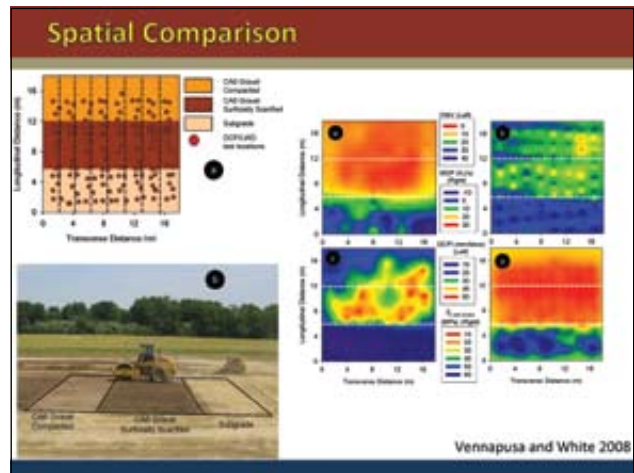
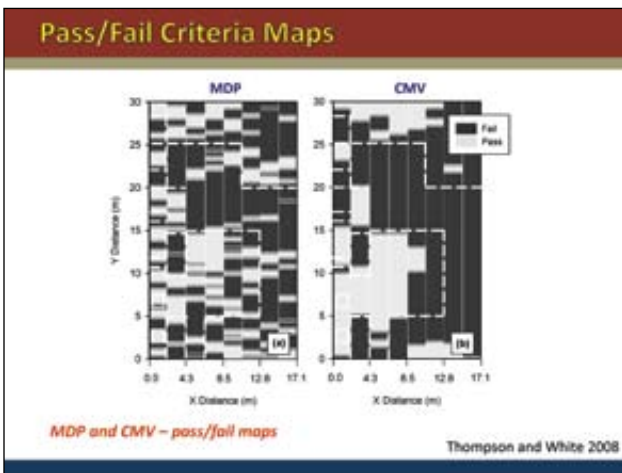
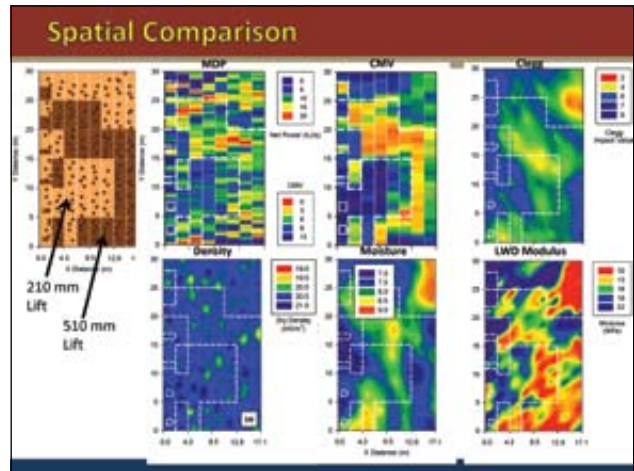

Intelligent Compaction for Soils and Aggregate

David White

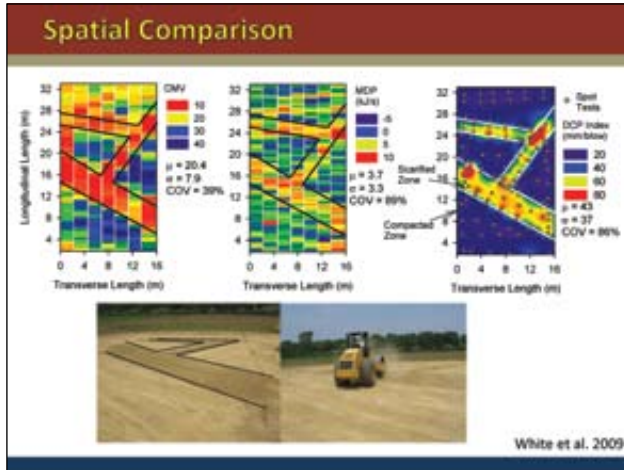

Lessons Learned

- ✓ Cannot run enough spot tests to create highly reliable spatial maps...IC is the best method
- ✓ IC data and LWD/DCP measurements show similar spatial variation

Case History

Bradshaw Field Training Area (BFTA) – Northern Territory, Australia

Joint Rapid Airfield Construction (JRAC) Program

June 11 – 25, 2007



Intelligent Compaction for Soils and Aggregate

David White

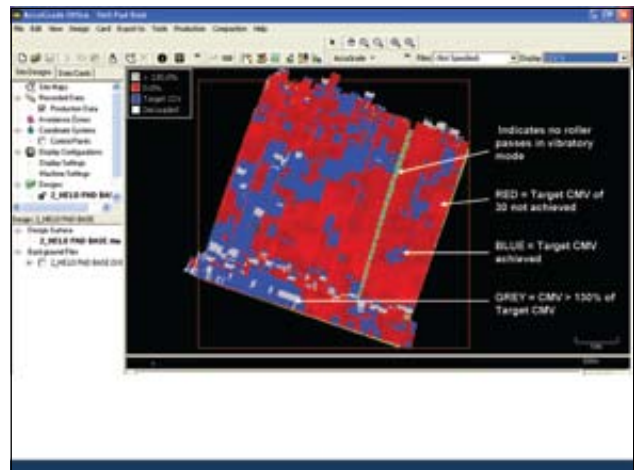
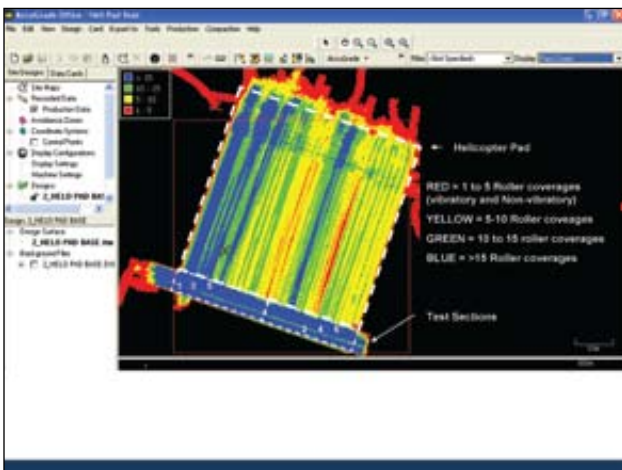
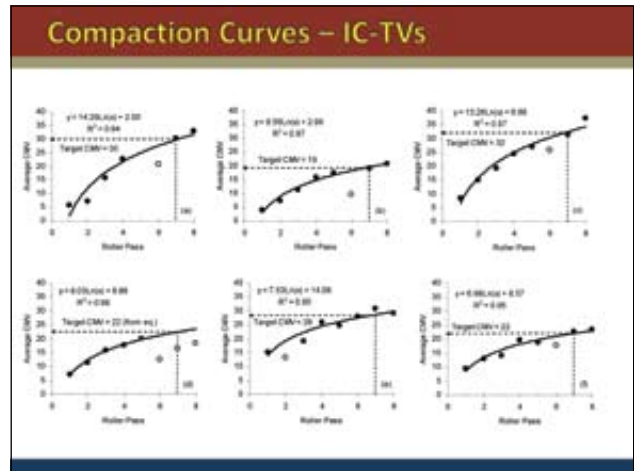

Intelligent Compaction for Hot Mix Asphalt

Lee Gallivan

Intelligent Compaction (IC) for Hot Mix Asphalt (HMA)

**Iowa
Intelligent Compaction
Workshop**

Lee Gallivan, HIPT
Federal Highway Administration



April 2, 2008

Presentation Outline

- ❑ What is Intelligent Compaction
- ❑ Who's doing what with IC
- ❑ Field Evaluation Studies
- ❑ Does IC work
- ❑ Real Time Data Management (Not yet)
- ❑ Correlation/Confirmation Testing ¹⁻²



What is Intelligent Compaction Technology

An Innovation in Compaction Control and Testing



Office of Pavement Technology
Federal Highway Administration
www.fhwa.dot.gov/pavement/

Intelligent Compaction ----Definition----

What is "Intelligence?"

- Oxford Dictionary: "...able to vary behavior in response to varying situations and requirements"
- Ability to:
 - Collect information
 - Analyze information
 - Make an appropriate decision
 - Execute the decision



3000-4000 TIMES A MINUTE

1-4

Importance of Compaction

We've known it for a long time...

"THE IMPORTANCE OF COMPACTION in highway construction has long been recognized. Recent laboratory and field investigation have repeatedly emphasized the value of thorough consolidation in both the base and surfacing courses. Thorough compaction is known to produce the following desirable results:

1. It increases interlocking of the aggregate particles, which is the primary factor in developing a high degree of stability.
2. It retards the entrance of moisture, thus preventing excessive loss of stability under adverse service conditions.
3. It reduces the flow of air and water through bituminous mixtures and is therefore an effective means of lessening damage from weathering and film stripping."

Reference -- "Public Roads, May 1939, authors J.T. Pauls and J.F. Goode"

1-5

Conventional Density Testing Shortcomings

- Density Acceptance...



Limited Number of Locations



After Compaction is Complete

1-6

Intelligent Compaction for Hot Mix Asphalt

Lee Gallivan

Basics of HMA Compaction

Compaction is the process of compressing hot mix asphalt into a smaller, denser volume.



Asphalt coated aggregate particles are reoriented and consolidated which increases the pavement density

Roadway Compaction

- Proper in-place density is vital for good performance
- Conventional compaction procedures have some limitations...
- Intelligent compaction technology appears to offer "a better way"



Benefits of IC for HMA

- Improve density....better performance
- Improve efficiency....cost savings
- Increase information...better QC/QA



IC for HMA

What are main components of IC

1. Vibratory rollers with a measurement system
2. Automatic feedback control system
3. GPS-based documentation system



IC for HMA

- How does an IC roller work?
 - Vibratory rollers
 - Accelerometers on drum measure materials response to vibratory impulses
 - On-board computer calculates roller measurement value (RMV) – **Manufacture Dependant**
 - RMV is displayed to the roller operator continuously during compaction process

1-11

IC for HMA

- How does an IC roller work? (cont.)
 - Feedback control system automatically adjusts parameters to optimize compaction
 - GPS tracks roller position and matches it with RMV, mat temperature, # roller passes
- **Printout – hardcopy**
- **Color-coded mapping capabilities**
- **Electronic record**

1-12

Intelligent Compaction for Hot Mix Asphalt

Lee Gallivan

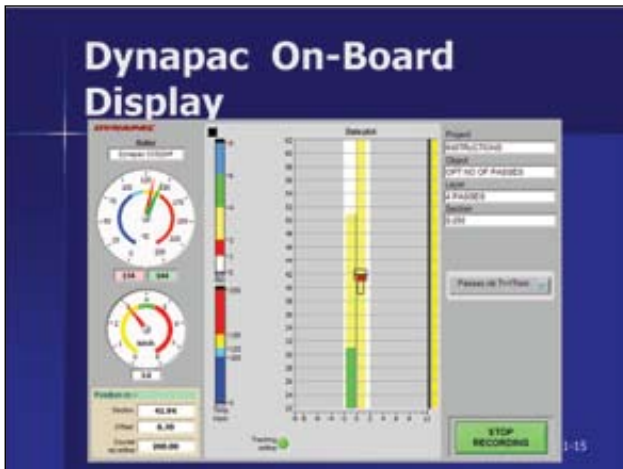

Intelligent Compaction for Hot Mix Asphalt

Lee Gallivan

NCHRP 21-09 Phase One Project



Iowa State University
Geotechnical Mobile Lab

"Advancing
Intelligent Construction"

1-19

NCHRP 21-09 Phase One Project



Bomag Tandem Drum IC Roller



BOMAG BW180AD-4AM double drum asphalt roller

Capabilities

- Stiffness (E_{VIB})
- Auto Feedback
- No GPS Mapping
- Strip Chart
 1. Temperature
 2. E_{VIB}
- Status: Available

1-21

Sakai Tandem Drum IC Roller



Sakai Intelligent Compaction equipped roller

Capabilities

- Stiffness (CCV)
- No Auto Feedback
- GPS Mapping
 1. CCV
 2. Temperature
 3. Roller Passes
- Status: Available

1-22

Caterpillar Tandem Drum IC Roller



Capabilities

- No Stiffness (CMV)
- No Auto Feedback
- GPS Mapping
 1. Temperature
 2. Roller Passes
- Status: Available

1-23

Dynapac Tandem Drum IC Roller



Capabilities

- No Stiffness (CMV)
- No Auto Feedback
- GPS Mapping
 1. Temperature
 2. Roller Passes
- Status: Available

1-24

Intelligent Compaction for Hot Mix Asphalt

Lee Gallivan

Ammann/Case Tandem Drum IC Roller



Capabilities

- Stiffness (kb) ?
- Auto Feedback
- GPS Mapping ?
- Status: Planned

1-25

FHWA Pooled Funds Study (Soils / HMA)

- 3 year study of IC for Subgrade, aggregate bases, and HMA materials
- Work has started October 1st, 2007
- 13 participating states
- Estimate 1+ project / State / year ~ 15-20?
- Close coordination with NCHRP project – No repeats though
- To work closely with roller suppliers to increase the number of IC rollers and manufacturers

1-26



Pooled Fund, Objectives

- **Objectives:** Based on data obtained from field studies:
 - Accelerated development of QC/QA specifications for granular and cohesive subgrade soils, aggregate base and Hot Mix Asphalt (HMA) pavement materials...

1-28

Pooled Fund, Objectives

- **Develop an experienced and knowledgeable IC expertise base within Pool Fund participating state DOT personnel**
- **Identify and prioritize needed improvements to and/or research of IC equipment and field QC/QA testing equipment (DCP, FWD, GeoGauge, etc)**
- **One Stop Shopping for IC (Web Page)**

1-29



www.intelligentcompaction.com

1-30

Intelligent Compaction for Hot Mix Asphalt

Lee Gallivan

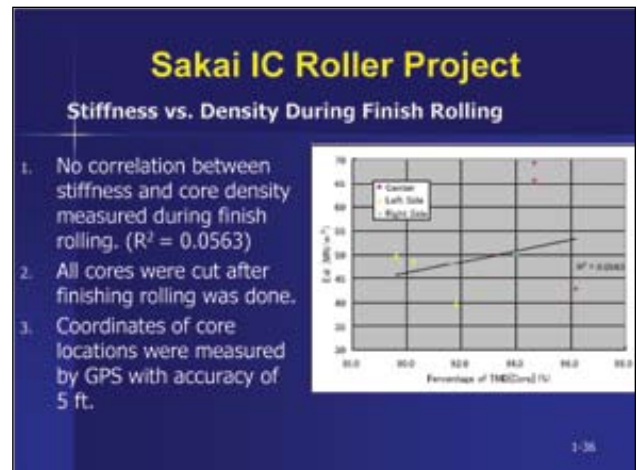
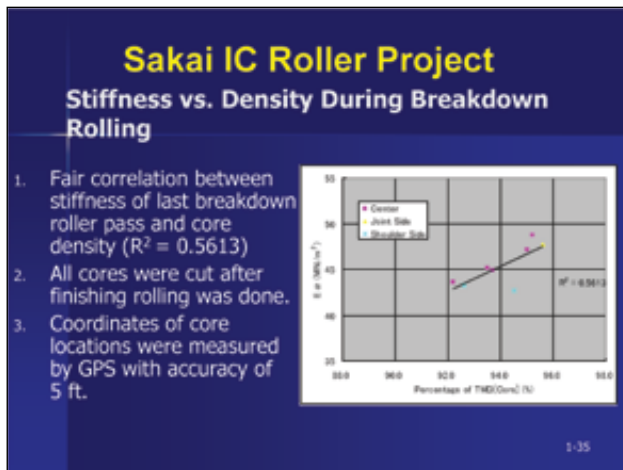
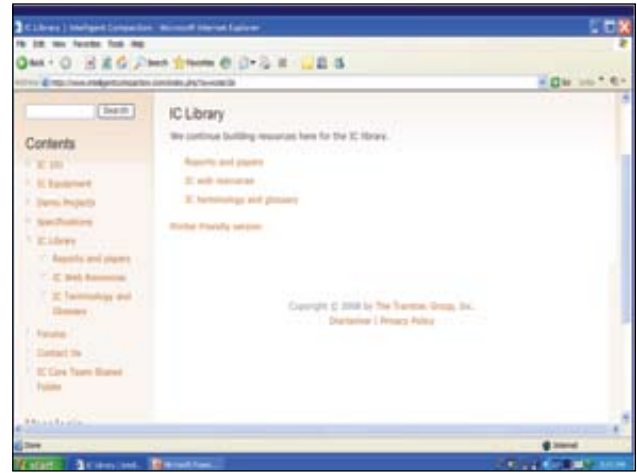
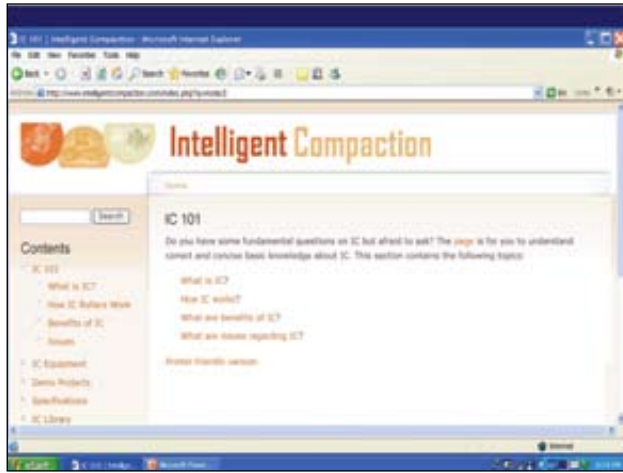

Intelligent Compaction for Hot Mix Asphalt

Lee Gallivan

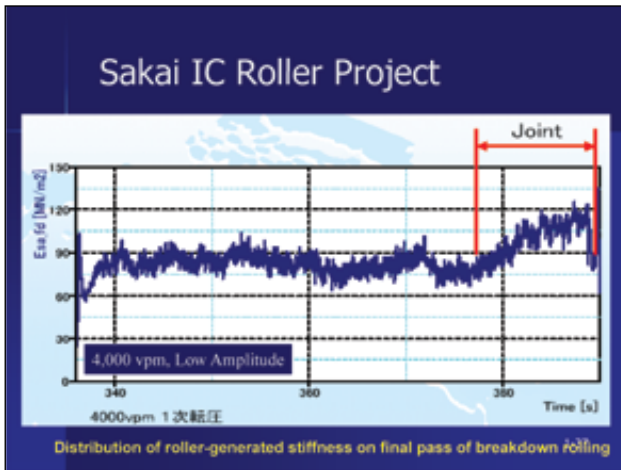

Special Issues for HMA IC

- Thin lift construction
- Mixture type and size
- Allowable temperature ranges
- Surface vs. internal temperature measurement during placement
- Non-destructive, in-situ stiffness
- Response parameters

1-38

Question: Does IC work?

- Soils and Aggregate materials have had good experiences to date.
- HMA- the jury is still out, but stay tuned for future updates.

1-39

What have we learned so far?

- IC technology appears to have great potential to improve the compaction process
- Improved and more uniform density should increase pavement service life
- There is a great deal of interest among industry as well as federal and state DOTs to learn more about it

1-40

What have we learned so far?

- Roller manufacturers are responding to this interest by performing R&D, providing rollers and by coordinate efforts with state and national research efforts
- Preliminary findings for HMA from studies in US are not glowing but are encouraging

1-41

What is next?

- FHWA is committed to working with others to accelerate the study and implementation of the technology
- Two major national studies of IC technology are being performed along with state projects
- A large number of projects are planned for the 2008-2010 construction seasons.
- Short term goals are to increase the number of IC rollers in the US, to **learn how to use the technology effectively** and to develop construction specifications for all material types

1-42

Intelligent Compaction for Hot Mix Asphalt

Lee Gallivan



Automated Technologies in Construction

Dan Streett

Automated Technologies in Construction



2008 Iowa Workshop
Dan Streett, PE & LS
New York State DOT

Automated Technologies

1. Primary Ingredient – Electronic Engineering Data (EED)
2. Three Technology Components
3. Multiple Business Benefits
4. NY 2007 Project Experiences
5. Building Confidence

April 2, 2008 2008 Iowa Workshop

Primary Ingredient

➤ **Electronic Engineering Data (EED) Types**
What to Transfer to Construction:

1. Coordinates & Alignments
2. DTM Surfaces (Feature Based)
3. Graphics
4. Storm & Sanitary Database
5. Quantity Manager Database

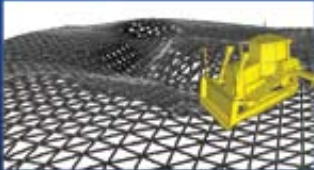
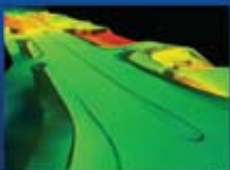
April 2, 2008 2008 Iowa Workshop

Primary Ingredient

➤ **Electronic Engineering Data (EED)**

1. Requires Consistent, Reliable & Accurate Electronic Data
2. Created by Either Contractors or by DOT
3. Designer Should Provide EED to Contractor
4. Should be No Difference, Electronic vs Paper



April 2, 2008 2008 Iowa Workshop

1st Technology Component

➤ **Automated Machine Guidance (AMG):**

1. On-Board Computer, GPS and Machine Sensors Continuously Measure Direction, Elevation, & Slope
2. AMG Interpolates Engineering Data, Compares to the Spatial Position and Provides Directional Guidance
3. Operator has On Screen Graphics and Indicator Lights for Guidance on Direction and Depth



April 2, 2008 2008 Iowa Workshop





April 2, 2008 2008 Iowa Workshop

Automated Technologies in Construction

Dan Streett



2nd Technology Component

➤ GPS Technology - Automated Stakeout & Inspection

1. Use of GPS/RTK Rovers for Geospatial Positioning
2. Engineering Data Input as Coordinates, Alignments and Surfaces
3. Provides Stakeout and Inspection for Construction
4. Can Collect Terrain Data Surfaces for Quantities
5. NY Leverages the NYS CORS Network



April 2, 2008 2008 Iowa Workshop 8

3rd Technology Component

➤ Automated Quantity Computations

1. Use of 3D Surfaces Instead of End Volumes
2. Staff Time Saved by Automating
3. Increased Accuracy & Fewer Mistakes
4. Document & Expedite Payment Quantities



April 2, 2008 2008 Iowa Workshop 9

Benefits of EED

1. Eliminates Re-engineering of Data
2. Eliminates Re-entry of Data
3. Visualization of Designer Intent
4. Early Identification of Conflicts
5. Automated Calculations
6. Immediate Field Access to Project Info
7. Promotes Sharing of Data Between Parties
8. AUTOMATES CONSTRUCTION OPERATIONS

April 2, 2008 2008 Iowa Workshop 10

Benefits of AMG

1. Increased Productivity
 - Greatest Gains on Placement, Grading or Removal of Granular Materials
 - 30%-50% Reductions in Time Delays, Material Rework or Waste, & Labor Costs
2. Decreased Need for Foreman Oversight
3. Increased Safety Due to Fewer People Within Range of Equipment
4. Fewer Obstacles to Avoid in Field (No Stakes)
5. Increased Accuracy of Placement/Removal
6. Produces Higher Quality Finished Product

April 2, 2008 2008 Iowa Workshop 11

AMG Screen Views

Calcut (FT)	▼ 6.1	▼ 32.8	0.0
Map	Map	Map	Map
Map	Map	Map	Map
Map	Map	Map	Map
Map	Map	Map	Map

Calcut (FT)	▼ 6.1	▼ 32.8	0.0
Map	Map	Map	Map
Map	Map	Map	Map
Map	Map	Map	Map
Map	Map	Map	Map

Cut Left (FT)	▼ 0.1
Cut Right (FT)	0.0
Design Elev (FT)	905.0
Tilt (%)	-32.8
Satellites	7

Northing (FT)	10301.8
Easting (FT)	9837.8
Elevation (FT)	848.4
GPS Status	High Accuracy
Satellites	9

April 2, 2008 2008 Iowa Workshop 12

Automated Technologies in Construction

Dan Streett

Benefits of Automated Stakeout & Inspection

1. 1 Person Can Accomplish Work Formerly of 2-3
 - > No Need for Measuring Tapes, Levels or Level Rods
 - > Measurements are Automated & Documented
 - > More Information Accessible to the Operator
2. Operators Prefer Independent Check of Locations
 - No Reliance on Stakes or Markers
3. Reduced Recalculation Mistakes or Keying Errors
4. Allows for More QC/QA of Work

April 2, 2008 2008 Inova Workshop 13

Benefits of Automated Quantity Computations

1. More Accurate Interpretation of 3D Data
2. Reduced Calculation or Keying Errors
3. Takes 80% Less Effort
4. Small Changes are Instantly Adjusted
5. Documented Surfaces at Each Phase

April 2, 2008 2008 Inova Workshop 14

NY 2007 AMG Experience

1. 8 Projects Evaluated in 2007
2. GPS Accuracy is Impressive
3. AMG Reduces Overuse/Undercut of Materials
4. Operators Learn Quick & Like Info Availability
5. AMG is Also Very Effective for Trenching
6. QC Against Known Locations & Elevations
7. AMG Uses Either 3D Surface Models, or Alignments, Profiles and Typical Sections



April 2, 2008 2008 Inova Workshop 15

2007 Automated Stakeout & Inspection Experience

1. AMG Necessitated Use of GPS for Inspection
2. Found Use of GPS Effective, Efficient & Accurate
3. Operators Have Taken to GPS & Don't Want to Work Without It
4. Allows for Real Time - On Demand Positioning Anywhere on Project
5. Provides Independent Checks for Contractor and Inspectors
6. Can be Connected to Bentley On-Site for Inspection Verification and Documentation
7. QC Against Known Control Points & Benchmarks

April 2, 2008 2008 Inova Workshop 16

Today's Graders W/ Robotic Total Station or GPS

April 2, 2008 2008 Inova Workshop 17

Building Confidence

1. NY Contractors Who Use AMG, Have High Confidence
2. Construction Needs EED Which Reflects Designer's Intent
3. Revised Survey Specs Now Require Sharing Electronic Data, and Verification of DTMs
4. Sharing Data Increases Level of Trust Between Parties
5. No Difference Between Paper or Electronic Responsibility
6. Need to Build QC/QA into Automated Procedures

April 2, 2008 2008 Inova Workshop 18

Automated Technologies in Construction

Dan Streett

Related Activities on AMG

- AASHTO Technology Implementation Group (TIG) on AMG: Sharing National Best Practices
- NY AGC/DOT Subcommittee on Emerging Technologies: Sharing Improved Business Practices
- AGC/DOT Practitioner's Meeting: Face-to-Face Discussions on What Data is Needed
- Southeast Area 2 Meeting: June 9-11, 2008 In Atlanta, GA

April 2, 2008 2008 Inova Workshop 19

Summary

1. Contractors and DOT Find AMG:
 - More Productive, Saves \$\$\$
 - Safer and Greener
 - Higher Quality Products
2. DOT Inspectors Find GPS:
 - Faster Measurements
 - More Accurate Positions
 - Independent Results
3. Contractors & DOT Find EED:
 - Real World Data – ID's 3D Issues
 - Expedites Quantities & Payments
 - Reduces Errors, Increases Accuracy
 - Increases Trust & Confidence



April 2, 2008 2008 Inova Workshop 20

Questions or Comments?

- Contact:
 - Daniel Streett, PE & LS
DSTRETT@DOT.STATE.NY.US
518-485-8227

April 2, 2008 2008 Inova Workshop 21

Earthworks Engineering Research Center

David J. White, Ph.D.
EERC Director
Wegner Professor of Civil Engineering
Geotechnical/Materials Division Leader
dwhite@iastate.edu

ctre
IOWA STATE UNIVERSITY
OF AMES, IOWA

Opportunity for Advancement...

- "The type and scope of geotechnical problems are changing, yet geotechnologists are for the most part not prepared for these changes." (NRC 2006)
- "One of the greatest challenges that professionals in the geo-construction industry face is delivering dependable, reliable and cost efficiently designed and constructed "products" ..." (ADSC 2005)
- "Addressing nation's 1.6 trillion infrastructure crisis ..." (ASCE 2005).

Thinking outside the box...GeoConE

- "The problems geo-engineers solve are important to society, and the current technological constraints are in many cases less likely to be solved by beating them with old approaches than they are to be cracked by new technologies and more interdisciplinary approaches..." (NRC 2006)
- Geo-engineers and construction engineers should look to entirely new technologies and approaches to solve problems faster, better, cheaper.

Geo-Construction Engineering
— 1st in the Nation

Earthworks Center – Business Model

- Vision
- Mission
- Focus
- Objectives
- Executive Board of Directors
- **Scientific and Policy Advisory Council**
- Sustaining Research Partners

Contact me with questions! Dr. David J. White, Iowa State University, Department of Civil, Construction and Environmental Engineering, 515.294.1463. Email at dwhite@iastate.edu

Strategies for Success

- Earthworks Engineering Research Center (EERC)
 - Innovative and Collaborative Research + Key Stakeholders+ Policy Changes + Education = Success
- Geo-Construction Engineering Academic Program
- Infrastructure Development
- Strategic Research Initiatives
 - Construction efficiency and innovation (e.g., TPF 1188)
 - National security (e.g. JRAC)
 - Mitigation of natural hazards
 - Frontier exploration and development

GEO-CONSTRUCTION ENGINEERING

A NEW GRADUATE PROGRAM FROM IOWA STATE UNIVERSITY

Coupling **ADVANCED** GEO-CONSTRUCTION STRATEGIES with **CUTTING-EDGE** TECHNOLOGY to offer the nation's **FIRST GRADUATE PROGRAM** in geo-construction engineering

Draw on a wide **VARIETY OF DISCIPLINES** to provide practical knowledge, solutions, and implementation tools ranging from the **NANOSCALE** to the **GLOBAL SCALE**.

For more information, contact Dr. David J. White, Iowa State University, Department of Civil, Construction and Environmental Engineering, 515.294.1463. Email at dwhite@iastate.edu.

Earthworks Engineering Research Center

David White

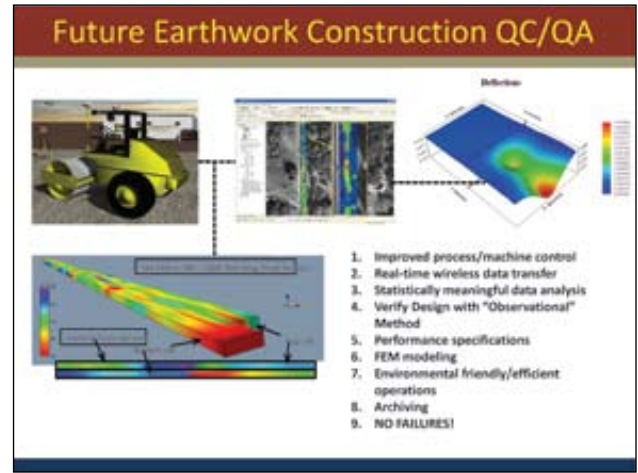

Intelligent Compaction at Mn/DOT

Glen Engstrom, Craig Collison, and Art Bolland

Intelligent Compaction at Mn/DOT



*Glenn Engstrom, Craig Collison and Art Bolland, Mn/DOT
April 2, 2008
Des Moines, Iowa*

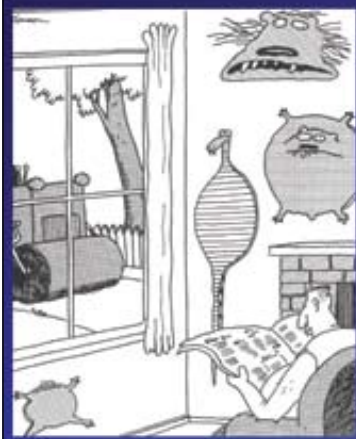

IC Reflections

WHY?

- Resources
- Mechanistic-Empirical Design
- Technology
 - IC
 - GPS
 - Data Storage
 - In-situ Testing
- Industry



QC/QA Task Force

- Membership
 - Materials, Construction, Districts, FHWA
- Design Sub Group
- Field Validation Sub Group



Task Force Objectives

- Define and implement QC/QA specifications and procedures
- Implement material property based compaction requirements.
- Implement statistically-based requirements and tests

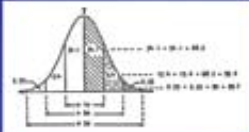

District Materials Perspective

Intelligent Compaction at Mn/DOT

Glen Engstrom, Craig Collison, and Art Bolland

Need for uniformity

- Soils
- Aggregates
- Hot-mixed Asphalt

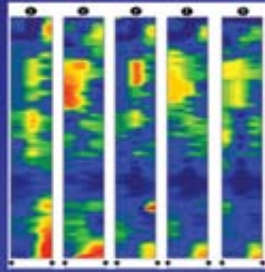

Verification

- Need to verify pavement design values
- Need to verify compaction by layer, not after completion



Common Density Determination Practices

- Labor intensive
- Point tests



Value to Contractor

- Guidance to roller operator
- Measure performance of the operator.
- Efficiency



District Construction Perspective

- Limited resources
- Limited expertise
- Limited time
- Fast, easy, accurate, reliable and cheap



Implementation Plan Goals

- ❖ Educate and train Mn/DOT staff and contractors to effectively use IC devices
- ❖ Refine current IC specifications based on lessons learned from IC implementation
- ❖ Advance the implementation of IC to use on non-granular materials and HMA pavements.
- ❖ Develop the link between M-E pavement design and construction.



Intelligent Compaction at Mn/DOT

Glen Engstrom, Craig Collison, and Art Bolland

IC Implementation Project

- Task A - Monitor and Implement
 - MnDOT Staff Time



IC Implementation Project

- Task B - IC Validation Equipment
 - LWD's, moisture, wireless, etc.



IC Implementation Project

- Task C - Training
 - Curriculum
 - Field Training



08/01/2007



Training Modules



IC Implementation Project

Task C - IC Data Management

- Tool for Inspectors in Field
 - Visualization of IC Data (plan & profile views)
 - Splitting & Combining Coverages
 - Application of Geostatistical Analyses
 - Link to QA Data

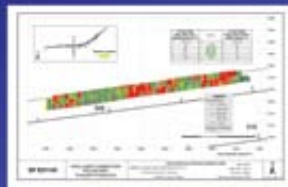

IC Implementation Project

- Task D - Refine and Develop Specs
 - Eliminate control strips
 - Develop target values for IC and LWD
 - IC for non-granular
 - Calibration procedures
 - Future specifications (Statistically based)



Intelligent Compaction at Mn/DOT

Glen Engstrom, Craig Collison, and Art Bolland

IC Implementation Project

- Task E - HMA Paving
 - Temperature and coverage



A technical diagram of a roller with red lines indicating sensor locations on the drum and chassis. A small sensor unit is shown below the roller.

IC Implementation Project

- Task F - Research Assessment



A photograph of a yellow roller operating on a dirt construction site under a clear blue sky.

IC Implementation Project

- Task G - Technology Transfer



A photograph of a laboratory setup featuring a vertical sensor probe on a table.

2007 IC Projects

- Metro (Steve Adamsky)
 - S.P. 6211-81, T.H. 36, Maplewood
 - Granular
 - Non-Granular
- District 4 (Shiloh Wahl)
 - S.P. 0301-47, T.H. 10, Detroit Lakes
 - Granular & Non-Granular
- District 3 (Darren Nelson)
 - S.P. 7702-72, T.H. 10, Staples
 - Granular
- District 7 (Bob Williams)
 - S.P. 1703-64, T.H. 60, Bigelow
 - Non-Granular

Implementation Issues

- CO - District - Contractor - Supplier - Manufacturer - etc
- Data retrieval
- Data analysis
- LWD's



A photograph of a yellow roller on a construction site, similar to the one in the top-right slide.

LWD



A photograph of a worker in a safety vest and hard hat using a portable LWD device on a dirt surface. A battery pack is visible on the ground.

Intelligent Compaction at Mn/DOT

Glen Engstrom, Craig Collison, and Art Bolland

Testing for Compaction



- Uniformity is the Priority
- Traditionally (Empirical Design, Trial/Error Based)
 - Specify Relative Density
 - Specify Moisture Limits
 - Test Rolling for some projects
- Future (Mechanistic Design, Stiffness Based)
 - Intelligent Compaction Equipment
 - Moisture Limits
 - DCP Strength, LWD Stiffness, or Test Rolling

Uniformity is the goal



Density Testing Issues

- Small Sample that is Labor Intensive
- Significant Lab Time
- Optimum Moisture for Compaction
- Strength May Not be Achieved
- Rutting Due to Moisture and Construction Traffic



Why Use Mechanistic Field Tests?

- Achieve agreement between construction quality assurance and pavement design.
- Quantify alternative materials and innovative construction practices.
- Show economic benefit of improved materials in terms of longer pavement life.
- Reward good construction practices.





Summary of Test Method (ASTM E2583-07)

- Type of plate-bearing test.
- Load: Force pulse
- Vertical movement (deflection) is measured.
- The peak deflection and estimated elastic modulus is recorded.



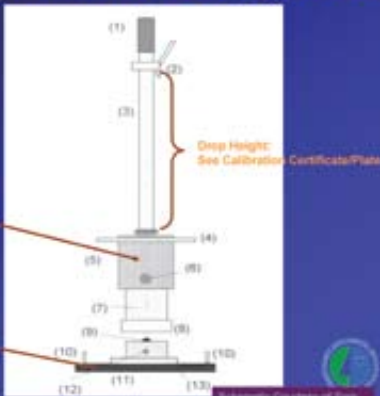

Mn/DOT Standard LWD Configuration

Mn/DOT currently supports the Zorn, ZFG2000 model.



Schematic Courtesy of Zorn



Light Weight Deflectometer Video



- 4 minutes in length

Intelligent Compaction at Mn/DOT

Glen Engstrom, Craig Collison, and Art Bolland



LWD Calibration

Calibration by Test Institute

- Recommended Intervals:
 - Annually
 - 10,000 measurement, but at least in every 2nd yr.
- Measure stress under the load plate
 - Standard Pressure = 0.20 MPa
 - Force = 6.28 kN
 - Drop Height = 54 cm
 - Load / Plate = 10 kg / 200 mm

Diagram labels: loading device, displacement-measuring instrument above testing cell, sensor attached to the center of the load plate, load plate, and base plate connected to the load plate, and base.

On-Site Verification Testing

Objective:
To determine the **repeatability** of deflection measurements under defined conditions.

On-Site Verification Testing (cont.)

- Frequency
 - (Re-) Commissioning
 - Annually
 - Not repeatable
- Environment
 - Room temperature
 - Batteries fully charged.
- On-Site Verification Facility
 - Unaltered over time
 - Concrete Foundation
 - Verification Pads

Control Strip - Roadbed Embankment

- Objective: LWD compaction target value
- Constructed for each:
 - Type and/or source of soil
 - Observable variations
 - Not-Limited to: gradation, texture, silt & clay content, moisture content
- Incorporated into final embankment.
- 300 ft long and 32 ft wide
- Total Thickness
 - Planned thickness
 - 4 ft maximum



(Roadbed Embankment)

Intelligent Compaction at Mn/DOT

Glen Engstrom, Craig Collison, and Art Bolland

Control Strip

- 65 and 95% of OMC or EOMC
- LWD Testing
 - 6 drops without moving plate.
 - $LWD-TV = \frac{E_1 + E_2 + E_3}{3}$
- Testing Frequency
 - Between each compaction pass
 - Minimum of 3 locations
 - 25 ft spacing

(Roadbed Embankment)

Acceptance Testing

- Testing Lot
 - 1000 ft length
 - Embankment Width
 - 1 ft increments
 - Minimum 3 / nominal vertical increment / testing lot
- Acceptance
 - $E_1 \geq 0.90 * LWD-TV$
 - Corrections as needed
 - Re-test
 - $E_1 > 1.20 * LWD-TV$
 - Re-evaluate LWD-TV selection
 - Construct new control strip



(Roadbed Embankment)

Typical Zorn LWD Values

Soil Type	LWD Modulus (MPa)
Sand w/ Silt	20-30
Silty gravel w/ sand	30-35
Silty sand w/ gravel	30-35
Poorly graded gravel	40-45
Silty sand	15-20
Clayey gravel	30-40
Well graded sand w/ silt	25-35



2008 LWD Quality Compaction Projects

- 17 Projects to Date - 2008
- 9 Projects - 2007
- 15 LWDs



Light Weight Deflectometer Technology Transfer Workshop



Baxter, Minnesota (November 14, 2007)

Attendees: Project & Resident Engineers, Inspectors, Materials Engineer



Scope of Discussions

- Presentation: Dr. Fleming "Experience with LWD for Routine In Situ Assessment of Foundation Stiffness"
- Presentation: Dr. White "Mn/DOT Intelligent Compaction Implementation Seminar #4: Lessons Learned from IC and LWD Testing"

Intelligent Compaction at Mn/DOT

Glen Engstrom, Craig Collison, and Art Bolland

Positive Characteristics

- Quick and Easy
- Inspector Remains on Grade
- Made Contractor more aware of what is needed for acceptance
- Better understanding of water content and processes.
- Improved Uniformity
- Improved over DCP
 - Quicker
 - Contractor better understands results
- Reliable Measurements
 - (e.g., 199 LWD tests out of ~ 200 matched those of the DCP).

Technology Transfer Commission



Troubles / Concerns

- Difficult portability in utility trenches.
- Can be a 2 person job.
- Not "light" weight.
- Water table can be drawn up and affect results.
- Set up of soil (soil curing) / bridging. Need to remove crust on clay prior to testing.
- LWD will move if sand is too wet and sloped.
- Need to level plate.
- Unable to obtain consistent LWD results with only 1 ft of sand above grade.

Technology Transfer Commission



QC Contractor Responsibility

- Moisture testing and control was a continual battle.
- Contractor personnel are interested and asking for LWD values.
- Contractor is learning that scrapers should be run in different spots to achieve passing values compaction.



Technology Transfer Commission



Changes Next Year

- Procedures need to be flexible, but balanced with the ability to enforce.
- Test on "surface" of aggregate base.
- Control strips need to be eliminated.
- Better if "over-built" and then dug down for testing with some confinement.

Technology Transfer Commission



Some Keys to Success

- Know Your Organization
- Who makes the decision
- Beware of the pessimist and the optimist
- Find people that you know and will work with you
- Don't hold new technology to a higher standard
- Select Low Hanging Fruit
- You need to find your Rebecca
- Select "simple" projects
- Communication



Mn/DOT's Lessons Learned

- Operators learn how to make better decisions.
- IC roller must maintain contact across the drum to produce valid data (ie level surface)
- Soft areas can be identified and corrected earlier.



Intelligent Compaction at Mn/DOT

Glen Engstrom, Craig Collison, and Art Bolland

Mn/DOT's Lessons Learned

- Works well on granular, 20% or less passing the #200.
- Produces a LOT of data - transfer and analysis methods need to be improved.
- Able to quantify grade stiffness variability



IC Future

- Continue to refine specifications
- Improve connection between field values and design criteria
- Create real-time data monitoring system
- Integrate data into construction quality system
- Monitor long-term pavement performance at IC projects



Questions?



Thank You!



European Experience with ICS

François Chaignon

European Experience with ICS

COLAS

François CHAIGNON

European Experience with ICS

- Introduction
 - COLAS in a few words
 - European perspectives
- Tests on site
- Conclusions

COLAS SA (Cold Asphalt)

- 65 000 employees
- 45 countries
- Road construction

Average number of Group employees in 2006

Total: 62,278 (in 2005: 60,176)

France only: 31,846 (in 2005: 30,757)

Year	Workers	Office staff	Management
2006	67.9%	21.6%	10.5%
2005	61%	25%	14%

Geographical breakdown of revenue

Year	Mainland France	North America	Europe (excl. France)	Africa/Indian Ocean/Asia	French overseas depts.
2005	54.9%	18.1%	18.7%	4.3%	4.0%
2006	54.8%	17.3%	19.2%	3.9%	4.8%

Breakdown of Group activity

in millions of €

Activity	Value (€)	Percentage
Roads	7,158	66.8%
Building materials	1,477	13.8%
Other	2,082	19.4%

Roads Breakdown:

- 16.7% Concessions: AKA R6 (Hungary), Adelaic (A41), Mars (Rains, Tramway)
- 853 Civil engineering, Pipes, Mains
- 279 Safety Signing
- 441 Waterproofing
- 311 Building
- 198 Railways

European Experience with ICS

François Chaignon

European Perspectives 

- Tenders as usual
 - Low bidder
 - Sometimes quality bid
 - UK
 - Alternatives (F)
- Tenders not as usual
 - Performances bid
 - PPP
 - Portsmouth 25 years contract



European Perspectives 

- Quality Assurance Plan
 - Document proposed by the contractor part of the contract
 - It explains what the contractor will do
 - It gives stop points in case of issues
 - It gives interactions between trades
 - It is discussed with the owner





European Perspectives 

- Quality assurance plan
 - At the end of the job
 - It says what was done
 - It says what went wrong and how it was dealt with
 - Records of all what happens
- So COMPACTION



European Perspectives 

- Contractors do they own QA/QC
- QC by the production means (lab, check list for the operations)
- QA by entity outside the construction site



European Perspectives 

- The owner
 - Checks the overall system
 - If it is weak or if he is not confident, the tests will be done randomly with a frequency function of the above
 - Checks the important characteristics for the owner
 - Smoothness, IRI
 - Skid resistance
 - Comfort and safety of the drivers: tax payers



What about compaction? 

- First factor: Quality Assurance Plan per job
- Second factor: Safety
 - In Europe, the pneumatic tire roller with 5t per wheel is forbidden for important safety concerns
- Soils and HMA



European Experience with ICS

François Chaignon

What about compaction?

- With these two important factors
- The arrival of ICS was interesting in order to:
 - Give important data for the QAP
 - Look at replacement of 5t per wheel PTR

ICS approach

- Soil
- Cement /lime treatment (sand, Gravel,...)
 - 13t axle weight
 - Important strong base course
 - Rarely gravel base on high traffic
- Hot mix Asphalt
 - Breaking roller was a PTR
 - Then a vibratory roller

AMMAN



BOMAG

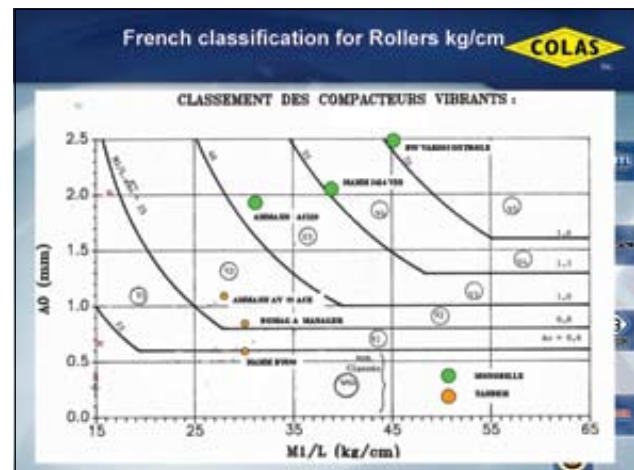

HAMM

European Experience with ICS

François Chaignon

TESTS on SITE

TESTS on site (1)

- Show the efficiency of the various systems
 - On HMA
 - Cement treated soil
 - Cement stabilized base
 - Cement treated sand

TESTS on site (2)

- Show the efficiency of the various systems
 - Compaction measurements
 - Nuclear gauge
 - Stationary nuclear device to check core (gradient)
 - Macro-texture
 - Sand patch test
 - Smoothness

Cement stabilized layer 250 mm (10")

EVOLUTION DU COMPACTAGE

Nombre de passes	Série N°1 (150 mm)	Série N°2 (200 mm)	Série N°3 (250 mm)
4	~98.5%	~98.5%	~98.5%
6	~99.5%	~99.5%	~99.5%
8	~99.8%	~99.8%	~99.8%
10	~100.0%	~100.0%	~100.0%
12	~100.2%	~100.2%	~100.2%
14	~100.2%	~100.2%	~100.2%

Série N°1 : 150 mm Série N°2 : 200 mm Série N°3 : 250 mm

- o very small gradient
- o Average compaction : 100.2 %
- o plaques: better surface aspects

o Aspect of the layer after compaction

the use of the plaques needs more water; the aspect is quite good

European Experience with ICS

François Chaignon

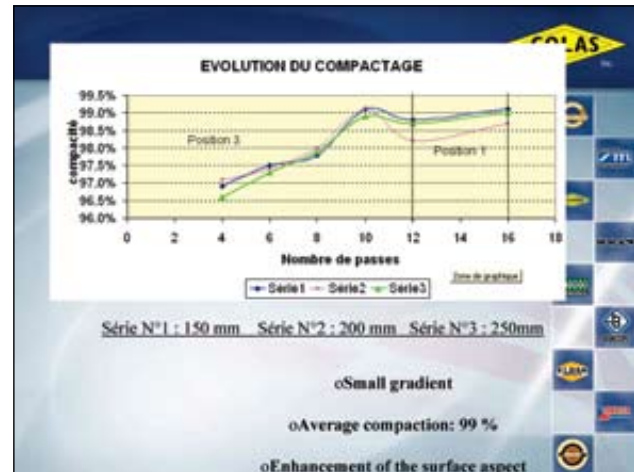

Comparison PTR +VR to VR

Compaction

Compaction Equipment	% voids AVERAGE	STD DEV
AV95 T (vibrant)	5.70%	0.033
AV95 ACE(vibrant)	5.70%	0.033
PTR 9+AV95 T	6.00%	0.037
PTR 9+AV95 ACE	6.40%	0.036

Comparison PTR +VR to VR

Macro-texture

COMPACTION EQUIPMENT	HSV AVERAGE	HSV MN	HSV MAXI
AV95 ACE(vibrant)	0.59	0.5	0.7
PTR 9+AV95 ACE	0.5	0.37	0.66

European Experience with ICS

François Chaignon

Comparison PTR +VR to VR



Smoothness

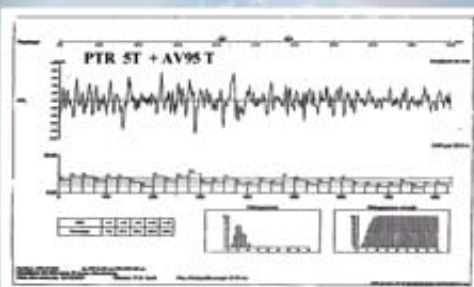



AV 95 CE: abacus for KB and mixes



Famille d'axe(s)	Ecartement d'application	Nombre de passes	VILLEIR KB (direction de support)	Nombre de passes (réelles)	Vitesse
2 passes en mode force à effectuer avant compactage en mode vibré (voir aussi abaques horaires)					
E.ME 020 ou OB 020	10 à 15	3	Support NT - KB = 70 Support BN - KB = 80	0	5 km/h
E.ME 014 ou OB 014	0 à 10	3	Support NT - KB = 80 Support BN - KB = 90	0	5 km/h
EME 020	0 à 10	Profilon 3.2 passes pure position 2	Support NT - KB = 80 Support BN - KB = 90	0	5 km/h
Grave bitume 014	0 à 10	2	Support NT - KB = 80 Support BN - KB = 90	0	5 km/h
SB 014	0	2	Support NT - KB = 70 Support BN - KB = 80	0	5 km/h
SB 010	0	2	Support NT - KB = 70 Support BN - KB = 100	4	5 km/h
SB MINCE	0	2	Support NT - KB = 80 Support BN - KB = 100	4	5 km/h
4 passes en mode force à effectuer après compactage en mode vibré (attention à l'axe ATTITUDE sur le terrain déformé la nuit)					











ASPHALT MANAGER

: Data base



Famille d'axe(s)	Ecartement d'application	Nombre de passes	Nombre de passes	Vitesse
2 passes en mode force à effectuer avant compactage en mode vibré (voir aussi abaques horaires)				
Grave bitume 020	10 à 15	3	0	5 km/h
Grave bitume 014	10 à 15	3	0	5 km/h
EME 020	10 à 15	3	0	5 km/h
EME 014	10 à 15	3	0	5 km/h
Grave bitume 014	0 à 10	2	0	5 km/h
EME 014	0 à 10	2	0	5 km/h
SB 014	0	2	0	5 km/h
SB 010	0	2	0	5 km/h
SB MINCE	0	1	0	5 km/h
4 passes en mode force à effectuer après compactage en mode vibré (attention à l'axe ATTITUDE sur le terrain déformé la nuit)				

Data base goal: Correlation between EVib / density



CONCLUSIONS (1)



- First generation
 - BOMAG
 - Ruggedness OK
 - Technology average
 - AMMAN
 - Ruggedness not OK
 - Technology very good



CONCLUSIONS (2)



- Operators have to be trained
- Operators have to be involved
- Strong link between Tech and Equipment
- 5t per wheel can be replaced





European Experience with ICS

François Chaignon

CONCLUSIONS (3) 

- As a contractor, we pave in the North of France 500-700t per day with one roller instead of two
- We are working very closely with the suppliers
- Are we doing it for them or for us?
- Other companies use them as usual



CONCLUSIONS (3) 



Kubota Schwab
Rolling ECHO NORD



Thank you for your attention 

- Any Questions?



Intelligent Compaction for Soil and Asphalt

Dean Potts

Intelligent Compaction for Soil and Asphalt



Dean Potts - Engineering Manager
Advanced Design Group



AccuGrade[®] Technologies

- AccuGrade[®] Cross Slope**
Controls the slope of the blade to maintain desired surface cross slope.
- AccuGrade[®] Sonic**
Maintains the blade at a vertical distance to an external reference.
- AccuGrade[®] Laser**
Provides constant elevation information for accurate blade positioning.
- AccuGrade[®] ATS (Advanced Tracking System)**
Instrument tracks a on-board target for precise 3D positioning.
- AccuGrade[®] GPS**
Compares the blade position to a 3D computerized site plan.
- AccuGrade[®] Site Reference System**
Allows the operator to set target grades relative to points on the work-site.

AccuGrade[®] Product Line

 Track Type Tractor AccuGrade Laser AccuGrade GPS	 Motor Grader AccuGrade Cross Slope AccuGrade Sonic AccuGrade Laser AccuGrade GPS AccuGrade ATS	 Excavator AccuGrade GPS (indicate only)	 Compactor AccuGrade Compaction GPS (indicate only)
 Backhoe Loader AccuGrade Site / Laser Reference System (indicate only)			

AccuGrade[®] Office

- Converts engineering design files to AccuGrade compatible format
- Supports wireless communication between the machine and office
- Allows "drill-down" of compaction data
- Compatible with all AccuGrade machines
- Supports text messaging in real time with operator
- Productivity module for cycle times, as-built data, and production related information
- Compaction module for detailed compaction analysis

AccuGrade[®] Office

Compaction Module

- Allows inspectors to analyze compaction data by providing a detailed view of the various layers, passes, and CCV's of the designated compaction area.
- The module saves and enables the inspector to view the time, date and location of compaction information such as...

- CCV/layer	- RMV
- CCV/pass	- Amplitude
- Thickness/pass	- Direction of travel
- Thickness/layer	- Vibration state

Intelligent Compaction for Soil and Asphalt

Dean Potts

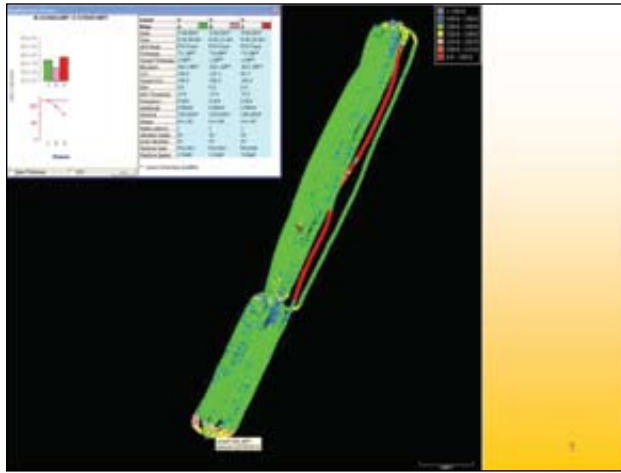

Four Types of Compactor based Compaction Measurement.

1. **The Compaction Meter Value method (CMV & CCV)**
 - Drum mounted accelerometer measures G-force at vibratory frequency and harmonics. (typically vertical accelerations only)
 - Signals can be used to control amplitude of drum.
2. **The Force vs Displacement method. (E-vib, Kb)**
 - Drum mounted accelerometers/position sensors.
 - Signals can be used to control drum amplitude and frequency.
3. **The Energy or Machine Drive Power (MDP) method.**
 - Measures driveline power used to roll over soil or asphalt with corrections made for grade and machine acceleration.
 - Works on both vibratory and non-vibratory compactors.
4. **Pass Count and Temperature Measurement (asphalt)**

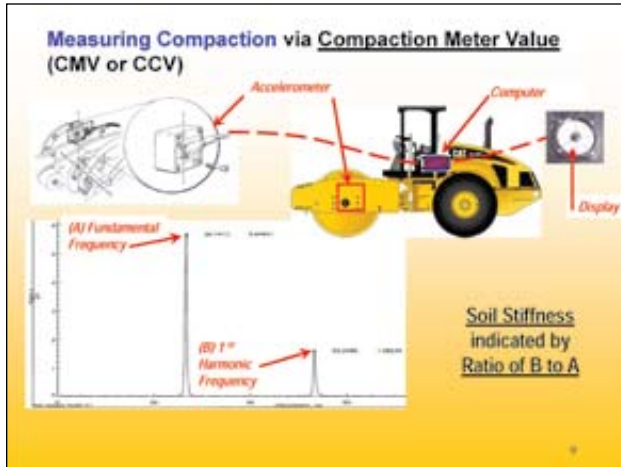

CAT AccuGrade® Compaction – CMV (CCV)



Intelligent Compaction for Soil and Asphalt

Dean Potts

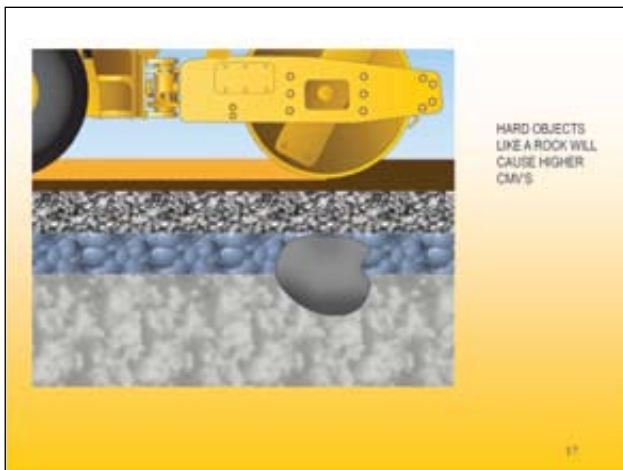
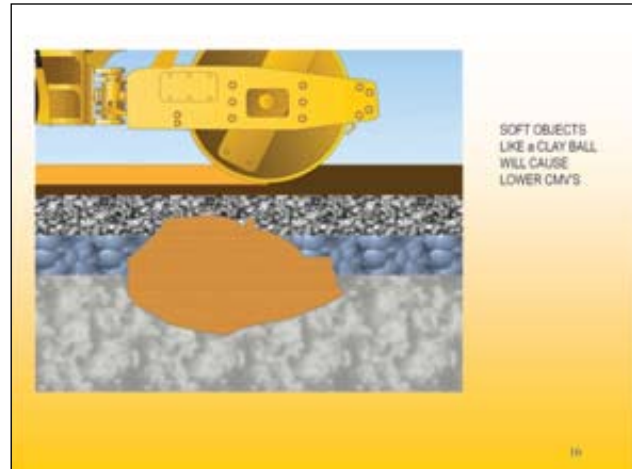

Intelligent Compaction for Soil and Asphalt

Dean Potts

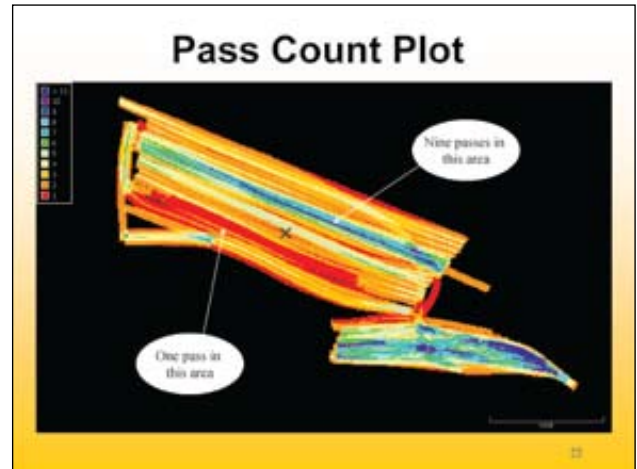
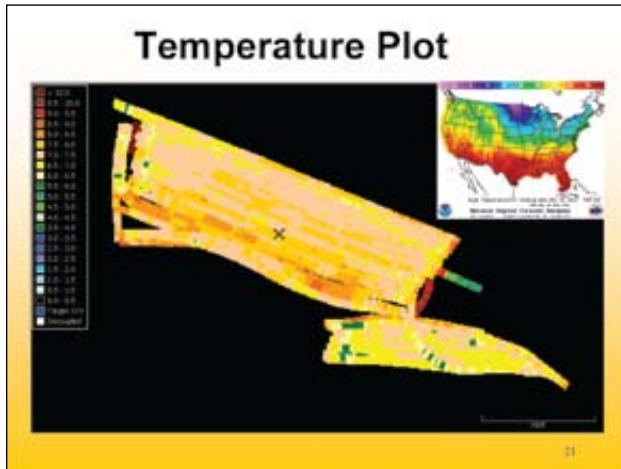
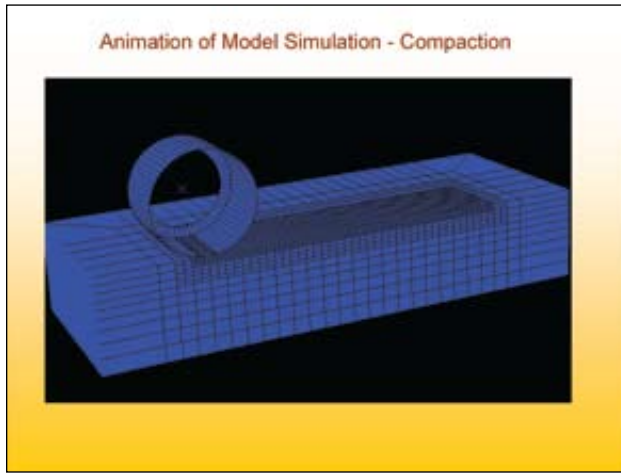

IC for Asphalt Compaction

Things to be aware of:

- Stiffness of asphalt changes greatly with temperature changes, even without compaction.
- Infra-red temperature sensors look at the surface temperature, not the mean or core temperature, or temperature of layer below the new asphalt. (reference all the inputs to Pave Cool program)
- Accelerometer based methods tend to measure both new lift and base below.

BOMAG

Asphalt Manager Intelligent Compaction



BOMAG

WHAT IS INTELLIGENCE

- 1) Collect Information
- 2) Use the Collected Information to Make a Decision
- 3) Execute the Decision

BOMAG History

Surface Covering Compaction Measurement

- 1983 Terrameter BTM 01 (OMEGA)
- 1993 Guidelines for Surface Covering Measurements National Research Association
- 1994 ZTVE / TP BF-StB 94, proof methods FDVK/ SCCC
- 1996 Compaction Management System BCM 03
- 1998 VARIOCONTROL
- 2001 Measuring device for evaluation of stiffness (Evib)
- 2004 Modular Measuring System with GPS support

BOMAG History

BOMAG Compaction Technology

- 1996** Variomatic for asphalt rollers
- 1998 Variocontrol for soil rollers
- 2000 Evib (MN/m²)
- 2001 Asphalt Manager
- 2004 Research project of German DOT (BAST), Oct / Nov. 2004;

BOMAG

VARIOMATIC roller with directed vibration



low dynamic energy

Compaction principle
static pressure and dynamic energy which is automatically adjusted to type of material, compactability, layer thickness and base layer conditions.

high dynamic energy

Applications: asphalt layers, granular bases and subbases

BOMAG Asphalt Manager

Worldwide proven design:

Several hundreds Tandem rollers



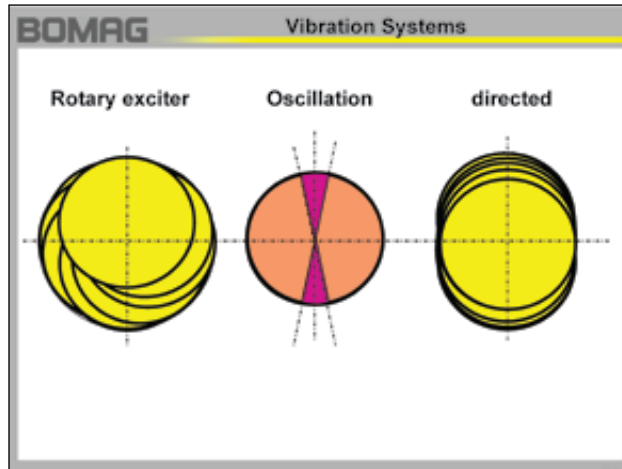
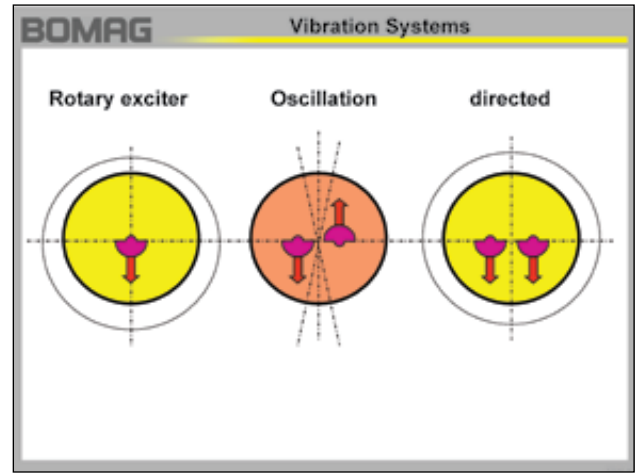
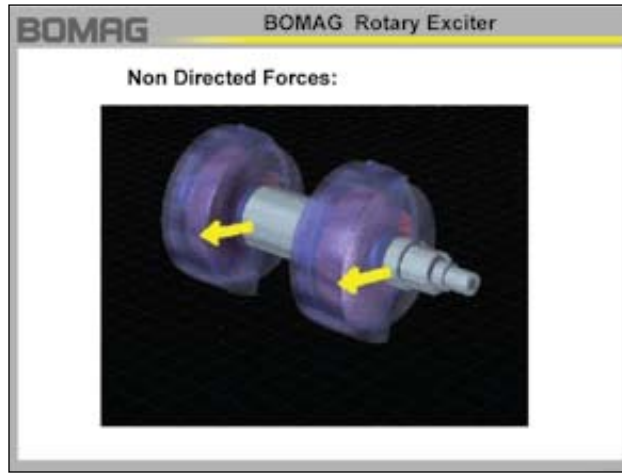

Asphalt Manager, Intelligent Compaction

Chris Connolly

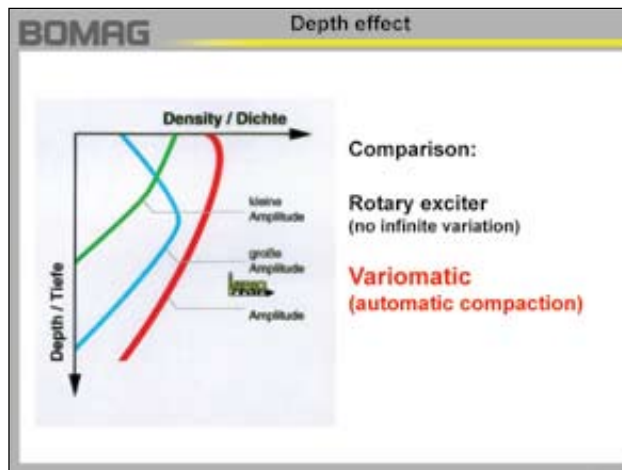

BOMAG Vibration systems / Overview

	Vibration	Oscillation	Variomatic
Principle	Rotary exciter with unbalanced weight	2 rotary exciters with unbalanced weight	2 rotary exciters with unbalanced weight counter rotating
Oscillation	non directed	directed horizontally	directed horizontally to vertically
Amplitudes	up to 8 up to 1,3 mm	2 fixed amplitudes ca. 1,3 mm	automatic variation 0 - 0,9 mm
Frequencies	35 - 70 Hz	33 - 42 Hz	35 - 50 Hz
Control system	manual	manual	automatic variation



- BOMAG** Directed exciter system
- Advantages vs. Rotary exciter:
- Better depth effect
 - Excellent Asphalt surfaces
 - Evenness
 - Grip / roughness

Asphalt Manager, Intelligent Compaction

Chris Connolly

BOMAG Asphalt Manager

Benefits for contractors:

- Universal use on
 - Road base
 - Wearing course layers
 - Thin layers
- Higher compaction performance
- Uniform compaction, even on sub-bases with inhomogeneous stiffness
- Better evenness and more uniform surface structure
- Low tendency to scuffing



BOMAG

Compaction of 6 cm asphalt binder course 0/10, RN13 France
Operating weight and compaction technique affect smoothness and evenness



15 t tandem vibratory roller 8 passes 8 t BOMAG VARIOMATIC BW 151 AD 8 passes

BOMAG

Density and roughness measurement on asphalt binder layer



Punctual compaction measurement with portable isotope probe Continuous compaction measurement with mobile isotope probe [1 measurement / 10 m]

BOMAG

Comparison between conventional compaction concept and VARIOMATIC

	Compaction			Roughness					
	Portable isotope probe	Mobile isotope probe [1 measurement/10 m]		Sand spot method					
	n	X1	σ	n	X1	σ	n	X2	σ
4 passes with 25 t rubber tire roller and 4 passes with 15 t tandem vibratory roller	14	92,5 %	1,22	59	94,6 %	1,29	12	0,46 mm	0,07
8 passes with BW 151 AD-3 VARIOMATIC	14	92,5 %	0,54	59	93,8 %	1,06	12	0,60 mm	0,05

n = number of measurements, X1 = mean value of achieved Gyrator test compaction value (93% Gyrator value = 30% Marshall value), X2 = mean value of characteristic roughness value

BOMAG

1996



Variomatic

1998



Variomatic 2

advanced, more powerful
also for split drums !

BOMAG

Latest developments of compaction technology

- 1996 Variomatic for asphalt rollers
- 1998 Variocontrol for soil rollers
- 2000 Evib (MN/m²)
- 2001 Asphalt Manager**

Asphalt Manager, Intelligent Compaction

Chris Connolly

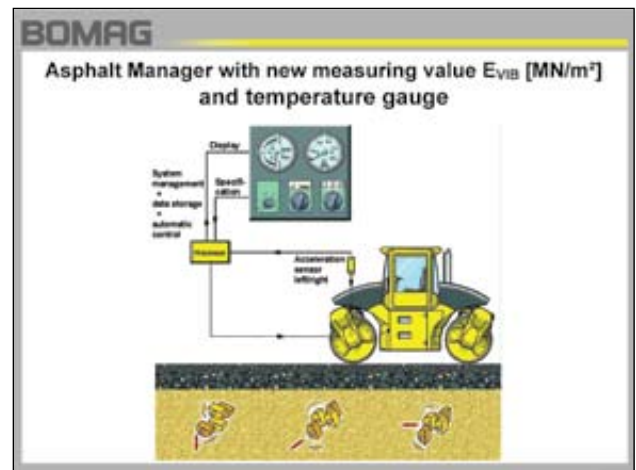
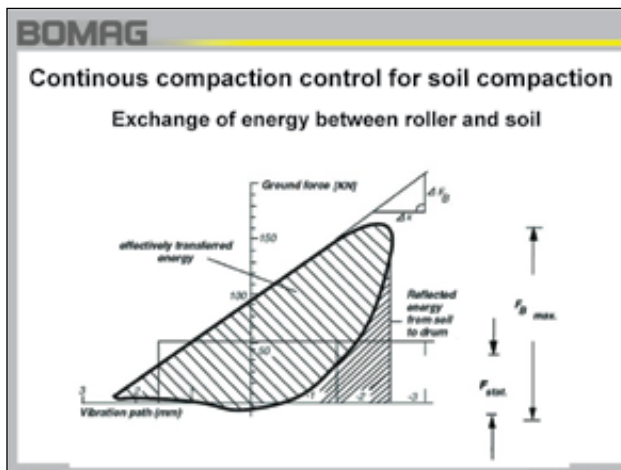
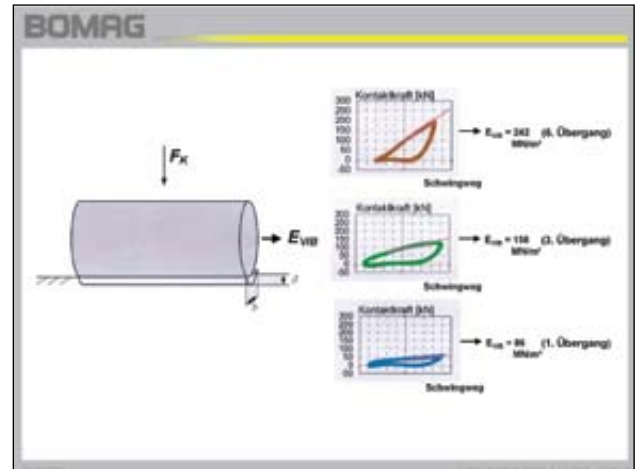
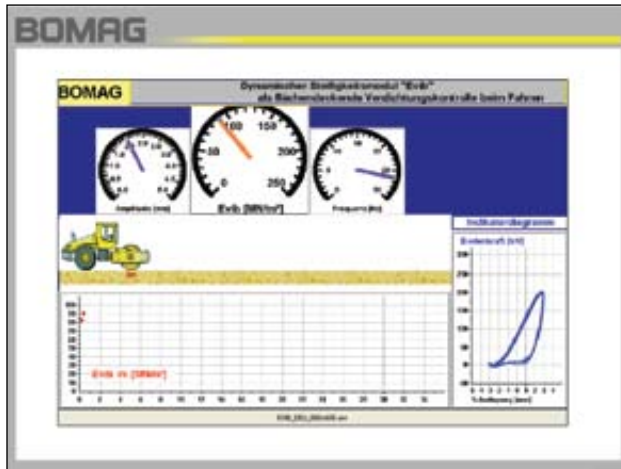
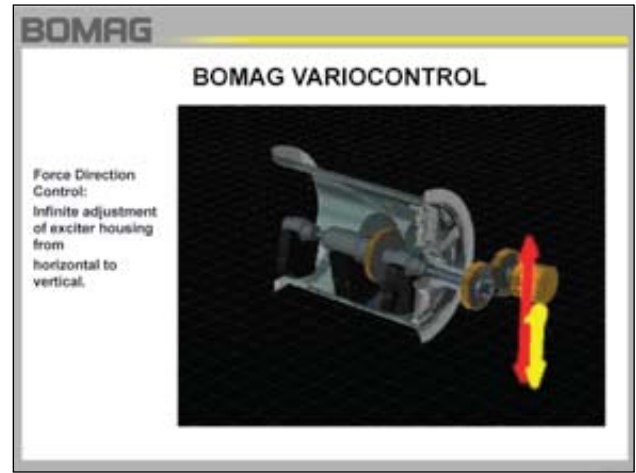
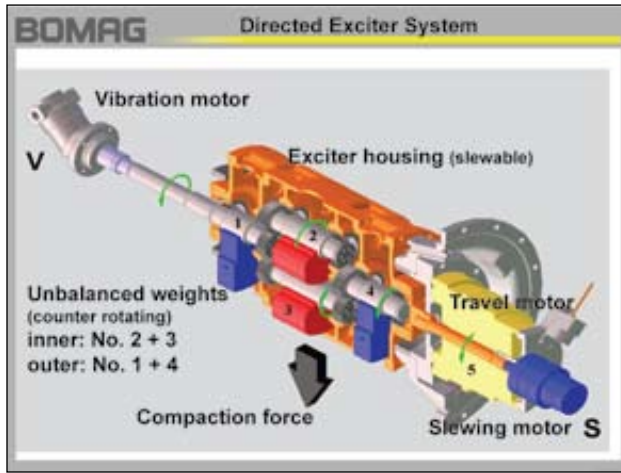

Asphalt Manager, Intelligent Compaction

Chris Connolly

BOMAG Acceleration meters

BOMAG Asphalt Manager

Benefits for Operators:

- No critical decisions required
- All operators achieve better results:
 - good and uniform compaction
- Continuous information on
 - asphalt temperature
 - compaction increase



BOMAG The Operator

Asphalt Manager: Easy to understand

BOMAG Asphaltmanager

Technical Data

PARAMETERS		BW 141 / 151 AD AM		BW 190 / 203 AD AM	
Front: AM		Rear: Std. Exciter			
Oper. weight	kg	8.000	8.400	12.000	13.100
Drum width	in	59	66	79	84
Amplitudes					
front	mm	0,95	0,95	0,93	0,73
rear	mm	0,64 / 0,27	0,6 / 0,25	0,86 + 0,37	0,7 / 0,3
Frequencies					
front / rear	Hz	45	45	40 + 50 / 46+57	40+50 / 40+50
Centr. force					
front	kN	160	165	247 / 158	247 / 158
rear	kN	80 / 34	80 / 34	167 / 109	126 / 84

BOMAG Bomag Operational Panel

Asphalt Manager, Intelligent Compaction

Chris Connolly

BOMAG Bomag Operational Panel



PRINTER

- Start
- Stop
- Print out
- Delete

Test procedure:

- Mark the track to be compacted
- „Manual operation mode“ with
- Fixed amplitude
- Fixed working speed

BOMAG Bomag Operational Panel



SETTINGS

- Escape
- Enter

BOMAG



BOMAG



BOMAG Printer



BOMAG E_{VIB} - Printer

LEBERGANG 1 VOR
BOMAG AB 40V 1 DEV
04 174 AB

Übertragung: Front / 0,40 mm
 E_{VIB} Min. = 100 MPa
 E_{VIB} Max. = 130 MPa
 E_{VIB} Mittelwert = 100 MPa
 Frequenz = 40,5 Hz
 Mittlere Fahrgeschw. = 2,2 km/h
 Rollradius = 0,55 m

Master Set: 10 20 30 40 50 60 70 80 90 100



- E_{VIB} Max. / E_{VIB} Min.
- E_{VIB} Average
- Frequenz
- Average Speed
- Track length
- Temperature

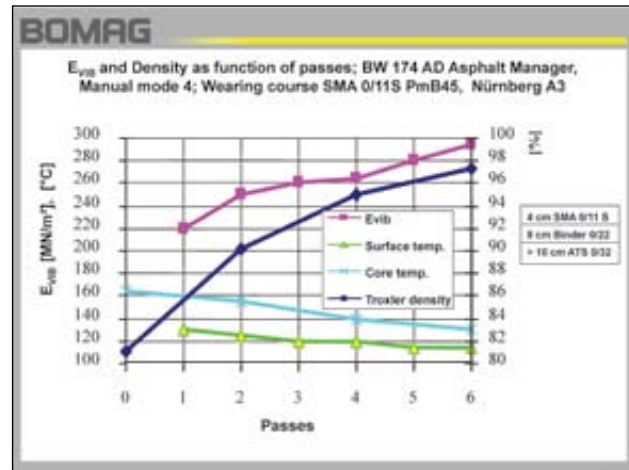
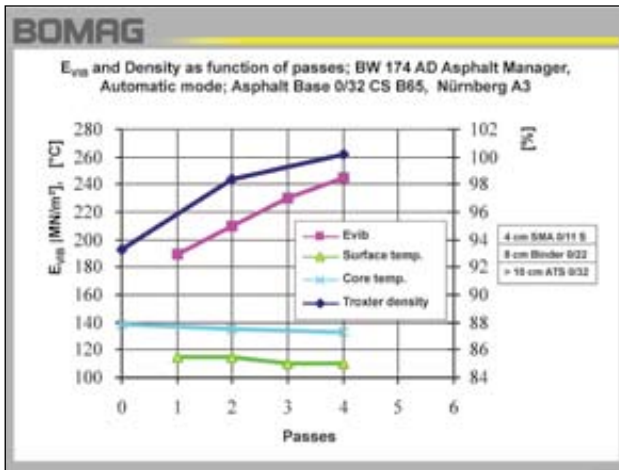

BOMAG Asphalt Manager

Advantages:

- Immediate determination of dynamic stiffness in MN/m^2 (E_{vib})
- E_{vib} can be correlated with the increase of compaction
- E_{vib} is widely independent from roller parameters
- E_{vib} printouts for area covering compaction control

In Development:

- Target E_{vib} values to be pre-selectable
- „Ready“ indication if target value is achieved (red light)
- „Ready“ indication if no further compaction is possible (red light)

BOMAG Number of passes with vibratory rollers

Recommended figures:

Layer thickness d [cm]	No. of passes with vibration of different tandem rollers		
	3 t	6 t	9 t
2	2 - 4	1 - 2 (L)	1 - 2 (L)
4	4 - 6	2 - 4 (L)	2 - 4 (L)
6	4 - 8	4 - 6 (L)	2 - 4 (L)
10	6 - 8	4 - 6 (L, H)	4 - 6 (L, H)
14	-	6 - 8 (H)	4 - 6 (H)
18	-	6 - 8 (H)	4 - 8 (H)
SMA (Stone mastix)	d = 2 d = 4	- -	1 - 2 (L) + stat. passes 4 - 6 (L) + stat. passes
Porous asphalt	d = 4	-	1 - 2 (L) + stat. passes 1 - 2 (L) + stat. passes

L = low amplitude, H = high amplitude
3 t = Machine with only the amplitude
Assumption: Compaction temperature > 100°C

BOMAG VARIOMATIC 2

**Further advantages:
better gradability- less shoving effect**

Automatic force adaption with travel direction

BOMAG Asphalt-Manager

E_{vib} (MN/m^2) Vibration modulus

- Equivalent for dynamic Stiffness;
- Directly picked up by the roller;
- Physical value for compaction increase on asphalt.

Asphalt Manager, Intelligent Compaction

Chris Connolly

BOMAG Asphalt Manager

Benefits for Contractors: Investment for Profit

Compaction

- Uniform and predictable results while rolling
- Avoids under / overcompaction
- Better eveness and roughness
- Eliminates drum bouncing

Economical and quality aspects

- More efficient roller utilization with fewer passes
- Reduced shock loads in sensitive environment e.g. buildings, bridges
- Area coverage method

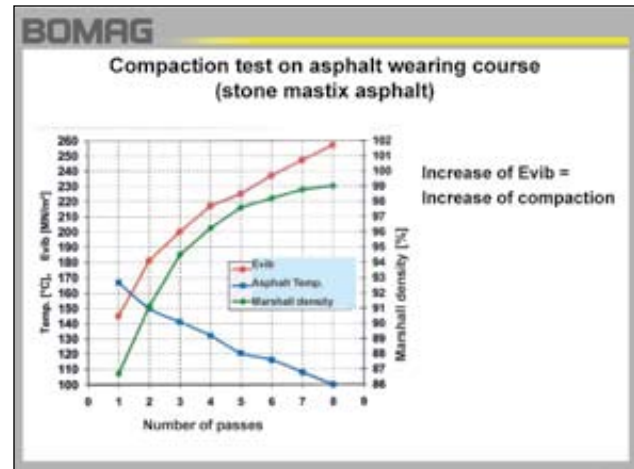
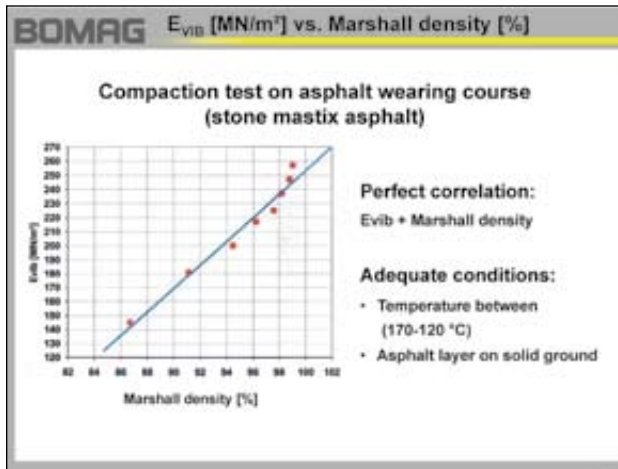
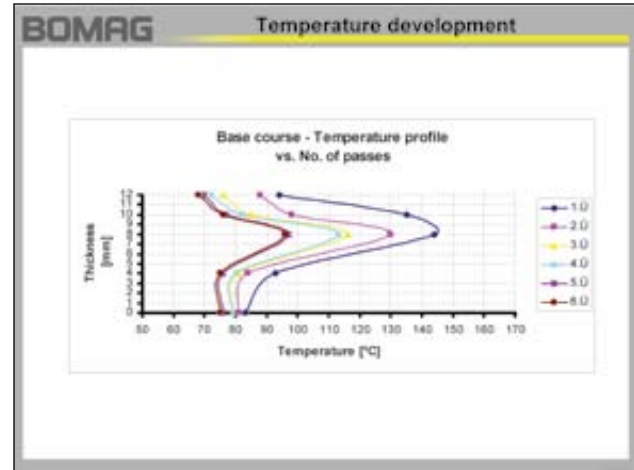

BOMAG Application

Comfort + Quality:

Compaction of joints hot against cold

- avoids shock loads
- no bouncing
- better eveness

BOMAG Application

Leipzig:

"Augustusplatz"

Compaction on a parking roof top;

Alternatives:

- 15 t static roller - 15 cm layers
- With BVM - 40 cm layers

Asphalt Manager, Intelligent Compaction

Chris Connolly

BOMAG Application



- Avoids shock loads on bridges and near buildings
- Depth control via force adjustment
- 3 automatic control ranges
- 6 manual force directions (fixed)

BOMAG Investment Series4

FEATURES	BENEFITS
Modular Design Principle: <ul style="list-style-type: none"> - Operator Platform - Central Electric System - Travel- / Vibration Pumps and Motors - Support Legs 	Less Expenses for Warehousing, Training, and Logistics;

BOMAG Surface Quality



Perfect Results:

- Roughness
- Evenness

BOMAG CONCISE OPERATING INSTRUCTIONS ASPHALT MANAGER

Application soil compaction
Support for compaction works and measuring paths on sub-grade, frost blanket layers and non-bonded bearing layers; the E₅₀ value increases with increasing compaction. Weak spots are localized.

Application asphalt compaction
Support for compaction works on asphalt layers. If compaction is performed within a narrow temperature range (i.e. 130° - 180°C) and the sub-layer is of sufficient stability, E₅₀ will show the increase in compaction. A denser statement on the density is only possible after performing compaction measurements with an isotope probe (Trodel). Compaction force and depth effect can be adapted to the layer to be compacted and to the substrate (see matrix of recommended applications).

Condition of the substrate	Setting	Asphalt bearing course		Asphalt binder		Asphalt pavement	
		Easy to compact	Difficult to compact	Easy to compact	Difficult to compact	Asphalt concrete	Stone mastic
ready for (ready)	Automatic	3	3.5	3	3	2	3
	Force level						
	alternative Manual/Profilbau	5.5	4.5	5.5	4.5	4.5	4.5
grading (soft)	Automatic	2	1.5	2	1	1	2
	Force level						
	alternative Manual/Profilbau	4.5	3.5	3.5	2.5	2.5	2.5
Layers on top	Automatic	1.5	1.5	1.5	1	1	1.5
	Force level						
	alternative Manual/Profilbau	3.5	2.5	2.5	2.5	2.5	2.5
	Automatic	1	1	1	1	1	1
	Force level						
	alternative Manual/Profilbau	2.5	1.5	1.5	1.5	1.5	1.5

Temperature specifications related to the asphalt surface. * In manual mode start with higher force level, and reduce after.

BOMAG CONCISE OPERATING INSTRUCTIONS ASPHALT MANAGER



- Display: direction of vibrations
- E₅₀ display
- Temperature gauge
- Emergency switch

Display of vibration direction and amplitude
Shows the direction of drum vibration and the size of the vertical amplitude.

E₅₀ display
E₅₀ shows the dynamic stiffness of the material to be compacted in kN/m².

- E₅₀ responds to changes in density. With increasing density the asphalt becomes firmer (stiffer). The E₅₀ value increases.
- E₅₀ responds to temperature changes. With dropping temperature the asphalt becomes firmer (stiffer), even if the end of compaction is not yet reached. E₅₀ increases with decreasing temperature.
- E₅₀ responds to deviations in the stiffness of the substrate (base layer). On a soft substrate and with a pre-selected high force level the E₅₀ may remain low.

Temperature gauge
The temperature is permanently detected as asphalt surface temperature. Depending on layer thickness, ambient temperature and wind force the max temperature inside the core of the layer may be up to 80°C higher. At a surface temperature of 80°C compaction should be completed.

Emergency switch
In case of an electronics failure the emergency switch enables the selection of two vibration directions: horizontal (left) or vertical (right).

Manual mode
3 selectable amplitudes, each with constant direction of vibration.

Automatic mode
3 selectable force ranges with amplitude control, limited to compaction force and depth effect.

BOMAG Current Developments

Asphalt Manager + BOMAG GPS System

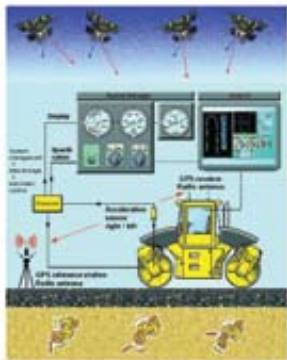

- Surface covering compaction control on asphalt layers
- GPS receiver
- GPS reference station
- Roller PC for data managing and graphical representation of roller position and stiffness values
- Position accuracy: better than 10 cm
- CAD based evaluation program

Asphalt Manager, Intelligent Compaction

Chris Connolly

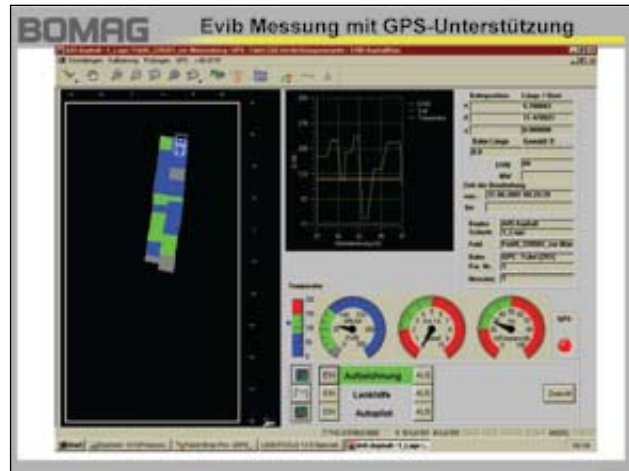
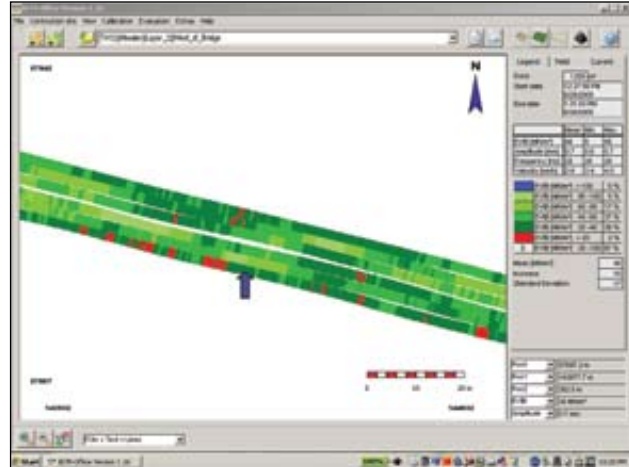

Asphalt Manager, Intelligent Compaction

Chris Connolly

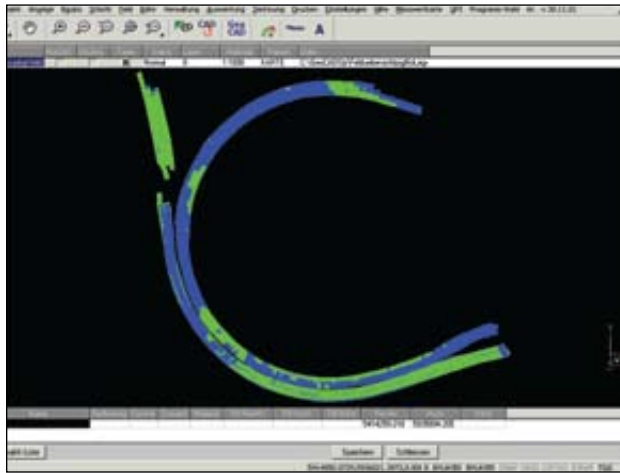

BOMAG Determination of roller positions with GPS

Reference station on the job site
High accuracy: up to 5 cm

GPS Reference service with reference satellite
Accuracy: up to 100 cm
> OmniSTAR (world wide) ~ 1500,- Euro annual charge
> EGNOS (Europe, not yet in operation) free of charge
> WAAS (North America)

Local Reference network (reference service)
High accuracy : up to 5cm (depending on service)
> Ascot (since 2001, Ruhrgas / Germany,
(only available in Rhine Area)

BOMAG GPS / positioning with Reference Station

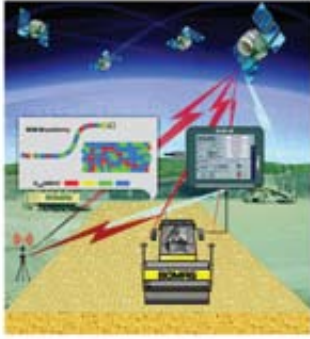

- Two GPS Antenna
- Reference station (Trimble)
- High accuracy (5cm)
- RTK (real time)
- BCM 05 positioning software

Intelligent Compaction for Soils and HMA

Stan Rakowski

Intelligent Compaction for Soils & HMA

SAKAI

Stan Rakowski
Inwa IC Workshop
April 2-4, 2009

Change of Drum Acceleration

Vibratory roller

Low stiffness in early stage of compaction

High stiffness in end of compaction

Drum Acceleration (Hz)

Amplitude Spectrum (Hz)

Roller Pass 1

Roller Pass 10

Time (sec)

Time (sec)

Frequency (Hz)

Frequency (Hz)

Changes in Amplitude Spectrum and Increase in Compaction

Amplitude Spectrum

Frequency (Hz)

Soft

Ground Condition

Hard

Filtered with band pass filters which correspond to 6 frequencies

SAKAI

From Acceleration to Compaction Value

1st Pass

2nd Pass

After Multiple Passes

Amplitude Spectrum

Frequency (Hz)

SAKAI

CCV formula;
 $CCV = \frac{(A1+A3+A4+A5+A6)}{(A1+A2)} \times 100$

Other formulas;
 $CMV = \frac{(A4)}{(A2)} \times 100$
 $CCV2 = \frac{(A3+A4+A5+A6)}{(A1+A2)} \times 100$
 $PWR1 = \frac{(\sqrt{(A3^2+A4^2+A5^2+A6^2)})}{(\sqrt{(A1^2+A2^2)})} \times 100$

*PWR1: Public Works Research Institute in Japan

Simulation Results

- Comparing acceleration output data using four formulas.

Type of soil: Sandy Loam

Type of Roller: SV160DV

Dry density (g/cm³)

Number of roller passes

CCV

CCV2

PWR1

CMV

CCV System

SAKAI

Intelligent Compaction for Soils and HMA

Stan Rakowski

Real Time Moving Display

VALUE directly under the vibrating drum

Moving display

Soft spot

Vibration Frequency in Hz

Target value indicates specified compaction level

Stiff spot: No more compaction is needed.

Adjusts CCV range from 30 to 100

Adjusts time range from 6 to 60 sec

Density/Stiffness Correlation

CCV is correlated with target density or stiffness using calibration switch

CAL switch

CCV

Density: γ_d (g/cm³)

$\gamma = 143.47x - 19391$
 $R^2 = 0.9302$

CAL-CCV value

Required density

Contractor Experience

- CCV correlates well with conventional single point tests.
- Increases project efficiency.
- Expectations are the same for asphalt pavements as observed for unbound aggregates.
 - Increased efficiencies
 - Lower risk
 - Better quality pavements

• CCV identifies weak areas prior to paving



Intelligent Compaction for Soils and HMA

Stan Rakowski

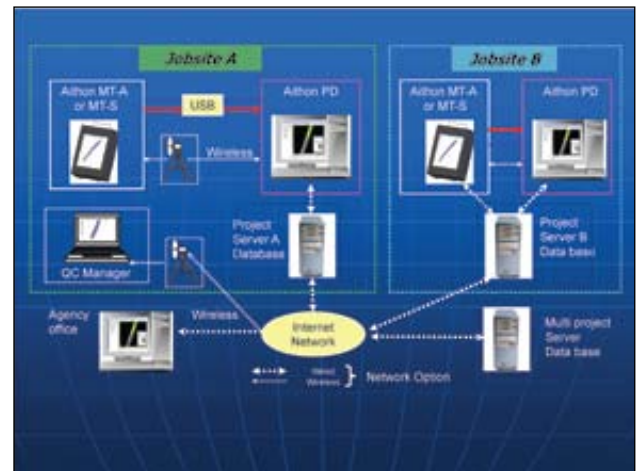
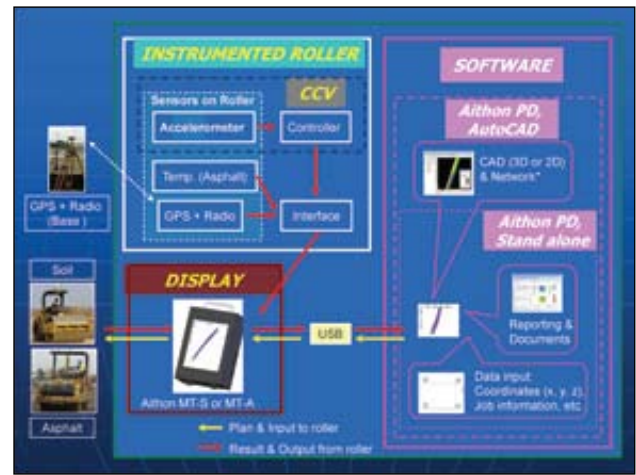
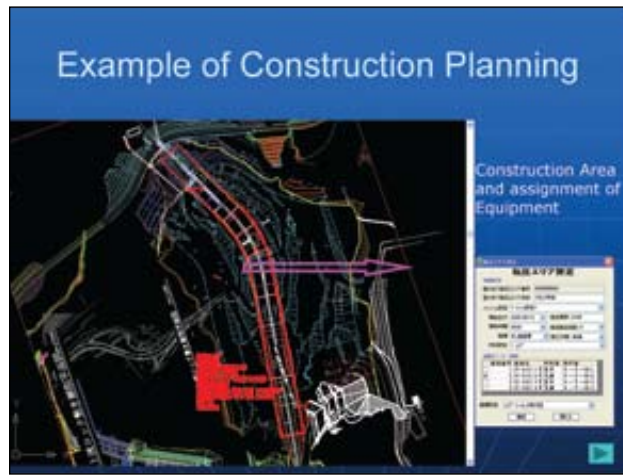

Intelligent Compaction for Soils and HMA

Stan Rakowski

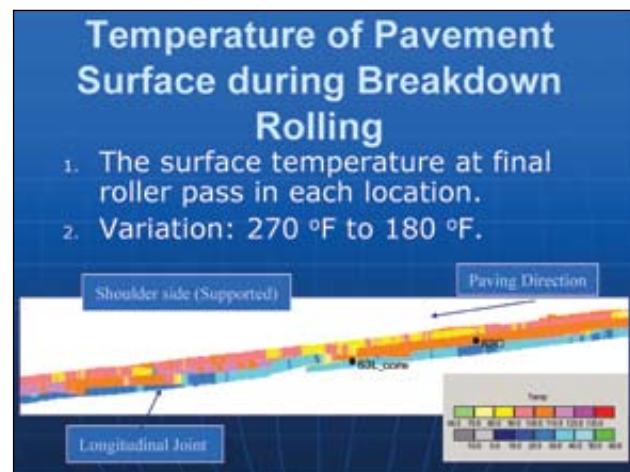
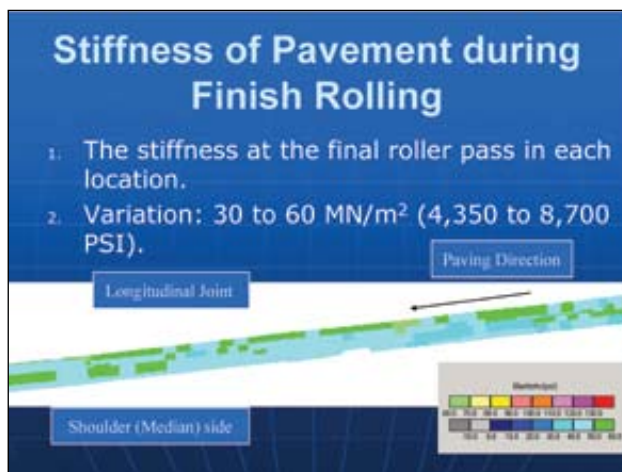
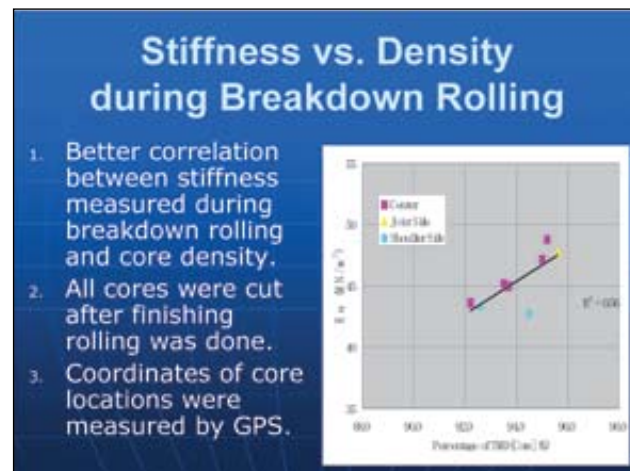
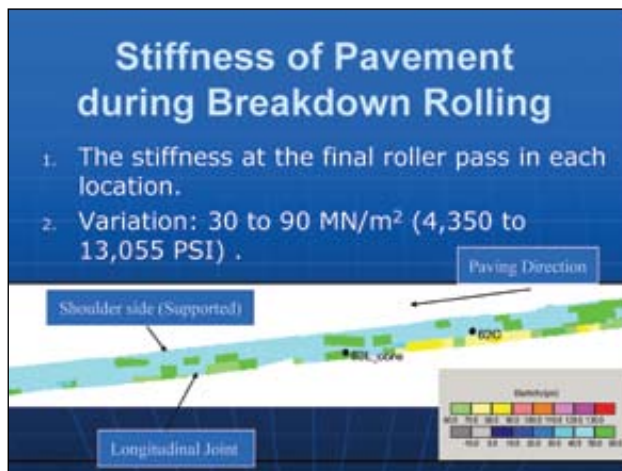

Intelligent Compaction for Soils and HMA

Stan Rakowski

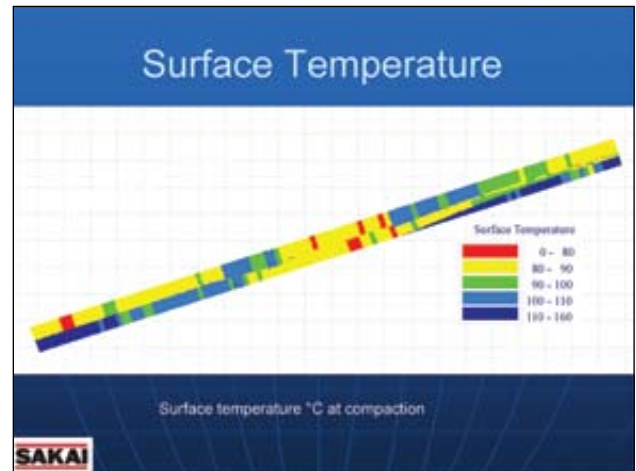
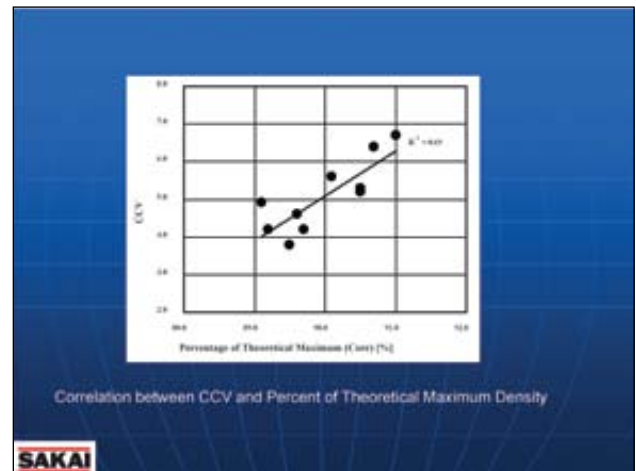
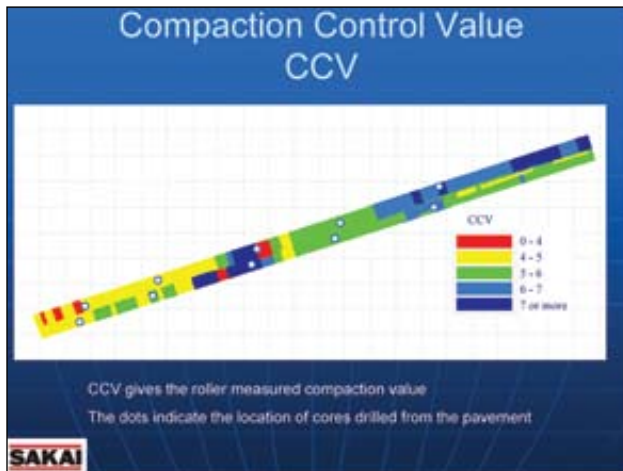
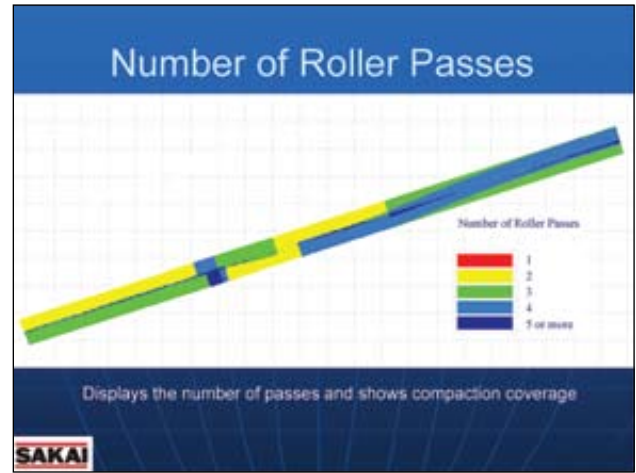

Intelligent Compaction for Soils and HMA

Stan Rakowski

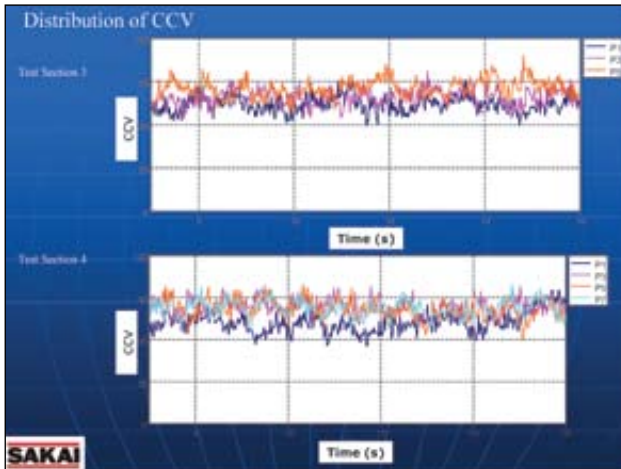
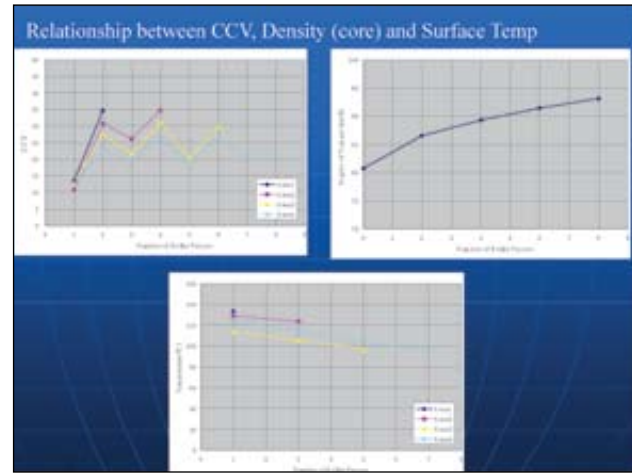

- ### HMA Factors
- Temperature affects stiffness
 - Uniformity of mat placed by paver
 - Material Segregation ,Temperature variations
 - Consistent paver speed and lift thickness
 - Subbase condition
 - Longitudinal Joint

- ### To get good information on HMA Monitor the initial conditions
- Smoothness should be measured before and after the test strip especially when paved over a milled surface.
 - Thermal and Material segregation should be measured after lay down.
 - Create new index to evaluate uniformity of compaction

Intelligent Compaction for Soils and HMA

Stan Rakowski



Evaluation of the Highway Subgrade Strength with the Acceleration Wave of the Vibration Roller

Stan Rakowski

Evaluation of the highway subgrade strength with the acceleration wave of the vibration roller

Japan Highway Public Corp., Y. Kitamura & K. Fujioka
 Sakai Heavy Industries, Ltd., K. Uchiyama
 Fudo Construction Co., T. Nishio
 Hazama Co., S. Nakajima

Objectives of Test Project

- Establish new compaction QC method for embankment and subgrade using acceleration of vibratory roller such as CCV
- Comparison of the conventional testing method with the new one such as CCV.
- Investigate the influence of various levels of stiffness of underlying layer on the drum acceleration measured on the upper layer

SAKAI CCV Compaction Control Value

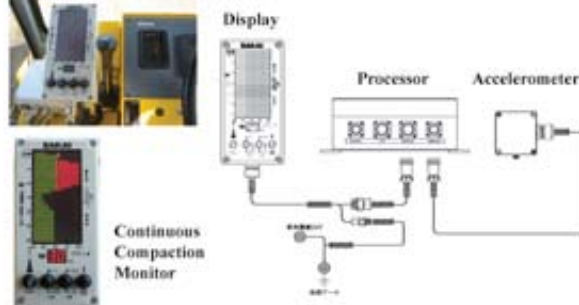

Test Section View

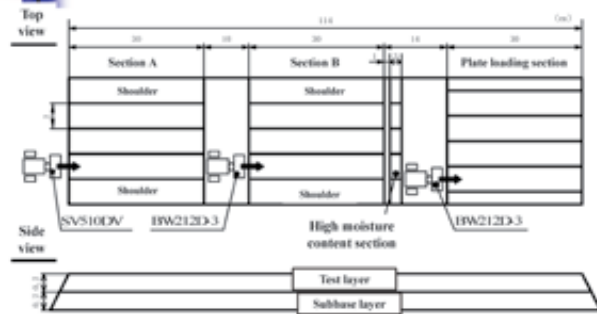

Roller in Test Section



Mechanical Quantities Measured

- CCV
- Density by nuclear gauge
- Stiffness by plate loading test
- Deflection by Benkelman beam and FWD
- Surface sinkage

Evaluation of the Highway Subgrade Strength with the Acceleration Wave of the Vibration Roller

Stan Rakowski

Material Information

Unified Classification System	Gravel Sand (GS)		Remarks
Density of soil particles	t/m ³	2.644	
Maximum aggregate size	mm	75.0	
Uniformity Coefficient U _c		16.7	
Max dry density	t/m ³	1.902	(E-b)
Optimum moisture content	%	12.0	
Average moisture content during test	%	8.3	

Test Rollers

Model		SV510DV	BW212D-3
Make		SAKAI	BOMAG
Mass	kg	11,400	11,750
Centrifugal force	kN	226	275
Frequency	Hz	30	30

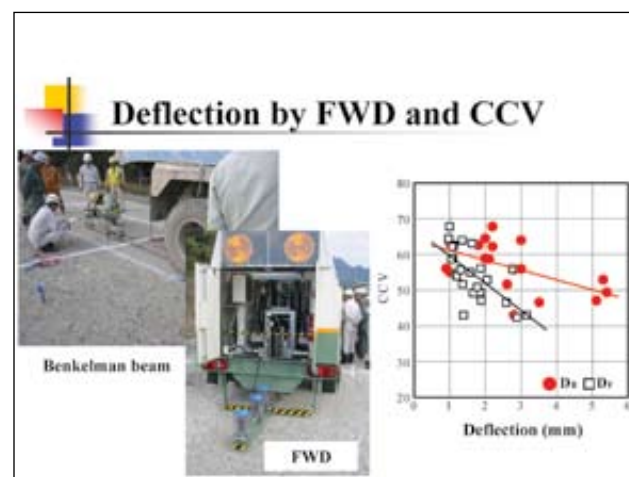
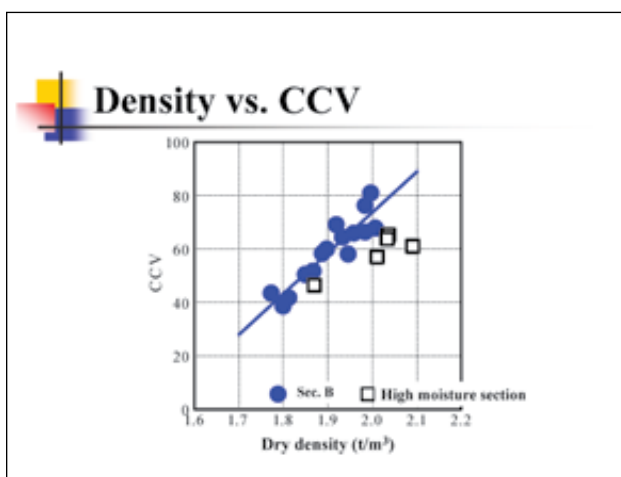
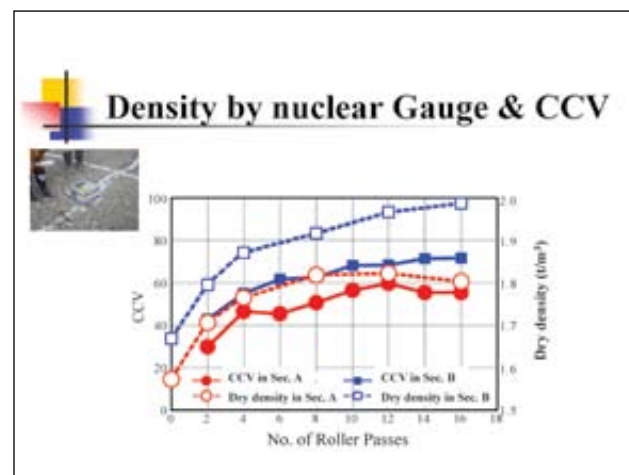
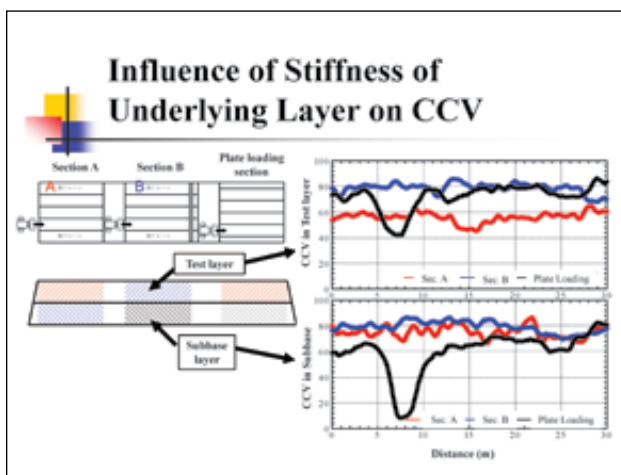

Evaluation of the Highway Subgrade Strength with the Acceleration Wave of the Vibration Roller

Stan Rakowski



Summary

- > **CCV measured on the overlying layer is affected by the stiffness of the underlying layer.**
- > **CCV increases with an increase of number of roller passes.**
- > **CCV showed better correlation between dry density.**
- > **CCV decreases with an increase of moisture content.**
- > **CCV correlates with the deflection measured by Benkelman bean and also the deflection measure by FWD.**

Intelligent Compaction: GPS-based Compaction Control

Kirby Carpenter

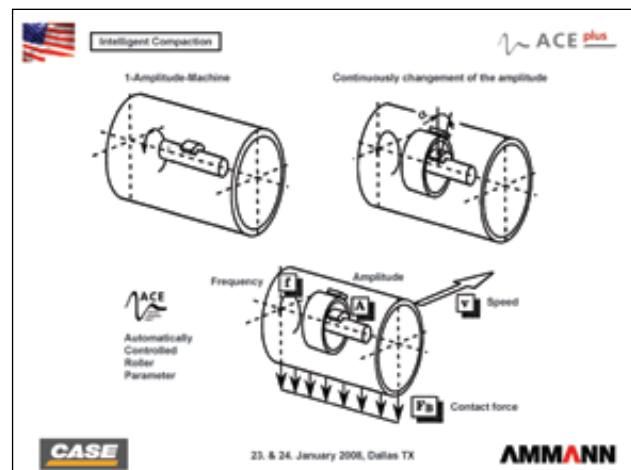
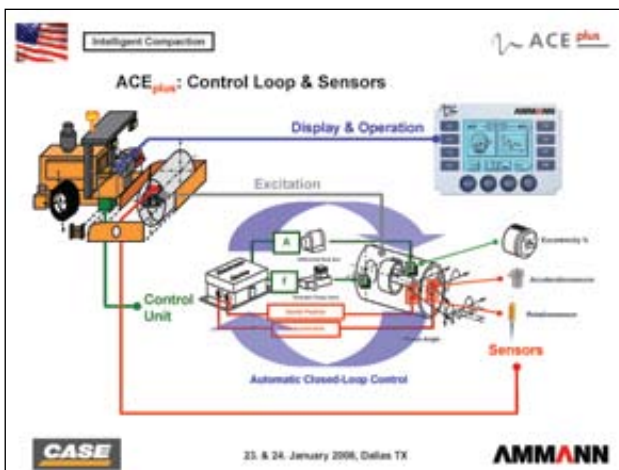
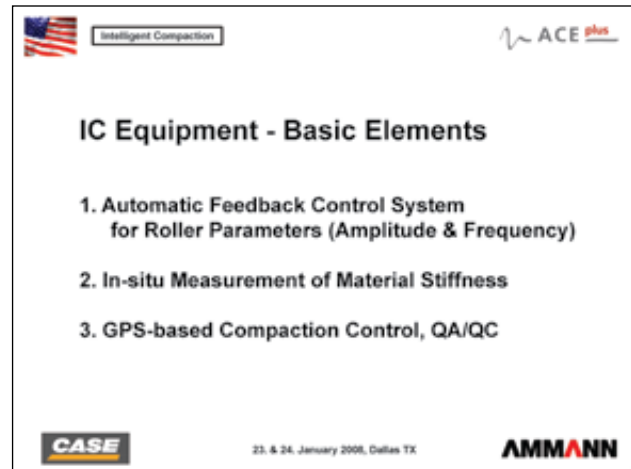
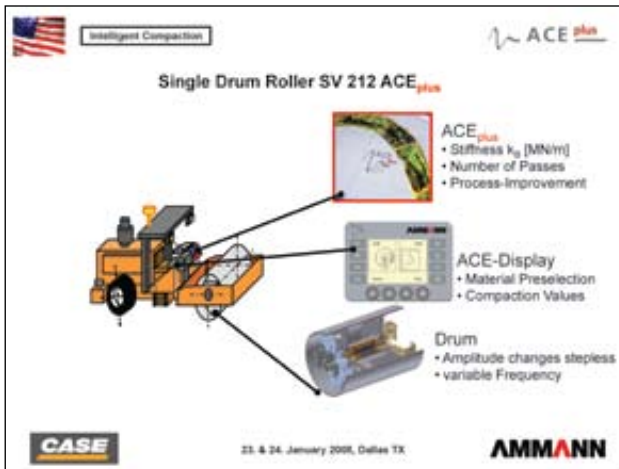

Intelligent Compaction: GPS-based Compaction Control

Kirby Carpenter

Intelligent Compaction ACE plus

Searching the Resonance Frequency

Natural Frequency: the frequency at which an Object vibrates by itself. This is the Point of maximum Transmitted Force

Weak Material

Low Frequency
High Amplitude

Hard Material

High Frequency
Low Amplitude

CASE **AMMANN**

23. & 24. January 2008, Dallas TX

Intelligent Compaction ACE plus

Drum

1-Amplitude

Continuously changment of the amplitude

CASE **AMMANN**

23. & 24. January 2008, Dallas TX

Intelligent Compaction ACE plus

ACE plus: Measuring the Soil Compaction

Loading the Plate
Force F_s

Measuring the Deflection
 x_s

Mechanistic Soil model:

$$F_s = k_d x_s + C_s x_s$$

Stiffness of Soil: $k_d = \frac{F_s}{x_s}$

CASE **AMMANN**

23. & 24. January 2008, Dallas TX

Intelligent Compaction ACE plus

Correlation with Plate Bearing Test

$N_{10} = 7 + 1.12 k_d$ $R^2 = 0.91$

N_{10} (MPa)

k_d (kN/m²)

Adequate Testing

Plate Bearing Test

CASE **AMMANN**

23. & 24. January 2008, Dallas TX

Intelligent Compaction ACE plus

Layered Soil Measurement

Soil stiffness k_d (kN/m²)

Amplitude x_s (mm)

Soil Stiffness Test Tip

CASE **AMMANN**

23. & 24. January 2008, Dallas TX

Intelligent Compaction ACE plus

ACE plus: Layered Soils

Measurement Depth of the ACE plus-System

Loam, compacted, acting as a Spring

Measuring into the Subgrade

Gravelly Soil, well compacted, acting as an snail

Measuring the Layer

CASE **AMMANN**

23. & 24. January 2008, Dallas TX

Intelligent Compaction: GPS-based Compaction Control

Kirby Carpenter

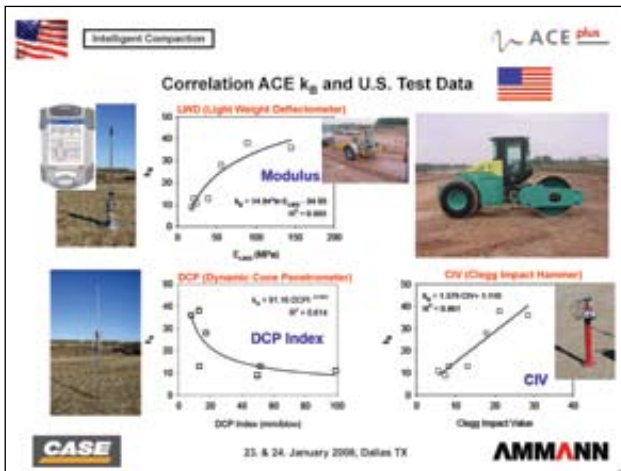
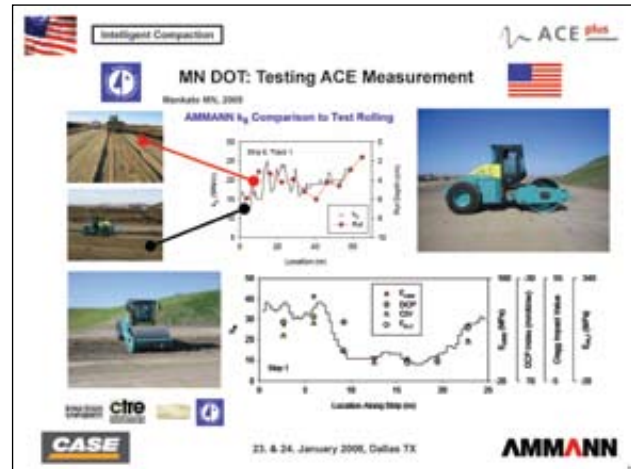
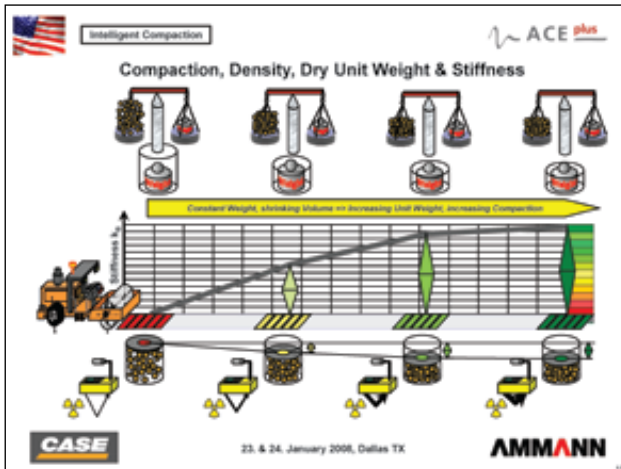
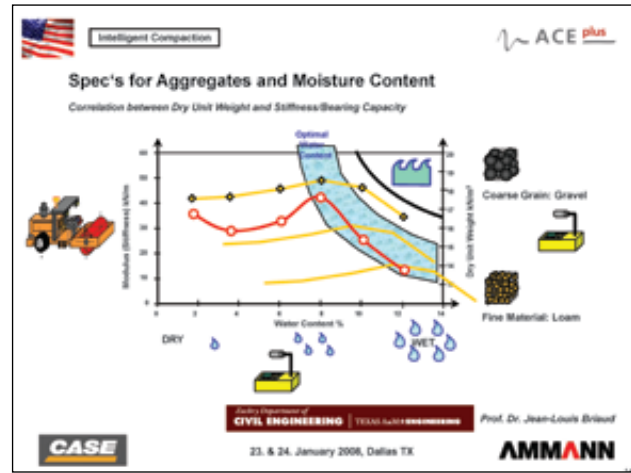
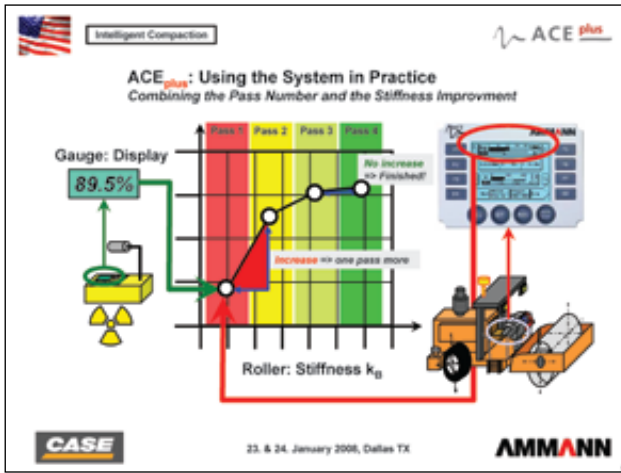

Intelligent Compaction: GPS-based Compaction Control

Kirby Carpenter

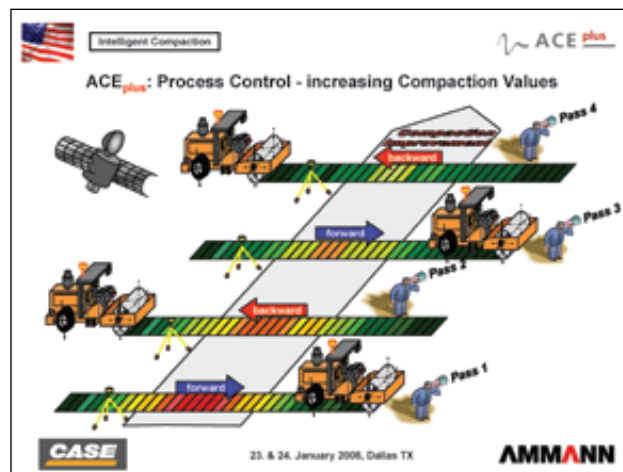
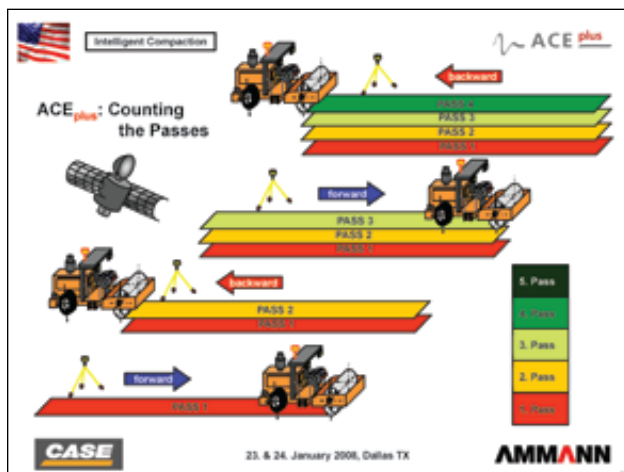
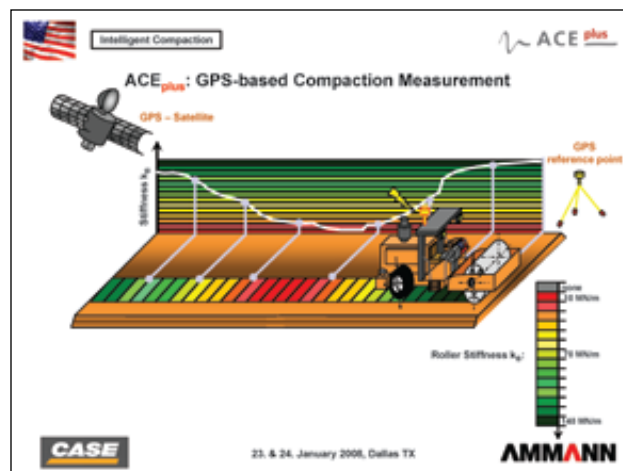
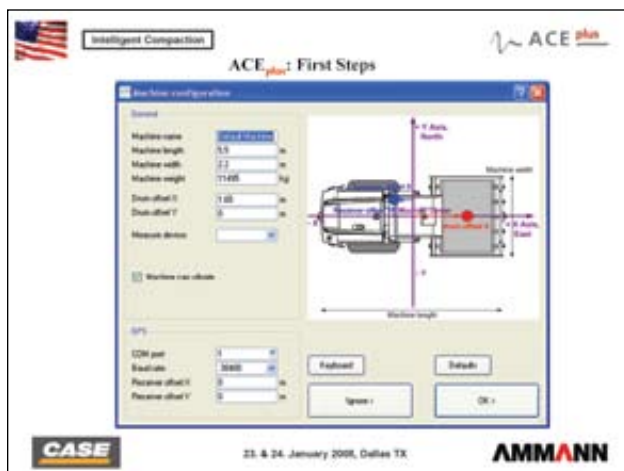
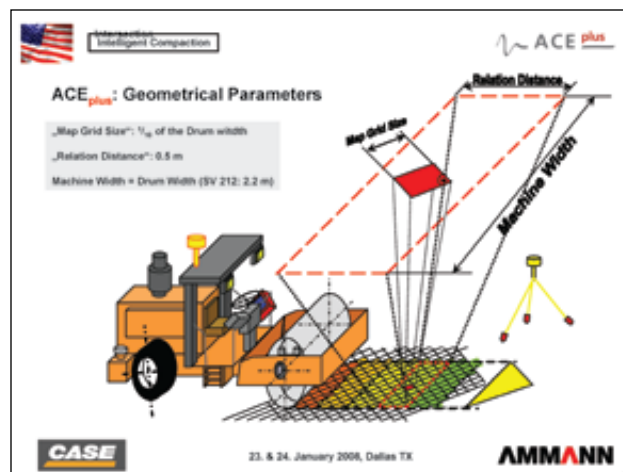
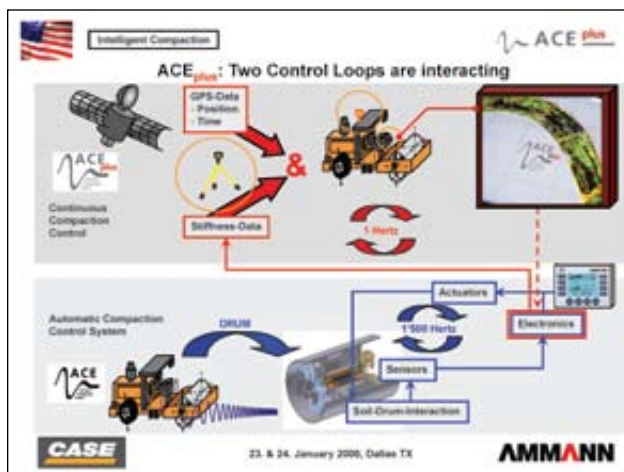

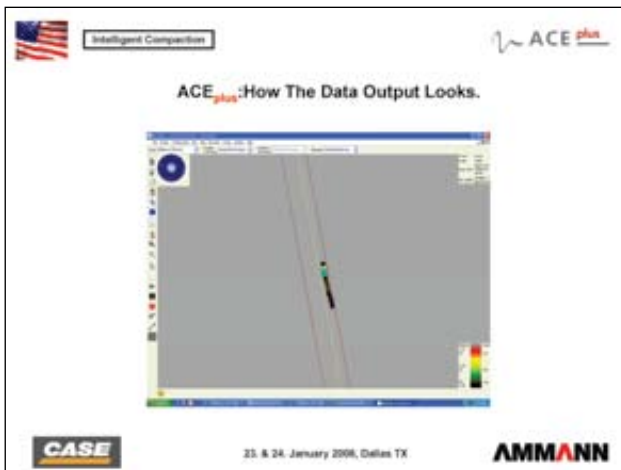
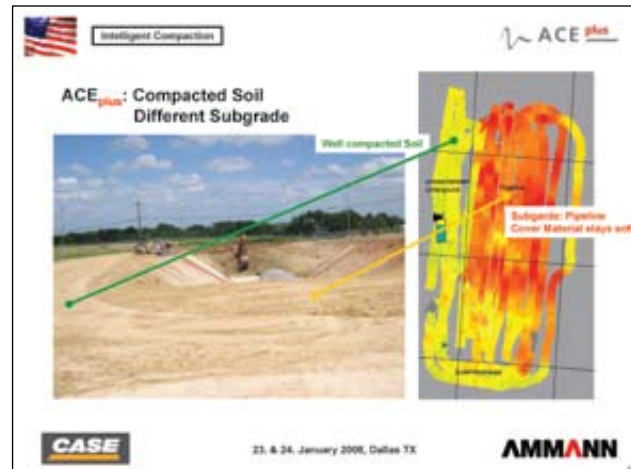
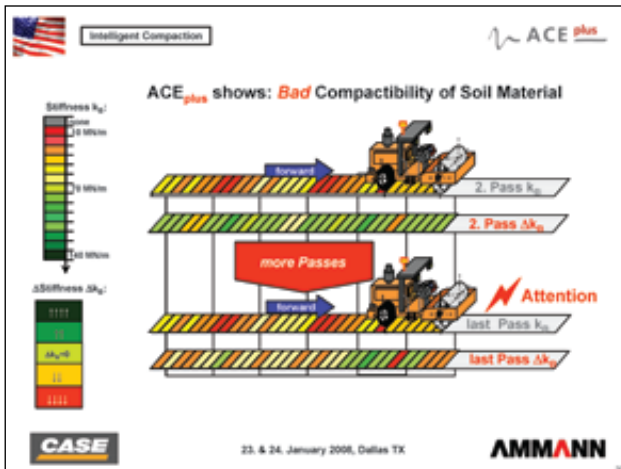
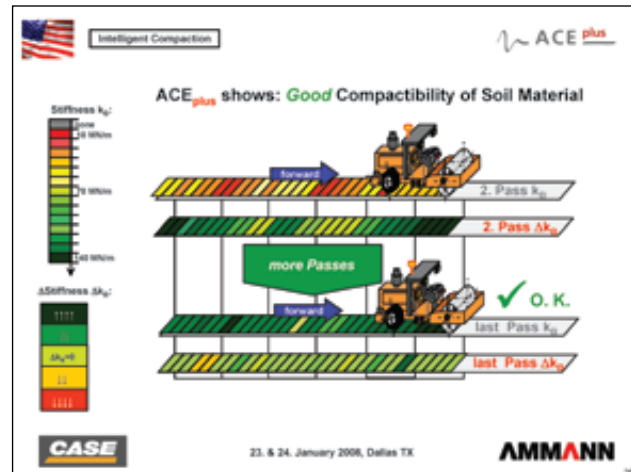
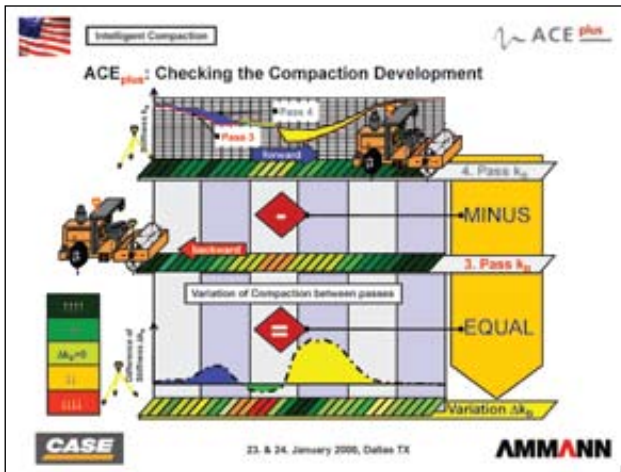

Intelligent Compaction: GPS-based Compaction Control

Kirby Carpenter



Intelligent Compaction: GPS-based Compaction Control



Kirby Carpenter

 Intelligent Compaction 

Sustainable Compaction

- Homogeneous, optimal Compaction Results.
- Continuous Compaction Control (GPS).
- Permanent Record.
- Peace of mind for owner.



 23. & 24. January 2008, Dallas TX 



 Intelligent Compaction 

Correlation Between Testing and performance is excellent!

- 100% Inspection of job.
- Possibility of reduced testing costs.
- Feedback Control System: Automatic Adjustment of Compaction Energy.
(Amplitude, Frequency, Impact Spacing)
- Process-Integrated Measurement of Soil Stiffness.





 23. & 24. January 2008, Dallas TX 

 Intelligent Compaction 

Efficiency

- Less Labor.
- Fewer Passes.
- Less Fuel.
- Lower Emissions.
- Less Wear & Tear on machine.
- No Over Compaction.
- No Time Wasted if Conditions do not Permit Compaction.



 23. & 24. January 2008, Dallas TX 

 Intelligent Compaction 

Advantages for Project Owner or Partner

- Best available state of the art technology.
- Supplemental process covering 100% of project.
- Provide a permanent record of project compaction.
- Detect compaction deficiencies deeper into the sub grade.
- Reduced machine operation to achieve compaction means less fuel burned and reduced emissions.

 23. & 24. January 2008, Dallas TX 

Intelligent Compaction

Khalil Maalouf



Intelligent Compaction

IC Technology Consensus

- Immediate and Comprehensive feedback to the operator
- Compaction measure need to be accurate to improve operation
- Transparent documentation with 100% coverage (QC)
- IC = Compaction Measure + Mapping Utility + Drum Feedback Control (But Two out of Three functionalities is OK also!)
- Need to identify which material and construction practices IC is best suited for
- Accuracy and Validation of benefits is an ongoing effort
- Accepted Standards for calibration methods (not necessarily the compaction measure) can help advancing the technology
- System Cost should be consistent with added job site efficiency

IC is one part that must fit well within the rest of the operation

Soil Compaction – Volkel Based System



Compaction Measure & Mapping Utility

Soil Compaction – Trimble Based System



Compaction Measure & High Precision GPS Mapping Utility

Asphalt Compaction – Research at Un. Of Oklahoma Intelligent Asphalt Compaction Analyzer (IACA)



- Haskell Lemon (Construction)
- University of Oklahoma (PI)
- Volvo Road Machinery (Sponsor)
- E. S. T. Inc. (Testing/GA)
- FHWA Award: \$200K

Principle of Operation of the IACA

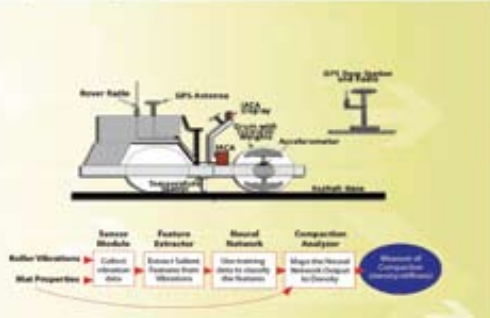

The diagram illustrates the data flow from the roller's sensors to the analysis software. It shows the 'Sensor Module' (Rubber Rollers) capturing 'Raw Properties' (Rubber Vibrations) and 'Raw Data' (Collected vibration data). This data is processed by the 'Feature Extractor' (Sensor Filters) to produce 'Raw Features' (Features from Vibrations). These are then analyzed by the 'Neural Network' (After training) to identify 'Raw Features' (Features to identify the Features). Finally, the 'Compaction Analyzer' (Merge the Neural Network Output for Density) produces the 'Amount of Compaction' (Amount of compaction).

Intelligent Compaction

Khalil Maalouf

IACA – Activities

- Tested in "initial" lab and field experiments with Encouraging Initial Results



The image shows two side-by-side elements. On the left is a screenshot of the 'Intelligent Asphalt Compaction Analyzer' (IACA) interface. It features a color-coded progress bar at the top (green, yellow, red) and a large digital display showing '95.3%'. Below the display are several smaller data fields and a 'Print' button. On the right is a photograph of the physical OCEGEMA sensor unit, which is a grey, rectangular device with a label that reads 'OCEGEMA' and 'Intelligent Asphalt Compaction Analyzer'.

**On Going Comprehensive Validation Program
on diverse construction sites**

Valve Construction Equipment Intelligent Compaction, IA presentation

Intelligent Compaction: Where we are at and where we need to be

Brett Stanton

INTELLIGENT COMPACTION

Where we are at and where we need to be.



INTRODUCTION

CONTRACTOR'S DEFINITION:
Intelligent compaction is a compaction system that allows increasing productivity while decreasing risk.

REGULATORY AGENCY'S DEFINITION:
Intelligent compaction is another means of measuring and recording the quality of compaction during the construction process.

2

INTRODUCTION

- Experience with Intelligent Compaction
 - Unbound Crushed Aggregate Base
 - Rubbilized Concrete
 - Asphalt Pavement
- Future Expectations

3

EXPERIENCE

- Intelligent Compaction on CABC
 - Good correlation between nuclear density gauges and CCV for aggregate base courses using established test strips



- Greatly improves efficiency by reducing over rolling
- Base courses were not left open to weather and traffic as long prior to paving
- Improved communication with inspectors and a reduction in QC testing intervals

4

EXPERIENCE

- Used to identify soft areas to be undercut
- Reduces cost to the DOT and time to traveling public
- Reduces risk to the contractor. Identifies areas prone to failure
- Continuous quality control due to ability to continuously log the roadway



5

EXPERIENCE

Intelligent Compaction on Rubbilized Concrete

- 426,000 tons of HMA over rubbilized concrete - MDOT Warranty project
- Rubbilized to stop reflective cracking
- Typical modulus values of the layer: 50ksi
- Correlated results from Falling Weight Deflectometer (FWD) to readings from CCV device

6

Intelligent Compaction: Where we are at and where we need to be

Brett Stanton

EXPERIENCE

- CCV ensured aggregate interlock of PCC layer by not over rubblizing
- Intelligent compaction is much quicker than translating FWD numbers and could be used to VALUE ENGINEER HMA overlays on rubblized PCC
- Could increase modulus numbers easily to 150ksi from 50ksi, a three fold increase



7

Experience

Intelligent Compaction on Asphalt Pavement

- Uniform asphalt pavement densities are related to:
 - Temperature
 - Mix Uniformity
 - Uniform rolling patterns
- Current technology allows the monitoring of
 - Temperature
 - Rolling Patterns
 - Density?

8



Roller equipped with GPS sensors monitor roller position

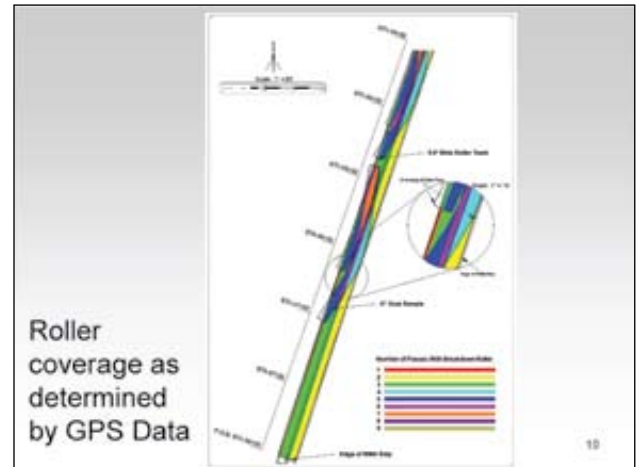

Roller coverage as determined by GPS Data

10

Experience

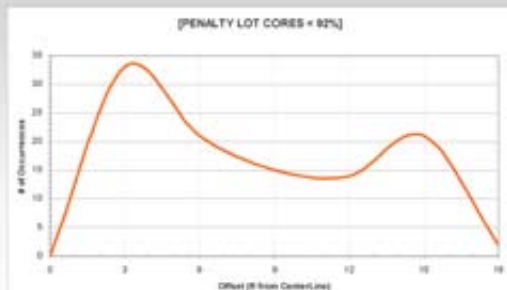

11

CONCLUSION

- Intelligent compactors correlated well with density results on CABC
- Can be used to determine amount of rubblization needed for rubblized PCC pavements
- Intelligent compaction has increased project efficiency
- Lowered contractors exposure to risk
- Allows for crucial future design data to be gathered for performance
- Can aid in value engineering pavement
- Can supply continuous QC information
- Benefits the traveling public by reducing user delays

12

Future Expectations

- Lower the overall risk on PWL projects and warranty work
- Provide better quality pavements by not damaging or over-rolling
 - Aggregate damage of SMA
 - Uniform density
 - Ride quality
 - Temperature monitoring can aid in detecting plant problems
- Further increase efficiency
 - Fewer number of rollers needed

13

QUESTIONS



14

Facilitator Report / Discussion

Tom Cackler, Ed Engle, Heath Gieselman,
Lisa Rold, Douglas Townes, David White

IOWA STATE UNIVERSITY
Civil, Construction & Environmental Engineering

Facilitator Report - Discussion

Intelligent Compaction for Soils and HMA Workshop
West Des Moines, Iowa
April 2-4, 2008

Facilitators: E. Tom Cackler, Ed Engle, Heath Gieselman, Lisa Rold,
Douglas Townes
Recorders: Jerod Gross, John Puls, Pavana Vennapusa,
David White, Paul Wiegand

ctre
Center for Transportation Research and Education

EERC
Earthquake Engineering Research Center

Dream it, Design it, Build it. www.ccee.engineering.iastate.edu

Sessions

- IC for Soils and Aggregate (3)
- IC for HMA (4)
- Implementation Strategies (2)

Knowledge Gaps Equipment Advancements Education and T² Specifications and Standards

Outcome: Develop a framework to move intelligent compaction/machine control forward into the mainstream of highway construction.



IC for Soils and Aggregate

Knowledge Gaps

- Correlation Studies (73)
 - Different Soil Types (Granular, Cohesive, Recycled, Stabilized)
 - Different Roller Configuration (Smooth, Padfoot)
- Rapid In-situ w% determination (14)
- Modulus Based QC/QA (12)
- Understanding what IC-MVs are? Experience (10)
- Measurement Influence Depth? (7)
- Acceptable Non-Uniformity? (4)
- Trouble Shooting – Unusual Conditions, Machine Capabilities, and Limitations (3)
- Data Visualization (1)
- Benefits? (1)

Equipment Advancements

- w% measurement on roller (29)
- Integrated solutions between multiple technologies (3D Design - 4D Construction) (18)
- Real-time data transfer/wireless (14)
- Retrofit systems (3)
- Repeatability/sensitivity of IC-MVs (2)
- Compaction diagnostics - red flag indicator (2)
- On-site geotechnical lab (2)
- Available machine configurations to match soil and site conditions (0)
- Machine/Technology maintenance differences (0)

Education/Technology Transfer

- Contractor/Field Engineer/Owner Training (52)
- Opportunity to promote good geotechnical practices (13)
- Cost/ROI (11):
 - Equipment Investment
 - Field Implementation
- Proven case histories to "sell" the technology (effectiveness to quality/efficiency) (9)
- Definitions of "IC" terminology (3)
- Operator/Inspector guide & Troubleshooting Manuals (3)
- Certification for contractor (1)
- Data amount and analysis (0)

Facilitator Report / Discussion

Tom Cackler, Ed Engle, Heath Gieselman,
Lisa Rold, Douglas Townes, David White

Specifications and Standards

- Uniformity criteria (20)
- Selecting engineering parameters to measure (e.g. density, modulus, stiffness) (19)
- Consolidate IC-MVs to one unified parameter or report raw accelerometer data (11)
- How will w% be specified? (5)
- Contractor/owner/researcher/manufacturer input for specification development (4)
- Establishing IC target values/test strip guidelines (1)
- Establish IC documentation standards (GPS and output parameters) (1)

IC for HMA

Knowledge Gap

- Correlation of IC-MVs to engineering properties (39)
- Understanding IC-MV non-uniformity (mixture) (10)
- Measurement Influence Depth/Adjustment (9)
- Key in-situ engineering parameters to measure (7)
- Mix design, binder grade, and aggregate on IC-MVs (5)
- Benefits of IC and reliability of current methods (5)
- Data Integration (3)
- Link between IC-MVs and performance (4)
- Best applications for IC (e.g., overlays, HMA, etc.) (2)
- Applications for IC for QA (1)
- Modeling of compaction and cooling mat (1)

Equipment Advancements

- Involvement of roller train or just the breakdown roller (14)
- Influence of temperature (surface /internal), compaction time/speed, frequency/amplitude, and roller passes (6)
- Retrofit (5)
- Real-time data transfer (5)
- Mapping of underlying layers and existing pavements (3)
- Similarities between IC output (2)
- Corrective action after map (1)
- Compare mapping of IC and pneumatic roller (1)
- Integrated systems approach (1)
- What are public agency needs (0)
- In-situ compaction test equipment (0)

Education and Technology Transfer

- Demonstration projects, open houses, and hands-on opportunities (10)
- Documented successes (4)
- Establish framework for training contractor/owner (3)
- Economic/contractor benefits (2)
- Software compatibility (design, machine, analysis) (1)
- Harmonization/standardization of technology (1)
- Communicate opportunities for IC projects with interested parties (0)
- Pooled fund website, NCAT research (?), NCHRP, international conference (0)

Specifications and Standards

- Establishing QC and QA criteria and framework (9)
- End-result specifications (7)
- Keep it simple (5)
- Standard calibration method to establish IC and in-situ target values (3)
- Mapping as QC tool (2)
- Structure to minimize risk to contractor and agency – total risk management (2)
- Allow for contractor QC plans to accommodate variations in equipment (2)
- Goal is better performance and optimized cost (1)
- Better define IC (0) & Eliminate IC definitions (1)
- Begin w/ contractor to use – transition (0)
- Model similar w/Superpave end-result (0)

Facilitator Report / Discussion

Tom Cackler, Ed Engle, Heath Gieselman,
Lisa Rold, Douglas Townes, David White

Implementation Strategies

Implementation Strategies

- Correlation between roller MVs and soil properties (12)
- Research
 - Demonstration projects (11)
 - NCHRP synthesis of existing practices (7)
 - FHWA IC pooled fund (4)
- Improved design tools
 - What stiffness value? (9)
 - Relation to MEPDG parameters (8)
 - Design life/quality (7)
 - 3/4D design (5)

Implementation Strategies

- Education and Training
 - Data interpretation (29)
 - Common standards (17)
 - NHI training courses (5)
 - IC 101 (4)
 - Knowledge sharing by contractor (2)
- Equipment Advancements
 - Moisture sensors in real-time (13)
 - Padfoot compaction in cohesive soils (12)
 - Real-time data transfer/wireless (9)
 - Method of marking problem areas (6)

Implementation Strategies

- Specifications
 - Incentive or directive needed (3)
 - QC easier to implement (2)
 - QA development (1)
- Partnerships/Communication (4)

Top 10 Overriding Issues – All Sessions!

1. Need correlation studies (cohesive, stabilized, granular, HMA, etc.) (136)
2. Education/training materials and programs (112)
3. Moisture content (influence + measurement) (61)
4. Integrated design + real-time data transfer (57)
5. Case histories + demos + benefit + successes (48)
6. Engineering parameter to measure (density, modulus, stiffness)? (47)
7. Addressing non-uniformity (34)
8. Establishing QC/QA framework - statistically significant (28)
9. Measurement influence depth? (19)
10. Promoting good geotechnical practices (13)

What Next?

A

→

B

Where we are at:

- Lack widely accepted IC specifications in U.S.
- Need education/training materials
- IC technologies provide documented benefits (smooth drum - granular)
- Great potential and some successes for cohesive and HMA
- Human IC network
- Increasing acceptance/GPS infrastructure for stakeless grading/machine guidance
- "Don't know what we don't know"

Where we are going:

- Standardized and credible IC specifications inclusive of various IC measurement systems
- Widespread implementation of IC technologies
- High quality database of correlations
- Better understanding of roadway performance - what are key parameters?
- Innovative new sensor systems and intelligent solutions
- Several documented successes for cohesive/stabilized/granular/HMA
- Compatible 3D electronic plans with improved integrated processes, efficiency and performance

Facilitator Report / Discussion

Tom Cackler, Ed Engle, Heath Gieselman,
Lisa Rold, Douglas Townes, David White

How?

A $\xrightarrow{\text{How Fast???$ } B



Research, T², Education

Guiding Objectives:

- ✓ Build strong working relationships between public agencies, industry, and researchers to advance research priority and accelerate research implementation.
- ✓ Facilitate strategic pooling of funding for increased leverage and impact.
- ✓ Facilitate changes to specifications and policies that result in innovation, increased value to public, and sustainable practices.

What can you do?

- Participate in partnerships for IC research and information exchange regionally and nationally
- Be an advocate for IC implementation
- Contribute to problem statement development for NCHRP, TRB, FHWA, AASHTO, ASCE Committees
- Participate in IC conferences/studies and the annual Earthwork Workshop
- Apply for membership: EERC Scientific and Policy Advisory Council (35 members) – IC and other issues
- Stay connected: Subscribe to EERC Technical Bulletins, Tech Transfer Summaries, Technical Reports, Educational Videos, etc.



Breakout Sessions

On day two, there were nine breakout sessions covering three topic areas: “IC for Soils and Aggregate,” “IC for HMA”, and “Implementation Strategies.” “IC for Soils and Aggregate” was discussed by three groups. “IC for HMA” was discussed by four different groups. “Implementation Strategies” was discussed by two groups. A sign-up sheet was provided on day one to target 20 participants per group. Each group had a facilitator and recorder.

The outcomes from the breakout sessions were centered on developing a framework to move intelligent compaction forward into the mainstream of highway construction. Each group was asked to address their topic around the following questions:

- What are the existing knowledge gaps?
- What equipment advancements are needed?
- What educational/technology transfer needs exist?
- What standards/specifications and guidelines need to be developed?

After the groups generated a list of topics for each question, the list was prioritized through discussion and, in some cases, voting. The following is a summary of the findings of each group. For some sessions, (#) indicates number of votes given to a topic for prioritization.

IC for Soils and Aggregate 1—Heath Gieselman (Facilitator), Pavana Vennapusa (Recorder)

Knowledge Gaps:

- Roller MVs in cohesive soils for both pad foot and smooth. (11)
- Intelligent compaction feedback control efficiency and effectiveness. (1)
- Increased moisture content information using simple techniques in field. (14)
- Relationships between roller outputs and soil properties. (10)
- Roller data overlaid on 3D project data. (1)

Equipment Advancements:

- Moisture measurement by rollers. (11)
- Retrofitting costs vs. new costs. (3)
- Knowledge of best machine model/size depending on soil conditions. (0)
- Pre-design tool?
- Machine maintenance issues (higher costs?)

Educational/Technology Transfer:

- Data amount and analysis.
- Contractor/operator and field engineer/owner training for IC. (12)

- Certification for contractor. (1)
- Proven case histories to “sell” the technology to the organization/contractor—quantitative information on efficiency of the technology. (9)
- Initial cost for contractor with using the technology.
- Implementation of technology without increasing the resources
- total \$\$ savings ROI. (11)

Standards/Specifications and Guidelines:

- What in situ measurement is needed for correlations? (5)
- Tolerance in specifications (as it relates to cost)—uniformity? (2)
- Control strip specifications—how to deal with highly variable material conditions, time to preparation. (1)

General:

- Continue with current technology.
- IC draft specifications.
- Demonstration projects by state.
- Look for a simple project and show success.
- Proper project selection.
- Partnership with contractors by state.
- FHWA support on projects and support from university researchers.

IC for Soils and Aggregate 2—Ed Engle (Facilitator), John Puls (Recorder)

Knowledge Gaps:

- Experience with technology (owner & contractor).
- Different technology by manufacturers, requirements for output, standard output by all manufacturers.
- Capabilities and limitations of operations: Response from sub-grade rather than base (but we pay for upper layers). May be an education issue. Can we identify expected stiffness values for given soils? Being able to adapt to real-world situations (expected vs. actual project soils). Site-specific achievements.
- Adopting stiffness level vs. moisture-density relationships—specifications changes?
- Ability to understand damping and mechanics for different materials—aggregates manufactured and soils natural. Lack of experience with cohesive soils in general. Need for “pre-investigation” prior to compaction. Timeframe for knowledge about soils—contractor. Variability in modulus/stiffness method.
- Defining important properties are required for a successful project: Relationship between

field measured and lab measured data. Quality control built into use of machine. Machine calibration—DOT or contractor operation? Machines to be calibrated on regular basis to ensure quality. Build reliability and confidence into the technology. Calibration standards for machines. Machine-specific parameters are proprietary. Correlation to parameters with which we are familiar.

- Identifying problem areas. How to determine corrective action? How do we measure this against the uniformity of the rest of the material consistently?
- Will stiffness actually replace density, or will it simply be used to correlate to expected density? Can we rely on it? What is more important: density or stiffness?
- How do you build reliability and repeatability into the technology to increase confidence level of the user?

Equipment Advancements:

- Integrated solution for all technologies. Data to designers. Geotechnical mobile offices—electronic solution (virtual on-site professionals). Limitations of staffing. On-site engineers a plus (soil identification and lab testing).
- Where does civil engineer come in to identify soils? Variability in soils and how they affect stiffness values. Understanding of what roller is doing, how soil is responding. Expected stiffness values?
- Standardize stiffness values for all entities. Need education and technology transfer.
- Moisture control measurements. Continuous measurements of moisture content to ensure quality.
- How do we approach the uniformity issue? Good or bad.
- Integrated solutions with regard to quantities: as-constructed quantities, provide data to designers and contractors, advantage to know what has been rolled vs. what hasn't, take time to run lab tests on this soil, cannot eliminate testing, but streamline it instead, make field/lab testing more efficient, mapping is a huge tool to be used for quality control, test spot selection (elimination and addition).
- Mapping prior to construction could be used for pre-construction risk analysis.
- Using MEPDG version for soils: sampling of soil, environmental conditions, and future traffic levels. Plug these into MEPDG and determine what stiffness you should have in the soil.

Educational/Technology Transfer:

- Joint education between industry and owners. Agreement on specifications.
- Agreement between terminology (CMV, CCV, etc) and units.
- Education program to be shared across all DOTs—national program.
- Listen to operators and learn from their experience.
- Opportunity to promote good geotechnical practices.

Standards/Specifications and Guidelines:

- Other acceptance criteria in addition to stiffness?
- Document procedures for specifications.
- Development of a standard to characterize the technology: standard deviation values, comparing equipment. Need awhile to continuously monitor calibration of a given machine.
- How to set levels of quality (90%, etc.)?
- Speed consistency of machines—is it an issue for soils and aggregates?
- Two major broad geotechnical issues: (1) what the machines can tell us and (2) how do we connect the two?

General:

- Stiffness replacing moisture density: Indices for moisture-density and stiffness? What methods do we have to measure moisture? How do we overcome these? Need fastest test possible. Replacing m-d relationship with stiffness, or adopting stiffness? Which stiffness are we monitoring—manufacturer (spring) or academic (modulus). What are we going to measure? How do we measure it? How do we develop acceptable criteria? Stiffness/Density. Machine value suitable for quality assurance?
- Soil characteristics identification for technology. Soils database for states. Boring logs/soil classification database for states.
- Don't have stiffness testing/data for these soils. Machine settings, soils, equipment used for various projects. Challenges associated with stiffness—layer (lift) thickness vs. stiffness. Quantity of historical data? No idea of quality of historical data. Variability during course of a project and evaluating site conditions. Finite element analysis could give insight.
- Mapping and stiffness used to minimize testing. Challenge is accurate, quick moisture content measurements. How to get equipment to job site if not a bid item? How is data submitted? Printout. Software. Programs different for manufacturers? How does contractor bid this? Need to develop correlations between machine data and standard testing.
- How do we intend to use QC values in the QA system? How is acceptance determined? What should be the proper form of verification? If/Then statements. How do contractors know what to bid for QC items? Lump sum?

IC for Soils and Aggregate 3—Ed Engle (Facilitator), Pavana Vennapusa (Recorder)

Knowledge Gaps:

- Correlations for roller MVs to soil properties (moisture, density, and stiffness). Laboratory testing—different soil types, moisture contents, LTPP database—correlations between modulus and soil classification properties for about 4000 soils (1500 subgrade soils). Regression equations are not all that good. Lab vs. field issues. Repeatability of testing, effective of sample size, stiffness might not correlate well with density. Many groups should be involved in research projects. Focus on field testing methods. Sensitivity analysis.

Difficult to get agreement on what soil property should be correlated between different groups.

- Measurement influence depth.
- What do you consider as the depth you want to be measuring?
- Proper soil characteristics and behavior and how it relates to roller MVs.
- Bridging effects?
- Application of IC to different types of materials (natural and recycled materials).
- Cohesive soils.
- Influence of moisture changes with depth?
- How do we get target stiffness? What is a target value?
- Use of Vibratory IC system for unstable boundary conditions (e.g. shallow water table)?
- What is the benefit to contractors?

Equipment Advancements:

- What does the roller give us? Need of real stiffness value.
- Specify the device type to check the roller data.
- Standardizing information from rollers.
- Real-time moisture sensing requirement (GPR, electrical resistivity).
- Repeatability of roller measurements—sensitivity analysis. What is the acceptable amount of variation?
- Goal-oriented compaction system (alarming the operator to stop compaction).
- Real-time data transfer.

Educational/Technology Transfer:

- NCHRP Synthesis project on existing practices.
- NHI courses.
- Different levels of education: operator/contractor, field engineers/owner, specification writers.
- Demonstration projects and shadow projects. Variable soil conditions? Pick some projects that are simple. Money. Not enough variables available at existing project sites. All levels of training and education included. Willing partners and communication. Documentation of demonstration projects. Develop plans. Reasonable expectations (both short-term and long-term).
- Troubleshooting manuals.

Standards/Specifications and Guidelines:

- Specify the device type to check the roller data.
- Specify speed limit and other requirements to be efficient during construction process. Other requirements of record: speed, frequency, amplitude, GPS location, lift thickness, stiffness measurement.
- Specifications on stiffness for acceptance, how do we measure it, and how do we relate those to roller MVs? Depends on the correlations. Need target ranges for stiffness and moisture. What type of stiffness? Who? Owner for acceptance and contractor for process control? NCHRP 21-09 study. Side by side projects. IC and non-IC project demo. Review Europe specifications. Bigger machines and thicker lifts in Europe. Fuel costs.
- Uniformity of response.
- Troubleshooting manuals. Who will pay for trouble shooting?
- Moisture content requirements depending on soil type.
- One number and have roller manufacturer figure out how to get that number.

IC for HMA 1—Tom Cackler (Facilitator), David White (Recorder)

Knowledge Gaps:

- Meaningful data tied to performance. (1)
- Correlation of machine data to engineering properties (methodology). (7)
- What engineering properties should be measured? (4)
- How to deal with depth of IC data? (2)
- Effects of binder grade and aggregate on stiffness data. (2)
- Mixture non-uniformity impact. (1)
- Links system performance to IC data. (1)
- How to integrate data IC and existing measures?
- How does technology affect design?
- Identifying variability of IC results and where to draw line. (3)
- Can IC data be used for acceptance? (1)
- Understanding depth of influence and how to adjust.
- Method for establishing target values?
- Statistical analysis of reliability of current methods. (2)
- Modeling of compaction and cooling mat. (1)
- System for complete data integration. (3)

- Is IC better than current baseline?
- How much IC data, and what kinds are needed?

Equipment Advancements:

- Mapping.
- Mapping underlying layers prior to compaction. (2)
- Corrective action after mapping. (1)
- Real-time data transfer.
- What do public agencies want?
- Uniform accepted and understand IC data. (2)
- In situ compaction test equipment?
- Verification of machine output.

Educational/Technology Transfer:

- Inexperience gap.
- Framework for training. (2)
- QC framework/requirements.
- Software compatibility. (1)
- Hands-on opportunities. (2)

Standards/Specifications and Guidelines:

- Goal is better performance and optimized cost. (1)
- Mapping as QC tool. (2)
- Moving to end-result specifications. (7)
- Structure to minimize risk to contractor and agency—total risk management. (2)
- Model similar w/ Superpave end-result.
- What are we going to put in specification?
- Don't over complicate. (5)
- Define positional accuracy.
- Structure to get broad support.
- Define IC.
- Allow for mix advancement.
- Eliminate definitions. (1)

General:

- FHWA IC project team to help implement IC in 13 states. Focus on four different materials. Experimental plan in place to move project forward.
- Mapping of the existing layers before asphalt construction. Opportunity to evaluate pavement layer system.
- Modeling of asphalt compaction to optimize compaction operations. Cooling.
- Mapping for QC—how to do this in uniform manner. How to specify such that all manufacturers are on level planning field.
- How can we use EED? Are there other tools that we need (nuclear data)? Electronic data integration. Real-time information.
- Hands-on opportunities.
- Huge inexperience gaps.
- Appropriateness of design. How is technology going to affect design?
- Why use density control if measuring modulus?
- How write specifications at high enough level such that contractors-industry-contractor... performance/end result/warranty specification?
- 80% overlays. When doing overlays map first. Correct bad spots before paving. How do you fix existing before? Corrective action after mapping?
- 50000 ft view. Risk management. Complex. Focus on total risk management. Changes completion of approach. Life of project issues.
- Definitions may become a barrier to advancing practice.
- Need data to convince contractor to use the technology. Show contractor that data is meaningful.
- Years ago used IC HMA in Michigan. Documented everything...temperature, roller... hit it hot...hit it again. Use to optimize process...speed, amplitude, passes. How does stiffness relate to density vs. stiffness? Requirement for initial QC.
- Better performing pavement? Goal is better performance and optimized performance.
- Do we know what we don't know? For HMA—correlation of machine value to engineering properties. Are we measuring the correct engineering properties?
- Knowledge gap—mixture non-uniformity. Just because we can measure it, we need to understand the variability and figure out what is OK. It is a variable product. Even if reduce variability...different temperature during the day. How interpret results? What range of variability is acceptable? Leads to specification development.
- Contractor wants to reduce risk. Owners want better performance. Need IC data that is meaningful and we understand? Understand how much data we need. Just because we can collect, what do we really need? What kind of data?
- How IC applied to overlays versus new construction?

- Lot of data out there. Subbase affects testing. Exactly how do you know what you are getting from base? Depth influence issues. At what point do you stop to define what is really needed? How deal with depth of influence?
- Software...AutoCAD. Make work with something else? Education between designers and contractors and industry. Compatibility.
- Relationship to quality pavement. If does not improve quality what is point? Meaningful data tied to performance.
- Education standards. How will training and guidelines be handled? Framework for training.
- Data transfer. How get info rapidly? Cell phone issues (GPS). Real-time data transfer?
- Need to change vocabulary. Is density the right parameter to measure? Working with huge variables—crushing, weather, etc. Hope to have an averaging product. Risk involved. Eliminate risk to contractors. Structure to minimize risk to contractor and agency.
- Specs! How we get paid and how owner is comfortable. Need to get past nuclear density gauge. If IC machine works better process control. Owner gets past phobia of changing what they are measuring. Use IC measurement values for QA?
- Correlate between IC measurement values and specifications that are being asked for. How do we capture the methodology for correlation?
- Need specification and standardization of equipment. Can't do this unless we know what we need to measure. Equipment dollars. Don't want to invest \$ if not going to be used in acceptance. End result specifications. Superpave...done on federal end otherwise each state going to do something different.
- Some DOTs don't want warranty projects. Relation to IC.
- What about warm mix asphalt? Need specs to reflect mixture technologies.
- Affects of binder grade on stiffness results.
- Can't have standardized framework. Somewhat standardized.
- Superpave is a QC/QA process. Concerned about geotech group. NCHRP superpave process to establish specification. End-result. How to use outside the box? Eliminate density? How measure stiffness? How on asphalt? LWD? Stiffen binder changes target.
- Depth affects and area of influence under machine. As vector of drum changes measurement influence dept changes. Mn/DOT 1.5 inch layer. Need to know what you are on top of. Try not to over complicate this thing. Don't really have a lot of data for HMA. Need to have practical amount of data. OK for research, but need to get to final result.
- Risk management. That's where this comes from. Proof. How much data do we need? Enough to provide it to manage risk. Maybe we don't need all passes and all data. Lower bonding costs. It has to last 10 years. You have proof along the way. Everyone has to agree on map as it covers the data.

- Identifying the affects of mixture non-uniformity on IC values?
- Accuracy? How accurate is accurate enough. GPS? Millimeter precision with base station critical? Define tolerances and position accuracy.
- Define IC for HMA. Different between different machines.
- Using the field IC results to system behavior. Linking system performance to IC data.
- Methods for establishing target values.
- Verify machine IC results?
- Don't get too complicated. If trying to sell new idea, easier if simple. Get more people on board.
- Format and output of data.
- System approach to data management. Info from batch plate, etc.
- Is IC better than conventional? Early evidence says yes, but need more baseline projects with success.
- Companion tests for asphalt. What about other tests for asphalt? How measure modulus? In situ companion test equipment.
- NCHRP 10-65. Out in the next month.
- What is important to public agencies in terms of output?
- Over confidence. Need solid statistical analysis as part of specification.
- Moving to end-result specifications: Complicated because of system issues. Contracting may not be suited to this approach for IC HMA? We know the performance design parameters such as strain at base of pavement layer...Roller operator needs to know if he is on it at right temperature. NPA has a program. How do we relate this information to agency? All of the above are tied together. What are the first generation IC specifications going to look like? Use a shadowing concept. Superpave projects decide that there would be projects...couple interstate, county, etc. with bid item for reimbursing contractor. How do we build confidence? Rapidly. No state ready to write specification. What does shadow concept measure? Make relationship between what IC can provide and what current known performance parameters are and current QC/QA protocols. What info is important to get from roller? Temperature, mapping, and modulus.
- First generation end-results shadow with temperature, mapping, stiffness, speed, frequency, amplitude (data set to capture). Keep the current acceptance criteria. Need to map underlying stiffness. Keep current acceptance criteria, shadow concept, current IC methods, temperature, mapping, stiffness data (map underlying support layer), speed, frequency, amplitude
- Correlation of machine data to engineering properties (methodology): Engineering properties (Density, temperature), Statistically valid plans, Different mix designs—overlay, warm mix, hot mix, different underlying ground stiffness conditions, Map all data? Current projects with Ham don't necessarily include mapping. Need to move beyond volunteer effort to build these requirements into specifications.

- Don't over complicate.
- What engr. properties should be measured?

IC for HMA 2—Lisa Rold (Facilitator), Paul Weigand (Recorder)

Educational/Technology Transfer:

- Up to now, industry has driven. Contractors and equipment folks are key.
- If we go to QA, agencies will need to be more involved.
- Comparative data to ensure that the contractors can make incentives.
- How do the mix characteristics impact the results?
- Does a brand of roller impact the results?
- Develop coordination with equipment manufacturers.
- Identify whether all equipment needs the IC or just isolated pieces.
- Is wireless communication in real-time transmitted over the internet an important item to include?
- Determine method of determining mat uniformity and measurable criteria.
- Hands on demonstrations for contractors, not workshop format.
- Use pool fund website to get info out.
- Emphasize the value to both contractors and agencies in price adjustments and quality of pavement.
- Share the knowledge.

General:

- Concern over costs—what are they? Costs vary. GPS: \$20,000; Base station: \$15,000. IC product costs: \$25,000
- Can IC systems be adapted to older equipment? May be difficult because of the complexity of the drum equipment.
- Consideration must be given to vandalism and weatherproofing.
- Differences in process and quality of measurements make it difficult to write a spec. Could this be handled by using test strips? Stiffness connection to density and permeability is a question.
- Some states are writing permeability specs.
- Need to develop that connection from machine information to good pavement.
- If only used for QC, no specifications are needed. Contractor use only, but they must see value
- Each project must be run as an isolated system related to density and permeability. Do test strip evaluation prior to the project so cores and other verification methods can be used.

- Stiffness and roller speed measurements are important, in addition to temp and number of passes. Speed especially important to DOT folks.
- Should all rollers have the equipment? DOT reps said yes in order to verify the quality.
- Can the ultimate density be predicted based on the breakdown roller activity? That is the assumption since the finish roller does not vibrate.
- Temperature is critical as it relates to final roller—that is a gap now. Monitoring of core temperature on all rollers will tell when to start and stop rolling.
- Will IC rollers be able to identify mix segregation since that will impact density? Equipment people say no.
- What information is of greatest value to operator? Stiffness corrected to core temperature.
- What is the program needed to make it a QA for DOTs? What is the correlation from stiffness to density? Research has developed one.
- Can there be an algorithm developing density output—yes say equipment people but only on vibratory equipment.
- Common/standard language related to machine language could be valuable in writing spec. Also universal file format for machine output.
- Current acceptance is based on density of cores (primarily) or nuclear density gauge.
- Are the agencies ready to pay for the use of IC equipment as a bid item to jump start use? Some DOT, will others not.
- Concern over frequency of calibration for the equipment? Equipment people say that the accelerometer annually. Also that is taken into account as the job setup with the project mix calibration.
- Will agencies start to require IC? The FHWA pooled fund project will establish baseline information. Minnesota has required it for earthwork, not HMA.
- Where to go—focus on QC initially to get data then for potentially QA. Must identify benefits to contractors initially.
- Where is the best place in the construction process for IC? Breakdown roller gets about 90% of the density.
- Internet transfer of information is a possibility.
- QC elements: speed, modulus, passes, temperature, density, accuracy of mapping (GPS) – lateral is more critical than longitudinal
- Questions: Take IC from QC to QA? Correlation between field info and performance values. Uniform reporting system across equipment. For instance, currently accept contractor's smoothness traces.
- How do we add the incentive to use IC? Have IC as a pay item? Recognize better pavement value from mat uniformity and lack of coring.

- Research priorities (in order of voting). Identify whether all equipment needs the IC or just isolated pieces of the roller train. Is it possible to incorporate rolling weight deflectometer? How do the mix variables and characteristics impact the results? Databases developed by agencies showing what works and what doesn't. Develop a measure of mat uniformity. Develop system to transmit IC data in real time over the internet to servers or laptops. Develop retro fit equipment for existing rollers. Develop coordination between equipment manufacturers related to uniform language. Correlate IC with long-term pavement performance. Not just material testing, but modifying the complete construction process/operation.

IC for HMA 3—Tom Cackler (Facilitator), David White (Recorder)

Knowledge Gaps:

- What is ultimate goal in field, and how does it relate to current acceptance. (3)
- Validate applicability as QA tool. (1)
- Non-correlations of IC data to density. (7)
- Correlation of field IC data to design parameters (combine above).
- Is measuring stiffness important. (1)
- What do we measure that relates to quality and life of road? (2)
- How do we use IC data considering depth of influence? (7)
- Where is IC best used. (1)
- Where is IC best used—size, base conditions, overlays, etc. (1)

Equipment Advancements:

- Correlate surface temp to internal temperature including time, internal temp, roller passes. (6)
- How to incorporate to existing equipment. (1)
- Can agencies use IC to evaluate existing pavements? (1)

Educational/Technology Transfer:

- Agency and contractor IC 101. (1)
- Communicate opportunities with IC.
- Harmonization of definitions and technology. (1)
- Economic benefits. (2)
- Benefits from contractor's perspective (combine above).

Standards/Specifications and Guidelines:

- Standard calibration method. (3)
- Begin w/ contractor to use—transition.

- Allow for contractor QC plans to accommodate variations in equipment. (2)
- What project size to use.

General:

- Mat temperature—get at internal temperature from surface temperature. Gives the roller operator more flexibility. Time + temperature + number of passes.
- Training for contractors/operators/state DOT people—broad-based education. “IC 101”.
- Roll immediately after construction at cooler temperature. Useful for future rehabilitation?
- What do we ultimately want to measure in the field? What is our ultimately goal in the field. How do we use the information in conjunction with what we are doing now?
- What are we trying to do? Under education—show me some projects with respect to correlations? More correlations studies. Communicate opportunities w/ IC.
- Depth of influence issues. 1 -3m? How do I restrict to thin lifts.
- Lots of milling and resurfacing. What do you hold contractor responsible to.
- Any info available now...large paving contractors using...mat temperature? Want benefit-cost analysis.
- Can IC be used as a QA tool?
- Standard calibration method.
- Where is IC best used?
- Appears that there is not a good correlation between stiffness and density? Go way you trust IC alone. Maybe mapping is the best tool.
- Allow either or. May take 20 years to implement. What about existing equipment? Begin with contractor option to use—transition.
- Contractor submits QC plan for review. 30 days to review. Allows it to be flexible. If they don't follow their plan then not pass.
- How does this relate back to the things we designed for? Are we looking at the right parameters? Relation to design parameters.
- How does subgrade affect HMA design?
- Is there a point where this is not appropriate (e.g., 2 inches of HMA of concrete overlay?)
Need to select appropriate technology.
- How will we get measurements that go over state lines? Will specifications be recognized state to state so contractor's equipment is widely useful?
- Custom specifications for each manufacturer? Some flexibility to contractor.
- Use IC to identify areas for strengthening.
- Size a project an issue? Minimum size to require?

- It would be interesting to get inspector input. Compare the inspector's observations with IC mapping capability.
- How do adjust HMA for pre-existing base conditions?
- Do the readings relate to how long the road last? Need to know what to measure to relate to the quality and life/performance of road.
- Economic of IC? If show that it has a financial advantage, then going to be a lot more popular.
- How to judge the quality the HMA layer, especially considering variability of underlying layers. Is measuring stiffness for HMA important?
- Need to harmonize—dictionary of terms. This is how the parameters relate.
- Doing it before the fact. Roll in low-vibe and combine with GPR to get existing info.
- New technology with great opportunity. Can add IC to existing equipment? What is the key—temperature or roller operations. Can you upgrade existing rollers?

IC for HMA 4—Lisa Rold (Facilitator), Paul Weigand (Recorder)

Knowledge Gaps:

- Research/Gaps (in order of voting): Develop correlation of IC technology with stiffness, density, modulus. For acceptance criteria use mapping of existing pavement and % improvement rather than smoothness. Use method spec vs. results spec. Determine the flexibility of IC relating to construction variability related to mix design and type of roller use.

Educational/Technology Transfer:

- Industry based for contractors is best because it is targeted to the equipment and what is important.
- Demonstration projects/open house information posted on the pooled fund website (www.intelligentcompaction.com).

General:

- Need incentive for contractors to get involved.
- How do you write a spec when knowledge isn't there?
- Add \$\$ to bids to get contractors to make the investment in equipment.
- Compare real field data and IC data.
- Measure what is important, not necessarily what has been measured in the past.
- Agencies need to define the parameters to develop uniformity across equipment.
- Standard method of implementing change must not be used. Work together between agencies and contractors.

- Break down implementation into steps of mapping (number of passes); temperature; and then stiffness.
- Shadow existing density verification work with IC to show the correlation and use a proof testing.
- Iowa contractors like to use pneumatic rollers to improve density, and it is important to determine the impact of pneumatic rollers on stiffness.
- Roller patterns and types of rollers will vary according to states and mix designs. For instance, roller sizes vary, use of pneumatic rollers, use of vibratory or static, etc.
- Roller speeds will impact stiffness results, although generally stiffness is mix dependent.
- Does stiffness from design and lab correlate with field measured stiffness across machines?
- What methods are best to relate machine information to stiffness? Different equipment developers use different methods.
- IC identifies weak spots that can be worked before the final paving operation. Also could be used to determine weak spots before paving.
- Use finish roller at low vibration to verify final results.
- Concern over differences in information provided by different pieces of equipment starting with the quality of the accelerometer and the algorithms used to convert the data into stiffness.
- Manufacturers would like to be told of the design characteristics (stiffness, modulus of elasticity, etc.) to target.
- Mapping, temperature, stiffness (density) are major issues to be included in IC.
- Manufacturing groups are the ones that are currently pushing the technology of IC. If it gets to QA, the agencies must get involved.
- Activities with IC must be flexible enough to accept changing technologies, such as mix (warm mix asphalt) and others.
- Is there a mechanism to get IC output from a pneumatic roller?

Implementation Strategies 1— Douglas Townes (Facilitator), John Puls (Recorder)

Knowledge Gaps:

- Collaborative design between contractor and designer. (2)
- Need a better tool for measuring existing conditions; pre-design. (6)
- Which standard to use? MEPDG. What are IC measurements going to be?(8)
- Equating measurement tool to design life/quality. (7)
- Is there a better way to measure compaction than what we already know? (2)

- 3/4D design lacking. (5)
- What stiffness values are we shooting for? How consistent is consistent? What are the target values? Stiffness/uniformity. Clay soils have more unknowns than granular soils. (9)
- IC machine data acceptance.
- IC machine data trust. (4)

Equipment Advancements:

- Moisture sensors in real-time. (13)
- GPS communication between manufacturers. (2)
- Sharing data wirelessly. Wireless real-time communication between operator and inspector/contractor management (office). Sharing operator data via wireless to other operators/foremen (portable) (9)
- Method of marking problem areas. (6)
- Padfoot compaction in cohesive soils. Measurement tool for cohesive soils is needed. (12)

Educational/Technology Transfer:

- Construction inspector training, design staff training, DOT materials group (training on acceptance), upper management (DOT), operator through owner education (contractor), vendors understanding of DOT role in the process.
- Knowledge of different available equipments.
- Learning to interpret data and work with contractor. (14)
- Acceptance standards. (15)
- Data processing/storage training. (1)
- Meaningful pre-design data to contractor (geotechnical data). (2)
- Soil identification (physical). (6)
- Interpretation raw data to meet state specifications: How to correct a failure? Critical thinking for corrective actions tying experience-based knowledge to IC technology. (9)
- Sharing of general knowledge/information. (1)
- Cross-communication between manufacturers. (1)
- Common official universal standard and terminology. (11)

Standards/Specifications and Guidelines:

- Standardizing data formats. Data to the contractor and data coming back from contractor.
- Deciding what to measure: How often? How accurately?
- Placing more risk onto contractor: Low control over on-site soils, performance-based specs.
- Specifications must evolve slowly.

- Uniformity is more important than absolute measurements.
- Would you (contractor) buy IC based on end-result specification?
- Variability in IC values determined by site conditions: Before and after rain: Will contractor be paid to re-do work? Contract end date does not change.
- Incentives for contractor. Incentives for increase quality.
- DOT: Writing incentives so that it's profitable for contractor to increase quality. Minimum level for compaction value and a bandwidth for uniformity. Higher incentives for better uniformity.

General:

- Challenges: Getting contractors on board to use IC on HMA.
- What's in it for the taxpayer? Road lasts longer, safety, smoother, higher quality, decrease in lane-closure time, savings \$.
- What's in it for the agency? Inspection costs, complete coverage, risk management, 100% coverage on inspection, less reliance on nuclear density measurements, public safety, facilitate change in technology, decreased maintenance costs, longer lasting pavements, better designs, construction costs,
- What's in it for the contractor? Compliance documentation, potential to increase productivity, employees have a career instead of a job, training, specialization, pride, increased communication, increased cross-training opportunities, increases responsibility of roller operator, potential for increased incentives, and data gives worker feedback for a good job.
- New industry: major financial companies can get into insurance of roads. Differing premiums. Insurance rather than warranty: potential for increased sales.
- Design tools, education, training and specifications.

Implementation Strategies 2—Heath Gieselman (Facilitator), Jerod Gross (Recorder)

Knowledge Gaps:

- Contractor motivation/incentive. (1)
- Communication from design through construction (plans and specs).
- Little experience with technology. (7)
- Standardization of industry for QA (long term). (5)
- Correlation between machine values and actual properties. (12)
- Proven technology.
- Upgrades in machinery and software. (2)
- Need to identify knowledge gaps in asphalt and soils separately. (6)

- Definition of equipment terminology and defining accuracy.
- What is our goal? QA or QC?
- Communication with industry of implementation plan.
- Cost of training.
- Integration of technology.
- Contractors should share knowledge.
- Translation of data to determine acceptance.
- Proper site selection for demo projects.
- Define acceptance limits.

Equipment Advancements:

- Need for rollers to measure all properties including internal temperatures. (1)
- Needs to be user friendly & ergonomics. (4)
- Initial cost.

Educational/Technology Transfer:

- Phased implementation of IC. (3)
- Document design/build projects.
- Contractors should share knowledge.
- Advertise IC through select projects. (2)

Standards/Specifications and Guidelines:

- Incentive or directive needed. (3)
- QC easier to implement. (2)
- QA requires development of specs. (1)
- IC not specified but is an advantage to contractors. (2)
- Dissimilarity of roller outputs for soil and asphalt. (6)
- Standardize data output.

Facilitator Report–Summary

The results of the breakout sessions were analyzed to identify the priorities for advancement in the outcome areas of “Knowledge Gaps,” “Equipment Advancements,” “Educational/Technology Transfer,” and “Standards/Specifications and Guidelines” for each of the topics areas: “IC for Soil and HMA,” “IC for HMA,” and “Implementation Strategies.” Prioritization was determined based on a detailed review of the recorder notes, finding common topics among sessions, and summarizing the participant votes. There were two levels of analysis of the results: (1) prioritize the results for each topic area, and (2) develop a broader top 10 list of key issues for needs and accelerating implementation of IC technologies.

The top priorities for each breakout session topic are summarized in the following:

IC for Soils and Aggregate

Knowledge Gaps

1. Correlation Studies: Different Soil Types (Granular, Cohesive, Recycled, Stabilized) and different Roller Configuration (Smooth, Padfoot) (73)
2. Rapid in situ w% determination (14)
3. Modulus-based QC/QA (12)
4. Understanding what IC-MVs are? Experience (10)
5. Measurement influence depth? (7)
6. Acceptable non-uniformity? (4)
7. Trouble shooting—unusual conditions, machine capabilities, and limitations. (3)
8. Data visualization. (1)
9. Benefits? (1)

Equipment Advancements

1. w% measurement on roller. (29)
2. Integrated solutions between multiple technologies (3D Design - 4D Construction). (18)
3. Real-time data transfer/wireless. (14)
4. Retrofit systems. (3)
5. Repeatability/sensitivity of IC-MVs. (2)
6. Compaction diagnostics—flag indicator. (2)
7. On-site geotechnical lab. (2)

Education/Technology Transfer

1. Contractor/field engineer/owner training. (52)
2. Opportunity to promote good geotechnical practices. (13)
3. Cost/ROI. (11):
4. Equipment investment.

5. Field implementation.
6. Proven case histories to “sell” the technology (effectiveness to quality/efficiency). (9)
7. Definitions of IC terminology. (3)
8. Operator/inspector guide & troubleshooting manuals. (3)
9. Certification for contractor. (1)

Standards/Specifications and Guidelines:

1. Uniformity criteria. (20)
2. Selecting engineering parameters to measure (e.g. density, modulus, stiffness). (19)
3. Consolidate IC-MVs to one unified parameter or report raw accelerometer data. (11)
4. How will w% be specified? (5)
5. Contractor/owner/researcher/manufacturer input for specification development. (4)
6. Establishing IC target values/test strip guidelines. (1)
7. Establish IC documentation standards (GPS and output parameters). (1)

IC for HMA

Knowledge Gaps

1. Correlation of IC-MVs to engineering properties. (39)
2. Understanding IC-MV non-uniformity (mixture). (10)
3. Measurement influence depth/adjustment. (9)
4. Key in situ engineering parameters to measure. (7)
5. Mix design, binder grade, and aggregate on IC-MVs. (5)
6. Benefits of IC and reliability of current methods. (5)
7. Data integration. (3)
8. Link between IC-MVs and performance. (4)
9. Best applications for IC (e.g., overlays, HMA). (2)
10. Applications for IC for QA. (1)
11. Modeling of compaction and cooling mat. (1)

Equipment Advancements

1. Involvement of roller train or just the breakdown roller. (14)
2. Influence of temperature (surface /internal), compaction time/speed, frequency/amplitude, and roller passes. (6)
3. Retrofit. (5)
4. Real-time data transfer. (5)
5. Mapping of underlying layers and existing pavements. (3)
6. Similarities between IC output. (2)
7. Corrective action after map. (1)

8. Compare mapping of IC and pneumatic roller. (1)
9. Integrated systems approach. (1)

Education/Technology Transfer

1. Demonstration projects, open houses, and hands-on opportunities. (10)
2. Documented successes. (4)
3. Establish framework for training contractor/owner. (3)
4. Economic/contractor benefits. (2)
5. Software compatibility (design, machine, analysis). (1)
6. Harmonization/standardization of technology. (1)

Standards/Specifications and Guidelines:

1. Establishing QC and QA criteria and framework. (9)
2. End-result specifications. (7)
3. Keep it simple. (5)
4. Standard calibration method to establish IC and in situ target values. (3)
5. Mapping as QC tool. (2)
6. Structure to minimize risk to contractor and agency—total risk management. (2)
7. Allow for contractor QC plans to accommodate variations in equipment. (2)
8. Goal is better performance and optimized cost. (1)
9. Better define IC (0) & Eliminate IC definitions. (1)

Implementation Strategies

Knowledge Gaps

1. Correlation between roller MVs and soil properties. (12)
2. Demonstration projects. (11)
3. What stiffness value? (9)
4. Relation to MEPDG parameters. (8)
5. NCHRP synthesis of existing practices. (7)
6. Design life/quality. (7)
7. 3/4D design. (5)
8. FHWA IC pooled fund. (4)

Equipment Advancements

1. Moisture sensors in real-time. (13)
2. Padfoot compaction in cohesive soils. (12)
3. Real-time data transfer/wireless. (9)
4. Method of marking problem areas. (6)

Education/Technology Transfer

1. Data interpretation. (29)
2. Common standards. (17)
3. NHI training courses. (5)
4. IC 101. (4)
5. Knowledge sharing by contractor. (2)

Standards/Specifications and Guidelines:

1. Partnerships/Communication. (4)
2. Incentive or directive needed. (3)
3. QC easier to implement. (2)
4. QA development. (1)

After analyzing the topic-specific results, an effort was made to find common needs across the topics areas and prioritize a top 10 list of overriding needs. The cross-cutting top 10 list of priority issues are summarized in Table 2.

Table 2. Summary of main IC technology research needs

Top 10 IC Technology Research Needs

1. Need correlation studies (cohesive, stabilized, granular, HMA, etc.) (136)
2. Education/training materials and programs (112)
3. Moisture content (influence + measurement) (61)
4. Integrated design + real-time data transfer (57)
5. Case histories + demos + benefit + successes (48)
6. Engineering parameter to measure (density, modulus, stiffness, core mat temperature)? (47)
7. Addressing non-uniformity (34)
8. Establishing QC/QA framework - statistically significant (28)
9. Measurement influence depth? (19)
10. Promoting good geotechnical practices (13)

Panel Discussion

A panel discussion was held on day three for one and a half hours and moderated by Max Grogg. Panel members included Chris Connolly, Lee Gallivan, Khalil Maalouf, Dean Potts, John Smythe, Stan Rakowski, and David White. The aim of discussion was to reflect on the outcomes determined from the breakout sessions and what was learned for the workshop that may have changed perspectives on intelligent compaction technology. Questions from the audience followed on specification needs and new technology developments. The discussion points are divided into four categories: reaction to breakout sessions, new perspectives, specifications, and technology developments. Each of these categories is summarized below.

Reaction to Breakout Sessions

- Facilitators boiled information down to a few key items that should be the focus of research.
- Exciting from manufacturer perspective to see high level of interest.
- Established a good baseline for technology and current state of implementation.
- Lots of opportunities ahead for implementation of IC and 3D/4D GPS technologies.

New Perspectives

- Significant level of interest from state DOTs.
- IC technology is further along than previous thought.
- Implementation should build on existing knowledge.
- IC is not going to change fundamental properties of soil (moisture content) or HMA (temperature, gradation). Therefore, can't replace good geotechnical and materials engineering.
- Tremendous potential for IC in QC applications and may become QA tool in the future, but will require courage and effort to change.

Specifications

- A question that still needs to be answered - what are the important properties to measure?
- Some specifications are being written as part of ongoing research projects, and Mn/DOT has implemented a specification(s) on actual projects for soils and aggregates.
- Several European specifications exist for continuous compaction control (CCC).
- IC specifications may eliminate unneeded testing by the QA agency.
- Machine specifications are needed.
- During early implementation, having some flexibility to revise the specification during the course of the project to make improvements may be an effective strategy to faster implementation.
- Contractors and state DOTs need to be educated on how IC can be used as a QC/QA tool.
- Calibration of the machine IC values to spot test measurements needs to be defined.

- With respect to IC standardization, need to allow the manufacturers to be innovative and not close the box too quickly with standardization.
- Focus the specification around rapid detection of road problems.
- Premature failure like HMA segregation is not a condition that IC measurement will necessarily detect, and thus inspectors and independent spot measurements will always be needed.
- The contractors need to be engaged in this process to determine what level of risk is being shifted with IC.

Technology Development

- What are next steps to develop onboard moisture and temperature sensors?
- Resolution of GPS-based maps need to be relatively accurate and precise to correlate with in situ spot test measurements.
- New sensors are needed to measure soil moisture content and are an area of ongoing research.
- Asphalt surface temperature is relatively easy to measure; the critical mat temperature is much more difficult to determine but good goal and challenge.
- Surface temperature can vary widely; therefore, internal mat temperature is needed.
- There are many factors that affect mat temperature, including several environmental factors, and it is not a trivial problem to solve.
- Core temperature could be measured with probe system. Heat loss occurs through the top and bottom of the mat is an issue
- Surface temperature combined with analytical model and onboard computer calculations may be useful. Some experimental research is underway with this effort to measure core mat temperature
- Manufacturers cannot solve all the issues.
- Collaborations and partnership are needed to identify critical needs and move technology implementation forward.

Summarizing the panel discussion comments, there are four central discussion points that were condensed as shown in Table 3.

Table 3. Summary of common themes from panel discussion

Common Themes from Panel Discussion Session

1. High level of interest from the state DOTs in further studying opportunities to implement IC.
2. Implementation strategies need to build on existing information and past research.
3. Specifications for IC and in situ testing should not restrict manufacturer/equipment developer innovations.
4. Contractor and state DOT field personnel and engineers need educational materials for IC and in situ QC/QA testing.

Group Exercise to Identify Implementation Strategies

Following the panel discussion, the audience was given instructions to break up into seven- to ten-person groups representing the contractor, manufacturer, or state DOT perspective. There were two groups for each category. Each group had representatives from the three positions. The groups were charged with looking five years into the future and brainstorming reasons why implementation of IC was successful. The question posed to each group was:

What specifically did you do to implement intelligent compaction technologies on projects, and why were you successful?

Each group designated a leader to present the results to the audience after a 20-minute brainstorming session. The groups' comments are summarized below by category.

Contractor Perspective

- Became more aware of IC technologies.
- Completed IC projects.
- Contributed to standardizing IC and it becomes part of normal operations.
- 30% of state DOTs now use IC.
- IC roller operators become certified.
- IC became common practice with the benefits being realized by documenting savings (no rework or overwork and fuel savings).
- Reduced risk and increased confidence in results and better process control.
- Developed a common language with state DOTs such that IC is accepted and understood.
- Further developed electronic plans implementation.
- Feel comfortable with IC measurements and eliminated barriers with a research program.

Manufacturer Perspective

- Soil moisture content measurement system was developed.
- HMA core map temperature measurement/analysis was solved.
- Common software was developed that meets the needs of the IC roller operator and state DOT inspectors.
- The roller IC computer interface was improved.
- Successful marketing.
- Collected feedback from owners and agencies to discuss issues and what is possible.
- Helped promote research and partnerships.
- Selected high profile demonstration projects.
- Listened to needs of state DOTs and contractors.

- IC certification over the winter months was developed as a joint venture between academia/state DOT/AGC.

State Agency Perspective

- IC was implemented early on projects with the right people, right project conditions, and reasonable cost.
- IC projects demonstrate that the final products are more consistent, there are less maintenance problems, reduced construction costs, and less routine inspection testing.
- More QC/QA information exchanging during the construction process.
- IC education was significantly improved.
- The top 10 list of research needs identified from this workshop were implemented.
- Reduced number of claims.
- DOT became better organized with more open communication.
- Encouraged participation from contractors/AGC/industry during the process of implementation of IC.
- Let several IC demonstration projects and partnered with successful contractors, university researchers to collect and analyze data.
- Clearly showed the benefits of IC measurements for QC.

Some common themes between the groups were identified as key implementation strategies as shown in Table 4.

Table 4. Summary of common themes from the group implementation strategy session

Common Themes from Group Implementation Strategy Session

1. Develop IC training and certification program.
2. Demonstrate benefits of IC through demonstration projects.
3. Promote partnership as key strategy to implementation.

Outcomes

The key outcomes from this workshop were as follows:

1. Technical information exchange.
2. Prioritized lists of knowledge gaps, education/technology transfer needs, specification and standards, and implementation strategies for IC for soil and aggregate and HMA.
3. A list of the top 10 overriding issues was developed that cut across the various IC technologies and materials.
4. Establishment of a network of people interested in partnership and implementation of IC technologies, specifications, and new developments with in situ testing.
5. Plans for a follow-up workshop to explore further IC technologies, in situ testing alternatives, educational/training program, and other earthwork technological advancements.

Next Steps

The IC workshop provided a baseline for stakeholders to provide input on current state of the practice/technology and next steps in terms of research and educational priorities and implementation strategies. At the conclusion of the workshop, a discussion centered on understanding where we are and where we are going. Table 5 summarizes some of the key points.

Table 5. Summary of key points

Where we are:	Where we are going:
<ul style="list-style-type: none"> • Lack widely accepted IC specifications in U.S. • Need education/training materials • Innovative IC and in situ testing equipment • IC technologies provide documented benefits (smooth drum - granular) • Great potential and some limited successes for cohesive and HMA • Poor database development for IC projects and case histories • Initiated human IC network • Increasing acceptance/GPS infrastructure for stakeless grading/machine guidance • "Don't know what we don't know" 	<ul style="list-style-type: none"> • Standardized and credible IC specifications inclusive of various IC measurement systems • Widespread implementation of IC technologies • High quality database of correlations • Several documented successes for cohesive/stabilized/granular/HMA • Better understanding of roadway performance - what are key parameters? • Innovative new sensor systems and intelligent solutions • Integrated and compatible 3D electronic plans with improved processes, efficiency and performance • Real-time wireless data sharing • Enhanced archival and visualization software • Improved analytical models of machine-ground interactions

To move from the current practice and knowledge base several key strategies were considered and are listed in Table 6.

Table 6. Strategies for moving forward

Strategies for Moving Forward
<ul style="list-style-type: none"> • Participate in partnerships for IC research and information exchange regionally and nationally • Be an advocate for IC implementation • Contribute to problem statement development for NCHRP, TRB, FHWA, AASHTO, ASCE Committees • Participate in IC conferences/studies and the annual EERC Workshop • Participate on EERC Scientific and Policy Advisory Council (35 members) – IC and other issues • Stay connected: Subscribe to EERC Technical Bulletins, Tech Transfer Summaries, Technical Reports, Educational Videos, etc. (www.intelligentcompaction.com). • Develop a comprehensive and strategic IC road map for research and educational/technology transfer

Although with many of these strategies it is clear how to move forward, developing a comprehensive road map for implementation of IC technology is a strategy that will require further input from many stakeholders, brainstorming events, problem statement identification, and research action plan development. Results from this workshop, however, provided significant information to outline a preliminary road map that can serve as a starting point for further discussions and assessment.

The vision for the road map is to identify and prioritize action items that accelerate and effectively implement IC technologies into earthwork and HMA construction practices. Coupled with the IC technologies are advancements with in situ testing technologies, data analysis and analytical models to better understand performance of geotechnical systems supported by compacted fill, software and wireless data transfer, GPS and 3D digital plan integration, new specification development, and risk assessment. What follows in Table 7 is a preliminary road map for implementation of IC technology based on information derived from the workshop sessions and the author's viewpoint.

Table 7. IC road map research and educational elements

IC Road Map Research and Educational Elements

1. **Intelligent Compaction Research Database.** This research element would define IC project database input parameters and generate web-based input protocols with common format and data mining capabilities. This element creates the vehicle for state DOTs to input and share data and an archival element. In addition to data management/sharing, results should provide an option for assessment of effectiveness of project results. Over the long term the database should be supplemented with pavement performance information. It is important for the contractor and state agencies to have standard guidelines and a single source for the most recent information. Information generated from this research element will contribute to research elements 2 through 5.
2. **Intelligent Compaction and In situ Correlation Studies.** This research element will develop field investigation protocols for conducting detailed correlation studies between various IC measurement values and various in situ testing techniques for earth materials and HMA. Standard protocols will ensure complete and reliable data collection and analysis. Machine operations (speed, frequency, vibration amplitude) and detailed measurements of ground conditions will be required for a wide range of conditions. A database and methods for establishing IC target values will be the outcome of this study. Information generated from this research element will contribute to research element 1, 4, and 5.
3. **Project Scale Demonstration Case Histories.** The product from this research element will be documented experiences and results from selected project level case histories for a range of materials, site conditions, and locations across the United States. Input from contractor and state agencies should further address implementation strategies and needed educational/technology transfer needs. Conclusive results with respect to benefits of IC technology should be reported and analyzed. Information from this research element will be integrated into research element 1, 4, and 5.
4. **Intelligent Compaction Specifications.** This research element will result in several specifications encompassing method, end-result, and performance-related options. This work should build on the work conducted by various state DOTs and from ongoing research as part of NCHRP 21-09 and the ongoing FHWA IC Pooled Fund Study 954.
5. **Educational Program/Certification Program.** This educational element will be the driver behind IC technology and specification implementation. Materials generated for this element should include a broadly accepted and integrated certification program than can be

delivered through short courses and via the web for rapid training needs. Operator/inspector guidebook and troubleshooting manuals should be developed. The educational programs need to provide clear and concise information to contractors and state DOT field personnel and engineers. A potential outcome of this element would be materials for NHI training courses.

6. **Understanding Roller Measurement Influence Depth.** Potential products of this research element include improved understanding of roller operations, roller selection, interpretation of roller measurement values, better field compaction problem diagnostics, selection of in situ QA testing methods, and development of analytical models that relate to mechanistic performance parameter values. This element represents a major hurdle for linking IC measurement values to traditional in situ test measurements.
7. **IC Technology Advancements and Innovations.** Potential outcomes of this research element include development of improved IC measurement systems, addition of new sensor systems such as moisture content and mat core temperature, new onboard data analysis and visualization tools, and integrated wireless data transfer and archival analysis. It is envisioned that much of this research will be incremental and several sub-elements will need to be developed.
8. **In situ Testing Advancements and Mechanistic Based QC/QA.** This research element will result in new in situ testing equipment and testing plans that target measurement of performance related parameter values including strength and modulus. This approach lays the groundwork for better understanding the relationships between the characteristics of the geo-materials used in construction and the long-term performance of the system.
9. **Data Management and Analysis.** The data generated from IC compaction operations is 100+ times more than tradition compaction QC/QA operations and presents new challenges. The research element should focus on data analysis, visualization, management, and be based on a statistically reliable framework that provides useful information to assist with the construction process control. This research element is cross cutting with research elements 1, 2, 3, 5, 7, and 8.
10. **Understanding Impact of Non-uniformity of Performance.** This track will investigate relationships between compaction non-uniformity and performance/service life of infrastructure systems—specifically pavement systems. Design of pavements is primarily based on average values, whereas failure conditions are affected by extreme values and spatial variations. The results of the research element should be linked to MEPDG input parameters. Much needs to be learned about spatial variability for earth materials and HMA and the impact on system performance. This element is cross cutting with research elements 4, 5, and 9.

The research elements above represent a first step in developing a formal research road map for implementation of IC technologies. Additional steps beyond fine-tuning the research elements will be developing an integrated research management plan, seeking peer review, establishing a schedule, and identifying organizations, contractors, and equipment manufacturers that want to partner and leverage funding and human resources to move the program forward. The Earthworks Engineering Research Center (EERC) Scientific and Policy Advisory Council (35 members representing government agencies, industry, and researchers) is one entity that can contribute to provide peer review and management of this effort. The council membership was discussed at the workshop, and the membership is being identified. Follow-up correspondence to the workshop attendees will transpire with respect to this report, the council, and the 2009 annual EERC workshop meeting.

Appendices

Appendix A: Workshop Agenda

Intelligent Compaction for Soils and HMA

April 2–4, 2008

Sheraton Hotel, West Des Moines, Iowa

Sponsors: Iowa Department of Transportation and Iowa State University Earthworks Engineering Research Center (EERC)

Mission: Building upon current knowledge and experience, this workshop will provide and record a collaborative exchange of ideas for using design tools and intelligent compaction technology for measuring and documenting performance and quality characteristics of soils, aggregates, and hot mix asphalt that are verifiable and appropriate for use for contractor quality control and owner acceptance decisions.

Day 1—Wednesday, April 2, 2008

6:30 a.m. Breakfast and Registration

AM Moderator: Sandra Larson

8:00 Welcome—Sandra Larson, Iowa DOT

Why are we here?—Kevin Mahoney, Iowa DOT

Workshop mission—John Smythe, Iowa DOT

8:30 Intelligent Compaction for Soils and Aggregate—Dr. David White, ISU

9:45 Break

10:15 Intelligent Compaction for Hot Mix Asphalt and Update on the Intelligent Compaction Pooled Fund Project—Lee Gallivan, FHWA

11:15 NYS DOT Experience with Machine Control/Intelligent Construction—Dan Streett, NYS DOT

12:15 p.m. Lunch

PM Moderator: Max Grogg

1:00 New Earthworks Engineering Research Center at Iowa State University—Dr. David White

1:15 Minnesota Experience with Intelligent Compaction and In situ Testing Projects—Glenn Engstrom, Mn/DOT

2:30 Break

3:00 European Experience with Intelligent Compaction—François Chaignon, COLAS

4:15 Wrap-up, Review of the Workshop Mission, Tomorrow's Session—Sandra Larson and John Smythe, Iowa DOT

Workshop attendees: dinner on your own

Day 2—Thursday, April 3, 2008

6:30 a.m. Breakfast

Moderator: Mike Kvach

7:30 Industry Equipment Manufacturer Presentations on Research and Development Efforts

9:15 Break

9:45 Charge to the Group—John Bartoszek, Payne & Dolan

10:15 Session 1— Breakout discussion groups (2 groups of each topic)

- IC for Soils and Aggregate
- IC for HMA
- Design tools, Education/training, Specifications

12:00 p.m. Lunch

1:00 Session 1 continues

1:45 Break

2:15 Session 2—Breakout discussion groups (2 groups of each topic)

- IC for Soils and Aggregate
- IC for HMA
- Design tools, Education/training, Specifications

4:45 Adjourn

Workshop attendees: dinner on your own

Day 3—Friday, April 4, 2008

6:30 a.m. Breakfast

Moderator: Max Grogg

7:30 Facilitators report on Day 2 discussions

- IC for Soils and Aggregate
- IC for HMA
- Design tools, Education/training, Specifications

9:00 Break

9:30 Panel Discussion and Questions—David White, Lee Gallivan, Dan Streett, Mn/DOT, John Bartoszek, Industry representatives

11:00 Wrapup and discussion of next steps—Sandra Larson, Iowa DOT

11:30 Adjourn

Appendix B: Workshop Attendees

John Adam

Statewide Operations Bureau
Iowa Department of Transportation
800 Lincoln Way
Ames, IA 50010
515-239-1333
John.adam@dot.iowa.gov

David Andrews

Pavement Engineering Manager
100 N Senate Ave
Indianapolis, IN 46204
317-232-5452
Dandrewski@indot.in.gov

Bob Arndorfer

Foundation & Pavement Engr Supv
Wisconsin Department of Transportation
3502 Kinsman Blvd.
Madison, WI 53704
608-246-7940
robert.arndorfer@dot.state.wi.us

Rick Barezinsky

Materials Field Engineer
Kansas DOT
Eisenhower State Office Building
700 SW Harrison St.
Topeka, KS 66603-3754
rickba@ksdot.org

Marc Beyer

Statewide HMA Specialist
Michigan Department of Transportation
425 W. Ottawa St., P.O. Box 30050
Lansing, MI 48909
517-322-1020
beyerm@michigan.gov

Brenda Boell

Office of Local Systems
Iowa Department of Transportation
800 Lincoln Way
Ames, IA 50010
515-239-1437
Brenda.boell@dot.iowa.gov

Art Bolland

Minnesota Department of Transportation
2505 Transportation Rd
Willmar, MN 56201
320-214-6349
Art.Bolland@dot.state.mn.us

Bryan Bradley

Office of Road Design
Iowa Department of Transportation
800 Lincoln Way
Ames, IA 50010
515-239-1862
Bryan.bradley@dot.iowa.gov

Dennis Bryant

Missouri Department of Transportation
105 W. Capitol Avenue
Jefferson City, MO 65102
573-751-8608
Dennis.Bryant@modot.mo.gov

Gloria Burke

Field Engineer
Asphalt Technology Division
Maryland State Highway Administration
528 East Main Street
Hancock, MD 21750
443-386-9266
GBurke@sha.state.md.us

Tom Cackler

Concrete Pavement Technology Center
2711 S Loop Dr Suite 4700
Ames, IA 50014
515-294-3230
tcackler@iastate.edu

Kirby Carpenter

Texana Machinery
4146 I-10 East
San Antonio, TX 78219
210-333-8000
kcarpenter@texanamachinery.com

Halil Ceylan

Civil, Construction & Environmental Eng
Iowa State University
482b Town Engr
Ames, IA 50011-3232
515-294-8051
hceylan@iastate.edu

François Chaignon

COLAS, Inc.
10 Madison Ave., Suite 4
Morristown, NJ 07960
973-290-9082
chaignon@colasinc.com

George Chang

The Transtec Group, Inc.
6111 Balcones Drive
Austin, TX 78731
512-451-6233
gkchang@thetranstecgroup.com

Chris Connolly

Eastern Region Mgr
Bomag Americas
12305 Rockledge Drive
Bowie, MD 20715
301-529-8477
Chris.Connolly@Bomag.com

Christopher Cressy

Research Project Engineer
South Dakota Department of Transportation
700 East Broadway
Pierre, SD 57501
605-773-3544
christopher.cressy@state.sd.us

Carol Culver

Research & Technology Bureau
Iowa Department of Transportation
800 Lincoln Way
Ames, IA 50010
515-239-1208
Carol.culver@dot.iowa.gov

Mark Dunn

Research & Technology Bureau
Iowa Department of Transportation
800 Lincoln Way
Ames, IA 50010
515-239-1447
mark.dunn@dot.iowa.gov

Richard Duval

Quality Assurance Engineer
Central Federal Lands Highway Division
12300 West Dakota Avenue
Lakewood, CO 80228
720-963-3532
richard.duval@fhwa.dot.gov

Kent Ellis

District 6 Staff Engineer
Iowa Department of Transportation
430 16th Ave SW, PO Box 3150
Cedar Rapids, IA 52406-3150
319-365-6986
kent.ellis@dot.iowa.gov

Ed Engle

Research & Technology Bureau
Iowa Department of Transportation
800 Lincoln Way
Ames, IA 50010
515-239-1382
Edward.Engle@dot.iowa.gov

Glenn Engstrom

Minnesota Department of Transportation
1400 Gervais Ave
Maplewood, MN 55109
651-366-5531
Glenn.Engstrom@dot.state.mn.us

George Fezell

District 4 Construction Engineer
Iowa Department of Transportation
63200 White Pole Rd
Atlantic, IA 50022
712-243-3355
George.fezell@dot.iowa.gov

Chuck Finnegan

L.L.Pelling Co., Inc.
1425 West Penn Street
P.O. Box 230
North Liberty, IA 52317
319-626-4600
chuckf@llpelling.com

Lee Gallivan

Federal Highway Administration
575 N. Pennsylvania Street, Rm 254
Indianapolis, IN 46204-1576
317-226-7493
Victor.Gallivan@fhwa.dot.gov

Gavin P. Gautreau, P.E.

Senior Geotechnical Research Engineer
Louisiana Transportation Research Center
4101 Gourrier Avenue, Room 207
Baton Rouge, LA 70808
225-767-9110
gavingautreau@dotd.la.gov

Heath Gieselman

Ctr for Transportation Research & Education
2711 S Loop Dr Suite 4700
Ames, IA 50014
515-294-3230
geise@iastate.edu

Melissa Grimes

Office of Road Design
Iowa Department of Transportation
800 Lincoln Way
Ames, IA 50010
515-239-1133
Melissa.grimes@dot.iowa.gov

Max Grogg

Federal Highway Administration
105 6th St
Ames, IA 50010
515-233-7306
Max.grogg@fhwa.dot.gov

Jerod Gross

Snyder & Associates
2727 SW Snyder Blvd.
Ankeny, IA 50023
515-964-2020
jgross@snyder-associates.com

Sheila Hines

State Bituminous Construction Engineer
Office of Materials and Research
Georgia Department of Transportation
15 Kennedy Drive
Forest Park, GA 30297
404-363-7501
Shines@dot.ga.gov

John Hinrichsen

Office of Materials
Iowa Department of Transportation
800 Lincoln Way
Ames, IA 50010
515-239-1601
John.hinrichsen@dot.iowa.gov

Tom Holtz

McAninch Corp.
PO Box 1486
Des Moines, Iowa 50305
515-267-2500
tholtz@mcaninchcorp.com

Bob Horan

Asphalt Institute
8314 Colmar Drive
Mechanicsville, VA 23116
804-539-3036
bhoran@asphaltinstitute.org

Morris Hunt

Soil Survey Specialist
Kansas DOT
2300 SW Van Buren St.
Topeka, KS 66611-1195
morris@ksdot.org

Kevin Jones
Office of Materials
Iowa Department of Transportation
800 Lincoln Way
Ames, IA 50010
515-239-1237
Kevin.jones@dot.iowa.gov

Larry Keach
Bomag Americas
2000 Kentville Road
Kewanee, IL 61443
309-852-6163
Larry.keach@bomag.com

Jon Ketterling
North Dakota Department of Transportation
300 Airport Road
Bismarck, ND 58504-0700
701-328-6908
jketterl@state.nd.gov

Ryan Kipp
CJ Moyna & Sons
24412 Highway 13
Elkader, IA 52043
563-245-1442
rkipp@cjmoyna.com

Steve Klocke
Snyder & Associates
2727 SW Snyder Blvd.
Ankeny, IA 50023
515-964-2020
sklocke@snyder-associates.com

Brent Kucera
Mathiowetz Construction
30676 County Road #24
Sleepy Eye, MN 56085
507-794-6953
brentkucera@Mathiowetzconst.com

Mike Kvach
Asphalt Paving Association of Iowa
116 Clark Avenue, Suite C
Ames, Iowa 50010
515-233-0015
m.kvach@apai.net

Sandra Larson
Research & Technology Bureau
Iowa Department of Transportation
800 Lincoln Way
Ames, IA 50010
515-239-1205
Sandra.larson@dot.iowa.gov

David Hosin Lee
4105 Seamans Center
University of Iowa
Iowa City, IA
319-384-0831
hosin-lee@uiowa.edu

Mark Lindemann
Materials & Research-Geotechnical Section
Nebraska Department of Roads
PO Box 94759
Lincoln, NE 68509-4759
402-479-4752
MarkLindemann@dor.state.ne.us

Jeremiah Littleton
Kentucky Transportation Cabinet
200 Mero Street
Frankfort, KY 40622
502-229-8626
Jeremiah.Littleton@ky.gov

Ron Loecher
New Hampton Construction Engineer
805 E Spring St
New Hampton, IA 50659
641-394-3161
Ronald.loecher@dot.iowa.gov

Kevin Mahoney
Highway Division Director
Iowa Department of Transportation
800 Lincoln Way
Ames, IA 50010
515-239-1124
Kevin.mahoney@dot.iowa.gov

Khalil Maalouf
Volvo Construction Equipment
312 Volvo Way
Shippensburg, PA 17257
717-532-9181, ext 5922
khalil.maalouf@volvo.com

G. W. “Bill” Maupin, Jr.,
Principal Research Scientist, P.E.
Virginia Transportation Research Council
530 Edgemont Road
Charlottesville, VA 22903
434-293-1948
Bill.Maupin@VDOT.Virginia.gov

Dwayne McAninch
McAninch Corp.
PO Box 1486
Des Moines, IA 50305
515-267-2500
dwayne@mcaninchcorp.com

Terry McCleary, P.E.
Illinois Dept of Transportation
District #3 Geotechnical Engineer
700 East Norris Drive
Ottawa, Illinois 61350-0697
815-433-7079
terry.mccleary@illinois.gov

Steve Megivern
Office of Road Design
Iowa Department of Transportation
800 Lincoln Way
Ames, IA 50010
515-239-1936
Stephen.megivern@dot.iowa.gov

Brady Meldrem
Norris Asphalt Paving Co.
14242 Terminal Ave
Ottumwa, IA 52501
641-682-3427
bradym@norrisasphalt.com

Julia Miller
Pavements Construction Staff Engineer
Ohio Department Of Transportation
1980 W. Broad St.
Columbus, OH 43223
614-644-6622
Julia.Miller@dot.state.oh.us

Jeff Mosley
Volvo Construction Equipment, N.A.
Product Manager

817 Pine Street
Stillwater, MN 55082
Mobile: 651-323-8654
jeff.mosley@volvo.com

Wes Musgrove
District 1 Construction Engineer
1020 S 4th St
Ames, IA 60010
515-239-1542
Wesley.musgrove@dot.iowa.gov

Sohel Nazarian
ENG Room A 207
University of Texas El Paso
El Paso, TX
915-747-6911
nazarian@utep.edu

Donald Nelson
Sr. Application Engineer
Sauer-Danfoss
2800 E 13th St
Ames, IA 50010
515-956-5388
dpnelson@sauer-danfoss.com

Kent Nicholson
Office of Road Design
Iowa Department of Transportation
800 Lincoln Way
Ames, IA 50010
515-239-1586
Kent.Nicholson@dot.iowa.gov

Ron Otto
Associated General Contractors of Iowa
701 E Court Ave Ste B
Des Moines, IA 50309
515-283-2424
rw.otto@mchsi.com

Bart Petersen
Peterson Contractors, Inc.
104 Blackhawk PO Box A
Reinbeck, IA 50669
319-345-2713
bartp@petersoncontractors.com

Dean Potts

Caterpillar Global Paving
9401 85th Ave. North
Brooklyn Park, MN 55445-2199
763-493-7514
potts_dean_r@cat.com

Sharon Prochnow

Concrete Pavement Technology Center
2711 S Loop Dr Suite 4700
Ames, IA 50014
515-294-3781

John Puls

Civil, Construction & Environmental Eng
394 Town Engr
Ames, IA 50011-3232
515-294-2140
jpuls@iastate.edu

Farhana Rahman

Department of Civil Engineering
2118 Fiedler Hall
Kansas State University
Manhattan, KS 66506
farhana@ksu.edu

Stan Rakowski

Sakai America
90 International Parkway
Adairsville, GA 30103
717-437-5400
s-rakowski@sakaiamerica.com

Brent Redenius

WFLHD/FHWA
South Century Drive Project Engineer
PO Box 2317
Sunriver, OR 97707
541-593-3861
Brent.Redenius@fhwa.dot.gov

Dan Redmond

District 4 Materials Engineer
Iowa Department of Transportation
63200 White Pole Rd
Atlantic, IA 50022
712-243-2346
Daniel.redmond@dot.iowa.gov

Tom Reis

Specifications Engineer
Iowa Department of Transportation
800 Lincoln Way
Ames, IA 50010
515-239-1566
thomas.reis@dot.iowa.gov

Brad Rister

Kentucky Transportation Cabinet
176 Raymond Blg
Lexington, KY 40508
brister@enr.uky.edu

Julia Rockenstein

California Dept of Transportation, Dist 3
703 B Street, P.O. Box 911
Marysville, CA 95901
530-741-5176
julia_rockenstein@dot.ca.gov

Lisa Rold

Federal Highway Administration
105 6th St
Ames, IA 50010
515-233-7307
Lisa.rold@fhwa.dot.gov

Mark Russell

Washington State Dept of Transportation
PO Box 47365
Olympia, WA 98504-7365
360-709-5479
Russelm@WSDOT.WA.GOV

Stacy Ryan

Office of Road Design
Iowa Department of Transportation
800 Lincoln Way
Ames, IA 50010
515-239-1586
Stacy.ryan@dot.iowa.gov

Greg Schiess

Manager, Strategic Initiatives
FDOT Chief Engineer's Office
605 Suwannee Street, MS- 57
Tallahassee, FL 32399-0450
850-414-4146
gregory.schiess@dot.state.fl.us

Jeff Schmitt

Office of Construction
Iowa Department of Transportation
800 Lincoln Way
Ames, IA 50010
515-239-1013
Jeffrey.Schmitt@dot.iowa.gov

Richard Seabrook

Federal Highway Administration
1200 New Jersey Ave, SE
Washington, DC 20590
202-366-9490
Richard.Seabrook@dot.gov

Radhey Sharma

Dept of Civil and Environmental Engrng
Louisiana State University
Baton Rouge, LA 70803
225-578-6503
rsharma@lsu.edu

Zhiming Si

Construction Division
Texas DOT
512-506-5901
ZSI@dot.state.tx.us

Jim Signore

University of CA Pavement Research Center
University of California, Berkeley
1353 S. 46th Street, Bldg 480
Richmond, CA 94804
510-665-3669
jmsignore@berkeley.edu

John Smythe

Office of Construction
Iowa Department of Transportation
800 Lincoln Way
Ames, IA 50010
515-239-1503
John.smythe@dot.iowa.gov

Jeroen Snoeck

Segment Manager - Paving
Trimble Construction Division
720-587-4414
Jeroen_Snoeck@Trimble.com

Brett Stanton

Payne & Dolan, Inc.
W6380 Design Drive
Greenville, WI 54942
920-757-7575
bstanton@payneanddolan.com

Dan Streett

Design Services - POD 24
NY State Dept of Transportation
50 Wolf Road
Albany, NY 12232
518-485-8227
dstreett@dot.state.ny.us

Pete Tollenaere

Asst Dist 5 Engineer
Iowa Department of Transportation
307 W Briggs, PO Box 587
Fairfield, IA 52556-0587
Peter.tollenaere@dot.iowa.gov

Douglas Townes

Federal Highway Administration
61 Forsyth Street, SW., Suite 17T26
Atlanta, GA 30303-3104
404-562-3914
Douglas.townes@fhwa.dot.gov

Yuki Tsukimoto

Sakai America
90 International Parkway
Adairsville, GA 30103
717-437-5400
y-nohse@sakhainet.co.jp

Shane Tymkowicz

Dist 3 Materials Engineer
Iowa Department of Transportation
2800 Gordon Drive
Sioux City, IA 51102-0987
712-239-4713
Shane.tymkowicz@dot.iowa.gov

Pavana Vennapusa

Civil, Construction & Environmental Eng
394 Town Engr
Ames, IA 50011-3232
515-294-2140
pavanv@iastate.edu

Harold von Quintus

Applied Research Associates, Inc.
2003 North Mays Street, Suite 105
Round Rock, TX 78664
512-218-5088
hvonquintus@aol.com

John Vu

Office of Construction
Iowa Department of Transportation
800 Lincoln Way
Ames, IA 50010
515-239-1280
John.vu@dot.iowa.gov

Steve Weidemann

Weidemann, Inc.
105 South Tracy
Dows, IA 50071
515-852-3802
weidemann@fbx.com

David J. White

Civil, Construction & Environmental Eng
476 Town Engr
Ames, IA 50011-3232
515-294-1463
djwhite@iastate.edu

Paul Wiegand

Ctr for Transportation Research & Education
2711 S Loop Dr, Ste 4700
Ames, IA 50011-1295
515-294-7082
pwiegand@iastate.edu

Chris Williams

Civil, Construction & Environmental Eng
482A Town Engr
Ames, IA 50011-3232
515-294-2140
rwilliams@iastate.edu

James Williams

Mississippi Department of Transportation
P.O. Box 1850
Jackson, MS 39215-1850
601-359-1796
jwilliams@mdot.state.ms.us

