

1. Report No. FHWA/LA.11/473		2. Government Accession No.	3. Recipient's Catalog No.
4. Title and Subtitle Long-Term Monitoring of the HPC Charenton Canal Bridge		5. Report Date August 2011	
		6. Performing Organization Code	
7. Author(s) Walid Alaywan, Ph.D., P.E.		8. Performing Organization Report No.	
9. Performing Organization Name and Address Louisiana Transportation Research Center 4101 Gourrier Avenue Baton Rouge, LA 70808-4443		10. Work Unit No.	
		11. Contract or Grant No. LTRC Project No. 03-7ST State Project No. 30000178	
12. Sponsoring Agency Name and Address Louisiana Department of Transportation and Development P.O. Box 94245 Baton Rouge, LA 70804-9245		13. Type of Report and Period Covered Final Report March 2006-August 2010	
		14. Sponsoring Agency Code	
15. Supplementary Notes Conducted in Cooperation with the U.S. Department of Transportation, Federal Highway Administration			
16. Abstract <p>The report contains long-term monitoring data collection and analysis of the first fully high performance concrete (HPC) bridge in Louisiana, the Charenton Canal Bridge. The design of this bridge started in 1997, and it was built and opened to traffic in 1999. High-strength concrete was used in the precast prestressed, concrete piles and girders. High performance cast-in-place concrete was used in the abutment, wing walls, pile caps, approach slabs, barriers slabs, and barrier rails.</p> <p>After the bridge was constructed, this study was initiated. The objective was to continue the long-term data collection and analysis for the instrumented bridge. The long-term monitoring consisted of collecting data from embedded strain gauges in the deck and four girders of Span 3 of the five-span structure. Data collected were for (1) deck strains at the mid span of Span 3; (2) prestress losses at the mid span of Girders 3A, 3B, 3C, and 3D; and (3) camber and deflection of Girders 3A, 3B, 3C, and 3D.</p> <p>It was observed that (1) the maximum absolute strain in the deck was 77 millionths, (2) the maximum prestress loss in the girders was slightly less than 50,000 psi with time-dependent losses being at about 2 percent of the total losses, and (3) measured camber and deflection of the instrumented girders was in the range of 1.5 to 1.8 in.</p> <p>In conclusion, values reported for strains in the deck, prestress losses in the girders and camber/deflection of the instrumented girders seem to fit very well within acceptable limits.</p>			
17. Key Words High Performance Concrete, HPC, deck, girders, intermediate diaphragm, steel relaxations, prestress losses, camber, deflection, elastic shortening, thermal stresses		18. Distribution Statement Unrestricted. This document is available through the National Technical Information Service, Springfield, VA 21161.	
19. Security Classif. (of this report) N/A	20. Security Classif. (of this page) N/A	21. No. of Pages 51	22. Price N/A

Project Review Committee

Each research project will have an advisory committee appointed by the LTRC Director. The Project Review Committee is responsible for assisting the LTRC Administrator or Manager in the development of acceptable research problem statements, requests for proposals, review of research proposals, oversight of approved research projects, and implementation of findings.

LTRC appreciates the dedication of the following Project Review Committee Members in guiding this research study to fruition.

LTRC Manager

Walid Alaywan

Senior Structures Research Engineer

Members

Gill Gautreau, DOTD

Paul Fossier, DOTD

Mike Boudreaux, LTRC

Arturo Aguirre, FHWA

Robert Bruce, Jr., Tulane University

Directorate Implementation Sponsor

Richard Savoie

Long-Term Monitoring of the HPC Charenton Canal Bridge

by

Walid R. Alaywan, MSCE, P.E.

Louisiana Transportation Research Center

4101 Gourrier Avenue

Baton Rouge, La 70808

State Project Number: 736-99-1122

Research Project Number: 03-7ST

conducted for

Louisiana Department of Transportation and Development

Louisiana Transportation Research Center

The contents of this report reflect the views of the author/principal investigator who is responsible for the facts and the accuracy of the data presented herein. The contents do not necessarily reflect the views or policies of the Louisiana Department of Transportation and Development or the Louisiana Transportation Research Center. This report does not constitute a standard, specification, or regulation.

August 2011

ABSTRACT

The report contains long-term monitoring data collection and analysis of the first fully high performance concrete (HPC) bridge in Louisiana, the Charenton Canal Bridge. The design of this bridge started in 1997, and it was built and opened to traffic in 1999. High-strength concrete was used in the precast prestressed, concrete piles and girders. High performance cast-in-place concrete was used in the abutment, wing walls, pile caps, approach slabs, barriers slabs, and barrier rails.

After the bridge was constructed, this study was initiated. The objective was to continue the long-term data collection and analysis for the instrumented bridge. The long-term monitoring consisted of collecting data from embedded strain gauges in the deck and four girders of Span 3 of the five-span structure. Data collected were for (1) deck strains at the mid span of Span 3; (2) prestress losses at the mid span of Girders 3A, 3B, 3C, and 3D; and (3) camber and deflection of Girders 3A, 3B, 3C, and 3D.

It was observed that (1) the maximum absolute strain in the deck was 77 millionths, (2) the maximum prestress loss in the girders was slightly less than 50,000 psi with time-dependent losses being at about 2 percent of the total losses, and (3) measured camber and deflection of the instrumented girders was in the range of 1.5 to 1.8 in.

In conclusion, values reported for strains in the deck, prestress losses in the girders and camber/deflection of the instrumented girders seem to fit very well within acceptable limits.

ACKNOWLEDGMENTS

The investigator would like to thank the Louisiana Transportation Research Center (LTRC) for sponsoring and funding this project. Also, the participation of Masood Rasoulian, Paul Fossier, and Dr. Bob Bruce in the field visits is appreciated. Appreciation is also extended to the LTRC Concrete Lab personnel for assisting in the data collection and traffic control.

The author would like to express special thanks to Dr. Brian Hassett for his support in providing the training for the data collection and his work in the data computation and analysis before and after this study was initiated.

IMPLEMENTATION STATEMENT

The Charenton Canal Bridge is the first bridge built in Louisiana with both the superstructure and substructure made out of HPC. After the bridge's completion in 1999, data collected and analyzed were very promising. As a result of being designed for high strength, the HPC used in the girders reduced the number of girders in each span from six to five, providing a savings of 365 linear feet of girders.

In addition, the low chloride permeability requirement reduces the ability of moisture and chloride ions to enter the concrete and therefore increases girders' life expectancy.

The successful performance of this bridge allowed the use of HPC in the design and construction of several additional bridges in Louisiana. In fact, the Rigolets Pass Bridge was constructed in 2008. In some of its spans, HPC 72-in. bulb-tee girders were incorporated.

It should be noted that the objective of building the Charenton Canal Bridge was to implement HPC and that reduction in linear feet of girders came as one of the secondary benefits.

In an effort to assess the benefits derived from using HPC, the author also performed an implementation assessment of the use of HPC girders in the I-10 Twin-Span Bridges. The use of HPC resulted in a savings of 25,920 linear feet of girders, resulting in a savings of 14.6 million dollars for the state of Louisiana. A detailed implementation update was published, "Use of High Performance, High Strength Concrete (HPC) Bulb-Tee Girders Saves Millions on I-10 Twin Span Bridge in New Orleans District." The update can be found at http://www.ltrc.lsu.edu/pdf/2009/riu_310.pdf.

TABLE OF CONTENTS

ABSTRACT.....	iii
ACKNOWLEDGMENTS	v
IMPLEMENTATION STATEMENT	vii
TABLE OF CONTENTS.....	ix
LIST OF TABLES	xi
LIST OF FIGURES	xiii
INTRODUCTION	1
Charenton Canal Bridge.....	1
Bridge Description	1
OBJECTIVE	5
SCOPE	7
METHODOLOGY	9
Super Structure Instrumentation	9
Girder Instrumentation.....	9
Prestressing Forces.....	10
Prestress Losses	10
Deck Strains	11
Deflections	12
DISCUSSION OF RESULTS.....	13
Data Analysis	13
Deck Strains at Mid-Span of Span 3.....	13
Prestress Losses at the Mid-span of Girders 3A, 3B, 3C, and 3D	14
Girder 3A	15
Girder 3B	15
Girder 3C	15
Girder 3D	15
Camber and Deflection Measurements at the Mid-span of Girders 3A, 3B, 3C, and 3D.	15
CONCLUSIONS.....	17
Field Performance Characteristics	17

Prestressing Forces.....	17
Prestress Losses	17
Camber and Deflection	17
RECOMMENDATIONS	19
ACRONYMS, ABBREVIATIONS & SYMBOLS.....	21
REFERENCES	23
APPENDIX A.....	25
Data for Instrumented Deck.....	25
APPENDIX B	27
Girder Prestress Losses	27
APPENDIX C	35
Camber/Deflection in Instrumented Girders.....	35

LIST OF TABLES

Table 1 Data from vibrating wire strain gauges 1, 2, and 3.....	25
Table 2 Girder 3A prestress losses.....	27
Table 3 Girder 3A prestress losses (cont'd).....	28
Table 4 Girder 3B prestress losses.....	29
Table 5 Girder 3B prestress losses (cont'd).....	30
Table 6 Girder 3C prestress losses.....	31
Table 7 Girder 3C prestress losses (cont'd).....	32
Table 8 Girder 3D prestress losses.....	33
Table 9 Girder 3D prestress losses (cont'd).....	34
Table 10 Girder camber and deflection measurements.....	35

LIST OF FIGURES

Figure 1	Location of Charenton Canal Bridge.....	1
Figure 2	New Charenton Canal Bridge.....	2
Figure 3	Cross-section of the superstructure	2
Figure 4	Shop drawing for the bridge framing plan	4
Figure 5	Section view through Span No. 3	10
Figure 6	VWSG at mid-span of Girders 3A, 3B, 3C, and 3D	11
Figure 7	Vibrating wire strain gauges at mid-span of Span 3.....	12
Figure 8	Strain from VWSG primary strain gauges in slab.....	13
Figure 9	Prestress loss for Girders 3A, 3B, 3C, and 3D	14
Figure 10	Camber/deflection vs. time.....	16



Figure 2
New Charenton Canal Bridge

The superstructure of the bridge, shown in Figure 3, consists of five prestressed concrete AASHTO Type III girders per span spaced at 10-ft. on centers supporting an 8-in. thick reinforced concrete slab. The total width of the bridge is 46 ft. 10 in. The Type III prestressed concrete girders contain 34 ½-in. diameter Grade 270, low-relaxation strands. Eight strands were debonded for various lengths at each end of the girders. Specified compressive strengths for the prestressed concrete girders were 7,000 psi at release of the prestressing strands and 10,000 psi after 56 days.

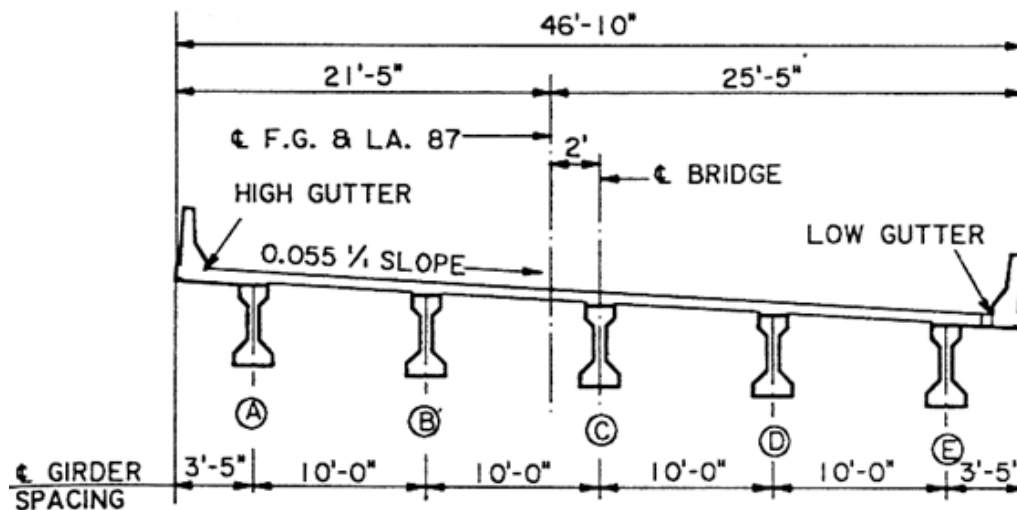

Figure 3
Cross-section of the superstructure

The 8-in. thick cast-in-place reinforced concrete deck had a specified concrete compressive strength of 4,200 psi at 28 days and was designed using LADOTD standard procedures and details. A dead load of 12 psf was included to allow for future wearing surfaces. The bridge deck was designed as a continuous span over the girders and satisfied both working stress and load factor design (LFD) requirements. For working stress requirements, the slab was designed as a double reinforced concrete slab with the main reinforcement perpendicular to the traffic direction. Reinforcement was grade 60 with a 2-in. cover to the top reinforcement and 1-in. cover to the bottom reinforcement. The transverse deck reinforcement consisted of 0.75-in. diameter truss bars and 0.5-in. diameter top and bottom straight bars. Longitudinal deck reinforcements consisted of top and bottom 0.5-in. diameter bars. Negative moment continuity over the piers is provided by longitudinal reinforcement in the deck. No positive connection is provided. Diaphragms are provided at each abutment, over each pier, and at the mid-span. Figure 4 shows the shop drawing for the bridge framing plan.

The requirements for the HPC used in the precast, prestressed girders and piles were high strength and durability. As a result, the specified concrete compressive strengths were 7,000 psi at release and 10,000 psi at 56 days. In addition, the permeability requirement was specified as a chloride permeability of less than or equal to 2,000 coulombs at 56 days. For the HPC used in the cast-in-place reinforced concrete bents and deck, durability was the only requirement. As result, the bents and deck had a compressive strength requirement of 4,200 psi at 28 days, and a chloride permeability requirement of less than 2,000 coulombs at 56 days.

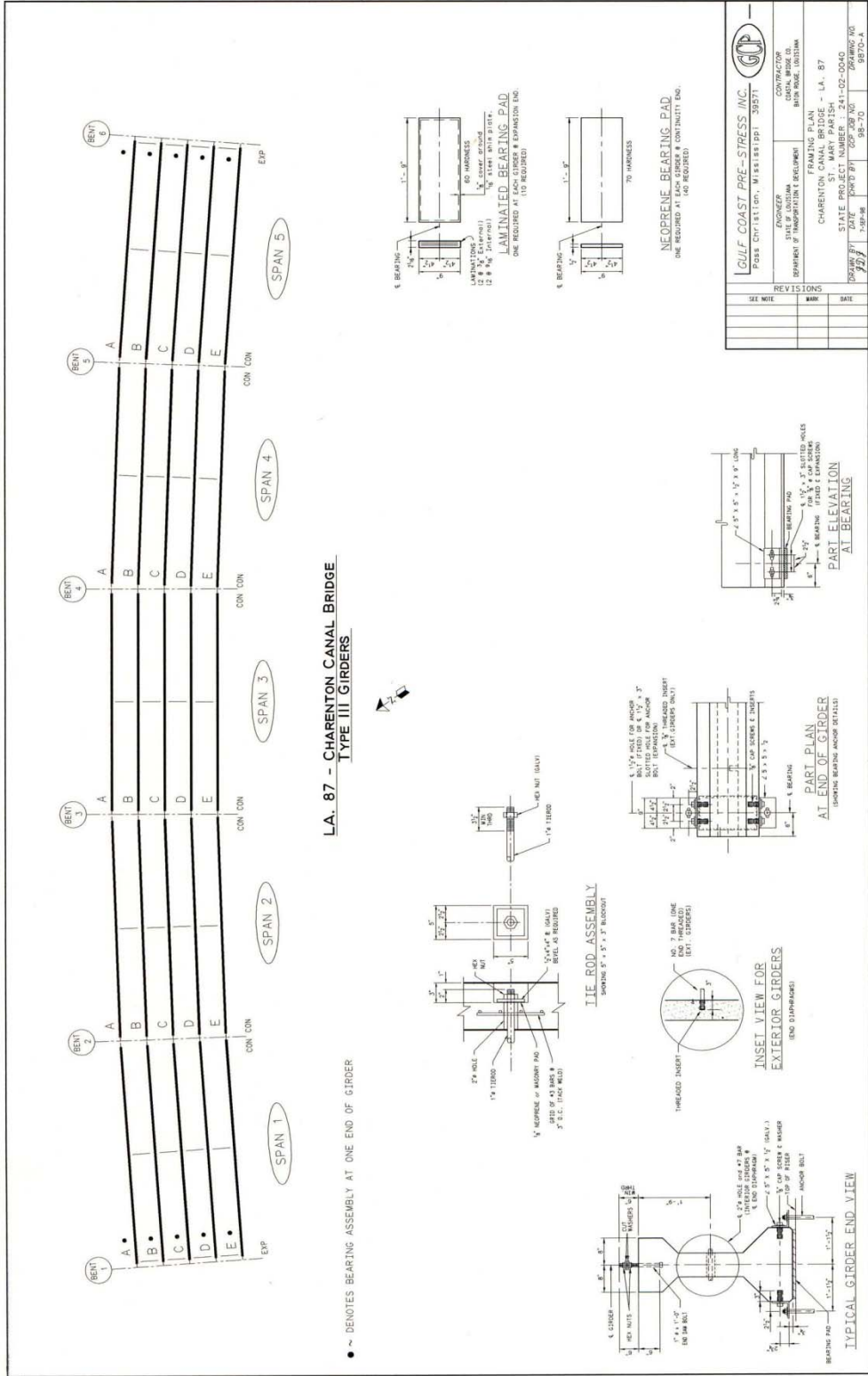

Figure 4
 Shop drawing for the bridge framing plan

OBJECTIVE

The original purpose of the instrumentation of the superstructure component of the bridge was to determine its performance during fabrication, construction, and for some time after the completion of the structure. The original work was published under LTRC Final Report No. 310 and can be found at http://www.ltrc.lsu.edu/pdf/2008/fr_310.pdf [1].

After this bridge was constructed, this long-term monitoring study was initiated. The objective of this study was to continue the long-term data collection and analysis for the instrumented Charenton Canal Bridge. The long-term monitoring consisted of collecting data from embedded strain gauges in the deck and four girders from Span 3 of the five-span structure. Data collected and analyzed were used for measuring:

- 1) deck strains at the mid-span of Span 3
- 2) prestress losses at the mid-span of Girders 3A, 3B, 3C, and 3D
- 3) camber and deflection of Girders 3A, 3B, 3C, and 3D

SCOPE

Since the objective of the study was the long-term monitoring of the Charenton Canal Bridge, the scope of this study consisted of the continuation of the data collection and analysis for this bridge. This was done by performing site visits and manually recording all data pertaining to strain and corresponding temperatures in deck and selected girders and measuring the deflection of those girders.

METHODOLOGY

Super Structure Instrumentation

Girder Instrumentation

Construction of the Charenton Canal Bridge provided a unique opportunity to gain knowledge about the performance of a bridge constructed of HPC and built in Louisiana using regional materials. The superstructure components were instrumented to determine the bridge's performance during fabrication, construction, and for some time after the completion of the structure. Information gained from instrumentation and data collection will be used to refine design and construction procedures as well as specifications for bridges built of HPC in Louisiana.

The instrumentation plan was developed based on the following four assumptions:

1. Three interior girders and one exterior girder were instrumented.
2. All four girders are located in Span 3 of the five-span bridge.
3. All instrumented girders were cast at the same time in the same bed.
4. A limited amount of instrumentation was placed in the deck slab of Span 3.

The four research bridge girders were identified as Girders 3A, 3B, 3C, and 3D. They were instrumented with thermocouples, load cells, vibrating wire strain gauges, and elevation reference points. These instruments were installed in order to monitor the girder curing temperatures, prestressing forces, prestress losses, concrete strains, and deflections, respectively. Figure 5 shows a section view through Span No. 3. The girder layout on the prestressing bed is shown in Figure 5. Descriptions of each type of instrumentation are provided in the following sections.

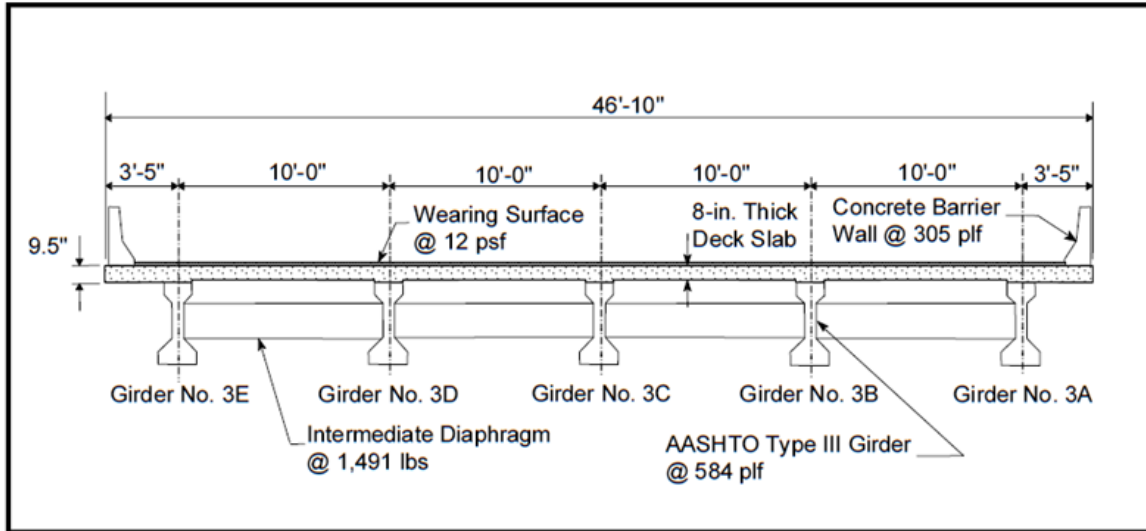

Figure 5
Section view through Span No. 3

Prestressing Forces

Although calibrated hydraulic jacks were used to tension the prestressing strands, the jacks only provide a measurement of the initial force applied to each strand. Transfer of force from the hydraulic jack to the strand anchorage and the increase in strand temperature during initial curing, result in a decrease in strand force prior to release. Consequently, when the strands are released, the force applied to the prestressed girder will be less than the initial force applied to the strands by the prestressing jack. Higher concrete temperatures that are typically associated with the utilization of high strength HPC can contribute to a corresponding decrease in prestressing force.

Measurements were made to monitor the force in the prestressing strand from the time of tensioning, during initial curing, and until the strands were released.

Prestress Losses

Previous research has indicated that prestress losses in high strength HPC girders can be considerably less than the losses in girders fabricated with conventional concrete [2]. However, additional data are required to determine if a reduction in the prestress losses currently assumed in design can be justified in some cases. As a result of this need for additional data, four girders were instrumented to determine the prestress losses due to elastic shortening, creep, and shrinkage. In addition, the instrumentation was used to measure concrete strains at the center of gravity of the prestressing strands resulting from changes in girder loading conditions.

The instrumentation used to measure the prestress losses consisted of three vibrating wire strain gauges installed at the mid-span of Girders 3A, 3B, 3C, and 3D. The cross-section locations of the gauges for these girders are shown in Figure 6. The vibrating wire strain gauges were Geokon Model VCE-4200, manufactured by Geokon, Inc. Each vibrating wire strain gauge was equipped with a thermistor to measure temperature at the gauge location.

In addition to the girders, one 6- x 12-in. (152- x 305-mm) concrete cylinder with an embedded vibrating wire strain gauge at the center was cast for each of the four girders and cured alongside the girders in the field. The purpose of these cylinders was to provide a calibration curve for the effect of temperature on the apparent strain during the initial curing period.

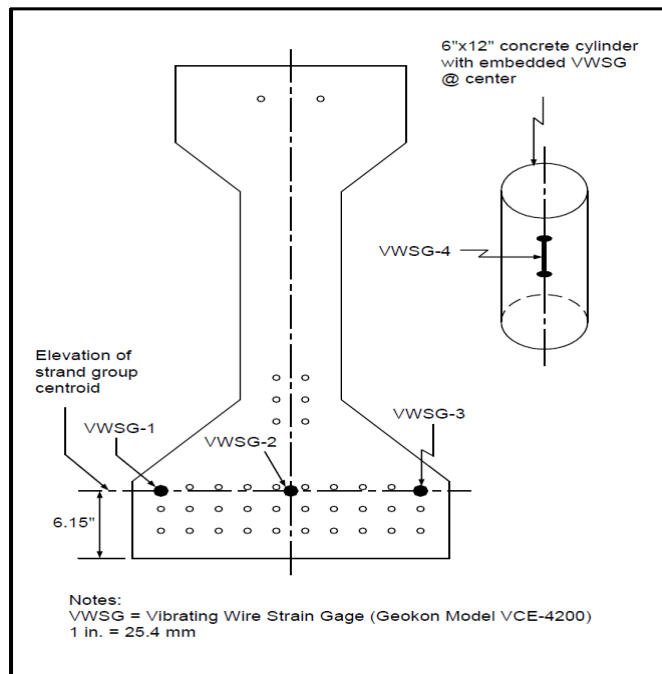

Figure 6
VWSG at mid-span of Girders 3A, 3B, 3C, and 3D

Deck Strains

Since HPC is a new material, little data were available concerning the combined effects of creep and shrinkage behavior of structural elements constructed of HPC.

Therefore, instrumentation was installed to measure the combined effects of shrinkage and creep of the HPC deck and the high strength HPC girders.

The instrumentation used to measure the deck strains consisted of three vibrating wire strain gauges installed at the mid-span of Span 3. One gauge was placed at the mid-depth of the concrete deck above the exterior Girder 3A and the interior Girder 3B. In addition, one gauge was placed at the mid-depth of the concrete span along the centerline between the two girders. The cross-section locations of the gauges are shown in Figure 7. The vibrating wire strain gauges were Model VCE-4200, manufactured by Geokon, Inc. Each vibrating wire strain gauge was equipped with a thermistor to measure temperature at the gauge location.

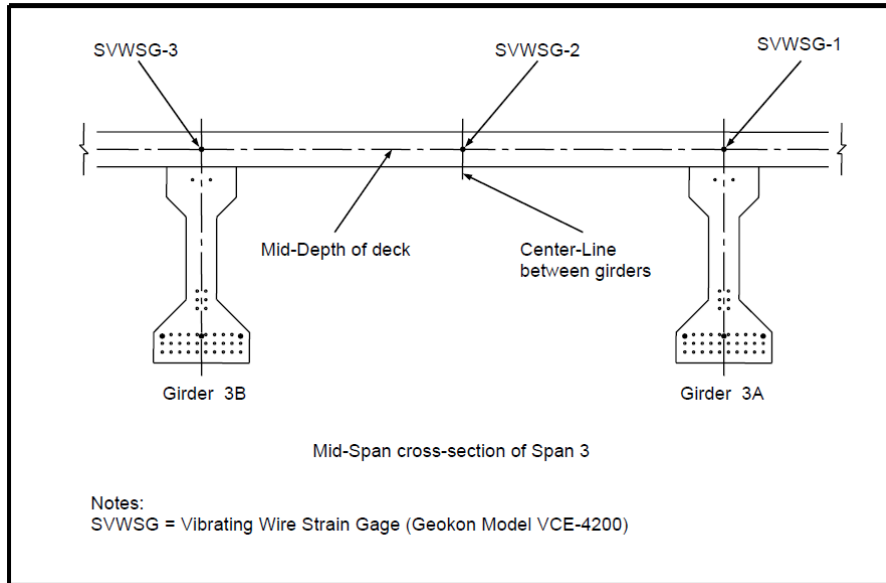

Figure 7
Vibrating wire strain gauges at mid-span of Span 3

Deflections

As mentioned previously, prestress losses with high strength HPC can be substantially less than with normal strength concrete. As a result, camber and long-term deflections may be different from those predicted using the properties of normal strength concrete. Therefore, mid-span deflections relative to each girder end were measured during and after construction of the bridge.

In order to provide a reference for early age camber and long-term deflection measurements, three steel bolts were partially embedded into the top concrete surface of the girder top flange during casting. One bolt was placed at mid-span, while the other two were placed close to the end of each girder. Girder camber was determined by using a surveyor's level to sight elevations of the mid-span reference bolt relative to the two end reference bolts. When the deck was cast, the reference bolts were extended to the surface of the deck for continued easy access after completion of the bridge.

DISCUSSION OF RESULTS

Data Analysis

Deck Strains at Mid-Span of Span 3

The purpose of these strain gauges was to measure the strains in the concrete deck caused by the combined effects of shrinkage and creep in the deck and girders. The instrumentation used to measure the deck strains consisted of three vibrating wire strain gauges installed at the mid-span of Span 3. One gauge was placed at the mid-depth of the concrete deck above the exterior Girder 3A. In addition, one gauge was placed at the mid-depth of the concrete span along the centerline between the two girders 3A and 3B. The cross-section locations of the gauges are shown in Figure 7. The vibrating wire strain gauges were Model VCE-4200 manufactured by Geokon, Inc. Each vibrating wire strain gauge was equipped with a thermistor to measure temperature at the gauge location. Figure 8 shows a plot of strain vs. time for the deck strain gauges. Figure 8 shows the strain variation in the slab vs. time.

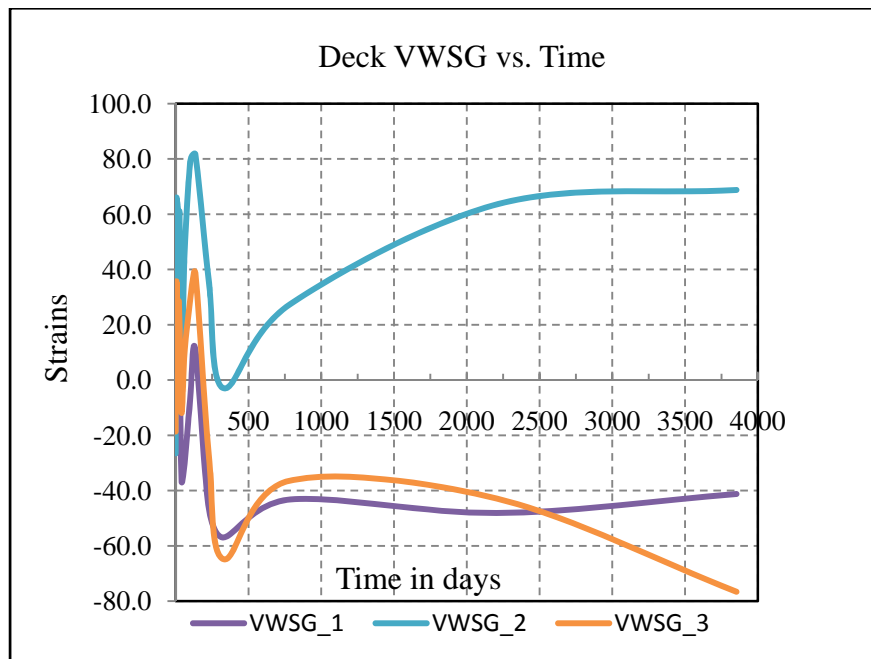

Figure 8
Strain from VWSG primary strain gauges in slab

Figure 8 shows the vibrating wire strain variation from the day the deck was poured on site to the day the last visit was performed, i.e., 4/6/2010. As expected, the strains at the middle of Span 3 were positive, whereas the strains at the end of the girders were negative.

Prestress Losses at the Mid-span of Girders 3A, 3B, 3C, and 3D

The purpose of the strain gauges installed at the mid-span of Girders 3A, 3B, 3C, and 3D is to determine the loss in prestress caused by elastic shortening, creep, and shrinkage. The instrumentation used to measure the prestress loss consisted of three vibrating wire strain gauges installed at the mid-span of girders 3A, 3B, 3C, and 3D. Each vibrating wire strain gauge was equipped with a thermistor to measure temperature at the gauge location. Figure 8 shows the prestress loss for Girders 3A, 3B, 3C, and 3D vs. time. Figure 9 shows a plot of prestress loss of instrumented girders vs. time since they were cast.

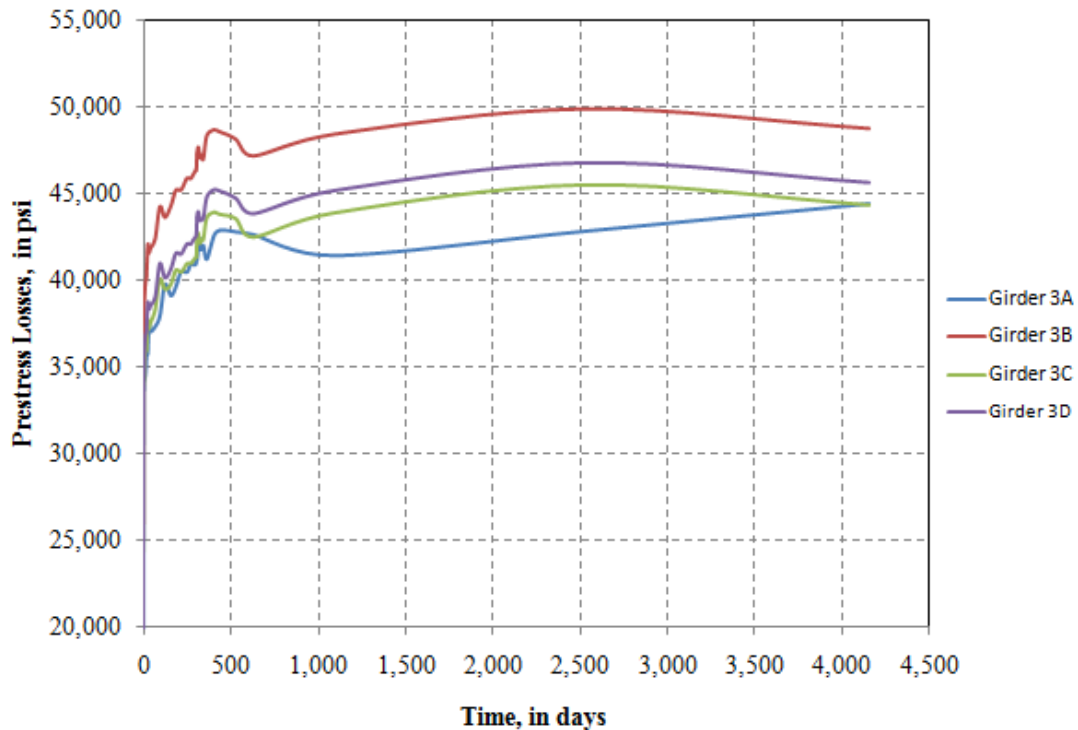

Figure 9
Prestress loss for Girders 3A, 3B, 3C, and 3D

Figure 9 shows the prestress losses of Girder 3A, 3B, 3C, and 3D vs. time. These losses are the combination of three different items:

- Prestress losses prior to casting of the girders (thermal and steel relaxation),
- Prestress losses immediately after strand release (elastic shortening), and

- Time-dependent prestress losses (creep and shrinkage measured from vibrating wire strain gauges and thermal and steel relaxation).

Girder 3A

Time-dependent prestress losses were 1,646 psi while the total prestress losses for this girder were 44,337 psi. Time-dependent prestress losses were about 3.8 percent of the total prestress losses for this girder.

Girder 3B

Time-dependent prestress losses were 1,330 psi while the total prestress losses for this girder were 48,719 psi. Time-dependent prestress losses were about 2.7 percent of the total prestress losses for this girder.

Girder 3C

Time-dependent prestress losses were 1,616 psi while the total prestress losses for this girder were 44,326 psi. Time-dependent prestress losses were about 3.3 percent of the total prestress losses for this girder.

Girder 3D

Time-dependent prestress loss was 1,544 psi while the total prestress losses for this girder were 45,589 psi. Time-dependent prestress losses were about 3.4 percent of the total prestress losses for this girder.

Camber and Deflection Measurements at the Mid-span of Girders 3A, 3B, 3C, and 3D

Prestress losses with high performance concrete are likely to be less than with normal strength concrete. As a result, camber and long-term deflections may be different from those predicated using the properties of normal strength concrete. Therefore, midspan deflection relative to each girder end on Girders 3A through 3D was measured immediately after casting and while the concrete was still plastic. Steel bolts were embedded in the top surface of each girder at the midspan and near both ends to provide permanent fixed reference points for camber measurements. The embedded bolts near each end are centered above the sole plate. Camber measurements were made using a level to sight elevations at each reference point. Figure 10 shows the measurement of camber and deflection from the day the bridge was constructed until the last visit performed on April 6, 2010.

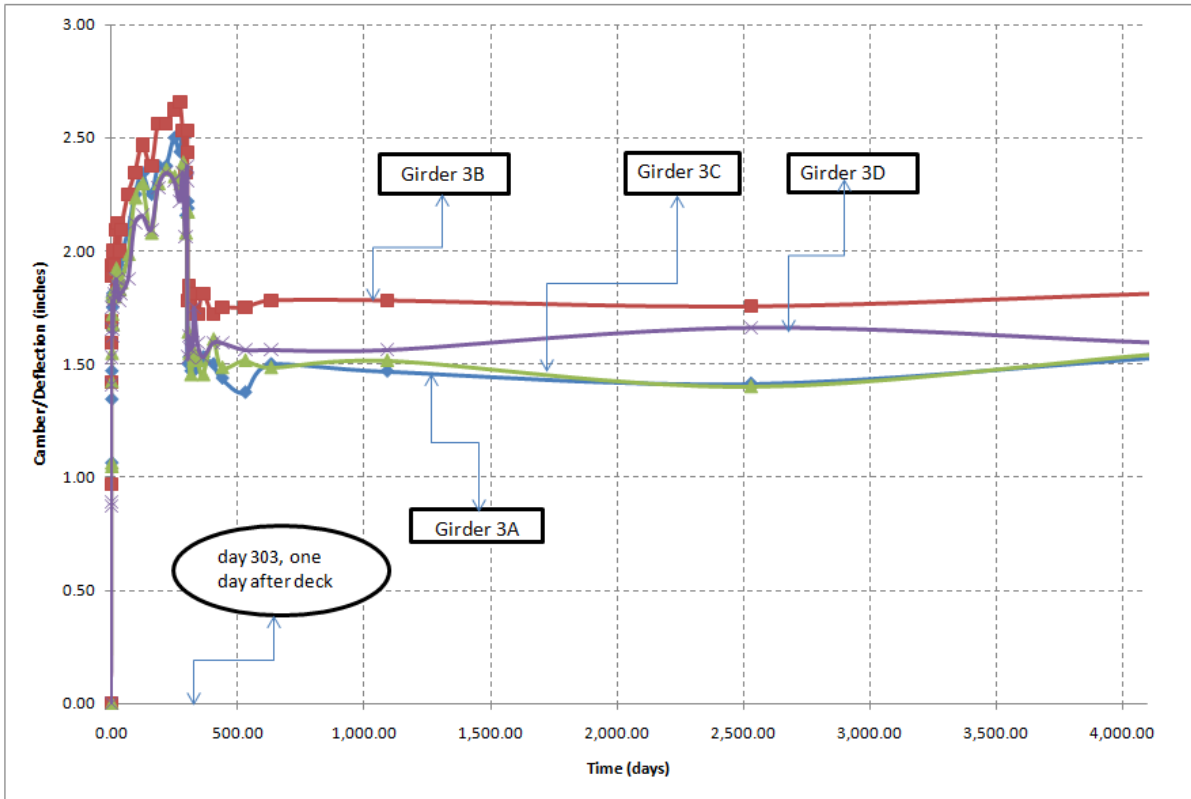

Figure 10
Camber/deflection vs. time

From Figure 10, the largest camber measurement was 2.66 in. It occurred at the midspan of Girder 3B on 8/18/1999. This is exactly one day before the girders were shipped from the plant to the bridge site for erection. It is to be noted that largest camber measurements for Girders 3A, 3C, and 3D were 2.50 in., 2.39 in., and 2.34 in., respectively. These maximum values were reached on 8/30/1999. This is exactly when the initial reading at the bridge site were taken. After the deck was poured in place, the camber measurement started to decrease gradually. The latest visit on 4/6/2010, i.e., after 3853 days from pouring the deck, camber readings for Girders 3A, 3B, 3C, and 3D were 1.53, 1.81, 1.55, and 1.59 in. accordingly.

CONCLUSIONS

Field Performance Characteristics

Prestressing Forces

The values of the prestressing forces computed in the original study did not change and, thus, will not be discussed here. The long-term monitoring was assumed from the day the deck was poured (11/15/2001) to the last trip to the bridge site where data were collected on 4/6/2010.

Prestress Losses

1. Prestress losses due to **thermal and steel relaxation** took place prior to casting and will not change as a result of long-term monitoring. Those losses were obtained from prestressing force calculations.
2. Prestress losses due to **elastic shortening** did not experience any additional change. This is due to the fact that those losses are not time-dependent. The elastic shortening prestress losses remained at 13,606 psi, 15,374 psi, 13,880 psi, and 14469 psi for Girders 3A, 3B, 3C, and 3D, respectively. Those losses were computed with vibrating wire strain gauges immediately after strand release.
3. Prestress losses due to **creep and shrinkage (time-dependent)** that were measured from vibrating wire strain gauges continued to increase from 18,313 psi to 18,745 psi for Girder 3A (2.4 percent increase); 22,385 psi to 22,676 psi for Girder 3B (1.3 percent increase); 19,102 psi to 19,491 psi for Girder 3C (2.0 percent increase); and 19,831 psi to 20,236 psi for Girder 3D (2.0 percent increase), respectively.
4. Prestress losses due to **steel relaxation (time-dependent)** that were measured from vibrating wire strain gauges continued to increase from 1,565 psi to 1,646 psi for Girder 3A (5.2 percent increase); 1,293 psi to 1,330 psi for Girder 3B (2.89 percent increase); 1,544 psi to 1,616 psi for Girder 3C (4.7 percent increase); and 1,482 psi to 1,544 psi for Girder 3D (4.8 percent increase), respectively.

Camber and Deflection

Camber and deflection measurements from the time the girders were removed from the casting bed until 800 days after the bridge was open to traffic found that once the bridge was open to traffic, there was very little change in the camber/deflection of the HPC girders. The following was observed:

1. For Girder 3A, camber/deflection increased from 1.47 in. to 1.53 in. (an increase of 4.0 percent). For Girder 3B, camber/deflection increased from 1.78 in. to 1.81 in. (an increase of 1.7 percent). For Girder 3C, camber/deflection increased from 1.52 in. to 1.55 in. (an increase of 2.0 percent). For Girder 3D, camber/deflection increased from 1.56 in. to 1.59 in. (an increase of 1.9 percent). The average deflection for all four girders increased from 1.58 in. to 1.62 in. (an increase of 2.5 percent).
2. It was observed that the deflection of Girders 3A, 3C, and 3D is around the 1.5 in. mark, while that of 3B was slightly higher than that.

RECOMMENDATIONS

The data analyzed in this report strongly support the decision of LADOTD to build more bridges with HPC members. The data collected and analyzed from this study confirms all design changes that were performed prior to the construction of this bridge.

ACRONYMS, ABBREVIATIONS & SYMBOLS

AASHTO	American Association of State Highway and Transportation Officials
ACI	American Concrete Institute
E	Modulus of Elasticity – Stress/strain
ft.	foot
HPC	High Performance Concrete
LFD	Load Factor Design
LRFD	Load and Resistance Factor Design
LTRC	Louisiana Transportation Research Center
LADOTD	Louisiana Department of Transportation and Development
lb.	pound
kPa	kilo Pascals
kN	kilo Newton
MPa	mega Pascals
mPa-s	viscosity unit millipascal second
Pascal	SI derived unit 1 pascal (Pa) = 1 N/m ²
PCI	Precast/Prestressed Concrete Institute
VWSG	Vibrating Wire Strain Gauge
°C	SI unit for temperature
1 ft. = 12 in. = 30.48 cm	

REFERENCES

1. Bruce, R. N., Russell, H.G., and Roller, J. J., “Implementation of High Performance Concrete in Louisiana Bridges” Final Report, Louisiana Transportation Research Center, Research Report No. 310, Baton Rouge, LA, 1998, 67 pp.
http://www.ltrc.lsu.edu/pdf/2008/fr_310.pdf
2. Bruce, R. N., Russell, H.G., Roller, J. J., and Martin B. T., “Feasibility Evaluation of Utilizing High Strength Concrete in Design and Construction of Highway Bridge Structures” Final Report, Louisiana Transportation Research Center, Research Report No. FHWA/LA-94-282, Baton Rouge, LA, 1994, 168 pp.
http://www.ltrc.lsu.edu/pdf/2008/fr_282.pdf

APPENDIX A

Data for Instrumented Deck

Table 1
Data from vibrating wire strain gauges 1, 2, and 3

Date / Time	Geokon VCE 4200 VWSG											
	Gage Factor = 0.9824											
	SVWSG-1				SVWSG-2				SVWSG-3			
Temp. (° C)	Temp. (° F)	Reading, mil.	Strain, mil	Temp. (° C)	Temp. (° F)	Reading, mil.	Strain, mil	Temp. (° C)	Temp. (° F)	Reading, mil.	Strain, mil	
09/17/1999 08:10	22.40	72.32	2725.00	0.00	22.60	72.68	2580.00	0.00	21.30	70.34	2752.00	0.00
09/18/1999 02:45	17.60	63.68	2698.00	-26.52	17.40	63.32	2553.00	-26.52	18.00	64.40	2733.00	-18.67
09/19/1999 10:00	27.70	81.86	2743.00	17.68	26.90	80.42	2629.00	48.14	27.20	80.96	2767.00	14.74
09/23/1999 11:15	18.50	65.30	2756.00	30.45	18.60	65.48	2647.00	65.82	18.90	66.02	2788.00	35.37
09/30/1999 10:45	18.00	64.40	2746.00	20.63	17.80	64.04	2645.00	63.86	18.40	65.12	2780.00	27.51
10/10/1999 09:30	23.50	74.30	2748.00	22.60	23.70	74.66	2640.00	58.94	23.80	74.84	2781.00	28.49
10/14/1999 10:25	23.50	74.30	2743.00	17.68	23.40	74.12	2642.00	60.91	24.00	75.20	2774.00	21.61
10/28/1999 13:50	22.70	72.86	2688.00	-36.35	24.00	75.20	2582.00	1.96	23.20	73.76	2740.00	-11.79
11/18/1999 10:30	15.80	60.44	2694.00	-30.45	15.60	60.08	2626.00	45.19	16.00	60.80	2762.00	9.82
12/28/1999 10:35	9.80	49.64	2719.00	-5.89	8.90	48.02	2661.00	79.57	10.10	50.18	2782.00	29.47
02/01/2000 11:35	8.60	47.48	2736.00	10.81	8.90	48.02	2663.00	81.54	9.30	48.74	2791.00	38.31
05/02/2000 10:30	22.60	72.68	2678.00	-46.17	21.90	71.42	2617.00	36.35	23.00	73.40	2725.00	-26.52
08/12/2000 11:15	30.30	86.54	2667.00	-56.98	31.30	88.34	2577.00	-2.95	32.40	90.32	2686.00	-64.84
11/15/2001 10:05	19.10	66.38	2681.00	-43.23	19.20	66.56	2608.00	27.51	19.80	67.64	2715.00	-36.35
10/26/2005 09:30	12.20	53.96	2676.00	-48.14	11.30	52.34	2645.00	63.86	12.30	54.14	2708.00	-43.23
04/06/2010 10:00	22.40	72.32	2683.00	-41.26	22.00	71.60	2650.00	68.77	22.50	72.50	2674.00	-76.63

APPENDIX B

Girder Prestress Losses

Table 2
Girder 3A prestress losses

<u>Prestressing Steel Properties:</u>		Project Charenton Canal Bridge				
		Subject Girder 3A Prestress Loss Calculations				
		using VWSG Data				
		Done By BMH				
Initial Force in Strand (lb) : 30,980		f_{pi} (psi) = 202,484				
Strand Area (in. ²) : 0.153		f_{py} (psi) = 270,000				
<u>Prestress Losses Prior to Casting (from Prestressing Force Calculations):</u>						
Thermal + Steel Relaxation Losses (psi) = 9,340						
<u>Prestress Losses Immediately After Strand Release (11/20/1998 07:40):</u>						
Elastic Shortening (psi) = 13,606 (From vibrating wire strain gages)						
<u>Time-Dependent Prestress Losses After Strand Release:</u>						
CR+SH (psi) measured from vibrating wire strain gages.						
$RE \text{ (psi)} = \Delta RE + RE = (f_{p,t}) \left(\frac{\text{Log}(t_2) - \text{Log}(t_1)}{45} \right) \left(\frac{f_{p,t}}{f_{py}} - 0.55 \right) + RE$						
		Prestress Losses				
Date:Hr:Mn	Elapsed Time	TH + RE	ES	SH + CR	RE	TOTAL
----	(Days)	(psi)	(psi)	(psi)	(psi)	(psi)
11/20/1998 07:29	0	9,340	0	0	0	9,340
11/20/1998 07:30	0	9,340	8	0	0	9,348
11/20/1998 07:31	0	9,340	386	0	0	9,726
11/20/1998 07:32	0	9,340	716	0	0	10,056
11/20/1998 07:33	0	9,340	1,520	0	0	10,860
11/20/1998 07:34	0	9,340	2,474	0	0	11,814
11/20/1998 07:35	0	9,340	3,382	0	0	12,722
11/20/1998 07:36	0	9,340	4,676	0	0	14,016
11/20/1998 07:37	0	9,340	6,190	0	0	15,530
11/20/1998 07:38	0	9,340	8,222	0	0	17,562
11/20/1998 07:39	0	9,340	10,984	0	0	20,324
11/20/1998 07:40	0	9,340	13,606	0	0	22,946
11/20/1998 07:41	0	9,340	13,606	123	17	23,086
11/20/1998 07:42	0	9,340	13,606	250	33	23,229
11/20/1998 07:43	0	9,340	13,606	314	48	23,307
11/20/1998 07:44	0	9,340	13,606	358	61	23,365
11/20/1998 07:45	0	9,340	13,606	436	74	23,455
11/20/1998 07:46	0	9,340	13,606	484	86	23,516
11/20/1998 07:47	0	9,340	13,606	520	97	23,563
11/20/1998 07:48	0	9,340	13,606	599	108	23,652
11/20/1998 07:49	0	9,340	13,606	626	117	23,689
11/20/1998 07:50	0	9,340	13,606	660	127	23,733
11/20/1998 08:00	0	9,340	13,606	1,045	202	24,192
11/20/1998 08:15	0	9,340	13,606	1,634	277	24,857
11/20/1998 16:20	0	9,340	13,606	6,830	729	30,505
11/21/1998 08:30	1	9,340	13,606	9,752	879	33,577
11/22/1998 11:30	2	9,340	13,606	10,065	970	33,981
11/23/1998 14:00	3	9,340	13,606	9,700	1,019	33,665
11/24/1998 10:45	4	9,340	13,606	10,124	1,048	34,117
11/25/1998 08:25	5	9,340	13,606	10,545	1,072	34,562

Table 3
Girder 3A prestress losses (cont'd)

<u>Prestressing Steel Properties:</u>		Project Charenton Canal Bridge					
Initial Force in Strand (lb) : 30,980		Subject Girder 3A Prestress Loss Calculations					
Strand Area (in. ²) : 0.153		using VWSG Data					
		Done By <u>BMH</u>					
		f _{pi} (psi) = 202,484					
		f _{py} (psi) = 270,000					
<u>Prestress Losses Prior to Casting (from Prestressing Force Calculations):</u>							
Thermal + Steel Relaxation Losses (psi) = 9,340							
<u>Prestress Losses Immediately After Strand Release (11/20/1998 07:40):</u>							
Elastic Shortening (psi) = 13,606 (From vibrating wire strain gages)							
<u>Time-Dependent Prestress Losses After Strand Release:</u>							
CR+SH (psi) measured from vibrating wire strain gages.							
$RE \text{ (psi)} = \Delta RE + RE = \left(f_{p,t} \left(\frac{\text{Log}(t_2) - \text{Log}(t_1)}{45} \right) \right) \left(\frac{f_{p,t}}{f_{py}} - 0.55 \right) + RE$							
Date:Hr:Mn	Elapsed Time	Prestress Losses					TOTAL
		TH + RE	ES	SH + CR	RE		
----	(Days)	(psi)	(psi)	(psi)	(psi)	(psi)	
12/02/1998 14:30	12	9,340	13,606	11,479	1,176	35,600	
12/08/1998 11:00	18	9,340	13,606	11,635	1,218	35,799	
12/15/1998 11:50	25	9,340	13,606	13,335	1,254	37,535	
12/22/1998 11:15	32	9,340	13,606	12,814	1,277	37,037	
12/29/1998 12:14	39	9,340	13,606	13,076	1,297	37,319	
01/26/1999 13:50	67	9,340	13,606	13,626	1,350	37,922	
02/22/1999 13:00	94	9,340	13,606	15,418	1,382	39,746	
03/23/1999 14:40	123	9,340	13,606	14,754	1,405	39,104	
04/27/1999 10:25	158	9,340	13,606	15,252	1,426	39,624	
05/25/1999 09:30	186	9,340	13,606	16,113	1,440	40,499	
06/24/1999 10:10	216	9,340	13,606	16,055	1,451	40,452	
07/27/1999 09:30	249	9,340	13,606	16,526	1,463	40,935	
08/18/1999 09:00	271	9,340	13,606	16,495	1,469	40,910	
08/30/1999 13:20	283	9,340	13,606	16,490	1,472	40,908	
09/17/1999 08:10	301	9,340	13,606	16,774	1,477	41,196	
09/18/1999 02:45	302	9,340	13,606	16,732	1,477	41,155	
09/19/1999 10:00	303	9,340	13,606	16,732	1,477	41,155	
09/23/1999 11:15	307	9,340	13,606	17,363	1,478	41,787	
09/30/1999 10:45	314	9,340	13,606	18,005	1,480	42,431	
10/10/1999 09:30	324	9,340	13,606	17,331	1,482	41,759	
10/14/1999 10:25	328	9,340	13,606	17,582	1,483	42,010	
10/28/1999 13:50	342	9,340	13,606	16,785	1,486	41,216	
11/18/1999 10:30	363	9,340	13,606	18,096	1,490	42,532	
12/28/1999 10:35	403	9,340	13,606	18,440	1,497	42,883	
02/01/2000 11:35	438	9,340	13,606	18,342	1,502	42,790	
05/02/2000 10:30	529	9,340	13,606	18,162	1,514	42,622	
08/12/2000 11:15	631	9,340	13,606	16,949	1,526	41,420	
11/15/2001 10:05	1,091	9,340	13,606	18,313	1,565	42,824	
10/26/2005 09:30	2,532	9,340	13,606	19,840	1,619	44,404	
04/06/2010 10:00	4,155	9,340	13,606	18,745	1,646	43,337	

**Table 4
Girder 3B prestress losses**

<u>Prestressing Steel Properties:</u>							
Initial Force in Strand (lb) : 30,980		f_{pi} (psi) = 202,484					
Strand Area (in. ²) : 0.153		f_{py} (psi) = 270,000					
<u>Prestress Losses Prior to Casting (from Prestressing Force Calculations):</u>							
Thermal + Steel Relaxation Losses (psi) = 9,340							
<u>Prestress Losses Immediately After Strand Release (11/20/1998 07:40):</u>							
Elastic Shortening (psi) = 15,374							
<u>Time-Dependent Prestress Losses After Strand Release:</u>							
CR+SH (psi) measured from vibrating wire strain gages.							
$RE \text{ (psi)} = \Delta RE + RE = \left(\frac{f_p}{f_{py}} \right) \left(\frac{\text{Log}(t_2) - \text{Log}(t_1)}{45} \right) \left(\frac{f_{pi}}{f_{py}} - 0.55 \right) + RE$							
Date:Hr:Mn	Elapsed Time (Days)	Prestress Losses					TOTAL (psi)
		TH + RE (psi)	ES (psi)	SH + CR (psi)	RE (psi)		
11/20/1998 07:29	0	9,340	0	0	0	9,340	
11/20/1998 07:30	0	9,340	3	0	0	9,343	
11/20/1998 07:31	0	9,340	489	0	0	9,828	
11/20/1998 07:32	0	9,340	1,021	0	0	10,360	
11/20/1998 07:33	0	9,340	1,930	0	0	11,270	
11/20/1998 07:34	0	9,340	3,009	0	0	12,349	
11/20/1998 07:35	0	9,340	4,349	0	0	13,689	
11/20/1998 07:36	0	9,340	5,833	0	0	15,173	
11/20/1998 07:37	0	9,340	7,654	0	0	16,994	
11/20/1998 07:38	0	9,340	10,098	0	0	19,438	
11/20/1998 07:39	0	9,340	13,202	0	0	22,542	
11/20/1998 07:40	0	9,340	15,374	0	0	24,714	
11/20/1998 07:41	0	9,340	15,374	0	16	24,730	
11/20/1998 07:42	0	9,340	15,374	285	31	25,030	
11/20/1998 07:43	0	9,340	15,374	388	45	25,146	
11/20/1998 07:44	0	9,340	15,374	547	57	25,318	
11/20/1998 07:45	0	9,340	15,374	616	69	25,399	
11/20/1998 07:46	0	9,340	15,374	674	80	25,468	
11/20/1998 07:47	0	9,340	15,374	735	90	25,539	
11/20/1998 07:48	0	9,340	15,374	786	100	25,600	
11/20/1998 07:49	0	9,340	15,374	828	109	25,651	
11/20/1998 07:50	0	9,340	15,374	879	118	25,711	
11/20/1998 08:00	0	9,340	15,374	1,285	188	26,186	
11/20/1998 08:15	0	9,340	15,374	1,882	257	26,853	
11/20/1998 16:20	0	9,340	15,374	8,182	673	33,569	
11/21/1998 08:30	1	9,340	15,374	11,393	801	36,909	
11/22/1998 11:30	2	9,340	15,374	11,885	875	37,474	
11/23/1998 14:00	3	9,340	15,374	11,925	915	37,554	
11/24/1998 10:45	4	9,340	15,374	12,488	938	38,140	
11/25/1998 08:25	5	9,340	15,374	12,962	957	38,632	
12/02/1998 14:30	12	9,340	15,374	14,131	1,037	39,882	
12/08/1998 11:00	18	9,340	15,374	14,407	1,069	40,190	
12/15/1998 11:50	25	9,340	15,374	16,223	1,095	42,032	

**Table 5
Girder 3B prestress losses (cont'd)**

Prestressing Steel Properties:

Initial Force in Strand (lb) : 30,980 f_{pi} (psi) = 202,484
 Strand Area (in.²) : 0.153 f_{py} (psi) = 270,000

Prestress Losses Prior to Casting (from Prestressing Force Calculations):

Thermal + Steel Relaxation Losses (psi) = 9,340

Prestress Losses Immediately After Strand Release (11/20/1998 07:40):

Elastic Shortening (psi) = 15,374

Time-Dependent Prestress Losses After Strand Release:

CR+SH (psi) measured from vibrating wire strain gages.

$$RE \text{ (psi)} = \Delta RE + RE = \left(f_{pt} \left(\frac{\text{Log}(t_2) - \text{Log}(t_1)}{45} \right) \right) \left(\frac{f_{pt}}{f_{pv}} - 0.55 \right) + RE$$

Date:Hr:Mn	Elapsed Time (Days)	Prestress Losses				
		TH + RE (psi)	ES (psi)	CR + SH (psi)	RE (psi)	TOTAL (psi)
12/22/1998 11:15	32	9,340	15,374	15,726	1,112	41,552
12/29/1998 12:14	39	9,340	15,374	15,940	1,126	41,780
01/26/1999 13:50	67	9,340	15,374	16,502	1,164	42,379
02/22/1999 13:00	94	9,340	15,374	18,310	1,186	44,210
03/23/1999 14:40	123	9,340	15,374	17,690	1,201	43,604
04/27/1999 10:25	158	9,340	15,374	18,342	1,216	44,271
05/25/1999 09:30	186	9,340	15,374	19,243	1,224	45,182
06/24/1999 10:10	216	9,340	15,374	19,232	1,232	45,178
07/27/1999 09:30	249	9,340	15,374	19,901	1,239	45,854
08/18/1999 09:00	271	9,340	15,374	19,872	1,243	45,829
08/30/1999 13:20	283	9,340	15,374	20,073	1,245	46,032
09/17/1999 08:10	301	9,340	15,374	20,376	1,247	46,337
09/18/1999 02:45	302	9,340	15,374	20,331	1,248	46,293
09/19/1999 10:00	303	9,340	15,374	20,331	1,248	46,293
09/23/1999 11:15	307	9,340	15,374	21,337	1,248	47,299
09/30/1999 10:45	314	9,340	15,374	21,687	1,249	47,650
10/10/1999 09:30	324	9,340	15,374	21,054	1,250	47,018
10/14/1999 10:25	328	9,340	15,374	21,262	1,251	47,226
10/28/1999 13:50	342	9,340	15,374	20,986	1,252	46,952
11/18/1999 10:30	363	9,340	15,374	22,344	1,255	48,313
12/28/1999 10:35	403	9,340	15,374	22,675	1,258	48,647
02/01/2000 11:35	438	9,340	15,374	22,556	1,260	48,530
05/02/2000 10:30	529	9,340	15,374	22,126	1,266	48,106
08/12/2000 11:15	631	9,340	15,374	21,157	1,272	47,143
11/15/2001 10:05	1,091	9,340	15,374	22,385	1,293	48,392
10/26/2005 09:30	2,532	9,340	15,374	23,821	1,318	49,853
04/06/2010 10:00	4,155	9,340	15,374	22,676	1,330	48,719

Table 6
Girder 3C prestress losses

<u>Prestressing Steel Properties:</u>						
Initial Force in Strand (lb) : 30,980		f_{pi} (psi) = 202,484				
Strand Area (in. ²) : 0.153		f_{py} (psi) = 270,000				
<u>Prestress Losses Prior to Casting (from Prestressing Force Calculations):</u>						
Thermal + Steel Relaxation Losses (psi) = 9,340						
<u>Prestress Losses Immediately After Strand Release (11/20/1998 07:40):</u>						
Elastic Shortening (psi) = 13,880						
<u>Time-Dependent Prestress Losses After Strand Release:</u>						
CR+SH (psi) measured from vibrating wire strain gages.						
$RE \text{ (psi)} = \Delta RE + RE = (f_{p,t}) \left(\frac{\text{Log}(t_2) - \text{Log}(t_1)}{45} \right) \left(\frac{f_{p,t}}{f_{py}} - 0.55 \right) + RE$						
		Prestress Losses				
Date:Hr:Mn	Elapsed Time	TH + RE	ES	SH + CR	RE	TOTAL
----	(Days)	(psi)	(psi)	(psi)	(psi)	(psi)
11/20/1998 07:29	0	9,340	0	0	0	9,340
11/20/1998 07:30	0	9,340	17	0	0	9,357
11/20/1998 07:31	0	9,340	30	0	0	9,370
11/20/1998 07:32	0	9,340	887	0	0	10,227
11/20/1998 07:33	0	9,340	1,832	0	0	11,172
11/20/1998 07:34	0	9,340	2,759	0	0	12,099
11/20/1998 07:35	0	9,340	3,779	0	0	13,119
11/20/1998 07:36	0	9,340	4,424	0	0	13,764
11/20/1998 07:37	0	9,340	6,783	0	0	16,123
11/20/1998 07:38	0	9,340	8,855	0	0	18,195
11/20/1998 07:39	0	9,340	12,397	0	0	21,737
11/20/1998 07:40	0	9,340	13,880	0	0	23,219
11/20/1998 07:41	0	9,340	13,880	98	17	23,335
11/20/1998 07:42	0	9,340	13,880	193	33	23,445
11/20/1998 07:43	0	9,340	13,880	272	47	23,539
11/20/1998 07:44	0	9,340	13,880	322	61	23,602
11/20/1998 07:45	0	9,340	13,880	377	73	23,670
11/20/1998 07:46	0	9,340	13,880	422	85	23,727
11/20/1998 07:47	0	9,340	13,880	485	96	23,800
11/20/1998 07:48	0	9,340	13,880	525	107	23,851
11/20/1998 07:49	0	9,340	13,880	557	116	23,893
11/20/1998 07:50	0	9,340	13,880	600	126	23,945
11/20/1998 08:00	0	9,340	13,880	1,010	200	24,430
11/20/1998 08:15	0	9,340	13,880	1,269	275	24,763
11/20/1998 16:20	0	9,340	13,880	7,008	729	30,956
11/21/1998 08:30	1	9,340	13,880	9,808	875	33,903
11/22/1998 11:30	2	9,340	13,880	9,975	964	34,159
11/23/1998 14:00	3	9,340	13,880	9,873	1,013	34,105
11/24/1998 10:45	4	9,340	13,880	10,264	1,041	34,524
11/25/1998 08:25	5	9,340	13,880	10,662	1,064	34,946
12/02/1998 14:30	12	9,340	13,880	11,472	1,166	35,857
12/08/1998 11:00	18	9,340	13,880	11,534	1,208	35,961
12/15/1998 11:50	25	9,340	13,880	13,220	1,243	37,683

Table 7
Girder 3C prestress losses (cont'd)

Prestressing Steel Properties:

Initial Force in Strand (lb) : 30,980 f_{pi} (psi) = 202,484
 Strand Area (in.²) : 0.153 f_{py} (psi) = 270,000

Prestress Losses Prior to Casting (from Prestressing Force Calculations):

Thermal + Steel Relaxation Losses (psi) = 9,340

Prestress Losses Immediately After Strand Release (11/20/1998 07:40):

Elastic Shortening (psi) = 13,880

Time-Dependent Prestress Losses After Strand Release:

CR+SH (psi) measured from vibrating wire strain gages.

$$RE \text{ (psi)} = \Delta RE + RE = (f_{p_i}) \left(\frac{\text{Log}(t_2) - \text{Log}(t_1)}{45} \right) \left(\frac{f_{p_i}}{f_{py}} - 0.55 \right) + RE$$

Date:Hr:Mn	Elapsed Time (Days)	Prestress Losses				TOTAL (psi)
		TH + RE (psi)	ES (psi)	SH + CR (psi)	RE (psi)	
12/22/1998 11:15	32	9,340	13,880	12,712	1,267	37,198
12/29/1998 12:14	39	9,340	13,880	12,993	1,286	37,498
01/26/1999 13:50	67	9,340	13,880	13,740	1,339	38,298
02/22/1999 13:00	94	9,340	13,880	15,450	1,370	40,040
03/23/1999 14:40	123	9,340	13,880	14,862	1,392	39,473
04/27/1999 10:25	158	9,340	13,880	15,121	1,413	39,753
05/25/1999 09:30	186	9,340	13,880	15,934	1,426	40,579
06/24/1999 10:10	216	9,340	13,880	15,790	1,438	40,447
07/27/1999 09:30	249	9,340	13,880	16,278	1,449	40,946
08/18/1999 09:00	271	9,340	13,880	16,270	1,455	40,945
08/30/1999 13:20	283	9,340	13,880	16,414	1,458	41,092
09/17/1999 08:10	301	9,340	13,880	16,644	1,463	41,326
09/18/1999 02:45	302	9,340	13,880	16,599	1,463	41,282
09/19/1999 10:00	303	9,340	13,880	16,599	1,463	41,282
09/23/1999 11:15	307	9,340	13,880	17,686	1,464	42,370
09/30/1999 10:45	314	9,340	13,880	18,024	1,466	42,709
10/10/1999 09:30	324	9,340	13,880	17,433	1,468	42,120
10/14/1999 10:25	328	9,340	13,880	17,639	1,469	42,327
10/28/1999 13:50	342	9,340	13,880	17,620	1,472	42,311
11/18/1999 10:30	363	9,340	13,880	18,888	1,476	43,583
12/28/1999 10:35	403	9,340	13,880	19,203	1,482	43,904
02/01/2000 11:35	438	9,340	13,880	19,082	1,487	43,788
05/02/2000 10:30	529	9,340	13,880	18,824	1,497	43,541
08/12/2000 11:15	631	9,340	13,880	17,746	1,508	42,473
11/15/2001 10:05	1,091	9,340	13,880	19,102	1,544	43,865
10/26/2005 09:30	2,532	9,340	13,880	20,674	1,592	45,485
04/06/2010 10:00	4,155	9,340	13,880	19,491	1,616	44,326

Table 8
Girder 3D prestress losses

Prestressing Steel Properties:

Initial Force in Strand (lb) : 30,980 f_{pi} (psi) = 202,484
 Strand Area (in.²) : 0.153 f_{py} (psi) = 270,000

Prestress Losses Prior to Casting (from Prestressing Force Calculations):

Thermal + Steel Relaxation Losses (psi) = 9,340

Prestress Losses Immediately After Strand Release (11/20/1998 07:40):

Elastic Shortening (psi) = 14,469

Time-Dependent Prestress Losses After Strand Release:

CR+SH (psi) measured from vibrating wire strain gages.

$$RE \text{ (psi)} = \Delta RE + RE = (f_p)_t \left(\frac{\text{Log}(t_2) - \text{Log}(t_1)}{45} \right) \left(\frac{(f_p)_t}{f_{py}} - 0.55 \right) + RE$$

Date:Hr:Mn	Elapsed Time (Days)	Prestress Losses				TOTAL (psi)
		TH + RE (psi)	ES (psi)	SH + CR (psi)	RE (psi)	
11/20/1998 07:29	0	9,340	0	0	0	9,340
11/20/1998 07:30	0	9,340	79	0	0	9,419
11/20/1998 07:31	0	9,340	472	0	0	9,812
11/20/1998 07:32	0	9,340	923	0	0	10,263
11/20/1998 07:33	0	9,340	1,971	0	0	11,311
11/20/1998 07:34	0	9,340	3,100	0	0	12,440
11/20/1998 07:35	0	9,340	4,347	0	0	13,686
11/20/1998 07:36	0	9,340	5,110	0	0	14,449
11/20/1998 07:37	0	9,340	7,819	0	0	17,158
11/20/1998 07:38	0	9,340	10,195	0	0	19,535
11/20/1998 07:39	0	9,340	13,304	0	0	22,644
11/20/1998 07:40	0	9,340	14,469	0	0	23,809
11/20/1998 07:41	0	9,340	14,469	111	17	23,936
11/20/1998 07:42	0	9,340	14,469	182	32	24,022
11/20/1998 07:43	0	9,340	14,469	264	46	24,119
11/20/1998 07:44	0	9,340	14,469	315	59	24,183
11/20/1998 07:45	0	9,340	14,469	373	72	24,253
11/20/1998 07:46	0	9,340	14,469	416	83	24,308
11/20/1998 07:47	0	9,340	14,469	461	94	24,364
11/20/1998 07:48	0	9,340	14,469	478	104	24,390
11/20/1998 07:49	0	9,340	14,469	537	114	24,459
11/20/1998 07:50	0	9,340	14,469	560	123	24,491
11/20/1998 08:00	0	9,340	14,469	1,081	196	25,086
11/20/1998 08:15	0	9,340	14,469	1,418	268	25,495
11/20/1998 16:20	0	9,340	14,469	6,716	709	31,234
11/21/1998 08:30	1	9,340	14,469	9,709	854	34,372
11/22/1998 11:30	2	9,340	14,469	10,044	940	34,793
11/23/1998 14:00	3	9,340	14,469	9,994	988	34,790
11/24/1998 10:45	4	9,340	14,469	10,499	1,015	35,322
11/25/1998 08:25	5	9,340	14,469	10,929	1,037	35,774
12/02/1998 14:30	12	9,340	14,469	11,864	1,133	36,806
12/08/1998 11:00	18	9,340	14,469	12,070	1,173	37,052
12/15/1998 11:50	25	9,340	14,469	13,674	1,206	38,689

Table 9
Girder 3D prestress losses (cont'd)

Prestressing Steel Properties:

Initial Force in Strand (lb) : 30,980 f_{pi} (psi) = 202,484
Strand Area (in.²) : 0.153 f_{py} (psi) = 270,000

Prestress Losses Prior to Casting (from Prestressing Force Calculations):

Thermal + Steel Relaxation Losses (psi) = 9,340

Prestress Losses Immediately After Strand Release (11/20/1998 07:40):

Elastic Shortening (psi) = 14,469

Time-Dependent Prestress Losses After Strand Release:

CR+SH (psi) measured from vibrating wire strain gages.

$$RE \text{ (psi)} = \Delta RE + RE = \left(f_{p,t} \left(\frac{\text{Log}(t_2) - \text{Log}(t_1)}{45} \right) \right) \left(\frac{f_{p,t}}{f_{py}} - 0.55 \right) + RE$$

Date:Hr:Mn	Elapsed Time (Days)	Prestress Losses				TOTAL (psi)
		TH + RE (psi)	ES (psi)	SH + CR (psi)	RE (psi)	
---	---	---	---	---	---	---
12/22/1998 11:15	32	9,340	14,469	13,240	1,228	38,276
12/29/1998 12:14	39	9,340	14,469	13,419	1,246	38,474
01/26/1999 13:50	67	9,340	14,469	13,883	1,295	38,987
02/22/1999 13:00	94	9,340	14,469	15,791	1,325	40,924
03/23/1999 14:40	123	9,340	14,469	14,951	1,345	40,105
04/27/1999 10:25	158	9,340	14,469	15,452	1,365	40,626
05/25/1999 09:30	186	9,340	14,469	16,340	1,377	41,526
06/24/1999 10:10	216	9,340	14,469	16,271	1,388	41,468
07/27/1999 09:30	249	9,340	14,469	16,839	1,398	42,046
08/18/1999 09:00	271	9,340	14,469	16,821	1,404	42,034
08/30/1999 13:20	283	9,340	14,469	17,037	1,407	42,253
09/17/1999 08:10	301	9,340	14,469	17,270	1,411	42,490
09/18/1999 02:45	302	9,340	14,469	17,303	1,411	42,523
09/19/1999 10:00	303	9,340	14,469	17,303	1,412	42,523
09/23/1999 11:15	307	9,340	14,469	18,394	1,413	43,615
09/30/1999 10:45	314	9,340	14,469	18,687	1,414	43,910
10/10/1999 09:30	324	9,340	14,469	18,165	1,416	43,389
10/14/1999 10:25	328	9,340	14,469	18,267	1,416	43,492
10/28/1999 13:50	342	9,340	14,469	18,248	1,419	43,476
11/18/1999 10:30	363	9,340	14,469	19,511	1,423	44,742
12/28/1999 10:35	403	9,340	14,469	19,936	1,428	45,173
02/01/2000 11:35	438	9,340	14,469	19,858	1,432	45,099
05/02/2000 10:30	529	9,340	14,469	19,439	1,442	44,689
08/12/2000 11:15	631	9,340	14,469	18,537	1,451	43,797
11/15/2001 10:05	1,091	9,340	14,469	19,831	1,482	45,122
10/26/2005 09:30	2,532	9,340	14,469	21,395	1,524	46,728
04/06/2010 10:00	4,155	9,340	14,469	20,236	1,544	45,589

APPENDIX C

Camber/Deflection in Instrumented Girders

Table 10
Girder camber and deflection measurements

Date	Elapsed Time (Days)	Temp. (° F)	Girder Deflections (in.)					Notes
			Girder 3A	Girder 3B	Girder 3C	Girder 3D	Average	
11/20/1998 06:30	0	64.0	0.00	0.00	0.00	0.00	0.00	
11/20/1998 07:50	0	-----	1.06	0.97	1.06	0.89	1.00	
11/20/1998 10:00	0	-----	1.34	1.42	1.05	0.88	1.17	
11/20/1998 10:55	0	77.5	1.47	1.59	1.42	1.41	1.47	
11/21/1998 09:15	1	55.0	1.66	1.69	1.55	1.53	1.61	
11/22/1998 11:50	2	69.0	1.80	1.94	1.81	1.75	1.82	
11/23/1998 09:00	3	-----	1.75	1.89	1.72	1.66	1.75	
11/24/1998 11:10	4	73.0	1.78	2.00	1.80	1.78	1.84	
11/25/1998 08:40	5	64.0	1.81	1.94	1.67	1.63	1.76	
12/02/1998 15:00	12	71.0	1.91	1.94	1.80	1.81	1.86	
12/08/1998 11:20	18	82.0	1.94	2.09	1.92	1.88	1.96	
12/15/1998 11:20	25	62.0	1.94	2.13	1.89	1.84	1.95	
12/22/1998 10:15	32	50.0	1.91	2.00	1.83	1.78	1.88	
12/29/1998 12:14	39	57.0	1.97	2.09	1.86	1.81	1.93	
01/26/1999 13:25	67	76.0	2.09	2.25	1.98	1.88	2.05	
02/22/1999 13:45	94	50.0	2.25	2.34	2.23	2.13	2.24	
03/23/1999 14:15	123	72.0	2.34	2.47	2.30	2.16	2.32	
04/27/1999 10:45	158	82.0	2.25	2.38	2.08	2.09	2.20	
05/25/1999 10:10	186	85.0	2.38	2.56	2.30	2.28	2.38	
06/24/1999 10:55	216	86.0	2.38	2.56	2.36	2.34	2.41	
07/27/1999 09:55	249	85.0	2.50	2.63	2.33	2.31	2.44	
08/18/1999 09:45	271	86.0	2.44	2.66	2.30	2.22	2.40	
08/30/1999 12:55	283	99.0	2.50	2.53	2.39	2.34	2.44	
09/10/1999 08:10	294	82.0	2.16	2.34	2.08	2.06	2.16	
09/17/1999 09:15	301	73.0	2.22	2.44	2.17	2.38	2.30	
09/18/1999 02:30	302	64.0	2.19	2.53	2.17	2.31	2.30	
09/19/1999 10:40	303	87.0	1.50	1.78	1.64	1.53	1.61	
09/23/1999 11:45	307	78.0	1.53	1.84	1.55	1.63	1.64	
09/30/1999 11:40	314	71.0	1.47	1.81	1.45	1.56	1.57	
10/10/1999 10:05	324	75.0	1.47	1.72	1.52	1.59	1.57	1
10/14/1999 11:00	328	82.0	1.53	1.81	1.55	1.75	1.66	1
10/28/1999 14:55	342	84.0	1.50	1.72	1.52	1.59	1.58	2
11/18/1999 11:00	363	72.0	1.53	1.81	1.45	1.53	1.58	
12/28/1999 11:20	403	52.0	1.50	1.72	1.61	1.59	1.61	
02/01/2000 12:15	438	56.0	1.44	1.75	1.48	1.59	1.57	
05/02/2000 11:00	529	77.0	1.38	1.75	1.52	1.56	1.55	
08/12/2000 11:30	631	90.0	1.50	1.78	1.48	1.56	1.58	
11/15/2001 11:00	1,091	70.0	1.47	1.78	1.52	1.56	1.58	
10/26/2005 10:15	2,532	----	1.41	1.76	1.40	1.66	1.56	3,4
04/06/2010 10:00	4,155	68.0	1.53	1.81	1.55	1.59	1.62	

Notes:

1. Metal work basket placed above Girder 3A approximately mid-way between the west end bolt and the mid-span bolt (see picture for details of basket).
2. Middle of deck covered with sand for entire length of bridge (see picture for details).
3. Readings were taken in feet.
4. Level rod was placed on top of recessed hole with bolt. No recalibration was done to account for the recessed depth of the reference bolt below the level of the slab.