

# Best Practices in Guidance for Workforce Transition and Succession Planning

Teresa Adams and Ernie Wittwer  
University of Wisconsin, Madison

WisDOT 0092-10-15, CFIRE 04-03  
May 2011



**WISCONSIN DOT**  
Wisconsin Department of Transportation Research & Library Unit



**CFIRE**  
National Center for Freight & Infrastructure Research & Education  
Wisconsin Transportation Center  
University of Wisconsin, Madison



# Best Practices in Guidance for Workforce Transition and Succession Planning

**CFIRE 04-03**  
April 2011

National Center for Freight & Infrastructure Research & Education  
Department of Civil and Environmental Engineering  
College of Engineering  
University of Wisconsin–Madison

**Authors:**

Ernie Wittwer  
National Center for Freight & Infrastructure Research & Education  
University of Wisconsin–Madison

**Principal Investigator:**

Teresa Adams, PhD  
National Center for Freight & Infrastructure Research & Education  
University of Wisconsin–Madison



# Technical Report Documentation

1. Report No. <b>CFIRE 04-03</b>	2. Government Accession No.	3. Recipient's Catalog No. <b>CFDA 20.701</b>	
4. Title and Subtitle Best Practices in Guidance for Workforce Transition and Succession Planning		5. Report Date <b>April 2011</b>	
		6. Performing Organization Code	
7. Author/s Ernie Witter and Teresa Adams		8. Performing Organization Report No. <b>CFIRE 04-03</b>	
9. Performing Organization Name and Address National Center for Freight and Infrastructure Research and Education (CFIRE) University of Wisconsin-Madison 1415 Engineering Drive, 2205 EH Madison, WI 53706		10. Work Unit No. (TRAIS)	
		11. Contract or Grant No. <b>0092-10-15</b>	
12. Sponsoring Organization Name and Address Wisconsin Department of Transportation 4802 Sheboygan Avenue P.O. Box 7999 Madison, WI 53707-799		13. Type of Report and Period Covered <b>Final Report [4/6/2010 – 4/30/2011]</b>	
		14. Sponsoring Agency Code	
15. Supplementary Notes Project completed by CFIRE with support from the Wisconsin Department of Transportation			
16. Abstract Public sector transportation agencies and the contractors who help them do their work will have a major challenge in meeting their workforce needs for the foreseeable future. By some estimates, the aging of the baby boom generation could allow up to fifty percent of the total workforce to retire within the next ten years. Overall demographic issues and stagnant enrollments in science and math professional programs, traditionally the major sources of new hires into the transportation industry, will make finding adequate qualified recruits difficult. This project deals with strategies for transition planning—in particular, strategies for transition planning in a specialist organization such as the Wisconsin Department of Transportation's Rail and Harbor Section			
17. Key Words Workforce, transition, succession, education, knowledge management	18. Distribution Statement <b>No restrictions. This report is available through the Transportation Research Information Services of the National Transportation Library.</b>		
19. Security Classification (of this report) <b>Unclassified</b>	20. Security Classification (of this page) <b>Unclassified</b>	21. No. of Pages <b>38</b>	22. Price <b>-0-</b>

**Form DOT F 1700.7 (8-72) Reproduction of form and completed page is authorized.**

## DISCLAIMER

This research was funded by the Wisconsin Department of Transportation. The contents of this report reflect the views of the authors, who are responsible for the facts and the accuracy of the information presented herein. This document is disseminated under the sponsorship of the Wisconsin Department of Transportation Policy Research Program, in the interest of information exchange. The Department assumes no liability for the contents or use thereof. The contents do not necessarily reflect the official views of the National Center for Freight and Infrastructure Research and Education, the University of Wisconsin, the Wisconsin Department of Transportation, or the US DOT RITA at the time of publication.

The Department assumes no liability for its contents or use thereof. This report does not constitute a standard, specification, or regulation.

The Department does not endorse products or manufacturers. Trade and manufacturers names appear in this report only because they are considered essential to the object of the document.

## Table of Contents

Technical Report Documentation .....	3
Table of Contents .....	5
Evaluation .....	6
Introduction .....	6
Workshop Survey Responses .....	6
Interviews .....	8
Looking to the Future .....	13
Appendix A: WisDOT Guide for Knowledge Management.....	14

## Table of Figures

Figure 1: How Relevant was the Material? .....	6
Figure 2: Was the Material Valuable? .....	7
Figure 3: Which Tools are Feasible? .....	8

# Evaluation

## Introduction

The University of Wisconsin produced the *WisDOT Guide for Knowledge Management* (see Appendix A) for the Wisconsin Department of Transportation (WisDOT) based on its review of the needs of the Rail and Harbor Section. This guide was intended to meet some of the immediate needs of the Section as well as offering ideas for the department as a whole. To meet the needs of the larger department, a workshop was held in November 2010. A range of managers attended from all divisions within the department.

To evaluate the utility of the tools described in the guide book, two steps were taken: 1) at the close of the workshop for implementing the guide book held in November 2010, participants were asked to complete a short survey; and 2) those workshop participants who completed the survey and included names and contact information were interviewed six months after the workshop.

## Workshop Survey Responses

Fifteen of the thirty-five workshop participants completed the survey. All of the participants found the materials presented relevant to their jobs. Figure 1 provides the responses to that question.

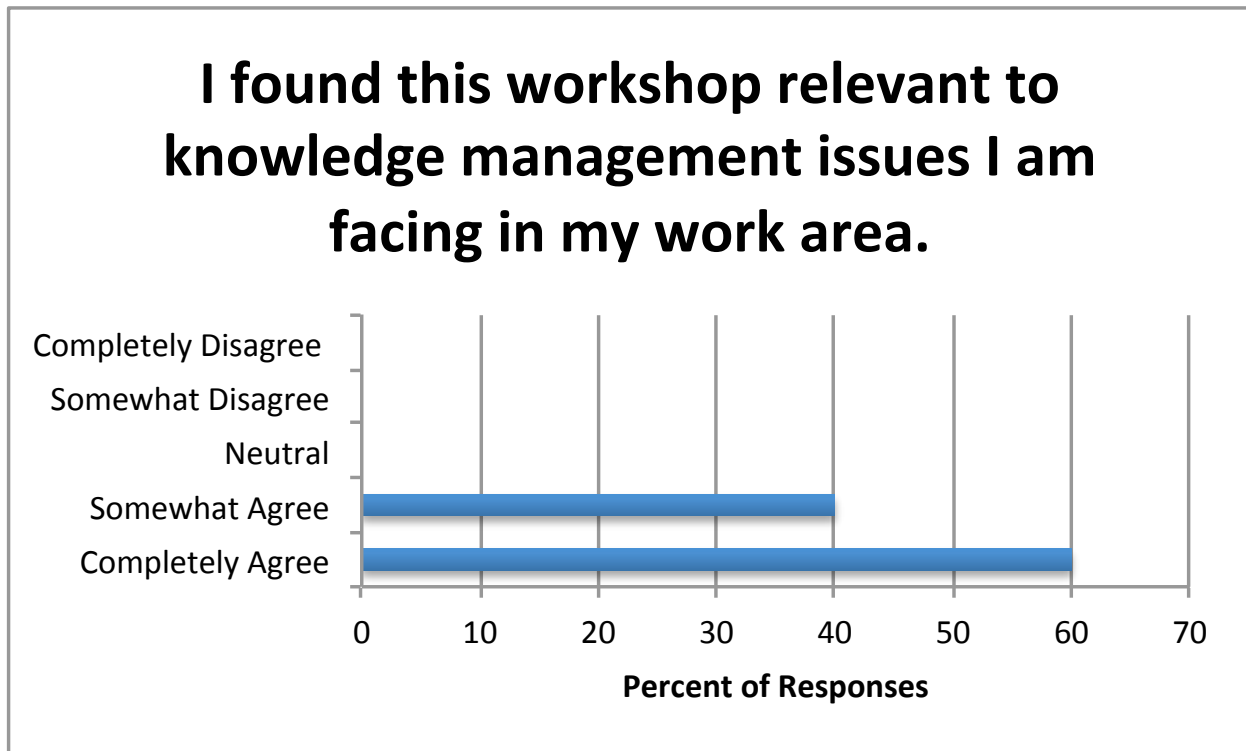

Figure 1: How Relevant was the Material?

The respondents also found the information to be valuable in addressing the knowledge management issues facing them, see Figure 2.

**I found the information presented at this workshop valuable to address knowledge management issues I am facing in my work area.**

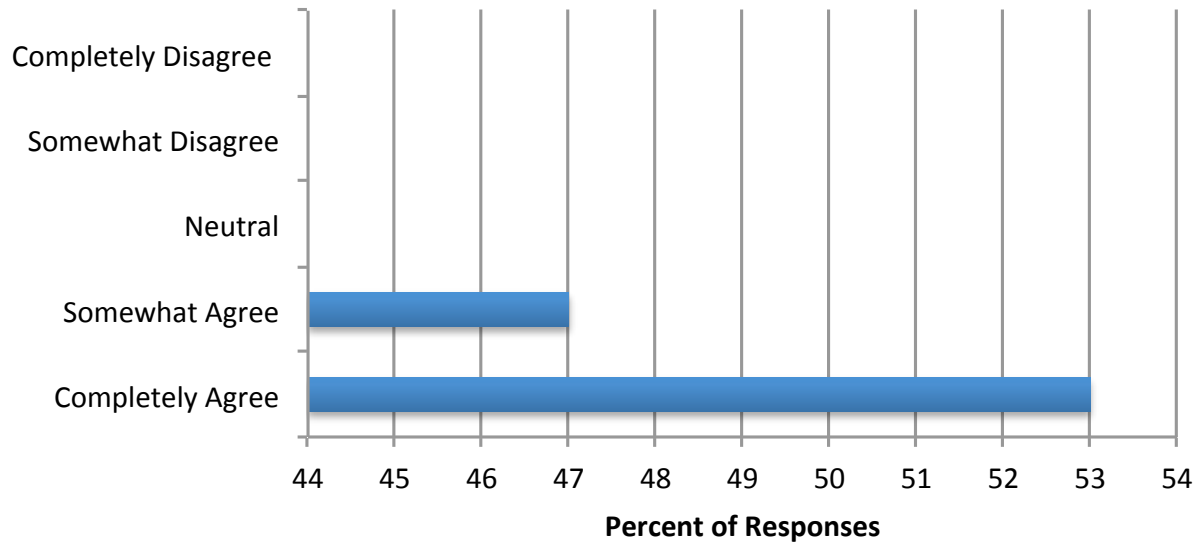

Figure 2: Was the Material Valuable?

Not all tools were considered to be equally useful or feasible. Figure 3 shows the tools that were viewed positively by respondents. All respondents agreed that mentoring and coaching and on-the-job training are feasible. Most agreed that process documentation, cross training, expert interviews, and leadership programs are feasible. The feasibility of videotaping, storytelling, share fairs, and war stories was questioned by most, but at least thirty percent of the respondents viewed these tools favorably.



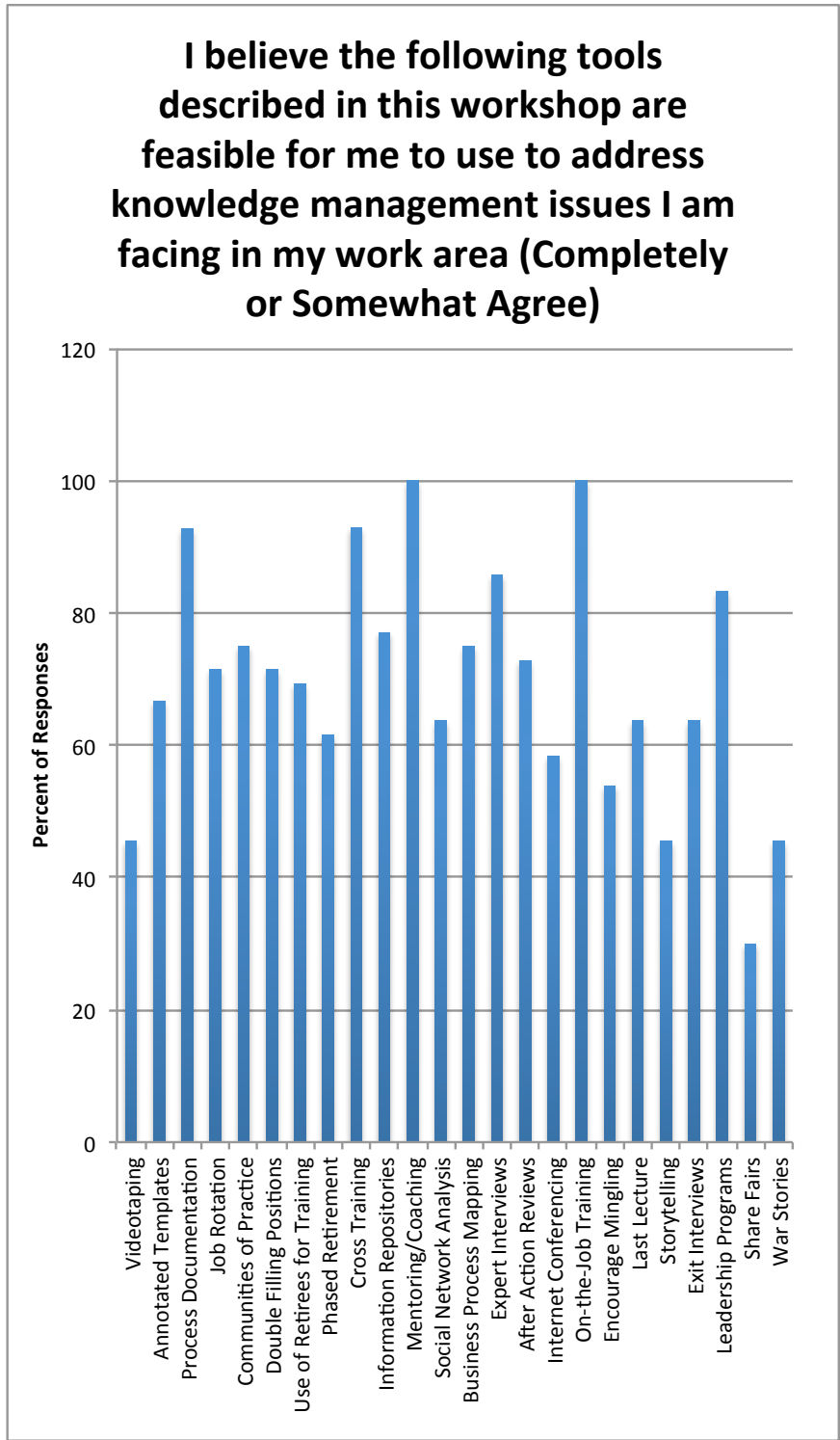

Figure 3: Which Tools are Feasible?

**Interviews**

Ten of the fifteen participants in the workshop who completed the survey also provided their contact information. Those ten people were interviewed about six months after the workshop on how their organizations were using the knowledge management tools. All five of the operating divisions of the department were represented in this sample. A number of knowledge management

tools were found in all divisions. Some were triggered by the workshop; some were refined as a result of the workshop; others have been in place for many years.

The tools in use within the agency include:

- Information repositories
- Process documentation
- Retirees for training
- Double-filling positions
- Cross-training
- On-the-job training
- Peer groups

Information repositories take three basic forms in the department. In the Division of Motor Vehicles (DMV) and the Wisconsin State Patrol (DSP), central office program managers communicate with people in the field through regular emails and conference calls. These communications typically deal with information on current or emerging topics. The emails are stored on a server and indexed so they can be retrieved by either topic or date. These electronic files become an ongoing resource for the field people who deal with issues as they arise.

The process works so well that DMV is attempting to move existing manuals that are in PDF format to a similar server with similar retrieval options.

In Transportation System Development (DTSD) the primary knowledge repository is the Facilities Development Manual (FDM). It is really a combination of knowledge repository and process documentation. It is a knowledge repository in that it contains policies that guide the division. It is a process documentation in that it also contains information on processes related to project development and implementation. It is available online for all who work in the field.

In the Division of Transportation Investment Management (DTIM) staff involved in traffic forecasts have stepped up their efforts to archive forecasts as they are made. This allows them to be available for future work where they can be updated rather than begun from scratch. Ironically, the departure of some of the long-standing employees has made this effort easier. Those now-departed employees resisted archiving their work because they did not see any benefit to it.

Process documentation also has taken several forms. In DMV much of the effort has been to automate processes through development of automated systems. Many long-term employees contributed to the effort and their accumulated knowledge was to a large degree captured in those systems. The systems were developed with intelligence to deal with routine issues. This leaves staff to deal with the exceptions and the appeals. As the experienced workers retire a major concern of some managers is that the remaining staff may no longer understand the process logic within the automated systems. They may be in the position of relying on complaints from their customers as checks on the logic of automated systems. As automation increases, some DMV managers see the role of staff evolving to the point of being primarily case and contract managers, which will require a higher level of knowledge for most staffers.

The FDM has already been mentioned as an effort in process documentation. It is a fairly elaborate effort to document a wide-range of processes. At the other end of the spectrum are several more informal or ad hoc efforts. For example, one DMV section chief adapted one of the knowledge management tools to meet the specific needs of section employees. Unit supervisors in the section, all of whom are topic and process experts, have been asked to document what they do, how they do it, and with whom they interact. They do this in a matrix that reflects the business of the section. The effort is revisited regularly at staff meetings and is evolving, with new activities being added over time.

Another less formal effort took place in DTIM. Before experienced people left, an effort was made to document their work, so that others would understand what was done. While the effort provided an outline of the processes, it did not capture the judgments made by an experienced employee doing those processes. New employees lacking the judgment gained from experience have had to struggle to do the work.

One approach to capturing some of the judgment of experience is using retirees, or would-be retirees, to help train new workers. Two examples were identified. In one section of DTIM a long-time employee who managed many functions of the office retired, but was persuaded to return as a part-time limited term employee. In this capacity, she was able to help train the new person in how to do the job.

Another example comes from one of the regions in DTSD. In this case, an experienced senior engineer in construction was about to retire. As an alternative to retirement, he was offered the chance to continue working for a time as an internal “consultant” to less-experienced employees. The arrangement was so satisfactory for both the senior employee and the new people that the senior engineer deferred retirement for two years. During that time, he helped many less-experienced people acquire the skills needed to successfully supervise construction.

The formal mechanism available in civil service to use about-to-be retirees for training is double-filling positions. Ideally, this process allows as much as a year in which a retiring employee can work with a new employee to help them learn a job. In practice, it requires adequate notice from the retiring employee and authority from management—both departmental and Department of Administration (DOA) management—to use an “alpha,” or extra, position to double fill. In the climate of recent times, both conditions are rarely met. Only two official double fills were identified in the interviews. Both were in the accounting area of the Division of Business Management (DBM) and involved fairly high-profile activities: 1) billing FHWA and 2) paying contractors. In each case, long-term retiring employees provided many months of notice. In both cases, the high profile nature of the jobs, or rather of the potential failure of the jobs to be performed correctly, caused management to also provide approvals.

Several other cases were identified in which employees provided notice, but senior management would not authorize the additional temporary positions. These cases dealt with experienced lead workers, technical experts, and subject matter experts. Denial of the extra positions left supervisors to follow less formal approaches to retaining the knowledge of those retiring employees.

These informal approaches involve identifying one or more younger employees who will likely be candidates for the job if it is posted and who might be successful in that candidacy. These employees are then asked to understudy the retiring worker. In this less-than-fulltime effort, the younger employees will gain some of the knowledge of the more experienced person. If they successfully compete for the job, the transition will have been somewhat similar to a double-fill. If the position is not posted, or if the person who has understudied is not successful, the understudy will have some of the knowledge and may be an asset to the organization. They may also be asked to assist the successful candidate in the transition. While the informal approach can be questioned on several grounds, it is one of the few tools available when the double-filling option is denied.

This informal approach to understudying could also be called cross-training. In fact, several examples of cross-training were identified. One involved a structural engineer with a unique set of skills that can only be gained from experience. This engineer is beyond normal retirement age, but has given no indication of an intent to leave. In the hope of transferring some of this person’s knowledge, the manager of the area assigned a newly hired person to work with the experienced person to assist and to learn. This was possible because senior management had decided to allocate additional positions to this function. Without the flexibility of added positions, the effort to retain unique skills and knowledge could not have been made.

Another example was in DSP. A section manages two very similar grant programs with different funding sources and differing budgets. The manager asked the two program managers to work together so that they would understand both programs. Both are now able to manage either program. If one leaves, the needed knowledge will survive.

A third example is in DBM. Experienced lead workers who are the subject matter experts were asked to take the time to understand each other's work. While the effort is ongoing, it has been difficult because the workload is so heavy that little time is available for effective cross-training.

A fourth example comes from DTIM. One section has program managers and functional experts in procurement and finance. New program managers tend to rely heavily on the procurement and finance experts. As they gain experience, the program managers learn the procurement and finance functions. With time, an experienced program manager will be able to do most of the functional experts' jobs. In the same manner, the functional experts tend to acquire much knowledge of the programs as they consult with newer program managers. Therefore, the departure of either the functional expert or the program manager leaves less of a knowledge gap than it might have if the two sets of positions worked more independently.

In the same section, seasonal workload requires that program managers assist each other to get the work done. By sharing grant evaluations, field visits, and similar tasks, program managers become familiar with all programs. Again, knowledge is retained and shared in the organization.

On the job training is a very disparate activity within the department. DSP and DMV have well-structured and formal training programs, both for new employees and for continuing employees. In both cases, new employees must complete a training program when they are hired and a number of in-service training days are mandated each year. Other divisions, or unique positions even in DMV and DSP, struggle to acquire adequate training. Most training tends to be more ad hoc and informal. One manager reported that a vendor offered training for a key IT tool but at locations out of state. Because of travel restrictions people using the tool could not obtain the training; instead they learned by trial and error.

Informal may not necessarily be bad. One section within DTIM sets aside time each week for discussions among staff. All share their experiences. More experienced people help less experienced people to learn. The weekly sessions began when the bureau had a major exodus of experienced staff and the bureau director used to tactic to help bring a new staff up to speed. It has continued.

The above informal training example is a type of peer group knowledge management strategy. In fact, two other examples of the use of peer groups were identified. One was in DMV where field employees are encouraged to use their peers as a resource in dealing with unusual issues. Through email and telephone, questions can be put to a wide range of people to find out whether they have encountered an issue and how it was handled.

Counterparts in other states are also used as peer groups. While program specifics and legal requirements may vary by state, many states share similar experiences and are able to learn from those experiences. Unfortunately, travel restrictions make renewing and maintaining such peer groups difficult.

While much knowledge management activity does exist, these efforts face many barriers and obstacles. The largest of these is time. Managers reported sections at 60 percent of staffing or less. One manager noted that they once felt a rating of seven or eight out of ten in the timeliness of their services was unacceptable. Now they are relieved to achieve a five or six. Another told of the need to get projects out, which left little time for anything more.

Another major obstacle is the current morale in the department. One manager noted that to do effective knowledge management employees had to be willing to give the extra effort. Many are not willing because of what they perceive to be a lack of respect from political leaders in the state.

A related major obstacle exists in most parts of the agency. The programs and roles of many employees are changing. This raises the basic question of what the needed skills and knowledge of the future will be. Will DTSD be an engineering organization or a contract management organization? Will DMV become an organization of case and contract managers? These basic questions on roles have a profound impact on the actions that should be taken to manage knowledge effectively. Unfortunately, they can probably only be answered through a process of evolution, which will require time.

Finally, for parts of the agency issues related to the needed mix of professional skills are also obstacles. One manager noted that DTSD once used different disciplines to meet its needs. Planners did planning and engineers did engineering. In recent years the division has become engineer-centric. This focus on a single set of skills removes alternative ways of thinking and approaching issues. It also narrows the pool of potential employees. At least in the view of this manager, it is a detriment to the success of the division.

## Looking to the Future

While the examples of knowledge management found throughout the department are a reason for hope for WisDOT's continued success, a great many challenges are still on the horizon. When the evaluation was being conducted the department newsletter reported the loss of employees with a total experience exceeding 2,000 years. At the same time the Department of Employee Trust Funds, the managers of the retirement program, report inquiries from employees—from all state and local agencies—about retirement are at an all-time high. As the exodus of experienced people continues, questions about the future role of the agency, and, therefore, about the skills employees will need, make ensuring appropriate hiring decisions more difficult and make knowledge management more difficult.

To meet these challenges, the agency might consider several steps:

- Provide on-going training for all managers on the importance of knowledge management and of the tools available to pursue it. The managers interviewed for this project all indicated that the November 2010 workshop was useful because it gave them some ideas for simple tools that might be employed. It also caused several to consider their role as knowledge managers. Making knowledge management an annual element of in-service training would continue to provide an impetus to managers to take serious a role in knowledge management.
- Consider establishing a repository for archived last lectures and storytelling that is available to all department employees. Also consider making the production of such materials a priority for experienced and retiring employees. Such a resource would help to keep an understanding of the history and traditions of the department alive. It would help newer employees better understand why the programs exist as they do and the role they were expected to fulfill.
- Encourage each division to engage in some strategic planning activities aimed at answering lingering questions about the role of the department in 21<sup>st</sup> century Wisconsin transportation. While the results of such an engagement may not be definitive, they should help to provide some direction for those charged with hiring and training future employees.
- Provide some resources in the form of internal consultants to assist managers who want to deal with knowledge management. Such a resource would help those managers to better understand the tools and to make those tools useful within the context of their organizations. This resource might be in the form of added staff members, or it might be an added duty for an existing staff in Human Resources (HR).
- Define criteria that will assist managers in differentiating critical positions for knowledge management focus from those that are less critical. For example, most managers interviewed pointed to their concerns over experienced lead workers or those with unique technical skills or program knowledge.
- Make the importance of knowledge management clear through the statements and actions of senior management. The greatest obstacle found in this review was time. Senior management must make it clear that time is available for this critical activity.

These actions will help the department meet its workforce and knowledge challenges.

# **Appendix A: WisDOT Guide for Knowledge Management**

# WisDOT Guide For Knowledge Management

Ernie Wittwer and Teresa Adams  
National Center for Freight & Infrastructure Research & Education (CFIRE)  
University of Wisconsin-Madison

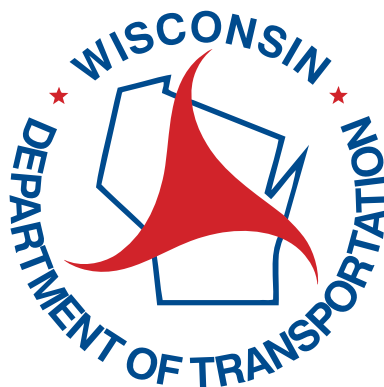





# Contents

Introduction.....	3
Types of Knowledge.....	5
Tools and Strategies.....	6
Differences in Organizations.....	9
Constraints and Barriers.....	13
Focusing on Key Knowledge, Skills, and Abilities.....	14
Implementation.....	18
References.....	24

**Figures**

Figure 1: WisDOT Employees Eligible for Retirement.....3

Figure 2: Knowledge and Time.....4

Figure 3: Sharing Tacit Knowledge.....5

Figure 4: Types of Knowledge and Appropriate Strategies.....8

Figure 5: A Traditional Organization.....9

Figure 6: A Specialist Organization.....10

Figure 7: DBM Potential Retirements .....11

Figure 8: DMV Potential Retirements .....11

Figure 9: DTIM Potential Retirements.....12

Figure 10: DTSD Central Office Potential Retirements.....12

Figure 11: Regional Office Potential Retirements .....13

Figure 12: Decision Steps.....14

Figure 13: Key Questions.....15

Figure 14: The Future.....15

Figure 15: Critical Knowledge Evaluation Form.....16

Figure 16: Selecting the Right .....17

Figure 17: Which Tool?.....17

Figure 18: Questions for Implementation.....18

Figure 19: Rail Engineering Training Outline.....20

Figure 20: Section Timeline.....21

Figure 21: Process Analysis Form.....22

**Section I  
INTRODUCTION**

The transportation industry in the US is facing a workforce challenge. Forty to fifty percent of today’s transportation workers will retire within the next ten years. Every category of worker will be affected. This exodus is happening when the annual growth rate in the workforce is at its lowest level in sixty years and when fewer people are choosing the science professions that have historically been the prime source for that workforce. WisDOT is similar to most other transportation agencies in this regard, as shown in Figure 1, below.

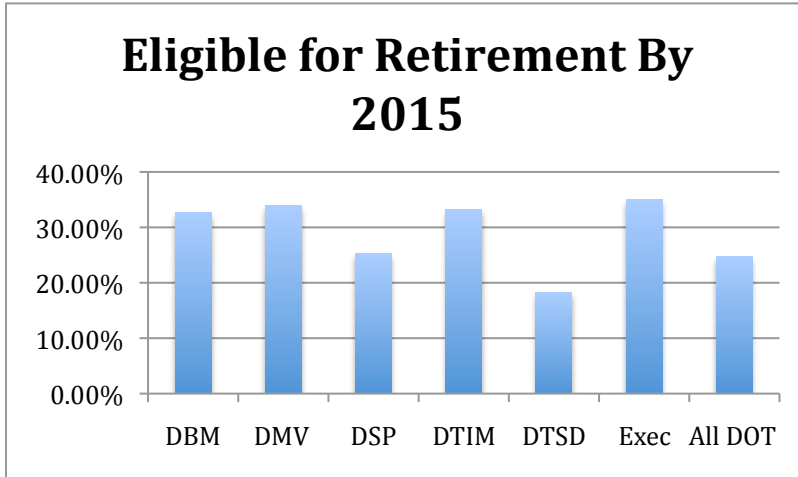

**Figure 1: WisDOT Employees Eligible for Retirement**

As workers leave, they take with them not only the productive skills for which they were originally employed, but also a breath of knowledge and information about the agency, its programs, and its methods of doing business. Preserving this knowledge for the future workforce, while recruiting, hiring, and

developing those new employees, is an issue that many agencies are now confronting.

The availability of qualified workers is one of the several challenges facing WisDOT. The need for continuous professional development as methodologies and technologies evolve presents another challenge. The agency needs strategies to ensure that new and current employees can attain full competency.

Every new recruit comes to a job with a lower level of knowledge and skill than will be required before that person can be considered to be at full competence (as illustrated in Figure 2). Consider a newly graduated engineer. When the new engineer emerges from college, one can assume that he or she knows the basics of engineering and is competent in his or her area of emphasis. For example, a civil engineer in transportation will understand the concepts of intersection traffic flow, pavement design, soil analysis, or bridge design. Such an engineer will bring these skills to the job on day one. Before that new-hire can be considered fully functional, however, he or she will have to expand these basic skills and knowledge to include the application of those concepts to the specific issues and within the specific processes, standards, and culture of the agency. Before attaining journeyman status, the recruit will probably also be required to demonstrate an ability to take leadership roles in moderately complex design and construction projects.

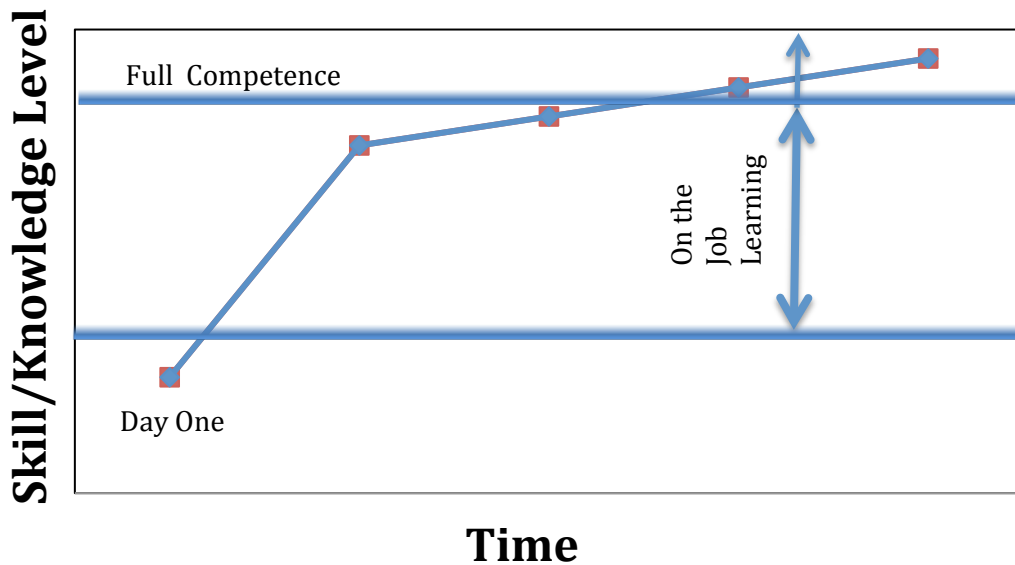

Figure 2: Knowledge and Time

All of this represents on-the-job learning. It is in WisDOT's interest to minimize the amount of learning required before full competence is attained as well as the amount of time required for that learning. One solution is to capture key information from existing staff and make it available to potential or actual new recruits in a timely manner. This is the heart of knowledge management, which NCHRP defined as:

...a trans-disciplinary approach to improving organizational outcomes and learning, through maximizing the use of knowledge. It involves the design, implementation, and review of social and technological activities and processes to improve the creating, sharing, and applying or using of knowledge.

The Federal Highway Administration has used a similar, but shorter definition: "the process of capturing and sharing a community's collective expertise to fulfill its mission."

The tools and strategies illustrated in this Guide were developed and piloted in WisDOT's Rail and Harbor Section (the Section). They can be adapted to wider application within the agency.

## Section II TYPES OF KNOWLEDGE

Knowledge is often thought of as being in two types: tacit and explicit. Tacit knowledge is the type of knowledge that all employees carry around in their heads. It may involve explicit facts or it may involve an understanding of cultural norms or people. It can be differentiated from explicit knowledge in that it has never been captured in any media that allows it to be broadly shared. Explicit knowledge is the type that has been captured on some media and can be stored, organized, and shared. Knowledge management strategies must address both types of knowledge as well as two methods for conveying tacit knowledge: directly between people and by making it explicit. Figure 3 illustrates these two avenues.

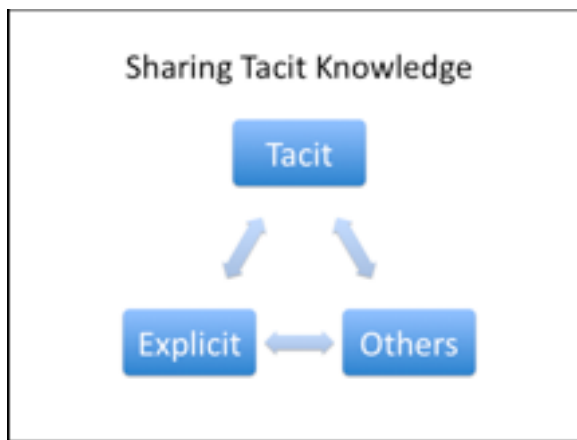

Figure 3: Sharing Tacit Knowledge

Knowledge is not an abstract notion. Knowledge (or knowledge, skills and abilities (KSAs)) must be attached to something; it must be about something. An understanding of the things about which we have knowledge will help in refining the tools that might be used to transfer that knowledge. The following is a list of areas around which knowledge might be focused:

1. **Tasks** might be thought of as the process of assembling a widget, if we were in a manufacturing setting. In the case of the Section, a task might be the preparation of grant, contract, or agreement documents. A task is an activity that immediately produces something. It might be a final product or an intermediate product.
2. **Processes** are groups of activities, typically involving several people or organizations, which result in some product. In the Section a process could be the execution of a contract or the selection of grants to be awarded.
3. **Technical** knowledge, as used here, is a body of professional knowledge such as engineering or finance.
4. **Analytics** are the steps in gathering, organizing, and using information to solve a problem. In the Section, a number of people have the responsibility for suggesting improvements to processes. To do this they would follow some analytic process.
5. **Standards** are the values or conditions defined as appropriate or acceptable within a profession. For example, the engineering profession defines standards for track crossing design. In the Section, many people have the responsibility for using or maintaining standards.

6. **People** skills are often discussed. The ability to deal with people in a positive manner is one aspect of people knowledge. Another is an understanding of the people with whom you interact. Who are they? What do they value? What are their quirks? In the Section many people have a responsibility for interacting with district staff, rail company staffs, or rail commission staff.
7. **Program** knowledge is an understanding of how and why a program is structured as it is, as well as its purpose, processes, and tasks. The Section has several programs: harbor maintenance, rail infrastructure, right-of-way preservation, etc.
8. **Organization** is knowledge about the entity within which the person works. It may be the section, bureau, division, or agency. Why does the organization exist? What are its cultural norms? What is its history?
9. **Leadership** encompasses a range of KSAs that allows a person to effectively provide direction to an organization or a program. The position descriptions of several of the Section staff call for them to provide leadership for the agency in their respective areas of competence.
10. **Supervisory/management** KSAs deal with those people who have a formal role in directing the work of others. While supervision and management do require a high degree of leadership skill, they also require skills in defining processes, managing resources, etc.

### Section III TOOLS AND STRATEGIES

Researchers have indentified a range of tools and strategies that can be used to manage knowledge. NCHRP report 365 is particularly useful for this purpose in that it presents research done specifically for the transportation industry. Some of the ideas found in NCHRP 365 and other sources are presented below.

1. **Videotaping** is a tool that could be used in concert with other strategies. As it is listed here, the intent is to simply videotape someone doing the job. The tape would thus provide a reference for someone in the future.
2. **Annotated templates** could be used as guides for the preparation of contracts or agreements. The template would simply be a standard document. The annotations would help the employee to understand the meaning of clauses or the type of information that is to be entered at given points.
3. **Process documentation** involves developing flow diagrams of a process that illustrate who does what in the overall process as well as the specific actions, participants, and products at each step in the process.
4. **Job rotation** involves moving people around in the organization to broaden their understanding of the organization and to ensure that more than a single person knows how to perform a given job.
5. **Communities of practice** are groups of people with similar jobs or interests. Knowledge can be transferred with a community of practice, if one exists or can be defined.
6. **Double filling positions** requires early notification of a departure. It allows the

- exiting person to train the incoming person.
7. **Retiree job banks** allow the use of retirees on a retainer basis to help the new person learn the job.
  8. **Phased retirement** can allow experienced people to stay on the job, perhaps in a diminished role and at less than full time.
  9. **Cross training** is rather like job rotation except that the person who is being cross-trained also retains his or her regular job. The objective is to get several people capable of doing several jobs, increasing flexibility and broadening knowledge.
  10. **Information repositories** are places in which explicit information is stored, organized, and made available. The title tends to suggest a major database or library, but it could also be a manual or a section bookshelf.
  11. **Mentoring/coaching** is a process of an experienced employee providing guidance to a less experienced employee. It may be structured or informal.
  12. **Social network analysis** is somewhat like process analysis, but the emphasis is more heavily on the people with whom the interactions take place and on the specific knowledge, skills, and abilities (KSAs) brought to the interaction by those people.
  13. **Business process mapping** is also somewhat similar to process analysis, but it tends to be broader in its approach and application so that it includes data sharing and interaction of business processes across organizational units.
  14. **Expert interviews** are attempts to capture tacit knowledge. This approach requires someone skilled as an interviewer asking questions of employees to make tacit knowledge explicit.
  15. **After action reviews** are an approach to learning that involves gathering people who have been a part of an action—perhaps a program development process—to dissect that action to determine what went right or wrong and how improvement could be made. In our context, documenting such a review could be used as a reference and a learning tool for new employees.
  16. **Internet conferencing** is a tool that could be used with other strategies, such as a community of practice, to share knowledge with people who are geographically dispersed.
  17. **On-the-job training** is often seen as training provided by doing work or shadowing more experienced employees. It could also be a structured process of learning in which a new person takes a defined set of short courses, attends a series of conferences, or reads specified articles or books.
  18. **Encourage mingling** is an approach to making the coffee pot conversation productive. It allows people to learn what happens on the other side of the partition or at the other end of the office. It is very informal, but it can produce results.
  19. **A last lecture** is an approach that encourages retiring employees to share their experiences with others by giving a last presentation. It could be at a staff meeting or in a brown bag setting. It could also be face-to-face or over a video link.
  20. **Story telling** is like a last lecture only you do not have to wait until someone is leaving to do it. Experienced employees share their knowledge and experience in



## Knowledge Management Guidebook

some venue such as a staff meeting or brown bag.

21. **Exit interviews** are typically a fairly formal process in which a departing employee is asked his or her impressions of the organization, why they are leaving, etc.
22. **Leadership programs** can be formal training programs, job shadowing, or mentoring efforts to develop the leadership skills of less experienced people.
23. **Share fairs** are structured events in which experienced people share knowledge. They could be internal conferences or simply brown bag events.
24. **War stories** are really not a standalone tool. Rather it is listed as a reminder to embellish any of the above with real events that make the stories and the knowledge more real.

The above strategies could all be used to capture explicit knowledge. Only a few are suitable for tacit knowledge.

A sound understanding of the types of knowledge to be transferred is key to selecting the right tools or strategies to deal with that knowledge. Figure 4 is a

Strategy/Knowledge Type	Task	Process	Technical	Analytic	Standards	Program	People	Organization	Leadership	Supervisory/Mgt.
<b>Videotaping</b>	*									
<b>Annotated Templates</b>	*	*								
<b>Process Documentation</b>	*	*								
<b>Job Rotation</b>	*	*	*	*	*	*	*	*		
<b>Communities of Practice</b>	*	*	*	*	*	*				
<b>Double Filling Positions</b>	*	*	*	*	*	*	*	*		
<b>Retiree Job Banks</b>	*	*	*	*	*	*	*	*	*	*
<b>Phased Retirement</b>	*	*	*	*	*	*	*	*	*	*
<b>Cross Training</b>	*	*	*	*	*	*	*	*		
<b>Information Repository</b>	*	*	*		*	*				
<b>Mentoring/Coaching</b>	*	*		*	*	*				
<b>Social Network Analysis</b>		*					*			
<b>Business Process Mapping</b>		*								
<b>Expert Interviews</b>		*				*		*		
<b>After-Action Reviews</b>		*				*	*			
<b>Internet Conferencing</b>			*			*	*	*	*	
<b>On-the-Job Training</b>			*	*	*	*		*	*	*
<b>Encourage Mingling</b>				*		*	*	*		
<b>Last Lecture</b>						*		*		
<b>Story Telling</b>						*	*	*	*	
<b>Exit Interviews</b>								*		
<b>Leadership Programs</b>									*	
<b>Share Fairs</b>						*		*		
<b>War Stories</b>						*	*	*		

Figure 4: Types of Knowledge and Appropriate Strategies

matrix that relates strategies or tools to the focus of knowledge. Some tools and strategies are suitable for some types of knowledge; others will work better for other knowledge areas. The shaded areas of Figure 4 indicate the knowledge types that tend to be tacit and the strategies that are best suited to transfer that type of knowledge.

#### **Section IV DIFFERENCES IN ORGANIZATIONS**

All parts of WisDOT are not alike. Different organizations may be of different sizes with different missions and staffing patterns. These differences can significantly impact the choice of knowledge management strategies to be used. For purposes of illustration, two very different organizations are shown: traditional and specialist.

In the traditional organization (Figure 5), new recruits are hired from educational institutions into entry-level positions. After months or years of learning while working with more experienced staff, their skills and knowledge are sufficient to move to the journeyman classifications. Still later, some may move to more senior or even management classifications. They will have learned by doing in mentoring relationships and in work groups where professionals do similar jobs. This is the way most organizations develop their people. On-the-job training is at the core of this process. Formal training programs or knowledge management efforts may also supplement and accelerate this process. This traditional approach has worked, and continues to work, but it requires a critical mass of people with similar duties and a reasonably consistent rate of turnover and recruitment.

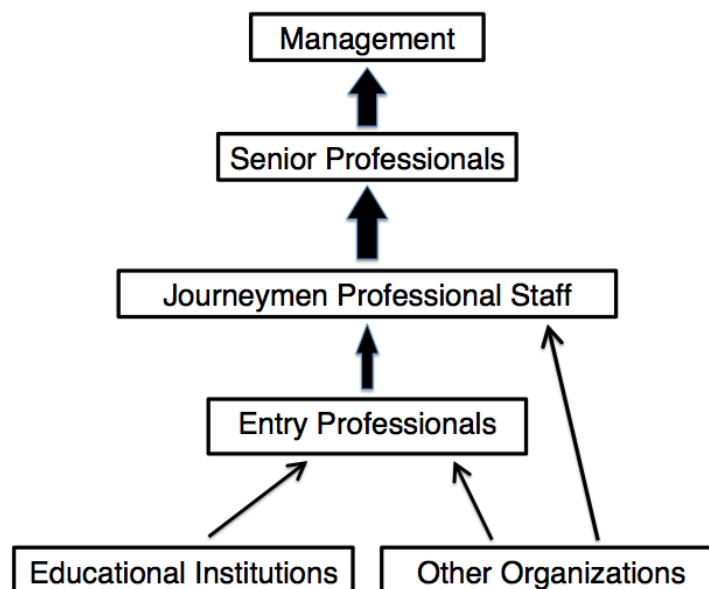

Figure 5: A Traditional Organization

Transportation agencies now have a wider range of responsibilities and the traditional model is not as widespread as once may have been the case. Agencies now employ a wider range of professionals with varying and often specialized skills. In many cases, these specialists are employed in organizational units that are largely comprised of people with unique skills and roles. These specialist organizations present greater challenges as workers retire.

Figure 6 illustrates a specialist organization that represents many parts of all transportation agencies. In the specialist organization, senior professional people perform highly specialized functions, reporting to a manager. Junior-level people may assist some of these senior professionals, but the pool of less experienced people is small and recruitments are rare. Some of the senior professionals may carry supervisory classifications, but their primary role is that of a professional specialist or program supervisor.

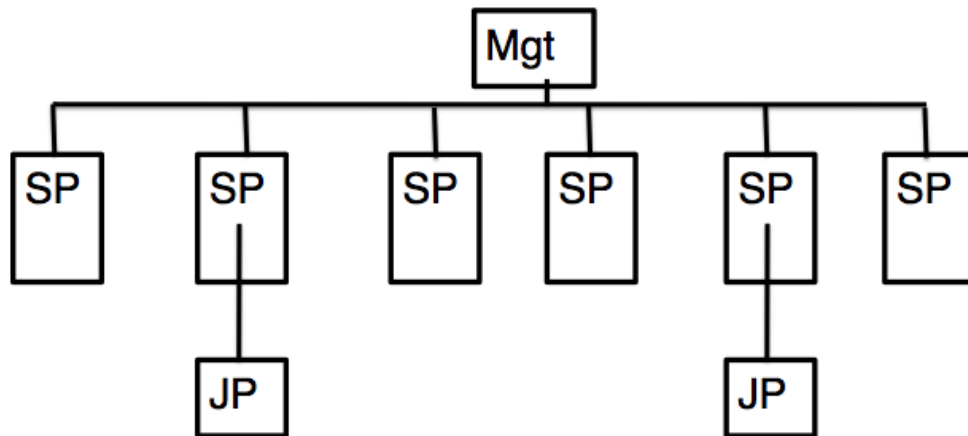

Figure 6: A Specialist Organization

A specialist organization is vulnerable to discontinuities in the knowledge and skill relationships when employees leave or retire. If all of the specialists are of similar age, say aging baby boomers, the problem is obvious: the entire staff could retire within a very short period of time and no one would have the skills and knowledge to administer its programs or carry out its functions. Even if the exodus of staff is slower, the organization will face a major challenge in ensuring that the people hired to replace existing specialists have the knowledge needed to be successful.

The Section is a specialist organization. The seven people employed in the Section are the agency's experts on issues related to their modes and their programs.

The utility of some knowledge management tools may be reduced in a true specialist organization. For example, a true peer group may not exist. Similarly, the amount of

explicit information may be proportionately small. The ability to carry out cross training or mentoring might also be reduced.

We may be tempted to dismiss the concept of a specialist organization as something of an anomaly, but a closer look at WisDOT suggests that many part of the agency may be facing a situation very similar to the Section. Figures 7, 8, 9, 10 and 11 depict the eligible retirements for DBM, DMV, DTIM and DTSD at a bureau level. With the exception of the regional offices of DTSD, all face the possibility of major turnover by 2015.

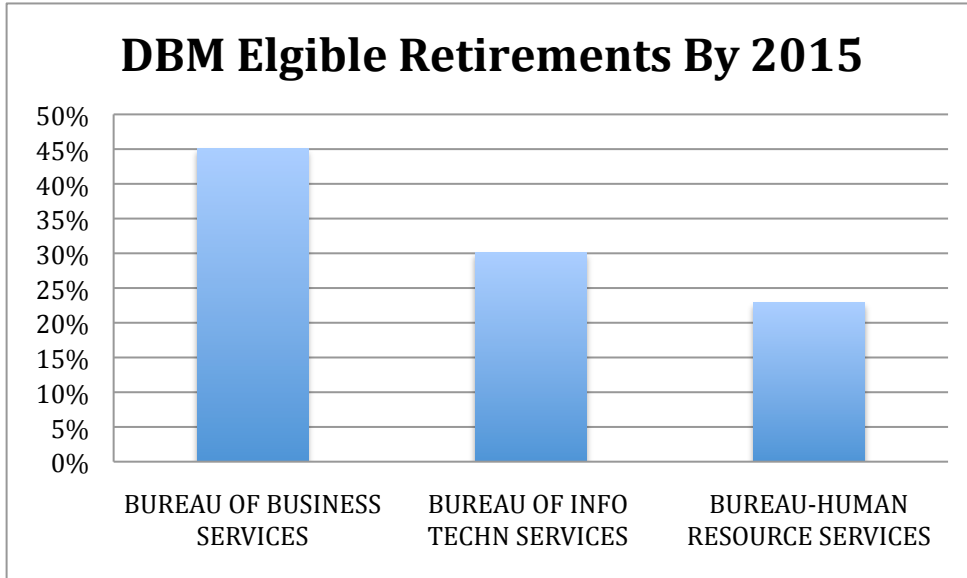

Figure 7: DBM Potential Retirements

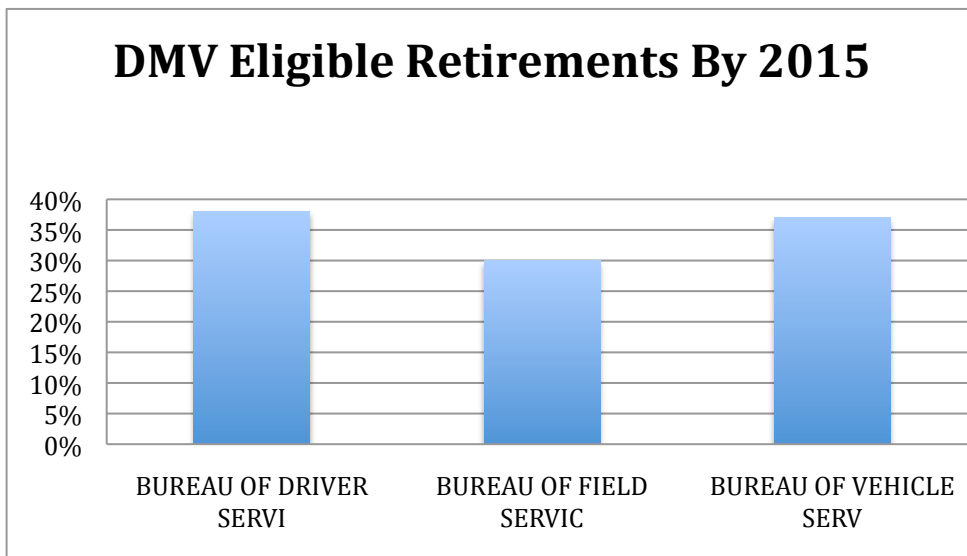

Figure 8: DMV Potential Retirements

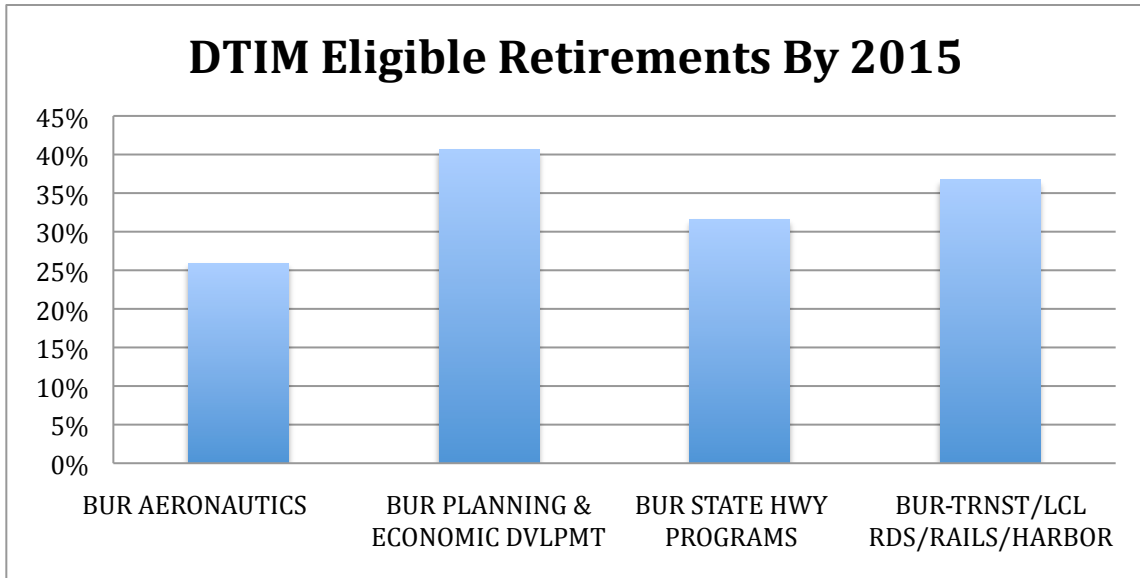

Figure 9: DTIM Potential Retirements

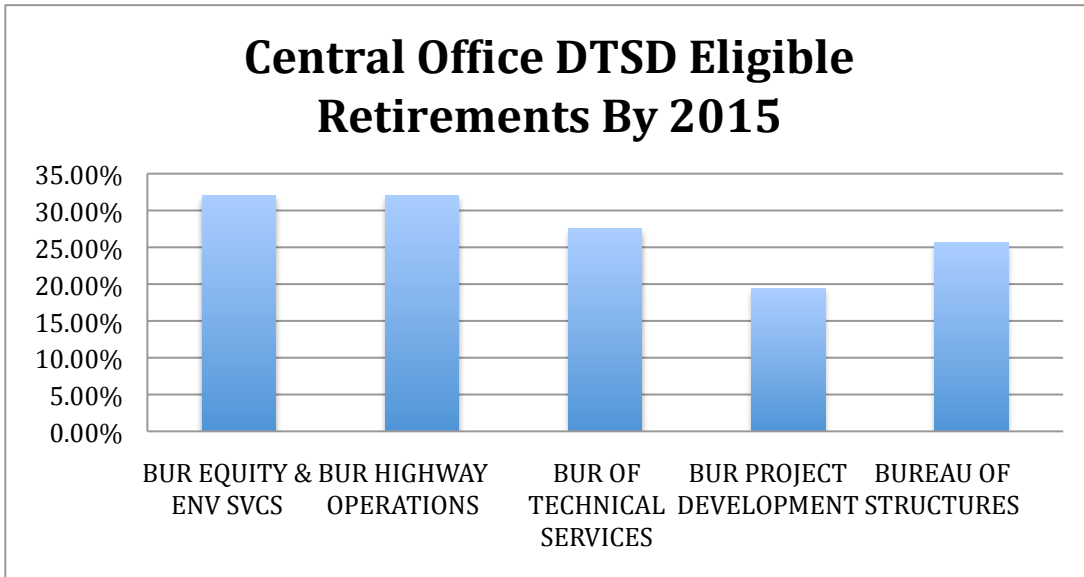

Figure 10: DTSD Central Office Potential Retirements

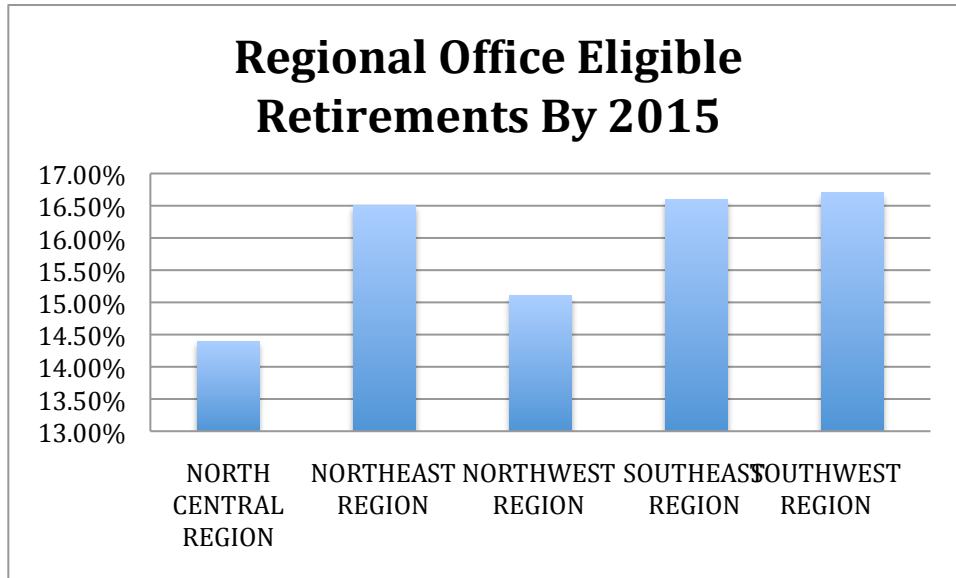

Figure 11: Regional Office Potential Retirements

### Section V

#### CONSTRAINTS AND BARRIERS

Implementing even simple and inexpensive knowledge management tools is not without problems. NCHRP 636, which deals with broad human resource issues in transportation, contains a listing of the top ten workforce issues facing transportation agencies. Five of those (in bold) could be barriers to implementing any knowledge management strategies:

- Workforce planning
- Attracting and retaining talent
- Next generation leaders
- **Downsizing**
- **Performance**
- HR efficiency
- **Outsourcing**
- **Change**
- Institutional knowledge
- **Retooling**

Downsizing, performance issues, outsourcing, change, and retooling all tend to threaten incumbent employees. When threatened, employees are less likely to participate positively in activities that could easily be seen as assisting in the elimination of their jobs or at least in major change to those jobs. NCHRP 636 was looking at the issues from a national perspective, but all of the issues could be found at WisDOT.

NCHRP 365, which dealt specifically with knowledge management, listed common barriers to successful implementation:

- Time and priority
- Management statements versus actions
- Knowledge is power
- Apathy
- Not invented here
- Rewards system
- Cultures and subcultures
- Lack of a common language

While all of these might come into play in some part of WisDOT, the largest barrier found in the Section is the first: time and priority. Time is the major issue. Staff numbers have been reduced at a time when workload and public expectations in the rail and harbor modes are growing. Employees are hard-pressed to dedicate the time that is needed to knowledge management. If knowledge management is given priority, normal workload is simply put aside to be picked up again. While the employees encountered tend to agree that knowledge management is positive and needed, they are hard-pressed to see how it will benefit them directly.

The other major barrier found that was not listed in NCHRP 365 is budget. Even the low-cost strategies used in this effort may have some price associated with them. Agency budgets for discretionary spending and training have been trimmed so far that even modest expenditures to compensate retirees for their continuing efforts or to fund training require extreme justification or creativity.

**Section VI**  
**FOCUSING ON KEY KNOWLEDGE, SKILLS, AND ABILITIES**

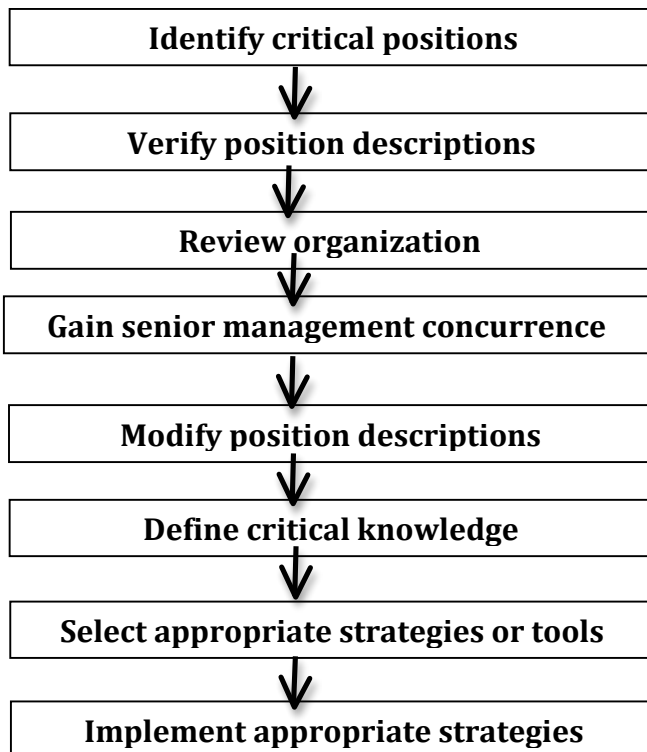

The first challenge is to define what was worthy of attention and what might be left until later or be forgotten. In attempting to differentiate between positions, knowledge types, and the appropriate tools, greater clarity and direction within the agency may be needed. Therefore, the eight-step decision process outlined in Figure 12 was developed.

The first step is to decide which positions are most critical for the future. In the pilot, three of the seven section employees were selected because they were closest to retirement and were deemed to hold the most critical knowledge.

Figure 12: Decision Steps

Figure 13 lists several questions that might be asked in trying to identify a critical position. It is important to bear in mind that the goal is to be prepared when people

depart, either because of a planned retirement or other less predictable reasons.

**Questions to Determine Key positions**

- Who has unique KSAs?
- Who would be most missed?
- Who is the “go-to” person?
- Who is the natural group leader?
- Who is responsible for the most unique or complex assignments?

The most useful document for defining the knowledge required for those positions is the position description (PD), but existing descriptions may be very old and may not accurately reflect what the positions really do. They may need to be updated.

**Figure 13: Key Questions**

The revised PDs should then provide a good view of the position’s functions, but it may not be clear that the current functions will be required in the same proportions, or at all, in the future. Each position should be evaluated within the context of the entire organization. Since WisDOT senior management closely holds organizational changes and the authority to hire, those senior managers must approve the future vision. PDs should be reviewed again in light of this future vision and revised accordingly.

When considering the future, a number of questions should be asked to best define how the position might fit into a future organization and in support of a future set of program responsibilities. As this is done, it is worth thinking about the hiring process as an action that will have consequences for the organization for decades to come. Figure 14 lists some questions.

**The Future?**

- What KSAs will others in the organization hold?
- How are the tools and technologies of the organization changing?
- Will programs be delivered in the same manner?
- Are the expectations of the organization changing?

**Figure 14: The Future**

Figure 15 outlines a process for selecting critical KSAs. The KSAs listed are directly from the position description of one of the employees. The employee was asked to rate both the importance of the KSA and the difficulty that a new person would have in attaining that KSA. The sum of the importance and difficulty ratings yielded a priority. Each priority item was subjected to a simple logic test both by the employee and by the steering team.

While the tool in Figure 15 was developed for a specific position, it could also be adapted to analyze the critical skills of an organization. In this case, a PD could be chosen as representative of employees in an organization, or the critical skills of several PDs could be used in a similar manner. Several employees and their



## Knowledge Management Guidebook

supervisors or managers could rate the KSAs from an organizational perspective. The result should provide a starting point for either a training program to strengthen critical knowledge areas or for a knowledge management effort to improve how those critical KSAs are shared between existing employees or with new hires.

KSA	Importance	Difficulty	Priority
Knowledge of FRA Track Inspection Standards			
Knowledge of AREMA standards			
Experience in developing and managing RR track rehab projects			
Management skills			
Written and verbal skills			
Experience negotiating			
Experience in inspecting RR construction project and determining compliance with standards			
Ability to recommend appropriate methods to ensure cost effective solutions to RR project needs			
Ability to review project proposals for compliance with department standards and objectives			
<ul style="list-style-type: none"> <li>• KSAs = Knowledge, skills, and abilities.</li> <li>• Importance = importance to the success of the person in the job in first 12 months.</li> <li>• Difficulty = Difficulty a new person would have in learning this KSA.</li> <li>• Rate importance and difficulty from 1 to 5, with 5 being the most important and most difficult.</li> <li>• Sum difficulty and importance to calculate priority.</li> </ul>			

**Figure 15: Critical Knowledge Evaluation Form**

Figure 3, reproduced below as Figure 16, lists a range of tools and strategies that can be used for knowledge management. It also suggests those that are best used with tacit and explicit knowledge. In deciding among the tools, it is first important to have a clear view of the objective of the knowledge management activity. Is it to share information with existing employees? To help train and develop new hires? To attract new candidates? Next it is useful to be clear on the type of knowledge being managed. Many tools that are useful for explicit knowledge cannot be used directly for tacit knowledge. Then it is important to be clear on the things about which knowledge is being managed. Task-related knowledge can be captured and shared with a number of tools. In the extreme videotaping a worker doing a task might suffice. Less quantifiable knowledge areas, for example people-oriented knowledge, might be better handled with tools such as storytelling. Finally, the resources and skills available must be considered. Some people are not comfortable

## Knowledge Management Guidebook

in doing presentations such as storytelling. The skills needed to do effective process analysis may not exist. Figure 17 lists some of the questions to be considered.

Strategy/Knowledge Type	Task	Process	Technical	Analytic	Standards	Program	People	Organization	Leadership	Supervisory/Mg
Videotaping	*									
Annotated Templates	*	*								
Process Documentation	*	*								
Job Rotation	*	*	*	*	*	*	*	*		
Communities of Practice	*	*	*	*	*	*				
Double Filling Positions	*	*	*	*	*	*	*	*		
Retiree Job Banks	*	*	*	*	*	*	*	*	*	*
Phased Retirement	*	*	*	*	*	*	*	*	*	*
Cross Training	*	*	*	*	*	*	*	*		
Information Repository	*	*	*		*	*				
Mentoring/Coaching	*	*		*	*	*				
Social Network Analysis		*					*			
Business Process Mapping		*								
Expert Interviews		*				*		*		
After-Action Reviews		*				*	*			
Internet Conferencing			*			*	*	*	*	
On-the-Job Training			*	*	*	*		*	*	*
Encourage Mingling				*		*	*	*		
Last Lecture						*		*		
Story Telling						*	*	*	*	
Exit Interviews								*		
Leadership Programs									*	
Share Fairs						*		*		
War Stories						*	*	*		

Figure 16: Selecting the Right Tool

Which Tool?

- What is the objective?
- What type of knowledge?
- What things is the knowledge about?
- What skills and resources are available?

Figure 17: Which Tool?

## Section VII IMPLEMENTATION

As implementation is begun the barriers and constraints discussed previously must be kept in mind. State service in Wisconsin and the rest of the nation is experiencing uncertainties unlike any that have occurred in the past. Those uncertainties will almost certainly raise concerns in the minds of some employees. Section VI raised some of these concerns. Figure 18 lists some of the questions that should be asked as implementation is begun.

<p style="text-align: center;"><b>Questions for Implementation</b></p> <ul style="list-style-type: none"><li>• Is the purpose of this knowledge management activity clear to employees?</li><li>• Is the time available for employees to do the activities?</li><li>• Are the resources available?</li><li>• Is management on board?</li></ul>
--

**Figure 18: Questions for Implementation**

The balance of this section reviews the implementation experiences within the Section. It may offer insights for other areas of the department.

Using the processes outlined in Figures 12 through 18 we were able to focus on three positions within the section, get updated information on the future of the positions, agree on key

knowledge areas, and select strategies for knowledge management. Since the

Section already has many documented processes, policies, and procedures, many of the strategies and much of the effort deals with those tacit knowledge areas that have thus far defied becoming explicit.

The primary barrier incurred with the section was time. Employees were hard pressed to complete the knowledge management tasks that were asked of them because of the press of daily business. The following are the activities that were completed.

### *Storytelling*

One of the areas of knowledge that the steering team felt needed to be preserved dealt with the history of the rail programs in Wisconsin. Storytelling seemed to be the natural tool for this objective. For this purpose, the chief of the Section, who experienced much of this history, will prepare presentations to be made at brown bags open to all staff in the department. The presentations will be videotaped and archived so that they remain available to future employees and others who might have an interest in the topic.

Another area for which storytelling seems most appropriate is the historic and unique relationship between the department and rail companies. In part this is a story of history, but it is also a story of people knowledge and skills, skills that have made the programs work. In this case, the chief will prepare a presentation and give it to the annual meeting of department and rail company staff. Again, it will be videotaped and archived.

## Knowledge Management Guidebook

The storytelling exercises above are intended to be in the range of thirty minutes. They will also be punctuated with war stories to make them more interesting and meaningful to the listeners. They will, in short, be true stories, but stories that carry significant meaning for the programs involved.

Story telling will also be used in a very different way for a different type of knowledge. The chief rail engineer has much experience in developing, both technically and contractually, rail rehabilitation projects with rail companies. He will prepare audio-visual presentations in a narrated PowerPoint format to share his knowledge of this topic. These presentations will be in the range of fifteen minutes. They will tend to be fairly technical in nature, but they will also use some war stories to maintain interest and illustrate key points. The presentations will be archived and made available to current and future employees.

These two types of storytelling illustrate an important point: the tool needs to be modified to meet specific needs. The first two examples can be longer and will be more effective when recorded before an audience. They can be longer since they will be more fully illustrated with experiences from the past and the war stories that make them interesting. By contrast the more technical presentations by the chief engineer will have to be shorter to better match the attention spans that most people have when watching archived “training” materials.

### *On the Job Training*

On the job training, as the term is used in this context, involves a planned course of development assembled before a new hire is found. It may include coursework, but it will also include a variety of experiential learning. The application of this strategy in the Section is related to the chief rail engineer’s position, which deals with rail projects as well as highway projects that involve rail work. This combination requires an individual to have a firm grounding in engineering and processes in both highway and rail. It would be very unusual to find a candidate with both sets of knowledge. Therefore, the task will be to hire for one and be prepared to train for the other.

Figure 19 is an early draft of a training program for rail engineering and related processes.

<b>Railroad Training</b>		
<b>Experience</b>	<b>Resource</b>	<b>Objective</b>
Extension RR Engineering classes	Contact name	Gain basic RR engineering concepts
AREMA Classes	Contact name	Gain specific RR engineering and rehab concepts. Define most important areas
Wis Southern RR	Contact name	Gain field experience with RR operations
CP (class 1 RR)	Contact name	Bigger gangs/Union work
State RR systems	Contact name	Understand extent of the state RR systems
State RR Programs	Contact name	Understand objectives and operations of RR programs
Rehab philosophy and approach	Contact name	Understand the trade-offs in RR investment
Visit regional offices	Contact names	Understand the role of regions in rail programs

**Figure 19: Rail Engineering Training Outline**

This training program will involve some classroom work involving the offerings of the Wisconsin University Extension Program and a national rail engineering association (AREMA). It will also involve field experience observing the work of a short line railroad and a class I railroad. Finally, it will use structured conversations with other state, federal, and railroad staff to gain knowledge on specific topics. Each experience lists a specific contact person and a specific objective for the experience. This latter is critical to helping the trainee better understand why he or she is being asked to take part in each experience. It will also help the providers—rail companies and public agency staff—better understand why they have been asked to take part in the overall effort.

Ideally, the final plan would be reviewed with the new hire very early in the appointment, modified to reflect the specific experiences and needs of that person, and made a part of the job expectations for the first six months of the job.

*Information Repository*

The term information repository conjures up a vision of databases or libraries containing lots of data. Our application is much more limited. It simply involves pulling together important information in one place for the use of all employees, but particularly less experienced employees.

## Knowledge Management Guidebook

Figure 20 illustrates one application of this concept. It is a timeline of all activities for all programs administered by the section.

Date	Program			Action	Party	Comment
	A	B	C			
2/7/10	x			Prepare budget	Tim	Collaborate with department budget office on biennial budget request
3/15/10		x		Solicit projects	Jane	Solicit projects from eligible applicants for 2 year program
4/21/10		x		Select projects for funding	Jane	Follow process in trans 240 to evaluate and select projects

**Figure 20: Section Timeline**

In actual application, this document would be many pages long, including all programs and recurring actions of the Section, and would best be displayed in a longer format so that the comments could be more descriptive. It would be an excellent reminder for experienced staff and an instructional device for new staff.

The other information repository tool under development is a small reference book for the rail and harbor programs. It will contain all of the statutes that created these programs, the administrative rules that have implemented by them, and the policy guidance that interprets the rules. Each document will be accompanied by a transcription of the notations made by current staff members that have helped them to use and understand these documents. This tool, which will be less than forty pages long, should provide any new staff member a firm background on each of the programs and the interpretations in rules and policies that have moved the program to its current situation.

### *Use of Retirees*

Recent retirees are a great source of information about both tasks and processes and about larger program and organizational issues. The section will be using some retirees on an on-call basis. Essentially, this will involve reaching agreement on an appropriate honorarium for the retiree to spend some time over the first year of a new person's appointment providing guidance, answering questions, and generally being available to help that new person learn the job. Given that this will be a cost item, it will be used very sparingly.

### *Communities of Practice*

A community of practice is a group of people who share a common set of duties or interests. The community of rail and harbor practice within the agency is very small. Therefore, cultivating that community may not yield major results. The more useful community for the purposes of the Section is the regional group of managers in other states who share common challenges and responsibilities in managing rail-

## Knowledge Management Guidebook

related grant and aid programs. While the details of each program may vary from state to state, some of the fundamentals of dealing with rail companies and rail shippers are the same.

Unfortunately, peer networks that were once strong have been weakened by budget cuts and restrictions on out-of-state travel. In an attempt to overcome this obstacle and reinvigorate this regional community of practice, the Section, with the help of the research team, will begin building an electronic community of practice. Using the several electronic tools that are available in most state agencies—video conferencing, web-based conferencing, and teleconferencing—quarterly electronic meetings will be initiated with rail staff across the AASHTO region. These meetings will begin with a fairly structured agenda and a facilitator.

### *Annotated Contact List*

Most members of the Section have contacts with many people both inside and outside of the department. One staff member is using the Outlook contact file to list key contacts and to include key information about those contacts. What is this person expert in? Why would he or she be contacted? This tool will help new employees more easily become acclimated to the range of the people with whom they will need to interact to be successful.

### *Process Analysis*

A process analysis can be a very complex undertaking. For the purposes of knowledge management, we have tried to simplify the process with a form, shown in Figure 21.

<b>Activity</b>	<b>Task Dependency</b>	<b>Railroads</b>	<b>Contact Role RR Commissions</b>
Review and analyze Rehabilitation, construction and spur track proposals			
Review bid documents for track projects			

**Figure 21: Process Analysis Form**

In the form shown in Figure 15, the activities are those major activities from the employee's PD. Task dependency is intended to indicate when or how the need to

## Knowledge Management Guidebook

perform this task is initiated. The contacts are all of the people who have a role in a task and the information that should be entered into each box is the actions or role that each contact has in the overall activity. Obviously, not all contacts will have a role in every activity. Some may have more than one role in a given activity. In actual application, this form is much larger than is shown in Figure 15. The goal is to outline who does what in any given process or activity for which the employee has responsibility.



### References

1. Alaska Department of Transportation. *Knowledge Transfer Information*, 2005.
2. Burke, Mike. Knowledge Management: Everyone Benefits by Sharing Information. *Public Roads*, Vol. 63. No. 3, November/December 1999.
3. Chang-Albitres, Carlos M., and Krugler, Paul E. A Summary of Knowledge Management Information Gathered From Literature, Web Sites and state Departments of Transportation. Texas Transportation institute, 2004.
4. Committee on Future Surface Transportation Agency Human Resource Needs: Strategies for Recruiting, Training, and Retaining Personnel. *TRB Special Report 275: The Workforce Challenge*. Transportation Research Board, National Academy of Sciences, 2003.
5. Lucero, Amy. Transportation Workforce Development. Presented at Penn State, April 2010. <http://outreach.psu.edu/programs/workforce-summit/presentations.html>. Accessed July 10, 2010.
6. Sarver, Randy and Lebwohl, Alison. Knowledge Management and Retention Strategies for WisDOT. Wisconsin Department of Transportation, 2009.
7. Shiplett, Myra Howz. *NCHRP 362: Training Programs, Processes, Policies, and Practices*. Transportation Research Board, National Academy of Sciences, 2006.
8. Spy Pond Partners. *NCHRP 636: Tools to Aid DOTs in Responding to Workforce Challenges*. Transportation Research Board, National Academy of Sciences, 2009.
9. Ward, Maryanne. *NCHRP 365: Preserving and Using Institutional Memory Through Knowledge Management Practices*. Transportation Research Board, National Academy of Sciences, 2007.
10. Warne, Thomas. *NCHRP 349: Developing Transportation Agency Leaders*. Transportation Research Board, National Academy of Sciences, 2005.
11. Washington Department of Transportation. *Workforce Analysis Task*, 2006. [http://www.wsdot.wa.gov/NR/rdonlyres/932BF085-4155-486E-B1F1-EFF5FAD8416E/0/WorkforceAssessment\\_SPMG.pdf](http://www.wsdot.wa.gov/NR/rdonlyres/932BF085-4155-486E-B1F1-EFF5FAD8416E/0/WorkforceAssessment_SPMG.pdf). Accessed April 15, 2010.
12. Wittwer, Adams, Toledo-Duran. *21<sup>st</sup> Century Workforce Development Summit*. University of Wisconsin, 2009. <http://www.wistrans.org/cfire/Research/CFIRE/GY01/10/index.html>. Accessed April 17, 2010.

Wisconsin Department of Transportation  
Research & Library Unit  
4802 Sheboygan Avenue, Room 104  
P.O. Box 7915  
Madison, WI 53707

**CFIRE**  
National Center for Freight & Infrastructure Research & Education  
Wisconsin Transportation Center  
2205 Engineering Hall  
1415 Engineering Drive  
Madison, WI 53706