

TECHNICAL REPORT STANDARD PAGE

1. Report No. FHWA/LA-92/258		2. Government Accession No.	3. Recipient's Catalog No.
4. Title and Subtitle CRASH TESTING OF LOUISIANA'S MULTI-DIRECTIONAL, SINGLE STEEL POST, SMALL SIGN SUPPORT		5. Report Date JUNE 1992	
		6. Performing Organization Code	
7. Author(s) D. LANCE BULLARD, JR.		8. Performing Organization Report No. 258	
9. Performing Organization Name and Address Texas Transportation Institute The Texas A & M University System College Station, TX 77843-3135		10. Work Unit No.	
		11. Contract or Grant No. LA HPR STUDY NO. 92-4SS(B)	
12. Sponsoring Agency Name and Address Louisiana Transportation Research Center P.O. Box 94245, Capitol Station Baton Rouge, LA 70804-9245		13. Type of Report and Period Covered Final Report February 1992 - July 1992	
		14. Sponsoring Agency Code	
15. Supplementary Notes Conducted in cooperation with the U.S. Department of Transportation, Federal Highway Administration.			
16. Abstract The Louisiana Department of Transportation and Development (LDOTD) contracted with the Texas Transportation Institute (TTI) to evaluate the impact characteristics of Louisiana's multi-directional, 5 inch diameter steel post, small sign support when impacted by an 1,800 lb vehicle at 20 and 60 mi/h. However, only the low-speed crash test was conducted. The crash test was conducted and evaluated in accordance with criteria provided in the 1985 American Association of State Highway and Transportation Officials (AASHTO) Guide: <u>Standards Specifications for Structural Supports for Highway Signs, Luminaires, and Traffic Signals</u> and the National Cooperative Highway Research Program (NCHRP) Report 230. The 60 mi/h crash test was not conducted due to the severity of damage sustained to the test vehicle and the results of the data collected in the low-speed test. The low-speed test failed to meet the test criteria by: (1) the sign installation violated the occupant compartment integrity and (2) excessive occupant impact velocity in the longitudinal direction. This sign installation in "strong soil" is unacceptable according to the evaluation criteria recommended in NCHRP Report 230 and the 1985 AASHTO Standards.			
17. Key Words crash testing, multi-directional bases, small sign supports		18. Distribution Statement No restriction. This document is available to the public through the National Technical Information Service, Springfield, VA 22161.	
19. Security Classif. (of this report) Unclassified	20. Security Classif. (of this page) Unclassified	21. No. of Pages 25	22. Price

CRASH TESTING OF LOUISIANA'S
MULTI-DIRECTIONAL, SINGLE STEEL POST,
SMALL SIGN SUPPORT

BY

D. LANCE BULLARD, JR.
ENGINEERING RESEARCH ASSOCIATE

Safety Division
Texas Transportation Institute
Texas A&M University System
College Station, Texas 77843-3135

Conducted for

Louisiana Department of Transportation and Development
Louisiana Transportation Research Center
in Cooperation with
Federal Highway Administration
U.S. Department of Transportation

The contents of this report reflect the views of the author who is solely responsible for the opinions, findings, and conclusions presented herein. The report does not necessarily reflect the official views or policies of the Louisiana Transportation Research Center, the Louisiana Department of Transportation and Development, or the Federal Highway Administration. This report does not constitute a standard, specification, or regulation. The Louisiana Department of Transportation and Development assumes no liability for its contents or use thereof.

JULY 1992

ABSTRACT

The Louisiana Department of Transportation and Development (LDOTD) contracted with the Texas Transportation Institute (TTI) to evaluate the impact characteristics of Louisiana's multi-directional, 5 inch diameter steel post, small sign support when impacted by an 1,800 lb vehicle at 20 and 60 mi/h. However, only the low-speed crash test was conducted. The crash test was conducted and evaluated in accordance with criteria provided in the 1985 American Association of State Highway and Transportation Officials (AASHTO) Guide: Standards Specifications for Structural Supports for Highway Signs, Luminaires, and Traffic Signals and the National Cooperative Highway Research Program (NCHRP) Report 230.

The 60 mi/h crash test was not conducted due to the severity of damage sustained to the test vehicle and the results of the data collected in the low-speed test. The low-speed test failed to meet the test criteria by: (1) the sign intallation violated the occupant compartment integrity and (2) excessive occupant impact velocity in the longitudinal direction. This sign installation in "strong soil" is unacceptable according to the evaluation criteria recommended in NCHRP Report 230 and the 1985 AASHTO Standards.

TABLE OF CONTENTS

I. INTRODUCTION	1
II. STUDY APPROACH	2
Description of Test Installations	2
Description of Crash Test Procedures	2
Data Analysis Procedures	7
Evaluation Criteria	8
III. CRASH TEST RESULTS	10
Test 7203-1	10
IV. CONCLUSION	25

LIST OF FIGURES

<u>Figure</u>		<u>Page</u>
1	Details of Multi-directional slip-base, single steel sign support installation	3
1	Details of Multi-directional slip-base, single steel sign support installation (Continued)	4
2	Multi-directional slip-base, single steel sign support installation before test 7203-1	5
3	Vehicle sign geometrics (test 7203-1)	6
4	Vehicle before test 7203-1	11
5	Details of multi-directional slip-base	12
6	Test vehicle properties (7203-1)	13
7	Final rest position of vehicle and sign installation after test 7203-1	14
8	Sequential photographs for test 7203-1	15
8	Sequential photographs for test 7203-1 (Continued)	16
9	Multi-directional slip-base, single steel sign support installation after test 7203-1	17
10	Vehicle after test 7203-1	18
11	Summary of results for test 7203-1	20
12	Vehicle angular displacements (test 7203-1)	21
13	Longitudinal accelerometer trace of test 7203-1	22
14	Lateral accelerometer trace of test 7203-1	23
15	Vertical accelerometer trace of test 7203-1	24

INTRODUCTION

The Louisiana Department of Transportation and Development (herein referred to as the Department) contracted with the Texas Transportation Institute (TTI) to conduct two full-scale crash tests on multi-directional, single steel post, small sign support installations installed in strong soil.

The objective of these crash tests was to evaluate the impact characteristics of Louisiana's multi-directional, single steel post, small sign support when impacted by 1,800 lb vehicles at 20 and 60 mi/h. However, only the 20 mi/h test was conducted, as will be addressed shortly. The sign installation was evaluated on its ability to perform in a safe and predictable manner. The crash test was conducted and evaluated in accordance with criteria provided in the 1985 American Association of State Highway and Transportation Officials (AASHTO) Guide: Standards Specifications for Structural Supports for Highway Signs, Luminaires, and Traffic Signals and the National Cooperative Highway Research Program (NCHRP) Report 230.

STUDY APPROACH

Description of Test Installations

A single-support sign installation was constructed from 5 in diameter schedule 40 steel pipe. The ground stub was anchored in a 1 ft-6 in dia. x 4 ft-0 in concrete footing placed in NCHRP Report 230 S-1 (strong) soil. The length of the sign support was 15 ft-6 in and the ground stub was 4 ft-0 in. The post and ground stub were fitted with a multi-directional slip base. The slip-base connection utilized 3/4 in diameter high strength bolts torqued to 369 in-lb, as specified in Louisiana DOTD standards. Attached to the support was a 4 ft x 8 ft type A sign panel. The sign panel was mounted to four Z-stiffeners with rivets. Each stiffener was attached to a flared leg mounting bracket with 2 bolts (5/16"-18 N.C.). A 3/4 in strap attached the sign blank assembly to the mounting brackets and support. The bottom of sign mounting height was 8 ft-0 in to the center of the slip-base. Figure 1 illustrates construction details of the sign installation. Figures 2 and 3 show the actual sign installation as tested.

Description of Crash Test Procedures

According to NCHRP Report 230 guidelines, two crash tests are recommended for the evaluation of single support sign installations:

Modified NCHRP Test Designation 62: 1,800-pound vehicle impacting the sign support at a speed of 20 miles per hour with the quarter point of the vehicle bumper.

NCHRP Test Designation 63: 1,800-pound vehicle impacting the sign support at a speed of 60 miles per hour with the quarter point of the vehicle bumper.

The crash test procedures were in accordance with the guidelines presented in NCHRP Report 230. The test inertia weight of the crash vehicle was 1,800 lb. This weight represents the weight of the test vehicle and all rigidly attached on-board test equipment. In addition, the gross static weight was 1,970 lb. The gross static weight is the vehicle inertial weight and an unrestrained anthropomorphic dummy.

The test vehicle was instrumented with three rate transducers to measure roll,

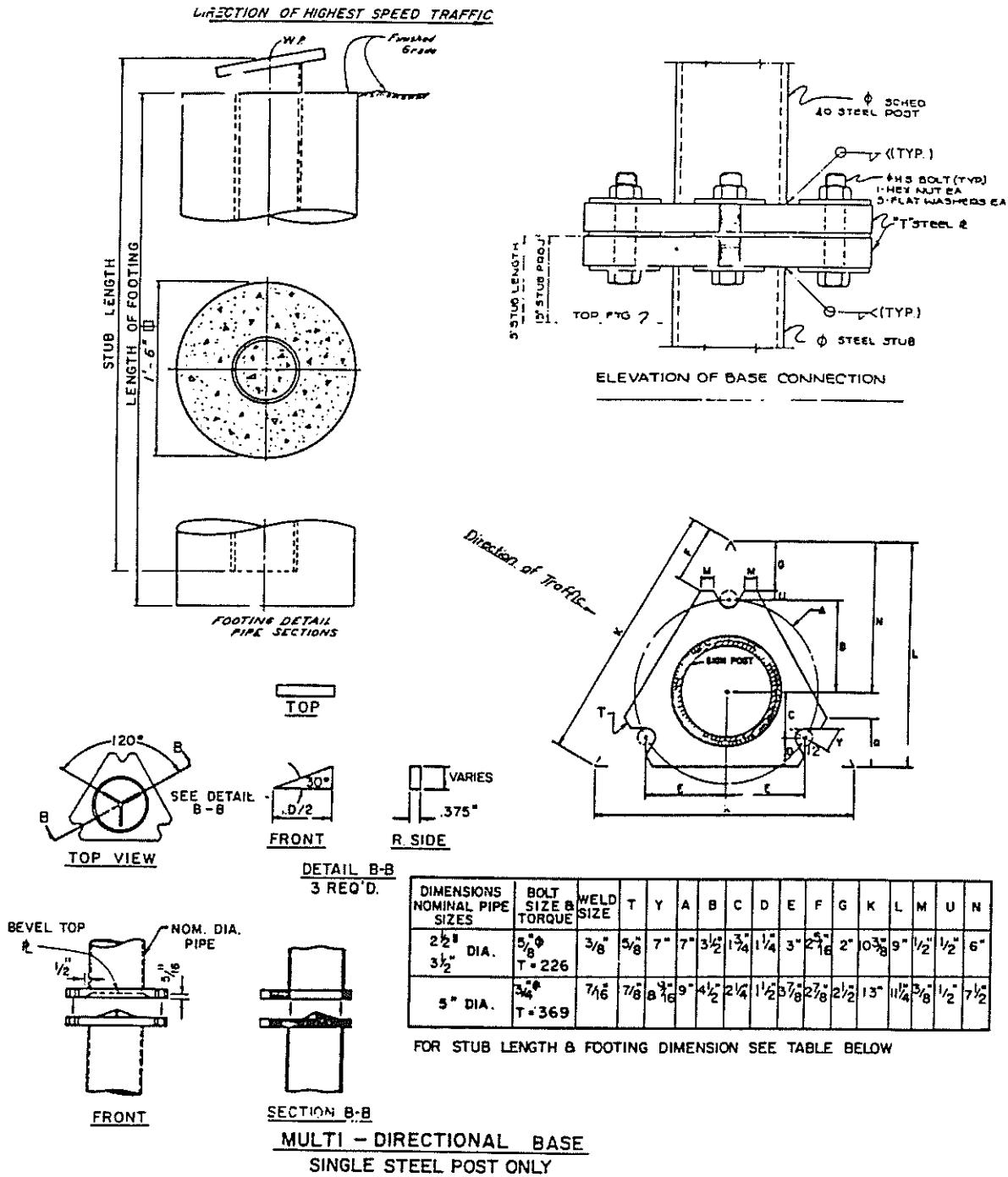

NOTE:
MULTI-DIRECTIONAL BREAK-AWAY FEATURE IS TO BE USED ONLY AT LOCATIONS WHERE SIGN IS LIKELY TO BE STRUCK FROM MORE THAN ONE COMMON DIRECTION.

Figure 1. Details of Multi-directional slip-base, single steel sign support installation.

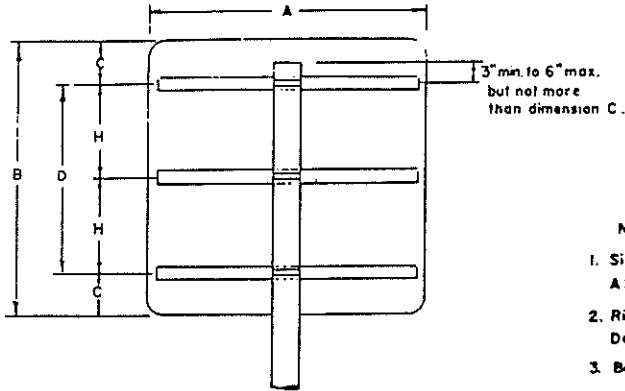

SQUARE, RECTANGLE, CIRCLE, OCTAGON and ROUTE MARKERS

A	B	C	D	H	STIFFENER	
					number required	
Variable 12" to 48"	6	3			1 when A ≥ 36	
	12	6			1 when A ≥ 36	
	15	7.5			1 when A ≥ 36	
	18	9			1 when A ≥ 36	
	24	6		12	2 when A ≥ 36	
	30	7.5		15	2 when A ≥ 36	
	36	7.5		21	2	
	48	10		28	2	
	60	9		42	21	3
	72	11		6	25	3
	84	10.5		6	21	4
48	96	12	6	24	4	

⊕ LOCATION OF BORDER ANGLE FROM EDGE

- NOTES:**
1. Sign Blanks shall be 0.080 inch Aluminum Alloy 6061-T6 or 5052-H38 A.S.T.M. Designation B-209.
 2. Rivets shall be 3/16" ϕ Aluminum Alloy 2024-T4, A.S.T.M. Designation B-316. Rivet Head Shall Be 3/8" Max. Diameter.
 3. Bolt shall be as required by applicable Mounting Detail Type.
 4. Stiffeners shall be Aluminum Alloy 6061-T6, A.S.T.M. Designation B-221. Stiffeners may be 1/2" x 1 1/2" Bar, C2 x 1 1/4 x 1.07 or 2 x 3/4 x 1 3/4 x 1.08 at the Contractors Option, Unless Otherwise Noted.
 5. Nylon Washers shall be Furnished for Sign Face Protection
 6. Sign Mounting Bracket, Strap and Seal Required for Mounting Detail (Type I) Shall be A.S.T.M. A167 Type 301 or Approved Equal. Hardware Shall be A.S.T.M. A167 Type 301 or Approved Equal.
 7. Sign Mounting Hardware Required for Mounting Detail (Type II) Shall be Hot Dipped Galvanized, A.S.T.M. A153 after Fabrication or Electroplated, A.S.T.M. B633 SC4, Type I Zinc Coating. Bolt Holes in Sign Support Shall be Field Drilled.

TYPE A SIGNS

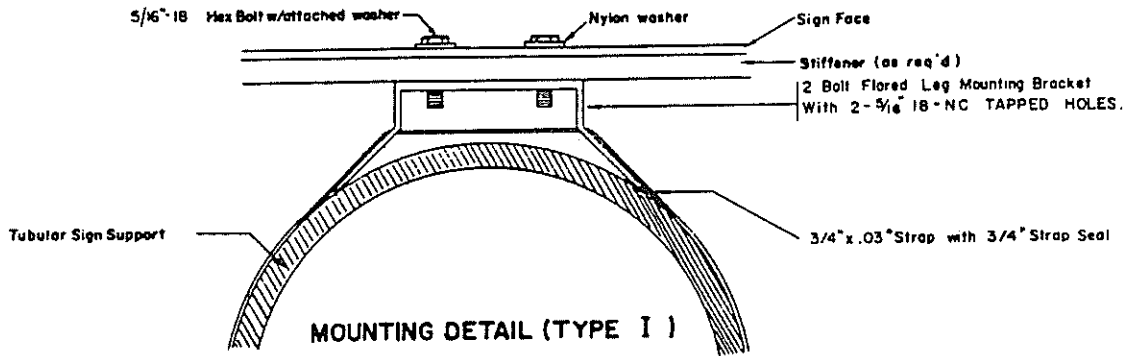

Figure 1. Details of Multi-directional slip-base, single steel sign support installation. (Continued)

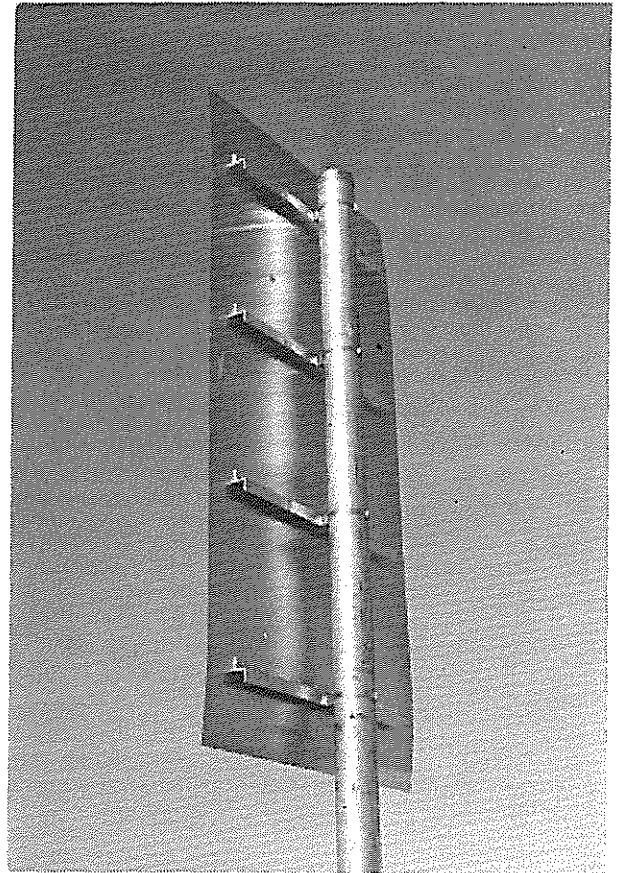

Figure 2. Multi-directional slip-base, single steel sign support installation before test 7203-1.

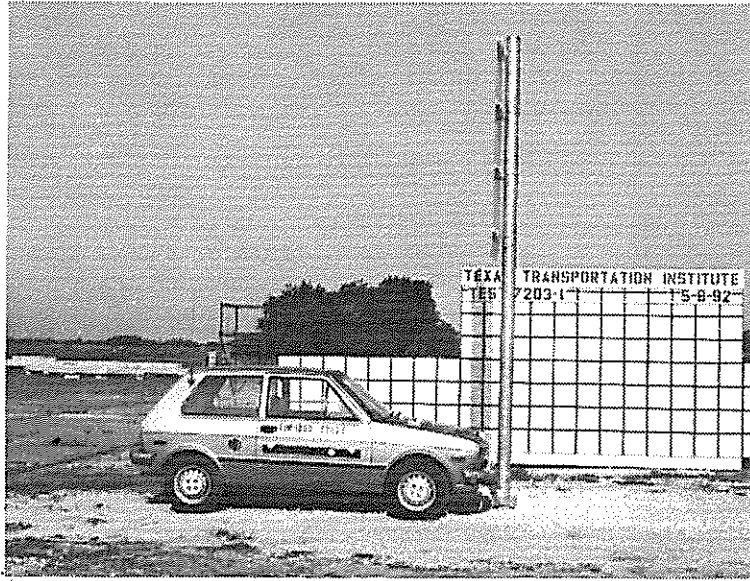

Figure 3. Vehicle sign geometrics (test 7203-1).

pitch, and yaw rates and a triaxial accelerometer near the vehicle center of gravity to measure acceleration. The electronic signals from the accelerometers and transducers were telemetered to a base station for recording on magnetic tape and for display on a real-time strip chart. Provision was made for transmission of calibration signals before and after the test, and an accurate time reference signal was simultaneously recorded with the data. Contact switches on the bumper were actuated just prior to impact by wooden dowels to indicate the elapsed time over a known distance to provide a measurement of impact velocity. The initial contact also produced an "event" mark on the data record to establish the exact instant of impact.

In accordance with NCHRP Report 230, an unrestrained, uninstrumented special-purpose 50th percentile anthropomorphic test dummy was positioned in the front seat of the test vehicle. The dummy was used to create an asymmetrical vehicle mass distribution. The effect of this load configuration was used to evaluate vehicle stability during impact.

Photographic coverage of the tests included two high-speed cameras, one perpendicular to the sign installation and the other located downstream at approximately 45 degrees from the point of impact. The films from these cameras were used to observe phenomena occurring during collision and to obtain time-event, displacement and angular data. A 3/4-inch video camera and 35 mm still cameras were also used for documentary purposes.

Data Analysis Procedures

The analog data from the accelerometers and transducers were digitized, using a microcomputer, for analysis and evaluation of performance. The digitized data were then analyzed using two computer programs: DIGITIZE and PLOTANGLE. Brief descriptions of these two computer programs are provided as follows.

The DIGITIZE program uses digitized data from vehicle-mounted linear accelerometers to compute occupant/compartments impact velocities, time of occupant/compartments impact after vehicle impact, and the highest 0.010-second average ridedown acceleration. The DIGITIZE program also calculates vehicle impact velocity

and the change in vehicle velocity at the end of a given impulse period. In addition, maximum average accelerations over 0.050-second intervals in each of three directions are computed. Acceleration versus time curves for the longitudinal, lateral, and vertical directions are then plotted from the digitized data of the vehicle-mounted linear accelerometers using commercially available software (Quattro Pro 3.0).

The PLOTANGLE program uses the digitized data from the yaw, pitch, and roll rate transducers to compute angular displacement in degrees at 0.00067-second intervals and then instructs a plotter to draw a reproducible plot: yaw, pitch, and roll versus time. These displacements are in reference to the vehicle-fixed coordinate system with the initial position and orientation of the vehicle-fixed coordinate system being that which existed at initial impact.

Evaluation Criteria

All crash tests were evaluated in accordance with the criteria presented in NCHRP Report 230 and 1985 AASHTO. As stated in NCHRP Report 230, "Safety performance of a highway appurtenance cannot be measured directly but can be judged on the basis of three factors: structural adequacy, occupant risk, and vehicle trajectory after collision". In accordance, the following safety evaluation criteria from Table 6, NCHRP Report 230 were used:

- Structural adequacy

- (B) The test article shall readily activate in a predictable manner by breaking away or yielding.
- (D) Detached elements, fragments or other debris from the test-article shall not penetrate or show potential for penetrating the passenger compartment or present undue hazard to other traffic.

- Occupant Risk

- (E) The vehicle shall remain upright during and after collision although moderate roll, pitching and yawing are acceptable. Integrity of the passenger compartment must be maintained with essentially no deformation or intrusion.

- (F) Impact velocity of hypothetical front seat passenger against vehicle interior, calculated from the vehicle accelerations and 24 in (0.61 m) forward and 12 in (0.30 m) lateral displacement, shall be less than:

<u>Occupant Impact Velocity - fps</u>	
<u>Longitudinal</u>	<u>Lateral</u>
15	N./A.

and vehicle highest 10 ms average accelerations subsequent to instant of hypothetical passenger impact should be less than:

<u>Occupant Ridedown Accelerations - g's</u>	
<u>Longitudinal</u>	<u>Lateral</u>
15	N./A.

● Vehicle Trajectory

- (H) After collision, the vehicle trajectory and final stopping position shall intrude a minimum distance, if at all, into adjacent traffic lanes.
- (J) Vehicle trajectory behind the test article is acceptable.

In addition, 1985 AASHTO states:

Satisfactory dynamic performance is indicated when the maximum change in velocity for a standard 1,800 pound (816.5 kg) vehicle, or its equivalent, striking a breakaway support at speeds from 20 mi/h to 60 mi/h (32 km/h to 97 km/h) does not exceed 15 fps (4.57 mps), but preferably does not exceed 10 fps (3.05 mps) or less.

CRASH TEST RESULTS

Test 7203-1

A 1986 Yugo (shown in Figures 3 & 4) impacted a 5 inch diameter steel pipe, multi-directional slip-base, sign installation (Figures 2 & 5) in strong (S-1) soil. The impact was at 20.8 miles per hour (33.4 km/h) using a cable reverse tow and guidance system. The point of impact was the front left quarter point of the vehicle bumper with the sign installation. Test inertia weight of the vehicle was 1,800 lb (817 kg) and its gross static weight was 1,970 lb (894 kg). The height from roadway surface to the lower edge of the vehicle bumper was 13.8 inches (34.9 cm) and 19.0 inches (48.3 cm) to the top of the bumper. Other dimensions and information on the vehicle are given in Figure 6.

The vehicle was free wheeling and unrestrained just prior to impact. Shortly after impact, the sign support displaced the bolts in the slip-base and began to rise up off the base plate. By approximately 0.068 seconds, the vehicle had reached maximum engagement with the support. As the support released, the vehicle yawed counterclockwise. The vehicle lost contact with the sign support temporarily at approximately 0.147 second. As the vehicle continued to move forward, the support was displaced over the hood of the vehicle. The sign panel impacted the roof (over the occupant compartment) of the vehicle at approximately 0.929 second. The vehicle came to rest 23.0 ft (7.0 m) from the point of impact and against the displaced sign installation as shown in Figure 7. Sequential photographs of the test are shown in Figure 8.

The installation yielded to the vehicle. Damage sustained to the sign installation is shown in Figure 9. The sign support and vehicle came to rest 23 ft (7.0 m) from the point of impact. The vehicle sustained moderate damage to the bumper, hood and roof as shown in Figure 10. In addition, the left front strut assembly and wheel were pushed rearward 3.3 in (8.3 cm). Maximum horizontal crush to the vehicle was 4.3 in (10.8 cm), located at the front left side of the hood and bumper. Maximum vertical crush was 4.8 in (12.1 cm) located over the front occupant flail space area.

A summary of the test results and other information pertinent to this test are



Figure 4. Vehicle before test 7203-1.

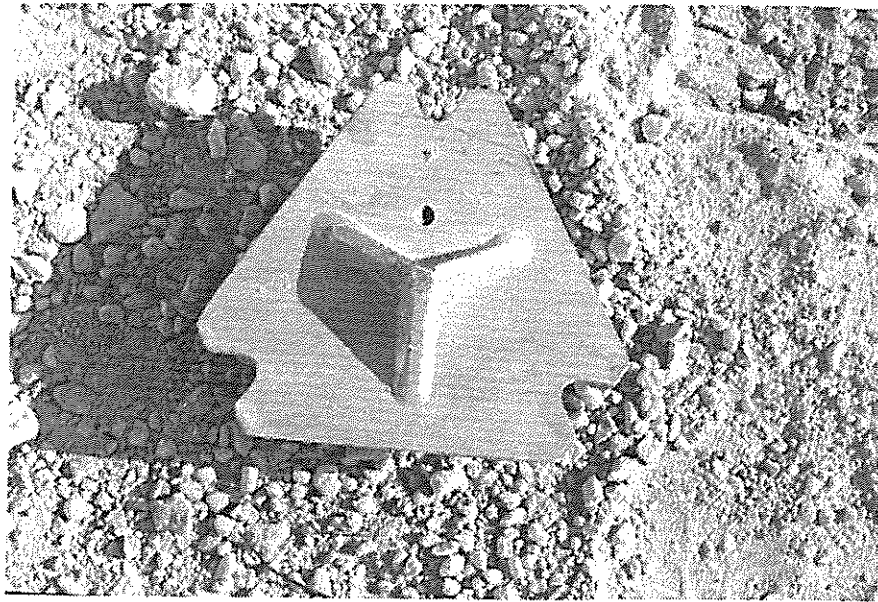
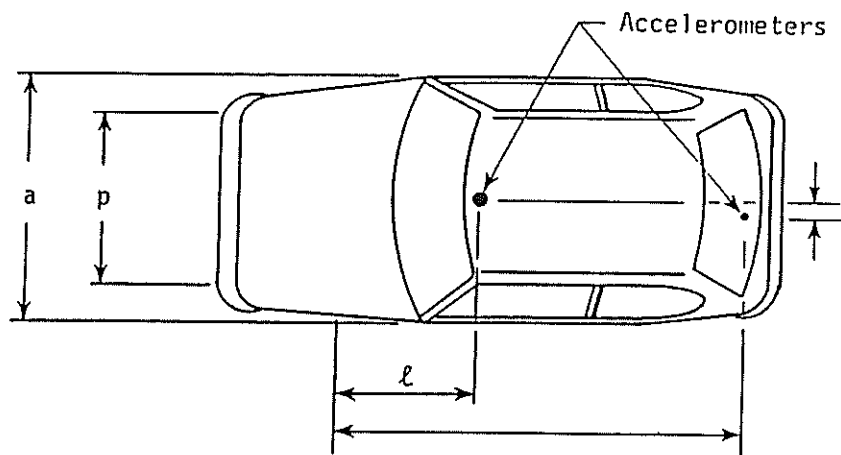

Figure 5. Details of multi-directional slip-base.

Date: 5-8-92 Test No.: 7203-1 VIN: VX1BA1218GK322466
 Make: Yugo Model: G.V. Year: 1986 Odometer: 74704
 Tire Size: 155-80R13 Ply Rating: _____ Bias Ply: _____ Belted: _____ Radial: X

Tire Condition: good _____
 fair X
 badly worn _____



Vehicle Geometry - inches

a	<u>60.25"</u>	b	<u>27.25"</u>
c	<u>84.75"</u>	d*	<u>55.75"</u>
e	<u>25.25"</u>	f	<u>137.25"</u>
g	_____	h	<u>30.30"</u>
i	_____	j	<u>31.00"</u>
k	<u>15.00"</u>	l	<u>31.00"</u>
m	<u>19.00"</u>	n	<u>2.75"</u>
o	<u>13.75"</u>	p	<u>51.50"</u>
r	<u>22.50"</u>	s	<u>14.25"</u>

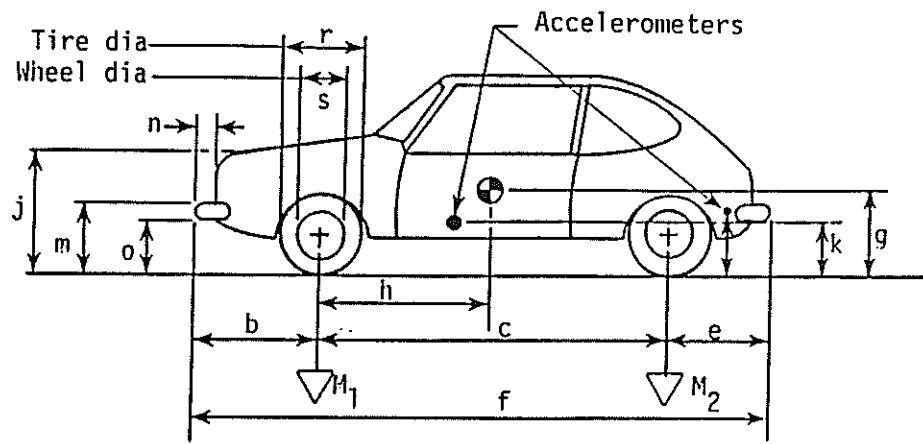

Engine Type: 4 cyl.
 Engine CID: 1100 cc
 Transmission Type:

4-wheel weight for c.g. det. lf 589 rf 568 lr 319 rr 324

Automatic or Manual
FWD or RWD or 4WD

Mass - pounds	Curb	Test Inertial	Gross Static
M_1	<u>1191</u>	<u>1157</u>	<u>1241</u>
M_2	<u>625</u>	<u>643</u>	<u>729</u>
M_T	<u>1816</u>	<u>1800</u>	<u>1970</u>

Body Type: Hatch
 Steering Column Collapse Mechanism:
 _____ Behind wheel units
 _____ Convoluted tube
 _____ Cylindrical mesh units
 _____ Embedded ball
 _____ NOT collapsible
 _____ Other energy absorption
 _____ Unknown

Note any damage to vehicle prior to test:
Cracked in windshield (marked)

Brakes:
 Front: disc X drum _____
 Rear: disc _____ drum X

*d = overall height of vehicle

Figure 6. Test vehicle properties (7203-1).

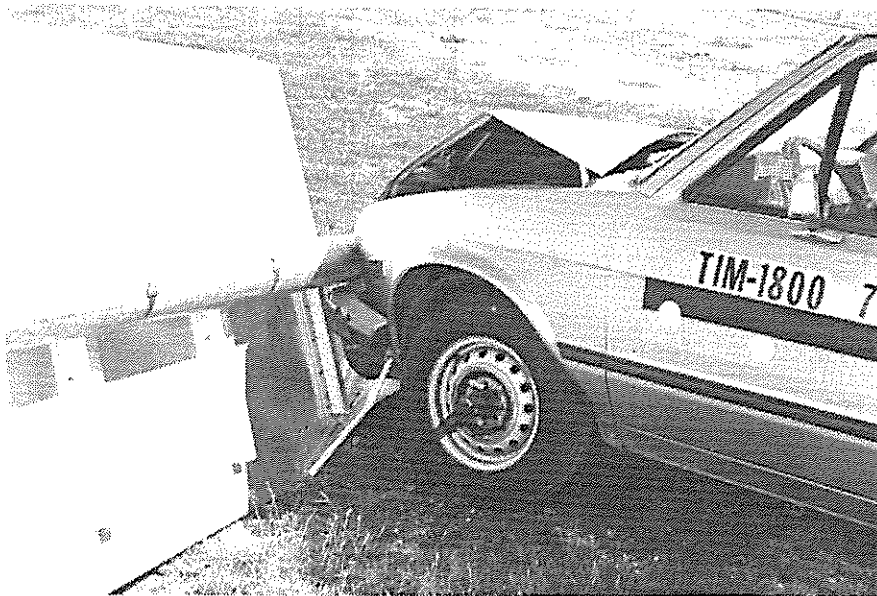
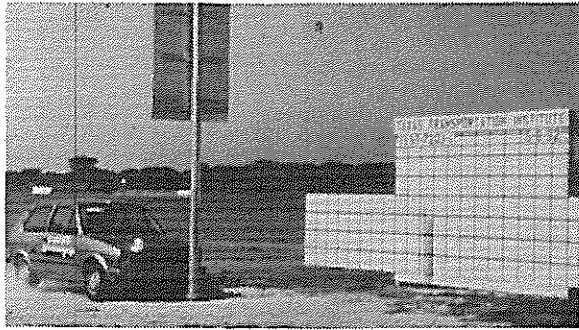
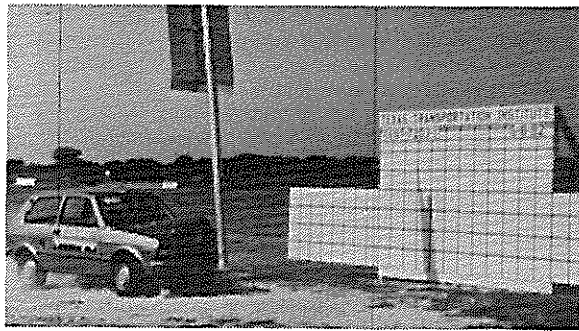
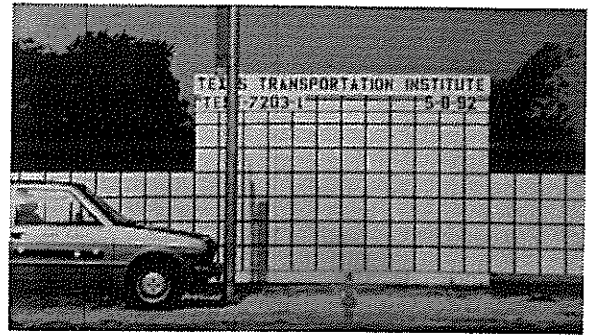

Figure 7. Final rest position of vehicle and sign installation after test 7203-1.



0.000 s



0.174 s

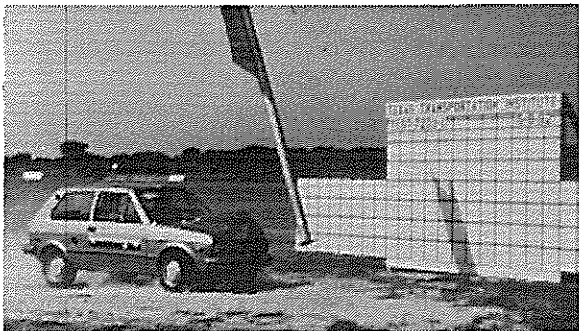

0.347 s



0.521 s



Figure 8: Sequential photographs for test 7203-1.

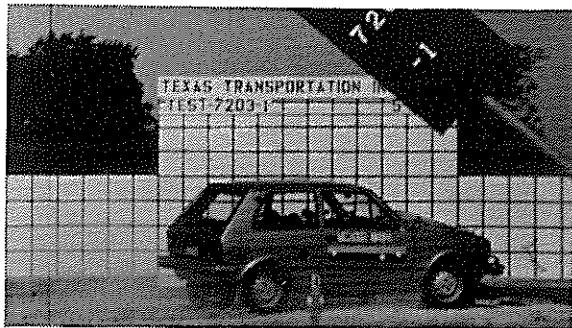

0.694 s



0.868 s

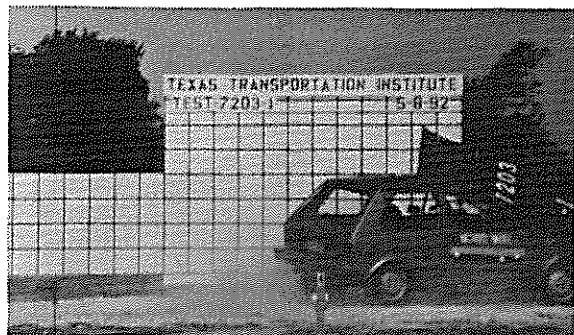

1.041 s

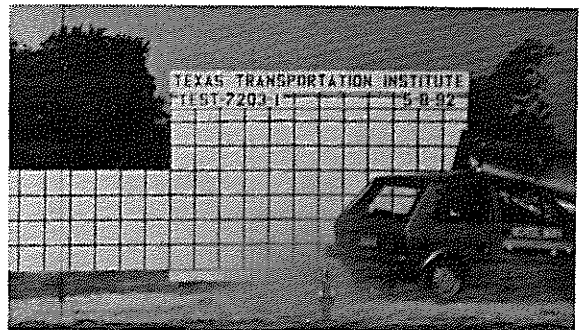

1.215 s

Figure 8. Sequential photographs for test 7203-1.
(cont.)

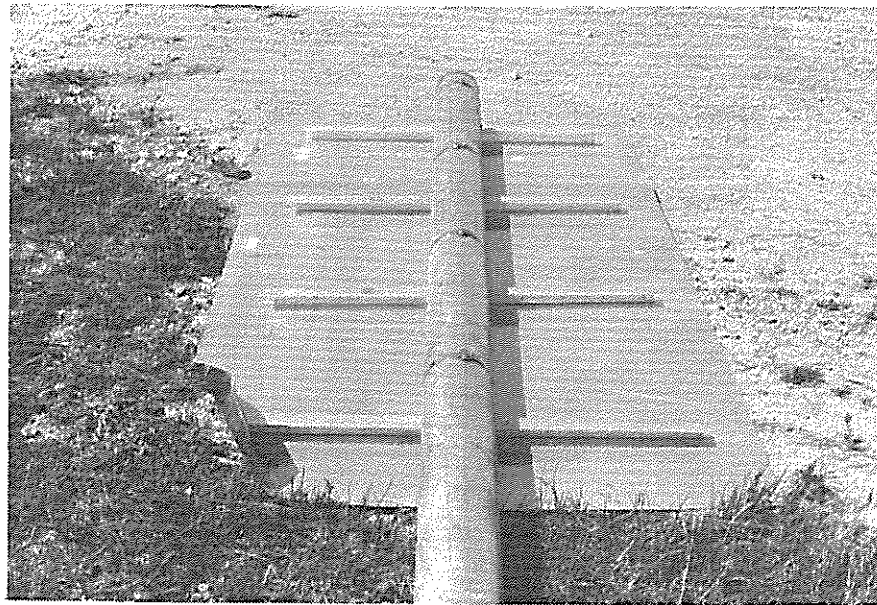
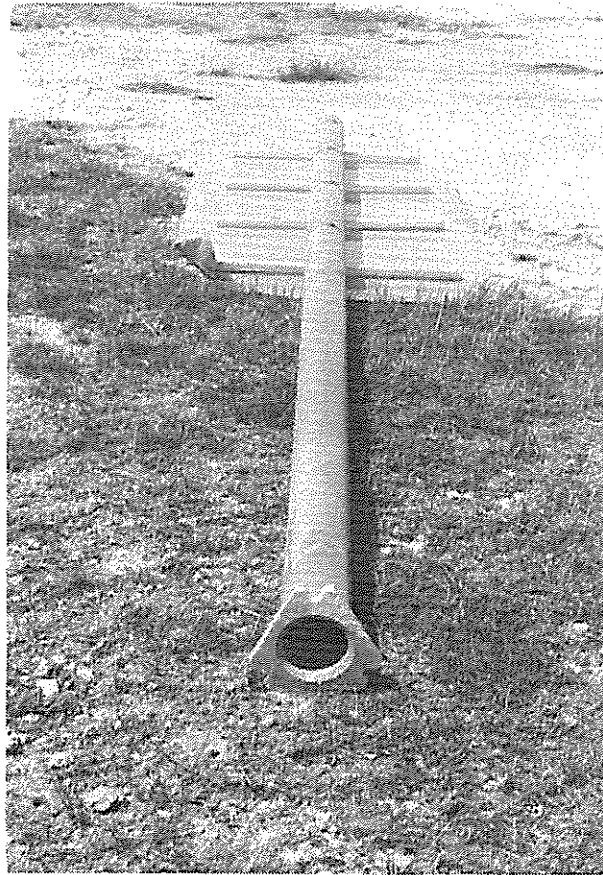

Figure 9. Multi-directional slip-base, single steel sign support installation after test 7203-1.

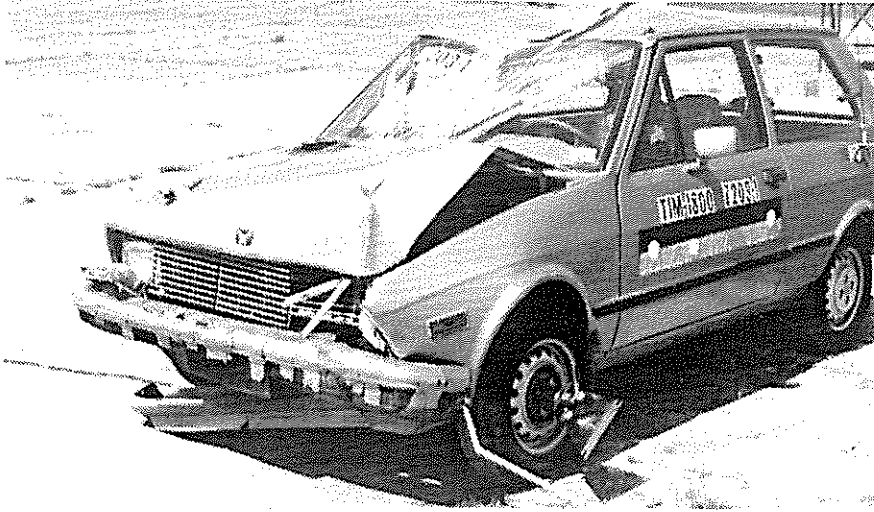
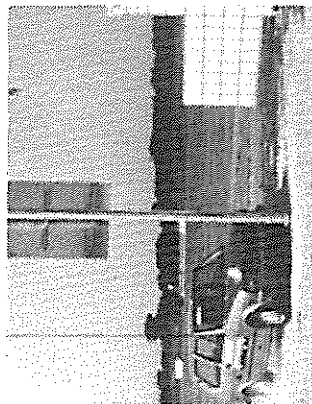
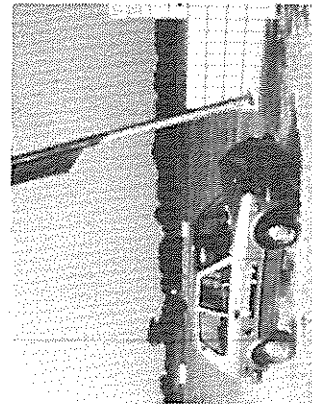
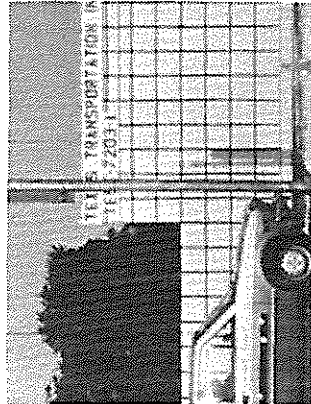

Figure 10. Vehicle after test 7203-1.

given in Figure 11. The maximum 0.050 second average acceleration experienced by the vehicle was -7.8 g in the longitudinal direction and -1.8 g in the lateral direction. Vehicle angular displacements are plotted in Figure 12 and vehicle accelerometer traces are displayed in Figures 13 through 15. Occupant impact velocity was 16.2 ft/s (4.9 m/s) in the longitudinal direction and -4.3 ft/s (1.3 m/s) in the lateral direction. Occupant ridedown accelerations in the longitudinal and lateral directions were -1.6 g's and 0.5 g's respectively. Change in vehicle velocity was 20.8 mi/h (33.4 km/h) and change in momentum was 1702.9 lb-s.



0.000 S



0.347 S

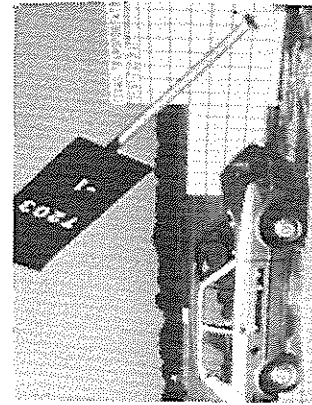
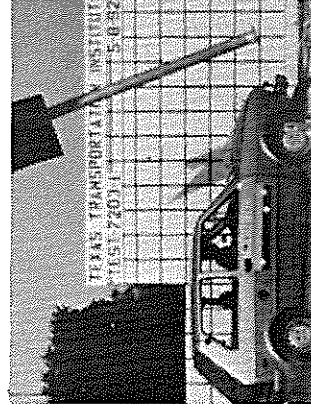

0.694 S

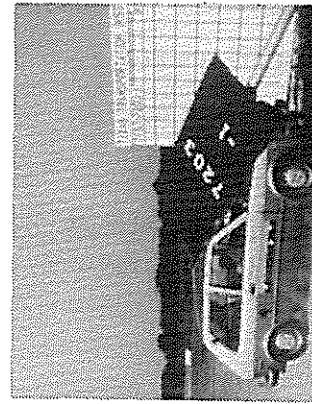
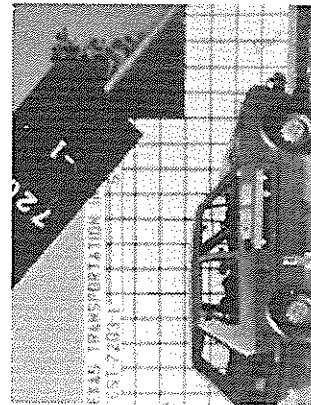

1.041 S

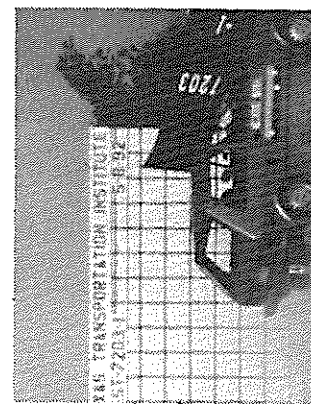

Test No. 7203-1.
 Date. 05/08/92.
 Test Article. . . Multi-directional slip base,
 Sign installation

Support 5 in. dia., schedule 40
 steel post.

Embedment. 18 in. dia. x 48 in. concrete
 footing

Vehicle. 1986 Yugo

Vehicle Weight

Test Inertia. .1800 lb (817 kg)

Gross Static. .1970 lb (894 kg)

Vehicle Damage Classification

TAD 12-FC-5

SAE 12FLAN2

Impact Speed. 20.8 mi/h (33.4 km/h)
 Change in Velocity. 20.8 mi/h (33.4 km/h)
 Change in Momentum. 1702.9 lbs.

Vehicle Accelerations
 (Max. 0.050-sec Avg)

Longitudinal -7.8 g

Lateral. -1.8 g

Occupant Impact Velocity

Longitudinal 16.2 ft/s (4.9 m/s)

Lateral. -4.3 ft/s (1.3 m/s)

Occupant Ridedown Accelerations

Longitudinal -1.6 g

Lateral. 0.5 g

Figure 11. Summary of results for test 7203-1

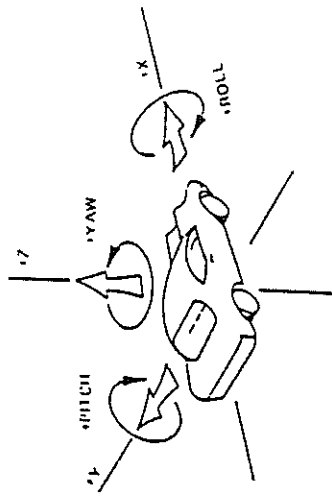

Axes are vehicle fixed.
Sequence for determining
orientation is:

1. Yaw
2. Pitch
3. Roll

7203-1

○ Roll —×— Pitch ——— Yaw

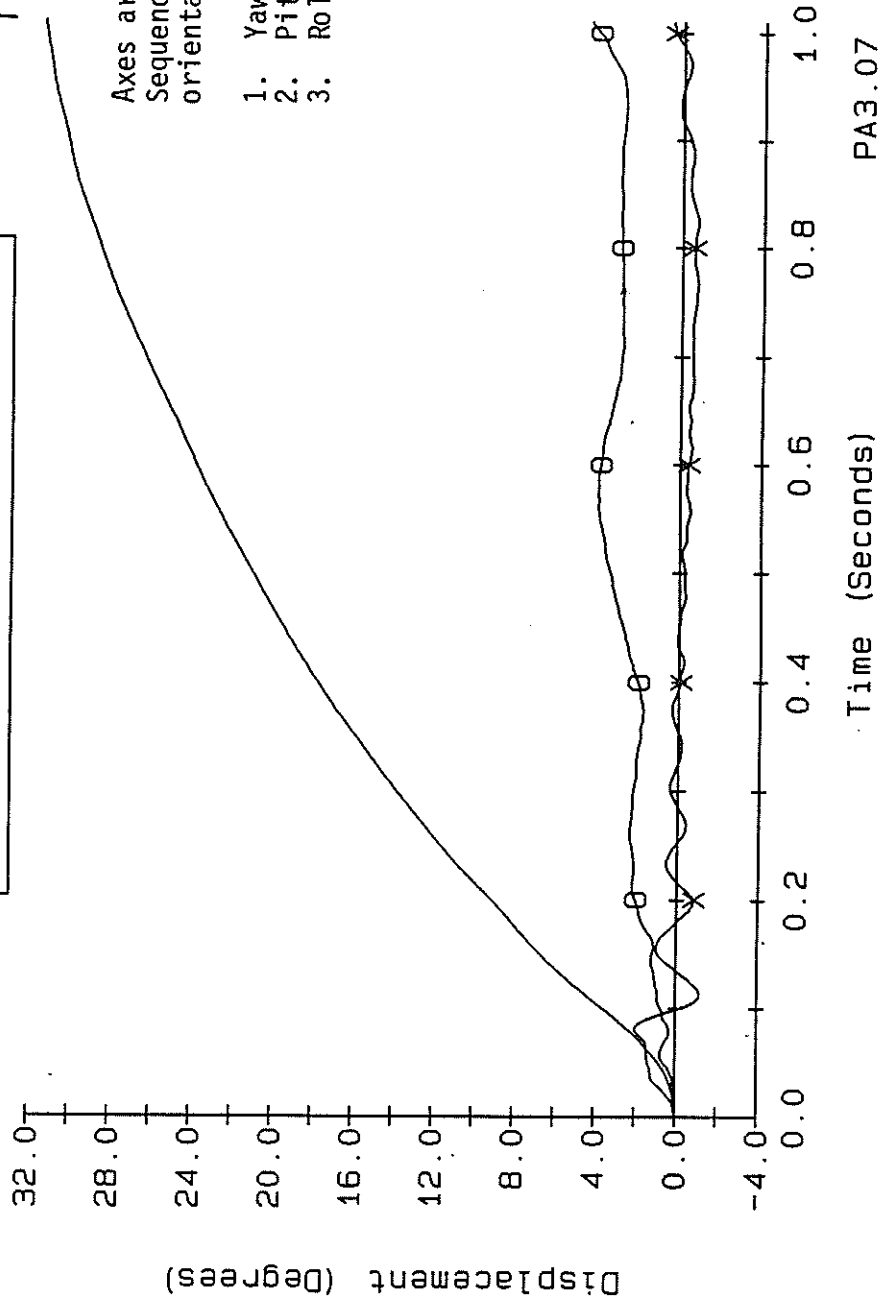

Figure 12. Vehicle angular displacements (test 7203-1).

CRASH TEST 7203-1
Class 180 Filter

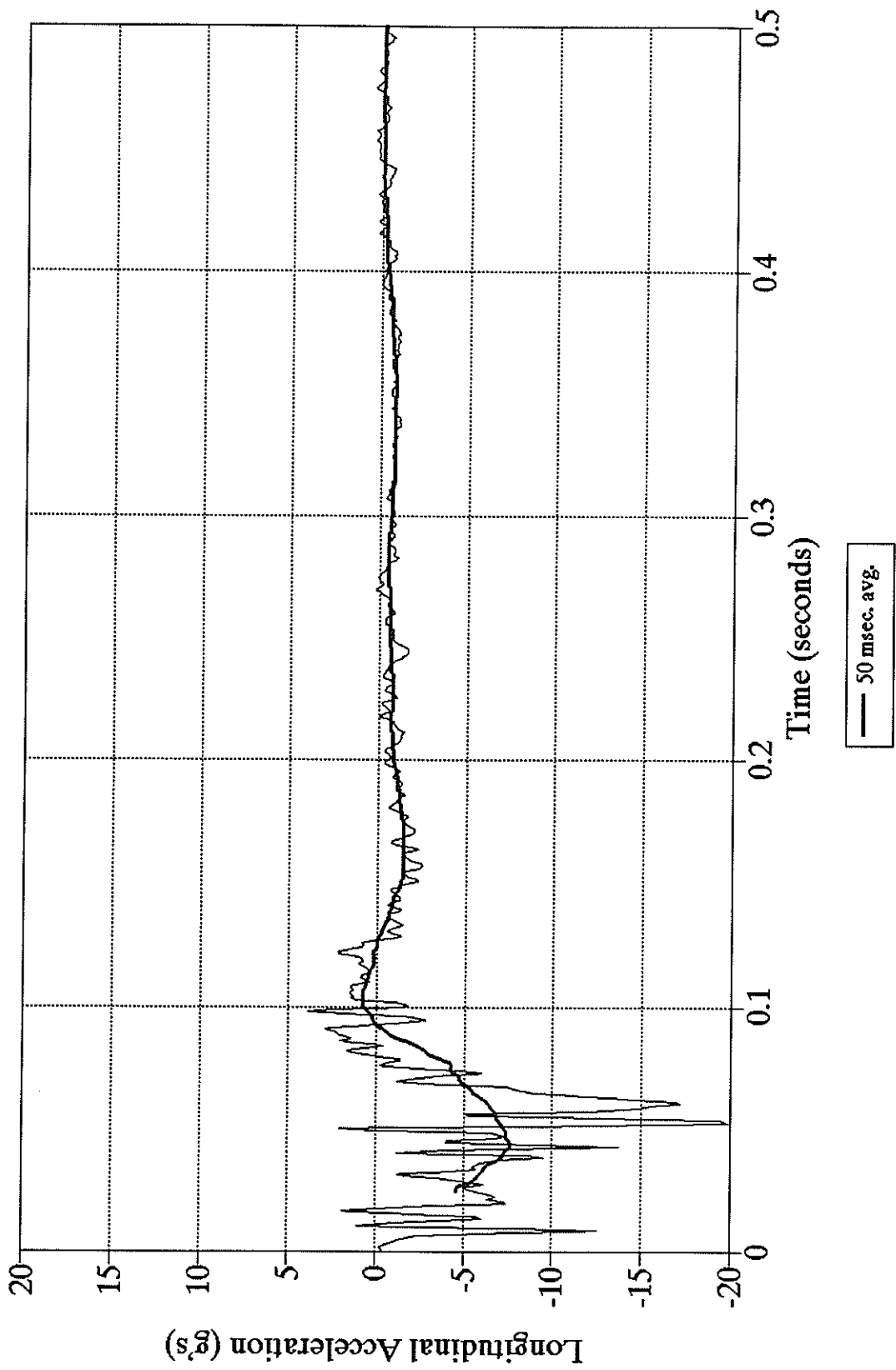

Figure 13. Longitudinal accelerometer trace of test 7203-1.

CRASH TEST 7203-1
Class 180 Filter

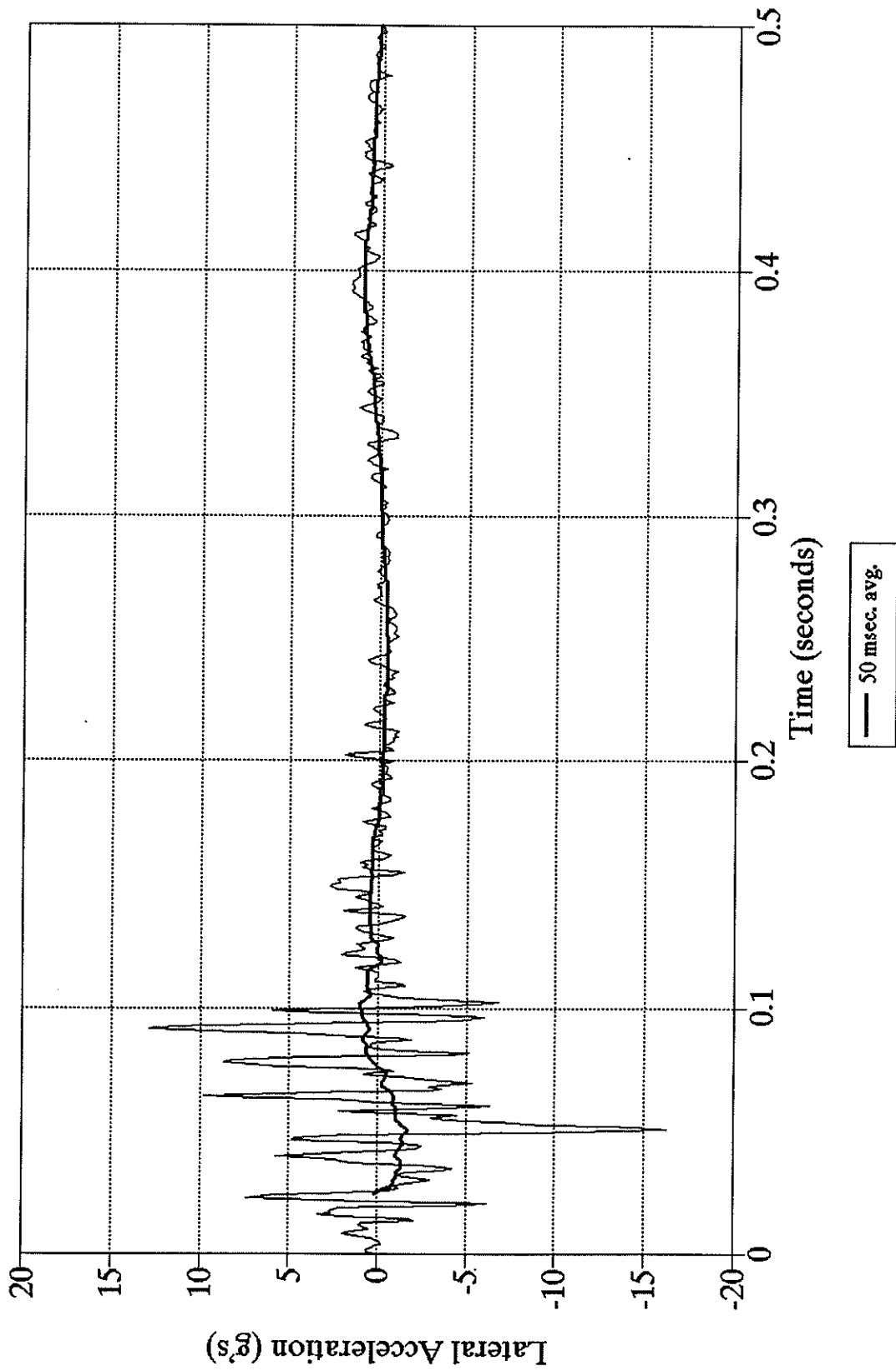

Figure 14. Lateral accelerometer trace of test 7203-1.

CRASH TEST 7203-1
Class 180 Filter

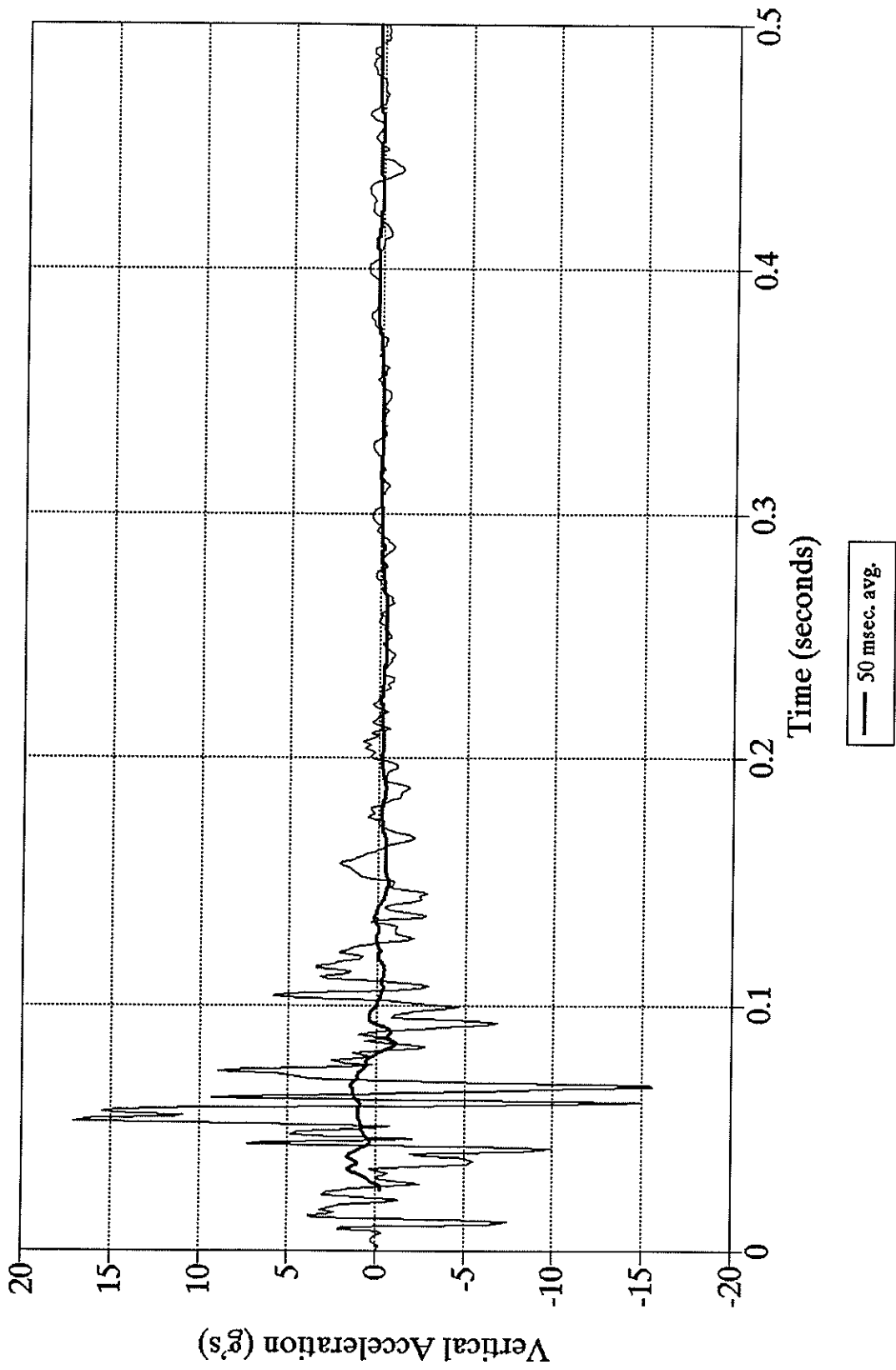

Figure 15. Vertical accelerometer trace of test 7203-1.

CONCLUSION

The 60 mi/h crash test was not conducted due to the severity of damage sustained to the test vehicle and the results of the data collected in that test.

The sign installation yielded to the vehicle. The vehicle sustained moderate damage and did not present undue hazard to other traffic. Occupant ridedown accelerations were within the recommended design limit of 15 g's, as specified in NCHRP 230. However, occupant impact velocity in the longitudinal direction (16.2 ft/s) was above the recommended limit of 16 ft/s as specified in NCHRP 230. In addition, an unacceptable amount of deformation was sustained to the roof over the occupant compartment. The integrity of the occupant compartment was violated due to the sign panel impacting the roof. It should be noted, it is permissible for any part of the sign installation to strike the roof as the vehicle passes. However, excessive deformation or intrusion that may present risk to the occupants is unacceptable. The damage sustained to the roof of the vehicle was located over the front occupant flail space area, thereby presenting a potentially severe hazard to the driver and potential occupant (See Figure 10).

Due primarily to the amount of intrusion into the occupant compartment and secondarily, to the excessive occupant impact velocity in the longitudinal direction, this sign installation in "strong soil" is unacceptable according to the evaluation criteria recommended in NCHRP Report 230 and the 1985 AASHTO Standards.

This public document is published at a total cost of \$ 821.23. One Hundred Seventy-Five (175) copies of this public document were published in this first printing at a cost of \$ 626.23. The total cost of all printings of this document including reprints is \$ 821.23. This document was published by Louisiana State University, Graphic Services, 3555 River Road, Baton Rouge, Louisiana 70802, to report and publish research findings of the Louisiana Transportation Research Center as required in R.S.48:105. This material was printed in accordance with standards for printing by State Agencies established pursuant to R.S.43:31. Printing of this material was purchased in accordance with the provisions of Title 43 of the Louisiana Revised Statutes.