

Project Review Committee

Each research project has an advisory committee appointed by the LTRC Director. The Project Review Committee (PRC) is responsible for assisting the LTRC Administrator or Manager in the development of acceptable research problem statements, requests for proposals, review of research proposals, oversight of approved research projects, and implementation of findings.

LTRC appreciates the dedication of the following Project Review Committee members in guiding this research study to fruition.

LTRC Manager

**Chris Abadie
Materials Research Administrator**

Members

**Sam Cooper, Jr., LTRC
Michael Boudreaux, LTRC
Doug Hood, DOTD
Barry Moore, Sr., LAPA (Retired)
Mike Ricca, DOTD
Luanna Cambas, DOTD**

Directorate Implementation Sponsor

William T. Temple, DOTD Chief Engineer

1. Report No. FHWA/LA.04/394		2. Government Accession No.		3. Recipient's Catalog No.	
4. Title and Subtitle Investigation of the Behavior of Asphalt Tack Interface Layer		5. Report Date August 4, 2005			
		6. Performing Organization Code LTRC			
7. Author(s) Louay N. Mohammad, Ph.D., Zhong Wu, Ph.D., P.E., and Md. Abdur Raqib		8. Performing Organization Report No. 394			
9. Performing Organization Name and Address Louisiana Transportation Research Center 4101 Gourrier Avenue Baton Rouge, LA 70808		10. Work Unit No. State Project No. 736-99-1028 LTRC Project No. 00-2B			
		11. Contract or Grant No.			
12. Sponsoring Agency Name and Address Louisiana Transportation Research Center 4101 Gourrier Avenue Baton Rouge, LA 70808		13. Type of Report and Period Covered Final Report			
		14. Sponsoring Agency Code LTRC			
15. Supplementary Notes					
16. Abstract Asphalt tack coat is a light application of asphalt, usually asphalt diluted with water. It ensures a bond between the surface being paved and the overlying course by providing increased shear strength between two interfaces. Normally hot asphalt cements, emulsified asphalts or cutback asphalts are used as tack coat. The objective of this study was to evaluate the practice of using tack coats through controlled laboratory simple shear tests and determine the optimum application rate. The influence of tack coat types, application rates, and test temperatures on the interface shear strength was examined. Six emulsions (CRS-2P, CRS-2L, SS-1, CSS-1, SS-1h and SS-1L) and two asphalt binders (PG 64-22 and PG 76-22M) were selected as tack coat materials. The residual application rates considered were 0.00 l/m ² (0.00 gal/yd ²), 0.09 l/m ² (0.02 gal/yd ²), 0.23 l/m ² (0.05 gal/yd ²), 0.45 l/m ² (0.1 gal/yd ²), and 0.9 l/m ² (0.2 gal/yd ²). A simple shear test was performed to determine the shear strength at the interface at two test temperatures, 25°C (77°F) and 55°C (131°F). The influence of vertical load levels on interface bonding strength was evaluated using the optimum tack coat material and application rate. Based on the statistical analysis of the interface bond strengths provided by various tack coat types at different application rates, both CRS-2P and CRS-2L were identified as the optimum tack coat types among the eight tack coats considered in this study. The preliminary test results indicated that CRS-2P emulsion provided the highest interface bond strength at the test temperature of 25°C (77°F) whereas CRS-2L provided the highest interface bond strength at the test temperature of 55°C (131°F), both at an optimum residual application of 0.09 l/m ² (0.02 gal/yd ²). In addition, it was found that shear resistance at the interface increased significantly with an increase in vertical load and decreased with an increase in temperature.					
17. Key Words Tack Coat, Emulsion, Asphalt Cement, Simple Shear Test, Interface Bond Strength			18. Distribution Statement Unrestricted. This document is available through the National Technical Information Service, Springfield, VA 21161.		
19. Security Classif. (of this report) N/A	20. Security Classif. (of this page) None	21. No. of P ages 126		22. Price N/A	

Investigation of the Behavior of Asphalt Tack Coat Interface Layer

By

Louay N. Mohammad, Ph.D.
Associate Professor of Civil and Environmental Engineering
Director, Engineering Materials Characterization Research Facility
Louisiana Transportation Research Center

Zhong Wu, Ph.D., P.E.
Materials Research Associate
Engineering Materials Characterization Research Facility
Louisiana Transportation Research Center

Md. Abdur Raqib
Former Graduate Student
Department of Civil and Environmental Engineering
Louisiana State University

LTRC Project No. 00-2B

Conducted for

Louisiana Transportation Research Center

The contents of this report reflect the views of the authors, who are responsible for the facts and the accuracy of the data presented herein. The contents do not necessarily reflect the official views or policies of the Louisiana Department of Transportation and Development, or the Louisiana Transportation Research Center. This report does not constitute a standard, specification, or regulation.

August 2005

ABSTRACT

Asphalt tack coat is a light application of asphalt, usually asphalt diluted with water. It ensures a bond between the surface being paved and the overlying course by providing increased shear strength between two interfaces. Normally, hot asphalt cements, emulsified asphalts or cutback asphalts are used as tack coat. The objective of this study was to evaluate the practice of using tack coats through controlled laboratory simple shear tests and determine the optimum application rate. The influence of tack coat types, application rates, and test temperatures on the interface shear strength was examined. Six emulsions (CRS-2P, CRS-2L, SS-1, CSS-1, SS-1h and SS-1L) and two asphalt binders (PG 64-22 and PG 76-22M) were selected as tack coat materials. The residual application rates considered were 0.00 l/m^2 (0.00 gal/yd^2), 0.09 l/m^2 (0.02 gal/yd^2), 0.23 l/m^2 (0.05 gal/yd^2), 0.45 l/m^2 (0.1 gal/yd^2), and 0.9 l/m^2 (0.2 gal/yd^2). A simple shear test was performed to determine the shear strength at the interface at two test temperatures, 25°C (77°F) and 55°C (131°F). The influence of vertical load levels on interface bonding strength was evaluated using the optimum tack coat material and application rate. Based on the statistical analysis of the interface bond strengths provided by various tack coat types at different application rates, both CRS-2P and CRS-2L were identified as the optimum tack coat types among the eight tack coat types considered in this study. The preliminary test results indicated that CRS-2P emulsion provided the highest interface bond strength at the test temperature of 25°C (77°F), whereas CRS-2L provided the highest interface bond strength at the test temperature of 55°C (131°F), both at an optimum residual application of 0.09 l/m^2 (0.02 gal/yd^2). In addition, the shear resistance at the interface increased significantly with an increase in vertical load and decreased with an increase in temperature.

ACKNOWLEDGEMENTS

This research was supported by the Louisiana Transportation Research Center (LTRC) and the Louisiana Department of Transportation and Development (LADOTD) as project No. 00-2B. The authors would like to express thanks to all the people involved in the Engineering Materials Characterization Research Facility – Amar Raghavendra, Keith Beard, David Wedlake, Gregory Tullier, and William Gueho – for all their help in conducting this research.

IMPLEMENTATION STATEMENT

The findings of this study provide a comparative performance evaluation of different types of asphaltic material used as tack coats. The tack coat materials evaluated were two asphalt cements (PG 64-22, PG 76-22M) and six emulsions (CRS-2L, CRS-2P, SS-1, CSS-1, SS-1h, SS-1L). Five residual application rates (0-, 0.02-, 0.05-, 0.10, 0.2- gal/yd²) were evaluated for each tack coat material. The results of this study demonstrated that applying certain types of tack coat did provide improved bond strength between the interfaces of two new asphalt concrete layers. The study has identified the optimum tack coat types (CRS-2P and CRS-2L) and the corresponding residual application rate (0.09 l/m²) for a tack coat application. These can be directly implemented in field construction.

Field monitoring test sections should be constructed to further validate the field performance of those recommended tack coat materials and the corresponding residual application rates on the existing surface types as indicated in Section 504 of the 2000 Edition of the Louisiana Standard Specification for Roads and Bridges.

It is recommended that the optimum tack coat materials identified (CRS-2P and CRS-2L) be implemented. It is further recommended that emulsion types: SS-1, CSS-1, SS-1P and SS-1L be disallowed as a specified tack coat material in Section 504 based on the results of this study.

TABLE OF CONTENTS

Abstract.....	iii
Acknowledgements.....	v
Implementation Statement.....	vii
List of Tables.....	xi
List of Figures.....	xv
Introduction.....	1
Background.....	2
Objectives.....	11
Scope.....	13
Methodology.....	15
Materials and Mixture Design.....	15
Tack Coat Materials.....	15
Emulsions.....	15
Properties of Tack Coats.....	17
Residue After Evaporation.....	18
Dynamic Shear Rheometer Tests.....	18
Rotational Viscometer Tests.....	22
Mixture Design.....	23
Specimen Preparation.....	26
Determine Tack Coat Amount.....	26
Estimate Minimum Curing Period of Emulsions.....	26
Compact Specimen.....	27
Condition Specimen.....	31
Test Facilities.....	31

Superpave Shear Tester.....	31
Shearing Device.....	32
Shear Strength Test.....	34
Discussion of Results.....	37
Influence of Application Rate.....	37
PG 64-22 as Tack Coat.....	37
PG 76-22M as Tack Coat.....	42
CRS-2L as Tack Coat.....	46
CRS-2P as Tack Coat.....	50
SS-1 as Tack Coat.....	54
CSS-1 as Tack Coat.....	58
SS-1h as Tack Coat.....	62
SS-1L as Tack Coat.....	66
Influence of Tack Coat Type.....	71
Application Rate 0.09 l/m ² (0.02 gal/sq.yd).....	71
Application Rate 0.23 l/m ² (0.05 gal/sq.yd).....	73
Application Rate 0.45 l/m ² (0.1 gal/sq.yd).....	76
Application Rate 0.9 l/m ² (0.2 gal/sq.yd).....	79
Optimum Tack Coat Type and Application Rate.....	81
Influence of Loads on Simple Shear Test.....	87
Influence of Shear Load on Shear Deformation.....	87
Influence of Normal Loads.....	88
Summary and Conclusions.....	93
Recommendations.....	95
References.....	97
Appendix A. Job Mix Formula for the Designed Mix.....	99
Appendix B. Determination of Tack Coat Amount to Be Applied on a Specimen Surface	101

LIST OF TABLES

Table 1 Test factorial used by Uzan et al. [2].....	2
Table 2 Test sample dimensions used by Hachiya and Sato [5].....	5
Table 3 Test factorial used by Hachiya and Sato.....	6
Table 4 Survey of 1998 regarding tack coat use in various states [6]	8
Table 5 Test factorial for varying type, application rate, and temperature.....	13
Table 6 Test factorial for varying normal load levels.....	14
Table 7 Louisiana specification requirements and sample test result for the binders	16
Table 8 Residue after evaporation of the emulsified asphalts	18
Table 9 Complex shear modulus and phase angle measured at 25°C	20
Table 10 Complex shear modulus and phase angle measured at 55°C	21
Table 11 Aggregate blend properties.....	24
Table 12 Compaction and volumetric properties at design asphalt content	25
Table 13 Minimum setting period of emulsions.....	27
Table 14 Interface bond strengths using PG 64-22 as tack coat at 25°C.....	38
Table 15 Statistical analysis of interface bond strengths using PG 64-22 as tack coat at test temperature of 25°C	39
Table 16 Interface bond strengths Using PG 64-22 as tack coat at 55°C.....	40
Table 17 Statistical analysis of interface bond strengths using PG 64-22 as tack coat at test temperature of 55°C	41
Table 18 Interface bond strengths using PG 76-22M as tack coat at test temperature of 25°C	42
Table 19 Statistical analysis of interface bond strengths using PG 76-22M as tack coat at test temperature of 25°C	43
Table 20 Interface bond strengths using PG 76-22M as tack coat at test temperature of 55°C	44
Table 21 Statistical analysis of interface bond strengths using PG 76-22M as tack coat at test temperature of 55°C	45
Table 22 Interface bond strengths using CRS-2L as tack coat at 25°C.....	46

Table 23 Statistical analysis of interface bond strengths using CRS-2L as tack coat at test temperature of 25°C	47
Table 24 Interface bond strengths using CRS-2L as tack coat at test temperature of 55°C ...	48
Table 25 Statistical analysis of interface bond strength using CRS-2L as tack coat at test temperature of 55°C	49
Table 26 Interface bond strengths using CRS-2P as tack coat at test temperature of 25°C ...	50
Table 27 Statistical analysis of interface bond strengths using CRS-2P as tack coat at test temperature of 25°C	51
Table 28 Interface bond strengths using CRS-2P as tack coat at test temperature of 55°C ...	52
Table 29 Statistical analysis of interface bond strengths using CRS-2P as tack coat at test temperature of 55°C	53
Table 30 Interface bond strengths using SS-1 as tack coat at temperature of 25°C	55
Table 31 Statistical analysis of interface bond strengths using SS-1 as tack coat at test	56
Table 32 Interface bond strengths using SS-1 as tack coat at test temperature of 55°C.....	57
Table 33 Statistical analysis of interface bond strength using SS-1 as tack coat at test.....	58
Table 34 Interface bond strengths using CSS-1 as tack coat at test temperature of 25°C.....	59
Table 35 Statistical analysis of interface bond strengths using CSS-1 as tack coat at test.....	60
Table 36 Interface bond strengths using CSS-1 as tack coat at test temperature of 55°C.....	61
Table 37 Statistical analysis of interface bond strengths using CSS-1 as tack coat at test.....	62
Table 38 Interface bond strengths using SS-1h as tack coat at test temperature of 25°C.....	63
Table 39 Statistical analysis of interface bond strengths using SS-1h as tack coat at test temperature of 25°C	64
Table 40 Interface bond strengths using SS-1h as tack coat at test temperature of 55°C.....	65
Table 41 Statistical analysis of interface bond strengths using SS-1h as tack coat at test	66
Table 42 Interface bond strengths using SS-1L as tack coat at test temperature of 25°C	67
Table 43 Statistical analysis of interface bond strengths using SS-1L as tack coat at test temperature of 25°C	68
Table 44 Interface bond strengths using SS-1L as tack coat at test temperature of 55°C.....	69
Table 45 Statistical analysis of interface bond strengths using SS-1L as tack coat at test temperature of 55°C	70

Table 46 Statistical analysis of mean interface bond strengths obtained at an application rate of 0.09 l/m ² at test temperature of 25°C	72
Table 47 Statistical analysis of mean interface bond strengths obtained at an application rate of 0.09 l/m ² at test temperature of 55°C	73
Table 48 Statistical analysis of mean interface bond strengths obtained at an application rate of 0.23 l/m ² at test temperature of 25°C	74
Table 49 Statistical analysis of mean interface bond strengths obtained at an application rate of 0.23 l/m ² at test temperature of 55°C	75
Table 50 Statistical analysis of mean interface bond strengths obtained at an application rate of 0.45 l/m ² at test temperature of 25°C	77
Table 51 Statistical analysis of mean interface bond strengths obtained at an application rate of 0.45 l/m ² at test temperature of 55°C	78
Table 52 Statistical analysis of mean interface bond strengths obtained at an application rate of 0.9 l/m ² at test temperature of 25°C	80
Table 53 Statistical analysis of mean interface bond strengths obtained at an application rate of 0.9 l/m ² at test temperature of 55°C	81
Table 54 Statistical analysis to determine optimum tack coat type and application rate at 25°C	82
Table 55 Statistical analysis to determine optimum tack coat type and application rate at 55°C	84
Table 56 Variation of interface bond strength with normal load levels at test temperature 25°C	89
Table 57 Variation of interface bonding strength with normal load levels at test temperature 55°C	90
Table 58 Applied Tack Coat Amounts at Various Application Rates	107

LIST OF FIGURES

Figure 1 Maximum shear stress vs. vertical pressure [2].....	3
Figure 2 Shear stress-strain graph for overlay cast on a standard traffic-worn surface [3]	4
Figure 3 Emulsified asphalt	17
Figure 4 Basic principles of dynamic shear rheometer.....	19
Figure 5 Stress-strain response in dynamic shear rheometer test	20
Figure 6 Variation of $G^*/\sin \delta$ with tack coat type at test temperature 25°C	21
Figure 7 Variation of $G^*/\sin \delta$ with tack coat type at test temperature 55°C	22
Figure 8 Rotational viscometer	22
Figure 9 Viscosities of tack coat materials	23
Figure 10 Aggregate gradation of the design mix	24
Figure 11 Design curve for air void vs. asphalt content	25
Figure 12 Tack coat application using a paintbrush	28
Figure 13 Placement of the compacted bottom half of a sample in mold.....	29
Figure 14 Placement of loose mix on top of a compacted bottom half	29
Figure 15 Placing compaction mold in the SGC for compaction	30
Figure 16 Superpave shear tester	32
Figure 17 Designed shear mold	33
Figure 18 Designed shear mold with a sample inside.....	33
Figure 19 Test arrangement for the simple shear test.....	34
Figure 20 Typical shear load vs. time for 55°C	35
Figure 21 Typical simple shear test result at 55°C	36
Figure 22 Plot of interface shear strength vs. application rate using PG 64-22 as tack coat at test temperature of 25°C	39
Figure 23 Plot of interface shear strength vs. application rate using PG 64-22 as tack coat at test temperature of 55°C	41
Figure 24 Plot of interface shear strength vs. application rate using PG 76-22M as tack coat at test temperature of 25°C	43
Figure 25 Plot of interface shear strength vs. application rate using PG 76-22M as tack coat at test temperature of 55°C	45
Figure 26 Shear strength vs. application rate using CRS-2L at 25°C	47

Figure 27 Plot of shear strength vs. application rate using CRS-2L as tack coat at test.....	49
Figure 28 Plot of interface shear strength vs. application rate using CRS-2P as tack coat at test temperature of 25°C.....	51
Figure 29 Plot of shear strength vs. application rate using CRS-2P as tack coat at test temperature of 55°C.....	53
Figure 30 Plot of shear strength vs. application rate using SS-1 as tack coat at test.....	55
Figure 31 Plot of shear strength vs. application rate using SS-1 as tack coat at test temperature of 55°C.....	57
Figure 32 Plot of shear strength vs. application rate using CSS-1 as tack coat at test temperature of 25°C.....	59
Figure 33 Plot of shear strength vs. application rate using CSS-1 as tack coat at test.....	61
Figure 34 Plot of shear strength vs. application rate using SS-1h as tack coat at test temperature of 25°C.....	63
Figure 35 Plot of shear strength vs. application rate using SS-1h as tack coat at test.....	65
Figure 36 Plot of shear strength vs. application rate using SS-1L as tack coat at test temperature of 25°C.....	68
Figure 37 Plot of shear strength vs. application rate using SS-1L as tack coat at test.....	70
Figure 38 Mean shear strength vs. tack coat type at an application rate of 0.09 l/m ² at test temperature of 25°C.....	71
Figure 39 Mean shear strength vs. tack coat type at an application rate of 0.09 l/m ² at test temperature of 55°C.....	73
Figure 40 Mean shear strength vs. tack coat type at an application rate of 0.23 l/m ² at test temperature of 25°C.....	74
Figure 41 Mean shear strength vs. tack coat type at an application rate of 0.23 l/m ² at test temperature of 55°C.....	75
Figure 42 Mean shear strength vs. tack coat type at an application rate of 0.45 l/m ² at test temperature of 25°C.....	76
Figure 43 Mean shear strength vs. tack coat type at application rate of 0.45 l/m ² at test.....	78
Figure 44 Mean shear strength vs. tack coat type at application rate of 0.9 l/m ² at test.....	79
Figure 45 Mean shear strength vs. tack coat type at application rate of 0.9 l/m ² at test temperature of 55°C.....	80

Figure 46 Mean shear strength vs. tack coat type at test temperature of 25°C.....	82
Figure 47 Mean shear strength vs. tack coat type at test temperature of 55°C.....	83
Figure 48 Ranking hierarchy of tack coat type at 25°C.....	85
Figure 49 Ranking hierarchy of tack coat type at 55°C.....	86
Figure 50 Simple shear tests results - peak points at 25°C.....	87
Figure 51 Simple shear tests results - peak points at 55°C.....	88
Figure 52 Variation of shear strength at interface with applied normal stress levels.....	91

INTRODUCTION

An asphalt tack coat is a film of bituminous binder that is used to enhance adhesive bonding, thus, increasing the interface strength between an existing and a new bituminous or Portland cement concrete layer. A tack coat provides the necessary binding between pavement surface layers to ensure that they act as a monolithic system to withstand traffic and environmental loads. Tack coats are routinely used in asphalt pavement construction to provide adhesion at the interfaces between two consecutive layers. Adhesion between pavement layers is extremely important if stresses are to be properly distributed among the pavement layers. Studies conducted on asphalt pavement interface strength have shown that a strong tack coat binding between the layers of a pavement is critical to transfer radial tensile and shear stresses into the entire pavement structure. On the other hand, no bond or an insufficient bond decreases pavement bearing capacity and may cause slippage. Insufficient bonding may also cause tensile stresses to be concentrated at the bottom of the wearing course. Such concentrated stress may accelerate fatigue cracking and lead to total pavement failure. Slippage can also be caused by excessive amount of tack coat.

Normally, hot asphalt cements (AC-20 and AC-30), cutback asphalts, or emulsified asphalts (SS-1, SS-1h, CRS-2, CMS-2, or CSS-1h) are used as tack coat materials. However, emulsified asphalts are increasingly being used instead of cutback asphalts or hot asphalt cements because they:

1. can be applied at lower application temperatures compared to cutback asphalts or hot asphalt cements.
2. are relatively pollution free.
3. have relatively high flash point temperatures and, therefore, are safer to use.

Important properties that influence the effectiveness of a tack coat are type, application rate, application temperature, and curing period prior to the application of the next layer. In Louisiana, the material used as tack coat must conform to section 1002 of the Louisiana Standard Specifications for Roads and Bridges [1]. Louisiana specifies tack coat type, application rate, minimum application temperature, and the maximum curing period.

This study was limited to investigating the influence of tack coat types and application rates on the interface bonding strength at varying temperatures and normal stresses.

Background

Tack coats are applied to provide adhesion at the interfaces between the various layers of pavements. The state of adhesion at the interfaces between different layers seriously influences stress and strain distribution among the pavement layers, and thus, affects the performance of flexible pavements. Therefore, knowledge of the degree of adhesion at the interfaces is extremely important.

Uzan et al. studied the interface adhesion properties of asphalt layers based on laboratory shear test results [2]. Direct shear tests at a constant shearing rate of 2.5 mm/min (0.1 in/min) were conducted to measure:

1. shear strength parameter at failure, and
2. the horizontal interface modulus.

The horizontal interface modulus is the ratio between shear force at the interface and the relative horizontal displacement caused by the application of direct shear load. Direct interface shear was applied at different test conditions. Test specimens were prepared using a 13 mm Marshall mix. Pen 60-70 asphalt was used in the preparation of the mixture and in the tack coat. The test factorial for the study is presented in Table 1.

The laboratory test results showed that the shear resistance of the interface increased significantly with increasing vertical pressure and decreased with increasing temperature. Laboratory test results also indicated that the shear resistance was the highest at an optimum tack coat application rate.

Table 1
Test factorial used by Uzan et al. [2]

Tack Coat Type	Application Rate		Normal Stress		Test Temperature	
	Kg/m ²	Gal/yd ²	Kpa	psi	°C	°F
Pen 60-70	0.0	0.0	4.9	0.71	25	77
	0.5	0.1	48.9	7.1		
	1.0	0.22	97.9	14.2	55	131
	1.5	0.32	245.5	35.6		
	2.0	0.43	490.2	71.7		

At 25°C (77°F), the optimum tack coat application rate was found to be 1.0 kg/m² (0.22 gal/yd²). At 55°C (131°F) the optimum tack coat application rate was found to lie between 0.5 kg/m² (0.1 gal/yd²) and 1.0 kg/m² (0.22 gal/yd²). Figure 1 shows the influence of tack coat application rates on the shear strength at 55°C (77°F).

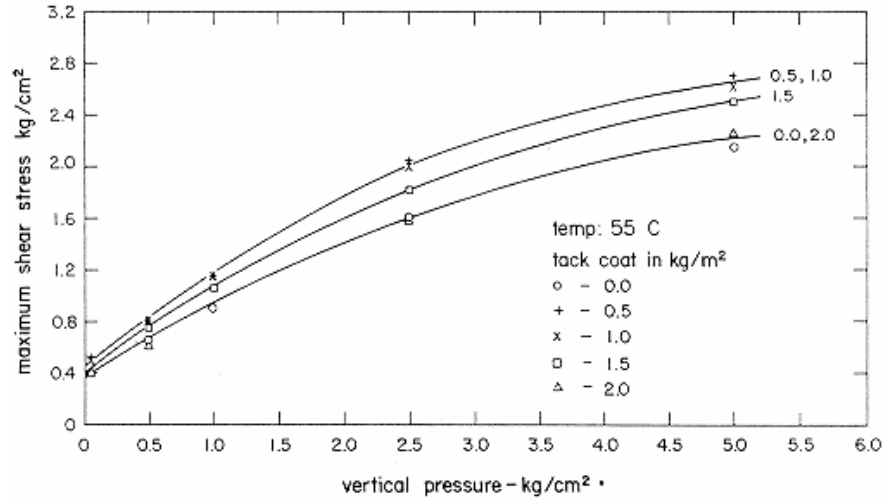

Figure 1
Maximum shear stress vs. vertical pressure [2]

Mrawira and Damude investigated the shear strength of tack coats between two asphalt concrete layers [3]. They compared the shear strength of an interface between fresh overlays with and without tack coating to determine the effectiveness of the tack coat. They adapted the test apparatus from ASTM D143, which is used to test shear strength of wood samples. Six sets of core samples from in-service pavements were used for testing. Each set consisted of five 102 mm (4.02 in) diameter cores. Slow setting asphalt emulsion grade SS-1 was used at an application rate of 0.27 kg/m² (0.06 gal/yd²). Tests were conducted at 22°C (72°F) by applying a constant rate-shearing load of 1 mm/min (0.04 in/min), and the load and deflection were recorded continuously until the ultimate load was reached. From their test results, Mrawira and Damude concluded that the tack coat did not improve the shear strength of the interface, since the non-tacked overlays exhibited slightly higher ultimate shear strengths compared to the tack coated overlays. The authors suggested that the applied tack coat weakened the interface bond by introducing a slip plane instead of mobilizing increased shear strength. Figure 2 shows the comparison of shear strength for tacked and non-tacked overlays.

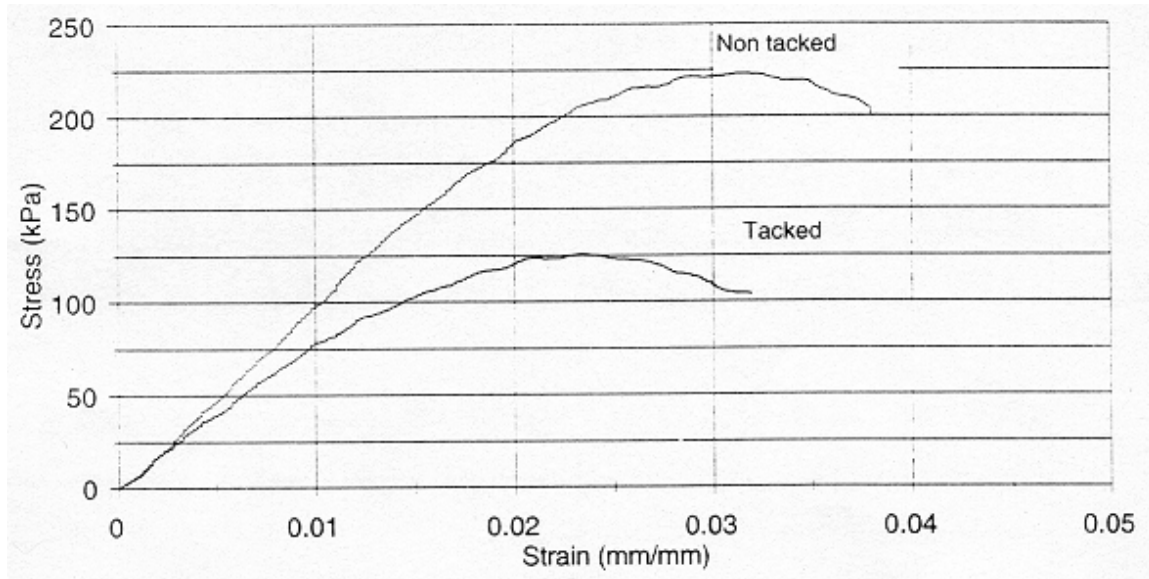

Figure 2
Shear stress-strain graph for overlay cast on a standard traffic-worn surface [3]

Romaneschi conducted laboratory direct shear and fatigue shear tests at several normal load levels [4]. He performed direct shear tests on cores extracted from existing pavements. From the total of 180 road cores extracted, 120 cores were used for the direct shear tests and the remaining 60 were used for fatigue shear tests. He considered the following variables:

1. interface type: with and without tack coat,
2. temperature: 15°C (59°F), 25°C (77°F), and 35°C (95°F), and
3. normal load level: 138, 276, 414, and 522 Kpa (20, 40, 60, and 80 psi).

Five cores were tested for each combination of the above-mentioned variables. The cores were 96 mm (3.78 in.) in diameter and 100 mm (3.94 in.) in height with an interface in the middle. The shear force was applied at the constant shear displacement rate of 0.2 mm/sec (0.01 in/sec) until failure. From the conducted tests, Romaneschi reported that the shear stress and displacement were proportional until the shear stress equaled the shear strength and the interface failed. The interface behavior was described using the following parameters:

1. the interface reaction modulus, K , which is the slope of the shear stress – displacement curves, and
2. the friction coefficient after failure, μ .

Romaneschi concluded that the values of interface reaction modulus K and shear strength S_{max} were not affected by the normal stress for an interface with a tack coat. The values were, however, affected for an interface without a tack coat. The study showed that the interface

bond might also fail in fatigue, and that the permanent shear displacement had a linear relationship with the number of load repetitions.

Hachiya and Sato performed simple shear tests with no normal pressure and simple tension tests on samples cut from laboratory-compacted asphalt concrete blocks [5]. Dimensions of the test samples used are listed in Table 2.

Table 2
Test sample dimensions used by Hachiya and Sato [5]

Test	Sample shape	Length		Width or diameter		Thickness	
		mm	in	mm	in	mm	in
Tension	Rectangular	100	3.94	50 wide	1.97 wide	50	1.97
Shear	Rectangular	100	3.94	50 wide	1.97 wide	100	3.94
Shear	Cylindrical	100	3.94	100 dia	3.94 dia	N/A	N/A

The two types of tack coats used in the sample preparation were cationic emulsified asphalt and rubberized emulsified asphalt. The cationic emulsified asphalts used in the study are shown below:

1. PK-4: cationic emulsified asphalt with a penetration of 60-Pen on residue;
2. PKR-T: cationic emulsified asphalt with a penetration of 100-Pen on residue;
3. PK-80: cationic emulsified asphalt with a penetration of 80-Pen on residue;
4. PK-R80: rubberized emulsified asphalt with a penetration of 80-Pen on residue;
5. PK-HR1: rubberized emulsified asphalt with a viscosity of 1,000 pa.s or more on residue; and
6. PK-HR2: rubberized emulsified asphalt with a viscosity of 10,000 pa.s or more on residue.

Table 3 shows the test factorial used in this study.

Table 3
Test factorial used by Hachiya and Sato

Tack Coat Type	Application Rate		Curing Period	Construction Procedure	Test Temperature		Loading Rate		
	L/m ²	Gal/yd ²			°C	°F			
PK-4	0.2	0.04	1 hour	Monolithic layer, Cold and hot joints, and Tack Coat	0	32	1mm/min		
PKR-T			40		104	100mm/min			
PK-80			0.4		0.09	24 hour			
PK-R80			0.6		0.13				
PK-HR1									
PK-HR2									

Hachiya and Sato concluded that at low temperature conditions (0°C) PK-HR2 provided the highest shear strength. At higher temperatures (40°C) PK-R80, PK HR-1 and PK HR-2 were almost equally effective. The optimum application rate was 0.2 l/m² (0.04 gal/yd²).

Paul and Scherocman [6] compiled a table listing the current practice of using tack coats in various states (Table 4). The authors distributed a questionnaire to materials engineers at all state departments of transportation regarding tack coat and fog seal practices. Some questions included were as follows: what type of material is used for tack coat; are tack coat materials diluted; what is the application rate; are these different rates used depending on the surface to be treated? The survey results indicate that almost all of the states used slow-set emulsions. The emulsions most commonly used as tack coats were SS-1, SS-1h, CSS-1 and CSS-1h. Only one state (Georgia) used hot asphalt (AC-20 and AC-30) as tack coats. The residual application rates of the emulsions varied between 0.06 l/m² (0.01 gal/yd²) and 0.26 l/m² (0.06 gal/yd²) depending on the type of surface for application. Table 4 indicates that three states had a maximum time that a tack coat could be left before placing asphalt concrete. Alaska specified a maximum curing period of two hours for CSS-1. Arkansas specified a maximum curing period of 72 hours for curing SS-1, while Texas specified a maximum curing period of 45 minutes for curing SS-1 or MS-2. Four states indicated that paving was required the same day the tack coat was applied. Many states specified a minimum time between tack coat application and placement of hot mix asphalt to provide adequate time for the emulsion to break down. The study was conducted in the wake of litigation resulting from an accident case to evaluate the potential for friction problems on tack-coated surfaces exposed to traffic. Paul and Scherocman finally concluded that application of a tack coat reduced the frictional capabilities of road surfaces for up to seven hours after application. Vehicles may be permitted to travel on tack-coated surfaces during this period only at a controlled low speed.

In 1998, the International Bitumen Emulsion Federation (IBEF) conducted a survey study, which showed that the tack coats are an essential part of road construction around the world (Spain, France, Italy, Japan, the Netherlands, United Kingdom, USA), and that they help ensure longer lasting pavements [7]. Three different tests – shear, tensile and torque – are available in the laboratory for tack coat bonding measurement. Although no in-situ test is available at this time, field test equipment is currently being developed by the IBEF.

A more recent survey [8] conducted in 13 mid-western and western states in the United States indicated that slow-setting emulsions are the primary materials used for tack coat, except California, where the AR-4000 was the most common tack coat material followed by either SS-1 or CSS-1. The Kansas Department of Transportation was the only agency that reported occasionally using cutback asphalts as tack coat. New Mexico and Texas reported that PG binders (asphalt cement) were occasionally used as tack coat materials.

Table 4
Survey of 1998 regarding tack coat use in various states [6]

State	Materials used for tack coat	Normal % dilution of SS	Tack coat application rate using SS type material (L/m ²)	Residual application rate* (L/m ²)	Time between tack coat application and placement of HMA layer	Is travel on the tack coat permitted?	Have any accidents occurred while traffic is traveling on tack coat?
Alabama	CSS-1 CSS-1h AC	No	a.) Normal range- 0.45 b.) Range on existing- evaluated c.) Range on overlay- none	0.26	Min time – after emulsion has cured	Yes - if SS is broken but not fully covered	No
Alaska	STE-1 CSS-1	STE-1 none CSS-1 50%	a.) Normal range- 0.32 b.) Range on existing- 0.32 c.) Range on overlay- none	0.09	Min. time – 15 min Max. time – 2 hrs	No	No
Arizona	SS-1 diluted 1:1 w/ water and AC	1:1 with water	a.) Normal range- 0.27-0.54 b.) Range on existing- same c.) Range on overlay- 0.18-0.36	0.15	Min. time - when emulsion breaks Max. time – no more tack than covered up in shift	No	Unknown
Arkansas	SS-1	No	a.) Normal range- 0.23 b.) Range on existing- 0.14-0.23 c.) Range on overlay- same	0.13	Min. time – after AC breaks Max. time – 72 hrs	Yes	No
California	RS-1 SS-11	0.14% Asphalt to water	a.) Normal range- 0.09-0.45 b.) Range on existing- 0.09 to 0.45 c.) Range on overlay- 0.09 to 0.23	0.26	Min. time – depends on climate conditions Max. time – no definite standard	No	No reply
Connecticut	Asphalt Emulsion	50%	a.) Normal range- 0.14 to 0.45 b.) Range on existing- same c.) Range on overlay- same	0.13	Not Specified	No	No
Florida	RS-1 RS-2	No	a.) Normal range- NA b.) Range on existing- NA c.) Range on overlay- NA	NA	Not Specified	NA	Yes
Georgia	AC-20 AC-30	NA	a.) Normal range- NA b.) Range on existing- NA c.) Range on overlay- NA	NA	NA	NA	NA
Hawaii	Emulsified Asphalt	1 to 1 by vol. with water	a.) Normal range- 0.23-0.05 b.) Range on existing- same c.) Range on overlay- same	0.13	Min. time – none, but after the surface cured. Max. time – 4 hours	Yes, when SS is cured	No
Illinois	Emulsified Asphalt	50%	a.) Normal range- 0.41 b.) Range on existing- same c.) Range on overlay- 0.10 RC-70	0.12	Min. time –after the emulsion breaks Max. time – if traffic allowed on seal coat, it's covered with fine aggregate	No	NA
Indiana	Asphalt Emulsion AE-T	NA	a.) Normal range- NA b.) Range on existing- NA c.) Range on overlay- NA	NA	Min. time – Emulsion break Max. time – NA	NA	No
Iowa	CSS-1 CSS-1h	No	a.) Normal range- 0.09-0.23 b.) Range on existing- same c.) Range on overlay- same	0.13	Min. time – subject to engineers approval Max. time – not specified	Yes	No
Kansas	SS-1h CSS-1h	80%	a.) Normal range- 0.14-0.23 residual b.) Range on existing- 0.14-0.23 residual c.) Range on overlay- 0.14-0.23 residual	0.14-0.23	Broken (about 1 hr.) 5-6 hrs		
Louisiana	SS-1h CSS-1h	50%	a.) Normal range- 0.09-0.36 b.) Range on existing- 0.32 c.) Range on overlay- 0.14	0.18	Min. time – Broken Max. time – none	Yes	No
Maine	HFMS-1	NA	a.) Normal range- NA b.) Range on existing- NA c.) Range on overlay- NA	NA	NA	NA	NA
Maryland	AE-4	As is from refinery	a.) Normal range- 0.05-0.14 b.) Range on existing- 0.05 min c.) Range on overlay- 0.05 min	0.08	Min. time – 15 min Max. time – NA	No	Spray and pickup from times
Michigan	SS-1h	Cannot exceed orig. vol.	a.) Normal range- specified by engineer b.) Range on existing- 0.45 c.) Range on overlay- 0.23	0.13	Min. time – when the bond coat has cured Max. time - NA	NA	No

(Table continued)

State	Materials used for tack coat	Normal % dilution of SS	Tack coat application rate using SS type material (L/m2)	Residual application rate* (L/m2)	Time between tack coat application and placement of HMA layer	Is travel on the tack coat permitted?	Have any accidents occurred while traffic is traveling on tack coat?
Mississippi	SS-1	Contract or is not to dilute	a.) Normal range- 0.23-0.45 b.) Range on existing- same c.) Range on overlay- same	0.26	Min. time – sufficient time to allow emulsion to break Max. time – none	Yes	No
Missouri	Emulsified Asphalt	As much as 50%	a.) Normal range- 0.09-0.45 b.) Range on existing- up to engineer c.) Range on overlay- uniform coverage	0.13	Min. time – when the tack has cured Max. time – NA	NA	No
Montana	SS-1	50%	a.) Normal range- 0.14-0.23 b.) Range on existing- same c.) Range on overlay- 0.23	0.06	Min. time – until the emulsion breaks Max. time – must be maintained intact	No	Paint damage to vehicles and rare windshield damage
Nevada	SS-1 SS-1h	60% to 40%	a.) Normal range- 0.23-0.45 b.) Range on existing- 0.23-0.32 c.) Range on overlay- 0.23	0.15	Min. time – after emulsion breaks Max. time – none	Yes	No
New Jersey	CSS-1h	50%	a.) Normal range- 0.18-0.68 b.) Range on existing- 0.18-0.68 c.) Range on overlay- 0.18-0.45	0.19	Max. time – same day	No	Problems with tracking of tack and tack on vehicles
New Mexico	SS-1	50%	a.) Normal range- 0.36-0.54 b.) Range on existing- + or – 0.54 c.) Range on overlay- + or – 0.36	0.15	Min. time – emulsion break, 15 minutes to 1 hour Max. time – NA	NA	NA
New York	HFMS-2h SS-1h CSS-1h	50%	a.) Normal range- 0.14-0.32 b.) Range on existing- same c.) Range on overlay- same	0.09	Min. time – as soon as emulsion breaks Max. time – placement of HMA layer	No	Only when wet
North Carolina	CRS-1 CRS-2	NA	a.) Normal range- NA b.) Range on existing- NA c.) Range on overlay- NA	NA	Min. time – immediately after tack coat application Max. time – same day as tack coat	No	Traffic not allowed on roads with tack coat
North Dakota	Emulsified asphalt	50%	a.) Normal range- NA b.) Range on existing- NA c.) Range on overlay- NA	NA	Not specified	NA	NA
Ohio	SS-1h	NA	a.) Normal range- 0.32-0.45 b.) Range on existing- same c.) Range on overlay- none	0.26	Min. time – several minutes Max. time - limited by traffic zone	No	No
Oklahoma	SS-1	50%	a.) Normal range- up to 0.45 b.) Range on existing- same c.) Range on overlay- same	0.13	Min. time – emulsion must break Max. time – same day	Yes	Splash on vehicles
Oregon	CSS-1	NA	a.) Normal range- 0.23-0.91 b.) Range on existing- same c.) Range on overlay- same	0.52			
Pennsylvania	CSS-1h	50%	a.) Normal range- 0.09-0.32 b.) Range on existing- engineers judgment c.) Range on overlay- Same as (b.)	0.32	Min. time – until cured Max. time – not specified	NA	No
Rhode Island	SS-1	40%	a.) Normal range- 0.23-0.09 b.) Range on existing- same c.) Range on overlay- none	0.08	None	No	No
South Carolina	CRS-2	NA	a.) Normal range- NA b.) Range on existing- NA c.) Range on overlay- NA	NA	Min. time – allow emulsion to break Max. time – on ambient air temperature, humidity and mat temperature	NA	No
South Dakota	SS-1h CSS-1h	1 to 1	a.) Normal range- 0.23 b.) Range on existing- same c.) Range on overlay- same	0.13	Min. time – emulsion must be broken Max. time – not specified	NA	Extremely slippery when rained on

(Table continued)

State	Materials used for tack coat	Normal % dilution of SS	Tack coat application rate using SS type material (L/m ²)	Residual application rate* (L/m ²)	Time between tack coat application and placement of HMA layer	Is travel on the tack coat permitted?	Have any accidents occurred while traffic is traveling on tack coat?
Texas	SS-1 MS-2	1 to 1	a.) Normal range- 0.05-0.23 b.) Range on existing- NA c.) Range on overlay- NA	0.06	Min. time – 30 minutes Max. time – 45 minutes	No	No
Vermont	RS-1	NA	a.) Normal range- NA b.) Range on existing- NA c.) Range on overlay- NA	NA	NA	NA	NA
Virginia	CSS-1h	50%	a.) Normal range- 0.23-0.45 b.) Range on existing- same c.) Range on overlay- 0.45	0.13	Min. time – asphalt must have broken Max. time – none	No	No
Washington State	CSS-1	50%	a.) Normal range- 0.45 b.) Range on existing- same c.) Range on overlay- same	0.13	Min. time – 30 minutes Max. time – NA	Yes	Do not allow traffic on tack
Washington D.C.	SS-1h	3 to 1	a.) Normal range- 0.09-0.23 b.) Range on existing- c.) Range on overlay-	0.10	Min. time – after it becomes tacky Max. time – regulated by the engineer	NA	No
West Virginia	SS-1h	50%	a.) Normal range- 0.09-1.4 b.) Range on existing- same c.) Range on overlay- not used	0.51	Min. time – cured Max. time – none	No	Tracking and asphalt on cars
Wisconsin	Asphalt Emulsion CSS-1	50%	a.) Normal range- 0.11 b.) Range on existing- same c.) Range on overlay- same	0.03	Min. time – after it breaks Max. time – NA	No	Only traffic allowed is construction traffic
Wyoming	CSS-1	50%	a.) Normal range- 0.14 b.) Range on existing- 0.14 c.) Range on overlay- 0.14	0.05	Broken	Yes	None usually overnight
Utah	SS-1 SS-1h CSS-1 CSS-1h	50%	a.) Normal range- 0.36-0.45 b.) Range on existing- 0.36-0.45 c.) Range on overlay- 0.36-0.45	0.36-0.45	Min. time – 20 min. Max. time – NA	No	Usually construction only

Residual application rate is based on 57% residual emulsion times the specified application rate and does not include the normal % dilution.

OBJECTIVES

The objective of this research was to provide a systematic evaluation of the current practice of applying tack coats through controlled laboratory shear tests. Tests were carried out using tack coat materials at varying temperatures, application rates, and normal stress levels.

The specific objectives of this research were as follows:

- To evaluate the influence of tack coat types, application rates, and test temperatures on the interface bond strength.
- To recommend optimum tack coat type and application rate.
- To evaluate the influence of vertical stress levels on the interface bond strength.

SCOPE

This study was aimed at evaluating the influence of tack coat types, application rates, test temperatures and normal loads on the interface bonding strength. A 19 mm Superpave asphalt concrete mixture was used for the preparation of test specimens. Six emulsions and two binders were used as tack coats. Five application rate levels and two test temperatures were used for each tack coat material. Table 5 presents the test factorial.

Table 5
Test factorial for varying type, application rate, and temperature

Tack Coat Material		Application Temperature		Test temperature		Application Rate	
		°C	°F	°C	°F	l/m ²	gal/yd ²
Binders	PG 64-22	160	320				
	PG 76-22 M	160	320				
Emulsions	SS-1	66	150	25	77	0.0	0.0
	SS-1h	71	160			0.09	0.02
	CRS-2P	71	160			0.23	0.05
	CSS-1	71	160	55	131	0.45	0.1
	CRS-2L	82	180			0.9	0.2
	SS-1L	49	120				

Triplicate samples were tested at each above-mentioned combination of tack coat type, application rate, and temperature. After completing all the shearing strength tests of the factorial, statistical analysis on the shearing strengths of the specimens were conducted to determine the optimum type and application rate of tack coat. In order to investigate the influence of normal stress levels on interface bonding strength, specimens were tested at six normal stress levels. At each normal stress level, tests were conducted at 25°C (77°F) and 55°C (131°F). The test factorial for determining the effect of normal stresses on the interface shearing strength is presented in Table 6.

Table 6
Test factorial for varying normal load levels

Tack coat material	Application rate		Normal load levels		Test temperature	
	l/m ²	gal/yd ²	Kpa	psi	°C	°F
CRS-2P	0.09	0.02	0	0	25	77
			137.9	20		
			275.8	40		
			413.6	60		
			551.5	80		
			689.4	100		

METHODOLOGY

Material And Mixture Design

As stated earlier, eight different tack coat materials were studied through a simple shear test protocol developed in this project. A 19 mm Superpave mixture obtained from an ongoing overlay project was used to prepare test specimens. A brief description of the asphalt tack coat materials selected and important features of the designed Superpave mixture are presented below.

Tack Coat Materials

The tack coat materials selected for this study include two types of performance-graded asphalt cements (PG 64-22 and PG 76-22M) and six emulsions (CRS-2L, CRS-2P, CSS-1, SS-1, SS-1h and SS-1L). As presented in table 7, both performance-graded asphalt cements satisfied the Louisiana specification requirements [9], and all of the emulsions selected met the test requirements as specified in AASHTO T59, AASHTO M140, and AASHTO M208.

Emulsions. Emulsions are generally a mixture of asphalt, water, and an emulsifying agent. Emulsions are manufactured by passing hot asphalt cement and water containing emulsifying agents through a colloid mill under high pressure. The colloid mill produces extremely small (less than 5-10 μm) globules of asphalt cement, which are suspended in water. Figure 3 shows asphalt globules suspended in water.

Table 7
Louisiana specification requirements and sample test result for the binders

Test Property	PG 76-22 M		PG 64-22	
	Spec	Sample Result	Spec	Sample Result
Original Binder				
Rotational Viscosity @135°C Pa-s	3.0-	1.34	3.0-	0.52
Dynamic Shear, 10rad/sec G*/ Sin δ, Kpa	1.00+ @76°C	1.22	1.30+ @64°C	1.59
Flash Point °C	232 +	279	232	290
Solubility %	99.0+	99.9	99.0+	99.9
Force Ductility Ratio (F2/ F1), 4°C, 5 cm/min, F2 @30 cm Elongation	.30+	.42		
Tests on RTFO Residue				
Mass Loss %	1.00-	0.31	1.00-	0.297
Dynamic Shear, 10 rad/sec G*/Sin δ, Kpa	2.20+ @76°C	2.46	2.20+ @64°C	3.14
Elastic Recovery, 25°C, 10 cm Elongation %	60+	75%		
Tests on PAV Residue				
Dynamic Shear, 10 rad/sec, G* Sin δ, Kpa, 25°C	5000-	3212	5000-	2210
Bending Beam Creep Stiffness, Smax, Mpa, Tested at -12°C	300-	240	300-	204
Bending Beam Creep Slope m Value, Min Tested at -12°C	0.300+	0.362	0.300+	0.342

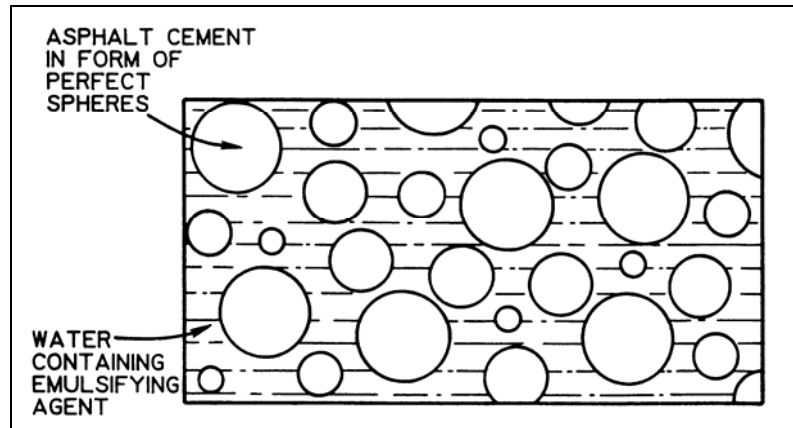

Figure 3
Emulsified asphalt

The emulsifying agent imparts electrical charges to the asphalt droplets. The emulsions are then classified as either cationic (C) or anionic based on the type of charge that the asphalt droplets carry. Anionic emulsions carry a negative charge, whereas cationic emulsions carry a positive charge.

Siliceous aggregates, such as sandstone, quartz, and siliceous gravels, are generally negatively charged and therefore are usually compatible with the positively charged cationic emulsified asphalts. Some limestone aggregates, on the other hand, bear a positive charge on their surface and are therefore usually compatible with the negatively charged anionic emulsified asphalts. Both anionic and cationic asphalts are further classified according to their setting rate as rapid setting (RS), medium setting (MS), and slow setting (SS). The setting rate of an emulsion is defined as the rate at which the emulsion breaks down when applied to an asphalt surface or mixed with an aggregate. The cationic emulsions used in this study were CRS-2P (cationic rapid setting polymer-modified asphalt), CRS-2L (cationic rapid setting latex-modified asphalt), and CSS-1 (cationic slow setting). The anionic emulsions used in the study were SS-1 (anionic slow setting), SS-1h (anionic slow setting with a harder base asphalt), and SS-1L (anionic slow setting with latex-modified asphalt).

Properties of Tack Coats

The tack coat materials were characterized through measuring the complex shear modulus, phase angle, and rotational viscosity. Tests were also conducted to verify the percentage of asphalt cement residue in the six emulsions selected for this study. Generally, properties of the asphalt tack coats measured in this study include:

1. Residue after evaporation.
2. Complex shear modulus and phase angle at 25° and 55°C.

3. Viscosity at 135°C.

A brief description of these measurement procedures is given below.

Residue after Evaporation. The residue by evaporation test (ASTM D 244) is used to indicate compositional characteristics of emulsified asphalts. A beaker containing 50 ± 0.1 grams of thoroughly mixed emulsified asphalt is placed in an oven for two hours at $163 \pm 3^\circ\text{C}$ to ensure complete evaporation. The beaker is weighed again at the end of this period to determine the weight of the residual emulsion. The ratio of the weights of residue after evaporation to the initial weight of the emulsion is reported in percentage of the residual emulsion. Table 8 lists the percent residues after evaporation together with application temperatures and specific gravity for the emulsified asphalts used in the study.

Table 8
Residue after evaporation of the emulsified asphalts

Emulsion	Application Temperature		Residue After Evaporation %	Specific Gravity
	°C	°F		
CRS-2P	71	160	65	0.9
CRS-2L	82	180	69	1.05
SS-1	66	150	57	0.9
CSS-1	71	160	57	1.01
SS-1H	71	160	62	1.06
SS-1L	49	120	62	1.05

Dynamic Shear Rheometer Tests. The Dynamic Shear Rheometer (DSR) characterizes the visco-elastic properties of an asphalt cement by measuring the properties of complex shear modulus (G^*) and phase angle (δ) of the binder. The test procedure is described in AASHTO TP5. The DSR subjects a small sample of binder to oscillatory shear stresses while sandwiched between two parallel plates.

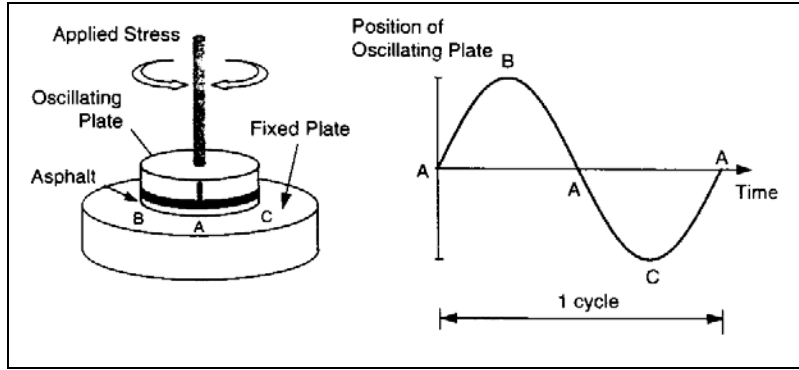

Figure 4
Basic principles of dynamic shear rheometer

As the force (or shear stress, τ) is applied to the asphalt by the spindle, the response (or shear strain, γ) of the asphalt to the force is measured by the DSR. The following formulas are used to calculate maximum shear stress (τ_{\max}) and maximum shear strain (γ_{\max}).

$$\tau_{\max} = 2T / \pi r^3$$

$$\gamma_{\max} = \theta r / h$$

Where,

T= maximum applied torque;

r= radius of binder specimen (either 12.5 or 4 mm);

θ = deflection (rotation angle); and

h = specimen height (either 1 or 2 mm).

The complex shear modulus (G^*) is computed as a ratio of applied shear stress and resulting shear strain. The phase angle (δ) is computed by multiplying the time lag (Δt) by the angular frequency (ω). Figure 5 shows the shear stress and shear strain curves plotted against time and the computations of complex shear modulus (G^*) and phase angle (δ) from them.

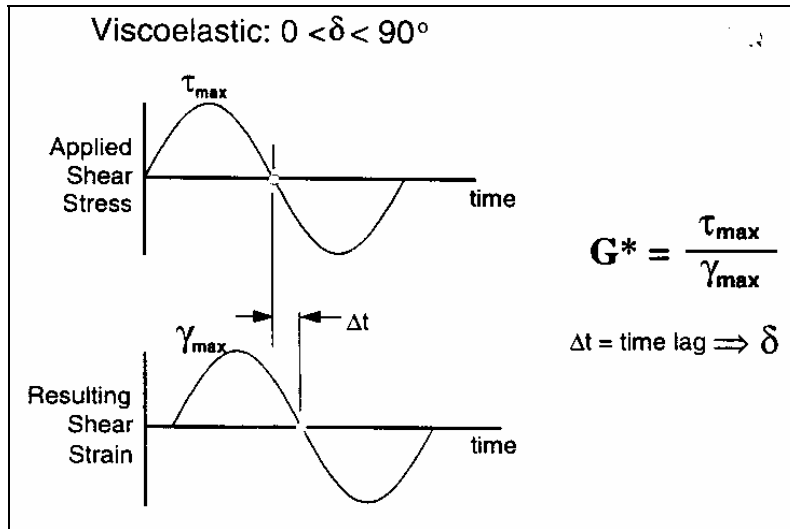

Figure 5
Stress-strain response in dynamic shear rheometer test

Table 9
Complex shear modulus and phase angle measured at 25°C

Tack coat type	Complex Modulus G^* (Kpa)	Phase Angle δ (Degree)	$G^*/ \sin \delta$ Kpa
PG 64-22	910.0	59.6	1055.1
PG 76-22 M	887.2	56.3	1066.4
CRS-2L	297.8	68.2	320.6
CRS-2P	210.8	63.1	236.4
CSS-1	135.7	70.5	144.0
SS-1	169.7	70.9	179.6
SS-1H	631.1	59.8	730.2
SS-1L	227.0	68.9	243.2

The complex shear modulus for each type of tack coat was measured at temperatures of 25°C (77°F) and 55°C (131°F). Tables 9 and 10 list the complex shear modulus and phase angles computed from the dynamic shear rheometer tests.

Table 10
Complex shear modulus and phase angle measured at 55°C

Tack coat type	Complex Modulus G* (Kpa)	Phase Angle δ (Degree)	G*/ Sin δ Kpa
PG 64-22	6.0	83.4	6.1
PG 76-22 M	10.9	70.1	11.6
CRS-2L	3.2	79.9	3.3
CRS-2P	3.4	75.3	3.5
CSS-1	1.2	85.4	1.2
SS-1	1.4	84.9	1.4
SS-1H	3.2	82.6	3.2
SS-1L	2.8	77.3	2.9

Although PG 64-22 had a higher complex modulus (G^*) at 25° C, the $G^*/ \text{Sin } \delta$ value for PG 76-22M was higher than that of PG 64-22 at test temperatures of both 25° and 55° C. A higher value of $G^*/ \text{Sin } \delta$ for PG 76-22M indicates a larger elastic component of stiffness compared to PG 64-22. A higher $G^*/ \text{Sin } \delta$ value for PG 76-22M, also validated the fact that the binder was modified through the addition of polymer to improve its elastic properties. CSS-1 had the lowest value of $G^*/ \text{Sin } \delta$ at both test temperatures. Figures 6 and 7 show the variation of the $G^*/ \text{Sin } \delta$ values with tack coat types at test temperatures of 25°C (77°F) and 55°C (131°F), respectively.

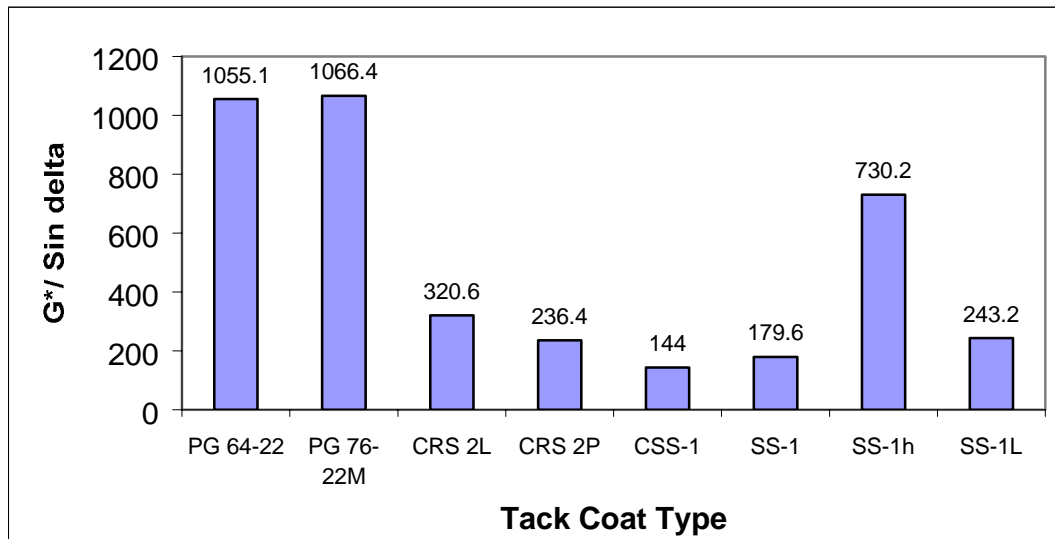

Figure 6
Variation of $G^*/ \text{Sin } \delta$ with tack coat type at test temperature 25°C

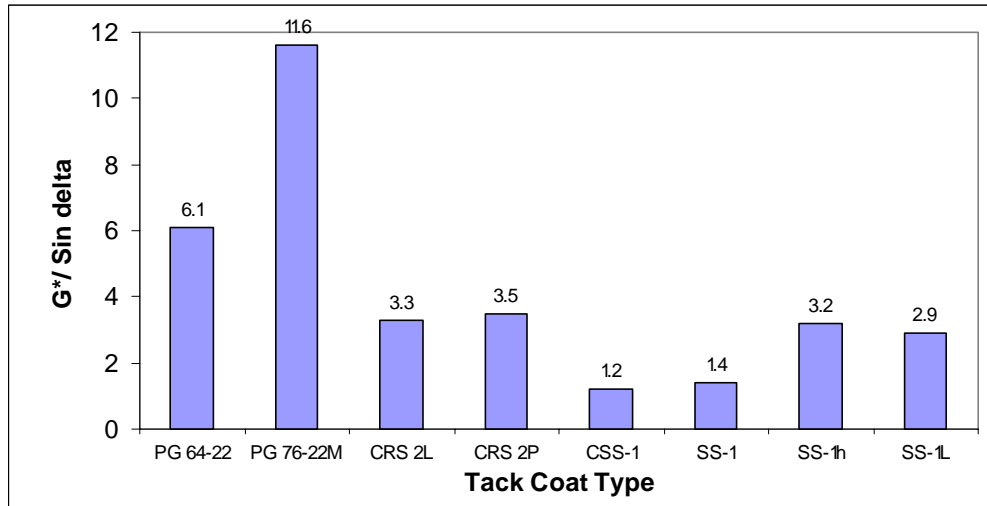

Figure 7
Variation of $G^*/\sin \delta$ with tack coat type at test temperature 55°C

Rotational Viscometer Tests. The rotational viscometer measures the torque required to maintain constant rotational speed of a cylindrical spindle that is submerged in a sample at a constant speed. The torque required to rotate the spindle at a constant speed (20 RPM) is directly related to the viscosity of the binder sample. The viscometer measures the viscosity and shows it in the rotational viscometer display. Figure 8 presents a rotational viscometer.

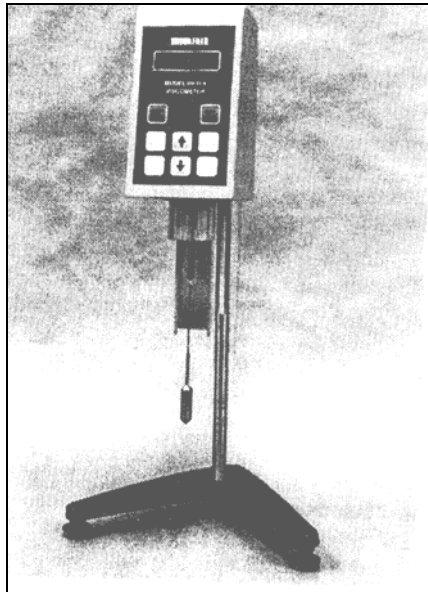

Figure 8
Rotational viscometer

Rotational viscosities of the tack coat materials were measured at a temperature of 135°C for this study. It is noted that superpave binder specification limits the viscosity of a binder to 3 Pa.s at 135°C (275°F) to ensure that the binder is sufficiently fluid for pumping and mixing. The test was conducted on the binders (PG 64-22 and PG 76-22M) and on the residues of the emulsified asphalts (CRS-2P, SS-1, CSS-1, and SS-1h) used as tack coats. The residues of the emulsified asphalts were obtained by placing a beaker containing 50 ± 0.1 grams of thoroughly mixed emulsified asphalt in an oven for two hours at 163 ± 3°C to ensure complete evaporation of the emulsifying agent. Figure 9 shows the rotational viscosities of the asphalt tack coats measured at 135°C.

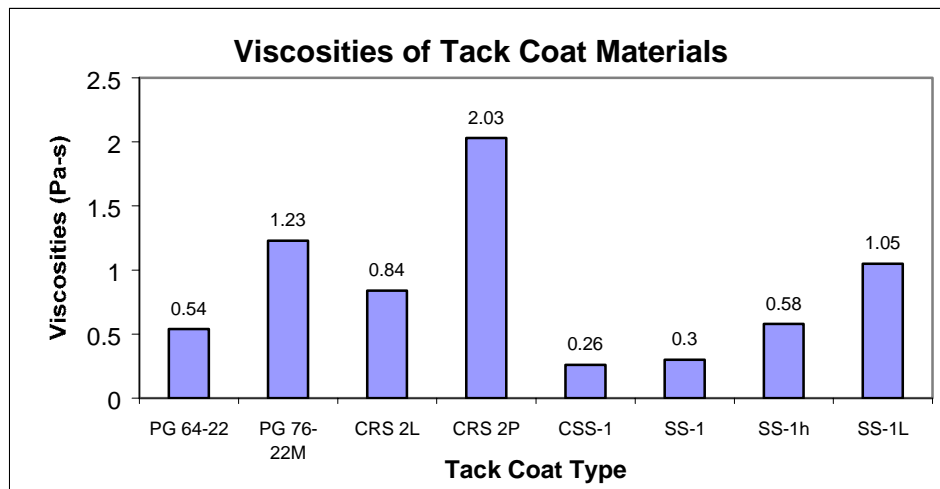

Figure 9
Viscosities of tack coat materials

It is noted that CRS-2P had the highest viscosity and CSS-1 had the lowest viscosity at 135°C. Viscosities of all the binders and residual emulsions were, however, lower than the limiting Superpave binder specification of 3 Pa.s.

Mixture Design

The 19 mm Superpave asphalt concrete mixture used in this study was designed for the wearing course of a Louisiana Department of Transportation and Development (DOTD) project. The asphalt concrete mixture was brought to the laboratory from the field project.

Based on the environmental information from the project site, PG 76-22M was selected as the binder. The job mix formula for the designed mix is attached in appendix A. The aggregate gradation for the sand stone used in the designed mix is shown in Figure 10.

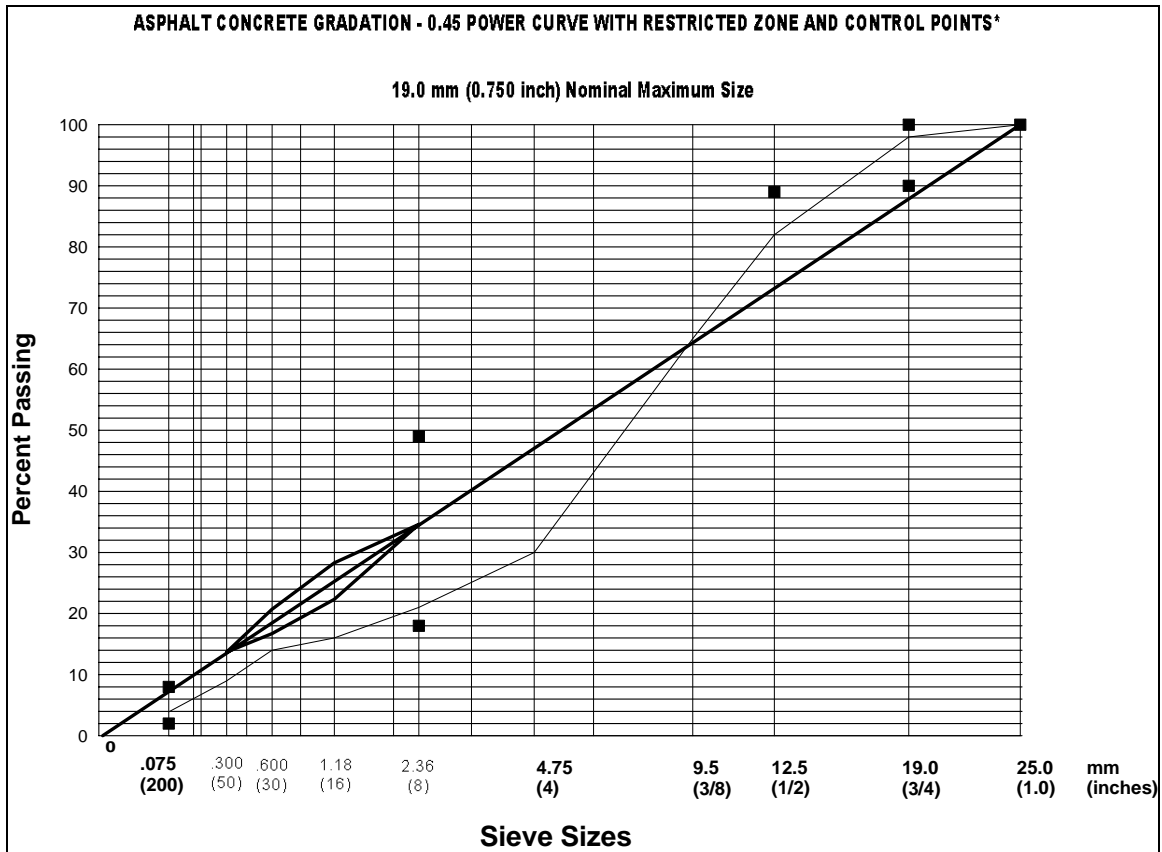

Figure 10
Aggregate gradation of the design mix

The aggregate blend properties and the corresponding Superpave mix design criterion are presented in Table 11.

Table 11
Aggregate blend properties

Property	Criterion	Agg. Blend
Coarse Aggregate Angularity, Min	98	98
Fine Aggregate Angularity, Min	45	45
Flat / Elongated, Max, 5:1	10	0
Sand Equivalent, Min	50	61
Combined Gsb	/	2.558
Combined Gsa	/	2.657

Three trial mixes with asphalt contents of 4.5, 5.0, and 5.5 percent were selected for the preparation of trial specimens, and two specimens each were prepared at each of these

asphalt contents. Compaction and volumetric properties of the samples were measured and plotted against the asphalt binder content. The design asphalt content of 4.9 percent was selected at 4 percent air void from the plot of air void versus asphalt content. The mixture properties at the selected asphalt content were then checked against the design criterion from the design curves. Figure 11 shows the design curve for air void versus asphalt content used to ascertain the optimum asphalt binder content for the design mix.

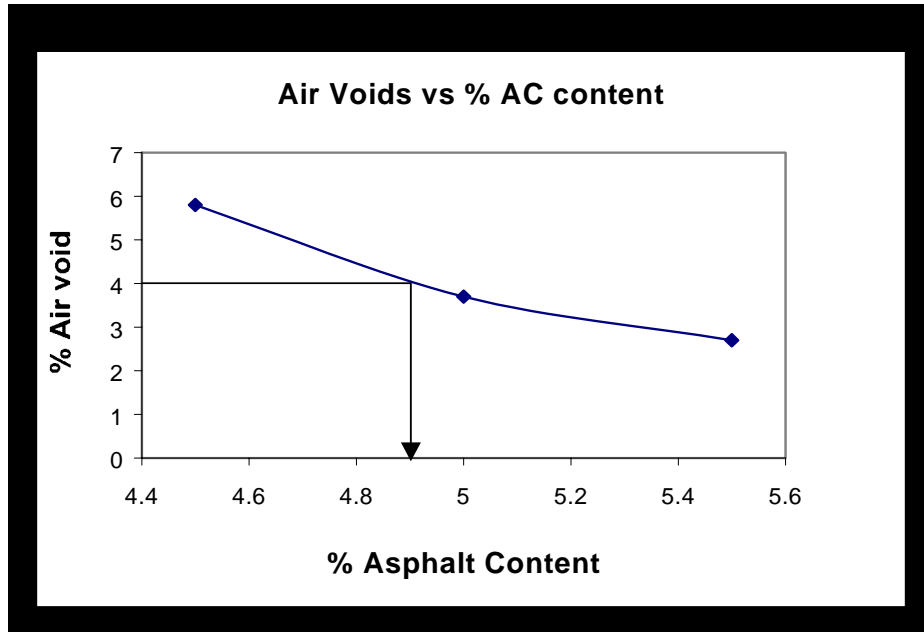

Figure 11
Design curve for air void vs. asphalt content

Since all the volumetric and design properties at 4.9 percent asphalt content were within the acceptable limits, the optimum asphalt content of 4.9 percent was taken as the design asphalt content. Table 12 presents the compaction and volumetric properties at the designed asphalt content.

Table 12
Compaction and volumetric properties at design asphalt content

Mix Property	Result	Criteria
Asphalt content	4.9	/
Air Voids, %	4.2	4.0
VMA, %	14.2	/
VFA, %	70	65-75
Dust Proportion	0.8	0.6-1.2
%Gmm @ Nini	85.0	Less than 89
%Gmm @ Nmax	97.5	Less than 98

Specimen Preparation

The following steps were required to prepare each sample for testing.

1. Determine amount of tack coat to be applied on a specimen surface.
2. Estimate minimum curing period of emulsions.
3. Compact specimen.
4. Condition specimen.

Determine Tack Coat Amount

A detailed procedure for determining the amount of tack coat to be applied on a specimen is described in Appendix B.

Estimate Minimum Setting Period of Emulsions

As stated earlier, emulsified asphalts are mixtures of asphalt cement, water, and an emulsifying agent. The water in an emulsion evaporates during or after its application to aggregates. This process is called setting of emulsions. Rapid setting emulsions (CRS-2P) set very fast, normally less than half an hour. Slow setting emulsions (SS-1, CSS-1, SS-1H), however, take longer to set. The minimum setting period of emulsions is generally estimated by visual observation. Emulsions are mostly brown in color, and they become black as they set due to the evaporation of water from the emulsions. A simple test was conducted to estimate the setting periods of emulsions. After applying emulsions on a cardboard surface, some limestone aggregate materials were placed on the emulsions. The aggregates' adhesion with the cardboard was tested by pulling stones from the cardboard surface at an interval of five minutes. It was assumed that an emulsion would be able to hold the aggregates firmly once it was set. The state of adhesion, along with the visual observation of change in color, was recorded after every five minutes. Setting was considered complete when an emulsion changed its color from brown to black and was able to hold the aggregates firmly. According to this estimation procedure, the minimum setting period for both CRS-2P and CRS-2L was about five minutes. The minimum setting period for the slow-setting emulsions ranged between 15 and 20 minutes. Table 13 lists the minimum setting period of emulsions determined through the laboratory experiment.

Table 13
Minimum setting period of emulsions

Emulsified Asphalt	Minimum Setting Period Minutes
CRS-2L	5
CRS-2P	5
SS-1	20
SS-1H	15
SS-1L	15
CSS-1	20

Compact Specimen

The test factorial for this research included one mix type, eight tack coat types, two temperatures, five application rates, and six normal load levels. Triplicate samples were tested at each condition. A total of 234 (192 + 42) specimens were required for testing. A complete specimen consisted of two layers with a tack coat at the interface of these layers and a diameter of 150 mm. The bottom half of each specimen was prepared by compacting the designed mix to a height of 56 mm at 165°C (329°F) using the Superpave gyratory compactor (SGC). The compacted specimen was then allowed to cool down to room temperature and its air void content was measured by determining the bulk density of the half. Compacted bottom halves having an air void of 6 ± 1 percent were selected for preparation of complete samples. Since bulk density measurement involved soaking the specimens in water for four minutes, the bottom halves were allowed to dry out at room temperature for at least four days before preparing complete specimens to allow drainage of any trapped water. The asphalt materials used as tack coat were heated to the specified application temperature by conditioning them in an oven at the required temperature. The bottom half of the specimen was placed on an electronic scale, which was set to zero. The calculated amount of preheated tack coat was then applied on one face of the sample by using a paintbrush. Before applying the tack on the specimen surface, the temperature of the tack coat was measured to ensure that it was at the application temperature. Figure 12 illustrates a tack coat application using a paintbrush.

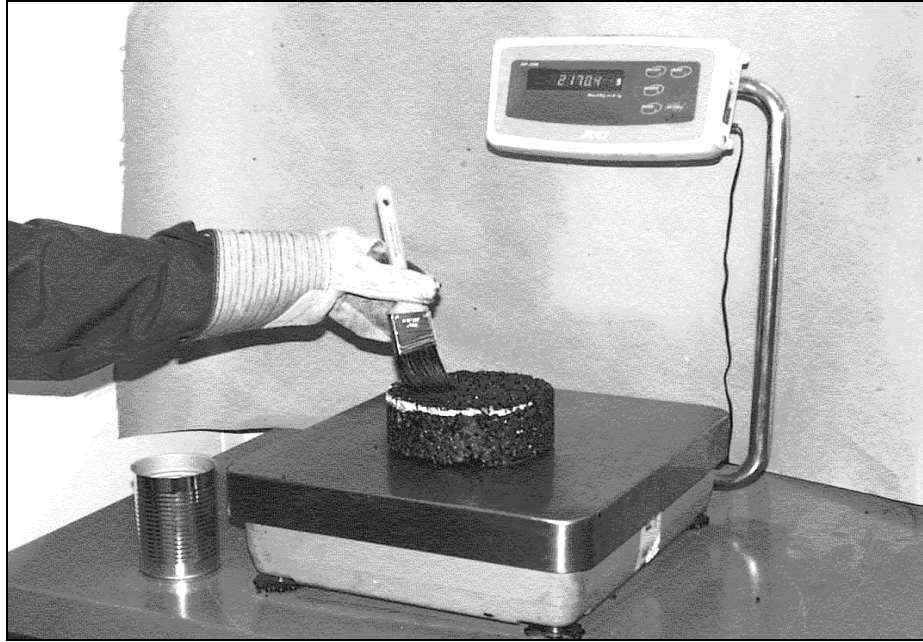

Figure 12
Tack coat application using a paintbrush

It is noted that two binders and six emulsions were used as tack coats and that the emulsions require some time to cure after their application on the specimen surface. In this study, both CRS-2P and CRS-2L were allowed to cure for an hour. Curing periods of one and one-half hours were allowed for SS-1, SS-1L, and SS-1H; two hours was allowed for CSS-1 to ensure complete curing of these emulsions.

Once the application and curing of the tack coat was complete, the top half of the sample was compacted by placing the bottom half in a compaction mold and compacting loose mix on top of the tack-coated bottom half. Figure 13 shows the placement of the bottom half of a sample in a mold. Figures 14 and 15 show placement of loose mix on top of a compacted bottom half, and placement of the mold in SGC for compaction, respectively.



Figure 13
Placement of the compacted bottom half of a sample in mold



Figure 14
Placement of loose mix on top of a compacted bottom half



Figure 15
Placing compaction mold in the SGC for compaction

The air void content of the compacted specimen was then calculated. Specimens having an air void content of 5-7 percent were considered acceptable for inclusion in the testing program.

Condition Specimen

Tests were conducted at two temperatures, 25°C (77°F) and 55°C (131°F) within a few days after sample fabrication, to determine the shearing strength of the interface layer of a complete specimen. For the tests conducted at 55°C (131°F), specimens were conditioned in an oven for at least two hours before fitting them in the shearing mold. The shearing mold assembly was then placed in the Superpave shear tester (SST). Since the shearing mold assembly's temperature decreases during its placement in the SST, it was conditioned for an additional one-half hour at 55°C (131°F) inside the SST machine before conducting the test. No oven conditioning was required for the 25°C (77°F) tests, since room temperature was controlled at 25°C (77°F). The specimens were conditioned only inside the SST environmental chamber at 25°C (77°F) prior to testing for an hour.

Test Facilities

Superpave Shear Tester (SST)

The SST is normally used for shear load-related performance tests in Superpave mixture analysis. The SST system includes the following components:

1. Loading device (load actuators of hydraulic system): The loading device of the SST produces vertical and horizontal loads using two hydraulic actuators (horizontal and vertical). The loading device can apply simultaneous vertical, horizontal, and confining loads on the test specimens and is controlled by a closed loop feedback system. It is possible to apply a maximum load of 22.2 KN (5,000 lb) in both the horizontal and the vertical direction using this machine.
2. Specimen deformation measurement equipment (linear variable differential transducers): Linear variable differential transducers are used to measure deformation in the axial (vertical) and shear (horizontal) directions.
3. Environmental chamber: The environmental chamber is used to control temperature and pressure during a test. It is capable of maintaining temperature in the range of 0°C (14°F) to 80°C (176°F) and confining pressure of up to 1,000 Kpa (145 psi) on the test specimen.
4. Control and data acquisition system: The control and data acquisition system can be used to record the load cycles, the applied horizontal and vertical loads, specimen deformation (in the axial, horizontal and the vertical direction), and the temperature and pressure conditions. The control and data acquisition system collects data during the test according to the frequency specified in the test procedure. Figure 16 shows the SST.

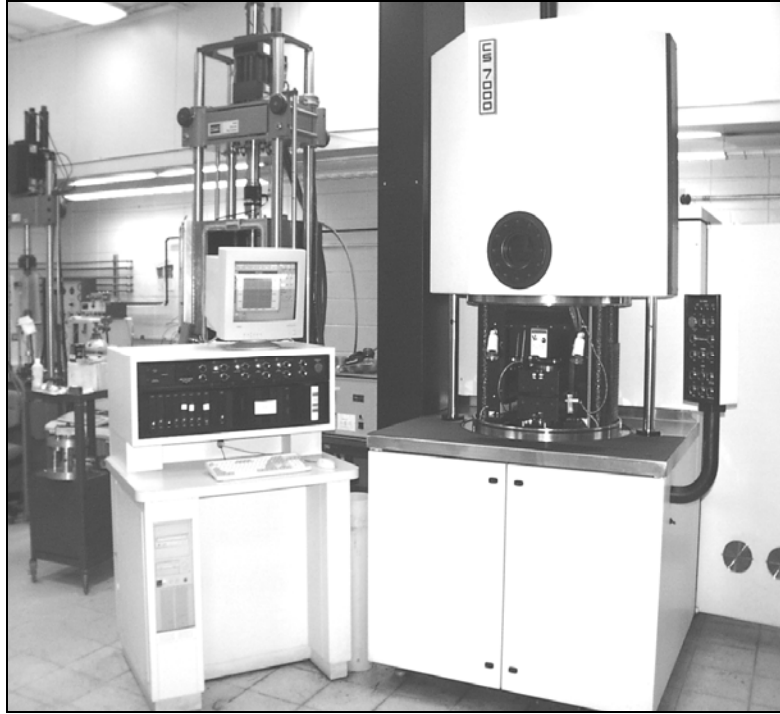

Figure 16
Superpave shear tester

Shearing Device

A shearing mold was specifically designed for the shear strength test in this study. The mold consists of two parts. Each part has a 150 mm (5.9 in.) diameter and 50.8 mm (2 in.) deep cylindrical groove in it, so that the mold can hold the specimens during testing. The mold has arrangements for mounting axial and shear LVDTs (Linear Variable Differential Transducers) on the sample. Figure 17 shows the parts of the designed shearing mold. Figure 18 shows the designed shear mold containing a sample.



Figure 17
Designed shear mold

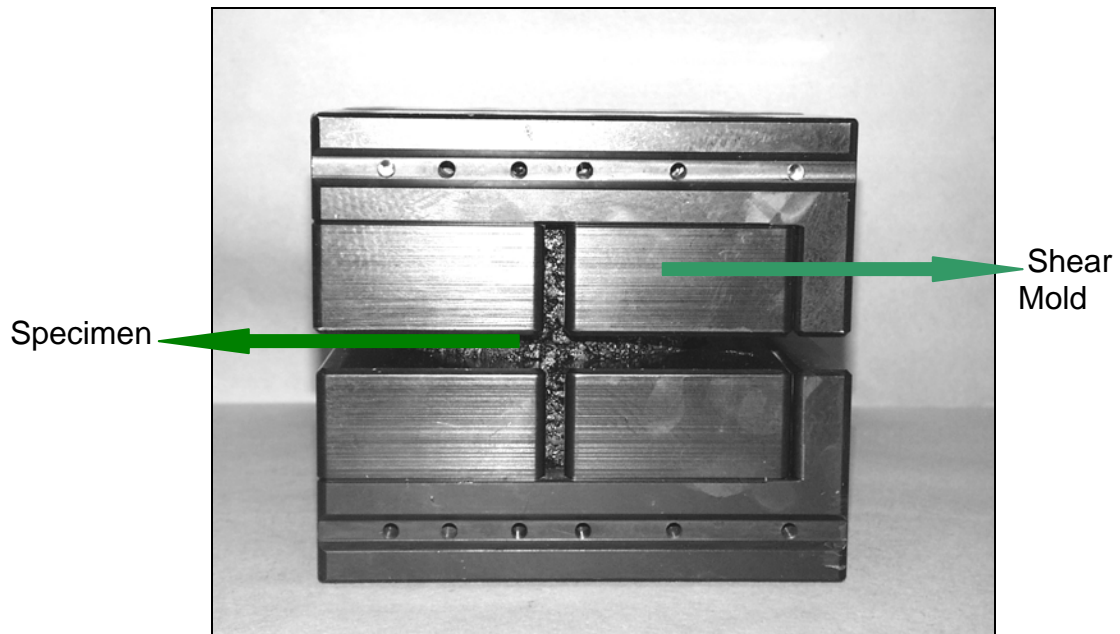

Figure 18
Designed shear mold with a sample inside

Shear Strength Test

The interface bonding strength in this study was estimated by measuring the shear strength of the test specimens at the interface. A simple shear test was conducted using the SST to determine the shear strength at the interface. Figure 19 shows the test arrangement (SST environmental chamber with test mold in it) for the simple shear test. The designed simple shear test applies the shearing load at a constant rate of 222.5 N/min (50 lb/min) on the specimen until failure. Figure 20 shows a plot of the applied shearing load on a test specimen versus time.

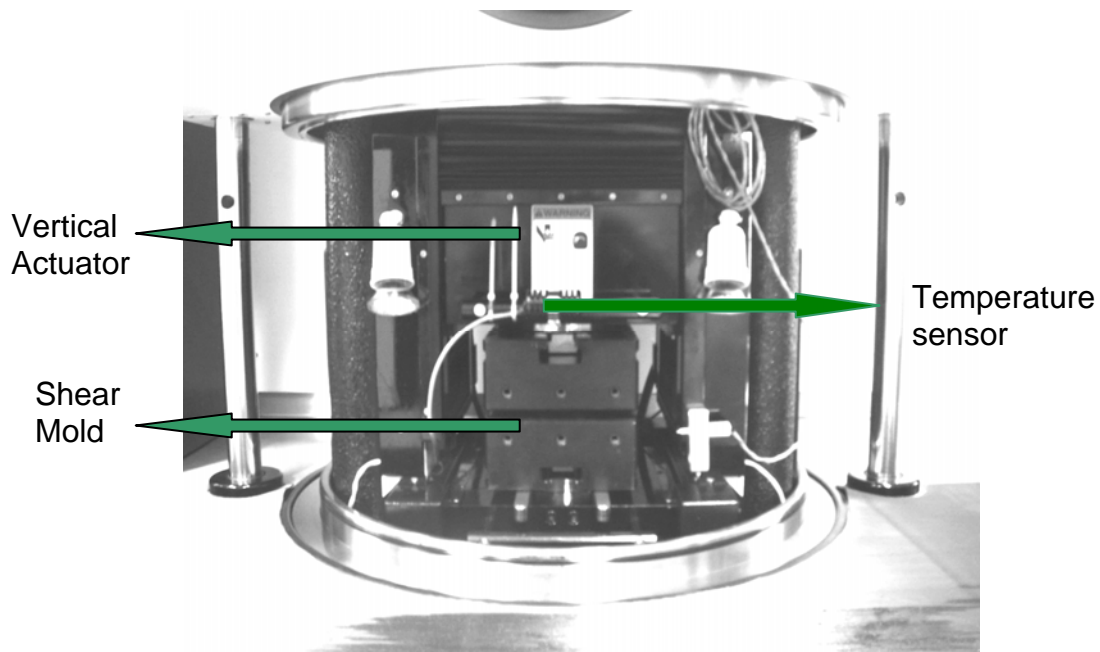

Figure 19
Test arrangement for the simple shear test

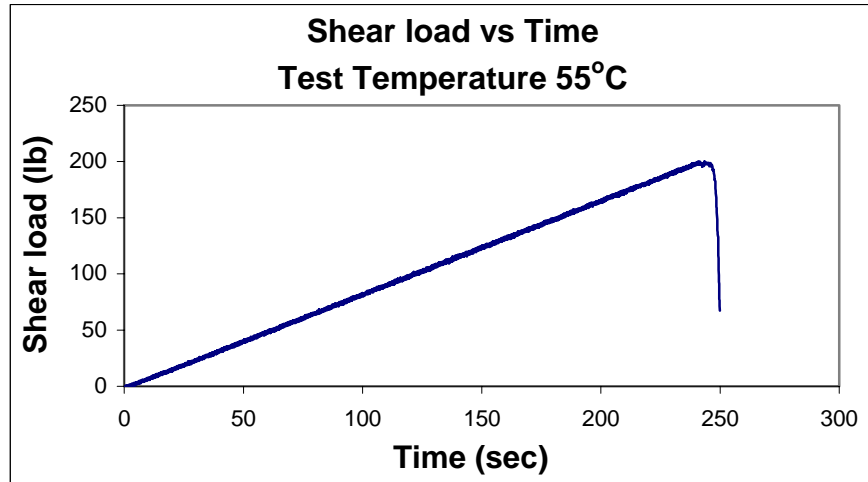

Figure 20
Typical shear load vs. time for 55°C

Applied shear stress on the interface was calculated by dividing the shear load by the cross sectional area of the interface.

$$\text{Shear Stress} = \frac{\text{ShearLoad}}{\text{Area}}$$

Where,

$$\text{Area} = \pi (R)^2; \text{ and}$$

R= radius of the sample.

In addition to applying and measuring the shear load the SST measured the displacement of the specimen interface due to the load applications using LVDT. Figure 21 presents a typical plot of the shear stress versus displacement. The shear strength was determined from the graph's peak value and used in the analysis.

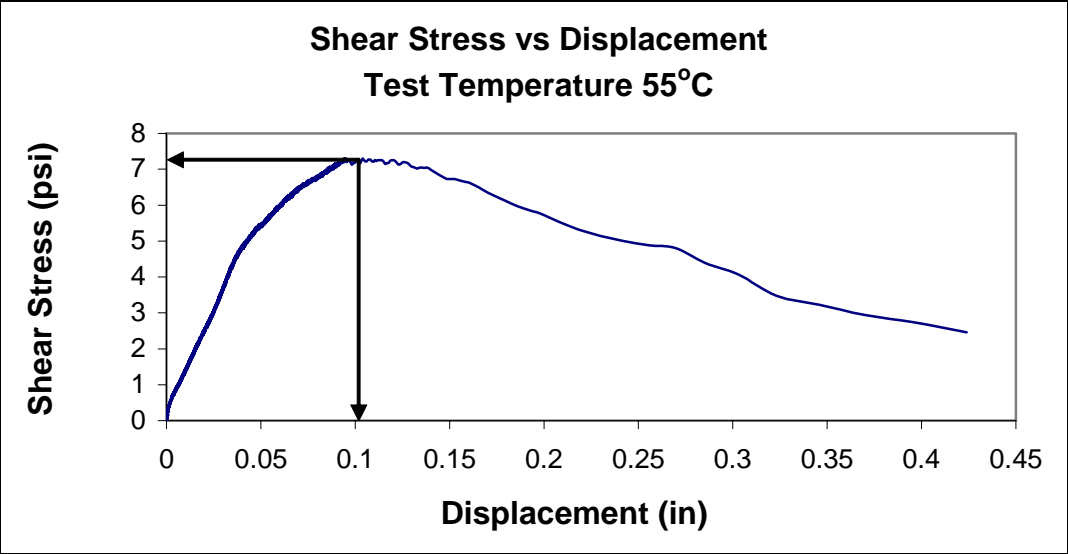

Figure 21
Typical simple shear test result at 55°C

DISCUSSION OF RESULTS

Simple shear test results were analyzed to determine the influence of different asphalt tack coats at varying application rates on the interface bonding strength. Test results were grouped according to test temperature and the type of tack coat used to characterize the variation of interface bonding strength with varying application rates at each test temperature. Test results were also grouped according to the tack coat application rates to illustrate the variation of shear strength at the interface with varying asphalt tack coat types at each test temperature. Statistical analyses of the test results were then carried out using the Statistical Analysis System (SAS) software. A multiple comparison procedure, Fisher's Least Significant Difference (LSD), was carried out with a 95 percent confidence interval. The multiple comparison procedure ranked the mean strength and failure strain values and placed them in groups designated by "A", "B", "C", "D", "A/B," etc. The letter "A" is used to rank the group with the highest mean shear strength, followed by the other letter grades in the appropriate order. A double letter designation, such as "A/B," indicates that the mean shear strength of that group is not significantly different from either of the groups "A" or "B."

Influence of Application Rate

Specimens were prepared by applying each type of asphalt tack coat at four different application rates to investigate the influence of tack coat application rates on the interface bonding strength. As stated earlier, six emulsions (CRS-2L, CRS-2P, SS-1, CSS-1, SS-1H, and SS-1L) and two asphalt cements (PG-64 22 and PG 76-22) were used as tack coats. The analysis of interface shear strength of specimens grouped according to asphalt tack coat type is presented below.

PG 64-22 as Tack Coat

Table 14 presents the simple shear test results (interface bond strength) along with their standard deviation and coefficient of variation at 25°C.

Table 14
Interface bond strengths using PG 64-22 as tack coat at 25°C

TESTS CONDUCTED USING PG 64-22 AS TACK COAT AT 25°C													
App. Rate		Sample ID	Air Void	Avg. Void	Std. Devn	Coeff Var	Shear Strength		Avg. Strength		Std. Devn		Coeff Var
l/m ²	gal/yd ²		%	%	%	CV%	Kpa	psi	KPa	psi	KPa	psi	CV %
0	0	WT-1	6.5				246.6	35.8					
		WT-2	5.8	6.2	0.4	6.1	272.9	39.6	266.6	38.7	17.7	2.56	6.6
		WT-3	6.2				280.2	40.6					
0.09	0.02	ALT-1	6.7				245.5	35.6					
		ALT-2	6.6	6.6	0.1	1.4	239.4	34.7	258.5	37.5	27.9	4.05	10.8
		ALT-3	6.5				290.6	42.2					
0.23	0.05	AMT-1	6.8				296.2	43.0					
		AMT-2	6.8	6.7	0.1	1.9	302.7	43.9	305.4	44.3	10.7	1.55	3.5
		AMT-3	6.6				317.1	46.0					
0.45	0.1	AHT-4	7.0				252.9	36.7					
		AHT-5	6.7	6.7	0.3	4.9	245.2	35.6	250.8	36.4	4.9	4.9	2.0
		AHT-6	6.4				254.3	36.9					
0.9	0.2	AVT-4	6.4				200.8	29.1					
		AVT-5	6.7	6.6	0.2	2.6	229.8	33.3	220.3	32.0	16.9	16.9	7.7
		AVT-6	6.6				230.3	33.4					

The first column of the table lists the application rates at which the tack coat (PG 64-22) was applied. The second column shows the sample IDs used to designate individual specimens during specimen preparation and testing. Test results indicate that the highest interface strength was obtained when PG 64-22 was applied at a rate of 0.23 l/m² (0.05 gal/yd²). Interface bonding strength increased with increasing application rates up to 0.23 l/m² (0.05 gal/yd²) and gradually decreased at higher application rates of 0.45 l/m² (0.1 gal/yd²) and 0.9 l/m² (0.2 gal/yd²). The mean shear strength reached a peak of 305.4 Kpa (44.3 psi) at an application rate 0.23 l/m² (0.05 gal/yd²). Figure 22 shows the variation of interface shear strength with application rates.

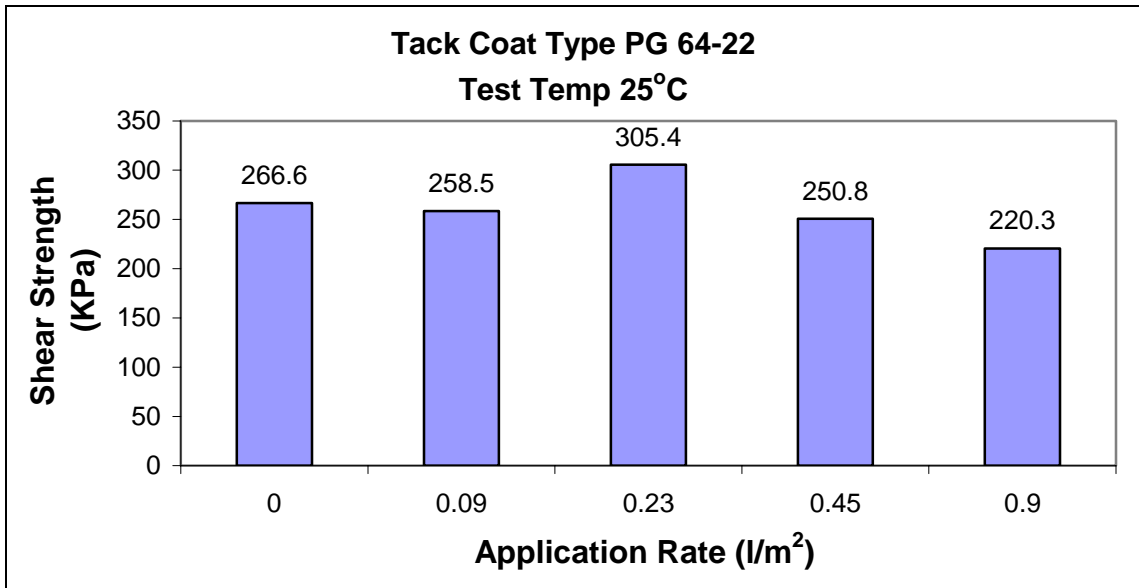

Figure 22
Plot of interface shear strength vs. application rate using PG 64-22 as tack coat at test temperature of 25°C

Test results presented in table 14 were analyzed to determine whether the average shear strengths of the groups were statistically different from one another and to rank them according to their mean shear strengths. The results of the statistical analysis are presented in table 15.

Table 15
Statistical analysis of interface bond strengths using PG 64-22 as tack coat at test temperature of 25°C

Application Rate		Mean Shear Strength		Ranking
l/m ²	gal/yd ²	Kpa	psi	
0.0	0.0	266.6	38.7	B
0.09	0.02	258.5	37.5	B
0.23	0.05	305.4	44.3	A
0.45	0.1	250.8	36.4	B/C
0.9	0.2	220.3	31.9	C

Mean shear strength of interface received the highest (“A”) and the lowest (“C”) rankings at tack coat application rates of 0.23 l/m² (0.05 gal/ yd²) and 0.9 l/m² (0.2 gal/ yd²), respectively.

Table 16 presents simple shear tests results at a temperature of 55°C. The test results indicate that the interface bond strength was insensitive to the tack coat application rate at 55°C. Although specimens without any tack coat had the highest interface strength, the variation of interface strength with increasing application rate was insignificant. Figure 23 shows the variation of interface bond strength with varying application rates of PG 64-22. Table 17 presents the statistical analysis of interface shear strengths obtained by using PG 64-22 as tack coat at various application rates.

Statistical analysis indicated that at 55°C, the mean shear strengths at different tack coat application rates were not significantly different from one another. The SAS analysis ranked all the mean shear strength groups as an “A”.

Table 16
Interface bond strengths Using PG 64-22 as tack coat at 55°C

TESTS CONDUCTED USING PG 64-22 AS TACK COAT AT 55°C													
App. Rate		Sample ID	Air Void	Avg. Void	Std. Devn	Coeff Var	Shear Strength		Avg. Strength		Std. Devn		Coeff Var
l/m ²	gal/yd ²		%	%	%	CV%	Kpa	psi	Kpa	psi	Kpa	psi	CV %
0	0	NT-8	6.9				51.4	7.5	56.6	8.2	4.5	0.66	8.0
		NT-9	6.7	6.9	0.1	1.6	59.2	8.6					
		NT-10	7.0				59.3	8.6					
0.09	0.02	ALT-4	6.5				43.4	6.3	53.2	7.7	8.5	1.24	16.0
		ALT-5	6.4	6.5	0.1	1.4	57.2	8.3					
		ALT-6	6.6				59.0	8.6					
0.23	0.05	AMT-4	6.9				47.4	6.9	51.4	7.5	3.7	0.54	7.2
		AMT-5	7.0	6.9	0.1	0.9	51.8	7.5					
		AMT-6	6.9				54.8	8.0					
0.45	0.1	AHT-1	6.9				47.5	6.9	53.7	7.8	5.4	0.78	10.0
		AHT-2	6.8	6.7	0.3	3.9	57.3	8.3					
		AHT-3	6.4				56.2	8.2					
0.9	0.2	AVT-1	5.9				48.3	7.0	51.7	7.5	4.8	0.69	9.2
		AVT-2	6.6	6.3	0.3	5.4	49.8	7.2					
		AVT-3	6.3				57.2	8.3					

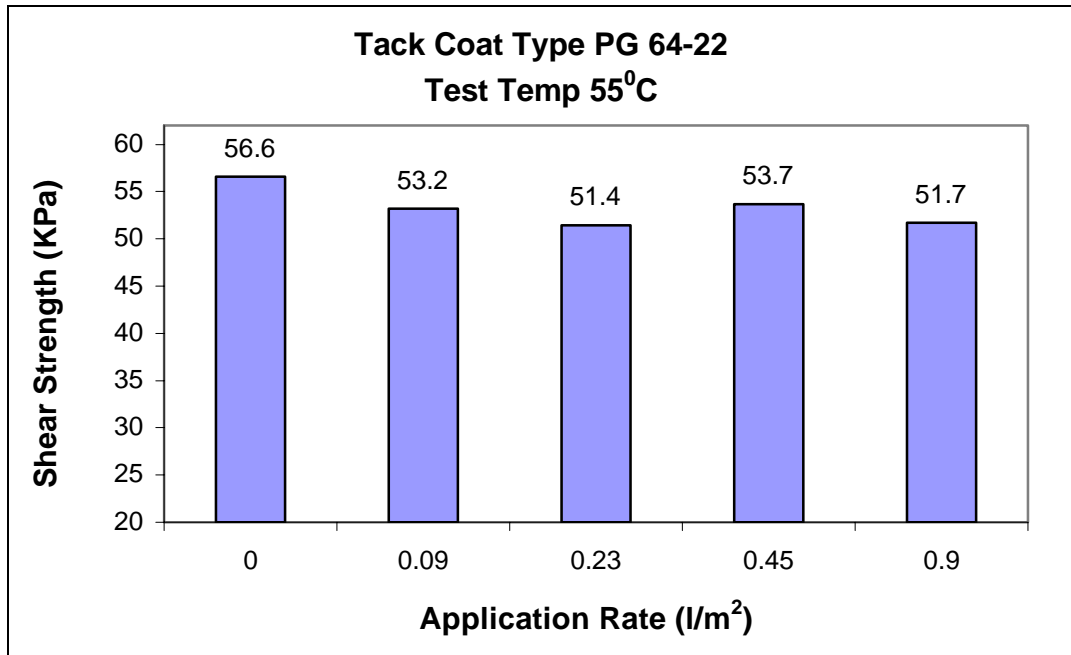

Figure 23
Plot of interface shear strength vs. application rate using PG 64-22 as tack coat at test temperature of 55°C

Table 17
Statistical analysis of interface bond strengths using PG 64-22 as tack coat at test temperature of 55°C

Application Rate		Mean Shear Strength		Ranking
l/m ²	gal/yd ²	Kpa	psi	
0.0	0.0	56.6	8.2	A
0.09	0.02	53.2	7.7	A
0.23	0.05	51.4	7.5	A
0.45	0.1	53.7	7.8	A
0.9	0.2	51.7	7.5	A

In summary, the influence of the application rate on interface strength at high temperatures was not significant; whereas, at 25°C, the application rate influenced the interface strength, and the highest strength was reached at 0.23 l/m² (0.05 gal/yd²).

PG 76-22M as Tack Coat

Table 18 presents simple shear tests results (mean maximum shear stress) along with their standard deviation and coefficient of variation. The test results indicate that the highest mean interface strength was obtained at an application rate of 0.23 l/m² (0.05 gal/yd²). Higher application rates of 0.45 (0.1 gal/yd²) and 0.9 l/m² (0.2 gal/yd²) provided lower mean interface bonding strengths. It is interesting to note that at 25°C, both the asphalt cements (PG 64-22 and PG 76-22M) provided the highest interface strength at the application rate of 0.23 l/m² (0.05 gal/yd²). Figure 24 shows the variation of mean shear strength with varying application rates of PG 76-22M.

Statistical analyses of the mean shear strengths of these specimens are presented in table 19.

Table 18
Interface bond strengths using PG 76-22M as tack coat at test temperature of 25°C

TESTS CONDUCTED USING PG 76-22M AS TACK COAT AT 25°C													
App. Rate		Sample ID	Air Void	Avg. Void	Std. Devn	Coeff Var	Shear Strength		Avg. Strength		Std. Devn		Coeff Var
l/m ²	gal/yd ²		%	%	%	CV%	Kpa	psi	KPa	psi	KPa	psi	CV %
0	0	WT-1	6.5				246.6	35.8					
		WT-2	5.8	6.2	0.4	6.1	272.9	39.6	266.6	38.7	17.7	2.56	6.6
		WT-3	6.2				280.2	40.6					
0.09	0.02	BLT-1	6.6				275.8	40.0					
		BLT-2	6.5	6.5	0.1	1.2	243.9	35.4	256.8	37.3	16.8	2.43	6.5
		BLT-3	6.4				250.8	36.4					
0.23	0.05	BMT-1	6.6				299.9	43.5					
		BMT-2	6.9	6.7	0.2	3.3	274.0	39.8	289.1	41.9	13.5	1.95	4.7
		BMT-3	6.5				293.4	42.6					
0.45	0.1	BHT-1	6.8				286.4	41.5					
		BHT-2	7.0	6.8	0.1	1.4	268.6	39.0	280.6	40.7	10.4	1.51	3.7
		BHT-3	6.8				286.8	41.6					
0.9	0.2	BVT-1	6.8				266.7	38.7					
		BVT-2	6.6	6.6	0.2	3.6	289.5	42.0	280.4	40.7	12.0	1.75	4.3
		BVT-3	6.3				284.9	41.3					

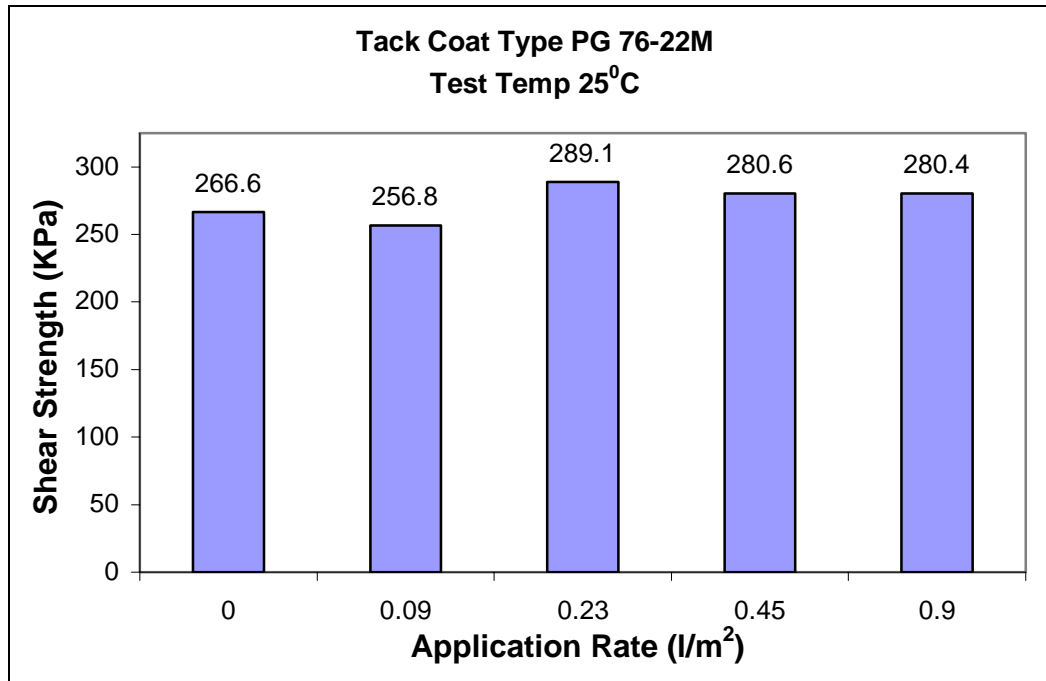

Figure 24
Plot of interface shear strength vs. application rate using PG 76-22M as tack coat at test temperature of 25°C

Table 19
Statistical analysis of interface bond strengths using PG 76-22M as tack coat at test temperature of 25°C

Application Rate		Mean Shear Strength		Ranking
l/m ²	gal/yd ²	Kpa	psi	
0.0	0.0	266.6	38.7	A/B
0.09	0.02	256.8	37.3	B
0.23	0.05	289.1	41.9	A
0.45	0.1	280.6	40.7	A/B
0.9	0.2	280.4	40.7	A/B

Statistical analysis ranked the mean interface strength group at an application rate 0.23 l/m² (0.05 gal/yd²) as an “A”. Although higher application rates of PG 76-22M resulted in lower interface strengths, the variation of interface strength was not statistically significant. As a result, the mean interface strengths at higher application rates of 0.45 l/m² (0.1 gal/yd²) and 0.9 l/m² (0.2 gal/yd²) were ranked as “A/Bs”.

Table 20 presents variation of interface strength with varying application rates of PG 76-22M at 55°C. Test results indicate that the highest interface strength was obtained at the highest application rate of 0.9 l/m² (0.2 gal/yd²). Interestingly, all the lower application rates of PG 76-22M failed to provide the no tack coat strength (strength at 0.0 l/m² application rate). The lowest interface strength was obtained at the application rate of 0.09l/m² (0.02 gal/yd²). Figure 25 shows the variation of interface shear strength with varying application rates of PG 76-22M at the test temperature of 55°C.

Statistical analyses of the mean shear strengths of these specimens are presented in table 21.

Table 20
Interface bond strengths using PG 76-22M as tack coat at test temperature of 55°C

TESTS CONDUCTED USING PG 76-22M AS TACK COAT AT 55°C													
App. Rate		Sample ID	Air Void	Avg. Void	Std. Devn	Coeff Var	Shear Strength		Avg. Strength		Std. Devn		Coeff Var
l/m ²	gal/yd ²		%	%	%	CV%	Kpa	psi	KPa	psi	KPa	psi	CV %
0	0	NT-8	6.9				51.4	7.5	56.6	8.2	4.5	0.66	8.0
		NT-9	6.7	6.9	0.1	1.6	59.2	8.6					
		NT-10	7.0				59.3	8.6					
0.09	0.02	BLT-4	6.9				43.6	6.3	49.2	7.1	6.1	0.88	12.3
		BLT-5	6.6	6.6	0.2	3.1	55.6	8.1					
		BLT-6	6.5				48.4	7.0					
0.23	0.05	BMT-4	6.4				52.3	7.6	55.2	8.0	2.9	0.42	5.2
		BMT-5	6.7	6.7	0.2	3.6	58.0	8.4					
		BMT-6	6.9				55.2	8.0					
0.45	0.1	BHT-4	6.7				52.1	7.6	54.0	7.8	1.9	0.28	3.6
		BHT-5	6.7	6.7	0.0	0.5	56.0	8.1					
		BHT-6	6.7				54.0	7.8					
0.9	0.2	BVT-4	6.7				58.0	8.4	58.3	8.5	3.9	0.57	6.8
		BVT-5	6.6	6.5	0.2	2.8	54.5	7.9					
		BVT-6	6.3				62.4	9.1					

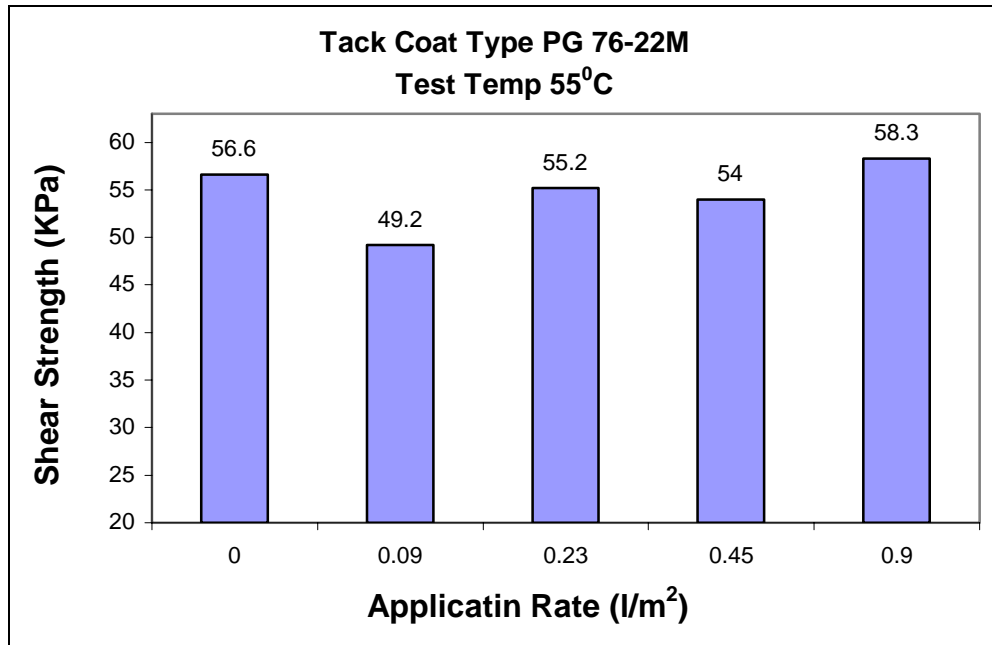

Figure 25

Plot of interface shear strength vs. application rate using PG 76-22M as tack coat at test temperature of 55°C

Table 21

Statistical analysis of interface bond strengths using PG 76-22M as tack coat at test temperature of 55°C

Application Rate		Mean Shear Strength		Ranking
l/m ²	gal/yd ²	Kpa	psi	
0.0	0.0	56.6	8.2	A/B
0.09	0.02	49.2	7.1	B
0.23	0.05	55.2	8.0	A/B
0.45	0.1	54.0	7.8	A/B
0.9	0.2	58.3	8.5	A

Statistical analysis ranked the mean interface strength at an application rate 0.9 l/m² (0.02 gal/yd²) as an A. Although mean interface strengths at application rates 0.23 l/m² (0.05 gal/yd²) and 0.45 l/m² (0.1 gal/yd²) failed to reach the no tack coat strength of 56.6 Kpa (8.2 psi), the variation among these strengths was not statistically significant. As a result, interface strengths at these application rates received the same ranking of “A/B”.

In summary, various application rates of PG 76-22M failed to provide significant increase in interface strength when compared to interface strength of specimens with no tack coat (application rate 0.0 l/m²) at both of the test temperatures.

CRS-2L as Tack Coat

Table 22 presents the measured interface bond strengths long with standard deviation and coefficient of variation, that were measured using CRS-2L as a tack coat material at a test temperature of 25°C. Test results indicate that the highest interface strength was obtained at a tack coat rate of 0.09 l/m² (0.02 gal/yd²) with a mean peak value of 321.4 Kpa (46.7 psi). Interface bonding strengths increased with increasing application rates up to 0.09 l/m² (0.02 gal/yd²) and then decreased at higher application rates. Figure 26 shows the variation of interface bond strength with different application rates.

Table 22
Interface bond strengths using CRS-2L as tack coat at 25°C

TESTS CONDUCTED USING CRS-2L AS TACK COAT AT 25°C													
App. Rate		Sample ID	Air Void	Avg. Void	Std. Devn	Coeff Var	Shear Strength		Avg. Strength		Std. Devn		Coeff Var
l/m ²	gal/yd ²		%	%	%	CV%	Kpa	psi	KPa	psi	KPa	psi	CV %
0	0	WT-1	6.5				246.6	35.8					
		WT-2	5.8	6.2	0.4	6.1	272.9	39.6	266.6	38.7	17.7	2.6	6.6
		WT-3	6.2				280.2	40.6					
0.09	0.02	HLT-1	6.6				343.0	49.8					
		HLT-2	7.0	5.6	0.3	5.6	269.7	39.1	321.4	46.7	45.2	6.6	14.1
		HLT-3	6.4				352.2	51.1					
0.23	0.05	HMT-1	6.7				289.6	42.0					
		HMT-2	6.4	6.0	0.5	8.5	259.8	37.7	280.4	40.7	18.0	2.6	6.4
		HMT-3	6.4				292.2	42.4					
0.45	0.1	HHT-1	6.4				271.7	39.4					
		HHT-2	6.5	5.9	0.2	3.6	256.8	37.3	261.2	37.9	9.0	1.3	3.4
		HHT-3	6.8				255.6	37.1					
0.9	0.2	HVT-1	7.0				217.7	31.6					
		HVT-2	6.8	5.8	0.1	2.4	191.4	27.8	213.1	30.9	20.0	2.9	9.4
		HVT-3	6.6				230.6	33.5					

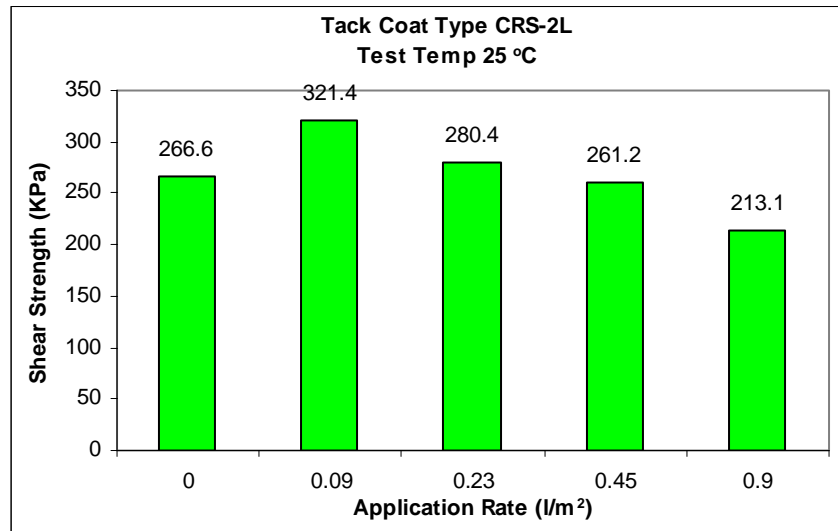

Figure 26
Shear strength vs. application rate using CRS-2L at 25°C

The statistical analysis of the measured interface bond strengths at 25°C is presented in Table 23. Results indicate that the mean interface bond strengths between samples with no CRS-2L application and with an application rate of 0.09 l/m² (0.02 gal/yd²) were statistically different. The mean strength value received the highest ranking of “A” at a tack coat application rate of 0.9 l/m² and a ranking of “B” at no tack application. On the other hand, the mean interface bond strengths showed no statistical difference among samples without tack coat and with tack coat application at higher application rates, e.g., 0.23 and 0.45 l/m². As the application rate reached 0.9 l/m², the interface bond strength received the lowest ranking of “C”.

Table 23
Statistical analysis of interface bond strengths using CRS-2L as tack coat at test temperature of 25°C

Application Rate		Mean Shear Strength		Ranking
l/m ²	gal/yd ²	KPa	psi	
0.0	0.0	266.6	38.7	B
0.09	0.02	321.4	46.7	A
0.23	0.05	280.4	40.7	B
0.45	0.1	261.2	37.9	B
0.9	0.2	213.1	30.9	C

Table 24 presents the simple shear test results for CRS-2L as tack coat material at 55°C. Similar to the results at 25°C, the specimens reached the highest mean interface strength at the application rate of 0.09 l/m² (0.02 gal/yd²). After the mean interface strength reached the peak, the interface bond strengths decreased gradually with the increased application rates higher than 0.09 l/m² of CRS-2L application. Figure 27 shows the variation of mean interface bonding strength with increasing application rates of CRS-2L at 55°C. The statistical analysis of the mean shear strengths of these specimens is presented in Table 25.

Table 24
Interface bond strengths using CRS-2L as tack coat at test temperature of 55°C

TESTS CONDUCTED USING CRS-2L AS TACK COAT AT 55°C													
App. Rate		Sample ID	Air Void	Avg. Void	Std. Devn	Coeff Var	Shear Strength		Avg. Strength		Std. Devn		Coeff Var
l/m ²	gal/yd ²		%	%	%	CV%	Kpa	psi	KPa	psi	KPa	psi	CV %
0	0	NT-8	6.9				51.4	7.5					
		NT-9	6.7	6.9	0.1	1.6	59.2	8.6	56.6	8.2	4.5	0.66	8.0
		NT-10	7.0				59.3	8.6					
0.09	0.02	HLT-4	6.5				61.8	9.0					
		HLT-5	6.5	6.6	0.2	2.6	72.8	10.6	67.4	9.8	5.5	0.8	8.2
		HLT-6	6.8				67.4	9.8					
0.23	0.05	HMT-4	6.5				59.5	8.6					
		HMT-5	6.3	6.5	0.1	1.7	69.6	10.1	64.1	9.3	5.2	0.8	8.2
		HMT-6	6.6				62.2	9.0					
0.45	0.1	HHT-4	6.7				57.6	8.4					
		HHT-5	6.7	6.7	0.0	0.3	53.6	7.8	54.4	7.9	2.6	0.4	4.8
		HHT-6	6.6				52.6	7.6					
0.9	0.2	HVT-4	6.7				44.7	6.5					
		HVT-5	6.4	6.5	0.2	3.8	43.8	6.4	44.8	6.5	0.8	0.1	1.6
		HVT-6	6.3				45.2	6.6					

As shown in Figure 27, the variation pattern of interface bond strength at various CRS-2L applications at 55°C was exactly the same as that at 25°C. Table 25 indicates that the statistical analysis of the interface bond strengths at 55°C also followed a similar ranking as those at 25°C (Table 23) with the highest ranking of “A” and lowest ranking of “C” at the tack coat application rate of 0.09 l/m² (0.02 gal/yd²) and 0.9 l/m² (0.2 gal/yd²), respectively.

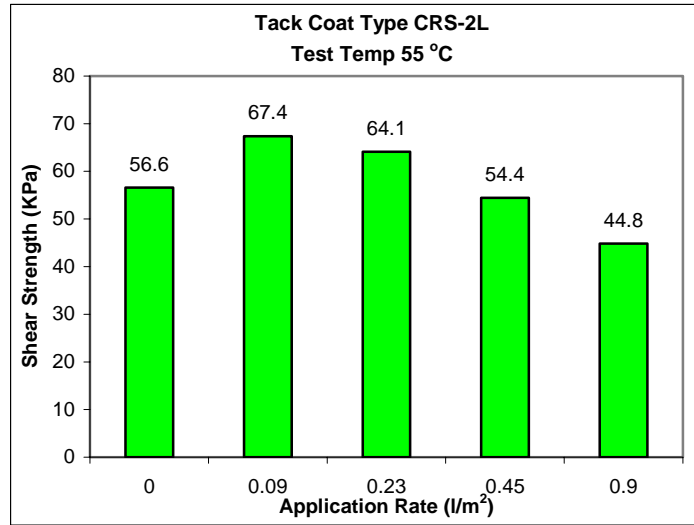

Figure 27
Plot of shear strength vs. application rate using CRS-2L as tack coat at test temperature of 55°C

Table 25
Statistical analysis of interface bond strength using CRS-2L as tack coat at test temperature of 55°C

Application Rate		Mean Shear Strength		Ranking
l/m ²	gal/yd ²	Kpa	psi	
0.0	0.0	56.6	8.2	B
0.09	0.02	67.4	9.8	A
0.23	0.05	64.1	9.3	B
0.45	0.1	54.4	7.9	B
0.9	0.2	44.8	6.5	C

In summary, the mean interface bond strengths for specimens with a CRS-2L application rate of 0.09 l/m² (0.02 gal/yd²) at the interface were observed to be significantly higher than those without tack coat application for both temperatures of 25°C and 55°C. This indicates that the emulsion material of CRS-2L can be used as the interface binding material (tack coat) to improve the bonding strength at the pavement interface.

CRS-2P as Tack Coat

Discussion of simple shear test results conducted on specimens prepared by using CRS-2P as tack coat is presented in the following sections.

Table 26 presents the simple shear test results (mean maximum shear stress) along with their standard deviation and coefficient of variation.

Table 26
Interface bond strengths using CRS-2P as tack coat at test temperature of 25°C

TESTS CONDUCTED USING CRS-2P AS TACK COAT AT 25°C													
App. Rate		Sample ID	Air Void	Avg. Void	Std. Devn	Coeff Var	Shear Strength		Avg. Strength		Std. Devn		Coeff Var
l/m ²	gal/yd ²		%	%	%	CV%	Kpa	psi	KPa	psi	KPa	psi	CV %
0	0	WT-1	6.5				246.6	35.8					
		WT-2	5.8	6.2	0.4	6.1	272.9	39.6	266.6	38.7	17.7	2.56	6.6
		WT-3	6.2				280.2	40.6					
0.09	0.02	CLT-1	6.3				410.0	59.5					
		CLT-2	6.0	6.1	0.2	2.5	351.5	51.0	351.4	51.0	58.6	8.50	16.7
		CLT-3	6.0				292.8	42.5					
0.23	0.05	CMT-1	6.0				266.0	38.6					
		CMT-2	6.6	6.0	0.5	8.3	295.8	42.9	279.1	40.5	15.2	2.20	5.4
		CMT-3	5.6				275.4	40.0					
0.45	0.1	CHT-1	5.8				243.0	35.3					
		CHT-2	6.0	6.2	0.5	8.5	258.6	37.5	252.1	36.6	8.1	1.17	3.2
		CHT-3	6.8				254.6	36.9					
0.9	0.2	CVT-1	6.8				255.3	37.0					
		CVT-2	6.1	6.6	0.4	6.1	250.2	36.3	241.7	35.1	19.4	2.81	8.0
		CVT-3	6.9				219.5	31.8					

The test results indicate that the highest interface strength was obtained at an application rate of 0.09 l/m² (0.02 gal/yd²). Higher application rates of CRS-2P resulted in a gradual decrease of interface strength. The behavior of CRS-2P is similar to that of PG 64-22 and PG 76-22M, except that the maximum interface strength is obtained at an application rate 0.09 l/m² (0.02 gal/yd²). It is noted that specimens without any tack coat had higher interface strengths than specimens with CRS-2P application rates of 0.45 l/m² (0.1 gal/yd²) and 0.9 l/m² (0.2 gal/yd²), i.e., too much tack coat material. Figure 28 shows the variation of interface bond strength with varying application rates of CRS-2P at 25°C.

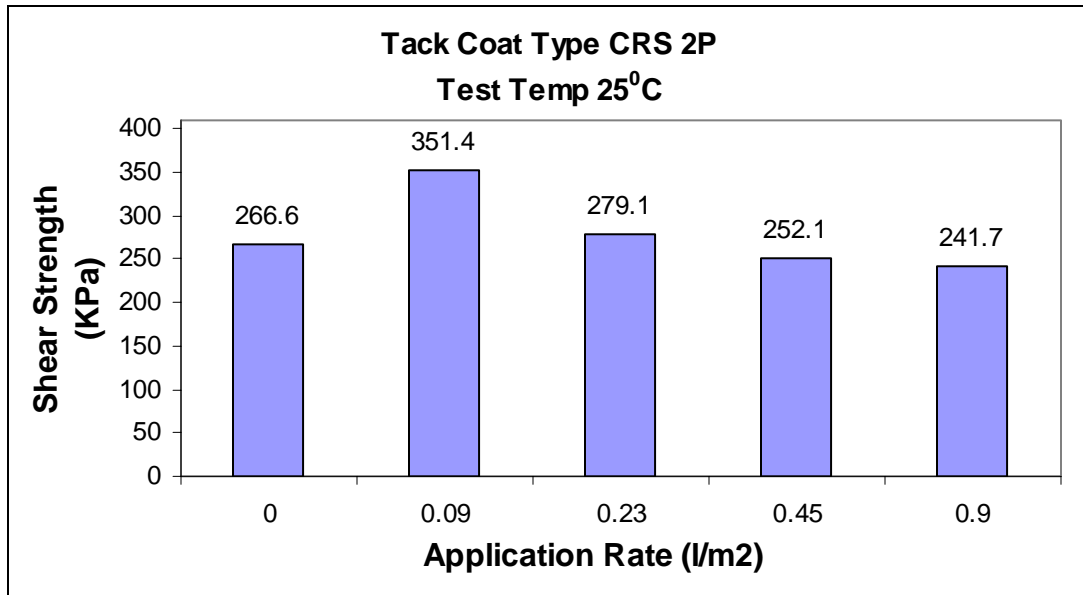

Figure 28
Plot of interface shear strength vs. application rate using CRS-2P as tack coat at test temperature of 25°C

The statistical analysis of the mean interface strengths of these specimens is presented in Table 27.

Table 27
Statistical analysis of interface bond strengths using CRS-2P as tack coat at test temperature of 25°C

Application Rate		Mean Shear Strength		Ranking
l/m ²	gal/yd ²	Kpa	psi	
0.0	0.0	266.6	38.7	B
0.09	0.02	351.4	51.0	A
0.23	0.05	279.1	40.5	B
0.45	0.1	252.1	36.6	B
0.9	0.2	241.7	35.1	B

The statistical analysis ranked the interface strength obtained at CRS-2P application rate of 0.09 l/m² (0.02 gal/yd²), as “A”, since it produced the highest interface strength of 351.4 Kpa (51.0 psi) at this application rate, similar to CRS-2L. Higher application rates of CRS-2P caused a gradual decrease in interface strengths. The decrease in bond strength, however, was not statistically significant. As a result, the SAS analysis ranked the mean interface strengths

at application rates of 0.23 l/m² (0.05 gal/yd²), 0.45 l/m² (0.1 gal/yd²), and 0.9 l/m² (0.2 gal/yd²) as “Bs.”

Table 28 presents the simple shear test results at 55°C. The test results show that, as the application rate increased, there was a decrease in interface bond strength. This decrease, however, was not significant except for the application rate of 0.9 l/m² (0.2 gal/yd²). It is interesting to note that specimens without any tack coat had the highest interface strength as compared to specimens with tack coats at various application rates. Figure 29 shows the variation of interface strength with varying application rates of CRS-2P at 55°C.

Table 28
Interface bond strengths using CRS-2P as tack coat at test temperature of 55°C

TESTS CONDUCTED USING CRS-2P TACK COAT AT 55°C													
App. Rate		Sample ID	Air Void	Avg. Void	Std. Devn	Coeff Var	Shear Strength		Avg. Strength		Std. Devn		Coeff Var
l/m ²	gal/yd ²		%	%	%	CV%	Kpa	psi	KPa	psi	KPa	psi	CV %
0	0	NT-8	6.9				51.4	7.5					
		NT-9	6.7	6.9	0.1	1.6	59.2	8.6	56.6	8.2	4.5	0.66	8.0
		NT-10	7.0				59.3	8.6					
0.09	0.02	CLT-4	6.3				58.9	8.6					
		CLT-5	6.6	6.4	0.2	3.2	50.6	7.3	55.2	8.0	4.2	0.62	7.7
		CLT-6	6.2				56.2	8.2					
0.23	0.05	CMT-4	6.0				58.7	8.5					
		CMT-5	6.4	6.3	0.2	3.0	53.2	7.7	55.1	8.0	3.2	0.46	5.7
		CMT-6	6.4				53.4	7.7					
0.45	0.1	CHT-4	6.8				50.1	7.3					
		CHT-5	6.6	6.6	0.2	3.5	43.8	6.4	49.3	7.2	5.1	0.74	10.4
		CHT-6	6.3				54.0	7.8					
0.9	0.2	CVT-4	6.6				44.5	6.5					
		CVT-5	6.1	6.5	0.4	5.5	38.4	5.6	43.7	6.3	5.0	0.72	11.4
		CVT-6	6.9				48.3	7.0					

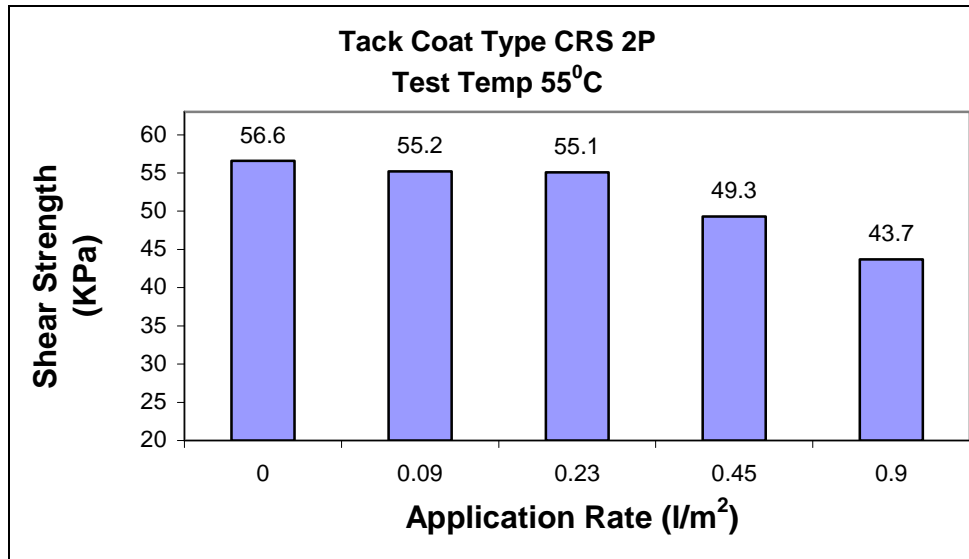

Figure 29

Plot of shear strength vs. application rate using CRS-2P as tack coat at test temperature of 55°C

The statistical analysis of the mean shear strengths of these specimens is presented in Table 29.

Table 29

Statistical analysis of interface bond strengths using CRS-2P as tack coat at test temperature of 55°C

Application Rate		Mean Shear Strength		Ranking
l/m ²	gal/yd ²	Kpa	psi	
0.0	0.0	56.6	8.2	A
0.09	0.02	55.2	8.0	A
0.23	0.05	55.1	8.0	A
0.45	0.1	49.3	7.2	A/B
0.9	0.2	43.7	6.3	B

The statistical analysis indicates that, although interface bond strength decreased with an increasing application rate of CRS-2P, the variation of interface strength among various application rates in the range of 0.0 l/m² (0.0 gal/yd²) to 0.45 l/m² (0.1 gal/yd²) was not statistically significant. As a result, interface-bond strengths exhibited the similar ranking for application rates of 0.0 l/m² (0.0 gal/yd²), 0.09 l/m² (0.02 gal/yd²), 0.23 l/m² (0.05 gal/yd²), and 0.45 l/m² (0.1 gal/yd²).

It can be said that the influence of the application rate on interface strength at high temperature was not significant. However, at 25°C, the application rate significantly influenced the interface strength and the highest interface strength was recorded at an application rate of 0.09 l/m² (0.02 gal/yd²).

SS-1 as Tack Coat

Discussion of simple shear test results conducted on specimens prepared by using SS-1 as tack coat is presented in the following sections.

Table 30 presents the simple shear test results (mean maximum shear stress) along with their standard deviations and coefficients of variation. Test results indicate that specimens without tack coat (application rate 0.0 l/m²) had the highest mean interface strength and that the interface strength decreased with increasing application rates of SS-1. The highest application rate of SS-1 (0.9 l/m²) provided the lowest interface bond strength of 210.2 Kpa (30.5 psi). Variation of interface bond strength, however, was not statistically significant when SS-1 was applied in the range of 0.0 l/m² (0.0 gal/yd²) to 0.23 l/m² (0.05 gal/yd²). Figure 30 illustrates the variation of interface bond strength with varying application rates of SS-1. The statistical analysis of the mean shear strengths of these specimens is presented in Table 31.

Table 30
Interface bond strengths using SS-1 as tack coat at temperature of 25°C

TESTS CONDUCTED USING SS-1 AS TACK COAT AT 25°C													
App. Rate		Sample ID	Air Void	Avg. Void	Std. Devn	Coeff Var	Shear Strength		Avg. Strength		Std. Devn		Coeff Var
l/m ²	gal/yd ²		%	%	%	CV%	Kpa	psi	KPa	psi	KPa	psi	CV %
0	0	WT-1	6.5				246.6	35.8	266.6	38.7	17.7	2.56	6.6
		WT-2	5.8	6.2	0.4	6.1	272.9	39.6					
		WT-3	6.2				280.2	40.6					
0.09	0.02	DLT-1	6.1				288.1	41.8	265.9	38.6	23.4	3.40	8.8
		DLT-2	6.6	6.4	0.3	4.4	241.4	35.0					
		DLT-3	6.3				268.3	38.9					
0.23	0.05	DMT-1	6.4				245.2	35.6	263.0	38.1	16.9	2.45	6.4
		DMT-2	6.3	6.5	0.1	2.2	265.0	38.4					
		DMT-3	6.6				278.8	40.4					
0.45	0.1	DHT-1	6.3				243.2	35.3	227.4	33.0	15.2	2.21	6.7
		DHT-2	6.2	6.2	0.1	1.0	226.1	32.8					
		DHT-3	6.1				212.9	30.9					
0.9	0.2	DVT-1	6.0				205.5	29.8	210.2	30.5	6.4	0.93	3.1
		DVT-2	5.9	6.1	0.2	2.9	217.5	31.6					
		DVT-3	6.3				207.6	30.1					

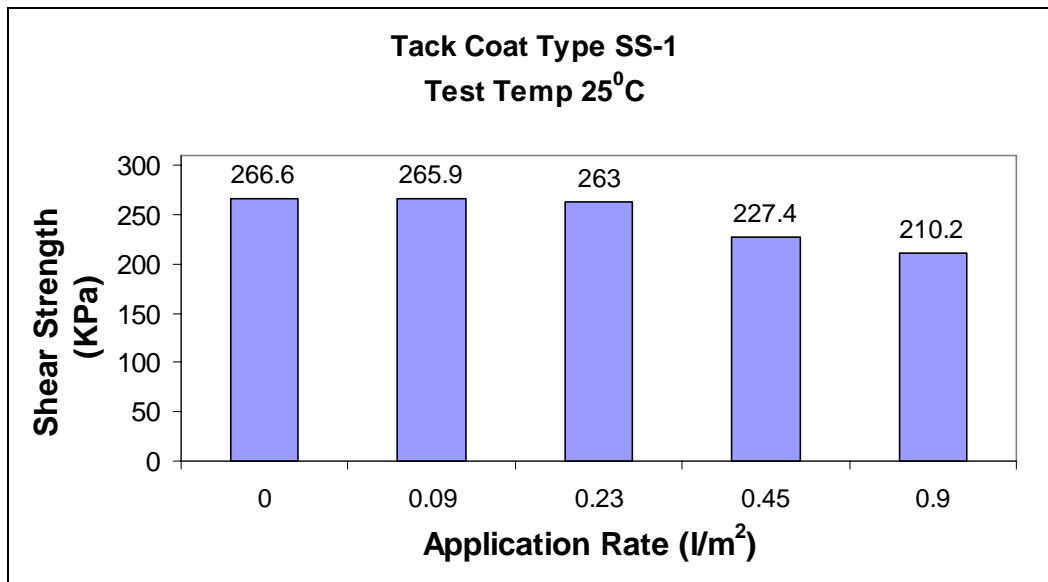

Figure 30
Plot of shear strength vs. application rate using SS-1 as tack coat at test temperature of 25°C

Table 31
Statistical analysis of interface bond strengths using SS-1 as tack coat at test temperature of 25°C

Application Rate		Mean Shear Strength		Ranking
l/m ²	gal/yd ²	Kpa	psi	
0.0	0.0	266.6	38.7	A
0.09	0.02	265.9	38.6	A
0.23	0.05	263.0	38.1	A
0.45	0.1	227.4	32.9	B
0.9	0.2	210.2	30.5	B

Although increasing application rates of SS-1 resulted in a gradual decrease of interface strength, the variation of interface strength was not statistically significant when SS-1 was applied in the range of 0.0 l/m² (0.0 gal/yd²) to 0.23 l/m² (0.05 gal/yd²). As a result, interface strengths at these application rates exhibited the same ranking of “A.”

Table 32 presents the simple shear test results (mean maximum shear stress) along with their standard deviations and coefficients of variation at 55°C. Interface strength variation with varying application rates of SS-1 followed a similar pattern at both the test temperatures of 25°C and 55°C. In both cases the specimens without any tack coat had the highest mean interface strength and increasing application rates of SS-1 resulted in decreasing mean interface strengths. Figure 31 shows the variation of mean interface bonding strength with increasing application rates of SS-1 at 55°C. The statistical analysis of the mean shear strengths of these specimens is presented in table 33.

Table 32
Interface bond strengths using SS-1 as tack coat at test temperature of 55°C

TESTS CONDUCTED USING SS-1 AS TACK COAT AT 55°C													
App. Rate		Sample ID	Air Void	Avg. Void	Std. Devn	Coeff Var	Shear Strength		Avg. Strength		Std. Devn		Coeff Var
l/m ²	gal/yd ²		%	%	%	CV%	Kpa	psi	KPa	psi	KPa	psi	CV %
0	0	NT-8	6.9				51.4	7.5	56.6	8.2	4.5	0.66	8.0
		NT-9	6.7	6.9	0.1	1.6	59.2	8.6					
		NT-10	7.0				59.3	8.6					
0.09	0.02	DLT-4	6.3				55.9	8.1	55.0	8.0	5.0	0.72	9.0
		DLT-5	6.1	6.2	0.1	1.4	49.6	7.2					
		DLT-6	6.2				59.4	8.6					
0.23	0.05	DMT-4	6.4				54.1	7.9	51.2	7.4	8.1	1.18	15.9
		DMT-5	6.5	6.4	0.1	2.0	57.4	8.3					
		DMT-6	6.3				42.0	6.1					
0.45	0.1	DHT-4	6.2				43.7	6.3	47.1	6.8	3.0	0.43	6.3
		DHT-5	6.0	6.2	0.2	2.4	48.3	7.0					
		DHT-6	6.3				49.3	7.2					
0.9	0.2	DVT-4	6.8				53.6	7.8	46.1	6.7	7.0	1.02	15.3
		DVT-5	6.3	6.7	0.3	4.4	44.9	6.5					
		DVT-6	6.9				39.7	5.8					

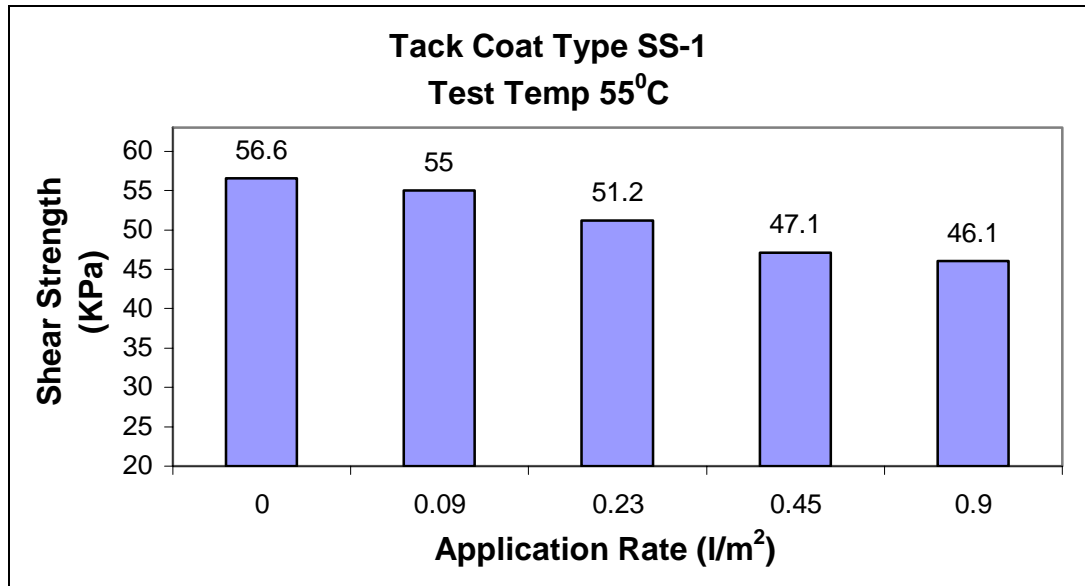

Figure 31
Plot of shear strength vs. application rate using SS-1 as tack coat at test temperature of 55°C

Table 33
Statistical analysis of interface bond strength using SS-1 as tack coat at test temperature of 55°C

Application Rate		Mean Shear Strength		Ranking
l/m ²	gal/yd ²	Kpa	psi	
0.0	0.0	56.6	8.2	A
0.09	0.02	55.0	8.0	A
0.23	0.05	51.2	7.4	A
0.45	0.1	47.1	6.8	A
0.9	0.2	46.1	6.7	A

Although specimens without any tack coat had the highest interface strength, the variation in interface strength with varying application rates of SS-1 was not statistically significant. As a result, the mean shear strengths at all the application rates exhibited the same ranking of “A”.

In summary, specimens without any tack coat had higher interface strengths compared to specimens with SS-1 as tack coat at both test temperatures. SS-1 failed to serve the intended purpose of increasing interface bond strength.

CSS-1 as Tack Coat

Discussion of simple shear test results conducted on specimens prepared by using CSS-1 as tack coat is presented in the following sections.

Table 34 presents the simple shear test results (mean maximum shear stress) along with their standard deviations and coefficients of variation. The test results show that the highest interface strength was obtained when CSS-1 was applied at a rate of 0.23 l/m² (0.05 gal/yd²). Interface strength decreased considerably at higher application rates of 0.45 l/m² (0.1 gal/yd²) and 0.9 l/m² (0.2 gal/yd²).

Table 34
Interface bond strengths using CSS-1 as tack coat at test temperature of 25°C

TESTS CONDUCTED USING CSS-1 AS TACK COAT AT 25°C													
App. Rate		Sample ID	Air Void	Avg. Void	Std. Devn	Coeff Var	Shear Strength		Avg. Strength		Std. Devn		Coeff Var
l/m ²	gal/yd ²		%	%	%	CV%	Kpa	psi	KPa	psi	KPa	psi	CV %
0	0	WT-1	6.5				246.6	35.8	266.6	38.7	17.7	2.56	6.6
		WT-2	5.8	6.2	0.4	6.1	272.9	39.6					
		WT-3	6.2				280.2	40.6					
0.09	0.02	ELT-1	6.3				248.0	36.0	250.9	36.4	3.1	0.45	1.2
		ELT-2	6.2	6.3	0.1	1.7	254.1	36.9					
		ELT-3	6.4				250.7	36.4					
0.23	0.05	EMT-1	6.1				267.5	38.8	272.6	39.5	23.9	4.82	12.2
		EMT-2	6.5	6.3	0.2	3.3	298.6	43.3					
		EMT-3	6.3				251.7	36.5					
0.45	0.1	EHT-1	6.3				223.2	32.4	202.6	29.4	18.0	2.61	8.9
		EHT-2	6.3	6.4	0.2	2.5	189.7	27.5					
		EHT-3	6.6				195.0	28.3					
0.9	0.2	EVT-1	6.7				141.1	20.5	157.3	22.8	14.4	2.08	9.1
		EVT-2	6.6	6.8	0.2	3.0	162.8	23.6					
		EVT-3	7.0				168.2	24.4					

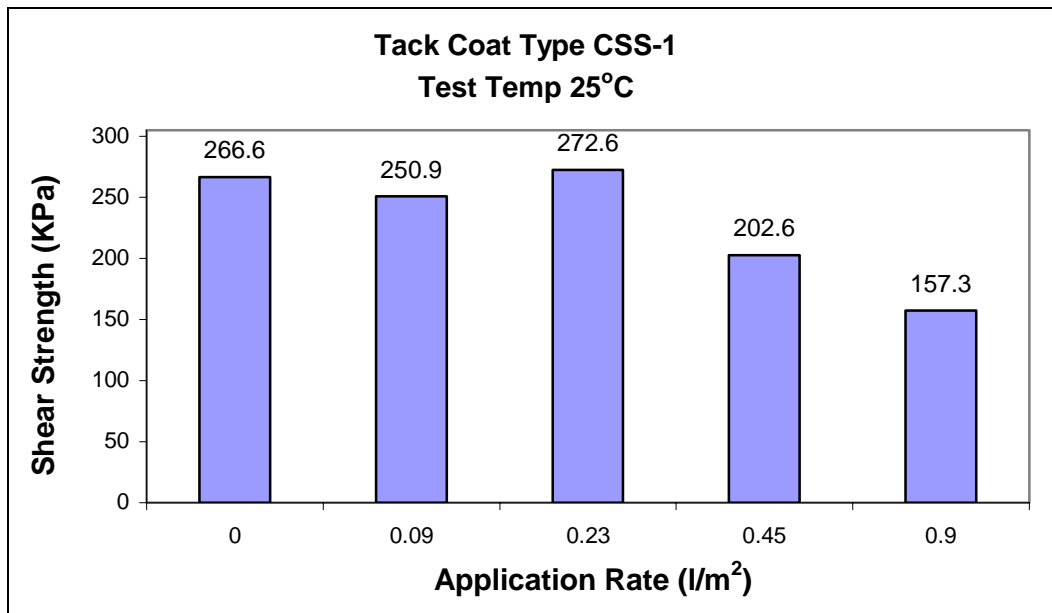

Figure 32
Plot of shear strength vs. application rate using CSS-1 as tack coat at test temperature of 25°C

The statistical analysis of the mean shear strengths of these specimens is presented in Table 35.

Table 35
Statistical analysis of interface bond strengths using CSS-1 as tack coat at test temperature of 25°C

Application Rate		Mean Shear Strength		Ranking
l/m ²	gal/yd ²	Kpa	psi	
0.0	0.0	266.6	38.7	A
0.09	0.02	250.9	36.4	A
0.23	0.05	272.6	39.5	A
0.45	0.1	202.6	29.4	B
0.9	0.2	157.3	22.8	C

Although interface strength was the highest at an application rate of 0.23 l/m² (0.05 gal/yd²), variation of interface strength was not statistically significant when CSS-1 was applied in the range 0.0 l/m² (0.0 gal/yd²) to 0.23 l/m² (0.05 gal/yd²). As a result, mean interface strength exhibited the statistical ranking of “A” in this range. Mean shear strengths at application rates of 0.45 l/m² (0.1 gal/yd²) and 0.9l/m² (0.2 gal/yd²) were ranked as “B” and “C”, respectively.

Table 36 presents the simple shear test results (mean maximum shear stress) along with their standard deviations and coefficients of variation. Interface strength variation with varying application rates of CSS-1 followed a similar pattern at both the test temperatures of 25°C and 55°C. Increasing application rates of CSS-1 caused a decrease in mean interface bond strength. Figure 33 shows the variation of interface bond strength with varying application rates of CSS-1.

The statistical analysis of the mean shear strengths of these specimens is presented in Table 37.

Table 36
Interface bond strengths using CSS-1 as tack coat at test temperature of 55°C

TESTS CONDUCTED USING CSS-1 AS TACK COAT AT 55°C													
App. Rate		Sample ID	Air Void	Avg. Void	Std. Devn	Coeff Var	Shear Strength		Avg. Strength		Std. Devn		Coeff Var
l/m2	gal/yd2		%	%	%	CV%	Kpa	psi	KPa	psi	KPa	psi	CV %
0	0	NT-8	6.9				51.4	7.5	56.6	8.2	4.5	0.66	8.0
		NT-9	6.7	6.9	0.1	1.6	59.2	8.6					
		NT-10	7.0				59.3	8.6					
0.09	0.02	ELT-4	6.6				54.4	7.9	53.9	7.8	1.8	0.26	3.3
		ELT-5	6.2	6.2	0.4	6.4	55.4	8.0					
		ELT-6	5.8				51.9	7.5					
0.23	0.05	EMT-4	6.7				59.1	8.6	53.7	7.8	4.7	0.68	8.7
		EMT-5	6.3	6.5	0.2	2.8	50.9	7.4					
		EMT-6	6.5				51.1	7.4					
0.45	0.1	EHT-4	6.2				48.5	7.0	52.3	7.6	3.7	0.53	7.0
		EHT-5	6.4	6.2	0.1	2.4	52.6	7.6					
		EHT-6	6.1				55.8	8.1					
0.9	0.2	EVT-4	6.9				35.0	5.1	39.5	5.7	4.1	0.59	10.4
		EVT-5	6.7	6.7	0.1	1.9	40.5	5.9					
		EVT-6	6.6				42.9	6.2					

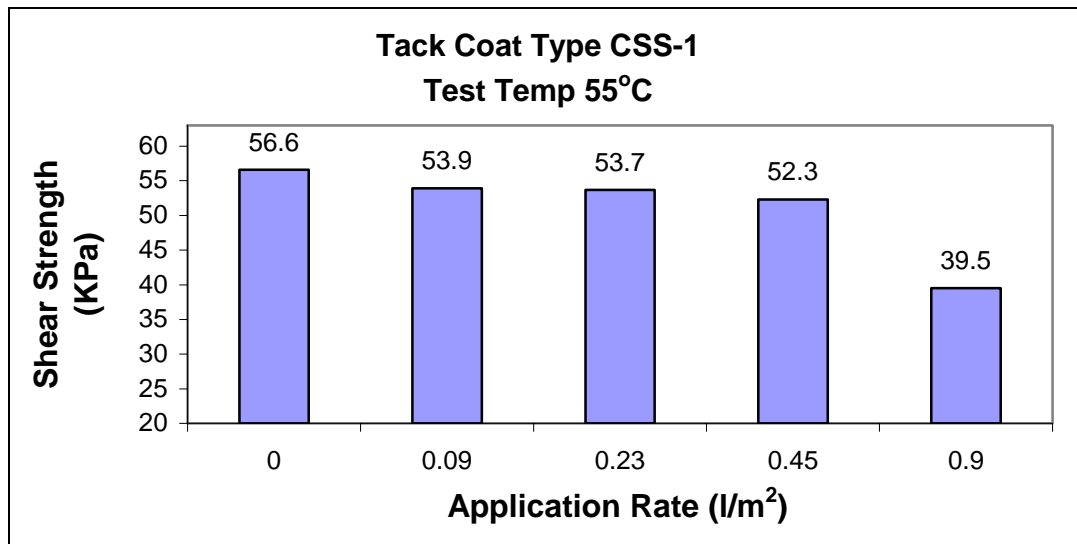

Figure 33
Plot of shear strength vs. application rate using CSS-1 as tack coat at test temperature of 55°C

Table 37
Statistical analysis of interface bond strengths using CSS-1 as tack coat at test temperature of 55°C

Application Rate		Mean Shear Strength		Ranking
l/m ²	gal/yd ²	Kpa	psi	
0.0	0.0	56.6	8.2	A
0.09	0.02	53.9	7.8	A
0.23	0.05	53.7	7.8	A
0.45	0.1	52.3	7.6	A
0.9	0.2	39.5	5.7	B

Although mean interface shear strength decreased as application rates of CSS-1 increased, the decrease in mean interface shear strength was not statistically significant in the range of application rates varying from 0.0 l/m² (0.0 gal/yd²) to 0.45 l/m² (0.1 gal/yd²). As a result, mean shear strengths at application rates of 0.0 l/m² (0.0 gal/yd²), 0.09 l/m² (0.02 gal/yd²), 0.23 l/m² (0.05 gal/yd²), and 0.45 l/m² (0.1 gal/yd²) exhibited the same ranking of “A.” Mean shear strength at the highest application rate of 0.9 l/m² (0.2 gal/yd²) was ranked as “B.”

In summary, CSS-1 failed to provide any significant increase in interface strength. Instead, increasing application rates of CSS-1 resulted in decreased interface shear strength at both test temperatures.

SS-1h as Tack Coat

Discussion of simple shear test results conducted on specimens prepared by using SS-1h as tack coat is presented in the following sections. Table 38 presents the simple shear test results (mean maximum shear stress) along with their standard deviations and coefficients of variation. These tests were conducted at 25°C.

Specimens without any tack coat at the interface had higher bonding strengths than the specimens with SS-1h as tack coat at various application rates. Table 38 shows that increasing application rates of SS-1h provided decreasing shear strength at the interface. Figure 34 shows the variation of interface bond strength with increasing application rates of SS-1h.

Table 38
Interface bond strengths using SS-1h as tack coat at test temperature of 25°C

TESTS CONDUCTED USING SS-1h AS TACK COAT AT 25°C													
App. Rate		Sample ID	Air Void	Avg. Void	Std. Devn	Coeff Var	Shear Strength		Avg. Strength		Std. Devn		Coeff Var
l/m ²	gal/yd ²		%	%	%	CV%	Kpa	psi	KPa	psi	KPa	psi	CV %
0	0	WT-1	6.5				246.6	35.8	266.6	38.7	17.7	2.56	6.6
		WT-2	5.8	6.2	0.4	6.1	272.9	39.6					
		WT-3	6.2				280.2	40.6					
0.09	0.02	FLT-1	6.9				189.2	27.4	229.4	33.3	39.2	5.69	17.1
		FLT-2	6.7	6.6	0.4	6.0	231.6	33.6					
		FLT-3	6.1				267.6	38.8					
0.23	0.05	FMT-1	6.4				234.9	34.1	234.8	34.1	9.0	1.31	3.8
		FMT-2	6.5	6.5	0.1	2.1	225.7	32.7					
		FMT-3	6.7				243.7	35.4					
0.45	0.1	FHT-1	6.6				233.8	33.9	233.4	33.9	8.2	1.20	3.5
		FHT-2	6.4	6.6	0.1	1.8	241.5	35.0					
		FHT-3	6.6				225.0	32.6					
0.9	0.2	FVT-1	6.7				188.4	27.3	194.1	28.2	5.9	0.85	3.0
		FVT-2	7.0	6.9	0.2	2.3	200.1	29.0					
		FVT-3	7.0				193.8	28.1					

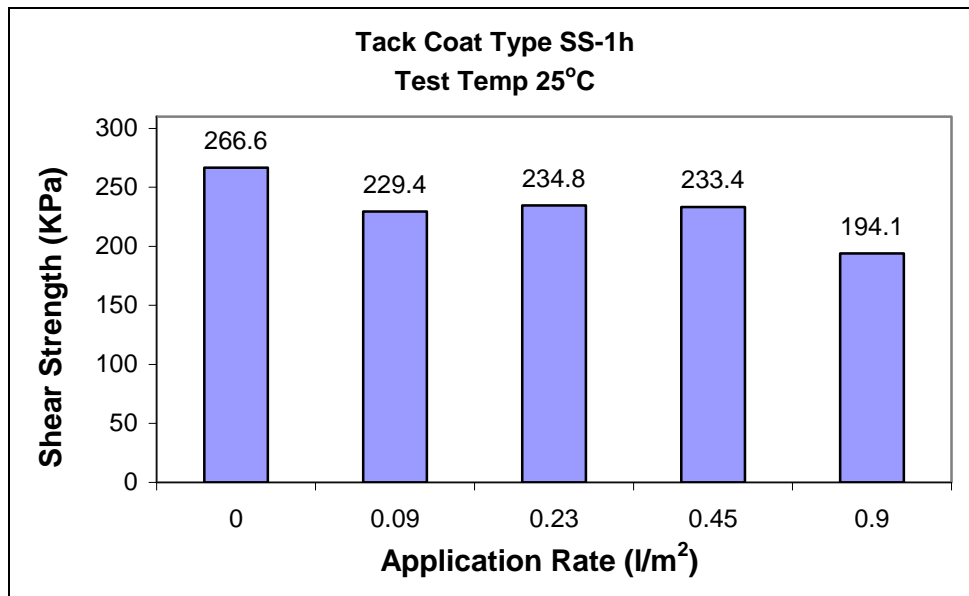

Figure 34
Plot of shear strength vs. application rate using SS-1h as tack coat at test temperature of 25°C

The statistical analysis of the mean shear strengths of these specimens is presented in Table 39.

Table 39
Statistical analysis of interface bond strengths using SS-1h as tack coat at test temperature of 25°C

Application Rate		Mean Shear Strength		Ranking
l/m ²	gal/yd ²	Kpa	psi	
0.0	0.0	266.6	38.7	A
0.09	0.02	229.4	33.3	B/C
0.23	0.05	234.8	34.1	A/B
0.45	0.1	233.4	33.9	A/B
0.9	0.2	194.1	28.2	C

The mean shear strength of specimens without any tack coat exhibited the highest statistical ranking of “A”, whereas mean shear strength of specimens with the highest application rate of SS-1h exhibited the lowest ranking of “C.”

Table 40 presents the simple shear test results (mean maximum shear stress) conducted at 55°C (77°F).

Table 40 indicates that increasing application rates of SS-1h caused a decrease in interface bonding strength. Specimens without any tack coat had the highest mean shear strength at the interface. Mean interface bonding strengths obtained at SS-1h application rates of 0.23 l/m² (0.05 gal/yd²), 0.45 l/m² (0.1 gal/yd²) and 0.9 l/m² (0.2 gal/yd²) were not significantly different from one another. Figure 35 shows the variation of mean shear strength at the interface with varying application rates of SS-1h.

Table 40
Interface bond strengths using SS-1h as tack coat at test temperature of 55°C

TESTS CONDUCTED USING SS-1h AS TACK COAT AT 55°C													
App. Rate		Sample ID	Air Void	Avg. Void	Std. Devn	Coeff Var	Shear Strength		Avg. Strength		Std. Devn		Coeff Var
l/m2	gal/yd2		%	%	%	CV%	Kpa	psi	KPa	psi	KPa	psi	CV %
0	0	NT-8	6.9				51.4	7.5	56.6	8.2	4.5	0.66	8.0
		NT-9	6.7	6.9	0.1	1.6	59.2	8.6					
		NT-10	7.0				59.3	8.6					
0.09	0.02	FLT-4	6.5				45.4	6.6	51.8	7.5	5.6	0.81	10.8
		FLT-5	6.3	6.4	0.1	2.2	54.1	7.9					
		FLT-6	6.3				55.8	8.1					
0.23	0.05	FMT-4	6.4				42.1	6.1	45.1	6.5	5.5	0.80	12.2
		FMT-5	6.5	6.4	0.1	1.1	51.5	7.5					
		FMT-6	6.4				41.8	6.1					
0.45	0.1	FHT-4	6.4				43.1	6.3	46.2	6.7	3.2	0.47	7.0
		FHT-5	6.2	6.3	0.1	2.0	46.1	6.7					
		FHT-6	6.4				49.6	7.2					
0.9	0.2	FVT-4	6.8				41.1	6.0	45.8	6.6	4.7	0.68	10.2
		FVT-5	6.5	6.7	0.2	2.3	46.0	6.7					
		FVT-6	6.6				50.4	7.3					

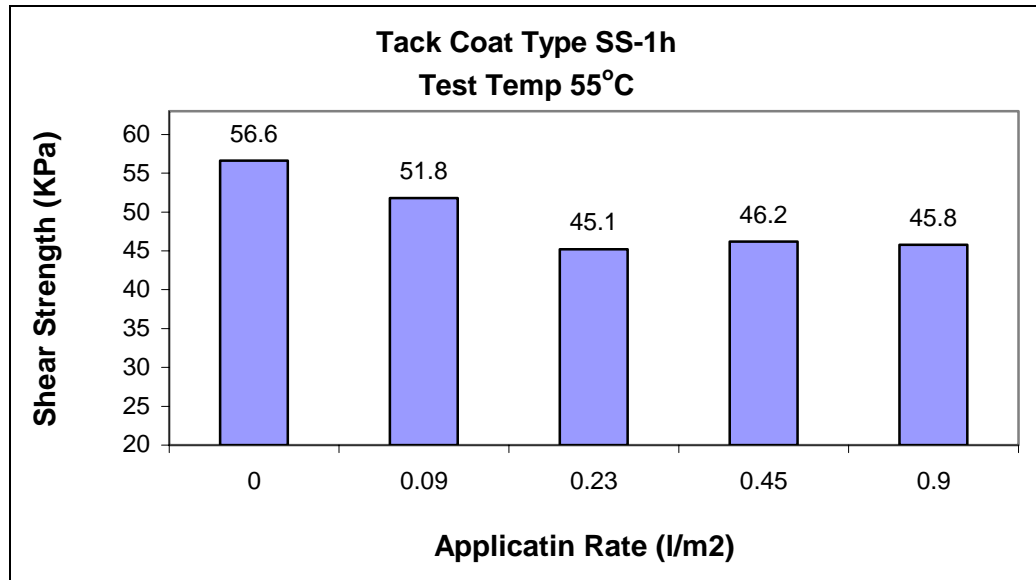

Figure 35
Plot of shear strength vs. application rate using SS-1h as tack coat at test temperature of 55°C

The statistical analysis of the mean shear strengths of these specimens is presented in Table 41.

Table 41
Statistical analysis of interface bond strengths using SS-1h as tack coat at test temperature 55°C

Application Rate		Mean Shear Strength		Ranking
l/m ²	gal/yd ²	Kpa	psi	
0.0	0.0	56.6	8.2	A
0.09	0.02	51.8	7.5	A/B
0.23	0.05	45.1	6.6	B
0.45	0.1	46.2	6.7	B
0.9	0.2	45.8	6.7	B

Specimens without any tack coat exhibited the highest rank of “A”. Variation of interface strength was not statistically significant when SS-1h was applied in the range of 0.23 l/m² (0.05 gal/yd²) to 0.9 l/m² (0.2 gal/yd²).

In summary, it can be said that SS-1h failed to serve the intended purpose of increasing interface strength at both the test temperatures.

SS-1L as Tack Coat

Discussion of simple shear test results conducted on specimens prepared by using SS-1L as tack coat is presented in the following sections.

Table 42 presents the simple shear test results (mean maximum shear stress) along with their standard deviations and coefficients of variation at 25°C.

Table 42
Interface bond strengths using SS-1L as tack coat at test temperature of 25°C

TESTS CONDUCTED USING SS-1L AS TACK COAT AT 25°C													
App. Rate		Sample ID	Air Void	Avg. Void	Std. Devn	Coeff Var	Shear Strength		Avg. Strength		Std. Devn		Coeff Var
l/m2	gal/yd2		%	%	%	CV%	KPa	psi	KPa	psi	KPa	psi	CV %
0	0	WT-1	6.5				246.6	35.8					
		WT-2	5.8	6.2	0.4	6.1	272.9	39.6	266.6	38.7	17.7	2.56	6.6
		WT-3	6.2				280.2	40.6					
0.09	0.02	GLT-1	6.8				204.3	29.6					
		GLT-2	6.4	6.5	0.3	5.3	307.3	44.6	258.4	37.5	51.7	7.5	20.0
		GLT-3	6.2				263.5	38.2					
0.23	0.05	GMT-1	7.0				247.6	35.9					
		GMT-2	6.8	6.6	0.5	7.2	282.2	40.9	266.5	38.7	17.5	2.5	6.6
		GMT-3	6.1				269.6	39.1					
0.45	0.1	GHT-1	6.8				204.2	29.6					
		GHT-2	6.6	6.8	0.2	2.8	233.8	33.9	216.3	31.4	15.6	2.3	7.2
		GHT-3	6.9				210.8	30.6					
0.9	0.2	GVT-1	7.0				213.6	31.0					
		GVT-2	6.9	7.0	0.0	0.7	204.8	29.7	215.7	31.3	12.2	1.8	5.7
		GVT-3	7.0				228.9	33.2					

As shown in Table 42, specimens with varied application rates of SS-1L did not provide any improvements in bonding strength values at the interface. On the contrary, specimens without any tack coat application possessed the highest mean bonding strength value among the groups listed in table 42. Figure 36 shows the variation of interface bond strength with increasing application rates of SS-1L. It indicates that increasing application rates of SS-1L would result in decreased bond strength at the pavement layers' interface.

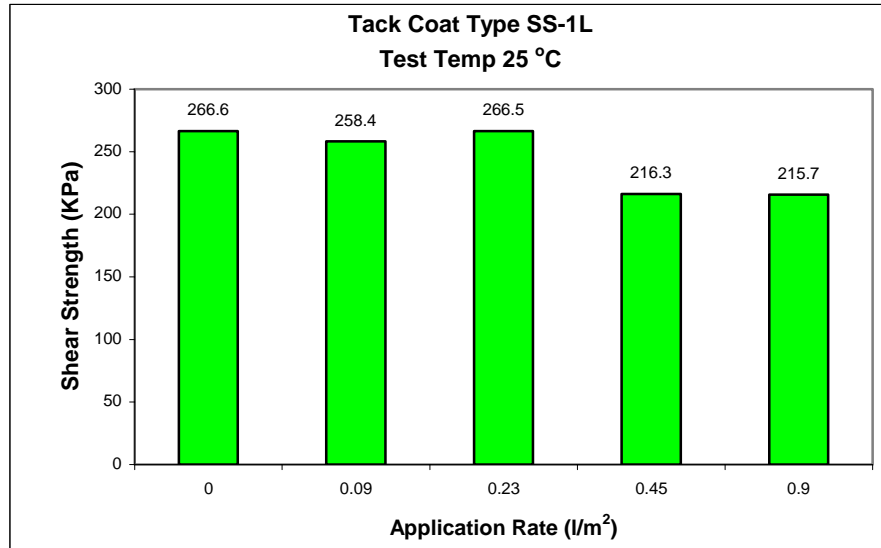

Figure 36
Plot of shear strength vs. application rate using SS-1L as tack coat at test temperature of 25°C

The statistical analysis of the mean shear strengths are presented in table 43. Table 43 indicates that at 25°C, there was generally no significant difference in the interface bond strengths among specimens without tack coat application or with a lower application rate up to 0.23 l/m². However, higher application rates of SS-1L would result in decreasing the interface bond strength.

Table 43
Statistical analysis of interface bond strengths using SS-1L as tack coat at test temperature of 25°C

Application Rate		Mean Shear Strength		Ranking
l/m ²	gal/yd ²	Kpa	psi	
0.0	0.0	266.6	38.7	A
0.09	0.02	258.4	37.5	A/B
0.23	0.05	266.5	38.7	A
0.45	0.1	216.3	31.4	B
0.9	0.2	215.7	31.3	B

Table 44 presents the simple shear test results (mean maximum shear stress) obtained at 55°C (77°F).

Table 44
Interface bond strengths using SS-1L as tack coat at test temperature of 55°C

TESTS CONDUCTED USING SS-1L AS TACK COAT AT 55°C													
App. Rate		Sample ID	Air Void	Avg. Void	Std. Devn	Coeff Var	Shear Strength		Avg. Strength		Std. Devn		Coeff Var
l/m ²	gal/yd ²		%	%	%	CV%	KPa	psi	KPa	psi	KPa	psi	CV %
0	0	NT-8	6.9				51.4	7.5					
		NT-9	6.7	6.9	0.1	1.6	59.2	8.6	56.6	8.2	4.5	0.66	8.0
		NT-10	7.0				59.3	8.6					
0.09	0.02	GLT-4	6.8				51.2	7.4					
		GLT-5	6.5	6.7	0.2	3.2	55.2	8.0	52.4	7.6	2.3	0.3	4.4
		GLT-6	6.9				51.0	7.4					
0.23	0.05	GMT-4	5.9				49.5	7.2					
		GMT-5	6.9	6.3	0.6	9.1	55.7	8.1	53.4	7.7	3.4	0.5	6.3
		GMT-6	6.0				54.9	8.0					
0.45	0.1	GHT-4	7.0				44.5	6.5					
		GHT-5	6.8	6.9	0.1	1.2	55.1	8.0	51.0	7.4	5.7	0.8	11.1
		GHT-6	6.9				53.5	7.8					
0.9	0.2	GVT-4	7.0				56.3	8.2					
		GVT-5	7.0	7.0	0.0	0.2	69.4	10.1	61.3	8.9	7.1	1.0	11.6
		GVT-6	7.0				58.3	8.5					

Table 44 indicates that, generally, specimens without any tack coat application at 55°C had a higher interface bond strength than those with SS-1L tack coat application up to 0.45 l/m². At an application rate of 0.9 l/m², however, specimens with SS-1L application achieved the highest interface strength value at this temperature. Figure 37 shows the variation of mean shear strength at the interface with varying application rates of SS-1L. The statistical analysis of the mean shear strengths of these specimens is presented in Table 45.

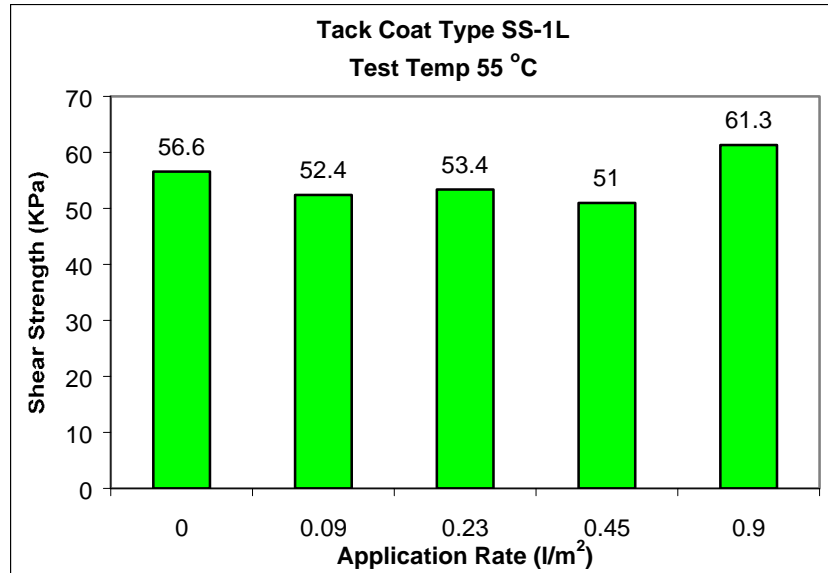

Figure 37
Plot of shear strength vs. application rate using SS-1L as tack coat at test temperature of 55°C

Table 45
Statistical analysis of interface bond strengths using SS-1L as tack coat at test temperature of 55°C

Application Rate		Mean Shear Strength		Ranking
l/m ²	gal/yd ²	Kpa	psi	
0.0	0.0	56.6	8.2	B
0.09	0.02	52.4	7.6	B
0.23	0.05	53.4	7.7	B
0.45	0.1	51.0	7.4	B
0.9	0.2	61.3	8.9	A

Table 45 indicates that at 55°C, specimens with no tack coat application or with an application rate less than 0.9 l/m² exhibited no statistical difference among the mean interface bond strength values. All of them ranked as a “B.” On the other hand, the mean bond strength at an application of 0.9 l/m² possessed the highest ranking of “A” among the group, which indicates a statistically higher strength value than any other application rates studied.

In summary, with varying tack coat application rates at 25°C, SS-1L failed to provide any improvement for interface bonding strength. However, at 55°C, test results suggested that

SS-1L might be able to provide an improved bonding strength value when an application rate greater than or equal to 0.9 l/m^2 was applied.

Influence of Tack Coat Type

Simple shear test results were grouped according to tack coat application rates and analyzed to investigate the influence of various tack coat types on interface bonding strength. Simple shear tests were conducted at four different tack coat application rates of 0.09 l/m^2 (0.02 gal/yd^2), 0.23 l/m^2 (0.05 gal/yd^2), 0.45 l/m^2 (0.1 gal/yd^2), and 0.9 l/m^2 (0.2 gal/yd^2). Analyses of these test results are presented below.

Application Rate 0.09 l/m^2 (0.02 gal/sq.yd)

Discussion of simple shear test results conducted on specimens prepared by using different tack coats at the application rate of 0.09 l/m^2 (0.02 gal/yd^2) is presented in the following sections.

Figure 38 presents the variation of interface bond strength with different tack coat types with an application rate of 0.09 l/m^2 (0.02 gal/yd^2) at a test temperature of 25°C (77°F).

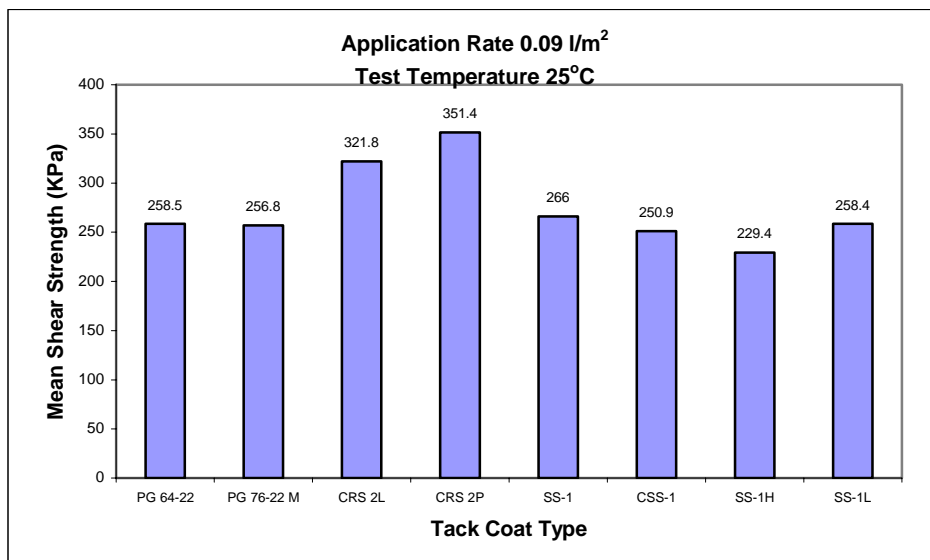

Figure 38
Mean shear strength vs. tack coat type at an application rate of 0.09 l/m^2 at test temperature of 25°C

Table 46 presents the statistical analysis of mean interface bond strengths obtained by using different tack coats types at an application rate of 0.09 l/m^2 .

Table 46
Statistical analysis of mean interface bond strengths obtained at an application rate of 0.09 l/m² at test temperature of 25°C

Tack Coat Type	Mean Shear Strength		Ranking
	Kpa	Psi	
PG 64-22	258.5	37.5	B
PG 76-22 M	256.8	37.3	B
CRS-2L	321.8	46.7	A/B
CRS-2P	351.4	50.9	A
SS-1	266.0	38.6	B
CSS-1	250.9	36.4	B
SS-1H	229.4	33.3	B/C
SS-1L	258.4	37.5	B

The statistical analysis indicated that at the application of 0.09 l/m², the highest mean interface bonding strength obtained by using CRS-2P as tack coat ranked as an A; whereas the second highest mean strength values by CRS-2L ranked as an A/B. Furthermore, the mean bond strengths obtained by using other tack coats were not significantly different from one another and were generally ranked as “B”s, except SS-1H, which was ranked as “B/C”.

Figure 39 shows the variation of interface bond strength with different types of tack coat materials at the test temperature of 55°C (131°F). Statistical analysis of mean interface bonding strengths, obtained by using different types of tack coats at the application rate of 0.09 l/m² (0.02 gal/yd²) is presented in table 47. Table 47 shows that except CRS-2L the variation of interface bonding strength among different tack coat types was not statistically significant. As a result, at 55°C, CRS-2L, with a mean bond strength of 67.4 Kpa, ranked itself as an A and all other tack coat materials ranked as Bs at an application rate of 0.09 l/m².

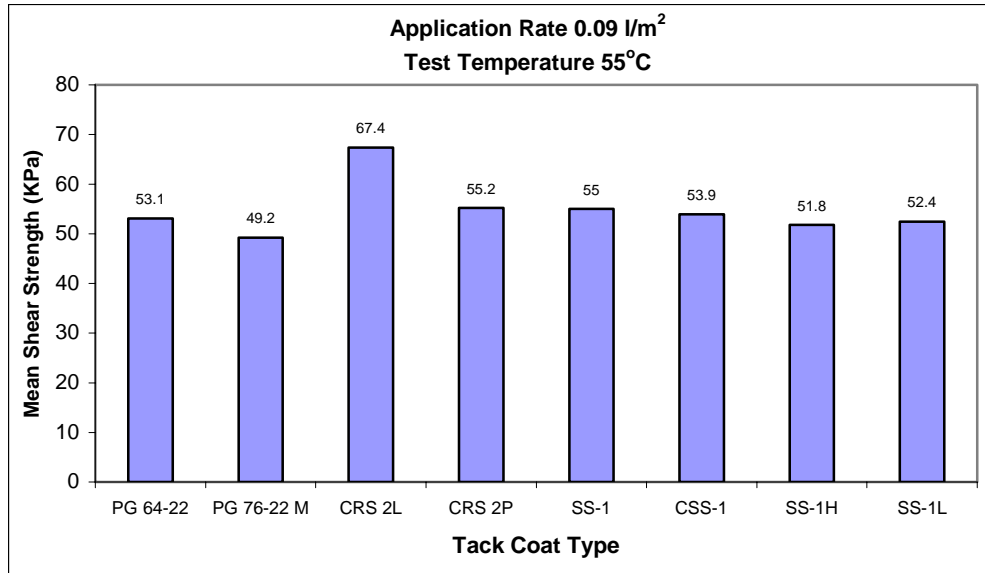

Figure 39
Mean shear strength vs. tack coat type at an application rate of 0.09 l/m² at test temperature of 55°C

Table 47
Statistical analysis of mean interface bond strengths obtained at an application rate of 0.09 l/m² at test temperature of 55°C

Tack Coat Type	Mean Shear Strength		Ranking
	Kpa	psi	
PG 64-22	53.1	7.7	B
PG 76-22 M	49.2	7.1	B
CRS-2L	67.4	9.8	A
CRS-2P	55.2	8.0	B
SS-1	55.0	8.0	B
CSS-1	53.9	7.8	B
SS-1H	51.8	7.5	B
SS-1L	52.4	7.6	B

Application Rate 0.23 l/m² (0.05gal/yd²)

Discussion of shear strength test results, conducted on specimens prepared by using various tack coats at an application rate of 0.23 l/m² (0.05 gal/yd²) is presented in the following sections. Figure 40 shows the variation of interface bond strength with tack coat types at the application rate of 0.23 l/m² (0.05 gal/yd²) and at the test temperature of 25°C (77°F).

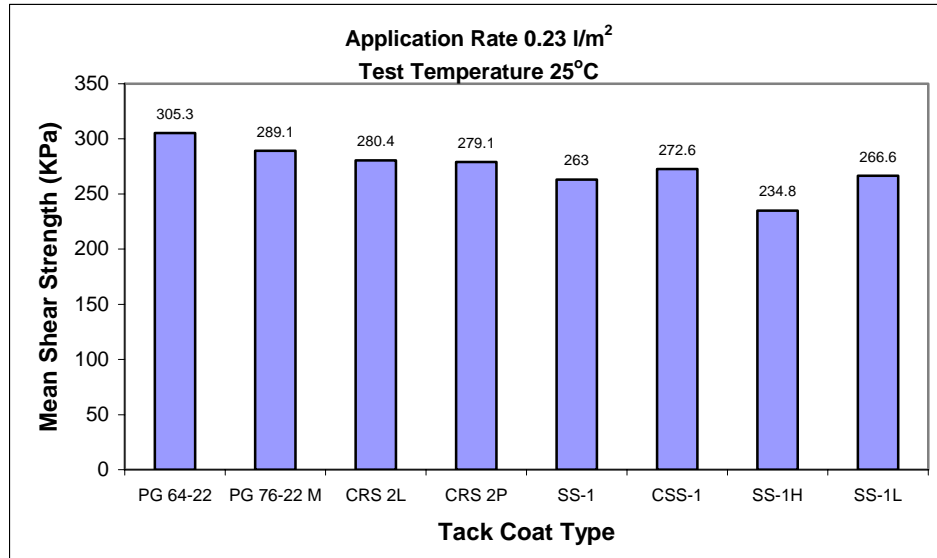

Figure 40
Mean shear strength vs. tack coat type at an application rate of 0.23 l/m² at test temperature of 25°C

The statistical analysis of mean interface bonding strengths obtained by using different types of tack coats at the application rate of 0.23 l/m² (0.05 gal/yd²) is presented in Table 48. Table 48 indicates that at an application rate 0.23 l/m², PG 64-22 and SS-1H provided the highest and the lowest interface bonding strengths, respectively. The interface bonding strengths provided by PG 76-22M, CRS-2L, and CRS-2P were not significantly different from that provided by PG 64-22. SS-1, SS-1L, and CSS-1 exhibited the same ranking of 'B'.

Table 48
Statistical analysis of mean interface bond strengths obtained at an application rate of 0.23 l/m² at test temperature of 25°C

Tack Coat Type	Mean Shear Strength		Ranking
	Kpa	psi	
PG 64-22	305.3	44.3	A
PG 76-22 M	289.1	41.9	A/B
CRS-2L	280.4	40.7	A/B
CRS-2P	279.1	40.5	A/B
SS-1	263.0	38.1	B
CSS-1	272.6	39.5	B
SS-1H	234.8	34.1	C
SS-1L	266.6	38.7	B

Figure 41 shows the variation of interface bond strength with tack coat type at the application rate of 0.23 l/m² (0.05 gal/yd²) and at the test temperature of 55°C (131°F).

Table 49 presents the statistical analysis of mean interface bonding strengths obtained by using different tack coat types at the application rate of 0.23 l/m² and at the test temperature of 55°C (131°F).

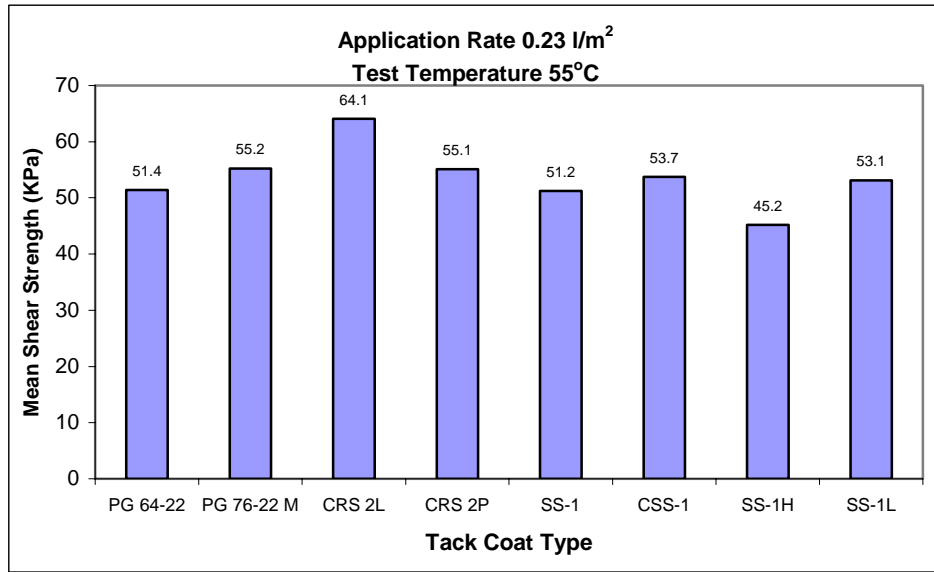

Figure 41
Mean shear strength vs. tack coat type at an application rate of 0.23 l/m² at test temperature of 55°C

Table 49
Statistical analysis of mean interface bond strengths obtained at an application rate of 0.23 l/m² at test temperature of 55°C

Tack Coat Type	Mean Shear Strength		Ranking
	Kpa	psi	
PG 64-22	51.4	7.5	B/C
PG 76-22 M	55.2	8.0	B
CRS-2L	64.1	9.3	A
CRS-2P	55.1	8.0	B
SS-1	51.2	7.4	B/C
CSS-1	53.7	7.8	B
SS-1H	45.2	6.6	C
SS-1L	53.1	7.7	B/C

The statistical analysis indicates that CRS-2L provided the highest interface bond strength and SS-1H provided the lowest. The mean interface bond strengths obtained by using PG 76-22M, CRS-2P, and CSS-1 as tack coat were not significantly different from one another and both were ranked as “B.” Meanwhile, no significant differences existed among the mean interface bond strengths obtained by using PG 64-22, SS-1, and SS-1L as tack coat, and both of them were ranked as “B/C.”

Application Rate 0.45 l/m² (0.1 gal/sq.yd)

Discussion of shear strength test results, conducted on specimens prepared by using various tack coats at an application rate of 0.45 l/m² (0.1 gal/yd²), is presented in the following sections.

Figure 42 presents the variation of interface bond strength with tack coat types at the application rate of 0.45 l/m² (0.1 gal/yd²) and at the test temperature of 25°C (77°F).

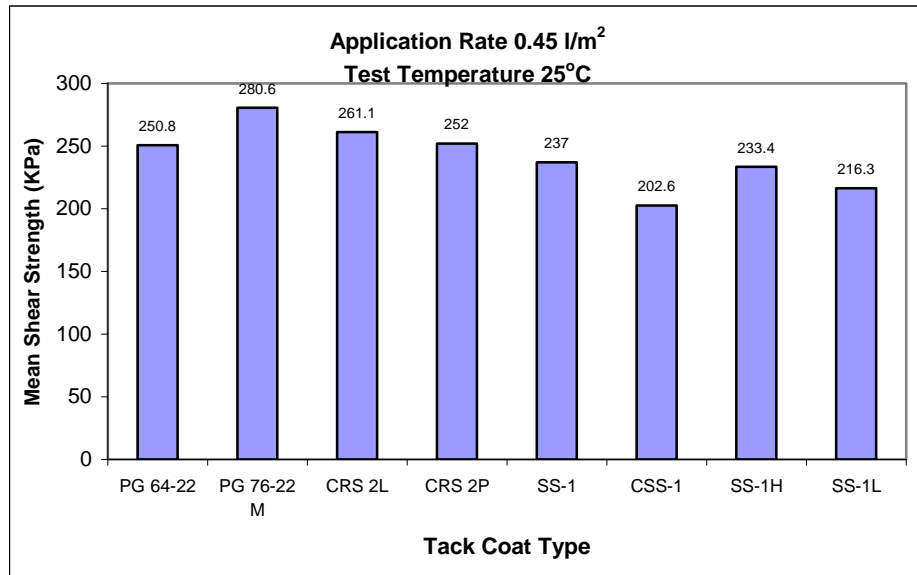

Figure 42
Mean shear strength vs. tack coat type at an application rate of 0.45 l/m² at test temperature of 25°C

Table 50 presents the statistical analyses of mean interface bonding strengths obtained by using different tack coat types at the application rate of 0.45 l/m² (0.1 gal/yd²) and the test temperature of 25°C (77°F).

Table 50
Statistical analysis of mean interface bond strengths obtained at an application rate of 0.45 l/m² at test temperature of 25°C

Tack Coat Type	Mean Shear Strength		Ranking
	Kpa	psi	
PG 64-22	250.8	36.4	B/C/D
PG 76-22 M	280.6	40.7	A
CRS-2L	261.1	37.9	B
CRS-2P	252.0	36.6	B/C
SS-1	227.4	32.9	D/E
CSS-1	202.6	29.4	F
SS-1H	233.4	33.9	D/E
SS-1L	216.3	31.4	E/F

Table 50 shows that the PG 76-22 M provided the highest interface bond strengths while CSS-1 provided the lowest. They ranked as “A” and “F,” respectively. Interface bond strengths obtained by using CRS-2L, PG 64-22, and CRS-2P as tack coats were not significantly different from one another and were ranked as “B,” “B/C” and “B/C/D,” respectively. Meanwhile, SS-1H and SS-1 were ranked as “D/E” and SS-1L as “E/F,” as shown in Table 50.

Figure 43 presents the variation of mean shear strength with tack coat type at the application rate of 0.45 l/m² (0.1 gal/yd²) and at the test temperature of 55°C. Table 51 presents the statistical analysis of mean interface bond strengths obtained by using different tack coat types at the application rate of 0.45 l/m² (0.1 gal/yd²) and at the test temperature of 55°C. Statistical ranking shows that CRS-2L provided the highest interface bonding strength followed by PG 64-22 and PG 76-22 M, while SS-1h provided the lowest interface bonding strength. CRS-2L was ranked as “A” and PG 64-22 and PG 76-22M were ranked as “A/B”s. SS-1H was ranked as “C.” Mean shear strengths obtained by using CRS-2P, SS-1, SS-1L, and CSS-1 were not significantly different from either of these groups and were ranked as either “A/B/C” or “B/C.”

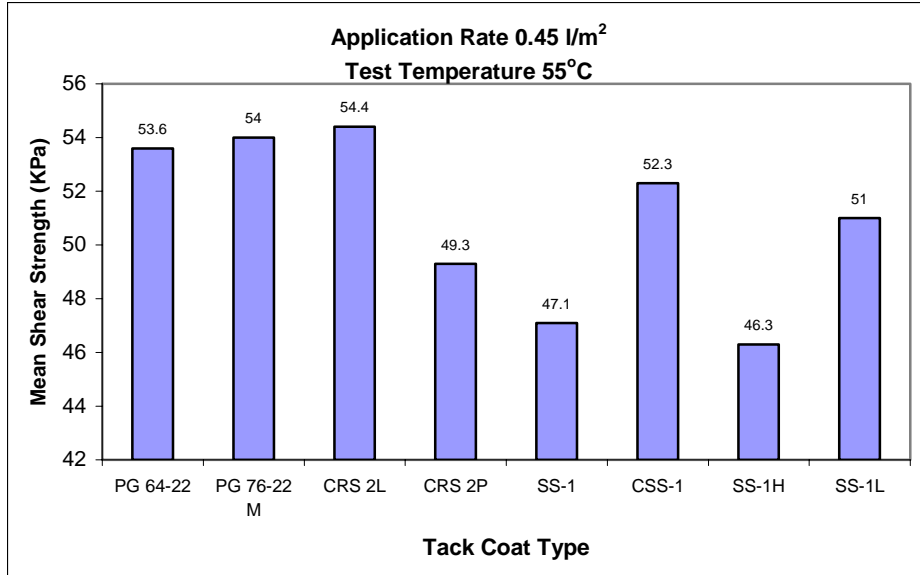

Figure 43
Mean shear strength vs. tack coat type at application rate of 0.45 l/m² at test temperature of 55°C

Table 51
Statistical analysis of mean interface bond strengths obtained at an application rate of 0.45 l/m² at test temperature of 55°C

Tack Coat Type	Mean Shear Strength		Ranking
	Kpa	psi	
PG 64-22	53.6	7.8	A/B
PG 76-22 M	54.0	7.8	A/B
CRS-2L	54.4	7.9	A
CRS-2P	49.3	7.2	A/B/C
SS-1	47.1	6.8	B/C
CSS-1	52.3	7.6	A/B/C
SS-1H	46.3	6.7	C
SS-1L	51.0	7.4	A/B/C

Application Rate 0.9 l/m² (0.2 gal/sq.yd)

Discussion of shear strength test results conducted on specimens prepared by using various tack coats at the application rate of 0.9 l/m² (0.2 gal/yd²) is presented in the following sections.

Figure 44 shows the variation of interface bond strength with varying tack coat types at an application rate of 0.9 l/m² (0.2 gal/yd²) and at the test temperature of 25°C (77°F). Table 52 presents the statistical analyses of mean interface bond strengths obtained by using different types of tack coats at the application rate of 0.9 l/m² (0.2gal/yd²) and at the test temperature of 25°C. Statistical analysis shows that PG 76-22 M provided the highest interface bond strength of 280.4 Kpa (40.7 psi), while CSS-1 provided the lowest interface bond strength of 157.3 Kpa (22.8 psi). Interface strengths obtained by using PG 64-22 and CRS-2P were not significantly different from one another and were ranked as “B/C” and “B,” respectively. CRS-2L, SS-1, and SS-1h were ranked as “C/D,” while SS-1H was ranked as “D” and CSS-1 as “E.”

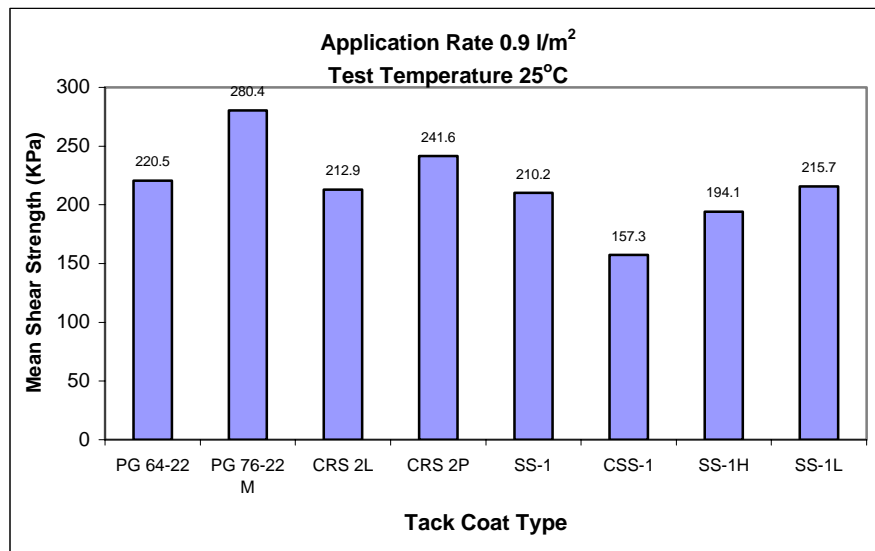

Figure 44
Mean shear strength vs. tack coat type at application rate of 0.9 l/m² at test temperature of 25°C

Table 52
Statistical analysis of mean interface bond strengths obtained at an application rate of 0.9 l/m² at test temperature of 25°C

Tack Coat Type	Mean Shear Strength		Ranking
	Kpa	psi	
PG 64-22	220.3	31.9	B/C
PG 76-22 M	280.4	40.7	A
CRS-2L	212.9	30.9	C/D
CRS-2P	241.6	35.1	B
SS-1	210.2	30.5	C/D
CSS-1	157.3	22.8	E
SS-1H	194.1	28.2	D
SS-1L	215.7	31.3	C/D

Figure 45 shows the variation of mean shear strength at the interface with varying tack coat types at the application rate of 0.9 l/m² (0.2 gal/yd²) and at the test temperature of 55°C (131°F).

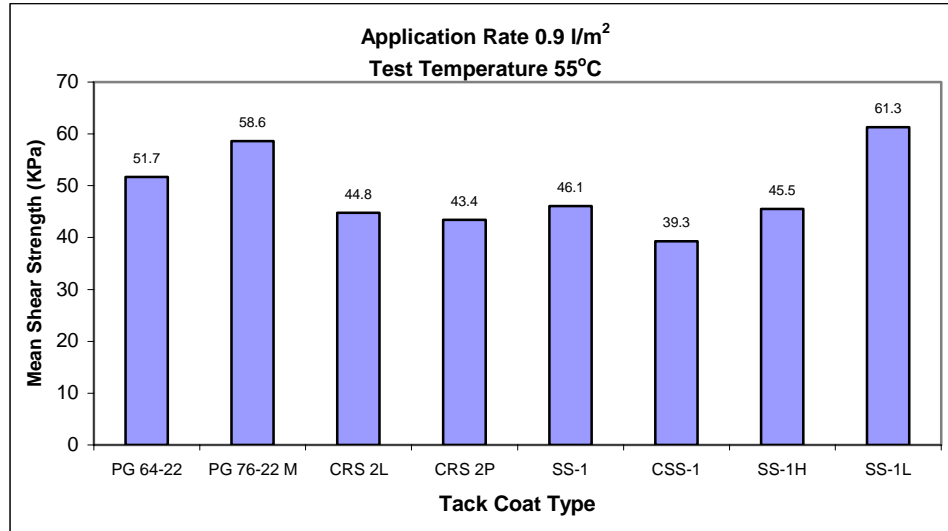

Figure 45
Mean shear strength vs. tack coat type at application rate of 0.9 l/m² at test temperature of 55°C

Table 53 presents the statistical analysis of mean interface bond strengths obtained by using different types of tack coats at an application rate of 0.9 l/m² (0.2 gal/yd²) and test temperature of 55°C (131°F).

Table 53
Statistical analysis of mean interface bond strengths obtained at an application rate of 0.9 l/m² at test temperature of 55°C

Tack Coat Type	Mean Shear Strength		Ranking
	Kpa	psi	
PG 64-22	51.7	7.5	B/C
PG 76-22 M	58.3	8.5	A/B
CRS-2L	44.8	6.5	C/D
CRS-2P	43.7	6.3	C/D
SS-1	46.1	6.7	C/D
CSS-1	39.4	5.7	D
SS-1H	45.8	6.6	C/D
SS-1L	61.3	8.9	A

Table 53 shows that the highest and the lowest interface bond strengths were provided by SS-1L and CSS-1, respectively. Interface bond strengths provided by CRS-2L, CRS-2P, SS-1, and SS-1H were not significantly different from one another and both were ranked as “C/D”s. PG 76-22 was ranked as “A/B” and PG 64-22 was ranked as “B/C.”

Optimum Tack Coat Type and Application Rate

The previous discussion on the influence of asphalt tack coat type and application rate on the interface bonding strength noted that for any given asphalt tack coat type, there was an optimum application rate at which the interface bonding strength was a maximum. These application rates were identified for each tack coat type in previous sections. Statistical analysis was then carried out in this section to identify the optimum tack coat type and application rate at each of the test temperatures of 25°C and 55°C.

Figure 46 shows the variation of maximum mean interface bond strengths obtained using different tack coat types at their optimum application rates. As shown in figure 46, the highest interface bond strength value of 351.4 KPa was achieved by using CRS-2P as tack coat material, followed by using CRS-2L with a second highest interface strength value of 321.4 KPa. The figure also shows that only five of eight tack coat materials selected provided a relatively higher mean interface bond strength value at 25°C under a certain application rate than the mean strength value obtained without tack coat application. These five tack coat materials are CRS-2P, CRS-2L, PG64-22, PG-76-22, and CSS-1. On the other hand, the maximum mean interface bond strengths obtained by using SS-1H, SS-1L, and SS-1 were

even lower than the ones obtained without any tack coat application. Thus, they failed to serve the intended purpose of providing an increased interface bond strength.

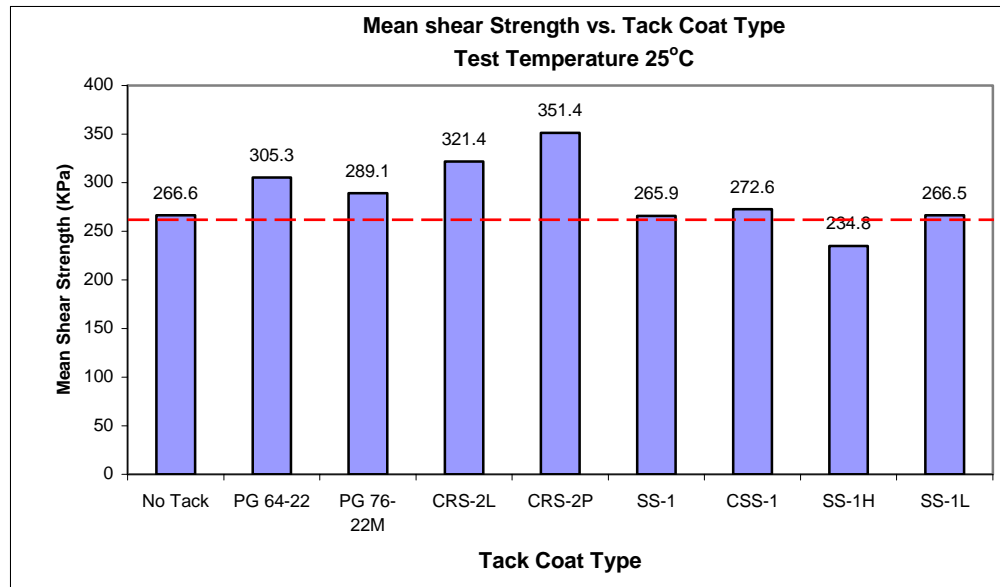

Figure 46

Mean shear strength vs. tack coat type at test temperature of 25°C bonding strength between pavement layers

Table 54 presents the results of statistical analysis of the mean interface bond strengths shown in Figure 45 to identify the optimum asphalt tack coat type and application rate at 25°C.

Table 54

Statistical analysis to determine optimum tack coat type and application rate at 25°C

Tack Coat Type	Application Rate		Mean Shear Strength		Ranking
	l/m ²	gal/yd ²	Kpa	psi	
CRS-2P	0.09	0.02	351.4	50.9	A
CRS-2L	0.09	0.02	321.4	46.7	A/B
PG 64-22	0.23	0.05	305.4	44.3	B
PG 76-22 M	0.23	0.05	289.1	41.9	B/C
CSS-1	0.9	0.2	272.6	39.5	C
<i>No Tack</i>	<i>0.0</i>	<i>0.0</i>	<i>266.6</i>	<i>38.7</i>	<i>C/D</i>
SS-1L	0.9	0.2	266.5	38.7	C/D
SS-1	0.09	0.02	265.9	38.6	C/D
SS-1h	0.23	0.05	234.8	34.1	D

As shown in Table 54, CRS-2P at an application rate of 0.09 l/m² provided the highest rank of “A” among all eight tack coat materials selected at 25°C. Statistical analysis indicates that among the eight different tack coat materials used, only CRS-2P, CRS-2L, and PG 64-22 (ranked as “A,” “A/B” and “B,” respectively) exhibited significantly higher interface shear strength values when compared to specimens without tack coat application (ranked as “C/D”). Although specimens with a certain amount of PG 76-22M or CSS-1 tack coat material also provided slightly higher mean interface bond strength values than those without any tack coat, the strength magnitude difference was not statistically significant among the three, with a statistical ranking of a “B/C” for PG 76-22M, a “C” for CSS-1 and a “C/D” for no tack application. In addition, statistical analysis also indicates that there would be no significant difference in mean interface bond strength values among specimens using tack coat types of SS-1, SS-1h, and SS-1L or no tack coat application. Therefore, CRS-2P has been selected as the optimum tack coat type at 25°C with an optimum application rate of 0.09 l/m². It is interesting to note that CRS-2P had the highest viscosity as measured by the Brookfield viscometer, Figure 9.

Similar analyses were conducted to determine the optimum tack coat type and application rate for the 55°C tests.

Figure 47 presents the variation of highest mean maximum shear stresses obtained by using different tack coat types at various application rates at a test temperature of 55°C.

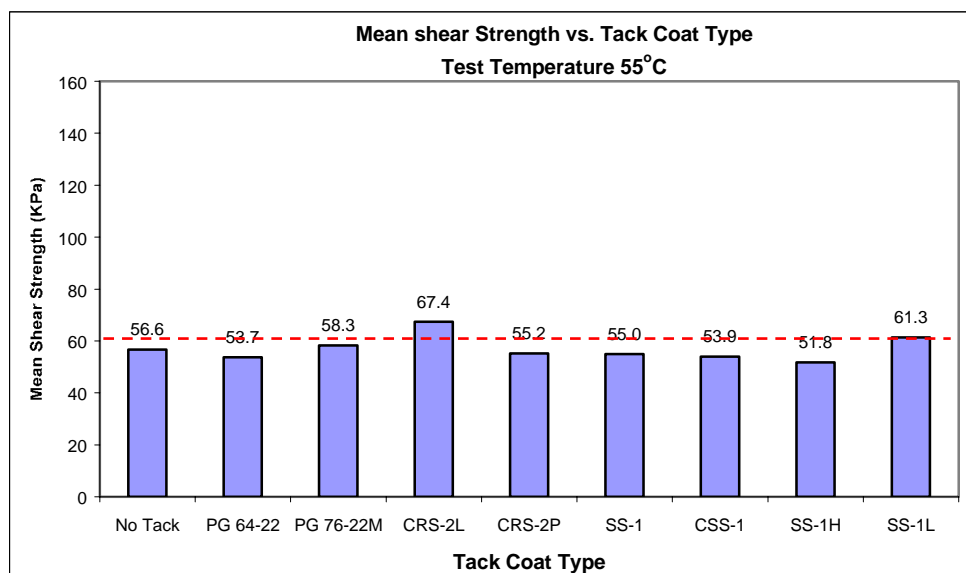

Figure 47
Mean shear strength vs. tack coat type at test temperature of 55°C

Table 55 presents the statistical analyses conducted to determine the optimum tack coat type and application rate for the 55°C tests.

Table 55
Statistical analysis to determine optimum tack coat type and application rate at 55°C

Tack Coat Type	Application Rate		Mean Shear Strength		Ranking
	l/m ²	gal/yd ²	Kpa	psi	
CRS-2L	0.09	0.02	67.4	9.8	A
SS-1L	0.9	0.2	61.3	8.9	A/B
No Tack	0.0	0.0	56.6	8.2	B
CRS-2P	0.09	0.02	55.2	8.0	B
PG 76-22 M	0.9	0.2	58.3	8.5	A/B
SS-1	0.09	0.02	55.0	8.0	B
CSS-1	0.09	0.02	53.9	7.8	B
PG 64-22	0.09	0.02	53.2	7.7	B
SS-1h	0.09	0.02	51.8	7.5	B/C

As shown in Table 55, statistical analysis ranked the mean interface bond strengths of eight out of all nine groups (except CRS-2L) as “A/B,” “B,” or “B/C” indicating that there was no significant difference among them. The highest mean interface bond strength at 55°C was obtained by using CRS-2L as tack coat at an application rate of 0.09 l/m². It is interesting to note that although CRS-2L did show statistically higher interface bond strength than any other tack coats, the biggest difference in bond strength value between CRS-2L and any other tack coats (including no tack application) was only 16 Kpa or 2.3 psi, as shown in Table 55.

In summary, for a test temperature of 25°C, CRS-2P provided the highest mean interface bond strength of 351.4 Kpa (50.9 psi) at an application rate of 0.09 l/m² (0.02 gal/yd²), whereas CRS-2L presented the highest mean interface bond strength of 67.4 Kpa (9.8 psi) at an application rate of 0.09 l/m² (0.02 gal/yd²) at 55°C. Furthermore, statistical analysis indicates that no significant difference existed between the maximum interface bond strengths at 25°C for the application of CRS-2P (ranked as “A”) and CRS-2L (ranked as “A/B”). However, at 55°C there existed a statistically significant difference within the maximum interface bond strengths among those tack coat materials, which ranked CRS-2L as “A” and CRS-2P as “B.” Figures 48 and 49 graphically show the hierarchy ranking for those eight tack coat materials selected in this study at two different test temperatures. Observations from Figures 48 and 49 are summarized as follows:

1. “No tack” application had a ranking of “C/D” at 25°C and “B” at 55°C, which indicates that the tack coat application did have potential to provide an improved interface bond strength between the interface of two asphalt concrete layers.
2. Under both test temperatures of 25° and 55°C, SS-1h provided itself with the worst ranking among the group. This seems to suggest that the applied SS-1h tack coat failed to improve or just weakened the interface bond strength by possibly introducing a slip plane instead of mobilizing increased shear strength. This finding tends to agree with the Mrawira et al. study [3], where only SS-1 was selected as tack coat material. Interestingly, SS-1 in this study also did not provide any significant improvement in the strength between the interface, as shown in above analysis.
3. The highest ranking tack coat material in this study was the CRS-2P at 25°C and the CRS-2L at 55°C.

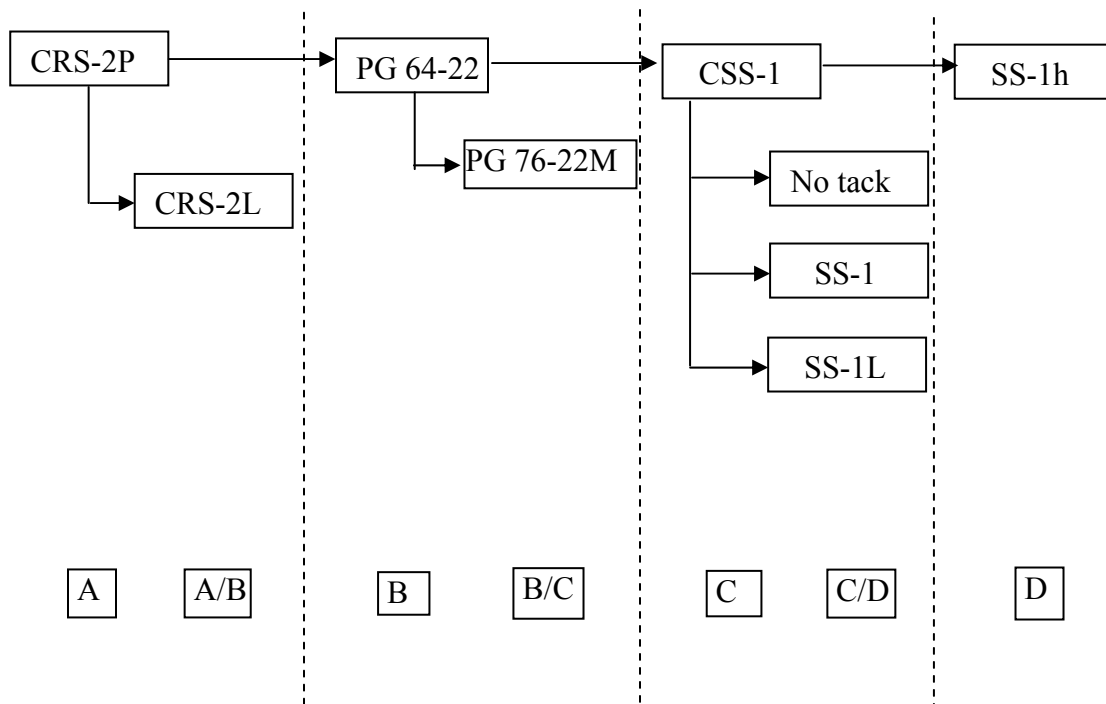

Figure 48
Ranking hierarchy of tack coat type at 25°C

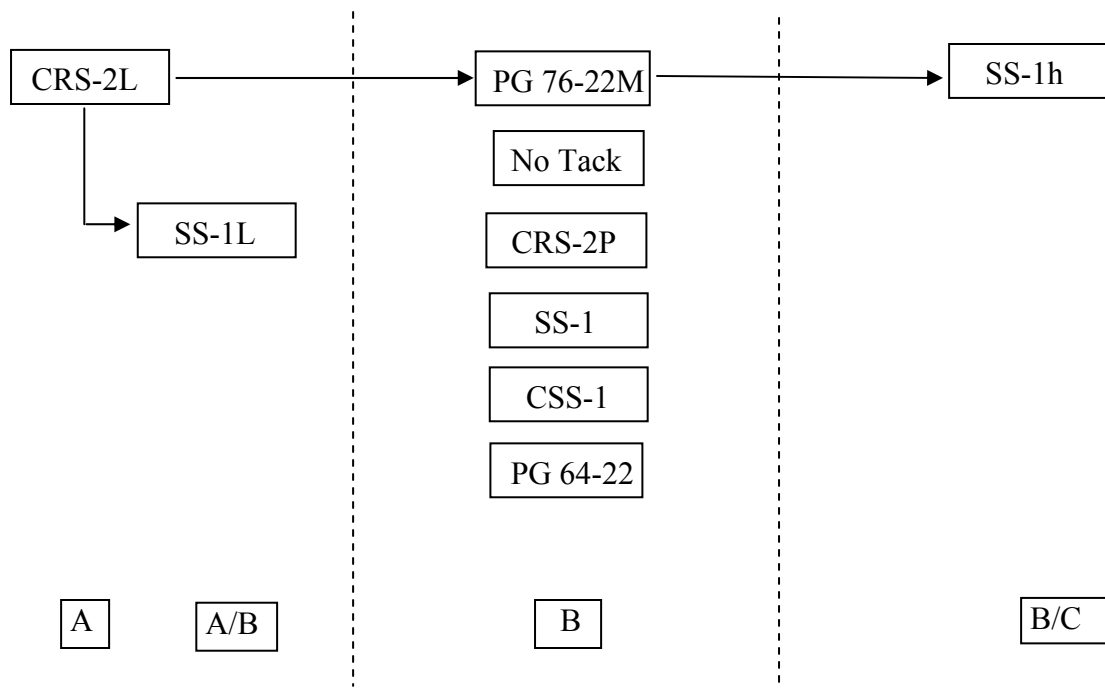

Figure 49
Ranking hierarchy of tack coat type at 55°C

By combining test results from two test temperatures, both CRS-2P and CRS-2L are recommended as the optimum tack coat types for this study. The CRS-2P emulsion provided the highest interface bond strength at the test temperature of 25°C (77°F), whereas CRS-2L provided the highest interface bond strength at the test temperature of 55°C (131°F). The optimum application rate for both materials was 0.09 l/m² (0.02 gal/yd²). It is interesting to note that Uzan et al [2] concluded in their study that the optimum tack coat application rate lied in between the application rates of 0.5 l/m² (0.1 gal/yd²) and 1.0 l/m² (0.22 gal/yd²), significantly higher than those found in this study.

The shear strength of the asphalt concrete mixture was determined in order to compare it with the highest shear strength obtained by using any tack coat. Monolithic specimens (having no interface) were compacted and tested to determine the shear strength of the asphalt concrete mixture. Mean shear strength of the asphalt concrete mixture was found to be 419.2 Kpa (60.8 psi) at 25°C and 121.3 Kpa (17.6 psi) at 55°C. The mean shear strength obtained at the interface by using CRS-2P as a tack coat at 25°C is about 83 percent of the shear strength of the asphalt concrete mix. Using CRS-2L as a tack coat at 55°C can achieve about 56 percent of the shear strength of the asphalt concrete mix.

Influence of Loads on Simple Shear Test

Influence of Shear Load on Shear Deformation

As described earlier, the designed simple shear test in this study applied shear load at a constant rate of 222.5 N/min at the interface of the specimen until failure. The applied load with time and the corresponding shear displacement were monitored. Typically, high values of peak shear load and corresponding shear displacement indicated a good bond at the interface whereas low values indicated a poor bond. Figure 50 shows a plot of the peak shear load versus corresponding shear displacement for all simple shear tests at 25°C. Figure 51 shows a plot of the peak shear load versus corresponding shear displacement for all simple shear tests at 55°C. The following observations can be made about the combinations of materials and interface conditions from Figures 50 and 51.

- When a shear deformation was relatively low, a low value of a peak shear load was usually related to it, e.g., SS-1, SS-1h, and SS-1L as shown in Figures 47 and 48. This confirmed a poor interface bonding strength for those tack coats.
- However, the highest values of peak shear load were not always related to the higher values of shear deformation in this study. Instead, the highest values of shear deformation were usually related to PG binders (PG 64-22 and PG 76-22M), which only possessed intermediate high values of peak shear load.

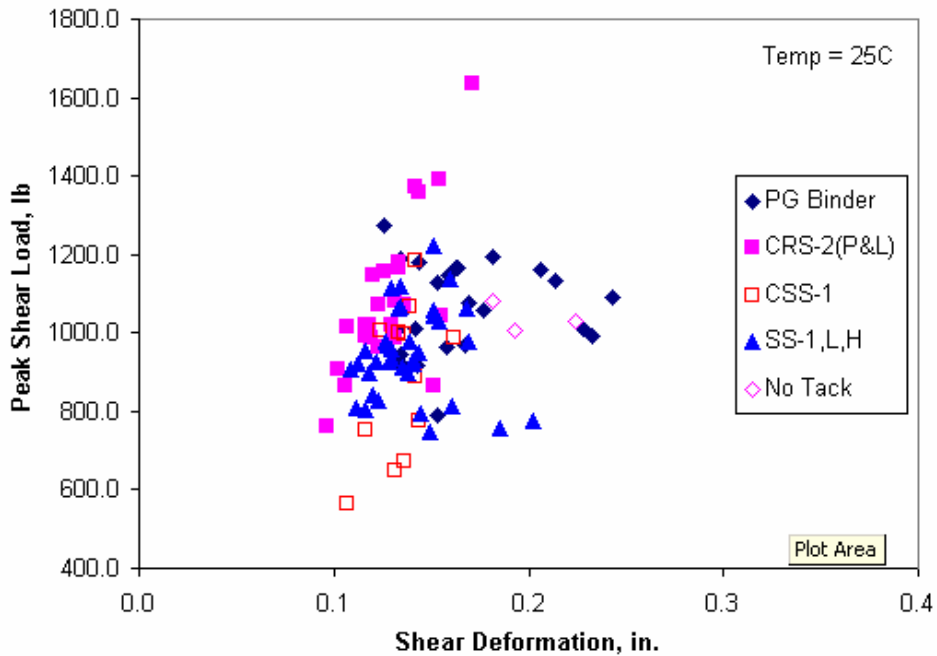

Figure 50
Simple shear tests results - peak points at 25°C

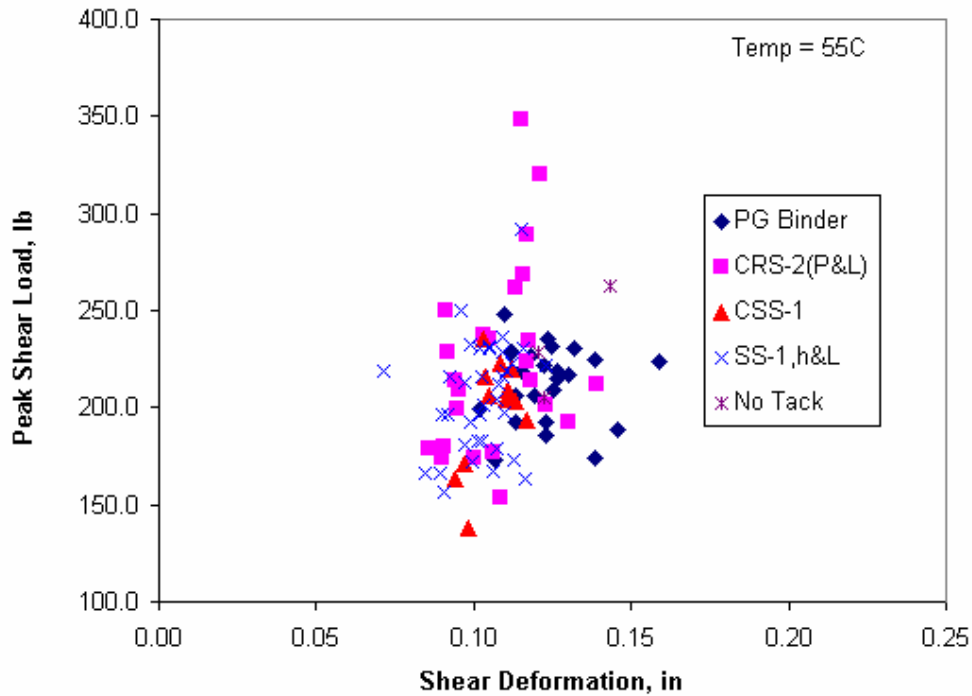

Figure 51
Simple shear tests results - peak points at 55°C

Influence of Normal Loads

In order to investigate the influence of normal stress on shear strength at interface, simple shear tests were conducted at five different normal load levels of 137.9 Kpa (20 psi), 275.8 Kpa (40 psi), 413.6 Kpa (60 psi), 551.5 Kpa (80 psi), and 689.4 Kpa (100 psi). Since CRS-2P was identified as one of the optimum tack coat materials and 0.09 l/m² was identified as the optimum application rate, it was used for the subsequent test factorial, which included one mix type and five normal load levels. Tests were conducted at 25°C and 55°C. Three specimens were prepared for testing at each combination of normal stress and temperature.

Table 56 presents the variation of interface strength with varying normal stress levels at a test temperature of 25°C.

Table 56
Variation of interface bond strength with normal load levels at test temperature 25°C

Tests conducted on specimens with CRS-2P as tack coat at 25°C									
Specimen ID	Normal Stress		Shear Strength		Average Strength		Standard Deviation		Coeff. of Variation CV%
	KPa	psi	KPa	psi	KPa	psi	KPa	psi	
CLT-1	0.0	0.0	410.2	59.5					
CLT-2	0.0	0.0	351.5	51.0	351.5	51.0	58.7	8.5	16.7
CLT-3	0.0	0.0	292.8	42.5					
CA-1	137.9	20	427.4	62.0					
CA-2	137.9	20	401.2	58.2	417.7	60.6	14.4	2.1	3.45
CA-3	137.9	20	424.5	61.6					
CB-1	275.8	40	553.2	80.3					
CB-2	275.8	40	548.1	79.5	550.4	79.8	2.6	0.4	0.47
CB-3	275.8	40	549.9	79.8					
CC-1	413.6	60	678.8	98.5					
CC-2	413.6	60	743.2	107.8	683.7	99.2	57.2	8.3	8.37
CC-3	413.6	60	629.1	91.3					
CD-1	551.5	80	714.4	103.6					
CD-2	551.5	80	796.2	115.5	773.6	112.2	51.7	7.5	6.69
CD-3	551.5	80	810.1	117.5					
CE-1	689.4	100	874.2	126.8					
CE-2	689.4	100	855.4	124.1	863.9	125.3	9.5	1.4	1.11
CE-3	689.4	100	862.0	125.0					

Table 56 shows that the mean shear strength at the interface increased as the normal stress increased. Figure 52 presents the mean shear strength at interface versus applied normal load. It indicates that the mean shear strength at the interface increased as the normal stress levels increased. Table 57 shows the variation in mean interface bonding strength with applied normal stress levels at the test temperature of 55°C.

Tables 56 and 57 shows that at both 25°C and 55°C, the mean shear strength at the interface increased with an increase in the normal stress level. This finding was similar to the one reported by Uzan et al. Figure 52 shows the variation of mean shear strength at interface with increasing normal stress levels. It is interesting to note that the two straight lines in Figure 52 have almost identical slopes, indicating that both temperatures had similar rates of change of interface shear strength with varying normal stress levels. Similar slopes of these straight lines imply that, at any given normal stress, interface-bonding strength at 25°C will be approximately 250 Kpa ($\cong 338.06-87.84$) higher than that at 55°C.

Table 57
Variation of interface bonding strength with normal load levels at test temperature
55°C

Tests conducted on specimens with CRS-2P as tack coat at 250C									
Specimen ID	Normal Stress		Shear Strength		Average Strength		Standard Deviation		Coeff. of Variation CV%
	KPa	psi	KPa	psi	KPa	psi	KPa	psi	
CLT-1	0.0	0.0	58.9	8.6					
CLT-2	0.0	0.0	50.6	7.3	55.2	8.0	4.3	0.62	7.69
CLT-3	0.0	0.0	56.2	8.2					
CA-1	137.9	20	216.5	31.4					
CA-2	137.9	20	224.8	32.6	225.4	32.7	9.1	1.32	4.04
CA-3	137.9	20	234.7	34.1					
CB-1	275.8	40	349.4	50.7					
CB-2	275.8	40	337.5	49.0	349.3	50.7	11.9	1.72	3.39
CB-3	275.8	40	361.2	52.4					
CC-1	413.6	60	480.9	69.8					
CC-2	413.6	60	485.1	70.4	473.0	68.6	17.5	2.54	3.70
CC-3	413.6	60	452.9	65.7					
CD-1	551.5	80	571.6	82.9					
CD-2	551.5	80	574.4	83.3	572.8	83.1	1.4	0.21	0.25
CD-3	551.5	80	572.5	83.1					
CE-1	689.4	100	676.9	98.2					
CE-2	689.4	100	679.7	98.6	671.7	97.4	11.6	1.68	1.73
CE-3	689.4	100	658.4	95.5					

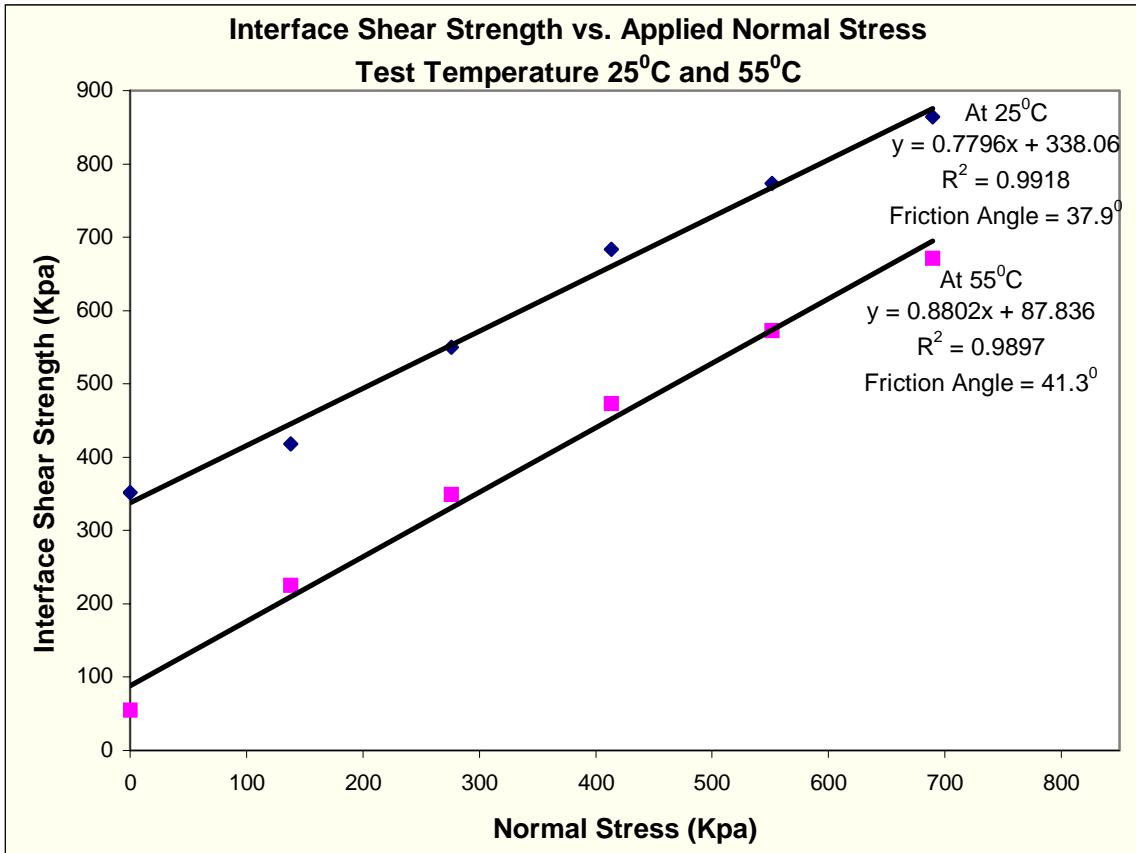

Figure 52
Variation of shear strength at interface with applied normal stress levels

SUMMARY AND CONCLUSIONS

Through controlled laboratory simple shear tests, a study was conducted to evaluate the practice of using tack coats and determine the optimum application rate. The influence of tack coat types, application rates, and test temperatures on the interface shear strength were examined. The tack coat materials included two types of performance graded asphalt cement, PG 64-22 and PG 76-22M, and six emulsions, CRS-2P, CRS-2L, SS-1, CSS-1, SS-1h, and SS-1L. The simple shear test was conducted at two temperatures.

Analysis of the test results indicated that applying certain types of tack coat did improve the bond strength between the interface of two asphalt concrete layers, as shown in Figures 46 and 47. Increasing application rates of tack coats generally resulted in a decrease in interface bond strength, especially at the higher test temperature. At the lower test temperature, however, CRS-2P, CRS-2L, PG 64-22, and PG 76-22M increased the interface bond strength at specific application rates. The optimum tack coat type and application rate at each of the test temperatures was identified through statistical analysis.

The statistical analysis indicated that among the eight different tack coat materials used, CRS-2P and CRS-2L provided significantly higher interface shear strengths than other tack coat materials. Therefore, both CRS-2P and CRS-2L were identified as the best tack coat types in this study. The optimum residual application rate for both CRS-2L and CRS-2P was 0.09 l/m^2 (0.02 gal/yd^2). The following are specific observations drawn from the test results.

- At 25°C , the optimum residual application rate of PG 64-22, PG 76-22M, CSS-1, SS-1h and SS-1L was 0.23 l/m^2 (0.05 gal/yd^2), and the optimum residual application rate of CRS-2L, CRS-2P, and SS-1 was found to be 0.09 l/m^2 (0.02 gal/yd^2).
- At 55°C , the optimum residual application rate for CRS-2L, CRS-2P, CSS-1, SS-1 and SS-1h was 0.09 l/m^2 (0.02 gal/yd^2), and the optimum residual application rate for PG 76-22M and SS-1L was 0.9 l/m^2 (0.2 gal/yd^2).
- Interface bond strength was insensitive to the application rate when PG 64-22 was used as tack coats at the test temperature of 55°C .
- Results of shear strength tests conducted at varying vertical loads showed that interface bond strength increased linearly with increasing vertical stress levels. The rate of increase of the interface bond strength was similar at both test temperatures.

RECOMMENDATIONS

The results of this study demonstrated that applying certain types of tack coat did provide improved bond strength between the interfaces of two new asphalt concrete layers. The study has identified the optimum tack coat types (CRS-2P and CRS-2L) and the corresponding residual application rate (0.09 l/m^2) for a tack coat application. These can be directly implemented in field construction.

Field monitoring test sections should be constructed to further validate the field performance of those recommended tack coat materials and the corresponding residual application rates on the existing surface types as indicated in Section 504 of the 2000 Edition of the Louisiana Standard Specification for Roads and Bridges.

It is recommended that the optimum tack coat materials identified (CRS-2P and CRS-2L) be implemented. It is further recommended that emulsion types: SS-1, CSS-1, SS-1P and SS-1L be removed from the Section 504 of the Specification as tack coat materials.

The present research focused on determining the interface bonding strength using a simple shear test. However, interface might fail in fatigue as well. Further research is recommended to examine the variation of interface bonding strength under fatigue at varying temperatures and normal load levels.

The application temperature and curing period of asphalt tack coats are two important properties that affect the interface bonding strength. Specifications generally allow a very wide range of temperatures for application of tack coats. Most specifications do not specify a specific minimum or maximum curing period for tack coats. Research should be conducted to determine the optimum application temperature and curing period for different types of tack coats.

REFERENCES

1. “Louisiana Standard Specification for Roads and Bridges,” State of Louisiana, Department of Transportation and Development, Baton Rouge, 1992 Edition.
2. Uzan, J., Livneh, M., Eshed, Y., “Investigation of Adhesion Properties between Asphaltic Concrete Layers,” *Journal of Asphalt Paving Technology*, Vol. 47, pp. 495-521, Proceedings of Association of Asphalt Paving Technologists, Technical Sessions, February, 1978.
3. Mrawira, D., and Damude, Darryl J., “Revisiting the effectiveness of Tack coats in HMA Overlays: The Shear Strength of Tack Coats in Young Overlays,” Proceedings of 14th Annual Conference, Canadian Technical Asphalt Association Proceedings, pp-116-129, 1999.
4. Romanoschi, S., “Characterization of pavement layer interfaces,” Ph.D. Dissertation, Louisiana State University, 1999.
5. Hachiya, Y., and Sato, K., “Effect of Tack Coat on Bonding Characteristics at Interface between Asphalt Concrete Layers,” Eighth International Conference on Asphalt Pavements Proceedings, Vol-1, pp-349-362, 1997.
6. Paul, Harold R., and Scherocman, James A., “Friction Testing of Tack Coat Surfaces,” *Transportation Research Record*, No.1616, pp-6-12, 1998.
7. Jean-Claude Roffe and Chaignon, F., “Characterization Tests on Bond coats: Worldwide Study, Impact, tests, Recommendations,” Proceeding of 3rd International Conference on Bituminous Mixtures and Pavements, pp603-609, Thessaloniki, Greece, November 21-22, 2002.
8. Cross, S.A. and Shrestha, P.P. “Guidelines for Using Prime and Tack Coats.” Final Report No. FHWA-CFL-04-001, Central Federal Lands Highway Division, Federal Highway Administration, Lackwood, CO, 2004.
9. “Louisiana Standard Specification for Roads and Bridges,” State of Louisiana, Department of Transportation and Development, Baton Rouge, 2000 Edition.

10. Tschegg, E. K., Kroyer, G., Tan, D., S. Stefanie, and E., Litzka J., "Investigation of Bonding Between Asphalt Layers on Road Construction," PP-309-316, *Journal of Transportation Engineering*, July-August, 1995.
11. Roberts, F.L., Kandhal, P.S., Brown, E.R., Lee, D., and Kennedy, T.W. *Hot Mix Asphalt Materials, Mixture Design, Construction*, Second Edition, NAPA Education Foundation, Lanham, Maryland, 1996.
12. "SUPERPAVE for the Generalist Engineer and Project Staff," Federal Highway Administration, Publication No. FHWA HI 97-031, July 1997.
13. Younger, K., Hicks, R. G., Gower, J., "Evaluation of Porous Pavements Used in Oregon," Volume-1 Final Report, Oregon Department of Transportation, Salem, OR, 1994.
14. Santagata, E., Canestrai, F., Santanaga F. "Laboratory Shear Testing of Tack Coat Emulsions," First World Congress on Emulsions, Paris, France, 1993.
15. Grove, J. D., "Bond Enhancement Techniques for PCC White-Topping," Final Report for Iowa Highway Research Board Project HR-341, Iowa Department of Transportation, Ames, Iowa, 1996.
16. Chen H. J., and D. A. Frederick, "Interlayers on Flexible Pavements," Transportation Research Board, Washington, DC, 1994, pp. 90-94.
17. Shahin M., Van Dam T., Kirchner K., and E. W. Blackmon. "Consequence of Layer Separation on Pavement Performance." Report DOT/ FAA/ PM-86/48, Federal Aviation Administration, Washington, D.C., 1987.
18. Sangiorgi C., A. C. Collop and N. H. Thom. "Laboratory Assessment of Bond Condition using the leutner shear test." Proceeding of 3rd International Conference on Bituminous Mixtures and pavements, pp603-609, Thessaloniki, Greece, November 21-22, 2002.

APPENDIX A

Job mix formula for the designed mix

Project: 454-01-0063 Mix code: 64 JMF No: 2 Plant code H129 Traffic(ADT) 48700 Date 9/8/99
 Proj.Eng. Joel Mcwilliams Design level: 3 Plant type Drum Prod. rate 450 Mix Time: Dry
 Submitted B & C Asphalt Mix type WC Nom.Max.Agg 19 Use WC Wet

Source code	Source Name	Aggregate Type	%	Apparent Gravity	Bulk Gravity	Absorbtion	FAA fine Agg	Sand Eq.	Flat & Elong	CAA	Friction Rating
AB13	Pine Bluff	#67	26	2.660	2.578	1.2			0	100	1
AB13	Pine Bluff	#78	44	2.663	2.561	1.5			0	100	1
AX23	B & C	Sm crush	15	2.628	2.472	2.4			0	86	3
				0.000							
AX40	B & C / Mcwilliams	Coarse	6	2.652	2.631	0.3	39	93			
AB13	Pine Bluff	1/4 + 0	9	2.667	2.584	1.2	49	39			1
				0.000							
				0.000							
Combined Aggregates Properties			100	2.657	2.558	1.46	45	61	0	97	

Mix gravities: 2.466 2.385

	Code	Product	Source	Percent	Sp. Grav
Asphalt Cement	41A3	PG-76-22M	Eagle	4.9	1.03
Asph. from RAP					
Anti-strip	5730	LA 2	Arr Maz	0.7	
Total					
Mineral Filer					
Other					
Other					

Design submitted by Contractor

Average Volumetrics	Average Oven Extracted
Gmm 2.407	2" 50 100
%Gmm, NI 85.1	1.5" 37.5 100
%Gmm, ND 95.9	1" 25 100
%Gmm, NF 97.6	3/4" 19 98
%GmbEst, ND 2.245	1/2" 12.5 84
%GmbCor, ND 2.307	3/8" 9.5 64
VMA 14.2	# 4 4.75 31
VFA 71.2	# 8 2.36 22
%Voids 4.1	# 16 1.18 17
%Design AC 4.9	# 30 0.60 14
Gsb agg 2.558	# 50 0.30 10
Slope 9.50	# 200 0.075 4
Comp Temp 315	Extracted %AC 4.9
Gmb (final) 2.348	dust/Peff 0.88
%Crushed 98	Gse 2.585
	Pabsorb 0.42
	Pbe 4.6

Gyratory Data at Optimum AC

Specimen #1				
Gyrations	Ht, mm	Gmb(est)	Gmb(cor)	%Gmm
NI 9	134.87	1.970	2.041	84.7
ND 125	119.59	2.222	2.302	95.6
NF 205	117.47	2.262	2.343	97.3
Gmm 2.409 Cor. factor 1.036 Gmb (final) 2.343 AIR 4694.9 WATER 2695.1 SSD 4699.3 VMA 14.4 VFA 69.4 %Voids 4.4 Slope 9.54				
Design AC:				4.9

AASHTO T283 as modified by PP28

Control PSI 95.4
 TSR, % 90

Proposal approved by: *Alent*
 Date approved 9/16/99
 Validation approved by:
 Date approved
 Submitted for contractor by:
 Date submitted

Gyratory Data at Optimum AC

Specimen #2				
Gyrations	Ht, mm	Gmb(est)	Gmb(cor)	%Gmm
NI 9	131.76	2.012	2.052	85.4
ND 125	116.95	2.267	2.312	96.2
NF 205	115.02	2.305	2.351	97.8
Gmm 2.404 Cor. factor 1.020 Gmb (final) 2.352 AIR 4685.3 WATER 2695 SSD 4687 VMA 14.0 VFA 72.9 %Voids 3.8 Slope 9.45				
Design AC:				4.9

QPave 9/8/99

APPENDIX B

Determination of tack coat amount to be applied on a specimen surface

Determination of tack coat amount:

Since tack coat application rates are expressed as volume of tack coat per unit area (l/m^2) the volume of tack coat to be applied on a specimen interface was calculated by multiplying the tack coat application rate by the surface area of a specimen. The resulting volume was then multiplied by the density of the tack coat to determine the weight of tack coat to be applied on a sample. A sample calculation for application of PG 64-22 at a rate of $0.09 l/m^2$ is shown below. The application rate of $0.09 l/m^2$ was first converted to an equivalent measurement of 0.009 cubic centimeters per square centimeter. Surface area of a specimen was calculated in square centimeters and multiplied by the application rate to find volume of tack coat required at that application rate. This volume was found to be 1.59 cubic centimeters. The tack coat weight was derived by multiplying this volume by the density of PG 64-22 of 1.03 grams per cubic centimeter.

$$\begin{aligned}\text{Surface Area of a Specimen} &= \Pi * \left(\frac{75.0}{25.4}\right)^2 \text{ Square inch} \\ &= 27.39 \text{ Square inch}\end{aligned}$$

Application rate = 0.02 gallons per square yard

$$0.02 \frac{\text{gal}}{\text{Sq.Yd}} = \left(0.02 \frac{\text{gal}}{\text{Sq.Yd}}\right) * \left(\frac{3.78l}{1\text{gal}}\right) * \left(\frac{1000\text{cc}}{l}\right) * \left(\frac{1\text{Sq.Yd}}{9\text{Sq.Ft}}\right) * \left(\frac{1\text{Sq.Ft}}{144\text{Sq.in}}\right)$$

$$0.02 \frac{\text{gal}}{\text{Sq.Yd}} = \left(0.0583 \frac{\text{cc}}{\text{Sq.in}}\right) * (\text{Area in Sq.in})$$

$$= \left(0.0583 \frac{\text{cc}}{\text{Sq.in}}\right) * 27.39 \text{ Sq. in.}$$

$$= 1.597 \text{ cc.}$$

$$= 1.597\text{cc} * 1.03 \frac{\text{gm}}{\text{cc}}$$

$$= 1.645 \text{ gm.}$$

The specified application rates of emulsions used in the study are residual application rates and specify the residual amount of asphalt required after evaporation of water from the emulsion. It is therefore necessary to divide the residual application rate of emulsion by the percent of residue present in the emulsion to determine the actual application rate of an emulsion.

Sample calculation for determining the mass of CRS-2P to be applied on a specimen surface at a residual application rate of 0.02gal/sq.yd.is shown below. The residual asphalt content was first divided by 0.65 since CRS 2P contains a residue of 65%. Other calculation procedures are the same as in PG 64-22.

Residual Application Rate = 0.02 gal/sq.yd.

Actual Application Rate $(\frac{0.02}{0.65})$ gal/sq. yd. = 0.030769 gal /sq.yd.

$$0.030769 \text{ gal /sq.yd} = (0.030769 \frac{\text{gal}}{\text{Sq.Yd}}) * (\frac{3.78\text{l}}{1\text{gal}}) * (\frac{1000\text{cc}}{\text{l}}) * (\frac{1\text{Sq.Yd}}{9\text{Sq.Ft}}) * (\frac{1\text{Sq.Ft}}{144\text{Sq.in}})$$

$$0.030769 \frac{\text{gal}}{\text{Sq.Yd}} = (0.089744 \frac{\text{cc}}{\text{Sq.in}}) * (\text{Area in Sq.in}) \quad [\text{Area} = \Pi * (\frac{75.0}{25.4})^2 \text{ Sq.in.}]$$

$$= (0.089744 \frac{\text{cc}}{\text{Sq.in}}) * 27.39 \text{ Sq. in.} \quad [\text{Calculated Area} = 27.39 \text{ Sq.in}]$$

$$= 2.46 \text{ cc.}$$

$$= 2.46 \text{ cc.} * 0.9 \frac{\text{gm}}{\text{cc}}$$

$$= 2.2 \text{ gm.}$$

Table 58 lists the calculated weights for various types of tack coats at different application rates.

Table 58
Applied Tack Coat Amounts at Various Application Rates

		SS-1 (150 F)				SS-1h (77F)			
App Rate	Resd.Rate			Wt.	Resd.Rate			Wt.	
lit/m2	lit/m2	cc/cm2	cc	gms	lit/m2	cc/cm2	cc	gms	
0.09	0.16	0.02	2.79	2.5	0.15	0.01	2.57	3.2	
0.23	0.40	0.04	7.13	6.4	0.37	0.04	6.56	8.1	
0.45	0.79	0.08	13.95	12.6	0.73	0.07	12.83	15.8	
0.90	1.58	0.16	27.90	25.1	1.45	0.15	25.65	31.6	
		CRS-2P (160 F)				CSS-1 (160 F)			
App Rate	Resd.Rate			Wt.	Resd.Rate			Wt.	
lit/m2	lit/m2	cc/cm2	cc	gms	lit/m2	cc/cm2	cc	gms	
0.09	0.14	0.01	2.45	2.2	0.16	0.02	2.79	2.8	
0.23	0.35	0.04	6.25	5.6	0.40	0.04	7.13	7.2	
0.45	0.69	0.07	12.23	11.0	0.79	0.08	13.95	14.1	
0.90	1.38	0.14	24.47	22.0	1.58	0.16	27.90	28.2	
		PG 64-22 (320 F)				PG 76-22 (320 F)			
App Rate	Resd.Rate			Wt.	Resd.Rate			Wt.	
lit/m2	lit/m2	cc/cm2	cc	gms	lit/m2	cc/cm2	cc	gms	
0.09	0.09	0.01	1.59	1.6	0.09	0.01	1.59	1.6	
0.23	0.23	0.02	4.06	4.2	0.23	0.02	4.06	4.2	
0.45	0.45	0.05	7.95	8.2	0.45	0.05	7.95	8.2	
0.90	0.90	0.09	15.90	16.4	0.90	0.09	15.90	16.4	

Calculated area of a sample=176.71 Sq. in