

LEVEL II

AD A103316

DTC
SECRET
AUG 26 1981
S H

12

1. Report No. FAA-AM-81-10		2. Government Accession No. AD-A103 316		3. Recipient's Catalog No.	
4. Title and Subtitle IMPROVING THE CRASHWORTHINESS OF GENERAL AVIATION AIRCRAFT BY CRASH INJURY INVESTIGATIONS,		5. Report Date MAY 1981		6. Performing Organization Code	
		8. Performing Organization Report No.		10. Work Unit No. (TRAIS)	
7. Author(s) William R. Kirkham		11. Contract or Grant No.		13. Type of Report and Period Covered	
9. Performing Organization Name and Address FAA Civil Aeromedical Institute P.O. Box 25082 Oklahoma City, Oklahoma 73125		14. Sponsoring Agency Code		15. Supplementary Notes This work was performed under Task AM-B-81-TOX-23.	
		12. Sponsoring Agency Name and Address Office of Aviation Medicine Federal Aviation Administration 800 Independence Avenue, S.W. Washington, D.C. 20591		16. Abstract <p>An accident investigative research program has correlated injuries to aircraft occupants with the accident severity and structural changes in the crash. Findings brought to the attention of aircraft manufacturers have led to specific aircraft being made more crashworthy. Following the finding of a failure in a shoulder harness attachment the manufacturer strengthened the attachment brace. The way a shoulder harness was joined to a lapbelt was modified as a followup to failure of the attachment in an accident. Noted fractures of lapbelt and shoulder harness cable tiedowns led to the use of stronger cables and modification of the installation. Other accident findings resulted in a shoulder strap guide being placed on an inertia reel and a side-mounted seat being modified.</p> <p>Described also are three seat-related features which, although meeting FAA standards, may, during the dynamics of a crash, lack desirable energy attenuation. These are: (1) an installation in which the seat is mounted directly over the wing spar so that there is little provision for attenuation of vertical impact forces on seat occupants, (2) a side-mounted seat which has been found to have broken from its mounting in several accidents, even after a modification, and, (3) seats with cast alloy legs and pedestals, that, in accidents, have been found to fracture and come loose from the seat tracks.</p> <p>These findings illustrate the value of making crash injury correlations in general aviation accidents.</p>	
17. Key Words Crashworthiness Crash injury Restraint systems Injury correlations		18. Distribution Statement Document is available to the public through the National Technical Information Service, Springfield, Virginia 22161			
19. Security Classif. (of this report) Unclassified		20. Security Classif. (of this page) Unclassified		21. No. of Pages 13	
				22. Price	

DTIC
SELECT
AUG 2 1981

084-250

ACKNOWLEDGEMENT

The author gratefully acknowledges the contributions to this report made by several Crash Injury Investigators from the Civil Aeromedical Institute, particularly James M. Simpson and Terry F. Wallace, who investigated aircraft accidents and participated in technical discussion with manufacturers' representatives and others.

Further, Paula M. Grape contributed significantly by assisting in the compiling and preparation of the material for this report.

Accession For	<input checked="" type="checkbox"/>
NIIS GRA&I	<input type="checkbox"/>
DTIC TAB	<input type="checkbox"/>
Unannounced	<input type="checkbox"/>
Justification	
By _____	
Distribution/	
Availability Codes	
Dist _____ and/or	
Special	

A

IMPROVING THE CRASHWORTHINESS OF GENERAL AVIATION AIRCRAFT BY CRASH INJURY INVESTIGATIONS

Introduction.

Statistics compiled by the National Transportation Safety Board (NTSB) show that a yearly average of 3911 accidents occurred in "small fixed-wing aircraft" (under 12,500 lb) for the 6-year period, 1973 through 1978. Of these, 663 accidents, or 17 percent, involved fatal injuries. In the fatal accidents, a yearly average of 1303 persons were killed, amounting to two aircraft occupants per accident. Studies have shown that the human body can withstand sizeable impact forces if such forces are properly distributed. Thus, it would appear that significant loss of life and seriousness of injuries could be lessened in survivable crashes if occupants of aircraft were better cushioned against the decelerative impact forces experienced in a crash. The most important improvements in the crashworthiness of light aircraft can be made by restraining occupants to afford them better protection against impact. In order to implement changes, aircraft accidents should be studied for crashworthiness.

One way to determine the crashworthiness of a vehicle is to investigate accidents as they happen, record information relative to the severity of the crash, document the integrity of the vehicular structures, note the function of the restraint systems, and study injuries received by the occupants. For over a decade, an ongoing biomedical and crash injury field investigative research program has been conducted at the Civil Aeromedical Institute (CAMI). A portion of this activity has been to correlate the types of injuries sustained by aircraft occupants with the severity of the impact, the deformation of the aircraft cabin, impact of occupants against aircraft structure, and the function of the restraint systems. The function and adequacy of restraint systems have been of particular concern in these research activities because modifications to afford better protection to occupants often can be made at relatively little expense to manufacturers or aircraft owners. Indeed, some specific changes made by manufacturers as a result of this investigative research have improved the crashworthiness of the involved aircraft and probably saved lives.

In this report we use selected examples of crashworthiness and crash injury findings to illustrate how such investigations have been used to effect changes. Some other specific examples of unresolved crashworthiness findings are illustrated.

Methods.

The investigation of general aviation aircraft accidents for crash injury correlations has been carried out by investigators at CAMI, not numbering over four persons at any time in the last decade. The decision to investigate an accident depended on any of a number of factors such as the proximity of the accident to CAMI, the type of aircraft, funds available for travel, personnel available to investigate the accident, information

relayed from investigators or persons at the scene, request for assistance from another person involved in investigating the accident and, to a great extent, current interest in a specific questionable feature that may be found in the crashed aircraft.

The usual method of investigating the accident consisted of becoming familiar with the circumstances of the accident as gathered by NTSB and FAA investigators; documenting the scene, noting the flight path, obstacles, impact points, distribution of wreckage, distribution of bodies, etc.; evaluating the intactness of cockpit/cabin area; examining each seat documenting the direction and extent of deformation with the force of impact and the sequence of multiple impacts, noting depressions in the instrument panel, the distribution of blood and tissue that might verify the direction and force of deceleration of the occupants; and reviewing and recording injuries as may be revealed by autopsies or by hospital records. Frequently survivors and witnesses were interviewed to gather their firsthand experiences with the accident. Photographs taken in all phases of the investigation were used to document findings.

Previous reports (1,2) have presented various aspects of findings from this accident investigation program. This report presents only selected findings that bear on accidents whose investigation led to modifications in the aircraft or pointed to certain questionable crashworthiness features.

Findings and Discussion.

Shoulder harness attachment brace.

Many aerial application aircraft have been built with a strong crashworthy cockpit frame. Pilots are provided a seat, lapbelt, a shoulder harness, and in many aircraft a large metallic roll on the panel to distribute impact forces over the pilot's body should he strike it in an accident. Further, the pilot usually wears a helmet. The crashworthiness of an aerial application aircraft was illustrated when, on fuel exhaustion, the aircraft stalled and struck the ground in a 45° nosedown attitude. As illustrated in Figure 1a there was moderately severe damage to the engine and hopper. The pilot, who was wearing a lapbelt and shoulder harness, received lacerations above the right eye and a fractured left arm and left knee. He had conspicuous shoulder harness and lapbelt abrasions and contusions. A notable finding was the forward bending of the shoulder harness attachment bracket and cracking of the bond where the bracket had been welded to the cockpit structural bars (Figure 1b). During deceleration the force of the pilot's body against the shoulder harness apparently caused this deformation. Fracturing of the seat pedestal and detachment of the seat from the seat track probably increased the freedom of the pilot's body, allowing it to come forward and strike the instrument panel. The intact upper torso restraint probably prevented the pilot from receiving lethal injuries.

A more severe impact in the same type aircraft occurred when an aircraft contacted three power lines 35 feet above the ground and then traveled 170 feet before striking the ground. The plane tumbled end-over-end 63 feet and stopped upright. The aft portion of the fuselage and empennage were torn off

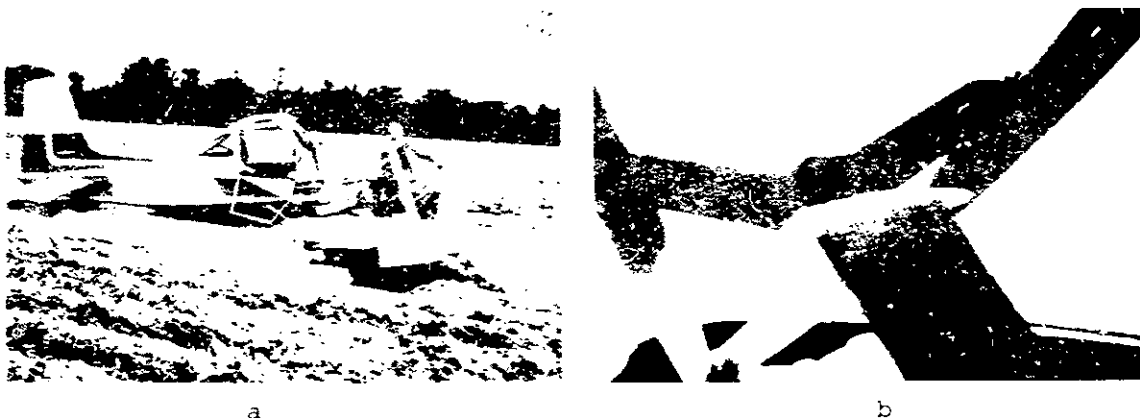

Figure I. In this accident damage was limited and cockpit was intact (a). However, shoulder harness attachment brace showed v-shaped deformation (b) due to force of pilot's body against restraint during crash.

(Figure IIa). The cockpit structure remained intact. The accident was fatal to the pilot and, although no autopsy was performed, the coroner



Figure II. Same type aircraft as in Figure I. Damage is more severe but cockpit is intact (a). Shoulder harness attachment brace has been pulled off sites where welded to cockpit structural bars (b).

reported that death was due to multiple injuries and possibly fractures of the neck. The pilot was wearing lapbelt, shoulder harness and crash helmet. The lapbelt was intact. The shoulder harness attachment bracket, where welded to the aft cockpit structural bars, had failed, allowing this bracket to separate from the structural bars (Figure IIb).

Although the pilot may have received fatal injuries during any of several motions in the deceleration or tumbling of the aircraft, it appears that at one point in the crash sufficient force was exerted on the shoulder harness to fail the attachment bracket.

The failure of the shoulder harness bracket was reported to the manufacturer who then modified the shoulder harness attachment brace using a longer piece of metal, wrapping it further around the structural bars and welding it securely (Figure III). The result was that the strength of the shoulder harness attachment was improved. In subsequent accidents of this aircraft we have not seen a failure of this improved shoulder harness attachment.



Figure III. Modified shoulder harness attachment brace has longer metal wrapped further around and more securely welded to cockpit structural members.

Shoulder harness.

Another modification in the restraint system in this series of aerial application aircraft resulted from crash injury investigation of a single accident. The aircraft struck at a 65° nose and rightwing down attitude, resulting in marked damage to the engine and hopper areas and upper displacement of the cockpit canopy. The pilot was wearing a lapbelt and shoulder harness (loosely), but not a crash helmet. The accident was immediately fatal to the pilot. No autopsy was performed but it was observed that there were extensive skull fractures with blood and spinal fluid coming from the left ear canal, multiple lacerations of the face, fracture of the right forearm and burns on each hand. An indentation on the extreme right of the instrument panel with tissue debris present was consistent with having been struck by the head of the occupant. Restraint system attachments and webbings remained intact except that the right shoulder strap separated where it was sewn to the lapbelt (Figure IV). There was fracturing of the legs on the seat. It appeared that the pilot, during deceleration, was thrown forward and to the right. The failure of the right shoulder strap, where it was attached to the right limb of the lapbelt, probably permitted the pilot to travel forward enough to strike his head on the right side of the instrument panel and cockpit frame.

U.S. GOVERNMENT PRINTING OFFICE: 1964

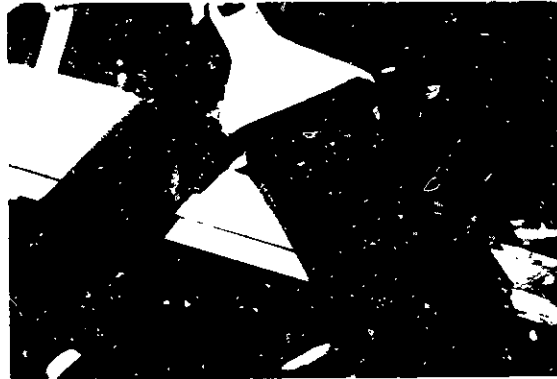

Figure IV. Threads tore where shoulder harness was sewn to lapbelt. Modification consisted of wrapping shoulder harness around lapbelt and sewing through the three layers of restraint webbing.

This failure of the attachment of the shoulder strap to the lapbelt was reported to the manufacturer in an informal conference and the manufacturer made a modification of the restraint system, wrapping the shoulder harness strap around the lapbelt and sewing it on both sides. Modifications or exchanges of the restraint systems were made in this model of aircraft. In investigations of subsequent accidents we have seen no failures of the shoulder harness where it was sewn to the lapbelts.

Inertia reel.

Further observations in accidents involving aerial application aircraft have revealed failures in the inertia reel in some cases. In one accident this involved failure of the latching mechanism to completely engage, resulting in the spooling out of the shoulder harness, allowing the pilot's head to strike the instrument panel. In other accidents the inertia reel housing fractured and the reel failed to restrain the pilot. In an accident investigated by others, but reported to us, a pilot was injured by the apparent failure of the inertia reel to latch and hold. The inertia reel was sent to us for examination. The common strap of the double shoulder harness normally is taken up on the spool of the reel. In this instance the strap had some separation of the webbing so that it appeared to have been rolled or folded upon itself while being taken up on the reel (Figure V). It appeared that the oval guide, an extension of the reel cover, was not sufficient to prevent the strap from rolling upon itself and thereby increasing the bulk on the spool. In so doing it could override and possibly interfere with the reel latching mechanism. Indeed, with a new reel, if the strap is led in from the side, as one in the pilot's seat would do repeatedly in removing the harness and letting it retract, the shoulder harness common strap can fold upon itself as it is taken up on the spool. Such folding can obstruct the reel-locking mechanism.

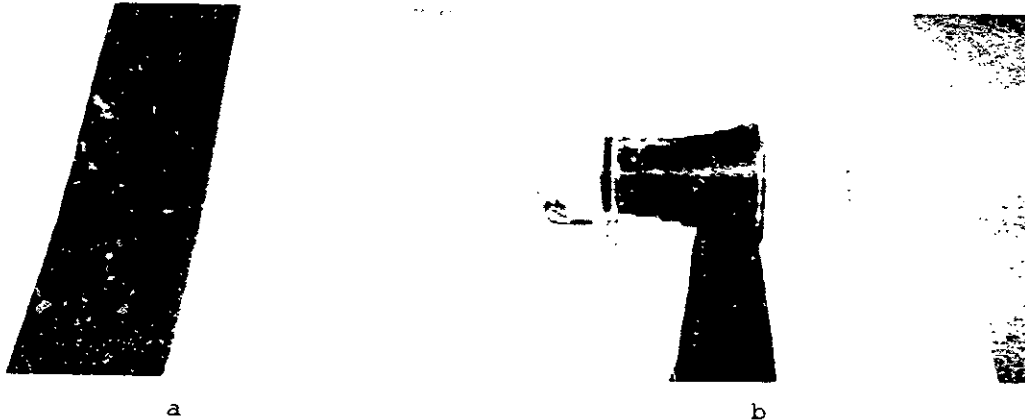

Figure V. Inertia reel was reported not to have held in accident of moderate impact. Separation between threads (a) suggested longitudinal folding of strap upon itself on reel. Such folding can interfere with reel-latching mechanism (b). Modification by use of a guide on reel housing should prevent this occurrence.

Again, as a result of informal conferences, the aircraft and inertia reel manufacturers agreed to modify the reel by placing a more precise shoulder harness strap guide on the reel housing rather than depending upon the more oval-shaped strap guide previously used. This modification should prevent the folding of the shoulder strap and obviate this as a cause of the inertia reel failing to latch. There has been no accident experience to evaluate the effectiveness of this change. The reliability of the latching mechanisms and the overall strength of inertia reels are subjects of continuing crash-worthiness investigations.

Cables attaching restraints.

The pilot of an aerial application aircraft inadvertently dipped his right wing in some wheat and, on recovering, struck a parked cotton trailer with the left wing tip. The aircraft hit the ground and came to rest inverted. The cockpit remained intact (Figure VIa) but the seatbelt attachment cables and the shoulder harness cable failed (Figure VIb), allowing the pilot to come forward. His head struck the metallic wirecutter in front of the windscreen and his chest made a broad impact on the panel. The pilot's helmet sustained a large vertical cleavage corresponding to the impact with the wirecutter and the pilot suffered a corresponding laceration of the forehead.

The crash injury investigator could not understand why all three cables would fail in such an accident. He began to look at other aircraft in service and study the cables. In this aircraft the cable to the shoulder harness coursed over a pulley and down behind the pilot to an inertia reel. The lap-belt attached to cables that passed through an opening in a bulkhead (around



a

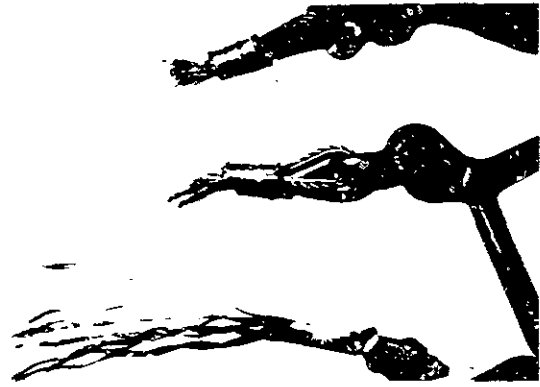

b

Figure VI. Pilot of aircraft (a) received head and chest injuries as, on impact, he came forward into windscreen, wirecutter, and instrument panel. Cables used on shoulder harness and lapbelts all failed (b). Stronger cables and modified routing apparently rectified the condition.

the pilot) and the cables were fixed to the frame of the aircraft. In both places, over the pulley and where cables pass through the bulkhead, they were subjected to wear and considerable recurrent acute bending. In some operational aircraft, filaments of the multistrand cable were found to be broken. This configuration of the cable attachments for the shoulder harness and lapbelts appeared to subject them to wear and bending that weakened and broke strands of the cable. Thus, in the aircraft accident investigated, the cables probably had been preweakened by wearing, bending and breaking of filaments; and during the impact the pilot's body probably exerted force on the restraint system sufficient to break the cables.

These observations were reported to others in the Federal Aviation Administration and published in General Aviation Inspection AIDS (3), a bulletin that calls technical matters to the attention of inspectors in the field. The manufacturer was also informed of the finding in this accident. Subsequent to the publication of this notice for inspectors, the manufacturer issued a service bulletin by which stronger and different cables were put in the aircraft and the configuration of the lead-in through the bulkhead was modified so as to eliminate most of the bending. Since the modification, there have been no accidents in which we have observed the cables to have broken and an examination of operational aircraft in the field has revealed no flaws in the cables.

Side-mounted seat.

One aircraft has the inertia reel mounted low on the back of the seat. The single shoulder strap passes forward through an opening in the upright

seat back and attaches to the lapbelt. The strength of the shoulder harness depends upon the strength of the seat-back latch to keep the seat upright during an impact. If the seat back were to break forward the shoulder harness would be of reduced value. Furthermore, the seat is mounted on rollers that extend from the seat frame to tracks on the sidewall and a center console (Figure VII). There are no legs or pedestals under this seat. The seat and upper torso restraint arrangement is such that the forward decelerative forces of the occupant transmitted to the shoulder harness must be borne by the seat attachment.

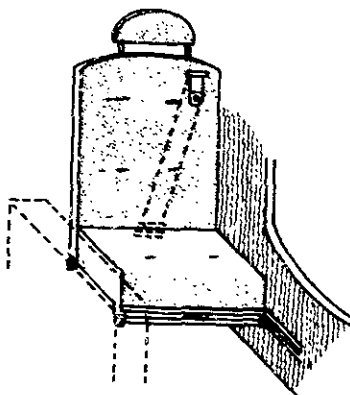

Figure VII. Schematic of side-mounted seat.

In an accident of an aircraft of this type carrying four persons, an infant was killed, a child received only minor injuries, and the pilot and his wife were seriously injured. The pilot received serious head injuries when his head struck the instrument panel. The pilot's seat (Figure VIIIa) was found loose in the cabin and the axles of all four rollers were either severely bent or the rollers were broken off the axles. The seat appeared to have broken downward under the impact loading.

Because of the way it is mounted it appeared that the value of the shoulder harness would depend, not only on the strength of the seat back latching mechanism, but upon the seat remaining in position. A breakdown of the seat from the track could allow the passenger, even though wearing a shoulder harness, to rotate forward into structures in front of him. The finding that the rollers were stripped from their axles suggested that this seat did not support the occupant in this crash.



Figure VIII. Pilot in this seat received head injuries in a survivable accident. Note bending of axles and fracturing of roller from axles. Modification to prevent seat breakdown was attachment of bar on seat to engage seat track.

The particulars of this accident were reviewed on an informal basis with engineering representatives of the manufacturer. Following this, the manufacturer issued a service bulletin which called for a strengthening of the seat back latching mechanism and for a bar to be bolted onto the seat frame so that if the seat rollers bent or were broken, the seat would collapse onto the seat track and the bar projecting out each side of the seat would engage the upper lip of the track and prevent the seat from collapsing into the floor. Shortly after the service bulletin was issued, the FAA issued an airworthiness directive (4) mandating the changes as prescribed in the service bulletin.

Since this modification, we have seen accidents in which the seat, in spite of the fact that the modification was present, broke down and became free in the cabin (Figure IX). Close examination of the bar that was added to prevent collapse of the seat, failed to indicate that it significantly engaged on the side tracks as it was designed to do. We further noted that in such accidents the axles of the rollers tend to be bent several inches from the roller itself. This finding suggests that the axle is pulled laterally during the impact as it is acutely bent. Lateral movement probably occurs because the fuselage, which is oval in shape, during impact undergoes top to bottom deformations, increasing the lateral dimension. Such deformation is readily discerned in high-speed motion pictures of aircraft fuselages undergoing drop tower testing conducted by the National Aeronautics and Space Administration. It thus appears that in this aircraft with side-mounted seats, the fuselage on impact deforms, causing the spreading apart of the sidetracks. This spreading extends the axles of the seat rollers laterally in their retainers. The force of the occupant is borne on the extended axle. Further, the bar which was placed on the seat to engage the track, appears to be too

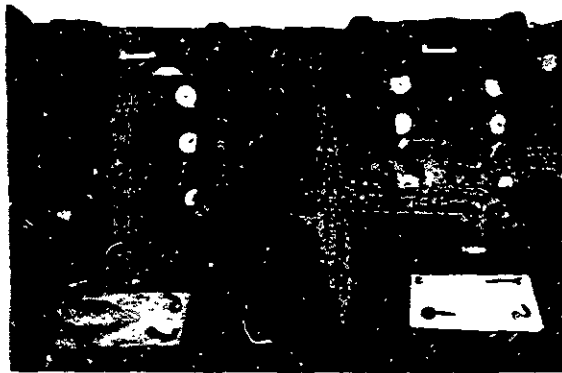

Figure IX. In this accident, seats, even though modified, broke down, probably adding to injuries of occupants. Note degree of bending of axles on rollers.

short to adequately engage the top of the track during lateral deformation or spreading of the fuselage.

Other crashworthiness features.

An additional crashworthiness feature involves an aircraft in which the main spar is a large aluminum tube that passes through the cockpit. This hollow tube serves also as a fuel cell. The two-seat aircraft has both seats mounted side by side on a small metallic track directly on top of the main spar. The bottom of the seat is plywood and the seat cushion consists of 2 inches of foam rubber. This arrangement appears to offer little attenuation of impact forces by the seat. During impact, forces, particularly vertical forces, would tend to be transmitted through the main spar to the pelvis and the axial spine of the occupant.

The aircraft in Figure X was in a stall-spin accident and, the fuselage remained relatively intact, yet there were severe spinal injuries to the two occupants. One can see that the seat mounting, as depicted in Figure XI, places the occupant directly over the main spar. In another accident of this type aircraft, vertical loading sufficient to fail the landing gear strut resulted in fracture of the pelvis and compression fractures of lumbar vertebrae.

A number of general aviation aircraft are equipped with seat frames, legs, and pedestals cast of magnesium-aluminum alloy. It has been observed in accidents that the legs and the pedestals of such seats are frequently fractured. Indeed, in a review of accidents of one aerial application aircraft employing this type seat (2), it was found that in 14 of the 18 accidents investigated, the seats left their tracks and in 14 of the 18 accidents one or more seat legs or pedestals were fractured. The cited report reviewed findings in an aerial application aircraft because this type of aircraft was specifically designed to be crashworthy. However, the problem extends beyond the aerial

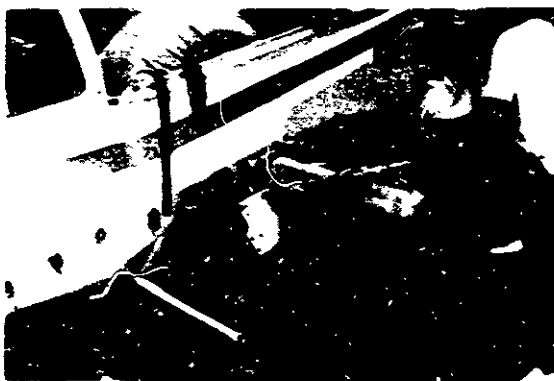

Figure X. Two occupants of this aircraft received severe spinal injuries. Note large tubular main spar that passes through cockpit under seats.

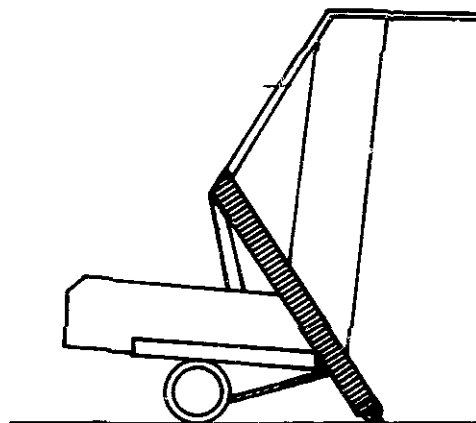

Figure XI. Schematic of aircraft seat showing mounting directly over large tubular main spar with little space or structure to attenuate vertical impact forces.

application aircraft as illustrated in Figure XII. The six people in this aircraft all received moderate to severe injuries. The pilot and person in the copilot position had facial injuries and spine fractures. The forward four seats were partially or completely separated from the seat tracks and the pilot's and copilot's seats had fractured seat pedestals as shown in the figure. Cast seat legs and parts are strong and meet all FAA requirements but in accidents when the failure point is reached they appear to break exposing the occupant to possible high peak decelerative forces in secondary impacts rather than deforming under the occupant and attenuating the energy of impact. At present we do not know how pervasive failures of seats are in general aviation aircraft or how such failures add to the severity of injuries. This is a matter of continuing crashworthiness investigations.



Figure XII. On impact, the occupants of this aircraft received serious injuries. Cast alloy seat pedestals were found to be fractured as can be seen in photograph.

Summary.

In summary, it is apparent that occupants of aircraft that crash could, in many cases, have the severity of their injuries reduced by well-designed seats and restraint systems. Further, it is clear that one can learn of the weak points in restraint systems by studying their effectiveness and failures in accidents. Significant findings brought to the attention of manufacturers can bring about changes to improve the crashworthiness of aircraft, thereby reducing injury and saving lives. Crash injury investigations are, therefore, an important and fruitful part of the investigation of many accidents.

REFERENCES

1. Swearingen, J. J.: General Aviation Structures Directly Responsible for Trauma in Crash Decelerations. FAA Office of Aviation Medicine Report No. 71-3, 1971.
2. Kirkham, W. R., J. M. Simpson, T. F. Wallace, and P. M. Grape: Aircraft Crashworthiness Studies: Findings in Accidents Involving an Aerial Application Aircraft. FAA Office of Aviation Medicine Report No. 80-3, 1980.
3. General Aviation Inspection AIDS, Federal Aviation Administration, AC No. 20-7M, November, 1975.
4. FAA Airworthiness Directive 77-16-09, August 4, 1977.