

Report No. FAA-AM-73-9	2. Government Accession No.	3. Recipient's Catalog No.	
Title and Subtitle IN-FLIGHT PERFORMANCE OF CIVILIAN PILOTS USING MOVING-AIRCRAFT AND MOVING-HORIZON ATTITUDE INDICATORS		5. Report Date June 1973	6. Performing Organization Code
Author(s) A. Howard Hasbrook and Paul G. Rasmussen		8. Performing Organization Report No.	
Performing Organization Name and Address FAA Civil Aeromedical Institute P. O. Box 25082 Oklahoma City, Oklahoma 73125		10. Work Unit No.	11. Contract or Grant No.
Sponsoring Agency Name and Address Office of Aviation Medicine Federal Aviation Administration 800 Independence Avenue, S.W. Washington, D.C. 20591		13. Type of Report and Period Covered	
Supplementary Notes		14. Sponsoring Agency Code	
Work was performed under Task No. AM-A-72-PHY-50.			
Abstract The in-flight performance of civilian instrument-rated pilots using two different types of attitude indicators in a general aviation aircraft was measured during typical instrument flying maneuvers. The instruments were an inside-out (moving-horizon) indicator and an outside-in (moving aircraft) indicator. The subjects were divided into low and high experience groups. The results of the study differ in some degree with those of some recent ground-based studies which used the same two concepts of attitude presentation. However, one result of the in-flight study agreed with many of the previous studies; low time pilots exhibited a narrower range of pitch excursions with the outside-in (moving aircraft) attitude indicator than they did with the inside-out (moving horizon) indicator. When combined with the authors' observations of a head-horizon tilt phenomenon relating to both humans and animals, the results of this study suggest the usefulness of a new concept for the design of the attitude indicator display. A new concept is described in this report.			
Key Words Aeronautics; Instrument Flight; Aviation Safety Flight; Human Engineering Research; Human Displays Design		18. Distribution Statement Availability is unlimited. Document may be released to the National Technical Information Service, Springfield, Virginia 22151, for sale to the public.	
Security Classif. (of this report) Unclassified	20. Security Classif. (of this page) Unclassified	21. No. of Pages 17	22. Price \$3.00



ACKNOWLEDGMENT

The authors wish to express their appreciation for the valuable assistance provided by the pilot subjects, as well as that of Mr. William Flores who produced many of the illustrations contained in the report.



IN-FLIGHT PERFORMANCE OF CIVILIAN PILOTS USING MOVING-AIRCRAFT AND MOVING-HORIZON ATTITUDE INDICATORS

I. Introduction

The first practical artificial horizon instrument—or attitude indicator, as it is called today—was developed in 1928 by Elmer Sperry, Jr. and was successfully test flown a year later in “blind flight” conditions in a U.S. Navy training plane by a Lt. James H. Doolittle of the U.S. Army Air Corps. Based on an early concept that a pilot’s primary frame of reference is his aircraft and that the earth and horizon move in relation to the pilot and his airplane, Lt. Doolittle specified that the instrument have a *moving-horizon bar*. A small gyroscope kept the bar (A, Fig. 1) parallel with the true horizon,

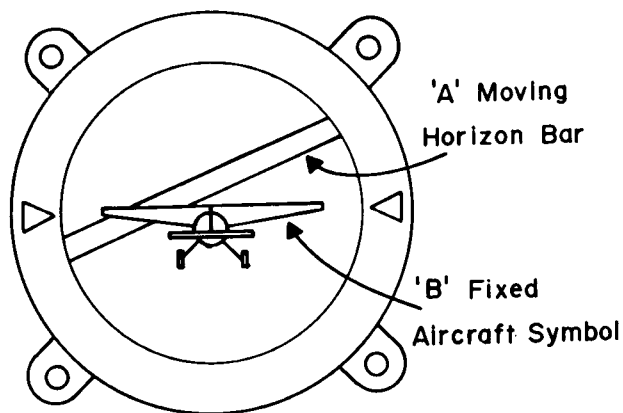

FIGURE 1. Artist's drawing of 1928 Doolittle-Sperry artificial horizon instrument. It was similar in appearance to contemporary attitude indicators except for the lack of a “sky pointer” and bank angle indices, regardless of normal banking and pitching motions of the aircraft. A fixed-aircraft symbol (B, Fig. 1) provided a means of relating the roll and pitch attitude of the aircraft to the horizon.

Although the basic design and operation of the “moving-horizon” type attitude indicator instrument has not changed in the intervening

43 years (1929–1972), there have been many researchers and pilots who have questioned the “human factors correctness” of using a moving horizon bar rather than a moving-airplane symbol in this all-important blind flight instrument.

There seems little doubt that the moving-horizon concept leaves much to be desired. Johnson and Roscoe (1970) showed, for example, that of the 89 plane crashes in 1968 classified as weather disorientation accidents, a substantial number occurred when an airplane with a *normally operating gyro horizon display* (moving-horizon instrument) was flown into the ground in a tight spiral. Fitts and Jones (1947), in their study of 270 errors made by pilots reading and interpreting instruments during instrument flight, showed that the artificial horizon (moving-horizon) instrument contributed to a number of reversal errors (turning or recovering in the wrong direction) and to errors due to illusions; seven percent of the errors involved interpretation of bank angle; another five percent was due to misconceptions of aircraft attitude because of conflicts between body sensations and instrument indications. Fitts and Jones also pointed out that “although this number [of reversal errors] is relatively small, the consequences of these errors are often tragic, and the amount of *over-learning* associated with the use of this display [moving-horizon instrument] should be closer to zero.” (Emphasis ours.) In the past 37 years, many other studies have been conducted to determine whether the moving-horizon bar or the moving-aircraft symbol is more natural and normal for human use. Poppen (1936) stated that the correct form of presentation should be an exact analog of what would be viewed through the windscreen in contact (VFR) flight. Despite the fact that virtually every research study relating to the problem has favored the *moving-*

airplane form of presentation (Johnson and Roscoe, 1970), the rationale favoring the moving horizon attitude form of presentation has prevailed through the years. Interestingly, most of these studies used ground-based, fixed (or in a relatively few cases, moving-base) trainers or simulators, *in which little or no acceleration forces were present*. The few studies which did use actual aircraft involved high-performance military planes in which "smooth arc" tracking tasks were performed by highly experienced military fighter pilots and test pilots. Unfortunately, these provided little indication of what the results might be during routine IFR conditions with ordinary civilian pilots. This is probably one of the major reasons why little serious thought has been given by operational personnel to switching over to the use of the moving-airplane instrument. Despite the weight of research evidence favoring its adoption, it seems that many operational people still feel the validity of results from ground-based simulators and training experiments has not been sufficiently established for situations in which physical acceleration cues are bound to be important. Perhaps they also feel the results of the few flight experiments conducted in the past have been too unrealistic in task requirements to be useful in making such a far-reaching decision. An interesting exception, however, is that the USAF Development Engineering Inspection Board for the North American F-108 long-range interceptor unanimously decided to adopt the moving-airplane steering display for the F-108 airplane. Unfortunately, the F-108 program was cancelled too soon for operational experience to be gained on the use of this "new" display concept.

In general, previous research, involving little or no acceleration forces, showed that:

1. Low-time pilots and non-pilots responded more rapidly and more often correctly to the moving-aircraft instrument.

2. Positive transfer for all pilots and non-pilots was greater when switching from the moving-horizon to the moving aircraft instrument.

3. All pilots and non-pilots demonstrated fewer reversals with the moving-aircraft instrument.

4. Low-time pilots and non-pilots subjectively "felt" that the moving-airplane instrument was more "natural" and "easier to interpret."

5. Initially, experienced high-time pilots subjectively were more "at ease" with the moving-horizon instrument.

Concerning these findings, however, Johnson and Roscoe (1970) pointed out "it is essential that certain critical experiments be conducted in-flight to eliminate the possibility of drawing spurious conclusions from a simulated flight environment. Both the speed of learning by relatively inexperienced pilots and the ease of transition of highly experienced and currently proficient pilots must be measured"; they also emphasized that "flight tasks must be operationally realistic and representatively difficult and stressful."

In order to examine the problem in an environment representative of several general aviation instrument flying situations—in which acceleration loads and some form of psychological flight stress would be present—an FAA-CAMI in-flight study was initiated. Designed to measure pilot performance while using the moving-airplane-symbol instrument and the moving-horizon-bar instrument, the in-flight study—utilizing a general aviation type aircraft—included the following maneuvers: (1) recoveries to level flight from shallow and steep turns; (2) performing a series of left and right turns while maintaining a level pitch attitude; and (3) maintaining a given airspeed while performing a series of spiraling descents.

Subjectively, these tasks appeared to be highly stressful to many of the subjects and, in fact, a few subjects lost control of the aircraft and gave up after unintentionally getting into "graveyard" spirals—some involving more than 5g normal acceleration. Because of this, as well as on the basis of the other results of this in-flight study, it is suggested that the data in this report may be viewed as being reasonably representative of pilot performance in certain "real life" instrument flying environments. However, these facts should be noted: (1) the attitude indicators used in the study were not exact duplicates in "face-format" (the aircraft symbol in the moving-aircraft instrument [A, Fig. 2] was smaller than the one in the moving-horizon instrument [B, Fig. 2]); (2) roll and pitch indices were not

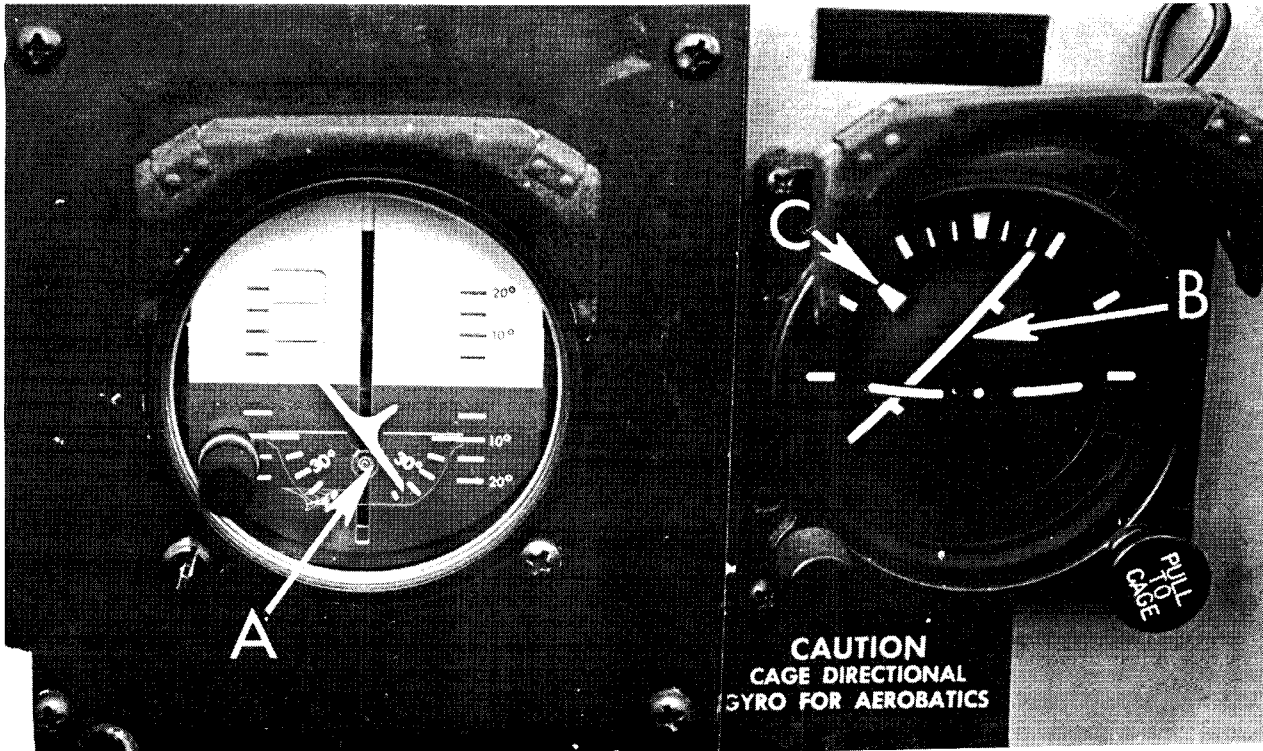

FIGURE 2. Outside-in (moving-aircraft) attitude indicator (left) utilized fixed-horizon and aircraft symbol that moved both vertically and rotationally for pitch and bank information. To provide space for these movements required use of a smaller aircraft symbol than that used in the contemporary inside-out (moving-horizon) attitude indicator (right). Both indicators in this photo depict an attitude of approximately 48° right bank and 10° nose down. However, the moving-horizon bar (B) can be mistaken for an aircraft symbol, giving initial impression of climbing turn to left. Pointer (C) moving toward left may also tend to psychologically say, "We're turning left."

identical in each indicator; (3) vertical displacement of the moving aircraft symbol for a given pitch change was twice that in the moving-horizon instrument; and (4) sky-ground colors on the instrument faces differed. It would, of course, have been ideal to have had identical appearance and pitch displacement in both instruments, but this could not be done within time and financial restraints.

II. Equipment and Methodology

A Beech T-34 two-place military trainer (Fig. 3) with tandem seating and a blind flying hood over the rear cockpit was used in the study. (This aircraft was particularly appropriate for the study because its design strength—more than 8g positive and 4g negative—eliminated much of the hazard involved in permitting the subjects to lose control of the aircraft, as some did.) A Lockheed model 417 recorder was installed in

the rear baggage compartment for the acquisition of pitch and roll data.

The test attitude indicators were installed in the instrument panel of the rear cockpit. Each subject was exposed to four different instrument displays (Figs. 4a, 4b, 4c, 4d), in a statistically designed sequence, during the recoveries from banks to level flight. These four consisted of two full panel displays (all flight instruments available for use) and two part panel (attitude indicator only) displays. In the alternating turns and the descending turns, only the part panel was utilized. However, the airspeed indicator was added to the part panel in the descending turn maneuver. Cardboard disks with adhesive tapes were used to cover instruments not used during the flights. A bank and pitch calibration unit was installed ahead of the windshield (Fig. 5); this was used by the safety pilot to calibrate the recorder and the visual indications of the rear cockpit attitude indicator in-

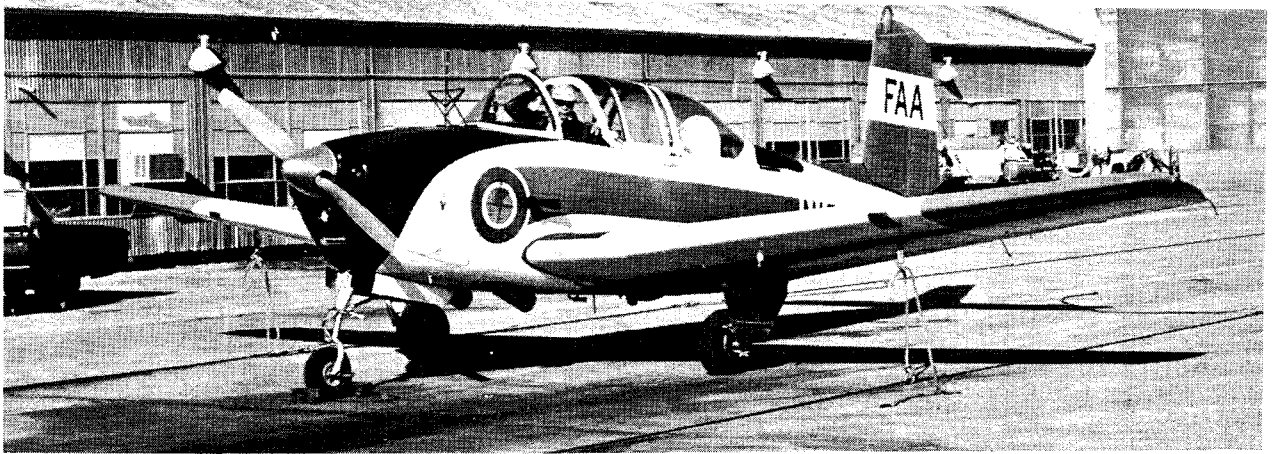

FIGURE 3. Aircraft used in study was a two-place Beechcraft Mentor (T-34) whose performance and handling characteristics are similar to contemporary, light 4-5 place general aviation aircraft; however, pitch and roll is by use of a stick rather than by a wheel.

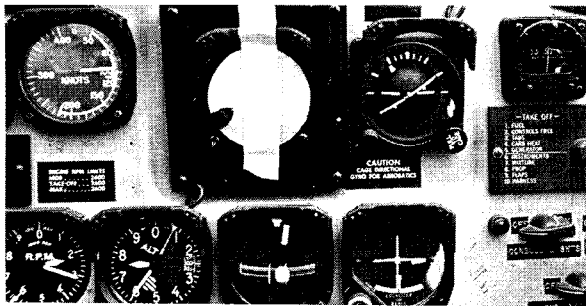

FIGURE 4A

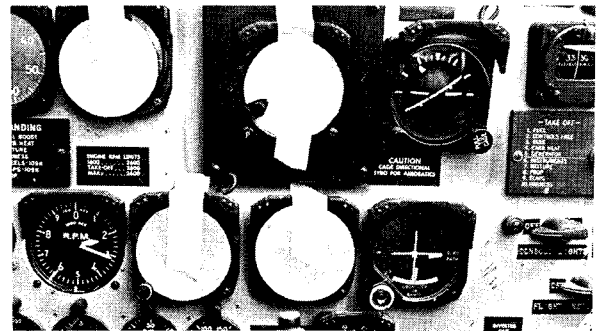

FIGURE 4C

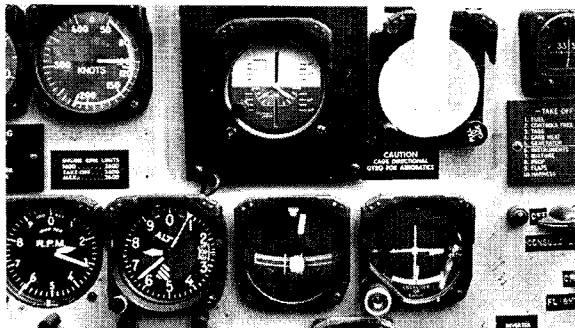

FIGURE 4B

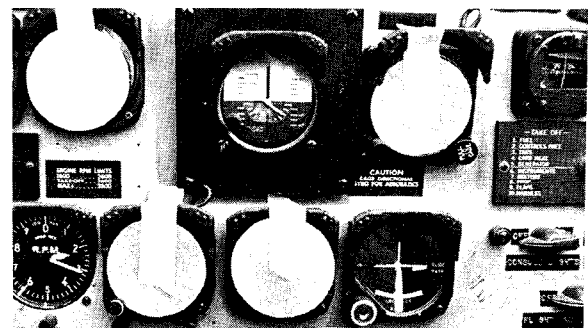

FIGURE 4D

FIGURE 4. Each subject was exposed to four different instrument displays in a statistically designed sequence—two utilizing the moving-horizon attitude instrument and two with the moving-aircraft instrument. Each of the two displays was divided into full (4a and 4b) and part (4c and 4d) panels. As shown in 4c and 4d, the only instrument available for aircraft attitude information was the attitude indicator. In descending turns, the airspeed indicator was also available in the part panel display.

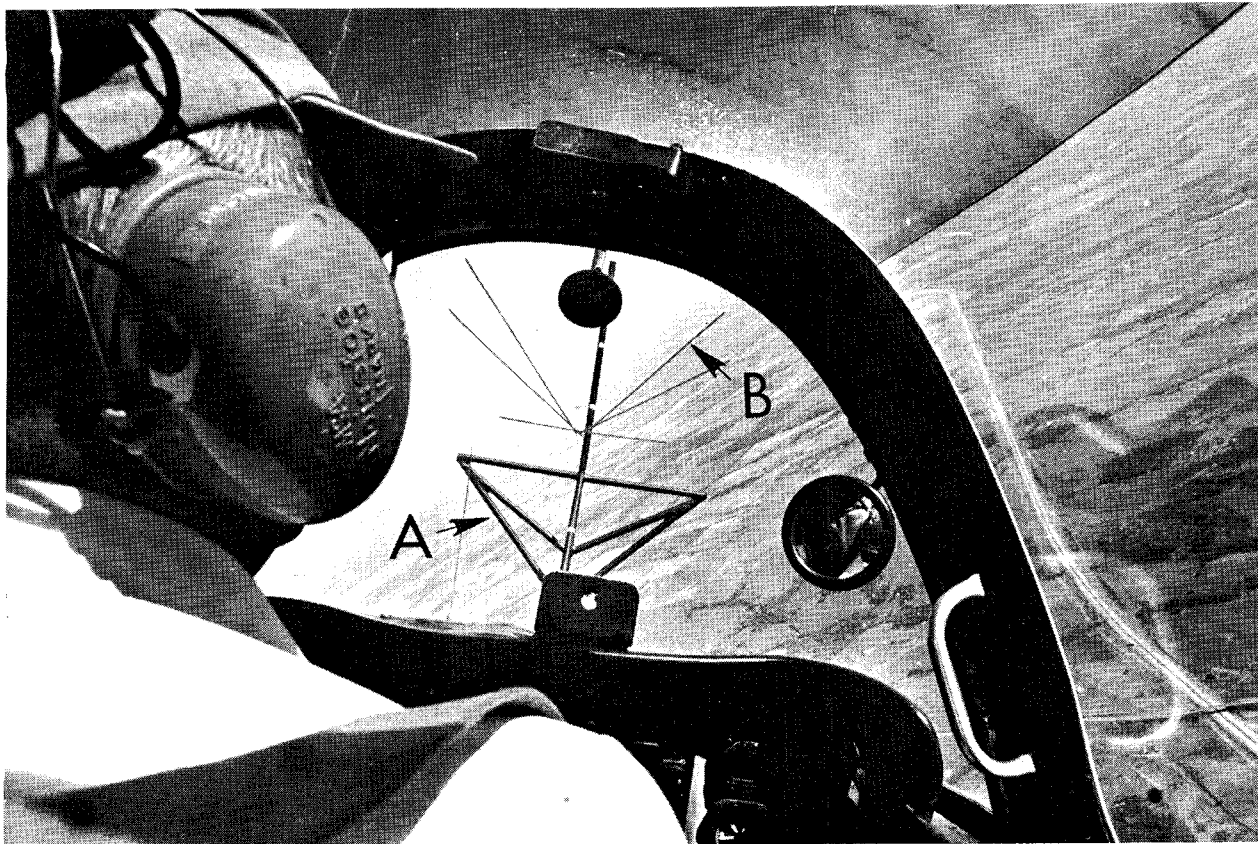

FIGURE 5. In-flight view showing sighting device (A) mounted ahead of windshield and windshield lines (B) used by safety pilot to place aircraft in proper attitude while he remained visually alert for other aircraft in area.

strument, and to accurately place the aircraft in proper attitude prior to letting the subject take control during each test segment of the flight.

Subjects. Thirty-two male, FAA-certificated pilots from 24 to 60 years of age (mean age, 43.5 years), were used as subjects. Nine held ATR ratings; another nine were commercial pilots; the remaining 14 held private pilot certificates. Only one (a commercial pilot) was not instrument rated; he was "in-training" for an instrument rating. Total flying time of the subjects ranged from 80 to 18,000 hours, with a mean of 4031 hours. They were divided into two groups of low time and high time. The low-time subjects had a total flight experience of less than 400 hours with a mean of 178 hours; the high-time subjects had more than 1000 hours, with a mean of 7885 hours (see appendix).

Statistical Methods. The flight protocol was designed to provide statistically valid data. The data were tested using two methods: Analysis of Variance (type SPF-P.qr Design, Roger

Kirk, pp. 299-307) and Simple Effects Test (Roger Kirk, pp. 303-306).

Briefing. Each subject received a standard pre-flight briefing, and was asked not to discuss the flight with other subjects-to-be. The pre-flight briefing consisted of informing the subject that he would be recovering to straight and level flight from medium and steep turns, flying a sequence of alternating left and right turns while attempting to maintain a level pitch attitude, and maintaining a given airspeed during descending left-hand and right-hand spirals. He was also informed that the aircraft would *never* be in an inverted attitude when control was given to him.

The aircraft was started, taxied and taken off by the safety pilot, with the subject in the rear cockpit. After departing the traffic pattern, and with the aircraft trimmed for cruise climb, control was turned over to the subject with instructions to climb to a given altitude. During this time, as well as during the subsequent familiari-

zation turns and calibration maneuvers, the subject remained "in-the-open" with the blind flight hood in a stowed position.

The flight task which each subject performed consisted of: 24 recoveries to level flight from 30° to 45° bank turns; eight 45° banked turns, rolling consecutively from bank to bank; and four 45° banked descending turns—or a total of 36 turns. A third of the first 24 turns were in a coordinated condition when control was given over to the subject; another third involved "slipping" entries; and the remaining third were in a "skidding" condition. Half of the 24 turns involved use of full (all flight instruments) panel conditions and half involved part (attitude indicator only) panel conditions. Slipping and skidding conditions were superimposed on the turns by the safety pilot for a time sufficient (more than 30 seconds) to confuse the subjects as to the direction of turn before the subjects took over control.

During the time the safety pilot was placing the aircraft in the appropriate turn condition, the subject kept his eyes closed and covered by his left hand to preclude any inadvertent cueing from shadows passing across his head. Also, he kept his right hand away from the control stick. Upon a spoken interphone command from the safety pilot, the subject opened his eyes and took control of the aircraft as he scanned the instrument panel.

The sequence and conditions of the turns (panel configuration, bank angle, direction of turn and "coordination condition") were systematically counterbalanced. A typical flight protocol for one subject is shown below:

Flight Protocol

S# _____ Name _____ Date _____

Recovery Sequence

#1. Moving-Aircraft Indicator (Full Panel)	#2. Moving-Horizon Indicator (Full Panel)
45 R SK	30 L SL
30 L SL	30 L SK
30 L SK	45 R SL
30 R CO	30 L C
45 L CO	45 R SK
45 R SL	45 R C

#3. Moving-Aircraft Indicator (Part Panel)	#4. Moving-Horizon Indicator (Part Panel)
45 L SL	45 R CO
45 L SK	30 L CO
30 R CO	30 R SL
30 R SL	45 L SL
45 L CO	30 R SK
30 R SK	45 L SK

Alternating Turns (45° Bank)

Moving-Aircraft Indicator	L-R-L-R
Moving-Horizon Indicator	R-L-R-L

Descending Turns (45° Bank)

Moving-Horizon Indicator	Left
Moving-Aircraft Indicator	Right
Moving-Horizon Indicator	Right
Moving-Aircraft Indicator	Left

Rate of entry into the turns was controlled by the safety pilot to prevent the subject from accurately assessing the direction of turn and the pitch attitude.

III. Results

Recovery from 30° and 45° Bank Angles. The mean values appearing in the various tables and figures of the text should be used only as comparisons rather than as absolutes. Not only were different magnitudes of initial bank angles employed, but switching from one instrument and panel combination to another may have introduced transfer or sequence effects that could have influenced the gross numbers used to express performance. However, the values are comparable because all such effects have been systematically counterbalanced.

Two magnitudes of initial bank angles and two directions of turn were employed to introduce a means of minimizing anticipatory estimations of required corrections by the subjects. All initial conditions were counterbalanced and the data combined for the purpose of statistical analyses.

Initial Control Reversals. A subject's control response was scored as a reversal if the indicated bank angle increased by two degrees or more above the value recorded at the time he took control of the aircraft. To avoid interpreting minor control irregularities during transfer of control as potential control reversals, the bank

angle trace had to demonstrate a specific departure from the established value (or trend of values where absolute consistency of bank angle could not be attained) in order to be scored as a reversal.

The mean number of bank angle reversals recorded for each sequence of six recoveries to level flight are presented in Table 1.

Pilot Experience	ATTITUDE INDICATOR			
	Moving Aircraft		Moving Horizon	
	Full Panel	Part Panel	Full Panel	Part Panel
High	0.81	1.00	0.56	0.31
Low	1.56	0.69	1.75	1.75

TABLE 1. Mean number of bank angle control reversals during each sequence of six recoveries to level flight.

Analysis of variance showed a significant interaction between experience level and type of attitude indicator, $F(1, 30) = 6.11, p < .05$. A simple effects test of the interaction indicated that there was a significant difference between the two experience levels when the moving-horizon indicator was used, $F(1, 60) = 27.56, p < .001$, but not when the moving-aircraft indicator was used. The components of the interaction are graphically depicted in Figure 6.

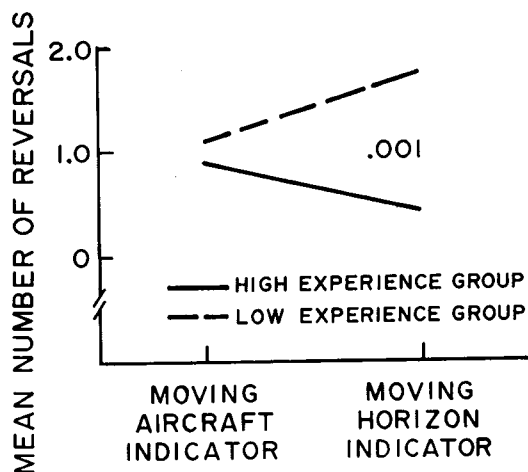

FIGURE 6. Mean number of reversals for each sequence of six recoveries to level flight (confidence level of significant difference is indicated where applicable).

Time to Recover First 10° of Bank Angle. This performance measure was based on the time

(in seconds, measured to the nearest quarter second) between the moment the experimenter relinquished control of the aircraft to the moment the subject had reduced the bank angle by 10°. This elapsed time included the period involving transfer of control, the subject's reading and interpreting the applicable instrument(s), and the time used to reduce the bank angle by 10°. Where initial control reversals were experienced, the time expended by these control actions were also included in the elapsed time. The mean times to recover the first 10° of bank angle are presented in Table 2.

Pilot Experience	ATTITUDE INDICATOR			
	Moving Aircraft		Moving Horizon	
	Full Panel	Part Panel	Full Panel	Part Panel
High	3.06	3.28	2.61	2.55
Low	4.88	3.91	4.58	4.13

TABLE 2. Mean time (in seconds) to recover first ten degrees of bank angle.

Analysis of variance showed a significant difference between recovery times for the moving horizon indicator (3.46 sec.) and the moving-aircraft indicator (3.78 sec.), $F(1, 30) = 4.32, p < .05$. There was also a significant interaction between pilot experience level and instrument panel configuration (full or part), $F(1, 30) = 5.63, p < .05$. A simple effects test showed that the high experience group performed significantly faster than the low experience group on both the full and partial panels. However, the low experience group recovered faster with the partial panel while the high experience group did equally well with either the full or partial panel.

Rate of Recovery from Established Bank Angles. Rate of recovery to wings-level flight is expressed in degrees-per-second rather than as elapsed time so as to minimize the effects of

Pilot Experience	ATTITUDE INDICATOR			
	Moving Aircraft		Moving Horizon	
	Full Panel	Part Panel	Full Panel	Part Panel
High	5.63	4.90	6.16	6.79
Low	3.71	3.89	3.76	3.83

TABLE 3. Mean rates of recovery (deg/sec) to level flight from established bank angles.

Groups	Mean Rate (Deg/sec)	F Ratio & df	Significance Level
High - Aircraft - Full	5.63	10.35 (1, 60)	.005
Low - Aircraft - Full	3.71		
High - Aircraft - Part	4.90	2.65 (1, 60)	N.S.
Low - Aircraft - Part	3.89		
High - Horizon - Full	6.16	14.72 (1, 60)	.001
Low - Horizon - Full	3.76		
High - Horizon - Part	6.79	22.44 (1, 60)	.001
Low - Horizon - Part	3.83		
Aircraft - High - Full	5.63	2.35 (1, 60)	N.S.
Horizon - High - Full	6.16		
Aircraft - High - Part	4.90	29.08 (1, 60)	.001
Horizon - High - Part	6.79		
Aircraft - Low - Full	3.71	< 1	
Horizon - Low - Full	3.76		
Aircraft - Low - Part	3.89	< 1	
Horizon - Low - Part	3.83		
Full - High - Aircraft	5.63	7.53 (1, 60)	.01
Part - High - Aircraft	4.90		
Full - High - Horizon	6.06	5.74 (1, 60)	.05
Part - High - Horizon	6.79		
Full - Low - Aircraft	3.71	< 1	
Part - Low - Aircraft	3.89		
Full - Low - Horizon	3.76	< 1	
Part - Low - Horizon	3.83		

Legend: High, Low - (pilot experience)
Aircraft, Horizon - (type of attitude indicator)
Part, Full - (panel configuration)

TABLE 4. Component comparisons of three-way interaction for rate of recovery from banks.

variations in initial bank angles. Individual recovery rates were calculated by dividing the initial bank angle by the time (to the nearest quarter second) required to bring the aircraft to an effective and constant wings-level attitude. For those subjects who failed to establish a relatively precise wings-level attitude, the total period was based on a time point after which no further bank corrections were made by the subject.

The mean rates of bank angle recovery are presented in Table 3.

Analysis of variance showed a significant interaction between pilot experience and type of attitude indicator, $F(1, 30) = 10.00, p < .005$. There was also a significant three-way interaction, $F(1, 30) = 5.43, p < .05$. A simple effects test of pilot experience by attitude indicator interaction showed that three of the four component comparisons were significant. Only the performance by the low experience group on the two types of attitude indicator failed to be significantly different. The interaction is shown in Fig. 7.

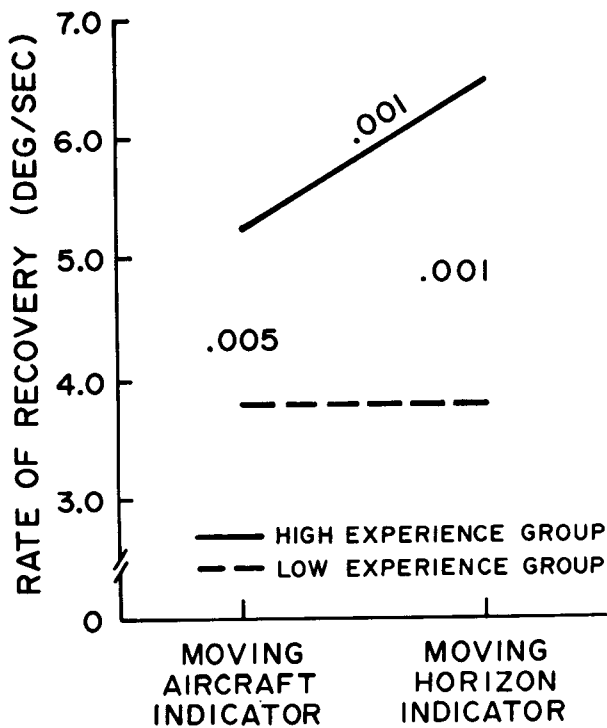

FIGURE 7. Mean rate of recovery from established bank angles (confidence levels of significant differences are indicated where applicable).

The results of the simple effects test of the three-way interaction have been tabulated by component comparisons in Table 4.

The panel components of the interaction can probably be ignored for practical purposes since they may represent an overlap from the other combinations—especially since there was no significant panel effect. Furthermore, the panel variable did not show a primary interaction with either of the other two variables.

Pitch Control During Recoveries. Initial pitch attitude (at the time control was given to the subject) was not systematically, nor precisely, controlled by the safety pilot; but there is no indication of systematic bias relative to magnitude or direction. The mean for all initial pitch attitudes was 3.53° from level flight; the algebraic mean was 0.66° nose-down.

Pitch control was measured by two criteria. One quantified the excess pitch movement of the aircraft. Excess pitch was defined as the total range of pitch change made during each recovery minus the amount which would have established a stabilized, level pitch attitude. The second performance criterion related to the rate at which pitch attitude was changed to obtain a stabilized pitch condition.

The results for excess pitch movement are presented in Table 5.

Pilot Experience	ATTITUDE INDICATOR			
	Moving Aircraft		Moving Horizon	
	Full Panel	Part Panel	Full Panel	Part Panel
High	3.19	3.21	2.59	2.64
Low	5.85	4.35	8.61	9.73

TABLE 5. Mean rates of pitch movement (in degrees) in excess of required pitch correction to establish effective control of aircraft.

An analysis of variance indicated a significant interaction between pilot experience and type of attitude indicator used, $F(1, 30) = 14.53, p < .001$. A simple effects test indicated that the low experience group made significantly larger excess pitch corrections than did the high experience group when the moving-horizon indicator was used, $F(1, 60) = 45.71, p < .001$. However, the low experience group made significantly smaller excess pitch corrections with the moving-aircraft

indicator than with the moving horizon indicator, $F(1, 30) = 22.23, p < .001$. On the other hand, there were no significant differences between the two groups when the moving-aircraft indicator was used, or between the two types of attitude indicators when used by the high experience group. The interaction is shown in Fig. 8.

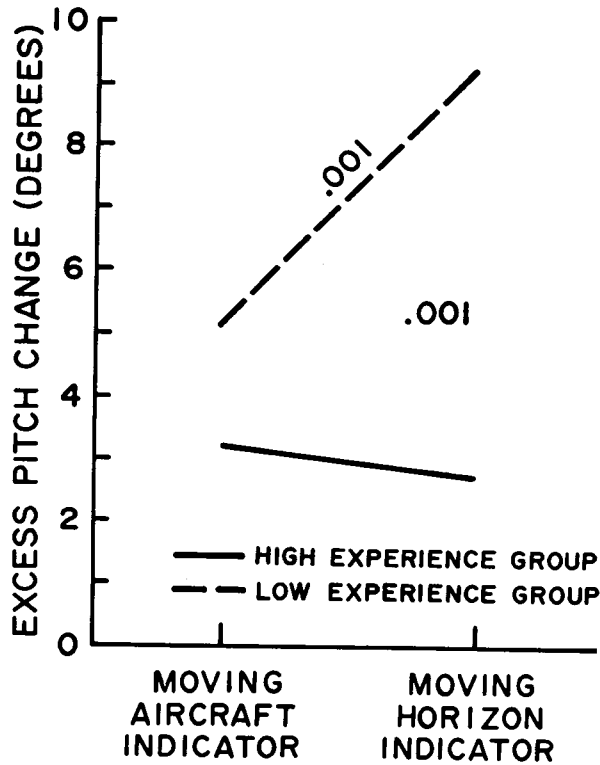

FIGURE 8. Mean range of excess pitch change during recovery to level flight (confidence levels of significant differences are indicated where applicable).

The results for rate of pitch correction are summarized in Table 6.

Pilot Experience	ATTITUDE INDICATOR			
	Moving Aircraft		Moving Horizon	
	Full Panel	Part Panel	Full Panel	Part Panel
High	.80	.78	.85	.76
Low	.49	.70	.44	.43

TABLE 6. Mean rates of pitch correction (deg/sec) during bank angle recoveries.

The relatively small values in Table 6 are attributed to the fact that the initial pitch angles

were relatively small, averaging between 3° and 4° .

An analysis of variance indicated that only the difference between pilot experience groups was significant, $F(1, 30) = 12.59, p < .001$.

Bank Angle Control During Alternating Turns. Attempts to quantify bank angle control during alternating turns on the basis of accuracy and consistency of performance were unsuccessful because performance by both pilot experience groups using either attitude indicator was too inconsistent to provide meaningful data.

Pitch Control During Alternating Turns. The criterion used to evaluate performance was the ability of the subjects to maintain zero pitch attitude. The means of the total ranges of pitch during the maneuver are presented in Table 7.

Pilot Experience	ATTITUDE INDICATOR	
	Moving Aircraft	Moving Horizon
High	12.13	11.00
Low	20.13	34.69

TABLE 7. Mean rates of ranges of pitch changes (degrees during alternating turns).

An analysis of variance indicated that there was a significant interaction between pilot experience and type of attitude indicator used $F(1, 30) = 6.63, p < .05$. A simple effects test showed that the low experience group made significantly larger changes than the high experience group when the moving-horizon indicator was used, $F(1, 60) = 32.25, p < .001$. The low experience group made significantly smaller pitch changes when using the moving-aircraft indicator than when using the moving-horizon indicator, $F(1, 30) = 11.43, p < .005$. The interaction is shown in Fig. 9.

Bank Control in Descending Turns. The objective of this maneuver was to maintain a 45° angle of bank in a series of descending turns. Each turn was terminated at the command of the safety pilot after the aircraft had descended at least a thousand feet. The percent of time the aircraft was held in a 45° bank ($\pm 5^\circ$) is presented in Table 8.

An analysis of variance indicated there were no significant differences between any of the values in Table 8.

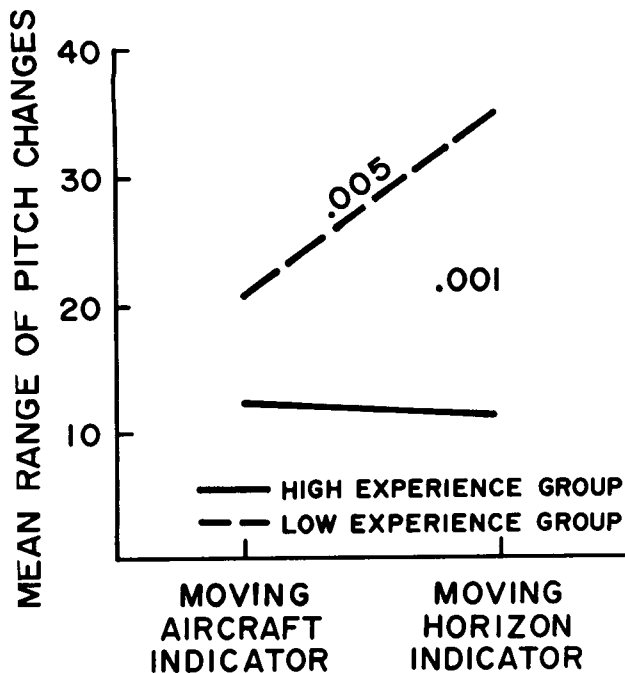

FIGURE 9. Mean range of pitch change during alternating turns (confidence levels of significant differences are indicated where applicable).

Pilot Experience	ATTITUDE INDICATOR	
	Moving Aircraft	Moving Horizon
High	49.03	47.43
Low	47.07	43.63

TABLE 8. Percent time pilot maintained $45^\circ (\pm 5^\circ)$ of bank during descending turn.

Pitch Control in Descending Turns. Pitch control was examined relative to pitch changes made by the subjects in their attempts to maintain the desired airspeed. Relatively large pitch changes were judged to indicate less satisfactory pitch control than smaller pitch changes. The pitch range means are presented in Table 9.

Pilot Experience	ATTITUDE INDICATOR	
	Moving Aircraft	Moving Horizon
High	15.50	15.28
Low	23.22	28.84

TABLE 9. Mean rates of ranges of pitch attitude (degrees) during descending turns.

An analysis of variance indicated a significant interaction between pilot experience level and

instrument type, $F(1, 30) = 11.50, p < .005$. A simple effects test showed that the high experience group demonstrated significantly smaller ranges of pitch change with the moving horizon indicator than did the low experience group, $F(1, 60) = 40.23, p < .001$. The high experience group was also superior with the moving-aircraft indicator, $F(1, 60) = 13.03, p < .001$. There were no significant differences between the two indicators for the high experience group, but the low experience group did significantly better with the moving-aircraft indicator, $F(1, 30) = 21.31, p < .001$. The interaction is graphically illustrated in Fig. 10.

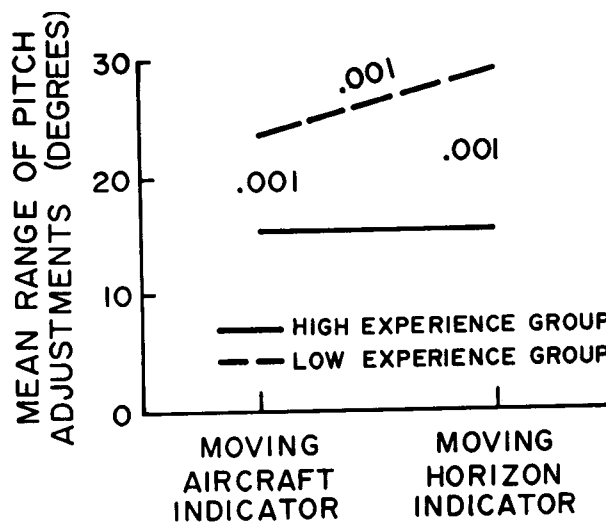

FIGURE 10. Mean range of pitch changes during descending turns (confidence levels of significant differences are indicated where applicable).

The results may be summarized as follows*:

Roll Recoveries.

- (1) Reversals (initially increasing bank angle while attempting to return to level flight): (a) there was no difference between attitude indi-

*NOTE: The summations given in this section refer to findings whose validity is based on the use of accepted statistical testing methods.

Differences in performance are expressed only where they were statistically significant at the .05 level of confidence or higher and not on the basis of the size of the numerical difference between the mean values.

Performances are expressed as being equal, comparable or identical when there was no statistically significant difference between the means regardless of the size of the numerical difference and in which direction it was weighed.

cators for either experience group; (b) there was no difference between groups when using the moving-aircraft attitude indicator; (c) when using the moving-horizon attitude indicator, the low experience group made more reversals than did the high experience group.

(2) Recovery of first 10° of bank: use of the moving-horizon indicator resulted in faster recoveries regardless of pilot experience.

(3) Roll recovery rate: (a) the subjects with high experience recovered to level flight at a faster rate than did the low experience group regardless of type of attitude indicator used; (b) the high experience group achieved level flight at a faster rate with the moving horizon-indicator than it did with the moving-aircraft indicator; (c) the subjects with low experience achieved level flight at the same rate regardless of type of attitude indicator used.

(4) Excess range of pitch changes: (a) performance of the high experience group was equal regardless of type of attitude indicator used; (b) the low experience group had less pitch change with the moving-aircraft indicator than with the moving-horizon indicator; (c) there was no difference in performance of the high and low groups when utilizing the moving-aircraft indicator; (d) the high experience group had less pitch change than did the low experience group when using the moving-horizon indicator.

(5) Pitch change rates: (a) the two attitude indicators provided equal performance; (b) the high experience group attained a faster rate than did the low experience group regardless of the attitude indicator utilized.

Performance During Alternating Turns.

(1) Bank angle performance: the data was too inconsistent to provide meaningful evaluation.

(2) Pitch control: (a) pitch excursion range was less for the high experience group than for the low group when the moving-horizon indicator was utilized; (b) pitch excursion range was the same for both groups when the moving-aircraft indicator was utilized; (c) the low experience group had less pitch excursion when using the moving-aircraft indicator than when using the moving-horizon indicator; (d) pitch excursion range of the high experience group was equal for both attitude indicators.

Performance During Descending Turns.

(1) Bank control: there were no differences between indicators or experience groups.

(2) Pitch control: (a) the high experience group had less pitch excursion than the low experience group regardless of the attitude indicator utilized; (b) the low experience group had less pitch excursion with the moving-aircraft indicator than with the moving-horizon indicator; (c) the high experience group had the same excursion range regardless of the attitude indicator utilized.

V. Discussion

The results of this in-flight study are somewhat surprising in relation to findings from previous research on the relative merits of inside-out and outside-in attitude indicators. Data from many of these earlier studies suggest that the outside-in (moving-aircraft) indicator provides better pilot performance; but this in-flight study fails, in the main, to show any such well defined, *overall* advantage.

In general, of the twenty-two performance comparisons in which statistical significance was .05 or better, there were only six in which the moving-aircraft indicator provided comparable or better performance than did the moving-horizon indicator. Five of these related to pitch control performance. Interestingly, in three of the five, the improvement was related to performance of the low experience pilot group.

In another eight comparisons, performance was comparable regardless of which type of indicator was used; of these eight, four related to pitch control and the other four to bank control. In three of the remaining eight comparisons, the high experience group demonstrated better performance with the moving-horizon indicator than did the low experience group; two of these related to pitch control and one to reversals. In another three, the high experience group performed better than the low group regardless of the type of indicator used; two of these three related to pitch control, and one to bank control. Of the two final comparisons, the moving horizon indicator provided better bank control performance within the high experience group than did the moving-aircraft indicator. In this group of eight comparisons, four related to pitch control and four to bank control.

Essentially, this indicates that use of the moving-aircraft indicator provided *comparable* or *better* performance in approximately 27% of the comparisons, the moving-horizon indicator provided better performance in about 23%, and in the remaining 50%, there was little reason to prefer one indicator over the other. However, it should be pointed out that these performance percentages represent a highly simplistic overview of the results of this in-flight study and it is evident that the results were mixed and that interactions took place which related to various combinations of type of attitude indicator used, pilot experience and type of maneuver performed.

Unfortunately, there is no way of knowing whether the different display pitch ratio in the moving-aircraft indicator contributed to improved pitch control performance by the low experience group. It is doubtful, however, that pitch performance was affected, since the high experience group showed no similar increase in pitch control performance when using the moving-aircraft indicator. The subjects' lack of familiarity with the moving-aircraft indicator may have contributed to low performance results with this instrument. Also, high experience pilots may have been so accustomed to the use of the older type indicator that it was more difficult for them to readily use the new (moving-aircraft) type indicator. Too, the existence of real accelerations and their resultant cues during flight may have induced results different from those which might be found in ground-based simulator studies.

Our inability to find conformity between our data and that from previous studies indicates a need, perhaps, for some additional research on the subject. As pointed out previously, the design of the two attitude indicators was not the same. The aircraft symbol and bank angle indices in the moving-aircraft indicator were much smaller than those on the moving-horizon indicator (Fig. 2); also, the indices were located below the aircraft symbol instead of around the upper periphery of the instrument case as in the contemporary indicator.

Because of space limitation, the size of the aircraft symbol in moving-aircraft attitude indicators has to be smaller (A, Fig. 2) than the symbol (B, Fig. 2) in the moving-horizon indicator. To provide a larger aircraft symbol, a

change would have to be made in the basic concept and operation of the moving-aircraft attitude indicator design so that the aircraft symbol, while moving in roll, would remain centered on the face of the instrument (A, Fig. 11); and the

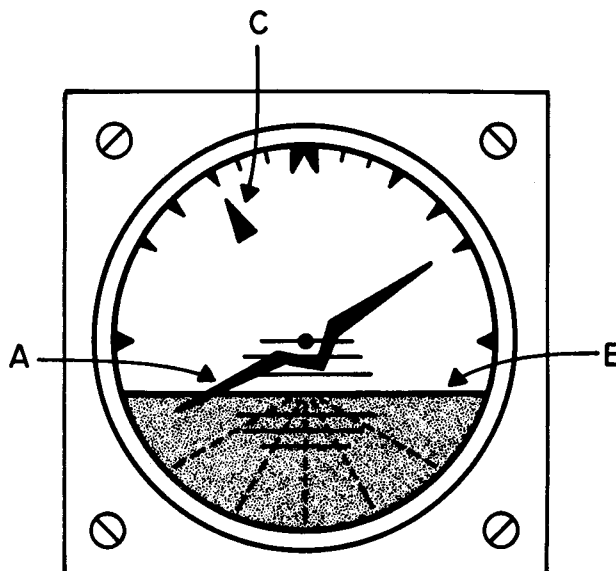

FIGURE 11. Attitude indicator display proposed by Hasbrook is based on theory that man prefers his visual frame of reference (horizon bar, in this case) to remain normal to his head axis and parallel to a plane drawn through his eyes. Large aircraft symbol (A) is centered on dial face and moves rotationally to indicate bank. Horizon (B) remains horizontal but moves vertically to indicate pitch changes (aircraft is shown pitched up 10°). Bank angle pointer (C) moves to left in left turn and to right in right turn.

horizon bar, while maintaining a horizontal relationship with the instrument face, would move vertically to depict pitch changes (B, Fig. 11).

This design concept would permit the use of the larger size symbol characteristics of the moving-horizon indicator while also providing the desired outside-in movement relationship advocated by many researchers.

In reviewing past studies on attitude indicators, it became evident that the design and use of the moving-horizon indicator was predicated primarily on the assumption that the real horizon moves visually in respect to the pilot's eyes during banked turns. In fact, a conversation with General James H. Doolittle (U.S.A.F. Ret.) brought out the point that as far back as 1928 (when the first attitude indicator was conceived by Doolittle and produced by Elmer Sperry, Jr.),

pilots were “trained to hold their bodies—and heads—straight with the aircraft, particularly in turns.” This would cause the real horizon to “roll” relative to the pilot (Fig. 12). However,

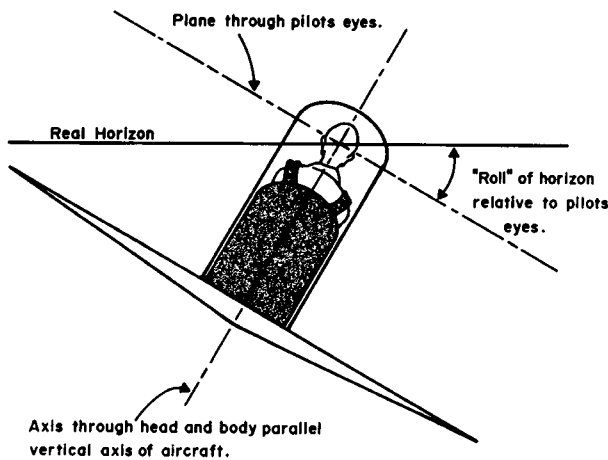

FIGURE 12. If pilot keeps his head “straight” with his aircraft in normal (non-acrobatic) turning maneuvers, real horizon will seem to “roll” or tilt. This head/aircraft relationship—stressed in training since the early 1920’s—was primarily responsible for original use of moving-horizon type of attitude indicator.

there is some indication that holding the head straight with the airplane, while making shallow or median banked turns with reference to the real horizon, may be psychologically unnatural. Our personal observation of head movements of pilots during performance of such ground-

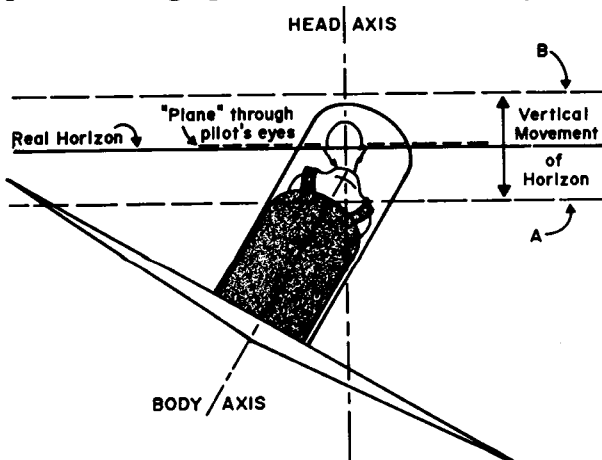

FIGURE 13. Natural tendency of many pilots during VFR flight is to hold head normal to the real world during shallow and medium banked turns, resulting in real horizon remaining fixed horizontally. Although climbing (A) or descending (B) turns cause horizon to move vertically, it remains horizontal to pilot’s eyes.

oriented maneuvers as “eights around a pylon” and “S-turns over a road” shows that many pilots subconsciously keep their heads normal to the real horizon (Fig. 13).

Interestingly, this holding the head (and therefore the plane of the eyes) normal to the horizon regardless of tilting of the body is also evident among ice skaters, skiers, and motorcyclists when they tilt their bodies from side to side during serpentine maneuvers. The phenomenon can also be observed among many members of the animal kingdom. In turns in which the animal’s body is tilted to counteract centrifugal force, the head is usually held normal to the *visual* horizon; this is dramatically demonstrated in Fig. 14 wherein a horse is shown



FIGURE 14. Horse holds his unrestrained head in vertical position while leaning body to counteract centrifugal force during turn around barrel. Authors believe this head position (normal to horizon) provides animal with maximum equilibrium, despite effects of centrifugal force. (Photo courtesy of American Quarter Horse Association.)

rounding a barrel during a rodeo contest. It can also be seen that the reins are completely slack with the horse free to hold its head in a manner which will provide maximum equilibrium.

Although few research references have been found relating to this particular subject, a Japanese study (1967) showed that people living in

buildings permanently tilted by earthquakes tended to visually orient their heads normal to the horizontal/vertical lines of the building's interior. Thus, it may be speculated that man prefers to keep his eyes normal to his visual environment. This would mean keeping his head normal to the real horizon during VFR flying; but during instrument flying, he would keep his head normal to the cockpit—and to the instruments. By this reasoning, the horizon bar in the attitude indicator should remain horizontal to the cockpit (and to the pilot) moving only in the vertical plane to depict pitch changes (Fig. 11). Rolling of the aircraft symbol to depict bank angle should also be psychologically acceptable, since man is used to seeing birds, animals, and airplanes bank in relation to the real horizon.

As a final note concerning this in-flight study, it should be mentioned that the subjective portion of our evaluation of the two attitude indi-

cators produced erroneous impressions. Although the investigator-pilot was trained as an objective observer, an unconscious bias apparently was activated, causing him to believe from his in-flight observations that the moving-aircraft indicator provided overall improvement in performance regardless of pilot experience. Also, many of the subjects stated they felt their performance was much better with the moving-aircraft instrument. Statistical analyses, of course, showed these beliefs to be erroneous in large part. This points out the hazard of testing and judging the relative merits of aircraft instruments and control systems on the basis of subjective evaluation—as has been done sometimes in the past—even when some or all the testers are highly trained and experienced professional test pilots. Only by use of judicious flight protocol design and statistical testing can the true merits of a particular instrument or system be disclosed.

REFERENCES

1. Anonymous: Attitude Indicator Attitudes. Prevention Branch, U.S. Army, Ft. Rucker, Ga., August 1968.
2. Anonymous: Integrated Flight Instrumentation Study. Project #16-56-0031, (AD 160-177) Page 87, U.S. Army Electronic Proving Ground, Ft. Huachuca, Ariz., March 1958.
3. Anonymous: Integrated Instrumentation for Aircraft. Dunlap and Associates, Inc., December 1954.
4. Anonymous: Pilot Performance with Two Different Attitude Displays. Dunlap and Associates, Inc. (Office of Naval Research Contract NONR 1076(00)), July 1955.
5. Anonymous: Equipment Used in Experiments to Solve the Problem of Fog Flying. The Daniel Guggenheim Fund for the Promotion of Aeronautics, Inc., March 1930 (Cornell Univ. Library).
6. Bonnell, C. R.: Outside Looking in Attitude Gyros. Society of Automotive Engineering, Report #690326, March 1969.
7. Brown, R. C. Figure and Ground in a Two-Dimensional Display. FPRC 781, University of Durham, England, July 1952.
8. Doolittle, J. H.: Early Blind Flying. Third Lester Gardner Lecture, MIT, April 1961.
9. Fitts, P. M. and Jones, R. E.: Psychological Aspects of Instrument Displays. I: Analysis of 270 "Pilot Error" Experiences in Reading and Interpreting Aircraft Instruments. Aero. Medical Lab., Engineering Division, Air Materiel Command, Dayton, Ohio. Rep. No. RSEAA-694-12A.
10. Fogel, Lawrence J., A New Concept, the Kinalog Display System. JOURNAL OF THE HUMAN FACTORS SOCIETY, pp. 30-37, April 1959.
11. Gardner, John F.: Speed and Accuracy of Response to Five Different Attitude Indicators. WADC TR 54-236, Wright Air Development Center, December 1954.
12. Gardner, John F., et al.: In-Flight Comparison of Pilot Performance on a Standard USAF and an Experimental Instrument Panel. NADC TR 57-270, Wright Air Development Center, September 1957.
13. Johnson, Steven L. and Stanley N. Roscoe: What Moves, the Airplane or the World? T. R. ONR-70-1. University of Illinois, June 1970.
14. Kirk, Roger E.: Experimental Design: Procedures for the Behavioral Sciences. Brooks/Cole Publishing Company Belmont, California 1968.
15. Kitahara, Masaaki and Uno, Ryoji: Equilibrium and Vertigo in a Tilting Environment. ANNALS OF OTOLOGY, RHINOLOGY AND LARYNOLOGY, 76:166-178, March 1967.
16. Marks, D. A. and D. G. C. Gronow: A Comparison of the Appreciation of Aircraft Attitude Given by Four Types of Non-toppling Attitude Indicator. FPRC #833, RAF Institute of Aviation Medicine, May 1953.
17. Poppen, J. R.: Equilibratory Functions in Instrument Flying. JOURNAL OF AVIATION MEDICINE, 6:148-160, 1936.
18. Rolfe, J. M.: The Evaluation of Visual Displays Techniques and Trends. IAM Scientific Memorandum #74, RAF Institute of Aviation Medicine, Farnborough, Hants, England, April 1966.
19. Skelton, Gerald E.: Evaluation of a Pictorial Turn and Bank Indicator. Report #NA-68-28, NAFEC, FAA, August 1968.

Appendix

Description of Low Time Flying Experience Subject Group

N:	16
Age:	24-53 yrs. (last birthday) Mean 40 yrs.
Total Hours:	80-326 hrs. (rounded to full hrs.) Mean hrs—178.
Recent Exp.:	Zero to 113 hrs. last 12 mos. Mean 27 hrs. 5 Ss with less than 10 hrs. last 12 mos. including one with no time during that period.
Instrument Exp.:	Two to 20 hrs total (including simulator time) Mean 7 hrs.
Licenses:	14 Private, 2 Commercial
Instructors:	None
T-34 Exp.:	Only two Ss had any previous experience with the T-34. One had 2 hrs.; the other 18 hrs.

Appendix

Description of High Time Flying Experience Subject Group

N:	16
Age:	25-60 yrs. (last birthday) Mean 47 yrs.
Total Hours:	1,300-18,000 hrs. (rounded to full hours) Mean 7,885 hrs.
Recent Exp.:	50-500 hrs. last 12 mos. Mean 145 hrs. Approximately half with 100 or more hrs.
Instrument Exp.:	100-4,500 hrs. total (including simulator time). Four Ss had 1,000 or more hrs.
Licenses:	9 ATR, 7 Commercial
Instructors:	11
T-34 Exp.:	6 had none; 10 had from 2 to 1,200 hrs.



