



MASH TEST 3-10 ON 31-INCH W-BEAM GUARDRAIL WITH STANDARD OFFSET BLOCKS



Crash testing performed at:
TTI Proving Ground
3100 SH 47, Building 7091
Bryan, TX 77807

Research Report 9-1002-4

Cooperative Research Program

**TEXAS TRANSPORTATION INSTITUTE
THE TEXAS A&M UNIVERSITY SYSTEM
COLLEGE STATION, TEXAS**

TEXAS DEPARTMENT OF TRANSPORTATION

in cooperation with the
Federal Highway Administration and the
Texas Department of Transportation
<http://tti.tamu.edu/documents/9-1002-4.pdf>

1. Report No. FHWA/TX-11/9-1002-4	2. Government Accession No.	3. Recipient's Catalog No.	
4. Title and Subtitle MASH TEST 3-10 ON 31-INCH W-BEAM GUARDRAIL WITH STANDARD OFFSET BLOCKS		5. Report Date November 2010 Published: March 2011	
7. Author(s) Roger P. Bligh, Akram Y. Abu-Odeh, and Wanda L. Menges		6. Performing Organization Code	
9. Performing Organization Name and Address Texas Transportation Institute Proving Ground The Texas A&M University System College Station, Texas 77843-3135		8. Performing Organization Report No. Report 9-1002-4	
12. Sponsoring Agency Name and Address Texas Department of Transportation Research and Technology Implementation Office P.O. Box 5080 Austin, Texas 78763-5080		10. Work Unit No. (TRAIS)	
15. Supplementary Notes Project performed in cooperation with the Texas Department of Transportation and the Federal Highway Administration. Project Title: Roadside Safety Device Crash Testing Program URL: http://tti.tamu.edu/documents/9-1002-4.pdf		11. Contract or Grant No. Project 9-1002	
16. Abstract The Texas Department of Transportation (TxDOT) initiated a review of their guardrail standards based on the outcome of recent crash test results and a Federal Highway Administration technical memorandum pertaining to guardrail height. TxDOT expressed interest in the use of a generic 31-inch tall guardrail to provide enhanced containment capacity for light trucks. However, some concerns were expressed regarding the increased size of the blockout used in the Midwest Guardrail System (MGS). Consequently, TxDOT requested an evaluation of a 31-inch tall guardrail system that incorporates conventional 8-inch deep offset blocks. The test reported herein corresponds to American Association of State Highway and Transportation Officials (AASHTO) <i>Manual for Assessing Safety Hardware (MASH)</i> test 3-10. This is primarily a severity test that assesses risk of injury to the vehicle occupants. This test was considered to be the more critical of the two tests due to the potential for increased vehicle-post interaction resulting from decreasing the depth of the offset blocks from 12 inches to 8 inches. The 31-inch W-beam guardrail with standard offset blocks met all required <i>MASH</i> performance criteria for test 3-10.		13. Type of Report and Period Covered Technical Report: September 2009–August 2010	
17. Key Words Guardrail, Longitudinal Barriers, Roadside Safety, Crash Test, <i>MASH</i>		14. Sponsoring Agency Code	
19. Security Classif.(of this report) Unclassified		18. Distribution Statement No restrictions. This document is available to the public through NTIS: National Technical Information Service Springfield, Virginia 22161 http://www.ntis.gov	
20. Security Classif.(of this page) Unclassified		21. No. of Pages 74	22. Price

**MASH TEST 3-10 ON 31-INCH W-BEAM GUARDRAIL WITH
STANDARD OFFSET BLOCKS**

by

Roger P. Bligh, P.E.
Research Engineer
Texas Transportation Institute

Akram Y. Abu-Odeh
Research Scientist
Texas Transportation Institute

and

Wanda L. Menges
Research Specialist
Texas Transportation Institute

Report 9-1002-4

Project 9-1002

Project Title: Roadside Safety Device Crash Testing Program

Performed in cooperation with the
Texas Department of Transportation
and the
Federal Highway Administration

November 2010

Published: March 2011

TEXAS TRANSPORTATION INSTITUTE
The Texas A&M University System
College Station, Texas 77843-3135

DISCLAIMER

This research was performed in cooperation with the Texas Department of Transportation (TxDOT) and the Federal Highway Administration (FHWA). The contents of this report reflect the views of the authors, who are responsible for the facts and the accuracy of the data presented herein. The contents do not necessarily reflect the official view or policies of the FHWA or TxDOT. This report does not constitute a standard, specification, or regulation, and its contents are not intended for construction, bidding, or permit purposes. In addition, the above listed agencies assume no liability for its contents or use thereof. The United States Government and the State of Texas do not endorse products or manufacturers. Trade or manufacturers' names appear herein solely because they are considered essential to the object of this report. The engineer in charge of the project was Roger P. Bligh, P.E. (Texas, #78550).

TTI PROVING GROUND DISCLAIMER

The results of the crash testing reported herein apply only to the article being tested.

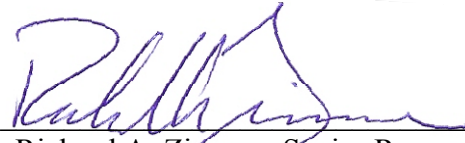

Wanda L. Menges, Research Specialist
Deputy Quality Manager

Richard A. Zimmer, Senior Research Specialist
Test Facility Manager
Quality Manager
Technical Manager

ACKNOWLEDGMENTS

This research project was conducted under a cooperative program between the Texas Transportation Institute, the Texas Department of Transportation, and the Federal Highway Administration. The TxDOT project director for this research was Rory Meza, P.E. with the Design Division. Bobby Dye with the Design Division served as project advisor and was also actively involved in this research. The TxDOT research engineer was Wade Odell, P.E. with the Research and Technology Implementation Office. The authors acknowledge and appreciate their guidance and assistance.

TABLE OF CONTENTS

	Page
LIST OF FIGURES	ix
LIST OF TABLES	x
CHAPTER 1. INTRODUCTION	1
1.1 INTRODUCTION	1
1.2 BACKGROUND	1
1.3 OBJECTIVES/SCOPE OF RESEARCH	4
CHAPTER 2. SYSTEM DETAILS	7
2.1 TEST ARTICLE DESIGN AND CONSTRUCTION	7
2.2 MATERIAL SPECIFICATIONS	7
2.3 SOIL CONDITIONS	7
CHAPTER 3. TEST REQUIREMENTS AND EVALUATION CRITERIA	11
3.1 CRASH TEST MATRIX	11
3.2 EVALUATION CRITERIA	11
CHAPTER 4. CRASH TEST PROCEDURES	13
4.1 TEST FACILITY	13
4.2 VEHICLE TOW AND GUIDANCE PROCEDURES	13
4.3 DATA ACQUISITION SYSTEMS	13
4.3.1 Vehicle Instrumentation and Data Processing	13
4.3.2 Anthropomorphic Dummy Instrumentation	14
4.3.3 Photographic Instrumentation and Data Processing	14
CHAPTER 5. CRASH TEST RESULTS	15
5.1 TEST DESIGNATION AND ACTUAL IMPACT CONDITIONS	15
5.2 TEST VEHICLE	15
5.3 WEATHER CONDITIONS	15
5.4 TEST DESCRIPTION	15
5.5 DAMAGE TO TEST INSTALLATION	18
5.6 VEHICLE DAMAGE	18
5.7 OCCUPANT RISK FACTORS	18
CHAPTER 6. SUMMARY AND CONCLUSIONS	25
6.1 ASSESSMENT OF TEST RESULTS	25
6.1.1 Structural Adequacy	25
6.1.2 Occupant Risk	25
6.1.3 Vehicle Trajectory	26
6.2 CONCLUSIONS	26

TABLE OF CONTENTS (CONTINUED)

	Page
CHAPTER 7. IMPLEMENTATION STATEMENT.....	29
REFERENCES	31
APPENDIX A. DETAILS OF THE TEST ARTICLE.....	33
APPENDIX B. CERTIFICATION DOCUMENTATION.....	41
APPENDIX C. SOIL STRENGTH DOCUMENTATION	47
APPENDIX D. TEST VEHICLE PROPERTIES AND INFORMATION.....	49
APPENDIX E. SEQUENTIAL PHOTOGRAPHS	53
APPENDIX F. VEHICLE ANGULAR DISPLACEMENTS AND ACCELERATIONS.....	57

LIST OF FIGURES

Figure	Page
Figure 1.1. Typical Cross Section of the Texas Metal Beam Guard Fence.....	3
Figure 2.1. Details of the TxDOT 31-inch Guardrail Installation.....	9
Figure 2.2. Test Article/Installation before Test No. 420020-5.....	10
Figure 5.1. Vehicle/Installation Geometrics for Test No. 420020-5.....	16
Figure 5.2. Vehicle before Test No. 420020-5.....	17
Figure 5.3. Position of the Vehicle after Test No. 420020-5.....	19
Figure 5.4. Installation after Test No. 420020-5.....	20
Figure 5.5. Vehicle after Test No. 420020-5.....	21
Figure 5.6. Interior of Vehicle for Test No. 420020-5.....	22
Figure 5.7. Summary of Results for <i>MASH</i> Test 3-10 on the TxDOT 31-inch W-Beam Guardrail.....	23
Figure C1. Test Day Static Soil Strength Documentation.....	47
Figure C2. Summary of Strong Soil Test Results for Establishing Installation Procedure.....	48
Figure D1. Vehicle Properties for Test No. 420020-5.....	49
Figure E1. Sequential Photographs for Test No. 420020-5 (Overhead and Frontal Views).....	53
Figure E2. Sequential Photographs for Test No. 420020-5 (Rear View).....	55
Figure F1. Vehicle Angular Displacements for Test No. 420020-5.....	57
Figure F2. Vehicle Longitudinal Accelerometer Trace for Test No. 420020-5 (Accelerometer Located at Center of Gravity).....	58
Figure F3. Vehicle Lateral Accelerometer Trace for Test No. 420020-5 (Accelerometer Located at Center of Gravity).....	59
Figure F4. Vehicle Vertical Accelerometer Trace for Test No. 420020-5 (Accelerometer Located at Center of Gravity).....	60
Figure F5. Vehicle Longitudinal Accelerometer Trace for Test No. 420020-5 (Accelerometer Located over Rear Axle).....	61
Figure F6. Vehicle Lateral Accelerometer Trace for Test No. 420020-5 (Accelerometer Located over Rear Axle).....	62
Figure F7. Vehicle Vertical Accelerometer Trace for Test No. 420020-5 (Accelerometer Located over Rear Axle).....	63

LIST OF TABLES

Table		Page
Table 1.1.	Summary of <i>MASH</i> Crash Tests Performed on Non-Proprietary Strong Post W-Beam Guardrail.....	4
Table 6.1.	Performance Evaluation Summary for <i>MASH</i> Test 3-10 on the TxDOT 31-inch W-Beam Guardrail.....	27
Table D1.	Exterior Crush Measurements for Test No. 420020-5.....	50
Table D2.	Occupant Compartment Measurements for Test No. 420020-5.....	51

CHAPTER 1. INTRODUCTION

1.1 INTRODUCTION

This project was set up to provide Texas Department of Transportation (TxDOT) with a mechanism to quickly and effectively evaluate high priority issues related to roadside safety devices. Roadside safety devices shield motorists from roadside hazards such as non-traversable terrain and fixed objects. To maintain the desired level of safety for the motoring public, these safety devices must be designed to accommodate a variety of site conditions, placement locations, and a changing vehicle fleet. Periodically, there is a need to assess the compliance of existing safety devices with current vehicle testing criteria.

Under this project, roadside safety issues are identified and prioritized for investigation. Each roadside safety issue is addressed with a separate work plan, and the results are summarized in an individual test report.

1.2 BACKGROUND

The American Association of State Highway and Transportation Officials (AASHTO) (2002) *Roadside Design Guide* defines a guardrail as “a longitudinal barrier used to shield motorists from natural or man-made obstacles located along either side of a traveled way.” Guardrail can be generally classified as weak post and strong post systems. Weak post systems are more flexible and have greater dynamic deflection than strong post systems. The weak posts serve primarily to support the rail elements at their proper elevation for contact with an impacting vehicle. The posts are readily detached from the rail element(s) and dissipate little energy as they yield to the impacting vehicle and are pushed to the ground.

In contrast, strong post barriers incorporate larger, stronger posts that absorb significant energy as they rotate through the soil during an impact. The increased post stiffness results in reduced dynamic deflection and increased vehicular deceleration rates. Spacer blocks are used to offset the rail element from the posts to minimize vehicle snagging on the posts. Severe vehicle-post interaction can impart high decelerations to the vehicle and lead to vehicle instability. Strong post systems are more widely used across the country due to their lower deflection and reduced maintenance requirements.

In the mid-1990s, Texas Transportation Institute (TTI) researchers conducted full-scale crash tests of all commonly used guardrail systems in accordance with National Cooperative Highway Research Program (NCHRP) *Report 350 Test 3-11 (1)* under a pooled fund study administered by Federal Highway Administration (FHWA) (2). It was under this testing program that performance issues associated with light trucks impacting the standard strong steel-post W-beam guardrail system, G4(1S), were first identified. Snagging of the pickup truck’s wheels on the steel support posts was aggravated by the collapse of the W6×9 steel offset blocks, and precipitated rollover of the truck as it exited the barrier. Subsequent testing demonstrated that a modified G4(1S) system that incorporates 8-inch deep wood or structural plastic offset blocks between the W-beam rail element and W6×9 steel posts in lieu of the original W6×9 steel

offset block was able to accommodate the 3/4-ton, 2-door, pickup truck design vehicle (denoted 2000P) and comply with *NCHRP Report 350* guidelines (3,4,5).

The strong wood-post W-beam guardrail system, G4(2W), which utilizes 6-inch × 8-inch wood posts and offset blocks, contained and redirected the 2000P pickup (2). However, instability of the pickup truck resulted in the test being classified as marginally acceptable.

Both of these strong-post W-beam guardrail systems are national standards and form the basis for TxDOT's current guard fence designs. Figure 1.1 shows a cross section of a typical TxDOT guard fence. The guard fence is constructed with 12-gauge, W-beam rail mounted at a height of 21 inches to the center on 6-ft long W6×9 steel, 7-inch diameter wood, or 6-inch × 8-inch wood posts spaced at 6 ft-3 inches. The 8-inch deep offset blocks inserted between the rail and posts may be fabricated from wood or an approved alternative.

Recent testing under the new 2009 AASHTO *Manual for Assessing Safety Hardware (MASH)* (6) has demonstrated that these strong-post W-beam guardrail systems are at or near their performance limits. Under NCHRP Projects 22-14(02) and 22-14(03), a series of crash tests were performed to assess the impact performance of commonly used barrier systems when impacted by the new 1/2-ton, four-door, pickup truck design vehicle (designated 2270P) under the AASHTO *MASH* guidelines. The increase in the weight of the new pickup truck from approximately 4400 lb to 5000 lb (2000 kg to 2270 kg) increases the impact severity of the structural adequacy test (Test 3-11) for longitudinal barriers by 13 percent. Table 1.1 shows a summary of these barrier tests.

A 27 5/8-inch tall, modified G4(1S) steel post W-beam guardrail failed due to rail rupture when impacted by a 5000-lb, 3/4-ton pickup truck. In a subsequent test of the same system with the 5000-lb, 1/2-ton, 4-door *MASH* pickup truck, the guardrail successfully contained and redirected the vehicle (7). However, the rail had a vertical tear through approximately half of its cross section, indicating that the modified G4(1S) guardrail is at its performance limits with no factor of safety. In a test of the G4(2W) wood post W-beam guardrail, the rail ruptured and failed to contain the heavier *MASH* pickup truck.

The implications of these tests are being examined by FHWA and AASHTO. Several states are considering or have already implemented the use of alternate strong-post guardrail systems that offer enhanced containment capacity. As an example, a modified guardrail design known as the Midwest Guardrail System (MGS) (8) has successfully met the *MASH* guidelines and has been shown to have additional capacity or factor of safety beyond the design impact conditions. The MGS guardrail increases the W-beam rail height from 27 inches to 31 inches, increases the depth of the offset blocks between the rail and posts from 8 inches to 12 inches, and moves the rail splice locations from the posts to mid-span between posts. There are also several proprietary guardrail systems (Gregory GMS, Nucore Nu-Guard, and Trinity T-31) that have successfully met the new *MASH* impact performance guidelines.

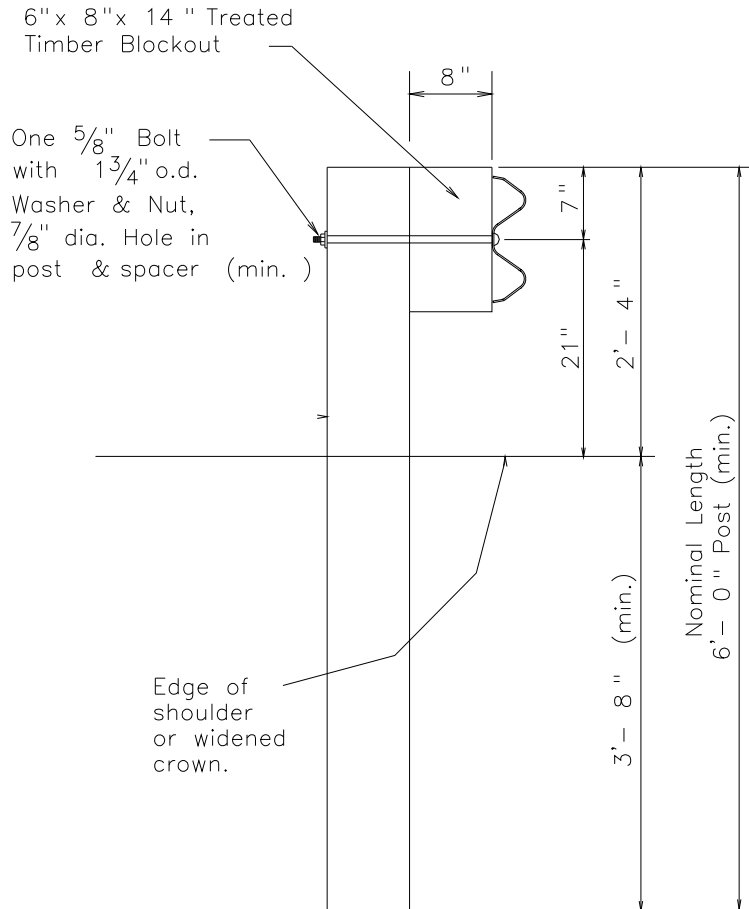

Figure 1.1. Typical Cross Section of the Texas Metal Beam Guard Fence.

On May 17, 2010, FHWA issued a technical memorandum to provide guidance to State DOTs on height of guardrail for new installations on the National Highway System (NHS) (9). The memorandum discusses performance issues with the modified G4(1S) guardrail and details the minimum mounting heights of steel post guardrail systems successfully crash tested under both *NCHRP Report 350* and *MASH*. In regard to *NCHRP Report 350*, it states that transportation agencies should ensure the minimum height of newly-installed modified G4(1S) W-beam guardrail is at least 27 3/4 inches to the top of the rail, including construction tolerance. A nominal installation height of 29 inches, ± 1 inch, may be specified and is considered acceptable for use on the NHS.

In regard to *MASH*, the memorandum recognizes performance issues with modified G4(1S) guardrail and recommends that transportation agencies consider adopting generic or proprietary 31-inch high guardrail designs (instead of the modified G4(1S) system) as standard for all new installations. It states that these systems have met *MASH* criteria and offer improved crash-test performance and increased capacity to safely contain and redirect higher center-of-gravity vehicles such as pickup trucks and SUVs.

Table 1.1. Summary of *MASH* Crash Tests Performed on Non-Proprietary Strong Post W-Beam Guardrail.

Agency Test No.	Test Designation	Test Article	Vehicle Make and Model	Vehicle Mass (lb)	Impact Speed (mph)	Impact Angle (deg)	PASS/ FAIL
2214WB-1 ^a	3-11	Modified G4(1S) Guardrail	2002 GMC 2500 3/4-ton Pickup	5000	61.1	25.6	FAIL ^c
2214WB-2 ^a	3-11	Modified G4(1S) Guardrail	2002 Dodge Ram 1500 Quad Cab Pickup	5000	62.4	26.0	PASS ^d
2214MG-1 ^a	3-11	Midwest Guardrail System (MGS)	2002 GMC 2500 3/4-ton Pickup	5000	62.6	25.2	PASS
2214MG-2 ^a	3-11	MGS	2002 Dodge Ram 1500 Quad Cab Pickup	5000	62.8	25.5	PASS
2214MG-3 ^a	3-10	MGS (Max. Height)	2002 Kia Rio	2588	60.8	25.4	PASS
476460-1-5 ^b	3-11	G4(2W) W-Beam Guardrail	2007 Chevrolet Silverado Pickup	5009	64.4	26.1	FAIL ^c

- a) Test performed at University of Nebraska under NCHRP Project 22-14(2)
- b) Test performed at TTI under NCHRP Project 22-14(3)
- c) Rail ruptured
- d) Rail tore through half its cross section

TxDOT initiated a review of their guardrail standards based on the outcome of these recent studies and the FHWA technical memorandum. TxDOT expressed interest in the use of a generic 31-inch tall guardrail to provide enhanced containment capacity for light trucks. However, some concerns were noted regarding the size of the blockout used in the MGS and the practical aspects of using it on new guardrail installations in Texas. The larger offset block will be more expensive and require more space than the offset blocks currently in use. Ideally, TxDOT desired a crashworthy guardrail system that meets *MASH* evaluation criteria, has improved containment capacity for larger passenger vehicles than the modified G4(1S), and incorporates a conventional 8-inch deep offset block.

1.3 OBJECTIVES/SCOPE OF RESEARCH

The objective of this test was to evaluate the performance of a 31-inch tall W-beam guardrail with standard offset blocks according to the *MASH* standards for Test Level 3 (TL-3) longitudinal barriers. The test performed was *MASH* test 3-10 involving a 1100C (2420 lb) vehicle impacting the critical impact point (CIP) of the length of need (LON) of the guardrail at a nominal impact speed and angle of 62 mi/h and 25 degrees, respectively. This test was selected

to investigate vehicle-barrier interaction to determine if a small passenger car can be successfully contained and redirected without excessive deceleration or unacceptable occupant compartment deformation.

Reported herein are the details of the 31-inch tall W-beam guardrail with standard offset blocks, test conditions, description of the test performed, assessment of test results, and implementation recommendations.

CHAPTER 2. SYSTEM DETAILS

2.1 TEST ARTICLE DESIGN AND CONSTRUCTION

The guardrail incorporates a standard 12-gauge corrugated W-beam rail section mounted at a height of 31 inches on 6-ft long, W6×8.5 steel posts. The posts were spaced on 6 ft-3 inch centers and embedded 40 inches in a compacted road base material. The rail was offset from the posts using 6-inch wide × 8-inch deep × 14-inch long routed wood offset blocks. The rail was attached to the blockout and post using a single 5/8-inch diameter × 10-inch long button head bolt. The rail splices were located midspan between posts.

The length of the W-beam guardrail section was 106.25 ft. A 37.5 ft, steel post ET-PLUS end treatment was attached to each end, making the overall length of the installation 181.25 ft.

Figure 2.1 shows details of the 31-inch W-beam guardrail with standard offset blocks. Figure 2.2 shows photographs of the completed test installation. Appendix A presents detailed drawings of the bridge rail.

2.2 MATERIAL SPECIFICATIONS

The W-beam guardrail conformed to AASHTO M 180, Standard Specification for Corrugated Sheet Steel Beams for Highway Guardrail. The W6×8.5 steel guardrail posts complied with American Society for Testing and Materials (ASTM) A36. The routed wood offset blocks were Grade 1 southern yellow pine. The guardrail post bolts and rail splice bolts complied with ASTM A307 and were galvanized in accordance with ASTM A153. The nuts complied with ASTM A563 and were galvanized in accordance with ASTM A153.

Appendix B contains mill certification sheets and other certification documents for the materials used in the 31-inch W-beam guardrail installation.

2.3 SOIL CONDITIONS

The guardrail and end treatment posts were installed in soil meeting AASHTO standard specifications for “Materials for Aggregate and Soil Aggregate Subbase, Base and Surface Courses,” designated M147-65(2004), grading B. In accordance with Appendix B of *MASH*, soil strength was measured the day of the crash test (see Appendix C, Figure C1). During construction of the guardrail installation for the full-scale crash test, two W6×16 posts were installed in the immediate vicinity of the guardrail, utilizing the same fill materials and installation procedures followed for the guardrail system and used in the reference tests (see Appendix C, Figure C2).

As determined from the reference tests shown in Appendix C, Figure C2, the minimum static post load required for deflections of 5 inches, 10 inches, and 15 inches, measured at a

height of 25 inches, is 3940 lb, 5500 lb, and 6540 lb, respectively (90 percent of static load for the initial reference installation). On the day of the test, April 14, 2009, load on the test post at deflections of 5 inches, 10 inches, and 15 inches was 7182 lbf, 8484 lbf, and 9424 lbf, respectively, as shown in Appendix C, Figure C1. The strength of the backfill material met minimum requirements.

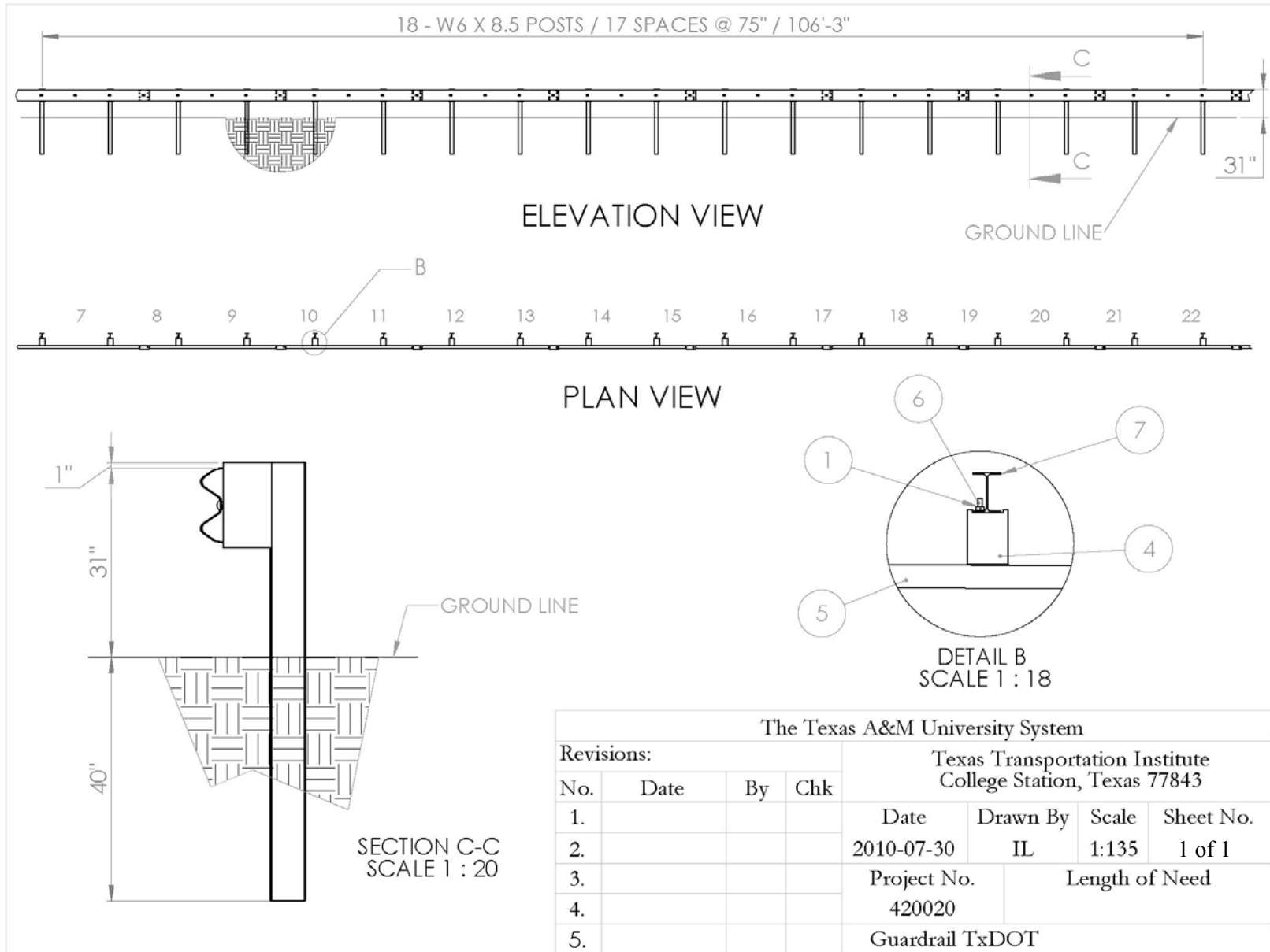

T:\2009-2010\420020 TxDOT\4-5 Guardrail\SolidWorks\Drawings\420020 Drawings 2010-07-19_31in_new

Figure 2.1. Details of the TxDOT 31-inch Guardrail Installation.



Figure 2.2. Test Article/Installation before Test No. 420020-5.

CHAPTER 3. TEST REQUIREMENTS AND EVALUATION CRITERIA

3.1 CRASH TEST MATRIX

Two tests are recommended to evaluate longitudinal barriers to TL-3 in accordance with *MASH*. Details of these tests are described below.

***MASH* test 3-10:** An 1100C (2425 lb) vehicle impacting the critical impact point (CIP) of the length of need (LON) of the barrier at a nominal impact speed and angle of 62 mi/h and 25 degrees, respectively. This test investigates a barrier's ability to contain and redirect a small passenger vehicle.

***MASH* test 3-11:** A 2270P (5000 lb) vehicle impacting the CIP of the LON of the barrier at a nominal impact speed and angle of 62 mi/h and 25 degrees, respectively. This is a strength test to verify a barrier's capacity for containing light trucks in a stable manner.

The test reported herein corresponds to *MASH* test 3-10. The CIP was determined to be 9 ft upstream of a post using Figure 2-8 in *MASH*. The target impact point was thus selected to be 9 ft upstream of post 14 or 33 inches upstream of post 13.

The crash test and data analysis procedures were in accordance with guidelines presented in *MASH*. Chapter 4 presents brief descriptions of these procedures.

3.2 EVALUATION CRITERIA

The crash test was evaluated in accordance with the criteria presented in *MASH*. The performance of the guardrail is judged on the basis of three factors: structural adequacy, occupant risk, and post impact vehicle trajectory. Structural adequacy is judged upon the guardrail's ability to contain and redirect the vehicle, or bring the vehicle to a controlled stop in a predictable manner. Occupant risk criteria evaluates the potential risk of hazard to occupants in the impacting vehicle, and to some extent other traffic, pedestrians, or workers in construction zones, if applicable. Post impact vehicle trajectory is assessed to determine potential for secondary impact with other vehicles or fixed objects, creating further risk of injury to occupants of the impacting vehicle and/or risk of injury to occupants in other vehicles. The appropriate safety evaluation criteria from table 5-1 of *MASH* were used to evaluate the crash test. These criteria are listed in further detail under the assessment of the crash test.

CHAPTER 4. CRASH TEST PROCEDURES

4.1 TEST FACILITY

The full-scale crash test reported herein was performed at Texas Transportation Institute (TTI) Proving Ground. TTI Proving Ground is an International Standards Organization (ISO) 17025 accredited laboratory with American Association for Laboratory Accreditation (A2LA) Mechanical Testing certificate 2821.01. The full-scale crash test was performed according to TTI Proving Ground quality procedures and according to the *MASH* guidelines and standards.

The Texas Transportation Institute Proving Ground is a 2000-acre complex of research and training facilities located 10 miles northwest of the main campus of Texas A&M University. The site, formerly an Air Force base, has large expanses of concrete runways and parking aprons well suited for experimental research and testing in the areas of vehicle performance and handling, vehicle-roadway interaction, durability and efficacy of highway pavements, and safety evaluation of roadside safety hardware. The site selected for construction and testing of the TxDOT guardrail evaluated under this project is along the edge of an out-of-service apron. The apron consists of an unreinforced jointed-concrete pavement in 12.5 ft by 15 ft blocks nominally 8 to 12 inches deep. The apron is over 50 years old, and the joints have some displacement, but are otherwise flat and level.

4.2 VEHICLE TOW AND GUIDANCE PROCEDURES

The test vehicle was towed into the test installation using a steel cable guidance and reverse tow system. A steel cable for guiding the test vehicle was tensioned along the path, anchored at each end, and threaded through an attachment to the front wheel of the test vehicle. An additional steel cable was connected to the test vehicle, passed around a pulley near the impact point, through a pulley on the tow vehicle, and then anchored to the ground such that the tow vehicle moved away from the test site. A two-to-one speed ratio between the test and tow vehicle existed with this system. Just prior to impact with the installation, the test vehicle was released to be free-wheeling and unrestrained. The vehicle remained free-wheeling, i.e., no steering or braking inputs, until the vehicle cleared the immediate area of the test site, at which time brakes on the vehicle were activated to bring it to a safe and controlled stop.

4.3 DATA ACQUISITION SYSTEMS

4.3.1 Vehicle Instrumentation and Data Processing

The test vehicle was instrumented with a self-contained, on-board data acquisition system. The signal conditioning and acquisition system is a 16-channel, Tiny Data Acquisition System (TDAS) Pro produced by Diversified Technical Systems, Inc. The accelerometers that measure the x, y, and z axis of vehicle acceleration are strain gauge type with linear millivolt output proportional to acceleration. Accelerometer data are measured with an expanded uncertainty of ± 1.7 percent at a confidence factor of 95 percent ($k=2$). Angular rate sensors, measuring vehicle roll, pitch, and yaw rates, are ultra small size, solid state units designs for

crash test service. Rate of rotation data is measured with an expanded uncertainty of 0.7 percent at a confidence factor of 95 percent ($k=2$).

The TDAS Pro hardware and software conform to the latest Society of Automotive Engineers (SAE) J211, Instrumentation for Impact Test. Each of the 16 channels is capable of providing precision amplification, scaling, and filtering based on transducer specifications and calibrations. During the test, data are recorded from each channel at a rate of 10,000 values per second with a resolution of one part in 65,536. Once recorded, the data are backed up inside the unit by internal batteries to prevent data loss should the primary battery cable be severed. Initial contact of the pressure switch on the vehicle bumper provides a time zero mark and initiates the recording process. After each test, the data are downloaded from the TDAS Pro unit into a laptop computer at the test site. The raw data are then processed by the Test Risk Assessment Program (TRAP) software to produce detailed reports of the test results. Each of the TDAS Pro units is returned to the factory annually for complete recalibration. Accelerometers and rate transducers are also calibrated annually with traceability to the National Institute for Standards and Technology.

TRAP uses the data from the TDAS Pro to compute occupant/compartment impact velocities, time of occupant/compartment impact after vehicle impact, and the highest 10-millisecond (ms) average ridedown acceleration. In addition, maximum average accelerations over 50-ms intervals in each of the three directions are computed. For reporting purposes, the acceleration versus time curves for the longitudinal, lateral, and vertical directions are plotted using a 60-Hz digital filter.

TRAP uses the data from the yaw, pitch, and roll rate transducers to compute angular displacement in degrees at 0.0001-s intervals and then plots yaw, pitch, and roll angles versus time. These displacements are in reference to the vehicle-fixed coordinate system with the initial position and orientation of the vehicle-fixed coordinate systems being initial impact.

4.3.2 Anthropomorphic Dummy Instrumentation

An Alderson Research Laboratories Hybrid II, 50th percentile male anthropomorphic dummy, restrained with lap and shoulder belts, was placed in the driver's position of the 1100C vehicle. The dummy was uninstrumented.

4.3.3 Photographic Instrumentation and Data Processing

Photographic coverage of the test included three high-speed cameras: one overhead with a field of view perpendicular to the ground and directly over the impact point; one placed behind the installation at an angle; and a third placed to have a field of view parallel to and aligned with the installation at the downstream end. A flashbulb activated by pressure-sensitive tape switches was positioned on the impacting vehicle to indicate the instant of contact with the installation and was visible from each camera. The films from these high-speed cameras were analyzed on a computer-linked motion analyzer to observe phenomena occurring during the collision and to obtain time-event, displacement, and angular data. A mini-DV camera and still cameras recorded and documented conditions of the test vehicle and installation before and after the test.

CHAPTER 5. CRASH TEST RESULTS

5.1 TEST DESIGNATION AND ACTUAL IMPACT CONDITIONS

MASH test 3-10 involves an 1100C vehicle weighing 2420 lb \pm 55 lb impacting the test article at an impact speed of 62.2 mi/h \pm 2.5 mi/h and an angle of 25 degrees \pm 1.5 degrees. The target impact point was 33 inches upstream of post 13, near the splice between posts 12 and 13. The 2003 Kia Rio used in the test weighed 2435 lb and the actual impact speed and angle were 60.4 mi/h and 25.6 degrees, respectively. The actual impact point was 38.0 inches upstream of post 13. Impact severity was calculated at 1778 kip-ft, or 0.4 percent below target.

5.2 TEST VEHICLE

A 2003 Kia Rio, shown in Figures 5.1 and 5.2, was used for the crash test. Test inertia weight of the vehicle was 2435 lb, and its gross static weight was 2609 lb. The height to the lower edge of the vehicle bumper was 8.5 inches, and the height to the upper edge of the bumper was 22.75 inches. Figure D1 in Appendix D gives additional dimensions and information on the vehicle. The vehicle was directed into the installation using the cable reverse tow and guidance system, and was released to be free-wheeling and unrestrained just prior to impact.

5.3 WEATHER CONDITIONS

The test was performed on the morning of August 26, 2010. Rainfall recorded prior to the test was 0.38 inches 10 days prior to the test date. Weather conditions at the time of testing were as follows: Wind speed: 7 mi/h; wind direction: 80 degrees with respect to the vehicle (vehicle was traveling in a northwesterly direction); temperature: 89°F, relative humidity: 45 percent.

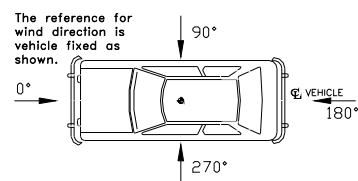

5.4 TEST DESCRIPTION

The 2003 Kia Rio, traveling at an impact speed of 60.4 mi/h, impacted the 31-inch W-beam guardrail with standard offset blocks 38 inches upstream of post 13 at an impact angle of 25.6 degrees. At approximately 0.015 s after impact, the W-beam rail element began to deflect toward the field side, and at 0.029 s, post 13 began to deflect toward the field side. The left front corner of the bumper of the vehicle contacted post 13 at 0.032 s, and the tire contacted post 13 at 0.039 s. Post 14 began to deflect toward the field side at 0.042 s. At 0.069 s, the vehicle began to redirect, and at 0.076 s, post 15 began to deflect toward field side. The left front corner of the vehicle contacted post 14 at 0.101 s, and post 16 began to deflect toward the field side at 0.179 s. At 0.199 s, the left front corner of the vehicle contacted post 15, and at 0.295 s, the left front corner of the vehicle contacted post 16. The vehicle became parallel with the guardrail at 0.327 s and was traveling at a speed of 37.3 mi/h. At 0.814 s, the vehicle lost contact with the guardrail and was traveling at an exit speed and angle of 29.2 mi/h and 15.0 degrees, respectively. Brakes on the vehicle were applied at 3.5 s, and the vehicle subsequently came to rest 185 ft downstream of impact and 47 ft from the traffic face of the rail toward traffic lanes. Figure E2 and Figure E3 in Appendix E show sequential photographs of the test period.



Figure 5.1. Vehicle/Installation Geometrics for Test No. 420020-5.



Figure 5.2. Vehicle before Test No. 420020-5.

5.5 DAMAGE TO TEST INSTALLATION

Damage to the test installation is shown in Figures 5.3 and 5.4. Post 1 was pulled downstream 0.5 inches at ground level, and post 12 was pushed toward the field side 0.25 inches at ground level. Post 13 was leaning downstream and toward the field side 25 degrees, and there were tire marks on the traffic side flange of the post. Posts 14 and 15 were leaning downstream 80 degrees, and post 16 was leaning downstream 30 degrees. Post 30 was pulled upstream 0.25 inches. The W-beam rail element was separated from posts 13 through 17, and the bolt hole at post 2 was torn. Working width was 2.38 ft. Maximum dynamic deflection of the W-beam rail element during the test was 2.38 ft, and maximum permanent deformation was 1.58 ft.

5.6 VEHICLE DAMAGE

The left front and left side of the 1100C vehicle were damaged as shown in Figures 5.5. The left front strut, left front strut tower, left front lower ball joint, left front lower ball joint, left front outer tie rod end, and left inner and outer CV joints were damaged. Also damaged were the front bumper, hood, grill, radiator and radiator support, left front fender, left front door, and left rear door. The left front tire and wheel rim were damaged and the windshield sustained stress cracking from the left lower corner. Maximum exterior crush to the vehicle was 12.5 inches in the side plane at the left front corner at bumper height. No occupant compartment deformation was noted. Figure 5.6 shows photographs of the interior of the vehicle. Exterior crush measurements and occupant compartment measures are provided in Appendix D, Tables D1 and D2.

5.7 OCCUPANT RISK FACTORS

Data from the accelerometer located at the vehicle center of gravity were digitized for evaluation of occupant risk. In the longitudinal direction, the occupant impact velocity was 21.0 ft/s at 0.130 s, the highest 0.010-s occupant ridedown acceleration was 8.8 Gs from 0.188 to 0.198 s, and the maximum 0.050-s average acceleration was -6.8 Gs between 0.058 and 0.108 s. In the lateral direction, the occupant impact velocity was 17.4 ft/s at 0.130 s, the highest 0.010-s occupant ridedown acceleration was 6.8 Gs from 0.162 to 0.172 s, and the maximum 0.050-s average was 5.6 Gs between 0.067 and 0.117 s. Theoretical Head Impact Velocity (THIV) was 29.2 km/h or 8.1 m/s at 0.126 s; Post-Impact Head Decelerations (PHD) was 10.1 Gs between 0.188 and 0.198 s; and Acceleration Severity Index (ASI) was 0.82 between 0.064 and 0.114 s. Figure 5.7 summarizes these data and other pertinent information from the test. Vehicle angular displacements and accelerations versus time traces are presented in Appendix F, Figures F3 through F9.



Figure 5.3. Position of the Vehicle after Test No. 420020-5.



Figure 5.4. Installation after Test No. 420020-5.



Figure 5.5. Vehicle after Test No. 420020-5.



Before Test

After Test



Figure 5.6. Interior of Vehicle for Test No. 420020-5.

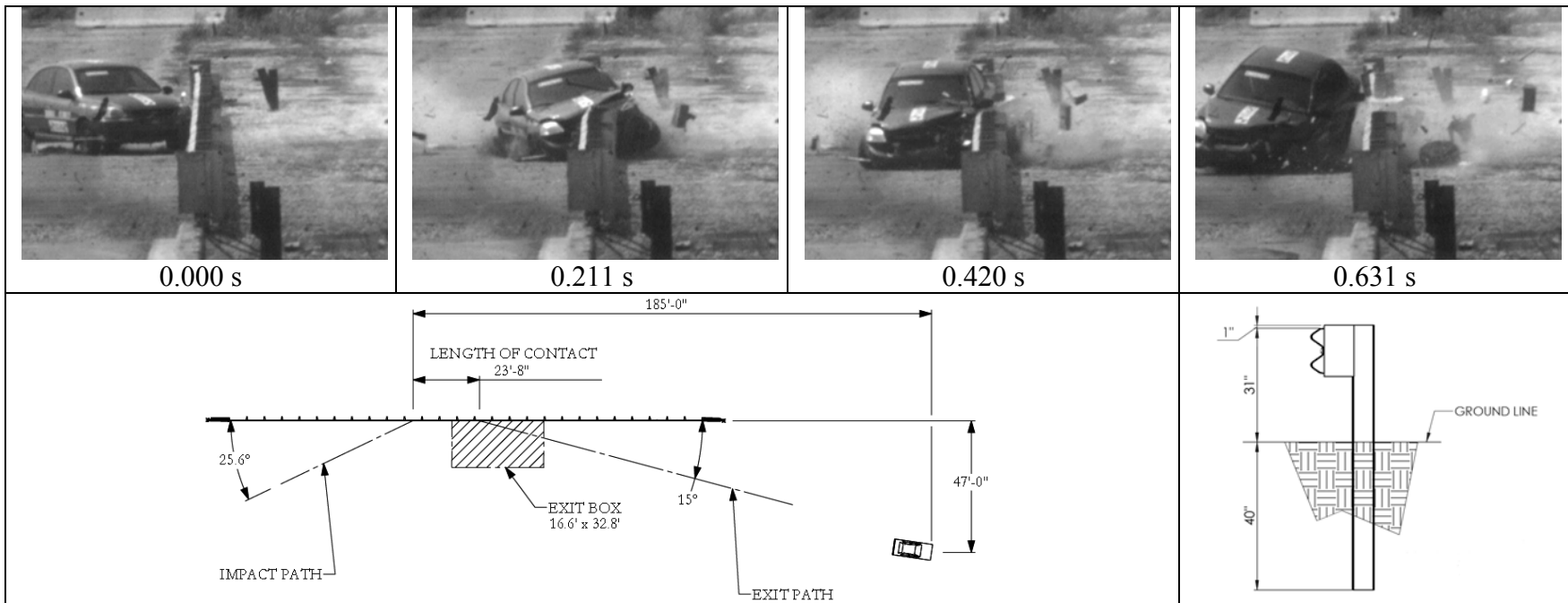

General Information

Test Agency..... Texas Transportation Institute (TTI)
 Test Standard Test No. MASH Test 3-10
 TTI Test No. 420020-5
 Date 2010-08-26

Test Article

Type..... Guardrail
 Name 31-inch W-Beam Guardrail with standard offset blocks
 Installation Length 181.25 ft
 Material or Key Elements 12-ga. W-beam rail, 8-inch deep routed wood blockouts

Soil Type and Condition..... Crushed Limestone, Dry

Test Vehicle

Type/Designation..... 1100C
 Make and Model 2003 Kia Rio
 Curb 2387 lb
 Test Inertial 2435 lb
 Dummy 174 lb
 Gross Static 2609 lb

Impact Conditions

Speed60.4 mi/h
 Angle.....25.6 degrees
 Location/Orientation38 inches upstrm

Exit Conditions

Speed29.2 mi/h
 Angle.....15.0 degrees

Occupant Risk Values

Impact Velocity
 Longitudinal21.0 ft/s
 Lateral17.4 ft/s
 Ridedown Accelerations
 Longitudinal 8.8 G
 Lateral 6.8 G
 THIV29.2 km/h
 PHD10.1 G
 ASI0.82
 Max. 0.050-s Average
 Longitudinal-6.8 G
 Lateral 5.6 G
 Vertical-1.8 G

Post-Impact Trajectory

Stopping Distance 185 ft dwnstrm
 47 ft twd traffic

Vehicle Stability

Maximum Yaw Angle..... 49 degrees
 Maximum Pitch Angle.....-11 degrees
 Maximum Roll Angle.....-16 degrees
 Vehicle Snagging..... No
 Vehicle Pocketing..... No

Test Article Deflections

Dynamic.....2.38 ft
 Permanent1.58 ft
 Working Width2.38 ft

Vehicle Damage

VDS 11LFQ4
 CDC 11LDEW3
 Max. Exterior Deformation.....12.5 inches
 OCDI..... LF0000000
 Max. Occupant Compartment Deformation..... 0

Impact Severity 1778 kip-ft (-0.4%)

Figure 5.7. Summary of Results for MASH Test 3-10 on the TxDOT 31-inch W-Beam Guardrail.

CHAPTER 6. SUMMARY AND CONCLUSIONS

6.1 ASSESSMENT OF TEST RESULTS

An assessment of the test based on the applicable *MASH* safety evaluation criteria is provided below.

6.1.1 Structural Adequacy

- A. *Test article should contain and redirect the vehicle or bring the vehicle to a controlled stop; the vehicle should not penetrate, underride, or override the installation although controlled lateral deflection of the test article is acceptable.*

Results: The 31-inch W-beam guardrail with standard offset blocks contained and redirected the 1100C vehicle. The vehicle did not penetrate, underride, or override the guardrail. Maximum dynamic deflection of the W-beam rail element during the test was 2.38 ft. (PASS)

6.1.2 Occupant Risk

- D. *Detached elements, fragments, or other debris from the test article should not penetrate or show potential for penetrating the occupant compartment, or present an undue hazard to other traffic, pedestrians, or personnel in a work zone.*

Deformation of, or intrusions into, the occupant compartment should not exceed limits set forth in Section 5.3 and Appendix E of MASH (roof ≤ 4.0 inches; windshield ≤ 3.0 inches; side windows = no shattering by test article structural member; wheel/foot well/toe pan ≤ 9.0 inches; forward of A-pillar ≤ 12.0 inches; front side door area above seat ≤ 9.0 inches; front side door below seat ≤ 12.0 inches; floor pan/transmission tunnel area ≤ 12.0 inches).

Results: The W-beam rail element detached from posts 13 through 17. However, the detached rail did not penetrate or show potential for penetrating the occupant compartment, nor to present hazard to others in the area. (PASS)
No occupant compartment deformation occurred. (PASS)

- F. *The vehicle should remain upright during and after collision. The maximum roll and pitch angles are not to exceed 75 degrees.*

Results: The 1100C vehicle remained upright during and after the collision event. Maximum roll and pitch angles were -16 degrees and -1 degrees, respectively. (PASS)

H. Occupant impact velocities should satisfy the following:
Longitudinal and Lateral Occupant Impact Velocity

<u>Preferred</u>	<u>Maximum</u>
30 ft/s	40 ft/s

Results: Longitudinal occupant impact velocity was 21.0 ft/s, and lateral occupant impact velocity was 17.4 ft/s. (PASS)

I. Occupant ridedown accelerations should satisfy the following:
Longitudinal and Lateral Occupant Ridedown Accelerations

<u>Preferred</u>	<u>Maximum</u>
15.0 Gs	20.49 Gs

Results: Longitudinal ridedown acceleration was 8.8 G, and lateral ridedown acceleration was 6.8 G. (PASS)

6.1.3 Vehicle Trajectory

For redirective devices, the vehicle shall exit the barrier within the exit box.

Result: The 1100C vehicle exited within the exit box. (PASS)

6.2 CONCLUSIONS

The 31-inch W-beam guardrail with standard offset blocks performed acceptably for *MASH* test 3-10, as summarized in Table 6.1.

Table 6.1. Performance Evaluation Summary for MASH Test 3-10 on the TxDOT 31-inch W-Beam Guardrail.

Test Agency: Texas Transportation Institute

Test No.: 420020-5

Test Date: 2010-08-26

MASH Test 3-10 Evaluation Criteria	Test Results	Assessment
<p>Structural Adequacy</p> <p>A. <i>Test article should contain and redirect the vehicle or bring the vehicle to a controlled stop; the vehicle should not penetrate, underride, or override the installation although controlled lateral deflection of the test article is acceptable</i></p>	<p>The 31-inch W-beam guardrail with standard offset blocks contained and redirected the 1100C vehicle. The vehicle did not penetrate, underride, or override the guardrail. Maximum dynamic deflection of the W-beam rail element during the test was 2.38 ft.</p>	<p>Pass</p>
<p>Occupant Risk</p> <p>D. <i>Detached elements, fragments, or other debris from the test article should not penetrate or show potential for penetrating the occupant compartment, or present an undue hazard to other traffic, pedestrians, or personnel in a work zone.</i></p>	<p>The W-beam rail element detached from posts 13 through 17. However, the detached rail did not penetrate or show potential for penetrating the occupant compartment, nor to present hazard to others in the area.</p>	<p>Pass</p>
<p><i>Deformations of, or intrusions into, the occupant compartment should not exceed limits set forth in Section 5.3 and Appendix E of MASH.</i></p>	<p>No occupant compartment deformation occurred.</p>	<p>Pass</p>
<p>F. <i>The vehicle should remain upright during and after collision. The maximum roll and pitch angles are not to exceed 75 degrees.</i></p>	<p>The 1100C vehicle remained upright during and after the collision event. Maximum roll and pitch angles were -16 degrees and -1 degrees, respectively.</p>	<p>Pass</p>
<p>H. <i>Longitudinal and lateral occupant impact velocities should fall below the preferred value of 30 ft/s, or at least below the maximum allowable value of 40 ft/s.</i></p>	<p>Longitudinal occupant impact velocity was 21.0 ft/s, and lateral occupant impact velocity was 17.4 ft/s.</p>	<p>Pass</p>
<p>I. <i>Longitudinal and lateral occupant ridedown accelerations should fall below the preferred value of 15.0 Gs, or at least below the maximum allowable value of 20.49 Gs.</i></p>	<p>Longitudinal ridedown acceleration was 8.8 G, and lateral ridedown acceleration was 6.8 G.</p>	<p>Pass</p>
<p>Vehicle Trajectory</p> <p><i>For redirective devices, the vehicle shall exit the barrier within the exit box.</i></p>	<p>The 1100C vehicle exited the barrier within the exit box.</p>	<p>Pass</p>

CHAPTER 7. IMPLEMENTATION STATEMENT

TxDOT initiated a review of their guardrail standards based on the outcome of recent crash test results and an FHWA technical memorandum pertaining to guardrail height. TxDOT expressed interest in the use of a generic 31-inch tall guardrail to provide enhanced containment capacity for light trucks. However, some concerns were expressed regarding the increased size of the blockout used in the Midwest Guardrail System (MGS). Consequently, TxDOT requested an evaluation of a 31-inch tall guardrail system that incorporates conventional 8-inch deep offset blocks.

MASH recommends two tests to evaluate guardrail systems to TL-3. The tests have the same impact speed and angle, but use different vehicles. *MASH* test 3-10 uses a small passenger car weighing 2420 lb, while *MASH* test 3-11 uses a 5000-lb, 4-door pickup truck.

The test reported herein corresponds to *MASH* test 3-10. This is primarily a severity test that assesses risk of injury to the vehicle occupants. This test was considered to be the more critical of the two tests due to the potential for increased vehicle-post interaction resulting from decreasing the depth of the offset blocks from 12 inches to 8 inches. The 31-inch W-beam guardrail with standard offset blocks met all required *MASH* performance criteria for test 3-10.

There currently is no implementation date for adopting *MASH*. TTI researchers recommend running test 3-11 to complete the *MASH* test matrix if TxDOT desires to adopt a *MASH* compliant 31-inch tall guardrail with standard offset blocks. If the impact performance in both tests is comparable to the impact performance of the MGS, it will provide enhanced justification to use other tested variations of the MGS with standard blockouts as well.

REFERENCES

1. Ross, Jr., H.E., Sicking, D.L., Zimmer, R.A. and Michie, J.D., “Recommended Procedures for the Safety Performance Evaluation of Highway Features,” National Cooperative Highway Research Program *Report 350*, Transportation Research Board, National Research Council, Washington, D.C., 1993.
2. Mak, K. K., Bligh, R. P., and Menges, W. L., “Testing of State Roadside Safety Systems—Volume XI: Appendix J—Crash Testing and Evaluation of Existing Guardrail Systems,” Research Report No. FHWA-RD-98-046, Federal Highway Administration, Washington, D.C., 1998.
3. Bullard, Jr., D.L., Menges, W.L., and Alberson, D.C., “NCHRP Report 350 Compliance Test 3-11 of the Modified G4(1S) Guardrail with Timber Blockouts,” Research Report No. FHWA-RD-96-175, Federal Highway Administration, Washington, D.C., 1996.
4. Bligh, R.P. and Menges, W.L., “Testing and Evaluation of a Modified Steel Post W-Beam Guardrail with Recycled Polyethylene Blockouts,” Research Report 400001-MPT, Texas Transportation Institute, College Station, TX, February 1997.
5. Alberson, D.C., Menges, W.L., and Schoeneman, S.K., “NCHRP Report 350 Test 3-11 of the Strong Post W-Beam Guardrail with Trinity Composite Blockout,” Research Report 400001-TRB3, Texas Transportation Institute, College Station, TX, May 2001.
6. AASHTO, *Manual for Assessing Safety Hardware*, First Edition, American Association of State Highway and Transportation Officials, Washington, D.C., 2009.
7. Polivka, K. A., Faller, R. K., Sicking, D. L., Rohde, J. R., Bielenberg, B. W., and Reid, J. D., *Performance Evaluation of the Modified G4(1S) Guardrail System – Update to NCHRP 350 Test No. 3-11 with 28” C.G. Height (2214-WB-2)*, Research Report No. TRP-03-169-06, Midwest Roadside Safety Facility, University of Nebraska-Lincoln, Lincoln, NE, October 2006.
8. Polivka, K. A., Faller, R. K., Sicking, D.L., Rohde, J. R., Bielenberg, B. W., and Reid, J. D., *Performance Evaluation of the Midwest Guardrail System – Update to NCHRP 350 Test No. 3-11 with 28” C.G. Height (2214MG-2)*, Research Report No. TRP-03-171-06, Midwest Roadside Safety Facility, University of Nebraska-Lincoln, Lincoln, NE, October 2006.
9. Roadside Design: Steel Strong-Post W-beam Guardrail, May 17, 2010, Memorandum, Office of Safety Design, Federal Highway Administration, U.S. Department of Transportation.

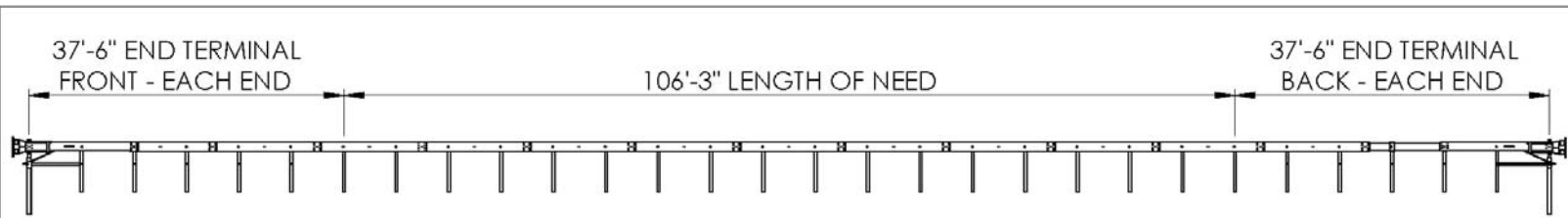

ELEVATION VIEW

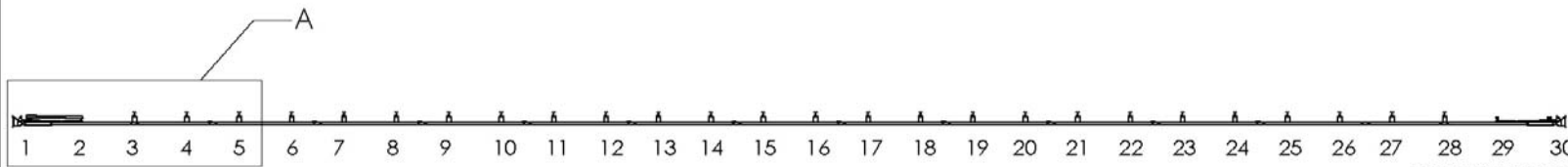

PLAN VIEW

POST NUMBERS

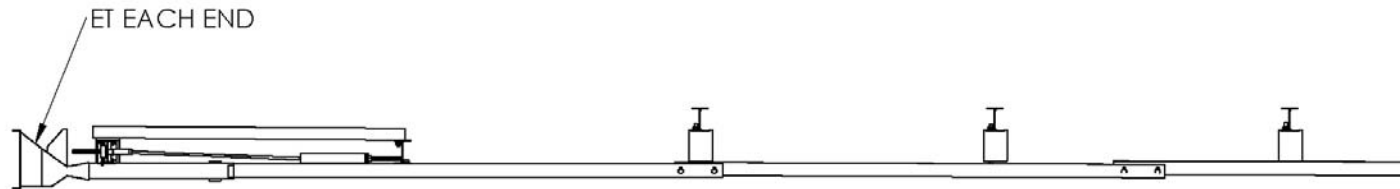

DETAIL A
SCALE 1 : 40

The Texas A&M University System							
Revisions:				Texas Transportation Institute College Station, Texas 77843			
No.	Date	By	Chk	Date	Drawn By	Scale	Sheet No.
1.				2010-07-30	IL	1:220	1 of 8
2.				Project No.		Full Rail	
3.				420020			
4.				Guardrail, TxDOT			
5.							
Approved: Akram Abu-Odeh:						Date: 2010-07-30	

*ALL POST SPACES - 75"

T:\2009-2010\420020 TxDOT\4-5 Guardrail\SolidWorks\Drawings\420020 Drawings 2010-07-19_31in_new

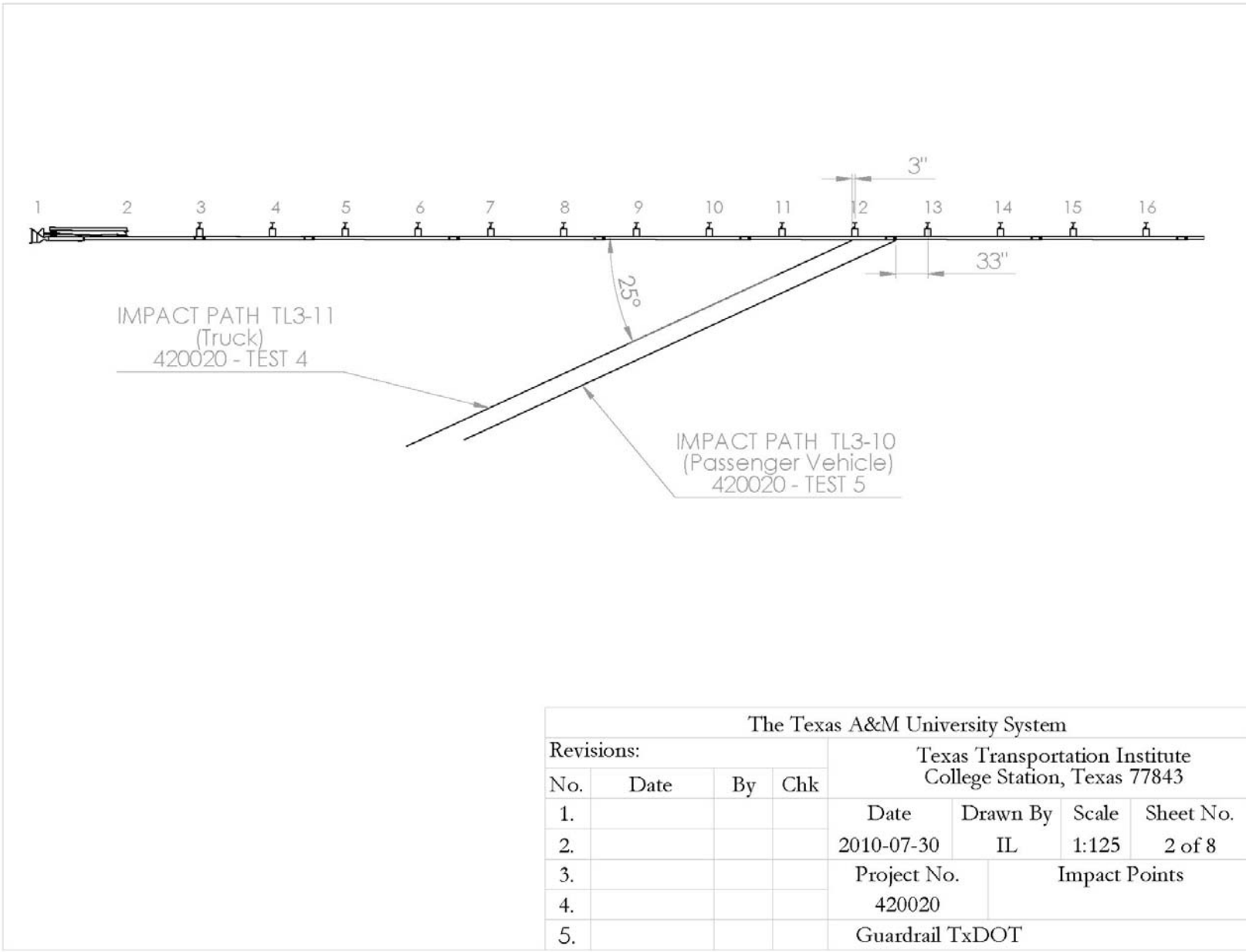

The Texas A&M University System							
Revisions:				Texas Transportation Institute College Station, Texas 77843			
No.	Date	By	Chk	Date	Drawn By	Scale	Sheet No.
1.				2010-07-30	IL	1:125	2 of 8
2.				Project No.		Impact Points	
3.				420020			
4.				Guardrail TxDOT			
5.							

T:\2009-2010\420020 TxDOT\4-5 Guardrail\SolidWorks\Drawings\420020 Drawings 2010-07-19_31in_new

#	PART NAME	QTY.
1	Nut, Recessed Guardrail	134
2	Bolt, Button-head 1 1/2"	114
3	Post, 31in. W-6x8.5 SYTP	10
4	Blockout, Wood W-beam Routed	26
5	W-Beam, 4- space 12 gauge	11
6	Bolt, Button-head 10 inch	26
7	Post, W6 x 8.5 SLP	18
8	W-Beam, 9'-4.5" - 12 gauge	2
9	5/16" nut	4
10	5/16" flat washer	8
11	Bolt, 5/16" -18 x 1-1/2" hex	4
12	ET plus head	2
13	Washer, 1" flat	4
14	Nut, 1" -8 hex	4
15	Anchor Bracket, ET Cable	2
16	W-beam, ET	2
17	3/4" Anchor Cable	2

#	PART NAME	QTY.
18	Post, CRP Bottom	2
19	CRP top, 31"	2
20	5/16" flat washer	8
21	Bolt, 5/16"-18x2 Hex	4
22	CRP bent plate washer	2
23	Strut, CRP	2
24	Washer, 5/8" flat	6
25	Bolt, 5/8"-11x2" Hex	6

The Texas A&M University System							
Revisions:				Texas Transportation Institute College Station, Texas 77843			
No.	Date	By	Chk	Date	Drawn By	Scale	Sheet No.
1.				2010-07-30	IL	1:500	3 of 8
2.				Project No.		Parts List	
3.				420020			
4.				Guardrail TxDOT			
5.							

T:\2009-2010\420020 TxDOT\4-5 Guardrail\SolidWorks\Drawings\420020 Drawings 2010-07-19_31in_new

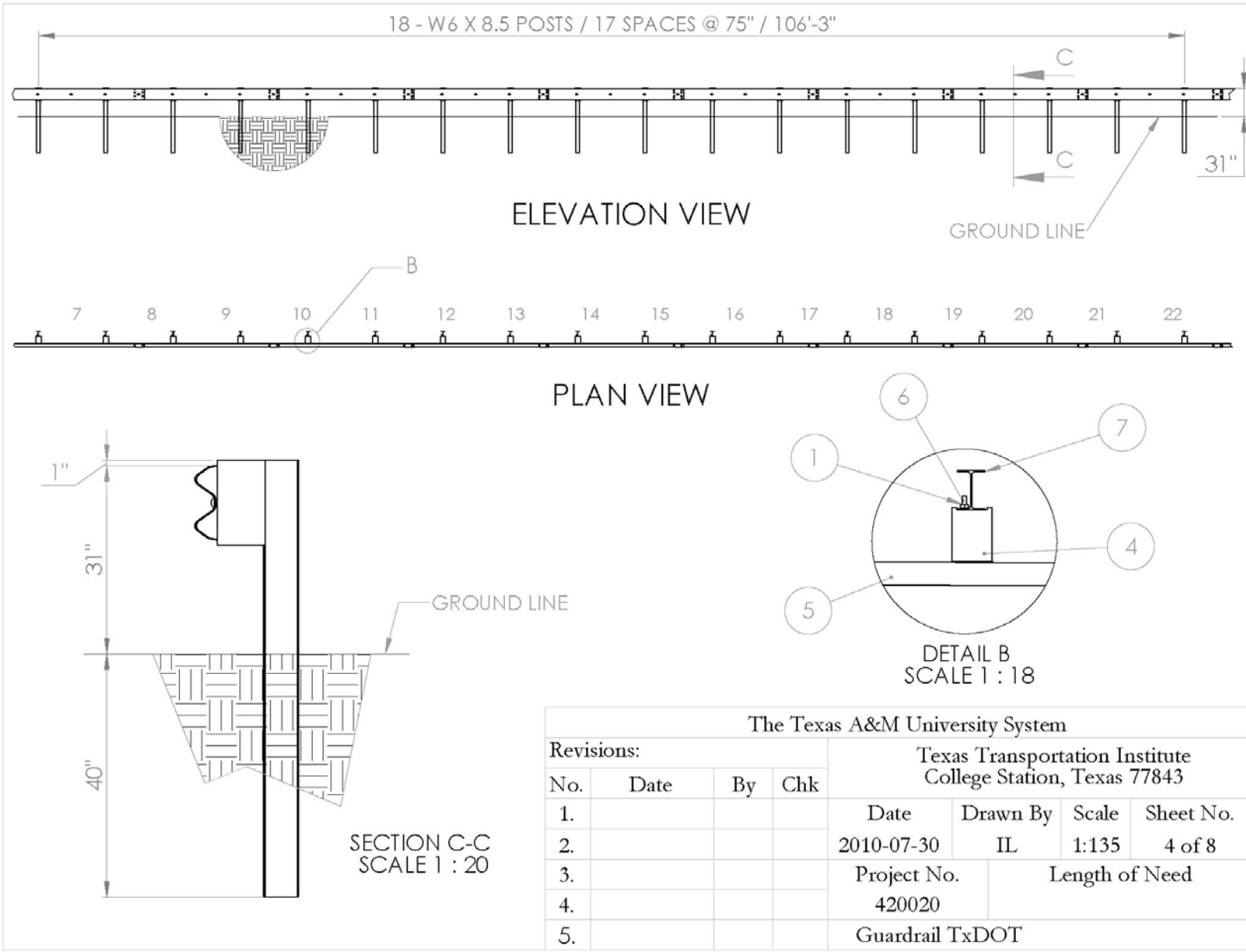

The Texas A&M University System							
Revisions:				Texas Transportation Institute College Station, Texas 77843			
No.	Date	By	Chk	Date	Drawn By	Scale	Sheet No.
1.				2010-07-30	IL	1:135	4 of 8
2.				Project No.		Length of Need	
3.				420020			
4.				Guardrail TxDOT			
5.							

T:\2009-2010\420020 TxDOT\4-5 Guardrail\SolidWorks\Drawings\420020 Drawings 2010-07-19_31in_new

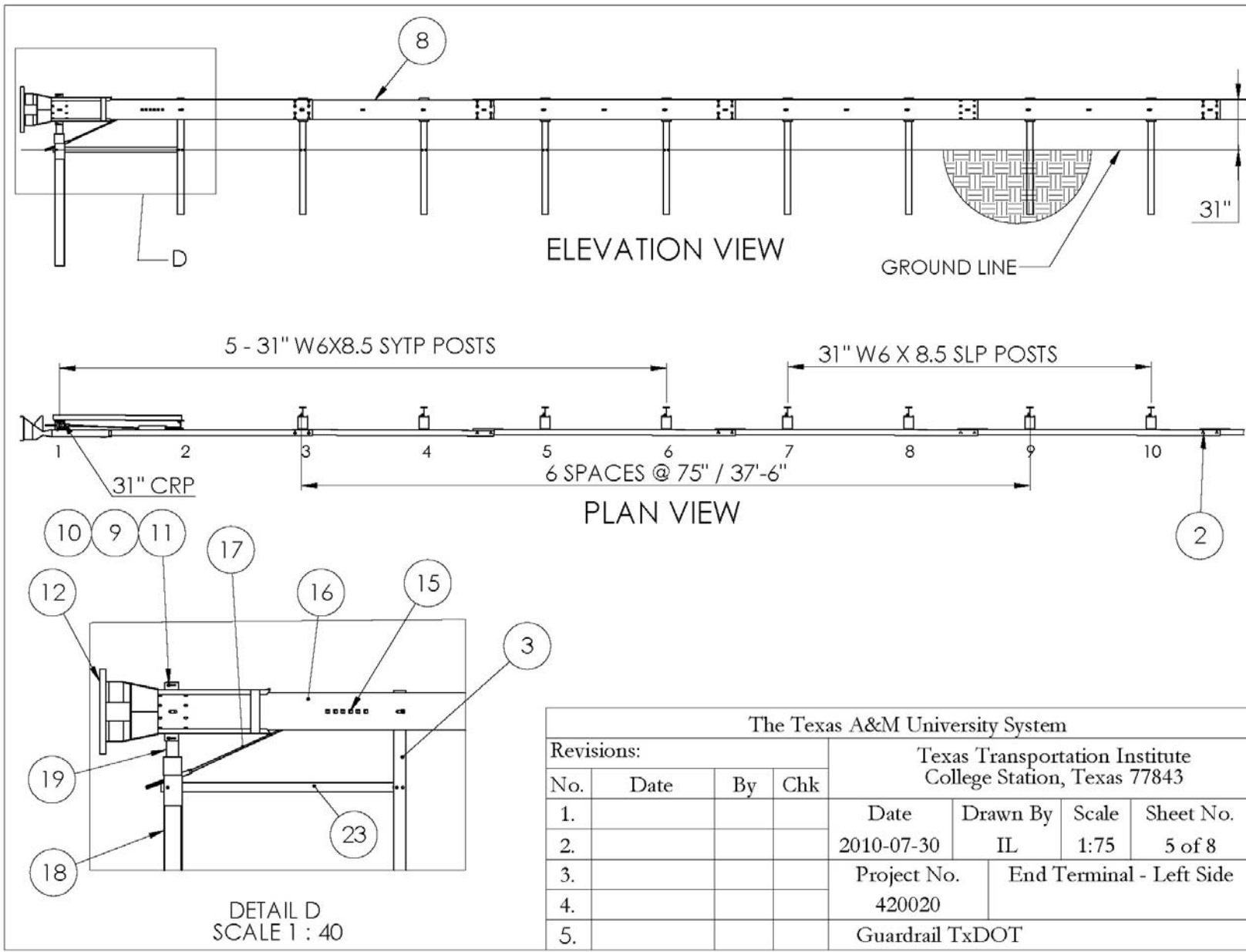

The Texas A&M University System							
Revisions:				Texas Transportation Institute College Station, Texas 77843			
No.	Date	By	Chk	Date	Drawn By	Scale	Sheet No.
1.				2010-07-30	IL	1:75	5 of 8
2.				Project No.		End Terminal - Left Side	
3.				420020			
4.				Guardrail TxDOT			
5.							

T:\2009-2010\420020 TxDOT\4-5 Guardrail\SolidWorks\Drawings\420020 Drawings 2010-07-19_31in_new

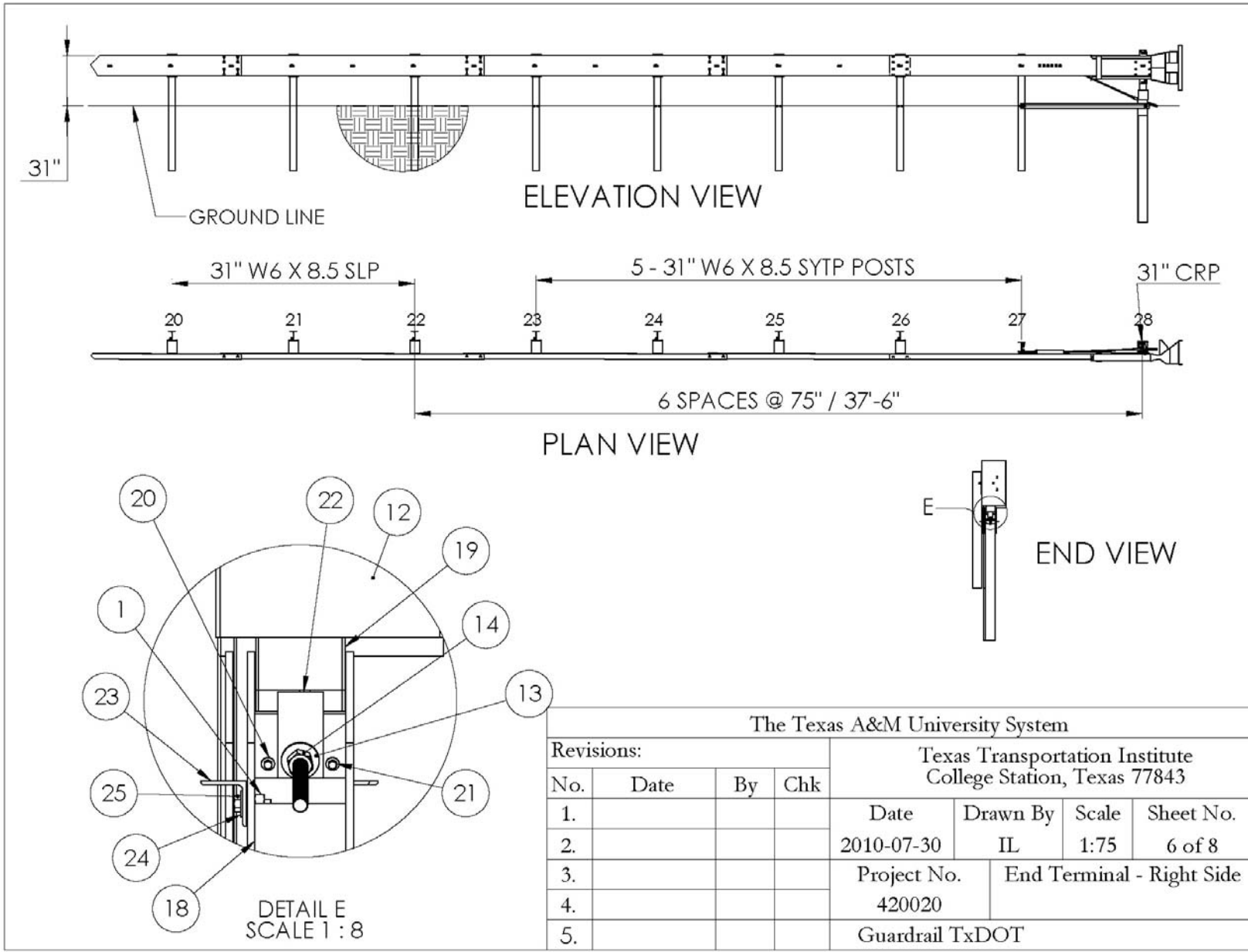

The Texas A&M University System							
Revisions:				Texas Transportation Institute College Station, Texas 77843			
No.	Date	By	Chk	Date	Drawn By	Scale	Sheet No.
1.				2010-07-30	IL	1:75	6 of 8
2.				Project No.		End Terminal - Right Side	
3.				420020			
4.				Guardrail TxDOT			
5.							

T:\2009-2010\420020 TxDOT\4-5 Guardrail\SolidWorks\Drawings\420020 Drawings 2010-07-19_31in_new

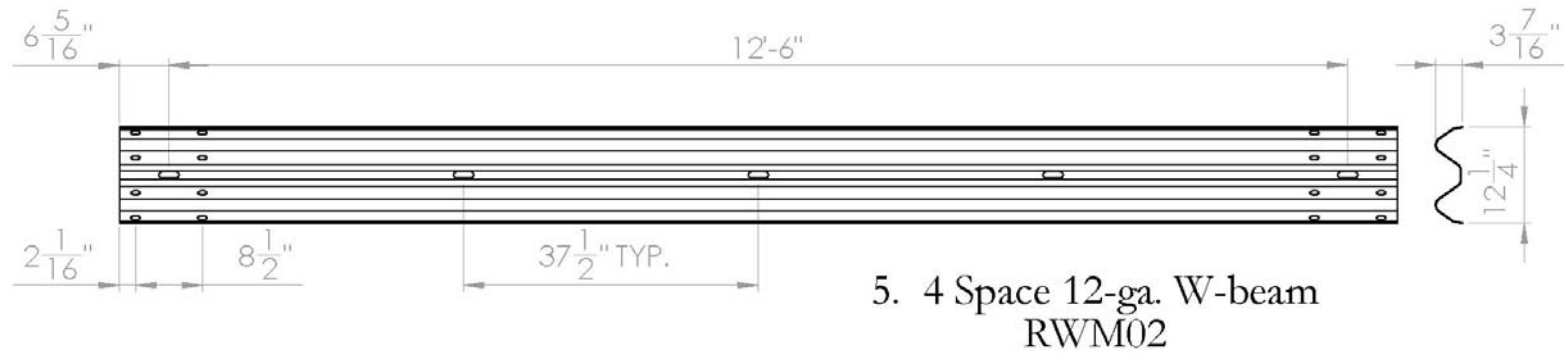

The Texas A&M University System							
Revisions:				Texas Transportation Institute College Station, Texas, 77843			
No.	Date	By	Chk	Date	Drawn By	Scale	Sheet No.
1.				2010-07-07	IL	1:20	7 of 8
2.				Project No.		Guardrail	
3.				420020			
4.				Guardrail TxDOT			
5.							

T:\2009-2010\420020 TxDOT\4-5 Guardrail\SolidWorks\Drawings\420020 Drawings 2010-07-19_31in_new

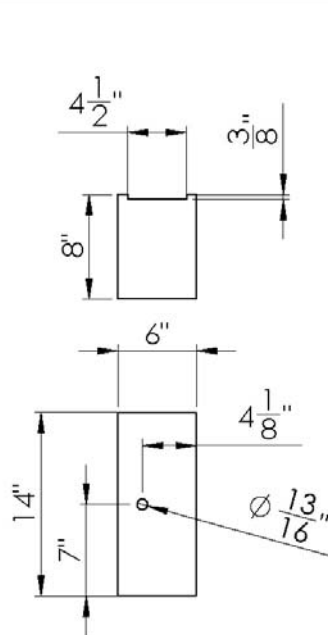
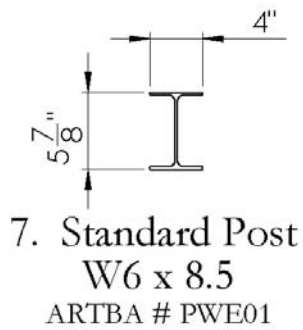
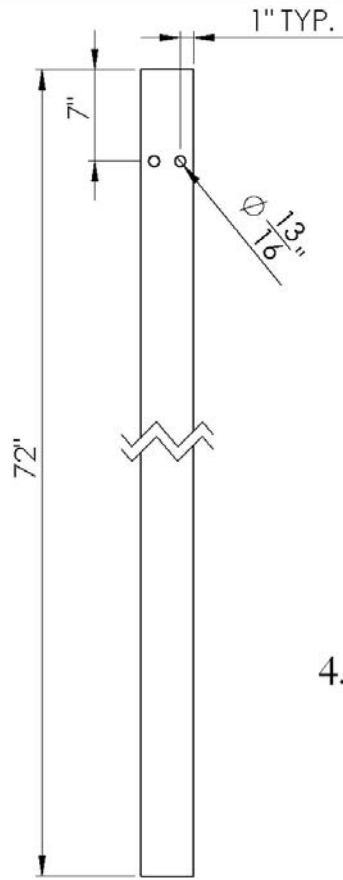

Bolts and Nut
Scale 1:2.5

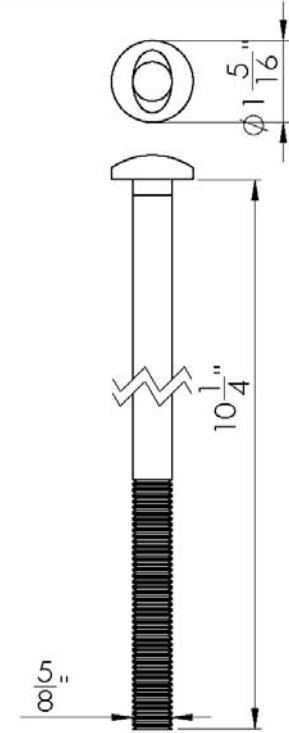
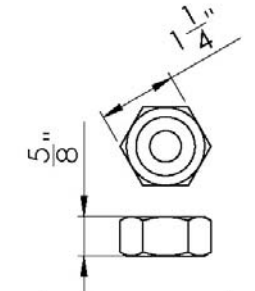
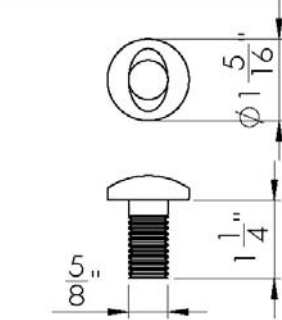

The Texas A&M University System							
Revisions:				Texas Transportation Institute College Station, Texas, 77843			
No.	Date	By	Chk	Date	Drawn By	Scale	Sheet No.
1.				2010-07-07	IL	1:12	8 of 8
2.				Project No.		Posts, etc.	
3.				420020			
4.				Guardrail TxDOT			
5.							

T:\2009-2010\420020 TxDOT\4-5 Guardrail\SolidWorks\Drawings\420020 Drawings 2010-07-19_31in_new

APPENDIX B. CERTIFICATION DOCUMENTATION

		MATERIAL USED		
TEST NUMBER	420020-5	Guardrail		
DATE	2010-08-26			
DATE RECEIVED	ITEM NUMBER	DESCRIPTION	SUPPLIER	HEAT #
2010-06-11	Parts-10	Guardrail parts	Trinity	see file
2010-06-28	Parts-11	Guardrail parts	Trinity	see file

This Memorandum

is an acknowledgement that a Bill of Lading has been issued and is not the original Bill of Lading, nor a copy or duplicate, covering the property named herein, and is intended solely for filing or record.

RECEIVED, subject to the classifications and tariffs in effect on the date of receipt by the carrier of the property described in the original Bill of Lading, at 6-10-10 20, 10 from TRINITY HIGHWAY PRODUCTS, LLC the property described below in apparent good order, except as noted (contents and condition of contents of packages unknown) packed, consigned and loaded as shown below which said company (the vessel company being understood throughout this contract as meaning the person or persons) is to be delivered to the consignee at the destination, if in its own interest, water line, highway, road or route, or within the territory of its regular operations, otherwise to deliver to another carrier on the route to said destination, it is mutually agreed, as to each carrier of all or any part of said property over all or any portion of said route to destination, and as to each party at any time interested in all or any of said property, that every service to be performed hereunder shall be subject to all the conditions not prohibited by law, whether printed or written, herein contained, including the conditions on back hereof, which are hereby agreed to by the consignor and accepted for transit and its consignee.

Carrier: TRINITY HIGHWAY PRODUCTS, LLC
 Shipper's No. 10-31300
 S/O No. 1072892

Consigned to: SAMPLES TESTING / CANNING MATERIALS Cust. PO. SS-1
 Destination: ATTN: GARY GEORGE TRINITY RIVERSIDE CAMPUS Load No.: 3,016.14
SAFETY & STRUCTURE DIV 1100 STATE HWY 47, BLDG 7090 Total Weight: 3,016.14
 City: SEFTON State: TX Zip: 77807 Ship: 6/10/10
 Contact: GARY GEORGE Phone: 339-323-4401 Arrive: 6/11/10 9:00 AM
 Delivering Carrier: Fedex Vehicle or Car Initial: NO

Subject to Section 7 of Conditions of applicable Bill of Lading, if this shipment is to be delivered to the consignee without recourse on the consignor, the consignor shall sign the following statement:
 The carrier shall not make delivery of this shipment without payment of freight and all other lawful charges.
TRINITY HIGHWAY PRODUCTS, LLC
 Per: _____
 (Signature of Consignor)

If charged by freight, write or stamp here, "To be Prepaid"

Received \$ _____ to apply in prepayment of the charges on the property described hereon.

Agent or Cashier
 Per: _____
 (The signature here acknowledges only the amount prepaid.)
 Charges advanced:

Collect On Delivery: C.O.D. charge Shipper
 \$ _____ and remit to: _____ to be paid by Consignee
 Street _____ City _____ State _____

No. Pkgs.	Piece Count	Description of Articles	Wt.	Class or Rate	Col.	No. Pkgs.	Piece Count	Description of Articles	Wt.	Class or Rate	Col.
Note: Delivery of all materials subject to Trinity Highway Products, LLC Storage Station Policy No. LG-001. Project Item: SAMPLES TESTING THIS ORDER FOR END TERMINALS ONLY											
4	110	121#X31 5S									
4	324	121#X31 5S									
40	5450	6# POSTION DOR									
4	794	CABLE ANCHOR BRET BT									
1	3900	5#X11.5" BEAR BUSHING									
4	3000	CRI 3/4X6#DBL SWG/10#									
394	3490	5/8" GR HEX NUT									
394	3490	5/8"X1.25" GR BOLT									
8	3000	1" ROUND WASHER F94									
6	3760	1" HEX NUT A563									
6	3690	7/16" WASHER F94									
6	3690	7/16"X1.5" HEX FOLT GRD 5									
6	3690	7/16" LOCK WASHER									
6	3690	7/16" HEX NUT A563 DR									
4	10670	1204 5-31.5S									
4	14570	68 7078 5#GYTP									
4	10000	40 STT PSYR 511" GR HT									
2	37050	SVT MAN STRT 3-RL 06									

2 - pallets
 1 - bundle

UNIONVILLE HWY STEEL
 NMFC ITEM 105460
 CLASS 50

10-31300

SPECIAL INSTRUCTIONS: **SHIPPER LOAD - CONSIGNEE UNLOAD** Total Weight **3**

*If the shipment moves between two ports by a carrier by water, the law requires that the bill of lading shall state whether it is "carrier's or shipper's weight".
 NOTE - Where the rate is dependent on value, shippers are required to state specifically in writing the agreed or declared value of the property.
 The agreed or declared value of the property is hereby specifically stated by the shipper to be not exceeding \$ _____

SHIPPER OR AGENT (SIGN HERE) I hereby authorize this shipment and make the declaration of values (if any) and agree to the contract terms and conditions hereof. DATE 6-10-10
 CONSIGNEE OR AGENT (SIGN HERE) Received the above described property in good condition except as noted on the back hereof and agree to the foregoing contract terms and conditions. DATE _____ TIME _____
 DRIVER (SIGN HERE) (The shipper) received subject to exceptions as noted and according to the terms and conditions hereof. DATE _____ DRIVER _____ NO

Permanent post-office address of shipper: TRINITY RIVERSIDE CAMPUS (This Bill of Lading is to be signed by the shipper and agent of the carrier issuing same.) CONSIGNEE/CUSTOMER COPY

Certified Analysis



Trinity Highway Products, LLC

2548 N.E. 23th St.

F: Worth, TX 76111

Customer: SAMPLES, TESTING, TRAINING MTRLS
2525 STEMMONS FRWY

DALLAS, TX 75207

Project: SAMPLES-TESTING THIS ORDER FOR END TERMINALS ONLY!

Order Number: 1072852

Customer PO:

BOL Number: 31302

Document #: 1

Skipped To: TX

Use State: TX

As of: 6/25/10

Qty	Part #	Description	Spec	CL	TY	Heat Code/ Heat #	Yield	TS	Elg	C	Mn	P	S	Si	Cu	Cb	Cr	Vn	ACW
14	11G	12/12*6/2*1.5/S	M-180	A	2	203281	51,200	73,500	30.0	0.200	0.770	0.008	0.003	0.020	0.120	0.00	0.050	0.003	4
			M-180	A	2	107781	52,600	74,900	28.0	0.193	0.750	0.011	0.007	0.020	0.150	0.000	0.060	0.003	4
			M-180	A	2	102782	51,900	73,900	29.0	0.203	0.810	0.009	0.002	0.010	0.140	0.000	0.050	0.003	4
			M-180	A	2	103049	50,300	73,600	28.0	0.200	0.780	0.010	0.003	0.020	0.130	0.000	0.060	0.002	4
			M-180	A	2	203282	50,000	73,500	30.0	0.190	0.760	0.008	0.003	0.030	0.120	0.000	0.050	0.003	4
4	32G	12/12*6/3/S ET2000 ANC	M-180	A	2	102476	58,100	77,900	26.0	0.190	0.750	0.009	0.001	0.020	0.130	0.00	0.060	0.002	4
			M-180	A	2	202939	56,800	78,400	25.0	0.190	0.770	0.009	0.004	0.020	0.130	0.000	0.050	0.003	4
40	545G	60 POST/DB:DDR	A-36			JK09103532	56,474	72,822	27.9	0.140	0.630	0.011	0.040	0.210	0.390	0.00	0.090	0.001	4
	545G		A-36			1034093	58,119	75,411	28.9	0.140	0.930	0.017	0.031	0.170	0.450	0.00	0.150	0.003	4
	545G		A-36			1034105	54,945	72,078	29.3	0.120	0.940	0.016	0.035	0.180	0.340	0.00	0.150	0.003	4
4	704A	CABLE ANCHOR BRKT	1018			45972C	0	0	0.0	0.170	0.700	0.011	0.020	0.160	0.250	0.00	0.009	0.000	4
5	782G	5/8"X8"X8" BEAR PL/OF	A-36			1005737	46,100	64,600	25.0	0.080	0.640	0.012	0.027	0.210	0.410	0.00	0.170	0.002	4
	782G		A-36			1002736	46,700	67,900	24.0	0.130	0.620	0.015	0.025	0.230	0.450	0.00	0.190	0.003	4
4	14578G	60 PST/8.5#/SYTP	A-36			1005535	55,226	72,178	25.8	0.100	0.930	0.007	0.033	0.170	0.320	0.00	0.110	0.002	4
4	15000G	60 SYT PST/8.5/31" GR HT	A-36			1004188	55,750	72,733	28.7	0.110	0.920	0.011	0.035	0.180	0.380	0.00	0.150	0.003	4
	15000G		A-36			1004104	54,637	72,751	27.0	0.110	0.920	0.020	0.034	0.180	0.350	0.00	0.170	0.004	4

43

Certified Analysis



Trinity Highway Products , LLC

2548 N.E. 28th St.

Ft Worth, TX 76111

Customer: SAMPLES,TESTING,TRAINING MTRLS

2525 STEMMONS FRWY

DALLAS, TX 75207

Project: SAMPLES-TESTING THIS ORDER FOR END TERMINALS ONLY!

Order Number: 1072852

Customer PO:

BOL Number: 31302

Document #: 1

Shipped To: TX

Use State: TX

As of: 6/25/10

TL -3 or TL-4 COMPLIANT when installed according to manufactures specifications

Upon delivery, all materials subject to Trinity Highway Products , LLC Storage Stain Policy No. LG-002.

ALL STEEL USED WAS MELTED AND MANUFACTURED IN USA AND COMPLIES WITH THE BUY AMERICA ACT.

ALL GUARDRAIL MEETS AASHTO M-180, ALL STRUCTURAL STEEL MEETS ASTM A36

ALL GALVANIZED MATERIAL CONFORMS WITH ASTM-123, UNLESS OTHERWISE STATED.

BOLTS COMPLY WITH ASTM A-307 SPECIFICATIONS AND ARE GALVANIZED IN ACCORDANCE WITH ASTM A-153, UNLESS OTHERWISE STATED.

NUTS COMPLY WITH ASTM A-563 SPECIFICATIONS AND ARE GALVANIZED IN ACCORDANCE WITH ASTM A-153, UNLESS OTHERWISE STATED.

3/4" DIA CABLE 6X19 ZINC COATED SWAGED END AISI C-1035 STEEL ANNEALED STUD 1" DIA ASTM 449 AASHTO M30, TYPE II BREAKING STRENGTH - 49100 LB

State of Texas, County of Tarrant. Sworn and subscribed before me this 25th day of June, 2010

Notary Public:
Commission Expires:

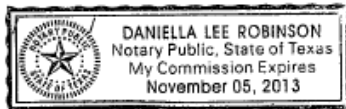

Certified By:

Trinity Highway Products, LLC

Quality Assurance

Certified Analysis



Trinity Highway Products , LLC

2548 N.E. 28th St.

Ft Worth, TX 76111

Customer: SAMPLES,TESTING,TRAINING MTRLS
2525 STEMMONS FRWY

DALLAS, TX 75207

Project: SAMPLES-TESTING THIS ORDER FOR END TERMINALS ONLY!

Order Number: 1072852

Customer PO:

BOL Number: 31302

Document #: 2

Shipped To: TX

Use State: TX

As of: 6/25/10

Qty	Part #	Description	Spec	CL	TY	Heat Code/ Heat #	Yield	TS	Elg	C	Mn	P	S	Si	Cu	Cb	Cr	Vn	ACW
4	10967G	12/9*4.5/3*1.5/S	M-180	A	2	100929	557,000	77,800	26.0	0.190	0.750	0.009	0.001	0.020	0.140	0.00	0.050	0.002	4
			M-180	A	2	100928	63,610	80,920	25.2	0.190	0.750	0.011	0.004	0.030	0.090	0.000	0.040	0.000	4
			M-180	A	2	101800	50,000	73,300	30.0	0.190	0.750	0.012	0.002	0.020	0.120	0.000	0.070	0.002	4
			A-500		2	202248	53,600	75,500	29.0	0.190	0.780	0.011	0.020	0.120	0.120	0.000	0.050	0.002	4
			M-180	A	2	202249	51,800	74,500	30.0	0.190	0.790	0.010	0.002	0.020	0.120	0.000	0.050	0.002	4
2	33795G	SYT-3"AN STRT 3-HL 6"	A-36			V906151	52,710	75,060	29.5	0.130	0.700	0.011	0.022	0.200	0.240	0.00	0.100	0.021	4

TL -3 or TL-4 COMPLIANT when installed according to manufactures specifications

Upon delivery, all materials subject to Trinity Highway Products , LLC Storage Stain Policy No. LG-002.

ALL STEEL USED WAS MELTED AND MANUFACTURED IN USA AND COMPLIES WITH THE BUY AMERICA ACT.

ALL GUARDRAIL MEETS AASHTO M-180, ALL STRUCTURAL STEEL MEETS ASTM A36

ALL GALVANIZED MATERIAL CONFORMS WITH ASTM-123, UNLESS OTHERWISE STATED.

BOLTS COMPLY WITH ASTM A-307 SPECIFICATIONS AND ARE GALVANIZED IN ACCORDANCE WITH ASTM A-153, UNLESS OTHERWISE STATED.

NUTS COMPLY WITH ASTM A-563 SPECIFICATIONS AND ARE GALVANIZED IN ACCORDANCE WITH ASTM A-153, UNLESS OTHERWISE STATED.

3/4" DIA CABLE 6X19 ZINC COATED SWAGED END AISI C-1035 STEEL ANNEALED STUD 1" DIA ASTM 449 AASHTO M30, TYPE II BREAKING STRENGTH - 49100 LB

State of Texas, County of Tarrant. Sworn and subscribed before me this 25th day of June, 2010

Notary Public:
Commission Expires:

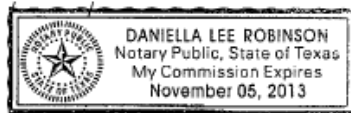

Trinity Highway Products, LLC

Certified By:

[Signature]
Quality Assurance

45

This Memorandum

is an acknowledgment that a Bill of Lading and is intended solely for filing or record.

and is not the original Bill of Lading, nor a copy or duplicate, covering the property named herein.

RECEIVED SUBJECT to the classifications and tariffs in effect on the date of receipt by the carrier or its agent on 11/23/10 at 20.

The property described below is apparent good order, except as noted, and conforms with conditions of carriage of packages unless otherwise provided in writing by person or corporation in possession of the property upon the contract of carriage, or when the contract of carriage is in writing, unless in writing in another contract on the route to said destination. It is delivered, and is to remain party of any loss sustained or all or any of said property, that may occur by fire, theft, pilferage, including the contents of such boxes, which are heavily sealed by the shipper, and subject to receipt and to the carrier.

Consigned to: ATTH GARY GERKE
Destination: SAFETY & STRUCT. SYST. DIV
 BRYAN TX 77807
 City: State: Zip:

Contact: GARY GERKE
 Phone: 979-945-6185

Delivering Carrier: FEDEX
Vehicle or Car: No.

Collect On Delivery: \$ _____
and remit to: _____
 Street City State

Carrier: 97-1
Load No.: 1,601.75
Total Weight: 62538
WT. BLDG 7099
62538 8:00:00AM
256238

Shipper's No.: 1072852
S/O No.:

Subject to Section 7 of Conditions of applicable Bill of Lading, if this shipment is to be delivered to the consignee without recourse on the consignor, the consignor shall sign the following statement:
 The carrier shall not make delivery of this shipment without payment of freight and all other lawful charges.

TRINITY HIGHWAY PRODUCTS, LLC
 Per _____
 (Signature of Consignor)

If charges are to be prepaid, write or stamp "Prepaid" in the Prepaid box.

Received \$ _____
 to apply in payment of the charges on the property described herein.

Agent or Cashier
 Per _____
 (The signature here acknowledges only the amount prepaid.)
 Charges advanced

No. Pkgs.	Piece Count	Description of Articles	WT.	Class or Rate	No. Pkgs.	Piece Count	Description of Articles	WT.	Class or Rate	Col.
		Project info: SAMPLES-TESTING THIS ORDER FOR END TERMINAL								
50	3000G	CSL 34X66/DBL SWG/NOH*								
50	3400G	5/8" GR HEX NUT								
50	5000G	5/8"X10" GR BOLT A307								
50	4076B	WD BLK RTD 6X6X14								

2-pallets

**GUARDRAIL HWY STEEL
 NMFC ITEM 105460
 CLASS 50**

SPECIAL INSTRUCTIONS:
SHIPPER LOAD - CONSIGNEE UNLOAD
 Total Weight **3**
 # **1,601**

*If the shipment moves between two ports by a carrier by water, the law requires that the bill of lading shall state whether it is "carrier's or shipper's weight."
 NOTE - Where the rate is dependent on value, shippers are required to state specifically in writing the agreed or declared value of the property.
 The agreed or declared value of the property is hereby specifically stated by the shipper to be not exceeding _____

SHIPPER OR AGENT: I hereby authorize this shipment and make the declaration of value (if any) and agree to the contract terms and conditions hereof. DATE: 6/23/10

CONSIGNEE OR AGENT: Received the above described property in good condition except as noted on the back hereof and agree to the foregoing contract terms and conditions. SIGN HERE: DATE: TIME: AM/PM

DRIVER: NO

(This Bill of Lading is to be signed by the shipper and agent of the carrier issuing same.)
CONSIGNEE/CUSTOMER COPY

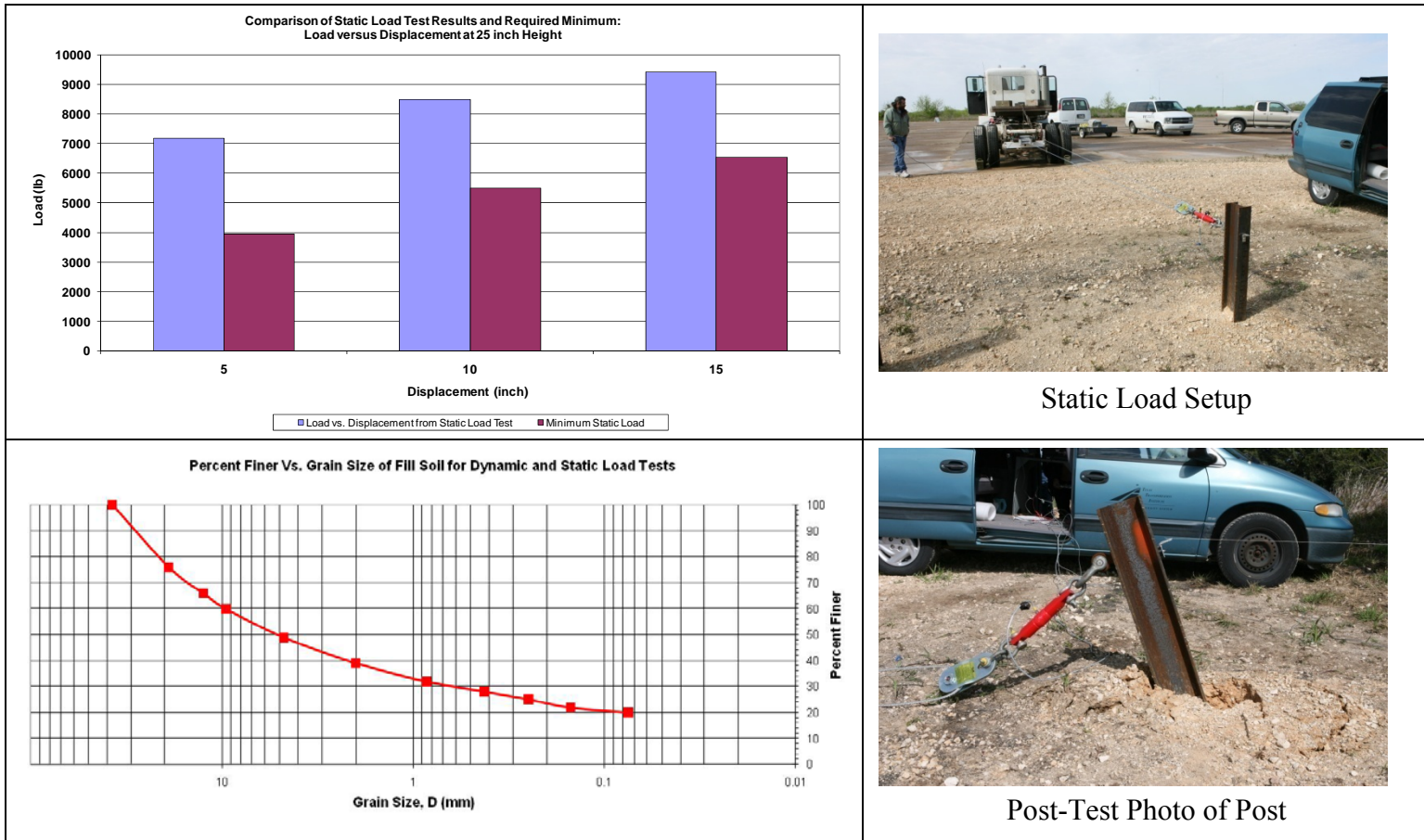

Date 2010-08-26

Test Facility and Site Location..... TTI Proving Ground – 3100 SH 47, Bryan, Tx

In Situ Soil Description (ASTM D2487) Sandy gravel with silty fines

Fill Material Description (ASTM D2487) and sieve analysis..... AASHTO Grade B Soil-Aggregate (see sieve analysis)

Description of Fill Placement Procedure 6-inch lifts tamped with a pneumatic compactor

Figure C1. Test Day Static Soil Strength Documentation.

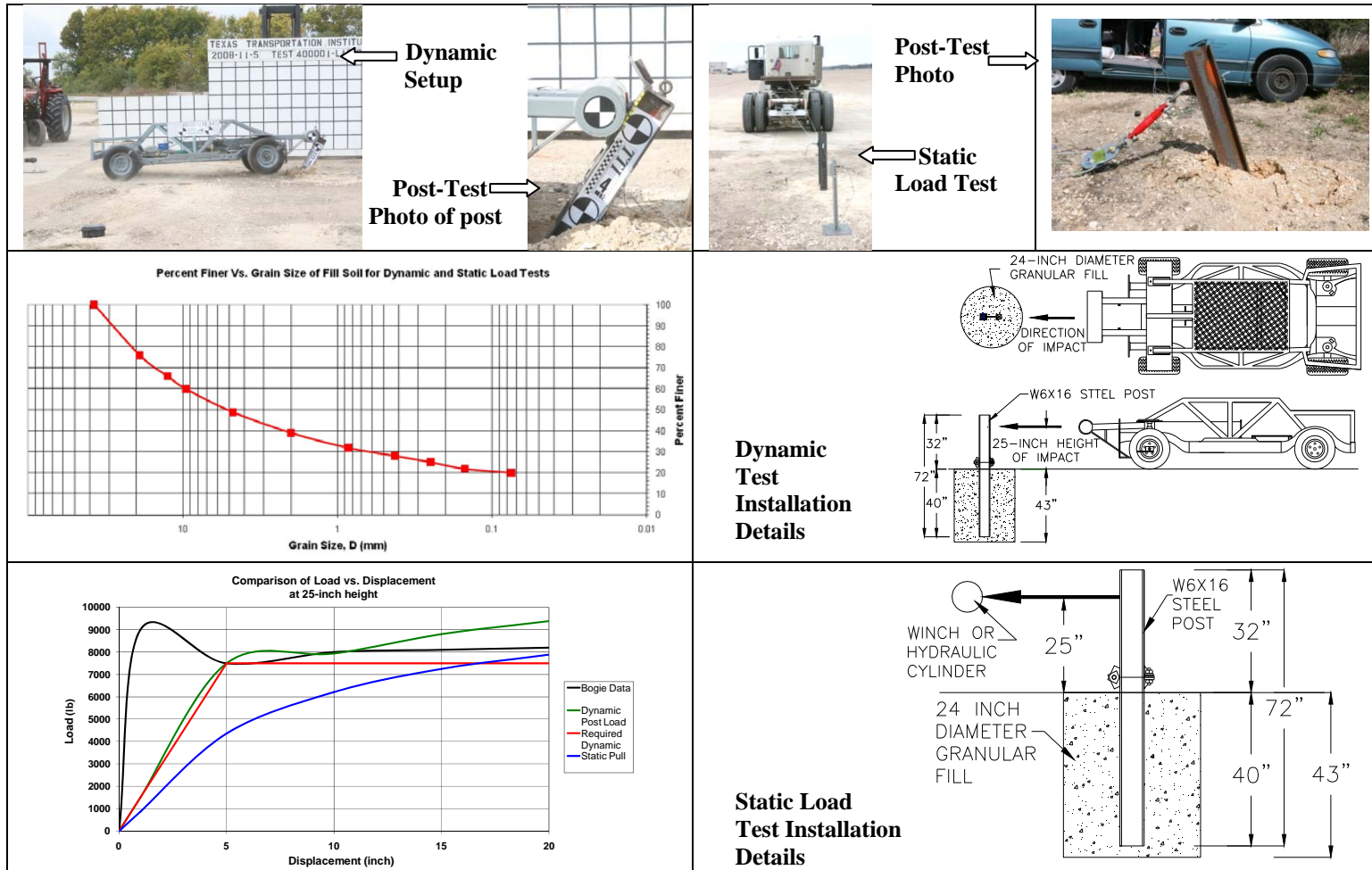

Date	2008-11-05
Test Facility and Site Location	TTI Proving Ground, 3100 SH 47, Bryan, TX 77807
In Situ Soil Description (ASTM D2487)	Sandy gravel with silty fines
Fill Material Description (ASTM D2487) and sieve analysis	AASHTO Grade B Soil-Aggregate (see sieve analysis above)
Description of Fill Placement Procedure	6-inch lifts tamped with a pneumatic compactor
Bogie Weight	5009 lb
Impact Velocity	20.5 mph

Figure C2. Summary of Strong Soil Test Results for Establishing Installation Procedure.

APPENDIX D. TEST VEHICLE PROPERTIES AND INFORMATION

Date: 2010-08-26 Test No.: 420020-5 VIN No.: KNADC125336223817

Year: 2003 Make: Kia Model: Rio

Tire Inflation Pressure: 32 psi Odometer: 134135 Tire Size: P175/65R14

Describe any damage to the vehicle prior to test: _____

• Denotes accelerometer location.

NOTES: _____

Engine Type: _____

Engine CID: _____

Transmission Type: _____

Auto or _____ Manual
 FWD _____ RWD _____ 4WD

Optional Equipment: _____

Dummy Data: _____

Type: 50th percentile male

Mass: 174 lb

Seat Position: Front Passenger

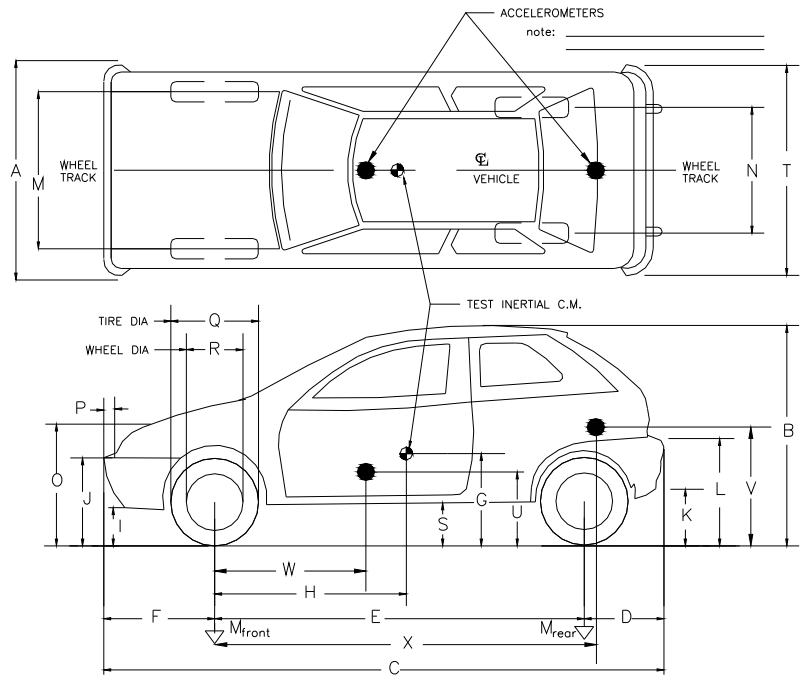

Geometry: inches

A	<u>62.50</u>	F	<u>32.00</u>	K	<u>12.00</u>	P	<u>3.25</u>	U	<u>15.50</u>
B	<u>56.12</u>	G	<u> </u>	L	<u>24.25</u>	Q	<u>22.50</u>	V	<u>20.00</u>
C	<u>164.25</u>	H	<u>34.42</u>	M	<u>56.50</u>	R	<u>15.50</u>	W	<u>39.00</u>
D	<u>37.00</u>	I	<u>8.50</u>	N	<u>57.00</u>	S	<u>8.62</u>	X	<u>103.25</u>
E	<u>75.25</u>	J	<u>22.75</u>	O	<u>28.00</u>	T	<u>63.00</u>		

Wheel Center Ht Front 10.75 Wheel Center Ht Rear 11.125

RANGE LIMIT: A = 65 ±3 inches; C = 168 ±8 inches; E = 98 ±5 inches; F = 35 ±4 inches; G = 39 ±4 inches;
 O = 24 ±4 inches; M+N/2 = 56 ±2 inches

GVWR Ratings:	Mass: lb	Curb	Test Inertial	Gross Static
Front <u>1804</u>	M_{front}	<u>1509</u>	<u>1555</u> Allowable	<u>1640</u> Allowable
Back <u>1742</u>	M_{rear}	<u>878</u>	<u>880</u> Range	<u>969</u> Range =
Total <u>3379</u>	M_{Total}	<u>2387</u>	<u>2435</u> 2420 ±55 lb	<u>2609</u> 2585 ±55 lb

Mass Distribution:

lb LF: 779 RF: 776 LR: 433 RR: 447

Figure D1. Vehicle Properties for Test No. 420020-5.

Table D2. Occupant Compartment Measurements for Test No. 420020-5.

Date: 2010-08-26 Test No.: 420020-5 VIN No.: KNADC125336223817
 Year: 2003 Make: Kia Model: Rio

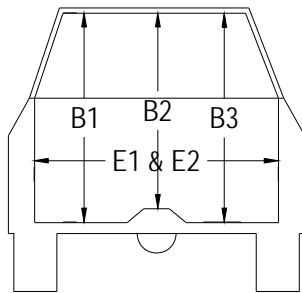
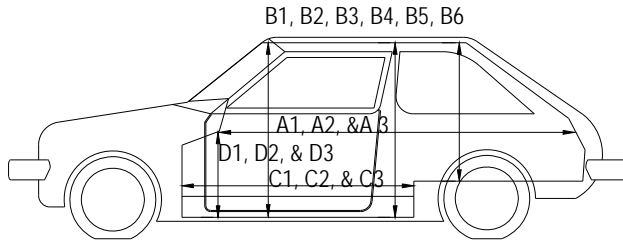
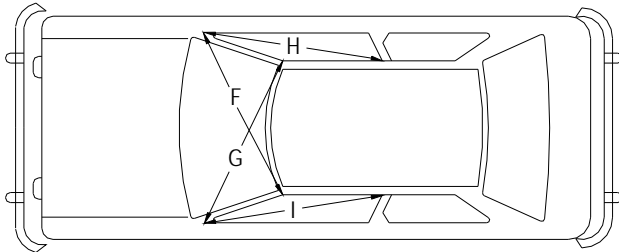

OCCUPANT COMPARTMENT DEFORMATION MEASUREMENT

	Before (inches)	After (inches)
A1	67.50	67.50
A2	35.50	35.50
A3	37.25	37.25
B1	39.75	39.75
B2	37.25	37.25
B3	39.12	39.12
B4	34.75	34.75
B5	35.00	35.00
B6	34.75	34.75
C1	26.75	26.75
C2	-----	-----
C3	26.50	26.50
D1	10.25	10.25
D2	-----	-----
D3	8.88	8.88
E1	48.50	48.50
E2	50.75	50.75
F	49.00	49.00
G	49.00	49.00
H	36.50	36.50
I	36.50	36.50
J*	50.25	50.25

*Lateral area across the cab from driver's side kickpanel to passenger's side kickpanel.

APPENDIX E. SEQUENTIAL PHOTOGRAPHS

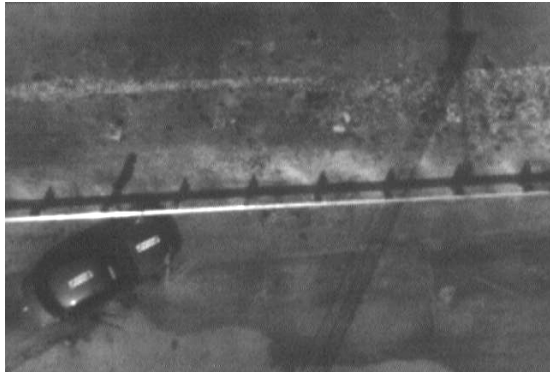

0.000 s



0.106 s



0.211 s



0.317 s



**Figure E1. Sequential Photographs for Test No. 420020-5
(Overhead and Frontal Views).**



0.420s



0.526 s

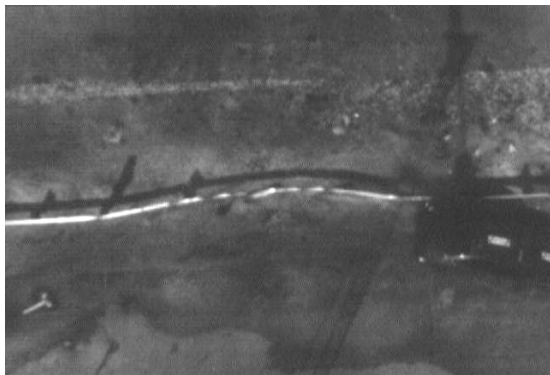

0.631 s



0.737 s



**Figure E1. Sequential Photographs for Test No. 420020-5
(Overhead and Frontal Views) (Continued).**



0.000 s



0.420 s



0.106 s



0.526 s



0.211 s



0.631 s



0.3174 s



0.737 s

Figure E2. Sequential Photographs for Test No. 420020-5 (Rear View).

Roll, Pitch, and Yaw Angles

57

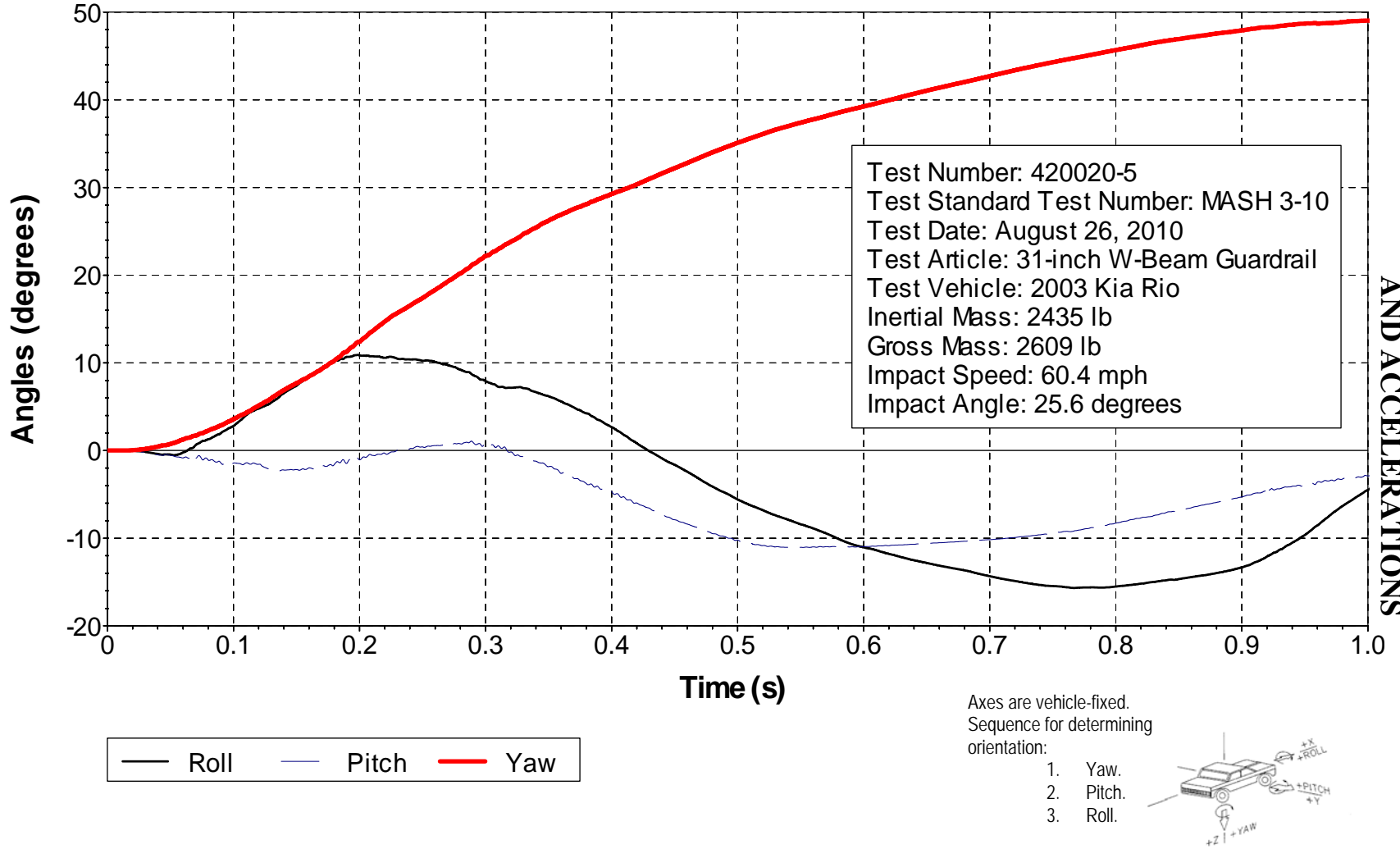
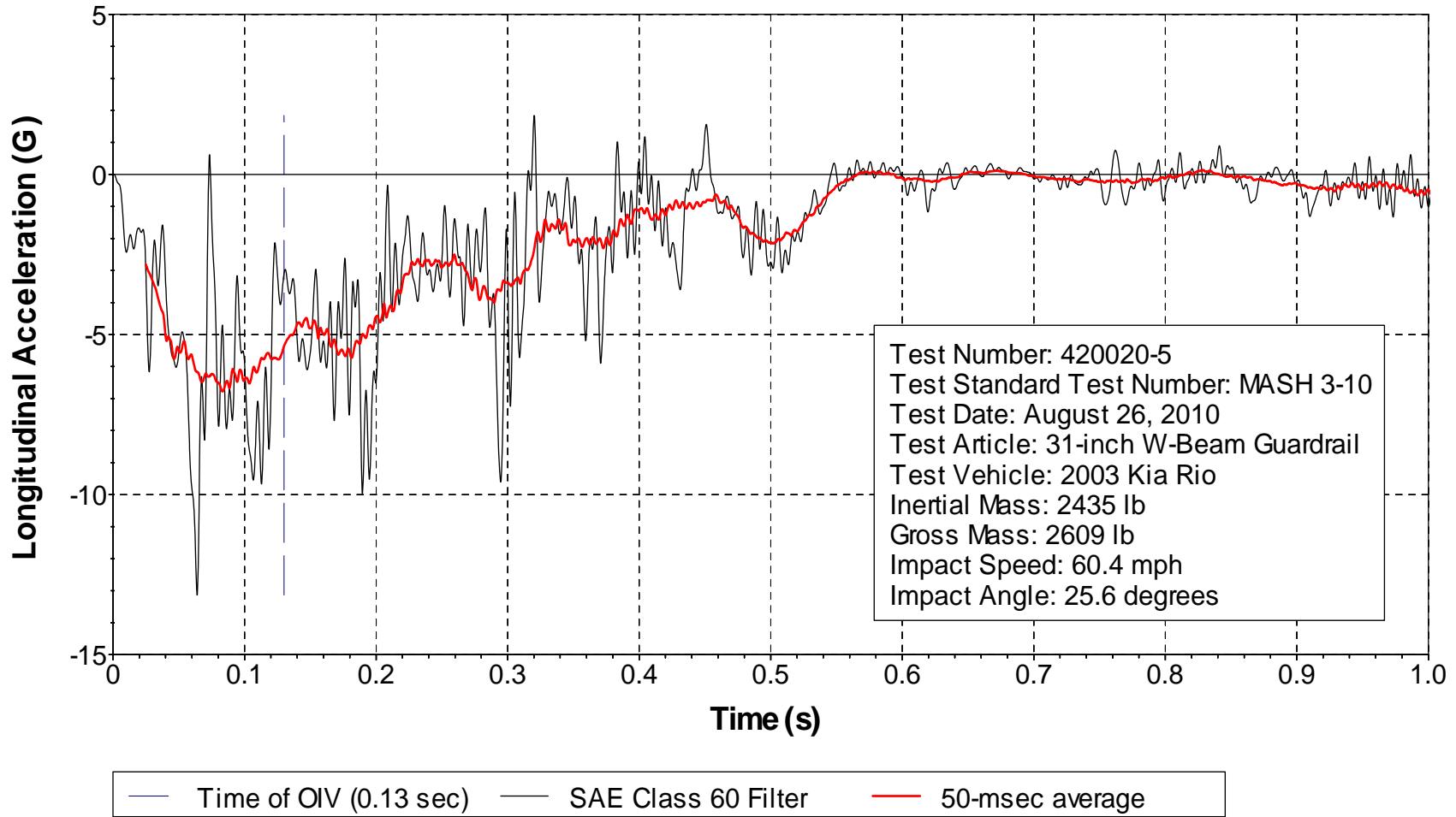

Figure F1. Vehicle Angular Displacements for Test No. 420020-5.

X Acceleration at CG



**Figure F2. Vehicle Longitudinal Accelerometer Trace for Test No. 420020-5
(Accelerometer Located at Center of Gravity).**

Y Acceleration at CG

59

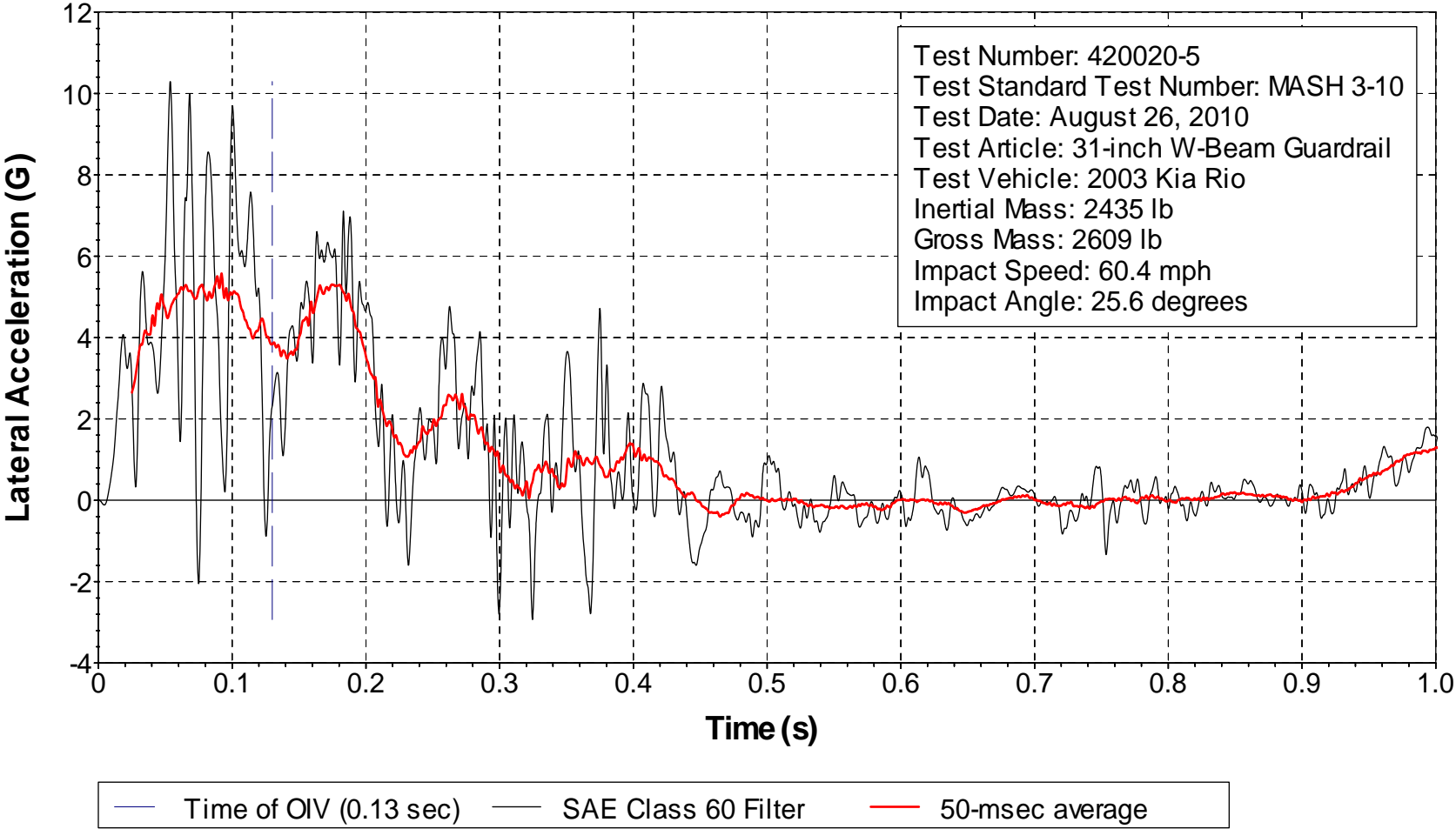
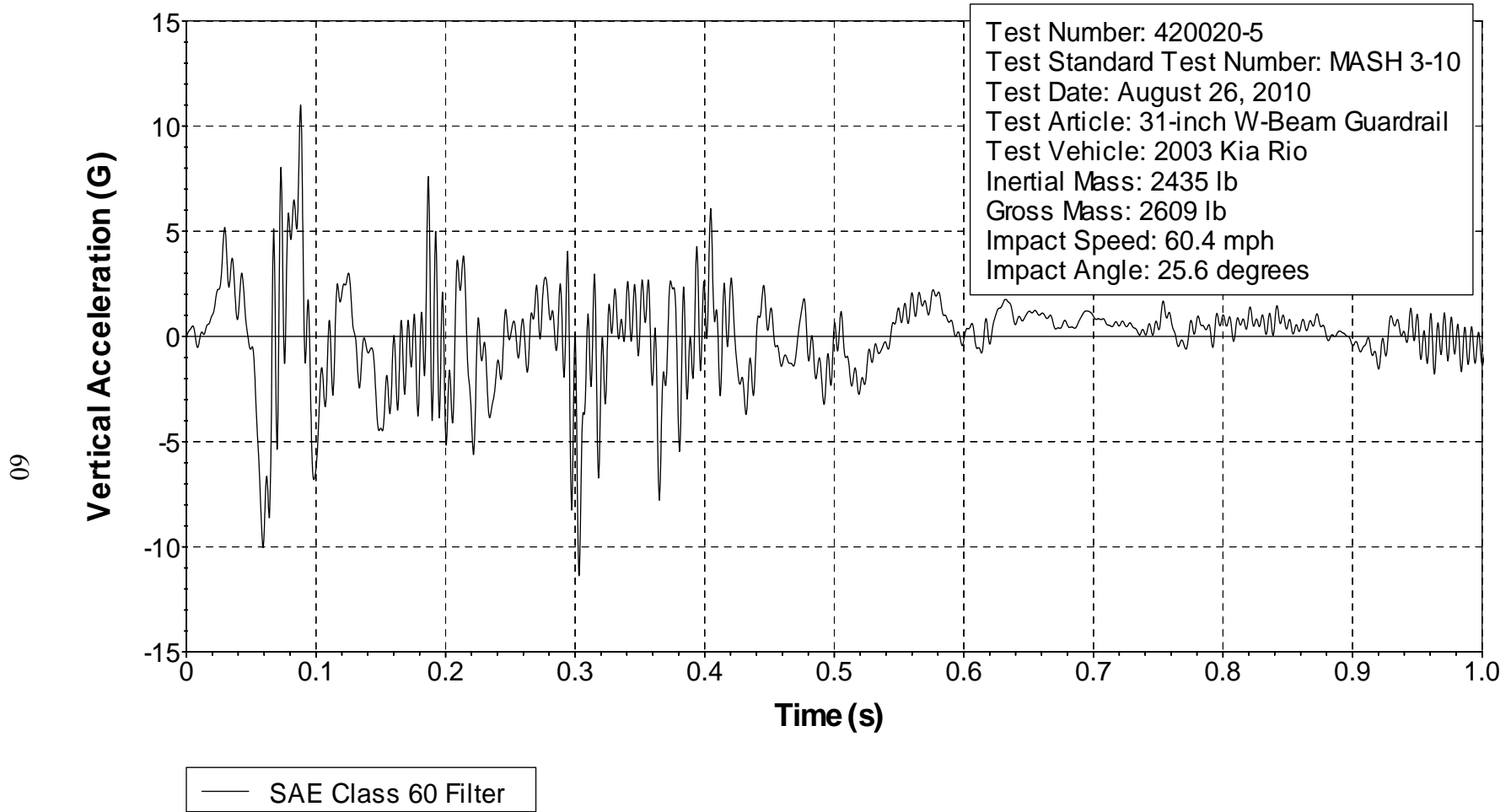

Figure F3. Vehicle Lateral Accelerometer Trace for Test No. 420020-5 (Accelerometer Located at Center of Gravity).

Z Acceleration at CG



**Figure F4. Vehicle Vertical Accelerometer Trace for Test No. 420020-5
(Accelerometer Located at Center of Gravity).**

X Acceleration over Rear Axle

69

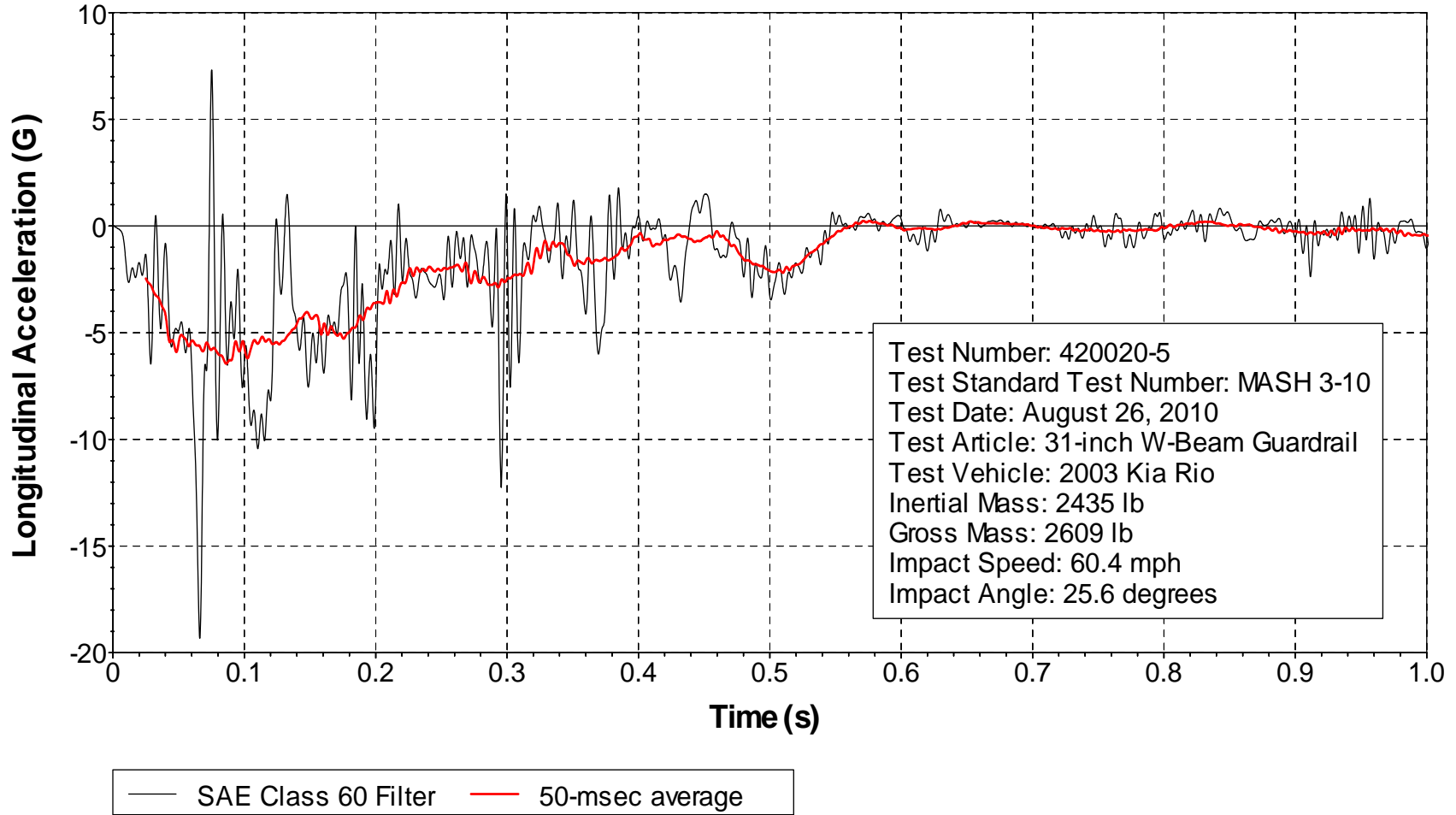
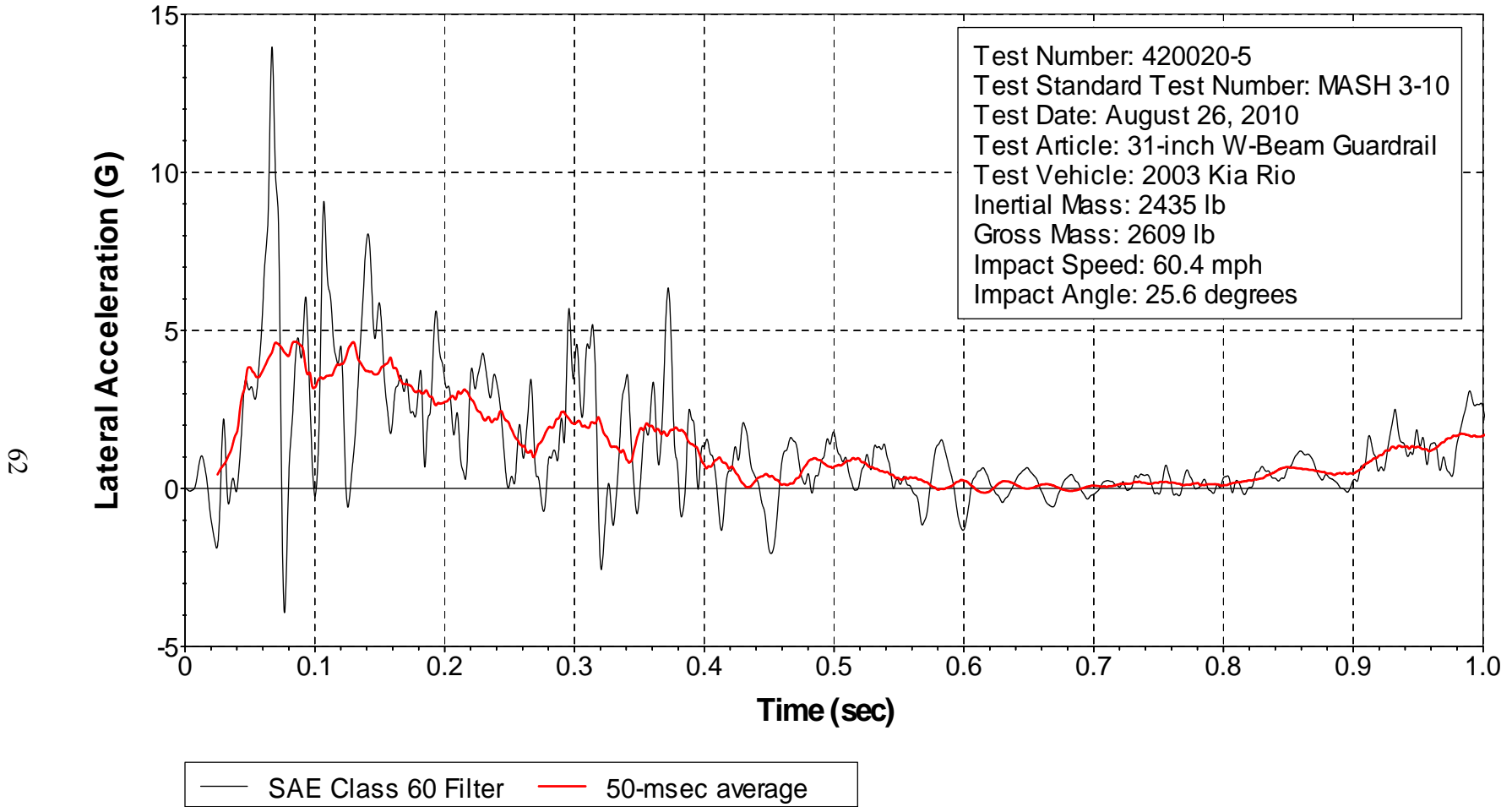

Figure F5. Vehicle Longitudinal Accelerometer Trace for Test No. 420020-5 (Accelerometer Located over Rear Axle).

Y Acceleration over Rear Axle



**Figure F6. Vehicle Lateral Accelerometer Trace for Test No. 420020-5
(Accelerometer Located over Rear Axle).**

Z Acceleration over Rear Axle

63

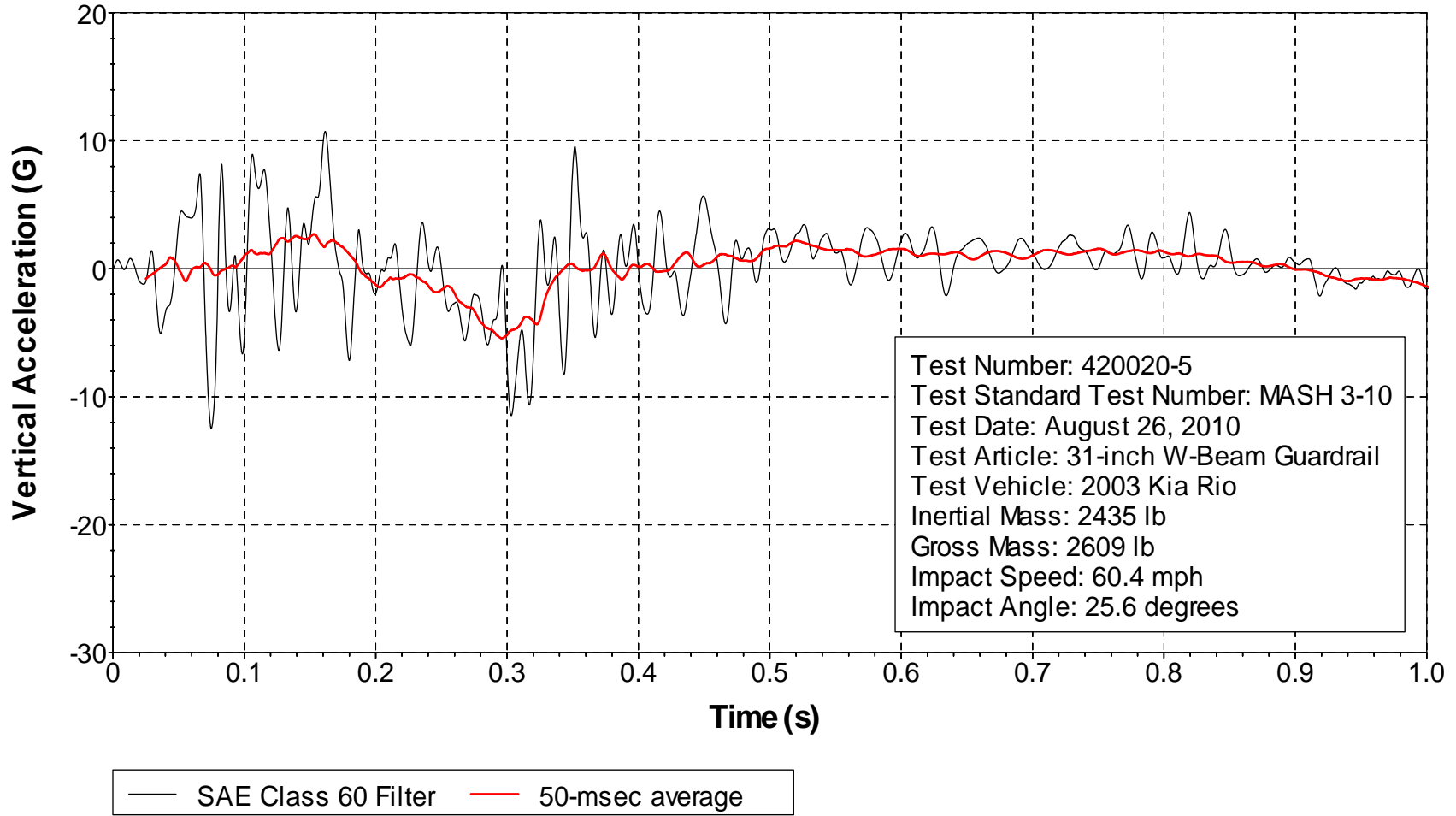

**Figure F7. Vehicle Vertical Accelerometer Trace for Test No. 420020-5
(Accelerometer Located over Rear Axle).**

