

Organizational Results Research Report

December 2010

OR11.009

Bridge Approach Slabs for Missouri DOT Looking at Alternative and Cost Efficient Approaches

Prepared by
University of Missouri-Kansas City,
University of Missouri-Columbia
and Missouri Department of
Transportation

FINAL Report

TRyy0915

**Bridge Approach Slabs for Missouri DOT
Looking at Alternative and Cost Efficient Approaches**

Prepared for
Missouri Department of Transportation
Organizational Results

by

PI: Ganesh Thiagarajan Ph.D., P.E., (ganesht@umkc.edu) 816-235-1288
Associate Professor, Civil Engineering,
University of Missouri Kansas City, Kansas City, MO-64110

Co-PI: V. Gopalaratnam Ph.D., P.E, (gopalaratnamv@missouri.edu)
573-882-2683
Professor, Civil Engineering
University of Missouri, Columbia, MO-65211

December 2010

The opinions, findings, and conclusions expressed in this publication are those of the principal investigators. They are not necessarily those of the Missouri Department of Transportation and the U.S. Department of Transportation, Federal Highway Administration. This report does not constitute a standard or regulation

TECHNICAL REPORT DOCUMENTATION PAGE

1. Report No. OR 11.009	2. Government Accession No.	3. Recipient's Catalog No.	
4. Title and Subtitle: Bridge Approach Slabs for Missouri DOT: Looking at Alternative and Cost Efficient Approaches		5. Report Date: December 2010	
		6. Performing Organization Code	
7. Author(s): Ganesh Thiagarajan (PI), V. Gopalaratnam (co-PI), Ceki Halmen, Sheetal Ajaonkar, Shuang Ma, Balu Gudimetla, Ravi Chamarthi		8. Performing Organization Report No.	
9. Performing Organization Name and Address University of Missouri Kansas City, Kansas City, MO-64110 University of Missouri, Columbia, MO-65211		10. Work Unit No.	
		11. Contract or Grant No. TRyy0915	
12. Sponsoring Agency Name and Address Missouri Department of Transportation Research, Development and Technology P. O. Box 270-Jefferson City, MO 65102		13. Type of Report and Period Covered Final Report	
		14. Sponsoring Agency Code	
15. Supplementary Notes The investigation was conducted in cooperation with the U. S. Department of Transportation, Federal Highway Administration.			
16. Abstract: The objective of this project is to develop innovative and cost effective structural solutions for the construction of both new and replacement deteriorated Bridge Approach Slabs (BAS). A cost study and email survey was performed to identify states whose BAS are lower in costs compared to Missouri and perform adequately. Finally, it was decided to recommend slabs with a span of 20 feet and 12 in thickness for new construction. An analytical beam on elastic foundation analysis based software has been developed and designs presented. A detailed three dimensional finite element analysis of BAS models was carried out in SAP to determine design moments. For slabs that need replacement, an innovative pretensioned precast slab with transverse ties is presented. The costs of both the new cast in place and precast slabs are around 25% cheaper than the current MoDOT slab and hence even the precast pretensioned solution could be tried out for new slab construction. A preliminary study on the usage of Controlled Low Strength Material soil (CLSM) as a replacement for the currently used practice of compacted soil and aggregate base is presented which could possibly be both cost effective and mitigate void issues under the slab is also presented. Life cycle cost analyses have been performed for the proposed solutions.			
17. Key Words: Bridge approach slab, integral abutment, cast in place slab design, precast prestressed slab design, cost optimization, finite element analysis, flowable fill		18. Distribution Statement: No restrictions. This document is available to the public through National Technical Information Center, Springfield, Virginia 22161	
19. Security Classification (of this report) Unclassified	20. Security Classification (of this page) Unclassified	21. No. of Pages 251	22. Price

Form DOT F 1700.7 (06/98)

EXECUTIVE SUMMARY

The main purpose of the project “Bridge Approach Slabs for Missouri Department of Transportation (MoDOT) - Looking at Alternative and Cost Efficient Approaches” was to explore the usage of alternate innovative structural solutions to reduce the cost of construction when a bridge approach slab (BAS) is needed. The primary objectives of the proposed project are to a) Investigate and recommend alternative design solutions with the aim to reduce the cost of construction of a bridge approach slab and b) Develop remedial measures or alternative designs for a replacement.

MoDOT currently uses two types of approach slabs namely, the Standard BAS, which is a twenty five feet span, twelve inch thick slab resting on the abutment at one end and connected to a sleeper slab with dowel rods at the pavement end and the Modified BAS which is similar in geometry to the Standard BAS but has approximately half the reinforcing steel and does not rest on a sleeper slab at the pavement end. Current costs of the Standard BAS have been calculated to be approximately \$55,500, which does not include the sleeper slab costs since sleeper slab designs vary with different DOTs. This project has developed three alternative design solutions all of which are over twenty percent less expensive than the current designs. The three solutions presented are a) 12 inch thick cast in place (CIP) slab of 20 feet span with a sleeper slab support b) 12 inch thick CIP slab of 25 feet span with no sleeper slab support and c) 10 inch thick precast, prestressed slabs with transverse ties and a span of 20 feet with sleeper slab for new construction and of 25 feet with sleeper slab for replacement slabs.

A detailed numerical analysis, both analytical and computer modeling, was performed to determine design moments considering loss of soil support (up to 50 percent) under the BAS and the worst loading conditions. AASHTO requires consideration of simultaneously acting lane and truck/tandem loads. However, due to the limited span length an alternative support method was used and only truck/tandem loads were evaluated as the worst loading condition. Results from the computer analysis indicate that a design moment value of 40 ft.kips/ft. of slab would be appropriate. This value compares favorably with design approaches used in a couple of other states. Numerical analysis indicates that with the exception of the 25 feet CIP slab without a sleeper slab, all developed design solutions have a moment capacity of 40 ft.kips/ft.

As part of alternative approaches and solutions for replacement BAS, precast pretensioned slab solutions have been studied. The solution proposed is a precast prestressed slab with transverse ties. Detailed cost analyses have been performed for the proposed solution. From the cost observations it is evident that these slabs could be cost effective in new construction as well. Hence, designs for both 20 feet span with sleeper slab (new construction) and 25 feet span with sleeper slab (old / replacement construction) have been proposed.

The use of Controlled Low Strength Materials (CLSM) to support the BAS as an alternative to compacted soils was also evaluated. A preliminary study indicated that CLSM mixtures suitable for this application can be designed using local MO materials. A methodology for life cycle cost analysis of alternative BAS designs was presented and applied to selected solutions developed in this report. All developed cost efficient design solutions are presented in a format similar to current MoDOT bridge specifications for easy implementation and in-situ testing in the future.

TABLE OF CONTENTS

LIST OF TABLES	IX
LIST OF FIGURES	XII
CHAPTER 1 INTRODUCTION	1
1.1 LITERATURE STUDY.....	2
1.2 BRIDGE APPROACH SLAB ISSUES.....	3
CHAPTER 2 TECHNICAL APPROACH.....	8
2.1 MODOT AND OTHER STATES DETAIL AND CLASSIFICATION.....	8
2.1.1 CURRENT MISSOURI DOT APPROACH SLAB DETAIL	8
2.1.2 APPROACH SLAB DETAILS FOR VARIOUS STATES	10
2.1.3 CLASSIFICATION OF BRIDGE APPROACH SLAB DETAILS	12
2.2 PERFORMANCE SURVEY STUDY OF BAS OF VARIOUS STATES	17
2.2.1 SURVEY INSTRUMENT AND RESPONSES.....	17
2.2.2 SURVEY ANALYSIS BASED ON STATES RESPONSES	17
2.2.3 SURVEY ANALYSIS BASED ON PERFORMANCE METRICS	20
2.2.4 SUMMARY AND CONCLUSION	21
2.3 SITE VISITS.....	21
2.3.1 SITE VISITS CONDUCTED.....	22
2.3.2 SUMMARY OF THE SITE VISITS	23
2.4 COST ANALYSIS FOR BRIDGE APPROACH SLABS	24
2.4.1 DEVELOPMENT OF EXCEL SHEET FOR MISSOURI COST PAY ITEMS ..	25
2.4.2 ANALYSIS OF STATES' BAS COSTS BASED ON MISSOURI COSTS	33
2.4.3 ANALYSIS OF RESULTS AND CONCLUSIONS.....	33

2.5	COST OPTIMAL STRUCTURAL DESIGN.....	37
2.5.1	BACKGROUND OF DESIGN.....	37
2.5.2	AASHTO SPECIFICATION (ASD, LFD, LRFD)	37
2.5.3	DESIGN PROCEDURE (LRFD)	38
2.5.4	INCLUSION OF COST INFORMATION IN DESIGN SELECTION	45
2.5.5	ANALYSIS RESULTS AND CONCLUSIONS.....	49
2.6	APPROACH SLAB NUMERICAL MODELING.....	51
2.6.1	MODEL MATRIX.....	52
2.6.2	MODEL DETAILS.....	54
2.6.3	LOAD CASES AND LOAD COMBINATIONS.....	61
2.6.4	ANALYSIS OF RESULTS	61
2.6.5	CONCLUSION.....	69
2.7	NEW CAST IN PLACE BAS DESIGN RECOMMENDATIONS	70
2.7.1	NEW CAST IN PLACE APPROACH SLABS	70
2.7.2	DESIGN BASED JUSTIFICATION.....	75
2.7.3	EXPECTED COSTS OF PROPOSED BAS	76
2.7.4	CONCLUSIONS.....	77
CHAPTER 3	BAS ANALYSIS AND DESIGN INCORPORATING ELASTIC SOIL SUPPORT.....	78
3.1	INTRODUCTION	78
3.2	THEORETICAL BASIS AND ANALYTICAL DEVELOPMENT.....	79
3.2.1	GOVERNING DIFFERENTIAL EQUATION AND HOMOGENEOUS SOLUTION FOR A SLAB ON ELASTIC SUPPORT.....	79

3.2.2	SLAB OF INFINITE LENGTH SUBJECTED TO CONCENTRATED FORCE	80
3.2.3	SLAB OF INFINITE LENGTH SUBJECTED TO CONCENTRATED MOMENT.....	81
3.2.4	CUSTOM SOLUTIONS TO PRESCRIBED LOAD CONFIGURATIONS.....	81
3.3	OBSERVATIONS ON THE BAS DESIGN INCORPORATING ELASTIC SOIL SUPPORT.....	83
3.4	INVESTIGATION OF WASH-OUT OF SOIL SUPPORT.....	87
3.4.1	PARTIAL SOIL SUPPORT AND RELATED WASHOUT PARAMETERS.....	87
3.4.2	FINITE DIFFERENCE MODEL OF BAS-ES WITH PARTIAL WASHOUT ...	88
3.4.3	PARAMETRIC STUDY OF WASHOUT LENGTH AND LOCATION	90
3.4.4	WASHOUT AND SOIL STIFFNESS.....	93
3.5	DESIGN EXAMPLE OF BAS-ES	94
3.5.1	SUMMARY REINFORCEMENT DETAIL FOR THE DESIGN EXAMPLE..	100
3.6	END ZONE AND OTHER REINFORCEMENT DETAILS	100
3.7	INITIAL CONSTRUCTION COST OF BAS-ES AND COMPARISON WITH STANDARD MODOT BAS	101
3.8	SUMMARY CONCLUSIONS.....	102
CHAPTER 4	PRECAST PRESTRESSED APPROACH SLAB.....	103
4.1	INTRODUCTION	103
4.2	PROPOSED PRECAST PRESTRESSED CONCEPT	104
4.3	ANALYSIS AND DESIGN	110
4.4	CONCLUSIONS.....	123

CHAPTER 5	CONTROLLED LOW STRENGTH MATERIALS (CLSM) ALTERNATIVE	124
5.1	BACKGROUND	124
5.2	CLSM STUDY	126
5.3	CONSTRUCTABILITY AND COST CONSIDERATIONS	128
CHAPTER 6	LIFE CYCLE COST ANALYSIS OF BAS DESIGN ALTERNATIVES	131
6.1	INTRODUCTION TO LIFE CYCLE COST ANALYSIS	131
6.2	REALCOST SOFTWARE	134
6.3	PROJECT DETAILS AND INPUT PARAMETERS	135
6.3.1	STANDARD MODOT BAS	135
6.3.2	BAS-20' SPAN DESIGN	135
6.3.3	PRECAST PRESTRESSED BAS	136
6.3.4	BAS - ELASTIC SOIL SUPPORT.....	136
6.3.5	REHABILITATION METHODS.....	136
6.3.6	PROJECT INPUTS.....	138
6.4	RESULTS AND DISCUSSIONS.....	143
6.4.1	CUMULATIVE DISTRIBUTION	143
6.4.2	MEAN DISTRIBUTIONS OF AGENCY AND USER COSTS	145
6.4.3	REHABILITATION ACTIVITIES	150
6.4.4	DETERMINISTIC VERSUS PROBABILISTIC RESULTS	155
6.4.5	DISCOUNT RATE.....	155
6.4.6	RURAL AND URBAN TRAFFIC PATTERNS.....	155
6.5	SUMMARY CONCLUSIONS.....	157
CHAPTER 7	CONCLUSIONS.....	159

CHAPTER 8 RECOMMENDATIONS	161
CHAPTER 9 IMPLEMENTATION PLAN	162
BIBLIOGRAPHY	163
APPENDIX A-1 STATES' BAS DETAILS	166
APPENDIX A-2 SURVEY RESPONSES	188
APPENDIX A-3 SITE VISIT PICTURES	195
APPENDIX A-4 PAY ITEM SUMMARY FROM MODOT	199
APPENDIX A-5 COST OF MODOT ROADWAY.....	204
APPENDIX A-6 PRECAST PRESTRESSED DESIGN DETAILS FROM COMPUTER ANALYSIS.....	206
APPENDIX A-7 DRAWINGS FOR NEW CAST IN PLACE CONSTRUCTION	213
APPENDIX A-8 DESIGN DRAWING FOR PRECAST PRESTRESSED SOLUTION	226

LIST OF TABLES

Table	Page
Table 1-1 Cost comparison of CIP and PCPS Slabs.....	3
Table 1-2 MoDOT's needs & grand challenges of AASHTO addressed.....	7
Table 2-1 Approach slab with integral abutment.....	11
Table 2-2 Approach slab with non-integral abutment	12
Table 2-3 Checklist for site observations.....	22
Table 2-4 States cost based on Missouri pay item report provided by MoDOT-1	31
Table 2-5 States Cost based on Missouri pay item report provided by MoDOT-2	32
Table 2-6 List of states with costs lower than MoDOT.....	36
Table 2-7 List of states with costs lower than MoDOT slabs and key problems faced.....	36
Table 2-8 Moment table for various load locations	41
Table 2-9 Design of Bridge Approach slab by ASD approach.....	46
Table 2-10 Design of Bridge Approach Slab by LFD approach	47
Table 2-11 Design of Bridge Approach Slab by LRFD approach.....	48
Table 2-12 Comparison for moments	51
Table 2-13 Model Matrix.....	54
Table 2-14 Reinforcement input for models.....	56
Table 2-15 Analysis results for BAS models (width =38')	62
Table 2-16 Comparison of results considering lane load and without lane load.....	66

Table 2-17 Revised moments, deflections and slopes for 50% washout.....	71
Table 2-18 Options recommended for new CIP BAS	74
Table 2-19 Reinforcement for new CIP BAS.....	76
Table 2-20 Expected costs of the proposed 20 feet slab.....	76
Table 3-1 Comparison of maximum design moment and corresponding area of flexural steel required for a 12" deep slab for various soil support conditions	86
Table 3-2 Comparison of maximum factored design moment and corresponding area of flexural steel required for 12" and 10" deep reinforced concrete slab for various soil support conditions	87
Table 3-3 Details of reinforcement based on incorporating elastic soil support	100
Table 3-4 Reinforcement details in the current and proposed BAS designs	101
Table 3-5 Comparison of initial construction in the current and proposed BAS designs.....	102
Table 4-1 Details of the matrix used for modeling PCPS approach slabs	111
Table 4-2 Moments for 20 feet and 25 feet span for the proposed PCPS BAS design	119
Table 4-3 Details of the costs of PCPS construction	123
Table 5-1 Chemical and physical analysis of fly ash.....	126
Table 5-2 Mixture proportions.....	127
Table 6-1 Parameters to be entered in the Analysis Options window	138
Table 6-2 Parameters to be entered in the Traffic Data window	140
Table 6-3 Value of time in \$/vehicle-hour for the 1990 base year and the year 2009.....	141
Table 6-4 Present values of agency costs for the four BAS alternatives	147
Table 6-5 Present values of user costs for the three BAS alternatives for urban and rural traffic	148

Table 6-6 Initial and rehabilitation costs, service life and work zone durations assumed.....	151
Table 6-7 Work zone user costs during initial construction and rehabilitation activities for urban and rural traffic demands.....	151
Table 6-8 Various initial construction and rehabilitation options investigated in the study	153
Table 6-9 Deterministic and probabilistic results of the three BAS design alternatives	154
Table 6-10 Life cycle agency, user and total costs for urban and rural traffic based on discount rates 4%, 7% and 10% for typical BAS alternatives and assumed rehabilitation strategies	158
Table 6-11 Comparison of probabilistic results of typical Rural and Urban scenarios	158

LIST OF FIGURES

Figure	Page
Figure 1-1: Bridge approach slab settlement[2].....	1
Figure 2-1: Missouri BAS Type 1	9
Figure 2-2: Missouri BAS Type 2	9
Figure 2-3: Missouri BAS Type 3	10
Figure 2-4: Singly reinforced moment capacity for Missouri BAS.....	13
Figure 2-5: States data sorted by span of BAS	14
Figure 2-6: States data sorted by depth of BAS.....	15
Figure 2-7: States data sorted by design moment capacity of BAS.....	16
Figure 2-8: Cost estimation for base preparation of BAS.....	26
Figure 2-9: Cost estimation for formwork of BAS.....	27
Figure 2-10: Cost estimation for reinforcement of BAS	28
Figure 2-11: Cost estimation for concrete pour	29
Figure 2-12: Total cost for BAS	30
Figure 2-13: States cost based on Missouri pay item report provided by MoDOT	34
Figure 2-14: States cost based on Missouri pay item report provided by MoDOT	35
Figure 2-15: Characteristics of design truck (AASHTO).....	39
Figure 2-16: Critical tandem load location for 25 feet span of slab	40

Figure 2-17: Design of bridge approach alab page 1	43
Figure 2-18: Design of bridge approach alab page 2.....	44
Figure 2-19: Comparison for reinforcement required for ASD, LFD and LRFD design procedures for span of 25'	49
Figure 2-20: Comparison for reinforcement required for ASD, LFD and LRFD design procedures for span of 20'	50
Figure 2-21: Cost comparison for BAS with different span.....	50
Figure 2-22: Schematic view of current MoDOT bridge approach slab arrangement	52
Figure 2-23: Typical finite element model for bridge approach slab	55
Figure 2-24: Shell element used in finite element model	55
Figure 2-25: Shell area element layer definition.....	56
Figure 2-26: AASHTO standard design truck	57
Figure 2-27: Load locations for maximum bending moment	58
Figure 2-28: Schematic view for vehicle locations.....	59
Figure 2-29: Tandem load for BAS model	59
Figure 2-30: Truck load for BAS model.....	60
Figure 2-31: Lane load BAS model	60
Figure 2-32: Moment pattern for standard MOBAS model case 1.....	63
Figure 2-33: Moment pattern for standard MOBAS model case 4.....	63
Figure 2-34: Moment pattern for Standard MOBAS model case 5	64
Figure 2-35: Moment pattern for CIP option model case 1	64
Figure 2-36: Moment pattern for CIP option model case 4	65
Figure 2-37: Moment pattern for CIP option model case 5	65

Figure 2-38: Design moment with and without lane loads	67
Figure 2-39: Deflection with and without lane loads.....	68
Figure 2-40: Slope with and without lane loads	69
Figure 2-41: Option 1-CIP BAS for new approaches.....	74
Figure 2-42: Option 2-CIP BAS for new approaches.....	75
Figure 3-1: Equilibrium of an infinitesimal element from a slab on elastic support	79
Figure 3-2: Slab of infinite length on continuous support subjected to concentrated force	80
Figure 3-3: Slab of infinite length on continuous elastic support subjected to moment.....	81
Figure 3-4: Simply supported slab of finite length on elastic support subjected to uniform load	82
Figure 3-5: Simply supported of finite length on elastic support subjected to two symmetric forces	83
Figure 3-6: User friendly front-end of BAS-ES Excel based software	85
Figure 3-7: Plot highlighting influence of soil support on design moment. Even considering a loose sand with $k=20$ psi/in it is possible to reduce the design moment required by 75% (see also Table 3.1)	86
Figure 3-8: Simply-supported slab subjected to uniformly distributed load, 1, showing soil washout (unshaded region of length L) and partial soil support (shaded regions) ..	88
Figure 3-9: Finite length elements with distributed load, q, and soil pressure, k_y , on the nodes.	89
Figure 3-10: Maximum moment versus washout location for various washout lengths	91
Figure 3-11: Moment diagrams of different location of 5 ft length soil washout.....	92
Figure 3-12: Maximum shear force versus washout location for various washout lengths.....	93
Figure 3-13: Moment reduction factor versus washout length for various soil moduli.....	94
Figure 3-14: One-ft-width strip of the BAS considered for the one way flexural action	94

Figure 3-15: End zone details of the BAS-ES design.....	101
Figure 4-1: Conceptual representation of the proposed PCPS Bridge Approach Slab.....	105
Figure 4-2: Abutment bearing detail.....	107
Figure 4-3: Tie rod detail shown (part plan view)	108
Figure 4-4 Keyway detail for water tight joint between panels.....	109
Figure 4-5: Simply supported slab showing loads, the end rotation and deflection	112
Figure 4-6: Moment values (ft.kips./ft.) for different cases.....	113
Figure 4-7: Deflection values (in) for different cases.....	113
Figure 4-8: Simply supported condition with lane loads-25 feet model.....	115
Figure 4-9: Simply supported condition without lane loads-25 feet model.....	115
Figure 4-10: Voids under slab with lane loads-25 feet model	116
Figure 4-11: Voids under slab without lane loads-25 feet model.....	116
Figure 4-12: Simply supported condition with lane loads-20 feet model.....	117
Figure 4-13: Simply supported condition without lane loads-20 feet model.....	117
Figure 4-14: Voids under slab with lane loads-20 feet model	118
Figure 4-15: Voids under slab without lane loads-20 feet model.....	118
Figure 4-16: Precast prestressed plan reinforcement detail	121
Figure 4-17: Cross section details of the 10 inch slab	122
Figure 5-1: Placement of CLSM behind bridge abutment [33]	125
Figure 5-2: Measurement of CLSM flow	127
Figure 5-3: Elastic modulus test data.....	128
Figure 5-4: Colorado DOT specification to backfill bridge abutments with flowable fill	129
Figure 6-1: Flow chart of a typical life cycle cost analysis for various BAS/Rehab options.	133

Figure 6-2: Real Cost software showing the user-friendly switchboard that facilitates data input.
..... 135

Figure 6-3: Hourly traffic demand history used for a typical urban (Montgomery County, I-70) and rural (Benton County, Rte. 7) used in the research are compared with default histories from RealCost. 142

Figure 6-4: Cumulative distributions of agency costs of typical BAS alternatives 144

Figure 6-5: Relative cumulative probability distributions of project user costs of typical BAS design alternatives for a) Urban traffic and b) Rural Traffic..... 146

Figure 6-6: Normal distribution of Agency costs of typical BAS alternatives..... 147

Figure 6-7: User cost distributions of typical BAS alternatives (a) Urban traffic (b) Rural traffic
..... 149

Figure 6-8: Agency costs for initial construction and rehabilitations during the analysis period
..... 150

Figure 6-9: Work zone user cost expenditure streams for initial construction and rehabilitation activities for the three different design alternatives for a) urban and b) rural traffic
..... 152

Figure 6-10: Agency cost distribution of various rehabilitation options considered for the Standard MoDOT BAS, BAS-20' Span Design and BAS-ES designs. 153

Figure 6-11: Agency cost distributions of various rehabilitation options considered for the PCPS - BAS 154

Figure 6-12: Correlation coefficients of user cost parameters for Standard MoDOT BAS (a) urban and (b) Rural traffic demands..... 156

Figure 6-13: Correlation coefficients of user cost parameters for PCPS BAS (a) Urban and (b)
Rural traffic demands..... 156

CHAPTER 1 INTRODUCTION

Bridge approach slabs are intended to serve as a gentle transition from a roadway pavement section to a bridge structure. They are provided to minimize differential settlement effects and to give a smooth transition from the pavement to the bridge deck. The bridge deck is a rigid structure compared to the road pavement. Approach slab settlement has been a major problem which occurs due to consolidation or erosion of the underlying soil which then leads to loss of support. Twenty five percent of the bridge approach slabs in the US experience some sort of failure [1]. Figure 1-1 shows schematic view for approach slab settlement [2]. For bridge approach slabs, failure indicates the failure to provide a smooth transition to the bridge reflected in a noticeable bump felt by motorists. Whether this bump is a safety issue or not may be debated; however, there is no question that it is both noticeable to motorists and maintenance issue for the bridge owners. Approach slab settlement was ranked as the second most significant geotechnical problem that the Missouri Department of Transportation (MoDOT) and other DOTs nationwide faced next only to slope instability [3].

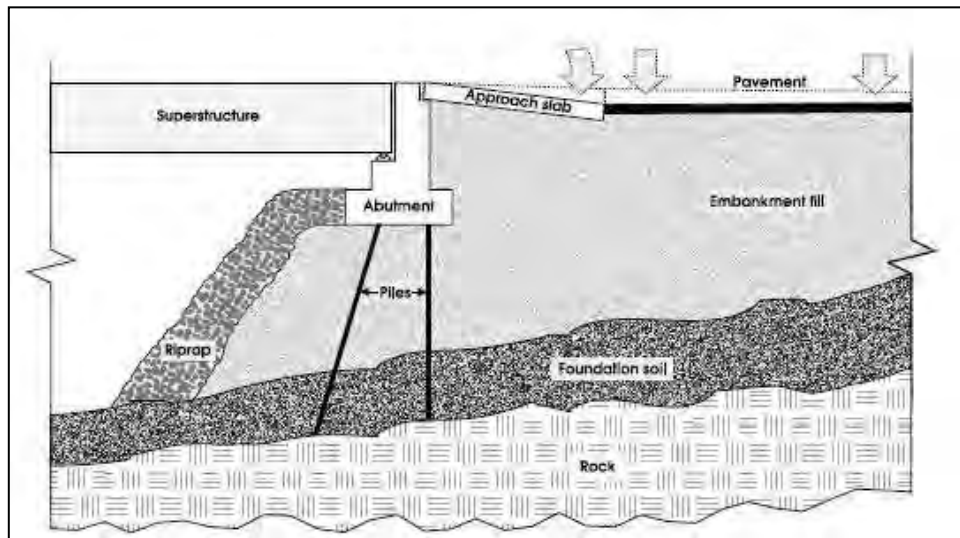

Figure 1-1: Bridge approach slab settlement[2]

The performance of the approach slab is affected by geotechnical and structural factors. The geotechnical factors affecting the performance are: approach fill settlement, compression of the embankment fills material due to inadequate compaction, poor drainage, erosion of the fill material, etc. The structural factors include: the slab thickness, reinforcement content and the soil-structure interaction characteristics.

It is clear that the problem of cracking and riding discomfort due to the ‘bump at the end of the bridge’ stems largely from geotechnical considerations. In many instances compaction of soil under uncertain conditions when the bridge is being constructed may not be properly achieved.

The goal of the proposed research is to provide *cost-effective structural solutions*, even if differential settlement problems cannot be entirely mitigated by geotechnical solutions.

1.1 LITERATURE STUDY

There are number of studies across the country to determine the issues with the bump problem and the settlement. Several comprehensive studies on approach slab performance have been performed by various states DOT’s over the years. The problem proves to be a difficult combination of structural, geotechnical and drainage conditions. The solution requires a multi-disciplinary approach to assess the root cause and engineer an appropriate solution.

The performance of the approach slab is affected by geotechnical and structural factors [4]. The performance of approach slabs depends on approach slab dimensions, steel reinforcement, use of a sleeper slab, and type of connection between the approach slab and the bridge. The geotechnical factors affecting the performance are: approach fill settlement, compression of the embankment fills material due to inadequate compaction, poor drainage and erosion of the fill material. The structural factors that govern the performance of approach slabs are slab depth, span, percentage of reinforcement and soil-structure interaction characteristics.

A literature review, related to cast in place (CIP) approach slabs, was conducted on the issues related to “bump at the end of approach slabs”. As of 1995, there were 600,000 bridges across the United States. Among them, 150,000 had problems with bumps at bridge ends [5]. Studies have been conducted to observe the performance of approach and transition slabs in New Jersey using a finite element approach [6]. They used ABAQUS, a commercial finite element software for stress analysis, to model the soil structure interaction and studied the cracking behavior under various conditions. The objective was to develop effective and alternate designs to reduce cracking. The effect of embankment settlement on the performance of approach slabs have also been investigated [7]. A 3-D finite element analysis was conducted considering the interaction between the approach slab and the embankment soil. The predicted internal moments of the approach slab provide the design

engineers with a scientific basis to properly design the approach slab considering different levels of embankment settlements. Also, investigation on general bridge approach settlement in Iowa observed that 25% of the 74 bridge sites studied had severe void development problems [4]. It was noted that the void development tends to occur in the first year of the approach slab construction. They concluded that approach pavement systems were performing poorly because of poor backfill properties, inadequate subsurface drainage, and poor construction practices.

In the past five years, the use of precast, prestressed concrete pavement has been advancing rapidly. Projects in Texas, California, Missouri, and Iowa have shown that precast prestressed pavements are not only viable and cost competitive, especially when life-cycle costs are considered, but also possesses some distinct advantages. Highways can be opened to traffic as soon as the panels are installed. One project in O’Brien County, Iowa has examined using precast prestressed (PCPS) slabs for bridge approach slab purposes [8]. Table 1-1 reflects the current costs of construction of MoDOT approach slabs and the Iowa DOT experimental project. The data is based on private communications of the Principal investigator (PI) in July 2008 with Iowa and Missouri DOT officials.

Table 1-1 Cost comparison of CIP and PCPS Slabs

	Missouri DOT (CIP Slab)	Iowa DOT (Precast Prestressed Slab)
Cost of construction	\$260 per square yard	\$740 per square yard

The installation can also be done at night and during non-peak traffic hours, without having to rely on favorable weather conditions. Experience has shown that the construction season can be extended in northern states. Prestressed concrete can also reduce/eliminate slab cracking, result in reduced slab thicknesses, and provides the ability to span voids/unsound support layers that would result in the deterioration of normal plain concrete or reinforced approach slabs. This technology may provide promise for rapid replacement for existing approach slab problems as well as a promising technique for new construction.

1.2 BRIDGE APPROACH SLAB ISSUES

There are no reported or adopted rational design procedures for bridge approach slabs in spite of their extensive usage. Often bridge approach slabs are supported on a corbel on the abutment side and a sleeper slab on the pavement side. Bridge designers often ignore the soil support under the slab and design them as simply supported slabs subjected to the standard AASHTO loads. A report for Iowa DOT has designed approach slabs based on the length of the voids observed [9]. They observed voids up to 15 feet in length and consequently designed approach slabs assuming 15 feet to be the simply supported span.

Many states have issues related to the poor performance of bridge approach slabs. These issues have been well documented by several groups. There are a number of reasons for the poor performance of the approach slabs. They include:

- a) Settlement of bridge approach slabs due to consolidation of soil under the slab over a period of time. Briaud et al. (1997)[5] reported that nationwide about twenty five percent of approximately 150,000 bridges needed rehabilitation costing an estimated \$100 million. It is reported that in 2004 alone California spent almost \$8 million in repairs or replacement of deteriorated approach slabs.
- b) Erosion of soil under the bridge approach slab and consequent void formation due to inadequate drainage near the abutment resulting in longitudinal cracks developing in approach slabs and has been reported by Wolde-Tinsae and Klinger (1987) [10].
- c) Movement of bridge abutment due to temperature and traffic loads causing erosion of soil near the abutment ([11], [12], and [13]).
- d) Incidental forces due to creep, shrinkage causing cracks in bridge abutments ([14], [15]).
- e) Transverse cracking in approach slabs has been reported as occurring due to traffic loads, backfill settlement and voids under the slab. Khodair (2001) [16] has reported that transverse cracking, caused by negative moments, due to traffic loads occur in the right or middle lanes. Transverse cracking near end of dowel bars at the bridge abutment has been observed in all lanes and has been attributed to void development and loss of support under approach slabs.

Service criteria

It has been shown that there is no standard design procedure for the design of approach slabs. In addition no service life or performance criteria standards exist. Since the approach slabs experience a myriad of severe conditions pertaining to both applied traffic loads and the support conditions it is important to quantify and characterize the service criteria pertaining to cracking, deflections and abutment end rotations. Existing literature establishes service limits based on the differential settlement and the end rotations of the bridge approach slab.

The differential displacement δ is defined as the difference between the vertical displacement between the two ends of the slab and the end rotation θ is the differential displacement divided by length of the slab. Grover (1978) [17] recommended a differential settlement limit of 1 inch and noted that differential displacements of 2 to 3 inches would be felt by the drivers. Settlements over 4 inches were considered to be unacceptable. Long et al. (1998) [18] proposed a bridge approach slab rating system in which a 1 inch settlement is designated as a bump, a 2 inch settlement is regarded as a moderate bump and a 3 inch or larger settlement is regarded as a significant bump requiring repair and rehabilitation. In terms of the end rotations, Wahls (1990) [19] observed that a slope change less than 1/200 radians is acceptable for riding comfort and a slope of 1/125 radians would cause riding discomfort.

Objective

The main purpose of the proposed project is to explore the usage of alternate innovative structural solutions to reduce the cost of construction when a bridge approach slab is needed.

The primary objectives of the proposed project are to:

- a) Investigate and recommend alternative design solutions with the aim to reduce the cost of construction of a bridge approach slab, and
- b) Develop remedial measures or alternative designs for a replacement.

It is clear that the problem of cracking and riding discomfort due to the ‘bump at the end of the bridge’ stems largely from geotechnical considerations. In many instances compaction of soil, when the bridge is being constructed, may not be properly achieved. The goal of the proposed research is to provide cost-effective structural solutions, even if differential settlement problems cannot be entirely mitigated by geotechnical solutions.

Scope and Task of the Project

In order to accomplish the above objectives, several tasks are briefly described as follows:

1. Evaluated and documented the current condition of existing bridge approach slabs with data available from MoDOT and additional data gathered from field studies as a part of this investigation. From this study, the primary issues associated with the performance of approach slabs were identified. Details are presented in chapter 2.
2. Performed a best practice study of similar work done around the country and examined suitable solutions. Review existing practices and innovations in Iowa, New Jersey, Nebraska, Louisiana and other DOTs. Details are presented in chapter 2.
3. Studied various alternatives to the existing approach slabs in new construction. Some of the alternatives are outlined here and presented in chapter 2.
 - a. Cast in place (CIP) approach slabs with expansion joint at the abutment (non integral),
 - b. CIP approach slabs with integral abutment, and
 - c. Precast prestressed approach slabs.
4. Performed a parametric study of the effect of
 - a. Span length variation,
 - b. Slab thickness variation,
 - c. Concrete strengths, and
 - d. End condition variations in order to facilitate design approach slab that could potentially withstand very demanding geotechnical conditions. Details are presented in chapter 2.

5. Examine the alternatives to existing approach slabs that have deteriorated significantly and need replacement. Provide solutions that would be based on minimizing the time of replacement rather than the lowest structural cost. Details are presented in chapter 4.
6. Studied both construction and life cycle costs of some of the solutions to the extent possible from data and methods available. Details are presented in chapter 5.
7. Provide final design specifications and acceptance criterion for the proposed bridge approach slab system(s).
8. Coordinate with MoDOT engineers to develop specifications for the field implementation of the recommended designs. The PIs worked towards getting information to MoDOT engineers to develop the design and construction drawings and specifications to be applied towards a new bridge construction.
9. Recently MoDOT has been experimenting with two new practices of using a modified bridge approach slab with no sleeper slab and also not using bridge approach slabs (BAS) on new bridges. Bridge performance using this new practice has not been systematically monitored or examined. There are a sufficient number of such bridges built for a field assessment of their performance. This project has explored the methods of assessing this new approach. Details are presented towards the end of section 3 as slab on grade analysis of bridge approach slabs.

Luna et al. (2004) [20] in a project for the Missouri Department of Transportation (MoDOT), have looked extensively at the geotechnical issues. To expand the research done by Luna et al., MoDOT initiated a research project titled ‘Evaluation of Bridge Approach Slabs, Performance and Design’ which is the subject of the research presented in this report. The research presented here aims to investigate and recommend cost effective alternative design solutions for bridge approach slabs, which are ready for implementation. The goal of the project is to provide cost-effective structural solutions even if differential settlement problems can not be entirely avoided by geotechnical solutions.

Deliverables

The primary deliverables, some in report form and some in the form of preliminary drawings of potential design solutions, for the research study included the following:

1. A report consisting of test data available from other state DOTs, analysis of results, and acceptance criteria for existing and the proposed bridge approach slab systems. It has included recommendations of field implementation of such systems. Results from detailed studies of the problems with existing bridge approach slabs were also highlighted.

2. MoDOT was provided with interim quarterly reports.
3. The final report contains the results of the tasks outlined in the scope of the study.
4. Recommended design specifications for adoption by MoDOT with supporting documentation.

Present Conditions

The traditional practice in Missouri, where bridge approach slabs (BAS) are used, is to use a twenty five feet span, twelve inch thick slab connected with dowel rods at the abutment end and resting on a sleeper slab at the pavement end. The objective of this project is to find cost effective alternative structural solutions for bridge approach slabs, which are ready for field implementation. Table 1-2 shows an overview of the relationship of the project meeting Missouri Department of Transportation’s (MoDOT) needs to the national needs as identified by the American Association of State Highway Officials (AASHTO) Grand Challenge issues.

Table 1-2 MoDOT’s needs & grand challenges of AASHTO addressed

Theme	Project	MoDOT Needs	AASHTO Grand Challenge (GC) Issues
Optimizing Bridge designs	Bridge approach slab	<ul style="list-style-type: none"> • Modular design • Rapid construction • Bridge cost reduction • Laboratory and field validations 	GC 2: Optimizing structural systems <ul style="list-style-type: none"> • Develop new prefabricated structural elements GC 3: Accelerating bridge construction <ul style="list-style-type: none"> • Identify methods for the rapid construction of precast slabs GC 4: Advancing the AASHTO Specifications <ul style="list-style-type: none"> • Develop design specifications

CHAPTER 2 TECHNICAL APPROACH

2.1 MoDOT and OTHER STATES DETAIL AND CLASSIFICATION

The design and detailing of BAS varies nationwide. Every US state DOT has its own practice for the design and construction for BAS. As a first step in this research project, approach slab drawings were collected from MoDOT and other US states by contacting DOTs. We gathered data for almost 40 states. This chapter presents the synthesized data collected. Data include slab span, thickness, reinforcement details, boundary conditions, and any other information. Furthermore, based on the data pertaining to the reinforcement details, the moment capacity of each slab has been determined assuming a singly reinforced slab. This data has been classified based on slab span, depth and moment capacities in order to capture any observable trends. The cross sectional details for US states approach slab are attached in Appendix A-1.

2.1.1 CURRENT MISSOURI DOT APPROACH SLAB DETAIL

The current standard Missouri Bridge Approach Slab is 25' long and 12" thick which rests on the abutment at one end and a sleeper slab at the pavement end. It is classified as an integral abutment slab (I-A Slab). Drainage material is placed below the entire slab and a perforated pipe is placed adjacent to the sleeper beam below the BAS. A standard bridge approach slab drawing is available on the MoDOT Bridge standards website, http://www.modot.mo.gov/business/standard_drawings2/documents/apn6_sq_n.pdf

There are three types of Bridge approach slabs used by Missouri DOT. They are:

Type 1) Standard bridge approach slabs (BAS): It has a 25 foot span and 12 inch depth which is used on all major routes regardless of pavement selection. This slab rests on a sleeper slab which was introduced by MoDOT in 1993 [3]. The bottom longitudinal and transverse reinforcement used is #8 @ 5" c/c and #6 @ 15" c/c respectively. The top longitudinal and transverse reinforcement used is #7 @ 12" c/c and #4 @ 18" c/c respectively. The schematic view for the slab is shown in Figure 2-1.

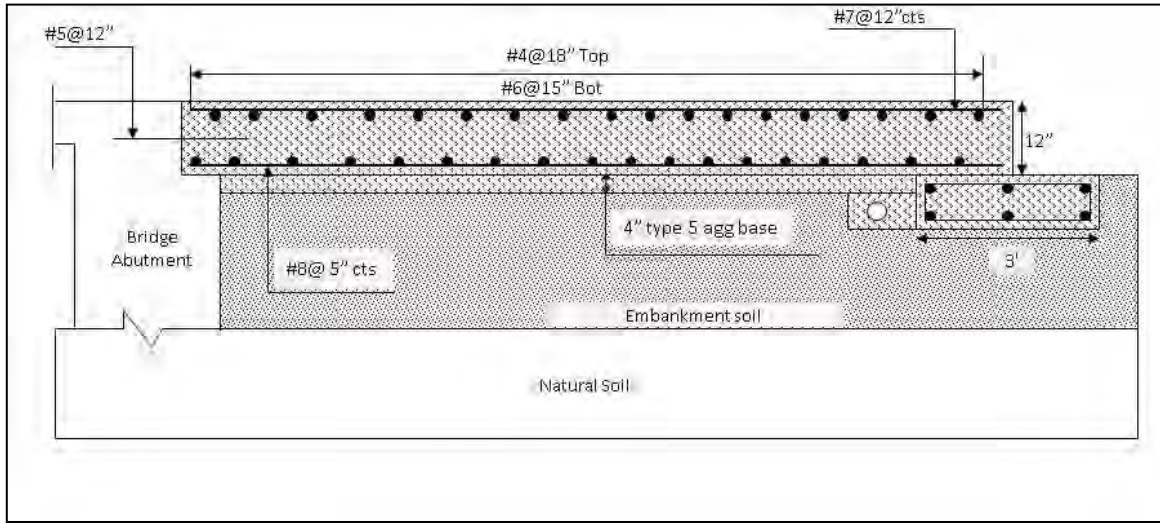

Figure 2-1: Missouri BAS Type 1

Type 2) A Modified BAS (MBAS) - which is used on minor routes only, only if the pavement selected by a contractor is concrete. Reinforcement used is 50% of the standard BAS. The bottom longitudinal and transverse reinforcement is #6 @ 6" c/c and #4 @ 12" c/c, respectively. The top longitudinal and transverse reinforcement used is 5 @ 12" c/c and #4 @ 18" c/c respectively. It has a span of 25 feet and depth of 12". The modified approach slab does not have a sleeper slab at the pavement end. The schematic view for the MBAS is shown in Figure 2-2.

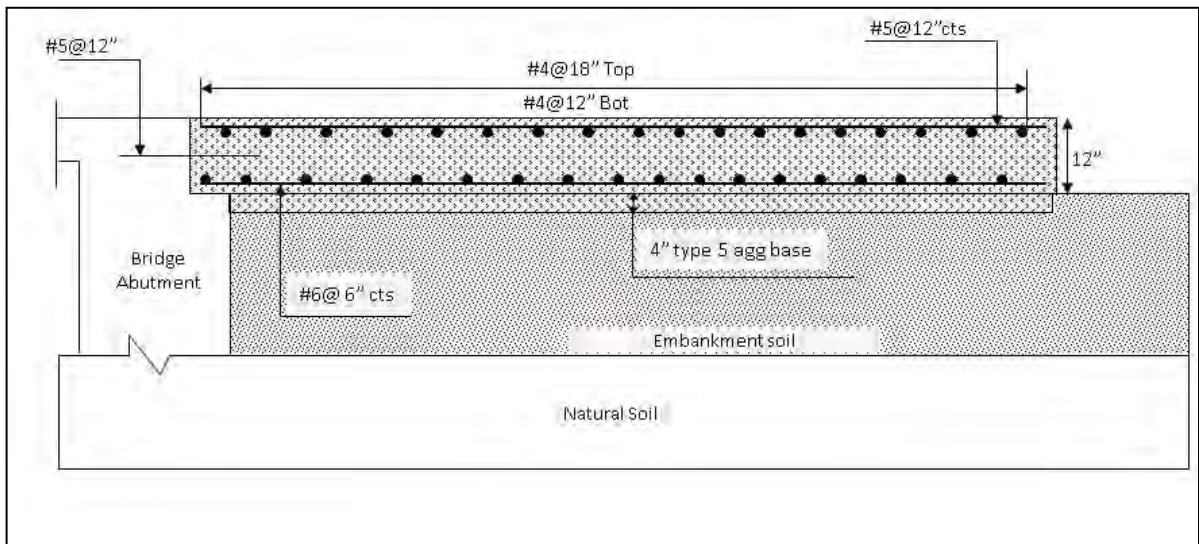

Figure 2-2: Missouri BAS Type 2

Type 3) Bridge concrete approach pavement: It is a shorter reinforced roadway version of the BAS with 15' span used for bridge replacement projects only. Both the BAS and the pavement may rest on a sleeper slab. The other end of the approach pavement may rest upon a concrete sill, if available. The bridge approach pavement that abuts the roadway approach pavement may be either concrete or asphalt, based on the material of the roadway approach pavement. The schematic view for the slabs above is as shown in Figure 2-3.

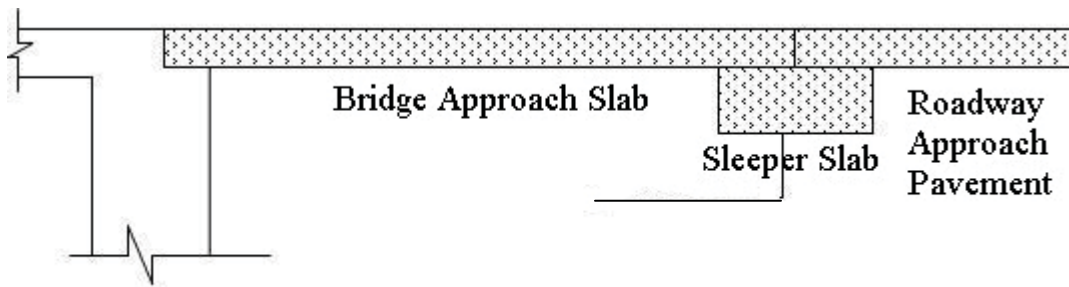

Figure 2-3: Missouri BAS Type 3

Currently, the cost of construction of Standard MoDOT approach slab is \$ 260/ sq yard. This data is based on private communications of the PI (in July 2008) with Missouri DOT officials. The cost break up is shown in a later section.

2.1.2 APPROACH SLAB DETAILS FOR VARIOUS STATES

Data collected typically involved span, depth and area of reinforcement provided, top and bottom cover for the reinforcement and connection with the abutment. In general there are two types of slab-bridge connection details that are followed by DOTs. The first is called “Integral abutment” (I-A) connection in which the bridge superstructure is cast integrally with the abutment. Hoppe et al. [2] reported that 71% of the state DOTs make the BAS use mechanical connectors, such as dowel bars, between the approach slab and the bridge. Keeping this in mind, the collected data was classified based on both Integral abutment (I-A) and non integral abutment (non I-A) slabs as shown in Table 2-1 and Table 2-2. Some of the states’ BAS do not provide reinforcement at the top of the approach slab. The BAS cross sectional details utilized by various US states are shown in Appendix A-1.

Table 2-1 Approach slab with integral abutment

Integral Abutment Slabs										
Sr No	States	Span'	Depth (in)	Bottom Main steel	Bottom dist steel dia	Top long steel dia	Top trans. steel dia	Cover (in)	Top Cover (in)	Connection with the abutment
1	Arizona	15	12	# 8 @ 9	# 5 @ 12	# 5 @ 12	# 5 @ 12	3	2.5	# 5 @12", 1/2" Bituminous jt. filler with Silicone sealant
2	California	30	14	# 8 @ 6	# 5 @ 12	# 6 @ 12	# 5 @ 18	2	2	#6 bar used
3	Florida	30	12	# 8 @ 9	# 5 @ 9	# 5 @ 12	# 5 @ 12	4	1.75	slab bars are anchored to the abutment
4	Idaho	20	12	# 8 @ 9	# 5 @ 12	# 4 @ 18	# 5 @ 12	3	2	#4 @12, polyethylene bond breaker
5	Illinois	30	15	# 9 @ 5	# 5 @ 8	# 5 @ 12	# 5 @ 12	2	-	#5 @ 12"
6	Kansas	13	10	# 6 @ 6	# 5 @ 18	# 5 @ 12	# 5 @ 12	2	-	continuing #5 bars from bridge deck to approach slab
7	Kentucky	25	17	# 8 @ 6	# 5 @ 10			3	-	Neoprene pad, 1.5"diam. Dowel
8	Missouri	25	12	# 8 @ 5	# 6 @ 15	# 7 @ 12	# 4 @ 18	2	2	#5 @12"
9	Nebraska	20	14	# 8 @ 6	# 5 @ 9	# 5 @ 12	# 5 @ 12	3	-	#6 @12"
10	Nevada	24	12	# 7 @ 6	# 4 @ 6	# 4 @ 12	# 4 @ 12	3	2.5	Approach slab restrainer @ 2'
11	North Dakota	20	14	# 6 @ 6	# 6 @ 6	# 5 @ 12	# 5 @ 12	3	-	#5 @12" with mechanical splice
12	Ohio	15	12	# 10 @ 10	# 5 @ 9	# 5 @ 18	# 5 @ 18	3	3	Approach slab restrainer
		20	13	# 10 @ 8	# 5 @ 8	# 5 @ 18	# 5 @ 18	3	3	
		25	15	# 10 @ 7	# 5 @ 8	# 5 @ 18	# 5 @ 18	3	3	
		30	17	# 10 @ 7	# 5 @ 9	# 5 @ 18	# 5 @ 18	3	3	
13	Oklahoma	20	13	# 9 @ 8	# 4 @ 12	# 4 @ 12	# 4 @ 12	2.5	2.5	#4 @ 12" & sawed and sealed joint
		24	13	# 9 @ 8	# 4 @ 12	# 4 @ 12	# 4 @ 12	2.5	2.5	
		29	13	# 9 @ 8	# 4 @ 12	# 4 @ 12	# 4 @ 12	2.5	2.5	
14	Oregon	20,33	12	# 7 @ 6	# 6 @ 12	# 6 @ 12	# 6 @ 12	2	2	#5 @ 12"
		30,33	14	# 9 @ 6	# 6 @ 12	# 6 @ 12	# 6 @ 12	2	2	
15	South Dakota	20	9	# 6 @ 6	# 6 @ 6	# 5 @ 12	# 5 @ 12	3	-	#7 @ 9" with mechanical splice
16	Texas	20	13	# 8 @ 6	# 5 @ 12	# 5 @ 12	# 5 @ 12	3	2	Abut-remf
17	Washington	25	13	# 8 @ 5	# 5 @ 9	# 6 @ 5	# 5 @ 18	2	2.5	1.5" diam x 18" dowel

Table 2-2 Approach slab with non-integral abutment

Non-Integral Abutment Slabs										
Sr No	States	Span'	Depth (m)	Bottom Main steel	Bottom dist steel dia	Top long steel dia	Top trans steel dia	Bottom Cover (m)	Top Cover (m)	Connection with the abutment
1	Alabama	20	9	# 6 @ 6	# 4 @ 15	# 4 @ 4	# 4 @ 12	3	2	no details.
2	Arkansas	20	9	# 5 @ 6	# 4 @ 12			2	2	no details.
			14.5	# 7 @ 6	# 5 @ 12	# 4 @ 18	# 4 @ 18	2	2.5	
3	Colorado	20	12	# 9 @ 6	# 5 @ 12	# 5 @ 12	# 5 @ 12	3	3	no details.
4	Connecticut	16	15	# 6 @ 6	# 5 @ 12	# 5 @ 12	# 5 @ 12	3	2	no details.
5	Delaware	18	15	# 5 @ 8	# 5 @ 12	# 5 @ 12	# 5 @ 12	3	2.5	Silicon sealer, bond breaker
			30	# 5 @ 8	# 5 @ 12	# 5 @ 12	# 5 @ 12	3	-	
6	Georgia	20	10	# 7 @ 8	# 5 @ 19	# 5 @ 12	# 5 @ 12	2	-	no details.
			30	# 7 @ 8	# 5 @ 19	# 5 @ 12	# 5 @ 12	3	-	no details.
7	Iowa	20	12	# 8 @ 12	# 5 @ 12	# 6 @ 12	# 5 @ 12	2.5	2.5	Expansion joint opening 2" to 3"
8	Louisiana	20	12	# 6 @ 6	# 4 @ 12	# 5 @ 12	# 5 @ 12	3	-	no details.
9	Maine	15.42	8	# 6 @ 6	# 5 @ 12	# 5 @ 12	# 5 @ 12	1	-	no details.
10	Massachusetts	20	10	# 7 @ 5	# 4 @ 18	# 4 @ 9	# 4 @ 18	3	-	no details.
11	Minnesota	20	12	# 6 @ 6	# 5 @ 12	# 5 @ 12	# 5 @ 12	3	-	#16 E (#5) bar
12	Mississippi	20	9	# 7 @ 12	# 5 @ 24	# 7 @ 24	# 5 @ 24	2	2	no details.
13	Missouri MAS	25	12	# 6 @ 6	# 4 @ 12	# 5 @ 12	# 4 @ 18	2	-	no details.
14	New Mexico	14	11	# 7 @ 6	# 5 @ 9	# 4 @ 9	# 4 @ 9	3.5	2.25	5" Evazote 380 seal
15	New York	10	12	# 5 @ 8	# 5 @ 12	# 5 @ 8	# 5 @ 12	3	3	no details.
16	North Carolina	25	12	# 6 @ 6	# 4 @ 12	# 5 @ 12	# 5 @ 12	2		no details.
17	Pennsylvania	25	16	# 10 @ 9	# 6 @ 12	# 5 @ 12	# 5 @ 12	3	2.5	no details.
18	South Carolina	20	12	# 9 @ 6	# 5 @ 12	# 5 @ 12	# 5 @ 12	3	2	no details.
19	Tennessee	24	12	# 6 @ 6	# 4 @ 18	# 5 @ 12	# 5 @ 12	2	-	no details.
20	Vermont	15	14	# 6 @ 6	# 5 @ 12			3	3	
			20	# 9 @ 10	# 5 @ 12			3	3	
			25	# 9 @ 9	# 5 @ 12			3	3	
21	Virginia	20	15	# 7 @ 6	# 5 @ 9	# 5 @ 12	# 5 @ 18	3.5	-	no details.
			22	# 8 @ 6	# 5 @ 9	# 5 @ 12	# 5 @ 18	3.5	-	no details.
			25	# 8 @ 6	# 5 @ 9	# 5 @ 12	# 5 @ 18	3.5	-	no details.
			28	# 9 @ 6	# 5 @ 9	# 5 @ 12	# 5 @ 18	3.5	-	no details.
22	Wisconsin	15.67	12	# 6 @ 6	# 4 @ 24	# 5 @ 12	# 5 @ 12	2	-	no details.
23	Wyoming	33	12	# 5 @ 8	# 5 @ 12	# 5 @ 12	# 5 @ 12	3	-	no details.

2.1.3 CLASSIFICATION OF BRIDGE APPROACH SLAB DETAILS

Every U.S. state follows different span, slab thickness and area of steel. From the states data gathered, it is observed that spans are varied from 10' to 33' and depth is varied from 8" to 17" for BAS. Design moment capacity (assuming singly reinforced sections) of each state DOT slab can be calculated as we know the geometric parameters and amount of steel provided for each slab. The design moment capacity of a reinforced concrete approach slab can be calculated as shown in Figure 2-4.

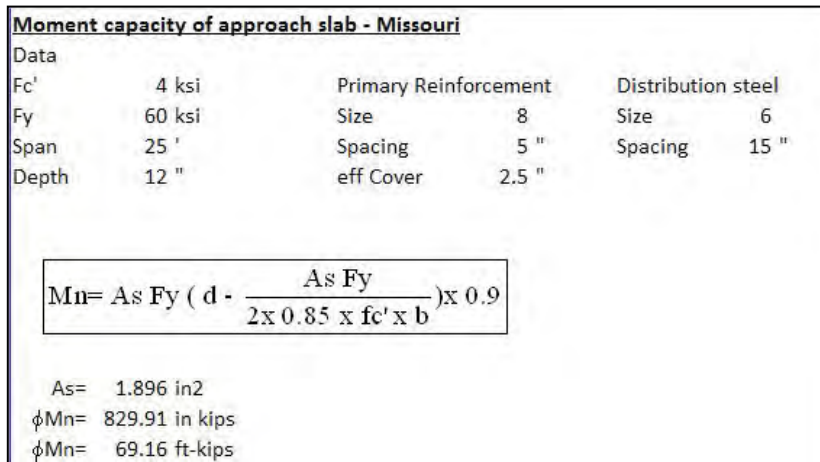

Figure 2-4: Singly reinforced moment capacity for Missouri BAS

Classification based on span, depth and moment capacities was done to see if they follow any trend.

- Figure 2-5 shows a bar chart of states and their respective spans in feet. From Figure 2-5 it can be seen that spans are varied from 10' to 33'. It is observed that 37% of the state DOTs use approach slabs with span of 20'.
- Figure 2-6 shows a bar chart of states and corresponding depth in inches. From Figure 2-6, it can be seen that depth is varied from 8" to 17" for BAS. It is observed that 33% of the state DOTs use approach slabs with depth of 12".
- The design moment capacities of existing slabs used in other state DOTs have been computed and data has been sorted based on design moment capacity as shown in Figure 2-7. Moment capacity of Missouri approach slab was found to be 69 ft.kips and for modified bridge approach slab, it is 37 ft.kips.

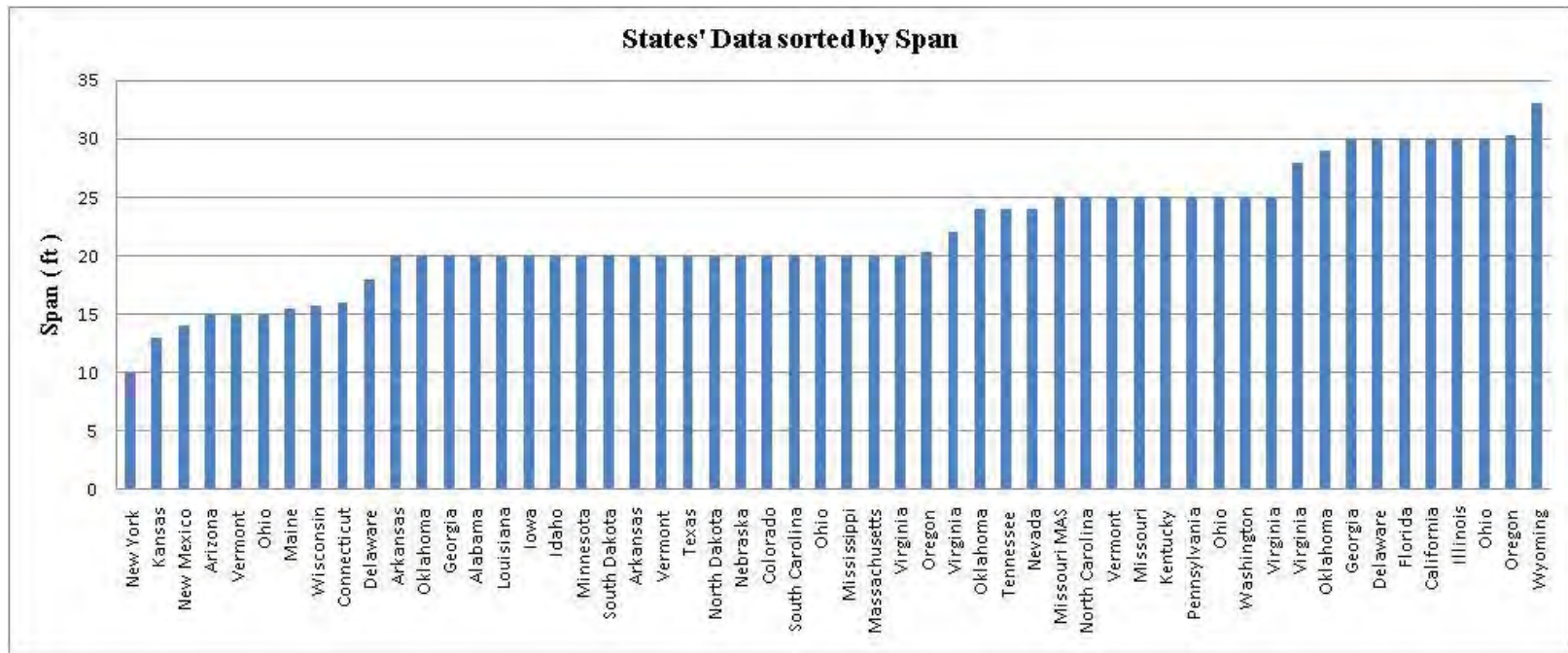

Figure 2-5: States data sorted by span of BAS

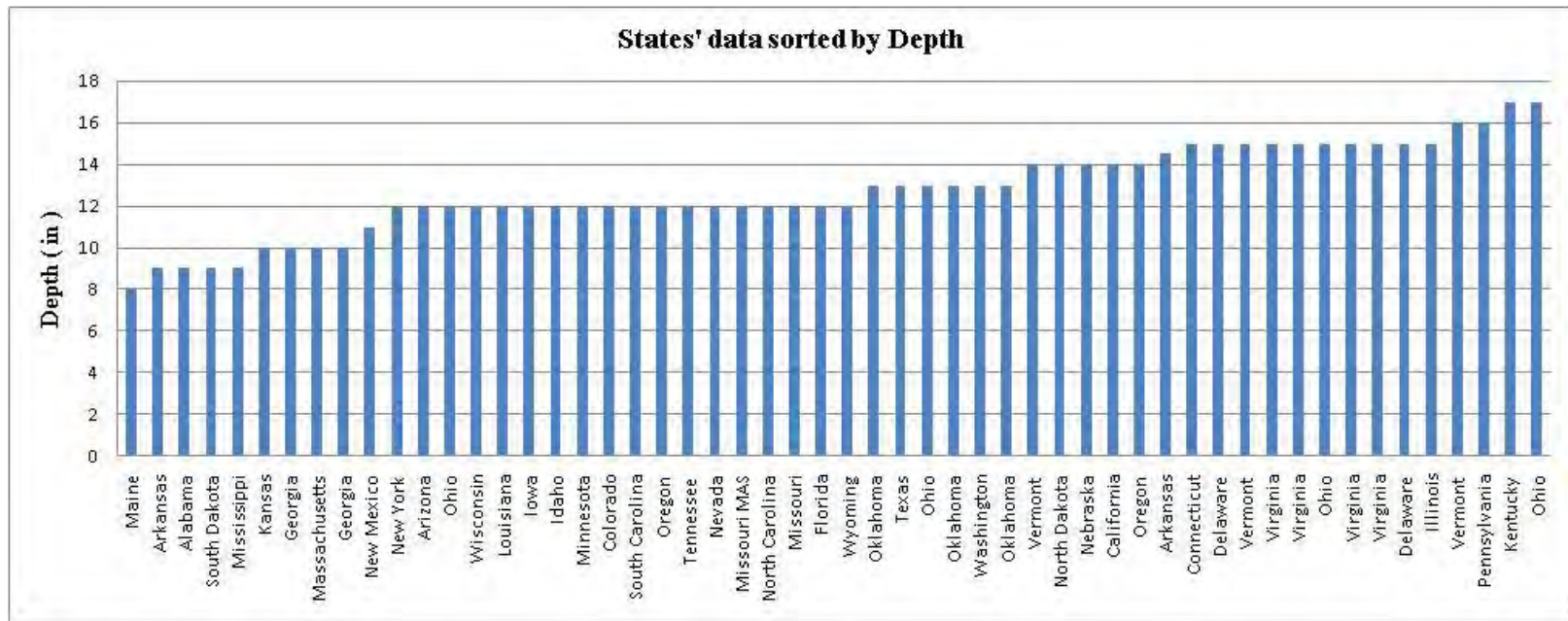

Figure 2-6: States data sorted by depth of BAS

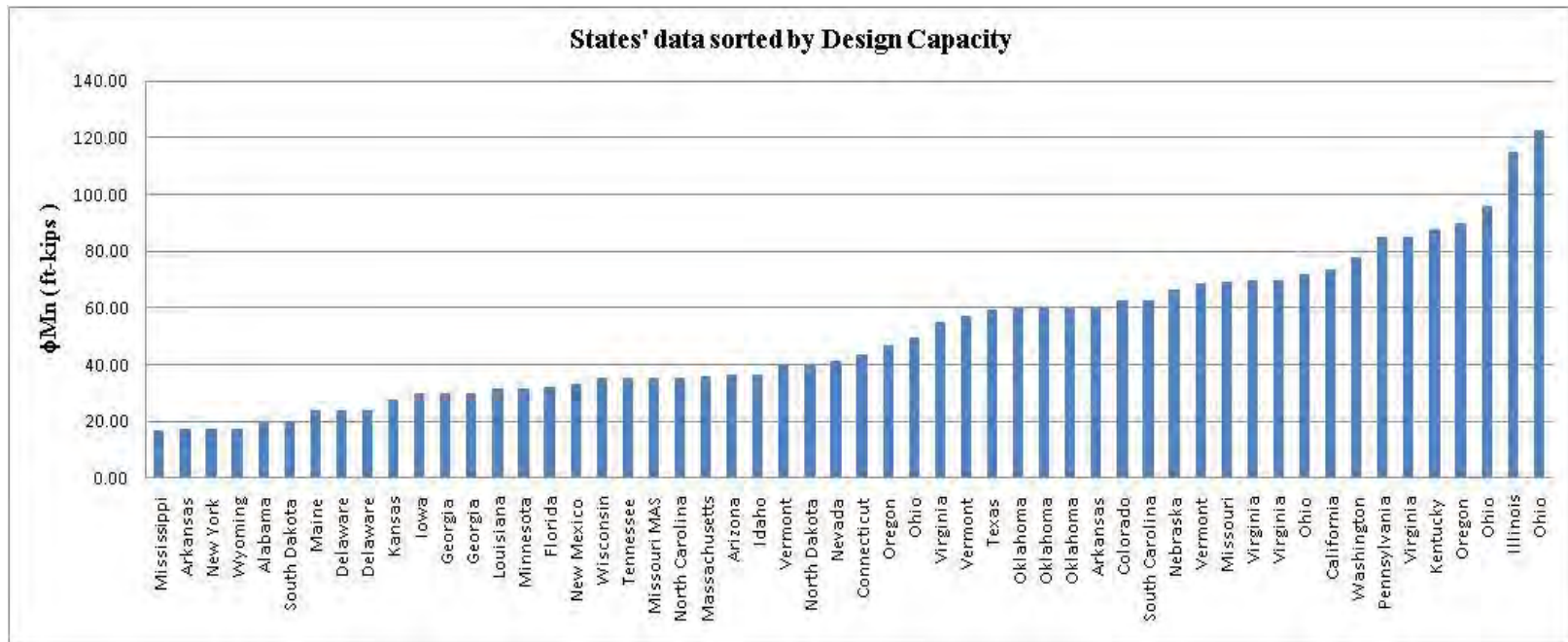

Figure 2-7: States data sorted by design moment capacity of BAS

From the data collected it is observed that there are many variations in approach slab dimensions and so as moment capacities practiced by US states. The next task was to find the problems faced by U.S. states and their experience with the BAS performance over time. A survey was designed and sent to various DOTs to give us some ideas about the performance of the BAS. Section 2.2 describes the survey conducted.

2.2 PERFORMANCE SURVEY STUDY OF BAS OF VARIOUS STATES

This section outlines the details of a survey developed and distributed to various DOTs in order to assess the performance of approach slabs in their state. The responses are classified and presented in this section. The questionnaire was limited to six basic questions. The survey questionnaire was sent via email to the state DOTs. The reason for making the questions of the survey simple and brief was to increase the response rate.

2.2.1 SURVEY INSTRUMENT AND RESPONSES

The six basic questions that were asked in the survey were as follows-

1. Do you face frequent problems with Bridge Approach Slabs in your state? If yes, how would you categorize the approach slab problem in your state?
2. What types of major failures do you see with the approach slabs? (A major failure is one which would require the replacement of the slab and or extensive mud jacking work to be performed).
3. What type of minor failures do you see with approach slabs? (A minor failure is one where the DOT maintenance personnel would be able to fix the problem).
4. Are you satisfied with the current design or are you planning to change it?
5. Do you always specify special backfill for all approach slabs? Or do you have certain minor routes where no special backfill is specified and that you see a greater number of approach slab failure problems under those conditions.
6. Any other thoughts on this problem that you would like to share.

Twenty state DOTs responded to the above questions. The detailed responses to the six questions are presented in Appendix A-2 along with the contact details for DOT's personnel. The responses have been synthesized and are presented below first classified on a statewide basis and then based on the questions asked.

2.2.2 SURVEY ANALYSIS BASED ON STATES RESPONSES

Alaska- Due to the relatively new history of approach slabs in Alaska, no major or minor failures have been reported to date of the survey. The only major issues with them are the cost and the hassle of placing them in a relatively short construction season due to the weather. To solve the weather related issue, Alaska DOT has considered using precast concrete instead of cast-in-place. Due to their cost, Alaska DOT has considered removing

approach slabs all together, as not too much benefit is observed. Instead, they considered the option of regrading/repaving every few years.

Arizona- No major failures except for some settlement and cracking in a few very old slabs, and minor local deterioration and cracking. The Arizona DOT always specifies a special backfill, and they are generally pleased with their design.

Arkansas- No frequent major failures have been experienced. Major failures experienced were movements requiring mud jacking, possibly due to water getting underneath the slab. They have done slab jacking with polyurethane. Minor settlement at the end of the bridge has been experienced, requiring sealing or patching spalls with rapid set concrete. Typically, no backfill is specified, and the Arkansas DOT is pleased with their current design.

Florida- The use of approach slabs is not frequent, but problems that may arise from them are settlement or displacement away from back wall. Minor problems include cracking or spalling of concrete, or erosion along the edge of the approach slab. Florida DOT uses the same standards for all bridges, and they are pleased with the design.

Illinois- Occasionally, Illinois DOT encounters major failures near the interface of the approach seat on the abutments. Also, an occasional minor problem that is encountered is cracking of the approach slab during the curing of concrete in integral abutments. The Illinois DOT is satisfied with the design as it is designed as a 30-foot span, able to span possible voids if the backfill were to settle. Uncompacted, porous, granular material is used for integral abutments, while porous granular embankments are used for pile supported or open abutments. The Illinois DOT finds drainage at the back of the abutment important in approach slab designs.

Indiana- Frequent problems have been faced with approach slabs, mostly found on bridges with integral end bents. Major failures include backfill settlement due to temperature induced expansion and contraction. Minor problems include cracking. Special backfill is always required, and the Indiana DOT is currently looking into the problem with integral structures from both a structural and geotechnical aspect, with possible design changes.

Iowa- Frequent significant problems have occurred, including failure of paving notch, failure at the end of the approach that rests on the paving notch, settlement of the slab, and large cracks in the approach slab panel. A minor problem that has occurred is the development of voids adjacent to the abutment underneath the slab. A special backfill is always required, and the Iowa DOT recently changed their design of approach slabs.

Kansas- Frequent problems have occurred, ranging from moderate to severe. Major problems include differential settlement, expansion joint problems, aggregate material problems (D-cracking), and fill material problems (expansive soils). Minor problems include early expansion joint problems, concrete surface spalls, and cracks. A special backfill is always required, and the current design has proven to be more successful than previous designs.

Minnesota- The only significant problem Minnesota DOT faces is maintaining the joint at the end of the approach panel. Extensive cracking or settlements are the main causes of occasional major failures, while minor problems seem to be due to inadequate drainage. The DOT uses the same backfill for all approach slabs, and they are currently updating their current standards.

Mississippi-The DOT faces frequent problems with their approach slab. Major problems include settlement issues, while minor problems include cracking and small potholes. The DOT does not specify a backfill, and they are currently looking to redesign their approach slabs by decreasing the elevation by 2-inches and placing hot mix asphalt.

Montana- Montana does not usually use approach slabs.

Nebraska- No frequent major failures have been experienced, but frequent minor cracking has occurred that has been remedied by increasing the amount of reinforcing steel. The DOT specifies granular backfill underneath all approach and paving sections, and is pleased with the current design.

“Our approach slabs consist of a 20 ft. approach section and a 30 ft. paving section. We place grade beams on piles 20 ft. away from the abutments. We also locate our expansion joints at the grade beams. The approach section is supported by this grade beam and at the abutment, therefore acting as a simple span member. One end of the paving section bears on the grade beam and the other end on the roadway embankment. This design has worked very well for us for many years and provides a relatively smooth ride on and off the bridge.”

New Mexico- Frequently face minor to moderate problems with severe settlement of approach embankment, minor joint failures, and minor settlements. Severe settlement failures were mitigated by changing backfill requirements and preconsolidating the soil (pre-construction), while minor settlement was remedied by an asphalt overlay for a smoother surface. For major roadways, backfills, flowable fills, or preconsolidation (if necessary) are specified. For minor roadways, A-1-a material at 100% Proctor is specified.

North Carolina- Faces problems with an estimated 2% of the bridges. Settlement is the most common problem requiring mud jacking but has never been a structural problem requiring replacing. Minor problems include failure of joint between approach slab and structure and few concrete surface spalls. The subgrade preparation has been changed, but no structural changes have been adopted. Special backfill is always required, with geofabrics included in heavily travelled primary routes.

Oklahoma- Frequent problems have been faced with approach slabs, including major settlement and cracking issues and minor settlement and shrinkage cracking along with a small bump at the end of the bridge. A special backfill is always specified, but the DOT is looking to using flowable fill instead of granular backfill with integral abutment design.

Pennsylvania- Pennsylvania DOT does not face problems with their approach slabs, and they do not require any maintenance. They always specify a free draining backfill, and they are pleased with their current design.

South Carolina- Face frequent minor to moderate problems. Major problems occur due to extensive voids underneath the slab. Minor problems include approach slab movements. A special backfill is not always specified, and the DOT is satisfied with their design.

South Dakota- Frequent problems have been faced with approach slabs, mostly due to embankment and/or backfill settlement below the slab. Other major issues include: joint failures, settlement of slab and/or supporting sleeper slab, and deterioration of ride quality due to poor roadway profile. Minor settlement, neoprene gland tearing or pulling out, and

steel extrusion anchorage failures are some of the minor failures experienced. Special backfill is always required, but has not proven to have a significant impact on failures.

Tennessee- Problems arise occasionally, but not frequently. Failures arise either from settlement due to lack of proper embankment compaction or from subsidence of ground under the embankment, with the degree of settlement defining whether the problem as minor or major. A special backfill is always specified, and the Tennessee DOT is pleased with the design.

Virginia- Virginia DOT faces frequent major problems with settlement issues due to lack of compaction of soil under the approach slab. Minor problems include settlement issues that can be solved by additional asphalt. The DOT recently started requiring select backfill material to be used behind abutments, and they have not had enough time to determine whether or not the design is appropriate.

2.2.3 SURVEY ANALYSIS BASED ON PERFORMANCE METRICS

The summary for the states DOTs responses as per the questions are given below.

Que. 1) Do you face frequent problems with Bridge Approach Slabs in your state? If yes, how would you categorize the approach slab problem in your state?

Most states have reported minor and infrequent problems. Minor problems include minor cracking and minor settlement. Only two states namely Indiana and Kansas have reported moderate to severe failure. Mississippi reported it as a common problem.

Que. 2) What types of major failures do you see with the approach slabs? (A major failure is one which would require the replacement of the slab and or extensive mud jacking work to be performed).

Types of major failure reported were as follows:

- a) Severe settlement of approach roadway embankment,
- b) Slab failure near the interface with the approach seat on bridge abutment,
- c) Severe settlement requiring mudjacking,
- d) Cyclic temperature induced expansion and contraction of bridge causing settlement of backfill under approach slab,
- e) Joint failure and settlement of sleeper slab,
- f) Differential settlement,
- g) Aggregate problems causing D-cracking, and
- h) Iowa reported severe cracks in approach slab panels.

Que. 3) What type of minor failures do you see with approach slabs? (A minor failure is one where the DOT maintenance personnel would be able to fix the problem).

Types of minor failure reported were as follows:

- a) Minor settlement and minor cracking/ spalling of concrete,

- b) Cracking near the abutment due to bridge movement during slab construction,
- c) Small bump at end of the bridge.

Que. 4) Are you satisfied with the current design or are you planning to change it?

Various states have made the following changes:

- a) Change the backfill requirement,
- b) Most states have reported no changes in the design, and
- c) Use of flowable fill.

Que. 5) Do you always specify special backfill for all approach slabs? Or do you have certain minor routes where no special backfill is specified and that you see a greater number of approach slab failure problems under those conditions?

Many states have replaced requiring special backfill as detailed below:

- a) Special flowable fill with preconsolidation,
- b) Uncompacted porous granular backfill, and
- c) Backfill material reinforced with geofabrics.

2.2.4 SUMMARY AND CONCLUSION

The key findings are as follows:

1. Out of the 20 responses, Montana is the only state that does not use Bridge Approach slab routinely.
2. Out of 19 states that use BAS routinely, 8 (42%) states face frequent problems with BAS.
3. Out of 19 states that use BAS routinely, 12 (63%) states report cracking problem.
4. Out of 12 states who report cracking, 10 (83%) states reported minor cracking and 2 (17%) reported extensive cracking.
5. Out of total 19 states, 15 (79%) reported embankment settlement issues.
6. Out of total 19 states, 15 (79%) provides special backfill material.
7. Out of total 19 states, 13 (68%) are satisfied with their current design.

2.3 SITE VISITS

A number of site visits were conducted during the term of the project in order to study defective approach slabs and also to observe the construction of new approach slabs. The observations pertaining to the new approach slabs were necessary to study the existing process prior to making any recommendation for changes. This section presents the observations pertaining to approach slabs with cracking and other issues and new construction.

Seven bridge approach slabs in Missouri were inspected out of which two of them were under construction while the remaining five were existing approach slabs in Kansas City and other parts of Missouri.

2.3.1 SITE VISITS CONDUCTED

The approach slabs with possible issues were identified by MoDOT engineers. A basic checklist was developed to note down the slab performance. The checklist with the observations pertaining to each of the existing slabs is described in Table 2-3. Some relevant pictures taken during the site visits are shown in Appendix A-3.

Table 2-3 Checklist for site observations

Cracking on top of the slab due to uneven settlement	
BRIDGE	OBSERVATIONS
MO-71 south Kansas City	Yes, Triangular area of the slab which was cracked and settled down about 6 inches or so
65 south end	No
Lynn County	Yes
Schuyler County	Yes, Major cracks were observed.
Randolph slab	No
Cracking near bridge end due to BAS settlement at other end	
MO-71 south Kansas City	A clear trough – dip – which is perceptible to the rider about 10 feet after the bridge
65 south end	None
Lynn County	None at south end. Major cracking at north end.
Schuyler County	Yes, transverse cracks at both south and north ends were observed.
Randolph slab	None
Approach slab rotating at the bridge end	
MO-71 south Kansas City	None
65 south end	None
Lynn County	None
Schuyler County	None
Randolph slab	None
Bump at end of Bridge Approach Slab	
MO-71 south Kansas City	Yes
65 south end	Yes
Lynn County	Yes about 1” at south end and ½” at north end.
Schuyler County	None
Randolph slab	None
Soil Erosion	
MO-71 south Kansas City	None

65 south end	Yes
Lynn County	None
Schuyler County	Yes
Randolph slab	Yes
Separation between BAS and roadway approach and/or embankment	
MO-71 south Kansas City	None. Improper drainage along the slab sides in one of them. The drainage trough was broken in three places and hence the water was draining directly to the ground rather than to the drain holes. This could be causing further erosion of the embankment.
65 south end	None
Lynn County	None
Schuyler County	None
Randolph slab	None
Any grouted precast holes placed during construction to determine if mudjacked in past	
MO-71 south Kansas City	None
65 south end	None
Lynn County	Yes. The slabs have been mud jacked in the past and the grout holes sealed water tight
Schuyler County	None
Randolph slab	None

2.3.2 SUMMARY OF THE SITE VISITS

One bridge approach slab (US 71-Kansas City) had extensive cracking and settlement issues. Deep triangular cracks were observed at this site. The bump at the end of bridge was also evident with over one inch of difference between the riding surfaces of the BAS and the bridge deck. Other observations at this site included damage to erosion control structures such at the outlet drain which had resulted in erosion of the embankment. No major defects were observed at the US 65 bridge site. Minor transverse cracking was observed. At the Lynn county site, differential settlement in the order of ½ - 1 inch between the BAS and the bridge deck and major transverse cracking were observed. Soil erosion of 6-8 inches underneath the slab near the abutment end was also observed.

In conclusion, the major defects observed were a) bump at the end of the bridge b) major transverse cracking c) pockets of cracked slabs and d) erosion of soil near the abutment end.

2.4 COST ANALYSIS FOR BRIDGE APPROACH SLABS

This section presents details of a cost study pertaining to the primary objective of the overall research, which is to provide cost effective solutions for new cast in place (CIP) bridge approach slabs in Missouri. The current 2009-10 cost of construction of Missouri standard BAS is approximately \$260 per square yard. The best design of BAS would be one with lower cost of construction and better performance over time.

In order to perform this task, a detailed MS Excel sheet based analysis was developed using extensive input from MoDOT and was validated for MO slabs. The geometric and reinforcement data from other U.S. states were then input to this spreadsheet and the costs of slabs from other states were computed. Subsequently cost comparison of slabs used in other states are performed and presented here. Analysis was performed based on slab spans and depths in order to see if there is any trend. Results from this analysis are presented in this chapter.

Based on the results of a cost analysis and discussions with the Technical Advisory Panel of MoDOT a few slabs, which were substantially lower in cost compared to the current Missouri slab were selected for moving forward for analysis and structural design. The performance survey presented in section 2.2 is also summarized in this chapter based on states with costs lower and higher than the current Missouri BAS. The results of this section forms the basis of the analytical studies and design presented in subsequent sections.

Objectives of the Cost Study: A cost study was performed in order to determine the least cost slab design. The objectives of the cost were two fold.

Objective 1: Perform a cost analysis from the data of slabs obtained from all the states and compare the cost of construction based on the costing method that MoDOT adopts and also the rates that MoDOT uses for all the approach slab items.

Objective 2: Perform a cost analysis based on a rational design procedure developed using the three design approaches, namely ASD, LFD and LRFD.

Tasks of the Cost Study: The tasks for the first objectives is outlined below.

Tasks for Objective 1: In order to compare the cost of construction for the designs adopted by various states the following tasks were performed.

1. Studied the task detail report provided by MoDOT for a standard BAS.
2. Developed basic calculations in Excel program for cost estimation.
3. Developed a Microsoft Excel spreadsheet to calculate cost data for each state. The detailed cost calculations are shown in Figure 2-8 to Figure 2-12. The variables for each state were the four pay items (shown in Appendix A-3) outlined in the MoDOT procedure. The cost calculation was broken down into sub-items variables like labor,

- equipment and material supplies to incorporate the effect of the geometry on the quantity.
4. Draw a bar chart of the cost of construction (total cost) for each state and compare.
 5. From the bar chart, identify the states that have built approach slabs at costs lesser than MoDOT and contact them personally again to see if there are any major issues with the performance.
 6. Created a table showing states whose cost is lower than the Missouri BAS
 7. Looked for lower cost alternative designs based on the information and results generated from this objective.

2.4.1 DEVELOPMENT OF EXCEL SHEET FOR MISSOURI COST PAY ITEMS

A task detail report forwarded by MODOT consists of a pay item summary for two typical bridge approach slabs. A copy of the original task detail report is enclosed in Appendix A-3. The cost calculations are shown in the form of total cost of construction. The total cost is broken down into four tasks for payment purposes.

- 1) Prepare Base for Approach Slab: Figure 2-8 shows calculation for base preparation cost
- 2) Formwork of Approach Slab: Figure 2-9 shows cost calculation for formwork of BAS
- 3) Approach Slab Steel: Figure 2-10 shows cost calculation for BAS reinforcement
- 4) Approach Slab Concrete: Figure 2-11 shows cost calculation for BAS concrete.

It should be noted that a sleeper slab is not included in the pay item. The sub items like labor, equipment and material supplies have been included in the calculations in order to account for change in geometry. For example material supply and labor for an approach slab with span 30 feet would be more than an approach slab of 25 feet span. It might take longer to cast this slab too. As per the task detail report, the typical cost calculation for a standard MoDOT BAS is as shown in Figure 2-8 to Figure 2-12. The width of slab is considered as 38 feet as per MoDOT's recommendation.

Observations: As per the calculation shown, the total cost for 25 feet span, 12 inch depth and 38 feet wide slab is \$ 55,316. The cost break up for labor, equipment and material used is shown in Figure 2-12. It is observed that 50% of the total task cost is due to material used and 37% of the total construction cost is due to approach slab reinforcement. Once the cost estimation for the MoDOT standard BAS was made, the cost for all other U.S. states' BAS can be calculated by simply following the procedure used as shown in Figure 2-8 to Figure 2-12. Another Excel worksheet was developed to simplify the procedure to show the results of all the calculations of all the states in one worksheet. The results are shown in Table 2-4 and Table 2-5. It shows total construction cost calculated for 40 U.S. states' BAS with their design moment capacity calculated as discussed in section 2.1.

Base preparation cost									
Span	25	ft							
width	38	ft							
depth	12	"							
productivity	=	25	cub yard /day						
quantity of base preparation	=	23	cub yard						
estimated time	=	0.92	days						
base preparation cost is broken up into three items									
1) labor									
2) Equipment									
3) Material / supplies									
1) Labor-									
		No	Days	Rate	Cost				
a) operator		2	0.92	471.79	868.09	Unit rate =	37.01	\$/ cub yard	
2) Equipment									
		No	Days	Rate	Cost				
a) Compactor		1	0.92	174.4	160.45				
b) loader cat		1	0.92	312.74	287.72				
					448.17 \$	Unit rate =	19.11	\$/ cub yard	
2) Material supplies									
		Qty	Rate	Cost					
a) Type V Aggregates		23.5	18.15	417.45					
adding 10% waste				459.2 \$		Unit rate =	19.58	\$/ cub yard	
Total task cost				= 868.09 + 448.17 + 459.2					
				= 1775.46 \$					
Overhead is 5% of total cost				= 88.77 \$					
Profit is 10.5% of total cost				= 186.42 \$					
Total cost				= 2050.65 \$		Unit rate =	87.42	\$/ cub yard	

Figure 2-8: Cost estimation for base preparation of BAS

Form Approach slab				
Span	25	ft		
width	38	ft		
form work qty	176 sq ft			
Cost of form for BAS is broken down into				
1) Labor				
2) Equipment				
3) Material / supplies				
1) Labor				
	No	Days	Rate	Cost
a) Foreman	1	1	437	437
b) laborer	2	1	374.5	749
c) operator	1	1	471.8	471.8
d) carpenter	2	1	441.85	883.7
				2541.5 \$
			Unit rate =	1270.8 \$ per BAS
2) Equipment				
	No	Days	Rate	Cost
a) loader cat	1	1	312.8	312.8
b) compressor	1	1	105.4	105.4
c) generator cat 45 kw	1	1	114.6	114.6
d) truck 2 ton flatbed	1	1	93.6	93.6
				626.4 \$
			Unit rate =	313.2 \$ per BAS
2) Material supplies				
Qty = span * width * 2/9	Qty		Rate	Cost
a) Forms approach slab(sf)	176.00		1.01	177.76
b) Timber header - 3" x 10"(lf)	103.95		3.26	338.88
				516.64 \$
			Unit rate =	258.3 \$ per BAS
Total cost for this task			= 2541.5 + 626.4 + 516.64	
			= 3684.5 \$	Unit rate = 1842.3 \$ per BAS
Overhead is 5% of total cost			= 184.23 \$	
Profit is 10.5% of total cost			= 386.88 \$	
Total cost			= 4255.6 \$	Unit rate = 2127.8 \$ per BAS

Figure 2-9: Cost estimation for formwork of BAS

Set approach slab steel								
productivity	=	20000	lbs/day					
quantity of BAS steel	=	19162	lbs	Refer to cost calculation excel sheet				
estimated time	=	0.96	day					
<table border="1" style="float: right; margin-left: 20px;"> <tr> <td>Top long. Bars #7@12</td> </tr> <tr> <td>Top dist. Bars #4@18</td> </tr> <tr> <td>Bot. long. Bars #8@5</td> </tr> <tr> <td>Bot. dist. Bars #6@15</td> </tr> </table>					Top long. Bars #7@12	Top dist. Bars #4@18	Bot. long. Bars #8@5	Bot. dist. Bars #6@15
Top long. Bars #7@12								
Top dist. Bars #4@18								
Bot. long. Bars #8@5								
Bot. dist. Bars #6@15								
Cost of BAS steel is broken down into								
1) Labor								
2) Equipment								
3) Material / supplies								
1) Labor								
	No	Days	Rate	Cost				
a) Foreman	1	0.96	437.05	419.57				
b) laborer	2	0.96	374.55	719.14				
c) operator	1	0.96	471.59	452.73				
d) iron worker	2	0.96	503.92	967.53				
			2559 \$	Unit rate = 0.13 \$/lb				
2) Equipment								
	No	Days	Rate	Cost				
a) loader cat	1	0.96	312.84	300.33				
b) compressor	1	0.96	105.40	101.18				
c) generator cat 45 kw	1	0.96	114.66	110.07				
d) truck 2 ton flatbed	1	0.96	93.52	89.779				
			601.36 \$	Unit rate = 0.03 \$/lb				
2) Material supplies								
	Qty	Rate	Cost					
a) Forms approach slab	19162	0.69	13221.8					
adding 10% waste			14544 \$	Unit rate = 0.76 \$/lb				
Total cost for this task								
			= 2558.96 + 601.36 + 14543.96					
			= 17704.3 \$					
Overhead is 5% of total cost			= 885.21 \$					
Profit is 10.5% of total cost			= 1858.9 \$					
Total cost			= 20448.4 \$	Unit rate = 1.07 \$/lb				

Figure 2-10: Cost estimation for reinforcement of BAS

Pour approach slab				
Span	25 ft	Depth	12 "	
width	38 ft			
Cost of form for BAS is broken down into				
1) Labor				
2) Equipment				
3) Material / supplies				
1) Labor				
	No	Days	Rate	Cost
a) Foreman	2	2.00	437	1748.00
b) laborer	8	2.00	374.48	5991.68
c) operator	2	2.00	471.78	1887.12
d) carpenter	1	2.00	441.85	883.70
e) finisher	2	2.00	480.55	1922.20
				12432.7 \$
				Unit rate = 6216.4 \$ per BAS
2) Equipment				
	No	Days	Rate	Cost
a) loader cat	1	2.00	312.80	625.60
b) compressor	1	2.00	105.40	210.80
c) con. B.D.F.	1	2.00	156.00	312.00
d) con. P.T.R.	1	2.00	982.00	1964.00
c) generator cat 45 kw	1	2.00	114.60	229.20
d) truck 2 ton flatbed	1	2.00	93.60	187.20
e) truck water	1	2.00	281.00	562.00
				4090.80 \$
				Unit rate = 2045.4 \$ per BAS
2) Material supplies				
Qty=2* L* B* D/27	Qty	Rate	Cost	
a) con. 4000 psi	70.37	106	7459.3	
adding 10% waste			8205.2 \$	Unit rate = 4102.6 \$ per BAS
Total cost for this task			= 12432.7 + 4090.8 + 8205.19	
			= 24728.7 \$	Unit rate = 12364 \$ per BAS
Overhead is 5% of total cost			= 1236.4 \$	
Profit is 10.5% of total cost			= 2596.5 \$	
Total cost			= 28561.6 \$	Unit rate = 14281 \$ per BAS

Figure 2-11: Cost estimation for concrete pour

Cost summary table BAS					
items	Base prep.	forms	Steel	pour	Total
Labor	868.09	2541.50	2558.96	12432.7	18401.25
Equipment	448.17	626.40	601.36	4090.8	5766.73
Material	459.20	516.64	14543.96	8205.2	23724.98
Task cost	1775.46	3684.54	17704.28	24728.7	47892.96
Overhed	88.77	184.23	885.21	1236.4	2394.65
Profit	186.42	386.88	1858.95	2596.5	5028.76
Total task cost	2050.65	4255.64	20448.44	28561.6	55316.37 ← total construction cost for BAS in \$

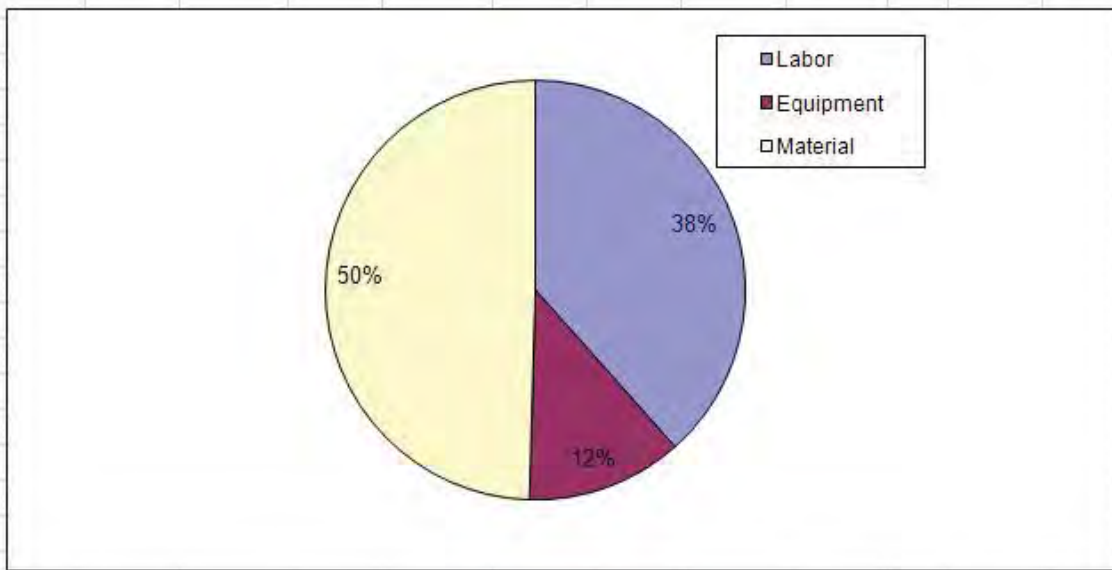

BAS total cost				
tasks	\$ Cost	Overheads 5%	profit 10.5%	\$ Cost
1) prepare base for BAS	1775.46	88.77	186.42	2050.65
2) formwork	3684.54	184.23	386.88	4255.64
3) set steel	17704.28	885.21	1858.95	20448.44
4) concrete pour	24728.69	1236.43	2596.51	28561.64
Total	47892.96	2394.65	5028.76	55316.37

Figure 2-12: Total cost for BAS

Table 2-4 States cost based on Missouri pay item report provided by MoDOT-1

Sr No.	States	span'	depth (in)	width'	Bottom Main steel	Bottom dist steel	Top long steel	Top trans. steel	Cover (in)	Steel cost \$	BP cost \$	FW cost \$	CP cost \$	Total cost \$	φMin (ft-kips)
1	New York	10	12	38	#5@ 8	#5@ 12	#5@ 8	#5@ 12	3.0	3627.43	694.74	3623.94	19805.57	32053.20	17.46
2	Kansas	13	10	38	#6@ 6	#5@ 18	#5@ 12	#5@ 12	2.0	5312.94	926.33	3636.06	20079.08	34597.34	27.63
3	Arkansas	20	9	38	#5@ 6	#4@ 12			2.0	3857.53	1466.68	3664.34	21446.61	35152.61	17.39
4	Vermont	15	14	38	#6@ 6	#5@ 12			3.0	4190.04	1080.71	3644.14	22267.13	36015.23	39.51
5	Maine	15.42	8	38	#6@ 6	#5@ 12	#5@ 12	#5@ 12	1.0	6769.36	1080.71	3645.83	19897.47	36259.36	23.67
6	New Mexico	14	11	38	#7@ 6	#5@ 9	#4@ 9	#4@ 9	3.5	6902.91	1003.52	3640.10	20735.50	37285.74	33.37
7	Wisconsin	16	12	38	#6@ 6	#4@ 24	#5@ 12	#5@ 12	2.0	5966.94	1157.91	3646.84	21666.51	37466.12	35.55
8	Mississippi	20	9	38	#7@ 12	#5@ 24	#7@ 24	#5@ 24	2.0	5915.33	1466.68	3664.34	21446.61	37529.37	16.53
9	Arizona	15	12	38	#8@ 9	#5@ 12	#5@ 12	#5@ 12	3.0	6972.62	1080.71	3644.14	21446.61	38281.41	36.62
10	Ohio	15	12	38	#10@ 10	#5@ 9	#5@ 18	#5@ 18	3.0	8275.66	1080.71	3644.14	21446.61	39786.43	49.75
11	Connecticut	16	15	38	#6@ 6	#5@ 12	#5@ 12	#5@ 12	3.0	6808.04	1157.91	3648.18	23087.65	40080.55	43.47
12	Delaware	18	15	38	#5@ 8	#5@ 12	#5@ 12	#5@ 12	3.0	5903.21	1312.29	3656.26	23908.17	40170.81	23.74
13	Alabama	20	9	38	#6@ 6	#4@ 15	#4@ 4	#4@ 12	3.0	8548.38	1466.68	3664.34	21446.61	40570.55	19.71
14	Georgia	20	10	38	#7@ 8	#5@ 19	#5@ 12	#5@ 12	1.5	8269.87	1466.68	3664.34	21993.62	40880.66	29.97
15	Louisiana	20	12	38	#6@ 6	#4@ 12	#5@ 12	#5@ 12	3.0	7979.89	1466.68	3664.34	23087.65	41809.33	31.59
16	Massachusetts	20	10	38	#7@ 5	#4@ 18	#4@ 9	#4@ 18	3.0	9225.08	1466.68	3664.34	21993.62	41983.93	35.66
17	Idaho	20	12	38	#8@ 9	#5@ 12	#4@ 18	#5@ 12	3.0	8493.48	1466.68	3664.34	23087.65	42402.53	36.62
18	Minnesota	20	12	38	#6@ 6	#5@ 12	#5@ 12	#5@ 12	3.0	8516.26	1466.68	3664.34	23087.65	42428.84	31.59
19	Vermont	20	15	38	#9@ 10	#5@ 12			3.0	7130.62	1466.68	3664.34	24728.69	42723.82	57.00
20	Iowa	20	12	38	#8@ 12	#5@ 12	#6@ 12	#5@ 12	2.5	8815.00	1466.68	3664.34	23087.65	42773.88	29.93
21	South Dakota	20	9	38	#6@ 6	#6@ 6	#5@ 12	#5@ 12	3.0	11212.97	1466.68	3664.34	21446.61	43648.15	19.71
22	Arkansas	20	14.5	38	#7@ 6	#5@ 12	#4@ 18	#4@ 18	2.0	8464.48	1466.68	3664.34	24455.18	43948.54	60.37
23	Oklahoma	20	13	38	#9@ 8	#4@ 12	#4@ 12	#4@ 12	2.5	9911.84	1466.68	3664.34	23634.66	44672.53	59.63
24	Tennessee	24	12	38	#6@ 6	#4@ 18	#5@ 12	#5@ 12	2.0	9358.67	1775.46	3680.50	24400.48	45293.44	35.55
25	Missouri MAS	25	12	38	#6@ 6	#4@ 12	#5@ 12	#4@ 18	2.0	9062.85	1775.46	3684.54	24728.69	45335.52	35.55
26	Virginia	20	15	38	#7@ 6	#5@ 9	#5@ 12	#5@ 18	3.5	9946.33	1466.68	3664.34	24728.69	45975.97	54.97
27	North Carolina	25	12	38	#6@ 6	#4@ 12	#5@ 12	#5@ 12	2.0	10124.76	1775.46	3684.54	24728.69	46562.02	35.55

Table 2-5 States cost based on Missouri pay item report provided by MoDOT-2

Sr No.	States	span'	depth (in)	width'	Bottom Main steel	Bottom dist steel	Top long steel	Top trans. steel	Cover (in)	Steel cost \$	BP cost \$	FW cost \$	CP cost \$	Total cost \$	φMin (ft-kips)
28	Texas	20	13	38	#8@ 6	#5@ 12	#5@ 12	#5@ 12	3.0	11703.52	1466.68	3664.34	23634.66	46741.93	59.28
29	North Dakota	20	14	38	#6@ 6	#6@ 6	#5@ 12	#5@ 12	3.0	11212.97	1466.68	3664.34	24181.67	46807.14	39.51
30	Oregon	20	12	38	#7@ 6	#6@ 12	#6@ 12	#6@ 12	2.0	12311.16	1466.68	3665.67	23195.96	46938.58	46.87
31	Nevada	24	12	38	#7@ 6	#4@ 6	#4@ 12	#4@ 12	3.0	11224.02	1775.46	3680.50	24400.48	47447.93	41.47
32	Nebraska	20	14	38	#8@ 6	#5@ 9	5 12	5 12	3.0	12188.20	1466.68	3664.34	24181.67	47933.54	66.39
33	Colorado	20	12	38	#9@ 6	#5@ 12	#5@ 12	#5@ 12	3.0	13707.91	1466.68	3664.34	23087.65	48425.19	62.70
34	South Carolina	20	12	38	#9@ 6	#5@ 12	#5@ 12	#5@ 12	3.0	13707.91	1466.68	3664.34	23087.65	48425.19	62.70
35	Oklahoma	24	13	38	#9@ 8	#4@ 12	#4@ 12	#4@ 12	2.5	11886.91	1775.46	3680.50	25056.89	48971.72	59.63
36	Ohio	20	13	38	#10@ 7.5	#5@ 8	#5@ 18	#5@ 18	3.0	13635.80	1466.68	3664.34	23634.66	48973.71	72.06
37	Vermont	25	16	38	#9@ 9	#5@ 12			3.0	9674.77	1775.46	3684.54	27463.75	49201.27	68.74
38	Georgia	30	10	38	#7@ 8	#5@ 19	#5@ 12	#5@ 12	1.5	12370.78	2161.43	3704.74	24728.69	49625.30	29.97
39	Virginia	22	15	38	#8@ 6	#5@ 9	5 12	#5@ 18	3.5	12812.66	1621.07	3672.42	25549.20	50421.93	69.95
40	Wyoming	33	12	38	#5@ 8	#5@ 12	#5@ 12	#5@ 12	3.0	10847.21	2393.01	3716.86	27354.34	51179.69	17.46
41	Delaware	30	15	38	#5@ 8	#5@ 12	#5@ 12	#5@ 12	3.0	9838.65	2161.43	3704.74	28831.28	51439.19	23.74
42	Kentucky	25	17	38	#8@ 6	#5@ 10			3.0	11392.77	1775.46	3684.54	28147.51	51975.32	87.72
43	Pennsylvania	25	16	38	#10@ 9	#6@ 12	#5@ 12	#5@ 12	3.0	12580.52	1775.46	3684.54	27463.75	52557.42	84.81
44	Florida	30	12	38	#8@ 9	#5@ 9	#5@ 12	#5@ 12	4.0	14581.83	2161.43	3704.74	26369.72	54074.47	31.88
45	Virginia	25	15	38	#8@ 6	#5@ 9	#5@ 12	#5@ 18	3.5	14601.85	1775.46	3684.54	26779.98	54102.30	69.95
46	Oklahoma	29	13	38	#9@ 8	#4@ 12	#4@ 12	#4@ 12	2.5	14405.14	2084.23	3700.70	26834.68	54313.59	59.63
47	Missouri	25	12	38	#8@ 5	#6@ 15	#7@ 12	#4@ 18	2.0	17704.35	1775.46	3684.54	24728.69	55316.45	69.16
48	Ohio	25	15	38	#10@ 7	#5@ 8	#5@ 18	#5@ 18	3.0	17920.10	1775.46	3684.54	26779.98	57934.88	95.76
49	Washington	25	13	38	#8@ 5	#5@ 9	#6@ 5	#5@ 18	2.0	21092.40	1775.46	3684.54	25412.45	60019.40	77.69
50	California	30	14	38	#8@ 6	#5@ 12	#6@ 12	#5@ 18	2.0	18087.97	2161.43	3704.74	28010.76	60019.45	73.50
51	Virginia	28	15	38	#9@ 6	#5@ 9	#5@ 12	#5@ 18	3.5	19188.77	2007.04	3696.66	28010.76	61103.22	85.20
52	Oregon	30	14	38	#9@ 6	#6@ 12	#6@ 12	#6@ 12	2.0	24066.05	2161.43	3706.07	28137.12	67071.62	89.70
53	Ohio	30	17	38	#10@ 6.5	#5@ 8.5	#5@ 18	#5@ 18	3.0	22522.68	2161.43	3704.74	30472.31	67984.63	122.93
54	Illinois	30	15	38	#9@ 5	#5@ 8	#5@ 12	#5@ 12	2.0	24764.56	2161.43	3704.74	28831.28	68678.61	115.27

2.4.2 ANALYSIS OF STATES' BAS COSTS BASED ON MISSOURI COSTS

The data shown in Table 2-4 and Table 2-5 was sorted by total construction cost and presented in bar chart format as shown in Figure 2-13. It should be noted that the cost calculation presented here is based on item rates that MoDOT uses in order to compare costs of various states' BAS. The total construction cost for Missouri standard BAS was found to be \$55,316.45 and that for modified Missouri BAS as \$45,336. The modified BAS is cheaper than the standard BAS because it consists of a lower percentage of reinforcement provided than the standard BAS.

There have been many states' BAS with lower construction cost than MoDOT BAS. We ignored the states that do not provide shrinkage reinforcement in BAS. The cost data was further sorted by BAS depth and span and presented in bar chart format as shown in Figure 2-14. It was observed that most of the states' whose costs were lower than that of Missouri are of 20 feet span with 12 in depth. The cost pattern shown in Figure 2-14 was observed and the states with cost lower than MoDOT standard BAS were shortlisted. Based on this observation, it was decided to focus on slabs with a span of 20 feet and 12 inch depth.

2.4.3 ANALYSIS OF RESULTS AND CONCLUSIONS

The main objective of this research was to provide an alternate structural solution which can reduce the cost of construction of new approach slabs. The extensive cost study presented in this section gives the overall picture about the construction cost of various Bridge Approach Slabs used by U.S. states. BAS with construction cost lower than that of MoDOT BAS and with satisfactory geometric properties have been shortlisted and presented in Table 2-6. It presents the type of slab abutment connection, geometric parameters, total construction cost, design moment capacity considering singly reinforced section and the reinforcement provided for each slab under consideration.

Shortlist and Cost Study Conclusion

Table 2-6, presents a short list of states whose approach slabs met the span, depth and cost criteria. The states whose cost is lower than the cost of standard Missouri approach slab are tabulated in Table 2-7. It should be noted that the costs calculated are based on Missouri pay item rates as discussed before.

The research team deemed that the Idaho slab details to be satisfactory as a total construction cost point of view. Results of this study were presented and discussed with the TAP officials of MoDOT. The structural design of the selected BAS was then studied in detail. Design of BAS with different spans and depth were checked and analyzed. The design methods are discussed in section 2.5.

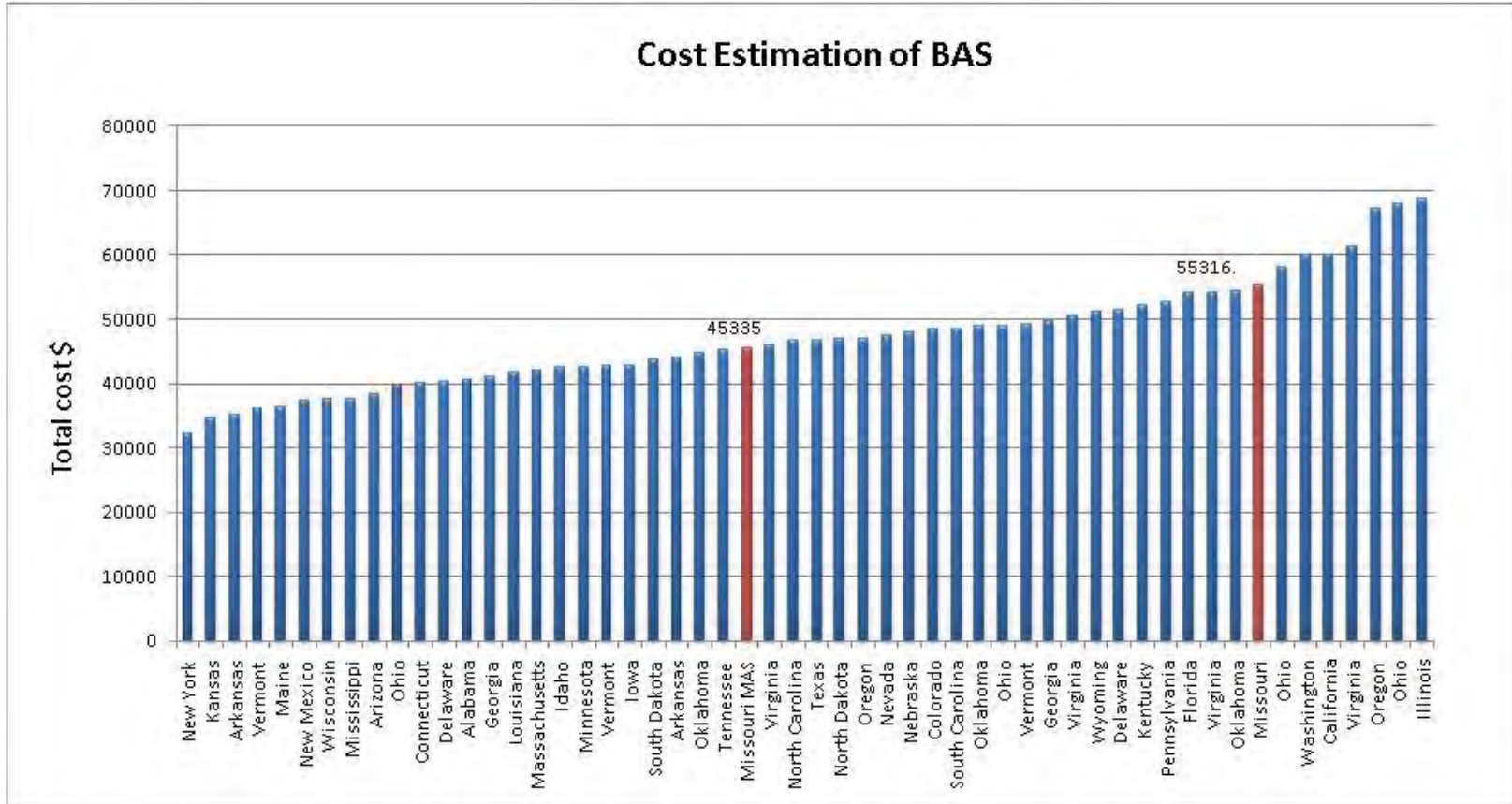

Figure 2-13: States cost based on Missouri pay item report provided by MoDOT

Table 2-6 List of states with costs lower than MoDOT

Rank	State	Type of Abutment	Span (ft)	Depth (m)	\$ Cost	ϕ Mn Ft-kips/ft (singly)	Bottom Reinf.	Top Reinf.
17	Idaho	I-A	20	12	42402.5	36.6	#8@9" #5@12"	#4@18" #5@12"
22	Arkansas	Non I-A	20	14.5	43948.5	60.4	#7@6" #5@12"	#4@18" #4@18"
23	Oklahoma	I-A	20	13	44672.5	59.6	#9@8" #4@12"	#4@12" #4@12"
24	Tennessee	Non I-A	24	12	45293.4	35.6	#6@6" #4@18"	#5@12" #5@12"
25	Missouri MAS	I-A	25	12	45335.5	35.6	#6@6" #4@12"	#5@12" #4@18"
27	North Carolina	Non I-A	25	12	46562.0	35.6	#6@6" #4@12"	#5@12" #5@12"
30	Oregon	I-A	20	12	46938.6	46.9	#7@6" #6@12"	#6@12" #6@12"
31	Nevada	I-A	24	12	47447.9	41.5	#7@6" #4@6"	#4@12" #4@12"
45	Missouri	I-A	25	12	55316.5	69.2	#8@5" #6@15"	#7@12" #4@18"

Table 2-7 List of states with costs lower than MoDOT slabs and problems faced

State	Problems faced
Idaho	Minor settlement was observed.
Arkansas	Don't have frequent problems with BAS constructed with current design
Oklahoma	Settlement issues – cracking
Tennessee	Settlement problem occurred from time to time.
North Carolina	Settlement was observed.

2.5 COST OPTIMAL STRUCTURAL DESIGN

This section presents the details for the design of a new cast in place bridge approach slab as per AASHTO design guidelines. Three different design approaches are considered here namely the Allowable Stress Design (ASD), Load Factor Design (LFD) and the Load and Resistance Factor Design (LRFD). Span variations from 15 to 25 feet in increments of 2.5 feet are considered along with a thickness variation of 12 to 16 inches. The cost excel sheet developed and outlined in an earlier section has been used here to evaluate the costs associated with each design. Graphs are shown to highlight this comparison. From the observations three span lengths namely 20 ft, 22.5 feet and 25 feet slabs have been shortlisted and compared in detail for final recommendation purposes.

2.5.1 BACKGROUND OF DESIGN

The performance of an approach slab depends on approach slab dimensions, steel reinforcement, use of a sleeper slab and type of connection between bridge and approach slab [4]. An approach slab can be designed by different approaches. Bridge approach slabs can be designed either as simply supported which span longitudinally or it can be designed as a beam on elastic foundation. BAS can also be designed by modeling slab and soil with computer aided finite element programs. Designing BAS considering slab on grade option can lead to unconservative design whereas designing BAS considering simply supported condition can lead to an uneconomical design. The correct method to choose can be critical.

The American Association of State Highway and Transportation Officials [21] specification does not provide any guidelines for designing an approach slab. AASHTO Standard Specifications for Highway Bridges and AASHTO Load and Resistance Factor Design [22] Bridge Design Specifications provide design specifications for a simply supported slab-bridge (in AASHTO 3.6.1.3.3) designed to span more than 15 feet longitudinally. The design guidelines, specifically for live loading, for the bridge deck can be adopted for the design of approach slab spanning longitudinally with simply supported condition. The approach slab could be considered as a slab-bridge. However, in modeling it as a slab on grade makes it behave more like a pavement but is expected to span in the event of a washout. This method saves time and gives simpler solutions. It is assumed that embankment soil under the approach slab has been washed out and the approach slab must withstand a considerable amount of voids that develop underneath the slab.

2.5.2 AASHTO SPECIFICATION (ASD, LFD, LRFD)

AASHTO provides loads and load combinations that can be used with either Allowable Stress Design method (ASD) or the Load Factor Design method (LFD). It provides for allowable overstress values for using the ASD design approach. It includes load factors and coefficients to be used as multiplier in the various load combinations. These factors are

given in Table 3.22.1A (AASHTO). The loads considered for the design are restricted to dead load and live load in evaluation of cast in place (CIP) bridge approach slabs. Creep and shrinkage loads are considered in case of prestressed or post-tensioned slabs.

AASHTO provides live load bending moment for one-way slab either reinforced parallel or normal to traffic. This approach gives an approximate approach to calculate the moment for service load level like in ASD. This moment value must be multiplied by the appropriate live load factor if the LFD method is used. The live load bending moment (LLM) per foot of width without impact load for slab spanning longitudinally is calculated as

LLM = $900 \times S$ where, S is span of the approach span in feet.

Impact for bending members is considered as 30 percent for span less than 45 feet. In short, the moment should be increased by 30 percent in order to account for impact load. The area for main steel reinforcement is then calculated as per ASD. The amount of distribution steel reinforcement should be calculated as a percentage of the main steel reinforcement area as given below.

$$\text{percentage} = \frac{100}{\sqrt{S}}$$

The amount of distribution reinforcement is limited to 50 percent. AASHTO also requires a minimum design value of either 1.2 times the cracking moment or one-third more steel than required by analysis.

2.5.3 DESIGN PROCEDURE (LRFD)

The AASHTO LRFD Specifications: The LRFD specifications provides load and resistance factors (γ and ϕ , respectively). Load combinations are defined as a series of combinations for strength, serviceability limit state as per AASHTO Table 3.4.1-1. LRFD approach can be used to calculate the expected strength of BAS using various combinations of dead load, live loads, etc. The loads considered are as follows.

DEAD LOAD: The dead load includes the self weight of Bridge Approach Slab. In the absence of information, the unit weights specified in AASHTO table 1 may be used for dead loads.

LIVE LOAD: The live load can be considered as vehicular live load (HL-93). The number of design lanes are determined by taking the integer part of the ratio $w/12$, where w is the clear roadway width of Bridge Approach Slab in feet between curbs. If the width of traffic lanes is less than 12 feet, the number of design lanes will be equal to the number of traffic lanes and the width of the design lane is taken as width of traffic lane. The vehicular live load (HL-93) considered consists of a combination of the design truck or design tandem and design lane load. The loads are assumed to occupy 10 feet transversely within a design lane. However, AASHTO LRFD Bridge Design Specifications permit modified design live loading based upon whether the slab bridge spans primarily in the transverse or longitudinal direction.

- a) DESIGN TRUCK- the design truck considered consists of three axles and as shown in Figure 2-15. The wheels are 6 feet apart in the lateral direction.
- b) DESIGN TANDEM-The design tandem consists of a pair of 25 kip axles spaced 4 feet apart. The transverse spacing of wheels is 6 feet.
- c) DESIGN LANE LOAD-The design lane load consists of 0.64 kips per linear foot uniformly distributed in the longitudinal direction. The design lane load is distributed transversely over a 10 foot width. The force effects from the design lane load shall not be subjected to a dynamic load allowance unlike for the design truck and tandem load.

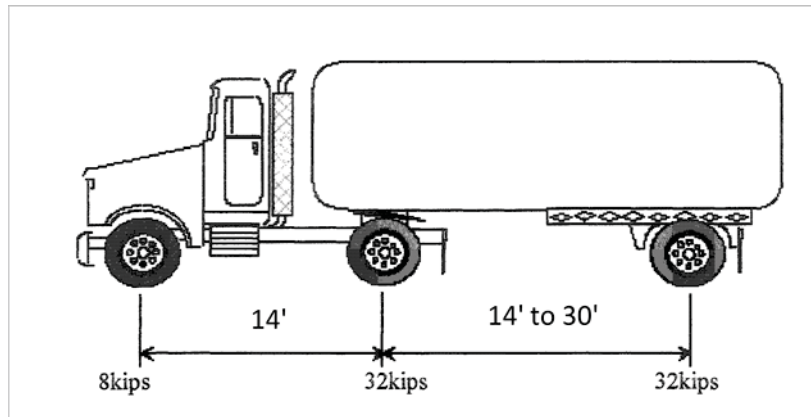

Figure 2-15: Characteristics of design truck (AASHTO)

Loading Condition and Load Location: Since we are considering a simply supported slab, the maximum load effect shall be taken as the larger of the a) design tandem with design lane load and b) design truck with the variable axle spacing combined with the design lane load. The axles that do not contribute the maximum effect under consideration shall be neglected. The design truck and the design tandem load are positioned to produce extreme force effects. It is obvious there will be only two axles traversing on the slab at a time. We should consider two axles with point load of 32 kips. Table 2-8 shows the maximum moment values in ft.kips under the first axle for different axle locations and it can be seen that maximum moment is achieved when the axle and tandem location are as shown in Figure 2-16. In this case the tandem load case will govern the design. However, by designing for a truck load, for spans in excess of approximately 28 feet, two axles at the minimum specified 14-foot spacing will begin to govern.

Based on meetings and discussions with MoDOT Technical Advisory Panel who provided the AASHTO requirements, one of the interpretations that could be drawn was that the lane load be excluded from consideration for the design of the approach slab. The exclusion is based on AASHTO-LRFD provision 3.6.1.3.3 which allows for decks and top slabs of culverts to be designed for only the axle loads of the design truck or design tandem for spans

less than 15 ft. The demand moment calculated considering 50% (10 ft.) of the span conservatively supported by poor soil and 50% voids.

Two sets of analyses are presented in the subsequent sections. Presented in the sections following immediately below this are hand calculations and cost analyses assuming a simply supported slab of span 20 feet. The analyses includes both truck/tandem and lane loads. In sections subsequently, wherein computer analysis using a slab on grade approach is presented the presence of lane load is excluded based on the interpretation and rationale presented in the previous paragraph.

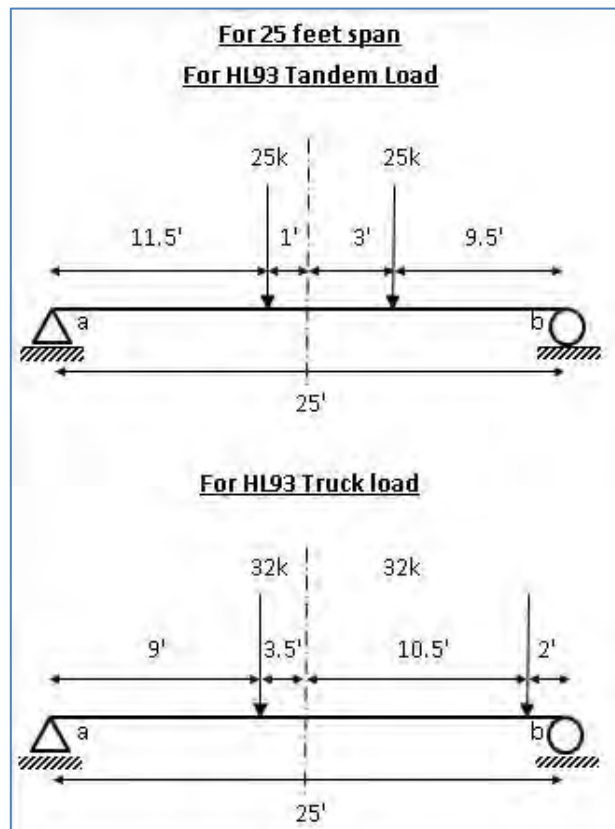

Figure 2-16: Critical tandem load location for 25 feet span of slab

Table 2-8 Moment table for various load locations

Tandem load				Truck load			
L'	y'	P (kips)		L'	y'	P (kips)	
25	4	25		25	14	32	
x'	Rb (k)	Ra (k)	Mmax ft-kips	x'	Rb (k)	Ra (k)	Mmax ft-kips
0	4	46	0	0	17.92	46.08	0
1	6	44	44	1	20.48	43.52	43.52
2	8	42	84	2	23.04	40.96	81.92
3	10	40	120	3	25.6	38.4	115.2
4	12	38	152	4	28.16	35.84	143.36
5	14	36	180	5	30.72	33.28	166.4
6	16	34	204	6	33.28	30.72	184.32
7	18	32	224	7	35.84	28.16	197.12
8	20	30	240	8	38.4	25.6	204.8
9	22	28	252	8.5	39.68	24.32	206.72
10	24	26	260	9	40.96	23.04	207.36
11	26	24	264	10	43.52	20.48	204.8
11.5	27	23	264.5	11	46.08	17.92	197.12
12	28	22	264				
13	30	20	260				
14	32	18	252				
15	34	16	240				
16	36	14	224				
17	38	12	204				
18	40	10	180				
19	42	8	152				
20	44	6	120				
21	46	4	84				

The impact load is termed as dynamic load allowance in LRFD terminology and is taken as 33 percent of the truck or tandem load. For the design of a slab, LRFD specifies that the full truck load be applied to a slab of effective width (E).

$$E = 84 + 1.44\sqrt{(L_1 \times W_1)}$$

Where:

E = equivalent width (in.)

L_1 = modified span length (ft.) but < 60 ft.

W_1 = modified edge-to-edge width (ft.) but < 30 ft. for a single lane

The approach slab designed for 12 feet lane width which carries only one lane of traffic. The area for main reinforcement is calculated as per LRFD design. The amount of distribution steel is provided as a percentage of the main reinforcement and is given by

$$\text{Percentage} = \frac{100}{\sqrt{S}} < 50\%$$

The depth of the slab should not be less than 7 inches. The LRFD specification provides no minimum thickness for slabs as a function of their span. It is recommended that the AASHTO Standard Specification rule-of-thumb for slab thickness be used for approach slabs. This is given by the formula:

$$t = 1.2(S + 10)/30$$

Where:

t = slab thickness (ft)

S = span (ft)

Finally, AASHTO LRFD requires a minimum design value of either 1.2 times the cracking moment or one-third more steel than required by analysis. The calculation for design moment capacity is shown in Figure 2-17 and Figure 2-18. The standard BAS used by MoDOT is considered for the calculations. The calculations are done in MathCAD.

Design of Bridge Approach Slab-Missouri

Dimensions

$$\text{Span } L = 25 \text{ ft}$$

$$\text{Width } W = 38 \text{ ft}$$

$$\text{Depth } D = 12 \text{ in}$$

$$\text{Clear cover } cc := 2 \text{ in}$$

$$d := D - cc - 0.5 = 9.5 \text{ in}$$

$$\text{Reinforcement \#8@5" c/c } A_s := 1.9 \text{ in}^2/\text{ft}$$

$$f_c := 4 \text{ ksi}$$

$$F_y := 60 \text{ ksi}$$

$$b := 12 \text{ in}$$

Equivalent strip width (E)

The equivalent width of longitudinal strip per lane for both shear and moment with more than one lane loaded is given by Eq 4.6.2.3-2 in AASHTO

$$E := 84 + 1.44\sqrt{L \cdot W} = 128.38 \text{ in} \quad 12 \frac{W}{3} = 152 \text{ in}$$

$$E_{\text{min}} := \frac{\min\left(E, 12 \frac{W}{3}\right)}{12} = 10.7 \text{ ft}$$

Loads considered for LRFD design

1) **Dead load** $W_{dl} := 0.15 \cdot \frac{12}{12} = 0.15 \text{ ksf}$

$$M_{dl} := \frac{W_{dl} \cdot L^2}{8} = 11.719 \text{ ft kips/ft}$$

2) **Live load** = lane load + Tandem load

a) **Lane load**

a uniformly distributed lane load is given as $0.064/E$ kips/ft

$$W_{la} := \frac{0.64}{E} = 0.05982 \text{ kips/ft}$$

Figure 2-17: Design of bridge approach slab page 1

b) **Tandem load**

Tandem load consisting two 25 kips point loads with a spacing of 4 ft considering Impact factor of 1.33

$$P := \frac{1.33 \cdot 25}{E} = 3.108 \text{ kips}$$

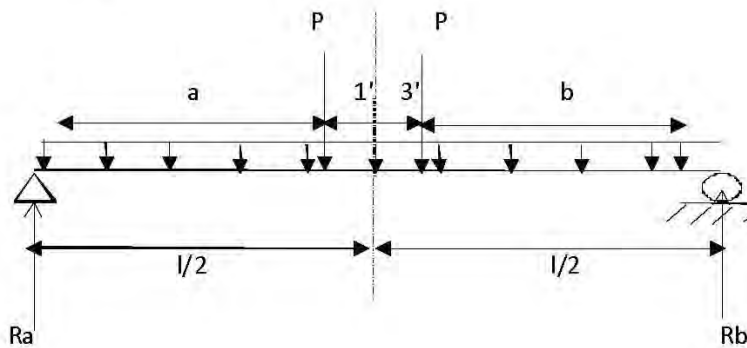

$$a := \left(\frac{L}{2}\right) - 1 = 11.5 \quad b := \left(\frac{L}{2}\right) - 3 = 9.5$$

Maximum moment can be calculated when the first point load is placed at 11.5' from the left support.

$$R_a := \frac{[P \cdot b + P \cdot (b + 4) + W \cdot a \cdot L^2 \cdot 0.5]}{L} = 3.61 \text{ kips}$$

$$M_{LL} := R_a \cdot a - W \cdot a \cdot a^2 \cdot 0.5 = 37.52 \text{ ft kips/ft}$$

LRFD Load combination for strength design

$$Q = 1.25DC + 1.75(LL + IM)(\text{Tandem load}) + 1.75(\text{Lane load})$$

$$M_u := 1.25 \cdot M_{dl} + 1.75 \cdot M_{LL} = 80.32 \text{ ft kips/ft}$$

Nominal moment strength

$$b := 12 \text{ in}$$

$$\phi M_n := A_s \cdot F_y \cdot \left(d - \frac{A_s \cdot F_y}{2 \cdot 0.85 \cdot f_c \cdot b} \right) \cdot \frac{0.9}{12} = 69.28 \text{ ft kips/ft}$$

Figure 2-18: Design of bridge approach slab page 2

2.5.4 INCLUSION OF COST INFORMATION IN DESIGN SELECTION

As discussed earlier, every U.S. state has its own design procedure for Bridge Approach Slabs. An extensive set of data was generated as a result of the tasks performed in the cost study. The design of approach slab was incorporated into the costing function excel sheet to study the options for economical design. A cost analysis was performed for the designs using the three design approaches, namely ASD, LFD and LRFD. In order to perform a cost comparison based on the rational design procedure the following tasks were performed.

1. Use the Microsoft Excel sheet developed for the cost estimation.
2. Perform hand calculations for structural design of approach slab using design procedures namely Allowable Stress Design (ASD), Load Factor Design (LFD), and Load and Resistance Factor Design (LRFD).
3. Use the Microsoft Excel sheets developed for the three design methods, mentioned above.
4. Vary two parameters, namely the depth of the slab and the span of the approach slab and design the required steel. The effective depth of the slab was varied from 12” to 16” in increments of 1 in and the span of the slab was varied from 15 ft to 25 ft in increments of 2.5 ft.
5. Develop the cost bar charts for LRFD design procedure and attempt to develop a cost effective design solution.
6. The data has been organized in the form of Excel tables and bar charts and is shown.

The list of result tables are as follows:

1. Cost based on Missouri pay item report for ASD procedure (Table 2-9),
2. Cost based on Missouri pay item report for LFD procedure (Table 2-10), and
3. Cost based on Missouri pay item report for LRFD procedure (Table 2-11).

Table 2-9 Design of bridge approach slab by ASD approach

ALLOWABLE STRESS DESIGN																											
Approach slab				f'c ksi	fy ksi	DL (klf)=DL*D/12	DL Moment (ft-kip)/ft	(LL+I) moment ft- kip/ft	(D+LL+I) moment ft- kip/ft	1.2Mcr ft-kip/ft	Design Moment ft-kip/ft	As reqd in ² /ft	Dist. steel range %	Dist. steel reqd m ² /ft	Main As prov m ² /ft	Dist steel prov m ² /ft	Temp. shrinkage steel reqd m ² /ft	Temp. shrinkage steel prov m ² /ft	Bottom				Top				Total cost \$
L'	D"	B'	d"																Main steel dia #	Dist steel s"	Long steel dia #	Trans steel s"	Main steel dia #	Dist steel s"	Long steel dia #	Trans steel s"	
15.0	12	38	9.50	4	60	0.15	4	18	22	14	21.77	1.29	26	0.33	1.35	0.35	0.26	0.27	8	7	6	15	5	14	5	14	39456
15.0	13	38	10.50	4	60	0.16	5	18	22	16	22.12	1.18	26	0.30	1.19	0.31	0.28	0.29	8	8	5	12	5	13	5	13	39211
15.0	14	38	11.50	4	60	0.18	5	18	22	19	22.47	1.09	26	0.28	1.19	0.29	0.30	0.31	8	8	5	13	5	12	5	12	39762
15.0	15	38	12.50	4	60	0.19	5	18	23	21	22.82	1.01	26	0.26	1.05	0.27	0.32	0.34	8	9	5	14	5	11	5	11	39884
15.0	16	38	13.50	4	60	0.20	6	18	23	24	24.29	0.99	26	0.26	1.03	0.27	0.35	0.37	7	7	5	14	5	10	5	10	40508
17.5	12	38	9.50	4	60	0.15	6	20	26	14	26.22	1.57	24	0.38	1.58	0.38	0.26	0.27	8	6	6	14	5	14	5	14	43315
17.5	13	38	10.50	4	60	0.16	6	20	27	16	26.70	1.44	24	0.34	1.58	0.34	0.28	0.29	8	6	5	11	5	13	5	13	43824
17.5	14	38	11.50	4	60	0.18	7	20	27	19	27.17	1.32	24	0.32	1.35	0.34	0.30	0.31	8	7	5	11	5	12	5	12	43542
17.5	15	38	12.50	4	60	0.19	7	20	28	21	27.65	1.23	24	0.29	1.35	0.29	0.32	0.34	8	7	5	13	5	11	5	11	44111
17.5	16	38	13.50	4	60	0.20	8	20	28	24	28.13	1.15	24	0.28	1.19	0.29	0.35	0.37	8	8	5	13	5	10	5	10	44197
20.0	12	38	9.50	4	60	0.15	8	23	31	14	30.90	1.87	22	0.42	1.90	0.44	0.26	0.27	8	5	6	12	5	14	5	14	48298
20.0	13	38	10.50	4	60	0.16	8	23	32	16	31.53	1.71	22	0.38	1.90	0.41	0.28	0.29	8	5	5	9	5	13	5	13	48934
20.0	14	38	11.50	4	60	0.18	9	23	32	19	32.15	1.58	22	0.35	1.58	0.35	0.30	0.31	8	6	6	15	5	12	5	12	47867
20.0	15	38	12.50	4	60	0.19	9	23	33	21	32.78	1.47	22	0.33	1.58	0.35	0.32	0.34	8	6	6	15	5	11	5	11	48783
20.0	16	38	13.50	4	60	0.20	10	23	33	24	33.40	1.38	22	0.31	1.58	0.35	0.35	0.37	8	6	6	15	5	10	5	10	49787
22.5	12	38	9.50	4	60	0.15	9	26	36	14	35.82	2.19	21	0.46	2.40	0.48	0.26	0.27	9	5	6	11	5	14	5	14	54797
22.5	13	38	10.50	4	60	0.16	10	26	37	16	36.61	2.00	21	0.42	2.40	0.44	0.28	0.29	9	5	6	12	5	13	5	13	55509
22.5	14	38	11.50	4	60	0.18	11	26	37	19	37.40	1.85	21	0.39	1.90	0.41	0.30	0.31	8	5	6	13	5	12	5	12	53122
22.5	15	38	12.50	4	60	0.19	12	26	38	21	38.19	1.73	21	0.36	1.90	0.38	0.32	0.34	8	5	6	14	5	11	5	11	54004
22.5	16	38	13.50	4	60	0.20	13	26	39	24	38.98	1.62	21	0.34	1.90	0.35	0.35	0.37	8	5	6	15	5	10	5	10	54960
25.0	12	38	9.50	4	60	0.15	12	29	41	14	40.97	2.52	20	0.50	2.54	0.53	0.26	0.27	10	6	6	10	5	14	5	14	59546
25.0	13	38	10.50	4	60	0.16	13	29	42	16	41.95	2.31	20	0.46	2.54	0.48	0.28	0.29	10	6	6	11	5	13	5	13	60255
25.0	14	38	11.50	4	60	0.18	14	29	43	19	42.92	2.14	20	0.43	2.40	0.44	0.30	0.31	9	5	6	12	5	12	5	12	60166
25.0	15	38	12.50	4	60	0.19	15	29	44	21	43.90	2.00	20	0.40	2.00	0.41	0.32	0.34	9	6	6	13	5	11	5	11	58404
25.0	16	38	13.50	4	60	0.20	16	29	45	24	44.88	1.88	20	0.38	1.90	0.38	0.35	0.37	8	5	6	14	5	10	5	10	58657

Table 2-10 Design of bridge approach slab by LFD approach

LOAD FACTOR DESIGN																											
Approach slab				fc'	fy	DL (klf)=DL*D/ 12	DL moment (ft-kip)/ft	(LL + I) moment ft-kip/ft	Factored moment ft-kip/ft	1.2Mcr ft kip/ft	Design Moment ft-kip/ft	As reqd in ² /ft	Dist. steel range %	Dist steel prov in ² /ft	Dist steel reqd in ² /ft	Temp, shrinkage steel reqd in ² /ft	Temp, shrinkage steel prov in ² /ft	Bottom				Top				clear cover ¹	Total cost \$
L'	D"	B'	d"															Main steel	Dist steel	Long steel		Trans steel					
				dia #	s"	dia #	s"	dia #	s"	dia #	s"	dia #	s"	dia #	s"	dia #	s"	dia #	s"	dia #	s"	dia #	s"				
15.0	12	38	9.50	4	60	0.150	4.22	17.55	43.59	13.7	43.59	1.12	26	0.31	0.29	0.26	0.27	7	6	5	12	5	14	5	14	2.0	38630
15.0	13	38	10.50	4	60	0.163	4.57	17.55	44.04	16.0	44.04	1.00	26	0.27	0.26	0.28	0.29	7	6	5	14	5	13	5	13	2.0	39093
15.0	14	38	11.50	4	60	0.175	4.92	17.55	44.50	18.6	44.50	0.91	26	0.25	0.24	0.30	0.31	7	7	5	15	5	12	5	12	2.0	39022
15.0	15	38	12.50	4	60	0.188	5.27	17.55	44.96	21.3	44.96	0.84	26	0.25	0.22	0.32	0.34	7	8	5	15	5	11	5	11	2.0	39180
15.0	16	38	13.50	4	60	0.200	5.63	17.55	45.41	24.3	45.41	0.78	26	0.25	0.20	0.35	0.37	7	9	5	15	5	10	5	10	2.0	39544
17.5	12	38	9.50	4	60	0.150	5.74	20.48	51.92	13.7	51.92	1.36	24	0.34	0.32	0.26	0.27	7	5	5	11	5	14	5	14	2.0	42452
17.5	13	38	10.50	4	60	0.163	6.22	20.48	52.54	16.0	52.54	1.22	24	0.29	0.29	0.28	0.29	7	5	5	13	5	13	5	13	2.0	42962
17.5	14	38	11.50	4	60	0.175	6.70	20.48	53.16	18.6	53.16	1.11	24	0.27	0.26	0.30	0.31	7	6	5	14	5	12	5	12	2.0	42502
17.5	15	38	12.50	4	60	0.188	7.18	20.48	53.78	21.3	53.78	1.02	24	0.25	0.24	0.32	0.34	7	7	5	15	5	11	5	11	2.0	42426
17.5	16	38	13.50	4	60	0.200	7.66	20.48	54.40	24.3	54.40	0.94	24	0.25	0.23	0.35	0.37	7	7	5	15	5	10	5	10	2.0	43313
20.0	12	38	9.50	4	60	0.150	7.50	23.40	60.55	13.7	60.55	1.62	22	0.37	0.36	0.26	0.27	8	5	5	10	5	14	5	14	2.0	47867
20.0	13	38	10.50	4	60	0.163	8.13	23.40	61.36	16.0	61.36	1.44	22	0.34	0.32	0.28	0.29	8	6	5	11	5	13	5	13	2.0	46838
20.0	14	38	11.50	4	60	0.175	8.75	23.40	62.18	18.6	62.18	1.31	22	0.31	0.29	0.30	0.31	7	5	5	12	5	12	5	12	2.0	46855
20.0	15	38	12.50	4	60	0.188	9.38	23.40	62.99	21.3	62.99	1.21	22	0.27	0.27	0.32	0.34	7	5	5	14	5	11	5	11	2.0	47540
20.0	16	38	13.50	4	60	0.200	10.00	23.40	63.80	24.3	63.80	1.12	22	0.25	0.25	0.35	0.37	7	6	5	15	5	10	5	10	2.0	47138
22.5	12	38	9.50	4	60	0.150	9.49	26.33	69.49	13.7	69.49	1.91	21	0.41	0.40	0.26	0.27	9	6	5	9	5	14	5	14	2.0	51880
22.5	13	38	10.50	4	60	0.163	10.28	26.33	70.52	16.0	70.52	1.69	21	0.37	0.36	0.28	0.29	8	5	5	10	5	13	5	13	2.0	51873
22.5	14	38	11.50	4	60	0.175	11.07	26.33	71.55	18.6	71.55	1.53	21	0.34	0.32	0.30	0.31	8	6	5	11	5	12	5	12	2.0	50746
22.5	15	38	12.50	4	60	0.188	11.87	26.33	72.58	21.3	72.58	1.41	21	0.31	0.30	0.32	0.34	7	5	5	12	5	11	5	11	2.0	50821
22.5	16	38	13.50	4	60	0.200	12.66	26.33	73.60	24.3	73.60	1.30	21	0.27	0.27	0.35	0.37	7	5	5	14	5	10	5	10	2.0	51685
25.0	12	38	9.50	4	60	0.150	11.72	29.25	78.74	13.7	78.74	2.22	20	0.44	0.44	0.26	0.27	9	5	6	12	5	14	5	14	2.0	57987
25.0	13	38	10.50	4	60	0.163	12.70	29.25	80.01	16.0	80.01	1.96	20	0.37	0.39	0.28	0.29	9	6	5	10	5	13	5	13	2.0	55853
25.0	14	38	11.50	4	60	0.175	13.67	29.25	81.28	18.6	81.28	1.77	20	0.35	0.35	0.30	0.31	8	5	6	15	5	12	5	12	2.0	56068
25.0	15	38	12.50	4	60	0.188	14.65	29.25	82.54	21.3	82.54	1.62	20	0.34	0.32	0.32	0.34	8	5	5	11	5	11	5	11	2.0	57071
25.0	16	38	13.50	4	60	0.200	15.63	29.25	83.81	24.3	83.81	1.50	20	0.31	0.30	0.35	0.37	8	6	5	12	5	10	5	10	2.0	55995

Table 2-11 Design of bridge approach slab by LRFD approach

Approach slab				HS 20 Truck load moment										Tandem moment										Bottom								Top				Total cost \$
L'	D'	D'	d'	Eq strip width $E=(24+1.44*\sqrt{L+W})/12$	$(12*W/N_c)/12$	f' _c ksi	f' _y ksi	DL (k/ft)-DL*D/12	DL moment (ft- kips)/ft	(LL+I) moment ft- kips/ft	(1.25*DL+1.75L L) # lap/ft	(Tandem+Lane load) #kips/ft	(1.25*DL+1.75L L) # lap/ft	1.2Mcrr # lap/ft	Design Moment ft-kips/ft	As reqd (in ² /ft)	As prov (in ² /ft)	Dist steel range %	Dist As prov in ² /ft	Dist steel reqd in ² /ft	Temp. shrinkage steel reqd in ² /ft	Temp. shrinkage steel prov in ² /ft	Bottom				Top									
																							Main steel dia #	s' s'	Dist steel dia #	s' s'	Long steel dia #	s' s'	Trans steel dia #	s' s'						
15.0	12	38	9.7	9.83	12.67	4	60	0.150	4.22	16.23	34	20.78	42	14	41.64	1.04	1.20	26	0.27	0.27	0.26	0.27	7	6	5	14	5	14	5	14	38485.45					
15.0	13	38	10.7	9.83	12.67	4	60	0.163	4.57	16.23	34	20.78	42	16	42.08	0.93	1.20	26	0.25	0.24	0.28	0.29	7	6	5	15	5	13	5	13	39034.79					
15.0	14	38	11.7	9.83	12.67	4	60	0.175	4.92	16.23	35	20.78	43	19	42.52	0.85	0.90	26	0.25	0.22	0.30	0.31	7	8	5	15	5	12	5	12	38484.05					
15.0	15	38	12.7	9.83	12.67	4	60	0.188	5.27	16.23	35	20.78	43	21	42.96	0.79	0.80	26	0.25	0.20	0.32	0.34	7	9	5	15	5	11	5	11	38773.59					
15.0	16	38	13.7	9.83	12.67	4	60	0.200	5.63	16.23	35	20.78	43	24	43.40	0.73	0.80	26	0.25	0.19	0.35	0.37	7	9	5	15	5	10	5	10	39543.90					
17.5	12	38	9.7	10.08	12.67	4	60	0.150	5.74	17.94	39	24.16	49	14	49.46	1.25	1.41	24	0.31	0.30	0.26	0.27	7	5	5	12	5	14	5	14	42306.50					
17.5	13	38	10.7	10.08	12.67	4	60	0.163	6.22	17.94	39	24.16	50	16	50.06	1.13	1.20	24	0.29	0.27	0.28	0.29	7	6	5	13	5	13	5	13	41807.28					
17.5	14	38	11.7	10.08	12.67	4	60	0.175	6.70	17.94	40	24.16	51	19	50.66	1.03	1.20	24	0.25	0.25	0.30	0.31	7	6	5	15	5	12	5	12	42434.51					
17.5	15	38	12.7	10.08	12.67	4	60	0.188	7.18	17.94	40	24.16	51	21	51.26	0.95	1.03	24	0.25	0.23	0.32	0.34	7	7	5	15	5	11	5	11	42426.17					
17.5	16	38	13.7	10.08	12.67	4	60	0.200	7.66	17.94	41	24.16	52	24	51.86	0.88	0.90	24	0.25	0.21	0.35	0.37	7	8	5	15	5	10	5	10	42702.40					
20.0	12	38	9.6	10.33	12.67	4	60	0.150	7.50	20.59	45	29.20	60	14	60.48	1.59	1.90	22	0.37	0.36	0.26	0.27	8	5	5	10	5	14	5	14	47866.50					
20.0	13	38	10.6	10.33	12.67	4	60	0.163	8.13	20.59	46	29.20	61	16	61.26	1.42	1.58	22	0.34	0.32	0.28	0.29	8	6	5	11	5	13	5	13	46837.86					
20.0	14	38	11.6	10.33	12.67	4	60	0.175	8.75	20.59	47	29.20	62	19	62.04	1.29	1.35	22	0.29	0.29	0.30	0.31	8	7	5	13	5	12	5	12	46231.78					
20.0	15	38	12.7	10.33	12.67	4	60	0.188	9.38	20.59	48	29.20	63	21	62.82	1.18	1.20	22	0.27	0.26	0.32	0.34	7	6	5	14	5	11	5	11	46249.61					
20.0	16	38	13.7	10.33	12.67	4	60	0.200	10.00	20.59	49	29.20	64	24	63.60	1.10	1.20	22	0.25	0.25	0.35	0.37	7	6	5	15	5	10	5	10	47137.58					
22.5	12	38	9.6	10.50	12.67	4	60	0.150	9.49	22.29	51	32.54	69	14	68.81	1.86	1.90	21	0.41	0.39	0.26	0.27	8	5	5	9	5	14	5	14	51164.08					
22.5	13	38	10.6	10.50	12.67	4	60	0.163	10.28	22.29	52	32.54	70	16	69.80	1.65	1.90	21	0.37	0.35	0.28	0.29	8	5	5	10	5	13	5	13	51872.62					
22.5	14	38	11.6	10.50	12.67	4	60	0.175	11.07	22.29	53	32.54	71	19	70.79	1.50	1.58	21	0.34	0.32	0.30	0.31	8	6	5	11	5	12	5	12	50746.08					
22.5	15	38	12.6	10.50	12.67	4	60	0.188	11.87	22.29	54	32.54	72	21	71.77	1.38	1.58	21	0.29	0.29	0.32	0.34	8	6	5	13	5	11	5	11	51478.21					
22.5	16	38	13.6	10.50	12.67	4	60	0.200	12.66	22.29	55	32.54	73	24	72.76	1.28	1.35	21	0.27	0.27	0.35	0.37	8	7	5	14	5	10	5	10	51114.58					
25.0	12	38	9.5	10.67	12.67	4	60	0.150	11.72	25.86	60	37.52	80	14	80.32	2.28	2.40	20	0.47	0.46	0.26	0.27	9	5	5	8	5	14	5	14	58096.18					
25.0	13	38	10.5	10.67	12.67	4	60	0.163	12.70	25.86	61	37.52	82	16	81.54	2.01	2.40	20	0.41	0.40	0.28	0.29	9	5	5	9	5	13	5	13	58826.80					
25.0	14	38	11.6	10.67	12.67	4	60	0.175	13.67	25.86	62	37.52	83	19	82.76	1.79	1.90	20	0.37	0.36	0.30	0.31	8	5	5	10	5	12	5	12	56119.41					
25.0	15	38	12.6	10.67	12.67	4	60	0.188	14.65	25.86	64	37.52	84	21	83.98	1.64	1.90	20	0.34	0.33	0.32	0.34	8	5	5	11	5	11	5	11	57070.78					
25.0	16	38	13.6	10.67	12.67	4	60	0.200	15.63	25.86	65	37.52	85	24	85.20	1.52	1.58	20	0.31	0.30	0.35	0.37	8	6	5	12	5	10	5	10	55994.79					

2.5.5 ANALYSIS RESULTS AND CONCLUSIONS

The method of design explained in this chapter gives a simple and rational approach to design of an approach slab using AASHTO LRFD bridge design specifications and also compares the results for ASD, LFD and LRFD design methods. The results obtained from the spreadsheet are presented in Figure 2-19 and Figure 2-20. The cost of construction as per the LRFD design method explained in the previous section was also compared and is shown in Figure 2-21.

Observations:

1. For a particular approach slab length and slab thickness, it can be shown from Figure 2-19 and Figure 2-20 that the LRFD approach consistently requires precisely the same steel as the LFD approach, but the steel required by ASD varies significantly in relation to these two strength design approaches.
2. When the cost of construction using the LRFD approach was compared, it was observed that span 20 feet with 12 in depth provides a less expensive design.
3. The results from Tables 2-9 to 2-11 and Figures 2-19 and 2-20 were discussed with MoDOT during the quarterly meetings. Although, there are less expensive alternatives that are either 14 inch deep or less than 20 feet in span, it was decided to proceed with spans not less than 20 feet and thickness of 12 inches based on discussions with MoDOT. The BAS option with 20 feet span and 12 inch depth was considered for the numerical modeling and for further analysis.

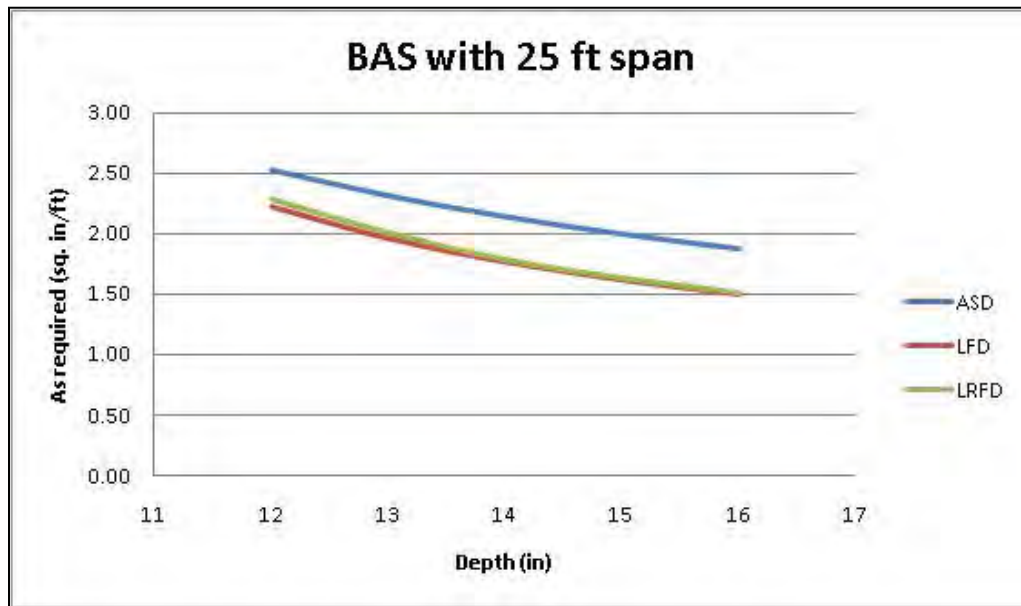

Figure 2-19: Comparison for reinforcement required for ASD, LFD and LRFD design procedures for span of 25'

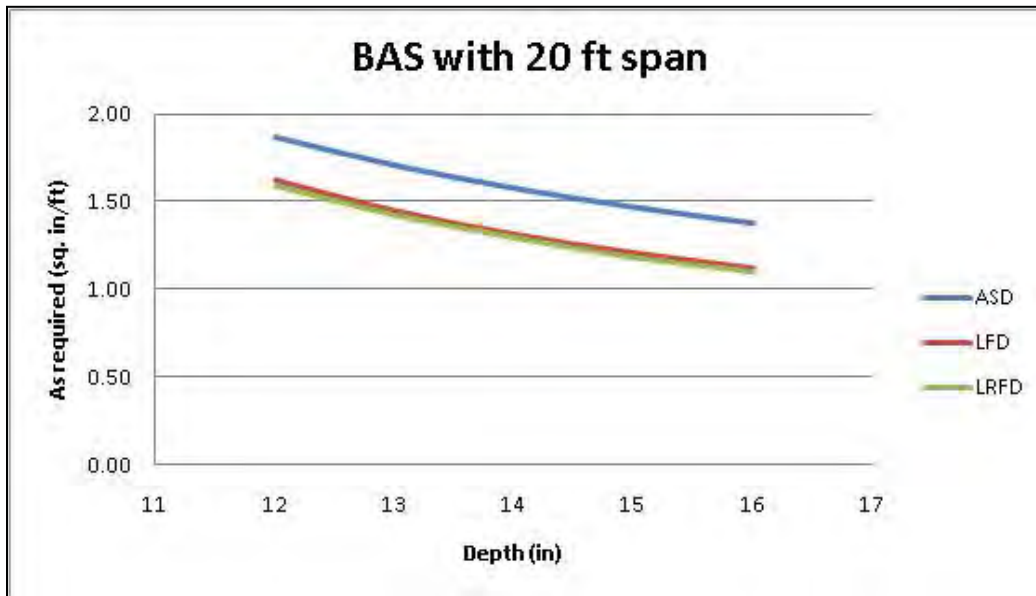

Figure 2-20: Comparison for reinforcement required for ASD, LFD and LRFD design procedures for span of 20'

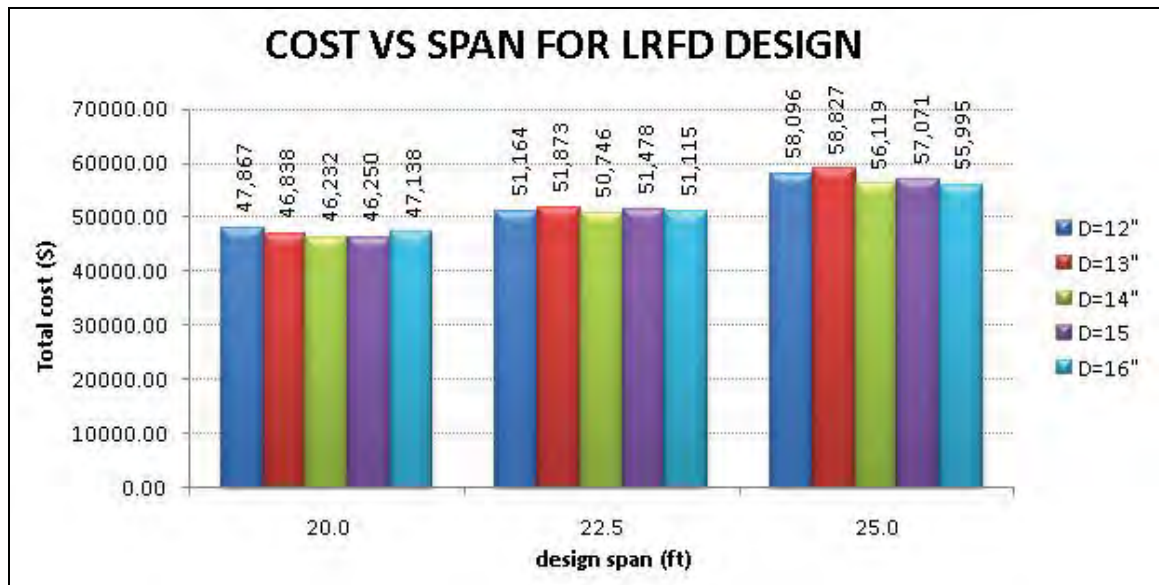

Figure 2-21: Cost comparison for BAS with different span

Table 2-12 Comparison for moments

Rank	State	Type of slab	Span (ft)	Depth (in)	\$ Cost	Mu Ft-kips/ft	ϕ Mn Ft-kips/ft singly	Bottom Reinforcement (Main/Distribution)	Top Reinforcement (longitudinal/Transverse)
18	Idaho	I-A	20	12	42402.53	60.48	38.99	#8@9" #5@12"	#4@18" #5@12"
24	Missouri MAS	I-A	25	12	45335.52	80.32	37.04	#6@6" #4@12"	#5@12" #4@18"
45	Missouri	I-A	25	12	55316.45	80.32	69.16	#8@5" #6@15"	#7@12" #4@18"

Observations and Recommendation for Further Investigation: From the analyses performed using a simply supported slab cost analysis it is observed that a **20 ft span x 12 inch thick** slab would be a very economical slab to consider for further investigations. The projected cost from this study is approximately \$47,900 which is less than that calculated for the currently used slab with 25 feet span and 12 inch thickness as per LRFD design computed at \$58,100. Both the costs do not include the cost of the sleeper slab in order to provide a uniform basis for cost comparison. This information had been presented to Missouri DOT officials in various meetings and is considered for slab on grade analysis which is presented in the next chapter.

The design calculation performed in this chapter is assuming simply supported boundary conditions. The design moment and available design moment capacity for slabs considered for further analysis is shown in Table 2-12. We also have to consider the slab on grade situation for the detailed design and analysis considering various degrees of void formation beneath the BAS. Analysis considering void formation can be achieved by modeling the BAS in a computer analysis program and incorporating the soil supports beneath the BAS. Section 2.7 explains the various models formation with different support condition.

2.6 APPROACH SLAB NUMERICAL MODELING

This section presents the results and observations from the analyses of various numerical models of the bridge approach slab using SAP 2000 [23]. Two basic models of 25 feet span and 20 feet span were constructed. The models were constructed in order to determine the design moments. Soil support conditions under the slab were considered by using elastic springs. Analyses were performed for full slab on grade condition to void formation up to 25%-50% of the span from the abutment end. Results from these analyses are used further for design recommendations.

A typical approach slab model would be a slab supported on the abutment at one end and a sleeper slab/beam at the pavement end. The abutment end would be a rigid structure compared to the pavement end. [7]. Designing the approach slab as a simply supported beam between the abutment and pavement is very conservative and uneconomical. AASHTO code provisions provide some loading, structural and geotechnical guidelines for designing approach slabs. Figure 2-22 shows a schematic representation of a bridge approach slab for MoDOT. The sleeper slab is used to prevent settlement and erosion due to piping water beneath the pavement end of

approach slab. The geometry for modeling was taken from the MoDOT standard bridge approach slab drawing that is available on the MoDOT Bridge standards website,

http://www.modot.mo.gov/business/standard_drawings2/documents/apn6_sq_n.pdf

2.6.1 MODEL MATRIX

Typical Detail of Bridge Approach Slab - The standard Bridge Approach Slab for Missouri Department of Transportation has span of 25 feet and depth of 12 inches. It is noted that a common roadway width of 38 feet (for 2-12 ft lanes of traffic, assuming 4 ft wide inside shoulder and 10 ft wide outside shoulder) is used in this study.

Figure 2-22 shows the reinforcement details of the MoDOT bridge approach slab which are: Bottom main steel- # 8 @ 5" c/c, bottom distribution steel- #6 @ 15" c/c, top longitudinal steel- #7 @ 12" c/c and top transverse steel- #4 @ 18" c/c.

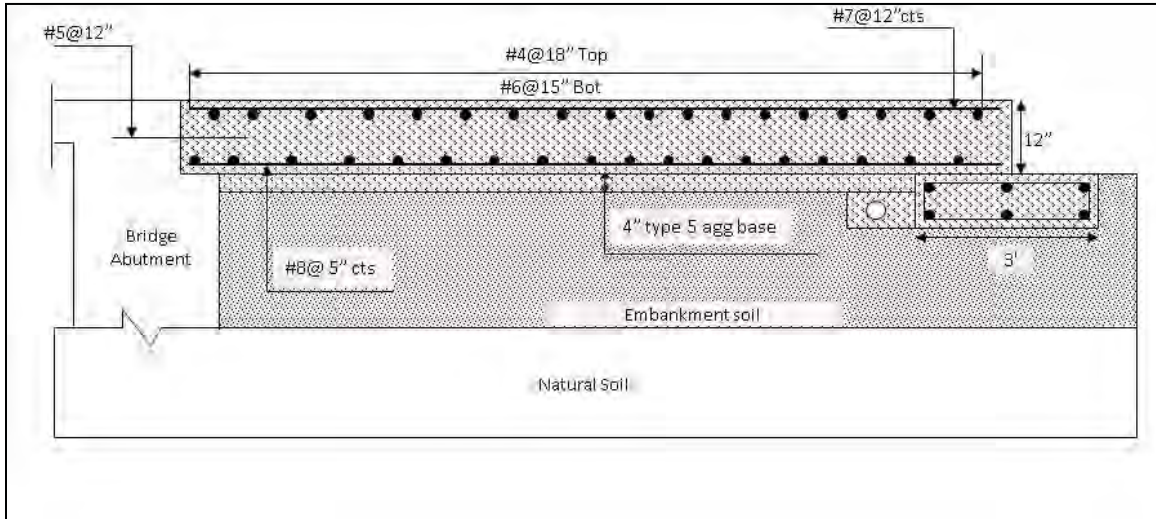

Figure 2-22: Schematic view of current MoDOT bridge approach slab arrangement

A matrix of various models considering different boundary conditions and support options was developed to incorporate the effect of void development below the approach slab. Springs were used to simulate the soil conditions and voids underneath the BAS were modeled by selectively removing springs in specified locations. A matrix of cases with variations in slab width, span, boundary and soil condition, and loading were analyzed. The different options representing the above conditions are described below followed by a table of the matrix itself.

Slab width and Span: As discussed earlier, Idaho slab seemed to be a good choice for this project from the cost analysis. The performance of this slab can be compared with the two types MoDOT slabs currently being used, by modeling and analyzing the results. Both 20 feet and 25 feet slabs for new cast in place approach slabs was analyzed using SAP 2000 [23]. The analysis was performed using a 38 feet wide slab (for 2-12 ft lanes of traffic, assuming 4 ft wide inside

shoulder and 10 ft wide outside shoulder). The slab width was selected based on communication with MoDOT officials.

IMPORTANT NOTE: However, keeping future requirements in mind the actual loading applied to the slab for computer analysis purposes was based on 3 lanes of traffic.

Slab Boundary and Soil Conditions: In this project the slabs have been analyzed as either simply supported slabs or with a slab on grade condition applied under the slab. Washout conditions under the slab near the abutment end have been considered for 15%, 25% and 50% span washout. No sleeper slab condition with full slab on grade support has also been considered as this represents the current Missouri modified approach slab. In order to consider soil conditions, a very poor soil condition is assumed under the slab with a soil subgrade modulus of 18.4 lb/in^3 . Since the elements of the slab in the finite element program are 1 ft x 1 ft the subgrade modulus is used to calculate a spring stiffness of











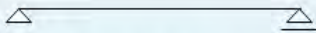



$$18.4 \frac{\text{lb}}{\text{in}^3} \times 12\text{in} \times 12\text{in} = 2,649.6 \frac{\text{lb}}{\text{in}} = 220.8 \frac{\text{lb}}{\text{ft}}.$$

Notation: The notation used is: BAS-span-thickness of slab-soil condition- span of soil support-soil stiffness. For example BAS-25-12-ES-18.75-18.4 stands for a 25 feet span, 12 inch thickness; elastic springs over 18.75 ft with 18.4 lb/in^3 shown in the Table 2-13. The soil considered here is a very poor soil. NS stands for no sleeper slab condition.

The list of model cases for the three types of slabs named as standard Missouri, Missouri Modified and Idaho BAS for the analysis of the cast in place slabs are shown in Table 2-13. The moments obtained from the three sets will be compared later in this chapter. The basic configuration for the five cases used in three sets of matrix models is described below.

- **Case 1:** Simply supported Bridge Approach Slab i.e. pinned at both ends and spanning longitudinally.
- **Case 2:** Slab on grade with no voids under the slab (elastic springs over entire span).
- **Case 3:** Slab on grade with 15% void development near the abutment end of BAS (elastic springs are modeled over 85% of the BAS span).
- **Case 4:** Slab on grade with 25% void development underneath abutment end of BAS (elastic springs are modeled over 75% of the BAS span).
- **Case 5:** Slab on grade with no sleeper slab and pinned at the abutment end.

Table 2-13 Model matrix

Case	Span	Depth	File Name	Support Conditions
SET 1 - Std Missouri BAS				
1	25'	12"	BAS-25-12-SSS	SS- Standard Missouri BAS 
2	25'	12"	BAS-25-12-ES-25-18.4	SS with linear springs over L with $k_s=18.4 \text{ lb/in}^3$ 
3	25'	12"	BAS-25-12-ES-21.25-18.4	SS with linear springs over 85% L  0.15L
4	25'	12"	BAS-25-12-ES-18.75-18.4	SS with linear springs over 75% L  0.25L
5	25'	12"	BAS-25-12-ES-25-18.4-NS	without sleeper slab 
SET 2 - Missouri Modified BAS				
1	25'	12"	MODBAS-25-12-SSS	Modified BAS for Missouri 
2	25'	12"	MODBAS-25-12-ES-25-18.4	SS with linear springs over L with $k_s=18.4 \text{ lb/in}^3$ 
3	25'	12"	MODBAS-25-12-ES-21.25-18.4	SS with linear springs over 85% L  0.15L
4	25'	12"	MODBAS-25-12-ES-18.75-18.4	SS with linear springs over 75% L  0.25L
5	25'	12"	MODBAS-25-12-ES-25-18.4-NS	without sleeper slab 
SET 3 - Idaho BAS				
1	20'	12"	ID-BAS-20-12-SSS	SS- Standard Missouri BAS 
2	20'	12"	ID-BAS-20-12-ES-20-18.4	SS with linear springs over L with $k_s=18.4 \text{ lb/in}^3$ 
3	20'	12"	ID-BAS-20-12-ES-17-18.4	SS with linear springs over 85% L  0.15L
4	20'	12"	ID-BAS-20-12-ES-15-18.4	SS with linear springs over 75% L  0.25L
5	20'	12"	ID-BAS-20-12-ES-20-18.4-NS	without sleeper slab 
SSS-Simply Supported Slab				

2.6.2 MODEL DETAILS

Model Generation: The computer program that was used to model the bridge approach slab was SAP 2000 V12.0.1. [23]. SAP models were developed to study the effect of span, thickness and reinforcement changes along with the effect of voids underneath the BAS. A 3D finite element model was developed, as shown in Figure 2-23, where four-node shell elements were used to form the finite element mesh as shown in Figure 2-24. The mesh size used in the model was of size 12 inches x 12 inches. The total number of nodes and shell elements in set one and set two are 1014 and 950 respectively. The total number of nodes and elements in set three and set four are 819 and 760 respectively. The elements used in the model are shell elements with defined layers of reinforcement as shown in Table 2-14. The distance from centre of each layer to the

centre of the cross section and its thickness are calculated. These values are used in defining shell area reinforcement layer. Values for models in set 1 are shown in Figure 2-25 as an example. Top bar 1 represents the top longitudinal reinforcement and top bar 2 represents the top transverse reinforcement whereas bottom bar 1 represents the bottom main reinforcement and bottom bar 2 represents the bottom distribution reinforcement. Material angle for top bar 2 and bottom bar 2 would be 90 degrees in this case.

The left end of the BAS model represents the slab-pavement interface and the right end of the approach slab represents slab-bridge interface. The slab-bridge interface and slab-pavement interface are modeled as pinned connection except in case 5 i.e. BAS with no sleeper slab scenario.

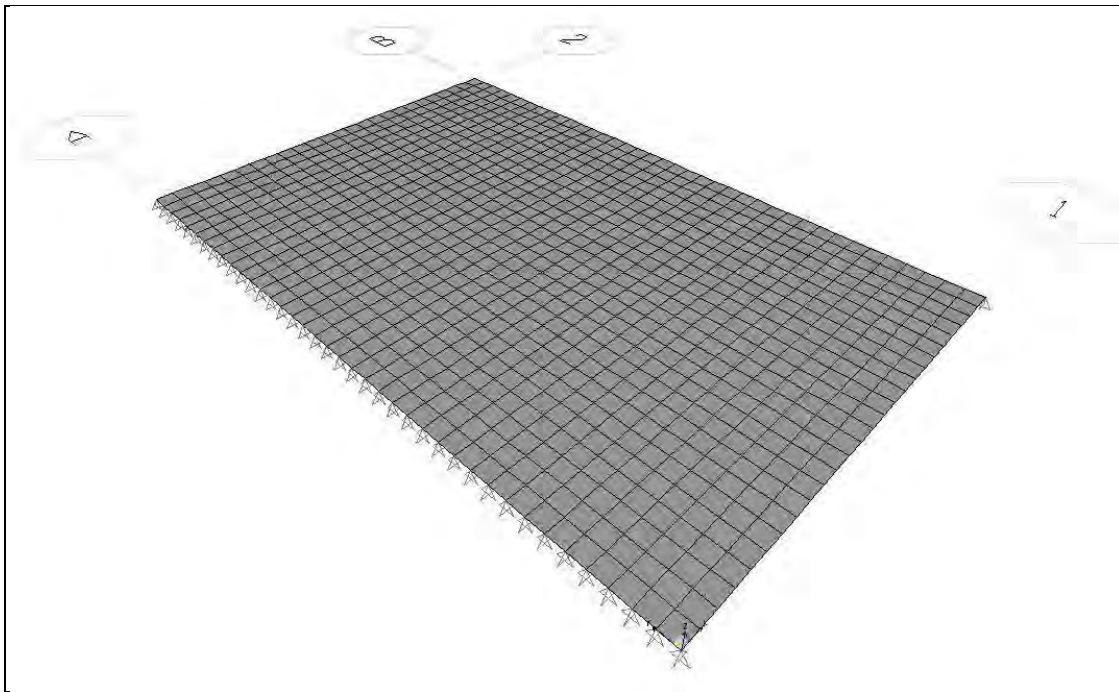

Figure 2-23: Typical finite element model for bridge approach slab

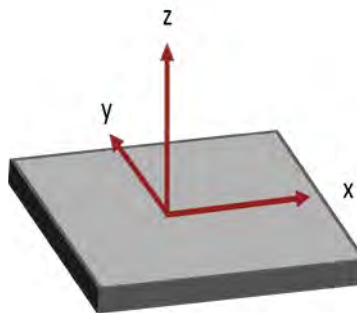

Figure 2-24: Shell element used in finite element model

Table 2-14 Reinforcement input for models

Set	Span (ft)	Depth (in)	Bottom reinforcement (Main / Distribution)	Top reinforcement (Longitudinal/ Transverse)
1-Std MO	25'	12'	#8@5" / #6@15"	#7@12" / #4@18"
2-MOD MO	25'	12'	#6@6" / #4@12"	#5@12" / #4@18"
3-ID	20'	12'	#8@9" / #5@12"	#4@18" / #5@12"

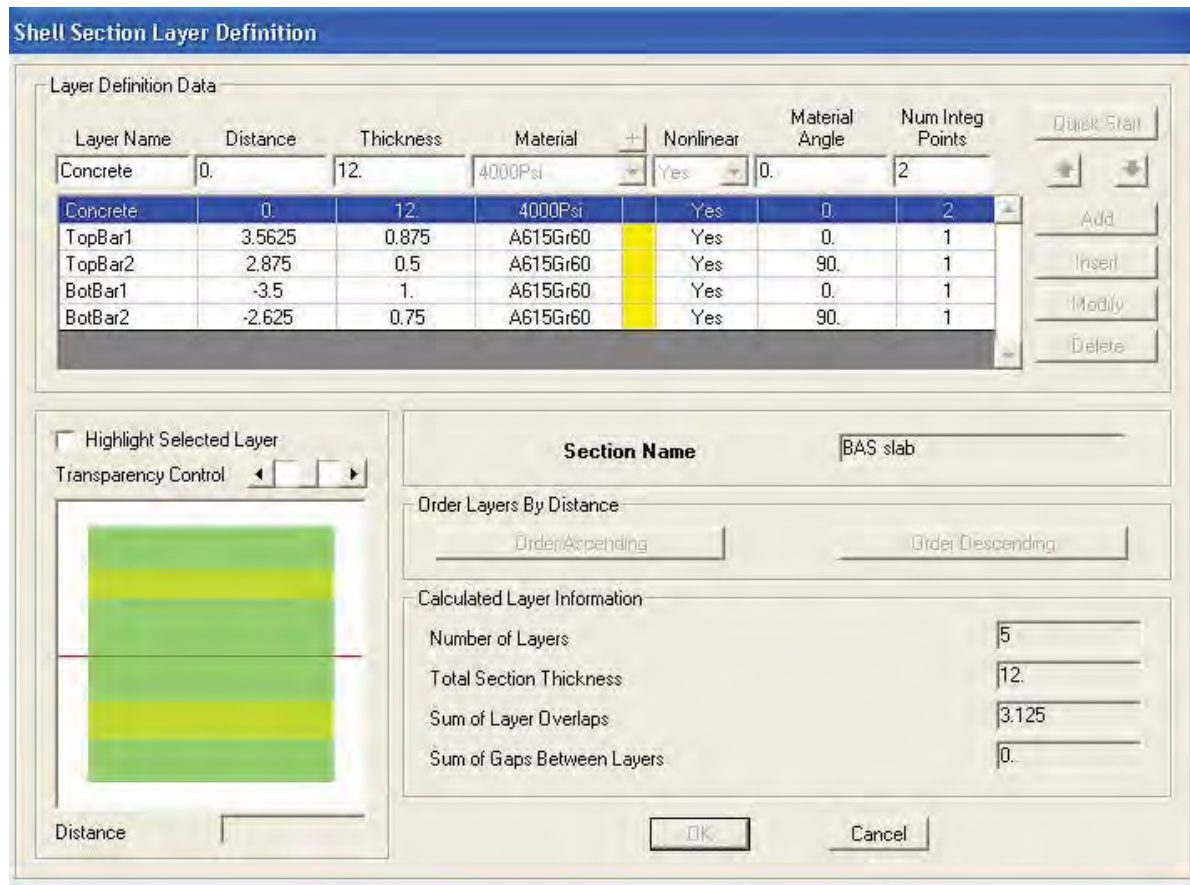

Figure 2-25: Shell area element layer definition

Material Properties

Concrete compressive strength considered was 4000 psi. The non linear material model for concrete available in SAP 2000 was used in the analysis. Based on this, the modulus of elasticity and modulus of rupture are calculated as per ACI 318 equations as shown below:

Modulus of Elasticity- $E_c = \frac{57000\sqrt{f_c'}}{1000} = 3,605$ ksi

Modulus of Rupture- $f_r = 7.5\sqrt{f_c'} = 474$ psi

The Poisson's ratio for concrete was considered as 0.2

Grade of steel was taken as 60,000 psi.

Soil Properties

The embankment soil underneath the bridge approach slab is modeled as a series of elastic springs with constant spring stiffness. Modulus of sub grade reaction is used to calculate the spring stiffness value [24]. The modulus of sub grade reaction controls the depth to which the slab on grade sinks. The value of sub grade reaction is directly proportional to the stiffness of the sub grade and is widely used in the structural analysis of foundation elements. A range of modulus of sub grade reactions are given in [25]. The value for modulus of sub grade reaction for loose sand type of soil or termed as poor soil condition is considered as 18.4 lb/in^3 . The spring used in the models is defined by SAP software as a "spring 1" type element. This spring element represents the soil underneath having stiffness corresponding to the modulus of subgrade reaction considered. The value for spring stiffness entered in SAP for each joint can be calculated by multiplying the width and length of each shell element and comes out to be 2649.6 lb/in.

Loads

The loading of the model has been done according to AASHTO LRFD bridge design specifications [22]. The design truck with three axles and gross weight of 72 kips is considered along with the design lane load. The tandem load is also considered along with the lane load. The design truck is 6 feet wide and the distance between front axle and middle axle is 14 feet. The distance between middle and rear axle varies from 14 feet to 30 feet. The distance between middle axle and rear axle has been considered as 14 feet as the span of approach slab modeled is either 20 feet or 25 feet. [26]. The design truck is shown in Figure 2-26 below.

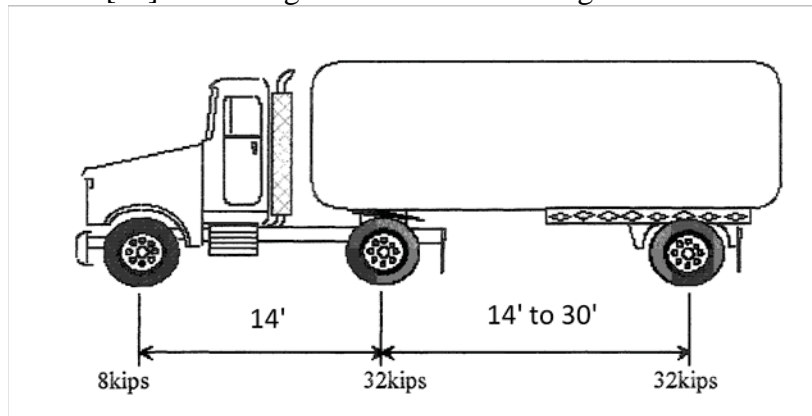

Figure 2-26: AASHTO standard design truck

The design lane load consists of a load of 0.64 kips per linear foot uniformly distributed along the span of the approach slab. The lane load is distributed transversely over 10 feet width. The

load has been applied as pressure loads on one square foot element. The pressure loads under each axle for every wheel was calculated as 12.5 ksf for tandem and 16 ksf for truck load. The slabs modeled here were considered to be 38 feet wide with 3 traffic lanes. The loading has been applied in steps with three design trucks entering the slab at the slab-pavement end and then traversing the slab. It is obvious that there will be only two axles traversing on the slab at a time. We have considered two axles with point load of 32 kips. The design truck and the design tandem load are positioned to produce extreme force effects as discussed in an earlier section. The critical axle and tandem position which will give the maximum moment are as shown in in Figure 2-27. The schematic view of vehicle position over the slab is shown in Figure 2-28. Tandem loads are applied to the model as shown in Figure 2-29. Truck loads are applied as shown in Figure 2-30. Lane loads are applied as shown in Figure 2-31.

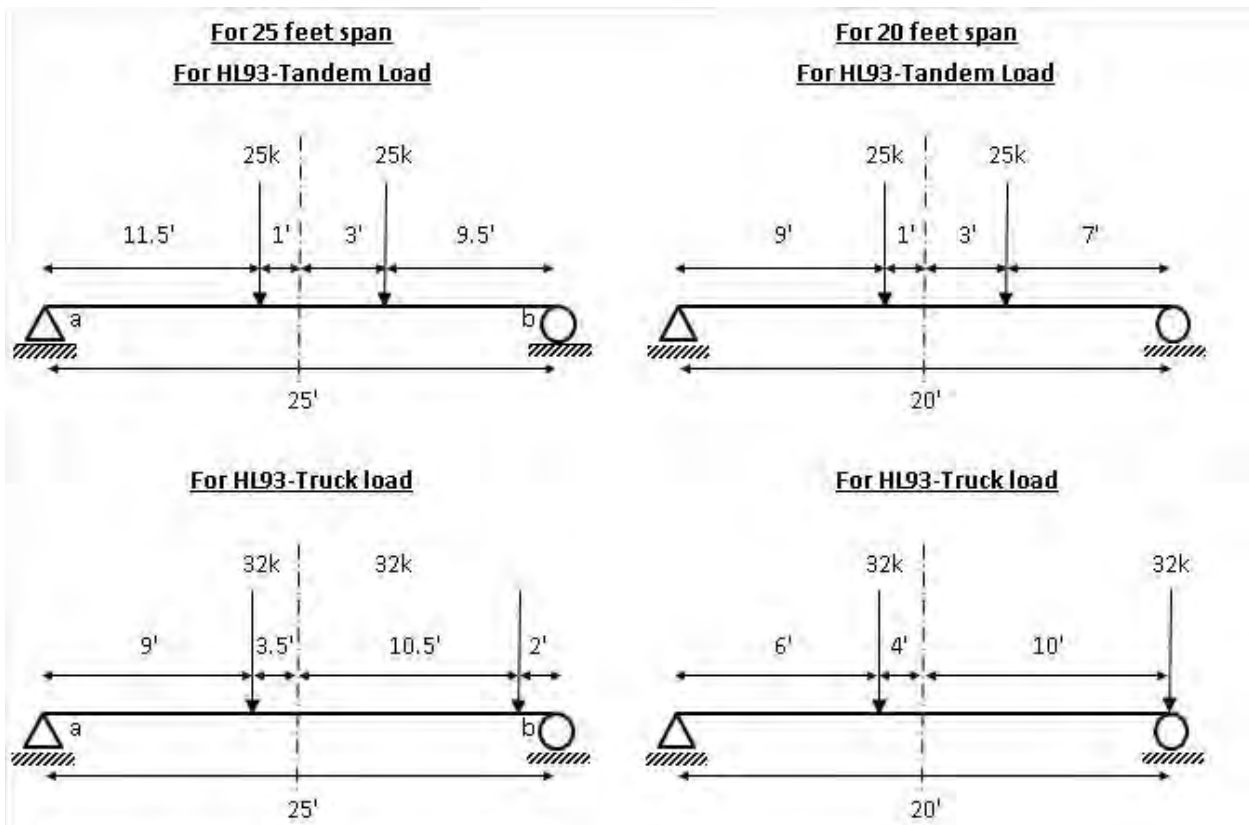

Figure 2-27: Load locations for maximum bending moment for simply supported slab

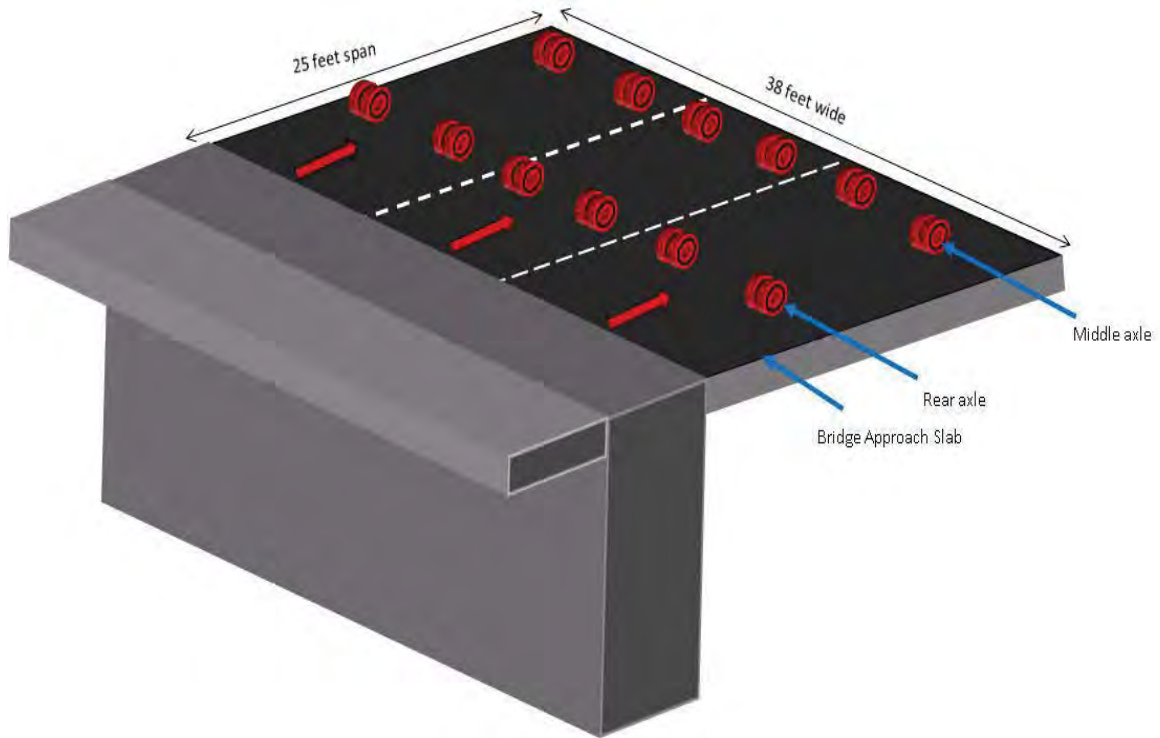

Figure 2-28: Schematic view for vehicle locations

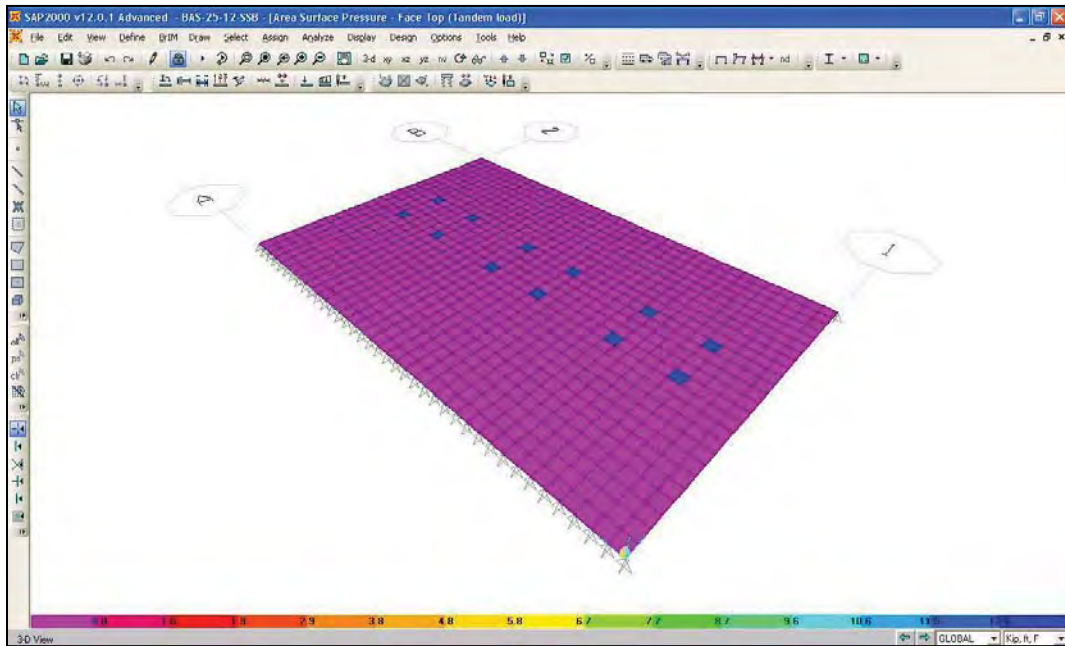

Figure 2-29: Tandem load for BAS model

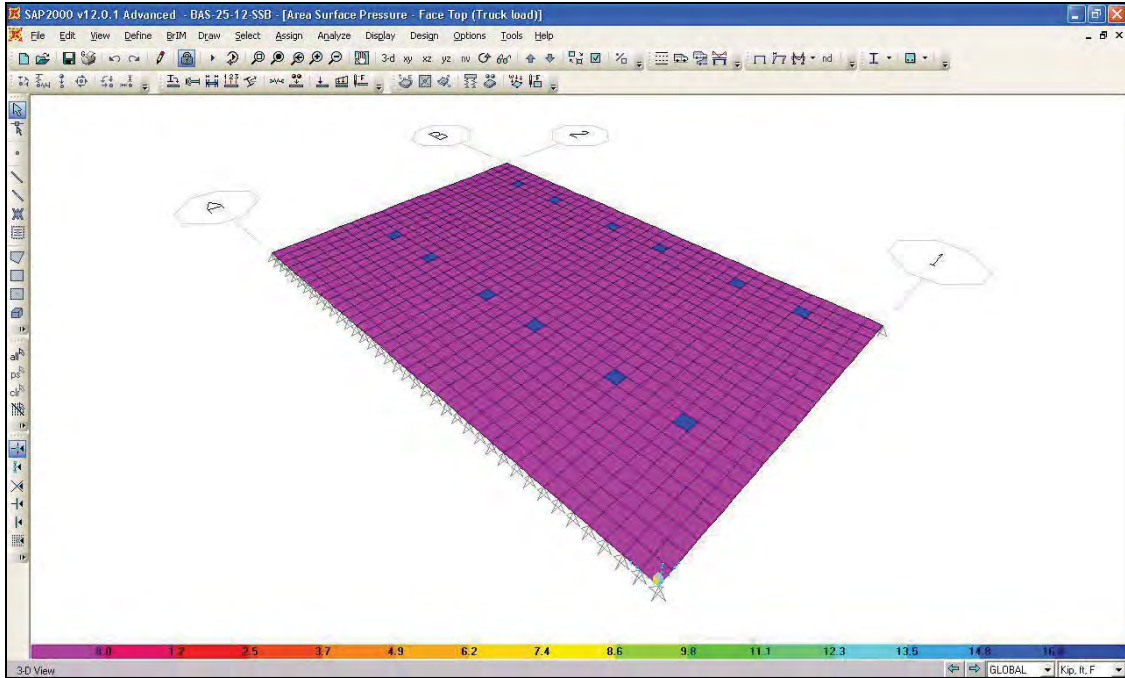

Figure 2-30: Truck load for BAS model

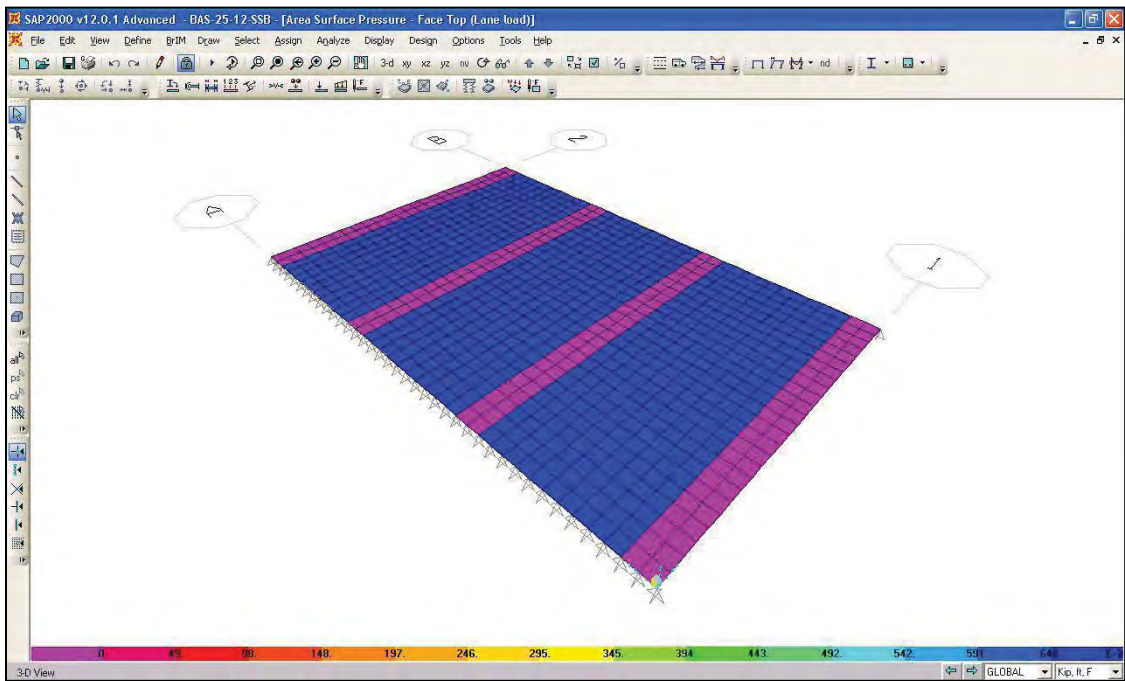

Figure 2-31: Lane load BAS model

2.6.3 LOAD CASES AND LOAD COMBINATIONS

Four static load cases were identified in order to account for the extreme loading conditions. Load cases and Load combinations considered are as below.

Load cases:

Case 1) Dead load (DL-self weight of slab)

Case 2) Truck load

Case 3) Tandem load

Case 4) Design lane load

Strength Load Combinations:

LC1- $1.25DL + 1.75 * 1.33 * \text{Tandem load} + 1.75 * \text{Lane load}$

LC2- $1.25DL + 1.75 * 1.33 * \text{Truck load} + 1.75 * \text{Lane load}$

Service Load Combinations:

LC3- DL+Truck+ Lane load

LC4- DL+ Tandem+Lane load

2.6.4 ANALYSIS OF RESULTS

The 15 models explained in model matrix were run and their output results are shown in Table 2-15 Analysis results for BAS models (width =38'). Some salient observations from the analysis are noted below.

- a) The maximum deflection at the centre for Standard Missouri approach slab is 0.63" for simply supported case whereas the maximum deflection of modified Missouri approach slab is 0.68" It can be found that Idaho slab deflection was found to be 0.36" for simply supported condition. The maximum deflection value for slab on grade with given percentage of voids was observed to be 0.3".
- b) The maximum moment for simply supported condition was observed to be 134.52 ft.kips per feet for the standard MO-BAS. Whereas the maximum moment for slab on grade option was found to be 63.15 ft.kips per feet.
- c) For all the models, the rebar bottom and rebar top stresses are observed to be much lower than the yield limits of the reinforcement.
- d) The values for concrete and rebar stresses for slab on grade conditions seemed to be lower than that of simply supported condition. This reflects the true behavior for slab on grade situation.

Table 2-15 Analysis results for BAS models (width =38')

Analysis results for BAS model											
Width of BAS is assumed as 38ft											
Sr no	Model	δ_{max} for service load	θ_{max} rad	θ_{max}^0	Con top		Con bot		Rebar top	Rebar bot	Mmax ft-kips
					Smax (psi)	Smin (psi)	Smax (psi)	Smin (psi)	Smax (psi)	Smin (psi)	
Missouri Standard BAS											
1	BAS25-12-SSB	0.63	0.0066	0.38	-2498.68	22.26	2498.68	-22.26	-11377.28	11177.68	134.52
2	BAS 25-12-ES25-18.4	0.28	0.0030	0.17	-1126.69	42.39	1126.69	-42.39	-5092.11	5002.78	60.32
3	BAS 25-12-ES21.25-18.4	0.28	0.0026	0.15	-1132.60	40.03	1132.60	-40.03	-5125.79	5035.87	60.70
4	BAS 25-12-ES18.75-18.4	0.29	0.0032	0.18	-1177.44	39.53	1177.44	-39.53	-5333.36	5329.76	63.15
5	BAS 25-12-ES25-18.4-NS	0.50	0.0031	0.18	-641.02	123.87	641.02	-123.87	-2815.25	2765.86	33.81
Modified Missouri BAS											
1	MODBAS25-12-SSB	0.68	0.0073	0.42	-2767.07	28.98	2767.07	-28.98	-13049.07	12828.48	131.33
2	MODBAS 25-12-ES25-18.4	0.29	0.0031	0.18	-1164.56	45.55	1164.56	-45.55	-5449.77	5357.40	54.97
3	MODBAS 25-12-ES21.25-18.4	0.29	0.0031	0.18	-1170.91	43.22	1170.91	-43.22	-5486.41	5393.42	55.35
4	MODBAS 25-12-ES18.75-18.4	0.30	0.0034	0.19	-1222.39	42.81	1222.39	-42.81	-5717.20	5620.23	57.67
5	MODBAS 25-12-ES25-18.4-NS	0.47	0.0031	0.18	-686.02	126.15	686.02	-126.15	-3125.25	3072.28	31.99
Idaho BAS											
1	ID-L20-12-SSB	0.36	0.0047	0.27	-2245.55	4.72	2245.55	-4.72	-8984.00	8265.95	91.63
2	ID-L20-12-ES20-18.4	0.21	0.0028	0.16	-1357.79	21.04	1357.79	-21.04	-5413.94	4980.12	55.29
3	ID-L20-12-ES17-18.4	0.21	0.0028	0.16	-1362.48	19.55	1362.48	-19.55	-5432.76	4998.14	55.48
4	ID-L 20-12-ES15-18.4	0.22	0.0029	0.17	-1386.65	18.01	1386.65	-18.01	-5529.81	5087.43	56.47
5	ID-L 20-12-ES20-18.4-NS	0.54	0.0034	0.19	-689.59	111.22	689.59	-111.22	-2677.41	2463.22	27.790

Simply supported slab showing loads, the end rotation and deflection

Moment Contours: Some visual results for moment contour were captured. The selected cases were considered and are as follows:

- a) 25 feet model – Simply supported condition with lane loads (Figure 2-32). The maximum moment value is 134 ft.kips/ft. distributed mainly at the center of the span,
- b) 25 feet model – 25% Voids under slab with lane loads (Figure 2-33),
- c) 25 feet model – Slab on grade with no sleeper slab (Figure 2-34),
- d) 20 feet model – Simply supported condition with lane loads (Figure 2-35),
- e) 20 feet model – 25% Voids under slab with lane loads (Figure 2-36), and
- f) 20 feet model – Slab on grade with no sleeper slab. (Figure 2-37).

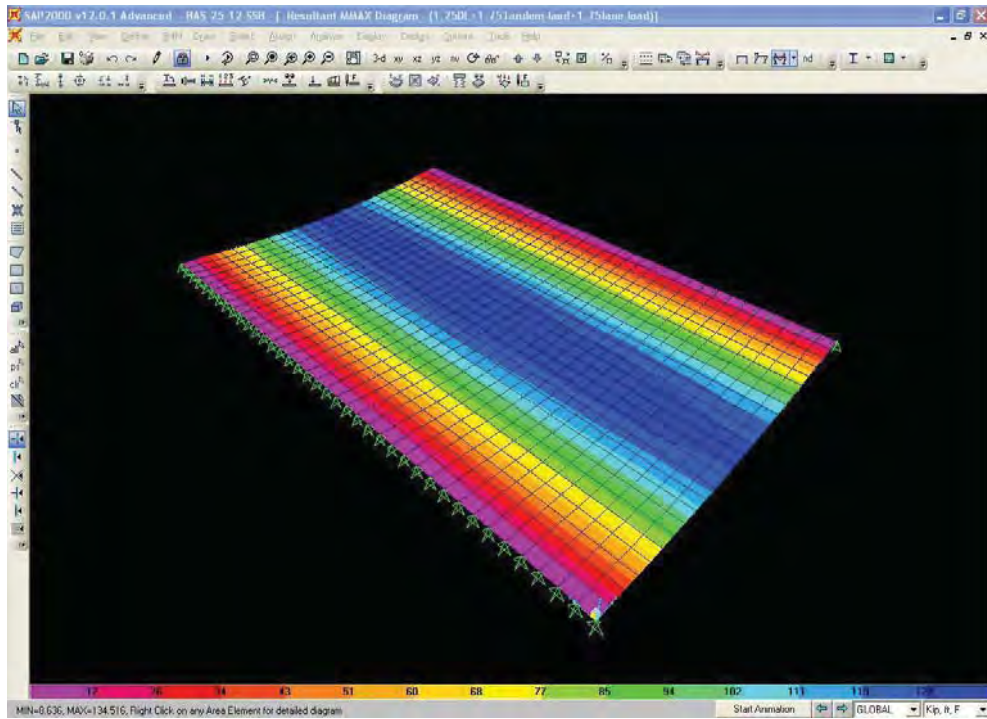

Figure 2-32: Moment pattern for standard MOBAS model case 1

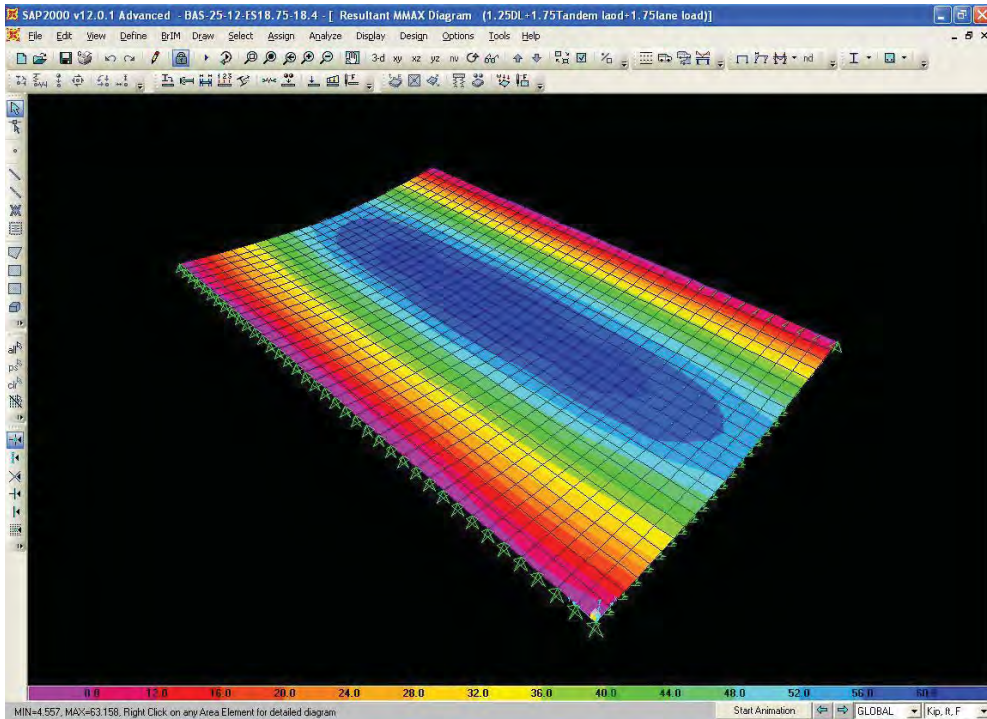

Figure 2-33: Moment pattern for standard MOBAS model case 4

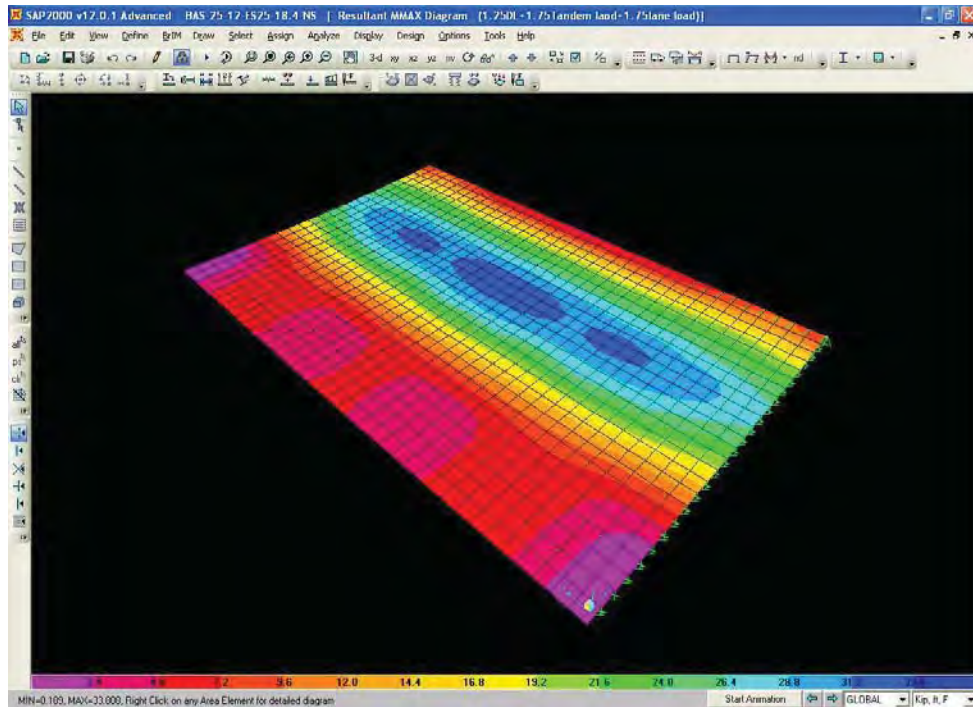

Figure 2-34: Moment pattern for Standard MOBAS model case 5

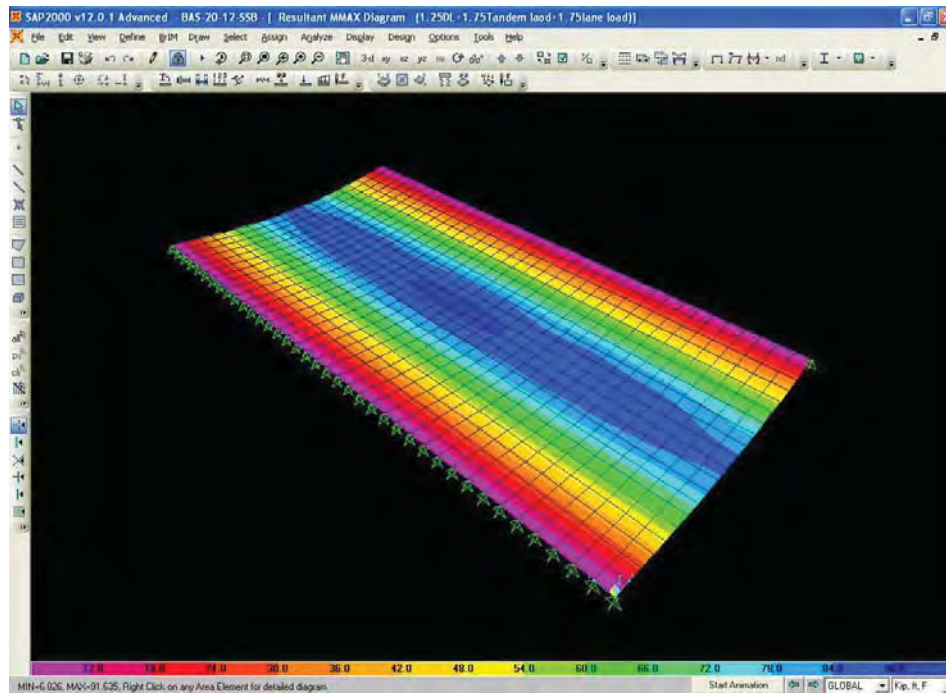

Figure 2-35: Moment pattern for CIP option model case 1

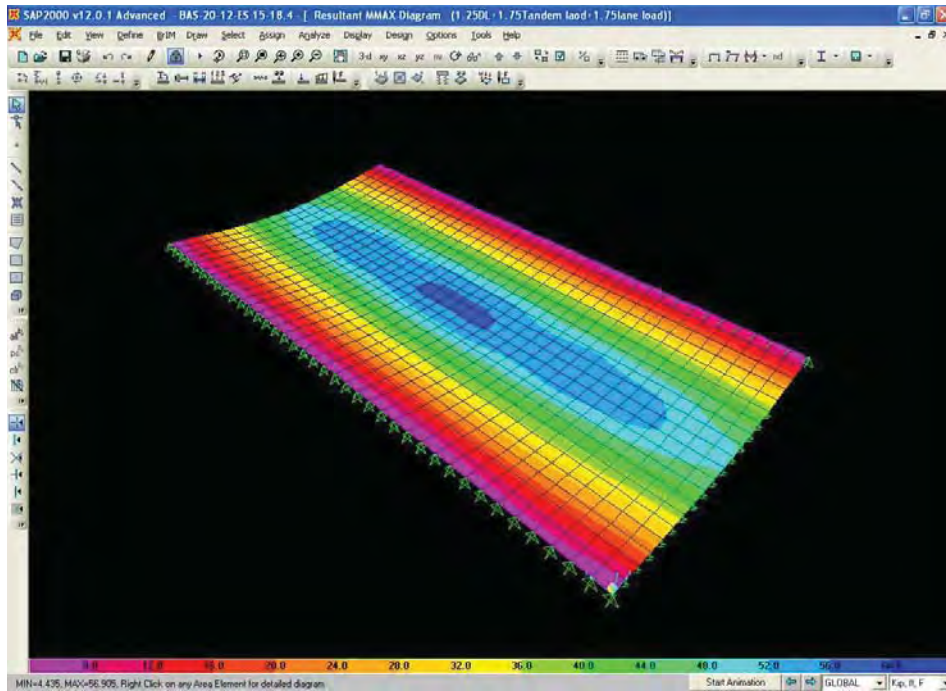

Figure 2-36: Moment pattern for CIP option model case 4

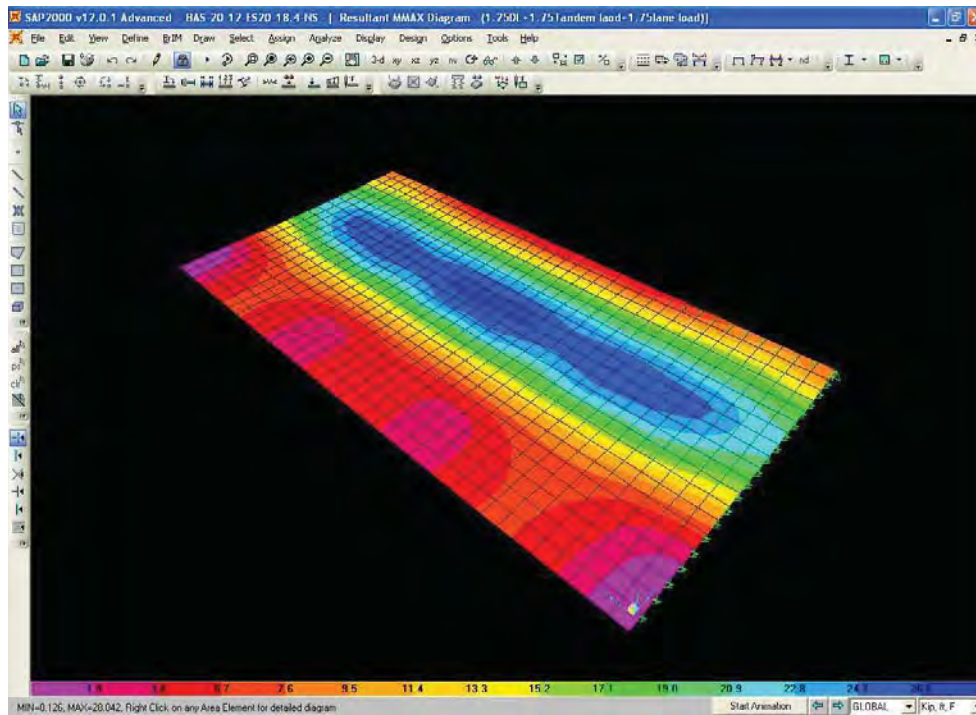

Figure 2-37: Moment pattern for CIP option model case 5

Special Load Condition: It should be noted that design lane load has been considered for all the models so far. From a practical point of view the slab lengths considered are such that the BAS can't cover the whole unit of truck. Hence, the lane load in combination with truck/tandem load

could possibly be excluded from consideration for the design of the approach slab. In addition article 3.6.1.3.3 of AASHTO-LRFD suggests that lane load can be excluded if the span is less than 15 feet. In the BAS application it may be reasonable to assume that if the voids are less than 15 feet in span lane loads could be excluded. This idea has been presented to the MoDOT Technical Advisory Panel (TAP) during the quarterly meetings and discussed in detail. The effect of the presence or absence of the design lane load was studied by carrying out a finite element analysis.

Results and Observations for Analyses with and without lane loads: All the model files were rerun with two separate load combinations considering no design lane load or in other words considering the effect of truck and tandem load only. The results are shown in Table 2-16.

Table 2-16 Comparison of results considering lane load and without lane load

Model file	Mu with lane loads(ft-kips /ft)	Mu without lane loads(ft-kips /ft)	δ " with lane loads	δ " without lane loads
BAS25-12-SSB	134.5	64.3	0.63	0.32
BAS 25-12-ES25-18.4	60.3	30.1	0.28	0.14
BAS 25-12-ES21.25-18.4	60.7	30.2	0.28	0.14
BAS 25-12-ES18.75-18.4	63.2	31.5	0.29	0.15
BAS 25-12-ES25-18.4-NS	33.8	21.0	0.50	0.21
MODBAS25-12-SSB	131.3	61.2	0.68	0.34
MODBAS 25-12-ES25-18.4	55.0	27.0	0.29	0.14
MODBAS 25-12-ES21.25-18.4	55.3	27.1	0.29	0.14
MODBAS 25-12-ES18.75-18.4	57.7	28.5	0.30	0.15
MODBAS 25-12-ES25-18.4-NS	32.0	19.7	0.47	0.19
ID-L20-12-SSB	91.6	46.6	0.36	0.19
ID-L20-12-ES20-18.4	55.3	28.8	0.21	0.11
ID-L20-12-ES17-18.4	55.5	28.9	0.21	0.11
ID-L 20-12-ES15-18.4	56.5	29.4	0.22	0.12
ID-L 20-12-ES20-18.4-NS	28.0	18.4	0.55	0.25

The analysis results for BAS models with and without design lane loads presented in Table 2-16. The data are reorganized in the form of bar charts in order to facilitate comparison of individual metrics. The moment values were compared for all model cases with and without lane loads. Figure 2-38 presents the bar chart showing peak moment values derived from the analysis for all the cases considered. Figure 2-39: Deflection with and without lane loads shows comparison for peak deflection obtained in each case and Figure 2-40 shows the comparison for slope.

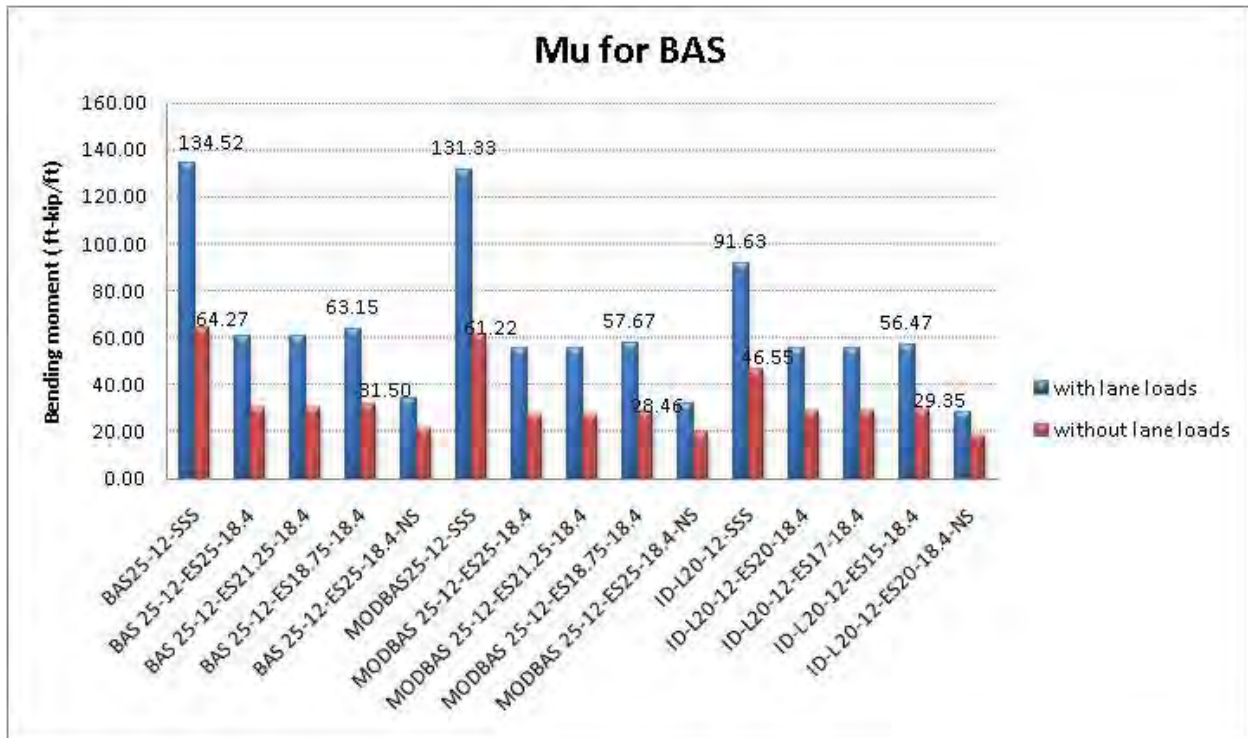

Figure 2-38: Design moment with and without lane loads

- a) **Moment comparison:** Figure 2-38 shows a comparison of moments for spans of 20 and 25 feet, with and without lane loads and also various void conditions under the slab. The following observations are made from Figure 2-38. Comparison is made for with and without lane load in cases presented below.

Simply supported case: it can be seen that the peak moment value occurs for the case of the simply supported condition with a value of 134.52 ft.kips /ft. for the combination with lane loads and a value of 64.27 ft.kips/ft. for the combination without lane loads. For the 20 feet span the corresponding values are 91.63 ft.kips/ft. and 46.5 ft.kips/ft. respectively. Hence, the removal of lane loads from consideration results in a decrease of 49 to 52 percent in the moment demand for simply supported cases.

Void (25%) formation case with springs over the remaining 75% span: It is also observed that for the 25% void formation case with lane load consideration the moment value drops from 63.15 ft.kips/ft. to 56.47 ft.kips/ft. for 25 feet and 20 feet slab case respectively. For the condition where lane load is not considered, with 25% void formation, the moment value drops from 31.5 ft.kips/ft. to 29.4 ft.kips/ft. for 25 feet and 20 feet slab case respectively. It is also seen that in all the cases except the simply supported case, for the analysis without lane loads the moment demand is less than 40 ft.kips/ft.

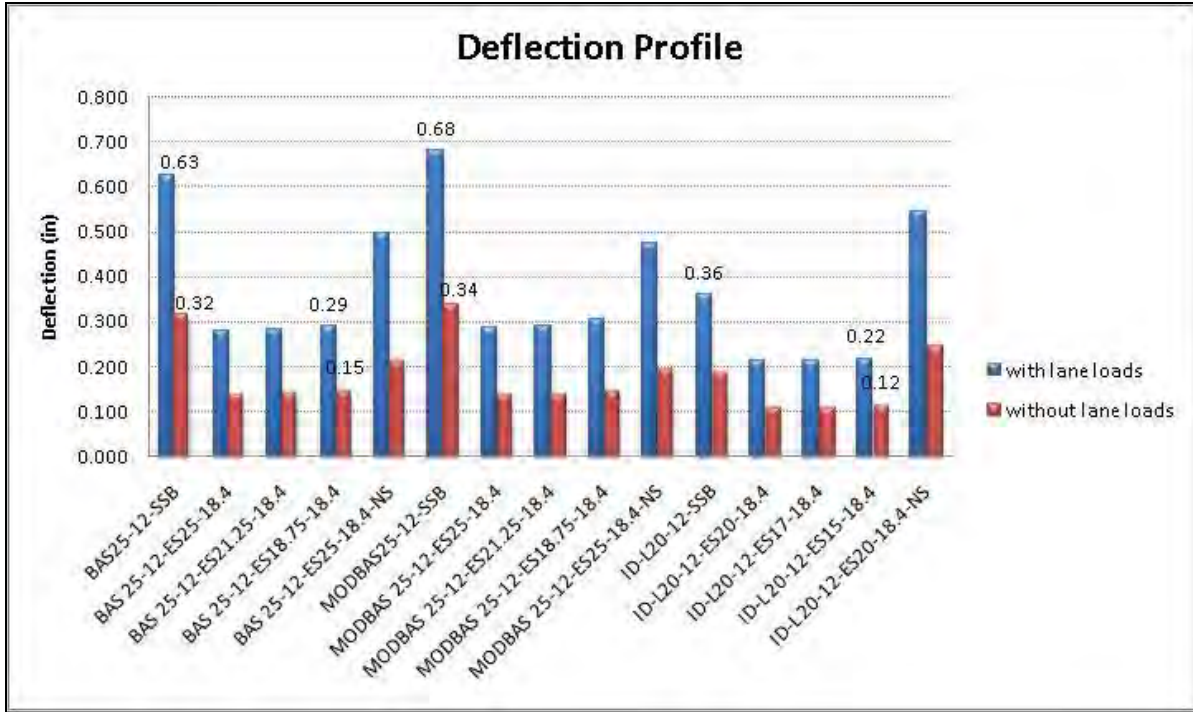

Figure 2-39: Deflection with and without lane loads

- b) **Deflection comparison:** The deflections have been taken from the worst of the service load cases. From Figure 2-39 it can be seen that the peak deflection value occurs for the case of the simply supported condition with a value of 0.68 inches for the combination with lane loads and a value of 0.338 inches for the combination without lane loads. For the 20 feet span the corresponding values are 0.356 inches and 0.187 inches respectively. Hence, the removal of lane loads from consideration results in a decrease of 47 to 49.5 percent in the deflection. It is also observed that with 25% void formation the deflection value drops from 0.304 inches to 0.219 inches for 25 feet and 20 feet span respectively. The peak deflection is 0.68 inches which is less than 1.5 and 1.2 inches, reported as a serviceability criterion [19]. Hence, the slab design appears to be satisfactory as per reported serviceability criteria.

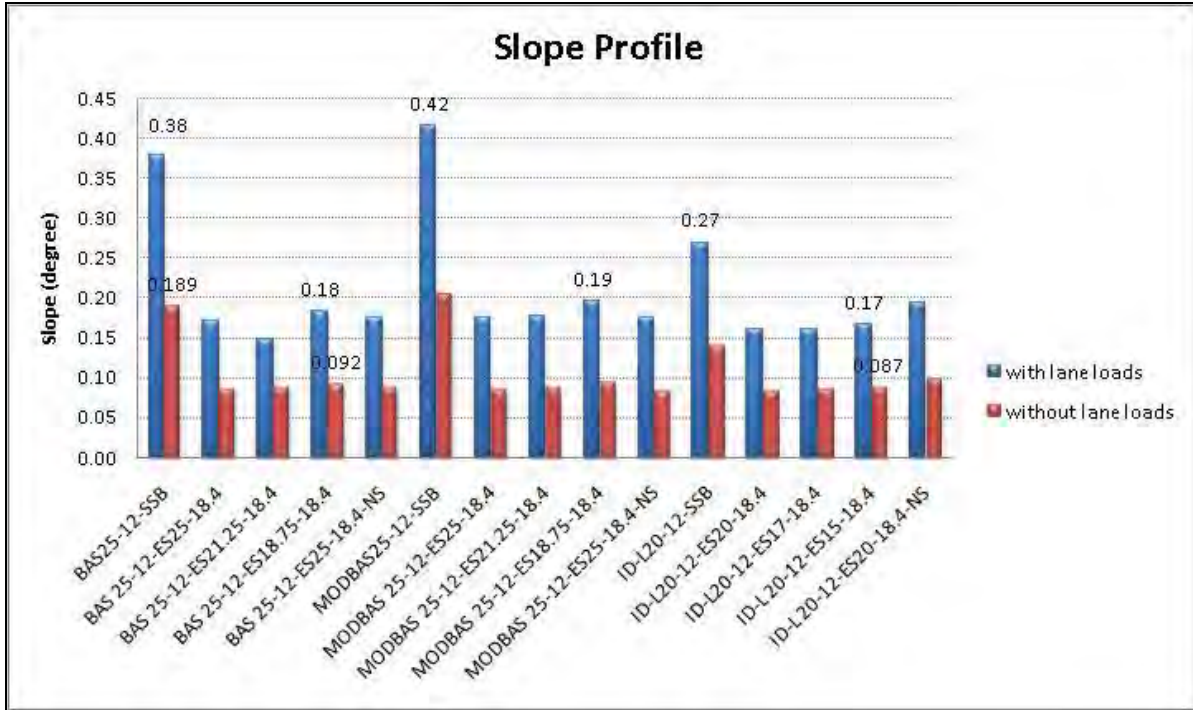

Figure 2-40: Slope with and without lane loads

c) **Slope comparison:** The slope at the abutment end have been taken from the worst of the service load cases. From Figure 2-40 it can be seen that the peak slope value occurs for the case of 25 feet span and the simply supported condition with a value of 0.42 degrees for the combination with lane loads and a value of 0.204 degree for the combination without lane loads. For the 20 feet span the corresponding values are 0.27 degree and 0.14 degree respectively. Hence, the removal of lane loads from consideration results in a decrease of 48 to 50 percent in the slope at the abutment. It is also observed that with 25% void formation the moment value drops to 0.18 and 0.17 degrees for 25 feet span and 20 feet span respectively. It is also noted that the peak slope for the modified BAS is 0.42 degrees which is more than 1/200 radians (0.287 radians), reported as a serviceability criterion [19]. The slabs appear to satisfy a reported serviceability criterion pertaining to slopes.

2.6.5 CONCLUSION

From the computer analyses presented above it can be observed that the design moment varies considerably depending on the boundary and void conditions assumed. It also depends on whether lane loads are considered along with truck/tandem loads. It is noted for a new slab of 20 ft span the peak moments were:

- 91.63 ft.kips/ft. for 20 ft span simply supported case with lane load,
- 46.5 ft.kips/ft. for 20 ft span simply supported case without lane load,
- 56.47 ft.kips/ft. for 20 ft span with 25% void formation and with lane loads, and
- 29.47 ft.kips/ft. for 20 ft span with 25% void formation and without lane loads.

Section 2.7 presents the design and design recommendations for the 20 feet long 12 inch deep new approach slabs that are proposed for new cast in place construction.

2.7 NEW CAST IN PLACE BAS DESIGN RECOMMENDATIONS

This section presents the final designs and design recommendations for new cast in place approach slabs. The recommendations are based on the cost analysis and shortlist of states' details presented earlier, design specifications presented in section 2.5 and the subsequent numerical modeling for the computation of moment values presented in section 2.6.

Two recommendations for the 20 feet span x 12 inch deep slab are presented along the details of the moment capacity in comparison with moment demand. Sectional drawings are presented in this section and the specification drawings based on the original MoDOT standard drawings are presented in the Appendix.

2.7.1 NEW CAST IN PLACE APPROACH SLABS

The analysis for the 20 feet span and 12 inch deep approach slab was done using SAP 2000 as discussed in the previous section. Analysis results for the 20 feet span BAS shows considerable amount of reduction in moment, deflection and slope when compared to current MoDOT BAS.

Based on the comments from the TAP we have further analyzed cases for 50% washout and updated results for this case. As the washout conditions are more severe an increase in moment is expected. Hence, numerical analysis was performed for the four soil subgrade moduli listed below and results are presented.

- a) A very poor soil (soft clay): of 18.4 psi/in,
- b) A very poor soil (soft clay): of 30 psi/in,
- c) Medium clay at its lower end of subgrade modulus: 50 psi/in, and
- d) Controlled Low Strength Material (CLSM): 175 psi/in.

It can be seen in chapter 5 that the subgrade modulus for Controlled Low Strength Material, from preliminary tests, is about 200 psi/in and a value of 175 psi/in is chosen for studies performed here.

Table 2-17 Revised moments, deflections and slopes for 50% washout

File name	Mmax with lane loads (ft-kips/ft)	Mmax without lane loads (ft-kips/ft)
BAS20-12-ES10-18.4	76.8	43.5
BAS20-12-ES10-30	68.0	38.9
BAS20-12-ES10-50	58.9	34.0
BAS20-12-ES10-100	46.7	27.5
File name	δ " with lane loads	δ " without lane loads
BAS20-12-ES10-18.4	0.261	0.137
BAS20-12-ES10-30	0.220	0.118
BAS20-12-ES10-50	0.183	0.096
BAS20-12-ES10-100	0.129	0.068
File name	θ with lane loads(degree)	θ without lane loads(degree)
BAS20-12-ES10-18.4	0.204	0.106
BAS20-12-ES10-30	0.179	0.093
BAS20-12-ES10-50	0.150	0.078
BAS20-12-ES10-100	0.113	0.059

Flexural Design of BAS considering 30 psi/in subgrade soil

The BAS of unit width ($b = 1' = 12''$) is designed as a singly reinforced beam,

$$C = T$$

$$0.85 f'_c b a = A_s f_y$$

$$M_u \geq \phi M_n = \phi A_s f_y \left(d - \frac{a}{2} \right)$$

$$\therefore \frac{f_y^2}{2 \times 0.85 f'_c b} A_{s,required}^2 - (f_y d) A_{s,required} + \frac{M_u}{\phi} = 0$$

In which (with $M_u=38.9$ ft.kips from Table 2-17),

$$\frac{f_y^2}{2 \times 0.85 f_c' b} = \frac{60^2}{2 \times 0.85 \times 4 \times 12} = 44.12$$

$$-f_y d = -60 \times 9 = 540$$

$$\frac{M_u}{\phi} = \frac{38.9 \times 12}{0.9} = 518.7 \text{ kip.in}$$

Therefore,

$$A_{s, \text{required}} = \frac{540 - \sqrt{540^2 - 4 \times 44.12 \times 518.7}}{2 \times 44.12} = 1.05 \text{ in}^2$$

Using $A_s = \#6 @ 5" = 1.056 \text{ in}^2$

$$a = \frac{A_s f_y}{0.85 f_c' b} = \frac{1.056 \times 60}{0.85 \times 4 \times 12} = 1.55 \text{ in}$$

$$c = \frac{a}{\beta_1} = \frac{1.55}{0.85} = 1.823 \text{ in}$$

$$\epsilon_s = \frac{d - c}{c} \times 0.003 = \frac{9 - 1.823}{1.823} \times 0.003 = 0.0118 > \epsilon_y$$

$$c / d = \frac{1.53}{9} = 0.202 < 0.42$$

$$\phi M_n = \phi A_s f_y \left(d - \frac{a}{2} \right) = 0.9 \times 1.056 \times 60 \times \left(9 - \frac{1.55}{2} \right) = 469 \text{ kip-in} > M_u = 467 \text{ kip-in}.$$

Check for Minimum Reinforcement Requirements

According to AASHTO 5.7.3.3.2, the amount of prestressed or non prestressed tensile reinforcement shall be adequate to develop a factored flexural resistance, M_r , at least equal to the lesser of $1.33M_u$ or $1.2M_{cr}$:

$$M_r = \phi M_n = 469 \text{ kip-in} \leq 1.33M_u = 620.8 \text{ kip-in} \text{ (not OK)}$$

$$1.2M_{cr} = 1.2 f_r S_c = 1.2 \times 7.5 \sqrt{f_c'} \times \left(\frac{1}{6} b h^2 \right)$$

$$= 1.2 \times (7.5 \times \sqrt{4000} / 1000) \times \left(\frac{1}{6} \times 12 \times 12^2 \right)$$

$$= 164 \text{ kip-in} \leq \phi M_n = 469.8 \text{ kip-in} \text{ (OK)}$$

The second check for minimum reinforcement is satisfied.

Crack Check for Service I

According to AASHTO 5.7.3.4 the steel stress under Service 1 should satisfy the following requirement:

$$s \leq \frac{700 \gamma_e}{\beta_s f_s} - 2d_c$$

Where,

$$\beta_s = 1 + \frac{d_c}{0.7(h-d_c)} = 1 + \frac{3.5}{0.7 \times (12-3.5)} = 1.588$$

The service moment from computer analysis for a soil subgrade modulus of 30 psi and no lane load is:

$$M_c = 246.5 \text{ kips-in}$$

The longitudinal reinforcements used are listed below:

$$\text{Top bar: } A_s' = \#5 @ 12" = 0.307 \text{ in}^2, (n-1)A_s' = 7 \times 0.307 = 2.149 \text{ in}^2$$

$$\text{Bottom bar: } A_s = \#6 @ 5" = 1.06 \text{ in}^2, nA_s = 8 \times 1.06 = 8.48 \text{ in}^2$$

Transformed cracked elastic section analysis provides:

$$\frac{12c^2}{2} + 2.149(c - 2.3125) = 8.48(8.625 - c)$$

$$6c^2 + 10.63c - 73.14 = 0$$

$$c = 2.72 \text{ in}$$

Moment of Inertia about Neutral Axis

$$\begin{aligned} I_{cr} &= \frac{12c^3}{3} + 2.149(c - 2.3125)^2 + 8.48(8.625 - c)^2 \\ &= \frac{12 \times 2.35^3}{3} + 2.149 \times (2.72 - 2.3125)^2 + 8.48 \times (8.625 - 2.72)^2 \\ &= 348 \text{ in}^4 \end{aligned}$$

Stress in tension steel under Service I condition is given by:

$$f_s = n \frac{M_c}{I_{cr}} y = 8 \times \frac{246.54}{348} \times (8.625 - 2.72) = 33.6 \text{ ksi}$$

Hence,

$$s = 5" \leq \frac{700 \times 1.00}{1.588 \times 33.6} - 2 \times 3.5 = 6.11"$$

Check for crack control is okay

Transverse Distribution Reinforcement

Transverse distribution reinforcement = $100/\sqrt{L} \leq 50\%$ of the longitudinal reinforcement
when $L = 20 \text{ ft}$, $100/\sqrt{20} = 22.3\%$

$$22.36\% A_s = 0.237 \text{ in}^2, 20\% A_s' = 0.06 \text{ in}^2$$

Use #5 @ 12" ($A_s = 0.31 \text{ in}^2$) as bottom and top reinforcement.

Temperature and Shrinkage Reinforcement

Per AASHTO 5.10.8, the temperature/shrinkage reinforcement is given by:

$$A_s \geq \frac{1.3bh}{2(b+h)f_y} = \frac{1.3 \times 12" \times 12"}{2(12" + 12") \times 60 \text{ ksi}} = 0.065 \frac{\text{in}^2}{\text{ft}}$$

$$0.11 \leq A_s \leq 0.60$$

$$A_s (\#5 @ 12 \text{ in } c/c) = 0.13 \text{ in}^2/\text{ft}.$$

Both A_s and A_s' are larger than 0.11 in^2 . The reinforcement provided is adequate

Table 2-18 shows the options recommended for new CIP BAS. Figure 2-41 and Figure 2-42 shows the sectional details of recommendations for new CIP bridge approach slab for MoDOT which were developed through this research study.

Table 2-18 Options recommended for new CIP BAS

Option	Span (ft)	Depth (in)	Cover (in)	Bottom Reinforcement (Main/Distribution)	Top Reinforcement (Longitudinal/Transverse)
1	20	12	3	#6@5" / #5@12"	#5@12" / #5@12"
2	20	12	3	#6@5" / #5@12"	#4@18" / #5@12"

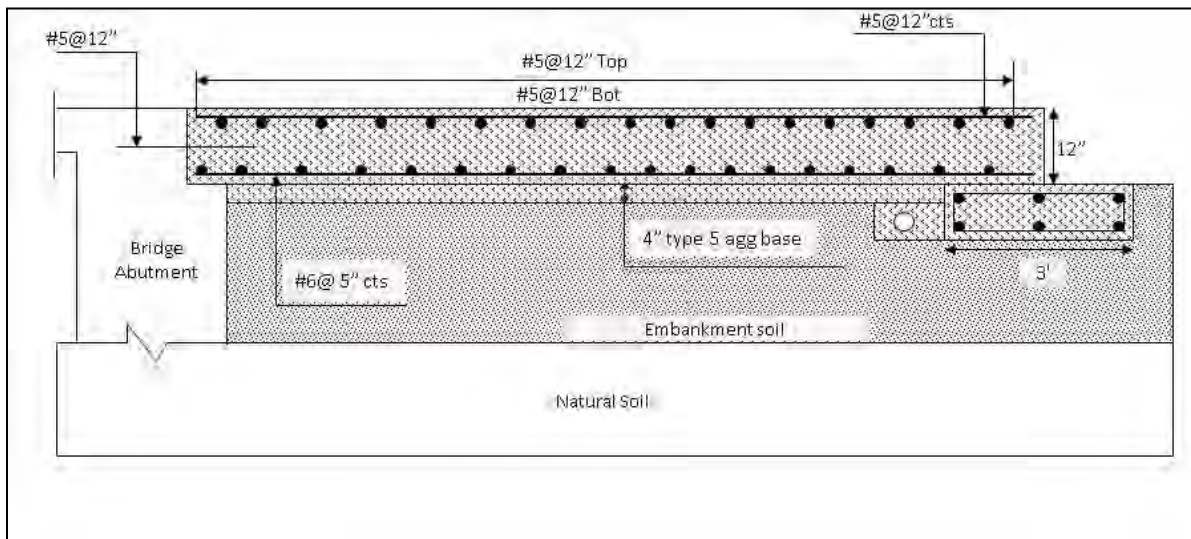

Figure 2-41: Option 1-CIP BAS for new approaches

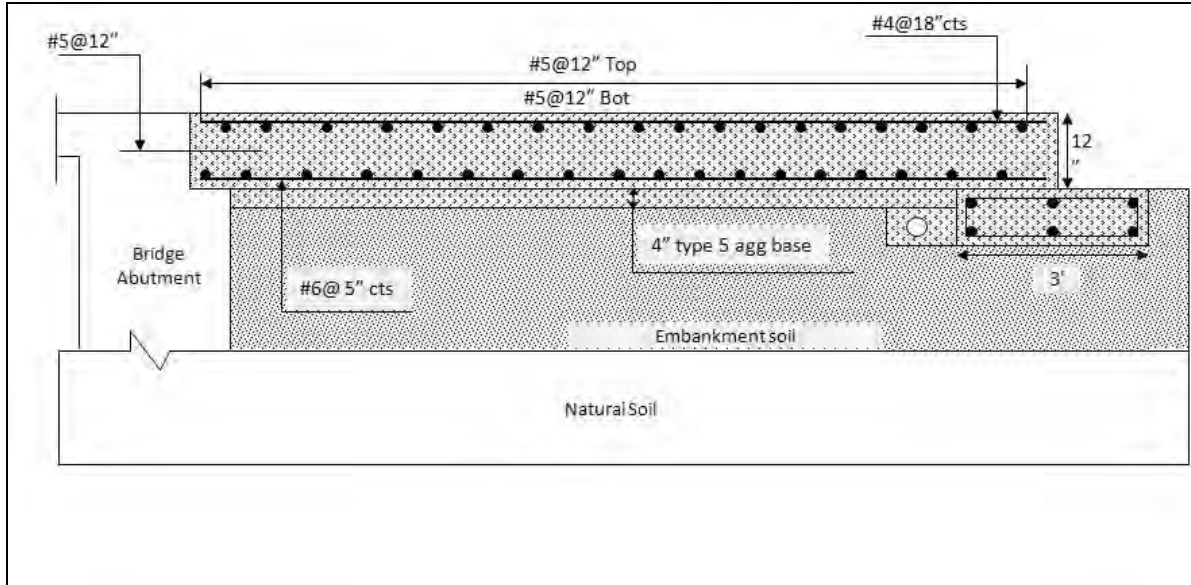

Figure 2-42: Option 2-CIP BAS for new approaches

The recommended options were discussed with MoDOT personnel. It was decided to go with option 2 as a new choice for the cast in place BAS.

2.7.2 DESIGN BASED JUSTIFICATION

Table 2-17 provides design moment demand values for 20 feet span considering various subgrade soil conditions and 50% void formation case. As discussed in section 2.5.3 and 2.7.4 the design lane load can be neglected for the span considered here. The demand moment for 20 feet span and 12 inch thick slab obtained from computer analysis ranges from 43.5 ft.kips/ft. for a poor clay to 27.5 ft.kips/ft for a medium clay soil case. The strength design was carried out for a demand moment value of 38.9 ft.kips/ft. assuming the soil subgrade modulus of 30 psi/in.

The area of main reinforcement required for the demand moment of 38.9 ft-kips/ft is 1.05 in² per feet of BAS width. The main rebars recommended here are #6 bars @ 5" which has an area 1.06 in² per feet of BAS width. The design moment capacity considering singly reinforced section is calculated as 39.83 ft.kips/ft. BAS width. The final recommendation for reinforcement for the new CIP BAS is shown in Table 2-19. It shows that the provided reinforcement satisfy the reinforcement requirement.

Table 2-19 Reinforcement for new CIP BAS

Reinforcement type	Area required (in ² /ft)	Reinforcement bars provided	Area provided (in ² /ft)
Bottom main	1.056 (as per strength design)	#6@5"	1.06
Bottom and top distribution	0.11	#5@12" #4@18"	0.31 0.12

Discussions with Idaho DOT personnel: After the design process we decided to speak with Idaho DOT personnel about any specific issues faced by their approach slabs. Mr. Mike Ebright (mike.ebright@itd.idaho.gov) was contacted in June 2010 personally for further information. Several items were discussed which are listed below.

- a) Idaho BAS is designed by considering a simply supported slab for 10 feet unsupported span. They have been using the slab for over ten years to date.
- b) A sleeper beam is used along with the approach slab.
- c) It appeared that the Idaho BAS does not face any major problems.
- d) Idaho uses Class A compaction to compact the soil under the slab.

2.7.3 EXPECTED COSTS OF PROPOSED BAS

Table 2-20 Expected costs of the proposed 20 feet slab

State	Approach slab			Bottom				Top				Cover	d'	Steel		BASE PREPARATION		FORMWORK		CONCRETE POUR		Total cost	φMn(ft-kips)
				Main steel		Dist steel		Long steel		Trans steel				QTY	Costing	Cost	Qty (sq yard)	Cost	Quantity (cub yards)	Cost			
	span'	depth (in)	width'	dia	s"	dia	s"	dia	s"	dia	s"			dia	s"	STEEL(lb)	Cost	Qty(cub yards)	BP cost	FW cost	CP cost		
Missouri MAS	25	12	38	6	6	4	12	5	12	4	18	2.0	2.4	9815.24	9062.85	23.46	1775.46	176.00	3684.54	70.37	24728.69	45335.52	35.55
Missouri	25	12	38	8	5	6	15	7	12	4	18	2.0	2.4	19162.09	17704.35	23.46	1775.46	176.00	3684.54	70.37	24728.69	55316.45	69.16
Option 1	20	12	38	6	5	5	12	5	12	5	12	3.0	2.4	10103.89	9347.77	18.77	1466.68	156.00	3664.34	56.30	23087.65	43389.24	37.30
Option 2	20	12	38	6	5	5	12	4	18	5	12	3.0	2.4	9215.18	8508.64	18.77	1466.68	156.00	3664.34	56.30	23087.65	42420.04	37.30

Table 2-20 shows the details of the cost computation for the proposed CIP BAS. It can be seen that the original Missouri Standard BAS, 25 feet span, costs \$55,316 per bridge while the proposed option of 20 feet span (option 2) costs \$43,389 per bridge. The costs of paving an additional 5 feet or roadway in the proposed option varies from \$850 - \$1,700 per bridge (per communication with MoDOT) resulting in a total cost of approximately \$45,000 for the proposed CIP BAS, resulting in approximately 20% reduction in costs. These costs do not include the cost of a sleeper slab which would remain the same for both the cases.

2.7.4 CONCLUSIONS

The design moment considering a simply supported BAS leads to a highly conservative design approach. The bridge approach slab recommended by this research cuts down almost 22% of the cost of construction if compared with the current MoDOT BAS cost of construction. It should be noted that elastic soil support has been considered in designing the BAS and is the basis of this recommended design. The demand moment calculated is considering 50% span supported by poor soil. Lane load in combination with the Truck or Tandem load is not included in the design.

Based on the analysis procedure followed in this research, it is evident that the design moments for bridge approach slabs can be significantly reduced even if the slab was assumed to be supported for 50% of BAS span on weak or poor soil having modulus of sub grade reaction of 30 psi/in. The expected deflection and slope for considered % void formation are within their allowable limits. It is recommended that the base material have a modulus of subgrade reaction of at least 30 psi/in.

CHAPTER 3 BAS ANALYSIS AND DESIGN INCORPORATING ELASTIC SOIL SUPPORT

3.1 INTRODUCTION

As described earlier in the report, bridge approach slabs (BAS) in Missouri are typically supported on the bridge end by a reinforced concrete abutment ledge and on the pavement end on a reinforced concrete sleeper slab. Between these two end supports, the BAS is supported on compacted fill of sand and a layer of 4" deep Type 5 aggregate base to provide improved drainage immediately below the approach slab. Reinforcing bars from the end bent connected to the approach slab at its mid-depth provide restraint to horizontal and vertical displacements but little restraint to rotation Figure 2-1. Traditionally, BAS is designed as simply-supported one-way slabs (in the traffic direction), taking into account the extreme case scenario of neglecting soil support altogether. It is possible to design the BAS more economically if one were to consider a practically more realistic and fundamentally sound design approach based on the mechanics of bridge approach slabs on elastic soil support (BAS-ES: Bridge Approach Slab incorporating Elastic soil Support). This chapter presents such an analysis and design approach, first developing the equations necessary for analysis of finite slabs on elastic soil support and then presenting an example design of reinforced concrete BAS. Additionally, the sleeper slab at the pavement end of the conventional MoDOT BAS design is replaced by a modified end-section reinforcement detailing to provide enhanced local two-way action, providing increased flexural rigidity in the direction transverse to the traffic direction. Summary comparisons of design moment and shear governing the design are developed for a wide range of values of soil elastic modulus ranging from dense sand to very loose sand. It has been demonstrated that in the very extreme case where the soil stiffness is assumed to be zero, predicted moment and shear solutions are identical to the case of a simply supported BAS. Results from systematic studies of design moments and shear forces assuming wash out of soil support are also presented using a customized finite-difference model of the BAS-ES. The influences of wash-out length and location have been discussed. Initial construction cost of this new design alternative is computed and presented along with a comparison between BAS-ES and Standard MoDOT BAS. This comparison highlights that a potential cost savings of approximately 30% can be realized using this alternate design approach. An accompanying MS Excel file using Visual Basic programming allows a user-friendly implementation of the design using the proposed BAS design incorporating Elastic Soil Support (BAS-ES) approach.

3.2 THEORETICAL BASIS AND ANALYTICAL DEVELOPMENT

3.2.1 GOVERNING DIFFERENTIAL EQUATION AND HOMOGENEOUS SOLUTION FOR A SLAB ON ELASTIC SUPPORT

The classical solution of a beam (a finite strip of a slab of unit width is treated here as a beam) on elastic support is developed here ([27],[28] [29]). This treatment is appropriate for the one-way bending dominant in the BAS. Consider a slab of an infinite length supported horizontally on an elastic medium (such as compacted fill of sand) and subjected to combinations of vertical concentrated forces and distributed forces (perpendicular to the axis of the slab), and concentrated moments. The action of these loads causes the slab to deflect, producing continuously distributed reaction forces, p (psi), due to the stiffness of the soil. It is assumed that these reaction forces are linearly proportional to the slab deflection, y (in) and the elastic modulus of the soil (often also referred as soil modulus parameter, k , measured as psi/in or pci), i.e. $p = ky$. Consideration of the equilibrium of an infinitesimal length of the slab shown in Figure 3-1 Equilibrium of an infinitesimal element from a slab on elastic support allows derivation of the governing differential equation of the problem.

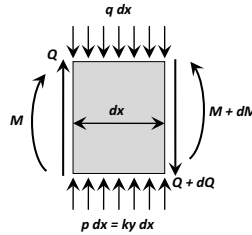

Figure 3-1 Equilibrium of an infinitesimal element from a slab on elastic support

From equilibrium of the vertical forces one can obtain:

$$\frac{dQ}{dx} = ky - q \quad (3.1)$$

and, from the equilibrium of moment one can obtain:

$$Q = \frac{dM}{dx} \quad (3.2)$$

Hence,

$$\frac{dQ}{dx} = \frac{d^2M}{dx^2} = ky - q \quad (3.3)$$

Using the moment curvature relations, along with Eqns. (3.1), (3.2) and (3.3), one obtains the governing differential equation for a slab on continuous elastic support as:

$$EI \frac{d^4y}{dx^4} = q - ky \quad (3.4)$$

where EI is the flexural rigidity of the slab. The homogeneous solution on Eqn. 3.4 (case where $q=0$), can be obtained as:

$$y = Ce^{-\lambda x} (\cos \lambda x + \sin \lambda x) \quad (3.5)$$

by making use of the observation that the deflection, y , is finite even as $x \rightarrow \infty$, and $(dy/dx)_{x=0} = 0$ (condition of symmetry), where,

$$\lambda = \sqrt[4]{\frac{k}{4EI}} \quad (3.6)$$

3.2.2 SLAB OF INFINITE LENGTH SUBJECTED TO CONCENTRATED FORCE

Using the homogeneous solution one can readily obtain the deflection, moment and shear force solutions for a slab of infinite length subjected to a concentrated force, F (Figure 3-2)

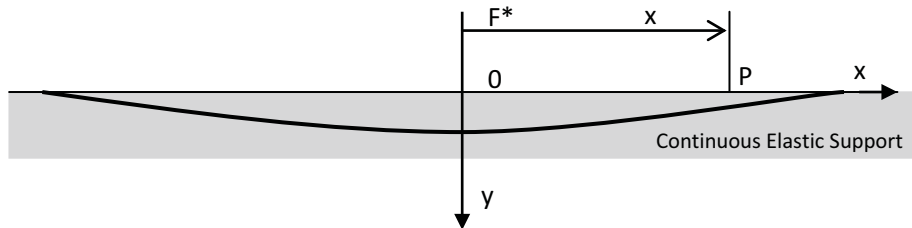

Figure 3-2 Slab of infinite length on continuous support subjected to concentrated force

For any point P ($x \geq 0$), the deflection, y , the slope, θ , the bending moment, M , and the shear force, Q for the case of loading shown in Figure 3-2 are given by:

$$\left. \begin{aligned} y &= \frac{F^* \lambda}{2k} C_{1,x} \\ \theta &= -\frac{F^* \lambda^2}{k} C_{2,x} \\ M &= \frac{F^*}{4\lambda} C_{3,x} \\ Q &= -\frac{F^*}{2} C_{4,x} \end{aligned} \right\} \quad (3.7)$$

where,

$$\left. \begin{aligned} C_{1,x} &= e^{-\lambda x} (\cos \lambda x + \sin \lambda x) \\ C_{2,x} &= e^{-\lambda x} \sin \lambda x \\ C_{3,x} &= e^{-\lambda x} (\cos \lambda x - \sin \lambda x) \\ C_{4,x} &= e^{-\lambda x} \cos \lambda x \end{aligned} \right\} \quad (3.8)$$

3.2.3 SLAB OF INFINITE LENGTH SUBJECTED TO CONCENTRATED MOMENT

Another fundamental solution that will be useful to determine bending moments in finite sized BAS, the case of an infinite slab on elastic support subjected to a clock-wise moment, M^* as shown in Figure 3.3.

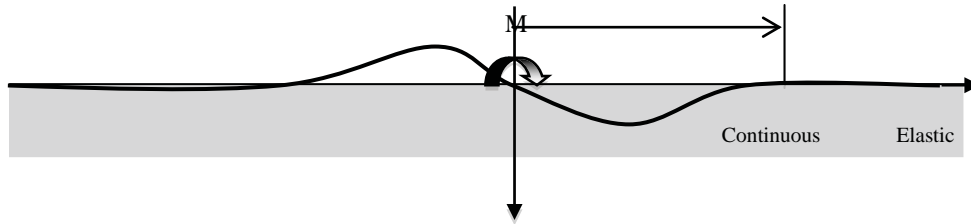

Figure 3-3 Slab of infinite length on continuous elastic support subjected to moment

Again, for any point P ($x \geq 0$), the deflection, y , the slope, θ , the bending moment, M , and the shear force, Q for the case of loading shown in Figure 3-3 are given by:

$$\left. \begin{aligned} y &= \frac{M^* \lambda^2}{k} C_{2,x} \\ \theta &= \frac{M^* \lambda^3}{k} C_{3,x} \\ M &= \frac{M^*}{2} C_{4,x} \\ Q &= -\frac{M^* \lambda}{2} C_{1,x} \end{aligned} \right\} \quad (3.9)$$

where λ and $C_{1,x}, C_{2,x}, C_{3,x}, C_{4,x}$ are defined in Eqns. 3.6 and 3.8.

3.2.4 CUSTOM SOLUTIONS TO PRESCRIBED LOAD CONFIGURATIONS

It is necessary to customize the classical fundamental solutions presented in Sections 3.2.2 and 3.2.3 for finite lengths of slab and for loading configurations that simulate self weight (slab dead load) and vehicular loads (lane, design truck and tandem loads) for computing the internal forces such as flexural moment and shear force in bridge approach slab on elastic soil support. This is necessary because in addition to satisfying the equations of equilibrium, the slab has to specifically satisfy the kinematic and static boundary conditions at its end supports as well. These exact solutions for finite length slabs will then be used in the design of BAS as shown in the design example in Section 3.5 and also developing the user-friendly Excel file (BAS design incorporating Elastic Soil Support – BAS-ES) as a design aid. The file, which includes a Visual Basic program, provides users with a two-step procedure to analyze and design reinforced concrete BAS for flexure with checks on shear capacity, crack control, distribution and temperature and shrinkage steel requirements.

The solutions developed in Sections 3.2.2 and 3.2.3 satisfy the governing differential equation of the slab obtained from equilibrium considerations. Using the principles of superposition, any combination of particular solutions of the governing differential equation will also satisfy equilibrium. It then follows that any combination of the solutions, all of which satisfy equilibrium, can be made to satisfy kinematic and static conditions at specific points on the infinite slab (such as end supports). Using this approach, solutions for finite slab lengths can be typically obtained in the following steps for any given loading as described below.

(i) Using the solutions for an infinite slab (such as the ones presented in Eqns 3.7-3.9), the moments and displacements at the left (M_A and y_A) and right (M_B and y_B) supports of the finite slab can be computed.

(ii) The end reaction, P'_o , and moment, M'_o which act on both the left ($x=0$) and right ($x=l$) supports (for this, a symmetric loading problem) can be determined along with moments $-M_A$, and $-M_B$, and displacements $-y_A$ and $-y_B$ at the supports A and B. These end forces when added to the solutions from (i) above ensure simply supported slab-end fixity conditions ($M = 0$, and $y = 0$ at both the left and right supports of the slab of length l). It can be shown that the end reaction, P'_o , and moment, M'_o are given as:

$$\left. \begin{aligned} P'_o &= 4\lambda F_l \left[M'_A C_{2,l} - 2\lambda^2 EI y'_A (1 + C_{4,l}) \right] \\ M'_o &= 2F_l \left[-M'_A (1 + C_{1,l}) + 2\lambda^2 EI y'_A (1 + C_{3,l}) \right] \end{aligned} \right\} \quad (3.10)$$

where the notation F_l represents:

$$F_l = - \frac{1}{C_{2,l}(1 + C_{3,l}) - (1 + C_{4,l})(1 + C_{1,l})} \quad (3.11)$$

a. Finite length simply supported slab subjected to uniform load

Using the above approach of superposition, it is possible to obtain maximum moment and support reactions for a loading geometry shown in Figure 3-4.

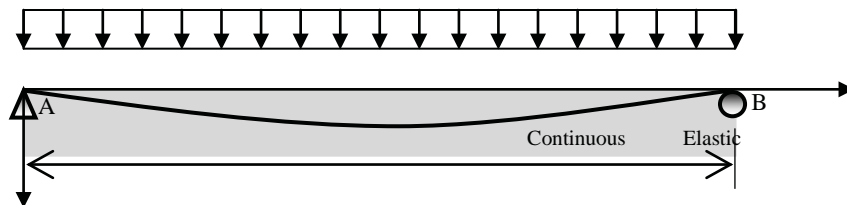

Figure 3-4 Simply supported slab of finite length on elastic support subjected to uniform load

The moment at the midspan, M_c ($x=l/2$) is given by:

$$M_c = \frac{q_0}{2\lambda^2} C_{2, \frac{l}{2}} + \frac{P_1}{2\lambda} C_{3, \frac{l}{2}} + M_1 C_{4, \frac{l}{2}} \quad (3.12)$$

The reaction forces at the left and right supports are obtained as:

$$R_A = R_B = -\frac{P_1}{2}C_{4,l} - \frac{\lambda M_1}{2}C_{1,l} - \frac{P_1}{2}C_{4,0} + \frac{\lambda M_1}{2}C_{1,0} + \frac{q_0}{4\lambda}(C_{3,l} - 1) \quad (3.13)$$

b. Finite length simply supported slab subjected to symmetric concentrated forces

Using the elastic superposition approach, it is possible to obtain maximum moment and support reactions for a loading geometry shown in Figure 3-5

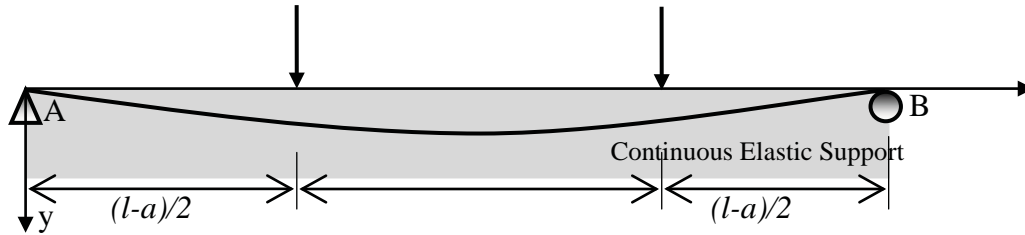

Figure 3-5 Simply supported of finite length on elastic support subjected to two symmetric forces

The moment at the midspan, $M_c (x=l/2)$ is given by:

$$M_c = 2\left(\frac{P_0'}{4\lambda}C_{3,\frac{l}{2}} + \frac{M_0'}{2}C_{4,\frac{l}{2}} + \frac{F}{4\lambda}C_{3,\frac{a}{2}}\right) \quad (3.14)$$

where $C_{3,\frac{l}{2}}$, $C_{4,\frac{l}{2}}$ and $C_{3,\frac{a}{2}}$ are constants defined in Eqn. 3.8 evaluated at $x = l/2$, $l/2$ and $a/2$, respectively and,

$$R_A = R_B = \frac{P_0'}{2}C_{4,x_1} + \frac{M_0'\lambda}{2}C_{1,x_1} + \frac{F}{2}C_{4,x_2} + \frac{F}{2}C_{4,x_3} + \frac{P_0'}{2}C_{4,x_4} - \frac{M_0'\lambda}{2}C_{4,x_4} \quad (3.15)$$

where

$$x_1 = l, \quad x_2 = \frac{l+a}{2}, \quad x_3 = \frac{l-a}{2}, \quad \text{and } x_4 = 0$$

3.3 OBSERVATIONS ON THE BAS DESIGN INCORPORATING ELASTIC SOIL SUPPORT

Customized solutions of finite length slab described earlier in Section 3.2 are used in the Excel-based Visual Basic design software for BAS using Elastic Soil Support (BAS-ES). Internal forces are computed for MoDOT prescribed bridge loading based on the mechanics model

described in Section 3.2. Figure 3-6 shows a user-friendly front-end of BAS-ES that allows a two-step design process that meets all AASHTO and MoDOT specifications

Figure 3-7 includes a plot of Strength I and Service I maximum bending moments as a function of soil elastic modulus, k (psi/in). A very wide range of k values relevant to Missouri conditions are plotted. A k -value of 20 psi/in represents loose submerged sand, while a k -value of 225+ represents dense sand (above the water table). The figure shows maximum moment values for soil stiffness values up to 500 psi/in (very dense sand). It should be noted that the theory for BAS analysis incorporating continuous elastic soil support in the limiting case of $k = 0$ psi/in predicts Strength I and Service I maximum moments that are identical to the conventional simply supported analysis (Strength I moment of 959 k-in and Service I moment of 588 k-in for the geometric and loading parameters considered).

Table 3.1 includes a comparison of the maximum moments for various support conditions for a 12" thick BAS and associate requirement of longitudinal flexural steel (bottom layer of steel in the longitudinal or traffic direction).

It is also interesting to observe that, when elastic soil support is considered as a basis for design, a reduction in slab thickness results in smaller required design moments. Table 3-2 lists maximum design moment and associated steel area required for two slab thicknesses (12" and 10", with effective depths of 9" and 7") for a range of soil elastic modulus. The reason for this result is the fact that lower slab flexural rigidity produces larger deflections and hence greater soil support. While one can take some advantage of this observation in optimizing design based on flexural strength, limiting serviceability parameters such as acceptable deflections and crack-widths may necessitate higher slab depths.

Based on the alternate analysis procedure presented in this document it is readily evident that the design moments and shear for a BAS can be significantly reduced even if the slab was assumed to be supported continuously on loose sand (i.e. BAS support does not need to come from a very stiff foundation).

The theory developed is based on well accepted principles of mechanics and the assumptions of elastic soil support are realistic and practically achievable. Ways to optimize BAS design to provide for reductions in initial cost as well as improve long-term performance through use of innovations in construction (improved quality control with precast slabs with cast-in-place topping of unreinforced or fiber reinforced concrete) and materials (use of hybrid reinforcement of conventional reinforcing steel with discrete steel fibers providing better crack control and improved impact and fatigue resistance) can be developed. This follow-up should allow, in addition to optimized initial design, improved attention to serviceability issues such as crack-control and durability. The BAS-ES approach in addition to initial cost reductions has the potential to offer innovations in BAS analysis and design.

UserForm1
X

BAS - ES

Design of Bridge Approach Slab Incorporating Elastic Soil Support

University of Missouri, Columbia University of Missouri, Kansas City Missouri Department of Transportation

User Instructions: The design involves a two step operation. Input the basic parameters and then click the "Calculate" button, generating Output 1. Next input steel reinforcement details in Input Reinforcement Details box, click the "Check" button, Output 2 Design Checks and Area of Reinforcing Steel will be generated.

Input 1
Basic Parameters

Span (ft) (eg. 25 ft)

Width (ft) (eg. 38 ft)

Number of Lanes (eg. 2)

Lane Width (ft) (eg. 12 ft)

d (in) (eg. 9 in)
Effective Depth of Tension Steel

dc (in) (eg. 2 in)
Effective Cover of Tension Steel

df (in) (eg. 1 in)
Thickness of Future Wearing Surface

fy (ksi) (eg. 60 ksi)
Yield Strength of Steel

fc' (ksi) (eg. 4 ksi)
Compressive Strength of Concrete

Soil Modulus (psi/in)

Typical values of soil modulus are:
no soil support* ~ 0.001psi/in loose sand ~ 25 psi/in
medium sand ~ 90psi/in dense sand ~ 225psi/in
*indicating simple-supported slab

Input 2
Reinforcement Details

Main Reinforcement

Bottom Steel Bar Size in # (eg. 6)

Bottom Steel Bar Spacing (in) (eg. 8 in)

Top Steel Bar Size in # (eg. 5)

Top Steel Bar Spacing (in) (eg. 12 in)

Distribution Reinforcement

Bottom Steel Bar Size in # (eg. 4)

Bottom Steel Bar Spacing (in) (eg. 12 in)

Top Steel Bar Size in # (eg. 4)

Top Steel Bar Spacing (in) (eg. 12 in)

Output 1
Moment and Shear (for 12" strip)

Max Moment (kips-in)

Strength Limit Max Shear (kips-in)

Max Moment (kips-in)

Service Limit Max Shear (kips-in)

Output 2
Area of Main Reinforcing Steel (for 12" strip)

Bottom As (in²/in)

Top As' (in²/in)

Output 2
Design Checks

Moment Capacity (kips-in) (For 12" strip)

Min Reinforcement Check (per AASHTO 5.7.3.3.2)

Max Reinforcement Check

Shear Check (per AASHTO 5.8.3.3)

Crack Check (per AASHTO 5.7.3.4)

Distribution Reinforcement Check

Temperature and Shrinkage Reinforcement
(Per AASHTO 5.10.8.2) (for 12" strip)

Bottom As (in²/in)

Top As' (in²/in)

Pavement End-Section Reinforcement Detail
Recommended for all BAS designs

End-Section Width Stirrups

Bottom Steel Top Steel

Calculate

Check

Print

Figure 3-6 User friendly front-end of BAS-ES Excel based software

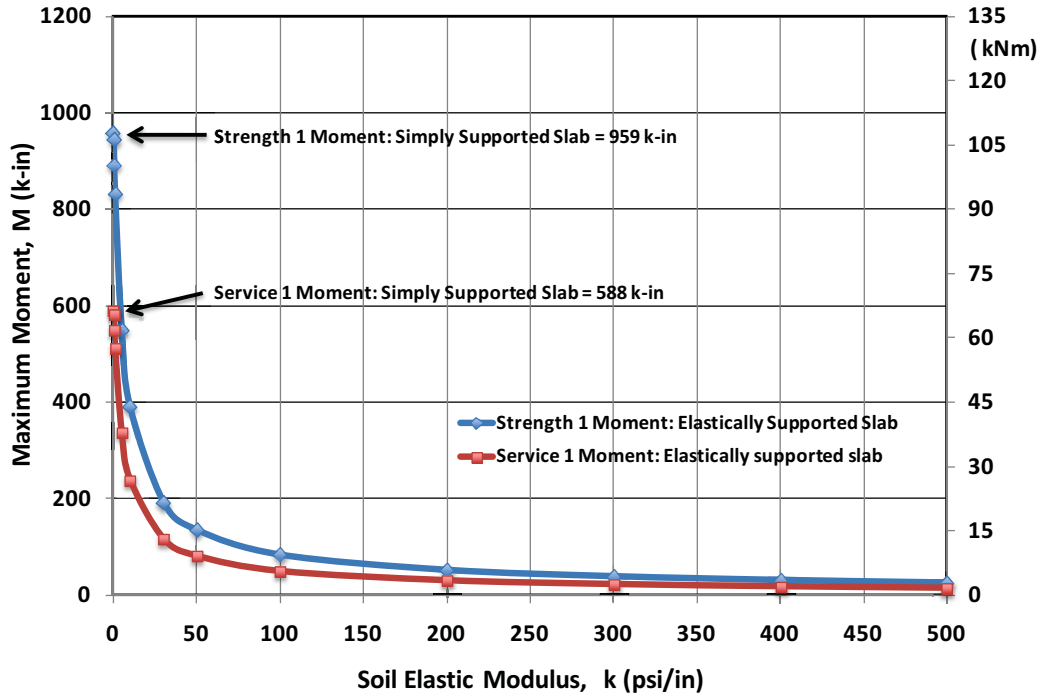

Figure 3-7 Plot highlighting influence of soil support on design moment. Even considering a loose sand with $k=20$ psi/in it is possible to reduce the design moment required by 75% (see also Table 3.1)

Table 3-1 Comparison of maximum design moment and corresponding area of flexural steel required for a 12" deep slab for various soil support conditions

Support Conditions	Soil Elastic Modulus (psi/in)	Maximum Moment (k-in)	Area of Steel Required (in ²)
Simply Supported	0	959	2.47
Elastically Supported Loose Sand	1	832	2.06
	5	548	1.26
	10	389	0.86
	20	254	0.55
	30	193	0.410
Elastically Supported Medium Sand	50	135	0.28
	80	97	0.20
	100	83	0.17
	150	63	0.13
Elastically Supported Dense Sand	200	51	0.11
	300	38	0.08
	400	30	0.06
	500	25	0.05

Table 3-2 Comparison of maximum factored design moment and corresponding area of flexural steel required for 12" and 10" deep reinforced concrete slab for various soil support conditions

Soil Elastic Parameter k (psi/in)	Slab Depth h (in), [d (in)]	Maximum Moment M (k-in)	Area of Steel Required (in ²)
Very Loose Sand 5	12 [9]	548	1.26
	10 [7]	411	1.25
Loose Sand 30	12 [9]	193	0.41
	10 [7]	129	0.35
Medium Sand 100	12 [9]	83	0.17
	10 [7]	57	0.15
Dense Sand 500	12 [9]	25	0.05
	10 [7]	14	0.04

3.4 INVESTIGATION OF WASH-OUT OF SOIL SUPPORT

3.4.1 PARTIAL SOIL SUPPORT AND RELATED WASHOUT PARAMETERS

One concern often expressed when assuming elastic soil support in the design of a slab-on-grade is the potential loss of soil support and void formation under the slab due to consolidation, poor drainage or other similar hydraulic/geotechnical events. It is for this reason an analysis of the influence of potential washout on the maximum moments and shear developed in the BAS needs to be studied. The focus of the parametric study described here is: to determine maximum moments and shear forces in the elastically soil supported slab resulting from a partial or complete washout of soil beneath the slab. Consider the elastically supported BAS shown in Figure 3-8. Partial washout of the soil support (washout length, L, unshaded portion beneath BAS) and location of the washout from the bridge abutment end (left-end), b (to the left-end of the washout region) are considered for a uniformly loaded slab. By varying L from 0' to the total length of the slab, *l* (25' for standard MoDOT BAS), one can validate maximum moments and shear forces for the "completely supported BAS" (BAS-ES per the design approach proposed here) to a "simply-supported BAS" (standard MoDOT BAS design approach). One can also study the influence of the location of the washout by varying "b" from 0' to desired lengths (based on washout length L used) to investigate the influence of washout exhaustively.

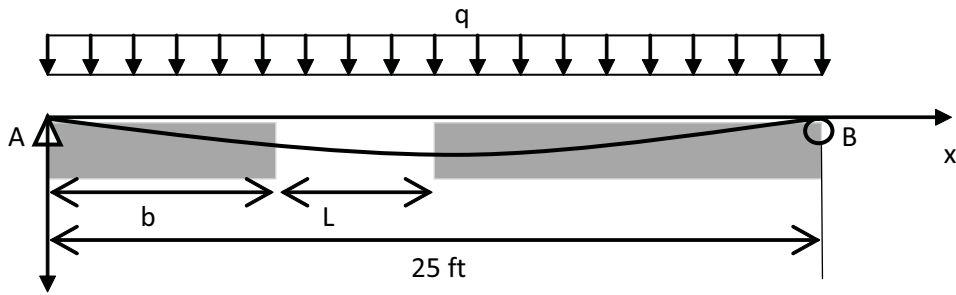

Figure 3-8 Simply-supported slab subjected to uniformly distributed load, q , showing soil washout (unshaded region of length L) and partial soil support (shaded regions)

3.4.2 FINITE DIFFERENCE MODEL OF BAS-ES WITH PARTIAL WASHOUT

A finite difference model of the BAS-ES was developed to study the influence of washout length and location on maximum moments and shear developed in the slab. The model uses the finite strip method (1' or 12" width strip transverse to traffic direction) of one-way bending of slab as is the current practice on design of BAS. The governing differential equation of a beam on elastic foundation is solved numerically using the finite difference approach. The finite difference approach allows a very elegant way of developing approximate solutions to the complicated problem of "beam on elastic foundation with washout". Instead of solving an ill-posed 4th order non-linear differential equation, the finite difference approach facilitates deflection solution using a system of linear algebraic equations. The solution involves the discretization of a 12" width strip of the BAS into finite length elements along the length of the slab (traffic direction). In the solutions described in this section, the 25 ft. slab length has been discretized into 50 elements, each of length, $h = 0.5$ ft (6"). The governing differential equation (GDE) for the problem is applied at each node of the model (51 nodes for the 50 element model - minus the two end nodes that are considered fixed supports - resulting in 49 nodes for GDE application). At each node the GDE of the beam on elastic support is given by Eq. 3.16:

$$EI \frac{d^4 y_i}{dx^4} = q_i - k y_i \quad (3.16)$$

The fourth derivative of the deflection, y , is represented using finite difference operators by

$$\frac{d^4 y_i}{dx^4} = \frac{y_{i+2} - 4y_{i+1} + 6y_i - 4y_{i-1} + y_{i-2}}{h^4} \quad (3.17)$$

Where, the subscript i refers to the i^{th} node in the discretization and y_i is the vertical deflection of the i^{th} node.

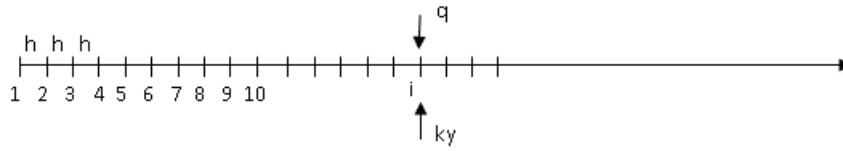

Figure 3-9 Finite length elements with distributed load, q , and soil pressure, k_y , on the nodes

Therefore, for the internal nodes (49 in this example), one can establish the relationship:

$$y_{i+2} - 4y_{i+1} + \left(6 + \frac{kh^4}{EI}\right)y_i - 4y_{i-1} + y_{i-2} = \frac{q_i h^4}{EI} \quad (3.18)$$

For the uniform dead load and lane load q ; $q_i (2 \leq i \leq 50) = q$;

For the concentrated tandem loads, F , acting on any node n , it is possible to establish an equivalent distributed load, assuming the concentrated force is distributed over one element:

$$q_i = \frac{F}{h}, \quad q_{i+1} = q_{i-1} = 0;$$

For the nodes within the washout region, the soil modulus, k is set to 0. Nodes at the boundaries of the washout region use a soil modulus value of one-half the actual soil modulus. For nodes outside the washout region (i.e. soil supported regions) the actual soil modulus is used.

Using 50 elements to discretize the BAS along its length, a 49 by 49 matrix can be built as shown in Eq. 3.19 (based on the analytical development described in Eqs. 3.16 – 3.18):

$$\begin{bmatrix}
 5 + \frac{kh^4}{EI} & -4 & 1 & 0 & 0 & \dots & 0 & 0 & 0 & 0 & 0 \\
 -4 & 6 + \frac{kh^4}{EI} & -4 & 1 & 0 & \dots & 0 & 0 & 0 & 0 & 0 \\
 1 & -4 & 6 + \frac{kh^4}{EI} & -4 & 1 & \dots & 0 & 0 & 0 & 0 & 0 \\
 0 & & & & & & 0 & 0 & 0 & 0 & 0 \\
 0 & 0 & & & & & 0 & 0 & 0 & 0 & 0 \\
 \dots & \dots & \dots & \dots & & & \dots & \dots & \dots & \dots & \dots \\
 \dots & \dots & \dots & \dots & & & \dots & \dots & \dots & \dots & \dots \\
 0 & 0 & 0 & 0 & 0 & \dots & 1 & -4 & 6 + \frac{kh^4}{EI} & -4 & 1 \\
 0 & 0 & 0 & 0 & 0 & \dots & 0 & 1 & -4 & 6 + \frac{kh^4}{EI} & -4 \\
 0 & 0 & 0 & 0 & 0 & \dots & 0 & 0 & 1 & -4 & 5 + \frac{kh^4}{EI}
 \end{bmatrix}
 \times
 \begin{pmatrix}
 y_2 \\
 y_2 \\
 y_4 \\
 y_5 \\
 \vdots \\
 \vdots \\
 \vdots \\
 \vdots \\
 \vdots \\
 y_{47} \\
 y_{48} \\
 y_{49} \\
 y_{50}
 \end{pmatrix}
 =
 \begin{pmatrix}
 q_2 \\
 q_2 \\
 q_4 \\
 q_5 \\
 \vdots \\
 \vdots \\
 \vdots \\
 \vdots \\
 \vdots \\
 q_{47} \\
 q_{48} \\
 q_{49} \\
 q_{50}
 \end{pmatrix}
 \frac{h^4}{EI} \quad (3.19)$$

The above system of linear algebraic equations can be used to solve for the nodal displacements, y_i , which can then be used to establish nodal moment and shear force values using the finite difference operators for the second and third derivatives as shown in Eqn. 3.20 and 3.21, respectively.

$$M_i = -EIy_i'' = -EI \frac{y_{i+1} - 2y_i + y_{i-1}}{h^2} \quad (3.20)$$

$$Q_i = -EIy_i''' = -EI \frac{y_{i+2} - 2y_{i+1} + 2y_{i-1} - y_{i-2}}{2h^3} \quad (3.21)$$

The finite difference solution thus obtained can be used to exhaustively develop shear and moment diagrams due to the critical combinations of self weight, lane load, truck and tandem loads in addition to variations in the washout parameters, L (washout length) and b, (washout location). The finite difference solutions represent numerical approximation of the exact closed-form solutions to the GDE of the problem and as such are prone to errors that can typically be minimized with finer discretization. The 50 elements discretization used in obtaining the results discussed here has been shown to be acceptably accurate (by comparing the solution to the two limiting cases of “complete soil support” and “no soil support”) and can be implemented very conveniently using an Excel spread sheet.

3.4.3 PARAMETRIC STUDY OF WASHOUT LENGTH AND LOCATION

Results presented in this section assume a soil modulus, $k = 30$ psi/in, standard loads (self-weight of slab, lane load and design tandem (more critical than truck load)), 12” slab strip width, and slab length of 25’. Results from various combinations of washout length from 0’ (completely soil supported) to 25’ (no soil support) and washout locations to produce maximum internal forces have been analyzed exhaustively.

Figure 3-10 shows the influence of washout parameters, L and b, on the maximum moment in the slab due to the most critical combinations of self-weight, lane load, truck load, and design tandem. The plot shows the maximum design moment required for various washout lengths (L) from 0’ (complete soil support) to 24’ (near complete washout or no soil support) as the washout location, b, is varied. When, $L = 0'$, the moment required is independent of the washout location, as expected, and is identical to the BAS-ES design moment (~200 k-in). When $L = 25'$, the maximum moment (959 k-in) is identical to that obtained for a simply supported slab with no soil support. For L values in the $0' < L < 25'$ range, the plot shows variations of the maximum moment and the location in 2’ increments of the washout length. Each such plot starts at a “b” value of 0’ and is terminated at a “b” value of $(25' - L)/2$ reflecting exhaustive variation in this parameter as the property of symmetry can be effectively used to establish maximum internal forces for all combinations of b and L.

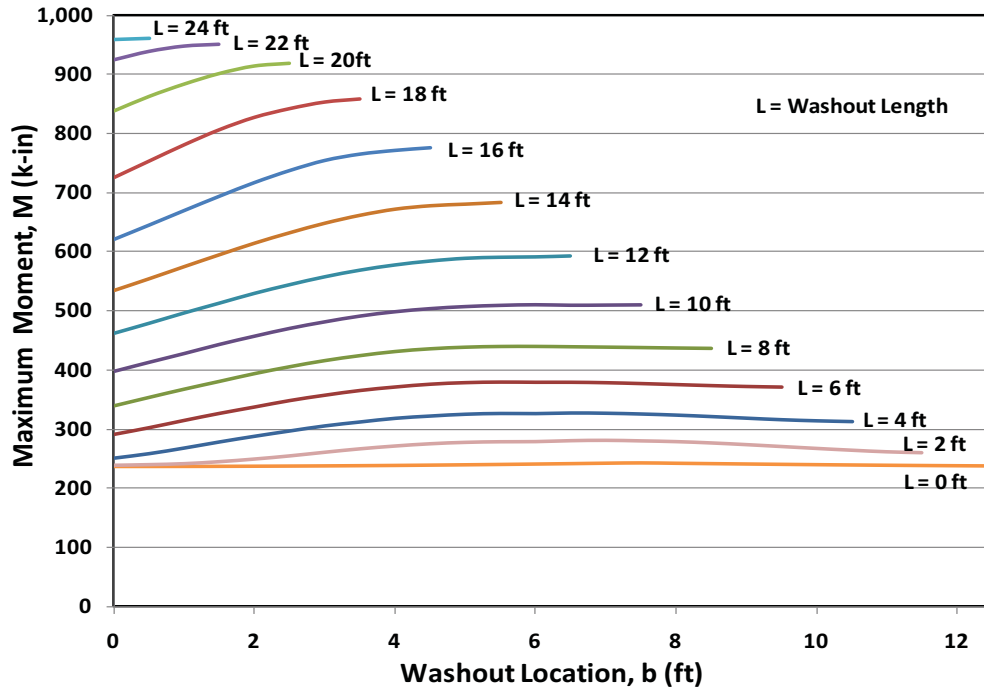

Figure 3-10 Maximum moment versus washout location for various washout lengths

As the washout length gets larger, the maximum moment approaches the maximum moment for a simply supported slab. Even if one assumes a washout length of 20% of the slab length (5 ft., representing quite significant void formation under the BAS), it is observed that the maximum moment exhibits an only 35% of the maximum moment calculated assuming simply supported design (i.e. no soil support). Figure 3-11 shows a plot of composite moment diagram (critical combination of all bridge loads) as a 5' washout region moves along the span. Three cases of washout are shown ($L = 5'$, with $b = 0'$, $5'$ and $10'$) along with the two limiting cases of no washout and complete washout ($L = 0'$, $b = 12.5'$ - no washout representing complete soil support, and $L = 25'$, $b = 0'$ - complete washout representing no soil support, same as being simply supported). It can be observed from the parametric study that washout regions closer to the midspan cause maximum moments in the slab. In addition to showing that if elastic soil support is considered in BAS designs, even fairly large washout lengths provide for significant reductions in maximum moment from that for a simply supported BAS. Figure 3-11 also highlights that washouts at locations closer to the abutment exhibit lower magnitudes of maximum moment compared to washouts closer to the midspan. Field observations of voids under the BAS have typically been observed to be closer to bridge abutments resulting from poor drainage and differential movement than closer to midspan of the BAS. It is hence reassuring that when BAS designs using elastic soil support are considered, the influence of potential washouts are relatively small. Even if design moments from BAS-ES are increased by multipliers to incorporate the influence of potential washout, significant savings can still be realized compared to the current standard MoDOT BAS design that relies on a simply supported assumptions with no soil support.

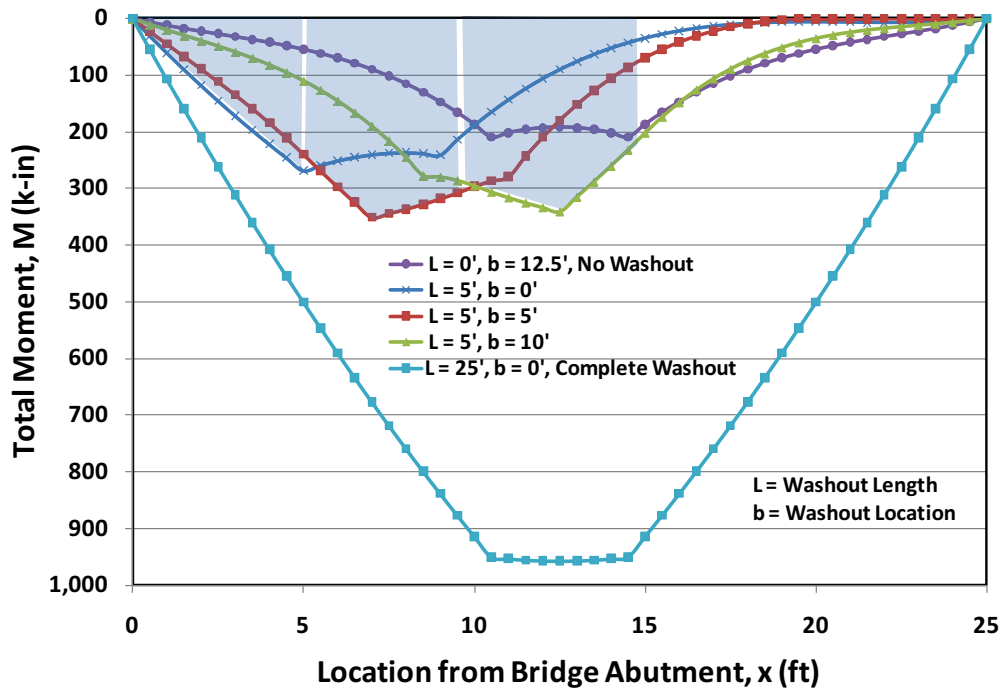

Figure 3-11 Moment diagrams of different location of 5 ft length soil washout

Figure 3-12 shows plots similar to Figure 3-10 for variations in the shear force along the length of the slab from the parametric study of washout lengths and locations. It is interesting to observe that washout locations closer to midspan result in smaller maximum shear forces compared to locations closer to the supports. This is, as expected, because shear forces are typically larger near the supports in common single-span flexural configurations. For the flexural design of BAS, as shown later in the design example in Section 3.5, the geometries and material strengths typically used make it a moment critical, and not a shear critical, design problem. Design shear capacities almost always far exceed ultimate shear force requirements. Hence even with increased shear forces, potential washout does not influence shear design requirements.

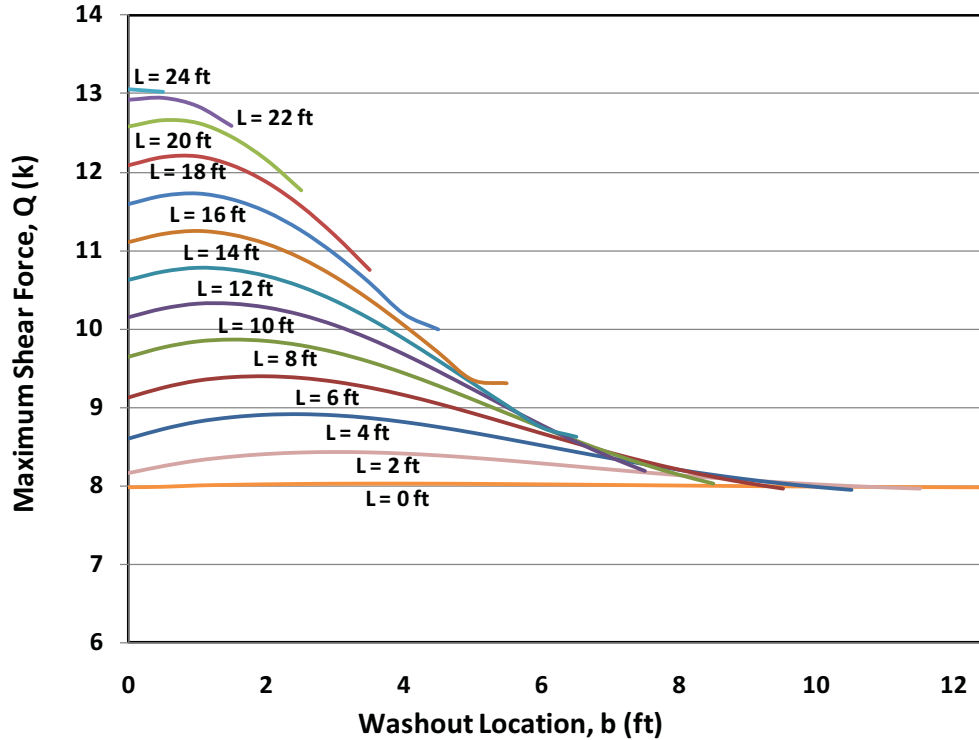

Figure 3-12 Maximum shear force versus washout location for various washout lengths

3.4.4 WASHOUT AND SOIL STIFFNESS

Figure 3-13 shows a plot of maximum moment reduction factor, M_R , versus washout length, L , for different soil modulus values, k , ranging from $k = 30$ psi/in to $k = 500$ psi/in. The limiting values of the washout length of 0' and 25' represent the cases of “complete soil support” (BAS-ES design) and “no soil support” (standard MoDOT BAS design), respectively. M_R is the nondimensional moment representing the ratio of the maximum moment of an elastically soil supported BAS with partial washout (placed to produce maximum internal forces) to the maximum moment from a simply supported slab with no soil support (standard MoDOT BAS design). M_R values less than one represent reductions in design moment required. For example, with $k = 30$ psi/in, the BAS-ES design with no washout can reduce the design moment to 25% of that of a simply supported BAS with no soil support. Even assuming a 5' washout anywhere along the length of the slab, the moment reduction is still significant at 37%. For $k = 500$ psi/in, the BAS-ES design with no washout can reduce the design moment to 9% from that of a simply supported BAS with no soil support. Even assuming a 5' washout anywhere along the length of the slab, the moment reduction is still large at 19%.

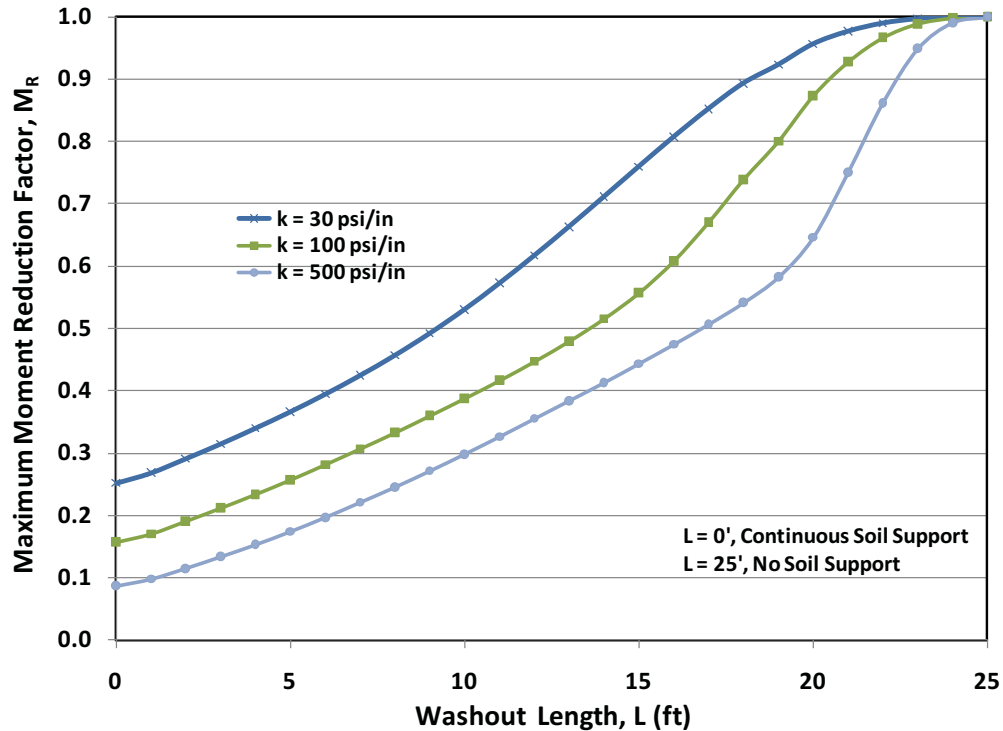

Figure 3-13 Moment reduction factor versus washout length for various soil moduli

3.5 DESIGN EXAMPLE OF BAS-ES

A reinforced concrete bridge approach slab 38 ft. wide (for 2-12 ft lanes of traffic, assuming 4 ft wide inside shoulder and 10 ft wide outside shoulder) and 25 ft span assuming continuous elastic soil support is designed. It is assumed that the soil support is provided by submerged loose sand with a soil modulus parameter, k , of 30 psi/in.

Concrete with $f'_c = 4,000$ psi, $E_c = 3,605$ ksi and $\gamma_c = 150$ pcf is used. Grade 60 conventional reinforcing steel is used. A representative 12" width ($b=12''$) of the slab is considered for computing all design parameters.

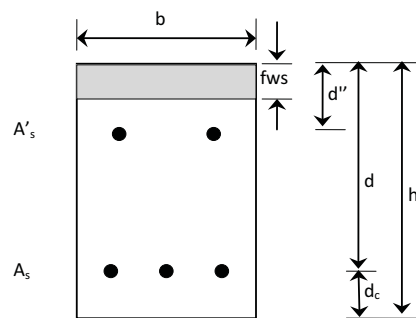

Figure 3-14 One-ft-width strip of the BAS considered for the one way flexural action

Geometric Parameters

The following geometric parameters are used:

$$b = 12''$$

$$fws = 3''$$

$$d = 9'$$

$$d_c = 2''$$

$$h = fws + d + d_c = 14''$$

$$A_c = bh = 168in^2 = 1.167ft^2$$

$$I_c = \frac{1}{12}bh^3 = 1728in^4 = 0.0833ft^4$$

The tension steel area, A_s , and the compression steel area A'_s are to be determined.

Loads Considered

Loads considered include dead load, HL-93 lane load, truck load or tandem load (in this case, tandem load dominates and hence is considered instead of the truck load)

The equivalent strip width is computed first.

For two wheels and lane load

$$E = (84 + 1.44\sqrt{L_1W_1})/12 = (84 + 1.44\sqrt{25 \times 38}) = 10.7' < 12'$$

$$\frac{12W}{N_L} = \frac{38}{2} = 19' > E$$

$$\therefore E = 10.7'$$

Live load distribution factor $\frac{1}{E} = \frac{1}{10.7} \text{ lane} / \text{ft}$

Therefore, for a width of $b=12''$, the two wheel loads and lane loads should be applied and multiplied by the live load distribution factor

Dead Load

The self-weight of the slab is given by the uniformly distributed load, q_{DL}

$$q_{DL} = \gamma_c A_c = 150 \times 1.167 = 175lb / ft = 0.175kip / ft$$

Live Load

Lane load equals the uniformly distributed load, q_{La}

$$q_{La} = \frac{1}{10.7} \times 640 = 59.8lb / ft = 0.0598kip / ft$$

Tandem load, 2 F, consider impact factor 1.33, and a spacing, a of 4'

$$F = 1.33 \times \frac{25}{10.7} = 3.10kips$$

Moment and Shear Computations

For the slab: $E_c I_c = 3,606 \times 1,728 \text{in}^4 = 43,260 \text{kip} - \text{ft}^2$

For the soil support $k = 30 \text{psi} / \text{in} \times 12 \text{in} = 0.36 \text{ksi} = 5.18 \text{kip} / \text{ft}$

Parameter $\lambda = \sqrt[4]{\frac{51.84}{4 \times 43260}} = 0.1316 \text{ft}^{-1}$

a. Moment and shear force under q_{DL} and q_{La}

Using the finite length slab with simple supports subjected to uniform load, $q_{DL} = 0.175 \text{kip} / \text{ft}$

$$M_c = 2.0208 \text{kip} - \text{ft}$$

$$R_A = R_B = 0.7082 \text{kips}$$

For the uniform lane load, $q_{La} = 0.0598 \text{kip} / \text{ft}$

$$M_c = 0.6908 \text{kip} - \text{ft}$$

$$R_A = R_B = 0.2421 \text{kips}$$

b. Moment and shear force subjected to two concentrated tandem loads, F

Two equal forces $F = 3.1 \text{ k}$ spaced at $a = 4 \text{ft}$.

$$M_c = 7.2410 \text{kip} - \text{ft}$$

$$R_A = R_B = -0.0128 \text{kips}$$

c. Combination loads to provide Strength I and Service I design parameters Strength I - Factored Load

$$\begin{aligned} M_u &= 1.25M_{c(DL)} + 1.75(M_{c(La)} + M_{c(Ta)}) \\ &= 1.25 \times 2.0208 + 1.75 \times (0.6908 + 7.2410) \\ &= 16.4067 \text{kip} - \text{ft} = 196.88 \text{kip} - \text{in} \end{aligned}$$

$$\begin{aligned} R_A &= 1.25R_{A(DL)} + 1.75(R_{A(La)} + R_{A(Ta)}) \\ &= 1.25 \times 0.7082 + 1.75 \times (0.2421 - 0.0128) \end{aligned}$$

$$V_u = 1.29 \text{kips}$$

Service I – Unfactored Service Loads

$$\begin{aligned} M_u &= M_{c(DL)} + M_{c(La)} + M_{c(Ta)} \\ &= 2.0208 + 0.6908 + 7.2410 \\ &= 9.9526 \text{kip} - \text{ft} = 119.43 \text{kip} - \text{in} \end{aligned}$$

$$R_A = R_{A(DL)} + R_{A(La)} + R_{A(Ta)}$$

$$= 0.7082 + 0.2421 - 0.0128$$

$$V_u = 0.94 \text{ kips}$$

Flexural Design of BAS

The BAS of unit width ($b = 1' = 12''$) is designed as a singly reinforced beam,

$$C = T$$

$$0.85 f_c' b a = A_s f_y$$

$$M_u \geq \phi M_n = \phi A_s f_y \left(d - \frac{a}{2} \right)$$

$$\therefore \frac{f_y^2}{2 \times 0.85 f_c' b} A_{s,required}^2 - (f_y d) A_{s,required} + \frac{M_u}{\phi} = 0$$

In which,

$$\frac{f_y^2}{2 \times 0.85 f_c' b} = \frac{60^2}{2 \times 0.85 \times 4 \times 12} = 44.12$$

$$- f_y d = -60 \times 9 = 540$$

$$\frac{M_u}{\phi} = \frac{196.88}{0.9} = 218.75$$

Therefore,

$$A_{s,required} = \frac{540 - \sqrt{540^2 - 4 \times 44.12 \times 218.75}}{2 \times 44.12} = 0.419 \text{ in}^2$$

Using $A_s = \#6 @ 8'' = 0.663 \text{ in}^2$

$$a = \frac{A_s f_y}{0.85 f_c' b} = \frac{0.663 \times 60}{0.85 \times 4 \times 12} = 1.30 \text{ in}$$

$$c = \frac{a}{\beta_1} = \frac{1.30}{0.85} = 1.53 \text{ in}$$

$$\varepsilon_s = \frac{d - c}{c} 0.003 = \frac{9 - 1.53}{1.53} \times 0.003 = 0.015 > \varepsilon_y$$

$$c / d = \frac{1.53}{9} = 0.17 < 0.42$$

$$\phi M_n = \phi A_s f_y \left(d - \frac{a}{2} \right) = 0.9 \times 0.663 \times 60 \times \left(9 - \frac{1.30}{2} \right) = 298.8 \text{ kip} - \text{in}$$

Check for Minimum Reinforcement Requirements

According to AASHTO 5.7.3.3.2, one of the following requirements should be satisfied:

$$\phi M_n > 1.33 M_u$$

$$\phi M_n > 1.2 M_{cr}$$

$$\phi M_n = 298.8 \text{kip-in} > 1.33 M_u = 261.85 \text{kip-in}$$

$$\phi M_n = 298.8 \text{kip-in}$$

$$> 1.2 M_{cr} = 1.2 f_r Z_b = 1.2 \times 7.5 \sqrt{f_c'} \times \left(\frac{1}{6} b h^2\right)$$

$$= 1.2 \times (7.5 \times \sqrt{4000} / 1000) \times \left(\frac{1}{6} \times 12 \times 11^2\right)$$

$$= 137.75 \text{kip-in}$$

Both checks for minimum reinforcement are okay

Check for Shear Capacity

The factored shear force at ultimate is

$$V_u = 1.16 \text{ kips}$$

V_n Should be the lesser of (per AASHTO 5.8.3.3)

$$V_n = V_c + V_s, \quad V_c = 0.0316 \beta \sqrt{f_c'} b_v d_v$$

$$V_n = 0.25 f_c' b_v d_v$$

for which,

$$d_v = 9 - \frac{a}{2} = 9 - \frac{1.3}{2} = 8.35 \text{in}$$

$$b_v = 12 \text{in}$$

Using a conservative value of $\beta = 2.0$

$$\phi V_n > \phi V_c = 0.8 \times 0.0316 \times 2.0 \times \sqrt{4} \times 12 \times 8.35$$

$$= 10.13 \text{kips}$$

$$> V_u = 1.29 \text{kips}$$

$$\phi V_n = \phi(0.25 f_c' b_v d_v) = 0.8 \times (0.025 \times 4 \times 12 \times 8.35)$$

$$= 80.16 \text{kips}$$

$$> V_u = 1.29 \text{kips}$$

Both shear capacity checks are okay.

Crack Check for Service I

According to AASHTO 5.7.3.4 the steel stress under Service 1 should satisfy the following requirement:

$$s \leq \frac{700 \gamma_e}{\beta_s f_s} - 2 d_c$$

Where,

$$\beta_s = 1 + \frac{d_c}{0.7(h - d_c)} = 1 + \frac{2}{0.7 \times (11 - 2)} = 1.317$$

The service moment was obtained earlier as:

$$M_c = 119.43 \text{ kips} - \text{in}$$

The longitudinal reinforcements used are listed below:

$$\text{Top bar: } A_s' = \#5 @ 12" = 0.307 \text{ in}^2, (n-1)A_s' = 7 \times 0.307 = 2.149 \text{ in}^2$$

$$\text{Bottom bar: } A_s = \#6 @ 8" = 0.663 \text{ in}^2, nA_s = 8 \times 0.663 = 5.304 \text{ in}^2$$

Transformed cracked elastic section analysis provides:

$$\frac{12c^2}{2} + 2.149(c - 2.3125) = 5.304(8.625 - c)$$

$$6c^2 + 7.453c - 50.72 = 0$$

$$c = 2.35 \text{ in}$$

Moment of Inertia about Neutral Axis

$$\begin{aligned} I_{cr} &= \frac{12c^3}{3} + 2.149(c - 2.3125)^2 + 5.304(8.625 - c)^2 \\ &= \frac{12 \times 2.35^3}{3} + 2.149 \times (2.35 - 2.3125)^2 + 5.304 \times (8.625 - 2.35)^2 \\ &= 261 \text{ in}^4 \end{aligned}$$

Stress in tension steel under Service I condition is given by:

$$f_s = n \frac{M_c}{I_{cr}} y = 8 \times \frac{119.43}{261} \times (8.625 - 2.35) = 22.97 \text{ ksi}$$

Hence,

$$s = 12 \leq \frac{700 \times 1.00}{1.317 \times 22.97} - 2 \times 2 = 19.0$$

Check for crack control is okay

Transverse Distribution Reinforcement

Transverse distribution reinforcement = $100/\sqrt{L} \leq 50\%$ of the longitude reinforcement when $L = 25 \text{ ft}$, $100/\sqrt{25} = 20\%$

$$20\% A_s = 0.133 \text{ in}^2, \quad 20\% A_s' = 0.06 \text{ in}^2$$

Use #4 @ 12" ($A_s = 0.196 \text{ in}^2$) as bottom and top reinforcement.

Temperature and Shrinkage Reinforcement

Per AASHTO 5.10.8.2, the temperature/shrinkage reinforcement is given by:

$$A_s \geq 0.11 A_g / f_y ; A_s \geq 0.11 \times (12 \times 12) / 60 = 0.264 \text{ in}^2$$

Both A_s and A_s' are larger than 0.264 in^2 . The reinforcement provided is adequate.

3.5.1 SUMMARY REINFORCEMENT DETAIL FOR THE DESIGN EXAMPLE

A summary of the reinforcement using the BAS-ES flexural design approach reported is included in Table 3.3. As noted in Section 3.5, the design meets all current MoDOT and AASHTO design specifications. The amount of reinforcement used for the design represents significant savings compared to the standard MoDOT BAS design as discussed in Section 3.7.

Table 3-3 Details of reinforcement based on incorporating elastic soil support

Layer	Reinforcement
Top Longitudinal Bars	#5 @ 12"
Top Distribution Bars	#4 @ 12"
Bottom Longitudinal Bars	#6 @ 8"
Bottom Distribution Bars	#4 @ 12"

3.6 END ZONE AND OTHER REINFORCEMENT DETAILS

The use of sleeper slabs are not recommended per the BAS-ES design as the entire slab is designed assuming soil support. As a result, the use of a Type 4 rock ditch liner is recommended to contain and confine the Type 5 aggregate ditch holding the perforated drain pipe (see the highlighted rectangle in Figure 3-15). Also, to allow for some two-way flexural action at the end of the slab (the end opposite to the bridge abutment), simulating the effect of a sleeper slab, additional transverse reinforcement in the bottom layer (8 #4 bars at 3" centers in the end zone) is recommended. Stirrup reinforcement (#4 bars @ 12" centers) similar to those provided in the sleeper slab is also recommended for the end zone of the BAS-ES. The additional transverse reinforcement will provide post-cracking stiffness for transverse bending and limit widths of potential longitudinal cracks in end zone. The stirrup reinforcement will provide confinement for the concrete in the end zone, improving overall slab performance in transverse bending. Additional reinforcement details are illustrated in the highlighted portion of Figure 3-15.

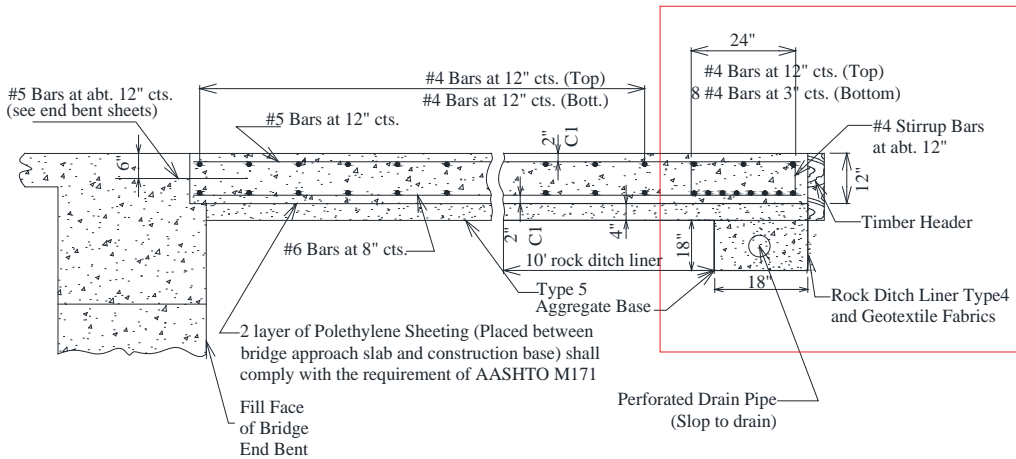

Figure 3-15 End zone details of the BAS-ES design

3.7 INITIAL CONSTRUCTION COST OF BAS-ES AND COMPARISON WITH STANDARD MODOT BAS

Table 3-4 includes a comparison of reinforcements used in the standard MoDOT BAS design with that used in the elastic soil supported BAS design proposed here. Table 3-5 includes the cost estimates based on pay-item details provided by MoDOT. The primary reductions in cost for the BAS-ES design come from reduced reinforcement costs and the elimination of sleeper slabs. The estimated initial construction costs for the standard MoDOT BAS is \$65,158 (including sleeper slabs) versus the new elastically soil supported design proposed of \$45,375. This represents a savings of approximately 30% (all cost estimates are for two approaches to the bridge, i.e. one at each end).

Table 3-4 Reinforcement details in the current and proposed BAS designs

Reinforcement	Standard MoDOT BAS	BAS-ES Design
Main Steel	Top #7 @ 12"	Top #5 @ 12"
	Bottom #8 @ 5"	Bottom #6 @ 8"
Distribution Steel	Top #4 @ 18"	Top #4 @ 12"
	Bottom #6 @ 15"	Bottom #4 @ 12"
Sleeper Slab	3'-0"×18"	Not used
	3 #6 Top and 3 #6 Bottom	
	Stirrup #4 @ 12"	
End Reinforcement	Not used	2'-0" ×12"
		8 #4 @ 3" Bottom Transverse
		Stirrup #4 @12"

Table 3-5 Comparison of initial construction in the current and proposed BAS designs

		Standard MoDOT BAS	BAS-ES Design
Base Preparation	Quantity yd ³	23	23
	Cost \$	2,051	2,051
Form Approach Slab	Quantity ft ²	176*	176
	Cost \$	4,256	4,256
Set Steel	Quantity lb	20,310	9,730
	Cost \$	21,683	10,508
Pour Approach Slab	Quantity yd ³	83	70
	Cost \$	33,706	28,561
Total Cost \$		60,912	45,375

**It is assumed that the sleeper slabs are poured after excavation per MoDOT practice without specifically forming them.*

3.8 SUMMARY CONCLUSIONS

The BAS design proposed in this chapter assuming elastic soil support has been shown to save up to 25% in initial construction costs. The slab design recommended still retains the 12” depth of the standard MoDOT BAS design while reducing the steel reinforcement to reflect the reduced internal forces due to elastic soil support. As the slab is assumed to be continuously supported by the soil, the use of a sleeper slab is not recommended. Special pavement end-zone detailing for the BAS-ES provides the two-way action that is expected to improve slab performance in transverse bending. The cost savings for the BAS-ES design are realized primarily due to reduced use of reinforcement as well as the elimination of sleeper slabs. Additional cost savings are also realized in forming the approach slab and reduced pouring costs. An exhaustive analysis of potential soil washout (both size and location studied) indicates that significant reductions in design moments can still be realized, even with 50% of the soil under the BAS providing no support. The cost savings in initial construction using the BAS-ES design can be partially used to enhance soil support through the use of controlled low-strength materials (CLSM, using fly ash stabilization of the base of the BAS). This can further guarantee that the reduction in design moments is effective for the life of the BAS.

CHAPTER 4 PRECAST PRESTRESSED APPROACH SLAB

4.1 INTRODUCTION

This chapter described the work undertaken to address the second objective of the proposal, namely to develop remedial measures or alternative designs for a replacement bridge approach slab. Solutions for a slab that has badly deteriorated and is designated to be replaced are presented here. Precast prestressed (PCPS) concrete pavements have been in use for a number of years all over the country. However, the use of precast prestressed slabs in approach slab construction is rather limited.

There have been a few Federal Highway Administration (FHWA) demonstration projects to assess the viability of using PCPS slabs in approach slab applications. The Texas Department of Transportation completed the first project in 2002 on Interstate 35 Frontage Road in Georgetown, Texas. California Department of Transportation constructed one on Interstate 10 in El Monte, California in 2004. More recently Iowa Department of Transportation constructed a PCPS slab on Highway 60 in 2007 [30] as a demonstration project. Some of the features of the slab included bi-directional post tensioning, installation of panels over an aggregate base, panels installed on a crowned pavement section and diamond grinding of the finished surface.

It has been reported [30] that the final unit cost of the Highway 60 was approximately \$739/yd². Compared to about \$280/yd² for cast in place slabs it would appear the cost would be prohibitive for usage under normal circumstances. Hence, one of the challenges of this project was to find *cost effective PCPS* solutions. The research team held a number of discussions with MoDOT officials in Jefferson City, district level engineers (in Kansas City) and Coreslab Structures (a precast producer) in order to come up with a cost effective solution.

Traditionally PCPS slabs have been post tensioned in one or both directions and have not been very cost effective. However, some of the increased costs were due to special considerations (such as experimental project, post tensioning, diamond ground finish etc.) and do not accurately reflect their actual costs. A *cost effective PCPS* approach slab solution is presented in this section. Some of the features incorporated in the solution include:

- a) Numerical (computer) structural analysis and load considerations in order to come up with optimal analysis values for design moments,
- b) Design of slabs for both replacement (25 ft span) and new slabs (20 ft span),
- c) Design with constructability issues as the main driving force, and
- d) Connection details that have been traditionally used by MoDOT in bridge slabs which would facilitate the acceptance of the proposed solution by MoDOT.

Cost analyses have also been presented and from the data it is seen to be a cost effective approach.

Advantages of Precast Prestressed Approach Slabs

There are a number of advantages of using PCPS slabs in bridge approach slab applications. They include:

- a) **Fast Installation:** As compared to cast in place concrete slabs PCPS slabs can be installed in a matter of a day or two for the entire operation and the lanes can be opened in a very short period.
- b) **Improved Performance and Durability:** In pavement construction PCPS has proven to be a highly durable solution with a greater quality control due to the precast nature of the slab. Lower permeability concrete, reduced curling or insufficient air entrainment issues can be controlled in a precast fabrication environment. Due to the prestressed nature of the slab it is possible to design slabs with a thinner section.
- c) **Competitive Cost:** It is demonstrated in this section that with the proposed concept the costs associated with construction and installation of PCPS slabs are comparable to that of the proposed new approach slabs and could possibly be effectively used in new construction situations as well.
- d) **User Cost Savings:** Faster installation of slabs allows the bridges to be opened quickly. The potential benefits in terms in user costs include reduced congestion of traffic due to lane closures, reduced pollution due to vehicles moving slowly, reduced fuel consumption, reduced loss of work time etc. These costs are often difficult to quantify but add significantly to the overall life cycle costs.
- e) **Improved DOT image:** Faster removal of a deteriorated slab and installation of a replacement slab effectively will help to enhance the image of the state DOT in the eyes of the public.

4.2 PROPOSED PRECAST PRESTRESSED CONCEPT

Details of the proposed PCPS approach slab concept are presented in this section. The details include:

- a) New and replacement slab types,
- b) Geometry and sectional details of the panels,
- c) Slab to abutment connection details,
- d) Transverse connection details,
- e) Panel joints,
- f) Grouting,
- g) Base preparation issues,
- h) Analysis and design considerations, and
- i) Construction steps.

New and Replacement Slab Types: The PCPS concept proposed in this research for the 38 feet wide bridge consists of a combination of 8 feet and 6 feet wide panels (along the lateral direction) and spanning either 20 feet or 25 feet in the longitudinal direction. Two span lengths

are proposed namely 20 feet long panels for *new construction* and 25 feet long panels for replacement slab applications. The designs for new construction has been proposed, although it was not required in the original objectives of the proposal, since a cost study has shown (presented later in this section) that they could be cost effective solutions. Figure 4-1 shows a schematic of the proposed PCPS concept. The considerations related to the fabrication and installation of the PCPS slab is described next. Sectional details, prestress and mild steel details, dowel details for connection to the bridge abutment and transverse tie details are presented.

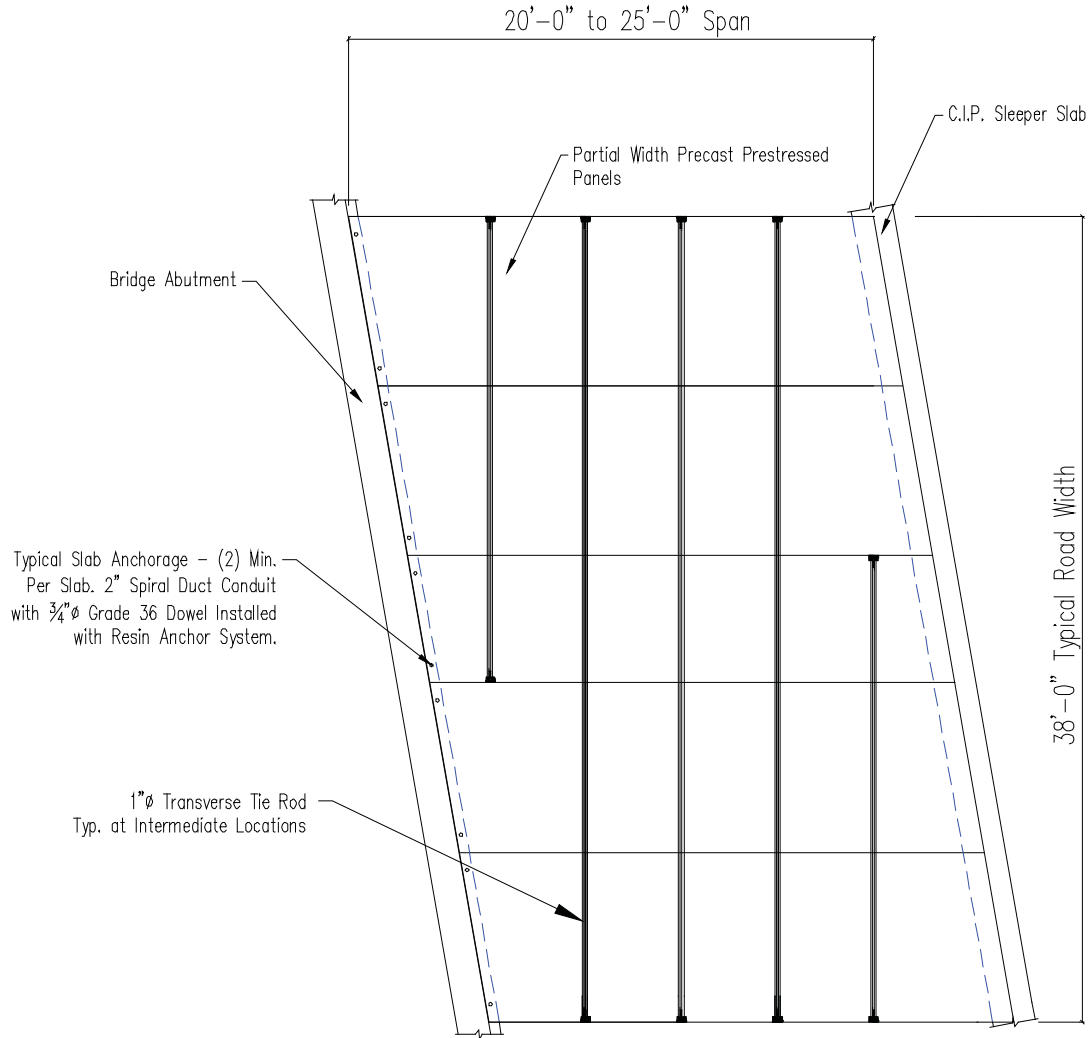

Figure 4-1: Conceptual representation of the proposed PCPS Bridge Approach Slab

Panel Geometry and Sectional Details: Upon making inquiries from two precast manufacturers it was determined that optimal maximum width for precasting the panels is 8 feet. Hence, for a 38 feet wide roadway with three lanes, 5 panels are proposed. Four panels that would be 8 feet wide and a fifth panel which would be 6 feet wide. Figure 4-1 shows the conceptual diagram of a

proposed skewed panel layout. Considering that the lane is typically 12 feet wide it would be impossible to avoid a tire running over the panel interface line. The goal would be an attempt to select a configuration that would minimize it. A symmetric layout is proposed in which the central panel would be 6 feet wide and the outer two panels on either side of the central panel would be 8 feet each.

A 10 inch thick slab is proposed with a 2 inch overlay – either asphalt or concrete. The slab thickness proposed is the same for both a 20 feet (new slab) and 25 feet span (replacement slab). This consideration was arrived based on the costs of getting a finished riding surface at the precasting facility. Providing a cast in place overlay would facilitate matching the crown layout of the bridge and also provide for a smoother transition between the approach slab and the bridge. Secondly, any repairs with regard to difference in elevations between the approach slab and the bridge may be easily and cost effectively addressed by using overlays. A broom finish at the plant while the panels are cast is proposed for a partial bonding with the overlay. However, the design does not account for the added stiffness provided by the overlay and the 10 inch slab is self-sufficient for carrying the design moments.

Slab to Abutment Connection: The slab to abutment connection in Integral Approach (IA) slabs are achieved typically by placing steel reinforcing bars in the middle of the slab in order to avoid a moment transfer. Currently MoDOT uses #5 steel reinforcing bars at 12 inches c/c running horizontally and anchored both in the abutment and the slab. It would be difficult to achieve a similar connection in a precast unit.

The proposed connection to the abutment is using $\frac{3}{4}$ inch Grade 36 epoxy dowel bars spaced at 24 in c/c. In order to facilitate construction and achieve the purpose of zero moment transfer, the type of connection proposed involves drilling holes in the abutment in order to place a adhesive/epoxy resin based anchor system and leaving corresponding conduits in the slab while precasting. An appropriate sized hole 6-8 inch deep can be drilled in the abutment at the dowel bar locations. Using an adhesive or epoxy based resin the dowel bars can be anchored in the abutment. The precast panels are cast with corresponding holes 2 inches in diameter with a spiral conduit. The hole in the slab can be filled with a non shrink grout. Figure 4-2 shows the proposed abutment bearing detail showing other details such as backer rods, sealants etc.

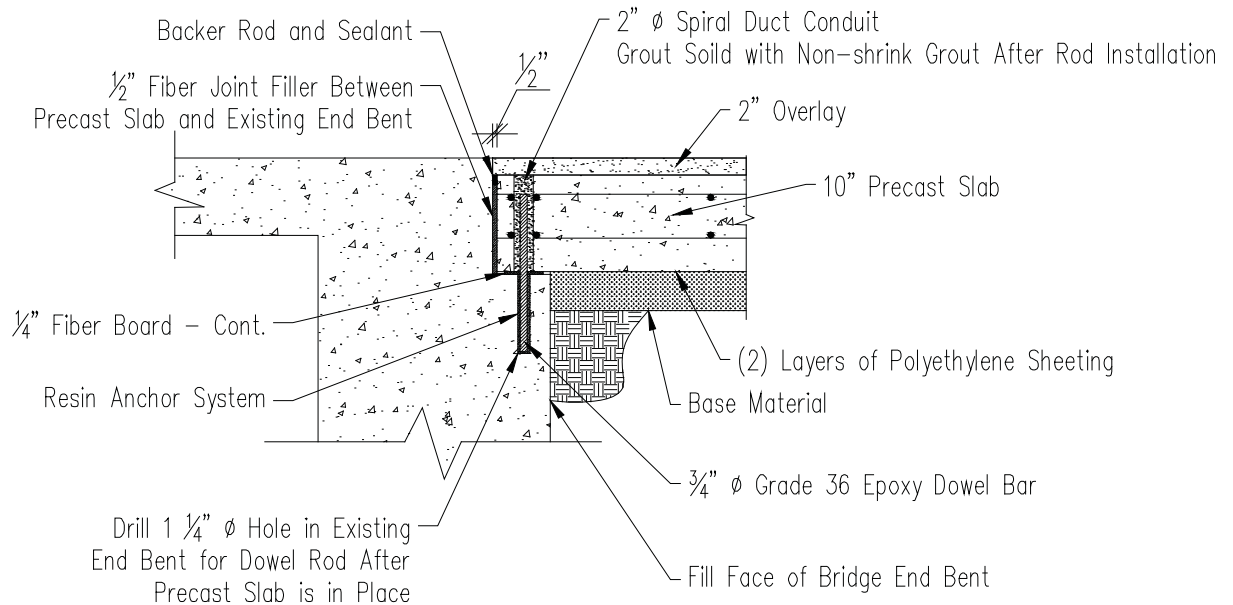
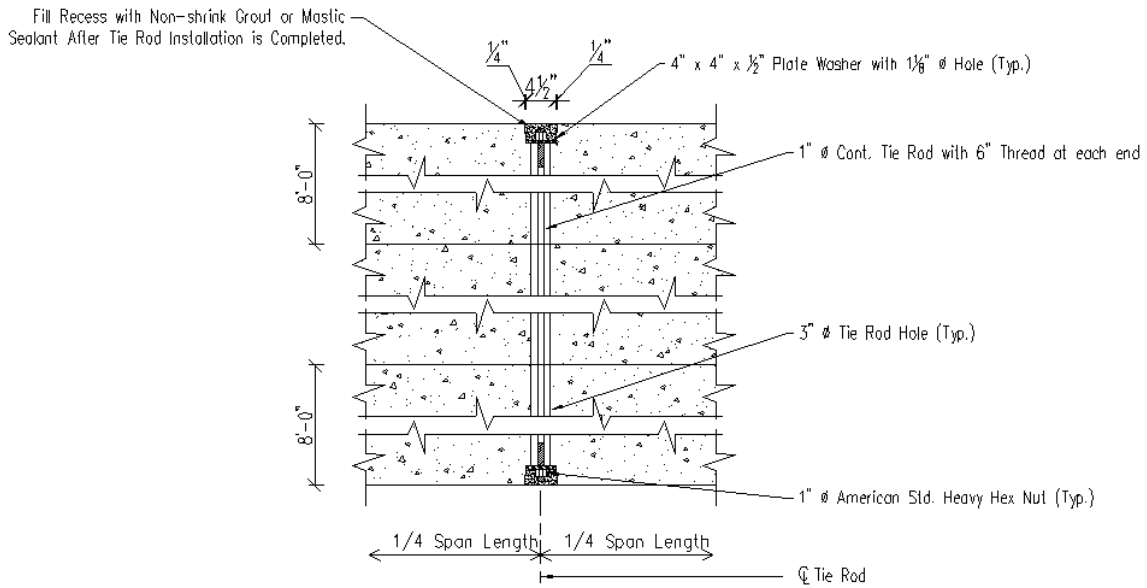

Figure 4-2 Abutment bearing detail

Transverse Tie Details: There are two approaches to tying the slab in the transverse direction. They are either using transverse tie rods or a post tensioned system. For this project it is proposed to use transverse tie rods, which are essentially threaded reinforcing bars that are cost effective while post tensioned systems are very expensive. However, the importance of a integral and combined slab system cannot be overemphasized in order to achieve uniform distribution of loads. The transverse ties also help to ensure the alignment of the slabs in the vertical direction and to keep the panel joint confined. One of the reasons for the selection of the transverse tie rod system is that MoDOT uses this type of detail regularly to connect voided slab systems for bridge decks used often by consultants for MoDOT on bridge projects. Since the proposed application for a bridge approach slab is a slab on ground compared to a bridge deck, it is hypothesized that system should be effective (pending an actual test). The system proposed is outlined below.

The transverse tie rod system consists of a typical 3 inch diameter tie rod hole laid out during the construction at $\frac{1}{4}$ span locations. After placement of the slabs on the ground they will be tied together using a 1 inch continuous tied rod with 6 inch thread at the ends. The end slabs will have a recess built in (5 in x 5 in x 1.5 in deep). A backer plate will be placed at the end of each slab and the tie rods tightened using nuts to one half of the tension specified for A325 bolts. The recess at the ends will be filled using a non-shrink grout. Figure 4-3 shows the typical detail of a transverse tie rod system.



PART PLAN SHOWING 1" \emptyset TIE ROD

NOTES:

All tie rods, plates, and nuts shall be galvanized in accordance with ASTM A123.

Tighten all tie rods to about one-half of the specified tension before proceeding with the final tensioning.

Tie rod nuts shall be tightened to provide a tension of one-half that specified for A325 bolts in Sec 712.10.2.

Tie rod plates shall be ASTM A709 Grade 36.

Tie rods and nuts shall be A307.

Tie rod hole distance from bottom of slab shall be within $\frac{1}{2}$ " \pm .

Tie rod hole horizontal distance from the ends of slabs shall be within $\frac{1}{2}$ " \pm .

Figure 4-3: Tie rod detail shown (part plan view)

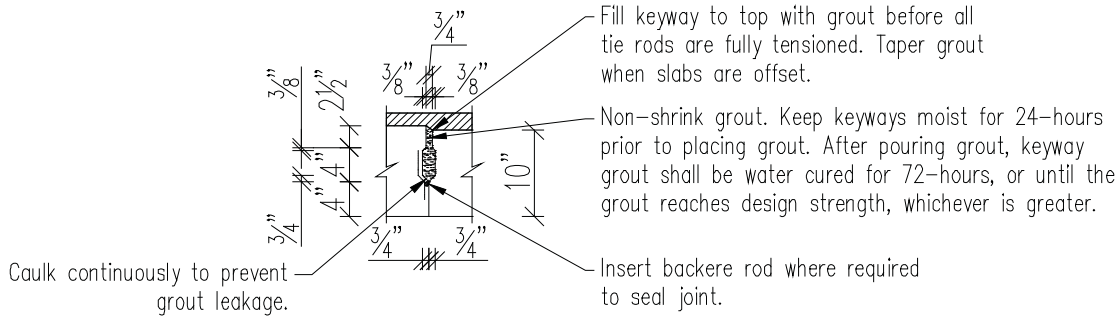

KEYWAY GROUT DETAIL

Figure 4-4 Keyway detail for water tight joint between panels

Panel joints: The two major considerations for panel joints were:

- Maintaining the vertical alignment between two panels and possibly help in load sharing, and
- Having a water tight joint.

These are two very challenging requirements that could have major cost implications. Two options have been considered for inter panel joints.

One option is to provide a keyway between the panels with one panel having a male and the other having a female segment. While this option helps considerably in maintaining the vertical alignment of the panels, it was recognized that the keyway – while adding cost to the system – may not function effectively unless the underlying base is perfectly horizontal. In a slab on ground situation it is unlikely to have a fairly level bed. Keyways could also be damaged and battered during the construction process[30]. Hence, upon discussions with engineers at Coreslab Structures it was decided **not to recommend** a male-to-female keyway. However, it is important to have water tightness as much as possible and for this a possible solution discussed was providing two female keyways on the sides of the panels and providing a water tight keyway. The details of the keyway are shown in Figure 4-4.

Grouting: The three locations where non shrink grouting is to be provided are a) in the slab side of the slab abutment joint where 2 inch diameter conduits are used b) ends of the transverse tie pockets and c) under the slab. Under the slab grouting would be needed in case of significant voids observed prior to placement of the slabs.

Base Preparation: Currently MoDOT typically uses a 3 inch thick graded Type V rock aggregate base for the cast in place slabs. Other options include a hot mix asphalt base. Using a

hot mix asphalt base which is flexible in nature will help avoid surface roughness issues and will assist in laying the PCPS slab and make it easier to install the transverse tied rods for vertical alignment. Either one layer or two layers of polyethylene sheeting should be used over the prepared base in order to provide the frictionless condition that will assist the slab in breathing during the thermal cycles that the slab will experience. These sheets have been used effectively in many past constructions of a similar kind.

4.3 ANALYSIS AND DESIGN

This section describes the rationale behind the selection of loading, methods of analysis and the analysis and design process itself. Precast post tensioned slab systems have been used frequently as roadways. The designs of a PCPS for roadway systems are different from that of an approach slab. Pavements are normally designed to withstand a number of 18 kip equivalent single axle load (ESAL) applications over the life of the pavement. However, unlike pavements approach slabs are often designed as simply supported slabs due to erosion possibilities of the soil underneath the slab.

Analysis span versus actual span: Upon some research, two methods to determine the span of the approach slab that have been adopted in different states were found. They are:

- a) The Iowa Highway 60 PCPS slab was designed for a span of 15 feet [30] although the actual slab itself was much longer than that. The rationale behind the assumption was a study [4] in Iowa that observed that the maximum length of the voids under the slab were 15 feet. Hence live load moments were determined based on a 15 feet span. The maximum moment noted in this report [30] for design purposes was 34.8 ft.kips/ft. of slab width.
- b) Upon telephonic discussions with Idaho DOT officials in June 2010, it was found that the Idaho slab while spanning 20 feet was designed for moments assuming a 10 feet span based on observations.

For this study a systematic computer based analysis was conducted using industry standard structural analysis software. A matrix of cases was analyzed by considering variations in:

- a) Slab width and span,
- b) Slab boundary and soil conditions, and
- c) Loading conditions on the slab.

The different options in the above conditions are described below followed by a table of the matrix itself.

Slab width and Span: Both 20 feet slabs for new approach slabs and 25 feet span for replacement approach slabs have been analyzed using SAP 2000 [23]. The analysis has been performed using an 8 feet wide slab. The slab width was selected based on the practical casting considerations indicated by a couple of precast manufacturers.

Slab Boundary and Soil Conditions: In this project the slabs have been analyzed as a combination of simply supported slabs with a slab on grade condition applied under the slab. Washout conditions under the slab near the abutment end have been considered for 15% span

washout, 25% span washout and no sleeper slab condition with full slab on grade support. In order to consider soil conditions, a very poor soil condition is assumed under the slab with a soil sub grade modulus of 18 lbs/in³. Table 4-1 shows the matrix used for the analysis of slabs.

Notation: The notation used is: BAS – span - thickness of slab-soil condition - span of voids - soil stiffness. For example BAS-25-12-ES-18.75-18.4 stands for a 25 feet span, 12 inch thickness, elastic spring, 18.75 ft where soil supports the slab as shown in the picture in the table with a soil stiffness of 18.4 ksi/in – which is a very poor soil. Table 4-1 shows the notation for three types of slabs named as Std Missouri, Missouri Modified and Idaho BAS in order to be consistent with the analysis performed for the cast in place slabs and also to compare the moments obtained from the three cases. NS stands for no sleeper slab.

Table 4-1 Details of the matrix used for modeling PCPS approach slabs

Matrix for BAS models					
Case	Span	Depth	File Name	Support Conditions	
Std Missouri BAS					
1	25'	12"	BAS-25-12-SSS	SS- Standard Missouri BAS	
2	25'	12"	BAS-25-12-ES-25-18.4	SS with linear springs over L with ks=18.4 lb/in3	
3	25'	12"	BAS-25-12-ES-21.25-18.4	SS with linear springs over 85% L	
4	25'	12"	BAS-25-12-ES-18.75-18.4	SS with linear springs over 75% L	
5	25'	12"	BAS-25-12-ES-25-18.4-NS	without sleeper slab	
Missouri modified BAS					
1	25'	12"	MODBAS-25-12-SSS	Modified BAS for Missouri	
2	25'	12"	MODBAS-25-12-ES-25-18.4	SS with linear springs over L with ks=18.4 lb/in3	
3	25'	12"	MODBAS-25-12-ES-21.25-18.4	SS with linear springs over 85% L	
4	25'	12"	MODBAS-25-12-ES-18.75-18.4	SS with linear springs over 75% L	
5	25'	12"	MODBAS-25-12-ES-25-18.4-NS	without sleeper slab	
Idaho BAS					
1	20'	12"	ID-BAS-20-12-SSS	SS- Standard Missouri BAS	
2	20'	12"	ID-BAS-20-12-ES-20-18.4	SS with linear springs over L with ks=18.4 lb/in3	
3	20'	12"	ID-BAS-20-12-ES-17-18.4	SS with linear springs over 85% L	
4	20'	12"	ID-BAS-20-12-ES-15-18.4	SS with linear springs over 75% L	
5	20'	12"	ID-BAS-20-12-ES-20-18.4-NS	without sleeper slab	
SSS-Simply Supported Slab					

Loading Conditions: Since approach slabs are not similar in support and boundary conditions to the traditional bridge slabs it would be conservative to design the slabs for the full traffic load per HL-93. Hence, two types of analyses, one with lane loads and one without lane loads, is carried out. Figure 4-5 shows a simply supported slab with both lane and tandem loads applied.

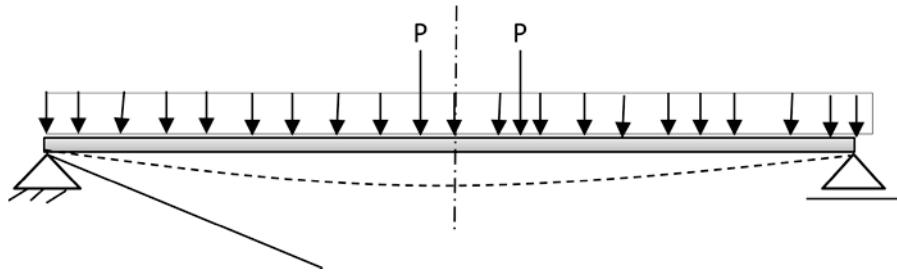

Figure 4-5: Simply supported slab showing loads, the end rotation and deflection

ASSUMED LOADING CONDITION: The BAS is not supported or built as a regular concrete bridge slab. Hence, in order to assess the actual loads acting on the slab, it is reasonable to assume that either in a 20 ft or a 25 ft span only the truck load or the design tandem load is included. This idea has been presented to the MoDOT Technical Advisory Panel during the quarterly meetings and discussed in detail. The exclusion of lane load is based on AASHTO-LRFD provision 3.6.1.3.3 which allows for decks and top slabs of culverts to be designed for only the axle loads of the design truck or design tandem for spans less than 15 ft. The demand moment calculated considering 50% (10 ft.) voids. A finite element analysis study was carried out in order to study the effect of the presence or absence of the lane load.

Analysis Results: The analysis results are presented in this section for the matrix of analyses performed. First, we compare the moment values from the analysis performed with and without lane loads. Figure 4-6 presents the peak moment values derived from this analysis. Figure 4-7 shows the peak deflections obtained in each case.

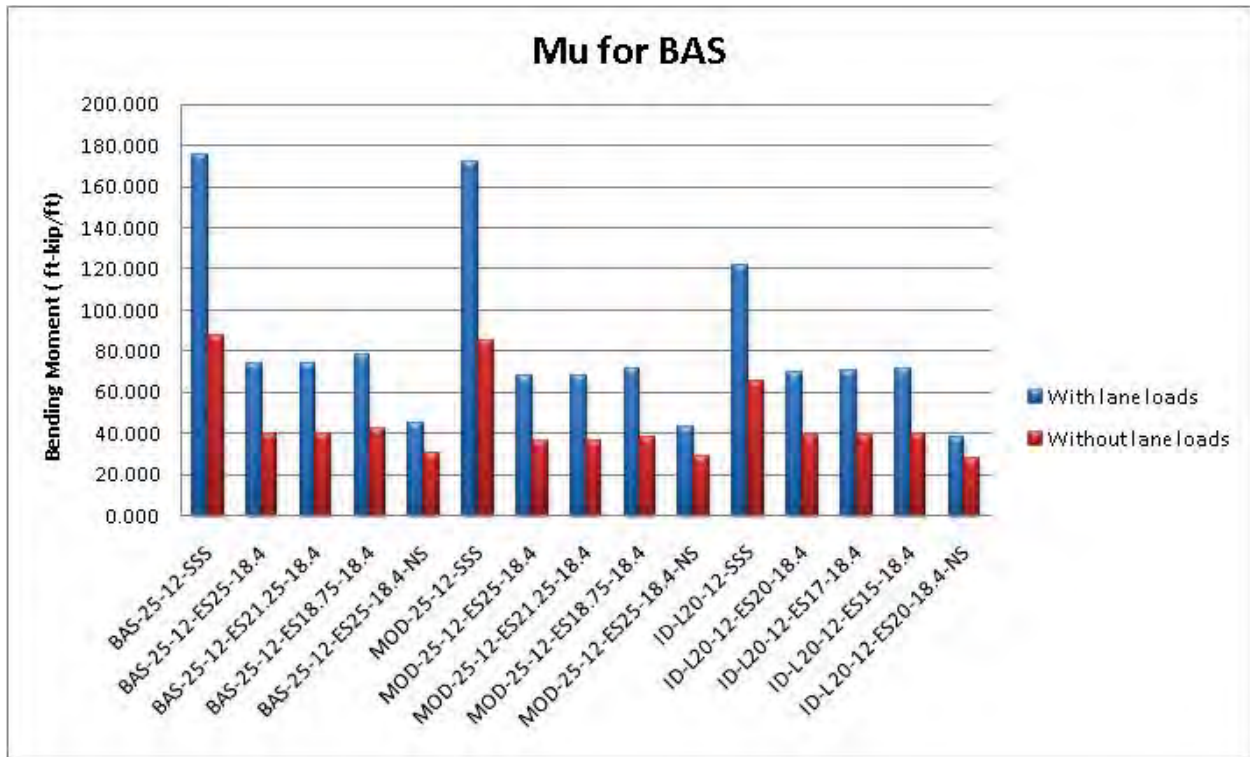

Figure 4-6: Moment values (ft.kips./ft.) for different cases

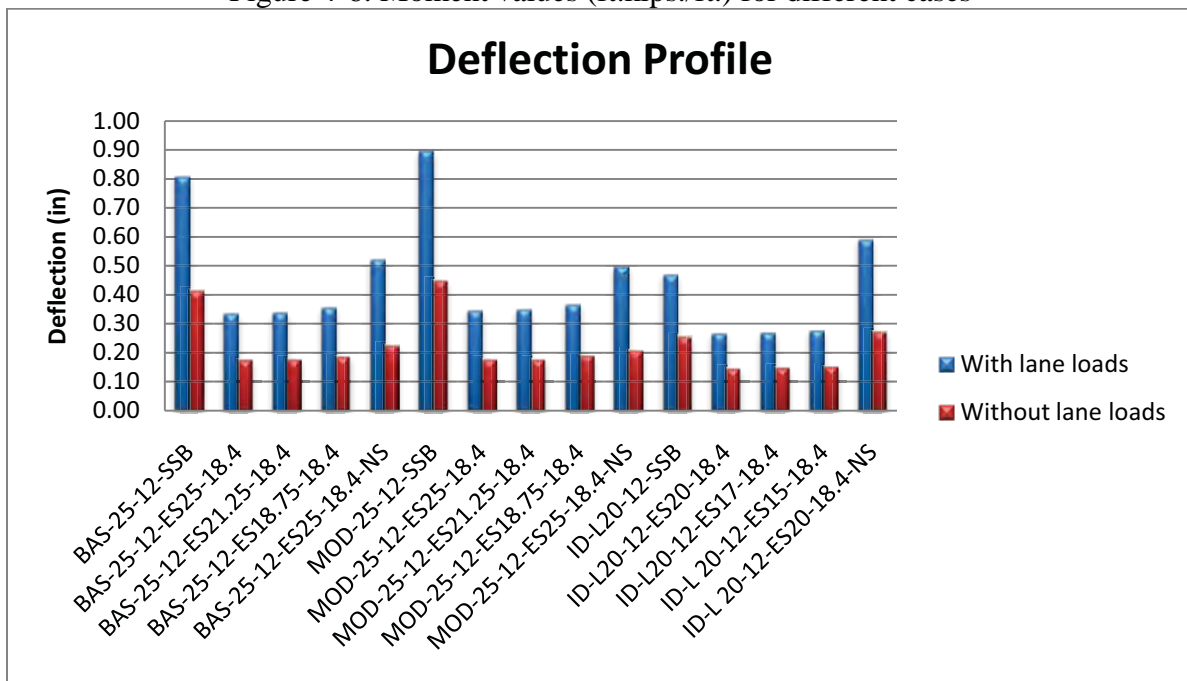

Figure 4-7: Deflection values (in) for different cases

Observations from ‘with lane load’ analysis: From Figure 4-6, it can be seen that the worst case scenario is the simply supported condition with lane load included and had a demand ultimate moment of about 175 ft.kips/ft. and 120 ft.kips/ft. for 25 feet and 20 feet span slab, respectively. For slabs analyzed with soil with void conditions underneath the slab the peak moments dropped to about 80 ft.kips and 75 ft.kips for the 25 feet and 20 feet spans respectively.

Observations from ‘without lane load’ analysis: From Figure 4-6 it can be seen that the worst case scenario is the simply supported condition with lane load included and had a demand ultimate moment of about 90 ft.kips/ft. and 65 ft.kips/ft. for 25 feet and 20 feet span slab respectively. For slabs analyzed with soil with void conditions underneath the slab the peak moments dropped to about 40 ft.kips/ft. for the 25 feet and 20 feet spans, respectively.

Moment Contours: In order to present some visual results moment contours obtained for some selected cases are shown below. The following cases are shown below:

- a) 25 feet model – Simply supported condition with lane loads (Figure 4-8)
- b) 25 feet model – Simply supported condition without lane loads (Figure 4-9)
- c) 25 feet model – Voids under slab with lane loads (Figure 4-10)
- d) 25 feet model – Voids under slab without lane loads (Figure 4-11)
- e) 20 feet model – Simply supported condition with lane loads (Figure 4-12)
- f) 20 feet model – Simply supported condition without lane loads (Figure 4-13)
- g) 20 feet model – Voids under slab with lane loads (Figure 4-14)
- h) 20 feet model – Voids under slab without lane loads (Figure 4-15)

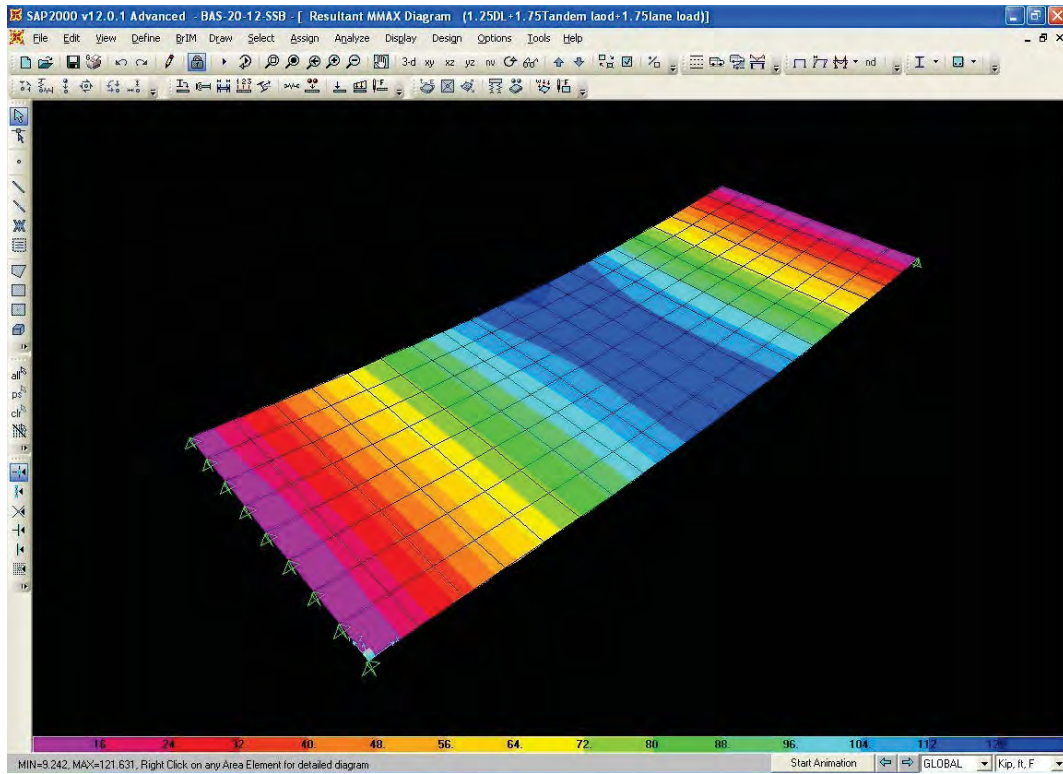

Figure 4-8: Simply supported condition with lane loads-25 feet model

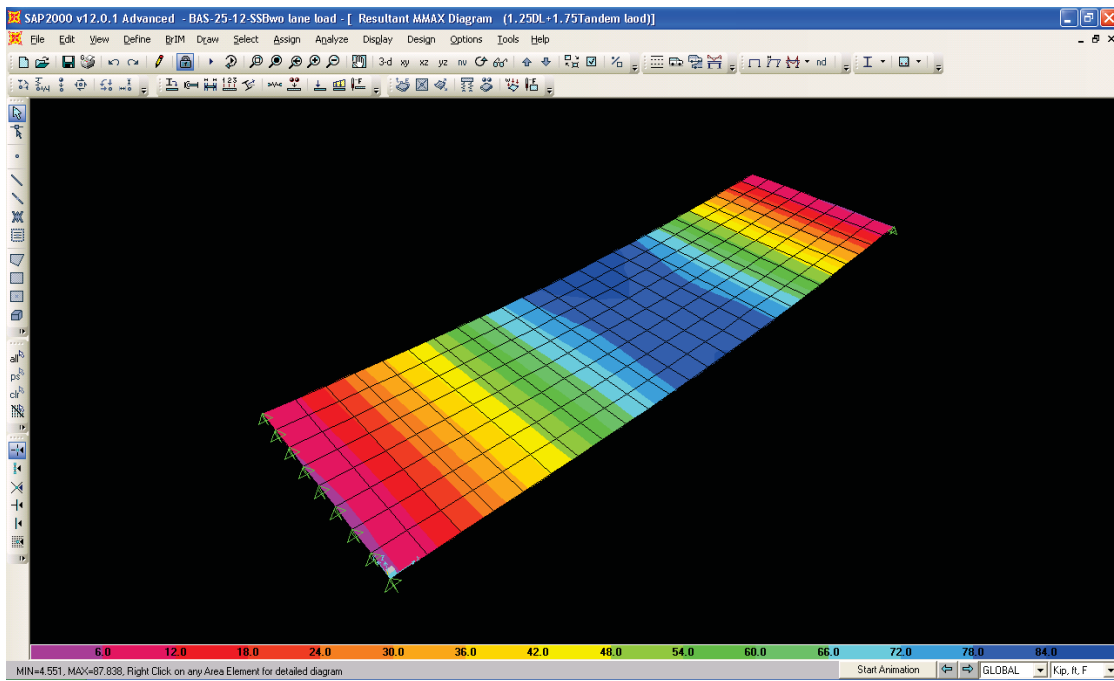

Figure 4-9: Simply supported condition without lane loads-25 feet model

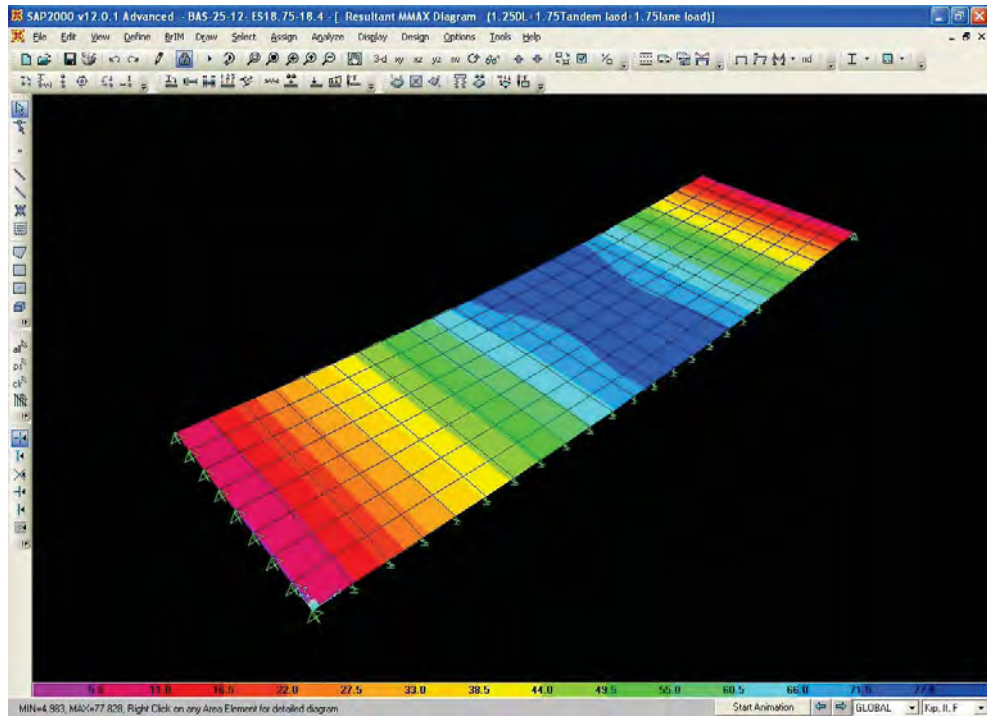

Figure 4-10: Voids under slab with lane loads-25 feet model

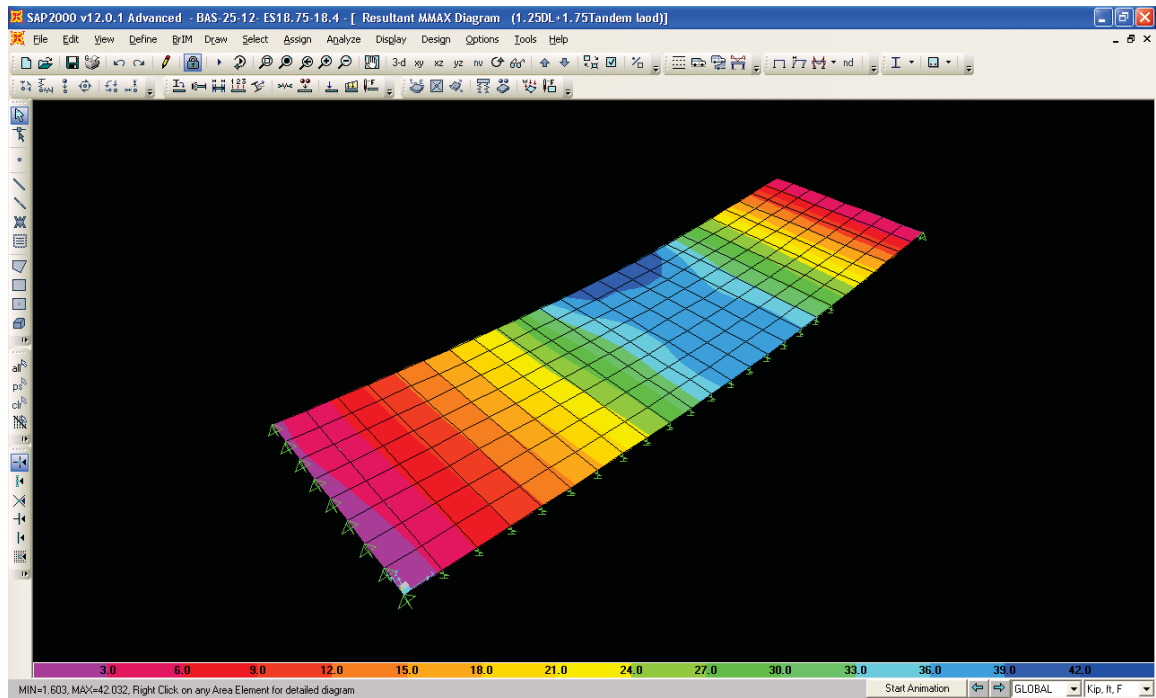

Figure 4-11: Voids under slab without lane loads-25 feet model

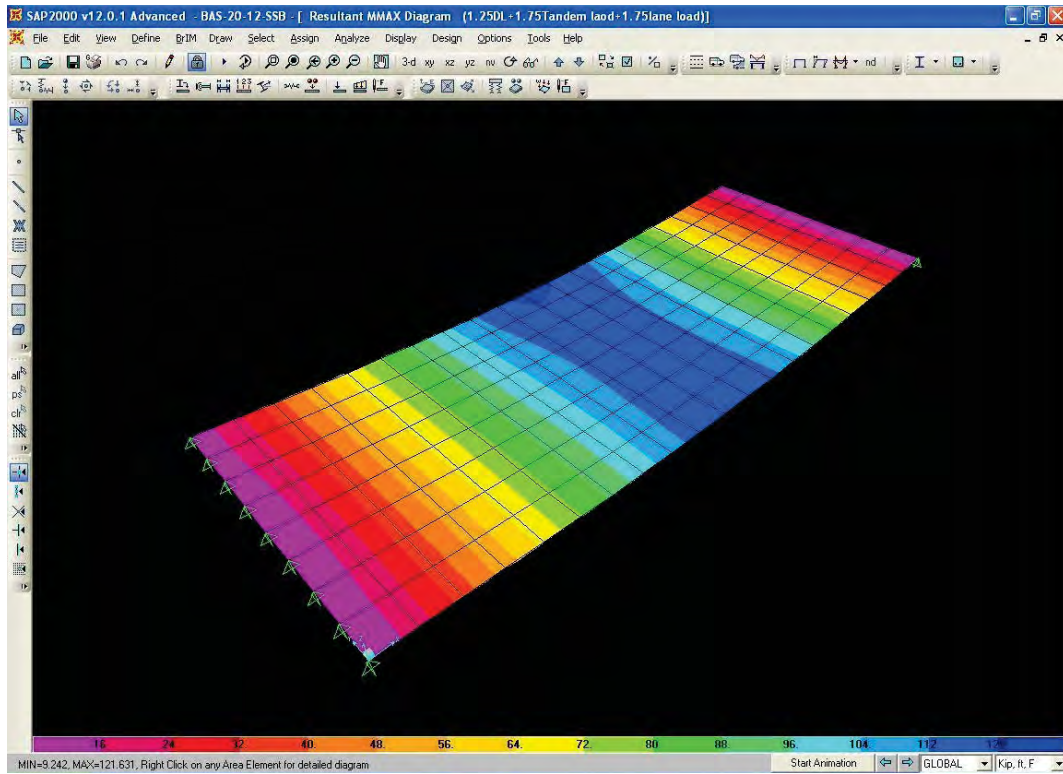

Figure 4-12: Simply supported condition with lane loads-20 feet model

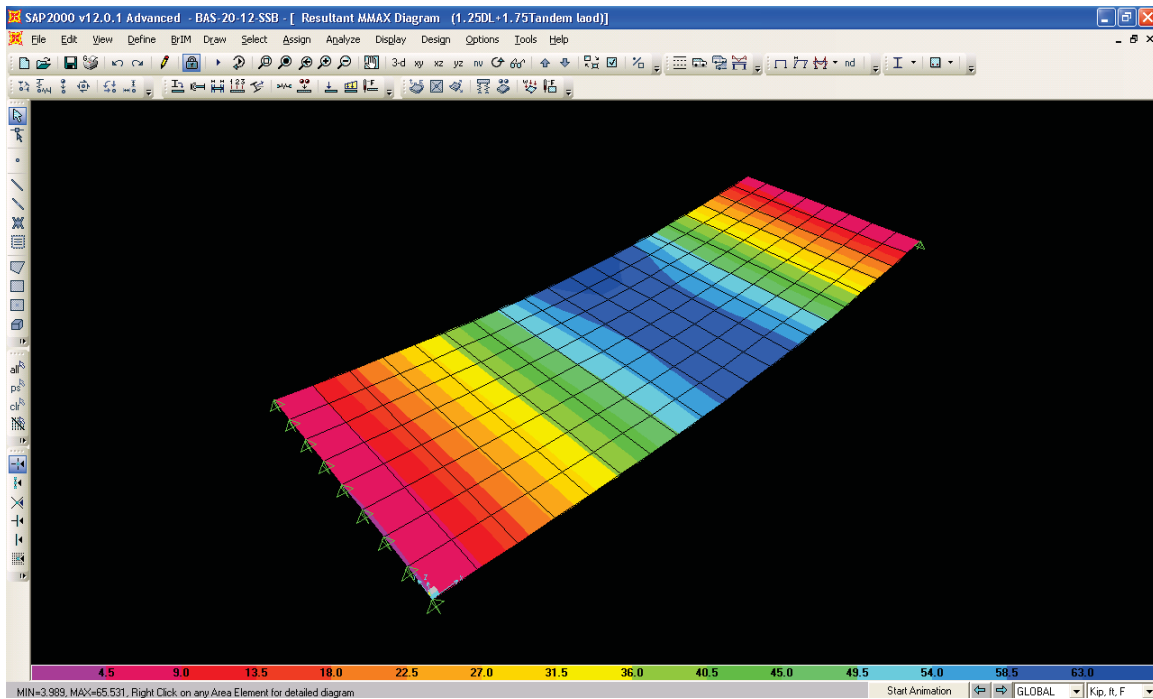

Figure 4-13: Simply supported condition without lane loads-20 feet model

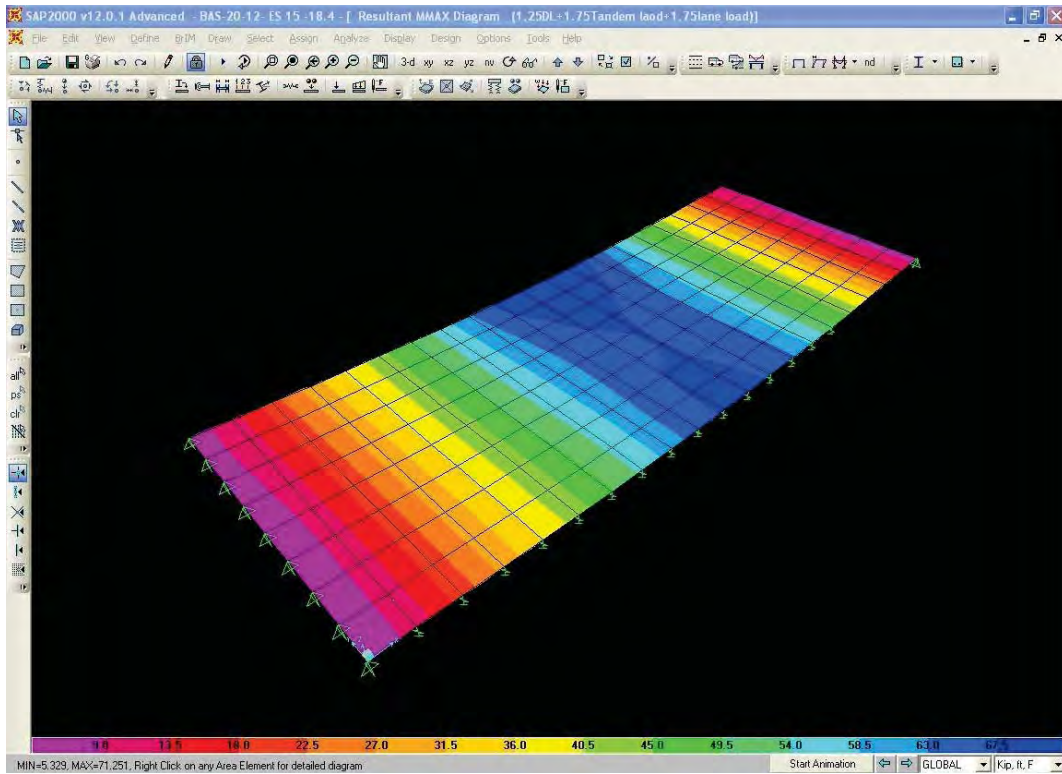

Figure 4-14: Voids under slab with lane loads-20 feet model

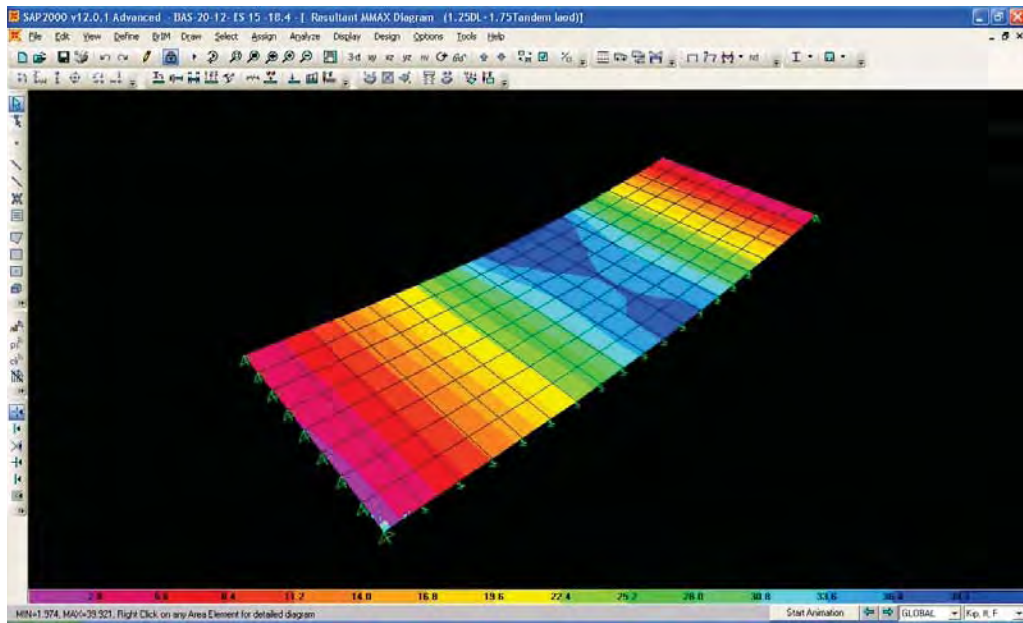

Figure 4-15: Voids under slab without lane loads-20 feet model

Updated Analysis Results: Based on the comments received from the Technical Advisory Panel to incorporate 50% washout cases, the analyses have been rerun to reflect this scenario and updated results for this case, possibly being the design case, and presented here.. It is expected that the moments would increase. However, it is to be noted that the soil stiffness assumed for the previous analyses is very low at 18.4 psi/in.

As the washout conditions are more severe an increase in moment is expected. Hence, the following cases were run and results are presented here for different values of subgrade modulus

- a) A very poor soil (soft sand): of 18.4 psi/in
- b) A very poor soil (soft sand): of 30 psi/in
- c) Medium sand at its lower end of subgrade modulus of 50 psi/in
- d) Soil with a subgrade modulus of 100 psi/in
- e) Soil with a subgrade modulus of 175 psi/in (representing CLSM)

Table 4-2 Moments for 20 feet and 25 feet span for the proposed PCPS BAS design

File name	Mmax with lane loads (ft-kips/ft)	Mmax without lane loads (ft-kips/ft)
BAS20-12-ES10-18.4	101.5	62.0
BAS20-12-ES10-30	90.5	55.8
BAS20-12-ES10-50	78.1	48.8
BAS20-12-ES10-100	62.0	39.8
BAS20-12-ES10-175	51.6	33.8
File name	δ " with lane loads	δ " without lane loads
BAS20-12-ES10-18.4	0.330	0.180
BAS20-12-ES10-30	0.281	0.154
BAS20-12-ES10-50	0.226	0.125
BAS20-12-ES10-100	0.156	0.088
BAS20-12-ES10-175	0.114	0.065
File name	θ with lane loads(degree)	θ without lane loads(degree)
BAS20-12-ES10-18.4	0.258	0.139
BAS20-12-ES10-30	0.224	0.121
BAS20-12-ES10-50	0.186	0.100
BAS20-12-ES10-100	0.138	0.075
BAS20-12-ES10-175	0.107	0.058

File name	Mmax with lane loads (ft-kips/ft)	Mmax without lane loads (ft-kips/ft)
BAS25-12-ES10-18.4	128.1	73.5
BAS25-12-ES10-30	111.3	64.7
BAS25-12-ES10-50	94.4	55.8
BAS25-12-ES10-100	75.3	45.8
BAS20-12-ES10-175	63.9	39.6
File name	δ " with lane loads	δ " without lane loads
BAS25-12-ES10-18.4	0.480	0.250
BAS25-12-ES10-30	0.390	0.200
BAS25-12-ES10-50	0.300	0.160
BAS25-12-ES10-100	0.204	0.110
BAS20-12-ES10-175	0.150	0.080
File name	θ with lane loads(degree)	θ without lane loads(degree)
BAS25-12-ES10-18.4	0.300	0.150
BAS25-12-ES10-30	0.260	0.132
BAS25-12-ES10-50	0.210	0.110
BAS25-12-ES10-100	0.154	0.070
BAS20-12-ES10-175	0.120	0.062

Recommendation for design based on analysis and observations: It has been noted that the Iowa precast prestressed bridge approach slab has been designed for a factored moment of 34.7 ft.kips./ft., From the analysis presented here it is observed that for a slab with no lane load considered, with a soil subgrade modulus of 175 psi/in, and with 50% of the slab underneath having voids near the abutment, the peak moments observed are of the order of 33.8 and 39.6 ft.kips./ft. for the 20 ft. and 25 ft. span slab respectively. From the moment patterns it is seen that these peak moments are concentrated in the central region and taper off towards the ends. Based

upon these observations and analysis and it was decided to design the PCPS slab for a factored moment of 40 ft.kips./ft.

Thickness Selection: The design process considered various options from the outset. Two of the obvious choices were:

- a) 10 inch slab with a 2 inch unbonded overlay – either with concrete or hot mix asphalt, and
- b) 12 in slab with a finished surface.

It is evident that the 12 inch slab would provide for a greater moment capacity but would be more expensive because of costs involved in creating the riding surface in the plant. Another major issue is the horizontal alignment – both on the bridge side as well as the pavement side. The constructability issues made us consider the 10 inch slab option.

10 inch slab with 2 inch overlay: After further communications with the precast producer – both from their design and plant personnel – it was decided that the best option would be to go for a 10 inch slab with a 2 inch overlay. It is evident that many horizontal and riding surface issues could be addressed in a better manner. Secondly, it has the attractive option of using hot mix asphalt for a finish which would facilitate any repair and maintenance issues in the future. It is quite inexpensive to come back to level any riding surface issues in the future with hot mix asphalt. From a cost perspective also as less concrete is being used it would be less expensive compared to the 12 inch thick slab, although the additional steel required could offset some of these costs. The producer did quote the same rate for both 10 inch and 12 inch slab at \$17.25 per square foot of the slab.

DESIGN DETAILS

The design of strands is based on a commercial program by Salmon Technologies used by Coreslab Structures. The details of the input and output are shown in the appendix and it can be seen that:

- a) Moment capacity of the section is shown as 3903 k.in which is 40.65 ft.kips. The moment capacity is calculated based on strain compatibility, and
- b) The Shear capacity – V_{ci} controlling is 224 kips at the ends and 101 kips at the center.

DESIGN DRAWINGS

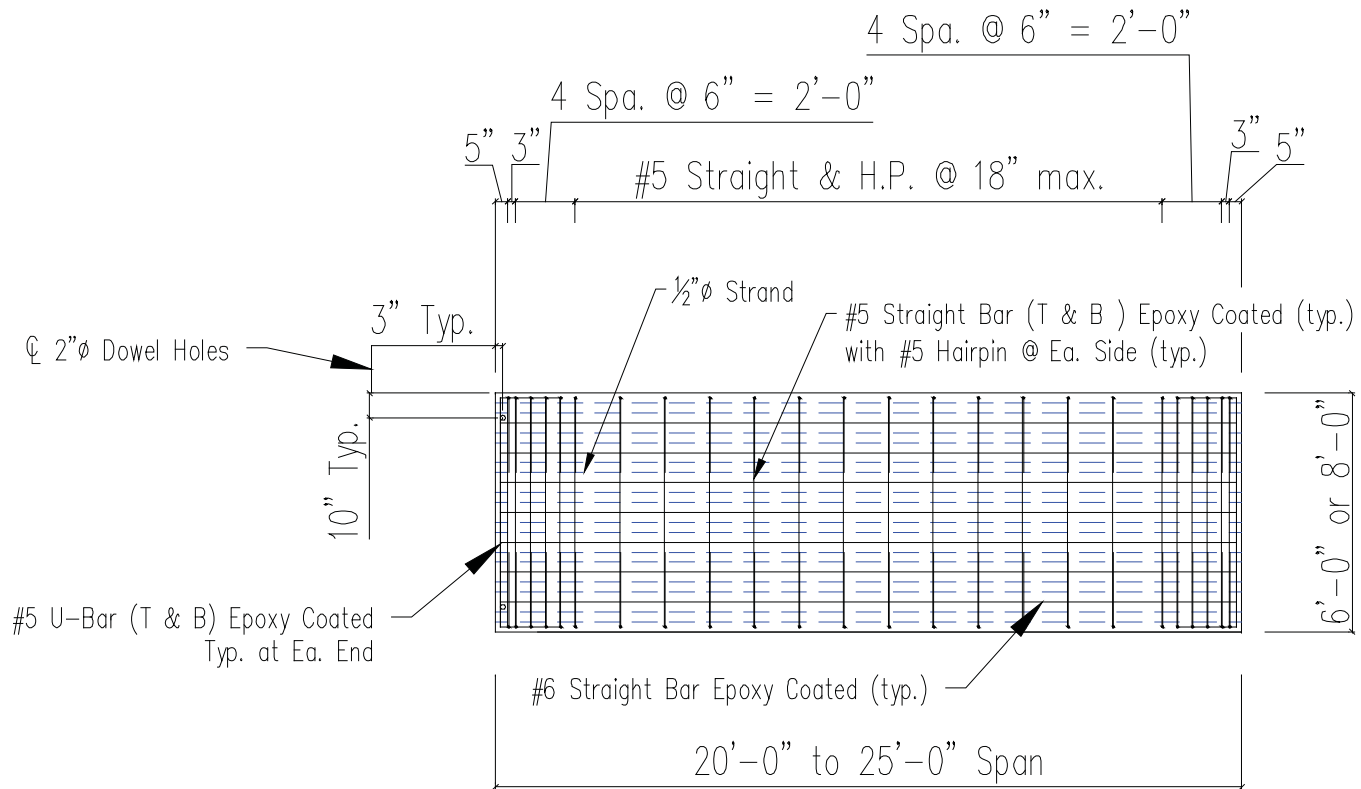
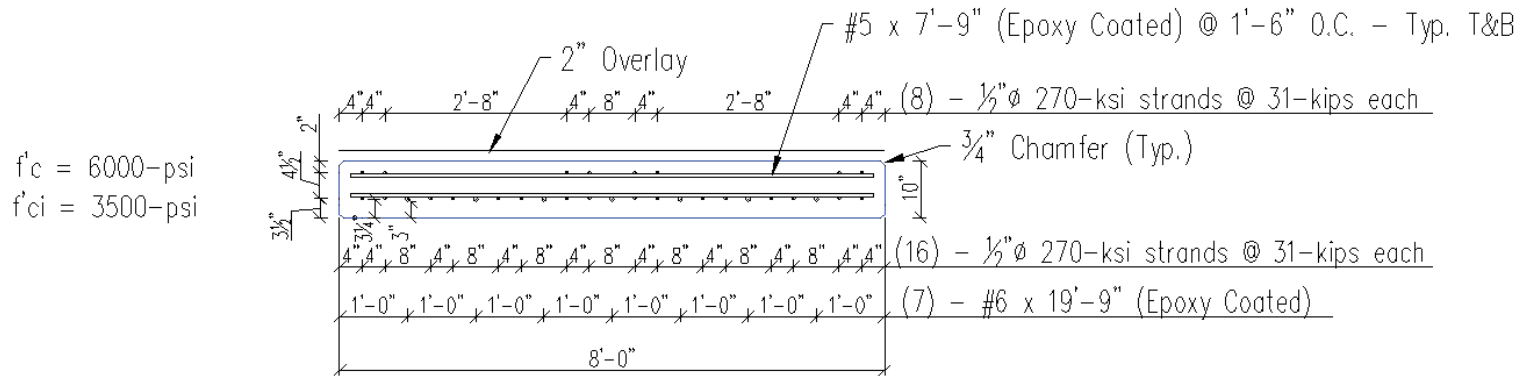

Figure 4-16: Precast prestressed plan reinforcement detail



10-inch PC Slab W/ 2" overlay - 20'-0" Span - $M_u = 40 \text{ ft}\cdot\text{k}/\text{ft}$ (without lane load)

Figure 4-17: Cross section details of the 10 inch slab

The main purpose of top layer of strands is to:

- a) Provide negative moment reinforcement in the slab if the base material washes out voids,
- b) Provide negative moment reinforcement during stripping, hauling, and erection,
- c) Minimize camber, and
- d) Provide substantial axial force in the cross section to increase durability.

ESTIMATED COSTS: Based on numerous consultations with Coreslab Structures located in Kansas via telephone and email the following estimate has been arrived at for the PCPS slab as described in this section. The basic estimate for the slab delivered to site within 100-150 miles is at \$17.25/sq.ft. for the PCPS. A copy of the communication regarding this estimate is attached at has been shared with MoDOT via email communication. The estimated (at a higher end) cost of the overlay has been taken from the data provided by MoDOT via email communication on May 19th 2010. Table 4-3 shows the costs of installation of the PCPS slabs of span 20 and 25 feet. Sleeper slab costs are not included in the calculations.

Table 4-3 Details of the costs of PCPS construction

Delivered Cost	\$ 17.25 per sq.ft. x 2 x 5 x (for 2-12 ft lanes of traffic, assuming 4 ft wide inside shoulder and 10 ft wide outside shoulder) (for 2-12 ft lanes of traffic, assuming 4 ft wide inside shoulder and 10 ft wide outside shoulder) ft. x 20 ft.	= \$ 26,220
Installation Cost	\$ 468 per slab x 2 x 5	= \$ 4,680
2 inch overlay cost	\$ 4,000 (high estimate)	= \$ 4,000
Base Preparation	\$ 3,684	= \$ 3,684
TOTAL COST	Estimated per bridge for 20 ft span	= \$ 38,584
	Estimated per bridge for 25 ft span	= \$ 45,139

Reducing the approach slab span to 20 feet would increase the length of the roadway to be placed and per communication with MoDOT (see appendix) it is estimated that the cost could range between \$40 to \$80 per square yard. For a 38 feet wide x 5 ft (approximately 42 square yd for both sides of the bridge) additional roadway construction this would add a cost of approximately \$1,700 - \$3,375 per bridge. Using this cost data the cost of the PCPS slab comes to \$46,839-\$48,514 compared to the \$55,316 for the current Standard MoDOT BAS. Sleeper slab costs would be identical in both the cases.

4.4 CONCLUSIONS

This chapter has presented the work related to the objective of proposing alternative solutions in situations where replacement slabs are needed. The solution proposed is a precast prestressed slab with transverse ties. Detailed cost analyses have been performed for the proposed solution. From the cost observations it is evident that these slabs could be cost effective in new construction as well. Hence, designs for both 20 feet span (new construction) and 25 feet span (old / replacement construction) have been proposed with appropriate subgrade modulus for the base soil. In both the cases the inclusion of a sleeper slab is recommended.

CHAPTER 5 CONTROLLED LOW STRENGTH MATERIALS (CLSM) ALTERNATIVE

Although this project evaluated cost effective alternative structural design solutions for repair and construction of bridge approach slabs, the use of Controlled Low Strength Materials (CLSM) as a better support material compared to compacted soils was also briefly evaluated. This chapter describes the short study performed to evaluate effectiveness and feasibility of this alternative in the State of Missouri using locally available materials.

5.1 BACKGROUND

Differential settlement between approach pavements and bridge decks, leading to deterioration and cracking of approach slabs, is typically caused by the compression of compacted embankment soils at the bridge/pavement interface and consolidation of natural soils under the compacted embankment. Two important causes of this local backfill settlement are inadequate compaction of backfill soils near the abutment and the drainage and erosion problems. Large compaction equipment used to compact the embankment soils under the approach pavement cannot be used in the close proximity of abutments due to accessibility issues. Therefore, hand compactors are typically used to finish the compaction next to the abutments. This difference in compactive effort typically leads to non-uniform soil density and eventually to differential settlements. Poor drainage around the bridge abutments and approach embankments may cause serious erosion and piping problems that can undermine approach slabs and cause large movements [31]. Although use of CLSM cannot prevent the consolidation settlement and secondary compression of underlying soils of the backfill, it can provide an erosion resistant, constant density, and homogenous support for the approach slab at the surface and reduce total settlement significantly. Homogenous stiff backfill layer decreases stresses induced in underlying soils by uniformly distributing the loads to a wide area.

Controlled Low Strength Material (CLSM) is a self-flowing cementitious material consisting typically of portland cement, fine aggregates, supplementary cementing materials (SCMs), and water. Fine aggregates and the SCMs are also referred to as filler material in the literature and these materials make up the largest portion of the mixture. CLSM is primarily used as a backfill material in lieu of compacted fill. In 1984, The American Concrete Institute (ACI) founded Committee 229 that reports on CLSM applications, developments, material properties, mix proportioning, and construction and quality control procedures. The Committee defined the upper limit of compressive strength of CLSM at 28 days as 1200 psi. Many different names, either technically correct or incorrect, were used in the literature for CLSM. CLSM is referred to as controlled density fill, controlled pavement base, controlled structural fill, controlled thermal fill, flowable fill, unshrinkable fill, flowable mortar, flowable fly ash, fly ash slurry, fly ash fill, flowable grout, plastic soil-cement, soil cement slurry, anti-corrosion fill, one-sack mix, K-Krete,

M-Crete, and S-Crete. However, ACI committee 229 consistently uses the term Controlled Low Strength Material. Because of their flowability, these mixtures can easily be discharged from a ready-mixed truck and fill up the inaccessible space behind the abutments and under the approach slabs to provide a uniform support with very low settlement. At the hardened state CLSM mixtures are much less prone to erosion and piping compared to soils.

Although CLSM generally costs more per cubic yard than most soil or granular backfill materials, its use may result in lower in-place costs due to its many advantages. Additionally, low cost fast setting CLSM mixtures produced without cement are also reported in the literature. These mixtures are mainly comprised of highly cementitious Class C fly ashes similar to the typical fly ashes produced in Missouri. Therefore these mixtures can easily be produced for economically feasible prices by ready mixed concrete producers and delivered to bridge construction sites. CLSM can easily be placed using chutes, pumps, and other methods. Due to its self leveling property, it needs little or no spreading and no compaction (Figure 5-1). Load carrying capacity of CLSM mixtures are higher compared to compacted soils and are more resistant to erosion. Unlike compacted soils that need to be tested for proper compaction at each lift, CLSM does not require test of compaction. Because it doesn't require workers to get into excavations to compact lifts of placed materials, CLSM is also a safer construction material. The beneficial use of by-products such as fly ash in CLSM is also important from sustainability point of view [32].



Figure 5-1: Placement of CLSM behind bridge abutment [33]

CLSM has been used by different states to backfill bridge abutments. In 1995 CLSM was used to fill the abutments of a bridge located along the Colorado State Highway 135 near Crested Butte, Colorado. 400 yd³ of CLSM was placed in two lifts, a 125 yd³ lift followed by a 275 yd³ lift. The use of CLSM to fill bridge abutments in Colorado cuts time and labor costs and eliminates the rough transition due to settlement of conventional backfill materials from pavement to bridge, known as the bump at the end of the bridge [34]. In 1998 the Oklahoma Department of Transportation constructed three new bridges on US 177 north of Stillwater, Oklahoma. One of the abutments was constructed using a CLSM mixture to compare its performance with conventional backfill and as a possible solution for the bump at the end of the bridge problem. A total volume of 207 yd³ of CLSM was placed in 4.5 hours using ready mixed trucks. Two ready mixed trucks were placing CLSM simultaneously. The total cost for the

CLSM and its placement, including the preparation of the abutment area and the finishing, was \$14,560 compared to \$1,500 for the conventional backfill. The duration of the construction was 2 days while the construction with conventional backfill materials lasted 4 days. Measurements indicated that the lateral earth pressure and settlement of the approach embankment were generally less compared to the conventional backfill materials [35].

5.2 CLSM STUDY

A short study was performed at UMKC to evaluate the feasibility of producing a low cost CLSM mixture using locally available materials. The objective of the study was to obtain a CLSM mixture with adequate flow in its fresh state and adequate strength and stiffness in its hardened state using only fly ash without cement to keep the cost low. Mixtures were produced using Holiday-Fordice sand. Fineness modulus, absorption coefficient, and specific gravity of the sand were determined to be 2.84, 0.4%, 2.62. Class C fly ash samples were obtained from LaCygne power plant in Missouri. Table 5-1 shows the chemical and physical analysis of fly ash. Important fresh and hardened properties of CLSM mixtures to be used under bridge approach slabs are flow, compressive strength, hardening time, shear strength, settlement, and freeze thaw resistance [36]. All CLSM mixtures were prepared following ASTM C 305, *Standard Practice for Mechanical Mixing Hydraulic Cement Pastes and Mortars of Plastic Consistency*.

Table 5-1 Chemical and physical analysis of fly ash

Chemical Analysis		Physical Analysis	
SiO ₂	38.28	Fineness, amount retained on #325 sieve	11.5
Al ₂ O ₃	19.47		
Fe ₂ O ₃	5.76	variation, %	0.25
SiO ₂ +Al ₂ O ₃ +Fe ₂ O ₃	63.5	Density, Mg/m ³	2.66
CaO	25.05	variation, %	1.37
MgO	4.81	Strength activity index with Portland cement at 7 days	94
SO ₃	1.24		
Moisture	0.06		
LOI	0.23	Autoclave expansion, %	0.03
Na ₂ O	1.62		
K ₂ O	0.47		

A total of 20 trial mixtures were prepared to measure their capacity to flow without segregation following ASTM D 6103, *Standard Test Method for Flow Consistency of Controlled Low Strength Material*. The test method uses a 3 x 6 inch cylinder that is vertically lifted, allowing

the CLSM to slump and flow. The final diameter of the CLSM patty is measured twice, perpendicular to each other, and averaged (Figure 5-2). This average diameter is used as a measure of flowability of the mixture and a diameter of approximately 8 inch or higher is typical of highly flowable mixtures. Results indicated that the water-fly ash ratio and the sand-paste ratio were two variables affecting the flow. Increasing sand-paste ratio at a constant water-fly ash ratio decreased the flow. Increasing water-fly ash ratio at constant sand-paste ratio increased the flow until mixtures started to segregate.



Figure 5-2: Measurement of CLSM flow

Following evaluation of mixtures, the CLSM mixture with a water-fly ash ratio of 0.5 and sand-paste ratio of 1.8 was selected for further evaluation of setting time, strength, and elastic modulus. Table 5-2 shows proportions of the selected mixture. The average initial flow of the selected mixture was approximately 7 in. Although its flow decreased to zero in about 10 minutes after mixing, the mixture retained its flow value, if the mixture was continuously mixed. The use of Delvo Stabilizer was evaluated to increase the initial flow value. Addition of 1 oz. of stabilizer per 100 lbs of fly ash increased the initial flow value to approximately 14 in. Increasing the stabilizer incrementally up to 4.5 oz. per 100 lbs of fly ash did not have a further effect on the initial flow value. The stabilizer did not have an effect on the flow retention over time.

Table 5-2 Mixture proportions

Water-fly ash ratio	Sand- paste ratio	Fly Ash (lb/yd ³)	Sand SSD (lb/yd ³)	Water (lb/yd ³)	Air (%)
0.5	1.8	868	2344	434	1.5

Cylinders, 3x6 in, were also cast and tested for compressive strength after 1 and 7 days of wet curing at 73°F. Average compressive strengths of cylinders were 48 and 219 psi at 1 and 7 days, respectively. The average elastic modulus of 3x6 in cylinders at 7 days was 1050 psi. This figure translates to a modulus of subgrade reaction (k) of approximately 196 pci. Figure 5-3 shows the elastic modulus test results of 2 cylinders. It should be noted that the fresh and

hardened properties of the selected mixtures fulfills the flowfill requirements of MoDOT specifications section 621 in terms of flow, minimum 1 and 28 days strengths.

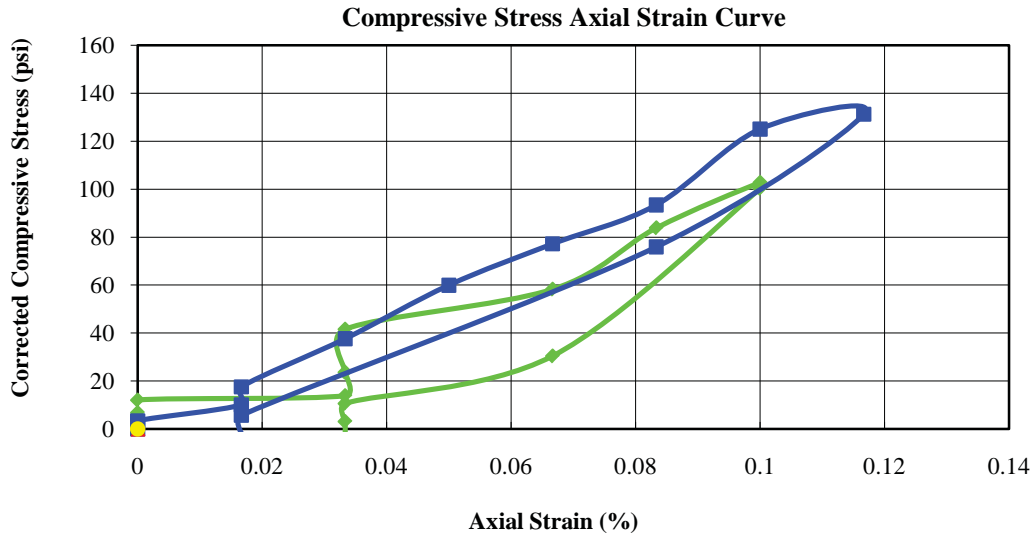

Figure 5-3: Elastic modulus test data

5.3 CONSTRUCTABILITY AND COST CONSIDERATIONS

Two different alternatives were considered for the use of CLSM under bridge approach slabs. The first alternative was to place CLSM under the sleeper beam to provide a stiff support with less differential settlement compared to the abutment. The second alternative was to place CLSM under the whole approach slab to provide a continuous good quality support which would allow design of the approach slab as a slab on grade. The second alternative was evaluated using a finite element analysis of the approach slab with CLSM support instead of compacted soil. The results of this study are shown in the following section. Colorado Department of Transportation has specifications for use of CLSM under the whole approach slab and sleeper beam as shown in Figure 5-4. These specifications require CLSM to be placed between the wing-walls starting from the bottom level of bridge abutment. The compacted soil is required to have a slope 2:1, which provides a smooth transition from stiffer CLSM support to compacted soil. Formwork or some kind of containment system (sandbags, etc.) needs to be used at the upper section of the embankment beyond the wing-walls. A water drainage system consisting of Class B filter material and perforated pipes is required behind the abutment and along the wing-walls. A 3 inch thick low density polystyrene sheet is placed between the abutment and CLSM to allow for movement of abutment.

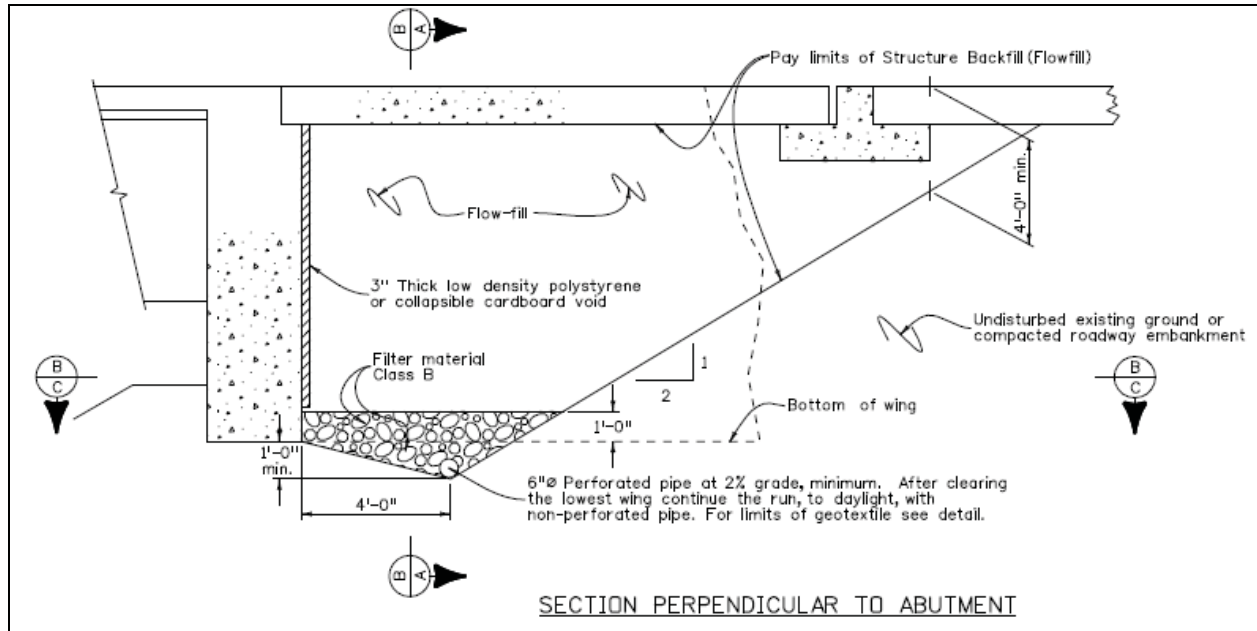

Figure 5-4: Colorado DOT specification to backfill bridge abutments with flowable fill

For the use of CLSM to backfill bridge abutments to be economically feasible, the cost of material and placement needs to be the same or less than the cost of placement, compaction, and testing of soils. Currently the cost of fly ash in Missouri is approximately \$40/ton picked up at the power plant with an average delivery cost of \$7.50/ton in pneumatic trucks. Conversations with Kansas City area ready mixed concrete producers indicates that due to low cost and availability of fly ash in Missouri, the estimated cost of CLSM similar to the mixture shown in Table 5-2 would be approximately \$62/yd³. This cost includes the delivery of mixtures to the site in a ready mixed concrete truck. Although the unit cost of CLSM is higher than select fill materials, considering the cost of compaction, testing, and time savings the use of CLSM may be a more cost effective alternative. Comparison of actual MoDOT base preparation costs with estimated cost of CLSLM should be performed to assess the economic feasibility of this material.

The use of CLSM mixtures with high flowability requires attention to constructability issues such as the hydrostatic pressure exerted by the fresh mixture and the uplift force that can be applied by the CLSM mixture. Due to the hydrostatic pressure fresh CLSM may need to be placed in lifts behind the bridge abutments with adequate waiting periods between the lifts for the mixtures to harden. The hardening time of the mixture evaluated in this study was approximately 1 hour. For a 10 ft deep bridge abutment to be backfilled following the requirements shown in Figure 5-4, about 218 yd³ of CLSM would be required. This number is calculated assuming a 10 ft deep and 38 ft wide approach slab and a 2:1 slope. Because of the fluid nature of fresh CLSM, a ready mixed truck can deliver 9 yd³ of CLSM. Assuming a discharge time of 20 minutes per truck and two trucks can be discharged simultaneously; a total of 24 trucks can complete the backfilling operation in approximately 8-9 hours. This time estimate assumes that the backfilling will be performed in three separate lifts with 1 hour of waiting time between the lifts. The estimated cost is \$13,500-\$14,000. This estimate does not

include the cost of preparation of the embankment and the cost of any containment that may be necessary for the top lift behind the wing walls. Following the same logic and assumptions the estimated cost for a 20 ft deep abutment would be approximately \$40,000 and estimated time required to finish backfilling would be 22 hours.

CLSM (flowable fill) is being used as an alternative material to backfill bridge approach slabs by different DOT's successfully. The higher cost of this material is an important challenge to its widespread use; however this initial study exhibited the possibility of producing fast setting, low cost CLSM mixtures using high quality Class C fly ash available in the state of Missouri. A further study to evaluate a larger number of mixtures at the laboratory and larger quantities of selected mixtures at the field is recommended. Freeze-thaw resistance of CLSM is another important property of CLSM for bridge approach slab applications that was not evaluated in this study. A detailed cost estimate analysis and comparison with actual MODOT base preparation costs may justify the use of these mixtures as a cost effective backfill material with better long term performance, and faster construction times.

CHAPTER 6 LIFE CYCLE COST ANALYSIS OF BAS DESIGN ALTERNATIVES

6.1 INTRODUCTION TO LIFE CYCLE COST ANALYSIS

Life Cycle Cost Analysis (LCCA) is an analytical technique that uses principles of engineering economics to evaluate alternative investment options for any given project. It is possible to use LCCA to study the cost to the agency as well as the users for competing alternatives. Consideration of total costs (total agency and user costs) leads typically to increased effectiveness of decision making. Differing levels of sophistication can be incorporated into such analysis depending upon the desired end use of the analysis results and on the types of input information available. The period over which the life cycle cost analysis is performed is known as the analysis period. Probabilistic analysis or risk analysis is performed to solve the uncertainty involved with the inputs used in the deterministic analysis. LCCA can be used to study new construction projects as well as to examine preservation strategies for existing transportation assets such as pavements and bridges. LCCA considers not only the initial investments but incorporates discounted future costs such as maintenance, user, rehabilitation, restoring and resurfacing costs over the life of the project. More than a simple cost comparison, LCCA offers sophisticated methods to determine and demonstrate the economic merits of the selected alternative in an analytical and evidence-based manner.

Figure 6-1 shows a flow chart of the LCCA process using alternate designs of the Bridge Approach Slab (BAS) and associated rehabilitation options. LCCA process begins by defining reasonable design or preservation strategy alternatives – in the example in Figure 6-1, four BAS designs are considered (Standard MoDOT BAS, BAS-20' Span Design, Precast Prestressed BAS (PCPS BAS), and BAS incorporating Elastic Soil Support (BAS ES)). For each proposed alternative, initial construction or rehabilitation activities, the necessary future rehabilitation and maintenance activities, and the timing of those activities are established. The various rehabilitation options illustrated in the flow chart include: URETEK method of slab lifting, mudjacking, joint sealing and placing of asphalt wedges. Best practice LCCA calls for including not only direct agency expenditures (for example, construction or maintenance activities) but also user costs. User costs are costs to the public resulting from work zone activities, including lost time and vehicle expenses. A predicted schedule of activities and their associated agency and user costs combine to form projected expenditures for each alternative. Once the expenditures have been determined for the different competing alternatives, the objective is to calculate the total life-cycle costs for each alternative. Since dollars spent at different times have different values to an investor, the projected activity costs for a project alternative cannot directly be added together to calculate total life-cycle cost. LCCA uses discounting to convert anticipated

future costs to present dollar values so that the lifetime costs of different alternatives can be directly compared. Discounting is an economic method of accounting for the time value of an investment. The calculations of discounting are identical to those of compound interest. As the level of service provided by each project alternative in the analysis is assumed to be the same, LCCA allows one to evaluate alternatives on the basis of their life-cycle costs.

It should be noted that LCCA is a subset of Benefit-Cost Analysis (BCA). While BCA compares costs and benefits and can address comparison of alternatives with dissimilar benefits, the LCCA compares only costs and assumes equivalent benefits for all options being compared. The LCCA approach is ideally suited for the comparison of various design alternatives of the BAS and their long-term rehabilitation. After exhaustive research, RealCost, an MS Excel-based software that was developed by the Federal Highway Administration (FHWA) [37-39] to support the application of LCCA for evaluating various pavement construction and rehabilitation strategies was chosen to compare BAS designs and rehabilitation options. Many states currently use this free software for evaluating pavement options. This is the first known application of RealCost to evaluate bridge approach slab designs. Salient features of the software are discussed in the next section.

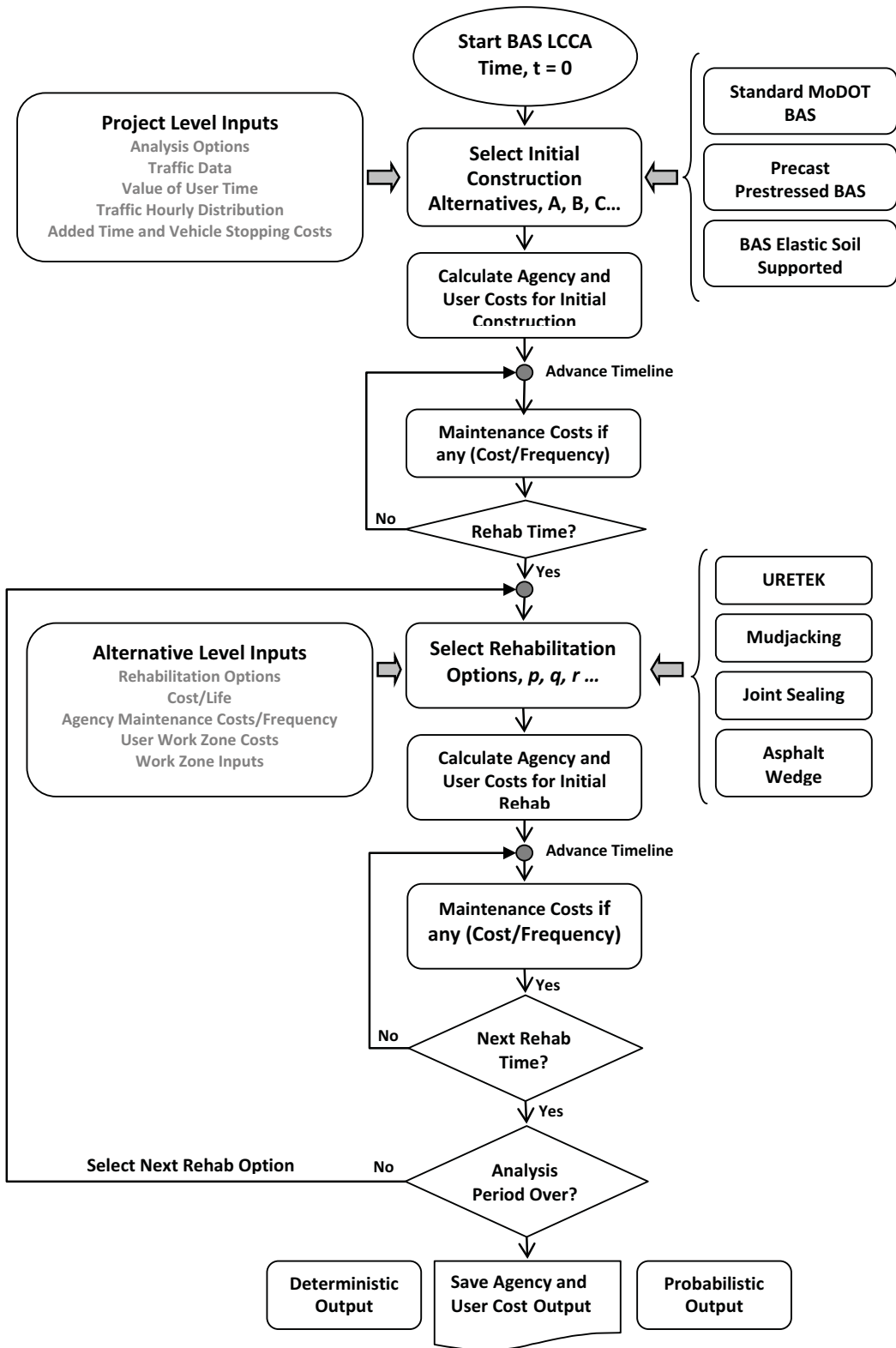

Figure 6-1: Flow chart of a typical life cycle cost analysis for various BAS/Rehab options.

6.2 REALCOST SOFTWARE

RealCost can perform deterministic as well as risk analysis for agency costs and user costs. It can compare up to 6 alternatives at a time. It uses Monte Carlo simulation to perform risk analysis and monitors the convergence after a prescribed number of iterations. The total iterations and the iterations at which the convergence has to be monitored can be specified by the user. It can generate seven different types of probability distributions including normal, truncated normal, triangular, uniform, beta, geometric and log normal.

Normal distribution is used to generate random values for all the inputs used in this study while performing risk analysis. The software uses Monte Carlo simulation for 2,000 iterations and RealCost monitors convergence for 50 iterations. The outputs generated from the software are available in a tabular as well as various graphical formats like tornado graphs, expenditure stream diagrams and median distributions. RealCost was designed to compare competing design alternatives for a given pavement project. It however lends itself well to LCCA of bridge approach slabs as demonstrated in this investigation.

RealCost uses a stored procedure (SP) within MS Excel to perform life cycle cost analysis and hence the Excel application should be executed in a macro-enabled environment. Immediately after the worksheet appears, the “Switchboard” panel opens on top of it (Figure 6-2). Two primary levels of input are required by RealCost. Project level input includes data on the various primary analysis options, traffic data, value of user time, traffic hourly distribution and added vehicle time and cost. Alternative level input allows input of cost and service life of the various rehabilitation options, agency maintenance costs and frequency, user work zone costs, and work zone input. The program allows one to input data either through the “Switchboard” or directly into the Input Worksheet. The next section contains details of the current project and associated inputs entered through the Switchboard. To input values directly into the Input Worksheet, the “Switchboard” interface needs to be closed by clicking the “X” in the upper right-hand corner of the window. To restore it later the drop down menu at the top of the Excel window allows selection of the “RealCost Switchboard.”

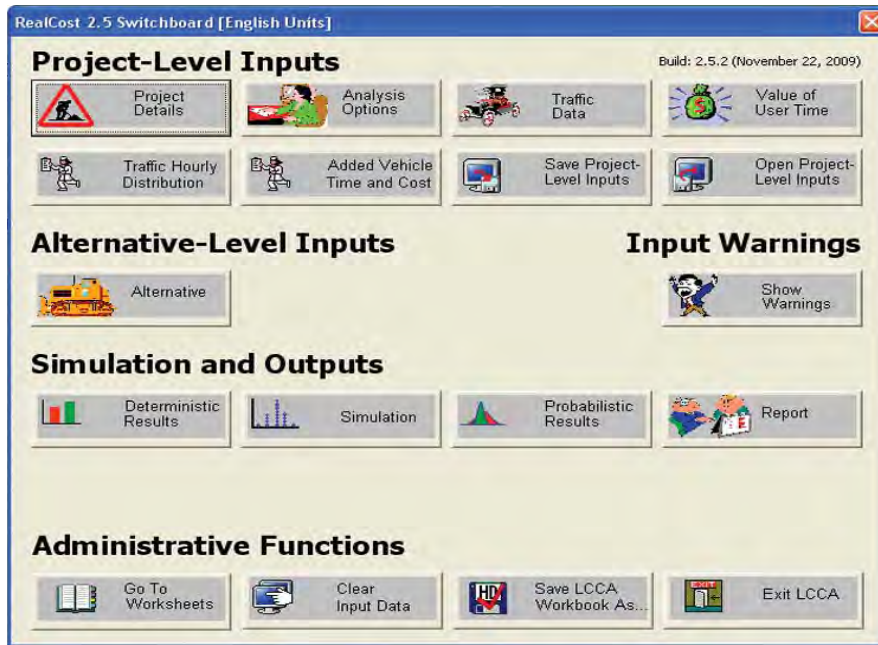

Figure 6-2: Real Cost software showing the user-friendly switchboard that facilitates data input.

6.3 PROJECT DETAILS AND INPUT PARAMETERS

Three alternate BAS designs are evaluated in addition to the currently used Standard MoDOT BAS design in the life cycle cost analysis presented in this chapter. These alternate designs include PCPS BAS, BAS – 20’ Span Design and BAS ES. Even while these designs have been presented and described in detail in the earlier chapters, a brief recap of the design features is included here for completeness of the LCCA discussions.

6.3.1 STANDARD MODOT BAS

The standard BAS used by MoDOT is a 12’’ deep doubly reinforced 25’ (span) approach slabs resting on the bridge abutment on one end and a sleeper slab on the embankment on the other end. The approach slab is designed as a simply supported slab neglecting soil support in between the two end supports. The Standard MoDOT BAS design has been detailed in Figure 2-1.

6.3.2 BAS-20’ SPAN DESIGN

The BAS-20’ Span Design proposed in this study is a 12’’ deep doubly reinforced 20’ (span) approach slab resting on the bridge abutment on one end and a sleeper slab on the embankment on the other end. The approach slab is designed as a simply supported slab neglecting soil support in between the two end supports. The BAS-20’ Span Design has been detailed in Figure 2-42.

6.3.3 PRECAST PRESTRESSED BAS

The PCPS BAS designs (12" and 10" depth options) that have been presented earlier can serve both as a replacement slab that facilitates rapid repairs as well as used for new construction. It's main advantage over the Standard MoDOT BAS is perhaps the potential for relatively rapid construction greatly minimizing delays to traffic. This feature, it will be shown using the LCCA, can offer significant savings particularly in user costs for urban applications. Two types of precast prestressed slabs are suggested; a 12" deep slab without a composite topping and a 10" deep slab with a 2" asphalt or concrete topping. The 12" deep slab without topping might require diamond grinding to improve ride quality. The 10" design with 2" cast-in-place topping and a span of 25' is included in the LCCA so that all designs that are compared have the same span. The PCPS BAS design has been detailed in Figure 4-17.

6.3.4 BAS - ELASTIC SOIL SUPPORT

An alternate design approach presented earlier (Figure 3-15) has allowed significant reductions in the design moments required for the approach slab when elastic soil support between the two end supports is considered. This design has been referred to as BAS – ES (Bridge Approach Slab incorporating Elastic Soil Support). Additionally, the sleeper slab at the pavement end of the conventional MoDOT BAS design is replaced by a modified end-section reinforcement detailing to provide enhanced local two-way action, providing increased flexural rigidity in the direction transverse to the traffic direction. This alternate BAS – ES design has been shown to require significantly smaller design moments even when partial washout of soil support is assumed. Results from the LCCA analysis presented in the next section will show that this design alternate would be ideally suited for rural traffic patterns where it has the advantage of low agency cost and relatively small user cost as well.

6.3.5 REHABILITATION METHODS

Various rehabilitation options are considered in the LCCA for the four design alternates presented in the earlier sub-sections. The following are the four rehabilitations investigated due to their popularity among many state DOTs. All of these rehabilitation methods have also been used by MoDOT. These methods include: (1) URETEK method, (2) Mudjacking, (3) Joint Sealing, (4) Use of an Asphalt Wedge. These rehabilitation options are described below.

6.3.5.1 URETEK METHOD

To counter the subsidence of the slab the URETEK method requires injecting grout under pressure under the slab. Holes of 5/8" diameter are drilled in the slabs, at approximately 4' centers, to the base soil and the grout is injected into the holes. The polymer is injected first to shallower locations (3'-6') and then to deeper locations (7'-30'). URETEK Inc., uses expanding polyurethane foam as a grout. Polyurethane grout expands 25 times the material's liquid volume,

stabilizing and tightening the weak soils, this also increases the load bearing capacity of the soils. The density of the injected polyurethane material depends on the depth of the injection process. URETEK method has an advantage over mud jacking as the injected polyurethane exhibits ductile behavior under pavement flexure. The movements of the slab are precisely monitored and controlled by laser level measuring devices on the surface. The URETEK method was invented in Finland in 1980 and has been used in the US since 1985. High density polymer is injected for lifting the concrete slab which also stabilizes the soil. This method can be used to stabilize low density compressible soils to depths of more than 30' and can lift the slab with an accuracy of 0.1".

6.3.5.2 MUDJACKING

Concrete mudjacking is a process in which a concrete grout is injected below sunken concrete slabs in order to raise them back to their original height. The grout fills the voids beneath the slab then pressurizes and hydraulically lifts the slab up to the original position.

Holes of 1-5/8" diameter at a center to center distance of 5' are drilled in the concrete slab and an organic or inorganic grout material mixture is pumped under the slab using a two piston pump at a pressure of 500-1,000 psi. The fill holes are then sealed with a water tight material to prevent the swelling of the cement patch. The fill holes are then patched with a 3:1 sand cement mixture and troweled to match the existing surface. The Standard MoDOT BAS have traditionally been provided with mudjacking holes during initial construction to allow for their use when required. This is done to avoid severing of reinforcing steel layers during later coring operations.

6.3.5.3 JOINT SEALING

Joint sealants are used to seal joints and other openings between two or more substrates. This prevents the entry of water, air and other environmental elements. The sealant is directly pumped from the original drum into the joint by use of an air powered pump. The joint sealant should fill the joint from the top of the backer rod to slightly below the pavement surface (3/8" below the pavement surface). If properly installed, the sealant can last between 5- 10 years. MoDOT uses silicone joint sealants (in preference to polysulfide sealants used by some other state DOTs).

Use of joint sealant as a rehabilitation option in the LCCA study has been studied for exclusive use with the PCPS BAS design. Since this design of BAS uses multiple precast slabs joined together with the use of stressed tie rods, the joint sealant can serve functionally to seal joints in the slab. This rehabilitation method has the advantage of significantly reduced construction times as a result of which user costs are significantly lower. This rehabilitation method can provide the PCPS BAS design a significant user cost advantage, particularly in an urban setting.

6.3.5.4 USE OF ASPHALT WEDGE

Use of an asphalt wedge is the least expensive rehabilitation option that can address the issue of a bump in the BAS at the bridge abutment due to relative settlement of the two ends of the BAS. Even while the life of an asphalt wedge may be relatively small compared to the other rehabilitation methods, the extremely low initial cost offers this approach an advantage. For this LCCA study, a service life of an asphalt wedge rehabilitation of 4 years is used.

6.3.6 PROJECT INPUTS

As noted earlier, RealCost allows use of deterministic as well as probabilistic (random risk and uncertainty based) LCCA. As the names suggest, one relies on fixed (deterministic) parameters as input (costs, life etc.), whereas for probabilistic analysis these parameters are assumed to vary, with the variation characterized by suitable statistical distribution functions. Normal distribution is assumed for all probabilistic investigations in this study.

6.3.6.1 DETERMINISTIC ANALYSIS INPUTS

In this approach, each LCCA input variable like the initial construction cost, service life of the project, cost of rehab, discount rate are assigned a fixed value. The inputs used here are assumptions based on the information provided by MoDOT and the information from FHWA manual, past experiences and professional judgment. The following sub-sections describe in detail all of the input data required for the deterministic analysis of life cycle costs.

Analysis Options

Table 6-1 highlights the input parameters that need to be entered in the Analysis Options window. All these parameters are described in this section, and wherever relevant values used in this study are reported.

Table 6-1 Parameters to be entered in the Analysis Options window

Analysis Units
Analysis Period
Discount Rate
Beginning of Analysis Period
Include Agency Cost Remaining Service Life
Include User Costs in Analysis
User Cost Computation Method
Traffic Direction
Include User Cost Remaining Service Life
No. of Alternatives

- *Analysis Units:* The units used in the analysis are ‘English’ units (the other option is ‘Metric’ units).
- *Analysis Period:* This is the period of time during which initial costs, rehabilitation costs and maintenance costs are evaluated and compared for the various alternatives. A nominal analysis period of 40 years is used in comparing the four design alternatives.
- *Discount rate:* Costs cannot be compared if they occur at different times, past-present and future without adjusting them to opportunity value of time. The discount rate is understood as an economic return (interest) on the funds when they are utilized in the next best alternative. As suggested by MoDOT a discount rate of 7% is assumed in the analysis for the basic cases simulated. Discount rates of 4% and 10% are also used to establish the effect of discount rates assumed on project costs. Real Cost recommends use of a discount rate of 4%.
- *Beginning of Analysis Period:* This is the starting year of the project. It is assumed as 2010.
- *Include Agency Cost Remaining Service Life:* This option is used to prorate the share of agency costs of the last rehabilitation activity if the analysis service life of different alternatives is different. All studies reported here include the cost of remaining service life.
- *Include User Costs in Analysis:* This option is used to allow consideration of user costs in the LCCA. User costs are included in all the cases studied here.
- *User Cost Computation Method:* User Costs can either be calculated manually or directly entered into the RealCost software.
- *Traffic Direction:* This option directs RealCost to calculate the user costs based on the input data for this parameter which include ‘Inbound’ lanes, ‘Outbound’ lanes or ‘Both’ lanes. The “Both lanes” option was selected for all the simulation runs reported here.
- *Include User Cost Remaining Service Life:* This is used to have the RealCost include the user costs for the remaining service life. This option was turned on in all the cases studied here.
- *No. of Alternatives:* Four alternative designs are compared for all the simulation runs reported in this chapter (as noted in sections 6.3.1– 6.3.4.).

Traffic Data

Table 6-2 highlights the input parameters that need to be entered in the Traffic Data window. All these parameters are described in this section, and wherever relevant values used in this study are reported.

Table 6-2 Parameters to be entered in the Traffic Data window

AADT in Both Directions
Single Unit Trucks as % of AADT
Combo Trucks as % of AADT
Annual Growth Rate of Traffic
Speed Limit under normal operating conditions
Lanes Open in each direction under Normal conditions
Free Flow Capacity
Queue Dissipation Capacity Normal
Maximum AADT in both Directions
Maximum Queue Length
Rural or Urban Traffic

- *AADT in Both Directions:* This is the total annual average daily traffic (AADT) for both directions in the year of construction of the project. AADT assumed is significantly different for urban and rural traffic histories. For urban traffic an AADT of 18,826 is assumed while for a rural traffic pattern the AADT value of 2,520 is assumed based on information provided by MoDOT.
- *Single and Combo Unit Trucks as % of AADT:* MoDOT provided information suggests that this parameter is 40% for urban traffic and 12% for rural traffic. This combined percentage is divided into single and combo truck percentages based on prior experience.
- *Annual Growth Rate of Traffic:* This parameter represents the AADT in both directions each year. With the information provided by MoDOT on the AADT's of the future year, the AADT increase is calculated by the following formula recommended by CalTrans. The values of 2% and 3% were obtained and used in the analysis for future year and current year, respectively.

$$Increase = \left[\left(\frac{FT}{CT} \right)^{\left(\frac{1}{(FY-CY)} \right)} - 1 \right] \times 100$$

where FT =Future Year (FY) AADT, and CT=Current Year (CY) AADT.

- *Speed Limit under normal operating conditions:* The speed limits of 70mph and 50mph for urban and rural traffic, respectively.
- *Lanes Open in Each Direction under Normal Conditions:* This is the number of lanes which are open in the normal operating conditions and is taken as 2.
- *Free Flow Capacity:* It is the maximum capacity a facility can handle under normal operating conditions. According to HCM 1994 the maximum capacity of a 2 lane directional highway is 2200 passenger cars per hour. This is varied according to the percentage of trucks and busses, reduced lateral clearances and restricted lane widths. It is calculated using the RealCost based on the % of single and combo trucks. This is 1,833vhpl in urban where as in a rural scenario it is 2,075 vhpl.

- *Queue Dissipation Capacity Normal:* This is the capacity of the Lane in the Queue dissipation conditions. This is assumed 200vph less than the free flow capacity of the lane according to FHWA.
- *Maximum AADT in both Directions:* this is calculated for 40 years based on the % of increase in the AADT as discussed above.
- *Maximum Queue Length:* The maximum queue length is calculated based on the number of vehicles queued in the traffic hourly distribution. This is calculated as 2 miles for urban traffic.
- *Rural or Urban Traffic:* ‘Rural’ or ‘Urban’ scenario is selected based on the traffic history which is being analyzed.

Value of User Time

These are the user delay costs. They differ for passenger cars and trucks. The base year values of each vehicle type for the year 1990 are taken from the FHWA manual to escalate them to present year based on the CPI values of base and current year.

$$\text{Escalation factor} = \frac{(\text{CPI of 2009})}{(\text{CPI of 1990})} = \frac{179.2}{130.7} = 1.37$$

Table 6-3 Value of time in \$/vehicle-hour for the 1990 base year and the year 2009

Value of Time	Passenger Cars	Single Unit Trucks	Combination Trucks
1990	9.75	14.96	21.42
2009	13.36	20.4952	29.35

Traffic Hourly Distribution

Default hourly traffic distribution for urban and rural cases are provided in RealCost. Figure 6-3 shows the default hourly traffic distribution of the vehicles along with MoDOT provided data for a typical urban (Montgomery County, I-70) and rural (Benton County, Rte. 7).

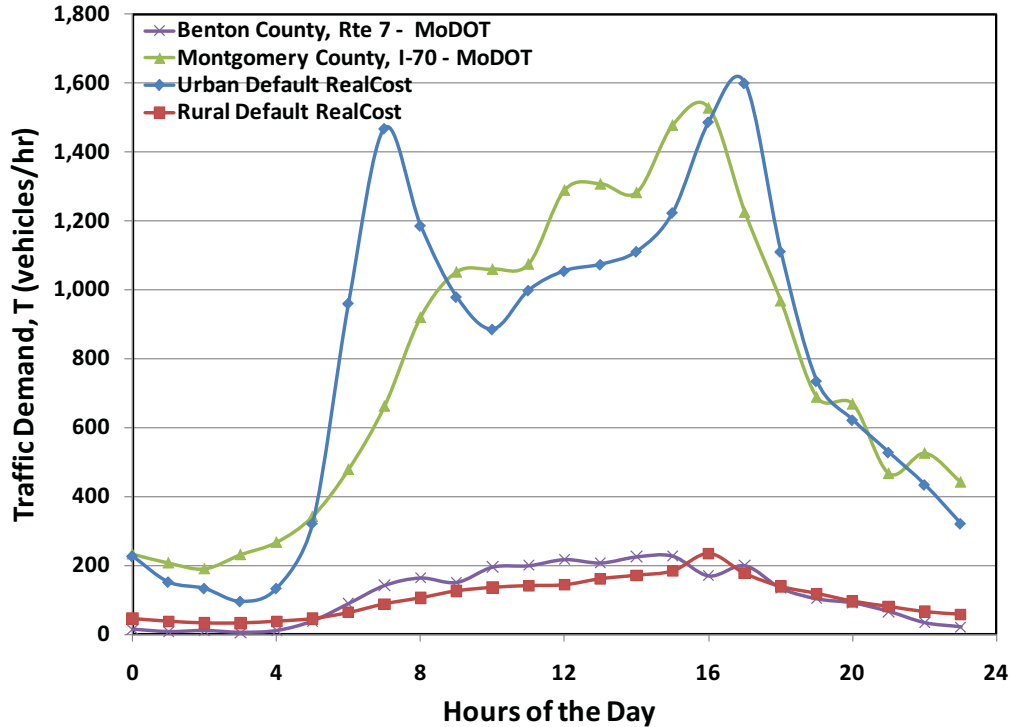

Figure 6-3: Hourly traffic demand history used for a typical urban (Montgomery County, I-70) and rural (Benton County, Rte. 7) used in the research are compared with default histories from RealCost.

Added Time per 1,000 stops and Vehicle Operating Costs

“Added Time per 1,000 Stops (hours)” and “Added Cost per 1,000 Stops (\$)” are the values used to calculate user delay costs and vehicle costs due to speed changes and stop and go conditions in the work zone. RealCost provides default values based on the NCHRP research. These values for the base year 1996 are adjusted (increased) to the present year based on the CPI for the present year.

Alternative level inputs

- *Alternative Description:* This parameter is entered based on the alternative we are working on. The four alternatives entered are ‘Standard MoDOT BAS’, ‘BAS-20’ Span Design’, ‘PCPS BAS’ and ‘BAS-Elastic Soil Support’.
- *Number of activities:* The number of activities such as the initial construction and rehabilitation activities is entered.
- *Activity Description:* The description of each alternative is entered based on whether it is initial construction, rehabilitation (such as URETEK, mudjacking etc.).
- *Agency Construction Costs:* The Agency costs involved in each activity such as initial construction and rehabilitation costs are entered in their respective activity tabs.
- *Activity Service Life:* The Activity Service Life of each activity is entered based on a combination of the service life estimates and information provided by MoDOT.

- *Work Zone Length (miles):* This is the work zone length being considered for initial construction and future rehabilitation activities. A work zone length of 25 ft. (approach slab length) was assumed.
- *Work Zone Duration (days):* The duration of days the work zone is in operation during the initial construction and the future rehabilitation activities.
- *Work Zone Capacity:* The vehicular capacity of one lane of the work zone for 1 hour. This was assumed to be 1,240 for a single lane closure based on MoDOT work zone guidelines.
- *Work Zone Speed Limit:* The speed limit within the work zone and is taken as 45 mph for urban and 30 mph for rural traffic per MoDOT recommendations.
- *No. of Lanes Open in Each Direction during Work Zone Operation:* This parameter represents the number of lanes open during work zone operations and it was assumed as 1 lane.

6.3.6.2 PROBABILISTIC ANALYSIS INPUTS

The default values for all data are deterministic. The inputs that are used in the risk analysis are identified by a small ellipsis button on the right of the data field in RealCost. Should one choose to perform probabilistic simulation, these features can be engaged. In this study, a normal distribution was chosen (with a default standard deviation of 1/6th of the deterministic parameter). Owing to the reason that the inputs used in the calculation of the net present value are uncertain, a probabilistic analysis is conducted in which random input values are generated and the net present value for each of those randomly generated values is calculated. Iteration in the risk analysis simulates real-life uncertainties.

6.4 RESULTS AND DISCUSSIONS

Results from all of the LCCA runs are presented in this section, classified based on the types of analysis, as well as with a focus on one or more parameters being studied.

6.4.1 CUMULATIVE DISTRIBUTION

The agency construction costs include all the costs incurred directly by the agency over the life of the project. They include the initial construction cost, rehabilitation, maintenance and resurfacing costs. Even though agency cost includes the salvage cost, it is not considered in the present project as there is very little salvage value for a cracked approach slab. RealCost uses the random number generation function in MS Excel to run the Monte Carlo simulation. The RAND function generates a value between 0 and 1. Using the mean and standard deviation of statistically varying parameters RealCost simulates a normal distribution using the NORMINV function in MS Excel.

Figure 6-4 presents the relative cumulative probability in % of the project agency costs (includes initial construction and all rehabilitation/maintenance during the analysis period); In this particular simulation run, an urban traffic history is assumed for all four design alternatives. While the rehabilitation used is 2 sequential applications of URETEK for the Standard MoDOT BAS, BAS-20' Span Design and the BAS – ES, 3 joint sealant applications was considered for the PCPS BAS.

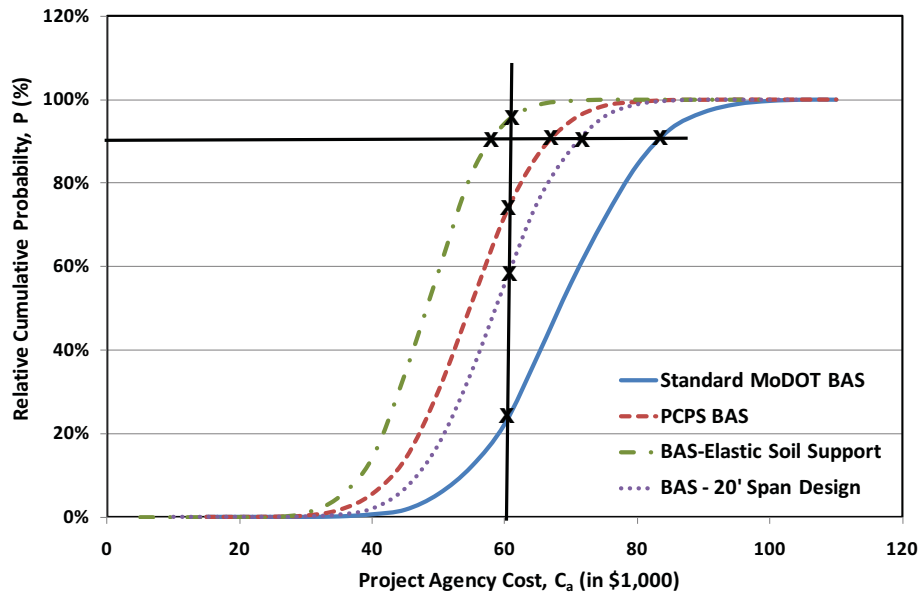

Figure 6-4 Cumulative distributions of agency costs of typical BAS alternatives

As illustrated in Figure 6-4, one can say with a 90% probability that the life cycle agency costs of the BAS - Elastic Soil Support is lower than that for the Standard MoDOT BAS, BAS-20'Span Design and the PCPS- BAS designs. It also shows that the Standard MoDOT BAS has a higher life cycle agency cost than the other three alternatives proposed. The relative cumulative probability plot can also be used to interpret results from the LCCA in another manner. When a net present value (NPV) of \$60,000 is considered there is a 22% probability that the Standard MoDOT BAS can be constructed at that cost. Comparable probabilities for the BAS – ES, PCPS – BAS and the BAS-20'Span Design designs are 95%, 75% and 58% respectively.

The relative cumulative probability percentages for project user costs are plotted in Figure 6-5 for the four design alternatives, for urban and rural traffic history in Figure 6-5a and Figure 6-5b respectively. User costs, as discussed earlier, include user delay costs, vehicle operating costs (VOC) and crash costs. As Figure 6-5 shows, one can state with 90% probability that the user costs for PCPS – BAS is going to be smaller than the remaining design alternates. This result is largely attributed to two facts: (1) initial construction time and hence user costs are significantly smaller for the PCPS– BAS design (the other three design alternates have identical construction times and hence user costs are comparable), and (2) multiple joint sealant rehabilitations have been assumed for the PCPS – BAS design, again involving significantly smaller lane closure times, compared to rehabilitation procedures assumed for the other three alternate designs.

URETEK and mudjacking can be used as rehabilitation procedures for PCPS BAS if it is ensured that coring operations do not damage prestressing tendons. These rehabilitation techniques result in higher initial agency cost in addition to higher user costs due to longer work zone lane closures. The differences in user costs between the design alternates are more significant, particularly for the urban scenario (Figure 6-5a) compared to the rural traffic pattern. For urban implementation, as a result, if total costs (agency + user costs) are considered PCPS – BAS would have a significant advantage. If only agency costs are considered, the decision would skew towards BAS – ES. In the case of rural BAS, since user costs account for only a small fraction of the total costs, BAS – ES has an edge.

During typical work zone operational periods, one lane is closed on the two lane approach slab which leads to a reduction in its capacity. According to the FHWA, queue dissipation rate, which is a measure of the work zone capacity to dissipate vehicle queues when the demand becomes larger than the capacity, can be approximated as 200 vphpl (vehicles/hour/lane) less than the free flow capacity (capacity of the approach slab when there is no work zone). This recommendation has been implemented in all LCCA simulation runs in the present investigation.

6.4.2 MEAN DISTRIBUTIONS OF AGENCY AND USER COSTS

The cumulative distribution diagrams presented earlier represent the probabilities (expressed as %) as a means of evaluation of the various design alternatives, whereas the mean distributions highlight the mean value of the normally distributed present values of agency and user costs. Table 6.4 includes statistical information related to the agency costs including mean, standard deviation and range for the reference simulation (Standard MoDOT BAS, BAS-20' Span Design and BAS – ES with two URETEK rehabs during the 40 year analysis period and PCPS – BAS with three joint sealing rehabs for an urban traffic pattern). It should be noted that agency costs do not differ much between urban and rural traffic patterns unlike user costs that are integrally tied to delays in traffic from work zones and associated closure durations. Hence, for convenience agency costs are presented only for the urban option in all tables and figures, while user cost information typically include an urban and rural classification. Table 6-4 and Figure 6-6 clearly illustrate the cost benefits to the agency (MoDOT) of the three alternate designs proposed in this report.

Table 6.5 and Figure 6-7 present statistical information of user costs for the reference case for both urban (Figure 6-7a) and rural (Figure 6-7b) traffic patterns. The significant differences in users costs between urban (mean costs in the range \$47,000 - \$87,000) and rural (\$2,400 - \$4,600) simulations result from significant difference in the traffic volume (AADT of 18, 826 for the urban simulation versus 2,520 for the rural simulation). It should be noted that when user costs are compared for the various design alternatives, PCPS - BAS comes out ahead, due as stated earlier, to reduced construction times both for the initial construction as well as the rehabilitation activities assumed for this option.

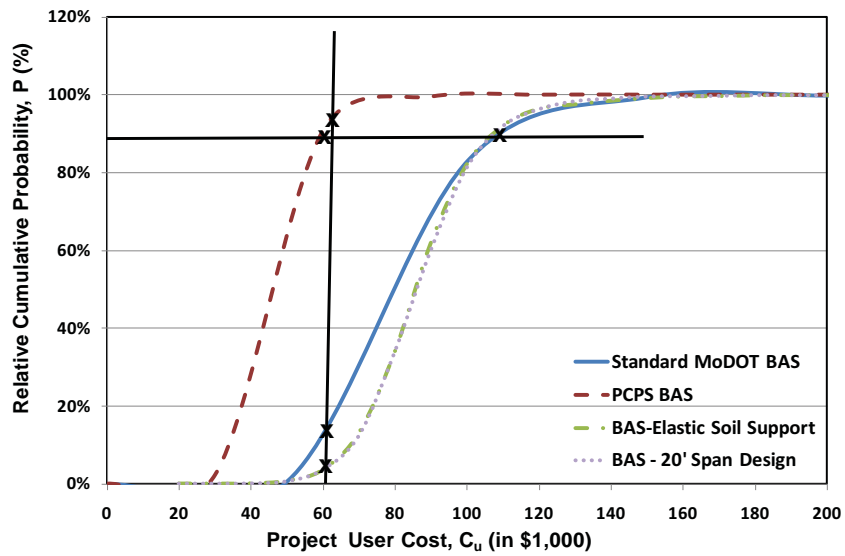

(a)

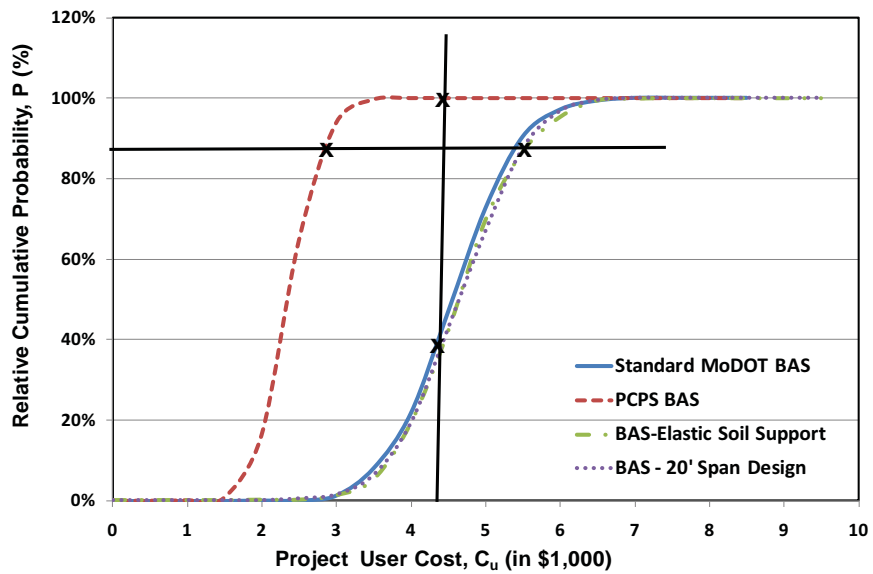

(b)

Figure 6-5 Relative cumulative probability distributions of project user costs of typical BAS design alternatives for a) Urban traffic and b) Rural Traffic

Table 6-4 Present values of agency costs for the four BAS alternatives

Total Cost (Present Value)	Agency Cost (Present Value)			
	Standard MoDOT BAS	PCPS BAS	BAS-Elastic Support	BAS-20'Span Design
Mean	\$68,410	\$54,810	\$48,020	\$58,780
Standard Deviation	\$11,280	\$9,270	\$7,570	\$9,390
Range	\$30,630- \$104,350	\$24,070- \$93,340	\$26,070- \$71,890	\$21,380- \$89,620

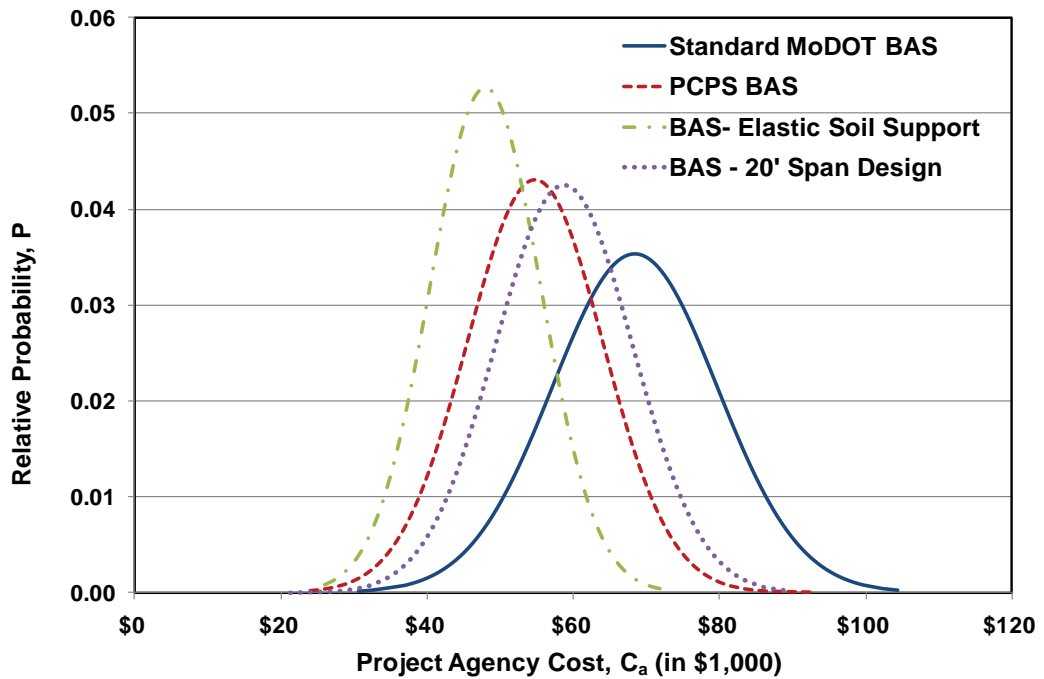
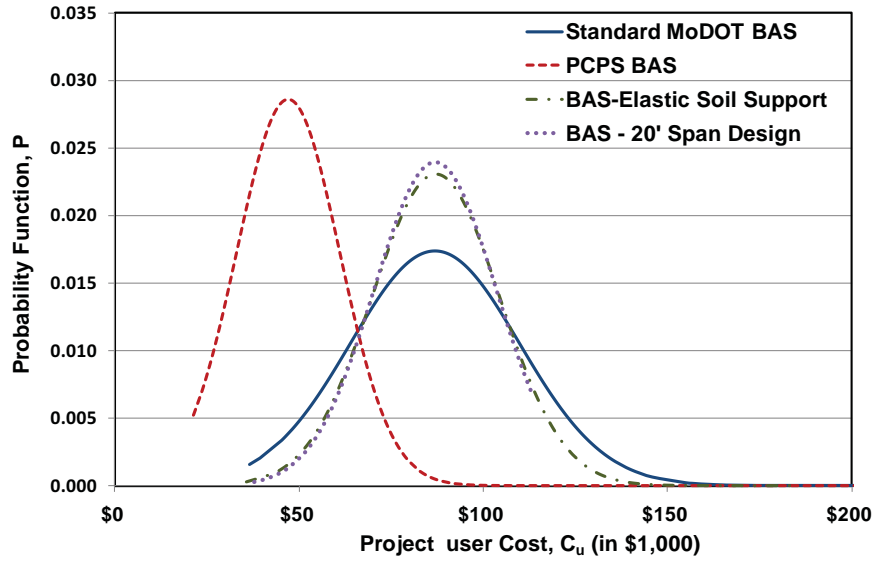

Figure 6-6 Normal distribution of Agency costs of typical BAS alternatives

Table 6-5 Present values of user costs for the three BAS alternatives for urban and rural traffic

Total Cost (Present Value)		User Cost			
		Standard MoDOT BAS	PCPS BAS	BAS-Elastic Support	BAS-20'Span Design
Urban	Mean	\$86,970	\$47,170	\$87,140	\$87,020
	Standard Deviation	\$22,930	\$13,940	\$17,320	\$16,660
	Range	\$36,660-\$619,330	\$21,460-\$368,720	\$35,650-\$186,150	\$37,740-\$178,180
Rural	Mean	\$4,600	\$2,370	\$4,640	\$4,630
	Standard Deviation	\$770	\$390	\$750	\$210
	Range	\$2,030-\$7,040	\$1,130-\$3,910	\$2,030-\$7,280	\$3,930-\$5,430



(a)

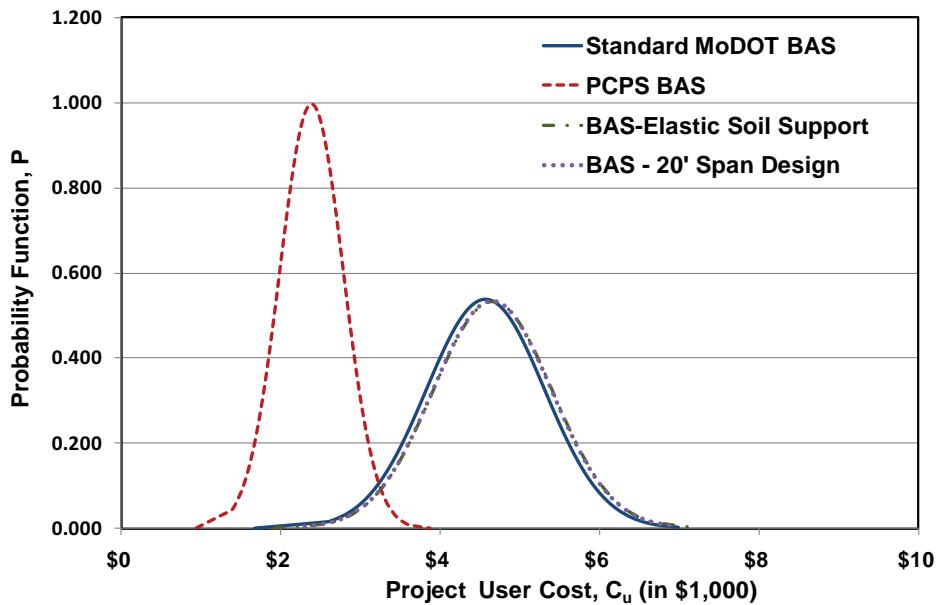

(b)

Figure 6-7 User cost distributions of typical BAS alternatives (a) Urban traffic (b) Rural traffic

It is interesting to note that the differences in user costs between the PCPS – BAS and BAS – ES in an urban setting is of the order of \$40,000 where as it is \$2,300 for a rural setting. While this cost differential puts PCPS – BAS at an advantage in the urban setting, the small cost differential in user cost in a rural setting coupled with the advantage that BAS – ES enjoys in agency costs

over PCPS – BAS (in both urban or rural settings, Table 6-4) makes BAS – ES ideal for a rural setting.

6.4.3 REHABILITATION ACTIVITIES

Figure 6-8 shows an expenditure stream diagram which is a graphical representation of agency expenditures over time. They help visualize the investments over time for initial construction and rehabilitation activities for all the design options under study.

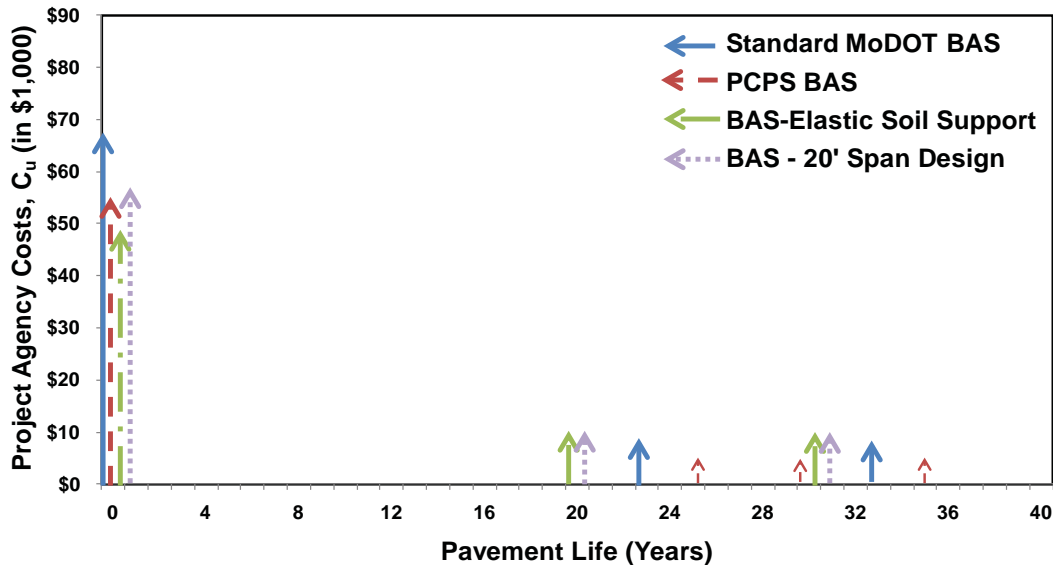

Figure 6-8 Agency costs for initial construction and rehabilitations during the analysis period

Figure 6-8 relates to a particular simulation where the rehabilitation procedures used for the Standard MoDOT BAS, BAS-20'Span Design and the BAS - Elastic Soil Support include URETEK method followed by mudjacking, while it includes 3 back-to-back applications of joint sealing method for the PCPS – BAS. A nominal analysis period of 40 years is considered for all the alternatives. Residual values of the alternatives after the analysis period is over are not shown in this expenditure stream plot. Table 6-6 presents the agency costs, service life and work zone duration for initial construction and all rehabilitation activities assumed in this study. The shaded cells in the table represent the “base reference” simulation used for initial construction/rehabilitation activities used for most plots. When plots or tables are made for other simulation runs (not the base reference), these are specifically described when discussing the simulation results.

Table 6-7 includes work zone user costs calculated in RealCost per standard FHWA procedures and using default cost values provided therein. User costs in these analyses as discussed earlier include vehicle operating costs, user delay costs and crash costs. Again the lower work zone user costs in each category for the PCPS – BAS design is attributed to smaller work zone closure

durations both for the initial construction as well as all rehabilitation activities. It should be noted that work zone user costs in Table 6-7 are nearly identical in all cases for Standard MoDOT BAS, BAS-20'Span Design and BAS – ES because identical durations have been assumed for initial construction as well as subsequent rehabilitation activities. The small variations are due to randomness of the uncertainties assumed.

Table 6-6 Initial and rehabilitation costs, service life and work zone durations assumed

Design Alternative	Cost, Service Life (Years), Work Zone Duration (Days)				
	Initial construction	URETEK Method	Mudjacking	Ashphalt Wedge	Joint Sealing
Standard MoDOT BAS	\$66 k 23 yrs 30d	\$7.14k 10 yrs 3d	\$5k 10 yrs 3d	\$0.6k 4 yrs 1d	-
PCPS BAS	\$54k 25 yrs 15d	-	-	\$0.6k 4 yrs 1d	\$1.4k 5 yrs 2d
BAS – Elastic Soil Support	\$45k 20 yrs 30d	\$7.14k 10yrs 3d	\$5k 10 yrs 3d	\$0.6k 4 yrs 1d	-
BAS-20'Span Design	\$56k 20 yrs 30d	\$7.14k 10yrs 3d	\$5k 10 yrs 3d	\$0.6k 4 yrs 1d	-

Table 6-7 Work zone user costs during initial construction and rehabilitation activities for urban and rural traffic demands

Alternative		Work Zone User Costs During Activity				
		Initial Construct ion Cost	Rehabilitation			Total Cost
			Activity 1	Activity 2	Activity 3	
Urban	Standard MoDOT	\$77,879	\$14,479	\$14,479	-	\$106,837
	PCPS BAS	\$38,939	\$9,653	\$9,653	\$9,653	\$67,898
	BAS- Elastic Soil	\$77,879	\$14,066	\$14,479	-	\$106,424
	BAS-20'Span Design	\$77,849	\$14,060	\$14,473	-	\$106,382
Rural	Standard MoDOT	\$4,378	\$690	\$695	-	\$5,763
	PCPS BAS	\$2,189	\$463	\$463	\$463	\$3,578
	BAS- Elastic Soil	\$4,378	\$650	\$695	-	\$5,723
	BAS-20'Span Design	\$4,371	\$650	\$694	-	\$5,715

Figure 6-9 is a graphical representation of Table 6-7 and shows expenditure streams for the various design alternatives as far as work zone user costs are concerned. Figure 6-9a is for urban traffic history while Figure 6-9b is for a rural traffic history.

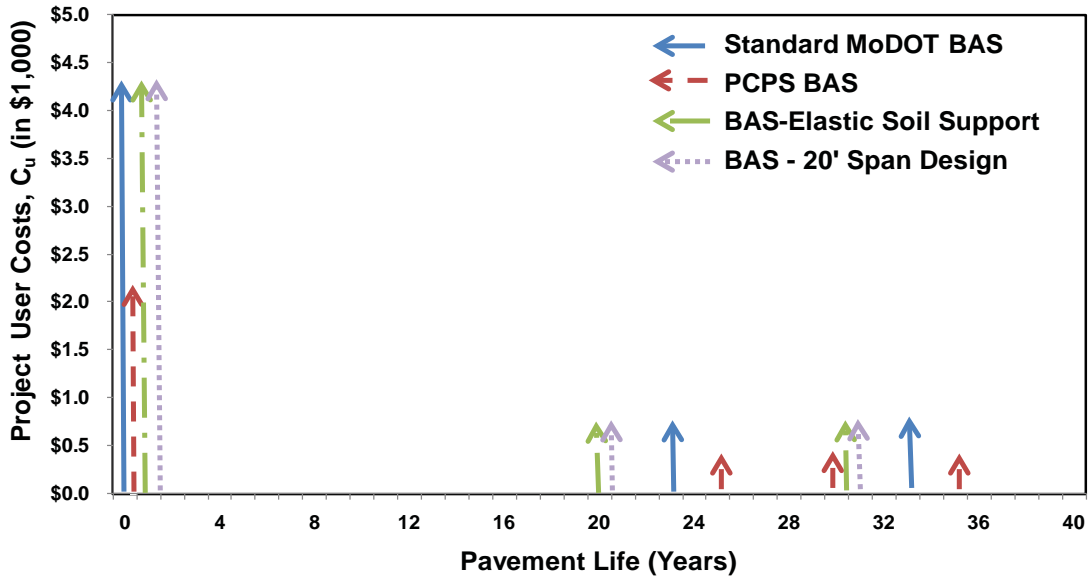

(a)

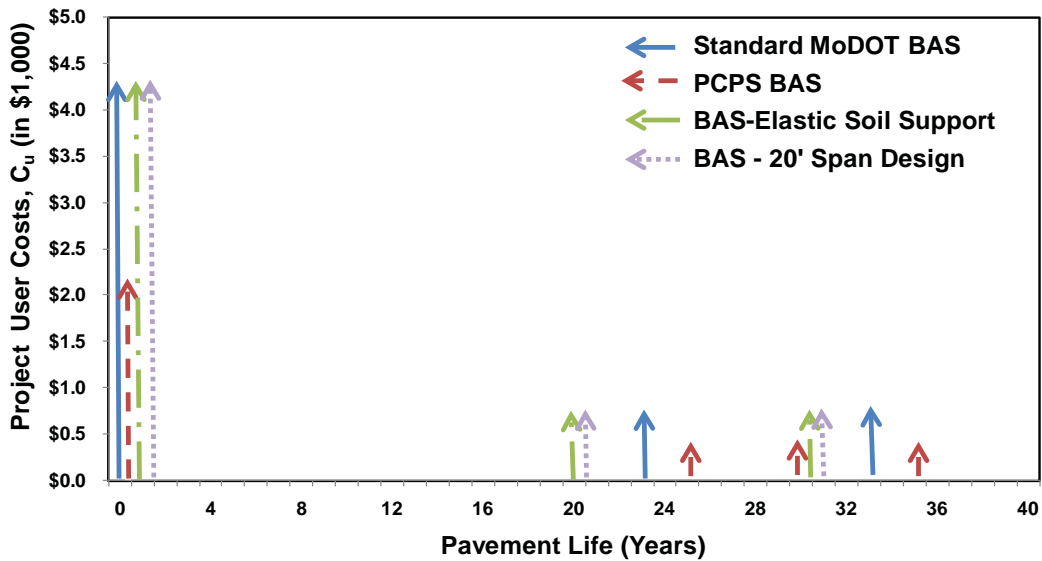

(b)

Figure 6-9 Work zone user cost expenditure streams for initial construction and rehabilitation activities for the three different design alternatives for a) urban and b) rural traffic

Table 6-8 provides information on the various alternates considered in simulation runs completed during this study. All of these simulations were run for both urban and rural traffic demands. Simulations included deterministic as well as probabilistic runs. The shaded cells in the table identify: the “base reference” simulation used for most of the plots and tables included in this chapter (unless it has been specifically identified differently when discussing specific figures or tables).

Table 6-8 Various initial construction and rehabilitation options investigated in the study

Alternative	Rehabilitations
Standard MoDOT BAS	2 URETEK
	2 Mudjacking
	1 URETEK and 2 Asphalt Wedge
	1 Mudjacking 2 Asphalt Wedge
PCPS BAS	3 Joint Sealing
	2 Joint Sealing and 2 Asphalt Wedge
BAS-Elastic Soil Support	2 URETEK
	2 Mudjacking
	1 URETEK and 3 Asphalt Wedge
	1 Mudjacking 3 Asphalt Wedge
BAS-20' Span Design	2 URETEK
	2 Mudjacking
	1 URETEK and 3 Asphalt Wedge
	1 Mudjacking 3 Asphalt Wedge

Figure 6-10 illustrates the agency cost distributions for several rehabilitation sequences, each (sequence) of which has a total life of 20 years. These rehabilitation strategies have been studied for application with Standard MoDOT BAS. Among the options compared in the plot, mudjacking (life of 10 years assumed) followed by two applications of asphalt wedges (life of 5 years each) is among the least cost options.

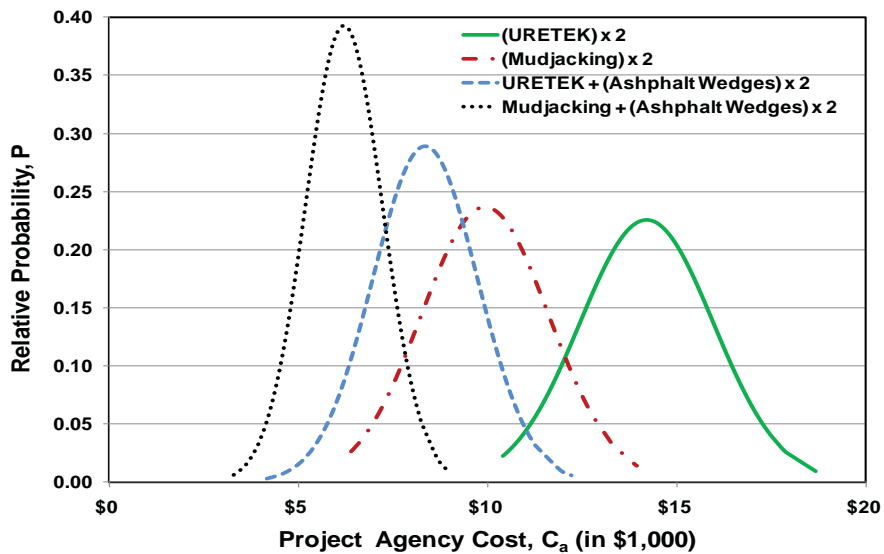

Figure 6-10 Agency cost distribution of various rehabilitation options considered for the Standard MoDOT BAS, BAS-20' Span Design and BAS-ES designs.

Figure 6-11 illustrates the agency cost distributions for two rehabilitation sequences, each (sequence) of which has a total life of 15 years. These rehabilitation strategies have been studied for application with PCPS - BAS design. Among the options compared in the plot, 2 sequential joint sealings (life of 5 years assumed for each sealing) followed by an application of asphalt wedges (life of 5 years) is the least cost option.

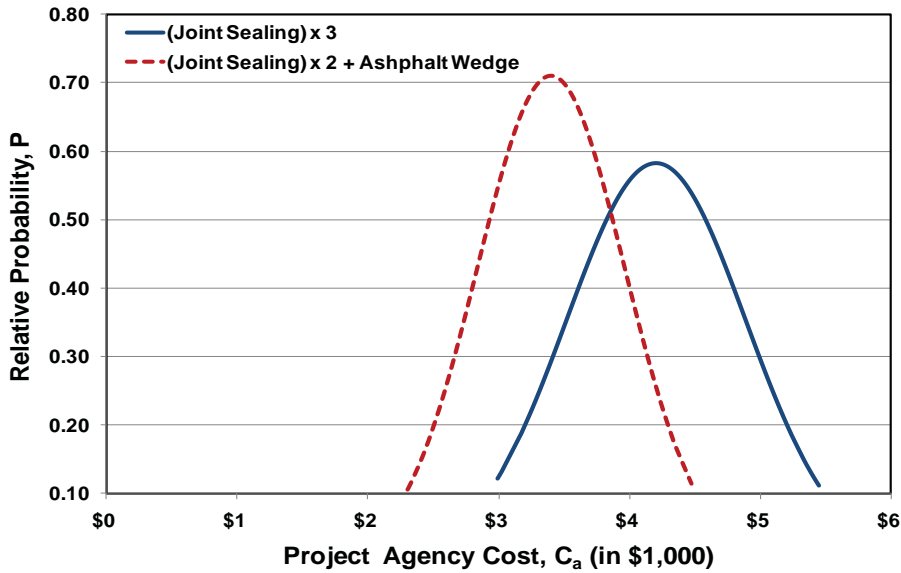

Figure 6-11 Agency cost distributions of various rehabilitation options considered for the PCPS - BAS

Table 6-9 Deterministic and probabilistic results of the three BAS design alternatives

Total Cost (Present Value)		Standard MoDOT BAS		PCPS BAS		BAS-Elastic Support		BAS-20' Span Design	
		Agency Cost	User Cost	Agency Cost	User Cost	Agency Cost	User Cost	Agency Cost	User Cost
Urban	Deterministic Results	\$68,129	\$82,196	\$54,573	\$42,890	\$47,783	\$83,416	\$58,783	\$83,384
	Probabilistic Results	\$68,410	\$86,970	\$54,810	\$47,170	\$48,020	\$87,140	\$58,780	\$87,020
	Standard Deviation	\$11,280	\$22,930	\$9,270	\$13,940	\$7,570	\$17,320	\$9,390	\$16,660
Rural	Deterministic Results	\$68,129	\$4,584	\$54,573	\$2,379	\$47,783	\$4,637	\$58,783	\$4,630
	Probabilistic Results	\$68,150	\$4,600	\$54,510	\$2,370	\$47,920	\$4,640	\$58,840	\$4,630
	Standard Deviation	\$11,240	\$770	\$10,210	\$390	\$7,620	\$750	\$830	\$210

6.4.4 DETERMINISTIC VERSUS PROBABILISTIC RESULTS

The results from the deterministic simulation in RealCost use user prescribed fixed input values for the various parameters (cost, life, etc.) whereas probabilistic results are obtained by modeling parameters that exhibit uncertainties using Monte Carlo simulation techniques.

Table 6-9 includes a comparison of the deterministic costs (both agency and user costs) with mean values from probabilistic simulations. Given the parameter values used in these simulations, it appears that there are no significant differences in agency costs for all three design alternatives. User costs are typically higher for the probabilistic simulations compared to deterministic simulations, with more differences when the simulation involves larger AADT values (urban traffic exhibits greater differences compared to rural traffic demands).

6.4.5 DISCOUNT RATE

In addition to the many parameters discussed earlier, the present value for any project also depends upon the discount rate and the service life of various design/rehabilitation alternatives considered. Discount rate is understood as an economic return on funds when they are utilized in the next best alternative. The default discount rate recommended in RealCost as well as many technical publications on LCCA is 4%. MoDOT recommended use of 7% as the base discount rate (which is the rate used for almost all simulation runs). MoDOT also suggested that simulations be run using discount rates of 4% and 10%. Table 6.10 includes a summary of simulation results using both deterministic as well as probabilistic simulations of urban and rural traffic for the “base reference” cases for all four design alternatives. Results also include simulation runs using three different discount rates (4%, 7%, and 10%). The following observations can be made from the table:

- Present value of agency and user costs across the board goes down as the discount rates go up. This is true whether the simulation relates to a deterministic or a probabilistic run, whether the traffic demand is urban or rural and for all three BAS design alternatives.
- The decrease in user cost is significantly more pronounced than reductions in agency costs. Also, the reduction in user costs are higher in the probabilistic simulations than deterministic simulations highlighting uncertainty modeling features in RealCost. This is expected because the multiple levels of uncertainties modeled in the user costs (initial cost, duration of work zone restrictions, user delays costs, and time value of money among the more significant uncertainty).

6.4.6 RURAL AND URBAN TRAFFIC PATTERNS

Correlation coefficient plots are another way of representing risk analysis results using RealCost. As part of the risk assessment, a sensitivity analysis can be performed on simulation results to identify significant input variables that are important in determining the output distributions. The results of this analysis are usually displayed in the form of a Tornado plot, as shown in Figure

6-12 (for user costs for Standard MoDOT BAS) and Figure 6-13 (for user costs for PCPS – BAS). In each figure the plot in (a) refers to urban traffic demand and (b) refers to rural traffic demand. The higher the correlation coefficient, the more significant the input variable is on determining the results. The variables listed at the top of the graph are more significant than those at the bottom. Typically, correlation coefficients less than about 0.6 are not very significant. Figure 6-12a (urban traffic) shows Initial Work Zone Duration has a correlation coefficient of 0.86. This means that if Initial Agency Cost moves one standard deviation (in either direction), then the present value for Standard MoDOT BAS will move 0.86 of a standard deviation in the same direction. If Initial Service Life in Figure 6-12a moves one standard deviation (in either direction), then expectations are that the present value for Standard MoDOT BAS will move 0.15 standard deviations in the opposite direction, because the relationship is reversed (as indicated by the negative correlation coefficient). As observed from Figure 6-12 and Figure 6-13 the initial work zone duration has an effect on the user costs both in the urban and rural simulations. Work zone capacities during rehabilitation activities have an effect on the user costs in the urban case but not in the rural case as evidenced in both Figure 6-12 and Figure 6-13. This is because of the higher traffic demand in the urban case.

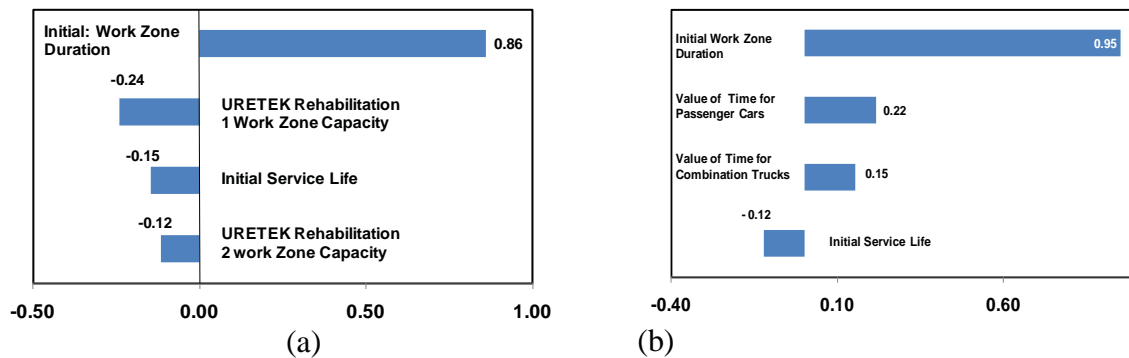

Figure 6-12 Correlation coefficients of user cost parameters for Standard MoDOT BAS (a) urban and (b) Rural traffic demands

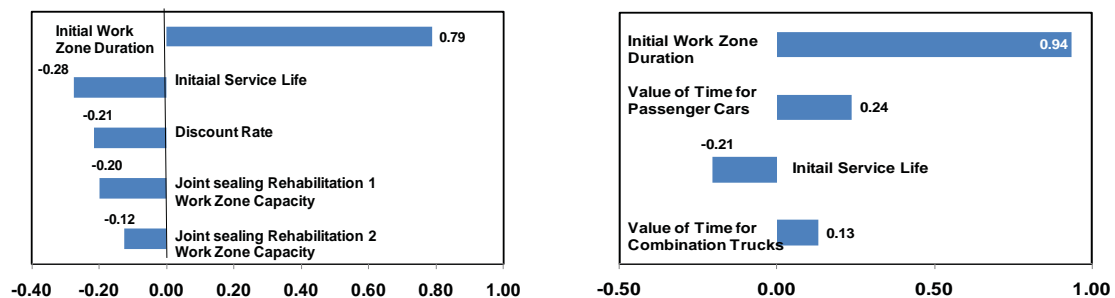

Figure 6-13 Correlation coefficients of user cost parameters for PCPS BAS (a) Urban and (b) Rural traffic demands

The user costs in typical rural case studies are lower because of the significantly lower AADT. In a typical urban simulation where the user costs dominate the total costs, the option with low user costs is more cost-effective. Table 6-11 highlights the fact that that in a typical urban scenario

the user costs of the PCPS – BAS design are less compared to Standard MoDOT BAS, BAS-20' Span and BAS-ES designs. Whereas in a rural scenario the total cost is dominated by the agency costs as shown in Table 6-11 and hence the BAS-ES design is the most cost-effective design alternative.

6.5 SUMMARY CONCLUSIONS

Results from this research have demonstrated that it is possible to use LCCA to study the cost to the agency as well as the users for competing BAS design alternatives and rehabilitation strategies. RealCost, originally developed by the FHWA for studying life cycle costs and cost-effective investment strategies in pavement technologies has been very effective for analyzing similar challenges in evaluating bridge approach slabs.

When only present values of agency costs are considered, BAS – Elastic Soil Support design offers the lowest cost option of the four alternates studied. When only present value of user costs are considered, PCPS – BAS offers the lowest cost option of the three alternates studied. When present value of total costs are considered, the BAS – Elastic Soil Support design is the most cost-effective when AADT counts are low, such as with rural traffic demand. When present value of total costs are considered, the PCPS - BAS design is the most cost-effective when AADT counts are high, such as with urban traffic demands. The shorter span design recommended in this investigation (BAS – 20' Span Design) falls between BAS ES and PCPS BAS design in agency as well as user costs.

Table 6-10 Life cycle agency, user and total costs for urban and rural traffic based on discount rates 4%, 7% and 10% for typical BAS alternatives and assumed rehabilitation strategies

Net Present Value			Standard MoDOT BAS			PCPS BAS			BAS-Elastic Soil Support			BAS-20'Span Design		
			Agency Cost	User Cost	Total Cost	Agency Cost	User Cost	Total Cost	Agency Cost	User Cost	Total Cost	Agency Cost	User Cost	Total Cost
Urban	Deterministic Results	4%	\$ 70,408	\$86,817	\$157,225	\$55,312	\$47,982	\$103,294	\$50,460	\$88,762	\$139,222	\$61,460	\$88,728	\$150,188
		7%	\$68,129	\$82,196	\$150,325	\$54,573	\$42,890	\$97,463	\$47,783	\$83,416	\$131,199	\$58,783	\$83,384	\$142,167
		10%	\$67,057	\$80,023	\$147,081	\$54,259	\$40,727	\$94,986	\$46,470	\$80,800	\$127,270	\$57,470	\$80,768	\$138,239
	Probabilistic Results	4%	\$70,370	\$91,530	\$161,900	\$55,010	\$55,490	\$110,500	\$49,980	\$97,150	\$147,130	\$61,480	\$97,000	\$158,480
		7%	\$68,410	\$86,970	\$155,380	\$54,810	\$47,170	\$101,980	\$48,020	\$87,140	\$135,160	\$58,780	\$87,020	\$145,800
		10%	\$67,270	\$81,690	\$148,960	\$54,240	\$42,550	\$96,790	\$46,330	\$83,800	\$130,130	\$57,750	\$83,080	\$140,830
Rural	Deterministic Results	4%	\$70,408	\$4,805	\$75,213	\$55,312	\$2,623	\$57,935	\$50,460	\$4,889	\$55,349	\$61,460	\$4,881	\$66,341
		7%	\$68,129	\$4,584	\$72,713	\$54,573	\$2,379	\$56,952	\$47,783	\$4,637	\$52,420	\$58,783	\$4,630	\$63,413
		10%	\$67,057	\$4,480	\$71,538	\$54,259	\$2,275	\$56,534	\$46,470	\$4,515	\$50,985	\$57,470	\$4,507	\$61,978
	Probabilistic Results	4%	\$70,460	\$4,790	\$75,250	\$54,900	\$2,580	\$57,480	\$50,300	\$4,850	\$55,150	\$61,380	\$4,870	\$66,250
		7%	\$68,150	\$4,600	\$72,750	\$54,510	\$2,370	\$56,880	\$47,920	\$4,640	\$52,560	\$58,840	\$4,630	\$63,470
		10%	\$67,340	\$4,500	\$71,840	\$54,310	\$2,260	\$56,570	\$46,670	\$4,530	\$51,200	\$57,570	\$4,510	\$62,080

Table 6-11 Comparison of probabilistic results of typical Rural and Urban scenarios

Probabilistic Total Cost (Present Value)		Standard MoDOT BAS			PCPS BAS			BAS -Elastic Soil Support			BAS-20'Span Design		
		Agency Cost	User Cost	Total Cost	Agency Cost	User Cost	Total Cost	Agency Cost	User Cost	Total Cost	Agency Cost	User Cost	Total Cost
Rural	Mean	\$68,150	\$4,600	\$72,750	\$54,510	\$2,370	\$56,880	\$47,920	\$4,640	\$52,560	\$58,840	\$4,630	\$63,470
	St Dev	\$11,240	\$770	\$12,010	\$10,210	\$390	\$10,600	\$7,620	\$750	\$8,370	\$830	\$210	\$1,040
Urban	Mean	\$68,410	\$86,970	\$155,380	\$54,810	\$47,170	\$101,980	\$48,020	\$87,140	\$135,160	\$58,780	\$87,020	\$145,800
	St Dev	\$11,280	\$22,930	\$34,210	\$9,270	\$13,940	\$23,210	\$7,570	\$17,320	\$24,890	\$9,390	\$16,660	\$26,050

CHAPTER 7 CONCLUSIONS

New Cast in Place Slabs: The bridge approach slab recommended by this research cuts down almost 22% of the cost of construction compared with the current MoDOT BAS cost of construction. It should be noted that elastic soil support has been considered in designing the BAS and is the basis of this recommended design. The demand moment calculated is considering 50% (10 ft.) of the span conservatively supported by poor soil and 50% voids. Lane load in combination with the Truck or Tandem load is not included in the final design. This exclusion is justified based on AASHTO-LRFD provision 3.6.1.3.3 which allows for decks and top slabs of culverts to be designed for only the axle loads of the design truck or design tandem for spans less than 15 feet (for a washout of 50% the effective span is at 10 feet). Further research is recommended to develop reliability based methodology for bridge approach slabs supported at the ends and by soil in between. The design recommendation for new slabs is a cast in place 20 feet in span and 12 inches thick with a sleeper slab for major roads and a cast in place 25 feet in span and 12 inches thick slab without a sleeper slab for minor roads. Design and implementation details along with drawings are presented in chapters 2 and 3.

Two types of analysis procedures have been presented in this research. The first one is the analytical beam on elastic foundation approach and the second one is a three dimensional detailed finite element study. Based on the analysis procedure followed in this research, it is evident that the design moments for bridge approach slabs can be significantly reduced even if the slab was assumed to be supported for 50% of the BAS span on weak or poor soil having modulus of sub grade reaction of 18.4 lb/in^3 . The expected deflection and slope for the considered 50 % void formation are within their allowable limits.

With the beam on slab analysis without the sleeper slab, the slab design recommended still retains the 12 inch depth of the standard MoDOT BAS design while reducing the steel reinforcement to reflect the reduced internal forces due to elastic soil support. As the slab is assumed to be continuously supported by the soil, the use of a sleeper slab is not recommended. Special pavement end-zone detailing for the BAS-ES provides the two-way action that is expected to improve slab performance in transverse bending. The cost savings for the BAS-ES design are realized primarily due to reduced use of reinforcement as well as the elimination of sleeper slabs. Additional cost savings are also realized in forming the approach slab and reduced pouring costs. An exhaustive analysis of potential soil washout (both size and location studied) indicates that significant reductions in design moments can still be realized, even with 50% of the soil under the BAS providing no support. The cost savings in initial construction using the BAS-ES design can be partially used to enhance soil support through the use of controlled low-

strength materials (CLSM, using fly ash stabilization for the base of the BAS). This can further guarantee that the reduction in design moments is effective for the life of the BAS.

New and Replacement Slabs (Precast Prestressed): For alternative solutions where replacement slabs are needed, a precast prestressed slab with transverse ties is proposed. Detailed cost analyses have been performed for the proposed solution. From the cost observations it is evident that these slabs could be cost effective in new construction as well. Hence, designs for both a 20 foot span (new construction) and 25 foot span (old/replacement construction) have been proposed. Sleeper slabs are recommended for both designs. It has been shown by a cost analysis that the proposed precast solution compares equally with the proposed cast in place solution and can be adopted for new construction as well resulting in considerable time and user cost savings.

Controlled Low Strength Materials (CLSM) as an Alternative to Compacted Backfill: The preliminary study indicated that fast setting, low cost CLSM (flowable fill) mixtures can be developed using high quality Class C fly ash available in the state of Missouri. CLSM mixtures with suitable fresh and hardened properties for bridge abutment backfill applications were produced. Preliminary mixture designs and cost estimates were presented. CLSM mixtures could be effective in reducing void formations under the slab and loss of support.

CHAPTER 8 RECOMMENDATIONS

Various recommendations have been presented at different sections of the report. The design recommendations presented are in the following sections.

- a) Design recommendations for new cast in place approach slabs are presented in section 2.7 (20 feet slab with sleeper slab) and section 3 (25 feet slab with no sleeper slab). Recommendations for the required soil subgrade modulus are also presented in the sections. The type of slabs to be adopted could depend on the volume of traffic in the bridge. Sleeper slabs are recommended where traffic volumes are moderate to heavy. Preliminary design drawings are enclosed in Appendix A-7. Since soil conditions are integral to the design process it is imperative that construction inspectors be notified in order to step up inspection. The geotechnical review and inspection of the fill material and conditions should be carefully done.
- b) Design recommendations for new and replacement precast prestressed (PCPS) slabs are presented in section 4. The design recommendation is a 10 inch thick precast prestressed slab with a 2 inch asphalt topping and a uses a sleeper slab. Each PCPS is eight (or six) feet wide which could be used for both 20 feet and 25 feet span BAS. For 38 feet wide BAS, 4 eight feet wide slabs and one 6 feet wide slab is recommended. Recommendations for the required soil subgrade modulus are also presented in the section. Preliminary design drawings are enclosed in Appendix A-8.
- c) Based on the results of the preliminary study, further evaluation of fast setting CLSM mixtures produced using locally available Class C fly ash is recommended. Laboratory approved CLSM mixtures should be tested at a larger scale in the field to evaluate the effect of larger batch sizes and field environment on fresh and hardened properties of CLSM. Material and construction cost of BASs using selected CLSM mixtures should be compared to the current material and construction costs of MoDOT. Researchers also recommend evaluation of freeze thaw resistance of CLSM mixtures to assess their suitability to be used under BASs.

CHAPTER 9 IMPLEMENTATION PLAN

The proposed project has recommended several solutions for both new and replacement approach slabs. Sectional details of the proposed solutions have been presented. The project is ready for the next phase – which is the implementation in the field and field evaluations. It is to be noted that the current project is an analytical and numerical study and no experiments have been performed to study the efficacy of the proposed solutions. The proposed implementation plan is as follows:

- 1) For new slabs there are two design recommendations. MoDOT could develop these designs directly to be constructed.
 - a) A 20 feet span and 12 inch thick cast in place slab with sleeper slab. Design details have been presented.
 - b) A 25 feet span and 12 inch thick cast in place slab with no sleeper slab is also presented.
- 2) For replacement slabs of 25 feet span or new construction of 20 feet span, precast prestressed slab designs (with a 10 inch thick slab with a 2 inch asphalt topping) with sleeper slabs have been presented which can be implemented in the field. Final designs and details based on any suggestions or concerns that MoDOT may have should be developed prior to implementation.
- 3) Since the precast prestressed slab design solution is an innovative solution presented, it is recommended that field studies regarding construction related issues, performance under overload conditions and long term behavior be performed to evaluate the efficiency of the proposed slab.
- 4) Field evaluation of new cast in place slabs are also recommended since this is the first time MoDOT would be adopting slabs of shorter span and issues related to both the underlying soil and structural conditions would have to be studied.

BIBLIOGRAPHY

1. Briaud, J., J. Seo, and H. Ha, *Investigation of Settlement at Bridge Approach Slab Expansion Joint: Numerical Simulation and Model Tests*. Texas Transportation Institute, 2002.
2. Hoppe, E., *Guidelines For The Use, Design, and Construction of Bridge Approach Slabs*. VTRC Report No. 00-R4, Virginia Transportation Research Council, 1999.
3. Bowders, J., et al., *Determination and prioritization of MoDOT Geotechnical Related Problems with Emphasis on Effectiveness of Designs for Bridge Approach Slabs and Pavement Edge Drains*. MoDOT project report 2002(R199-029 Missouri Dept. of Transportation).
4. White, D., et al., *Identification of The Best Practices for Design, Construction, and Repair of Bridge Approaches*. Report No. CTRE Project, 2005: p. 02-118.
5. Briaud, J., R. James, and S. Hoffman, *Settlement of bridge approaches*. 1997: Transportation Research Board.
6. Nassif, H., T. Abu-Amra, and N. Shah, *Finite Element Modeling of Bridge Approach and Transition Slabs*. Rep. No. FHWA-NJ-2002, 2002. 7.
7. Cai, C., et al., *Structural Performance of Bridge Approach Slabs Under Given Embankment Settlement*. Journal of Bridge Engineering, 2005. 10: p. 482.
8. David K. Merritt, A.J.M., Richard B. Rogers, Robert Otto Rasmussen, *Construction of the Iowa Highway 60 Precast Prestressed Concrete Pavement Bridge Approach Slab Demonstration Project*. 2007.
9. White, D., et al., “Underlying” Causes for Settlement of Bridge Approach Pavement Systems. Journal of Performance of Constructed Facilities, 2007. 21: p. 273.
10. Wolde-Tinsae, A. and J. Klinger, *Integral Bridge Design and Construction*. 1987, Report FHWA/MD-87/04, Maryland Department of Transportation.
11. Ruf, K.A.H., F.A.; and Sehn, A.L., *Finite element analyses of earth pressures and structural forces and moments for integral abutment highway bridges*. 1995, Dept. of CE, University of Akron.
12. Hoppe, E. and J. Gomez, *Field study of an integral backwall bridge*. Virginia Transportation Research Council, Charlottesville, 1997.
13. Ng, C., S. Springman, and A. Norrish, *Soil-structure interaction of spread-base integral bridge abutments*. Soils and foundations, 1998. 38(1): p. 145-162.
14. GangaRao, H., et al., *Survey and Design of Integral Abutment Bridges*. Constructed Facilities Center at West Virginia University, Morgantown WV, 1996.
15. Soltani, A. and A. Kukreti, *Performance evaluation of integral abutment bridges*.
16. Khodair, Y., *Finite Element Modeling of Approach and Transition Slabs*, in *Department of Civil and Environmental Engineering*. 2001, Rutgers University.
17. Grover, R., *Movements of Bridge Abutments and Settlements of Approach Pavements in Ohio*. 1978.
18. Long, J., et al., *Differential Movement at Embankment-Bridge Structure Interface in Illinois*. Transportation Research Record: Journal of the Transportation Research Board, 1998. 1633(-1): p. 53-60.

19. Wahls, H., *Design and construction of bridge approaches*. 1990: Transportation Research Board.
20. Luna, R., J. Robison, and A. Wilding, *Evaluation of Bridge Approach Slabs, Performance and Design*. Rep. No. RDT 04, 2004. **10**.
21. AASHTO, L. and R. Design, *Bridge Specifications*. American Association of State Highway and Transportation Officials, Washington, DC, 1998.
22. AASHTO, L., *LRFD Bridge Design Specifications*. LRFDUS-3 or LRFD SI-3, 2004.
23. Wilson, E. and A. Habibullah, *Sap 2000 Integrated Finite Element Analysis and Design of Structures Basic Analysis Reference Manual*. Computers and Structures, Berkeley, 1998.
24. Al-Nasra, M. and L. Wang, *Parametric Study of Slab-on-Grade Problems Due to Initial Warping and Point Loads*. ACI Structural Journal, 1994. **91**(2).
25. Bowles, J.E., *Foundation Analysis and Design* 1996.
26. Roy, S., *Nonlinear Finite Element Analysis of Reinforced Concrete Bridge Deck/Bridge Approach Slab Using ABAQUS*. 2005, UNIVERSITY OF MISSOURI-KANSAS CITY.
27. Hetényi, M., *Beams on elastic foundation*. 1946: The Univ. of Michigan Press.
28. Timoshenko, S. and S. Woinowsky-Krieger, *Theory of plates and shells*. 1959: McGraw-Hill New York.
29. Timoshenko, S. and J. Goodier, *Theory of Elasticity*.(ed.). New York, 1970.
30. David K. Merritt, A.J.M., Richard B. Rogers, Robert Otto Rasmussen, *Construction of the Iowa Highway 60 Precast Prestressed Concrete Pavement Bridge Approach Slab Demonstration Project*. July 2007, Iowa Highway Research Board, Iowa Department of Transportation: Ames, Iowa.
31. Kramer, S.L. and P. Sajer, *Bridge Approach Slab Effectiveness*, W.S.T.C. (TRAC), Editor. 1991, Washington State Transportation Center (TRAC): Seattle, WA. p. 223.
32. ACI229, *Controlled Low Strength Materials (CLSM)*. 1994, American Concrete Institute: Farmington Hills, MI.
33. Snethen, D.R. and J.M. Benson, *Construction of CLSM Approach Embankment to Minimize the Bump at the End of the Bridge*, in *The Design and Application of Controlled Low-Strength Materials (Flowable Fill)*, ASTM STP 1331, A.K. Howard and J.L. Hitch, Editors. 1998, American Society for Testing and Materials.
34. Hook, W. and D.A. Clem, *Innovative Uses of Controlled Low Strength Materials (CLSM) in Colorado*, in *The Design and Application of Controlled Low Strength Materials (Flowable Fill) ASTM STP 1331*, A.K.H.a.J.L. Hitch, Editor. 1998, American Society for Testing Materials: West Conshohocken, PA. p. 137-150.
35. Snethen, D.R. and J.M. Benson, *Construction of CLSM Approach Embankment to Minimize the Bump at the End of the Bridge*, in *The Design and Application of Controlled Low Strength materials (Flowable Fill) ASTM STP 1331*, J.L.H. A.K. Howard, Editor. 1998, ASTM: West Conshohocken, PA. p. 165-179.
36. Folliard, K.J., et al., *NCHRP report 597: Development of a Recommended Practice for Use of Controlled Low Strength Material in Highway Construction*, NCHRP, Editor. 2008, Transportation Research Board: Washington DC. p. 151.
37. Federal Highway Administration, *Life-Cycle Cost Analysis in Pavement Design: In Search of Better Investment Decisions, Interim Technical Bulletin*. 1998: Washington DC. p. 107.

38. Federal Highway Administration, *Life-Cycle Cost Analysis Primer* 2002: Washington DC. p. 24.
39. California Department of Transportation, *Life-Cycle Cost Analysis Procedures Manual*. 2007: p. 134.

APPENDIX A-1 STATES' BAS DETAILS

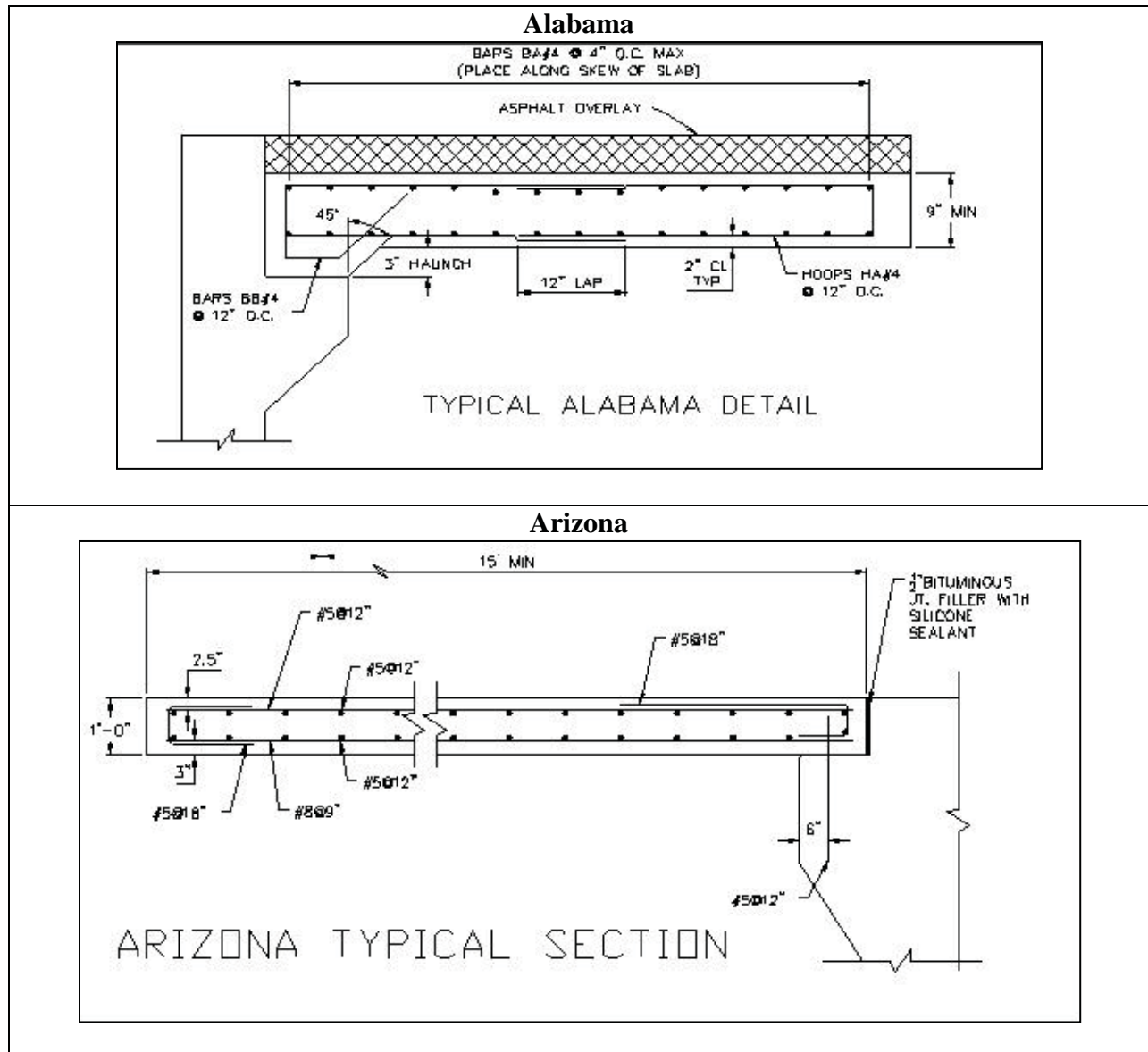

Connecticut

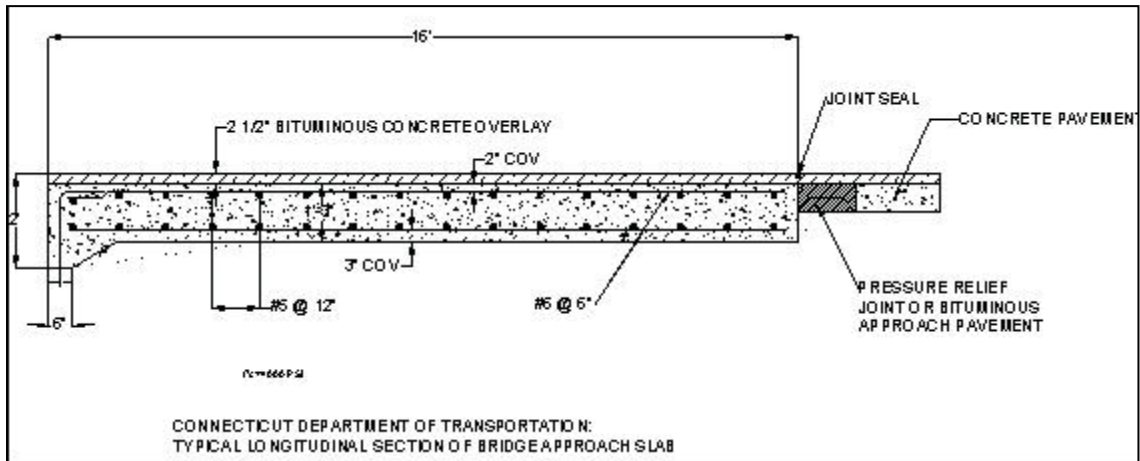

Delaware

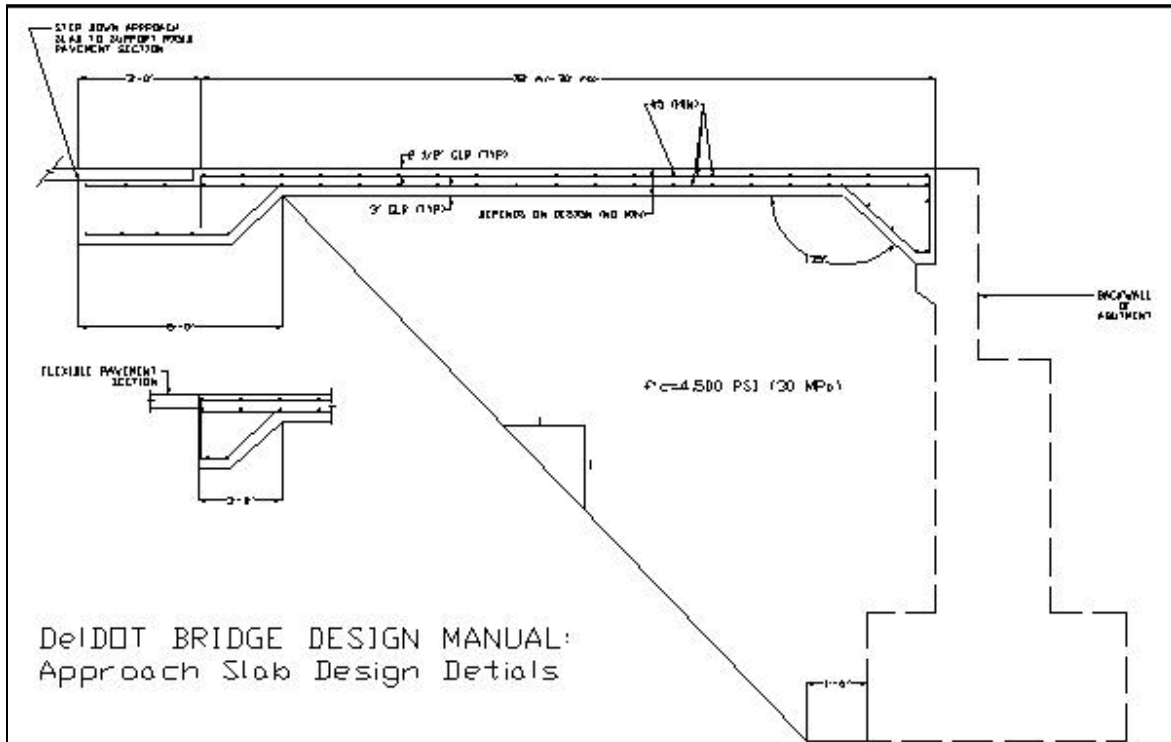

Florida

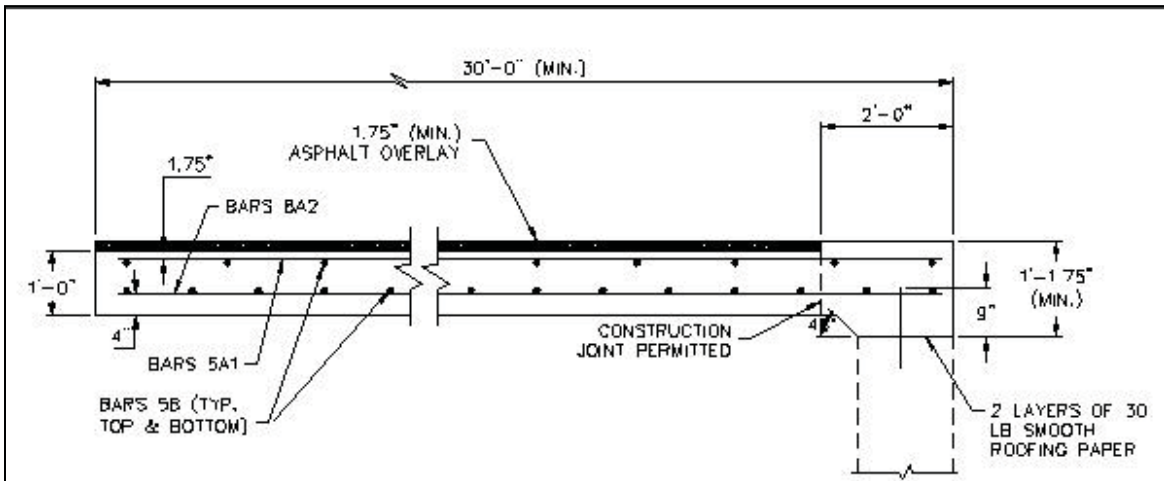

FLORIDA TYPICAL SECTION

Idaho

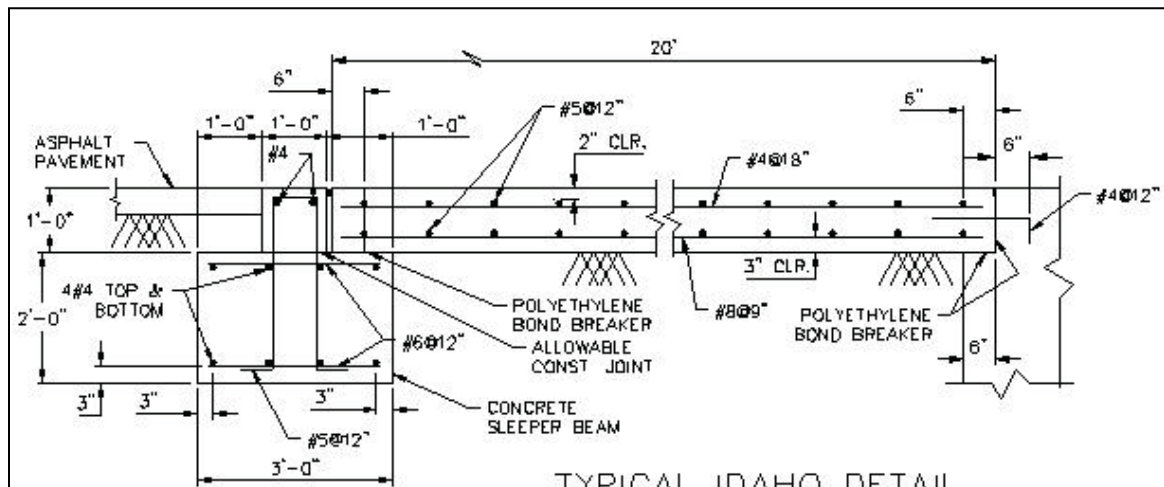

TYPICAL IDAHO DETAIL

Illinois

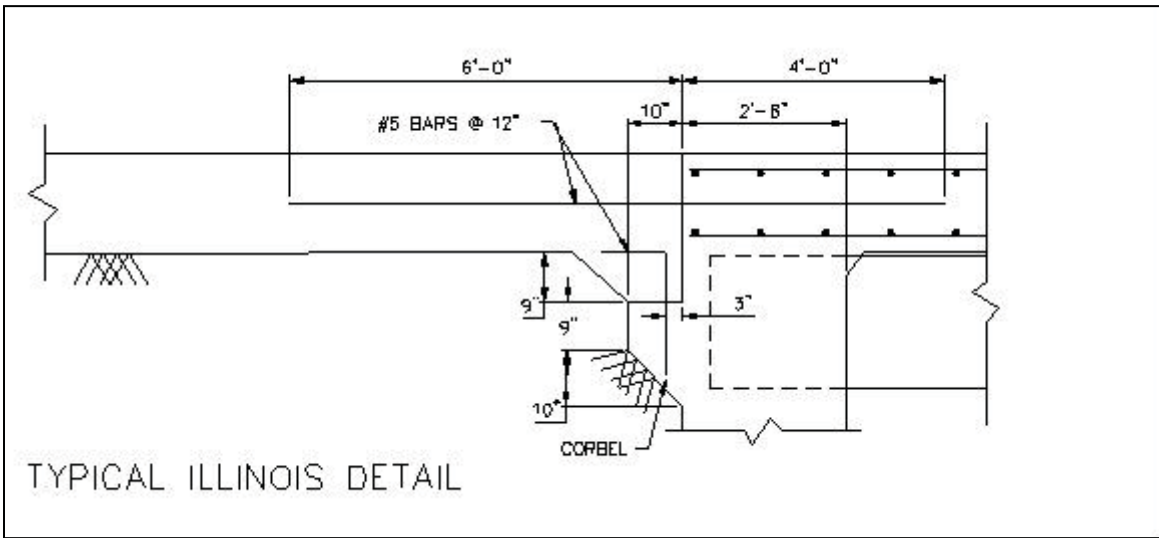

Indiana

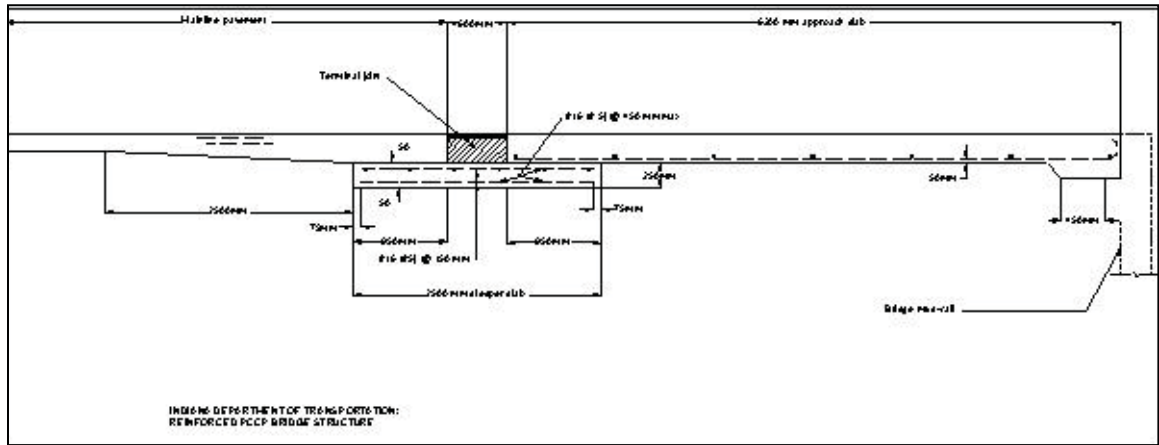

Iowa

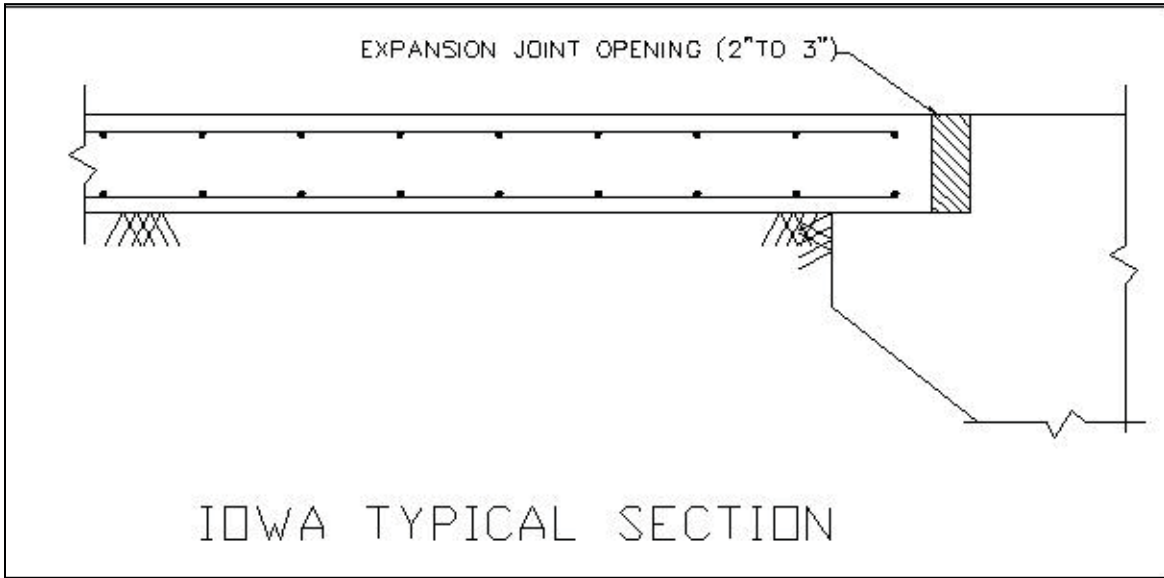

Kansas

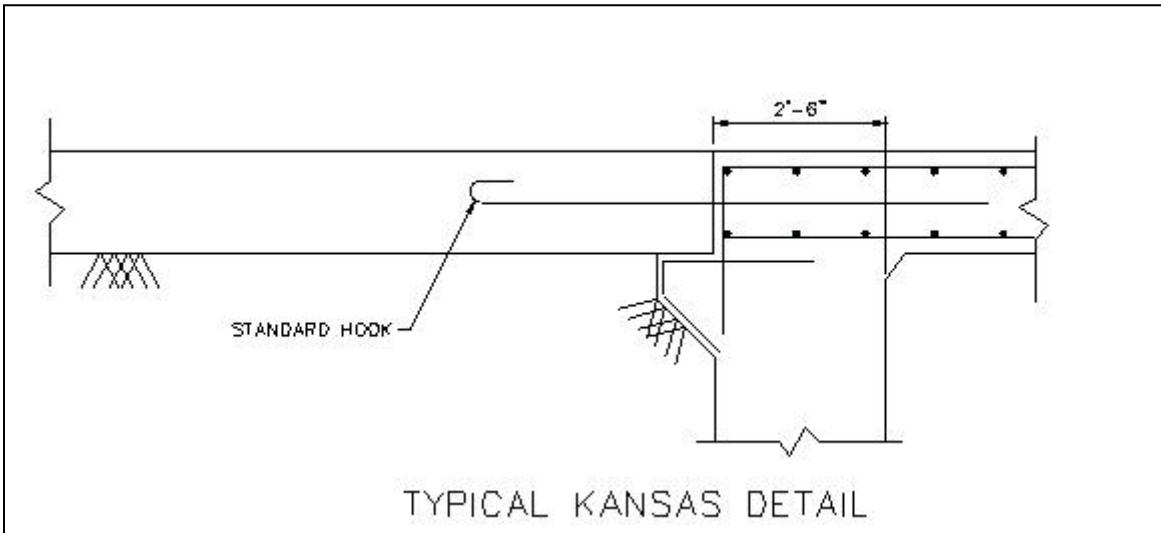

Kentucky

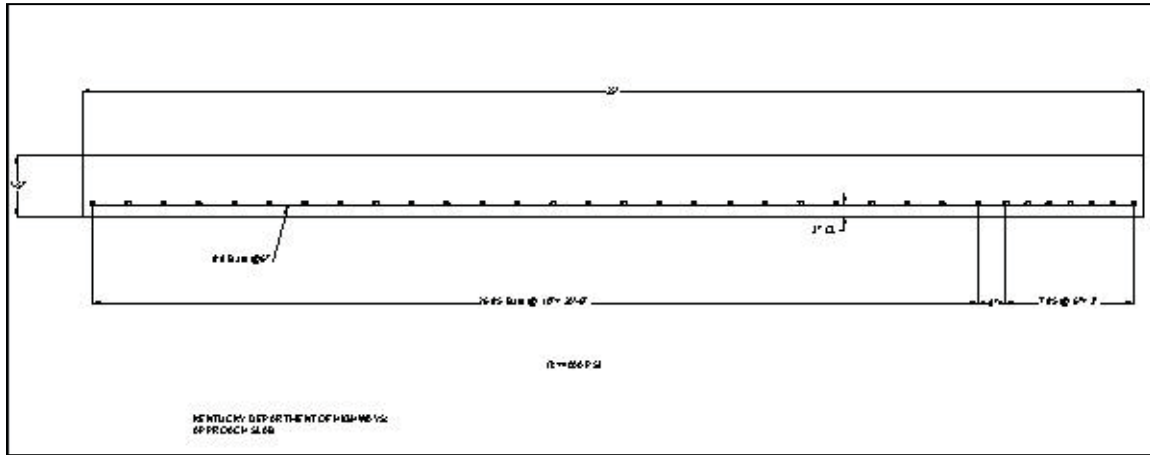

Louisiana

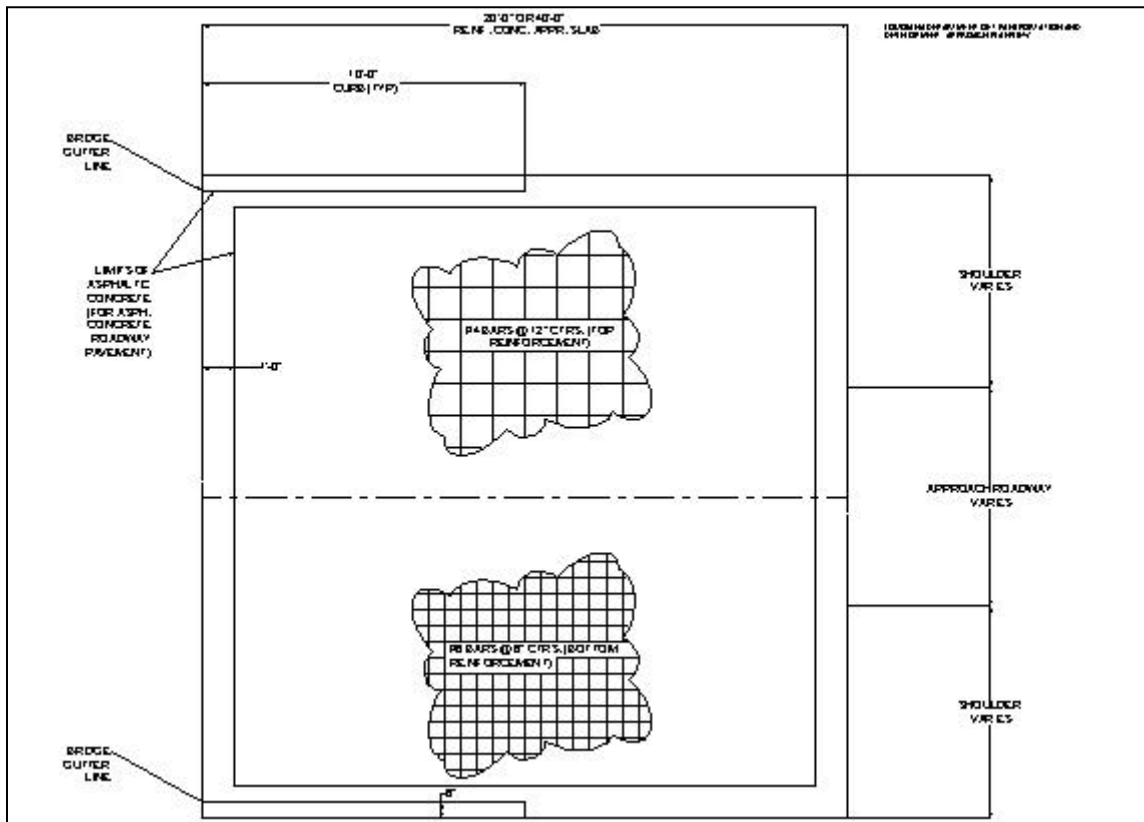

Maine

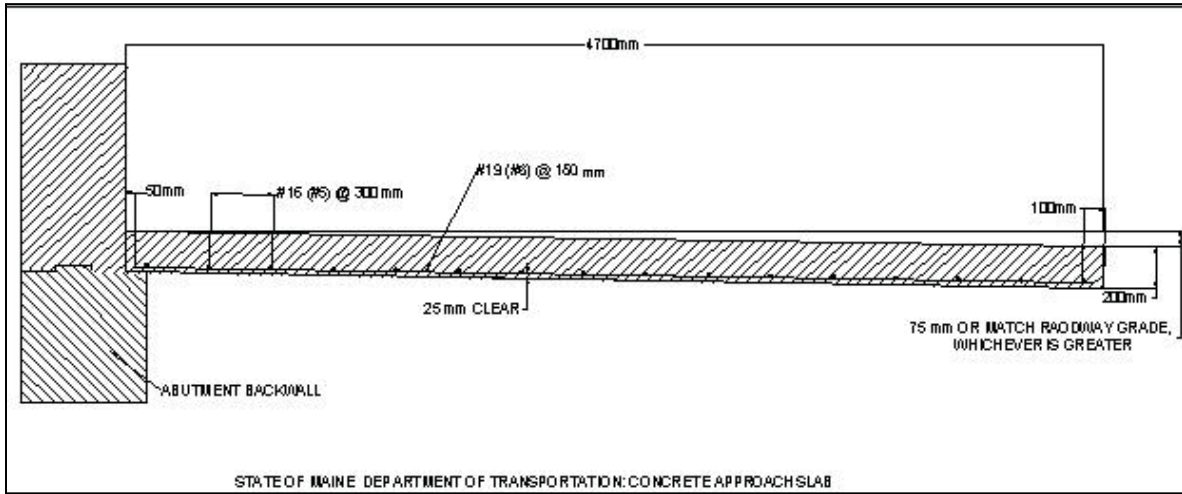

Massachusetts

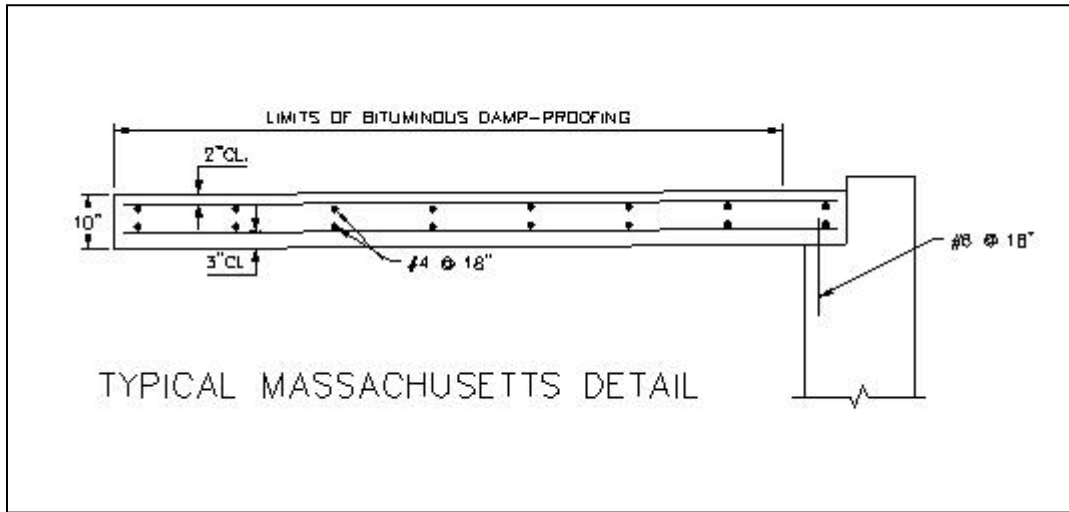

Minnesota

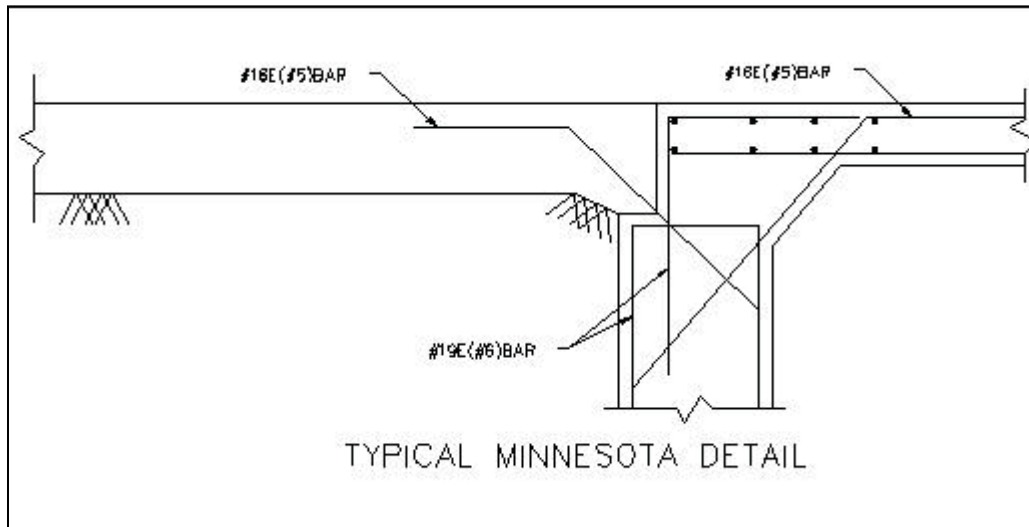

Mississippi

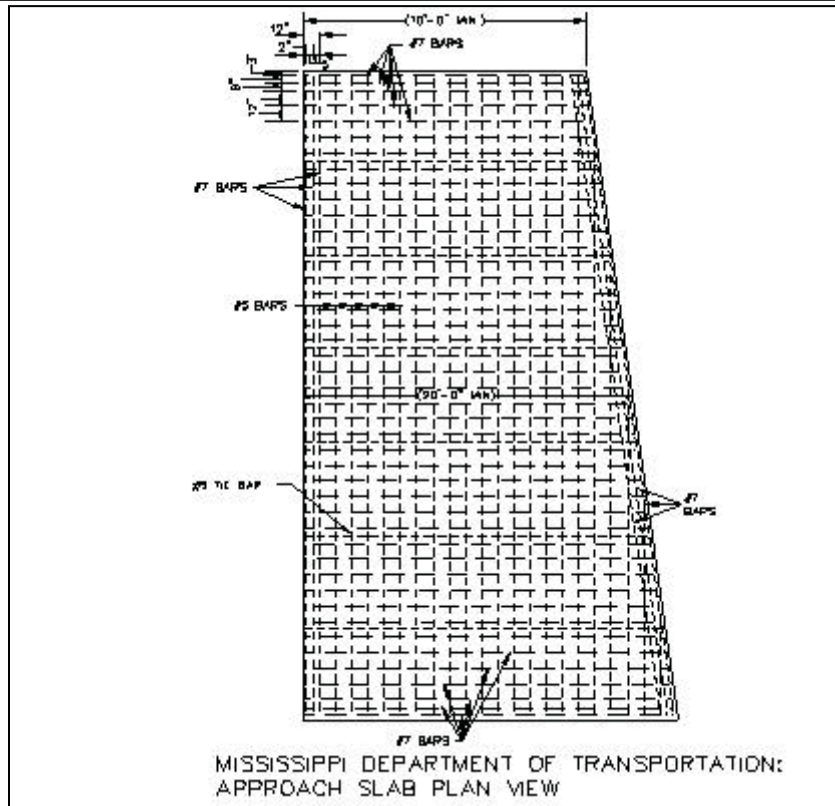
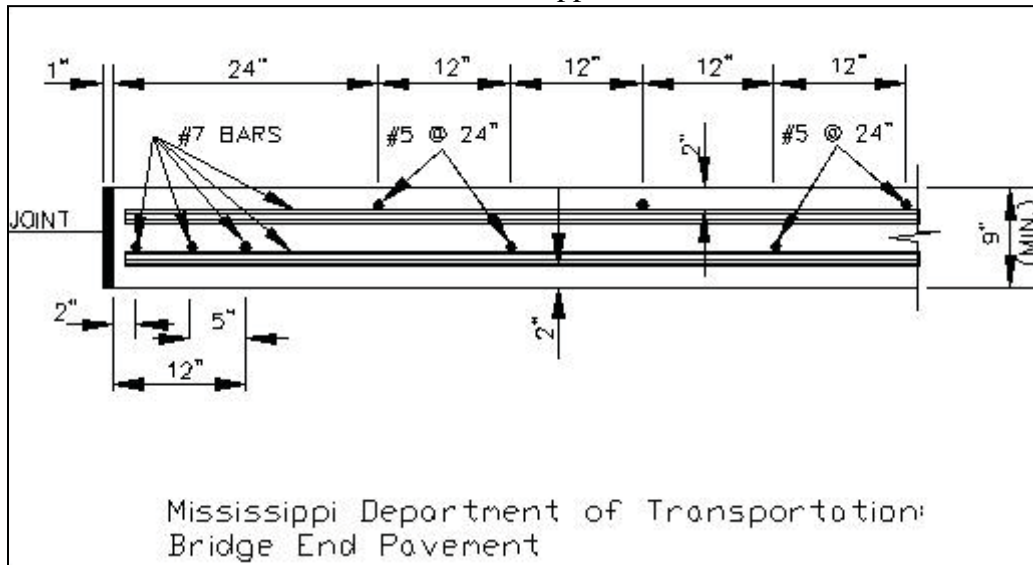

Missouri

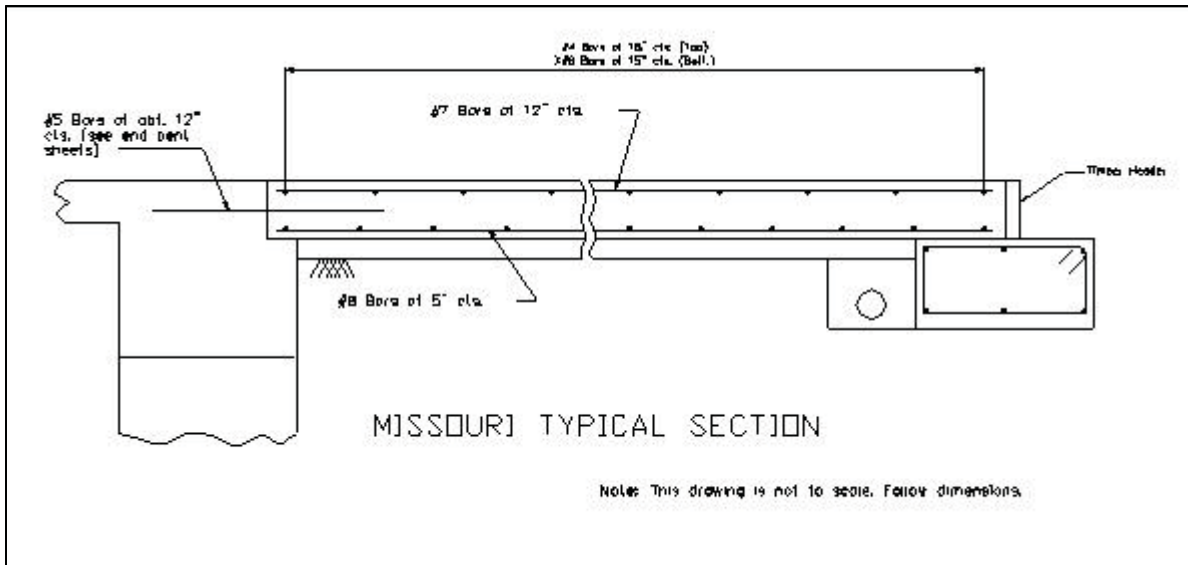

Nebraska

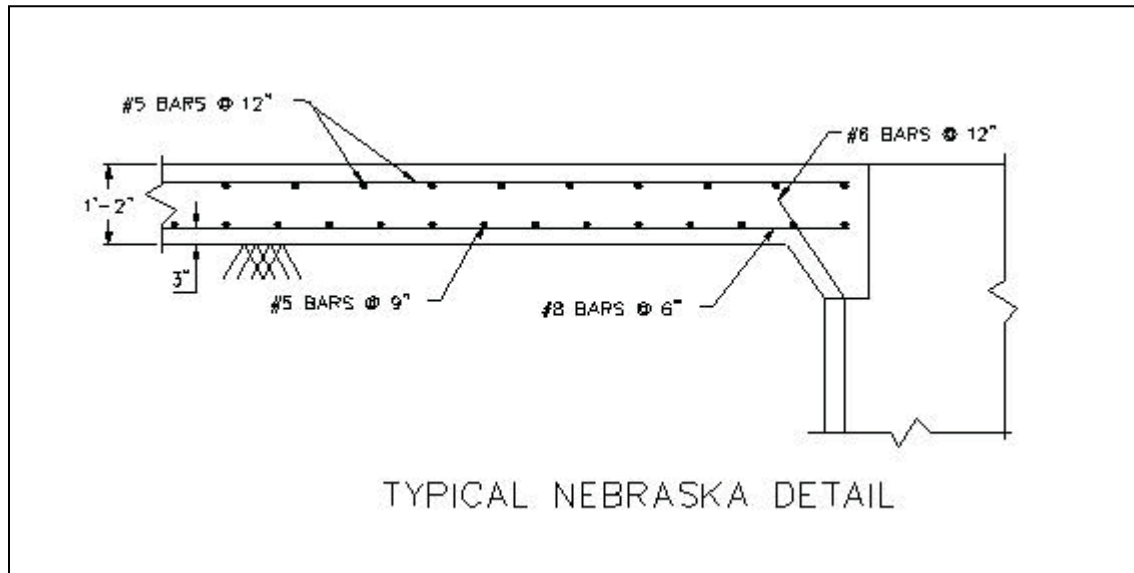

New York

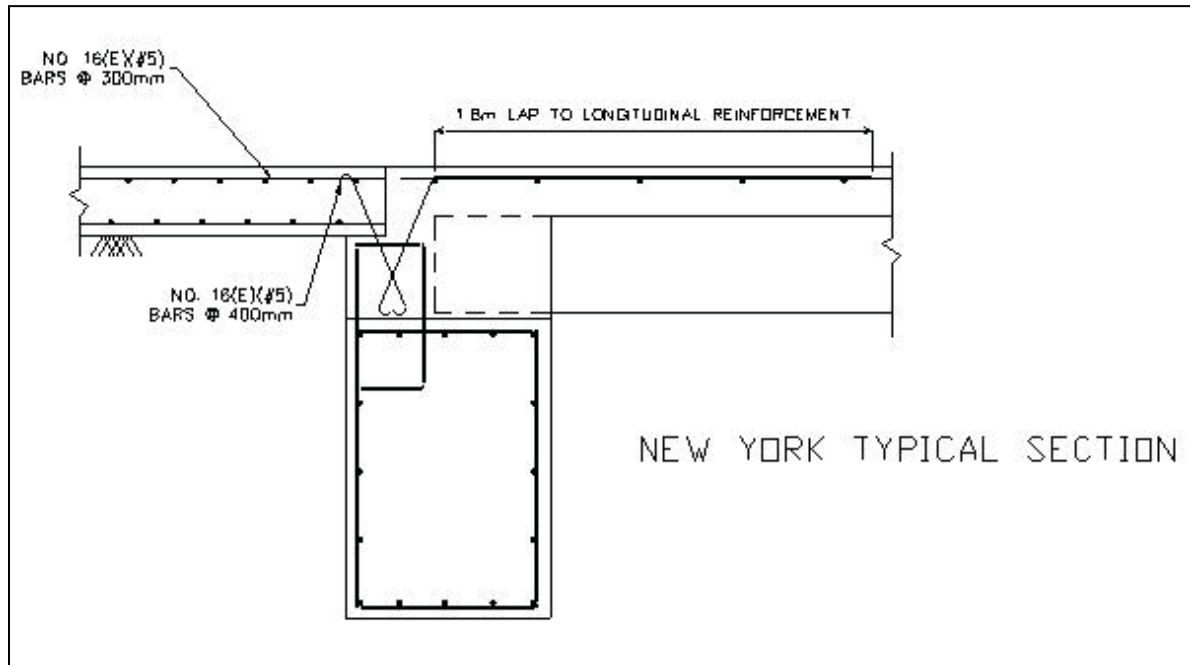

North Carolina

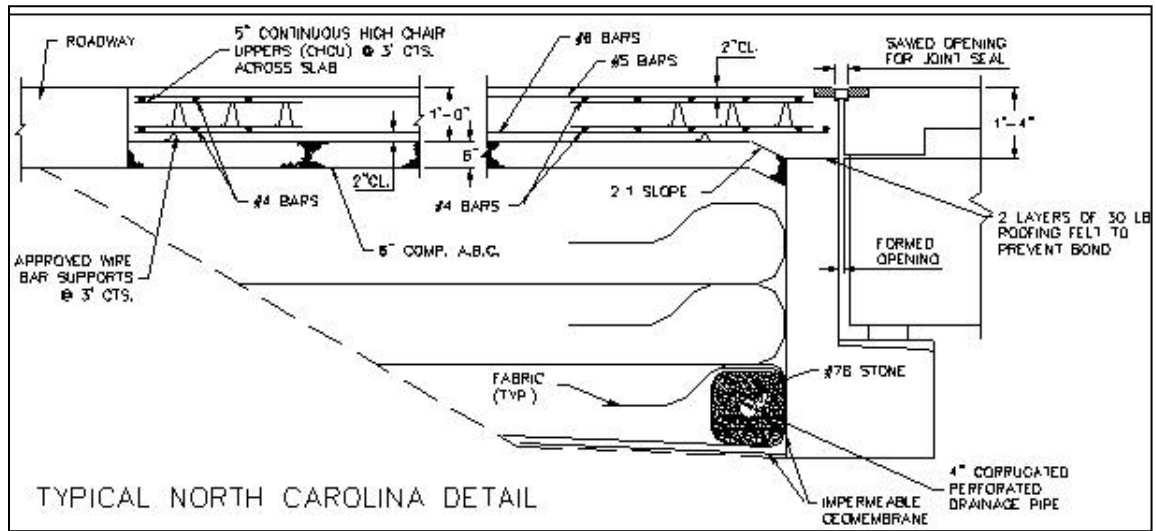

North Dakota

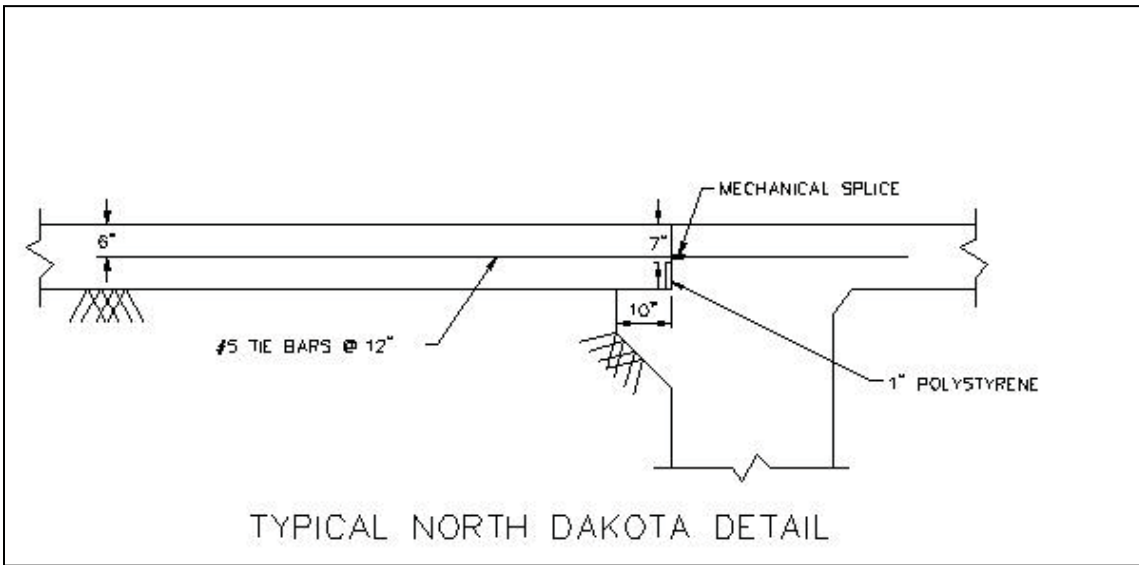

Ohio

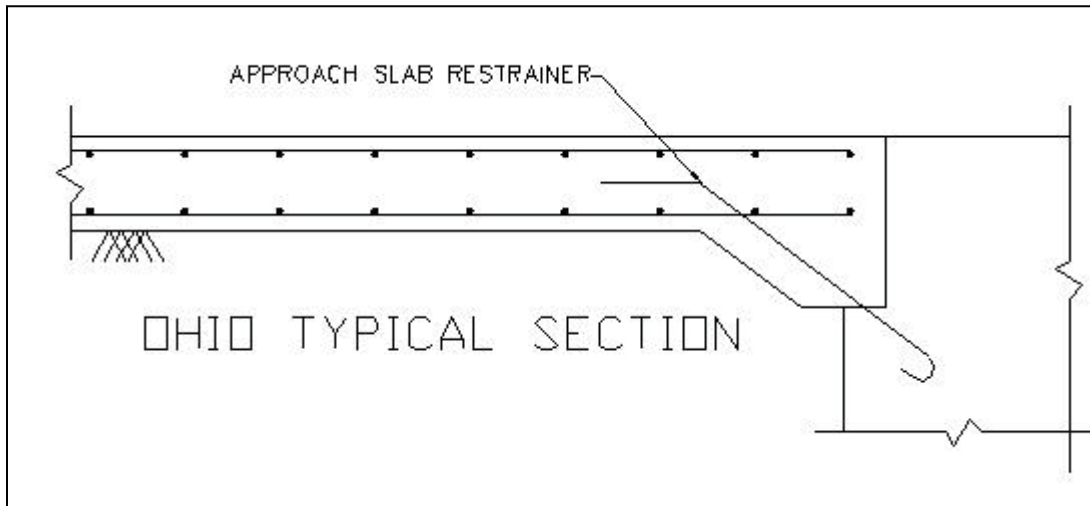

Oklahoma

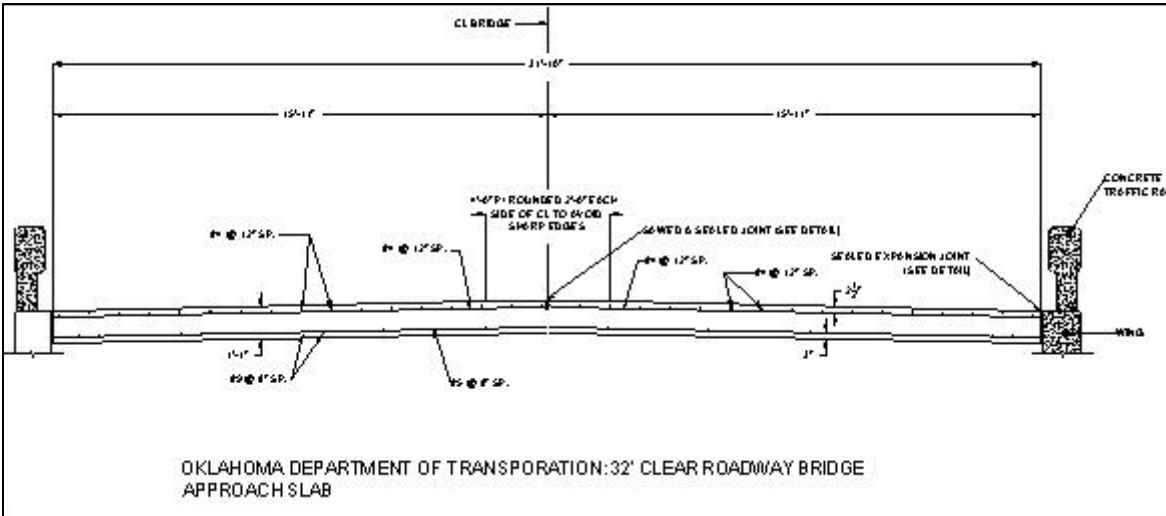
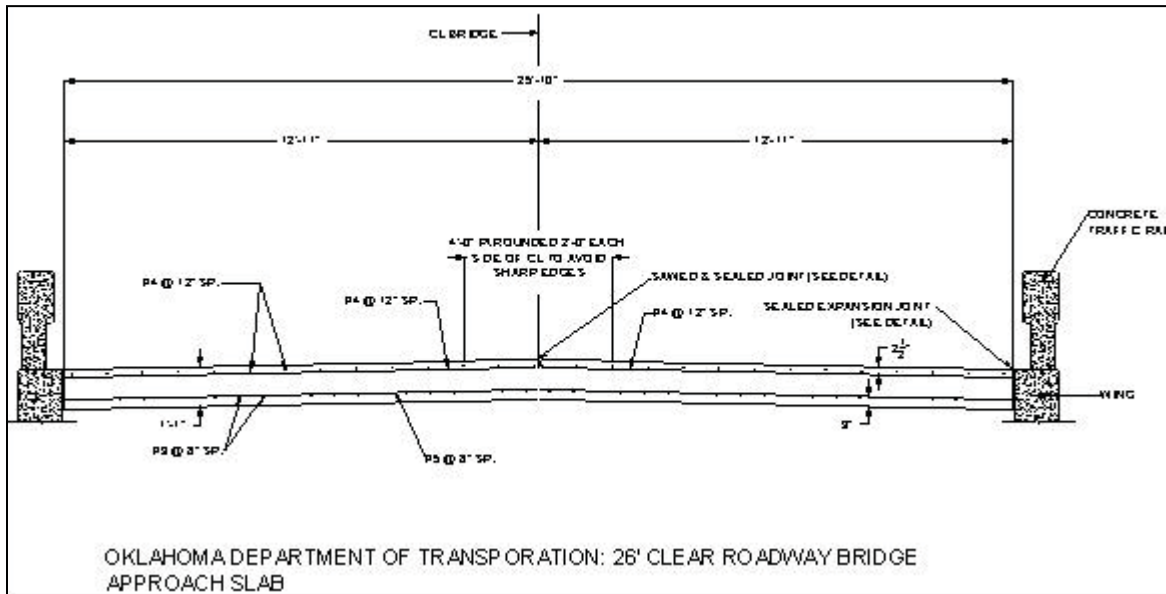

Oregon

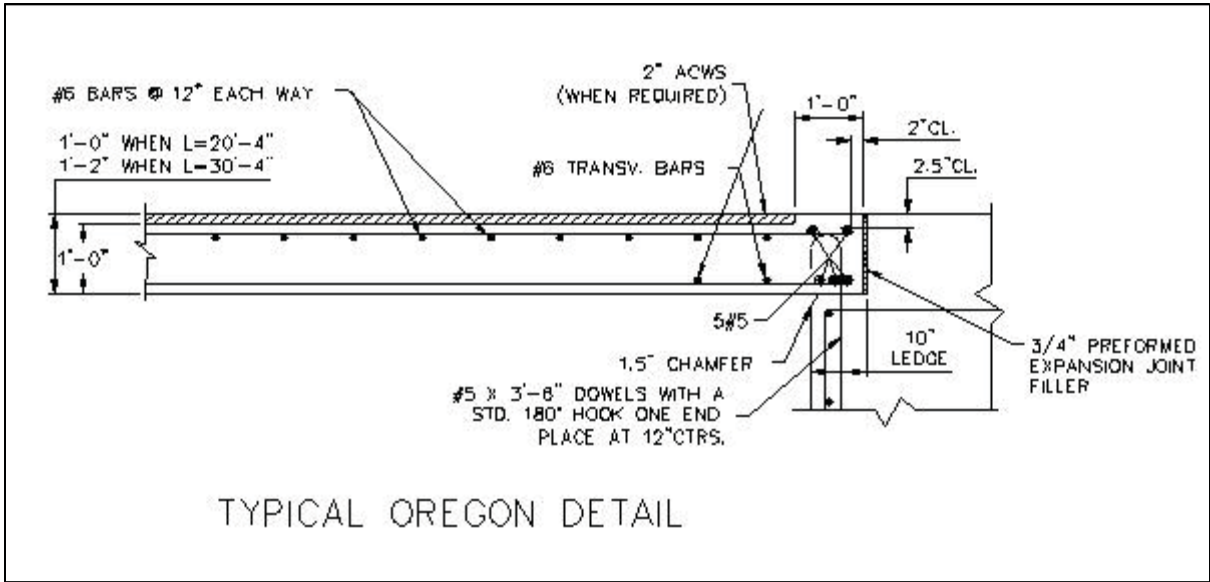

Pennsylvania

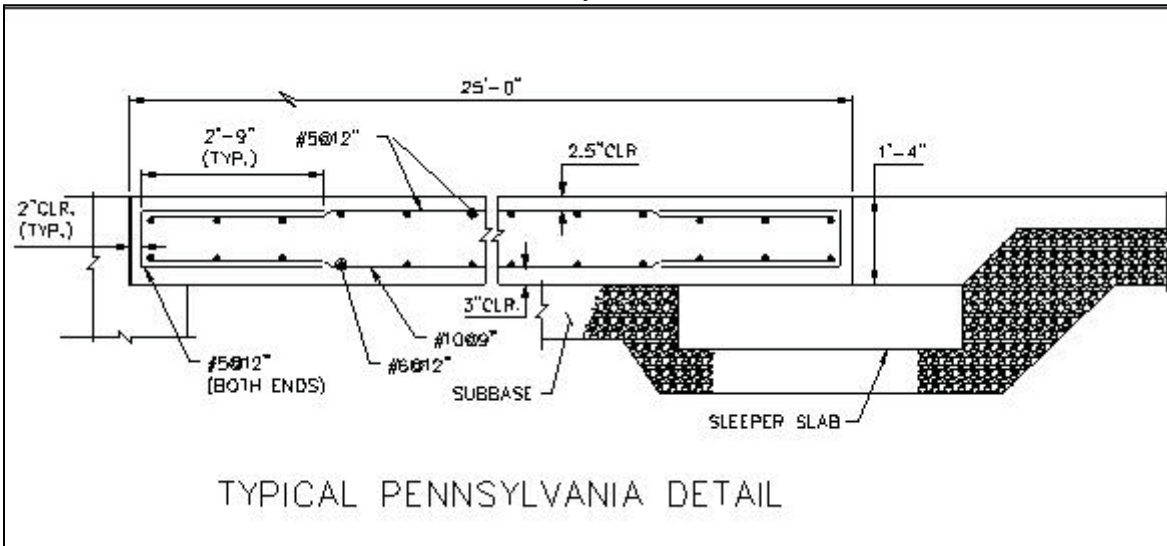

Rhode Island

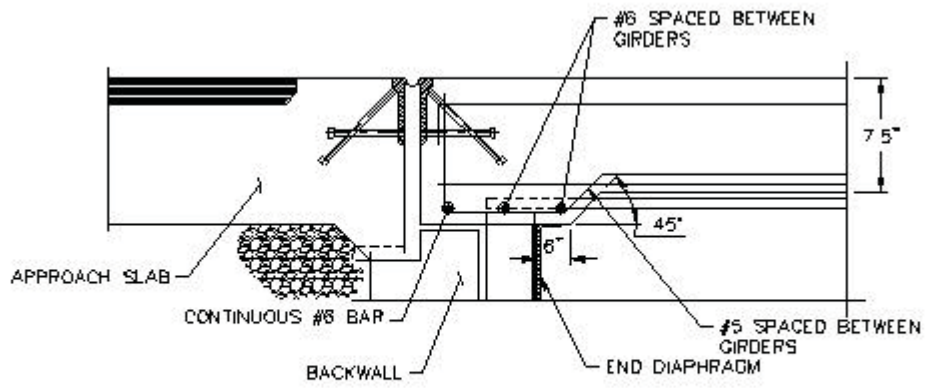

TYPICAL RHODE ISLAND DETAIL

South Dakota

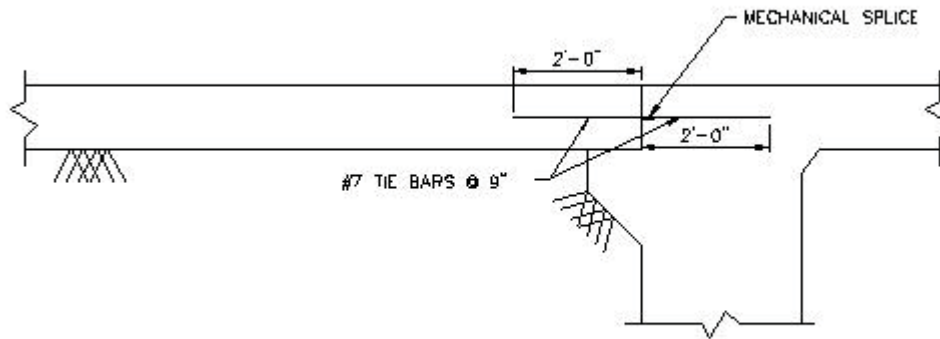

TYPICAL SOUTH DAKOTA DETAIL

Tennessee

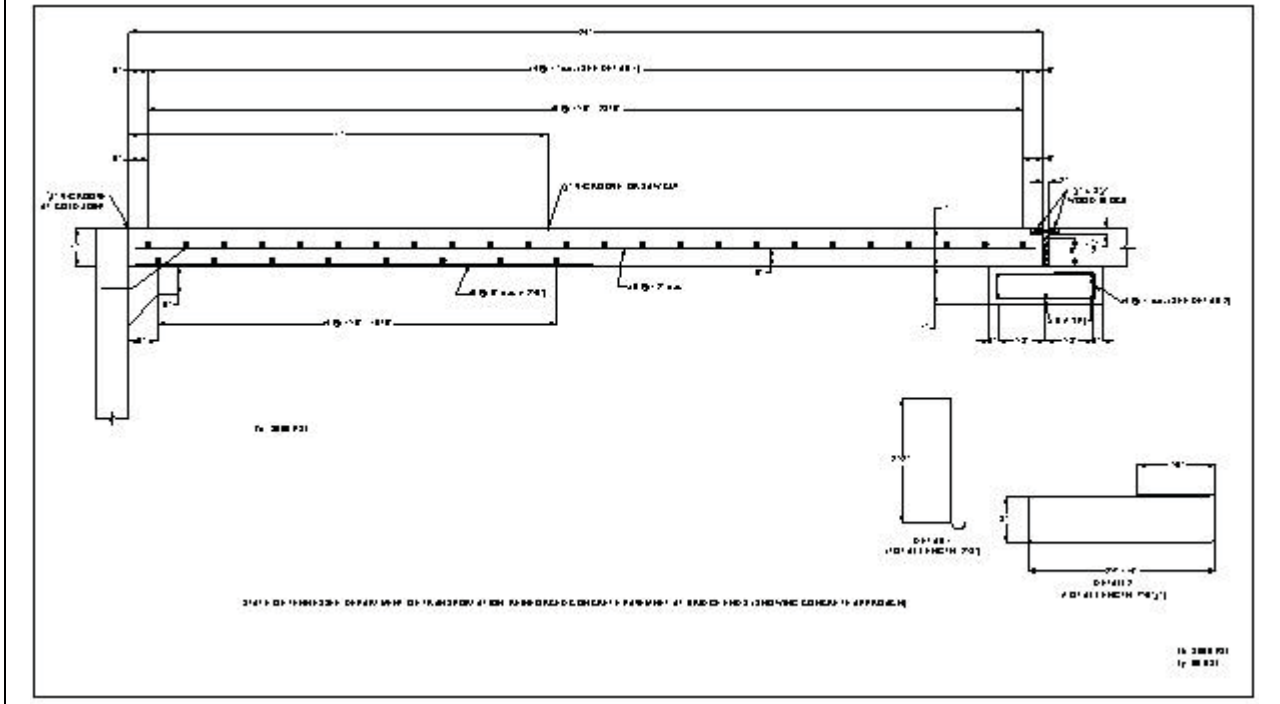

Texas

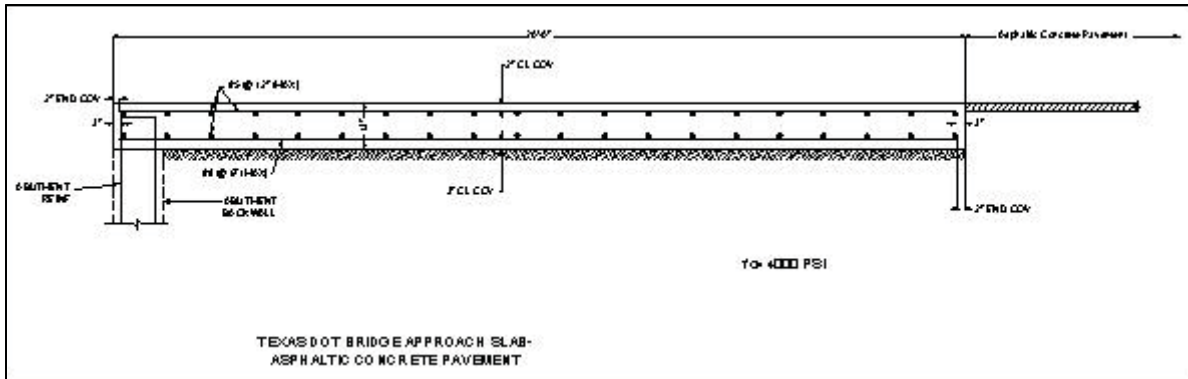
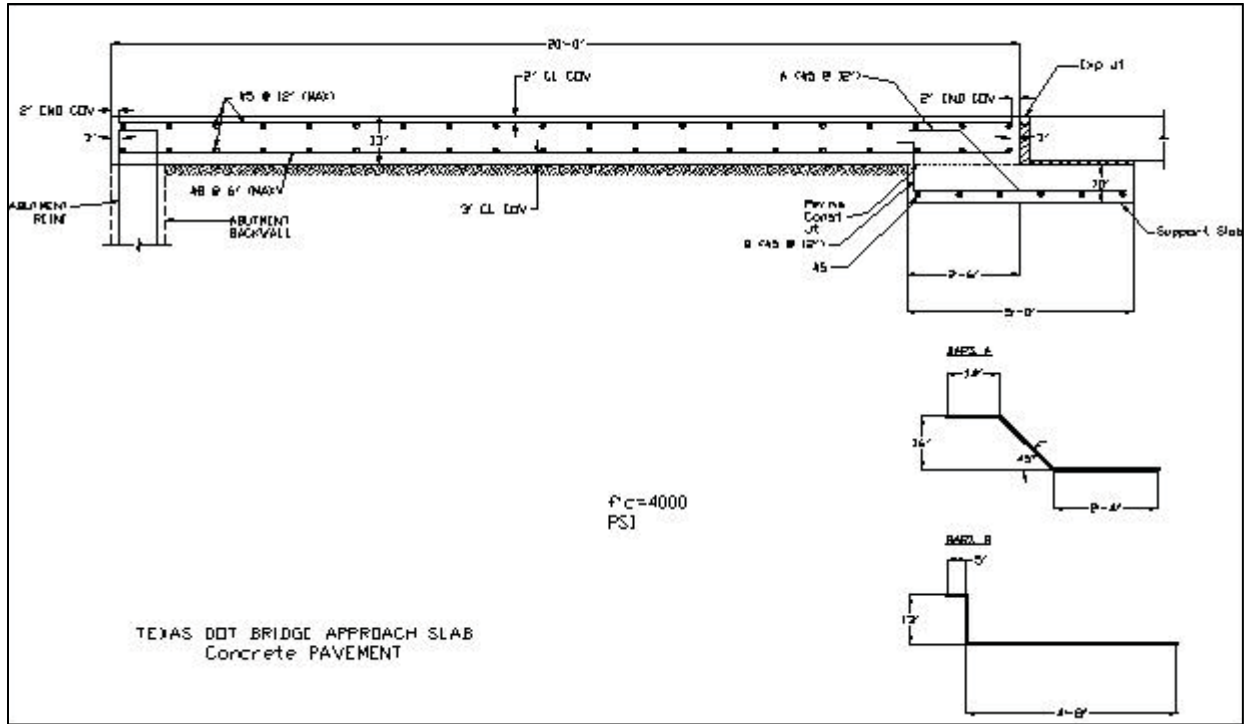

Vermont

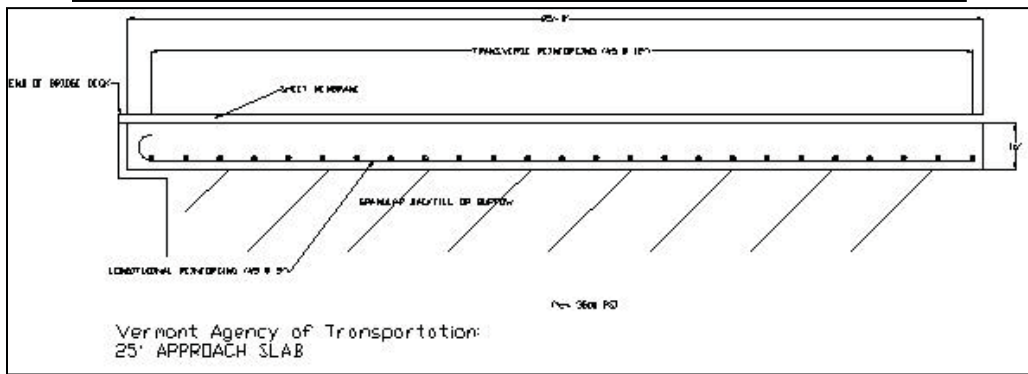
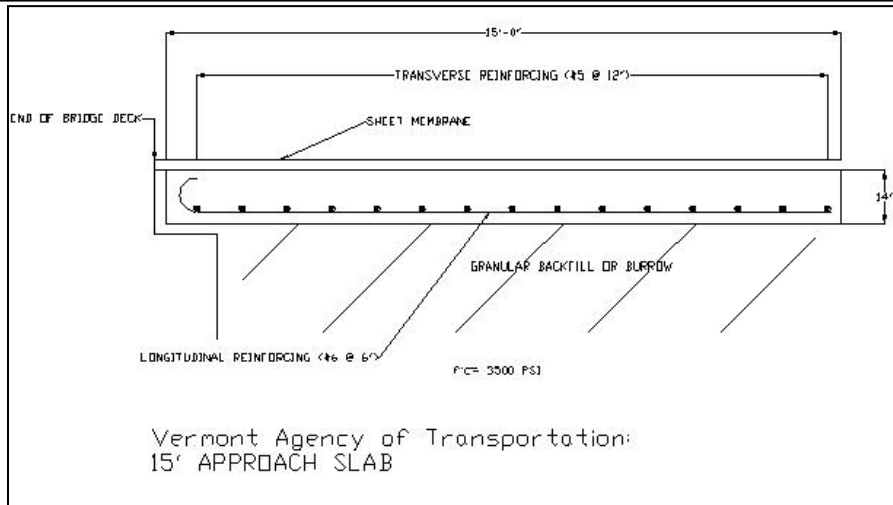
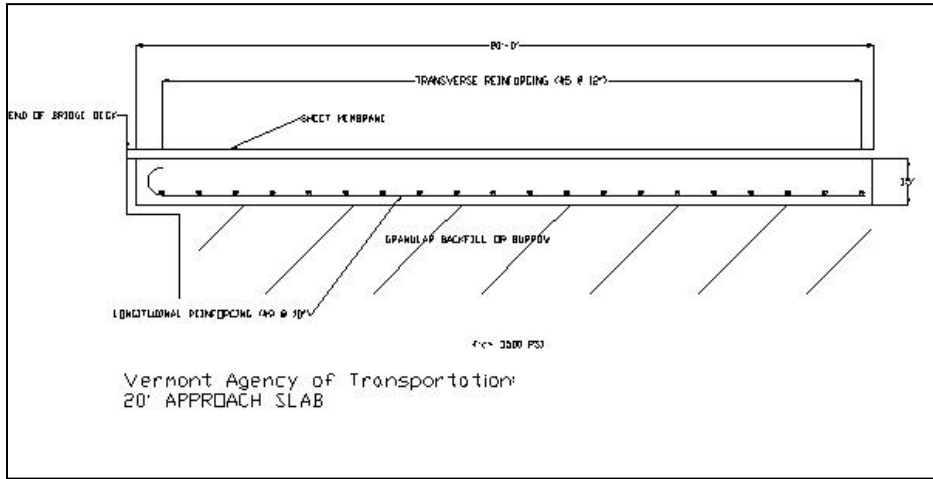

Virginia

VDOT: APPROACH SLAB: 0°-20° SKEW

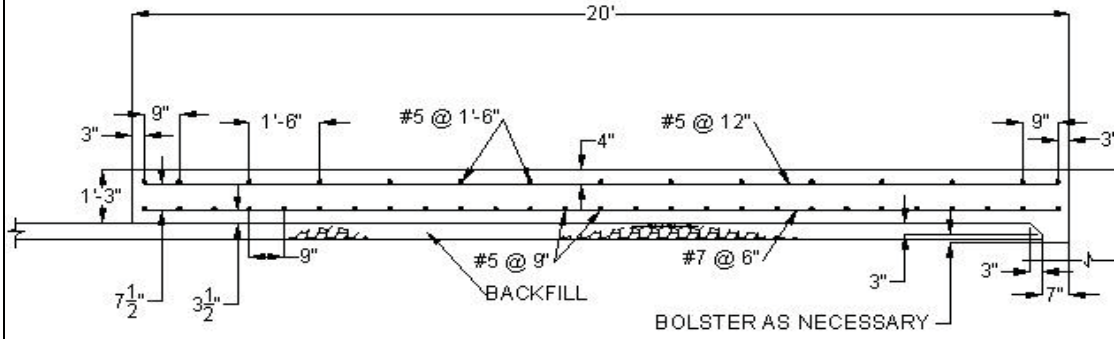

VDOT: APPROACH SLAB: 20°-35° SKEW

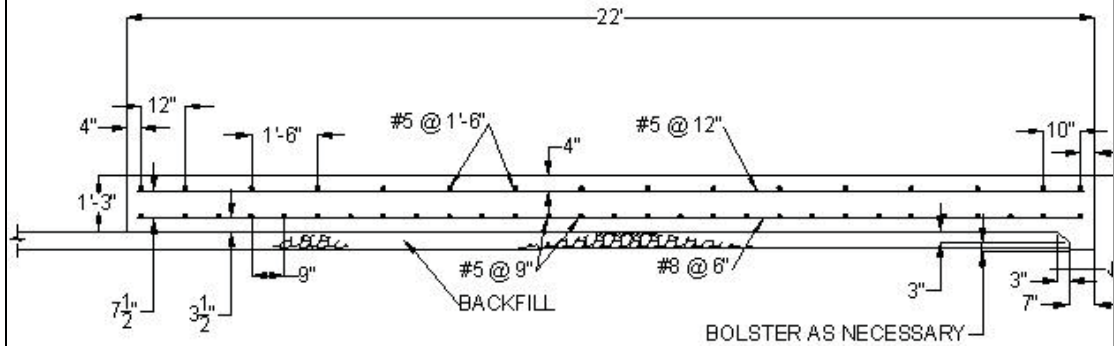

VDOT: APPROACH SLAB: 35°-46° SKEW

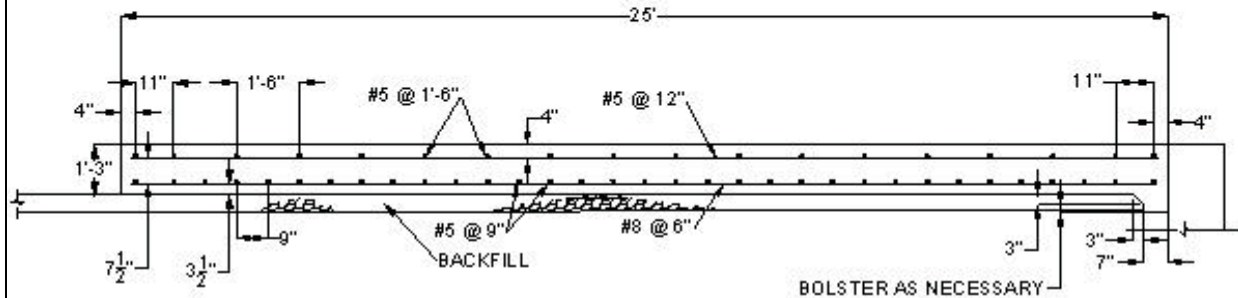

VDOT: APPROACH SLAB: 45°-50° SKEW

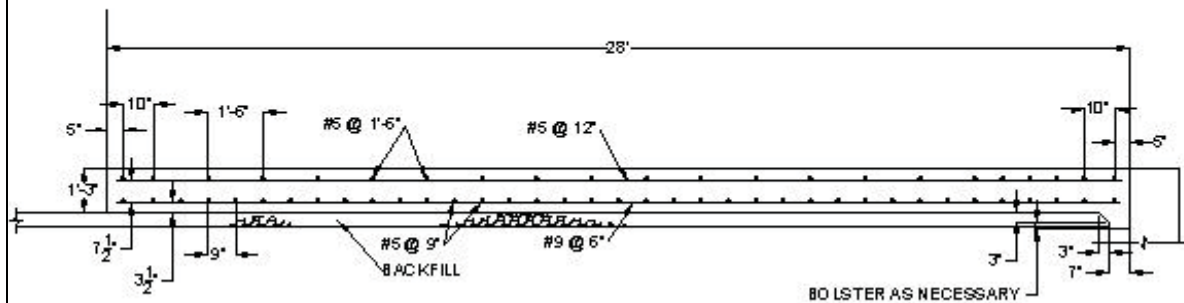

Washington

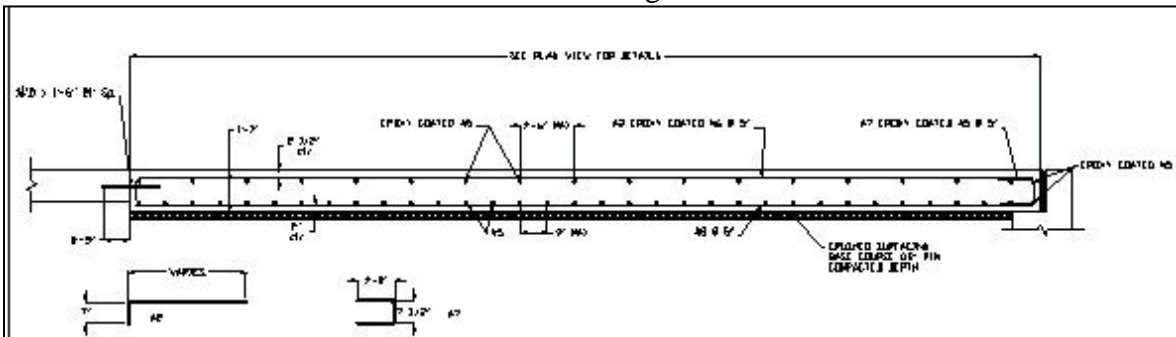

WASHINGTON STATE DEPARTMENT OF
TRANSPORTATION: APPROACH SLAB DESIGN

APPENDIX A-2 Survey Responses

Table A-2- 1 Detailed Response for the state survey

Question 1) Do you face frequent problems with Bridge Approach Slabs in your state? If yes, how would you categorize the approach slab problem in your state	
State	Response
New Mexico	Yes. Approach slab problems are minor to moderate.
Utah	
Alaska	Alaska has used approach slabs for less than 10 years, so we don't have much history of problems. The most common issue is relatively high cost -- Approximately \$50,000 per bridge. Also, with our relatively short construction season (cold climate), the contractors are rushed to cast the approach slab late in the Summer and into the Fall. Sometimes we just delete the approach slabs from the contract if the contractor gets too far behind in his construction schedule
Illinois	Illinois has not experienced frequent problems with their bridge approach slabs.
Arizona	NO
Nebraska	Nebraska has had some minor cracking in some of our approach slabs. They would categorize these problems as minor.
Arkansas	AHTD does not have "frequent problems" with Bridge Approach Slabs constructed with current details. Categorization is Minor.
North Carolina	problems faced with 2% of our 13,000 bridges
Tennessee	The experiences with approach slab problems could not be characterized as frequent, but do occur from time to time. The problems are settlement-related.
Florida	Approach Slab problems are not frequent.
Indiana	There have been some failures of Bridge Approach Slabs in Indiana. These are mostly found on bridges that have been constructed with integral end bents.
Oklahoma	Occasionally face settlement issues with our approach slabs - often times there is a bump at the end of the bridge
South Dakota	The majority of the problems are associated with approach slab settlement (Embankment and/or backfill below the slabs).
Kansas	They have some moderate problems which cost \$40,000 to \$ 75,000 per end on 40' roadway

Iowa	A significant problem
Minnesota	Yes, they face problem in maintaining the joint between BAS and pavement
Pennsylvania	No, they don't face any problems
Montana	They don't use BAS routinely
South Carolina	Minor to moderate problems
Mississippi	A common problem
Virginia	Settlement issues due to lack of compact of approach fill
Question 2) What types of major failures do you see with the approach slabs? (A major failure is one which would require the replacement of the slab and or extensive mud jacking work to be performed).	
State	Response
New Mexico	Severe settlement of the approach roadway embankment. Some of these failures were due to the foundation soils not being preconsolidated before the roadway and bridge were built.
Utah	
Alaska	No major failures encountered to date.
Illinois	Occasionally, Illinois has experienced bridge approach slab failures near the interface with the approach seat on bridge abutments. They sense this problem is sometimes caused during the construction of the approach slab not being fully seated on the abutments because the backfill has covered the top of the approach seat. When this backfill eventually migrates from the top of that seat, there is a gap left which causes the approach slab to settle.
Arizona	No major failures except some settlement and cracking problems in few very old approach slabs.
Nebraska	Nebraska has not had major failures with their approach slabs.
Arkansas	In Arkansas the main failure is movement which requires mud jacking. Suspect the cause is water getting under the slab. Have done some slab jacking with polyurethane.
North Carolina	Settlement is the by far the most common problem. They typically would mudjack these. They have not seen any "structural" failures, which would require replacing the approach slab.
Tennessee	Problems arise from either settlement due to lack of proper embankment compaction or subsidence of ground under the embankment.
Florida	Major problems would be settlement or displacement away from the backwall.
Indiana	Through researching the situation they have found that the cyclic temperature-induced expansion and contraction of the bridges has caused settlement of the backfill under the approach slabs. This situation leaves a void under the slab which quickly cracks.

Oklahoma	They had some settlement issues – cracking
South Dakota	Joint failures, settlement of slab and/or supporting "sleeper" slab and deterioration of ride quality due to poor roadway profile are the more major issues.
Kansas	They have considerable problems with the approach slabs. 1) Differential settlement issues. a) Often caused by the public's demand to open a roadway as fast as we can which doesn't allow enough time for large fill areas to settle out. b) Kansas goes through an extensive number of freeze-thaw cycles per year (per day on some days). c) Drainage problems which creates voids. 2) Expansion joint problems-maintain water tight joints which always allow proper movement. a) Joint materials don't perform well with movements in all directions. 3) Aggregate problems, D-cracking, etc. 4) Fill material problems-expansive soils.
Iowa	They have experienced the following problems 1. Failure of the paving notch on the abutment. 2. Failure at the end of approach slab that rests on the paving notch 3. Settlement of the approach slab at 20'+ from the bridge 4. Large cracks in the approach slab panels
Minnesota	Extensive cracking or settlement
Pennsylvania	N/A
Montana	N/A
South Carolina	Extensive voids underneath due to either poor material and/or water leakage.
Mississippi	Settlement issues
Virginia	Settlement issues due to lack of compaction of approach fill
Question 3) What type of minor failures do you see with approach slabs? (A minor failure is one where the DOT maintenance personnel would be able to fix the problem).	
State	Response
New Mexico	Minor joint failures, minor settlement. Minor settlement is fixed by overlaying the approach slab with asphalt to get a smoother riding surface.
Utah	
Alaska	No minor failures encountered to date.
Illinois	One minor problem encountered is when bridge approach slab used with integral abutment (joint-less bridges) is tied to the bridge deck slab with a series of longitudinal bars. As the bridge approach slab is poured and begins curing, the bridge may expand and contract during that curing that can lead to some cracking in the approach slab.
Arizona	Minor local deterioration and cracks

Nebraska	Nebraska has had some minor cracking in some of our approach slabs. They have recently increased the amount of reinforcing steel in the paving and approach sections to alleviate this cracking.
Arkansas	Minor settlement at the end away from the bridge. Not Many. Mostly cracking which would be sealed or patching a spall with rapid set concrete.
North Carolina	Only "minor" failure would be in the joint between the approach slab and the structure. They may also have a few concrete surface spalls, but not much else.
Tennessee	Minor vs. major is solely defined by the degree of settlement and what it takes to correct the problem. If paving can correct the problem, it's minor. If slab replacement or jacking is the solution, it's major.
Florida	Minor problems would be cracking or spalling of the concrete, or erosion along edges of approach slabs.
Indiana	Minor cracking can be seen in some other approaches. If any maintenance is done on these it would be just to seal the cracks.
Oklahoma	Small bump at the end of the bridge, minor settlement, shrinkage cracks
South Dakota	Minor joint repairs not involving significant settlement, neoprene gland tearing or pullout, and steel extrusion anchorage failure are some minor issues not requiring replacement or mudjacking of the slab itself.
Kansas	Expansion joint problems-if caught in a timely manner District's can make repairs. All Districts contract most mud jacking operations but some do minor repairs themselves. District patches spalls, seal cracks and level uneven pavement with asphalts.
Iowa	Development of voids adjacent to the abutment below the approach slab, some of the voids have been very large.
Minnesota	Problems with the joint at the end, and some issues with erosion due to inadequate drainage.
Pennsylvania	N/A
Montana	N/A
South Carolina	Approach slab movement.
Mississippi	Cracking and small pot holes.
Virginia	Settlement issues that can be solved by additional asphalt to the approaches.
Question 4) Are you satisfied with the current design or are you planning to change it?	
State	Response
New Mexico	Changed our backfill requirements, and we are doing more preconsolidation in areas where we are building large fills.
Utah	
Alaska	Generally satisfied with their current design. May consider going to a precast concrete slab instead of cast-in-place to eliminate end of construction season / cold weather related problems with curing concrete.
Illinois	Illinois is currently satisfied with their bridge approach slab design and details. It

	is designed as a structural member able to span the 30 foot length. That way if the backfill settles near the abutment, the approach slab can span that void.
Arizona	Yes, they are satisfied with the current practices.
Nebraska	Yes, they are satisfied with their current design. They don't plan to change it.
Arkansas	Currently satisfied with no plans to change.
North Carolina	They have changed the subgrade preparation a few times, but the basic reinforced concrete slab has remained unchanged. They don't see any changes.
Tennessee	They are satisfied with the current design.
Florida	They are satisfied with the current design.
Indiana	They are currently looking into the problem with integral structures from both a structural and geotechnical aspect. Design changes may be recommended.
Oklahoma	They are planning to change their integral abutment design to place flowable fill under the approaches instead of granular backfill material.
South Dakota	The plan is to continue to use current details/design; however they are always looking to improve.
Kansas	<p>They have had better success recently (15 years) by tying first 13' approach section into bridge decks (6 years). Abutment strip drains (10 years) have also helped a great deal.</p> <p>They are going to a new joint system (District One has used for 5 years) that the Districts are more willing and able to maintain by themselves (Polytite—recent price \$110/Ft installed, District 5). A number of areas in District One have completed installations themselves.</p> <p>They are currently looking at a new idea using an asphalt wedge between concrete slabs to be used as a buffer for expansion and contraction (see attachment). The districts would be able to maintain the asphalt wedge easier and more effectively.</p>
Iowa	They changed the design of the approach slab and the paving notch. The approach slab panel adjacent to the bridge has been designed to be a structural beam, allowing it to carry load when sub-grade support is lost. The paving notch width has been increased to 15" and a piece of the fiber board laps onto the front 4" of the notch to "shield" the corner from load.
Minnesota	They are in the process of updating the standards.
Pennsylvania	<p>They have design standards and construction standards for approach slabs that are available on the internet.</p> <p>Design Standards</p> <p>ftp://ftp.dot.state.pa.us/Bridge%20Standards/Current%20Bridge%20Design%20Standards%20-%20BD-600M%20Series/bd628m.pdf</p>
Montana	N/A
South Carolina	Satisfied with the current design.
Mississippi	They are currently looking at a minor re-design, dropping the elevations down about 2 inches and placing a lift of HMA on them.

Virginia	For the last two years (+/-) they have been changing the selection of backfill material behind the abutments.
Question 5) Do you always specify special backfill for all approach slabs? Or do you have certain minor routes where no special backfill is specified and that you see a greater number of approach slab failure problems under those conditions.	
State	Response
New Mexico	They do not always specify special backfill. On Interstates, U.S. routes and major NM routes, they specify special backfill or flowable fill and preconsolidation if necessary. On minor routes, we specify A-1-a material compacted to 100% standard proctor density.
Utah	
Alaska	Alaska always requires special embankment compaction at bridge approaches.
Illinois	For integral abutments Illinois uses uncompacted porous granular embankment and for pile supported abutments and open abutments they use porous granular embankments.
Arizona	Yes, always specifies some sort of special backfill.
Nebraska	Nebraska specifies granular backfill underneath all our approach and paving sections.
Arkansas	Arkansas typically does not specify the backfill material under the approach slab.
North Carolina	Special backfill is always required, but heavily traveled primary routes would have the subgrade backfill material reinforced with geofabrics. The secondary routes may not get this, but traffic will be somewhat reduced.
Tennessee	Always specify special backfill.
Florida	The standards are the same for all bridges.
Indiana	Special backfill is required in all cases.
Oklahoma	Yes
South Dakota	Whenever a reinforced concrete approach slab is part of the plans, it gets special bridge end backfill. The type and configuration of the special backfill has varied over the years, but it does not seem to have had a significant impact on number of approach slab failure problems.
Kansas	They do specify better materials and compaction requirements within certain limits of the bridge.
Iowa	They specify special backfill. Recently, they have required that “flooding or jetting” be used during placement of the backfill.
Minnesota	They use the same backfill for all approach slabs.
Pennsylvania	They always specify a backfill that is free draining, typically we receive #57 aggregate.
Montana	N/A
South Carolina	They don’t specify special backfill.
Mississippi	They don’t specify special backfill.
Virginia	They use special backfill.

Question 6) Any other thoughts on this problem that you would like to share.	
State	Response
New Mexico	They would like to see what the results of our survey show. Perhaps some of the states may have solutions that would work in NM state.
Utah	
Alaska	They have considered eliminating approach slabs on future projects. They are expensive and don't appear to offer a lot of benefit. It may be more cost effective to re-grade / re-pave the bridge approaches every couple of years.
Illinois	Drainage along the back of the abutment is important. See their details on the following site. http://www.dot.il.gov/cell/details.pdf
Arizona	-
Nebraska	Their approach slabs consist of a 20 ft. approach section and a 30 ft. paving section. They place grade beams on piles 20 ft. away from the abutments. They also locate our expansion joints at the grade beams. The approach section is supported by this grade beam and at the abutment, therefore acting as a simple span member. One end of the paving section bears on the grade beam and the other end on the roadway embankment. This design has worked very well for us for many years and provides a relatively smooth ride on and off the bridge.
Arkansas	AHTD does not construct Approach Slabs for every bridge. Their current policy is to provide Approach Slabs for new construction on Interstate Routes or on bridges in high seismic zones.
North Carolina	They somewhat relate settlement problems to settlement in the embankment and natural material beneath the new embankment. They are always studying ways to reduce the settlement problems.
Tennessee	None
Florida	None
Indiana	None
Oklahoma	None
South Dakota	None
Kansas	None
Iowa	
Pennsylvania	N/A
Montana	N/A
South Carolina	N/A
Mississippi	N/A
Virginia	They have not evaluated approach slabs with full integral and semi-integral bridges, especially with the use of a sleeper pad.

APPENDIX A-3 SITE VISIT PICTURES

Table A-3- 1 Site Visit Pictures

MO-71 Kansas City



Cracking



Surface cracking

Bridge at Front street-Kansas City



Sleeper slab



Approach slab base



Sleeper slab reinforcement



Pouring of Sleeper slab



Pouring of Concrete in BAS



Pouring completed

US 65-Chillicothe

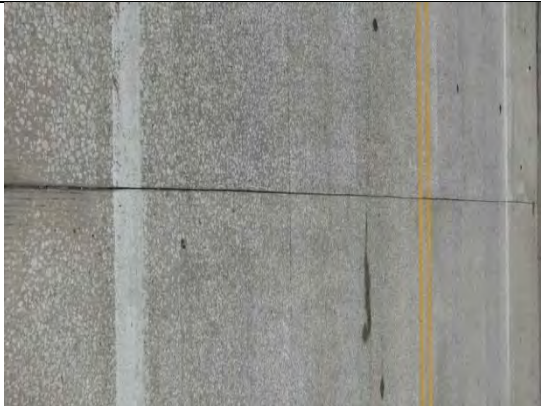

BAS surface



Erosion of soil underneath BAS



BAS movement from the abutment



Bump

Lynn County



1" Bump at end of the bridge



Surface cracking due to uneven settlement



1/2" Bump at other end of the bridge

Randolph



Erosion of soil underneath BAS



Erosion of soil underneath BAS

Schuyler County



Soil erosion underneath BAS



Surface cracking



Surface cracking

APPENDIX A-4 PAY ITEM SUMMARY FROM MODOT

TASK DETAIL REPORT

Date: 02/17/2009
Time: 13:43:50

Project: **A7540** Project No.: **J8P0683C**
 Location: **GREENE CO.** Bid Date: **02/15/2009**

Pay Item: **503-10.10 BRIDGE APPROACH SLAB (BRIDGE)**
 Pay Item Quantity: **185.000 S.Y.**

Task: **Prepare Base for App. Slab** Estimated Time: **0.84 days**
 Task Quantity: **21.00 C.Y.** Productivity: **25.00 c.y./day**
0.800 manhours/C.Y.

LABOR									
description	number	days	base rate	loaded rate	S.T. cost	Overtime		total cost	unit cost
operator	2.0	0.84	276.49	471.79	541.20	46.50		792.60	37.74
	2.0	1.68			541.20	46.50		792.60	37.74
EQUIPMENT									
description	number	days	Rate/day	ownership	oper cost	rental equip	operation	total cost	unit cost
compactor 8 ton roller	1.0	0.84	174.40	47.00	23.50	30.20	45.80	146.50	6.98
loader cat	1.0	0.84	312.74	117.60	37.00	47.00	61.10	262.70	12.51
	2.0	1.68		164.60	60.50	77.20	106.90	409.20	19.49
MATERIAL/SUPPLIES									
description	quan+waste	units	unit price	sub-total	waste	sales tax		total cost	unit cost
Type V Aggregate	23.100	C.Y.	18.15	381.15	10.00%	0.00%		419.27	19.97
				381.15	38.12	0.00		419.27	19.97

	total cost	unit cost
TOTAL TASK COST:	1,621.07	77.20
Overhead:	81.05	3.86
Profit:	170.21	8.11
Other Mark-Up:	0.00	0.00
TOTAL COST PLUS MARK-UP:	1,872.33	89.17

TASK DETAIL REPORT

Date: 02/17/2009
Time: 13:43:50

Project: **A7540** Project No.: **J8P0683C**
Location: **GREENE CO.** Bid Date: **02/15/2009**

Pay Item: **503-10.10 BRIDGE APPROACH SLAB (BRIDGE)**
Pay Item Quantity: **185.000 S.Y.**

Task: **Form Approach Slab** Estimated Time: **1.00 days**
Task Quantity: **2.00 EACH** Productivity: **2.00 each/day**
30,000 manhours/EACH

LABOR description	number	days	base rate	loaded rate	S.T. cost	Overtime	total cost	unit cost
foreman	1.0	1.00	380.00	437.00	437.00	0.00	437.00	218.50
laborer	2.0	1.00	221.40	374.50	515.90	44.30	749.00	374.50
operator	1.0	1.00	276.50	471.80	322.10	27.70	471.80	235.90
carpenter	2.0	1.00	274.10	441.85	638.70	54.80	883.70	441.85
	6.0	6.00			1,913.70	126.80	2,541.50	1,270.75

EQUIPMENT description	number	days	Rate/day	ownership	oper cost	repair part	rental equip	operation	total cost	unit cost
loader cat	1.0	1.00	312.80	140.00	44.00	56.00	72.80	312.80	156.40	
compressor	1.0	1.00	105.40	24.00	12.00	14.00	55.40	105.40	52.70	
generator cat 45 kw	1.0	1.00	114.60	28.00	16.00	16.00	54.60	114.60	57.30	
truck 2ton flatbed	1.0	1.00	93.60	26.40	8.00	7.60	51.60	93.60	46.80	
	4.0	4.00		218.40	80.00	93.60	234.40	626.40	313.20	

MATERIAL/SUPPLIES description	quant+waste	units	unit price	sub-total	waste	sales tax	total cost	unit cost
Forms-approach slab	180.950	S.F.	1.01	166.15	10.00%	0.00%	182.77	91.38
Timber Header - 3" x 10"	103.950	L.F.	3.26	308.07	10.00%	0.00%	338.88	169.44
				474.22	47.42	0.00	521.64	260.82

	total cost	unit cost
TOTAL TASK COST:	3,689.54	1,844.77
Overhead:	184.48	92.24
Profit:	387.40	193.70
Other Mark-Up:	0.00	0.00
TOTAL COST PLUS MARK-UP:	4,261.42	2,130.71

TASK DETAIL REPORT

Date: 02/17/2009
Time: 13:43:51

Project: **A7540** Project No.: **J8P0683C**
Location: **GREENE CO.** Bid Date: **02/15/2009**

Pay Item: **503-10.10 BRIDGE APPROACH SLAB (BRIDGE)**
Pay Item Quantity: **185.000 S.Y.**

Task: **Set Approach Slab Steel** Estimated Time: **0.88 days**
Task Quantity: **17,575.00 LBS** Productivity: **20,000.00 lbs/day**
0.003 manhours/LBS

LABOR description	number	days	base rate	loaded rate	S.T. cost	Overtime	total cost	unit cost
foreman	1.0	0.88	380.00	437.05	384.60	0.00	384.60	0.02
laborer	2.0	0.88	221.42	374.55	454.00	39.00	659.20	0.04
operator	1.0	0.88	276.48	471.59	283.40	24.30	415.00	0.02
iron worker	2.0	0.88	237.50	503.92	487.00	41.80	886.90	0.05
	6.0	5.28			1,609.00	105.10	2,345.70	0.13

EQUIPMENT description	number	days	Rate/day	ownership	oper cost	repair part	rental equip	operation	total cost	unit cost
loader cat	1.0	0.88	312.84	123.20	38.70	49.30	64.10	275.30	0.02	0.02
compressor	1.0	0.88	105.45	21.10	10.60	12.30	48.80	92.80	0.01	0.01
generator cat 45 kw	1.0	0.88	114.66	24.60	14.10	14.10	48.10	100.90	0.01	0.01
truck 2ton flatbed	1.0	0.88	93.52	23.20	7.00	6.70	45.40	82.30	0.00	0.00
	4.0	3.52		192.10	70.40	82.40	206.40	551.30	0.04	0.04

MATERIAL/SUPPLIES description	quant+waste	units	unit price	sub-total	waste	sales tax	total cost	unit cost
Reinforcing Steel Epoxy	19,332.500	LBS	0.69	12,126.75	10.00%	0.00%	13,339.43	0.76
				12,126.75	1,212.68	0.00	13,339.43	0.76

	total cost	unit cost
TOTAL TASK COST:	16,236.43	0.93
Overhead:	811.83	0.05
Profit:	1,704.83	0.10
Other Mark-Up:	0.00	0.00
TOTAL COST PLUS MARK-UP:	18,753.09	1.07

TASK DETAIL REPORT

Date: 02/17/2009
Time: 13:43:51

Project: **A7540**
Location: **GREENE CO.**

Project No.: **J8P0683C**
Bid Date: **02/15/2009**

Pay Item: **503-10.10 BRIDGE APPROACH SLAB (BRIDGE)**
Pay Item Quantity: **185.000 S.Y.**

Task: **Pour Approach Slab**
Task Quantity: **2.00 EACH**

Estimated Time: **2.00 days**
Productivity: **1.00 each/day**
150,000 manhours/EACH

LABOR	description	number	days	base rate	loaded rate	S.T. cost	Overtime	total cost	unit cost
	foreman	2.0	2.00	380.00	437.00	1,748.00	0.00	1,748.00	874.00
	laborer	8.0	2.00	221.40	374.48	4,126.90	354.20	5,991.60	2,995.80
	operator	2.0	2.00	276.50	471.78	1,288.50	110.60	1,887.10	943.55
	carpenter	1.0	2.00	274.10	441.85	638.70	54.80	883.70	441.85
	finisher	2.0	2.00	246.20	480.55	1,147.30	98.50	1,922.20	961.10
		15.0	30.00			8,949.40	618.10	12,432.60	6,216.30

EQUIPMENT	description	number	days	Rate/day	ownership	oper cost	rental equip	operation	total cost	unit cost
	loader cat	1.0	2.00	312.80	280.00	88.00	112.00	145.60	625.60	312.80
	compressor	1.0	2.00	105.40	48.00	24.00	28.00	110.80	210.80	105.40
	concrete bridge deck finisher	1.0	2.00	156.00	216.00	16.00	16.00	64.00	312.00	156.00
	concrete pump truck rental	1.0	2.00	982.00	0.00	0.00	1,600.00	364.00	1,964.00	982.00
	generator cat 45 kw	1.0	2.00	114.60	56.00	32.00	32.00	109.20	229.20	114.60
	truck 2ton flatbed	1.0	2.00	93.60	52.80	16.00	15.20	103.20	187.20	93.60
	truck water	1.0	2.00	281.00	268.00	48.00	32.00	214.00	562.00	281.00
		7.0	14.00		920.80	224.00	1,835.20	1,110.80	4,090.80	2,045.40

MATERIAL/SUPPLIES	description	quan+waste	units	unit price	sub-total	waste	sales tax	total cost	unit cost
	Concrete 4000 psi	81.400	C.Y.	106.00	7,844.00	10.00%	0.00%	8,628.40	4,314.20
					7,844.00	784.40	0.00	8,628.40	4,314.20

	total cost	unit cost
TOTAL TASK COST:	25,151.80	12,575.90
Overhead:	1,257.59	628.80
Profit:	2,640.93	1,320.47
Other Mark-Up:	0.00	0.00
TOTAL COST PLUS MARK-UP:	29,050.32	14,525.16

PAY ITEM SUMMARY

Date: 02/17/2009
Time: 13:43:51

Project: **A7540** Project No.: **J8P0683C**
Location: **GREENE CO.** Bid Date: **02/15/2009**

Pay Item: **503-10.10 BRIDGE APPROACH SLAB (BRIDGE)**
Pay Item Quantity: **185.000 s.y.**

	<i>Total Amount</i>	<i>Unit Amount</i>		<i>Total Amount</i>	<i>Unit Amount</i>
LABOR			EQUIPMENT		
Number:	29		Number:	17	
ManTime:	43.0 Days		Equipment Time:	23.2 Days	
Regular Time:	11,198.24	60.53	Ownership:	1,495.89	8.09
Overtime:	896.46	4.85	OPER COST:	434.90	2.35
Payroll Taxes:	1,814.41	9.81	REPAIR PART:	488.40	2.64
Insurance:	0.00	0.00	RENTAL EQUIP:	1,599.99	8.65
Fringe Benefits:	4,202.39	22.72	Fuel:	49.10	0.27
Labor (plug):	0.00	0.00	Tires:	1,609.39	8.70
			Oil/Grease:	0.00	0.00
Subtotal Labor:	18,111.50	97.90	Equipment (plug):	0.00	0.00
Mark-Up:	2,807.43	15.18			
LABOR TOTAL:	20,918.93	113.08	Subtotal Equipment:	5,677.65	30.69
Avg Daily Cost:	421.59		Mark-Up:	880.05	4.76
			EQUIPMENT TOTAL:	6,557.70	35.45
			Avg Daily Cost:	244.73	

MATERIAL			SUPPLIES		
Sub-Total:	20,659.45	111.67	Sub-Total:	166.50	0.90
Waste:	2,065.95	11.17	Waste:	16.65	0.09
Sales Tax:	0.00	0.00	Sales Tax:	0.00	0.00
Material (plug):	0.00	0.00	Supplies (plug):	0.00	0.00
Material Cost:	22,725.40	122.84	Supplies Cost:	183.15	0.99
Mark-Up:	3,522.51	19.04	Mark-Up:	28.33	0.15
MATERIAL TOTAL:	26,247.91	141.88	SUPPLIES TOTAL:	211.48	1.14

OTHER COSTS			SUBCONTRACTS		
Indirects:	0.00	0.00	Sub-Total:	0.00	0.00
Hauling:	0.00	0.00	Mark-Up:	0.00	0.00
Other Costs:	0.00	0.00	SUB TOTAL:	0.00	0.00
Other Sub-Total:	0.00	0.00			
Mark-Up:	0.00	0.00			
OTHER COST TOTAL:	0.00	0.00			

	<i>Total Amount</i>	<i>Unit Amount</i>
PAY ITEM SUBTOTAL	46,697.70	252.42
Overhead	2,334.70	12.62
Profit	4,902.50	26.50
Other Mark-Up	0.00	0.00
PAY ITEM TOTAL	53,934.90	291.54

APPENDIX A-5 COST OF MODOT ROADWAY

From: [Travis Koestner@modot.mo.gov](mailto:Travis.Koestner@modot.mo.gov)
To: [Jennifer Harper@modot.mo.gov](mailto:Jennifer.Harper@modot.mo.gov); [Paul Hickens@modot.mo.gov](mailto:Paul.Hickens@modot.mo.gov)
Cc: Thiagarajan_Ganesh
Subject: Re: MTI approach slab project
Date: Monday, March 15, 2010 3:18:24 PM
Attachments: [pic22483.jpg](#)

Paul can you help them out with the precast supplier question below.

As far as 5' of roadway, if the project is in conjunction with a roadway project make quite a difference. If it is part of a larger job the price would be approx. \$40/SY for the pavement + base, if not part of a larger project I believe I would pretty well double that \$80/SY. Hope this helps.

Travis Koestner, PE
Assistant State Construction and Materials Engineer
Missouri Department of Transportation
P.O. Box 270, Jefferson City, MO 65102
573-751-1037 fax 573-526-4354 cell 573-645-3875

Jennifer L
Harper/SC/MODOT

To
Travis D Koestner/SC/MODOT@MODOT

03/15/2010 02:33 PM

cc
"Thiagarajan, Ganesh"
<ganesh@umkc.edu>
Subject
MTI approach slab project

Travis,
Can you get Ganesh information on what a typical cost would be for 5 feet of a 38ft. wide roadway? (Basically, how much it would cost in roadway if we shortened the approach slab 5 feet.)

Also, can you send him a list of our precast suppliers, or do I need to get that from someone else?

Thanks!
Jen

(Embedded image moved to file: pic22483.jpg)

From: Travis.Koestner@modot.mo.gov
To: Jennifer.Harper@modot.mo.gov
Cc: Thiagarajan_Ganesh; Gopalaratnam, Vellore S.
Subject: Re: Fw: 2 inch overlay
Date: Wednesday, May 19, 2010 7:02:36 AM
Attachments: [pic25484.jpg](#)

Just assuming a 38' x 40' wide for estimating purposes would result in approx. 20 tons and an average price for a small quantity such as that would be approx. \$140-\$200/ton depending on the mix type. So I would say a price range of \$3000 to \$4000 for a single location. Need to understand that most of the cost for a small quantity is for the crew to show up and do the work. If the project already has a significant amount of asphalt on the project in the vicinity of the bridge the price would be significantly lower, likely about 1/2.

Let me know if this works. Thanks

Travis Koestner, PE
Assistant State Construction and Materials Engineer
Missouri Department of Transportation
P.O. Box 270, Jefferson City, MO 65102
573-751-1037 fax 573-526-4354 cell 573-645-3875

Jennifer L
Harper/SC/MODOT

05/18/2010 01:58 PM

To
Travis D Koestner/SC/MODOT@MODOT

cc
"Thiagarajan, Ganesh"
<ganesh@umkc.edu>, "Gopalaratnam,
Vellore S."
<GopalaratnamV@missouri.edu>

Subject
Fw: 2 inch overlay

Travis,
Does C&M have an idea for in-place costs of a 2-inch overlay for a 38 foot bridge approach slab on either end of a bridge? Ganesh has said he is waiting on quotes from contractors as well.
Thanks!
Jen

(Embedded image moved to file: [pic25484.jpg](#))
----- Forwarded by Jennifer L Harper/SC/MODOT on 05/18/2010 01:55 PM -----

"Thiagarajan,
Ganesh"

APPENDIX A-6 PRECAST PRESTRESSED DESIGN DETAILS FROM COMPUTER
ANALYSIS

Load Type	(k/ft)	(k/ft)	(ft)	(ft)	(in)
P/C Self Weight	1.000	1.000	0.00	20.00	0.000
Non-comp. Dead Load	0.000	0.000	0.00	20.00	0.000
Composite Dead Load	0.000	0.000	0.00	20.00	0.000
Live Load	0.000	0.000	0.00	20.00	0.000

At Release Only: Suction = 0.000 k/ft Core Material = 0.000 k/ft

NOTE: 0.00% of all distributed and concentrated live loads are sustained.

Bearing Plates

 Nu = 0.20*Pu Height= 0.00 in Bearing Pad Thickness = 0.250 in
 Eff. Brg. Surface: Width = 0.00 in Length = 0.000 in
 Plate Rebar: Angle = 10.00 deg fy = 60.00 ksi
 Confinement for non-debonded prestressing strand assumed -> NO

***** OUTPUT *****

INITIAL STRESSES (psi, at release)

 A)DL beam + core material (if any) + suction (if any)
 Beam is supported at 0.00 ft from LEFT end and 0.00 ft from RIGHT end

X(ft) From Left End	Initial P/S		Init.P/S + BM		Aux. steel area (ACI 18.4.1)
	Top	Bot.	Top	Bot.	
2.00	716	685	851	552	0.00
2.08	746	714	886	576	0.00
4.00	746	714	986	477	0.00
6.00	746	714	1061	403	0.00
8.00	746	714	1106	359	0.00
10.00	746	714	1121	344	0.00
12.00	746	714	1106	359	0.00
14.00	746	714	1061	403	0.00
16.00	746	714	986	477	0.00
17.92	746	714	886	576	0.00
18.00	716	685	851	552	0.00

NOTE: Required f'ci = 3500 psi based on assigned minimum.

STRAND STRESSES (Based on f'ci=3.500 ksi, f'c=6.000 ksi, by PCI Committee)

X(ft) from Left End	at Tensioning ksi	at Release ksi	DL and Sust. LL ksi	Final* ksi	P/S Loss ksi	P/S Loss %
0.00	202.5	194.9	0.0	0.0	202.50	100.00
2.00	202.5	195.0	170.2	170.2	32.34	15.97
4.00	202.5	195.0	177.2	177.2	25.26	12.47
6.00	202.5	195.0	177.2	177.2	25.26	12.47
8.00	202.5	195.0	177.2	177.2	25.26	12.48
10.00	202.5	195.0	177.2	177.2	25.27	12.48
12.00	202.5	195.0	177.2	177.2	25.26	12.48
14.00	202.5	195.0	177.2	177.2	25.26	12.47
16.00	202.5	195.0	177.2	177.2	25.26	12.47
18.00	202.5	195.0	170.2	170.2	32.34	15.97
20.00	202.5	194.9	0.0	0.0	202.50	100.00

*NOTE: Final strand stresses include elastic regain for Live Load.

SERVICE LOAD MOMENTS (k-in)

X(ft) From Left End	Beam Moment	Non-Comp. DL Moment	Composite DL Moment	Live Load Moment	Prestress Moment
0.00	0	0	0	0	0
2.00	216	0	0	0	0
4.00	384	0	0	0	0
6.00	504	0	0	0	0
8.00	576	0	0	0	0
10.00	600	0	0	0	0
12.00	576	0	0	0	0
14.00	504	0	0	0	0
16.00	384	0	0	0	0
18.00	216	0	0	0	0
20.00	0	0	0	0	0

FINAL STRESSES (psi)

X(ft) From Left End	FP + BM		FP + DL + Sustained LL			FP + DL + All LL		
	Top	Bot	Topg	Top	Bot	Topg	Top	Bot
0.00	0	0	---	0	0	---	0	0
1.00	397	249	---	397	249	---	397	249
2.00	786	497	---	786	497	---	786	497
3.00	869	467	---	869	467	---	869	467
4.00	918	419	---	918	419	---	918	419
5.00	959	378	---	959	378	---	959	378
6.00	993	345	---	993	345	---	993	345
7.00	1019	319	---	1019	319	---	1019	319
8.00	1038	300	---	1038	300	---	1038	300
9.00	1049	289	---	1049	289	---	1049	289
10.00	1053	286	---	1053	286	---	1053	286
11.00	1049	289	---	1049	289	---	1049	289
12.00	1038	300	---	1038	300	---	1038	300
13.00	1019	319	---	1019	319	---	1019	319
14.00	993	345	---	993	345	---	993	345
15.00	959	378	---	959	378	---	959	378
16.00	918	419	---	918	419	---	918	419
17.00	869	467	---	869	467	---	869	467
18.00	786	497	---	786	497	---	786	497
19.00	397	249	---	397	249	---	397	249
20.00	0	0	---	0	0	---	0	0

NOTE: Allowable precast tensile stress = $7.5 \cdot \sqrt{f'c} = -581$ psi

ULTIMATE MOMENT: (k-in)

X(ft) From Left End	Required Mu		Provided phi*Mn		
	by Fact'd Loads	by 1.2*Mcr (ACI 18.8.2)	by Strain- compat.	by Other Limits (see notes)	Flex. phi Factor (ACI 9.3.2)
0.00	0			0 (3)	0.75
1.00	160 {1}			1508 (3)	0.75
2.00	302 {1}			2670 (1)	0.73
3.00	428 {1}			2986 (1)	0.72
4.00	538 {1}			3201 (1)	0.72
5.00	630 {1}			3340 (1)	0.72
6.00	706 {1}		3903		0.83
7.00	764 {1}		3903		0.83
8.00	806 {1}		3903		0.83
9.00	832 {1}		3903		0.83

10.00	840	{1}	2418*	3903		0.83
11.00	832	{1}		3903		0.83
12.00	806	{1}		3903		0.83
13.00	764	{1}		3903		0.83
14.00	706	{1}		3903		0.83
15.00	630	{1}			3340 (1)	0.72
16.00	538	{1}			3201 (1)	0.72
17.00	428	{1}			2986 (1)	0.72
18.00	302	{1}			2670 (1)	0.73
19.00	160	{1}			1508 (3)	0.75
20.00	0				0 (3)	0.75

{n}: Load Case {n} controls.
 (1): Development length controlled by strand.
 (3): Development length controlled by both strand and rebar.
 *NOTE: $\phi * M_n > 2 * M_u$, ACI 18.8.3 requirements can be ignored.

VERTICAL SHEAR REINFORCING

X(ft) Left End	From D in.	Vu kips	Tu k-in	Vci kips	Vcw kips	-- Required Reinforcing --		
						for Avci in-2/ft	for Avcw in-2/ft	for Avmin in-2/ft
0.42	8.00	13.42	0.0	224	239	0.000	0.000	0.000
1.00	8.00	12.60	0.0	136	283	0.000	0.000	0.000
2.00	8.00	11.20	0.0	102	358	0.000	0.000	0.000
3.00	8.00	9.80	0.0	101	365	0.000	0.000	0.000
4.00	8.00	8.40	0.0	101	365	0.000	0.000	0.000
5.00	8.00	7.00	0.0	101	365	0.000	0.000	0.000
6.00	8.00	5.60	0.0	101	365	0.000	0.000	0.000
7.00	8.00	4.20	0.0	101	365	0.000	0.000	0.000
8.00	8.00	2.80	0.0	101	365	0.000	0.000	0.000
9.00	8.00	1.40	0.0	101	365	0.000	0.000	0.000
10.00	8.00	0.00	0.0	101	365	0.000	0.000	0.000
11.00	8.00	-1.40	0.0	101	365	0.000	0.000	0.000
12.00	8.00	-2.80	0.0	101	365	0.000	0.000	0.000
13.00	8.00	-4.20	0.0	101	365	0.000	0.000	0.000
14.00	8.00	-5.60	0.0	101	365	0.000	0.000	0.000
15.00	8.00	-7.00	0.0	101	365	0.000	0.000	0.000
16.00	8.00	-8.40	0.0	101	365	0.000	0.000	0.000
17.00	8.00	-9.80	0.0	101	365	0.000	0.000	0.000
18.00	8.00	-11.20	0.0	102	358	0.000	0.000	0.000
19.00	8.00	-12.60	0.0	136	283	0.000	0.000	0.000
19.58	8.00	-13.42	0.0	224	239	0.000	0.000	0.000

: Minimum based on ACI Eq. 11-13. (prestress < 40% tensile strength)
 (2) : Minimum based on ACI Eq. 11-14. (prestress > 40% tensile strength)
 NOTE: Avmin not required for $\phi * V_c > V_u > \phi * V_c / 2$ (ACI 11.5.5.1(c)).
 NOTE: Req'd. reinf. does not include suspension steel for ledges & pockets.
 NOTE: Req'd. reinf. is based on a total web width =96.000 in.
 NOTE: No significant torsion was found (ACI 11.6.1).
 NOTE: Design assumes web reinforcing is carried as close to compression
 and tension surfaces as possible per ACI 12.13.1.

SUMMARY OF MINIMUM VERTICAL AND LONGITUDINAL WEB REINFORCEMENT REQUIREMENTS

NOTE: The specified section type does not have a bottom ledge.
 For Vertical Reinf, select from columns (1), (2), (3) or (4) : (in-2/ft)
 For Longitudinal Reinf, select from columns (A) or (B) : (in-2)

X(ft) Left End	From in	Ph	(1) Ash	(2) Av/2+At	(3) Av/2+Ash	(4) Av/2+Awv	(A) Al/2	(B) Awl
-------------------	------------	----	------------	----------------	-----------------	-----------------	-------------	------------

0.42	0.0	<3>	0.000	<3>	0.000	0.000	0.000
1.00	0.0	<3>	0.000	<3>		0.000	
2.00	0.0	<3>	0.000	<3>		0.000	
3.00	0.0	<3>	0.000	<3>		0.000	
4.00	0.0	<3>	0.000	<3>		0.000	
5.00	0.0	<3>	0.000	<3>		0.000	
6.00	0.0	<3>	0.000	<3>		0.000	
7.00	0.0	<3>	0.000	<3>		0.000	
8.00	0.0	<3>	0.000	<3>		0.000	
9.00	0.0	<3>	0.000	<3>		0.000	
10.00	0.0	<3>	0.000	<3>		0.000	
11.00	0.0	<3>	0.000	<3>		0.000	
12.00	0.0	<3>	0.000	<3>		0.000	
13.00	0.0	<3>	0.000	<3>		0.000	
14.00	0.0	<3>	0.000	<3>		0.000	
15.00	0.0	<3>	0.000	<3>		0.000	
16.00	0.0	<3>	0.000	<3>		0.000	
17.00	0.0	<3>	0.000	<3>		0.000	
18.00	0.0	<3>	0.000	<3>		0.000	
19.00	0.0	<3>	0.000	<3>		0.000	
19.58	0.0	<3>	0.000	<3>	0.000	0.000	0.000

Awv=Awl= 0.000(left), 0.000(right)=Vertical and longitudinal web reinf. for bending due to torsional equil. reactions (ledge face,in-2), based on:
 Tu = 0.0 k-in at Left End, = 0.0 k-in at Right End
 ds = 94.000 in Hs = 8.000 in

Ash=Hanger reinforcement (ledge face only).

NOTE: The above values for steel are for one face only. Columns (2) & (A) should be applied to both faces. All other columns need only be applied to the ledge face.

<3>NOTE: Section does not have a ledge, or is defined as a General Section.

PREDICTED DEFLECTIONS

 Based on : Rational approach and PCI Committee Recommendations for losses.
 f'ci = 3.500 ksi, f'c = 6.000 ksi and ACI-209
 Eci = 3587 ksi, Ec = 4696 ksi, Camber Mult.= 1.000
 Modified : Cu = 1.493 eshu = 362 E-06
 NOTE: Negative values indicate camber.

	Midspan Position (in)
Release : PS(0.00)+BM DL(0.12)	0.13
Creep Before Erection	0.08
Erection: PS+BM DL (@ 4 weeks)	0.21
Change Due to Non-Comp.DL : PS+BM DL+Non-Comp.DL	0.00
Change Due to Comp.DL+SustLL : PS+All DL+Sust.LL	0.21
Long Term Creep	0.11
Final : PS+All DL+Sust.LL : PS+All DL+LL	0.32
	0.32

MISC. PRODUCTION INFORMATION

 Initial prestress force = 744 kips Final prestress force = 651 kips
 Concrete strengths used in design:
 Release strength f'ci= 3500 psi Final strength f'c= 6000 psi
 Beam is NORMAL WEIGHT concrete. Piece weight = 20.00 kips.

Estimated shortening between supports at erection time :

	Curvature			
	at C.G.	Effect	Total	
Top	0.11	0.03	0.13	<<<Length correction not to exceed this value
C.G	0.11	0.00	0.11	
Bot	0.11	-0.03	0.08	

HORIZONTAL ANCHOR REINFORCEMENT & BEARING STRESS ON BEARING PAD

 Confinement for prestressing strand assumed -> NO

Factored Reaction: Pu = 14.0 kips Pw = 10.0 kips at LEFT support
 React. Components: Pdl,nc= 10.0 kips Pdl,c= 0.0 kips Pll= 0.0 kips
 Factored Shear : Vu = 14.0 kips Nu = 2.8 kips
 Calculated : Height= 10.00 in Bearing Surface Width = 96.00 in

Bearing Length (in)	Avf Reqd. (in-2)	Factored Brg. Stress (ksi)	Brg. Pad Stress (ksi)	Sugg. Pad Type
3.0	0.14	0.049	0.035	(1)
3.5	0.14	0.042	0.030	(1)
4.0	0.14	0.036	0.026	(1)
5.0	0.14	0.029	0.021	(1)
6.0	0.14	0.024	0.017	(1)
7.0	0.14	0.021	0.015	(1)

Factored Reaction: Pu = 14.0 kips Pw = 10.0 kips at RIGHT support
 React. Components: Pdl,nc= 10.0 kips Pdl,c= 0.0 kips Pll= 0.0 kips
 Factored Shear : Vu = 14.0 kips Nu = 2.8 kips
 Calculated : Height= 10.00 in Bearing Surface Width = 96.00 in

Bearing Length (in)	Avf Reqd. (in-2)	Factored Brg. Stress (ksi)	Brg. Pad Stress (ksi)	Sugg. Pad Type
3.0	0.14	0.049	0.035	(1)
3.5	0.14	0.042	0.030	(1)
4.0	0.14	0.036	0.026	(1)
5.0	0.14	0.029	0.021	(1)
6.0	0.14	0.024	0.017	(1)
7.0	0.14	0.021	0.015	(1)

NOTE: As-detailed bearing lengths must be longer than minimum used in calcs to allow for as-built tolerances. Suggest minimum added length be 1/2 in. + difference in shortening between top and bottom of member.

NOTE: Reactions are used for concrete bearing strength check and bearing pad design, shear is used for design of Avf.

Pad Types: (following PCI Handbook 5th Edition)

(1): AASHTO Grade Neoprene (60 durometer) or Random Oriented Fiber (ROF)

APPENDIX A-7 DRAWINGS FOR NEW CAST IN PLACE CONSTRUCTION

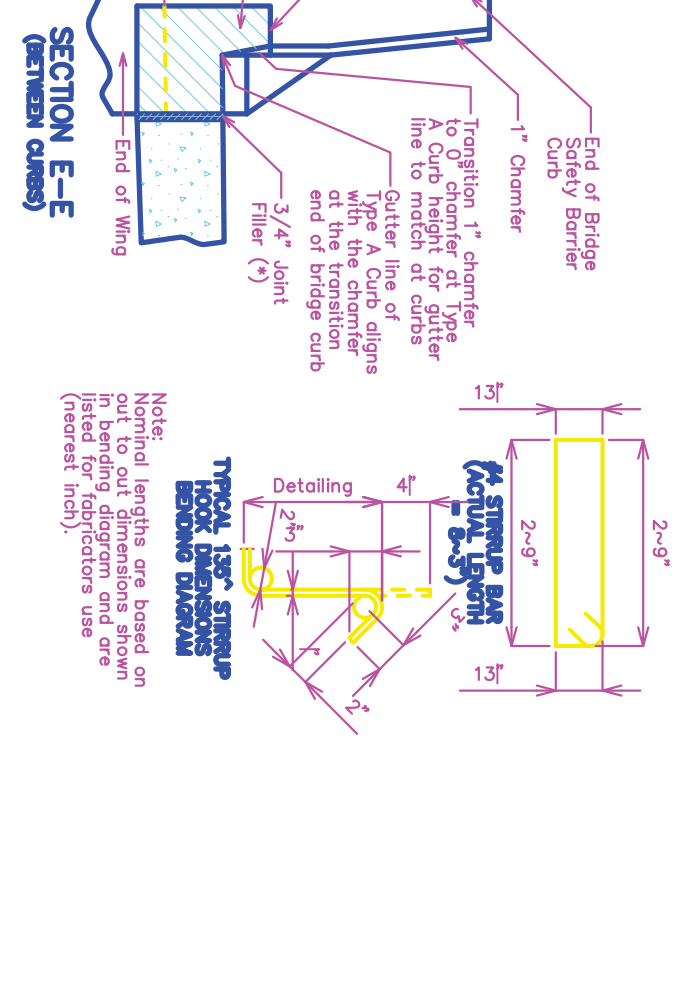
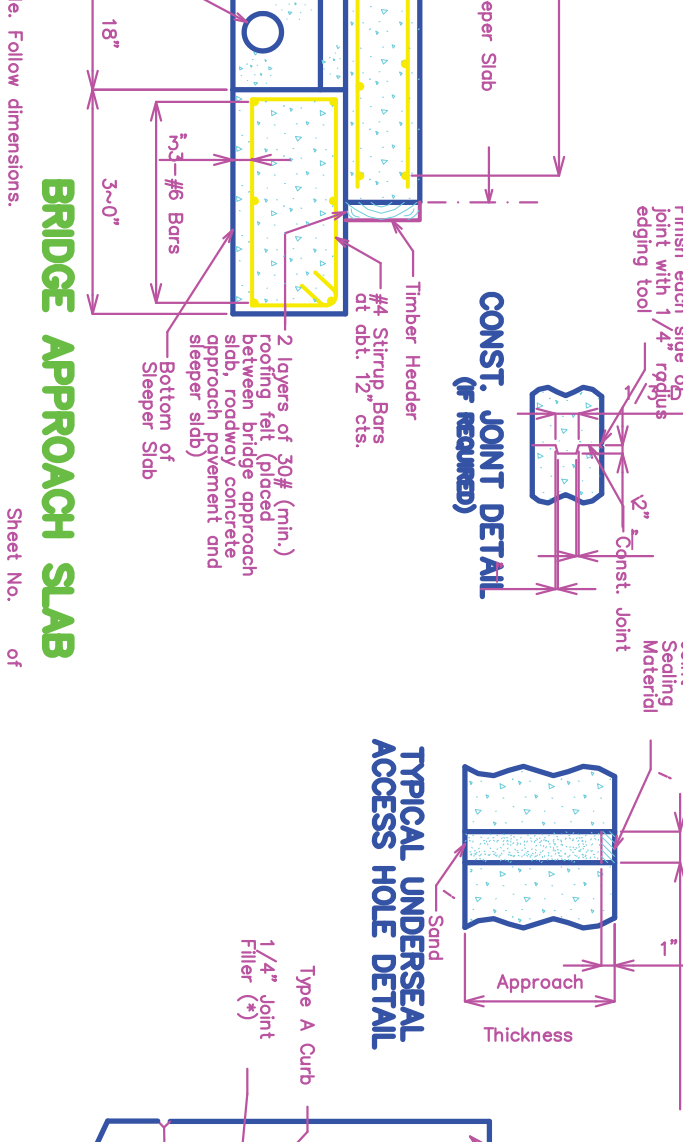
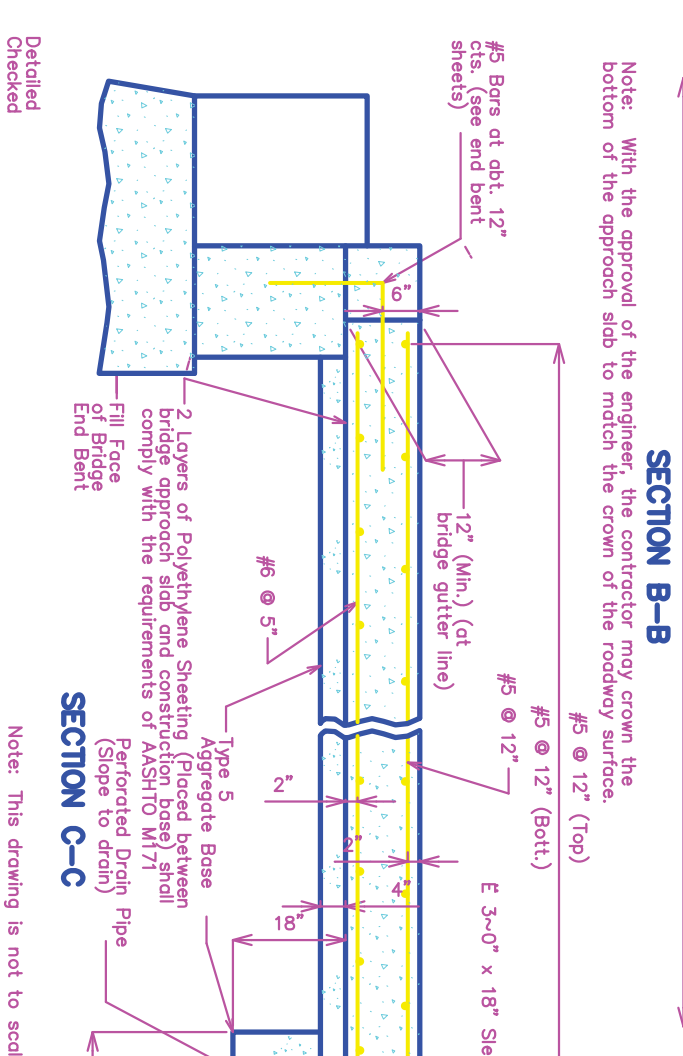
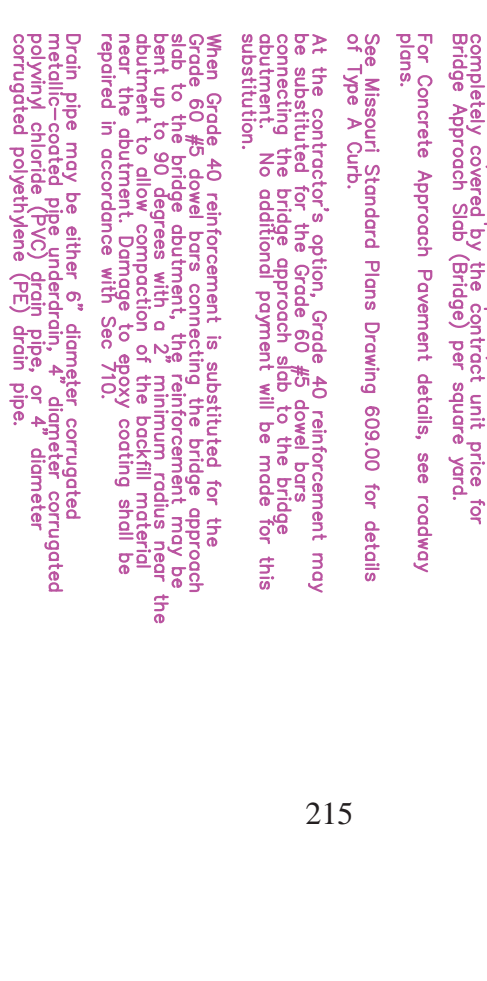
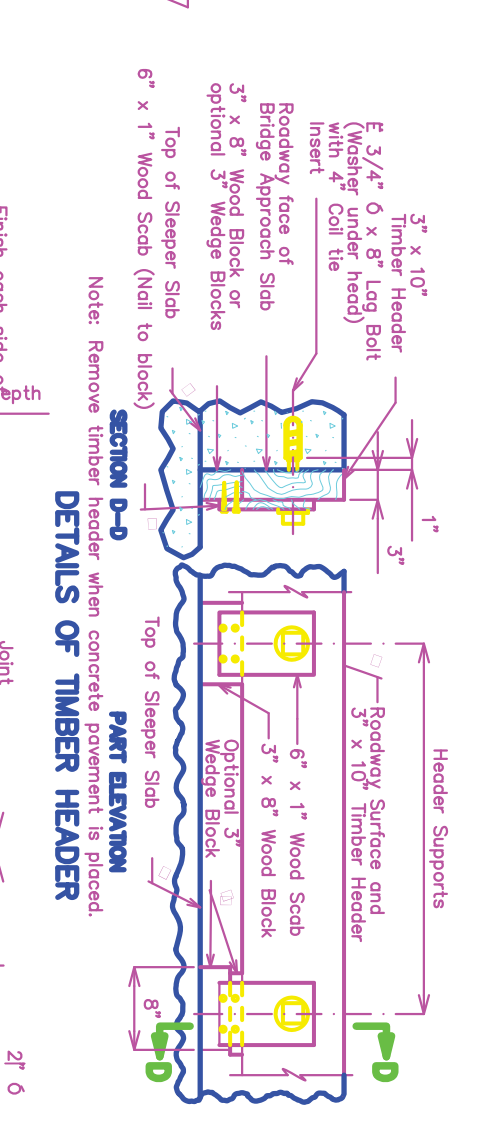
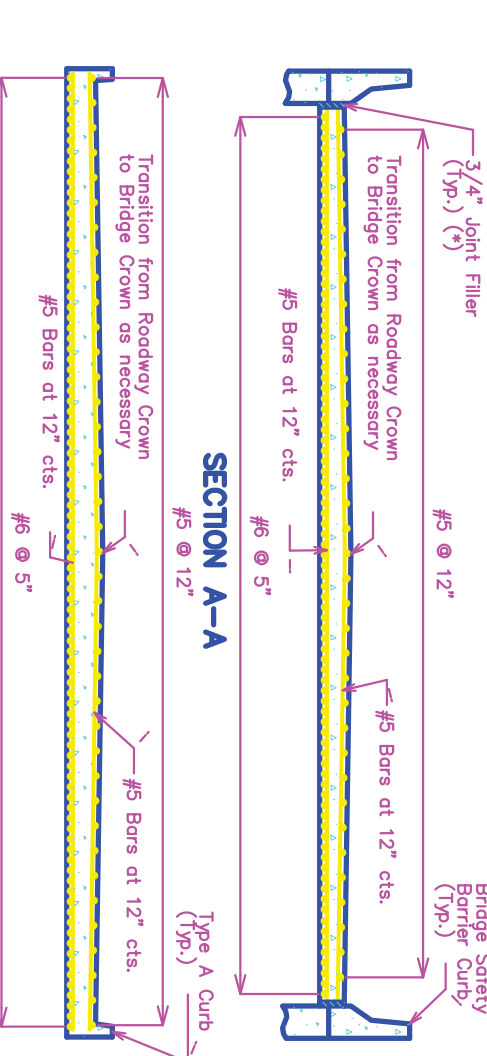
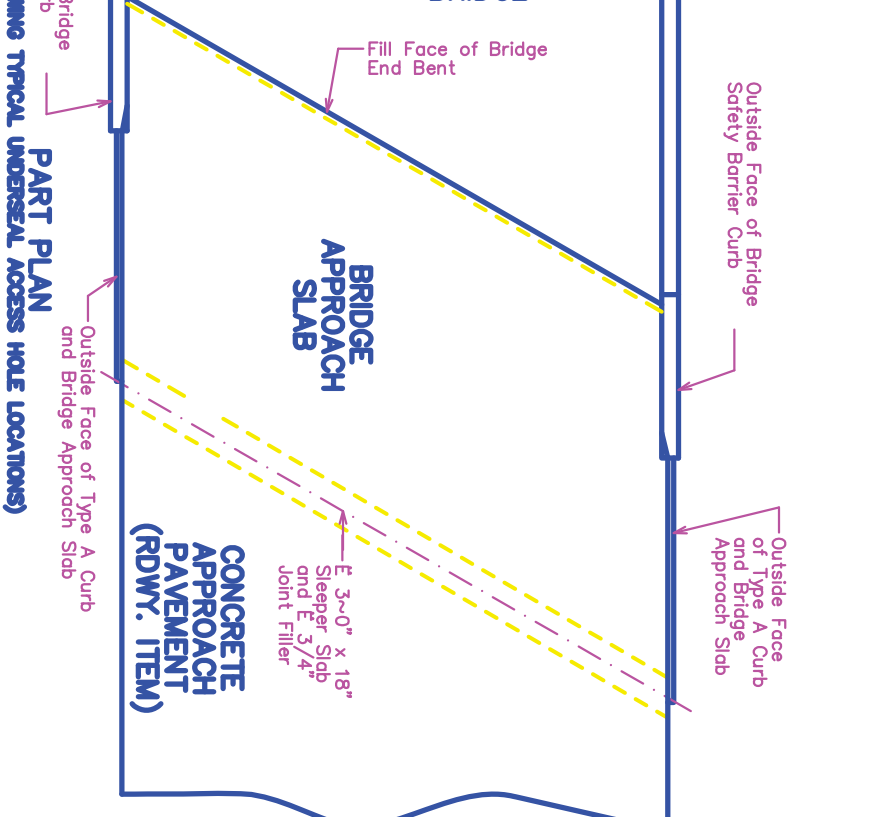
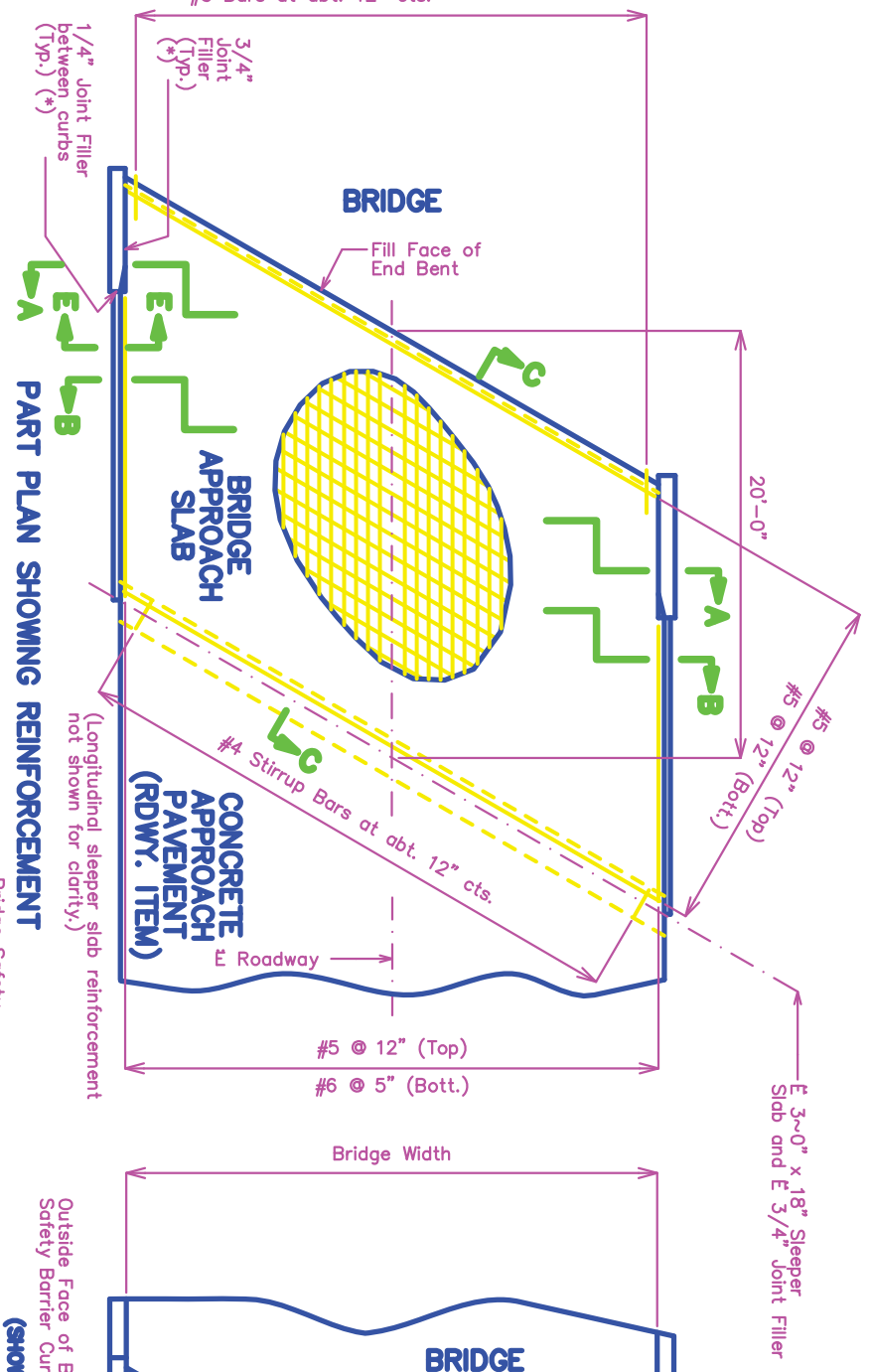

GENERAL NOTES:

All concrete for the bridge approach slab and sleeper slab shall be in accordance with Sec 503 (f'c = 4,000 psi).

All joint filler shall be in accordance with Sec 1057 for preformed fiber expansion joint filler, except as noted.

The reinforcing steel in the bridge approach slab and the sleeper slab shall be epoxy coated Grade 60 with Fy = 60,000 psi.

Minimum clearance to reinforcing steel shall be 1 1/2", unless otherwise shown.

The reinforcing steel in the bridge approach slab and the sleeper slab shall be continuous. The transverse reinforcing steel may be made continuous by lap splicing the #4 & #6 bars 18" and 2'-2", respectively.

Mechanical bar splices shall be in accordance with Sec 706.

(*) Seal joint between vertical face of approach slab and wing with "Silicone Joint Sealant for Saw Cut and Formed Joints" in accordance with Sec 717.

Hooks and bends shall be in accordance with the GRSI Manual of Standard Practice for Detailing Reinforced Concrete Structures, Stirrup and Tie Dimensions.

The contractor shall pour and satisfactorily finish the bridge or semi-deep slab before pouring the bridge approach slabs.

Longitudinal construction joints in approach slab and sleeper slab shall be aligned with longitudinal construction joints in bridge or semi-deep slab.

Payment for furnishing all materials, labor and excavation, necessary to construct the approach slab, including the timber header, sleeper slab, underdrain, Type 5 aggregate base, joint filler and all other appurtenances and incidental work as shown on this sheet, complete in place, will be considered completely covered by the contract unit price for Bridge Approach Slab (Bridge) per square yard.

For Concrete Approach Pavement details, see roadway plans.

See Missouri Standard Plans Drawing 609.00 for details of Type A Curb.

At the contractor's option, Grade 40 reinforcement may be substituted for the Grade 60 #5 dowel bars connecting the bridge approach slab to the bridge abutment. No additional payment will be made for this substitution.

When Grade 40 reinforcement is substituted for the Grade 60 #5 dowel bars connecting the bridge approach slab to the bridge abutment, the reinforcement may be bent up to 90 degrees with a 2" minimum radius near the abutment to allow compaction of the backfill material near the abutment. Damage to epoxy coating shall be repaired in accordance with Sec 710.

Drain pipe may be either 6" diameter corrugated metallic-coated pipe underdrain, 4" diameter corrugated polyvinyl chloride (PVC) drain pipe, or 4" diameter corrugated polyethylene (PE) drain pipe.

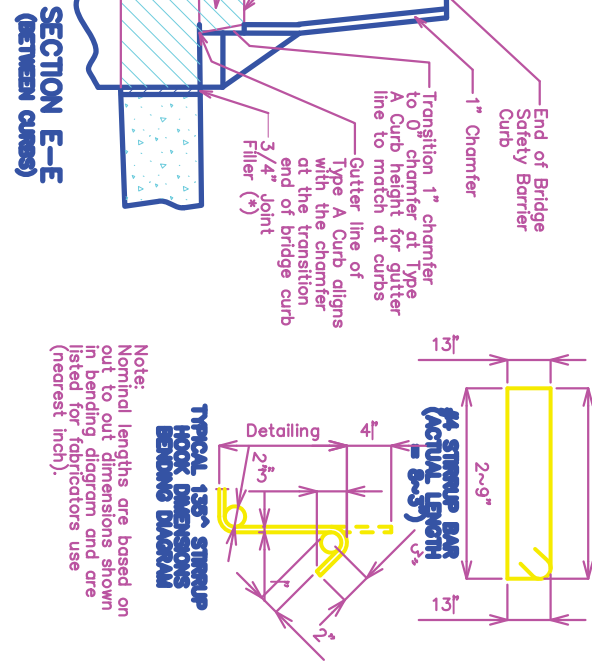
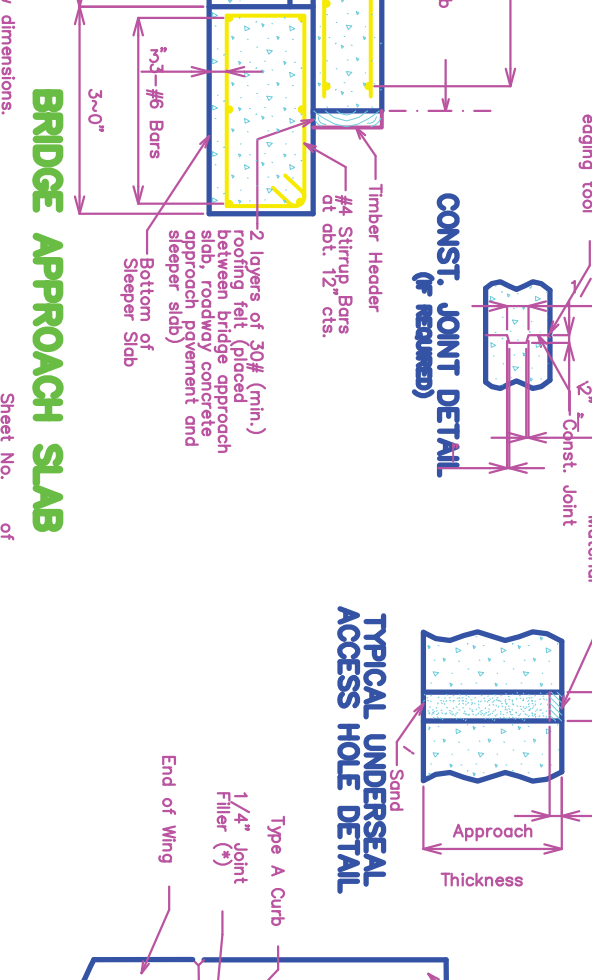
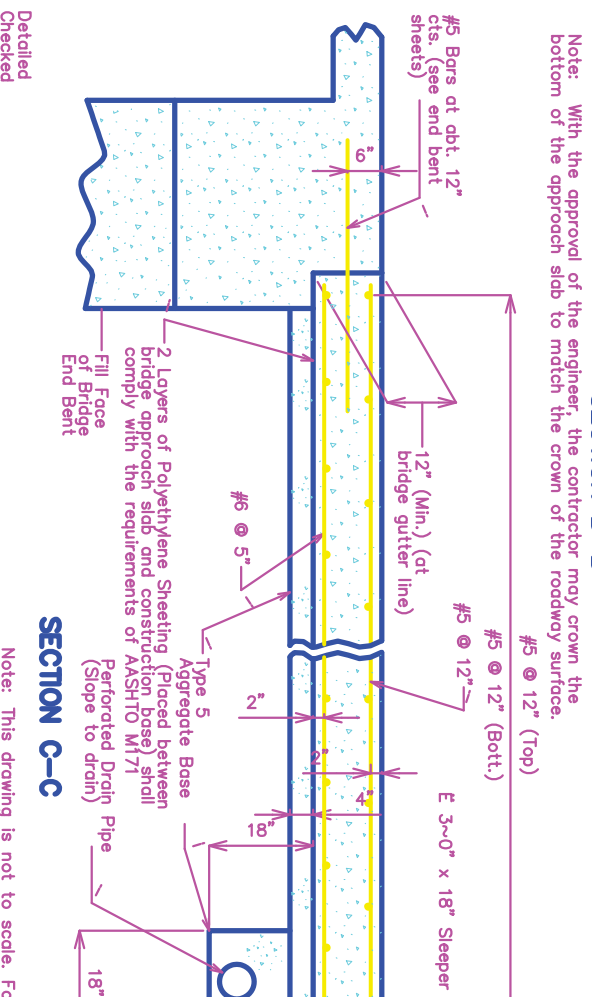
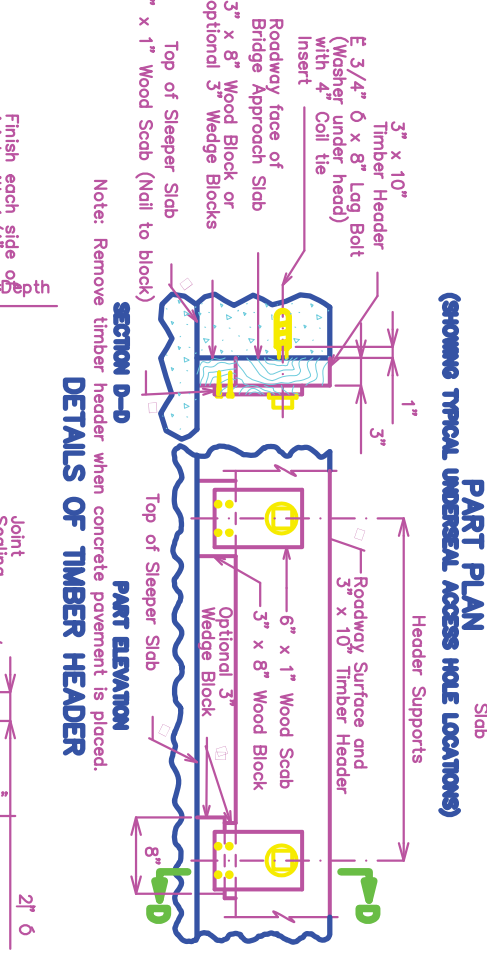
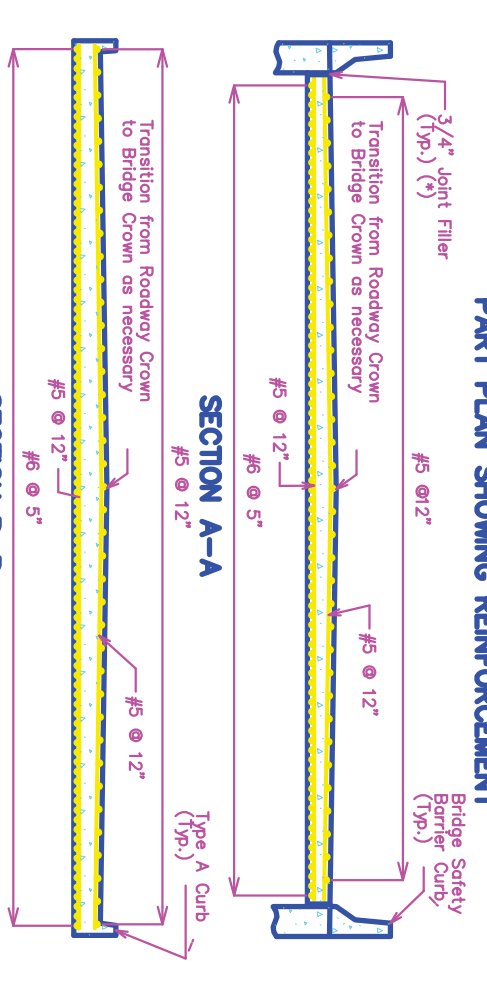
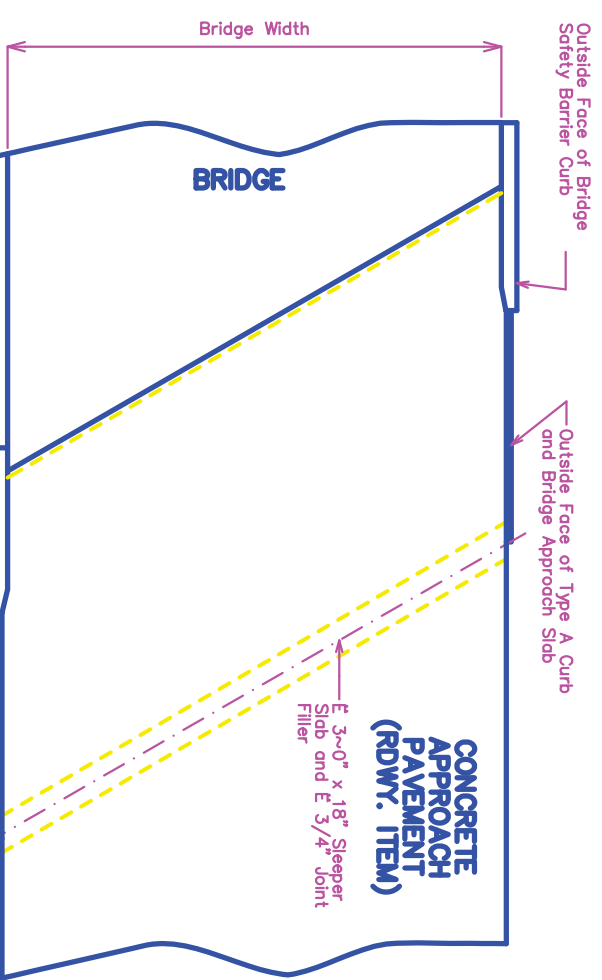
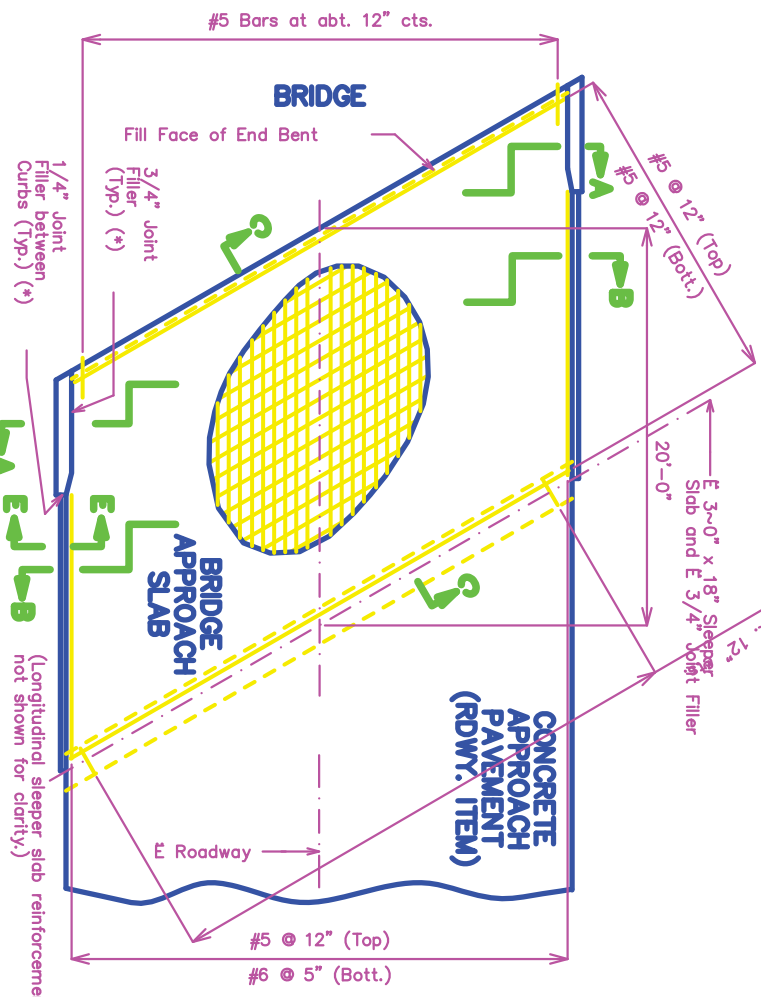

GENERAL NOTES:

All concrete for the bridge approach slab and sleeper slab shall be in accordance with Sec 503 (f'c = 4,000 psi).
All joint filler shall be in accordance with Sec 1057 for preformed fiber expansion joint filler, except as noted.

The reinforcing steel in the bridge approach slab and the sleeper slab shall be epoxy coated Grade 60 with $F_y = 60,000$ psi.
Minimum clearance to reinforcing steel shall be 1 1/2", unless otherwise shown.

The reinforcing steel in the bridge approach slab and the sleeper slab shall be continuous. The transverse reinforcing steel may be made continuous by lap splicing the #4 & #6 bars 18" and 2'-2", respectively. Mechanical bar splices shall be in accordance with Sec 706.

(*) Seal joint between vertical face of approach slab and wing with "Silicone Joint Sealant for Saw Cut and Formed Joints" in accordance with Sec 717.

Hooks and bends shall be in accordance with the CRSI Manual of Standard Practice for Detailing Reinforced Concrete Structures, Stirrup and Tie Dimensions.
The contractor shall pour and satisfactorily finish the bridge or semi-deep slab before pouring the bridge approach slabs.

Longitudinal construction joints in approach slab and sleeper slab shall be aligned with longitudinal construction joints in bridge or semi-deep slab.

Payment for furnishing all materials, labor and excavation necessary to construct the approach slab, including the timber header, sleeper slab, underdrain, Type 5 aggregate base, joint filler and all other appurtenances and incidental work as shown on this sheet, complete in place, will be considered completely covered by the contract unit price for Bridge Approach Slab (Bridge) per square yard.
For Concrete Approach Pavement details, see roadway plans.
See Missouri Standard Plans Drawing 609.00 for details of Type A Curb.

At the contractor's option, Grade 40 reinforcement may be substituted for the Grade 60 #5 dowel bars connecting the bridge approach slab to the bridge abutment. No additional payment will be made for this substitution.

When Grade 40 reinforcement is substituted for the Grade 60 #5 dowel bars connecting the bridge approach slab to the bridge abutment, the reinforcement may be bent up to 90 degrees with a 2" minimum radius near the abutment to allow compaction of the backfill material near the abutment. Damage to epoxy coating shall be repaired in accordance with Sec 710.

Drain pipe may be either 6" diameter corrugated metallic coated pipe underdrain, 4" diameter corrugated polyvinyl chloride (PVC) drain pipe, or 4" diameter corrugated polyethylene (PE) drain pipe.

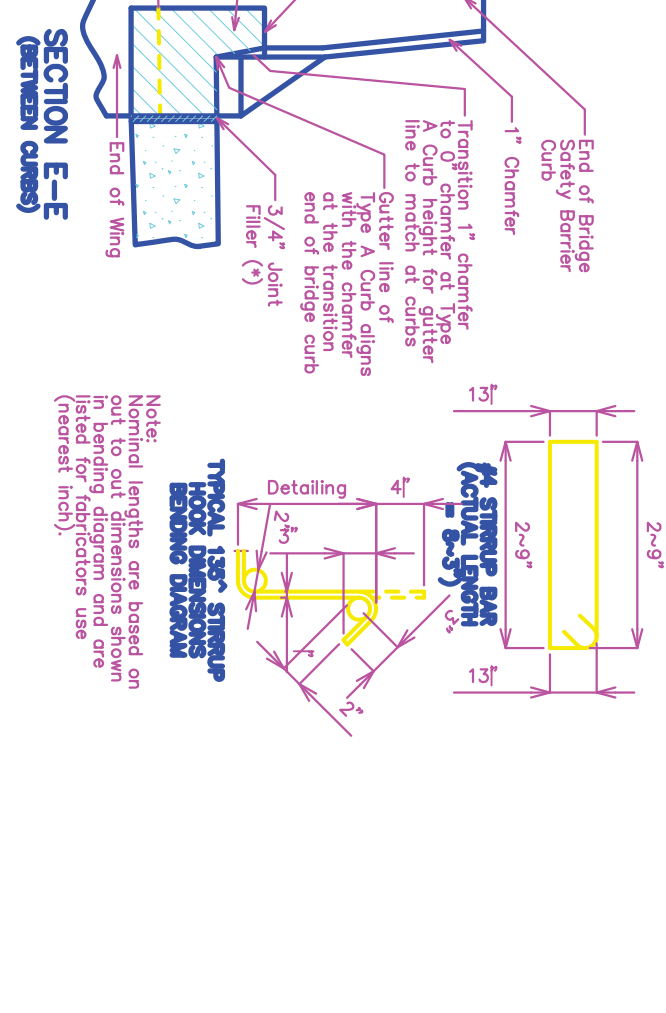
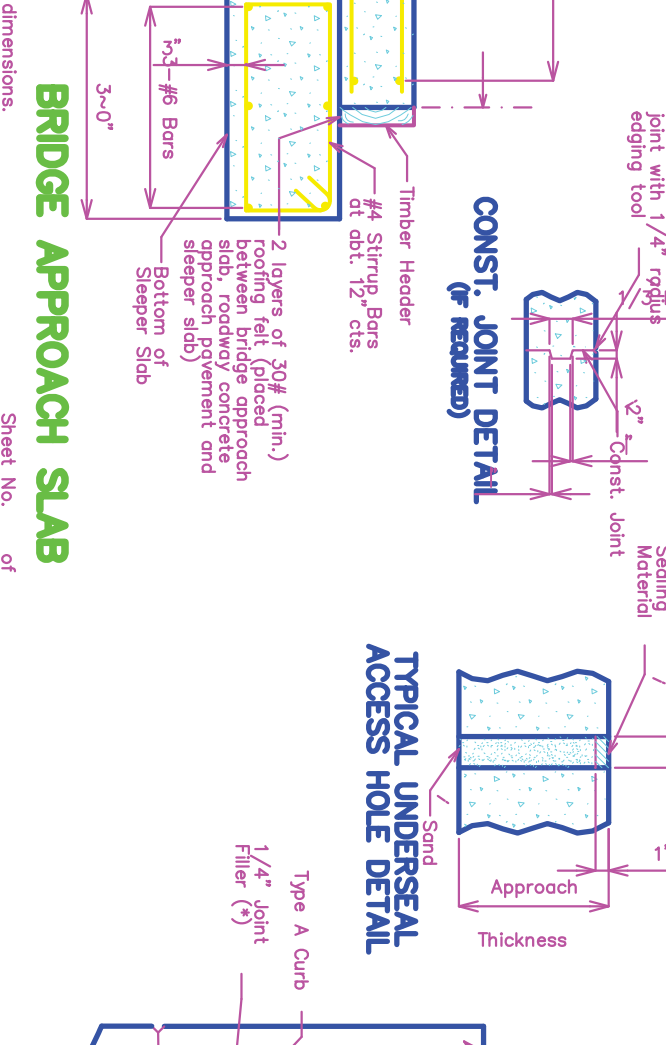
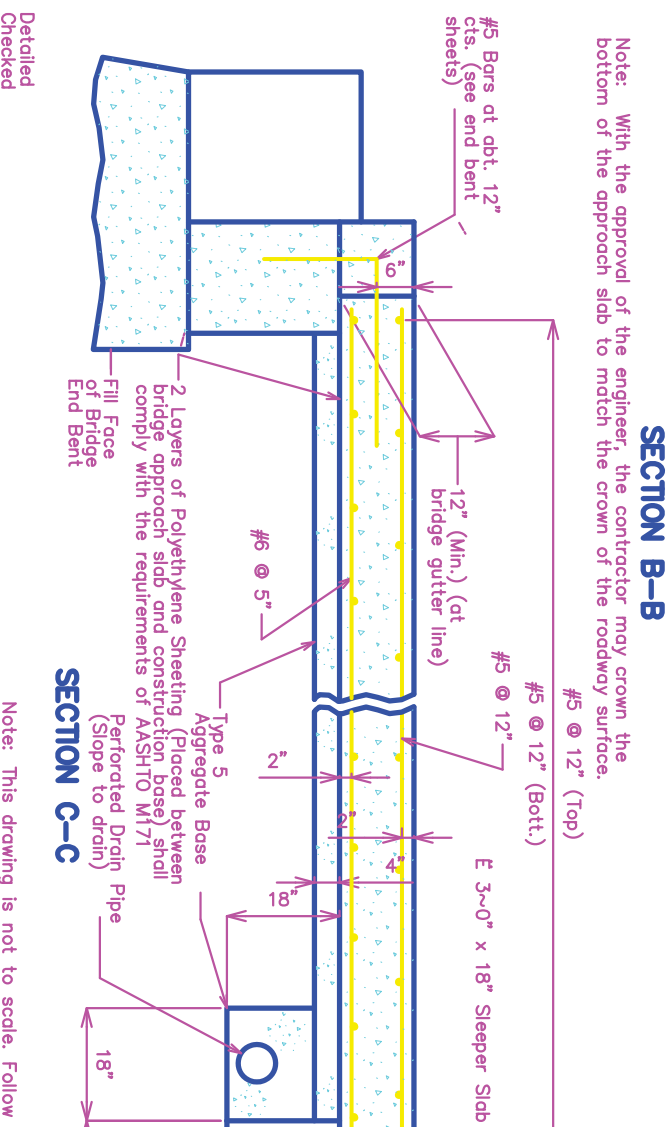
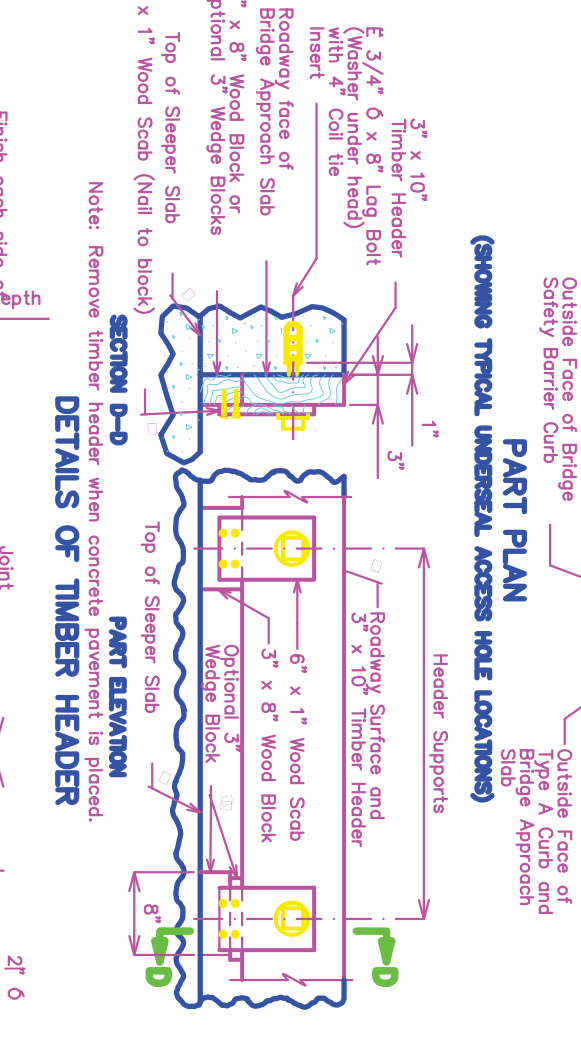
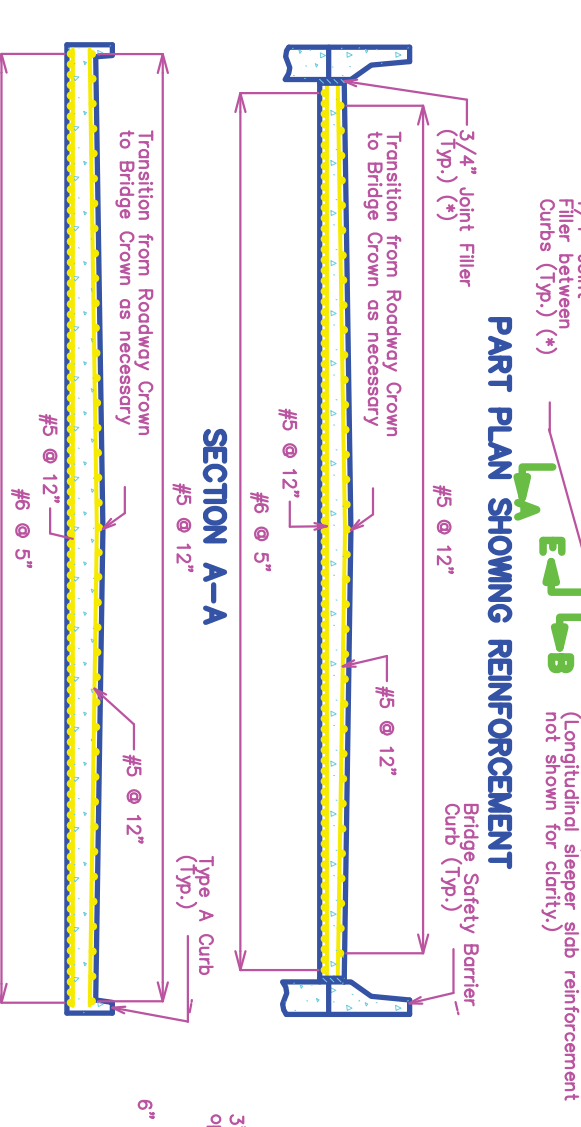
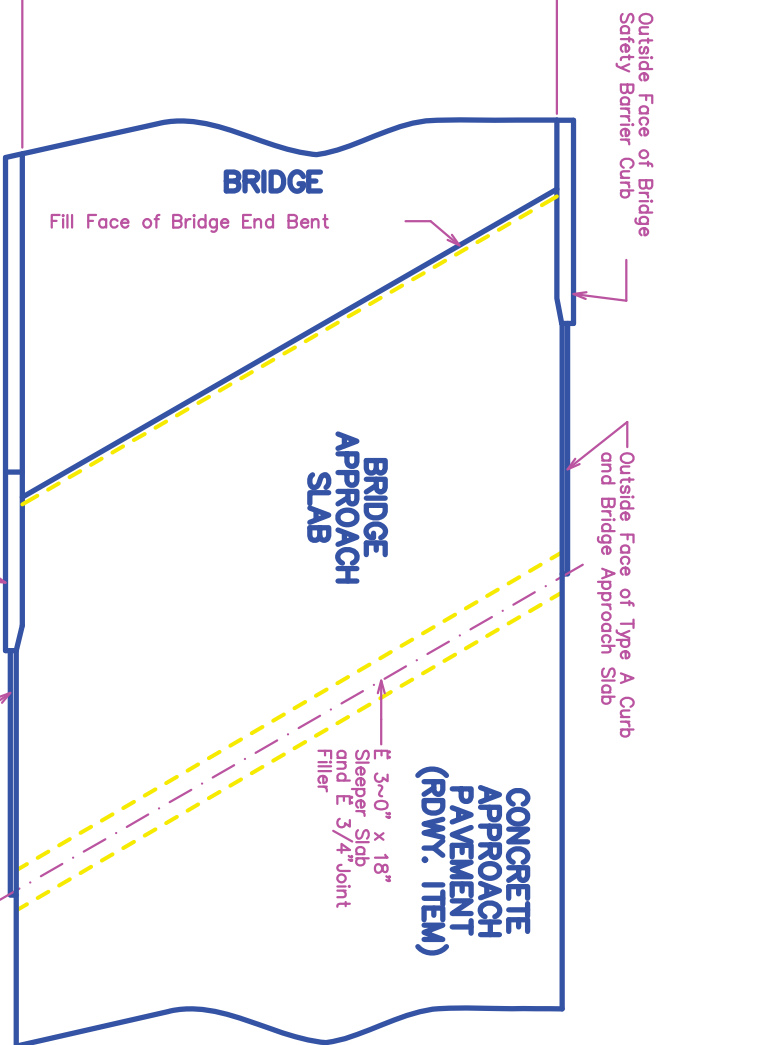
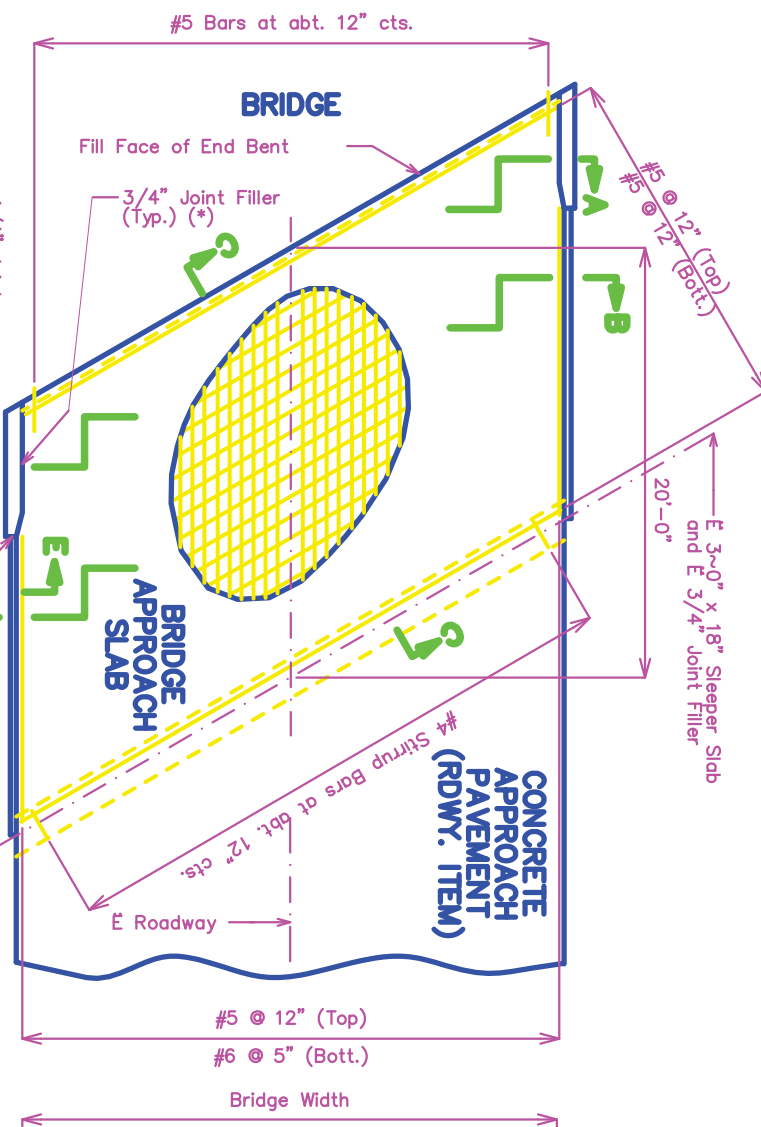

GENERAL NOTES:
 All concrete for the bridge approach slab and sleeper slab shall be in accordance with Sec 503 (f'c = 4,000 psi).
 All joint filler shall be in accordance with Sec 1057 for preformed fiber expansion joint filler, except as noted.
 The reinforcing steel in the bridge approach slab and the sleeper slab shall be epoxy coated Grade 60 with Fy = 60,000 psi.
 Minimum clearance to reinforcing steel shall be 1 1/2", unless otherwise shown.
 The reinforcing steel in the bridge approach slab and the sleeper slab shall be continuous. The transverse reinforcing steel may be made continuous by lap splicing the #4 & #6 bars 18" and 2'-2", respectively. Mechanical bar splices shall be in accordance with Sec 706.
 (*) Seal joint between vertical face of approach slab and wing with "Silicone Joint Sealant for Saw Cut and Formed Joints" in accordance with Sec 717.
 Hooks and bends shall be in accordance with the CRSI Manual of Standard Practice for Detailing Reinforced Concrete Structures, Stirrup and Tie Dimensions.
 The contractor shall pour and satisfactorily finish the bridge or semi-deep slab before pouring the bridge approach slabs.
 Longitudinal construction joints in approach slab and sleeper slab shall be aligned with longitudinal construction joints in bridge or semi-deep slab.
 Payment for furnishing all materials, labor and excavation necessary to construct the approach slab, including the timber header, sleeper slab, underdrain, Type 5 aggregate base, joint filler and all other appurtenances and incidental work as shown on this sheet, complete in place, will be considered completely covered by the contract unit price for Bridge Approach Slab (Bridge) per square yard.
 For Concrete Approach Pavement details, see roadway plans.
 See Missouri Standard Plans Drawing 609.00 for details of Type A Curb.
 At the contractor's option, Grade 40 reinforcement may be substituted for the Grade 60 #5 dowel bars connecting the bridge approach slab to the bridge abutment. No additional payment will be made for this substitution.
 When Grade 40 reinforcement is substituted for the Grade 60 #5 dowel bars connecting the bridge approach slab to the bridge abutment, the reinforcement may be bent up to 90 degrees with a 2" minimum radius near the abutment to allow compaction of the backfill material near the abutment. Damage to epoxy coating shall be repaired in accordance with Sec 710.
 Drain pipe may be either 6" diameter corrugated metallic-coated pipe underdrain, 4" diameter corrugated polyvinyl chloride (PVC) drain pipe, or 4" diameter corrugated polyethylene (PE) drain pipe.

Note: With the approval of the engineer, the contractor may crown the bottom of the approach slab to match the crown of the roadway surface.
 Note: This drawing is not to scale. Follow dimensions.
 Note: Nominal lengths are based on out to out dimensions shown in bending diagram and are listed for fabricators use (nearest inch).

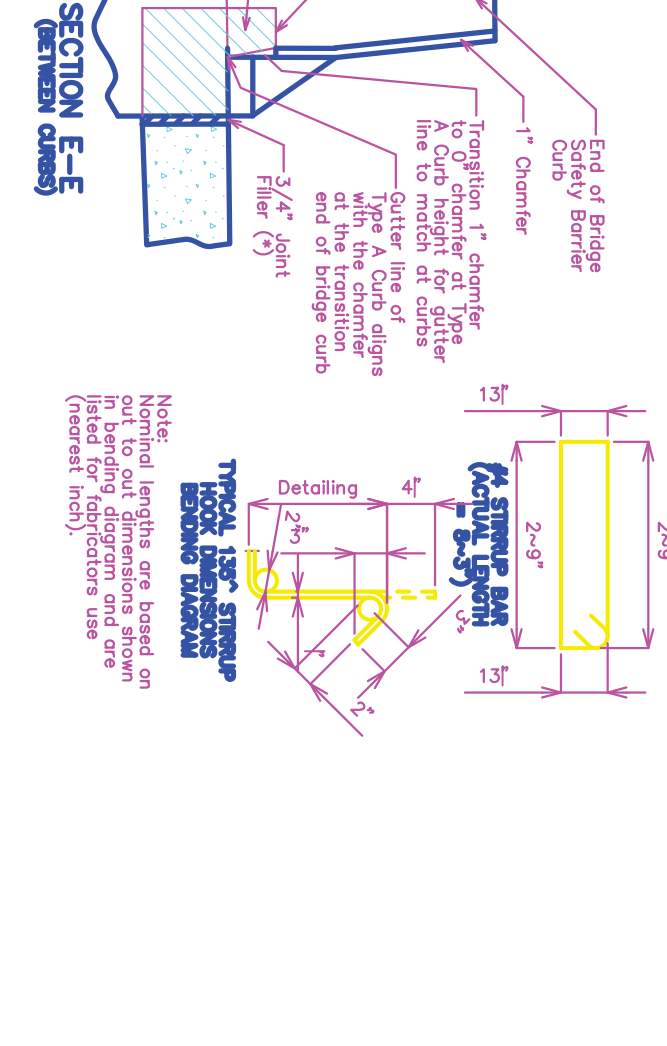
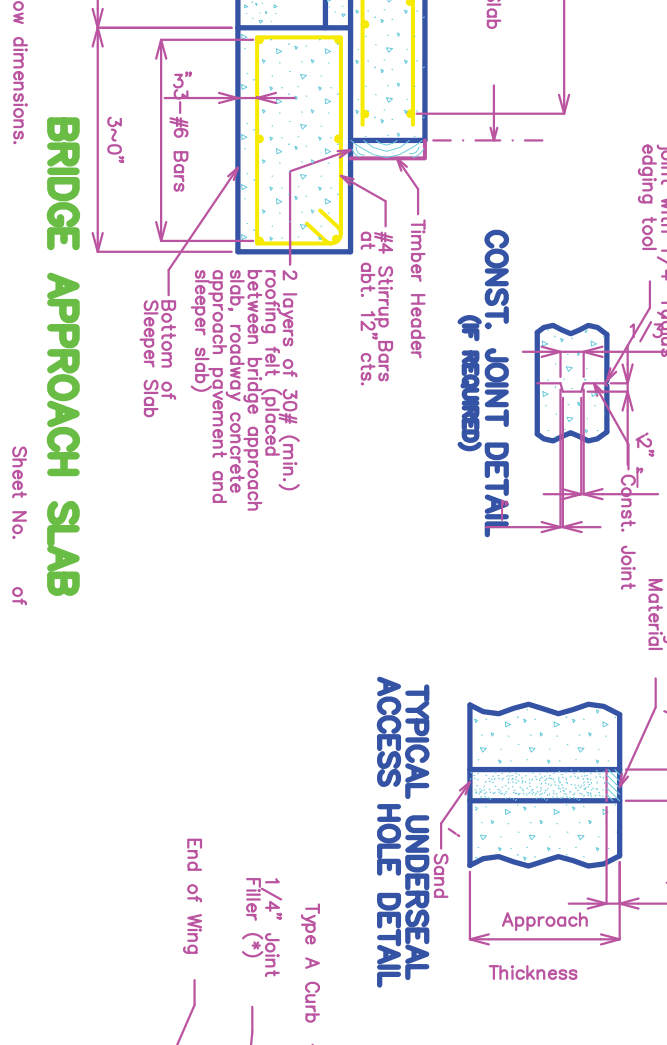
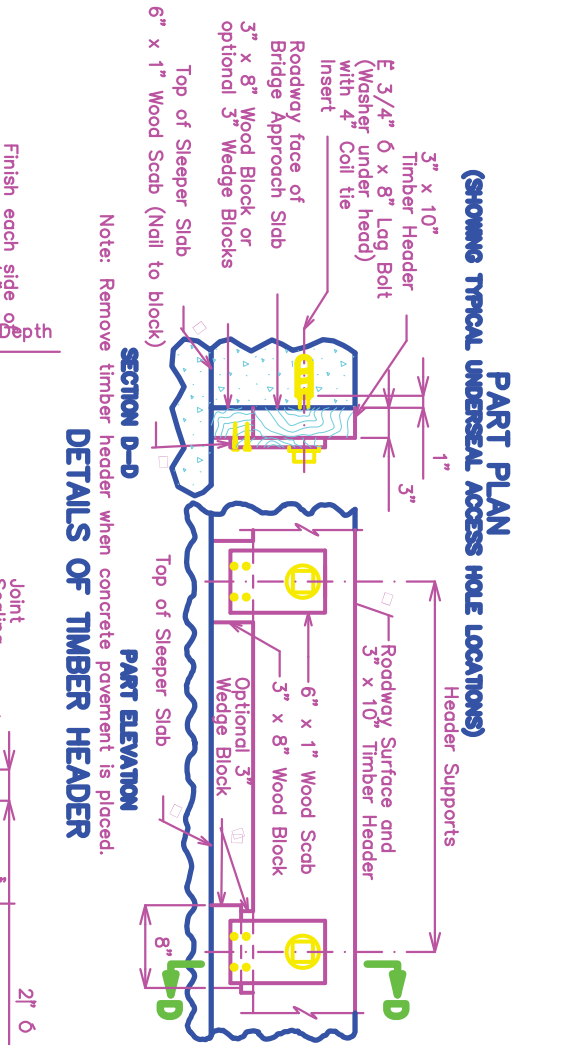
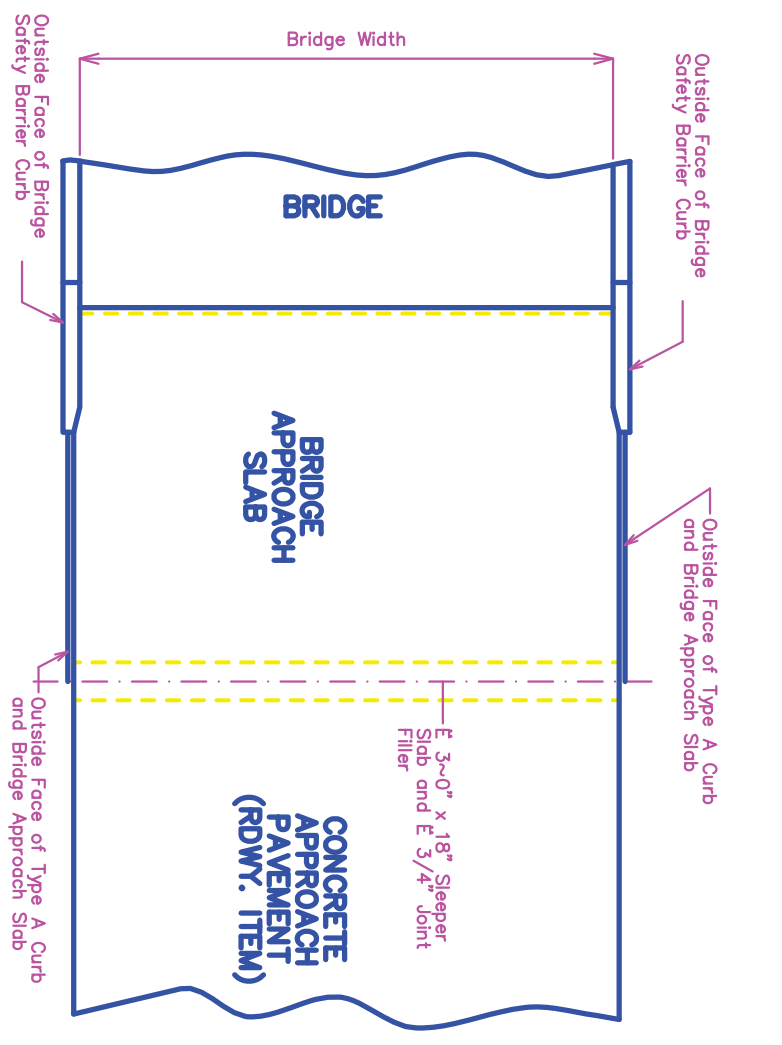
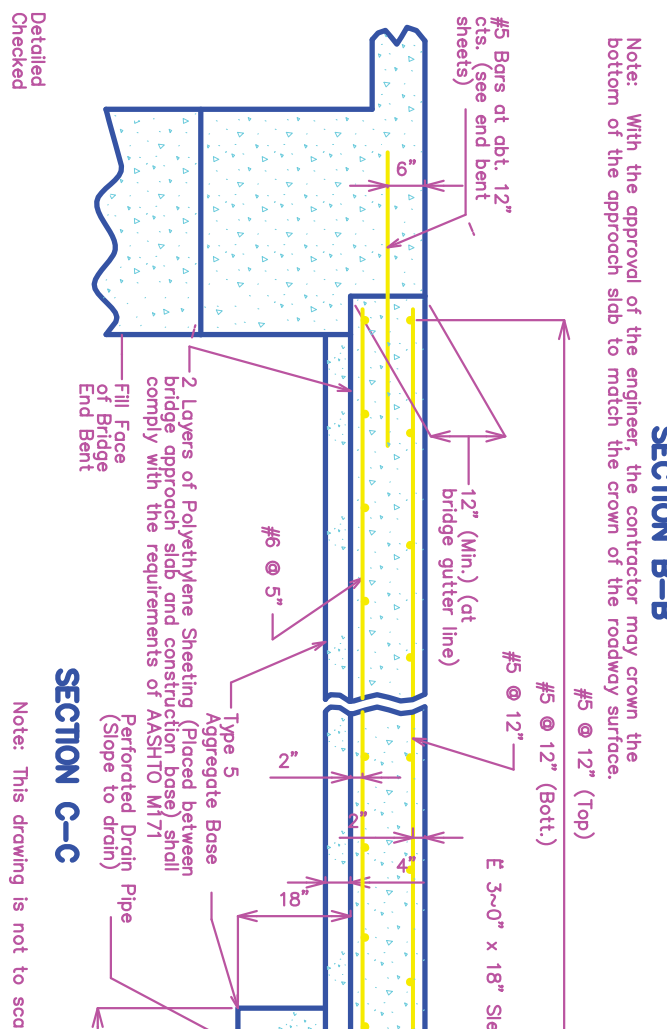
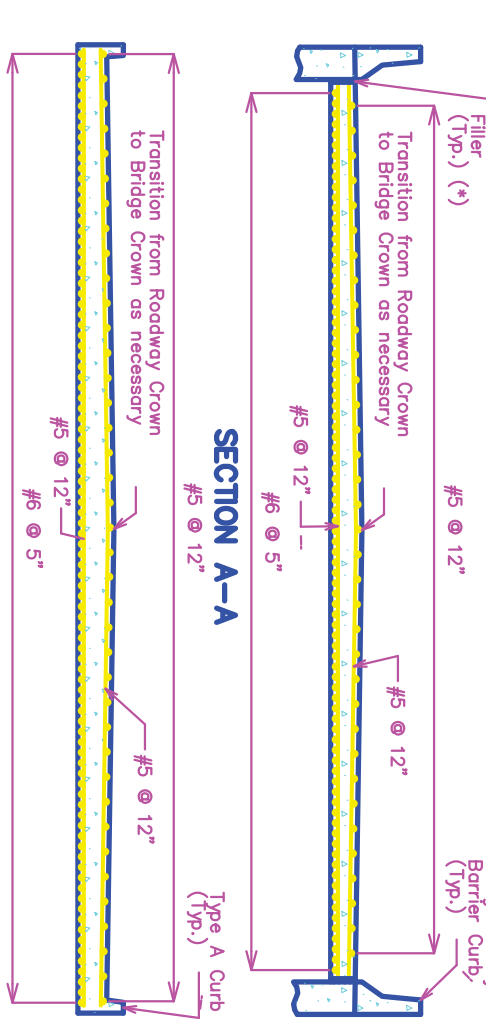
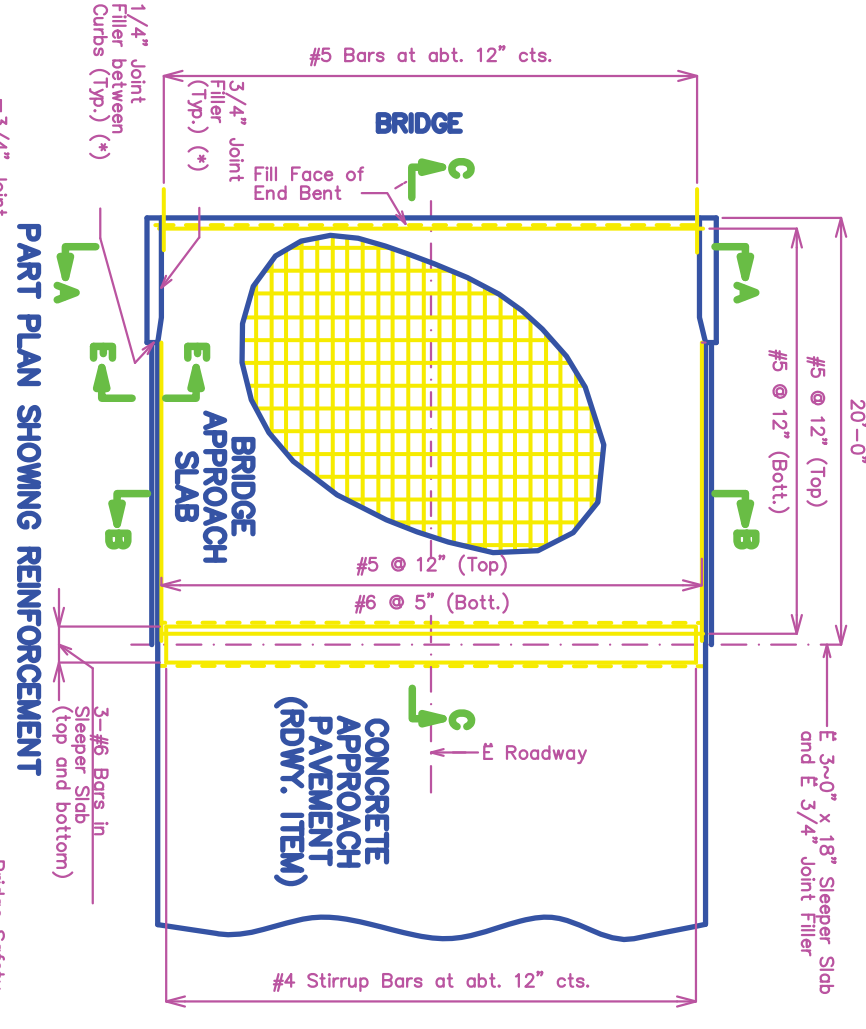

GENERAL NOTES:

All concrete for the bridge approach slab and sleeper slab shall be in accordance with Sec 503 (f c = 4,000 psi).

All joint filler shall be in accordance with Sec 1057 for preformed fiber expansion joint filler, except as noted.

The reinforcing steel in the bridge approach slab and the sleeper slab shall be epoxy coated Grade 60 with $F_y = 60,000$ psi.

Minimum clearance to reinforcing steel shall be 1 1/2", unless otherwise shown.

The reinforcing steel in the bridge approach slab and the sleeper slab shall be continuous. The transverse reinforcing steel may be made continuous by lap splicing the #4 & #6 bars 18" and 2'-2", respectively. Mechanical bar splices shall be in accordance with Sec 706.

(*) Seal joint between vertical face of approach slab and wing with "Silicone Joint Sealant for Saw Cut and Formed Joints" in accordance with Sec 717.

Hooks and bends shall be in accordance with the CRSI Manual of Standard Practice for Detailing Reinforced Concrete Structures, Stirrup and Tie Dimensions.

The contractor shall pour and satisfactorily finish the bridge or semi-deep slab before pouring the bridge approach slabs.

Longitudinal construction joints in approach slab and sleeper slab shall be aligned with longitudinal construction joints in bridge or semi-deep slab.

Payment for furnishing all materials, labor and excavation necessary to construct the approach slab, including the timber header, sleeper slab, underdrain, Type 5 aggregate base, joint filler and all other appurtenances and incidental work as shown on this sheet, complete in place, will be considered completely covered by the contract unit price for Bridge Approach Slab (Bridge) per square yard.

For Concrete Approach Pavement details, see roadway plans.

See Missouri Standard Plans Drawing 609.00 for details of Type A Curb.

At the contractor's option, Grade 40 reinforcement may be substituted for the Grade 60 #5 dowel bars connecting the bridge approach slab to the bridge abutment. No additional payment will be made for this substitution.

When Grade 40 reinforcement is substituted for the Grade 60 #5 dowel bars connecting the bridge approach slab to the bridge abutment, the reinforcement may be bent up to 90 degrees with a 2" minimum radius near the abutment to allow compaction of the backfill material near the abutment. Damage to epoxy coating shall be repaired in accordance with Sec 710.

Drain pipe may be either 6" diameter corrugated metallic-coated pipe underdrain, 4" diameter corrugated polyvinyl chloride (PVC) drain pipe, or 4" diameter corrugated polyethylene (PE) drain pipe.

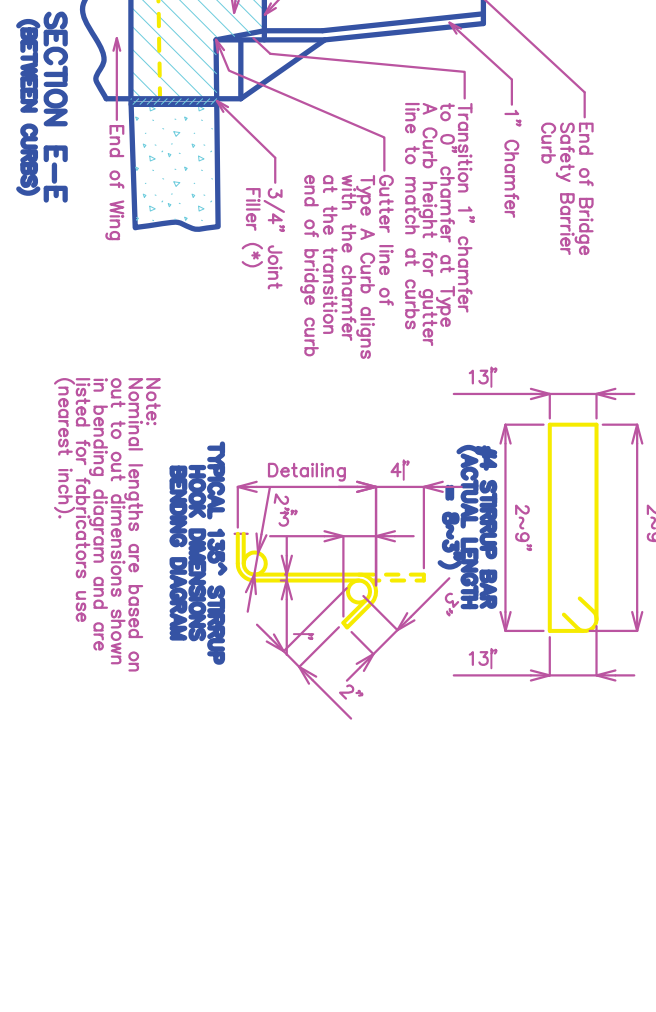
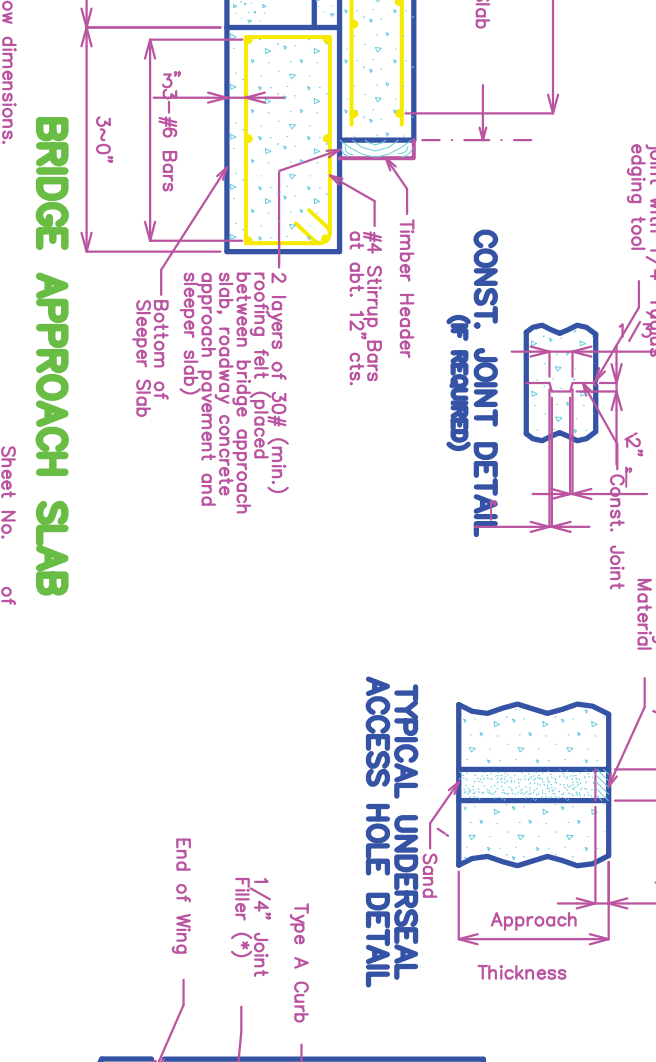
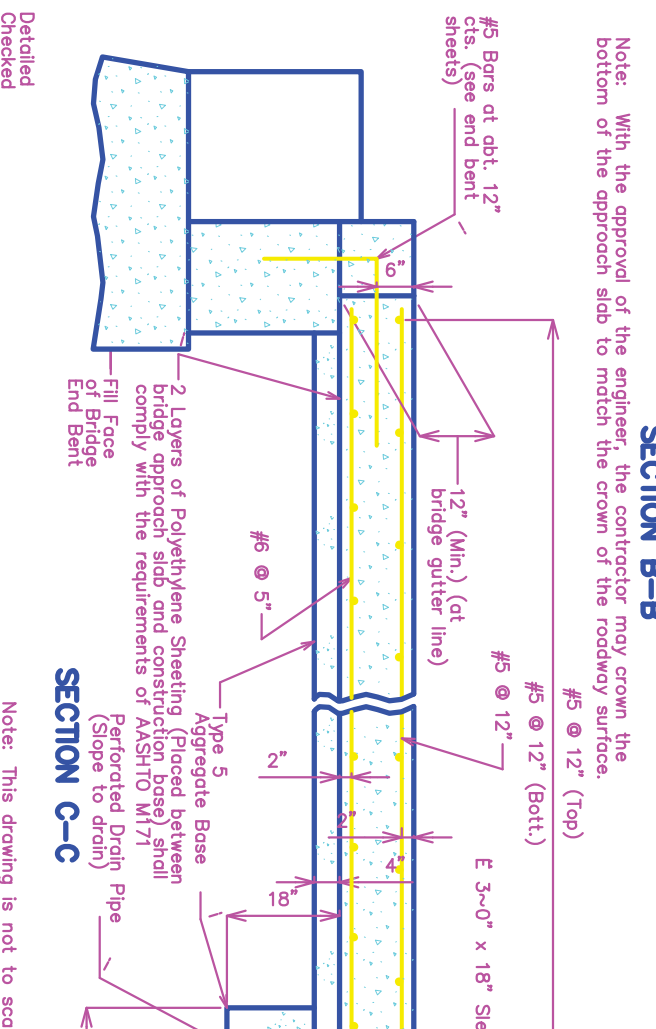
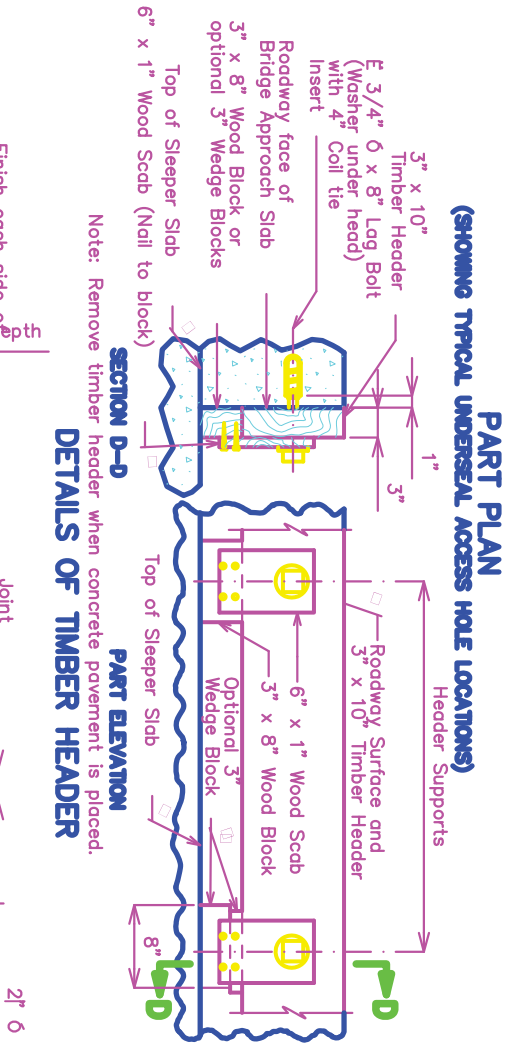
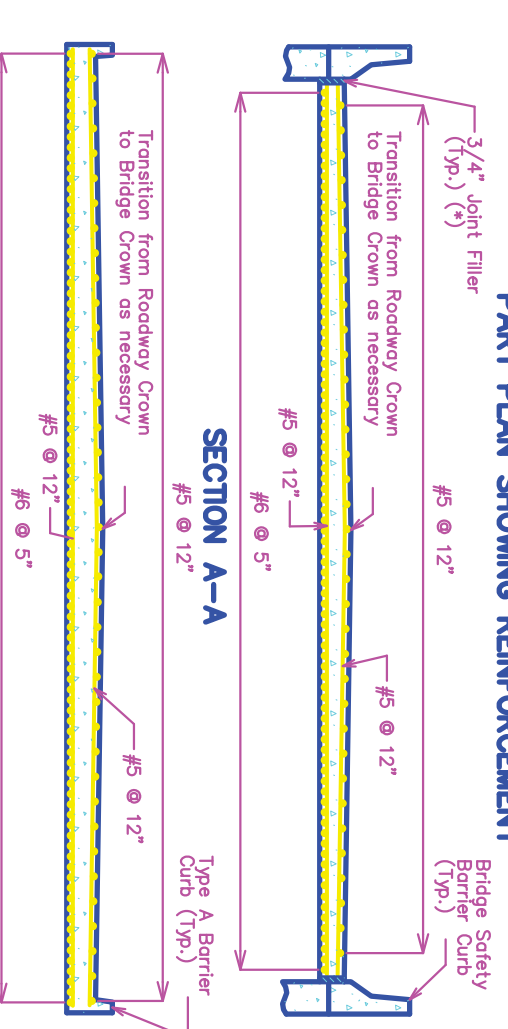
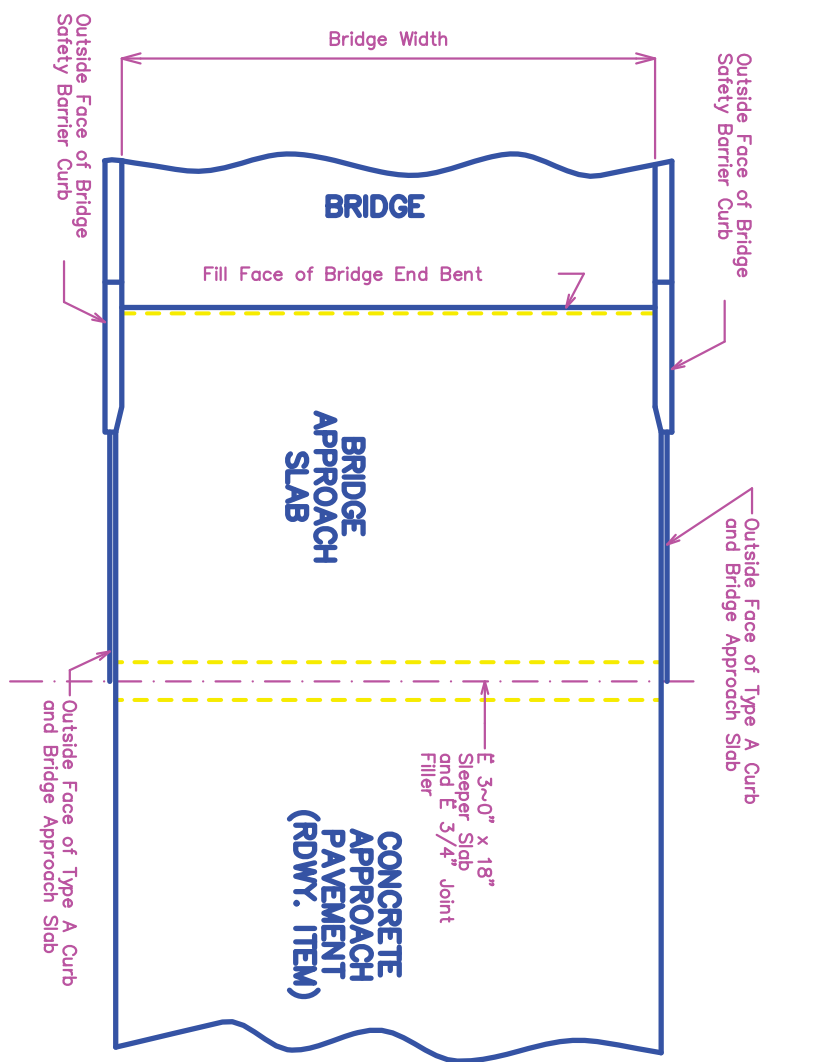
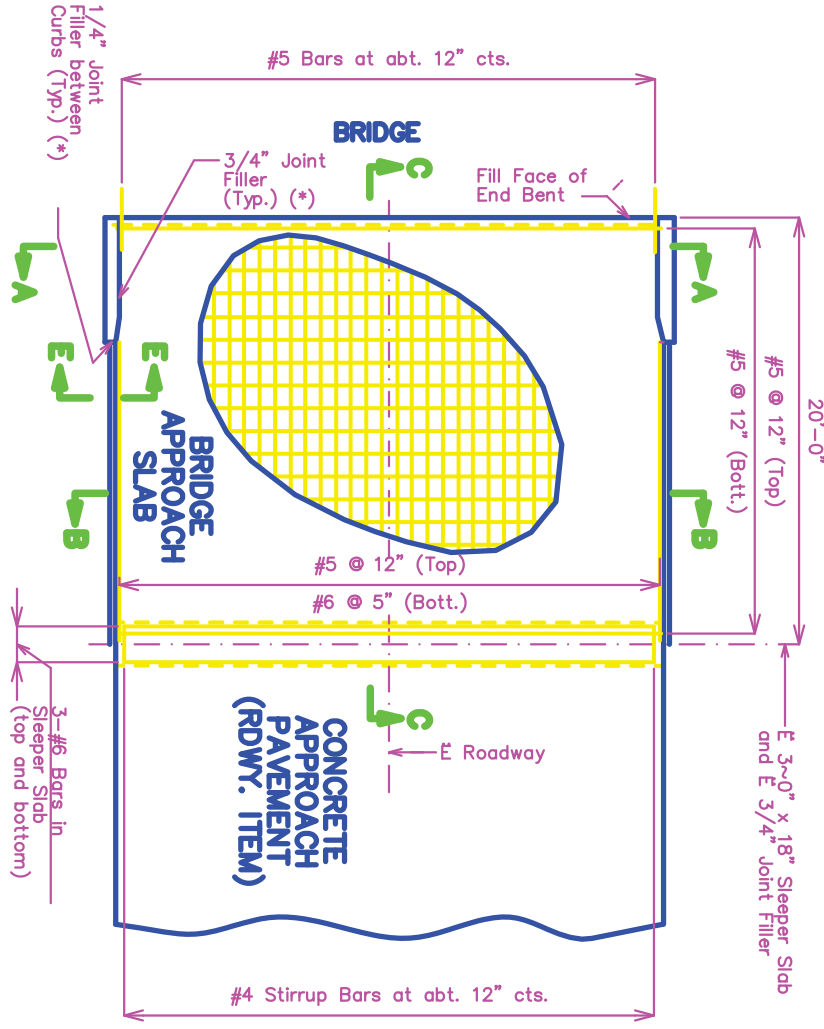

GENERAL NOTES:
 All concrete for the bridge approach slab and sleeper slab shall be in accordance with Sec 503 (f c = 4,000 psi).
 All joint filler shall be in accordance with Sec 1057 for preformed fiber expansion joint filler, except as noted.
 The reinforcing steel in the bridge approach slab and the sleeper slab shall be epoxy coated Grade 60 with Fy = 60,000 psi.
 Minimum clearance to reinforcing steel shall be 1 1/2", unless otherwise shown.
 The reinforcing steel in the bridge approach slab and the sleeper slab shall be continuous. The transverse reinforcing steel may be made continuous by lap splicing the #4 & #6 bars 18" and 2'-2", respectively. Mechanical bar splices shall be in accordance with Sec 706.
 (*) Seal joint between vertical face of approach slab and wing with "Silicone Joint Sealant for Saw Cut and Formed Joints" in accordance with Sec 717.
 Hooks and bends shall be in accordance with the CRSI Manual of Standard Practice for Detailing Reinforced Concrete Structures, Stirrup and Tie Dimensions.
 The contractor shall pour and satisfactorily finish the bridge or semi-deep slab before pouring the bridge approach slabs.
 Longitudinal construction joints in approach slab and sleeper slab shall be aligned with longitudinal construction joints in bridge or semi-deep slab.
 Payment for furnishing all materials, labor and excavation necessary to construct the approach slab, including the timber header, sleeper slab, underdrain, Type 5 aggregate base, joint filler and all other appurtenances and incidental work as shown on this sheet, complete in place, will be considered completely covered by the contract unit price for Bridge Approach Slab (Bridge) per square yard.
 For Concrete Approach Pavement details, see roadway plans.
 See Missouri Standard Plans Drawing 609.00 for details of Type A Curb.
 At the contractor's option, Grade 40 reinforcement may be substituted for the Grade 60 #5 dowel bars connecting the bridge approach slab to the bridge abutment. No additional payment will be made for this substitution.
 When Grade 40 reinforcement is substituted for the Grade 60 #5 dowel bars connecting the bridge approach slab to the bridge abutment, the reinforcement may be bent up to 90 degrees with a 2" minimum radius near the abutment to allow compaction of the backfill material near the abutment. Damage to epoxy coating shall be repaired in accordance with Sec 710.
 Drain pipe may be either 6" diameter corrugated metallic-coated pipe underdrain, 4" diameter corrugated polyvinyl chloride (PVC) drain pipe, or 4" diameter corrugated polyethylene (PE) drain pipe.
 Note: Nominal lengths are based on out to out dimensions shown in bending diagram and are listed for fabricators use (nearest inch).

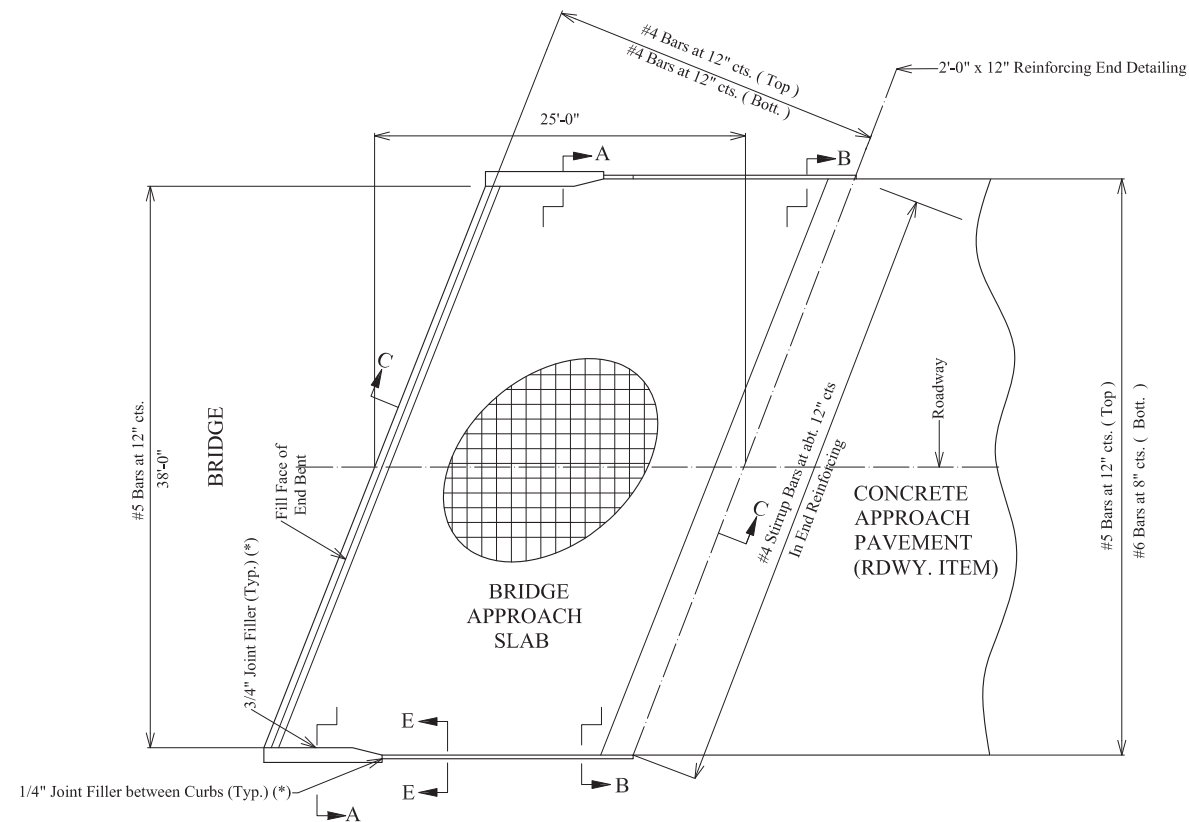

PART PLAN SHOWING REINFORCEMENT

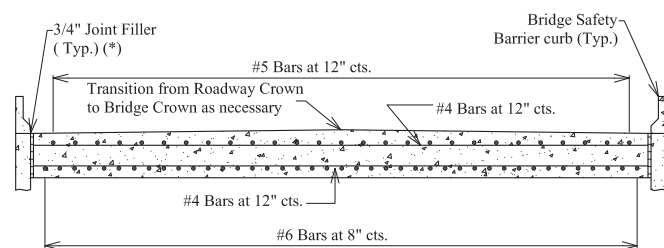

SECTION A-A

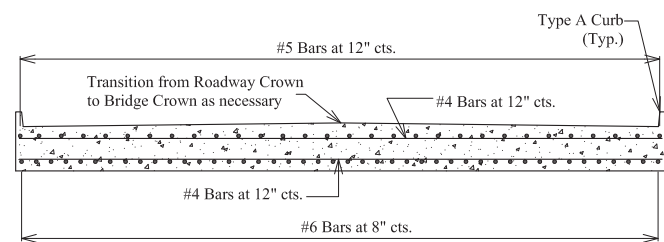

SECTION B-B

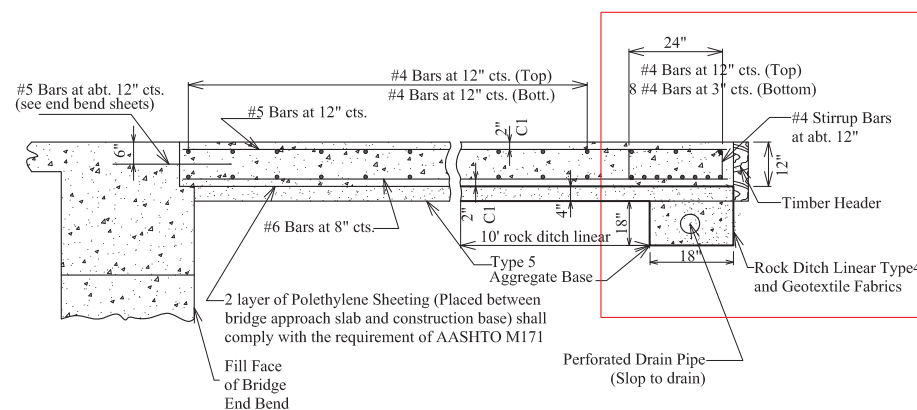

BRIDGE APPROACH SLAB

Left Advanced Integral End Bent

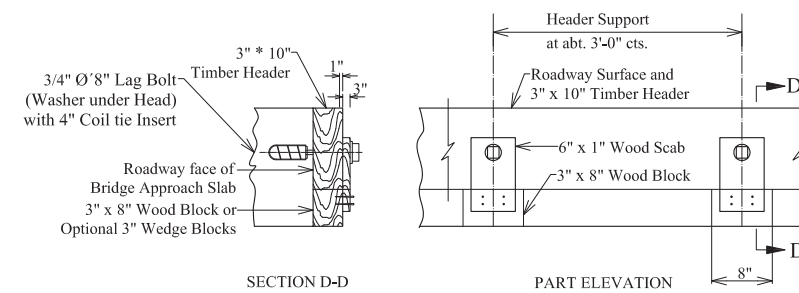

DETAILS OF TIMBER HEADER

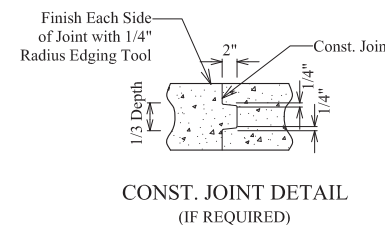

CONST. JOINT DETAIL (IF REQUIRED)

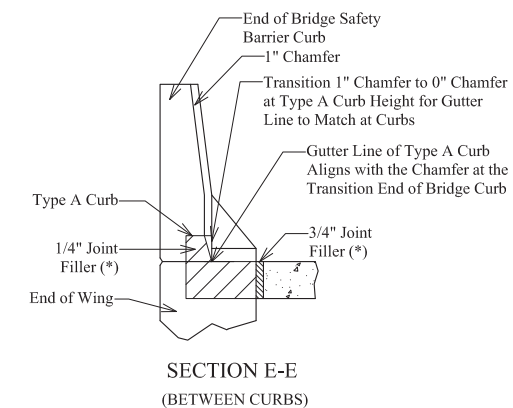

SECTION E-E (BETWEEN CURBS)

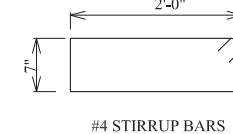

#4 STIRRUP BARS

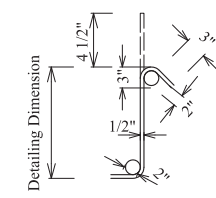

Typical 135° Stirrup Hook Dimensions Ending Diagram

General Notes:

All concrete for the bridge approach slab and sleeper slab shall be in accordance with Sec 503 ($f_c = 4,000$ psi).

All joint filler shall be in accordance with Sec 1057 for preformed fiber expansion joint filler, except as noted.

The reinforcing steel in the bridge approach slab and the sleeper slab shall be epoxy coated Grade 60 with $F_y = 60,000$ psi. Minimum clearance to reinforcing steel shall be 1 1/2", unless otherwise shown.

The reinforcing steel in the bridge approach slab and the sleeper slab shall be continuous. The transverse reinforcing steel may be made continuous by lap splicing the #4 & #6 bars 18" and 2'-2", respectively. Mechanical bar splices shall be in accordance with Sec 706.

(*) Seal joint between vertical face of approach slab and wing with "Silicone Joint Sealant for Saw Cut and Formed Joints" in accordance with Sec 717.

Hooks and bends shall be in accordance with the CRSI Manual of Standard Practice for Detailing Reinforced Concrete Structures, Stirrup and Tie Dimensions.

The contractor shall pour and satisfactorily finish the bridge or semi-deep slab before pouring the bridge approach slabs.

Longitudinal construction joints in approach slab shall be aligned with longitudinal construction joints in bridge or semi-deep slab.

Payment for furnishing all materials, labor and excavation necessary to construct the approach slab, including the timber header, sleeper slab, underdrain, Type 5 aggregate base, joint filler and all other appurtenances and incidental work as shown on this sheet, complete in place, will be considered completely covered by the contract unit price for Bridge Approach Slab (Bridge) per square yard.

For Concrete Approach Pavement details, see roadway plans. See Missouri Standard Plans Drawing 609.00 for details of Type A Curb.

At the contractor's option, Grade 40 reinforcement may be substituted for the Grade 60 #5 dowel bars connecting the bridge approach slab to the bridge abutment. No additional payment will be made for this substitution.

When Grade 40 reinforcement is substituted for the Grade 60 #5 dowel bars connecting the bridge approach slab to the bridge abutment, the reinforcement may be bent up to 90 degrees with a 2" minimum radius near the abutment to allow compaction of the backfill material near the abutment. Damage to epoxy coating shall be repaired in accordance with Sec 710.

Drain pipe may be either 6" diameter corrugated metallic-coated pipe underdrain, 4" diameter corrugated polyvinyl chloride (PVC) drain pipe, or 4" diameter corrugated polyethylene (PE) drain pipe.

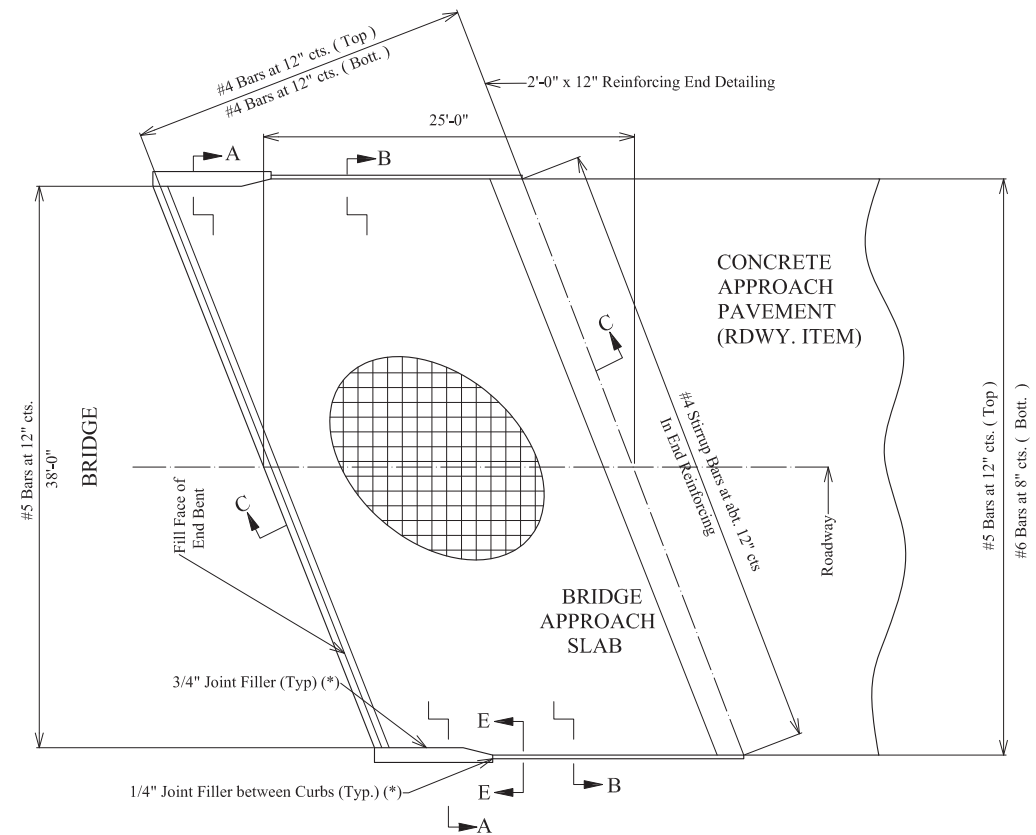

PART PLAN SHOWING REINFORCEMENT

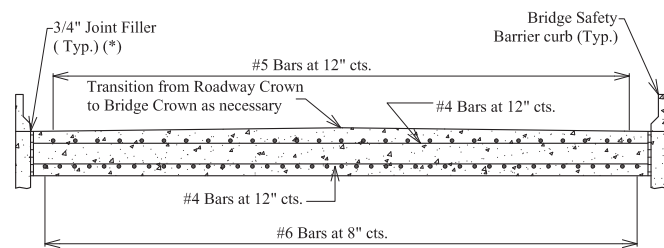

SECTION A-A

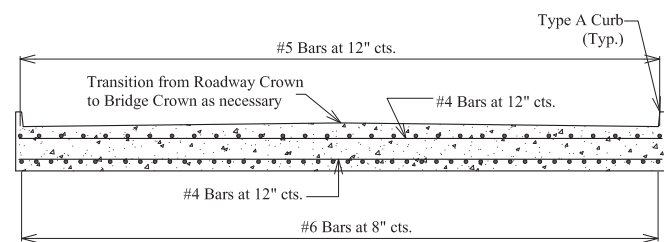

SECTION B-B

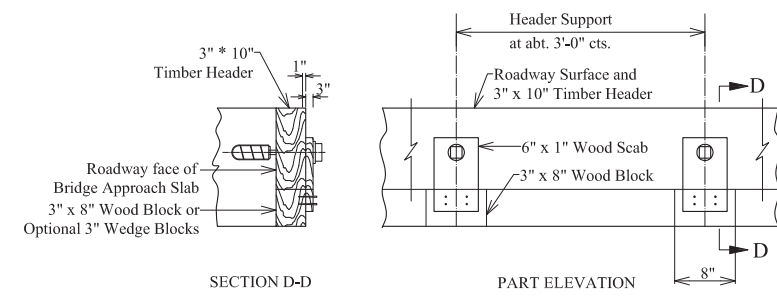
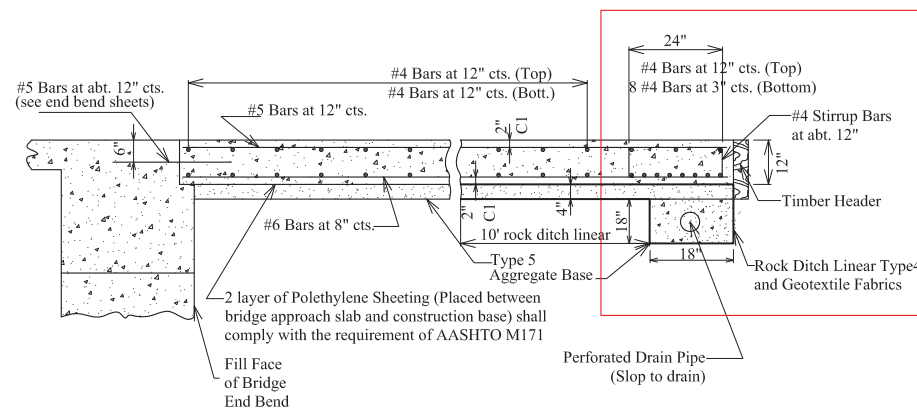

DETAILS OF TIMBER HEADER

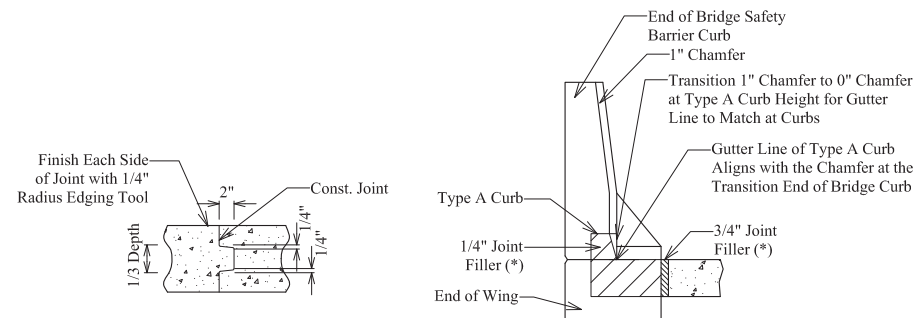

CONST. JOINT DETAIL (IF REQUIRED)

SECTION E-E (BETWEEN CURBS)

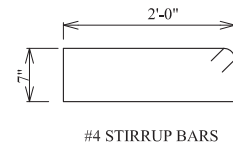

#4 STIRRUP BARS

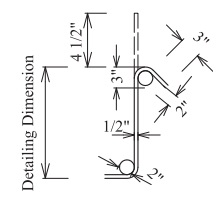

Typical 135° Stirrup Hook Dimensions Ending Diagram

General Notes:

All concrete for the bridge approach slab and sleeper slab shall be in accordance with Sec 503 ($f_c = 4,000$ psi).

All joint filler shall be in accordance with Sec 1057 for preformed fiber expansion joint filler, except as noted.

The reinforcing steel in the bridge approach slab and the sleeper slab shall be epoxy coated Grade 60 with $F_y = 60,000$ psi. Minimum clearance to reinforcing steel shall be 1 1/2", unless otherwise shown.

The reinforcing steel in the bridge approach slab and the sleeper slab shall be continuous. The transverse reinforcing steel may be made continuous by lap splicing the #4 & #6 bars 18" and 2'-2", respectively. Mechanical bar splices shall be in accordance with Sec 706.

(*) Seal joint between vertical face of approach slab and wing with "Silicone Joint Sealant for Saw Cut and Formed Joints" in accordance with Sec 717.

Hooks and bends shall be in accordance with the CRSI Manual of Standard Practice for Detailing Reinforced Concrete Structures, Stirrup and Tie Dimensions.

The contractor shall pour and satisfactorily finish the bridge or semi-deep slab before pouring the bridge approach slabs.

Longitudinal construction joints in approach slab shall be aligned with longitudinal construction joints in bridge or semi-deep slab.

Payment for furnishing all materials, labor and excavation necessary to construct the approach slab, including the timber header, sleeper slab, underdrain, Type 5 aggregate base, joint filler and all other appurtenances and incidental work as shown on this sheet, complete in place, will be considered completely covered by the contract unit price for Bridge Approach Slab (Bridge) per square yard.

For Concrete Approach Pavement details, see roadway plans.

See Missouri Standard Plans Drawing 609.00 for details of Type A Curb.

At the contractor's option, Grade 40 reinforcement may be substituted for the Grade 60 #5 dowel bars connecting the bridge approach slab to the bridge abutment. No additional payment will be made for this substitution.

When Grade 40 reinforcement is substituted for the Grade 60 #5 dowel bars connecting the bridge approach slab to the bridge abutment, the reinforcement may be bent up to 90 degrees with a 2" minimum radius near the abutment to allow compaction of the backfill material near the abutment. Damage to epoxy coating shall be repaired in accordance with Sec 710.

Drain pipe may be either 6" diameter corrugated metallic-coated pipe underdrain, 4" diameter corrugated polyvinyl chloride (PVC) drain pipe, or 4" diameter corrugated polyethylene (PE) drain pipe.

BRIDGE APPROACH SLAB

Right Advanced Integral End Bent

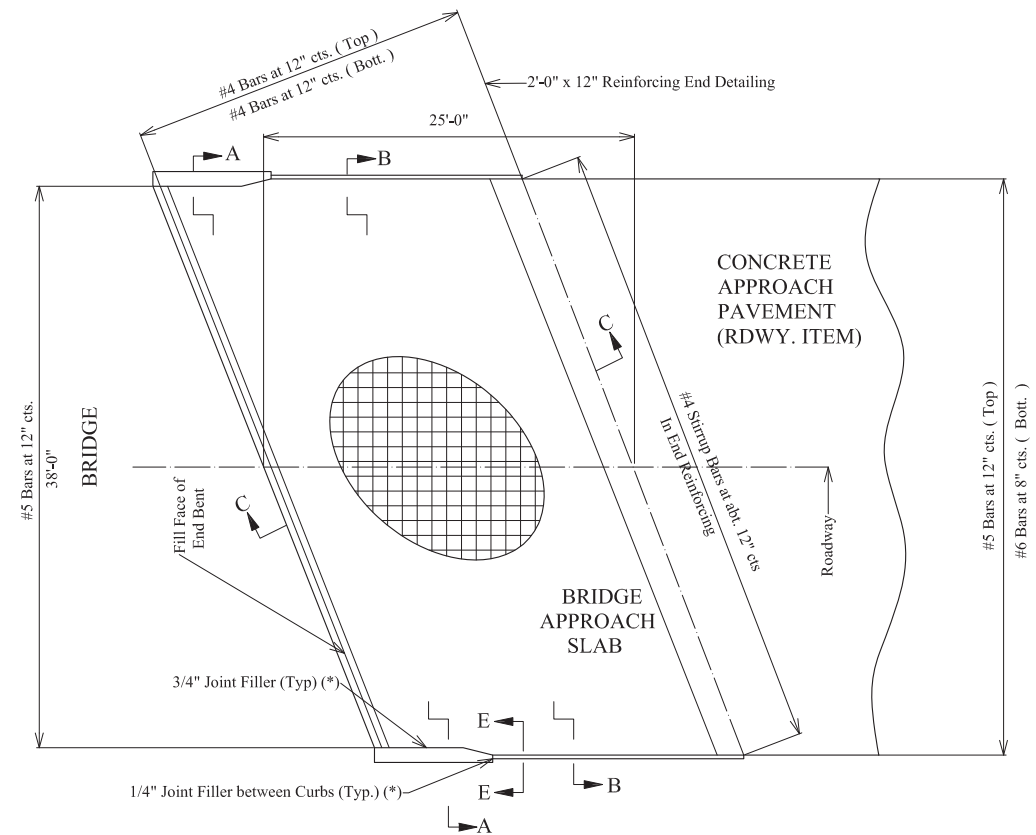

PART PLAN SHOWING REINFORCEMENT

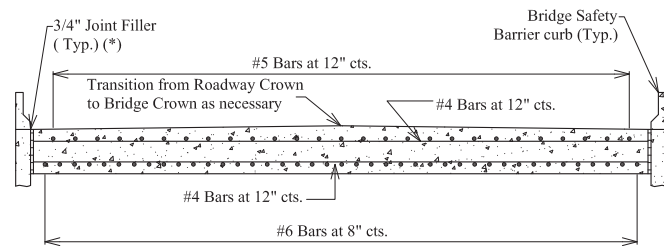

SECTION A-A

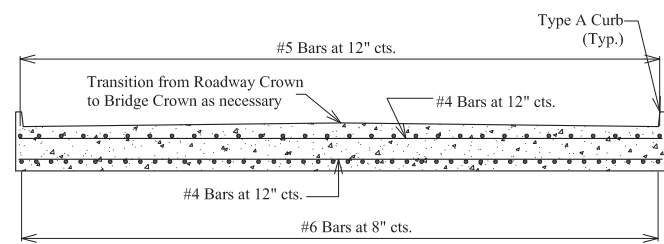

SECTION B-B

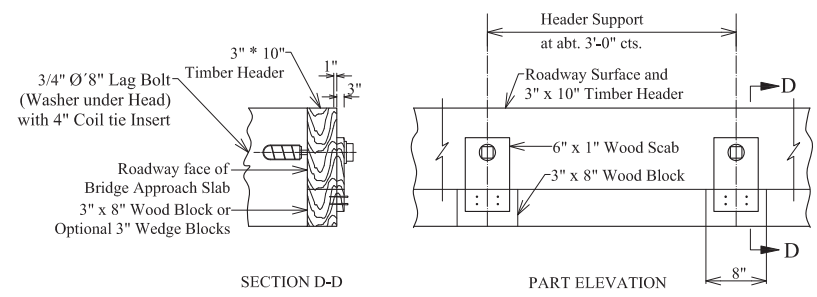
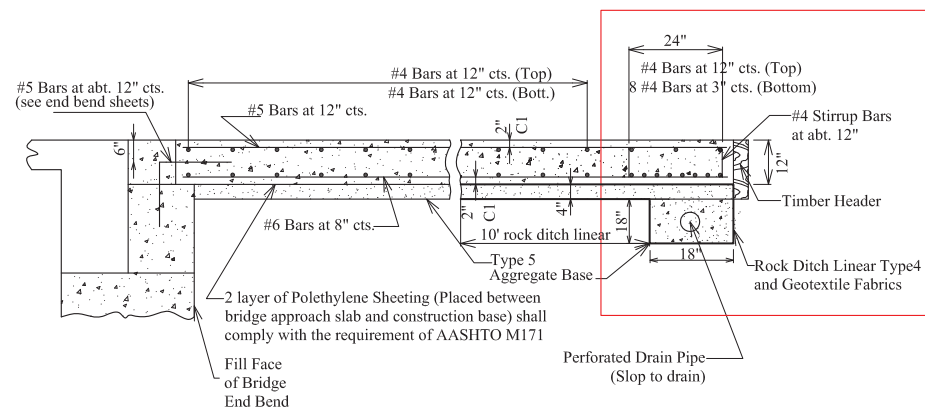

DETAILS OF TIMBER HEADER

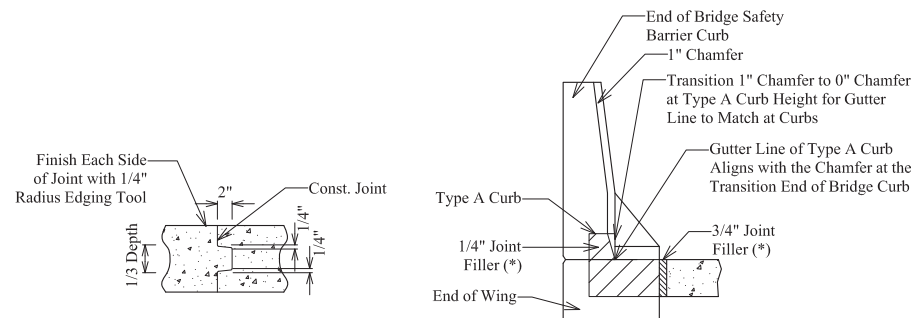

CONST. JOINT DETAIL (IF REQUIRED)

SECTION E-E (BETWEEN CURBS)

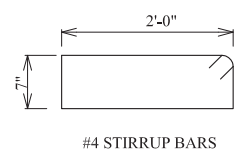

#4 STIRRUP BARS

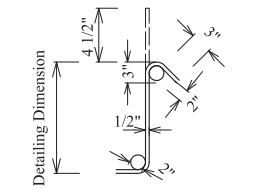

Typical 135° Stirrup Hook Dimensions Ending Diagram

General Notes:

All concrete for the bridge approach slab and sleeper slab shall be in accordance with Sec 503 ($f_c = 4,000$ psi).
 All joint filler shall be in accordance with Sec 1057 for preformed fiber expansion joint filler, except as noted.
 The reinforcing steel in the bridge approach slab and the sleeper slab shall be epoxy coated Grade 60 with $F_y = 60,000$ psi.
 Minimum clearance to reinforcing steel shall be 1 1/2", unless otherwise shown.
 The reinforcing steel in the bridge approach slab and the sleeper slab shall be continuous. The transverse reinforcing steel may be made continuous by lap splicing the #4 & #6 bars 18" and 2'-2", respectively. Mechanical bar splices shall be in accordance with Sec 706.
 (*) Seal joint between vertical face of approach slab and wing with "Silicone Joint Sealant for Saw Cut and Formed Joints" in accordance with Sec 717.
 Hooks and bends shall be in accordance with the CRSI Manual of Standard Practice for Detailing Reinforced Concrete Structures, Stirrup and Tie Dimensions. The contractor shall pour and satisfactorily finish the bridge or semi-deep slab before pouring the bridge approach slabs.
 Longitudinal construction joints in approach slab shall be aligned with longitudinal construction joints in bridge or semi-deep slab.
 Payment for furnishing all materials, labor and excavation necessary to construct the approach slab, including the timber header, sleeper slab, underdrain, Type 5 aggregate base, joint filler and all other appurtenances and incidental work as shown on this sheet, complete in place, will be considered completely covered by the contract unit price for Bridge Approach Slab (Bridge) per square yard.
 For Concrete Approach Pavement details, see roadway plans.
 See Missouri Standard Plans Drawing 609.00 for details of Type A Curb.
 At the contractor's option, Grade 40 reinforcement may be substituted for the Grade 60 #5 dowel bars connecting the bridge approach slab to the bridge abutment. No additional payment will be made for this substitution.
 When Grade 40 reinforcement is substituted for the Grade 60 #5 dowel bars connecting the bridge approach slab to the bridge abutment, the reinforcement may be bent up to 90 degrees with a 2" minimum radius near the abutment to allow compaction of the backfill material near the abutment. Damage to epoxy coating shall be repaired in accordance with Sec 710.
 Drain pipe may be either 6" diameter corrugated metallic-coated pipe underdrain, 4" diameter corrugated polyvinyl chloride (PVC) drain pipe, or 4" diameter corrugated polyethylene (PE) drain pipe.

BRIDGE APPROACH SLAB
 Right Advanced Non-Integral End Bent

General Notes:

All concrete for the bridge approach slab and sleeper slab shall be in accordance with Sec 503 ($f_c = 4,000$ psi).

All joint filler shall be in accordance with Sec 1057 for preformed fiber expansion joint filler, except as noted.

The reinforcing steel in the bridge approach slab and the sleeper slab shall be epoxy coated Grade 60 with $F_y = 60,000$ psi.

Minimum clearance to reinforcing steel shall be $1\frac{1}{2}$ ", unless otherwise shown.

The reinforcing steel in the bridge approach slab and the sleeper slab shall be continuous. The transverse reinforcing steel may be made continuous by lap splicing the #4 & #6 bars 18" and 2'-2", respectively. Mechanical bar splices shall be in accordance with Sec 706.

(* Seal joint between vertical face of approach slab and wing with "Silicone Joint Sealant for Saw Cut and Formed Joints" in accordance with Sec 717.

Hooks and bends shall be in accordance with the CRSI Manual of Standard Practice for Detailing Reinforced Concrete Structures, Stirrup and Tie Dimensions.

The contractor shall pour and satisfactorily finish the bridge or semi-deep slab before pouring the bridge approach slabs.

Longitudinal construction joints in approach slab shall be aligned with longitudinal construction joints in bridge or semi-deep slab.

Payment for furnishing all materials, labor and excavation necessary to construct the approach slab, including the timber header, sleeper slab, underdrain, Type 5 aggregate base, joint filler and all other appurtenances and incidental work as shown on this sheet, complete in place, will be considered completely covered by the contract unit price for Bridge Approach Slab (Bridge) per square yard.

For Concrete Approach Pavement details, see roadway plans.

See Missouri Standard Plans Drawing 609.00 for details of Type A Curb.

At the contractor's option, Grade 40 reinforcement may be substituted for the Grade 60 #5 dowel bars connecting the bridge approach slab to the bridge abutment. No additional payment will be made for this substitution.

When Grade 40 reinforcement is substituted for the Grade 60 #5 dowel bars connecting the bridge approach slab to the bridge abutment, the reinforcement may be bent up to 90 degrees with a 2" minimum radius near the abutment to allow compaction of the backfill material near the abutment. Damage to epoxy coating shall be repaired in accordance with Sec 710.

Drain pipe may be either 6" diameter corrugated metallic-coated pipe underdrain, 4" diameter corrugated polyvinyl chloride (PVC) drain pipe, or 4" diameter corrugated polyethylene (PE) drain pipe.

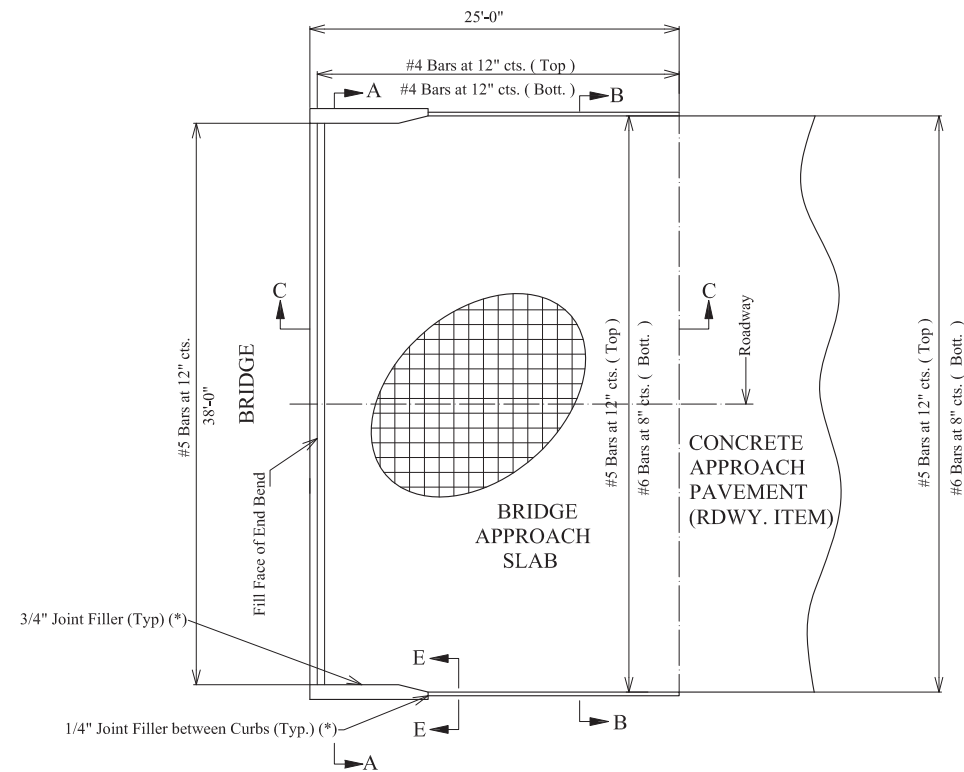

PART PLAN SHOWING REINFORCEMENT

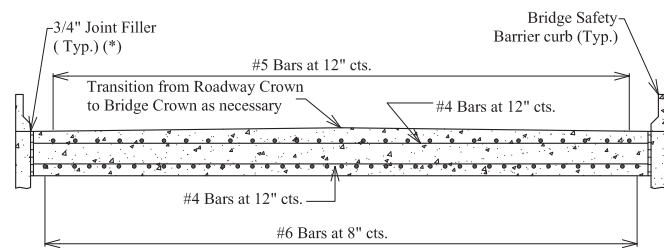

SECTION A-A

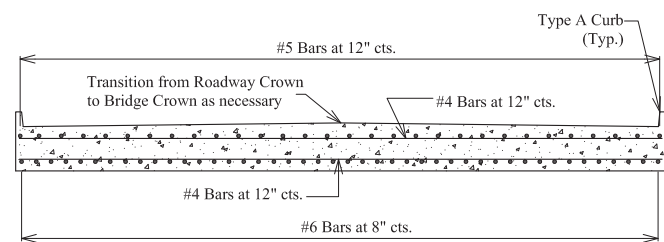

SECTION B-B

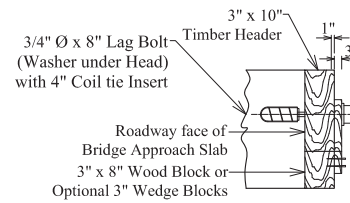
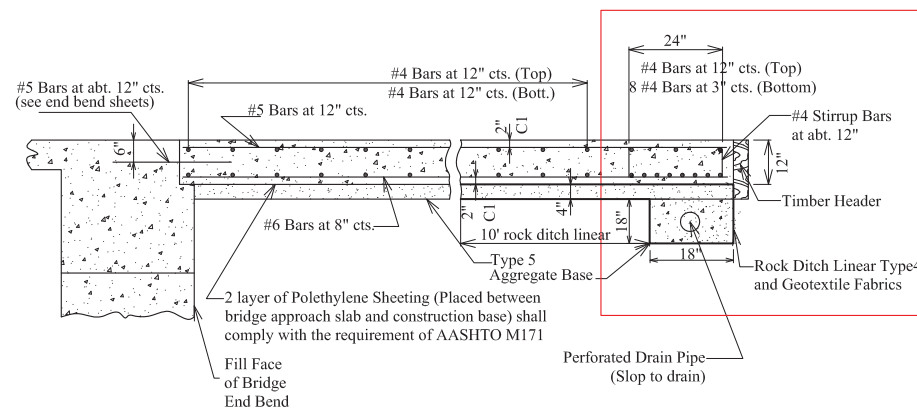

SECTION D-D

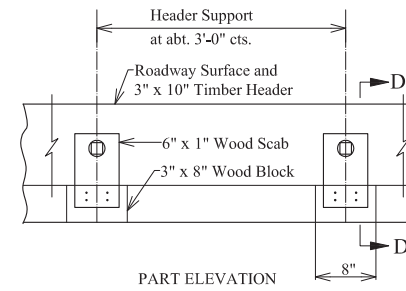

DETAILS OF TIMBER HEADER

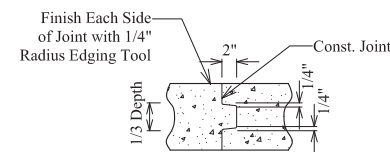

CONST. JOINT DETAIL
(IF REQUIRED)

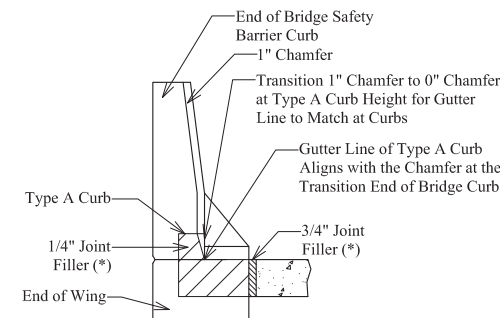

SECTION E-E
(BETWEEN CURBS)

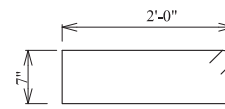

#4 STIRRUP BARS

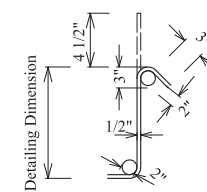

Typical 135° Stirrup Hook
Dimensions Ending Diagram

BRIDGE APPROACH SLAB

Square Integral End Bent

General Notes:

All concrete for the bridge approach slab and sleeper slab shall be in accordance with Sec 503 ($f_c = 4,000$ psi).

All joint filler shall be in accordance with Sec 1057 for preformed fiber expansion joint filler, except as noted.

The reinforcing steel in the bridge approach slab and the sleeper slab shall be epoxy coated Grade 60 with $F_y = 60,000$ psi.

Minimum clearance to reinforcing steel shall be $1\frac{1}{2}$ ", unless otherwise shown.

The reinforcing steel in the bridge approach slab and the sleeper slab shall be continuous. The transverse reinforcing steel may be made continuous by lap splicing the #4 & #6 bars 18" and 2'-2", respectively. Mechanical bar splices shall be in accordance with Sec 706.

(*) Seal joint between vertical face of approach slab and wing with "Silicone Joint Sealant for Saw Cut and Formed Joints" in accordance with Sec 717.

Hooks and bends shall be in accordance with the CRSI Manual of Standard Practice for Detailing Reinforced Concrete Structures, Stirrup and Tie Dimensions.

The contractor shall pour and satisfactorily finish the bridge or semi-deep slab before pouring the bridge approach slabs.

Longitudinal construction joints in approach slab shall be aligned with longitudinal construction joints in bridge or semi-deep slab.

Payment for furnishing all materials, labor and excavation necessary to construct the approach slab, including the timber header, sleeper slab, underdrain, Type 5 aggregate base, joint filler and all other appurtenances and incidental work as shown on this sheet, complete in place, will be considered completely covered by the contract unit price for Bridge Approach Slab (Bridge) per square yard.

For Concrete Approach Pavement details, see roadway plans.

See Missouri Standard Plans Drawing 609.00 for details of Type A Curb.

At the contractor's option, Grade 40 reinforcement may be substituted for the Grade 60 #5 dowel bars connecting the bridge approach slab to the bridge abutment. No additional payment will be made for this substitution.

When Grade 40 reinforcement is substituted for the Grade 60 #5 dowel bars connecting the bridge approach slab to the bridge abutment, the reinforcement may be bent up to 90 degrees with a 2" minimum radius near the abutment to allow compaction of the backfill material near the abutment. Damage to epoxy coating shall be repaired in accordance with Sec 710.

Drain pipe may be either 6" diameter corrugated metallic-coated pipe underdrain, 4" diameter corrugated polyvinyl chloride (PVC) drain pipe, or 4" diameter corrugated polyethylene (PE) drain pipe.

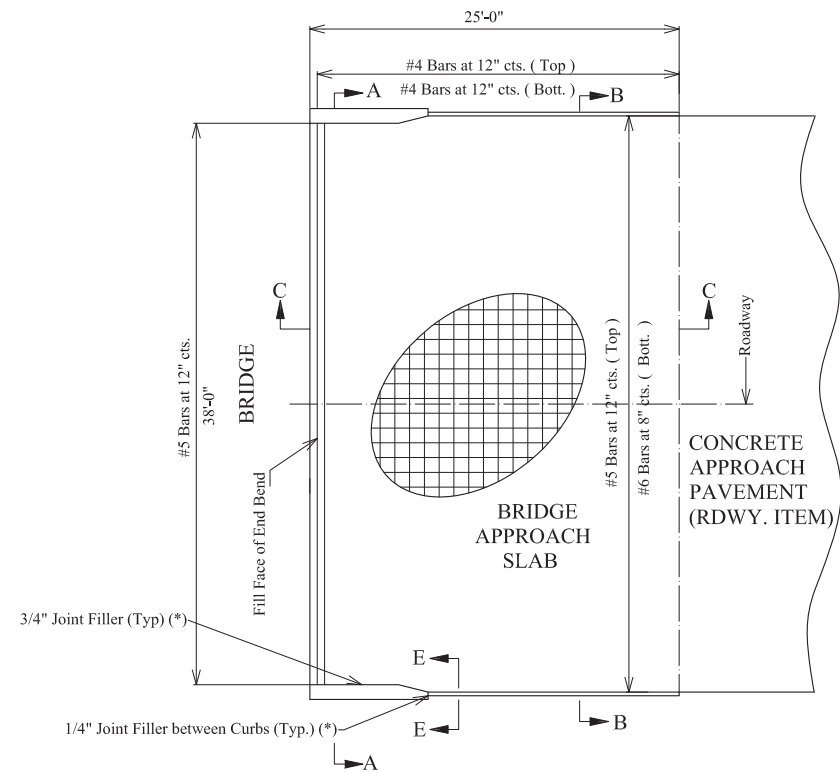

PART PLAN SHOWING REINFORCEMENT

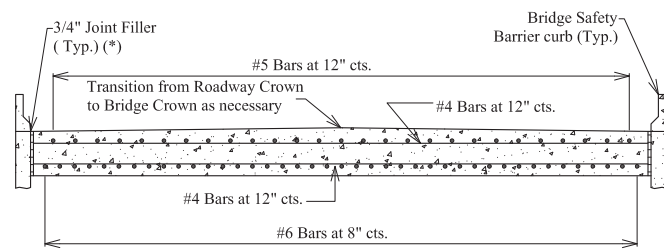

SECTION A-A

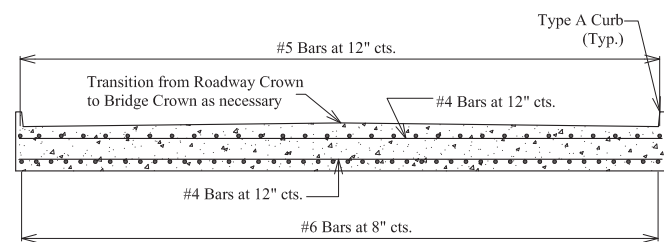

SECTION B-B

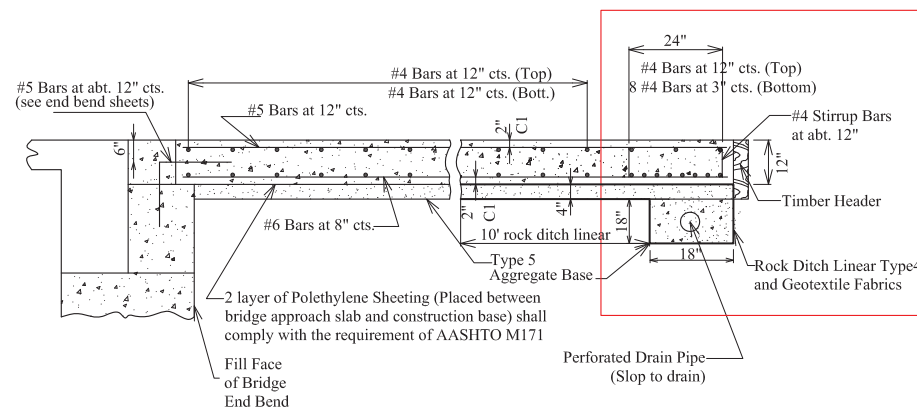

BRIDGE APPROACH SLAB

Square Non-Integral End Bent

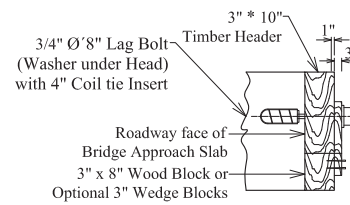

SECTION D-D

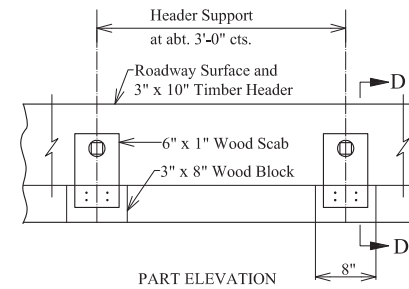

PART ELEVATION

DETAILS OF TIMBER HEADER

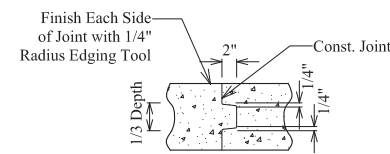

CONST. JOINT DETAIL
(IF REQUIRED)

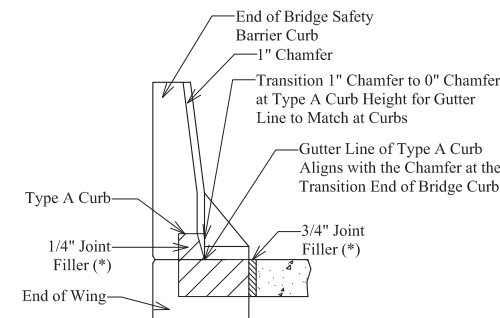

SECTION E-E
(BETWEEN CURBS)

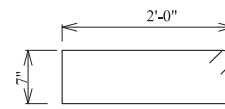

#4 STIRRUP BARS

APPENDIX A-8 DESIGN DRAWING FOR PRECAST PRESTRESSED SOLUTION

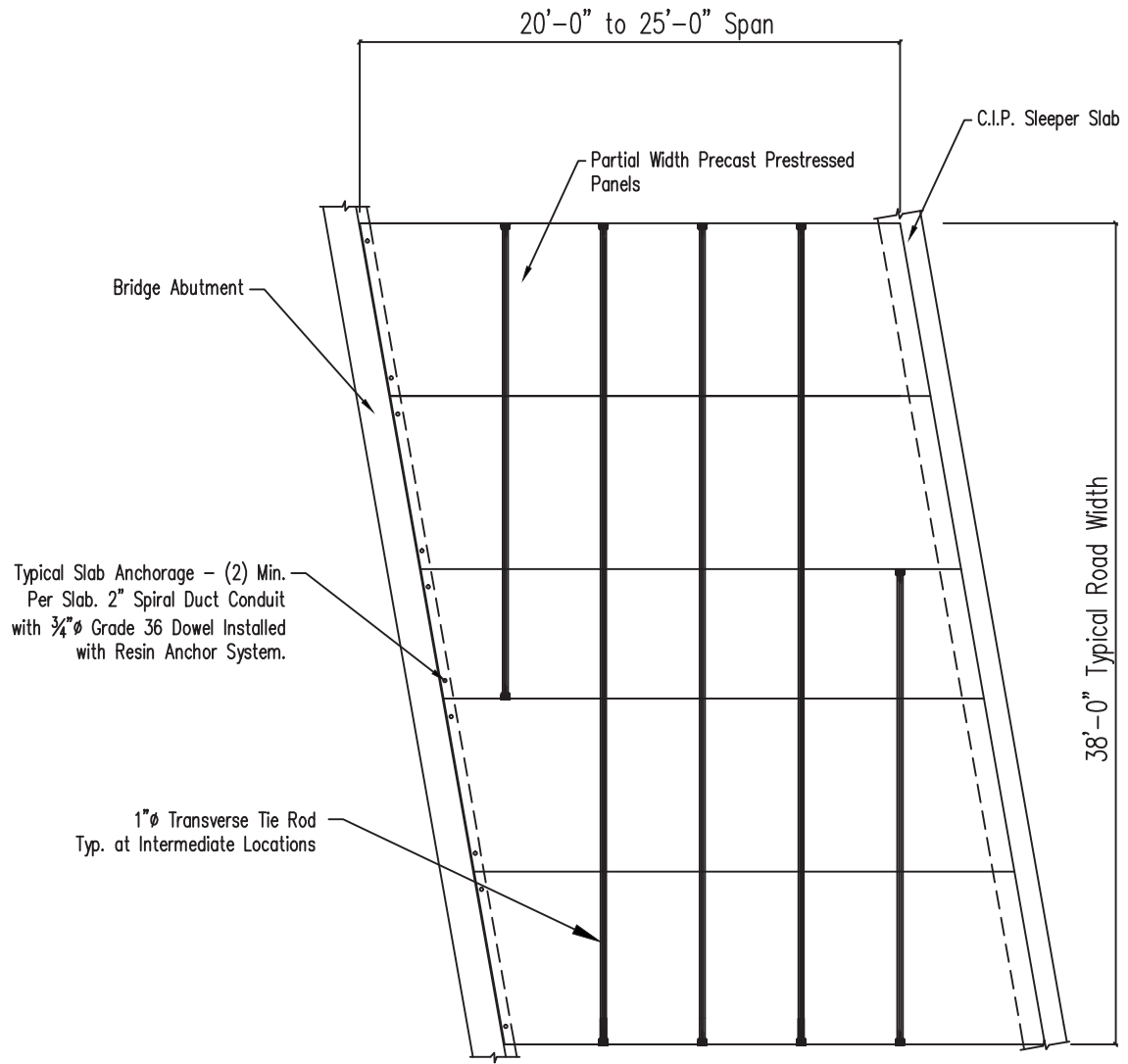

PRECAST PRESTRESSED PANEL PLAN (ONE END)

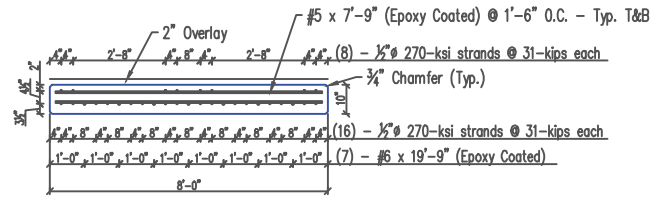

SECTION THROUGH SLAB

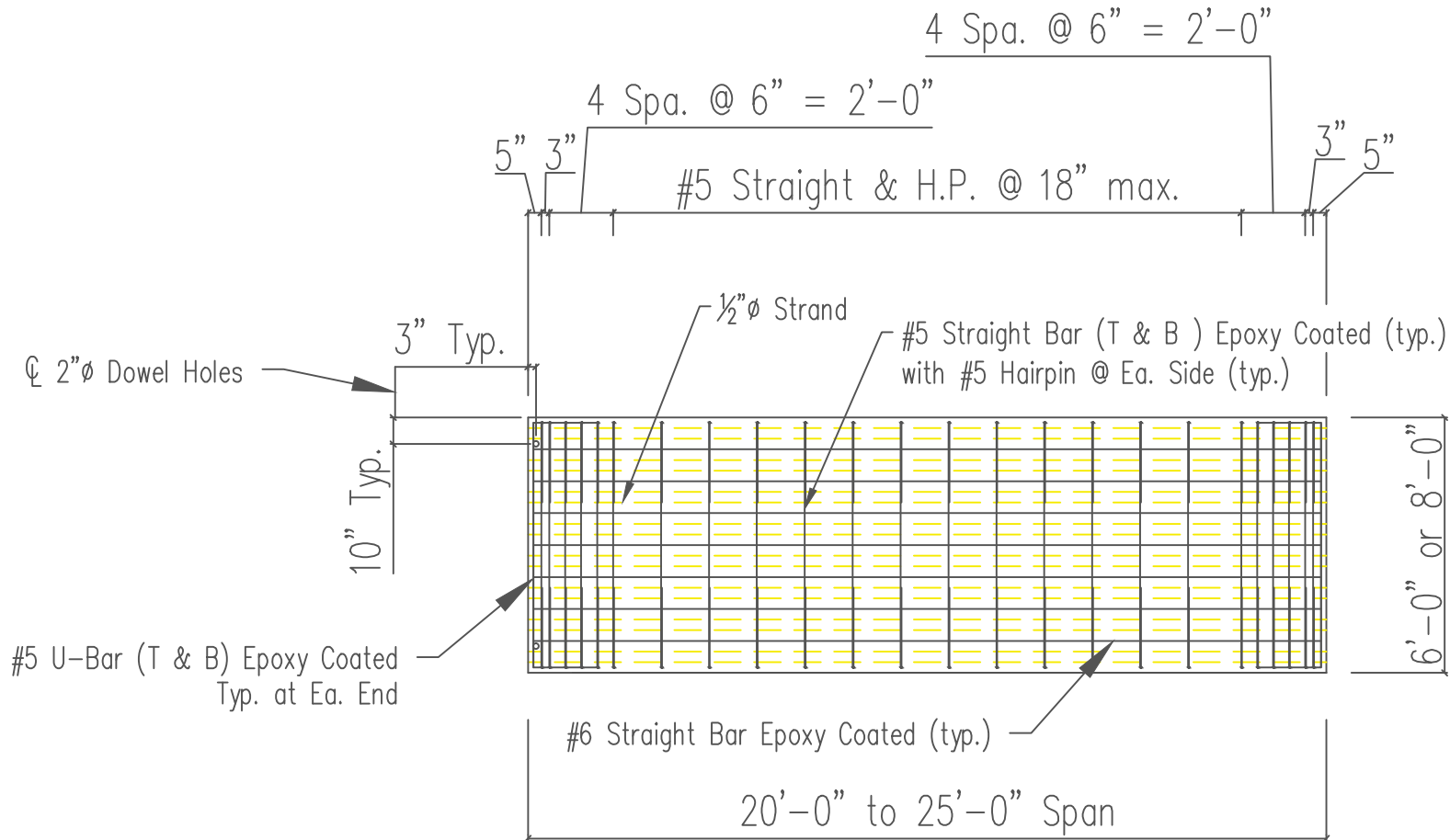

PANEL REINFORCEMENT - PLAN

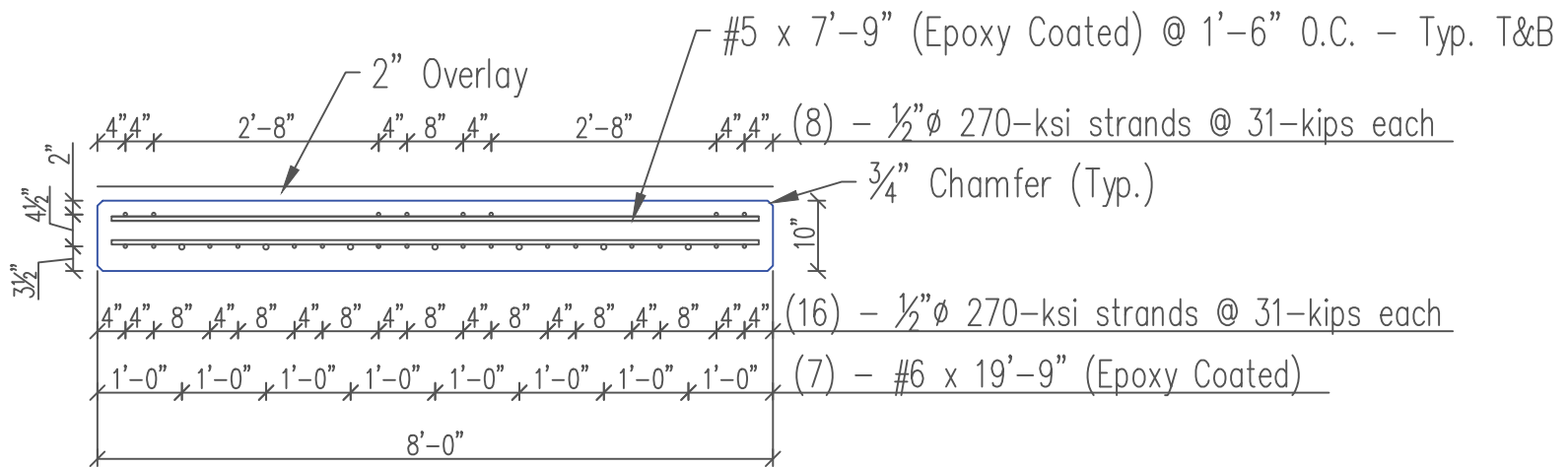

SECTION THROUGH SLAB

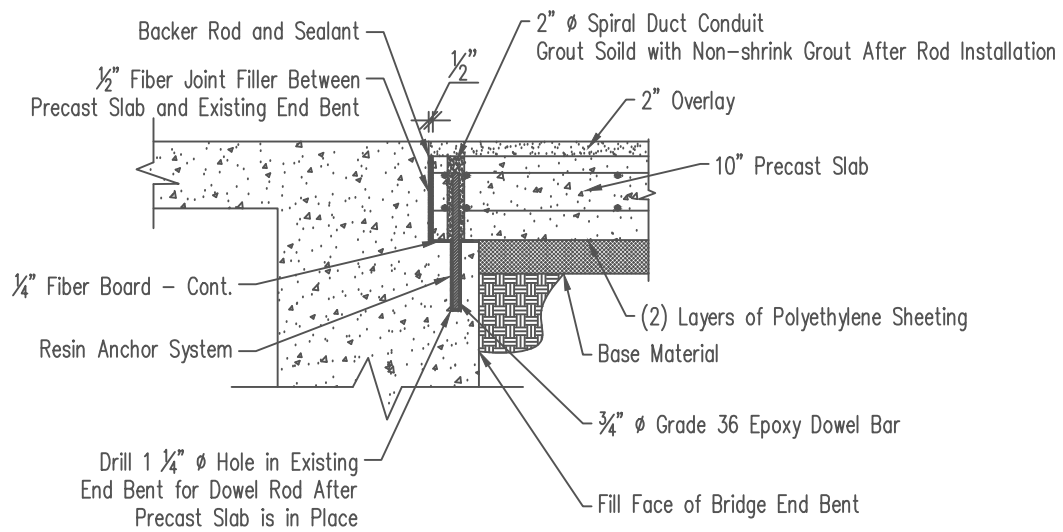

SLAB ANCHORAGE DETAIL AT END BENT

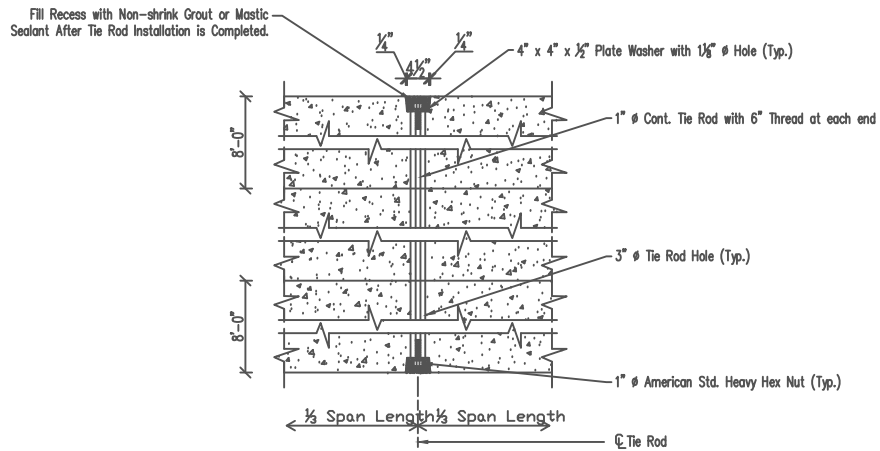

NOTES:

All tie rods, plates, and nuts shall be galvanized in accordance with ASTM A123.

Tighten all tie rods to about one-half of the specified tension before proceeding with the final tensioning.

Tie rod nuts shall be tightened to provide a tension of one-half that specified for A325 bolts in Sec 712.10.2.

Tie rod plates shall be ASTM A709 Grade 36.

Tie rods and nuts shall be A307.

Tie rod hole distance from bottom of slab shall be within $1/2"$.

Tie rod hole horizontal distance from the ends of slabs shall be within $1/2"$.

PART PLAN SHOWING 1" ϕ TIE ROD

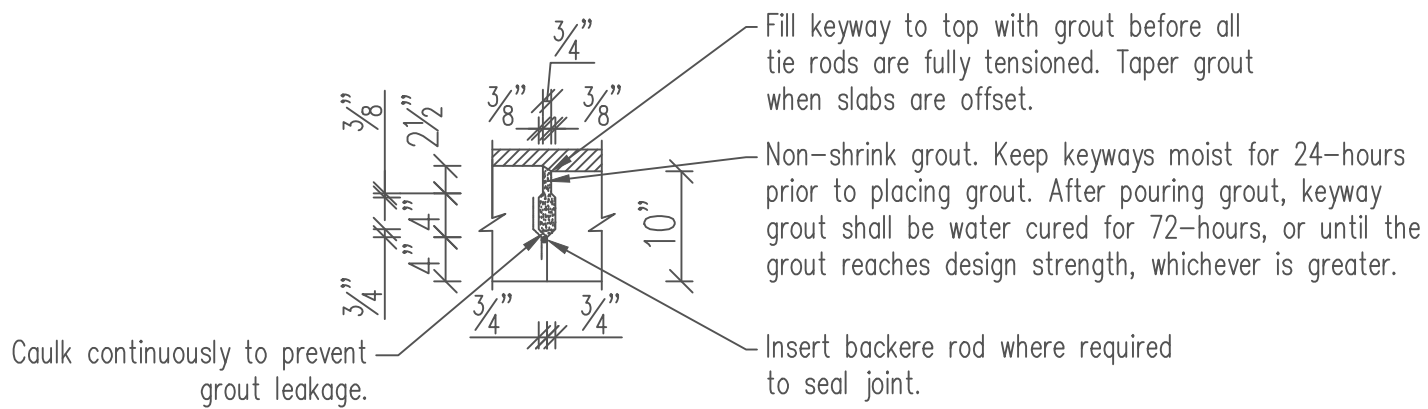

KEYWAY GROUT DETAIL



Missouri Department of Transportation
Organizational Results
P. O. Box 270
Jefferson City, MO 65102

573.526.4335
1.888.ASK.MODOT
innovation@modot.mo.gov