



TH-36 Full Closure Construction Evaluation of Traffic Operations Alternatives

Minnesota
Department of
Transportation

**RESEARCH
SERVICES**

Office of
Policy Analysis,
Research &
Innovation

John Hourdos, Principal Investigator
Department of Civil Engineering
University of Minnesota

January 2010

Research Project
Final Report #2010-04

Your Destination... Our Priority



Technical Report Documentation Page

1. Report No. MN/RC 2010-04	2.	3. Recipients Accession No.	
4. Title and Subtitle TH-36 Full Closure Construction: Evaluation of Traffic Operations Alternatives		5. Report Date January 2010	
		6.	
7. Author(s) John Hourdos and Feili Hong		8. Performing Organization Report No.	
9. Performing Organization Name and Address Civil Engineering Dept University of Minnesota 500 Pillsbury Dr. SE Minneapolis, MN 55455		10. Project/Task/Work Unit No.	
		11. Contract (C) or Grant (G) No. (c) 89261 (wo) 66	
12. Sponsoring Organization Name and Address Minnesota Department of Transportation Research Services Section 395 John Ireland Boulevard, MS 330 St. Paul, MN 55155-1899		13. Type of Report and Period Covered Final Report	
		14. Sponsoring Agency Code	
15. Supplementary Notes http://www.lrrb.org/pdf/201004.pdf			
16. Abstract (Limit: 250 words) <p>According to the 2007 Urban Mobility Report, \$78 billion was lost due to congestion on urban roadways. Many urban corridors around the country experience demand that is close to or greater than the available capacity. Although most agree that the transportation system has matured and that we will not build ourselves out of congestion, existing infrastructure still often requires expansion. Such expansion in an already developed system most likely does not involve new roadway construction but results in existing roadway upgrades. Such roadways normally already serve considerable demand, a fact that increases the importance of the impact to the roadway users, estimated as Road User Costs (RUCs), and raises safety concerns both for the driving public as well as for the people working on reconstruction projects. New construction methods like Full Road Closure claim to reduce RUCs as well as reduce capital costs. This project follows the first large-scale Full Closure in Minnesota in an attempt to learn from the experience and propose the most appropriate tools and methodologies for planning, staging, and executing the construction. For the latter, three traffic analysis tools are selected for estimating RUCs due to the construction project. Their effort and data requirements, as well as their accuracy is evaluated and compared to the empirical, engineering-judgment-based, method used by Mn/DOT.</p>			
17. Document Analysis/Descriptors Full Closure, Traffic analysis tools, Simulation, BCA, Construction management, Traffic models, Travel costs, Travel demand, High volume roads, Reconstruction		18. Availability Statement No restrictions. Document available from: National Technical Information Services, Springfield, Virginia 22161	
19. Security Class (this report) Unclassified	20. Security Class (this page) Unclassified	21. No. of Pages 155	22. Price

TH-36 Full Closure Construction Evaluation of Traffic Operations Alternatives

Final Report

Prepared by

John Hourdos
Feili Hong

Department of Civil Engineering
University of Minnesota

January 2010

Published by

Minnesota Department of Transportation
Research Services Section
Transportation Building
395 John Ireland Boulevard, MS 330
St. Paul, Minnesota 55155-1899

This report represents the results of research conducted by the authors and does not necessarily represent the views or policies of the Minnesota Department of Transportation and/or the University of Minnesota. This report does not contain a standard or specified technique.

The authors and the Minnesota Department of Transportation and/or the University of Minnesota do not endorse products or manufacturers. Any trade or manufacturers' names that may appear herein do so solely because they are considered essential to this report.

Acknowledgements

We would like to acknowledge Mn/DOT's forward thinking and openness to learn that prompted recognition of the opportunity presented with the full closure reconstruction of TH-36 for creating a real before, during, and after case study. Specifically, we would like to thank the project Technical Liaisons Chris Roy and Colleen VanWagner, as well as the Administrative Liaison Bruce Holdhusen for their patience and valuable guidance during the course of this project.

We would like also to thank all the people in Mn/DOT, Ramsey County, and the City of North St. Paul who are too numerous to mention but who all contributed to collecting as much knowledge from this study as possible.

Table of Contents

1. Introduction.....	1
2. Full Road Closure	4
Case Studies	4
Evaluation during the Planning Stage.....	7
Post-Construction Evaluation	9
Traffic Impacts of Reconstruction	10
Summary.....	11
3. Analysis of Full Closure Impact on Traffic Conditions.....	12
Freeway Detector Data Analysis	12
AM period.....	13
I-694 and TH-36 interchange.....	15
White Bear Ave and I-694 interchange	16
I-35E and TH-36 interchange	17
TH-61 and TH-36 interchange.....	18
I-94 and I-694 interchange.....	19
PM period.....	20
I-694 and TH-36 interchange.....	22
White Bear Ave and I-694 interchange	23
I-35E and TH-36 interchange	24
TH-61 and TH-36 interchange.....	25
I-94 and I-694 interchange.....	26
Local Street Tube Count Analysis	27
AM period (From 6:00am to 10:59am)	27
Location 1, Location 3 and Location 4	27
Origins and destinations in 2007	27
Traffic condition analysis	28
Data analysis	28
Location 1 and Location 2	29
Origins and destinations in 2007	29
Traffic condition analysis	30
Data analysis	30
Location 2 and Location 13	31
Origins and destinations in 2007	31
Traffic condition analysis	31
Data analysis	32
Location 3, Location 4 and Location 5	32
Origins and destinations in 2007	32
Traffic condition analysis	32
Location 4, Location 8 and Location 9	33
Origins and destinations in 2007	33
Traffic condition analysis	34
Data analysis	34
Location 9 and Location 11	35

Origins and destinations in 2007	35
Traffic condition analysis	35
Data analysis	35
Location 7, Location 11, Location 12 and Location 13.....	36
Origins and destinations in 2007	36
Traffic condition analysis	36
Data analysis	37
PM period (from 2:00pm to 8:59pm).....	37
Location 1, Location 3 and Location 4	37
Traffic condition analysis	38
Data analysis	38
Location 1 and Location 2	39
Traffic condition analysis	39
Data analysis	39
Location 2 and Location 13	40
Traffic condition analysis	40
Data analysis	40
Location 4, Location 8 and Location 9	41
Traffic condition analysis	41
Data analysis	42
Location 9 and Location 11	42
Traffic condition analysis	43
Data analysis	43
Location 7, Location 11, Location 12 and Location 13.....	43
Traffic condition analysis	44
Data analysis	44
4. Selecting the Appropriate Traffic Analysis Tool.....	49
Road User Costs (RUCs)	49
Components of RUC.....	50
Delay costs.....	50
VOC.....	50
Accident costs.....	50
Application of RUCs.....	51
Methods of RUCs calculation.....	52
Methodologies of RUCs Calculation in the TH-36 Project.....	53
Empirical estimation of RUCs	53
Sketch-planning tool: QuickZone	54
Limitations of QuickZone.....	55
Improved QuickZone methodology.....	55
Travel demand model: Cube Voyager	57
Simulation model: AIMSUN NG	58
Calibration of microscopic simulation model.....	59
Implementation of Analysis Methodologies.....	62
QuickZone.....	62
Cube Voyager	63
Base Case validation	64

Full Closure validation.....	65
AIMSUN NG	67
Network geometry	68
Traffic demand.....	68
Traffic control plans.....	68
Model calibration	70
Freeway calibration.....	70
Network calibration	75
AIMSUN model validation.....	84
Base Case validation.....	84
Full Closure validation.....	86
Results of the Evaluation of TH-36 Project Construction Alternatives.....	88
Traffic diversion analysis.....	88
Full Closure.....	88
AM period.....	88
PM period	91
Partial Closure.....	92
AM period.....	92
PM period	94
RUCs results	95
Result sensitivity to modeling assumptions.....	97
QuickZone	98
Cube Voyager	99
AIMSUN NG.....	100
Hypothetical scenarios for BCA	102
Cost variation scenario.....	102
Duration variation scenario.....	103
Combined time and cost variation scenario.....	103
Minnesota winter scenario	104
5. Collecting Experience.....	106
Weighing the Public Opinion	106
Pre-closure market research.....	106
Post-closure market research	108
Public Participation (Public Roads article, Barnard, 2009).....	108
Stakeholder Interviews	109
Pre-interview communication.....	110
Planning and execution of Full Closure.....	111
Public relation and reaction to Full Closure	114
Lessons Learned from this Full Closure.....	115
General Comments	116
6. Conclusions.....	118
References.....	119
Appendix A: Task 8 Deliverable: Lessons Learned	

List of Tables

Table 1 Project characteristic (FHWA, 2003 Dunston et al, 1998).....	5
Table 2 The V/C ratio of Location 1, 3, 4 AM data.....	28
Table 3 The V/C ratio of Location 1, 2 AM data.....	30
Table 4 The V/C ratio of Location 1, 2 AM data.....	31
Table 5 The V/C ratio of Location 4, 8 and 9 AM data.....	34
Table 6 The V/C ratio of Location 9 and 11 AM data.....	35
Table 7 The V/C ratio of Location 7, 11, 12 and 13 AM data.....	36
Table 8 The V/C ratio of Location 1, 3, 4 PM data	38
Table 9 The V/C ratio of Location 1, 2 PM data	39
Table 10 The V/C ratio of Location 1, 2 PM data	40
Table 11 The V/C ratio of Location 4, 8 and 9 PM data	41
Table 12 The V/C ratio of Location 9 and 11 PM data	43
Table 13 The V/C ratio of Location 7, 11, 12 and 13 PM data	44
Table 14 The V/C ratio of 13 locations. AM data	45
Table 15 The V/C ratio of 13 locations PM data.....	46
Table 16 Simulation days.....	71
Table 17 Values of major global parameters	73
Table 18 Goodness of fit results of mainline stations after calibration	73
Table 19 Results of O/D matrix adjustment	79
Table 20 Regression statistics for OD adjustment.....	79
Table 21 RUCs results for TH-36 reconstruction.....	96
Table 22 RUCs estimation effort per tool.....	96
Table 23 Link capacities of two networks	98
Table 24 RUCs results of two networks	99
Table 25 Comparison of analysis model and test scenarios	99

List of Figures

Figure 1 TH-36 reconstruction project area and improvement plans (source: Mn/DOT)	2
Figure 2 The volume % difference during the AM period	13
Figure 3 I-694 and TH-36 interchange AM data	15
Figure 4 I-694 and White Bear Ave interchange AM data	16
Figure 5 I-35E and TH-36 interchange AM data	17
Figure 6 TH-61 and TH-36 interchange AM data	18
Figure 7 I-94, I-494, and I-694 interchange AM data	19
Figure 8 The volume % difference during the PM period	20
Figure 9 I-694 and TH-36 interchange PM data	22
Figure 10 I-694 and White Bear Ave interchange PM data	23
Figure 11 I-35E and TH-36 interchange PM data	24
Figure 12 TH-61 and TH-36 interchange PM data	25
Figure 13 I-94, I-494, and I-694 interchange PM data	26
Figure 14 The volume difference on Location 1, 3, 4 AM data	27
Figure 15 The volume difference on Location 1, 2 AM data	29
Figure 16 The volume difference on Location 2, 13 AM data	31
Figure 17 The volume difference on Location 3, 4 and 5 AM data	32
Figure 18 The volume difference on Location 4, 8 and 9 AM data	33
Figure 19 The volume difference on Location 9 and 11 AM data	35
Figure 20 The volume difference on Location 7, 11, 12 and 13 AM data	36
Figure 21 The volume difference on Location 1, 3, 4 PM data	37
Figure 22 The volume difference on Location 1, 2 PM data	39
Figure 23 The volume difference on Location 2, 13 PM data	40
Figure 24 The volume difference on Location 4, 8 and 9 PM data	41
Figure 25 The volume difference on Location 9 and 11 PM data	42
Figure 26 The volume difference on Location 11, 12 and 13 PM data	43
Figure 27 Flowchart for estimating RUC (Daniels et. al, 1999)	50
Figure 28 QuickZone methodology framework	56
Figure 29 Travel demand model RUCs methodology framework	59
Figure 30 Traffic simulation methodology framework	60
Figure 31 Flowchart for network calibration	61
Figure 32 QuickZone network	62
Figure 33 Selected impact area for Cube Voyager	64
Figure 34 Linear regression for Base Case in Cube Voyager	65
Figure 35 Bland-Altman plot for Base Case in Cube Voyager	65
Figure 36 Linear regression for Full Closure in Cube Voyager	66
Figure 37 Bland-Altman plot for Full Closure in Cube Voyager	67
Figure 38 AIMSUN network	67
Figure 39 Contour for real speed in I-35E SB	74
Figure 40 Contour for simulated speed in I-35E SB	75
Figure 41 Time depend O/D matrices calculation (AIMSUN manual 2008)	77
Figure 42 Linear regression results for old O/D	80
Figure 43 Linear regression results for new O/D	80
Figure 44 Percentage difference of daily volume from all detectors before calibration	82
Figure 45 R-square of very time interval	84

Figure 46 Percentage difference for time interval (15-min)	85
Figure 47 Regression for Base Case in AIMSUN	85
Figure 48 Bland-Altman plot for Base Case in AIMSUN	86
Figure 49 Percentage difference in Base Case after calibration	86
Figure 50 Regression for Full Closure in AIMSUN.....	87
Figure 51 Bland-Altman plot for Full Closure in AIMSUN.....	87
Figure 52 Traffic diversions in AM (real data).....	90
Figure 53 Traffic diversions of Full Closure in AM (Cube Voyager).....	90
Figure 54 Traffic diversions of Full Closure in AM (AIMSUN)	91
Figure 55 Traffic diversions of Full Closure in PM (Cube Voyager).....	91
Figure 56 Traffic diversions of Full Closure in PM (AIMSUN)	92
Figure 57 Traffic diversions of Partial Closure in AM (Cube Voyager).....	93
Figure 58 Traffic diversions of Partial Closure in AM (AIMSUN)	93
Figure 59 Traffic diversions of Partial Closure in PM (Cube Voyager).....	94
Figure 60 Traffic diversions of Partial Closure in PM (AIMSUN)	94
Figure 61 Daily RUCs of 9 replications	101
Figure 62 Percentage change of daily RUCs	101
Figure 63 B/C ratio of cost-variation scenario.....	102
Figure 64 B/C ratio of cost-variation scenario.....	103
Figure 65 B/C ratios of combined scenario	104
Figure 66 B/C ratios of winter scenario	105

Executive Summary

As of Spring 2007, the TH-36 project in North St. Paul, MN, was the biggest Full Closure (FC) of a major urban arterial Mn/DOT had ever planned and executed. Recognizing this fact early on, Mn/DOT focused on capitalizing on this experience to both learn and try some innovative construction and contracting alternatives. With the assistance of the federal government, which designated the TH-36 project Highways for Life and the funding that ensued from this designation, exploring several alternatives became possible but more important, increased data collection and observation of the project state and operation was feasible. Such data gathering and in-depth analysis are not customary of any project regardless of the size.

The observation and analysis effort, being of such a diverse nature, were undertaken by different groups from the public (Mn/DOT, FHWA), private (CH2M Hill), and academia (University of Minnesota) sectors. This document focuses on presenting the results from the University of Minnesota “TH-36 Full Closure Construction: Evaluation of Traffic Operations Alternatives” project. The project tasks have changed during the course of the research to maximize benefits while adapting to funding agency needs as expressed through the Technical Liaisons (TLs) and the Technical Advisory Panel (TAP). The research effort covered the following subjects:

- Full Closure literature review
- TH-36 construction project area of influence and impact based on real data before and during the FC.
- Evaluation of available methodologies and tools for the selection and planning of project construction methodology.
- Stakeholder interviews outlining the lessons and experience gained from this FC project.
- Drafting a lessons learned guide combining findings of the analysis of planning, public engagement, and traffic operations aspects of the project. For brevity this guide is not included in this document but is available as a separate document.

Analysis of Full Closure Impact on Traffic Conditions

The analysis of the impact the TH-36 FC had on the surrounding roadways is divided into two parts: freeways and local streets. For the freeway system several days worth of Mn/DOT detector data from I-35E, I-694, TH-36 and I-94 were utilized. The local street FC impact analysis was based on measurements collected by an independent contractor in 12 locations around the project area and over three two-day periods before (2006), during (2007) and after (2008) the construction project of TH-36.

The analysis of the freeway data had two objectives: the determination of the extent of the FC impact on the transportation network; and the determination of the length and characteristics of the transition period between the initiation of the FC and the time the network reached a new equilibrium. On the local streets, data collection timing allowed only for the replication of the first objective. In both systems, the original intent was to conduct the analysis by comparing measurements from before, during, and after the FC. The later period was finally not included because the collapse of the I-35W bridge had such a strong impact on the entire system, which masked the effects from the TH-36 FC.

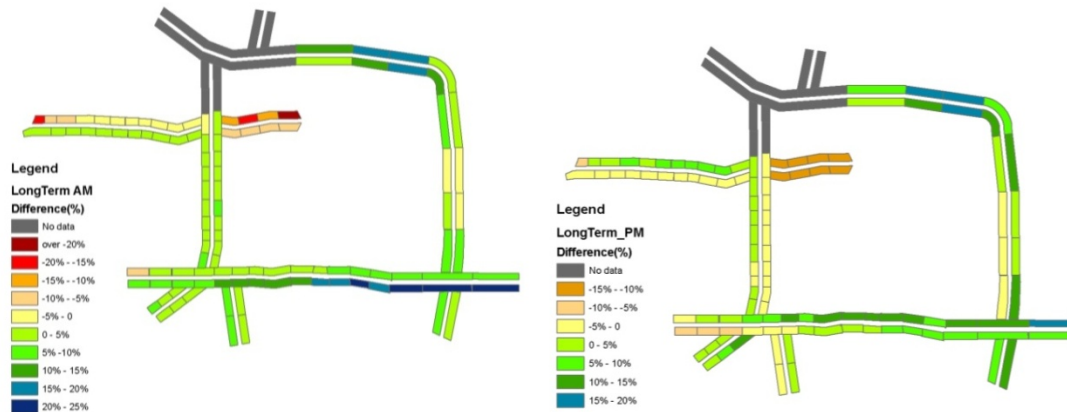

From the analysis of the freeway data we can summarize the following:

- The TH-36 FC had a very short transition period. One reason for this behavior could be the fact that the preferred and obvious diversion routes had enough spare capacity so drivers did not have to search long for the best route. Additionally, there has been an extensive information effort well before the FC initiation allowing drivers to leisurely explore the available alternatives even before the FC was initiated. Finally, it has been the opinion of several project stakeholders that one influential factor was that the FC was implemented on a Tuesday allowing Monday drivers to explore the alternative routes.
- The impact of the FC was mild but extended over a very large area of the system. One contributing factor for the latter is that a lot of the commuter traffic on TH-36 originates in Wisconsin utilizing the Stillwater Bridge. These users diverted to I-94 before crossing over to Minnesota.
- Drivers adhered to the suggested by Mn/DOT diversion routes only on the eastbound direction. In contrast, on the westbound direction they preferred the same/reverse route over the longer, but potentially faster, recommended route. This behavior is not unreasonable since the shortest route spatially proved to have enough spare capacity and therefore negated the incentive to follow a longer path.

From the analysis of the tube counter measurements, it was concluded that the majority of local streets also had enough spare capacity and although demand increased there were no instances of severe congestion. Only two of the twelve locations experienced noticeable change and some congestion while only one of them, County Road B between McKnight Road and White Bear Avenue, experienced Volume/Capacity ratios greater than one during the afternoon peak hour.

Selecting the Appropriate Traffic Analysis Tool

The original plan in this research project was to utilize a microscopic simulator for the evaluation of the implemented FC construction method and the now hypothetical Partial Closure (PC). Considering that the decision was made purely on financial reasons, the PC required more than the available funds, without any proper analysis of traffic conditions or a Benefit Cost Analysis that contradicted the two options, the goal was to actually quantify the full benefit, if any, of the FC as compared to the traditional PC. During the course of the project it became evident that due to the large difference in construction costs, the FC was an obvious best alternative. The benefit from a detailed analysis based on a single methodology was minimal. Instead, a lack of guidance on the available tools for analyzing FCs and more importantly the lack of clear understanding on

the pros and cons of the different tools and methods was noticed. Therefore, the objective of the project was altered and became the evaluation of available tools and methodologies of construction methodologies and specifically FCs. The most important element differentiating FCs from other less radical methods is the potential for a very large social cost increase. Such costs, termed Road User Costs (RUCs), incur during the construction period and depend on the impact the construction methodology has on the rest of the network. All construction projects generate RUCs. PCs, as compared to FCs, have much lower daily RUCs but last longer, complicating the determination of which method exhibits the lowest total RUCs. Additionally, the shorter duration of the FC allows for an earlier reaping of the benefits from the improved roadway.

Following the directions and resources found in the FHWA “Traffic Analysis Tools Primer”, three tools, with increasing levels of cost, complexity, and features, were selected. The tools selected are: a Sketch-planning Tool, QuickZone; a Travel Demand Model, Cube Voyager; and a Simulation Model, AIMSUN NG. For each of these tools a methodology for RUCs estimation is described noting the effort required, accuracy achieved, and the variance of the results in relation to changes in assumptions made or parameters selected. The results from an empirical analysis performed by Mn/DOT are included for comparison.

	Full Closure				Partial Closure			
Tools	Daily RUCs	Total RUC	B/C ratio w RUCs	B/C ratio w/o RUCs	Daily RUC	Total RCU	B/C ratio w RUCs	B/C ratio w/o RUCs
Empirical	\$69K	\$11,160K	2.91*	3.99*	\$9K	\$5,464K	3.0*	3.47*
QuickZone	\$69K	\$12,114K	3.6*	3.7*	\$18K	\$11,293K	2.8*	3.1*
Voyager	\$79K	\$13,680K	4.10	4.59	\$19K	\$11,840K	3.32	3.68
AIMSUN	\$83K	\$14,781K	6.98	7.52	\$25K	\$15,726K	5.54	6.02

*Ratios only include RUCs and capital costs. No life-of-project benefits.

Collecting Experience

The TH-36 FC evaluation project covers post construction interviews with important project stakeholders. These interviews were complimentary to the post construction public survey Mn/DOT developed and executed and have a dual objective. First it is important to know the details that may have influenced the public’s perception regarding the impact and success the FC had, and second, collecting the professionals’ opinion and experiences regarding this construction project will enhance the decision assistance guide, which was the final project task. The interviews aimed in collecting all experience gained from this FC construction project and formulate it into Do’s and Don’ts that can guide future decisions. The project TL’s have provided the University of Minnesota team with a list of suggested people for the interviews. In this report, a compilation of these expert opinions is presented. Opinions that range from simple advice like starting road closure projects on a Tuesday or the negative impact of a FC not concluded in one construction season to lessons learned regarding public participation and the rigors of minimizing the impact to the public and local businesses. Also it was pointed out that

the use of A+B contracting, early completion incentives, and lane rental were vital to reducing contract time and delays before and after the full closure

Lessons Learned Guide

The most salient points of the aforementioned tasks were combined with an account of the efforts and results of the other teams into a lessons learned document that hopefully will serve as a resource in the planning and execution of future FC construction projects. The guide is included in this report as Appendix A.

Conclusions

The importance of the TH-36 FC project as a learning and possibly eye-opening experience was overshadowed only by the much bigger de-facto full closure of the I-35W freeway in Minneapolis. Regardless, the complications ensuing from that catastrophe and the logical availability of detailed information only after the fact reduce its value as a quantifiable lesson. The TH-36 FC was planned and fully capitalized as a learning experience. We hope the compilation of the results from the different aspects analyzed presented in this report will help in future reconstruction projects. The fact that, as the network matures, more and more of the links requiring reconstruction will be congested increases the importance of RUCs and therefore the importance of tools for their accurate estimation and methodologies that help minimize them.

1. Introduction

According to the 2007 Urban Mobility Report, 78 billion dollars were lost due to congestion on urban roadways (Schrank et al, 2007). Many urban corridors around the country experience demand that is close or greater than the available capacity. Although most agree that the transportation system has matured and that we will not build ourselves out of congestion (Davis et al, 2001), existing infrastructure often requires expansion. Such expansion in an already developed system most likely does not involve new roadway construction but results in existing roadway upgrades. Such roadways normally already serve considerable demand, a fact that increases the importance of the impact to the roadway users, expressed as Road User Costs (RUCs) in the rest of this document, and raises safety concerns both for the driving public as well as for the people working on reconstruction projects. Departments of transportation (DOTs), which always look for ways to maintain safe service delivery during construction projects, continually explore new alternatives. From accelerated construction techniques and prefabricated elements to innovative contracting and road safety audits, DOTs have a growing range of strategies at their disposal to improve safety, maintain traffic throughput, and minimize construction-related headaches for nearby residents and daily commuters. The reconstruction of TH-36 in North St. Paul, MN was one of the cases where a number of new methodologies were employed.

The goal of the TH-36 reconstruction project was to increase safety and improve access through the cities of Maplewood and North St. Paul. The project involved the elimination of all at-grade intersections (six) on a 2.2 mile section between White Bear Avenue in Maplewood and Highway 120 (Century Avenue) in North St. Paul. It included a diamond interchange at TH-36 and McKnight Road (County Highway 68); a bridge to carry traffic on Margaret Street over TH-36; a pedestrian bridge over the highway to enhance safety for users of the Gateway Trail; and a frontage road from McKnight Road to 1st Street. Figure 1 presents a description of the area and various elements of the project.

The TH-36 project has a long history of planning, scope growth, and modifications in almost all of its details. A comprehensive timeline of these plans can be found in the April 2006 Environmental Assessment (Mn/DOT, 2006) and in the presentation given at the projects opening by North St. Paul city engineer Dave Kotilinek (Kotilinek, 2007). In summary, the project began in May 1994, when Mn/DOT developed the TH-36 Access Plan in response to the growing need to control access and increase the capacity and efficiency of the highway in Ramsey and Washington Counties. In 1997 the city of North St. Paul received the first funding for a pedestrian bridge and in 1999 they received funding for the Margaret street grade separation. In 2002 Mn/DOT committed funds for the construction of the McKnight interchange. Up until 2004 when Mn/DOT finished the final layout, the project was planned as a partial closure. Based on the preliminary budget it became clear that there were not enough funds for a partial closure since it involved the construction of 3 bypasses. Research suggested potential savings of 15%-20% by closing the road, fact corroborated by more detailed cost estimates. This is how the Full Closure became the de facto construction method.

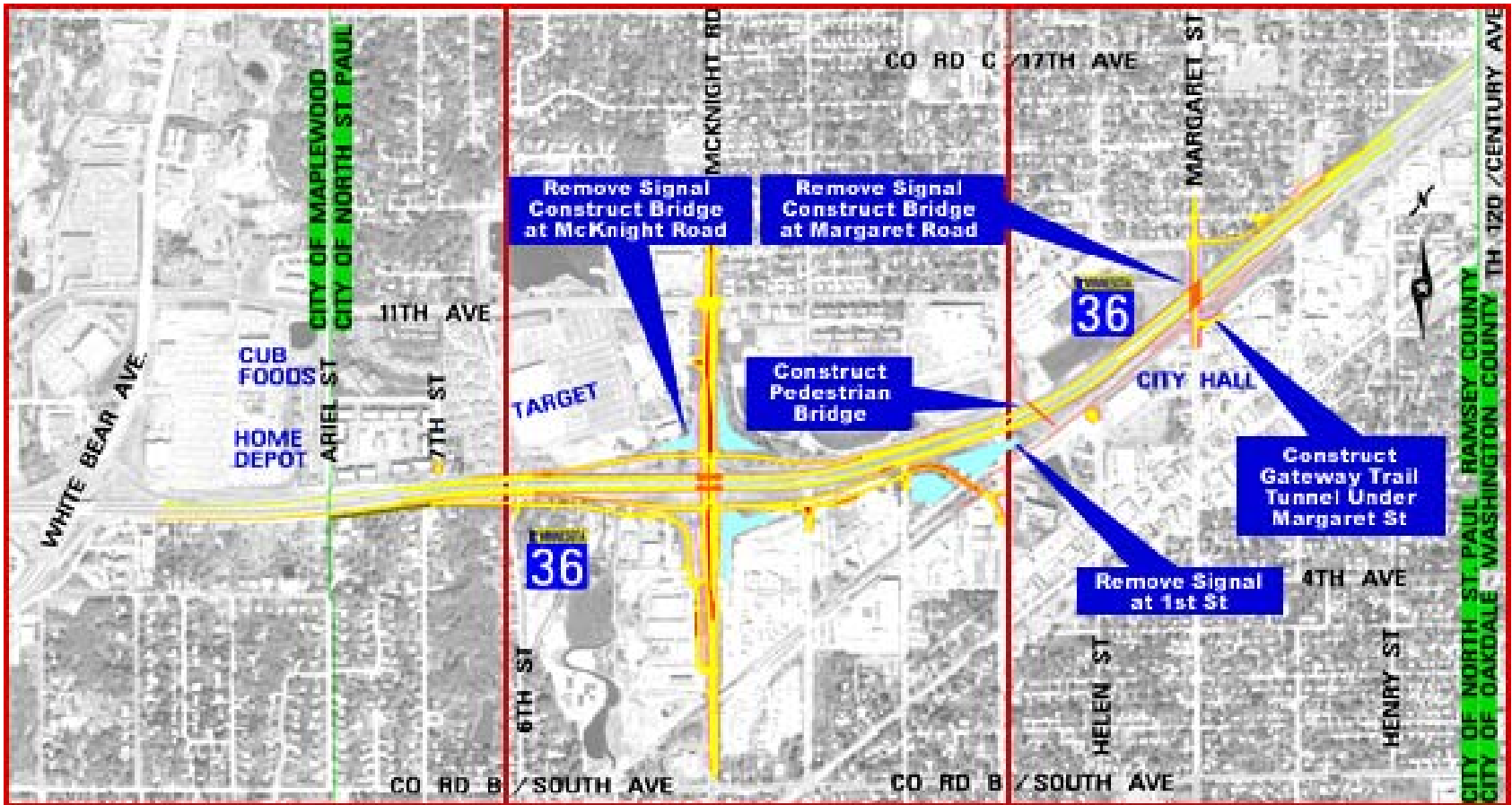

Figure 1 TH-36 reconstruction project area and improvement plans (source: Mn/DOT)

We can only hypothesize that the Full Closure was not considered as an alternative until it was absolutely necessary. Being a relatively new construction methodology it still carries a level of uncertainty and the potential of considerable social cost. As it turned out, the Full Closure was by far the best choice both in terms of the actual outcome of the project but also, as it will be examined later in this document, by the small additional Road User Costs (RUCs) as compared to the savings in labor and time. Regardless, being an unknown methodology both to engineers and the public, Mn/DOT initiated a market research and public involvement campaign, seeking both to educate the public and business affected as well as involve them in the formulation of the traffic operations plans during the road closure. In this report, these procedures will be briefly outlined, referencing documents and sources with more comprehensive information. Separately, for the purposes of this project, the opinion, retrospective analysis, and observations of engineers involved in the project were collected and compiled in a series of lessons learned.

Specifically this document is concerned primarily with the exploration of Full Closure as a construction methodology, its comparison to the more traditional partial road closure, and with an evaluation of the available tools and methodologies for the estimation of Road User Costs. Regardless, a comprehensive analysis of what really happened during the Full Closure. In terms of diversion and congestion is presented after a literature review Full Road Closure as a construction methodology.

2. Full Road Closure

There is a growing need to repair and maintain deteriorating infrastructure as well as to increase roadway capacity. For these reasons, roadway reconstruction will be all too common in the near future. As a potentially effective way to balance the conflicting needs of mobility and safety in the work-zone, Full Road Closure (FC) is often considered by transportation agencies. Evidence suggests that it can reduce the project duration significantly, enhance product quality, and make workers and travelers feel safer during construction, compared to the partial closure alternative.

Case Studies

There have been many successful projects using different kinds of FCs and variations like weekend full closure, limited capacity closure, nighttime/off-peak full closure, ramp closure and intermittent closure (FHWA, 2003). By definition, full road closure is “the removal or suspension of traffic operations either directionally or bi-directionally from a segment of roadway for the purpose of construction activities.” (FHWA, 2003). Usually, weekend full closures will begin from Friday night after the peak period to Monday morning before the peak period. Limited capacity closure can be used to suspend traffic based on vehicle type and/or destination. Nighttime/Off-peak closures, as the name implies, suspends traffic operations during the night or in off-peak traffic periods (midday). Intermittent closure suspends the traffic five to thirty minutes when roadwork is needed. (FHWA, 2003). In this project we were mostly interested in long term FC projects but mention several weekend full closures since in some aspects have interesting similarities. Table 1 lists some successful full road closure projects.

There are four long term FC projects and four weekend FC projects presented in the table. Most projects which used weekend FC method involved only re-paving or other roadway repairs activities which could be done within a short time period. Longer periods of full road closure usually involved reconstruction projects such as road widening and bridge repair. As seen in the table, two-weekend FC projects involved closing of one direction of the roadway. However, in all cases of longer period FC, both directions were closed for the extent of the project. In the TH-36 project, which this study is using as a pilot, FC of both directions was selected. The utilization of FC reduced the construction duration from close to two years to 7 months (4 months of FC and 3 months of partial and intermittent closures).

Although the ADT on the roadways involved in the construction projects covers a wide range, from 30,000 to 180,000, most projects involved roads at, or close, to capacity. As seen in the table, five of eight projects are Interstate freeways and carry over 60,000 vehicles per day. The ADT of TH-36 at the time of the project was about 39,000. Since the closure stretches on most projects were very busy, FC method aimed in reducing the construction duration and in extend reduce the traffic impact on daily operations.

Table 1 Project characteristic (FHWA, 2003 Dunston et al, 1998)

Location	Closure Duration	Facility Type	Land Miles	ADT	Cost	Traffic Model during Planning	Project Date
Portland, Oregon, I-84	Two weekends	Interstate	33	180,000	\$5M	Yes	2002
Louisville, Kentucky I-65	Two weekends	Interstate	6-mile section	130,000	\$4.15M	No	2000
Detroit, Michigan, M-10	Two months	State Highway	7.6	97,900	\$12.5M	No	2002
Columbus, Ohio, I-670	18 months	Interstate	8	62,000	\$36.7M	Yes	2003
Kennewick, Washington, SR 395	One weekend	Arterial	3 (Intersections)	30,000	\$0.5 to 1M	No	2000
Wilmington, Delaware, I-95	Seven months	Interstate	24.4	100,000	\$23.5M	Yes	2000
Seattle, Washington, I-405	Two weekends	Interstate	5.5			No	1997
North St. Paul, Minnesota, TH 36	5 months (scheduled) 4 months (actual)	Trunk Highway	2	39,000	\$ 27M	No	2007

The reported evidence in *Full Road Closure for Work Zone Operations - A Cross-Cutting Study* (FHWA, 2003) suggests three major benefits from FC. First, the construction duration is much shorter. Seven of eight projects reported over 60 percent reduction of construction duration. The significant reduction of duration could mitigate the traffic impacts and save user costs. In addition, the shorter construction duration might also make the public sentiment more positive towards the project. In fact, all the projects in the table reported positive public sentiment. Second, FC might improve the workers' productivity. This is because workers have more work space for construction and less distraction by the traffic. Five of eight projects reported better construction quality. Last but not least, safety was also a benefit. Both travelers and workers felt safer during FC construction. Travelers did not pass through the work-zone and the workers were not expected to be hit by traffic. Six of eight projects cited improved safety.

Alternate routes are critical in utilizing the full benefits from full closure. Availability of alternate routes helps carry diverted traffic and reduce the congestion in the corridor. All projects, except in the I-405 project, had proposed detours which were parallel to the segment under construction or high-grade roadways such as freeways or major highways. The proposed detours of TH-36 were I-94 and I-694, both freeways. Some cases cited that the projected congestion impacts typically were over estimated because the actual demand during the construction was less than expected. Some studies assumed that diverted traffic would follow the proposed detours during the construction but they found that many drivers found other routes. Considering the frequently limited diversion planning, this research will focus on the evaluation of the predicted and actual diversion routes on the TH-36 project.

Only three of the eight projects conducted traffic modeling during planning stages. It is important to estimate the traffic conditions during the construction period. Traffic modeling might be a good way to evaluate the condition of alternative routes. Planners can make suitable traffic operations plans on alternate routes to improve the traffic conditions. Without the simulation, the cost estimation might be less accurate and the traffic operation plan may not cover all affected routes, which might increase user costs. In fact as discussed later on, the studies that discuss methodologies for the planning of full closures recommend some sort of wide area traffic analysis during the design stage.

The I-670 project in Columbus required eighteen months to complete the pavement reconstruction, widening and bridge repair. So far, it is the longest FC project, and the one that reported the most significant overall costs reduction. As reported, if this project used partial closure, it would have taken at least four years and the tight area was not safe for traffic when workers performed the work. To reduce the construction period and improve work zone safety, planners decided to use full road closure.

The shortest project was SR-395 in Kennewick, WA. It is an arterial and does not carry heavy traffic. The construction only took one weekend of bi-direction closure. In the previous reconstruction projects in that area, Washington State Department of Transportation (WSDOT) received many complaints and there were also some traffic issues during the construction. Therefore, their goal in using FC was to accelerate construction and reduce complaints from the public. Regardless of the length of the project, the common purpose for utilizing FC method in all projects was to reduce the construction duration and traffic impact.

Both the I-84 project in Portland, OR and the I-65 project in Louisville, KY were weekend full closures. It was reported that the I-84 project had a construction cost reduction, while the overall

cost of the I-65 project was increased compared to the partial closure method. The Oregon Department of Transportation (ODOT) decided to use FC after selecting the contractor and the I-84 project reported savings of about \$100,000, mainly from benefits due to higher contractor efficiency and lower traffic management costs. Unfortunately in this case the cost estimation did not account for user costs. On the other hand, Kentucky Transportation Cabinet (KYTC) spent about \$125,000 for a public relations campaign on the I-65 project. As cited, that was an important reason for the success of the project even though the overall costs of the projects were increased. It is hard to indentify if the selection of FC reduced overall costs or construction costs without a comprehensive analysis.

The M-10 is a state highway and important access to downtown Detroit. Many businesses were affected by the construction. The Michigan Department of Transportation (MDOT) used FC to reduce construction time within one construction season and increase safety for travelers and workers. The reduced construction duration aimed specifically to minimize the impacts to travelers and businesses. MDOT engineers found that not all drivers followed the proposed detours but instead many of them chose other routes and the network reached equilibrium in about two weeks after the closure. TH-36, in addition to being a large commuter route, is also an important access to the city of North St. Paul, and the construction affected many businesses and local residents.

It took four year to plan the I-95 FC project in Wilmington, DE which lasted for seven months. This project also spent \$13M to implement a transportation management plan (TMP). The TMP not only benefited the I-95 project, but also addressed other transportation issues and improved traffic conditions in the corridor. The duration was reduced from two years to 185 days, which mitigated the construction impact on travelers. Due to reduction of work zone exposure for both travelers and workers, both felt safer compared to using a partial closure method.

The I-405 project in Seattle, WA was also a weekend FC project. Actually, this method was tested at the first time during that project. Although few alternative high speed routes were available during the construction, the authors do not specify if there was a significant impact on travelers and communities. However, after the simulation of different scenarios and a small survey, researchers were convinced that the weekend FC did not result in much distress on travelers but on the contrary it provided many benefits. Public response to this project was positive and most travelers stated that they preferred this method rather than the traditional partial closure.

Evaluation during the Planning Stage

Krammes et al. (1989) produced a report about the use of analysis tools in the evaluation of travel impacts on major highway reconstruction projects during the planning stage. Major highway reconstruction indicates projects that are undertaken in urban areas and carry heavy traffic. The researchers concluded that the FC method would cause severe travel impacts; therefore, the user costs might increase in comparison to a partial closure. However, if FC would reduce the construction costs and duration, it could be a viable option. In the report, the researchers make specific recommendations for evaluating the traffic impacts of the FC method. The first step is to define the affected area. It should include uncongested boundaries of the affected corridor including all alternative routes that can be affected by the construction. Following this, an estimate of the roadway capacity of highway links and transit routes is

produced using highway capacity analysis procedures in terms of levels of service (LOS), average speeds and travel times. This step needs:

1. The highway network link geometry
2. Traffic control characteristics
3. The data for traffic volume and vehicle occupancy
4. The data for transit ridership on all transit routes.

Another method could involve the use of a network-based traffic assignment procedure to estimate total vehicle-miles, vehicle-hours, average speeds and travel times. Alternatively, one could also use a freeway corridor simulation model to estimate average speeds and travel times. Following the definition of the affected area, the next step is to compare corridor-wide demand and capacity. If the demand is higher than the capacity, the traffic management plan in the alternative routes should be revised in order to increase the capacity of the entire corridor. Meanwhile, the capacity of each important alternative route might be estimated using the highway capacity manual analysis procedures to make sure the capacities are adequate.

According to the report, not only is the capacity of the corridor important but also the travel patterns. Towards that, the third step is to estimate the changes in corridor travel patterns using a network-based traffic assignment procedure. An Origin-Destination trip table is required for this step. The final step is to estimate operational and economic Measures of Effectiveness (MOEs). Such MOEs could be LOS, average speeds and travel times as well as total vehicle-miles and vehicle-hours. This report concentrated particularly on the comparison of demand and capacity in the affected corridor. It recommended specific analysis tools for each step and in total five MOEs to evaluate the traffic management plans on the alternative routes. Nevertheless, this report did not provide the analysis tools for changes in departure time or traffic mode. Those two impacts might also affect the traffic patterns in the corridor.

In planning the I-84 project in Portland, ODOT used the EMME/2 traffic assignment model to evaluate traffic conditions (FHWA, 2003). It assessed the “before”, “during”, and “net change” conditions during the weekend peak period on all routes of the corridor. The volumes on Saturday and Sunday were selected to be the 80% and 75% of a normal weekday respectively. The results of the EMME/2 assignment model and the actual traffic counts agreed during the “before” base case indicating a sufficient model calibration. The model “during” results indicated that 500 to 700 additional vehicles per hour (vph) would divert to each primary route. The other routes in the corridor would receive 100 to 500 vph of diverted traffic. Meanwhile, ODOT also conducted several scenarios about the impacts on and resulting from I-5 closures, which is parallel to I-84 and was scheduled for construction during the same period. ODOT made a closure plan based on the simulation results of those scenarios. The cooperative closure plan between I-84 and I-5 minimized the traffic impacts and made the whole process more manageable. So, the lesson here is that, the existence of other construction projects in the corridor should be taken under consideration during the planning stage. If this doesn’t happen, the traffic impacts might be more severe than expected due to lack of coordination. ODOT conducted the simulation only to evaluate the impacts of the weekend full closures and the coordination between projects. The engineers did not consider the alternative of partial closure. It is interesting that in the case of TH-36, although there was no actual evaluation of alternatives conducted before the project, Mn/DOT conducted continues travel time studies on the nearby I-

35E/I-694 construction site. The aim was that, in case there was considerable service reduction in that construction zone, there were going to be detected quickly and changes in the partial closure plants on that construction project would be implemented. As it turns out there was no such need.

Anderson et al. (2000) provided a synthesis about the considerations regarding reducing and mitigating impacts of construction. Even though this synthesis was not specifically for full road closures, it provides some general information on evaluating economic impacts and traffic impacts when planning construction projects. The workzone traffic control costs can be high especially on long term lane closures or high traffic-volume roadways. Sometimes, the cost for traffic control maintaining safety and mobility in the workzone can be higher than the benefits of reducing or eliminating long delays and queues. In long term lane closures or high traffic-volume roadways, even during partial closures, traffic would divert to other routes; drivers will change their departure time or change their traffic mode to avoid congestion. This behavior influences the entire corridor. Traditionally, analysis procedures just included the part of workzone traffic control costs. Furthermore, early in the construction, travelers appeared to select different routes and departure times, which caused traffic conditions to vary daily. The author recommends three components of user costs: vehicle operation costs (VOC), motorist delay costs and crash costs. VOC can be small in comparison to motorist delay costs. The motorist delay costs usually only take workzone into consideration rather than considering a corridor-wide area. This synthesis listed three major traffic impacts, traffic diversion, changes of departure time, and changes of traffic mode. In the evaluation of traffic impacts, the synthesis did not provide or propose specific analysis tools and only focused on the workzone rather than the whole affected corridor. In addition, the VOC might not be small if the capacities of alternative routes are not adequate to service significant diversion. Therefore, during the planning stage, in order to select a construction method for high traffic volume roadways, planners should consider the traffic control costs of the workzone traffic control as well as the ones corresponding to the entire affected corridor.

Post-Construction Evaluation

The evaluation of a weekend FC of I-405 in Washington State by Dunston, (1989) focused on construction quality and user impacts. The study used surface smoothness, in-place densities, gradation, longitudinal joints, cyclic segregation and other surface defects to assess the construction quality. Furthermore, for the reason that it is hard to directly compare construction costs between different paving projects, the study recommended production rate to be a measure. This study evaluated the difference of construction quality between the weekend FC and the traditional method by way of comparing the data of the I-405 project to other projects following the traditional method within and outside the state of Washington. In order to evaluate the traffic impact of the weekend full closure, the researchers conducted surveys of travelers and local businesses. The survey results of the I-405 project were evaluated through a multinomial logit model. This model included information on subjects' gender, age, income, and education and other. In the survey, they analyzed the change of travel plans, route selection, changes of departure time, trip cancellation, and shopping behavior to evaluate the impacts of closure on users. In this case, most of the people changed their routes, approximately 50% altered their departure time, few people canceled the trips and less than 10% of the travelers shopped at different places or spent less money.

Furthermore, the researchers used the XXE simulation model to compare the traffic impacts of the single direction weekend FC versus a night-time partial closure by measuring vehicle travel times and total vehicle-miles-traveled. The XXE model is a deterministic, macroscopic assignment model based on user-equilibrium theory. The inputs to the model include: a network file, a vehicle OD file, and a traffic control file. In addition, the XXE model was also used to estimate the emission factors. Since emission factors change with the speed of the vehicle, this model used the average speed of each link to revise the emission factors and calculated mobile emissions for each link. The advantage of this study is that the researchers conducted both surveys and simulation experiments, which can evaluate the traffic impact in a comprehensive way. In addition, this study also considered the environment issues and used a simulation model to assess them. However, the XXE model did not consider the changes of departure time and traffic mode, which might limit the precision of simulation results. In addition, the study did not mention any information about the affected corridor area. It might have not considered all the routes affected by the full closure.

Traffic Impacts of Reconstruction

Saag et al. (1999) analyzed the traffic impacts of reconstruction of urban freeways and expressways. This synthesis was for any reconstruction method and not especially for FCs. There were six major findings from the study of five projects throughout the United States (Saag et al, 1999).

- “The percentage reduction in average daily traffic volumes was approximately equal to the percentage reduction in capacity at the construction zones on heavily traveled urban freeways”.
- “Traffic volumes on the freeway varied considerably during the first several weeks of reconstruction while motorists experimented with alternative routes and adjusted their travel patterns”.
- “Among those motorists who changed their travel patterns, diversion to another route in the corridor was much more common than diversion to another mode (mass transit, ride-sharing)”
- “Some discretionary trips during off-peak periods were canceled during reconstruction.”
- “Little change in total corridor-wide traffic volumes was observed at projects where complete screen lines were monitored”
- “Changes in corridor-wide traffic conditions were relatively minor at some projects, but were fairly substantial at others”.

These six aspects can be used to analyze the traffic impacts of reconstruction projects. For full road closure, the second to fourth points might be approximately the same. Since the traffic will divert variedly in the first several weeks, the traffic pattern might be complicated to evaluate during this period of time. The fifth one raises the issue that traffic conditions are hard to predict therefore both alternatives must be planned for. In FC projects the probability of having substantial changes in corridor-wide traffic conditions is higher.

The authors of the synthesis also examined the validity of prior planning assumptions regarding two possible impacts of full road closure. The first deals with the reasonable assumption that the

ride-share (HOV) mode will increase as a result of the full closure. In some of the examples cited in the report, the planners of the closure assumed higher HOV percentages and also planned the transition of normal lanes to HOV for the duration of the project. In most cases follow-up analysis showed that there was not a significant increase of HOV vehicles. An explanation for this deviation from this logical assumption was the conservative estimation of congestion on the alternative routes. In the cases where severe congestion was avoided, travelers did not consider ride-share.

The second assumption deals with the merit of good information regarding the changes the FC will bring on the network and the sufficiency the alternative routes were explained to the traveling public. In all cases where the travel time in the corridor increased but this information was sufficiently transmitted to the drivers few complaints emerged and the drivers still remained satisfied. Travelers that were well aware of the project tolerated the inconvenience. In this case the assumption was justified.

Krammes et al. (1989) did research on the US-10, John C. Lodge Freeway reconstruction in Detroit, MI a two-year project. The stretch of the project area was 8.4 miles and the ADT was about 125,000 vehicles at the busiest point. The project closed one direction at a time. The northbound lanes were closed from April to July 1987 while the southbound lanes were closed the following four months. In the direction of the closure, the traffic volume on the surface streets increased by roughly 25 percent. Moreover, average speeds decreased by 23 to 31 percent on the three proposed detours and on one surface street route. However, the traffic flow on the detours was not significantly influenced because of improved signal coordination and special signing. In order to reduce traffic congestion, an express bus service was implemented and it was expected to be used by ~320 commuters. As it turned out, only an average of 35 persons utilized the service on a daily basis. Furthermore, the researchers conducted a poll to study public acceptance. It was reported that 85% of travelers in the survey indicated little or no inconvenience during reconstruction. The survey also reported that the changes in travel mode were less than expected. However, this study did not focus on the costs of traffic impacts.

Summary

This section reviewed prior FC projects, as well as evaluation methodologies proposed in earlier studies. Rarely a comprehensive analysis was included during the planning stage to select the proper method between FC and PC. Even though the observed results of FC are usually better than PC, it needs a systematic methodology to get comparable data. In earlier proposed studies of construction planning, several simulation models were proposed to assess the traffic impacts of full road closure. Regardless none of these models were comprehensive enough to provide accurate results on changes in traffic pattern for the whole corridor. Unfortunately, only one study was directly related to the evaluation of FC after the construction was finished and it was only about a short-term weekend full closure. There is no study dealing with the evaluation of long-term FC impacts.

3. Analysis of Full Closure Impact on Traffic Conditions

A very important part of the project was the recording and analysis of the impact the TH-36 FC had on the surrounding roadways and freeway network. The results from this analysis were valuable the year of the construction project to assess what happened and provide the public with quantitative information. The analysis of the impact the TH-36 Full Closure (FC) had on the surrounding roadways is divided into two parts; freeways and local streets. The analysis of the freeway data had two objectives. First was the determination of the extent of the FC impact on the transportation network. Second the length and characteristics of the transition period between the initiation of the FC and the time the network reached a new equilibrium were determined. On the local streets, data collection timing allowed only for the replication of the first objective. In both systems the original intent was to conduct the analysis by comparing measurements from before, during, and after the FC. The later period was finally not included because the collapse of the I-35W Bridge had such a strong impact on the entire system that masked the effects from the TH-36 FC.

Freeway Detector Data Analysis

The Minnesota Department of Transportation has one of the most advanced freeway traffic detection systems in the country. More than 4000 loop detectors are deployed in all Twin Cities freeway collecting data every 30 seconds. Specifically, the Northeast corner of the ring road (part of the TH-36 investigation) came online shortly before the implementation of the FC. This fortunate event allowed for better analysis of the impacts of the full closure in the larger area that surrounds TH-36.

Part of the scope of the analysis was to determine how far reaching this impact is and in extend elaborate on the area of influence of the TH-36 FC. Although the investigation extended over entire network, it quickly became clear that the following freeway sections experienced the biggest changes.

- I-35E from Downtown St. Paul to North of I-694
- I-694 from Rice street to the junction with I-494
- The entire TH-36 from I-35W to I-694
- I-94 from Downtown St. Paul to the borders of Minnesota and Wisconsin

The last section (I-94) was originally analyzed till the junction with I-694/I-494 but the measurements indicated that re-routing was taking place well beyond this point. The first draft of this report does not contain the entire analysis regarding this section since it is still active. It will be added immediately upon completion. Although other freeway segments beyond the ones described above have also registered changes the university research team chose not to expand the area further since these changes are not much higher than the normal demand fluctuations.

The analysis was divided into two sections corresponding to the AM and PM peak periods. Specifically, in order to capture the effects of possible peak spreading due to departure time changes the AM period denotes a period of time during 6am to 10am while PM period denotes a period of time during 2pm to 9pm. The volumes are defined as the total traffic volume during these two periods respectively. The data representing the period before the closure were extracted from nine midweek days: March, 7th, 8th, 14th, 15th, 20th, 21st, 22nd, 27th, and 28th. These

nine days are termed the “pre-closure”. The data representing the period after the closure were extracted from another nine midweek days: June 5th, 6th, 14th, 19th, 20th, 21st, 26th, 27th and 28th. Correspondingly, these nine days are termed the “during closure”. Since the data of detectors in parts of I-694 were missing during the aforementioned pre-closure the data of I-694 were from another set of nine days: March 21st, 22nd, 27th, 29th, April 3rd, 4th, 5th, 10th, and 12th.

As described in the Mn/DOT traveler information package, there are two proposed detours around the TH-36 full closure. Detour one is for eastbound and suggests travelers on TH-36 to go to TH-61 NB merge into EB I-694 and rejoin TH-36. Detour two is a westbound-detour which suggested that travelers on WB TH-36 outside the loop merge into SB I-694 to I-94 WB and turn north in I-35E to join again with TH-36.

AM period

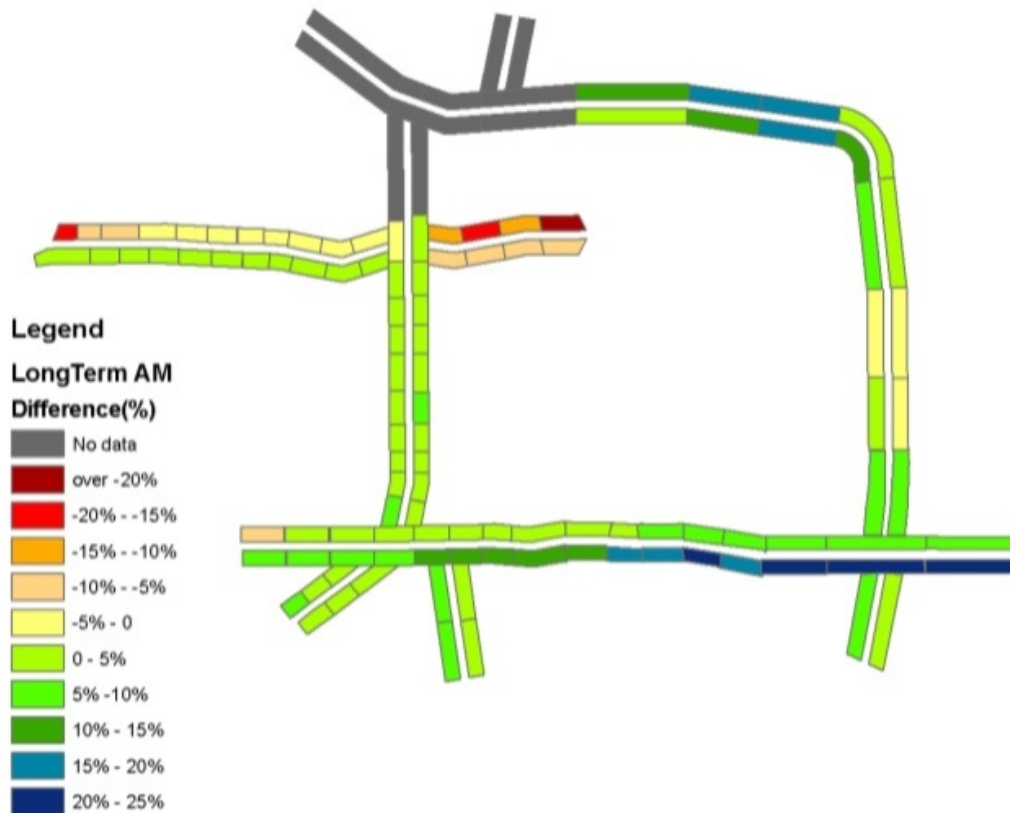

Figure 2 The volume % difference during the AM period

The colors in Figure 2 represent the volume % difference between the “before” and “after” periods as described earlier. In the legend, no data means that stations in this area did not produce any data during the study periods (offline due to the “unweave-the-weave” project on I-35W/I-694). Red to yellow color indicates that there was a decrease in the station volume while light green to dark green and blue indicates an increase in that station.

Since TH-36 is an east-west orientation highway, we are mainly concerned about the east-west traffic flows around the area before and after the closure of TH-36. From Figure 2, we see that traffic on TH-36 (west of I-694) moving westward, diverted into I-694 NB and I-694 SB. Even though I-694 SB is the proposed detour for westward trips, travelers prefer I-694 NB. On the latter, a large percent of detoured travelers got out at the White Bear and I-694 interchange. Unfortunately, the detectors at the TH-61 interchange are not operational due to the “unweave-the-weave” construction so we have no clear way of knowing how many of these trips returned to TH-36 through TH-61. For sure the additional traffic on SB I-35W indicates that most of the diverted trips did not reach that far. In the other direction, eastbound, diverted traffic due to the closure of TH-36 came into I-694 from White Bear Ave. The White Bear and I-694 interchange is important for analyzing the traffic patterns after the closure. We will look at it closer in the following analysis. In the north-south orientation of I-694 from the middle points (yellow sections) we see that there was actually a decrease in trips traversing these sections. This leads us to believe that only local trips diverted to I-694 in this segment and pass through trips or trips destined to farther away directions on TH-36 followed a completely new route. Regarding the local trips, we suspect that the exits on 34th St. and 10th St. would have been revealing as to which communities were affected by the closure. Unfortunately, the data before the closure at these interchanges were not available.

Both directions of I-94 exhibited volume increases but EB I-94 had the largest. Specifically in the AM period, the diverted traffic in that direction increased more than the opposite direction, even though the total volume in the opposite direction was two time larger. This observation brings up questions regarding work related trips to the east not currently captured well by the Metro planning model. Meanwhile, the volume in both directions of I-35E increased as well. It is safe to say that the increases in I-35E were slight compared to the total volume in this period. It is reasonable because TH-36 is an east-west direction highway and the diverted traffic due to the closure might not affect I-35E significantly. Again the lack of data in the segment of I-35E north of TH-36 does not allow for a clear picture on the diversion. Still some understanding is formed later through the analysis of the Interchange with TH-36.

From Figure 2, we can see that WB TH-36 (west of I-35E) had a slight decrease in volume and the part east of I-35E had a significant one especially in the area of the TH-61 / TH-36 interchange. We will look at it closer in the following analysis. Considering that the decrease in volume grows as we move west on TH-36, we hypothesize that the remaining traffic on TH-36 had a large percent of trips destined at the city of Roseville and its vicinity. Few trips used TH-36 to reach I-35W and beyond; probably diverted to I-94 or I-694 north. On the other hand, EB TH-36 (west of I-35E) exhibited a slight increase up to the I-35E interchange but decreased beyond that. The increase was less than 5% of the total volume; therefore we can assume that this part was not significantly affected by the closure of TH-36.

I-694 and TH-36 interchange

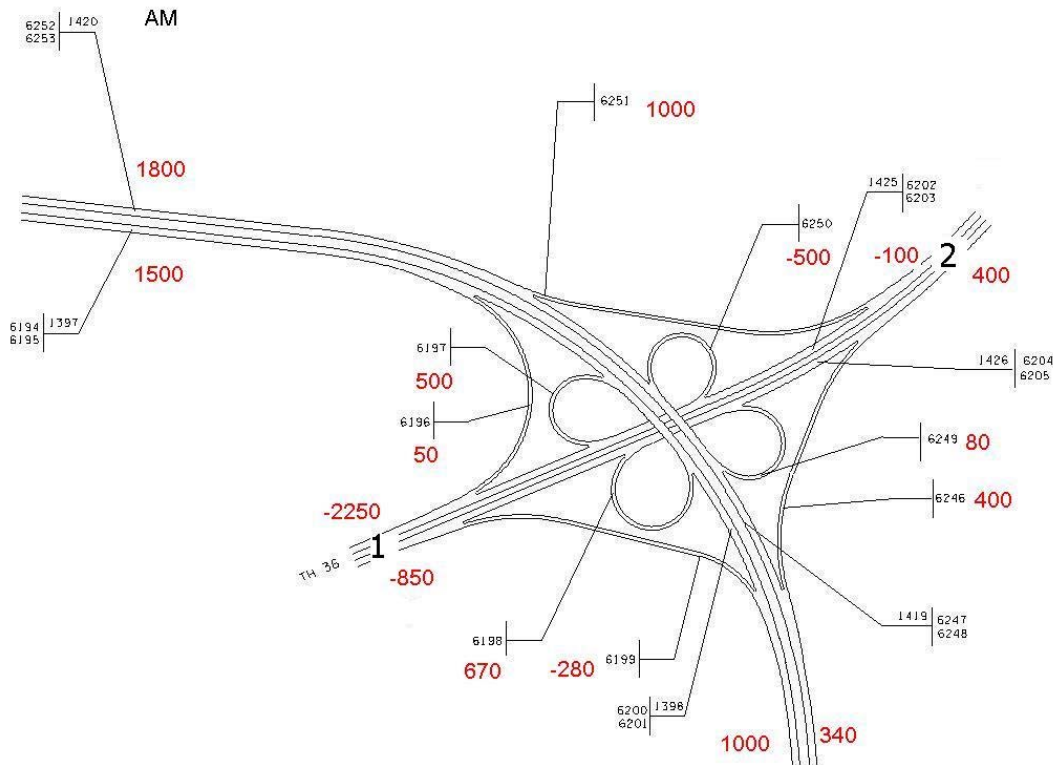

Figure 3 I-694 and TH-36 interchange AM data

The numbers in red on Figure 3 represent the volume difference during the AM period (4 hours) before and after the closure of TH-36. Negative means the total volume after the closure is less than that before the closure (Decrease) while the positive number means increase. This interchange is a decision point for travelers that remained on TH-36 and will have to detour through North or South I-694.

From Figure 3, the volume in Point 2 decreased by approximately 100 veh, which possibly means travelers who used this interchange before did not change their routes in spite of the closure. However, the volume in Point 1 decreased by approximately 2,250 veh. Therefore, there were 2,150 vehicles seeking a detour. From the ramp data, we can see that 45% of those (approximately 1,000veh) went to NB I-694 which was not the proposed detour. Only 23% (approximately 500veh) followed the proposed detour. Another important reason of this decrease is that fewer vehicles came from NB I-694 (approximately 500veh). Based on this evidence we can safely say that travelers did not take the proposed detour. Drivers preferred to cope with the discomfort of dealing with signalized intersections on TH-61 and White Bear Ave or going through the “unweave-the-weave” construction zone than following the possibly faster but longer proposed detour. As it is indicated in the full map some diversion to south 694 took place but it was only to local destinations since not the entire south portion presented an increase in demand. It is important to note here that as presented later in the local street analysis there was no significant congestion (in the AM) on the aforementioned alternate routes while the construction zone did not generate much congestion either. From the above analysis it is also

important to note that there was little decrease on the westbound demand on TH-36 which increases the mystery of the large increase in volume observed on I-94.

In the opposite direction (eastbound), the volume in Point 1 decreased by approximately 850 veh constituting 28% decrease while the volume in Point 2 increased by 400veh. The indication is that the diverted traffic, possibly mostly regional trips, joined back TH-36 through this interchange. From the ramp data, we can see that roughly 400veh were from south of I-694 (south of TH-36) while there were 670 from north of I-694 (north of TH-36). The north origin is also the proposed detour route which travelers choose to follow in this direction. Regardless, the evidence suggests that in the eastbound travelers still choose the geographically shortest path that did not involve too much local street interaction.

White Bear Ave and I-694 interchange

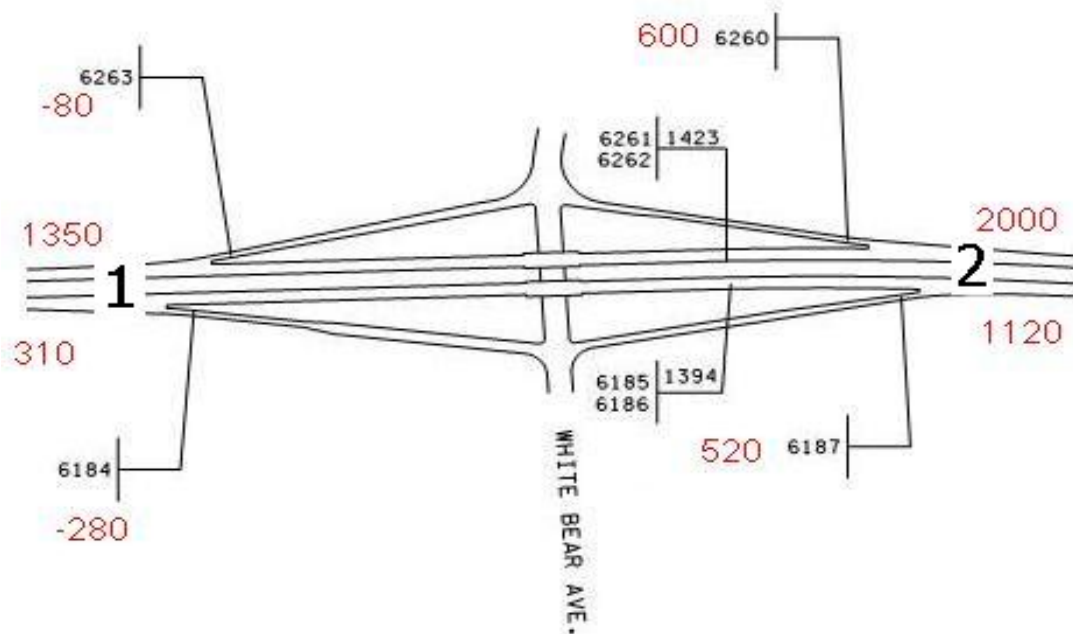

Figure 4 I-694 and White Bear Ave interchange AM data

From Figure 4, we can see that the volume increase in Point 1 is smaller than the one in Point 2 (numbers on Figure 4). From the ramp detectors in this interchange, we observe that from east to west, approximately 600veh exit this interchange. Although there was no significant congestion on the “unweave-the-weave” construction zone, approximately 40% of the diverted traffic from TH-36 chooses to return as soon as possible regardless the signalized intersection on White Bear Ave. On the same direction, approximately 80 veh did not use this interchange after the closure. From the analysis of the local streets volume changes, we see that these additional 600 vehicles barely register at the TH-36 interchange enforcing a point we will be making later regarding the participation of Beam Ave and County Road C west of White Bear Ave.

In the opposite direction, even though increase in Point 1 was not significant approximately 520 diverted vehicles came into I-694 after the closure. As it will be discussed in the local roads

volume analysis, there was no great increase in the trips going North on White Bear Ave at the TH-36 interchange. Additionally, based on the “unweave-the-weave” staging plans there was no reason for travelers coming from the north of the loop to divert into White Bear Ave. One plausible explanation for the two contradictory measurements (TH-36&White Bear low NB, White Bear&I-694 high EB) is that at the TH-36 and White Bear Ave interchange there was a replacement of trips from local to diverted traffic. It is possible that travelers originally using this interchange they diverted to other local roads and replaced by travelers detouring around the TH-36 full closure. As we are going to see later, even if this happened it did not generate additional problems on the local streets.

I-35E and TH-36 interchange

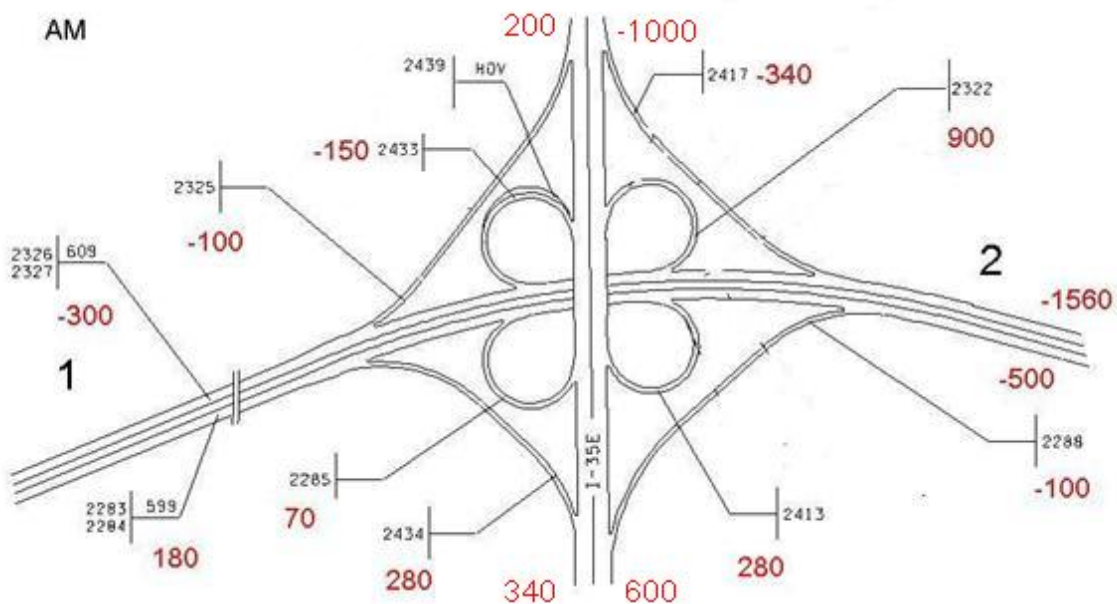

Figure 5 I-35E and TH-36 interchange AM data

This interchange is the first out of three possible points where travelers can divert to go around the TH-36 closure. While this one involves passing over another major construction zone the other two options (TH-61 and White Bear Ave) involve signalized intersections. The difference in Point 1 EB was approximately 180 vehicles which were only 2% increase of the total volume during the pre-closure. As mentioned earlier this observation suggests that travelers did not avoid using TH-36 in view of the full closure. The volume of Point 2 EB decreased approximately by 500 vehicles. The decrease was small as compared to the total volume (8%) and occurred because 280 additional vehicles went to SB I-35E, and 280 additional vehicles went to NB I-35E even though neither south of I-35E nor north of I-35E was a proposed detour.

The volume in Point 2 WB decreased roughly by 1560 vehicles which constitute a 14% decrease. However, the volume in Point 1 WB decreased only by 300 vehicles, a 2% decrease. Thus, we may assume that 1260 veh spread out to other routes and came back to TH-36 through this interchange. From the ramp data, 900 additional vehicles came from south of I-35E, which were 70% of these 1260 veh. This is an interesting observation since the diverted traffic on the east

end of the closure did not choose to follow the proposed diversion route therefore the question arises on where these 900 vehicles originated from. A plausible explanation is that diversion took place between TH-36 and I-94 east of the loop.

TH-61 and TH-36 interchange

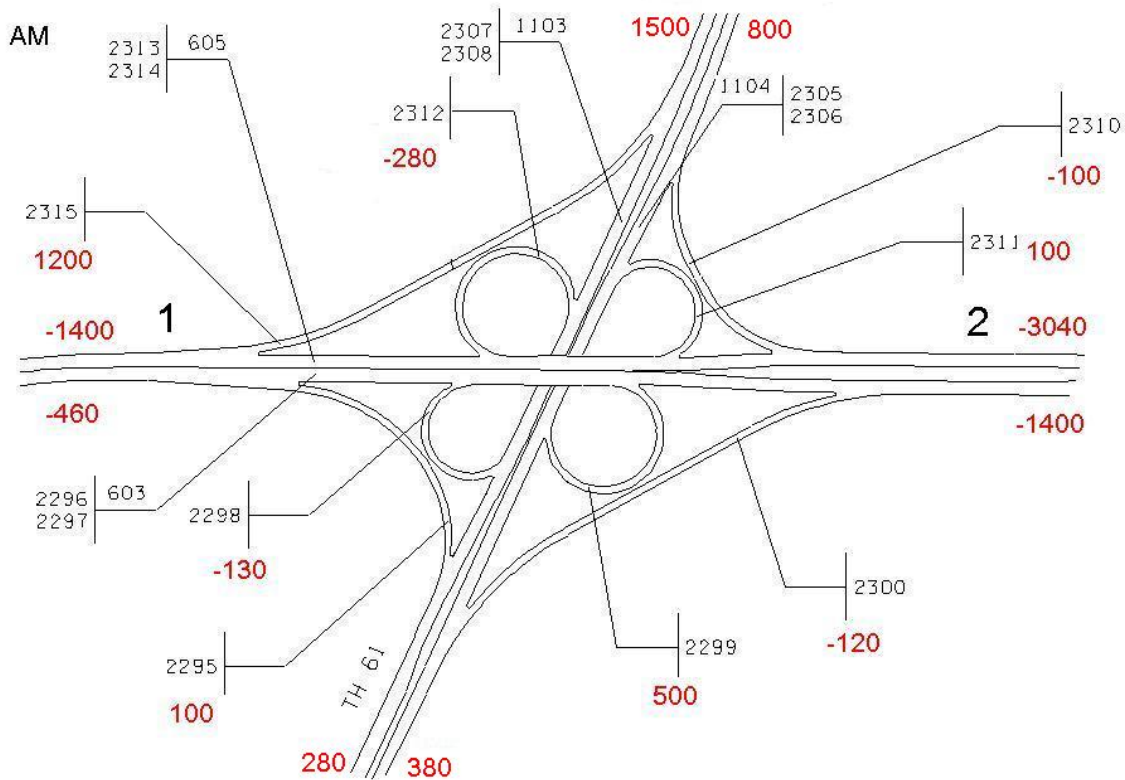

Figure 6 TH-61 and TH-36 interchange AM data

This interchange is the beginning of the officially proposed detour route for eastbound trips. The proposed detour informed travelers to follow NB TH-61 and merge into WB I-694. The volume in Point 1EB decreased by approximately 460 vehicles, a 7% decrease, while the volume in Point 2 EB decreased by approximately 1,400 veh, a 27% decrease. Thus, we assume 940veh exited or did not enter the interchange in this direction because of the closure. From the ramp data, we can observe two important differences in the ramps. One is that there are 130 fewer vehicles from north TH-61 and the other one is that there are 500 additional vehicles going into north TH-61. These 630veh constitute the 67% of the 940veh mentioned previously. The additional vehicles going into SB TH-61 were only 100 veh which were much fewer than the additional vehicles going into NB TH-61. Meanwhile, the total volume in Point 2 EB was 5,300veh during the pre-closure while it was approximately 3,800 veh during the during closure, noting that not all the travelers followed the proposed detour. It is possible that they continued on TH-36 and exited at the White Bear Ave and TH-36 interchange.

The volume in Point 2 WB decreased by approximately 3,040 vehicles, a 33% decrease, while the volume in Point 1 WB decreased by 1,400 veh, a 13% decrease. We can assume that 1,640 veh went to other routes and came back to TH-36 after this interchange. From the ramp data, we

can observe an increase of 1,200 veh coming from north of TH-61 but only 100 additional vehicles coming from south. These 1,200 travelers might possibly come from I-694 although this route is not the proposed detour from east to west. This enforces the previous statement that travelers preferred this route.

I-94 and I-694 interchange

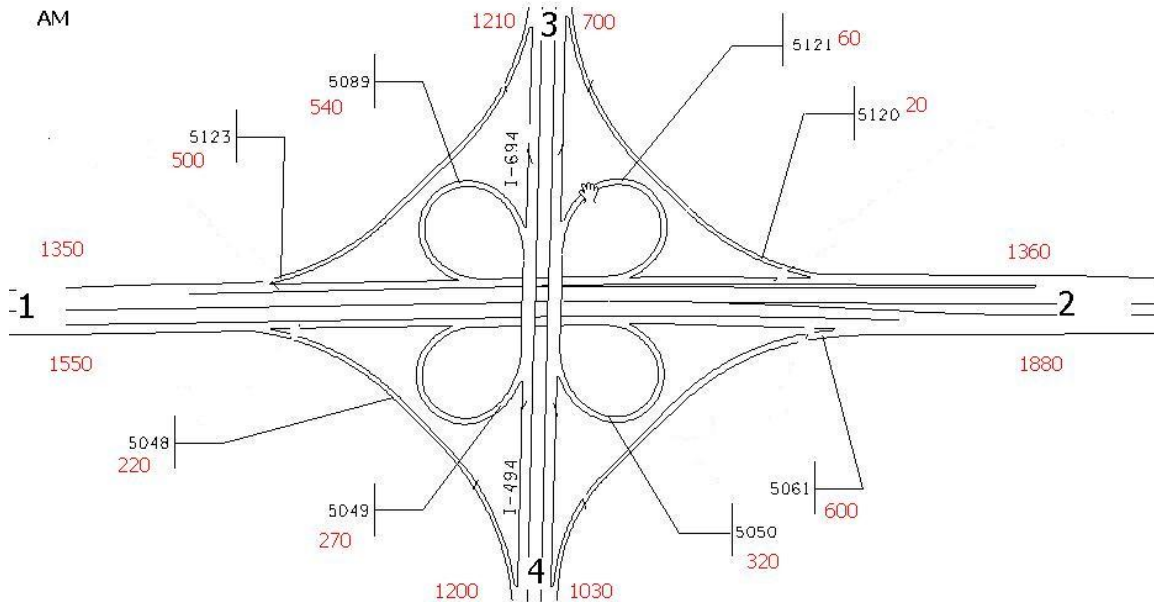

Figure 7 I-94, I-494, and I-694 interchange AM data

Although in the following sections we present a detailed analysis of the volume differences exhibited around the I-94, I494, and I-694 interchange, the overarching observation is that following the TH-36 FC there was a large increase of volume on I-94 in both directions. Considering that the traffic on TH-36 east of the closure did not change considerably it is difficult to understand why this happened. An investigation did not succeed in relating this increase with any other active construction projects in the area nor this can be the result of non-recurring congestion since the data are averages over several days carefully screened. These facts introduce difficulties in the definition of demand for the subsequent simulation model. This subject will be discussed in detail in subsequent reports.

The volume in Point 2 WB increased by approximately 1,360veh and the volume in Point 1 WB increased similarly by 1,350veh. From the ramp detector measurements, we can see that roughly 540veh exited this interchange to SB I-94. Meanwhile, there are approximately 500veh coming from north of I-694 (north of I-94). Earlier from Figure 3, we observed that 500veh exited the I-694 and TH-36 interchange into SB I-694. It is a stretch but it is possible that these 500veh followed the proposed detour. The volume in Point 3 SB increased by 1,200veh and 270 of them went to EB I-94. The rest continued on into SB I-494.

On the other hand, the volumes in Point 2 EB increased by approximately 1,880veh (exiting the interchange) and the volume in Point 1 EB increased by 1,550veh (entering the interchange). The volume in Point 4 NB increased by 1,030veh and 600 of them went to EB I-94. From Figure 2, we know that there was a significant increase in EB I-94 in the AM period. It is possible that in

this period, diverted traffic which used TH-36 toward the east chose I-94 instead of TH-36. The volume in Point 1 EB increased by approximately 1,550veh and only 550 of them exited the interchange, which means two thirds of these 1,550 veh went east. Volumes in Point 4 SB increased by 1,200 vehicles and 440 veh of them came from Point 3 and the rest were from I-94. From ramp data, the major part came from I-94 WB (east of I-694).

PM period

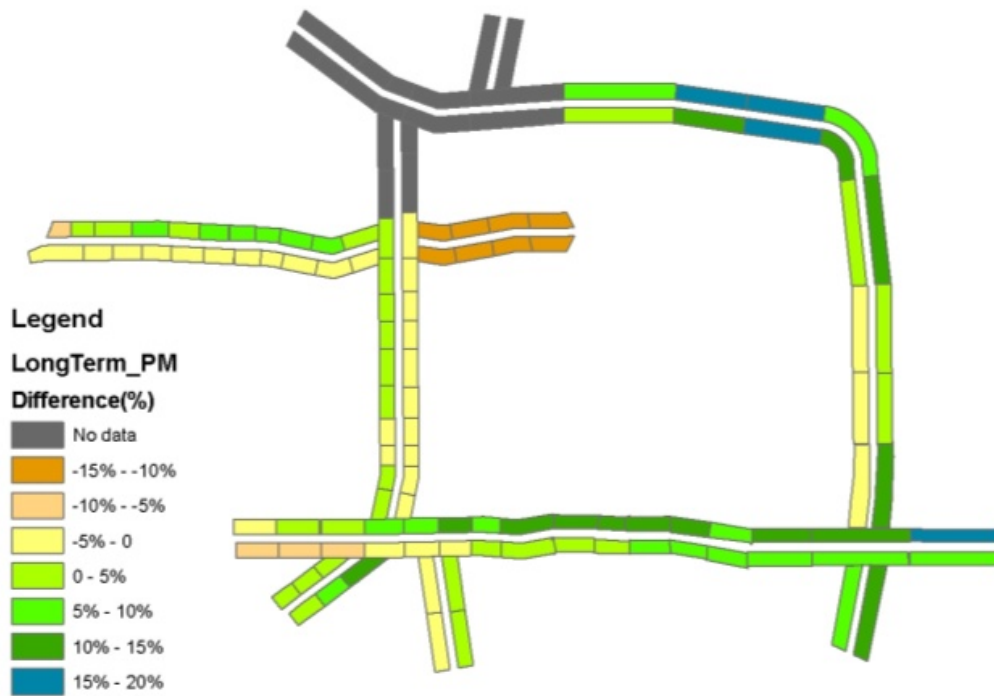

Figure 8 The volume % difference during the PM period

The colors in Figure 8 represent the volume % difference between the “before” and “after” periods during the PM peak period (7 hours, 2pm to 9pm). Red to yellow color indicates that there was a decrease in the station volume while light green to dark green and blue indicates an increase in that station.

From Figure 8, we see that traffic on TH-36 (west of I-694) moving westward diverted into I-694 NB and I-694 SB. Similar to the AM period, travelers preferred to follow I-694 NB instead of the proposed detour route. A large percent of detoured travelers got out at the White Bear Ave & I-694 interchange. Additionally, in the other direction of east-west section of I-694, the significant increases near the I-694 & TH-36 interchange indicate that travelers use this route as a detour. It also indicates that travelers use White Bear more than TH-61 as a detour to get into I-694 and go east. As we mentioned earlier, the detectors at the TH-61 interchange are unfortunately not operational due to the “unweave-the-weave” construction. However, we will look at it closer later in the analysis of White Bear and I-694 interchange. In the north-south orientation of I-694, there is a small decrease on the southbound direction south of the TH-36

interchange. In addition, the middle point of I-694 NB has less increase than the segment near the TH-36 interchange. This indicates that only local trips diverted to I-694 in this segment and pass through trips or trips destined to farther away directions on TH-36 followed the north route. Unfortunately, the data before the closure at interchanges of 34th St and 10th St. are not available.

Both directions of I-94 again exhibited volume increases but different from the AM period, for example, WB I-94 had a larger increase. Also, in EB I-94, the segments near the I-94, I-694 and I-494 interchange have significant increases. Specifically, in the westbound direction, we observed a large volume increase coming from the east. Part of that increase is spreading locally on I-694 and I-494. Farther down I-94 the volume increases get bigger and keep these levels till downtown St. Paul where it seems to absorb most of the extra volume with a smaller part following I-35E SB. In the other direction, eastbound, there was a large decrease of volume coming to downtown St. Paul from the west while the part immediately after the interchange with I-35E remained relatively unchanged. As we progress east the volume increases grow larger and larger peaking up around the I-494/694 interchange. It is clear that more travelers from the inside the study area used I-94 to head east. Similarly to the AM period, observations in both direction of I-94 bring up questions for the assumptions used to build the Metro planning model which does not indicate a large laborshed for this area in the east and why the TH-36 closure might affected this trips.

The volume in I-35E NB decreased while the volume in I-35E SB increased. According to the data, it is safe to say that these changes were slight. It is reasonable because TH-36 is an east-west direction highway and the diverted traffic due to the closure did not utilize this segment of I-35E. Again the lack of data in the segment of I-35E north of TH-36 does not allow for a clear picture on the diversion. Still some understanding is formed later through the analysis of the Interchange with TH-36.

WB TH-36 (west of I-35E) exhibited a small increase in volume but had a significant decrease in the segment east of I-35E especially in the area of the TH-61/TH-36 interchange. This increase might indicate that travelers came from I-35 (north of TH-36) and merged into TH-36 to go westward. However, small decrease at the end of TH-36 WB indicates that these vehicles did not use TH-36 to reach I-35W and beyond. Meanwhile, EB TH-36 (west of I-35E) exhibited a slight decrease in volume up to the I-35E interchange and a significant decrease beyond that. We will look at it closer in the following analysis. It is possible that trips on EB TH-36 (west of I-35E) went to NB I-35E passing over the “unweave-the-weave” construction zone.

from north of I-694 (north of TH-36). Therefore, confirmed by the AM period analysis, the evidence suggests that in the eastbound travelers still choose the geographically shortest path that did not involve too much local street interaction.

White Bear Ave and I-694 interchange

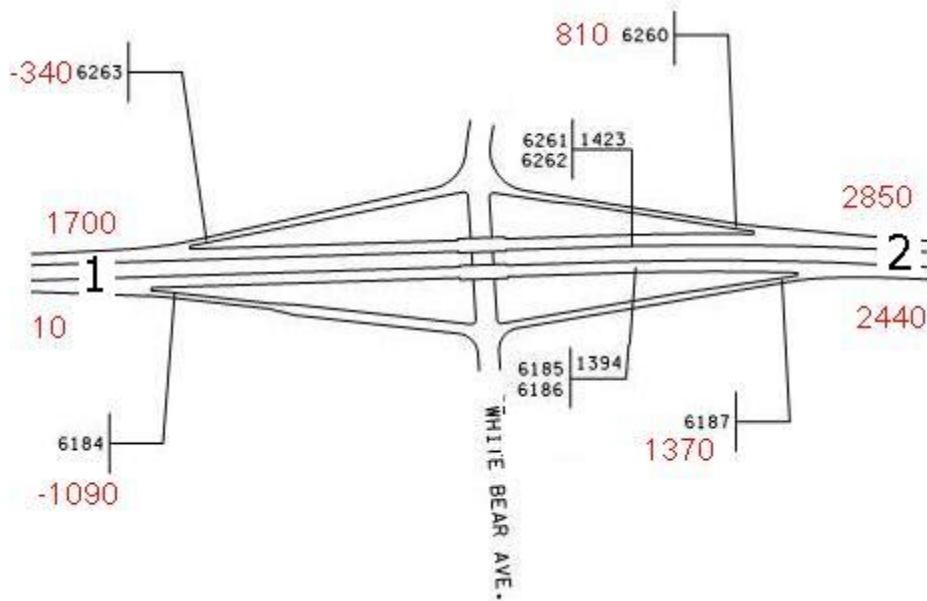

Figure 10 I-694 and White Bear Ave interchange PM data

From Figure 8, we can see that the volume increase in Point 1 is smaller than the one in Point 2 (red numbers on Figure 10). From east to west, approximately 810veh exited this interchange. On the same direction, approximately 340veh did not use this interchange after the closure. By analyzing the local streets volume changes, we see that these additional 810 vehicles barely register at the TH-36 interchange enforcing a point we will be making later regarding the participation of Beam Ave and County road C west of White Bear Ave. In the opposite direction, there was a tiny increase in Point 1 but there were 2,440 additional vehicles in Point 2. From the ramp data, approximately 1,370veh came from White Bear and 1,090veh did not exit at this interchange.

I-35E and TH-36 interchange

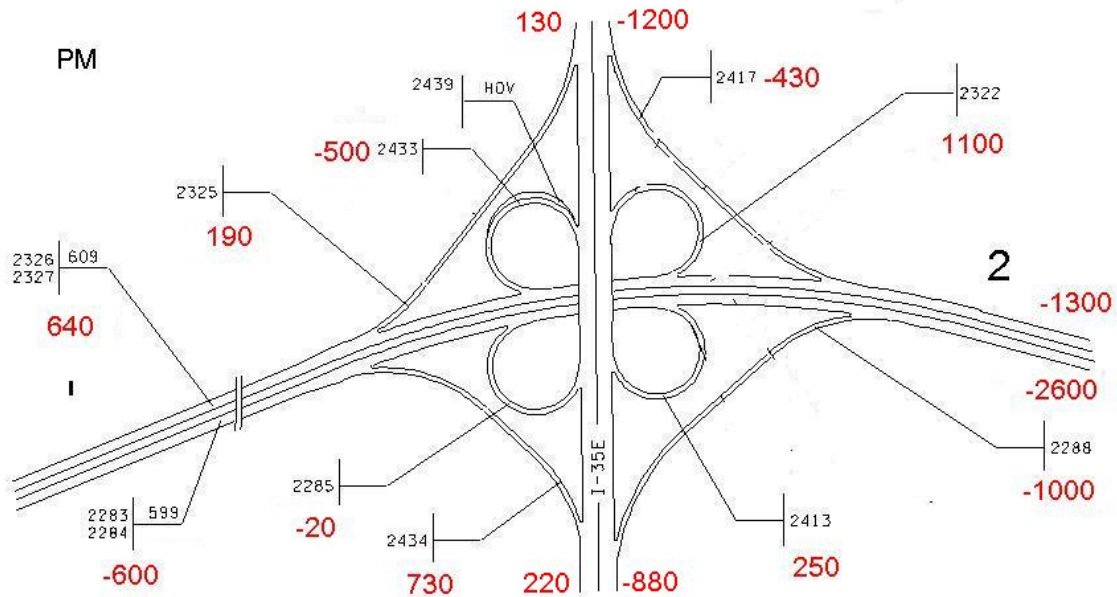

Figure 11 I-35E and TH-36 interchange PM data

This interchange is the first out of three possible points where travelers, going east, can divert to go around the TH-36 closure. While this one involves passing over another major construction zone, the other two options (TH-61 and White Bear Ave) involve signalized intersections. The volume in Point 1 EB decreased by approximately 600 vehicles which were only 3% of the total volume in the PM period during the pre-closure period. As mentioned earlier, this observation suggests that travelers did not avoid using TH-36 in view of the full closure. The volume of Point 2 EB decreased approximately by 2,600 vehicles, a 15% decrease. This is mainly because, approximately 1,000veh did not come from NB I-35E (south of TH-36) and 730veh went to SB I-35E.

The volume in Point 2 WB decreased roughly by 1,300 vehicles, a 10% decrease. However, the volume in Point 1 WB increased by 640 vehicles, a 4% increase. Thus, we may assume that 1,940 veh spread out to other routes and came back to TH-36 through this interchange. From the ramp data, 1,100 additional vehicles came from south of I-35E, which were 56% of these 1,940 veh. As mentioned earlier, the diverted traffic on the east end of the closure did not choose to follow the proposed diversion route therefore the question arises on where these 1,100 vehicles originated from.

TH-61 and TH-36 interchange

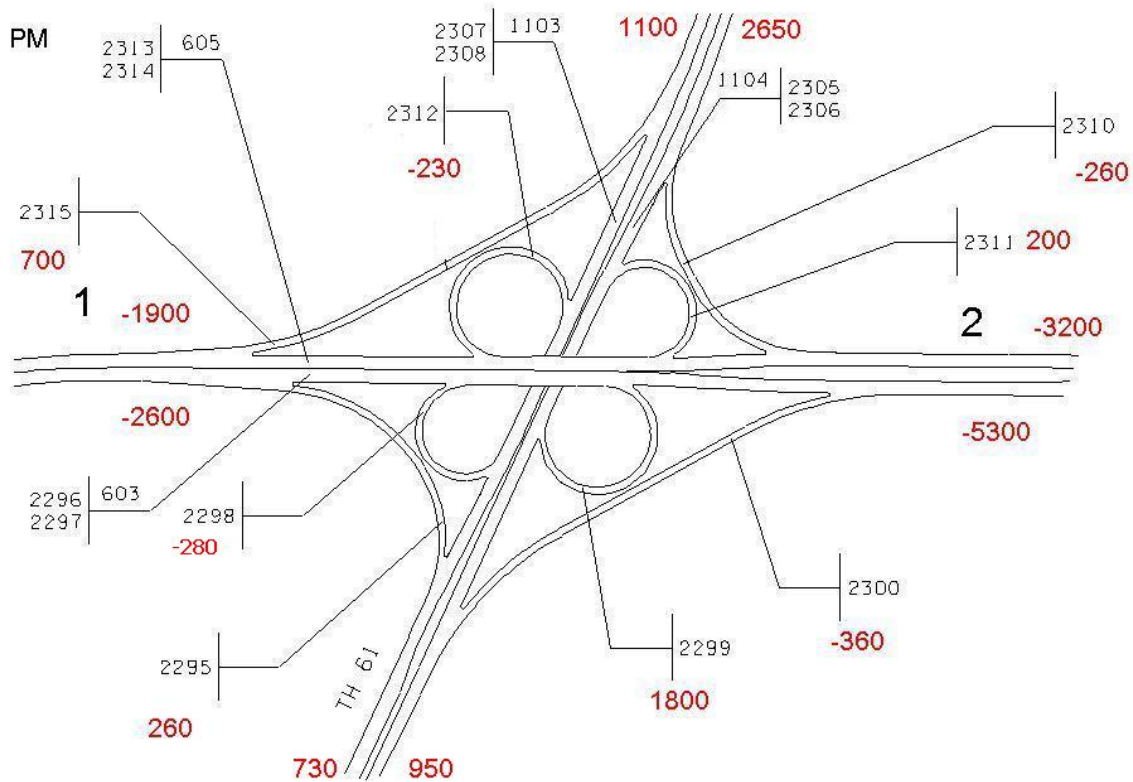

Figure 12 TH-61 and TH-36 interchange PM data

This interchange is the beginning of the officially proposed detour route for eastbound trips. The proposed detour informed travelers to follow NB TH-61 and merge into WB I-694.

The volume in Point 1EB decreased by approximately 2,600 vehicles, a 15% decrease, while the volume in Point 2 EB decreased by approximately 5,300veh, a 35% decrease. Thus, we assume 2,700 veh exited or did not enter the interchange in this direction because of the closure. From the ramp data, we see that there are 1,800 additional vehicles going into north TH-61. These 1,800 veh constitute the 67% of the 2,700veh mentioned previously. The additional vehicles going into SB TH-61 were only 260 veh which were much fewer than the additional vehicles going into NB TH-61.

The volume in Point 2 WB decreased by approximately 3,200 vehicles, a 32% decrease, while the volume in Point 1 WB decreased by 1,900 veh, a 15% decrease. We can assume that 1,300 veh went to other routes and came back to TH-36 at this interchange. From the ramp data, we can observe an increase of 700 veh coming from north of TH-61 but only 200 additional vehicles coming from south. These 700 travelers might possibly come from I-694, which enforces the previous statement that travelers preferred this route.

I-94 and I-694 interchange

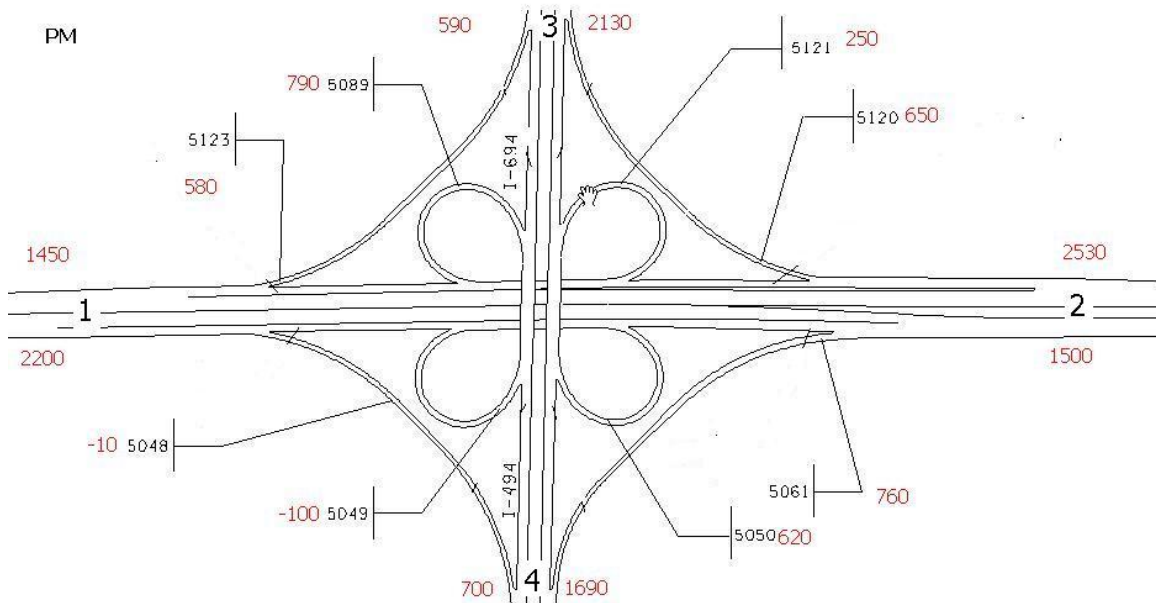

Figure 13 I-94, I-494, and I-694 interchange PM data

Similar to the AM period, there was a large increase of volume on I-94 in both directions. Considering that the traffic on TH-36 east of the closure did not change considerably, it is difficult to understand why this happened.

The volume in Point 2 WB increased by approximately 2,530veh, while the volume in Point 1 WB increased by 1,450veh. From the ramp detector measurements, we can see that roughly 790veh exited this interchange to SB I-494 and roughly 650veh exited to NB I-694. Meanwhile, 580 additional vehicles came from I-694 and only 250 additional vehicles came from I-494. Earlier from Figure 9, we observed that 800 veh exited the I-694 and TH-36 interchange into SB I-694. If we assume that 580veh here followed the proposed detour, then there were 220veh searching a new detour before passing this interchange. The volume in Point 3 SB increased by 590veh; therefore probably these vehicles all went to EB I-94. The volume in Point 4 SB increased by 700veh, mainly due to traffic originating on Point 2.

In the other direction, the volume in Point 2 EB increased by approximately 2,530veh (exiting the interchange) and the volume in Point 1 EB increased by 1,450veh (entering the interchange). The volume in Point 4 NB increased by 1,690veh and 760 of them went to EB I-94 but only 250 of them went to WB I-94. From Figure 8, we know that there was a significant increase in EB I-94 in the PM period. It is possible that in this period, diverted traffic which used TH-36 toward the east chose I-94 instead of TH-36. However, there was also an increase in the I-694 and TH-36 interchange. A question arises as to why the entrances to these two east-west orientation roadways have increased in volume at the same time.

Local Street Tube Count Analysis

The network includes five important urban streets: White Bear Avenue, County Rd C, Century Avenue (TH-120), 7th Avenue, and County Rd B. Tube detectors in thirteen locations collected hourly traffic volumes on October 25th and 26th in 2006 and later on July 26th and 27th in 2007. In some locations, the days in 2006 were October 18th and 19th. A map of the data collection locations can be found in Exhibit 1 in the introduction document. In the following analysis, AM period denotes a period of time from 6am to 10am while PM period is from 2pm to 8pm. The total volumes in AM period and PM period refer to the average total volume in these two days during each period of time. We selected to analyze the above period total volumes instead of the peak hour one because we aim in capturing possible Peak Spreading that might have occurred due to change of departure times by the travelers. The numbers in red on the maps indicate the difference in total volume during each period between 2006 and 2007. Furthermore, we assume that the main reason for these differences is the closure of TH-36. In other words, these differences of total volume were mainly diverted trips from TH-36 due to the closure. In the following analysis, we divide the network into seven sections. By analyzing these seven sections, we will highlight possible impact scenarios due to the closure of TH-36.

AM period (From 6:00am to 10:59am)

Location 1, Location 3 and Location 4

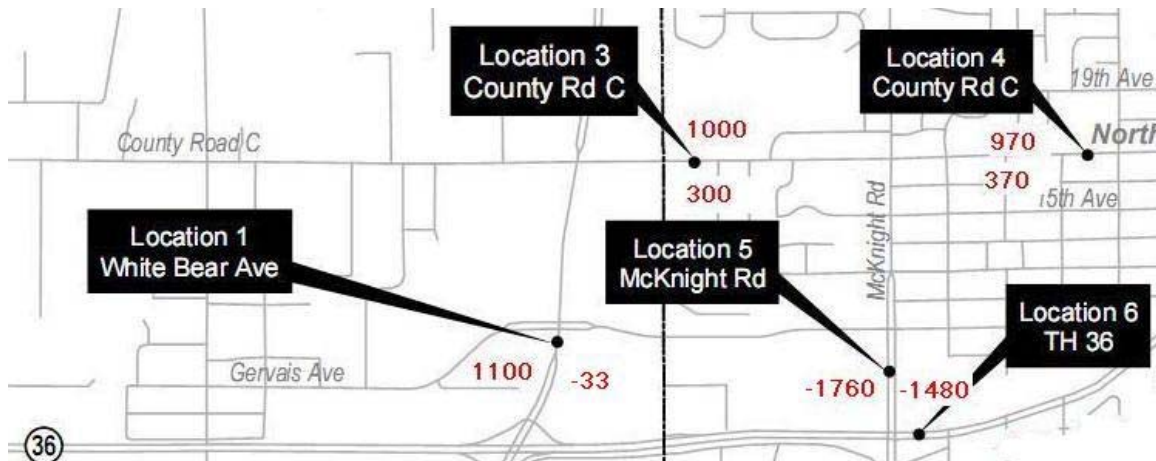

Figure 14 The volume difference on Location 1, 3, 4 AM data

*Positive means increase and negative means decrease

Origins and destinations in 2007

From eastbound to westbound, several possible routes are recognized. One is from County Rd C (east of White Bear Ave) to WB County Rd C. The other one is also from County Rd C but follows SB White Bear Ave to WB TH-36. It is also possible for travelers to go to NB White Bear Ave to merge in to WB I-694. However, the ramp data of the entrance from White Bear to I-694 decreased by approximately 100 vehicles. Therefore, we will not further discuss this route possibility.

Similarly, from westbound to eastbound, two possible routes are recognized. One is from TH-36 to NB White Bear Ave and to EB County Rd C. The other one is from County Rd C (west of White Bear Ave) continuing on to EB County Rd C. We do not consider travelers exiting I-694 to SB White Bear Ave and turn to EB County Rd C since these path would only serve local O/D that have little reason to change because of the TH-36 closure.

Traffic condition analysis

Table 2 The V/C ratio of Location 1, 3, 4 AM data

Roadways	Locations	Directions	Capacity*	Volume(2006)	Volume(2007)	V/C(2006)	V/C(2007)
White Bear	1	SB	1700	720	1002	0.42	0.59
		NB	1700	740	759	0.44	0.45
County Rd C	3	WB	600	238	527	0.40	0.88
		EB	600	91	195	0.15	0.32
County Rd C	4	EB	750	99	197	0.13	0.26
		WB	750	184	477	0.24	0.64

* Capacity according to the 2010 Metro planning model

White Bear is an urban arterial with two lanes in each direction and County Rd C is an urban street with one lane in each direction. The volume denotes the traffic flow during peak hour in AM period in each location. V/C denotes the volume and capacity ratio. According to table 2, we can assume that these urban streets were not congested during the peak hour. However, the V/C of WB County Rd C in 2007 is closer to 1, which means it is closer to its congestion point. Since the data were the average of two days, it is possible that congestion might have occurred in this location sporadically at different days. In general, the traffic conditions in the rest of the locations was generally well below capacity therefore congestion events must have been infrequent.

Data analysis

From the data on the map we see that, the volume of SB White Bear Ave increased by 1,100 vehicles during the 5 hour period. This extra demand most likely originated from County Rd C WB since the additional volume in WB Location 3 is also approximately 1,000 veh. The increased volume in Location 3 WB is significant since it constitutes a 150% increase. Meanwhile, the increase of volume in WB Location 4 is also significant; an increase of 970veh constitutes a 140% increase. From the increases in these two locations we deduce that, travelers diverting from TH-36 most likely went straight from Location 4 to Location 3 without traveling out of County Rd C and that the local traffic did not generate observable differences.

In difference, the volume of NB Location 1 did not display a significant difference (-33veh). Therefore, it is possible that there is no significant diversion from TH-36 EB into NB White Bear to local streets. One possible situation is that the travelers who used TH-36 traveling toward east before the closure detoured through TH-61 and County Rd C instead. This small increase (approximately 300veh on Location 3), although it constitutes a 90% increase, it still implies local O/Ds.

Location 1 and Location 2

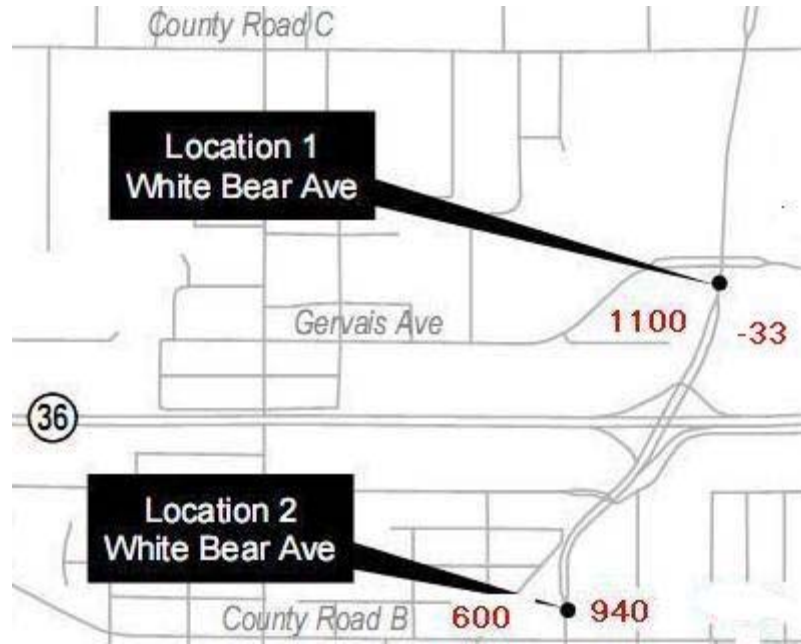

Figure 15 The volume difference on Location 1, 2 AM data

Origins and destinations in 2007

From eastbound to westbound, two possible routes are recognized. One is from White Bear Ave (north of TH-36) to WB TH-36 while the other one is from White Bear Ave (south of TH-36) to WB TH-36.

Similarly, there are also two possible routes to choose when travelers go from westbound to eastbound. One is from TH-36 to NB White Bear and the other one is to SB White Bear. As stated in the introduction we are only concerned with paths that can be affected by the TH-36 closure. The only significant local trip path that could have been affected from the closure of McKnight is the one that provides access to the retail services mall north of TH-36. Trips directed or originated towards that location utilizing McKnight or Margaret streets would have directed to White Bear Ave.

Traffic condition analysis

Table 3 The V/C ratio of Location 1, 2 AM data

Roadways	Location	Direction	Capacity	Volume(2006)	Volume(2007)	V/C(2006)	V/C(2007)
White Bear	1	SB	1700	720	1002	0.42	0.59
		NB	1700	740	759	0.44	0.45
White Bear	2	SB	1500	668	807	0.45	0.54
		NB	1500	800	1018	0.53	0.68

From the V/C ratios in table 3, it is safe to assume that the traffic conditions in these two locations are good even though we do not have detailed information on the intersections of White Bear Ave.

Data analysis

In the westbound direction, most of diverted traffic went on SB White Bear instead of NB White Bear since the additional vehicles in SB Location 2 were 600 while the situation of Location 1 can be seen as no change between 2006 and 2007. These 600veh constitute a 23% increase.

In the direction from east to west, approximately 1100veh came from north of White Bear Ave to TH-36 and 940 came from south of White Bear Ave. From the data, we cannot conclude which route travelers prefer the most since both routes carried similar amount of diversion. As discussed in the next section County road B has similar traffic conditions as Co-C. This similarity in diversion volumes can signal that these two routes have reached a local equilibrium although they serve different area sizes. It would have been interesting to see what short term fluctuations these two routes experienced in the first couple of weeks of the closure.

Location 2 and Location 13



Figure 16 The volume difference on Location 2, 13 AM data

Origins and destinations in 2007

From westbound to eastbound, three possible routes are recognized. The first is from White Bear (Location 2) to County Rd B (Location 13). The second one is from County Rd B (west of White Bear) continuing east. The third one is from south of White Bear to EB County Rd B. Similarly, these three routes can be important in the westbound direction

Traffic condition analysis

Table 4 The V/C ratio of Location 1, 2 AM data

Roadways	Location	Direction	Capacity	Volume(2006)	Volume(2007)	V/C(2006)	V/C(2007)
White Bear	2	SB	1500	668	807	0.45	0.54
		NB	1500	800	1018	0.53	0.68
County Rd B	13	WB	750	278	667	0.37	0.89
		EB	750	114	339	0.15	0.45

County Rd B is an urban street with one lane in each direction. From the data in table 4, the traffic conditions in these two locations were good in 2006 since the V/C ratios were generally low. However, the V/C ratio in WB Location 13 in 2007 is high, 0.89, which indicates that sometimes congestion might occur. Since the data are from only two days, it is likely that congestion may have occurred on them.

Data analysis

There were approximately 1,500 additional vehicles (over 5 hours) in County Rd B WB (Location 13) while there were only 940 additional vehicles going north on White Bear (Location 2). If we assume that all of the 940veh were part of the 1,500veh increase on County Rd B, there were more than 500 additional vehicles either continuing on County Rd B WB (towards TH-61) or went on White Bear SB. However, considering the small increase registered on North St. Paul rd (Location 12), it is safe to say that drivers selected to stay on County Rd B towards TH-61.

Similarly, there were approximately 600 additional vehicles on White Bear SB (Location 2). However, in Location 13 there were approximately 880 additional vehicles. If we also assume all 600veh from White Bear Ave went on County Rd B EB, there could still be approximately 300 vehicles coming from County Rd B east of White Bear or White Bear NB. A possible conclusion, later enforced by additional data from the PM peak period is that the diverted demand using County Rd B east of White Bear was underestimated and not measured which leaves the operation of the County Rd B/ TH-61 intersection at a disadvantage.

Location 3, Location 4 and Location 5

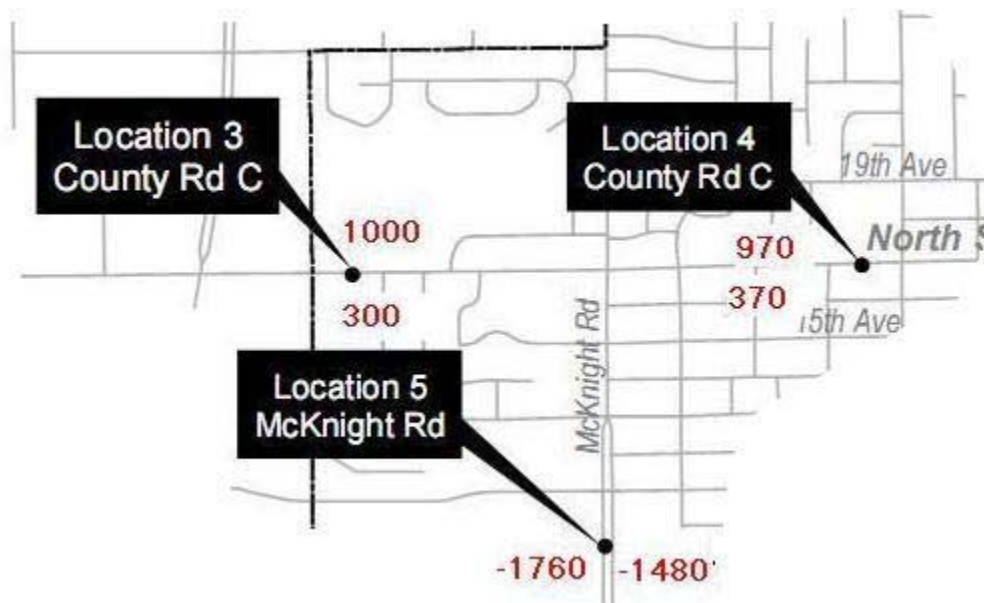

Figure 17 The volume difference on Location 3, 4 and 5 AM data

Origins and destinations in 2007

We assume that diverted traffic in this section will follow County Rd C toward west or east. Since McKnight was closed during the 2007 data collection period, the diverted traffic might go on County Rd C.

Traffic condition analysis

McKnight Rd was an urban street with two lanes in each direction and an intersection with TH-36. The traffic conditions at Location 3 and Location 4 have been described previously. The traffic condition in McKnight Rd (Location 5) was only available in 2006 due to its closure in

2007. The V/C ratio of it was 0.23 in northbound and 0.26 in southbound. Therefore, McKnight does not appear to have been experiencing severe congestion.

The additional vehicles in WB Location 4 were approximately 970 while the additional vehicles in WB Location 3 were 1,000. These 970veh were most likely to go straightly on County Rd C. In the other direction, the additional vehicles in EB Location 3 were approximately 300veh while the additional vehicles in EB Location 4 were 370. Although the amounts of the increases were small, they constituted 90% and 100% increases. Therefore, there was no great change on Location 3 or Location 4, which means the local traffic that used McKnight Rd was little and that the traffic that was using it to go or come from TH-36 now uses other routes instead but not County Rd C.

Location 4, Location 8 and Location 9



Figure 18 The volume difference on Location 4, 8 and 9 AM data

Origins and destinations in 2007

This point is the decision point for travelers using TH-36. Following the stated underlying assumption that all volume increases are due to the TH-36 closure, we assume that travelers would go into Century Avenue either northbound or southbound to reach parallel arterials. Moreover, we also assume that the travelers who used TH-36 before will go back to TH-36 (west of TH-120) after they detoured on other routes.

Traffic condition analysis

Table 5 The V/C ratio of Location 4, 8 and 9 AM data

Roadways	Location	Direction	Capacity	Volume(2006)	Volume(2007)	V/C(2006)	V/C(2007)
TH-120	8	NB	750	364	547	0.49	0.73
		SB	750	317	424	0.42	0.57
TH-120	9	NB	750	441	476	0.59	0.63
		SB	750	301	483	0.40	0.64

From the V/C ratio in table 5, it is possible that no major congestion materialized in these two locations, neither did on location 4 as presented in table 2. However, the V/C ratio in NB TH-120 is high which has the worst traffic condition compared to the others in the table. In addition, the second worst is SB TH 120 which also belongs to an alternative route of TH 36.

Data analysis

According to the measurements collected at Location 8, the volume of NB TH-120 increased by 680veh. This extra demand most likely originates from TH-36 WB since the additional volume in NB Location 9 is approximately 100veh. So, we assume that at least 580veh would divert from TH-36 to NB TH-120 (Location 8) due to the closure. On the other hand, the additional volume in SB Location 8 is 340veh while the additional volume in SB Location 9 is 660veh. Since we do not have data in TH-36 in this section, we assume that approximately 320veh to 660veh came from TH-36.

Location 9 and Location 11

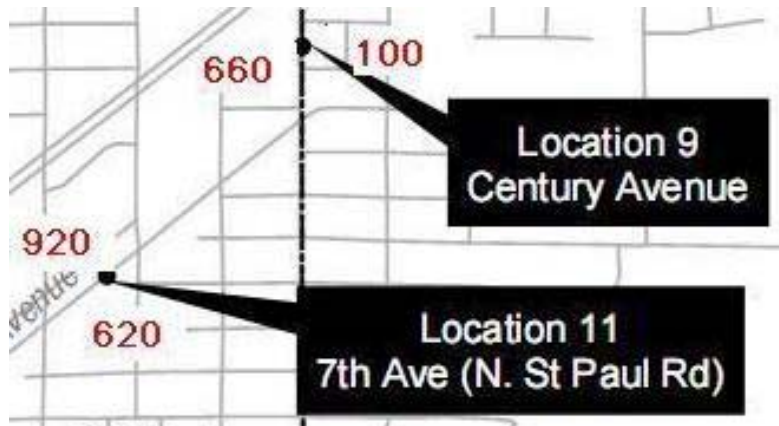

Figure 19 The volume difference on Location 9 and 11 AM data

Origins and destinations in 2007

Westbound, we assume that diverted traffic from TH-36 to SB TH-120 would have two possible routes. One is to 7th Avenue and the other one continues on SB TH-120. Additionally, we also assume that travelers might come from 7th Avenue or TH-120 (south of 7th Avenue) toward TH-36 (east of TH-120).

Traffic condition analysis

Table 6 The V/C ratio of Location 9 and 11 AM data

Roadways	Location	Direction	Capacity	Volume(2006)	Volume(2007)	V/C(2006)	V/C(2007)
7 th Ave	11	WB	750	175	427	0.23	0.57
		EB	750	101	296	0.13	0.39

The traffic condition in Location 9 has been described previously. From the V/C ratio in table 6, it is logical to deduce that no congestion occurred often in these two directions.

Data analysis

The volume of WB Location 11 increased by approximately 920 veh, while the volume of SB Location 9 increased by 660veh. Therefore, at least 320 veh came from SB TH-120 (south of 7th Avenue). As seen in the map there were an additional 100 veh in EB Location 9 and an additional 620 veh vehicles in EB Location11. If we assume that all 100veh originated from the 620, then 520 veh would go to SB TH-120. This pattern might be due to trips with local destinations spreading out into the area south of TH-36 rather than coming back to it.

Location 7, Location 11, Location 12 and Location 13

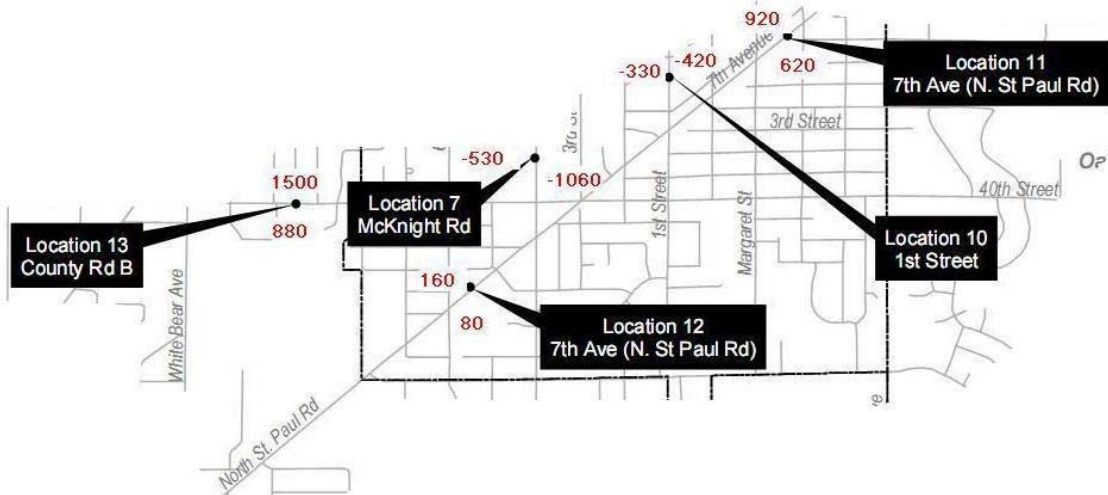

Figure 20 The volume difference on Location 7, 11, 12 and 13 AM data

Origins and destinations in 2007

From westbound to eastbound, one possible route is from County Rd B (Location 13) to 7th Avenue (Location 11) since this route is the proposed detour. Another possible route is from County Rd B (Location 13) continuing toward east. In the opposite direction, travelers can follow 7th Avenue and County Rd B toward east. In addition, they can also follow 7th Avenue and McKnight Rd SB. Also, travelers can choose County Rd B(from east of 7th to west of 7th) toward west.

Traffic condition analysis

The traffic conditions in Location 11 and Location 13 have been described previously. The traffic conditions in Location 11 were good after the closure of TH-36, but the WB Location 13 might be congested.

Table 7 The V/C ratio of Location 7, 11, 12 and 13 AM data

Roadways	Location	Direction	Capacity	Volume(2006)	Volume(2007)	V/C(2006)	V/C(2007)
McKnight	7	SB	1500	496	308	0.33	0.21
		NB	1500	702	346	0.47	0.23
7 th Ave	12	WB	750	270	285	0.36	0.38
		EB	750	107	137	0.14	0.18

From the V/C ratio in the table 7, it is safe to say that the traffic conditions in Location 7 and Location 12 are good since the V/C ratio is low.

Data analysis

There were approximately 1,500 additional vehicles in County Rd B WB (Location 13) while there were only 920 additional vehicles coming from 7th Ave (Location 11). We can safely assume that most of these 920 vehicles did not go to North St Paul Rd since the additional vehicles at location 12 were only 160. Even if all 920veh from location 11 went to County Rd B, there were still approximately 600veh that need to either come from McKnight or County Rd B (east of McKnight). It is possible that these 600veh before traveled to McKnight Rd (Location 7) to reach TH-36 since there were approximately 1060 less vehicles in Location 7. Therefore, these 600veh which used to go McKnight and then go TH-36 toward west went to County Rd B instead.

In the other direction, there were approximately 880 additional vehicles in County Rd B EB (Location 13) while there were only 620 additional vehicles going into 7th Ave (Location 11). If we assume all 620veh came from 880veh, there could still be approximate 260veh continuing on County Rd B EB or going into McKnight Rd SB.

PM period (from 2:00pm to 8:59pm)

The origins and destinations in the PM period are similar to the AM period. In the following analysis we also are concerned about the possible routes mentioned previously.

Location 1, Location 3 and Location 4

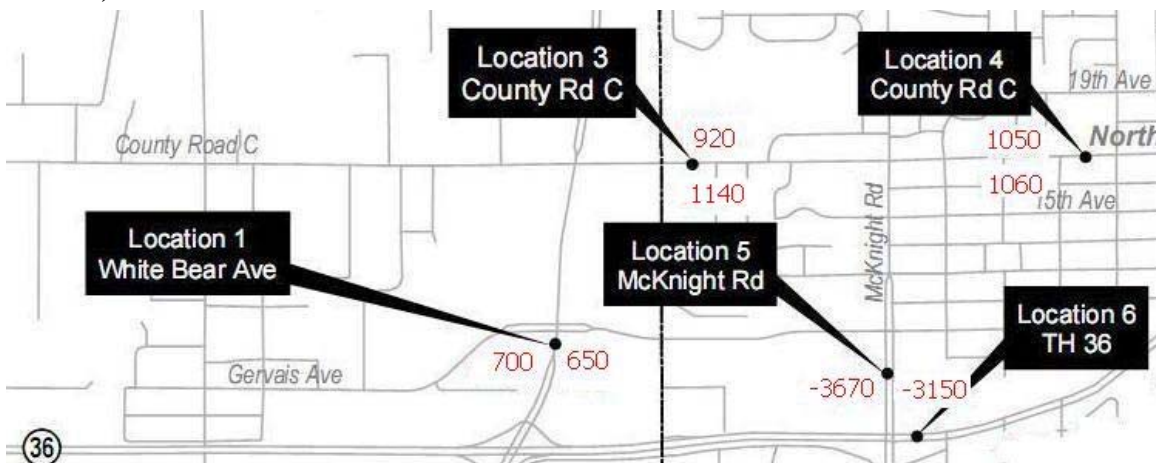

Figure 21 The volume difference on Location 1, 3, 4 PM data

Traffic condition analysis

Table 8 The V/C ratio of Location 1, 3, 4 PM data

Roadways	Location	Direction	Capacity*	Volume(2006)	Volume(2007)	V/C(2006)	V/C(2007)
White Bear	1	SB	1700	939	1061	0.55	0.62
		NB	1700	699	704	0.41	0.41
County Rd C	3	WB	600	158	323	0.26	0.54
		EB	600	292	511	0.49	0.85
County Rd C	4	EB	750	225	418	0.30	0.56
		WB	750	188	405	0.25	0.54

* Capacity according to the 2010 Metro planning model

The volume denotes the traffic flow during peak hour during the PM period (2pm-9pm) in each location. According to table 8, these urban streets were not congested during the peak hour in 2006. The traffic conditions of White Bear Ave (Location 1), County Rd C (Location 4), and County RC WB (Location 3) were also fine in 2007. However, the V/C ratio of EB County Rd C (Location 3) is closer to 1. In the AM period, the V/C ratio of the WB of this location was also high; therefore, travelers might follow the same routes in the PM period.

Data analysis

From the data on the map we see that the volume of SB White Bear Ave increased by approximately 700veh during the seven-hour period. These likely originated from County Rd C WB since this is a proposed detour. The increased volume in Location 3 WB is higher than that in SB Location 1. Specifically, it is 920veh, a 125% increase. There are two possible situations. One is that travelers continue on County Rd C (west of White Bear). The other one is that travelers might go to the retail services mall north of TH-36. The latter is less likely since in the 7 hour period they would be eventually counted in one of the two positions. Meanwhile, the increase of volume in WB Location 4 is 1,050veh, a 100% increase. From the increases in Location 3 and 4, we can also confirm the deduction in AM period that travelers diverting from TH-36 most likely went straight from Location 4 to Location 3 without traveling out of County Rd C and that the local traffic did not generate observable differences.

Different from the AM period, the volume of NB Location 1 had an increase of 650 vehicles. The volume of EB Location 3 increased by approximately 1140 vehicles, a 92% increase. If part of these vehicles went to retail mall north of TH-36, at least 500 vehicles came from County Rd C (west of White Bear) to Location 3 EB during the seven-hour period. The additional volume in Location 4 was 1,060 veh, so travellers might go straight from Location 3 to Location 4.

Location 1 and Location 2



Figure 22 The volume difference on Location 1, 2 PM data

Traffic condition analysis

Table 9 The V/C ratio of Location 1, 2 PM data

Roadways	Location	Direction	Capacity	Volume(2006)	Volume(2007)	V/C(2006)	V/C(2007)
White Bear	2	SB	1500	951	1161	0.63	0.77
		NB	1500	899	968	0.60	0.65

From the V/C ratios in table 9 we see that the traffic conditions in the PM period were worse than that in the AM period. The V/C ratios are not very high but it is also possible that congestion might occur in some days.

Data analysis

Different from the AM period, the increase in the volume in these two locations was similar in both directions; we cannot conclude which route travelers prefer the most. The increases equal to approximately 10% to 20% in this period. This can also signal a local equilibrium in this interchange.

Location 2 and Location 13



Figure 23 The volume difference on Location 2, 13 PM data

Traffic condition analysis

Table 10 The V/C ratio of Location 1, 2 PM data

Roadways	Location	Direction	Capacity	Volume(2006)	Volume(2007)	V/C(2006)	V/C(2007)
County Rd B	13	WB	750	180	442	0.24	0.59
		EB	750	388	783	0.52	1.04

From table 10, we see a significant change in the V/C of EB Location 13. The capacity is from the 2010 Metro planning model. It is possible that the capacity is underrated but still, the V/C ratio is over one in this case. Congestion might occur frequently in this location in 2007. However, the traffic conditions in 2006 as well as WB in 2007 were fine.

Data analysis

There were approximately 1,330 veh additional vehicles (over 7 hours) in Location 13 while there were only 740 additional vehicles going north on White Bear (Location 2). If we assume that these 740veh were part of 1,330 veh, there were approximately 600veh either continuing on County Rd B WB (towards TH-61) or went to White Bear SB. Since the increases in Location 12 were small (Figure 13), it is safe to say that travelers selected to stay in County Rd B toward TH-61.

Similarly, there were approximately 740 additional vehicles in White Bear SB (Location 2) and there were approximately 1,920 additional vehicles in Location 13 EB. If we also assume all 740veh went to County Rd B EB, there could still be near 1200 vehicles coming from County Rd B (west of White Bear) or NB White Bear (south of County Rd B). This amount of increase is significant for traffic conditions in County Rd B (west of White Bear) and White Bear (south of County Rd B). As the situation in the AM period, the diverted demand using County Rd B west of White was underestimated.

Location 4, Location 8 and Location 9

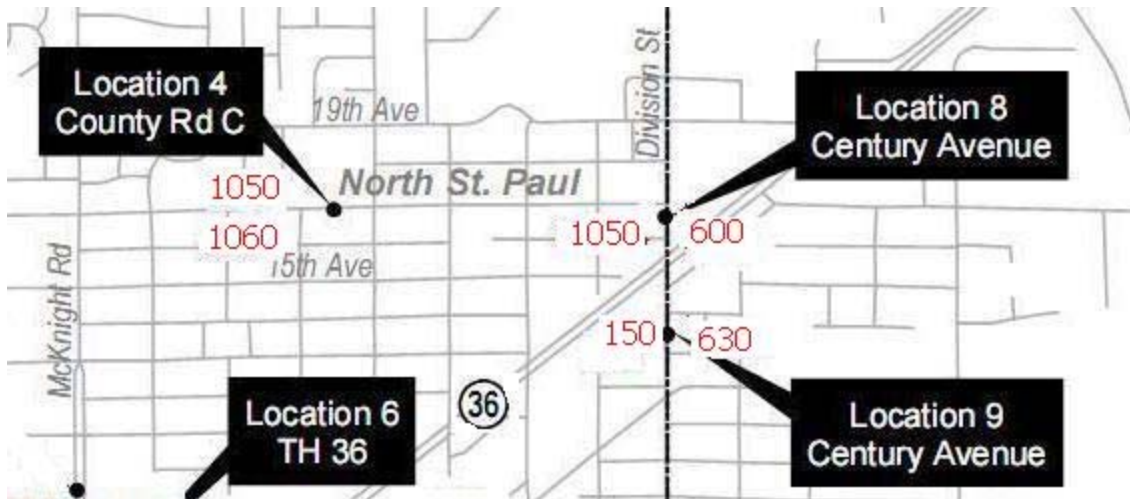

Figure 24 The volume difference on Location 4, 8 and 9 PM data

Traffic condition analysis

Table 11 The V/C ratio of Location 4, 8 and 9 PM data

Roadways	Location	Direction	Capacity	Volume(2006)	Volume(2007)	V/C(2006)	V/C(2007)
TH-120	8	NB	750	533	525	0.71	0.70
		SB	750	392	551	0.52	0.73
TH-120	9	NB	750	551	601	0.73	0.80
		SB	750	488	484	0.65	0.64

From table 11, we see that the V/C ratios are high in the PM period both in 2006 and 2007. In 2006, the traffic conditions in NB Location 8 and NB Location 9 might be congested sometimes. In 2007, the traffic conditions in NB Location 8 and SB Location 9 were the same as in 2006.

However, the traffic conditions in SB Location 8 and NB Location 9 became worse in 2007. Especially the V/C ratio of NB Location 9 is closer to 1.

Data analysis

From the map, we see that the volume of SB Location 9 increased by approximately 150veh, which means that at most 150 vehicles are coming from TH-36 WB in this seven-hour period. Meanwhile, NB Location 8 had an increase of 600veh which might originate from TH-36 WB. It is safe to say that diverted traffic which went toward west chose TH-120 NB (Location 8) rather than this route. In addition, the volume of SB Location 8 increased by 1,050veh, a 50% increase. This extra demand most likely merged to TH-36 EB since the increase in volume at SB Location 9 was small. There were 630 additional vehicles in NB Location 9, which might merge into TH-36.

According to the data in Location 4 and Location 8, we see that diverted traffic in EB Location 4 probably turned to SB Location 8 because the increases in volume are similar. Furthermore, at least 450 vehicles came from the local area to WB Location 4, which constituted 43% of the 1,050 vehicles, since the increase in NB Location 8 was only 600.

Location 9 and Location 11



Figure 25 The volume difference on Location 9 and 11 PM data

Traffic condition analysis

Table 12 The V/C ratio of Location 9 and 11 PM data

Roadways	Location	Direction	Capacity	Volume(2006)	Volume(2007)	V/C(2006)	V/C(2007)
7 th Ave	11	WB	750	214	365	0.29	0.49
		EB	750	253	470	0.34	0.63

The traffic condition in Location 9 has been described previously. From the V/C ratio in table 11, it is logical to deduce that no congestion occurred often in these two directions.

Data analysis

The volume of WB Location 11 increased by approximately 940veh, while the volume of SB Location 9 increased by 150veh. Therefore, there were approximately 800veh coming from NB TH-120 (south of 7th Ave) into 7th Ave during this seven-hour period. As we seen in the map, there were an additional 630veh in NB Location 9 and an additional 1,160veh in EB Location 11. If we assume that all 630veh originated from the 1,160, then 530veh would go to SB TH 120. As we deduced in the AM, this pattern might be due to trips with local destinations spreading out into the area south of TH-36 rather than coming back to it.

Location 7, Location 11, Location 12 and Location 13

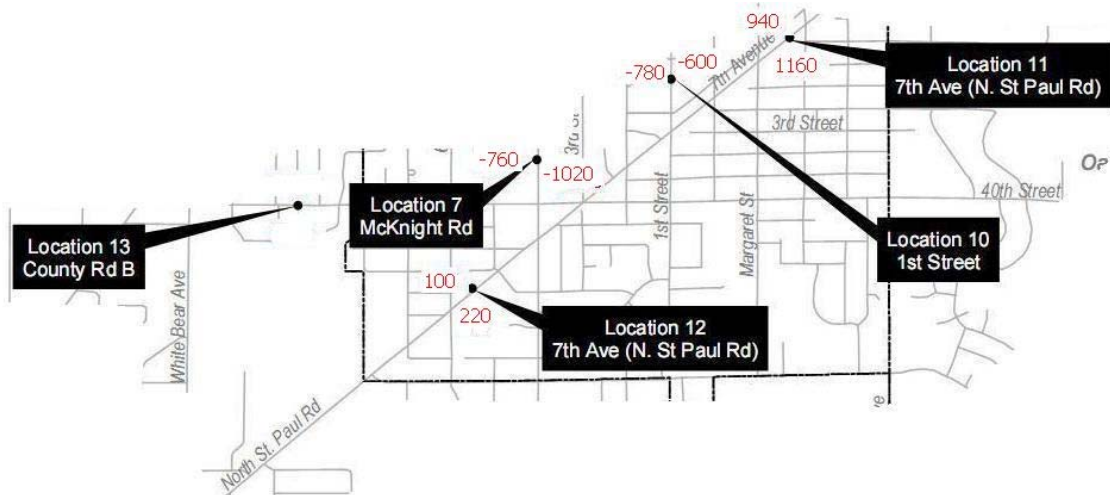

Figure 26 The volume difference on Location 11, 12 and 13 PM data

Traffic condition analysis

Table 13 The V/C ratio of Location 7, 11, 12 and 13 PM data

Roadways	Location	Direction	Capacity	Volume(2006)	Volume(2007)	V/C(2006)	V/C(2007)
McKnight	7	SB	1500	496	308	0.33	0.21
		NB	1500	702	346	0.47	0.23
7 th Ave	12	WB	750	270	285	0.36	0.38
		EB	750	107	137	0.14	0.18

The traffic conditions in Location 11 and Location 13 have been described previously. The traffic conditions in Location 11 had infrequent congestion while in Location 13, the congestion occurred more frequently. From the V/C ratios in table 13, we see that the traffic conditions in these two locations were fine.

Data analysis

There were approximately 1,330 additional vehicles in Location 13 WB while there were only 940 additional vehicles in WB Location 11. Similar to the AM period, we can also safely assume that most of these 940veh did not go to North St Paul Rd since the additional vehicles at Location 12 were only 100. Even if all 940veh from Location 11 went to County Rd B, there were still approximately 400veh that need to either come from McKnight or County Rd B (east of McKnight). It is possible that these 400veh traveled to McKnight Rd (Location 7) to reach TH-36 before the closure since there were 1,020 less vehicles in Location7 NB. Therefore, the 400veh went to County Rd B instead of TH-36 to west.

In the other direction, there were 1,920 additional vehicles in Location 13 EB while there were 1,160 additional vehicles in Location 11 EB. If we assume all 1,160veh were part of the 1,920veh, there could still be 760veh came continuing on County Rd B EB or going into McKnight Rd SB.

Table 14 The V/C ratio of 13 locations. AM data

Roadways	Location	Direction	Capacity	Speed	Volume (2006)	Volume (2007)	V/C (2006)	V/C (2007)
White Bear	1	SB	1700	39	720	1002	0.42	0.59
		NB	1700	39	740	759	0.44	0.45
White Bear	2	SB	1500	31	668	807	0.45	0.54
		NB	1500	31	800	1018	0.53	0.68
County Rd C	3	WB	600	30	238	527	0.40	0.88
		EB	600	30	91	195	0.15	0.32
County Rd C	4	EB	750	31	99	197	0.13	0.26
		WB	750	31	184	477	0.24	0.64
McKnight	5	SB	1700	33	443	0	0.26	0.00
		NB	1700	33	397	0	0.23	0.00
TH-36	6	EB	2200	40	762	0	0.35	0.00
		WB	2200	40	1165	Closed	0.53	0.00
McKnight	7	SB	1500	31	496	308	0.33	0.21
		NB	1500	31	702	346	0.47	0.23
TH-120	8	NB	750	31	364	547	0.49	0.73
		SB	750	31	317	424	0.42	0.57
TH-120	9	NB	750	31	441	476	0.59	0.63
		SB	750	31	301	483	0.40	0.64
7th Ave	11	WB	750	31	175	427	0.23	0.57
		EB	750	31	101	296	0.13	0.39
7th Ave	12	WB	750	31	270	285	0.36	0.38
		EB	750	31	107	137	0.14	0.18
County Rd B	13	WB	750	31	278	667	0.37	0.89
		EB	750	31	114	339	0.15	0.45

Location 5 and Location 6 were closed in June 2007, therefore the flow was zero.

Table 15 The V/C ratio of 13 locations PM data

Roadways	Location	Direction	Capacity	Speed	Volume (2006)	Volume (2007)	V/C (2006)	V/C (2007)
White Bear	1	SB	1700	39	939	1061	0.55	0.62
		NB	1700	39	699	704	0.41	0.41
White Bear	2	SB	1500	31	951	1161	0.63	0.77
		NB	1500	31	899	968	0.60	0.65
County Rd C	3	WB	600	30	158	323	0.26	0.54
		EB	600	30	292	511	0.49	0.85
County Rd C	4	EB	750	31	225	418	0.30	0.56
		WB	750	31	188	405	0.25	0.54
McKnight	5	SB	1700	33	652	0	0.38	0.00
		NB	1700	33	616	0	0.36	0.00
TH-36	6	EB	2200	40	1377	0	0.63	0.00
		WB	2200	40	850	0	0.39	0.00
McKnight	7	SB	1500	31	514	402	0.34	0.27
		NB	1500	31	710	533	0.47	0.36
TH-120	8	NB	750	31	533	525	0.71	0.70
		SB	750	31	392	551	0.52	0.73
TH-120	9	NB	750	31	551	601	0.73	0.80
		SB	750	31	488	484	0.65	0.64
7th Ave	11	WB	750	31	214	365	0.29	0.49
		EB	750	31	253	470	0.34	0.63
7th Ave	12	WB	750	31	214	199	0.29	0.27
		EB	750	31	323	335	0.43	0.45
County Rd B	13	WB	750	31	180	442	0.24	0.59
		EB	750	31	388	783	0.52	1.04

Location 5 and Location 6 were closed in June 2007, therefore the flow was zero.

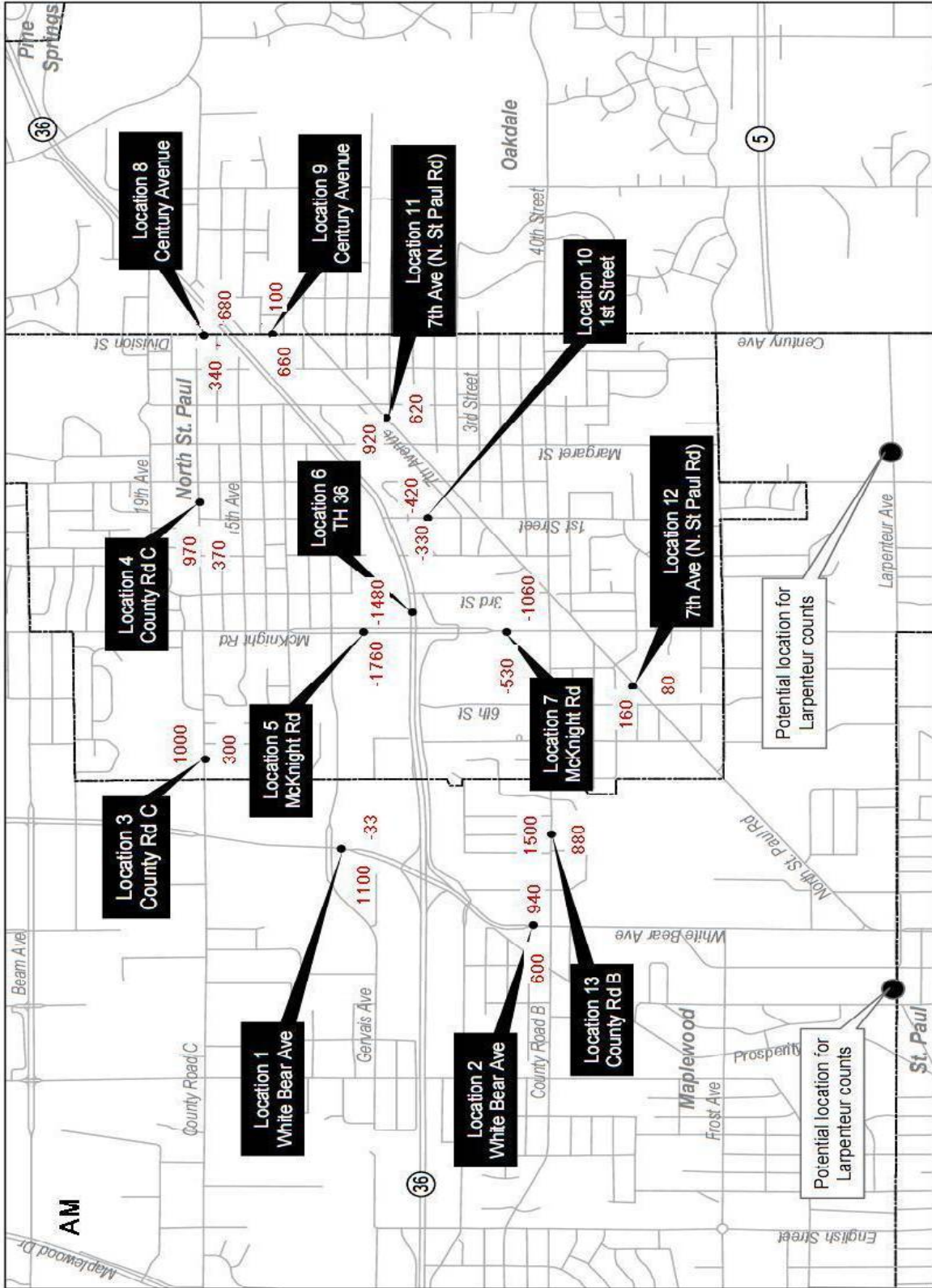

4. Selecting the Appropriate Traffic Analysis Tool

The original plan in this research project was to utilize a microscopic traffic simulator for the evaluation of the implemented FC construction method and compare the results with the abandoned PC alternative. Considering that the decision was made purely on financial reasons, the PC required more than the available funds, without any detailed analysis of traffic conditions or a Benefit Cost Analysis that contradicted the two options, the aim was to actually quantify the full benefit, if any, of the FC as compared to the traditional PC. During the course of the project it became evident that due to the large difference in construction costs the FC was an obvious best alternative. The benefit from a detailed analysis based on a single methodology was minimal. Instead, a lack of guidance on the available tools for analyzing FCs and more importantly the lack of clear understanding on the pros and cons of the different tools and methods was revealed. To maximize the benefit from this research, the objective of the project was altered and became the evaluation of available tools and procedures for selecting construction methodologies and specifically evaluating FCs.

The most important element differentiating FCs from other less radical methods is the potential for very large social costs. Such costs, termed Road User Costs (RUCs), incur during the construction period and depend on the impact the construction methodology has on the rest of the network. All construction projects generate RUCs. PCs, as compared to FCs, have much lower daily RUCs but normally last a lot longer complicating the determination of which method exhibits the lowest total RUCs. Additionally, the shorter duration of the FC allows for an earlier reaping of the benefits from the improved roadway. These and other contradicting characteristics between the two alternatives make it difficult to determine the best choice and in many cases require detailed analysis of all alternatives.

Road User Costs (RUCs)

User costs during construction, maintenance, or rehabilitation activities are usually defined as Road User Costs (RUCs), which are additional delay costs, Vehicle Operation Costs (VOC), and crashes costs for road users. (LCCA, 1998; NJ/DOT, 2001). These are the cost discrepancies between the Base Case and Project Alternatives during the construction phase. There are many factors that affect RUCs, such as the duration and characteristics of the work zone and the volume and operating characteristics within the impacted area (NJ/DOT, 2001).

Daniels (1999) suggests that RUCs applies when the capacity of the roadway is added, traffic volume in construction area is very high, and economic impacts are expected. These are three main situations when RUCs are important to the projects. Daniels also presents a procedure for calculating user costs, which is shown in Figure 27. This is a flowchart for estimating RUCs. First of all, the analyst needs to decide whether RUCs need to be estimated. Then, the analysis methodologies are selected accordingly, to estimate the components of RUCs. Last but not least, proper adjustment of RUCs is needed to implement in contracting.

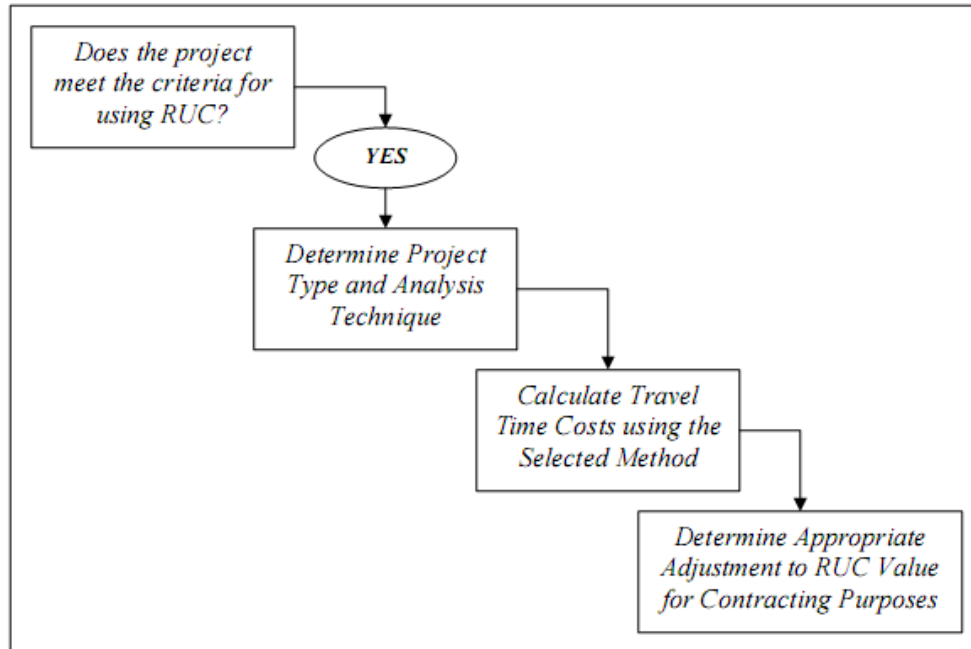

Figure 27 Flowchart for estimating RUC (Daniels et. al, 1999)

Components of RUC

Delay costs

The comprehensive delay costs can include speed change delay (due to accelerating or decelerating), reduced speed delay, queue delay (due to waiting time in a queue under forced flow conditions), and detour delay (due to additional time spent in taking different routes) (NJ/DOT, 2001; James et al., 1998).

VOC

Vehicle Operating Costs are general concepts describing costs due to changes in vehicle operation, such as fuel, consumed tires, maintenance of the vehicles, and so on. Generally, VOC includes speed change in work zone, queue idling VOC (which is “stop and go” issues during a queue in a work zone), and circuitry VOC, which is due to additional travel distance (NJ/DOT, 2001; Walls et al., 1998).

Accident costs

Accident Costs (AC) include fatal accidents, non-fatal injury accidents, and property damage only (Salem & Genaidy, 2008). AC can be a function of crash rate and Vehicle Distance Travel (VDT). However, since the data for work zone crashes is limited, and the exposure of the work zone is unclear for calculation, the evaluation of this component is suspect (Walls et al., 1998).

The actual consideration of RUCs usually differs from the ideal conditions mentioned above. The NJ /DOT RUC manual (2001) only considers reduced speed delay, queue delay, queue idling VOC, detour delay, and circuitry VOC. The estimation methodologies of these five

components are only based on a spreadsheet. Salem and Genaidy (2008) in Ohio Department of Transportation (O/DOT) selected speed change delay, reduced speed delay, stopping delay, and queue delay as delay cost measures and selected speed change VOC, stopping VOC, and idling VOC as VOC measures. Both of these DOTs do not consider accident costs as part of RUCs.

Adams (2005) conducted a survey for DOTs about the implementation of RUCs in contracting. This survey has thirteen valid samples and includes three areas: methods for applying user costs, methods for determining user costs, and adjustment. From the survey, three states do not consider RUCs at all. Six consider delay and VOC, five consider delay, VOC, and accident costs, and four of them only consider delay costs. Arizona is the only state in the survey that considers social impacts as RUCs. In delay estimation, seven states use the reduced speed to determine the time lost in work zones, and eight states consider time lost in detour. Among these eight states, only three calculate the time lost in detours by utilizing analysis tools. None of the agencies in the survey consider environmental impact.

Salem and Genaidy (2008) also conducted a survey for 22 states. The objective of the survey was to identify the role of RUCs in pavement-type selection process. Among these 22 states, 14 states do not consider RUCs at all when they design or select the alternative for pavement projects. The rest considered delay costs and VOC. However, none of the states surveyed take accident costs into account, due to the difficulty of monetizing the costs of crashes.

Application of RUCs

User costs have two major applications. One is to compare different project alternatives in economic analysis. The other one is to estimate the additional costs due to work zone activities (Ellis, 1997). The former is usually the user costs implemented in BCA procedure, while the latter is implemented in Life Cycle Cost Analysis (LCCA) or contracting, which is also called RUCs.

In LCCA, RUCs is used for selecting pavement alternatives. LCCA is also a procedure that conducts economic analysis to evaluate economic efficiency between the Base Case and Project Alternatives over a facilities' lifetime. Two cost elements are included in LCCA: agency costs and RUCs. This is distinct from BCA, where the analysis period usually starts when the project is in the operating phase; the analysis period of LCCA usually covers the construction phase and the operating phase. LCCA is implemented when the benefits of the project alternatives are essentially identical. However, if the benefits of the project alternatives are not identical, BCA should be implemented (FHWA, 2003). In other words, BCA is implemented when planners or policy makers need to decide which project deserves implementation, while LCCA is implemented to select the best alternative for the project that is already being implemented. RUC during the construction phase is emphasized in LCCA process (Walls, 1998; FHWA, 2002; Salem & Genaidy, 2008), while only a few studies (FHWA, 2003) in the literature mention that RUCs should be considered in the BCA process.

In contracting implementation, RUCs can be used for incentive or disincentive methods (I/D method), A+B contracting, and lane rental (Adams, 2005). The I/D method involves giving the contractor a bonus if they finish the project ahead of time, with penalties when they are delayed in the construction. The A+B method means the bid for contractors needs to include the construction costs as well as the amount of time for construction. Lane rental needs RUCs as well: the contractors will be charged for the time that the lane is closed during the construction (Herbsman, 1998; Adams, 2005). In addition, RUCs can be also used for determining

construction scheme and staging, lane closure schedule, and project delivery method (Gillespie, 1998). RUCs in contracting methods are also mentioned in “User Benefits Analysis for Highways” (AASHTO, 2003). The authors present different contracting methods that might generate different RUC during construction. However, this study resource does not clearly illustrate when the differences are due to different duration or due to different daily RUCs.

Methods of RUCs calculation

In order to obtain RUCs, traffic analysis tools can be used. These tools should be capable of obtaining delay measures, VOC measures, and accident measures. Alexiadis et. al (2004) describes seven categories of traffic analysis tools and reviews their use, advantages, and limitations. These tools are: sketch-planning tools, travel demand models, HCM-based tools, traffic signal optimization tools, macroscopic simulation models, mesoscopic simulation models, and microscopic simulation models. In general, a sketch-planning tool is the least costly. It is better suited to preliminary proposals that do not need in-depth analysis. Travel demand models can be used for predicting future demand, obtaining origin destination data, and performing static traffic assignment. HCM-based tools can quickly estimate capacity, delay, and queues on isolated links and intersections, but do not do well in a system where congestion is a larger problem. Traffic signal optimization tools are good for designing and optimizing signal phasing and timing plans. Simulation models involve high data-intensity and effort requirements, but can potentially provide the most detailed results.

In a survey, Ellis (1997) summarizes seven general methods to calculate RUCs in a work zone, which are: the AASHTO Red Book method, MicroBENCOST, QUEWZ-PC, TRDF relationships, HDM-III VOC Sub-model, and the ARFCOM model. In addition the survey shows that a broad range of methods are utilized by different agencies, from simple formulas to software packages. Some DOTs do not even have a formal method for RUCs calculation. No generally accepted approach of RUCs calculation existed at the time the survey was conducted (Ellis, 1997).

Adams (2005) shows that QuickZone, DelayE, as well as DUCK can also be used for RUCs calculation. The authors recommend DelayE and DUCK for the Utah Department of Transportation (U/DOT) for contracting evaluation. Salem and Genaidy (2008) summarize eleven tools for RUCs calculation for LCCA in pavement projects. These include WorkZone RUC, CO3, New Jersey spreadsheet, and some other models developed by other countries or the World Bank. The objective of reviewing these tools for RUCs calculation was to find out a better method for O/DOT in the LCCA process, to select the best pavement alternative. Besides these tools, Edara (2007) mentions that Highway Capacity Manual 1994, as well as the 2000 manual, and microscopic simulation models can be implemented for RUCs calculation. This paper also visits the issues of data-intensity and effort requirement for the RUCs calculation tools in short-term construction projects.

A few papers present an evaluation of these tools by using field data from work zones. Benekohal et al. (2003) compares FRESIM, QUEWZ, and QuickZone by using field data from 11 work zones in Illinois. From the results of the comparison, none of the tools achieved accurate results. Schnell et al. (2002) evaluates six traffic analysis tools with field data from four work zones in Ohio. These six tools were the Highway Capacity Software (HCS), Synchro, CORSIM, NetSim, QUEWZ 92, and a spreadsheet tool developed by the Ohio Department of Transportation. The paper indicates that the microscopic simulation models underestimate the

queue length, and that they cannot estimate the oversaturated conditions of a work zone. QUEWZ 92 obtained the most accurate results among all these tools. These comparisons focus on comparing the estimation from tools within the field data, such as speed, queue length, and travel time. They do not extend the comparison into the entire impacted corridor or area.

Krammes et al.. (1989) also evaluates traffic analysis tools for highway construction. They present a selection of tools for evaluating area-wide impacts due to highway construction. This paper focuses on projects involving high demand roadways, such as freeways and highways, and examines area-wide impacts due to construction activities, such as diversion and change of mode. This paper concludes that the tools that have a traffic assignment function are important for area-wide analysis in highway construction. Travel demand models are especially recommended for this kind of analysis. However, analysis effort costs are not included in this paper.

Methodologies of RUCs Calculation in the TH-36 Project

Estimating RUCs involves the estimation of traffic operations and crashes in the No-Build case (before) and during all phases of construction. Even if the latter is well defined, depending on the project size, the effort required can vary from little to financially infeasible depending on the level of accuracy desired and tools/methodologies used. According to the FHWA “Work Zone Best Practices Guidebook” (FHWA, 2000) state of the art, “transportation agencies would need to use computer modeling to assess the traffic and safety impacts as well as the construction duration.” Deviating a little from this guidance, three methodologies based on computer modeling are implemented in the TH-36 project are joined with a summary and results from the empirical, engineering judgment based method followed by Mn/DOT. The computer model based methodologies vary greatly in terms of complexity, effort, and accuracy/trust achieved. It is prudent to note upfront that the more complex methodologies are clearly inappropriate for a project of the size and complexity of TH-36 which is used in this case as a convenient testing ground.

Following the directions and resources found in the FHWA “Traffic Analysis Tools Primer” (Alexiadis et al. 2004), three tools, with increasing levels of cost, complexity, and features, were selected. The tools selected are: a “Sketch-planning tool” QuickZone (FHWA, 2000), a “Travel Demand Model”, Cube Voyager (Citilabs, 2009), and a “Simulation Model”, AIMSUN NG (TSS, 2009). For each of these tools a methodology for RUCs estimation is described noting the effort required, accuracy achieved, and the variance of the results in relation to changes in assumptions made or parameters selected. The objective of this section is to be a resource in selecting the proper traffic analysis tool for calculating RUCs. HCM and optimization tools are not discussed as a choice since they are more relevant in evaluating isolated facilities and offer little in cases where diversion is involved, the major issue in FCs. Travel demand models are able to perform traffic assignment and mode choice but have higher data intensity and effort requirements than tools like QuickZone. Microscopic simulation models require the greatest effort among the three, especially for calibration.

Empirical estimation of RUCs

As mentioned earlier, the Office of Investment Management performed an empirical RUCs estimation following a methodology directly based on assumptions and engineering judgment (Memo of August 17, 2006). As it will be presented later on, this comparatively simple

methodology nevertheless produced an estimate very close to the ones produced with the more sophisticated tools. The engineers, based solely on direct knowledge of the network, selected four possible diversion routes, two freeway routes serving long commuting trips using TH-36 as a pass-through and two routes utilizing local streets serving the surrounding neighborhoods. Simple visits of these diversion routes enhanced the engineer's knowledge with measurements of travel times, while existing detection infrastructure on the freeways provided very accurate descriptions of existing traffic conditions. On the local streets Mn/DOT deployed temporary tube counters on 12 locations surrounding the FC site. These measurements along with existing AADTs on record formed the base for assumptions on the amount of traffic each diversion route would take during the FC. Further, assuming that the additional traffic in each diversion will not cause significant difference in traffic conditions, the additional travel times and travel distances were estimated. Simple calculation produced the estimated total delay cost and VOC due to the FC. The RUCs of the FC were estimated at \$69,000 a day while the PC was estimated at \$9,000 a day. Please note that the RUCs value for the PC refers to the second stage of the project (3 months of one lane open after the FC). For convenience, in this and the other three methodologies, we used this value for the whole length of the 20-month PC alternative.

Sketch-planning tool: QuickZone

QuickZone, developed based on Microsoft Excel, is easy to use and quick in obtaining results. It uses a simple deterministic queuing model to estimate delays and queue lengths in the work zone as well as RUCs due to diversion. Volume variation over a day and season can be considered in describing the demand. It also takes into account various factors such as peak spreading, trip cancelation, and route changes. The traffic impacts in QuickZone are expressed in terms of user costs, user delay, queue length, and traffic behavior (trip cancelation, time shift, etc)

QuickZone estimates the hour-by-hour delay and queue length in the mainline by comparing link demand with capacity. If hourly demand is over the capacity, then there is a queue in the current link at that hour. The hourly demand is the demand described by the user plus the queue length left from the previous hour. In addition, link flow is considered to be constrained by upstream conditions. If there is congestion, the demand downstream of the bottleneck is lower since part of it is metered by the upstream links. The hourly demand of a link is the sum of outflow of the upstream link and the queue length from the previous hour. This concept is implemented for No-Build case that represents the condition before the construction and for During case that represents the condition during the construction.

When the reduction of capacity in the work zone causes significant delay, vehicles in the mainline will be assigned to detours. QuickZone initially assumes that all vehicles will stay in the mainline during the construction, which means the demand of each link at the beginning of calculation remain the same as in the No-Build case. According to the results of this initial calculation, QuickZone will assign parts of the demand into a detour to mitigate the congestion in the work zone but the rest of the demand will still remain in the mainline. The principle is to assign appropriate amount of vehicles so that congestion will not occur on the detours.

In order to obtain reliable results, five pieces of information are required by QuickZone: Network, Project data, Travel demand and Corridor management data. Network data include the information of geometry of the network (link length and number of lanes), the capacity, and jam density of every link. Project data includes the information of construction strategies such as the duration of construction and the reduction of capacity in the work zone. Travel demand data

describes the hourly demand of every link in the network. This hourly demand can be obtained either from real data or the AADT and the traffic pattern. Corridor Management data is about congestion mitigation strategies such as the improvement of detours to increase the capacity, Variable Message Signs, and mode change or trip cancelation fractions.

RUCs in QuickZone have two components: delay costs and operation costs. Total delay is the aggregated average delay of every hour, which is calculated as the average of the queue at the beginning and at the end of that hour. The delay costs are calculated by total delay multiplied by the unit cost. The operation costs are the product of diversion demand, additional distance and unit cost. Besides RUCs, QuickZone can also provide plots of the system delay, queue length in mainline and travel behavior.

Limitations of QuickZone

Although QuickZone takes many factors into account, it has some serious limitations. First of all, QuickZone can only evaluate queue delay in the selected mainline. Since QuickZone will never allow the detour route to exceed capacity due to redirected demand, only the cost from the additional distance travelled by the diverted traffic is calculated. Other links in the network, not in the mainline or detour, are ignored during the analysis. Second, QuickZone, in version 2.0, can only use one detour. This means only one detour carries diverted traffic during the construction. This might simplify the calculation; however, in reality drivers can choose many possible routes in their goal to minimize delay. In our case we have identified three. Finally, the traffic assignment algorithm in QuickZone is based on spare capacity of the detour. If the user chooses a congested or close to congested roadway as a detour, little traffic will be assigned to the detour and therefore the congestion in the mainline significantly increases. In such case, the delay and user costs in the mainline will be overestimated. It is interesting to also note that following the directions in the manual, the attempt to describe the FC as a work zone with capacity zero caused the tool to crash.

Improved QuickZone methodology

Considering the advantages and limitations of QuickZone, we propose an improvement to allow evaluation of area-wide impacts. As mentioned before, QuickZone can only evaluate the mainline and one detour conditions. In this improvement, all roadways in the network can be evaluated, while, more routes can carry diversions. Figure 28 presents the general methodology framework of QuickZone while the process of improvement is as follow:

Step 1. Select project area and demand

As mentioned, the impact area is defined by the user. This area needs to cover the work zone and all routes that can service significant diverted demand. Once the geometry of the network is built, demand and other inputs are provided. As noted in the figure, this step is purely based on assumptions and engineering judgment. QuickZone can offer no assistance other than provide the engineer with a streamlined tool to explore the impact of these assumptions on the RUCs.

Step 2. Calculate the No-build scenario costs

The baseline case scenario describes the traffic conditions before the construction. In order to obtain the existing delay for the entire network, users need to define in turn each roadway as mainline and run QuickZone. For example, if the corridor has three roadways including the work zone, users define the work zone as mainline, obtain delay and corresponding costs, then choose

one of the diversion routes and define it as mainline and so on. Finally, in summing up all delay costs it is important not to double count overlapping links. The final results indicate the traffic condition of the entire network in the No-build case.

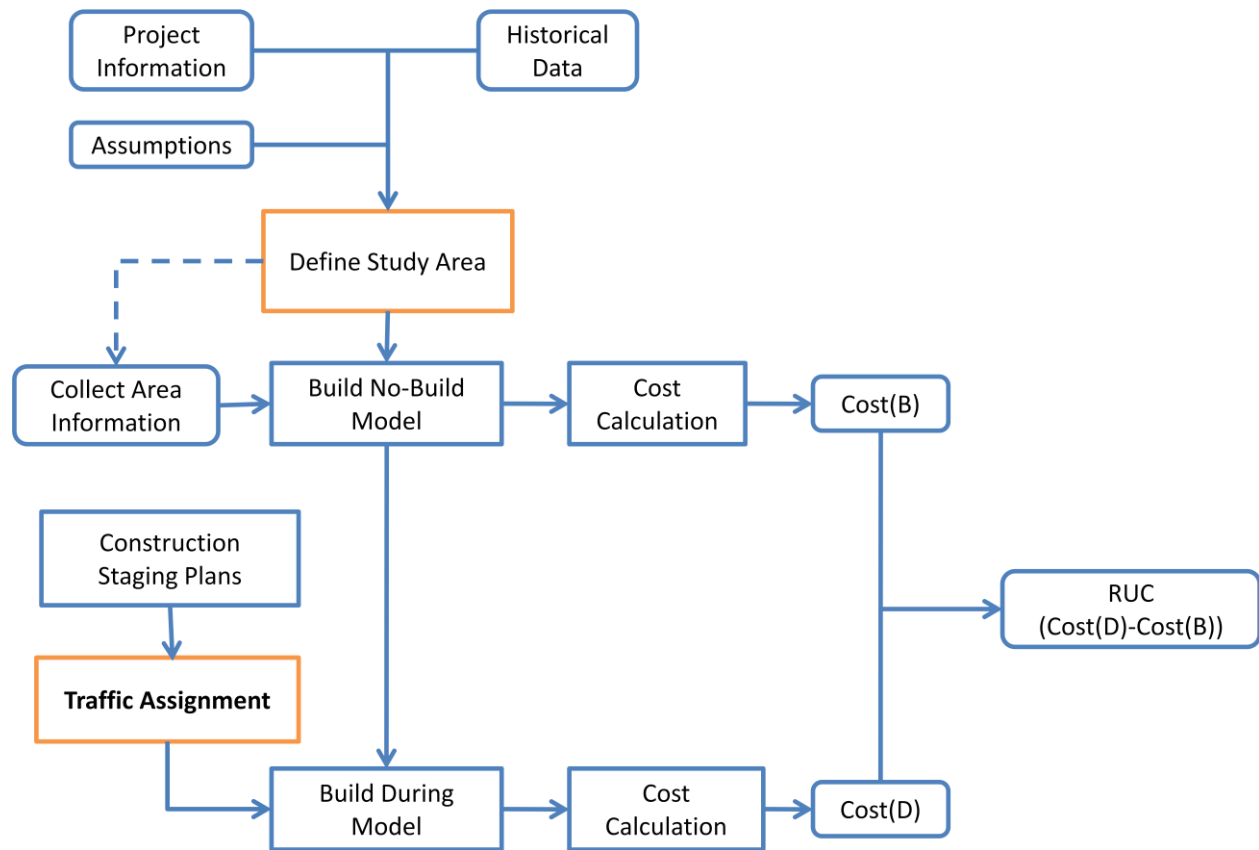

Figure 28 QuickZone methodology framework

Step 3. Traffic assignment

The QuickZone model cannot offer help in terms of traffic assignment. Although it can assign traffic into a detour, the amount of assigned traffic is according to the spare capacity of the detour. We believe it is a better idea to allow the user to define the diversion demand. Based on experience, engineering judgment, and the role of each roadway in the network, users can estimate better the spread traffic due to the construction. The objective of this step is to define the new demand of each link during the construction period. Again the streamlined operation of QuickZone can assist in the exploration of the impact these assumptions have on the final result.

Step 4. Calculate the costs during the construction

This step includes two sub-steps. First of all, the user changes the inputs of the network by replacing the initial demand with new demand from step 3 and reduces the capacity in the work zone based on the design scenario information. After these inputs are changed, a repeat of step 2 provides the costs of delay on all roadways in the network during the construction.

Step 5. Calculate RUC of entire network

Since QuickZone does not take safety costs into account, user costs discussed here include only two components, travel time costs and vehicle operating costs. The travel time costs can be

obtained by subtracting the delay costs of the Base Case by the delay costs of the During Case of the Project Alternative.

Operation costs are included in the total RUCs calculated by the following equation:

$$C_o = \sum_{i=1}^N (D_i \times L_i \times c)$$

Where C_o is the operation cost. D_i is the assigned amount of traffic to detour i . L_i is the additional distance between detour i and the initial route where the work zone is while c is the unit operation cost.

From these five steps, the user obtains the delay cost of the No-Build and During scenarios. According to the definition of the RUCs, the difference between these two results is the estimated delay costs. The final RUCs are the sum of estimated delay costs and operation costs.

Travel demand model: Cube Voyager

It leaves no argument that using a Travel Demand Model (TDM) is only feasible if a pre-existing, calibrated regional model is available. The long and expensive process involved in building such a model renders its development prohibitive even for the biggest highway construction project. Although reduced, the RUCs estimation methodology with Voyager is not without assumptions. TDMs like Voyager usually involve the four-step method in estimating future demands. Assuming that nobody will change home or employment location due to the construction operations, in calculating the RUC during the construction period only the traffic assignment step is employed to estimate link flows for the No-Build, During, and As-Build cases. The difference of link flows between the first two scenarios indicates the condition of traffic diversion while the third is needed for the full BCA. Additionally, although OD demand may change between the periods of before, and during, and after the construction, the effort of obtaining new ODs is significant. For this reason, OD demand is usually assumed to be constant during the three scenarios (demand increase is handled in the BCA for the projects lifetime). Mode choice can also change during the construction but experience from many previous projects shows that diversion is much more common than mode change (Krammes, 1989). Following these assumptions it is clear that the purpose of using a travel demand model is to evaluate diversion allowing for congestion mitigation strategies on the work zone, the assigned detours, and the rest of the impacted area.

Building and maintaining a travel demand model for even an average sized metropolitan area is not a simple task. Usually, such a model is the responsibility of the local Metropolitan Planning Organization (MPO) and is used mostly for long term planning purposes. One negative characteristic encountered often in such models is the large discrepancies found on a link by link basis. It is very difficult to calibrate such big models and often there are no sufficient data for the task. Generally, the goal of the MPO is to capture the big movements of people commuting in and out of the area. It is possible that the area of the construction may not have been satisfactory calibrated; therefore the effect of the closing or capacity reduction of a single link may not be captured adequately. To avoid such problems, recent, preferably hourly, volumes of important links in the vicinity of the planned construction should be collected and compared with the results of the travel demand model. Most additional calibration will only involve adjusting traffic assignment parameters.

In difference to QuickZone, Voyager cannot generate RUCs directly. It can only provide the results of link flow, link travel times, total vehicle-hour-travel (VHT), and total vehicle-distance-travel (VDT). RUCs can be calculated based with these through the following:

- Delay costs

$$C_d = (VHT_A - VHT_B) \times c_1$$

- Operation costs

$$C_o = (VDT_A - VDT_B) \times c_2$$

- Daily RUC

$$C = C_d + C_o$$

- Total RUC

$$C_{total} = C \times d$$

Where VHT_A is the vehicle-hour-travel in the During case while VHT_B is the same in the No-Build case. VDT_A is the vehicle-distance-travel During while VDT_B is the same in No-Build. c_1 and c_2 are the unit costs of delay and operation respectively. d is the number of construction days. The framework of the RUCs estimation methodology with a TCM can be seen in figure 29.

Simulation model: AIMSUN NG

Microscopic simulation models are the most complex and powerful of the traffic analysis tools. They require the greatest effort as well as require the most data. Generally, implementing a microscopic simulation model requires detailed knowledge of the network geometry, traffic demand, signal control plans etc. In order to obtain reliable results, calibration of the network is paramount and usually very time consuming. However, microscopic simulation models provide higher quality results than QuickZone and TDMs, such as average travel time, total travel time, average delay, queue sizes, number of stops, fuel consumption and others. These additional results can be used for calculating the RUCs in greater detail. The calculation procedure of RUCs is the same as with the TDM. However, the static traffic assignment of the TDM is replaced with a dynamic traffic assignment in the same of micro-simulation. Figure 3 presents the outline of the methodology involving the use of a microscopic traffic simulation model. Although in this work AIMSUN NG was used the steps involved are applicable to any traffic simulator in the market (VISSIM, PARAMICS, CORSIM, etc.) although the effort involved can be affected by the applications streamlined design.

The goal in the use of AIMSUN is similar with that of Voyager. In both cases, the model must be able to emulate road user decisions (on the disaggregate level in the first and the aggregate level in the second) so it not only closely replicates current conditions but it is able to accurately predict conditions during and after the construction, normally unknown at the time of the analysis. Although the engineer largely depends on the TDM's quality, in the case of the simulation it is his/her responsibility to calibrate and validate the model. The calibration of the model is the most time consuming stage and it increases in complexity with the size of the network and the amount/type of real information available. The calibration of such a large micro-simulation model must be approached systematically in order to be efficient. It is out of the scope of this document to describe this procedure in detail but a small summary is provided along with the results from the calibration of the TH-36 model.

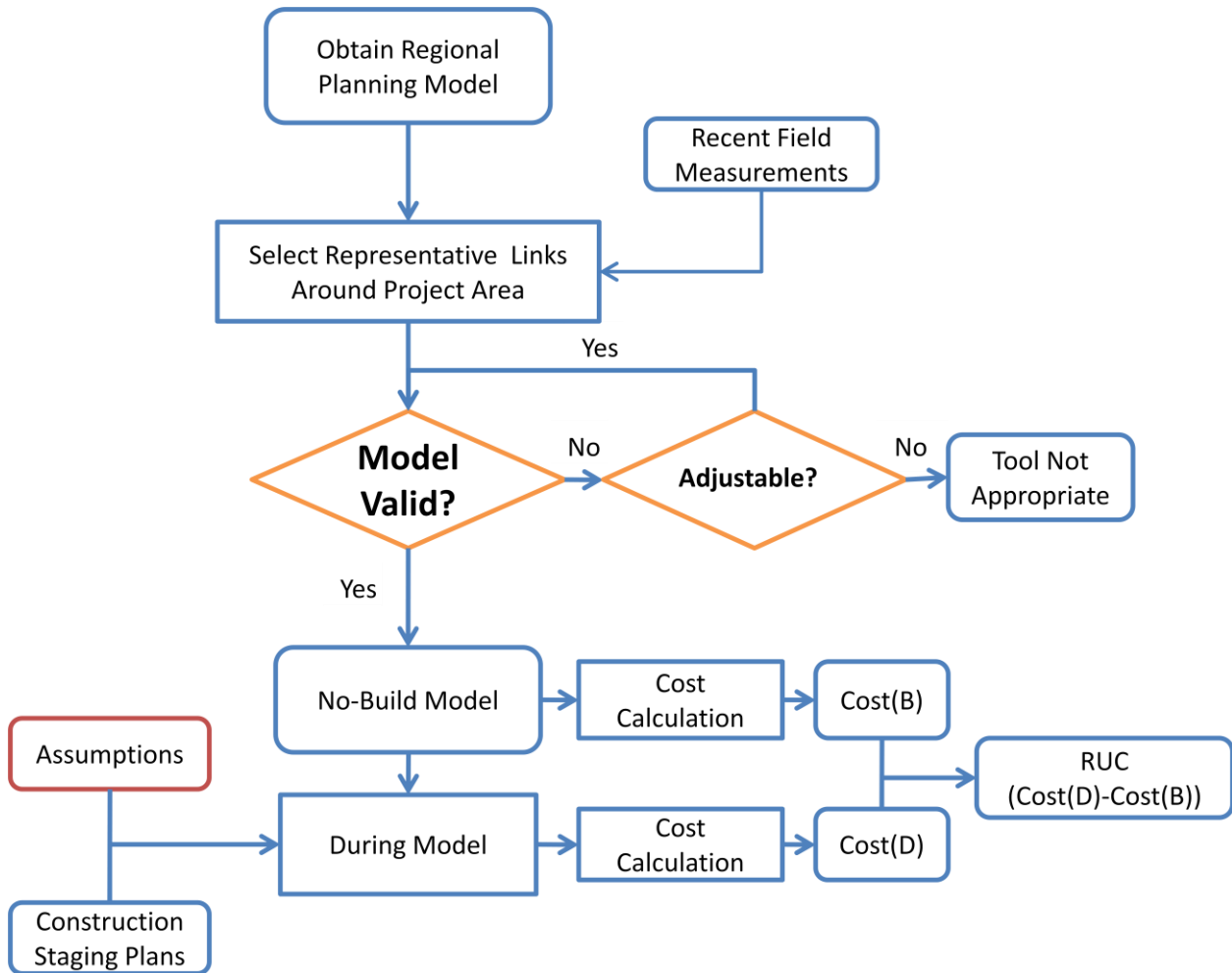

Figure 29 Travel demand model RUCs methodology framework

Calibration of microscopic simulation model

One can consider that microscopic simulation is the result of two parallel models, one controlling driving behavior and the other controlling route choice. In a complex network of freeways and arterials like the one used in this study, the interrelations between these two models are strong. The calibration will be an iterative process starting with the O/D matrixes adjustment, followed by the driver behavior parameter calibration based on the freeway sections only, and concluding with the link cost and routing algorithm parameter calibration. The reason why we propose to base the driving behavior parameters only on the freeway sections is because in these, usually overly instrumented, sections we can describe demand in greater accuracy in addition to the fact that changes in driving behavior parameters produce greater effect (Hourdakakis, et al, 2003). The macro model calibration is originally based either on information of link AADT or the volumes produced by the TDM (which should be close if the TDM is valid). The freeway calibration is based on detector volume and speed measurements while the full network route choice calibration is based on all of the above. It is important that the real data are as homogeneous as possible in space and time fact that was not optimal in this study since the detector data were primarily on the freeways leaving only AADTs on the arterials. A flow chart describing the aforementioned steps can be seen in Figure 31.

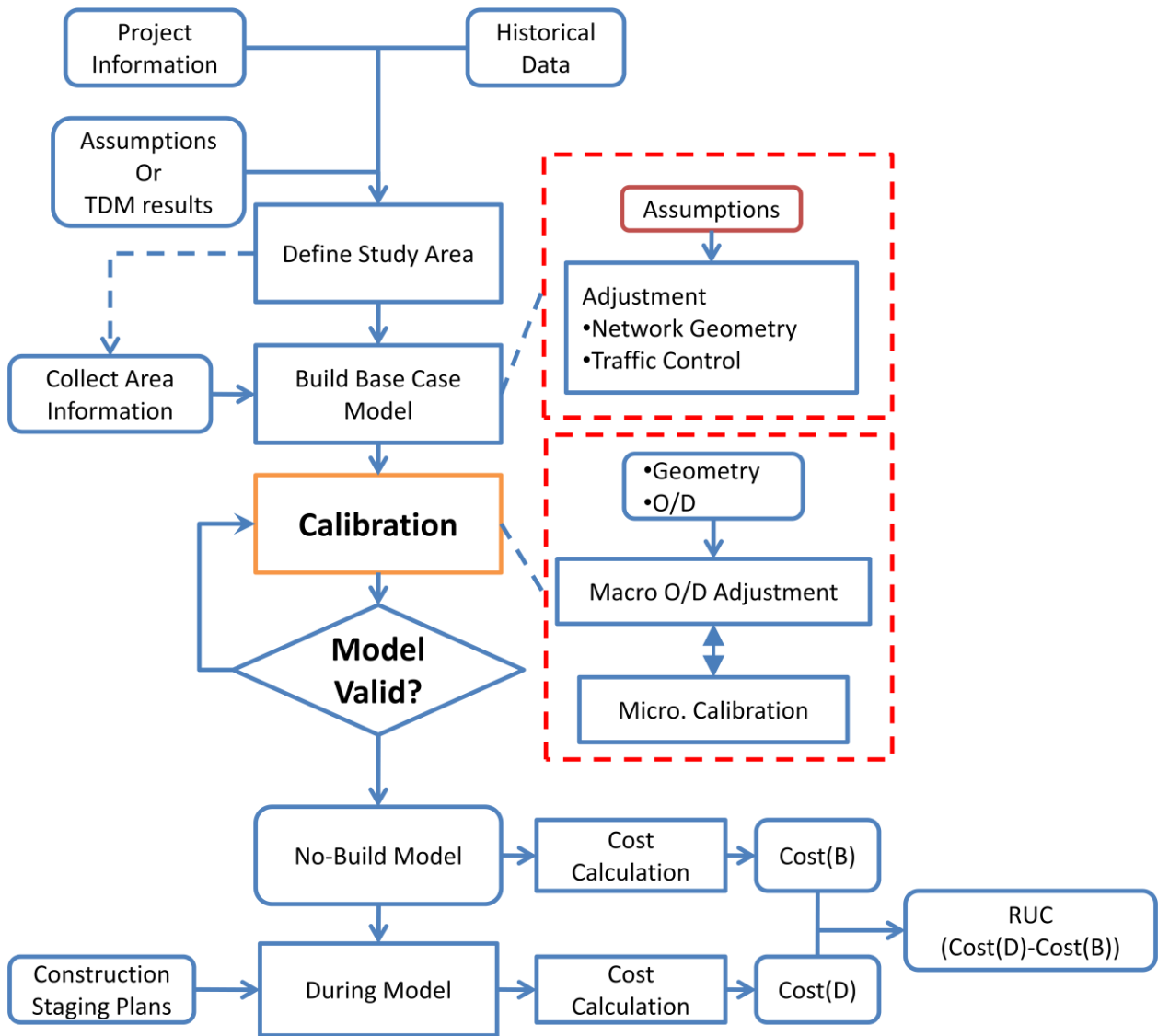

Figure 30 Traffic simulation methodology framework

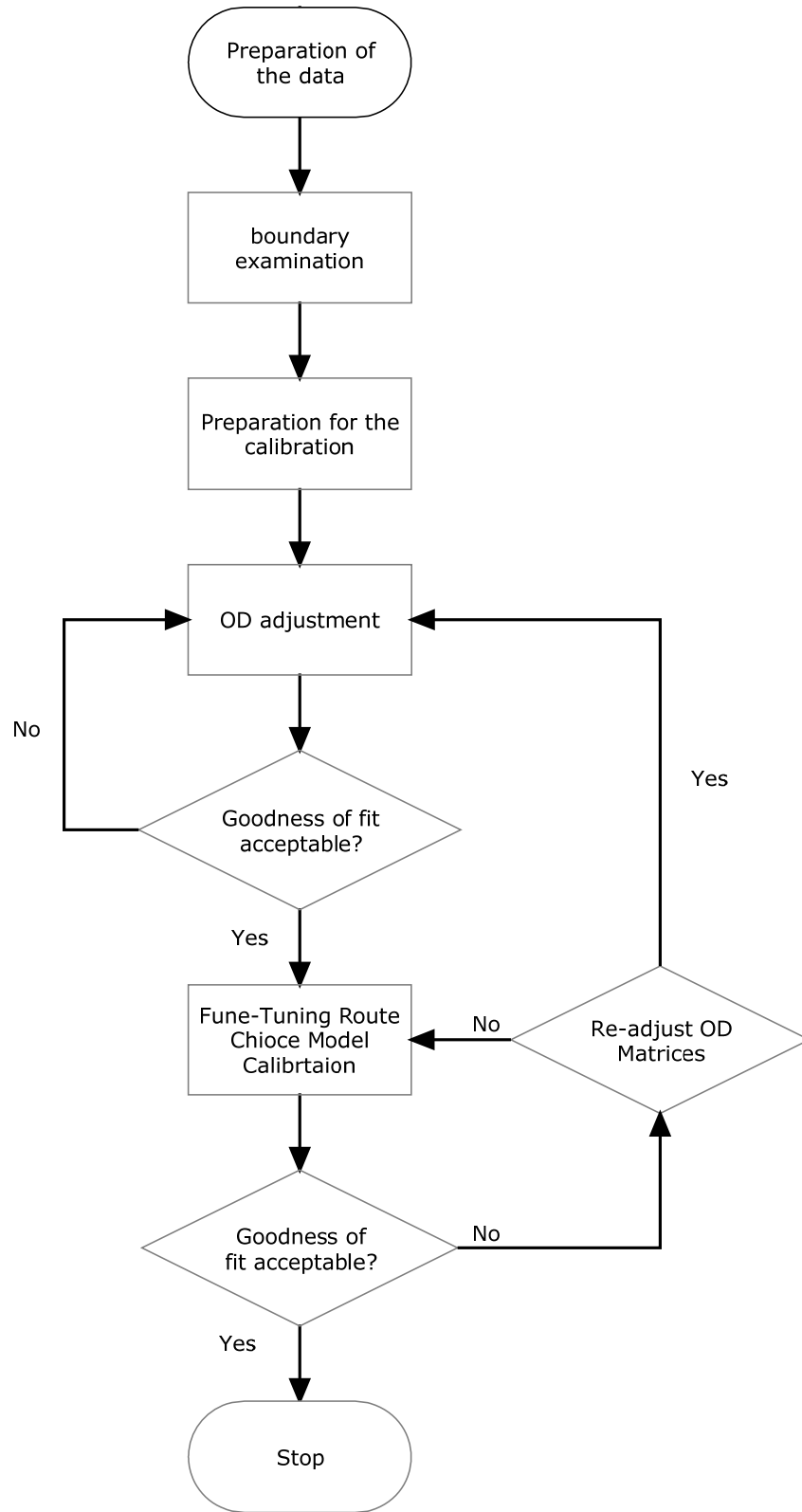

Figure 31 Flowchart for network calibration

Implementation of Analysis Methodologies

QuickZone

In utilizing QuickZone, the selection of the affected network is based solely on engineering judgment. Following the assumptions made by Mn/DOT engineers during project planning except in the use of one of the freeway diversion routes, we selected one freeway, I-694, to be the main diversion route (Detour One) and two urban streets to be the secondary detours. The difference between the main and secondary routes is only on the traveler information provided by the DOT, which offers only the main as a diversion. This action leaves the secondary to be selected by people that are already familiar with the area. The capacities of the links in the network are from historical data as well as the HCM. The AADTs were retrieved from the 2005 AADT map while the traffic pattern is estimated by using loop detector data as well as HCM methodologies.

From the project information, there were two freeway detours and two local detours, which were County Rd B and County Rd C. The selection of detours was greatly influenced by the ongoing unweave-the-weave project in I-35E and I-694. These two projects had overlapping periods of construction. Only one freeway detour is selected in the QuickZone network, since the analysis of the real data showed that people did not utilize the longer one. Both directions of Detour One are selected as the detours for eastbound and westbound diversion. They are two important parallel routes for TH-36 in the local area, so they should be evaluated. The final network in QuickZone consisted of one freeway detour, two local detours, and the TH-36 mainline—shown in Figure 32.

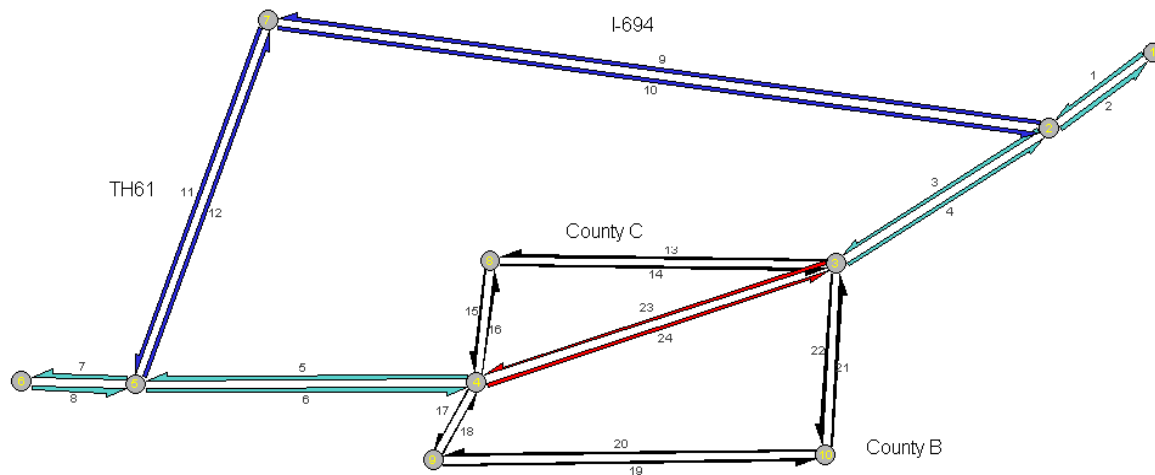

Figure 32 QuickZone network

In this network, four routes are defined. One route is TH-36, which consists of light blue and red links in Figure 32. The red links represent work zones. Links 11, 12, 13, and 14 are defined as freeway detours, while Links 15 to 18 are defined as County Rd C detour and Links 19 to 24 are defined as County Rd B detour. Both County Rd C and County Rd B detours are local detours.

This network is the same for both the Full Road Closure alternative and the Partial Closure alternative.

In QuickZone, traffic assignment is based on engineering judgment, reasonable assumptions, and simple algorithms. For the Full Closure Alternative, the During Case consisted of Full Closure and One Lane Open scenarios. In the Full Closure scenario, TH-36 is completely closed, and all traffic should be diverted to other routes. It is assumed that demands in link 3 and link 4 are going through TH-36. All of these vehicles will divert to freeway detours. It is also assumed that the demand difference between link 3 and 4 and link 23 and 24 are from the local area. 50% will use the County Rd C detour, and 50% will use the County Rd B detour. For the Partial Closure alternative, 30% of the demand in link 3 and 4 are assumed to use the freeway detour and the rest are assumed to stay in TH-36. In this case, local detours are not used.

After traffic assignment, the traffic demand of each link needs to be updated, and the user costs can be calculated for the During Case. Before the calculation, the capacities of the work zone links are revised. Initially, these capacities of work zone links are 2,200 veh/hr. For the Full Closure scenario, the capacities of the work zone links are zero, while in the One Lane Open and One Lane Closure scenarios the capacities become 1,100 veh/hr. The eventual user costs of the During Case in the Full Road Closure alternative are the aggregated results of the Full Closure and One Lane Open scenarios. The eventual user costs of the During Case in the Partial closure alternative are the results of the One Lane Closure scenario.

RUC contain two components: delay costs and vehicle operating costs (VOC). The difference in user costs between the Base Case and the During Case was the delay costs, while VOC is calculated by the equations explained in the Methodology Chapter. The final RUCs results will be shown later.

Cube Voyager

The Twin Cities Regional Planning model provided by the Metropolitan Council was created many years ago and, in its latest major release, it is based on socioeconomic data collected in 2000 and continuously calibrated since then. One benefit in using a TDM is the fact that the engineer does not have to make assumptions regarding the projects area of influence or for which are the logical diversion routes available in the area. The analysis by default covers the entire metropolitan area. Considering that the actual area influenced will be much smaller, after the execution of the model the results are tabulated only for the links that show reasonable effect. In the case of this project the Twin Cities Regional Planning Model has more than 25,000 links over 1500 zones but the RUCs and the subsequent BCA were based on a subarea of 3400 links and 259 zones. The eventual network for Cube Voyager is shown in Figure 33.

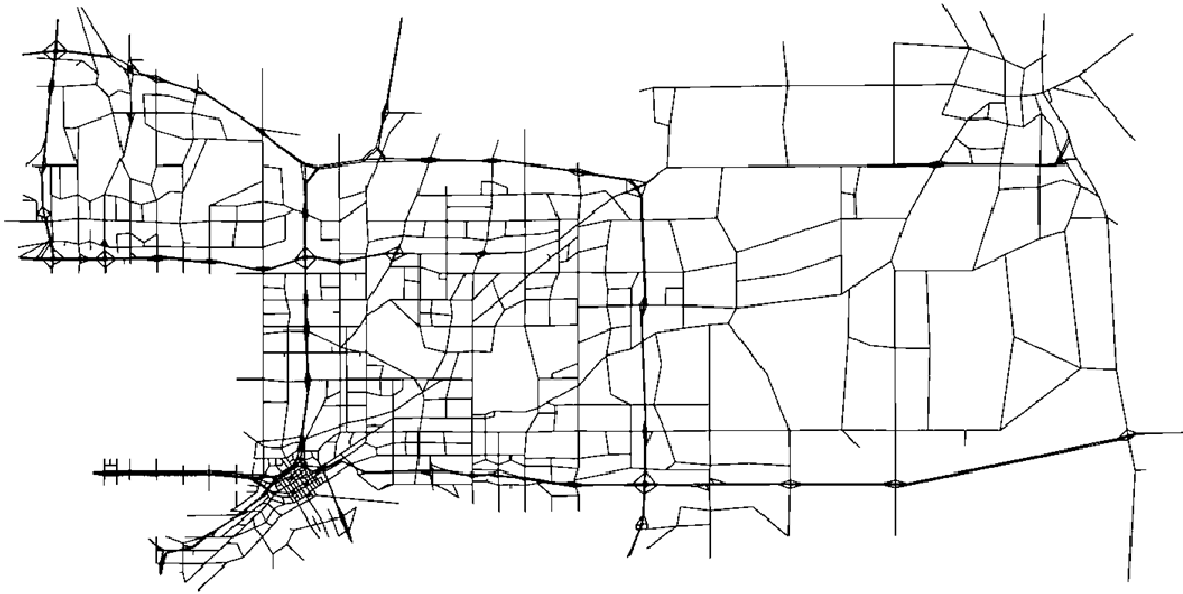

Figure 33 Selected impact area for Cube Voyager

In the case of TH-36 before calculating the RUCs of FC and PC scenarios, model validation was conducted by comparing daily Voyager and real detector volumes. For study completeness we also validated the results of the TDM for the period of the FC although this is outside to the normal analysis procedure.

Base Case validation

Linear regression was implemented to estimate the traffic assignment results of the Base Case. The regression results are shown in Figure 34. The real data in the figure is the average daily volume of 30 days from loop detectors before full closure is implemented. The Cube Voyager data are the corresponding daily volumes from the traffic assignment model. As shown in Figure 34, the slope is 0.99. The correlation coefficient is 0.96, which indicates that the linear dependence between these two variables is strong.

The Bland-Altman plot is shown in Figure 35. The x-axis is the average daily volumes of 30 days from loop detectors, as well as Tube Count data and link daily volumes from Cube Voyager, while the y-axis is the volume difference between them, which is calculated by subtracting Cube Voyager data from real data. If most points are above the x-axis, it means that the Cube Voyager data is generally higher than real data. On the other hand, if most points are below the x-axis, the Cube Voyager data is generally lower than the real data. From this figure, most data points are around the x-axis, which means the Cube Voyager data achieved a good estimation of the real data. Although the regression line in the figure shows a positive slope, this is acceptable since it is only 0.01.

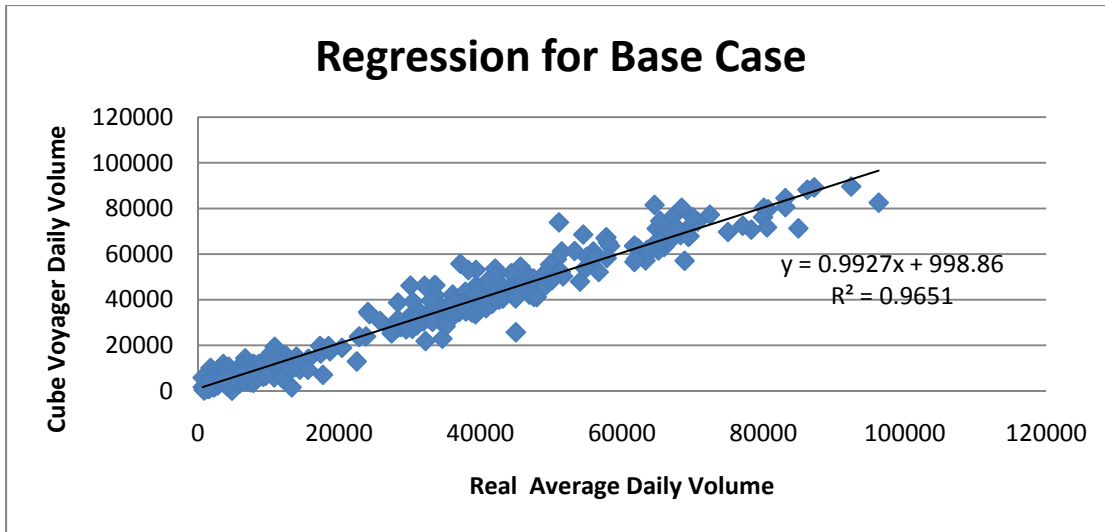

Figure 34 Linear regression for Base Case in Cube Voyager

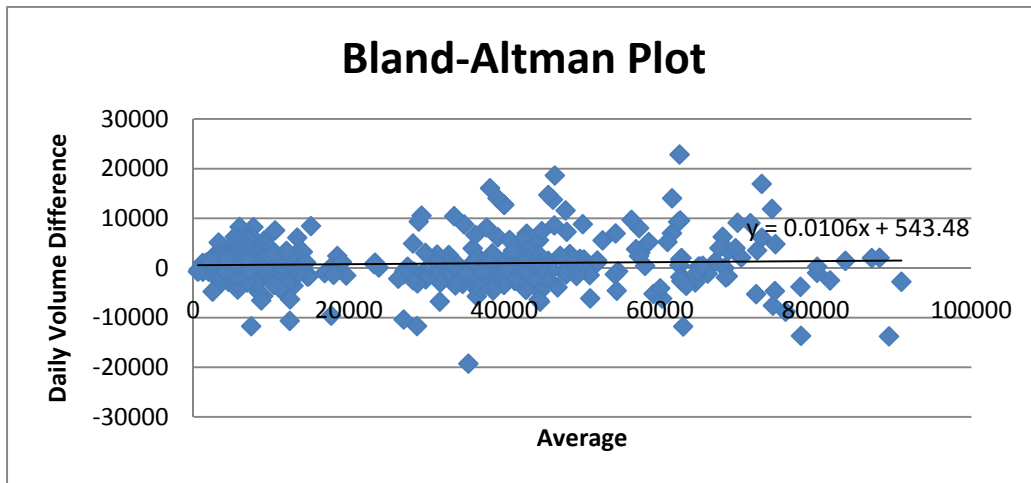

Figure 35 Bland-Altman plot for Base Case in Cube Voyager

Full Closure validation

The model validation for Full Closure requires additional examination. In the planning stage, the real data during the construction cannot be available for the analysis. When planners conduct BCA, they can only evaluate the model validation for the Base Case and assume the model theory is accurate enough to predict the results. However, the project used in this case study was finished, and the data was available for examining whether the tools can generate acceptable results against the real data. The real data was also the average daily volume from 465 detectors. In this study, the available data during the construction was utilized for an in-depth analysis of the model theory of Cube Voyager, which is a typical tool implemented in travel demand model theory. This additional examination is to observe whether Cube Voyager can accurately predict the traffic diversion during full closure of TH-36.

Figure 36 shows the linear regression between real data and Cube Voyager data. Real data is the average daily traffic volume of 30 days during the full road closure construction, while the Cube

Voyager data is the corresponding daily traffic volume from the traffic assignment. Similar to the results in the Base Case, the slope of the regression line is close to 1 and the correlation coefficient is 0.95. This figure shows that the traffic assignment for the During Case in Cube Voyager is a good estimation of the real data, although some bias points exist. Most of bias points are from ramps, but traffic volumes in the freeway mainline are acceptable in this case.

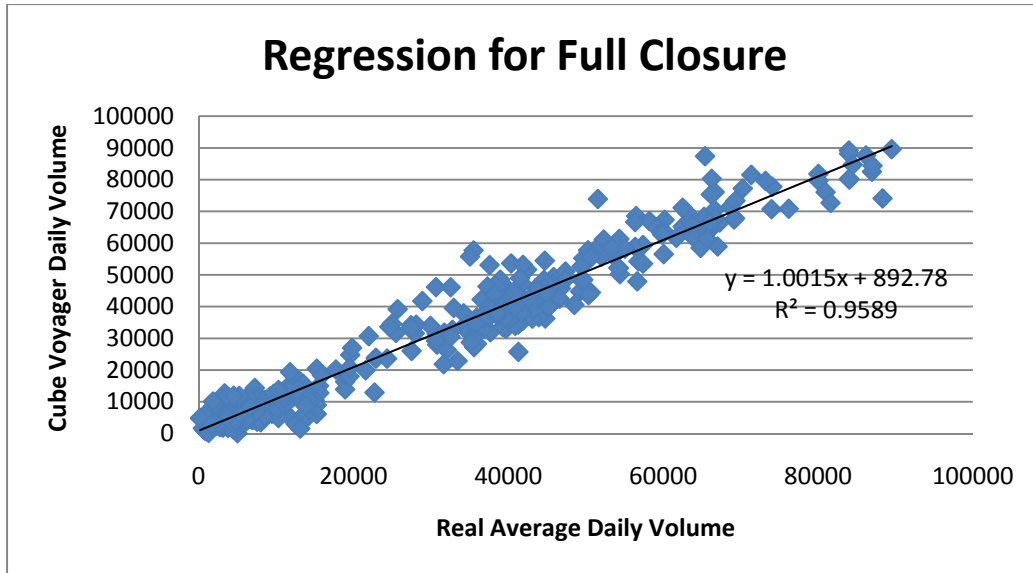

Figure 36 Linear regression for Full Closure in Cube Voyager

The good estimate from Cube Voyager can also be seen in Figure 37, which is a Bland-Altman plot. The average represents the average volumes of Cube Voyager and real data, while the difference was the volume difference between the two. Most of the data points were around the x-axis, which means the Cube Voyager data was close to the real data. In addition, the slope of the regression line is 0.04. The average of the difference of daily volume is approximately 930, which indicates that the Cube Voyager data can be generally higher than real data. In this case, the traffic assignment results from Cube Voyager for the Full Closure scenario were a good estimate of the real data, except for some bias points from the ramps.

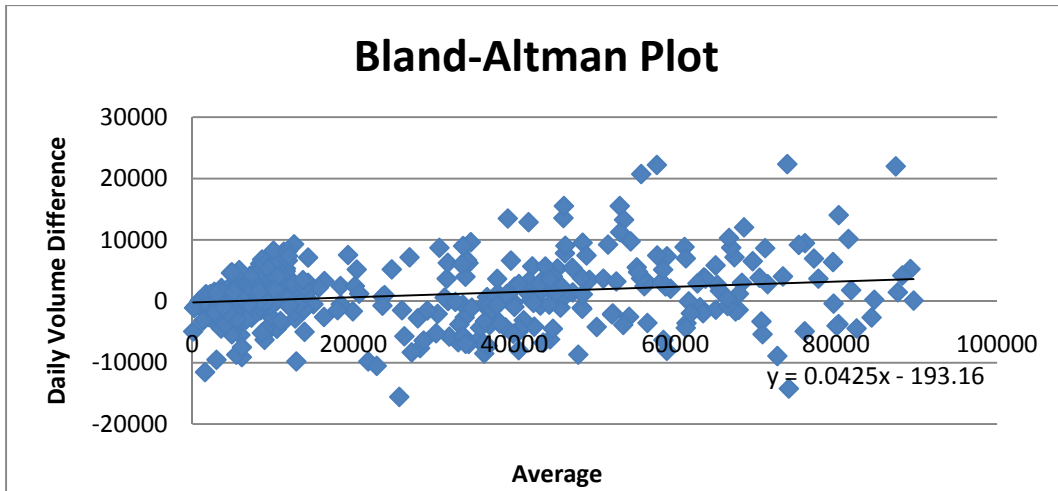

Figure 37 Bland-Altman plot for Full Closure in Cube Voyager

AIMSUN NG

The basic inputs of an AIMSUN model are the network geometry, traffic demand, traffic analysis zones, traffic control information, and vehicle characteristics. The simulator cannot be of assistance in the estimation of the projects area of influence. Considering thought that demand information for the micro model is extracted from the regional planning model if available, it is logical to use the TDM as described earlier to decide on the area of influence and implement that subarea in the micro model. This practice also offers better rapport between geometry and demand information while it allows for better model calibration. Therefore, the AIMSUN implementation also includes 259 zones but it has 3568 links since in the micro model additional minor roads surrounding the project area were added to better describe traffic conditions. The model geometry for the microscopic simulation is presented in Figure 38.

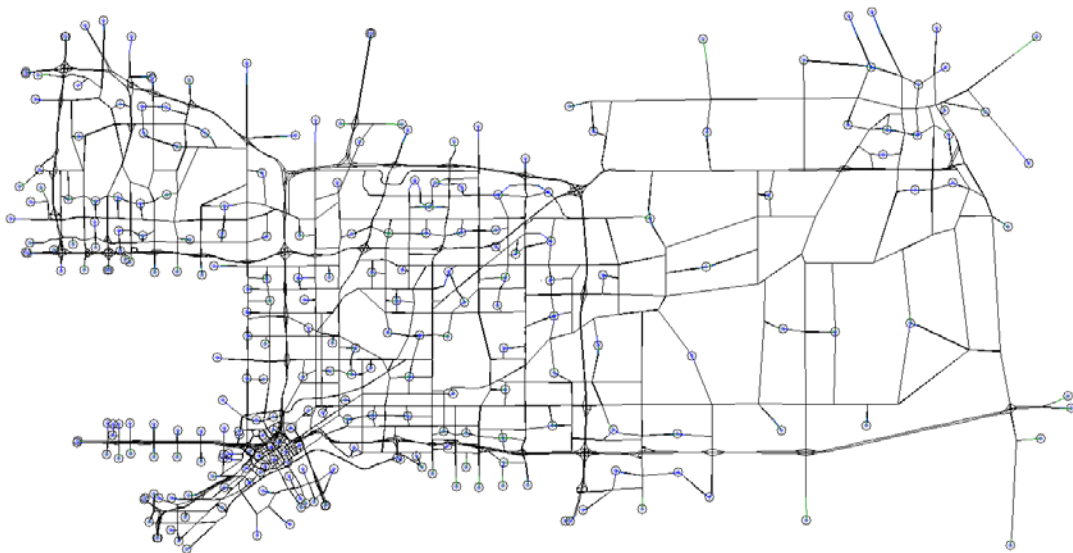

Figure 38 AIMSUN network

As mentioned in earlier, three basic inputs are needed for AIMSUN models: network, traffic demand, and traffic control. The network contains the information about roadway geometry, layout of roadways and intersections, and locations of traffic equipment, such as loop detectors. The traffic demand can be either Traffic States or OD Matrices. The traffic control plans contain the signal phases and timing for signalized intersections and priority information for un-signalized intersections. In addition, other inputs such as route choice model parameters are needed as well.

Network geometry

The impacted area was selected based on the traffic analysis described in the Site Description Chapter. Due to the size of the network, the AIMSUN network was imported from an ArcGIS shape file extracted from the 2010 Twin Cities Regional Planning Model, instead of being manually built by the analyst. The importation could have saved time, however. Since the links in ArcGIS are all straight lines that cannot exactly describe the geometry of the network, effort was spent correcting the geometry of each link of the AIMSUN network. For the size of the selected network, the adjustment of the geometry after the importation of the shape file based on aerial imagery is time-consuming but not complicated. There are two major reasons for this task taking such a long time. The most important one is the speed of the computer. The size of the aerial imagery necessary for geometry details to be clear was large, causing a memory overload on all PCs that ran Windows. Each air photo is approximately 3.5 megabyte, and 100 air photos are needed to cover the entire network. In addition, the analysis area is large, and included approximately 710 sections of freeways and 2,850 sections of other road types. Most of them needed to be adjusted, except for some small arterials and connectors. In addition, the connections of ramps and freeways had the greatest effect in the model operation and therefore required the most attention. Approximately two months were spent in the adjustment of the geometry.

Traffic demand

The source for the traffic demands in this model was the Traffic States from loop detector data and Origin/Destination information extracted from the 2010 Twin Cities Regional Planning Model. The Traffic States were used for freeway calibration while the O/D matrices were used in network calibration. The O/D matrices used for this model was the traffic demand in the Base Case. There were three sets of matrices, indicating different vehicle types: HOV, SOV, and truck. HOV and SOV mean high occupancy vehicle demand and single occupancy vehicle demand, respectively, while truck represents the commercial vehicle demand. Apart from a few HOV bypass lanes on metered ramps; this network did not involve any real HOV facilities. In addition, each set of matrices also included 24 matrices representing 24 periods in a day. The time periods were based on the rate of change of traffic conditions, rather than being simply hourly. Since there are 259 centroids in the entire network, each matrix includes 259*258 pairs of origins and destinations.

Traffic control plans

Since this large network includes many arterials, traffic control plans are needed to manage traffic. However, not all traffic control plans on all intersections were available, nor would it have been efficient to seek out and implement all of them. The traffic control information on

intersections closest to the construction site, such as White Bear Avenue and Central Avenue, were replicated exactly based on control plans acquired from Mn/DOT and Ramsey County.

For the remainder of the system, default control information for key intersections is implemented, to avoid severe unrealistic congestion affecting the results of the simulation. The artificial traffic control plans are implemented mainly for downtown St Paul and TH-36 east of I-694 to the eastern boundary of the network. For non-key intersections, only stop/yield sign control is utilized. In addition, since the network did not consider ramp metering strategies on the ramps, the traffic control plans for ramp metering were not implemented either from real data or artificial design. Some errors in simulation could have happened due to this limitation. However, for the network in such large scale, this drawback can be accepted in state of practice.

The procedure of signal timing design is as follow:

Step One. Collect the demand of intersections

The initial traffic demands of the intersections are collected by conducting static traffic assignment in the AIMSUN model. These traffic demands are important to develop phase plans and calculate critical lane volumes. However, traffic assignment results only show the section flows. The flow of each movement is not available from the aggregate data. Therefore, all intersections only have two default phases of pre-timed operation at the beginning. Whether a protected left turn signal is needed is mainly based on observation by utilizing animation in step three. In addition, the geometry information of the intersections is utilized as well. If the leg of the section has a left turn lane, the protected left turn signal might be implemented in reality.

Step Two. Parameters and assumptions

The yellow time, all-red clearance time, total lost time, and cycle length are calculated in this step. The Webster delay formula is implemented in this study:

$$C = \frac{1.5L + 5}{1 - Y}$$

Where C is cycle length, L is total lost time, and Y is the sum of critical phase flow ratios (Webster, 1966). Equations of yellow time, all-red time, and so on can be found in *Traffic Engineering*, by R.P. Roess et al. (2004).

The average approaching speed S of an intersection is defined as the speed limit of that intersection, since the speed acceptance in the network is 1.1, which allows vehicles to travel at a higher speed than the defined section speed which is the speed during off-peak. If different speed limits are found, the lowest one is selected. Saturation flow rate is defined as 1,800 tvu's per hour of green. The distance from stop line to far side of the most distant crosswalk in all intersections is defined as 40 ft, even though this value varies in different intersections. Standard vehicle length is defined as 15 ft, which is the length of SOV in vehicle characteristic dialog, although there are three types of vehicles in the network. Reaction time t is defined as 1.0 second and deceleration rate is $14 \text{ ft}/\text{s}^2$, which is the vehicle parameter calibrated in freeway calibration process. (Roess, R.P. et al., 2004).

Step Three. Signal timing revising

The initial demands of the sections are from static traffic assignment, which only considers the travel time and link capacity. However, the dynamic traffic assignment in microscopic simulation models might be different, since traffic control plans are considered. Vehicles might not follow the same routes in dynamic traffic assignment; so, the demand of the sections might be changed. In this case, the animation simulation is implemented to observe the traffic conditions of intersections. If the default control plans designed in step two does not work well, revision is needed to reduce the delay in the intersections. In this step, the left turn movement is observed. Since in step two, all left turns are permitted instead of protected, the delay due to conflicting and yielding in the intersections might increase when the demand for left turns is high. The cycle length is recalculated, when the left turn phase is implemented. In addition, a side lane is built for left turn movement when the left turn phase is implemented.

By and large, the signal design follows the process presented in *Traffic Engineering* (Roess, R.P. et al., 2004) but the cycle length calculation is from the Webster delay formula (Webster, 1966). The implementation of signal control is to make sure that the system works well and maintain the traffic condition within the network in a reasonable level. The objective is not to obtain optimal control plans for all intersections, but only to maintain the system by avoiding significantly delay due to improper traffic control plans. In general, approximately 100 intersections use signal control plans and others are controlled by stop/yield signs. Real information of traffic control plans is implemented for the intersections near the TH-36 work zone area, which are mainly in White Bear, TH-61, and TH-120 (Central Avenue).

Model calibration

The reliability of AIMSUN is based on its capability to generate results close to reality. In order to judge this reliability, calibration is needed, which is an iterative trial-and-error process for adjusting model parameters, and comparing the model to the system being simulated until the discrepancies between the model and actual system are accepted. Calibration of this AIMSUN model includes two parts: freeway calibration and network calibration. Freeway calibration was only used for freeway sections of the network. Each freeway direction was an individual system and there were no routing issues in this calibration process. All freeway sections share the same calibrated global parameters, while local parameters for each model vary. Network calibration involved route choice calibration, besides the same process for freeway calibration. O/D matrices estimation was also included in network calibration, to obtain better representation of the traffic demand.

Freeway calibration

For freeway calibration, only two types of input data are required: network and traffic demand. In contrast to the network geometry mentioned before, the geometry here has only freeway segments. The vehicles did not have routing issues, since the different freeways were not connected to each other, and each freeway direction was an individual system. The movement of vehicles was based on link flows and turning percentages instead of origin and destination information. Link flows and turning percentages were contained in Traffic States in the AIMSUN model. The objective of the freeway calibration was to obtain well-calibrated global parameters and proper local parameters for simulating traffic behavior of vehicles. Then these global parameters were used in the network calibration.

Traffic States

The traffic states contained the traffic demand information for freeway calibration, which included the input flows of all entrances in the system and the turning percentages for flow splits. The traffic states can be estimated from loop detector data. Input flow was the flow from all entrances, including all entrance ramps and the mainline boundary of the freeway. The turning percentages define the probability for each vehicle to either exit the freeway or stay in the mainline. With certain percentage, any vehicle is randomly assigned to next section.

In the calibration process, loop detector data from a typical day was selected. The selection of this typical day was important for freeway calibration. In order to select a typical day, plenty of candidate days should be selected. The data from these candidate days should be valid, which means that no weather issues, crash issues, and event issues happen on these days that cause a change in normal traffic patterns. In addition, the loop detectors should be valid. If system errors occur in some detectors on some days, those days cannot be candidates, either. In this case, DataPlot (Mn/DOT, 2007) was implemented for the typical day selection. Eventually, the typical day was selected from those candidates by using GEH statistics (Chu et. al, 2004). If the GEH results of data from 80% of the detectors were less than five, the day can be defined as typical day. The average data is presented in the Site Description Chapter.

$$GEH = \sqrt{\frac{(V - V_a)^2}{(V + V_a)/2}}$$

In the TH-36 project, five typical days were selected for AIMSUN simulation. The details are shown in Table 16. The data from typical days was used for model calibration and model validation.

Table 16 Simulation days

Scenarios	Date
Base Case	April 26 th 2007 (Thursday)
Full Closure	June 20 th 2007(Wednesday)
One lane open	September 19 th 2007 (Wednesday)

From the observations in DataPlot, the peak hours in westbound traffic were found to be approximately 6:30 to 8:30 in the morning. The peak hours in eastbound traffic were found to be approximately 4:00 to 6:00 in the afternoon. If only peak hours were evaluated, the congestion situation may not be fully observed during the time period, since the queue may not be clear before the end of the simulation. The exact beginning and ending times of the peak hours were unknown and varied in different detectors. If the upstream conditions were affected by downstream bottlenecks, the peak hours of upstream could be later than that of downstream, but the congestion duration could be less. In order to capture all operation issues, the duration of the evaluation was extended from 5:00 to 10:00 in the morning and 2:00 to 8:00 in the afternoon.

The interval was 15 minutes. Although loop detectors record the traffic data every 30 seconds, it is unnecessary to use this short of an interval. Because the evaluation durations are about five hours in the morning and six hours in the afternoon, a 15-minute interval is a reasonable assumption.

The vehicle composition was also important for the simulation, since each vehicle type has different parameters to define different driver behaviors. By looking up data from the 2010 Twin Cities Regional Planning Model, the composition of cars was observed to be between 93% -97% for all types of vehicles. To simplify, 95% was chosen for cars, 3% for trucks, and 2% for semis.

Freeway calibration process

The freeway calibration contains two main steps: volume-based calibration and speed-based calibration. Usually, volume calibration is performed first and followed by speed calibration. However, this is an iterative process. In general, after volume-based calibration is preliminarily processed, the speed-based calibration follows to fine-tune the parameters, which could affect the results of volume calibration as well.

Volume-based calibration is mainly implemented in this case study. Global parameters are mainly concerned with volume-based calibration process. These global parameters (e.g., vehicle characteristics, Driver's reaction time, max desired speed, etc.) affect the driving behavior of all vehicles within the network. Additionally, the local parameters (e.g., speed limit of the section, distance zone 1 and 2, etc.) are also adjusted to calibrate the driving behavior models. All global parameters were initially obtained from another well-calibrated AIMSUN network. The model was proven to be valid.

There are many global parameters in an AIMSUN model, and different combinations of the parameters might obtain similar driving behavior for vehicles. In this case study, Driver's reaction time, Max desired speed, and Maximum acceleration and deceleration were adjusted. Driver's reaction time was adjusted from 0.6 s to 0.8 s, with increments of 0.05 s. Driver's reaction time is the time that a driver takes to react to speed changes in the preceding vehicle. Theoretically, since this value is related to the simulation step, a lower reaction time in the model will improve the traffic conditions in the system, but it will take a longer time to run the simulation. With a certain reaction time selected, the Max desired speed was adjusted from 70 mph to 90 mph with increments of 5 mph. The comparison of goodness-of-fit of simulated volumes was conducted each time, with parameter adjustment, to find the best combination of those parameters. The Max acceleration and deceleration were calibrated in a similar process, but the adjustment of the values was from a small scale.

Followed by preliminary volume-based calibration, speed-based calibration was conducted for obtaining simulated mainline speeds as close as possible to the detector measurements. The bottlenecks in the freeways were captured and simulated. Since in volume-based calibration global parameters are adjusted to a point where the discrepancies of simulated volumes and real volumes are accepted, the parameter adjustment in speed-based calibration is mostly local parameter fine-tuning. The initial section speed of each freeway section was defined as the average maximum speed that is observed from detector data. In addition, Distance Zone 1 and Distance Zone 2 were adjusted along with the section speeds, to simulate the bottleneck generated through weaving. For speed-based calibration, speed contour plots were implemented, to observe the bottlenecks in actual freeway systems and simulation models.

When parameters are changed, goodness-of-fit of simulated volumes (i.e., volume) are examined. For volume-based calibration, if the correlation coefficients were over 0.80 and RMS is lower 0.25, the simulated volumes of the detectors were acceptable. Otherwise, more adjustment of local parameters are needed. For speed-based calibration, engineering judgment is implemented to evaluate the bottlenecks in the simulation models. The goodness-of-fit of simulated speed plays a less important role than speed contour plots since the object is to capture the bottlenecks, and the slight difference between simulated speed and real speed is acceptable. Adjustment of parameters can be stopped until the accuracy of the simulated data is judged.

a. Parameter results

The initial values of global parameters are shown in Table 17. The final values of major global parameters are kept the same for network calibration later.

Table 17 Values of major global parameters

	<i>Before freeway calibration</i>	<i>After freeway calibration</i>
<i>Reaction time</i>	<i>0.75 s</i>	<i>0.65 s</i>
<i>Reaction time at stop</i>	<i>1.35 s</i>	<i>1.15 s</i>
<i>Max Desired Speed of SOV</i>	<i>70 mph</i>	<i>85 mph</i>
<i>Max Acceleration of SOV</i>	<i>9.84 ft/s²</i>	<i>14.40 ft/s²</i>
<i>Normal deceleration of SOV</i>	<i>16.40 ft/s²</i>	<i>16.04 ft/s²</i>

b. Volume-based calibration results

Table 18 show the goodness-of-fit results from volume-based calibration. All R-squares are between 0.85 and 0.99, which indicate that the linear dependent between simulated volumes and real volumes is strong. The RMS shows that the discrepancies of simulated volumes and real volumes can be accepted.

Table 18 Goodness of fit results of mainline stations after calibration

Freeways	Highest R ²	Lowest R ²	Largest RMS	Lowest RMS
I-94WB	0.99	0.86	0.14	0.04
I-94EB	0.98	0.91	0.17	0.05
TH-36WB	0.99	0.93	0.10	0.04
TH-36-EB	0.99	0.96	0.07	0.01
I-35E NB	0.98	0.90	0.21	0.05
I-35E SB	0.98	0.93	0.18	0.06
I-694 EB	0.99	0.92	0.22	0.03
I-694 WB	0.99	0.94	0.16	0.05

c. Speed-based calibration results

Here is one example of speed contours in final speed-based calibration. The color-map of two figures is from 10 mph to 80 mph. The y-axis is the detector Id and the x-axis is the time from 5

am to 10 am. The same color indicates the same speeds between them. The blue ones indicate the bottleneck in the freeway, which is in detector 634, starting from 7 am in reality. The congestion condition lasts until detector 639, and the congestion period lasts until 8 am. In Figure 40, the bottleneck occurs approximately at the same detector, and the congestion lasts for the same duration in the simulation model. In this case, although the numbers of the simulated speeds do not match the real speeds, the speed-based calibration for I-35E SB can also be finished from an engineering perspective.

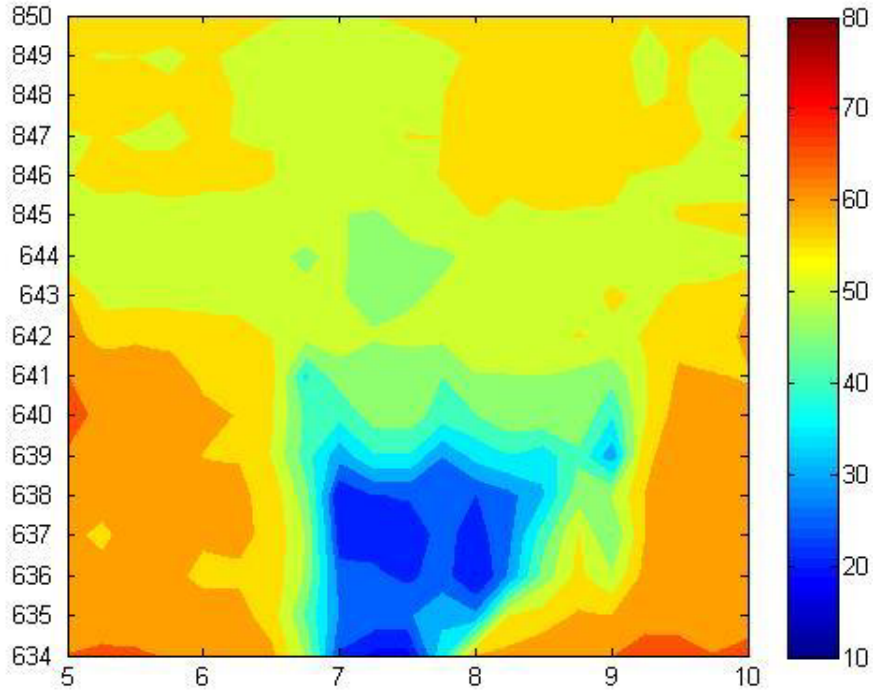

Figure 39 Contour for real speed in I-35E SB

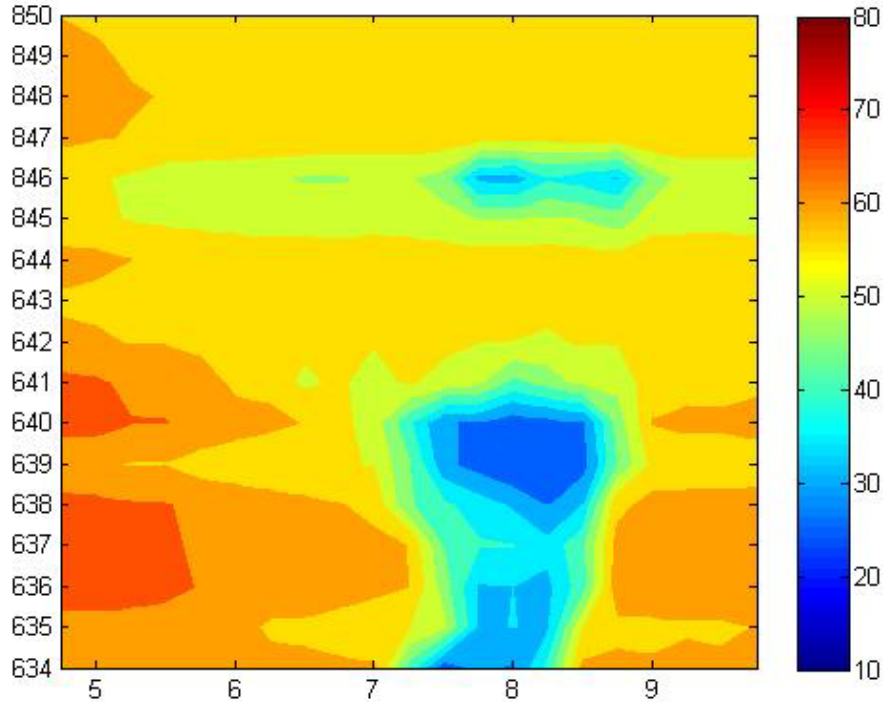

Figure 40 Contour for simulated speed in I-35E SB

Network calibration

Followed by freeway calibration, network calibration is conducted to calibrate route choice parameters. In this calibration process, O/D matrices are adjusted to obtain a better representation of the traffic demand. Traffic control plans for intersections are revised to better manage the system. A similar volume-based validation is implemented to examine network calibration. The same goodness-of-fit measures are implemented in this calibration process.

As mentioned before, the basic inputs for the AIMSUN model are network, traffic demand, and traffic control plans. The network is shown in Figure 38. Differently from freeway calibration, the traffic demand for the entire network was in terms of 24 O/D matrices, which were obtained from the 2010 Regional Planning Model of the Twin Cities Metropolitan Area. The traffic control plans can be divided into two categories in this case study. One is the real data from Mn/DOT and Ramsey County; the other is a plan following the procedure mentioned above. After the basic input data was prepared, boundary condition verification was conducted.

Preparation for network calibration

Before the network calibration begins, two preliminary steps were conducted to obtain reasonable traffic conditions and better default values for model parameters. First, some of the traffic control plans were redesigned to obtain a higher level of service in the intersections. The procedure is presented above. Second, link costs parameters were adjusted, relying on a judgment of the discrepancies between simulated volumes and real volumes (e.g., detector data and AADT). Several runs of the simulation were conducted to compare the improvement of simulated data.

In this model, link capacity and speed were obtained from the 2010 Twin Cities Regional Planning Model, which has been calibrated in regards to link flows, capacities, free-flow speeds, link distances, and travel times. Such initial values might be a good start for calibrating link costs parameters in the calibration process. However, the link speed in the Regional Planning Model can be different from that of a microscopic simulation model. The speed in the previous model is estimated by the measured travel time, which takes the travel time in the links as well as the delays in the intersections into account. However, if those speeds are defined as the maximum average speed in AIMSUN, the delay in the intersections will be double counted. Therefore, the initial values of the speeds should be carefully considered, and those values may be adjusted during the O/D matrices estimation and route choice model calibration. After the levels of service of intersections were acceptable and link costs parameters are defined, the network calibration can start.

Origin/Destination matrices estimation

O/D matrices estimation was conducted to obtain time-dependent O/D demand for the microscopic simulation model, as well as to obtain better representation of the traffic demand for the simulation. In this case, although 24 O/D matrices were available from the 2010 Twin Cities Regional Planning Model, time dependent O/D with shorter intervals were needed to obtain better simulation. The time interval between those 24 O/D matrices is approximately an hour. The discrepancy between the demands of each period might influence the simulation results, since each matrix is discretely implemented. Time dependent matrices with 15-minute intervals were used to obtain a better representation of trip demand and to reduce the gap between two O/D matrices. Furthermore, the adjusted O/D matrices may achieve better representation of the traffic demand.

O/D matrix adjustment is based on optimization algorithms and most of the current O/D adjustment methods depend on traffic counts (Han et al., 1981). The AIMSUN model utilizes heuristic approaches to split static O/D matrix into time dependent O/D matrices with shorter time intervals. First of all, according to real data, analysts define the time interval that the global matrix will be split into and the percentage of the sub-matrix to the seed matrix. AIMSUN will conduct static traffic assignment by using the sub-matrix, and adjust this sub-matrix with observed flows within that time interval. Eventually, the estimated OD matrix will be generated for that time interval, which can be used for dynamic simulation. The comparison of global OD and sub-matrix is shown in Figure 41.

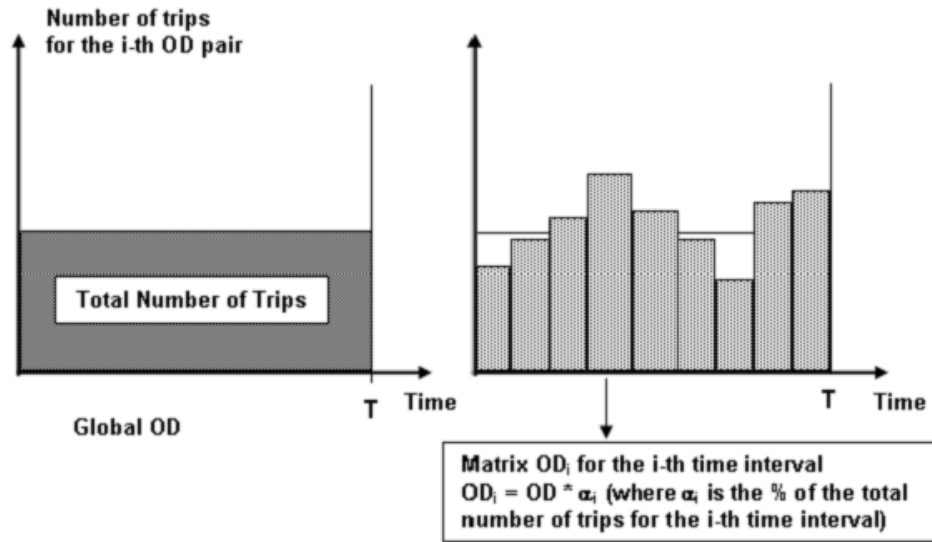

Figure 41 Time depend O/D matrices calculation (AIMSUN manual 2008)

Link costs parameter calibration

Before O/D matrices were adjusted, link costs parameters were calibrated. In the AIMSUN-planner, the static traffic assignment is based on Volume Delay Functions (VDF). In this case study, the defaults VDF in AIMSUN were implemented, whose major parameters are link capacity and link length. Due to the size of the network, the link capacity was not estimated but imported from the Regional Planning Model, which should contain well-calibrated link capacities for the entire Twin-Cities metropolitan area. In this process, the major objective was to select suitable VDF for each link.

Different VDF were selected based on the type of roadway. Based on the selected VDF, a static traffic assignment was conducted to obtain link volumes. Such data was compared to two reference sets: real data and static traffic assignment results from Cube Voyager. Goodness-of-fit was implemented to judge the discrepancies between simulated link volumes and real link volumes (i.e., AADT), based on which VDF of the link might be re-selected. Due to the limitation of the data, link volumes from Cube Voyager were used as another reference, since that model was proven to be valid. Generally, VDF of the links was calibrated until the discrepancies between simulated link volumes and real link volumes were acceptable; then O/D matrix adjustment was conducted.

O/D matrix adjustment procedure

After the VDF was selected for all links, O/D adjustment was conducted by using the AIMSUN-planner. The estimation of time dependent matrices was as follow:

- a. Step One. Estimate the percentage of each sub-matrix

There are 24 O/D matrices available in this study. Each matrix of those 24 O/D matrices can be seen as one global O/D matrix. Sub-matrices with 15-minute for each global O/D matrix are time dependent matrices during the particular time period. For example, a global O/D matrix was for 8:30 am to 9:30 am. There were four 15-minutes sub-matrices during this time period, which are from 8:30 am to 8:45 am; 8:45 am to 9:00 am; 9:00 am to 9:15 am; and 9:15 am to 9:30 am. The

percentage of each sub-matrix should be defined in the AIMSUN model, and the sum of each percentage for a particular global O/D matrix can be 100% or less. Take this last example as well. The percentage could be 24%, 26%, 27%, and 23% for sub-matrices of different periods.

For the TH-36 project, the percentage of each sub-matrix was roughly estimated from loop detector data. First of all, some typical detectors were selected and the traffic volumes with 15-minute intervals were obtained for 24 hours. According to the time periods of those 24 global O/D matrices, the traffic volumes of an entire day, from loop detectors, were divided into 24 respective time periods. The percentage can be calculated by the following equation:

$$P = \frac{V_1}{V_{total}} \times 100\%$$

Where P is the percentage of the time dependent matrix, V_1 is the traffic volume during each 15-minute interval, and V_{total} is the traffic volume during the entire time period of the global matrix.

There were three types of vehicles defined in the AIMSUN network in this case study: SOV, HOV, and Truck. 24 global matrices were available for each type of vehicle. Since the flow proportion of HOV and Truck were unknown, it was assumed that SOV was 95% of total traffic volumes and the rest was HOV and Truck. In this case, only time dependent O/D matrices of SOV were estimated, and the traffic demand for HOV and Truck were still in global matrices. There were two reasons for this assumption. First of all, HOV and Truck demand were not generally distributed within the entire network. There can be some locations that have a high demand of HOV or Truck, and these locations were unknown in this case. If the global matrices of HOV and Truck were split into sub-matrices by using a uniform percentage, the demand in those locations might be decreased, while demand in other locations might be increased. In addition, the traffic demand of HOV and Truck were so small that the discrepancy between the global matrices of HOV or Truck does not influence the representation of the real traffic pattern. Therefore, only O/D matrices of SOV were split into sub-matrices with 15-minute intervals. Accordingly, the equation for calculating the matrix percentage was revised as follows:

$$P = \frac{V_1}{V_{total}} \times 95\%$$

Where 95% was the flow proportion of SOV of total traffic volume, and the others were the same as in last equation.

b. Step Two. Time dependent O/D matrix estimation

The sub-matrix from each global matrix was the target matrix used in the first iteration in the matrix estimation process. AIMSUN adjusted the matrix by using bilevel optimization methods to seek the fitted matrix. Static traffic assignment and least square methods were used against the observed data of link flows.

c. Step Three. Validation of adjusted matrices

The target of each O/D matrix adjustment was to obtain over a 90% coefficient correlation and less than 5% of a Relative Gap. The corresponding results of each converted sub-matrix are listed in Table 19. The results indicated that the adjusted matrices are capable of generating very good traffic patterns against the real link flows. All of the R-squares are higher than 93% and all

Relative Gap are lower than 3.5%. From the table, it can be seen that all adjusted matrices reached the target.

Table 19 Results of O/D matrix adjustment

	R-square	Gap %
minimum	0.931	0.261
maximum	0.988	3.085

In addition, the static traffic assignment was implemented to compare the results of O/D matrix adjustment. The linear regression results are presented in Figure 42 and Figure 43. The data in the figures are the daily volumes of 465 loop detectors.

Table 20 Regression statistics for OD adjustment

<i>Regression Statistics</i>	<i>Before Adjustment</i>	<i>After Adjustment</i>
Multiple R	0.9728	0.9903
R Square	0.9464	0.9806
Adjusted R Square	0.9462	0.9806
Standard Error	5398.2	3540.8
Observations	465	465

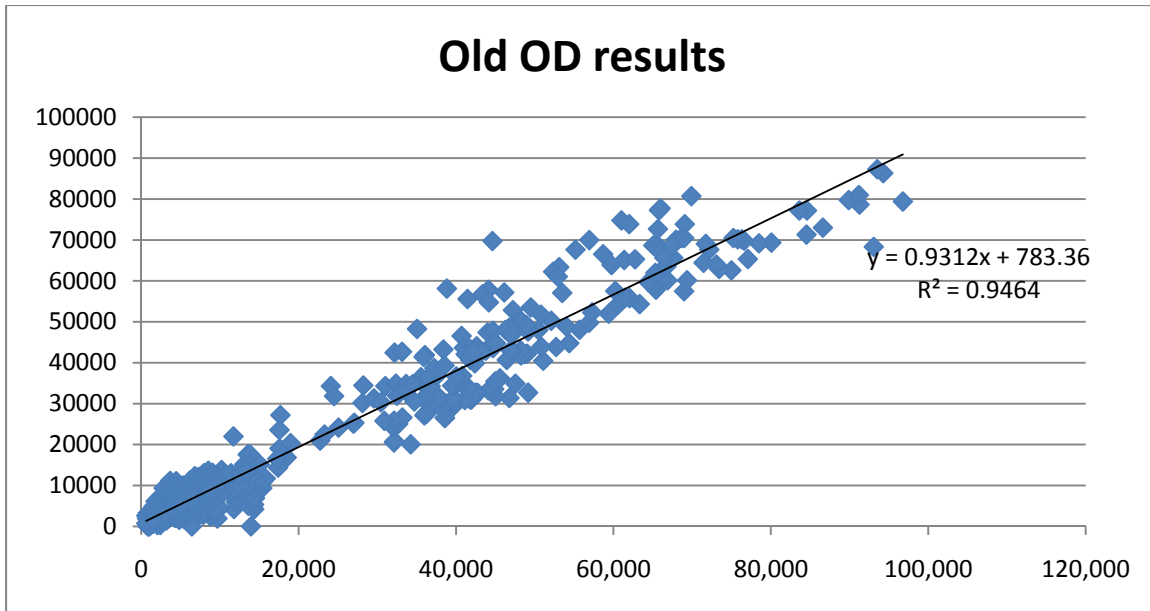

Figure 42 Linear regression results for old O/D

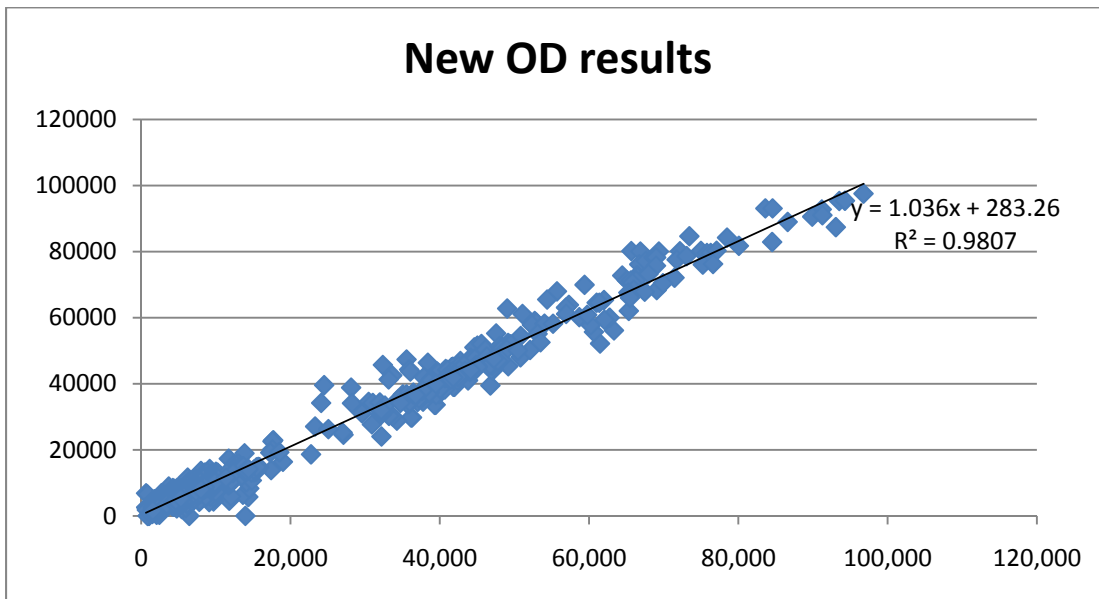

Figure 43 Linear regression results for new O/D

The R-square before adjustment is 0.946, while after adjustment it is 0.98. The Standard Errors are reduced from 5398.2 to 3540.8. The regression statistics results indicate that the link flows with adjusted O/D matrices have better representations than initial O/D matrices. From these statistical results, new O/D matrices were accepted, and the calibration of link costs parameters (i.e. VDF) was not needed again. Such adjusted O/D matrices were implemented for route choice model calibration in the next step:

Route choice model calibration

Route choice model calibration can be conducted based on user defined paths, which can be aggregated data or individual data obtained by surveys (Chu et al., 2004). However, in this case, the path information was not available for calibration. An alternative method is designed to calibrate the route choice for vehicles. In this process of calibration, the global parameters of route choice model were preliminarily calibrated first. The traffic conditions were improved and local parameters were calibrated based on those initial parameters.

In traffic assignment, the travelers' decision is made based on route choice models, which, in the AIMSUN simulator, are based on discrete choice theory. Route choice models describe the probability for travelers to select a path from all available alternatives. In the AIMSUN simulator, there are seven route choice models: Fixed Using Travel Time in free flow condition, Fixed Using Travel Time in warm-up period, Binominal, Proportional, Multinomial Logit, C-Logit, and User-Defined Models. In this case study, the Multinomial Logit Model was selected, and the corresponding initial parameters were selected from a similar project.

The route choice model is used to define the probability of a path being selected from all possible alternative paths. In multinomial logit model, this probability is expressed as follow:

$$P_k^i = \frac{e^{-\theta t_k^i}}{\sum_l e^{-\theta t_l^i}} = \frac{1}{1 + \sum_{l \neq k} e^{-\theta(t_l^i - t_k^i)}}$$

This equation illustrates that the probability of a selected alternative is based on the difference between the measured utilities of that path and all other available paths. (AIMSUN manual, 2008). P_k^i is the probability of choosing path k amongst all alternative routes of O/D pair i. t_k^i is the expected travel time on path k of O/D pair i. θ is a shape or scale factor parameter, while t is the expected travel time on path k of OD pair i. $\theta < 1$ vehicles tend to use many alternative routes, while $\theta > 1$ will concentrate on selecting alternatives among a few paths. In other words, when the θ becomes larger, the probability for selecting the shortest path will be higher. This scale factor parameter, θ , is the parameter defined by analysts.

Link costs parameters calibration

Since the path information of travelers is not available, vehicles cannot exactly follow the paths in reality, which increases the difficulty of route choice model calibration. An alternative was thereby designed to conduct route choice calibration. It was observed that the simulated volumes are higher than observed volumes in the freeway sections, which is shown in Figure 44. The data is the Percentage Difference of daily volumes for all detectors, which is defined as:

$$PD = (V_s - V_o) / V_o \times 100\%$$

Where PD is Percentage difference, V_s is the simulated volume of 24 hours, and V_o is the observed volume of 24 hours.

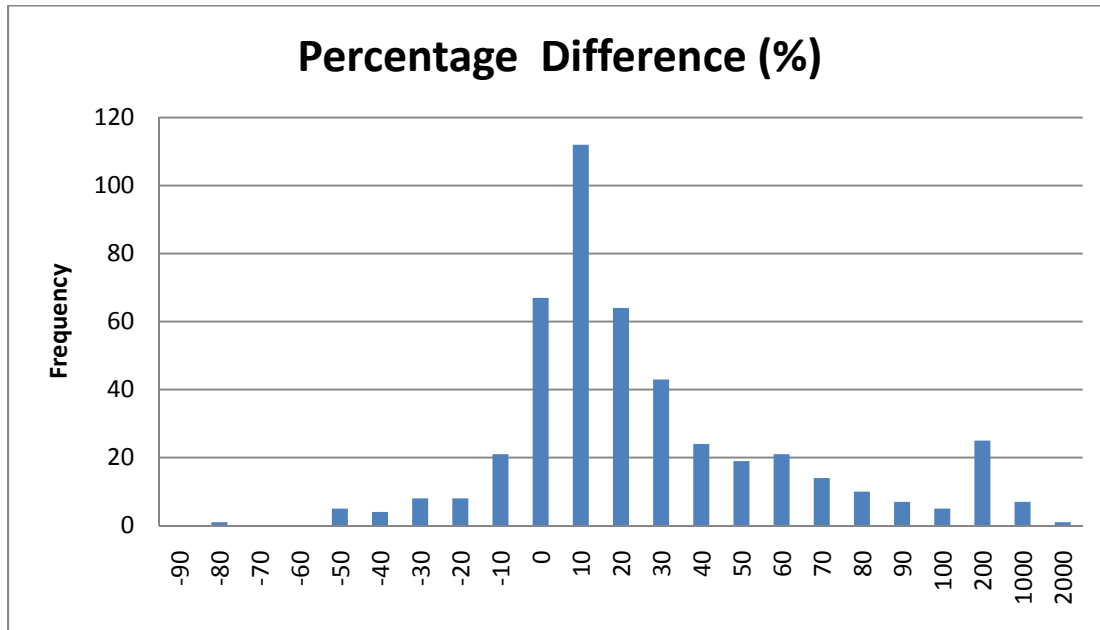

Figure 44 Percentage difference of daily volume from all detectors before calibration

The mean of the Percentage Difference in Figure 44 is 29.6% and the standard deviation is 0.996. One sample t-test result shows that the P value is 0 in a confidence of 95%, which allows a rejection of the null hypothesis that the mean is zero. In addition, Percentages of the data from half of detectors are over 20%. By and large, the volumes in the freeway sections can be said to be higher than in reality. There might be two reasons for this. First, the traffic demand is generally higher than in reality. Second, freeways are more attractive in the AIMSUN model than in reality. Since O/D matrices adjustments have been conducted and obtained good results, the traffic demand is assumed to be at the same level as in reality. Therefore, the reason for higher volumes in the simulation model was assumed to be due to the higher attraction of the freeway sections.

In order to reduce the attraction of freeway sections, an attempt was made to increase the costs of using freeways. In this case, User Defined Cost was implemented in ramps to increase the link costs of freeway paths. The vehicles in AIMSUN network follow the shortest paths in terms of lowest costs paths. The costs of a path are the aggregated costs of all links that belong to that path. Each link contains a section and a turning movement. The link costs are calculated by following equation (AIMSUN manual, 2008):

$$DynCost_j = ETT_j + ETT_j \times \varphi \times (1 - CL_j / CL_{max}) + \tau \times UDC_s$$

Where $DynCost_j$ is the dynamic cost of link j , ETT_j is the estimated travel time of the link j , φ is a user-defined capacity weight parameters that control the importance of link capacity in link costs calculation, CL_j is the capacity of link j , CL_{max} is the theoretically estimated maximum link capacity, τ is the user-defined costs weight parameter that controls the importance of user defined costs in link costs calculation, and UCD_s is the user defined cost of the section s which belongs to link j .

According to this equation, if UCD_s is increased, the shortest paths for vehicles will change, due to the increased dynamic costs of link j . If the access of freeways has higher costs, the freeway will be less attractive; thus, the flows in freeways might be reduced.

UDC is also implemented to prevent a flip-flop of traffic flows; therefore, both entrance and exit ramps have UDC. Since vehicles can change their routes when they encounter congestion, once freeways have significant congestion, vehicles might divert to parallel arterials and come back to freeway sections to avoid the congested sections. However, in reality, most vehicles choose to stay on the freeway and wait in the queue, even though the congestion in the freeway is significant. In this case, the route choice model in AIMSUN network is too flexible for drivers to change routes. In order to emulate this situation in reality, such diversion should be prevented. If both exit and entrance ramp have UDC, the total costs of diversion can be higher than the costs of waiting in freeways, and the vehicles might choose to stay in the freeways. The objective is to figure out the balance between the costs of congestion and the UDC of exit as well as entrance ramps.

Based on this idea, User Defined Costs (UDC) of all ramps are calibrated in two steps:

a. Step One. Define initial uniform UDC

Since simulated flows in freeways are generally higher than observed data and information about UDC is not available, an initial uniform UDC is defined first to examine whether this idea works. In order to calibrate UDC, statistical results of simulated link flows are also utilized. Similarly to the process of adjusting global parameters in freeway calibration, UDC is designed as zero and increased with an interval of five. Eventually, a value of 60 is defined as the uniform UDC for all ramps.

b. Step Two. Calibrate local UDC

Through examining each plot of simulated verses observed link flow, as well as goodness-of-fit—such as correlation coefficient, RMS, and Percentage difference—the UDC of each ramp is adjusted to calibrate suitable costs of the shortest paths.

Although the data in arterials are limited, the calibration of route choice model can be based on Annual Average Daily Traffic (AADT) of arterials. In this case study, the AADT of the entire network is available from Mn/DOT (2007). If arterials are underutilized in AIMSUN network, the attraction of these arterials is increased; while if they are over-utilized, the attraction is decreased. Such attraction is in terms of speed, capacity, and UDC. As mentioned before, the speed and capacity of all arterial sections are from 2010 Regional Planning Model. They might not be suitable in a dynamic traffic assignment model in the AIMSUN simulator. It is assumed that the daily volumes from loop detectors in AIMSUN are comparable to AADT in reality. If

daily volume in the AIMSUN network is 15% different from AADT of real data, the parameters are adjusted to increase or decrease the attraction. However, not all arterials sections are calibrated. In this case study, sections in TH-61, White Bear Ave, McKnight Ave, and TH-120 are calibrated.

AIMSUN model validation

Base Case validation

First of all, a correlation coefficient is implemented to evaluate the traffic volume of each 15-minute interval (There are 96 time intervals for 24 hours). The simulated data for each time interval is the traffic volumes of all detectors (i.e., 465 detectors) during the time period (i.e., 15 minutes). The real data is traffic volumes of corresponding detectors during the same time. Figure 45 shows that all correlation coefficients of 96 intervals are higher than 0.93 and most of them are close to 0.99, which indicates that the correlation between the simulated data and real data is strong. In addition, the percentage difference shows the discrepancies between them. As shown in Figure 46, most of the percentage difference are between -10% and 10%, which is acceptable in this study.

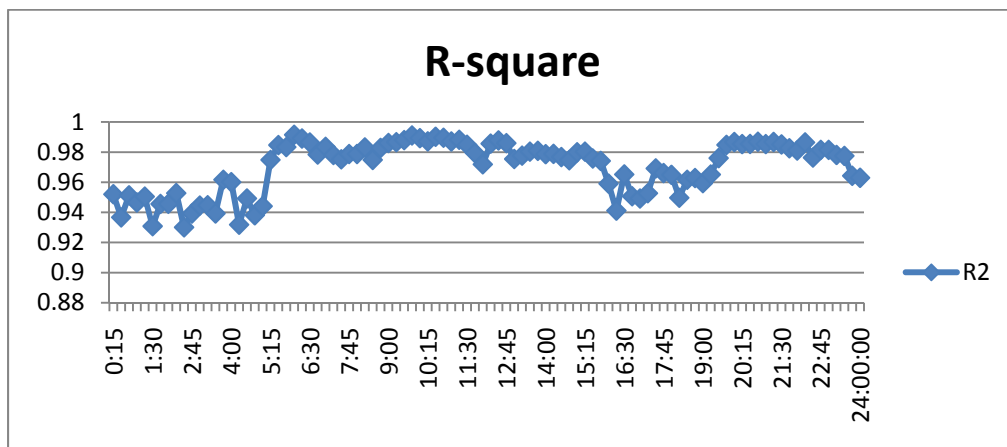

Figure 45 R-square of very time interval

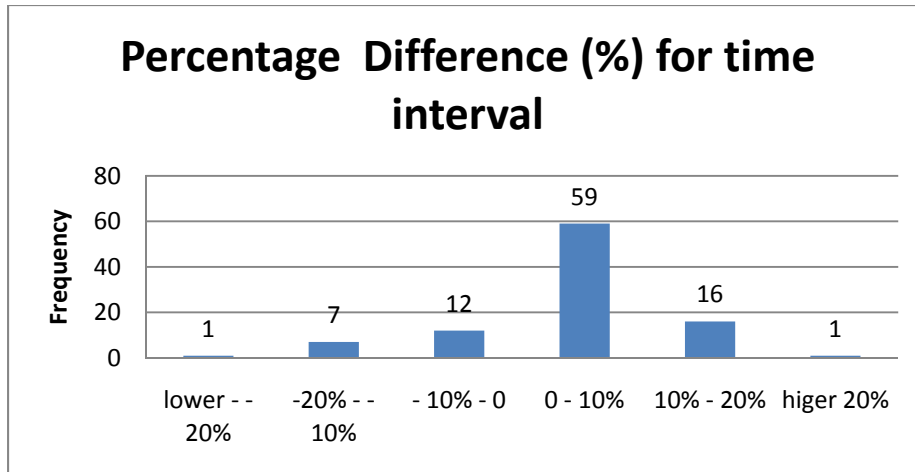

Figure 46 Percentage difference for time interval (15-min)

Linear regression and a Bland-Altman plot are also used. As shown in Figure 47, the slope of the regression line is 1.04 and the intercept is 353.9. From the regression results, the p values of the intercepts are 0.11 and the 95% confidence interval for the intercepts is between -90 and 800. The Bland-Altman plot shows that the data points are around the x-axis, which means the AIMSUN data obtained a good estimation of the real data. The slope of the regression is 0.05. However, the t test results show that the p value is 0, which indicates that the hypothesis that the value is zero can be rejected. Additionally, the average of percentage difference of all detectors after the calibration is 13% and the t test shows a rejection of the null hypothesis. Although after calibration the volumes in freeways are reduced significantly (the percentage difference was reduced from 0.29 to 0.13), the volumes in AIMSUN are still higher than the real data. However, in general, AIMSUN has better results in statistical analysis.

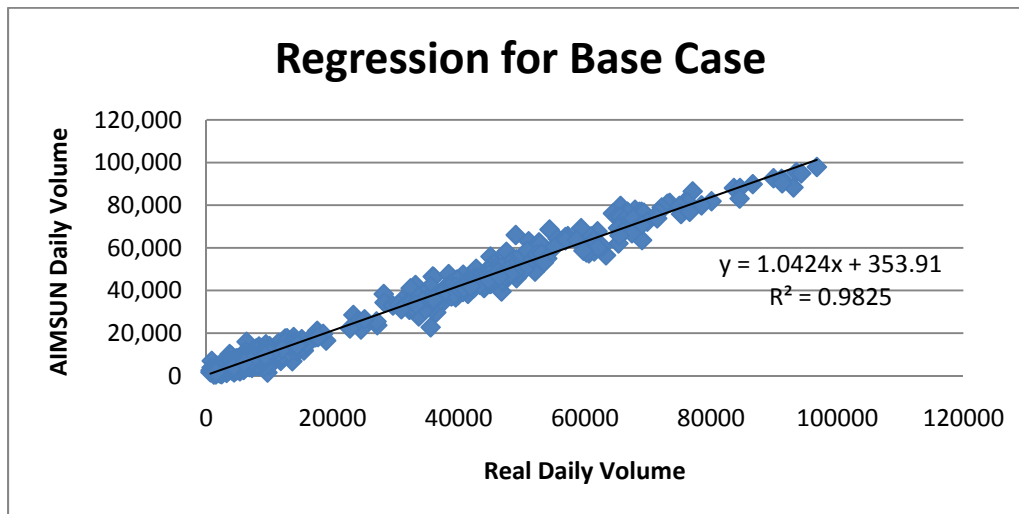

Figure 47 Regression for Base Case in AIMSUN

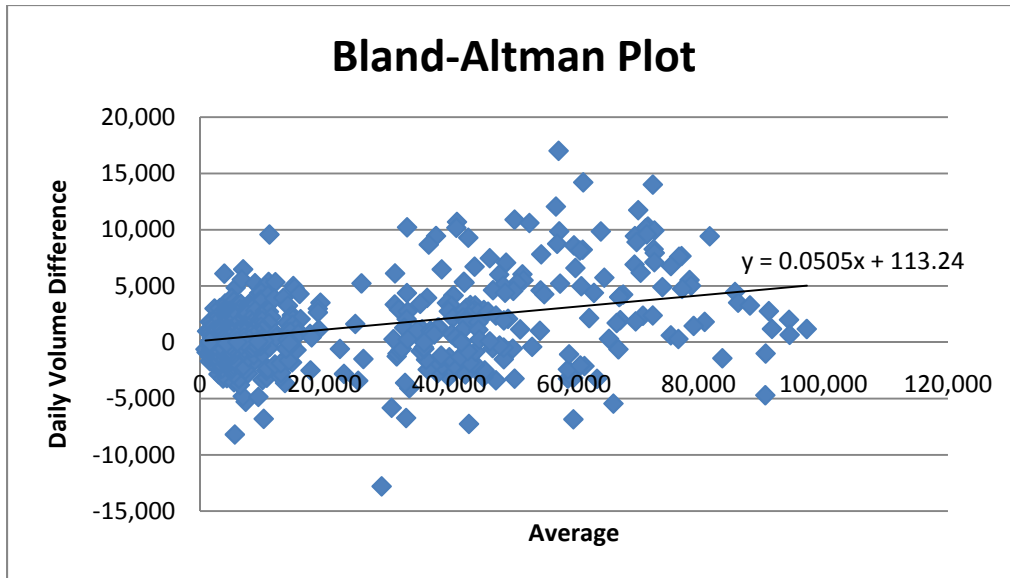

Figure 48 Bland-Altman plot for Base Case in AIMSUN

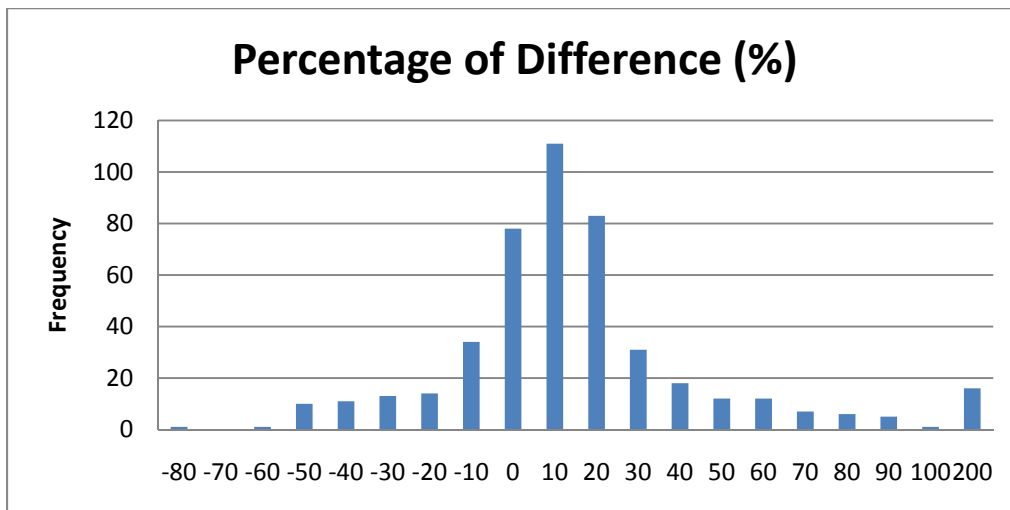

Figure 49 Percentage difference in Base Case after calibration

Full Closure validation

Similar to the Cube Voyager model validation, real data during the full closure of TH-36 was also used for examining the model validation for AIMSUN. Figure 50 shows the linear regression of real daily volume of the detectors and simulated daily volume in AIMSUN. The slope of the regression line is close to 1 and the correlation coefficient is 0.98. Similar to the Base Case, the Bland-Altman plot (Figure 51) also shows that the simulation data is higher than

the real data. The slope of the regression line is 0.07, and the t test shows a rejection of null hypothesis as well.

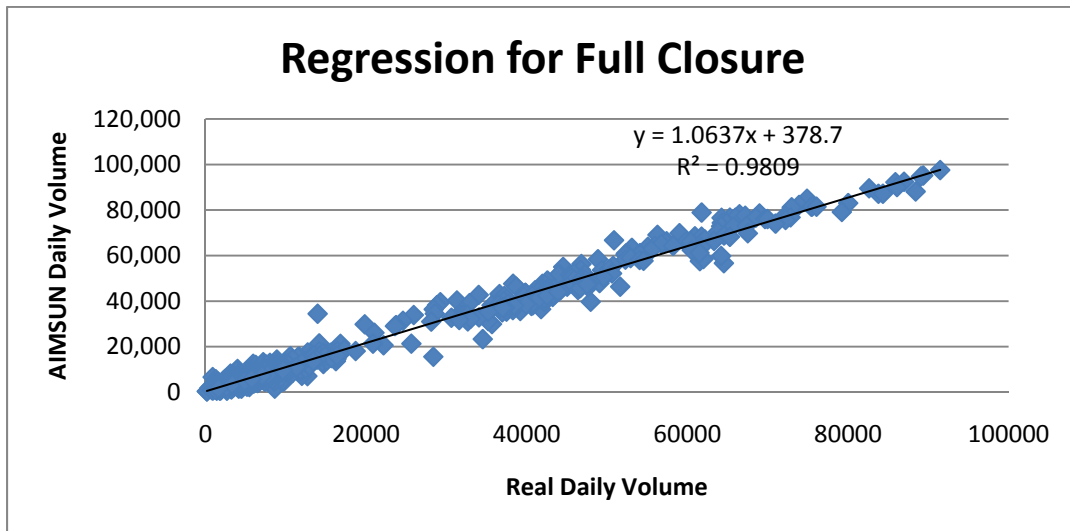

Figure 50 Regression for Full Closure in AIMSUN

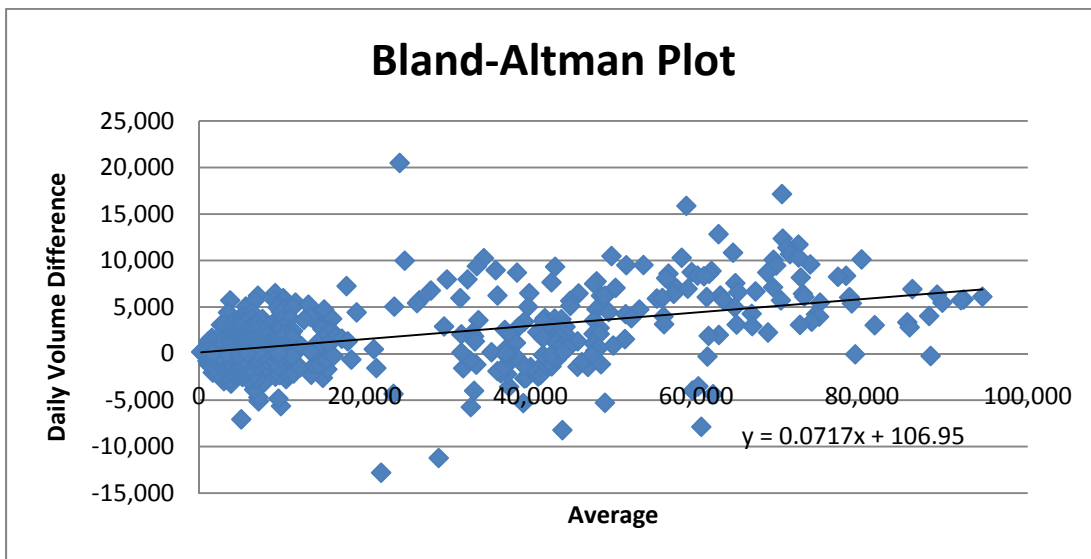

Figure 51 Bland-Altman plot for Full Closure in AIMSUN

Results of the Evaluation of TH-36 Project Construction Alternatives

The evaluation results are divided into two sections corresponding to the two major questions the analyst has: What will be the project Impact Area and Diversion behavior? What are the RUCs generated from each alternative? In the following section we present the results of the analysis while at the end we present a preliminary sensitivity analysis of the evaluation results for each methodology. A more comprehensive sensitivity analysis is outside the scope of this project.

Traffic diversion analysis

The three tools used in this case study were implemented for area-wide RUC calculation. One important area-wide impact is traffic diversion due to the construction. QuickZone did not predict the traffic diversion, while Cube Voyager and AIMSUN can both be used for traffic diversion analysis. Agencies can use this analysis to develop several effective options for a Transportation Management Plan, to mitigate disruptions due to the construction (Hardy et al., 2009).

The traffic diversions in Cube Voyager and AIMSUN were analyzed by comparing the link volumes discrepancies between Base Case and During Cases, which include Full Closure and Partial Closure. An AM period (i.e., 5 am-10 am) and a PM period (i.e., 2 pm – 8 pm) were selected, since traffic diversion can be more obvious during peak hours. The traffic diversion analysis was described in the Site Description Chapter, and the analysis was designed to compare the traffic diversions in reality and in simulation models for Full Closure. In addition, traffic diversions in Partial Closure are also analyzed in order to compare the impact due to different alternatives. The objective of this traffic diversion analysis for Cube Voyager and AIMSUN is to examine whether these two tools can predict the same routing due to the disruption of the TH-36 construction.

Full Closure

The traffic diversions are analyzed in terms of percentage difference of volume during the period defined in the Implementation Chapter. The actual diversion is briefly mentioned here, while the details can be found in the Site Description Chapter. The results from Cube Voyager and AIMSUN are compared with the actual diversion.

AM period

The traffic diversions during Full Closure in the AM period are shown in Figure 52 (real data), Figure 53 (Cube Voyager), and Figure 8.3 (AIMSUN). The traffic volumes used for Figure 52 were average data from loop detectors and volume measurements in 13 locations near TH-36. From this figure, we can see that the volumes in TH-36 have a significant decrease and the parallel roadways (e.g., County Rd C and County Rd B) have a significant increase. East-west-oriented I-694 (from the interchange of TH-36 to the interchange of TH-61) has increased volumes as well. Vehicles originally traveling on TH-36 WB might take this freeway as a detour instead of following the official detour route, which includes I-694 SB, I-94WB, and I-35NB. Since data is limited, the diversion of these vehicles cannot be captured beyond the interchange of TH-61 and I-694. In addition, there is an increase in I-94 WB in the AM period. It is possible that the travelers who used to travel on TH-36 took I-94 instead. However, due to the limitations of the data, the traffic diversions in reality cannot be fully captured; however, it is still a good reference for examining the performance of the traffic analysis tools.

Figure 53 shows the traffic diversions in Cube Voyager. Compared to Figure 52, the parallel roadways to TH-36 also have a significant increase in volume during this period. The percentage differences are on the same scale as in Figure 52. There is a slight increase in I-694 and in TH-61, which indicates that the WB travelers use I-694 and TH-61 to come back to TH-36. These two facts shown in Figure 53 agree with the real facts in Figure 52. However, the decrease in volume in the sections between the interchange of I-35E and the interchange of TH-61 was not captured. In addition, it also shows that there is a decrease of volumes on McKnight St., due to the closure. In Figure 52, we only have data for four links, while the impacts on the other links can be seen in Cube Voyager. The influence on McKnight St. is significant, since almost the entirety of McKnight from I-694 to I-94 is affected.

However, the increase in volume on I-94 was not captured by Cube Voyager. The traffic assignment was conducted for the entire Twin-Cities network, including some areas in Wisconsin. The model should have captured such a diversion if the demand was accurate for the model. However, this might indicate that a large number of work-based trips in the east area are not included in the model.

Figure 54 shows the traffic diversion in AIMSUN. The impacted area in this tool is wider than Cube Voyager. Similarly, the increases in volumes on parallel roadways to TH-36 are emulated, and the values of percentage difference are on the same scale as in reality. There is an increase, which is between 10% -20% in east-west oriented I-694 sections (this agrees with the conditions in Figure 52). In addition, the volumes in TH-61 in both AIMSUN and Cube Voyager are increased, while the volumes in the common area of I-35E and I-694 do not show a significant change. Since the models for AIMSUN and Cube Voyager were proven to be valid through statistical analysis, it is safe to conclude that most of the long-trip travelers use the route that is consisted of TH-61 and I-694 links as their detour during the TH-36 full closure construction. AIMSUN also shows that McKnight is significantly influenced, due to the closure.

However, AIMSUN does not capture the diversion in I-94 as well. There may be two reasons causing this discrepancy. First, the traffic demand may not include the large number of work-based trips that we identifying missing from the regional planning network. Second, trips that enter the network from the centroids in Stillwater or east-end of I-94 cannot select the best entrance, due to the limitation of the connection between the entrance in Stillwater and the entrance in I-94. In reality, travelers from Wisconsin can select the best entrance for them from the two bridges in the boundary. However, the selected network in AIMSUN has a limitation in considering such route diversion. It is reasonable that the volume does not increase in I-94, since those travelers cannot make the diversion “outside” the network.



Figure 52 Traffic diversions in AM (real data)



Figure 53 Traffic diversions of Full Closure in AM (Cube Voyager)

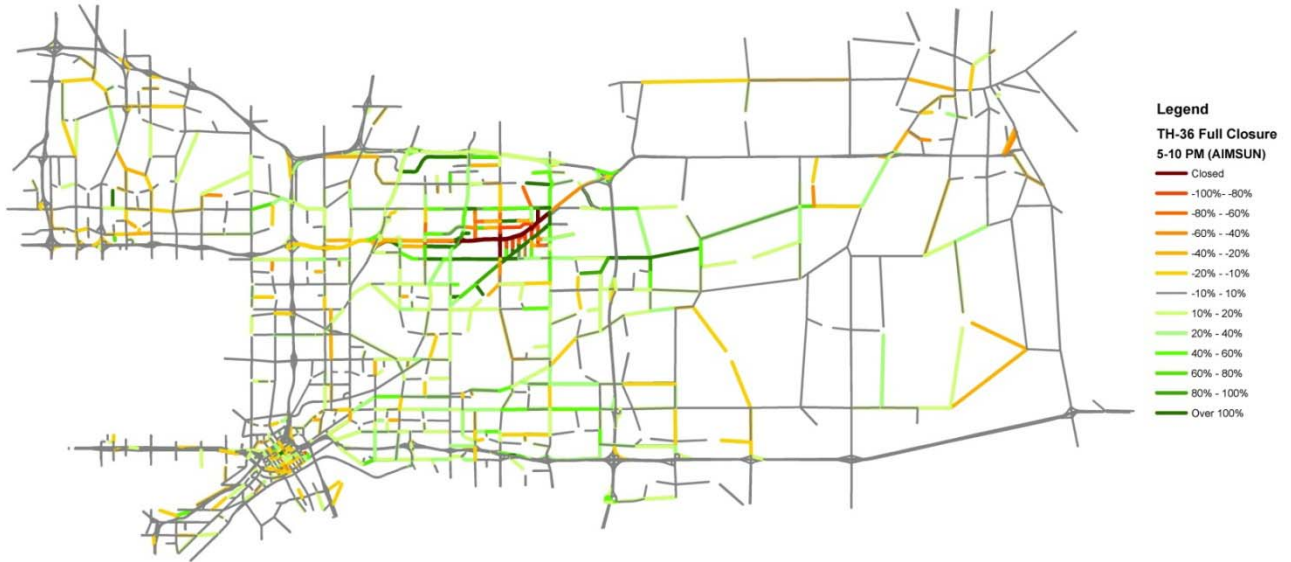

Figure 54 Traffic diversions of Full Closure in AM (AIMSUN)

PM period

The traffic diversions during Full Closure in the PM period are shown in Figure 52 (real data), Figure 55 (Cube Voyager), and Figure 56 (AIMSUN). These figures have the same legend as the figures in the AM period. Similar conclusions can be made based on these three figures. In general, both Cube Voyager and AIMSUN capture the diverted traffic in parallel local roadways as well as the TH-61 and I-694 route.



Figure 55 Traffic diversions of Full Closure in PM (Cube Voyager)

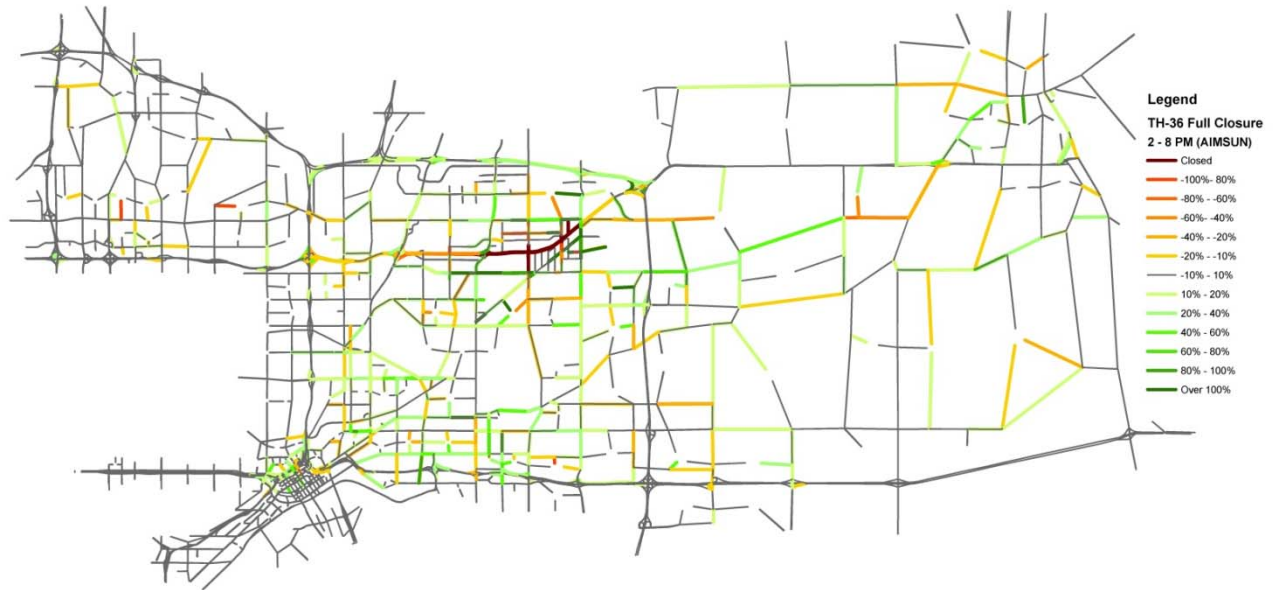

Figure 56 Traffic diversions of Full Closure in PM (AIMSUN)

Partial Closure

A Partial Closure Alternative is another construction alternative for TH-36, although it was not implemented in reality. In order to comprehensively compare these two models, traffic diversions generated by Cube Voyager and AIMSUN are also analyzed, but the real data was not available in this case. Since the traffic diversion analysis shown in last section indicates that these two tools predict a similar conclusion to reality, their prediction of the Partial Closure may be trustworthy enough to understand the difference between the two construction alternatives. For Partial Closure, the analyses for the AM period and the PM period are separated as well.

AM period

The traffic diversions in Partial Closure during the AM period are shown in Figure 57 (Cube Voyager) and Figure 58 (AIMSUN). From Figure 57, we can see that the impacted area is smaller than in Full Closure. The volumes in freeways do not show a significant change, while the volume increases in parallel roadways to TH-36 in Cube Voyager are slight. In contrast to Cube Voyager, AIMSUN shows a wider impacted area. As mentioned in the Implementation chapter, the volumes in freeways system are higher than reality in an AIMSUN network. This might indicate that the arterials do not have enough demand when compared to reality. However, only AADT is available for arterial analysis in this case, so the validation of simulated volumes during the AM or PM periods is unknown. If the travel volumes in arterial links are low, the percentage difference might show bias, since the absolute discrepancies of link volumes between Base Case and During Case are low.

Similarly, the volume changes of the links around TH-36 are in the same scale as Cube Voyager. In addition, HW 5 in both cases gets influences, which indicate the impacts due to the Partial Closure reach only the local area around the work zone but also the roadways far away.



Figure 57 Traffic diversions of Partial Closure in AM (Cube Voyager)

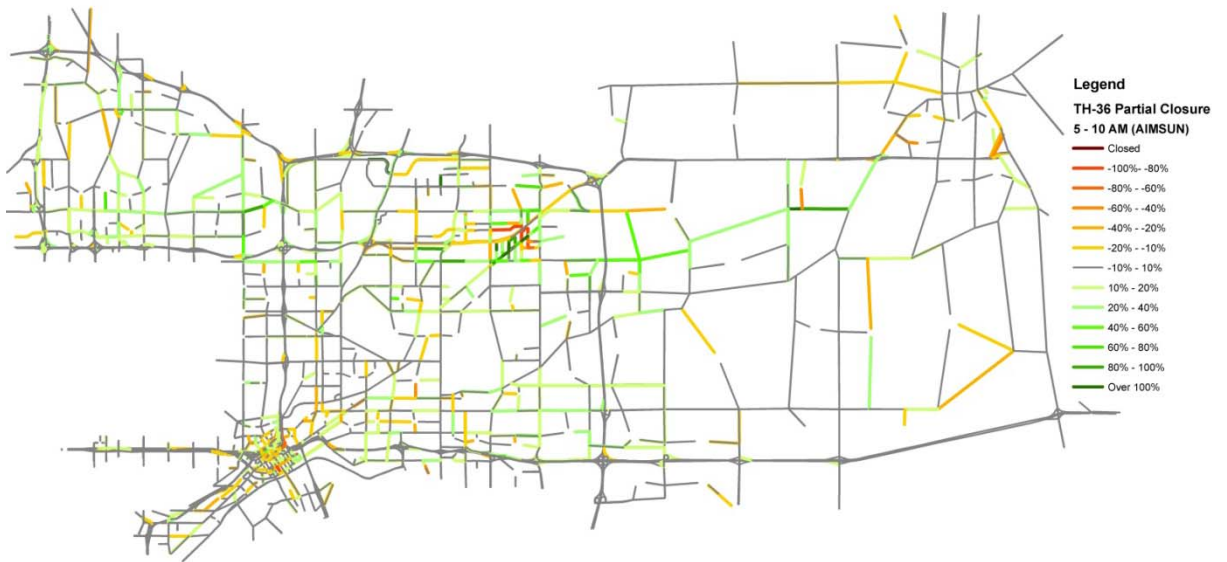

Figure 58 Traffic diversions of Partial Closure in AM (AIMSUN)

PM period



Figure 59 Traffic diversions of Partial Closure in PM (Cube Voyager)

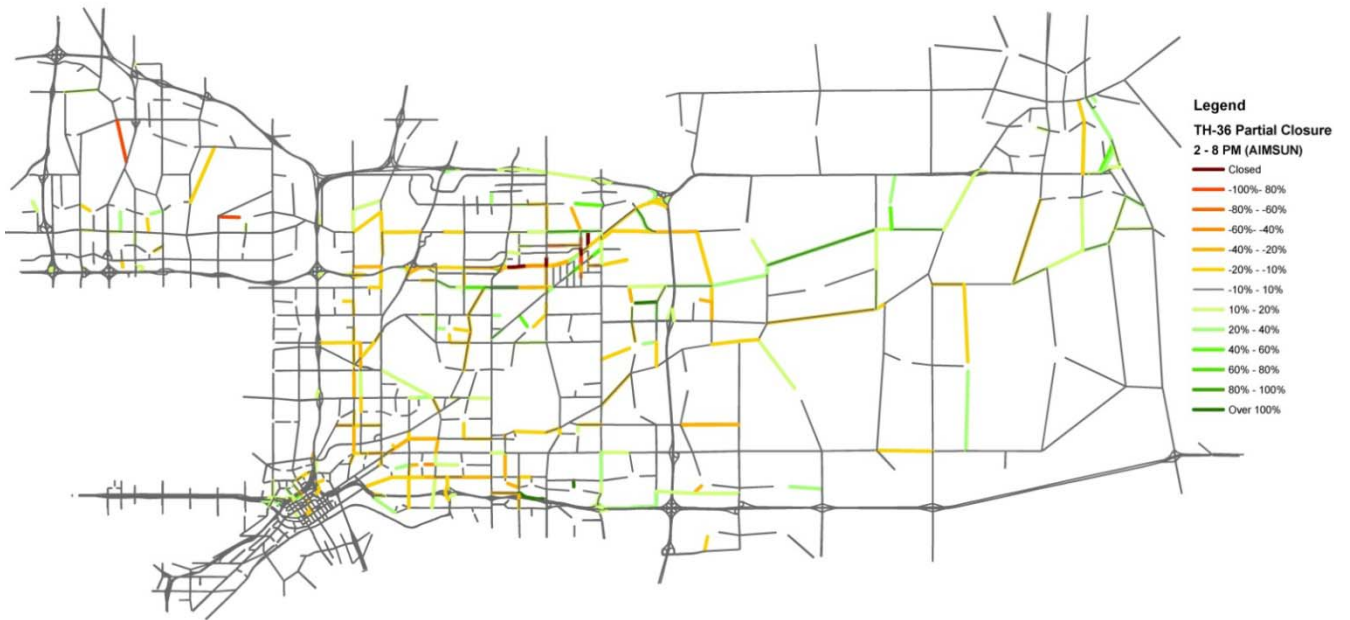

Figure 60 Traffic diversions of Partial Closure in PM (AIMSUN)

From the figures shown above, one can conclude that the Cube Voyager and AIMSUN models can predict traffic diversion in most cases. Both tools show that the local roadways around the work zone get significant diversion, and their results agree with the real data that most of the travelers use TH-61 and east-west oriented I-694 as a freeway detour during TH-36 full closure.

In addition, the Full Closure impact area is wider than the impact area of Partial Closure, and the influences for Partial Closure are not only in local areas near the work zone, but in other areas as well.

RUCs results

The RUCs results from the empirical method and all three tools are compared in order to better understand the capability of each tool. In order to calculate the RUCs for Project Alternatives, information about the Base Case and the During Case should be known. For the Full Closure alternative, the During Case includes a Full Closure scenario in which TH-36 is completely closed in both directions, and a One Lane Open scenario in which one lane of TH-36 (each direction) is opened for traffic. In the Project Alternative design, the construction stage of Full Closure takes five months, while the next stage of construction in Full Closure Alternative -- One Lane Open-- takes three months. Accordingly, the total RUCs in this alternative include the RUCs during Full Closure and the RUCs during One Lane Open. For the Partial Closure Alternative, the During Case includes only one construction stage: One Lane Closure, in which one lane of TH-36 is closed for traffic for 20 months to finish the construction of TH-36.

In the QuickZone calculation, the network consists of four roadways: TH-36, I-694 (which is assumed as a freeway detour), County Rd B, and County Rd C (which are assumed as arterial detours). The daily RUCs are the user costs differences of these four roadways between the Base Case and the During Case.

In the Cube Voyager calculation, the impacted area is selected based on a traffic assignment model. The daily RUCs are the user costs differences of all links within the impacted area. In AIMSUN, the impacted area is the same as Cube Voyager, and the daily RUCs is also the user costs differences of all links within the impacted area. The final RUCs are presented in Table 21.

In Table 21, the daily RUCs are obtained from the tools, while the total RUCs are calculated by multiplying the daily RUCs with the number of days during the corresponding construction period. It is assumed that the daily RUCs do not change during construction. The daily RUCs in the Full Closure alternative only includes the daily RUCs for the Full Closure scenario. The daily RUCs in the One Lane Open scenario in the Full Closure alternative is the same as in the One Lane Closure scenario in the Partial Closure alternative. It is assumed that daily traffic conditions of these two scenarios are the same. Both scenarios have the same network geometry, demand, and assumptions for calculation; therefore, the daily RUCs can be seen as the same for both scenarios. The total RUCs in the Full Closure alternative in Table 21 is the sum of the total RUCs in the Full Closure scenario and the One Lane Open scenario.

Table 21 RUCs results for TH-36 reconstruction

	Full Closure				Partial Closure			
Tools	Daily RUC	Total RUC	B/C ratio w RUCs	B/C ratio w/o RUCs	Daily RUC	Total RUC	B/C ratio w RUCs	B/C ratio w/o RUCs
Empirical	\$69,000	\$11,160,000	2.91*	3.99*	\$9,000	\$5,307,000	3.0*	3.47*
QuickZone	\$69,600	\$12,114,000	3.6*	3.7*	\$18,600	\$10,969,920	2.8*	3.1*
Voyager	\$79,500	\$13,680,000	4.10	4.59	\$19,500	\$11,492,000	3.32	3.68
AIMSUN	\$83,000	\$14,781,000	6.98	7.52	\$25,900	\$15,273,600	5.54	6.02

*Ratios only include RUCs and capital costs. No life-of-project benefits.

Table 22 RUCs estimation effort per tool

	QuickZone	Cube Voyager	AIMSUN
Collecting data	2-3 days	~1 month	1-2 months
Engineering analysis with assumptions	2-3 days	2-3 days	2-3 days
Coding the network	hours		2 months
Calibration/validation	n/a	days	8 months
Executing the model	minutes	hours	2 hrs/replication (Total : 1 weeks)
Interpretation of the results	1 day	2-3 days	2-3 days
Total	1-2 weeks	1.5 month	12 months

Looking only the RUCs results one observes that the estimate increases with the complexity of the tool. This is reasonable since the additional complexity most frequently results in additional reasons to increase delay. For example, the empirical method assumed that there is plenty of spare capacity so there will be no queue delay even in the PC while all other tools take such delay into consideration. QuickZone and Voyager only count delay when and as demand reaches capacity respectively, while AIMSUN, emulating traffic control on intersections, generates delays even when the road is uncongested. The latter is even more evident in PC where the one lane available to traffic on each direction still has to stop on 3 signalized intersections. Interestingly, although the RUCs increase with the models complexity so do the B/C ratios suggesting that the more complex model is also more sensitive to the benefits from the finished project.

Part of the original objective of the study was to use the results of the analysis to redo the Benefit Cost Analysis for both alternatives. True to this objective we completed the BCA for Voyager and AIMSUN methodologies and estimated rough B/C ratios for the empirical and QuickZone methods. This was done because neither the empirical nor QuickZone provide detailed numbers for VMT and VHT especially for the as-build casae. A new question is to see whether Benefit Costs Analysis (BCA) results can be different with and without considering Road User Costs (RUCs). A Benefit Costs Analysis was conducted for Full Closure and Partial Closure. Due to the limitations of the data, several assumptions were made in this analysis. The costs in the analysis were in terms of Time Cost and Vehicle Operating Costs, and the benefits are the cost savings between different alternatives. A 5% discount rate was selected, as recommended by the US office of Management and Budget (2007). The annual increase of Vehicle Hour Travel and Vehicle Mile Travel was defined as 1% (Polzin, 2006). The total number of the days in one year was defined as 350. The final results are presented in Table 21. To simplify the process, the maintenance costs for both alternatives were the same and only construction costs were considered as costs.

Apart of the actual results and their similarities and differences, the different methodologies have considerably different requirements in terms of effort and data (also translated in effort). During this work we made an effort to record the effort involved in each stage of the implementation the methodologies. Table 22 presents estimates of the time involved in each implementation when the task is undertaken by a single engineer. In these estimates, the assumption is made that the engineer is familiar with the tool so these durations do not include any learning time. As pointed out earlier, it leaves no doubt that in the particular project the use of micro-simulation was unwarranted although it may have produced slightly more accurate results. The data needs and effort required do not make it a cost effective approach. Regardless, in other projects such a tool may be necessary. Cases where ITS, traffic adaptive control, or other strategies that dynamically affect traffic conditions are part of the construction impact mitigation plans, simulation probably is the only applicable tool. Such a case study though would not though allow juxtaposition of results with the other methodologies.

Result sensitivity to modeling assumptions

As pointed out on several occasions, all methodologies are dependent on user assumptions of varying degrees. For example, QuickZone requires assumptions of link capacities, link demands, and traffic assignment; in Cube Voyager, the travel time and capacity in the work zone is defined by the user. The AIMSUN simulator, in addition to modeling assumptions and parameter selection, due to the stochastic nature of its model, the RUCs may change for different

replications of the simulation. It should be noted that the sensitivity tests presented here are not a formal sensitivity analysis but only a selective analysis for better understanding the relationship between RUCs and the modeling assumptions. The engineer utilizing one of these methods in a project should apportion time for conducting similar checks to determine the inherited variance in the results.

QuickZone

The initial demand of each link is defined through the AADTs measured in 2006 and the 24 hourly pattern determined from freeway mainline detector measurements. The link capacities are roughly estimated based on the Highway Capacity Manual (National Research Council, 2000) and from the Regional Planning Model. Since the Regional Planning Model of the Twin Cities Metropolitan Area contains information about link capacities, it is interesting to know the difference in results between the current network and the network with the link capacities from the Regional Planning Model. One scenario is designed to examine such a difference.

In the test the only difference between the network finally used in the analysis and the test scenario is the link capacities, while other input data—such as network geometry, link demand, project information, and traffic assignment results—remain the same. The objective is to examine whether RUCs results are significantly different between these two networks. The link capacities of the two network alternatives are shown in Table 23, and the RUCs results are shown in Table 24. “Analysis Model” indicates the initial design for QuickZone, and “Test Model” indicates the test scenario for RUCs sensitivity.

Table 23 Link capacities of two networks

Capacity*	Analysis Model	Test Model
TH-36	1100	1100
I-694	2200	1750
TH-61	1500	1300
White Bear Ave	1000	1000
County Rd B	800	800
County Rd C	800	800

*The unit of the capacity is vehicle/hour/lane

Table 24 RUCs results of two networks

	Full Closure alternative	Partial Closure alternative
	Daily RUCs	Daily RUCs
Analysis Model	\$70,000	\$18,500
Test Model	\$1,010,000	\$920,000

Table 24 shows that the daily RUCs in the Test Model are greater than the Analysis Model. Since traffic assignment results are the same for both scenarios, the link capacities in the Test Model may be too low to carry the assigned demand. From Table 3, the capacities in I-694 and TH-61 are different, which are two roadways of the freeway detour. This experiment indicates that link capacity assumptions affect the RUCs results significantly. QuickZone requires significant amounts of engineering judgment and knowledge of the network to avoid pitfalls like these.

Cube Voyager

Considering that the Voyager model is not developed for the purposes of the analysis but used as received from the MPO, there are no assumptions necessary for the Full Closure alternative, while an assumption is needed in Partial Closure regarding the link capacities in the work zone. There are plenty of resources in the literature assisting in the estimation of capacity in a work zone but still it is an assumption made by the engineer. In our analysis we assumed that the capacity will be half of the capacity before the closure, in which case the capacity is reduced from 2200 veh/hr to 1100 veh/hr. An engineer could have chosen a different value if he/she had additional information, for example, regarding the intersection control plans during the construction. For the purposes of the sensitivity analysis we assume a different capacity. Furthermore, in the analysis model, only link capacity is reduced, while the speed reduction due to the work zone is not considered. The travel time might increase due to reduced speed, which might affect the results of the traffic assignment. In this case, another two alternatives are designed to examine whether increased travel time affects the final RUCs. The scenarios' designs as well as the corresponding daily RUCs are presented in Table 25.

Table 25 Comparison of analysis model and test scenarios

	Speed in the WorkZone (mph)	Daily RUCs (dollars)	Work Zone Capacity (veh/hr/ln)	Percentage Change
Analysis Model	40	19,500	1100	0%
Test Scenario 1	40	18,800	1500	-4%
Test Scenario 2	30	22,400	1100	15%
Test Scenario 3	25	34,600	1100	77%

In Table 25, the Percentage change is calculated by following equation:

$$P = (RUC_T - RUC_I) / RUC_I \times 100\%$$

Where P is the Percentage change, RUC_T and RUC_I are the Daily RUCs of the Test Scenario and Analysis Model.

From Table 25, we can see that the change in the capacity of the work zone only causes a 4% difference in RUCs. It is possible that the work zone in the Partial Closure alternative is not significantly congested and that the diversion is not severe when the speed is 40 mph. The increase of the work zone capacity does not help to reduce the delay in the work zone. However, the speed of the work zone affects the traffic assignment results significantly. Test Scenario 2 has a 15% increase of Daily RUCs while Test Scenario 3 has 77%. It turns out that initial travel time of the link is more important than capacity, from the results of these Test Scenarios. The reduction of capacity in the work zone reduces the speed in the work zone and causes traffic diversion. Therefore, it would be better to consider this effect before traffic assignment is conducted. The Daily RUCs in Test Scenario 2 are much closer to the daily RUCs of AIMSUN in the Partial Closure alternative.

AIMSUN NG

AIMSUN is a comprehensive tool for traffic simulation. While it requires the calibration of a large number of parameters it requires fewer assumptions in order to build the simulation model. However, due to the stochastic nature of Microscopic Simulation models, the AIMSUN simulator generates different VHT and VDT for daily RUCs calculation. If the change of VHT and VDT does not cause a significant change in RUCs, a few replications might be enough. On the other hand, if the RUCs are sensitive to the change in VHT and VDT, the number of replications should be carefully considered. In this sensitivity analysis, the objective is to evaluate the stability of the network and determine how the number of replications affects the result.

The daily RUCs are calculated in terms of the difference in VHT and VDT between the Base Case and the During Case. Each replication is independent, and there is no correspondence between the replications for the Base Case and the During Case. In order to examine the sensitivity of daily RUCs for the AIMSUN simulator, nine replications are run for, respectively, the Base Case, the Full Closure During Case, and the Partial Closure During Case. Different combinations of replications for the Base Case and the During Case generate different RUCs. In total, 81 daily RUCs in Full Closure and 81 daily RUCs in Partial Closure can be generated by those simulation replications. In this sensitivity analysis, only the results of a few replications are shown to illustrate the idea. The Daily RUCs of nine replications is shown in Figure 61 and the percentage change is shown in Figure 62.

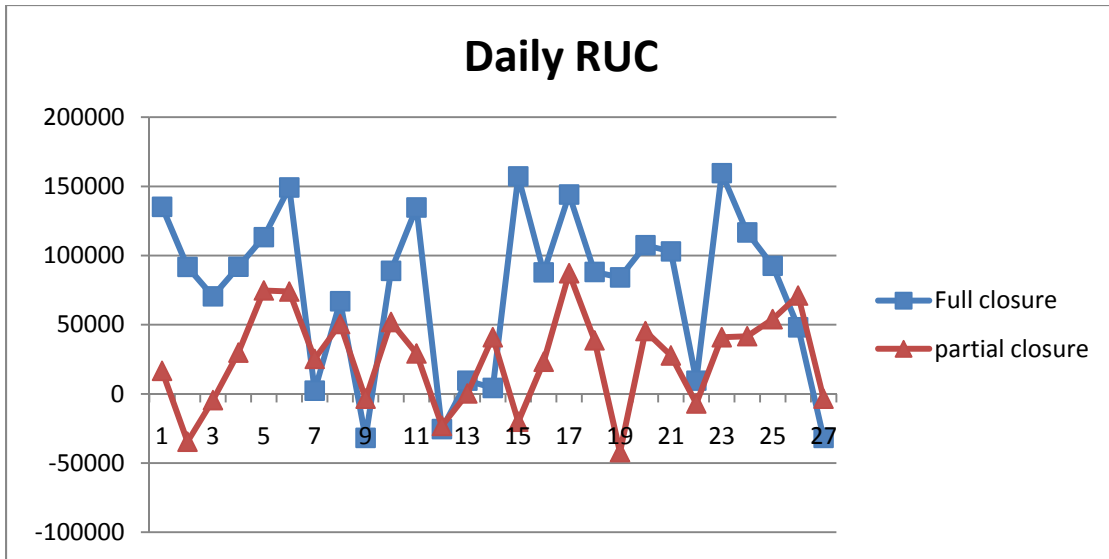

Figure 61 Daily RUCs of 9 replications

The standard deviation of the percentage change for the Full Closure is 76%, while the standard deviation for the Partial Closure is 136%. From these results we can reach two conclusions. First, the simulation model does not seem to have achieved a good stability. Small changes in the boundary conditions result in significant changes in route choice. Second, the RUCs are extremely sensitive to the number of replications especially on a network that is suboptimal in calibration.

From the sensitivity experiments we conclude that RUCs estimation with any methodology can result in great dependence on the modeling assumptions or the quality of the calibration. It is therefore essential that such sensitivity experiments are conducted to inform the engineer of the inherent variance and in extend risk in the results.

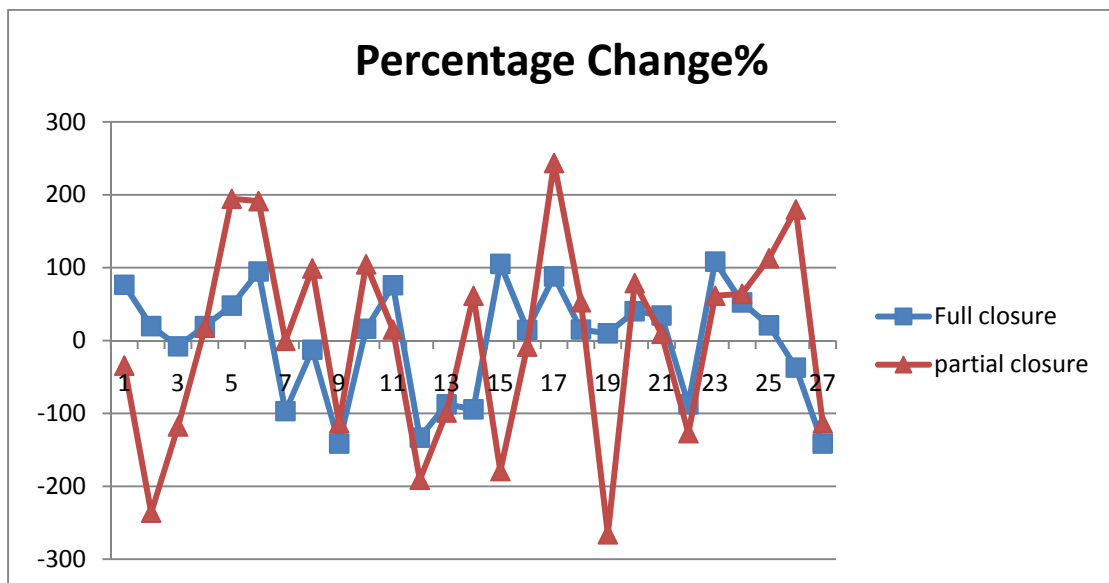

Figure 62 Percentage change of daily RUCs

Hypothetical scenarios for BCA

In the TH-36 project the advantages of Full Closure in terms of shorter construction duration and lower costs are so obvious that make the Full Closure a better choice irrelevant of the inclusion of RUCs in the BCA or not. In an effort to expand the investigation but still utilize as much as possible the parameters set by the case study, four hypothetical scenarios based on the TH-36 reconstruction project are designed to better illustrate the role of RUCs. By changing construction costs, duration of full closure, and including the effect of a half year construction period as is the norm in Minnesota, the changes on B/C ratios are illustrated along with the possibility of a decision switch on the selection of full closure as the construction alternative. B/C ratios generated with and without RUC are used to illustrate the weight RUC has in the decision.

Cost variation scenario

The Cost Variation Scenario is designed to illustrate how RUCs affect the B/C ratios as the construction cost of Full Closure changes. In this scenario, based on the initial bid costs of Full Closure (i.e. 27.6 million), the construction costs in each step are increased or decreased by 100 thousand dollars. The net present values of benefit in Full Closure remain the same. The B/C Ratio in each step is calculated and listed in Figure 63.

In Figure 63, the y axis is the B/C Ratio while the x axis is the construction costs of Full Closure. The two horizontal lines are the constant B/C Ratios of Partial Closure as estimated with and without RUCs. Point A is the intersect point of the lines of Full Closure and Partial Closure in the case with RUCs while Point B is the intersect point in the case without RUCs. From this figure, we observe that the corresponding construction cost of Point A (34 million) is less than that in Point B (34.5 million). This indicates that RUCs affects the value of the difference in bid costs between the alternatives but only by less than 1.5%. This is not a surprising result since the RUCs are affected only by the difference in durations between alternatives and its daily values. In this case the difference between total RUCs is approximately 1.5%.

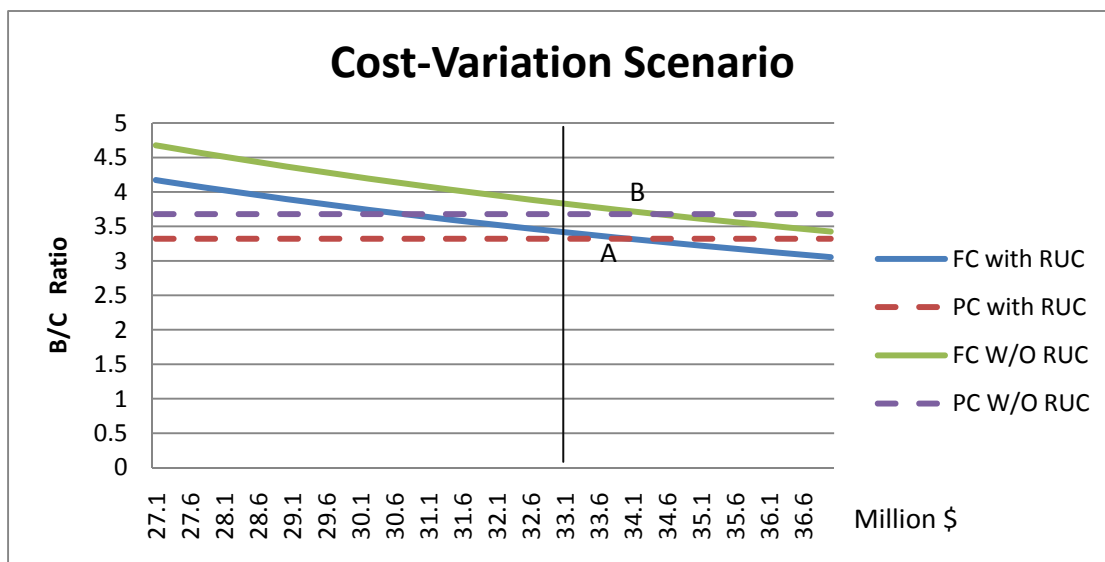

Figure 63 B/C ratio of cost-variation scenario

Duration variation scenario

The second scenario is designed to observe how RUCs affect the B/C ratios when the construction duration of the Full Closure is varied. The longer the duration, the higher the total RUCs of the Full Closure will be. In this scenario, starting from the initial construction duration (5 months), the duration of Full Closure is increased or decreased by one month (3 months to 8 months). The upper limit of 8 months was established due to the fact that it is highly unrealistic to extend a full closure during the winter months in Minnesota. The construction cost of both Full and Partial Closures remain the same as well as the duration for the Partial Closure. The B/C Ratio is calculated for each combination and plotted in Figure 64.

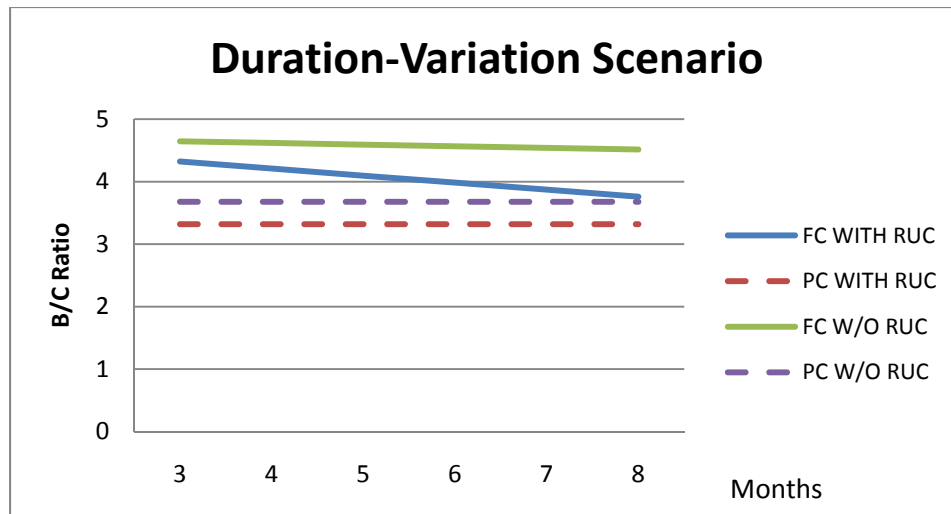

Figure 64 B/C ratio of cost-variation scenario

The y axis in Figure 64 is the B/C ratio while the x axis is the duration of the Full Closure. From this figure we observe that with the inclusion of RUCs the impact of the FC duration is considerably greater (slope). This is indicative of the risk level involved in Full Closure operations can be greatly underestimated if RUCs are not considered in the BCA. Taking under consideration the other project parameters, it is clear that the value of time is greater in the Full Closure alternative and if the danger for delays is large, Partial Closure could be a safer choice.

Combined time and cost variation scenario

It is realistic to assume that the longer the time of construction the higher the costs. Although this is not applicable in fixed bid contract cases it is illustrative of the project size difference between alternatives. This scenario is designed to vary the construct duration and cost. For simplicity, the monthly cost of Full Closure is the initial amount of 27.6 million divided by the initial duration of 5 months. The construction cost of each combination is calculated by multiplying the monthly cost with the duration. Since the total RUCs are calculated by multiplying the daily RUCs with construction duration, they are increased or decrease along with the increase or decrease of the duration.

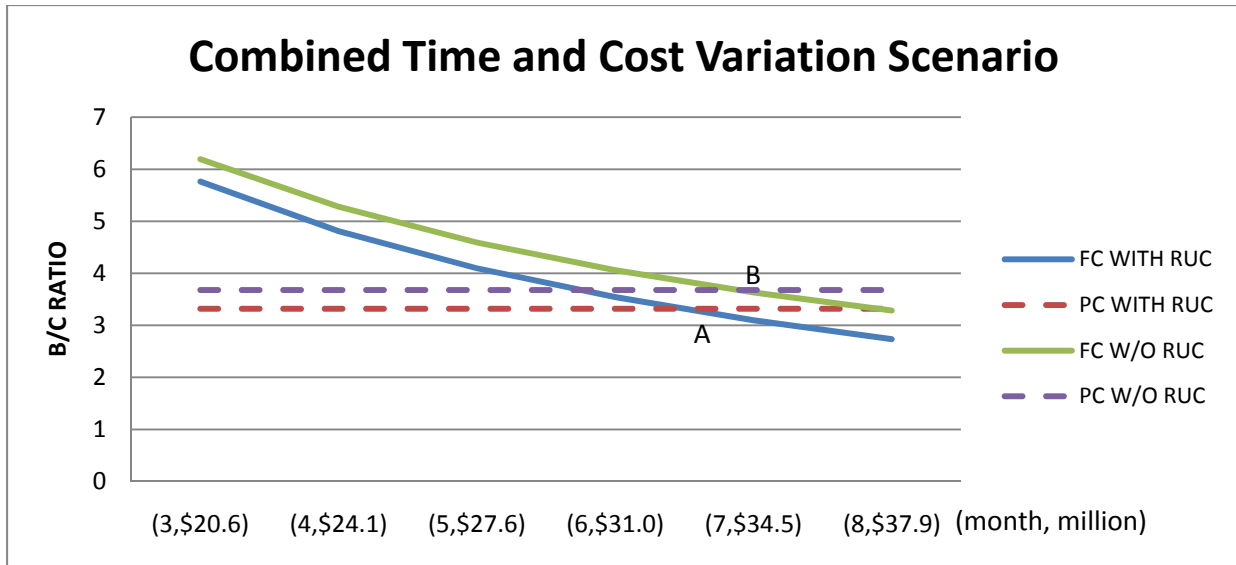

Figure 65 B/C ratios of combined scenario

The x axis tracks the different combinations of duration and costs for example the first point refers to the case where the FC lasts 3 months and costs \$20.6M. It is obvious that inclusion of RUC in BCA can affect the decision. The risk level of the construction alternative increases as the difference of cost between alternatives reduces. If the construction duration between Full Closure and Partial Closure is short, the Partial Closure can be a safer and better choice when RUC is considered.

Minnesota winter scenario

Scenario 2 considered the importance of the RUCs in terms of change of the FC duration. In the explored variation a year round construction season is assumed allowing the PC stage of the FC alternative to follow as soon as the FC stage is completed. Similarly, the 8 month long FC ending in December is assumed a viable combination. It will be more realistic to take into account the half year construction season experienced in Minnesota. In this scenario it is assumed that work cannot progress between the months of December and March. The project will remain in the stage reached by the end of November till April 1st. The same duration variation is implemented as in scenario 2 but with the aforementioned constraint. Figure 66 illustrates the change in B/C ratios with the variation of FC duration.

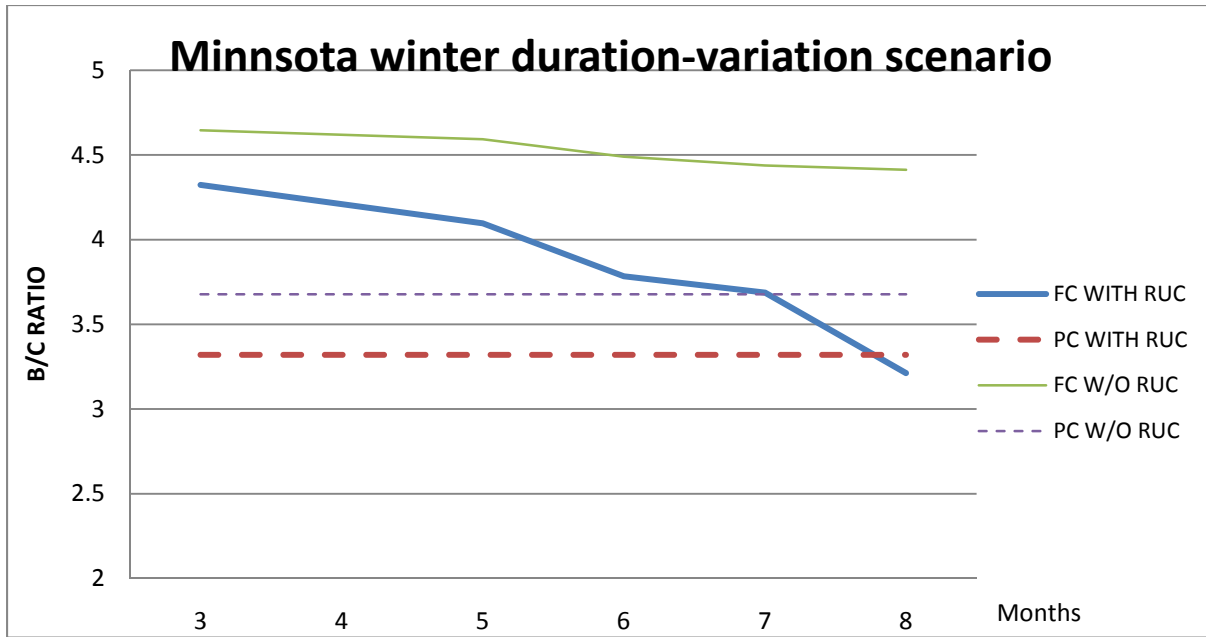

Figure 66 B/C ratios of winter scenario

As illustrated in figure 66, if we take into account the work pause during the winter months the inclusion of RUC results in considerably different B/C ratios as compared to the case where RUC is ignored. Even if the FC does not extend over the winter the extension of the next construction date from 90 to 180 days eliminates almost all benefit from the reduced cost FC alternative. According to this scenario it was very fortunate that the actual TH-36 FC was concluded one month ahead of time allowing the following PC to finish before December. If the FC was instead delayed by a month the benefit difference between alternatives would have been reduced by 50%. The slope change in the case where RUCs are ignored is only due to the change of time where the benefits from the new road start to accrue.

The hypothetical scenarios presented in this section do not reveal something that was not evident from the original results but clearly illustrate the importance of RUCs under different project circumstances and point out the fact that time is a lot more valuable in the case of a FC increasing the risk of any delay. Such risk can be greatly underestimated if RUC is not taken into account during the Benefit Cost Analysis.

5. Collecting Experience

The basic drive that created and guided this project was a desire to collect as much experience from this first large full closure on a major link in Minnesota. The in depth analysis of both the real information as well as the model results for the hypothetical scenarios have provided experience valuable to the engineers that need to provide facts and accurate estimates to decision makers. There is also another aspect of collecting experience from this project. Due to its breaking new ground nature the areas of Public Relations and Market Research received additional attention and closely followed the planning, execution, and aftermath of the project from the public's point of view. Although it is not the scope of this report to present these aspects of the project, the following sections record the available resources and provide a summary of the information collected.

Weighing the Public Opinion

As mentioned in the introduction, the planning and design of the TH-36 project was spread out over more than a decade. It was only near the end of the process that Full Closure was considered as an alternative and maybe only because the funds for a Partial Closure were not available and the project was in danger. Both from the analysis but also more importantly from the actual outcome of the project, it is clear that the FC was the better choice both in terms of capital costs and RUCs. Therefore, retrospectively there was no reason other than concerns of public reaction that generated the avoidance of the FC alternative till it was the only feasible option.

Mn/DOT recognizing that although the FC was the only alternative it could still experience strong opposition from the public and businesses, organized and carried through a comprehensive public involvement and relations campaign to record the public view, educate the road users, and prepare them for the changes during the construction period. To conclude the experience and although the outcome during the construction was clear, a post-closure market research study was organized and executed. In the following sections an outline of the public involvement actions is presented along with highlights of some of the pre and post closure market research results. The interested reader is advised to seek more detail in the available reports and presentations describing these studies in detail. In addition, a very good outline of all the innovations involved in the TH-36 project can be found in the article in Public Roads by Barnard (2009).

Pre-closure market research

The mix of innovations that helped make the project a success started with a survey of the public about whether to partially or fully close the road during construction. This pre-closure study (Mn/DOT, 2006) had the following objectives:

- Mn/DOT was interested in public opinion regarding traffic flow during the reconstruction work on TH-36. Mn/DOT offered two scenarios of road closures, detours and weaving traffic that needed to be tested with potentially affected users of TH-36.
- Mn/DOT wanted to measure support for the reconstruction project in general, finding out who supports or rejects each of the two reconstruction scenarios and why. They also

wanted to determine what kinds of communications' information would be most helpful to their customers, especially those who may oppose the reconstruction.

Four population groups were interviewed: Residents who live within a few miles of the affected area, Through Commuters who regularly drive through the affected area, Businesses within a few miles of the affected area and people who regularly use the I-694/I-35E Commons Area (where detoured traffic might have been routed). Interviewing began on February 7, 2006 and concluded on February 23rd. Telephone interviewers from Cook Research & Consulting, Inc. and Market Solutions Group conducted the 1,074 interviews. While favoring the overall project, the Residents showed no particular preference for either of the two scenarios proposed for the reconstruction. Among those who favored the 2-Years with Constant, Non-Peak Delays, their major reason for preferring this scenario was that they would still be able to drive TH-36 without needing to find an alternate route.

Through Commuters favored the reconstruction of TH-36 just as the Residents did. When evaluating the two scenarios independently, the Through Commuters did not rate either of the two as significantly better than the other. Through Commuters did expect that the 5-Month Closure Scenario would be more "inconvenient" for them than the 2-Years with Constant, Non-Peak Delays. Those who preferred the 5-Month Closure Scenario simply wanted to get the project "done and over with" and would put up with the inconvenience for 5 months. Still being able to drive on TH-36 was the major reason for preferring the 2-Year Non-Peak Delays Scenario.

I-694/I-35E Commons Users evaluated the TH-36 Project from the perspective that traffic might be re-routed to I-694 and I-35 during the reconstruction time, thus increasing the amount of traffic passing through the Commons Area. They rated the 2-Years with Constant, Non-Peak Delays Scenario slightly more positively than they did the other scenario. They also thought the 2-Years' Scenario would be less inconvenient overall.

Business owners/managers were less supportive of a reconstruction of TH-36 than the other three populations interviewed for this study. While 58% reported being favorable towards the reconstruction, there were still 42% who were "somewhat" or "very" negative to the TH-36 Project. When asked which of the two scenarios they preferred, they showed a clear preference for the 2-Years of Constant, Non-Peak Delays Scenario. This is not surprising in light of the investment in their businesses they believed they needed to protect. Worrying that their customers may not be able to get to their businesses for 5 months and potentially facing going out of business were their major reasons for supporting the 2-Years' Scenario.

It is interesting to note that conducting such a market research is very tricky. The descriptions of the alternatives have to be factual and present the intended outcome (minimize delays) without showing any preference. As it will be discussed in the next section, it is the opinion of DOT and county engineers involved in the project, that the partial closure description was very optimistic and did not well explain the delays involved especially for the Residents who would need to traverse the construction site. The city of North St. Paul was already divided due to the heavy through traffic of TH-36 (a major argument in favor of the project), the PC would have had made it a lot worse for almost 2 years. By nature the Full Closure is a lot more straightforward to describe and therefore unduly downgraded as an option. It would be interesting to consider if there are other methods of conducting such a survey that would not have this problem.

Post-closure market research

Although as quoted from a Mn/DOT engineer “The TH-36 full closure construction was the biggest Non-event of the year”. It is the general consensus that due to a combination of appropriate planning, ample resources, strong on-site management, and a healthy dose of good luck, the four month full closure of TH-36 took place with no observable disturbance to the system and the surrounding communities. Regardless, in order for Mn/DOT to conclude the original plan of following and evaluating every step of this project, a post-closure market research study was conducted to capture the public opinion regarding the completed full closure (Mn/DOT, 2008). The survey data were collected April 21 – May 13, 2008, via telephone interviewing by Information Specialists Group under the direction of Readex Research and Mn/DOT Market Research, replicating the pre-closure sampling frame. The sample for the residents and businesses was pulled from a mapped area around North St. Paul, bordered by White Bear Avenue, I-694, and Larpenteur Avenue East. Through-commuters were selected based on zip codes in the surrounding communities and screened based on the number of round trips made on TH-36 in an average week (must have been 4 or more). The interview was terminated if the respondent was not aware of the construction project.

After the closure phase of the project was completed, the decision to close TH-36 for construction was well-received by local residents, businesses, and through-commuters, in general. Agreement with the decision to close was “strong” or “somewhat” among 92% of Residents, 84% of Businesses, and 89% of through Commuters. The most common reason given for agreement with the decision to close TH-36 was that it allowed the project to be completed faster. Many also mentioned the safety aspects and money savings associated with the road closure. Among the few who offered negative reasons for their opinion of the closure decision, the comments focused mainly on how they perceived its effect on local businesses and the inconvenience of getting around during the road closure.

Suggestions for what Mn/DOT could have done to improve the project were minimal, with nearly half in each segment indicating there was nothing that could have been done better. Among the few respondents who had any suggestions, the top mentions include doing more work on the road – removing additional stoplights/completing the Margaret Street bridge – and improving the signage/helping more with detours.

Public Participation (*Public Roads article, Barnard, 2009*)

Public involvement on this project did not end with the phone surveys. Recognizing that full road closure would detour traffic away from downtown North St. Paul, the department took steps to reduce the impact on city residents and businesses. Specifically, Mn/DOT hosted open houses and workshops in North St. Paul, the community most affected by the construction. At these meetings, representatives from Mn/DOT showed layouts and timelines for the project stages and answered questions from the public.

During construction, the department provided regular updates at city council meetings and business and local organization gatherings. Mn/DOT also sponsored a meeting in nearby Maplewood, a city located at the edge of the project area.

Additional meetings with business groups in North St. Paul provided a forum to brainstorm advertising and marketing ideas with local merchants to help them attract customers to their businesses during construction. A workshop, "Open for Business — Surviving and Thriving

During Construction," presented by Mn/DOT, drew more than 150 people. The workshop provided an overview of the project and the anticipated traffic patterns, and then shared sample marketing tactics such as holding construction-themed sales to let customers know the businesses were still open during construction and printing project information on placemats at local restaurants. Mn/DOT stressed to merchants the value of projecting a positive attitude and offering good service as ways to entice customers to find alternative routes to their businesses during the highway closure.

Mn/DOT also sponsored events targeting the broader community. For example, a group of local businesses, city officials, and staff from Mn/DOT Public Affairs hosted a celebration christened "Detour Days" to mark the highway's official closing. The celebration included a 3-mile (5-kilometer) road race, a coloring contest for children, and local vendors selling food and other items. Other special events marked project milestones, such as the grand opening of a pedestrian bridge crossing the highway. An old-fashioned Christmas celebration in downtown North St. Paul also became part of the city's roster of events and continues to this day. The holiday celebration included a visit from Santa Claus, a dance, and special offers at area restaurants. Local businesses even hosted their own events. For example, a kung fu studio invited children to decorate Christmas ornaments.

"Mn/DOT worked extensively with the citizens and businesses to make this project as painless as possible and provide some benefits for them," says Jan Walczak, North St. Paul city council member and city council liaison to Mn/DOT.

In addition, the department distributed news releases covering not only construction updates but also community events — an uncommon combination of purposes for DOT news releases. Weekly updates from the project engineer were sent to an e-mail list and posted on the project Web site, which was set up well in advance of project startup. Mn/DOT also posted photographs of construction activity on the project's Web site. Media coverage included regular project updates and stories on activities to celebrate milestones. By the end of the project, 677 people had signed up for the project's e-mail updates.

Even though the results of the post-closure survey revealed that the community deemed the project a success, Chris McMahan, director of Mn/DOT's Market Research unit, cautions that each community is likely to be different, and some might be much more averse to a full closure. "North St. Paul was a community split in two by the highway, which likely promoted favorable response to the closure, since the construction would eliminate the bottleneck for residents traveling from one side of the town to the other," she says. Further, McMahan recommends using market research techniques to survey a community and through travelers for reaction before making decisions about full closure.

"Going the extra mile with the market research and working with residents and businesses to devise and promote community events around the construction was critical to the project's success," McMahan adds. "That extra effort paid off. Although there was opposition to the highway closure, by being accessible and responding to concerns, we were able to soften the effects of construction through North St. Paul and actually gain support for the work."

Stakeholder Interviews

Part of the U of M TH-36 Full closure evaluation project covers post construction interviews with important project stakeholders. These interviews have a dual objective. First it is important

to know the details that may have influenced the public’s perception regarding the impact and success the full closure had and second, collecting the professionals’ opinion and experiences regarding this construction project helped enhance the decision assistance guide that was also a product of this project. The interviews aimed in collecting all experience gained from this Full Closure construction project and formulate it into Do’s and Do not’s that can guide future decisions. The project TL’s have provided the U team with a list suggested people for the interviews. The following table presents this list along with an indication if it was finally possible to interview each professional.

Adamsky, Steve	Mn/DOT,	X
Dockter, Timothy	Mn/DOT	
Goess, Mark	Mn/DOT	X
Kary, Brian	Mn/DOT	X
Kotilinek, Dave	City of North St. Paul	X
Kordosky, Steve	Mn/DOT	X
Kramasz, Todd	Mn/DOT	X
Misgen, Steve	Mn/DOT	
Paine, Robert	Ramsey County	X

In all occasions the first contact was done by email where an introductory letter describing the project and task needs was included along with a series of open ended questions (described in the next section) to prepare for the interview. All interviews but one was conducted in person at the individual’s office. Mark Goess provided an email response to the questions of the opening letter and by that time it was concluded that there is no need for a face to face interview. The following section presents the introduction and questions provided to the interviewees prior to the meeting. Following that is two sections presenting the summary of the interviews in terms of 4 areas, namely Planning and Execution of Full Closure, Public Relations & Reaction to Full Closure, Lessons Learned from Full Closure, and General Comments.

Pre-interview communication

The following text was transmitted to the interviewees prior to the meeting.

With an increasingly aging infrastructure, efficient and socially conscious construction project methodologies are becoming important. While all projects completed increase the experience of engineers and institutions there are certain out of the ordinary projects where such an education is too important to be left on chance. Undeniably the TH-36 full road closure was one of these rare projects and collecting / compiling all experiences from its progress is deemed of great importance by Mn/DOT.

The Minnesota Traffic Observatory at the University of Minnesota has been asked to conduct a series of interviews with project stakeholders in order to accomplish the aforementioned objective. The following are a few open ended questions that can assist in the collection of information pertinent to the lessons learned from the TH-36 Full Road Closure.

1. *Do you believe the TH-36 project was a success in the following areas?*
 - a. *Coordination of traffic operations in and around the workzone.*

- b. Planning of traffic operations in the area affected by the full road closure.*
- 2. Looking at the project retrospectively, do you think it would have had the same success if the progress was not closely monitored?*
 - 3. During the planning stage of the project a number of assumptions were made regarding traffic impacts on local streets as well as the surrounding freeways. Which of these assumptions were proven true and which had to be adjusted?*
 - 4. What adjustments had to take place after the project started to accommodate traffic around the workzone? How many of these were planned and how many were in response to problems observed in the field?*
 - 5. There were a number of innovative construction techniques being successfully employed in the TH-36 project. Did the full road closure assist, inhibit, or was irrelevant to the success of these methods?*
 - 6. Did you receive any feedback from the construction crew regarding their experience working under a full closure in contrast to a partial one?*
 - 7. From your own observations or recollection, what was the public's acceptance of the full road closure? Any voiced complains? How many of these were from local residents and how many from people living farther away using the area to access work and retail services?*
 - 8. Do you believe the public was adequately informed regarding the impacts of the road closure? Where the planning stage participatory processes like open houses and public hearing adequate?*
 - 9. Do you consider the public information steps taken leading to the full road closure adequate?*
 - 10. Retrospectively, what were the questions generated by the public after the project started? Were these questions a result of not enough information or the medium was not as successful as expected?*
 - 11. Do you consider the preparation towards the full road closure was adequate? Any additional considerations?*
 - 12. If you were to plan another full road closure somewhere in the metro area what would you do differently?*

Planning and execution of Full Closure

The TH-36 reconstruction has a long history. It begun in 1997 with the city of North St. Paul securing funding of a pedestrian bridge and later in 1999 with an even bigger package aimed in the grade separation of Margaret Street. In 2002 Mn/DOT committed \$7.5M for the reconstruction of McKnight as an interchange leading to additional funding secured both by Mn/DOT, the city and Ramsey County. Regardless, in 2007 when the final project was scheduled for commencement, the three players had to come up with an agreement to cover a \$3M shortfall. The latter even after the cheaper Full Closure had been decided.

The original plan for the reconstruction of TH-36 was to be executed as a traditional Partial Closure with the construction of two bypasses. That plan had economical issues since the overall budget was higher than the funds available. Details diverge on the point of who came first with the idea for a full closure, Mn/DOT or the city/county. Regardless, Mn/DOT engineers were called to price the alternative of a Full Closure. The main question/issue was the length of the closure. Mn/DOT asked for the advice of contractors on similar older projects. Approximately 6 to 7 contractors were called in for individual meetings to discuss the possible length of a

potential Full Closure. Apart from the public reaction regarding the length of the full closure one other major concern was the unfortunate possibility of increasing traffic on the Unweave-the-weave construction zone prompting a claim from the contractor. To minimize the chances for the latter happening, prior and during the full closure, Mn/DOT conducted almost daily travel time runs over the I-35E/I-694 corridor which showed no significant increase in TT and delay on that construction zone. All in all as quoted by several interviewees “the Decision for Full Closure was economically driven”.

Following the initial decision to seriously consider the full closure two issues had to be addressed, the planning of alternative routes and the promotion of the plan to the public. The latter is explored in the following section while in this section we outline the first as presented by the interviewees. Even before the final selection was made, the engineers responsible of exploring the Full Closure alternative conducted eight travel time runs, three of them logged during rush hours, on the supporting routes. Specifically, the TH-36->I-694->I-94->I-35E->TH-36 route was only about 10 minutes longer than a similar time period straight TH-36 with the reverse more or less on the same order. The selection of alternative routes was not difficult since in consideration with the TH-36 commuter demand, I-94 and I-694 were the de facto available freeways to consider. Regarding the local traffic on TH-36 (not trivial based on the ADT reported by Mn/DOT), the interviewees indicated that the only two streets that had any traffic of note in the immediate area were TH-36 and White Bear Avenue. This supported the assumption that there was enough extra capacity to handle the locally diverted trips. It is unclear if the knowledge of local traffic distribution was based on actual measurements on local streets or what if scenarios explored on the Travel Demand Model of the Twin Cities metro region. Most likely a little of both since it was mentioned that the construction engineer met with planners a year ahead of the project commencement while it was also stated that predictions of diversion flow were very accurate. The comments from the engineers as well as the large public participation effort described later show that there was a serious concern of the state of local streets after demand was diverted.

Shortly before the TH-36 Full Closure the County and the City improved conditions mainly on left turns on Beam Avenue which is a parallel route to the north of TH-36. According to Mn/DOT engineers this small project was useful to the overall operation during the Full Closure since TH-61 was utilized as an alternative route both in the AM and PM peak periods. In addition to the above, specifically for the purposes of the TH-36 project, conditions on surrounding intersections and specifically on ones being on designated diversion routes were observed during the first weeks of the full closure. This resulted in both Mn/DOT and the county adjusting timings on White Bear Avenue as well as on TH-61. The interviewees when asked their opinion if such retiming should have been performed prior to the commencement of the full closure indicated that it is normal for such a procedure to take place after the start of construction. It is more efficient to wait, observe conditions, and do the retiming once. The procedure involved manual observation by traffic operations personnel who also conducted the retiming of the signal transferring green on phases experiencing increases in demand. All in all it was a unanimous opinion that the coordination of traffic operations in and around the work zone was a success since Mn/DOT worked closely with Ramsey County and the affected cities to adjust signal timing and to monitor backups (if occurring) or any other operational issues that might had arose. The only reported problem reported and solved through signal retiming was on the intersection of County Road C & White Bear Avenue. Mn/DOT and the county received complaints from the public about excessive backups on Co. Rd. C.

In addition to the aforementioned prevention steps RTMC engineers actively watched cameras on TH-36 (1717) and TH-61 (1713, 1714, and 1715) during the entire course of the full closure. As an added surveillance and preventive measure the RTMC was called to employ some ITS features based on temporary sensors for reporting Travel Times on the alternative routes. While other ITS enhancement, planned in advance, worked out this particular one did not succeed in making the technology work in the time allotted. More comments on this can be found on the lessons learned section. All in all it was the general opinion in the interviews that planning of traffic operations was a success because Mn/DOT planned the detours with Ramsey County and the affected Cities. Additionally one should not forget that the DNR Gateway Trail also had to be detoured.

The number one assumption proven true was that the official detour and the local roadway system were well thought out as no roadway failed under this complete closure. Regardless the following are a series of comments referring to specific locations and instances where the above did or did not hold as well:

- Due to the TH-36 Full closure, HW-95 southbound between Stillwater and I-94 experienced increased traffic. The same can be said about HW-5, both mostly during the morning peak period. It was stated that on HW-5 west of I-694 one had to wait for two cycles to cross the intersection.
- There was no big change on TH-36 westbound of I-35E before August 1 when I-35W Bridge collapsed. This indicates that most traffic utilized the alternative routes to rejoin their original path.
- During the First few days of the Full Closure the meter from TH-61 to TH-36 westbound was turned off. There were complaints from MTA during those times that the increased ramp volume made difficult the use of the slip ramp.
- In general, backups were less than expected. It was mentioned that I-94 had less than the expected congestion (WB36 to WB694...). Although the original premise is supported by the data, I-94 experienced some peculiar increases.
- McKnight road worked well under Full Closure even as the single lane on McKnight was fully utilized. Regardless, travel time on McKnight south was increased a lot. One factor that may have affected this was the all way stop implemented in the junction with County Road B.
- TH-120 encountered some problems. Specifically, since the routing following NB TH-120 -> county road C -> TH-61 was an easier one as compared to White Bear Avenue to reach TH-36 there where longer queues on the TH-36 and TH-120 intersection. In the same area, vehicles from TH-120 NB spread over on 18th west because it was an easier left turning as compared to the 17th (county road C) which was often blocked by southbound queued vehicles.
- After one-lane opened, according to the county, Mn/DOT put too much green on TH-36 and TH-120 became congested.
- More to the west, 11th Ave was used a lot because 17th Ave is a known speed trap.
- County road B got more traffic west of White Bear Ave. Still there was no congestion issue just more traffic.
- As reported also later by the freeway loop detector data analysis, traffic stayed on I-694 during Westbound and Eastbound trips.

Following the completion of the Full Road Closure of TH-36, Mn/DOT surveyed the local street pavement quality finding no impact from additional traffic (or heavy traffic). Finally it was the opinion of the City and county interviewees that the Margaret bridge construction was slow progressing comparatively to the rest of the project. In regards to this final comment it is important to note that the weather during the period of the full closure was almost perfect. Only lost 2 days due to rain and there was no work on Sundays. This fortunate happenstance was instrumental in the completion ahead of time of the full closure part while it contributed greatly in the impression of a more fast paced progress.

Public relation and reaction to Full Closure

It was the general consensus during the interviews that the public participation efforts undertaken during the consideration of the two construction alternatives (open houses and the public hearing) were adequate, because Mn/DOT was also a presence at all community events during the planning process and after construction started. The participation of the public was deemed to be adequate and while a large effort was undertaken to convince the public on the benefits of the Full Closure all were surprised that 4 months were enough. One concern that particularly came up several times during the open house was on behalf of parents worrying about children being able to access the school bordering the construction site on the north.

Regardless of the effort put on public participation, the public was very slow to accept the full closure. Most residents and local business owners thought North St. Paul would become a ghost town. There were many complaints especially from local business owners who favored the partial closure alternative since they wanted the road open during construction. Mn/DOT had to explain that approximately a third of the traffic would still be using the local system as well as point out the taxpayer dollars saved. The most important argument Mn/DOT presented was the fact that regardless of the selection of partial or full closure, access to North St. Paul's downtown would be exactly the same. Aiding the task by the planners was a large group of the public who indicated that they would prefer that the project is completed as quickly as possible; opinion that clearly favored the full closure alternative. It is interesting to note that during those meetings a lot of questions directed to planners had to do with precise time intervals, during partial and full closure, when portions would be completed, e.g. the pedestrian bridge, Margaret Street Bridge, Gateway Trail, and specific local roads. Most of this type of info would not be available till the contractor laid out his schedule therefore answers for these questions was highly speculative.

Mn/DOT also spearheaded meetings with the business community giving them advice on things to do to help them thru the construction. There were several such meetings during which business leaders asked for a lot of signs to be deployed. This apparently became a sticky issue since it was the only case where the interviewees indicated that friction had developed. For example, in addition to a large number of direction signs for business, city leaders wanted the logo (snowman) on the signs. It is not clear if the number of signs and the logo were initially agreed compromises but both were later retracted by on site construction engineers since the desired locations and designs did not satisfy the MMUTCD safety requirements for signage on state owned roadways. Some signs should have gone up immediately but Mn/DOT waited. A lot of signs did not go up at all. To recap, directions to businesses were a reported problem but more on the organization/communication process rather than an actual problem one. The reality is that people found active solution. For example, the aggregate business on McKnight put its own signs on locations where it was allowed. Other business simply told customers to follow the aggregate

signs. Regardless of the aforementioned issue the consensus was that the preparation towards the full closure was adequate. The interviewees were not qualified to state an opinion of the impact of the construction on local business. This aspect will hopefully be explored by the post construction market research conducted by Mn/DOT. Regardless, there were anecdotal comments that Target had some reduced sales while other businesses with more drive-by nature had benefited.

Regarding safety and general operations, the State Patrol and local police was originally on call for a week but after 2 days were not needed, while Ramsey County received a small number of calls/complaints regarding McKnight which they fielded to the on-site Project Manager.

According to the project manager who was responsible for coordinating the traffic on the workzone, there was no special planning in regards to construction truck traffic on 7th Ave since the road was not weight restricted. Not denying the fact, the interviewee from the city pointed out that there was a lot of traffic of heavy construction vehicles on 7th hauling material. This prompted some small traffic problems on that street. There was no feedback from the construction crew regarding their experience working under a Full Closure as compared to a Partial Closure. Still there was reported that conditions and movements of heavy vehicles was a lot easier and faster in this construction site. The latter supports that notion that full closure assists workzone operation and may actually have an impact on construction quality in addition to cost.

Lessons Learned from this Full Closure

One of the main goals of this research is to collect, understand, and when possible generalize all the aspects dealing with full closure construction. The development of lessons-learned and good practices directions will hopefully assist in future decisions involving full road closures. We leave it to the project TAP to decide how the interviews helped achieve this goal.

It was a common opinion that, retrospectively one lesson learned from this particular project is to start discussions regarding alternative construction methods much sooner. The decision to explore closing TH-36 was made fairly late in the project development process as a means to control the cost. The decision needs to be made, even if it is just to study the possibility of closing a roadway, much sooner. This way the possible benefit can be better weight out while one can better describe the pros and cons to the public.

Even with the time provided for the consideration of the traditional partial closure, since it was not juxtaposed against any other alternatives the details of the impacts on users was not immediately described. For example, both the plan of operating a bypass of two lanes per direction with lights on McKnight and the same with one lane and no lights were very ambitious plans. Additionally, in this particular case regular Partial Closure would have needed more than two summers due to complicated elements like the deep storm sewer and the retaining walls. These details were not fully explored and transmitted neither to the public nor to the people involved in the B/C analysis of the alternatives. The main comment is that the benefits from the full closure are actually higher than the reported 15% savings generally reported. The lesson learned from this particular project was that construction planning should have been more vocal about the length and impact of the Partial Closure while a longer more detailed analysis of the Partial Closure is required. Additionally, in regards to the full closure alternative, the final

agreement was conservative in terms of contractor incentives since more aggressive scheduling was possible and would have been preferable.

As it was mentioned in the previous section one error on the part of the outreach program was that the actual access to downtown North St. Paul under both alternatives was not adequately explained to the public early in the process.

In terms to the details of full closure two comments/lessons were mentioned during the interviews. The first suggests that it is not a good idea for a full closure to extend through the winter months. This practically confines the extent of full closure projects to a single construction season. Considering the later lessons learned from the de facto full closure of the I-35W reconstruction project for almost 14 months the opinion is not well justified. In contrast, more than one of the interviewees mentioned what a good idea was to initiate the full closure on a Tuesday. One of the justifications was that this assisted first day's operation since people had fresh in their memory the signs of construction length and alternative routes.

One of the questions provided to the interviewees requested their opinion regarding the need and benefits of active and close monitoring of the full closure operations. There was a split of opinions. Some claimed that close monitoring was essential to the success of the project while others claimed that the project would have had the same success even if it was not closely monitored. It is unclear if this is an actual split of opinions or it was a misunderstanding on the part of the interviewees thinking that by success in the construction project the questions was referring to actual final roadway quality instead of a user cost minimization due to traffic impacts. The subject was not important enough to seek post interview clarifications and can be adequately resolved at the next TAP meeting.

One lesson surfaced from the interviews was the fact that planning early and in detail is important even for small projects. People do not like surprises. Additionally, it is a good practice to include operations people in the planning early in the process. In this case they were included only during the last few months prior to the initiation of the full closure. One benefit of that inclusion is the more successful planning and execution of active traveler information systems and other ITS applications. In general, ITS solutions are currently being considered a bonus and not a real need or solution. This usually results in not enough time to develop and deploy them. According to RTMC interviewees an ITS system requires a minimum of 6 months of development prior to deployment. An example of a system that could have been beneficial in the case of this and future full closures is a web map illustrating real-time information specific to the particular project.

General Comments

In this sections we would like to outline comments that either do not fit on any other section of represent personal opinions mentioned during the interviews. The fact that these opinions surfaced from the very professional and experienced group interviewed renders them worthy of mention even if the supporting evidence is weak.

- The use of A+B contracting, early completion incentives, and lane rental were vital to reducing contract time and delays before and after the full closure
- People are not likely to divert. If they encounter a peak that they are not use to they will spread. This comment seems to be supported by the evidence collected both during the

- 20K vehicles were lost from the system. Although the freeway detector data do not corroborate this notion in the case of the TH-36 full closure, they certainly do it in the case of I-35W.
- Construction site was working great.
- The public will be OK if you stick to what you tell them. (opinion)
- Daylight savings hour may cause a problem (hunch).
- Lafayette Bridge is a good candidate for Full Closure. While the Work on TH-62/I-35W crossroads could have been a successful Full Closure if I-494 had more lanes. If the option had been considered early in the process the relevant preparation could have take place.

6. Conclusions

The importance of the TH-36 FC project as a learning and possibly eye-opening experience was overshadowed only by the much bigger de-facto FC of the I-35W freeway in Minneapolis. Regardless, the complications ensuing from that catastrophe and the logical availability of detailed information only after the fact reduce its value as a quantifiable lesson. The TH-36 FC was planned and fully capitalized as a learning experience.

This report represents an account of all the effort given in gaining experience from this construction project. This experience comes from the detailed analysis of real measurements before and during the TH-36 FC, from the modeling of the two alternatives, FC and PC, estimating the actual RUCs incurring, and from the before, during, and after communication with the public and all stakeholders involved. Finally, this work tested and evaluated three tools for RUCs estimation requiring varying amounts of effort, data, and expertise. Some of these tools were a good fit for this project and some were overkill. Regardless, the goal was to develop, execute and streamline the process of utilizing each of them leaving the decision of future uses to the analyst.

We hope that this multifaceted research effort provides enough insight and guidance to planners and engineers considering FC as the construction methodology in future projects in Minnesota and elsewhere. The fact that, as the network matures, more and more of the links requiring reconstruction will be congested, increases the importance of RUCs and therefore the importance of tools for their accurate estimation and methodologies that help minimize them.

References

- Adams, M.R. *Development of a User Cost Estimation Procedure for Work Zones*. Thesis. Brigham Young University, Provo, UT, 2005.
- Alexiadis, V., Jeannotte, K., Chandra, A. *Traffic Analysis Toolbox. Vol. 1, Traffic Analysis Tools Primer*. Federal Highway Administration, Research, Development, and Technology, Springfield, VA, 2004.
- American Association of State Highway and Transportation Officials. *User Benefit Analysis for Highways Manual*. American Association of State Highway and Transportation Officials, Washington, D.C., 2003.
- Anderson, S., Ullman, G. *NCHRP Reducing and Mitigating Impacts of Lane Occupancy during Construction and Maintenance*. Transportation Research Board, 2000.
- Barceló, J., Casas, J. “Stochastic Heuristic Dynamic Assignment Based on AIMSUN Microscopic Traffic Simulator”. *Transportation Research Record*. No. 1964, 2006, pp. 70-80.
- Barceló, J., Casas, J. “Heuristic Dynamic Assignment Based on Microscopic Traffic Simulation”. *Proceedings of the 9th Meeting of the Euro Working Group on Transportation*, 2002.
- Benefit-Cost Analysis for Transportation Projects*. Minnesota Department of Transportation, St. Paul, MN, 2005.
- Benekohal, R.F., Kaja-Mohideen, A., Chitturi, M.V. *Evaluation of Construction Work Zone Operational Issues Capacity, Queue, and Delay*. University of Illinois at Urbana-Champaign, Dept. of Civil and Environmental Engineering, 2003.
- California Life-Cycle Benefit/Cost Analysis Model (Cal-B/C): User's Guide*. Booz Allen Hamilton, [S.l.], 1999.
- Buffington, J., Wildenthal, M. *Estimated Economic Impact of Selected Highway Widening Projects in Texas*. Texas Transportation Institute, College Station, TX, January 1998.
- Cascetta, E., Inaudi, D., Marquis, G. “Dynamic Estimators of Origin-Destination Matrices Using Traffic Counts”. *Transportation Science*. Vol. 27, No. 4, 1993.
- Chu, L. “A Calibration Procedure for Microscopic Traffic Simulation”. *Proceedings of the 2003 IEEE International Conference on Intelligent Transportation Systems*. Shanghai, China, 2003, pp. 1574-1579.
- Citilabs. *Cube Voyager Help Manual*, 2009.
- Daniels, G., Stockton, W.R., Ellis, D.R. *Techniques for Manually Estimating Road User Costs Associated with Construction Projects*. Texas Transportation Institute, College Station, TX, 1999.
- Daniels, G., Stockton, W.R., Hundley, R. “Estimating Road User Costs Associated with Highway Construction Projects: Simplified Method”. *Transportation Research Record*. No. 1732, 2000.

- Davis, G.A., Anderson, K.I. *Building Our Way Out of Congestion?: Highway Capacity for Twin Cities*. Minnesota Dept. of Transportation, Office of Research Administration; Available from the National Technical Information Service, St. Paul, MN; Springfield, VA, 2001.
- Dunston, P.S., Mannering, F. "Evaluation of the Full Weekend Closure Strategy for Highway Reconstruction Projects I-405 Tukwila to Factoria". WA-RD 454.1. Washington State Transportation Center, Seattle, WA, December 1998, 177 p.
- Economic Analysis Primer*. Office of Asset Management, Washington, D.C., 2003.
- Edara, P. *Estimation of Traffic Impacts at Work Zones: State of the Practice*. Virginia Transportation Research Council, Charlottesville, VA, 2006.
- Elliott, A.C., Woodward, W.A. *Statistical Analysis Quick Reference Guidebook: With SPSS Examples*. Sage Publications, Thousand Oaks, CA, 2007.
- Ellis, R.D., Herbsman, Z.J., Ellias, A.M. *Development for Improved Motorist User Cost Determinations for FDOT Construction Projects*. University of Florida, College of Engineering, Dept. of Civil Engineering, Engineering & Industrial Experiment Station, Springfield, VA, 1997.
- Farrington, N. *TH-36 Bid Estimate Study*. CH2M Hill, 2008.
- Forkenbrock, D.J., Weisbrod, G.E. *Guidebook for Assessing the Social and Economic Effects of Transportation Projects*. National Academy Press, Washington, D.C., 2001.
- Full Road Closure for Work Zone Operations: A Case Study. Reducing the Impact of Construction during the Rehabilitation of a Major Interstate Freeway: Interstate 95 in Wilmington, Delaware*. Federal Highway Administration, Washington, D.C., 2004.
- Gillespie, J.S. *Estimating User Costs as a Basis for incentive/disincentive Amounts in Highway Construction Contracts*. Virginia Transportation Research Council, Springfield, VA, 1998.
- Gou, J., Zhang, L., Altman, J.C., Davis, W. "QuickZone Improvement for Rural Freeway and Model Validation". *Transportation Research Record*. No. 2107, 2009.
- Han, A.F. *Deriving Origin-Destination Information from Routinely Collected Traffic Counts: Volume II: Trip Table Synthesis for Multipath Networks*. Institute of Transportation Studies, University of California, Berkeley, 1981.
- Hardy, M., Wunderlich, K. *Traffic Analysis Toolbox: A Guide for Analysts Volume IX, Work Zone Modeling and Simulation*. U.S. Dept. of Transportation, Federal Highway Administration, Office of Operations, Washington, D.C., 2009.
- Herbsman, Z.J., Chen, W.T., Epstein, W.C., Brown, L.K., Herbsman, Z.J. "Time is Money: Innovative Contracting Methods in Highway Construction". *Journal of Construction Engineering and Management*. Vol. 123, No. 1, 1997, pp. 99.
- Hourdos, J., Michalopoulos, P.G., Kottommannil, J. "Practical Procedure for Calibrating Microscopic Traffic Simulation Models". *Transportation Research Record*. No. 1852, Washington, D.C., 2003, pp. 130-139.

- Krammes, R.A., Ullman, G.L., Dresser, G.B. *Application of Analysis Tools to Evaluate the Travel Impacts of Highway Reconstruction with Emphasis on Microcomputer Applications*. National Technical Information Service, Springfield, VA, 1989.
- Lambert, J.H., Joshi, N.N., Ferguson, W.S. *Benefits Estimates of Highway Capital Improvements with Uncertain Parameters*. Virginia Transportation Research Council, Charlottesville, VA, 2006.
- Lewis, D.L. *Road User and Mitigation Costs in Highway Pavement Projects*. National Academy Press, Washington, D.C., 1999.
- Life Cycle Cost Analysis in Pavement Design in Search of Better Investment Decisions*. Federal Highway Administration, Washington, D.C., 1998.
- Life-Cycle Cost Analysis Primer*. Federal Highway Administration, Washington, D.C., 2004.
- Martin, P., Stevanovic, A. "Design/Build vs. Traditional Construction User Delay Modeling: An Evaluation of the Cost Effectiveness of Innovative Construction Methods for New Construction. Part 1". MPC Report No. 07-187A, Mountain-Plains Consortium, North Dakota State University, Fargo, ND, May 2007.
- Meeting the Customer's Needs for Mobility and Safety during Construction and Maintenance Operations: Model Work Zone Traffic Management Program and Self Evaluation Guide*. Federal Highway Administration, Office of Program Quality Coordination, Washington, D.C., 1998.
- Road-User Cost due to Unavailability of Interstate 35W Mississippi River Crossing at Minneapolis*. Minnesota Department of Transportation, St. Paul, MN, 2007.
- Road-User Cost for SP 6211-81: Reconstruction of TH-36 in North Saint Paul*. Minnesota Department of Transportation, St. Paul, MN, 2006.
- Road User Cost Manual*. New Jersey Department of Transportation, 2001.
- Roess, R.P., Prassas, E.S., McShane, W.R. *Traffic Engineering*. Pearson/Prentice Hall, Upper Saddle River, NJ, 2004.
- Saag, J.B. "NCHRP Synthesis of Highway Practice 273: Project Development Methodologies for Reconstruction of Urban Freeways and Expressways". Transportation Research Board, Washington, D.C., 1999.
- Salem, S., Genaidy, A.M. *Improved Models for User Costs Analysis*. Ohio Department of Transportation, Columbus, OH, 2008.
- Schnell, T. *Evaluation of Traffic Flow Analysis Tools Applied to Work Zones Based on Flow Data Collected in the Field*. Operator Performance Laboratory, Center for Computer Aided Design, University of Iowa, Iowa City, IA, 2001.
- Schrank, D.L., Lomax, T.J. *The 2007 Urban Mobility Report*. Texas Transportation Institute, Texas A & M University and Texas Transportation Institute, College Park, TX, 2007.
- Sekhar, A. *Issues in Freeway Corridor Simulation*. Thesis, University of Minnesota, Minneapolis, 2002.
- Ullman, G.L. "NCHRP Synthesis of Traffic Management Techniques for Major Freeway Construction". Transportation Research Board, Washington, D.C., 1989.

Webster, F.V., Cobbe, B.M. *Traffic Signals*. H.M.S.O. and Road Research Laboratory, London, UK, 1966.

Appendix A: Task 8 Deliverable: Lessons Learned

University of Minnesota

TH-36 Full Closure Construction:
Evaluation of Traffic Operations
Alternatives

Task 8 Deliverable:

Lessons Learned

December 2009

Table of Contents

Introduction.....	A-3
Full Road Closure Background.....	A-3
Benefit Costs Analysis for Full Closure Projects	A-5
Selecting the appropriate Traffic Analysis tool	A-5
Empirical Estimation of RUCs	A-6
Sketch-Planning Tool: QuickZone	A-7
Travel Demand Model: Cube Voyager	A-7
Simulation Model: AIMSUN NG	A-8
Results.....	A-8
Project analysis organization	A-9
Weighing the Public Opinion.....	A-11
Pre-Closure Market Research	A-11
Post-Closure Market Research.....	A-12
Public Participation (Public Roads article, Barnard, May/June 2009)	A-13
Lessons learned.....	A-13
Planning and Execution of Full Closure	A-13
Public Relation & Reaction to Full Closure	A-14
Lessons Learned from this Full Closure	A-15
BCA lessons learned	A-16
Conclusions.....	A-17

List of Figures

Figure 1. TH-36 Reconstruction project area and improvement plans

List of Tables

Table 1 RUCs results for TH-36 reconstruction

Table 2 RUCs estimation effort per tool

Introduction

According to the 2007 Urban Mobility Report, 78 billion dollars were lost due to congestion on urban roadways (Schrang et al, 2007). Many urban corridors around the country experience demand that is close or greater than the available capacity. Roadways undergoing major reconstruction normally already serve considerable demand, a fact that increases the importance of the impact to the roadway users, expressed as Road User Costs (RUCs) in the rest of this document, and raises safety concerns both for the driving public as well as for the people working on reconstruction projects. Departments of transportation (DOTs), which always look for ways to maintain safe service delivery during construction projects, continually explore new alternatives. One such alternative is Full Road Closure (FC).

The first long-term FC of a major urban highway in Minnesota was the TH-36 reconstruction initiated spring of 2007. The goal of the TH-36 reconstruction project was to increase safety and improve access through the cities of Maplewood and North St. Paul. The project involved the elimination of all at-grade intersections (six) on a 2.2 mile section between White Bear Avenue in Maplewood and Highway 120 (Century Avenue) in North St. Paul, as shown in Figure 1. The TH-36 project had a long history of planning, scope growth, and modifications in almost all of its details. A comprehensive timeline of these plans can be found in the April 2006 Environmental Assessment (Mn/DOT, 2006) and in (Kotilinek, 2007). Up until 2004 when Mn/DOT finished the final layout, the project was planned as a Partial Closure (PC). Due to shortage of funds a FC construction method was finally selected.

FC, being a relatively new construction methodology, still carries a level of uncertainty and the potential of considerable social cost. As it turned out, the FC was by far the best choice both in terms of the actual outcome of the project but also, as it will be examined later in this document, by the small additional RUCs as compared to the savings in labor and time. Regardless, Mn/DOT considered this project a good opportunity for learning and this FC “lessons learned” document is based on the experience collected during the TH-36 project. This guide outlines the market research and public involvement campaign activities, referencing documents and sources with more comprehensive information. Additionally, the opinion, retrospective analysis, and observations of engineers involved in the project were collected and compiled in a series of lessons learned. Finally, a quantitative assessment of the FC as compared to a hypothetical PC is made outlining the ways such an alternative be evaluated in terms of RUCs. A comprehensive analysis of what really happened during the Full Closure in terms of diversion and congestion is included in the “TH-36 Full Closure Construction: Evaluation of Traffic Operations Alternatives” project final report (Hourdos et al. 2009).

Full Road Closure Background

The reported evidence in Full Road Closure for Work Zone Operations - A Cross-Cutting Study (FHWA, 2003) suggests three major benefits from FC. First, the construction duration is much shorter. Seven of eight projects reported over 60 percent reduction of construction duration. The significant reduction of duration could mitigate the traffic impacts and save user costs. In addition, the shorter construction duration might also make the public sentiment more positive

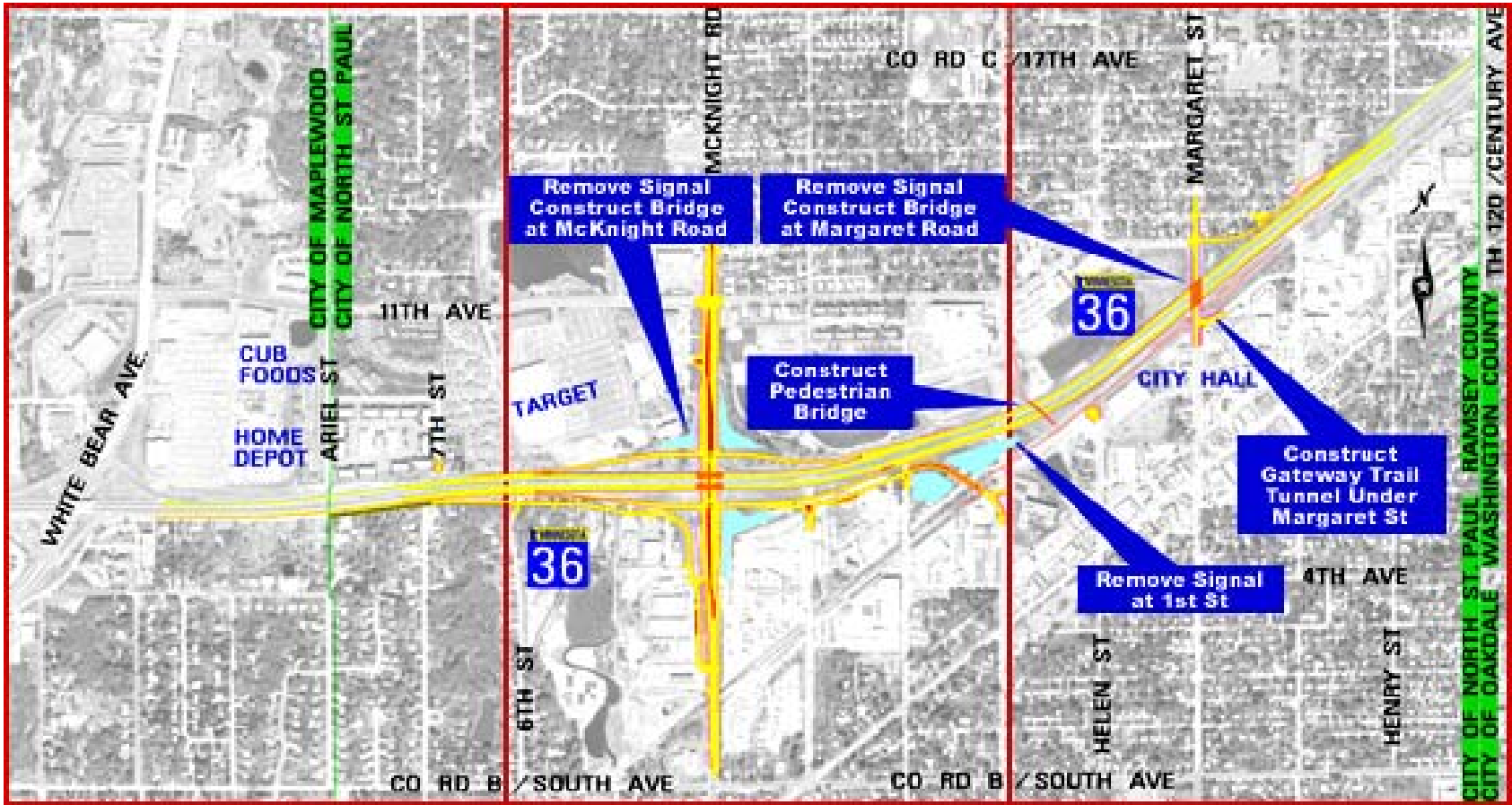

Figure 1. TH-36 Reconstruction project area and improvement plans (source: Mn/DOT)

towards the project. In fact, all the projects in the study reported positive public sentiment. Second, FC might improve the workers' productivity. This is because workers have more work space for construction and less distraction by the traffic. Five of eight projects reported better construction quality. Last but not least, a higher level of safety was realized. Both travelers and workers felt safer during FC construction. Travelers did not pass through the work-zone and the workers were not exposed to open traffic. Six of eight projects cited improved safety. From the FHWA study one can take the following as important issues:

- Alternate routes are critical in utilizing the full benefits from FC. Availability of alternate routes helps carry diverted traffic and reduce the congestion in the corridor.
- While it is important to estimate the traffic conditions during the construction period, this is rarely the state of the practice. Traffic modeling used properly may be a good way to evaluate the condition of alternative routes. Planners can make suitable traffic operations plans on alternate routes to improve the traffic conditions.
- The greater benefit from the FC stems from its substantially shorter duration as compared to partial closure. This does not come without a price, as FC incurs higher Daily RUCs.

Benefit Costs Analysis for Full Closure Projects

The Benefit Cost Analysis (BCA) is a well defined procedure and one of the foundations in transportation system planning and development. User costs (RUCs) during the construction period are one of the weaker links in BCA. These costs incur from the additional delay due to reduced speeds, vehicle operating costs due to longer trip distances over detours, and costs from crashes that can be attributed to the construction operations. (FHWA, 1998; NJ/DOT, 2001). There is no consensus for how different states treat RUCs, if they consider them at all.

While the differences between PC alternatives focus on capital costs (# of bypasses, etc), the difference in RUCs between FC and PC can be, at least conceptually, extremely large and play a decisive factor both in the ranking of a project during program development, as well as in the selection of the most appropriate construction methodology.

The importance of the RUCs in the BCA is neither emphasized in the currently available guides, nor do the guides mention the cases where RUCs may be important. Regardless, the importance of the RUCs has increased recently not only due to the proliferation of FCs but also due to the benefits recognized in innovative contracting techniques like A+B bidding, Lane Rental, Incentives/Liquidated Savings and others.

RUCs should be included in the BCA procedure early on, but with a staged increase of resolution/accuracy fitting the needs of the project. This staged approach is closely related to the methodology followed for the RUCs estimation.

Selecting the appropriate Traffic Analysis tool

In this section we outline four alternative methodologies for RUCs estimation, we evaluate their efficiency in terms of effort and accuracy achieved, and we propose some recommendations on the selection of the estimation method(s).

Estimating RUCs involves the estimation of traffic operations and crashes in the No-Build case (before) and During all phases of construction. According to the FHWA "Work Zone Best Practices Guidebook" (FHWA, 2000), "transportation agencies would need to use computer modeling to assess the traffic and safety impacts as well as the construction duration." For the

purposes of this guide, the three methodologies based on computer modeling that were implemented in the TH-36 project are summarized and compared to results from an empirical, engineering-judgment-based, method used by Mn/DOT. The three computer model methodologies vary greatly in terms of complexity, effort, and accuracy achieved. It is prudent to note up front that the more complex methodologies are clearly inappropriate for a project of the size and complexity of TH-36 which is used in this case as a convenient testing ground. Details of the models and the analysis procedures can be found in the final report of the TH-36 Full Closure project.

Directions and instructions on the selection of the most appropriate analysis tools are available in the FHWA “Traffic Analysis Tools Primer” (Alexiadis et al. 2004). The project manager having outlined the particular project characteristics selects the appropriate tool(s). Project characteristics to consider can be the following:

- Availability of detours and level of confidence in predicting which routes will be utilized. For example, in the case where the detour routes are either numerous or the ratio of diversion demand each will carry, a Travel Demand Model or a Dynamic Traffic Assignment model may be required to help the analyst.
- Complexity of capacity improvement plans. For example, if the available detours require modifications in geometry (bottleneck elimination) or traffic control (congestion pricing), a microscopic simulation model may be required.
- Retiming of a large portion of urban intersections to improve detour capacity may require the involvement of a signal optimization tool.
- Complicated construction staging plans may require the combination of the above with a construction management tool like CA4PRS, briefly discussed at the end of this section.

Assessing the needs and characteristics of the TH-36 project and this guide, three tools, with increasing levels of cost, complexity, and features, were selected. The tools selected are: a “Sketch-planning tool” QuickZone (FHWA, 2000), a “Travel Demand Model”, Cube Voyager (Citilabs, 2009), and a “Simulation Model”, AIMSUN NG (TSS, 2009). For each of these tools a methodology for RUCs estimation is briefly described below noting the effort required and accuracy achieved. The objective of this section is to be a resource in selecting the proper traffic analysis tool for calculating RUCs. HCM and optimization tools are not discussed as a choice since they are more relevant in evaluating isolated facilities and offer little in cases where diversion is involved, the major issue in FCs.

Empirical Estimation of RUCs

The Office of Investment Management performed an empirical RUCs estimation following a methodology directly based on assumptions and engineering judgment (Memo of August 17, 2006). This comparatively simple methodology nevertheless produced an estimate very close to the ones produced with the more sophisticated tools. The engineers, based solely on direct knowledge of the network, selected four possible diversion routes; two freeway routes serving long commuting trips using TH-36 as a pass-through and two routes utilizing local streets serving the surrounding neighborhoods. Short visits in these diversion routes provided travel time estimates while existing detection infrastructure on the freeways provided very accurate descriptions of current traffic conditions. Assuming that the additional traffic in each diversion will not cause significant difference in traffic conditions, the additional travel times and travel

distances were estimated. Simple calculation produced the estimated total delay cost and vehicle operational costs due to the FC. The RUCs of the FC were estimated at \$69,000 per day, while RUCs for the PC was estimated at \$9,000 per day. Please note that the RUCs value for the PC refers to the second stage of the project (3 months of one lane open after the FC). For convenience, in this and the other three methodologies, we used this value for the entire duration of the 20-month PC alternative.

Sketch-Planning Tool: QuickZone

QuickZone, developed by FHWA and based on Microsoft Excel, is easy to use and quick in obtaining results. It uses a simple deterministic queuing model to estimate delays and queue lengths in the work zone as well as RUCs due to diversion. Volume variation over a day and season can be considered in describing the demand. It also takes into account various factors such as peak spreading, trip cancelation, and route changes. The traffic impacts in QuickZone are expressed in terms of user costs, user delay, queue length, and traffic behavior (trip cancelation, time shift, etc).

Although QuickZone takes many factors into account, it has some serious limitations. First of all, QuickZone can only evaluate queue delay in the selected mainline. Since QuickZone will never allow the detour route to exceed capacity due to redirected demand, only the cost from the additional distance travelled by the diverted traffic is calculated. Other links in the network, not in the mainline or detour, are ignored during the analysis. Second, QuickZone, in version 2.0, can only use one detour. This means only one detour carries diverted traffic during the construction. Finally, the traffic assignment algorithm in QuickZone is based on spare capacity of the detour. If the user chooses a congested or close to congested roadway as a detour, little traffic will be assigned to the detour and therefore the congestion in the mainline significantly increases. In such case, the delay and user costs in the mainline will be overestimated. It is interesting to also note that following the directions in the manual, the attempt to describe the FC as a work zone with capacity zero caused the tool to crash.

Considering the advantages and limitations of QuickZone, in the TH-36 project we proposed an improvement to allow evaluation of area-wide impacts. As mentioned earlier, QuickZone can only evaluate the mainline and one detour conditions. In this improvement, all roadways in the network can be evaluated, while, more routes can carry diversions. The process of improvement, being outside the immediate scope of this document, can be found in the “TH-36 Full Closure Construction: Evaluation of Traffic Operations Alternatives” project final report (Hourdos et al. 2009).

QuickZone is a good choice when there is no ambiguity on the detour routes drivers will use during the construction. Also it works best when the analyst has good knowledge of the capacity of the detour routes, a major assumption in this tool. Rural road construction projects are good candidates for this analysis tool.

Travel Demand Model: Cube Voyager

Using a Travel Demand Model (TDM) is only feasible if a pre-existing, calibrated regional model is available. Assuming that nobody will change home or employment location due to the construction operations, from the whole 4-step method, only the final traffic assignment step is employed to estimate link flows for the No-Build, During, and As-Build cases. The difference of link flows between the first two scenarios indicates the condition of traffic diversion while the

third is needed for the full BCA. Additionally, although Origin/Destination demand may change between the periods of before, and during, and after the construction, the effort of obtaining new ODs is significant. For this reason, OD demand is usually assumed to be constant during the three scenarios (demand increase is handled in the BCA for the projects lifetime). Mode choice can also change during the construction but experience from many previous projects shows that diversion is much more common than mode change (Krammes, 1989). Following these assumptions it is clear that the purpose of using a travel demand model is to evaluate diversion allowing for congestion mitigation strategies on the work zone, the assigned detours, and the rest of the impacted area.

Generally, the goal of the MPO who develops and maintains the TDM is to capture the big movements of people commuting in and out of the metro. It is possible that the area of the construction may not have been satisfactory calibrated and the effect of the closing or capacity reduction of a single link may not be captured adequately. To avoid such problems, recent, preferably hourly, volumes of important links in the vicinity of the planned construction should be collected and compared with the results of the travel demand model. Most additional calibration will only involve adjusting traffic assignment parameters.

A TDM is required when knowledge of driver re-route behavior is unreliable or the impacted area can be large. The TDM can be used alone after properly validated or in combination with QuickZone or some other simpler tool. In the latter case the TDM helps the analyst verify the assumed detour behavior trends. Projects inside dense urban areas almost always require the involvement of a TDM tool as long as no special ITS and other traffic management methods are not involved during the construction.

Simulation Model: AIMSUN NG

Microscopic simulation models are the most complex and powerful of the traffic analysis tools. They require the greatest effort as well as require the most data. Generally, implementing a microscopic simulation model requires detailed knowledge of the network geometry, traffic demand, signal control plans etc. In order to obtain reliable results, calibration of the network is paramount and usually very time consuming. However, microscopic simulation models provide higher quality results than sketch/planning tool and TDMs, such as average travel time, total travel time, average delay, queue sizes, number of stops, fuel consumption and others. These additional results can be used for calculating the RUCs in greater detail. The calculation procedure of RUCs is the same as with the TDM.

Only the most complicated projects may require the use of microscopic simulation. Projects that include permanent or temporary capacity improving elements, either based on geometry changes or traffic control plans, require a simulation model if the success of these improvements is unknown. Cases of Active Traffic Management or other ITS tools may also be a good reason for selecting this tool. Finally, if the detour routes involve congested or close to congestion freeway routes, only a simulation tool will reliably predict the probability and effect of flow breakdown.

Results

Although not directly applicable to the objective of this guide, the results from the four methodologies are summarized in order to illustrate better the conclusions and recommendations produced. Table 1 shows the results from the four methodologies for the estimation of RUCs and the respective results of the BCA with and without RUCs. The B/C ratios for the empirical and

the QuickZone methods only include RUCs and capital costs with no consideration for life-of-project benefits. They are comparable with themselves but not numerically with the other methodologies. This is due to the fact that additional effort, and assumptions, beyond the RUCs estimation is needed with these two methodologies to tabulate the benefits and costs over 20 years. The B/C ratios from Voyager and AIMSUN include the entire BCA methodology since the tools require little additional effort in producing the 20 year values.

Apart of the actual results and their similarities and differences, the different methodologies have considerably different requirements in terms of effort and data. During this work we made a point to record the effort involved in each stage of implementation of the methodologies. Table 2 presents estimates of the time involved in each implementation when the task is undertaken by a single engineer. In these estimates, the assumption is made that the engineer is familiar with the tool so these durations do not include any learning time. As pointed out earlier, for the TH-36 project the use of micro-simulation was unwarranted although it may have produced slightly more accurate results. The data needs and effort required do not make it a cost effective approach. Regardless, in other projects such a tool may be necessary.

Progressively, from QuickZone to simulation, the number of assumption the analyst needs to make decreases. The project manager should also consider the effort involved in formulating and checking these assumptions. Normally, seasoned engineers familiar with the project area can safely make these assumptions with little effort and suffer a small loss of accuracy; evidence to this is the agreement of the empirical estimation method with all the other more complicated methods. Regardless, checking the result sensitivity to these assumptions can easily double or triple the effort of the empirical and QuickZone methods. Calibration of a simulation model can be a bottomless pit, therefore it should be better handled by an experienced modeler and capitalize on prior use of this method in other projects in the area. A large number of model parameters remain the same from location to location and their use can significantly reduce the effort involved. In the final report of the TH-36 project, the interested reader can find the results of a preliminary sensitivity analysis of the three methods presented.

Project analysis organization

Although the TH-36 FC is not a good example for a complicated construction project, other cases like for example the Unweave-the-Weave project on I-35E are. In such more complicated projects usually a number of shorter period FCs are involved complicating the analysis. Tools like the *Construction Analysis for Pavement Rehabilitation Strategies* (CA4PRS, <http://www.dot.ca.gov/research/roadway/ca4prs/index.htm>) developed by Caltrans for FHWA can help organize the analysis and keep track of the RUCs produced at every stage of the construction period. CA4PRS does not replace the analysis tools mentioned earlier since the daily RUCs are an input provided by the user. Instead it offers a good organizations environment for projects with complicated staging plans and short term FCs and PCs.

Table 1 RUCs results for TH-36 reconstruction

	Full Closure				Partial Closure			
Tools	Daily RUC	Total RUC	B/C ratio w RUCs	B/C ratio w/o RUCs	Daily RUC	Total RUC	B/C ratio w RUCs	B/C ratio w/o RUCs
Empirical	\$69,000	\$11,160,000	2.91*	3.99*	\$9,000	\$5,307,000	3.0*	3.47*
QuickZone	\$69,600	\$12,114,000	3.6*	3.7*	\$18,600	\$11,969,000	2.8*	3.1*
Voyager	\$79,500	\$13,680,000	4.10	4.59	\$19,500	\$11,492,000	3.32	3.68
AIMSUN	\$83,000	\$14,781,000	6.98	7.52	\$25,900	\$15,273,600	5.54	6.02

*Ratios only include RUCs and capital costs. No life-of-project benefits.

Table 2 RUCs estimation effort per tool

	QuickZone	Cube Voyager	AIMSUN
Collecting data	2-3 days	~1 month	1-2 months
Engineering analysis with assumptions	2-3 days	2-3 days	2-3 days
Coding the network	hours		2 months
Calibration/validation	n/a	days	8 months
Executing the model	minutes	hours	2 hrs/replication (Total : 1 weeks)
Interpretation of the results	1 day	2-3 days	2-3 days
Total	1-2 weeks	1.5 month	12 months

Weighing the Public Opinion

Mn/DOT recognized that although the FC was the only alternative, there could be strong opposition from the public and businesses. Therefore Mn/DOT organized and carried out a comprehensive public involvement and relations campaign to record the public view, educate the road users, and prepare them for the changes during the construction period. To conclude the experience, a post-closure market research study was organized and executed.

In the following sections an outline of the public involvement actions is presented along with highlights of some of the pre- and post-closure market research results. The interested reader is advised to seek more detail in the available reports and presentations describing these studies in detail. In addition, a very good outline of all the innovations involved in the TH-36 project can be found in the article by Barnard in *Public Roads* (May/June 2009).

Pre-Closure Market Research

The mix of innovations that helped make the project a success started with a survey of the public about whether to partially or fully close the road during construction. This pre-closure study conducted by Mn/DOT in 2006 had the following objectives:

- Mn/DOT was interested in public opinion regarding traffic flow during the reconstruction work on TH-36. Mn/DOT offered two scenarios of road closures, detours and weaving traffic that needed to be tested with potentially affected users of TH-36.
- Mn/DOT wanted to measure support for the reconstruction project in general, finding out who supports or rejects each of the two reconstruction scenarios and why. They also wanted to determine what kinds of communications' information would be most helpful to their customers, especially those who may oppose the reconstruction.

Four population groups were interviewed:

- Residents who live within a few miles of the affected area,
- Through Commuters who regularly drive through the affected area,
- Businesses within a few miles of the affected area and
- People who regularly use the I-694/I-35E Commons Area (where detoured traffic might have been routed).

While favoring the overall project, the Residents showed no particular preference for either of the two scenarios proposed for the reconstruction. Through Commuters favored the reconstruction of TH-36 just as the Residents did. When evaluating the two scenarios independently, the Through Commuters did not rate either of the two as significantly better than the other. Through Commuters did expect that the 5-Month Closure Scenario would be more "inconvenient" for them than the 2-Years with Constant, Non-Peak Delays. People who regularly use the I-694/I-35E Commons area evaluated the TH-36 Project from the perspective that traffic might be re-routed to I-694 and I-35 during the reconstruction time, thus increasing the amount of traffic passing through the Commons Area. They rated the 2-Years with Constant, Non-Peak Delays Scenario slightly more positively than they did the other scenario. They also thought the 2-Years' Scenario would be less inconvenient overall.

Business owners/managers were less supportive of a reconstruction of TH-36 than the other three populations interviewed for this study. While 58% reported being favorable towards the reconstruction, there were still 42% who were “somewhat” or “very” negative to the TH-36 Project. When asked which of the two scenarios they preferred, they showed a clear preference for the 2-Years of Constant, Non-Peak Delays Scenario. This is not surprising in light of the investment in their businesses they believed they needed to protect. Worrying that their customers may not be able to get to their businesses for 5 months and potentially facing going out of business were their major reasons for supporting the 2-Years’ Scenario.

It is interesting to note that conducting such a market research is very tricky. The descriptions of the alternatives have to be factual and present the intended outcome (minimize delays) without showing any preference. As it will be discussed in the next section, it is the opinion of DOT and county engineers involved in the project, that the partial closure description was very optimistic and did not well explain the delays involved especially for the Residents who would need to traverse the construction site. The city of North St. Paul was already divided due to the heavy through traffic of TH-36 (a major argument in favor of the project), the PC would have had made it a lot worse for almost 2 years. By nature the Full Closure is a lot more straightforward to describe and therefore unduly downgraded as an option. It would be interesting to consider if there are other methods of conducting such a survey that would not have this problem.

Post-Closure Market Research

Although as quoted from a Mn/DOT engineer “The TH-36 full closure construction was the biggest Non-event of the year”. It is the general consensus that due to a combination of appropriate planning, ample resources, strong on-site management, and a healthy dose of good luck, the four month full closure of TH-36 took place with only minor disturbance to the system and the surrounding communities. In order for Mn/DOT to conclude the original plan of following and evaluating every step of this project, a post-closure market research study was conducted by Mn/DOT in 2008 to capture the public opinion regarding the completed full closure.

After the closure phase of the project was completed, the decision to close TH-36 for construction was well-received by local residents, businesses, and through-commuters, in general. Agreement with the decision to close was “strong” or “somewhat” among 92% of Residents, 84% of Businesses, and 89% of through Commuters. The most common reason given for agreement with the decision to close TH-36 was that it allowed the project to be completed faster. Many also mentioned the safety aspects and money savings associated with the road closure. Among the few who offered negative reasons for their opinion of the closure decision, the comments focused mainly on how they perceived its effect on local businesses and the inconvenience of getting around locally during the road closure.

Suggestions for what Mn/DOT could have done to improve the project were minimal, with nearly half in each segment indicating there was nothing that could have been done better. Among the few respondents who had any suggestions, the top mentions include doing more work on the road – removing additional stoplights/completing the Margaret Street Bridge – and improving the signage/helping more with detours.

Public Participation (Public Roads article, Barnard, May/June 2009)

Public involvement on this project did not end with the phone surveys. Recognizing that FC would detour traffic away from downtown North St. Paul, Mn/DOT took steps to reduce the impact on city residents and businesses. Specifically, Mn/DOT hosted open houses and workshops in North St. Paul, the community most affected by the construction. At these meetings, representatives from Mn/DOT showed layouts and timelines for the project stages and answered questions from the public.

During construction, Mn/DOT provided regular updates at city council meetings and business and local organization gatherings. Mn/DOT also sponsored a meeting in nearby Maplewood, a city located at the edge of the project area. Additional meetings with business groups in North St. Paul provided a forum to brainstorm advertising and marketing ideas with local merchants to help them attract customers to their businesses during construction. A workshop, "Open for Business — Surviving and Thriving During Construction," presented by Mn/DOT, drew more than 150 people.

Mn/DOT also sponsored events targeting the broader community. For example, a group of local businesses, city officials, and staff from Mn/DOT Public Affairs hosted a celebration christened "Detour Days" to mark the highway's official closing. The celebration included a 3-mile (5-kilometer) road race, a coloring contest for children, and local vendors selling food and other items.

Lessons learned

Post-project information was collected from the stakeholders involved in the planning, execution, and local traffic operations of the TH-36 reconstruction. Specifically, a series of interviews with Mn/DOT, county, and city engineers took place and their after-the-fact evaluation of project operations and lessons learned are compiled. This information is combined with lessons learned during the evaluation of BCA methodologies in a list of issues engineers and planners should be aware of in future projects where Full Closure is considered.

Planning and Execution of Full Closure

When Mn/DOT engineers were called to price the alternative of a FC, the main question was the length of the closure. Mn/DOT asked for the advice of contractors on similar older projects. Approximately 6 to 7 contractors were called in for individual meetings to discuss the possible length of a potential FC.

Apart from the public reaction regarding the length of the FC, one other major concern was the unfortunate possibility of increasing traffic on the Unweave-the-weave construction zone prompting a claim from the contractor. To minimize the chances for the latter happening, prior and during the full closure, Mn/DOT conducted almost daily travel time runs over the I-35E/I-694 corridor which showed no significant increase in TT and delay on that construction zone.

Following the initial decision to seriously consider the FC the planning of alternative routes was raised as one of the main issues involved. Even before the final selection was made, the engineers responsible of exploring the FC alternative conducted eight travel time runs, three of them logged during rush hours, on the supporting routes. The selection of alternative routes was

not difficult since in consideration with the TH-36 commuter demand, I-94 and I-694 were the de facto available freeways to consider. Regarding the local traffic on TH-36 (not trivial based on the ADT reported by Mn/DOT), the interviewees indicated that the only two streets that had any traffic of note in the immediate area were TH-36 and White Bear Avenue. This supported the assumption that there was enough extra capacity to handle the locally diverted trips. The comments from the engineers as well as the large public participation effort described later show that there was a serious concern of the state of local streets after demand was diverted.

Shortly before the TH-36 Full Closure, the County and City engineers improved conditions on surrounding intersections. Specifically, intersections on HW-61 between TH-36 and I-694 were widened to accommodate left turn pockets. The designated diversion routes were observed during the first weeks of the FC prompting the retiming of a number of intersections that exhibited long queues. The interviewees when asked their opinion if such retiming should have been performed prior to the commencement of the FC indicated that it is normal for such a procedure to take place after the start of construction. It is more efficient to wait, observe conditions, and do the retiming once.

As an added surveillance and preventive measure, the RTMC was called to employ some ITS features based on temporary sensors for using portable variable message signs reporting travel times on the alternative routes. While other ITS enhancements like 511 updates and increased RTMC surveillance and monitoring of speeds on the alternative routes, planned in advance, worked out, this particular one did not succeed in making the technology work in the time allotted. All in all it was the general opinion in the interviews that planning of traffic operations was a success because Mn/DOT planned the detours with Ramsey County and the affected Cities. Additionally, it should be noted that the DNR Gateway Trail also had to be detoured.

The number one assumption proven true was that the official detour and the local roadway system were well thought out as no roadway failed under this complete closure.

Following the completion of the Full Road Closure of TH-36, Mn/DOT surveyed the local street pavement quality finding no impact from additional traffic (or heavy traffic). Finally it was the opinion of the City and county interviewees that the Margaret street bridge construction was too slow compared to the rest of the project. In regards to this final comment it is important to note that the weather during the period of the full closure was almost perfect. Only 2 days were lost due to rain and there was no work on Sundays. This fortunate weather was instrumental in the completion ahead of time of the full closure period and it contributed greatly in the impression of fast paced progress.

Public Relation & Reaction to Full Closure

It was the general consensus during the interviews that the public participation efforts undertaken during the consideration of the two construction alternatives (open houses and the public hearing) were adequate, because Mn/DOT was also a presence at all community events during the planning process and after construction started. The participation of the public was deemed to be adequate and while a large effort was undertaken to convince the public on the benefits of the Full Closure, all were surprised that 4 months were enough. One concern that came up several times during the open house was on behalf of parents worrying about children being able to access the school bordering the construction site on the north.

In the Mn/DOT meetings with the business community a lot of signs directing motorists to the businesses were agreed to be deployed. This apparently became a sticky issue since it was the only case where the interviewees indicated that friction had developed. For example, in addition to a large number of direction signs for business, city leaders wanted the logo (snowman) on the signs. It is not clear if the number of signs and the logo were initially agreed compromises but both were later retracted by on site construction engineers since the desired locations and designs did not satisfy the MMUTCD safety requirements for signage on state owned roadways. Some signs should have gone up immediately but Mn/DOT waited. A lot of signs did not go up at all. To recap, directions to businesses were a reported problem but more on the organization/communication process rather than an actual problem during the project. The reality is that people found active solutions. For example, the aggregate business on McKnight road put its own signs on locations where it was allowed. Other business simply told customers to follow the aggregate signs. Regardless of the aforementioned issue the consensus was that the preparation towards the full closure was adequate. The interviewees were not qualified to state an opinion of the impact of the construction on local business.

Regarding safety and general operations, the State Patrol and local police were originally on call for a week but after 2 days it was clear that they were not needed, while Ramsey County received a small number of complaints regarding McKnight road which they referred to the on-site Project Manager.

According to the project manager who was responsible for coordinating the traffic in the work zone, there was no special plan in regard to construction truck traffic on 7th Ave since the road was not weight restricted. Not denying the fact, the interviewee from the city pointed out that there was a lot of traffic of heavy construction vehicles on 7th hauling material. This prompted some small traffic problems on that street. There was no feedback from the construction crew regarding their experience working under a Full Closure as compared to a Partial Closure. Still it was reported that conditions and movements of heavy vehicles was a lot easier and faster in this construction site. The latter supports that notion that full closure assists work zone operation and may actually have an impact on construction quality in addition to cost.

Lessons Learned from this Full Closure

One of the main goals of this research was to collect, understand, and when possible generalize all the aspects dealing with full closure construction. The development of lessons-learned and good practices directions will hopefully assist in future decisions involving full road closures.

It was a common opinion that one lesson learned from this project is to start discussions regarding alternative construction methods much sooner. The decision to explore closing TH-36 was made fairly late in the project development process as a means to control the cost. The decision needs to be made, even if it is just to study the possibility of closing a roadway, much sooner. This way the possible benefit can be better weighed out while one can better describe the pros and cons to the public.

Even with the time provided for the consideration of the traditional partial closure, since it was not juxtaposed against any other alternatives, the details of the impacts on users was not immediately described. For example, both the plan of operating a bypass of two lanes per direction with lights on McKnight and the same with one lane and no lights were very ambitious

plans. Additionally, in this particular case regular Partial Closure would have needed more than two summers due to complicated elements like the deep storm sewer and the retaining walls. These details were not fully explored and transmitted neither to the public nor to the people involved in the BCA of the alternatives. The main comment is that the benefits from the full closure are actually higher than the reported 15% savings generally reported. The lesson learned was that construction planning should have been more vocal about the length and impact of the Partial Closure while a longer, more detailed analysis of the Partial Closure is required. Additionally, in regards to the full closure alternative, the final agreement was conservative in terms of contractor incentives since more aggressive scheduling was possible and would have been preferable.

The emphasis on the project was to open the road to one-lane in each direction as quickly as possible. After it was realized that full closure impacts were not that bad, the City admitted that it would had been better to keep the roadway closed for a longer period of time until the entire four lanes were ready to open.

In terms to the details of full closure two comments/lessons were mentioned during the interviews. The first suggests that it is not a good idea for a full closure to extend through the winter months. This practically confines the extent of full closure projects to a single construction season.

More than one of the interviewees mentioned what a good idea was to initiate the full closure on a Tuesday. One of the justifications was that this assisted first day's operation since people had fresh in their memory the signs of construction length and alternative routes.

One lesson surfaced from the interviews was the fact that planning early and in detail is important even for small projects. People do not like surprises. Additionally, it is a good practice to include operations people in the planning early in the process. In this case they were included only during the last few months prior to the initiation of the full closure. One benefit of that inclusion is the more successful planning and execution of active traveler information systems and other ITS applications. In general, ITS solutions are currently being considered a bonus and not a real need or solution. This usually results in not enough time to develop and deploy them. According to RTMC interviewees an ITS system requires a minimum of 6 months of development prior to deployment. An example of a system that could have been beneficial in the case of this and future full closures is a web map illustrating real-time information specific to the particular project.

Finally, although not the subject was out of the scope of this guide, it is important to mention that the use of A+B contracting, early completion incentives, and lane rental were vital to reducing contract time and delays before and after the FC.

BCA lessons learned

The case of TH-36 was not the best in evaluating the importance of RUCs in the decision making process. The capital cost savings from the full closure combined with the available capacity on the roadways serving as detours generated a one sided comparison. Such fortunes are not to be considered normal and considering the large daily RUCs of the FC the distance between the two alternatives can close very fast with even modest delays in the construction schedule. A

comprehensive BCA that takes RUCs into account helps quantify the actual benefits if any and more importantly quantify the level of risk involved in the selection of a FC as the construction alternative.

In this guide a numbers of difficulties in estimating RUCs were outlined and it was shown that in order to achieve a certain level of accuracy the effort involved in the analysis is not trivial. Especially for projects that involve all the new concepts of ITS technologies and deal with already congested networks, the use of the very expensive simulation methodology may be warranted. Regardless, at least for the TH-36 project the value of engineering skills and judgment was also highlighted prompting us to a scaled, hybrid approach. Early in the planning stage, all construction alternatives should be considered to give the chance for new concepts like FC to participate. At that level an empirical estimation of RUCs will help quantify all the costs involved in the project, especially the ones incurring during the construction period. In addition, such a preliminary analysis will help identify the peculiarities of the project, quantify the level of risk involved in each alternative, and allow the BCA to produce a more accurate comparison of project alternatives as well as projects in the program themselves. Having gone through the empirical estimation of RUCs, it will be easier and more efficient to decide what level of accuracy and methodology is appropriate.

The use of QuickZone as proposed in this study increases its applicability as assistance in the empirical analysis and avoids the problems present if used as its developers intended. The regional planning model is an extremely valuable resource but it must be used with care. The smaller the project under analysis is, the higher the probability that the answers given by the TDM will not be reliable. When the TDM is actually used for estimation of RUCs or even for determining the availability of spare capacity in the network, validation with recent, relevant measurements is essential. In this study it was not necessary to enhance the network with additional links and therefore increase the need for calibration but the possibility should be considered. Simulation can be an amazing tool but it can also be an effort drain. It should be approached with caution and when necessary. There is no way that one can overestimate the resources needed for calibrating a microscopic simulation model. Although not explored in this study, the use of a mesoscopic model may be the answer between the rather bland TDM and the expensive micro-simulation. One investment that could reduce the cost of using simulation would be the development and maintenance of a metro-wide model similar to the macroscopic regional planning model. Such a model will help capitalize on earlier completed projects, reduce the effort in developing the particular study area sub model, and help develop the necessary data collection infrastructure a mature and congested roadway network will eventually require.

Finally, it was interesting observing the sensitivity results manifest due to modeling assumptions and features involved in each of the outlined methodologies. Such a sensitivity evaluation should become standard practice to help avoid the mistake of misusing a model that is considered calibrated, but such a belief is based only on the inadequacy of the available validation information.

Conclusions

This document attempts to capitalize on the TH-36 Full Closure experience to draw conclusions and lessons on aspects of roadway reconstruction planning, benefit/cost analysis, public participation, and the role of social costs during the construction period. The TH-36

reconstruction project was not selected for this task because it represents the majority of reconstruction projects but because it was one of the first applications of Full Closure construction operations, innovative contracting, and accelerated construction techniques (not covered in this document). Although the authors attempted to minimize it, the reader should always be aware of the influence some unique features of this project affected the outcome of both the market surveys and the BCA. This document offers assistance to the engineers involved in the planning and implementation of future reconstruction projects and if nothing else it will serve as an easy resource in drawing from the TH-36 project experience.

References mentioned in this document can be found in the TH-36 final report document.