

1. Report No. FHWA/TX-10/0-6029-1		2. Government Accession No.		3. Recipient's Catalog No.	
4. Title and Subtitle IMPROVED INTERSECTION OPERATIONS DURING DETECTOR FAILURES				5. Report Date November 2009 Published: March 2010	
				6. Performing Organization Code	
7. Author(s) Srinivasa Sunkari, Praprut Songchitruksa, Hassan Charara, and Xiaosi Zeng				8. Performing Organization Report No. Report 0-6029-1	
9. Performing Organization Name and Address Texas Transportation Institute The Texas A&M University System College Station, Texas 77843-3135				10. Work Unit No. (TRAIS)	
				11. Contract or Grant No. Project 0-6029	
12. Sponsoring Agency Name and Address Texas Department of Transportation Research and Technology Implementation Office P.O. Box 5080 Austin, Texas 78763-5080				13. Type of Report and Period Covered Technical Report: September 2007–August 2009	
				14. Sponsoring Agency Code	
15. Supplementary Notes Project performed in cooperation with the Texas Department of Transportation and the Federal Highway Administration. Project Title: Fully Adaptive Detection-Control System for Isolated Intersections URL: http://tti.tamu.edu/documents/0-6029-1.pdf					
16. Abstract The objective of this project was to develop three modules that would improve the efficiency of intersection operations at isolated signalized intersections. The motivation for these modules was to use the existing detectors more efficiently. This would in turn reduce the number of detectors required at the intersection and also improve operations in case of detector failures. The adaptive variable initial module (Module 1) can improve the typical variable initial feature available in most signal controllers by factoring the turning movements at the intersections in real time along with queue distribution, and activity on driveways between the detectors and stop bar. The detector failure module (Module 2) develops a rolling database of phase utilizations of all phases at the intersections. The module uses this database to determine the appropriate phase time when a detector failure is identified. The variable detector module (Module 3) monitors the phase utilizations on the major-street phase and the volume on the right-turn and left-turn detectors to vary the delay programmed on detectors to further improve the intersection operations. Researchers evaluated Module 1 and Module 2 and found them improving the intersection operations. However, initial implementations of Module 3 showed limited benefits and only under very rare conditions. Thus, researchers did not develop Module 3 further. Modules 1 and 2 require data that are easily available within the controller and can be incorporated into the signal controller firmware.					
17. Key Words Variable Initial, Detector Failure, Intersection Efficiency, Detector Delay, D-CS			18. Distribution Statement No restrictions. This document is available to the public through NTIS: National Technical Information Service Springfield, Virginia 22161 http://www.ntis.gov		
19. Security Classif.(of this report) Unclassified		20. Security Classif.(of this page) Unclassified		21. No. of Pages 86	22. Price

IMPROVED INTERSECTION OPERATIONS DURING DETECTOR FAILURES

by

Srinivasa Sunkari
Research Engineer
Texas Transportation Institute

Praprut Songchitruksa
Associate Research Scientist
Texas Transportation Institute

Hassan Charara
Research Scientist
Texas Transportation Institute

and

Xiaosi Zeng
Research Associate
Texas Transportation Institute

Report 0-6029-1

Project 0-6029

Project Title: Fully Adaptive Detection-Control System for Isolated Intersections

Performed in cooperation with the
Texas Department of Transportation
and the
Federal Highway Administration

November 2009

Published: March 2010

TEXAS TRANSPORTATION INSTITUTE
The Texas A&M University System
College Station, Texas 77843-3135

DISCLAIMER

This research was performed in cooperation with the Texas Department of Transportation (TxDOT) and the Federal Highway Administration (FHWA). The contents of this report reflect the views of the authors, who are responsible for the facts and the accuracy of the data presented herein. The contents do not necessarily reflect the official view or policies of the FHWA or TxDOT. This report does not constitute a standard, specification, or regulation.

This report is not intended for construction, bidding, or permit purposes. The engineer in charge of the project was Srinivasa Sunkari, P.E. (Texas) #87591. The United States Government and the State of Texas do not endorse products or manufacturers. Trade or manufacturers' names appear herein solely because they are considered essential to the object of this report.

ACKNOWLEDGMENTS

This research was conducted during a one-year study under a cooperative research program with TxDOT and FHWA. Kelli Williams of the Odessa District was the project director. Other TxDOT members of the project monitoring committee included, Larry Colclasure, Noberto Aguirre, Don Baker, Adam Chodkeiwicz, Ted Copeland, Gordon Harkey, Ed Kloboucnik, Rebecca Wells, and Wade Odell.

Texas Transportation Institute (TTI) researchers specifically thank signal technicians from the Waco District, Houston District, and the City of Bryan for assisting us in the installation of the equipment for this project. This project would not have been implemented without their assistance.

TABLE OF CONTENTS

	Page
List of Figures	viii
List of Tables	ix
Introduction	1
Background.....	1
Advance Safety Strategies at Isolated Traffic Signals.....	1
Efficiency Issues at Isolated Signals.....	4
Existing Controller Features to Implement Improvements.....	4
Module Development	9
Variable Initial	9
Queue Length Estimation	10
Simplified Case.....	15
Adaptive Control.....	16
Detector Failure	16
Detector Delay	18
Module Methodology	23
Variable Initial	23
Scope.....	23
Methodology.....	23
Detector Failure	25
Scope.....	26
Methodology.....	26
Variable Delay	29
Scope.....	30
Methodology.....	30
Module Implementation	33
Site Selection	33
Waco District	33
Bryan District.....	33
Houston District.....	33
Software Configuration.....	37
Variable Initial	39
Detector Failure	42
Variable Delay	44
Field Implementation	45
Evaluation and Conclusion	49
Module 1	49
Module 2	53
Measures of Effectiveness	53
Evaluation Scenarios.....	55
Evaluation Results	55
Conclusions.....	72
References	75

LIST OF FIGURES

	Page
Figure 1. Typical Dilemma Zone Detector Layout for TxDOT (4).....	2
Figure 2. Potential Detector Layouts Used for D-CS, PIA, and AWECS Type of Strategies.	3
Figure 3. Variable Initial Timing.	5
Figure 4. Input-Output Technique for Queue and Delay Estimation.....	12
Figure 5. Hybrid Technique for Queue and Delay Estimation.	13
Figure 6. Factors Influencing RTOR Capacity.	20
Figure 7. Turn Bay, Driveway, and Detector Locations.	25
Figure 8. Detector Failure (Module 2) Architecture.	28
Figure 9. Illustration of Database Format.	29
Figure 10. Flow Chart of the Factors Affecting Variable Delay Module.	32
Figure 11. Site Location in Waco District.	34
Figure 12. Detector and Intersection Configuration at the Site in Waco District.	34
Figure 13. Site Location in Bryan District.	35
Figure 14. Intersection and Detector Configuration at the Site in Bryan District.	35
Figure 15. Site Location in Houston District.	36
Figure 16. Intersection and Detector Configuration at the Site in Houston District.	36
Figure 17. Phase Setting Configuration.	38
Figure 18. Detector Mapping Configuration.	39
Figure 19. Variable Initial Setting Screen.	40
Figure 20. Driveway Setting Screen for Variable Initial.	41
Figure 21. Variable Initial Prediction.	42
Figure 22. Detector Failure Log.	43
Figure 23. Green Prediction Log.	44
Figure 24. Right-Turn Delay Module Settings.	45
Figure 25. D-CS Implementation Architecture.	47
Figure 26. Installation of Adaptive D-CS in the Houston District near Conroe.	48
Figure 27. Accuracy of Predicted Initial Green (Phase 2).	50
Figure 28. Accuracy of Predicted Initial Green (Phase 6).	51
Figure 29. Relationship between Predicted Green and Queue Clearance (Phase 2).	51
Figure 30. Relationship between Predicted Green and Queue Clearance (Phase 6).	52
Figure 31. Error in Predicting the Initial Green.	53
Figure 32. Example Comparison of Algorithms (Waco, Phase 2, 50% Failure).	59
Figure 33. Example Comparison of Algorithms (Waco, Phase 4, 50% Failure).	60
Figure 34. Example Comparison of Algorithms (Waco, Phase 5, 50% Failure).	60
Figure 35. Example Comparison of Algorithms (Conroe, Phase 2, 50% Failure).	64
Figure 36. Example Comparison of Algorithms (Conroe, Phase 4, 50% Failure).	64
Figure 37. Example Comparison of Algorithms (Conroe, Phase 5, 50% Failure).	65
Figure 38. Example Comparison of Algorithms (Bryan, Phase 2, 50% Failure).	69
Figure 39. Example Comparison of Algorithms (Bryan, Phase 4, 50% Failure).	69
Figure 40. Example Comparison of Algorithms (Bryan, Phase 5, 50% Failure).	70
Figure 41. Comparison of Algorithm Performance by Site (RMSE).	72

LIST OF TABLES

	Page
Table 1. Modules Deployed at Each Site in This Project.	48
Table 2. Root Mean Square Error Comparison.	53
Table 3. Waco—Mean and Variance of Green Durations (Mondays).	56
Table 4. Waco—Mean and Variance of Change in Green Durations (Mondays).	57
Table 5. Naïve Prediction versus Ground Truth by Phase (Waco, 50% Failure).	58
Table 6. Advanced Algorithm versus Ground Truth by Phase (Waco, 50% Failure).	58
Table 7. Comparison of Algorithm Performance by Phase (Waco, 50% Failure).	58
Table 8. Comparison of Performance for All Phases (Waco, 50% Failure).	59
Table 9. Conroe—Mean and Variance of Green Durations (Mondays).	61
Table 10. Conroe—Mean and Variance of Change in Green Durations (Mondays).	62
Table 11. Naïve Prediction versus Ground Truth by Phase (Conroe, 50% Failure).	63
Table 12. Advanced Algorithm versus Ground Truth by Phase (Conroe, 50% Failure).	63
Table 13. Comparison of Algorithm Performance by Phase (Conroe, 50% Failure).	63
Table 14. Comparison of Algorithm Performance for All Phases (Conroe, 50% Failure).	64
Table 15. Bryan—Mean and Variance of Green Durations (Mondays).	66
Table 16. Bryan—Mean and Variance of Change in Green Durations (Mondays).	67
Table 17. Naïve Prediction versus Ground Truth by Phase (Bryan, 50% Failure).	68
Table 18. Advanced Algorithm versus Ground Truth by Phase (Bryan, 50% Failure).	68
Table 19. Comparison of Algorithm Performance by Phase (Bryan, 50% Failure).	68
Table 20. Comparison of Algorithm Performance for All Phases (Bryan, 50% Failure).	69
Table 21. Overall Performance Comparison at Varying Rates of Detector Failure.	71
Table 22. Detector Failure Rate and Average Length of Failure Time.	71

INTRODUCTION

BACKGROUND

Improving operations at signalized intersections is an important objective for the Texas Department of Transportation (TxDOT). TxDOT has been proactively tackling the issue of improving safety by using alternative signal control strategies over the past few years. The Texas Transportation Institute (TTI) with support from TxDOT has developed a number of strategies to address the issue of improving safety at high-speed isolated signalized intersections. These include Detection-Control System (D-CS) (1), Platoon Identification Algorithm (PIA) (2), and Advance Warning of End-of-Green System (AWEGS) (3). These advance strategies improve the safety at the intersections and enhance the signal operations.

Along with improving safety, there is a need to improve the overall efficiency of the intersection operations. The implementation of the above-mentioned advance strategies has highlighted the importance of detection at the intersection for efficient operations. There are many controller features available to improve the efficiency of intersections. However, these features are deployed without considering existing volume conditions. Therefore, this project developed an adaptive system that considers the current traffic and historical traffic conditions in order to improve the intersection efficiency. Such a system is not only applicable at intersections utilizing advance safety strategies like D-CS but also at non-D-CS intersections, thereby significantly increasing the utility of this system. It is also anticipated that signal controller vendors will be interested in incorporating this system into the signal controller firmware, making it very easy to implement by TxDOT.

Advance Safety Strategies at Isolated Traffic Signals

TxDOT typically uses two to three detectors per lane on high-speed approaches to improve safety by reducing dilemma zone conflicts (4). TxDOT's configuration is illustrated in Figure 1. The detector locations are based on approach speeds and operate in pulse mode with an extension ranging from 1.2 to 2.0 seconds. The configuration also calls for a stop-bar detector, which is configured as a queue discharge detector.

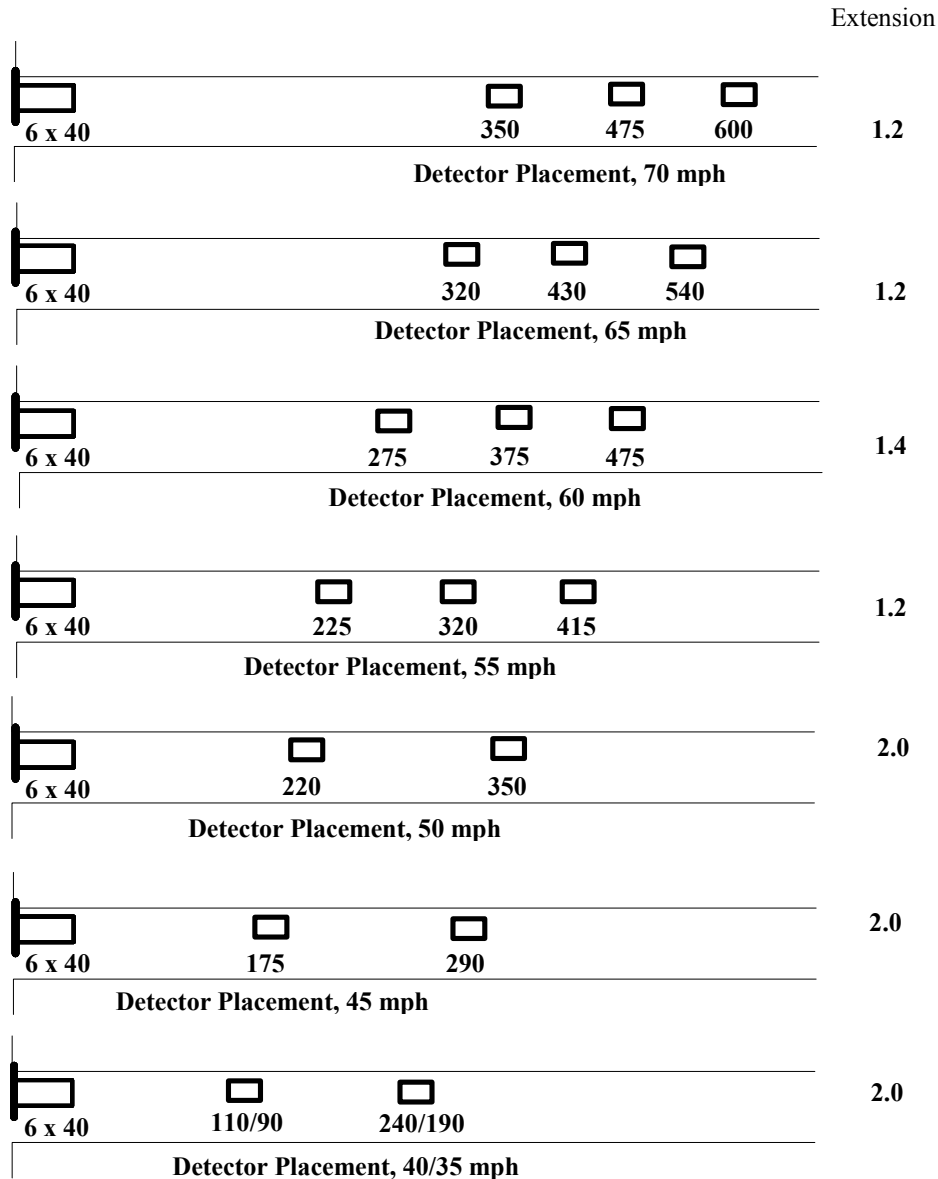

Figure 1. Typical Dilemma Zone Detector Layout for TxDOT (4).

Over the past few years, TxDOT and TTI have developed three advance strategies to further improve safety on high-speed approaches to isolated signalized intersections. These are the D-CS, PIA, and AWECS. All three strategies use advance detection on the high-speed approaches. The advance detection is in the form of two detectors per lane at a distance of between 750 feet to 1200 feet and depends on the approach speeds. The objective of the advance detectors is to detect high-speed vehicles, their speeds, and their classification. Even though the detector configuration in Figure 1 includes a stop-bar detector, some TxDOT districts do not

install stop-bar detectors. This is primarily because detectors at stop bars typically have higher failure rates due to the rigors of vehicles braking/stopping and accelerating on them. The function of stop-bar detectors is to improve intersection efficiency by clearing the queue at the start of green, and the districts modify the controller parameters to account for the absence of stop-bar detectors. Figure 2 illustrates a typical detector layout being used at locations.

PIA and AWEGS strategies use the existing TxDOT detector configuration illustrated in Figure 2 along with the advance detectors, even though stop-bar detectors are not required for the PIA and AWEGS algorithms. On the other hand, the D-CS strategy does not require dilemma zone detectors for its operation but does require stop-bar detectors.

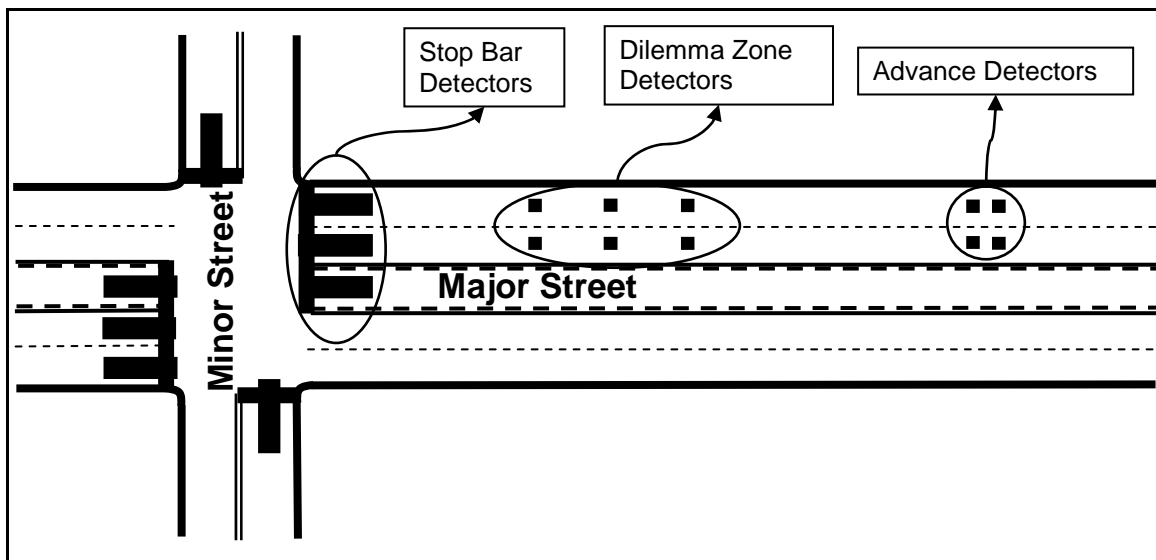

Figure 2. Potential Detector Layouts Used for D-CS, PIA, and AWEGS Type of Strategies.

Strategies like D-CS (1), PIA (2), and AWEGS (3) have proved to significantly improve safety at signalized intersections by reducing red-light running by over 35 to 60 percent. Moreover, the same infrastructure can be used to enhance operational efficiency at intersections. These improvements to efficiency can further improve the functionality of intersections where strategies like D-CS, PIA, and AWEGS are deployed. These improvements to operational efficiency are also applicable to typical intersections across the state.

Efficiency Issues at Isolated Signals

There are a number of techniques to improve operational efficiency at signalized intersections. This project developed three strategies of using both historical and real-time detector information to improve intersection efficiency. Two of the strategies are:

- to use detection from advance detectors to efficiently customize and determine the minimum green required in the absence of stop-bar detectors, and
- to operate the intersection during detector failures without relying on a constant call on the phase(s) resulting in a max out.

A third strategy for varying the detector delay for right-turn detectors and left-turn detectors was developed. Researchers, however, found that the strategy had very limited applicability and the benefits from the strategy were limited. Therefore, researchers did not incorporate this strategy into the system. Still, this report will discuss TTI researcher's efforts in developing this strategy.

Existing Controller Features to Implement Improvements

Traffic signal controllers have numerous features (5) to improve intersection operations. Some of these features can specifically be applied to improve the intersection efficiency for the strategies mentioned earlier. These are discussed in this section.

Variable Initial (6)

Under variable initial timing, the duration of the initial portion of the green (the first timed portion of the green interval) can increase depending on the number of vehicle actuations stored on the phase while its signal is displaying yellow or red. The variable initial timing period can be thought of as a “variable minimum green” and is determined by the following three parameters:

- minimum green time, which determines the minimum variable initial time period;
- seconds per actuation, which determines the time by which the variable initial time will be increased (starting from zero) with each vehicle actuation received during the yellow and red intervals of the phase; and
- maximum initial, which is the maximum of the variable initial timing period.

Figure 3 shows the effect of these parameters on the variable initial timing period. The figure shows how the initial timing starts with the minimum green time. Once the number of vehicle actuations multiplied by the seconds per actuation becomes larger than the minimum green time, the initial timing takes on the former value, until it reaches the maximum initial value, which acts as an upper limit.

Variable initial timing is most effectively used when setback detectors are provided such that in the absence of stop-bar detection, the initial timing can be incremented to the appropriate value required to service vehicles that queue between the stop line and the setback detector. Variable initial timing requires point detection to operate, so it may not be appropriate to use with the zone detection provided by video detection.

Variable initial can be very easily applied for a single lane approaching an intersection that has low turning movement volumes and where there are no driveways between the advance detector and intersection stop bar. However, programming the variable initial becomes more complicated for multi-lane approaches and at locations where a common lead-in wire is used for multiple detectors.

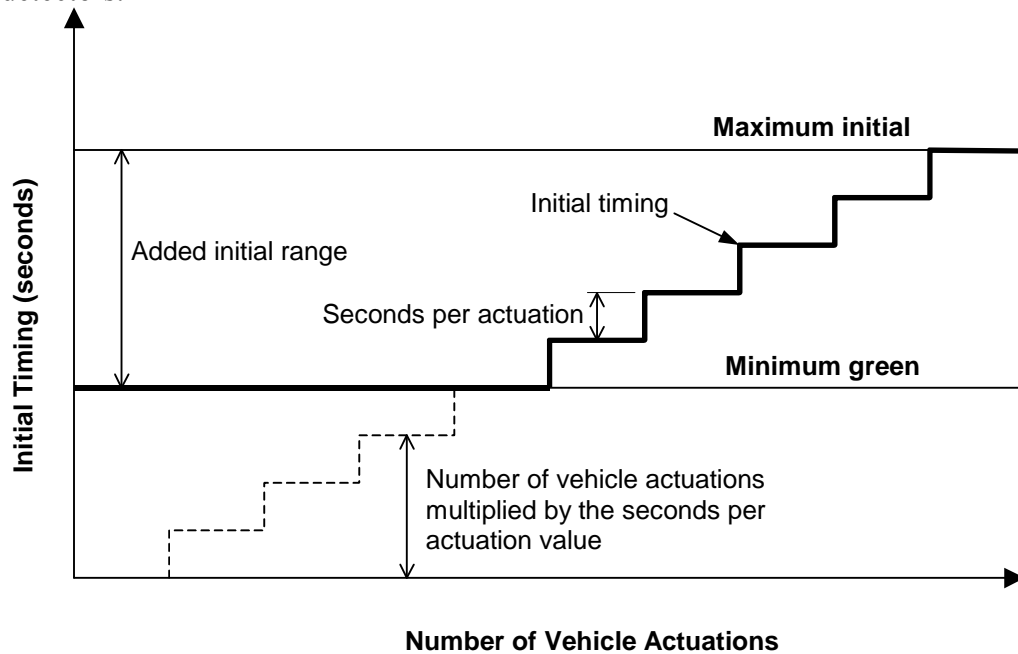

Figure 3. Variable Initial Timing.

Detector Failure

One of the causes of inefficient intersection control is due to detector failure. It is reported that about 50 percent of the inductive loops are malfunctioning at any given time. The

National Traffic Signal Report Card (7), which surveyed 378 agencies across the country, indicates that the detection system received a grading of F for detector systems. Failure of detectors results in the controller receiving a continuous call for that particular phase. This results in a significantly inefficient operation.

Over the years, a number of fully adaptive systems have been developed with the objective of predicting the traffic demand based on historical volumes. The Smart Diamond Project (8) conducted by TTI in the mid-1990s looked at predicting volumes by populating a database of measured traffic volumes. The objective was to mine historical patterns of traffic data and make strategic and tactical decisions about future traffic demands. The Smart Diamond study developed a database of four-week traffic demand. The system used the observed traffic demands combined with historical demands to produce forecast demands that were to be used to generate new signal timings. The same philosophy can be used to predict traffic demand during detector failures. Current controllers have the capability to log the green utilization for each phase. This parameter can be an indicator of the traffic demand at the intersection and can potentially be used to predict the traffic demand due to malfunction of detectors.

Delay on Detectors

Currently, traffic engineers using National Electrical Manufacturers Association (NEMA) controllers (5) have the capability to program a specific amount of delay into the controller for a specific detector. Historically, engineers programmed the same delay into the detector amplifier. According to NEMA TS-2 specifications (5), a delay is defined as the ability of a detector to delay its output for a predetermined length of time after a vehicle has entered its zone of detection. When selected, the detector output is delayed for the time set. If the vehicle departs before the time set, an output does not occur and the timer is reset. The delay time is adjustable over the range of 0 to 30 seconds and remains a constant value.

A detector delay is typically used to permit the left-turning vehicles on the permitted portion of the protected-permitted left-turn phase along the arterial to find gaps in the opposing through movements. This delay reduces the unnecessary terminations of the opposing arterial phase. A similar strategy is used to allow the right-turning vehicles on minor streets to find gaps in the major-street through movements. A variable call delay based on traffic volumes at the intersections can improve intersection efficiency.

The controller features currently employed to improve efficiency operate in a static manner. They also do not react to detector failures. The adaptive system proposed in this project can make the features more efficient and allow these improvements to be incorporated into the signal controller software.

MODULE DEVELOPMENT

Researchers developed and evaluated three modules in this project to improve intersection operations. The first module's objective is to improve the use of variable initial features in the absence of stop-bar detection. Such a system is adaptive in nature and accounts for various detector configurations, the number of lanes, and the number, location, and use of driveways. The objective of the second module is to improve intersection operations during detection failure. Currently during a detector failure for a particular phase, the phase gets a continuous call, resulting in inefficient operation. However, in this module, when a detector failure is identified, the system relies upon historical traffic demand data to assign appropriate phase time to improve intersection operations. The third module applies an appropriate delay for the right-turn detector and/or left-turn detector to minimize phase terminations for the major movements. This feature can improve intersection efficiency and safety.

VARIABLE INITIAL

The variable initial (VI) is a timing feature in a controller designed to allocate a varying amount of initial green based on traffic demand as observed by the number of non-green actuations at respective phases. The VI time is a computed value that is at least as large as the minimum green time and not more than the maximum initial time.

The VI timing period is determined by the following time settings (9):

- The minimum green setting determines the minimum VI time period.
- The added initial setting determines the time by which the VI time period will be increased from zero with each vehicle actuation received during the associated phase yellow and red intervals.
- The maximum initial setting determines the maximum VI time period. The maximum initial setting is subordinate to the minimum green time setting. Therefore, the minimum green time must be satisfied regardless of the maximum initial setting.

The VI time period can be expressed as follows:

$$VI = \text{Minimum Green} + (\text{Non} - \text{Green Actuations})(\text{Seconds per Actuation})$$

$$VI > \text{Minimum Green}; VI \leq \text{Maximum Initial}$$

The following section provides an overview of past research on queue length estimation. In a variable initial module, queue length is a key variable in determining how the initial green should be configured. This section summarizes methodology and results of past research attempts on this issue.

Queue Length Estimation

Li (10) proposed an online queue length estimation algorithm using the flow conservation law. The algorithm requires both stop-bar and advance detectors to work properly. Let $m_{(t+1),i}$ be the number of vehicles stored between stop-bar and advance detectors at the end of $(t+1)^{th}$ green for the subject lane i ; then, $m_{(t+1),i}$ can be calculated as

$$m_{(t+1),i} = m_{t,i} + ma_{t,i} + na_{t,i} - md_{t,i}$$

Where:

$m_{t,i}$ = number of vehicles between two detectors at the end of t^{th} green for lane i ,

$ma_{t,i}$ = new arrivals observed by the advance detector until the end of t^{th} red,

$na_{t,i}$ = vehicle arrivals observed by the advance detector during the next $(t+1)^{th}$ green, and

$md_{t,i}$ = departures observed by the stop-bar detector during the $(t+1)^{th}$ green.

While Li's algorithm can theoretically track the number of vehicles in the queue, its performance is subject to uncontrollable cumulative errors stemmed from detector malfunctions. Xu et al. (11) proposed an online algorithm to estimate queue length at isolated signalized intersections. The algorithm uses the vehicle arrival information from stop-bar and advance detections to estimate queue length. The proposed algorithm consists of two parts. First, the algorithm tries to identify the first vehicle in the queue after the amber onset. Then, the algorithm estimates the physical queue lengths using the following parameters: (a) the average distance from the front bumper of the first vehicle in the queue to the stop bar, (b) the average inter-vehicle spacing of vehicles in the queue, and (c) the vehicle lengths. The vehicles are considered joining the queue if their speed drops below a pre-specified threshold.

This algorithm was tested only in a simulated environment. It considered only a simplified case of a single-lane approach with no turn lanes. No specific discussions on how it could be extended to multi-lane approaches were provided. Several parameters required for the algorithm must be properly calibrated, but no guidelines were provided on how these parameters

should be configured. A sensitivity analysis of the parameters in the algorithm was also not studied.

Sharma et al. (12) proposed a hybrid algorithm using real-time advance and stop-bar detections to estimate queue length and delay at a signalized intersection. Traffic engineers commonly use three types of delay to evaluate intersection performance:

- stopped delay: delay incurred when a vehicle stops completely;
- approach delay: delay incurred when a vehicle decelerates, stops, and then accelerates again until it crosses a stop bar; and
- control delay: delay incurred when a vehicle decelerates, stops, and then accelerates until it resumes the desired travel speed.

This paper described two approaches for estimating delay and maximum queue length. The input-output technique uses advance detector actuations, phase change data, and parametric data (e.g., saturation headway, storage capacity, etc.) as model inputs. The advance detector actuations are used to track arrivals at intersection approach over time. The phase status and saturation headway data are used to estimate the number of departures from the stop bar over time. These two profiles are combined to estimate the queue accumulation at the intersection approach. The second approach, the hybrid technique, incorporates stop-bar actuations as additional model inputs. In comparison with the first approach, the stop-bar actuations and phase statuses are used to estimate real-time vehicle departures instead of saturation headway. The inductive loop detector (ILD) vehicle signature identification techniques are used to count vehicles crossing the stop bar. Both techniques estimate delay and maximum queue length once each cycle. The techniques were developed based on the assumptions that the vehicles do not change lanes after passing the advance detectors and that the vehicles in the queue will follow the first-in-first-out (FIFO) principle. Figure 4 and Figure 5 depict the profiles obtained from input-output and hybrid algorithms, respectively.

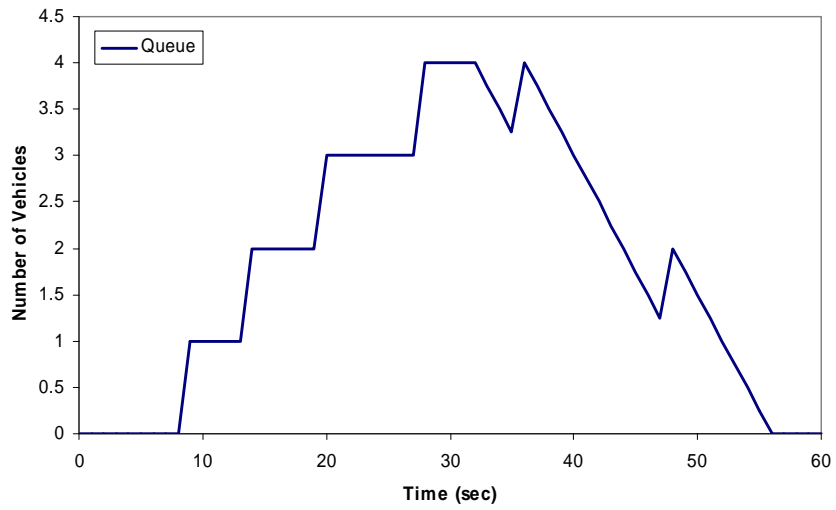
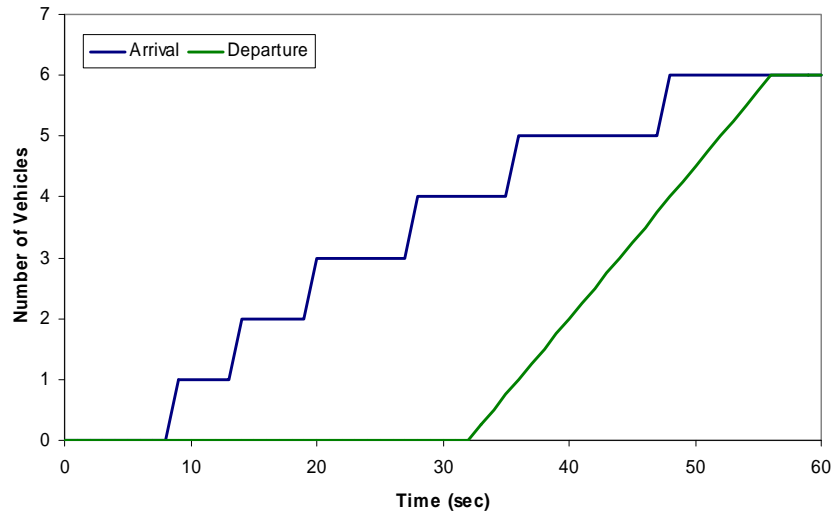

Figure 4. Input-Output Technique for Queue and Delay Estimation.

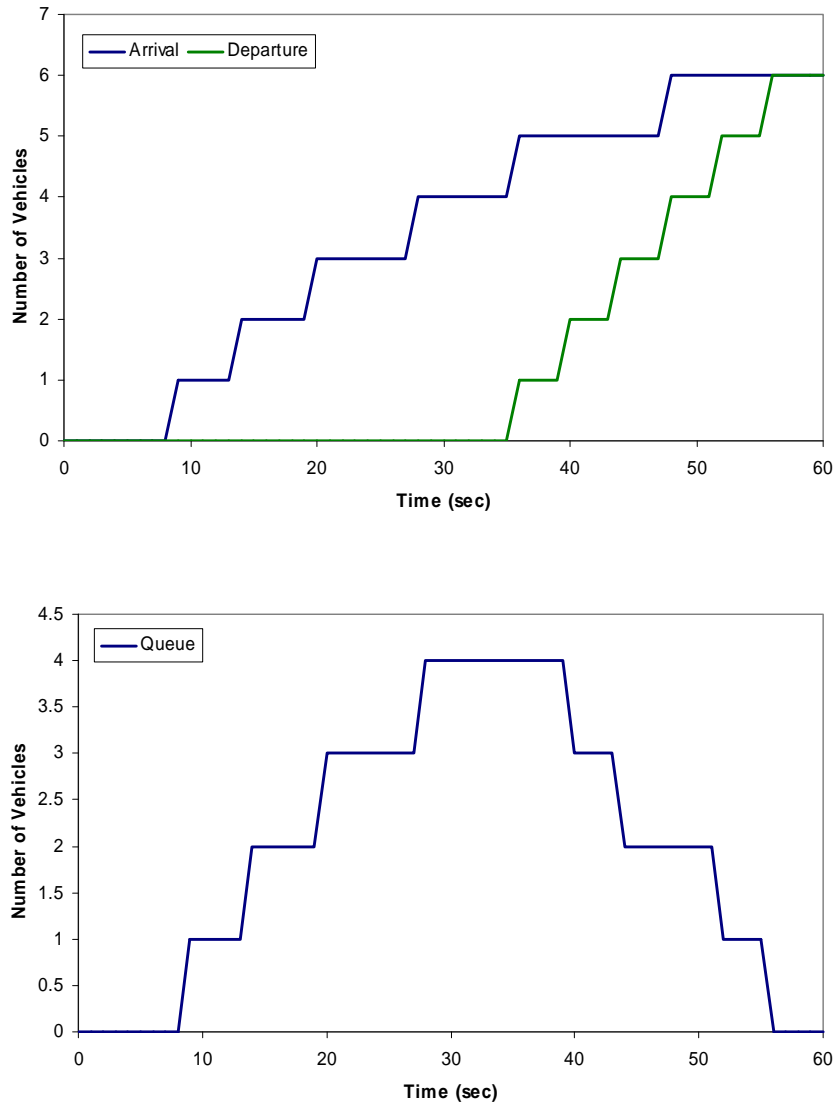

Figure 5. Hybrid Technique for Queue and Delay Estimation.

From the queue polygon, the maximum queue length of six vehicles occurs at 28 seconds. The delay can be accumulated for each vehicle arrival and departure. The total delay, which is the sum of delays from all vehicles, is equal to the area under the queue profile. The average vehicular delay is equal to the total delay divided by the number of vehicle arrivals/departures during a cycle.

Both input-output and hybrid techniques consist of three modules:

- *Arrival profile module.* Advance detector actuations are used to determine shifted arrival times, which are adjusted arrival times from advance detectors to stop bars.

Maximum queue length is determined by the number of detector actuations prior to the end of red plus the start-up loss time. If the queue length reaches the storage capacity, a linear extrapolation based on historical arrival flow rate is used to extend the profile.

- *Departure profile module.* For the input-output technique, the queue is discharged at the rate of saturation headway after the end of red plus start-up loss time. For the hybrid technique, the stop-bar actuations are used to determine the departure profile. The vehicle headway is used to determine when the queue is cleared, i.e., when the headway is greater than the pre-specified “queue clearance headway.”
- *Delay estimation module.* For the input-output technique, the total delay is the difference of departure from arrival profile. For the hybrid technique, the algorithm will first check the balance between the number of arrivals and departures and then apply appropriate adjustment prior to delay calculation.

The study (12) found that the hybrid technique did not perform better than the input-output technique, mainly because of the stop-bar detection performance and the presence of long left-turn and right-turn bays at the studied site. The hybrid technique, however, may be more beneficial at intersections where there is significant driveway traffic between the advance detectors and the stop bar. The sites with large variability in saturation flow rate due to changing weather conditions may benefit from the hybrid technique as well.

Gard (13) developed models for estimating maximum queue lengths at two-way stop-controlled intersections using regression equations. The data used for model calibration were collected from 15 two-way stop-controlled intersections in Sacramento, California. The developed models predict the maximum vehicle queue for subject movement during a one-hour observation period. The author chose to opt for the maximum queue length rather than the 95th percentile queue length in this study in order to simplify the data collection process. The explanatory variables found to be statistically significant in the models include:

- hourly traffic volume divided by peak-hour factor (PHF) for subject movement,
- hourly traffic volume divided by PHF that conflicts with subject movement,
- presence of a traffic signal located on the major street within one-quarter mile of the subject intersection,
- number of through lanes occupied by conflicting traffic,

- posted speed limit on major street, and
- percentage of right-turn vehicles on shared minor-street approach.

While the empirical regression equations proposed in this study may be suitable for engineering design applications, they are not meant for real-time intersection control applications where queue lengths must be estimated at regular intervals in response to changes in traffic conditions. Transferability of the models could potentially be another issue for empirical equations. The models developed using specific data sets may not be readily applicable to other locations without necessary modifications.

Geroliminis and Skabardonis (14) proposed an analytical methodology for predicting platoon arrival profiles and queue length along signalized arterials. The proposed model was evaluated using CORSIM simulation. The simulation output was first compared with field data (delays and travel times) to verify that the model reasonably replicates field conditions at the test sites. Then, the simulated queue lengths predicted by the proposed model and the simulation were compared and found to be in agreement.

To predict the queue length at a traffic signal, the proposed model predicts the time that the traffic signal starts serving the groups of uninterrupted vehicles, i.e., it predicts the effective extension of the red time because of the discharge of the queued vehicles.

Simplified Case

The simplified case is used as a basis for further algorithm modifications to account for various factors that could affect the queue length and thus the appropriate setting for variable initial. The algorithm for variable initial estimates the queue length on a cycle-by-cycle basis. The simplified case assumes the following:

- There is no remaining queue from the previous cycle.
- The through-traffic lanes are not shared by any turning movements.
- There are no driveway activities between the advance detectors and the stop bar.
- Through-traffic vehicles are distributed equally across all lanes.
- There are no trucks in the composition of queued vehicles.
- Non-green traffic demand does not exceed the storage capacity, i.e., the number of vehicles that can be stored between the advance detectors and the stop bar.

The estimated queue length for this case is:

$$l_q = \frac{N_a}{n}$$

Where:

N_a = number of actuations during yellow and red periods and n = number of through lanes.

Adaptive Control

Liu et al. (15) proposed an adaptive signal control system with an online signal performance measure. The proposed method uses a real-time delay estimation technique based on vehicle re-identification using an algorithm that matches individual vehicle waveforms or signatures obtained from advanced inductive loop detectors. The two objectives considered in signal optimization algorithm are system efficiency and system fairness. For system efficiency, three measures of effectiveness (MOEs) are evaluated: total intersection delay, total throughput, and average delay. The fairness of the system is measured via standard deviation of movement delays. A multi-objective signal control technique was used to compromise these two conflicting objectives.

The proposed system was evaluated in a simulation environment for a single intersection using Paramics microscopic simulation software. The system was applied to both pre-timed and actuated controllers for evaluation. The simulation experiments indicated that the proposed adaptive control system could be an efficient method even under the application of a simple algorithm for adapting the signal timing plan.

DETECTOR FAILURE

Detector failure is the primary cause of inefficient operations at signalized intersections. It is reported that about 50 percent of the inductive loops are malfunctioning at any given time. The National Traffic Signal Report Card (7), which surveyed 378 agencies across the country, indicates that the detection system received a grade of F for detector systems. Failure of detectors results in the controller receiving a continuous call for that particular phase. This results in a significantly inefficient operation. If the traffic demand at intersections can be predicted, and a detector failure identified, a system can be developed to provide appropriate green times for phases with detector failures. Such a system will reduce the wastage of green and minimize intersection delay.

The primary challenge in this module is the identification of a detector failure. TS-2 controllers have some detector diagnostics features that can be used to identify various types of detector failures. The EPAC (9) and Naztec (16) controllers usually use three parameters to identify a detector failure. The maximum presence limit diagnostic specifies the maximum interval a detector is occupied (in minutes) prior to being considered a fault. This type of failure is most common due to an open loop fault. However, an open loop fault is diagnosed by the detector amplifier and results in a constant call, which is very inefficient. If the value set for maximum presence failure is not very high, such a failure can also be triggered during some unique circumstances where a vehicle is stationary on a detector for an extended period of time, like during preemption, during manual control of the intersection, or due to a vehicle breakdown over a detector. Upon diagnosing the maximum presence fault, the controller will provide the larger of the minimum green or the specified fail time. The detector starts functioning normally when the detector is reset.

The no activity limit diagnostic, on the other hand, specifies the maximum time between detector actuations (in minutes) before the detector is considered to be faulty. Care should be taken when programming this parameter to ensure that the controller does not diagnose the detector to be faulty during light traffic conditions (like late at night). Upon diagnosing the no activity fault, the controller will provide the larger of the minimum green or the specified fail time. The detector starts functioning normally when the detector receives a call and resets the no activity failure. The third diagnostic is the erratic count diagnostic, which establishes the maximum actuations per minute that can occur prior to being considered a fault. According to the Naztec controller manual (16), typical values of the range of erratic counts are from 40 to 70 per minute. Current controllers have the capability to log the green utilization for each phase. This parameter can be an indicator of the traffic demand at the intersection and can potentially be used to predict the traffic demand due to malfunction of detectors.

There have been a few studies that developed methods for short-term traffic volume forecasting. These methods function as a key component in many intelligent transportation systems (ITS). However, the stochastic nature of traffic flows makes it a challenging task to consistently and accurately forecast traffic volumes.

Forecasting algorithms can be categorized as neural networks, dynamic wavelets neural networks, non-parametric regression, time series models, pattern recognition, spectral analysis,

Kalman filtering techniques, adaptive predictive system, and Gaussian maximum likelihood models (17). Most short-term forecasting studies use data aggregated over 5 to 15 minute intervals to forecast traffic volumes. However, some studies have used intervals as small as 3 minutes or as large as 30 minutes. Larger intervals like 15 minutes to 30 minutes average out local fluctuations and smooth out predictable traffic volume data, while smaller intervals can capture some of the smaller fluctuations in the traffic patterns. However, traffic patterns can get a bit noisy, thus reducing the confidence in the prediction of volumes.

These short-term forecasting studies were designed to observe traffic patterns and forecast traffic volumes in the short term. However, the application for detector failure would require a methodology that uses traffic patterns over a long-term time period to predict traffic volumes in the absence of detections. Moreover, the algorithm may need to perform this function for an extended period of time till the detectors are fixed. Hence, the methodologies developed for short-term prediction are of limited use. A statistically robust approach that considers traffic patterns both over a long-term period as well as in the immediate past would be more appropriate to forecast traffic demand.

DETECTOR DELAY

Delay is sometimes used for stop-bar detectors in exclusive turn lanes. Delay can be used either for left-turn lanes or right-turn lanes as long as permitted operation is used. The primary purpose of using the detector delay function is to minimize unnecessary terminations of a major movement (major-street through) to service a minor movement (major-street left turn and minor-street right turn). National Transportation Communication for ITS Protocol (NTCIP), defines detector delay as the ability of a detector to delay its output for a predetermined length of time after a vehicle has entered its zone of detection (5). Delaying the detector output gives the turning vehicle an opportunity to find a gap in the conflicting traffic stream, thus removing the need to terminate the conflicting phase. Detector delay can be implemented in either the detector or the controller. A delay programmed in the detector will delay the detector output to the controller for the predetermined amount of time, irrespective of the traffic signal status. This means that the delay is applied every time a vehicle actuates the detector. However, a detector delay programmed in the controller delays the actuation only when the signal phase the detector

is tied to is not green. Hence, the delay is applied only when the signal indication is yellow or red to give an opportunity for the turn vehicle to find a gap.

Detector delay is applied to right-turn movements on the minor road when an exclusive right-turn lane is available and Right-Turn-on-Red (RTOR) is allowed. Typically, a delay of 8 to 14 seconds is used (18). This delay facilitates a right-turn vehicle to find a gap in the through movement of the major road. If the vehicle finds a gap, the delay timer is reset and the controller does not receive the call from that vehicle. If the right-turning vehicle does not find a gap, the signal controller receives a call and responds accordingly. The controller at an appropriate time will terminate the major-street movement and service the right-turn vehicle if the vehicle still has not found a gap.

Detector delay can also be applied to a left-turn phase if an exclusive left-turn lane is available and protected-permitted phasing is used. Typically, a delay of 5 to 12 seconds is used for protected-permitted left-turn phasing (18) and is particularly useful during low volume conditions. Before the controller registers the vehicle call, delay gives an opportunity to left-turn vehicles arriving during the permitted portion of the phase to find gaps in the opposing through movement. Under low volume conditions, this delay will minimize the termination of opposing through movements, thus avoiding stopping through vehicles to service a single left-turning vehicle. Frequently, the left-turn vehicle may just find a gap as the opposing through gaps out, resulting in an unnecessary phase termination. Minimizing terminating the opposing through phase becomes more critical if the approach speeds are high and/or if the approach volumes are higher than the left-turn volumes.

The selection of the detector delay value depends on numerous factors. Detector delay will increase delay to the turning movements for which the detector delay is applied. For RTOR vehicles, the delay incurred depends on the ability to find gaps in the main-street through movements and the right-turn volume. The ability to find gaps in the main-street through traffic depends on the through-traffic volume, sight distance, and approach speed. There have been a few studies that investigated the capacities of RTOR for right turns and permitted left-turn movement for left turns. Factors influencing the capacity of RTOR from an exclusive right turn are as follows (19) and are illustrated in Figure 6:

- volume of conflicting traffic, which includes:
 - through traffic in the right-most lane from the left (V_T),

- protected left-turn traffic from the opposite direction (V_L), and
- a proportion of the right-turn traffic from the left that is proportionate to the drivers that do not turn the right-turn indicator (V_R);
- pedestrian volume (V_P); and
- red duration in the cycle (T_R).

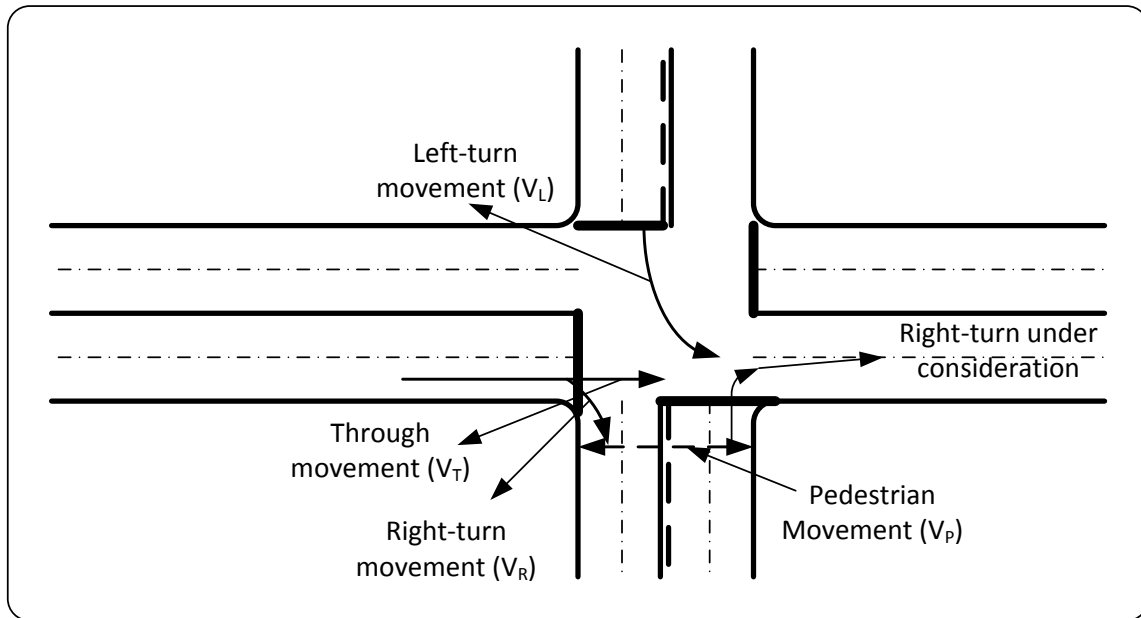

Figure 6. Factors Influencing RTOR Capacity.

Longer red duration on an approach can potentially increase the number of vehicles serviced by RTOR. However, the time available by RTOR vehicles is the red duration less the saturation green time for the conflicting movements and is known as the unsaturated red time. During the unsaturated red time, RTOR vehicles will have to come to a stop at the stop bar and select a gap when it is available to complete the maneuver. The delay for the detector should be large enough that an RTOR vehicle will have an opportunity to complete these maneuvers during the unsaturated red time. Numerous studies have investigated the methodology used to estimate the capacity of right-turn movement at stop-controlled signs. According to the Highway Capacity Manual (HCM) (20), a right-turn vehicle will accept a critical gap of 5.5 seconds to make a right turn at a stop sign. It is expected that RTOR drivers will accept similar gaps to complete the maneuver. The same methodology refers to a follow-up gap of 2.6 seconds. This means that a 5.5 second or greater gap allows the first vehicle turning right to accept the gap. If the gap is

8.1 seconds ($5.5 + 2.6$) or greater, both first and second vehicles in the queue can make the right turn (21). A gap of 10.7 seconds can provide for three vehicles.

The utility of detector delay for right-turn movement thus depends on the ability of right-turning vehicles to find gaps in conflicting movements. However, adequate gaps are difficult to find under high-volume conditions, so under such conditions, detector delay actually increases the delay experienced by right-turn traffic. Thus, detector delay tends to be beneficial only under the following conditions:

- low to moderate volumes of conflicting traffic, and
- low to moderate right-turn volumes.

MODULE METHODOLOGY

TTI researchers developed three modules during this project. This section describes the scope and methodology used to develop the module.

VARIABLE INITIAL

Traffic signal controllers have numerous features (5) to improve intersection operations. This section summarizes the variable initial methodology developed in this project. This module's objective is to estimate the initial green time required at the onset of the green on a cycle by cycle basis for clearing the through-traffic queue up to the location of advanced detectors (typically dilemma zone detectors). If the queue extends beyond the advanced detectors, subsequent actuations will extend the green time in the same manner as those registered at stop-bar detectors.

Scope

This methodology was developed for the following conditions:

- signalized intersections without stop-bar detectors, and
- signalized intersections with advanced detectors.

Methodology

Under variable initial (6) timing, the duration of the initial portion of the green (the first timed portion of the green interval) can increase depending on the number of vehicle actuations stored on the phase while its signal is displaying yellow or red. The variable initial timing period which is also known as a "variable minimum green" is determined by the following three parameters:

- minimum green time, which determines the minimum variable initial time period;
- seconds per actuation, which determines the time by which the variable initial time will be increased (starting from zero) with each vehicle actuation received during the yellow and red intervals of the phase; and
- maximum initial, which is the maximum of the variable initial timing period.

Variable initial timing is effectively when stop-bar detectors are absent and only setback detectors are present. In such cases, the initial timing is incremented to the appropriate value that

is required to service vehicles queued up between the stop line and the setback detector. Variable initial timing requires point detection to operate, so it may not be appropriate to use with the zone detection provided by video detection.

For a single lane approaching an intersection with low turning movement volumes and no driveways between the advance detector and intersection stop bar variable initial can be very easily applied. However, programming the variable initial becomes more complicated for multi-lane approaches and at locations where a common lead-in wire is used for multiple detectors.

The proposed methodology estimates the number of through vehicles waiting during the cycle based upon the number of actuations observed at the advanced detectors. Since the configurations of advanced detectors also depend on site-specific factors such as number of lanes and operating speed, site-specific equations must be established to relate the number of actuations to actual vehicle arrivals. The method first estimates the number of vehicles based on observed actuations under assumed ideal conditions, which are:

- no exclusive left-turn and right-turn lanes,
- no driveways, and
- no heavy vehicles.

Once methodology estimates the number of vehicles under ideal conditions, the adjustment factors are then applied to account for any departures from ideal conditions. Once the adjusted number of through vehicles is calculated, a proper initial green time can be allocated for that cycle. Figure 7 illustrates the factors impacting the estimation of the through vehicles on an intersection approach. It will not be possible to get an approach in the real world that is ideal, i.e., without any exclusive turn lanes, driveways, and heavy vehicles. However, some sites that had very few of the factors were identified to generate field data to develop adjustment factors. TTI researchers collected data from two AWECS (3) sites in Waco and College Station that do not have any driveways on one or both approaches to generate adjustment factors from almost ideal field sites.

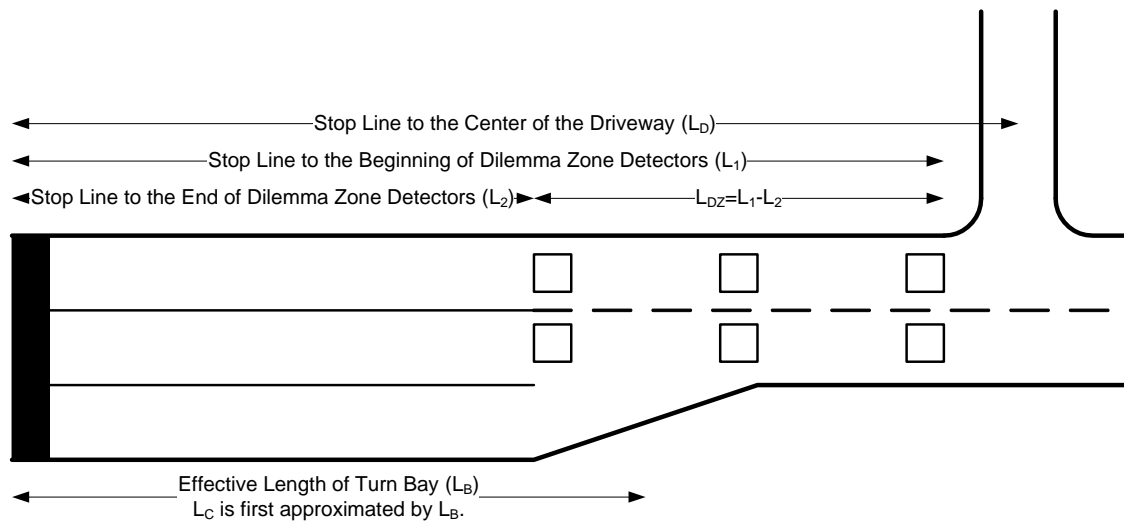

Figure 7. Turn Bay, Driveway, and Detector Locations.

Researchers used the data in the field to generate equations for estimating the through vehicles on an approach when no stop-bar detection is present. These equations were based on the number of detector actuations, which in turn will be based on the number of upstream detectors, the number of lanes, and the location of the detectors with respect to the stop bar. Equations also considered the percentage of left-turning vehicles based on left-turn phase utilization. Since it was difficult to estimate the percentage of right-turn traffic, users were prompted to estimate the percentage right-turn traffic. These turning percentages were then taken into consideration to develop their impact on the number of through vehicles at the intersections. The impact of driveways, their location, and their use on the estimation of through vehicles were estimated in an analytical manner. Similarly, the impact of heavy vehicles on the number of through vehicles was incorporated. These equations will be developed using both simulation as well as analytical techniques.

DETECTOR FAILURE

This section documents the methodology used to develop the detector failure module. The objective of the detector failure model is two-fold. First is to identify a detector failure either for a particular movement or for the entire intersection, and second is to operate the intersection in a more efficient manner. During detector failure, the signal controller typically receives a continuous detection for the detector that has failed. Such an operation is very inefficient. The detector failure model would develop a rolling four-week historical operational log. In case of a

detector failure, either for a phase or the entire intersection, this historical log will be used to determine the expected intersection operations and implement those operations. Such an operation, while not truly representative of existing traffic demand, is more efficient than operations with a faulty detector.

Scope

The scope of the module is limited to providing a mode of operations that would be appropriate for normal, average traffic conditions. This means that during a detector failure, the module would determine the expected demand from historical data and provide the appropriate phase duration for the expected demand. However, the module will not be able to account for unexpected surges in traffic demand due either to special events or incidents. This system will improve operations during detector(s) failures.

Methodology

The methodology of the detector failure module primarily consists of three parts. The first part is to identify a detector failure. Once the detector failure is identified, the module should determine the traffic demand for the movement(s) served by the detector that has failed. This determination would be based on a historical log of either traffic demand or a parameter that is a surrogate of traffic demand. Finally, the appropriate phase time would be implemented in the controller.

Identifying Detector Failure

Traffic signal controllers have detector diagnostics features. These features allow users to specify the criteria to be used to diagnose detectors and identify a failure. The typical criteria available are maximum presence, no call, and erratic count. Maximum presence criteria are used to identify a detector failure when a constant call is seen on a specific detector for a user specified time. Typically, a detector amplifier places a constant call when a fault is identified in an inductive loop. In the case of video detection, sometimes due to a fault in the video processor, a constant call is seen. If the duration of a constant call exceeds the user-specified threshold (in minutes) within the detector diagnostics in the controller, a failure is identified. On a similar note, if for some reason the controller does not receive a call or does not see any activity for a duration exceeding the user-specified threshold (in minutes) within the detector diagnostics

parameter in the controller, the controller diagnoses the detector as a failure. Finally, if the controller sees an unreasonably large number of detections within a very short period of time (number of calls per minute) and exceeds the user-specified threshold, the detector is diagnosed as a failure. The user specifies the thresholds for the three diagnostics criteria, and those thresholds depend on the traffic patterns at the intersections.

When a controller identifies a detector failure, usually the controller places a constant call on that detector. This causes the phase mapped to the failed detector maxing out every time, resulting in very inefficient operations during off-peak timings. Some controllers, however, give an option to the user to specify how long the phase should be on during a detector failure. This can result in a more efficient operation during off-peak timings but can be inefficient during the peak timings.

The detector failure module (Module 2) will monitor detector activity through the detector Bus Interface Unit (BIU). The module will identify the detector failure if the criteria programmed in the controller are used. However, the module will monitor the controller's response to the detector failure and use that as a criterion to implement a more appropriate phase time. Figure 8 illustrates the architecture of the detector failure module.

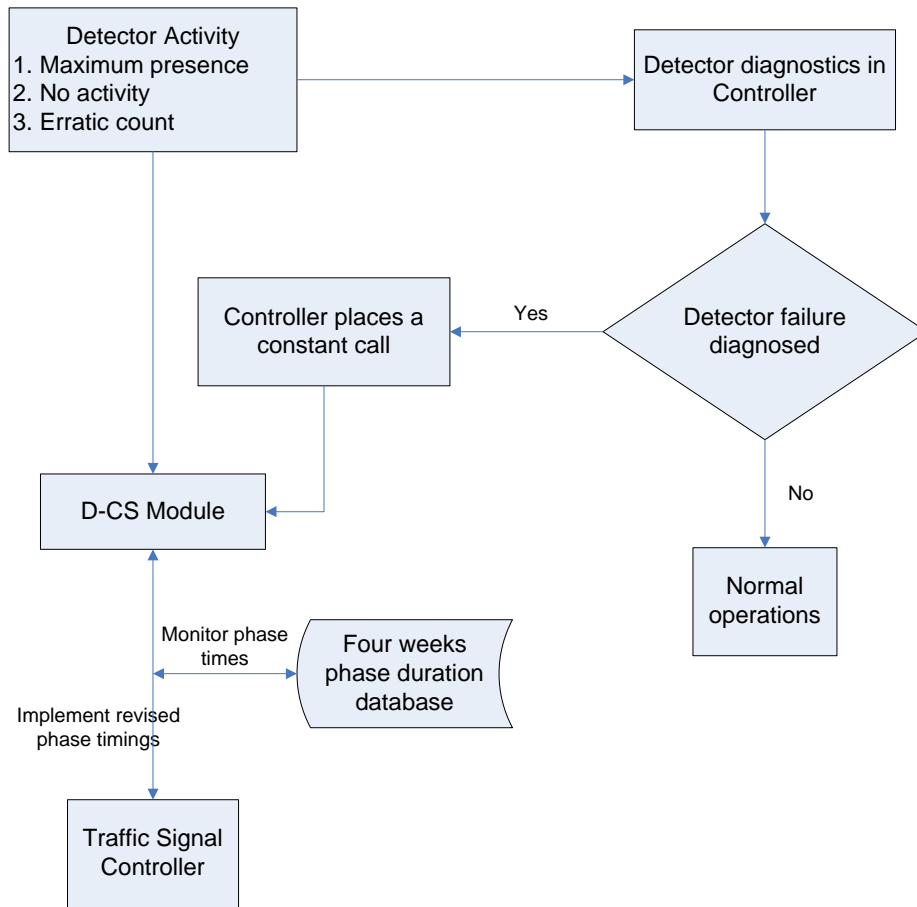

Figure 8. Detector Failure (Module 2) Architecture.

Determining the Expected Traffic Demand

Once the detector failure is identified, the detector failure module determines the appropriate phase time for the phase mapped to the detector that has failed from a phase durations database consisting of the previous four weeks. These phase durations are logged for each 15-minute period starting at midnight. The database consists of the phase durations of each and every separate phase that is complete (i.e., start and complete) within each 15-minute interval. Thus, each 15-minute interval consists of the number of phases complete within that interval as well as the average of the complete phases. These two pieces of information are logged for each phase for each 15-minute interval of the day. An example of a slice of data for one time interval in the database is illustrated in Figure 9.

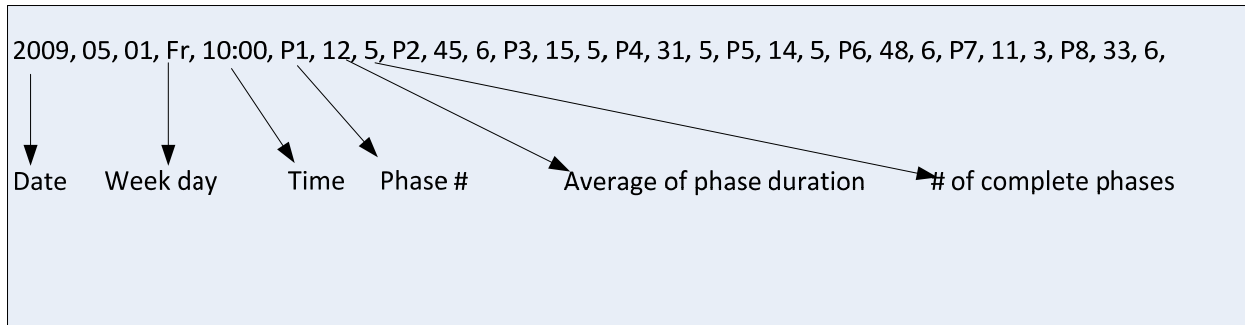

Figure 9. Illustration of Database Format.

The database consists of such data for all 15-minute intervals of the day for all 28 days. At the end of each day, at midnight, the data for that particular day replaces the data from a similar day at the beginning of the database. For example, at the end of a Monday, the data from that day will replace the data for Monday 1 of the database. Thus, a rolling four-week database of phase durations is maintained in the database.

Implementing the Detector Failure Module

Upon identifying a detector failure, the detector failure module will extract for the appropriate phase the phase durations and the number of complete phases for the appropriate time slice. This extraction of data will be conducted from each of the weekdays for a weekday scenario or from the weekend days for a weekend scenario. The module will then calculate the average of the phase durations from the database and implement the phase duration in the controller and implement it.

Implementation of the phase duration is accomplished using the force-off function. Upon diagnosis of a detector failure, the controller will place a constant call on a phase. The detector failure module then terminates the phase by applying a “ring force off” once the phase duration has exceeded the optimum duration determined by the module. This force off ends the phase and brings on the next phase. Thus, maxing out of the phase is avoided and intersection operations are more efficient.

VARIABLE DELAY

Traffic engineers using NEMA controllers (5) have the capability to program a specific amount of delay into the controller for a specific detector. Historically, the same delay was programmed into the detector amplifier. According to NEMA TS-2 specifications (5), a delay is

defined as the ability of a detector to delay its output for a predetermined length of time after a vehicle has entered its zone of detection. When selected, the detector output is delayed for the time set. If the vehicle departs before the time set, an output does not occur and the timer is reset. The delay time is adjustable over the range of 0 to 30 seconds and remains a constant value.

The delay feature, when used for protected-permissive left-turn phases, reduces the number of times the opposing arterial phase is terminated due to left-turning vehicles. A similar strategy is used to allow the right-turning vehicles on minor streets to find gaps in the major-street through movements. The existing configuration uses a constant delay throughout the day. A variable call delay based on traffic volumes at the intersections has the potential to further improve the efficiency of the intersection operations.

Scope

The scope of the module is limited to left-turn movements with protected-permissive phasing and right-turn movements with exclusive turn bays with detectors coming on separate channels.

Methodology

Use of detector delay is a well-established practice to improve the efficiency at fully actuated traffic signals. Detector delay on arterial left-turn phases using protected-permitted phasing will minimize unnecessary termination of the major-street through movement. This is particularly the case during low volume conditions when major-street traffic has many acceptable gaps in the traffic stream and a left-turning vehicle will most likely find a gap without stopping. Similarly, a right-turning vehicle on the minor street can easily find gaps in the major-street movement during light volume conditions and not call the minor-street phase. However, fewer gaps are available for turning vehicles when major-street volume increases, requiring the turning vehicles to wait past the delay time before placing a call on the respective phase. These turning vehicles will then be serviced either when they find a gap or when the phase is serviced. However, when the major-street volumes get very high, the only way to service these turning vehicles is by calling a phase. In such cases, these turning vehicles may have to wait longer than the maximum time to be serviced. Under such circumstances, use of the constant delay value increases delay to the arterial left-turn and minor-street right-turn movements.

There are numerous factors that the variable delay module will consider to determine the appropriateness of using detector delay functions as well as the duration of the detector delay. Following is a description of the factors primarily influencing the use of detector delay. Figure 10 illustrates these factors, as well.

- Major-street volumes: It is expected that as the major-street volumes increase, there will be fewer acceptable gaps in the traffic stream, resulting in fewer vehicles taking these gaps. So, the higher the volume, the more the turning vehicles will be delayed.
- Gap acceptance characteristics: Gap acceptance characteristics vary among motorists. More aggressive drivers will accept smaller gaps, and less aggressive drivers will accept only larger gaps. Hence, the type of drivers in an area will influence the gap acceptance characteristics.
- Turning movement volumes: In case the major-street volumes are very high (they do not gap out), turning movements with higher volumes will experience greater delay at the intersections. This delay experienced will increase if detector delay is employed. If the vehicle has to wait to be served by its phase, it has to wait for the duration of the delay (d seconds) as well as the duration of the conflicting phase (major-street movement) (P seconds). If, however, the phase serving the turning movement has a v/c ratio of less than one (i.e., the phase serves all the vehicles in the queue), the detector delay is reset and is applied again for the next set of vehicles and, hence, they have to wait for $d+P$ seconds till they are serviced. If, on the other hand, the v/c ratio of the turning movement phase is greater than 1 (i.e., some of the vehicles in the queue are not cleared), the detector delay is not reset and the next set of vehicles will have to wait for P seconds to be serviced. Thus, from this discussion, detector delay can be eliminated when the following conditions are met:
 - Major-street volumes are high enough that gaps are not available.
 - Turning movement volumes are low enough that the minor phase can clear all the vehicles.

Previous research (18) on the duration of detector delay provided the following guidelines:

- right-turn detector delay—8 to 14 seconds, and
- left-turn detector delay—5 to 12 seconds.

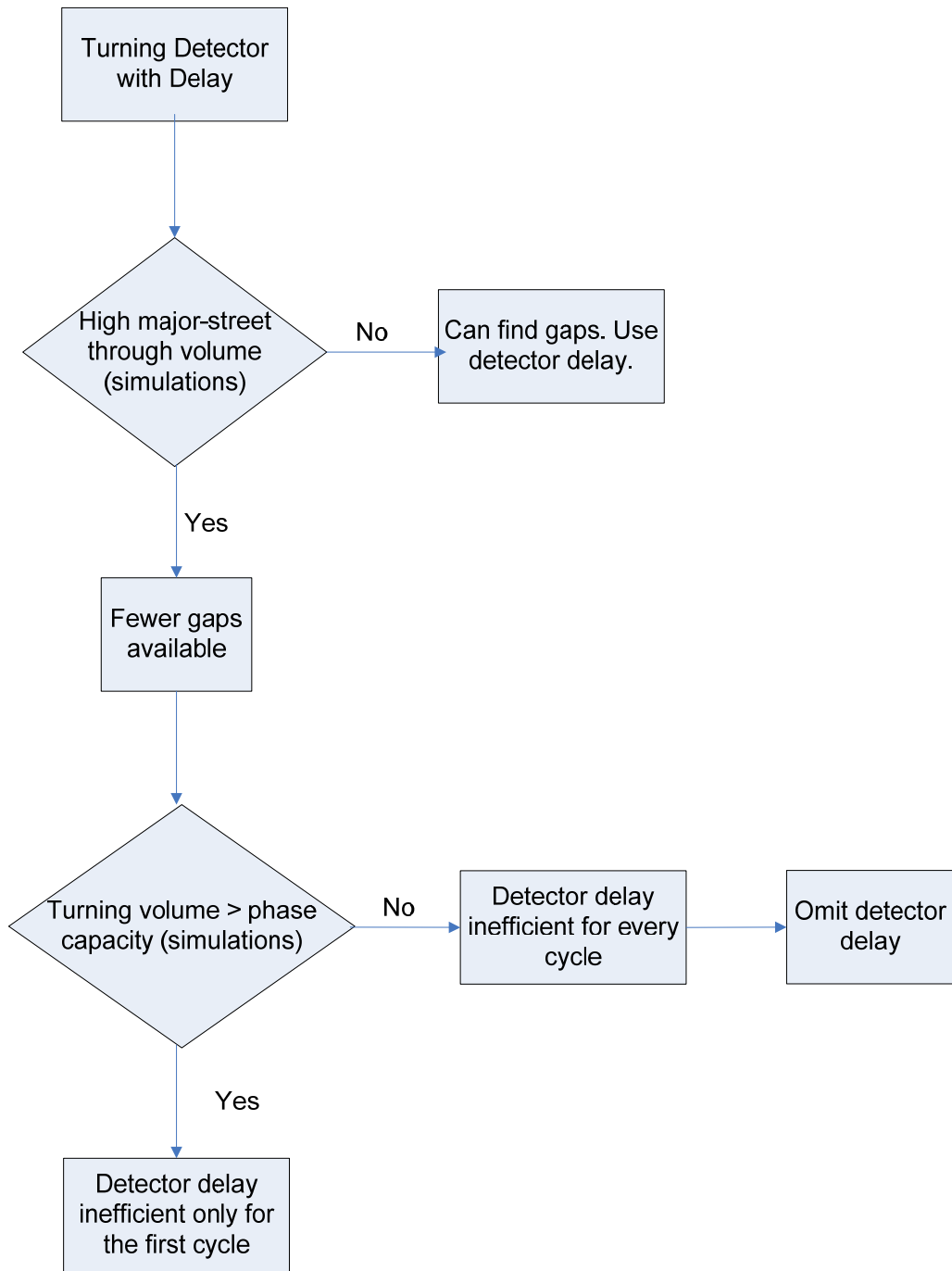

Figure 10. Flow Chart of the Factors Affecting Variable Delay Module.

These settings have been accepted across the industry and are applied appropriately. The methodology will refer to the local agency’s preferences to determine the duration of detector delay.

MODULE IMPLEMENTATION

SITE SELECTION

Based on the criteria set for each module, three sites were selected for deploying the modules. These sites are located in the Waco District, Bryan District, and Houston District. Not all modules were applicable at all sites. The modules deployed depended on the intersection as well as detection configuration. Module 2 was, however, deployed at all intersections. The system deployment required an intersection operating with a TS-2 cabinet and enough space in the cabinet to place an industrial personal computer.

Waco District

The site in Waco is located at the intersection of US 84 and Aviation Parkway (Figure 11). This site has setback detectors with inductive loops at over 960 feet from the stop bar on US 84. The intersection, however, has video detection for detection at the stop bar (Figure 12). The variable initial module, the detector failure module, and the variable delay module were deployed at this site.

Bryan District

The site in Bryan is located at the intersection of SH 21 and Business 6 (Figure 13). This site has only video detection on all four approaches at the stop bars (Figure 14). Only the detector failure module was deployed at this site.

Houston District

The site in the Houston District is located at the intersection of SH 105 and FM 3083 in Conroe (Figure 15). The intersection uses only inductive loops on all four approaches at the intersection. This includes the dilemma zone detectors at 475 feet, 375 feet, and 275 feet from the stop bar on the SH 105 approaches and stop-bar detectors in all lanes (Figure 16). The variable initial module and the detector failure module were deployed at this site.

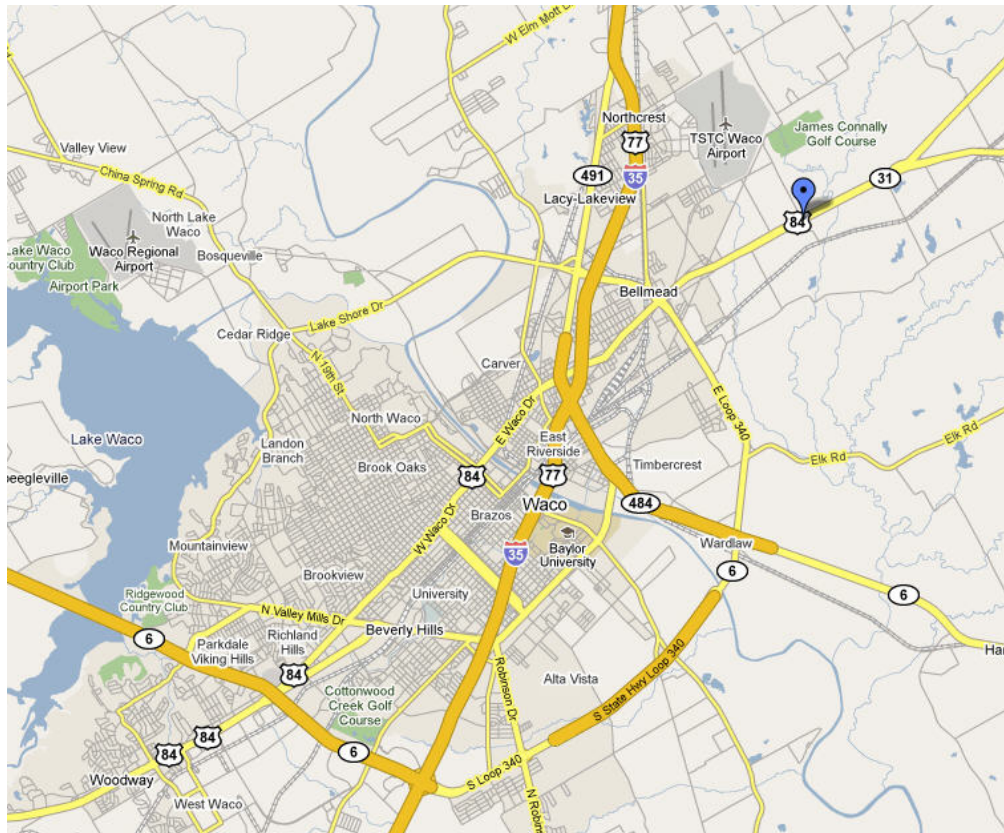

Figure 11. Site Location in Waco District.

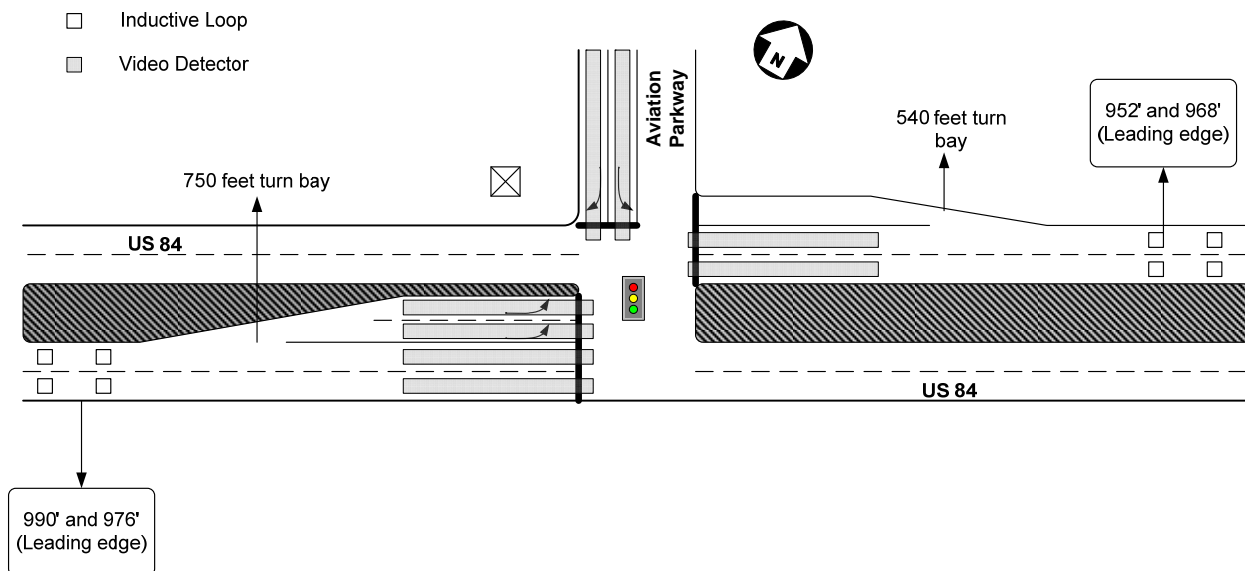

Figure 12. Detector and Intersection Configuration at the Site in Waco District.

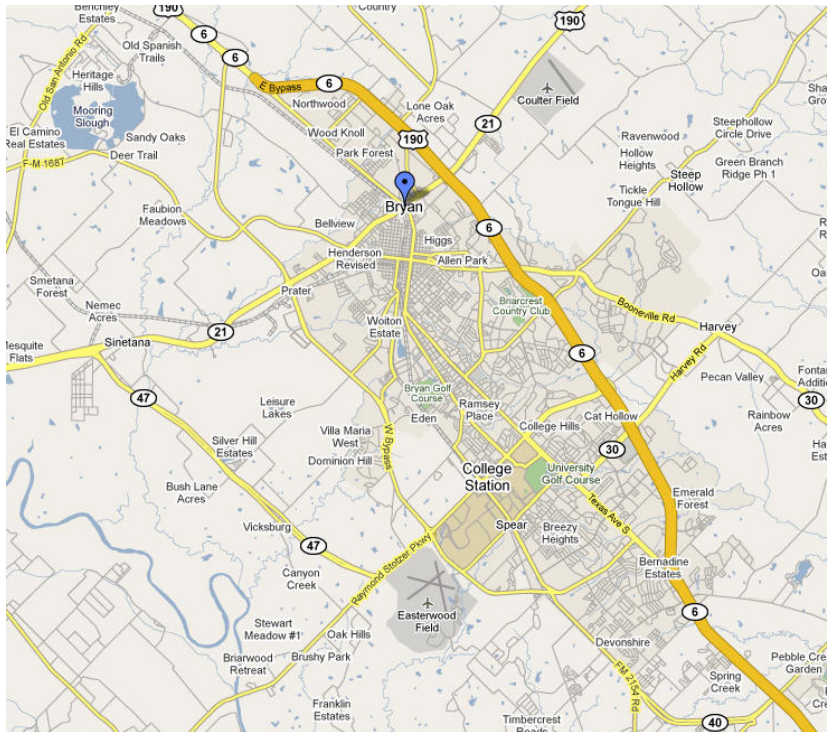

Figure 13. Site Location in Bryan District.

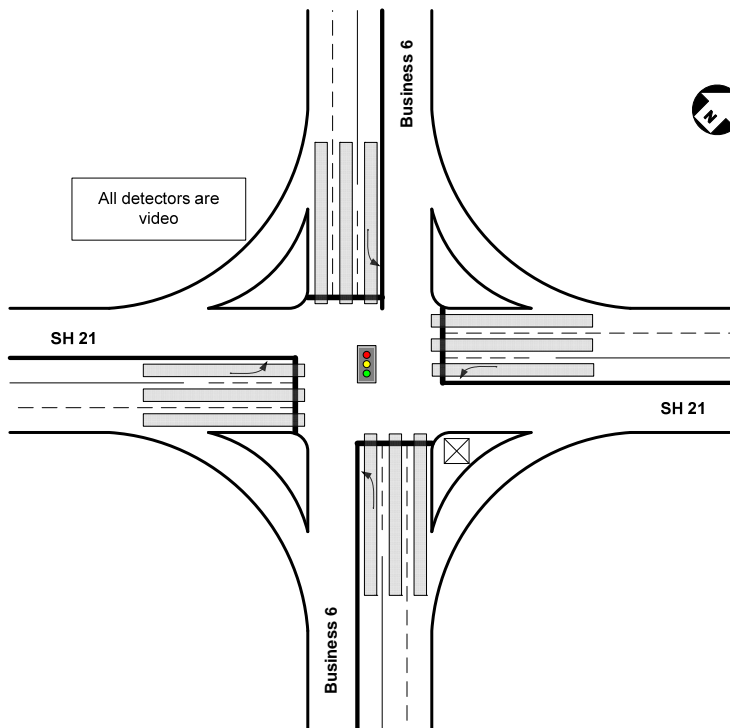

Figure 14. Intersection and Detector Configuration at the Site in Bryan District.

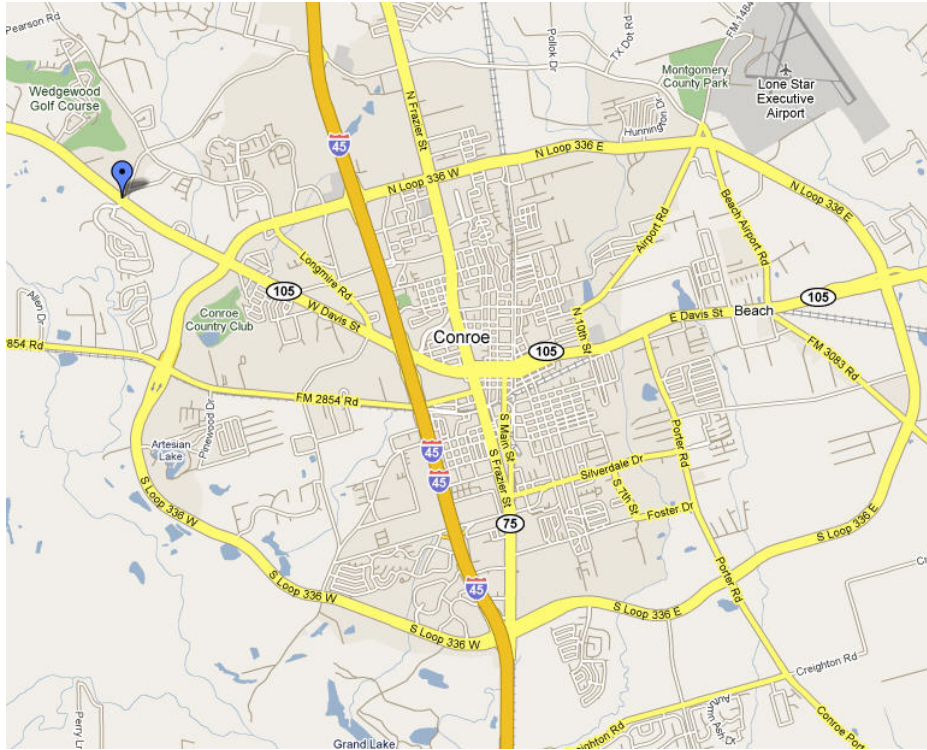

Figure 15. Site Location in Houston District.

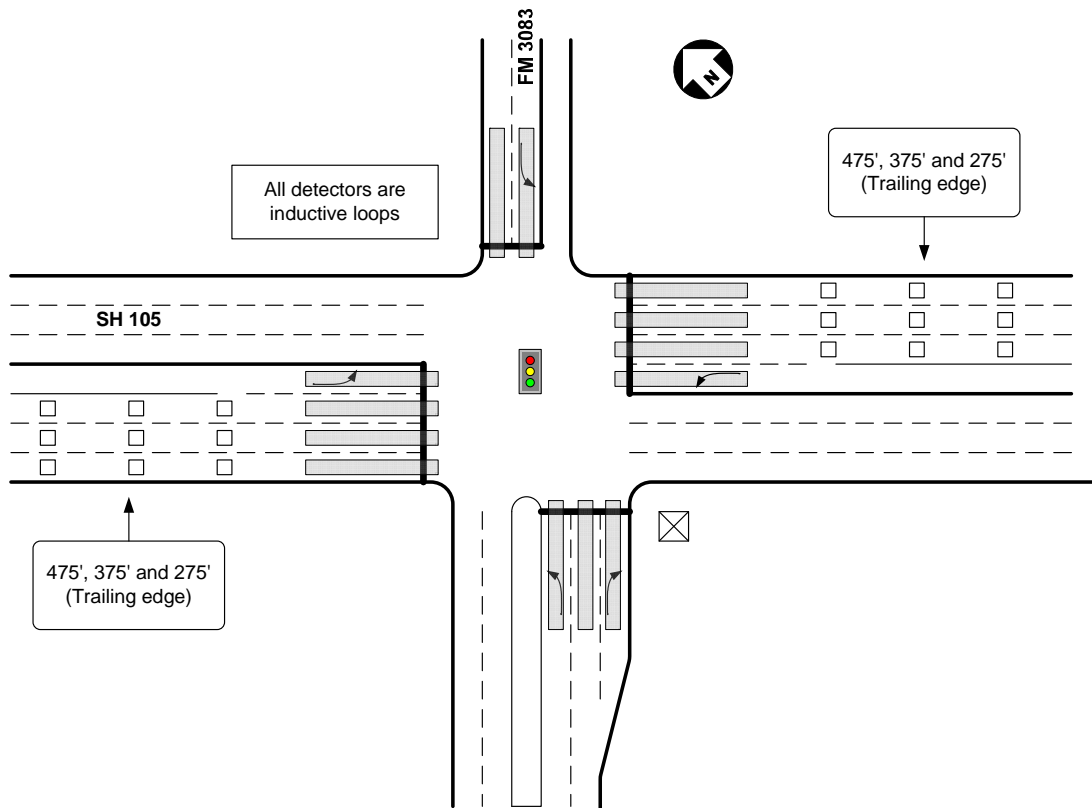

Figure 16. Intersection and Detector Configuration at the Site in Houston District.

SOFTWARE CONFIGURATION

Once the algorithms for the three modules were developed with simulation and analytical methods, TTI researchers developed the modules for field implementation. This included a graphical user interface (GUI) for configuring the modules as well as developing the appropriate output files to log the various processes both within the controller as well as within the three modules. Every effort was made to minimize user input requirements. When the input was required from the user, it was made to be as simple as practical. The three modules were developed sequentially. They were tested in the TransLink® Laboratory using a cabinet in the loop simulation. The GUI and the output files were fine-tuned.

Figure 17 and Figure 18 illustrate the general configuration required for all the three modules. This configuration is all that is needed for the detector failure module. Once this configuration is completed, configuration screens specific for variable initial and variable delay will be available to the user if these modules are applicable and if the user chooses to implement them. The detector failure module is applicable under all circumstances. The user can specify the configuration of phase numbering schemes, phasing sequences, number of lanes per approach, and basic phase setting in the phase configuration screen.

The detector mapping to various phases, the type of detector, and the detector diagnostics are configured in the detector mapping configuration screen. Sixteen detectors can be configured in this screen.

Phase Configuration ✖

Phase Settings

Phase	1	2	3	4	5	6	7	8
Main Phase	<input type="checkbox"/>	<input checked="" type="checkbox"/>	<input type="checkbox"/>	<input type="checkbox"/>	<input type="checkbox"/>	<input checked="" type="checkbox"/>	<input type="checkbox"/>	<input type="checkbox"/>
Direction	<input type="text"/>	EB	<input type="text"/>	<input type="text"/>	<input type="text"/>	WB	<input type="text"/>	<input type="text"/>
Phase On	<input type="checkbox"/>	<input checked="" type="checkbox"/>	<input type="checkbox"/>	<input checked="" type="checkbox"/>	<input checked="" type="checkbox"/>	<input checked="" type="checkbox"/>	<input type="checkbox"/>	<input type="checkbox"/>
Phase Check	<input type="checkbox"/>	<input checked="" type="checkbox"/>	<input type="checkbox"/>	<input checked="" type="checkbox"/>	<input checked="" type="checkbox"/>	<input checked="" type="checkbox"/>	<input type="checkbox"/>	<input type="checkbox"/>
Memory On	<input type="checkbox"/>	<input type="checkbox"/>	<input type="checkbox"/>	<input type="checkbox"/>	<input type="checkbox"/>	<input type="checkbox"/>	<input type="checkbox"/>	<input type="checkbox"/>
Minor Phase	<input type="checkbox"/>	<input type="checkbox"/>	<input type="checkbox"/>	<input checked="" type="checkbox"/>	<input type="checkbox"/>	<input type="checkbox"/>	<input type="checkbox"/>	<input type="checkbox"/>
Art Left Phase	<input type="checkbox"/>	<input type="checkbox"/>	<input type="checkbox"/>	<input type="checkbox"/>	<input checked="" type="checkbox"/>	<input type="checkbox"/>	<input type="checkbox"/>	<input type="checkbox"/>
Protected/Permitted	<input type="checkbox"/>	<input type="checkbox"/>	<input type="checkbox"/>	<input type="checkbox"/>	<input checked="" type="checkbox"/>	<input type="checkbox"/>	<input type="checkbox"/>	<input type="checkbox"/>
Lagging Left	<input type="checkbox"/>	<input type="checkbox"/>	<input type="checkbox"/>	<input type="checkbox"/>	<input checked="" type="checkbox"/>	<input type="checkbox"/>	<input type="checkbox"/>	<input type="checkbox"/>
Omitted During Prmpt	<input type="checkbox"/>	<input type="checkbox"/>	<input type="checkbox"/>	<input type="checkbox"/>	<input type="checkbox"/>	<input type="checkbox"/>	<input type="checkbox"/>	<input type="checkbox"/>
Track Phase	<input type="checkbox"/>	<input type="checkbox"/>	<input type="checkbox"/>	<input type="checkbox"/>	<input type="checkbox"/>	<input type="checkbox"/>	<input type="checkbox"/>	<input type="checkbox"/>
Lanes per Approach	2	2	2	2	2	2	2	2
Detector Type		DCS-DUM		DUM	SBD-DUM	DCS-DUM		
MIN GRN	5	10	5	10	8	25	5	5
MAX # 1	10	35	10	25	20	35	10	10
PASSAGE	2	2	2	1	1	2	2	2
C1 to SB Dist	0	540	0	0	0	540	0	0
C3 to SB Dist	0	320	0	0	0	320	0	0
Avg. Speed	55	57	55	55	55	60	55	55
85th Speed	60	62	60	60	60	65	60	60
Det. Delay	0	0	0	0	0	0	0	0

Figure 17. Phase Setting Configuration.

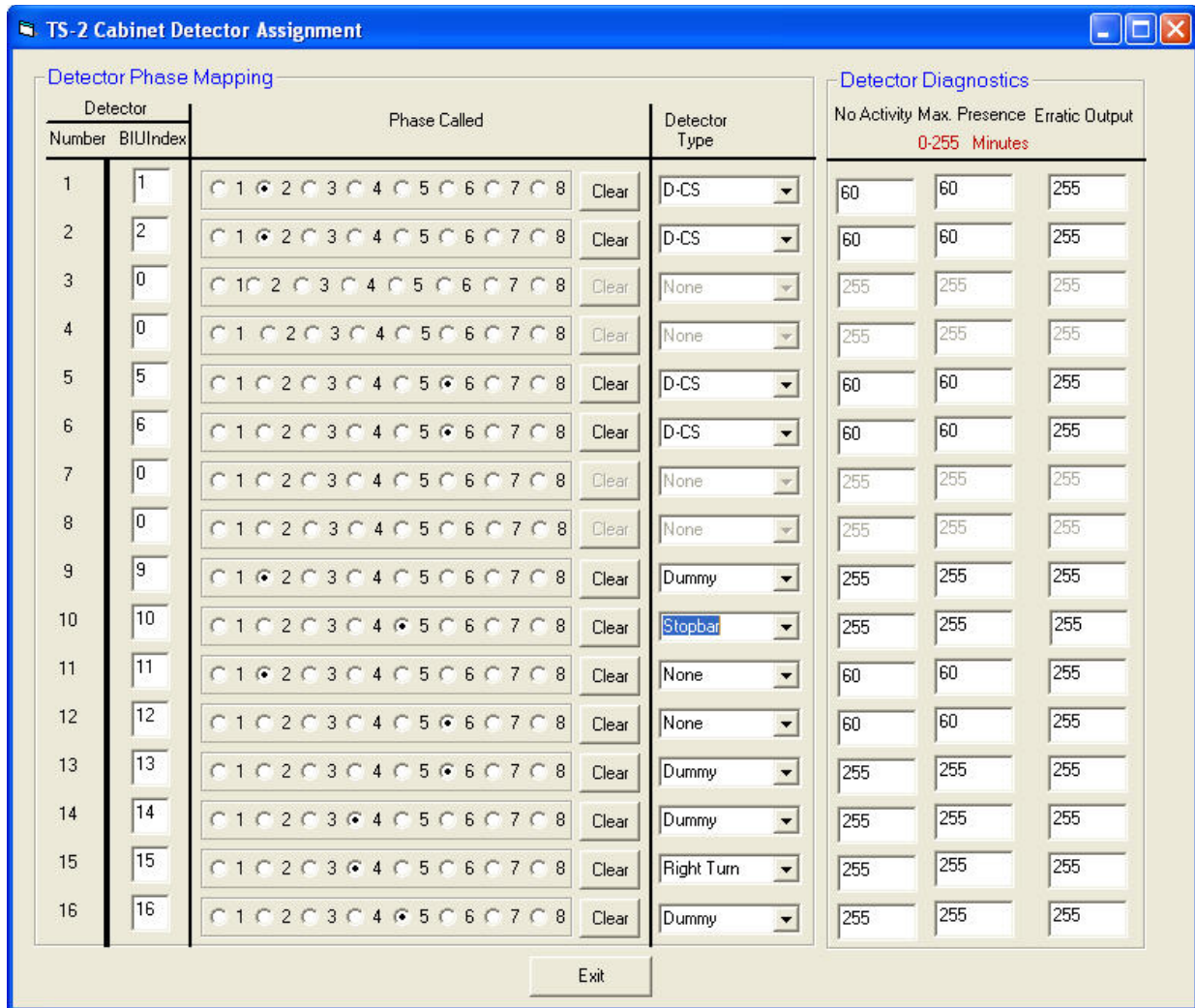

Figure 18. Detector Mapping Configuration.

Variable Initial

Configuration of the variable initial feature requires information about location of upstream detectors, type of detectors, traffic arrival type, and other information illustrated in Figure 19. Information regarding the location of driveways including location and type of use can be configured in a screen, as illustrated in Figure 20.

Once the module is operational, the algorithm will count the vehicles arriving on the detectors on yellow and red and estimate the variable initial. The module logs this information in a log file, as illustrated in Figure 21. Based on a count on red (COR), a value of initial green (IG) is predicted.

Phase Initial Green Settings

2 Enable Variable Initial for this Phase

Select a phase

2

Number of Lanes per Approach

Detector Settings

D-CS 0

Detector Type: Number of Detectors per Lane

875

Distance from Stopbar to Beginning of Detection Zone

850

Distance from Stopbar to End of Detection Zone

Volume Settings

Dynamic 0

Vol Estimation Method Fixed Volume

Exclusive 750

Left Turn Type Length Left Turn Bay

Dynamic 0

Left Turn Estimation Method % Left Turn Volume

None 0

Right Turn Type Length Right Turn Bay

0 5

% Right Turn Volume %Trucks

General Settings

2 2

Seconds Per Vehicle Passenger Car Equivalent Ratio

UNBALANCED 0.6

Queue Distribution Method Queue Distribution Value

10

Number of Cycles

Exit Update Variable Initial Data

Figure 19. Variable Initial Setting Screen.

DriveWay Settings

Select a phase 2

Number of Driveways 0

Driveway Settings

Driveway #	Driveway Net Traffic	Stop-Bar Distance
1		
2		
3		
4		
5		
6		
7		
8		
9		
10		

Exit Update Driveway Info

Figure 20. Driveway Setting Screen for Variable Initial.

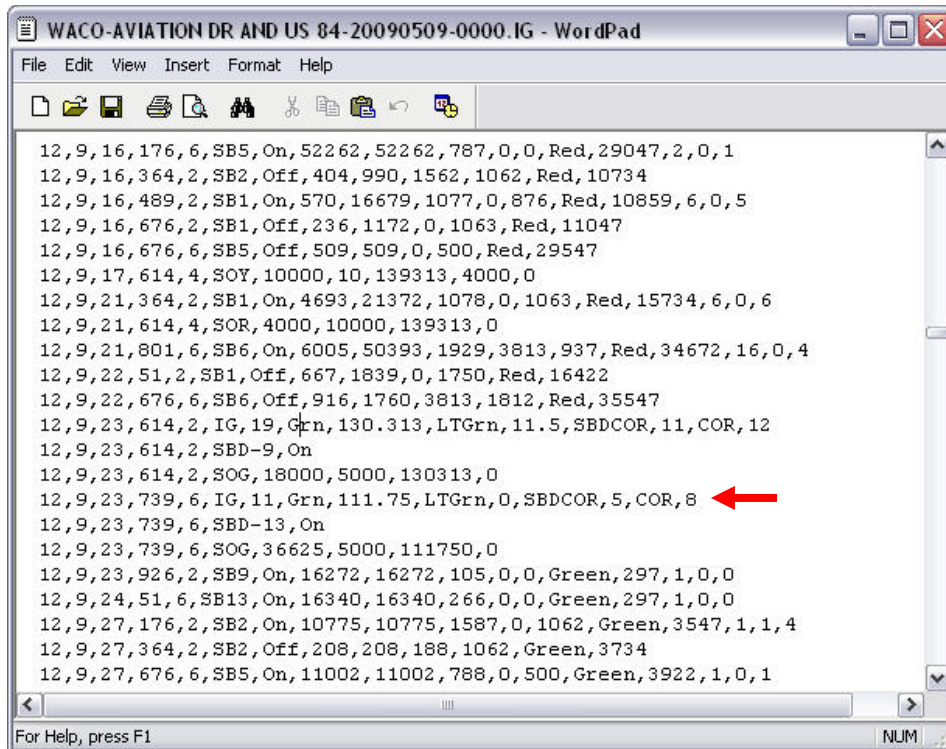

Figure 21. Variable Initial Prediction.

Detector Failure

The screens illustrated in Figure 17 and Figure 18 are used to configure the detector failure module. The module is constantly monitoring the health of the detectors according to the stated detector diagnostics. Detector diagnostic results are logged in a file, as illustrated in Figure 22. A detector failure due to a max presence at 23:59:47 hours on phase 5 in detector 10 is logged.

The module also predicts the expected green at the beginning of each phase. The predicted green time (in milliseconds) is also logged and is illustrated in Figure 23. The log illustrates the predicted green, the actual green, and the difference between the two values.

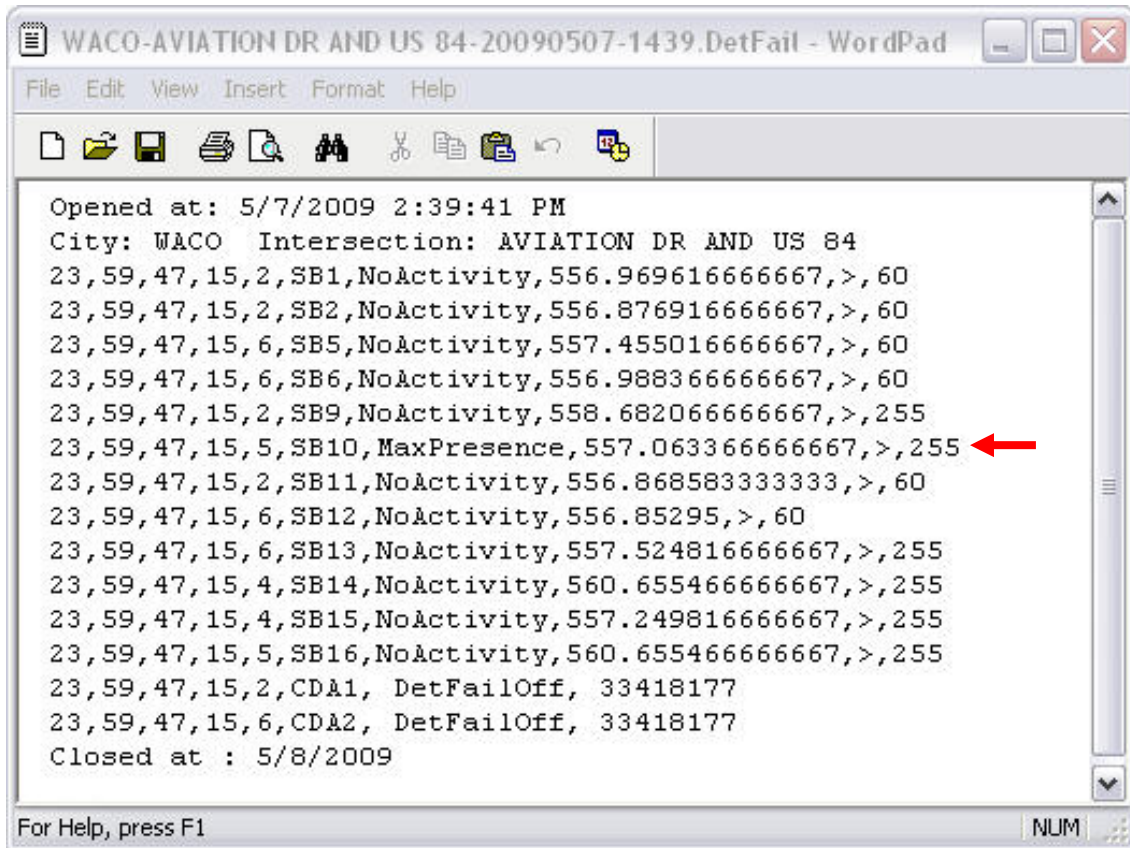

Figure 22. Detector Failure Log.

Line	Col 1	Col 2	Col 3	Col 4	Col 5	Col 6	Col 7	Col 8	Col 9	Col 10
12	3	32	989	4	ActualGrn	12063	PredictedGrn	10	2.1	
12	5	28	364	4	ActualGrn	10000	PredictedGrn	10	0.0	
12	7	20	864	4	ActualGrn	10000	PredictedGrn	10	0.0	
12	9	47	926	4	ActualGrn	10000	PredictedGrn	10	0.0	
12	11	55	926	4	ActualGrn	10000	PredictedGrn	10	0.0	
12	17	13	676	4	ActualGrn	11687	PredictedGrn	10	1.7	
12	21	53	426	4	ActualGrn	10000	PredictedGrn	10	0.0	
12	25	20	489	4	ActualGrn	10000	PredictedGrn	10	0.0	
12	31	51	364	4	ActualGrn	10000	PredictedGrn	10	0.0	
12	33	8	301	4	ActualGrn	10937	PredictedGrn	10	0.9	
12	34	56	676	4	ActualGrn	13812	PredictedGrn	10	3.8	
12	43	28	51	4	ActualGrn	10000	PredictedGrn	10	0.0	
12	46	21	489	4	ActualGrn	10000	PredictedGrn	10	0.0	
12	47	19	51	4	ActualGrn	10000	PredictedGrn	10	0.0	
12	51	13	489	4	ActualGrn	10063	PredictedGrn	10	0.1	
13	3	49	551	4	ActualGrn	10062	PredictedGrn	10	0.1	
13	5	41	489	4	ActualGrn	10000	PredictedGrn	10	0.0	
13	7	32	426	4	ActualGrn	10000	PredictedGrn	10	0.0	
13	8	25	864	4	ActualGrn	13875	PredictedGrn	10	3.9	
13	11	41	489	4	ActualGrn	10000	PredictedGrn	10	0.0	
13	15	13	864	4	ActualGrn	18813	PredictedGrn	10	8.8	
13	16	41	51	4	ActualGrn	10000	PredictedGrn	11	-1.0	
13	20	18	489	4	ActualGrn	10000	PredictedGrn	11	-1.0	
13	21	39	51	4	ActualGrn	10000	PredictedGrn	11	-1.0	
13	31	55	51	4	ActualGrn	10000	PredictedGrn	11	-1.0	
13	34	0	489	4	ActualGrn	10000	PredictedGrn	11	-1.0	

Figure 23. Green Prediction Log.

Variable Delay

The variable delay module is applicable for right-turning vehicles from right-turn bays with an exclusive right-turn detector and left-turning vehicles from left-turn bays with protected-permissive operations. The module requires some configuration, like conflicting volumes, to disable the detector delay. Additional information like size of the detector, speeds of turning vehicles, and percentage trucks can also be configured to implement the variable delay module. Figure 24 illustrates the configuration screen for right-turn delay settings.

4
Select a phase

Enable Right Turn Delay

20
Right Turn Detector Length

10
Right Turn Estimated Speed

60
Main Street Speed

5
%Trucks Minor Street

5
%Trucks Main Street

400
Main Str. Hourly Volume Threshold

Update Right Turn Delay data

Exit

Figure 24. Right-Turn Delay Module Settings.

FIELD IMPLEMENTATION

Project 0-6029 developed three modules for improving signal operations at isolated signals. These modules were deployed at three sites in TS-2 cabinets. In a TS-2 cabinet, the signal controller communicates with the detector's rack and the back panel using BIUs with Synchronous Data Link Communication (SDLC). The adaptive D-CS system operates in an industrial PC in the cabinet. This industrial PC communicates with the cabinet using a special set

of BIUs called enhanced BIUs. These enhanced BIUs have a serial port in addition to an SDLC port. The BIUs communicate with the signal controller using SDLC communication. The industrial PC communicates with the BIUs using the serial communication through the serial port. The implementation architecture is illustrated in Figure 25. These enhanced BIUs replace the detector BIU (BIU-D) and BIU # 1 (BIU-1) so that the adaptive D-CS can monitor the detector activity and signal status and also have the capability to place calls and force-offs. Figure 26 illustrates the system deployed at the site near Conroe. Table 1 also summarizes the modules implemented at each of the sites in Texas.

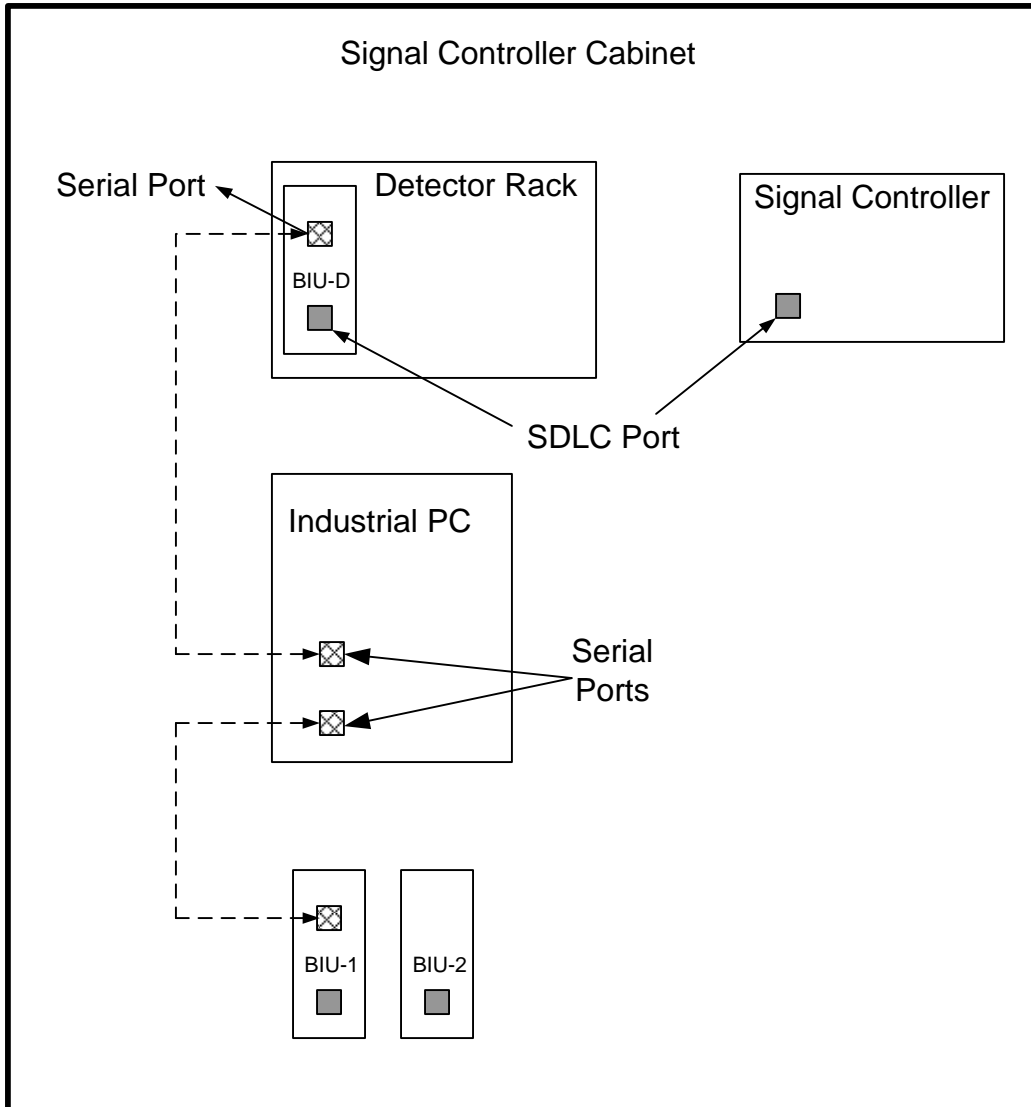

Figure 25. D-CS Implementation Architecture.



Figure 26. Installation of Adaptive D-CS in the Houston District near Conroe.

Table 1. Modules Deployed at Each Site in This Project.

	Module 1—Variable Initial	Module 2—Detector Failure	Module 3—Variable Detector Delay
Site 1—Waco	Yes	Yes	Yes
Site 2—Bryan	No	Yes	No
Site 3—Conroe	Yes	Yes	No

EVALUATION AND CONCLUSION

Researchers evaluated three modules in this project. The variable initial module (Module 1) and the detector failure module (Module 2) had numerous applications. Module 1 was applicable in many cases where stop-bar detection was not installed. In many cases, it eliminates the need for stop-bar detectors, thereby reducing installation and maintenance costs. Module 1 can be used at D-CS type installations or any other intersection having only upstream detectors. These include intersections with dilemma zone detectors. Module 2 is applicable at all intersections that are operating fully actuated, including D-CS type intersections. The module can provide significant benefits when a few detectors either fail or malfunction for a period of time. Variable detector delay (Module 3), however, was found to have very little use. A static value of detector delay provides some benefits by minimizing unnecessary terminations for the major-street movement. However, the benefits of variable delay were very limited and under rare circumstances. Hence, researchers did not deploy Module 3 after a preliminary deployment in Waco and did not evaluate it further.

MODULE 1

Researchers calibrated the adaptive variable initial module at the site in Waco. The Waco site was a four-lane highway with two lanes in each direction approaching the intersection. The Waco site had a D-CS installed and hence had a pair of detectors in each lane over 950 feet from the intersection. There were no driveways between the detectors and the stop bar. However, there was a significant variation in the turning percentage at the intersection. Researchers observed a significant imbalance in the queue distribution. The intersection, though, did have video detection and hence stop-bar detection. The occupancy in stop-bar detection is therefore a good measure to validate the methodology for the adaptive variable initial.

Module 1 was then implemented at site 3 near Conroe. As mentioned earlier, the site in Conroe is a six-lane highway with three lanes in each direction. The site has dilemma zone detectors in each lane at 475 feet, 375 feet, and 275 feet from the stop bar. Thus, the intersection in Conroe has significantly different characteristics compared to the intersection in Waco where the model was calibrated. The Conroe site also had stop-bar detectors. These stop-bar detectors facilitated a thorough evaluation of the adaptive variable initial module. The module logged the parameters used to determine the variable initial as well as the recommended initial green. These

included the detector counts during the red portion, the predicted initial green, and the time taken to clear the queue for each cycle. Figure 27 and Figure 28 illustrate the relationship between the counts on red and the predicted initial green for phase 2 and phase 6, respectively. The same graph also illustrates the actual queue clearance for the same counts. The graph clearly illustrates a strong correlation between counts on red and initial green. The upper and lower limits of queue clearance values straddle the predicted initial green values for the number of detector actuations. This is an indication that the predicted initial green values are close to the time required for the queue to clear. To further evaluate this aspect, researchers compared the predicted initial greens with the observed queue clearance times for both phase 2 and phase 6, as illustrated in Figure 29 and Figure 30. A line was drawn with a slope of 1 in each of these graphs. These figures illustrate that the predicted initial green values in general are close to the queue clearance values.

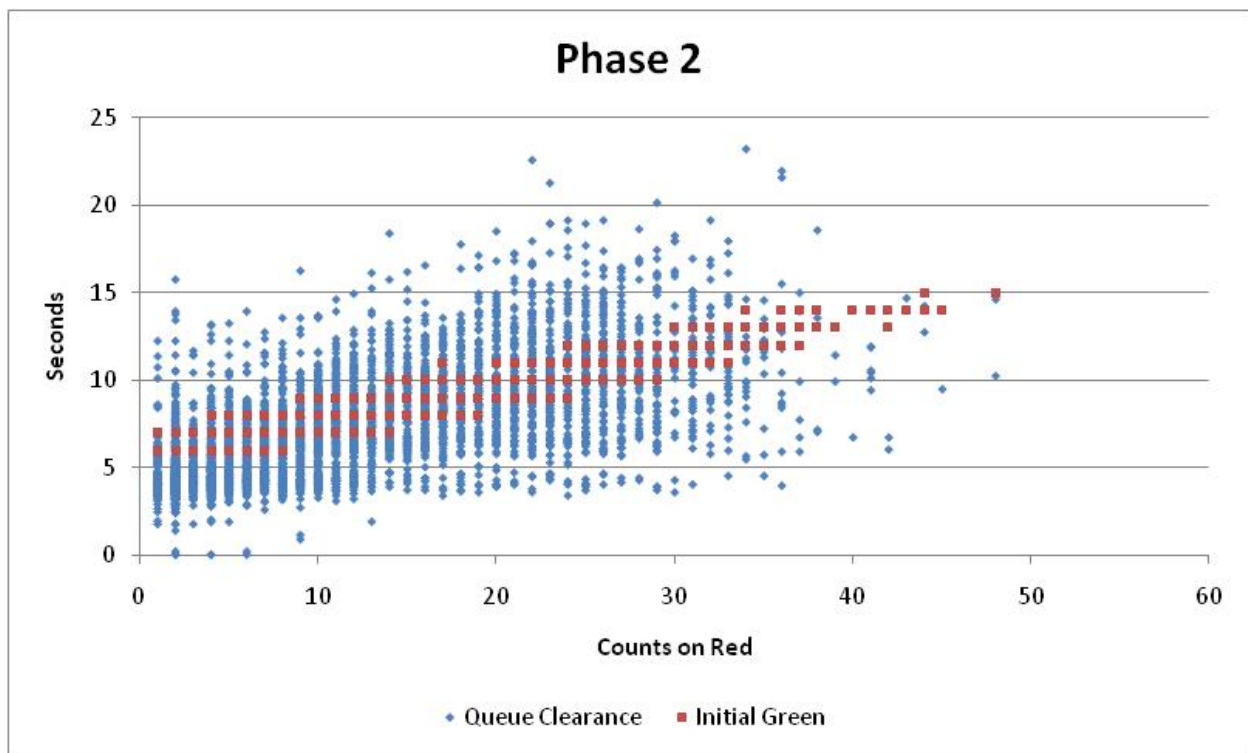

Figure 27. Accuracy of Predicted Initial Green (Phase 2).

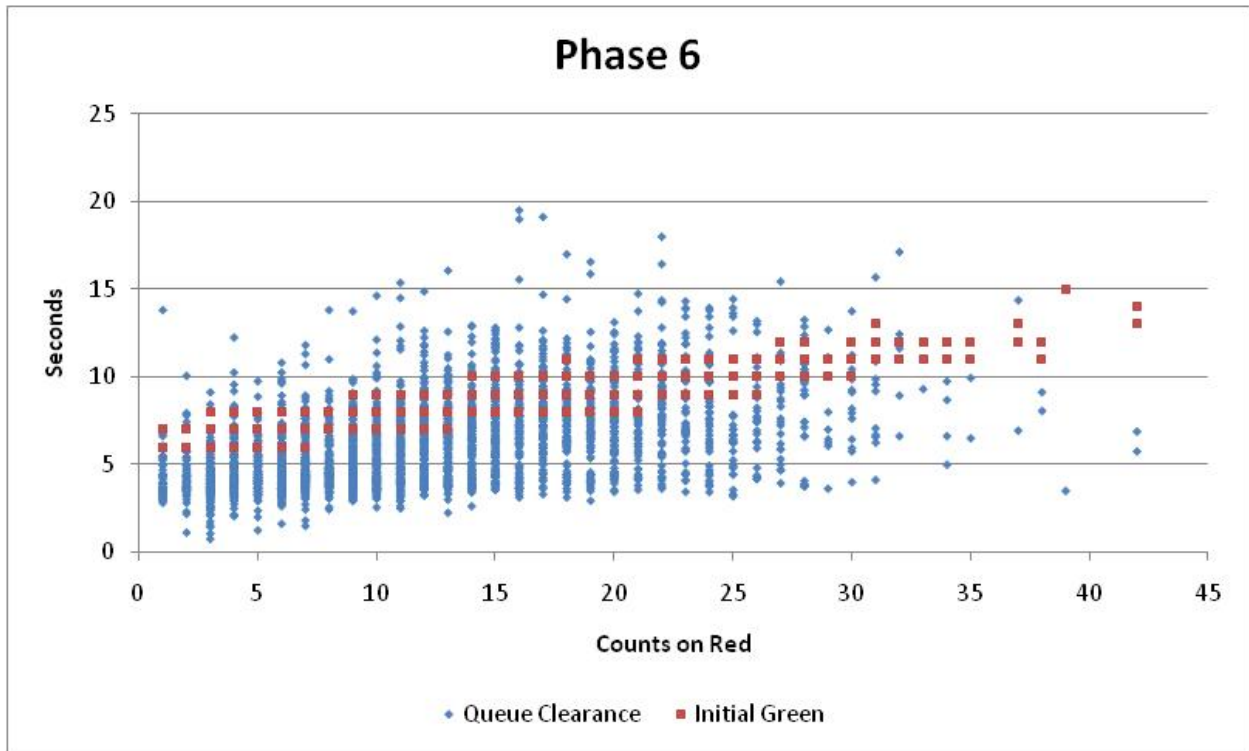

Figure 28. Accuracy of Predicted Initial Green (Phase 6).

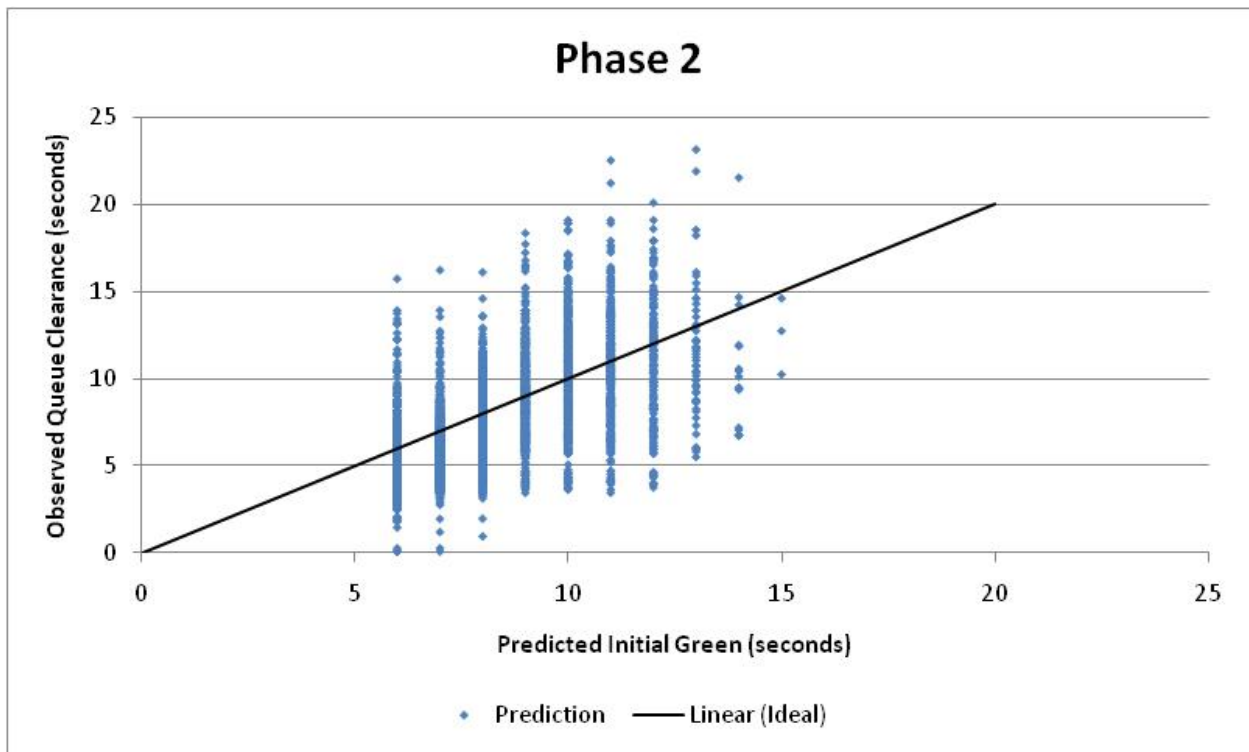

Figure 29. Relationship between Predicted Green and Queue Clearance (Phase 2).

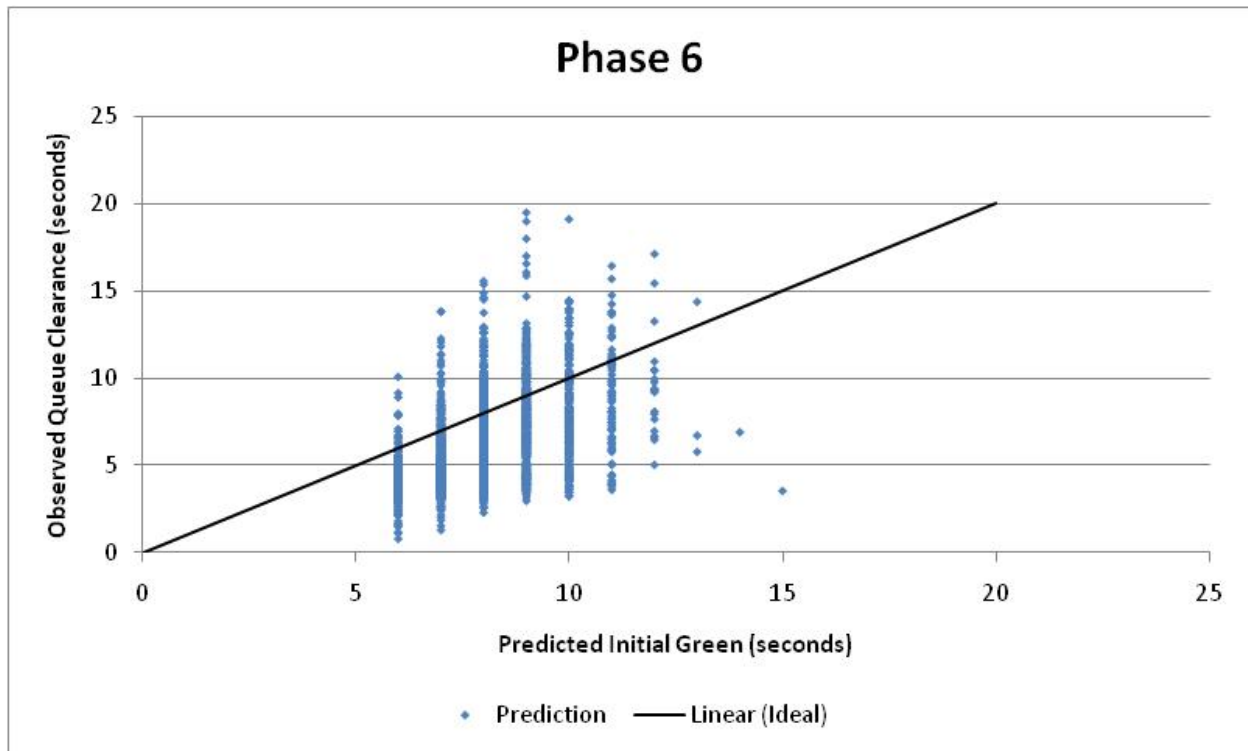

Figure 30. Relationship between Predicted Green and Queue Clearance (Phase 6).

To further evaluate the accuracy of the predicted initial green, the error in predicting the initial green with respect to the queue clearance was calculated. A histogram of this error for phase 2 and phase 6 is illustrated in Figure 31. A key issue to understand in this error is the error experienced during low volume conditions. Frequently during low volume conditions, there may be a queue of just one or two vehicles. The time taken to clear this small queue of one or two vehicles is smaller than the minimum green for phase 2 and phase 6. This fact is represented as an error in the estimation of the initial green where the minimum value of the predicted initial green is the minimum green. It can be seen from Figure 31 that a significant portion of the error in predicting the initial green is between 0 and 3 seconds. This is the minimum green factor. The error in prediction was then compared for phase 2 and phase 6 and also for the error for weekdays and weekends. Table 2 illustrates the root mean square error (RMSE) for the prediction of the initial green. It is seen that phase 6 has a slightly higher RMSE compared to phase 2, and RMSE on a weekday appears to be slightly higher than for the weekend. However, all these errors are very marginal and are usually greater than the queue clearance time.

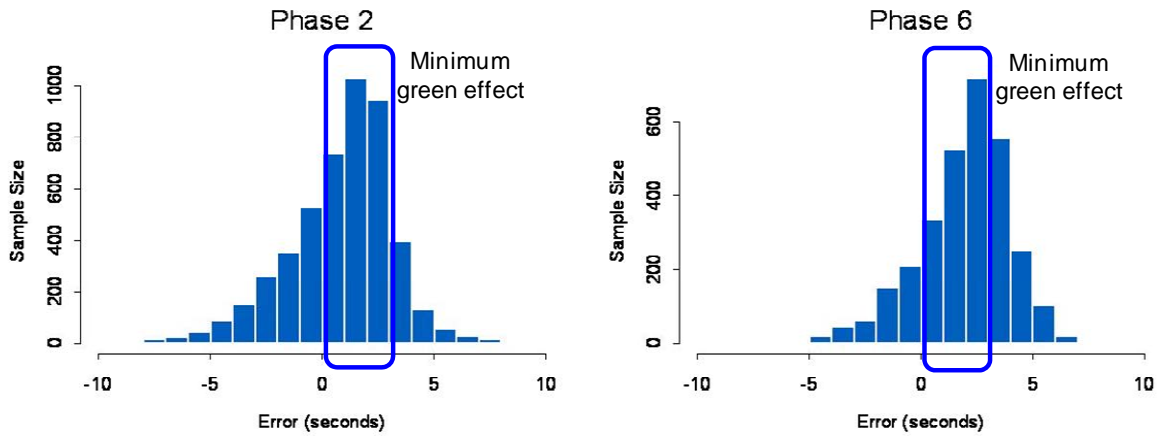

Figure 31. Error in Predicting the Initial Green.

Table 2. Root Mean Square Error Comparison.

	RMSE (Seconds)	Sample Size
All data	2.740	7,853
Phase 2 only	2.522	4,829
Phase 6 only	3.056	3,024
Weekday only	2.817	5,235
Weekend only	2.580	2,618

MODULE 2

Researchers evaluated the performance of both naïve and advanced prediction algorithms proposed in this study. Three signalized intersections in Waco, Bryan, and Houston Districts were selected as study sites for the evaluation. For each study site, data collection software was deployed in a field-hardened computer installed inside a signal cabinet to collect the historical green durations for all the phases. A minimum of four weeks of historical data were collected at each site for the evaluation.

Measures of Effectiveness

The evaluation procedure considers the actual green duration observed for the interval as a ground truth data. Therefore, the differences between the predicted and actual green durations

are the prediction errors. The desirable prediction algorithms should minimize these errors. For the purpose of evaluation, researchers assumed that certain percentages of the detectors failed and therefore required the prediction. Then, we quantified the differences between the predicted values and what we actually observed from the data. The following MOEs were calculated to quantify the performance of the two algorithms (naïve and advanced predictions) with respect to the ground truth durations:

- root mean square of errors (RMSE),
- mean absolute errors (MAE),
- mean absolute percentage of errors (MAPE),
- mean error,
- standard deviation of error,
- percentage of comparison intervals, and
- percentage of incalculable historical input data.

Let g_i be the ground truth data for the interval i and \hat{g}_i be the predicted values for the corresponding interval i , where $i = 1, 2, \dots, n$. The n is the total number of intervals considered in the comparison.

RMSE is expressed as

$$RMSE = \sqrt{\frac{\sum_{i=1}^n (\hat{g}_i - g_i)^2}{n}}.$$

MAE is expressed as

$$MAE = \frac{\sum_{i=1}^n |\hat{g}_i - g_i|}{n}$$

MAPE is expressed as

$$MAPE = \frac{\sum_{i=1}^n \frac{|\hat{g}_i - g_i|}{g_i} \times 100}{n}$$

Evaluation Scenarios

For each study site, the researchers varied different rates of detector failure ranging from 10 percent to 100 percent. Researchers did not consider zero percent failure because that would imply the detector is functioning 100 percent of the time and thus would require no prediction. Failure intervals were randomly assigned to the evaluation data. For each failure interval, two prediction algorithms—naïve and advanced prediction—were applied and the predicted values were recorded for comparison. Naïve prediction simply utilizes the historical means from the same time of day and the same day of week as a predictor. Researchers evaluated the performance measures by phase and by the intersection (all phases combined).

For the purpose of evaluation, the data set used to populate the input tables is referred to as calibration data. The data set used to test the performance of the algorithm is the validation data. Ideally, calibration data and validation should be two separate data sets. However, due to the limited amount of resources for the data collection, only the Waco site had sufficient data for splitting into calibration and validation data sets. The other two sites in Bryan and Conroe relied on the same set of data for both calibration and validation tasks.

Evaluation Results

This section documents the evaluation results from each of the three study sites evaluated in this study. Researchers compared results from the two prediction algorithms at each site. The percentages of detector failure scenarios evaluated are 10 percent, 25 percent, 50 percent, 75 percent, 90 percent, and 100 percent.

Waco

Below are the dates of data used for the evaluation of the algorithms at the Waco site:

- calibration data: 04/15/2009 – 07/05/2009;
- validation data: 07/23/2009 – 08/23/2009; and
- observed phases: 2, 4, 5, and 6.

Table 3 and Table 4 show examples of input data tables for the advanced prediction algorithm. These tables show the input data calculated for Mondays using 15-minute intervals from interval #25 to #88. There are 96 intervals in one day; interval #1 represents 12:00AM – 12:15AM, and thus intervals #25 to #88 would be equivalent to 6:00AM – 10:00PM.

Table 3. Waco—Mean and Variance of Green Durations (Mondays).

Monday Interval	Mean Green Duration (sec)				Variance of Green Durations (sec ²)			
	2	4	5	6	2	4	5	6
25	182.3	10.0	9.0	57.6	29274.3	0.0	4.4	1194.4
26	295.3	10.1	9.2	75.5	27699.0	0.2	4.8	7347.7
27	279.9	10.9	9.8	45.8	20516.1	3.1	7.1	579.2
28	269.2	10.5	10.8	38.4	41722.4	3.4	9.6	219.4
29	188.7	10.3	10.6	36.7	12579.5	0.7	8.9	228.1
30	153.8	11.3	14.3	33.4	9333.1	11.6	19.4	64.0
31	161.3	10.6	15.4	36.6	17053.0	2.2	19.9	118.8
32	167.9	10.2	11.8	37.5	17124.0	0.7	17.0	207.8
33	249.4	11.0	9.7	44.5	17092.6	6.1	7.4	897.5
34	200.1	10.1	9.9	43.7	34060.3	0.4	8.7	383.5
35	138.7	10.2	9.8	58.4	11569.6	1.0	9.3	2332.7
36	240.4	10.1	9.7	61.4	25940.8	0.2	5.8	1908.1
37	236.4	10.3	9.5	62.9	46360.2	0.7	7.9	1864.3
38	237.7	10.1	10.3	68.3	30129.3	0.1	9.5	2782.9
39	151.1	10.2	9.9	61.7	14233.3	0.2	10.4	1446.3
40	185.1	10.0	10.4	52.7	15051.7	0.0	15.1	1349.7
41	149.2	10.5	10.5	54.1	15621.0	2.6	15.0	2114.4
42	169.4	10.2	10.0	58.0	11618.2	0.3	11.6	1455.4
43	170.2	10.1	9.9	60.8	15642.8	0.1	9.9	1741.9
44	171.0	10.2	10.3	51.4	11110.1	0.5	13.0	1102.2
45	137.0	10.1	9.7	61.2	14250.2	0.2	7.0	2271.6
46	168.2	10.2	10.5	56.1	25007.8	0.6	13.0	1036.0
47	141.6	10.6	9.7	56.2	11915.2	2.7	9.7	1340.0
48	128.0	10.2	11.1	56.5	6231.7	0.7	13.6	1794.5
49	176.8	10.4	9.6	58.1	12701.7	1.0	7.8	1967.7
50	176.4	10.5	10.4	55.1	14571.2	2.1	12.0	1379.3
51	196.2	10.4	9.6	44.3	27000.5	1.0	8.0	574.6
52	236.8	10.5	10.2	42.4	34942.6	3.6	10.8	409.4
53	215.7	10.1	10.0	40.6	22024.8	0.1	10.1	535.8
54	258.6	10.0	11.3	38.5	47650.6	0.0	14.4	333.5
55	231.3	10.5	11.5	35.7	23885.3	0.9	12.5	124.6
56	180.5	10.1	10.0	41.4	22553.7	0.2	10.7	559.6
57	138.8	10.4	9.9	54.5	14390.6	1.5	10.6	2149.2
58	166.7	10.5	10.2	51.8	14072.4	2.4	11.7	1424.5
59	66.1	10.3	11.4	39.8	1512.0	1.3	14.1	449.9
60	143.2	10.5	9.9	49.6	9571.1	1.8	10.3	761.9
61	155.3	10.2	10.3	47.8	17261.2	0.4	12.2	722.8
62	156.3	10.4	10.4	42.3	17329.2	1.4	10.2	515.9
63	135.1	10.3	10.6	37.1	9342.2	1.0	14.5	511.9
64	180.1	10.6	12.0	34.2	11652.0	1.6	18.4	123.4
65	203.2	10.1	13.5	31.1	13524.0	0.3	20.9	51.4
66	139.4	10.5	11.5	34.3	12880.7	1.3	13.0	192.9
67	64.0	10.5	10.8	35.0	1787.5	1.9	13.6	158.9
68	96.8	10.3	9.7	45.9	6494.6	0.6	6.2	1164.6
69	101.5	10.4	9.6	47.4	7330.5	2.0	7.4	771.4
70	107.2	10.1	10.0	45.9	7605.4	0.4	17.4	910.2
71	162.5	10.0	9.8	62.5	8368.5	0.0	9.2	2302.7
72	142.8	10.6	9.4	68.1	12561.1	5.4	7.2	2287.4
73	143.1	10.2	10.0	75.8	15273.4	0.7	9.4	5879.1
74	163.1	10.1	9.5	94.9	16284.8	0.2	10.4	11489.2
75	190.0	10.6	9.5	72.5	23095.2	3.3	14.4	2786.7
76	221.8	10.2	8.9	82.4	27279.7	0.3	3.3	3366.0
77	150.1	10.2	10.4	91.4	22802.9	1.8	16.5	8457.7
78	198.8	10.3	8.9	101.7	30574.9	1.0	5.8	8443.9
79	234.9	10.0	9.0	96.5	28614.5	0.0	4.1	8755.1
80	267.0	10.3	10.1	103.6	30144.3	1.0	11.9	11912.0
81	222.4	10.0	9.3	101.4	11719.4	0.0	6.0	7228.8
82	123.3	10.1	9.1	93.3	10469.4	0.2	6.6	4788.7
83	168.5	10.1	8.9	103.4	17020.4	0.4	3.5	9937.2
84	144.8	10.0	8.6	86.8	7579.2	0.0	2.5	3758.0
85	150.9	10.0	8.5	82.1	7690.3	0.0	3.2	6521.0
86	206.1	10.5	8.7	74.3	19621.0	1.3	2.4	3955.3
87	254.9	10.4	8.8	59.1	41513.9	2.4	4.0	2451.8
88	345.5	10.0	9.4	57.1	61417.9	0.0	7.7	1659.5

Table 4. Waco—Mean and Variance of Change in Green Durations (Mondays).

Monday Interval	Average Change (sec)				Variance of Change in Green (sec ²)			
	2	4	5	6	2	4	5	6
25	-175.9	-0.1	-0.3	15.7	74022.3	0.2	0.5	81.3
26	96.1	0.1	0.2	33.8	22376.9	0.0	1.8	2145.2
27	-11.0	0.7	0.6	-45.7	22887.2	0.9	0.8	2453.1
28	124.7	0.4	1.0	-8.8	90882.3	10.5	1.1	180.3
29	-66.7	-0.6	-0.2	-1.4	78237.8	6.0	2.7	68.9
30	-3.0	0.8	3.7	-3.7	20784.5	2.8	2.6	37.5
31	-3.6	-0.7	1.1	3.5	15992.9	3.3	2.7	16.5
32	12.2	-0.4	-3.6	0.8	7660.0	0.8	2.1	38.6
33	136.5	1.2	-2.1	8.1	26391.5	1.5	2.5	125.7
34	-93.8	-1.0	0.1	-1.6	56513.9	1.8	1.7	115.9
35	-92.4	0.0	-0.2	21.2	51751.6	0.5	2.4	589.8
36	99.0	0.0	0.0	-2.1	17074.5	0.0	2.8	308.3
37	55.5	0.2	-0.2	1.2	64223.4	0.5	1.3	218.3
38	-108.5	-0.2	1.0	6.6	79977.8	0.1	2.1	623.6
39	-113.1	0.0	-0.7	-5.0	32545.4	0.3	4.6	163.6
40	7.2	-0.2	0.7	-11.8	13919.3	0.1	3.2	309.7
41	4.0	0.6	0.2	3.9	19732.5	1.7	6.3	244.6
42	-16.2	-0.4	-0.9	2.7	23103.8	1.1	6.9	330.6
43	13.6	-0.1	-0.1	2.9	18547.1	0.1	0.5	371.1
44	-10.4	0.1	0.5	-10.8	19862.2	0.1	2.3	173.2
45	-43.6	-0.1	-0.5	12.7	14298.5	0.1	2.0	279.5
46	77.4	0.4	0.8	-7.0	10799.4	1.8	2.6	357.5
47	-38.1	0.0	-0.9	-1.0	9117.8	2.8	5.2	135.5
48	-25.0	-0.2	1.6	1.7	5668.2	0.9	8.6	475.5
49	42.4	0.1	-1.7	-0.3	17629.3	0.9	9.0	234.5
50	-5.6	0.2	0.8	-1.7	15947.9	1.4	6.7	200.7
51	43.6	-0.1	-0.7	-12.6	24870.9	2.3	3.8	218.9
52	53.7	0.0	0.6	-2.3	9392.0	1.8	1.2	29.1
53	13.0	-0.4	-0.2	-1.7	65237.0	1.1	0.1	12.7
54	119.3	-0.1	1.2	-1.0	42746.9	0.0	1.5	174.0
55	-134.7	0.5	0.4	-4.0	79963.1	0.4	2.4	130.5
56	-77.3	-0.3	-1.5	5.7	6047.2	0.5	1.3	22.0
57	-54.3	0.9	-0.2	18.2	25673.8	5.3	1.7	685.0
58	50.3	-0.7	0.3	-7.1	13104.7	5.8	2.8	544.3
59	-130.4	-0.1	1.2	-12.4	9621.4	0.6	2.3	137.5
60	61.6	0.3	-1.4	10.1	5067.4	0.6	4.9	8.2
61	78.0	-0.4	0.3	-1.7	29429.2	0.8	1.7	86.2
62	-13.7	0.2	0.0	-5.5	35732.5	0.5	2.3	65.8
63	-39.5	-0.2	0.3	-5.2	5574.8	0.4	1.6	154.3
64	78.6	0.3	1.4	-3.5	5573.0	0.5	2.3	62.2
65	19.5	-0.4	1.5	-3.1	7741.9	0.3	1.9	6.6
66	-81.2	0.5	-2.0	3.4	14146.9	0.8	1.2	14.4
67	-71.8	0.0	-0.7	0.5	2455.6	1.0	3.5	27.7
68	50.3	-0.3	-1.2	12.6	4025.3	0.5	2.2	248.4
69	-9.7	0.1	-0.1	0.3	5039.2	0.5	1.4	157.4
70	4.1	-0.3	0.4	-0.6	3749.0	0.4	1.3	164.0
71	53.2	-0.1	0.0	17.2	3303.1	0.1	3.7	467.9
72	-6.1	0.5	-0.6	9.5	5532.0	0.9	3.0	893.8
73	-28.4	-0.3	0.6	7.6	17737.7	1.1	1.8	638.7
74	-11.7	0.0	0.0	40.3	16469.5	0.1	5.5	6568.2
75	44.0	0.4	-0.8	-46.5	20358.6	1.7	9.2	8633.8
76	-19.6	-0.4	0.0	15.6	4879.0	1.5	6.8	1012.8
77	-19.2	0.0	2.6	24.3	48441.0	0.4	12.8	2515.4
78	8.3	0.1	-2.8	-8.6	129961.3	0.7	10.8	8353.4
79	-153.6	-0.4	1.0	-5.0	85792.7	0.4	4.1	1023.1
80	-22.6	0.2	-0.5	35.7	44.7	0.1	9.8	17621.0
81	76.8	-0.2	-0.2	-16.4	8019.9	0.1	3.9	21344.1
82	-107.9	0.1	0.4	-24.5	8431.4	0.0	7.0	6256.7
83	77.6	0.0	-1.2	50.7	13046.4	0.1	2.6	16431.6
84	-47.2	-0.1	-0.4	-59.8	17083.7	0.0	1.1	18974.5
85	-22.7	0.0	0.1	-2.9	3446.6	0.0	0.8	417.2
86	29.7	0.4	0.1	-4.3	19404.8	0.7	1.2	2110.7
87	20.7	0.3	0.1	-20.5	23729.8	3.5	0.8	1723.4
88	178.8	-0.6	0.6	-3.9	20352.3	1.8	1.7	378.0

Table 5 through Table 8 summarize the performance evaluation results by phase and by intersection (all phases). The results indicated that phase 4 will benefit most from the proposed algorithm. This is because phase 4 is a side-street phase with no recall; therefore, the green times observed from both the historical and immediate past are more likely to reflect the true demand for the green times.

Table 5. Naïve Prediction versus Ground Truth by Phase (Waco, 50% Failure).

Phase	2	4	5	6
Number of Compared Intervals	2236	2726	2975	3005
RMSE (sec)	125.4	1.9	1.0	71.1
MAE (sec)	82.0	1.1	0.6	33.0
MAPE	50.0%	9.0%	6.6%	27.4%
Mean Error (Bias)	-27.9	0.3	0.0	-14.0
SD of Error	122.2	1.9	1.0	69.7

Table 6. Advanced Algorithm versus Ground Truth by Phase (Waco, 50% Failure).

Phase	2	4	5	6
Number of Compared Intervals	2236	2726	2975	3005
RMSE	124.7	1.6	1.1	68.4
MAE	84.4	0.9	0.7	34.2
MAPE	52.8%	7.5%	7.5%	30.6%
Mean Error (Bias)	-21.8	0.2	0.0	-9.4
SD of Error	122.8	1.6	1.1	67.8

Table 7. Comparison of Algorithm Performance by Phase (Waco, 50% Failure).

Comparison by Phase	2	4	5	6
RMSE Improvement	0.5%	13.7%	-12.1%	3.8%
MAE Improvement	-2.9%	16.5%	-14.4%	-3.6%
MAPE Improvement	-2.8%	1.6%	-0.9%	-3.2%
Bias Improvement	21.6%	37.1%	-79.5%	33.2%
Error Variance Improvement	-0.4%	13.2%	-12.1%	2.8%
* Base: Naïve prediction using historical means.				
** Advanced: Proposed algorithm using means and variances.				
*** Difference = Advanced - Base				

Table 8. Comparison of Performance for All Phases (Waco, 50% Failure).

All Phases	Base	Advanced	Difference
RMSE Improvement	67.8	66.8	1.5%
MAE Improvement	26.3	27.1	-3.0%
MAPE Improvement	21.8%	23.1%	-1.3%
Bias Improvement	-9.5	-7.0	26.3%
Error Variance Improvement	4388.6	4342.3	1.1%
* Base: Naïve prediction using historical means.			
** Advanced: Proposed algorithm using means and variances.			

Figure 32 through Figure 34 display the selected comparison of the prediction algorithms. Phase 2 is difficult to predict, as expected, because the phase is operating in the recall mode and the demand from the conflict movements needed to terminate the green times are intermittent. Phases 4 and 5 are relatively predictable with more consistent demand from the conflicting phases.

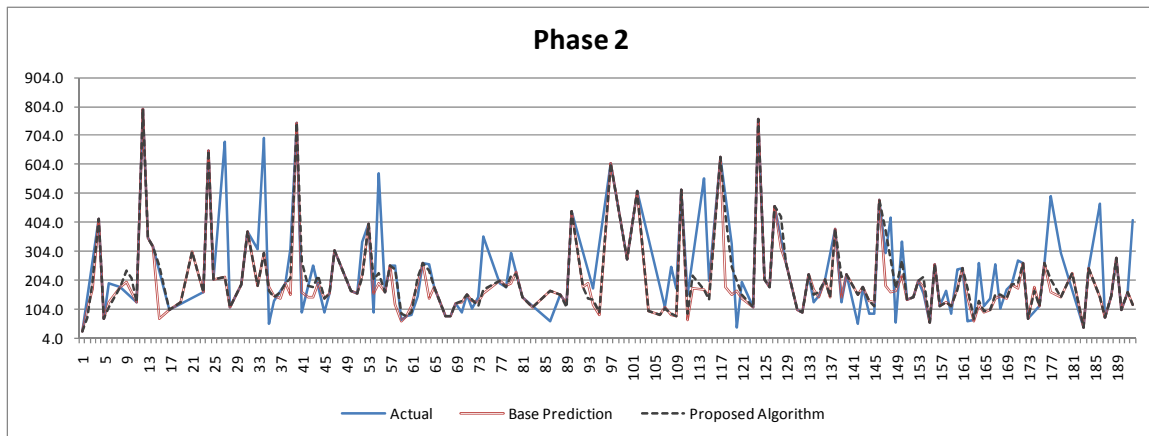

Figure 32. Example Comparison of Algorithms (Waco, Phase 2, 50% Failure).

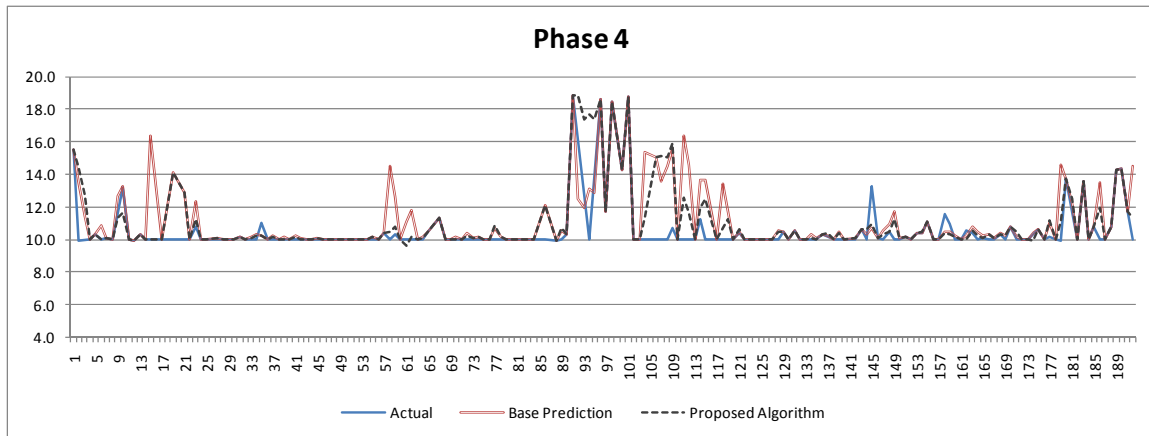

Figure 33. Example Comparison of Algorithms (Waco, Phase 4, 50% Failure).

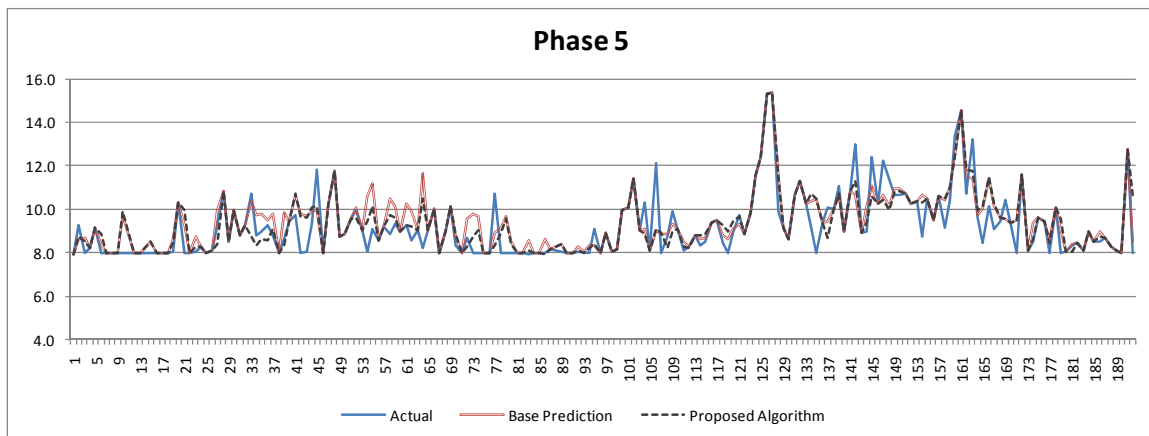

Figure 34. Example Comparison of Algorithms (Waco, Phase 5, 50% Failure).

Houston District

Below are the data descriptions used for the performance evaluation of the algorithms at the Conroe site:

- calibration and validation data: 07/23/2009 – 08/23/2009; and
- observed phases: 1 to 8.

Table 9 and Table 10 show the examples of input data used for the calculation of the advanced algorithm on Mondays from 6:00AM to 10:00PM.

Table 9. Conroe—Mean and Variance of Green Durations (Mondays).

Monday Interval	Mean Green Duration (sec)								Variance of Green Durations (sec ²)							
	1	2	3	4	5	6	7	8	1	2	3	4	5	6	7	8
25	10.3	25.6	7.3	8.0	6.1	83.0	9.3	7.4	17.5	71.9	3.9	5.1	0.9	6616.8	NA	4.2
26	12.4	30.2	8.1	6.9	5.9	63.0	7.2	8.4	28.8	267.8	7.8	4.1	0.3	1487.8	0.0	12.5
27	12.5	29.5	9.3	7.9	6.2	54.3	8.3	10.1	26.5	147.4	9.1	13.1	1.8	1188.1	8.8	24.0
28	12.7	29.1	8.5	7.8	6.6	60.7	7.2	9.5	29.0	131.2	3.1	7.4	2.5	851.3	5.7	16.2
29	14.3	33.5	8.7	6.1	6.9	62.9	9.1	11.3	36.0	189.5	5.3	2.2	3.4	1178.5	22.8	41.3
30	19.3	33.7	10.1	5.8	6.5	65.1	8.3	11.2	57.3	209.5	8.7	0.7	1.4	713.7	10.0	23.4
31	19.9	32.3	10.9	6.9	6.8	61.8	9.4	15.5	50.6	154.2	14.0	1.6	1.4	611.8	16.5	62.5
32	16.6	33.7	10.9	7.8	6.8	58.2	5.7	13.0	34.2	167.5	13.9	5.7	2.6	559.2	NA	28.5
33	14.6	36.7	10.2	7.5	6.8	51.4	NA	12.8	47.9	204.5	12.0	7.2	1.8	311.9	NA	41.4
34	13.1	33.2	10.1	6.9	7.2	56.9	9.9	11.8	29.2	141.0	11.4	2.4	3.5	697.9	21.6	32.6
35	15.3	34.3	10.2	6.7	7.1	48.7	9.2	12.7	22.2	259.7	10.7	3.9	3.8	349.9	8.9	40.0
36	14.1	32.8	10.8	7.7	6.3	59.2	19.2	12.1	32.4	204.5	10.5	12.7	1.3	385.7	143.4	29.4
37	13.2	34.9	9.7	5.5	6.7	68.2	7.7	9.8	22.4	221.5	14.4	0.5	1.9	219.8	0.5	20.7
38	13.9	33.0	8.7	7.3	6.5	72.8	5.8	9.6	32.2	163.6	5.2	6.3	2.1	2232.4	1.3	18.5
39	15.0	33.9	9.4	6.4	6.1	63.6	5.7	11.8	34.0	189.6	7.7	1.9	0.4	987.2	NA	39.3
40	13.7	38.5	10.1	6.9	6.2	55.4	5.6	11.1	26.1	235.2	11.9	7.6	0.7	407.4	0.7	36.0
41	12.4	32.9	8.8	6.0	7.2	52.8	13.7	11.4	26.7	186.3	4.6	1.0	4.3	554.4	66.0	35.1
42	13.9	42.5	10.5	6.5	7.0	67.6	17.5	13.4	34.3	297.7	10.9	5.2	2.9	1901.5	263.1	59.7
43	14.5	35.6	9.8	6.6	7.1	62.9	13.9	12.2	23.8	153.7	7.1	1.4	2.1	1077.9	110.6	42.5
44	15.2	35.3	9.8	8.1	7.3	54.5	10.4	10.4	45.7	133.7	8.4	13.7	4.1	466.5	10.6	19.5
45	16.1	44.2	10.9	7.8	7.1	69.7	9.4	10.1	38.7	264.7	14.5	1.5	3.4	387.3	18.1	8.5
46	14.3	38.3	10.9	6.1	7.4	63.9	12.5	10.7	32.7	167.0	28.6	0.5	2.3	708.3	78.5	18.1
47	14.6	36.9	10.1	6.8	6.3	61.4	14.5	13.1	24.1	243.8	9.7	2.9	2.0	1163.7	17.1	43.2
48	15.2	41.5	12.0	7.7	6.5	63.7	10.1	13.8	33.1	158.6	10.4	5.7	1.0	340.7	91.3	44.8
49	18.1	48.8	11.6	6.6	6.9	66.7	15.9	15.5	37.8	225.6	10.7	2.9	5.7	334.8	107.9	47.8
50	17.5	40.1	12.3	6.5	7.4	61.0	9.5	12.9	58.3	192.8	21.1	2.1	4.1	406.0	7.5	31.6
51	18.6	37.9	11.5	6.5	7.4	55.8	8.9	13.8	62.7	196.4	16.3	3.2	4.5	365.3	10.4	68.4
52	16.7	40.9	10.4	6.4	6.3	57.0	13.1	14.6	33.1	235.1	12.9	1.6	1.0	589.0	43.6	61.6
53	17.6	42.1	10.8	6.2	7.4	67.0	7.2	14.2	41.1	213.2	9.9	1.2	4.8	902.4	1.2	49.5
54	17.0	41.0	9.5	7.4	6.4	63.0	12.6	12.3	47.7	182.5	10.3	3.9	1.1	656.4	33.5	42.4
55	19.0	39.8	10.6	8.7	6.6	65.5	14.0	11.0	36.6	244.3	8.6	43.9	1.5	690.7	64.0	18.3
56	15.0	39.2	11.6	11.5	6.4	64.9	11.8	15.1	33.0	200.3	19.7	34.7	1.0	1134.8	76.9	63.5
57	17.4	42.5	10.4	6.7	7.0	66.4	12.1	13.6	46.8	218.8	6.2	0.9	2.6	847.3	0.9	51.5
58	16.6	43.5	11.2	5.8	6.2	61.1	12.6	15.0	44.4	224.4	8.6	1.0	2.2	461.0	48.6	43.9
59	14.9	42.0	10.8	5.9	7.9	63.5	12.4	11.0	40.6	311.5	16.6	0.8	25.0	438.8	71.0	27.9
60	15.3	39.2	10.0	7.6	7.3	62.1	9.5	11.9	38.1	227.4	4.4	9.0	5.4	866.8	2.6	44.0
61	18.6	45.8	11.0	9.3	7.3	58.4	12.4	14.0	55.3	186.2	13.6	39.7	6.1	660.3	67.5	68.6
62	17.8	46.3	12.3	16.6	7.9	74.3	7.8	18.8	48.2	181.3	14.3	40.8	13.0	473.0	6.8	140.5
63	18.6	44.8	11.0	14.2	6.4	66.7	8.8	17.6	29.0	218.6	12.7	45.1	1.3	789.1	17.3	115.5
64	16.3	46.9	11.8	7.0	6.9	67.9	11.8	13.0	42.0	234.8	17.5	1.2	1.8	352.3	140.0	46.2
65	18.3	46.6	11.4	7.6	7.0	63.5	11.8	14.5	47.1	211.3	7.1	2.6	4.7	269.5	3.7	50.1
66	19.2	47.7	12.2	7.0	7.2	70.7	14.1	13.3	51.9	168.9	23.0	10.6	3.4	747.2	28.9	45.6
67	20.0	44.2	13.7	8.9	7.1	64.2	8.4	14.0	58.4	182.0	28.9	12.8	4.0	466.4	7.8	35.3
68	22.3	48.4	12.9	7.0	7.4	74.2	9.8	14.3	47.3	161.6	18.7	4.7	3.8	479.9	23.7	43.8
69	24.4	55.6	12.5	6.8	6.9	78.8	8.6	15.8	33.5	79.3	23.6	2.7	2.5	189.8	7.5	47.4
70	21.4	49.2	12.4	10.1	7.4	71.7	13.0	14.2	32.6	140.4	19.7	50.6	3.6	189.7	48.4	37.4
71	20.8	49.8	12.7	6.5	6.6	70.3	8.7	15.1	38.7	226.4	16.1	2.4	2.3	496.4	6.7	52.8
72	19.2	45.5	10.8	7.6	8.1	73.5	9.8	13.0	50.4	194.4	11.5	2.5	3.9	619.0	NA	37.2
73	16.4	39.1	9.8	9.8	6.2	68.7	11.8	11.4	44.0	190.4	20.0	53.5	1.1	556.9	63.4	39.1
74	14.5	35.3	10.1	8.9	7.0	51.4	8.6	9.9	24.0	177.7	16.6	31.5	4.9	621.6	11.0	24.5
75	13.3	34.2	9.8	9.4	6.4	55.0	6.2	11.7	39.1	123.6	14.5	60.9	1.6	1125.5	0.1	80.8
76	11.9	32.7	7.9	8.1	7.8	54.4	9.0	8.7	28.4	243.3	8.0	27.6	7.3	561.2	29.6	23.9
77	12.6	31.5	8.2	6.8	7.5	67.9	8.3	8.1	20.4	287.0	11.5	8.6	4.4	1723.6	25.4	18.6
78	9.7	33.1	7.7	7.1	7.3	64.8	7.3	8.1	12.1	293.1	4.1	2.1	4.4	2227.8	3.2	9.8
79	8.9	29.1	8.2	7.4	6.1	63.4	6.5	7.1	10.6	288.4	14.2	15.9	0.9	1070.9	0.7	3.8
80	10.6	28.4	7.1	7.7	6.0	52.7	11.1	7.4	12.7	134.4	3.4	14.5	0.3	1550.0	75.3	11.0
81	9.1	28.7	8.4	7.4	6.5	82.9	6.1	8.2	13.8	330.6	11.4	9.9	2.2	4343.4	1.0	17.6
82	9.8	30.9	7.2	7.6	6.3	54.9	7.9	7.4	21.2	212.5	2.7	7.9	0.4	1084.2	NA	4.7
83	9.5	31.1	7.2	6.0	6.5	60.0	6.8	7.5	12.2	470.9	2.8	1.0	2.1	1726.2	0.6	10.8
84	9.8	30.1	7.1	7.2	6.7	58.9	7.6	8.0	11.6	222.9	3.0	9.6	2.3	1531.1	NA	17.6
85	8.9	31.2	7.6	7.3	6.3	76.3	5.7	7.6	7.8	327.8	3.2	14.8	1.0	2974.5	1.0	11.6
86	7.5	32.6	6.8	5.8	6.5	71.8	6.0	6.3	6.8	615.2	1.3	3.1	1.4	4240.3	0.3	2.8
87	8.0	35.5	7.8	7.0	7.1	101.8	5.0	7.5	7.2	451.1	3.5	14.2	6.0	8742.2	NA	9.0
88	7.9	35.2	6.8	5.4	6.3	82.0	NA	6.1	5.8	506.3	1.0	0.5	0.3	9218.3	NA	1.2

Table 10. Conroe—Mean and Variance of Change in Green Durations (Mondays).

Monday Interval	Average Change (sec)								Variance of Change in Green (sec ²)							
	1	2	3	4	5	6	7	8	1	2	3	4	5	6	7	8
25	1.8	-1.5	0.2	2.2	0.7	-6.3	NA	0.4	2.0	4.2	2.0	1.4	0.6	1640.6	NA	1.5
26	2.0	4.7	0.8	-0.8	-0.1	-20.0	NA	1.0	1.0	0.5	1.8	0.4	0.4	55.1	NA	4.8
27	0.1	-0.8	1.3	1.0	0.4	-8.4	3.1	1.8	7.0	7.4	1.4	5.8	0.5	150.8	NA	2.7
28	0.2	-0.3	-0.9	-0.1	0.0	6.7	NA	-0.9	4.0	0.1	0.8	9.8	1.6	384.7	NA	5.7
29	1.6	4.5	0.3	-1.8	0.5	2.7	-1.4	1.9	1.7	8.2	2.5	3.3	0.2	95.7	NA	16.0
30	5.1	0.1	1.4	-0.2	-0.5	1.9	-3.5	0.0	2.5	12.8	5.1	0.3	0.2	330.9	28.1	14.8
31	0.7	-1.3	0.8	1.0	-0.1	-2.8	6.3	4.3	13.5	37.7	2.6	0.2	0.0	93.2	4.7	1.8
32	-3.6	1.2	0.1	1.0	0.1	-4.4	-0.8	-2.5	9.8	2.4	2.9	3.0	0.3	44.4	NA	3.3
33	-1.7	3.1	-0.9	-0.2	0.0	-7.3	NA	-0.1	8.4	57.1	4.3	11.8	0.7	47.5	NA	8.8
34	-1.8	-3.3	0.0	-0.8	-0.1	6.2	NA	-0.9	6.3	75.6	1.9	1.2	0.3	165.8	NA	6.5
35	2.2	1.5	0.2	-0.7	-1.0	-8.2	-2.1	0.9	1.6	100.4	3.2	1.5	8.7	396.6	NA	7.0
36	-1.2	-1.9	0.5	0.7	-0.8	10.1	10.0	-0.7	3.1	82.4	8.2	6.5	1.7	248.5	239.3	13.1
37	-1.0	1.8	-1.0	-1.6	0.1	10.1	-20.4	-2.1	4.4	25.4	10.5	2.9	0.5	244.7	NA	10.1
38	0.9	-1.9	-1.2	1.6	0.3	4.5	-1.4	-0.4	3.0	5.0	6.3	2.7	1.1	1173.4	NA	2.6
39	0.9	0.9	0.7	-0.4	-0.5	-10.4	NA	2.1	4.9	2.9	0.2	1.5	2.6	304.0	NA	3.0
40	-1.2	5.4	0.7	0.1	0.3	-7.7	-0.1	-0.5	4.7	52.0	3.0	2.3	0.0	72.6	NA	7.5
41	-1.4	-5.7	-1.3	-0.7	0.7	-2.9	NA	0.2	5.8	140.1	0.5	1.6	2.4	93.5	NA	2.2
42	1.5	9.0	1.8	0.4	0.0	17.6	5.8	1.8	4.7	116.2	2.5	2.0	0.9	887.9	594.0	7.7
43	0.5	-6.7	-0.7	0.9	-0.2	-7.1	15.3	-1.0	6.3	95.2	3.3	0.2	1.2	520.6	NA	12.0
44	1.0	-0.5	0.1	1.0	0.5	-9.2	-3.9	-2.0	12.5	51.4	3.0	12.8	2.2	170.5	108.7	11.9
45	0.6	9.1	0.9	-2.2	0.1	15.6	-2.3	-0.3	12.4	80.2	2.9	32.2	0.3	71.9	4.0	3.8
46	-1.7	-5.8	0.1	-2.0	0.2	-6.0	3.8	0.7	8.7	77.5	1.3	3.3	3.3	42.2	72.8	2.8
47	0.3	-1.6	-0.9	0.6	-1.2	-0.7	4.5	3.1	8.7	62.1	2.5	0.0	1.4	100.1	42.4	8.0
48	0.7	4.5	2.0	0.6	0.0	0.3	-8.0	0.1	6.8	36.5	1.5	2.3	1.6	240.2	16.4	5.9
49	2.8	7.3	-0.3	-0.7	0.3	3.2	8.5	1.7	11.0	9.7	2.7	1.0	0.4	45.8	220.9	8.0
50	-0.6	-8.6	0.7	-0.4	0.8	-4.9	-7.7	-2.6	8.6	74.6	0.9	1.9	1.0	201.1	141.1	1.6
51	1.1	-2.2	-0.8	0.1	0.0	-5.7	-0.2	1.0	10.3	10.7	8.8	1.3	6.8	55.9	6.7	14.4
52	-2.0	2.8	-1.1	-0.4	-1.2	1.2	6.6	0.6	12.6	26.1	1.6	0.7	2.7	66.8	38.2	8.7
53	0.9	1.4	0.4	-0.1	1.2	9.7	-7.5	-0.6	3.4	18.4	3.5	0.6	1.4	281.6	88.6	0.7
54	-0.7	-1.4	-1.3	0.7	-1.0	-2.8	8.4	-1.7	5.4	41.7	0.4	2.1	1.2	243.5	46.7	12.5
55	2.0	-1.1	1.2	2.4	0.1	2.7	-6.4	-1.3	4.7	19.4	1.5	23.0	0.9	124.9	127.7	3.0
56	-4.0	-0.7	1.0	3.2	-0.3	-1.6	0.3	4.3	1.9	1.3	1.3	8.6	1.6	301.8	240.2	26.5
57	2.4	3.3	-1.3	-4.0	0.7	1.4	-3.4	-1.6	15.8	1.1	1.1	25.0	0.8	431.2	157.5	25.5
58	-0.8	1.1	0.9	-1.0	-1.1	-5.5	1.5	1.5	22.9	42.4	0.6	1.7	0.1	130.9	40.2	1.8
59	-1.6	-1.3	-0.4	0.2	1.8	2.5	-0.4	-4.1	14.5	57.3	0.7	1.0	2.3	59.7	23.8	12.1
60	0.3	-2.9	-1.0	1.5	-0.3	-1.3	-7.3	0.7	30.5	48.6	1.0	0.4	4.6	26.1	123.2	8.3
61	3.6	6.4	1.0	3.4	-0.3	-2.5	2.1	2.3	25.6	29.0	1.5	2.5	6.6	73.7	28.9	3.4
62	-0.7	0.7	1.3	2.5	0.7	14.6	-5.0	5.0	73.7	31.7	1.2	17.0	2.8	158.4	67.5	111.8
63	0.6	-1.7	-1.2	3.3	-1.3	-7.0	-2.6	-1.6	22.0	64.0	0.5	16.8	1.2	99.7	NA	28.4
64	-2.3	2.3	0.8	-6.9	0.4	1.0	-3.4	-4.5	11.4	97.5	6.6	47.4	1.4	38.0	NA	34.7
65	1.9	-0.4	-0.4	1.0	0.2	-4.2	-2.8	1.5	16.0	45.8	7.1	4.8	0.3	317.5	221.3	18.2
66	1.2	1.4	0.8	-0.8	0.3	6.2	5.4	-1.2	10.7	39.4	4.4	2.6	0.2	40.4	48.1	12.1
67	0.5	-3.8	1.5	3.1	-0.2	-6.5	-14.1	0.7	10.7	82.6	13.8	10.9	2.0	13.6	NA	4.6
68	2.5	4.3	-0.8	-1.0	0.2	10.0	3.5	0.5	15.1	12.4	13.3	0.3	2.2	20.1	NA	1.6
69	1.9	7.1	-0.4	-0.2	-0.4	5.6	-1.7	1.3	31.5	13.6	2.6	3.6	1.4	18.3	8.1	11.7
70	-2.9	-6.6	-0.1	1.6	0.4	-8.2	5.0	-0.5	30.9	60.2	1.3	20.3	0.4	106.8	59.0	30.0
71	-0.8	0.5	0.4	-3.0	-0.8	-0.1	-5.0	-0.3	30.5	74.1	2.2	19.9	1.8	107.7	102.5	20.7
72	-1.2	-3.8	-2.0	0.5	1.6	2.6	-1.9	-2.1	38.2	18.9	2.7	3.3	1.4	207.7	NA	4.9
73	-2.9	-5.8	-0.7	3.3	-2.0	-4.3	-2.7	-1.3	8.8	64.7	1.8	48.7	2.3	281.4	NA	0.3
74	-2.2	-4.8	-0.1	-3.8	0.9	-18.4	-3.2	-1.7	6.3	113.7	3.1	53.7	1.8	207.1	27.4	2.1
75	-1.1	-0.5	0.2	-0.2	-0.5	4.9	-1.8	1.8	5.2	40.8	4.5	21.7	2.9	277.2	6.2	8.1
76	-1.4	-1.9	-2.2	-0.7	1.2	-1.6	1.5	-3.1	10.0	80.8	5.6	7.7	6.2	210.6	1.6	21.4
77	0.6	-1.5	0.2	-1.3	0.5	14.8	1.5	-0.4	8.5	23.1	3.5	9.4	12.1	110.4	19.9	10.3
78	-2.9	1.9	-0.2	0.0	-1.1	-2.7	-6.2	-0.3	0.2	36.6	8.5	1.4	5.2	718.3	77.0	5.1
79	-0.8	-4.0	0.0	0.3	-1.3	-3.0	-0.7	-0.7	0.7	9.7	2.1	3.2	1.0	316.3	4.3	2.2
80	1.9	-0.7	-0.9	2.8	0.2	-9.6	8.4	0.0	2.9	4.7	0.4	46.9	0.6	220.2	185.9	2.4
81	-1.7	0.6	1.3	-2.7	0.3	32.2	NA	0.8	3.0	111.2	3.0	72.6	0.4	214.7	NA	4.6
82	0.7	1.7	-1.3	-0.2	-0.1	-30.9	NA	-0.8	2.8	35.4	4.5	7.9	0.1	1101.3	NA	3.5
83	-0.4	0.6	0.2	-1.1	0.2	6.6	NA	0.2	3.6	96.2	3.3	2.6	0.5	248.3	NA	1.5
84	0.3	-1.2	-0.3	1.3	0.4	-0.4	0.6	0.5	5.7	149.3	2.7	0.4	2.0	274.7	NA	0.8
85	-0.8	1.0	0.4	0.0	-0.1	15.5	NA	-0.4	1.4	38.4	3.4	7.9	7.8	727.0	NA	2.3
86	-1.4	1.8	-0.6	-1.6	-0.5	-0.9	0.7	-1.4	0.8	17.3	3.0	4.8	2.9	491.8	NA	2.8
87	0.5	3.2	0.9	1.2	1.3	34.6	NA	1.2	0.2	119.7	0.6	6.8	8.2	3524.1	NA	5.8
88	0.0	-0.9	-0.9	-1.6	-1.3	-19.7	NA	-1.4	0.2	50.4	0.9	6.7	7.9	3326.4	NA	4.0

Table 11 through Table 14 summarize the performance evaluation results by phase and by intersection (all phases). The results also indicated that phase 4 will benefit most from the proposed algorithm. This is because phase 4 is a side-street phase with no recall; therefore, the green times observed from both the historical and immediate past are more likely to reflect the true demand for the green times.

Table 11. Naïve Prediction versus Ground Truth by Phase (Conroe, 50% Failure).

Phase	1	2	3	4	5	6	7	8
Number of Compared Intervals	1412	1409	1231	1190	1116	1286	685	1341
RMSE (sec)	1.7	37.1	1.2	2.4	1.1	61.8	4.0	2.0
MAE (sec)	1.1	12.7	0.9	1.4	0.7	27.5	2.6	1.3
MAPE	9.3%	15.4%	9.3%	18.4%	9.7%	24.2%	27.6%	12.7%
Mean Error (Bias)	0.0	-3.0	0.0	0.0	0.0	-6.8	0.2	0.0
SD of Error	1.7	37.0	1.2	2.4	1.1	61.5	4.0	2.0

Table 12. Advanced Algorithm versus Ground Truth by Phase (Conroe, 50% Failure).

Phase	1	2	3	4	5	6	7	8
Number of Compared Intervals	1412	1409	1231	1190	1116	1286	685	1341
RMSE	1.8	37.8	1.3	2.3	1.1	60.0	3.9	2.1
MAE	1.3	14.8	1.0	1.4	0.7	28.3	2.6	1.5
MAPE	10.5%	18.7%	10.4%	18.2%	10.0%	26.5%	26.8%	14.1%
Mean Error (Bias)	-0.1	-1.5	0.0	0.0	0.0	-4.3	0.1	0.0
SD of Error	1.8	37.8	1.3	2.3	1.1	59.9	3.9	2.1

Table 13. Comparison of Algorithm Performance by Phase (Conroe, 50% Failure).

Comparison by Phase	1	2	3	4	5	6	7	8
RMSE Improvement	-7.1%	-1.8%	-10.1%	1.7%	5.2%	2.9%	1.2%	-8.2%
MAE Improvement	-14.8%	-16.5%	-12.4%	1.1%	-3.1%	-2.8%	1.3%	-11.4%
MAPE Improvement	-1.2%	-3.4%	-1.1%	0.2%	-0.3%	-2.4%	0.8%	-1.4%
Bias Improvement	-22.5%	49.7%	290.4%	-1908.2%	218.2%	37.5%	61.3%	151.8%
Error Variance Improvement	-7.1%	-2.1%	-10.1%	1.7%	5.2%	2.6%	1.1%	-8.2%
* Base: Naïve prediction using historical means.								
** Advanced: Proposed algorithm using means and variances.								
*** Difference = Advanced - Base								

Table 14. Comparison of Algorithm Performance for All Phases (Conroe, 50% Failure).

All Phases	Base	Advanced	Difference
RMSE Improvement	26.7	26.3	1.5%
MAE Improvement	6.4	6.9	-7.2%
Bias Improvement	-1.3	-0.8	40.8%
Error Variance Improvement	704.5	687.6	2.4%
* Base: Naïve prediction using historical means.			
** Advanced: Proposed algorithm using means and variances.			

Figure 35 through Figure 37 display the selected comparison of the prediction algorithms. Similarly, phases on recall mode with intermittent demand from the conflicting movements, such as phase 2, are difficult to predict with high accuracy. Phases 4 and 5 are relatively more predictable, as they experience more consistent demand from the conflicting phases.

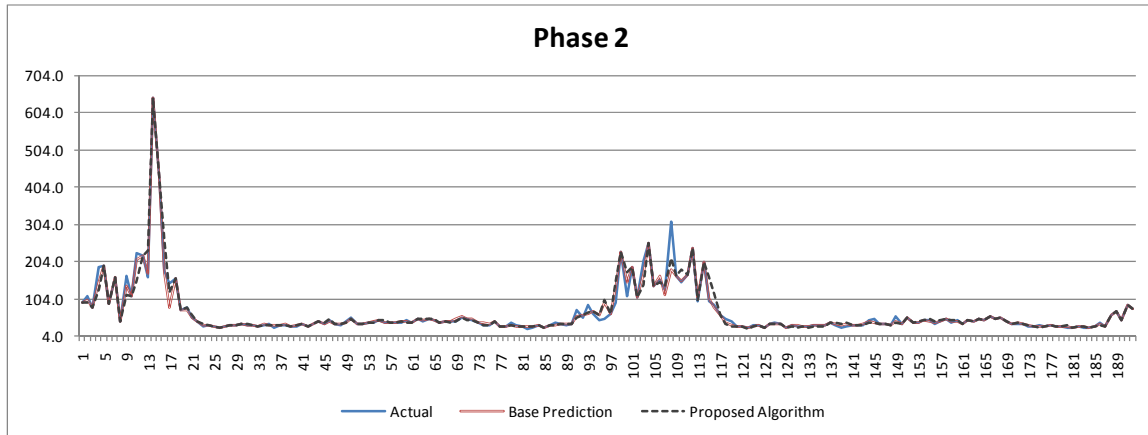

Figure 35. Example Comparison of Algorithms (Conroe, Phase 2, 50% Failure).

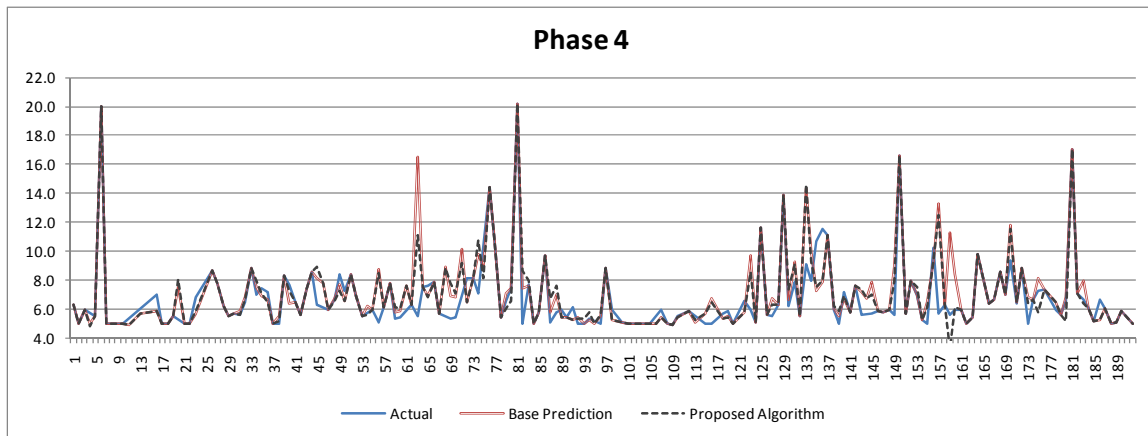

Figure 36. Example Comparison of Algorithms (Conroe, Phase 4, 50% Failure).

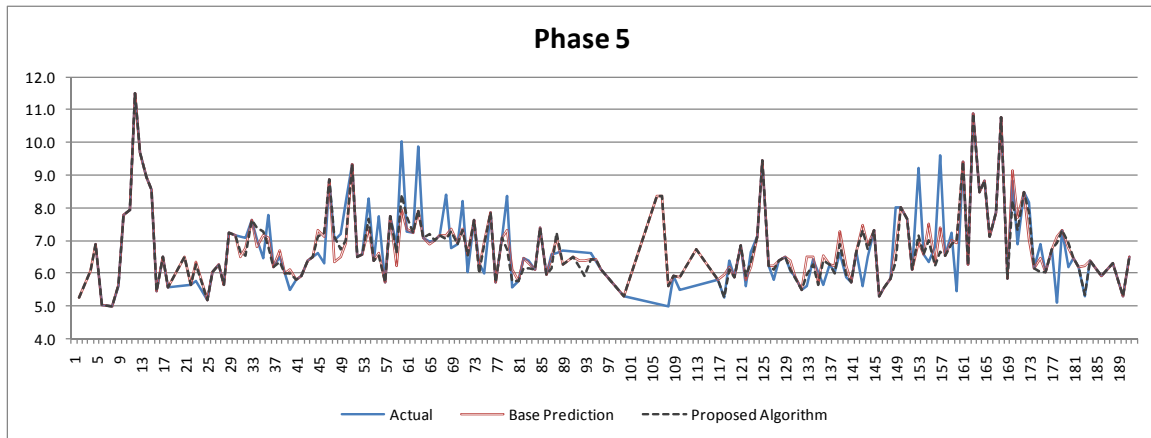

Figure 37. Example Comparison of Algorithms (Conroe, Phase 5, 50% Failure).

Bryan

Below are the data descriptions used for the performance evaluation of the algorithms at the Bryan site:

- calibration and validation data: 07/03/2009 – 08/12/2009; and
- observed phases: 1 to 8.

Table 15 and Table 16 show the examples of input data used for the calculation of the advanced algorithm on Mondays from 6:00AM to 10:00PM.

Table 15. Bryan—Mean and Variance of Green Durations (Mondays).

Monday Interval	Mean Green Duration (sec)								Variance of Green Durations (sec ²)							
	1	2	3	4	5	6	7	8	1	2	3	4	5	6	7	8
25	11.7	10.3	8.7	14.5	7.2	13.7	7.9	15.6	36.6	27.3	5.6	36.1	0.4	76.5	2.6	49.6
26	11.5	12.6	9.5	17.4	8.0	16.4	8.1	17.0	35.1	49.6	10.4	35.7	3.3	87.0	3.8	47.2
27	7.4	16.6	11.5	18.2	8.4	14.5	9.0	17.8	0.6	92.1	25.4	48.9	6.5	60.8	5.4	45.6
28	8.4	17.3	12.1	16.8	9.1	15.6	9.9	16.3	11.1	113.8	23.4	48.4	12.3	70.0	12.8	52.4
29	8.5	19.5	11.9	18.6	9.0	18.0	10.9	16.7	4.0	106.9	19.7	55.5	5.7	74.9	14.0	28.1
30	8.6	21.6	14.2	22.7	9.4	18.0	14.3	19.8	11.0	94.7	31.3	77.2	10.0	80.3	23.2	28.4
31	8.1	23.9	14.2	23.0	10.6	19.8	15.0	20.5	5.8	76.5	26.1	45.6	14.3	63.1	19.1	22.0
32	8.6	20.4	11.7	19.8	9.8	18.5	11.9	18.0	7.6	76.3	22.8	37.6	9.9	61.1	16.5	28.5
33	8.3	18.3	11.3	19.2	9.1	18.2	11.3	17.9	6.7	104.5	19.1	45.8	8.3	63.5	14.6	44.7
34	8.2	20.1	11.1	18.4	9.4	18.4	10.4	15.5	3.1	118.0	19.8	39.1	7.7	65.9	13.9	30.6
35	8.9	18.9	11.3	19.5	9.5	18.5	10.7	17.0	10.0	76.6	15.8	38.0	9.0	67.3	14.0	35.6
36	7.8	18.5	11.0	18.1	9.0	17.8	10.9	16.2	2.9	114.4	18.1	48.2	11.5	63.3	11.8	25.6
37	7.7	18.8	10.6	18.3	9.9	18.5	9.8	16.1	1.6	92.7	18.6	35.8	13.5	71.0	7.9	27.5
38	8.4	20.7	11.6	17.7	10.1	21.6	9.9	17.9	4.4	90.8	26.6	39.8	15.7	59.8	7.1	45.2
39	8.5	19.7	10.8	18.0	8.4	18.5	10.1	17.3	5.5	90.5	13.6	33.9	3.4	65.3	12.0	36.2
40	8.3	19.7	11.8	19.3	10.9	19.4	9.9	18.6	2.9	95.6	24.4	47.3	16.3	52.1	7.1	31.3
41	8.9	20.7	11.5	18.4	9.5	19.0	10.3	16.4	3.5	72.2	17.6	55.4	8.3	76.0	10.5	31.0
42	8.8	19.3	11.2	18.2	10.4	17.6	10.5	18.1	10.8	92.1	19.3	46.0	10.8	44.2	12.2	42.1
43	8.9	18.1	11.5	18.6	10.7	18.1	10.7	18.3	7.7	55.1	19.5	44.7	17.6	52.4	13.9	23.0
44	8.7	18.0	12.0	18.7	9.5	18.7	9.8	18.6	5.7	51.5	19.4	42.8	10.4	50.9	10.4	35.0
45	9.4	18.3	12.6	18.4	9.6	18.1	10.6	18.8	6.0	67.5	23.6	40.0	7.5	52.0	7.7	28.5
46	10.2	20.5	11.8	17.4	11.3	18.4	9.8	19.4	13.0	60.6	20.6	22.3	16.0	60.0	8.0	20.5
47	9.2	21.5	11.8	19.4	10.7	18.8	11.0	20.1	6.8	68.6	20.8	23.4	12.0	52.6	11.7	42.7
48	8.9	21.4	12.9	19.7	11.4	18.7	12.5	19.1	4.9	79.0	21.0	25.9	14.3	48.9	11.9	26.8
49	9.7	21.1	13.2	20.6	11.6	19.0	12.2	20.4	8.7	78.9	26.1	41.8	17.8	48.3	19.5	21.0
50	9.9	19.3	11.8	20.6	10.7	20.1	11.5	19.5	8.5	59.3	20.2	24.5	11.1	55.1	11.1	27.7
51	10.1	20.2	11.9	20.4	10.5	20.8	11.7	19.5	13.2	47.9	23.2	25.8	13.0	50.7	17.9	30.1
52	9.4	21.0	13.0	19.1	10.4	20.8	11.1	20.2	11.8	80.7	21.6	44.2	9.8	47.1	10.8	32.5
53	9.4	18.3	11.4	19.0	10.1	19.7	10.5	18.7	5.3	86.1	21.9	32.1	11.4	47.8	10.7	36.0
54	9.2	21.6	12.4	19.9	10.3	17.9	10.1	20.1	8.3	68.8	22.5	55.0	12.1	50.3	8.1	27.8
55	9.4	19.6	10.7	20.9	11.0	19.8	11.1	18.9	5.6	77.1	14.3	44.1	11.1	47.9	16.4	28.3
56	9.0	21.1	12.3	19.1	10.6	19.3	10.4	19.7	6.7	66.0	24.8	44.7	14.1	37.8	7.7	31.0
57	9.6	16.4	12.3	19.8	10.1	19.7	11.0	20.8	8.3	41.7	25.8	36.7	7.0	51.7	14.3	49.8
58	9.6	20.1	12.4	18.5	10.4	20.3	10.4	19.6	8.7	85.4	16.7	33.5	11.9	40.9	10.3	38.2
59	9.1	19.2	11.9	20.0	10.1	18.8	10.8	20.3	7.4	49.5	18.5	35.1	10.7	42.1	7.7	32.9
60	9.5	20.7	12.2	18.0	10.2	20.2	10.5	19.7	7.6	87.7	21.7	50.3	13.5	44.0	11.7	39.4
61	9.8	19.2	11.8	19.1	10.1	18.5	9.6	21.4	12.5	46.3	26.8	39.1	9.1	55.5	8.7	43.2
62	10.4	19.6	13.2	19.2	10.0	20.9	11.2	21.1	12.6	62.8	26.9	20.6	10.5	50.6	11.9	28.2
63	10.2	23.1	13.5	18.7	12.0	21.3	10.7	21.8	10.4	86.3	13.5	18.8	19.0	34.4	11.5	35.1
64	9.6	21.6	14.1	18.1	11.3	20.3	10.1	20.6	10.1	88.7	25.6	23.6	12.9	41.3	7.6	34.3
65	9.7	21.3	13.3	17.8	10.7	20.7	9.8	20.9	8.7	52.9	22.1	22.7	13.1	35.9	6.6	30.3
66	10.8	21.0	14.2	18.5	11.3	21.4	10.2	22.2	13.2	65.9	18.5	19.6	14.3	42.2	7.5	24.6
67	9.8	24.2	14.1	19.2	12.0	21.8	10.9	21.7	11.0	56.3	13.4	26.2	14.4	33.4	10.9	25.8
68	10.4	23.0	16.1	20.0	11.1	23.5	11.4	24.2	8.5	53.6	19.3	17.7	12.7	24.7	14.4	24.7
69	11.5	23.7	16.4	19.7	11.9	23.4	11.1	25.7	11.8	58.3	33.1	20.6	16.0	25.6	8.4	47.7
70	10.3	27.1	15.4	19.0	14.5	22.7	10.3	24.4	12.6	108.6	14.2	17.8	17.3	30.6	6.5	20.4
71	11.2	21.0	13.7	17.8	10.6	21.9	10.5	21.7	13.6	67.1	20.0	29.3	13.5	38.9	10.4	36.3
72	9.9	17.1	12.4	16.5	9.7	20.4	9.5	19.2	6.6	55.0	16.1	15.2	13.2	55.4	9.9	35.0
73	9.1	18.1	12.0	16.9	8.8	18.6	10.0	19.7	7.7	40.4	19.3	20.6	4.6	34.9	9.4	30.8
74	9.1	17.4	11.3	14.9	9.2	19.9	9.3	17.9	6.8	60.2	12.5	32.9	5.6	49.0	10.0	33.5
75	9.2	15.3	11.1	13.2	9.2	18.4	8.8	16.5	14.1	63.0	18.8	25.6	4.7	54.3	4.6	40.3
76	9.2	16.6	10.4	13.7	8.7	17.6	8.7	15.8	11.5	60.4	18.3	23.7	6.7	46.8	3.5	36.4
77	8.8	15.6	12.6	14.3	8.8	19.7	8.1	20.2	5.7	62.3	39.5	31.8	5.5	62.4	2.9	91.3
78	8.8	17.0	13.8	12.9	8.5	17.0	8.4	21.3	6.6	68.1	50.5	13.2	3.3	46.8	4.2	75.7
79	8.8	15.3	10.8	13.0	8.1	16.0	8.5	15.5	8.3	59.0	25.3	30.3	3.1	64.8	13.4	71.5
80	10.7	15.0	13.2	15.2	9.1	20.1	10.6	16.5	26.2	72.9	42.6	43.0	12.3	99.2	33.5	52.4
81	8.6	14.9	10.7	13.1	8.1	18.1	9.8	16.3	9.7	55.3	21.3	46.5	3.1	73.0	31.3	60.5
82	9.3	16.6	12.3	13.6	7.7	19.2	9.0	17.2	6.3	92.1	29.9	23.9	1.5	75.2	15.7	47.4
83	8.2	16.0	12.8	13.4	7.2	21.1	7.9	21.3	3.5	74.4	29.1	30.0	0.2	50.9	2.8	71.9
84	8.5	17.7	12.6	13.5	7.8	19.9	8.8	20.4	4.9	124.5	26.4	41.0	1.5	74.3	13.2	98.7
85	9.4	16.9	11.4	12.0	8.9	18.9	8.0	18.9	12.7	84.2	28.4	22.4	8.2	87.2	3.7	59.9
86	8.5	16.2	11.9	13.5	8.1	17.5	7.5	18.7	11.1	73.8	32.2	41.4	3.5	82.3	1.6	83.9
87	8.3	15.0	11.2	13.3	7.4	16.5	7.7	17.6	7.7	77.9	28.1	36.7	0.7	72.6	2.5	120.8
88	8.0	14.9	9.5	11.6	7.1	17.3	7.7	15.8	7.0	137.8	14.7	28.2	0.3	134.2	3.0	63.5

Table 16. Bryan—Mean and Variance of Change in Green Durations (Mondays).

Monday Interval	Average Change (sec)								Variance of Change in Green (sec ²)							
	1	2	3	4	5	6	7	8	1	2	3	4	5	6	7	8
25	3.9	-0.1	0.7	2.7	0.0	4.2	0.4	2.3	29.3	0.6	1.2	2.3	0.1	22.2	0.1	1.1
26	-0.8	2.9	0.7	2.9	0.6	3.1	0.2	1.4	40.3	42.2	0.7	5.3	0.6	82.2	0.7	9.3
27	-2.9	4.6	2.1	0.9	0.6	-1.8	1.0	1.4	16.8	11.0	3.5	6.9	1.7	48.4	0.8	26.7
28	1.1	1.3	0.8	-1.0	0.6	1.7	1.0	-1.3	4.1	10.3	3.4	9.8	0.9	20.7	0.8	3.1
29	0.1	1.5	-0.3	1.6	-0.1	2.0	1.0	0.1	2.1	18.0	2.1	11.9	4.8	3.8	0.5	6.3
30	0.6	2.1	2.4	3.9	1.0	-0.1	3.6	2.8	8.1	9.0	6.9	18.9	6.2	5.5	7.6	2.5
31	-1.0	1.8	-0.1	0.2	0.6	1.1	0.6	0.5	5.3	17.5	7.3	10.9	5.5	2.3	4.9	1.6
32	0.2	-3.7	-2.4	-3.2	-0.8	-1.4	-3.1	-2.5	2.5	28.9	10.6	2.9	2.0	2.2	1.5	1.5
33	-0.1	-1.7	-0.6	-0.5	-0.7	0.2	-0.6	0.0	0.5	7.9	10.3	3.4	3.1	6.5	5.6	4.0
34	-0.3	2.0	0.0	-0.7	0.3	0.2	-0.9	-2.6	3.9	5.9	5.9	0.5	0.5	2.3	1.5	9.1
35	0.9	-1.5	-0.1	0.8	0.0	-0.1	0.2	1.5	2.0	14.5	5.1	7.8	1.1	8.9	1.0	5.2
36	-1.0	0.1	-0.2	-1.1	-0.4	0.0	0.2	-0.6	0.9	8.7	3.3	10.8	1.9	3.8	0.4	1.1
37	0.0	-0.1	-0.4	0.1	1.2	0.1	-1.1	-0.3	0.4	7.2	3.9	4.5	2.2	9.4	0.5	7.4
38	0.5	1.3	0.9	-0.7	-0.1	2.4	0.0	1.9	1.1	3.3	2.6	5.8	2.2	9.5	1.0	2.6
39	0.2	-0.6	-0.8	0.3	-1.7	-2.5	0.4	-0.5	2.8	13.0	2.6	1.2	2.6	5.7	1.7	6.6
40	-0.2	0.0	1.1	1.4	2.6	0.6	-0.4	1.3	2.1	38.4	0.1	1.8	4.3	3.4	2.3	4.8
41	0.7	0.9	-0.2	-0.8	-1.5	-0.3	0.2	-1.9	0.6	41.7	5.1	5.4	3.9	9.3	1.5	16.1
42	-0.2	-1.9	-0.5	-0.4	0.8	-1.8	0.4	1.3	1.5	21.6	10.7	7.5	2.2	12.7	0.6	30.7
43	0.2	-1.0	0.4	0.4	0.6	0.7	0.1	0.3	1.8	13.4	2.9	2.5	3.1	1.6	2.4	6.4
44	-0.2	0.0	0.3	0.1	-1.4	0.7	-0.8	0.3	1.3	5.4	7.3	12.2	3.2	0.6	1.2	7.5
45	0.7	0.2	0.8	-0.4	0.1	-0.5	0.7	0.2	1.4	3.7	3.7	16.5	2.0	3.6	1.7	1.1
46	0.7	2.0	-0.9	-0.9	1.7	0.2	-0.8	0.6	1.4	20.2	10.6	2.0	4.2	2.6	0.6	1.1
47	-0.8	1.2	-0.1	2.0	-0.7	0.2	1.2	0.8	2.6	35.4	1.5	4.2	4.3	8.2	1.9	3.9
48	-0.4	-0.3	1.2	0.2	0.8	0.0	1.4	-1.2	0.8	24.6	3.0	5.1	4.6	0.5	3.4	1.7
49	0.8	-0.2	0.3	1.0	0.2	0.4	-0.3	1.3	0.7	12.5	4.8	9.5	0.2	5.5	6.1	5.4
50	0.2	-1.7	-1.4	-0.1	-0.9	1.1	-0.7	-0.8	0.8	7.2	3.6	6.5	0.8	8.1	2.8	5.7
51	0.2	0.7	0.2	-0.1	0.0	0.6	0.3	0.0	0.5	3.4	0.5	2.3	6.4	9.4	1.9	2.9
52	-0.7	1.2	1.1	-1.4	-0.2	0.0	-0.7	0.7	0.9	16.3	2.4	4.4	8.4	6.4	2.3	5.3
53	-0.1	-2.9	-1.7	-0.1	-0.3	-1.0	-0.7	-1.4	2.0	7.6	1.1	3.2	2.6	3.7	2.0	10.7
54	-0.2	3.1	1.2	1.0	0.2	-1.8	-0.4	1.3	0.5	7.2	6.1	1.6	2.3	3.3	0.9	10.8
55	0.2	-1.8	-1.8	1.0	0.4	2.0	1.0	-1.2	0.3	13.8	3.2	1.3	5.6	4.2	1.6	7.0
56	-0.2	1.4	1.6	-1.7	-0.2	-0.5	-0.8	0.8	1.5	18.1	3.2	6.5	5.6	9.2	4.1	3.8
57	0.5	-4.6	0.0	0.7	-0.6	0.3	0.7	1.2	1.2	6.5	9.4	3.5	2.1	3.2	2.5	1.8
58	0.1	3.5	0.2	-1.4	0.3	0.5	-0.6	-1.4	2.4	5.4	4.8	7.2	0.4	0.7	1.7	4.6
59	-0.6	-0.9	-0.6	1.5	-0.3	-1.4	0.4	0.8	3.4	2.5	0.3	8.4	1.4	1.5	1.7	6.8
60	0.4	1.5	0.2	-1.9	0.1	1.3	-0.3	-0.6	1.0	7.1	2.3	5.0	3.4	7.0	1.6	1.9
61	0.3	-1.6	-0.2	1.0	0.1	-1.6	-0.9	1.7	5.0	15.6	3.7	4.9	1.6	12.2	1.3	1.2
62	0.5	0.6	1.3	0.1	-0.2	2.3	1.7	-0.3	3.1	8.1	2.2	3.5	4.3	6.2	0.9	0.6
63	0.0	3.5	0.3	-0.5	2.1	0.4	-0.6	0.7	3.7	8.7	4.1	2.3	2.2	2.4	2.2	5.0
64	-0.7	-1.5	0.5	-0.6	-0.6	-1.0	-0.6	-1.0	3.6	8.6	6.5	3.9	2.2	1.5	0.5	8.2
65	0.1	-0.4	-0.8	-0.4	-0.4	0.3	-0.3	0.2	1.3	3.4	3.2	1.4	3.4	3.9	1.0	4.0
66	1.1	-0.2	1.0	0.8	0.3	0.8	0.4	1.3	3.5	16.6	2.4	1.0	9.2	3.4	1.6	8.7
67	-0.9	3.2	-0.1	0.6	0.6	0.4	0.7	-0.6	1.7	11.6	4.7	4.8	4.3	9.7	1.4	1.0
68	0.7	-1.3	2.0	0.8	-0.8	1.6	0.5	2.5	0.2	9.3	3.4	3.7	3.0	3.7	2.9	3.7
69	1.0	0.8	0.7	-0.2	0.8	0.0	-0.3	1.9	0.9	1.9	14.9	11.3	0.7	3.6	4.7	14.8
70	-1.3	3.5	-1.2	-0.6	2.6	-0.6	-0.8	-1.5	3.4	9.6	15.4	3.6	1.8	5.5	0.7	6.3
71	1.0	-6.2	-1.8	-1.2	-3.8	-0.7	0.2	-2.7	7.0	11.3	2.9	1.5	3.4	1.6	2.0	1.0
72	-1.4	-4.0	-1.3	-1.4	-1.0	-1.6	-1.1	-2.8	1.7	5.9	2.0	1.7	1.4	3.3	1.7	1.4
73	-0.8	1.1	-0.3	0.5	-0.9	-1.7	0.5	0.7	1.2	5.7	1.3	2.4	2.2	3.4	0.7	4.5
74	-0.1	-0.6	-0.8	-2.1	0.4	1.2	-0.6	-1.9	0.6	3.0	3.0	4.9	0.4	9.5	2.6	8.3
75	0.0	-2.0	-0.2	-1.6	0.0	-1.3	-0.6	-1.4	3.9	3.6	6.8	4.8	2.8	16.2	2.8	4.5
76	0.1	1.4	-0.6	0.4	-0.5	-0.8	-0.2	-0.7	3.2	2.9	1.9	8.4	2.6	4.2	0.7	1.9
77	-0.3	-0.8	2.3	0.5	0.0	2.1	-0.5	4.4	1.1	4.1	5.6	2.1	2.7	4.1	0.5	12.3
78	-0.2	1.3	1.5	-1.3	-0.3	-2.6	0.2	1.2	1.7	10.7	12.4	2.8	0.3	1.8	0.1	17.8
79	0.0	-1.6	-3.4	0.1	-0.3	-0.7	0.3	-5.9	1.4	4.7	17.8	0.6	2.8	8.7	3.3	10.5
80	1.6	-0.4	2.8	2.5	0.9	3.8	2.2	0.8	9.0	5.4	18.4	5.5	4.1	26.9	24.0	16.5
81	-1.7	-0.2	-2.9	-2.2	-0.9	-2.1	-1.2	-0.2	10.7	12.5	25.7	14.4	6.9	18.5	55.1	5.6
82	0.5	1.5	1.6	0.3	-0.4	1.1	-0.6	1.1	2.1	17.8	9.0	3.7	0.6	2.6	6.9	14.4
83	-0.9	-0.1	0.7	0.0	-0.5	2.2	-1.2	4.1	0.9	10.7	1.1	5.1	0.2	13.6	1.6	18.6
84	0.4	2.4	-0.2	0.2	0.5	-0.7	1.1	-0.1	1.3	7.7	7.1	0.9	0.3	8.4	2.1	22.9
85	0.9	-1.5	-0.9	-1.7	1.4	-0.9	-0.9	-1.8	6.0	9.9	1.6	2.9	3.1	2.9	3.3	7.1
86	-1.0	-0.9	-0.1	1.6	-0.8	-1.6	-0.5	-0.4	2.3	4.7	4.7	2.2	1.1	5.4	0.3	1.5
87	0.0	-1.2	-0.3	0.0	-1.0	-1.2	0.2	-0.3	1.3	1.0	3.7	5.9	2.3	10.3	0.1	24.3
88	-0.3	0.8	-2.0	-1.9	-0.2	1.4	0.0	-2.5	1.1	7.6	7.5	5.3	0.3	12.8	0.8	52.1

Table 17 through Table 20 summarize the performance evaluation results by phase and by intersection (all phases).

Table 17. Naïve Prediction versus Ground Truth by Phase (Bryan, 50% Failure).

Phase	1	2	3	4	5	6	7	8
Number of Compared Intervals	1819	1853	1832	1854	1709	1853	1837	1853
RMSE (sec)	1.1	5.4	1.7	1.7	1.0	5.7	1.2	2.1
MAE (sec)	0.7	3.6	1.1	1.2	0.7	3.8	0.8	1.5
MAPE	7.3%	18.0%	10.4%	8.9%	7.2%	17.9%	8.6%	9.9%
Mean Error (Bias)	0.0	-0.6	0.0	-0.1	0.0	-0.7	-0.1	-0.1
SD of Error	1.1	5.4	1.7	1.7	1.0	5.7	1.2	2.1

Table 18. Advanced Algorithm versus Ground Truth by Phase (Bryan, 50% Failure).

Phase	1	2	3	4	5	6	7	8
Number of Compared Intervals	1819	1853	1832	1854	1709	1853	1837	1853
RMSE	1.1	4.4	1.7	1.9	1.1	4.5	1.3	2.2
MAE	0.7	2.9	1.2	1.4	0.7	2.9	0.9	1.7
MAPE	7.7%	15.0%	11.5%	10.4%	8.0%	14.1%	9.4%	11.2%
Mean Error (Bias)	0.0	0.0	0.0	0.0	0.0	0.0	-0.1	-0.1
SD of Error	1.1	4.4	1.7	1.9	1.1	4.5	1.3	2.2

Table 19. Comparison of Algorithm Performance by Phase (Bryan, 50% Failure).

Comparison by Phase	1	2	3	4	5	6	7	8
RMSE Improvement	-2.7%	17.5%	-4.5%	-11.2%	-8.9%	20.8%	-7.4%	-5.0%
MAE Improvement	-5.3%	18.8%	-9.5%	-16.9%	-12.3%	24.8%	-10.3%	-11.9%
MAPE Improvement	-0.4%	3.0%	-1.1%	-1.6%	-0.8%	3.8%	-0.8%	-1.3%
Bias Improvement	487.9%	93.6%	76.2%	78.9%	23.1%	94.8%	-30.6%	43.8%
Error Variance Improvement	-2.7%	17.0%	-4.5%	-11.3%	-8.9%	20.2%	-7.3%	-5.2%
* Base: Naïve prediction using historical means.								
** Advanced: Proposed algorithm using means and variances.								
*** Difference = Advanced - Base								

Table 20. Comparison of Algorithm Performance for All Phases (Bryan, 50% Failure).

All Phases	Base	Advanced	Difference
RMSE Improvement	3.1	2.7	14.0%
MAE Improvement	1.7	1.6	7.1%
Bias Improvement	-0.2	0.0	82.6%
Error Variance Improvement	9.5	7.1	25.3%
* Base: Naïve prediction using historical means.			
** Advanced: Proposed algorithm using means and variances.			

Figure 38 through Figure 40 display the comparison of the prediction algorithms on phases 2, 4, and 5 on selected time of day and day of week. All the graphs shown were the evaluation results from the 50 percent detector failure scenario.

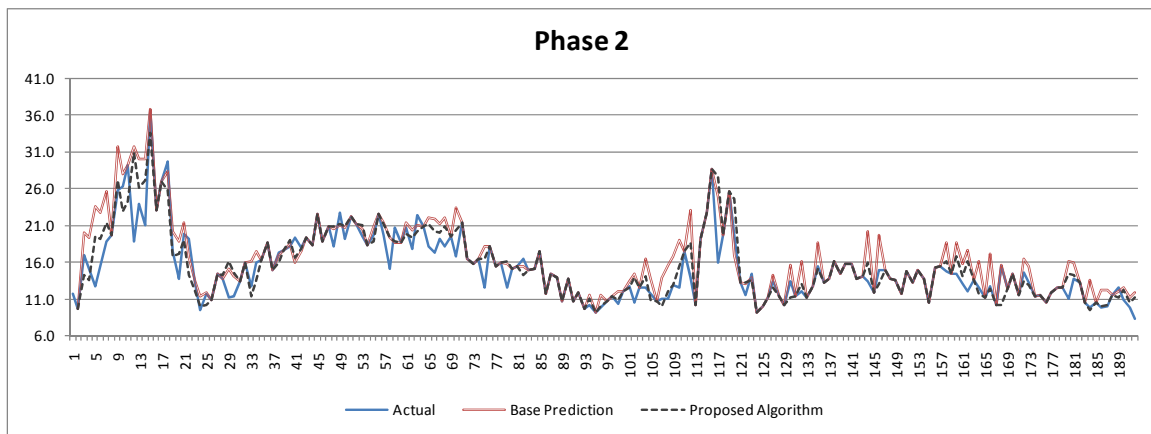

Figure 38. Example Comparison of Algorithms (Bryan, Phase 2, 50% Failure).

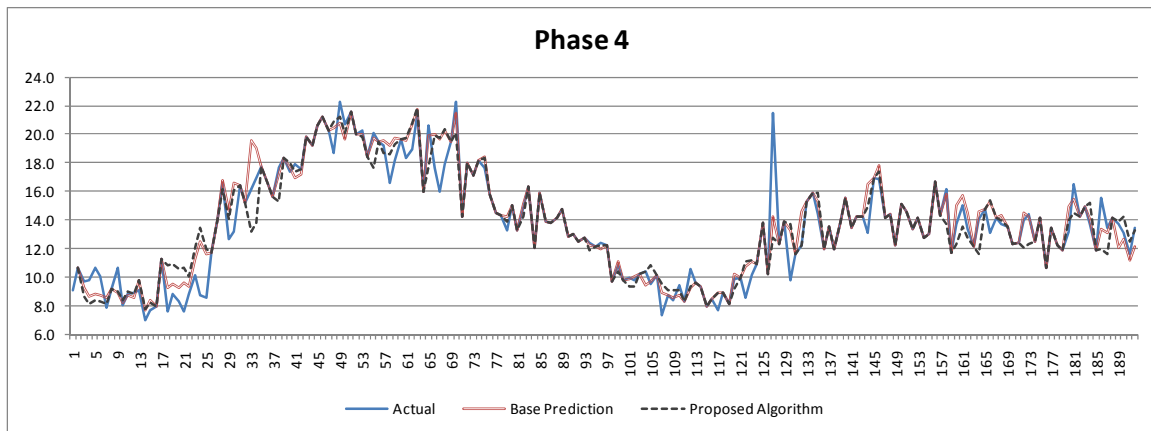

Figure 39. Example Comparison of Algorithms (Bryan, Phase 4, 50% Failure).

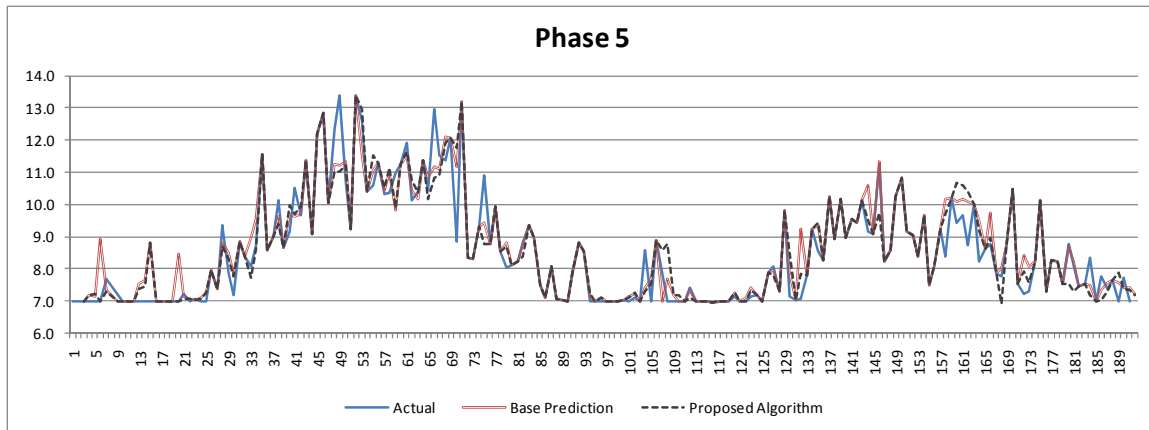

Figure 40. Example Comparison of Algorithms (Bryan, Phase 5, 50% Failure).

Overall Performance Comparison

Table 21 compares the evaluation results using all phases combined for each study site with varying rates of detector failure. The one-interval prediction refers to the scenario at which the detector only fails one interval at a time and thus the immediate past data are always available as an input into the prediction equation using the proposed algorithm. With varying rates of the detector failure, the likelihood of the availability of immediate past data decreases with the increasing rates of detector failure. In cases where the immediate past data are not available, the proposed algorithm will utilize the predicted values from the previous intervals as the immediate past data and continue this pattern recursively until the detector resumes normal behavior. With 100 percent detector failure rate, the advanced algorithm will rely entirely upon the predicted values as model inputs rather than the immediate past data (as the data are not available). As a result, the advantage of utilizing the immediate past data for the proposed algorithm diminishes with the increasing rates of detector failure.

Researchers can convert the rates of detector failure into the average length of time the algorithm will go into recursive prediction mode, i.e., utilizing the predicted values from the previous interval rather than the actual immediate past data. Table 22 summarizes the relationship between the detector failure rate and average length of time.

Figure 41 shows the performance of the algorithms at different detector failure rates. The Bryan site sees the largest improvement among those evaluated because the site is the intersection of two moderate-volume roadways with consistent demand for all phases, unlike the other two sites where the volumes are heavy on the main street and very intermittent on the side street.

Table 21. Overall Performance Comparison at Varying Rates of Detector Failure.

Conroe	Percent Failure						Continuous Prediction
<u>Overall Comparison</u>	100%	90%	75%	50%	25%	10%	1-Interval
RMSE Improvement	0.2%	0.7%	0.4%	1.5%	4.5%	2.6%	3.8%
MAE Improvement	-1.5%	-3.3%	-4.4%	-7.2%	-5.9%	-8.8%	-5.5%
Bias Improvement	1.0%	12.1%	25.8%	40.8%	48.4%	22.5%	43.7%
Error Variance Improvement	0.4%	1.2%	0.3%	2.4%	7.9%	4.8%	6.7%
Bryan	Percent Failure						Continuous Prediction
<u>Overall Comparison</u>	100%	90%	75%	50%	25%	10%	1-Interval
RMSE Improvement	0.6%	11.9%	14.7%	14.0%	17.5%	17.5%	17.6%
MAE Improvement	0.0%	6.1%	8.1%	7.1%	7.9%	7.3%	9.1%
Bias Improvement	-0.6%	51.2%	81.3%	82.6%	94.2%	0.3%	87.6%
Error Variance Improvement	1.1%	22.0%	26.6%	25.3%	31.5%	32.2%	31.5%
Waco	Percent Failure						Continuous Prediction
<u>Overall Comparison</u>	100%	90%	75%	50%	25%	10%	1-Interval
RMSE Improvement	0.1%	0.2%	0.8%	1.5%	1.7%	3.5%	2.4%
MAE Improvement	-1.6%	-1.8%	-2.4%	-3.0%	-3.6%	-1.3%	-3.2%
Bias Improvement	3.3%	8.8%	15.8%	26.3%	26.9%	32.0%	33.8%
Error Variance Improvement	-0.2%	-0.3%	0.2%	1.1%	1.9%	4.7%	2.3%
MAPE Improvement	-0.5%	-0.6%	-1.0%	-1.3%	-1.2%	-1.3%	-1.6%

Table 22. Detector Failure Rate and Average Length of Failure Time.

% Failure	Average Length of Failure Time (min)
90%	150
75%	60
50%	30
25%	20
10%	17

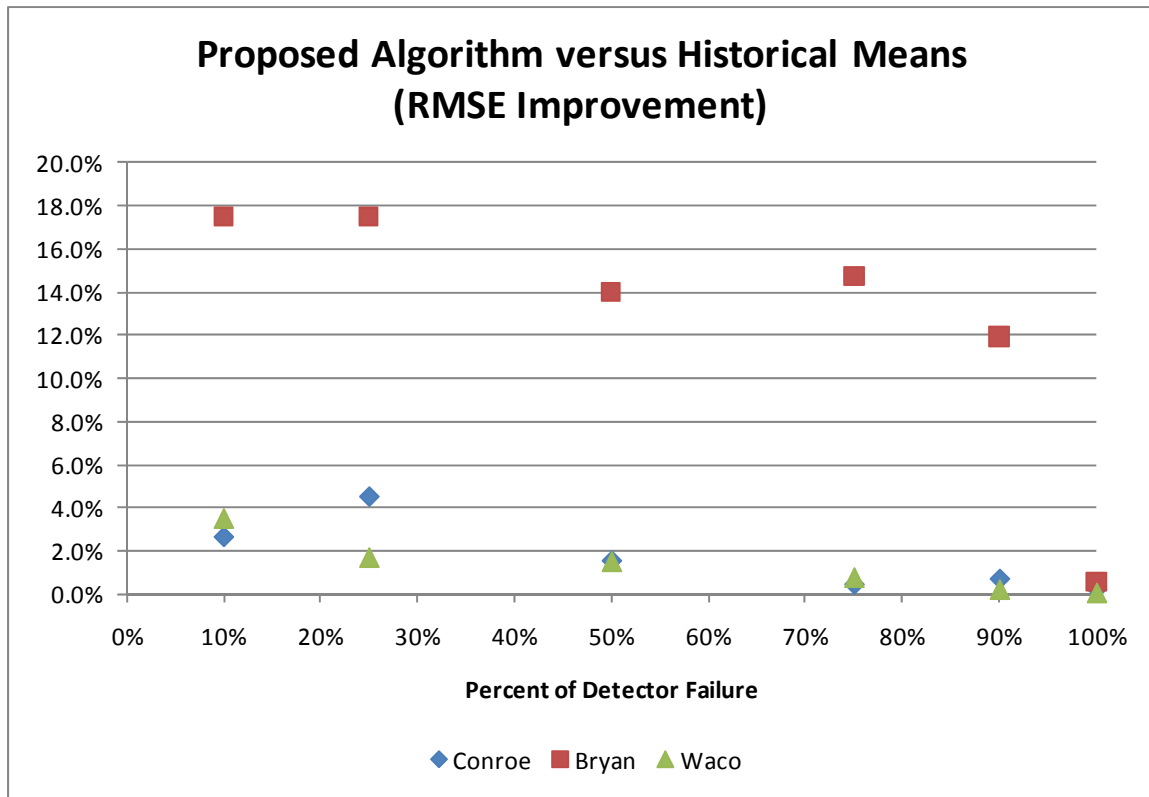

Figure 41. Comparison of Algorithm Performance by Site (RMSE).

CONCLUSIONS

TTI researchers developed and evaluated the adaptive variable initial module (Module 1) and the detector failure module (Module 2) in this project. Researchers compared Module 1 performance with actual queue clearance times and found good correlation between the predicted initial green and the queue clearance times after considering the minimum green factor. The performance was accurate for both of the approach phases as well as weekdays and weekends. Module 1 can be used at intersections where stop-bar detectors are not installed to improve the intersection operations. It can also be used at intersections that have both stop-bar and upstream detectors if the stop-bar detectors malfunction.

The detector failure module (Module 2) predicted the phase duration at the onset of the phase using two methodologies. One was a rolling average of the phase utilization from a database of four weeks of data. The second was a model that used variances in phase utilization both within the historical database as well as from the current day. These two models predicted

the phase utilizations for detector failures ranging from 10 percent to 100 percent. The rolling average model was implemented in the field. TTI researchers then compared these two predictions with the actual phase duration for each phase. This project discovered that the rolling average model was very accurate for predicting the phase duration. These predictions were more accurate during time periods having consistent activity on the phases (peak periods). During the extremely low volume periods, the predictions were not very accurate due to the randomness of vehicle arrival patterns. The advance module predicted the phase duration as accurately as the rolling average module in the Waco and Conroe sites. However, the advance module was more accurate than the rolling average in Bryan. The sites in Waco and Conroe had very low volumes on the cross streets for most of the day. Random arrival patterns on the minor streets during low volume periods impacted the accuracy of the major movements by both the prediction models. However, the Bryan site experienced equally high volumes on the minor streets as compared to the major movements. These volume patterns caused the advance phase prediction model to be more accurate than the rolling average model. Data requirements for the two models are easily available within the traffic signal controller.

REFERENCES

1. *Bonneson, J.A., D.R. Middleton, K.H. Zimmerman, H.A. Charara, and M.M. Abbas.* New Detection System for Rural Signalized Intersections. Report No. 0-4022-S. *Texas Department of Transportation, Austin, Texas, March 2004.*
2. *Chaudhary, N.A., M.M. Abbas, H.A. Charara, and R.T. Parker.* An Intelligent Control System for Detecting and Progressing Platoons at Isolated Traffic Signals. Report No. 0-4304-S. *Texas Department of Transportation, Austin, Texas, April 2005.*
3. *Messer, C.J., S.R. Sunkari, H.A. Charara, and R.T. Parker.* Advance Warning for End-of-Green Phase to Reduce Red-Light-Running. Report No. 0-4260-S. *Texas Department of Transportation, Austin, Texas, September 2004.*
4. *Bonneson J.A., S.R. Sunkari, and M.H. Pratt.* Traffic Signal Operations Handbook. Report No. TX-09/0-5629-P1. *Texas Department of Transportation, Austin, Texas, March 2009.*
5. *NEMA Standards Publications TS 2-2003 v02.06: Traffic Controller Assemblies with NTCIP Requirements.* National Electrical Manufacturers Association, Rosslyn, Virginia, 2003.
6. *Engelbrecht, R.J., S.P. Venglar, and Z.Z. Tian.* Research Report on Improving Diamond Interchange Operations using Advanced Controller Features. Report No. TX-02/4158-1. *Texas Department of Transportation, Austin, Texas, October 2001.*
7. National Traffic Signal Report Card. Technical Report. *National Transportation Operations Coalition, Washington, D.C., 2007.*
8. *Venglar, S.P., and T. Urbanik.* Real-Time, Multimodal Traffic-Adaptive Diamond Interchange Control System: Laboratory Demonstration. TTI/ITS RCE-95/01. Texas Transportation Institute, College Station, Texas, June 1995.
9. *EPAC300 Actuated Signal Control with NTCIP.* Product Manual Rev D.00 PIM-177n, *Eagle Traffic Control Systems, Austin, Texas, February 2002.*
10. *Li, H.* Traffic Adaptive Control for Isolated, Over-Saturated Intersections. Ph.D. Dissertation, *University of Hawaii at Manoa, Honolulu, 2002.*
11. *Xu, H., K. Li, and M. Zheng.* An On-Line Queue Length Estimation Algorithm for Adaptive Control Strategies at Isolated Signalized Intersections. Proceedings of 85th Transportation Research Board Annual Meeting (CD-ROM), *Washington, D.C., 2006.*
12. *Sharma, A., D. Bullock, and J. A. Bonneson.* Input-Output and Hybrid Techniques for the Real-Time Prediction of Delay and Maximum Queue Length at a Signalized Intersection.

Proceedings of 86th Transportation Research Board Annual Meeting (CD-ROM), *Washington, D.C., 2007.*

13. *Gard, J. T. Estimation of Maximum Queue Lengths at Unsignalized Intersections. ITE Journal, November 2001, pp. 26-34.*

14. *Geroliminis, N., and A. Skabardonis. Prediction of Arrival Profiles and Queue Lengths Along Signalized Arterials by Using a Markov Decision Process. Transportation Research Record: Journal of the Transportation Research Board, Vol. 1934, TRB, National Research Council, Washington, D.C., 2005, pp. 116-124.*

15. *Liu, H. X., J. S. Oh, and W. Recker. Adaptive Signal Control System with Online Performance Measure for a Single Intersection. Transportation Research Record 1811, TRB, National Research Council, Washington, D.C., 2002, pp. 131-138.*

16. *Naztec Incorporated. Naztec Training Manual, TS-2 Version 50.x., 61.x, Sugarland, Texas, 2008.*

17. *Xie, Y., Y. Zhang, and Z. Ye. Short-Term Traffic Volume Forecasting Using Kalman Filter with Discrete Wavelet Decomposition. Computer-Aided Civil and Infrastructure Engineering. Blackwell Publishing, MA, 2007.*

18. *Bonneson, J.A., and P.T. McCoy. Manual of Traffic Detector Design, 2nd Edition. Institute of Transportation Engineers, Washington, D.C., January 2005.*

19. *Luh, J.Z., and Y. Lu. Capacity Computations of Right-Turn-On-Red Using the Highway Capacity Manual. ITE Journal, Institute of Transportation Engineers, Washington, D.C., April 1990.*

20. *Highway Capacity Manual 2000. 4th ed. Transportation Research Board, Washington, D.C., 2000.*

21. *Virkler, M.R., and M.A. Krishna. Gap Acceptance Capacity for Right Turns at Signalized Intersections. Transportation Research Record 1646, Transportation Research Board, Washington, D.C., 1998, pp. 47-53.*