

---

# A Guide for Roadside Vegetation Management

---

Dr. Jason Ferrell, Dr. Bryan  
Unruh, Dr. Jason Kruse

---

FDOT Contract #: BDK75 977-11  
Final Report  
October 2009

---

## **DISCLAIMER**

Every effort has been made to ensure the accuracy of this document. However, if there is an instance where a recommendation in this document is contrary to the product label, the information on the label assumes absolute priority and must be followed. The information on a herbicide label is legally binding while the recommendations found herein are not. Additionally, no guarantee is given as to the efficacy of any herbicide recommended within this document. Herbicide failures should be documented and presented to product manufacturer.

Product trade names will be used throughout this publication to provide clarity to the reader. But this is by no means an endorsement of one product over another and no discrimination of comparable products is intended.

The opinions, findings, and conclusions expressed in this publication are those of the authors and not necessarily those of the State of Florida Department of Transportation.

## METRIC CONVERSION TABLE

SYMBOL	WHEN YOU KNOW	MULTIPLY BY	TO FIND	SYMBOL
<b>LENGTH</b>				
<b>in</b>	inches	25.4	millimeters	mm
<b>ft</b>	feet	0.305	meters	m
<b>yd</b>	yards	0.914	meters	m
<b>mi</b>	miles	1.61	kilometers	km

SYMBOL	WHEN YOU KNOW	MULTIPLY BY	TO FIND	SYMBOL
<b>AREA</b>				
<b>in<sup>2</sup></b>	square inches	645.2	square millimeters	mm <sup>2</sup>
<b>ft<sup>2</sup></b>	square feet	0.093	square meters	m <sup>2</sup>
<b>yd<sup>2</sup></b>	square yard	0.836	square meters	m <sup>2</sup>
<b>ac</b>	acres	0.405	hectares	ha
<b>mi<sup>2</sup></b>	square miles	2.59	square kilometers	km <sup>2</sup>

SYMBOL	WHEN YOU KNOW	MULTIPLY BY	TO FIND	SYMBOL
<b>VOLUME</b>				
<b>fl oz</b>	fluid ounces	29.57	milliliters	mL
<b>gal</b>	gallons	3.785	liters	L
<b>ft<sup>3</sup></b>	cubic feet	0.028	cubic meters	m <sup>3</sup>
<b>yd<sup>3</sup></b>	cubic yards	0.765	cubic meters	m <sup>3</sup>

NOTE: volumes greater than 1000 L shall be shown in m<sup>3</sup>

SYMBOL	WHEN YOU KNOW	MULTIPLY BY	TO FIND	SYMBOL
<b>MASS</b>				
<b>oz</b>	ounces	28.35	grams	g
<b>lb</b>	pounds	0.454	kilograms	kg
<b>T</b>	short tons (2000 lb)	0.907	mega grams (or "metric ton")	Mg (or "t")

Adapted from: <http://www.fhwa.dot.gov/aaa/metricp.htm>

## CONVERSION FACTORS

### Mass (Weights)

1 lb = 16 oz = 453.6 g = 0.4536 kg

1 oz = 28.35 g

### Area

1 A = 43,560 sq ft = 0.405 ha

1 ha = 2.47A = 10,000 m<sup>2</sup>

1 yd<sup>2</sup> = 9 ft<sup>2</sup> = 0.836 m<sup>2</sup>

1 ft<sup>2</sup> = 144 in<sup>2</sup> = 0.09 m<sup>2</sup>

#A = [length (ft) x width (ft)] ÷ 43,560 ft<sup>2</sup>

### Velocity

1 mph = 5,280 ft/hr = 88 ft/min = 1.467 ft/sec

1 m/sec = 196.85 ft/min = 2.24 mph

### Length

1 mi = 5,280 ft = 1.6093 km

1 yd = 3 ft = 36 in = 91.44 cm

1 ft = 12 in = 30.48 cm

1 in = 2.54 cm

### Liquid

1 gal = 231 in<sup>3</sup> = 4 qt = 8 pt = 16 C = 8.4 lb (water)

1 qt = 2 pt = 4 C = 32 fl oz = 0.946 L = 946 ml

1 pt = 2 C = 16 fl oz = 0.473 L = 473 ml = 32 tbsp

1 fl oz = 2 tbsp = 6 tsp = 1.8 in<sup>3</sup> = 0.02957 L = 29.57 ml

1 tbsp = 3 tsp = 0.5 oz = 14.78 ml

1 tsp = 0.166 oz = 4.92 ml

1 ml = 0.0338 fl oz = 1 cc

## TECHNICAL REPORT DOCUMENTATION

1. Report No. <i>FHWA Report #, if applicable</i>	2. Government Accession No.	3. Recipient's Catalog No.	
4. Title and Subtitle <i>Title/Subtitle of Report: Changes to the title during the course of the project must be approved in advance of final report submission.</i> <b>A Guide for Roadside Vegetation Management</b>		5. Report Date <i>Date Final Report is produced. Date should not precede date of approval of draft final.</i> <b>October 2009</b>	
		6. Performing Organization Code	
7. Author(s) <i>Name(s) of author(s) of the report</i> <b>Dr. Jason Ferrell, Dr. Bryan Unruh, Dr. Jason Kruse</b>		8. Performing Organization Report No. <i>Contractor report number, if applicable</i>	
9. Performing Organization Name and Address <i>Organization</i> <i>Address</i> <i>City, State, Zip Code</i>		10. Work Unit No. (TRAIIS)	
		11. Contract or Grant No. <i>FDOT Contract Number</i> <b>BDK75 977-11</b>	
12. Sponsoring Agency Name and Address <b>Florida Department of Transportation</b> <b>605 Suwannee Street, MS 30</b> <b>Tallahassee, FL 32399</b>		13. Type of Report and Period Covered <i>Draft Final or Final Report</i> <i>Period covered by report</i> <b>Final Report</b>	
		14. Sponsoring Agency Code	
15. Supplementary Notes <i>Provide additional information as appropriate (e.g., names of additional reviewers).</i>			
16. Abstract <i>Provide a brief description of the problem, the objectives, the findings, the conclusions, and the benefits.</i>			
17. Key Word <i>Provide a list of key words that may be used to index the report.</i>		18. Distribution Statement <b>No restrictions.</b>	
19. Security Classif. (of this report) <b>Unclassified.</b>	20. Security Classif. (of this page) <b>Unclassified.</b>	21. No. of Pages <i>Number of pages, inclusive.</i> <b>102</b>	22. Price

# TABLE OF CONTENTS

- DISCLAIMER.....ii**
- METRIC CONVERSION TABLE.....iii**
- CONVERSION FACTORS.....iv**
- TECHNICAL REPORT DOCUMENTATION.....v**
- INTRODUCTION .....1**
- SECTION 1: TURF MANAGEMENT RESOURCES.....2**
  - GENERAL.....2*
  - TURF AND TURFGRASSES.....2*
    - TURF TYPES.....3
      - Lawn Turf .....3
      - Utility Turf.....3
  - TURF MANAGEMENT .....3*
  - TURF QUALITY.....4*
    - VISUAL QUALITY .....4
      - Density.....4
      - Texture .....4
      - Uniformity.....4
      - Color .....4
      - Smoothness.....4
      - Growth habit.....4
    - FUNCTIONAL QUALITY.....5
      - Rigidity .....5
      - Elasticity .....5
      - Yield.....5
      - Verdure.....5
      - Rooting .....5
  - TURFGRASS SELECTION .....6*
    - PERMANENT GRASSES.....6
      - Bahiagrass.....7
      - Bermudagrass.....8
      - Centipedegrass.....9
      - St. Augustinegrass.....10
    - TEMPORARY GRASSES .....12
      - Brown-top Millet.....12
      - Annual Ryegrass.....13
    - OTHER DESIRABLE PLANTS .....13
      - Nurse Crops.....13
      - Flowering Plants.....13

Natural Areas .....	14
<i>SOILS</i> .....	14
SOIL COMPOSITION .....	14
Organic matter .....	14
Minerals .....	14
SOIL TEXTURE AND STRUCTURE.....	15
Soil Texture.....	15
Soil Structure.....	16
SOIL FERTILITY.....	16
SOIL pH .....	16
<b>SECTION 2: TURF MANAGEMENT PROCEDURES .....</b>	<b>18</b>
<i>TURF ESTABLISHMENT</i> .....	18
SITE PREPARATION .....	18
PLANTING.....	18
Seeding.....	18
Sodding.....	22
Plugging .....	24
Sprigging.....	24
EROSION CONTROL MATERIALS.....	26
Mulching .....	26
<i>CULTURAL PRACTICES</i> .....	26
MOWING.....	26
Rotary Mowers.....	27
Flail Mowers.....	28
Mowing operations .....	31
FERTILIZATION .....	45
Macro-Nutrients.....	45
Secondary Nutrients.....	46
Micronutrients.....	47
Analysis.....	48
Timing and Frequency of Application .....	48
Application Rates .....	50
AERATION .....	51
PEST MANAGEMENT .....	51
Insects.....	51
<i>WEED MANAGEMENT</i> .....	52
PESTICIDE SAFETY, STORAGE AND DISPOSAL .....	52
Pesticide Licenses .....	52
Worker Protection Standard (WPS) .....	53
Personal Protective Equipment (PPE).....	53
Pesticide Storage.....	53
Pesticide Disposal .....	54
Pesticide Transport.....	54

Mixing and Loading .....	55
Pesticide Spills .....	55
FIRST AID PROCEDURES.....	55
Pesticide Exposure.....	55
Managing Heat Stress .....	56
CALIBRATION.....	57
Factors to Consider in Calibration .....	57
Typical Calibration Problems .....	57
<i>Spot Treatment</i> .....	61
<i>1/128th Acre Method</i> .....	62
Checklist Before Field Operation of Sprayers .....	62
Guide to Field Operation of Sprayers .....	63
Maintenance, Care and Cleaning Of Sprayers.....	63
ADJUVANTS .....	65
Surfactants.....	66
Compatibility Agents.....	68
Acidifiers and Buffers.....	68
Anti-Foaming Agents and Spray Colorants.....	68
Drift Control Agents .....	68
<i>SUMMARY</i> .....	68
<b>SECTION 3: OPERATOR SAFETY .....</b>	<b>69</b>
<i>GENERAL SAFETY PROCEDURES</i> .....	69
BEFORE MOWING OPERATIONS.....	69
DURING MOWING OPERATIONS.....	69
ACCIDENT PROCEDURES .....	70
TRACTOR SAFETY.....	70
How to Avoid Overturning.....	70
How to Avoid Backward Tip-Over.....	71
How to Shut Down the Equipment.....	72
MOWER SAFETY BY TYPE OF MOWER .....	73
Rotary Mowers.....	73
Flail Mowers.....	73
Specialized Rotary Slope Mowers.....	74
Small Machine Mowers.....	74
<b>SECTION 4: EQUIPMENT MAINTENANCE .....</b>	<b>79</b>
<i>OPERATION AND MAINTENANCE OF MOWING EQUIPMENT</i> .....	79
MAINTENANCE CHECKLISTS.....	79
Automotive and Trucking Equipment Through One Ton.....	79
Mowing Tractors.....	80
Mowers .....	80
Trailers.....	81



<b>APPENDIX.....</b>	<b>82</b>
<i>MILES TO ACRES CONVERSION CHART .....</i>	<i>82</i>
<i>HERBICIDES FOR HIGHWAY RIGHTS-OF-WAY<sup>1</sup>.....</i>	<i>84</i>
<i>CONTROL OF HARD TO MANAGE WEEDS ALONG HIGHWAY RIGHTS-OF-WAY<sup>1</sup>.....</i>	<i>89</i>
<i>GENERAL LAWS AND REGULATIONS.....</i>	<i>94</i>

## INTRODUCTION

Implementing a comprehensive turf management program significantly reduces the overall cost of managing the vegetation along state roadways. This guide provides methods for efficiently and effectively managing the activities that will achieve and maintain a high level of turf quality.

The information in this guide is presented in four sections:

**Section 1: Turf Management Resources** defines terms, describes soil characteristics and identifies the different types of turfgrasses and desirable plants managed by Florida Department of Transportation (FDOT).

**Section 2: Turf Management Procedures** covers the methods and procedures used to manage turf including methods for successful establishment, and cultural practices necessary for maintaining the turf at a desired level of quality.

**Section 3: Operator Safety** covers safe operation of mowing equipment.

**Section 4: Equipment Maintenance** covers maintenance of mowing equipment.

## **SECTION 1: TURF MANAGEMENT RESOURCES**

### **GENERAL**

Temperature and moisture are the major climatic factors determining species adaptation within the warm, humid region of the southeast United States. Within this region, climatic conditions vary considerably.

The warm, humid region is generally characterized by seasonal high rainfall and shallow infertile soils. This is especially true in the Florida peninsula and along the coast in the Florida panhandle. Because of the nature of soils, a relatively short period without rainfall can result in drought stress. Even a short lapse in maintenance can result in turf becoming thin and subject to weed invasion. Likely, the two most serious problems confronting turf are weed control and fertility level.

Very few of the hundreds of grasses capable of growing in warm, humid regions are suitable for turf usage. Food materials essential for growth and development of roots and stems are produced in the leaves; yet the leaves are removed by frequent mowing during the growing season. Only a very few grasses are able to withstand such treatment and still produce desirable turf.

Choice of turfgrass depends on geographic location, season of use, degree of shade, kind of usage, turf quality desired, availability of water, and the amount of time and money the grower is willing to spend on establishment and maintenance.

### **TURF AND TURFGRASSES**

Today the importance of erosion control is second only to the need for adequate design and location considerations. To achieve an effective and harmonious control between the highway right-of-way and the adjoining countryside, it is imperative that vegetation – normally turf – be used to control erosion with a minimum of delay, thereby making possible their restriction as an integral part of an aesthetically pleasing, unobtrusive, and natural roadside environment. The complete highway is not a reality until all soil areas are protected with appropriate vegetation.

Turfgrasses are plants that form a continuous ground cover that persists under regular mowing and traffic. Turf includes both the interconnecting community of one or more turfgrasses and the soil in which the grass is growing. Because turfgrasses exist in close association with their environment, all components of the environment, natural and artificial, affect the persistence and quality of turf.

## **TURF TYPES**

The Florida Department of Transportation (FDOT) manages two types of turf: lawn turf and utility turf.

### ***Lawn Turf***

Lawn turf is located primarily at rest areas and office complexes. It prevents soil erosion and provides an open area for clear visibility. It also services a decorative function and provides areas for recreation and relaxation. Ideally, the lawn turf should form a dense, low-growing, uniform ground cover.

### ***Utility Turf***

Most of the turf managed by the FDOT is utility turf. Utility turf is used primarily for soil stabilization along roadways. The binding effect of the below-ground plant parts (roots and rhizomes) helps to prevent erosion from wind and water. The aerial shoots or leaf blades provide additional soil stabilization and help reduce soil temperature during periods of extreme heat. Additionally, turfgrasses aid in dust stabilization, noise abatement, and glare reduction while also providing areas for rain water entrapment and ground water recharge, and organic chemical and pollutant entrapment and degradation.

Turfgrasses are used along roadways because their relatively low growing heights allow a clear view of the roadway area. They also provide an aesthetically pleasing appearance for motorists traveling at highway speeds.

A utility turf should be managed so that the root system will bind the soil to help prevent erosion. It is also important for utility turf to have sufficient leaf growth to provide adequate carbohydrate (food) reserves for persistence during stressful conditions, such as drought.

## **TURF MANAGEMENT**

Turf management deals with people and the manner in which they are organized and directed in order to carry out the objectives and functions. It involves knowledge, skills, and the training of people, as well as planning and directing organized activities.

Turf management consists of the range of activities used to establish and sustain a turf stand at a desired level of quality. Proper management is critical to the development of a successful turf. A high-quality turf is usually the result of correct grass selection for the site conditions, proper establishment procedures, and effective cultural practices, such as mowing, fertilization, and pest control programs. When turf quality falls below an acceptable level, mismanagement is often the cause.

## TURF QUALITY

Turf quality is evaluated both visually and functionally. Many of the factors affecting visual quality and functional quality are related.

### VISUAL QUALITY

Six factors contribute to the visual quality of turf: density, texture, uniformity, color, smoothness, and growth habit.

**Density** refers to the number of turfgrass plants in a given area. Turf density varies with the different species and cultivars of turfgrass. Density is also affected by management activities, such as mowing. Proper mowing height, for example, results in a denser turf.

**Texture** refers to the width of the leaf blades. A fine-textured turfgrass, such as bermudagrass, has narrow leaves, while a coarser grass, such as St. Augustinegrass, has wider leaves.

Density and texture are often related features in turfgrass. As growing density increases, the texture of the leaf blades usually becomes finer.

**Uniformity** refers to the evenness of the turf's growth. Uniformity deals with turf composition (the mass of aerial shoots) and the evenness of the surface of the turf. When a turf is not uniform, weeds, insects, or mechanical damage is usually responsible.

**Color** can be a useful indicator of the general health of the turfgrass. A yellow color (chlorosis) may indicate a nutrient deficiency or disease. An overly dark color may indicate excessive fertilization, wilting, or disease.

**Smoothness** is a surface feature that affects the appearance of the turf. The smoothness is directly affected by mowing. Using a mower with sharp blades produces a smooth appearance because the leaves are cut cleanly and evenly. Mowers with dull blades produce ragged and discolored leaf tips. Mowing too close to the ground line (scalping) reduces the smoothness of the turfgrass and can severely injure it.

**Growth habit** refers to the type of leaf growth and the method by which the turfgrass plant spreads. Classified according to growth habit, turfgrasses fall into three categories:

**Bunch Type:** These grasses spread exclusively by tillering, the development of new leaves, and thus tend to grow in bunches. Examples of undesirable bunch-type grasses are smut grass and love grass.

**Rhizomatous:** Rhizomatous turfgrasses spread primarily through below-ground shoots called rhizomes (Figure 1). Bahiagrass is an example of a turfgrass that forms an extensive system of rhizomes.

*Stoloniferous*: These grasses spread by above-ground, lateral shoots called stolons (Figure 1). Centipedegrass and St. Augustinegrass spread by stolons.

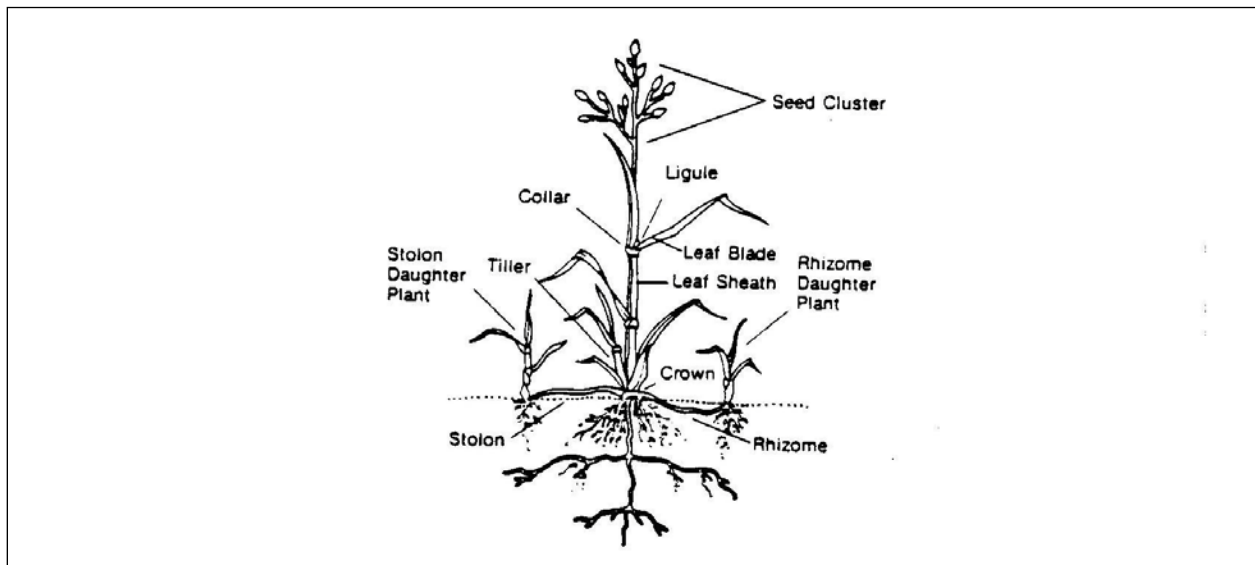

Figure 1. Typical turfgrass plant.

## FUNCTIONAL QUALITY

The functional quality of turf is affected primarily by five characteristics: rigidity, elasticity, yield, verdure, and rooting. Depending on the purpose of which the turf is maintained, the functional quality of the turf will also be affected by many of the characteristics that influence the visual quality of the turf.

**Rigidity** refers to the resistance of the turfgrass leaves to compression (from foot or vehicular traffic).

**Elasticity** is the ability of the turfgrass leaves to spring back after they have been compressed.

**Yield** is a measure of the clippings removed by mowing. The amount of yield is an indication of the turfgrass growth as influenced by cultural practices and the natural environment.

**Verdure** is a measure of the amount of length of the vertical leaf blades remaining after mowing. Greater mowing heights leave more of the leaf blades. The mowing height greatly affects both the functional and the visual quality of the turf.

**Rooting** is the amount of root growth evident at any one time during the growing season. The rooting of plants is a good indicator of their condition. Healthy, well-maintained turfgrasses develop strong root systems. Also, turfgrasses cut at higher mowing heights develop deeper, more extensive root systems than grasses cut at lower heights.

## TURFGRASS SELECTION

Although all grasses are members of the same family of plants, only a few of the plant species are tolerant enough of mowing and traffic to be used as turfgrasses. The selection of a certain turfgrass species for planting should be based on the range of environmental conditions (soil, weather, location) present at the site and on the purpose for which the turf is to be established (utility turf or lawn turf).

FDOT uses two general categories of grasses: permanent grasses and temporary grasses. Permanent grasses are perennial grasses that continue to grow from year to year when properly maintained. All permanent grasses used by the FDOT are warm-season grasses. Their optimum temperature range for growth is 26.7 °C (80 °F) to 35.0 °C (95 °F).

### PERMANENT GRASSES

The primary permanent grasses used by the FDOT are Bahiagrass and common bermudagrass grass. Less frequently used permanent grasses include centipedegrass and St. Augustinegrass. Table 1 summarizes the important characteristics of the primary permanent grasses used by the FDOT.

**Table 1. Permanent grass characteristics.**

	<b>Bahiagrass</b>	<b>Bermudagrass</b>	<b>Centipedegrass</b>	<b>St. Augustinegrass</b>
Area Adapted To	Statewide	Statewide	N. Florida and Panhandle (one cultivar adapted to South Florida)	Statewide
Mowing Height	3"-4"	<i>Cultivar Dependent</i> 0.5"-1.5"	1.5"-2.0"	<i>Cultivar Dependent</i> 1.5"-4"
Soil	Acid, sandy	Wide range	Acid, infertile	Wide range
Leaf Texture	Coarse-medium	<i>Cultivar Dependent</i> Fine-medium	Medium	<i>Cultivar Dependent</i> Coarse-medium
Salt Tolerance	Poor	Good	Poor	Good
Shade Tolerance	Poor	Poor	Fair	Good
Wear Tolerance	Poor	Good- excellent	Poor	Poor
Nematode Tolerance	Very good	Poor	Poor	Good
Maintenance Level	Low	<i>Cultivar Dependent</i> Medium-High	Low	Medium
Establishment Methods	Seed, sod	Sod, sprigs, plugs, seed	Seed, sod, sprigs, plugs	Sod, plugs, sprigs

## ***Bahiagrass***

Bahiagrass is a low-growing perennial grass that spreads slowly either by seed or by short, below-ground runners called rhizomes (Figure 2). When mowed at its proper height and frequency, Bahiagrass grass forms a tough, coarse-textured, wear-resistant utility turf especially well suited for use along inland roadways.

Bahiagrass, a stress-tolerant turfgrass, is the species best adapted to most of the soil conditions found throughout the State of Florida. It thrives in sandy, infertile soils and drought conditions. However, Bahiagrass grass is susceptible to damage from mole crickets and, during the summer months, it continuously forms tall seed heads.

Two varieties of bahiagrass grass are commonly used by the FDOT: 'Argentine' and 'Pensacola'.

*Argentine Bahiagrass* has a lower growing height and broader leaves than Pensacola bahiagrass and forms a denser turf. It is most frequently used around office complexes and at rest areas.

*Pensacola Bahiagrass* has a finer leaf texture and a higher growing height than Argentine bahiagrass. It is also more resistant to drought, cold, and pests. Pensacola bahiagrass grass is most frequently used as a roadside utility turf.



Figure 2. Bahiagrass (*Paspalum notatum*)



### ***Bermudagrass***

Bermudagrass is a warm-season perennial grass that forms a low, dense, wear-resistant turf. It spreads by rhizomes, stolons, and seed (Figure 3).

Bermudagrass grows well in most soils. Because of its inability to grow in sandy soils having a relatively high degree of salinity (salt content), Bermudagrass is recommended for use in coastal roadway areas. It does not do well in wet or shaded areas, however, and because of its aggressive growing characteristics, it may escape into areas where it is not desired, such as pavement cracks, landscaped areas, and adjacent property.

Bermudagrass tolerates the use of selective herbicides better than most other turfgrasses.

Two types of bermudagrass are used: common and hybrid. Common bermudagrasses are generally coarser and are mowed at higher heights-of-cut. They also produce seedheads that are 4" to 8" tall.

Hybrid bermudagrasses are generally finer textured and are mowed a heights-of-cut less than 2". Hybrid bermudagrass generally will be used in higher maintenance median strips.



Figure 3. Bermudagrass (*Cynodon* spp).

### ***Centipedegrass***

Centipedegrass is a medium-textured, slow-growing grass that forms a low, dense turf. It spreads primarily by stolons (Figure 4). It may be established through seed, sod, sprigs, or stolons.

Although centipedegrass grows in a wide range of soil types, in Florida it grows best in the moist, clay, or organic soils of the northern (above Interstate 4) and panhandle regions. The sandy soils of South Florida do not support centipedegrass as well. Centipedegrass is most often used by the FDOT as a lawn turf in selected locations, such as rest areas and office complexes. It may also be used along urban roadways. Centipedegrass is easily damaged by nematodes, mole crickets, two-lined spittlebugs, and ground pearls.

Centipedegrass cultivars include 'Common,' 'TifBlair,' and 'Hammock.'

'*Common*' (*Red or Yellow Stem*) is the predominate variety available. Most centipedegrass purchased through retail outlets is common centipedegrass unless noted otherwise.

'*TifBlair*' is a newer selection from Tifton, GA with improved cold tolerance.

'*Hammock*' is a new release from the University of Florida. It is reportedly more heat tolerant than other centipedegrass varieties and requires less frequent mowing due to a slow growth habit. It appears to go into winter dormancy more quickly than other centipedegrass varieties making it unacceptable for northern climates. It was selected for use in South Florida.



Figure 4. Centipedegrass (*Eremochloa ophiuroides*)

**St. Augustinegrass**

St. Augustinegrass is a coarse-textured, aggressively growing grass that reproduces primarily through the growth of stolons (Figure 5). Unlike the other turfgrasses, St. Augustinegrass can be established only through sodding, sprigging, or plugging.

It is adapted to a wide range of soil conditions but grows best in moist, well-drained, sandy, slightly acidic soils of moderate to high fertility. To look its best, St. Augustinegrass needs adequate moisture. St. Augustinegrass is the most shade tolerant of the permanent grasses used by FDOT. St. Augustinegrass is used as a lawn turf at rest areas and office complexes. It is also used along urban roadside areas adjacent to developed property. St. Augustinegrass is susceptible to damage from chinch bugs and large patch (*Rhizoctonia solani*).

St. Augustinegrass cultivars include ‘Classic,’ ‘Delmar,’ ‘Floritam,’ ‘Mercedes,’ ‘Palmetto,’ ‘Raleigh,’ ‘Sapphire,’ and ‘Seville.’

‘Classic’ is a cultivar released by Woerner Turf. It appears to have better cold tolerance than many other St. Augustinegrass cultivars.

*'Delmar'* is a dwarf cultivar with small leaf blades and a dense growth habit. It does well in shade (needs at least 4 hours of sunlight a day) and also will do well in full sun. 'Delmar' has good cold tolerance, although it will go dormant in north Florida in the winter. Like other dwarf grasses, it tends to become thatchy, particularly under high fertilization and irrigation regimes. 'Delmar' is also susceptible to brown patch when conditions are favorable.

*'Floratam'* continues to be the most commonly used St. Augustinegrass in Florida. It can be distinguished by wider leaf blades and thicker stolons than most other St. Augustinegrasses. 'Floratam' was released in the early 1970s and at that time was widely used because it had good resistance to chinch bugs. Over time, however, and with repeated use of pesticides, much of this resistance has been lost.

*'Mercedes'* is not widely used in Florida but is sometimes found in the northern areas of the state. It is generally noted for cold tolerance and is used further north of Florida. It is coarse-textured and can be mowed at heights up to 3 inches.

*'Palmetto'* appeared in the late 1990s. It has semi-dwarf characteristics (shorter, thinner leaf blades than 'Floratam'), which make it more appealing to many people. It has better drought and shade tolerance than 'Floratam' but research has shown its shade tolerance is not as good as some of the dwarf cultivars.

*'Raleigh'* was developed at North Carolina State University, so it has very good cold tolerance. It is often used in north Florida and some of the other southern states because of this. It is susceptible to chinch bug damage, grey leaf spot, and brown patch.

*'Sapphire'* is a new release of St. Augustinegrass for use in lawns. Little information is known about this cultivar.

*'Seville'* is a dwarf cultivar that also performs well in shade or full sun. Like 'Delmar', it grows densely due to small leaf blades and has a dark green color. Its cold tolerance is not as good as 'Delmar's.



Figure 5. St. Augustinegrass (*Stenotaphrum secundatum*)

**TEMPORARY GRASSES**

Temporary grasses are used to provide short-term coverage of a seeding site until a permanent grass can be established. The roots of the temporary grass stabilize the soil. The leaves help prevent wind erosion and reduce direct exposure of the permanent grass seedlings to the sun.

The two temporary grasses used by the FDOT are brown-top millet and annual ryegrass. Both are established through seeding. These annual grasses die out at the end of their growing season and, when proper seeding rates are used, do not present long-term competition for the permanent grass seedlings. The decaying temporary grass provides a secondary benefit by adding organic materials to the soil, thus increasing the levels of nutrients essential for plant growth.

***Brown-top Millet***

Brown-top millet is a warm-season temporary grass that may be planted spring through summer. It has a lower growing height than most other varieties of millet and shades the developing permanent-grass seedlings from direct sunlight. In areas of South Florida having little seasonal change in temperatures, brown-top millet may be used year round. Other species of millet should not be used as temporary grasses because they are too competitive.

Do not exceed the recommended seeding rates (see Table 2 below) when planting brown-top millet. A too dense stand of millet can shade out the growing permanent turfgrass seedlings, thus hindering their growth or causing them to die.

### ***Annual Ryegrass***

Annual ryegrass is an aggressive, low-growing, cool-season temporary grass that is normally planted in the fall and winter. It dies out in the heat of spring and summer.

## **OTHER DESIRABLE PLANTS**

### ***Nurse Crops***

On many portions of the right-of-way, legumes are useful as a long-lived nurse crop, aiding the establishment of the permanent grass cover. Mowing height need not be based on the legumes in the area. The lower growing legumes are sometimes used as more permanent species with the lower growing grasses. Legumes easily withstand the same mowing regime used for grasses. When used for slope protection, legumes should not be mowed more than two times during the establishment period and then should be cut high for control of undesirable species.

Encouraging the establishment of leguminous nurse crops, such as clover, can be beneficial to turf. These nurse crops enrich the soil by accumulating and restoring nitrogen, a nutrient essential for turfgrass growth. Further, as dead plants decay, organic matter in the soil increases. Nurse crops also help moderate ground temperatures during hot weather.

### ***Flowering Plants***

Flowering plants and wildflower sites may be established and maintained within existing mowing limits if their locations are compatible with routine maintenance operations. Locations selected for wildflower plantings should be highly visible from the roadway and relatively free from competitive or noxious weeds.

Desirable flowering plants, such as phlox, crimson clover, Black Eyed Susan, coreopsis, and planted wildflowers, should not be mowed, treated with herbicides, or otherwise disturbed during their growing, blooming, and seed-ripening seasons. Periodic mowing may be required at certain times to promote or assure regeneration of the flowers.

For information on native wildflowers for roadsides in central and south Florida see <http://edis.ifas.ufl.edu/EP138>

For information on performance of native Florida plants under north Florida conditions see [http://edis.ifas.ufl.edu/document\\_ep341](http://edis.ifas.ufl.edu/document_ep341)

### ***Natural Areas***

Encouraging natural growth or the planting of native trees, shrubs, and ground cover appropriate to the local environment is desirable. Such growth reduces the area the FDOT must maintain through mowing and thus the overall cost for maintenance operations. In addition, regenerated areas improve the appearance of Florida's roadways and serve as valuable habitats for native wildlife.

## **SOILS**

Plant growth is influenced by environmental factors such as light, temperature, moisture, and edaphic (soil). Although it plays an important role in supporting turfgrass growth, soil is often taken for granted in many turfgrass management programs.

Soil is the weathered, upper surface of the earth's crust. Turfgrasses and other plants depend on soil for nutrients, physical support, and moisture. How well a turfgrass grows in a certain type of soil is determined by the soil's characteristics, as well as by other environmental factors. Soil characteristics include the soil's composition, texture and structure, fertility, and pH level. Turfgrasses grow best in well-aerated soils with adequate moisture and nutrients. A problem encountered in roadside turf management is that the soils used in roadway construction to meet engineering requirements are not compatible with agronomic needs. Roadway soils must be compacted whereas soils for growing plants need to be well-aerated.

### **SOIL COMPOSITION**

Approximately 50 percent of all soil is composed of a mixture of solid materials including organic matter and minerals. The other half consists of pore spaces that are filled with air and water.

***Organic matter*** includes all dead or decaying material in the soil. Soil with the most organic matter is usually best able to support active plant growth. As it decomposes, organic matter releases nutrients into the soil and helps the soil retain moisture and maintain its structure. Florida's muck soils are very high in organic matter and are generally more productive than the sandy soils.

***Minerals*** in the soil come from the soil's parent material such as rocks. Over time, this parent material has been broken down into soil through the effects of constant weathering.

## SOIL TEXTURE AND STRUCTURE

**Soil Texture** refers to the fineness or coarseness of the soil. Soil particles may be either sand, silt, or clay. The amount of each type of particle found in the soil determines the texture. Sand particles are the largest in the soil, silt particles are of medium size, and clay particles are the smallest of the three.

The range of soil textures can be seen on a soil triangle (Figure 6). For example, a soil containing 10% clay, 20% silt, and 70% sand is a Sandy Loam. Soils with a high percentage of silt are called loams. Different types of turfgrasses are suited to different types of soil textures. Soils with a high percentage of sand are considered light soils. Soils high in clay particles are called heavy soils. Light soils heat and cool faster, are lighter in color than heavy soils, and are more prone to erosion. Light soils also absorb water and drain faster than heavier soils, but do not retain moisture as well.

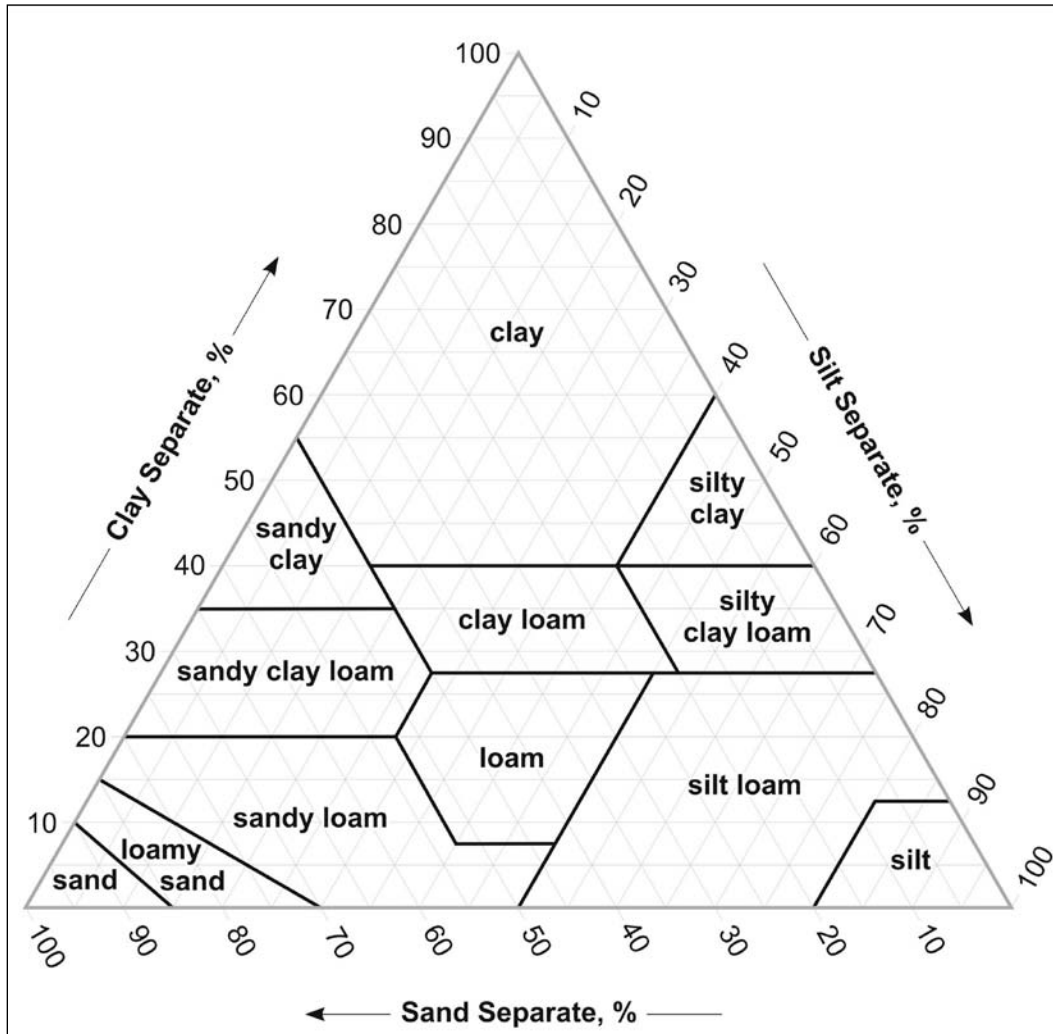

Figure 6. USDA Soil Texture Triangle.



**Soil Structure** refers to the way the sand, silt, and clay particles group together to form aggregates or granules. Soil structure influences the speed with which water penetrates the soil, the soil's retentiveness of water and nutrients, and its resistance to erosion and compaction. Soil structure is fragile and can be destroyed by excessive traffic and cultivation (such as tilling). Excessive traffic can also result in soil compaction.

## **SOIL FERTILITY**

Just as soils vary in texture and structure, they also vary in fertility. Fertility is one of the most important chemical properties of soil. The more nutrients in the soil, the more fertile the soil is and the better it will be able to sustain plant growth. Soils containing a large amount of organic matter are usually fertile. Unless replaced, the nutrients will decrease over time as they are used by the plants or leached from the soil. Commercial fertilizers are generally effective and efficient in restoring nutrients to the soil and maintaining a healthy turf. (Fertilizers and the major nutrients are described beginning on page 45.)

## **SOIL pH**

Another important chemical property of soil is its pH, or potential level of hydrogen ions. A low pH indicates that the soil is acidic; a high pH indicates that the soil is alkaline (basic or low in acidity). Most turfgrasses thrive best in soils with a pH range of 6.5 to 8.0. Prior to turf establishment and then on a routine basis (annually), representative soil samples should be taken and analyzed by an accredited soil testing laboratory to determine the soil pH. In areas with a continuing turf-establishment problem, a soil analysis may be required to determine whether the problem is the result of a pH level that is either too low or too high.

Soil pH influences nutrient absorption and plant growth. Each nutrient has a pH level at which it is most available for use by the turfgrass (Figure 7). Nutrient availability can often be improved by correcting the soil pH. Applications of lime **increase** soil pH (decrease acidity). Acidifying fertilizers, such as those containing ammonium sulfate, **decrease** the pH (increase acidity) in areas where it is higher than desired. Applications of sulfur also reduce soil pH levels. However, such applications have been shown to have only short-term effects. Applications of sulfur to existing stands of turf can also result in chemical burning of the grass plants.

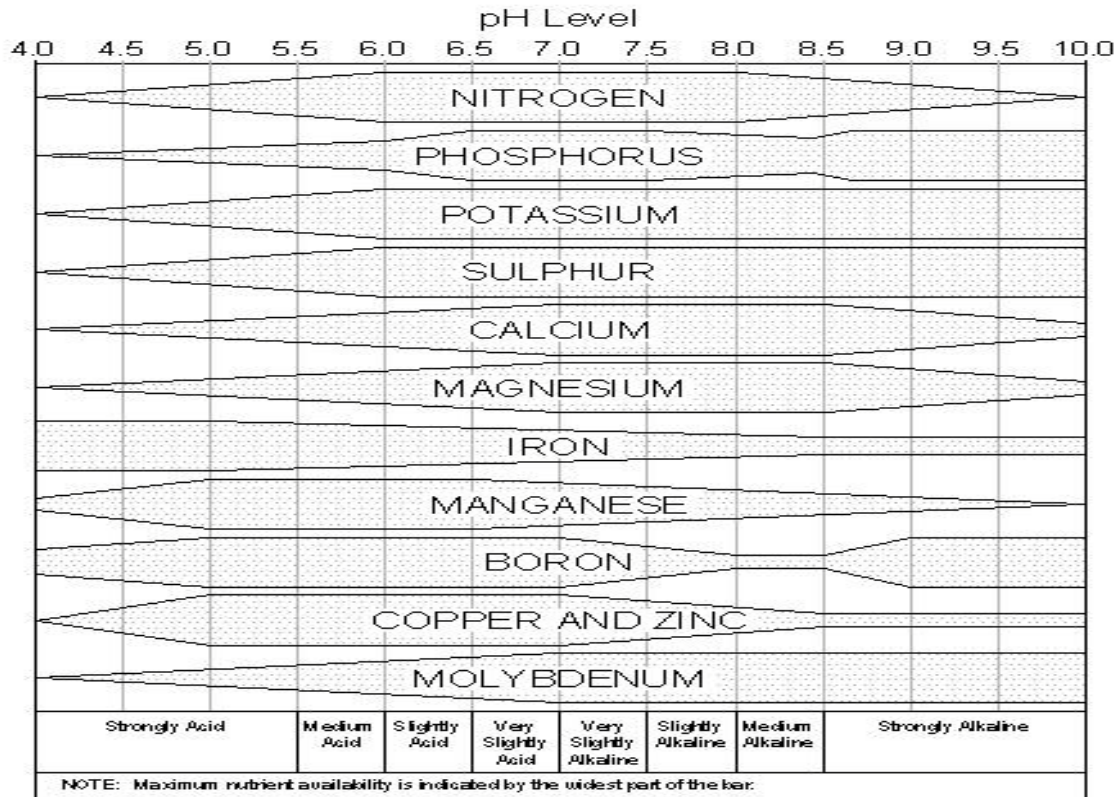

Figure 7. Influence of soil pH on nutrient availability.

## **SECTION 2: TURF MANAGEMENT PROCEDURES**

### **TURF ESTABLISHMENT**

Turf can be established using seed or vegetative plantings (sod, sprigs, and plugs). Regardless of the method used, the site must be properly prepared, the soil adequately moist, and correct planting procedures followed for optimum results.

### **SITE PREPARATION**

Good site preparation is key to successful turf establishment. The following site preparation steps should be followed, regardless of establishment method (sod, seed, sprigs, or plugs) used:

1. Clean the Site: remove any construction debris that may be present. This may include concrete or asphalt left behind after construction or road resurfacing. Eradicate any invasive or hard-to-control weeds that may be growing on the planting site using non-selective herbicides.
2. Construct Proper Grade: to permit proper drainage, grade the area to at least a 1% slopes. Too steep of a slope can lead to severe erosion problems, mowing hazards, and excessive runoff.
3. Soil Cultivation: once the grade is established, cultivate the soil to a depth of 6 to 8" using a disc or a rototiller. This will help alleviate compaction caused during the construction. Over-tilling can damage the soil structure and can increase soil compaction. If soil tests recommend soil amendments, apply them at this time.
4. Prepare Final Grade: firm the soil by rolling. The final grade should be firm enough to prevent footprints of more than ½" depth.

### **PLANTING**

#### ***Seeding***

Seedling vigor and rate of seedling establishment of turfgrasses are directly related to the supply of the factors necessary for growth – water, air, nutrients, light, oxygen, and carbon dioxide – and to the competition among seedlings for these factors.

As seedlings develop, light and, perhaps, soil oxygen are the limiting factors for growth most frequently encountered. Vigor of individual seedlings is also affected by temperature. Grass seedlings must have a well-developed root system before exposure to adverse environmental conditions. Vigor and plant survival will be greatly reduced if seedlings with an undeveloped root system are subjected to temperature extremes, inadequate moisture, or low nutrient levels.

Seeding is the least expensive method of turf establishment. Obtaining high-quality seed and following proper storage practices will help ensure good germination after planting.

*Seed Quality:* Minimum requirements for the purity and viability of commercial seed are set by the Department of Agriculture and Consumer Services and Florida's Seed Law. FDOT's minimum standards for seed meet or exceed those set by Florida's Seed Law.

The primary factors influencing seed quality are the seed's purity and germination percentage. These two factors are combined to give an estimate of pure live seed.

*Seed purity* is the percentage by weight of pure seed of an identified species or variety present in the particular lot of seed. Seed purity is generally less than 100% because inter matter, weed seed, and other crop seed are present in the bag of seed.

*Germination percentage* is the percentage of desired seed that is alive and that will germinate under standard laboratory test conditions. For maximum effectiveness and cost-efficiency, use seed with at least an 85 percent germination rate.

*The percentage of Pure Live Seed (PLS)* in a given sample can be determined by multiplying the percentage of pure seed by the germination percentage. For example, a seed lot with 90 percent purity and 75 percent germination will contain 67.5 percent Pure Live Seed ( $.90 \times .75 = .675$ ).

#### *Seed Storage*

The care given seed in handling and storing of seed significantly affects its ultimate viability.

To preserve the quality of grass seed, store it in a relatively cool, dry area. Never store seed in hot, humid warehouses, against an outside wall, near fertilizers or pesticides, or in direct sunlight. Bags of seeds should be stored on pallets rather than directly on the floor. All seed storage facilities should be well ventilated. Leaving walkways between pallets of stored seed is a good way of providing adequate ventilation.

Stored seed rapidly loses its viability in Florida's high summer temperatures and humidity. Therefore, seed should be used as soon as possible after purchase. Also, use bags of seed in the order in which they are received. If the quality of seed is questionable, submit a request to the area Department of Agriculture and Consumer Services, Feed, Seed and Fertilizer Laboratories (<http://www.flaes.org/complimonitoring/seedsection.html>) to have the seed sampled and tested. An increase in seeding rates may be necessary if seed quality is found to be below the labeled percentage of germination.

#### *Seeding Activities*

Successful turfgrass establishment from seed depends upon seeding at the correct time, using the correct quantity of seed per unit of area, and proper distribution, covering, and soil

preparation. Unsatisfactory stands often are the direct result of failure to meet these essential requirements in the seeding operation.

*Timing.* Grasses are classed as warm-season and cool-season based upon their temperature tolerance. The potential for success is greatest when seeding is performed under conditions that favor rapid germination and vigorous seedling growth. A period of warm weather with adequate moisture after seeding promotes rapid growth. An average temperature of at least 20.0° C (68° F) is optimum for ensuring seed germination and turf establishment. Proper timing, site preparation, seeding rate, and seed placement are critical for seed germination and turf establishment.

The best time for planting permanent grasses is spring through early summer. Under average conditions, seeding should not be performed later than early July for most warm-season grasses. Late summer seeding may result in germination, but complete establishment may not have time to occur before cooler temperatures prevail.

*Seeding rates.* Seed quality will affect the seeding rate of grasses. Low percentages of purity and germination will reduce the number of viable seeds in any lot and require higher seeding rates to compensate for this reduction. Seed for permanent turfgrasses should be distributed uniformly over the planting site in relatively large quantities. A general guideline is to apply a sufficient number of Pure, Live Seed to develop approximately 144 seedlings per square meter (13.4 seedlings per square foot). When seeding rates are too high, the resulting seedling stands may be so dense that individual plants fail to develop properly because of competition for available nutrients.

Fairly low seeding rates should be used with temporary grasses. If the stands of temporary grass are too thick, they may deprive the permanent grass seedlings of light and compete for important soil nutrients. (Appropriate seeding rates for the various permanent and temporary grasses used by the FDOT are provided in Table 2.)

**Table 2. Seed application rates for various regions in Florida.**

Species/Location **	North Florida		Central Florida		South Florida	
	Apr – Sep	Nov – Mar	Mar – Oct	Nov – Mar	Feb – Nov	Dec - Feb
<b>Coastal Regions</b>						
<b>Permanent Grasses</b>						
Bahiagrass	30 lbs		30 lbs	30 lbs	30 lbs	30 lbs
Bermudagrass	15 lbs		15 lbs	15 lbs	15 lbs	15 lbs
Centipedegrass	13 lbs		13 lbs			
<b>Temporary Grasses</b>						
Brown-Top Millet	20 lbs		20 lbs		20 lbs	
Annual Ryegrass		20 lbs		20 lbs		20 lbs
<b>Inland Regions</b>						
<b>Permanent Grasses</b>						
Bahiagrass	30 lbs		30 lbs	30 lbs	30 lbs	30 lbs
Bermudagrass	15 lbs		10 lbs	15 lbs	10 lbs	15 lbs
Centipedegrass	13 lbs		13 lbs			
<b>Temporary Grasses</b>						
Brown-Top Millet	20 lbs		20 lbs		20 lbs	
Annual Ryegrass		20 lbs		20 lbs		20 lbs

\*\* The arbitrary dividing line between north and central Florida is a straight east-west line from coast to coast through Ocala, and the dividing line between central and south Florida is a line from coast to coast through Tampa and Vero Beach.

*Seed Placement.* Seed can be sown using a variety of equipment including a broadcast spreader, a cultipacker seeder, or a slit-seeder. These methods are commonly used by FDOT. Hydroseeding is gaining in popularity and is especially useful for steep slopes and other difficult areas. Hydroseeding is a method of spraying seed over the soil surface in a slurry of water, mulch, and fertilizer (Figure 8).

Research and experience have shown that best results are achieved when permanent grass seed is placed 6.35 mm to 12.70 mm (0.25 in to 0.50 in) below the soil surface with a seed drill, rake, or other appropriate implement. If seed is not placed into the soil, it is usually washed away by surface water runoff or eaten by birds. When seed is placed too deep into the soil, the growing seedling's food reserves may be depleted before the seedling reaches the surface or before it can develop enough for photosynthesis (food production within the plant) to begin.

After seeding, the planting site should be lightly rolled to ensure firm contact between the seed and soil particles. It may be necessary to use an erosion-control material during or after seeding to help protect the soil from erosion and ensure seed germination.



Figure 8. Hydroseeding common bermudagrass.

### ***Sodding***

Although sodding is more expensive than seeding, under favorable conditions, it forms an established turf soon after planting. Sod may be planted year-round as long as conditions are favorable. However, ideal planting in North Florida is from early spring (April) through late summer (August). In Central and South Florida, sod may be planted year round. However, sod should not be planted during very dry weather or when freezing temperatures are expected.

Sod is used when a quickly established turf is desired or necessary. It is preferred for steep slopes, ditch bottoms, or other areas subject to soil erosion. It is also used at office complexes and rest areas.

Choose a sod variety that suits the environmental conditions at the site and the purpose for which the turf is to be established. In addition, make sure that any sod purchased is of good quality and is weed and nematode-free.

### ***Sod Placement***

Sod deteriorates very rapidly and must be laid within 24 to 48 hours after cutting. Areas can either be solid-sodded or planted in patches or in strips. Sod can be obtained in slabs (16" or 24" wide by 24" to 48" length) mini-rolls (24" X 60") (Figure 9), or big rolls (30" to 48" wide by 125') (Figure 10). The method used most often by the FDOT is the solid-sodding sod placement method.





Figure 9. A "mini-roll" of sod typically measures 24" wide by 60" long.



Figure 10. Big roll sod.

*Solid-sod placement method.* When the solid-sod placement method is used, stagger the joints between the blocks of sod perpendicular to the roadway for best erosion control. The individual blocks should be firmly fitted against adjacent blocks and lightly tamped or rolled to provide uniform contact with the soil. Placing soil in the joints between the blocks of sod will help them knit (grow) together.



When sod is placed on steep slopes, secure it with wooden stakes or sod staples to prevent it from slipping.

### **Plugging**

Plugging involves planting small square or circular pieces of sod in rows. Plugs are usually 2 to 4" wide and should be planted on 6 to 18" centers. The larger the plug, the farther apart they can be planted. Planting plugs closer to each other results in a more rapid cover. The plugs should be firmly tamped into the soil and the soil kept moist until the grass is well rooted. Plugging is very labor-intensive and is recommended only for small areas.



Figure 11. Plugs of turf can be used to establish turf areas.

### **Sprigging**

Sprigs (pieces of stolons or rhizomes) can be used as a means of propagating turfgrasses. Sprigs with at least two nodes (joints) each are planted in rows with the nodes covered by soil. Approximately 25% of the sprig's length should remain above the soil surface to allow photosynthesis to take place. Sprigging is generally done by machine but can be done by hand spreading of the plant material and then inserted into the soil using a machine with coulter discs and rollers to *punch* the sprig into the soil (Figure 12). After planting, the area should be rolled to firm the soil around the sprig (Figure 13). Adequate moisture is essential to ensure successful survival of the sprigs.



Figure 12. Sprigging of turfgrass using a sod-to-sprig machine.



Figure 13. Areas established from sod, sprigs, or plugs should be rolled after planting.

## **EROSION CONTROL MATERIALS**

### ***Mulching***

The use of a mulch on newly seeded turfgrass areas is one of the oldest and soundest practices employed in the establishment operation. As the final step in the procedure, it acts as a short term insurance policy to provide for the successful development of the turfgrass stand. Successful establishment from seed does not require the protection afforded by mulching, but many seeding failures can be attributed to its absence.

The advantages of mulching go beyond the protection it provides against soil erosion. When properly applied, mulch reduces the rate at which the soil dries out. Mulch prevents surface crusting, dissipates the energy of falling raindrops, and has a modifying effect on temperature.

Mulches and other erosion-control materials may be applied during or after seeding or other planting activities to temporarily stabilize the soil surface until the turf becomes established. The proper use of erosion-control materials is important in developing a successful turf.

An effective erosion-control material should provide three primary benefits. It should:

1. protect the surface from wind and water erosion,
2. protect the seed from excessive temperature changes and direct sunlight, and
3. provide a favorable environment for seed germination and turf establishment.

Dry mulches, such as straw or hay, are most commonly used during seeding activities. Normally they are distributed uniformly over the site in a loose layer and cut into the soil during the drill-seeding process. To prevent the introduction of undesirable vegetation or materials into the seeding site, make sure that dry mulches are reasonably free of weeds and debris.

Jute, cotton, or other fiber netting; peanut hulls; wood cellulose fibers; plastic sheeting; and latex and asphalt emulsions are the most effective in preventing erosion and promoting turf establishment. Emulsions may be used alone or with dry mulch for additional erosion protection.

## **CULTURAL PRACTICES**

The cultural practices used by the FDOT to manage turf are mowing, fertilization, aeration, and pest management.

### **MOWING**

Mowing involves the periodic removal of a portion of the turfgrass leaf. Mowing is performed to enhance appearance and to control undesirable vegetation.

Highway mowing is an important and useful maintenance operation when correctly performed. It enhances the natural beauty of the roadside and, more important, it improves highway safety by providing definition to roadside areas beyond the travel way. Mowing may also aid in managing the invasion of right-of-way areas by undesirable species.

There are several factors which, in general, should influence the time of mowing. Very early spring mowing, although it may be desirable, is not recommended because the taller grasses will shade out the germinating weeds.

Areas established with the shorter growing grasses may require routine mowing depending on their growth rate. In general, mowing for these areas should take place when the height is 30% above the desired height. For example, if the desired mowing height is 2", mow the turf when it reaches 3" in height.

Areas established in the taller grasses should not require mowing other than for spot weed control. Such weed control mowing should be delayed until the time of year when seed heads of the weeds are present, but have not yet reached maturity.

Normally, the part of the plant above ground balances with the part below ground. A reduction in one may cause a reduction in the other. Close mowing will not only reduce the leaf surface of the plant, but force a corresponding reduction in the root system. Thus, the plant's effectiveness in erosion control is reduced, as is its resistance to extended periods of hot, dry weather.

Mowing needs differ on various parts of the right-of-way. In general, areas that require mowing are medians, parts of interchange islands, and along the front slope to frame and define the roadway. Areas that require more intensive mowing should be established in grass species that will tolerate such cutting. Back slopes, fill areas, and generally, the remaining parts of the right-of-way, do not require mowing except where necessary for weed management.

Although there are a number of different types of mowers, the FDOT primarily uses rotary mowers.

### ***Rotary Mowers***

Rotary mowers cut by impact. A horizontally mounted blade rotates around a vertical shaft, cutting off the leaf blades. Because of the horizontal blade action, flying debris is a constant hazard and safety precautions should be followed (Figure 14).





Figure 14. Rotary mower used for mowing along rights-of-way.

### ***Flail Mowers***

Flail mowers consist of numerous small knives hinged horizontally to a shaft. As the shaft rotates, the knives are held out by centrifugal force. Because of the small clearance between the knives and the mower housing, clippings are recut until they are small enough to clear the housing and are discharged downward.

Flail mowers are much safer than rotary mowers. The knives fold away when striking rocks or other hard obstructions. They also discharge debris downward, reducing the danger from flying projectiles. For these reasons, flail mowers may be used in urban as well as rural areas.

### ***Blade Sharpening and Replacement***

Regardless of the type of mower used, it is important that the blades be sharpened regularly and replaced when worn. Dull blades result in tearing rather than cutting of the grass leaves (Figure 15). Ragged torn ends recover slowly, make the plant more susceptible to stress, and create entry points for disease.

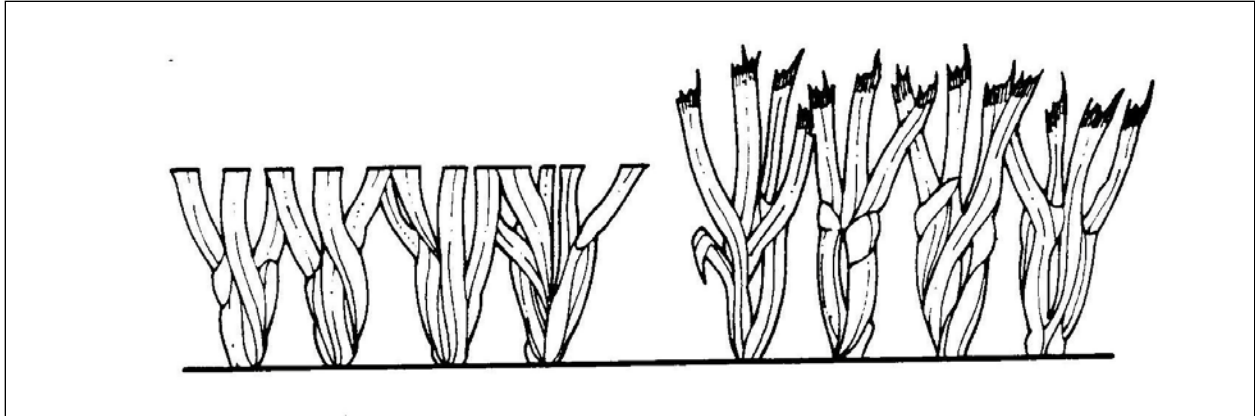

Figure 15. Effect of blade sharpness on turfgrass quality of cut (left - sharp; right - dull).

### *Clippings*

When clippings are not uniformly distributed behind the mower, large clumps of clippings may remain on the surface of the grass. These clumps can shade the grass underneath, causing it to die. Clumps may occur when mowers are set too low for the grass height or when improper fertilization results in excessive leaf growth. To reduce clumping, set the mowing height so that no more than one-third of the leaf portion is removed at any one time. Also, monitor the application of fertilizer. Excessive soluble-nitrogen-application levels cause rapid top growth, which requires frequent, intense mowing.

The problem of large clumps of clippings most often occurs with rotary mowers. Flail mowers reduce the vegetation to a finely ground mulch, so that clippings are less likely to form clumps even at lower height settings. If necessary, rotary mowers may be modified to increase the distribution of the cuttings and reduce clumping. This can be done by adjusting the skids and chain guards, or by extending the mower housing to provide additional space between the blades and the guards.

### *Mowing Height and Frequency*

Improper mowing practices are a prime contributor to turf problems. Improper mowing can lead to deterioration of the turf, soil erosion, and weed infestation. Two major variables in mowing affect the quality of turfgrass: mowing height and mowing frequency.

*Mowing height.* Mowing height is the height of the turfgrass immediately after mowing. Each type of turfgrass has a minimum mowing height for satisfactory turf. Mowing below this height may produce a turf that is visually pleasing, but it can damage the plants.

Scalping (mowing too close to the ground line) is **extremely** detrimental to turfgrass. When too much leaf area is removed through mowing, the plant loses its carbohydrate reserves and the ability to replace those reserves. Removing too much leaf area also stops root growth. Plants that are cut too close to the ground line are less able to tolerate heat, cold, and drought; more prone to disease; less able to compete with undesirable vegetation; and more dependent on a carefully implemented and managed cultural program. **Never** scalp the turf.

Rural areas: For rural areas the mowing height should be six inches or higher. Plants at this height can retain enough leaf growth to carry out photosynthesis and adequate food reserves to persist through stress periods. They also can help abate the erosion of the soil from rain and wind. In addition, this height range provides a visually pleasing roadside for motorists traveling at highway speeds.

Urban areas and lawn turfs: A higher standard of maintenance is usually desired for rest areas, office complexes, and urban locations. A general rule for determining the mowing height and frequency for moderately to intensively cultivated turf areas is to remove no more than one-third of the blade height per mowing. Removing more than one-third of the blade height suppresses plant growth and makes the plant more susceptible to disease and stress. Figure 16 shows the relationship between mowing height, plant density, and root growth.

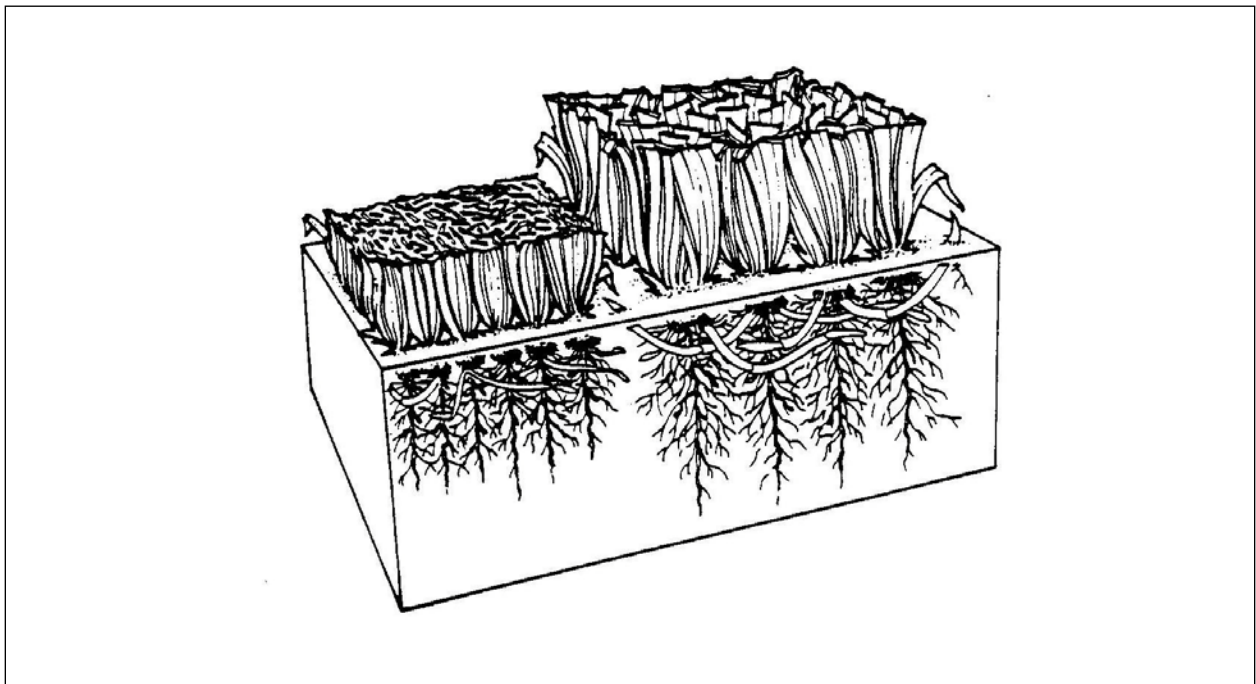

Figure 116. Relationship between mowing height, plant density, and root growth.

*Mowing frequency.* Mowing frequency is the number of mowings during a given period of time. Overly frequent mowing results in less rooting and a depletion of the plant's carbohydrate reserves. Less frequently mowed grass is better able to accumulate food reserves to promote growth following mowing and stress periods. However, mowing should be performed frequently enough so that no more than one-third of the blade height of the grass must be removed to achieve the desired mowing height.

Mowing frequency should be based on need rather than a preset time schedule. To avoid damaging the turf, do not mow during stress periods. Late season mowing reduces the ability

of turfgrass to persist through cold weather and should take place only when required. Late season mowing should not be performed as a routine clean-up activity.

### ***Mowing operations***

#### **Legend to Figures 17-28**

R/W:	Right-of-way line
PL:	Property line
	Center line of roadway
T-1:	T-1 maintenance, mowed as scheduled
T-2:	T-2 maintenance, normally not mowed

#### ***Type of Maintenance***

**T-1:** Roadside areas to be mowed as scheduled.

- Shoulders, front slopes, ditch bottoms, and back slopes, if applicable, (Figure 17).
- Areas adjoining residential and commercial property (arterial roads only).
- Intersections and hazardous locations.
- Urbanized areas, not from city limit to city limit but those areas adjacent to property having a high density population and heavy commercial or residential development.
- All median areas less than 70 feet wide should be mowed entirely. Where the width of the median is 70 feet or greater, mow a minimum of 30 feet to a maximum of 35 feet from the median edge of the roadway.

**T-2:** Roadside areas normally not mowed.

- Areas adjoining agricultural and undeveloped roadside properties.
- Wet weather swamps and ponds.
- Locations where adjoining property is undisturbed natural terrain.
- Strips of medians in excess of 70 feet.



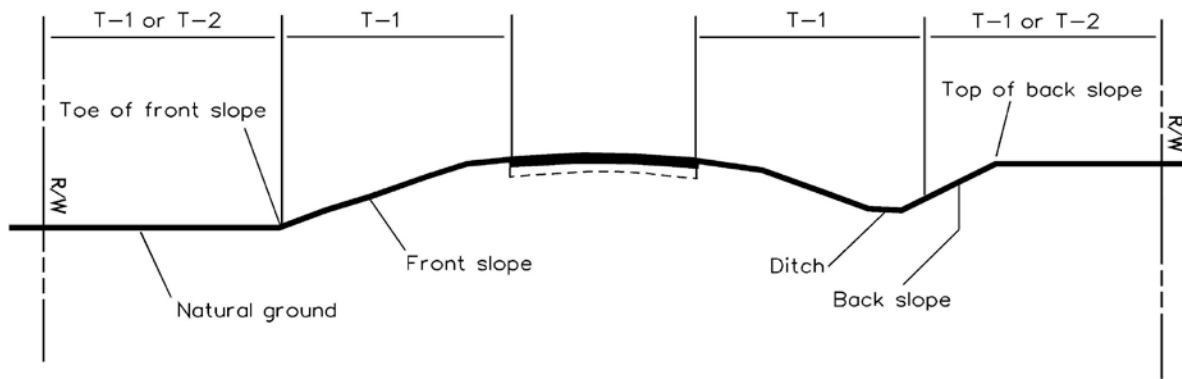

Figure 127. Roadside mowing: Typical section.

### *Type T-1 Roadside Maintenance*

T-1 maintenance involves the use of roadside mowing to control the growth of the planted and/or natural grasses, weeds, and other vegetation for safety reasons, as well as for scenic enhancement.

### Urban-Area Mowing Limits (Arterial Roads Only)

Urban mowing areas are those areas adjacent to property having a high-density population and heavy commercial or industrial development.

Urban-area mowing includes areas from city limit to city limit and all areas adjacent to property having a high density population and heavy commercial or residential development (Figure 18).

At some locations, it may be feasible to reduce these limits because of unique field conditions, such as areas of functional or natural landscaping.

### Rural-Area Mowing Limits

Rural mowing areas are those areas adjacent to locations having low-density population and light commercial or industrial development.

Roadside – the area between the edge of the pavement and the right-of-way line.

- a. Normal roadside mowing limits are confined to within 5 feet beyond the top of the ditch back slope if the height of the ditch back slope is less than 5 feet (Figure 19, View A).
- b. Where the ditch back slope is 5 feet or greater in height, the mowing limit is a maximum of 5 feet up the face of the ditch back slope from the bottom of the ditch (Figure 19, View B).
- c. In normal fill sections not requiring slope mowing (slopes flatter than 3:1), the mowing limit is a maximum of 5 feet beyond the toe of the fill slope (Figure 19, View C).

Median – the area between roadways on divided highways.

- a. All medians less than 70 feet wide should be mowed entirely (Figure 20).

- b. To permit the regeneration of natural growth and encourage flowering plants in medians 70 feet wide or wider, the mowing area is a minimum of 30 feet to a maximum of 35 feet from the median edge of the roadway. The native growth or grass allowed to remain must be a minimum of 10 feet wide unless otherwise approved by the District Maintenance Engineer (Figure 22).

Steep slopes – Specialized equipment must be used for mowing slopes having grades greater than 3:1. Slope mowing should be performed periodically in conjunction with scheduled mowing operations.

- a. When the distance from the pavement edge to the right-of-way line is less than 70 feet or the right-of-way adjoins residential or commercial property, mow the entire right-of-way (Figure 21, View A).
- b. When the distance from the roadway edge to the right-of-way line is 70 feet or greater, or where the right-of-way adjoins agricultural or undeveloped property, mow a minimum of 5 feet to a maximum of 10 feet beyond the shoulder point or guardrail (Figure 21, View B).

Special areas – locations that require special attention due to safety considerations, adjacent property use, unique highway conditions, or vegetation type.

- a. **Highway signs.** When roadside conditions provide insufficient visibility of highway signs, an approach cut must be made to provide a minimum ¼-mile sight distance. The approach cut should be to a point at least 5 feet beyond the outer edge of the sign panel and the transition back to the normal mowing limits should be at a 45-degree angle (Figure 23).  
**NOTE:** Do not cut to provide sight distance for outdoor advertising or other privately erected signs.
- b. **Hazardous locations.** For safety reasons, normal mowing limits may need to be extended to provide additional visibility at potentially hazardous locations, such as intersections of state, county or city roads; driveways or other entranceways; the inside of horizontal curves; and railroad crossings (Figure 24).
- c. **Clear zones.** In certain locations, the normal roadside mowing limits are extended to create unobstructed clear zones. These areas provide vehicles leaving the roadway with an extra margin of safety.
- d. **Developed property (Arterial Roads ONLY).** Mow to the right-of-way line in front of developed residential and commercial property. Transition cuts from the normal mowing limits to the right-of-way line should be made at 30- to 45-degree angles (Figure 25).
- e. **Grade separations and interchange infields.**
  - (1.) Where a ramp pavement edge is less than 70 feet from the thru lane or an adjacent ramp, mow the entire area (Figures 26, View A, and 27).
  - (2.) Where a ramp pavement edge is 70 feet or more from the thru lane or an adjacent ramp, mow a minimum of 5 to a maximum of 10 feet beyond the shoulder point or guardrail (Figures 26, View B, and 27).

- (3.) Normal roadside mowing limits should be maintained between ramps of equal elevation (Figures 26, View A, and 27).
- f. **Roadside accent.** Contour mowing is performed in certain locations to enhance the appearance of the roadside by blending the maintained roadside with the attending native growth or land use. This blending is accomplished through variable mowing widths connected by sweeping curves. The mowing widths are governed by the terrain and adjacent land use and should accentuate the natural appearance of the roadside (Figure 28).
  - g. **Flowering plants.** Desirable flowering plants should not be mowed, treated with herbicides, or otherwise disturbed during their growing, blooming, and seed-ripening seasons. Periodic mowing may be required at other times to promote or assure regeneration of the flowers. Transitions from routinely mowed areas to adjacent flower sites should be made in a smooth manner to create a pleasing effect (Figures 18 and 28).

#### T-1 Maintenance Tips

The list below provides general guidelines that should be followed when roadside mowing is performed.

1. The minimum mowing height for established sites is 6 inches for all rural mowing areas. A higher standard of maintenance may be required for rest area facilities, office complexes, and sites within urban limits. At these locations, no more than one-third of the blade height of the desired grass (excluding seed heads) should be removed during a mowing cycle. This will result in a healthier turf better able to compete with undesired vegetation.
2. Do not scalp or mow excessively close to the soil surface. Mowing too low increases soil temperature, contributes to erosion, lowers plant tolerance to cold and drought, results in the thinning of the turf and increases undesirable vegetation.
3. Mow only when necessary. Consider seasons, locations and turf conditions when scheduling mowing operations. Mowing should not be performed during periods of drought or growth stress.
4. Mow or disc a strip 5 to 10 feet in width to permit inspection and repair of the fence line on rural limited-access facilities. This is to be performed annually at the discretion of the Maintenance Engineer (Figure 21, View B).
5. Make smooth, free-flowing transitions when changing cutting width.
6. To avoid damage to the mowing equipment, do not mow unnecessarily close to roadside obstacles, such as signs, delineator posts, fences and guardrails.
7. Never mow beyond the FDOT right-of-way line. Under normal conditions, mowing beyond the right-of-way line is a violation of state law.
8. Never mow over debris that would damage the equipment or that might be picked up and thrown out by the mower. Stop and remove objects, such as old tires, limbs and other debris, from the mowing area.
9. Park equipment on the right-of-way as far from the roadway as feasible, in an area least susceptible to fire and vandalism.

### *Type T-2 Roadside Maintenance*

Except under unique field conditions, T-2 maintenance areas are normally not mowed. This encourages the regeneration of natural growth and allows the areas outside the established mowing limits to return to their native state.

Encouraging natural growth or the planting of native trees, shrubs, and ground cover appropriate to the local environment is desirable. Such growth reduces the area the FDOT must maintain through mowing and thus the overall cost for maintenance operations. In addition, regenerated areas improve the appearance of Florida's roadways and serve as valuable habitats for native wildlife.

Wildflower sites may be established and maintained within existing mowing limits if their locations are compatible with routine maintenance operations. Sites may occasionally be located outside the normal mowing limits, including areas of natural regeneration. Locations selected for wildflower sites should be highly visible from the roadway and relatively free from competitive or noxious plants.

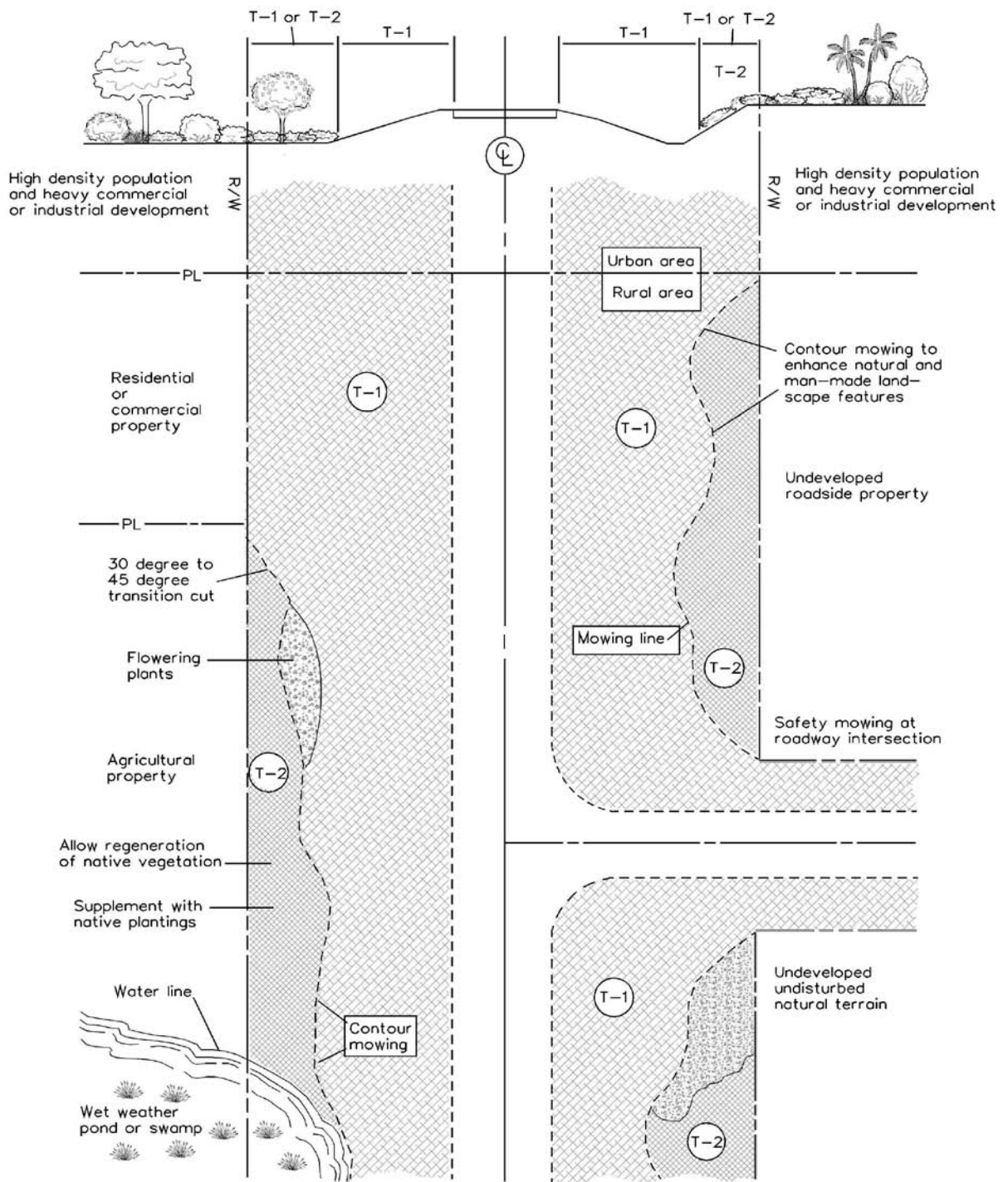

Figure 18. Mowing Plan (Arterial Roads Only)

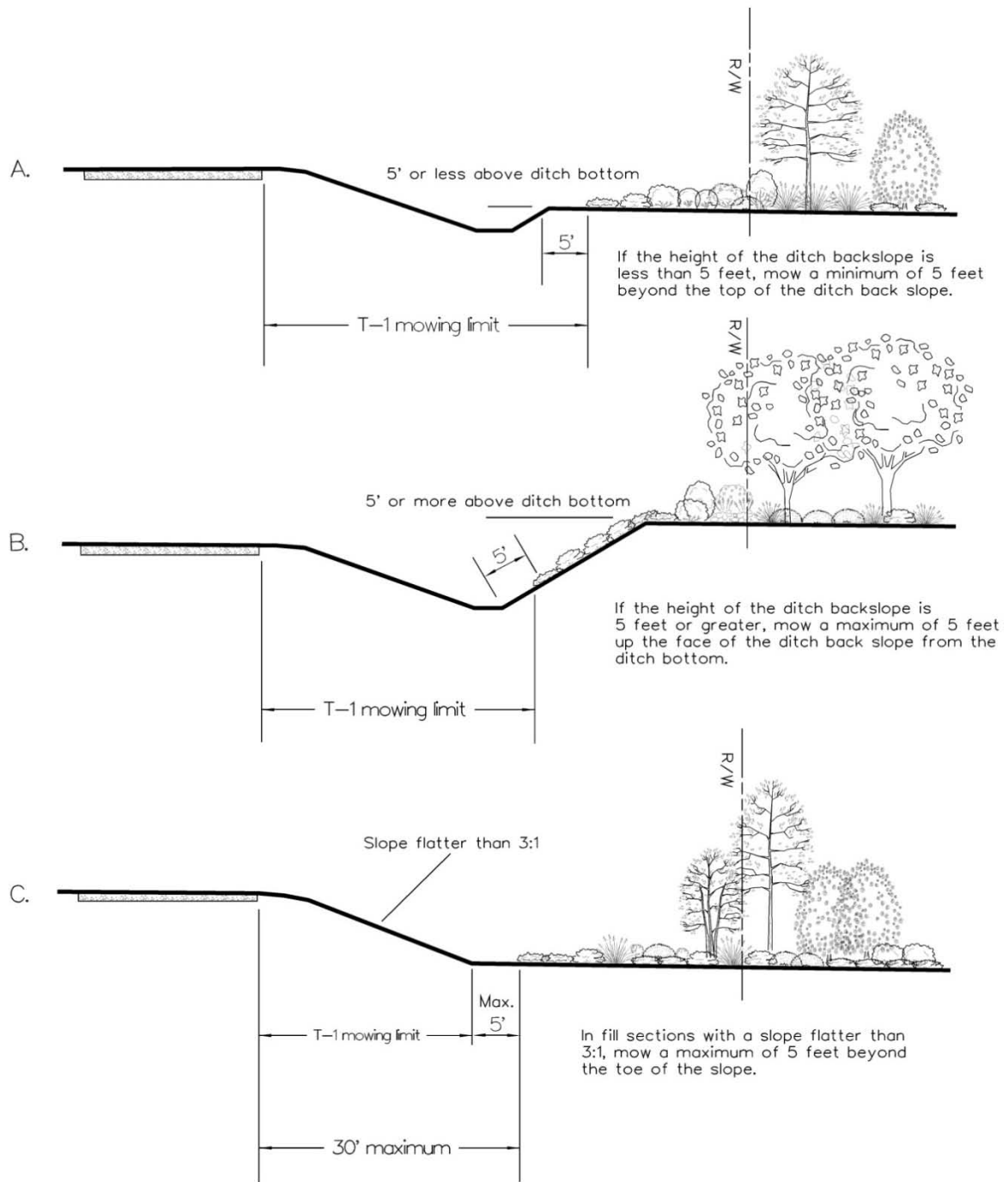

Figure 19. Normal roadside mowing limits: Rural and limited access.

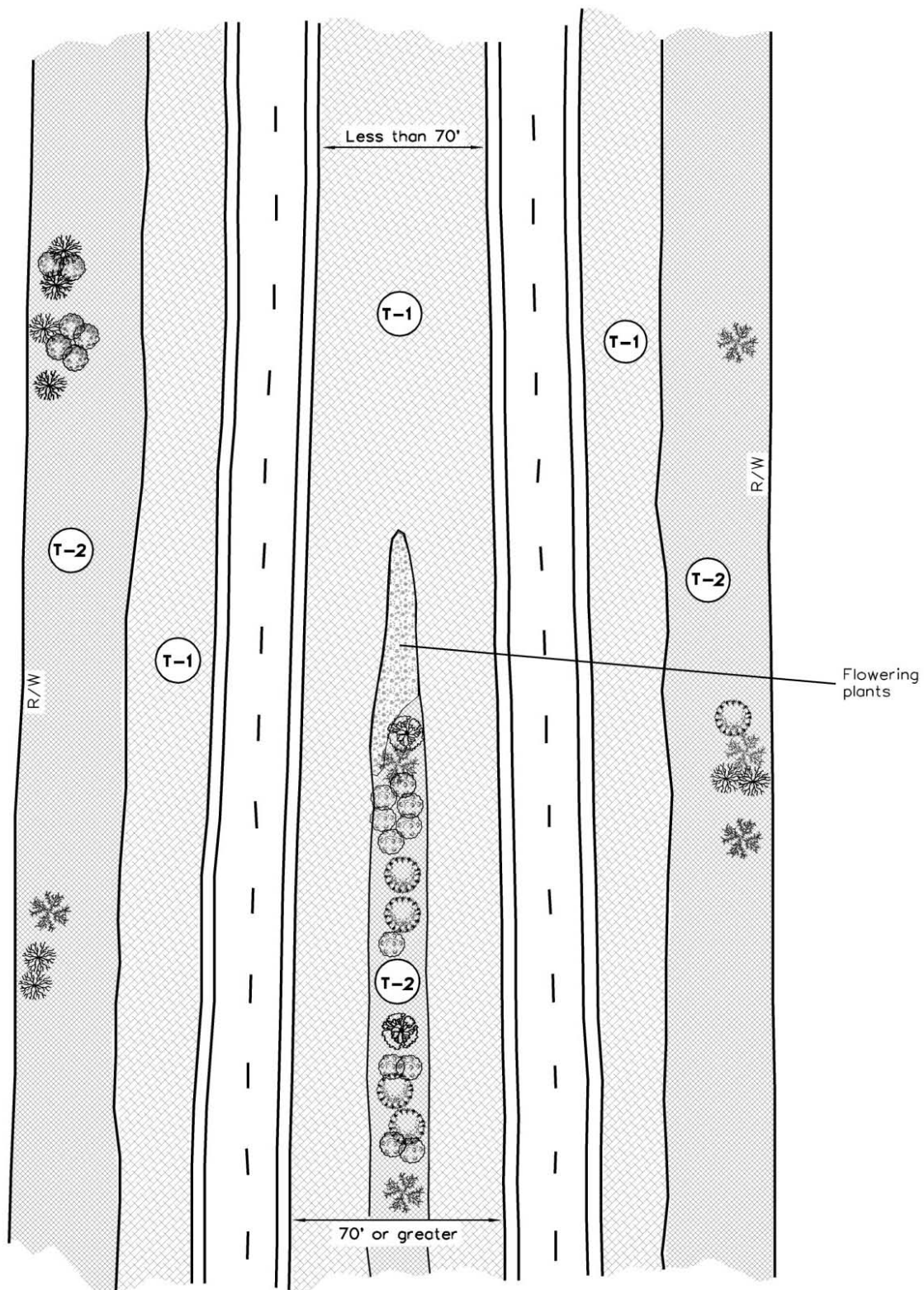

Figure 20. Median mowing limits: Rural arterial and all limited access (overhead view).

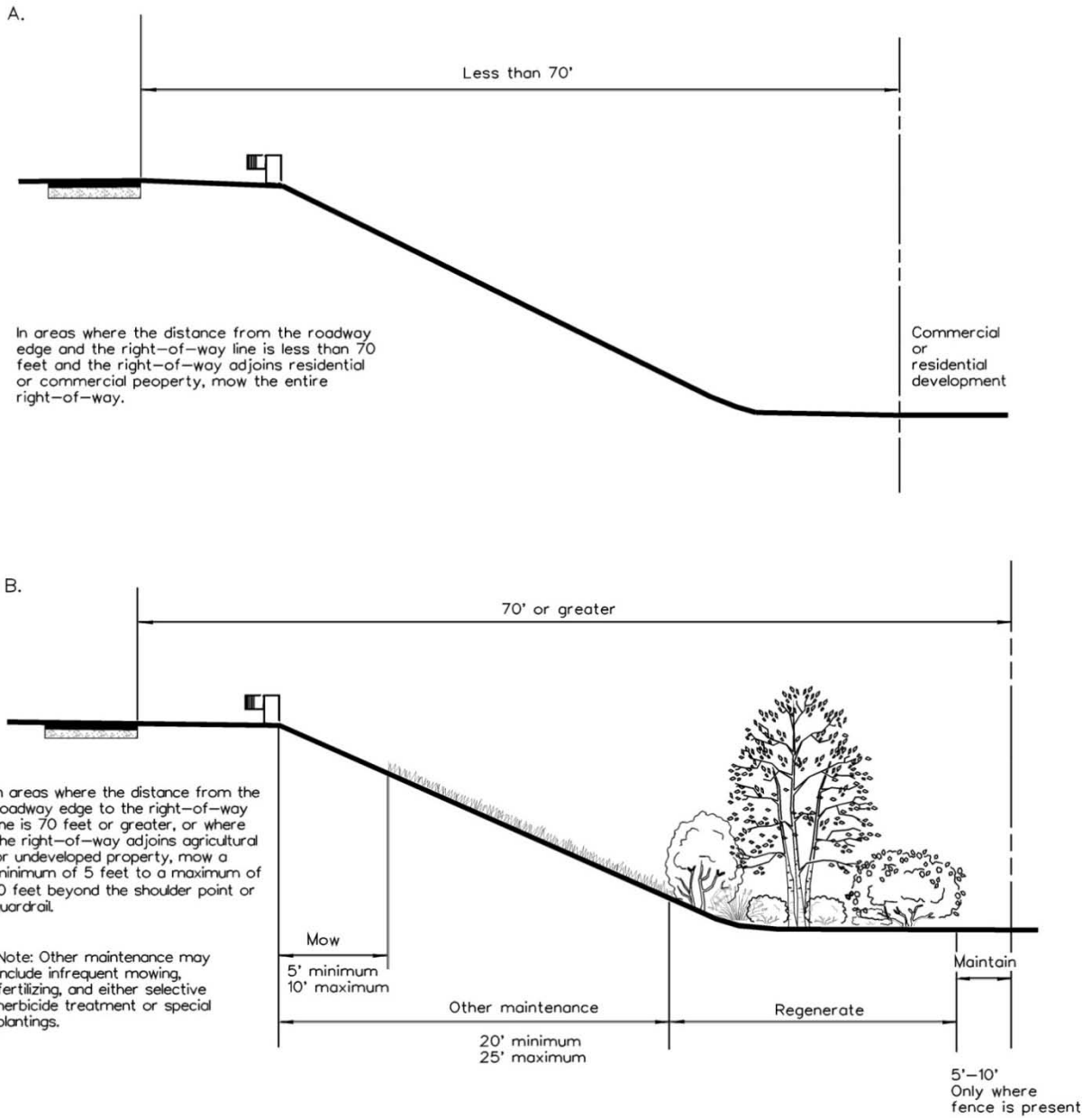
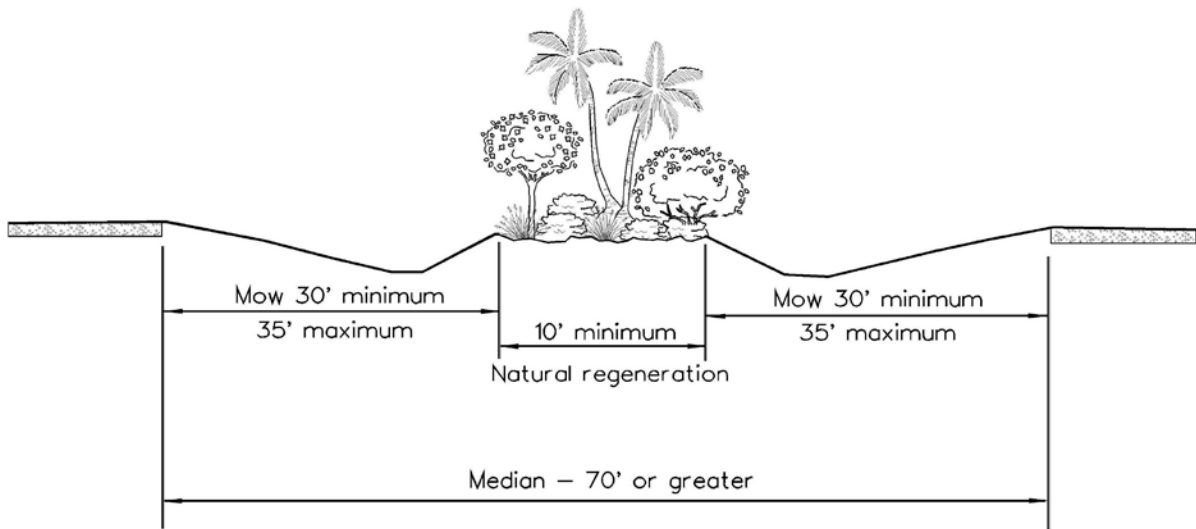

Figure 21. Slope mowing limits: Rural arterial and all limited access.





Where the width of the median is 70 feet or greater, mow a minimum of 30 feet to a maximum of 35 feet from the median edge of the roadway. Remaining strips of native growth or grass must be at least 10 feet wide.

All median areas less than 70 feet wide should be entirely mowed.

Figure 22. Median mowing limits: Rural arterial and all limited access (cross-sectional view).

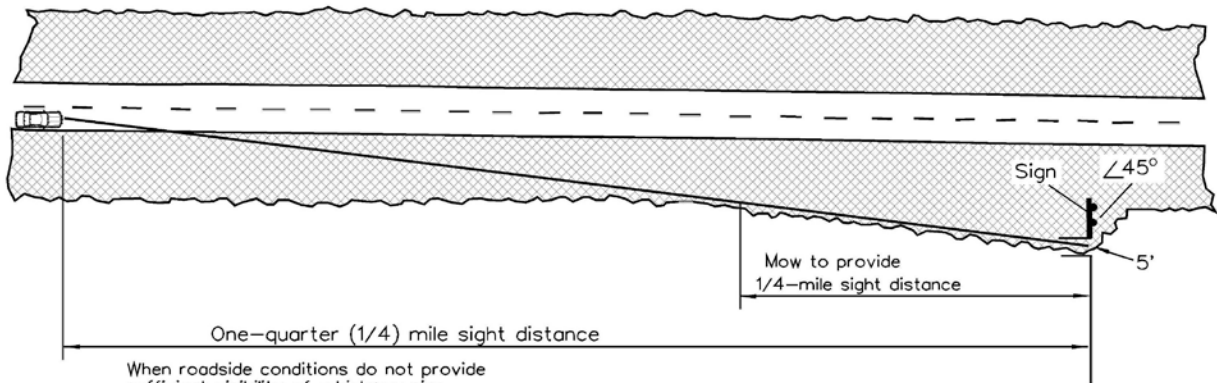

When roadside conditions do not provide sufficient visibility of a highway sign, make an approach cut to provide a minimum of 1/4 mile sight distance. The approach cut should be to a point at least 5 feet from the outer edge of the sign panel. The transition back to the normal mowing limit should be at a 45-degree angle.

Do not cut to provide sight distance for outdoor advertising or other privately erected signs

Figure 23. Highway sign mowing limits.

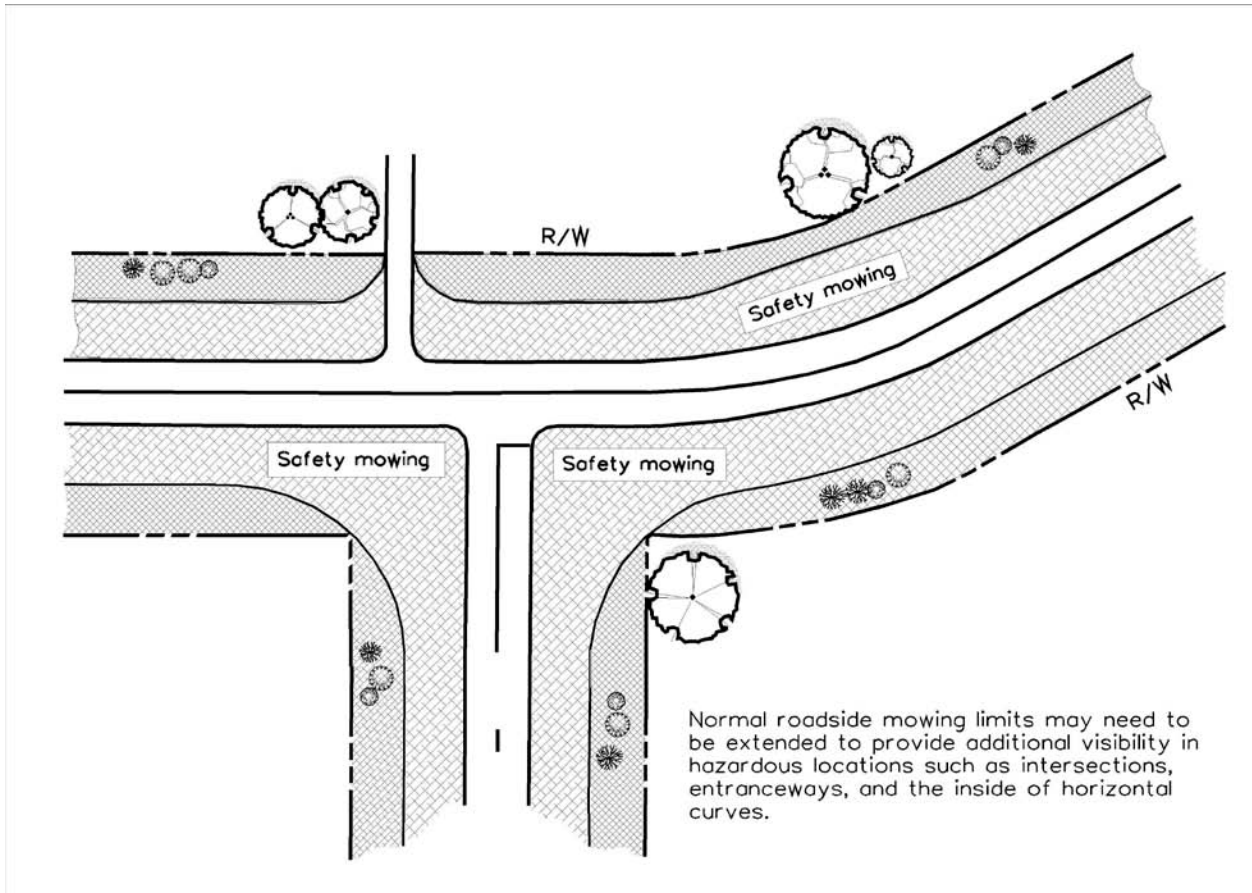

Figure 24. Safety mowing limits.

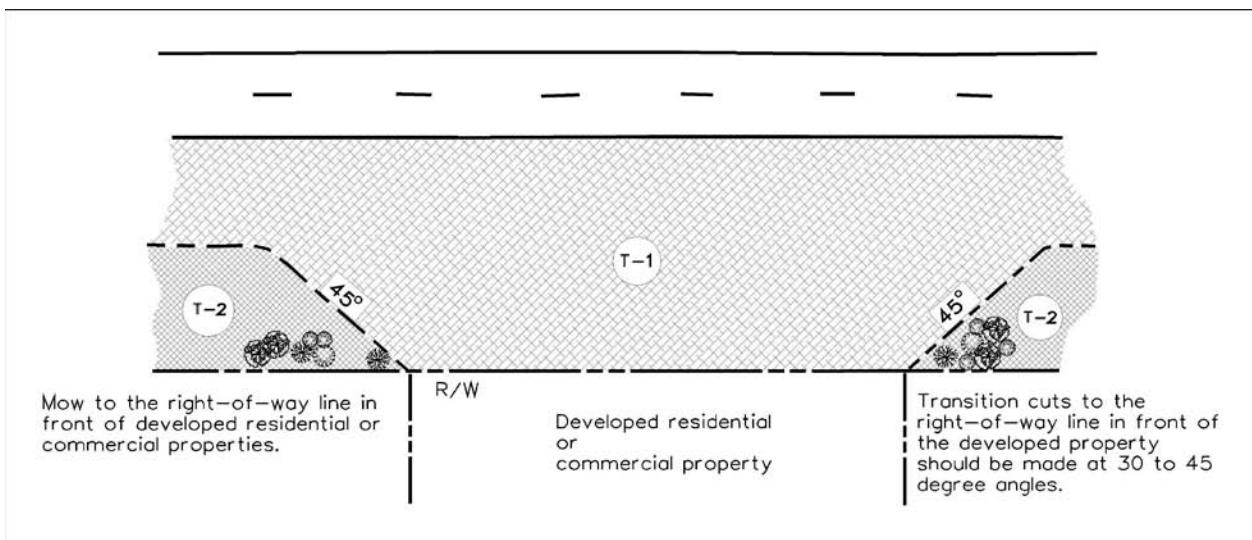
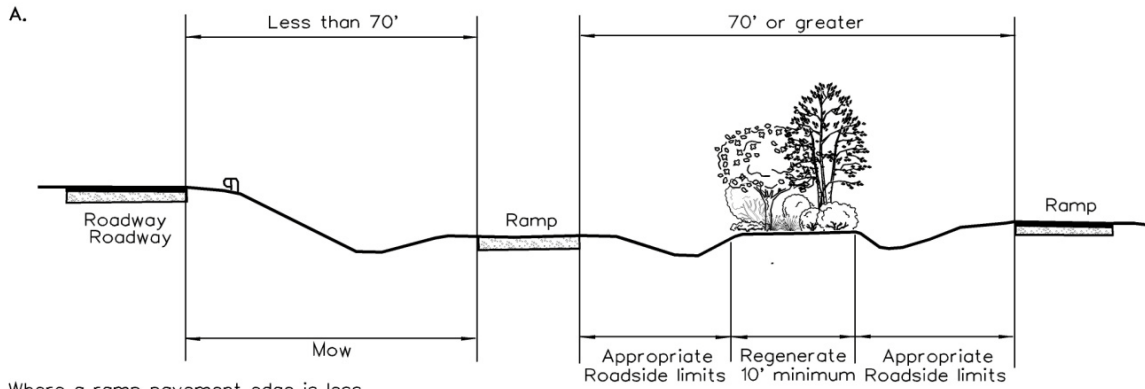
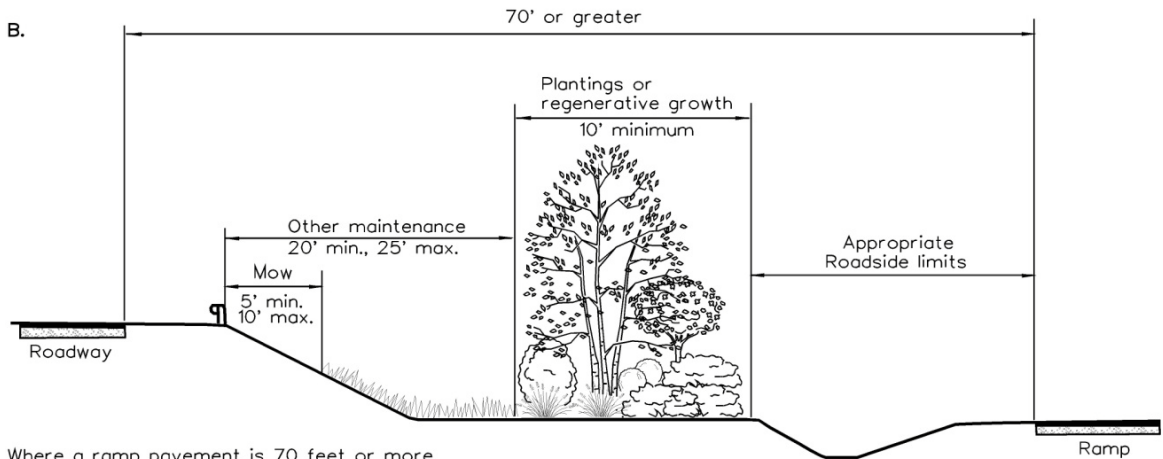

Figure 25. Developed property mowing limits: Rural (arterial roads only).



Where a ramp pavement edge is less than 70 feet from the thru lane or an adjacent ramp, mow the entire area.

Normal roadside mowing limits should be maintained between ramps of equal elevation.



Where a ramp pavement is 70 feet or more from the thru lane or an adjacent ramp, mow a minimum of 5 feet to a maximum of 10 feet beyond the shoulder point or guardrail.

Note: Other maintenance may include infrequent mowing, fertilizing, and either selective herbicide treatment or special plantings.

Figure 26. Grade separations and interchange infields: Rural (cross-sectional views).

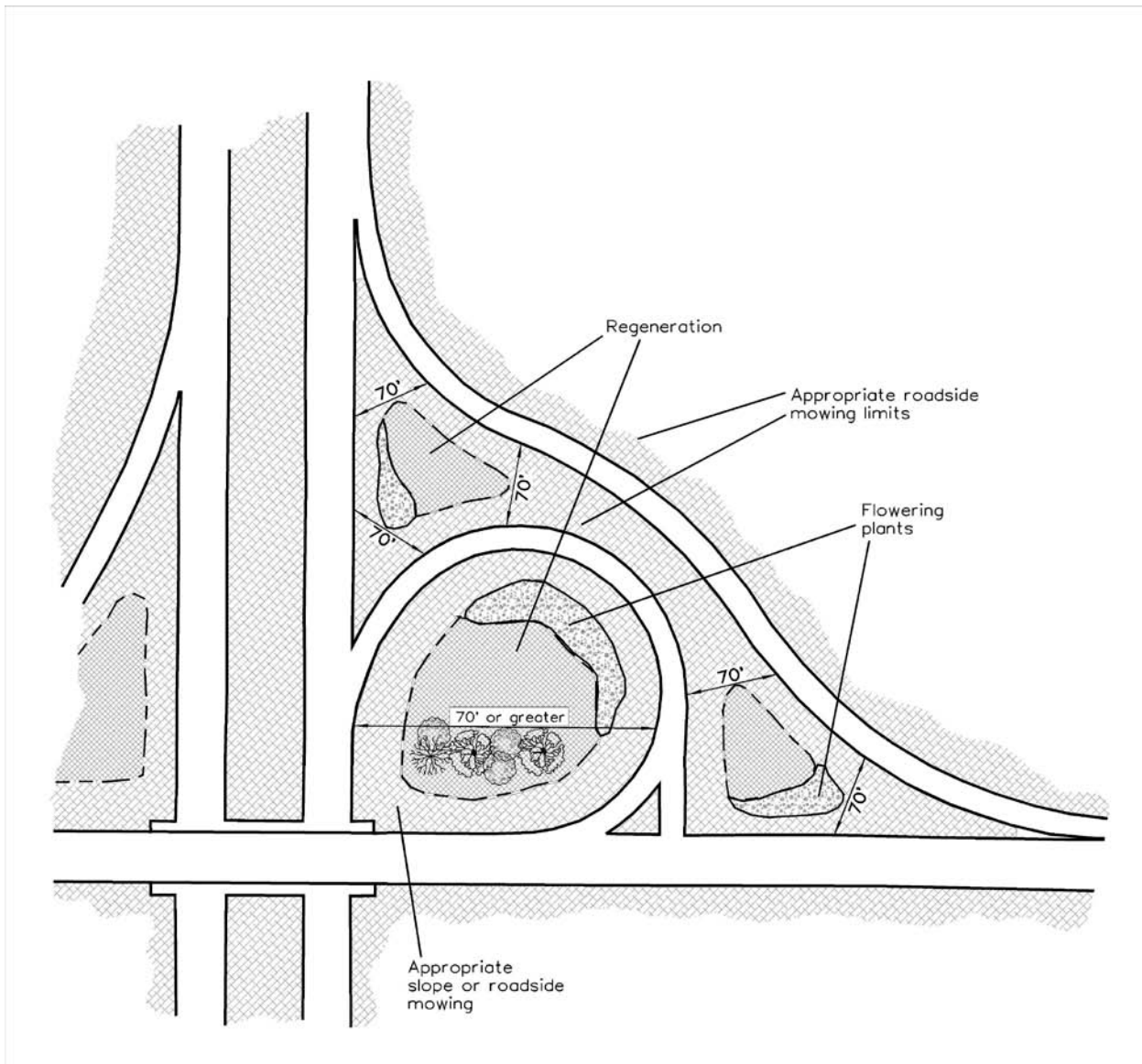
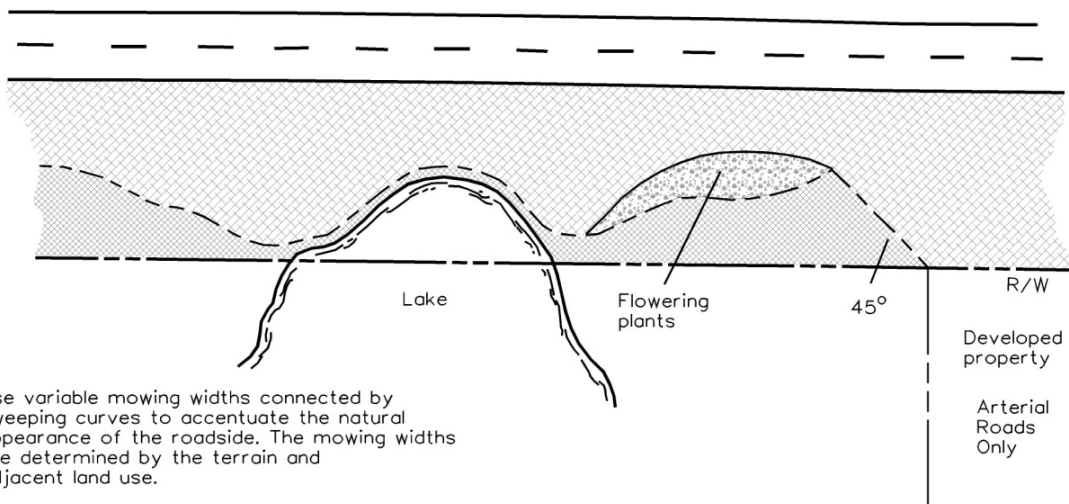
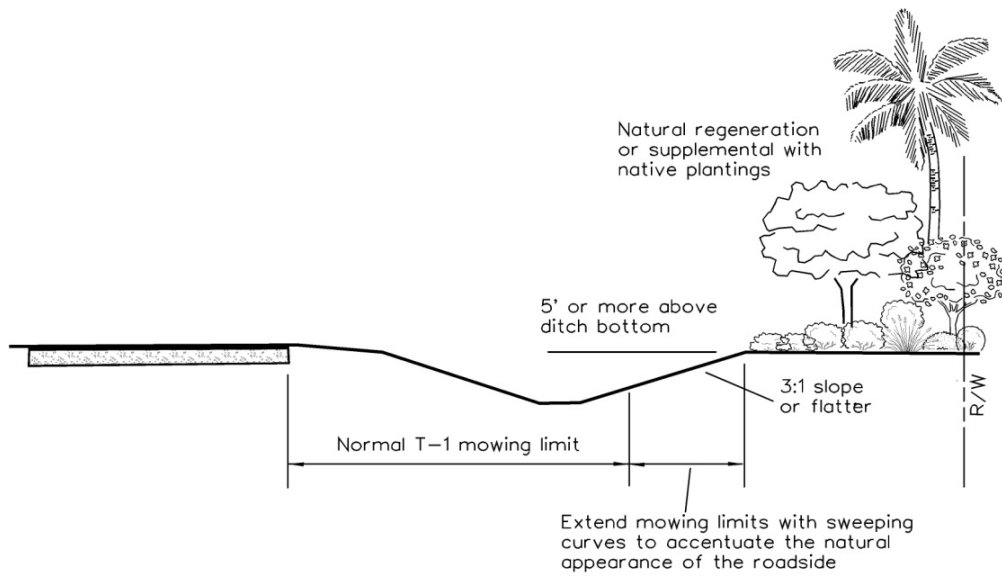

Figure 27. Grade separations and interchange infields: Rural (overhead view).



Use variable mowing widths connected by sweeping curves to accentuate the natural appearance of the roadside. The mowing widths are determined by the terrain and adjacent land use.

Do not mow desirable flowering plants during growing, blooming, and seed-ripening seasons. Transitions from routinely mowed areas to adjacent flower sites should be made in a smooth manner.

Figure 28. Roadside accent mowing.

## **FERTILIZATION**

Fertilizer is used to add essential nutrients to the soil to support the growth of the turfgrass. Improving the vigor and density of turfgrass through a sound, systematic program of fertilization produces an environment least favorable to undesirable vegetation. Proper fertilization is a primary determinant of turfgrass persistence and quality. It is also one of the least time consuming and least costly components of a complete turf management program and should be a primary tool in roadside vegetation management.

Properly fertilized grass makes more efficient use of water. A thick turf with dense root system helps slow water movement and keeps it in the root zone. Grass which is properly fertilized develops a deep root system which is very important under roadside conditions.

Thirteen mineral elements found in soil are recognized as essential for plant growth. The three primary nutrients necessary for plant growth and the ones found in greatest concentration in fertilizers, called macronutrients, are nitrogen, phosphorus, and potassium.

### ***Macro-Nutrients***

*Nitrogen (N):* Nitrogen is essential for healthy growth and is the nutrient required in greatest amounts by turfgrass. It is a key component of chlorophyll, amino acids, and other substances vital to the internal processes of the plant.

Nitrogen is depleted as it is used by the turfgrass and as it is leached (washed) from the soil especially during periods of high rainfall. Nitrogen deficiencies may be indicated by chlorosis (yellowing) of the leaves, slow growth, and low plant density.

Nitrogen used in fertilizers may be soluble, insoluble, or a combination of the two.

*Soluble nitrogen* is also referred to as quick-release nitrogen. The nitrogen carrier dissolves when wet, promptly releasing the nutrient into the soil. Because the nitrogen is quickly released, it is either rapidly used by the turfgrass or leached from the soil before plants can take it in through their root systems.

A characteristic of soluble nitrogen is rapid but short-term turfgrass response. Soluble nitrogen also has a high chemical-burn potential and must be used with care to avoid damaging the turfgrass. There is also the possibility of environmental contamination from excessive nitrogen levels when soluble nitrogen is used improperly.

Examples of commercially available sources of soluble nitrogen include ammonium sulfate, ammonium nitrate, potassium nitrate, and urea.

*Insoluble nitrogen*, or slow-release nitrogen, is made available to the plant gradually over a longer period of time. The rate at which insoluble nitrogen is released depends upon the speed at which moisture or microbial action within the soil breaks down the nitrogen carrier.

Insoluble nitrogen is characterized by slow initial but long-term response. Because insoluble nitrogen is released into the soil gradually, there is less chance that overly high nitrogen levels will chemically burn the turfgrass or cause environmental contamination.

Insoluble, or slow-release, nitrogen carriers include composted sewage sludge, ureaformaldehyde, isobutylidene urea (IBDU), and polymer or sulfur-coated urea.

*A combination of soluble and insoluble nitrogen* is frequently used in commercial fertilizers. With a combination of the two types, both the initial quick-growth reaction from the soluble nitrogen and the long-term response characteristic of insoluble nitrogen are available.

*Phosphorus (P)*: Phosphorus is another macro nutrient necessary for healthy plant growth. It provides plants with the means for holding and transferring energy for metabolic processes. Applications of phosphorus through fertilization are most important during early turf establishment. After a turf has been established, the addition of supplemental phosphorus is less likely to be needed. Many of Florida's peninsular soils are naturally high in phosphorus. A soil test should be performed before supplemental phosphorus is incorporated into a fertilization program.

Other important functions of phosphorus are to maintain the pH in cells and for special roles in germination of seeds and seedling growth, the ripening of seeds and fruits, and the development of roots.

Phosphorus deficiencies are most evident early in the establishment period. Signs of insufficient phosphorus are reduced growth, dark to reddish leaf coloration, and narrow leaf blades.

*Potassium (K)*: Potassium is second only to nitrogen in the amount required for turfgrass growth. Potassium is important in the synthesis of numerous plant compounds and in the regulation of many physiological processes. It promotes root growth and development and aids the plant in withstanding stress. Potassium is lost through plant use and through leaching in sandy soils. Deficiencies in this nutrient result in increased respiration and transpiration, reduced environmental stress tolerances (especially to drought), increased incidence of disease, and a reduction in growth.

### ***Secondary Nutrients***

Calcium, magnesium, and sulfur are secondary nutrients but only in the quantity required in the plants.

*Calcium (Ca):* Calcium is required in growth regions of the plant for cell production and is an important constituent of cell walls. Calcium influences absorption of other nutrients, especially potassium and magnesium, by the roots. Calcium also influences soil structure because of its electrical attraction to negatively charged colloids. Visual deficiencies are uncommon.

*Magnesium (Mg):* Magnesium is a central part of the chlorophyll molecule (makes plants green) and is an important catalyst in enzymatic reactions in the plant. Deficiencies result in a loss of green color on older leaves.

*Sulfur (S):* Sulfur is used in plants as a constituent of some amino acids that are required for protein synthesis. Visual deficiency symptoms include reduced shoot growth and a yellowing of new leaves.

### ***Micronutrients***

Plants must contain adequate levels of the micronutrients to function; however, the quantity of each nutrient in the plant is very small.

*Iron (Fe):* Iron is part of the catalytic enzymes and is required for chlorophyll synthesis. It affects photosynthesis, nitrogen fixation, and respiration. Visual deficiency symptoms occur on younger leaves as interveinal yellowing. Continued deficiency will result in leaves turning pale yellow to white; exhibiting a thin, spindly growth, and older leaves exhibiting chlorosis.

*Manganese (Mn):* Manganese is involved in photosynthesis, is a cofactor for enzymes, and is involved in lignin biosynthesis. Reduced lignin content in Mn deficient roots may make them more susceptible to certain diseases since lignification causes root cell walls to be thicker. Visual deficiency symptoms include chlorosis on youngest leaves and reduced root growth.

*Boron (B):* Boron is found in the cell wall and is probably required for the structural integrity of the cell wall. Visual deficiency symptoms occur initially on younger leaves as leaf tip chlorosis, followed by interveinal chlorosis of young and older leaves, and curling leaves. Roots may be stunted and thickened.

*Copper:* Copper is a component of a protein involved in photosynthesis and is a cofactor for a variety of oxidative enzymes. Visual deficiency symptoms appear on youngest to middle leaves as yellowing and chlorosis of leaf margins.

*Zinc (Zn):* Zinc is a structural component of enzymes. Protein synthesis also requires zinc and carbohydrate metabolism is affected by Zn. Visual deficiency symptoms are chlorotic leaves with some mottling and stunting. Leaf margins may roll or appear crinkled – generally on younger leaves.



*Molybdenum (Mo):* Molybdenum use is primarily related to nitrogen metabolism and it has structural and catalytical functions of enzymes. Visual deficiency symptoms are similar to nitrogen deficiency – chlorosis of older leaves and stunted growth with some mottling and interveinal chlorosis.

*Chlorine (Cl):* Chlorine is rarely deficient because of high solubility. It is required for the oxygen evolving reactions of photosynthesis. Chlorine also appears to be required for cell division in both leaves and shoots.

### ***Analysis***

Fertilizer analysis or grade is the minimum guaranteed percentage by weight of nitrogen (N), phosphorus ( $P_2O_5$ ), and potassium ( $K_2O$ ). It is the proportion or ratio in which each of the nutrients is present. A 45.40 kg (100 lb) bag of 20-5-10 fertilizer, for example, contains 9 kg (20 lb) of nitrogen, 2.30 kg (5 lb) of phosphorus, and 4.50 kg (10 lb) of potassium.

Complete fertilizers include some percentage of each of the macro nutrients. When a fertilizer is incomplete, zeros are used to indicate the missing nutrients. A fertilizer with a 20-0-0 analysis, for example, contains 20 percent nitrogen, but no phosphorus or potassium. For more information on fertilizers used in turfgrass fertilization, refer to [http://edis.ifas.ufl.edu/document\\_ss318](http://edis.ifas.ufl.edu/document_ss318)

### ***Timing and Frequency of Application***

Quality turf along the roadside is achieved and maintained only as long as an adequate and continuing program of fertilizer is in effect. An erosion-resistant cover of grass does not happen because the seed was sown and an indulgent mother nature provided the elements necessary for growth.

However, the need for fertilizer depends on the turfgrass species. Certain species, such as centipedegrass, have relatively low requirements, while others, like St. Augustinegrass, grow best with higher rates of nutrients.

*Newly seeded sites:* For newly seeded sites, research has shown that fertilizer should be applied approximately five weeks after the seed has germinated. At this time, the seedlings have sprouted and a developed root system extensive enough to allow them to capture and utilize the nutrients from the fertilizer. Applying fertilizer during the seeding operation is inefficient because the plants do not have a sufficient root system capable of taking up the nutrients. Fertilizer applied during the seeding operation will have been leached from the soil or washed away in surface runoff.

The application of fertilizer approximately five weeks after germination provides the nutrients necessary for continued vigorous plant growth. Take care not to apply excessive amounts of

fertilizer. Excessive fertilization may cause chemical burning or overstimulation of top growth to the detriment of the rest of the plant.

*Established turf:* The application of fertilizer to areas of established turf should be based on an evaluation of the turf quality and should take place only when a need has been identified. The optimum conditions for the release of nitrogen are the same as those for plant growth. Lawn turf fertilization should be based on the turfgrass species being grown and the location within Florida. (Table 3). The quantities listed in Table 3 are yearly amounts and should be divided into multiple applications.

Utility turfs should be fertilized at least once per year (twice per year in urban areas receiving higher standards of maintenance). Table 4 provides an ideal schedule for a program of fertilization for utility and lawn turfs.

**Table 3. Recommended fertilizer rates for various turfgrass species.**

<b>Species/Location**</b>	<b>Interim N Recommendations (lbs 1000 ft<sup>-2</sup> yr<sup>-1</sup>)</b>	<b>Interim N Recommendations (lbs acre yr<sup>-1</sup>)</b>
North Florida		
Bahiagrass	1	43
Bermudagrass	2	87
Centipedegrass	1	43
St. Augustinegrass	2	87
Central Florida		
Bahiagrass	1	43
Bermudagrass	3	130
Centipedegrass	1	43
St. Augustinegrass	2	87
South Florida		
Bahiagrass	2	87
Bermudagrass	4	175
Centipedegrass	2	87
St. Augustinegrass	3	130

\*\* The arbitrary dividing line between north and central Florida is a straight east-west line from coast to coast through Ocala, and the dividing line between central and south Florida is a line from coast to coast through Tampa and Vero Beach.

Any program actually implemented should be based on need and coincide with turfgrass growth periods and adequate rainfall. When only one application per year is desirable, the best time to fertilize is usually late spring.

For an established turf, a fertilizer with a 1:0:1 ratio of nitrogen, phosphorus, and potassium (such as a 15-0-15 analysis) is generally recommended for once a year applications. Phosphorus should be added only if a soil test recommends doing so.

Properly fertilized grass use water more efficiently. A thick turf and dense root system helps allow water movement and keeps it in the root zone. Grass which is adequately fertilized develops a deep root system, which is very important under roadside conditions.

**Table 4. Generalized Fertilizer Application Schedule.**

	Jan.	Feb.	Mar.	Apr.	May	June	July	Aug.	Sept.	Oct.	Nov.	Dec.
North Florida**												
Bahiagrass				X								
Bermudagrass				X					X			
Centipedegrass				X								
St. Augustinegrass				X					X			
Central Florida												
Bahiagrass			X						X			
Bermudagrass			X		X				X			
Centipedegrass			X									
St. Augustinegrass			X						X			
South Florida												
Bahiagrass		X								X		
Bermudagrass		X		X			X			X		
Centipedegrass		X								X		
St. Augustinegrass			X			X				X		

**NOTE:** This table represents an ideal schedule for an intensive fertilization program based off of “General Recommendations for Fertilization of Turfgrasses on Florida Soils” [http://edis.ifas.ufl.edu/document\\_lh014](http://edis.ifas.ufl.edu/document_lh014) Any program actually implemented should be based on observed needs at this site.

\*\* The arbitrary dividing line between north and central Florida is a straight east-west line from coast to coast through Ocala, and the dividing line between central and south Florida is a line from coast to coast through Tampa and Vero Beach.

### **Application Rates**

The maximum amount of fertilizer that may safely be applied at any one site depends on the type of nitrogen carrier (Table 3). In the past, it was customary to recommend the application of 1 pound of actual nitrogen per 1000 ft<sup>2</sup> of turfgrass. Due to potential environmental concerns it is now recommended that no more than one half (0.5) pound of the nitrogen in the application be in a soluble (quick release) form. Therefore, to make an application of 1 pound of actual nitrogen per 1000 ft<sup>2</sup> of turfgrass you would need to use a blended fertilizer product containing no more than 50% of the total N in soluble form with the rest of the nitrogen originating from a slow-release N source.

## **AERATION**

To remain healthier and to be able to absorb water from the soil, plant roots must have oxygen. The amount of oxygen which soil water can contain is rather limited and will not supply plant roots very long unless it were renewed. This renewal process is called aeration. Perhaps one of the most neglected maintenance items of roadside turf is soil aeration. The generally poor soil conditions and severe soil compaction caused by vehicular traffic and mowing equipment are factors that should be given more consideration. The quality as well as the functional value of roadside turf will be enhanced by including this operation in many roadside turf maintenance programs.

In areas where the soil has become severely compacted from heavy traffic, topsoil erosion, or continued close mowing, aeration may be required. Aeration is the process of mechanically loosening or breaking up the compacted soil to allow air, water, and nutrients to penetrate and thus to improve growing conditions. It is often performed through coring, slicing, or spiking of the soil. Benefits from aeration include the following:

- Improved wetting of dry soils
- Increased root strength
- Increased shoot growth
- Improved response to fertilizers

Aeration should be performed during periods of vigorous turfgrass growth. Because it temporarily increases plant susceptibility to desiccation and disease, aeration should not take place during periods of drought or cold stress. Care should be taken not to overly disturb the soil surface or to destroy existing turfgrasses.

## **PEST MANAGEMENT**

### ***Insects***

Insects are the most abundant animals on Earth. Many insects are beneficial; they help decompose organic matter, prey on harmful insects and organisms, and play a vital role in plant reproduction. However, other insects are pests which seriously injure the turf.

Some of the most common insect pests encountered in managing the FDOT's turf are red imported fire ants, mole crickets, chinch bugs, and nematodes.

### ***Red Imported Fire Ants***

Red Imported Fire Ants (RIFA) commonly infest roadside turf. The large mounds of soil they excavate look unsightly, disturb the roots of the turfgrass, and may smother and damage the grass. In addition, RIFA inflict painful bites when disturbed. If only a few nests are present in an area, insecticide should be used to spot-treat around the openings of the individual nests. If a

general area is infested, a broadcast treatment may be necessary. For more information on RIFA, refer to [http://edis.ifas.ufl.edu/document\\_lh059](http://edis.ifas.ufl.edu/document_lh059)

#### *Mole Crickets*

Mole crickets feed on the roots of turfgrass and their burrowing also uproots plants and allows the soil to dry out. Newly seeded turf can be seriously damaged by only a few mole crickets. Areas infested with mole crickets should be treated as soon as possible after the damage is noticed. Bahiagrass is particularly impacted by mole crickets. For more information on mole crickets, refer to [http://edis.ifas.ufl.edu/document\\_lh039](http://edis.ifas.ufl.edu/document_lh039)

#### *Chinch Bugs*

Chinch bugs commonly infest St. Augustinegrass and feed by sucking the plant juices from the turfgrass. Injured areas typically show as patches with brown, dead centers and yellowish margins. These areas are often first noticed in unshaded areas, especially during dry periods. For more information on chinch bugs, refer to <http://edis.ifas.ufl.edu/LH036>

#### *Nematodes*

Nematodes are microscopic, wormlike organisms that feed on the roots of turfgrass. Florida's sandy soils are natural habitats for most nematode species. Symptoms of nematode damage can be deceptive because they are similar to those of drought stress and low soil fertility. Although certain insecticides help control nematodes, the best and most economical methods are through correct turfgrass selection, proper mowing practices, and a sound fertilization program. For more information on nematodes, refer to [http://edis.ifas.ufl.edu/document\\_in126](http://edis.ifas.ufl.edu/document_in126)

## **WEED MANAGEMENT**

### **PESTICIDE SAFETY, STORAGE AND DISPOSAL**

#### ***Pesticide Licenses***

Florida DOT requires a pesticide license for those who handle or apply pesticides. To obtain a license, the individual should contact their local UF-IFAS County Extension Office to schedule the exam. Study materials can be obtained by contacting the IFAS Extension Bookstore (800-226-1764, <http://www.ifasbooks.ufl.edu/merchant2/>).

There are several license categories, but the CORE certification (aka general standards) is required for every pesticide license. The specific categories you will be required to obtain will be dictated by your supervisor, but the most common license categories for FDOT employees are aquatic and right-of-way pest control.

After successfully passing the required exams, the license will be valid for exactly 4 years. During this time, the license holder will be required to attend certified pesticide training courses to obtain recertification credits (commonly called continuing education units, or CEUs). The number of CEUs required for license recertification varies depending on the license type and can be found at [http://edis.ifas.ufl.edu/document\\_pi077](http://edis.ifas.ufl.edu/document_pi077), or by contacting your local UF-IFAS County Extension Office. If sufficient credits are not obtained within the 4-year allotted timeframe, the license will expire and the license holder will be required to retake the certification exams.

CEUs are commonly through local meetings administered by the UF-IFAS Extension Service. However, if an insufficient number of meetings are being held in your area to fulfill recertification requirements, CEUs can be obtained online (<http://pested.ifas.ufl.edu/onlinepesticideceus/>) for \$20 per CEU.

### ***Worker Protection Standard (WPS)***

WPS provide safety standards for users, employers, workers and handlers of agricultural pesticides. Although pesticide users designated to control vegetation along rights-of-way are not covered by WPS, it is an excellent source for safety practices and is directed toward the working conditions of employees who handle agricultural pesticides. For more information about WPS, see publication [http://edis.ifas.ufl.edu/topic\\_wps](http://edis.ifas.ufl.edu/topic_wps)

### ***Personal Protective Equipment (PPE)***

Personal Protective Equipment (comprised of respirators, goggles, gloves, etc) must be used for all pesticide applications. The PPE that is required is specific to each pesticide and is documented on the first page of every pesticide label. If spraying two pesticides together, you are required to comply with the most restrictive requirements.

Compliance with PPE standards is not optional. It is the responsibility of the supervisor to ensure that clean, proper fitting PPE is available to each pesticide applicator. The required PPE should be put on prior to pesticide handling and worn until the cleanup is complete. For more information about PPE, see publication [http://edis.ifas.ufl.edu/document\\_pi156](http://edis.ifas.ufl.edu/document_pi156).

### ***Pesticide Storage***

Proper storage is essential for safe pesticide use and handling. There are several facility features that are important to ensure worker safety and pesticide container safety:

1. When planning for the correct amount of space, plan to have *slightly more than you must have*. Ten percent more space is suggested for the largest amount of pesticide ever expected. Crowding tends to cause spilling accidents and it is difficult to increase a facility's size while maintaining all the safety features. It is better to store none at all so promptly use whatever you buy.

2. The pesticide storage location should be planned according to easy accessibility, easy visibility, terrain limitations and local zoning ordinances.
3. The pesticide storage facility should also provide spill containment, weather shelter, vapor venting, heat relief and an ergonomic doorway.
4. Three needed workspace features within the storage facility are ample air exchange, suitable shelving and adequate lighting.
5. Storage facilities should provide effective safeguards by installing easy-to-read signs, and providing fire control, spill cleanup equipment, exterior lighting, an equipment locker, an external water supply, and a multi-layered security system.

There are only three (3) kinds of things that belong in a pesticide storage facility: containers that have pesticide in them, materials and supplies used for cleaning the storage facility and materials used for keeping storage facility records. Everything else belongs somewhere else. The label is the law and most pesticide products say something about its storage. Storage facilities are not mix/load sites so make sure every partially-used container is securely closed before entering. For more information about Pesticide Storage, see publication [http://edis.ifas.ufl.edu/topic\\_series\\_secure\\_pesticide\\_storage](http://edis.ifas.ufl.edu/topic_series_secure_pesticide_storage)

### ***Pesticide Disposal***

Empty storage bags that have not been in direct contact with the pesticide can be disposed of in a sanitary landfill. If pesticide has spilled into the bag, they must be triple rinsed before disposal. Empty jugs or non-refillable containers must be triple- or pressure-rinsed, adding the rinse water to the spray tank. After triple rinsing, the container must be punctured and recycled or taken to a sanitary landfill. For refillable containers, properly seal the container and contact the manufacturer to pickup.

Disposal of excess spray mixture is best accomplished by applying it to a labeled site. However, it is best not to store this mixture for greater than 24 hours. Storage of excess spray mixture can often lead to accidental spills, or loss of pesticide efficacy. It is important to mix and measure carefully to avoid generating excess spray mixture.

### ***Pesticide Transport***

1. Do not store any pesticide, either concentrate or dilute solution, in the passenger section of the vehicle.
2. Do not leave the vehicle unattended if pesticide is stored in an unlocked or accessible location.
3. Secure the pesticide such that it is not likely to shift or spill during transport.
4. Material Safety Data Sheets (MSDS) and herbicide labels must be available for every pesticide in your possession. Also, MSDS sheets and labels must be specific to the product, not the active ingredient. For example, Rodeo and Accord Concentrate share the same active ingredient and formulation. However, if you are transporting Rodeo,

you must possess the MSDS sheet and label for Rodeo - the MSDS and label for Accord Concentrate will not substitute.

For more information about Pesticide Transport, see publication

[http://edis.ifas.ufl.edu/topic\\_transporting\\_pesticides](http://edis.ifas.ufl.edu/topic_transporting_pesticides)

### ***Mixing and Loading***

Before loading herbicides make sure application equipment is calibrated properly. If possible, mix and load on a permanent or portable containment pad to avoid saturating the soil with pesticide. Mix and load operations are conducted at locations well away from ground water wells and surface water bodies. It is important to remember that the pesticide storage facilities are NOT mix/load sites.

### ***Pesticide Spills***

Pesticide spills are uncommon, but proper action is required in the event that they occur. Remaining calm and following a proper course of action will often result in a successful cleanup.

1. The first action should be to put on appropriate PPE prior to pesticide exposure.
2. Control the source of the spill. If a container is leaking, place the container in a plastic bag or bucket to prevent further pesticide loss. If the container is too large to handle, call the Department of Environmental Protection, and your immediate supervisor, to report the spill.
3. Keep individuals not wearing PPE out of the spill site.
4. Contain the spill. Place absorbent "snakes" around the perimeter of the spill, or place absorbent material directly on the spill. This can be accomplished with kitty litter, absorbent pads, sawdust, or soil taken directly from the spill site.
5. Soil contaminated at a spill site can be scooped away and disposed of on a labeled site. Materials such as containment snakes or absorbent pillows must be disposed of as hazardous waste.

For more information on Pesticide Spills, see publication

[http://edis.ifas.ufl.edu/document\\_pi196](http://edis.ifas.ufl.edu/document_pi196)

## **FIRST AID PROCEDURES**

### ***Pesticide Exposure***

The first and most important step in first aid happens before anyone is exposed to a pesticide. That is, you must read and understand the pesticide label to know what the risks are and to be able to act accordingly.

1. If you get any pesticide in your mouth or swallow it, immediately rinse your mouth with plenty of water. Follow the First Aid section of the label to see if the chemical should be diluted or to induce vomiting and have someone take you to a physician immediately.
2. If you inhale any pesticide, get to fresh air.



3. If you get pesticides on yourself, immediately remove all contaminated clothing and wash the area with soap and water.
4. If you splash pesticides in your eyes, immediately wash out your eyes with plenty of clean water for 15 minutes. Seek medical attention immediately.
5. Always read the label and follow all instructions when using any chemical.
6. Seek medical attention if there is ANY doubt.

Adapted from information contained at <http://msucare.com/pubs/publications/p1862.htm>

### ***Managing Heat Stress***

Herbicide applications can often be hot and intense work. These factors are further complicated by wearing the required PPE for proper herbicide application. Therefore, it is important to be familiar with heat related illness in order to protect yourself and fellow workers.

*Heat Cramps.* Heat cramps are the mildest form of heat illness and are generally felt in the arms, stomach, or legs. These symptoms often appear after work or when relaxing. Heat cramps occur when an individual endures heavy sweating by drinking water. In return, electrolyte concentrations (particularly salt and potassium) become skewed and muscle cramping results. Cramps do not result in permanent damage and are easily reversed by consuming sports drinks.

*Heat Exhaustion.* Heat exhaustion is more severe than cramps. This occurs when the body begins to overheat due to insufficient fluid intake. Essentially, the body has sweat out more liquid that has been replaced by proper drinking. The symptoms of heat exhaustion include: headache, heavy sweating, nausea, dizziness, fatigue, loss of coordination, loss of appetite, tingling hands or feet, weak and rapid pulse (120-200). If these symptoms occur, move the individual to a cool location and have them lie down. Loosen their clothing, cover with damp cloths, and have them drink cool liquids. Depending on the severity of the symptoms, it may be necessary to contact a healthcare professional. Regardless, the individual should be given a day of light duty to fully recover.

*Heat Stroke.* Heat stroke is a dangerous condition and may prove fatal. The symptoms are often mistaken for heart attack and the individual may collapse while working. The early symptoms of heat stroke are high body temp (103° F), lack of sweating, red dry skin, rapid pulse, difficulty breathing, constricted pupils, as well as the symptoms of heat exhaustion. Advanced symptoms are loss of consciousness, seizures, body temp over 108° F. It is essential to cool this person immediately by pouring cold water, or applying ice packs. Emergency medical care should be called without delay.

Adapted from information contained at <http://ehs.okstate.edu/training/Heat.htm>.

## **CALIBRATION**

There are two primary reasons to calibrate a sprayer: 1) to ensure that the correct amount of solution is applied, and 2) to determine the amount of herbicide and water needed to correctly apply the herbicide to the desired area. Herbicides are usually recommended at certain rates per acre. In order to apply a herbicide correctly, the application rate, in gallons per acre (gal/A) or pounds per acre (lb/A), must be determined. Since most herbicides are applied as sprays, the following discussion of calibration is directed specifically toward spraying.

### ***Factors to Consider in Calibration***

The amount of liquid that a sprayer applies to a given area can be varied by changing one or more of the following: (1) pressure that forces liquid through the nozzle tip, (2) nozzle orifice (tip opening) size, (3) sprayer ground speed, and/or (4) spacing of nozzles on the boom or width of spray pattern.

1. **Pressure:** Adjusting the nozzle pressure is a good way to make small changes in sprayer output. Increasing the pressure will increase the nozzle output, but the increase is only proportional to the square root of the pressure increase (e.g., the pressure would have to be increased four times to double the output of the nozzle). Since herbicide spraying should be done in a pressure range of 20 to 50 psi, it is obvious that only minor changes in nozzle flow can be achieved by varying the pressure. Low pressures are recommended for herbicide spraying in order to reduce the drift potential of the spray.
2. **Nozzle Orifice:** Large changes in spray output are made by changing the nozzles. Nozzles are rated as to capacity in gallons per minute (gal/min) at a certain pressure (40 psi). Manufacturers' data sheets give the discharge of various nozzles at different pressures. This information should be used when selecting the nozzle for a sprayer to apply the desired rate, at a selected speed and operating pressure. After selecting the nozzle, it is often necessary to make small adjustments in the pressure during calibration to get the exact gal/A desired. All nozzles should spray within 5% of the expected GPM and within 10% of the other nozzles on the boom. If a nozzle(s) does not fall within these ranges, replace the nozzle and then recheck. It is often necessary to replace all nozzles at one time.
3. **Sprayer Ground Speed:** The speed of the vehicle while spraying is generally governed by the terrain, safety, or by some other operation done at the same time as the spraying. Proper nozzles should be used to get the desired application rate at the speed best suited to the operation or field conditions.
4. **Spacing of Nozzles:** The amount of spray depends on the number of nozzles per row, or on the boom. The application rate in a band-treated area decreases with a given nozzle as the band width increases.

### ***Typical Calibration Problems***

There are two primary types of calibration problems encountered by an applicator of herbicides. One type of problem is where a given application rate is to be applied and the

sprayer nozzles must be selected to achieve the desired rate. The other type is where the sprayer is already nozzled and its application rate must be determined. This section discusses both situations.

### *Selecting Nozzles for a Desired Application Rate*

The simplest method to demonstrate how problems of this type are solved is with a typical example.

Example: An applicator has a boom sprayer 30-feet long that has 18 nozzles spaced on 20-inch centers. The applicator wishes to broadcast a herbicide in a pasture at an application rate of 15 gal/A. Field conditions dictate a vehicle speed of 6 mph. What size nozzles should be selected, if the sprayer pressure used is 30 psi? STEP 1: Write the basic equation which is applicable for any type of calibration problem.

$$\text{Gal/acre} = \frac{\text{GPM}}{\text{acres/min}}$$

Equation 1

In this problem the gal/A or GPA was given as 15, so the gal/min or GPM can be determined, if the acres per minute being treated are known. The volume of product added should be included with the carrier to equal the total volume of spray mixture. STEP 2: Determine acres per minute.

$$\text{Acres/min} = \frac{\text{Swath(ft)} \times \text{Speed(mph)}}{495}$$

Equation 2

Example : The swath is 30 feet and the speed is 6 mph or 528 ft/min.

$$\text{Acres/min} = \frac{30 \times 6}{495} = 0.364 \text{ or } 0.36$$

Equation 3

STEP 3: Determine the GPM required to have an application rate of 15 GPA when treating 0.36 acres per minute.

$$\begin{aligned} \text{GPM} &= \text{GPA} \times \text{Acres/min} \\ &= 15 \times 0.36 \\ &= 5.4 \end{aligned}$$

Equation 4

STEP 4: Determine the nozzle capacity needed. The capacity rating per nozzle at 30 psi is:

$$\begin{aligned} \text{GPM/nozzle} &= \frac{\text{Total GPM}}{\text{Number of nozzles}} \\ &= \frac{5.4}{18} \\ &= 0.3 \text{ at 30 psi} \end{aligned}$$

Equation 5a

Another method used to determine the nozzle capacity needed:

$$\begin{aligned} \text{GPM} &= \frac{\text{GPA} \times \text{nozzle spacing (in)} \times \text{mph}}{5940} \\ \text{GPM} &= \frac{15 \times 20 \times 6}{5940} = 0.3 \end{aligned}$$

Equation 5b

A nozzle would be selected from the nozzle manufacturer's catalog that delivers close to 0.3 GPM when operating at 30 psi. After selecting the nozzle and nozzling the boom, the applicator should conduct a calibration test like that outlined in the following section, because many factors tend to make the flow different from what was determined mathematically. Spraying materials more viscous than water (the catalogs are based on spraying water), and having less pressure at the nozzle than shown at the gauge due to friction loss tend to make the nozzle flow less than figured. Installing used and worn nozzles tend to make the flow greater than expected because the catalog performance data is based on new orifices.

*Calibrating the Already-Nozzled Sprayer*  
*The Tank Refill Method*

1. Set two stakes, 330 feet apart, in a stretch of right-of-way that is typical of the area to be sprayed. The sprayer is to be operated through one round trip between these stakes, or a distance of 660 feet.
2. Partially fill the sprayer tank with water.
3. Operate the sprayer unit to see that all of the parts are operating properly, and adjust the pressure regulator to achieve the desired pressure with the engine turning at the RPM to be used while spraying. Shut off the sprayer.
4. Fill the sprayer tank completely, or to some measurable point with water. A measuring stick or gauge on the tank may be used if the water is likely to splash out of the tank as the unit moves.
5. Beginning 20 to 30 feet from the first stake, drive the vehicle toward this stake at the desired speed with the sprayer cutoff valve closed.
6. Upon passing the first stake, open the cutoff valve or turn the sprayer "on" for spraying.
7. Upon passing the second stake, turn off the sprayer, and turn the unit around. Spray the course again on the return trip. Be sure to maintain uniform speed and pressure throughout the course.

8. Measure, to the nearest quart, the amount of water required to refill the tank, or to restore the original level. When refilling, be sure that the sprayer is in the same location as for the first filling, or is resting level in both instances to avoid possible error.
9. Determine application rate by use of the following equation:

$$\text{GPA} = \frac{\text{Gallons to refill tank} \times 66}{\text{Spray Width (feet)}}$$

Equation 6

Example : Assume that it took 6.75 gal to refill the tank and that the swath width was 30 feet:

$$\text{GPA} = \frac{6.75 \times 66}{30} = 14.85 \text{ or } 15$$

Equation 7

10. Add the recommended amount of chemical to the sprayer tank. The amount is dictated by the application rate (GPA), and the volume of spray in the tank. For example, if you want to apply 2 lb of chemical per acre and you are applying 15 gal of water per acre, add 2 lb of chemicals to every 15 gal of water to make up the spray mixture for the sprayer. The volume of product added should be included with the carrier to equal the total volume of spray mixture.

*Alternate Method*

Mathematical calculations have resulted in a formula that can be used as a quick and easy method of checking or rechecking the calibration of ground equipment. The formula is:

$$\text{ml per 30 sec} = \frac{21.7 \times \text{nozzle spacing (in)} \times \text{GPA desired}}{\text{Speed (sec/100 ft)}}$$

Equation 8

This formula will provide the volume in milliliters to catch when you know the gal/A that you want to apply, and you have already measured the nozzle spacing and determined the travel speed in the area typical of that to be sprayed. An example is:

$$\frac{21.7 \times 20 \text{ in nozzle spray} \times 20 \text{ GPA}}{17 \text{ sec} / 100 \text{ ft}} = 510 \text{ ml per 30 sec nozzle}$$

Equation 9

Therefore, you should collect 510 ml in 30 seconds at each nozzle to achieve an application of 20 gal/A. If you do not have metric equipment, the milliliters can be divided by 29.6 to give the answer in ounces (i.e., 510 divided by 29.7 equals 17.2 oz per 30 seconds). Be sure to check each nozzle to assure uniformity. If you do not collect the amount of spray needed for the GPA desired, you can adjust pressure, change nozzle size, change speed, or adjust nozzle spacing. To

determine the amount of pesticide to add to the spray tank, especially when the recommendation is only given in lb of active ingredient per acre, another short formula may be utilized. For liquid:

$$\text{ml of pesticide to add to one gal of spray mix} = \frac{\frac{\text{what you want}}{\text{what you have}} \times 3785}{\text{GPA}}$$

Equation 10

Where: what you want is lb of active ingredient to apply per acre and what you have is the formulated pesticide. The volume of product added should be included with the carrier to equal the total volume of spray mixture. Example: Apply Prowl at 1.0 lb ai and Prowl is a 3.3 lb/gal material:

$$\frac{\frac{\text{want 1.0}}{\text{have 3.3}} \times 3785}{\text{GPA}} = \frac{1147}{20} = 57.4 \text{ ml/gal of spray mix}$$

Equation 11

To convert milliliters to ounces, divide by 29.7. For powders, dry flowables or other non-liquids the formula is changed slightly; i.e., 454 must be substituted for 3,785 to give grams of pesticide to add per gallon of spray mix. The adjusted formula is:

$$\text{Grams of pesticide to add to one gal of spray mix} = \frac{\frac{\text{what you want}}{\text{what you have}} \times 454}{\text{GPA}}$$

Equation 12

Example : Apply 1.0 lb active ingredient of Zorial 80DF per acre at 20 GPA.

$$\frac{\frac{\text{want 1.0}}{\text{have 0.80}} \times 454}{20 \text{ GPA}} = \frac{567.5}{20} = 28.4 \text{ of Zorial to be added per gal of spray mix}$$

Equation 13

Grams may be converted to ounces by dividing grams by 28.4.

### *Spot Treatment*

Herbicide labels will sometimes allow for spot treatments. In this case, the recommended amount of herbicide is given in % v/v solution. This often results in confusion and in an excess amount of herbicide being applied. To determine the correct amount of herbicide to add to the spray tank, see the following example: A grower wants to apply glyphosate at 1.5% v/v to a 20 gallon tank.

20 gal (remember a % means  
x1.5% moving the decimal place to  
0.30 gal multiply)

$$0.30 \text{ gal} \times \frac{128 \text{ oz}}{\text{gal}} = 38.4 \text{ oz of glyphosate should be added to a 20 gallon spray tank}$$

Equation 14

### *1/128th Acre Method*

Another simple calibration method is the 1/128th Acre Method. The 1/128th acre, baby bottle, and 100-foot methods of calibration are based on spraying 1/128th acre. There are 128 ounces per gallon; therefore, ounces sprayed per 1/128th acre equal gallons sprayed per acre. This procedure results in a treated acre calibration.

1. Determine nozzle spacing or swath width. (Note: if you are making band applications and use nozzle spacings, you will figure the gallons of spray per planted acre.)
2. Refer to Table 6 for length of calibration course and mark calibration course in the field or 340 ft<sup>2</sup> per nozzle swath width (feet) course length.
3. Record time required to drive length of calibration course at gear, engine rpm, and implement settings to be used while spraying.
4. Park sprayer, maintain engine rpm used to drive course, and turn on sprayer.
5. Collect all spray from one nozzle for time equal to that required to drive the calibration course.
6. Measure the ounces caught. Ounces caught equal gallons per acre of spray applied.
7. Repeat Steps 5 and 6 for several other nozzles.

\*NOTE: If multiple nozzles are used per row, use the width of area treated by all nozzles as the swath width for step 1 and catch the flow from all nozzles directed to the row in Step 5.

### ***Checklist Before Field Operation of Sprayers***

A little time and effort spent checking and preparing the sprayer will ensure a more effective and trouble-free spray operation.

1. Clean the supply tank and fill it with clean water. Sand or other small particles will cause excessive wear of the pump and nozzles and results in clogged screens.
2. Clean suction and line strainer.
3. Remove all nozzle tips, nozzle strainers, and boom endcaps.
4. Start the sprayer, and flush the hoses and boom with plenty of clean water.
5. Inspect nozzle tips and strainers for defects and cleanliness, and make sure all tips are the same type and size. Mixed nozzle tips along the boom will give uneven spray distribution.
6. Replace the nozzles and strainers, and check for proper operation and alignment.
7. Check all connections for leaks.
8. Adjust the pressure regulator to desired operating pressure. Operate sprayer with water, and check nozzle discharge for uniformity. This can be done by placing containers under each nozzle, operating sprayer for a few minutes, and then checking to see if the

same amount of water is in each container. This will detect worn, defective, or incorrect nozzles.

9. Calibrate sprayer. Check calibration figures.
10. Add chemical to tank to correct ratio for desired rate of application.

### ***Guide to Field Operation of Sprayers***

The following information should be used as a guide for operating a sprayer in the field.

1. Check wind. Excessive wind will affect the uniformity of spray application and could result in spray drift. Do not spray until winds are calm.
2. Operate the vehicle at a uniform speed. This must be the same speed and gear that were used in calibrating the sprayer.
3. Strive to keep the spray boom parallel to the ground.
4. Maintain proper height of boom. The height of the nozzle above the spray surface determines the width of the spray pattern at the surface. On a boom sprayer, with nozzles spaced for complete broadcast coverage, the nozzle must be at the correct height to obtain uniform coverage across the boom width. Manufacturers' data sheets list the correct height for each type of nozzle.
5. Make regular observations of the operation pressure while spraying. Maintain pressure as determined by calibration.
6. Observe nozzle patterns continuously to detect clogged nozzles, or nozzle position changes that might arise. Clogged nozzles or nozzle strainers are common problems affecting spray distribution. By using only clean water, selecting and using proper nozzle strainers, and cleaning nozzles and strainers daily, this problem will be reduced to a minimum. A toothbrush is excellent for cleaning nozzles.
7. Stop the pump immediately when the liquid is gone. Pumps can be seriously damaged when operated without liquid.
8. Always completely flush the entire system with clean water after completing the spraying job. With some spray materials, the system should be cleaned every night. Dispose of rinse water as directed on the pesticide label.

### ***Maintenance, Care and Cleaning Of Sprayers***

The owner's instruction manual, furnished by the sprayer manufacturer, is a good reference and guide to operation, care, and maintenance of a sprayer. All owners should have a manual for their sprayer, study it thoroughly, and keep it for future reference. Sprayer pump and nozzle wear, caused by the abrasive particles in the spray material, or water and sprayer deterioration from chemical corrosive action are the most costly maintenance problems affecting sprayers. The wear can be held to a minimum by always using clean water for the spray mixture, using care in selecting less abrasive spray materials, making sure the spray, chemicals and water have been well mixed before starting the pump, keeping the proper strainers in place at all times, and never operating the pump without liquid in the tank.

Corrosion can be reduced by thoroughly cleaning the sprayer after each period of use. An ordinary field sprayer should never be used for applying liquid fertilizers, because these



fertilizers are very corrosive to metals other than stainless steel. Before storage at the end of the season, and after thoroughly cleaning the sprayer, run a few gallons of fuel oil through the sprayer to help prevent rust. Store nozzle tips and all strainers in a can of light machine oil. Gear and piston pumps should be filled with oil. Roller and diaphragm pumps should be flushed with rust inhibitor, and then all openings should be capped.

Herbicide sprayers should be thoroughly washed and cleaned after each use. The sprayer should first be flushed with water, and then cleaned with one of the following materials in 50 gal of water by flushing the mixture through the sprayer.

- 1/2 gal of household ammonia (let stand in sprayer overnight)
- Commercial sprayer cleanup solution

**Table 5. Nozzle Types, Spray Patterns and Suggested Uses.**

Type	Spray Pattern	Pressure (psi)	Suggested Use/Comment
Flat Fan	Fan-like pattern of medium droplets. Not uniform across width.	20-40 (15-40 psi for LP nozzle)	Pre- and postemergence, broadcast booms. Available in low pressure tips that reduce clogging and drift potential. Requires 30% overlap for uniform distribution.
Even Fan	Fan-like pattern. Uniform volume across entire width.	20-40	Pre- and postemergence. Good for banding.
Flooding Fan	Wide, flat pattern of coarse droplets.	10-30	Broadcast booms, chemical-fertilizer mixture, layby. Requires 100% overlap for uniform distribution.
Off-Center Flat Fan (up to OCO8)	Flat-fan pattern. Directed to one side of tip. Swath width 20-144 inches.	20-40	Post-directed, low-profile spraying. Larger drops and increased volume deposited on the top of pattern. Reasonably uniform deposits are not expected.
Large Off-Center Flat Fan	Swath directed to one side from 12 to 33 feet width.	30-40	Herbicide application to ditches and roadsides. Reasonably uniform deposits are not expected.
Boomless Nozzle Cluster	Wide swath (up to 60 feet). Pattern easily distorted by wind. High spray trajectory.	20-40	Pastures and broadcast spraying where obstructions to booms exist. High drift potential. Not suitable for orchard spraying. Reasonably uniform deposits are not expected.

NOTE: If using computerized spraying systems, refer to manufactures' operation manual for proper calibration, cleanup, and other essential activities.

**Table 6. Distance for each nozzle to spray.**

<b>Effective Swath Width (in)</b>	<b>Course Distance (ft)</b>
6	681
8	510
10	408
12	340
14	292
16	255
18	227
20	204
22	186
24	170
30	136
36	113
38	107
40	102
42	97
48	85

## **ADJUVANTS**

Adjuvants are substances used with a herbicide or other pesticide to enhance performance. Adjuvants may be added to the product at the time of formulation, or by the applicator to the spray mix just prior to treatment. Adjuvants include surfactants, compatibility agents, anti-foaming agents and spray colorants (dyes), and drift control agents.

Care should be taken when selecting an adjuvant. Herbicide performance can differ depending on what type of adjuvant is used. The herbicide label will state if specific surfactants are required and the amount (%) of active ingredient it must contain. Turf injury or reduced herbicide activity may occur if these guidelines are not followed.

The intent of this section is to list the different types of adjuvants used in pesticide application. In addition, this section provides some background on how these materials aid in pesticide

application and performance. It is not intended as a guide for selecting which adjuvant to use with a particular pesticide product.

### ***Surfactants***

Surfactants (surface-active ingredients) are substances that improve the emulsifying, dispersing, spreading, wetting, or other surface modifying properties of liquids. A surfactant increases the spray coverage on the foliage. This helps more of the herbicide to be taken up in the plant. Surfactants include emulsifying agents, wetting agents (spreaders), crop oil concentrates, silicone surfactants and stickers.

### ***Emulsifying Agents***

An emulsion is a mixture of two incompletely mixed liquids, one of which is dispersed in the other. The surrounding liquid is called the *continuous phase*, while the dispersed liquid is known as the *discontinuous phase*. Emulsifying agents promote the suspension of one liquid in another.

There are two types of emulsions used in the application of herbicides. The type more commonly used is the "oil-in-water" emulsion, in which water is the continuous phase. When using this type of emulsion, the consistency of the spray mixture is usually similar to water. The second type of emulsion is the "water-in-oil" emulsion, in which the oil is the continuous phase. These emulsions, also referred to as "invert" emulsions, are normally rather viscous.

It seems that the character of the emulsifying agent is a large factor in determining the kind of emulsion that is formed. The "oil-in-water" emulsions are widely used in the formulation of herbicides to aid in getting an oil-soluble herbicide dispersed in a water mixture so that the active ingredient may be applied as a water spray. Invert emulsions are used to aid in drift control, to improve resistance of the herbicide treatment to the effects of weather (rain), to improve accuracy of delivery of the herbicide, and to enhance herbicide activity.

### ***Wetting Agents (Spreaders)***

Wetting agents or spreaders are added to spray mixtures to decrease the surface tension of the mixture, causing a larger portion of each spray droplet to come into contact with the surface of the vegetation. This is done to increase the coverage and thus the effectiveness of the herbicide, although in some cases it may alter herbicide selectivity.

There are four types of spreaders available: anionic, cationic, nonionic, and amphoteric. Anionic and cationic surfactants have electrical charges in water while nonionic surfactants do not have an overall electrical charge. Amphoteric may have positive or negative charges depending on the pH of the solution. Be sure that the type, if any, recommended in the herbicide label is selected. Most herbicides will recommend the use of a non-ionic type surfactant.

### *Crop Oil Concentrates*

A crop oil concentrate refers to products that contain 80 to 85% petroleum or vegetable oil plus 15 to 20% surfactant and emulsifiers. An emulsifiable oil generally refers to products that contain about 98% oil and 1 to 2% emulsifiers. This group is often called nonphytotoxic oils and phytobland oils.

### *Silicone Surfactants*

Silicone surfactants are silicone-based and provide a tremendous reduction in water surface tension at very low concentrations. Typical concentrations range from 0.10 to 0.25% on a volume/volume basis.

### *Stickers*

Stickers are adjuvants that cause the herbicide to adhere to the plant foliage. They prevent runoff of the spray mixture from the target vegetation. By increasing the amount of spray remaining in contact with the vegetation and increasing the contact time of the herbicide, the desired result is an increase in the effectiveness of a herbicide application.

### *Surfactant Selection*

The numerous types of surfactants available often lead to confusion. The following suggestions will aid in selecting a suitable surfactant:

1. Purchase a surfactant specifically manufactured and marketed for its specified use. This is the case particularly for non-ionic surfactants, where only those sold specifically for pesticide use should be used.
2. Purchase a surfactant on the basis of percentage active ingredient. For example, it is less profitable to purchase a product with 10% active ingredient at \$4/gal than it is to purchase a product with 85% active ingredient at \$12/gal.
3. Isopropyl alcohol or water should not be considered as active ingredients. If the label on the container does not specifically state the percentage active ingredient in the container, ask the dealer for this information.
4. Products manufactured for household use should not be used with adjuvants.
5. Be careful with claims that a surfactant may cost more, but can allow herbicides to be used at lower concentrations than with conventional surfactants. Evidence does not exist that there is any one particular surfactant being marketed that is so effective that herbicide rates may be reduced and still obtain normal control.
6. Ignore claims such as: *the surfactant contains some agent that will help keep the spray equipment clean, or the surfactant increases water penetration into the soil, or the use of the surfactant will increase root penetration and nutrient uptake by the turf.*
7. There are no "miracle" surfactants. There are none that perform substantially better that justify a significant price increase.
8. Some products are recommended to be used with certain surfactants. Consult the label for the approved list.

### ***Compatibility Agents***

These adjuvants are used to aid in the suspension of herbicides when they are combined with other pesticides or fertilizers. They are used primarily when the carrier solution is a liquid fertilizer.

### ***Acidifiers and Buffers***

Acidifiers are acids that can be added to herbicide spray mixtures if there is a need to neutralize alkaline solutions and lower the pH. Acidifiers do not have a buffering action. Buffers are capable of changing the pH of a water solution to a certain level, which will be maintained even if the pH of the solution changes.

### ***Anti-Foaming Agents and Spray Colorants***

An anti-foaming agent can eliminate the excess foam that can result when certain herbicide mixtures undergo mixing or agitation in the spray tank. Spray colorants are dyes that can be added to the spray tank so an applicator can see the areas that have been treated.

### ***Drift Control Agents***

Drift of herbicide sprays can be a problem. One way to reduce herbicide drift is to increase the droplet size of the spray. Adjuvants (drift control agents) that are used to control drift do so in part by reducing the number of fine spray droplets. Thickeners may also be used as drift control agents.

## **SUMMARY**

Good turf is the result of a well-planned and continuing management program. The following is suggested as a brief guideline to the development and maintenance of a pleasing and useful turfgrass cover.

- Select an adapted grass, taking into consideration both the geographic location and specific site including, especially, shade.
- Apply fertilizer according to the plants needs and recommendations based on soil testing.
- Prepare a good seedbed and establish the turf according to recommended procedure.
- Mow at appropriate height and intervals using sharp blades and well-adjusted mowers.
- Follow a regular fertilizer schedule to maintain active, continuous growth during the growing season.
- Control turf diseases, insects, and weeds using appropriate pesticides and application practices.
- Use grass mixtures or overseeding where appropriate to extend the season of turf use.
- Renovate thin areas which may develop and correct or adjust the management program to maintain healthy turf.

## **SECTION 3: OPERATOR SAFETY**

This section of *A Guide for Roadside Vegetation Management* provides basic procedures for the safe operation of mowing equipment. It also points out some of the hazardous situations that may be encountered on the job and suggests possible ways to deal with them.

The information provided is meant to **supplement** the specific information contained in manufacturers' operating manuals and the FDOT's Accident Prevention Procedures handbook. Additional precautions may also be necessary, depending on conditions at the work site or in the service area.

### **GENERAL SAFETY PROCEDURES**

It is very important for the operator to be familiar with the mowing equipment before using it by reading and understanding the manufacturer's operating manual. Know the equipment's capabilities, its operating characteristics, and the purpose of all controls, gauges and dials.

A list of general safety procedures is provided below.

#### **BEFORE MOWING OPERATIONS**

- Before using mowing equipment, make sure that it is in good operating order. Never operate equipment that is in less than safe condition.
- Keep all protective and warning devices in place. All guards, shields, and safety equipment must be properly installed and in working order (Figures 30 – 33).
- Before mowing begins, the crew leader should inspect the area to identify physical hazards. These may include washouts, ruts, culverts, markers and other obstructions.
- Employees must be fully clothed and wearing the proper personal protective equipment which shall include a safety vest, hard hat and hearing protection. Respirators and gloves are optional equipment and will be required based on work conditions and/or supervisor recommendations.

#### **DURING MOWING OPERATIONS**

- When operating equipment, always comply with the guidelines provided in the FDOT's Accident Prevention Procedures handbook.
- Amber flashing lights, mounted on tractors and slope-mowing equipment, must be on and working properly during mowing operations (Figures 29 and 33).
- Never allow riders on the tractor, on the drawbar, or on any towed equipment.
- Operate equipment in the direction of the traffic flow when making the first cut along the roadside. Any additional cuts may be made in either direction.

- When it is necessary to pull mowing equipment onto the pavement, come to a complete stop and disengage the power takeoff (PTO). Check traffic in all directions before attempting to cross any roadway.
- Avoid travel during heavy traffic periods, and use proper blinker and/or hand signals. When on highways, tractor operators must abide by the accepted rules for automobile drivers.
- Check the brakes for equal application when they are locked together for highway use.
- Never operate equipment while taking medication that might impair reflexes or thinking ability. Equipment operators must remain alert at all times while mowing.

**REMEMBER: GOOD SAFETY PRACTICES NOT ONLY PROTECT YOU, THEY ALSO PROTECT THE PEOPLE AROUND YOU!**

### **ACCIDENT PROCEDURES**

The supervisor must be notified immediately of any accident involving damage to equipment or private property, no matter how slight it may seem. Unless absolutely necessary, the equipment should not be moved until the supervisor has completed an investigation.

Any accident involving personal injury must also be reported immediately.

### **TRACTOR SAFETY**

Misuse of the features that make the tractor a useful and versatile piece of equipment can result in serious accidents, producing injuries or death. Many such accidents can be prevented by following simple safety guidelines.

#### ***How to Avoid Overturning***

A large percentage of tractor accidents are due to overturning. Many factors contribute to or cause overturning: lack of appropriate operator training, speed too high for the conditions, sharp turns, improper equipment hook-ups, and operator impairment.

Mowing on slopes presents one of the most dangerous situations in tractor-mowing operations because of the increased possibility of overturning the equipment (Figure 29). For this reason, slopes with a grade steeper than 3:1 must only be mowed with specially designed slope-mowing equipment. By mowing these areas with slope-mowing equipment, the operator will minimize the possibility of the slope eroding due to rutting or scarification of the turf.

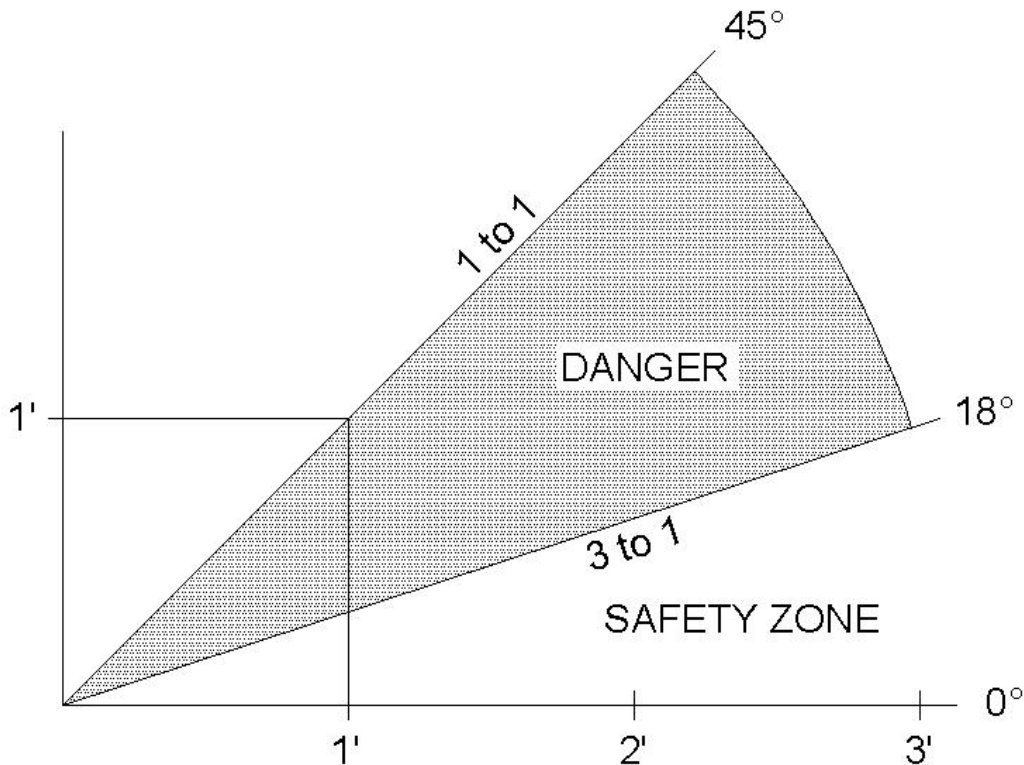

Figure 29. Slope hazards.

To avoid the possibility of overturning, tractor operators should observe the following rules:

- Make wide, gradual turns whenever possible. If it is necessary to turn sharply, do so slowly and carefully. Most tractors will overturn sideways if a sharp turn is made at excessive speed.
- Slow down when operating on rough terrain or in areas where vision is limited.
- Add front-end weights when operating on hilly terrain and proceed with caution. Use lower gears when going downhill.
- Avoid running over washouts, deep ruts, holes, and other obstacles or debris that might bounce or tip the tractor.

Welds or alterations must never be made to the roll-over protection structure. Welds weaken the strength of the structure and could cause it to fail during an accident.

### ***How to Avoid Backward Tip-Over***

Backward tip-over is another major hazard in tractor operation because power applied to the rear wheels tends to lift the front end of the tractor off the ground. This type of accident is most likely to occur when the operator is driving over soft ground, going up an incline, or trying to pull an improperly hitched load.

To avoid backward tip-over, follow the guidelines listed below:



- When traveling over soft ground, the tractor's drive wheels may slip or become lodged, so that the tractor gets stuck. Do not accelerate the engine quickly or place blocks in front of the rear wheels because this greatly increases the chance of tipping over backwards. If the tractor becomes stuck, always try to back out. If backing out is not possible, get help to be pulled out.
- Going up an incline, such as a slope or climbing out of a ditch, shifts the tractor's weight to the rear. If the clutch is engaged too quickly while power is applied, the tractor may tip over backwards. When climbing an incline, proceed cautiously and reduce speed when approaching the top. Add front-end weights to the tractor if necessary.
- Pulling a load attached to the tractor's axle or to a drawbar that is raised too high can cause the tractor to tip over backwards. When pulling a load, hitch only to the drawbar. Keep the drawbar hitch set to the manufacturer's recommended height. Make sure that the hitch length is not too short. With the proper hitch length, the hitch lowers rapidly as the front wheels begin to rise. This action quickly reduces the force causing the backward tip-over.

### ***How to Shut Down the Equipment***

Always park the mowing equipment as far from the roadway as possible and in an area least susceptible to fire and vandalism. When possible, park the equipment on level ground. If it is necessary to park on a slope, position the equipment across the slope, set the parking brake, turn the wheels so they are pointed uphill, and lower the mower to the ground.

Correct shutdown of the equipment is important. Follow the general steps listed below and any specific procedures provided by the manufacturer's manual or departmental policy.

- Place the controls in NEUTRAL.
- Disengage the PTO clutch or transmission drive.
- Set the parking brake.
- Lower the mower to the ground.
- Lower, latch and/or block wings (when applicable).
- Idle the engine three to five minutes for gradual cooling.
- Shut off the engine.
- Wait for all movement to stop.
- Move the hydraulic controls several times in all directions, to eliminate any residual pressure.
- Lock the ignition and remove the key.
- Dismount carefully, using the handholds and step plates.

## **MOWER SAFETY BY TYPE OF MOWER**

### ***Rotary Mowers***

Flying debris is a constant hazard when rotary mowers are used. For this reason, they should be used only in rural or other unpopulated areas.

When operating rotary mowers, take the following precautions:

- Replace missing chain debris guards. The danger from flying debris is greatly increased when chain debris guards are poorly spaced or missing. Do not operate the mower if the guards are missing (Figure 31).
- Make sure that the mower height is set properly. The danger from flying debris is also increased when mowers are set too low.
- Before starting a rotary mower, make sure that no one is on or near the equipment. Never operate the mower with bystanders in the work area.
- Always disengage the PTO before crossing a roadway.
- When parking the mower, always place it in its lowest position.
- Before servicing the blades, make sure that the tractor is in neutral, the PTO disengaged, the parking brake set, the mower secured, and the engine shut off.
- Because blades may be sharp or nicked or have metal burrs on the edges, always wear gloves when servicing them.
- Examine the blades for cracks or failures before installing them.
- After installation, double-check the blades to make sure that they are secure.
- Replace all shaft, belt and pulley guards before operating a mower that has been serviced (Figure 31).

### ***Flail Mowers***

Flying debris is not as great a hazard with flail mowers as it is with rotary mowers because flail mowers discharge the cuttings downwards. All precautions should be taken to avoid running over any objects that could cause debris to be thrown out by the mower.

Safety procedures for flail mowers are generally the same as those for rotary mowers:

- Check all shields and chain guards daily to make sure that they are in place before operating the equipment (Figure 32).
- Make sure that there are no bystanders in the work area before starting the mower.
- Disengage the PTO before crossing roadways.
- Place the mower in its lowest position when parking it.
- Before removing the mower blades for servicing, place the tractor in neutral, disengage the PTO, set the parking brake, secure the mower and shut off the engine.
- Examine the blades carefully for any defects before installing them.
- After installation, double-check the blades to make sure that they are secure.
- Replace all shaft, belt and pulley guards before operating any mower after it has been serviced (Figure 32).

### ***Specialized Rotary Slope Mowers***

Mowing on slopes presents one of the most dangerous situations in tractor-mowing operations because of the increased possibility of overturning the equipment. For this reason, slopes with a grade steeper than 3:1 must only be mowed with specially designed slope-mowing equipment. In addition, by mowing these areas with slope-mowing equipment, the operator will minimize the possibility of the slope eroding due to rutting or scarification of the turf.

Rotary slope mowers are used for a variety of purposes, such as hedging, trimming brush, and mowing slopes. The danger from flying debris is greater with slope mowers than with other rotary mowers because of the manner in which they are used.

Slope-mower operations must comply with the same safety rules as towed-mower operations:

- Check all safety shields daily to ensure that they are in working condition. Replace missing chain debris guards (Figure 33).
- When using a boom-type mower, do not engage the blade prior to lifting the mowing head off the ground.
- Make sure that other personnel are well clear of the mower before putting it into operation.
- When parking the mower, always place it in its lowest position.
- As with other mowing equipment, follow all safety procedures when servicing the mower blades.

### ***Small Machine Mowers***

Small machine mowers are used in landscaped areas and in similar locations that require mowing, but that are inaccessible to conventional tractor units.

When operating small mowers, take the following precautions:

- Inspect the mowing area to locate hazardous objects. Clear away any debris that may be thrown out by the mower.
- Avoid mowing on wet slopes.
- Always keep hands and feet away from rotating blades.
- Shut off the engine before leaving the mower unattended and when refueling.
- To avoid spills when refueling the mower, use only the proper refill devices. If a spill occurs, make sure that all spilled fuel has been cleaned up before restarting the engine.
- Disconnect the ignition wires when servicing the mower or replacing the blades.
- Make sure that all belt and pulley guards are in place before operating the mower after it has been serviced.

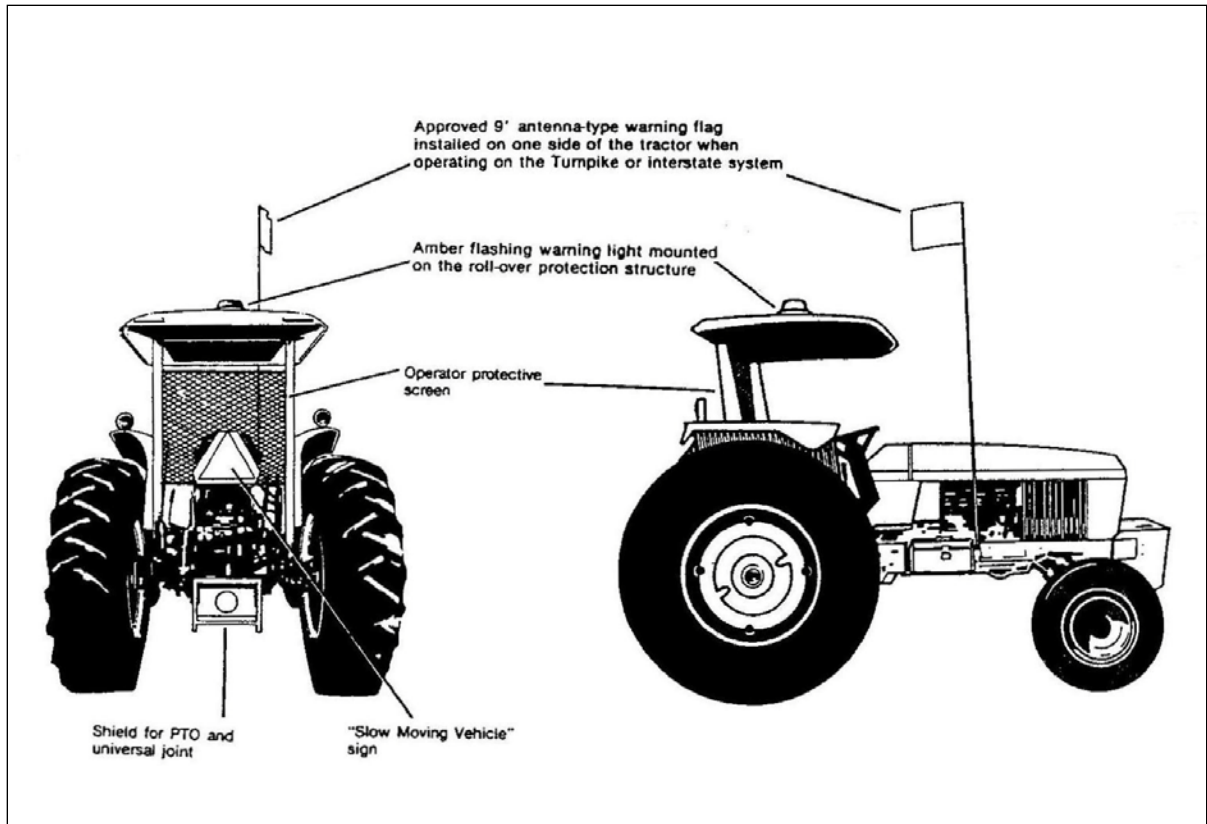
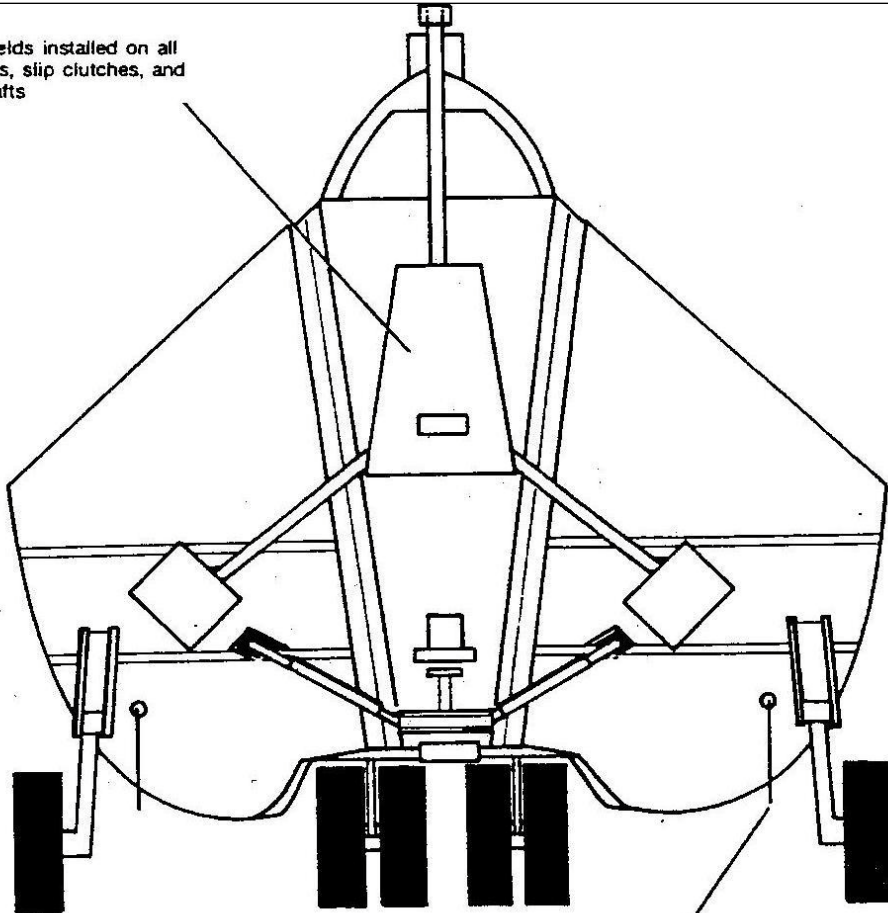
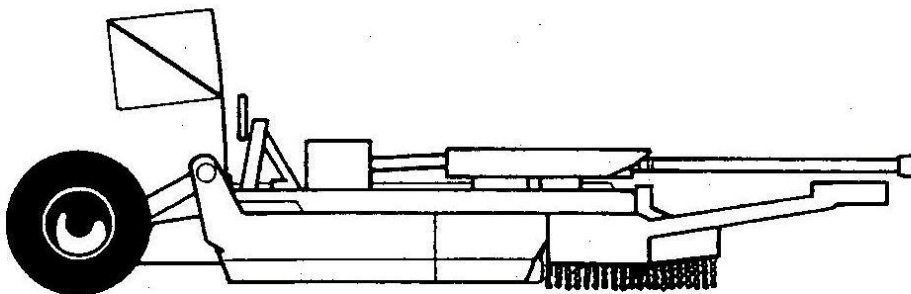

Figure 30. Tractor safety devices.

Protective shields installed on all universal joints, slip clutches, and tube drive shafts



Approved warning flags mounted on each wing of the mower



Rotary mowers must be shielded around their entire perimeter. Chain guards must be installed at the front and rear. Sides must be covered by floating or adjustable skids.

Figure 31. Rotary mower safety devices.

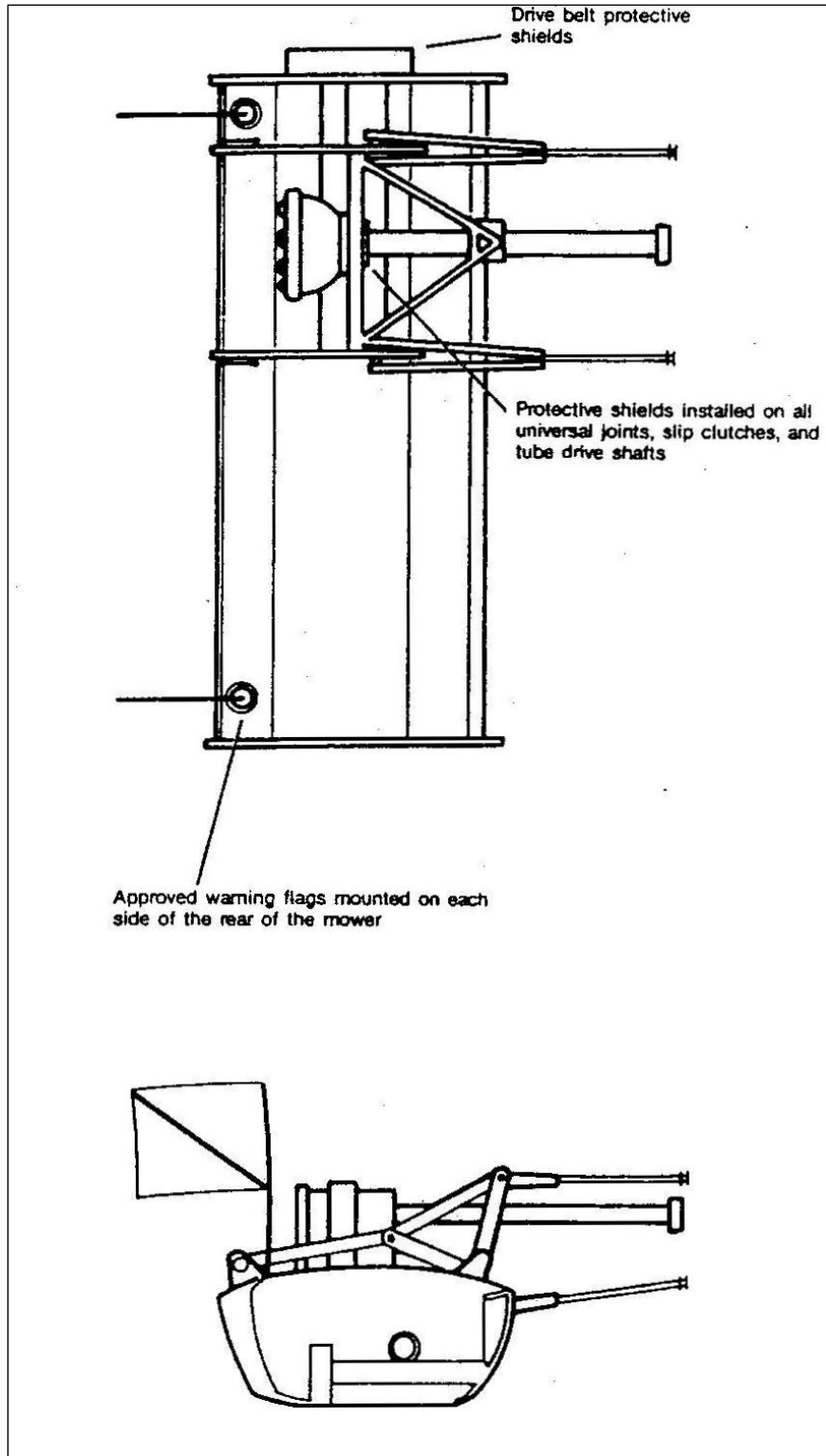

Figure 32. Flail mower safety devices.

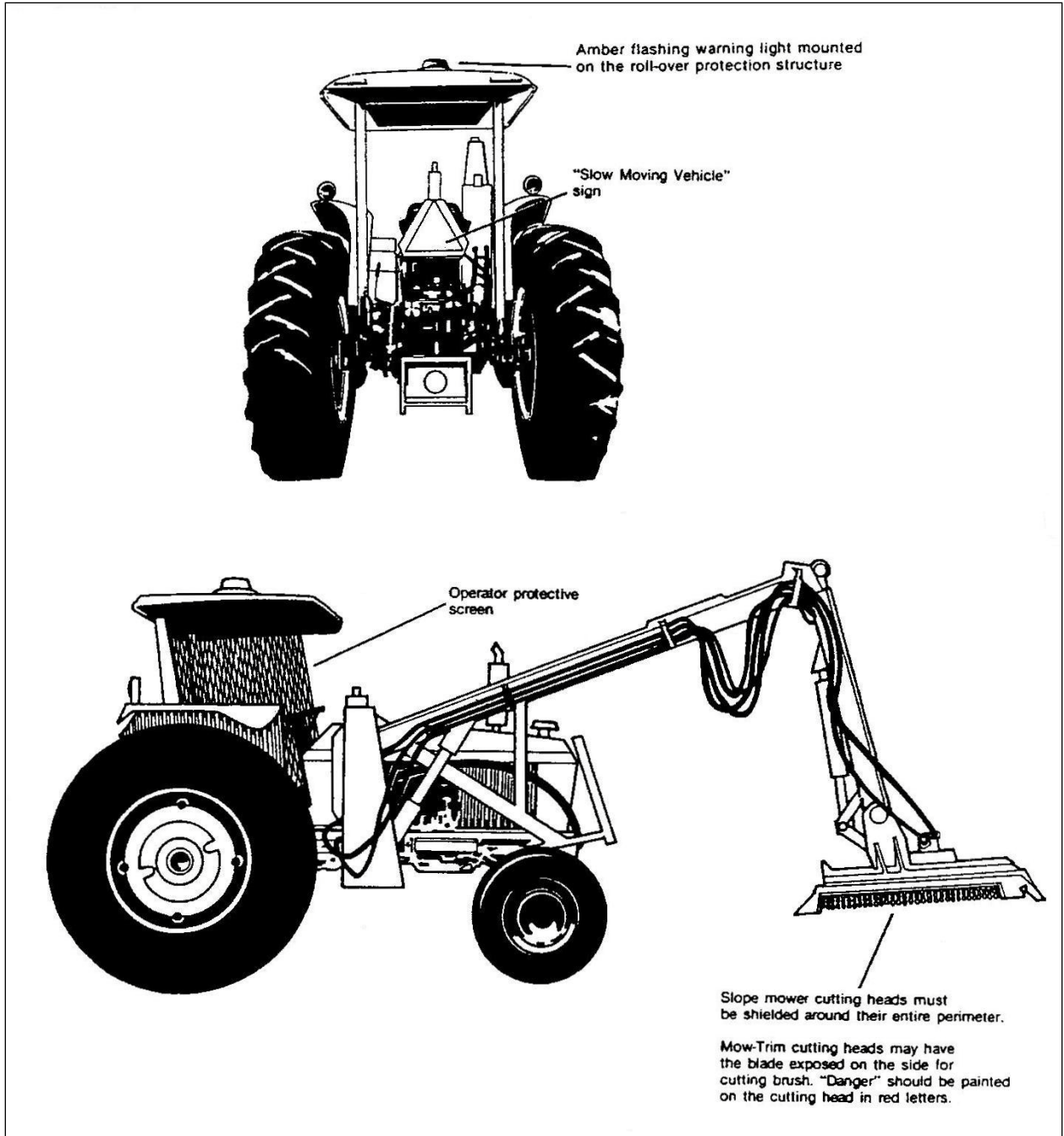

Figure 33. Slope mower safety devices.

## **SECTION 4: EQUIPMENT MAINTENANCE**

### **OPERATION AND MAINTENANCE OF MOWING EQUIPMENT**

Always exercise care when operating or maintaining FDOT tractors and other mowing equipment. Follow the instructions outlined in the manufacturer's manual and any specific FDOT requirements for proper equipment operation and servicing.

For any questions related to equipment maintenance not covered by the available manuals, or for maintenance beyond the expected responsibility of the operator, refer to the shop supervisor.

In general, equipment life can be extended by using high-grade lubricants, changed at the correct intervals. Filters should also be inspected and changed frequently.

The following pages provide operator checklists for servicing equipment commonly used in mowing operations. Observing these guidelines can extend the life of the equipment and reduce overall maintenance costs.

### **MAINTENANCE CHECKLISTS**

#### ***Automotive and Trucking Equipment Through One Ton***

##### *Daily:*

- Fuel, oil, and water (check fluid levels, leaks).
- Tires (check condition).
- Damage (check after an accident; check for missing components, rust).
- Instruments and controls (check gauges, warning lights, knobs, wipers, washers, and switches).
- Lights and horn (check operation, condition).
- Steering (check for free play).
- Brakes (check pedal free travel, stopping action).
- Clutch (check pedal free travel).
- Interior (check cleanliness).

##### *Weekly:*

- Tires (check air pressure, visual check).
- Belts (check tension, condition).
- Battery (check fluid level, corrosion).
- Exterior of vehicle (wash/polish as required).



## **Mowing Tractors**

### *Daily:*

- Fuel, oil, water, and hydraulic fluids (check fluid levels, leaks).
- Belts (check tension, condition).
- Tires, wheels, and lugs (check condition, tightness).
- Damage (check after accident, for missing components).
- Hitch (check for bent or broken frame, arms; damaged hoses and lines).
- All pivot points and pins (lubricate as necessary).
- Instruments and controls (check gauges, knobs, levers, pedals and switches).
- Lights and warning devices (check operation, condition).
- Brakes (check pedal free travel, stopping action).
- Clutch (check pedal free travel).
- Steering (check for looseness).

### *Weekly:*

- Tires (check air pressure).
- Filters, sediment bowls (drain water, sediment).
- Air cleaner (clean dirt and trash).
- Battery (check fluid level, corrosion).
- Cleanliness of equipment (wash or steam clean as required).
- Lubrication (per lubrication chart).

## **Mowers**

### *Daily:*

- Gear boxes (check oil level; clean vents and breathers).
- Drive belts (check tension, condition).
- Drive shafts, slip joints and U-joints (check condition).
- Hydraulic cylinders (check leaks, ram condition, mounts, hoses, and lines).
- Cutting edges (check condition of blades, bed knife, cutter blade knife, and flail knife).
- Pulleys and idlers (check condition, mountings).
- Slip clutches (check condition, operation).
- Shielding (check condition, mounting).
- Wings (check hinge condition).
- Height crank (check condition, operation).
- Wheels and tires (check condition, bearing adjustment).
- Reels, rotors and cutter bars (check condition, operation).
- All fittings, slip joints and hinges (lubricate).

## **Trailers**

### *Daily:*

- Landing gear (check pads or wheels, operation).
- Lunette and hitches (check for cracks, loose mountings).
- King pin (check for cracks in mounting).
- Wheels, tires and lugs (check condition, tightness).
- Lights and reflectors (check operation, condition).
- Brakes (check stopping action; drain air tanks).

### *Weekly:*

- Tires (check air pressure).

## APPENDIX

### MILES TO ACRES CONVERSION CHART

FOUR FEET WIDE														
Miles	0.25	0.5	1	2	3	4	5	6	7	8	9	10	11	12
Acres	0.1	0.2	0.5	1.0	1.5	1.9	2.4	2.9	3.4	3.9	4.4	4.8	5.3	5.8
Miles	13	14	15	16	17	18	19	20	21	22	23	24	25	26
Acres	6.3	6.8	7.3	7.8	8.2	8.7	9.2	9.7	10.2	10.7	11.2	11.6	12.1	12.6
Miles	27	28	29	30	31	32	33	34	35	36	37	38	39	40
Acres	13.1	13.6	14.1	14.5	15.0	15.5	16.0	16.5	17.0	17.5	17.9	18.4	18.9	19.4
SIX FEET WIDE														
Miles	0.25	0.5	1	2	3	4	5	6	7	8	9	10	11	12
Acres	0.2	0.4	0.7	1.5	2.2	2.9	3.6	4.4	5.1	5.8	6.5	7.3	8.0	8.7
Miles	13	14	15	16	17	18	19	20	21	22	23	24	25	26
Acres	9.5	10.2	10.9	11.6	12.4	13.1	13.8	14.5	15.3	16.0	16.7	17.5	18.2	18.9
Miles	27	28	29	30	31	32	33	34	35	36	37	38	39	40
Acres	19.6	20.4	21.1	21.8	22.5	23.3	24.0	24.7	25.5	26.2	26.9	27.6	28.4	29.1
EIGHT FEET WIDE														
Miles	0.25	0.5	1	2	3	4	5	6	7	8	9	10	11	12
Acres	0.2	0.5	1.0	1.9	2.9	3.9	4.8	5.8	6.8	7.8	8.7	9.7	10.7	11.6
Miles	13	14	15	16	17	18	19	20	21	22	23	24	25	26
Acres	12.6	13.6	14.5	15.5	16.5	17.5	18.4	19.4	20.4	21.3	22.3	23.3	24.2	25.2
Miles	27	28	29	30	31	32	33	34	35	36	37	38	39	40
Acres	26.2	27.2	28.1	29.1	30.1	31.0	32.0	33.0	33.9	34.9	35.9	36.8	37.8	38.8
TEN FEET WIDE														
Miles	0.25	0.5	1	2	3	4	5	6	7	8	9	10	11	12
Acres	0.3	0.6	1.2	2.4	3.6	4.8	6.1	7.3	8.5	9.7	10.9	12.1	13.3	14.5
Miles	13	14	15	16	17	18	19	20	21	22	23	24	25	26
Acres	15.8	17.0	18.2	19.4	20.6	21.8	23.0	24.2	25.5	26.7	27.9	29.1	30.3	31.5
Miles	27	28	29	30	31	32	33	34	35	36	37	38	39	40
Acres	32.7	33.9	35.2	36.4	37.6	38.8	40.0	41.2	42.4	43.6	44.8	46.1	47.3	48.5
TWELVE FEET WIDE														
Miles	0.25	0.5	1	2	3	4	5	6	7	8	9	10	11	12
Acres	0.4	0.7	1.5	2.9	4.4	5.8	7.3	8.7	10.2	11.6	13.1	14.5	16.0	17.5
Miles	13	14	15	16	17	18	19	20	21	22	23	24	25	26
Acres	18.9	20.4	21.8	23.3	24.7	26.2	27.6	29.1	30.5	32.0	33.5	34.9	36.4	37.8
Miles	27	28	29	30	31	32	33	34	35	36	37	38	39	40
Acres	39.3	40.7	42.2	43.6	45.1	46.5	48.0	49.5	50.9	52.4	53.8	55.3	56.7	58.2

FOURTEEN FEET WIDE														
Miles	0.25	0.5	1	2	3	4	5	6	7	8	9	10	11	12
Acres	0.4	0.8	1.7	3.4	5.1	6.8	8.5	10.2	11.9	13.6	15.3	17.0	18.7	20.4
Miles	13	14	15	16	17	18	19	20	21	22	23	24	25	26
Acres	22.1	23.8	25.5	27.2	28.8	30.5	32.2	33.9	35.6	37.3	39.0	40.7	42.4	44.1
Miles	27	28	29	30	31	32	33	34	35	36	37	38	39	40
Acres	45.8	47.5	49.2	50.9	52.6	54.3	56.0	57.7	59.4	61.1	62.8	64.5	66.2	67.9
SIXTEEN FEET WIDE														
Miles	0.25	0.5	1	2	3	4	5	6	7	8	9	10	11	12
Acres	0.5	1.0	1.9	3.9	5.8	7.8	9.7	11.6	13.6	15.5	17.5	19.4	21.3	23.3
Miles	13	14	15	16	17	18	19	20	21	22	23	24	25	26
Acres	25.2	27.2	29.1	31.0	33.0	34.9	36.8	38.8	40.7	42.7	44.6	46.5	48.5	50.4
Miles	27	28	29	30	31	32	33	34	35	36	37	38	39	40
Acres	52.4	54.3	56.2	58.2	60.1	62.1	64.0	65.9	67.9	69.8	71.8	73.7	75.6	77.6
EIGHTEEN FEET WIDE														
Miles	0.25	0.5	1	2	3	4	5	6	7	8	9	10	11	12
Acres	0.5	1.1	2.2	4.4	6.5	8.7	10.9	13.1	15.3	17.5	19.6	21.8	24.0	26.2
Miles	13	14	15	16	17	18	19	20	21	22	23	24	25	26
Acres	28.4	30.5	32.7	34.9	37.1	39.3	41.5	43.6	45.8	48.0	50.2	52.4	54.5	56.7
Miles	27	28	29	30	31	32	33	34	35	36	37	38	39	40
Acres	58.9	61.1	63.3	65.5	67.6	69.8	72.0	74.2	76.4	78.5	80.7	82.9	85.1	87.3

## HERBICIDES FOR HIGHWAY RIGHTS-OF-WAY<sup>1</sup>

J.A. Ferrell and K. A. Langeland<sup>2</sup>

**Table 1. Postemergence Broadcast Applications**

Herbicide	Rate	Comments
Arsenal or Arsenal Powerline	64 fl oz/A Surfactant required: 0.5% v/v NIS or 1% v/v MSO	For control of cogongrass and undesirable trees only. <b>DO NOT</b> apply Arsenal to turf or complete death will occur. <b>DO NOT</b> apply Arsenal over the root-zone of desirable trees. Arsenal possesses considerable soil residual activity and application can result in bare ground for several weeks or months. For best results, spray cogongrass when actively growing in the fall.
2,4-D amine (Hi-Dep, others)	2 to 4 pt/A	Excellent postemergence control of broadleaf weeds including Spanish needle, pigweed, Carolina geranium, and wild radish. Possesses little or no soil residual activity against most weeds. The use rate of 2 pt/A will be highly effective on most broadleaf weeds that are less than 4 inches in height. 2,4-D is weak on briars and almost all “brush” weeds. <b>The Organo-auxin rule must be obeyed when using this herbicide.</b> The amine formulation is essentially non-volatile, but application of the ester formulation is not advised. Applications near sensitive crops (vegetables, cotton, tobacco) should be avoided.
Garlon 3A  Triclopyr amine	1 to 2 pt/A 6-8 qt/A, brush	Effective for various broadleaf weeds and hard to manage species such as briars and brush. <b>The Organo-auxin rule must be obeyed when using this herbicide.</b> An essentially non-volatile triclopyr amine formulation, but application near sensitive crops (vegetables, cotton, tobacco) when physical drift could occur should be avoided.
Garlon 4 Ultra  Triclopyr ester	8-16 fl oz/A 4-6 qt/A, brush	Control spectrum is similar to Garlon 3A, but the 4 EC formulation is generally more potent. <b>The Organo-auxin rule must be obeyed when using this herbicide.</b> A somewhat volatile triclopyr ester formulation. Application near sensitive crops (vegetables, cotton, tobacco) should be avoided.
Milestone VM  aminopyralid	3 to 7 fl oz/A	Excellent postemergence control of broadleaf weeds including Spanish needle, pigweed, ragweed, Carolina geranium, tropical soda apple, thistle, and Florida betony. Possesses several months of soil residual activity on tropical soda apple, ragweed, and Spanish needle. Milestone VM is weak on dogfennel, but may be mixed with other herbicides to improve control. <b>The Organo-auxin rule must be obeyed when using this</b>

		<b>herbicide.</b> An essentially non-volatile aminopyralid amine formulation, but application near sensitive crops (vegetables, cotton, tobacco) when physical drift could occur should be avoided.
Plateau imazapic	1 to 4 fl oz/A Surfactant required: 0.25% v/v NIS	For excellent postemergence control of a range of grass and broadleaf weeds. Crabgrass, vaseygrass, and nutsedge, will be controlled. Plateau can also be used on 'Pensacola' bahiagrass to regulate plant growth. Generally, 3 to 4 weeks of growth suppression will occur for every 1 fluid ounce applied. <b>DO NOT</b> apply more than 4 fl oz/A. Beware of overlapping while spraying. If excessive Plateau rates are applied, 'Pensacola' bahiagrass will be severely injured for several weeks. <b>DO NOT</b> apply Plateau to drought stressed bahiagrass turf. <b>**Using Plateau to reduce mowing frequency is currently not an acceptable practice for FDOT rights-of-way.</b>
Vanquish dicamba	4 to 32 fl oz/A	Vanquish is similar in activity and complimentary to 2,4-D. Short-lived residual activity is often observed on certain weed species. <b>The Organo-auxin rule must be obeyed when using this herbicide.</b> Vanquish is volatile and any application near sensitive crops (vegetables, cotton, tobacco) should be avoided.
Velpar hexazinone	2 to 4 pt/A	For excellent control of smutgrass and selected broadleaf weeds. For smutgrass control, apply during the summer months when rainfall is common. Applications made in spring or winter are rarely effective. Beware of applying Velpar near desirable trees. Oaks are extremely sensitive to Velpar and can be killed if the herbicide is absorbed by roots.
Vista* fluroxypyr	8-16 fl oz/A	Effective for various broadleaf weeds; very effective on dogfennel. <b>The Organo-auxin rule must be obeyed when using this herbicide.</b> An essentially non-volatile fluroxypyr ester formulation, but application near sensitive crops (vegetables, cotton, tobacco) when physical drift could occur should be avoided. Safe to use in the root zone of desirable trees.
Overdrive* Dicamba + diflufenzapyr	4 to 8 oz/A dry weight	For post emergent broadleaf weed control with little soil activity.
* denotes products not currently found on the FDOT bid list.		

**Table 2. Postemergence Broadcast applications – Dormant grass**

Herbicide	Rate	Comments
Glyphosate (Roundup Pro, Accord XRT*, etc)	0.5 to 4 pt/A	For use where total vegetation control is desired. If broadcast, desirable turf must be dormant or excessive injury or death will occur. DO NOT apply glyphosate where wildflowers are present. Glyphosate provides excellent control of most broadleaf and grass weeds, but possesses no soil residual activity. Glyphosate works well when mixed with 2,4-D, Milestone VM, or other herbicides.
* denotes products not currently found on the FDOT bid list.		

**Table 3. Postemergence Broadcast Applications – Guard Rails or other locations where total vegetation control is desired**

Herbicide	Rate	Comments
Glyphosate (Roundup Pro, Accord XRT*, etc)	0.5 to 4 pt/A or 1 to 3% solution	Glyphosate has no soil residual activity. Expect weeds to die within 14 days of application, but to recolonize from seed within 1 to 2 months after application. Weeds must be actively growing for glyphosate to be effective. Low rates are effective on air potato when applied in late summer/early fall. Many species (such as oaks) are fairly tolerant of low rates.
Journey*  Imazapic + glyphosate	32 fl oz/A Surfactant required: 0.5% v/v NIS or 1% v/v MSO	Excellent control of most grass and broadleaf weeds. Significant soil residual activity for weeks or months after application. May be mixed with glyphosate 1qt fl oz/A for additional knock down of larger vegetation.
Milestone VM  Aminopyralid	7 fl oz/A; 14 fl oz/A, spot applications	Excellent postemergence control of broadleaf weeds including Spanish needle, pigweed, ragweed, Carolina geranium, tropical soda apple, thistle, Florida betony and marestail. Possesses several months of soil residual activity on tropical soda apple, ragweed, Spanish needle, and marestail. Milestone VM is weak on dogfennel. Should be mixed with glyphosate for grass control. The Organo-auxin rule must be obeyed when using this herbicide. An essentially non-volatile aminopyralid amine formulation, but application near sensitive crops (vegetables, cotton, tobacco) when physical drift could occur should be avoided.
* denotes products not currently found on the FDOT bid list.		

**Table 4. Preemergence herbicides for ornamental plant beds**

Herbicide	Rate	Comments
Casoron 4G (Dichlobenil)	100 – 150 lb/A	Spectrum of weed control is limited, but controls Florida betony (rattlesnake weed) and suppresses nutsedge in many established woody ornamentals. Volatile and should only be used in the late fall, winter or early spring. Granules should be placed under mulch or watered in as soon as possible.
Gallery (Isoxaben)	0.25-0.5 oz/1000 ft <sup>2</sup>	Controls a wide variety of broadleaf weeds, including chamberbitter and cudweed. Gallery is weak on grasses and should be mixed with other herbicides such as Surflan or Pennant. Do not apply Gallery to new beds until soil has been settled with sufficient packing or irrigation.
Pennant Magnum (s-metolachlor)	14-21 ml/1000 ft <sup>2</sup>	Excellent on annual grasses and small seeded broadleaf weeds. Will suppress yellow nutsedge.
Surflan AS (oryzalin)	1.5-3 fl oz/1000 ft <sup>2</sup>	Excellent on annual grasses and small seeded broadleaf weeds. More persistent than Pennant. No postemergence activity, but works well when applied with glyphosate. Surflan will remain active on the soil surface for 21 days after application, but irrigation or rainfall is necessary to incorporate and activate the herbicide.
Pendulum 2G  Pendulum Aquacap (pendimethalin)	2.3-4.6 lb/1000 ft <sup>2</sup>  1.6-3.2 fl oz /1000 ft <sup>2</sup>	Similar activity Surflan.
Ronstar G (oxadiazon)	2.2-4.5 lb/1000 ft <sup>2</sup>	Control of annual grasses and small seeded broadleaf weeds. Can be applied to newly planted or established ornamentals, during periods of active growth or dormant season.
Barricade and others (prodiamine)	0.37-0.83 oz/1000 ft <sup>2</sup>	Excellent control of troublesome annual grasses.
Princep Liquid	2-3 qt/A	For broadleaf weeds and select annual grasses (such as bluegrass). For use around woody ornamentals only. Do not apply until soil firmly settles around roots.
Preen (trifluralin)	1 oz/10 ft <sup>2</sup>	Similar to Surflan. Do not apply to desirable plants while foliage is wet. Water or rake in granules immediately. Sweep stray granules off pavement to prevent staining.



**Table 5. Postemergence herbicides for ornamental plant beds**

Herbicide	Rate	Comments
Basagran T/O (bentazon)	0.55-0.75 fl oz/1000 ft <sup>2</sup>	Control of yellow nutsedge and certain broadleaf weeds. Does not control purple nutsedge. Can be applied over the top of certain ground covers, but should be applied as a directed spray around most ornamentals. A crop oil concentrate adjuvant is recommended.
Envoy Plus (clethodim)	9-16 fl oz/A	Control of annual and perennial grasses in ornamental beds. Can be safely applied to most flower and shrub species without injury. Does not control nutsedge. A non-ionic surfactant (0.25% v/v) is recommended.
Segment (sethoxydim)	1.5-2.25% solution	Similar to Envoy, but less effective on bermudagrass. No surfactant necessary.
Reward and others (diquat)	1.5-2 pt/A	Non-selective to both grass and broadleaf plants. Rapid activity, but weak on perennial weeds. Do not allow spray to contact desirable foliage. Can be used to side-trim around sidewalks. No soil residual activity.
Finale (glufosinate)	2-4 fl oz/gal	Similar to Reward.
Roundup Pro and others (glyphosate)	0.5-5% solution	Non-selective on annual and perennial grass and broadleaf weeds. Do not allow spray to contact desirable foliage. Low rates are effective on most annual species (0.5 to 1% solution), perennials (especially nutsedge) may require higher rates. No soil residual activity. There are many glyphosate herbicides, but not all are labeled for use in ornamental settings. Ensure proper product labeling prior to application.
Sedgehammer (halosulfuron)	0.66-1.3 oz/A	Excellent on nutsedges and select broadleaf weeds. Apply as a directed spray (avoiding foliage) around any ornamental grass or woody perennial. A non-ionic surfactant is required.
Certainty (sulfosulfuron)	0.25-2.0 oz/A	Similar to Sedgehammer, but slightly more effective on kyllinga.

## Footnotes

1. This document is SS-AGR-271, one of a series of the Agronomy Department, Florida Cooperative Extension Service, Institute of Food and Agricultural Sciences, University of Florida. Original publication date July 2007. Visit the EDIS Web Site at <http://edis.ifas.ufl.edu>.
2. J. A. Ferrell, assistant professor, Department of Agronomy; K.A. Langeland, Professor, Agronomy Department, Center for Aquatic and Invasive Plants, Cooperative Extension Service, Institute of Food and Agricultural Sciences, University of Florida, Gainesville, FL 32611.

## CONTROL OF HARD TO MANAGE WEEDS ALONG HIGHWAY RIGHTS-OF-WAY<sup>1</sup>

Jason Ferrell and Ken Langeland<sup>2</sup>

**Table 6. Control of upland invasive weeds**

Herbicide	Rate	Comments
<b>Cogongrass</b>		
Glyphosate (Roundup Pro, etc)	4 to 8 pt/A or 3 to 5% solution	Cogongrass is most sensitive to glyphosate when applied in the fall. Spring applications are less effective. Mowing existing vegetation and treating the regrowth approximately 2 weeks later is often best. Multiple applications are often required before complete control is achieved.
Arsenal or Arsenal Powerline*  imazapyr	64 fl oz/A or 1% solution	Cogongrass is most sensitive to Arsenal when applied in the fall. Spring applications are less effective. Mowing existing vegetation and treating the regrowth approximately 2 weeks later is often best. Arsenal is more effective on cogongrass than glyphosate, but expect total vegetation control and bare ground for 2 to 4 months after application. <b>DO NOT</b> apply Arsenal over the root zone of desirable hardwood trees. Multiple applications are often required before complete control is achieved.
<b>Tropical Soda Apple</b>		
Garlon 4 Ultra  Triclopyr ester	1 qt/A or 0.5% solution for spot application	A broadcast application of Garlon 4 is effective on TSA if applied near blooming or after regrowth from mowing. Applications made in late summer months or while fruiting are less effective. Garlon 4 has no soil residual activity and recolonization from seed is likely to occur after application. If spot-spraying, it is important to achieve full coverage. <b>The Organo-auxin rule must be obeyed when using this herbicide.</b>
Milestone VM  aminopyralid	5 to 7 fl oz/A or 0.1% solution for spot application	A broadcast application of Milestone VM is effective on TSA at any growth stage or time of year. Mowing is not necessary to improve control. Milestone VM has significant soil residual activity and control of seedlings is likely to occur for over 6 months after application. If spot-spraying, it is important to achieve full coverage. <b>The Organo-auxin rule must be obeyed when using this herbicide.</b>
<b>Brazilian Pepper or Chinese Tallow</b>		
Garlon 4 Ultra	10%-25%	Basal bark or cut-stump application, rate will depend on

Triclopyr ester	diluted in oil	applicator technique and site conditions, e.g. soil water content.
Pathfinder II or Remedy RTU	Undiluted	Basal bark application
Garlon 3A Triclopyr amine	50 - 100%	Cut stump application. Apply herbicide immediately after felling.
Garlon 3A Triclopyr amine	0.50-1.5%	Brazilian pepper only. Foliar application. Use sufficient volume to ensure thorough coverage.
Escort XP Metsulfuron methyl	1-2 oz/acre	
<b>Kudzu</b>		
Escort XP* Metsulfuron methyl	3 – 4 oz/A	Apply Escort XP when kudzu is actively growing for optimum control. Several hardwood species are sensitive to Escort XP at these rates. Escort XP should not be used for kudzu control if desirable hardwoods are present.
Transline* † Clopyralid	5 to 21 fl oz/A	Transline should be applied from late summer through fall for optimum control. For small populations that are not well established, lower application rates are acceptable. For larger, more mature stands, the maximum application rate should be used. Transline is safer on hardwood species than Escort XP. Transline is only labeled for use in select counties in North Florida. See product label for specifics. <b>The Organo-auxin rule must be obeyed when using this herbicide.</b>
<b>Air Potato</b>		
Glyphosate (Roundup Pro, etc)	1 – 2% solution	Glyphosate gives good control when applied late season, such as August-October. Early-season applications may require repeat treatments, and applications made after plants begin yellowing result in limited control. Desirable vegetation under air potato may not be damaged when lower rates of glyphosate are used. Removal of bulbils from the ground will aid long term control.
<b>Climbing ferns – Lygodium</b>		
Escort XP* Metsulfuron	1 – 2 oz/A or 2 oz/100 gallon	Apply Escort XP or glyphosate to all live fronds for best results. Treatment of Lygodium often results in non-target damage due to the climbing nature of these species. In long-

methyl		established stands of Lygodium, re-treatment will be required in < 6 months due to re-sprouts and new fern growth from spores. If not included in the product, an appropriate NIS surfactant at 0.5% v/v should be added to the herbicide solution. For fronds growing high in trees, cut at waist level and treat remaining rooted fronds.
Glyphosate (Rodeo, Roundup Pro, etc)	7.5 pints/A or 2% solution	
* denotes products not currently found on the FDOT bid list.		
† Transline is only labeled for use in specific counties in Florida.		

**Table 7. Aquatic Vegetation Control**

Herbicide	Rate	Comments
<b>Cattail</b>		
Habitat* imazapyr	32 fl oz/A Surfactant required: 0.5% v/v NIS or 1% v/v MSO	Apply to actively growing cattails in the spring, summer, or fall. <b>DO NOT</b> apply in the root zones of desirable hardwood vegetation. Do not apply to irrigation water The addition of an approved aquatic surfactant is required.
Clearcast* Imazamox	64 fl oz/A Surfactant required: 0.5% v/v NIS or 1% v/v MSO	Apply to actively growing cattails in the spring, summer, or fall. Can be used in the root zones of desirable hardwood vegetation. Refer to current label for irrigation and watering restrictions. The addition of an approved aquatic surfactant is required.
Glyphosate (Rodeo, Accord Concentrate, etc.)	7.5 pt/A or 0.75-1.5% solution	Fall applications are most effective. The addition of an approved aquatic surfactant is required.
<b>Alligator weed</b>		
Habitat* imazapyr	32 fl oz/A Surfactant required: 0.5% v/v NIS or 1% v/v MSO	Apply to actively growing alligator weed in the spring, summer, or fall. <b>DO NOT</b> apply in the root zones of desirable hardwood vegetation. Do not apply to irrigation water
Clearcast* imazamox	64 fl oz/A Surfactant required: 0.5% v/v NIS or 1% v/v MSO	Apply to actively growing alligator weed in the spring. For summer and fall applications, add glyphosate 32 fl oz/A. Can be used in the root zones of desirable hardwood vegetation. Refer to current specimen label for irrigation and watering restrictions.
Glyphosate (Rodeo, etc)	0.75-1.5% solution	Repeat applications will be necessary. Addition of approved surfactant is necessary.

Renovate Triclopyr amine	3-8 qt/acre or .75-1.0% solution	Repeat treatments will be necessary, especially to floating mats. Additional surfactant may improve performance.
<b>Water Hyacinth</b>		
2,4-D amine*	2-4 qt per acre or 0.5-1.0% solution	Refer to specific product label to ensure that the 2,4-D brand used is labeled for aquatic weed control. Refer to label for water use restrictions.
Reward diquat	0.5-2.0 gal/acre or 0.5% solution	Addition of an approved surfactant is essential. Refer to label for water use restrictions.
Glyphosate (Rodeo, etc)	5-6 pints per acre or 0.75- 1.0% solution	Addition of an approved surfactant is essential. Refer to label for water use restrictions. Visual symptom are not observed until over three weeks after application.
<b>Water Lettuce</b>		
Reward diquat	0.5-1.0 gal/acre or 0.5 to 1.0% solution	Addition of an approved surfactant is essential.
Stingray Carfentrazone	3.4-13.5 oz/acre	Addition of an approved surfactant is necessary.
<b>Torpedograss</b>		
Glyphosate (Rodeo, etc.)	2-3% solution	Torpedograss control will be improved when maximum leaf surface is exposed above the water line. Regardless of herbicide or application rate, multiple applications will be required for complete control. The addition of an approved aquatic surfactant is required.
Habitat imazapyr	1% solution	
* denotes products not currently found on the FDOT bid list. † Transline is only labeled for use in specific counties in Florida.		

#### Footnotes

1. This document is SS AGR 275, one of a series of the Agronomy Department, Florida Cooperative Extension Service, Institute of Food and Agricultural Sciences, University of Florida. Original publication date September 2007. Visit the EDIS Web Site at <http://edis.ifas.ufl.edu>.
2. Jason Ferrell, assistant professor, Agronomy Department; Ken Langeland, professor, Agronomy Department, Florida Cooperative Extension Service, Institute of Food and Agricultural Sciences, University of Florida, Gainesville, FL 32611.

The use of trade names in this publication is solely for the purpose of providing specific information. UF/IFAS does not guarantee or warranty the products named, and references to

them in this publication does not signify our approval to the exclusion of other products of suitable composition. All chemicals should be used in accordance with directions on the manufacturer's label.

## **GENERAL LAWS AND REGULATIONS**

### **FLORIDA PESTICIDE LAW AND RULES**

- Florida Pesticide Regulation and Safety – Chapter 487 Florida Statutes  
[www.flsenate.gov/Statutes/index.cfm?App\\_mode=Display\\_Statute&URL=Ch0487/ch0487.htm](http://www.flsenate.gov/Statutes/index.cfm?App_mode=Display_Statute&URL=Ch0487/ch0487.htm)
- Chapter 5E-2 “Pesticides” and 5E-9 “Licensed Pesticide Applicators and Dealers”, Florida Administrative Code  
[www.flrules.org/gateway/chapterhome.asp?chapter=5e-2](http://www.flrules.org/gateway/chapterhome.asp?chapter=5e-2)  
[www.flrules.org/gateway/chapterhome.asp?chapter=5e-9](http://www.flrules.org/gateway/chapterhome.asp?chapter=5e-9)

### **AQUATIC PLANT CONTROL PERMITS**

- Florida Aquatic Weed Control Act – Chapter 369.20 Florida Statutes  
[www.flsenate.gov/Statutes/index.cfm?App\\_mode=Display\\_Statute&Search\\_String=&URL=Ch0369/SEC20.HTM&Title=-%3E2008-%3ECh0369-%3ESection%2020#0369.20](http://www.flsenate.gov/Statutes/index.cfm?App_mode=Display_Statute&Search_String=&URL=Ch0369/SEC20.HTM&Title=-%3E2008-%3ECh0369-%3ESection%2020#0369.20)
- Chapter 62C-20 Rules of Florida Department of Environmental Protection (FDEP)  
[www.dep.state.fl.us/lands/invaspec/3rdlevpgs/perrule2.htm](http://www.dep.state.fl.us/lands/invaspec/3rdlevpgs/perrule2.htm)

### **APPLICATION FOR AQUATIC PLANT CONTROL PERMIT**

See attached

### **HERBICIDE APPLICATION LOG**

See attached