

**Alternative Images for Perpendicular Parking:
A Usability Test
of a Multi-Camera Parking Assistance System**

**Sean Michael Walls, John Amann, Brian Cullinane,
Paul Green, Sujata Gadgil, and Rachel Rubin**



Technical Report Documentation Page

1. Report No. UMTRI-2004-17		2. Government Accession No.		3. Recipient's Catalog No.	
4. Title and Subtitle Alternative Images for Perpendicular Parking: A Usability Study of a Multi-Camera Parking Assistance System				5. Report Date October, 2004	
				6. Performing Organization Code account 381577	
7. Author(s) Sean Michael Walls, John Amann, Brian Cullinane, Paul Green, Sujata Gadgil, and Rachel Rubin				8. Performing Organization Report No. UMTRI-2004-17	
9. Performing Organization Name and Address The University of Michigan Transportation Research Institute (UMTRI) 2901 Baxter Rd, Ann Arbor, Michigan 48109-2150 USA				10. Work Unit no. (TRAIS)	
				11. Contract or Grant No. Contract	
12. Sponsoring Agency Name and Address Nissan Research Center Nissan Motor Co., Ltd. 1 Natsushima-cho Yokosuka, 237-8523 Japan				13. Type of Report and Period Covered April – October 2004	
				14. Sponsoring Agency Code	
15. Supplementary Notes AVM and Low Speed Maneuvers: Human Factors Issues Project					
16. Abstract <p>The parking assistance system evaluated consisted of four outward facing cameras whose images could be presented on a monitor on the center console. The images presented varied in the location of the virtual eye point of the camera (the height above the vehicle and forward depression angle) and the number of camera images (one or multiple) appearing together.</p> <p>In the experiment, 16 drivers (eight under age 30, eight over age 65) parked a 2002 Infiniti Q45 in an 8.5-foot-wide stall. Each subject parked 24 times, using the various image combinations or no assistance at all.</p> <p>Parking clearances (the closest approach distance on the driver and passenger side, distance to a wall in front) declined with practice, stabilizing to 4 inches laterally and 13 inches in front after about three unrecorded practice trials and 15 test trials.</p> <p>Overall, age and sex differences were not large, though older drivers were more variable than younger drivers in how far they parked from the end of a stall.</p> <p>Finally, there were no statistically significant differences among camera image combinations, or differences from no-assistance conditions. Only half of the subjects made significant use of the assistance system, which is not an unusual outcome given its early state of system development. Of the image combinations examined, those with a single image field resulted in subjects parking 2 inches closer to the wall than those with multiple fields. Overall, subjects preferred scenes presenting what appeared to be a single image. Subjects reported that the aerial view was the most helpful.</p>					
17. Key Words Driving Performance, Parking, Accidents, Crashes, Motor Vehicles, ITS, Human Factors, Ergonomics, Safety, Usability, Telematics, Driver Vision			18. Distribution Statement No restrictions. This document is available to the public through the National Technical Information Service, Springfield, Virginia 22161		
19. Security Classify. (of this report) (None)		20. Security Classify. (of this page) (None)		21. No. of pages 75	22. Price

ALTERNATIVE IMAGES FOR PERPENDICULAR PARKING: A USABILITY STUDY OF A MULTI-CAMERA PARKING ASSISTANCE SYSTEM

UMTRI Technical Report 2004-17

October, 2004

Sean Michael Walls, John Amann, Brian Cullinane, Paul Green, Sujata Gadgil, and Rachel Rubin

University of Michigan
Transportation Research Institute
Ann Arbor, Michigan
USA

Primary Issues

1. Were there differences in how closely drivers parked to the space boundaries among the six image combinations?
2. Which type of image leads to better parking performance, direct or indirect?
3. Does the number of images (one or more than one) shown on the monitor lead to better parking performance?
4. Which images did drivers prefer?
5. Does how close people drive to other vehicles vary with driver age and sex?
6. Does parking performance change with practice?
7. How could the camera-based parking system be improved?
8. How should the experimental protocol be modified in future studies?

Methods

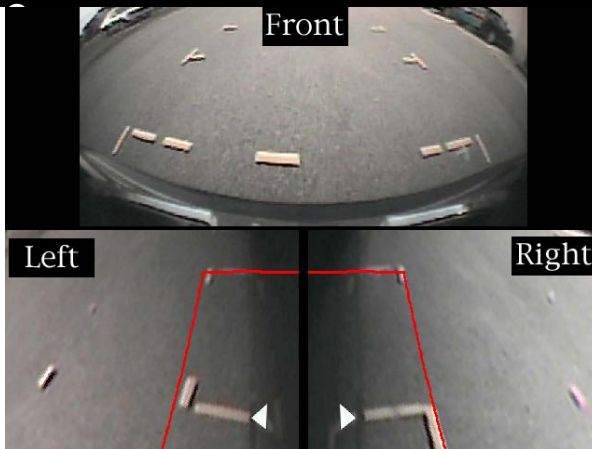

Image 1 (3-Panel) – Front bumper is at the bottom of the top panel; Triangles show tire location, and red corners represent the farthest point when the wheel is turned to either lock.

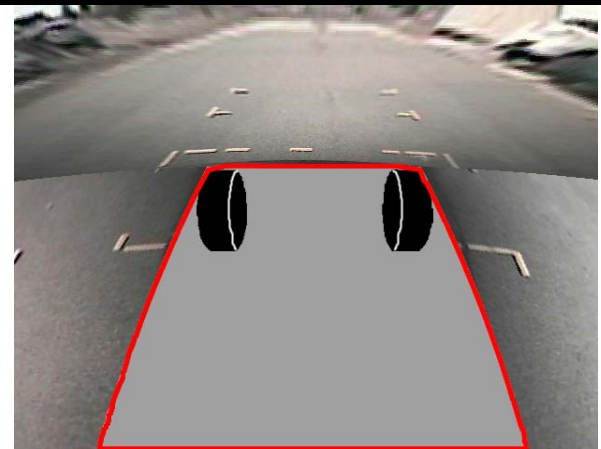

Image 2 (Virtual) – Red is outline of concealed car body; tires do not move with steering wheel.

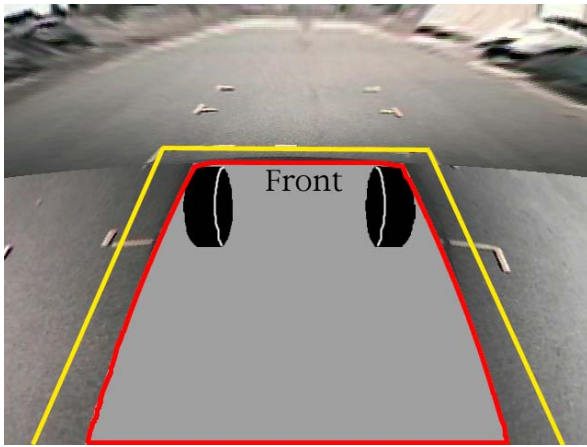

Image 3 (Virtual with Lines) – Image 2 plus yellow parking assist line.

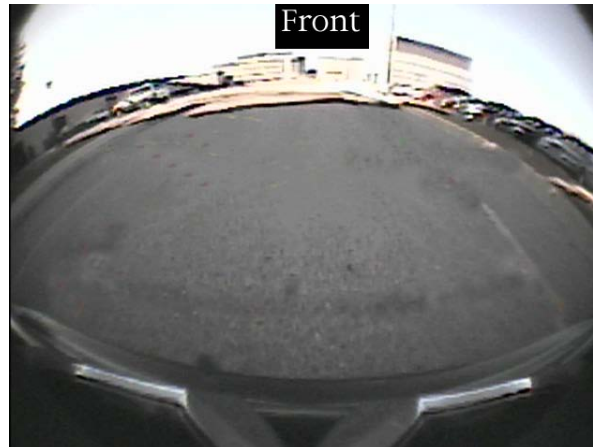

Image 4 (Front Fisheye) – Front bumper is at bottom; highly distorted.

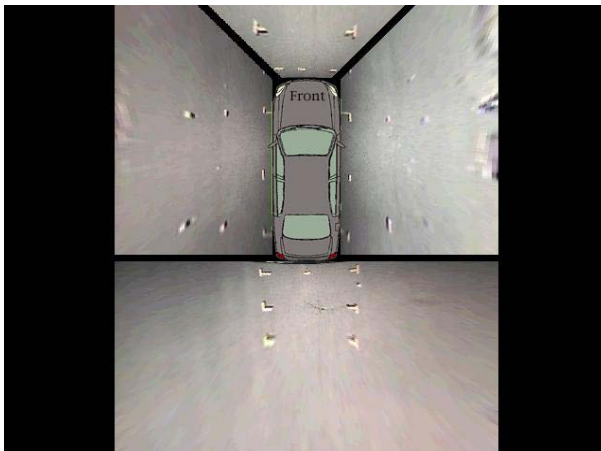

Image 5 (Aerial) – Car icon is a graphic; passing vehicles (not shown) appear distorted.

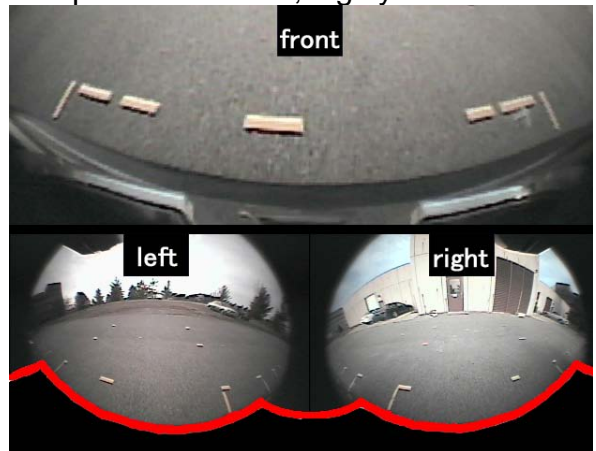

Image 6 (3-Panel Fisheye) – Front bumper is at bottom of top panel; red line represents side of test vehicle.

Parking Trial Sequence



- 1) Park 3 times, get out, and check clearance (familiarize in practice spot)
 - 2) Park 3 times without assistance (baseline)
 - 3) Park 18 times (6 images x 3 times each)
 - 4) Park 3 times without assistance (baseline check)
- Total = 24 times

Subjects (16 total)

	Men	Women
Young	4	4
Old	4	4

Results and Conclusions

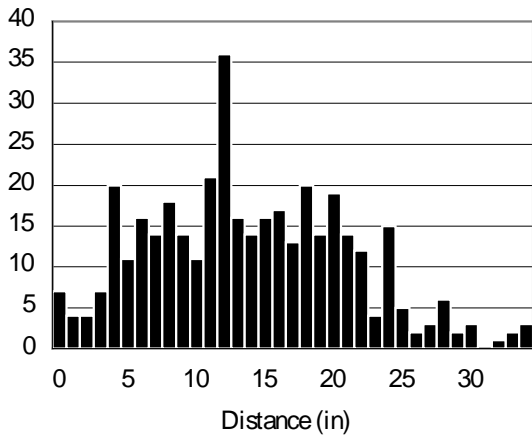

Front Bumper to the Wall (*wide range*)

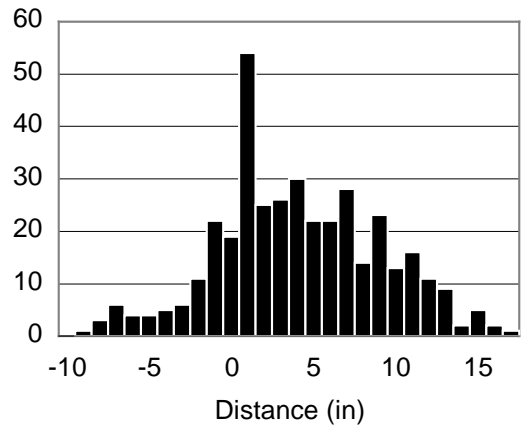

Passenger Side to Line (*wide range*)

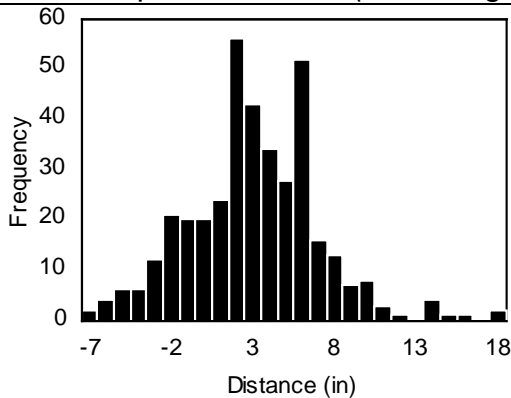

Driver Side to Line (*3 in typical*)

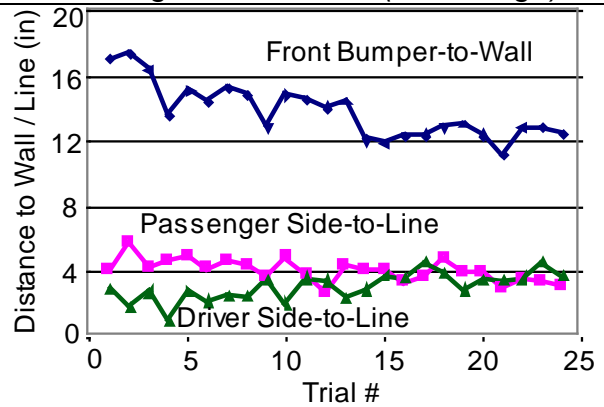

Effect of Practice (*stabilize at 15 trials*)

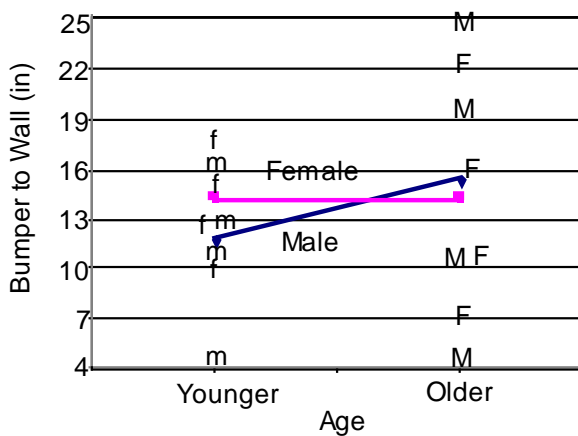

Front Bumper to Wall (*large individual differences but no major sex or age differences*)

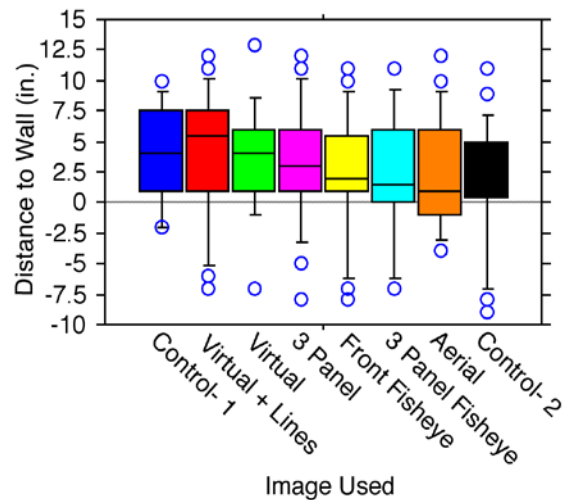

Front Bumper to Wall (*no difference*)

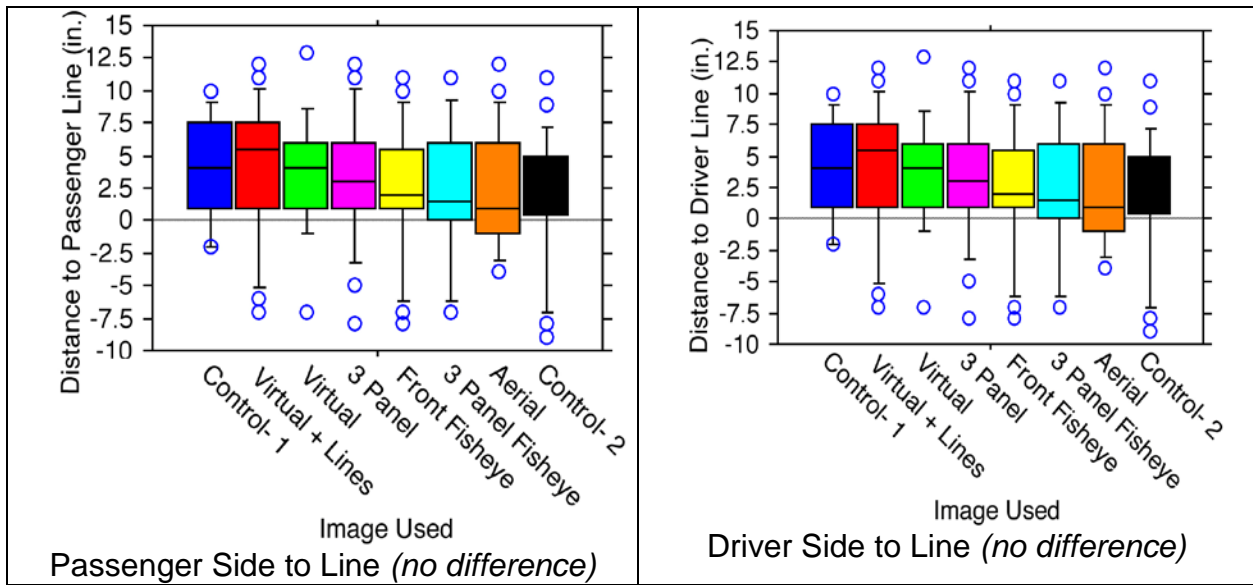

Also, no major difference between direct and indirect (virtual) images
 Sometimes, 1 image was easier to use than 3.

Subject Preferences

- Image 5 – Aerial (users and non-users)
- Image 4 – Front Fisheye (non-users only)
- Not Image 6 – 3 Fisheyes (images are too small for 7 in display and confusing)

Improvements

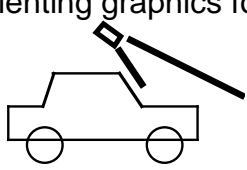
<p>Parking Assistance System</p> <ul style="list-style-type: none"> * Provide superimposed virtual scales with distances * Add distance thresholds (yellow and red lines) * Provide better corner coverage (either increase camera resolution or relocate/add cameras) * Add orienting graphics for each image, e.g.,  <ul style="list-style-type: none"> * Revise bumper labels (to “front bumper”) * Replace front label with “forward” * Reduce distortion in fisheye views * Avoid interfaces with 3 separate images * Enhance interface to support backing up while perpendicular parking 	<p>Test Protocol</p> <ul style="list-style-type: none"> * As long as the usability needs improvement, explain what the monitor shows to subjects to encourage use and feedback on how the interface could be improved * When the interface is easy to use, shift to “walk up and use” (no questions allowed) experiments * To assess experienced users, allow for at least 18 practice trials
---	---

INTRODUCTION

TABLE OF CONTENTS

INTRODUCTION..... 1

TEST PLAN..... 5

 Overview..... 5

 Participants..... 6

 Camera Images and Virtual Eye Point..... 9

 Parking Lot and Equipment Set Up..... 12

 The Wall 17

 Test Car..... 18

 Sequence of Experimental Tasks 20

RESULTS..... 23

 Data Reduction..... 23

 Overall, How Close Did Subjects Park to the Wall and Adjacent Vehicles? 23

 Which Factors Significantly Affected the Closest Approach? 25

 Effect of Practice on Closest Approach 26

 Differences Due to Driver Age and Sex on Closest Approach..... 27

 Effect of Images on Closest Approach..... 30

 How Well Were the Images Rated?..... 33

 How Did Subjects Feel About the System Overall? 34

 What did the subjects have to say about the images?..... 36

CONCLUSIONS 37

 1. Overall, were there differences in how closely drivers parked to the space boundaries as a function of the six image combinations provided? 37

 2. In general, which type of camera image, direct or indirect, leads to better parking performance? 37

 3. In general, how many images shown on the monitor leads to better parking performance, one or more than one? 37

 4. Which image(s) did drivers prefer? 38

 5. Does how close people drive to other vehicles and park vary with driver age and sex? 38

 6. Does parking performance change with practice? 38

 7. How could the camera-based parking system be improved? 38

 8. How should the experimental protocol be modified in future studies? 40

CLOSING THOUGHTS..... 41

INTRODUCTION

INTRODUCTION

Over the last decade, automotive manufacturers and suppliers have integrated many new intelligent transportation systems and features into motor vehicles. Among these items are navigation systems and collision warning systems. These systems are intended, among other things, to make driving safer, more convenient, more productive, and more pleasurable.

One application that has received less attention is parking assistance systems. Several manufacturers, as shown in Table 1, have introduced parking assistance systems based on ultrasonic sensors or cameras. Systems with ultrasonic sensors use visual and/or auditory signals to alert drivers of objects in their close surroundings. The camera-based systems use cameras placed in various spots on the outside of the vehicle to present images on an LCD screen located inside the vehicle.

Table 1: Parking Assistance Systems

Manufacturer/ Supplier	Vehicle (Year, Make, Model) or Aftermarket	Technology (Camera or Ultrasonic)	URL
Valeo	Aftermarket	Front & Rear Ultrasonic	http://www.valeo.com/gb/activities/switches_systems/park_assist.asp
Electronic Commerce Sales, Ltd	Aftermarket	Front & Rear Ultrasonic	www.parking-sensor.co.uk
Buick	2004 Buick Rendezvous	Standard Rear Ultrasonic	http://www.buick.com/rendezvous/features/safety/ultrasonicrearparkassist.html
Daimler Chrysler	2005 Chrysler 300C	Standard Rear Ultrasonic	http://www.chrysler.com/300/features/exterior_features/park_assist.html?context=300-features-exterior_features-index&type=modelsub
Aglaia	Aftermarket	Front & Rear Camera	http://www.aglaia-gmbh.de/english/angebot/prototypen/rueckfahrkamera.html
Toyota	Corolla (Prototype)	Optional Front Corner &/or Rear Camera	http://www.toyota-europe.com/showroom/corolla_verso/kce_3.html
Infiniti	2002 Infiniti Q45	Standard Rear Camera	http://www.infiniti.com/content/0,,cid-32769_sctid-32005,00.html

INTRODUCTION

The human factors and crash research data available for these systems are surprisingly limited. Information includes previous human factors studies of how people park and previous studies of crash frequency associated with parking.

As an initial step in this project, the human factors literature on parking (10 studies) was reviewed. In addition, crash files (Michigan Traffic Facts), which included 10,400 parking crashes between 2000-2002, were analyzed. Finally, six State Farm Insurance agents were interviewed regarding parking and low-speed crashes. The primary conclusions from those three sources were summarized in Smith, Green, and Jacob (2004) as follows:

1. There are very few human factors studies of how people actually park.
2. Much of the literature (10 studies were examined) on parking crashes is outdated by 20 years or more. This is a concern because the vehicle mix (cars vs. light trucks and SUVs) has changed, as has the use of the various parking maneuvers (more parking lots and less parallel parking).
3. Many of the studies involve unique situations (e.g., small towns, the Midwest U.S.) that may not be representative of the U.S. as a whole.
4. Much of the published data (e.g., for the State of Michigan) is for crashes that primarily occur on public roads. However, many parking crashes occur on private property and are not reported.
5. The predominate parking crash (occurring at least half the time) is backing out of a parking spot into either:
 - a. Another car that is backing out of an adjacent space, or
 - b. Another car moving down the parking aisle.
6. There are few day-night differences in crash rates and most crashes occur in the daytime, when most driving occurs.
7. Parking crashes very rarely involve alcohol or drugs.

Based on these conclusions, Smith, Green, and Jacob (2004) suggested that one way to prevent parking crashes, especially those associated with backing up, would be the implementation of an assistive device such as a camera-based parking assistance system.

Accordingly, the experiment described in this report examined an early prototype of a camera-based parking assistance system being developed by Nissan. The system utilizes four fixed wide field-of-view cameras placed around the car (centrally located in the front and rear as well as under the exterior mirrors). An image-processing unit that “stitches” together images from multiple cameras to provide a wide field of view and remove lens distortions manipulates the camera output. Images presented to the driver may be either direct (an image presented directly from the camera) or indirect (an image that is created from components that are stitched together, i.e. a “virtual image,” usually involving a viewpoint change, and as noted, one or more than one images).

To determine a baseline of parking data (that is, data for no camera assistance), Cullinane, Smith, and Green (2004) carried out a field study in Ann Arbor, Michigan,

INTRODUCTION

where they measured how well 102 cars were parked in perpendicular, angle, and parallel parking spaces. In addition, they also completed phone interviews with 20 drivers concerning how often they parked and problems they had while parking.

Results from the biographical data showed that men and women parked equally often in all three types of parking spaces. Younger drivers parallel parked relatively less often than middle age drivers and perpendicularly parked relatively more often than middle age drivers; however, the relative distributions were very similar. Interestingly, 47% of the respondents reported they felt their parking was more accurate than the rest of the driving population. An equal amount reported they felt as accurate as the rest of the driving population, and the remaining few admitted they felt less accurate.

The survey showed that at least 75% of the parking instances involved perpendicular parking with significantly fewer parking events in parallel spaces and much fewer still in angular spaces. In addition, 75% of the reported problems involved leaving a parking spot.

The field study contains data concerning parking situations ordinarily encountered by U.S. drivers. For parallel parking, spaces averaged about 24 feet long. When an excess of space was available, drivers tended to be positioned forward in the space such that the excess was at the rear of the vehicle. Interestingly, there was no relationship between the size of the vehicle and the space around it. The distance to the curb was typically about 4 inches.

For angle parking, the head-in distance was bimodally distributed, with some vehicles having the nose over the end of the space, and others falling short. The same was true for perpendicular parking, though the extent depended on whether a wall was present at the end of the space.

To follow up on these previous reports, three experiments were conducted to examine perpendicular parking, parallel parking, and the minimum clearance desired for parking in general. This report describes the first experiment concerning how well people perpendicularly park with and without camera assistance. The main purpose of this experiment was to select a "best" image or type of image for further development and evaluation, as well as to gather ideas for improvements to the interface.

INTRODUCTION

Given this general purpose, the following questions were considered:

1. Overall, were there differences in how closely drivers parked to the space boundaries as a function of the six image combinations provided?

Performance measures of interest are:

- a. How close the subject drives to adjacent vehicles.
- b. How close the final position is to a wall at the end of the parking space.

2. In general, which type of camera image, direct or indirect, leads to better parking performance?

Performance measures of interest are:

- a. How close the subject drives to adjacent vehicles.
- b. How close the final position is to a wall at the end of the parking space.

3. In general, what number of images (one or more than one) shown on the monitor leads to better parking performance?

Performance measures of interest are:

- a. How close the subject drives to adjacent vehicles.
- b. How close the final position is to a wall at the end of the parking space.

4. Which images did drivers prefer?

5. Does how close people drive to other vehicles to park vary with driver age and sex?

6. Does parking performance change with practice?

7. How could the camera-based parking system be improved?

8. How should the experimental protocol be modified in future studies?

TEST PLAN

Overview

When entering a parking space, the primary concern is striking adjacent vehicles and walls, commonly with the front bumper, driver side back fender, or passenger side front bumper corner. For reasons of safety, this experiment was designed to practically eliminate contacts with other vehicles. Therefore an associated measure, the closest approach for each of these areas, was captured using overhead cameras. Other cameras also provided an overview of the entire maneuver, recorded the subject's face and torso, and the images from the parking assistance system.

The experiment was conducted in a parking lot at UMTRI, between June 25 and June 30, 2004, during daylight hours and in clear weather. The parking space was between two parked cars perpendicular to the traffic aisle. The space had a simulated brick wall as a frontal barrier. (See Figure 1.) The turning radius into the parking space was limited by another vehicle parked across the aisle. Each subject parked three times without a parking assistance system, then three times with each of 6 images, and then an additional three trial without the system for a total of 24 trials per subject.

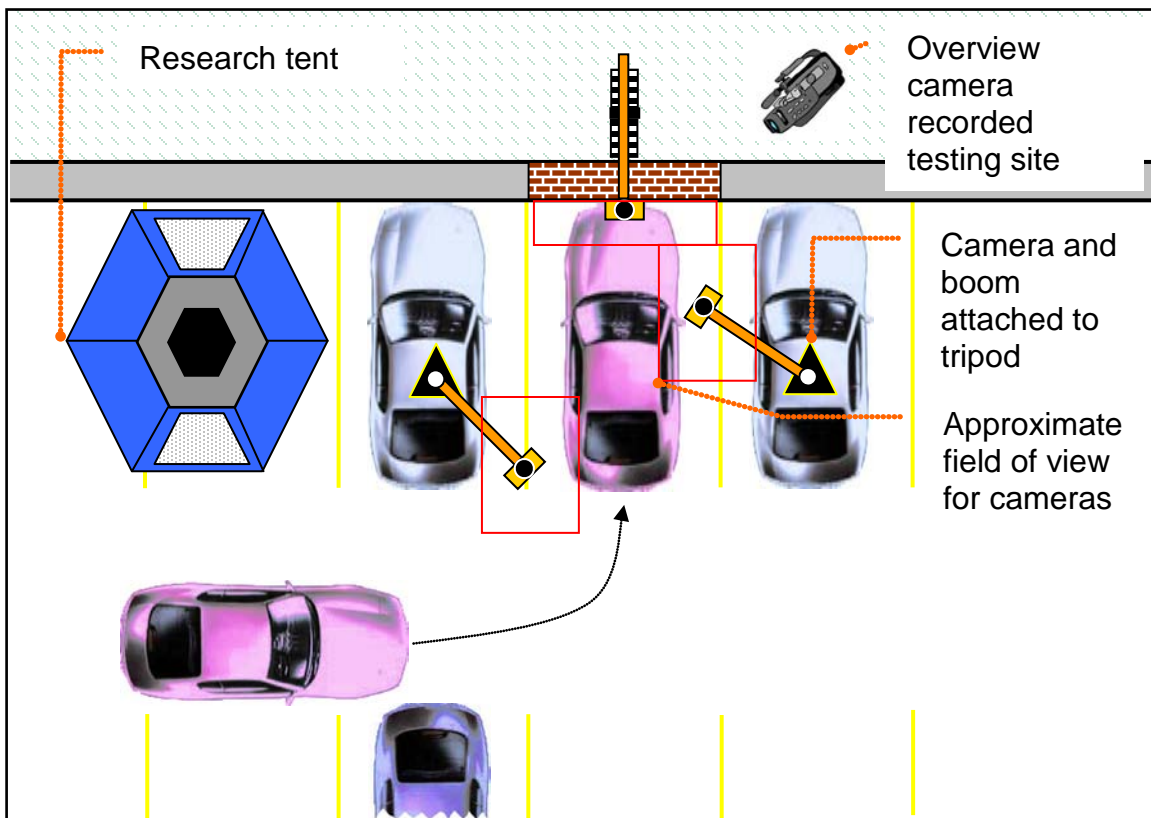

Figure 1. Test Site Overview (not to scale)

TEST PLAN

Participants

Sixteen participants (eight young (18-30) and eight old (over 60)) volunteered roughly 90 minutes of their time and were paid \$30 to complete this experiment. The younger subjects were friends of the experimenters and had not participated in previous UMTRI experiments. All of the older subjects were obtained from lists of participants from previous studies who had indicated interest in further participation and had previously been recruited via advertisements for subjects in the local newspaper. No subjects had driven the test vehicle previously.

Of the eight younger subjects, four were students, two were software engineers, one was a human resources employee, and one was a middle school teacher. All of the older subjects were retired.

To determine how representative the subjects were to the driving population, each was measured for height, weight, and seated eye position within the test vehicle. Statistical summaries appear in Table 2. These heights and weights are reasonably typical of adults in the U.S.

Table 2: Anthropometric Data

Dimension	Device	Mean	Range
Weight	Continental Health-O-Meter Model 230 kg	79 kg	56 - 117 kg
Height	210 cm SiberHegner & Co standing anthropometer	169.8 cm	151.9 - 189.1 cm
Vertical Seated Eye Height	210 cm SiberHegner & Co standing anthropometer	116.5 cm	111 - 121 cm
Horizontal Seated Eye Position	210 cm SiberHegner & Co standing anthropometer	91.9 cm	83.8 - 103.3 cm

For the seated eye height, the horizontal coordinate originated from the interior driver side door bracket that was located 593 mm on the horizontal (longitudinal) axis from the center of the front wheel (which is the origin for all measurements), and the vertical coordinate originated from the road surface. As shown in Figure 2, there was no relationship between eye height and fore-aft location. Typically, the two are correlated with taller drivers sitting farther aft. In this vehicle the power seat and adjustable steering column provided significant flexibility in positioning.

TEST PLAN

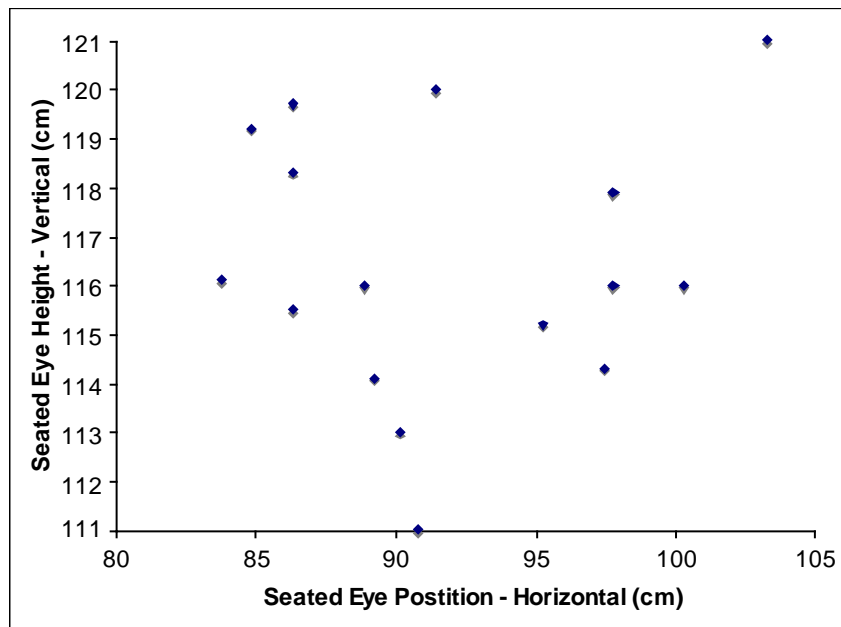

Figure 2. Subject Seated Eye Height Positions

In addition, the subjects' vision was checked for acuity using the Landolt Ring eye test on a Stereo Optical Optec 2000 vision tester on the Far #2 setting without a lens and then again with an 80 cm lens. All eight younger subjects had normal or corrected vision, although one subject was not wearing corrective lenses at the time of the experiment.

The 16 subjects on average drove 9,600 miles, with a range of 400 to 20,000 miles, per year. This value is close to the U.S. mean of 10,000 miles/year. Table 3 below provides mean information regarding the parking frequency of the 16 subjects. The frequency of perpendicular parking is somewhat lower than was found in the prior phone survey.

Table 3. Mean and Percentage Parking Occurrences per Month

	Parallel	Perpendicular	Angular	
Weekdays	15 (14%)	42 (38%)	17 (15%)	67 %
Weekends	7 (6 %)	21 (19%)	8 (7%)	33%
	20%	57%	23%	

Of all 16 subjects, five had experienced a parking-related crash within the past five years. Of those five, four subjects had experienced only one crash and one subject had experienced two parking-related crashes. Six subjects reported experiencing at least one non-parking crash within the last five years. Of these six, five subjects reported one crash and one subject reported three crashes.

The subjects' personal vehicle's age ranged from brand new to 14 years old with a mean of four years; they were typically driving newer vehicles. Fourteen of the 16

TEST PLAN

subjects' vehicles were cars. The two remaining vehicles were an SUV and a minivan. Only three subjects reported having driven with an in-car parking camera. One of these three stated that their primary vehicle was a 2004 Lexus LS430, which is equipped with the Lexus Intuitive Parking Assistance system.

To get a sense of their aggressiveness/risk acceptance, drivers were asked where they would drive on an expressway with three lanes on each side of a barrier. Twelve subjects reported that they usually drive in the center lane (with three commenting they drove in the right lane equally often). The remaining subjects, all below the age of 30, stated that they normally drive in the left lane. Overall, the sample is close to being average in terms of risk acceptance (where lane choice is not biased left or right).

TEST PLAN

Camera Images and Virtual Eye Point

A total of six images (Table 4) was displayed three times each. Each image contains at least one label (e.g., front, left, right) to aid in recognition.

Table 4: Images and Descriptions

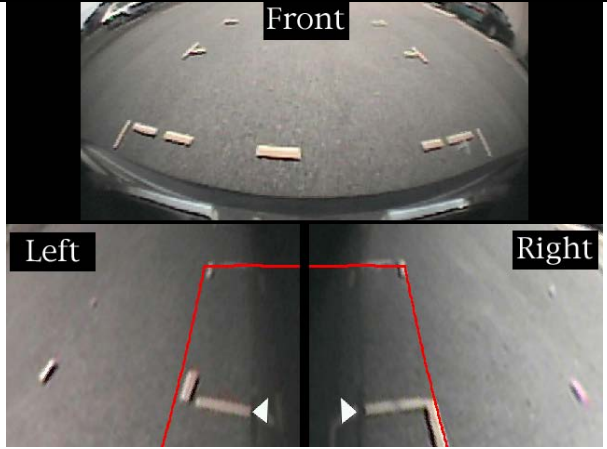
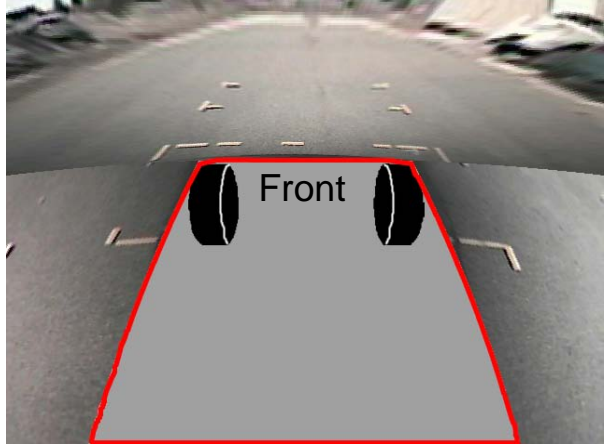
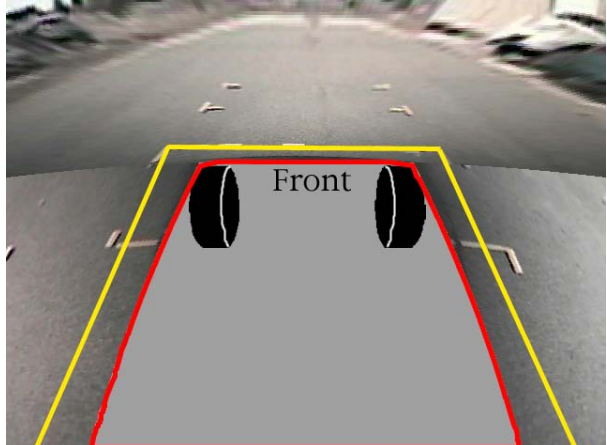
#	Image	Description
1- 3 Panel		<p>This image, divided into three panels, shows the front bumper camera output (with the bumper at the bottom of the image) on the top panel of the image and the two sides looking downward towards the front tires on the lower panels. Triangles represent the bottom of tires and red corners represent the furthest point when the wheel is turned to either lock. Using three close-ups provides detail in the key areas of interest.</p>
2- Virtual		<p>This image shows an elevated virtual eye point as if the driver was able to see through the vehicle's body. The red outline represents the vehicle's footprint (shaded area), and the black ovals represent the front tires on the vehicle. The tires do not move when the steering wheel is turned. The image components in this image are better integrated than those in Image 1.</p>
3- Virtual with Lines		<p>This image is similar to Image 2, but with the addition of yellow parking assist lines on the front and sides of the footprint. As subjects pull into a spot, the natural inclination is to line up the lines on the images with the parking lines, thus helping them pull straight into the parking spot.</p>

TEST PLAN

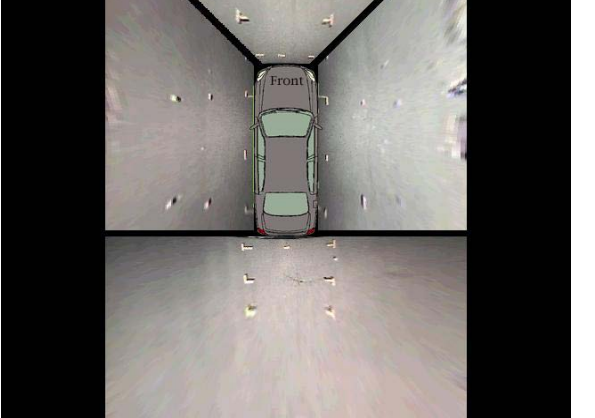
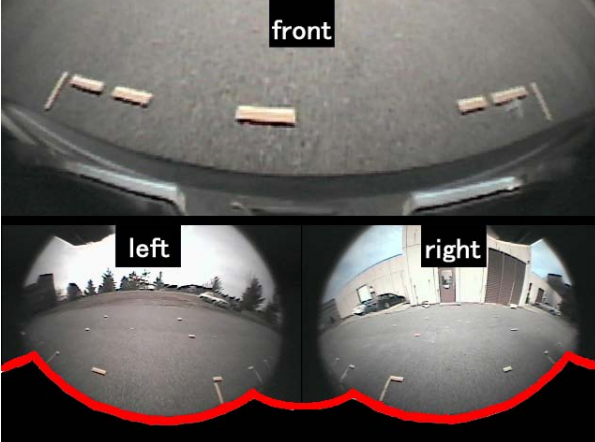
4- Front Fisheye		<p>This image is a fish-eye view from the front camera. The image shows the front bumper and a substantial amount of the horizon. Although the wide angle is a plus of the fish-eye view, the resulting negative is a highly distorted image.</p>
5- Aerial		<p>Described as an “aerial view,” this image uses all four cameras and a superimposed car icon to show a 360-degree view around the car. This view is presented as if there were a camera flying over the car as it moves. When passing close to other vehicles, those vehicles appear distorted (not shown here) in the vertical plane.</p>
6- 3 Panel Fisheye		<p>The top panel of this three-panel image is a close-up of the area in front of the front bumper and is used in final positioning. The horizon is not visible. The bottom two panels are the fish-eye views straight out from the side cameras. The red line, added by the image system, represents the side of the car. This line, as in Image 3, helps to aid in lining the car up within the pavement markings.</p>

According to Shepard and Metzler (1971) and related literature, the time to make same-different judgments concerning pairs of images (in this case the image on a monitor and an internal reference) is linearly related to the angular difference (e.g. in degrees) in orientation of the two images. Also a consideration is the number of dimensions over which translation and/or rotation must occur.

A key issue, which came into play when discussing which image was best suited to the task of perpendicular parking, was that of the placement of the “virtual eye point,” the apparent location of the camera; a change achieved by the image processing system. There are unlimited numbers of camera combinations and virtual eye points that could have been examined. However, given the limited number of conditions that could be

TEST PLAN

examined, some effort was made to examine various heights and forward distances for the virtual viewpoint of the camera as shown in Figure 3. Only locations in the YZ plane were considered.

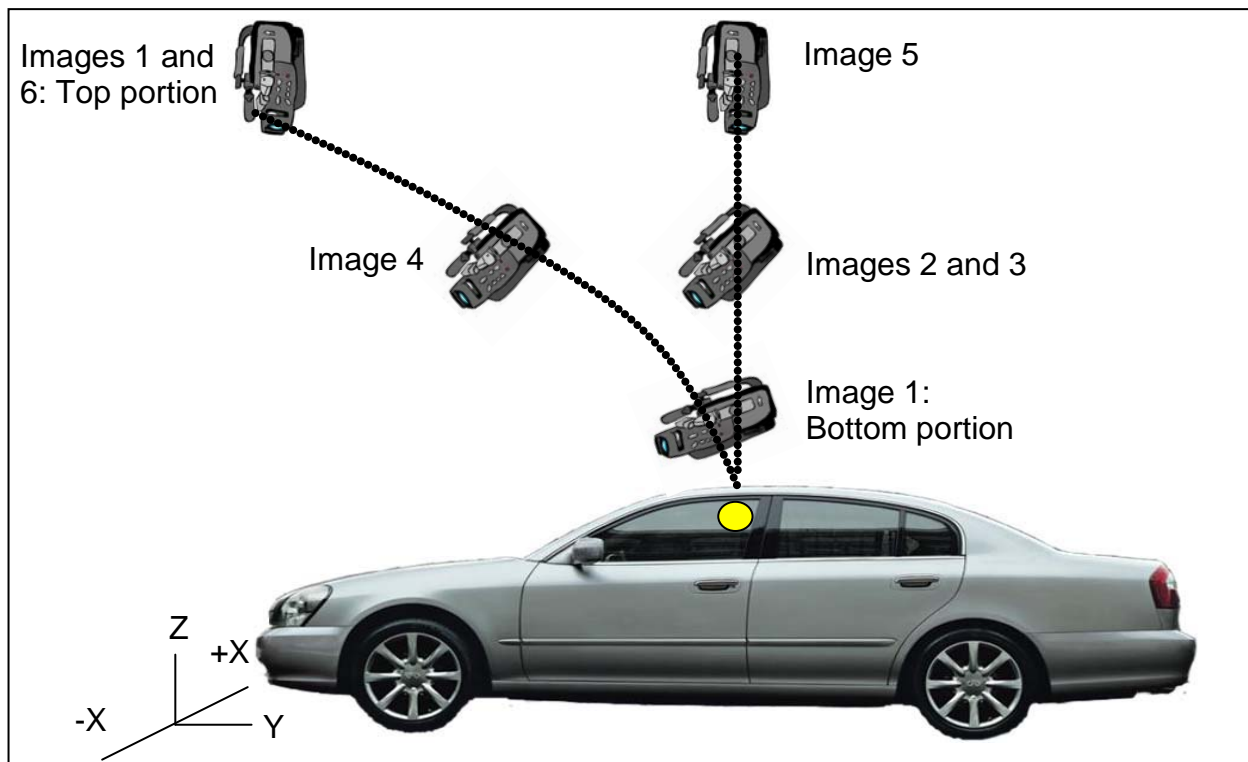

Figure 3. Candidate Virtual Eye Points

The camera location is likely to depend on the viewer's task. For example, in situations where horizontal distances are important, an elevated vertical perspective is desired. For the front bumper, the best position for the virtual eye is directly over and between the bumper and the forward obstacle of interest. The view should be straight down to aid in distance judgment. Any rotation away from this vertical angle would result in a poor perspective that would not accurately represent the distance between the two objects.

The six images were chosen to allow the best location of the "virtual-eye" viewpoint to be examined in a somewhat systematic manner. Eye point location partially confounded another key variable, zoom and its affect on the field of view and image quality, which was not analyzed due to the limited scope of this study.

TEST PLAN

Parking Lot and Equipment Setup

Subjects completed the experiment in portions of the east parking lot at the University of Michigan Transportation Research Institute (UMTRI) in Ann Arbor, MI. The as-built plan for the east lot is shown in Appendix I.

Four parking spaces measuring 20 feet long by 8 feet, 6 inches wide, from center line to center line, were used during the course of the experiment. Three adjacent spaces contained the two parked cars, cameras, and the test space. A car was also parked in the fourth space (on the opposite side of the aisle) to restrict the turn radius of the test vehicle. Space dimensions for the fourth space were the same as the testing space.

As shown in Figure 1, driving performance was recorded using four video cameras external to the test car and mounted above the space to record key distances. Table 5 lists the locations and cameras used, as well as the height of each camera over the ground.



Table 5: Camera Locations and Heights

Location	Camera	Height	
		Ft.	In.
Overview camera	Sony Handycam Vision CCD-TRV615 NTSC	5	0
Driver side	Panasonic GP-KS162 with 3 mm lens	9	5.25
Passenger side	Panasonic GP-KS162 with 3 mm lens	7	6.75
Front bumper	EIA Model KPC-S400	7	2.25

As shown in Table 6, the two side cameras were mounted to 8-foot long, 2 x 4-inch wooden booms and attached in the middle to Bogen Model #3061 tripods. The forward wall camera was mounted to an 8-foot long, 2 x 4-inch wooden boom and clamped to a Werner folding ladder. All cameras were high enough that the subjects could not use them to guide the car into the space.

TEST PLAN

Table 6: Camera Apparatus and Setup

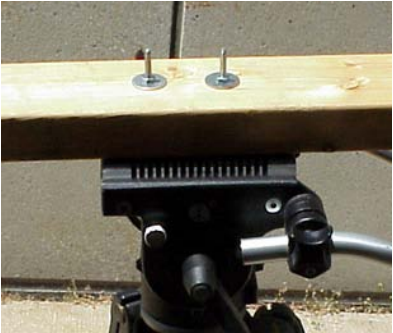
Driver Side Apparatus	Description
 <p data-bbox="592 1564 961 1759"> 1- Tripod leg 2- Wood block 3- Anti-slip mat </p>	<p data-bbox="992 260 1409 436">The driver side camera is mounted to a 1/4" piece of plywood which has protective 2 x 4-inch blocks on either side as seen below.</p>  <p data-bbox="992 806 1409 1016">This mounting plate is then attached to the 2 x 4-inch boom, and the boom is attached to the tripod with bolts and accompanying nuts and washers as seen below.</p>  <p data-bbox="992 1358 1409 1818">The tripod and boom apparatus is positioned on the BMW and stabilized by wooden blocks (2) that are attached to the BMW with tape and have holes in them for the tripod legs (1). A layer of anti-slip mat (3) was positioned between the car and the blocks to prevent damage to the car surface while providing a firm surface.</p>
Passenger Side Apparatus	Description

TEST PLAN



Similar to the driver side camera, the passenger side camera is mounted to a 1/4-inch piece of plywood which has protective 2 x 4-inch blocks on either side.



This mounting plate is then attached to the 2 x 4-inch boom, and the boom is attached to the tripod with bolts, nuts, and washers. See the driver side apparatus for a close up.



The tripod and boom apparatus is positioned on the Taurus and stabilized by wooden blocks that are attached to the Taurus with tape and have holes in them for the tripod legs. A layer of anti-slip mat was positioned between the car and the blocks to prevent damage to the car surface while providing a firm surface. A detailed image is shown in the driver side description.

The external overview video camera is also shown in this picture. The camera was positioned between the wall and the Taurus.

Front Bumper Apparatus	Description
------------------------	-------------

TEST PLAN

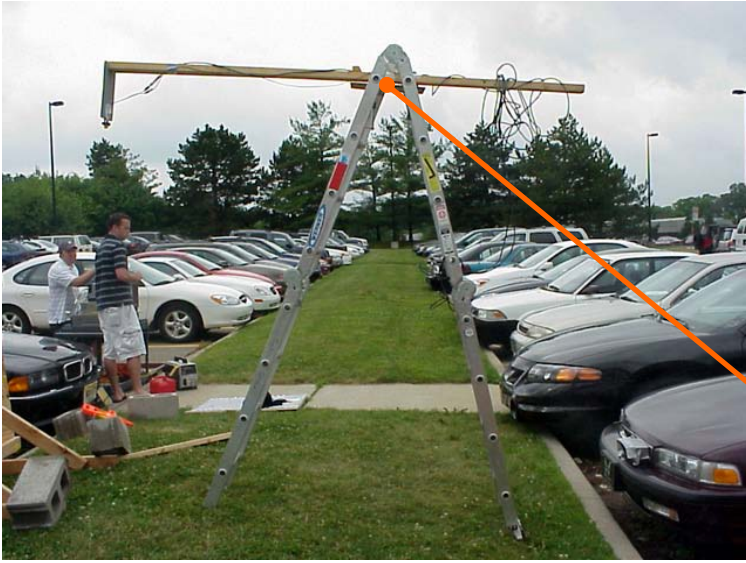

The forward bumper camera was mounted to a 1/4-inch piece of plywood, and then attached to the boom. Due to the area of coverage required by the camera, it was not possible to mount protective block on the side of the mounting plate.

The attachment of the boom was different from the side cameras. Because of the required height, the boom had to be placed on the top of a ladder. The boom was attached to the ladder with two large C-clamps as shown below.



Shown on the left is the overall view of the forward bumper camera. The camera boom hangs over the wall, and records the distance between the front bumper of the car and the wall.

The external instrument stack is shown in Figure 4, and a logical diagram of the external setup and an equipment list can be found in appendices F and H respectively.

TEST PLAN

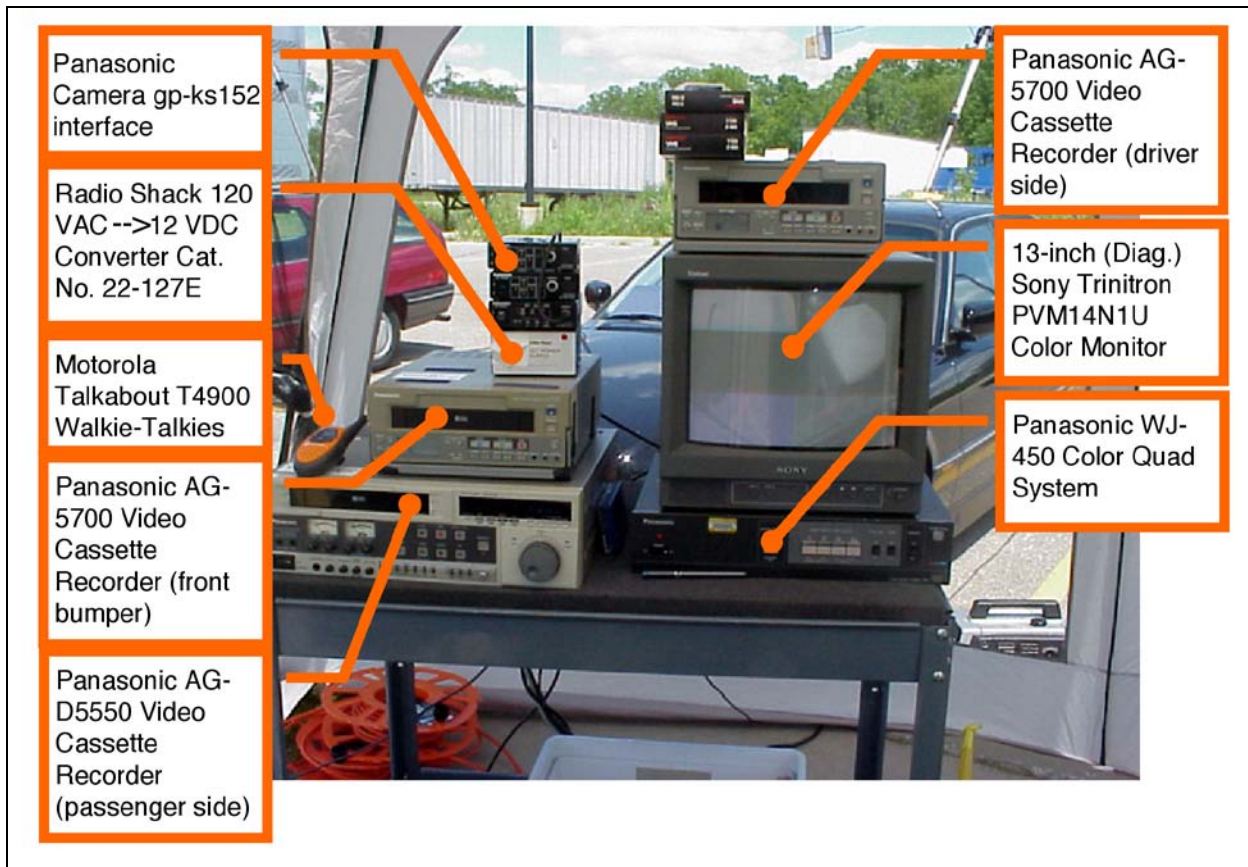

Figure 4. External Instrument Stack

The on-foot experimenter was in charge of overseeing the video recording equipment for each of the three parking stall cameras. The equipment was on a cart located under a tent to prevent sunlight washout of the monitor and overheating of the equipment and the experimenter.

TEST PLAN

The Wall

A simulated brick wall (Figure 5) was constructed and placed even with the edge of the curb to simulate situations where a parking space has a wall in the front, as in a parking structure. The wall was built from a 4 x 8-foot sheet of 1/2-inch plywood covered with a 3/4-inch sheet of insulating foam and faced with simulated brick siding (Nailite International, "Used Buff," <http://www.nailiteinternational.com>). The wall looked realistic and, unlike real brick or brick veneer, was easy to move. The wall was supported on the back by horizontal legs braced to the 2 x 4-inch frame, and weighed down by cinder blocks. This design allowed for a sturdy wall that was both resilient to low-speed collisions and unlikely to cause damage if struck by the car.

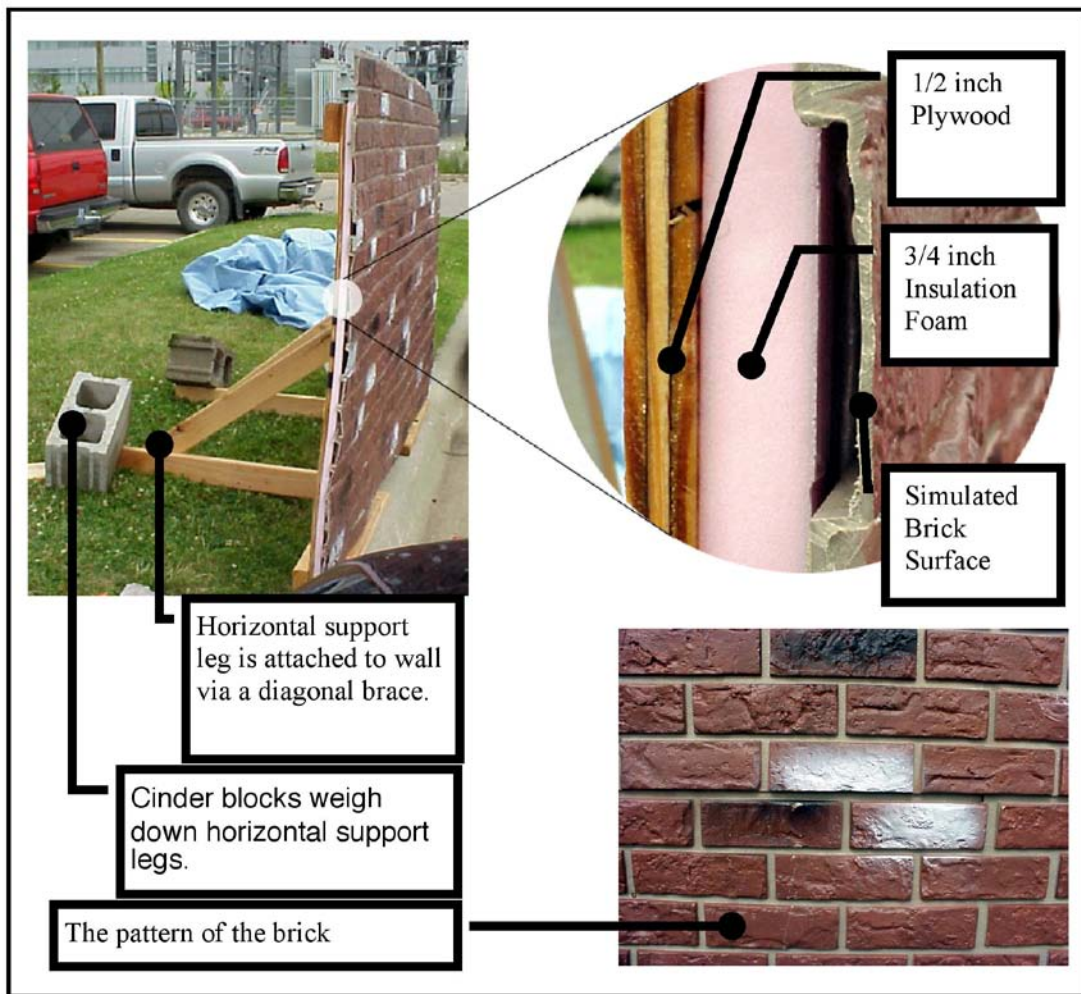

Figure 5. Simulated Wall Construction

TEST PLAN

Test Car

Subjects completed the experiment using a black, instrumented 2002 Infinity Q45. Per the sponsor's specifications, an 8-inch diagonal LCD monitor was mounted to the top of the front dashboard to display the test images. A proprietary six-button control device, used to change images, was mounted into the existing control console as shown in Figure 6. The monitor was situated approximately 5 degrees below eye level and 30 degrees from the center of the line-of-sight.

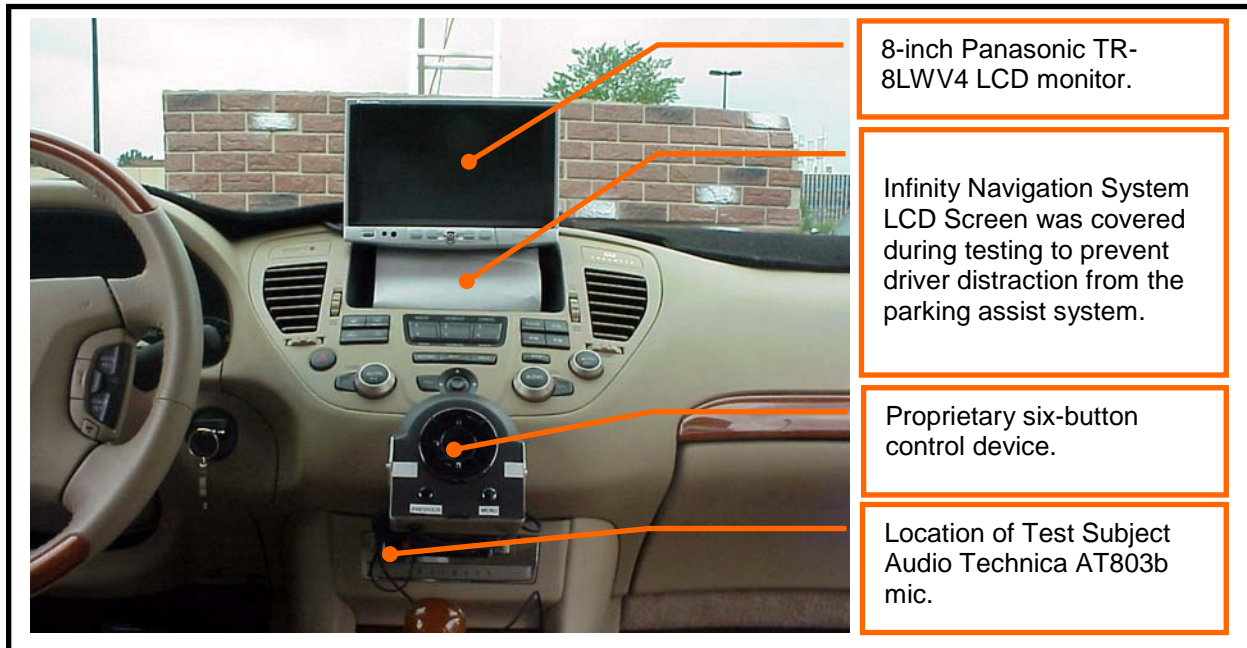

Figure 6. Q45 Center Console Layout

Inside the car, two identical microphones recorded dialog between the experimenters and the subject. One microphone was located under the six-button control device and the other was mounted to the in-car instrument rack. In addition, there were two cameras to record the subject and interaction with the parking assistance system.

The in-car electronics stack, operated by the in-car experimenter, is shown in Figure 7. A logical diagram of the equipment setup within the Q45 can be found in Appendix G and an equipment list in Appendix H.

TEST PLAN

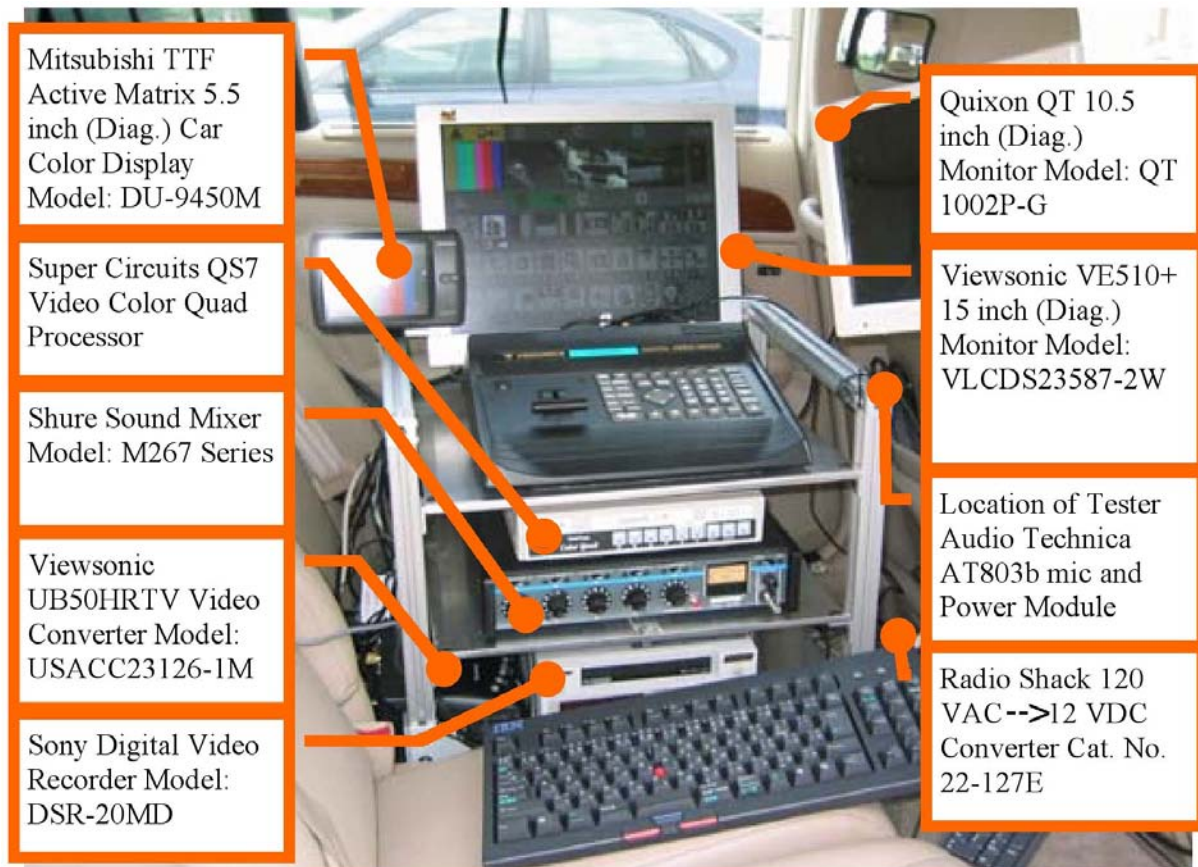

Figure 7. In-Car Electronics Stack (Looking left from the right rear passenger seat)

Nissan developed the camera-based parking assistance system. The in-car electronics were powered with dual AC-DC and DC-AC converters to ensure a clean power supply of the desired voltage. All proprietary image processing hardware as well as a Dell Latitude D505 was stored in the trunk. As mentioned previously, the software could manipulate each of the signals from the four cameras (located on the front and rear bumpers and on the two side mirrors) and present either a single image or an image with multiple components to the driver.

Based on interaction with UMTRI, Nissan programmed the software for the image processor. Images could be changed using the keyboard and a 10.5-inch monitor from the back seat, or by using the proprietary control device from the front seat.

TEST PLAN

Sequence of Experimental Tasks

The experiment lasted approximately 90 minutes and followed the sequence listed in Table 7. When subjects arrived, they were escorted into the UMTRI building. The subject signed a consent form (Appendix A) and completed a biographical form (Appendix B). The experimenter followed a predetermined script (Appendix C).

Table 7: Procedure and Descriptions

Step	Task	Description	Approx. Time (min)
1	Biographical Forms	Forms were completed with information such as name, gender, height, weight, type of car usually driven, parking patterns, car crashes, and results of an eye exam.	15
2	Introduction to Car	Experimenters showed subject how to adjust the seat, measured seated eye height (horizontal and vertical), and demonstrated adjusting the mirrors.	5
3	Introduction and Explanation	Experimenters briefly described the experiment to the subject including the general task to be completed.	5
4	Vehicle Acclimation	Subject parked three times in a parking spot with no cars on either side. Each time, the subject got out of the car to check spacing.	10
5	Parking Protocol (Trials 1-3: Control Trials)	Subject parked three times with no assistance from the system	5
6	Parking Protocol (Trials 4-21: with AVM)	Subject parked 18 times three times with each of six different image combinations	35
7	Parking Protocol (Trials 22-24: Control Trials)	Subject parked three times without assistance from the system	5
8	Post-Experiment Evaluation	Subject filled out forms rating each individual image and the AVM system as a whole.	10

TEST PLAN

After step 1, the subject proceeded to the car and adjusted the driver's seat to a comfortable driving position. The subject's seated eye height was then measured.

The subject then adjusted the mirrors and the two in-car experimenters got into the car to begin the next phase of the experiment. The subject was told the purpose of the experiment was to determine if pictures from TV cameras mounted on the car could help with parking. Subjects were told to keep the car running at all times to avoid problems with the camera system. To become familiar with the test vehicle, subjects looped around the parking lot three times and pulled into a designated practice spot located on their left. The practice spot had at least one empty spot on each side. Each time subjects parked, they got out of the car and observed how close the car actually was to objects around it.

While this occurred, the on-foot experimenter started the VCRs recording the stationary cameras of the test space which were focused on the driver and passenger sides, and the wall. Next, a grid of 1-inch squares was placed in the field of view of each camera at a designated height for calibration. Furthermore, the front seat safety observer, whose role was to watch for pedestrians, traffic, and any other hazards, monitored all activities.

Once all three experimenters and the subject were ready, the on-foot experimenter held up a clipboard displaying the subject, image, and trial numbers. The in-car experimenter verified these numbers, and walkie-talkies were used to resolve potential errors. Upon verification, the subject was instructed to drive in a counter-clockwise loop around the parking lot. As the subject was looping, the on-foot experimenter held up the clipboard to display the subject, image, and trial number for each camera. This set of numbers would be used later when the tapes were analyzed to label trials for the tape reviewers.

As the subject completed the loop, the in-car experimenter instructed them to park to their left in a designated spot between the Taurus and the BMW. When the subject was satisfied with the position in the parking space, the subject put the car in park and waited for instruction to drive the loop again. Subjects were only given a single approach and not allowed to back up. If subjects were too close to either vehicle, the front seat safety observer, the back seat experimenter, or the driver could terminate the trial, but this did not happen during the experiment. After the in-car experimenter verified the next trial number with the on-foot experimenter (to make sure each image was shown the desired number of times in the desired order), the subject backed out of the parking space, looped around, and parked again.

After the subject parked for the third control trial, the in-car experimenter started the DV recorder and while the car was in park, the first image was displayed for the subject to interpret. Subjects were encouraged to use the images to help them park when it was safe to do so.

There were a total of 24 trials; three baseline trials without the cameras, 18 trials with the cameras (six image combinations, each shown three times in a row), and then three additional baseline trials to check for learning. The order of image combinations was counterbalanced across subjects.

TEST PLAN

When the 24 trials were believed to be complete, the on-foot experimenters verified completion using the image check sheet and by communicating with the in-car experimenter. The subject then filled out the post-experiment evaluation form (Appendix E), rated each image as it was displayed on the screen, and answered questions about the usefulness of the system as a whole. The subject was then compensated \$30.

RESULTS

RESULTS

Data Reduction

Due to time constraints, the videotape data was reduced by two analysts working in parallel. The closest point of approach was determined from each of the three cameras (wall, driver side, passenger side) for each trial by first manually advancing the VCR to when the closest approach occurred (as determined by an analyst) on the recorded tape. After this point was determined, a plastic ruler was placed on the viewing monitor to measure the distance of interest perpendicular from a line of bricks on the wall (at bumper height) or the yellow lines indicating the parking space boundaries. To allow the actual distance to be determined from the videotape, a calibration sheet of one-inch squares was held at the bumper height for each camera. By measuring the on-screen separation of the one-inch squares, a correction factor was determined and then multiplied by the recorded distance from the monitor to determine the actual distance.

To ensure consistency, each analyst reduced one tape showing the bumper to wall distance from one subject (24 data points). Each analyst reviewed the same tape twice, with at least four hours between viewings to negate any residual memory of the previous values.

Table 8 shows the within and between correlation coefficients from a single subject. All values are extremely high. Furthermore, no two comparable measurements ever differed by more than 0.125 inches between analysts. For that reason, the data reduction procedure using two analysts was considered extremely reliable and the method of having two analysts split the workload to decrease the reduction time was deemed appropriate.

Table 8: Run-to-Run Correlations

		Analyst 1	
		Run 1	Run 2
Analyst 2	Run 1	.996	.996
	Run 2	.995	.995

Overall, How Close Did Subjects Park to the Wall and Adjacent Vehicles?

Figure 8 below illustrates the distribution of front-bumper-to-the-wall distances from all trials (both with and without camera assistance) for all 16 subjects. The mean was 14 inches with a range of 0 to 34 inches.

There is a large spike approximately at 12 inches from the wall. This was primarily due to a few young female drivers being extremely consistent.

RESULTS

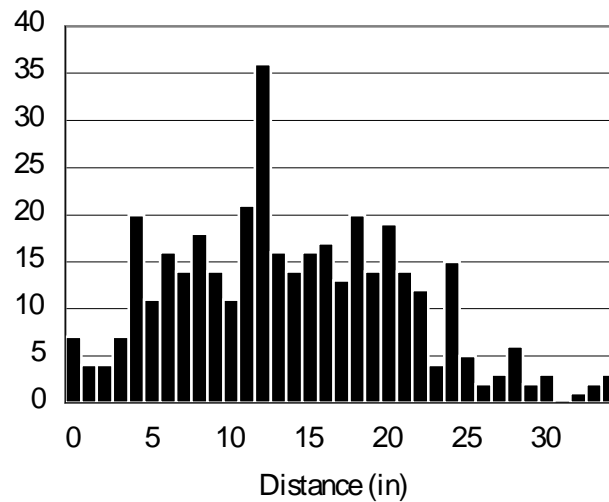

Figure 8. Frequency Distribution of Distances from the Front Bumper to the Wall

Figure 9 shows the distribution of distance values from the passenger side of the test vehicle to the interior edge of the yellow painted line designating the boundary of the parking spot. This interior edge is the designated origin for all values, with positive ranged numbers being on the test space side, and negative numbers being in the adjacent space. The mean value was 4 with a range of -9 to 17. The car parked in the adjacent space on the passenger side was 13 inches from the origin, such that the closest approach value of -9 translates to a distance of approximately 4 inches from the parked car on the driver side.

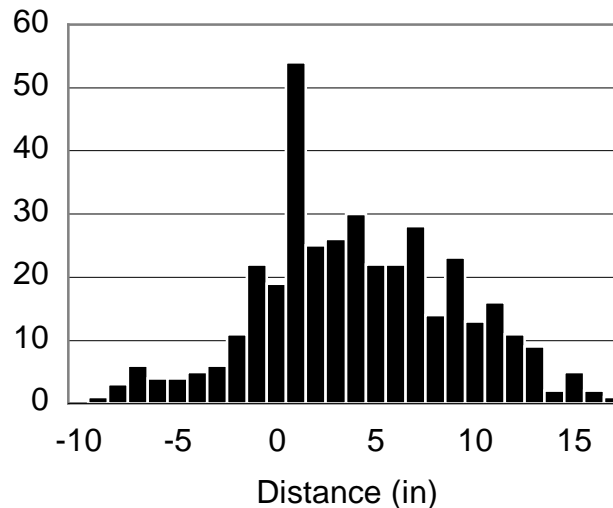

Figure 9. Frequency Distribution of Distances from Passenger Side to Line

Again, a large spike appeared, this time at a distance of 1 inch. Ignoring the spike (which was attributed to subject 3 who was within 1 inch of the 12 inches mark for 23 of the 24 trials) the distance values appear normally distributed.

RESULTS

Figure 10 shows the distribution of closest approach on the driver side. The mean distance to the line was 3 inches with a range of -7 to 18 inches. Interestingly, there were peaks at 2 and 6 inches. Upon examining the raw data, there is no single factor that accounts for the spike that occurs at either point.

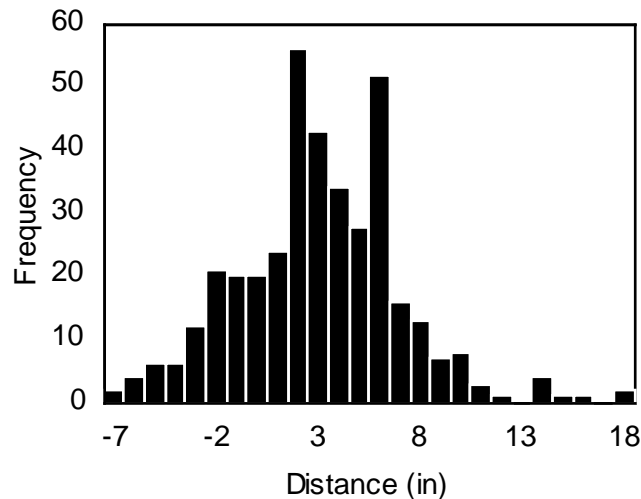

Figure 10. Frequency Distribution of Distances from Driver Side to Line

The parked vehicle was 21 inches from the interior of the line (origin of measurements) so the closest approach was 14 inches from the car on the driver side. Drivers appeared to be biased towards a slightly lower clearance on the driver side, a side that was easier to see from the driver's perspective.

Which Factors Significantly Affected the Closet Approach?

The primary method for examining the factor data was an ANOVA. Typically, UMTRI driver interface experiments reveal strong effects of age (with younger subjects doing better-shorter task times, fewer errors) and an age \times sex interaction (older men worst, young men best). However, in this case those age and sex differences were not as strong. As a result, in many of the analyses the age and sex differences were ignored.

However, an important observation was that not subjects used the parking assistance system as they were not required to do so. Although this diminished the feedback available to improve the interface, it provided a sense of the system's usefulness for this type of parking maneuver.

Accordingly, subjects were partitioned into two groups: users of the parking assistance system (consisting of eight subjects: four men and four women, five of whom were young) and non-users (the remaining subjects). A subject was classified as a user if he or she made an average of two or more glances at the image for each parking maneuver. Users/non-users were not split equally among the four age \times sex cells.

Each of the three closest approach measures (front, driver side, passenger side) was examined separately in an ANOVA. The main effects were subjects (eight users), image (six images + two repetitions of the control condition), and repetitions. Subjects

RESULTS

and images were treated as nominal factors, and trial effects were treated as continuous. Furthermore, since image differences were likely to be random for non-users, only the data for users were examined.

In the ANOVA for front distance, there were significant differences between subjects ($p < 0.05$) and trials ($p < 0.01$), but not between images ($p = 0.39$). Also noteworthy was a significant subject - image interaction ($p < 0.05$) and a subject - image - trial interaction ($p < 0.05$).

For the passenger side, there were significant differences between subjects ($p < 0.0001$), no differences due to images ($p = 0.51$), and limited differences due to trial ($p < 0.1$).

For the driver side, subjects were not significant ($p = 0.28$), nor were the images ($p = 0.37$), and trials were barely significant ($p < 0.10$). Thus, laterally, the primary impact of all of the factors examined was on the passenger side, not the driver side.

This data suggests that in general there were individual differences and differences due to practice, but not many differences due to the different images.

Effect of Practice on Closest Approach

Figure 11 shows the closest approach distances for users and non-users. It is most appropriate to consider the data for all subjects, not just system users, because the basic question is how parking performance changed with practice. The first three and last three trials were control trials during which the parking assistance system was not available. Furthermore, the order of the presented images was counterbalanced, so the figure that follows should only reflect practice. To avoid cluttering the figure, standard error data for each trial are not shown, but were on the order of 1.5 to 2 inches.

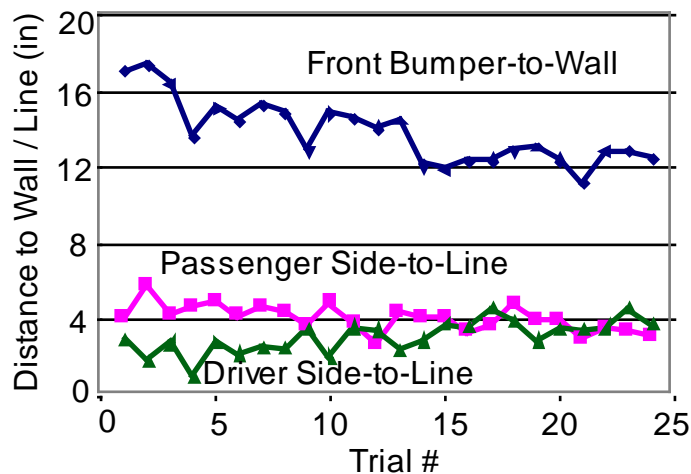

Figure 11. Effect of Practice on the Closest Approach

RESULTS

Trial-to-trial mean differences for the 16 subjects were on the order of an inch or less, decreasing somewhat erratically to trial 14, and then stabilizing at just over 12 inches (about 5 inches less than the clearance from early trials).

The situation with lateral clearances is somewhat different. Subjects began with a greater clearance (at about 5 inches) on the passenger side than on the driver side (at about 3 inches). The two values approach equality over time, with the differences being quite small after 15 trials. Because the approach into the space involves turning, it is not necessarily the case that a close approach on the driver side will always lead to a wide approach on the passenger side (a hypothesis based on side bias), in part because drivers who park poorly could make misjudgments in all directions. Figure 12 shows the relationship between the lateral closest approach measures for each trial for all subjects. There is only a weak relationship between the driver and passenger side clearances during the approach.

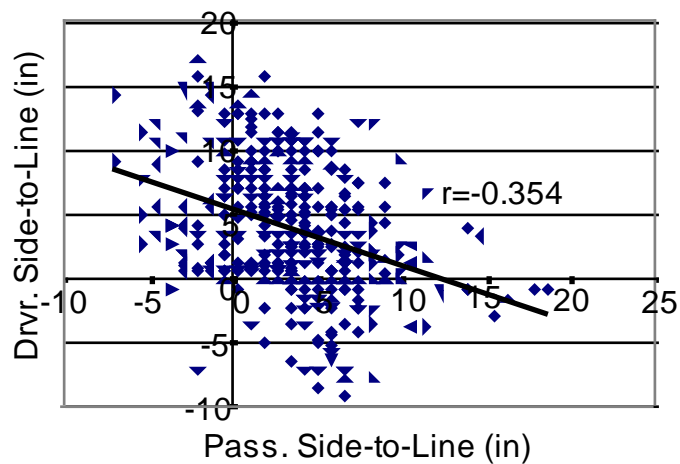

Figure 12. Correlation Test Between Driver and Passenger Sides-to-Line Values

Differences Due to Driver Age and Sex on Closest Approach

Means were computed for all subjects for each of the three distance measures (front bumper to wall, and driver and passenger vehicle to line distance). Figure 13 shows the means for each subject coded by age and sex. Notice that the range of subject differences for younger subjects is much smaller than for older subjects, though there was one young male who parked much closer than the other younger subjects. That is, to a large extent, the older group had subjects that parked both closest (4 inches) and farthest (25 inches) from the wall.

RESULTS

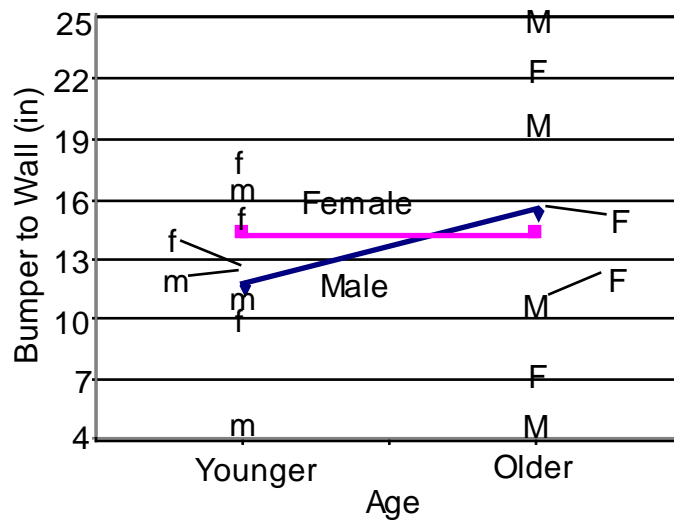

Figure 13. Age/Sex Interaction for Front-Bumper-to-Wall Distance (f,F = female subjects; m,M = male subjects)

For the passenger side (Figure 14), younger drivers came about 4 inches from the line (17 inches from an adjacent vehicle), with older drivers being much more variable than younger drivers. The smallest clearance, the -4 inch distance to the line (13 inches from the adjacent vehicle), was for an older driver.

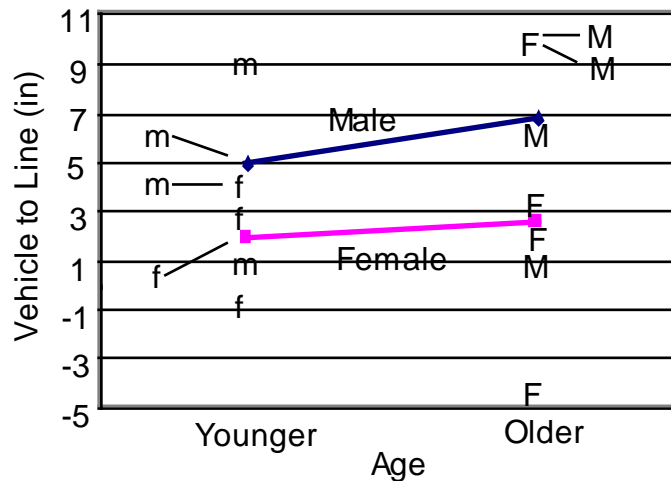

Figure 14. Age/Sex Interaction for Passenger-Side-to-Line Distance (f,F = female subjects; m,M = male subjects)

For the driver side, clearance values of 3 to 4 inches from the line were typical. In contrast to the previous figure, Figure 15 shows that the variability of older and young drivers was about the same. Interestingly, older men and women had roughly the same clearance, whereas younger women had larger clearances than younger men. This ordering is the reverse of the passenger side, where men selected larger clearances.

RESULTS

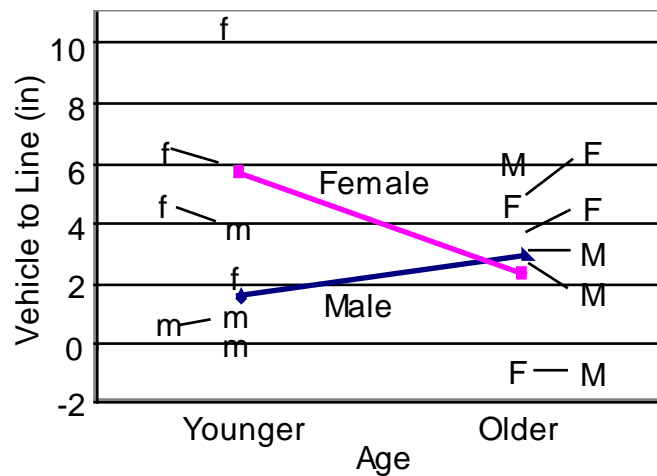

Figure 15. Age/Sex Interaction for Driver-Side-to-Line Distance (f,F = female subjects; m,M = male subjects)

Given the significant effects of practice and subject differences, consideration of interaction between these two factors is appropriate. There were no indications of any interactions between age or sex and trial number within image (see Figures 16, 17, and 18). Furthermore, there were no indications of nonlinear practice effects within images. The difference between trials 1 and 2 was similar to that between trials 2 and 3.

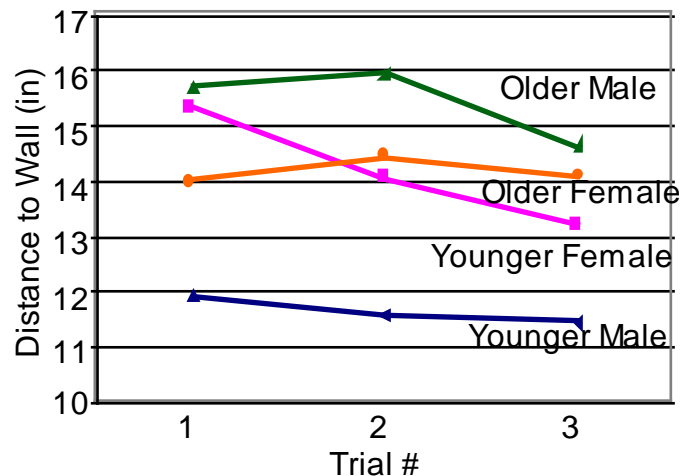

Figure 16. Across Trial Comparison for Front-Bumper-to-Wall Distances

RESULTS

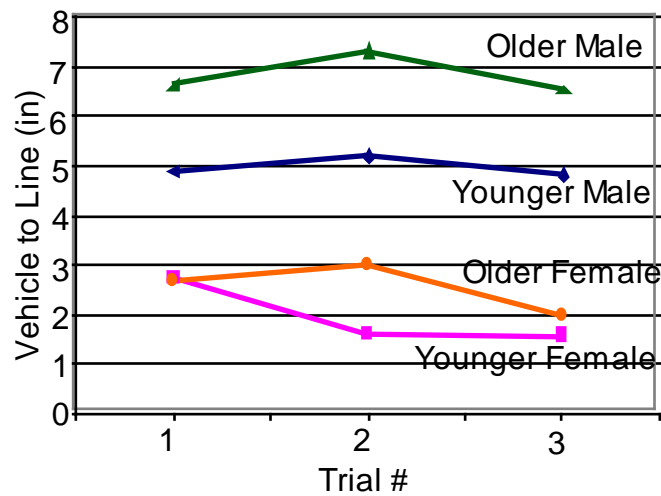

Figure 17. Across Trial Comparison for Passenger-Side-to-Line Distances

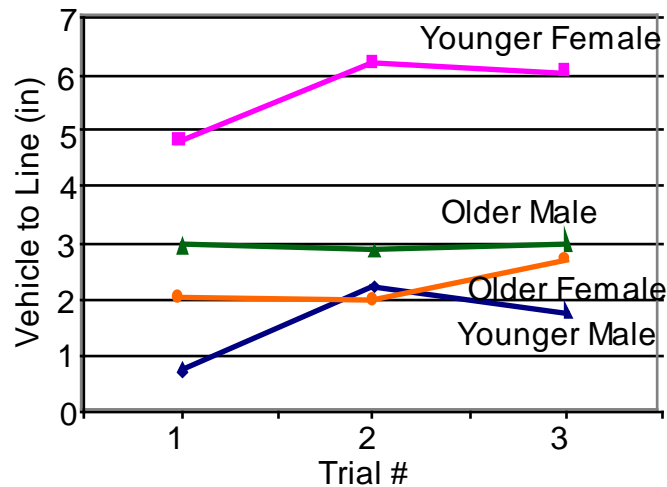

Figure 18. Across Trial Comparison for Driver-Side-to-Line Distances

Effect of Images on Closest Approach

As was noted earlier, there were no statistically significant differences among images in terms of closest approach values. Figure 19 shows the mean closest approach to the wall for each presented image. Not only were the differences among images insignificant, but practice effects (comparing use of no image at the beginning, control-1, with the last block with no image, control-2) were much larger than image differences. It is interesting that of the images examined, clearances were smallest for the aerial images. Figures comparing users and non-users appear in Appendix I.

RESULTS

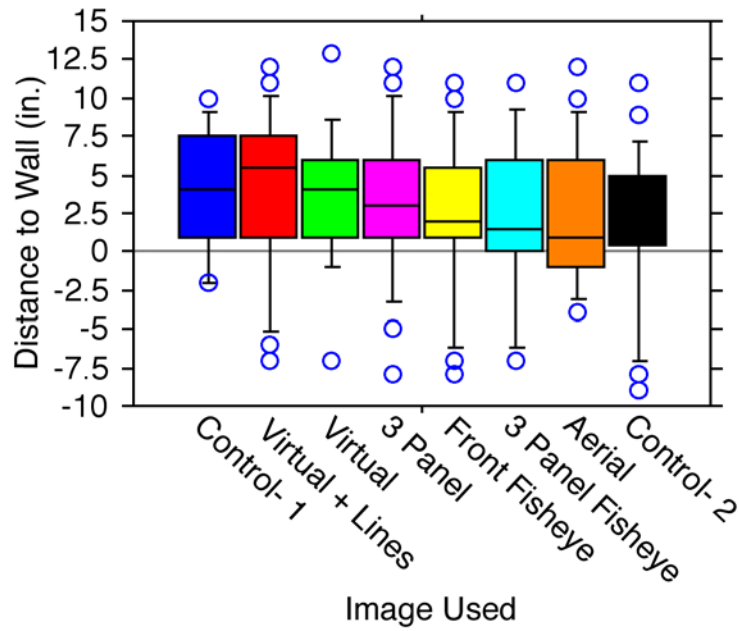

Figure 19. Front-Bumper-to-Wall Closest Approach by Image

Figures 20 and 21 show the differences among images were both insignificant and negligible in size. Again, the main differences were related to practice.

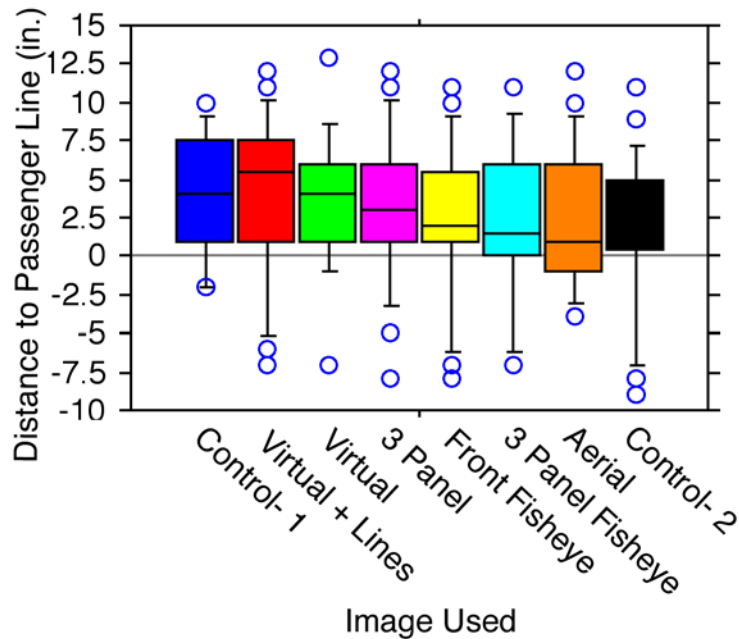

Figure 20. Passenger-Side-to-Line Closest Approach by Image

RESULTS

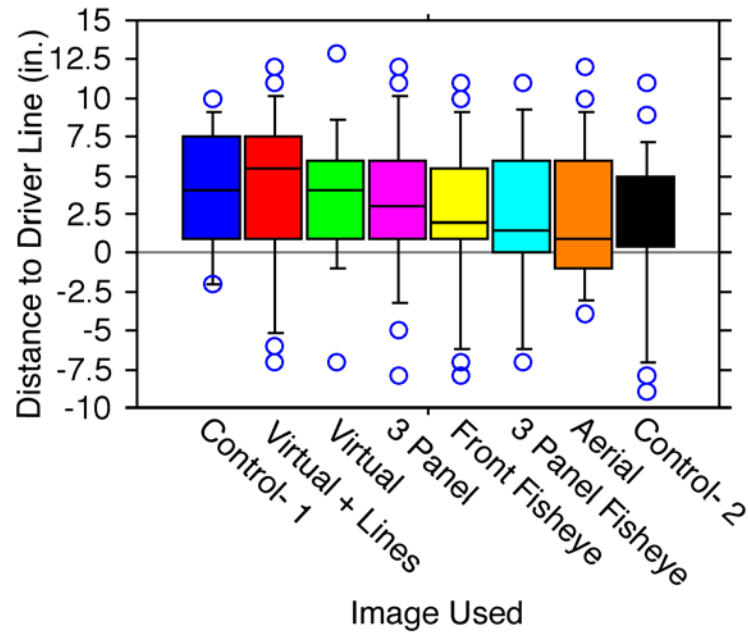

Figure 21. Driver-Side-to-Line Closest Approach by Image

Given the lack of differences among images, the data were pooled in various ways to determine if there were trends across images. Figure 22 shows the mean distances for the three closest approaches. “Direct” refers to where the image was as observed directly by a camera (images 1 (three-panel), 4 (front fisheye), and 6 (three front fisheyes)), whereas “indirect” refers to where images were combined, usually to form a virtual image (images 2 (virtual front), 3 (virtual + lines), and 5 (aerial view)). When using indirect images, drivers parked about an inch closer to the wall. This difference had no other effect on parking.

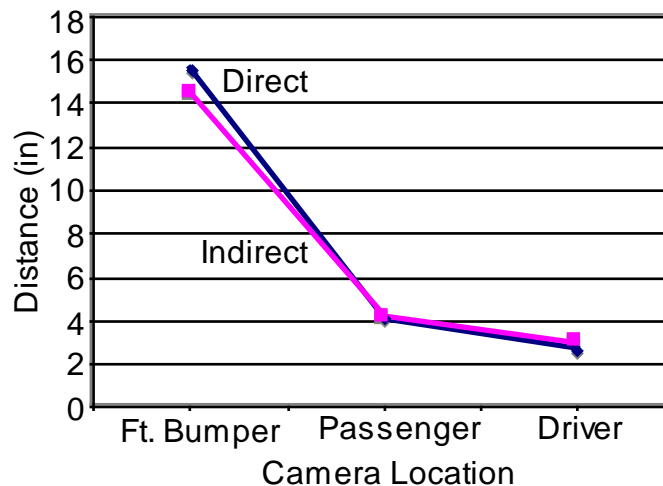

Figure 22. Direct vs. Indirect Viewpoint Effect on Parking Performance

RESULTS

Another underlying issue was how many images to show on the screen at any one time. As shown in Figure 23, drivers tended to drive closer, primarily to the front wall, when a single image was shown (images 2, 3, 4, and 5) than when multiple images were shown (images 1 and 6). The difference was about 2 inches for the front and 1 inch for the passenger side.

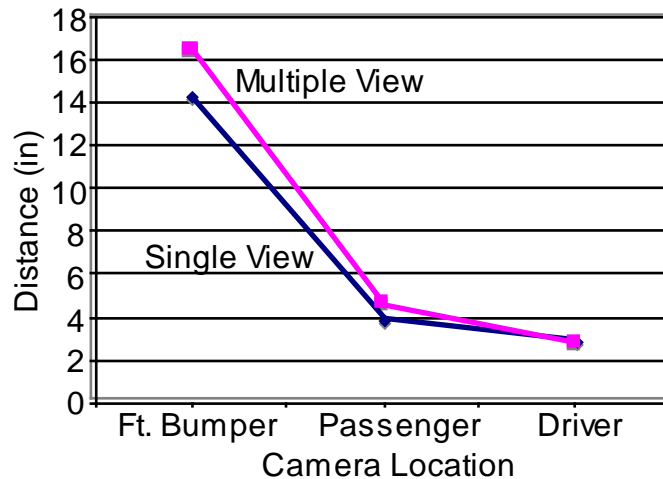

Figure 23. Single vs. Multiple Image Effect on Parking Performance

How Well Were the Images Rated?

Interestingly, in post-test ratings, both users and non-users rated the indirect images as being more useful (by 13%) than the direct images even though the non-users did not actually use them. Table 9 shows the means. The non-user data does not make sense. The mean ratings of 5.4 and 4.1 suggest the systems were neither useful nor useless, yet generally, they were not used. This could reflect the subjects wanting to please the experimenters with regard to the systems being evaluated. However, the user data is consistent with parking performance where users parked closer to the wall while using the system, even though they may not have used it more than two times during the maneuver.

Table 9: Image Ratings by Virtual Eye Viewpoint and User Type
(1= extremely useless, 10= extremely useful)

Viewpoint	System Users	System Non-Users
Indirect	6.8	5.4
Direct	5.5	4.1

As shown in Table 10, single image systems were rate 17% higher than multiple image systems for system users. Further, there was no appreciable difference between single and multiple image systems for non-users; intuitively because they did not use the images to aid in them in parking.

Table 10: Mean Image Ratings by Image and User Type

RESULTS

(1=worst, 10=best)

Image Components	System Users	System Non-Users
Single	6.7	4.8
Multiple	5.0	4.3

Finally, Table 11 shows the images that subjects found most confusing and most helpful as based on the free response question. Users rated the three-panel fisheye (image 5) as being most useful. Not all subjects chose a most useful image, and not all subjects chose a most useless image. Some subjects remained neutral. Consequently, the totals across rows does not sum to 16.

Table 11: Images and Usefulness (by number of subjects)

Image	Users		Non-Users	
	Useful	Not Useful	Useful	Not Useful
1- Virtual + Lines	0	2	0	2
2- Virtual	1	0	1	3
3- Three Panel	1	2	1	3
4- Front Fisheye	2	1	2	4
5- Three-Panel Fisheye	5	0	2	3
6- Aerial	0	4	0	4

How Did Subjects Feel about the System Overall?

Test subjects also rated the parking assistance system on comfort, parking ability, and as a product overall. Users provided ratings close to 7 for these three characteristics (on a 1-to-10 scale, where a score of 10 represents the most positive attribute). In contrast, non-user ratings were neutral (5.5). In theory, however, non-users should have scored each image with a value of 1. It could be that the non-users found some merit in these images or they were, as noted earlier, seeking to please the experimenters. See Table 12 for additional information on these ratings.

Table 12: Mean Parking Assistance System Performance Ratings

	System Users	System Non-Users
Comfort (1=very uncomfortable, 10=very comfortable)	7.2	5.8
Parking Ability (1=made much worse, 10=made much better)	7.1	5.3
Overall Like (1=strongly dislike, 10=strongly like)	6.7	5.2

RESULTS

Table 13 below summarizes subject reports of how the parking assistance system changed the way they parked. Overall, reported changes were minimal. For non-users, the data are inconsistent (it did not make driving safer but it decreased hazards.)

Table 13. Effects of the Parking Assistance Program

Characteristic	Outcome	Users	Non-Users
System Use and Mirrors	Supplement	4	6
	Alternative	4	2
Parking	Made safer	4	2
	Not made safer	4	6
Time to Park	More time	3	3
	No change	1	3
	Less time	4	2
Hazards	Increased	4	3
	Decreased	4	5

Table 14 shows how much subjects (divided into users and non-users) were willing to pay for a parking assistance system. Many subjects found that this early prototype had no value.

Table 14: Suggested Price for System

Users	Non-Users
0	0
0	0
100	0
200	0
300	0
400	0
550	150
1500	400

RESULTS

What Did the Subjects Have to Say about the Images?

During the experiment, many subjects gave vocal feedback about the images and the system. A selection of comments from the in-car videos is included in Table 15. It was apparent from these and other comments that without explanation, subjects did not understand what many of the images were showing.

Table 15: User Comments

Image	Subject	Comment
2, virtual	1	This is kinda blurry, looks like a fish-eye lens effect.
		Getting close to that wall, that top image. It's kind of interesting; it looks like you're driving down, as I'm getting closer. These side images are different, they point more forward and down, I feel.
	1	At first I didn't like the gray box, but now it's kind of handy. The other one was so close together; it was hard to tell them apart.
	15	I really like that one.
3, virtual with lines	1	I like this one the best so far. It's really clear on the parts I really want to see.
	10	The two different lines are confusing. I don't know what the yellow or red lines mean.
4, front fisheye	15	God, I hate this thing.
	16	I'm completely ignoring this one.
6, 3 panel fisheye	15	It doesn't make a lot of sense.
	15	So far, in my opinion, this is useless.
	16	For someone who gets seasick really easy, that's tough!
	16	The trick is to not look at the picture.

CONCLUSIONS

1. Overall, were there differences in how closely drivers parked to the space boundaries as a function of the six image combinations provided?

There were no statistically significant differences in how closely the 16 drivers approached adjacent cars or an end wall as a function of the images provided by the parking assistance system. In part, this was because half of the subjects made limited or no use of the camera-based system provided. Given the early state of the development of the driver interface, the low level of potential customer acceptance is not surprising.

Clearance values for the front wall were larger than those for the lateral spacing. For users of the system, differences occurred among images throughout the experiment. Images 4 (front fisheye), 5 (aerial), and 6 (three fisheyes) led drivers to park slightly closer to the wall and farther to the passenger side than did images 1 (three panels), 2 (virtual front), and 3 (virtual front + lines). For non-users of the system, both the driver- and passenger-side-to-line distances varied minutely, while the average front-bumper-to-wall-distance decreased by 3 inches.

2. In general, which type of camera image, direct or indirect, leads to better parking performance?

Other than parking an inch closer to the front wall using an indirect image, there were no differences in parking performance between direct and indirect image interfaces. The lack of differences could be due to subjects not fully understanding what the images were showing, even though they used them to some degree.

3. Does the number of images (one or more than one) shown on the monitor lead to better parking performance?

The effect of image components was small. Drivers using single images tended to park closer to the wall (by 2 inches) than when using multiple images. One of the images (image 4) simply displayed a large view from the front bumper camera. This image provided a large view that obviously enhances a driver's ability to park closer to a front object. A single image component also produced a closer distance by a difference of 1 inch for the passenger-side-to-line distance over multiple image components. No effect was seen for driver-side-to-line distances. This suggests that the parking assistance system should generally show only one image. However, there is the unconfirmed possibility that it may be acceptable to place two images on a display, which are the same size individually as a single image. Furthermore, it should be noted that the single image recommendation might be specific to the particular display size, screen resolution, or camera quality used in testing.

CONCLUSIONS

4. Which image(s) did drivers prefer?

Overall, subjects preferred images with a single component view that was placed on an indirect virtual eye viewpoint. Images 2 (virtual front), 3 (virtual front + lines), and 5 (aerial) fit this description. For both users and non-users of the camera-based parking system, image 6 (three fisheyes) was deemed the most confusing. System users believed that image 5 (aerial) was the most helpful, while system non-users thought both image 4 (front fisheye) and 5 (aerial) were equally the most helpful. Two subjects reported that no image was confusing.

5. Does how close people drive and park to other vehicles vary with driver age and sex?

In this study, more than is typically the case, differences in parking were individually specific, rather than attributable to age or sex. Overall, older subjects were more variable in how close they parked to the wall than younger subjects, but on average, all age and sex groups parked at approximately the same distance.

For lateral clearance, there were no major differences in the mean or standard deviation of lateral closest point of approach due to age. In terms of gender, women came about 6 inches closer on the passenger side and about the same distance away on the driver side. Keep in mind that the total sample was only 16 subjects, with four subjects in each age-sex group. These data suggest that age and sex differences do not have much impact on lateral placement in parking, and may not need to be controlled in future studies of that topic.

6. Does parking performance change with practice?

How closely drivers approached the parking boundaries changed substantially with practice. For example, over the experiment, the distance from the front wall declined from 17 to 13 inches on average (a reasonable amount considering drivers were unfamiliar with the test vehicle, and some had not driven a large car within recent memory). Performance stabilized at about 15 trials.

7. How could the camera-based parking system be improved?

With practice, drivers equalized the clearance on the driver and passenger sides, and parked closer to the wall. Again, half of the drivers did not use the interface to any significant degree, suggesting considerable room for its improvement.

Distance indicators (e.g., superimposed virtual scales with distances in inches or centimeters) should be evaluated in future enhancements of the parking assistance system. In addition, there may be merits in exploring the addition of threshold indicators (“yellow lines” or “red lines”).

Drivers were not able to judge distance using the camera images, in part because distance references were absent. At this early stage, it seemed most appropriate to test the interfaces without references to determine which interface was best, and to

CONCLUSIONS

explore enhancements of the interface in subsequent evaluations. In fact, one of the subsequent studies has collected data on minimum clearance that will be appropriate for providing design guidance.

The system should be modified to provide better corner coverage. When parking perpendicularly, the critical areas of interest include the front bumper and the corners. The corner locations are the most difficult to judge because they are far from the driver, and due to the body curvature of the vehicle, lacking in landmarks. However, it was at the corners that camera image quality was poorest. Because the cameras were located on the sides of the vehicle and not at the corners, the corners of the vehicle lie on the periphery of the image captured by the camera. As a result, the corners are highly distorted and highly pixilated when presented to the driver. Options for improvement include placing cameras at the corners, modifying the current cameras to increase resolution in the corners, or both.

Prior reports associated with this project have shown that the majority of parking-related crashes occur when backing out of a parking space. Corner coverage is particularly critical for the rear when backing out, and yet cameras fail to provide an image that is as good as or better than the view a driver can obtain by turning his or her head around to look for oncoming traffic. Because of the poor camera quality, and the low placement of the camera on the vehicle, the driver's own eyes provide better coverage in all situations, except when the vehicles on either side of the car are taller than the driver's vertical seated eye height. Because rear corner coverage was not provided, the major problem, prevention of backing crashes, was not assessed.

In addition, when images were shown to drivers, in some sense, they simply did not "get it." Drivers did not understand where the viewpoint was relative to the scene or the scene orientation. One potential solution would be to have a graphic in a corner of the display to provide orienting information. (Figure 24 provides an example.)

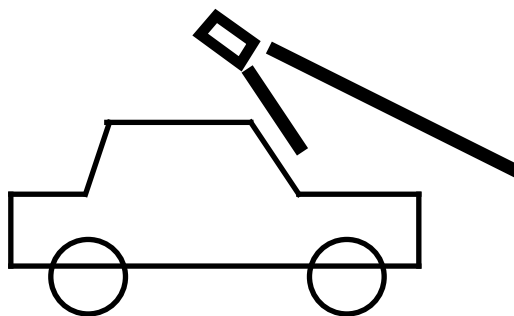

Figure 24. Example Orienting Graphic

In addition, it was often not apparent to subjects that a bumper was appearing in a scene (a problem that could be resolved with a label, e.g., front bumper). A confusion that arose was seeing the word "back" located at the top of an image when the bottom of the image showed the bumper. Labels should be revised to say

CONCLUSIONS

“Back Bumper” and “Front Bumper” and be placed directly on the bumper in the image.

8. How should the experimental protocol be modified in future studies?

Given the noteworthy effects of practice on parking with an assistance system, future studies should continue to counterbalance the order in which systems are evaluated within subject experiments. Furthermore, if studies are to consider parking of experienced drivers, at least 15 trials are required (on average) in addition to three trials where drivers get out of the vehicle to see how closely they parked to a boundary. Most of the improvements seem to be generic rather than specific to a particular interface. Given the typical two-hour limit of a human performance study, this suggests that the number of systems that can be examined in a study of experienced subjects is quite limited.

This experiment examined a worst-case scenario: a driver attempting to park a relatively unfamiliar vehicle using an entirely unfamiliar system. In many ways the drivers who most need parking assistance systems are those who are unfamiliar with the vehicle they are driving. Admittedly, subjects obtained some experience in parking the test vehicle prior to the testing portion of the experiment by parking several times and getting out and checking the vehicle location during the familiarization trials. Those improvements are reflected in the difference between the initial and final control trials. However, the familiarization acquired is far short of the experience one has after years of driving a vehicle, but that level of expertise is impossible to gain within the limited timeframe of an experiment.

Until the interface is useful, what appears on the monitor should be explained to subjects in future studies. In this experiment, drivers were not given any explanation of how the parking assistance system functioned or what the images represented. That approach indicated that drivers did not understand what was being shown and, accordingly, would not and often did not use the interface. Given that is the case, more needs to be known about why drivers do not understand these interfaces, how they can be improved, and if they did understand them, how they would be used, if at all. Obtaining that information will require much more subject-experimenter interaction than was allowed in this experiment.

If a system is meant to be easy to use (which is the goal for these systems), then eventually no explanation should be required before someone tries to use it. After the improvements outlined here are completed, a “walk up and use” experiment such as this one would be appropriate.

CONCLUSIONS

CLOSING THOUGHTS

Upon first examination of the system, experimenters felt that there were design flaws that may limit the scope and capabilities of the system. These concerns were verified by the experiment both in terms of driver comments and parking performance.

Specifically, the purposes of this experiment were to determine (1) if the current parking interfaces were helpful (they were not), (2) how the interfaces might be improved (relocate cameras or improve resolutions, provide orienting graphics, modify scene labels, and add distance marks), and (3) how the evaluation method might be improved (more interaction between the subject and experimenter).

An appropriately designed parking assistance system should reduce parking-related crashes. This and prior work continue to emphasize the need for enhancement of the interface and hardware to support backing out when perpendicular parking. The authors believe these changes will lead to major improvements in the interface and the test method, and that the interface is worthy of continued development.

REFERENCES

REFERENCES

Cullinane, B., Smith, D., and Green, P. (2004). Where, When, and How Well People Park: A Phone Survey and Field Measurements (Technical Report UMTRI 2004-18), Ann Arbor, Michigan: University of Michigan Transportation Research Institute.

Smith, D., Green, P., and Jacob, R. (2004). Parking and Low-Speed Crashes: Crash Database, Literature, and Insurance Agent Perspectives (Technical Report UMTRI 2004-9), Ann Arbor, Michigan: University of Michigan Transportation Research Institute.

Shepherd, R.N. and Metzler, J. (1971). Mental Rotation of 3-Dimensional Objects, Science, 171, 701-703.

APPENDIX A – SUBJECT CONSENT FORM

APPENDIX A – SUBJECT CONSENT FORM



UMTRI
University of Michigan
Transportation Research Institute
2901 Baxter Road, Ann Arbor, MI 48109-2150

Participant
number: _____

Parking and Low Speed Driving – Inside Subjects
Investigators: Paul Green (763 3795) UMTRI Human Factors

An automotive manufacturer is developing devices to help people park and drive a slow speeds. In this experiment you will be parking a test car in the UMTRI parking lot a number of times using a vehicle outfitted with a special camera system to help you park. This system has similarities to those in luxury cars but is more sophisticated. We will be recording what you do and asking for your preferences for various system features.

All of the parking will be in the UMTRI lot and at no time should your speed exceed 20 mph. In fact, most of the driving will be at 3-5 mph, so the risk of a serious crash is minimal.

The results of this study, summarized in a report for the sponsor and the public, will be used to make future vehicles easier and safer to drive.

There are no risks associated with this experiment other than those associated with ordinary driving. You may withdraw from this study at any time without penalty. The study should take 1-2 hours. Time spent as a subject will be covered by the project account. There is not additional compensation.

As noted when you were recruited, to record the process of what drivers do and where drivers look, we will be recording this experiment on videotape.

I HAVE READ AND UNDERSTAND THE INFORMATION PRESENTED ABOVE. MY PARTICIPATION IN THIS STUDY IS ENTIRELY VOLUNTARY.

Print your name

Date

Sign your name

Witness (experimenter)

I agree to be videotaped in this study and realize my face will appear on the tape. I understand that segments from the tapes may be used in presentations to explain the results. My name will not be disclosed with the tape. The raw tapes will be erased 10 years after the project is completed.
[Optional]: Sign your name _____

Segments from videotapes of my sessions may be used by the media (e.g., on TV) to help explain this research to the public.
[Optional]: Sign your name _____

Should you have questions regarding your participation in research, please contact Kate Keever: Human Subjects Projection Office, IRB Behavioral Sciences, 540 East Liberty Street, Suite 202, Ann Arbor, MI 48104-2210, Ph: 936-0933, fax: 647 9084, email: IRBhsbs@umich.edu, web: <http://www.irb.research.umich.edu>

APPENDIX B – SUBJECT BIOGRAPHICAL FORM

University of Michigan Transportation Research Institute
 Human Factors Division

Subject:

Around View Monitor Study Biographical Form Date:

Name: _____

Male Female (please circle) Date of Birth: / /
mm / dd / yy

Seated Eye Height Ver. (cm) _____ Weight (kg) _____ Height (cm) _____

Seated Eye Height Hor. (in.) _____ Occupation _____
(e.g. mechanical engineer, courier, etc)

What kind of motor vehicle do you drive the most?
 year: _____ make: _____ model: _____



Miles you drive per year: _____

During the past 5 years, in how many:

Parking crashes have you been involved? _____

Non-parking crashes have you been involved? _____

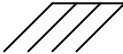
How many times per month do you park in:

<u>Angular spaces:</u> 	On Weekdays:	On Weekends:
_____	_____	_____
<u>Parallel spaces:</u> 	_____	_____
<u>Perpendicular spaces:</u> 	_____	_____

In how many previous UMTRI studies have you participated? _____

Have you ever driven a car with an in-vehicle parking camera? _____

If you were driving on a 3-lane highway, what lane would you typically drive in?

Left Center Right

For Experimenter:

Vision Correction: Yes (Eye Glass, Hard Contact Lens, Soft Contact Lens), No
 Titmus Vision: (Landolt Rings)

1	2	3	4	5	6	7	8	9	10	11	12	13	14
T	R	R	L	T	B	L	R	L	B	R	B	T	R
20/200	20/100	20/70	20/50	20/40	20/35	20/30	20/25	20/22	20/20	20/18	20/17	20/15	20/13

1	2	3	4	5	6	7	8	9	10	11	12	13	14
T	R	R	L	T	B	L	R	L	B	R	B	T	R
20/200	20/100	20/70	20/50	20/40	20/35	20/30	20/25	20/22	20/20	20/18	20/17	20/15	20/13

APPENDIX C – PRETEST SCRIPT

APPENDIX C – PRETEST SCRIPT

Hello <Subject's Name>, my name is <Your Name>, and I am going to get you set up for this study. The first thing we need to do is to get some paperwork out of the way. So please fill out this form

Give subject participation form to fill out

This form basically states that you are aware of the type of study being conducted, you know how long the study will take, and that the study takes place in a car that you will be driving at low speeds.

In addition, the form also informs you that you will be video taped during the study, and your video may be used in presentations to explain the results of the test. It also states that the media may use your video. In both cases, your name will NOT be disclosed anywhere on or with the video.

Do you have any questions? Then please print and sign your name where appropriate, and when you are finished, please hand the form to me.

Because this study involves driving, while using an in-car display, we need to know how good your eyesight is, so we will now do a brief vision test. May I please see your driver's license?

Verify validity of license, and make sure birth date is correct.

Ok, please have a seat at the eye test machine.

Clean head pad with alcohol swab.

Ok, for the entire test, please keep looking straight ahead. Can you see that in the first diamond one of the circles is complete, but the other three are incomplete? For each diamond, please tell me its number, and the location of the complete circle, top, bottom, left, or right.

Perform visual acuity test Far #2 without lenses in place.

Ok, good. Now we are going to do a similar test. Again, please tell me the number of the diamond, and the location of the complete circle.

Perform visual acuity test Far #2 with 80 cm lenses

Because your position within the car will be important we need to get some biographical dimension data from you. The first measurement that we need to take is your weight. Please remove your shoes, and empty your pockets of their contents. Please also

APPENDIX C – PRETEST SCRIPT

remove any watches, cell glasses or any other objects you may be carrying. This is also a good time to turn off any cell phones or pagers that you have.

Measure and record weight.

Next we need to measure your height, so step off the scale and stand up straight next to our measuring device with your head level to the ground.

Measure and Record height.

Ok, we are ready to go out to the test vehicle. Go ahead and put your shoes back on, and gather your belongings. This will also be the last time to use the restroom or to get a drink until the conclusion of the study. If you need to use the restroom or get a drink, please do so now.

Walk to test car.

This is <Experimenter Name>, and <Experimenter Name>, they will be helping with the study from here. Please have a seat in the car, and adjust the seat so you are comfortable. There are controls on the bottom left side of the seat to control the seat position.

Show subject controls.

When you feel that you are in a comfortable driving position, please place your hands on your lap, so we may measure your seated eye height. This measurement is important so we can tell what your field of view was like while in the vehicle.

Measure seated eye height, height first (vertical distance), and then distance from car reference (horizontal distance).

Very good. We are now going to begin the study. The car is already started, so please close the door, and adjust your mirrors to your needs.

Show subject control for side mirrors.

APPENDIX D – PERPENDICULAR PARKING INSTRUCTIONS

APPENDIX D – PERPENDICULAR PARKING INSTRUCTIONS

Perpendicular Parking Procedure Instructions for AVM Project

Note: This task is done with the AVM system on.

Part 1: Introduction and Explanation

The purpose of this experiment is to determine if pictures from TV cameras mounted on this car can help with parking. You will park 6 times without the camera system and 18 times with it (3 attempts with each of 6 views) for a total of 24 times. Each time you park, enter a spot on the left, put the gearshift in park when in the final position, back out, and then loop around via the access road to re-enter the same spot. Driving on the access road is safer than down the parking lot aisle. Once you begin entering the parking spot, do not back out to realign the car within the slot. However, if you might hit a car or are uncomfortable with your parking, back out of the spot, loop around the parking lot, and try again.

To avoid problems with the cameras, do not turn the car off at any point during the experiment, even when the experiment is over. Also be very careful when driving and parking this very expensive car to avoid hitting other cars. Do you have any questions?

Part 2: Vehicle Familiarization

To get a “feel” for this car, slowly drive around the parking lot a couple of times. We would also like you to park in an empty spot on your left that does not have cars on either side. Once you have parked the car, put the car into park, get out, and check how far the car is from the boundaries of the spot. Use these practice trials to get a sense of how close the car actually is to objects around it. You will practice parking in an empty spot 3 times before data collection begins. Between each parking maneuver, please drive around the lot, and return to the spot, and re-park. Any questions?

Ok, please pull around the UMTRI building and drive towards the parking lot on the other side. Before leaving this lot, make sure to signal and check for oncoming traffic. Always drive counter-clockwise around the parking lot so that you can enter the parking spot from the left.

After the acclimation trials and when the subject is ready to begin, have him or her drive to the testing tent to begin the experiment. The experimenter on foot will hold up the image and trial number to the car, and then in front of each camera. The experimenter inside the car will verify they image order on the Image Selection Sheet and will adjust the AVM system so that the appropriate image is displayed on the monitor.

Part 3: Parking Protocol (Trials 1-3: Control Trials)

Please drive a counter-clockwise loop around the parking lot. This first set of parking maneuvers will be done without the camera system.

APPENDIX D – PERPENDICULAR PARKING INSTRUCTIONS

The in-vehicle experimenter should ensure that the AVM system display is turned off. While subject is driving, the experimenters should ensure that at no time is the car in a position to cause or receive damage.

As the car approaches the parking spot (which should be on the left), say:

Now, enter the parking spot. When you are satisfied with your parking result, stop the car and let me know.

After the subject is satisfied with his or her parking result, motion to the on-foot experimenter, who will hold a clipboard in front of the car and cameras showing the next image number to be tested. The experimenter inside the car will verify they image order on the Image Selection Sheet.

When you are ready, please back the car out of the spot and loop around the parking lot to begin your next trial.

Repeat Part 3 until all 3 trials are complete.

After the subject is satisfied with his or her parking result, motion to the on-foot experimenter, who will hold a clipboard in front of the car and cameras showing the next image number to be tested. The experimenter inside the car will verify the image order on the Image Selection Sheet.

Turn on AVM system display and adjust the AVM to the appropriate image.

Part 4: Parking Protocol (Trials 4-21 with AVM)

When the subject has completed the control trials, turn the AVM to the appropriate map.

For the next set of parking maneuvers there will be an image on the dashboard screen showing varying views around this car. You should try to use these images to help you park when it is safe to do so. To familiarize you with the system, please look at this first image for a few seconds and then we will continue with the experiment. Unfortunately we are unable to answer questions pertaining directly to an individual image, but if you have general questions about the system or experiment, do not hesitate to ask.

A final word before we begin. Even though there are other people in the car, ultimately, as the driver, you are responsible that this car is driven safely. Those other people are not there to guide you, so drive as if they were not present.

Now back out of the space and loop around the parking lot.

As the car approaches the parking spot (which should be on the left), say:

Now, enter the parking spot. When you are satisfied with your parking result, stop the car and let me know.

APPENDIX D – PERPENDICULAR PARKING INSTRUCTIONS

After the subject is satisfied with his or her parking result, motion to the on-foot experimenter, who will hold a clipboard in front of the car and cameras showing the next image number to be tested. The experimenter inside the car will verify they image order on the Image Selection Sheet

**Repeat Part 4 until all 18 trials are complete.
Change the image ONLY when parked.
Repeat Part 3 for last 3 control trials.**

After the final trial is completed, the on-foot experimenter should verify there are no missing data points on the data collection sheet, and everything written is legible. If something is uncertain, cross out the value and write the correction next to it – do not erase or write over data. If everything is accounted for, signal to the interior experimenter.

When the on-foot experimenter gives the go-ahead signal, the in-vehicle experimenter should say:

We now would like you to complete a brief post-experiment evaluation regarding the camera system's usability. Please shift into park and leave the car running.

After the subject completes the evaluation, the in-vehicle experimenter should verify that everything is legible. If something is uncertain, cross out the value and write the correction next to it – do not erase or write over data. If everything is accounted for, say:

We have completed this experiment. Here is your payment and we thank you for your time.

APPENDIX E – POST-TEST EVALUATION FORM
SUBJECT POST-EXPERIMENT EVALUATION

IMAGE 1: Rate image 1 by placing a tick mark on the scale below

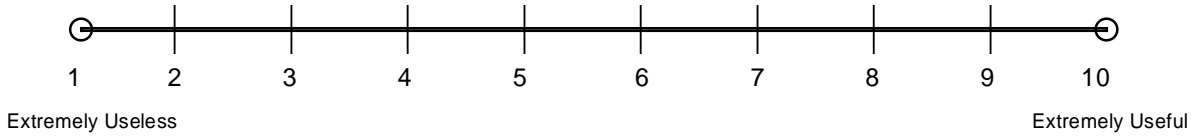

IMAGE 2: Rate image 1 by placing a tick mark on the scale below

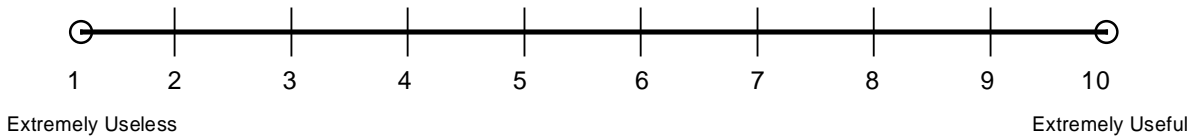

IMAGE 3: Rate image 1 by placing a tick mark on the scale below

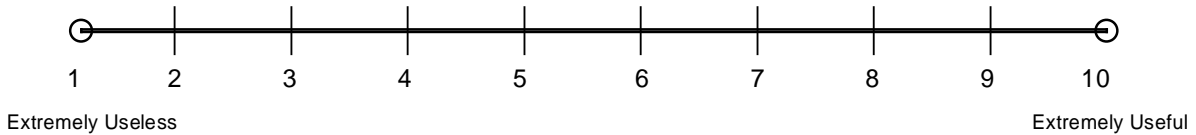

IMAGE 4: Rate image 1 by placing a tick mark on the scale below

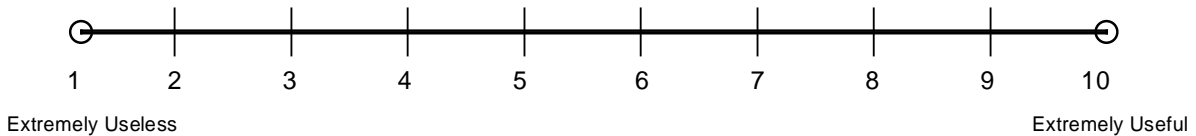

IMAGE 5: Rate image 1 by placing a tick mark on the scale below

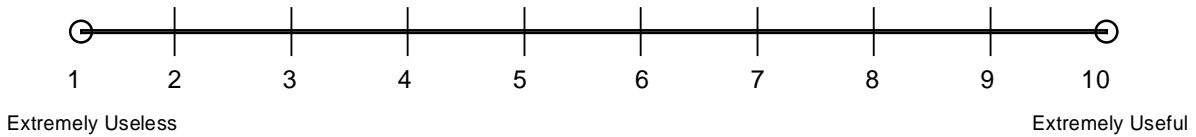
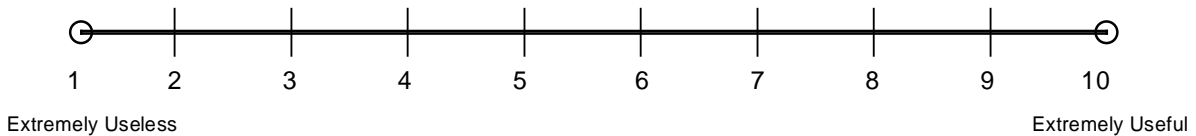
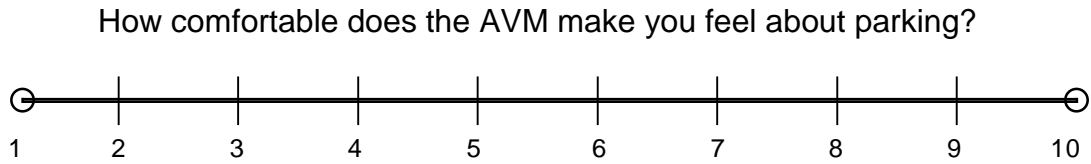
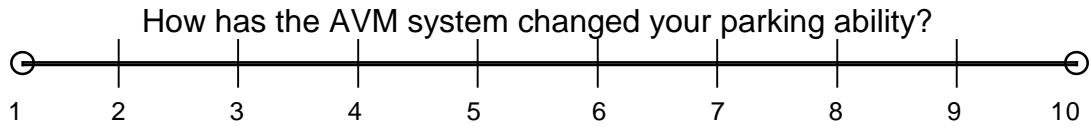

IMAGE 6: Rate image 1 by placing a tick mark on the scale below



APPENDIX E – POST-TEST EVALUATION FORM



Do you feel safer in your vehicle while using the AVM system? Yes No

Did you find yourself using the AVM system as a supplement to your mirrors or as an alternative? Supplement Alternative

Do you feel it took more or less time for you to park? More time Less Time

Which image did you find most helpful and why?

Did you feel the AVM system created hazards to your parking ability? Is so, what hazards?

Which image or parts of an image were confusing and why?

How would you solve these problems?

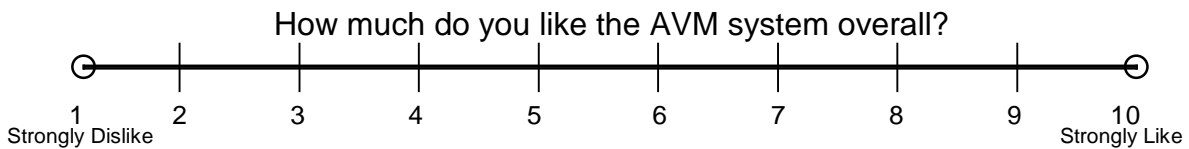

How much would you be willing to pay for the AVM system in your vehicle?
\$ _____

APPENDIX F – EXTERNAL EQUIPMENT WIRING DIAGRAM

APPENDIX F – EXTERNAL EQUIPMENT WIRING DIAGRAM

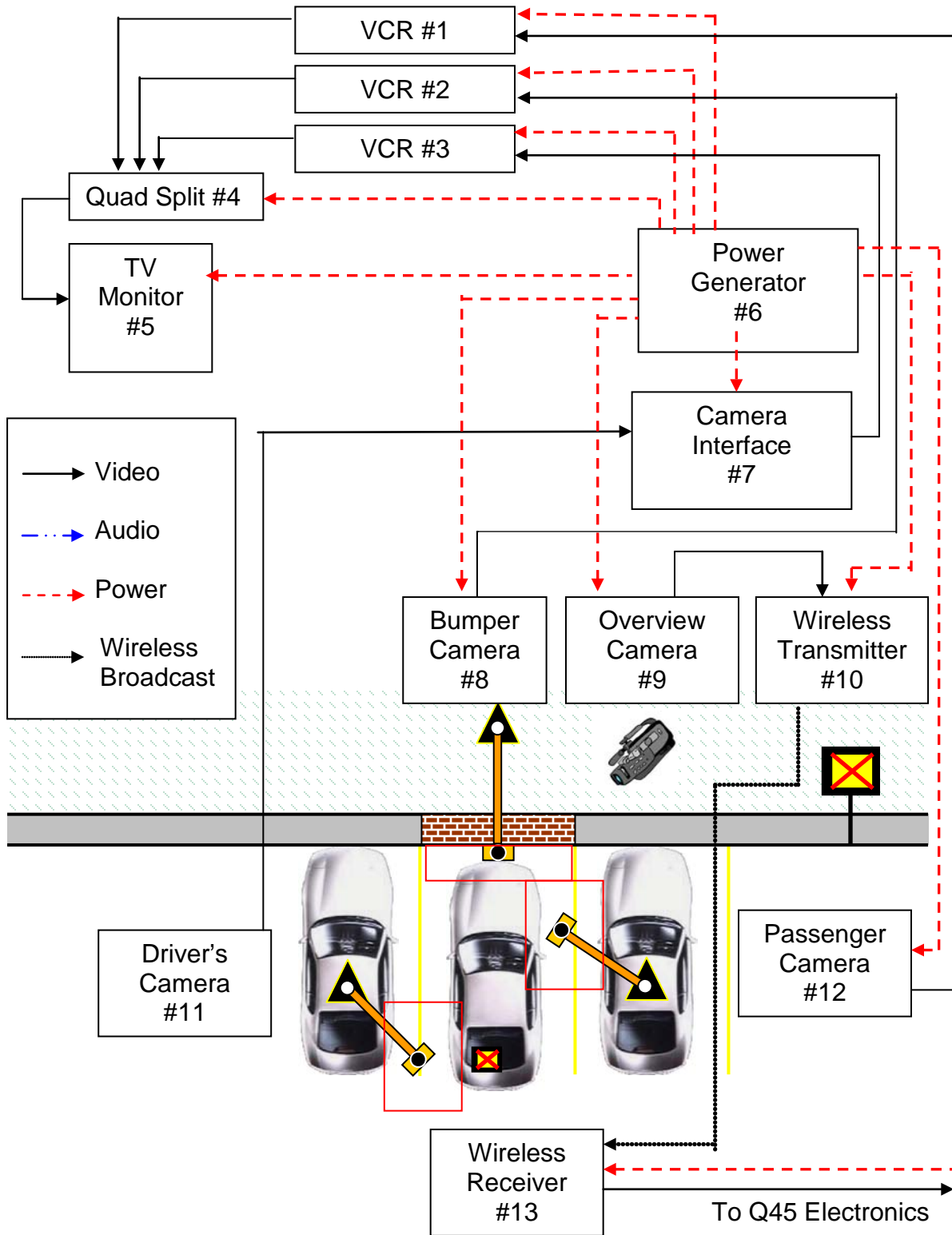

APPENDIX G - INFINITY Q-45 TEST VEHICLE WIRING DIAGRAM

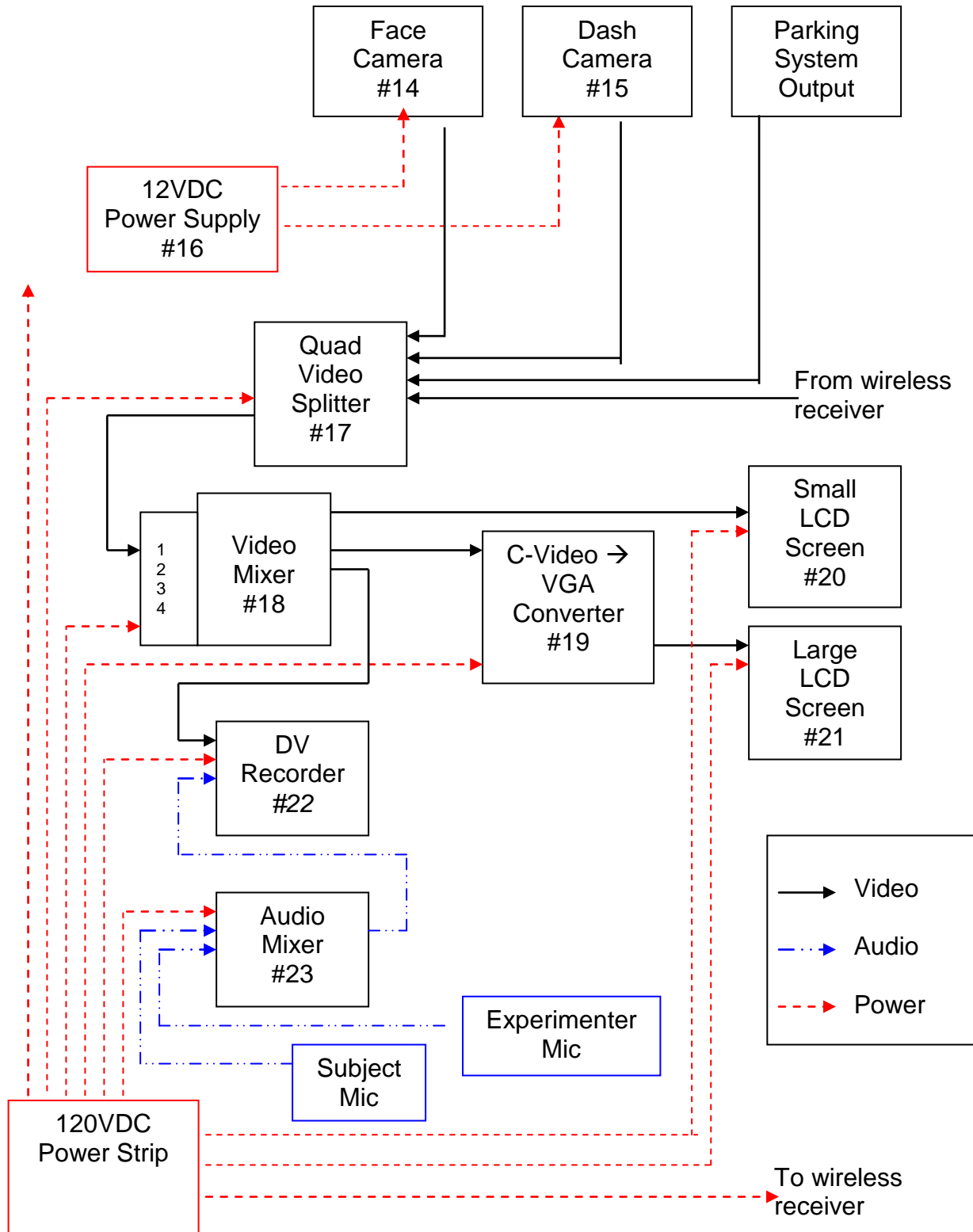

APPENDIX H – EQUIPMENT LIST

APPENDIX H – EQUIPMENT LIST

	Name	Device	Location
1	Passenger VCR	Panasonic AG-D5550 Video Cassette Recorder	Test Tent
2	Bumper VCR	Panasonic AG-5700 Video Cassette Recorder	Test Tent
3	Driver VCR	Panasonic AG-5700 Video Cassette Recorder	Test Tent
4	Quad Splitter	Panasonic WJ-450 Color Quad System	Test Tent
5	TV Monitor	13-inch Sony Trinitron PVM14N1U Color Monitor	Test Tent
6	Power Generator	Honda ***	Test Tent
7	Camera Interface	Panasonic GP-KS152 camera interface	Test Tent
8	Bumper Camera	Supercircuits Model KPC-S400	Parking Spot
9	Overview Camera	Sony Handycam Vision CCD-TRV615 NTSC	Parking Spot
10	Wireless Transmitter	Supercircuits ML10WR 2.4 GHz transmitter	Parking Spot
11	Driver Camera	Panasonic GP-KS162 with 3 mm lens	Parking Spot
12	Passenger Camera	Panasonic GP-KS162 with 3 mm lens	Parking Spot
13	Wireless Receiver	Supercircuits ML10WR 2.4 GHz transmitter	Parking Spot
14	Face Camera	Supercircuits Model KPC-S400 black & white camera	Q45
15	Dash Camera	KT&C Color B136956 camera	Q45
16	12VDC Power Supply	Radio Shack 120 VAC - 12 VDC Converter Cat. No. 22-127E	Q45
17	Quad Splitter	Supercircuits QS7 Video Color Quad Processor	Q45
18	Video Mixer	Videonics Digital Video Mixer: Model MX-1	Q45
19	Video Converter	Viewsonic UB50HRTV Video Converter Model: USACC23126-1M	Q45
20	Small LCD Screen	Mitsubishi TTF Active Matrix 5.5 inch (Diag.) Car Color Display Model: DU-9450M	Q45
21	Large LCD Screen	Viewsonic VE510+ 15 inch (Diag.) Monitor Model: VLCDS23587-2W	Q45
22	DV Recorder	Sony Digital Video Recorder Model: DSR-20MD	Q45
23	Audio Mixer	Shure Sound Mixer Model: M267	Q45

APPENDIX I – DRAWING OF UMTRI EAST PARKING LOT FROM BLUEPRINT

APPENDIX I – DRAWING OF UMTRI EAST PARKING LOT FROM BLUEPRINT

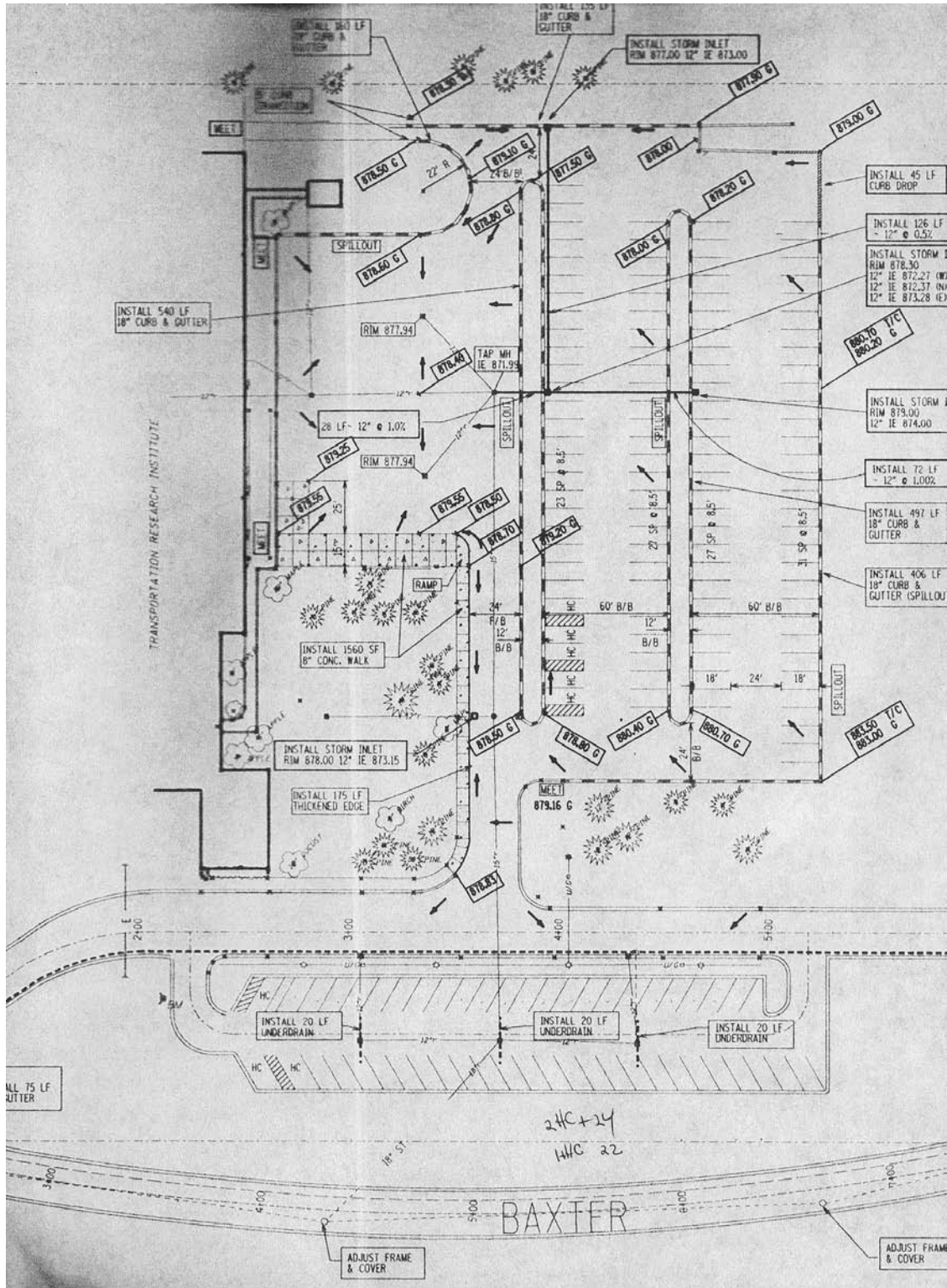

APPENDIX J – ADDITIONAL FIGURES

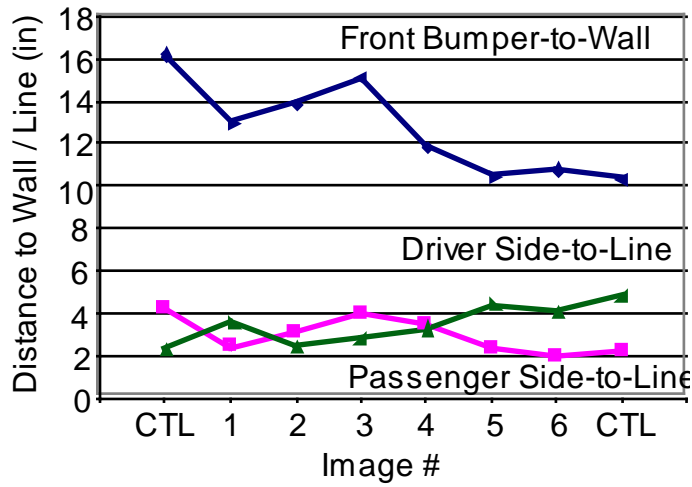

Figure 25. Image Effect on Various Distances for Drivers Who Used the AVM System

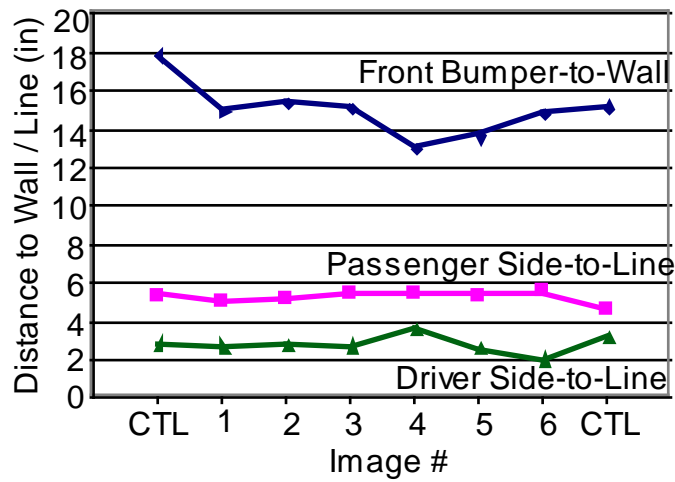

Figure 26. Image Effect on Various Distances for Drivers Who Did Not Use the AVM System