

---

# Development and Validation of Light-Duty Vehicle Modal Emissions and Fuel Consumption Values for Traffic Models

---

PUBLICATION NO. FHWA-RD-99-068

MARCH 1999



U.S. Department of Transportation  
**Federal Highway Administration**

Research, Development & Technology  
Turner-Fairbank Highway Research Center  
6300 Georgetown Pike  
McLean, VA 22101-2296

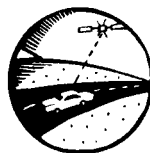

## FOREWORD

The research study, "Development and Validation of Light-Duty Modal Emissions and Fuel Consumption Values for Traffic Models," was conducted as a methodology for developing modal vehicle emissions and fuel consumption models to be used in the Federal Highway Administration's TRAF-series of models. These traffic models are used to evaluate the impact of roadway design on emissions and fuel consumption. As a verification exercise, the models were used to predict cycle emissions and fuel consumption, and the results were compared to certification-type tests on a different population of vehicles. The result of this research was that the verification exercise proved that the developed models could generally predict cycle emissions and fuel consumption with error rates comparable to the variability of repeated dynamometer tests.

This report presents the results of a study in Project A5a, "Development and Validation of Light-Duty Modal Emissions and Fuel Consumption Values for Traffic Models," of the Nationally Coordinated Program (NCP) of Research and Development. The study was conducted for the Office of Safety and Traffic Operations Research and Development, McLean, Virginia, under Contract DTFH61-94-Y-00001 and covers the period of research from September 1994 to January 1997.

Sufficient copies of this report are being distributed to provide a minimum of one copy to each FHWA resource center, one copy to each division office, and one copy to each State highway agency.

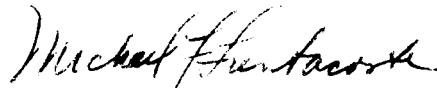

Michael F. Trentacoste  
Director  
Office of Safety Research  
and Development

## NOTICE

This document is disseminated under the sponsorship of the Department of Transportation in the interest of information exchange. The United States Government assumes no liability for its contents or use thereof. This report does not constitute a standard, specification, or regulation.

The United States Government does not endorse products or manufacturers. Trade and manufacturers' names appear in this report only because they are considered essential to the object of the document.

1. Report No.  FHWA-RD-99-068		2. Government Accession No.		3. Recipient's Catalog No.	
4. Title and Subtitle Development and Validation of Light-Duty Vehicle Modal Emissions and Fuel Consumption Values for Traffic Models				5. Report Date March 1999	
				6. Performing Organization Code	
7. Author(s) Brian H. West; Ralph N. McGill; Scott Sluder				8. Performing Organization Report No.	
9. Performing Organization Name and Address Oak Ridge National Laboratory P.O. Box 2009 Oak Ridge, TN 37831-8087				10. Work Unit No. (TRAIS)	
				11. Contract or Grant No. DTFH61-94-Y-0001	
12. Sponsoring Agency Name and Address Intelligent Systems and Technology Division Federal Highway Administration 6300 Georgetown Pike McLean, VA 22101				13. Type of Report and Period Covered  Final Report September 1994 - January 1997	
				14. Sponsoring Agency Code	
15. Supplementary Notes Contracting Officer's Technical Representative (COTR): Aladdin Barkawi, HSR-10					
16. Abstract A methodology for developing modal vehicle emissions and fuel consumption models has been developed by Oak Ridge National Laboratory (ORNL), sponsored by the Federal Highway Administration. These models, in the form of look-up tables for fuel consumption and emissions as functions of vehicle speed and acceleration, are designed for simulations such as the Federal Highway Administration's TRAF-series of models. These traffic models are used to evaluate the impacts of roadway design on emissions and fuel consumption. Vehicles are tested on-road and on a chassis dynamometer to characterize the entire operating range of each vehicle. Engine parameters are measured on-the-road as functions of vehicle speed and acceleration while driving the cars through their entire operating envelope. Following road testing, the vehicles are driven on the chassis dynamometer while making transient and steady-state emissions and fuel consumption measurements as functions of the same engine parameters. The two data sets are merged numerically to deliver data-based models of fuel consumption and emissions as functions of vehicle speed and acceleration. The data-based models are models only in the sense that numerical methods are used to create a smooth surface using discreet data points; no simulations or assumptions are made in the creation of the data-based models. As a validation exercise, the models were used to predict cycle emissions and fuel consumption and the results were compared to certification-type tests on a different population of vehicles. Results of the verification exercise show that the developed models can generally predict cycle emissions and fuel consumption with error rates comparable to the variability of repeated dynamometer tests.  Follow-on work at ORNL has included testing of additional vehicles, superemitters, and additional validation. The additional validation focuses on certification-type test comparisons on the single-vehicle level. Validation exercises continue to yield positive results. This work is not discussed in the current report, although the data from the current report as well as from follow-on work is currently available by contacting ORNL. These look-up tables represent a valuable source of data for a variety of efforts, including and beyond the original purpose of supporting the TRAF-series of models.					
17. Key Words Emissions and fuel consumption values, traffic model simulation.			18. Distribution Statement No restrictions. This document is available to the public through the National Technical Information Service, Springfield, Virginia 22161.		
19. Security Classif. (of this report)  Unclassified		20. Security Classif. (of this page)  Unclassified		21. No. of Pages  99	22. Price

# SI\* (MODERN METRIC) CONVERSION FACTORS

## APPROXIMATE CONVERSIONS TO SI UNITS

## APPROXIMATE CONVERSIONS FROM SI UNITS

Symbol	When You Know	Multiply By	To Find	Symbol	When You Know	Multiply By	To Find	Symbol
<b>LENGTH</b>								
in	inches	25.4	millimeters	mm	millimeters	0.039	inches	in
ft	feet	0.305	meters	m	meters	3.28	feet	ft
yd	yards	0.914	meters	m	meters	1.09	yards	yd
mi	miles	1.61	kilometers	km	kilometers	0.621	miles	mi
<b>AREA</b>								
in <sup>2</sup>	square inches	645.2	square millimeters	mm <sup>2</sup>	square millimeters	0.0016	square inches	in <sup>2</sup>
ft <sup>2</sup>	square feet	0.093	square meters	m <sup>2</sup>	square meters	10.764	square feet	ft <sup>2</sup>
yd <sup>2</sup>	square yards	0.836	square meters	m <sup>2</sup>	square meters	1.195	square yards	yd <sup>2</sup>
ac	acres	0.405	hectares	ha	hectares	2.47	acres	ac
mi <sup>2</sup>	square miles	2.59	square kilometers	km <sup>2</sup>	square kilometers	0.386	square miles	mi <sup>2</sup>
<b>VOLUME</b>								
fl oz	fluid ounces	29.57	milliliters	mL	milliliters	0.034	fluid ounces	fl oz
gal	gallons	3.785	liters	L	liters	0.264	gallons	gal
ft <sup>3</sup>	cubic feet	0.028	cubic meters	m <sup>3</sup>	cubic meters	35.71	cubic feet	ft <sup>3</sup>
yd <sup>3</sup>	cubic yards	0.765	cubic meters	m <sup>3</sup>	cubic meters	1.307	cubic yards	yd <sup>3</sup>
NOTE: Volumes greater than 1000 l shall be shown in m <sup>3</sup> .								
<b>MASS</b>								
oz	ounces	28.35	grams	g	grams	0.035	ounces	oz
lb	pounds	0.454	kilograms	kg	kilograms	2.202	pounds	lb
T	short tons (2000 lb)	0.907	megagrams (or "metric ton")	Mg (or "t")	megagrams (or "metric ton")	1.103	short tons (2000 lb)	T
<b>TEMPERATURE (exact)</b>								
°F	Fahrenheit temperature	5(F-32)/9 or (F-32)/1.8	Celsius temperature	°C	Celsius temperature	1.8C + 32	Fahrenheit temperature	°F
<b>ILLUMINATION</b>								
fc	foot-candles	10.76	lux	lx	lux	0.0929	foot-candles	fc
fl	foot-Lamberts	3.426	candela/m <sup>2</sup>	cd/m <sup>2</sup>	candela/m <sup>2</sup>	0.2919	foot-Lamberts	fl
<b>FORCE and PRESSURE or STRESS</b>								
lbf	poundforce	4.45	newtons	N	newtons	0.225	poundforce	lbf
lbf/in <sup>2</sup>	poundforce per square inch	6.89	kilopascals	kPa	kilopascals	0.145	poundforce per square inch	lbf/in <sup>2</sup>

(Revised September 1993)

\* SI is the symbol for the International System of Units. Appropriate rounding should be made to comply with Section 4 of ASTM E380.

# TABLE OF CONTENTS

Section	Page
ABSTRACT .....	1
INTRODUCTION .....	1
EXPERIMENTAL METHODS .....	2
Vehicle Selection .....	2
On-Road .....	4
Dynamometer .....	4
Data Processing .....	8
RESULTS .....	12
VALIDATION .....	13
UNIVERSITY OF MICHIGAN STUDY .....	17
SUMMARY AND CONCLUSIONS .....	17
RECOMMENDATIONS .....	18
Additional Testing and Model Development .....	18
Existing Engine-Out Data .....	19
APPENDIX: FUEL CONSUMPTION AND EMISSIONS LOOKUP TABLES .....	19
Chevrolet Corsica .....	20
Oldsmobile Cutlass Supreme .....	28
Oldsmobile Eighty-Eight .....	36
Geo Prizm .....	44
Subaru Legacy .....	52
Mercury Villager .....	60
Jeep Grand Cherokee .....	68
Chevrolet Pickup Truck .....	76
Eight-Vehicle Composite .....	84
REFERENCES .....	92

## LIST OF FIGURES

Figure	Page
1. Tedlar bag and solenoid valve arrangement .....	5
2. Transient response of gas analyzers .....	6
3. Fuel calibration curve for Oldsmobile Eighty-Eight .....	7
4. Time response of pulsewidth-based fuel flow vs. Max flowmeter for Jeep Cherokee ...	8
5. On-road MAP vs. rpm for Chevrolet pickup truck .....	9
6. Dynamometer MAP vs. rpm for Chevrolet pickup truck .....	9
7. Fuel consumption and emissions surfaces for Oldsmobile Eighty-Eight .....	11
8. Fuel consumption for Jeep Grand Cherokee showing acceleration limits .....	12
9. Fuel consumption and emissions surfaces for eight-vehicle composite .....	13
10. Composite vehicle and FTPRP fuel consumption .....	15
11. Composite vehicle and FTPRP CO emissions .....	16
12. Composite vehicle and FTPRP NO <sub>x</sub> emissions .....	16
13. Composite vehicle and FTPRP HC emissions .....	17

## LIST OF TABLES

Table	
1. Test vehicle and industry average specifications .....	3
2. Data collected on-road .....	4
3. FTPRP test vehicle average specifications .....	14

## LIST OF NOMENCLATURE AND ABBREVIATIONS

AED	Advanced Electronic Diagnostics
ARB02	High-load dynamometer driving cycle designed by CARB
CARB	California Air Resources Board
cc	cubic centimeter (cm <sup>3</sup> )
CO	Carbon monoxide
CO <sub>2</sub>	Carbon dioxide
DAS	Data Acquisition System
DOE	Department of Energy
DOT	Department of Transportation
ECM	Engine Control Module
EPA	Environmental Protection Agency
FHWA	Federal Highway Administration
FR	Fuel-injector frequency
FTP	Federal Test Procedure (also Urban Dynamometer Driving Cycle)
FTPRP	Federal Test Procedure Revision Project - Joint program between EPA and the automotive industry to revise the FTP to include higher loads and speeds
g	gram
gal/h	gallons per hour
GVWR	Gross Vehicle Weight Rating
h	hour
HC	Hydrocarbons
HDV	Heavy-duty vehicle (vehicles greater than 4536 kg (10,000 lb) GVWR)
HL07	High-load engineered dynamometer driving cycle
HLDT	Heavy light-duty trucks (light trucks between 3856 kg (8500 lb) and 4536 kg (10,000 lb) GVWR)
kPa	kilopascals (kN/m <sup>2</sup> )
L	liters
MAF	Mass Air Flow
MAP	Manifold Absolute Pressure
mg	milligram (0.001 gram)
mi	miles
NO <sub>x</sub>	Oxides of nitrogen (nitric oxide (NO), nitrogen dioxide (NO <sub>2</sub> ))
OEM	Original Equipment Manufacturer
ORNL	Oak Ridge National Laboratory
PW	Fuel-injector pulsewidth
REP05	High-load dynamometer driving cycle designed by EPA
rpm	revolutions per minute (engine speed)
s	second
TPS	Throttle Position Sensor
US06	High-load dynamometer driving cycle that includes portions of REP05 and ARB02
V	volts





## **ABSTRACT**

A methodology for developing modal vehicle emissions and fuel consumption models is described. These models, in the form of look-up tables for fuel consumption and emissions as functions of vehicle speed and acceleration, are designed for simulations such as the Federal Highway Administration's TRAF-series of models. These traffic models are used to evaluate the impacts of roadway design on emissions and fuel consumption. Vehicles are tested on-road and on a chassis dynamometer to characterize the entire operating range of each vehicle. Engine parameters are measured on-the-road as functions of vehicle speed and acceleration while driving the cars through their entire operating envelope. Following road testing, the vehicles are driven on the chassis dynamometer while making transient and steady-state emissions and fuel consumption measurements as functions of the same engine parameters. The two data sets are merged numerically to deliver data-based models of fuel consumption and emissions as functions of vehicle speed and acceleration.

As a verification exercise, the models were used to predict cycle emissions and fuel consumption, and the results were compared to certification-type tests on a different population of vehicles. Results of the verification exercise show that the developed models can generally predict cycle emissions and fuel consumption with error rates comparable to the variability of repeated dynamometer tests.

## **INTRODUCTION**

There are numerous computer models for predicting motor vehicle emissions, each with its own approach and intended purpose. The MOBILE and EMFAC series of models are macroscopic in nature, intended to predict emissions of thousands of vehicles over millions of miles of travel for large areas. Microscopic models are generally considered those that simulate individual vehicles in traffic. Examples of microscopic models are the TRAF-series of models (CORSIM, NETSIM, and FRESIM) developed by the Federal Highway Administration (FHWA) of the U.S. Department of Transportation. Models such as TRAF need modal emissions and fuel consumption data in a lookup-table format in order to predict emissions and fuel consumption. TRANSIMS, a new microsimulation model under development at Los Alamos National Laboratory, will also need this type of data to make any fuel consumption or emissions predictions.

In the early 1980s, Oak Ridge National Laboratory (ORNL) developed fuel consumption models for TRAF based on testing of 15 light-duty vehicles. The vehicles were tested on-road and on a chassis dynamometer to develop the models, which were presented in the form of lookup tables. Emissions measurements were also made on 6 of the 15 vehicles, and these results were used to develop lookup tables for hydrocarbon (HC), oxides of nitrogen (NO<sub>x</sub>), and carbon monoxide (CO) emissions. The tables provide fuel consumption (or emissions) as functions of vehicle speed and acceleration.<sup>[1]\*</sup>

---

\*Numbers in brackets refer to references at the end of the report.

Given the advances in automotive technology since the early 1980s, FHWA decided that the tables needed to be updated. This report outlines the measurement and mapping procedures used to develop these tables, and verification of the final results.

## EXPERIMENTAL METHODS

In the early 1980s study, ORNL researchers developed a unique method of “mapping” dynamometer-based measurements onto road-based measurements.<sup>[1]</sup> Due to advances in automotive, data collection, and computer technology, this methodology was improved for the reported work. Although many researchers have recently made emissions measurements on-road with portable instruments and have generated interesting and valuable results (see references 2-5), the authors felt that the combined on-road/dynamometer approach offered several advantages over all road- or all dynamometer-based measurements. Most researchers will agree that actual road loads are more realistic than simulated (dynamometer) road loads. Since excess weight (analyzers and batteries) is not carried along during road testing, the road loads are more realistic than an all-road method. Measuring emissions and fuel consumption on the dynamometer allows steady-state measurements under a number of loads that are either not possible or very difficult on-road. Also, laboratory-grade instruments generally provide more accurate measurements than the more portable type. The dynamometer loads in this case do not have to exactly replicate any given road condition, since the emissions are mapped as functions of *engine conditions*, which are measured on the dynamometer as well as on-the-road. That is, the given load at the wheels is matched to an engine condition, so it is not critical that the fraction of the load attributed to aerodynamic drag or the fraction attributed to rolling resistance be exact. The engine conditions under which the emissions are generated are known exactly, and the engine conditions are the mapping parameters.

Vehicle Selection: Eight vehicles have been tested thus far in the current study. The test vehicles were selected based on their weight, engine size, and availability. Expectations were that several more vehicles would be tested in subsequent fiscal years to provide a more statistically significant sample. Recognizing that there was at least a possibility that budget constraints would not allow additional vehicle testing, the eight-vehicle list was comprised of vehicles of mainstream weight and engine size. Sales volume, vehicle weight, and engine data were consulted to assist in the selection. Since pickup trucks, sport utility vehicles, and minivans (grouped together in the industry as light-duty trucks (LDT)) have gained popularity in recent years, it was felt that a vehicle mix should contain at least one light truck of each type. With the exception of the first “mule” test vehicle, all vehicles were model year 1993 or later, and all had less than 80,000 km (50,000 mi) on their odometers. Initial tests were begun with a 1987 Buick Regal, owned by the University of Tennessee. The Buick was originally part of an ORNL test program, and as such, much was known about its emissions history. ORNL had the ability to reprogram its engine control module (ECM). Early project goals involved reprogramming the ECM to change the enrichment schedule to enhance understanding of the effects of enrichment on performance and emissions. Unfortunately, the Buick was stolen just prior to the beginning of rigorous testing, and with it, some custom fuel lines and power and communications cables. Fortunately, no expensive test equipment was in the vehicle. Another university vehicle, a 1988 Chevrolet Corsica, was then commandeered for the initial testing. With the approval of FHWA, each of the vehicles shown in table 1 was acquired and tested. Note that the average engine displacement of the eight vehicles is 3.3 L, the average number of cylinders is 5.75, and the

average curb weight is 1500 kg (3300 lb). Although this is a small sample, the average is very representative given that industry reports show that the average sales-weighted domestic engine displacement for 1995 was 3.5 L, with an average of 5.8 cylinders (the sales-weighted averages for cars were 2.9 L and 5.4 cylinders, and for trucks, 4.6 L and 6.5 cylinders). The sales-weighted average curb weight of passenger cars has been steady at around 1300 kg (2900 lb) for a number of years. Light trucks are generally classed by Gross Vehicle Weight Rating (GVWR) as opposed to curb weight. In 1995, 73 percent of the more than 6 million light trucks sold were less than 2700 kg (6000 lb) GVWR. Light trucks have accounted for some 38 to 44 percent of total light-vehicle sales in recent years (see references 6-10).

Table 1. Test vehicle and industry average specifications.

Year	Make/Model (Odometer miles)	Engine PFI=Port Fuel Injection, TBI=Throttle Body Injection	Transmission M=Manual, L=Automatic with lockup	Curb Weight (lb)	Rated hp	EPA Fuel Economy (city/hwy mi/gal)
1988	Chevrolet Corsica (18k)	2.8-L pushrod V6, PFI	M5	2665	130	19 / 29
1994	Oldsmobile Cutlass Supreme (18k)	3.4-L DOHC V6, PFI	L4	3290	210	17 / 26
1994	Oldsmobile Eighty- Eight (26k)	3.8-L pushrod V6, PFI	L4	3360	170	19 / 29
1995	Geo Prizm (22k)	1.6-L OHC I4, PFI	L3	2460	105	26 / 30
1993	Subaru Legacy (49k)	2.2-L DOHC flat 4, PFI	L4	2800	130	22 / 29
	<b>5-car average</b>	2.76 L, 5.2 cylinders		2915	149	21 / 29
1995	<b>LDV industry average</b>	2.9 L, 5.4 cylinders		2900		
1994	Mercury Villager Van (13k)	3.0-L pushrod V6, PFI	L4	4020	151	17 / 23
1994	Jeep Grand Cherokee (25k)	4.0-L pushrod I6, PFI	L4	3820	190	15 / 20
1994	Chevrolet Silverado Pickup (35k)	5.7-L pushrod V8, TBI	L4	4020	200	14 / 18
	<b>3-truck average</b>	4.23 L, 6.7 cylinders		3953	180	15 / 20
1995	<b>LDT industry average</b>	4.6 L, 6.5 cylinders				
	<b>8-vehicle average</b>	3.3 L, 5.75 cylinders		3300	160	19 / 26
1995	<b>LDV+LDT, industry average</b>	3.5 L, 5.8 cylinders				

OHC - Overhead cam

DOHC - Double overhead cam

1 lb = 0.454 kg, 1 hp = 0.745 kW, 1 mi/gal = 0.42 km/L

**On-Road:** Vehicles were first instrumented, using as many on-board sensors as possible to minimize setup time. Type K thermocouples and exhaust sample ports were installed before and after the catalytic converter. An optical fifth wheel was used to sense vehicle speed, and all data were collected using a portable data logger capable of logging 45 analog signals in concert with a serial communications link with many of the vehicles' engine control modules (ECM). After installation of instrumentation, the vehicle would be road tested at steady speeds from 32 to 105 km/h (20 to 65 mi/h), in nominal 4-km/h (2.5-mi/h) increments on public roads with minimal grade. All data were gathered in two opposite directions on the same road so that grade and wind effects, if any, were minimized. Testing was never conducted in very windy conditions, or in rain or snow. Cruise control was used whenever possible during steady-speed data collection.

Following steady-speed road testing, the vehicle was tested on a 1.6-km (1-mi) airport runway. The airport runway was used for very low- and very high-speed runs, and acceleration and deceleration runs that could not be safely conducted on public roads. Acceleration runs were typically performed at 10 different fixed throttle settings, from 10-percent throttle to wide-open throttle (WOT). All data at the airport were also gathered in both directions to nullify wind and grade effects, and typically, two full sets of data were gathered. The runway has a maximum grade of 1 percent. Typical parameters collected on-road are shown in table 2.

Table 2. Data collected on-road.

<b>Parameter</b>	<b>Units</b>
Speed	m/s
Ambient Temperature	°C
Engine Speed	rpm
Manifold Absolute Pressure (MAP)	kPa, V
Mass Air Flow (MAF)	g/s, V
Fuel-Injector Pulsewidth (PW)	ms
Fuel-Injector Frequency (FR)	Hz
Exhaust Temperatures (before and after catalyst)	°C
Throttle Position (TPS)	%

**Dynamometer:** Following on-road data collection, the test vehicle was brought to the chassis dynamometer at the University of Tennessee for emissions and fuel consumption measurements. The same data logger used on-road was used for collecting data during dynamometer runs. Measured parameters included all those collected on-road, and in addition, fuel consumption and engine-out and tailpipe emissions constituents (HC, CO, NO<sub>x</sub>, CO<sub>2</sub>, O<sub>2</sub>). The two parallel raw exhaust streams were pumped by a two-head stainless steel/teflon diaphragm pump and cooled with a thermoelectric chiller (to remove condensation). Two identical emissions benches

measured the engine-out and tailpipe exhaust species, using flame ionization detectors for hydrocarbons, non-dispersive infrared detectors for CO and CO<sub>2</sub>, chemiluminescence detectors for NO<sub>x</sub>, and paramagnetic detectors for oxygen. Each bench was equipped with two CO detectors (0 to 2000 parts per million (ppm) and 0 to 7.5 percent) due to the wide range of CO emissions possible from spark-ignition engines.

In order to evaluate transient emissions during testing, the sample transport time and individual gas analyzer response times had to be quantified. A gas-sample bag was filled with a mixture of span gases and air to yield a gas mixture with concentrations of each measured gas that was within the selected range of each analyzer. The bag was plumbed to a solenoid valve arrangement as shown in figure 1. While valve 2 was open, valve 1 was closed, and the sample system was drawing room air. Upon application of voltage to the valves, valve 2 closed and valve 1 opened, allowing the sample system to draw the gas mix from the bag. With this setup, random switching of the solenoid valves introduced “slugs” of gas so that the transport and response time of each analyzer could be determined. Analyzer response is a complex issue and has been the focus of considerable research (see references 11-14); however, it was not the focus of this project. The purpose of this exercise was to allow relative alignment of the emissions data with other gathered data. Figure 2 shows a typical output trace for six analyzers.

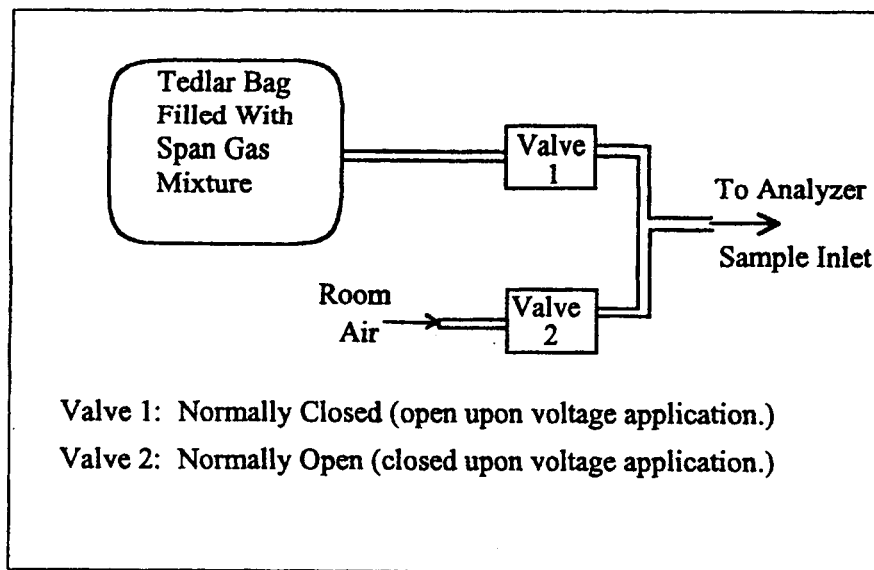

Figure 1. Tedlar bag and solenoid valve arrangement.

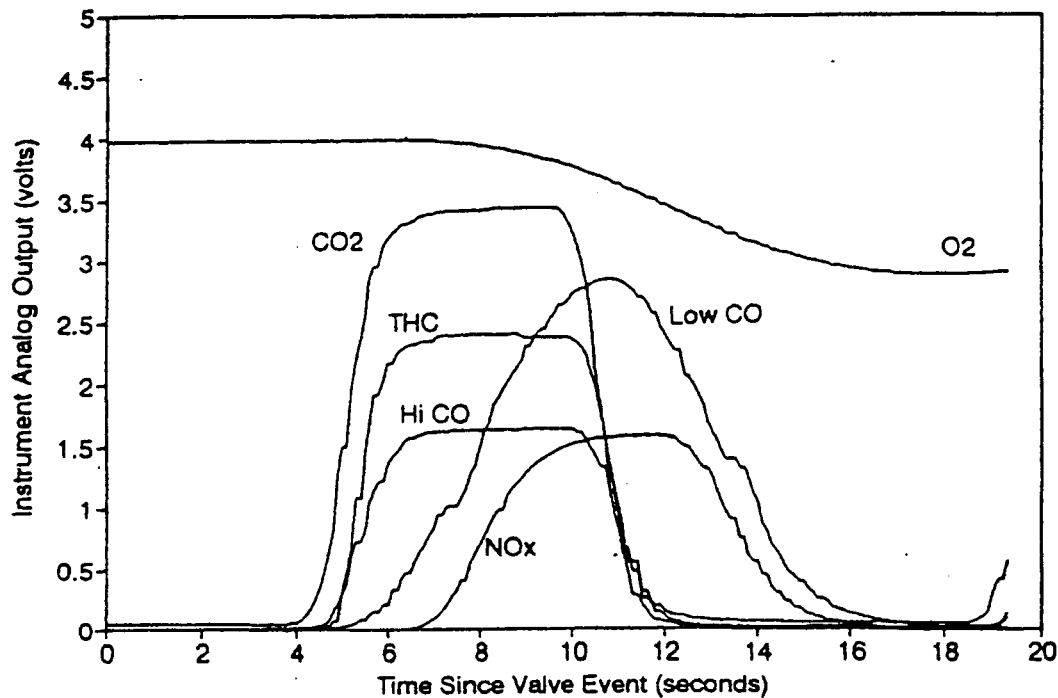

Figure 2. Transient response of gas analyzers.

Fuel consumption was measured using a Max Machinery 710 Fuel Flow Measurement System. Fuel supply to multipoint fuel-injected engines is typically in a recirculating system such that both the supply and return flows are very high at idle and light loads. As such, measuring fuel consumption can be somewhat difficult. If the supply and return flows are measured separately, very large errors can result at low consumption rates since the net consumption rate can be on the same order as the error of the instruments. The Max system contains a positive-displacement fuel flowmeter, heat exchanger, pumps, level controller, pressure regulators, and vapor eliminators to facilitate measuring the *net* fuel consumed by fuel-injected engines. The fuel flow measurement system is accurate to  $\pm 0.5$  percent with a turndown ratio of 200:1; however, it can take several seconds for it to respond to a transient event. As such, the flowmeter was used to measure fuel consumption under steady conditions on the dynamometer while recording fuel-injector pulsewidth and frequency. A fuel-injection calibration curve was developed for each vehicle tested so that on-road pulsewidth and frequency data could be used to infer instantaneous fuel consumption from the on-road data. The fuel flow (cc/s) is divided by the injector frequency to

yield fuel injected per pulse (cc). A curve is fit to the data to predict fuel injected per pulse as a function of pulsewidth. A sample fuel calibration curve is shown in figure 3. The improved response of the pulsewidth-based fuel consumption over the MAX flowmeter can be seen in figure 4.

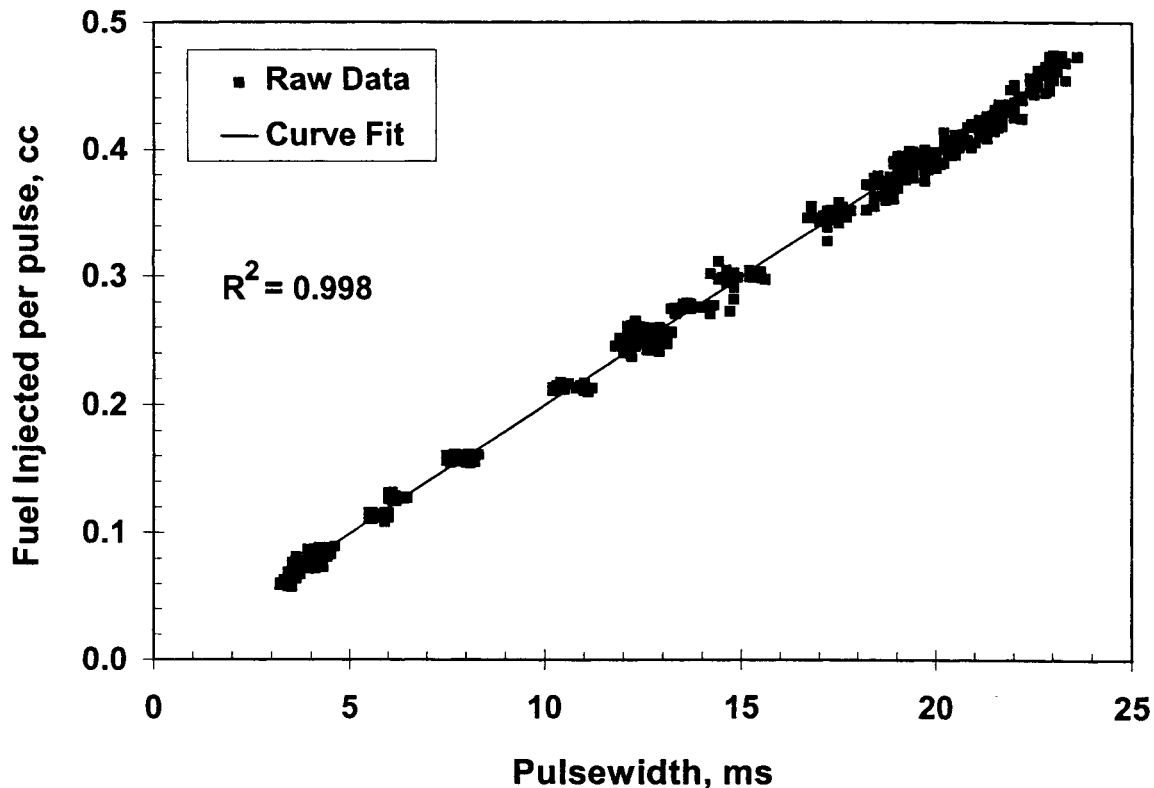

Figure 3. Fuel calibration curve for Oldsmobile Eighty-Eight.

On-road high-speed cruise and acceleration data were used to set the vehicles' aerodynamic drag and mass on the dynamometer. The aerodynamic drag setting was adjusted until the high-speed cruise engine speed (revolutions per minute (rpm)), manifold absolute pressure (MAP), and fuel consumption on the dynamometer matched the same condition on-road. The vehicle mass setting was then adjusted until the time required to accelerate at WOT from 32 to 97 km/h (20 to 60 mi/h) matched the same condition on-road. The chassis dynamometer used in these tests is a twin-roll, eddy-current Sun Roadamatic at the University of Tennessee.

The MAP and rpm data were plotted to provide a guide for dynamometer measurements so that on-road engine conditions could be duplicated on the dynamometer. An example plot of on-road MAP vs. rpm is shown in figure 5 for the Chevrolet pickup truck. During dynamometer testing, engine conditions (MAP and rpm) were held steady for about 10 s while emissions data were recorded, and transient data were recorded between the steady set points. Data were gathered until the on-road MAP vs. rpm plot was adequately covered with dynamometer data, with roughly 200-rpm increments from idle to near redline, and MAP increments of about 10 kPa (or ~0.5 V). Transients were also recorded from idle to 121 km/h (75 mi/h, or 110 ft/s) at various throttle settings to ensure full coverage of the engine map and to provide the resulting models

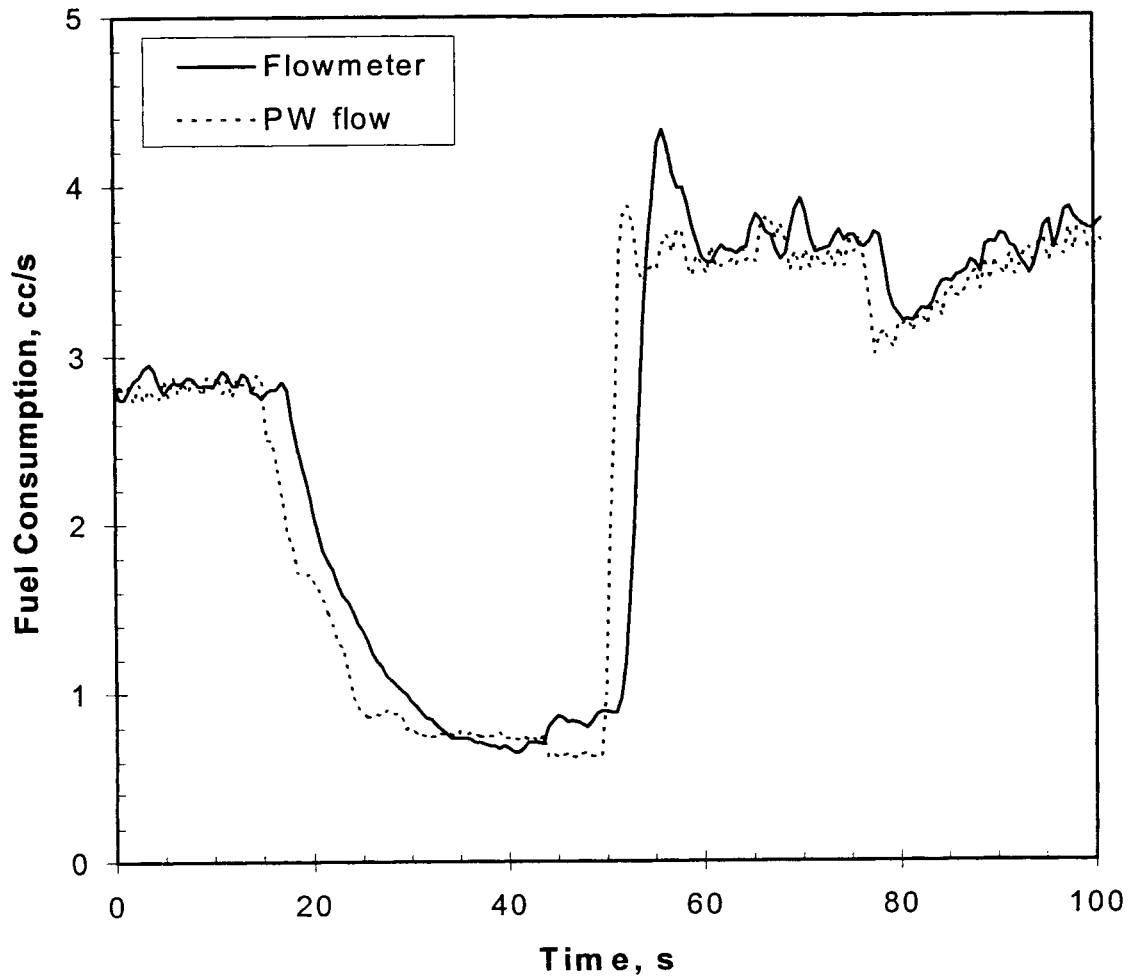

Figure 4. Time response of pulsewidth-based fuel flow vs. Max flowmeter for Jeep Cherokee.

with a mix of transient and steady-state data. Figure 6 shows the dynamometer MAP vs. rpm for the same vehicle.

**Data Processing:** The on-road and dynamometer data were processed using desktop personal computers and commercially available software. Each steady-speed or acceleration event on-road generated a binary data file that was converted to ASCII format using a utility provided by the data logger manufacturer. All on-road data files were then concatenated into one conglomerate file. Custom FORTRAN programs were used to smooth the on-road data and reduce the conglomerate file to a more manageable size. On-road data were collected at 10 Hz (10 samples per second); as such, it was not unusual for the conglomerate on-road data file to contain more than 30,000 lines of data. The smoothing routine reduced the file size to one-fourth its original size.



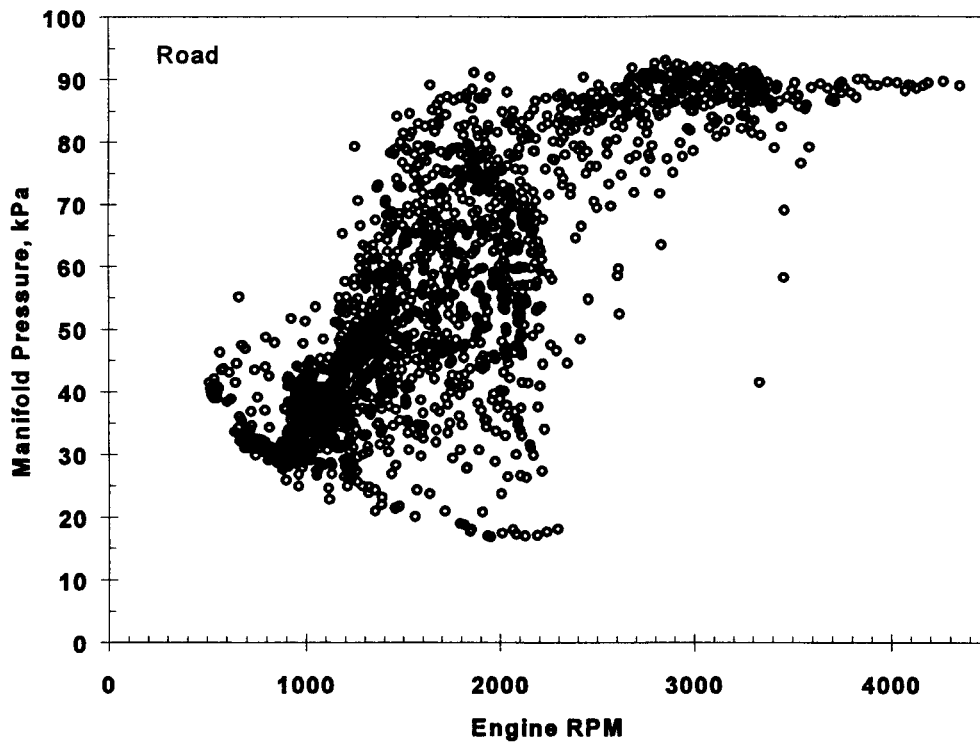

Figure 5. On-road MAP vs. rpm for Chevrolet pickup truck.

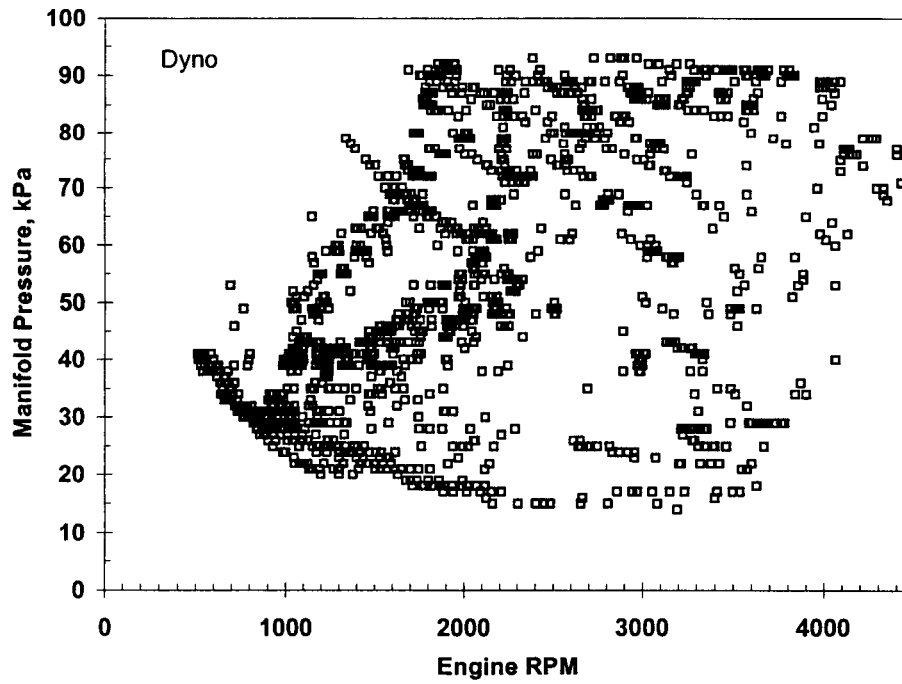

Figure 6. Dynamometer MAP vs. rpm for Chevrolet pickup truck.

The dynamometer data were collected at 2 Hz because the response of the gas analyzers and fuel flowmeter was on the order of seconds. Similar to the on-road data, dynamometer data were also collected in numerous files or “snapshots” of several seconds or, at most, several minutes to allow the engine and catalyst to cool to normal operating temperatures following high-load operation. A shell and tube heat exchanger was plumbed into many of the vehicles’ cooling systems to assist in cooling on very hot days. No vehicle overheating problems were experienced throughout the test program.

The dynamometer files were also converted to ASCII format and concatenated into one large file. Each data column was shifted an appropriate amount in time to align all data with real-time measurements of engine parameters. Much of the dynamometer data were gathered under steady conditions, but transients were also conducted. Shifting the data values in time allows both the steady-state and the transient data to be used in the generation of the final maps of emissions and fuel consumption.

The data collected were generally simple analog voltage signals that had to be converted to engineering units. Gas analyzers measure concentration in mole percent or ppm, from which mass emissions rates were calculated. Following computation of emissions rates (mg/s), surface or contour maps of emissions were generated as functions of rpm and MAP using commercially available contouring and three-dimensional surface mapping software.

On-road data were used to generate surface maps of MAP and rpm as functions of vehicle speed and acceleration. Using these two road data surface maps for any given speed and acceleration, the engine condition (rpm and MAP) can be computed. Given rpm and MAP, emissions (or fuel consumption) can be computed from the dynamometer maps. The resulting maps, or tables, provide emissions and fuel consumption as functions of vehicle speed and acceleration. These tables have been provided to FHWA for use in models such as the TRAF-series of models. Surface plots of the results for a 1994 Oldsmobile Eighty-Eight are shown in figure 7. It is important to note that although the emissions data are shown as surfaces, the emissions are not truly “point functions.” That is, tailpipe emissions are a function of more than simply the instantaneous engine condition (rpm and MAP). Engine and catalyst temperature, transient conditions, and other factors can affect the tailpipe emissions, so the emissions at any given speed and acceleration can vary. The surfaces shown represent a statistical average of the tailpipe emissions under these conditions, since measurements were made under steady as well as various transient conditions. Engine-out measurements were also made throughout this research program, and the authors recommend that further work be conducted with the engine-out data. Due to funding and time constraints, and the desire of FHWA to have a useable product that is easily incorporated into TRAF, efforts were concentrated on developing the tailpipe models. Other modelers have shown that engine-out emissions are more easily predicted.<sup>[15-17]</sup> However, if engine-out emissions models were developed, a catalyst model would also be required to compute tailpipe emissions. A rudimentary catalyst model was developed at the University of Michigan, and will be discussed later in the report.<sup>[17]</sup>

Note in the surface plots in figure 7 that the surface extends to all corners of the speed/acceleration plane. Although none of the vehicles tested was able to accelerate at the highest accelerations at very high speeds, the TRAF model and the format of the tables dictate that a value be provided for each cell or bin in the rectangular matrix. The acceleration limits of each

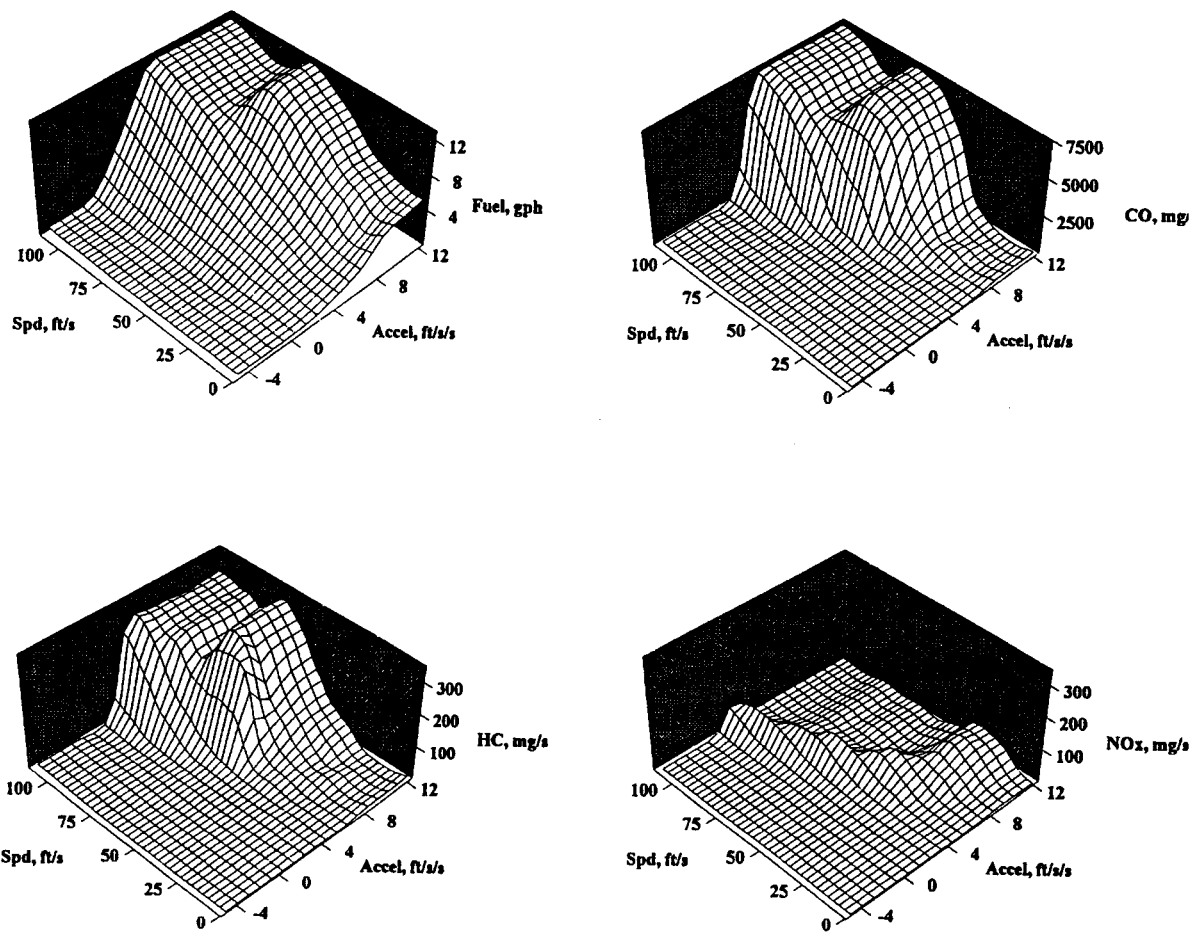
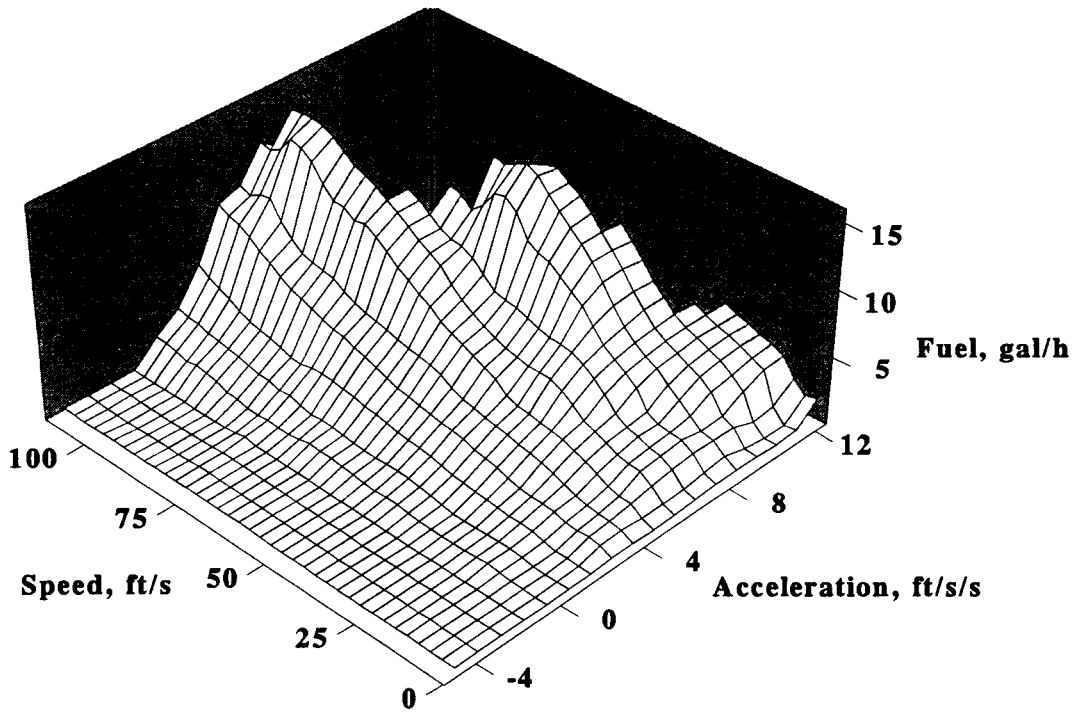

Figure 7. Fuel consumption and emissions surfaces for Oldsmobile Eighty-Eight.

vehicle tested are easily determined from the data, and there was experimentation with producing the tables with some other value in the cells in which the vehicle cannot perform. An example plot is shown in figure 8 for the Jeep Grand Cherokee in which the unattainable bins were filled with zeroes. While this method of presentation is more informative for a single vehicle, a problem exists with TRAF in its current form if tables in this format are used. If the emissions and fuel consumption tables for TRAF are provided as a single composite vehicle, then how is the performance limit defined (which is different for each vehicle from which the composite is computed), and how does TRAF know where this limit is? Without adding new code to TRAF to “query” each bin and look for zero or some other flag value, the “filled matrix” approach makes the most sense. The tables produced in the earlier 1980s project simply followed the assumption that the fuel consumption (or emissions) at an unattainable acceleration was simply the same as at the highest attainable acceleration at that same speed. At present, this still appears to be the best approach, until logic is added to the traffic models to prevent them from “requesting”

unrealistic accelerations. However, if the traffic models are realistic in their modeled speeds and accelerations, then any errors associated with the lack of acceleration limits in the lookup tables should be small. Driving behavior surveys showed that the speed and acceleration limits of the current Federal Test Procedure (FTP) encompass a large portion of real-world driving.<sup>[18-20]</sup> As such, the effect of the filled matrix on overall model accuracy should be minor. Although the tables provided to FHWA in electronic format used this nearest neighbor approach to filling the matrix, the individual printed tables at the end of this report have the unattainable bins filled with zeroes to define this region (with the exception of the composite vehicle table).



1 ft = 0.305 m, 1 gal = 3.79 L

Figure 8. Fuel consumption for Jeep Grand Cherokee showing acceleration limits.

## RESULTS

Lookup tables for fuel consumption and CO, HC, and NO<sub>x</sub> emissions were generated for each of the eight vehicles. Four spreadsheet workbooks were created, one each for fuel, CO, HC, and NO<sub>x</sub>. Each workbook contains the eight individual vehicle lookup tables for fuel or the appropriate emissions constituent. The user can input the fractions of each vehicle to be used in generating the composite table. The initial composite tables used 12.5 percent of each of the eight vehicles. Surface plots of the composite vehicle fuel consumption and emissions are shown in figure 9. Individual vehicle tables and the composite vehicle tables for fuel consumption and the three emissions constituents are shown in the appendix.

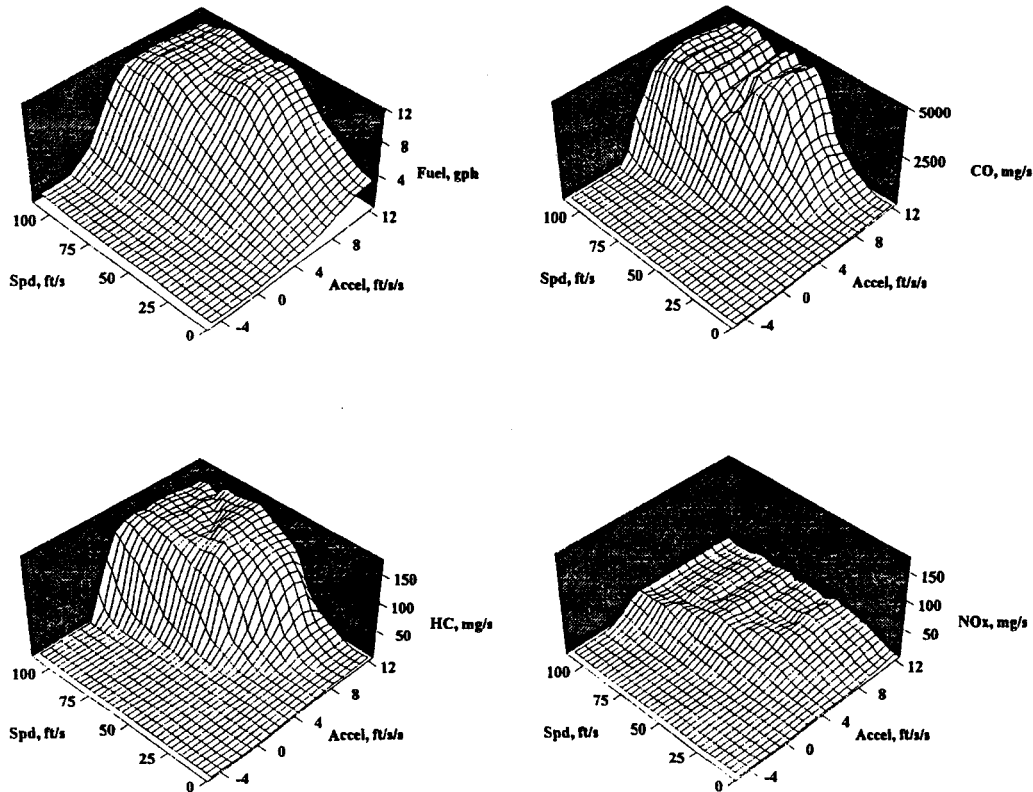

1 ft = 0.305 m, 1 gal = 3.79 L

Figure 9. Fuel consumption and emissions surfaces for eight-vehicle composite.

## VALIDATION

A recent government/industry cooperative research program, the Federal Test Procedure Revision Program (FTRP), has provided emissions and fuel consumption data for a number of light-duty vehicles driven over four different cycles.<sup>[21]</sup> The purpose of the program was to examine the effects of “off-cycle” driving on vehicle emissions. “Off-cycle” designates those vehicle speeds and accelerations not represented by the current Federal Test Procedure (FTP) for compliance testing of motor vehicle emissions. Several new test cycles were developed based on driving pattern studies,<sup>[18-20]</sup> and each vehicle tested in the program was tested at least twice on at least three of the new cycles in addition to the current FTP. The other three cycles were designated ARB02, REP05, and HL07. For a thorough explanation of the intent of these other cycles, the reader is encouraged to consult the literature.<sup>[18-19,21]</sup> The results of the FTRP database were used to compute a representative light-duty vehicle (LDV) and light-duty truck (LDT) emissions and fuel consumption baseline for comparison purposes.

To verify the accuracy and utility of the resulting models of the ORNL project, driving-cycle emissions and fuel consumption were computed from the models for four of the driving cycles in the FTPRP (FTP, ARB02, REP05, and HL07) and compared to actual FTPRP results. The ORNL composite models were used to estimate driving-cycle emissions and fuel consumption for each of the “hot-stabilized” phases or “bags” of the FTPRP cycles. Cold-start emissions were not predicted as the TRAF-NETSIM models currently have no cold-start algorithm. The emissions and fuel consumption of each phase were computed as follows:

- (1) Compute acceleration for each second of cycle.
- (2) Look up instantaneous fuel consumption and emissions values in tables given vehicle speed and acceleration.
- (3) Integrate speed, emissions, or fuel consumption over specified number of seconds to obtain distance traveled, total grams of emissions, or total volume of fuel consumed over each phase, or in each “bag”.

To generate a baseline for comparison, FTPRP bag results for all light-duty vehicles (LDV) and all light-duty trucks (LDT) were averaged by vehicle type and by test phase. A composite result was then obtained by adding 5/8 of the LDV and 3/8 of the LDT results for each bag (because the ORNL test sample contained five LDVs and three LDTs). Averaged specifications for the FTPRP vehicles are shown in table 3. Readers familiar with the FTPRP should note the following:

- The number of vehicles used to compute the average varied slightly since apparently not all vehicles were tested on all driving cycles.
- The LDT average computed herein did not include the four heavy light-duty trucks (GVWR>3856 kg (8500 lb)) tested in the FTPRP.
- Results from so-called “Stoich Chip” runs were omitted. (The FTPRP included tests of several vehicles with stoichiometric recalibrations in which the fueling calibration was revised to eliminate any power enrichment, to provide an indicator of the potential benefits of constraining power enrichment.)<sup>[21]</sup>

The modeled results were compared to FTPRP results because a so-called “certification” dynamometer was not readily available for cycle testing the eight test vehicles. The dynamometer at the University of Tennessee was sufficient for providing engine loads such that emissions and fuel consumption measurements could be made, but it is somewhat limited in its ability to accurately simulate coast-downs and some transients. Also, a constant-volume sampling system (exhaust dilution tunnel) was not available until recently.

Table 3. FTPRP test vehicle average specifications.

Average Year	Vehicle Type	Number in Avg.	Avg. Engine	Avg. Curb Weight (lb)	Avg. Rated hp
1993	Light-Duty Vehicles	21-22	3.0 L, 5.7 cyl	3270	162
1994	Light-Duty Trucks	8-9	3.9 L, 6.2 cyl	3650	164
	5/8 LDV + 3/8 LDT composite		3.4 L, 5.9 cyl	3410	163

1 lb = 0.454 kg, 1 hp = 0.745 kW

Figure 10 shows the per-vehicle fuel consumption for each phase of each driving cycle for the ORNL model prediction vs. the weighted average of the measured fuel consumption for the FTPRP dynamometer runs. The CO, NO<sub>x</sub>, and HC emissions for each bag are shown in figures 11, 12, and 13, respectively. The phases are ranked from lowest to highest consumption or emissions in each of the four figures to show that the models not only make reasonable predictions of emissions and fuel consumption for a completely different population of vehicles, but that they also predict the proper *trends*. That is, when the change in *modal activity* results in higher fuel consumption or emissions, the models generally predict an appropriate increase.

While an eight vehicle model cannot be expected to accurately predict the absolute emissions of the entire population of vehicles, the exercise shows that the models can predict the proper trends, thus providing traffic engineers with a tool to evaluate one traffic scenario against another, while also providing a handle on the order of magnitude of the inventory contributions of such activities. The differences between the modeled and measured emissions are within the typical run-to-run variation of dynamometer tests on a given vehicle. Emissions variations in repeat tests of FTPRP vehicles ranged from 10 to 170 percent.<sup>[22]</sup>

The comparison exercise shows that the developed models can generally make reasonable fuel consumption and emissions predictions. A better comparison (for validation purposes) would involve testing the same vehicles used in model development on the actual driving cycles, and this activity is currently underway. The purpose of these models is not to predict absolute emissions for one, two, or even eight vehicles, but to provide the proper trends due to changing modal activity. Armed with this type of data, a model such as NETSIM can provide the traffic engineer with a much better estimate of how changing traffic conditions will affect emissions and fuel consumption.

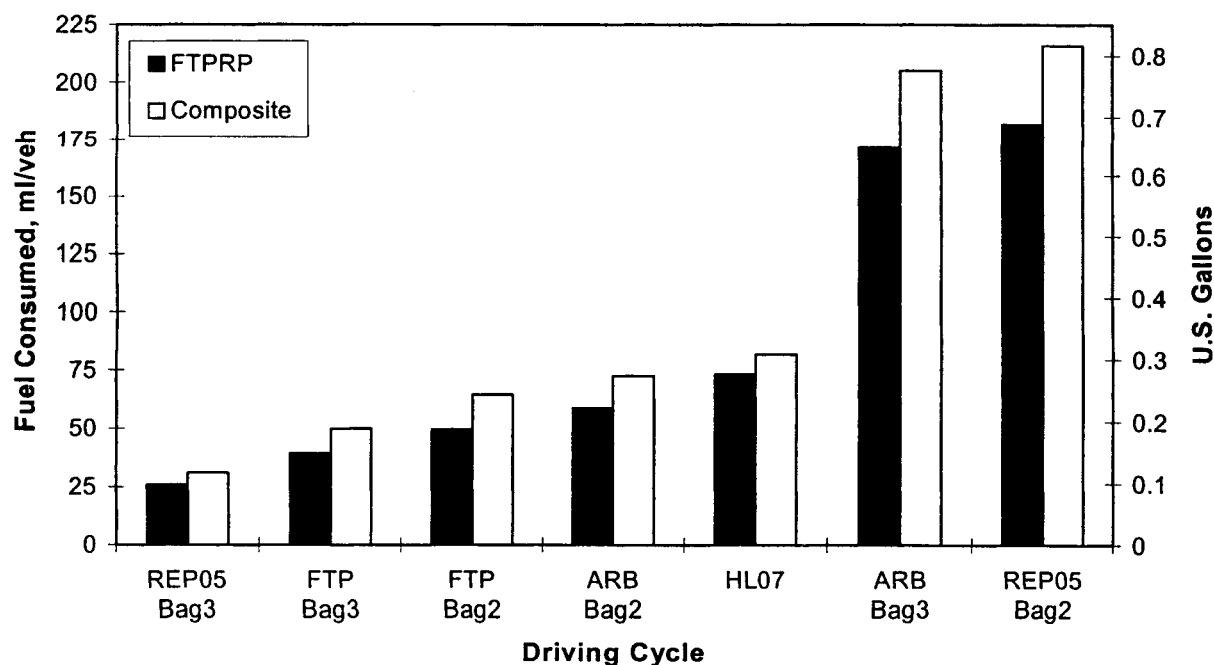

Figure 10. Composite vehicle and FTPRP fuel consumption.

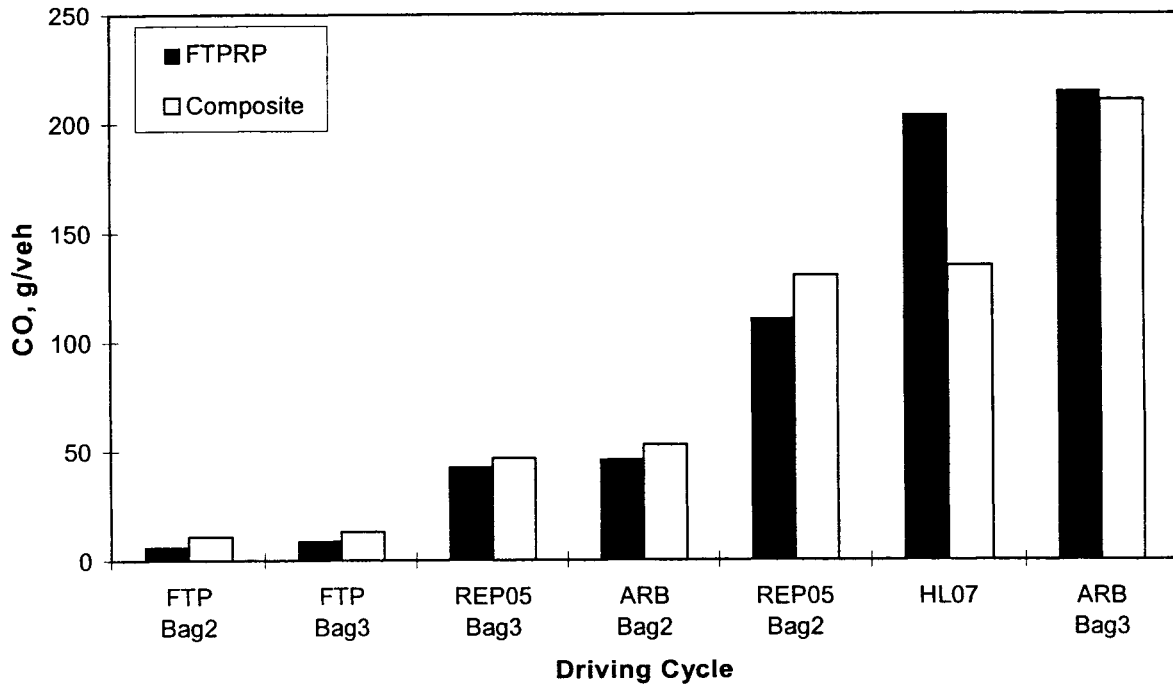

Figure 11. Composite vehicle and FTPRP CO emissions.

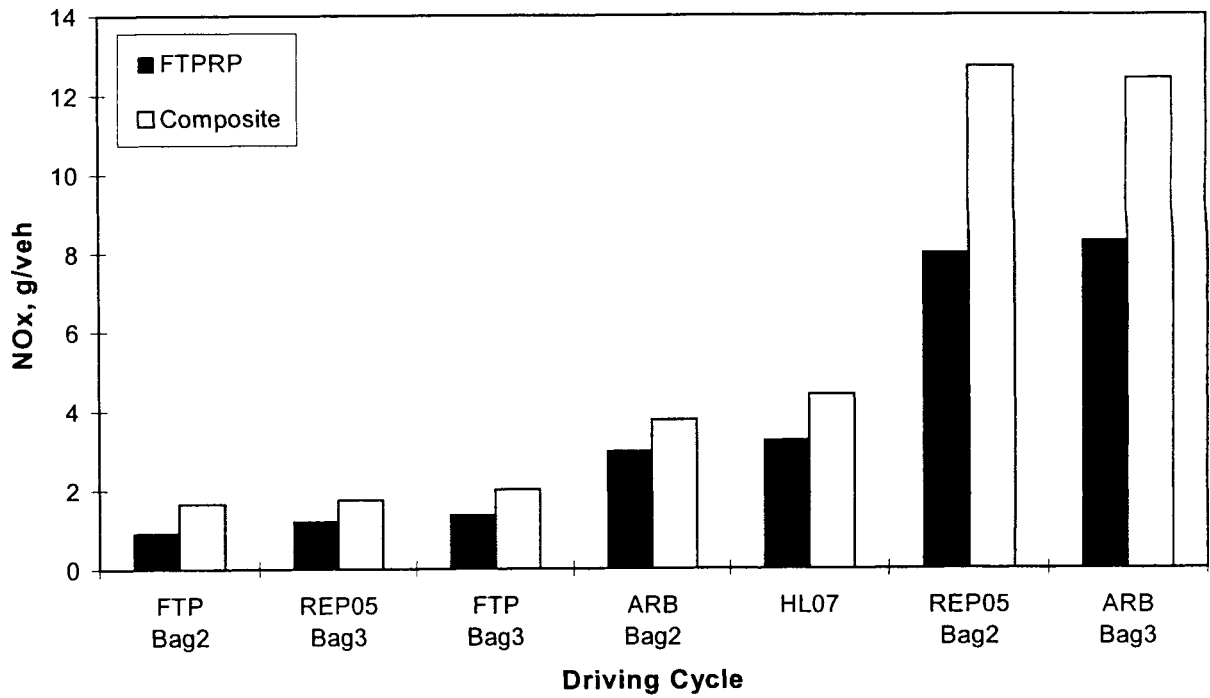

Figure 12. Composite vehicle and FTPRP NO<sub>x</sub> emissions.



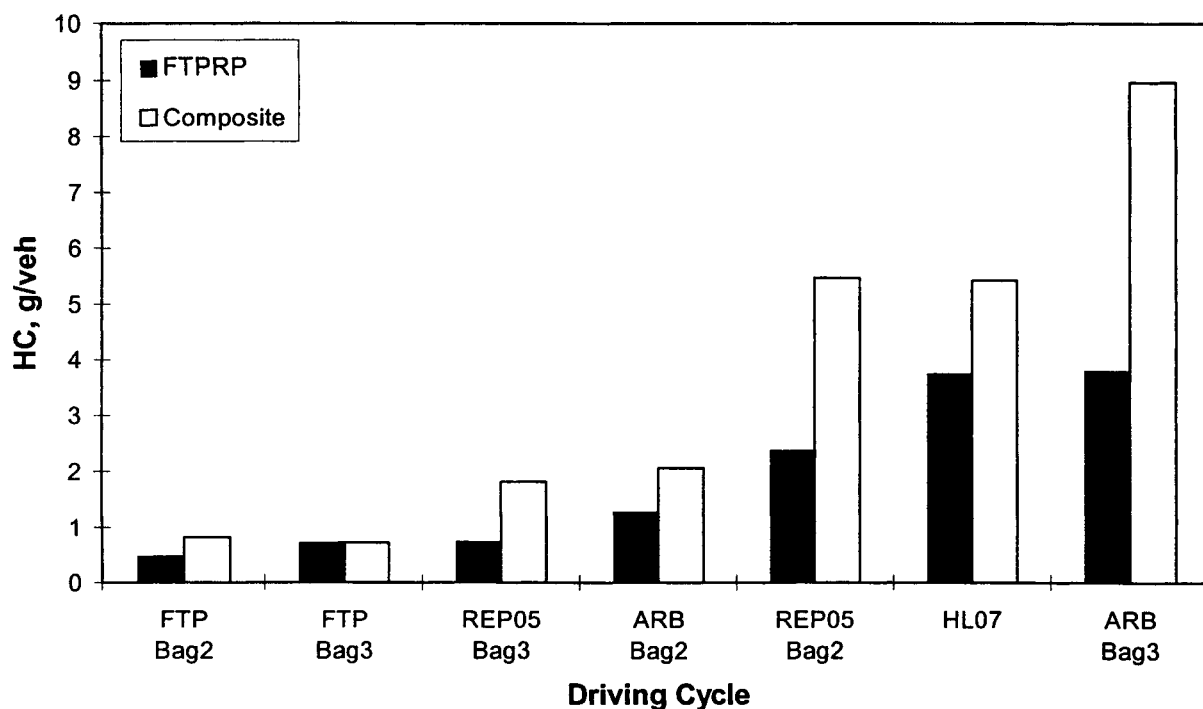

Figure 13. Composite vehicle and FTPRP HC emissions.

## UNIVERSITY OF MICHIGAN STUDY

The University of Michigan was supported under subcontract to develop generalized emissions models based on empirical data from the FTPRP. The intent was to find the underlying parameters that affect differences in emissions from vehicle to vehicle, such that data could be extrapolated to the larger fleet. It was a goal that models developed based on these principles would require only a small amount of new data on different vehicles in order to be equally applicable to a different population of vehicles. This would obviate the need to develop thorough databases on new model vehicles as they become available.

Using the FTPRP database, models for tailpipe CO, HC, and NO<sub>x</sub> were developed based on the fuel consumption rate. The fuel consumption rate must be modeled separately or measured. In the final empirical model, HC, CO, and NO<sub>x</sub> emissions are functions of instantaneous fuel consumption and catalyst pass fraction (CPF). The CPF is a function of fuel consumption rate and engine-out emissions. Exercising the model with *input* fuel consumption from the actual *measured* fuel consumption from the FTPRP database, comparisons of modeled to measured emissions showed good agreement, generally within 20 percent. While the work shows promise, the researchers feel that more work is needed on the catalyst model, cold start, and transients.<sup>[17]</sup>

## SUMMARY AND CONCLUSIONS

Modal models have been developed for eight light-duty vehicles based on extensive road and dynamometer testing. A composite set of models based on the eight vehicles has been used to predict cycle fuel economy and emissions, and the results have been compared to those of a different fleet of light-duty vehicles that have been dynamometer-tested on the same cycles. The

resulting predictions are generally within the typical run-to-run variation in repeat dynamometer tests, and show similar changes in emissions or fuel consumption from cycle to cycle. Since the purpose of the developed models is to evaluate how changes in traffic (driving cycle, or modal activity) will affect emissions and fuel consumption, the authors feel that the models provide realistic predictions.

## RECOMMENDATIONS

**Additional Testing and Model Development:** Development of modal models by the procedures described in this report is very labor intensive, but this approach was deemed necessary to capture all modes of a vehicle's operation. Although every vehicle sold in the United States is emissions certified on a dynamometer, the resulting data have limited use since the maximum acceleration in the current Federal Test Procedure is only 5.3 km/h/s (3.3 mi/h/s), and the maximum speed is only 90 km/h (56 mi/h). Also, the FTP data are reduced to only a few average emissions numbers: a gram per km average for each of the three phases (bags) and a composite number (i.e., there are currently no *modal* data reported from the certification results). However, a recently adopted regulation will require that the future FTP tests (supplemental FTP) include the US06 cycle, which requires more severe accelerations (up to 12.9 km/h/s (8 mi/h/s)) and higher speeds (up to 129 km/h (80 mi/h)). Because of the wider range of speeds and accelerations in the supplemental FTP, the authors feel that it may be possible to develop modal models from second-by-second data from the supplemental FTP, if these types of data were routinely collected. The authors feel that future emissions inventory models will become more and more modal in nature. If second-by-second data were gathered during routine emissions testing, which is required by law, and if these data could be used to make effective modal models, then future traffic and inventory models would benefit from a vast vehicle modal database.

One of the perceived shortcomings of the developed models and the TRAF approach is the absence of any cold-start algorithms. Contentions that fuel consumption and emissions predictions are unrealistic without the additional emissions inherent in cold-start due to enrichment and a cool catalyst are correct. However, if the purpose of the models is to evaluate one traffic scenario against another, then the actual inventory from each scenario is not as important as the relative change from one to the other. On the other hand, if models such as TRAF are to be used to assist in inventory modeling, then cold-start emissions would be important. Cold-start emissions could be readily modeled by developing multiplier factors to account for the cool catalyst and enrichment from cold start. These factors could be a function of the recent temperature and load history of the engine, and could be developed from existing databases (such as FTPRP), then verified and refined with additional start and warmup testing. For any follow-on work, the authors propose that the cold-start issue be examined.

Early in the planning of the project, the topic of "superemitters" was discussed. Some researchers might argue that the developed composite vehicle models suffer serious shortcomings by their lack of any "clunker" in the fleet mix. Recent research suggests that only a small percentage of in-use vehicles are responsible for more than half of the mobile source emissions (see references 2-5). While the developed models are considered a valuable tool for the traffic engineer to use for evaluating one traffic scenario against another, the authors recognize that the absolute emissions could certainly be orders of magnitude higher with one superemitter in the fleet mix, and potentially overwhelm any perceived benefit of a change in modal activity by traffic

management. As such, work is currently underway to develop models for a pre-emissions-control vehicle (c. 1968) and a mid-1980s high emitter.

Existing Engine-Out Data: Throughout the testing program, while fuel consumption and tailpipe emissions were being measured, engine-out emissions were also being collected. The engine-out data were largely used to verify that the catalytic converters were active, and to compute and verify the air/fuel ratio. Based on the work at the University of Michigan and EPA-Ann Arbor,<sup>[15-17]</sup> the authors feel that the engine-out data could be examined in more detail. The tailpipe emissions models have been shown here to satisfactorily predict modal emissions, but it is conceivable that engine-out data are more predictable, as shown by these other researchers. However, if engine-out models were developed, a suitable model(s) for catalyst efficiency would also be required.

## **APPENDIX: FUEL CONSUMPTION AND EMISSIONS LOOKUP TABLES**

The following 72 pages contain the developed models (lookup tables) for fuel consumption, CO, HC, and NO<sub>x</sub> for each of the 8 test vehicles, and the composite vehicle. The approximate acceleration limit of each vehicle is indicated by empty cells (bins) in the lookup tables in this document, although the tables originally supplied to FHWA as the deliverable for this project used nearest neighboring bin filling, as discussed earlier in the report. Units herein are as requested by FHWA. Speed is in ft/s down the leftmost column, and acceleration is in ft/s/s across the top row. Fuel consumption is in gal/h, and emissions are in mg/s.

ft/s	Corsica Fuel Consumption, gal/h																	
	ft/s/s	-5	-4	-3	-2	-1	0	1	2	3	4	5	6	7	8	9	10	11
0	0.45	0.45	0.45	0.45	0.46	0.54	0.81	1.09	1.25	1.44	1.71	1.89	2.15	2.54	2.77	2.96	3.3	3.48
1	0.45	0.45	0.45	0.45	0.47	0.57	0.8	1.06	1.23	1.41	1.65	1.87	2.16	2.51	2.77	3	3.29	3.48
2	0.45	0.45	0.46	0.46	0.48	0.57	0.79	1.03	1.2	1.37	1.59	1.83	2.12	2.48	2.77	3.03	3.3	3.47
3	0.46	0.46	0.46	0.46	0.49	0.58	0.78	1	1.17	1.32	1.53	1.79	2.09	2.44	2.77	3.05	3.3	3.46
4	0.46	0.46	0.47	0.47	0.49	0.57	0.76	0.97	1.13	1.28	1.48	1.74	2.04	2.4	2.75	3.05	3.29	3.44
5	0.47	0.47	0.47	0.47	0.48	0.56	0.73	0.94	1.1	1.23	1.43	1.69	1.98	2.35	2.72	3.04	3.28	3.43
6	0.47	0.47	0.47	0.47	0.48	0.54	0.7	0.91	1.08	1.21	1.39	1.65	1.93	2.3	2.67	3.01	3.27	3.44
7	0.48	0.47	0.47	0.47	0.47	0.52	0.67	0.88	1.07	1.2	1.38	1.62	1.89	2.25	2.62	2.97	3.28	3.48
8	0.48	0.47	0.47	0.47	0.47	0.51	0.64	0.87	1.08	1.22	1.39	1.62	1.87	2.22	2.58	2.94	3.3	3.55
9	0.48	0.47	0.47	0.47	0.46	0.5	0.62	0.86	1.1	1.26	1.42	1.64	1.88	2.21	2.56	2.93	3.33	3.66
10	0.49	0.48	0.47	0.47	0.46	0.49	0.62	0.87	1.14	1.32	1.48	1.68	1.92	2.24	2.57	2.93	3.38	3.76
11	0.49	0.48	0.47	0.47	0.47	0.5	0.62	0.89	1.2	1.4	1.55	1.74	1.98	2.3	2.61	2.96	3.42	3.85
12	0.49	0.48	0.47	0.47	0.48	0.51	0.64	0.93	1.27	1.5	1.64	1.82	2.07	2.4	2.69	3	3.46	3.9
13	0.49	0.48	0.48	0.48	0.49	0.53	0.68	0.98	1.35	1.6	1.75	1.93	2.18	2.51	2.8	3.08	3.51	3.95
14	0.49	0.49	0.48	0.49	0.51	0.56	0.72	1.04	1.43	1.7	1.86	2.04	2.3	2.65	2.93	3.19	3.58	3.99
15	0.49	0.49	0.48	0.49	0.53	0.6	0.76	1.1	1.51	1.8	1.98	2.17	2.43	2.8	3.1	3.34	3.7	4.06
16	0.49	0.49	0.48	0.5	0.56	0.64	0.81	1.15	1.58	1.89	2.09	2.3	2.58	2.97	3.29	3.55	3.87	4.18
17	0.5	0.49	0.49	0.51	0.58	0.68	0.86	1.21	1.64	1.98	2.2	2.43	2.74	3.15	3.51	3.8	4.1	4.35
18	0.5	0.49	0.49	0.52	0.6	0.72	0.9	1.26	1.7	2.05	2.31	2.57	2.91	3.35	3.75	4.08	4.37	4.58
19	0.5	0.49	0.49	0.53	0.63	0.75	0.95	1.31	1.75	2.11	2.41	2.71	3.09	3.56	4	4.38	4.67	4.84
20	0.5	0.49	0.49	0.54	0.65	0.79	0.99	1.36	1.8	2.16	2.5	2.85	3.29	3.78	4.25	4.68	4.99	5.13
21	0.5	0.49	0.5	0.54	0.68	0.82	1.03	1.41	1.83	2.21	2.58	3	3.49	4.01	4.5	4.98	5.31	5.43
22	0.5	0.49	0.5	0.55	0.7	0.85	1.07	1.45	1.87	2.24	2.66	3.16	3.71	4.24	4.75	5.29	5.63	5.72
23	0.5	0.49	0.5	0.56	0.71	0.88	1.1	1.49	1.9	2.27	2.74	3.32	3.94	4.49	5.01	5.59	5.96	6.01
24	0.5	0.49	0.5	0.57	0.73	0.9	1.13	1.53	1.92	2.29	2.8	3.47	4.17	4.74	5.3	5.92	6.28	6.29
25	0.5	0.49	0.5	0.57	0.73	0.91	1.15	1.57	1.95	2.31	2.87	3.63	4.4	5.01	5.6	6.27	6.6	6.54
26	0.5	0.49	0.5	0.57	0.73	0.91	1.17	1.6	1.97	2.34	2.92	3.77	4.63	5.29	5.94	6.63	6.9	6.75
27	0.5	0.49	0.5	0.57	0.73	0.91	1.19	1.63	2	2.36	2.97	3.9	4.85	5.59	6.31	7	7.18	6.9
28	0.5	0.49	0.5	0.57	0.73	0.91	1.2	1.65	2.03	2.39	3.02	4.02	5.07	5.91	6.69	7.34	7.42	7
29	0.5	0.49	0.5	0.56	0.72	0.91	1.22	1.68	2.06	2.43	3.06	4.12	5.29	6.24	7.07	7.66	7.6	7.06
30	0.5	0.49	0.5	0.56	0.71	0.91	1.24	1.71	2.1	2.47	3.11	4.22	5.49	6.57	7.44	7.93	7.75	7.11
31	0.5	0.49	0.5	0.56	0.71	0.91	1.26	1.75	2.15	2.52	3.16	4.3	5.68	6.9	7.78	8.15	7.86	7.17
32	0.5	0.49	0.5	0.56	0.71	0.92	1.29	1.8	2.21	2.58	3.21	4.39	5.87	7.2	8.08	8.32	7.95	7.27
33	0.5	0.5	0.5	0.55	0.71	0.94	1.33	1.85	2.26	2.65	3.28	4.47	6.03	7.46	8.32	8.45	8.03	7.41
34	0.5	0.5	0.5	0.56	0.72	0.97	1.38	1.9	2.32	2.72	3.35	4.56	6.18	7.67	8.51	8.54		
35	0.5	0.5	0.5	0.56	0.73	0.99	1.43	1.95	2.38	2.8	3.45	4.66	6.3	7.82	8.64	8.6		
36	0.51	0.5	0.5	0.56	0.74	1.03	1.48	2	2.44	2.88	3.56	4.77	6.4	7.92	8.7			
37	0.51	0.51	0.5	0.56	0.76	1.06	1.52	2.04	2.49	2.96	3.68	4.88	6.46	7.95	8.71			
38	0.52	0.51	0.5	0.56	0.77	1.09	1.56	2.08	2.54	3.05	3.82	4.99	6.5	7.93				
39	0.52	0.51	0.5	0.56	0.77	1.1	1.59	2.1	2.58	3.15	3.96	5.11						
40	0.53	0.52	0.51	0.57	0.77	1.11	1.61	2.12	2.62	3.24	4.11	5.23						
41	0.53	0.53	0.52	0.57	0.76	1.1	1.61	2.13	2.66	3.33	4.26							
42	0.54	0.53	0.52	0.57	0.75	1.09	1.61	2.14	2.7	3.43								
43	0.55	0.54	0.53	0.57	0.74	1.07	1.6	2.16	2.74	3.52	4.55							
44	0.55	0.55	0.54	0.57	0.73	1.05	1.6	2.18	2.79	3.61	4.69	5.83						
45	0.56	0.55	0.55	0.58	0.72	1.05	1.61	2.2	2.85	3.69	4.83	6.02						
46	0.56	0.55	0.54	0.58	0.73	1.06	1.62	2.24	2.9	3.78	4.97	6.21	7.25					
47	0.56	0.55	0.54	0.58	0.74	1.08	1.65	2.28	2.95	3.86	5.11	6.42	7.48					
48	0.55	0.53	0.53	0.57	0.75	1.12	1.69	2.32	3	3.94	5.25	6.63	7.72					
49	0.54	0.52	0.51	0.57	0.77	1.16	1.73	2.36	3.06	4.03	5.41	6.84	7.95	8.58				
50	0.52	0.5	0.5	0.56	0.78	1.2	1.77	2.4	3.11	4.13	5.58	7.05	8.17	8.77				
51	0.51	0.49	0.49	0.55	0.79	1.23	1.8	2.43	3.16	4.24	5.76	7.27	8.36	8.94				
52	0.5	0.48	0.48	0.55	0.8	1.25	1.83	2.47	3.22	4.36	5.96	7.48	8.54	9.09				
53	0.49	0.48	0.48	0.55	0.8	1.26	1.85	2.5	3.29	4.48	6.15	7.69	8.7	9.22				
54	0.49	0.48	0.48	0.55	0.81	1.27	1.86	2.54	3.36	4.62	6.35	7.89	8.86	9.34				
55	0.49	0.49	0.49	0.56	0.82	1.27	1.88	2.58	3.44	4.76	6.55	8.08	9.01					
56	0.5	0.5	0.5	0.57	0.83	1.29	1.89	2.62	3.54	4.91	6.73	8.26	9.16					
57	0.51	0.51	0.51	0.58	0.84	1.31	1.92	2.68	3.65	5.07	6.91	8.45	9.32					
58	0.52	0.52	0.53	0.6	0.87	1.34	1.95	2.74	3.78	5.23	7.07	8.63	9.48					
59	0.53	0.53	0.54	0.62	0.89	1.37	1.99	2.81	3.91	5.39	7.23	8.81	9.64					
60	0.53	0.53	0.55	0.63	0.92	1.41	2.03	2.88	4.05	5.55	7.37	8.99	9.78					
61	0.54	0.54	0.56	0.64	0.94	1.45	2.08	2.95	4.18	5.69	7.51	9.15	9.91					
62	0.54	0.55	0.56	0.65	0.96	1.49	2.12	3.01	4.3	5.83	7.64	9.29	10					
63	0.55	0.55	0.56	0.65	0.97	1.52	2.16	3.07	4.41	5.97	7.77	9.4	10.07					
64	0.56	0.56	0.57	0.65	0.99	1.55	2.2	3.12	4.5	6.11	7.89	9.49	10.11					
65	0.57	0.57	0.58	0.66	1	1.56	2.23	3.16	4.59	6.26	8	9.54						
66	0.58	0.58	0.59	0.67	1	1.57	2.25	3.2	4.68	6.4	8.1	9.57						
67	0.58	0.6	0.61	0.68	1.01	1.57	2.26	3.24	4.77	6.54	8.19							
68	0.59	0.61	0.63	0.7	1.01	1.56	2.27	3.28	4.85	6.66	8.25							
69	0.6	0.63	0.65	0.72	1.02	1.56	2.28	3.31	4.92	6.76	8.29							
70	0.61	0.64	0.66	0.74	1.03	1.55	2.29	3.35	4.98	6.84								
71	0.62	0.65	0.68	0.76	1.04	1.55	2.3	3.4	5.04									
72	0.62	0.66	0.69	0.77	1.05	1.56	2.33	3.44	5.1									
73	0.63	0.66	0.7	0.79	1.07	1.58	2.36	3.48	5.16									
74	0.64	0.67	0.7	0.8	1.1	1.61	2.4	3.53	5.22									
75	0.65	0.67	0.71	0.81	1.12	1.65	2.44	3.57	5.29	7.23								
76	0.66	0.68	0.72	0.83	1.15	1.69	2.49	3.61	5.36	7.33								
77	0.67	0.69	0.73	0.85	1.19	1.73	2.53	3.66	5.43	7.44								

ft/s	Corsica Fuel Consumption, gal/h												11	12				
	ft/s/s	-5	-4	-3	-2	-1	0	1	2	3	4	5			6	7	8	9
78	0.68	0.7	0.75	0.88	1.23	1.78	2.57	3.7	5.51	7.55								
79	0.69	0.72	0.77	0.91	1.27	1.82	2.61	3.76	5.6	7.65	8.89							
80	0.71	0.73	0.78	0.93	1.31	1.86	2.66	3.83	5.7	7.75	8.96							
81	0.72	0.75	0.8	0.96	1.34	1.9	2.7	3.91	5.82	7.86	9.04							
82	0.74	0.77	0.81	0.97	1.37	1.93	2.75	4	5.94	7.98	9.13							
83	0.76	0.78	0.83	0.99	1.4	1.97	2.79	4.09	6.07	8.1	9.21							
84	0.78	0.8	0.84	1	1.42	2.01	2.84	4.18	6.2	8.22	9.3							
85	0.8	0.82	0.86	1.01	1.45	2.05	2.9	4.27	6.32	8.34	9.39							
86	0.82	0.84	0.87	1.02	1.47	2.09	2.95	4.36	6.43	8.46								
87	0.84	0.86	0.89	1.03	1.48	2.12	3	4.44	6.54	8.58								
88	0.86	0.88	0.9	1.05	1.5	2.13	3.05	4.53	6.64	8.68								
89	0.88	0.9	0.92	1.06	1.5	2.14	3.09	4.62	6.75	8.78								
90	0.91	0.92	0.94	1.07	1.51	2.15	3.13	4.72	6.86	8.87								
91	0.93	0.94	0.96	1.09	1.51	2.16	3.18	4.81	6.96	8.94								
92	0.96	0.97	0.98	1.1	1.52	2.17	3.22	4.91	7.06	9								
93	0.99	1	1	1.12	1.52	2.19	3.28	5	7.14	9.04								
94	1.02	1.03	1.03	1.14	1.54	2.21	3.34	5.1	7.21	9.07								
95	1.06	1.06	1.06	1.16	1.55	2.25	3.4	5.18	7.25	9.07								
96	1.1	1.1	1.09	1.18	1.57	2.28	3.48	5.27	7.29									
97	1.14	1.14	1.12	1.21	1.6	2.33	3.55	5.35	7.31									
98	1.18	1.18	1.15	1.24	1.63	2.37	3.63	5.43	7.33									
99	1.21	1.21	1.19	1.27	1.67	2.43	3.72	5.52	7.35									
100	1.25	1.24	1.22	1.3	1.71	2.49	3.81	5.62	7.38									
101	1.28	1.27	1.25	1.34	1.75	2.55	3.92	5.73	7.43									
102	1.3	1.29	1.28	1.37	1.8	2.63	4.03	5.85	7.5									
103	1.32	1.32	1.31	1.41	1.86	2.72	4.15	5.98	7.59									
104	1.34	1.34	1.33	1.45	1.92	2.8	4.27	6.12	7.69									
105	1.35	1.35	1.36	1.48	1.98	2.89	4.39	6.25	7.79									
106	1.36	1.37	1.38	1.52	2.04	2.96	4.49	6.38	7.9									
107	1.37	1.38	1.39	1.55	2.08	3.03	4.58	6.5	8.01									
108	1.38	1.39	1.41	1.57	2.12	3.08	4.66	6.6	8.11									
109	1.39	1.4	1.43	1.6	2.16	3.13	4.74	6.7	8.2									
110	1.4	1.41	1.44	1.63	2.18	3.18	4.81	6.73	8.26									



ft/s	Corsica CO Emissions, mg/s												6	7	8	9	10	11	12
	ft/s/s	-5	-4	-3	-2	-1	0	1	2	3	4	5							
78	27.06	31.18	31.2	32.99	16.06	1.3	4.64	62.55	462.38	1920.9									
79	29.5	31.55	30.32	32.94	17.38	1.38	5.29	72.79	509.09	1969.75	2905.61								
80	31.15	31.52	29.19	32.36	18.47	1.46	6.04	86.14	555.08	1989.17	2929.36								
81	31.99	31.23	27.95	31.51	19.3	1.53	6.92	101.63	600.67	1979.49	2910.77								
82	32.22	30.76	26.84	30.72	19.89	1.61	7.99	117.46	645.91	1948.05	2858.57								
83	32.15	30.22	26.17	30.29	20.28	1.7	9.33	131.68	690.22	1908.87	2789.99								
84	32.01	29.72	26.15	30.39	20.53	1.82	11.08	143.07	733.09	1879.05	2726.65								
85	31.85	29.32	26.81	30.96	20.63	1.97	13.36	152.02	774.61	1873.89	2689.97								
86	31.63	29.07	27.99	31.83	20.55	2.12	16.23	160.44	815.75	1901.1									
87	31.32	29.03	29.45	32.8	20.29	2.27	19.7	170.76	857.95	1958.3									
88	31.02	29.29	30.9	33.73	19.92	2.4	23.65	184.44	902.89	2034.04									
89	30.99	29.91	32.1	34.57	19.57	2.52	28	201.3	951.72	2112.5									
90	31.49	30.83	32.74	35.24	19.37	2.64	32.74	219.95	1004.48	2178.56									
91	32.6	31.75	32.5	35.61	19.39	2.79	37.9	238.95	1059.36	2221.85									
92	34.1	32.17	31.12	35.52	19.62	2.99	43.52	257.37	1112.93	2238.09									
93	35.54	31.57	28.52	34.84	19.95	3.24	49.66	274.84	1160.78	2228.01									
94	36.38	29.73	24.97	33.52	20.25	3.53	56.44	291.19	1198.61	2194.91									
95	36.1	26.79	20.95	31.62	20.34	3.83	64.13	306.55	1223.16	2142.77									
96	34.41	23.23	17.03	29.24	20.12	4.16	73.1	321.44	1233.69										
97	31.37	19.64	13.63	26.5	19.57	4.55	83.72	336.99	1233.35										
98	27.54	16.48	11	23.52	18.79	5.08	96.06	354.71	1229.53										
99	23.79	14.02	9.17	20.49	17.99	5.87	109.72	376.42	1231.75										
100	20.89	12.29	8.1	17.62	17.41	7.06	123.65	404.11	1248.26										
101	19.04	11.17	7.64	15.12	17.16	8.75	136.21	439.63	1283.53										
102	17.78	10.44	7.61	13.1	17.22	10.95	145.75	484.44	1338.38										
103	16.43	9.87	7.82	11.57	17.44	13.67	151.53	539.45	1411.89										
104	14.62	9.34	8.11	10.45	17.69	16.93	154.48	605.23	1502.83										
105	12.48	8.84	8.39	9.68	17.98	20.82	157.05	682.01	1609.12										
106	10.53	8.46	8.62	9.19	18.39	25.42	161.99	768.82	1726.02										
107	9.19	8.3	8.8	8.92	19.01	30.58	170.61	861.54	1844.73										
108	8.57	8.34	8.91	8.81	19.77	35.76	181.86	951.07	1952.6										
109	8.45	8.49	8.98	8.79	20.48	40.05	192.6	1023.66	2035.38										
110	8.5	8.62	9.01	8.8	20.92	42.51	199.18	1064.72	2080.46										





ft/s	Corsica HC Emissions, mg/s											12					
	-5	-4	-3	-2	-1	0	1	2	3	4	5		6	7	8	9	10
78	4.21	4.63	4.47	4.81	2.93	1.38	3.28	6.48	15.05	47.72							
79	4.49	4.64	4.27	4.67	3.11	1.46	3.44	6.78	16.06	49.50	68.41						
80	4.66	4.59	3.99	4.40	3.26	1.54	3.57	7.16	17.09	50.67	69.78						
81	4.72	4.51	3.63	4.05	3.37	1.62	3.69	7.58	18.17	51.13	69.89						
82	4.71	4.40	3.25	3.68	3.43	1.70	3.79	7.97	19.31	50.97	68.90						
83	4.67	4.26	2.91	3.37	3.47	1.80	3.89	8.30	20.48	50.41	67.17						
84	4.62	4.09	2.68	3.16	3.49	1.91	4.00	8.55	21.66	49.71	65.18						
85	4.57	3.91	2.56	3.05	3.50	2.04	4.12	8.73	22.81	49.12	63.36						
86	4.47	3.70	2.55	3.03	3.47	2.16	4.25	8.90	23.92	48.82							
87	4.27	3.47	2.61	3.05	3.42	2.26	4.38	9.13	25.00	48.87							
88	3.98	3.24	2.70	3.10	3.35	2.33	4.51	9.44	26.05	49.22							
89	3.63	3.05	2.78	3.16	3.28	2.37	4.64	9.82	27.12	49.79							
90	3.32	2.94	2.83	3.21	3.19	2.38	4.77	10.23	28.19	50.43							
91	3.14	2.88	2.81	3.23	3.10	2.39	4.90	10.65	29.27	51.06							
92	3.09	2.85	2.69	3.20	2.99	2.41	5.07	11.06	30.30	51.66							
93	3.14	2.76	2.45	3.11	2.88	2.45	5.26	11.47	31.20	52.27							
94	3.20	2.59	2.13	2.98	2.78	2.53	5.48	11.87	31.89	52.97							
95	3.19	2.32	1.78	2.80	2.68	2.63	5.75	12.26	32.27	53.76							
96	3.06	2.00	1.45	2.58	2.58	2.74	6.06	12.65	32.29								
97	2.80	1.69	1.18	2.35	2.48	2.85	6.41	13.06	31.99								
98	2.45	1.43	0.98	2.09	2.38	2.97	6.81	13.50	31.56								
99	2.10	1.24	0.85	1.83	2.30	3.10	7.23	14.00	31.24								
100	1.85	1.11	0.76	1.57	2.26	3.25	7.64	14.57	31.25								
101	1.71	1.03	0.71	1.35	2.26	3.41	8.02	15.25	31.72								
102	1.64	0.97	0.68	1.16	2.27	3.57	8.32	16.04	32.64								
103	1.54	0.93	0.67	1.00	2.28	3.72	8.54	16.98	34.02								
104	1.38	0.87	0.67	0.88	2.24	3.84	8.67	18.10	35.90								
105	1.16	0.81	0.66	0.79	2.15	3.93	8.77	19.45	38.29								
106	0.96	0.76	0.66	0.72	2.02	3.98	8.89	21.07	41.12								
107	0.80	0.71	0.66	0.68	1.87	4.00	9.08	22.91	44.14								
108	0.71	0.68	0.65	0.66	1.72	3.99	9.32	24.79	46.97								
109	0.67	0.66	0.64	0.64	1.61	3.97	9.54	26.39	49.18								
110	0.66	0.65	0.64	0.64	1.55	3.95	9.68	27.31	50.39								

ft/s	Corsica NOx Emissions, mg/s																		
	ft/s/s	-5	-4	-3	-2	-1	0	1	2	3	4	5	6	7	8	9	10	11	12
0	0.05	0.05	0.05	0.05	0.12	0.67	1.30	1.97	2.18	2.19	1.87	1.31	1.10	2.25	6.17	9.30	9.79	7.73	
1	0.05	0.05	0.05	0.05	0.13	0.66	1.30	2.00	2.33	2.49	2.22	1.55	1.16	2.23	6.25	9.32	9.81	7.64	
2	0.04	0.05	0.05	0.05	0.13	0.63	1.29	2.03	2.58	3.02	2.90	2.10	1.35	2.18	6.25	9.16	9.69	7.46	
3	0.04	0.05	0.05	0.05	0.13	0.58	1.25	2.06	2.83	3.65	3.84	2.94	1.76	2.09	5.95	8.65	9.33	7.28	
4	0.04	0.06	0.06	0.06	0.12	0.51	1.17	2.05	2.97	4.15	4.83	3.94	2.38	1.97	5.32	7.80	8.79	7.24	
5	0.04	0.07	0.06	0.06	0.10	0.42	1.06	1.98	2.98	4.38	5.65	4.86	3.09	1.82	4.48	6.83	8.28	7.52	
6	0.05	0.07	0.07	0.07	0.08	0.33	0.91	1.87	2.90	4.42	6.17	5.52	3.68	1.71	3.66	5.99	7.92	8.06	
7	0.07	0.08	0.06	0.06	0.06	0.25	0.77	1.78	2.86	4.46	6.44	5.84	3.98	1.67	3.06	5.41	7.68	8.59	
8	0.09	0.09	0.06	0.06	0.05	0.18	0.65	1.74	2.98	4.71	6.55	5.84	3.90	1.71	2.82	5.17	7.46	8.73	
9	0.11	0.09	0.06	0.05	0.04	0.14	0.57	1.81	3.28	5.20	6.56	5.59	3.49	1.86	3.03	5.30	7.23	8.36	
10	0.12	0.09	0.06	0.05	0.04	0.11	0.55	2.00	3.71	5.75	6.38	5.10	2.91	2.15	3.74	5.88	7.16	7.66	
11	0.13	0.10	0.08	0.06	0.06	0.12	0.59	2.25	4.07	6.00	5.84	4.37	2.34	2.63	4.91	6.96	7.45	7.02	
12	0.14	0.11	0.10	0.08	0.09	0.16	0.69	2.49	4.16	5.69	4.88	3.47	1.91	3.26	6.34	8.39	8.08	6.68	
13	0.15	0.12	0.12	0.11	0.14	0.24	0.84	2.63	3.90	4.80	3.65	2.54	1.67	3.95	7.72	9.84	8.80	6.62	
14	0.16	0.13	0.14	0.15	0.20	0.36	1.04	2.62	3.40	3.66	2.45	1.75	1.58	4.53	8.70	10.86	9.28	6.66	
15	0.17	0.15	0.15	0.18	0.27	0.50	1.24	2.48	2.82	2.59	1.57	1.22	1.58	4.87	9.08	11.17	9.30	6.60	
16	0.18	0.16	0.15	0.20	0.35	0.67	1.43	2.28	2.32	1.84	1.10	0.97	1.65	4.94	8.83	10.69	8.79	6.31	
17	0.19	0.17	0.16	0.24	0.44	0.85	1.58	2.09	1.96	1.46	0.99	0.98	1.80	4.78	8.10	9.54	7.82	5.75	
18	0.20	0.18	0.17	0.28	0.55	1.05	1.71	1.96	1.79	1.44	1.22	1.23	2.06	4.53	7.09	7.96	6.51	4.94	
19	0.20	0.19	0.18	0.34	0.70	1.26	1.83	1.89	1.84	1.74	1.75	2.46	4.31	6.00	6.25	5.06	3.99		
20	0.20	0.20	0.20	0.41	0.87	1.48	1.96	1.87	2.09	2.30	2.67	2.57	3.05	4.20	5.00	4.71	3.72	3.08	
21	0.20	0.20	0.21	0.48	1.05	1.69	2.06	1.88	2.44	3.06	3.85	3.68	3.80	4.19	4.18	3.53	2.69	2.36	
22	0.20	0.20	0.21	0.57	1.20	1.86	2.12	1.91	2.80	3.92	5.20	4.99	4.62	4.19	3.56	2.75	2.05	1.91	
23	0.20	0.20	0.22	0.64	1.31	1.98	2.12	1.95	3.08	4.75	6.50	6.26	5.29	4.09	3.07	2.25	1.71	1.67	
24	0.20	0.20	0.23	0.70	1.37	2.04	2.06	1.98	3.23	5.42	7.53	7.22	5.65	3.80	2.63	1.92	1.53	1.53	
25	0.20	0.20	0.23	0.73	1.39	2.06	2.00	2.00	3.27	5.85	8.15	7.70	5.60	3.33	2.22	1.67	1.41	1.42	
26	0.20	0.20	0.23	0.73	1.39	2.06	1.96	1.99	3.24	6.05	8.38	7.71	5.23	2.76	1.86	1.48	1.32	1.33	
27	0.20	0.20	0.23	0.70	1.37	2.03	1.94	1.98	3.22	6.15	8.40	7.46	4.73	2.23	1.59	1.35	1.25	1.26	
28	0.20	0.20	0.23	0.66	1.35	2.00	1.93	1.96	3.25	6.31	8.42	7.20	4.27	1.84	1.42	1.25	1.19	1.23	
29	0.20	0.20	0.22	0.61	1.33	1.97	1.94	1.97	3.41	6.67	8.63	7.13	3.96	1.62	1.31	1.18	1.16	1.22	
30	0.20	0.20	0.22	0.57	1.31	1.95	1.94	2.01	3.73	7.30	9.10	7.27	3.79	1.52	1.24	1.11	1.13	1.23	
31	0.20	0.20	0.21	0.55	1.30	1.94	1.92	2.09	4.23	8.15	9.76	7.53	3.70	1.49	1.18	1.06	1.11	1.22	
32	0.20	0.20	0.21	0.55	1.29	1.95	1.90	2.22	4.88	9.09	10.49	7.75	3.63	1.47	1.13	1.02	1.09	1.20	
33	0.21	0.20	0.21	0.56	1.30	1.96	1.88	2.37	5.56	9.95	11.10	7.82	3.53	1.43	1.09	1.00	1.07	1.17	
34	0.22	0.20	0.21	0.58	1.32	1.97	1.88	2.52	6.18	10.57	11.47	7.71	3.39	1.39	1.07	0.99			
35	0.23	0.21	0.22	0.60	1.35	1.98	1.93	2.67	6.65	10.88	11.52	7.45	3.21	1.35	1.07	0.99			
36	0.25	0.23	0.23	0.63	1.41	2.00	2.05	2.84	6.98	10.88	11.29	7.08	3.04	1.33	1.08				
37	0.27	0.25	0.24	0.66	1.48	2.04	2.22	3.04	7.19	10.64	10.86	6.67	2.92	1.34	1.09				
38	0.31	0.27	0.26	0.68	1.54	2.10	2.41	3.23	7.26	10.25	10.35	6.28	2.84	1.35					
39	0.34	0.31	0.29	0.71	1.57	2.14	2.56	3.32	7.13	9.75	9.80	5.94							
40	0.38	0.35	0.34	0.72	1.56	2.14	2.65	3.32	6.78	9.18	9.16	5.61							
41	0.41	0.40	0.40	0.72	1.51	2.08	2.71	3.25	6.28	8.48	8.35								
42	0.44	0.46	0.47	0.71	1.43	1.99	2.77	3.21	5.74	7.60									
43	0.50	0.53	0.55	0.71	1.32	1.87	2.86	3.23	5.26	6.57	6.18								
44	0.57	0.61	0.64	0.72	1.24	1.77	2.97	3.30	4.91	5.52	5.08	3.24							
45	0.64	0.69	0.71	0.73	1.18	1.68	3.05	3.35	4.66	4.63	4.20	2.63							
46	0.70	0.74	0.75	0.76	1.16	1.61	3.08	3.36	4.49	4.01	3.59	2.19	1.32						
47	0.74	0.76	0.78	0.77	1.16	1.57	3.03	3.32	4.39	3.66	3.22	1.91	1.24						
48	0.75	0.77	0.79	0.78	1.18	1.54	2.96	3.33	4.37	3.55	3.01	1.71	1.14						
49	0.75	0.77	0.79	0.78	1.20	1.54	2.91	3.44	4.47	3.61	2.87	1.57	1.03	0.72					
50	0.75	0.77	0.79	0.78	1.22	1.56	2.90	3.69	4.71	3.80	2.76	1.44	0.92	0.60					
51	0.75	0.77	0.79	0.78	1.25	1.59	2.96	4.06	5.08	4.09	2.68	1.33	0.83	0.51					
52	0.75	0.77	0.79	0.78	1.28	1.60	3.06	4.52	5.54	4.43	2.61	1.25	0.77	0.46					
53	0.75	0.77	0.79	0.78	1.31	1.60	3.17	5.00	6.05	4.79	2.55	1.18	0.74	0.45					
54	0.75	0.77	0.79	0.78	1.34	1.58	3.26	5.42	6.50	5.09	2.49	1.14	0.73	0.45					
55	0.75	0.77	0.79	0.78	1.35	1.56	3.29	5.72	6.78	5.29	2.40	1.10	0.73						
56	0.75	0.77	0.79	0.78	1.35	1.52	3.28	5.86	6.86	5.32	2.27	1.07	0.72						
57	0.75	0.77	0.79	0.78	1.33	1.48	3.26	5.89	6.77	5.18	2.10	1.02	0.70						
58	0.75	0.77	0.79	0.78	1.28	1.42	3.26	5.86	6.56	4.90	1.89	0.97	0.66						
59	0.75	0.77	0.79	0.78	1.20	1.34	3.29	5.78	6.29	4.52	1.66	0.91	0.60						
60	0.75	0.77	0.79	0.78	1.12	1.27	3.30	5.64	5.96	4.11	1.45	0.85	0.55						
61	0.75	0.77	0.79	0.78	1.05	1.21	3.26	5.41	5.59	3.71	1.29	0.80	0.50						
62	0.75	0.77	0.79	0.78	0.99	1.17	3.15	5.09	5.18	3.37	1.19	0.77	0.47						
63	0.75	0.77	0.79	0.78	0.97	1.16	2.98	4.72	4.77	3.11	1.14	0.75	0.47						
64	0.75	0.77	0.79	0.78	0.98	1.16	2.78	4.33	4.40	2.93	1.13	0.74	0.47						
65	0.75	0.77	0.79	0.78	1.01	1.17	2.57	3.95	4.06	2.79	1.14	0.74							
66	0.75	0.77	0.79	0.78	1.06	1.17	2.36	3.57	3.75	2.67	1.14	0.73							
67	0.75	0.77	0.79	0.78	1.10	1.16	2.16	3.22	3.43	2.54	1.13								
68	0.75	0.77	0.79	0.78	1.13	1.16	1.98	2.90	3.13	2.41	1.09								
69	0.75	0.77	0.79	0.78	1.16	1.17	1.85	2.65	2.87	2.27	1.05								
70	0.75	0.77	0.79	0.78	1.18	1.20	1.82	2.52	2.71	2.16									
71	0.75	0.77	0.79	0.78	1.19	1.24	1.87	2.51	2.65										
72	0.75	0.77	0.79	0.78	1.18	1.29	2.01	2.60	2.67										
73	0.75	0.77	0.79	0.78	1.16	1.35	2.20	2.75	2.73										
74	0.75	0.77	0.79	0.78	1.13	1.40	2.40</												

ft/s	Corsica NOx Emissions, mg/s																		
	ft/s	-5	-4	-3	-2	-1	0	1	2	3	4	5	6	7	8	9	10	11	12
78	0.75	0.77	0.79	0.78	0.96	1.48	2.92	3.42	3.00	1.50									
79	0.75	0.77	0.79	0.78	0.92	1.51	2.96	3.45	2.96	1.44	0.64								
80	0.75	0.77	0.79	0.78	0.90	1.54	2.99	3.46	2.90	1.37	0.63								
81	0.75	0.77	0.79	0.78	0.88	1.59	3.04	3.45	2.82	1.31	0.62								
82	0.75	0.77	0.79	0.78	0.89	1.67	3.12	3.47	2.75	1.24	0.62								
83	0.75	0.77	0.79	0.78	0.92	1.82	3.29	3.54	2.71	1.18	0.62								
84	0.75	0.77	0.79	0.78	0.98	2.06	3.56	3.70	2.69	1.12	0.63								
85	0.75	0.77	0.79	0.78	1.07	2.39	3.93	3.94	2.69	1.07	0.63								
86	0.75	0.77	0.79	0.78	1.20	2.79	4.36	4.20	2.67	1.02									
87	0.75	0.77	0.79	0.78	1.36	3.20	4.75	4.41	2.60	0.97									
88	0.75	0.77	0.79	0.78	1.53	3.58	5.04	4.51	2.49	0.91									
89	0.75	0.77	0.79	0.78	1.70	3.87	5.23	4.52	2.34	0.87									
90	0.75	0.77	0.79	0.78	1.85	4.12	5.35	4.47	2.20	0.83									
91	0.75	0.77	0.79	0.78	2.02	4.33	5.46	4.41	2.07	0.81									
92	0.75	0.77	0.79	0.78	2.19	4.52	5.55	4.31	1.96	0.80									
93	0.75	0.77	0.79	0.78	2.35	4.65	5.59	4.18	1.87	0.80									
94	0.75	0.77	0.79	0.78	2.47	4.68	5.54	4.01	1.78	0.80									
95	0.75	0.77	0.79	0.78	2.52	4.61	5.39	3.80	1.70	0.82									
96	0.75	0.77	0.79	0.78	2.49	4.45	5.15	3.59	1.64										
97	0.75	0.77	0.79	0.78	2.41	4.23	4.86	3.38	1.59										
98	0.75	0.77	0.79	0.78	2.31	3.98	4.55	3.18	1.54										
99	0.75	0.77	0.79	0.78	2.21	3.76	4.28	3.00	1.49										
100	0.75	0.77	0.79	0.78	2.15	3.63	4.09	2.87	1.44										
101	0.75	0.77	0.79	0.78	2.16	3.62	4.03	2.79	1.39										
102	0.75	0.77	0.79	0.78	2.27	3.74	4.11	2.75	1.33										
103	0.75	0.77	0.79	0.78	2.49	3.99	4.31	2.73	1.28										
104	0.75	0.77	0.79	0.78	2.77	4.32	4.59	2.73	1.22										
105	0.75	0.77	0.79	0.78	3.07	4.66	4.90	2.72	1.18										
106	0.75	0.77	0.79	0.78	3.39	4.99	5.21	2.70	1.14										
107	0.75	0.77	0.79	0.78	3.72	5.30	5.50	2.66	1.12										
108	0.75	0.77	0.79	0.78	4.05	5.59	5.78	2.59	1.09										
109	0.75	0.77	0.79	0.78	4.35	5.82	6.01	2.51	1.08										
110	0.75	0.77	0.79	0.78	4.52	5.96	6.14	2.46	1.06										

		Oldsmobile Cutlass Fuel Consumption, gal/h																	
ft/s	ft/s/s	-5	-4	-3	-2	-1	0	1	2	3	4	5	6	7	8	9	10	11	12
0	0.66	0.66	0.66	0.66	0.66	0.69	0.69	0.74	0.85	1.1	1.43	1.63	2.04	2.77	3.21	3.91	6.89	7.09	6.94
1	0.66	0.66	0.66	0.66	0.67	0.7	0.7	0.75	0.87	1.14	1.48	1.68	2.08	2.81	3.26	4.03	6.9	7.09	6.94
2	0.66	0.66	0.66	0.68	0.72	0.72	0.77	0.91	1.2	1.56	1.77	2.17	2.89	3.39	4.28	6.92	7.08	6.94	
3	0.66	0.66	0.66	0.7	0.75	0.75	0.79	0.95	1.28	1.68	1.91	2.33	3.04	3.6	4.65	6.94	7.07	6.94	
4	0.66	0.66	0.66	0.73	0.79	0.79	0.83	1	1.36	1.81	2.09	2.55	3.25	3.9	5.11	6.98	7.06	6.96	
5	0.66	0.66	0.67	0.78	0.84	0.84	0.87	1.05	1.45	1.96	2.3	2.79	3.5	4.22	5.55	7	7.04	6.98	
6	0.66	0.66	0.68	0.85	0.89	0.89	0.93	1.12	1.53	2.11	2.51	3.03	3.74	4.53	5.91	7.02	7.02	7.02	
7	0.66	0.66	0.71	0.92	0.94	0.94	1	1.22	1.63	2.28	2.71	3.24	3.95	4.79	6.17	7.03	7	7.05	
8	0.66	0.67	0.75	0.99	0.99	1.01	1.09	1.33	1.75	2.45	2.89	3.42	4.11	4.99	6.36	7.04	6.98	7.09	
9	0.66	0.68	0.81	1.05	1.05	1.08	1.18	1.46	1.86	2.61	3.06	3.58	4.22	5.13	6.51	7.05	6.97	7.11	
10	0.67	0.72	0.89	1.09	1.11	1.15	1.27	1.57	1.97	2.76	3.22	3.73	4.31	5.23	6.64	7.07	6.98	7.13	
11	0.69	0.77	0.97	1.12	1.16	1.2	1.35	1.66	2.05	2.87	3.37	3.88	4.38	5.28	6.75	7.09	7.01	7.15	
12	0.74	0.85	1.04	1.14	1.19	1.24	1.41	1.73	2.12	2.94	3.5	4.02	4.44	5.31	6.83	7.11	7.04	7.17	
13	0.81	0.94	1.09	1.15	1.2	1.26	1.44	1.78	2.18	3	3.62	4.15	4.51	5.33	6.89	7.13	7.09	7.19	
14	0.92	1.03	1.12	1.14	1.19	1.27	1.46	1.83	2.24	3.05	3.73	4.28	4.59	5.36	6.9	7.14	7.14	7.23	
15	1.03	1.1	1.13	1.14	1.17	1.26	1.47	1.87	2.32	3.11	3.83	4.4	4.7	5.41	6.87	7.15	7.23	7.31	
16	1.12	1.15	1.13	1.13	1.15	1.25	1.48	1.91	2.41	3.2	3.93	4.52	4.83	5.46	6.78	7.17	7.37	7.45	
17	1.17	1.19	1.14	1.13	1.14	1.24	1.5	1.97	2.52	3.3	4.02	4.64	4.97	5.54	6.66	7.22	7.57	7.66	
18	1.19	1.21	1.14	1.13	1.13	1.23	1.52	2.03	2.63	3.41	4.11	4.73	5.12	5.66	6.57	7.22	7.83	7.92	
19	1.18	1.22	1.15	1.13	1.14	1.24	1.56	2.1	2.74	3.51	4.19	4.81	5.25	5.82	6.54	7.45	8.09	8.18	
20	1.16	1.22	1.16	1.14	1.15	1.25	1.59	2.17	2.85	3.6	4.25	4.87	5.37	6.02	6.61	7.61	8.31	8.4	
21	1.15	1.22	1.18	1.14	1.17	1.28	1.63	2.23	2.95	3.67	4.3	4.92	5.49	6.27	6.75	7.77	8.46	8.54	
22	1.14	1.2	1.19	1.15	1.2	1.31	1.67	2.3	3.04	3.73	4.36	4.98	5.61	6.53	6.96	7.92	8.55	8.62	
23	1.13	1.18	1.2	1.16	1.23	1.35	1.71	2.37	3.13	3.79	4.45	5.06	5.75	6.8	7.19	8.03	8.58	8.63	
24	1.13	1.17	1.21	1.17	1.26	1.4	1.76	2.43	3.21	3.87	4.57	5.17	5.92	7.04	7.43	8.13	8.56	8.61	
25	1.13	1.15	1.21	1.19	1.31	1.46	1.81	2.5	3.28	3.95	4.72	5.29	6.12	7.26	7.67	8.21	8.52	8.55	
26	1.13	1.14	1.22	1.22	1.36	1.53	1.86	2.56	3.35	4.06	4.9	5.43	6.36	7.45	7.91	8.32			
27	1.13	1.14	1.22	1.25	1.41	1.59	1.91	2.62	3.41	4.18	5.08	5.59	6.6	7.6	8.14	8.46			
28	1.13	1.13	1.22	1.27	1.45	1.65	1.96	2.67	3.47	4.31	5.25	5.77	6.85	7.74	8.38	8.68			
29	1.13	1.13	1.22	1.3	1.49	1.71	2.01	2.72	3.54	4.44	5.42	5.96	7.08	7.88	8.62	8.97			
30	1.14	1.14	1.22	1.31	1.52	1.75	2.07	2.77	3.61	4.58	5.58	6.16	7.3	8.04	8.88	9.33			
31	1.14	1.14	1.23	1.33	1.53	1.79	2.13	2.83	3.71	4.72	5.74	6.38	7.49	8.22	9.17	9.74			
32	1.14	1.15	1.23	1.34	1.53	1.8	2.17	2.89	3.81	4.87	5.91	6.61	7.68	8.42	9.49	10.17			
33	1.14	1.16	1.25	1.35	1.52	1.81	2.2	2.95	3.94	5.02	6.09	6.86	7.85	8.64	9.84	10.61			
34	1.14	1.16	1.27	1.37	1.5	1.82	2.2	3.02	4.07	5.19	6.3	7.12	8.02	8.86	10.22	11.03			
35	1.14	1.17	1.29	1.38	1.49	1.83	2.2	3.09	4.21	5.37	6.52	7.38	8.19	9.1	10.64	11.44			
36	1.14	1.17	1.3	1.39	1.49	1.84	2.19	3.16	4.34	5.56	6.75	7.63	8.39	9.37	11.09	11.84			
37	1.14	1.17	1.29	1.39	1.5	1.85	2.19	3.23	4.45	5.76	6.98	7.86	8.6	9.7	11.58	12.24			
38	1.14	1.16	1.27	1.39	1.51	1.85	2.2	3.29	4.55	5.96	7.21	8.07	8.86	10.1	12.08	12.63			
39	1.14	1.16	1.25	1.37	1.52	1.84	2.21	3.35	4.64	6.17	7.41	8.28	9.16	10.55	12.58	13.01			
40	1.14	1.16	1.23	1.36	1.53	1.82	2.23	3.4	4.73	6.38	7.61	8.49	9.52	11.03	13.03	13.35			
41	1.14	1.16	1.23	1.34	1.52	1.81	2.25	3.45	4.82	6.58	7.79	8.72	9.92	11.5	13.44	13.68			
42	1.14	1.16	1.24	1.33	1.52	1.8	2.28	3.49	4.93	6.78	7.95	8.95	10.34	11.95	13.81	14			
43	1.13	1.16	1.24	1.31	1.5	1.8	2.31	3.53	5.06	6.97	8.11	9.19	10.74	12.4	14.17	14.32			
44	1.14	1.16	1.23	1.29	1.48	1.81	2.34	3.57	5.21	7.15	8.27	9.43	11.12	12.88	14.52	14.64			
45	1.14	1.16	1.22	1.26	1.46	1.83	2.39	3.63	5.35	7.32	8.44	9.69	11.5	13.42	14.88	14.96			
46	1.15	1.16	1.21	1.23	1.44	1.86	2.44	3.7	5.48	7.48	8.64	9.98	11.88	14	15.24	15.28			
47	1.17	1.17	1.19	1.21	1.43	1.89	2.48	3.78	5.6	7.63	8.87	10.29	12.28	14.6	15.59	15.58			
48	1.19	1.19	1.19	1.2	1.43	1.92	2.53	3.87	5.7	7.79	9.13	10.62	12.67	15.15	15.94	15.85			
49	1.23	1.22	1.2	1.2	1.44	1.94	2.57	3.98	5.81	7.95	9.4	10.94	13.05	15.64	16.26	16.07			
50	1.25	1.25	1.21	1.21	1.46	1.95	2.6	4.11	5.94	8.09	9.65	11.26	13.4	16.04	16.54	16.23			
51	1.27	1.26	1.23	1.23	1.48	1.95	2.62	4.25	6.06	8.21	9.85	11.55	13.76	16.34	16.79				
52	1.27	1.26	1.23	1.23	1.51	1.93	2.64	4.39	6.19	8.29	10.02	11.83	14.15	16.56	16.99				
53	1.25	1.24	1.21	1.23	1.53	1.91	2.67	4.51	6.29	8.32	10.14	12.1	14.57	16.7	17.15				
54	1.22	1.21	1.17	1.21	1.54	1.91	2.72	4.61	6.39	8.34	10.25	12.35	14.98	16.81					
55	1.19	1.17	1.13	1.19	1.55	1.91	2.77	4.68	6.47	8.37	10.36	12.6	15.33	16.9					
56	1.16	1.14	1.1	1.17	1.55	1.93	2.83	4.73	6.56	8.46	10.47	12.84	15.59	17.02					
57	1.14	1.12	1.09	1.16	1.56	1.95	2.88	4.76	6.66	8.59	10.6	13.09	15.77	17.17					
58	1.13	1.12	1.09	1.17	1.57	1.96	2.91	4.78	6.77	8.75	10.75	13.33	15.88						
59	1.13	1.13	1.12	1.2	1.58	1.97	2.92	4.8	6.88	8.92	10.91	13.53	15.94						
60	1.16	1.16	1.16	1.23	1.59	1.98	2.94	4.83	7.01	9.09	11.08	13.67	15.94						
61	1.21	1.21	1.21	1.27	1.6	1.99	2.96	4.87	7.14	9.25	11.22	13.69	15.88						
62	1.26	1.26	1.26	1.31	1.61	2.01	3.01	4.92	7.28	9.41	11.33	13.58	15.72						
63	1.3	1.3	1.31	1.35	1.63	2.03	3.07	5	7.42	9.54	11.41	13.39	15.47						
64	1.33	1.33	1.33	1.37	1.65	2.04	3.13	5.11	7.55	9.64	11.46	13.17	15.13						
65	1.34	1.34	1.34	1.39	1.66	2.05	3.2	5.24	7.65	9.69	11.49	12.99	14.78						
66	1.35	1.34	1.35	1.4	1.68	2.07	3.27	5.38	7.72	9.73	11.52	12.86	14.48						
67	1.37	1.36	1.37	1.41	1.7	2.1	3.34	5.52	7.77	9.77	11.56	12.78	14.26	17.67					
68	1.41	1.41	1.41	1.44	1.72	2.13	3.44	5.66	7.81	9.85	11.63	12.73	14.1	17.62					
69	1.49	1.48	1.47	1.46	1.73	2.18	3.55	5.78	7.84	9.98	11.75	12.68	13.96	17.51					
70	1.56	1.56	1.53	1.47	1.73	2.23	3.68	5.9	7.89	10.14	11.92	12.67	13.79	17.31					
71	1.63	1.62	1.56	1.46	1.72	2.27	3.82	6.02	7.95	10.32	12.13	12.71	13.61						
72</																			

ft/s	Oldsmobile Cutlass Fuel Consumption, gal/h																		
	ft/s/s	-5	-4	-3	-2	-1	0	1	2	3	4	5	6	7	8	9	10	11	12
78	1.71	1.6	1.3	1.29	1.75	2.39	4.61	7.11	8.95	11.42									
79	1.7	1.57	1.32	1.31	1.77	2.42	4.69	7.22	9.15	11.6	13.54								
80	1.69	1.55	1.35	1.36	1.79	2.42	4.74	7.32	9.34	11.78	13.7								
81	1.66	1.53	1.41	1.42	1.81	2.41	4.76	7.42	9.51	11.96	13.86								
82	1.63	1.53	1.51	1.5	1.84	2.38	4.79	7.52	9.65	12.14	14.01								
83	1.59	1.54	1.63	1.63	1.86	2.35	4.83	7.62	9.76	12.32	14.15								
84	1.55	1.56	1.8	1.8	1.89	2.34	4.89	7.7	9.86	12.47	14.27								
85	1.51	1.56	1.99	2	1.93	2.37	4.96	7.78	9.97	12.57	14.36								
86	1.49	1.56	2.16	2.21	1.97	2.42	5.02	7.86	10.09	12.61	14.42								
87	1.47	1.54	2.27	2.35	2.01	2.47	5.06	7.94	10.22	12.6	14.43								
88	1.46	1.51	2.27	2.38	2.03	2.52	5.07	8.03	10.36	12.55	14.4								
89	1.45	1.49	2.16	2.28	2.03	2.55	5.07	8.14	10.5	12.49	14.33								
90	1.45	1.47	1.98	2.08	2.01	2.55	5.09	8.28	10.65	12.48	14.3								
91	1.45	1.46	1.79	1.87	1.99	2.54	5.15	8.43	10.81	12.53	14.35								
92	1.45	1.46	1.63	1.71	1.99	2.55	5.26	8.61	10.99	12.66	14.55								
93	1.45	1.46	1.54	1.6	1.99	2.57	5.41	8.8	11.17	12.87	14.89								
94	1.46	1.46	1.5	1.56	2.01	2.61	5.57	8.97	11.34	13.11	15.28								
95	1.46	1.46	1.48	1.55	2.04	2.64	5.72	9.14	11.49	13.35	15.65								
96	1.47	1.47	1.48	1.55	2.06	2.67	5.87	9.29	11.6	13.56	15.9								
97	1.48	1.48	1.49	1.56	2.08	2.69	6.04	9.45	11.7	13.72	16								
98	1.49	1.49	1.49	1.56	2.09	2.71	6.28	9.64	11.8	13.85	15.98								
99	1.5	1.5	1.5	1.57	2.1	2.75	6.58	9.86	11.94	13.98	15.91								
100	1.51	1.51	1.51	1.58	2.12	2.82	6.94	10.1	12.14	14.14									
101	1.52	1.52	1.52	1.59	2.17	2.93	7.31	10.37	12.41	14.34									
102	1.53	1.53	1.53	1.61	2.24	3.04	7.63	10.66	12.76	14.58									
103	1.55	1.55	1.55	1.64	2.32	3.13	7.91	10.95	13.14	14.81									
104	1.56	1.56	1.56	1.66	2.39	3.18	8.15	11.26	13.52	15.02									
105	1.58	1.58	1.58	1.68	2.42	3.22	8.4	11.57	13.9	15.19									
106	1.59	1.59	1.59	1.68	2.41	3.27	8.67	11.85	14.25	15.36									
107	1.6	1.6	1.59	1.67	2.38	3.33	8.95	12.1	14.59	15.54									
108	1.6	1.6	1.59	1.65	2.34	3.39	9.18	12.27	14.91	15.75									
109	1.61	1.6	1.58	1.64	2.31	3.45	9.35	12.38	15.16										
110	1.61	1.6	1.58	1.63	2.3	3.5	9.44	12.43	15.31										

ft/s	Oldsmobile Cutlass CO Emissions, mg/s																	
	ft/s	-5	-4	-3	-2	-1	0	1	2	3	4	5	6	7	8	9	10	11
0	7.06	7.06	7.06	7.04	6.03	4.33	4.45	5.42	6.72	6.07	5.64	3.92	12.31	26.14	37.12	137.88	175.39	175.39
1	7.06	7.06	7.06	6.98	5.77	4.34	4.55	5.61	6.53	5.73	5.41	3.93	11.95	25.59	36.45	138	175.39	175.39
2	7.06	7.06	7.06	6.83	5.33	4.36	4.57	5.59	5.95	5.07	5.01	4.05	11.88	23.66	36.39	139.51	175.39	175.39
3	7.06	7.06	7.06	6.53	4.87	4.25	4.36	5.19	5.04	5.02	6.15	5.6	12.91	21.96	43.89	144.4	175.39	176.2
4	7.06	7.06	7.04	5.98	4.39	3.94	3.82	4.32	4.16	6.69	9.9	9.13	14.14	24.42	67.52	152.55	175.49	179.46
5	7.06	7.06	6.93	5.08	3.85	3.42	3.12	3.46	3.77	10.4	15.87	14.07	14.89	34.64	106	161.52	176.22	208.12
6	7.06	7.06	6.59	4.24	3.28	2.81	2.59	3.29	4.36	14.84	20.15	17.08	14.67	50.99	143.47	167.3	179.49	274.87
7	7.06	7.06	6.04	3.88	2.71	2.2	3.25	6.88	7.69	18.76	20.99	16.89	14.31	63.77	162.35	169.79	185.12	376.41
8	7.06	7.01	5.42	4.5	2.75	2.69	7.67	17.67	15.23	21.33	18.66	13.95	14.3	68.96	163.11	170.61	192.34	467.14
9	7.06	6.78	5.14	5.98	4.94	6.83	17.48	35.3	27.22	22.86	15.59	10.91	14.43	68.08	159.1	173.33	202.59	525.49
10	7.01	6.19	5.48	8.93	10.68	14.63	31.37	54.41	40.78	24.02	12.74	9.06	14.61	67.03	168.6	209.99	250.21	560.82
11	6.83	5.43	6.61	12.74	20.14	27.4	45.89	68.09	53.72	26.4	10.49	8.81	15.01	76.17	212.36	237.24	297.14	601.08
12	6.14	5.15	8.16	16.47	29.97	40.27	57.59	75.68	65.23	29.87	8.93	9.83	16.26	98.52	312.9	429.68	487.89	651.04
13	5.17	5.97	9.63	17.51	36.57	53.26	66.26	79.67	76.11	33.44	8.36	11.76	18.2	142.02	506.36	623.94	656.62	772.25
14	7.25	8.77	10.54	16.07	36.33	56.83	69.58	83.68	85.48	34.78	8.59	14.12	20.64	189.25	735	857.67	870.99	972.77
15	13.13	12.86	10.91	13.32	31.11	53.35	68.89	87.82	91.51	33.21	9.37	16.49	23.39	227.49	920.43	1110.91	1139.84	1269.03
16	21.47	17.99	11.1	11.62	23.78	41.94	63.72	91.89	92.37	28.83	10.4	18.52	26.82	240.07	932.59	1312.28	1512.35	1627.33
17	25.19	22.15	11.62	10.97	19.2	34.08	59.45	94.75	89.06	22.85	12.02	20.25	30.96	236.68	837.96	1502.94	1948.87	2051.99
18	23.65	25.22	12.8	10.97	17.22	29.71	56.86	97.33	82.95	17.08	14.39	21.73	37.54	243.31	742.93	1733.38	2429.64	2512.27
19	18.81	26.53	14.76	10.97	18.11	31.59	58.34	98.45	75.09	13.12	17.74	23.17	45.45	293.75	813.33	2046.45	2779.31	2847.19
20	15.02	26.53	17.25	10.97	20.3	35.81	61.24	99.06	65.9	11.65	21.33	24.36	60.64	455.41	1089.13	2374.24	2971.34	3002.53
21	12.8	25.22	19.73	10.97	24.2	43.59	65.83	98.93	56.12	12.29	24.52	25.7	90.94	734.61	1525.67	2655.15	3005.27	3003.9
22	11.62	22.87	21.82	11.23	28.6	51.69	70.85	98.86	47.21	14.26	26.53	28.3	150.62	1147.03	2036.1	2833.97	2998.86	2989.64
23	11.1	20.12	23	12.28	33.81	59.89	77.52	100.04	39.33	17.41	28.06	36.02	256.3	1592.81	2456.72	2924.12	2995.5	2996.3
24	10.97	17.25	23.92	15.87	40.34	66.45	84.81	101.23	33.01	21.16	29.61	51.12	418.85	2022.41	2735.64	2936.3	2992.13	3002.82
25	10.97	14.89	24.44	21.85	49.06	73.79	94.27	104.05	28.82	25.28	32.61	74.42	661.61	2342.3	2809.71	2908.01	2984.63	2996.3
26	12.68	13.32	25.35	29.58	58.63	80.66	104.21	106.47	27.35	29.33	37.87	106.08	980.27	2543.5	2796.33	2882.29		
27	16.36	13.06	25.87	36.48	68.1	87.83	115.39	107.96	28.15	35.72	55.84	155.71	1340.84	2644.68	2775.61	2917.02		
28	22.27	13.99	26.27	42.28	76.86	94.83	125.11	107.9	30.18	45.96	97.56	234.9	1663.39	2681.72	2883.13	3098.2		
29	27.13	15.83	25.87	46.7	84.8	102.4	136.63	106.15	32.31	65.28	166	347.25	1894.58	2712.31	3138.13	3425.83		
30	30.41	18.06	25.09	49.38	90.12	108.74	147.45	104.12	34.61	93.33	243.85	485.48	2034.39	2780.96	3494.83	3807.08		
31	31.59	21.21	24.96	49.84	91.17	111.54	157.69	100.9	37.37	131.46	312.5	664.14	2155.04	2949.77	3850.76	4113.67		
32	32.12	24.89	26.26	48.88	87.92	109.49	159.54	96.7	41.55	169.49	375.24	918.17	2303.68	3222.6	4128.88	4290.84		
33	32.25	28.81	29.15	48.51	82.51	104.87	154.38	92.25	46.49	205.15	461.35	1280.19	2497.98	3545.14	4320.92	4431.95		
34	32.25	31.74	34.31	50.74	77.46	99.33	142.01	87.01	51.72	234.07	613.98	1704.86	2689.68	3847.88	4484.67	4588.54		
35	32.25	33.96	41.34	54.76	74.45	95.71	130.42	82.12	58.33	279.46	867.98	2115.74	2879.41	4098.85	4670.23	4823.79		
36	32.25	35.14	49	59.19	73.66	93.32	120.79	76.19	70.69	367.1	1228.51	2431.43	3084.1	4315.73	4918.01	5085.08		
37	32.25	35.16	51.43	61.26	74.9	93.09	116.05	71.47	93.26	526.01	1654.17	2657.54	3347.7	4534.02	5212.46	5387.84		
38	32.25	34	48.63	61.95	77.86	94.37	114.88	67.68	126.95	743.24	2059.1	2820.04	3659.27	4790.32	5521.7	5661.06		
39	32.25	33.43	45.03	62.36	81.81	97.15	116.51	65.62	165.02	991.63	2369	2975.55	4005.2	5099.9	5808.09	5897.57		
40	32.23	34.43	46.54	64.34	85.41	99.53	117.7	63.01	202.15	1239.51	2548.11	3142.91	4373.88	5450.5	6045.33	6076.47		
41	32.19	37.59	53.32	66.8	87.46	100.82	116.32	59.38	232.33	1466.71	2630.96	3352.25	4765.55	5785.97	6253.01	6251.33		
42	35.7	43.12	59.67	68.37	87.77	100.44	114.46	55.91	261.71	1658.7	2665.72	3597.3	5150.44	6064.25	6435.87	6433.1		
43	42.8	50.26	63.45	68.36	86.88	99.88	113.14	53.75	299.61	1799.34	2711.79	3887.6	5466	6268.22	6608.37	6613.98		
44	53.5	57.79	64.26	67.32	85.72	100.2	115.02	54.03	336.87	1897.35	2795.26	4186.76	5679.17	6429.27	6755.47	6766.27		
45	60.64	62.35	64.5	66.18	84.72	102.36	116.91	55.17	385.28	1956.02	2916.43	4467.62	5813.05	6579.13	6886.86	6891.83		
46	64.21	64.3	64.48	65.34	84.57	106.36	119.45	56.99	438.41	1998.79	3076.39	4706.56	5928.22	6738.06	7007.06	7001.34		
47	64.25	64.3	64.45	64.93	85.06	110.39	118.83	59.29	488	2038.21	3280.08	4922.83	6063.97	6900.73	7123.99	7108.64		
48	64.31	64.33	64.43	64.93	86.85	115.16	115.73	61.82	546.64	2110.3	3551.09	5135.92	6215.37	7056.46	7228.45	7199.43		
49	64.3	64.35	64.46	65.16	88.73	117.98	110.53	65.37	617.21	2229.13	3852.03	5336.6	6365.21	7194.92	7322.75	7276.82		
50	64.23	64.33	64.47	65.58	89.71	117.43	103.65	68.31	698.68	2390.33	4157.71	5520.23	6505.55	7316.22	7409.8	7329.92		
51	64.15	64.28	64.46	66.11	88.95	111.96	95.68	72.18	775.91	2565.77	4419.81	5692.8	6653.44	7414.87	7489.66			
52	64.24	64.32	64.44	66.52	87.39	104.74	85.57	77.97	840.8	2736.17	4658.98	5872.24	6828.74	7494.39	7553.6			
53	64.36	62.8	60.85	64.94	86.23	99.98	76.89	87.19	907.16	2895.93	4862.92	6050.25	7020.61	7549.39	7596.46			
54	64.5	59.69	53.68	60.91	85.47	97.65	69.64	97.33	981.52	3048.58	5055.56	6220.3	7190.4	7586.01				
55	64.5	54.9	42.89	55.12	85.74	98.1	65.41	104.83	1066.83	3209.2	5224.04	6362.88	7297.28	7603.88				
56	64.44	51.66	35.68	51.39	87.34	101	62.19	113.52	1161.7	3385.57	5371.23	6484.49	7350.66	7614.89				
57	64.32	50.98	33.26	51.72	90.81	107.55	61.6	127.72	1271.86	3584.71	5479.64	6584.74	7378.54	7625.18				
58	64.25	53.52	38.02	56.29	94.61	114.94	62.56	150.49	1399.16	3762.2	5563.75	6690.17	7406.95					
59	64.25	57.7	46.49	63.23	98.43	122.54	66.73	180.01	1535.5	3907.93	5635.6	6788.17	7428.98					
60	66.08	63.3	57.98	70.35	102.25	131.15	72.08	214.3	1673.68	4036.75	5727.89	6859.67	7435.48					
61	70.16	69.57	68.16	76.44	106.95	142.69	77.37	253.43	1812.54	4181.69	5812.99	6869.38	7424.51					
62	76.76	76.76	77.07	81.01	111.82	154.92	80.24	290.98	1957.71	4363.31	5883.06	6801.17	7377.41					
63	82.02	82.02	82.25	84.12	115.82	163.99	80.92	334	2098.27	4504.85	5900.15	6659.43	7264.9					
64	84.71	84.71	84.94	85.86	118.39													

ft/s	Oldsmobile Cutlass CO Emissions, mg/s											6	7	8	9	10	11	12
	ft/s	-5	-4	-3	-2	-1	0	1	2	3	4							
78	98.7	93.81	83.42	83.34	106.95	129.91	146.9	1344.78	3175.42	5040.98								
79	98.45	92.82	84.42	85.07	105.77	122.04	150.27	1369.13	3320.42	5174.25	6231.63							
80	97.93	91.85	85.61	86.62	105.32	116.55	159.6	1404.9	3472.61	5281.46	6296.59							
81	96.99	91.23	87.17	88.38	106.98	117.3	173.19	1460.73	3592.71	5366.62	6366.95							
82	95.83	91.54	89.41	90.76	109.35	119.57	184.94	1525.95	3673.44	5467.14	6442.36							
83	96.09	94.51	93.6	94.66	112.32	124.11	195.08	1572.69	3727.61	5579.72	6513.8							
84	102.59	103.52	102.92	103.28	114.75	128.03	198.75	1612.86	3792.66	5680.25	6568.88							
85	119.18	119.65	118.68	118.2	118.64	133.53	198.52	1655.76	3890.43	5739.83	6608.48							
86	145.69	141.74	134.55	133.71	122.85	134.11	190.79	1726.21	4015.75	5741.12	6632.5							
87	173.21	163.89	148.25	144.97	126.61	130.23	184.89	1814.24	4131.74	5693.9	6634.44							
88	193.71	182.51	152.04	143.34	129.42	126.79	187.24	1912.58	4227.37	5617.08	6602.97							
89	203.15	194.63	158.09	140.6	132.77	132.32	206.31	2010.38	4298.71	5557.78	6535.58							
90	205.85	201.27	161.85	137.16	138.38	146.28	246.81	2130.77	4384.38	5543.26	6464.28							
91	205.85	204.07	174.87	145.99	143.93	159.45	307.19	2274.7	4485.86	5583.49	6441.81							
92	205.85	205.17	186.81	157.46	146.86	161.67	387.39	2442.63	4608.29	5667.44	6507.05							
93	205.85	205.69	198.98	170.16	145.39	151.82	479.11	2590.83	4721.26	5786.6	6657.32							
94	205.85	205.85	204.22	176.02	141.43	133.93	576.55	2717.37	4814.98	5922.52	6840.76							
95	205.85	205.85	205.85	177.86	137.87	118.85	664.43	2829.26	4895.35	6053.49	7004.52							
96	205.85	205.85	205.85	178.17	136.4	110.6	741.44	2951.06	4965.48	6156.15	7104.93							
97	206.59	206.59	206.59	179.27	136.63	111.96	822.64	3090.33	5029.71	6214.67	7127.69							
98	208.06	208.06	208.06	181.28	135.76	113.35	928.54	3241.85	5079.06	6237.89	7083.48							
99	210.28	210.28	210.28	183.67	132.83	111.55	1082.28	3432.39	5145.07	6260.02	7023.31							
100	211.75	211.75	211.75	185.43	126.78	98.6	1265.78	3659.24	5252.81	6331.2								
101	212.49	212.49	212.49	185.47	118.29	80.93	1478.43	3931.73	5430.34	6474.61								
102	212.49	212.49	212.49	183.21	107.71	61.09	1696.97	4226.39	5659.43	6654.91								
103	208.55	208.55	208.55	176.66	97.45	49.61	1920.56	4546.57	5921.73	6826								
104	200.66	200.66	200.66	167.48	90.38	44.3	2146.35	4873.4	6168.2	6937.23								
105	188.84	188.84	188.84	158	87.47	44.38	2381.58	5186.61	6379.98	6998.59								
106	180.95	180.95	180.95	153.6	89.14	48.29	2660.11	5473.32	6553.03	7030.91								
107	177.01	177.01	177.01	154.15	96.1	64.23	2963.8	5716.43	6712.96	7081.27								
108	177.01	177.01	177.01	157.51	106.65	91.7	3250.51	5905.55	6873.43	7168.42								
109	177.01	177.01	177.01	160.39	117.73	123.95	3450.81	6025.38	7017.17									
110	177.01	177.01	177.01	161.74	124.13	144.32	3546.81	6081.45	7106.2									

ft/s	Oldsmobile Cutlass HC Emissions, mg/s												11	12				
	-5	-4	-3	-2	-1	0	1	2	3	4	5	6			7	8	9	10
0	1.46	1.46	1.46	1.46	1.39	0.85	0.79	1.00	1.23	1.08	1.13	0.88	1.29	3.19	2.89	3.53	3.42	3.42
1	1.46	1.46	1.46	1.46	1.25	0.83	0.80	1.04	1.20	1.04	1.09	0.89	1.25	3.08	2.78	3.53	3.42	3.42
2	1.46	1.46	1.46	1.45	1.03	0.81	0.81	1.05	1.12	0.94	1.00	0.89	1.31	2.90	2.73	3.51	3.42	3.42
3	1.46	1.46	1.46	1.39	0.88	0.77	0.78	0.99	0.98	0.83	1.03	0.97	1.63	2.80	2.84	3.48	3.42	3.45
4	1.46	1.46	1.46	1.23	0.81	0.73	0.71	0.83	0.85	0.84	1.50	1.33	2.09	2.64	3.28	3.44	3.42	3.57
5	1.46	1.46	1.45	0.98	0.79	0.66	0.60	0.69	0.74	1.13	2.48	2.03	2.46	2.60	3.92	3.42	3.42	3.95
6	1.46	1.46	1.41	0.74	0.73	0.58	0.51	0.59	0.68	1.84	3.56	2.78	2.54	2.64	4.51	3.41	3.42	4.65
7	1.46	1.46	1.31	0.61	0.62	0.50	0.48	0.79	0.75	2.82	4.03	3.14	2.46	2.86	4.55	3.42	3.42	5.57
8	1.46	1.46	1.13	0.60	0.53	0.47	0.61	1.51	1.30	3.59	3.77	3.04	2.33	3.17	4.05	3.42	3.42	6.35
9	1.46	1.43	0.89	0.66	0.51	0.59	1.05	2.71	2.38	3.76	3.07	2.70	2.25	3.45	3.44	3.48	3.48	6.82
10	1.46	1.31	0.70	0.74	0.65	0.82	1.83	4.00	3.70	3.24	2.51	2.39	2.20	3.64	3.16	3.81	3.84	7.03
11	1.45	1.07	0.63	0.81	0.90	1.36	2.78	4.82	4.57	2.60	2.16	2.16	2.21	3.75	3.52	4.49	4.57	7.22
12	1.33	0.79	0.66	0.86	1.15	2.11	3.63	5.15	4.78	2.16	1.99	1.97	2.31	3.80	5.39	5.50	5.66	7.43
13	1.10	0.64	0.72	0.87	1.27	3.05	4.17	5.19	4.28	2.05	1.87	1.89	2.49	3.86	9.74	8.66	7.36	9.84
14	0.87	0.66	0.75	0.84	1.23	3.37	4.42	5.19	3.47	2.03	1.78	1.97	2.75	3.83	15.73	13.77	11.15	14.76
15	0.85	0.79	0.75	0.79	1.09	3.08	4.41	5.16	2.62	2.05	1.72	2.20	3.08	3.96	20.65	20.63	17.39	22.51
16	1.00	0.95	0.75	0.76	0.93	2.18	4.16	4.99	2.19	2.06	1.70	2.50	3.46	4.46	20.93	25.71	28.80	32.64
17	1.10	1.10	0.75	0.75	0.81	1.55	3.87	4.67	2.22	2.05	1.76	2.84	3.81	5.46	18.14	31.53	43.40	46.10
18	1.04	1.22	0.76	0.75	0.76	1.22	3.74	4.28	2.52	1.99	1.95	3.18	4.09	6.66	15.00	39.49	60.63	62.11
19	0.89	1.29	0.79	0.75	0.79	1.23	3.96	3.85	2.69	1.87	2.25	3.50	4.28	8.35	16.02	51.96	73.54	75.68
20	0.79	1.29	0.86	0.75	0.86	1.43	4.29	3.49	2.57	1.73	2.58	3.72	4.36	13.36	23.19	64.69	81.94	83.86
21	0.76	1.22	0.96	0.75	0.96	1.89	4.58	3.14	2.22	1.63	2.87	3.87	4.30	22.91	36.08	75.90	85.09	86.92
22	0.75	1.11	1.07	0.75	1.08	2.64	4.74	2.91	1.84	1.66	3.08	3.97	4.19	38.08	53.45	83.35	86.65	87.45
23	0.75	0.97	1.16	0.76	1.27	3.40	4.84	2.83	1.56	1.82	3.26	3.99	4.25	54.17	69.14	88.51	86.77	87.13
24	0.75	0.86	1.23	0.83	1.71	4.01	4.90	2.98	1.44	2.13	3.46	3.91	5.65	69.45	81.66	91.30	86.92	86.81
25	0.75	0.79	1.25	0.96	2.45	4.44	4.81	3.39	1.42	2.55	3.64	3.75	10.97	80.19	86.74	91.95	87.24	87.13
26	0.81	0.76	1.27	1.18	3.34	4.78	4.64	3.78	1.50	2.95	3.75	3.61	22.93	86.67	88.71	93.89		
27	0.95	0.75	1.27	1.44	4.07	4.98	4.35	3.95	1.66	3.25	3.59	3.52	39.94	88.79	91.25	102.35		
28	1.15	0.76	1.27	1.74	4.53	4.90	4.00	3.82	1.94	3.31	3.80	4.17	56.90	87.82	104.70	125.16		
29	1.30	0.79	1.25	2.04	4.73	4.57	3.89	3.55	2.26	3.14	4.72	5.57	68.95	86.32	135.65	162.68		
30	1.38	0.87	1.22	2.22	4.81	4.27	4.21	3.28	2.58	2.92	6.70	8.28	75.59	88.89	180.04	204.72		
31	1.39	1.00	1.20	2.27	4.82	4.27	5.00	3.00	2.84	2.97	8.70	12.08	79.26	107.03	225.21	246.36		
32	1.39	1.16	1.22	2.33	4.74	4.61	5.33	2.76	3.02	3.43	10.42	19.78	80.85	144.87	261.76	281.22		
33	1.39	1.29	1.26	2.55	4.55	4.94	4.94	2.59	3.13	4.41	12.09	33.08	81.74	196.53	292.33	327.01		
34	1.39	1.36	1.60	3.00	4.32	5.13	3.81	2.51	3.17	5.50	15.14	51.03	83.03	243.85	332.66	373.95		
35	1.39	1.38	2.22	3.46	4.14	5.15	2.84	2.55	3.15	6.95	21.79	68.13	90.02	278.84	379.93	424.60		
36	1.39	1.38	3.05	3.78	4.14	5.16	2.25	2.62	3.07	9.15	33.94	79.45	107.40	307.12	431.46	457.73		
37	1.39	1.39	3.28	3.91	4.30	5.15	2.15	2.66	3.01	12.95	50.79	85.25	142.52	339.71	470.00	483.90		
38	1.39	1.39	2.90	3.98	4.54	5.13	2.37	2.64	3.20	18.62	67.68	88.99	190.99	382.75	497.93	500.99		
39	1.39	1.39	2.42	4.05	4.75	5.09	2.80	2.61	3.70	26.27	79.82	96.54	249.44	431.30	516.02	517.51		
40	1.39	1.43	2.55	4.14	4.89	5.04	3.26	2.66	4.48	36.07	85.55	112.38	311.68	477.91	530.54	530.31		
41	1.40	1.57	3.29	4.20	4.95	5.00	3.45	2.67	5.09	46.96	87.14	141.90	377.04	513.66	544.32	542.95		
42	1.73	2.04	3.91	4.23	4.97	4.98	3.60	2.63	5.44	57.14	86.58	186.46	438.73	536.79	557.72	555.98		
43	2.38	2.77	4.22	4.23	4.97	4.99	3.74	2.52	5.79	64.97	85.45	246.23	482.59	550.41	571.12	569.27		
44	3.36	3.60	4.23	4.23	4.96	5.03	4.17	2.50	6.47	70.72	85.71	307.35	506.27	560.74	581.97	580.49		
45	4.01	4.10	4.26	4.23	4.91	5.07	4.54	2.56	7.65	75.02	90.01	362.03	514.76	570.99	591.25	590.65		
46	4.33	4.32	4.28	4.26	4.86	4.96	4.94	2.66	8.78	78.35	103.78	400.76	521.09	581.94	599.73	600.31		
47	4.33	4.32	4.30	4.28	4.82	4.70	5.11	2.73	9.81	80.75	131.95	433.24	529.57	593.24	609.42	610.94		
48	4.31	4.31	4.30	4.29	4.83	4.19	5.15	2.79	10.63	82.87	176.83	459.14	540.16	604.87	618.15	619.10		
49	4.26	4.27	4.29	4.29	4.87	3.79	4.93	2.89	11.78	84.64	231.42	480.35	551.36	616.80	626.08	624.65		
50	4.20	4.22	4.26	4.28	4.91	3.65	4.51	3.04	13.07	87.64	287.70	494.71	562.05	627.79	633.12	626.88		
51	4.16	4.18	4.23	4.26	4.93	3.99	3.85	3.16	14.70	92.13	338.02	505.98	573.28	636.68	640.07			
52	4.18	4.19	4.22	4.24	4.94	4.52	3.04	3.24	16.70	102.14	382.07	517.43	587.30	642.84	645.46			
53	4.21	4.11	3.91	4.14	4.93	4.91	2.38	3.27	19.49	114.78	417.78	528.78	603.45	646.33	648.66			
54	4.26	3.94	3.30	3.83	4.90	5.08	2.05	3.28	23.08	129.15	446.18	539.91	618.75	648.09				
55	4.28	3.64	2.36	3.32	4.88	5.10	2.07	3.31	27.53	146.20	467.21	550.17	628.71	648.75				
56	4.30	3.44	1.73	2.91	4.87	4.98	2.16	3.44	32.84	168.64	481.01	559.71	633.45	649.30				
57	4.32	3.46	1.41	2.92	4.86	4.65	2.30	3.58	39.89	205.32	488.20	568.49	635.22	649.81				
58	4.33	3.68	1.73	3.39	4.81	4.10	2.42	3.74	47.91	243.03	491.74	577.23	636.52					
59	4.33	4.00	2.38	4.05	4.73	3.60	2.57	3.81	56.94	280.09	494.71	585.33	637.21					
60	4.41	4.30	3.44	4.55	4.62	3.56	2.65	4.12	65.09	308.59	500.96	590.79	637.11					
61	4.54	4.54	4.22	4.84	4.53	4.05	2.62	4.63	72.34	338.68	507.35	591.72	636.44					
62	4.74	4.74	4.74	4.91	4.47	4.93	2.46	5.26	80.07	371.50	513.77	586.03	632.96					
63	4.81	4.81	4.81	4.88	4.48	5.48	2.28	5.79	88.03	394.72	516.42	575.25	622.76					
64	4.87	4.87	4.86	4.83	4.53	5.55	2.20	6.62	95.34	397.70	515.79	560.76	601.66					
65	4.89	4.89	4.89	4.81	4.59	5.13	2.23	8.15	97.52	377.04	511.14	547.48	575.36					
66	5.00	5.00	4.98	4.83	4.60	4.74	2.33	10.36	95.08	346.71	502.87	536.16	553.18					
67	5.03	5.03	5.03	4.85	4.59	4.57	2.37	12.79	90.67	322.62	494.59	527.97	543.75	650.84				
68	4.98	4.98	4.98	4.85	4.61	4.72	2.40	14.96	87.17	308.35	487.79	519.79	542.68	650.84				
69	4.86	4.86	4.86	4.84	4.68	5.01	2.43	16.48	85.56	302.58	486.28	512.70	542.61	650.76				
70	4.76	4.75	4.74	4.82	4.69	5.35	2.53	17.30	84.61	306.52	487.96	506.56	537.37	6				



		Oldsmobile Cutlass HC Emissions, mg/s																	
ft/s	ft/s/s	-5	-4	-3	-2	-1	0	1	2	3	4	5	6	7	8	9	10	11	12
78	4.76	4.61	4.79	4.77	4.30	3.81	3.05	41.55	111.85	445.31									
79	4.76	4.56	4.71	4.68	4.10	3.89	3.16	43.13	136.15	459.42	546.85								
80	4.75	4.49	4.59	4.56	3.86	3.47	3.28	45.29	166.05	469.75	552.44								
81	4.71	4.44	4.50	4.48	3.67	2.92	3.43	49.41	194.87	478.26	558.59								
82	4.64	4.41	4.45	4.43	3.53	2.20	3.53	54.98	213.00	488.12	563.70								
83	4.57	4.54	4.40	4.38	3.48	2.07	3.63	59.71	223.21	499.13	568.34								
84	4.91	5.09	4.45	4.50	3.48	2.66	3.66	62.42	230.71	509.14	571.32								
85	6.26	6.25	4.61	4.74	3.76	3.95	3.66	63.32	242.98	514.81	573.87								
86	8.40	7.95	4.89	5.05	4.27	4.93	3.56	63.80	263.65	514.91	575.45								
87	10.51	9.58	5.15	5.12	5.03	5.35	3.47	64.83	285.90	510.56	576.20								
88	11.44	10.74	5.20	4.93	5.56	5.32	3.36	66.35	306.83	503.43	575.02								
89	11.60	11.25	5.70	5.09	5.87	5.38	3.34	68.70	322.03	497.87	571.57								
90	11.40	11.40	6.56	5.81	5.93	5.63	3.34	73.55	337.95	495.60	567.06								
91	11.40	11.40	8.21	7.30	5.79	5.85	3.54	81.06	357.74	497.21	565.24								
92	11.40	11.40	9.66	8.67	5.43	5.77	4.09	90.55	380.58	501.71	568.76								
93	11.40	11.40	10.81	9.53	4.91	5.46	5.29	98.57	402.60	508.74	578.27								
94	11.40	11.40	11.25	9.78	4.60	4.98	7.32	105.06	419.01	517.81	590.62								
95	11.40	11.40	11.40	9.78	4.65	4.64	9.65	112.32	430.00	526.86	602.44								
96	11.40	11.40	11.40	9.88	5.03	4.53	12.46	121.91	436.69	534.73	610.45								
97	11.58	11.58	11.58	10.22	5.48	4.72	16.19	134.03	441.56	540.19	612.52								
98	11.93	11.93	11.93	10.82	5.74	4.87	22.23	149.93	446.34	544.10	609.39								
99	12.46	12.46	12.46	11.48	5.79	4.79	30.87	174.97	453.85	547.84	604.48								
100	12.81	12.81	12.81	11.88	5.67	4.13	41.59	211.55	466.10	554.33									
101	12.99	12.99	12.99	12.01	5.20	3.22	54.26	255.42	483.49	564.71									
102	12.99	12.99	12.99	11.86	4.34	2.39	71.66	301.41	503.71	576.79									
103	12.14	12.14	12.14	10.93	3.18	2.15	92.27	349.73	525.00	587.60									
104	10.44	10.44	10.44	9.25	2.34	2.24	117.22	399.20	544.44	594.61									
105	7.88	7.88	7.88	7.04	1.98	2.47	146.35	445.11	560.82	598.48									
106	6.18	6.18	6.18	5.64	2.12	2.59	194.53	479.69	573.65	601.11									
107	5.33	5.33	5.33	5.02	2.41	2.66	259.82	502.05	585.51	606.75									
108	5.33	5.33	5.33	5.07	2.71	2.72	331.91	514.84	597.86	614.10									
109	5.33	5.33	5.33	5.11	2.92	2.74	383.72	521.49	609.81										
110	5.33	5.33	5.33	5.12	3.01	2.74	409.10	524.23	617.49										

ft/s	Oldsmobile Cutlass NOx Emissions, mg/s																		
	ft/s/s	-5	-4	-3	-2	-1	0	1	2	3	4	5	6	7	8	9	10	11	12
0	0.10	0.10	0.10	0.10	0.09	0.05	0.04	0.07	0.10	0.10	0.10	0.10	0.19	0.73	1.34	3.35	6.92	7.82	7.82
1	0.10	0.10	0.10	0.10	0.08	0.05	0.04	0.07	0.10	0.10	0.11	0.20	0.70	1.35	3.48	6.95	7.82	7.82	
2	0.10	0.10	0.10	0.09	0.07	0.04	0.04	0.07	0.10	0.12	0.15	0.25	0.77	1.65	3.93	7.05	7.82	7.81	
3	0.10	0.10	0.10	0.09	0.06	0.04	0.04	0.07	0.10	0.18	0.27	0.40	1.05	2.46	4.83	7.24	7.81	7.78	
4	0.10	0.10	0.10	0.08	0.05	0.03	0.03	0.06	0.11	0.29	0.49	0.69	1.63	3.74	5.92	7.44	7.79	7.67	
5	0.10	0.10	0.09	0.06	0.04	0.03	0.03	0.05	0.13	0.46	0.81	1.12	2.43	5.12	6.88	7.61	7.73	7.44	
6	0.10	0.10	0.09	0.05	0.03	0.02	0.03	0.06	0.19	0.67	1.18	1.61	3.39	6.33	7.43	7.68	7.65	7.10	
7	0.10	0.10	0.08	0.04	0.03	0.02	0.05	0.12	0.31	0.90	1.51	2.11	4.37	7.15	7.65	7.71	7.55	6.73	
8	0.10	0.10	0.07	0.04	0.03	0.04	0.10	0.24	0.50	1.13	1.76	2.58	5.32	7.63	7.66	7.71	7.44	6.40	
9	0.10	0.09	0.06	0.05	0.05	0.06	0.19	0.45	0.76	1.36	1.99	3.12	6.22	7.88	7.60	7.62	7.26	6.16	
10	0.10	0.08	0.06	0.06	0.07	0.10	0.30	0.70	1.02	1.60	2.36	3.84	7.08	8.04	7.46	7.35	6.93	5.94	
11	0.09	0.07	0.06	0.08	0.10	0.14	0.43	0.94	1.21	1.86	2.97	4.83	7.88	8.15	7.19	6.82	6.42	5.71	
12	0.08	0.06	0.06	0.09	0.12	0.19	0.54	1.09	1.31	2.15	3.78	5.99	8.58	8.17	6.77	6.18	5.88	5.50	
13	0.07	0.06	0.07	0.10	0.13	0.22	0.63	1.17	1.34	2.41	4.65	7.16	9.09	8.04	6.29	5.63	5.48	5.34	
14	0.07	0.07	0.08	0.09	0.13	0.23	0.67	1.18	1.34	2.63	5.41	8.14	9.33	7.76	5.90	5.32	5.29	5.26	
15	0.08	0.08	0.08	0.09	0.12	0.22	0.68	1.16	1.35	2.81	6.02	8.84	9.27	7.43	5.69	5.21	5.26	5.27	
16	0.10	0.09	0.08	0.08	0.11	0.21	0.66	1.14	1.41	3.04	6.55	9.24	8.96	7.13	5.65	5.23	5.41	5.47	
17	0.11	0.11	0.09	0.08	0.10	0.19	0.64	1.12	1.57	3.43	7.07	9.37	8.50	6.94	5.72	5.37	5.79	5.97	
18	0.11	0.11	0.09	0.08	0.09	0.19	0.64	1.14	1.88	4.09	7.64	9.22	7.94	6.77	5.80	5.66	6.46	6.82	
19	0.11	0.12	0.09	0.08	0.10	0.20	0.68	1.20	2.36	5.01	8.17	8.80	7.38	6.56	5.81	6.13	7.33	7.81	
20	0.10	0.12	0.10	0.08	0.10	0.23	0.73	1.31	3.01	6.06	8.58	8.20	6.87	6.24	5.79	6.74	8.20	8.72	
21	0.09	0.11	0.10	0.08	0.11	0.27	0.79	1.48	3.73	7.03	8.76	7.59	6.47	5.98	5.94	7.45	8.92	9.35	
22	0.09	0.11	0.11	0.08	0.12	0.32	0.85	1.70	4.47	7.83	8.74	7.11	6.25	5.97	6.41	8.16	9.44	9.76	
23	0.08	0.10	0.11	0.09	0.14	0.40	0.92	1.98	5.22	8.41	8.54	6.78	6.24	6.37	7.18	8.74	9.75	9.96	
24	0.08	0.10	0.11	0.10	0.18	0.52	1.01	2.31	5.99	8.80	8.21	6.59	6.41	7.02	8.03	9.15	9.88	10.05	
25	0.08	0.09	0.11	0.12	0.25	0.68	1.10	2.69	6.71	8.96	7.75	6.46	6.64	7.71	8.81	9.49	9.90	10.00	
26	0.08	0.09	0.12	0.14	0.35	0.84	1.20	3.12	7.33	8.86	7.30	6.38	6.85	8.27	9.52	9.96			
27	0.09	0.09	0.12	0.17	0.45	0.97	1.27	3.54	7.73	8.52	6.97	6.41	7.04	8.71	10.21	10.62			
28	0.09	0.09	0.12	0.21	0.55	1.04	1.31	3.92	7.92	8.13	6.93	6.60	7.27	9.08	10.68	11.12			
29	0.10	0.10	0.12	0.25	0.63	1.04	1.33	4.22	7.95	7.85	7.11	6.84	7.54	9.33	10.65	10.98			
30	0.10	0.10	0.12	0.28	0.69	1.01	1.32	4.44	7.92	7.79	7.35	7.00	7.78	9.39	9.95	9.89			
31	0.11	0.10	0.13	0.29	0.70	0.98	1.32	4.60	7.91	7.85	7.39	6.92	7.98	9.21	8.76	8.22			
32	0.11	0.11	0.13	0.28	0.68	0.98	1.37	4.75	7.88	7.88	7.20	6.73	8.18	8.82	7.44	6.61			
33	0.11	0.11	0.14	0.26	0.63	1.00	1.45	4.88	7.79	7.77	6.85	6.63	8.42	8.29	6.36	5.62			
34	0.11	0.12	0.16	0.25	0.60	1.03	1.56	4.96	7.60	7.52	6.51	6.82	8.71	7.72	5.65	5.21			
35	0.11	0.13	0.18	0.25	0.57	1.05	1.67	5.01	7.38	7.19	6.28	7.29	8.96	7.18	5.30	5.20			
36	0.11	0.13	0.19	0.26	0.57	1.07	1.78	5.08	7.23	6.86	6.26	7.94	9.10	6.73	5.23	5.35			
37	0.11	0.13	0.19	0.27	0.60	1.09	1.89	5.26	7.23	6.59	6.45	8.56	9.01	6.40	5.37	5.58			
38	0.11	0.12	0.18	0.28	0.64	1.11	2.03	5.56	7.32	6.43	6.84	8.99	8.62	6.16	5.64	5.86			
39	0.11	0.12	0.16	0.30	0.70	1.13	2.18	5.92	7.43	6.40	7.33	9.12	7.96	5.99	5.93	6.11			
40	0.11	0.12	0.16	0.32	0.75	1.14	2.33	6.25	7.46	6.48	7.80	8.91	7.17	5.89	6.14	6.27			
41	0.11	0.12	0.16	0.34	0.78	1.15	2.47	6.47	7.41	6.64	8.17	8.48	6.51	5.89	6.23	6.31			
42	0.11	0.13	0.17	0.33	0.77	1.15	2.57	6.59	7.34	6.84	8.41	7.96	6.10	5.94	6.17	6.22			
43	0.12	0.14	0.18	0.31	0.73	1.13	2.64	6.65	7.28	7.04	8.50	7.42	5.90	5.98	6.04	6.07			
44	0.13	0.15	0.18	0.27	0.67	1.11	2.70	6.69	7.24	7.22	8.47	6.92	5.81	5.97	5.91	5.93			
45	0.14	0.16	0.18	0.23	0.61	1.07	2.74	6.69	7.18	7.35	8.34	6.48	5.76	5.93	5.81	5.83			
46	0.15	0.16	0.17	0.20	0.56	1.04	2.77	6.67	7.11	7.44	8.16	6.17	5.74	5.87	5.75	5.77			
47	0.15	0.16	0.17	0.19	0.53	1.01	2.80	6.65	7.06	7.49	7.91	5.98	5.76	5.83	5.73	5.74			
48	0.16	0.16	0.17	0.18	0.52	1.00	2.87	6.64	7.04	7.52	7.60	5.88	5.81	5.82	5.74	5.74			
49	0.18	0.17	0.17	0.18	0.52	1.00	2.94	6.58	7.03	7.53	7.23	5.81	5.86	5.82	5.76	5.75			
50	0.19	0.19	0.18	0.20	0.55	1.03	3.01	6.51	7.00	7.48	6.84	5.77	5.89	5.82	5.79	5.76			
51	0.20	0.20	0.19	0.22	0.58	1.06	3.05	6.44	6.96	7.33	6.47	5.76	5.90	5.81	5.79				
52	0.20	0.20	0.19	0.23	0.61	1.10	3.07	6.41	6.88	7.06	6.13	5.77	5.89	5.79	5.78				
53	0.19	0.19	0.18	0.23	0.62	1.13	3.09	6.38	6.77	6.74	5.87	5.79	5.87	5.75	5.75				
54	0.18	0.17	0.16	0.21	0.62	1.15	3.15	6.36	6.63	6.47	5.73	5.83	5.84	5.73					
55	0.17	0.15	0.14	0.19	0.61	1.18	3.30	6.36	6.51	6.33	5.72	5.88	5.82	5.71					
56	0.16	0.14	0.12	0.19	0.61	1.21	3.53	6.41	6.40	6.24	5.73	5.91	5.80	5.70					
57	0.16	0.14	0.11	0.20	0.62	1.25	3.77	6.46	6.30	6.14	5.70	5.91	5.79	5.70					
58	0.15	0.14	0.12	0.22	0.63	1.26	3.95	6.46	6.21	5.97	5.61	5.89	5.78						
59	0.16	0.15	0.14	0.26	0.64	1.26	4.04	6.41	6.16	5.83	5.54	5.86	5.76						
60	0.19	0.19	0.19	0.32	0.65	1.26	4.16	6.40	6.13	5.73	5.51	5.85	5.75						
61	0.29	0.29	0.30	0.42	0.68	1.30	4.39	6.48	6.12	5.70	5.57	5.85	5.75						
62	0.45	0.45	0.47	0.57	0.74	1.42	4.76	6.65	6.11	5.68	5.65	5.89	5.76						
63	0.61	0.61	0.63	0.71	0.81	1.59	5.18	6.83	6.10	5.65	5.73	5.95	5.79						
64	0.70	0.70	0.73	0.81	0.86	1.77	5.52	6.95	6.17	5.69	5.76	6.00	5.84						
65	0.67	0.67	0.71	0.84	0.89	1.92	5.72	6.98	6.35	5.84	5.76	6.04	5.87						
66	0.58	0.58	0.64	0.83	0.91	2.06	5.85	6.93	6.64	6.09	5.72	6.05	5.90						
67	0.55	0.55	0.62	0.83	0.93	2.23	5.97	6.87	6.95	6.36	5.68	6.04	5.92	5.71					
68	0.66	0.66	0.71	0.88	0.96	2.46	6.14	6.83	7.22	6.57	5.64	6.01	5.93	5.71					
69	0.86	0.86	0.89	0.97	1.01	2.72	6.35	6.82	7.41	6.72	5.63	5.97	5.93	5.72					
70	1.07	1.07	1.06	1.04	1.04	2.95	6.53	6.81	7.54	6.83	5.66	5.94	5.94	5.74					
71	1.21	1.20	1.15	1.04	1.03	3.10	6.65	6.80	7.60	6.89	5.71	5.95	5.97						
72	1.26	1.24	1.14	0.98	0.97	3.14	6.68	6.79	7.62	6.89	5.78	6.02	6.02						
73	1.28	1.23	1.05	0.87	0.91	3.07	6.60	6.78	7.62	6.83	5.86	6.11							
74	1.28	1.19	0.																

ft/s	Oldsmobile Cutlass NOx Emissions, mg/s																		
	ft/s/s	-5	-4	-3	-2	-1	0	1	2	3	4	5	6	7	8	9	10	11	12
78	1.27	1.12	0.78	0.75	0.97	3.15	6.36	6.93	7.76	6.54									
79	1.27	1.11	0.82	0.81	1.02	3.25	6.40	6.95	7.61	6.39	6.12								
80	1.25	1.10	0.87	0.87	1.04	3.20	6.30	6.94	7.41	6.22	6.08								
81	1.24	1.11	0.94	0.94	1.05	3.04	6.09	6.92	7.26	6.10	6.05								
82	1.21	1.12	1.02	1.00	1.05	2.87	5.89	6.90	7.18	6.06	6.01								
83	1.17	1.12	1.08	1.04	1.04	2.82	5.84	6.89	7.14	6.06	5.98								
84	1.11	1.10	1.12	1.07	1.03	2.91	5.96	6.90	7.05	6.05	5.96								
85	1.02	1.04	1.21	1.17	1.03	3.09	6.18	6.94	6.91	6.01	5.94								
86	0.92	0.99	1.44	1.42	1.04	3.29	6.42	7.00	6.73	5.92	5.92								
87	0.84	0.96	1.74	1.74	1.08	3.43	6.57	7.06	6.53	5.82	5.90								
88	0.78	0.94	1.90	1.92	1.10	3.48	6.64	7.12	6.35	5.72	5.89								
89	0.76	0.90	1.75	1.78	1.07	3.42	6.60	7.14	6.19	5.64	5.90								
90	0.75	0.84	1.39	1.43	1.02	3.31	6.55	7.14	6.06	5.61	5.93								
91	0.75	0.79	1.03	1.07	0.97	3.26	6.53	7.11	5.95	5.63	5.95								
92	0.75	0.76	0.83	0.87	0.96	3.32	6.56	7.05	5.89	5.67	5.95								
93	0.75	0.75	0.76	0.80	1.01	3.50	6.60	6.99	5.88	5.73	5.92								
94	0.75	0.75	0.76	0.80	1.12	3.78	6.65	6.93	5.92	5.78	5.89								
95	0.75	0.75	0.75	0.82	1.32	4.11	6.69	6.87	5.94	5.82	5.87								
96	0.78	0.78	0.78	0.89	1.62	4.46	6.78	6.81	5.89	5.84	5.85								
97	0.87	0.87	0.87	1.04	1.98	4.76	6.86	6.74	5.80	5.86	5.85								
98	1.05	1.05	1.06	1.27	2.32	5.00	6.94	6.67	5.70	5.86	5.84								
99	1.27	1.27	1.27	1.49	2.58	5.17	6.96	6.59	5.64	5.87	5.84								
100	1.45	1.45	1.46	1.67	2.78	5.36	6.98	6.46	5.60	5.87									
101	1.54	1.54	1.55	1.78	3.01	5.59	6.91	6.24	5.59	5.87									
102	1.60	1.60	1.61	1.92	3.34	5.89	6.77	5.96	5.61	5.86									
103	1.68	1.68	1.69	2.10	3.74	6.20	6.54	5.66	5.64	5.85									
104	1.83	1.83	1.84	2.34	4.12	6.47	6.33	5.46	5.70	5.83									
105	2.02	2.02	2.03	2.53	4.37	6.63	6.15	5.42	5.77	5.82									
106	2.17	2.17	2.19	2.62	4.45	6.68	6.05	5.52	5.83	5.81									
107	2.25	2.25	2.26	2.60	4.42	6.63	5.96	5.67	5.86	5.80									
108	2.28	2.28	2.29	2.54	4.34	6.54	5.89	5.79	5.88	5.80									
109	2.28	2.28	2.29	2.48	4.29	6.45	5.83	5.86	5.88										
110	2.28	2.28	2.29	2.46	4.27	6.41	5.8	5.89	5.87										

Oldsmobile 88 Fuel Consumption, gal/h																			
ft/s	ft/s/s	-5	-4	-3	-2	-1	0	1	2	3	4	5	6	7	8	9	10	11	12
0		0.4	0.4	0.4	0.4	0.41	0.42	0.53	0.7	1.07	1.52	1.97	2.53	3.62	4.81	5.25	5.39	5.52	5.69
1		0.4	0.4	0.4	0.4	0.4	0.42	0.53	0.71	1.08	1.53	1.98	2.53	3.59	4.75	5.21	5.36	5.5	5.68
2		0.4	0.4	0.4	0.4	0.4	0.42	0.54	0.73	1.1	1.54	1.98	2.53	3.54	4.63	5.12	5.3	5.47	5.68
3		0.4	0.4	0.4	0.4	0.4	0.42	0.55	0.76	1.13	1.56	1.99	2.53	3.47	4.48	5.02	5.24	5.44	5.67
4		0.4	0.4	0.4	0.4	0.41	0.43	0.57	0.79	1.16	1.58	2	2.54	3.39	4.32	4.91	5.19	5.41	5.67
5		0.4	0.4	0.41	0.41	0.41	0.43	0.59	0.83	1.2	1.6	2.01	2.54	3.31	4.16	4.82	5.16	5.39	5.67
6		0.4	0.41	0.42	0.42	0.42	0.45	0.61	0.87	1.24	1.62	2.01	2.55	3.25	4.03	4.75	5.15	5.39	5.68
7		0.41	0.42	0.43	0.44	0.44	0.46	0.64	0.91	1.28	1.64	2.01	2.56	3.2	3.94	4.71	5.16	5.41	5.7
8		0.42	0.43	0.45	0.46	0.46	0.49	0.67	0.96	1.32	1.65	2.02	2.58	3.18	3.9	4.72	5.2	5.44	5.73
9		0.43	0.45	0.48	0.49	0.49	0.52	0.71	1.01	1.35	1.67	2.03	2.6	3.19	3.9	4.75	5.26	5.49	5.76
10		0.45	0.47	0.5	0.51	0.52	0.55	0.75	1.05	1.39	1.69	2.05	2.63	3.22	3.94	4.82	5.34	5.55	5.8
11		0.46	0.48	0.52	0.54	0.55	0.59	0.8	1.09	1.42	1.71	2.07	2.67	3.27	4.03	4.93	5.44	5.63	5.85
12		0.47	0.5	0.54	0.56	0.58	0.62	0.84	1.14	1.46	1.73	2.11	2.72	3.35	4.15	5.06	5.55	5.72	5.9
13		0.48	0.51	0.55	0.58	0.6	0.65	0.88	1.18	1.5	1.77	2.16	2.78	3.44	4.3	5.21	5.68	5.81	5.96
14		0.49	0.51	0.56	0.59	0.61	0.66	0.91	1.23	1.54	1.81	2.22	2.85	3.55	4.47	5.39	5.82	5.91	6.03
15		0.49	0.51	0.55	0.58	0.61	0.68	0.95	1.28	1.58	1.85	2.28	2.94	3.69	4.67	5.59	5.96	6.02	6.1
16		0.49	0.51	0.54	0.57	0.59	0.68	0.98	1.33	1.64	1.91	2.36	3.05	3.85	4.88	5.79	6.12	6.13	6.17
17		0.48	0.5	0.53	0.55	0.58	0.68	1.01	1.38	1.69	1.98	2.45	3.17	4.04	5.11	5.98	6.26	6.25	6.25
18		0.47	0.49	0.51	0.53	0.55	0.67	1.04	1.43	1.75	2.05	2.55	3.3	4.24	5.33	6.17	6.41	6.36	6.34
19		0.46	0.47	0.49	0.51	0.53	0.67	1.07	1.48	1.81	2.13	2.65	3.44	4.45	5.54	6.33	6.54	6.47	6.42
20		0.45	0.46	0.47	0.49	0.51	0.67	1.1	1.52	1.88	2.22	2.75	3.57	4.65	5.73	6.47	6.66	6.58	6.51
21		0.45	0.45	0.46	0.47	0.49	0.67	1.13	1.56	1.94	2.32	2.85	3.69	4.83	5.88	6.58	6.77	6.68	6.6
22		0.44	0.44	0.45	0.46	0.48	0.67	1.15	1.6	2.01	2.42	2.95	3.81	4.99	6.01	6.68	6.87	6.78	6.7
23		0.43	0.43	0.44	0.45	0.47	0.68	1.18	1.63	2.07	2.53	3.05	3.91	5.13	6.12	6.76	6.96	6.88	6.8
24		0.43	0.43	0.43	0.44	0.46	0.69	1.2	1.66	2.14	2.63	3.15	4.02	5.26	6.21	6.85	7.07	6.99	
25		0.42	0.42	0.43	0.43	0.45	0.7	1.22	1.7	2.22	2.75	3.25	4.13	5.38	6.31	6.96	7.18	7.1	
26		0.42	0.42	0.42	0.43	0.45	0.72	1.24	1.73	2.31	2.86	3.36	4.25	5.5	6.42	7.08	7.32	7.22	
27		0.42	0.42	0.42	0.43	0.45	0.73	1.26	1.78	2.4	2.98	3.47	4.39	5.63	6.54	7.22	7.47	7.36	
28		0.42	0.42	0.42	0.42	0.44	0.74	1.29	1.82	2.5	3.1	3.59	4.53	5.77	6.68	7.39	7.64	7.52	
29		0.42	0.42	0.42	0.42	0.44	0.75	1.31	1.86	2.6	3.21	3.72	4.69	5.91	6.84	7.58	7.82	7.7	
30		0.42	0.42	0.42	0.42	0.44	0.76	1.33	1.91	2.7	3.32	3.86	4.85	6.05	7.02	7.78	8.02	7.89	
31		0.42	0.42	0.42	0.42	0.44	0.78	1.36	1.96	2.78	3.42	4.01	5.02	6.19	7.21	8	8.22	8.11	
32		0.42	0.41	0.41	0.42	0.44	0.79	1.39	2.01	2.85	3.51	4.16	5.18	6.32	7.4	8.23	8.44		
33		0.41	0.41	0.41	0.41	0.44	0.81	1.42	2.05	2.9	3.58	4.31	5.34	6.46	7.6	8.45			
34		0.41	0.41	0.41	0.41	0.44	0.83	1.45	2.1	2.94	3.65	4.46	5.49	6.6	7.79	8.68			
35		0.41	0.41	0.41	0.41	0.44	0.85	1.48	2.15	2.97	3.7	4.6	5.64	6.73	7.97	8.9	9.09		
36		0.41	0.41	0.41	0.41	0.44	0.87	1.52	2.19	3	3.75	4.72	5.78	6.86	8.14	9.11	9.31	9.3	
37		0.41	0.41	0.41	0.41	0.44	0.89	1.55	2.24	3.03	3.8	4.84	5.9	6.99	8.31	9.31	9.52	9.52	9.5
38		0.41	0.41	0.41	0.42	0.45	0.91	1.58	2.29	3.06	3.85	4.94	6.03	7.13	8.47	9.5	9.72	9.74	9.72
39		0.41	0.41	0.41	0.42	0.45	0.94	1.6	2.33	3.1	3.91	5.04	6.15	7.27	8.64	9.69	9.91	9.94	
40		0.41	0.41	0.41	0.42	0.46	0.96	1.63	2.38	3.15	3.98	5.12	6.28	7.43	8.82	9.88	10.1	10.13	
41		0.41	0.41	0.42	0.42	0.47	0.98	1.66	2.43	3.21	4.06	5.21	6.41	7.61	9.02	10.06	10.28		
42		0.41	0.41	0.42	0.43	0.47	1	1.68	2.48	3.28	4.14	5.3	6.55	7.81	9.24	10.25			
43		0.41	0.41	0.42	0.43	0.48	1.02	1.71	2.52	3.35	4.23	5.39	6.69	8.03	9.47	10.43			
44		0.41	0.41	0.42	0.43	0.49	1.04	1.74	2.57	3.42	4.33	5.49	6.84	8.26	9.7	10.61			
45		0.41	0.41	0.42	0.43	0.49	1.05	1.76	2.63	3.51	4.44	5.6	6.99	8.5	9.94	10.78			
46		0.41	0.41	0.42	0.43	0.49	1.07	1.79	2.68	3.59	4.56	5.71	7.15	8.74	10.17	10.94			
47		0.41	0.41	0.42	0.43	0.5	1.08	1.82	2.73	3.68	4.69	5.84	7.32	9	10.39	11.1			
48		0.41	0.42	0.43	0.44	0.5	1.1	1.85	2.79	3.77	4.81	5.97	7.51	9.25	10.61	11.25			
49		0.41	0.42	0.43	0.44	0.5	1.11	1.88	2.85	3.86	4.94	6.12	7.7	9.49	10.81	11.4			
50		0.42	0.42	0.43	0.44	0.51	1.12	1.91	2.91	3.95	5.05	6.27	7.89	9.72	11	11.55			
51		0.42	0.42	0.43	0.44	0.51	1.13	1.94	2.97	4.03	5.16	6.41	8.09	9.93	11.19	11.7			
52		0.42	0.43	0.43	0.44	0.52	1.14	1.96	3.03	4.11	5.26	6.56	8.27	10.13	11.36	11.85			
53		0.42	0.43	0.44	0.44	0.53	1.15	1.98	3.09	4.19	5.36	6.7	8.44	10.3	11.52	12			
54		0.43	0.43	0.44	0.45	0.53	1.16	1.99	3.15	4.27	5.45	6.83	8.59	10.45	11.68	12.15			
55		0.43	0.44	0.44	0.45	0.54	1.17	2.01	3.21	4.35	5.53	6.94	8.7	10.57	11.83	12.3			
56		0.43	0.44	0.45	0.45	0.55	1.17	2.02	3.26	4.44	5.62	7.04	8.79	10.66	11.97	12.45			
57		0.44	0.44	0.45	0.46	0.56	1.18	2.04	3.32	4.52	5.71	7.13	8.84	10.73	12.1	12.6			
58		0.44	0.45	0.45	0.46	0.57	1.19	2.06	3.38	4.61	5.8	7.22	8.87	10.79	12.23				
59		0.45	0.45	0.46	0.46	0.58	1.21	2.08	3.44	4.71	5.9	7.3	8.88	10.83	12.35				
60		0.45	0.46	0.46	0.47	0.6	1.23	2.11	3.5	4.81	6.01	7.38	8.9	10.88	12.46				
61		0.46	0.46	0.47	0.48	0.62	1.25	2.14	3.55	4.9	6.13	7.48	8.93	10.93	12.55				
62		0.46	0.47	0.47	0.48	0.64	1.28	2.18	3.61	5	6.25	7.6	8.98	10.99	12.62				
63		0.47	0.47	0.48	0.49	0.66	1.3	2.22	3.67	5.1	6.38	7.73	9.06	11.06	12.66				
64		0.47	0.48	0.49	0.5	0.69	1.33	2.27	3.73	5.19	6.52	7.88	9.17	11.13					
65		0.48	0.48	0.49	0.51	0.72	1.36	2.32	3.78	5.29	6.67	8.05	9.29	11.18					
66		0.48	0.49	0.5	0.52	0.75	1.39	2.37	3.84	5.38	6.82	8.22	9.42	11.19					
67		0.49	0.49	0.5	0.53	0.79	1.42	2.42	3.89	5.47	6.97	8.4	9.54						
68		0.49	0.5	0.51	0.54	0.82	1.44	2.47	3.94	5.56	7.12	8.57	9.64	11.07					
69		0.5	0.5	0.51	0.55	0.84	1.46	2.52	4	5.65	7.27	8.74	9.71	10.94					
70		0.5	0.51	0.52	0.56	0.86	1.46	2.56	4.06	5.74	7.42	8.9	9.77	10.79					
71		0.51	0.51	0.52	0.56	0.87	1.46	2.61	4.12	5.83	7.56	9.05	9.81						
72		0.51	0.52	0.52	0.57	0.88	1.46	2.65	4.19	5.91	7.71	9.19	9.85						

		Oldsmobile 88 Fuel Consumption, gal/h																					
ft/s	ft/s/s	-5	-4	-3	-2	-1	0	1	2	3	4	5	6	7	8	9	10	11	12				
78	0.57	0.57	0.57	0.59	0.87	1.51	2.92	4.71	6.49	8.56	9.98												
79	0.58	0.58	0.59	0.6	0.88	1.54	2.98	4.79	6.6	8.71	10.1												
80	0.59	0.59	0.61	0.62	0.89	1.56	3.04	4.88	6.72	8.87	10.22												
81	0.6	0.61	0.63	0.63	0.9	1.59	3.1	4.96	6.83	9.02	10.34												
82	0.61	0.62	0.65	0.65	0.91	1.63	3.16	5.03	6.94	9.17	10.46												
83	0.62	0.64	0.66	0.67	0.92	1.66	3.22	5.11	7.04	9.32	10.57												
84	0.63	0.65	0.68	0.69	0.94	1.7	3.28	5.18	7.13	9.46	10.68												
85	0.64	0.66	0.69	0.7	0.95	1.73	3.34	5.25	7.22	9.6	10.79												
86	0.65	0.67	0.7	0.71	0.97	1.77	3.4	5.32	7.3	9.73	10.9												
87	0.66	0.67	0.7	0.71	0.98	1.82	3.46	5.39	7.38	9.87	11.01												
88	0.67	0.68	0.71	0.72	0.99	1.86	3.53	5.47	7.47	10.01	11.12												
89	0.67	0.68	0.71	0.72	1.01	1.9	3.59	5.55	7.56	10.15	11.23												
90	0.68	0.69	0.71	0.72	1.01	1.95	3.66	5.64	7.67	10.29	11.34												
91	0.69	0.69	0.71	0.72	1.02	1.99	3.73	5.73	7.78	10.44	11.44												
92	0.7	0.7	0.71	0.73	1.03	2.03	3.81	5.83	7.9	10.58	11.54												
93	0.71	0.71	0.71	0.73	1.04	2.07	3.88	5.93	8.03	10.71	11.64												
94	0.72	0.71	0.72	0.74	1.04	2.11	3.97	6.03	8.17	10.84	11.74												
95	0.73	0.72	0.73	0.74	1.05	2.15	4.06	6.13	8.3	10.95	11.83												
96	0.74	0.73	0.73	0.75	1.06	2.19	4.14	6.24	8.44	11.07	11.93												
97	0.75	0.74	0.74	0.76	1.08	2.24	4.23	6.34	8.58	11.18	12.02												
98	0.76	0.76	0.75	0.77	1.09	2.29	4.32	6.44	8.72	11.29													
99	0.78	0.77	0.76	0.78	1.12	2.35	4.4	6.55	8.86	11.4													
100	0.79	0.78	0.77	0.78	1.15	2.42	4.49	6.66	9	11.51													
101	0.8	0.79	0.78	0.8	1.18	2.49	4.57	6.78	9.15	11.62													
102	0.81	0.8	0.79	0.81	1.22	2.57	4.66	6.9	9.29	11.74													
103	0.83	0.81	0.81	0.82	1.26	2.66	4.75	7.02	9.43	11.85													
104	0.84	0.83	0.82	0.84	1.3	2.75	4.84	7.15	9.57	11.95													
105	0.86	0.85	0.84	0.86	1.34	2.85	4.94	7.28	9.71	12.04													
106	0.88	0.87	0.86	0.87	1.38	2.93	5.04	7.4	9.83														
107	0.9	0.89	0.88	0.89	1.42	3	5.13	7.51	9.94														
108	0.93	0.91	0.9	0.91	1.45	3.06	5.2	7.59	10.02														
109	0.94	0.93	0.91	0.92	1.47	3.1	5.26	7.66	10.08														
110	0.95	0.93	0.92	0.93	1.48	3.12	5.29	7.69	10.12														

		Oldsmobile 88 CO Emissions, mg/s																	
t/s	t/s/s	-5	-4	-3	-2	-1	0	1	2	3	4	5	6	7	8	9	10	11	12
0	1.48	1.47	1.47	1.47	1.47	1.47	1.47	1.54	2.19	3.11	3.36	3.04	11.32	119.48	258.22	257.26	239.82	265.39	300.89
1	1.47	1.47	1.47	1.47	1.47	1.47	1.47	1.58	2.31	3.26	3.44	3.67	12.9	115.46	244.38	240.22	220	245.75	283.22
2	1.47	1.47	1.47	1.47	1.47	1.47	1.48	1.65	2.54	3.55	3.7	5.07	15.86	107.53	218.12	208.8	184.78	210.33	250.37
3	1.47	1.47	1.49	1.48	1.48	1.48	1.5	1.79	2.89	3.94	4.28	7.41	19.8	96.06	182.5	167.96	141.62	165.78	206.98
4	1.49	1.49	1.54	1.52	1.52	1.56	2.03	3.34	4.42	5.34	10.8	24.14	81.87	142.07	124.14	98.6	119.8	159.14	
5	1.52	1.54	1.85	1.62	1.64	1.72	2.42	3.86	5.02	7	15.14	28.19	66.24	102.1	83.64	62.21	79.11	113.17	
6	1.59	1.63	1.85	1.85	1.9	2.05	3	4.42	5.82	9.28	20.14	31.25	50.7	67.27	51.11	35.88	47.98	74.35	
7	1.7	1.8	2.16	2.25	2.36	2.64	3.81	4.99	6.93	12.11	25.38	32.77	36.65	40.47	28.56	20.08	27.77	45.84	
8	1.85	2.06	2.62	2.88	3.09	3.57	4.87	5.6	8.45	15.37	30.41	32.49	25.06	22.3	15.66	13.36	17.46	28.23	
9	2.06	2.39	3.22	3.76	4.1	4.86	6.11	6.27	10.46	18.97	34.88	30.43	16.29	11.67	10.97	13.86	14.78	20	
10	2.3	2.81	3.92	4.85	5.34	6.46	7.44	7.1	13.01	22.92	38.58	26.92	10.22	6.82	13.33	20.33	17.33	18.48	
11	2.58	3.26	4.66	6.03	6.67	8.2	8.66	8.14	16.12	27.31	41.34	22.52	6.45	6.52	22.67	32.39	23.15	20.83	
12	2.88	3.7	5.35	7.15	7.94	9.86	9.58	9.48	19.88	32.28	42.99	17.88	4.65	10.82	40.07	50.14	30.96	24.93	
13	3.16	4.07	5.89	8.02	8.95	11.18	10.03	11.16	24.42	37.91	43.35	13.57	4.96	21.39	66.97	73.51	40.17	29.74	
14	3.4	4.32	6.21	8.47	9.56	11.99	9.96	13.24	29.87	44.12	42.27	10.02	8.3	41.17	104.23	101.71	50.86	35.33	
15	3.58	4.43	6.27	8.46	9.66	12.2	9.41	15.73	36.27	50.55	39.69	7.48	16.47	73.43	151.1	132.96	63.72	42.71	
16	3.68	4.4	6.09	8.01	9.26	11.88	8.57	18.6	43.46	56.52	35.72	31.81	120.26	204.73	164.67	79.95	53.4		
17	3.7	4.27	5.73	7.26	8.47	11.15	7.65	21.71	50.98	61.03	30.68	5.82	56.23	180.86	260.2	193.95	100.99	69.21	
18	3.81	4.07	5.29	6.4	7.46	10.2	6.84	24.81	58.11	63	25.01	6.71	90	250.63	311.32	218.38	128.26	92.09	
19	3.45	3.82	4.86	5.59	6.42	9.2	6.22	27.61	64.02	61.62	19.29	8.67	130.93	321.63	351.96	236.72	162.77	123.97	
20	3.23	3.55	4.49	4.94	5.52	8.28	5.82	29.82	67.94	56.67	14.09	11.72	174.77	384.82	377.65	249.48	204.83	166.48	
21	2.98	3.29	4.23	4.49	4.83	7.56	5.62	31.36	69.42	48.74	9.93	16.15	216.97	433.05	386.8	258.82	253.88	220.31	
22	2.74	3.07	4.07	4.22	4.38	7.07	5.61	32.29	68.37	39.11	7.2	22.85	254.89	463.5	381.28	268.13	308.51	284.64	
23	2.55	2.93	3.98	4.07	4.13	6.84	5.79	32.89	65.03	29.33	6.28	33.56	289.26	478.43	366.07	281.45	367.07	357.23	
24	2.41	2.88	3.94	4	4.01	6.87	6.19	33.46	59.74	20.82	7.59	50.68	323.7	483.96	348.46	303.03	428.49		
25	2.33	2.9	3.91	3.97	3.98	7.09	6.82	34.27	52.84	14.5	11.79	76.78	362.73	488.04	337.09	337.04	493.01		
26	2.29	2.95	3.88	3.97	3.99	7.43	7.66	35.4	44.71	10.74	19.77	113.81	409.44	498.76	340.98	387.07	562.19		
27	2.27	2.99	3.82	3.98	4.01	7.77	8.65	36.78	35.84	9.43	32.64	162.39	464.29	523.94	368.8	455.5	637.98		
28	2.26	2.97	3.71	3.99	4.04	8.01	9.72	38.23	26.95	10.17	51.5	221.53	525.76	571.56	428.05	543.31	721.87		
29	2.26	2.88	3.56	4	4.05	8.07	10.8	39.49	18.86	12.33	77.19	288.88	592.23	649.97	524.56	651.37	815.64		
30	2.26	2.75	3.4	4	4.06	7.93	11.8	40.35	12.25	15.19	109.96	361.34	663.94	766.53	662.17	783.34	924.36		
31	2.27	2.62	3.25	4.01	4.05	7.62	12.65	40.58	7.45	18.06	149.1	435.65	743.72	924.49	842.77	948.67	1060.05		
32	2.29	2.54	3.17	4.01	4.05	7.19	13.34	40.04	4.37	20.45	192.76	508.88	836.15	1119.45	1066.45	1162.43			
33	2.33	2.54	3.18	4.01	4.04	6.71	13.9	38.61	2.64	22.29	237.85	578.4	945.22	1338.17	1331.6				
34	2.42	2.62	3.28	4.02	4.05	6.24	14.42	36.27	1.78	23.91	280.28	641.71	1072.07	1561.87	1563.24				
35	2.56	2.8	3.44	4.02	4.05	5.82	15.02	33.12	1.41	25.86	315.67	696.38	1213.81	1773.88	1973.59	2204.76			
36	2.76	3.04	3.61	4.02	4.07	5.49	15.83	29.4	1.26	28.63	340.32	740.53	1364.54	1968.53	2343.05	2661.15	2710.12		
37	3.01	3.29	3.77	4.02	4.09	5.27	16.9	25.43	1.2	32.31	352.38	774.11	1518.09	2156.51	2740.58	3127.6	3190.88	3210.85	
38	3.27	3.53	3.88	4.02	4.14	5.16	18.3	21.51	1.19	36.59	352.8	800.25	1671.58	2363.06	3162.76	3574.71	3646.43	3667.1	
39	3.52	3.73	3.96	4.02	4.23	5.15	20.01	17.92	1.22	40.91	345.49	825.82	1828.3	2618.87	3603.41	3984.23	4052.3		
40	3.72	3.87	3.99	4.02	4.36	5.21	22	14.8	1.31	44.83	336.53	860.43	1998.95	2947.31	4050.77	4351.03	4403.18		
41	3.87	3.95	4.01	4.02	4.55	5.32	24.23	12.2	1.52	48.34	332.61	914.91	2200.65	3353.43	4486.69	4678.51			
42	3.95	3.99	4.02	4.02	4.8	5.49	26.62	10.08	1.93	52.01	339.65	1000.67	2453.41	3819.97	4889.12				
43	3.99	4.01	4.02	4.02	5.1	5.7	29.07	8.35	2.71	56.88	362.17	1130.87	2774.2	4312.02	5237.94				
44	4.01	4.02	4.02	4.03	5.43	5.99	31.45	6.93	4.07	64.14	403.82	1321.67	3169.6	4788.09	5521.6				
45	4.02	4.02	4.03	4.07	5.78	6.38	33.64	5.72	6.27	74.93	468.44	1590.26	3629.67	5212.72	5741.59				
46	4.02	4.03	4.06	4.16	6.16	6.9	35.54	4.68	9.59	90.1	560.85	1947.95	4126.42	5565.46	5912.22				
47	4.02	4.04	4.13	4.35	6.57	7.59	37.07	3.77	14.24	110.36	686.77	2391.13	4619.39	5843.58	6055.54				
48	4.04	4.09	4.27	4.67	7.02	8.45	38.17	3.02	20.33	136.32	851.87	2896.23	5067.45	6058.63	6193.36				
49	4.09	4.21	4.55	5.16	7.5	9.44	38.8	2.43	27.86	168.49	1060.21	3423.87	5442.33	6229.31	6339.68				
50	4.21	4.44	4.98	5.78	7.98	10.46	38.91	2	36.76	207.06	1312.1	3931.27	5737.15	6373.89	6496.68				
51	4.44	4.82	5.56	6.49	8.46	11.39	38.47	1.75	47.02	251.37	1601.71	4385.9	5965.58	6504.68	6655.72				
52	4.82	5.36	6.25	7.18	8.92	12.12	37.44	1.64	58.74	299.43	1915.06	4772.41	6152.13	6626.25	6802.93				
53	5.36	6.02	6.96	7.77	9.39	12.61	35.82	1.67	72.13	347.87	2230.04	5090.08	6318.73	6737.12	6926.33				
54	6.01	6.72	7.59	8.2	9.91	12.87	33.73	1.87	87.32	392.55	2519.96	5344.91	6475.01	6833.79	7021.32				
55	6.69	7.37	8.06	8.47	10.48	12.96	31.39	2.25	104.17	429.82	2760.76	5543.19	6616.87	6914.76	7091.69				
56	7.3	7.88	8.38	8.65	11.14	12.96	29.08	2.89	122.07	457.93	2939.47	5690.39	6732.93	6982.6	7146.57				
57	7.76	8.24	8.59	8.84	11.86	12.94	27.1	3.83	140.02	477.97	3059.55	5793.67	6814.29	7043.08	7195.28				
58	8.07	8.52	8.8	9.18	12.64	12.97	25.68	5.11	156.87	493.77	3139.76	5863.73	6861.4	7102.39					
59	8.3	8.85	9.17	9.79	13.43	13.14	24.88	6.73	171.67	510.83	3206.51	5913.21	6884.94	7164.27					
60	8.57	9.35	9.8	10.71	14.21	13.56	24.63	8.67	184.03	534.85	3283.61	5952.38	6901.01	7228.74					
61	9.02	10.15	10.76	11.93	14.93	14.33	24.71	10.83	194.17	570.53	3384.76	5985.89	6924.14	7292.97					
62	9.76	11.24	11.99	13.32	15.56	15.54	24.84	13.13	202.8	621.11	3511.75	6012.81	6961.76	7352.95					
63	10.81	12.53	13.33	14.76	16.03	17.19	24.73	15.45	210.9	688.68	3657.83	6029.95	7012.06	7404.51					
64	12.11	13.86	14.61	16.16	16.26	19.1	24.12	17.7	219.62	775.15	3812.87	6035.7	7065.27						
65	13.49	15.05	15.65	17.51	16.17	20.95	22.86	19.84	230.47	883.43	3967.37	6031.93	7107.29						
66	14.8	16.02	16.4	18.86	15.71	22.28	20.91	21.87	245.52	1018.48	4114.54	6023.16	7124.29						
67	15.92	16.74	16.88	20.22															

Oldsmobile 88 CO Emissions, mg/s																							
f/s	f/s	-5	-4	-3	-2	-1	0	1	2	3	4	5	6	7	8	9	10	11	12				
78	39.92	40.13	38.39	38.69	20.02	7.35	2.81	103.75	970.86	4255.88	5394.16												
79	43.9	44.02	42.76	42.7	22.24	8.53	3.19	122.77	1067.1	4420.7	5483.1												
80	48.05	48.08	47.35	47.23	24.38	10	3.65	144.23	1183.56	4574.33	5572.43												
81	52.27	52.26	52.18	52.25	26.61	11.7	4.14	167.49	1321.05	4722.34	5662.13												
82	56.44	56.4	57.22	57.66	29.19	13.6	4.65	191.63	1475.29	4867.6	5752.94												
83	60.38	60.37	62.41	63.31	32.29	15.71	5.19	215.75	1638.5	5010.52	5847.13												
84	64.05	64.07	67.63	68.93	35.96	18.05	5.81	239.45	1803.94	5150.2	5948.18												
85	67.49	67.55	72.73	74.19	40.09	20.61	6.6	263.17	1970.69	5286.08	6059.41												
86	70.9	71	77.55	78.76	44.54	23.25	7.66	288.22	2145.14	5419.49	6182.29												
87	74.52	74.64	81.93	82.52	49.21	25.77	9.13	316.44	2337.56	5553.9	6315.22												
88	78.49	78.63	85.85	85.63	54.13	27.96	11.16	349.54	2555.53	5693.56	6453.49												
89	82.89	83.01	89.4	88.52	59.41	29.75	13.89	388.5	2798.68	5841.06	6590.4												
90	87.7	87.79	92.85	91.69	65.15	31.34	17.55	433.23	3057.78	5995.17	6718.87												
91	92.92	92.93	96.48	95.47	71.43	33.05	22.41	482.67	3318.38	6150.44	6833.05												
92	98.52	98.42	100.45	99.97	78.22	35.2	28.87	535.18	3566.32	6298.8	6929.48												
93	104.42	104.17	104.83	105.1	85.45	37.76	37.42	589.14	3791.94	6432.7	7007.49												
94	110.48	110.04	109.62	110.81	92.93	40.33	48.62	643.3	3991.6	6547.87	7068.96												
95	116.58	115.91	114.84	117.11	100.41	42.26	62.94	697.02	4167.06	6644.63	7117.46												
96	122.63	121.72	120.55	123.97	107.56	43.1	80.63	750.26	4323.77	6727.12	7157.29												
97	128.62	127.46	126.69	131.19	114.14	42.84	101.36	803.64	4469.09	6801.15	7192.56												
98	134.46	132.99	133	138.38	120.03	41.99	124.14	858.64	4610.55	6871.92													
99	139.92	138.01	139.07	145.22	125.34	41.16	147.28	917.9	4754.34	6942.57													
100	144.75	142.23	144.63	151.69	130.33	40.59	168.73	985.36	4904.13	7013.83													
101	148.83	145.57	149.65	158.06	135.34	39.89	186.55	1066	5060.52	7084.72													
102	152.31	148.33	154.39	164.7	140.62	38.31	199.52	1164.92	5220.94	7153.49													
103	155.51	150.99	159.1	171.7	146.11	35.23	207.53	1285.85	5380.12	7218.15													
104	158.65	153.82	163.75	178.75	151.4	30.64	211.57	1429.58	5530.76	7276.62													
105	161.63	156.6	168	185.29	155.8	25.16	213.38	1592.6	5664.87	7326.69													
106	164.08	158.74	171.31	190.77	158.6	19.75	214.75	1766.31	5775.59														
107	165.62	159.7	173.33	194.86	159.47	15.21	216.85	1937.23	5859.16														
108	166.17	159.39	174.08	197.58	158.72	11.96	219.84	2088.36	5915.82														
109	166.04	158.39	174.01	199.13	157.24	10	222.92	2201.91	5949.25														
110	165.77	157.56	173.76	199.81	156.14	9.11	224.89	2262.97	5964.29														

ft/s	Oldsmobile 88 HC Emissions, mg/s																		
	ft/s	-5	-4	-3	-2	-1	0	1	2	3	4	5	6	7	8	9	10	11	12
0	0.37	0.37	0.37	0.37	0.37	0.37	0.37	0.37	0.38	0.39	0.35	0.27	0.62	6.68	13.66	13.62	12.95	14.36	16.13
1	0.37	0.37	0.37	0.37	0.37	0.37	0.37	0.37	0.38	0.39	0.34	0.29	0.72	6.48	12.97	12.72	11.82	13.25	15.16
2	0.37	0.37	0.37	0.37	0.37	0.37	0.37	0.37	0.38	0.39	0.34	0.35	0.90	6.07	11.61	11.04	9.82	11.26	13.41
3	0.37	0.37	0.37	0.37	0.37	0.37	0.37	0.37	0.39	0.40	0.35	0.47	1.14	5.45	9.72	8.83	7.40	8.76	11.04
4	0.37	0.37	0.37	0.37	0.37	0.37	0.37	0.37	0.40	0.41	0.39	0.65	1.42	4.66	7.54	6.46	5.05	6.22	8.42
5	0.37	0.37	0.37	0.37	0.37	0.37	0.37	0.38	0.41	0.42	0.47	0.89	1.68	3.79	5.38	4.30	3.13	4.03	5.91
6	0.37	0.37	0.37	0.37	0.38	0.38	0.39	0.43	0.44	0.59	1.18	1.89	2.92	3.53	2.62	1.83	2.43	3.83	
7	0.37	0.37	0.38	0.38	0.39	0.39	0.42	0.44	0.49	0.74	1.48	2.00	2.16	2.17	1.51	1.11	1.47	2.38	
8	0.37	0.37	0.38	0.40	0.41	0.42	0.46	0.46	0.55	0.92	1.77	2.01	1.56	1.31	0.90	0.87	1.06	1.57	
9	0.37	0.38	0.40	0.43	0.44	0.48	0.52	0.48	0.65	1.11	2.02	1.91	1.14	0.84	0.68	0.96	1.04	1.29	
10	0.37	0.38	0.42	0.47	0.49	0.55	0.58	0.51	0.79	1.32	2.24	1.72	0.86	0.63	0.76	1.31	1.25	1.34	
11	0.37	0.39	0.45	0.52	0.55	0.64	0.65	0.56	0.95	1.55	2.41	1.49	0.70	0.59	1.12	1.88	1.56	1.53	
12	0.38	0.41	0.48	0.58	0.61	0.73	0.70	0.63	1.15	1.82	2.52	1.24	0.61	0.70	1.82	2.65	1.90	1.71	
13	0.38	0.42	0.50	0.62	0.67	0.80	0.73	0.71	1.39	2.13	2.57	1.02	0.58	1.01	2.90	3.58	2.21	1.81	
14	0.39	0.43	0.51	0.64	0.70	0.84	0.71	0.81	1.68	2.49	2.54	0.85	0.64	1.65	4.35	4.63	2.49	1.85	
15	0.39	0.43	0.51	0.64	0.70	0.85	0.67	0.94	2.03	2.87	2.42	0.73	0.84	2.74	6.11	5.72	2.76	1.90	
16	0.40	0.43	0.50	0.61	0.68	0.83	0.60	1.09	2.45	3.25	2.22	0.65	1.31	4.37	8.01	6.73	3.10	2.03	
17	0.40	0.42	0.49	0.56	0.63	0.78	0.54	1.27	2.89	3.57	1.96	0.62	2.17	6.47	9.84	7.55	3.56	2.33	
18	0.40	0.41	0.46	0.52	0.57	0.72	0.48	1.45	3.33	3.75	1.68	0.62	3.44	8.88	11.39	8.10	4.19	2.85	
19	0.39	0.41	0.44	0.47	0.52	0.66	0.44	1.61	3.70	3.72	1.39	0.65	5.05	11.28	12.46	8.34	5.02	3.64	
20	0.39	0.40	0.43	0.44	0.47	0.60	0.42	1.73	3.95	3.47	1.13	0.71	6.78	13.32	12.95	8.33	6.08	4.74	
21	0.38	0.39	0.42	0.42	0.44	0.56	0.40	1.81	4.05	3.04	0.92	0.82	8.37	14.79	12.86	8.20	7.37	6.21	
22	0.37	0.38	0.41	0.41	0.42	0.54	0.40	1.85	4.00	2.50	0.77	1.00	9.67	15.60	12.28	8.14	8.90	8.07	
23	0.37	0.38	0.41	0.41	0.41	0.53	0.40	1.86	3.82	1.95	0.69	1.31	10.68	15.82	11.39	8.39	10.72	10.37	
24	0.36	0.38	0.41	0.41	0.40	0.53	0.42	1.89	3.54	1.49	0.68	1.87	11.54	15.62	10.41	9.25	12.97		
25	0.36	0.38	0.41	0.41	0.40	0.54	0.45	1.94	3.18	1.14	0.76	2.76	12.44	15.17	9.62	11.07	15.94		
26	0.36	0.38	0.40	0.41	0.40	0.57	0.50	2.02	2.74	0.92	0.98	4.06	13.46	14.67	9.31	14.18	19.97		
27	0.36	0.38	0.40	0.41	0.41	0.59	0.55	2.12	2.25	0.82	1.38	5.75	14.56	14.29	9.78	18.70	25.29		
28	0.36	0.38	0.40	0.41	0.41	0.61	0.61	2.23	1.75	0.82	2.03	7.73	15.63	14.31	11.25	24.39	31.77		
29	0.36	0.38	0.40	0.41	0.41	0.61	0.67	2.33	1.29	0.90	2.96	9.83	16.60	15.03	13.77	30.56	38.73		
30	0.36	0.37	0.39	0.41	0.41	0.60	0.72	2.40	0.92	1.04	4.18	11.85	17.46	16.71	17.21	36.32	45.17		
31	0.36	0.37	0.39	0.41	0.41	0.58	0.76	2.44	0.67	1.21	5.65	13.64	18.34	19.51	21.28	41.02	50.21		
32	0.36	0.37	0.38	0.41	0.41	0.55	0.80	2.43	0.52	1.36	7.27	15.08	19.45	23.33	25.71	44.63			
33	0.36	0.37	0.38	0.41	0.41	0.52	0.82	2.36	0.44	1.46	8.90	16.15	20.97	27.76	30.39				
34	0.36	0.37	0.39	0.41	0.41	0.49	0.84	2.23	0.41	1.53	10.35	16.86	23.01	32.21	35.38				
35	0.37	0.37	0.39	0.41	0.41	0.46	0.87	2.05	0.41	1.60	11.47	17.32	25.52	36.17	40.86	56.21			
36	0.37	0.38	0.40	0.41	0.41	0.44	0.91	1.83	0.40	1.71	12.13	17.64	28.34	39.41	46.94	62.08	67.37		
37	0.38	0.39	0.40	0.41	0.41	0.43	0.97	1.60	0.40	1.87	12.29	17.98	31.23	42.16	53.54	68.43	72.84	74.36	
38	0.39	0.40	0.41	0.41	0.41	0.42	1.05	1.38	0.39	2.07	12.01	18.55	34.03	45.03	60.42	74.41	78.00	79.04	
39	0.40	0.40	0.41	0.41	0.42	0.41	1.15	1.19	0.38	2.28	11.46	19.62	36.72	48.72	67.25	79.51	82.33		
40	0.40	0.41	0.41	0.41	0.42	0.41	1.27	1.03	0.38	2.45	10.93	21.39	39.44	53.73	73.79	83.80	85.98		
41	0.41	0.41	0.41	0.41	0.43	0.41	1.40	0.91	0.37	2.58	10.73	23.88	42.51	60.11	79.96	87.84			
42	0.41	0.41	0.41	0.41	0.44	0.42	1.54	0.81	0.38	2.68	11.12	26.94	46.36	67.46	85.84				
43	0.41	0.41	0.41	0.41	0.45	0.42	1.69	0.74	0.41	2.80	12.30	30.44	51.32	75.16	91.60				
44	0.41	0.41	0.41	0.41	0.47	0.43	1.84	0.69	0.48	2.99	14.46	34.56	57.58	82.59	97.35				
45	0.41	0.41	0.41	0.41	0.49	0.45	1.98	0.64	0.58	3.27	17.79	39.93	65.06	89.39	103.16				
46	0.41	0.41	0.41	0.41	0.51	0.47	2.11	0.59	0.76	3.66	22.59	47.49	73.44	95.43	109.02				
47	0.41	0.41	0.41	0.42	0.53	0.50	2.21	0.55	1.00	4.17	29.14	58.09	82.26	100.84	114.98				
48	0.41	0.41	0.42	0.44	0.55	0.55	2.29	0.50	1.32	4.82	37.65	72.10	91.11	105.87	121.20				
49	0.41	0.42	0.43	0.46	0.57	0.60	2.34	0.46	1.71	5.67	48.22	89.46	99.84	110.85	127.91				
50	0.42	0.42	0.45	0.49	0.60	0.66	2.35	0.43	2.13	6.79	60.85	109.81	108.75	116.15	135.34				
51	0.42	0.44	0.48	0.53	0.62	0.71	2.34	0.40	2.59	8.22	75.41	132.77	118.66	122.13	143.62				
52	0.44	0.47	0.52	0.57	0.64	0.75	2.28	0.39	3.07	9.95	91.43	157.78	130.63	129.07	152.80				
53	0.47	0.50	0.55	0.60	0.66	0.78	2.18	0.38	3.58	11.87	107.94	183.81	145.48	137.17	163.01				
54	0.50	0.54	0.59	0.62	0.69	0.79	2.05	0.39	4.13	13.80	123.39	209.10	163.28	146.61	174.43				
55	0.54	0.58	0.61	0.63	0.72	0.79	1.90	0.40	4.72	15.54	136.06	231.48	183.23	157.60	187.26				
56	0.57	0.60	0.62	0.63	0.76	0.79	1.76	0.44	5.32	16.95	144.79	249.13	203.94	170.35	201.35				
57	0.59	0.61	0.63	0.63	0.81	0.79	1.63	0.49	5.88	18.07	149.54	261.45	224.13	184.84	216.11				
58	0.60	0.62	0.63	0.65	0.85	0.79	1.55	0.56	6.33	19.13	151.54	269.19	242.92	200.71					
59	0.60	0.63	0.64	0.68	0.90	0.79	1.51	0.66	6.64	20.43	152.57	273.96	259.83	217.13					
60	0.61	0.65	0.68	0.73	0.95	0.81	1.51	0.76	6.80	22.26	154.15	277.30	274.51	233.06					
61	0.63	0.69	0.73	0.80	1.00	0.84	1.53	0.88	6.84	24.77	156.87	279.97	286.55	247.58					
62	0.67	0.76	0.81	0.89	1.03	0.91	1.56	1.00	6.84	27.92	160.42	281.95	295.69	260.22					
63	0.73	0.84	0.89	0.97	1.06	1.00	1.57	1.12	6.86	31.47	164.00	282.88	302.09	271.03					
64	0.81	0.92	0.97	1.05	1.08	1.11	1.55	1.22	6.97	35.10	166.90	282.60	306.46						
65	0.90	0.99	1.03	1.12	1.07	1.23	1.49	1.31	7.24	38.52	168.22	281.38	309.87						
66	0.98	1.05	1.07	1.20	1.04	1.33	1.39	1.39	7.74	41.57	168.01	279.77	313.19						
67	1.04	1.08	1.09	1.28	0.98	1.24	1.46	1.46	8.64	44.34	166.33	278.29							
68	1.09	1.11	1.10	1.37	0.90	1.32	1.08	1.52	10.14	47.18	163.76	277.24	320.06						
69	1.13	1.14	1.11	1.45	0.82	1.20	0.90	1.61	12.41	50.54	161.21</								



ft/s	Oldsmobile 88 HC Emissions, mg/s												6	7	8	9	10	11	12
	ft/s/s	-5	-4	-3	-2	-1	0	1	2	3	4	5							
78	2.43	2.45	2.33	2.34	1.28	0.48	0.39	3.91	46.42	99.63	175.45								
79	2.67	2.68	2.60	2.58	1.40	0.55	0.40	4.43	50.65	103.83	177.56								
80	2.92	2.92	2.87	2.85	1.51	0.63	0.43	5.01	55.34	108.14	180.68								
81	3.18	3.18	3.16	3.16	1.61	0.73	0.45	5.64	60.38	112.91	185.15								
82	3.43	3.43	3.46	3.48	1.73	0.83	0.47	6.30	65.44	118.47	191.11								
83	3.67	3.67	3.77	3.82	1.90	0.95	0.49	6.94	70.14	124.95	198.59								
84	3.89	3.89	4.08	4.17	2.10	1.08	0.51	7.57	74.27	132.25	207.47								
85	4.08	4.08	4.39	4.49	2.34	1.22	0.53	8.22	78.07	140.12	217.42								
86	4.27	4.27	4.67	4.76	2.58	1.38	0.57	8.97	82.22	148.45	227.78								
87	4.46	4.47	4.93	4.96	2.83	1.53	0.63	9.94	87.56	157.43	237.64								
88	4.69	4.69	5.14	5.10	3.09	1.66	0.70	11.29	94.70	167.45	246.01								
89	4.94	4.94	5.33	5.23	3.37	1.75	0.81	13.12	103.68	178.77	252.13								
90	5.20	5.21	5.50	5.37	3.69	1.82	0.95	15.49	114.05	191.17	255.76								
91	5.49	5.49	5.69	5.57	4.03	1.90	1.14	18.37	125.10	203.90	257.20								
92	5.80	5.79	5.89	5.81	4.41	2.01	1.39	21.66	136.19	215.99	257.24								
93	6.12	6.11	6.12	6.08	4.81	2.18	1.72	25.24	146.86	226.61	256.84								
94	6.45	6.43	6.36	6.38	5.23	2.36	2.15	28.97	156.87	235.46	256.95								
95	6.77	6.73	6.62	6.70	5.66	2.50	2.70	32.72	166.10	242.78	258.16								
96	7.08	7.03	6.91	7.07	6.06	2.56	3.39	36.38	174.53	249.22	260.70								
97	7.39	7.32	7.23	7.47	6.43	2.52	4.20	39.87	182.34	255.48	264.36								
98	7.69	7.61	7.57	7.86	6.74	2.44	5.09	43.12	189.87	262.11									
99	7.98	7.88	7.90	8.22	7.02	2.39	5.99	46.15	197.57	269.24									
100	8.22	8.09	8.19	8.54	7.27	2.38	6.79	49.04	205.86	276.67									
101	8.42	8.23	8.43	8.85	7.53	2.39	7.40	51.91	214.93	283.89									
102	8.57	8.33	8.65	9.18	7.81	2.35	7.77	54.90	224.71	290.35									
103	8.71	8.43	8.89	9.56	8.13	2.19	7.91	58.10	234.73	295.59									
104	8.86	8.57	9.14	9.95	8.45	1.90	7.86	61.57	244.15	299.32									
105	9.03	8.74	9.38	10.31	8.73	1.55	7.71	65.23	251.88	301.38									
106	9.16	8.87	9.56	10.60	8.90	1.22	7.58	68.96	256.94										
107	9.24	8.91	9.65	10.81	8.94	0.95	7.52	72.53	258.91										
108	9.24	8.86	9.66	10.94	8.85	0.78	7.55	75.63	258.28										
109	9.19	8.75	9.62	11.01	8.70	0.68	7.63	77.93	256.40										
110	9.15	8.66	9.58	11.03	8.60	0.65	7.69	79.17	254.90										

ft/s	Oldsmobile 88 NOx Emissions, mg/s																		
	ft/s/s	-5	-4	-3	-2	-1	0	1	2	3	4	5	6	7	8	9	10	11	12
0	0.02	0.02	0.02	0.02	0.02	0.02	0.02	0.02	0.04	0.06	0.14	0.36	1.11	1.78	6.43	8.09	6.40	3.67	2.78
1	0.02	0.02	0.02	0.02	0.02	0.02	0.02	0.02	0.04	0.07	0.17	0.42	1.24	1.91	6.27	8.06	6.62	4.05	3.20
2	0.02	0.02	0.02	0.02	0.02	0.02	0.02	0.03	0.04	0.08	0.22	0.53	1.51	2.20	6.04	8.05	7.04	4.78	4.02
3	0.02	0.02	0.02	0.02	0.02	0.02	0.02	0.03	0.05	0.11	0.29	0.70	1.90	2.66	5.86	8.10	7.66	5.80	5.23
4	0.02	0.02	0.02	0.02	0.02	0.02	0.02	0.03	0.06	0.15	0.39	0.90	2.41	3.29	5.84	8.28	8.48	7.09	6.76
5	0.02	0.02	0.02	0.02	0.02	0.02	0.02	0.04	0.08	0.21	0.51	1.11	2.98	4.03	6.00	8.66	9.56	8.63	8.58
6	0.02	0.02	0.03	0.03	0.03	0.03	0.03	0.05	0.11	0.28	0.64	1.31	3.58	4.80	6.33	9.31	10.99	10.48	10.68
7	0.03	0.03	0.03	0.03	0.03	0.03	0.03	0.06	0.14	0.37	0.77	1.51	4.17	5.48	6.80	10.30	12.88	12.77	13.13
8	0.03	0.03	0.04	0.04	0.04	0.04	0.04	0.07	0.19	0.47	0.90	1.71	4.72	6.03	7.43	11.71	15.30	15.63	16.05
9	0.03	0.04	0.05	0.05	0.04	0.05	0.10	0.24	0.57	1.03	1.92	5.21	6.44	8.27	13.64	18.28	19.18	19.62	
10	0.04	0.04	0.05	0.06	0.05	0.06	0.12	0.30	0.68	1.16	2.18	5.64	6.77	9.47	16.16	21.80	23.49	23.92	
11	0.04	0.05	0.06	0.06	0.06	0.07	0.15	0.37	0.79	1.28	2.50	6.01	7.14	11.17	19.34	25.80	28.48	28.96	
12	0.05	0.05	0.07	0.07	0.07	0.09	0.19	0.44	0.90	1.41	2.89	6.34	7.71	13.55	23.15	30.18	34.00	34.56	
13	0.05	0.06	0.07	0.08	0.08	0.10	0.22	0.53	1.02	1.54	3.36	6.65	8.66	16.71	27.44	34.82	39.76	40.41	
14	0.05	0.06	0.07	0.08	0.08	0.10	0.26	0.63	1.14	1.69	3.89	7.04	10.24	20.65	31.99	39.61	45.45	46.10	
15	0.06	0.06	0.07	0.08	0.08	0.11	0.30	0.75	1.26	1.86	4.45	7.62	12.67	25.24	36.57	44.46	50.78	51.24	
16	0.06	0.06	0.07	0.08	0.08	0.11	0.33	0.87	1.40	2.09	5.02	8.52	16.09	30.22	41.02	49.35	55.56	55.58	
17	0.06	0.06	0.07	0.07	0.08	0.11	0.35	1.00	1.54	2.43	5.61	9.84	20.45	35.21	45.32	54.29	59.69	59.69	
18	0.05	0.05	0.06	0.07	0.07	0.10	0.37	1.12	1.72	2.89	6.21	11.58	25.47	39.85	49.55	59.28	63.21	61.66	
19	0.05	0.05	0.06	0.06	0.07	0.10	0.39	1.22	1.94	3.51	6.86	13.64	30.65	43.84	53.78	64.27	66.21	63.71	
20	0.05	0.05	0.06	0.06	0.06	0.10	0.42	1.30	2.21	4.26	7.63	15.87	35.44	47.06	58.06	69.10	68.77	65.41	
21	0.05	0.05	0.05	0.05	0.06	0.10	0.45	1.37	2.56	5.14	8.57	18.11	39.40	49.57	62.37	73.58	70.99	66.96	
22	0.04	0.05	0.05	0.05	0.06	0.10	0.48	1.44	2.96	6.09	9.76	20.35	42.39	51.64	66.70	77.57	72.94	68.50	
23	0.04	0.04	0.05	0.05	0.06	0.10	0.52	1.50	3.41	7.13	11.28	22.70	44.56	53.70	71.03	80.96	74.68	70.09	
24	0.04	0.04	0.05	0.05	0.06	0.11	0.56	1.59	3.90	8.29	13.17	25.33	46.28	56.15	75.35	83.75	76.20		
25	0.04	0.04	0.05	0.05	0.06	0.12	0.60	1.70	4.45	9.64	15.47	28.38	47.98	59.28	79.53	85.91	77.49		
26	0.04	0.04	0.05	0.05	0.06	0.13	0.64	1.86	5.07	11.28	18.19	31.87	49.97	63.08	83.32	87.40	78.46		
27	0.04	0.04	0.05	0.05	0.06	0.14	0.68	2.08	5.77	13.26	21.29	35.65	52.37	67.17	86.32	88.18	79.03		
28	0.04	0.04	0.05	0.05	0.05	0.14	0.72	2.34	6.54	15.55	24.74	39.50	55.12	70.87	88.15	88.25	79.24		
29	0.04	0.04	0.05	0.05	0.05	0.15	0.76	2.65	7.34	18.00	28.44	43.27	58.01	73.40	88.49	87.65	79.14		
30	0.04	0.04	0.05	0.05	0.05	0.15	0.80	2.97	8.09	20.36	32.26	46.92	60.78	74.12	87.24	86.41	78.80		
31	0.04	0.04	0.05	0.05	0.05	0.15	0.85	3.31	8.73	22.33	36.10	50.55	63.15	72.74	84.48	84.44	78.06		
32	0.04	0.04	0.05	0.05	0.05	0.15	0.89	3.65	9.19	23.72	39.84	54.28	64.83	69.42	80.44	81.47			
33	0.04	0.04	0.05	0.05	0.05	0.16	0.95	3.99	9.48	24.49	43.42	58.16	65.58	64.78	75.42				
34	0.04	0.04	0.05	0.05	0.05	0.16	1.01	4.36	9.63	24.82	46.88	62.09	65.26	59.64	69.69				
35	0.04	0.04	0.05	0.05	0.05	0.17	1.08	4.74	9.69	25.07	50.29	65.91	63.87	54.82	63.47	63.81			
36	0.04	0.04	0.05	0.05	0.05	0.18	1.15	5.12	9.75	25.63	53.78	69.44	61.65	50.82	57.00	55.63	54.44		
37	0.04	0.05	0.05	0.05	0.05	0.20	1.22	5.49	9.86	26.80	57.47	72.59	58.96	47.67	50.48	47.62	46.73	46.53	
38	0.05	0.05	0.05	0.05	0.05	0.21	1.31	5.82	10.08	28.69	61.39	75.33	56.21	44.99	44.15	40.72	40.15	40.23	
39	0.05	0.05	0.05	0.05	0.05	0.23	1.39	6.09	10.42	31.19	65.43	77.62	53.69	42.19	38.23	35.50	35.36		
40	0.05	0.05	0.05	0.05	0.05	0.26	1.48	6.31	10.90	34.08	69.36	79.37	51.41	38.73	32.88	31.98	32.37		
41	0.05	0.05	0.05	0.05	0.06	0.28	1.57	6.47	11.52	37.08	72.84	80.43	49.12	34.36	28.19	29.70			
42	0.05	0.05	0.05	0.05	0.06	0.31	1.68	6.61	12.32	40.02	75.60	80.59	46.41	29.26	24.17				
43	0.05	0.05	0.05	0.05	0.06	0.34	1.79	6.74	13.34	42.87	77.47	79.66	42.88	23.90	20.77				
44	0.05	0.05	0.05	0.05	0.06	0.37	1.92	6.90	14.64	45.71	78.43	77.44	38.40	18.86	17.93				
45	0.05	0.05	0.05	0.05	0.06	0.40	2.07	7.13	16.27	48.68	78.54	73.82	33.19	14.63	15.57				
46	0.05	0.05	0.05	0.05	0.06	0.43	2.24	7.44	18.23	51.86	77.86	68.80	27.74	11.45	13.61				
47	0.05	0.05	0.05	0.05	0.06	0.46	2.44	7.86	20.50	55.21	76.38	62.67	22.69	9.30	12.01				
48	0.05	0.05	0.05	0.05	0.06	0.49	2.66	8.35	23.00	58.55	74.03	55.94	18.53	8.02	10.73				
49	0.05	0.05	0.05	0.05	0.07	0.52	2.89	8.90	25.62	61.69	70.75	49.29	15.50	7.38	9.77				
50	0.05	0.05	0.05	0.05	0.07	0.55	3.11	9.47	28.25	64.50	66.54	43.32	13.54	7.20	9.15				
51	0.05	0.05	0.05	0.06	0.07	0.58	3.33	10.02	30.82	66.92	61.58	38.31	12.43	7.37	8.91				
52	0.05	0.05	0.05	0.06	0.07	0.61	3.52	10.54	33.28	68.99	56.19	34.25	11.85	7.85	9.10				
53	0.05	0.05	0.06	0.06	0.08	0.62	3.67	11.03	35.70	70.83	50.84	30.92	11.60	8.61	9.73				
54	0.05	0.06	0.06	0.06	0.08	0.64	3.79	11.53	38.18	72.57	46.02	28.07	11.53	9.63	10.75				
55	0.06	0.06	0.06	0.06	0.08	0.64	3.87	12.09	40.86	74.35	42.12	25.55	11.62	10.83	12.10				
56	0.06	0.06	0.06	0.06	0.08	0.65	3.93	12.77	43.91	76.26	39.30	23.34	11.85	12.14	13.66				
57	0.06	0.06	0.06	0.06	0.09	0.66	3.96	13.62	47.42	78.29	37.46	21.44	12.23	13.49	15.28				
58	0.06	0.06	0.06	0.07	0.09	0.67	4.01	14.70	51.40	80.38	36.28	19.82	12.70	14.82					
59	0.07	0.07	0.07	0.07	0.10	0.69	4.07	16.01	55.75	82.37	35.35	18.49	13.20	16.09					
60	0.07	0.07	0.07	0.07	0.11	0.73	4.17	17.56	60.27	84.09	34.35	17.42	13.69	17.30					
61	0.07	0.07	0.07	0.07	0.12	0.77	4.33	19.26	64.66	85.38	33.12	16.67	14.14	18.43					
62	0.07	0.07	0.07	0.08	0.13	0.82	4.54	21.01	68.65	86.14	31.70	16.30	14.56	19.46					
63	0.07	0.07	0.08	0.08	0.14	0.87	4.80	22.66	72.06	86.33	30.22	16.35	14.95	20.31					
64	0.07	0.08	0.08	0.08	0.16	0.94	5.11	24.12	74.81	85.95	28.87	16.78	15.31						
65	0.08	0.08	0.08	0.09	0.19	1.01	5.46	25.34	76.96	84.99	27.77	17.47	15.58						
66	0.08	0.08	0.08	0.09	0.22	1.08	5.84	26.38	78.61	83.39	27.02	18.26	15.70						
67	0.08	0.08	0.08	0.10	0.25	1.15	6.25	27.36	79.88	81.02	26.65	18.97							
68	0.08	0.08	0.08	0.10	0.30	1.19	6.70	28.46	80.80	77.75	26.66	19.49	15.38						
69	0.08	0.																	

ft/s	Oldsmobile 88 NOx Emissions, mg/s											6	7	8	9	10	11	12
	-5	-4	-3	-2	-1	0	1	2	3	4	5							
78	0.13	0.13	0.12	0.12	0.30	1.27	12.72	53.18	75.23	35.46	34.88							
79	0.15	0.15	0.14	0.14	0.32	1.39	13.58	55.57	73.85	35.34	34.28							
80	0.17	0.17	0.16	0.17	0.35	1.54	14.50	57.81	72.18	35.49	33.22							
81	0.20	0.20	0.19	0.20	0.39	1.70	15.46	59.92	70.18	35.64	31.78							
82	0.23	0.23	0.23	0.24	0.44	1.89	16.40	61.94	67.94	35.59	30.09							
83	0.26	0.26	0.27	0.28	0.48	2.08	17.28	63.88	65.57	35.24	28.24							
84	0.28	0.29	0.32	0.33	0.53	2.29	18.07	65.77	63.17	34.53	26.31							
85	0.31	0.31	0.36	0.39	0.58	2.50	18.75	67.61	60.73	33.47	24.36							
86	0.34	0.34	0.40	0.43	0.62	2.71	19.36	69.40	58.13	32.08	22.44							
87	0.37	0.38	0.44	0.48	0.66	2.95	19.96	71.11	55.20	30.41	20.57							
88	0.41	0.41	0.48	0.52	0.70	3.23	20.59	72.69	51.88	28.53	18.78							
89	0.45	0.45	0.51	0.55	0.73	3.56	21.30	74.12	48.25	26.51	17.14							
90	0.49	0.49	0.54	0.58	0.76	3.92	22.14	75.39	44.56	24.45	15.68							
91	0.53	0.53	0.57	0.62	0.78	4.24	23.19	76.51	41.08	22.46	14.48							
92	0.57	0.57	0.60	0.65	0.80	4.48	24.56	77.49	38.04	20.66	13.58							
93	0.61	0.61	0.63	0.68	0.81	4.62	26.36	78.34	35.54	19.12	12.99							
94	0.64	0.64	0.66	0.70	0.81	4.69	28.68	79.02	33.56	17.88	12.73							
95	0.68	0.68	0.69	0.72	0.82	4.77	31.52	79.52	32.00	16.94	12.75							
96	0.71	0.71	0.72	0.74	0.82	4.93	34.78	79.84	30.75	16.26	13.02							
97	0.73	0.73	0.74	0.75	0.82	5.19	38.27	79.96	29.71	15.79	13.48							
98	0.75	0.75	0.75	0.76	0.82	5.54	41.75	79.90	28.80	15.49								
99	0.76	0.76	0.76	0.77	0.82	5.94	45.07	79.65	27.96	15.36								
100	0.77	0.77	0.77	0.77	0.82	6.37	48.16	79.17	27.14	15.37								
101	0.77	0.77	0.77	0.76	0.82	6.90	51.08	78.40	26.30	15.53								
102	0.77	0.77	0.76	0.75	0.82	7.60	53.94	77.24	25.46	15.80								
103	0.76	0.77	0.75	0.73	0.83	8.53	56.84	75.65	24.63	16.16								
104	0.75	0.76	0.74	0.71	0.84	9.65	59.80	73.60	23.90	16.57								
105	0.74	0.75	0.72	0.69	0.88	10.79	62.76	71.14	23.36	16.96								
106	0.73	0.76	0.71	0.67	0.93	11.77	65.60	68.42	23.08									
107	0.72	0.77	0.70	0.64	1.00	12.44	68.16	65.65	23.07									
108	0.73	0.79	0.70	0.62	1.07	12.76	70.27	63.13	23.27									
109	0.73	0.81	0.70	0.61	1.14	12.84	71.77	61.21	23.53									
110	0.74	0.82	0.7	0.6	1.18	12.82	72.55	60.17	23.71									

ft/s	Geo Prizm Fuel Consumption, gal/h																	
	-5	-4	-3	-2	-1	0	1	2	3	4	5	6	7	8	9	10	11	12
0	0.28	0.28	0.28	0.28	0.28	0.28	0.55	0.66	0.7	1.18	1.26	1.42	1.65	2.4	2.63			
1	0.28	0.28	0.28	0.28	0.28	0.28	0.56	0.66	0.77	1.18	1.27	1.43	1.64	2.36	2.64			
2	0.28	0.28	0.28	0.28	0.28	0.28	0.56	0.66	0.8	1.18	1.28	1.44	1.47	2.36	2.52			
3	0.28	0.28	0.28	0.28	0.28	0.28	0.57	0.65	0.81	1.19	1.29	1.44	1.39	2.34	2.39			
4	0.28	0.28	0.28	0.28	0.28	0.28	0.57	0.7	0.81	1.18	1.3	1.45	1.43	2.36	2.33			
5	0.28	0.28	0.28	0.28	0.28	0.28	0.58	0.77	0.82	1.22	1.31	1.46	1.51	2.32	2.34			
6	0.28	0.28	0.28	0.28	0.28	0.28	0.61	0.8	0.83	1.3	1.44	1.47	1.6	2.36				
7	0.26	0.28	0.36	0.65	0.43	0.28	0.64	0.81	0.84	1.4	1.58	1.48	1.68	2.29	2.36			
8	0.26	0.29	0.35	0.64	0.34	0.28	0.66	0.81	0.88	1.56	1.71	1.49	1.74	2.36				
9	0.25	0.3	0.33	0.61	0.28	0.27	0.69	0.82	0.91	1.82	1.78	1.53	1.78	2.3	2.38			
10	0.25	0.31	0.34	0.53	0.25	0.3	0.72	0.83	1.12	2.1	1.84	1.57	1.83	2.35	2.43			
11	0.26	0.3	0.33	0.47	0.25	0.35	0.77	0.84	1.3	2.19	1.87	1.63	1.9	2.31	2.48			
12	0.28	0.28	0.32	0.42	0.27	0.4	0.81	0.88	1.4	2.07	1.87	1.69	2	2.41	2.55			
13	0.28	0.26	0.31	0.39	0.28	0.43	0.81	0.9	1.43	1.87	1.84	1.76	2.13	2.52	2.63			
14	0.27	0.25	0.28	0.38	0.3	0.44	0.78	0.93	1.52	1.76	1.82	1.88	2.25	2.59	2.7			
15	0.25	0.24	0.27	0.38	0.32	0.45	0.74	1.02	1.66	1.69	1.83	2.01	2.38	2.65	2.77			
16	0.24	0.24	0.26	0.39	0.34	0.44	0.7	1.16	1.76	1.64	1.86	2.16	2.49	2.69	2.83			
17	0.24	0.25	0.28	0.39	0.34	0.41	0.66	1.3	1.77	1.61	1.94	2.34	2.6	2.76	2.9			
18	0.23	0.24	0.3	0.38	0.32	0.39	0.65	1.41	1.74	1.62	2.04	2.52	2.71	2.83	2.98			
19	0.23	0.23	0.3	0.36	0.29	0.37	0.7	1.51	1.7	1.67	2.17	2.7	2.8	2.91	3.06			
20	0.23	0.22	0.3	0.34	0.26	0.35	0.77	1.63	1.7	1.73	2.32	2.83	2.88	3	3.14			
21	0.22	0.22	0.3	0.33	0.24	0.35	0.82	1.66	1.7	1.79	2.51	2.93	2.96	3.09	3.23			
22	0.23	0.23	0.3	0.34	0.23	0.37	0.86	1.64	1.7	1.83	2.7	3	3.04	3.17	3.31			
23	0.23	0.23	0.31	0.35	0.23	0.4	0.9	1.6	1.7	1.87	2.83	3.03	3.11	3.24	3.35			
24	0.23	0.23	0.31	0.36	0.23	0.47	0.96	1.61	1.69	1.91	2.92	3.08	3.19	3.3	3.37			
25	0.23	0.23	0.32	0.36	0.25	0.5	1.04	1.64	1.69	1.97	2.93	3.12	3.27	3.37				
26	0.23	0.23	0.32	0.36	0.26	0.5	1.12	1.67	1.7	2.06	2.91	3.17	3.36	3.47				
27	0.23	0.23	0.31	0.36	0.27	0.47	1.18	1.67	1.73	2.16	2.9	3.24	3.46	3.57				
28	0.23	0.23	0.28	0.35	0.29	0.47	1.25	1.66	1.78	2.3	2.9	3.31	3.55	3.68				
29	0.23	0.23	0.25	0.34	0.31	0.49	1.32	1.65	1.81	2.41	2.91	3.41	3.65	3.8				
30	0.23	0.23	0.22	0.33	0.36	0.53	1.37	1.64	1.81	2.52	2.93	3.5	3.75	3.91				
31	0.23	0.23	0.23	0.35	0.42	0.55	1.37	1.61	1.78	2.57	2.95	3.6	3.84	4.03				
32	0.23	0.23	0.24	0.39	0.47	0.57	1.32	1.58	1.77	2.61	2.98	3.69	3.94	4.17				
33	0.24	0.24	0.26	0.43	0.5	0.59	1.29	1.58	1.79	2.63	3.01	3.75	4.04	4.32				
34	0.24	0.24	0.27	0.46	0.51	0.59	1.26	1.58	1.82	2.65	3.04	3.81	4.15	4.47				
35	0.24	0.24	0.23	0.47	0.5	0.59	1.29	1.58	1.87	2.68	3.08	3.86	4.29	4.59				
36	0.24	0.24	0.19	0.46	0.5	0.58	1.31	1.59	1.94	2.71	3.12	3.92	4.46	4.69				
37	0.24	0.24	0.15	0.46	0.5	0.6	1.39	1.6	2.04	2.74	3.16	3.98	4.65	4.76				
38	0.25	0.25	0.14	0.46	0.5	0.62	1.45	1.61	2.15	2.79	3.21	4.09	4.88	4.8				
39	0.26	0.26	0.14	0.48	0.5	0.65	1.49	1.63	2.24	2.84	3.25	4.22	5.1	4.89				
40	0.28	0.28	0.14	0.47	0.51	0.64	1.51	1.68	2.33	2.9	3.31	4.42	5.31					
41	0.28	0.28	0.14	0.46	0.52	0.67	1.53	1.72	2.42	2.96	3.37	4.65	5.52					
42	0.28	0.28	0.1	0.45	0.52	0.7	1.55	1.77	2.49	3.03	3.46	4.91	5.73					
43	0.28	0.28	0.05	0.44	0.52	0.72	1.55	1.8	2.56	3.1	3.57	5.16	5.95					
44	0.28	0.28	0.03	0.43	0.52	0.73	1.54	1.83	2.62	3.18	3.68	5.4	6.19					
45	0.19	0.19	0.08	0.42	0.51	0.76	1.54	1.87	2.68	3.25	3.82	5.7	6.45					
46	0.13	0.14	0.16	0.42	0.51	0.83	1.56	1.92	2.74	3.33	3.93	5.99	6.71					
47	0.13	0.14	0.21	0.42	0.51	0.9	1.59	1.97	2.8	3.4	4.05	6.35	6.95					
48	0.13	0.14	0.24	0.43	0.55	0.94	1.6	2.03	2.84	3.47	4.13	6.62	7.11					
49	0.13	0.14	0.24	0.37	0.58	0.93	1.6	2.1	2.87	3.54	4.24	6.79	7.15					
50	0.13	0.14	0.23	0.31	0.61	0.92	1.59	2.17	2.89	3.62	4.29	6.74	7.07					
51	0.13	0.14	0.23	0.24	0.62	0.9	1.61	2.25	2.93	3.69	4.36	6.54	6.87					
52	0.13	0.14	0.22	0.23	0.63	0.88	1.65	2.32	2.98	3.77	4.37	6.19	6.62					
53	0.13	0.14	0.21	0.22	0.64	0.88	1.69	2.41	3.03	3.83	4.37	5.79	6.37					
54	0.13	0.14	0.21	0.22	0.66	0.89	1.71	2.48	3.09	3.88	4.29	5.38	6.19					
55	0.13	0.14	0.22	0.22	0.67	0.92	1.7	2.53	3.16	3.9	4.17	4.93	6.13					
56	0.13	0.14	0.22	0.22	0.69	0.96	1.7	2.56	3.21	3.89	4.04	4.53	6.18					
57	0.13	0.14	0.22	0.22	0.72	1	1.73	2.58	3.24	3.87	3.97	4.25	6.3					
58	0.13	0.14	0.22	0.22	0.76	1.02	1.76	2.62	3.27	3.87	3.99	4.22	6.4					
59	0.13	0.14	0.21	0.22	0.78	1.03	1.79	2.65	3.3	3.91	4.08	4.36	6.5					
60	0.13	0.14	0.21	0.22	0.79	1.05	1.83	2.68	3.36	4.01	4.21	4.58						
61	0.13	0.14	0.21	0.22	0.78	1.07	1.87	2.71	3.43	4.13	4.34	4.76						
62	0.13	0.12	0.21	0.22	0.76	1.07	1.92	2.76	3.54	4.28	4.45	4.89						
63	0.13	0.14	0.21	0.22	0.73	1.05	1.96	2.79	3.67	4.44	4.54	4.97						
64	0.13	0.14	0.21	0.22	0.71	1.05	2.02	2.81	3.84	4.6	4.63							
65	0.13	0.14	0.21	0.21	0.69	1.08	2.06	2.83	4.03	4.74								
66	0.13	0.14	0.21	0.21	0.68	1.09	2.07	2.84	4.25	4.87								
67	0.13	0.16	0.21	0.21	0.66	1.07	2.06	2.81	4.43	4.98								
68	0.13	0.18	0.2	0.22	0.64	1.03	2.02	2.75	4.51	5.06								
69	0.13	0.2	0.2	0.23	0.63	1.06	1.99	2.67	4.52	5.11								
70	0.13	0.19	0.19	0.25	0.63	1.13	1.98	2.63	4.5	5.14								
71	0.12	0.19	0.19	0.25	0.64	1.23	2	2.63	4.49	5.17								
72	0.12	0.18	0.18	0.24	0.65	1.28	2.04	2.68	4.51	5.23								
73	0.12	0.17	0.18	0.22	0.67	1.29	2.06	2.73	4.53	5.3								
74	0.12	0.15	0.17	0.2	0.69	1.28	2.1	2.77	4.56	5.37								
75	0.12	0.13	0.17	0.19	0.69	1.29	2.16	2.82	4.57	5.47								
76	0.13	0.13	0.17	0.18	0.67	1.33	2.22	2.87	4.59	5.57								
77	0.14	0.15	0.17	0.18	0.66	1.35	2.27	2.94	4.67	5.69								

		Geo Prizm Fuel Consumption, gal/h																	
ft/s	ft/s/s	-5	-4	-3	-2	-1	0	1	2	3	4	5	6	7	8	9	10	11	12
78	0.15	0.15	0.17	0.19	0.66	1.38	2.28	3	4.8	5.78									
79	0.16	0.16	0.17	0.21	0.67	1.41	2.3	3.06	5	5.86									
80	0.16	0.16	0.17	0.22	0.68	1.47	2.35	3.11	5.21	5.94									
81	0.18	0.18	0.18	0.23	0.72	1.49	2.42	3.14	5.39	6.01									
82	0.19	0.19	0.19	0.23	0.75	1.49	2.47	3.18	5.51	6.05									
83	0.2	0.2	0.19	0.22	0.75	1.46	2.52	3.26	5.55	6.05									
84	0.19	0.19	0.19	0.22	0.7	1.47	2.57	3.34	5.59	6.04									
85	0.19	0.19	0.2	0.2	0.66	1.5	2.62	3.44	5.64	6.07									
86	0.18	0.18	0.2	0.21	0.68	1.56	2.68	3.5	5.72	6.09									
87	0.18	0.17	0.2	0.23	0.75	1.61	2.71	3.55	5.79	6.14									
88	0.18	0.16	0.2	0.25	0.87	1.66	2.74	3.59	5.83	6.16									
89	0.17	0.16	0.2	0.26	0.97	1.69	2.78	3.63	5.82	6.17									
90	0.16	0.15	0.2	0.27	1.03	1.74	2.83	3.67	5.78	6.15									
91	0.16	0.15	0.21	0.28	1.07	1.78	2.89	3.71	5.75	6.13									
92	0.15	0.14	0.22	0.31	1.11	1.82	2.93	3.73	5.74	6.1									
93	0.14	0.14	0.22	0.33	1.14	1.84	2.96	3.77	5.72	6.03									
94	0.14	0.14	0.21	0.32	1.13	1.83	2.96	3.82	5.66	5.9									
95	0.15	0.14	0.18	0.28	1.09	1.84	2.97	3.88	5.53	5.71									
96	0.15	0.15	0.17	0.26	1.08	1.9	3	3.91	5.28	5.46									
97	0.15	0.15	0.16	0.25	1.1	2.01	3.05	3.91	4.97	5.15									
98	0.16	0.16	0.16	0.25	1.12	2.06	3.11	3.86	4.64	4.84									
99	0.17	0.17	0.16	0.24	1.1	2.02	3.14	3.82	4.39	4.55									
100	0.19	0.19	0.17	0.24	1.05	2.01	3.23	3.86	4.16	4.27									
101	0.21	0.21	0.17	0.24	1.04	2.08	3.38	3.95											
102	0.22	0.22	0.17	0.25	1.13	2.2	3.51	4											
103	0.22	0.22	0.18	0.27	1.27	2.27	3.53	3.93											
104	0.21	0.21	0.19	0.3	1.37	2.32	3.55	3.83											
105	0.2	0.2	0.21	0.33	1.43	2.39	3.64	3.81											
106	0.19	0.19	0.24	0.39	1.45	2.46	3.76	3.88											
107	0.19	0.19	0.28	0.47	1.5	2.55	3.84	4.04											
108	0.18	0.18	0.32	0.56	1.58	2.59	3.86	4.21											
109	0.18	0.17	0.34	0.62	1.64	2.64	3.96	4.4											
110	0.18	0.17	0.34	0.65	1.67	2.65	4.02	4.51											

ft/s	Geo Prizm CO Emissions, mg/s												10	11	12				
	ft/s	-5	-4	-3	-2	-1	0	1	2	3	4	5				6	7	8	9
0	0.65	0.65	0.94	2.09	4.52	3.04	5.67	4.81	3.68	1.94	1.38	1.43	2.21	5.26	7.53				
1	0.65	0.62	0.89	2.09	4.2	2.15	4.2	4.81	3.68	1.94	1.38	1.43	2.21	5.26	7.53				
2	0.45	0.45	0.62	1.38	2.21	1.47	3.04	3.81	3.54	1.94	1.38	1.43	2.21	3.59	7.48				
3	0.35	0.35	0.45	0.94	1.43	0.97	2.09	2.86	2.76	1.94	1.38	1.43	1.5	3.59	7.48				
4	0.24	0.24	0.35	0.45	0.65	0.48	1.38	2.02	1.94	1.31	1.38	1.43	1.5	3.59	7.24				
5	0.17	0.17	0.24	0.31	0.35	0.35	0.89	1.94	1.83	1.31	1.38	1.43	2.21	3.59	7.24				
6	0.09	0.11	0.17	0.17	0.24	0.24	0.57	1.23	1.23	1.31	1.38	1.47	2.21	4.9					
7	0.09	0.09	0.11	0.11	0.11	0.13	0.41	0.83	1.23	1.31	2.02	2.15	3.18	4.9	7.48				
8	0.08	0.07	0.09	0.07	0.07	0.09	0.36	0.74	1.13	1.83	2.09	2.94	4.2	6.81					
9	0.08	0.07	0.07	0.08	0.08	0.07	0.3	0.74	1.13	1.94	2.86	3.97	4.52	7.24	9.29				
10	0.08	0.07	0.07	0.07	0.07	0.08	0.3	0.64	1.13	2.63	3.81	4.2	6.25	9.1	10.91				
11	0.07	0.07	0.07	0.06	0.06	0.1	0.3	0.64	1.7	2.76	3.97	5.67	6.81	9.1	11.33				
12	0.07	0.07	0.07	0.06	0.06	0.11	0.36	0.64	1.7	3.68	4.81	5.67	8.7	10.52	14.27				
13	0.07	0.07	0.07	0.06	0.06	0.11	0.43	0.83	2.47	3.68	5.17	7.31	9.41	11.94	14.27				
14	0.07	0.07	0.07	0.07	0.08	0.13	0.43	1	2.47	4.57	5.85	8.59	10.04	13.02	18.71				
15	0.07	0.07	0.07	0.08	0.08	0.13	0.53	1	2.63	4.57	6.52	9.41	10.98	16.26	22.21				
16	0.07	0.07	0.07	0.08	0.08	0.13	0.53	1	3.36	5.37	6.74	9.18	11.94	18.71	28.43				
17	0.06	0.07	0.07	0.08	0.08	0.11	0.53	1.54	3.54	5.37	7.66	10.09	14.16	25.49	51.52				
18	0.06	0.06	0.07	0.07	0.08	0.11	0.53	1.54	4.39	5.85	8.59	10.71	17.42	34.35	81.21				
19	0.06	0.06	0.06	0.06	0.07	0.11	0.53	1.7	4.39	5.98	8.22	14.16	20.68	57.83	148.79				
20	0.07	0.06	0.06	0.06	0.06	0.11	0.53	1.7	4.57	6.74	9.18	17.42	37.17	94.13	148.79				
21	0.07	0.07	0.06	0.06	0.06	0.11	0.64	1.83	4.57	6.74	9.39	21.11	57.83	155.38	233.87				
22	0.07	0.07	0.07	0.06	0.06	0.11	0.64	2.47	4.57	7.66	10.71	26.65	96.18	233.87	323.35				
23	0.07	0.07	0.07	0.07	0.07	0.11	1	2.63	5.37	7.66	12.19	36.43	146.05	318.7	415.26				
24	0.07	0.07	0.07	0.07	0.07	0.15	1.13	2.63	5.37	8.22	14.65	57.88	224.83	415.26	477.84				
25	0.07	0.07	0.07	0.06	0.07	0.15	1.13	2.76	5.37	8.22	17.5	88.87	291.51	477.84	477.84				
26	0.07	0.07	0.06	0.06	0.07	0.17	1.23	3.54	5.85	9.18	21.11	128.82	332.85	497.52					
27	0.07	0.06	0.06	0.06	0.08	0.17	1.7	3.68	5.85	9.39	25.64	201.55	419.86	562.97					
28	0.06	0.06	0.06	0.07	0.08	0.17	1.7	3.68	6.52	10.71	36.43	245.17	414.79	577.33					
29	0.06	0.06	0.08	0.08	0.11	0.17	1.83	3.68	6.74	10.71	36.43	245.17	404.42	634.39					
30	0.08	0.08	0.08	0.09	0.11	0.2	1.83	4.57	6.74	12.19	52.82	258.94	448.86	765.5					
31	0.08	0.08	0.09	0.11	0.13	0.25	1.83	4.57	7.66	12.19	88.87	336.2	765.5	960.15					
32	0.08	0.09	0.11	0.13	0.13	0.25	1.83	4.57	7.66	14.65	88.87	315.99	960.15	1316.63					
33	0.09	0.11	0.13	0.13	0.2	0.25	2.47	4.57	7.66	14.65	88.87	404.42	1186.16	1542.4					
34	0.13	0.13	0.13	0.2	0.2	0.29	2.47	4.57	7.66	14.65	146.05	511.12	1376.38	1804.29					
35	0.13	0.13	0.2	0.2	0.2	0.29	2.47	4.57	8.59	17.42	146.05	634.39	1701.01	1841.95					
36	0.13	0.2	0.2	0.2	0.24	0.29	2.47	4.57	8.22	17.42	224.83	765.5	1873.22	1896.35					
37	0.16	0.2	0.2	0.29	0.29	0.29	2.63	4.81	9.18	21.11	318.7	930.98	1880.92	1892.44					
38	0.2	0.2	0.24	0.29	0.29	0.35	2.63	5.37	9.18	21.11	291.51	1079.34	1896.18	2052.74					
39	0.2	0.2	0.24	0.29	0.35	0.43	3.36	5.37	9.39	26.65	388.18	1306.79	1910.41	2278.57					
40	0.2	0.2	0.24	0.29	0.35	0.43	3.54	5.85	10.71	36.43	477.84	1571.29	2094.01						
41	0.21	0.24	0.24	0.29	0.35	0.43	3.54	5.85	12.31	57.88	562.97	1711.01	2158.02						
42	0.24	0.24	0.24	0.24	0.35	0.51	4.2	6.74	12.19	96.18	617.7	1882.02	2376.84						
43	0.24	0.24	0.24	0.24	0.35	0.66	4.2	6.74	14.65	146.05	662.16	1909.75	2601.51						
44	0.24	0.24	0.24	0.24	0.35	0.82	4.39	6.74	17.42	224.83	806.67	1884.37	2714.05						
45	0.35	0.35	0.35	0.35	0.51	1.09	4.39	7.66	17.5	291.51	975.68	1909.06	2673.64						
46	0.43	0.43	0.35	0.35	0.51	1.09	4.79	7.23	21.11	388.18	1110.46	1988.49	2633.57						
47	0.66	0.66	0.51	0.51	0.51	1.75	5.04	8.22	25.64	419.86	1388.73	2011.29	2524.93						
48	1.09	1.09	0.82	0.51	0.82	1.75	5.04	8.22	36.43	497.52	1452.77	2158.02	2524.93						
49	2.05	2.05	1.38	0.82	0.82	2.12	5.04	9.18	36.43	562.97	1654.46	2180.41	2524.93						
50	2.86	2.86	1.75	1	1	2.12	5.42	9.39	52.82	494.68	1711.01	2158.02	2557.19						
51	2.86	3.13	2.12	1	1	2.12	5.42	9.39	52.82	577.33	1711.01	2129.64	2579.53						
52	3.62	3.62	2.53	1	1	2.12	5.42	10.71	88.87	634.39	1711.01	1988.49	2700.68						
53	3.25	3.25	2.12	1.14	1.14	2.12	5.42	12.19	77.57	634.39	1654.46	1897.25	2708.66						
54	3.25	3.25	2.12	1.14	1.14	2.3	5.55	12.19	128.82	598.98	1571.29	1891.3	2666.04						
55	2.12	2.12	1.63	1.14	1.14	2.3	5.55	14.65	128.82	765.5	1458.58	1909.56	2429.06						
56	1.63	1.63	1.14	1.14	1.14	2.81	5.55	14.65	167.23	765.5	1458.58	1839.21	2179.96						
57	1	1	1.14	1.14	1.19	2.76	6.31	17.5	167.23	765.01	1316.63	1774.99	2079.71						
58	0.59	0.59	0.72	1.19	1.19	2.76	5.53	17.5	245.17	765.01	1376.38	1676.43	2039.18						
59	0.4	0.42	0.67	1.19	1.19	2.76	5.53	17.5	187.38	984.64	1376.38	1676.43	2039.18						
60	0.33	0.33	0.44	0.74	1.19	2.99	6.35	21.11	258.94	1186.16	1542.4	1804.29							
61	0.27	0.29	0.42	0.72	1.64	2.99	6.35	20.14	242.56	1376.38	1701.01	1804.29							
62	0.27	0.27	0.33	0.72	1.64	2.99	5.67	25.64	315.99	1564.25	1804.29	1873.22							
63	0.27	0.27	0.33	0.72	1.64	2.99	6.45	25.64	404.42	1804.29	1880.92	1880.92							
64	0.2	0.2	0.33	0.44	1.13	2.99	6.45	36.43	598.98	1841.95	1896.35								
65	0.2	0.2	0.29	0.44	1.19	2.99	6.45	32.96	765.5	1896.35									
66	0.2	0.2	0.27	0.33	1.19	2.99	6.45	32.96	960.15	1879.62									
67	0.2	0.2	0.25	0.33	1.19	2.99	6.45	36.43	1147.95	1892.44									
68	0.13	0.19	0.25	0.29	1.19	2.99	6.45	36.43	1316.63	1910.41									
69	0.13	0.13	0.2	0.29	0.74	2.55	6.45	36.43	1458.58	1934.58									
70	0.13	0.13	0.19	0.25	1.19	3.06	7.28	26.65	1458.58	2009.58									
71	0.09	0.09	0.13	0.25	1.19	3.06	7.28	26.65	1571.29	2052.74									
72	0.09	0.09	0.13	0.2	1.19	3.06	7.28	26.65	1654.46	2052.74									
73	0.07	0.07	0.09	0.14	1.14	3.54	7.28	37.17	1774.99	2094.01									
74	0.06	0.07	0.09	0.13	1.14	3.09	7.37	37.17	1839.21	2129.64									
75	0.06	0.07	0.07	0.09	1.14	3.09	7.37	37.17	1872.76	2317.42									
76	0.06	0.06	0.07	0.09	1.14	3.44	7.37	57.83	1882.02	2349.06									
77	0.06	0.06	0.07	0.09	1</														

ft/s	Geo Prizm CO Emissions, mg/s											5	6	7	8	9	10	11	12
	ft/s/s	-5	-4	-3	-2	-1	0	1	2	3	4								
78	0.06	0.06	0.07	0.07	0.07	0.67	3.27	8.1	96.18	1895.07	2576.53								
79	0.06	0.06	0.07	0.09	0.09	0.67	3.27	9.69	155.38	1890.59	2601.51								
80	0.06	0.07	0.07	0.09	0.09	0.67	3.51	11.61	224.83	1897.25	2619.4								
81	0.06	0.07	0.07	0.09	0.09	0.59	3.51	11.61	318.7	1909.06	2719.34								
82	0.07	0.07	0.07	0.09	0.09	0.59	3.51	13.99	291.51	1988.49	2714.05								
83	0.07	0.07	0.07	0.09	0.09	0.42	3.83	13.33	388.18	2011.29	2714.05								
84	0.07	0.07	0.07	0.09	0.09	0.42	4.08	15.46	477.84	2158.02	2705.38								
85	0.06	0.07	0.07	0.09	0.09	0.42	4.08	18.26	497.52	2180.41	2673.64								
86	0.06	0.07	0.07	0.13	0.13	0.67	5.4	16.21	497.52	2349.06	2673.64								
87	0.06	0.07	0.07	0.13	0.13	0.72	5.4	20.13	494.68	2376.84	2657.66								
88	0.06	0.07	0.09	0.2	1.19	6.72	20.13	577.33	2376.84	2657.66									
89	0.06	0.07	0.09	0.2	1.64	7.26	24.2	577.33	2376.84	2657.66									
90	0.06	0.07	0.09	0.25	1.44	8.58	24.2	634.39	2376.84	2673.64									
91	0.06	0.06	0.09	0.27	1.84	8.58	24.2	634.39	2547.19	2687.15									
92	0.06	0.06	0.07	0.27	2.07	9.38	30.94	765.5	2349.06	2700.68									
93	0.06	0.06	0.07	0.27	2.07	9.99	30.94	765.5	2317.42	2722.1									
94	0.06	0.06	0.07	0.21	1.9	9.99	24.31	765.5	2231.77	2690.93									
95	0.06	0.06	0.06	0.2	2.29	10.24	36.78	765.5	2009.58	2475.48									
96	0.06	0.06	0.06	0.14	2.29	10.74	36.78	765.01	1892.44	2179.96									
97	0.06	0.06	0.06	0.14	2.29	10.74	27.99	765.01	1866.1	1908.01									
98	0.06	0.06	0.06	0.14	2.29	11.01	40.48	765.01	1776.01	1807.67									
99	0.06	0.06	0.06	0.1	2.29	11.01	40.48	765.01	1564.25	1564.99									
100	0.06	0.06	0.06	0.14	2.29	11.23	54.67	765.01	984.64	1029.41									
101	0.06	0.06	0.06	0.14	2.29	11.25	76.37	765.01											
102	0.06	0.06	0.06	0.2	2.42	11.5	106.74	786.66											
103	0.07	0.07	0.07	0.27	2.73	11.59	195.94	786.66											
104	0.09	0.09	0.13	0.29	4.29	13.27	258.31	786.66											
105	0.2	0.2	0.2	0.31	5.22	13.47	343.48	786.66											
106	0.29	0.29	0.29	0.45	6.19	18.32	571.63	853.25											
107	0.33	0.31	0.29	0.72	7.06	18.62	699.1	1029.41											
108	0.44	0.29	0.47	1.13	6.97	18.62	853.25	1216.24											
109	0.45	0.45	0.72	1.64	7.22	28.67	853.25	1399.32											
110	0.74	0.72	0.8	2.31	6.41	28.67	1029.41	1399.32											

ft/s	ft/s/s	Geo Prizm HC Emissions, mg/s																		
		-5	-4	-3	-2	-1	0	1	2	3	4	5	6	7	8	9	10	11	12	
0	0.17	0.17	0.22	0.35	0.73	0.49	0.87	0.75	0.61	0.40	0.29	0.27	0.39	0.89	1.22					
1	0.17	0.18	0.23	0.35	0.66	0.36	0.66	0.75	0.61	0.40	0.29	0.27	0.39	0.89	1.22					
2	0.16	0.16	0.18	0.29	0.39	0.27	0.49	0.59	0.67	0.40	0.29	0.27	0.39	0.68	1.17					
3	0.15	0.15	0.16	0.22	0.27	0.21	0.35	0.46	0.50	0.40	0.29	0.27	0.28	0.68	1.17					
4	0.12	0.12	0.15	0.16	0.17	0.15	0.29	0.37	0.40	0.31	0.29	0.27	0.28	0.68	1.11					
5	0.08	0.08	0.12	0.14	0.15	0.15	0.23	0.40	0.44	0.31	0.29	0.27	0.39	0.68	1.11					
6	0.04	0.05	0.08	0.08	0.12	0.12	0.19	0.33	0.33	0.31	0.29	0.27	0.39	0.81						
7	0.04	0.04	0.05	0.05	0.05	0.07	0.17	0.24	0.33	0.31	0.37	0.36	0.54	0.81	1.17					
8	0.03	0.04	0.04	0.04	0.04	0.04	0.17	0.25	0.35	0.44	0.35	0.46	0.66	1.04						
9	0.03	0.04	0.04	0.03	0.03	0.04	0.16	0.25	0.35	0.40	0.46	0.61	0.73	1.11	1.38					
10	0.03	0.04	0.04	0.03	0.03	0.05	0.16	0.26	0.35	0.56	0.59	0.66	0.95	1.33	1.56					
11	0.04	0.04	0.04	0.03	0.03	0.06	0.16	0.26	0.48	0.50	0.61	0.87	1.04	1.33	1.59					
12	0.04	0.04	0.04	0.03	0.03	0.08	0.20	0.26	0.48	0.61	0.75	0.87	1.27	1.52	1.79					
13	0.04	0.04	0.04	0.03	0.03	0.08	0.20	0.34	0.62	0.61	0.79	1.09	1.39	1.69	1.79					
14	0.04	0.04	0.04	0.04	0.05	0.10	0.20	0.35	0.62	0.74	0.93	1.30	1.47	1.74	2.02					
15	0.04	0.04	0.04	0.05	0.05	0.10	0.26	0.35	0.56	0.74	1.00	1.39	1.64	1.94	2.12					
16	0.04	0.04	0.04	0.05	0.05	0.10	0.26	0.35	0.74	0.89	1.10	1.49	1.69	2.02	2.28					
17	0.03	0.04	0.04	0.05	0.05	0.08	0.26	0.50	0.67	0.89	1.20	1.57	1.86	2.29	2.95					
18	0.03	0.03	0.04	0.04	0.05	0.08	0.26	0.50	0.77	0.93	1.30	1.72	2.05	2.52	3.70					
19	0.03	0.03	0.03	0.03	0.04	0.08	0.26	0.48	0.77	1.02	1.38	1.86	2.15	3.20	5.65					
20	0.03	0.03	0.03	0.03	0.03	0.08	0.26	0.48	0.74	1.10	1.49	2.05	2.66	4.16	5.65					
21	0.03	0.03	0.03	0.03	0.03	0.08	0.26	0.44	0.74	1.10	1.64	2.22	3.20	6.05	8.49					
22	0.03	0.03	0.03	0.03	0.03	0.08	0.26	0.62	0.74	1.20	1.72	2.38	4.32	8.49	11.48					
23	0.03	0.03	0.03	0.03	0.04	0.08	0.35	0.56	0.89	1.20	1.85	2.68	5.98	11.95	15.66					
24	0.03	0.03	0.03	0.03	0.04	0.09	0.35	0.56	0.89	1.38	1.95	3.26	8.60	15.66	18.83					
25	0.03	0.03	0.03	0.03	0.04	0.09	0.35	0.50	0.89	1.38	2.09	4.20	11.36	18.83	18.83					
26	0.03	0.03	0.03	0.03	0.04	0.11	0.33	0.67	0.93	1.49	2.22	5.55	13.07	19.54						
27	0.03	0.03	0.03	0.03	0.05	0.11	0.48	0.61	0.93	1.64	2.38	8.06	16.44	22.19						
28	0.03	0.03	0.03	0.04	0.05	0.11	0.48	0.61	1.00	1.72	2.68	9.77	15.46	20.47						
29	0.03	0.03	0.05	0.05	0.08	0.11	0.44	0.61	1.10	1.72	2.68	9.77	13.47	18.92						
30	0.05	0.05	0.05	0.07	0.08	0.14	0.44	0.74	1.10	1.85	3.14	10.10	12.45	18.98						
31	0.05	0.05	0.07	0.08	0.10	0.15	0.44	0.74	1.20	1.85	4.20	12.80	18.98	20.59						
32	0.05	0.07	0.08	0.10	0.10	0.15	0.44	0.74	1.20	1.95	4.20	11.13	20.59	26.94						
33	0.07	0.08	0.10	0.10	0.14	0.15	0.62	0.74	1.20	1.95	4.20	13.47	22.94	28.61						
34	0.10	0.10	0.10	0.14	0.14	0.19	0.62	0.74	1.20	1.95	5.98	16.07	26.03	31.59						
35	0.10	0.10	0.14	0.14	0.14	0.19	0.62	0.74	1.30	2.05	5.98	18.92	30.02	32.10						
36	0.10	0.14	0.14	0.14	0.18	0.19	0.62	0.74	1.38	2.05	8.60	18.98	32.77	33.78						
37	0.13	0.14	0.14	0.19	0.19	0.19	0.56	0.75	1.49	2.22	11.95	22.39	33.00	34.71						
38	0.14	0.14	0.18	0.19	0.19	0.23	0.56	0.89	1.49	2.22	11.36	25.40	34.47	36.41						
39	0.14	0.14	0.18	0.19	0.23	0.24	0.74	0.89	1.64	2.38	15.11	29.58	35.25	38.06						
40	0.14	0.14	0.18	0.19	0.23	0.24	0.67	0.93	1.72	2.68	18.83	30.94	36.85							
41	0.14	0.18	0.18	0.19	0.23	0.24	0.67	0.93	1.79	3.26	22.19	33.02	37.49							
42	0.18	0.18	0.18	0.18	0.23	0.29	0.84	1.10	1.85	4.32	24.40	34.60	38.63							
43	0.18	0.18	0.18	0.18	0.23	0.32	0.84	1.10	1.95	5.98	22.84	34.97	39.81							
44	0.18	0.18	0.18	0.18	0.23	0.39	0.77	1.10	2.05	8.60	26.93	35.75	41.18							
45	0.23	0.23	0.23	0.23	0.29	0.45	0.77	1.20	2.09	11.36	26.91	36.10	43.11							
46	0.24	0.24	0.23	0.23	0.29	0.45	0.92	1.26	2.22	15.11	29.76	36.44	43.35							
47	0.32	0.32	0.29	0.29	0.29	0.65	0.88	1.38	2.38	16.44	30.80	36.72	45.87							
48	0.45	0.45	0.39	0.29	0.39	0.65	0.88	1.38	2.68	19.54	31.62	37.49	45.87							
49	0.68	0.68	0.56	0.39	0.39	0.79	0.88	1.49	2.68	22.19	32.15	37.66	45.87							
50	0.87	0.87	0.65	0.45	0.45	0.79	0.98	1.64	3.14	18.02	33.02	37.49	45.72							
51	0.87	0.82	0.79	0.45	0.45	0.79	0.98	1.64	3.14	20.47	33.02	37.22	45.61							
52	1.00	1.00	0.87	0.45	0.45	0.79	0.98	1.72	4.20	18.92	33.02	36.44	42.99							
53	1.03	1.03	0.79	0.49	0.49	0.79	0.98	1.85	3.88	18.92	32.15	35.85	41.20							
54	1.03	1.03	0.79	0.49	0.49	0.87	1.06	1.85	5.55	15.56	30.94	35.06	41.33							
55	0.79	0.79	0.66	0.49	0.49	0.87	1.06	1.95	5.55	18.98	29.24	33.67	39.33							
56	0.66	0.66	0.49	0.49	0.49	0.99	1.06	1.95	6.94	18.98	29.24	33.21	37.22							
57	0.45	0.45	0.49	0.49	0.50	1.00	1.14	2.09	6.94	16.93	26.94	32.12	36.34							
58	0.33	0.33	0.34	0.50	0.50	1.00	1.14	2.09	9.77	16.93	26.03	30.63	35.92							
59	0.26	0.27	0.35	0.50	0.50	1.00	1.14	2.09	7.59	19.52	26.03	30.63	35.92							
60	0.24	0.24	0.26	0.33	0.50	1.01	1.27	2.22	10.10	22.94	28.61	31.59								
61	0.20	0.22	0.27	0.34	0.65	1.01	1.27	2.20	9.01	26.03	30.02	31.59								
62	0.20	0.20	0.23	0.34	0.65	1.01	1.23	2.38	11.13	27.98	31.59	32.77								
63	0.20	0.20	0.24	0.34	0.65	1.01	1.38	2.38	13.47	31.59	33.00	33.00								
64	0.16	0.16	0.24	0.26	0.46	1.01	1.38	2.68	15.56	32.10	33.78									
65	0.16	0.16	0.22	0.26	0.50	1.01	1.38	2.57	18.98	33.78										
66	0.16	0.16	0.20	0.23	0.50	1.01	1.38	2.57	20.59	34.08										
67	0.16	0.16	0.20	0.24	0.50	1.01	1.38	2.68	24.01	34.71										
68	0.12	0.16	0.20	0.22	0.50	1.01	1.38	2.68	26.94	35.25										
69	0.12	0.12	0.16	0.22	0.33	0.85	1.38	2.68	29.24	35.71										
70	0.12	0.12	0.16	0.20	0.50	0.94	1.40	2.38	29.24	35.94										
71	0.09	0.09	0.12	0.20	0.50	0.94	1.40	2.38	30.94	36.41										
72	0.08	0.09	0.12	0.16	0.50	0.94	1.40	2.38	32.15	36.41										
73	0.06	0.06	0.09	0.13	0.49	0.99	1.40	2.66	32.12	36.85										
74	0.04	0.06	0.08	0.12	0.49	0.85	1.53	2.66	33.21	37.22										
75	0.04	0.06	0.06	0.09	0.49	0.85	1.53	2.66	34.00	38.36										
76	0.04	0.04	0.06	0.09	0.49	0.89	1.53	3.20	34.60	38.54										
77	0.04	0.04	0.06	0.09	0.45	0.8														



ft/s	Geo Prizm HC Emissions, mg/s												5	6	7	8	9	10	11	12
	ft/s/s	-5	-4	-3	-2	-1	0	1	2	3	4									
78	0.04	0.04	0.06	0.06	0.35	0.76	1.60	4.32	35.43	39.81										
79	0.04	0.04	0.06	0.09	0.35	0.76	1.73	6.05	35.51	39.81										
80	0.04	0.06	0.06	0.09	0.35	0.80	1.80	8.60	35.85	39.81										
81	0.04	0.06	0.06	0.09	0.33	0.80	1.80	11.95	36.10	41.16										
82	0.06	0.06	0.06	0.09	0.33	0.80	1.94	11.36	36.44	41.18										
83	0.06	0.06	0.06	0.09	0.27	0.70	1.84	15.11	36.72	41.18										
84	0.06	0.06	0.06	0.09	0.27	0.75	1.97	18.83	37.49	41.22										
85	0.04	0.06	0.06	0.09	0.27	0.75	2.10	19.54	37.66	43.11										
86	0.04	0.06	0.06	0.12	0.35	0.76	1.95	19.54	38.54	43.11										
87	0.04	0.06	0.06	0.12	0.34	0.76	2.10	18.02	38.63	43.21										
88	0.04	0.06	0.08	0.16	0.50	0.72	2.10	20.47	38.63	43.21										
89	0.04	0.06	0.09	0.16	0.65	0.80	2.15	20.47	38.63	43.21										
90	0.04	0.06	0.09	0.20	0.55	0.78	2.15	18.92	38.63	43.11										
91	0.03	0.04	0.09	0.20	0.58	0.78	2.15	18.92	39.80	43.04										
92	0.03	0.04	0.06	0.20	0.72	0.77	2.29	18.98	38.54	42.99										
93	0.03	0.04	0.06	0.20	0.72	0.86	2.29	18.98	38.36	42.99										
94	0.03	0.03	0.06	0.17	0.56	0.86	2.00	18.98	37.67	41.27										
95	0.03	0.03	0.04	0.16	0.68	0.85	2.41	18.98	35.94	39.59										
96	0.03	0.03	0.04	0.13	0.68	0.95	2.41	16.93	34.71	37.22										
97	0.03	0.03	0.04	0.13	0.68	0.95	2.05	16.93	33.40	34.36										
98	0.03	0.03	0.03	0.13	0.68	1.03	2.43	16.93	31.01	31.94										
99	0.03	0.03	0.03	0.09	0.68	1.03	2.43	16.93	27.98	27.98										
100	0.03	0.03	0.03	0.13	0.68	1.13	2.58	16.93	19.52	19.56										
101	0.04	0.04	0.04	0.13	0.68	1.09	3.12	16.93												
102	0.04	0.04	0.04	0.16	0.54	1.19	3.86	16.04												
103	0.06	0.06	0.06	0.20	0.63	1.28	5.19	16.04												
104	0.09	0.09	0.12	0.22	0.55	1.25	6.41	16.04												
105	0.16	0.16	0.16	0.21	0.52	1.32	8.02	16.04												
106	0.22	0.22	0.22	0.21	0.53	1.35	11.70	16.60												
107	0.23	0.21	0.17	0.26	0.56	1.40	13.94	19.56												
108	0.24	0.17	0.19	0.26	0.53	1.40	16.60	22.60												
109	0.21	0.21	0.26	0.29	0.57	1.54	16.60	25.48												
110	0.33	0.30	0.22	0.28	0.55	1.54	19.56	25.48												



		Geo Prizm NOx Emissions, mg/s																	
ft/s	ft/s/s	-5	-4	-3	-2	-1	0	1	2	3	4	5	6	7	8	9	10	11	12
78	0.59	0.59	0.87	0.91	3.14	3.13	10.88	16.94	14.05	14.68									
79	0.59	0.59	0.87	1.30	3.14	3.13	11.87	17.28	15.46	15.46									
80	0.59	0.87	0.87	1.30	3.14	3.61	12.32	17.57	15.09	15.09									
81	0.59	0.87	0.87	1.30	3.63	3.61	12.32	17.39	14.73	14.73									
82	0.87	0.87	0.87	1.30	3.63	3.61	13.14	17.13	15.51	15.51									
83	0.87	0.87	0.87	1.30	3.28	2.94	12.03	17.01	15.11	15.11									
84	0.87	0.87	0.87	1.30	3.28	3.59	12.80	16.70	15.48	15.48									
85	0.59	0.87	0.87	1.30	3.28	3.59	13.55	16.84	15.28	15.28									
86	0.59	0.87	0.87	1.79	3.14	3.59	12.18	16.84	15.36	15.36									
87	0.59	0.87	0.87	1.79	2.44	3.59	13.05	17.28	15.22	15.22									
88	0.59	0.87	1.26	2.37	2.43	2.82	13.05	17.11	15.22	15.22									
89	0.59	0.87	1.30	2.37	2.60	3.57	12.54	17.11	15.22	15.22									
90	0.59	0.87	1.30	2.72	2.06	2.95	12.54	17.20	15.22	15.22									
91	0.41	0.59	1.30	2.90	2.26	2.95	12.54	17.20	14.74	14.74									
92	0.41	0.59	0.91	2.90	2.87	2.70	12.15	16.73	15.36	15.36									
93	0.41	0.59	0.91	2.90	2.87	3.38	12.15	16.73	15.57	15.57									
94	0.41	0.41	0.87	2.51	2.32	3.38	11.62	16.73	16.24	16.24									
95	0.41	0.41	0.59	2.37	2.76	3.35	12.28	16.73	17.19	17.19									
96	0.41	0.41	0.59	1.87	2.76	4.12	12.28	16.46	17.42	17.42									
97	0.41	0.41	0.59	1.87	2.76	4.12	12.60	16.46	18.36	18.36									
98	0.41	0.41	0.41	1.87	2.76	5.00	13.32	16.46	17.76	17.76									
99	0.41	0.41	0.41	1.37	2.76	5.00	13.32	16.46	16.36	16.36									
100	0.41	0.41	0.41	1.87	2.76	6.01	15.12	16.46	16.10	16.10									
101	0.59	0.59	0.59	1.87	2.76	5.98	15.63	16.46											
102	0.59	0.59	0.59	2.37	2.16	7.10	16.03	16.27											
103	0.91	0.91	0.91	2.90	2.47	8.16	16.66	16.27											
104	1.30	1.30	1.79	2.96	1.58	8.19	16.52	16.27											
105	2.37	2.37	2.37	2.27	1.22	9.20	16.42	16.27											
106	2.96	2.96	2.96	1.22	1.20	9.08	16.44	16.54											
107	2.92	2.27	1.51	0.87	1.35	10.05	16.46	16.61											
108	1.90	1.51	0.75	0.99	1.36	10.05	16.54	16.61											
109	1.22	1.22	0.87	1.15	1.82	9.81	16.54	16.52											
110	1.74	1.19	0.73	0.93	1.91	9.81	16.61	16.52											

ft/s	Subaru Fuel Consumption, gal/h																		
	ft/s/s	-5	-4	-3	-2	-1	0	1	2	3	4	5	6	7	8	9	10	11	12
0	0.28	0.28	0.28	0.28	0.29	0.29	0.32	0.4	0.57	0.81	1.1	1.43	1.67	2.03	2.46	3.05	3.42	3.59	
1	0.28	0.28	0.28	0.28	0.29	0.29	0.34	0.44	0.63	0.88	1.19	1.51	1.75	2.07	2.51	3.08	3.45	3.59	
2	0.28	0.28	0.28	0.29	0.29	0.3	0.37	0.52	0.75	1.01	1.33	1.64	1.88	2.13	2.59	3.11	3.5	3.6	
3	0.28	0.28	0.28	0.29	0.3	0.31	0.42	0.61	0.88	1.15	1.47	1.76	2.01	2.22	2.68	3.15	3.53	3.61	
4	0.28	0.28	0.28	0.29	0.3	0.31	0.46	0.71	1.02	1.28	1.58	1.87	2.13	2.32	2.75	3.18	3.54	3.6	
5	0.28	0.28	0.28	0.29	0.3	0.32	0.51	0.8	1.14	1.39	1.67	1.97	2.25	2.45	2.84	3.2	3.53	3.58	
6	0.28	0.28	0.27	0.29	0.31	0.33	0.55	0.87	1.24	1.48	1.74	2.05	2.36	2.59	2.92	3.22	3.49	3.54	
7	0.28	0.27	0.27	0.29	0.32	0.34	0.58	0.92	1.31	1.55	1.82	2.15	2.49	2.73	3.01	3.25	3.43	3.49	
8	0.28	0.27	0.27	0.3	0.33	0.35	0.6	0.96	1.35	1.61	1.91	2.27	2.63	2.88	3.1	3.27	3.39	3.44	
9	0.27	0.27	0.27	0.3	0.34	0.37	0.62	0.97	1.38	1.66	2.01	2.42	2.79	3.03	3.2	3.32	3.37	3.4	
10	0.27	0.27	0.27	0.31	0.34	0.38	0.63	0.98	1.4	1.7	2.13	2.6	2.97	3.19	3.32	3.4	3.42	3.43	
11	0.27	0.27	0.27	0.31	0.35	0.39	0.64	0.99	1.4	1.75	2.25	2.78	3.15	3.35	3.46	3.53			
12	0.27	0.27	0.27	0.31	0.35	0.39	0.64	0.99	1.41	1.8	2.37	2.94	3.32	3.5	3.62	3.7	3.71		
13	0.27	0.27	0.27	0.31	0.35	0.39	0.65	0.98	1.42	1.86	2.47	3.07	3.45	3.65	3.78	3.89	3.91		
14	0.27	0.27	0.27	0.31	0.35	0.39	0.65	0.99	1.43	1.93	2.56	3.19	3.55	3.78	3.94	4.05	4.1		
15	0.27	0.27	0.27	0.32	0.36	0.4	0.66	0.99	1.46	2.02	2.67	3.3	3.65	3.9	4.08	4.19	4.24		
16	0.27	0.27	0.27	0.32	0.36	0.41	0.68	1.01	1.5	2.1	2.77	3.4	3.73	4	4.18	4.28	4.33		
17	0.27	0.27	0.27	0.32	0.37	0.42	0.7	1.03	1.55	2.18	2.85	3.47	3.8	4.09	4.27	4.35	4.4		
18	0.27	0.27	0.27	0.33	0.39	0.44	0.72	1.05	1.6	2.22	2.88	3.49	3.85	4.16	4.34	4.42	4.46		
19	0.27	0.27	0.27	0.34	0.4	0.46	0.74	1.07	1.65	2.23	2.87	3.46	3.87	4.22	4.41	4.49	4.52		
20	0.27	0.27	0.27	0.34	0.4	0.47	0.75	1.09	1.68	2.21	2.82	3.4	3.87	4.27	4.48	4.56	4.58		
21	0.27	0.27	0.27	0.34	0.41	0.47	0.76	1.1	1.7	2.19	2.77	3.35	3.88	4.34	4.56	4.64	4.65		
22	0.27	0.27	0.27	0.34	0.41	0.47	0.76	1.12	1.72	2.18	2.74	3.32	3.91	4.4	4.64	4.72			
23	0.27	0.27	0.27	0.34	0.41	0.47	0.76	1.13	1.74	2.18	2.74	3.32	3.95	4.47	4.73	4.81			
24	0.27	0.27	0.27	0.34	0.4	0.47	0.76	1.16	1.77	2.21	2.76	3.35	4.01	4.54	4.82	4.9			
25	0.27	0.27	0.27	0.34	0.41	0.47	0.77	1.19	1.81	2.27	2.81	3.41	4.08	4.62	4.91	4.99			
26	0.27	0.27	0.27	0.35	0.42	0.49	0.78	1.23	1.85	2.34	2.87	3.48	4.16	4.72	5.01				
27	0.27	0.27	0.27	0.35	0.43	0.51	0.81	1.28	1.91	2.41	2.94	3.57	4.26	4.83	5.13				
28	0.27	0.27	0.27	0.36	0.46	0.55	0.83	1.33	1.96	2.5	3.02	3.67	4.36	4.95	5.26				
29	0.27	0.27	0.27	0.38	0.48	0.58	0.86	1.37	2.02	2.58	3.1	3.77	4.48	5.08	5.41				
30	0.27	0.27	0.27	0.38	0.5	0.61	0.89	1.42	2.07	2.67	3.2	3.88	4.6	5.22	5.56				
31	0.27	0.27	0.27	0.39	0.51	0.63	0.91	1.46	2.13	2.75	3.3	3.98	4.73	5.36	5.73				
32	0.27	0.27	0.27	0.4	0.52	0.64	0.93	1.5	2.19	2.84	3.4	4.09	4.86	5.52	5.9				
33	0.27	0.27	0.27	0.4	0.52	0.65	0.95	1.53	2.26	2.92	3.5	4.21	5.01	5.68	6.08				
34	0.27	0.27	0.27	0.4	0.52	0.65	0.97	1.56	2.32	3	3.61	4.34	5.16	5.86	6.27				
35	0.27	0.27	0.27	0.4	0.52	0.65	0.99	1.59	2.38	3.09	3.71	4.46	5.32	6.05	6.46				
36	0.27	0.27	0.27	0.4	0.53	0.66	1.02	1.63	2.45	3.17	3.81	4.59	5.48	6.24	6.66				
37	0.28	0.28	0.27	0.4	0.54	0.67	1.05	1.67	2.52	3.25	3.92	4.72	5.64	6.44	6.86				
38	0.28	0.28	0.27	0.41	0.55	0.68	1.08	1.71	2.6	3.34	4.02	4.85	5.8	6.64	7.07				
39	0.28	0.28	0.27	0.41	0.56	0.7	1.11	1.75	2.67	3.43	4.13	4.97	5.96	6.83	7.29				
40	0.28	0.28	0.28	0.42	0.56	0.71	1.14	1.79	2.74	3.51	4.23	5.08	6.11	7.02	7.5				
41	0.28	0.28	0.28	0.42	0.57	0.72	1.16	1.83	2.81	3.6	4.32	5.19	6.26	7.2	7.7				
42	0.29	0.28	0.28	0.43	0.58	0.73	1.19	1.87	2.87	3.68	4.42	5.3	6.4	7.38	7.89				
43	0.29	0.29	0.28	0.43	0.59	0.74	1.21	1.9	2.94	3.75	4.5	5.4	6.54	7.55	8.07				
44	0.29	0.29	0.28	0.44	0.6	0.76	1.24	1.94	3	3.83	4.59	5.49	6.67	7.7	8.23				
45	0.3	0.29	0.29	0.45	0.61	0.77	1.27	1.98	3.07	3.91	4.67	5.59	6.8	7.86	8.38				
46	0.3	0.3	0.29	0.46	0.62	0.79	1.3	2.02	3.15	3.99	4.75	5.68	6.92	8	8.52				
47	0.31	0.3	0.3	0.47	0.64	0.82	1.33	2.07	3.22	4.07	4.83	5.77	7.02	8.12					
48	0.31	0.31	0.3	0.48	0.66	0.84	1.37	2.12	3.3	4.15	4.91	5.84	7.08	8.18					
49	0.32	0.31	0.31	0.49	0.68	0.87	1.41	2.18	3.38	4.24	4.98	5.89	7.08	8.14					
50	0.32	0.32	0.31	0.5	0.69	0.89	1.44	2.23	3.46	4.32	5.05	5.9	6.99	8					
51	0.33	0.32	0.31	0.51	0.71	0.91	1.47	2.29	3.54	4.41	5.11	5.87	6.82	7.79					
52	0.33	0.32	0.32	0.52	0.73	0.93	1.5	2.34	3.6	4.49	5.17	5.82	6.6	7.56					
53	0.33	0.33	0.32	0.53	0.75	0.96	1.53	2.39	3.67	4.57	5.23	5.78	6.42	7.37					
54	0.33	0.33	0.33	0.54	0.76	0.98	1.56	2.43	3.74	4.65	5.31	5.77	6.31	7.26					
55	0.33	0.33	0.33	0.55	0.78	1	1.58	2.48	3.81	4.74	5.38	5.79	6.31						
56	0.34	0.33	0.33	0.56	0.79	1.01	1.61	2.52	3.89	4.83	5.46	5.85	6.39						
57	0.34	0.33	0.33	0.57	0.8	1.03	1.65	2.58	3.98	4.92	5.54	5.92	6.5						
58	0.34	0.34	0.34	0.58	0.82	1.06	1.69	2.63	4.07	5.02	5.62	5.99	6.62						
59	0.34	0.34	0.34	0.59	0.84	1.09	1.72	2.69	4.16	5.13	5.7	6.06	6.73						
60	0.34	0.34	0.34	0.6	0.86	1.12	1.76	2.75	4.25	5.23	5.78	6.16	6.85						
61	0.35	0.34	0.34	0.6	0.87	1.14	1.8	2.81	4.33	5.32	5.88	6.26	6.96						
62	0.35	0.34	0.33	0.61	0.89	1.16	1.83	2.86	4.41	5.42	5.98	6.38	7.07						
63	0.36	0.34	0.33	0.61	0.9	1.18	1.87	2.91	4.48	5.51	6.1	6.5	7.17						
64	0.36	0.34	0.32	0.61	0.91	1.21	1.91	2.96	4.56	5.61	6.23	6.62	7.26						
65	0.37	0.34	0.31	0.61	0.93	1.26	1.96	3.02	4.64	5.72	6.38	6.74							
66	0.38	0.34	0.29	0.61	0.95	1.33	2.02	3.08	4.73	5.84	6.54	6.86							
67	0.38	0.34	0.28	0.63	1.01	1.41	2.1	3.15	4.82	5.96	6.69								
68	0.39	0.34	0.27	0.65	1.06	1.5	2.17	3.22	4.9	6.07	6.83								
69	0.39	0.34	0.27	0.67	1.1	1.56	2.23	3.29	4.97	6.17	6.96								
70	0.4	0.35	0.27	0.68	1.12	1.59	2.26	3.33	5.04	6.26	7.07								
71	0.4	0.35	0.28	0.68	1.11	1.57	2.26	3.36	5.1	6.35	7.19								
72	0.4	0.36	0.29	0.67	1.08	1.52	2.25	3.38	5.17	6.44	7.31								
73	0.39	0.36	0.3	0.67	1.06	1.47	2.24	3.41	5.25	6.54	7.44								
74	0.38	0.35	0.3	0.66	1.05	1.45	2.25	3.45	5.35	6.65	7.57								
75	0.36	0.33	0.29	0.66	1.05	1.45	2.28	3.51	5.46	6.78	7.71								

ft/s	Subaru Fuel Consumption, gal/h																	
	-5	-4	-3	-2	-1	0	1	2	3	4	5	6	7	8	9	10	11	12
81	0.28	0.3	0.33	0.71	1.08	1.45	2.42	3.78	5.96	7.37	8.41							
82	0.29	0.32	0.34	0.72	1.08	1.45	2.43	3.81	6.04	7.48	8.54							
83	0.3	0.33	0.35	0.74	1.1	1.47	2.45	3.86	6.13	7.6	8.67							
84	0.31	0.34	0.36	0.75	1.12	1.5	2.49	3.92	6.23	7.73	8.79							
85	0.32	0.34	0.35	0.75	1.14	1.55	2.54	3.99	6.33	7.84								
86	0.33	0.34	0.33	0.75	1.16	1.6	2.59	4.06	6.41	7.93								
87	0.34	0.33	0.3	0.74	1.18	1.64	2.64	4.12	6.48	8								
88	0.34	0.32	0.28	0.73	1.2	1.68	2.7	4.19	6.55	8.06								
89	0.35	0.32	0.27	0.73	1.22	1.73	2.76	4.26	6.62	8.11								
90	0.35	0.32	0.27	0.74	1.25	1.77	2.82	4.34	6.68	8.13	9.13							
91	0.35	0.32	0.27	0.76	1.27	1.8	2.88	4.4	6.7	8.11	9.07							
92	0.35	0.33	0.29	0.78	1.3	1.82	2.92	4.46	6.65	8.01	8.94							
93	0.36	0.33	0.3	0.8	1.32	1.85	2.96	4.48	6.53	7.83								
94	0.36	0.34	0.31	0.82	1.35	1.89	3	4.48	6.38	7.64								
95	0.36	0.34	0.31	0.84	1.38	1.93	3.03	4.46	6.27	7.51								
96	0.35	0.33	0.3	0.84	1.4	1.97	3.04	4.43	6.24	7.48								
97	0.34	0.32	0.29	0.85	1.42	2.01	3.07	4.42	6.29	7.54								
98	0.32	0.3	0.28	0.86	1.46	2.05	3.1	4.44	6.39	7.64								
99	0.3	0.29	0.28	0.88	1.49	2.1	3.16	4.48	6.5	7.74								
100	0.28	0.27	0.27	0.89	1.53	2.15	3.23	4.56	6.63									
101	0.26	0.25	0.26	0.91	1.56	2.2	3.3	4.66	6.77									
102	0.25	0.24	0.26	0.92	1.59	2.24	3.37	4.77	6.91									
103	0.25	0.24	0.26	0.94	1.62	2.28	3.43	4.87	7.05									
104	0.25	0.25	0.27	0.97	1.65	2.31	3.49	4.96	7.16									
105	0.26	0.26	0.29	0.99	1.69	2.36	3.56	5.05	7.26									
106	0.26	0.27	0.3	1.03	1.74	2.42	3.64	5.14	7.35									
107	0.26	0.27	0.31	1.06	1.79	2.49	3.74	5.23	7.42									
108	0.26	0.27	0.32	1.09	1.84	2.55	3.82	5.31	7.48									
109	0.25	0.27	0.32	1.11	1.86	2.59	3.88	5.36	7.51									
110	0.25	0.27	0.32	1.11	1.88	2.61	3.9	5.38	7.53									

ft/s	ft/s/s	Subaru CO Emissions, mg/s																	
		-5	-4	-3	-2	-1	0	1	2	3	4	5	6	7	8	9	10	11	12
0	0.28	0.28	0.28	0.29	0.29	0.31	0.33	0.34	0.35	0.38	0.42	0.61	1.03	1.54	2.09	2.55	2.97	2.97	2.97
1	0.28	0.28	0.29	0.29	0.31	0.32	0.35	0.38	0.39	0.42	0.65	1.14	1.78	2.36	2.76	3.09	3.09	3.09	3.09
2	0.28	0.29	0.29	0.3	0.31	0.35	0.41	0.46	0.48	0.51	0.75	1.41	2.38	3.08	3.35	3.51	3.51	3.51	3.51
3	0.29	0.29	0.3	0.31	0.34	0.4	0.49	0.59	0.63	0.66	0.93	1.93	3.52	4.52	4.62	4.7	4.7	4.7	4.7
4	0.29	0.29	0.3	0.32	0.37	0.46	0.6	0.77	0.85	0.88	1.21	2.79	5.38	7.02	7.14	7.7	7.7	7.7	7.7
5	0.29	0.3	0.31	0.34	0.41	0.53	0.72	1	1.16	1.2	1.67	4.06	8.06	11.09	12	14.42	14.42	14.42	14.42
6	0.29	0.3	0.32	0.36	0.47	0.6	0.86	1.26	1.52	1.6	2.33	5.7	11.62	17.52	21.06	27.89	27.89	27.89	27.89
7	0.29	0.3	0.32	0.39	0.52	0.68	0.99	1.53	1.93	2.08	3.19	7.58	16.25	27.52	36.98	51.75	51.75	51.75	51.75
8	0.29	0.3	0.33	0.42	0.57	0.74	1.1	1.78	2.34	2.6	4.13	9.53	22.21	42.43	62.44	89.11	89.11	89.11	89.11
9	0.29	0.3	0.33	0.45	0.62	0.79	1.21	2.03	2.75	3.13	5	11.49	29.99	63.33	99.11	141.07	141.07	141.07	141.07
10	0.29	0.3	0.34	0.47	0.66	0.83	1.31	2.27	3.14	3.62	5.73	13.74	40.37	90.83	146.92	205.94	205.94	205.94	205.94
11	0.29	0.29	0.34	0.49	0.68	0.86	1.42	2.52	3.53	4.1	6.46	17.18	54.74	125.39	204.32	279.7			
12	0.29	0.29	0.34	0.5	0.7	0.88	1.52	2.77	3.91	4.66	7.7	23.46	75.22	167.69	268.95	357.14	357.14	357.14	357.14
13	0.29	0.29	0.34	0.5	0.7	0.9	1.63	3.01	4.29	5.47	10.25	34.58	104.08	218.36	338.13	433.11	433.11	433.11	433.11
14	0.29	0.3	0.34	0.5	0.7	0.91	1.74	3.22	4.68	6.68	14.86	52.01	142.41	276.74	408.52	503.18	503.18	503.18	503.18
15	0.29	0.3	0.34	0.49	0.69	0.93	1.84	3.42	5.05	8.27	21.7	75.57	188.64	339.71	475.98	564.07	564.07	564.07	564.07
16	0.29	0.3	0.34	0.49	0.67	0.95	1.96	3.59	5.37	9.99	30.04	102.81	238.19	401.85	536.2	614.21	614.21	614.21	614.21
17	0.29	0.3	0.34	0.48	0.66	0.97	2.09	3.75	5.62	11.38	38.35	129.66	284.8	457.32	586.34	654.14	654.14	654.14	654.14
18	0.29	0.3	0.33	0.47	0.64	1	2.23	3.93	5.75	12.03	45.02	152.04	323.11	502.3	626.27	686.51	686.51	686.51	686.51
19	0.29	0.3	0.33	0.46	0.62	1.04	2.4	4.13	5.75	11.82	49.14	167.59	350.7	536.43	658.71	715.39	715.39	715.39	715.39
20	0.3	0.3	0.33	0.45	0.6	1.09	2.57	4.34	5.66	10.96	50.87	176.42	368.67	562.59	688.21	745.22	745.22	745.22	745.22
21	0.3	0.31	0.34	0.45	0.59	1.13	2.73	4.53	5.53	9.93	51.2	180.61	380.66	585.56	719.7	779.97	779.97	779.97	779.97
22	0.31	0.32	0.34	0.45	0.59	1.17	2.87	4.68	5.39	9.19	51.44	183.16	391.41	610.6	757.6	822.54	822.54	822.54	822.54
23	0.31	0.33	0.35	0.46	0.59	1.21	2.96	4.76	5.29	9.07	52.68	186.99	405.58	642.35	805.02	874.25	874.25	874.25	874.25
24	0.32	0.34	0.36	0.46	0.59	1.24	3.01	4.77	5.24	9.73	55.7	194.47	426.76	683.77	862.91	934.25	934.25	934.25	934.25
25	0.33	0.35	0.37	0.47	0.6	1.25	3.03	4.71	5.25	11.24	61	207.15	456.7	734.82	928.85	999.05	999.05	999.05	999.05
26	0.34	0.36	0.38	0.48	0.61	1.27	3.02	4.6	5.36	13.69	68.88	225.6	494.56	791.72	996.7				
27	0.35	0.37	0.4	0.48	0.61	1.3	3.01	4.47	5.66	17.25	79.56	249.4	537.06	847.57	1057.7				
28	0.37	0.39	0.41	0.49	0.62	1.34	3.01	4.37	6.26	22.19	93.28	277.47	579.81	895.11	1103.79				
29	0.39	0.4	0.42	0.5	0.64	1.39	3.03	4.33	7.35	28.93	110.35	308.73	619.56	930.53	1131.8				
30	0.41	0.41	0.43	0.52	0.66	1.45	3.08	4.36	9.12	37.98	131.22	342.75	656.34	956.67	1146.51				
31	0.42	0.43	0.45	0.54	0.68	1.52	3.14	4.49	11.81	49.76	156.26	380.02	693.99	983	1159.8				
32	0.44	0.44	0.47	0.56	0.72	1.62	3.22	4.76	15.65	64.43	185.52	421.61	738.6	1021.77	1185.8				
33	0.45	0.46	0.48	0.58	0.76	1.72	3.31	5.21	20.74	81.75	218.52	468.54	795.43	1082.02	1233.96				
34	0.48	0.48	0.51	0.61	0.81	1.85	3.43	5.9	27.07	101	254.34	521.1	866.25	1165.05	1304.62				
35	0.52	0.52	0.55	0.65	0.86	1.99	3.57	6.86	34.41	121.25	291.85	578.59	948.46	1264.17	1389.39				
36	0.58	0.58	0.61	0.69	0.92	2.13	3.72	8.12	42.45	141.58	329.92	639.33	1036.43	1368.36	1476.04				
37	0.65	0.65	0.68	0.74	0.99	2.27	3.87	9.65	50.84	161.37	367.58	700.96	1123.71	1467.17	1554.18				
38	0.74	0.74	0.76	0.8	1.05	2.39	4.01	11.45	59.4	180.47	404.12	760.92	1204.79	1553.68	1618.68				
39	0.82	0.81	0.82	0.84	1.1	2.46	4.13	13.47	68.12	199.21	439.33	817.14	1276.09	1625.02	1669.75				
40	0.88	0.87	0.88	0.87	1.13	2.49	4.21	15.71	77.25	218.49	473.82	868.78	1336.36	1681.48	1711.19				
41	0.92	0.91	0.91	0.89	1.14	2.49	4.28	18.19	87.24	239.7	509.2	916.83	1386.88	1725.83	1748.29				
42	0.94	0.93	0.92	0.9	1.15	2.47	4.37	21	98.74	264.56	547.83	963.75	1431.33	1763.11	1786.45				
43	0.95	0.94	0.92	0.9	1.17	2.48	4.54	24.31	112.51	294.79	592.1	1012.59	1474.86	1799.93	1830.22				
44	0.97	0.95	0.92	0.9	1.21	2.53	4.85	28.34	129.27	331.62	643.47	1065.53	1522.43	1843.01	1882.63				
45	1	0.96	0.93	0.91	1.27	2.65	5.34	33.3	149.58	375.41	701.83	1122.88	1576.79	1896.69	1944.48				
46	1.04	0.99	0.95	0.94	1.36	2.82	6.05	39.38	173.66	425.45	765.39	1182.68	1636.8	1960.38	2013.37				
47	1.1	1.04	0.98	0.97	1.47	3.03	6.99	46.66	201.25	480.04	831	1240.78	1696.36	2026.81					
48	1.17	1.1	1.03	1.01	1.59	3.28	8.19	55.09	231.56	536.66	894.46	1290.9	1744.38	2082.26					
49	1.23	1.16	1.08	1.06	1.7	3.53	9.62	64.47	263.2	592.19	950.69	1324.66	1765.95	2109.17					
50	1.27	1.2	1.12	1.09	1.8	3.79	11.26	74.45	294.4	643.06	993.84	1331.95	1745.19	2091.01					
51	1.27	1.22	1.14	1.11	1.89	4.05	13.11	84.64	323.33	685.81	1018.08	1303.07	1669.84	2018.13					
52	1.25	1.21	1.14	1.11	1.97	4.34	15.16	94.79	348.66	717.76	1019.2	1232.5	1536.94	1892.78					
53	1.22	1.19	1.12	1.1	2.07	4.66	17.43	104.88	369.87	737.7	1020.22	1169.57	1349.76	1700.01					
54	1.18	1.15	1.09	1.1	2.18	5.05	19.96	115.12	387.32	746.33	1013.11	1116.94	1194.6	1540.79					
55	1.15	1.12	1.06	1.1	2.33	5.52	22.79	125.83	402.13	746.28	1003.51	1085.54	1085.54						
56	1.12	1.09	1.04	1.12	2.52	6.07	25.99	137.36	415.92	741.95	975.22	1039.18	1039.18						
57	1.11	1.07	1.02	1.17	2.76	6.73	29.64	149.96	430.65	738.9	948.32	995.01	995.01						
58	1.09	1.06	1.02	1.24	3.06	7.5	33.81	163.73	448.2	742.96	932.54	964.94	964.94						
59	1.08	1.05	1.02	1.34	3.4	8.38	38.52	178.51	469.94	758.85	936.18	959.16	959.16						
60	1.07	1.04	1.03	1.46	3.77	9.34	43.66	193.91	496.27	789.21	964.35	984.1	984.1						
61	1.05	1.04	1.04	1.58	4.11	10.32	49.04	209.34	526.68	834.22	1018.19	1041.42	1041.42						
62	1.03	1.03	1.06	1.68	4.36	11.23	54.42	224.34	560.14	891.95	1094.97	1127.91	1127.91						
63	1.01	1.03	1.08	1.76	4.49	11.99	59.66	238.94	595.79	959.16	1188.85	1236.19	1236.19						
64	1	1.03	1.1	1.79	4.49	12.57	64.82	253.79	633.29	1031.94	1291.83	1355.78	1355.78						
65	1	1.04	1.13	1.81	4.39	13.03	70.14	270.03	672.8	1106.36	1338.21	1283.87							
66	1.02	1.07	1.16	1.83	4.27	13.43	75.99	288.73	714.41	1178.77	1377.73	1192.23							
67	1.08	1.12	1.21	1.89	4.19	13.9	82.72	310.38	757.65	1246.17	1403.								

		Subaru CO Emissions, mg/s																	
ft/s	ft/s/s	-5	-4	-3	-2	-1	0	1	2	3	4	5	6	7	8	9	10	11	12
81	5.55	5.86	7.46	11.69	17.1	72.59	315.38	735.91	1285.99	1722.26	1914.99								
82	6.12	6.4	7.86	12.16	17.92	75.67	321.81	750.8	1319.62	1781.59	2005.92								
83	6.68	6.92	8.21	12.58	18.7	78.36	325.87	762.71	1354.27	1848.72	2102.17								
84	7.24	7.39	8.51	12.97	19.48	80.9	327.97	771.29	1387.95	1919.78	2200.68								
85	7.78	7.81	8.76	13.35	20.33	83.56	328.81	776.9	1419.1	1990.55									
86	8.22	8.13	8.94	13.69	21.28	86.7	329.64	781.32	1447.55	2057.43									
87	8.51	8.3	9	13.97	22.39	90.67	332.18	787.48	1474.17	2117.41									
88	8.56	8.3	8.94	14.15	23.46	95.72	338.04	798.06	1499.15	2166.78									
89	8.39	8.11	8.76	14.25	24.66	101.97	348.05	813.61	1519.58	2199.18									
90	8.03	7.79	8.49	14.28	25.97	109.35	361.68	831.2	1528	2204.77	2590.41								
91	7.58	7.4	8.18	14.3	27.36	117.51	377.02	844.64	1513.54	2172.28	2573.43								
92	7.14	7.02	7.88	14.29	28.78	125.85	391.44	846.79	1466.21	2093.94	2519.1								
93	6.79	6.71	7.63	14.25	30.08	133.57	402.65	832.86	1382.24	1970.9									
94	6.62	6.55	7.46	14.17	31.14	140	409.65	802.99	1267.73	1815.84									
95	6.68	6.58	7.43	14.1	31.9	144.81	413.03	762.5	1137.78	1650.33									
96	7.01	6.85	7.59	14.11	32.43	148.16	414.51	719.68	1011.6	1497.97									
97	7.57	7.35	7.99	14.32	32.87	150.6	416.05	682.51	905.78	1376.74									
98	8.3	8.04	8.65	14.82	33.38	152.74	419.11	656.12	829.57	1294.37									
99	9.06	8.81	9.48	15.57	34.02	155.07	424.44	642.11	783.71	1248.13									
100	9.72	9.53	10.37	16.45	34.79	157.96	432.36	639.4	762.7										
101	10.17	10.07	11.14	17.28	35.62	161.81	443.14	645.72	758.3										
102	10.37	10.37	11.69	17.88	36.51	167.15	457.2	658.72	762.52										
103	10.35	10.43	11.96	18.14	37.51	174.62	474.91	676.35	768.92										
104	10.17	10.33	12	18.07	38.73	184.67	496.28	696.83	772.75										
105	9.94	10.16	11.91	17.73	40.27	197.28	520.61	718.47	770.63										
106	9.74	10.04	11.8	17.26	42.11	211.78	546.45	739.62	760.75										
107	9.64	10.03	11.77	16.79	44.12	226.85	571.71	758.7	743.48										
108	9.66	10.15	11.85	16.42	46.05	240.71	593.91	774.34	722.01										
109	9.75	10.33	11.99	16.21	47.6	251.4	610.53	785.42	702.07										
110	9.82	10.46	12.1	16.11	48.47	257.24	619.44	791.16	689.99										

		Subaru HC Emissions, mg/s																	
ft/s	ft/s/s	-5	-4	-3	-2	-1	0	1	2	3	4	5	6	7	8	9	10	11	12
0	0.08	0.08	0.08	0.08	0.08	0.08	0.08	0.09	0.11	0.13	0.17	0.26	0.45	0.65	0.98	1.29	1.60	1.60	1.60
1	0.08	0.08	0.08	0.08	0.08	0.08	0.09	0.10	0.12	0.15	0.18	0.26	0.47	0.67	0.97	1.27	1.58	1.58	1.58
2	0.08	0.08	0.08	0.09	0.09	0.09	0.09	0.11	0.15	0.18	0.21	0.32	0.51	0.71	0.99	1.27	1.56	1.56	1.56
3	0.09	0.09	0.09	0.09	0.09	0.09	0.10	0.13	0.19	0.23	0.25	0.36	0.55	0.81	1.07	1.33	1.56	1.56	1.56
4	0.09	0.09	0.09	0.09	0.10	0.10	0.11	0.16	0.24	0.30	0.32	0.41	0.63	0.97	1.25	1.48	1.65	1.65	1.65
5	0.09	0.09	0.09	0.10	0.10	0.10	0.12	0.19	0.31	0.40	0.42	0.48	0.74	1.20	1.55	1.75	1.88	1.88	1.88
6	0.09	0.09	0.09	0.10	0.11	0.11	0.13	0.22	0.39	0.51	0.54	0.58	0.90	1.48	1.97	2.21	2.40	2.40	2.40
7	0.09	0.09	0.10	0.10	0.11	0.14	0.24	0.46	0.63	0.68	0.71	1.11	1.79	2.58	3.03	3.49	3.49	3.49	3.49
8	0.09	0.09	0.10	0.10	0.12	0.15	0.27	0.52	0.74	0.82	0.88	1.34	2.16	3.48	4.47	5.47	5.47	5.47	5.47
9	0.09	0.09	0.10	0.11	0.12	0.15	0.29	0.56	0.83	0.95	1.07	1.55	2.62	4.79	6.70	8.47	8.47	8.47	8.47
10	0.09	0.09	0.10	0.11	0.13	0.16	0.31	0.60	0.89	1.06	1.23	1.69	3.19	6.45	9.60	12.26	12.26	12.26	12.26
11	0.09	0.09	0.10	0.11	0.13	0.16	0.32	0.63	0.94	1.14	1.33	1.80	3.88	8.32	12.81	16.29			
12	0.09	0.09	0.10	0.11	0.13	0.17	0.34	0.65	0.98	1.19	1.38	1.96	4.81	10.35	16.01	20.05	20.05		
13	0.09	0.09	0.10	0.11	0.13	0.17	0.35	0.67	1.01	1.24	1.44	2.38	6.15	12.63	19.06	23.24	23.24		
14	0.09	0.09	0.10	0.11	0.13	0.17	0.36	0.69	1.03	1.31	1.64	3.26	8.10	15.29	21.93	25.75	25.75		
15	0.09	0.09	0.10	0.11	0.13	0.18	0.38	0.71	1.05	1.43	2.02	4.68	10.62	18.23	24.46	27.55	27.55		
16	0.09	0.09	0.10	0.11	0.13	0.18	0.40	0.73	1.07	1.58	2.57	6.47	13.96	21.08	26.45	28.68	28.68		
17	0.09	0.09	0.10	0.11	0.14	0.19	0.42	0.75	1.10	1.71	3.10	8.18	15.77	23.38	27.77	29.35	29.35		
18	0.09	0.09	0.09	0.11	0.14	0.20	0.45	0.79	1.13	1.76	3.45	9.41	17.43	24.93	28.61	29.87	29.87		
19	0.09	0.09	0.09	0.11	0.14	0.21	0.49	0.82	1.16	1.70	3.52	9.98	18.31	25.89	29.28	30.50	30.50		
20	0.09	0.09	0.10	0.11	0.14	0.22	0.52	0.86	1.18	1.58	3.40	10.03	18.73	26.60	30.07	31.29	31.29		
21	0.09	0.09	0.10	0.11	0.14	0.23	0.54	0.90	1.19	1.45	3.23	9.88	19.07	27.38	31.09	32.16	32.16		
22	0.09	0.09	0.10	0.11	0.15	0.24	0.56	0.92	1.20	1.37	3.13	9.81	19.63	28.38	32.32	33.02			
23	0.09	0.10	0.10	0.11	0.15	0.25	0.58	0.94	1.21	1.34	3.16	9.95	20.46	29.62	33.70	33.89			
24	0.09	0.10	0.10	0.11	0.15	0.25	0.58	0.96	1.21	1.37	3.33	10.37	21.55	31.03	35.15	35.15			
25	0.10	0.10	0.10	0.11	0.14	0.26	0.59	0.96	1.22	1.45	3.65	11.07	22.81	32.48	36.56	36.56			
26	0.10	0.10	0.10	0.11	0.15	0.26	0.60	0.97	1.22	1.58	4.11	12.04	24.14	33.85	37.77				
27	0.10	0.10	0.11	0.11	0.15	0.27	0.61	0.98	1.23	1.77	4.71	13.22	25.42	34.96	38.62				
28	0.10	0.11	0.11	0.12	0.15	0.28	0.62	0.99	1.26	2.02	5.45	14.54	26.53	35.63	38.93				
29	0.11	0.11	0.11	0.12	0.15	0.30	0.64	1.00	1.30	2.34	6.31	15.92	27.40	35.77	38.61				
30	0.11	0.11	0.11	0.12	0.16	0.32	0.67	1.02	1.36	2.76	7.33	17.36	28.05	35.44	37.77				
31	0.11	0.11	0.11	0.12	0.16	0.33	0.69	1.04	1.46	3.30	8.53	18.87	28.63	35.00	36.82				
32	0.11	0.11	0.11	0.12	0.16	0.35	0.71	1.06	1.60	3.99	9.92	20.44	29.38	34.99	36.37				
33	0.11	0.11	0.11	0.13	0.17	0.36	0.74	1.08	1.80	4.82	11.45	22.03	30.56	35.94	37.03				
34	0.11	0.11	0.11	0.13	0.17	0.38	0.76	1.10	2.05	5.73	13.04	23.59	32.26	38.05	38.98				
35	0.11	0.11	0.11	0.13	0.17	0.40	0.79	1.14	2.37	6.68	14.62	25.09	34.42	41.00	41.87				
36	0.11	0.11	0.11	0.13	0.18	0.42	0.81	1.18	2.74	7.61	16.17	26.58	36.76	44.10	44.91				
37	0.12	0.12	0.12	0.13	0.18	0.45	0.84	1.23	3.14	8.50	17.66	28.11	38.95	46.66	47.26				
38	0.12	0.12	0.12	0.13	0.19	0.47	0.86	1.29	3.56	9.40	19.13	29.69	40.72	48.24	48.48				
39	0.13	0.13	0.13	0.14	0.19	0.48	0.88	1.36	3.99	10.37	20.61	31.31	41.97	48.85	48.85				
40	0.13	0.13	0.13	0.14	0.19	0.49	0.89	1.44	4.45	11.51	22.18	32.93	42.76	48.83	48.83				
41	0.13	0.13	0.13	0.14	0.20	0.49	0.89	1.52	4.97	12.85	23.87	34.51	43.27	48.60	48.60				
42	0.13	0.13	0.13	0.14	0.20	0.49	0.89	1.61	5.57	14.39	25.68	36.03	43.73	48.58	48.58				
43	0.14	0.13	0.13	0.14	0.20	0.50	0.89	1.72	6.29	16.09	27.56	37.48	44.29	48.92	49.59				
44	0.14	0.14	0.14	0.14	0.21	0.51	0.91	1.86	7.16	17.86	29.45	38.86	45.00	49.61	51.14				
45	0.14	0.14	0.14	0.14	0.22	0.53	0.93	2.04	8.14	19.65	31.27	40.10	45.81	50.48	52.68				
46	0.14	0.14	0.14	0.15	0.23	0.56	0.97	2.28	9.23	21.39	32.97	41.14	46.60	51.35	53.85				
47	0.15	0.15	0.14	0.15	0.25	0.60	1.02	2.56	10.36	22.99	34.42	41.89	47.27	52.07					
48	0.16	0.15	0.15	0.16	0.27	0.63	1.07	2.89	11.47	24.36	35.56	42.30	47.71	52.54					
49	0.16	0.16	0.16	0.16	0.29	0.67	1.13	3.26	12.51	25.46	36.34	42.35	47.82	52.68					
50	0.17	0.16	0.16	0.17	0.30	0.70	1.19	3.66	13.45	26.35	36.77	42.01	47.43	52.36					
51	0.17	0.17	0.17	0.18	0.32	0.72	1.25	4.07	14.29	27.06	36.92	41.24	46.32	51.44					
52	0.18	0.18	0.18	0.19	0.34	0.75	1.32	4.48	15.04	27.67	36.83	40.00	44.35	49.80					
53	0.18	0.18	0.18	0.20	0.35	0.78	1.40	4.90	15.70	28.15	36.58	38.49	41.77	47.61					
54	0.19	0.19	0.19	0.20	0.37	0.81	1.49	5.33	16.28	28.46	36.14	36.91	39.01	45.23					
55	0.19	0.19	0.19	0.21	0.39	0.84	1.59	5.80	16.77	28.55	35.48	35.44	36.51						
56	0.19	0.19	0.20	0.22	0.42	0.88	1.72	6.31	17.19	28.41	34.51	33.94	34.32						
57	0.20	0.20	0.20	0.23	0.45	0.92	1.86	6.87	17.58	28.15	33.33	32.39	32.42						
58	0.20	0.20	0.21	0.24	0.48	0.97	2.03	7.49	17.99	27.96	32.17	30.93	30.81						
59	0.21	0.21	0.21	0.26	0.52	1.02	2.23	8.18	18.49	28.04	31.38	29.95	29.76						
60	0.21	0.21	0.22	0.28	0.57	1.08	2.47	8.92	19.14	28.51	31.22	29.72	29.46						
61	0.22	0.22	0.22	0.30	0.62	1.14	2.73	9.68	19.94	29.45	31.81	30.28	29.85						
62	0.23	0.23	0.24	0.32	0.66	1.19	3.00	10.42	20.91	30.89	33.15	31.46	30.65						
63	0.25	0.25	0.25	0.34	0.69	1.21	3.28	11.11	22.04	32.82	35.20	33.14	31.52						
64	0.27	0.27	0.27	0.35	0.70	1.21	3.55	11.75	23.32	35.16	37.87	37.87	37.87						
65	0.29	0.29	0.28	0.36	0.70	1.20	3.80	12.37	24.73	37.71	40.94	40.94							
66	0.32	0.31	0.30	0.37	0.69	1.18	4.06	13.05	26.23	40.21	44.00	44.00							
67	0.34	0.32	0.31	0.39	0.69	1.17	4.32	13.80	27.76	42.39	46.59								
68	0.37	0.35	0.33	0.41	0.69	1.16	4.61	14.62	29.20	43.99	48.33								
69	0.39	0.37	0.35	0.44	0.71	1.18	4.95	15.49	30.45	44.94	49.05								
70	0.41	0.39	0.38	0.49	0.75	1.22	5.34	16.35	31.48	45.28	48.87								
71	0.43	0.42	0.41	0.55	0.81	1.30	5.81	17.22	32.35	45.23	48.09								
72	0.45	0.44	0.45	0.62</															



ft/s	Subaru HC Emissions, mg/s												6	7	8	9	10	11	12
	ft/s/s	-5	-4	-3	-2	-1	0	1	2	3	4	5							
81	0.65	0.69	0.81	1.21	1.64	2.89	12.28	23.90	39.00	46.96	51.51								
82	0.73	0.76	0.96	1.24	1.65	2.98	12.40	24.18	39.56	47.81	52.84								
83	0.80	0.83	0.90	1.25	1.66	3.06	12.48	24.39	40.08	48.67	54.07								
84	0.86	0.88	0.93	1.26	1.66	3.14	12.49	24.50	40.46	49.44	55.16								
85	0.91	0.93	0.95	1.27	1.67	3.24	12.47	24.50	40.68	50.05									
86	0.96	0.96	0.95	1.28	1.68	3.37	12.43	24.45	40.75	50.51									
87	0.99	0.98	0.96	1.27	1.69	3.55	12.43	24.46	40.77	50.88									
88	1.00	0.98	0.95	1.27	1.70	3.77	12.51	24.62	40.86	51.23									
89	0.99	0.98	0.93	1.25	1.70	4.02	12.69	25.00	41.07	51.59									
90	0.97	0.95	0.91	1.23	1.71	4.29	12.98	25.56	41.35	51.87	57.84								
91	0.92	0.92	0.88	1.21	1.72	4.60	13.33	26.14	41.46	51.82	57.63								
92	0.87	0.86	0.84	1.18	1.73	4.94	13.71	26.52	40.98	51.05	56.91								
93	0.81	0.81	0.79	1.15	1.73	5.27	14.04	26.54	39.65	49.32									
94	0.75	0.75	0.75	1.12	1.72	5.57	14.31	26.25	37.54	46.73									
95	0.72	0.72	0.71	1.08	1.71	5.79	14.54	25.89	35.32	43.97									
96	0.71	0.70	0.70	1.06	1.68	5.95	14.75	25.67	33.61	41.71									
97	0.73	0.71	0.70	1.04	1.67	6.06	15.00	25.69	32.76	40.33									
98	0.76	0.74	0.72	1.06	1.67	6.17	15.28	25.83	32.46	39.56									
99	0.80	0.78	0.76	1.11	1.69	6.27	15.57	26.01	32.39	39.10									
100	0.83	0.81	0.81	1.17	1.73	6.36	15.84	26.16	32.32										
101	0.85	0.84	0.84	1.23	1.76	6.43	16.10	26.36	32.33										
102	0.85	0.85	0.87	1.27	1.79	6.51	16.43	26.67	32.49										
103	0.84	0.84	0.87	1.29	1.81	6.66	16.91	27.16	32.77										
104	0.82	0.83	0.87	1.28	1.83	6.93	17.57	27.79	33.02										
105	0.79	0.80	0.85	1.26	1.84	7.34	18.37	28.46	33.05										
106	0.76	0.78	0.83	1.23	1.87	7.84	19.24	29.07	32.78										
107	0.74	0.76	0.82	1.19	1.91	8.36	20.07	29.53	32.23										
108	0.73	0.77	0.82	1.17	1.96	8.82	20.78	29.82	31.55										
109	0.74	0.78	0.83	1.16	2.01	9.14	21.28	29.95	30.94										
110	0.74	0.79	0.85	1.15	2.04	9.31	21.54	30.00	30.58										

ft/s	ft/s/s	Subaru NOx Emissions, mg/s																
		-5	-4	-3	-2	-1	0	1	2	3	4	5	6	7	8	9	10	11
0	0.49	0.49	0.51	0.56	0.49	0.49	0.49	0.53	0.45	0.43	0.32	0.37	0.66	0.67	12.58	14.47	14.47	14.47
1	0.49	0.49	0.50	0.52	0.44	0.47	0.52	0.52	0.41	0.40	0.38	0.46	0.64	0.63	11.41	13.57	13.57	13.57
2	0.44	0.49	0.42	0.40	0.34	0.46	0.55	0.47	0.47	0.43	0.48	0.53	0.66	0.64	9.41	11.94	11.94	11.94
3	0.38	0.44	0.32	0.29	0.24	0.41	0.50	0.55	0.65	0.63	0.61	0.61	0.74	1.19	7.71	9.53	9.53	9.53
4	0.33	0.38	0.22	0.18	0.19	0.38	0.38	0.76	0.75	0.73	0.77	0.62	1.22	3.40	7.02	7.98	7.98	7.98
5	0.29	0.29	0.18	0.16	0.18	0.33	0.25	0.96	0.98	0.73	0.80	0.74	1.97	7.96	8.73	7.58	7.58	7.58
6	0.25	0.25	0.17	0.16	0.19	0.29	0.22	1.06	1.08	0.79	0.73	0.87	3.31	8.33	10.13	10.26	10.26	10.26
7	0.21	0.24	0.17	0.16	0.20	0.25	0.22	1.06	1.32	1.02	0.92	0.69	0.94	4.89	10.82	11.76	9.69	9.69
8	0.21	0.28	0.19	0.16	0.20	0.22	0.23	1.10	1.32	1.08	0.79	0.96	5.98	11.92	13.12	12.97	12.97	12.97
9	0.22	0.37	0.21	0.16	0.20	0.21	0.30	1.07	1.33	1.07	0.96	1.42	5.90	15.98	13.76	12.37	12.37	12.37
10	0.24	0.44	0.23	0.16	0.20	0.21	0.37	1.12	1.34	1.04	1.30	2.20	5.48	16.88	13.47	14.38	14.38	14.38
11	0.28	0.49	0.23	0.16	0.20	0.20	0.46	1.18	1.35	1.04	1.70	4.86	7.06	15.79	11.83	12.13		
12	0.32	0.49	0.23	0.17	0.20	0.19	0.49	1.25	1.39	1.16	4.28	8.99	10.99	15.32	11.04	11.49	11.49	
13	0.35	0.44	0.23	0.19	0.20	0.20	0.49	1.26	1.46	1.27	8.57	12.86	15.81	14.11	11.02	11.37	11.37	
14	0.35	0.38	0.22	0.20	0.21	0.20	0.49	1.25	1.51	1.39	15.47	17.03	17.79	13.19	10.86	11.25	11.25	
15	0.33	0.33	0.21	0.20	0.21	0.21	0.53	1.32	1.53	2.20	19.30	18.48	16.76	11.98	10.74	11.14	11.14	
16	0.33	0.33	0.20	0.20	0.21	0.20	0.60	1.40	1.52	3.50	20.10	18.62	13.77	10.89	10.38	10.82	10.82	
17	0.33	0.32	0.21	0.20	0.21	0.18	0.68	1.48	1.49	5.46	18.19	16.59	11.79	10.32	10.10	10.50	10.50	
18	0.33	0.28	0.21	0.19	0.21	0.17	0.74	1.49	1.46	8.23	17.50	15.61	11.16	10.09	9.83	10.24	10.24	
19	0.33	0.24	0.21	0.18	0.21	0.17	0.73	1.51	1.38	11.56	19.26	16.57	11.61	9.86	9.42	10.06	10.06	
20	0.33	0.21	0.20	0.16	0.21	0.17	0.72	1.55	1.32	14.27	21.86	17.58	12.01	9.46	9.13	9.87	9.87	
21	0.29	0.20	0.19	0.16	0.21	0.19	0.69	1.57	1.27	15.41	24.04	18.28	12.27	9.11	8.71	9.63	9.63	
22	0.25	0.19	0.19	0.16	0.21	0.20	0.74	1.58	1.22	14.14	24.86	18.28	12.01	9.01	8.62	9.27	9.27	
23	0.21	0.18	0.19	0.16	0.21	0.21	0.77	1.58	1.31	13.33	24.50	17.64	11.89	9.69	9.57	9.24	9.24	
24	0.21	0.18	0.20	0.16	0.21	0.20	0.89	1.59	1.95	12.52	23.94	16.94	11.42	11.08	10.62	9.89	9.89	
25	0.21	0.18	0.19	0.16	0.21	0.21	1.07	1.58	2.72	14.48	23.12	16.23	11.18	13.33	13.20	11.86		
26	0.19	0.19	0.19	0.16	0.21	0.25	1.18	1.56	4.39	17.28	21.98	16.06	10.89	15.73	14.98			
27	0.18	0.19	0.19	0.18	0.21	0.32	1.22	1.53	5.78	21.49	20.44	15.72	10.94	17.59	17.34			
28	0.18	0.20	0.19	0.19	0.21	0.43	1.18	1.50	7.11	24.27	19.01	15.53	11.00	19.56	19.29			
29	0.19	0.20	0.19	0.21	0.21	0.53	1.28	1.48	9.73	26.00	17.90	15.34	11.07	22.38	24.13			
30	0.20	0.19	0.19	0.20	0.21	0.68	1.28	1.41	12.23	26.06	17.40	14.99	11.99	26.69	30.98			
31	0.19	0.19	0.19	0.20	0.20	0.77	1.30	1.34	14.85	25.62	17.20	14.29	12.94	31.26	35.89			
32	0.18	0.18	0.18	0.19	0.20	0.82	1.25	1.21	17.17	24.64	17.00	13.40	13.97	33.74	35.99			
33	0.18	0.18	0.18	0.19	0.20	0.80	1.27	1.29	19.43	23.37	16.50	12.60	15.53	31.39	29.64			
34	0.17	0.18	0.18	0.18	0.21	0.80	1.27	1.28	21.62	22.14	15.53	11.70	17.80	29.43	28.40			
35	0.17	0.18	0.18	0.18	0.20	0.80	1.35	2.00	21.78	20.77	14.69	10.93	22.01	34.70	36.82			
36	0.17	0.17	0.18	0.18	0.20	0.78	1.43	2.68	23.22	19.23	13.73	10.31	24.83	45.89	49.44			
37	0.17	0.17	0.18	0.18	0.19	0.78	1.51	3.52	24.60	17.73	13.03	10.20	27.20	55.58	57.83			
38	0.18	0.18	0.18	0.19	0.19	0.79	1.52	4.63	26.20	16.44	12.31	10.20	29.14	57.63	57.04			
39	0.18	0.18	0.19	0.19	0.19	0.83	1.52	5.68	26.22	15.73	11.31	10.89	33.61	49.50	48.74			
40	0.18	0.18	0.19	0.19	0.20	0.85	1.52	6.88	26.11	14.81	10.42	11.44	36.54	40.18	39.90			
41	0.18	0.18	0.18	0.19	0.20	0.85	1.49	7.13	25.12	14.06	9.89	12.24	38.89	28.62	28.70			
42	0.20	0.18	0.18	0.19	0.22	0.78	1.47	9.31	24.13	13.09	10.00	12.49	39.74	23.57	25.02			
43	0.22	0.21	0.18	0.19	0.23	0.76	1.44	11.29	22.80	12.79	10.08	13.13	39.37	19.48	22.01			
44	0.24	0.24	0.20	0.21	0.26	0.71	1.45	13.81	22.15	11.97	11.02	13.93	39.66	18.10	20.59			
45	0.24	0.27	0.23	0.24	0.27	0.79	1.40	14.77	21.35	11.46	12.00	14.81	38.90	17.51	18.73			
46	0.24	0.26	0.25	0.26	0.27	0.85	1.36	16.93	20.95	10.93	14.66	15.73	39.33	17.32	16.87			
47	0.26	0.25	0.25	0.26	0.28	0.89	1.29	19.12	20.05	10.93	16.23	16.84	36.40	17.94				
48	0.27	0.27	0.26	0.28	0.29	0.87	1.23	20.75	19.27	11.89	17.81	17.38	33.42	18.52				
49	0.29	0.28	0.28	0.29	0.30	0.86	1.37	22.64	18.28	12.89	18.00	17.44	31.33	18.54				
50	0.29	0.30	0.30	0.31	0.30	0.91	1.52	24.41	17.28	14.47	18.20	16.78	28.92	17.92				
51	0.29	0.29	0.31	0.31	0.29	1.00	1.72	26.50	16.39	15.49	20.07	16.60	30.02	17.58				
52	0.29	0.29	0.32	0.32	0.28	1.03	2.15	27.01	15.68	16.46	21.61	15.39	32.80	22.39				
53	0.30	0.29	0.32	0.32	0.30	1.08	2.61	27.48	15.42	17.40	25.20	13.80	29.09	25.48				
54	0.30	0.30	0.32	0.32	0.33	1.11	3.06	27.59	14.86	17.94	28.06	13.52	23.69	29.14				
55	0.30	0.30	0.32	0.34	0.36	1.15	3.15	27.69	14.41	18.50	30.97	13.02	16.07					
56	0.30	0.30	0.32	0.35	0.36	1.17	3.28	27.18	13.48	20.50	33.54	13.31	15.04					
57	0.33	0.30	0.32	0.36	0.36	1.16	4.14	26.70	12.97	24.06	36.03	11.08	10.61					
58	0.35	0.33	0.34	0.36	0.40	1.16	5.18	25.25	11.90	27.71	36.88	10.06	7.12					
59	0.38	0.35	0.36	0.36	0.48	1.20	6.87	23.08	11.37	29.91	36.06	9.06	5.81					
60	0.38	0.38	0.37	0.36	0.57	1.20	8.52	20.90	11.22	30.44	33.13	10.12	7.49					
61	0.38	0.38	0.37	0.36	0.59	1.23	10.39	19.76	11.27	29.72	30.64	11.37	10.52					
62	0.38	0.38	0.37	0.37	0.63	1.23	11.76	18.31	11.32	28.46	28.87	12.43	12.79					
63	0.39	0.39	0.38	0.38	0.71	1.26	12.90	16.89	11.02	27.30	28.53	12.40	13.79					
64	0.39	0.40	0.40	0.38	0.86	1.26	13.59	15.20	11.06	27.79	33.34	17.14	13.67					
65	0.39	0.41	0.41	0.38	0.95	1.26	14.55	14.86	11.09	29.04	42.84	24.33						
66	0.38	0.41	0.41	0.39	0.99	1.27	15.59	14.75	11.11	33.41	52.50	34.57						
67	0.37	0.41	0.41	0.39	0.97	1.26	17.06	14.78	11.99	39.86	58.39							
68	0.35	0.40	0.42	0.40	0.95	1.31	18.27	14.00	13.35	44.60	57.77							
69	0.34	0.38	0.41	0.42	0.90	1.36	19.19	13.19	15.22	45.76	56.80							
70	0.31	0.38	0.40	0.45	0.87	1.43	19.92	11.68	16.25	44.74	48.31							
71	0.29	0.37	0.38	0.45	0.87	1.44	20.94	10.50	16.80	44.67	40.96							
72	0.26	0.33	0.35	0.39	0.91	1.41	21.86	9.68	17.35	42.72	32.77							
73	0.26	0.30	0.31	0.33	1.02	1.29	22.33	9.00	17.87	41.06	31.93							

ft/s	Subaru NOx Emissions, mg/s																	
	-5	-4	-3	-2	-1	0	1	2	3	4	5	6	7	8	9	10	11	12
81	0.38	0.38	0.43	0.99	1.05	2.76	25.06	15.53	29.77	24.60	16.87							
82	0.42	0.42	0.46	1.05	0.86	2.48	24.41	16.23	28.76	20.29	17.16							
83	0.46	0.46	0.47	1.05	0.87	2.63	23.72	17.03	29.94	19.16	17.99							
84	0.46	0.46	0.47	1.05	0.87	3.06	23.03	17.82	31.11	17.79	18.78							
85	0.46	0.46	0.47	1.06	0.88	3.43	22.71	18.02	35.81	18.47								
86	0.47	0.47	0.53	1.07	0.94	3.52	22.18	18.70	38.59	18.48								
87	0.47	0.47	0.66	1.09	0.99	3.60	21.93	19.84	42.03	18.49								
88	0.47	0.47	0.79	1.10	1.02	4.02	21.35	22.20	41.15	18.46								
89	0.67	0.47	0.92	1.10	1.01	4.55	20.93	24.62	39.40	18.37								
90	0.86	0.67	0.99	1.10	1.01	4.66	20.48	26.83	38.71	18.26	16.43							
91	1.06	0.86	1.06	1.11	1.03	4.20	20.08	27.57	38.10	18.27	16.53							
92	1.08	1.06	1.08	1.12	1.08	4.01	18.62	28.47	38.50	18.24	17.06							
93	1.10	1.08	1.10	1.13	1.13	4.37	17.30	29.05	33.60	31.44								
94	1.12	1.11	1.12	1.13	1.16	5.03	15.97	30.42	34.30	32.38								
95	1.12	1.13	1.13	1.13	1.16	5.73	15.64	30.97	29.49	30.27								
96	1.13	1.14	1.14	1.13	1.15	6.57	15.12	30.99	26.35	14.40								
97	1.03	1.14	1.14	1.14	1.14	7.21	14.96	30.46	18.37	11.20								
98	0.87	1.14	1.15	1.14	1.13	7.83	14.99	30.04	14.96	11.19								
99	0.72	0.98	0.98	0.98	1.09	7.61	14.81	29.06	14.12	10.89								
100	0.67	0.82	0.82	0.82	1.08	7.20	14.09	27.15	13.59									
101	0.63	0.85	0.66	0.66	1.08	6.71	13.36	25.90	13.59									
102	0.60	0.62	0.64	0.66	1.34	7.96	12.84	25.75	13.59									
103	0.56	0.58	0.61	0.63	1.68	9.31	12.94	29.15	13.65									
104	0.56	0.56	0.58	0.60	2.02	10.34	12.28	31.33	13.76									
105	0.53	0.53	0.57	0.57	2.10	9.78	11.75	32.22	14.12									
106	0.50	0.50	0.55	0.57	2.00	9.81	11.70	29.64	13.95									
107	0.47	0.47	0.52	0.56	1.90	10.07	12.19	28.54	14.02									
108	0.47	0.47	0.51	0.55	1.90	10.17	12.68	29.81	14.25									
109	0.47	0.49	0.52	0.55	1.98	9.77	13.49	31.87	13.83									
110	0.47	0.51	0.54	0.56	2.06	9.14	14.53	32.9	13.13									



ft/s	ft/s/s	Villager Fuel Consumption, gal/h																	
		-5	-4	-3	-2	-1	0	1	2	3	4	5	6	7	8	9	10	11	12
81	1.62	1.61	1.59	1.63	1.66	1.7	2.93	4.96	7.92	9.73									
82	1.65	1.65	1.64	1.69	1.73	1.77	3.05	5.13	8.12	9.91									
83	1.7	1.72	1.71	1.78	1.81	1.86	3.16	5.27	8.28	10.07									
84	1.74	1.79	1.81	1.88	1.89	1.94	3.26	5.39	8.43	10.21									
85	1.79	1.86	1.89	1.95	1.95	2	3.35	5.51	8.53	10.31									
86	1.8	1.89	1.93	2	2	2.05	3.43	5.61	8.63	10.4									
87	1.82	1.92	1.97	2.05	2.07	2.13	3.52	5.71	8.72	10.51	11.49								
88	1.83	1.94	2	2.11	2.16	2.25	3.62	5.83	8.83	10.64									
89	1.86	1.97	2.05	2.18	2.25	2.35	3.72	5.96	8.96	10.78									
90	1.88	1.98	2.08	2.21	2.3	2.38	3.76	6.08	9.08	10.9									
91	1.93	2.02	2.11	2.22	2.29	2.35	3.8	6.2	9.23	11.01									
92	1.97	2.03	2.12	2.22	2.3	2.35	3.88	6.33	9.36	11.07									
93	2.02	2.05	2.12	2.24	2.35	2.41	4.04	6.49	9.48	11.09									
94	2.08	2.08	2.13	2.26	2.39	2.47	4.18	6.61	9.55	11.08									
95	2.14	2.12	2.14	2.27	2.42	2.52	4.28	6.68	9.53	11									
96	2.21	2.17	2.18	2.32	2.5	2.63	4.39	6.69	9.43	10.87									
97	2.27	2.23	2.25	2.4	2.58	2.71	4.44	6.63	9.23	10.44									
98	2.33	2.29	2.32	2.47	2.64	2.75	4.46	6.54	9.02	9.97									
99	2.39	2.34	2.38	2.52	2.67	2.75	4.45	6.45	8.82										
100	2.43	2.39	2.43	2.57	2.73	2.81	4.5	6.44	8.71										
101	2.48	2.44	2.46	2.6	2.76	2.86	4.56	6.46	8.69										
102	2.49	2.46	2.47	2.6	2.74	2.84	4.6	6.51											
103	2.49	2.46	2.48	2.61	2.75	2.85	4.67	6.58											
104	2.48	2.47	2.5	2.68	2.87	3.01	4.82	6.7											
105	2.5	2.49	2.55	2.77	2.99	3.16	4.92	6.75											
106	2.52	2.53	2.61	2.84	3.06	3.22	4.94	6.76											
107	2.56	2.57	2.64	2.85	3.05	3.19	4.87	6.69											
108	2.59	2.58	2.63	2.85	3.06	3.22	4.83	6.64											
109	2.63	2.6	2.63	2.87	3.12	3.32	4.79	6.57											
110	2.66	2.62	2.64	2.89	3.17	3.4	4.79	6.53											

		Villager CO Emissions, mg/s																	
ft/s	ft/s/s	-5	-4	-3	-2	-1	0	1	2	3	4	5	6	7	8	9	10	11	12
0	0.85	0.85	0.85	0.85	0.88	1.19	2.28	4.99	11.95	27.56	55.34	93.88	137.18	175.34	190.06	196.78	207.96		
1	0.85	0.85	0.85	0.85	0.87	1.16	2.19	4.9	12.2	29.54	60.09	99.5	141.72	177.02	189.14	194.79	206.29		
2	0.85	0.85	0.85	0.85	0.87	1.12	2.05	4.71	12.59	33.15	68.87	109.87	149.69	179.28	186.3	189.46	200.38		
3	0.85	0.85	0.85	0.85	0.86	1.06	1.89	4.45	13.17	38.39	81.11	124.26	159.36	178.88	178.76	178.83	186.55		
4	0.85	0.85	0.85	0.85	0.85	1.02	1.78	4.25	14.26	46.22	97.14	140.54	166.37	171.43	163.34	160.44	164.58		
5	0.83	0.83	0.84	0.85	0.86	1.03	1.78	4.2	16.33	57.43	116.35	155.22	165.69	153.46	139.74	136.72	137.5		
6	0.81	0.81	0.82	0.87	0.91	1.12	1.94	4.49	19.88	71.88	135.92	162.39	153.73	128.7	113.84	111.92	111.02		
7	0.77	0.78	0.82	0.94	1.06	1.38	2.36	5.27	25.33	88.04	150.45	157.09	132.11	104.11	92.28	91.94	90.02		
8	0.75	0.75	0.85	1.06	1.29	1.78	2.93	6.38	31.08	99.92	152.85	139.74	109.15	88.13	79.88	78.56	78.98		
9	0.75	0.76	0.9	1.19	1.56	2.25	3.47	7.38	34.79	101.86	140.14	116.47	92.58	81.38	74.61	72.81	82.91		
10	0.79	0.8	0.97	1.29	1.76	2.53	3.65	7.68	33.3	88.98	114.62	96.48	86.94	81.76	74.26	76.15	105.71		
11	0.87	0.89	1.05	1.34	1.82	2.55	3.51	7.54	28.74	69.39	88.25	85.32	88.95	84.74	76.47	90.17	145.9		
12	0.97	0.99	1.13	1.37	1.76	2.34	3.24	7.5	24.09	51.78	70.13	83.24	94.31	88.67	82.72	117.16	196.33		
13	1.05	1.07	1.19	1.38	1.66	2.12	3.18	8.29	23.33	45.06	64.94	86.1	98.53	92.97	95.47	155.59	246.08		
14	1.1	1.13	1.25	1.39	1.59	1.99	3.39	9.76	25.43	45.79	66.95	89.47	100.94	99.08	121.51	210.74	290.26		
15	1.12	1.17	1.29	1.41	1.59	2	3.81	11.62	29.13	50.38	71.14	91.01	102.93	115.29	176.04	287.21	323.69		
16	1.19	1.23	1.34	1.45	1.64	2.1	4.34	13.55	32.78	54.53	73.68	91.23	108.7	153.05	273.12	388.2	343.95		
17	1.4	1.38	1.4	1.51	1.73	2.28	4.91	15.3	35.94	57.53	74.5	92.67	128.27	232.02	418.07	495.58	341.83	202.71	
18	1.8	1.64	1.51	1.58	1.8	2.42	5.32	16.48	37.91	58.58	74.06	101.9	179.71	358.97	582.08	576.54	318	151.85	
19	2.32	1.96	1.61	1.61	1.76	2.4	5.4	16.8	38.4	58.18	74.92	130.76	285.37	535.69	730.25	602.87	278.65	127.05	
20	2.78	2.2	1.63	1.5	1.54	2.1	5.03	16.51	38.18	57.5	79.77	190.44	454.24	743.28	836.11	576.04	241.12		
21	3.03	2.23	1.46	1.25	1.2	1.69	4.61	16.42	38.45	57.79	94.38	292.44	680.16	967.06	908.02	528.64			
22	3.13	2.17	1.22	0.95	0.88	1.35	4.48	17.23	39.87	59.16	121.96	436.77	945.92	1196.38	975.27	504.55			
23	3.3	2.28	1.12	0.72	0.7	1.3	4.94	19.07	42.14	61.46	168.36	631.73	1246.48	1428.87	1059.16				
24	3.67	2.72	1.33	0.66	0.64	1.43	5.75	21.38	44.73	64.76	233.36	874.89	1583	1673.42	1189.64				
25	4.14	3.35	1.78	0.77	0.67	1.67	6.69	23.59	47.26	69.82	322.11	1178.02	1957.9	1919.91					
26	4.58	3.96	2.33	0.97	0.73	1.91	7.49	25.43	49.76	78.42	438.55	1529.15	2342.65	2163.08					
27	5.02	4.52	2.86	1.2	0.8	2.12	8.15	26.99	52.13	93.16	592.45	1910.87	2694.88	2393.84					
28	5.72	5.22	3.35	1.36	0.87	2.26	8.7	28.35	54.08	116.76	783.05	2275.17	2970.04	2629.98					
29	6.83	6.19	3.82	1.43	0.9	2.35	9.24	29.61	55.36	149.42	997.07	2587.66	3172.72	2878.19					
30	8.4	7.43	4.31	1.44	0.92	2.42	9.84	30.69	55.95	188.08	1205.87	2826.12	3309.13	3068.64					
31	10.44	8.89	4.95	1.58	0.96	2.49	10.53	31.73	56.49	230.01	1387.91	2990.43	3367.11	3102.16					
32	12.99	10.64	5.92	1.95	1.05	2.59	11.23	32.81	57.51	274.69	1534.89	3071.56	3290.33	2907.08					
33	15.98	12.72	7.36	2.66	1.22	2.72	11.97	34.13	59.38	323.64	1653.96	3059.17	3060.38	2574.17					
34	18.91	14.91	9.16	3.64	1.45	2.93	12.83	35.63	61.75	374.32	1741.44	2948.27	2741.5	2268.95					
35	21.03	16.74	11.08	4.79	1.74	3.29	14.03	37.39	64.25	422.64	1795.42	2775.43	2457.68	2131.05					
36	21.74	17.8	12.73	5.94	2.09	3.86	15.7	39.29	66.55	466.65	1820.16	2598.25	2297.87	2153.37					
37	20.86	17.9	13.8	6.92	2.49	4.61	17.73	41.17	68.68	509.63	1843.61	2480.54	2253.11	2220.6					
38	19.01	17.22	14.09	7.49	2.89	5.35	19.47	42.5	71.52	556.9	1884.9	2432.48	2249.01	2236.83					
39	16.8	15.94	13.5	7.51	3.19	5.8	20.26	42.96	76.6	611.44	1944.9	2426.94	2230.15	2194.32					
40	14.95	14.39	12.18	6.97	3.32	5.85	19.89	42.71	88.52	679.17	2000.92	2414.16	2196.57	2161.06					
41	13.36	12.64	10.41	6.12	3.31	5.69	19.28	45.06	116.03	761.89	2029.35	2372.64	2180.73	2183.32					
42	12.02	10.91	8.57	5.22	3.29	5.8	20.47	54.8	168.1	865.35	2031.23	2312.13	2197.36	2248.26					
43	10.69	9.22	6.91	4.5	3.37	6.69	25.36	76.8	244.71	978.76	2027.07	2264.77	2236.14	2308.07					
44	9.51	7.75	5.6	4.02	3.55	8.33	33.82	107.51	330.87	1096.85	2056.45	2257.37	2270.72	2319.11					
45	8.41	6.59	4.74	3.82	3.85	10.11	43.06	139	408	1198.96	2117.54	2288.13	2285.48	2294.14					
46	7.61	5.92	4.43	3.92	4.25	11.17	49.49	161.93	465.96	1281.04	2188.4	2331.65	2282.58						
47	6.94	5.68	4.62	4.33	4.78	11.25	50.61	169.56	493.52	1318.01	2218.69	2357.76	2282.67						
48	6.54	5.8	5.14	4.91	5.26	10.37	46.04	158.81	485.24	1308.36	2195.41	2352.17	2298.72						
49	6.06	5.87	5.55	5.32	5.5	8.93	36.5	128.36	435.1	1255.69	2128.92	2317.96	2324.65						
50	5.6	5.74	5.62	5.34	5.35	7.25	25.61	91.67	381.58	1222.9	2065.07	2270.05	2343.37						
51	4.96	5.24	5.23	5.02	4.97	5.85	16.78	61.9	356.24	1253.28	2046.93	2232.08	2344.6						
52	4.36	4.61	4.66	4.57	4.55	5.04	12.79	51.15	385.46	1365.57	2089.23	2217.83	2335.68						
53	3.68	3.86	4.03	4.14	4.26	4.75	12.07	53.64	442.54	1505.5	2165.74	2224.13	2324.79						
54	3.1	3.2	3.43	3.72	4.05	4.73	12.71	63.22	513.15	1639.88	2235.37	2228.93							
55	2.65	2.71	2.96	3.38	3.93	4.75	13.1	75.15	591.59	1761.44	2280.67	2218.75							
56	2.51	2.56	2.78	3.24	3.9	4.8	13.47	91.69	694.82	1901.22	2308.84	2193.53							
57	2.67	2.76	3	3.41	3.99	4.88	14.23	116.21	823.87	2056.82	2326.7								
58	3.12	3.26	3.45	3.72	4.13	4.99	15.78	152.63	974.21	2201.5	2321.06								
59	3.78	3.9	3.94	4.04	4.29	5.14	18.16	203.68	1139.83	2304.03	2276.83								
60	4.64	4.65	4.39	4.3	4.46	5.32	21.3	267.11	1313.37	2354.74	2194.14								
61	5.71	5.5	4.92	4.65	4.7	5.51	24.94	333.92	1470.97	2361.44	2106.8								
62	6.8	6.38	5.62	5.18	5	5.68	29.2	395.16	1583.31	2330.18									
63	7.74	7.15	6.39	5.88	5.39	5.87	34.45	451.23	1651.49	2288.88									
64	8.25	7.64	7.04	6.58	5.86	6.16	41.43	515.04	1716.38	2272.95									
65	8.49	7.91	7.43	7.15	6.5	6.7	50.34	596.14	1818.42	2312.91	2210.72								
66	8.58	8.06	7.62	7.56	7.29	7.49	60.45	689.64	1955.02	2392.17	2314.97								
67	8.79	8.21	7.69	7.85	8.03	8.38	70.36	774.15	2078.99	2462.64	2378.99								
68	9.06	8.36	7.72	7.96	8.36	9.01	78.98	832.87	2148.75	2480.98									
69	9.35	8.49	7.7	7.75	7.92	9.12	86.84	865.84	2155.7	2436.4									
70	9.54	8.52	7.54	7.17	6.86	8.76	95.45	889.74	212										

ft/s	Villager CO Emissions, mg/s																	
	-5	-4	-3	-2	-1	0	1	2	3	4	5	6	7	8	9	10	11	12
81	3.6	3.7	3.8	3.71	3.52	14.52	335.92	1973.64	2133.49	2253.25								
82	3.72	3.81	3.89	3.61	3.27	16.92	367.08	1394.34	2113.55	2232.82								
83	3.85	3.95	4.01	3.51	3.04	18.67	389.81	1412.13	2104.57	2235.04								
84	3.92	4.05	4.09	3.39	2.85	19.36	396.82	1416.09	2104.59	2257.89								
85	3.89	4.04	4.06	3.26	2.73	19.01	386.02	1394.95	2103.55	2295.33								
86	3.68	3.81	3.85	3.11	2.66	18.18	362.7	1350.46	2096.65	2338.73								
87	3.31	3.44	3.57	2.98	2.64	16.98	332.34	1293.53	2089.67	2387.24	2569.39							
88	2.89	3.03	3.27	2.85	2.62	15.23	298.44	1232.71	2085.23	2439.2								
89	2.56	2.73	3.01	2.7	2.53	12.44	264.68	1177.92	2084.71	2492.26								
90	2.37	2.5	2.73	2.48	2.34	9.2	238.96	1139.62	2085.54	2541.93								
91	2.24	2.3	2.42	2.2	2.05	6.48	230.55	1133.65	2092.59	2582.35								
92	2.1	2.08	2.09	1.88	1.74	5.3	240.01	1157.4	2105.23	2608.98								
93	1.98	1.89	1.79	1.56	1.47	5.78	262.47	1202.63	2121.89	2616.64								
94	1.86	1.72	1.53	1.29	1.33	7.62	289.14	1250.4	2132.48	2602.48								
95	1.75	1.56	1.3	1.1	1.39	10.55	314.94	1286.95	2126.48	2567.83								
96	1.64	1.41	1.12	1.05	1.64	14.24	335.42	1298.99	2093.04	2517.17								
97	1.52	1.28	1.03	1.17	2.07	18.72	352.75	1289.77	2035.54	2458.61								
98	1.4	1.19	1.07	1.48	2.6	23.18	364.35	1262.06	1961.21	2391.13								
99	1.3	1.17	1.26	1.92	3.23	27.23	371.01	1226.66	1883.81									
100	1.3	1.29	1.59	2.46	3.97	30.04	367.99	1183.12	1808.09									
101	1.45	1.57	2.04	3.09	4.91	32.53	365.24	1149.9	1745.21									
102	1.82	2.01	2.62	3.92	6.49	36.08	365.78	1129.9										
103	2.33	2.6	3.41	5.26	9.5	42.56	373.62	1125.33										
104	2.99	3.36	4.61	7.63	15.24	53.62	378.05	1112.32										
105	3.88	4.46	6.48	11.96	25.23	69.39	376.57	1084.89										
106	5.39	6.09	9.37	19.24	40.43	90.78	370.25	1041.08										
107	7.69	8.52	13.78	30.14	60.78	115.89	365.54	994.34										
108	10.8	11.67	19.88	43.67	83.18	143.07	366.61	950.93										
109	13.83	14.94	26.5	56.73	103.05	166.41	371.23	917.82										
110	15.79	17.08	30.99	64.9	114.63	180.47	375.88	899.52										

ft/s	ft/s/s	Villager HC Emissions, mg/s											12					
		-5	-4	-3	-2	-1	0	1	2	3	4	5		6	7	8	9	10
0	0.24	0.24	0.24	0.24	0.24	0.24	0.27	0.36	0.44	0.51	0.82	1.21	1.61	2.07	2.73	4.42	6.44	8.05
1	0.24	0.24	0.24	0.24	0.24	0.24	0.26	0.36	0.44	0.51	0.83	1.25	1.67	2.12	2.82	4.57	6.67	8.30
2	0.24	0.24	0.24	0.24	0.24	0.24	0.25	0.35	0.43	0.51	0.86	1.35	1.79	2.23	3.00	4.85	7.01	8.64
3	0.24	0.24	0.24	0.24	0.24	0.24	0.25	0.35	0.42	0.51	0.92	1.51	1.94	2.39	3.27	5.21	7.32	8.83
4	0.24	0.24	0.24	0.24	0.24	0.24	0.34	0.40	0.52	1.00	1.73	2.13	2.65	3.64	5.60	7.44	8.72	
5	0.23	0.23	0.23	0.23	0.23	0.23	0.33	0.39	0.52	1.13	2.02	2.38	3.03	4.14	5.87	7.32	8.20	
6	0.21	0.21	0.21	0.22	0.22	0.23	0.31	0.37	0.53	1.30	2.34	2.69	3.57	4.71	5.99	6.88	7.30	
7	0.20	0.20	0.20	0.21	0.22	0.23	0.29	0.36	0.55	1.51	2.65	3.07	4.24	5.24	5.92	6.25	6.14	
8	0.18	0.18	0.18	0.21	0.22	0.23	0.29	0.37	0.61	1.77	2.93	3.48	4.96	5.62	5.74	5.52	4.98	
9	0.17	0.17	0.17	0.21	0.23	0.25	0.29	0.37	0.70	2.08	3.19	3.94	5.66	5.83	5.48	4.85	4.05	
10	0.16	0.16	0.17	0.21	0.22	0.26	0.28	0.37	0.84	2.41	3.47	4.47	6.25	5.93	5.18	4.30	3.50	
11	0.15	0.15	0.15	0.19	0.21	0.25	0.26	0.38	1.03	2.74	3.79	5.06	6.69	6.01	4.83	3.91	3.36	
12	0.13	0.13	0.14	0.17	0.18	0.22	0.24	0.41	1.31	3.07	4.17	5.69	6.98	6.06	4.54	3.73	3.56	
13	0.12	0.12	0.12	0.14	0.16	0.20	0.23	0.48	1.65	3.37	4.57	6.25	7.09	6.05	4.38	3.79	3.96	
14	0.11	0.11	0.12	0.13	0.15	0.18	0.23	0.59	2.03	3.65	4.96	6.64	7.00	5.99	4.41	4.18	4.41	
15	0.11	0.11	0.12	0.13	0.14	0.18	0.24	0.72	2.40	3.93	5.31	6.73	6.77	5.92	4.73	4.97	4.79	
16	0.12	0.12	0.13	0.13	0.15	0.18	0.26	0.84	2.73	4.21	5.56	6.50	6.48	6.00	5.46	6.11	5.05	
17	0.13	0.13	0.13	0.14	0.16	0.19	0.30	0.93	3.02	4.47	5.62	6.04	6.31	6.36	6.69	7.31	5.13	3.60
18	0.17	0.15	0.14	0.15	0.17	0.20	0.33	1.00	3.22	4.66	5.47	5.51	6.40	7.15	8.26	8.17	4.97	3.26
19	0.22	0.17	0.15	0.15	0.17	0.20	0.35	1.02	3.32	4.74	5.13	5.12	6.98	8.47	9.84	8.47	4.59	2.97
20	0.26	0.20	0.15	0.16	0.16	0.20	0.35	1.01	3.37	4.72	4.71	5.08	8.17	10.33	11.17	8.26	4.11	
21	0.29	0.22	0.15	0.15	0.15	0.19	0.35	1.01	3.46	4.60	4.33	5.57	10.04	12.75	12.22	7.84		
22	0.30	0.23	0.14	0.14	0.15	0.19	0.35	1.06	3.66	4.37	4.13	6.70	12.60	15.67	13.21	7.54		
23	0.31	0.24	0.14	0.13	0.15	0.19	0.38	1.20	3.94	4.11	4.14	8.63	15.94	18.95	14.38			
24	0.33	0.27	0.16	0.13	0.15	0.20	0.43	1.39	4.22	3.92	4.36	11.56	20.07	22.33	16.02			
25	0.35	0.31	0.18	0.13	0.15	0.21	0.48	1.58	4.44	3.87	4.80	15.66	24.83	25.49				
26	0.37	0.35	0.22	0.14	0.16	0.22	0.52	1.75	4.62	3.93	5.52	20.87	29.66	28.13				
27	0.40	0.39	0.25	0.14	0.16	0.24	0.55	1.90	4.74	4.03	6.61	26.76	33.88	30.36				
28	0.45	0.45	0.29	0.15	0.17	0.25	0.57	2.05	4.76	4.11	8.19	32.47	36.98	32.71				
29	0.54	0.54	0.33	0.15	0.18	0.25	0.58	2.17	4.62	4.17	10.34	37.16	39.13	35.66				
30	0.67	0.65	0.37	0.16	0.18	0.25	0.58	2.24	4.33	4.21	13.00	40.34	40.75	38.75				
31	0.86	0.79	0.44	0.17	0.18	0.24	0.58	2.28	4.00	4.23	15.99	42.17	42.06	41.01				
32	1.11	0.92	0.54	0.19	0.18	0.23	0.57	2.32	3.76	4.22	19.07	43.10	42.77	41.73				
33	1.42	1.06	0.69	0.22	0.18	0.21	0.57	2.40	3.68	4.18	21.99	43.51	42.63	41.60				
34	1.72	1.18	0.86	0.26	0.18	0.21	0.59	2.52	3.70	4.15	24.51	43.50	42.26	42.23				
35	1.94	1.28	1.05	0.33	0.18	0.22	0.64	2.67	3.72	4.16	26.52	43.10	42.95	44.75				
36	1.99	1.34	1.20	0.41	0.18	0.24	0.74	2.82	3.66	4.24	28.05	42.64	45.52	48.68				
37	1.86	1.36	1.29	0.49	0.19	0.26	0.88	2.92	3.49	4.39	29.25	42.79	49.20	52.01				
38	1.62	1.34	1.30	0.55	0.21	0.29	1.02	2.93	3.28	4.63	30.36	44.01	52.14	54.24				
39	1.39	1.27	1.23	0.57	0.23	0.31	1.11	2.83	3.09	4.98	31.52	46.21	53.91	56.74				
40	1.22	1.16	1.10	0.54	0.25	0.33	1.11	2.68	3.03	5.52	32.82	48.60	56.06	61.57				
41	1.09	1.03	0.93	0.48	0.26	0.34	1.07	2.55	3.07	6.29	34.01	50.68	60.42	67.83				
42	0.99	0.88	0.76	0.42	0.28	0.37	1.07	2.50	3.20	7.36	34.98	52.51	66.47	72.82				
43	0.88	0.74	0.62	0.38	0.31	0.43	1.15	2.49	3.41	8.68	35.66	54.70	71.78	74.22				
44	0.79	0.65	0.53	0.39	0.38	0.54	1.30	2.53	3.73	10.21	36.26	57.45	74.27	72.47				
45	0.77	0.65	0.54	0.47	0.54	0.74	1.49	2.61	4.13	11.74	36.84	60.51	73.80	69.22				
46	0.88	0.81	0.69	0.67	0.81	1.06	1.68	2.74	4.56	13.06	37.47	63.29	71.55					
47	1.13	1.13	1.03	1.00	1.16	1.44	1.85	2.85	4.85	13.89	38.13	65.41	68.80					
48	1.46	1.56	1.48	1.40	1.50	1.78	1.99	2.86	4.91	14.26	38.86	66.70	66.23					
49	1.76	1.94	1.88	1.75	1.76	1.96	2.07	2.73	4.69	14.46	39.63	67.31	64.20					
50	1.92	2.15	2.08	1.91	1.87	1.96	2.08	2.49	4.32	15.03	40.36	67.42	62.92					
51	1.89	2.12	2.05	1.89	1.87	1.84	2.02	2.20	3.89	16.38	41.03	67.34	62.62					
52	1.74	1.94	1.87	1.76	1.82	1.70	1.92	1.97	3.64	18.59	41.60	66.99	63.50					
53	1.54	1.70	1.66	1.62	1.76	1.63	1.85	1.84	3.76	21.45	42.02	65.97	65.50					
54	1.37	1.50	1.49	1.48	1.70	1.62	1.82	1.91	4.43	24.68	42.16	63.72						
55	1.26	1.37	1.38	1.36	1.67	1.64	1.84	2.16	5.75	28.10	41.95	60.28						
56	1.22	1.34	1.33	1.31	1.66	1.65	1.89	2.50	7.56	31.52	41.50	56.43						
57	1.25	1.40	1.36	1.35	1.67	1.65	1.95	2.96	9.74	34.74	40.94							
58	1.36	1.54	1.45	1.43	1.70	1.63	2.00	3.15	12.17	37.50	40.44							
59	1.51	1.73	1.58	1.54	1.76	1.62	2.04	3.42	14.93	39.61	40.05							
60	1.66	1.93	1.73	1.66	1.86	1.63	2.11	3.68	17.96	40.95	39.83							
61	1.73	2.06	1.89	1.80	2.02	1.69	2.22	3.96	21.10	41.53	39.91							
62	1.70	2.10	2.00	1.95	2.16	1.76	2.33	4.29	24.15	41.63								
63	1.59	2.01	2.02	2.07	2.23	1.82	2.41	4.74	26.96	41.59								
64	1.46	1.87	1.98	2.13	2.16	1.82	2.43	5.33	29.55	41.87								
65	1.36	1.71	1.93	2.14	2.00	1.81	2.41	6.05	31.90	42.77	49.68							
66	1.31	1.61	1.91	2.12	1.79	1.84	2.39	6.84	34.03	44.41	53.95							
67	1.30	1.56	1.92	2.08	1.63	1.96	2.37	7.61	35.82	46.48	56.54							
68	1.31	1.57	1.93	2.05	1.54	2.13	2.35	8.30	37.26	48.47								
69	1.34	1.60	1.94	2.04	1.54	2.29	2.34	8.84	38.35	49.84								
70	1.35	1.62	1.93	2.07	1.60	2.36	2.33	9.22	39.22	50.53								
71	1.36	1.63	1.89	2.11	1.70	2.29	2.30	9.43	39.93	50.94								
72	1.37	1.62	1.82	2.12	1.81	2.12	2.20	9.67	40.53	51.79								
73	1.40	1.63	1.75	2.07	1.89	1.92	2.03	10.12	41.05	53.70								
74	1.45	1.65	1.68	1.96	1.90	1.74	1.84	10.93	41.49	56.71								
75	1.50	1.68	1.65	1.81	1.80	1.62	1.71	11.98	41.81	60.35								
76	1.55	1.70	1.63	1.65	1.62	1.56	1.63	13.13	42.03	63.78								
77	1.58	1.71	1.60	1.50	1.43	1.54	1.60	14.26	42.26	66.52								
78	1.59	1.71	1.55	1.38	1.31	1.52	1.57	15.43										



ft/s	Villager HC Emissions, mg/s																		
	ft/s/s	-5	-4	-3	-2	-1	0	1	2	3	4	5	6	7	8	9	10	11	12
81		1.48	1.45	1.34	1.27	1.18	1.29	1.59	20.32	46.59	70.24								
82		1.42	1.37	1.38	1.28	1.14	1.21	1.68	22.04	48.55	69.63								
83		1.41	1.38	1.49	1.31	1.12	1.16	1.77	23.34	50.48	68.72								
84		1.43	1.45	1.62	1.32	1.12	1.06	1.80	24.08	52.26	67.63								
85		1.46	1.51	1.67	1.32	1.11	0.94	1.77	24.20	53.88	66.41								
86		1.45	1.50	1.62	1.28	1.04	0.80	1.71	23.95	55.46	65.02								
87		1.39	1.42	1.48	1.20	0.91	0.70	1.64	23.60	57.22	63.57	57.38							
88		1.29	1.30	1.29	1.05	0.77	0.63	1.57	23.49	59.34	62.22								
89		1.16	1.16	1.08	0.87	0.65	0.57	1.49	23.79	61.98	61.16								
90		1.01	0.99	0.88	0.71	0.57	0.52	1.40	24.70	65.01	60.43								
91		0.85	0.82	0.70	0.59	0.49	0.46	1.31	26.23	68.07	60.01								
92		0.71	0.67	0.58	0.50	0.42	0.40	1.27	28.35	70.67	59.88								
93		0.61	0.57	0.50	0.42	0.35	0.36	1.32	30.74	72.55	60.10								
94		0.54	0.50	0.44	0.36	0.29	0.34	1.51	33.04	73.49	60.81								
95		0.49	0.45	0.38	0.30	0.26	0.35	1.81	34.78	73.02	62.12								
96		0.43	0.40	0.32	0.26	0.25	0.39	2.24	35.75	70.41	63.97								
97		0.39	0.35	0.28	0.24	0.26	0.45	2.73	36.14	65.44	65.90								
98		0.35	0.31	0.25	0.25	0.29	0.52	3.25	36.18	59.13	67.29								
99		0.31	0.28	0.24	0.27	0.33	0.61	3.78	36.15	53.28									
100		0.28	0.26	0.25	0.31	0.39	0.76	4.34	35.93	49.25									
101		0.26	0.26	0.28	0.37	0.47	0.96	4.98	35.78	47.15									
102		0.26	0.28	0.33	0.45	0.60	1.34	5.67	35.68										
103		0.29	0.33	0.40	0.58	0.82	1.86	6.41	35.70										
104		0.34	0.40	0.51	0.80	1.20	2.69	7.18	35.22										
105		0.43	0.53	0.67	1.13	1.80	3.77	7.95	34.04										
106		0.58	0.74	0.91	1.64	2.64	5.08	8.82	31.97										
107		0.82	1.03	1.24	2.32	3.75	6.39	9.75	29.59										
108		1.15	1.33	1.64	3.17	4.86	7.63	10.85	27.32										
109		1.48	1.57	2.07	3.97	5.76	8.65	11.82	25.72										
110		1.70	1.70	2.36	4.49	6.23	9.27	12.45	24.90										

ft/s	Villager NOx Emissions, mg/s																	
	-5	-4	-3	-2	-1	0	1	2	3	4	5	6	7	8	9	10	11	12
0	0.25	0.25	0.25	0.25	0.25	0.28	0.41	0.69	1.20	2.02	2.89	3.59	4.29	5.78	8.66	11.92	14.61	
1	0.25	0.25	0.25	0.25	0.25	0.28	0.41	0.68	1.20	2.06	2.97	3.68	4.46	6.05	8.97	12.16	14.75	
2	0.25	0.25	0.25	0.25	0.25	0.28	0.40	0.67	1.21	2.15	3.13	3.89	4.80	6.58	9.54	12.58	14.93	
3	0.25	0.25	0.25	0.25	0.25	0.27	0.39	0.65	1.23	2.29	3.38	4.25	5.36	7.36	10.29	13.05	15.04	
4	0.25	0.25	0.25	0.25	0.26	0.28	0.38	0.64	1.28	2.51	3.75	4.77	6.15	8.34	11.11	13.45	14.95	
5	0.25	0.25	0.25	0.26	0.26	0.28	0.39	0.65	1.37	2.80	4.25	5.49	7.17	9.45	11.88	13.66	14.57	
6	0.25	0.25	0.25	0.27	0.28	0.30	0.40	0.67	1.52	3.20	4.88	6.40	8.37	10.58	12.50	13.62	13.88	
7	0.24	0.24	0.25	0.28	0.30	0.33	0.43	0.73	1.74	3.71	5.65	7.46	9.64	11.61	12.90	13.31	12.89	
8	0.24	0.24	0.26	0.29	0.32	0.36	0.47	0.83	2.05	4.33	6.52	8.61	10.87	12.44	13.04	12.74	11.69	
9	0.24	0.24	0.26	0.30	0.34	0.39	0.52	0.98	2.47	5.06	7.48	9.77	11.95	13.03	12.95	11.97	10.38	
10	0.24	0.24	0.27	0.31	0.36	0.42	0.58	1.17	3.00	5.89	8.48	10.86	12.82	13.38	12.67	11.10	9.07	
11	0.24	0.24	0.27	0.31	0.37	0.44	0.63	1.42	3.61	6.77	9.48	11.83	13.47	13.54	12.29	10.19	7.86	
12	0.24	0.25	0.27	0.32	0.37	0.45	0.69	1.71	4.30	7.67	10.42	12.63	13.92	13.59	11.87	9.32	6.81	
13	0.24	0.25	0.27	0.31	0.37	0.45	0.76	2.06	5.03	8.53	11.24	13.23	14.20	13.57	11.44	8.54	5.97	
14	0.25	0.26	0.28	0.32	0.37	0.45	0.84	2.43	5.75	9.33	11.91	13.63	14.34	13.49	11.03	7.85	5.31	
15	0.27	0.27	0.29	0.32	0.37	0.46	0.94	2.82	6.46	10.05	12.41	13.81	14.34	13.34	10.60	7.26	4.83	
16	0.31	0.30	0.30	0.33	0.38	0.48	1.04	3.19	7.12	10.66	12.72	13.79	14.19	13.08	10.14	6.76	4.49	
17	0.37	0.34	0.32	0.34	0.39	0.51	1.16	3.54	7.72	11.17	12.84	13.59	13.88	12.65	9.61	6.32	4.27	3.61
18	0.45	0.40	0.35	0.36	0.41	0.54	1.26	3.86	8.27	11.56	12.78	13.21	13.39	12.04	9.02	5.95	4.17	3.68
19	0.55	0.46	0.37	0.37	0.43	0.58	1.37	4.16	8.75	11.81	12.56	12.72	12.73	11.27	8.42	5.66	4.19	3.87
20	0.65	0.54	0.41	0.39	0.46	0.61	1.47	4.47	9.18	11.91	12.24	12.17	11.93	10.41	7.86	5.49	4.33	
21	0.75	0.61	0.44	0.41	0.48	0.66	1.59	4.80	9.58	11.91	11.90	11.62	11.06	9.55	7.42	5.46		
22	0.83	0.68	0.48	0.42	0.50	0.70	1.73	5.19	9.94	11.84	11.62	11.12	10.20	8.80	7.17	5.59		
23	0.91	0.76	0.52	0.44	0.53	0.75	1.90	5.61	10.29	11.78	11.45	10.69	9.42	8.25	7.14			
24	1.00	0.85	0.58	0.46	0.55	0.80	2.09	6.06	10.61	11.76	11.40	10.32	8.80	7.97	7.35			
25	1.10	0.95	0.65	0.48	0.58	0.86	2.29	6.48	10.90	11.80	11.43	10.01	8.40	8.00				
26	1.22	1.08	0.73	0.51	0.60	0.91	2.48	6.85	11.13	11.88	11.48	9.76	8.30	8.42				
27	1.38	1.25	0.84	0.55	0.63	0.96	2.64	7.14	11.27	11.96	11.50	9.61	8.63	9.38				
28	1.62	1.47	0.99	0.60	0.66	1.00	2.77	7.34	11.30	12.00	11.46	9.66	9.55	11.09				
29	1.94	1.76	1.18	0.68	0.69	1.03	2.87	7.44	11.22	11.94	11.37	10.06	11.28	13.81				
30	2.36	2.15	1.44	0.78	0.71	1.03	2.93	7.47	11.04	11.81	11.30	10.99	14.05	17.81				
31	2.89	2.61	1.77	0.91	0.73	1.03	2.98	7.47	10.82	11.61	11.34	12.62	18.01	23.12				
32	3.48	3.12	2.18	1.09	0.74	1.01	3.04	7.47	10.61	11.38	11.58	15.08	23.13	29.36				
33	4.06	3.61	2.62	1.31	0.76	1.00	3.12	7.52	10.42	11.16	12.11	18.38	28.99	35.69				
34	4.57	4.02	3.06	1.56	0.80	1.01	3.26	7.61	10.26	10.97	12.96	22.33	34.80	40.90				
35	4.94	4.30	3.46	1.84	0.85	1.04	3.44	7.71	10.08	10.82	14.14	26.50	39.53	43.91				
36	5.16	4.46	3.77	2.09	0.91	1.11	3.65	7.78	9.85	10.74	15.55	30.32	42.29	44.10				
37	5.21	4.53	3.96	2.28	0.98	1.18	3.83	7.74	9.55	10.70	17.05	33.19	42.59	41.61				
38	5.12	4.51	4.03	2.38	1.04	1.25	3.93	7.57	9.19	10.70	18.45	34.75	40.61	37.21				
39	4.93	4.41	3.94	2.37	1.08	1.30	3.93	7.27	8.82	10.72	19.59	34.93	36.98	31.99				
40	4.66	4.23	3.71	2.24	1.09	1.33	3.81	6.88	8.45	10.72	20.40	33.95	32.60	26.96				
41	4.32	3.94	3.34	2.03	1.08	1.32	3.62	6.45	8.07	10.67	20.87	32.25	28.30	22.84				
42	3.92	3.54	2.89	1.78	1.04	1.29	3.39	6.00	7.65	10.53	21.11	30.29	24.66	19.96				
43	3.46	3.06	2.40	1.52	0.99	1.25	3.15	5.54	7.17	10.32	21.23	28.44	21.95	18.26				
44	2.98	2.56	1.95	1.29	0.94	1.20	2.90	5.06	6.63	10.09	21.36	26.93	20.17	17.43				
45	2.49	2.10	1.57	1.11	0.90	1.15	2.65	4.59	6.07	9.90	21.59	25.86	19.12	17.02				
46	2.05	1.71	1.29	0.99	0.87	1.09	2.40	4.14	5.54	9.81	21.95	25.19	18.52					
47	1.66	1.40	1.10	0.91	0.85	1.04	2.18	3.75	5.09	9.87	22.46	24.83	18.11					
48	1.35	1.18	0.98	0.87	0.84	1.00	2.01	3.45	4.77	10.10	23.09	24.68	17.74					
49	1.14	1.03	0.91	0.85	0.84	0.97	1.90	3.25	4.58	10.51	23.84	24.66	17.38					
50	1.00	0.94	0.88	0.85	0.84	0.96	1.84	3.14	4.52	11.11	24.75	24.78	17.11					
51	0.93	0.91	0.87	0.86	0.85	0.95	1.83	3.10	4.58	11.88	25.86	25.09	17.01					
52	0.92	0.91	0.88	0.87	0.86	0.96	1.85	3.11	4.75	12.81	27.24	25.73	17.17					
53	0.93	0.92	0.90	0.89	0.88	0.96	1.87	3.15	5.00	13.87	28.95	26.86	17.63					
54	0.95	0.95	0.93	0.91	0.89	0.97	1.90	3.22	5.33	15.04	31.01	28.62						
55	0.97	0.97	0.95	0.92	0.89	0.98	1.94	3.31	5.76	16.35	33.37	31.05						
56	0.97	0.97	0.95	0.93	0.90	0.99	1.97	3.44	6.31	17.84	36.00	34.07						
57	0.97	0.96	0.94	0.92	0.89	0.99	2.02	3.60	6.99	19.62	38.83							
58	0.95	0.94	0.92	0.91	0.88	1.00	2.06	3.79	7.87	21.82	41.81							
59	0.93	0.92	0.90	0.89	0.87	1.01	2.12	4.00	8.96	24.52	44.82							
60	0.92	0.90	0.89	0.88	0.87	1.02	2.17	4.25	10.27	27.65	47.67							
61	0.93	0.90	0.88	0.87	0.86	1.03	2.23	4.52	11.79	30.99	50.09							
62	0.95	0.92	0.89	0.88	0.87	1.05	2.28	4.81	13.44	34.22								
63	0.99	0.94	0.91	0.89	0.88	1.07	2.35	5.13	15.14	37.00								
64	1.03	0.97	0.92	0.90	0.90	1.10	2.42	5.48	16.79	39.07								
65	1.06	0.99	0.94	0.92	0.92	1.14	2.50	5.86	18.33	40.32	50.96							
66	1.09	1.01	0.95	0.93	0.95	1.19	2.59	6.25	19.72	40.76	48.74							
67	1.09	1.01	0.95	0.94	0.97	1.23	2.68	6.66	20.95	40.46	45.70							
68	1.08	1.01	0.95	0.94	0.98	1.27	2.76	7.10	22.06	39.54								
69	1.06	1.00	0.95	0.94	0.98	1.29	2.82	7.58	23.10	38.20								
70	1.03	0.99	0.94	0.93	0.97	1.29	2.86	8.12	24.12	36.62								
71	1.01	0.97	0.93	0.91	0.94	1.27	2.88	8.72	25.17	34.98								
72	0.99	0.95	0.91	0.89	0.92	1.24	2.90	9.41	26.24	33.39								
73	0.96	0.93	0.90	0.88	0.90	1.22	2.93	10.17	27.31	31.90								
74	0.93	0.91	0.89	0.87	0.88	1.20	2.98	10.98	28.31	30.52								
75	0.91	0.89	0.88	0.86	0.88	1.19	3.05	11.82	29.20	29.27								
76	0.89	0.87	0.87	0.86	0.88	1.19	3.15	12.67	29.93	28.16								
77	0.87	0.86	0.87	0.86	0.88	1.20	3.27	13.55</										

ft/s	Villager NOx Emissions, mg/s																	
	-5	-4	-3	-2	-1	0	1	2	3	4	5	6	7	8	9	10	11	12
81	0.87	0.87	0.89	0.90	0.96	1.34	4.37	17.91	31.72	24.38								
82	0.88	0.89	0.91	0.93	0.99	1.41	4.85	19.17	31.67	23.50								
83	0.90	0.92	0.95	0.96	1.03	1.50	5.40	20.37	31.40	22.44								
84	0.92	0.95	0.99	1.01	1.08	1.61	6.00	21.43	30.88	21.26								
85	0.94	0.98	1.04	1.06	1.15	1.75	6.64	22.28	30.10	20.09								
86	0.97	1.02	1.10	1.14	1.24	1.94	7.33	22.90	29.10	19.03								
87	1.01	1.07	1.17	1.23	1.38	2.18	8.05	23.30	27.91	18.17	14.09							
88	1.06	1.13	1.26	1.36	1.56	2.50	8.82	23.49	26.60	17.53								
89	1.13	1.22	1.38	1.53	1.82	2.91	9.64	23.53	25.25	17.08								
90	1.24	1.34	1.54	1.78	2.17	3.42	10.53	23.50	23.94	16.76								
91	1.38	1.51	1.77	2.11	2.64	4.06	11.49	23.49	22.79	16.52								
92	1.58	1.73	2.07	2.54	3.22	4.81	12.52	23.57	21.87	16.36								
93	1.83	2.02	2.44	3.06	3.92	5.68	13.60	23.79	21.23	16.25								
94	2.13	2.37	2.90	3.67	4.69	6.61	14.70	24.15	20.91	16.23								
95	2.49	2.78	3.42	4.35	5.51	7.56	15.77	24.63	20.90	16.32								
96	2.90	3.25	4.01	5.07	6.33	8.46	16.77	25.20	21.18	16.53								
97	3.38	3.79	4.66	5.80	7.08	9.27	17.64	25.78	21.67	16.84								
98	3.93	4.40	5.34	6.51	7.74	9.94	18.37	26.27	22.22	17.21								
99	4.56	5.07	6.04	7.16	8.27	10.47	18.91	26.57	22.67									
100	5.27	5.79	6.72	7.72	8.67	10.87	19.29	26.57	22.90									
101	6.02	6.52	7.35	8.16	8.96	11.19	19.51	26.27	22.87									
102	6.76	7.21	7.89	8.50	9.15	11.45	19.60	25.72										
103	7.45	7.80	8.31	8.72	9.28	11.67	19.59	24.99										
104	8.01	8.27	8.61	8.86	9.36	11.88	19.50	24.20										
105	8.43	8.60	8.80	8.94	9.42	12.05	19.36	23.42										
106	8.71	8.80	8.91	8.98	9.46	12.18	19.19	22.72										
107	8.87	8.92	8.97	8.99	9.48	12.28	19.01	22.15										
108	8.95	8.97	8.99	9.00	9.50	12.33	18.85	21.73										
109	8.98	8.99	9.00	9.00	9.50	12.35	18.73	21.46										
110	9	9	9	9	9.51	12.35	18.66	21.32										

Jeep Grand Cherokee Fuel Consumption, gal/h																			
ft/s	ft/s/s																		
	-5	-4	-3	-2	-1	0	1	2	3	4	5	6	7	8	9	10	11	12	
0	0.61	0.61	0.61	0.61	0.61	0.61	0.61	0.62	0.72	0.74	0.64	0.68	0.77	0.91	0.9	0.9	0.79	0.92	2.34
1	0.61	0.61	0.61	0.61	0.61	0.61	0.61	0.63	0.84	0.84	0.68	0.71	0.83	0.97	0.98	0.87	0.79	0.88	2.07
2	0.61	0.61	0.61	0.61	0.61	0.61	0.61	0.65	0.98	1	0.78	0.82	0.91	1.07	1.14	0.87	0.78	0.83	2.07
3	0.61	0.61	0.61	0.61	0.61	0.61	0.61	0.67	1.12	1.16	0.97	0.98	1.03	1.24	1.45	1.02	0.79	0.81	2.07
4	0.61	0.61	0.61	0.61	0.61	0.61	0.61	0.69	1.19	1.26	1.16	1.21	1.25	1.5	1.72	1.38	0.89	0.85	2.13
5	0.61	0.61	0.61	0.61	0.63	0.61	0.71	1.23	1.3	1.36	1.48	1.6	1.79	1.99	1.77	1.1	1.01	1.01	2.26
6	0.61	0.61	0.61	0.61	0.65	0.61	0.72	1.22	1.31	1.52	1.82	2	2.17	2.13	2.1	1.56	1.73	2.86	
7	0.61	0.61	0.61	0.61	0.67	0.61	0.72	1.2	1.31	1.61	2.12	2.31	2.41	2.21	2.23	2.22	2.73	3.62	
8	0.61	0.61	0.61	0.61	0.67	0.61	0.71	1.15	1.31	1.64	2.31	2.46	2.68	2.23	2.33	2.9	3.64	4.06	
9	0.63	0.63	0.62	0.61	0.67	0.63	0.71	1.13	1.31	1.58	2.37	2.51	2.71	2.38	2.52	3.38	4.05	4.25	
10	0.66	0.66	0.63	0.61	0.68	0.66	0.74	1.12	1.31	1.61	2.38	2.54	2.72	2.57	2.87	3.61	4.17	4.44	
11	0.66	0.68	0.63	0.61	0.73	0.73	0.81	1.17	1.36	1.68	2.4	2.59	2.69	2.85	3.35	3.89	4.38	4.6	
12	0.63	0.67	0.63	0.61	0.78	0.78	0.89	1.24	1.42	1.82	2.44	2.65	2.75	3.04	3.8	4.14	4.53	4.67	
13	0.61	0.65	0.63	0.61	0.84	0.85	0.96	1.31	1.48	1.96	2.49	2.74	2.8	3.28	4.1	4.44	4.67		
14	0.61	0.63	0.62	0.61	0.88	0.87	1.02	1.39	1.54	2.09	2.56	2.84	2.8	3.48	4.31	4.63	4.84		
15	0.61	0.61	0.61	0.61	0.91	0.92	1.09	1.46	1.62	2.23	2.64	2.94	2.92	3.72	4.48	4.83	5.01		
16	0.61	0.61	0.61	0.61	0.88	0.92	1.15	1.52	1.74	2.35	2.76	3.01	3.1	3.94	4.61	5.01	5.18		
17	0.61	0.61	0.61	0.61	0.85	0.92	1.19	1.56	1.87	2.48	2.88	3.09	3.22	4.18	4.77	5.12			
18	0.61	0.61	0.61	0.61	0.82	0.9	1.21	1.58	2	2.59	2.99	3.18	3.35	4.36	4.94	5.23	5.32		
19	0.61	0.61	0.61	0.61	0.8	0.89	1.2	1.59	2.11	2.69	3.11	3.33	3.61	4.63	5.11	5.37	5.45		
20	0.61	0.61	0.61	0.61	0.79	0.87	1.19	1.58	2.19	2.81	3.23	3.5	4.09	4.86	5.28	5.51	5.59		
21	0.61	0.61	0.61	0.61	0.77	0.86	1.17	1.59	2.27	2.95	3.35	3.73	4.6	5.13	5.42	5.6	5.57		
22	0.61	0.61	0.61	0.61	0.76	0.86	1.21	1.61	2.37	3.09	3.47	4.01	4.94	5.28	5.62	5.71	5.69		
23	0.61	0.61	0.61	0.61	0.75	0.86	1.24	1.64	2.47	3.21	3.59	4.33	5.19	5.47	5.74	5.82			
24	0.61	0.61	0.61	0.61	0.76	0.84	1.27	1.66	2.56	3.28	3.72	4.62	5.29	5.63	5.86	5.94	5.95		
25	0.61	0.61	0.61	0.61	0.77	0.81	1.28	1.71	2.63	3.33	3.91	4.89	5.47	5.82	6.03	6.06			
26	0.61	0.61	0.61	0.61	0.77	0.79	1.32	1.81	2.69	3.37	4.13	5.13	5.63	6	6.16	6.22			
27	0.61	0.61	0.61	0.61	0.75	0.79	1.36	1.94	2.76	3.41	4.38	5.33	5.85	6.22	6.39	6.47			
28	0.61	0.61	0.61	0.61	0.73	0.79	1.39	2.05	2.81	3.43	4.58	5.53	6.07	6.42	6.58				
29	0.61	0.61	0.61	0.61	0.72	0.79	1.41	2.12	2.87	3.48	4.76	5.74	6.29	6.68	6.92				
30	0.61	0.61	0.61	0.61	0.72	0.8	1.43	2.19	2.93	3.54	4.91	5.96	6.52	6.96	7.24				
31	0.61	0.61	0.61	0.61	0.73	0.83	1.48	2.28	3.01	3.61	5.09	6.17	6.75	7.3	7.54				
32	0.61	0.61	0.61	0.61	0.75	0.88	1.53	2.34	3.09	3.67	5.22	6.32	7.07	7.64	7.78				
33	0.61	0.61	0.61	0.61	0.78	0.96	1.58	2.39	3.16	3.72	5.32	6.42	7.46	8.02	8.13				
34	0.61	0.61	0.61	0.61	0.81	1.02	1.61	2.42	3.23	3.75	5.36	6.5	7.85	8.46	8.5				
35	0.61	0.61	0.61	0.61	0.84	1.07	1.64	2.45	3.27	3.79	5.37	6.56	8.19	8.87	8.91				
36	0.63	0.63	0.61	0.61	0.87	1.13	1.66	2.52	3.33	3.81	5.34	6.58	8.47	9.26	9.29				
37	0.66	0.66	0.63	0.63	0.89	1.16	1.73	2.61	3.36	3.86	5.32	6.59	8.69	9.6	9.67				
38	0.68	0.68	0.66	0.66	0.95	1.22	1.78	2.73	3.42	3.93	5.31	6.6	8.89	10	9.97				
39	0.68	0.68	0.68	0.68	0.99	1.28	1.85	2.84	3.47	4.08	5.35	6.63	9.07	10.3	10.27				
40	0.68	0.68	0.68	0.68	1.03	1.34	1.89	2.92	3.54	4.32	5.41	6.68	9.28	10.61	10.58				
41	0.68	0.68	0.68	0.68	1.03	1.39	1.95	2.96	3.61	4.59	5.51	6.76	9.47	10.91	10.9				
42	0.68	0.68	0.68	0.68	1.02	1.39	2	2.98	3.66	4.85	5.61	6.86	9.67	11.2	11.18				
43	0.68	0.68	0.68	0.68	1	1.39	2.07	2.99	3.71	5.02	5.71	6.96	9.87	11.46	11.48				
44	0.69	0.69	0.68	0.68	0.98	1.4	2.12	3.01	3.75	5.13	5.77	7.07	10.09	11.69	11.83				
45	0.69	0.69	0.69	0.69	0.97	1.41	2.17	3.04	3.81	5.26	5.85	7.16	10.32	11.95	12.14				
46	0.7	0.7	0.7	0.69	0.98	1.41	2.2	3.09	3.91	5.42	5.92	7.25	10.47	12.22	12.45				
47	0.7	0.7	0.7	0.7	1.01	1.41	2.23	3.16	4.03	5.59	6.02	7.35	10.55	12.46	12.72				
48	0.7	0.7	0.7	0.7	1.04	1.41	2.25	3.24	4.2	5.72	6.15	7.46	10.56	12.71	12.96				
49	0.71	0.7	0.7	0.7	1.1	1.37	2.27	3.31	4.37	5.83	6.3	7.56	10.57	12.92	13.1				
50	0.72	0.7	0.7	0.7	1.13	1.37	2.29	3.35	4.55	5.97	6.44	7.58	10.71	13.17	13.27				
51	0.74	0.7	0.7	0.7	1.17	1.37	2.33	3.38	4.71	6.11	6.56	7.54	11.05	13.48					
52	0.75	0.72	0.71	0.7	1.2	1.42	2.4	3.41	4.8	6.24	6.68	7.5	11.53	13.84					
53	0.77	0.74	0.73	0.72	1.25	1.43	2.45	3.46	4.9	6.36	6.84	7.53	12.15	14.19					
54	0.77	0.76	0.74	0.73	1.26	1.45	2.54	3.52	4.98	6.46	7.01	7.72	12.65	14.45					
55	0.77	0.76	0.74	0.74	1.3	1.46	2.61	3.56	5.06	6.59	7.18	7.98	13.04	14.65					
56	0.77	0.76	0.75	0.75	1.32	1.47	2.67	3.59	5.15	6.74	7.33	8.25	13.24	14.84					
57	0.77	0.77	0.76	0.76	1.37	1.5	2.71	3.67	5.22	6.9	7.56	8.5	13.34	14.92					
58	0.77	0.77	0.77	0.77	1.38	1.55	2.74	3.77	5.26	7.1	7.78	8.71	13.41	14.93					
59	0.77	0.76	0.77	0.77	1.41	1.6	2.77	3.88	5.28	7.33	7.99	8.99	13.31	14.74					
60	0.76	0.76	0.76	0.76	1.43	1.62	2.82	3.95	5.33	7.53	8.25	9.27	13.14	14.49					
61	0.76	0.76	0.76	0.76	1.46	1.62	2.89	4.06	5.41	7.71	8.54	9.55	12.79	14.23					
62	0.76	0.76	0.76	0.76	1.48	1.65	2.97	4.17	5.48	7.83	8.9	9.69	12.34	14.08					
63	0.76	0.76	0.76	0.77	1.48	1.73	3.02	4.32	5.52	7.98	9.14	9.74	11.86	14.04					
64	0.76	0.76	0.76	0.77	1.44	1.81	3.06	4.44	5.58	8.13	9.33	9.75	11.45						
65	0.76	0.77	0.77	0.78	1.37	1.86	3.08	4.57	5.66	8.33	9.52	9.78							
66	0.76	0.78	0.79	0.79	1.31	1.81	3.12	4.69	5.79	8.54	9.67								
67	0.76	0.8	0.8	0.8	1.25	1.73	3.18	4.79	5.89	8.72	9.85								
68	0.76	0.8	0.8	0.8	1.21	1.67	3.23	4.87	5.96	8.9	9.95								
69	0.78	0.8	0.8	0.8	1.18	1.7	3.25	4.93	6	9.05	10.18								
70	0.79	0.8	0.8	0.8	1.18	1.76	3.27	5.03	6.01	9.29	10.4								
71	0.8	0.8	0.8	0.8	1.19	1.79	3.31	5.14	6.06	9.52	10.62								
72	0.8	0.8	0.8	0.8	1.19	1.9	3.36	5.26	6.14	9.78	10.77								
73	0.8	0.8	0.8	0.87	1.22	2.04	3.39	5.31	6.25	9.96	10.91								
74	0.78	0.8	0.8	0.93	1.26														

		Jeep Grand Cherokee Fuel Consumption, gal/h																					
ft/s	ft/s/s	-5	-4	-3	-2	-1	0	1	2	3	4	5	6	7	8	9	10	11	12				
81	0.77	0.68	0.69	0.73	1.2	2.33	3.22	6.02	7.33	10.74	12.36												
82	0.73	0.68	0.69	0.7	1.29	2.34	3.31	6.13	7.33	10.87	12.52												
83	0.72	0.68	0.68	0.69	1.38	2.35	3.43	6.23	7.35	11.07	12.67												
84	0.72	0.68	0.68	0.68	1.4	2.34	3.52	6.31	7.44	11.32	12.79												
85	0.72	0.68	0.68	0.68	1.4	2.37	3.62	6.39	7.52	11.37	12.9												
86	0.73	0.68	0.68	0.68	1.41	2.43	3.69	6.48	7.59	11.36	13.01												
87	0.73	0.68	0.67	0.68	1.44	2.55	3.74	6.56	7.6	11.33	13.14												
88	0.73	0.68	0.66	0.68	1.53	2.63	3.74	6.66	7.64	11.47	13.34												
89	0.73	0.68	0.66	0.68	1.66	2.7	3.79	6.8	7.73	11.8	13.51												
90	0.72	0.68	0.67	0.68	1.8	2.8	3.92	7	7.86	12.19	13.77												
91	0.72	0.67	0.68	0.68	1.86	2.9	4.02	7.2	8.03	12.62	13.96												
92	0.73	0.66	0.68	0.68	1.9	3	4.08	7.38	8.27	13.01	14.26												
93	0.77	0.65	0.68	0.68	1.94	3	4.09	7.57	8.54	13.43	14.42												
94	0.78	0.64	0.68	0.68	2	3.02	4.17	7.77	8.8	13.71	14.57												
95	0.77	0.64	0.68	0.68	2.07	3.07	4.3	7.96	9.04	13.92	14.69												
96	0.74	0.64	0.68	0.68	2.11	3.09	4.45	8.1	9.41	14.04	14.82												
97	0.73	0.66	0.68	0.68	2.09	3.06	4.6	8.31	9.88	14.16	14.93												
98	0.73	0.67	0.68	0.68	2.01	3.06	4.74	8.49	10.35	14.24	14.96												
99	0.73	0.69	0.68	0.68	1.94	3.21	4.9	8.7	10.7	14.25	14.97												
100	0.72	0.7	0.69	0.68	2.02	3.41	5.07	8.81	10.86	14.07	14.94												
101	0.72	0.69	0.7	0.68	2.16	3.51	5.21	9	10.78	13.65	14.9												
102	0.73	0.68	0.71	0.68	2.28	3.5	5.27	9.18	10.55	13.13	14.86												
103	0.74	0.69	0.71	0.69	2.33	3.48	5.35	9.33	10.27	12.71	14.86												
104	0.73	0.71	0.71	0.71	2.36	3.52	5.43	9.4	10.12	12.57	14.82												
105	0.74	0.72	0.71	0.72	2.46	3.55	5.59	9.43	10.04	12.64	14.81												
106	0.75	0.71	0.72	0.72	2.5	3.57	5.68	9.48	10.1	12.74	14.79												
107	0.77	0.71	0.72	0.72	2.51	3.64	5.86	9.65	10.23	12.81	13.16												
108	0.78	0.71	0.72	0.73	2.47	3.77	6.12	9.87	10.4	12.85	11.55												
109	0.77	0.72	0.72	0.76	2.49	3.92	6.6	10.17	10.55	12.96													
110	0.76	0.72	0.72	0.79	2.51	3.97	6.98	10.34	10.61	13.07													



		Jeep Grand Cherokee CO Emissions, mg/s																					
ft/s	ft/s/s	-5	-4	-3	-2	-1	0	1	2	3	4	5	6	7	8	9	10	11	12				
81	1.18	0.83	0.83	1.2	3.51	7.14	6.98	142.26	468.89	4713.3	7330.3												
82	1.18	0.85	0.85	1	4.51	7.14	7.34	255.9	482.54	4328	9020.6												
83	1.18	0.85	0.85	0.85	5.64	7.14	8.17	369.26	482.54	3900.3	9037.1												
84	1.18	0.85	0.85	0.85	5.64	7.13	8.29	384.8	482.54	5222.6	9079.4												
85	1.18	0.85	0.85	0.85	5.15	7.71	8.61	391.21	512.35	5475.5	9197.2												
86	1.18	0.85	0.85	0.85	5.64	7.97	9	399.6	552.57	5332.6	9375.4												
87	1.18	0.85	0.85	0.85	5.64	5.69	8.17	318.71	552.57	3845.7	9441.2												
88	1.18	0.85	0.61	0.85	5.64	5.46	9.48	364.6	552.57	5222.6	9476.2												
89	1.16	0.85	0.61	0.85	10.25	5.46	9	382.46	976.33	7276.3	9733.3												
90	1.18	0.85	0.85	0.85	10.71	5.92	9.48	407.97	1030.75	9254.8	9755.3												
91	1.18	0.85	0.85	0.85	10.71	11.85	9.37	671.54	1121.68	9441.2	10079.1												
92	1.18	0.61	0.85	0.85	10.77	11.85	9.8	851.65	1161.89	9733.3	10121.9												
93	1.14	0.62	0.85	0.85	7.71	10.08	10.18	1003.87	1410.35	10079.1	10375.6												
94	1.14	0.62	0.85	0.85	7.14	11.85	10.18	1055.19	1425.15	10329	10399.4												
95	1.14	0.58	0.85	0.85	7.14	10.08	10.18	1277.08	1536.09	10353	10431.2												
96	1.18	0.62	0.85	0.85	5.96	8.16	19.29	1362.89	1675.01	10353	10620												
97	1.18	0.61	0.85	0.85	6.32	11.28	21.07	1410.35	4402.46	10353	10666.5												
98	1.18	0.85	0.85	0.85	6.48	13.66	28.85	1543.9	4401.41	10493.6	10666.5												
99	1.18	0.85	0.85	0.85	8.16	7.84	21.97	1536.09	5307.62	10493.6	10666.5												
100	1.16	0.85	0.85	0.85	10.77	6.8	30.02	1566.06	4713.3	10417.1	10727.2												
101	1.18	0.85	1	0.85	5.46	7.4	31.33	1675.01	5136.3	9868.6	10666.5												
102	1.18	0.85	1	0.85	14.02	7.33	31.33	2678.39	4552.71	9343.6	10620												
103	1.14	0.85	0.85	0.85	14.02	7.69	31.33	3416.67	3611.66	9037.1	10620												
104	1.14	1	0.85	1	11.28	7.33	88.67	3754.27	3421.83	9055.8	10620												
105	1.2	1	1	1	12.44	17.97	89.7	3171.09	3498.62	9197.2	10620												
106	1.2	0.85	1	1	9.85	18.24	108.12	3444.36	3421.83	9375.4	10620												
107	1.32	0.85	1	1	16.68	18.24	99.75	3479.94	3498.62	9406.5	10620												
108	1.2	1.16	1	1.18	17.85	43.54	159.41	3974.92	4249.82	9429.7	10620												
109	1.2	1.18	1	1.18	23.59	42.31	366.04	4108.22	4401.41	9527.7													
110	1.18	1.18	1	1.18	61.38	41.88	462.7	4249.82	4552.71	9868.6													

		Jeep Grand Cherokee HC Emissions, mg/s																	
ft/s	ft/s/s	-5	-4	-3	-2	-1	0	1	2	3	4	5	6	7	8	9	10	11	12
	0	0.16	0.16	0.16	0.16	0.16	0.16	0.16	0.16	0.14	0.15	0.17	0.16	0.15	0.23	0.27	0.27	0.21	0.28
1	0.16	0.16	0.16	0.16	0.16	0.16	0.16	0.16	0.17	0.16	0.16	0.16	0.15	0.27	0.33	0.25	0.21	0.26	1.29
2	0.16	0.16	0.16	0.16	0.16	0.16	0.16	0.15	0.22	0.24	0.17	0.18	0.17	0.38	0.47	0.26	0.20	0.24	1.26
3	0.16	0.16	0.16	0.16	0.16	0.16	0.16	0.15	0.31	0.36	0.25	0.26	0.27	0.52	0.75	0.38	0.21	0.23	1.24
4	0.16	0.16	0.16	0.16	0.16	0.16	0.16	0.15	0.37	0.46	0.40	0.44	0.49	0.78	1.02	0.70	0.28	0.25	1.30
5	0.16	0.16	0.16	0.16	0.16	0.16	0.16	0.14	0.40	0.50	0.59	0.70	0.81	1.06	1.27	1.06	0.43	0.38	1.41
6	0.16	0.16	0.16	0.16	0.16	0.15	0.16	0.14	0.39	0.52	0.75	1.00	1.16	1.42	1.38	1.36	0.85	0.92	1.72
7	0.16	0.16	0.16	0.16	0.16	0.14	0.16	0.14	0.38	0.52	0.83	1.26	1.44	1.63	1.45	1.48	1.37	1.56	2.16
8	0.16	0.16	0.16	0.16	0.16	0.14	0.16	0.14	0.34	0.52	0.85	1.42	1.59	1.82	1.46	1.63	1.88	2.16	2.40
9	0.15	0.15	0.16	0.16	0.16	0.14	0.15	0.14	0.31	0.51	0.80	1.49	1.63	1.84	1.56	1.75	2.16	2.40	2.54
10	0.15	0.15	0.16	0.16	0.16	0.15	0.15	0.15	0.31	0.51	0.83	1.49	1.64	1.83	1.69	1.96	2.30	2.51	2.63
11	0.15	0.14	0.15	0.16	0.16	0.15	0.15	0.15	0.35	0.58	0.88	1.49	1.68	1.79	1.86	2.15	2.43	2.64	2.77
12	0.15	0.14	0.15	0.16	0.16	0.15	0.17	0.42	0.66	0.98	1.51	1.73	1.82	1.96	2.36	2.55	2.78	2.91	
13	0.16	0.15	0.16	0.16	0.18	0.18	0.21	0.51	0.74	1.08	1.53	1.72	1.85	2.09	2.50	2.68	2.92		
14	0.16	0.16	0.16	0.16	0.21	0.22	0.26	0.61	0.75	1.17	1.55	1.72	1.85	2.20	2.59	2.83	3.21		
15	0.16	0.16	0.16	0.16	0.24	0.27	0.32	0.66	0.79	1.29	1.56	1.74	1.88	2.33	2.66	3.03	3.50		
16	0.16	0.16	0.16	0.16	0.23	0.27	0.37	0.69	0.85	1.39	1.61	1.80	1.92	2.43	2.72	3.28	3.77		
17	0.16	0.16	0.16	0.16	0.21	0.26	0.40	0.69	0.95	1.45	1.71	1.87	1.96	2.53	2.87	3.48			
18	0.16	0.16	0.16	0.16	0.19	0.23	0.43	0.70	1.03	1.51	1.83	1.94	2.03	2.59	3.08	3.73	4.04		
19	0.16	0.16	0.16	0.16	0.18	0.20	0.40	0.71	1.09	1.58	1.87	2.03	2.18	2.77	3.28	4.05	4.26		
20	0.16	0.16	0.16	0.16	0.17	0.17	0.38	0.72	1.13	1.67	1.91	2.11	2.42	2.98	3.71	4.33	4.48		
21	0.16	0.16	0.16	0.16	0.17	0.15	0.36	0.74	1.20	1.69	1.92	2.22	2.79	3.42	4.06	4.49	4.44		
22	0.16	0.16	0.16	0.16	0.17	0.15	0.40	0.77	1.28	1.71	1.98	2.40	3.05	3.86	4.56	4.81	4.77		
23	0.16	0.16	0.16	0.16	0.17	0.15	0.44	0.81	1.38	1.76	2.02	2.72	3.59	4.39	4.82	5.14			
24	0.16	0.16	0.16	0.16	0.16	0.15	0.47	0.84	1.46	1.81	2.16	3.20	3.96	4.69	5.14	5.46	5.56		
25	0.16	0.16	0.16	0.16	0.15	0.14	0.49	0.88	1.52	1.86	2.40	3.79	4.61	5.39	6.17	7.01			
26	0.16	0.16	0.16	0.16	0.15	0.14	0.53	0.96	1.57	1.90	2.79	4.45	5.11	6.70	8.24	8.97			
27	0.16	0.16	0.16	0.16	0.15	0.14	0.57	1.04	1.61	1.94	3.36	5.21	5.97	8.73	10.30	11.45			
28	0.16	0.16	0.16	0.16	0.15	0.14	0.61	1.11	1.64	1.98	3.89	6.07	7.62	10.32	11.48				
29	0.16	0.16	0.16	0.16	0.15	0.14	0.61	1.16	1.70	2.02	4.35	7.40	9.36	11.82	14.00				
30	0.16	0.16	0.16	0.16	0.15	0.14	0.62	1.22	1.75	2.04	4.59	8.63	10.87	13.17	16.48				
31	0.16	0.16	0.16	0.16	0.15	0.14	0.67	1.28	1.84	2.07	4.87	9.77	11.70	15.99	19.44				
32	0.16	0.16	0.16	0.16	0.15	0.16	0.72	1.31	1.91	2.10	5.01	10.30	14.54	19.97	22.31				
33	0.16	0.16	0.16	0.16	0.15	0.21	0.77	1.33	1.95	2.13	5.11	10.69	19.45	26.05	27.40				
34	0.16	0.16	0.16	0.16	0.17	0.27	0.78	1.36	1.96	2.15	5.00	10.88	25.54	31.98	32.27				
35	0.16	0.16	0.16	0.16	0.18	0.31	0.81	1.39	1.97	2.16	4.90	10.98	30.20	37.26	38.00				
36	0.15	0.15	0.16	0.16	0.21	0.34	0.84	1.43	1.99	2.16	4.69	10.97	33.11	42.15	42.68				
37	0.15	0.15	0.15	0.15	0.22	0.36	0.88	1.50	1.99	2.24	4.56	10.71	34.85	44.06	45.22				
38	0.14	0.14	0.15	0.15	0.26	0.42	0.91	1.61	2.01	2.33	4.45	10.59	36.04	45.91	46.92				
39	0.14	0.14	0.14	0.14	0.28	0.48	0.95	1.71	2.02	2.54	4.45	10.84	37.44	46.29	47.58				
40	0.14	0.14	0.14	0.14	0.31	0.56	0.99	1.77	2.05	2.81	4.49	11.50	38.82	48.47	49.46				
41	0.14	0.14	0.14	0.14	0.31	0.60	1.03	1.78	2.07	3.16	4.60	12.23	40.26	48.49	50.09				
42	0.14	0.14	0.14	0.14	0.30	0.62	1.07	1.80	2.10	3.50	4.68	12.99	41.47	48.81	50.65				
43	0.14	0.14	0.14	0.14	0.29	0.61	1.11	1.81	2.14	3.81	4.83	13.60	43.24	47.90	50.34				
44	0.16	0.16	0.15	0.14	0.27	0.60	1.15	1.83	2.15	4.03	4.90	14.85	45.47	48.87	51.28				
45	0.17	0.17	0.17	0.16	0.26	0.59	1.20	1.86	2.17	4.50	5.31	16.00	46.10	49.51	52.01				
46	0.19	0.19	0.18	0.17	0.25	0.59	1.21	1.89	2.28	4.87	5.90	17.33	45.99	50.91	53.85				
47	0.19	0.19	0.19	0.19	0.25	0.59	1.22	1.94	2.41	5.19	6.87	17.97	45.10	51.96	56.79				
48	0.19	0.19	0.19	0.19	0.28	0.59	1.21	1.97	2.65	5.38	8.02	18.63	46.24	52.97	57.82				
49	0.19	0.19	0.19	0.19	0.31	0.58	1.21	2.02	2.90	5.81	9.43	19.17	47.16	53.44	57.58				
50	0.18	0.19	0.19	0.19	0.33	0.57	1.23	2.03	3.15	6.78	10.49	19.37	48.79	53.12	54.48				
51	0.18	0.19	0.19	0.19	0.34	0.57	1.27	2.04	3.31	7.98	11.26	19.33	48.79	52.43					
52	0.17	0.18	0.19	0.19	0.37	0.61	1.35	2.02	3.37	9.06	11.75	18.88	49.51	52.51					
53	0.17	0.18	0.18	0.19	0.40	0.63	1.43	2.03	3.46	9.94	12.56	19.18	49.72	52.77					
54	0.17	0.17	0.18	0.18	0.42	0.67	1.49	2.04	3.53	10.54	13.62	21.35	50.63	52.72					
55	0.17	0.17	0.18	0.18	0.47	0.71	1.51	2.05	3.69	11.31	14.45	24.74	51.04	52.99					
56	0.17	0.17	0.18	0.18	0.52	0.74	1.53	2.05	3.80	11.90	15.69	28.79	51.36	53.71					
57	0.17	0.17	0.17	0.17	0.59	0.75	1.57	2.12	3.93	12.61	18.82	32.22	51.15	54.20					
58	0.17	0.17	0.17	0.17	0.62	0.77	1.60	2.19	3.95	14.43	22.28	35.17	50.82	54.29					
59	0.18	0.18	0.18	0.18	0.65	0.79	1.63	2.26	3.96	17.22	25.32	37.86	50.18	53.50					
60	0.19	0.19	0.18	0.18	0.66	0.81	1.65	2.31	4.05	19.93	28.91	41.01	50.41	52.63					
61	0.19	0.19	0.19	0.19	0.66	0.83	1.69	2.42	4.26	22.14	32.69	44.22	50.56	51.81					
62	0.19	0.19	0.19	0.19	0.65	0.85	1.74	2.53	4.47	23.51	37.60	47.05	51.28	51.72					
63	0.19	0.19	0.19	0.19	0.64	0.90	1.79	2.69	4.57	25.71	41.17	48.15	51.93	53.29					
64	0.19	0.19	0.19	0.19	0.61	0.93	1.82	2.79	4.64	27.40	44.87	48.78	52.97						
65	0.19	0.19	0.19	0.19	0.56	0.93	1.84	2.98	5.03	29.82	47.41	48.90							
66	0.19	0.19	0.19	0.19	0.51	0.92	1.87	3.13	5.63	32.51	48.56								
67	0.19	0.19	0.19	0.19	0.49	0.90	1.93	3.38	6.31	35.06	47.26								
68	0.19	0.19	0.19	0.19	0.47	0.91	1.98	3.53	6.65	36.57	46.38								
69	0.19	0.19	0.19	0.19	0.46	0.94	2.00	3.68	6.79	37.60	45.94								
70	0.19	0.19	0.19	0.19	0.46	0.97	2.01	3.89	6.88	38.87	47.91								
71	0.19	0.19	0.19	0.19	0.47	1.00	2.04	4.08	7.28	40.93	49.40								
72	0.19	0.19	0.19	0.19	0.47	1.04	2.07	4.35											



		Jeep Grand Cherokee HC Emissions, mg/s																	
f/s	f/s/s	-5	-4	-3	-2	-1	0	1	2	3	4	5	6	7	8	9	10	11	12
81	0.18	0.18	0.17	0.17	0.48	1.32	1.99	8.36	16.61	48.43	52.79								
82	0.17	0.17	0.17	0.17	0.55	1.96	1.99	8.69	16.61	48.54	52.72								
83	0.18	0.17	0.17	0.17	0.60	1.37	2.04	9.06	16.98	48.12	53.38								
84	0.18	0.17	0.17	0.17	0.63	1.35	2.10	9.35	17.78	48.45	55.57								
85	0.18	0.17	0.17	0.17	0.63	1.34	2.17	9.69	18.62	48.72	57.25								
86	0.18	0.17	0.17	0.17	0.64	1.37	2.21	9.93	19.31	49.17	57.91								
87	0.17	0.17	0.16	0.17	0.67	1.44	2.24	10.13	19.48	48.39	56.28								
88	0.18	0.17	0.15	0.17	0.73	1.48	2.25	10.37	20.23	49.82	54.94								
89	0.18	0.17	0.15	0.17	0.83	1.53	2.28	11.65	21.76	51.50	53.85								
90	0.18	0.17	0.16	0.17	0.93	1.66	2.38	14.08	23.70	53.26	54.06								
91	0.18	0.16	0.17	0.17	0.98	1.80	2.42	16.75	26.06	53.48	54.74								
92	0.17	0.15	0.17	0.17	1.02	1.91	2.43	18.87	29.39	53.27	54.58								
93	0.18	0.13	0.17	0.17	1.05	1.92	2.38	20.70	33.02	53.77	54.39								
94	0.18	0.13	0.17	0.17	1.09	1.94	2.45	22.96	36.62	53.75	54.03								
95	0.18	0.14	0.17	0.17	1.12	1.94	2.65	25.22	38.44	53.92	53.98								
96	0.17	0.15	0.17	0.17	1.11	1.88	2.95	26.96	42.14	55.05	55.05								
97	0.17	0.15	0.17	0.17	1.06	1.81	3.19	29.52	45.37	55.00	55.00								
98	0.18	0.16	0.17	0.17	1.01	1.80	3.46	31.72	47.96	54.66	54.66								
99	0.18	0.17	0.17	0.17	1.02	1.92	3.80	34.66	48.49	53.18	54.11								
100	0.18	0.17	0.17	0.17	1.09	2.01	4.18	36.33	48.21	53.21	54.01								
101	0.18	0.17	0.17	0.17	1.19	2.03	4.56	39.04	48.94	52.76	53.80								
102	0.18	0.17	0.17	0.17	1.26	1.99	4.68	41.42	48.52	52.14	53.52								
103	0.17	0.17	0.17	0.17	1.27	1.99	5.21	43.44	47.52	51.59	53.49								
104	0.17	0.17	0.17	0.17	1.24	2.05	5.57	42.67	46.19	52.17	53.56								
105	0.17	0.17	0.17	0.17	1.29	2.09	6.15	41.32	45.40	53.84	53.84								
106	0.18	0.17	0.17	0.17	1.36	2.11	6.28	40.25	45.73	53.80	53.84								
107	0.17	0.17	0.17	0.17	1.42	2.39	6.83	41.43	46.27	53.16	53.16								
108	0.17	0.18	0.17	0.17	1.44	2.67	8.24	42.91	47.28	51.46	51.46								
109	0.16	0.18	0.17	0.19	1.66	3.05	12.12	44.91	48.57	51.45									
110	0.16	0.18	0.17	0.20	1.87	3.13	15.58	46.24	49.55	51.39									

Jeep Grand Cherokee NOx Emissions, mg/s																			
ft/s	ft/s/s	-5	-4	-3	-2	-1	0	1	2	3	4	5	6	7	8	9	10	11	12
0	0.22	0.22	0.22	0.23	0.23	0.23	0.23	0.22	0.21	0.24	0.24	0.25	0.25	0.48	0.58	0.56	0.36	0.62	19.92
1	0.22	0.22	0.22	0.23	0.23	0.23	0.23	0.22	0.37	0.35	0.24	0.25	0.27	0.63	0.86	0.52	0.36	0.56	14.26
2	0.22	0.22	0.22	0.23	0.23	0.23	0.22	0.23	0.66	0.77	0.34	0.40	0.33	0.91	1.66	0.54	0.37	0.51	14.37
3	0.22	0.22	0.22	0.22	0.22	0.22	0.22	0.23	1.09	1.40	0.83	0.78	0.77	1.55	4.31	1.09	0.41	0.47	15.06
4	0.22	0.22	0.22	0.22	0.22	0.22	0.22	0.23	1.39	1.96	1.51	1.71	1.97	3.81	7.57	4.68	0.63	0.54	16.56
5	0.22	0.22	0.22	0.22	0.22	0.22	0.22	0.23	1.57	2.23	2.62	4.28	7.17	8.11	12.20	8.93	1.57	1.06	19.16
6	0.22	0.22	0.22	0.22	0.21	0.22	0.22	0.23	1.55	2.29	4.52	10.31	14.95	15.01	15.01	12.77	6.44	11.38	28.87
7	0.22	0.22	0.22	0.22	0.21	0.22	0.22	0.23	1.48	2.31	5.99	17.73	22.37	21.26	16.90	13.59	16.29	26.28	42.45
8	0.22	0.22	0.22	0.22	0.21	0.22	0.22	0.22	1.23	2.29	6.77	23.22	25.73	28.07	16.80	13.12	28.11	42.12	50.09
9	0.22	0.22	0.22	0.22	0.21	0.22	0.22	1.11	2.27	5.60	25.18	27.14	29.29	19.55	18.24	38.32	50.63	52.38	
10	0.21	0.21	0.22	0.22	0.26	0.21	0.26	1.06	2.27	5.86	25.06	28.14	29.58	23.36	25.42	43.79	56.06	56.06	
11	0.21	0.21	0.22	0.22	0.32	0.27	0.30	1.30	2.95	7.06	26.08	29.18	28.44	28.81	37.32	49.02	55.96	55.96	
12	0.22	0.21	0.22	0.22	0.40	0.34	0.40	1.80	3.65	10.51	27.41	29.37	29.92	31.74	46.37	52.75	53.13	53.13	
13	0.22	0.21	0.22	0.22	0.52	0.52	0.58	2.49	4.35	14.33	28.82	30.20	31.24	34.99	55.04	55.04	55.04	55.04	
14	0.22	0.22	0.22	0.22	0.66	0.70	0.83	3.36	4.96	18.31	28.71	31.66	31.09	38.90	57.52	57.52	57.52	57.52	
15	0.22	0.22	0.22	0.22	0.77	0.91	1.13	4.00	5.95	22.53	28.15	33.81	32.83	43.85	55.89	55.89	55.89	55.89	
16	0.22	0.22	0.22	0.22	0.71	0.92	1.52	4.51	8.59	26.06	28.38	36.05	34.67	50.14	52.43	52.43	52.43	52.43	
17	0.22	0.22	0.22	0.22	0.62	0.86	1.81	4.75	12.10	27.16	30.51	38.17	35.87	52.93	49.02	49.02	49.02	49.02	
18	0.22	0.22	0.22	0.22	0.51	0.72	2.05	4.88	15.87	26.20	33.75	40.41	36.49	54.27	45.95	45.95	45.95	45.95	
19	0.22	0.22	0.22	0.22	0.47	0.58	1.78	5.01	18.47	24.94	37.42	43.52	41.66	51.25	42.96	42.96	42.96	42.96	
20	0.22	0.22	0.22	0.22	0.42	0.45	1.55	5.12	19.62	26.08	41.97	46.22	46.84	48.94	48.94	48.94	48.94	48.94	
21	0.22	0.22	0.22	0.22	0.42	0.37	1.32	5.40	20.35	29.62	49.31	48.07	49.37	43.49	43.49	43.49	43.49	43.49	
22	0.22	0.22	0.22	0.22	0.40	0.37	1.65	5.72	21.30	35.02	55.75	44.75	46.85	39.50	39.50	39.50	39.50	39.50	
23	0.22	0.22	0.22	0.22	0.37	0.35	2.00	6.30	22.94	41.31	54.15	41.10	41.80	39.93	39.93	39.93	39.93	39.93	
24	0.22	0.22	0.22	0.22	0.33	0.32	2.29	6.84	25.07	45.54	47.13	35.84	38.39	44.45	44.45	44.45	44.45	44.45	
25	0.22	0.22	0.22	0.22	0.31	0.29	2.37	7.75	27.26	49.16	39.07	34.45	38.88	50.93	50.93	50.93	50.93	50.93	
26	0.22	0.22	0.22	0.22	0.29	0.28	2.72	10.44	28.18	51.43	35.86	34.94	45.97	53.32	53.32	53.32	53.32	53.32	
27	0.22	0.22	0.22	0.22	0.28	0.28	3.06	13.92	28.98	52.98	34.33	40.69	53.47	55.79	55.79	55.79	55.79	55.79	
28	0.22	0.22	0.22	0.22	0.28	0.28	3.36	17.14	29.39	52.42	34.24	49.19	59.25	56.67	56.67	56.67	56.67	56.67	
29	0.22	0.22	0.22	0.22	0.28	0.28	3.51	19.60	30.91	50.63	35.75	58.84	60.82	59.20	59.20	59.20	59.20	59.20	
30	0.22	0.22	0.22	0.22	0.28	0.27	3.71	21.65	32.70	49.04	37.92	63.69	62.84	62.85	62.85	62.85	62.85	62.85	
31	0.22	0.22	0.22	0.22	0.28	0.29	4.33	23.38	34.89	47.31	39.29	64.40	65.25	65.42	65.42	65.42	65.42	65.42	
32	0.22	0.22	0.22	0.22	0.28	0.37	4.94	24.20	37.58	46.52	40.29	63.21	68.07	65.23	65.23	65.23	65.23	65.23	
33	0.22	0.22	0.22	0.22	0.29	0.59	5.73	24.66	39.87	46.03	40.96	63.11	68.18	58.31	58.31	58.31	58.31	58.31	
34	0.22	0.22	0.22	0.22	0.35	0.86	6.11	25.51	42.53	46.90	40.60	64.31	63.81	52.68	52.68	52.68	52.68	52.68	
35	0.22	0.22	0.22	0.22	0.42	1.07	6.67	26.23	44.17	47.59	39.92	64.58	58.90	50.89	50.89	50.89	50.89	50.89	
36	0.22	0.22	0.22	0.22	0.56	1.21	7.02	27.05	46.24	48.53	38.14	65.20	56.31	60.30	60.30	60.30	60.30	60.30	
37	0.21	0.21	0.22	0.22	0.62	1.33	8.41	28.48	48.35	46.66	37.63	64.36	57.98	67.64	67.64	67.64	67.64	67.64	
38	0.21	0.21	0.21	0.21	0.80	1.72	9.49	30.56	51.11	42.60	37.45	63.23	60.68	72.59	72.59	72.59	72.59	72.59	
39	0.21	0.21	0.21	0.21	0.91	2.32	11.41	32.34	53.95	38.12	38.01	61.44	62.55	69.91	69.91	69.91	69.91	69.91	
40	0.21	0.21	0.21	0.21	1.03	3.10	12.67	33.29	54.43	35.80	38.93	60.62	63.14	69.29	69.29	69.29	69.29	69.29	
41	0.21	0.21	0.21	0.21	1.03	3.60	14.15	33.40	52.95	35.33	41.40	60.34	63.25	67.26	67.26	67.26	67.26	67.26	
42	0.21	0.21	0.21	0.21	0.97	3.90	15.81	34.02	50.26	35.17	43.81	60.99	65.34	63.44	63.44	63.44	63.44	63.44	
43	0.21	0.21	0.21	0.21	0.94	3.73	17.86	34.51	47.37	34.11	47.35	61.86	67.61	67.61	67.61	67.61	67.61	67.61	
44	0.30	0.30	0.27	0.21	0.85	3.70	19.86	35.21	47.15	33.49	48.70	61.60	70.70	70.70	70.70	70.70	70.70	70.70	
45	0.39	0.39	0.36	0.30	0.80	3.60	21.28	35.63	46.54	35.30	50.85	60.37	69.55	69.55	69.55	69.55	69.55	69.55	
46	0.48	0.48	0.45	0.39	0.72	3.66	22.11	37.17	45.04	39.15	52.01	58.85	67.56	67.56	67.56	67.56	67.56	67.56	
47	0.48	0.48	0.48	0.48	0.71	3.67	22.16	39.77	42.63	44.05	53.83	59.91	66.02	66.02	66.02	66.02	66.02	66.02	
48	0.47	0.48	0.48	0.48	0.89	3.58	21.75	42.56	40.55	49.38	54.68	60.95	67.09	67.09	67.09	67.09	67.09	67.09	
49	0.46	0.48	0.48	0.48	1.06	3.28	21.14	44.93	39.07	54.15	56.47	62.20	67.11	67.11	67.11	67.11	67.11	67.11	
50	0.44	0.48	0.48	0.48	1.19	3.13	21.54	46.05	37.50	58.06	57.62	62.03	66.85	66.85	66.85	66.85	66.85	66.85	
51	0.46	0.49	0.48	0.48	1.25	3.08	22.60	46.68	36.48	59.65	58.98	60.74	60.74	60.74	60.74	60.74	60.74	60.74	
52	0.48	0.51	0.50	0.49	1.39	3.51	24.12	48.10	37.49	59.63	59.45	61.33	61.33	61.33	61.33	61.33	61.33	61.33	
53	0.51	0.52	0.53	0.51	1.55	3.87	25.48	48.79	37.92	60.09	59.99	62.26	62.26	62.26	62.26	62.26	62.26	62.26	
54	0.51	0.53	0.55	0.53	1.65	4.47	26.84	50.93	38.45	60.11	60.01	62.71	62.71	62.71	62.71	62.71	62.71	62.71	
55	0.51	0.52	0.55	0.55	2.17	4.90	28.36	51.12	37.68	60.76	63.25	60.81	60.81	60.81	60.81	60.81	60.81	60.81	
56	0.51	0.52	0.54	0.53	2.67	5.17	29.77	51.72	37.64	61.63	66.08	59.75	59.75	59.75	59.75	59.75	59.75	59.75	
57	0.51	0.51	0.52	0.52	3.40	5.43	30.82	49.36	37.60	63.56	66.74	60.53	60.53	60.53	60.53	60.53	60.53	60.53	
58	0.52	0.53	0.51	0.51	3.67	5.83	31.42	48.56	38.45	64.67	63.07	61.41	61.41	61.41	61.41	61.41	61.41	61.41	
59	0.55	0.56	0.54	0.54	3.98	6.87	31.72	46.72	38.94	63.64	59.60	60.21	60.21	60.21	60.21	60.21	60.21	60.21	
60	0.58	0.59	0.57	0.57	4.08	7.66	31.65	46.76	40.50	61.31	55.76	60.38	60.38	60.38	60.38	60.38	60.38	60.38	
61	0.60	0.60	0.60	0.60	4.19	8.53	32.36	44.13	40.84	58.71	53.20	63.31	63.31	63.31	63.31	63.31	63.31	63.31	
62	0.60	0.60	0.60	0.59	4.25	9.05	34.06	43.08	41.11	57.05	51.92	66.45	66.45	66.45	66.45	66.45	66.45	66.45	
63	0.60	0.60	0.60	0.58	4.25	10.39	35.95	41.51	40.41	54.90	57.49	67.80	67.80	67.80	67.80	67.80	67.80	67.80	
64	0.60	0.60	0.60	0.57	3.92	11.25	36.99	42.61	42.16	54									

		Jeep Grand Cherokee NOx Emissions, mg/s																	
ft/s	ft/s/s	-5	-4	-3	-2	-1	0	1	2	3	4	5	6	7	8	9	10	11	12
81	0.58	0.44	0.45	0.53	2.99	23.04	38.87	57.91	62.32	67.53	67.53								
82	0.49	0.43	0.46	0.51	4.42	25.64	39.89	57.38	61.22	65.93	65.93								
83	0.56	0.42	0.43	0.46	5.81	26.72	42.01	57.77	60.83	62.94	62.94								
84	0.56	0.42	0.42	0.42	6.54	26.76	43.75	59.16	62.60	60.73	60.73								
85	0.54	0.42	0.42	0.42	6.54	26.35	46.02	60.51	64.32	59.93	59.93								
86	0.52	0.42	0.40	0.42	6.77	26.02	46.41	62.75	66.30	62.10	62.10								
87	0.50	0.42	0.35	0.42	7.40	26.32	47.19	65.07	66.16	59.64	59.64								
88	0.52	0.42	0.30	0.42	9.81	26.35	47.23	66.92	65.40	60.04	60.04								
89	0.54	0.42	0.30	0.42	12.62	27.38	47.07	67.38	63.73	63.73	63.73								
90	0.56	0.42	0.35	0.42	15.54	29.75	45.91	66.53	61.53	61.53	61.53								
91	0.57	0.37	0.40	0.40	16.20	32.99	45.57	65.28	58.64	58.64	58.64								
92	0.50	0.30	0.42	0.40	16.85	36.01	45.50	62.84	54.71	54.71	54.71								
93	0.58	0.23	0.42	0.40	17.66	36.44	46.52	61.87	51.25	51.25	51.25								
94	0.51	0.20	0.42	0.42	18.94	37.43	45.89	61.03	52.60	52.60	52.60								
95	0.56	0.23	0.42	0.42	19.21	38.55	45.18	59.86	54.81	54.81	54.81								
96	0.45	0.25	0.42	0.42	18.38	38.62	45.76	57.95	60.82	60.82	60.82								
97	0.50	0.30	0.42	0.42	16.46	37.05	46.62	55.78	64.92	64.92	64.92								
98	0.52	0.36	0.42	0.42	15.05	37.06	49.75	54.41	68.42	68.42	68.42								
99	0.54	0.42	0.42	0.42	15.14	42.54	50.57	52.95	68.07	68.07	68.07								
100	0.56	0.46	0.44	0.42	18.35	50.68	50.83	52.99	66.32	66.32	66.32								
101	0.56	0.42	0.46	0.42	21.74	55.61	48.99	57.87	67.74	67.74	67.74								
102	0.52	0.41	0.48	0.43	24.89	56.18	48.16	63.11	68.99	68.99	68.99								
103	0.48	0.43	0.47	0.45	25.81	55.75	48.59	67.49	70.29	70.29	70.29								
104	0.48	0.48	0.47	0.48	27.22	52.04	49.28	65.55	70.00	70.00	70.00								
105	0.49	0.51	0.48	0.50	27.49	48.47	50.08	63.74	70.13	70.13	70.13								
106	0.52	0.49	0.50	0.53	24.97	43.08	50.31	62.66	69.82	69.82	69.82								
107	0.45	0.50	0.50	0.55	21.31	39.84	51.11	65.23	69.44	69.44	69.44								
108	0.43	0.52	0.50	0.52	18.76	37.65	54.19	67.80	69.02	69.02	69.02								
109	0.37	0.55	0.50	0.65	19.10	34.93	55.84	69.95	69.41	69.41	69.41								
110	0.36	0.55	0.5	0.77	19.8	34.04	56.81	70.06	70.03	70.03	70.03								

Chevrolet Truck Fuel Consumption, gal/h																			
ft/s	ft/s/s	-5	-4	-3	-2	-1	0	1	2	3	4	5	6	7	8	9	10	11	12
0	0.54	0.54	0.54	0.54	0.54	0.54	0.54	0.54	0.57	0.73	0.83	0.98	1.15	1.52	1.87	2.34	2.85	3.35	
1	0.54	0.54	0.54	0.54	0.54	0.54	0.55	0.54	0.58	0.78	0.89	1.06	1.24	1.54	1.9	2.48	2.78	3.22	
2	0.54	0.54	0.54	0.54	0.54	0.54	0.56	0.54	0.6	0.83	0.98	1.2	1.4	1.69	2.05	2.61	2.77	3.18	5.57
3	0.56	0.56	0.56	0.56	0.56	0.56	0.58	0.54	0.63	0.87	1.06	1.32	1.59	1.89	2.32	2.77	3.01	3.43	5.57
4	0.6	0.6	0.6	0.6	0.6	0.6	0.58	0.56	0.65	0.89	1.19	1.43	1.75	2.04	2.6	2.95	3.27	3.68	5.53
5	0.61	0.61	0.61	0.61	0.61	0.61	0.6	0.59	0.66	0.91	1.34	1.52	1.89	2.19	2.77	3.06	3.51	3.93	5.51
6	0.61	0.61	0.61	0.61	0.61	0.61	0.62	0.62	0.67	0.93	1.42	1.64	1.98	2.36	2.92	3.23	3.78	4.3	5.5
7	0.6	0.61	0.61	0.61	0.61	0.61	0.62	0.65	0.72	1	1.48	1.62	2.02	2.43	3.06	3.46	4.05	4.47	5.5
8	0.6	0.62	0.62	0.62	0.62	0.62	0.61	0.64	0.79	1.18	1.62	1.73	1.99	2.47	3.13	3.66	4.28	4.63	5.77
9	0.6	0.6	0.62	0.62	0.62	0.62	0.66	0.7	1.04	1.42	1.71	1.82	2.11	2.69	3.32	3.83	4.46	4.86	6.21
10	0.6	0.6	0.62	0.62	0.62	0.62	0.72	0.74	1.34	1.59	1.83	1.92	2.28	2.85	3.45	3.9	4.6	5.27	6.54
11	0.6	0.6	0.6	0.6	0.6	0.6	0.76	0.79	1.69	1.79	1.9	2.07	2.42	3.01	3.51	3.98	4.84	5.66	6.66
12	0.6	0.6	0.6	0.58	0.58	0.62	0.69	1.84	1.85	1.98	2.21	2.58	3.13	3.64	4.2	4.85	5.75	6.66	
13	0.6	0.6	0.6	0.57	0.57	0.57	0.59	1.88	1.86	1.98	2.36	2.75	3.17	3.85	4.38	4.86	5.92	6.73	
14	0.59	0	0	0.59	0.59	0.58	0.63	1.9	1.85	1.93	2.49	2.99	3.26	4.05	4.5	4.91	6.23	7.13	
15	0.59	0	0.59	0.59	0.59	0.61	0.66	1.88	1.97	2.18	2.67	3.1	3.37	4.27	4.63	5.18	6.69	7.61	
16	0.59	0.57	0.57	0.57	0.6	0.65	0.7	1.88	2.05	2.36	2.88	3.2	3.46	4.54	4.88	5.41	7.01	7.8	
17	0.57	0.57	0.57	0.57	0.64	0.67	0.73	1.9	2.1	2.47	3.1	3.29	3.66	4.81	5.05	5.6	7.26	8.07	
18	0.57	0.58	0.58	0.58	0.65	0.71	0.75	1.93	2.13	2.61	3.26	3.34	3.99	4.9	5.15	5.69	7.47	8.34	
19	0.57	0.57	0.57	0.58	0.66	0.76	0.82	1.95	2.15	2.79	3.4	3.4	4.33	5.03	5.32	5.83	7.88	8.55	
20	0.57	0.57	0.57	0.59	0.67	0.79	0.9	1.95	2.15	2.99	3.48	3.51	4.72	5.21	5.68	6.1	8.33	9	
21	0.58	0.58	0.58	0.61	0.67	0.85	1.05	1.95	2.16	3.05	3.52	3.68	5.01	5.39	5.88	6.34	8.68	9.54	
22	0.59	0.59	0.61	0.61	0.65	0.9	1.13	1.98	2.18	3.25	3.61	4.08	5.21	5.55	6	6.39	9.2	9.97	
23	0.59	0.59	0.61	0.62	0.73	1	1.21	2.02	2.21	3.37	3.68	4.57	5.31	5.78	6.21	6.54	9.65	10.16	
24	0.59	0.62	0.62	0.62	0.85	1.09	1.25	2.05	2.26	3.4	3.65	4.83	5.44	6.05	6.49	6.91	9.98	10.4	
25	0.59	0.59	0.63	0.64	0.95	1.13	1.33	2.07	2.32	3.44	3.72	4.95	5.63	6.16	6.67	7.3	10.28	10.76	
26	0.59	0.59	0.64	0.66	0.91	1.13	1.48	2.08	2.43	3.45	3.75	5.08	5.63	6.28	6.85	7.86	10.72	11.12	
27	0.59	0.59	0.64	0.91	0.91	1.08	1.59	2.11	2.57	3.39	3.9	5.12	5.84	6.44	7.24	8.61	11.08	11.55	
28	0.58	0.59	0.64	0.64	0.85	1	1.6	2.15	2.63	3.37	4.06	5.24	6.07	6.6	7.43	9.32	11.5	11.92	
29	0.58	0.59	0.59	0.82	0.82	0.96	1.53	2.18	2.76	3.38	4.26	5.3	6.14	6.84	7.52	10.46	11.75	12.09	
30	0.58	0.59	0.59	0.85	0.85	0.96	1.42	2.18	2.84	3.38	4.37	5.48	6.31	6.93	7.81	11.03	12.07	12.41	
31	0.58	0.6	0.6	0.87	0.87	0.96	1.36	2.2	2.97	3.45	4.59	5.55	6.38	7.1	8.35	11.24	12.48	13	
32	0.59	0.6	0.6	0.85	0.85	0.96	1.43	2.19	3.1	3.54	4.68	5.63	6.46	7.45	8.6	11.53	12.83	13.27	
33	0.59	0.6	0.6	0.86	0.86	0.97	1.55	2.22	3.24	3.7	4.74	5.79	6.49	7.54	8.84	12.11	13.11	13.56	
34	0.6	0.61	0.61	0.93	0.93	1.02	1.72	2.28	3.38	3.81	4.78	5.85	6.5	7.68	9.5	12.54	13.33	13.88	
35	0.61	0.61	0.61	1	1	1.05	1.7	2.34	3.47	3.93	4.78	5.92	6.64	7.83	10.09	12.9	13.57	14.09	
36	0.61	0.61	0.61	1.05	1.05	1.08	1.8	2.34	3.55	4.01	4.83	5.99	6.64	7.99	10.68	13.2	13.92	14.35	
37	0.61	0.6	0.6	1.09	1.09	1.12	1.81	2.41	3.59	4.21	4.93	6.08	6.61	8.19	11.31	13.63	14.26	14.63	
38	0.61	0.6	0.6	1.12	1.12	1.14	1.91	2.56	3.63	4.4	5.07	6.23	6.75	8.31	12.18	13.61	14.53	14.85	
39	0.6	0.59	0.59	1.12	1.12	1.14	1.94	2.75	3.68	4.49	5.23	6.26	6.88	8.61	12.57	13.79	14.72		
40	0.59	0.59	0.59	1.13	1.13	1.12	2.01	2.86	3.72	4.62	5.37	6.34	7.07	9.37	12.92	14.3	15.06		
41	0.59	0.59	0.59	1.09	1.09	1.09	1.98	2.98	3.8	4.76	5.6	6.42	7.21	10.06	13.34	14.49	15.17		
42	0.59	0.59	0.59	1.14	1.14	1.09	2.06	3.01	3.86	4.87	5.72	6.5	7.31	10.87	13.33	14.87	15.36		
43	0.59	0.59	0.59	1.13	1.13	1.12	2.1	3.05	3.89	4.98	5.84	6.59	7.66	11.14	13.34	15.34	15.75		
44	0.58	0.58	0.58	1.12	1.12	1.14	2.12	3.1	3.95	5.11	5.97	6.76	7.84	11.79	13.76	15.59	15.77		
45	0.58	0.58	0.58	1.14	1.14	1.16	2.13	3.14	4.02	5.23	6.11	6.87	8.2	12.01	13.92	15.73			
46	0.58	0.58	0.58	1.14	1.14	1.19	2.11	3.19	4.02	5.28	6.37	7.01	9.01	11.8	13.75	15.81			
47	0.59	0.58	0.58	1.14	1.14	1.26	2.12	3.24	4.15	5.36	6.53	7.23	9.49	12.05	13.84	15.79			
48	0.59	0.59	0.59	1.2	1.2	1.33	2.14	3.28	4.3	5.41	6.73	7.37	9.9	12.5	14.36	15.88			
49	0.59	0.6	0.6	1.25	1.25	1.41	2.16	3.26	4.39	5.53	6.92	7.63	10.6	12.46	14.38	15.88			
50	0.6	0.61	0.61	1.26	1.26	1.48	2.17	3.23	4.56	5.6	7.03	7.98	11.03	12.55	14.46	15.97			
51	0.61	0.61	0.61	1.32	1.32	1.42	2.18	3.36	4.7	5.75	7.16	8.44	11.26	12.74	14.29	16.03			
52	0.62	0.61	0.61	1.35	1.35	1.45	2.2	3.45	4.79	5.88	7.3	8.77	11.54	12.94	14.32				
53	0.62	0.62	0.62	1.37	1.37	1.45	2.22	3.5	4.81	6	7.41	9.01	11.76	12.98	14.5				
54	0.62	0.63	0.63	1.39	1.39	1.46	2.25	3.64	4.88	6.11	7.51	9.27	11.89	13.06	14.49				
55	0.62	0.63	0.63	1.41	1.41	1.55	2.32	3.67	4.89	6.45	7.57	9.97	12.09	13.09	14.64				
56	0.62	0.64	0.64	1.44	1.44	1.56	2.51	3.78	4.86	6.65	7.71	10.27	12.33	13.16	14.65				
57	0.63	0.64	0.64	1.44	1.44	1.55	2.52	3.89	4.86	6.86	7.78	10.57	12.4	13.24	15.03				
58	0.63	0.63	0.63	1.45	1.45	1.5	2.6	3.93	4.9	7.01	7.95	10.95	12.58	13.32					
59	0.63	0.64	0.64	1.47	1.47	1.49	2.41	3.97	5	7.06	8.18	11.23	12.81	13.36					
60	0.64	0.64	0.64	1.49	1.49	1.49	2.4	3.95	5.09	7.11	8.54	11.58	12.99	13.49					
61	0.65	0.65	0.65	1.51	1.51	1.51	2.49	3.98	5.39	7.13	8.88	11.97	13.26	13.58					
62	0.66	0.65	0.65	1.52	1.52	1.53	2.61	4.06	5.45	7.15	9.25	12.23	13.34	13.65					
63	0.67	0.66	0.66	1.56	1.56	1.59	2.63	4.19	5.51	7.18	9.59	12.51	13.59	13.75					
64	0.68	0.67	0.67	1.6	1.6	1.63	2.58	4.29	5.59	7.29	9.91	12.92	13.76	13.82					
65	0.7	0.68	0.68	1.6	1.6	1.64	2.58	4.23	5.66	7.41	10.22	13.1	13.89						
66	0.71	0.69	0.69	1.64	1.64	1.66	2.58	4.24	5.74	7.53	10.51	13.35	14						
67	0.72	0.7	0.7	1.71	1.71	1.66	2.64	4.26	5.91	7.83	10.69	13.64	14.17						
68	0.73	0.72	0.72	1.77	1.77	1.65	2.71	4.33	6.07	7.99	10.99	13.85	14.37						
69	0.74	0.73	0.73	1.76	1.76	1.75	2.77	4.47	6.14	7.97	11.33	14.09	14.48						
70	0.75	0.75	0.75	1.8	1.8	1.81	2.76	4.55	6.24	8.06	11.82	14.16	14.59						

		Chevrolet Truck Fuel Consumption, gal/h																	
ft/s	ft/s/s	-5	-4	-3	-2	-1	0	1	2	3	4	5	6	7	8	9	10	11	12
81	0.53	0.51	0.55	0.49	1.88	2.17	3.76	5.45	7.88	10.89	14.88	16.21							
82	0.45	0.46	0.51	0.42	1.84	2.26	3.8	5.57	8.16	11.12	14.87	16.37							
83	0.36	0.37	0.5	0.38	1.63	2.4	3.8	5.51	8.33	11.29	15.19	16.5							
84	0.3	0.31	0.51	0.35	1.2	2.42	3.84	5.45	8.42	11.68	15.36	16.34							
85	0.25	0.25	0.51	0.4	1.19	2.45	3.92	5.57	8.21	11.8	15.39	16.27							
86	0.24	0.22	0.47	0.37	1.27	2.51	4	5.82	8.35	12.15	14.86	16.4							
87	0.22	0.21	0.42	0.36	1.23	2.66	4.09	6.28	8.79	12.15	14.48	16.43							
88	0.22	0.2	0.34	0.33	1.39	2.83	4.18	6.52	9.09	12.34	14.91								
89	0.24	0.2	0.29	0.26	1.66	2.82	4.26	6.67	9.48	12.36	14.62								
90	0.3	0.23	0.27	0.24	1.9	2.59	4.31	6.92	9.94	12.4	14.08								
91	0.39	0.26	0.25	0.23	1.91	2.66	4.29	7.07	10.43	12.47	13.87								
92	0.51	0.32	0.27	0.23	2.11	2.92	4.37	7.19	10.81	12.56	14.16								
93	0.55	0.45	0.34	0.24	1.85	2.9	4.44	7.1	11.18	12.55	13.54								
94	0.59	0.6	0.5	0.29	1.46	2.89	4.63	7.2	11.59	12.64	13.51								
95	0.57	0.65	0.74	0.36	1.37	2.99	4.7	7.44	11.76	12.73	13.94								
96	0.54	0.63	0.83	0.46	1.52	3.09	4.82	7.72	12	12.76									
97	0.53	0.5	0.86	0.53	1.87	3.07	4.8	8.09	12.17	12.84									
98	0.6	0.43	0.7	0.53	1.8	3	4.81	8.59	12.42	12.91									
99	0.62	0.4	0.5	0.55	1.78	2.92	4.8	9.03	12.53	13.02									
100	0.66	0.41	0.43	0.54	2.02	3.08	5.03	9.26	12.69	13.05									
101	0.7	0.5	0.43	0.54	2.15	3.42	5.08	8.93	12.83	13.1									
102	0.71	0.6	0.48	0.55	2.28	3.6	5.11	8.48	12.96	13.15									
103	0.71	0.66	0.57	0.57	2.26	3.62	5.21	8.36	13	13.24									
104	0.74	0.68	0.63	0.58	2.59	3.65	5.21	8.62	13.11	13.41									
105	0.78	0.67	0.62	0.54	2.55	3.6	5.2	8.94	13.21	13.57									
106	0.83	0.7	0.64	0.63	2.7	3.64	5.55	9.92	13.35	13.68									
107	0.85	0.71	0.68	0.72	2.82	3.67	5.55	10.36	13.49	13.87									
108	0.85	0.76	0.74	0.77	2.95	3.78	5.78	10.38	13.6	13.97									
109	0.86	0.78	0.79	0.81	2.56	4.19	6.17	10.49	13.68	14									
110	0.84	0.79	0.82	0.87	2.48	4.37	6.15	10.51	13.76	14.02									

Chevrolet Truck CO Emissions, mg/s																			
ft/s	ft/s/s	-5	-4	-3	-2	-1	0	1	2	3	4	5	6	7	8	9	10	11	12
0	7.02	7.04	7.67	5.87	5.71	5.81	5.75	5.72	7.22	9.55	13.66	22.9	17.8	10.69	3.86	11.31	2.45		
1	7.02	7.07	7.62	5.97	5.9	5.92	5.77	5.72	7.52	11.17	16.3	22.24	15.02	8.89	5.13	10.87	2.55		
2	7.02	7.11	7.53	6.19	6.26	6.16	5.84	5.72	8.02	14.67	19.59	19.28	10.79	7.13	6.46	9.37	2.9	9.68	
3	7.02	7.15	7.45	6.54	6.67	6.51	6.02	5.74	8.63	19.33	20.64	13.68	7.23	6.45	6.95	6.92	3.8	10.51	
4	7.02	7.2	7.41	6.92	6.89	6.84	6.32	5.84	9.51	22.8	17.5	8.1	5.67	6.2	5.71	5.03	5.63	9.84	
5	7.02	7.24	7.42	7.24	6.78	6.95	6.63	6.21	11.81	22.25	11.71	4.76	5.49	5.3	4.93	5.49	8.4	8.01	
6	7.02	7.28	7.46	7.44	6.4	6.69	6.66	7.01	14.62	17.34	6.44	3.9	5.21	4.52	6.17	8.42	11.18	5.9	
7	7.02	7.29	7.5	7.55	6.02	6	6.17	8.13	16.26	10.7	3.5	3.79	4.68	4.45	9.89	11.9	12.34	4.16	
8	7.02	7.27	7.54	7.61	5.78	5	5.17	8.63	13.92	5.63	2.66	3.56	4.4	5.95	13.84	13.33	10.88	2.9	
9	7.02	7.23	7.56	7.64	5.71	4	3.95	7.89	9.35	3.35	2.67	3.23	4.45	8.65	15.44	11.49	7.6	2.19	
10	7.06	7.17	7.57	7.65	5.77	3.41	2.99	5.96	5.25	3.05	2.93	3.1	4.29	11.57	13.56	7.81	4.35	2.02	
11	7.12	7.11	7.57	7.64	5.92	3.48	2.62	4.32	3.57	3.37	3.15	3.33	4.19	12.93	9.47	4.29	2.45	2.33	
12	7.21	7.07	7.57	7.62	6.04	4.07	2.79	3.62	3.37	3.52	3.92	5.04	5.36	11.76	5.39	2.26	2.02	3.09	
13	7.26	7.06	7.56	7.49	6	4.71	3.14	3.85	3.52	3.67	8.68	9.96	8.84	9.03	2.84	1.63	2.56	4.59	
14	7.28	7.08	7.47	7.17	5.68	4.93	3.27	4.31	3.91	4.82	19.08	17.78	13.95	6.39	1.94	1.96	3.91	7.43	
15	7.28	7.13	7.29	6.62	5.16	4.55	3.09	4.46	4.59	10.37	31.62	25.61	18.39	4.71	2.24	2.97	6.25	12.95	
16	7.28	7.2	6.97	5.96	4.54	3.83	2.78	4.23	5.39	20.99	39.58	29.82	19.22	4.06	3.36	4.78	10.55	27.4	
17	7.28	7.25	6.56	5.26	3.97	3.13	2.64	3.73	5.85	33.61	38.19	29.26	16.2	4.41	5.14	7.45	21.18	69.16	
18	7.2	7.21	5.98	4.61	3.48	2.74	2.75	3.33	5.8	41.29	32.35	25.31	12.81	5.35	7.16	10.89	56.85	168.49	
19	7.07	7.05	5.28	4.1	3.18	2.67	3.12	3.18	5.24	41.57	25.75	20.36	10.79	6.34	9.74	16.46	144.41	329.75	
20	6.89	6.8	4.55	3.86	3.13	2.84	3.87	3.2	4.5	37.78	22.71	16.87	10.87	6.93	16.4	35.36	294.07	512.82	
21	6.7	6.58	4.01	3.93	3.31	3.58	4.96	3.17	3.89	33.62	21.52	14.78	12.62	8.87	33.84	80.9	447.02	616.76	
22	6.5	6.34	3.83	4.23	3.71	5.23	6.03	3.02	3.76	30.77	21.28	17.02	24.72	22.09	75.33	153.08	509.13	590.54	
23	6.19	6.08	4.03	4.61	4.26	7.62	6.5	2.83	4.21	28.66	20.42	32.4	61.26	51.77	130.05	222.57	527.84	537.3	
24	5.9	5.69	4.35	4.86	5.2	9.81	6.18	2.78	5.38	27.7	15.95	135.13	144.9	128.44	293.34	841.83	1324.11	1201.94	
25	5.61	5.31	4.45	4.92	6.09	10.86	5.35	2.97	7.58	28	13.7	196.61	133.97	257.12	650.25	1649.27	2134.34	1892.63	
26	5.42	4.97	4.19	4.78	6.42	10.39	4.47	3.46	11.78	28.89	12.23	228.77	101.34	554.06	1285.55	2543.23	2705.43	2424.4	
27	5.21	4.79	3.74	4.66	5.69	8.71	3.81	4.17	18.22	29.78	11.56	218.37	93.77	994.49	2115.02	3031.4	2941.85	2645.92	
28	4.97	4.72	3.38	4.67	4.4	6.49	3.43	4.95	27.04	30.07	11.56	218.37	93.77	994.49	2115.02	3031.4	2941.85	2645.92	
29	4.8	4.72	3.28	4.85	3.32	4.72	3.24	5.58	36.04	29.79	11.18	178.47	144.3	1462.92	2711.11	3173.07	2977.34	2662.85	
30	4.72	4.71	3.36	5.08	2.78	3.87	3.13	5.91	43.27	29.02	10.64	129.95	240.34	1892.36	2886.77	3060.43	3169.13	2881.93	
31	4.72	4.6	3.42	5.23	2.65	3.73	3.04	5.92	45.88	27.9	9.46	87.64	329.64	2329.94	2597.26	3055.39	3411.72	3363.68	
32	4.72	4.39	3.45	5.31	2.69	3.77	3.02	5.74	43.95	26.19	8.04	57.58	357.78	2754.01	2260.4	2873.42	3382.49	3766.96	
33	4.72	4.13	3.47	5.33	2.93	3.8	3.07	5.45	39.32	23.67	6.64	37.83	321.53	3077.12	2177.49	2650.38	3006.22	3610.26	
34	4.72	4.07	3.52	5.42	3.42	3.97	3.22	5.4	34.76	19.97	5.81	28.08	260.88	3211.2	2337.7	2390.56	2583.71	3088.9	
35	4.72	4.2	3.54	5.58	4.23	4.43	3.44	5.87	31.2	15.5	5.53	24.84	232.51	3184.86	2466.94	2360.39	2465.03	2608.9	
36	4.72	4.47	3.58	5.79	5.24	5.03	3.64	7.83	27.67	11.06	5.87	26.45	231.97	3019.19	2427.28	2678.17	2841.23	2456.06	
37	4.64	4.65	3.66	5.87	6.31	5.53	3.74	12.47	23.78	8.28	6.61	30.76	242.97	2729.48	2318.83	3346.66	3641.28	2453.72	
38	4.49	4.65	3.86	5.72	7.16	5.61	3.7	20.97	20.26	8.47	7.34	37.12	249.08	2370.43	2247.64	4100.02	4598.42	2578.21	
39	4.25	4.5	4.08	5.42	7.68	5.3	3.57	31.63	18.34	11.27	7.77	47.61	262.51	2139.93	2240.4	4672.26	5336.5		
40	4.04	4.3	4.2	5.13	7.68	4.83	3.37	40.6	17.74	14.23	8.15	65.08	294.84	2168.85	2293.37	5103.57	5803.72		
41	3.84	4.09	4.17	4.96	7.15	4.55	3.2	44.39	17.47	14.42	9.84	98.54	345.94	2418.32	2396.79	5653.43	6163.31		
42	3.64	3.91	4	4.98	6.2	4.55	3.05	43.37	16.48	11.92	14.89	149.72	417.39	2714.21	2554.86	6296.19	6567.96		
43	3.49	3.68	3.76	5.22	5.29	4.69	2.94	40.85	14.96	9.81	26.12	215.43	484.39	2920.53	2713.25	6735.09	6989.96		
44	3.38	3.51	3.52	5.75	4.78	4.72	2.83	38.93	13.39	12.76	50.05	280.11	513.96	3019.02	2927.87	6697.29	7322.78		
45	3.4	3.43	3.43	6.48	4.73	4.53	2.73	37.82	12.46	26.44	92.41	331.81	476.99	3004.95	3197.07	6203.6			
46	3.53	3.53	3.66	7.34	4.78	4.12	2.68	36.08	12.39	56.52	149.73	357.94	427.15	2946.39	3576.22	5585.29			
47	3.84	3.75	3.18	8.04	4.67	3.61	2.7	33.62	12.92	104.32	199.02	343.93	467.3	2861.78	3966.63	5170.22			
48	4.28	4.08	4.75	8.34	4.31	3.15	2.75	30.87	13.8	155.45	219.32	309.6	726.36	2804.24	4259.64	5159.86			
49	4.78	4.48	5.19	8.04	3.85	2.84	2.78	28.83	14.43	189.08	229.88	341.04	1196.9	2721.61	4297.08	5388.43			
50	5.22	4.92	5.41	7.31	3.39	2.72	2.8	27.79	14.52	188.75	319.36	568.82	1771.46	2613.62	4096.24	5641.93			
51	5.46	5.27	5.47	6.48	3.03	2.74	2.83	27.39	13.76	166.18	569.78	1089.23	2244.83	2453.15	3761.4	5737.44			
52	5.51	5.46	5.42	5.91	2.81	2.88	2.91	26.88	12.86	153.54	1065.38	1793.19	2533.18	2299.02	3490.55				
53	5.43	5.46	5.36	5.62	2.76	3.09	3.03	25.92	12.2	189.53	1693.11	2466.87	2676.84	2172.29	3385.66				
54	5.31	5.43	5.3	5.52	2.82	3.32	3.14	24.52	11.71	314.64	2308.33	2928.91	2785.51	2111.95	3426.8				
55	5.19	5.33	5.25	5.41	2.93	3.51	3.22	22.95	10.67	549.93	2730.58	3224.05	2870.48	2084.84	3491.36				
56	5.18	5.28	5.3	5.2	3	3.62	3.22	21.15	9.19	893.3	3018.86	3398.9	2826.08	2050.64	3406.82				
57	5.57	5.31	5.7	4.91	3.03	3.63	3.14	19.19	7.9	1287.89	3255.05	3399.56	2633.43	2006.46	3222.08				
58	6.64	5.77	6.48	4.64	3.03	3.52	3.1	17.11	7.27	1660.27	3405.7	3154.43	2473.28	1994.5					
59	8.25	6.86	7.74	4.47	3.03	3.35	3.24	15.18	7.26	1924.67	3294.78	2891.14	2614.33	2140.07					
60	10.11	8.47	8.98	4.44	3.06	3.23	3.61	13.24	7.6	2006.24	2885.81	2926.62	3176.89	2486.86					
61	11.81	10.33	10.47	4.61	3.15	3.23	4.14	11.18	8.17	1883.74	2394.86	3320.61	3801.75	3058.03					
62	13.37	12.02	11.7	4.96	3.34	3.38	4.69	8.96	8.89	1592.93	2123.73	3686.88	4136	3706.96					
63	14.35	13.61	13.04	5.44	3.54	3.58	5.12	6.93	9.75	1279.8	2203.27	3632.05	3846.02	4256.93					
64	14.75	14.78	13.95	5.87	3.7	3.74	5.32	5.42	11.43	1008.96	2494.86	3169.35	3254.44	4416.88					
65	14.48	15.43	14.56	6.13	3.75	3.78	5.34	4.52	14.25	828.72	2825.41	2659.57	2672.45						

ft/s	Chevrolet Truck CO Emissions, mg/s												7	8	9	10	11	12
	-5	-4	-3	-2	-1	0	1	2	3	4	5	6						
81	5.83	5.58	5.87	6.46	11.98	24.53	15.3	8.54	291.01	2650.83	5511.98	6418.78						
82	5.91	5.83	6.21	6.72	14.09	33.58	13.43	8.71	270.2	2786.88	5783.47	5638.8						
83	5.96	6.34	6.62	7.23	15.88	42.77	11.43	8.69	259.86	2884.48	5978.06	5062.18						
84	6.19	7.25	7.37	8.4	17.15	50.67	9.82	9.47	254.9	2940.59	5880.18	4772.01						
85	6.88	8.71	8.88	10.6	18.4	55.47	8.45	13.8	246.01	2959.68	5720.55	4624.73						
86	8.43	10.73	11.42	13.36	20.92	55.9	7.36	25.87	281.86	2924.11	5241.47	4547.45						
87	10.8	13.14	14.54	15.94	25.54	52.04	6.35	48.13	494.58	2871.05	4654.03	4544.65						
88	13.75	15.54	17.33	17.82	32.68	45.33	5.6	73.41	1006.32	2812.74	4079.02							
89	16.51	17.54	19.09	18.99	40.49	39.02	4.96	93.06	1730.43	2776.47	3642.15							
90	18.68	18.95	19.95	19.74	47.32	34.8	4.37	97.75	2407.86	2732.38	3398.38							
91	19.94	19.9	20.4	20.2	51.7	33.57	3.76	94.04	2824.19	2668.56	3292.57							
92	20.74	20.75	21.11	20.55	54.46	33.96	3.17	86.91	3029.01	2565.01	3291.15							
93	21.59	21.96	22.69	20.95	56.36	34.62	2.76	88.34	3136.54	2435.95	3349.57							
94	23.12	23.78	25.48	22.15	58.4	34.01	2.6	104.65	3158.24	2291.42	3433.33							
95	25.56	26.13	29.2	24.45	61.39	31.82	2.71	146.19	3021.75	2170.85	3328.56							
96	28.63	28.6	32.67	28.03	65.91	28.71	3.1	214.36	2757.1	2139.54								
97	31.75	30.97	35.18	31.69	70.88	25.85	3.59	294.41	2558.74	2279.18								
98	34.33	33.15	36.52	34.7	73.74	23.79	4.04	369.41	2598.1	2647.97								
99	36.13	35.13	37.21	36.49	72.23	22.18	4.38	416.87	2938.41	3221.57								
100	37.14	36.61	37.44	37.32	67.07	20.75	4.79	439.02	3480.07	3875.28								
101	37.51	37.35	37.45	37.47	60.84	19.42	5.42	437.55	4020.03	4397.43								
102	37.47	37.39	37.48	37.45	56.8	18.74	6.24	438.54	4318.09	4594.55								
103	37.43	37.31	38.55	37.72	56.03	18.85	7.16	474.06	4220.79	4390.14								
104	38.53	38.36	42.23	39.38	58.8	19.72	8.05	619.48	3774.56	3879.72								
105	42.56	42.45	50.53	45.94	63.67	20.58	8.83	951.4	3182.06	3258.39								
106	51.6	51.38	63.88	59.77	69.6	20.79	9.35	1471.09	2669.36	2729.3								
107	66.36	65.69	79.88	80.63	75.67	19.97	9.6	2050.61	2358.67	2405.08								
108	85.28	82.09	96.1	101.12	81.57	18.59	9.8	2509.59	2246.7	2282.35								
109	103.6	96.25	109.1	116	87.09	17.25	10.03	2763.26	2252.46	2282.66								
110	115.13	103.95	116.85	122.54	90.55	16.52	10.25	2851.84	2283.06	2308.93								

		Chevrolet Truck HC Emissions, mg/s																	
ft/s	ft/s/s	-5	-4	-3	-2	-1	0	1	2	3	4	5	6	7	8	9	10	11	12
0		1.72	1.72	1.40	0.91	1.19	1.25	1.22	1.20	1.37	1.57	2.23	3.83	3.75	4.64	1.48	3.00	0.80	
1		1.72	1.72	1.36	0.93	1.28	1.31	1.24	1.20	1.40	1.83	2.78	3.80	4.09	3.55	1.46	3.14	0.81	
2		1.72	1.72	1.30	0.99	1.46	1.43	1.26	1.20	1.45	2.50	3.38	4.02	3.54	2.41	2.03	2.89	0.85	1.52
3		1.72	1.72	1.26	1.10	1.60	1.60	1.33	1.20	1.50	3.35	3.74	3.48	2.45	1.91	2.13	2.09	0.95	1.93
4		1.72	1.72	1.24	1.25	1.58	1.68	1.47	1.21	1.60	3.92	3.66	2.53	1.57	1.78	1.83	1.32	1.06	2.18
5		1.72	1.73	1.24	1.36	1.37	1.61	1.61	1.26	1.86	3.93	2.87	1.41	1.51	1.60	1.02	0.99	1.20	2.18
6		1.72	1.71	1.24	1.43	1.13	1.38	1.56	1.38	2.50	3.20	1.87	1.08	1.52	0.98	0.93	1.14	1.42	1.95
7		1.72	1.69	1.23	1.44	0.96	1.10	1.30	1.46	2.90	2.07	1.05	1.22	1.12	0.93	1.06	1.35	1.74	1.65
8		1.72	1.62	1.23	1.45	0.91	0.83	0.93	1.59	2.44	1.09	0.78	1.10	0.93	0.95	1.13	1.57	1.97	1.37
9		1.72	1.57	1.23	1.44	0.89	0.64	0.64	1.21	1.38	0.55	0.69	0.81	1.24	0.93	1.16	1.65	1.84	1.17
10		1.72	1.50	1.23	1.45	0.89	0.55	0.49	0.79	0.49	0.47	0.56	0.80	1.56	0.93	1.09	1.48	1.49	1.09
11		1.72	1.42	1.23	1.45	0.93	0.57	0.46	0.31	0.30	0.41	0.56	1.47	1.49	0.99	0.97	1.18	1.20	1.07
12		1.73	1.34	1.23	1.42	0.97	0.66	0.51	0.27	0.31	0.44	0.70	1.75	1.30	1.08	0.84	0.98	1.14	1.02
13		1.73	1.25	1.23	1.37	0.97	0.77	0.57	0.30	0.34	0.45	0.76	2.13	1.63	1.18	0.78	1.02	1.13	1.03
14		1.74	1.22	1.23	1.25	0.90	0.80	0.57	0.32	0.36	0.44	1.13	2.92	2.77	1.17	0.83	1.18	1.08	1.21
15		1.74	1.21	1.17	1.09	0.80	0.74	0.51	0.33	0.36	0.45	1.72	4.08	3.66	1.14	1.07	1.32	1.16	1.68
16		1.74	1.22	1.12	0.92	0.72	0.63	0.43	0.36	0.37	0.90	2.07	4.43	3.48	1.23	1.30	1.36	1.45	2.52
17		1.69	1.24	1.01	0.81	0.66	0.55	0.38	0.40	0.38	1.52	2.15	3.54	2.54	1.39	1.49	1.51	2.11	4.34
18		1.64	1.24	0.92	0.74	0.63	0.49	0.35	0.43	0.40	1.85	1.72	2.37	1.71	1.84	1.97	1.93	3.65	7.62
19		1.51	1.18	0.82	0.73	0.60	0.44	0.34	0.46	0.45	1.72	1.46	1.61	1.82	2.28	2.51	2.54	6.99	12.53
20		1.44	1.12	0.74	0.72	0.59	0.39	0.36	0.48	0.51	1.49	1.13	1.12	1.91	2.61	3.04	3.23	11.81	17.62
21		1.36	1.06	0.69	0.71	0.57	0.37	0.41	0.49	0.58	1.55	0.98	1.02	2.36	2.83	3.61	4.65	17.05	21.18
22		1.27	1.04	0.66	0.68	0.54	0.44	0.47	0.50	0.65	1.62	0.95	1.16	2.69	2.90	4.82	7.53	19.35	20.49
23		1.17	0.98	0.63	0.64	0.52	0.55	0.47	0.51	0.74	1.65	0.92	1.91	3.57	4.20	7.99	10.89	16.60	16.07
24		1.01	0.91	0.62	0.63	0.53	0.63	0.40	0.51	0.81	1.73	0.92	3.61	5.18	6.43	10.85	11.61	15.33	14.30
25		0.94	0.82	0.60	0.64	0.57	0.65	0.31	0.51	0.86	1.98	0.96	5.71	6.39	7.92	11.63	16.24	22.68	20.71
26		0.88	0.77	0.58	0.66	0.59	0.63	0.24	0.50	0.91	2.48	1.03	7.44	6.67	8.84	13.69	25.87	33.62	31.23
27		0.83	0.73	0.56	0.65	0.54	0.56	0.21	0.49	1.09	3.17	1.14	7.86	6.33	12.56	21.94	37.53	41.77	38.64
28		0.78	0.73	0.57	0.67	0.45	0.47	0.21	0.48	1.51	3.89	1.31	7.33	7.04	18.74	31.63	42.71	39.85	38.43
29		0.73	0.73	0.59	0.69	0.37	0.39	0.22	0.46	2.09	4.33	1.51	6.27	8.92	23.73	38.96	40.02	38.48	35.26
30		0.73	0.73	0.60	0.71	0.34	0.39	0.24	0.47	2.83	4.41	1.66	5.22	10.93	26.32	38.99	43.00	43.53	38.09
31		0.73	0.73	0.60	0.71	0.33	0.41	0.26	0.49	3.34	4.05	1.77	4.38	12.05	29.50	35.34	46.35	51.76	48.86
32		0.73	0.69	0.59	0.70	0.32	0.40	0.28	0.53	3.55	3.51	1.76	3.75	11.74	34.25	31.00	51.24	55.29	58.48
33		0.73	0.65	0.59	0.68	0.32	0.37	0.30	0.60	3.30	2.88	1.74	3.39	10.26	38.11	30.97	53.57	52.89	59.07
34		0.73	0.62	0.60	0.64	0.33	0.34	0.32	0.72	2.91	2.38	1.67	3.31	10.52	39.45	35.41	56.14	53.25	52.39
35		0.73	0.66	0.60	0.61	0.36	0.35	0.33	0.85	2.53	1.93	1.71	3.35	11.63	40.07	40.24	52.94	51.76	52.75
36		0.73	0.70	0.58	0.56	0.41	0.39	0.36	0.95	2.13	1.56	1.85	3.50	12.83	40.80	44.78	45.43	47.77	54.27
37		0.73	0.73	0.59	0.52	0.46	0.42	0.40	1.00	1.71	1.32	2.15	3.63	11.77	39.71	50.44	41.87	44.90	54.05
38		0.71	0.73	0.62	0.47	0.51	0.43	0.43	1.23	1.32	1.35	2.55	3.90	10.78	35.72	54.22	43.88	47.24	47.28
39		0.68	0.71	0.65	0.43	0.54	0.39	0.46	1.80	1.08	1.72	2.78	4.28	10.66	32.09	52.10	44.99	50.19	
40		0.66	0.68	0.67	0.40	0.54	0.36	0.48	2.36	0.98	2.08	2.80	4.88	11.51	32.86	48.04	45.63	50.76	
41		0.66	0.67	0.66	0.38	0.51	0.36	0.51	2.61	0.93	2.17	2.77	5.72	13.25	36.96	45.43	48.88	52.71	
42		0.65	0.67	0.64	0.38	0.45	0.41	0.53	2.57	0.91	1.99	2.97	7.43	15.16	40.73	45.68	55.31	56.45	
43		0.66	0.66	0.62	0.39	0.39	0.46	0.55	2.74	0.94	2.08	3.41	9.55	17.50	41.98	46.74	60.03	59.03	
44		0.67	0.66	0.61	0.43	0.39	0.49	0.57	3.30	1.01	2.50	4.12	11.88	18.77	41.57	46.15	62.41	61.71	
45		0.67	0.67	0.61	0.47	0.43	0.47	0.61	4.04	1.12	3.11	5.68	13.86	17.69	39.93	45.62	61.86		
46		0.68	0.69	0.62	0.53	0.46	0.43	0.63	4.67	1.25	3.75	8.45	15.03	14.34	37.61	44.86	57.19		
47		0.68	0.70	0.63	0.57	0.44	0.35	0.65	4.93	1.44	4.69	11.59	14.94	12.32	36.40	46.40	51.90		
48		0.68	0.70	0.65	0.57	0.38	0.31	0.67	4.91	1.58	5.96	13.04	12.57	14.24	36.24	47.53	49.08		
49		0.68	0.68	0.66	0.54	0.32	0.30	0.72	4.80	1.70	7.03	11.84	10.64	21.22	36.93	48.88	49.71		
50		0.68	0.68	0.68	0.47	0.29	0.29	0.80	4.82	1.73	7.42	10.69	12.36	29.45	36.24	49.21	51.10		
51		0.70	0.68	0.68	0.42	0.27	0.27	0.91	4.79	1.81	7.10	12.99	18.95	36.69	34.17	50.41	51.51		
52		0.68	0.69	0.68	0.38	0.26	0.27	1.04	4.67	1.85	6.73	18.96	29.60	40.02	31.74	51.26			
53		0.71	0.69	0.68	0.36	0.24	0.26	1.16	4.35	2.05	7.12	28.29	38.21	40.73	30.31	51.65			
54		0.74	0.72	0.71	0.36	0.23	0.26	1.29	4.03	2.30	8.30	35.45	42.95	40.15	29.96	51.70			
55		0.76	0.75	0.75	0.35	0.22	0.27	1.47	3.73	2.46	11.61	39.48	43.61	39.44	29.73	51.25			
56		0.75	0.76	0.76	0.33	0.22	0.27	1.66	3.47	2.47	16.60	39.79	43.85	37.92	29.73	51.49			
57		0.75	0.79	0.78	0.29	0.23	0.27	1.83	3.05	2.41	22.31	40.42	42.76	34.78	29.14	52.76			
58		0.77	0.81	0.80	0.26	0.24	0.28	1.92	2.66	2.51	26.83	41.95	39.75	32.83	29.95				
59		0.79	0.86	0.84	0.25	0.25	0.28	1.92	2.31	2.62	30.16	41.47	36.87	37.09	32.38				
60		0.82	0.88	0.87	0.25	0.26	0.29	1.79	2.12	2.74	31.87	37.49	40.50	46.32	38.10				
61		0.87	0.90	0.90	0.27	0.27	0.29	1.60	1.88	2.78	30.45	32.39	48.47	57.82	45.97				
62		0.95	0.93	0.93	0.28	0.27	0.29	1.38	1.60	2.82	26.43	30.31	55.57	61.68	54.94				
63		1.07	1.00	0.94	0.30	0.27	0.29	1.20	1.35	2.87	20.88	32.16	56.06	60.55	62.01				
64		1.18	1.16	1.00	0.36	0.27	0.30	1.08	1.16	2.94	17.71	37.20	52.41	53.88	65.05				
65		1.25	1.31	1.08	0.45	0.29	0.31	1.01	1.05	3.05	15.04	41.73	49.21	49.61					
66		1.35	1.44	1.19	0.53	0.30	0.31	1.00	1.01	3.18	13.82	45.00	51.13	51.13					
67		1.36	1.47	1.26	0.59	0.33	0.31	1.00	1.02	3.46	11.94	46.54	55.55	55.55					
68		1.38	1.54	1.27	0.63	0.35	0.31	1.06	1.06	3.91	11.65	47.54	57.16	58.02					
69		1.25	1.54	1.23	0.66	0.37	0.32	1.14</											



ft/s	Chevrolet Truck HC Emissions, mg/s												7	8	9	10	11	12
	ft/s/s	-5	-4	-3	-2	-1	0	1	2	3	4	5						
81	0.72	0.71	0.71	0.71	0.37	0.92	1.08	1.75	11.98	40.67	51.83	64.46						
82	0.70	0.70	0.71	0.71	0.43	1.32	1.07	1.69	11.23	41.45	52.40	59.24						
83	0.69	0.70	0.71	0.71	0.50	1.81	1.07	1.62	11.13	41.07	53.17	54.44						
84	0.68	0.70	0.71	0.72	0.56	2.23	1.11	1.63	11.25	39.86	52.91	52.91						
85	0.68	0.71	0.73	0.77	0.62	2.56	1.15	1.80	11.18	38.82	52.01	52.01						
86	0.70	0.75	0.79	0.86	0.69	2.63	1.15	2.31	10.27	38.21	49.23	49.23						
87	0.75	0.82	0.91	0.96	0.89	2.42	1.12	3.26	11.34	37.52	49.29	49.29						
88	0.84	0.92	1.07	1.04	1.19	2.03	1.06	4.57	17.94	37.00	49.31							
89	1.01	1.06	1.23	1.13	1.59	1.58	1.04	5.37	29.28	36.75	50.56							
90	1.19	1.21	1.38	1.25	1.90	1.31	1.01	5.67	38.83	36.75	50.58							
91	1.47	1.40	1.56	1.41	2.12	1.22	0.97	5.25	42.57	35.99	53.27							
92	1.75	1.68	1.79	1.59	2.23	1.27	0.98	4.94	42.43	34.65	56.22							
93	2.07	2.05	2.13	1.81	2.40	1.38	1.04	4.64	41.90	41.90	58.48							
94	2.37	2.43	2.56	2.07	2.51	1.47	1.12	5.02	41.19	41.19	58.91							
95	2.67	2.74	3.00	2.46	2.61	1.46	1.23	6.36	38.69	38.69	55.63							
96	2.97	2.97	3.34	2.86	2.68	1.33	1.33	8.89	35.79	35.79								
97	3.22	3.13	3.52	3.23	2.77	1.18	1.45	12.32	34.73	34.73								
98	3.44	3.29	3.64	3.45	2.77	1.06	1.50	15.11	37.90	40.04								
99	3.62	3.46	3.74	3.63	2.61	1.01	1.50	16.75	44.21	48.46								
100	3.77	3.64	3.83	3.77	2.36	0.99	1.48	16.61	51.79	57.05								
101	3.85	3.78	3.90	3.86	2.12	0.99	1.51	15.99	58.48	63.12								
102	3.90	3.86	3.96	3.93	1.97	0.98	1.63	15.43	61.70	65.03								
103	3.93	3.93	4.07	4.01	1.96	0.94	1.80	14.57	61.03	63.03								
104	4.04	4.04	4.40	4.11	2.03	0.89	2.08	14.13	57.23	58.71								
105	4.37	4.37	5.10	4.43	2.21	0.86	2.42	16.89	52.84	54.07								
106	5.10	5.10	6.28	5.64	2.44	0.84	2.78	24.19	49.27	50.12								
107	6.37	6.28	7.77	7.58	2.71	0.85	2.97	33.08	47.68	47.94								
108	8.08	7.82	9.07	9.97	3.04	0.94	3.03	39.41	48.24	48.28								
109	10.06	9.12	10.51	11.41	3.31	1.09	2.99	41.97	49.92	49.55								
110	11.41	9.89	11.41	12.09	3.51	1.22	2.97	42.70	51.25	50.78								

		Chevrolet Truck NOx Emissions, mg/s																	
ft/s	ft/s/s	-5	-4	-3	-2	-1	0	1	2	3	4	5	6	7	8	9	10	11	12
0	0.08	0.08	0.07	0.07	0.07	0.07	0.07	0.07	0.07	0.09	0.12	0.22	0.34	0.77	1.40	2.47	5.28	20.70	
1	0.08	0.08	0.07	0.07	0.07	0.07	0.07	0.07	0.07	0.09	0.16	0.27	0.42	1.06	1.77	3.30	5.59	21.26	
2	0.08	0.08	0.07	0.07	0.07	0.07	0.07	0.07	0.07	0.10	0.23	0.34	0.75	1.58	2.78	4.44	6.90	23.25	21.02
3	0.08	0.08	0.07	0.07	0.07	0.07	0.07	0.07	0.07	0.11	0.30	0.50	1.34	2.40	4.32	7.25	10.42	25.61	26.86
4	0.08	0.08	0.07	0.07	0.07	0.07	0.07	0.07	0.07	0.13	0.38	0.90	2.11	3.57	7.25	12.54	17.60	24.10	34.29
5	0.08	0.08	0.07	0.07	0.07	0.07	0.08	0.08	0.08	0.16	0.57	1.48	2.94	5.03	11.44	17.95	20.69	21.81	41.02
6	0.08	0.08	0.07	0.07	0.07	0.07	0.08	0.08	0.08	0.22	0.90	2.09	3.80	6.86	16.17	20.78	22.31	21.62	44.90
7	0.08	0.08	0.07	0.07	0.07	0.07	0.08	0.11	0.43	1.32	2.61	4.68	8.65	19.23	22.11	22.59	27.13	47.68	
8	0.08	0.08	0.07	0.07	0.07	0.08	0.09	0.29	0.59	1.87	3.31	5.74	10.57	21.21	24.06	27.80	34.09	49.53	
9	0.08	0.07	0.07	0.07	0.07	0.11	0.12	0.40	0.83	2.67	4.44	7.09	13.04	23.29	27.48	33.24	40.18	51.01	
10	0.08	0.07	0.07	0.07	0.07	0.12	0.16	0.74	1.20	3.72	6.17	9.29	16.80	26.07	30.04	37.65	45.06	53.07	
11	0.08	0.07	0.07	0.07	0.07	0.12	0.16	1.43	2.12	4.70	8.45	12.81	21.19	28.67	32.58	41.53	48.46	56.09	
12	0.08	0.07	0.07	0.07	0.07	0.10	0.14	2.73	3.24	5.92	10.33	17.72	25.73	30.76	35.87	44.74	51.87	60.13	
13	0.08	0.07	0.07	0.07	0.07	0.08	0.12	3.73	4.33	6.68	11.41	24.06	30.66	33.37	39.16	46.32	56.20	61.85	
14	0.08	0.07	0.07	0.07	0.07	0.08	0.13	4.28	4.92	6.90	11.23	31.15	35.42	36.48	41.42	47.36	59.76	60.97	
15	0.08	0.07	0.07	0.07	0.08	0.08	0.18	4.45	5.03	6.41	10.18	35.34	38.12	40.02	43.62	49.38	59.90	64.81	
16	0.08	0.07	0.07	0.07	0.08	0.10	0.25	5.11	4.98	5.95	10.41	35.03	38.78	44.48	46.85	52.37	60.64	76.84	
17	0.08	0.07	0.07	0.08	0.10	0.14	0.33	5.93	5.16	5.81	12.59	31.29	40.11	48.61	50.91	55.32	69.88	93.14	
18	0.08	0.07	0.07	0.09	0.11	0.20	0.37	6.58	5.81	5.88	16.33	28.89	42.74	52.02	55.29	60.07	86.24	101.07	
19	0.08	0.07	0.08	0.10	0.14	0.27	0.40	7.03	6.89	6.63	18.64	29.66	45.17	54.33	61.12	71.72	97.88	97.55	
20	0.08	0.07	0.09	0.12	0.17	0.32	0.43	7.24	8.13	8.55	19.35	30.47	47.62	57.91	70.79	84.23	97.45	89.66	
21	0.08	0.07	0.12	0.15	0.20	0.35	0.49	7.65	9.28	11.48	19.96	32.55	52.90	65.09	79.83	92.66	90.13	84.76	
22	0.08	0.07	0.16	0.18	0.24	0.41	0.58	8.04	10.08	14.40	20.70	35.13	59.83	71.62	84.92	92.12	87.47	88.49	
23	0.08	0.07	0.19	0.21	0.27	0.48	0.66	8.64	10.66	17.07	22.66	40.00	63.92	77.08	86.79	89.98	95.08	99.44	
24	0.08	0.07	0.21	0.22	0.30	0.55	0.82	8.94	11.16	19.57	25.56	45.40	62.23	77.38	88.05	94.27	104.20	108.57	
25	0.08	0.08	0.23	0.23	0.34	0.58	1.03	8.84	11.82	22.89	30.25	48.79	61.48	79.20	95.02	98.14	106.82	111.64	
26	0.08	0.08	0.23	0.24	0.37	0.60	1.26	8.46	12.75	26.42	35.20	50.91	67.91	84.83	99.64	96.15	103.28	109.97	
27	0.08	0.08	0.22	0.26	0.36	0.58	1.37	7.94	13.29	30.20	39.33	51.75	79.34	88.70	96.31	86.36	93.30	102.92	
28	0.08	0.08	0.19	0.26	0.35	0.53	1.41	7.44	14.37	33.50	42.19	54.21	88.99	89.61	89.42	79.91	90.96	98.05	
29	0.08	0.08	0.14	0.27	0.36	0.50	1.37	7.04	14.69	35.90	43.78	57.61	92.25	88.00	81.71	88.92	91.54	97.12	
30	0.08	0.08	0.11	0.27	0.39	0.53	1.38	7.09	16.55	36.93	44.94	61.67	92.49	88.63	84.53	99.85	97.47	100.11	
31	0.08	0.08	0.11	0.28	0.43	0.57	1.38	7.41	17.84	36.71	46.12	65.50	92.49	88.70	93.29	105.88	98.25	99.91	
32	0.08	0.09	0.11	0.29	0.44	0.54	1.56	7.96	20.28	36.17	47.43	70.04	93.48	85.98	110.38	105.91	101.84	95.83	
33	0.08	0.09	0.11	0.29	0.44	0.49	1.89	8.83	21.94	36.23	48.75	73.76	93.92	82.90	122.69	112.98	118.02	101.89	
34	0.08	0.10	0.10	0.31	0.44	0.44	2.49	10.09	23.36	37.27	49.82	76.98	91.87	81.85	123.82	127.84	136.64	122.68	
35	0.08	0.09	0.10	0.34	0.46	0.45	3.06	11.42	24.11	39.68	50.75	79.70	89.64	81.79	118.06	146.17	155.30	143.96	
36	0.08	0.08	0.11	0.39	0.51	0.49	3.79	12.61	24.40	42.39	51.65	83.39	88.01	82.25	115.59	156.69	161.36	159.50	
37	0.08	0.08	0.11	0.44	0.57	0.54	4.72	13.25	24.99	44.50	52.66	87.75	89.02	85.01	120.96	159.30	157.02	165.43	
38	0.08	0.08	0.10	0.48	0.63	0.55	5.54	13.19	25.62	45.09	53.98	91.79	90.46	90.01	131.40	160.51	148.40	170.34	
39	0.09	0.08	0.10	0.50	0.65	0.50	6.54	12.44	26.12	44.69	56.07	94.61	92.34	94.90	144.27	164.59	142.69		
40	0.09	0.09	0.09	0.50	0.66	0.44	7.24	11.42	25.97	44.61	60.55	96.19	93.35	95.55	153.63	157.82	137.42		
41	0.10	0.09	0.09	0.49	0.62	0.40	8.17	11.55	26.53	45.72	66.83	96.70	92.28	92.48	158.65	134.83	123.53		
42	0.10	0.10	0.10	0.48	0.55	0.41	8.64	12.92	28.31	48.35	74.09	95.49	90.18	89.34	160.06	105.92	104.56		
43	0.12	0.10	0.10	0.50	0.47	0.44	9.20	16.32	32.06	52.67	78.68	93.59	87.31	87.00	160.28	93.77	92.64		
44	0.12	0.12	0.11	0.54	0.42	0.48	9.69	21.02	35.74	57.24	81.20	91.13	86.29	86.95	161.38	102.96	86.50		
45	0.14	0.12	0.13	0.58	0.41	0.51	10.31	26.69	38.91	61.62	82.92	89.04	89.61	87.18	160.91	123.87			
46	0.15	0.14	0.17	0.62	0.43	0.58	10.66	31.89	40.58	63.25	85.48	87.58	97.98	90.48	158.56	145.12			
47	0.17	0.15	0.20	0.64	0.41	0.69	10.82	35.69	41.40	62.32	87.80	87.86	106.68	93.55	152.92	154.21			
48	0.18	0.17	0.21	0.66	0.40	0.87	10.90	37.95	41.72	59.38	89.73	92.67	110.76	98.59	149.89	153.43			
49	0.19	0.19	0.21	0.66	0.41	1.06	11.18	38.82	42.68	57.95	95.24	100.77	108.92	101.40	148.04	150.58			
50	0.20	0.19	0.20	0.66	0.51	1.21	11.57	39.23	44.17	60.03	102.00	106.75	105.98	103.48	151.11	151.46			
51	0.19	0.20	0.20	0.66	0.67	1.33	12.18	39.03	46.31	65.56	105.96	106.04	105.07	104.59	154.28	154.50			
52	0.20	0.20	0.21	0.67	0.80	1.45	12.79	38.90	47.68	72.46	102.70	98.19	105.50	106.78	158.70				
53	0.21	0.20	0.21	0.68	0.90	1.63	13.39	38.47	48.37	79.74	93.22	91.95	103.42	107.86	160.23				
54	0.22	0.21	0.21	0.68	0.97	1.82	14.12	38.20	48.88	85.70	85.94	88.84	97.47	107.41	158.02				
55	0.23	0.21	0.22	0.68	1.05	1.98	14.96	38.00	49.85	89.51	82.34	86.42	90.99	106.06	155.95				
56	0.24	0.23	0.23	0.72	1.14	2.05	15.81	37.85	51.35	89.66	82.47	81.24	88.71	106.06	156.99				
57	0.26	0.24	0.25	0.82	1.20	2.11	16.06	37.84	52.49	89.24	80.83	79.28	94.62	108.66	157.71				
58	0.28	0.25	0.27	1.05	1.34	2.15	15.53	37.91	53.57	86.35	78.72	84.32	102.09	111.18					
59	0.30	0.27	0.29	1.44	1.50	2.19	14.61	38.03	55.43	84.93	80.45	93.83	105.21	112.48					
60	0.31	0.29	0.30	1.92	1.67	2.19	13.60	38.17	58.60	84.37	88.91	100.18	101.62	109.77					
61	0.31	0.30	0.30	2.25	1.79	2.21	13.00	38.24	62.32	87.42	101.18	101.82	96.14	104.94					
62	0.31	0.30	0.30	2.22	1.86	2.27	12.59	38.56	65.11	93.09	113.66	99.85	94.36	99.14					
63	0.33	0.31	0.31	1.91	1.98	2.39	12.25	38.76	67.57	98.96	119.84	98.87	96.85	94.93					
64	0.36	0.32	0.31	1.59	2.21	2.66	12.06	39.02	70.37	101.06	121.06	105.26	112.12	93.06					
65	0.38	0.33	0.33	1.33	2.62	3.03	12.17	39.25	75.09	101.80	117.84	119.47	131.86						
66	0.41	0.35	0.36	1.16	3.06	3.23	12.50												

		Chevrolet Truck NOx Emissions, mg/s																	
ft/s	ft/s/s	-5	-4	-3	-2	-1	0	1	2	3	4	5	6	7	8	9	10	11	12
81	0.95	1.16	1.18	1.20	3.06	5.11	29.45	57.30	94.22	96.26	136.70	129.05							
82	0.94	1.15	1.19	1.22	2.74	5.31	30.27	57.96	95.79	93.24	132.05	148.02							
83	0.93	1.16	1.21	1.23	2.43	5.62	31.09	57.44	95.69	91.74	125.78	156.30							
84	0.98	1.16	1.21	1.21	2.15	5.82	32.02	58.49	94.83	90.96	125.09	159.19							
85	1.05	1.16	1.20	1.13	2.02	6.08	33.06	62.12	94.68	91.06	129.06	159.89							
86	1.11	1.11	1.11	1.01	2.08	6.41	34.50	70.37	97.83	91.10	139.75	160.30							
87	1.09	1.03	0.98	0.91	2.39	6.83	35.82	79.94	103.27	91.26	146.16	158.78							
88	1.00	0.94	0.90	0.85	2.82	6.98	37.14	87.92	104.00	91.16	151.65								
89	0.93	0.91	0.93	0.85	3.34	7.08	38.54	92.82	99.04	90.61	153.83								
90	0.94	0.96	1.06	0.91	3.75	7.30	39.87	95.69	93.83	90.54	152.70								
91	1.05	1.08	1.19	1.02	4.08	7.80	40.90	96.34	92.59	91.91	146.98								
92	1.11	1.15	1.22	1.13	4.26	8.46	41.72	95.02	91.72	94.28	137.02								
93	1.07	1.09	1.08	1.17	4.34	9.52	42.62	93.59	87.08	97.39	126.12								
94	0.92	0.91	0.85	1.10	4.41	10.92	43.25	94.77	83.39	100.96	112.49								
95	0.76	0.72	0.61	0.89	4.46	12.47	44.21	96.57	85.68	104.87	104.84								
96	0.63	0.62	0.50	0.68	4.61	13.42	45.53	97.53	92.70	107.45									
97	0.53	0.56	0.46	0.55	4.74	13.93	47.65	95.06	99.14	107.44									
98	0.48	0.54	0.47	0.52	4.95	14.28	49.16	92.06	101.26	104.81									
99	0.47	0.54	0.48	0.51	5.28	15.58	50.55	89.93	100.35	100.68									
100	0.49	0.53	0.50	0.50	5.68	18.34	51.67	90.45	98.49	96.54									
101	0.50	0.52	0.52	0.51	6.18	21.81	53.07	91.28	96.46	93.85									
102	0.51	0.51	0.56	0.54	6.73	24.50	53.93	91.87	94.87	92.68									
103	0.54	0.53	0.60	0.59	7.29	25.09	54.40	93.43	94.39	93.29									
104	0.59	0.58	0.67	0.63	7.93	24.45	54.92	97.57	96.67	96.74									
105	0.66	0.65	0.76	0.68	8.57	23.55	55.95	101.56	103.41	105.16									
106	0.76	0.76	0.91	0.83	9.15	23.98	57.72	101.97	115.06	118.96									
107	0.90	0.91	1.07	1.05	9.45	25.87	61.03	97.70	128.58	135.03									
108	1.08	1.12	1.20	1.33	9.60	29.67	63.97	92.75	139.65	148.78									
109	1.32	1.25	1.38	1.51	9.62	33.56	68.46	89.62	146.16	156.31									
110	1.51	1.32	1.51	1.61	9.63	36.17	71.08	88.61	148.7	159.01									

ft/s	ft/s/s	Composite Fuel Consumption, gal/h																
		-5	-4	-3	-2	-1	0	1	2	3	4	5	6	7	8	9	10	11
0	0.45	0.45	0.45	0.45	0.46	0.47	0.57	0.69	0.86	1.09	1.30	1.56	1.95	2.42	2.78	3.36	3.58	3.81
1	0.45	0.45	0.45	0.45	0.46	0.48	0.57	0.71	0.90	1.12	1.33	1.59	1.98	2.43	2.81	3.36	3.56	3.76
2	0.45	0.45	0.45	0.45	0.46	0.48	0.58	0.75	0.95	1.17	1.39	1.65	2.01	2.48	2.85	3.34	3.54	4.04
3	0.45	0.45	0.45	0.46	0.47	0.49	0.59	0.78	1.00	1.23	1.46	1.72	2.07	2.57	2.92	3.37	3.56	4.03
4	0.45	0.45	0.46	0.47	0.48	0.49	0.61	0.81	1.04	1.30	1.54	1.81	2.16	2.68	3.04	3.42	3.59	4.03
5	0.46	0.46	0.46	0.48	0.49	0.50	0.62	0.85	1.08	1.39	1.62	1.92	2.27	2.76	3.16	3.47	3.64	4.04
6	0.46	0.46	0.46	0.49	0.50	0.51	0.64	0.87	1.11	1.47	1.74	2.04	2.39	2.85	3.27	3.56	3.76	4.11
7	0.46	0.46	0.48	0.54	0.53	0.52	0.67	0.90	1.16	1.54	1.84	2.13	2.48	2.91	3.35	3.68	3.89	4.21
8	0.46	0.46	0.49	0.56	0.54	0.53	0.68	0.93	1.22	1.62	1.94	2.20	2.58	2.99	3.43	3.80	4.03	4.31
9	0.46	0.47	0.50	0.57	0.55	0.56	0.72	0.99	1.28	1.70	2.01	2.28	2.67	3.08	3.54	3.92	4.13	4.42
10	0.47	0.48	0.51	0.57	0.56	0.60	0.75	1.05	1.37	1.80	2.09	2.37	2.76	3.19	3.66	4.01	4.24	4.53
11	0.47	0.49	0.52	0.57	0.58	0.64	0.80	1.13	1.45	1.87	2.17	2.47	2.85	3.29	3.80	4.14	4.37	4.63
12	0.48	0.50	0.53	0.57	0.59	0.64	0.82	1.19	1.51	1.93	2.25	2.58	2.95	3.42	3.97	4.24	4.48	4.70
13	0.49	0.51	0.54	0.57	0.60	0.65	0.83	1.24	1.56	1.96	2.33	2.69	3.05	3.56	4.13	4.37	4.60	4.79
14	0.51	0.45	0.47	0.57	0.62	0.66	0.85	1.28	1.62	2.00	2.41	2.82	3.15	3.70	4.26	4.48	4.74	4.92
15	0.52	0.46	0.55	0.57	0.62	0.68	0.87	1.33	1.70	2.09	2.50	2.93	3.27	3.85	4.38	4.62	4.90	5.08
16	0.54	0.54	0.54	0.57	0.62	0.69	0.90	1.38	1.77	2.16	2.60	3.04	3.41	4.01	4.51	4.76	5.06	5.20
17	0.54	0.55	0.55	0.57	0.63	0.70	0.92	1.43	1.84	2.24	2.72	3.17	3.56	4.18	4.63	4.90	5.20	5.34
18	0.54	0.55	0.55	0.57	0.63	0.70	0.94	1.48	1.90	2.32	2.82	3.27	3.72	4.32	4.74	5.03	5.36	5.50
19	0.54	0.54	0.55	0.57	0.63	0.72	0.98	1.52	1.95	2.41	2.93	3.39	3.90	4.48	4.87	5.17	5.55	5.65
20	0.54	0.54	0.55	0.57	0.63	0.73	1.01	1.56	1.99	2.49	3.02	3.50	4.10	4.64	5.03	5.33	5.74	5.83
21	0.54	0.54	0.55	0.57	0.63	0.74	1.05	1.59	2.04	2.56	3.10	3.61	4.30	4.82	5.18	5.49	5.89	6.01
22	0.54	0.54	0.56	0.58	0.63	0.76	1.09	1.62	2.09	2.65	3.20	3.77	4.47	4.98	5.33	5.62	6.08	6.18
23	0.54	0.54	0.56	0.59	0.65	0.79	1.12	1.65	2.14	2.72	3.29	3.94	4.62	5.15	5.49	5.75	6.25	6.31
24	0.55	0.55	0.56	0.59	0.67	0.82	1.16	1.69	2.19	2.78	3.37	4.09	4.76	5.31	5.65	5.92	6.39	6.43
25	0.56	0.56	0.57	0.60	0.69	0.84	1.19	1.73	2.24	2.84	3.47	4.22	4.92	5.47	5.81	6.09	6.51	6.56
26	0.57	0.56	0.58	0.61	0.70	0.85	1.24	1.77	2.30	2.91	3.56	4.36	5.06	5.63	5.99	6.30	6.69	6.71
27	0.57	0.57	0.59	0.65	0.70	0.85	1.29	1.81	2.37	2.97	3.68	4.48	5.24	5.80	6.21	6.56	6.87	6.88
28	0.57	0.57	0.59	0.62	0.71	0.86	1.32	1.86	2.43	3.05	3.80	4.62	5.42	5.98	6.42	6.83	7.05	7.02
29	0.58	0.58	0.58	0.65	0.71	0.87	1.34	1.89	2.50	3.13	3.93	4.77	5.59	6.18	6.64	7.17	7.30	7.23
30	0.59	0.59	0.58	0.66	0.73	0.89	1.35	1.93	2.55	3.21	4.04	4.93	5.77	6.37	6.88	7.45	7.53	7.41
31	0.60	0.60	0.59	0.67	0.74	0.91	1.37	1.96	2.62	3.30	4.17	5.08	5.93	6.59	7.16	7.68	7.77	7.63
32	0.62	0.61	0.60	0.68	0.75	0.92	1.39	1.99	2.69	3.38	4.28	5.22	6.10	6.83	7.40	7.91	8.01	7.82
33	0.64	0.63	0.62	0.69	0.76	0.94	1.43	2.03	2.76	3.47	4.38	5.36	6.28	7.05	7.65	8.19	8.24	8.02
34	0.66	0.65	0.64	0.71	0.77	0.96	1.47	2.08	2.83	3.54	4.48	5.49	6.45	7.28	7.96	8.45	8.47	8.24
35	0.66	0.66	0.64	0.73	0.79	0.98	1.49	2.12	2.90	3.62	4.57	5.62	6.63	7.49	8.25	8.70	8.69	8.46
36	0.67	0.67	0.64	0.74	0.80	1.00	1.52	2.16	2.97	3.70	4.67	5.74	6.80	7.70	8.54	8.94	8.93	8.69
37	0.68	0.68	0.64	0.75	0.82	1.02	1.56	2.21	3.03	3.79	4.77	5.86	6.95	7.90	8.82	9.19	9.16	8.92
38	0.68	0.68	0.65	0.77	0.84	1.04	1.61	2.28	3.10	3.89	4.88	5.99	7.13	8.10	9.12	9.37	9.37	9.13
39	0.68	0.68	0.65	0.77	0.85	1.06	1.64	2.35	3.17	4.00	5.00	6.11	7.31	8.32	9.36	9.58	9.57	9.31
40	0.67	0.67	0.64	0.77	0.86	1.07	1.68	2.40	3.23	4.12	5.12	6.26	7.51	8.64	9.63	9.85	9.83	9.57
41	0.66	0.66	0.64	0.75	0.86	1.08	1.69	2.45	3.30	4.25	5.25	6.41	7.71	8.92	9.87	10.06	10.03	9.79
42	0.66	0.66	0.62	0.76	0.87	1.09	1.72	2.48	3.37	4.37	5.37	6.57	7.90	9.22	10.05	10.28	10.24	10.00
43	0.66	0.65	0.61	0.75	0.86	1.10	1.75	2.51	3.44	4.49	5.50	6.72	8.13	9.45	10.23	10.54	10.49	10.27
44	0.66	0.65	0.61	0.74	0.86	1.11	1.77	2.55	3.51	4.60	5.62	6.90	8.35	9.73	10.47	10.76	10.68	10.47
45	0.65	0.64	0.61	0.75	0.86	1.13	1.80	2.60	3.59	4.72	5.74	7.07	8.59	9.99	10.69	10.97	10.85	10.68
46	0.65	0.63	0.62	0.75	0.87	1.16	1.83	2.65	3.67	4.83	5.89	7.25	8.89	10.19	10.86	11.16	11.03	10.88
47	0.65	0.63	0.63	0.75	0.89	1.20	1.86	2.71	3.76	4.94	6.02	7.45	9.13	10.44	11.04	11.32	11.17	11.05
48	0.65	0.64	0.64	0.77	0.91	1.23	1.90	2.77	3.85	5.05	6.17	7.63	9.34	10.70	11.27	11.47	11.31	11.19
49	0.66	0.65	0.65	0.78	0.94	1.25	1.93	2.83	3.94	5.15	6.32	7.81	9.56	10.86	11.38	11.56	11.40	11.28
50	0.67	0.66	0.65	0.78	0.96	1.27	1.95	2.88	4.04	5.26	6.45	7.95	9.72	10.98	11.47	11.63	11.48	11.34
51	0.67	0.66	0.66	0.78	0.99	1.28	1.98	2.96	4.14	5.37	6.57	8.07	9.85	11.08	11.50	11.68	11.54	11.39
52	0.68	0.67	0.66	0.79	1.01	1.30	2.02	3.03	4.22	5.47	6.69	8.14	9.98	11.15	11.54	11.49	11.37	11.21
53	0.67	0.67	0.66	0.80	1.03	1.31	2.05	3.09	4.30	5.57	6.79	8.20	10.11	11.18	11.59	11.54	11.44	11.28
54	0.67	0.66	0.66	0.80	1.03	1.31	2.08	3.16	4.38	5.66	6.89	8.26	10.22	11.22	11.61	11.56	11.47	11.33
55	0.67	0.66	0.65	0.79	1.04	1.32	2.10	3.20	4.46	5.78	6.96	8.37	10.33	11.27	11.67	11.62	11.53	11.42
56	0.67	0.66	0.65	0.80	1.05	1.33	2.14	3.25	4.53	5.89	7.03	8.43	10.44	11.35	11.72	11.65	11.56	11.48
57	0.67	0.66	0.65	0.81	1.07	1.36	2.18	3.32	4.61	6.00	7.11	8.51	10.48	11.38	11.74	11.66	11.55	11.49
58	0.67	0.67	0.66	0.82	1.09	1.37	2.21	3.37	4.69	6.13	7.22	8.62	10.53	11.40	11.48	11.40	11.28	11.23
59	0.67	0.67	0.68	0.84	1.11	1.39	2.22	3.43	4.78	6.25	7.34	8.75	10.56	11.39	11.45	11.36	11.23	11.17
60	0.68	0.68	0.68	0.85	1.13	1.41	2.25	3.49	4.88	6.38	7.50	8.91	10.35	11.18	11.06	10.98	10.84	10.78
61	0.69	0.68	0.69	0.86	1.15	1.44	2.29	3.55	5.01	6.51	7.66	9.06	10.40	11.24	11.38	11.31	11.17	11.09
62	0.70	0.69	0.69	0.87	1.16	1.46	2.35	3.61	5.11	6.63	7.84	9.14	10.35	11.22	11.36	11.29	11.16	11.06
63	0.72	0.70	0.71	0.88	1.17	1.49	2.39	3.70	5.21	6.76	8.00	9.20	10.30	11.21	11.33	11.28	11.16	11.05
64	0.73	0.72	0.72	0.89	1.18	1.52	2.43	3.77	5.32	6.89	8.15	9.21	10.18	11.12	11.24	11.21	11.09	10.97
65	0.74	0.73	0.73	0.90	1.18	1.54	2.47	3.84	5.43	7.02	8.30	9.28	10.16	11.15	11.27	11.25	11.14	11.02
66	0.75	0.74	0.73	0.92	1.19	1.56	2.51	3.91	5.55	7.15	8.44	9.36	10.17	11.18	11.30	11.29	11.20	11.08
67	0.75	0.75	0.74	0.94	1.21	1.58	2.57	3.97	5.66	7.30	8.58	9.47	10.22	11.23	11.34	11.24	11.15	11.16
68	0.76	0.76	0.75	0.96	1.23	1.60	2.62	4.03	5.75	7.42	8.71	9.56	10.30	11.07	11.17	11.18	11.13	11.04
69	0																	

ft/s	Composite Fuel Consumption, gal/h																	
	-5	-4	-3	-2	-1	0	1	2	3	4	5	6	7	8	9	10	11	12
78	0.80	0.78	0.78	0.85	1.33	1.80	3.04	4.70	6.61	8.83	10.30	10.71	10.80	10.84	11.12	11.35	11.39	11.41
79	0.80	0.77	0.77	0.85	1.33	1.83	3.08	4.79	6.75	8.96	10.43	10.83	10.90	10.92	11.12	11.41	11.46	11.47
80	0.80	0.77	0.76	0.84	1.32	1.86	3.12	4.88	6.92	9.08	10.56	10.93	10.99	11.00	11.12	11.45	11.51	11.53
81	0.80	0.77	0.77	0.85	1.32	1.88	3.16	4.96	7.08	9.20	10.70	11.06	11.11	11.11	11.17	11.50	11.60	11.61
82	0.79	0.78	0.79	0.86	1.35	1.91	3.22	5.05	7.21	9.34	10.81	11.17	11.21	11.21	11.21	11.52	11.68	11.69
83	0.78	0.78	0.82	0.89	1.36	1.94	3.28	5.12	7.31	9.48	10.95	11.28	11.29	11.29	11.29	11.52	11.73	11.75
84	0.78	0.79	0.86	0.92	1.32	1.97	3.34	5.18	7.41	9.64	11.05	11.33	11.32	11.33	11.29	11.47	11.74	11.76
85	0.78	0.80	0.90	0.96	1.33	2.00	3.41	5.28	7.47	9.74	11.13	11.41	11.38	11.38	11.35	11.45	11.76	11.80
86	0.78	0.80	0.92	0.99	1.37	2.05	3.47	5.38	7.57	9.84	11.14	11.50	11.45	11.45	11.43	11.47	11.79	11.88
87	0.78	0.80	0.93	1.02	1.39	2.13	3.53	5.50	7.69	9.90	11.16	11.57	11.52	11.51	11.50	11.80	11.94	11.94
88	0.79	0.80	0.92	1.03	1.46	2.20	3.58	5.60	7.80	9.99	11.29	11.45	11.40	11.38	11.39	11.35	11.60	11.80
89	0.79	0.80	0.91	1.02	1.54	2.24	3.63	5.70	7.93	10.08	11.31	11.47	11.43	11.39	11.41	11.37	11.55	11.80
90	0.81	0.81	0.89	1.00	1.60	2.24	3.69	5.83	8.07	10.18	11.29	11.46	11.43	11.38	11.39	11.36	11.46	11.75
91	0.83	0.81	0.87	0.98	1.62	2.27	3.74	5.94	8.21	10.28	11.31	11.49	11.46	11.38	11.40	11.38	11.42	11.69
92	0.85	0.83	0.86	0.97	1.66	2.33	3.81	6.06	8.35	10.37	11.41	11.60	11.58	11.47	11.48	11.47	11.47	11.69
93	0.87	0.85	0.86	0.97	1.64	2.35	3.88	6.14	8.47	10.44	11.38	11.60	11.56	11.43	11.42	11.42	11.39	11.55
94	0.89	0.88	0.89	0.98	1.62	2.38	3.98	6.25	8.59	10.50	11.42	11.67	11.61	11.46	11.43	11.44	11.40	11.48
95	0.91	0.89	0.92	0.99	1.62	2.42	4.06	6.36	8.65	10.53	11.51	11.77	11.71	11.54	11.49	11.50	11.47	11.49
96	0.91	0.90	0.93	1.01	1.66	2.48	4.15	6.46	8.71	10.54	11.38	11.64	11.59	11.41	11.34	11.35	11.33	11.31
97	0.92	0.90	0.95	1.03	1.73	2.52	4.22	6.56	8.77	10.51	11.33	11.56	11.51	11.35	11.26	11.26	11.25	11.21
98	0.95	0.91	0.94	1.05	1.73	2.54	4.31	6.68	8.83	10.47	11.25	11.43	11.40	11.25	11.15	11.14	11.15	11.11
99	0.96	0.92	0.93	1.06	1.73	2.57	4.39	6.80	8.89	10.43	11.15	11.29	11.27	11.16	11.04	11.02	11.03	11.00
100	0.98	0.94	0.94	1.07	1.79	2.65	4.54	6.91	8.95	10.39	11.11	11.22	11.21	11.13	11.01	10.96	10.98	10.97
101	1.00	0.96	0.95	1.09	1.85	2.76	4.67	6.99	9.00	10.35	11.08	11.18	11.17	11.12	11.00	10.93	10.94	10.94
102	1.01	0.98	0.96	1.10	1.91	2.83	4.77	7.04	9.09	10.36	11.12	11.20	11.20	11.16	11.04	10.95	10.96	10.98
103	1.01	0.99	0.98	1.12	1.96	2.88	4.88	7.13	9.16	10.38	11.15	11.23	11.24	11.21	11.09	10.98	10.97	11.00
104	1.02	1.01	1.00	1.15	2.06	2.94	4.97	7.26	9.23	10.40	11.14	11.21	11.23	11.20	11.10	10.97	10.94	10.98
105	1.03	1.02	1.02	1.17	2.11	3.00	5.08	7.39	9.30	10.45	11.12	11.18	11.22	11.20	11.11	10.97	10.92	10.95
106	1.05	1.03	1.04	1.21	2.16	3.06	5.22	7.60	9.41	10.50	11.10	11.15	11.21	11.19	11.12	10.98	10.90	10.93
107	1.06	1.04	1.06	1.24	2.19	3.11	5.32	7.76	9.53	10.60	10.94	10.99	11.05	11.03	10.98	10.85	10.75	10.76
108	1.07	1.05	1.08	1.27	2.23	3.18	5.43	7.86	9.65	10.68	10.77	10.81	10.89	10.87	10.83	10.70	10.59	10.57
109	1.08	1.06	1.09	1.29	2.20	3.29	5.59	7.97	9.74	10.75	10.98	11.01	11.09	11.07	11.04	10.92	10.79	10.76
110	1.08	1.06	1.10	1.31	2.21	3.35	5.67	8.02	9.80	10.80	11.01	11.04	11.12	11.10	11.07	10.96	10.82	10.78

ft/s	ft/s	Composite CO Emissions, mg/s																
		-5	-4	-3	-2	-1	0	1	2	3	4	5	6	7	8	9	10	11
0	2.50	2.52	2.66	2.55	2.74	2.51	2.72	3.10	4.32	6.31	10.19	17.10	36.60	60.07	63.95	78.28	87.87	94.11
1	2.54	2.57	2.73	2.60	2.74	2.47	2.55	3.15	4.41	6.73	11.18	17.96	36.34	58.30	61.20	75.63	85.03	91.96
2	2.57	2.63	2.80	2.59	2.54	2.49	2.43	3.17	4.50	7.60	12.84	19.34	35.97	54.79	57.15	70.67	79.62	86.44
3	2.64	2.71	2.94	2.60	2.50	2.54	2.36	3.03	4.60	8.95	15.01	21.22	35.74	50.45	52.27	64.24	72.10	80.53
4	2.71	2.77	3.08	2.59	2.42	2.55	2.31	2.92	4.75	10.76	17.66	23.80	35.21	45.67	48.15	57.29	63.69	71.92
5	2.81	2.83	3.18	2.58	2.34	2.54	2.33	2.93	5.35	12.88	20.80	27.08	34.46	40.14	46.79	51.22	56.14	66.77
6	2.93	2.87	3.21	2.55	2.25	2.46	2.39	3.08	6.30	15.33	24.37	29.27	32.55	36.92	45.54	47.27	51.56	68.82
7	3.09	2.92	3.16	2.59	2.19	2.35	2.62	3.82	7.80	17.44	27.22	29.70	28.95	32.93	44.95	47.62	52.17	79.05
8	3.26	2.99	3.09	2.78	2.28	2.40	3.30	5.49	9.40	19.10	28.19	28.00	25.36	31.59	45.76	50.10	54.97	96.20
9	3.42	3.06	3.05	3.11	2.72	2.98	4.63	7.88	11.10	19.84	26.99	24.53	22.89	32.43	48.76	55.51	63.44	114.15
10	3.55	3.15	3.12	3.65	3.66	4.11	6.46	10.21	12.47	18.97	24.14	21.05	23.10	35.90	56.19	69.48	82.42	135.15
11	3.64	3.21	3.33	4.33	5.11	5.95	8.39	11.86	13.81	17.55	21.35	20.02	24.59	41.75	69.44	92.59	109.57	158.88
12	3.64	3.33	3.63	5.01	6.60	7.89	9.98	12.94	15.41	16.97	18.85	20.33	28.03	50.97	93.39	126.03	146.20	185.44
13	3.56	3.54	3.92	5.31	7.61	9.77	11.14	13.80	17.40	17.41	19.12	22.83	33.09	63.83	132.39	168.53	186.13	218.20
14	3.82	3.95	4.12	5.20	7.74	10.39	11.63	15.00	19.65	19.14	21.51	25.17	39.67	80.42	178.91	218.92	230.68	257.51
15	4.52	4.48	4.21	4.82	7.07	9.91	11.46	16.10	22.00	21.19	23.45	29.35	47.74	100.12	225.55	273.74	280.97	306.88
16	5.52	5.10	4.22	4.48	6.02	8.33	10.72	17.37	23.80	23.74	25.47	33.35	56.32	121.41	256.72	325.02	341.53	359.63
17	5.96	5.60	4.23	4.22	5.24	7.05	10.09	18.35	25.15	25.40	26.17	37.14	68.55	148.96	282.51	375.21	408.45	422.20
18	5.75	5.97	4.30	4.05	4.73	6.24	9.67	19.17	25.69	25.60	26.42	41.14	86.75	185.07	312.36	426.77	481.90	497.21
19	5.15	6.10	4.45	3.90	4.51	6.25	9.87	19.73	25.23	26.36	25.80	47.23	110.46	234.20	362.26	486.67	554.51	577.51
20	4.67	6.06	4.65	3.79	4.53	6.53	10.20	20.14	24.46	24.86	26.13	56.68	146.96	303.02	421.95	538.57	605.66	629.70
21	4.37	5.84	4.85	3.72	4.82	7.42	10.86	20.35	23.18	23.09	27.83	71.74	191.57	387.69	512.36	595.06	654.20	669.51
22	4.18	5.49	5.05	3.72	5.23	8.52	11.65	20.66	22.06	21.51	31.64	94.00	249.13	496.42	606.63	649.98	695.81	696.76
23	4.07	5.11	5.20	3.84	5.84	9.80	12.68	21.25	21.04	20.68	38.06	127.66	319.14	602.21	695.47	710.38	748.58	735.68
24	4.05	4.75	5.38	4.30	6.71	10.91	13.72	21.76	20.02	20.48	48.60	174.12	412.22	709.89	772.48	784.12	826.93	796.26
25	4.06	4.49	5.51	5.06	7.89	12.00	15.00	22.53	19.20	21.08	61.54	235.37	510.01	796.97	834.45	894.97	944.22	889.03
26	4.30	4.34	5.66	6.03	9.14	12.88	16.34	23.60	18.93	22.66	82.40	303.76	613.29	890.04	964.40	1100.86	1098.63	1007.41
27	4.79	4.36	5.73	6.91	10.25	13.64	18.12	24.45	19.06	25.76	107.78	384.84	724.55	1014.77	1124.36	1311.57	1265.72	1142.46
28	5.59	4.55	5.78	7.67	11.21	14.29	19.49	24.92	19.75	30.88	148.76	460.86	810.89	1139.19	1335.06	1491.79	1358.84	1197.38
29	6.32	4.89	5.78	8.27	12.10	15.04	21.13	25.08	20.47	38.60	188.57	520.67	896.28	1279.62	1542.83	1638.03	1409.23	1199.38
30	6.92	5.32	5.75	8.66	12.73	15.73	22.67	25.23	21.90	48.80	236.17	573.29	980.39	1431.68	1700.87	1751.51	1523.86	1271.85
31	7.32	5.88	5.85	8.78	12.86	16.05	24.18	24.98	22.32	60.99	281.06	643.93	1074.86	1576.67	1784.52	1844.89	1648.78	1392.95
32	7.71	6.54	6.18	8.76	12.48	15.79	24.64	24.09	22.74	74.15	317.44	711.85	1129.53	1746.09	1838.37	1900.90	1744.86	1533.14
33	8.11	7.29	6.79	8.84	11.88	15.19	24.44	23.53	23.42	87.41	353.24	780.30	1220.07	1918.74	1944.91	1992.33	1782.58	1600.33
34	8.50	7.97	7.74	9.31	11.96	14.59	23.12	22.86	24.57	100.13	400.28	848.86	1300.95	2043.27	2075.75	2055.52	1829.10	1644.69
35	8.80	8.57	8.95	10.02	11.13	14.23	21.96	22.25	26.23	115.08	448.46	907.62	1372.35	2114.83	2155.65	2154.63	1908.15	1688.41
36	8.94	8.98	10.18	10.78	11.22	14.07	21.24	21.80	28.65	134.33	514.54	954.98	1454.02	2209.13	2365.19	2373.13	2278.11	2006.20
37	8.88	9.11	10.68	11.22	11.66	14.24	21.11	21.44	32.43	162.94	584.39	1001.49	1527.86	2482.14	2706.93	2722.12	2643.33	2280.92
38	8.71	8.97	10.45	11.40	12.20	14.53	21.51	22.03	37.67	200.12	640.71	1043.72	1585.47	2489.89	2719.24	3087.87	3042.43	2578.16
39	8.47	8.79	9.99	11.46	12.89	14.94	22.13	23.75	43.95	242.01	703.20	1102.40	1712.78	2677.80	2865.19	3151.32	3139.10	2922.94
40	8.26	8.74	10.07	11.65	13.40	15.36	22.76	24.25	51.40	289.42	746.87	1169.52	1887.01	2791.12	3083.23	3407.89	3413.28	3194.42
41	8.07	8.90	10.71	11.86	13.65	15.49	22.85	24.55	60.10	334.48	775.62	1228.66	2011.69	3029.70	3254.43	3611.01	3601.00	3382.93
42	8.32	9.31	11.24	11.96	13.63	15.49	23.13	25.41	71.71	378.64	795.96	1304.94	2228.91	3051.10	3324.13	3719.96	3759.13	3547.61
43	9.00	9.89	11.42	11.87	13.46	15.57	23.88	27.79	87.33	425.38	816.24	1376.97	2406.30	3212.63	3403.70	3902.52	3864.83	3667.03
44	10.12	10.53	11.23	11.65	13.31	15.87	25.55	31.77	105.99	469.82	863.35	1458.86	2588.41	3518.46	3730.26	3919.85	3930.10	3762.44
45	10.84	10.85	11.04	11.45	13.26	16.43	27.25	36.32	124.63	508.42	929.87	1561.28	2716.61	3826.30	4023.17	4147.64	4234.07	4109.16
46	11.10	10.88	10.85	11.30	13.32	17.08	28.75	39.81	142.51	555.01	1005.34	1679.01	2887.78	3909.95	4136.55	4310.70	4238.23	4160.76
47	10.96	10.75	10.76	11.21	13.42	17.72	28.79	41.56	158.03	585.54	1119.12	1796.17	3011.10	4187.57	4440.67	4316.83	4229.79	4188.27
48	10.88	10.71	10.76	11.15	13.70	18.29	28.12	41.08	170.81	622.13	1201.25	1929.40	3087.39	4276.26	4575.21	4608.26	4500.75	4477.06
49	10.87	10.77	10.81	11.13	13.94	18.62	26.54	38.60	179.38	661.22	1306.36	2060.58	3249.47	4377.09	4664.08	4721.61	4591.68	4565.02
50	10.85	10.83	10.82	11.07	14.03	18.32	24.59	35.46	193.13	682.58	1408.39	2201.19	3416.19	4458.55	4709.95	4817.14	4669.26	4623.48
51	10.72	10.80	10.80	11.00	13.86	17.79	22.64	33.46	204.29	736.84	1524.76	2353.21	3643.18	4526.73	4756.83	4912.10	4751.58	4678.53
52	10.75	10.81	10.79	10.97	13.66	16.93	20.95	34.26	225.18	803.20	1679.98	2505.56	3720.82	4588.20	4813.38	4718.61	4552.68	4452.91
53	10.64	10.54	10.27	10.75	13.55	16.45	19.98	37.13	243.80	860.90	1847.26	2639.47	4020.40	4613.89	4826.72	4734.64	4569.77	4441.20
54	10.62	10.12	9.34	10.25	13.51	16.29	19.24	40.86	272.93	918.45	2001.82	2753.93	4280.78	4619.63	4872.28	4790.03	4632.36	4504.47
55	10.47	9.37	7.91	9.50	13.64	16.48	18.55	45.00	297.98	1013.70	2111.02	2886.92	4302.55	4594.36	4854.56	4789.93	4643.48	4515.18
56	10.44	8.93	6.96	9.01	14.11	17.01	18.30	49.68	337.90	1101.83	2194.62	2927.68	4283.91	4572.22	4732.54	4692.37	4559.21	4435.99
57	10.47	8.84	6.76	9.07	14.69	17.92	18.59	56.62	372.78	1201.70	2251.06	2940.89	4274.11	4568.65	4673.55	4662.88	4543.00	4428.53
58	10.63	9.26	7.49	9.71	15.32	19.12	19.17	65.95	421.92	1283.69	2369.08	2949.58	4262.17	4525.75	4478.31	4499.06	4392.56	4287.02
59	10.92	10.02	8.83	10.71	15.97	20.28	20.53	78.37	456.81	1391.03	2380.89	2937.57	4310.88	4530.91	4489.60	4539.65	4447.51	4349.26
60	11.56	11.11	10.61	11.79	16.65	21.58	23.36	93.99	509.42	1523.58	2377.76	3047.49	4353.50	4523.58	4468.79	4542.01	4467.08	4373.24
61	12.46	12.36	12.35	12.89	17.49	23.27												

ft/s	Composite CO Emissions, mg/s																	
	-5	-4	-3	-2	-1	0	1	2	3	4	5	6	7	8	9	10	11	12
81	24.68	23.85	23.17	24.41	23.70	31.60	108.68	538.61	1450.36	3265.93	4331.82	4563.02	4528.21	4506.08	4532.95	4612.74	4620.61	4651.01
82	25.19	24.46	24.04	25.34	24.85	33.95	115.15	567.04	1496.13	3265.77	4602.08	4498.67	4473.62	4450.52	4448.65	4529.12	4557.27	4575.77
83	25.90	25.40	25.24	26.57	26.07	36.54	119.78	607.64	1533.61	3260.21	4659.70	4459.74	4441.26	4418.12	4395.84	4466.30	4521.27	4530.27
84	27.16	27.12	27.20	28.54	27.10	38.76	121.75	631.86	1589.71	3469.47	4698.75	4458.36	4443.38	4418.39	4383.11	4437.11	4522.63	4529.76
85	29.79	29.75	30.11	31.44	28.30	40.74	121.08	643.17	1637.14	3536.81	4713.48	4464.07	4452.56	4426.84	4385.07	4417.15	4531.99	4549.70
86	33.72	33.18	33.15	34.43	29.89	41.70	117.45	653.71	1713.04	3548.53	4713.46	4712.97	4704.93	4679.28	4635.11	4645.15	4782.62	4824.39
87	37.86	36.67	35.96	36.77	31.62	41.13	114.11	655.50	1789.39	3385.65	4684.31	4745.58	4740.85	4716.82	4674.88	4666.31	4815.05	4890.27
88	41.21	39.78	37.38	37.32	33.63	40.70	111.72	686.58	1900.74	3580.46	4653.61	4719.09	4716.67	4693.15	4656.33	4637.25	4783.60	4894.54
89	43.21	42.11	38.89	37.59	36.42	41.34	112.39	705.57	2092.13	3864.15	4664.39	4722.43	4722.20	4697.31	4666.82	4644.50	4775.51	4915.03
90	44.42	43.76	39.94	37.71	38.84	43.51	116.97	736.86	2234.45	4140.56	4668.44	4722.98	4723.59	4693.46	4667.49	4647.07	4752.28	4905.58
91	45.30	44.91	41.97	39.36	41.03	46.66	126.55	796.82	2370.35	4188.42	4724.77	4781.08	4778.82	4739.69	4714.72	4697.54	4772.73	4919.01
92	46.21	45.79	43.80	41.35	42.82	48.28	141.89	867.93	2424.87	4238.28	4756.88	4822.17	4811.64	4760.44	4731.51	4716.43	4763.77	4884.74
93	47.17	46.58	45.67	43.50	43.56	48.36	159.40	918.50	2505.30	4284.00	4819.78	4898.56	4877.17	4813.89	4776.22	4760.25	4787.51	4870.61
94	48.19	47.29	46.78	44.88	44.32	47.66	177.19	953.82	2527.57	4299.37	4842.54	4935.17	4905.99	4834.64	4784.63	4764.15	4779.25	4827.08
95	49.22	47.93	47.56	45.91	45.34	46.56	196.14	1008.88	2514.66	4257.30	4810.31	4913.88	4882.88	4810.27	4746.76	4719.31	4728.02	4751.22
96	50.18	48.54	48.22	46.95	46.54	45.98	213.03	1047.96	2494.02	4205.94	4642.42	4753.63	4726.94	4661.30	4585.76	4549.91	4553.29	4567.26
97	51.08	49.25	49.00	48.14	48.10	47.07	228.65	1084.13	2812.60	4174.43	4617.35	4735.53	4715.97	4663.90	4580.59	4536.06	4532.77	4541.94
98	51.92	50.10	49.90	49.40	49.13	48.10	250.70	1131.46	2810.68	4210.11	4629.79	4754.62	4744.02	4709.53	4624.47	4571.20	4559.68	4563.57
99	52.72	51.04	50.92	50.54	49.51	47.74	275.20	1164.18	2951.12	4241.45	4649.44	4782.27	4781.54	4762.18	4679.95	4618.23	4599.31	4594.41
100	53.35	51.83	51.85	51.50	49.18	46.63	306.00	1205.17	2894.25	4248.10	4657.71	4798.50	4809.37	4798.59	4719.98	4649.47	4625.55	4613.95
101	53.84	52.39	52.68	52.19	47.49	45.25	340.34	1263.82	3024.91	4227.62	4681.05	4829.92	4854.07	4843.30	4765.50	4685.31	4658.03	4642.61
102	54.19	52.74	53.42	52.66	47.72	43.89	376.19	1446.00	3042.26	4213.76	4708.89	4863.50	4902.93	4888.58	4810.17	4719.40	4688.33	4671.63
103	53.98	52.58	53.79	52.77	47.60	44.23	420.32	1606.37	2971.53	4174.69	4588.27	4745.78	4802.43	4784.91	4707.67	4607.08	4569.98	4552.31
104	53.36	52.12	54.04	52.88	48.48	46.31	467.72	1734.72	2950.10	4127.35	4517.91	4676.21	4752.46	4735.50	4663.41	4555.70	4509.80	4491.65
105	52.59	51.57	54.42	53.74	51.01	51.13	511.40	1771.72	2937.40	4068.73	4422.04	4580.60	4677.25	4663.97	4599.23	4488.92	4431.95	4413.34
106	52.97	52.10	55.90	56.41	54.29	56.67	580.33	1944.73	2915.07	4024.16	4338.34	4496.24	4612.24	4605.09	4547.53	4439.89	4370.55	4350.93
107	54.65	53.80	58.23	60.90	59.86	63.70	637.12	2103.53	2945.11	3999.93	4294.58	4448.34	4579.65	4580.01	4527.71	4427.89	4348.33	4323.57
108	57.39	56.26	61.16	65.93	65.10	75.49	704.40	2296.38	3081.32	4007.51	4283.47	4427.91	4569.82	4578.19	4529.16	4440.62	4348.36	4320.11
109	60.04	58.38	63.66	70.01	70.50	85.01	759.68	2403.12	3150.32	4046.60	4301.77	4434.05	4581.96	4597.36	4549.92	4472.77	4372.65	4338.07
110	61.74	59.57	65.19	72.17	77.83	90.09	808.57	2450.10	3188.29	4097.55	4301.22	4424.55	4575.13	4594.77	4547.93	4478.03	4373.74	4334.83

ft/s	Composite HC Emissions, mg/s																	
	ft/s/s	-5	-4	-3	-2	-1	0	1	2	3	4	5	6	7	8	9	10	11
0	0.65	0.65	0.62	0.57	0.64	0.55	0.55	0.63	0.72	0.74	0.87	1.18	2.11	3.62	3.61	4.11	4.36	5.08
1	0.66	0.66	0.62	0.58	0.64	0.55	0.53	0.63	0.71	0.76	0.95	1.20	2.14	3.40	3.49	4.02	4.25	4.96
2	0.67	0.67	0.63	0.59	0.61	0.56	0.51	0.61	0.72	0.83	1.03	1.29	2.06	3.07	3.37	3.78	4.04	4.75
3	0.68	0.69	0.65	0.60	0.61	0.58	0.50	0.59	0.69	0.93	1.12	1.30	1.94	2.82	3.18	3.42	3.76	4.48
4	0.69	0.69	0.67	0.61	0.59	0.59	0.51	0.55	0.67	1.01	1.22	1.33	1.88	2.60	2.99	3.06	3.44	4.12
5	0.70	0.70	0.68	0.59	0.56	0.58	0.51	0.54	0.69	1.08	1.33	1.38	1.95	2.43	2.79	2.81	3.15	3.75
6	0.70	0.69	0.67	0.57	0.53	0.54	0.50	0.54	0.75	1.13	1.44	1.55	2.00	2.27	2.73	2.72	2.99	3.47
7	0.72	0.69	0.66	0.55	0.48	0.50	0.48	0.56	0.82	1.17	1.52	1.74	2.01	2.26	2.71	2.78	3.00	3.41
8	0.74	0.68	0.62	0.55	0.47	0.46	0.47	0.67	0.86	1.24	1.57	1.83	2.06	2.37	2.77	3.02	3.20	3.60
9	0.75	0.68	0.58	0.56	0.47	0.46	0.51	0.78	0.91	1.27	1.59	1.85	2.18	2.56	2.94	3.37	3.53	4.02
10	0.76	0.67	0.55	0.58	0.49	0.49	0.60	0.90	1.02	1.33	1.63	1.89	2.34	2.83	3.29	3.88	4.04	4.66
11	0.76	0.64	0.53	0.60	0.54	0.57	0.72	0.96	1.20	1.35	1.69	2.05	2.46	3.13	3.78	4.46	4.67	5.38
12	0.75	0.60	0.54	0.61	0.58	0.68	0.84	1.03	1.33	1.45	1.81	2.15	2.63	3.49	4.53	5.14	5.40	6.07
13	0.72	0.58	0.55	0.61	0.61	0.82	0.91	1.08	1.40	1.56	1.90	2.31	2.89	3.91	5.61	6.08	6.13	6.89
14	0.68	0.58	0.56	0.60	0.61	0.86	0.94	1.14	1.41	1.69	2.04	2.59	3.33	4.38	6.99	7.31	7.08	7.93
15	0.67	0.59	0.56	0.58	0.58	0.81	0.93	1.19	1.41	1.81	2.20	2.95	3.84	4.99	8.29	8.73	8.26	9.24
16	0.68	0.60	0.56	0.55	0.54	0.66	0.88	1.23	1.49	2.00	2.34	3.25	4.28	5.74	9.04	9.91	10.03	10.81
17	0.68	0.62	0.54	0.53	0.50	0.54	0.83	1.26	1.59	2.18	2.44	3.37	4.68	6.63	9.48	11.21	12.24	12.92
18	0.66	0.63	0.53	0.51	0.46	0.47	0.82	1.27	1.74	2.28	2.45	3.42	5.10	7.61	9.90	12.73	14.90	15.54
19	0.63	0.63	0.52	0.51	0.43	0.44	0.85	1.25	1.83	2.29	2.43	3.48	5.67	8.73	10.91	14.89	17.41	18.28
20	0.61	0.62	0.52	0.50	0.42	0.45	0.90	1.23	1.87	2.23	2.39	3.55	6.33	10.28	12.37	16.78	19.37	20.22
21	0.60	0.61	0.53	0.50	0.41	0.49	0.94	1.21	1.88	2.17	2.38	3.71	7.10	12.50	14.79	18.88	21.14	21.78
22	0.58	0.59	0.53	0.49	0.41	0.60	0.99	1.22	1.88	2.11	2.40	4.00	7.98	15.42	17.81	20.80	22.53	22.64
23	0.57	0.57	0.54	0.48	0.42	0.71	1.02	1.24	1.91	2.05	2.46	4.53	9.10	18.70	20.98	22.83	23.41	23.19
24	0.55	0.55	0.55	0.48	0.47	0.80	1.04	1.30	1.93	2.06	2.58	5.41	10.65	21.93	23.70	24.44	24.57	24.10
25	0.55	0.54	0.55	0.50	0.56	0.86	1.03	1.39	1.93	2.11	2.77	6.60	12.76	24.44	25.17	26.41	26.59	25.61
26	0.55	0.53	0.56	0.53	0.68	0.91	1.02	1.51	1.93	2.24	3.03	8.02	15.44	26.09	26.79	29.72	29.81	28.71
27	0.57	0.53	0.56	0.56	0.77	0.93	1.02	1.57	1.94	2.42	3.38	9.59	18.86	27.95	29.92	34.78	32.96	31.96
28	0.59	0.54	0.57	0.61	0.82	0.92	1.00	1.59	1.99	2.58	3.91	11.07	21.81	29.34	34.24	40.38	35.38	32.43
29	0.62	0.55	0.58	0.65	0.84	0.87	1.00	1.59	2.05	2.69	4.60	12.32	24.07	30.81	40.75	46.86	40.30	33.45
30	0.64	0.58	0.58	0.69	0.85	0.83	1.05	1.61	2.13	2.79	5.56	13.55	25.71	32.85	48.08	54.45	48.24	35.78
31	0.67	0.62	0.60	0.70	0.85	0.83	1.17	1.60	2.20	2.85	6.70	15.05	27.75	37.27	54.96	61.70	57.82	39.46
32	0.70	0.65	0.62	0.71	0.84	0.88	1.23	1.59	2.24	2.97	7.69	16.29	29.00	44.92	60.94	68.45	65.85	43.36
33	0.74	0.68	0.66	0.75	0.83	0.92	1.22	1.59	2.25	3.14	8.68	18.65	30.37	53.73	66.38	75.94	72.74	45.64
34	0.78	0.71	0.73	0.82	0.80	0.95	1.10	1.62	2.25	3.34	9.98	21.53	32.34	61.90	74.01	84.02	79.05	47.93
35	0.81	0.74	0.85	0.89	0.79	0.96	1.00	1.66	2.28	3.61	11.45	24.26	35.27	68.23	82.72	92.01	85.56	52.35
36	0.82	0.76	0.97	0.94	0.80	0.97	1.09	1.69	2.28	4.00	13.81	25.88	39.38	73.94	92.08	97.46	90.69	58.47
37	0.81	0.78	1.02	0.97	0.83	0.99	1.00	1.72	2.28	4.64	16.78	27.27	45.06	79.34	99.45	102.05	95.31	63.99
38	0.78	0.79	0.99	0.99	0.88	1.01	1.08	1.77	2.30	5.56	19.19	28.54	52.32	85.62	105.14	106.10	99.92	68.56
39	0.75	0.78	0.92	1.00	0.92	1.01	1.21	1.82	2.39	6.83	21.49	30.68	60.64	92.53	108.88	109.69	104.09	74.65
40	0.73	0.77	0.93	1.01	0.95	1.02	1.29	1.89	2.55	8.44	22.98	33.70	69.62	100.01	112.04	112.62	107.43	81.94
41	0.72	0.77	0.99	1.01	0.96	1.02	1.34	1.90	2.71	10.25	23.94	38.63	79.29	106.77	115.40	116.09	111.24	90.46
42	0.75	0.80	1.04	1.00	0.96	1.03	1.40	1.90	2.87	12.07	24.59	45.57	88.88	111.88	118.76	119.92	115.45	98.39
43	0.81	0.86	1.05	0.99	0.96	1.05	1.45	1.92	3.08	13.76	24.83	54.45	96.50	114.87	121.66	123.30	119.47	104.40
44	0.91	0.93	1.02	0.98	0.97	1.08	1.54	2.00	3.37	15.39	26.11	63.85	101.48	117.10	123.83	126.19	123.14	109.91
45	0.98	0.98	1.01	0.98	0.99	1.12	1.64	2.15	3.75	16.93	27.67	72.59	104.06	119.05	125.71	128.63	126.32	115.68
46	1.03	1.02	1.00	0.98	1.02	1.15	1.75	2.31	4.17	18.45	31.13	79.56	105.79	120.95	127.43	130.51	127.46	120.08
47	1.05	1.05	1.03	1.01	1.05	1.19	1.81	2.43	4.59	19.51	36.46	85.85	108.24	123.43	130.15	132.95	129.07	124.37
48	1.09	1.09	1.08	1.03	1.10	1.18	1.85	2.49	4.98	20.71	43.90	91.48	111.46	125.93	132.38	134.91	130.46	127.15
49	1.13	1.15	1.13	1.07	1.13	1.18	1.86	2.54	5.33	21.77	52.49	96.88	115.43	128.68	134.67	136.86	132.35	129.00
50	1.15	1.18	1.15	1.07	1.16	1.18	1.85	2.61	5.72	22.17	61.57	102.10	119.58	131.19	136.65	138.13	134.29	129.80
51	1.13	1.15	1.15	1.05	1.16	1.21	1.79	2.65	6.06	23.63	70.49	107.71	123.53	133.31	139.16	139.40	136.45	130.61
52	1.12	1.15	1.13	1.03	1.16	1.27	1.71	2.68	6.59	25.38	79.26	113.77	127.25	134.80	141.33	140.35	138.23	131.61
53	1.10	1.11	1.05	1.00	1.15	1.32	1.64	2.71	7.11	27.81	87.40	119.49	131.18	136.08	143.26	141.58	139.92	133.64
54	1.09	1.07	0.96	0.94	1.15	1.36	1.62	2.74	8.05	30.12	94.14	124.44	135.40	137.38	144.99	143.12	141.57	136.50
55	1.05	0.99	0.81	0.86	1.15	1.37	1.65	2.82	8.97	33.85	99.00	128.18	138.70	138.30	146.17	144.65	142.84	139.38
56	1.03	0.94	0.71	0.80	1.16	1.38	1.69	2.93	10.19	37.95	102.13	131.26	141.08	139.38	146.55	145.79	143.43	141.40
57	1.01	0.93	0.67	0.80	1.18	1.35	1.75	3.05	11.50	43.59	103.81	133.34	142.74	140.74	147.99	148.23	145.14	143.95
58	1.01	0.96	0.71	0.87	1.19	1.30	1.80	3.16	13.32	49.55	104.96	134.71	144.37	142.62	146.41	147.60	143.84	142.87
59	1.03	1.03	0.82	0.98	1.21	1.25	1.85	3.27	14.67	55.71	105.76	136.07	146.76	144.95	147.90	149.75	145.67	144.47
60	1.06	1.09	0.98	1.05	1.23	1.28	1.91	3.46	16.54	60.71	107.07	138.25	149.33	147.29	149.16	151.33	147.49	145.78
61	1.09	1.15	1.12	1.14	1.27	1.37	1.95	3.66	17.86	65.47	108.41	140.58	152.57	150.31	151.11	153.38	150.29	147.88
62	1.13	1.20	1.25	1.22	1.30	1.51	1.96	3.90	19.65	70.13	110.61	142.30	154.49	153.34	153.28	155.57	153.54	150.36
63	1.15	1.24	1.32	1.30	1.33	1.61	1.99	4.12	21.46	73.87	112.32	142.33	154.52	155.68	155.15	157.47	156.48	152.75
64	1.17	1.29	1.39	1.36	1.33	1.63	2.01	4.43	23.16	75.14	115.36	141.66	153.11	157.02	156.34	158.69	158.50	154.76
65	1.21	1.34	1.45	1.44	1.34	1.59	2.03	4.81	24.45	73.95	117.05	140.67	150.60	156.26	155.63	157.92	158.24	155.10
66	1.27	1.42	1.53	1.50	1.32	1.55	2.06	5.31	24.99	71.73	117.81	14						



ft/s	Composite HC Emissions, mg/s																	
	-5	-4	-3	-2	-1	0	1	2	3	4	5	6	7	8	9	10	11	12
81	1.96	1.90	1.80	1.89	1.58	1.56	3.29	16.11	52.96	111.22	134.68	142.24	141.68	141.62	138.21	153.02	154.21	155.63
82	1.98	1.91	1.79	1.89	1.60	1.55	3.36	17.15	56.27	113.27	135.89	141.95	141.21	142.09	137.06	150.79	153.35	154.66
83	2.01	1.95	1.80	1.89	1.63	1.62	3.40	18.56	58.65	115.28	137.25	142.04	141.14	142.83	137.54	148.08	152.85	154.07
84	2.08	2.04	1.84	1.92	1.66	1.77	3.46	19.62	60.74	117.21	138.59	143.17	142.06	144.21	139.59	145.53	153.21	154.32
85	2.27	2.20	1.89	1.99	1.74	2.01	3.50	20.00	63.24	118.90	140.15	144.79	143.49	145.75	142.26	143.44	153.94	155.03
86	2.56	2.42	1.96	2.07	1.84	2.18	3.48	20.23	66.77	119.78	141.18	145.95	144.47	146.45	144.39	141.65	153.87	155.32
87	2.82	2.62	2.03	2.11	1.97	2.25	3.50	20.42	70.74	120.05	142.31	147.04	145.49	146.93	146.36	141.24	153.18	155.78
88	2.93	2.76	2.07	2.10	2.11	2.24	3.51	21.33	75.57	120.45	143.18	147.85	146.44	147.12	147.94	141.96	151.45	156.22
89	2.94	2.83	2.16	2.13	2.24	2.25	3.56	22.24	80.69	121.33	143.78	148.26	147.40	147.26	149.07	143.57	148.96	156.64
90	2.91	2.87	2.29	2.24	2.31	2.30	3.62	23.53	85.96	122.83	144.00	148.32	148.24	147.23	149.53	145.37	146.21	156.63
91	2.94	2.89	2.51	2.46	2.35	2.38	3.72	25.42	91.26	124.56	144.66	148.87	149.38	147.52	149.80	147.45	144.41	156.18
92	2.98	2.93	2.71	2.67	2.37	2.44	3.90	27.62	96.14	126.40	145.64	150.08	150.46	147.78	149.62	149.07	143.65	154.32
93	3.05	2.98	2.88	2.81	2.36	2.49	4.17	29.61	100.77	129.46	147.10	151.87	151.58	148.17	149.18	150.11	143.93	150.87
94	3.12	3.03	2.97	2.88	2.35	2.51	4.54	31.52	104.29	131.25	148.40	153.37	152.43	148.39	148.31	150.14	144.60	146.46
95	3.18	3.07	3.01	2.93	2.42	2.52	5.09	33.57	106.22	132.71	149.29	154.01	153.02	148.51	147.22	149.34	145.29	142.61
96	3.23	3.09	3.04	3.00	2.51	2.54	5.70	35.64	107.52	134.03	147.88	151.92	151.41	146.82	144.42	146.32	144.10	138.87
97	3.29	3.12	3.09	3.11	2.60	2.57	6.40	38.45	108.45	135.15	148.03	151.38	151.43	147.29	144.12	145.42	144.94	139.02
98	3.35	3.19	3.16	3.23	2.66	2.61	7.51	41.54	109.53	136.92	148.39	151.06	151.45	148.42	144.98	145.42	146.31	140.94
99	3.44	3.29	3.27	3.35	2.68	2.64	8.90	45.70	111.13	138.68	148.66	150.88	151.33	149.63	146.30	145.69	147.42	143.27
100	3.50	3.37	3.36	3.44	2.68	2.63	10.56	50.89	113.04	140.37	148.98	150.69	151.06	150.56	147.28	145.59	147.64	145.16
101	3.54	3.42	3.42	3.50	2.65	2.57	12.49	57.09	116.75	142.85	150.59	151.89	152.11	152.25	148.66	145.99	147.90	147.26
102	3.55	3.44	3.46	3.52	2.57	2.54	15.00	63.45	120.76	145.20	152.63	153.20	153.33	153.74	149.70	146.24	147.65	148.60
103	3.46	3.35	3.41	3.47	2.51	2.60	18.03	70.22	124.64	146.89	153.08	152.80	152.99	153.42	149.31	145.27	145.89	147.78
104	3.27	3.18	3.29	3.33	2.49	2.72	21.57	76.84	127.84	147.66	153.62	152.37	152.96	153.36	149.84	145.36	145.00	147.17
105	3.00	2.93	3.11	3.17	2.57	2.92	25.72	83.32	130.48	147.66	153.22	151.24	152.49	152.74	150.27	145.53	144.11	146.04
106	2.89	2.85	3.10	3.23	2.74	3.13	32.48	88.98	132.63	147.00	152.37	149.83	151.82	151.84	150.40	145.67	143.31	144.74
107	2.96	2.93	3.23	3.50	2.95	3.38	41.25	93.84	134.81	146.78	151.82	148.88	151.32	151.04	150.31	145.99	142.88	143.72
108	3.21	3.14	3.44	3.93	3.14	3.62	51.04	97.17	137.01	147.32	151.71	148.35	150.89	150.31	149.88	146.42	142.77	143.00
109	3.48	3.33	3.68	4.22	3.32	3.86	58.21	99.23	139.09	148.73	152.32	148.53	150.90	150.05	149.66	147.29	143.26	142.92
110	3.69	3.44	3.82	4.38	3.42	3.98	62.32	100.00	140.20	149.62	152.64	148.50	150.72	149.72	149.29	147.70	143.45	142.75

t/s	Composite NOx Emissions, mg/s																		
	t/s/s	-5	-4	-3	-2	-1	0	1	2	3	4	5	6	7	8	9	10	11	12
0	0.43	0.43	0.48	0.55	0.65	0.64	0.84	0.92	1.00	1.09	1.13	1.26	1.63	2.88	5.96	7.55	9.68	12.01	
1	0.43	0.45	0.50	0.55	0.61	0.61	0.78	0.94	1.03	1.13	1.20	1.34	1.72	2.97	5.97	7.54	9.70	11.10	
2	0.39	0.40	0.44	0.52	0.54	0.58	0.74	0.94	1.17	1.24	1.37	1.54	1.94	3.21	5.95	7.56	9.80	11.04	
3	0.33	0.34	0.37	0.45	0.49	0.52	0.71	0.99	1.26	1.45	1.64	1.89	2.30	3.96	6.33	7.80	9.88	11.66	
4	0.27	0.28	0.31	0.36	0.40	0.42	0.66	1.04	1.35	1.64	2.05	2.43	3.12	5.28	7.50	8.56	9.55	12.66	
5	0.23	0.23	0.25	0.30	0.30	0.36	0.61	1.10	1.46	1.90	2.67	3.53	4.38	7.26	9.08	9.08	9.35	13.91	
6	0.18	0.19	0.21	0.21	0.25	0.30	0.56	1.09	1.47	2.29	3.71	4.95	6.08	8.59	10.21	10.30	11.04	16.09	
7	0.18	0.19	0.18	0.18	0.18	0.24	0.49	1.04	1.58	2.65	4.92	6.34	7.72	9.80	10.85	11.67	13.68	18.25	
8	0.16	0.19	0.18	0.17	0.17	0.21	0.50	1.10	1.71	3.06	5.87	7.18	9.30	10.49	11.43	14.46	17.16	20.05	
9	0.17	0.20	0.17	0.15	0.16	0.21	0.53	1.15	1.88	3.18	6.49	7.85	10.03	11.87	12.87	16.67	19.18	20.66	
10	0.17	0.20	0.18	0.15	0.17	0.24	0.57	1.30	2.09	3.62	6.93	8.59	10.74	13.16	14.54	18.66	21.19	22.01	
11	0.19	0.21	0.18	0.17	0.20	0.26	0.62	1.53	2.49	4.04	7.56	9.76	11.54	14.33	16.63	20.01	21.79	22.49	
12	0.20	0.21	0.19	0.18	0.22	0.32	0.75	1.86	2.85	4.78	8.47	11.08	13.04	15.43	18.82	21.52	22.55	23.26	
13	0.20	0.21	0.19	0.19	0.24	0.36	0.81	2.21	3.20	5.41	9.45	12.70	14.71	16.69	20.91	22.59	23.97	24.31	
14	0.21	0.21	0.19	0.20	0.30	0.45	0.89	2.43	3.40	5.97	10.43	14.55	15.82	17.92	22.31	23.86	25.62	25.38	
15	0.21	0.21	0.19	0.23	0.32	0.49	1.06	2.58	3.54	6.54	10.84	15.69	16.75	19.71	22.92	24.46	26.04	26.25	
16	0.22	0.21	0.19	0.23	0.32	0.52	1.16	2.77	3.96	7.17	11.19	16.23	17.11	21.49	23.33	24.88	26.19	27.81	
17	0.22	0.22	0.20	0.24	0.33	0.49	1.25	2.99	4.44	7.64	11.68	15.99	17.90	23.07	24.05	25.50	27.58	30.08	
18	0.23	0.22	0.20	0.22	0.33	0.50	1.33	3.13	5.11	8.08	12.68	16.28	19.00	24.12	24.55	26.12	29.58	31.03	
19	0.25	0.22	0.21	0.22	0.32	0.53	1.33	3.23	5.71	8.77	13.97	17.18	20.57	24.61	25.44	27.88	31.21	30.75	
20	0.24	0.23	0.21	0.23	0.34	0.55	1.34	3.34	6.18	9.84	15.24	18.23	22.34	25.00	27.70	30.64	32.16	30.74	
21	0.25	0.22	0.22	0.25	0.37	0.58	1.34	3.48	6.63	11.11	16.99	19.26	23.84	25.53	28.65	31.66	30.97	29.82	
22	0.25	0.23	0.22	0.26	0.40	0.63	1.44	3.72	7.08	12.36	18.34	19.53	24.89	26.00	29.23	31.49	30.33	29.97	
23	0.26	0.23	0.23	0.26	0.42	0.66	1.57	3.93	7.64	13.68	18.89	20.11	25.07	27.06	30.21	31.74	31.60	31.66	
24	0.27	0.25	0.24	0.28	0.43	0.71	1.65	4.15	8.27	14.88	18.67	20.50	24.59	28.18	31.76	33.42	33.73	33.82	
25	0.28	0.26	0.25	0.30	0.45	0.74	1.74	4.33	8.92	16.24	18.63	21.12	24.66	29.86	34.33	35.27	35.30	35.48	
26	0.29	0.28	0.28	0.31	0.47	0.83	1.84	4.79	9.56	17.60	19.07	21.77	26.49	31.65	36.01	35.89	35.61	36.04	
27	0.31	0.31	0.29	0.32	0.50	0.85	2.00	5.23	10.05	19.26	19.66	23.04	29.18	33.31	36.80	35.53	35.11	35.91	
28	0.36	0.34	0.30	0.33	0.52	0.87	2.07	5.67	10.56	20.26	20.33	24.79	31.58	34.49	36.85	35.39	35.41	35.87	
29	0.40	0.38	0.35	0.37	0.57	0.88	2.09	6.01	11.31	20.88	21.08	26.94	32.80	35.65	37.23	37.36	36.29	36.56	
30	0.48	0.46	0.38	0.42	0.59	0.96	2.13	6.36	12.19	21.41	22.05	28.61	33.87	37.28	39.15	39.53	37.82	37.76	
31	0.55	0.51	0.46	0.44	0.64	0.99	2.22	6.68	13.11	21.45	23.01	29.84	35.03	38.58	41.28	40.94	38.53	38.40	
32	0.62	0.62	0.52	0.52	0.64	1.00	2.33	6.91	14.15	21.48	23.84	30.96	36.42	38.76	43.40	40.96	38.89	37.82	
33	0.73	0.69	0.62	0.54	0.72	1.02	2.56	7.17	15.01	21.43	24.58	32.24	37.49	37.32	43.22	41.05	40.01	37.62	
34	0.86	0.79	0.68	0.66	0.73	1.14	2.72	7.52	15.85	21.58	25.15	33.68	37.63	36.13	42.20	42.05	41.41	39.19	
35	0.91	0.83	0.81	0.70	0.75	1.17	2.92	7.95	16.23	21.84	25.63	34.95	37.78	36.35	41.84	43.75	43.18	41.19	
36	0.94	0.93	0.86	0.74	0.86	1.21	3.13	8.38	16.85	22.12	26.00	36.30	37.59	38.36	43.32	45.34	44.37	43.47	
37	1.01	0.94	0.88	0.86	0.91	1.25	3.46	8.82	17.42	22.22	26.57	37.43	38.11	40.30	45.00	45.43	43.89	44.20	
38	1.02	0.94	0.96	0.89	0.96	1.38	3.77	9.35	18.05	21.80	27.24	38.23	38.11	40.78	45.39	45.00	42.63	44.62	
39	1.00	0.93	0.95	0.89	1.06	1.49	4.24	9.66	18.71	21.39	28.07	38.50	38.35	39.10	44.38	44.42	41.31	40.63	
40	0.97	0.92	0.93	0.88	1.08	1.59	4.46	9.84	18.77	21.42	29.17	38.68	37.88	36.77	43.05	43.78	41.33	40.83	
41	0.93	0.96	0.89	0.86	1.08	1.64	4.77	9.89	18.55	21.79	30.62	38.50	37.02	33.53	40.90	38.49	37.56	37.32	
42	0.96	0.92	0.84	0.80	1.05	1.70	5.09	10.49	18.47	22.32	32.07	38.17	36.20	31.00	39.29	33.35	33.90	33.97	
43	0.92	0.87	0.79	0.77	1.01	1.67	5.41	11.19	18.47	22.97	33.27	37.80	35.17	29.76	38.79	31.43	32.08	32.41	
44	0.88	0.84	0.76	0.75	0.97	1.66	5.69	12.16	18.90	23.60	33.67	36.88	34.59	29.17	38.63	32.28	30.97	31.46	
45	0.93	0.89	0.82	0.82	1.00	1.66	5.94	13.06	19.35	24.51	34.17	35.97	34.03	28.46	37.91	34.15	30.60	31.13	
46	0.91	0.87	0.81	0.83	0.98	1.67	6.12	14.27	19.51	25.43	34.60	35.00	34.21	28.24	36.92	35.99	36.49	36.96	
47	0.92	0.89	0.85	0.88	0.97	1.71	6.12	15.41	19.51	26.30	35.07	34.39	34.00	28.10	35.67	36.48	36.88	37.23	
48	0.91	0.89	0.86	0.88	1.01	1.71	6.08	16.27	19.55	27.15	35.28	34.34	33.75	28.71	35.21	36.21	36.54	36.78	
49	0.94	0.93	0.87	0.90	1.04	1.69	6.07	17.02	19.68	28.12	35.90	34.63	32.80	28.85	34.74	35.53	35.83	35.98	
50	0.96	0.96	0.90	0.87	1.04	1.70	6.27	17.76	19.95	29.59	36.38	34.54	31.84	28.92	34.98	35.42	35.70	35.82	
51	0.95	0.94	0.89	0.87	1.07	1.73	6.54	18.17	20.35	31.00	36.74	33.71	30.97	28.28	34.67	35.01	35.27	35.40	
52	0.97	0.96	0.95	0.88	1.11	1.82	6.90	18.58	21.03	32.38	36.03	32.18	31.35	29.26	35.35	35.58	35.81	35.97	
53	0.97	0.97	0.91	0.82	1.09	1.89	7.24	19.04	21.39	33.83	34.92	30.98	30.71	29.98	35.74	35.89	36.09	36.29	
54	0.97	0.98	0.91	0.82	1.12	1.96	7.70	19.41	21.92	35.01	34.08	30.57	29.53	30.71	35.73	35.83	35.98	36.20	
55	0.91	0.91	0.84	0.82	1.20	2.04	8.05	19.59	22.30	35.98	34.27	29.87	27.62	29.80	35.35	35.43	35.52	35.73	
56	0.84	0.84	0.76	0.83	1.27	2.16	8.38	19.71	22.73	36.77	34.93	29.04	27.45	29.67	36.13	36.20	36.23	36.42	
57	0.83	0.83	0.76	0.84	1.29	2.15	8.76	19.66	23.30	37.69	35.30	28.84	28.11	30.00	36.23	36.31	36.29	36.41	
58	0.84	0.83	0.68	0.79	1.34	2.20	9.01	19.54	24.05	38.53	34.96	29.73	29.06	30.92	31.00	31.09	31.02	31.06	
59	0.83	0.80	0.78	0.85	1.40	2.33	9.17	19.23	24.82	38.98	34.86	30.85	29.44	31.60	31.67	31.74	31.66	31.63	
60	0.80	0.80	0.73	0.83	1.44	2.42	9.38	19.23	26.17	39.19	35.22	32.14	29.27	31.78	31.78	31.84	31.76	31.68	
61	0.78	0.78	0.82	0.97	1.49	2.54	9.68	19.02	27.41	39.63	36.40	33.04	29.64	31.78	31.69	31.72	31.65	31.56	
62	0.80	0.80	0.80	0.99	1.51	2.63	10.13	19.06	28.51	40.55	37.58	33.38	30.34	31.84	31.60	31.61	31.56	31.48	
63	0.83	0.82	0.87	0.97	1.54	2.85	10.66	18.94	29.31	41.14	39.08	33.65	31.41	32.03	31.61	31.59	31.51	31.49	
64	0.78	0.78	0.88	0.97	1.47	3.02	10.92	19.17	30.36	41.87	40.16	35.22	33.75	32.43	31.79	31.73	31.71	31.66	
65	0.79	0.78	0.8																

ft/s	Composite NOx Emissions, mg/s																	
	-5	-4	-3	-2	-1	0	1	2	3	4	5	6	7	8	9	10	11	12
81	0.70	0.73	0.72	0.86	1.75	5.27	16.83	29.54	39.13	33.82	36.51	35.00	34.86	34.86	34.88	34.72	34.51	34.38
82	0.72	0.74	0.74	0.88	1.88	5.61	17.25	30.02	38.85	32.67	35.58	37.10	36.93	36.97	37.09	36.98	36.75	36.63
83	0.74	0.75	0.76	0.89	1.98	5.77	17.58	30.49	38.55	31.73	34.14	37.53	37.37	37.47	37.66	37.60	37.35	37.23
84	0.74	0.75	0.77	0.90	2.06	6.01	18.15	31.25	38.48	30.99	33.55	37.45	37.33	37.47	37.71	37.69	37.41	37.29
85	0.71	0.75	0.80	0.91	2.07	6.15	18.86	32.28	38.82	30.67	33.60	37.15	37.08	37.25	37.49	37.48	37.18	37.06
86	0.71	0.75	0.83	1.01	2.13	6.28	19.09	34.02	39.34	30.64	34.90	37.24	37.19	37.37	37.59	37.57	37.25	37.11
87	0.70	0.75	0.88	1.06	2.21	6.51	19.67	36.00	39.87	30.00	35.08	36.48	36.43	36.61	36.79	36.74	36.40	36.25
88	0.70	0.74	0.96	1.17	2.62	6.62	19.98	37.75	39.14	29.70	35.58	35.45	35.39	35.54	35.67	35.58	35.23	35.06
89	0.73	0.75	0.99	1.17	3.11	7.04	20.23	38.91	37.43	29.75	36.11	36.02	35.94	36.06	36.16	36.02	35.65	35.45
90	0.77	0.80	1.00	1.22	3.52	7.43	20.42	39.59	35.76	29.15	35.42	35.36	35.28	35.37	35.43	35.26	34.86	34.63
91	0.81	0.81	1.01	1.25	3.75	7.98	20.72	39.74	34.50	28.62	34.19	34.16	34.09	34.15	34.18	33.99	33.57	33.31
92	0.84	0.87	0.99	1.30	4.03	8.54	20.90	39.44	33.51	28.26	32.50	32.50	32.46	32.50	32.51	32.31	31.88	31.59
93	0.89	0.89	1.02	1.37	4.26	9.02	21.34	39.32	31.50	29.69	30.89	30.90	30.89	30.94	30.92	30.73	30.30	30.00
94	0.90	0.90	1.05	1.39	4.49	9.57	21.54	39.63	31.09	30.36	29.62	29.65	29.66	29.71	29.69	29.50	29.10	28.80
95	0.94	0.93	1.05	1.44	4.72	10.14	22.09	39.87	30.96	30.88	29.25	29.29	29.31	29.37	29.34	29.18	28.83	28.54
96	0.97	0.99	1.12	1.45	4.77	10.63	22.77	39.80	32.09	29.95	30.53	30.57	30.60	30.65	30.63	30.51	30.21	29.95
97	1.03	1.07	1.21	1.54	4.67	10.72	23.68	39.20	32.45	30.16	31.18	31.21	31.23	31.28	31.27	31.18	30.94	30.73
98	1.10	1.18	1.30	1.66	4.64	11.08	24.85	38.62	32.58	30.20	31.22	31.24	31.24	31.28	31.29	31.24	31.07	30.91
99	1.19	1.28	1.39	1.69	4.77	12.01	25.56	38.03	32.08	29.47	30.29	30.29	30.28	30.30	30.32	30.32	30.21	30.10
100	1.30	1.38	1.49	1.82	5.29	13.56	26.28	37.77	31.45	28.68	29.41	29.38	29.35	29.36	29.39	29.42	29.37	29.30
101	1.42	1.47	1.59	1.87	5.84	14.68	26.57	38.15	31.30	28.57	29.05	28.99	28.93	28.92	28.96	29.02	29.02	28.98
102	1.51	1.56	1.67	1.99	6.34	15.55	26.92	38.58	31.09	28.76	28.96	28.86	28.76	28.75	28.78	28.88	28.91	28.89
103	1.64	1.68	1.77	2.11	6.70	16.09	27.48	39.42	31.05	29.13	28.98	28.83	28.70	28.66	28.69	28.81	28.88	28.87
104	1.78	1.82	1.94	2.17	6.98	15.92	27.90	39.59	31.18	29.60	29.48	29.29	29.11	29.05	29.08	29.22	29.32	29.32
105	2.00	2.03	2.07	2.12	7.14	15.64	28.42	39.56	31.99	30.62	30.53	30.29	30.08	29.98	29.99	30.16	30.29	30.30
106	2.14	2.15	2.19	2.03	6.94	15.20	29.03	38.77	33.37	32.26	32.17	31.88	31.63	31.49	31.48	31.67	31.83	31.87
107	2.17	2.11	2.04	2.01	6.58	15.31	29.93	38.03	35.02	34.32	34.22	33.88	33.60	33.42	33.38	33.59	33.79	33.84
108	2.07	2.05	1.97	2.04	6.32	15.60	31.02	37.53	36.40	36.06	35.94	35.55	35.24	35.03	34.96	35.19	35.42	35.50
109	2.02	2.05	2.01	2.09	6.48	15.69	32.08	37.38	37.23	37.20	37.05	36.63	36.30	36.05	35.97	36.21	36.46	36.57
110	2.11	2.06	2.01	2.09	6.61	15.84	32.77	37.24	37.56	37.63	37.47	37.03	36.68	36.43	36.32	36.58	36.84	36.97

## REFERENCES

1. McGill, Ralph N.; John N. Hooker; and Jeffrey W. Hodgson, *Fuel Consumption and Emissions Values for Traffic Models*, Report No. FHWA/RD-85/053, Federal Highway Administration, May 1985.
2. Kelly, Nelson A.; and Peter J. Groblicki, "Real-World Emissions From a Modern Production Vehicle Driven in Los Angeles," *J. Air Waste Manag. Assoc.*, 43:1351-1357, October 1993.
3. Coordinating Research Council, Inc., *Proceedings of the Fourth CRC-APRAC On-Road Vehicle Emissions Workshop*, Atlanta, GA, 1994.
4. Coordinating Research Council, Inc., *Proceedings of the Fifth CRC On-Road Vehicle Emissions Workshop*, Atlanta, GA, 1995.
5. Coordinating Research Council, Inc., *Proceedings of the Sixth CRC On-Road Vehicle Emissions Workshop*, Atlanta, GA, 1996.
6. Ward's Communications, *Ward's Automotive Reports*, Vol. 70, No. 51, December 18, 1995, Southfield, MI: Intertec Publishing.
7. Ward's Communications, *Ward's Automotive Yearbook, 1996*, Fifty-Eighth Edition, Southfield, MI: Intertec Publishing.
8. Crain Communications, *Automotive News Market Data Book*, May 1995.
9. Crain Communications, *Automotive News Market Data Book*, Volume 1, April 1996.
10. Davis, S.C., *Transportation Energy Data Book, Edition 15*, Oak Ridge National Laboratory Report No. 6856, May 1995.
11. Beaumont, A.J.; A.D. Noble; and A.D. Pilley, "Signal Reconstruction Techniques for Improved Measurement of Transient Emissions," Society of Automotive Engineers (SAE) Paper No. 900233.
12. Chan, S.H.; and X.S. Chen, "Characterization and Signal Inference of an NDIR Automotive Emissions Analyzer Used for Dynamic Measurement," SAE Paper No. 950223.
13. Messer, J. Todd; Nigel N. Clark; and Donald W. Lyons, "Measurement Delays and Modal Analysis for a Heavy-Duty Transportable Emissions Testing Laboratory," SAE Paper No. 950218.
14. Summers, T.; and N. Collings, "Signal Reconstruction Applied to a Fast-Response Flame Ionization Detector," SAE Paper No. 952541.

15. Thomas, Martin; and Marc Ross, "Development of Second-by-Second Fuel Use and Emissions Models Based on an Early 1990s Composite Car," draft paper, University of Michigan, October 1996.
16. Koupal, John; and John German, "Real-Time Simulation of Vehicle Emissions Using VEMISS," U.S. EPA, Office of Mobile Sources, Presented at the 5th CRC On-Road Vehicle Emissions Workshop, 1995.
17. Goodwin, Robert Wayne, "A Model of Automobile Exhaust Emissions During High-Power Driving Episodes and Related Issues," Doctoral Dissertation, University of Michigan, 1997.
18. Environmental Protection Agency, *Federal Test Procedure Review Project: Preliminary Technical Report*, EPA 420-R-93-007, May 1993.
19. Environmental Protection Agency, *Final Technical Report on Aggressive Driving Behavior for the Revised Federal Test Procedure Notice of Proposed Rulemaking*, Office of Mobile Sources, January 1995.
20. Kishan, S.; T.H. DeFries; and C.G. Weyn, "A Study of Light-Duty Vehicle Driving Behavior: Application to Real-World Emission Inventories," SAE Paper No. 932659, October 1993.
21. Haskew, Harold M.; Kevin Cullen; Thomas F. Liberty; and William K. Langhorst, "The Execution of a Cooperative Industry/Government Exhaust Emission Test Program," SAE Technical Paper 94C016, 1994.
22. FTP Revision Program Emissions Database, CD-ROM from cooperative program between the EPA, CARB, AAMA, AIAM, and the EDS Corporation, January 1995.

