

DEVELOPMENT OF SELF-CLEANING BOX CULVERT DESIGNS

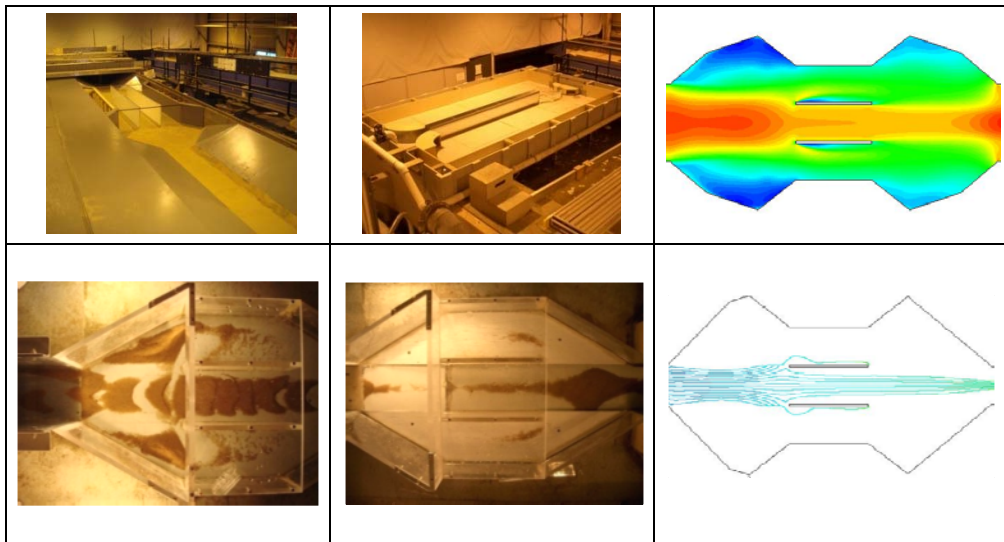

Sponsored by:

The Iowa Highway Research Board
The Iowa Department of Transportation
Research and Technology Bureau
800 Lincoln Way, Ames, Iowa 50010

Investigators:

M. Muste (PI), R. Ettema (Co-PI), H-C. Ho (RA), S. Miyawaki (RA)

The University of Iowa
IIHR-Hydroscience & Engineering
Hydraulics Laboratory
Iowa City, IA 52242-1585
Phone: 319-335-5237
Fax: 319-335-5238

Iowa City, June 2009



About the IIHR- Hydroscience & Engineering

IIHR, a unit of The University of Iowa's College of Engineering, is one of the nation's premier and oldest fluids research and engineering laboratories. Situated on the Iowa River in Iowa City, Iowa, IIHR seeks to educate students and to conduct research in the broad fields of hydraulics and fluid mechanics.

Disclaimer Notice

The contents of this report reflect the views of the authors, who are responsible for the facts and the accuracy of the information presented herein. The opinions, findings and conclusions expressed in this publication are those of the authors and not necessarily those of the sponsors.

The sponsors assume no liability for the contents or use of the information contained in this document. This report does not constitute a standard, specification, or regulation.

The sponsors do not endorse products or manufacturers. Trademarks or manufacturers' names appear in this report only because they are considered essential to the objective of the document.

The opinions, findings, and conclusions expressed in this publication are those of the author and not necessarily those of the Iowa Department of Transportation

Statement of Non-Discrimination

Federal and state laws prohibit employment and/or public accommodation discrimination on the basis of age, color, creed, disability, gender identity, national origin, pregnancy, race, religion, sex, sexual orientation or veteran's status. If you believe you have been discriminated against, please contact the Iowa Civil Rights Commission at 800-457-4416 or Iowa Department of Transportation's affirmative action officer. If you need accommodations because of a disability to access the Iowa Department of Transportation's services, contact the agency's affirmative action officer at 800-262-0003.

Non-Discrimination Statement

The University of Iowa does not discriminate on the basis of race, color, age, religion, national origin, sexual orientation, gender identity, sex, marital status, disability, or status as a U.S. veteran. Inquiries can be directed to the Director of Equal Opportunity and Diversity at the University of Iowa, (319) 335-0705.



Summary

The main function of a roadway culvert is to effectively convey drainage flow during normal and extreme hydrologic conditions. This function is often impaired due to the sedimentation blockage of the culvert. This research sought to understand the mechanics of sedimentation process at multi-box culverts, and develop self-cleaning systems that flush out sediment deposits using the power of drainage flows. The research entailed field observations, laboratory experiments, and numerical simulations. The specific role of each of these investigative tools is summarized below:

- a) The field observations were aimed at understanding typical sedimentation patterns and their dependence on culvert geometry and hydrodynamic conditions during normal and extreme hydrologic events.
- b) The laboratory experiments were used for modeling sedimentation process observed in-situ and for testing alternative self-cleaning concepts applied to culverts. The major tasks for the initial laboratory model study were to accurately replicate the culvert performance curves and the dynamics of sedimentation process, and to provide benchmark data for numerical simulation validation.
- c) The numerical simulations enhanced the understanding of the sedimentation processes and aided in testing flow cases complementary to those conducted in the model reducing the number of (more expensive) tests to be conducted in the laboratory.

Using the findings acquired from the laboratory and simulation works, self-cleaning culvert concepts were developed and tested for a range of flow conditions. The screening of the alternative concepts was made through experimental studies in a 1:20 scale model guided by numerical simulations. To ensure the designs are effective, performance studies were finally conducted in a 1:20 hydraulic model using the most promising design alternatives to make sure that the proposed systems operate satisfactory under closer to natural scale conditions.



ACKNOWLEDGEMENTS

The field, laboratory, and numerical simulation work associated with the present project were funded by the Iowa Highway Research Board, as Research Project TR-545.

A Technical Advisory Committee, provided advice and recommendations during the project development. The members of the Committee and their affiliations are listed below:

David Claman
Roger Schletzbaum
Jon Ites

Iowa Department of Transportation
Marion County, Iowa
Buena Vista County, Iowa

Conduct of the project was coordinated with Mark Dunn, Iowa Department of Transportation.



TABLE OF CONTENTS

1. Introduction..... 1

 1.1 Study Background..... 1

 1.2 Study Objects and Approaches..... 2

2. Literature Review..... 4

 2.1 Culvert Definition..... 4

 2.2 Expansion and Contraction in Open Channel..... 5

 2.3 Culvert Hydraulics..... 8

 2.4 Sedimentation at Culvert..... 19

 2.5 Culvert Design Considerations..... 20

 2.6 Numerical Modeling of Culvert Hydraulics..... 22

3. Field Visit of Culverts in Iowa..... 24

 3.1 Johnson County..... 24

 3.2 Marion County..... 41

 3.3 Buena Vista County..... 51

4. Laboratory and numerical modeling..... 59

 4.1 Introduction..... 59

 4.2 Baseline tests..... 60

 4.2.1 Model 1:20 Configuration and Operation..... 60

 4.2.2 Baseline test 1..... 63

 4.2.3 Baseline test 2..... 64

 4.2.4 Baseline test 3..... 68

 4.3 Screening tests for the self-cleaning designs..... 74

 4.3.1 Fillets (F)..... 74

 4.3.2 Vanes..... 80

 4.4 Numerical simulation of flow through culverts..... 82

 4.4.1 Simulation cases..... 82

 4.4.2 Computational grid..... 83

 4.4.3 Flow modeling..... 84

 4.4.4 Post processing..... 84

 4.4.5 Numerical model testing..... 85

 4.4.6 Numerical simulation for the self-cleaning design FA..... 89

5. Performance Tests..... 91

 5.1 Introduction..... 91

 5.2 Laboratory experiment for the reference culvert model..... 92

 5.3 LSPIV experiments in the 1:5 culvert model..... 95

 5.4 Performance tests for the selected self-cleaning design..... 96

6. Conclusion and recommendation..... 98

References..... 101



LIST OF FIGURES

Figure 1-1. Culvert site at Iowa City, blue arrow indicates flow direction: a) upstream view from the culvert, b) downstream view from the channel left bank..... 3

Figure 2-1-1 Typical Iowa culvert (near Solon, Iowa)..... 5

Figure 2-1-2 Cross drains usually connect road ditches on the side of a roadway 5

Figure 2-2-1 Contraction effect of the culvert 6

Figure 2-3-1 Classification of culvert flow 9

Figure 2-3-2 Types of inlet control..... 11

Figure 2-3-3 Culvert entrance acts like a weir..... 11

Figure 2-3-4 Culvert entrance acting as a submerged sluice gate 14

Figure 2-3-5 Types of outlet control..... 17

Figure 2-3-6 Culvert with submerged upstream and downstream..... 17

Figure 2-3-7 Culvert with unsubmerged upstream and downstream..... 18

Figure 2-5-1: Culvert retrofitting using uneven invert: a) pre-construction condition in 1992, b) post-construction in 2000..... 22

Figure 3-1-1 Iowa Map indicate the counties which were visited in this research..... 24

Figure 3-1-2. Three-box culverts in Johnson County: the yellow markers are field visit locations and red marker is USGS stream station in this county 25

Figure 3-2-1 Marion County: the yellow markers are field visit locations and red marker is USGS stream station in this county 41

Figure 3-3-1 Buena Vista County Map: the yellow markers are field visit locations and red marker is USGS stream station in this county 51

Figure 4-2-1 Overview of the flume 61

Figure 4-2-2 Layout of the culvert model..... 61

Figure 4-2-3 Sediment feeder 62

Figure 4-2-4. Trial flow conditions of the experiment..... 63

Figure 4-2-5 Sediment accumulation upstream of the culvert inlet..... 64

Figure 4-2-6 Sediment load distribution..... 65

Figure 4-2-7 Sediment accumulation over 6 hours of observation..... 66

Figure 4-2-8 Rate of sediment accumulation in the expansion and three barrels..... 67

Figure 4-2-9 Dune height variation with time from one-hour to six-hours 67

Figure 4-2-10 Layout of the culvert model B..... 69

Figure 4-2-11 Flow condition in baseline test 3 69



Figure 4-2-12 Surface flow field for case B (HW/D=0.5): (a) Velocity vectors, (b) Velocity vectors and velocity magnitude contour, (c) Streamlines 71

Figure 4-2-13 Surface flow field for Flatbed C with headwater depth 0.382ft: (a) Velocity vectors, (b) Velocity vectors and velocity magnitude contour, (c) Streamlines 72

Figure 4-2-14 Rate of sediment accumulation in the culvert area for flow Case B..... 72

Figure 4-2-15 Hourly sediment accumulation in the expansion area for flow case B..... 73

Figure 4-3-1 Sedimentation pattern compare to the baseline test result 75

Figure 4-3-2 Sedimentation pattern compare to the baseline test result 77

Figure 4-3-3 Sedimentation pattern compare to the baseline test result 78

Figure 4-3-4 Sedimentation pattern compare to the baseline test result 79

Figure 4-3-5 Sedimentation pattern compare to the baseline test result 81

Figure 4-3-6 Sedimentation pattern compare to the baseline test result 82

Figure 4-4-1 Calculation domains for numerical simulation: (a) domain for model 1/20B, (b) domain for model 1/20B+FA design 83

Figure 4-4-2 Near-surface flow field in flow Case B obtained with numerical simulations: 85
(a) streamlines, (b) streamwise velocity, (c) out of plane vorticity 85

Figure 4-4-3 Sediment transport characteristics in flow Case B obtained from numerical simulations : (a) shear velocity, (b) sediment paths 86

Figure 4-4-5 Surface flow field for flow case B obtained in laboratory tests with LSPIV and imagery: (a) Streamline and velocity magnitude contour at the free surface, (b) streamwise velocity at the free surface, (c) vorticity at the free surface, and (d) sedimentation (Relevant comparisons: 4-4-2 a, b, and c with 4-4-5 a, b, and c, respectively and 4-4-3b with 4-4-5d.) 86

Figure 4-4-5 Near surface flow field for flow case C obtained with numerical simulations: 87
(a) streamlines (b) streamwise velocity (c) out of plane vorticity 87

Figure 4-4-6 Surface flow field for flow case C obtained in laboratory test with LSPIV: (a) Streamline and velocity magnitude contour, (b) streamwise velocity, (c) vorticity 87

Figure 4-4-7 The mesh resolution: (a) the numerical model mesh, (b) the LSPIV analysis mesh 88

Figure 4-4-8 Comparison of average velocities error between numerical simulations (with FLUENT) and experimental results (with LSPIV) :(a) flow Case B, and (b) flow Case C 89

Figure 4-4-9 Simulated near-surface flow field for flow case B over the fillets FA set in the expansion: (a) streamlines, (b) streamwise velocity, (c) out of plane vorticity 90

Figure 4-4-10 Simulated sediment transport characteristics for flow case B over fillets FA set in the expansion: (a) shear velocity, (b) sediment paths 90

Figure 5-1-1. Schematic View of the physical model 91

Figure 5-1-2 Upstream view of the model 92

Figure 5-2-1 Sediment deposition patterns: a) Initial condition, b) Case A, c) Case B, d) Case C



..... 93

Figure 5-2-2 Elevation of sediment deposition at the cross-section under different flow conditions 94

Figure 5-3-1 Streamlines condition: a) reference model, b) FA design model 95

Figure 5-3-2 Velocity contour: a) reference model, b) FA design model 96

Figure 5-4-1 Self-cleaning fillet geometry 97

Figure 5-4-2 Sediment deposition patterns for the culvert fitted with fillets FA: a) Initial condition, b) flow Case A, c) flow Case B, d) flow Case C 97

LIST OF TABLES

Table 1-1 Department of Transportation Multi-barrel Culvert Survey Result 1

Table 3-1-1. Culvert types and numbers in Johnson County 25

Table 4-3-1 Summary of Design FA 75

Table 4-3-2 Summary of Design FB 76

Table 4-3-3 Summary of Design FC 77

Table 4-3-4 Summary of Design FD 78

Table 4-3-5 Summary of Design VA 80

Table 4-3-6 Summary of Design VB 81

Table 4-4-1. Simulation case (HW= water depth, D=depth of the culvert, FA= type FA fillet-based self-cleaning design set in the upstream expansion area, A,B,C= flow conditions in case A,B,C see Figures 4-2-4 and 4-2-11) 83



LIST OF PLATES

Plate 1: J_Site 1: Culvert on Hwy #382..... 26

Plate 2: J_Site 2: Culvert on Hwy #382..... 28

Plate 3: J_Site 3: Culvert on Racine Ave 30

Plate 4: J_Site 4: Culvert on Hwy #218..... 32

Plate 5: J_Site 5: Culvert on Black Hawks Ave..... 34

Plate 6: J_Site 6: Culvert on Sand Road 36

Plate 7: J_Site 7: Culvert on 480th St..... 37

Plate 8: J_Site 8: Culvert on Kansas Ave..... 38

Plate 9: J_Site 9: Culvert on Newport Rd..... 39

Plate 10: J_Site 10: Culvert on Prairie Du Chien Rd..... 40

Plate 11: M_Site1: Culvert on Hwy. G-76 East and Hwy. 14..... 42

Plate 12: M_Site2: Culvert on Hwy. G-76 West and Hwy. S-45 44

Plate 13: M_Site 3: Culvert on Lisbon St. and Hwy. S-45 46

Plate 14: M_Site 4: Culvert on 200 Ave North and Beardsley St..... 47

Plate 15: M_Site 5: Culvert on Hwy G-28 and Hwy. T-15 South..... 49

Plate 16: M_Site 6: Culvert on 218th Ave and Hwy. T-17 East..... 50

Plate 17: BV_Site 1: Culvert on 580th St and 70th Ave 52

Plate 18: BV_Site 2: Culvert on 565th St 54

Plate 19: BV_Site 3: Culvert on 640th St and 10th Ave 55

Plate 20: BV_Site 4: Culvert on Hwy 71 and 500th St..... 57

1. Introduction

1.1 Study Background

A culvert traditionally has been the economical means of conveying drainage flows across road cross-sections. Culverts may comprise multiple culvert pipes (a multi-barrel culvert) or a single culvert pipe. Typically, larger flows and road embankment heights entail the use of multi-barrel culverts. The advantage of a multi-barrel culvert is that the requirement of upstream headwater is smaller than for a single-barrel culvert. Further, building a multi-barrel culvert formed by several smaller-diameter pipes is more economical than a relatively large single-barrel culvert. A survey of state transportation engineers conducted in February 2007, revealed that multi-barrel culverts are commonly used throughout the U.S. (Table 1-1).

Table 1-1 Department of Transportation Multi-barrel Culvert Survey Result (Gary, 2008)

State	Multiple culvert use	Circular or box	Lowered invert on one barrel
Alaska, Arkansas, Colorado, Connecticut, Maine, Maryland, Michigan, Minnesota, Nebraska, Nevada, North Dakota, South Carolina	Yes	Both	Yes
Montana, Utah	Yes	Box	Yes
Georgia, Hawaii, New Mexico, Wyoming	Yes	Both	No
Iowa	Yes	Box	No
California, Idaho, Kentucky	Yes	Circular	No, or uncommon
Indiana, Ohio, Washington	No	—	—

The transition between a natural approach channel and a culvert may vary considerably. The design of a transition structure (expansion/contraction) is required for culvert design. In cases where the channel width is larger than the geometry of culvert, the normal design of channel transition for culverts involves contraction of the channel upstream of the openings, and expansion to the natural channel width on the downstream side. Extensive literature exists for these conditions, especially with regard to backwater effects and use of backwater stage to estimate channel discharge for flood analyses. In another case where the design procedure suggests that required size and geometry of culverts extend beyond the width of the natural channel, channel transitions are also required to convey drainage flow to and from the culvert. An expansion is needed upstream of the culvert, and a contraction is downstream



of the culvert. The transitions, though, may disturb the channel's balance of water flow and sediment transport, and have undesirable consequences such as sediment deposition immediately upstream of, and through, the culvert.

In many areas of Iowa, drainage flow through box culverts is minimal throughout most of the year. Box culverts are generally designed to handle events with a 50-year return period. For multi-barrel culverts, it is not uncommon for one barrel to carry the flow most of the time, when flows are reduced. Over many years of lower flow, sediment deposition can cause some of the barrels of multi-box culverts to silt-in and become partially filled with sediment. Figure 1-1 shows a three-barrel box culvert at Iowa City, Iowa, as viewed from the road and upstream channel. Each barrel has 10ft height and 10ft wide. The picture was taken approximately through the center line of the culvert. The width of the approach channel is narrower than the culvert span. Figure 1-1(a) shows an expansion region between the channel and the culvert that is contrary to the normal culvert design in which the culvert width is smaller than the channel. Figure 1-1 (b) shows sediment accumulated in the expansion region and barrels. It is common for multi-barrel culverts, designed to handle flood events, to accumulate sediment within and upstream the culvert during lower flow conditions. Sediment accumulation reduces flow capacity, and decreases safety, because the culvert will not have its design flow capacity.

1.2 Study Objectives and Approaches

The research findings obtained by Bodhaine (1968) and Normann (1985) are widely used for culvert design. Culverts are designed to pass a design discharge associated with a certain return-period flood, such as 50-year return period. Further, culvert flows are classified as either low-head or high-head flows. At large flow-rate, culverts may have a contraction upstream the culvert and an expansion downstream the culvert. This is the normal assumption and a standard analysis for culvert designers. From low to moderate flows, however, culverts can perform in an opposite way: an expansion at the entrance and a contraction at the exit. Consequently, sediment movement and deposition associated with lower flow may occur differently than during large flood events.

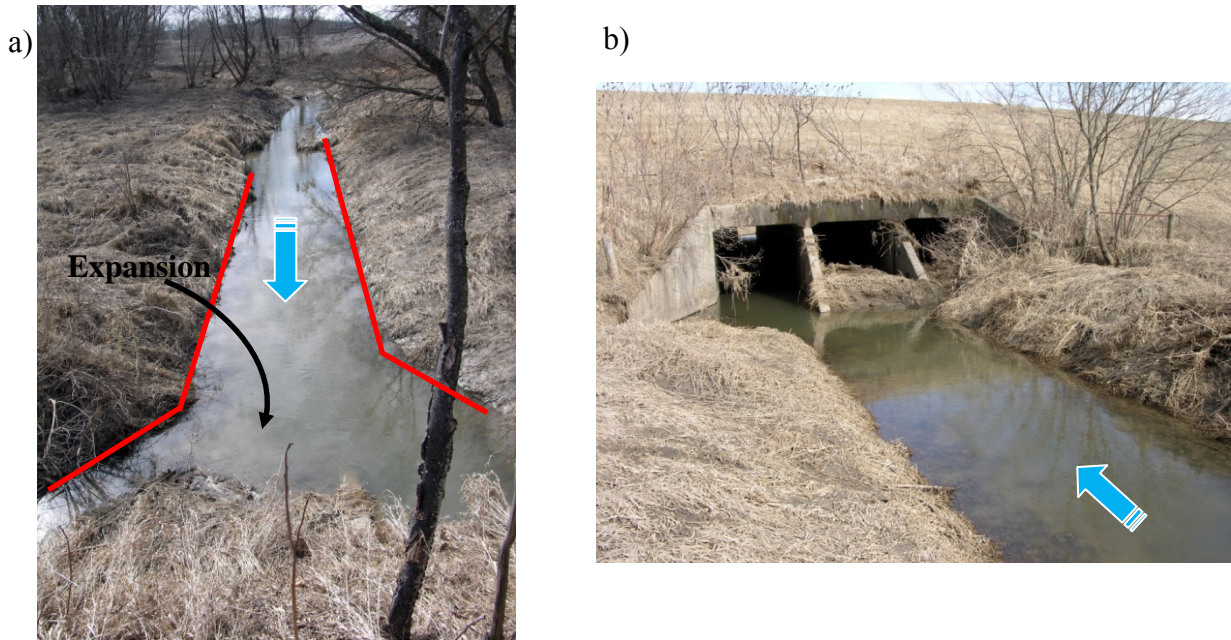

Figure 1-1. Culvert site at Iowa City, blue arrow indicates flow direction: a) upstream view from the culvert, b) downstream view from the channel left bank

The general goals of this study were to understand the hydraulics of multi-barrel box culverts, and evaluate how sediment moves and deposits at them. Special attention is given to conditions immediately upstream of culverts where sediment deposition may cause culvert blockage. The study's overarching purpose was to develop designs for constructing, or retrofitting culverts with the means to minimize sediment deposition and consequent blockage in the culvert vicinity.

The specific objectives to achieve these goals were as follow:

- 1) analyze the culvert hydraulic performance curve currently used in culvert design
- 2) conduct field visits to identify potential factors contributing to the sedimentation and understanding the mechanics of the process
- 3) conduct laboratory experiments in small- and large-scale models to accommodate tests for baseline flow conditions, screening of the self-cleaning design alternatives, and assessment of the efficiency of the design alternatives
- 4) conduct companion numerical simulations to guide the laboratory experiments.



2. Literature Review

2.1 Culvert Definition

In general terms, a culvert is a closed conduit or pipe located transversely under a roadway or embankment so as to facilitate flow drainage from a natural channel or drainage ditch. Culvert flow is an open channel flow when the culvert flows partially full. For the purpose of culvert design and maintenance, various definitions for the culvert are used. Different agencies, and geographic regions, distinguish culverts from bridges in accordance with various criteria.

The most common criterion is based on culvert span. For example, a drainage construction with an interior width of 6.1 ft or less is defined as a culvert by New York State Department of Transportation (NYSDOT), whether there are single or multiple spans of this dimension. Any structure with a span or diameter less than 10ft when measured parallel to the centerline of the roadway is defined as a culvert by the Ohio Department of Transportation (ODOT). A culvert is any structure under the roadway with a clear opening of 20 ft or less measured along the center of the roadway between inside of end walls, otherwise, it is defined as bridges by Washington State Department of Transportation (WSDOT) and Texas Department of Transport (TxDOT).

Another categorization is based on construction. A structure that passes flow and has a paved bottom is defined by the Maryland Department of the Environment as a culvert. This definition is also used by Maryland State Highway Administration (SHA).

For the present study, a culvert is simply defined as a hydraulically short conduit under the roadway that transports stream from one side of the embankment to the other (a definition developed by Chow, 1959). A culvert is usually covered with embankment, and is composed of structural material around the entire perimeter (Figure 2-1-1). It can be supported on spread footings with the streambed or concrete riprap channel serving as the bottom.

A specific type of culvert is called a runoff management culvert. It is strategically placed to



manage and route roadway runoff along, under, and away from the roadway. Frequently this culvert type is used to transport upland runoff, accumulated in road ditches on the upland side of the roadway, to the lower side for disposal (Figure 2-1-2). The term “cross-drain” is sometimes used instead of culvert.



Figure 2-1-1 Typical Iowa culvert (near Solon, Iowa)



Figure 2-1-2 Cross drains usually connect road ditches on the side of a roadway

2.2 Expansion and Contraction in Open Channel

The culvert drainage system is built to pass channel flow under a roadway. To connect the culvert and natural channel, transition structures between them are needed, because of their geometrically dissimilar cross-sections. Channel transition, involving expansion and contraction, entails the change of cross-sectional dimensions occurring in relatively short distance. Such change in channel geometry produces rapidly varied flow, for which the flow depth and velocity vary markedly over a short distance of flow.

Transition flow performance is generally analyzed through the use of flow continuity, energy, and momentum equations. For example, a horizontal contraction transition in the rectangular channel is showed in Figure 2-2-1. The momentum equation applied between section 1, 2 and 3 gives

$$\frac{1}{2}\gamma b_1 y_1^2 - \frac{1}{2}\gamma b_2 y_2^2 - \frac{1}{2}\gamma b_3 y_3^2 - F_f = \rho Q(\beta_3 V_3 - \beta_1 V_1) \quad (1)$$

where F_f is a total force of friction, and β_1, β_3 are momentum coefficients.

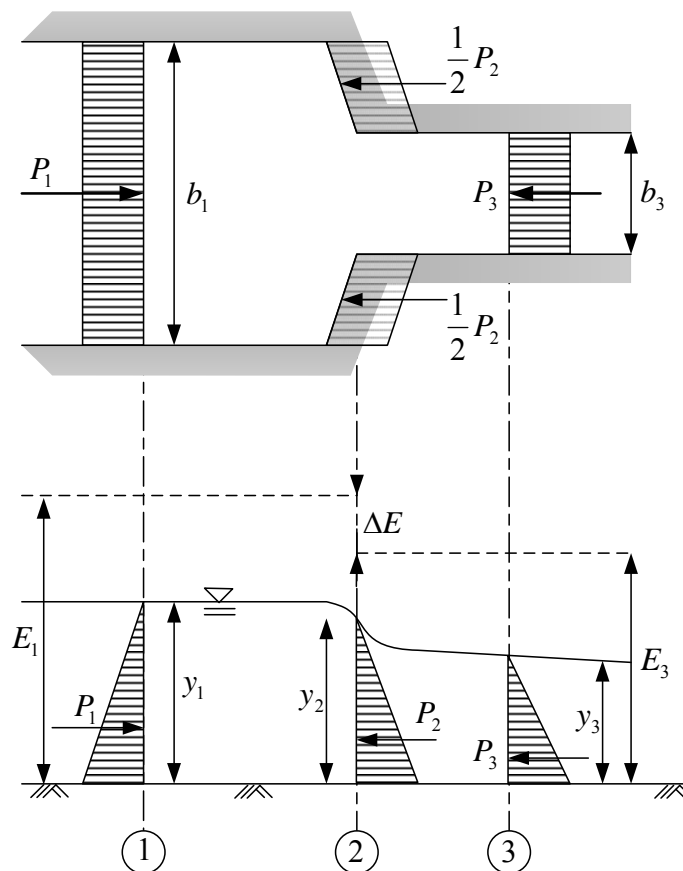

Figure 2-2-1 Contraction effect of the culvert

The friction force, theoretically, is small because of the short flow length, and can be neglected. Momentum coefficients are assumed to be equal to unit. Chow's (1959) classic analysis simplifies equation (1) with continuity equation and $y_2 = y_3$



$$Fr_1^2 = \frac{\left(\frac{y_3}{y_1}\right) \left[\left(\frac{y_3}{y_1}\right)^2 - 1 \right]}{2 \left[\left(\frac{y_3}{y_1}\right) - \frac{1}{(b_3/b_1)} \right]} \quad (2)$$

where Fr_1 is Froude number at section 1. Equation (2) is the general form of channel transition to specify the flow condition.

A primary design criterion usually is to avoid supercritical flow occurring in a transition which may have oblique wave problems.

The energy loss can be represented:

$$\Delta E = \left(y_1 + \frac{V_1^2}{2g}\right) - \left(y_2 + \frac{V_2^2}{2g}\right) \quad (3)$$

Energy losses can be separated into two parts: friction loss and eddy loss. The former loss is due to bed friction within channel transitions, the other loss is associated with expansion or contraction of the flow. Friction loss can be assessed by means of Manning's equation. Approaches to quantify these expansion and contraction losses vary. Even with the assumption of one-dimensional flow, exact solutions are not available. If flow condition remains subcritical through sudden expansion, Henderson (1966) presented the following approximate result for energy loss:

$$\Delta E = \frac{V_1^2}{2g} \left[\left(1 - \frac{b_1}{b_3}\right)^2 + \frac{2Fr_1^2 b_1^3 (b_3 - b_1)}{b_3^4} \right] \quad (4)$$

In the limit for small Froude numbers, equation (4) can be simplified:

$$\Delta E = \frac{(V_1 - V_3)^2}{2g} \quad (5)$$

Chow (1956) also shows the similar result for subcritical condition:

$$\Delta E = \varepsilon \frac{(V_1 - V_3)^2}{2g} \quad (6)$$



where ε is a coefficient for sudden expansions. A sudden expansion or contraction, however, is not always used between different channel sections. Sometimes a smooth or faired transition is used to decrease excessive energy losses. This energy loss depends on the shape of the transition and is expressed as:

$$\Delta E = C_L \Delta h_v \quad (7)$$

in which C_L is loss coefficient and should be determined experimentally, Δh_L is the difference of velocity head.

2.3 Culvert Hydraulics

The design hydraulics and input hydrology for culverts essentially involves the optimal selection of the barrel cross-section that passes the design discharge. Culvert construction reflects considerations of requisite structural strength, hydraulic roughness, durability, and corrosion/abrasion resistance for a culvert.

Culvert hydrologic analysis seeks to estimate a design discharge, and hydraulic analysis is required for sizing the culvert to pass the design flow. A complete description of the hydrologic and hydraulic analyses for culverts is beyond the scope of the present report. It is important to comment that flow regimes vary from culvert to culvert, and even vary with flow rate for a given culvert.

Bodhaine (1982) classified culvert flow into six types during the peak flow. The types are illustrated in the Figure 2-3-1, which differentiates them on the basis of the location of the flow control section and the relative height of the headwater and tailwater elevations. Three flow types (1, 2, and 3) are for low-head flow, when the ratio of headwater depth and the opening of culvert is less than 1.5. Two types are for high-head flow (5, and 6) when the ratio is larger than or equal to 1.5. The remaining flow type is for fully submerged flow through a culvert.



TYPE	EXAMPLE	TYPE	EXAMPLE
1 CRITICAL DEPTH AT INLET $\frac{h_1 - z}{D} < 1.5$ $\frac{h_4}{h_c} < 1.0$ $S_0 > S_c$	 $Q = CA_c \sqrt{2g(h_1 - z + a_1 \frac{V_1^2}{2g} - d_c - h_{f_{1,2}})}$	4 SUBMERGED OUTLET $\frac{h_1 - z}{D} > 1.0$ $\frac{h_4}{D} > 1.0$	 $Q = CA_0 \sqrt{\frac{2g(h_1 - h_4)}{1 + \frac{29C^2 n^2 L}{R_0^{4/3}}}}$
2 CRITICAL DEPTH AT OUTLET $\frac{h_1 - z}{D} < 1.5$ $\frac{h_4}{h_c} < 1.0$ $S_0 < S_c$	 $Q = CA_c \sqrt{2g(h_1 + a_1 \frac{V_1^2}{2g} - d_c - h_{f_{1,2}} - h_{f_{2,3}})}$	5 RAPID FLOW AT INLET $\frac{h_1 - z}{D} > 1.5$ $\frac{h_4}{D} \approx 1.0$	 $Q = CA_0 \sqrt{2g(h_1 - z)}$
3 TRANQUIL FLOW THROUGHOUT $\frac{h_1 - z}{D} < 1.5$ $\frac{h_4}{D} \approx 1.0$ $\frac{h_4}{h_c} > 1.0$	 $Q = CA_3 \sqrt{2g(h_1 + a_1 \frac{V_1^2}{2g} - h_3 - h_{f_{1,2}} - h_{f_{2,3}})}$	6 FULL FLOW FREE OUTFALL $\frac{h_1 - z}{D} \approx 1.5$ $\frac{h_4}{D} \approx 1.0$	 $Q = CA_0 \sqrt{2g(h_1 - h_3 - h_{f_{1,2,3}})}$

Figure 2-3-1 Classification of culvert flow (Bodhaine, 1982)

The National Bureau Standards (NBS) completed a series of culvert studies, sponsored by Federal Highway Administration (FHWA), in early 1950's. These reports provide a comprehensive analysis of culvert hydraulics under various flow conditions. They were used to develop culvert design graphs or nomographs for use in sizing culverts for various types of flow control and then design for the control which produces the minimum performance. In their research, flow conditions include the cross-section of a culvert flowing full and partially full. The former condition is pressure flow and the other is free-surface flow.

Normann (1985) classified two basic types of flow control from the preceding result of NBS and FHWA: inlet and outlet control. The concept used to classify culverts is the location of the control section. The classification, summarized below, is presented in Hydraulic Design of Highway Culverts (Normann, 1985) and is widely used in the culvert design.

1. Culverts with inlet control have supercritical flow in barrels and the control section is near inlet.
2. Culverts with outlet control have subcritical flow in barrels and the control section is



- at the downstream end of the culvert.
3. Culverts, with inlet and outlet submerged conditions, perform as a conduit. However, the hydrodynamic of culvert is regarded as open channel if culverts have either inlet or outlet in unsubmerged condition.
 4. Culvert may operate under either inlet or outlet control with a given flowrate, so the actual operating condition is not easily determined. Instead, the concept of the culvert minimum performance is used to design a culvert under the peak discharge.

Figure 2-3-2 illustrates four different examples of inlet control that depends upon the submergence of inlet and outlet ends of the culvert. In Figure 2-3-2a, neither the inlet nor the outlet of the culvert is submerged. The control section just downstream of the entrance and the flow in the barrel is supercritical. Partly full flow occurs through the barrel, and approaches normal depth at the outlet. Figure 2-3-2b shows that the outlet is submerged and inlet is unsubmerged. In this case, flow just downstream of the inlet is supercritical and a hydraulic jump occurs in the barrel. Figure 2-3-2c is a typical design situation. The inlet is submerged and the outlet flows freely. The flow in the barrel is supercritical and partially full over its length. Critical depth is located just downstream of the culvert entrance, and the flow is approaching normal depth at the downstream end. Figure 2-3-2d shows an unusual condition illustrating the fact that even submergence of both the inlet and the outlet ends of the culvert does not have full flow through the barrel. In this case, a hydraulic jump may form in the barrel; the median inlet provides ventilation of the culvert barrel.

A culvert under inlet control performs as weir when the inlet is unsubmerged, and as orifice when it is submerged. If the entrance is unsubmerged, the inlet control section is near the entrance of the culvert. Application of the energy equation, neglecting head loss at control section (figure 2-3-3), gives

$$y_c + \frac{V_c^2}{2g} = E_c = HW \quad (8)$$

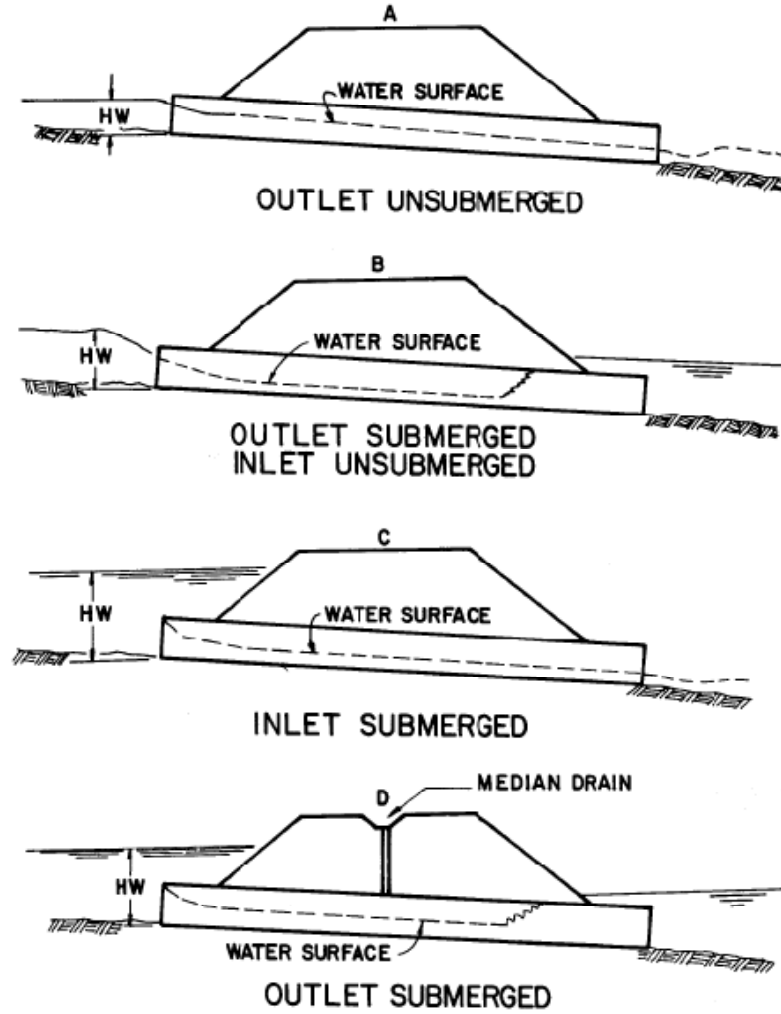

Figure 2-3-2 Types of inlet control, (Normann, 1985)

In equation (8), y_c is critical depth near the entrance of culvert, V_c is critical velocity, E_c is critical specific energy, and HW is headwater.

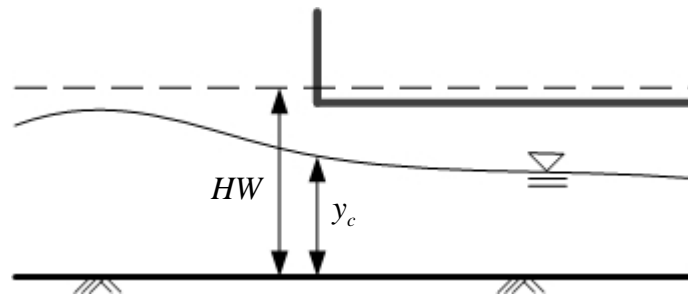

Figure 2-3-3 Culvert entrance acts like a weir



For critical flow in a rectangular box culvert, $y_c = 2/3 E_c$, as derived by Charbeneau (2006) using equation (8) assuming $V_c = Q/(C_b B y_c)$, where Q = barrel discharge, C_b = coefficient expressing effective width contraction associated with the culvert entrance edge conditions, and B = width (span) of culvert. Therefore, equation (8) can be written as

$$\frac{HW}{D} = \frac{3}{2} \left(\frac{1}{C_b} \right)^{2/3} \left(\frac{Q}{A\sqrt{gD}} \right)^{2/3} \quad (9)$$

In equation (9), D = culvert rise (height); and A = full culvert cross section area ($A = BD$ for a box culvert).

If head loss is considered and the distance between entrance and control section is substantial, energy equation at control section yields

$$HW = E_c + h_L - L'S \quad (10)$$

In equation (10), h_L is head loss, L' is distance between entrance and control section, and S is channel slope. For rectangular box culvert, the above equation could be written as

$$\frac{HW}{D} = \frac{3}{2} \left(\frac{1}{C_b} \right)^{2/3} \left(\frac{Q}{A\sqrt{gD}} \right)^{2/3} + \frac{h_L}{D} - \frac{L'}{D} S \quad (11)$$

Based on studies of NBS, FHWA developed two equations for unsubmerged inlet control performance similar in form to equation (9):

$$\frac{HW}{D} = \frac{E_c}{D} + K g^{M/2} \left[\frac{Q}{A\sqrt{gD}} \right]^M - 0.5S \quad (12)$$



$$\frac{HW}{D} = Kg^{M/2} \left[\frac{Q}{A\sqrt{gD}} \right]^M \quad (13)$$

In equation (12) and (13), S is slope of the culvert, K and M are the coefficients based on the culvert configuration. Equation (12) could be modified for rectangular box culvert (Charbeneau, 2002):

$$\frac{HW}{D} = \frac{3}{2} \left[\frac{Q}{A\sqrt{gD}} \right]^{2/3} + Kg^{M/2} \left[\frac{Q}{A\sqrt{gD}} \right]^M - 0.5S \quad (14)$$

According to Normann (1985), the constant M = 0.667) for a rectangular culvert box. Then,

$$\frac{HW}{D} = Kg^{1/3} \left[\frac{Q}{A\sqrt{gD}} \right]^{2/3} \quad (15)$$

When a culvert inlet is submerged, the culvert performs as either an orifice or as a sluice gate. For orifice performance (Norman, 1985)

$$Q = C_d A \sqrt{2gh} = C_d B D \sqrt{2g(HW - 1/2 D)} \quad (16)$$

In equation (16), C_d is a discharge coefficient that must be evaluated for different inlet conditions, A is the culvert inlet full area, h is the head on the culvert centroid, and H is the upstream headwater. The discharge coefficient $C_d = 0.6$ for square-edge entrance conditions. The equation resulting when the culvert acts as a sluice gate is similar. For a sluice gate the performance equation is (Henderson, 1966):

$$Q = C_c B D \sqrt{2g(HW - C_c D)} \quad (17)$$

In equation (17), C_c is a contraction coefficient. The above equations can be expressed as the performance equation. Charbeneau (2006) applied energy equation with HW representing the headwater specific energy shown in Figure 2-3-4:

$$HW = \frac{v_{en}^2}{2g} + C_c D \quad (18)$$

In equation (18), v_{en} =velocity within the culvert entrance; and C_c =contraction coefficient associated with flow passing the culvert entrance. Energy losses can be neglected and be included within coefficients. With the equation (18), the discharge is calculated from:

$$Q = (C_b B)(C_c D)v_{en} = C_b C_c A \sqrt{2g(HW - C_c D)} \quad (19)$$

Equation (19) could be written as a performance equation:

$$\frac{HW}{D} = \frac{1}{2(C_b C_c)^2} \left(\frac{Q}{A \sqrt{gD}} \right)^2 + C_c \quad (20)$$

For submerged inlet conditions, Normann (1985) have been fit the data from experiments performed by National Bureau of Standards an equation:

$$\frac{HW}{D} = Y + cg \left[\frac{Q}{A \sqrt{gD}} \right]^2 - 0.5S \quad (21)$$

In equation (21), Y and c are constants based on the culvert configuration.

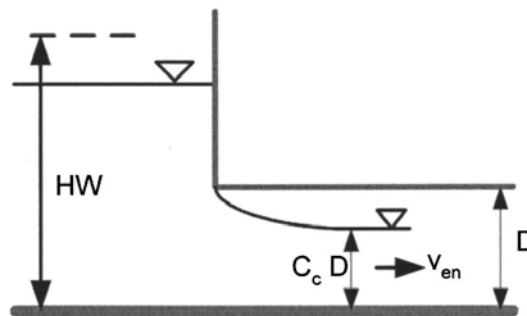

Figure 2-3-4 Culvert entrance acting as a submerged sluice gate (Charbeneau, 2006)



For culvert flows with outlet control, critical depth does not occur near the entrance, and the flow condition in the culvert barrel is subcritical. Figure 2-3-5 illustrates five examples of outlet control in which all cases have the control section at the outlet end or further downstream. Outlet control occurs when the barrel is incapable of conveying as much flow as the inlet opening. Figure 2-3-5a represents the classic full flow condition, with both inlet and outlet submerged. The barrel is in pressure flow throughout its length. This condition is often assumed in calculations, but seldom actually exists. Figure 2-3-5b depicts the outlet submerged with the inlet unsubmerged. For this case, the headwater is shallow enough so that the inlet crown is exposed as the flow contracts into the culvert. Figure 2-3-5c shows the entrance submerged to such a degree that the culvert flows full throughout its entire length while the exit is unsubmerged. This is a rare condition, requiring an extremely high headwater to maintain full barrel flow with no tailwater. The outlet velocities are usually high under this condition. Figure 2-3-5d is the typical condition. The culvert entrance is submerged by the headwater and the outlet end flows freely with a low tailwater. For this condition, the barrel flows partly full over at least part of its length (subcritical flow) and the flow passes through critical depth just upstream of the outlet. Figure 2-3-5e is another typical condition, with neither the inlet nor the outlet end of the culvert submerged. The barrel flows partly full over its entire length, and the flow profile through the barrel is subcritical.

The outlet-control flow condition can be described using the energy equation. Full flow, as depicted in Figure 2-3-6, is typical for outlet control culverts. The culvert flow full can be computed between section 1 and 4. Neglecting the velocity head in section 1, and friction loss between 1 and 2, and between 3 and 4, the energy equation gives

$$H + S_0L = TW + \frac{V_4^2}{2g} + h_L + h_{2-3} + h_{ex} \quad (22)$$

In equation (22), H is water depth at section 1 that can be replaced as HW , TW is water depth at section 4, h_L is loss due to entrance contraction, h_{2-3} is friction loss between 2 and 3, and h_{ex} is loss due to sudden expansion between 3 and 4. According to Jain (2001),



$h_L = \left[\left(\frac{1}{C_d^2} \right) - 1 \right] \left(\frac{V_3^2}{2g} \right)$ and $h_{ex} = \left[\left(\frac{V_3^2}{2g} \right) - \left(\frac{V_4^2}{2g} \right) \right]$, where C_d is discharge coefficient.

Based on Manning discharge formula, h_{2-3} could be written into $n^2 L V_3^2 / R_0^{4/3}$. An expression of equation (22) can be modified as a performance equation:

$$\frac{HW}{D} = \frac{TW}{D} + \frac{n^2 L g}{R_0^{4/3}} \left(\frac{Q}{A \sqrt{gD}} \right)^2 + \frac{1}{2C_d^2} \left(\frac{Q}{A \sqrt{gD}} \right)^2 - \frac{L}{D} S_0 \quad (23)$$

In equation (23), R_0 is hydraulic radius in the barrel, and n is Manning coefficient.

Compared to the formulation for inlet control, the HW and discharge relationship under outlet control is affected not only entrance geometry of the culvert, but also TW and roughness in the barrel.

Normann (1985) considered the full flow culvert and calculated the outlet control flow condition with energy equation.

$$HW + \frac{V_1^2}{2g} = TW + \frac{V_4^2}{2g} + H_{loss} \quad (24)$$

neglected the approaching velocity and exit velocity, and obtained:

$$HW = TW + H_{loss} \quad (25)$$

Where H_{loss} is total loss and represented as:

$$H_{loss} = \left(1 + K_e + \frac{2gn^2L}{R_0^{4/3}} \right) \frac{V^2}{2g} \quad (26)$$

In equation (26), K_e is a coefficient varying with inlet configuration, and V is velocity in the barrel.

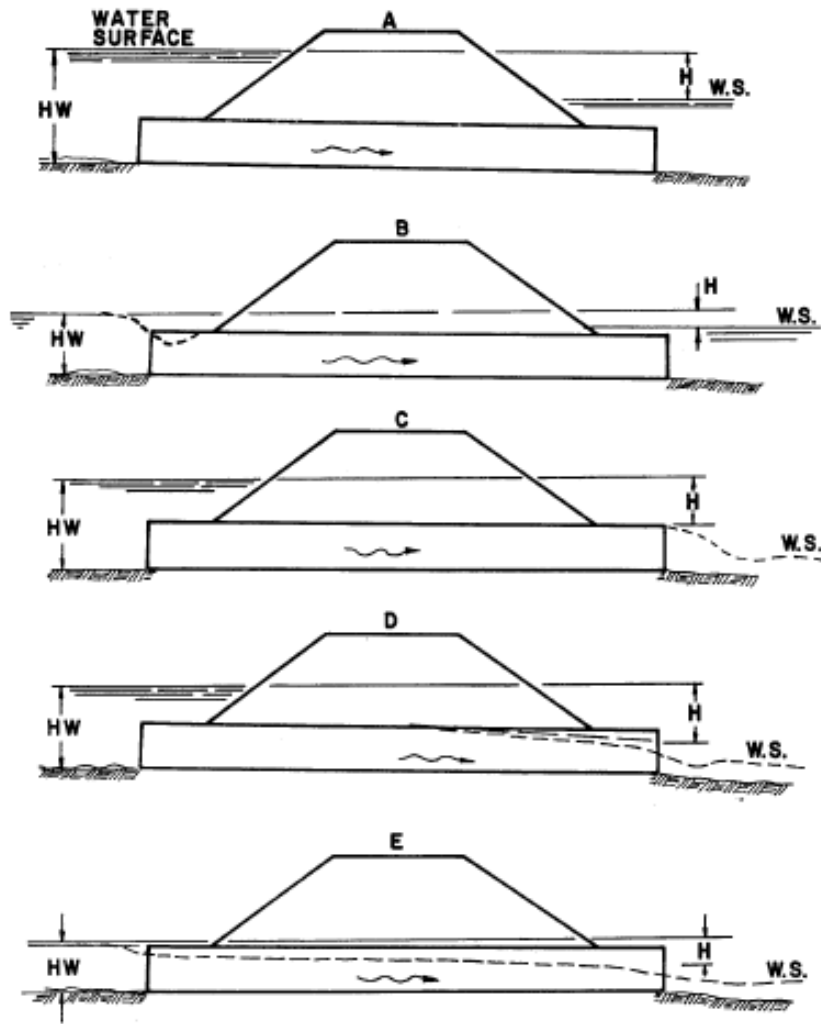

Figure 2-3-5 Types of outlet control (Normann, 1985)

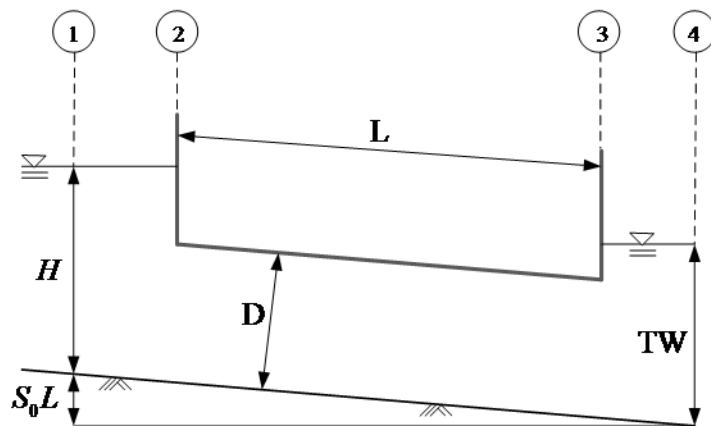

Figure 2-3-6 Culvert with submerged upstream and downstream

If a culvert's upstream and downstream ends are both unsubmerged, the flow with mild channel slope can have free-surface flow in the culvert (figure 2-3-7). The control section would occur at the outlet end or further downstream. The flow is partly full in the culvert and can be described by the energy equation between section 1 and 3 if control section is at section 3 in Figure 2-3-7.

$$H + \frac{V_1^2}{2g} + S_0 L = y_3 + \frac{V_3^2}{2g} + h_L + h_{1-2} + h_{2-3} \quad (27)$$

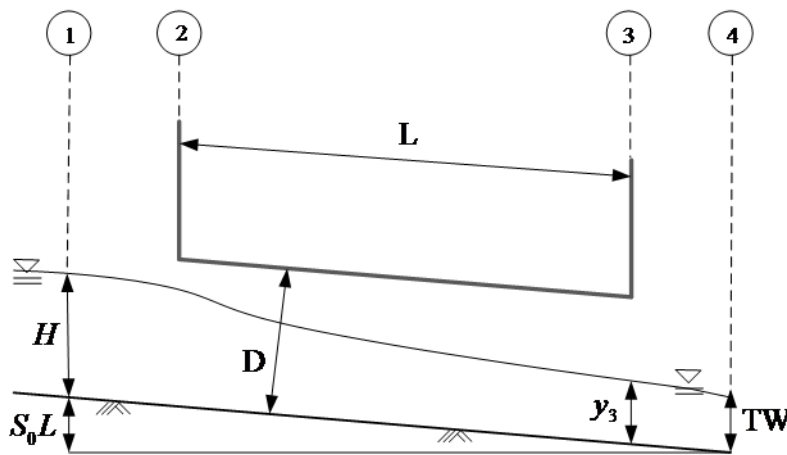

Figure 2-3-7 Culvert with unsubmerged upstream and downstream

If the control section were at the further downstream, the energy equation should apply between section 1 and 4:

$$H + \frac{V_1^2}{2g} + S_0 L = y_4 + \frac{V_4^2}{2g} + h_L + h_{1-2} + h_{2-3} \quad (28)$$

However, for the inlet to remain unsubmerged, the depth in section 3 is equal to that in section 4. Therefore, the above two equations can be similarly analyzed. In equation (27), the water depth at section 3 can be replaced as TW (Jain, 2001), head loss $h_L = (1/C^2 - 1)V_3^2/2g$ due to entrance, h_{2-3} could be written into $L(Q^2 / K_2 K_3)$, and h_{1-2} can be neglected.

$$HW = TW - \frac{V_1^2}{2g} + \frac{1}{C_d^2} \frac{V_3^2}{2g} + \frac{LQ^2}{K_2 K_3} \quad (29)$$



From the studies of NBS and FHWA, the outlet control flow conditions were only analyzed for full barrel flow. If free-surface flow is occurring as Figure 2-3-7, the factors along the culvert all influence the performance of the culvert. Equation (28) cannot easily be written into a performance equation. It is necessary to calculate the backwater profile based on the tailwater depth.

2.4 Sedimentation at Culvert

Site condition, stream characteristics, or economic considerations can require that a culvert have multiple barrels. Multi-barrel box culverts are more economical than a single wide-span culvert because the structural requirements of a long span are costly. Experience, however, has shown that significant problems may arise at multi-barrel culvert sites, including erosion at the inlet and outlet, sediment buildup in the barrels, and clogging of the barrels with debris. Attention to the effects of these interactions between the stream channel and the culvert is necessary in the culvert design.

The balance of forces associated with flow and sediment transport in natural streams and manmade channels can be locally disrupted by culvert presence. One outcome of the disruption is the deposition of transported sediment, or scour of sedimentary boundaries at the ends of the culvert. Sedimentation is a common occurrence at culvert inlets.

Sedimentation of a culvert entrance, and within a culvert, could be influenced by the many factors, including the size and characteristics of material of which the channel is composed, the hydraulic characteristics generated under different hydrology events, the culvert geometry design, channel transition design, and the vegetation around the channel. Most hydraulic manuals provide only clear water designs for culverts; few may comment that sediment might deposit at normal flow condition and then be flushed out during storm events. Culverts commonly are usually constructed on relative mild channels to avoid supercritical flow upstream the entrance. The relative mild slope will increase the potentiality of sedimentation even during storm events. Sediment deposition building up through the culvert can decrease the discharge capacity of the culvert. This decrease in the



capacity of the culvert ultimately can lead to flooding under some specific hydrology events. Vassilios (1995) indicates a significant rainfall occurred in the winter and spring of 1992, and resulted sediment deposition in the reinforced concrete box culvert constructed in 1991 under 10th Street West in California. The city maintenance placed sandbags around the area of inlet of the culvert as a temporary freeboard which were used to provide additional head water and prevent the coming storm. They expected the coming storm can flush out sediment in the barrel, but this did not occur. The coming large rainfall occurred in May 1992. As the flow and sediment moving through, the culvert was entirely silted and blocked, causing local flooding and creating maintenance difficulties for the city.

Sediment deposition in culverts could occur as sediment laden storm water passes through a culvert; the sediment falls out of suspension and collects. Richards and Zeller (1996) presented two analytical methods to estimate sediment conveyance and deposition potential in the culvert. It compared the sediment discharge rates for the upstream channel and through the culvert. If the sediment discharge rate through the culvert is less than the upstream sediment discharge rate for the channel, sedimentation of the culvert can be expected to occur. The first method involves calculating the actual bed-material sediment discharge rate for the channel and culvert with existing equations for sediment transport. The other method calculates the ratio of bed-material sediment transport rates of the approach channel and the designed culvert.

2.5 Culvert Design Considerations

Well established methods exist for sizing culverts. In general, culvert design procedure includes the follow steps (Iowa Stormwater Management Manual, 2007):

1. Determine design data;
2. Trial culvert size;
3. Calculate assuming inlet control;
4. Calculate assuming outlet control;
5. Compare HW values for step 3 and 4 (the higher HW governs);
6. Try an alternate culvert size and repeat step 3; and
7. Compute outlet velocity.



The design considers culvert hydraulic performance during prescribes flood events. However, there are certain situations that require more advanced analysis; hence recursion is made to computer programs to complete the culvert design (ex, *Iowa Culvert Hydraulics V2.0*). The procedure is a combination of hand calculations, charts and nomographs used to evaluate a culvert. The software programs can be relatively easy to use but the methods used are not always fully understood by the user. The general concept is used primarily on either inlet or outlet flow conditions for the hydraulic analysis. There are several basic steps that must be completed. Culvert design is an iterative design procedure; therefore, the steps are often repeated several times for a given design discharge.

The effect of sediment transport, mentioned in previous section, became an important subject which is needed to consider for the culvert design. In 1992, the Maryland State Highway Administration (SHA) initiated new design considerations to limit the impact of constructing culverts and bridges in stream. They started to update the SHA design manual to address consideration of stream morphology. The design manual is still under elaboration. The driving design concept is to construct a stream configuration at the location of the culvert that is stable and that neither scours nor aggrades. Elements of this approach include maintaining the consistency of dimension, pattern, and profile of the stream with particular attention given to maintaining bankfull width and width/depth ratio. Flood plain culverts are provided where appropriate to relieve the hydraulic load on the main channel culvert to limit downstream scour and erosion. Andrzej et. (2001) presented that SHA proposed a replacement of culvert over Beaverdam Run because of sediment buildup at the upstream reach and scour at the downstream reach in 1992. The sedimentation caused fish blockage under normal flow condition. Figure 2-5-1a shows its deteriorated condition. SHA engineers replaced a pipe arch in the channel with its invert buried 0.6 m below the streambed to provide for fish passage. This culvert will accommodate flows up to the bankfull flow. The inverts of the flanking pipe arch and 3-m round structural plate pipes were placed at the bankfull elevation, approximately 0.6 m above the streambed to convey the out-of-bank flows. The construction of replaced culvert was finished in 1994 (figure 2-5-1b). During 6 years of post-construction monitoring, the new design has no scour hole downstream and

forms a well-defined thalweg with in the center of the stream. Fish have been observed passing through the structure.

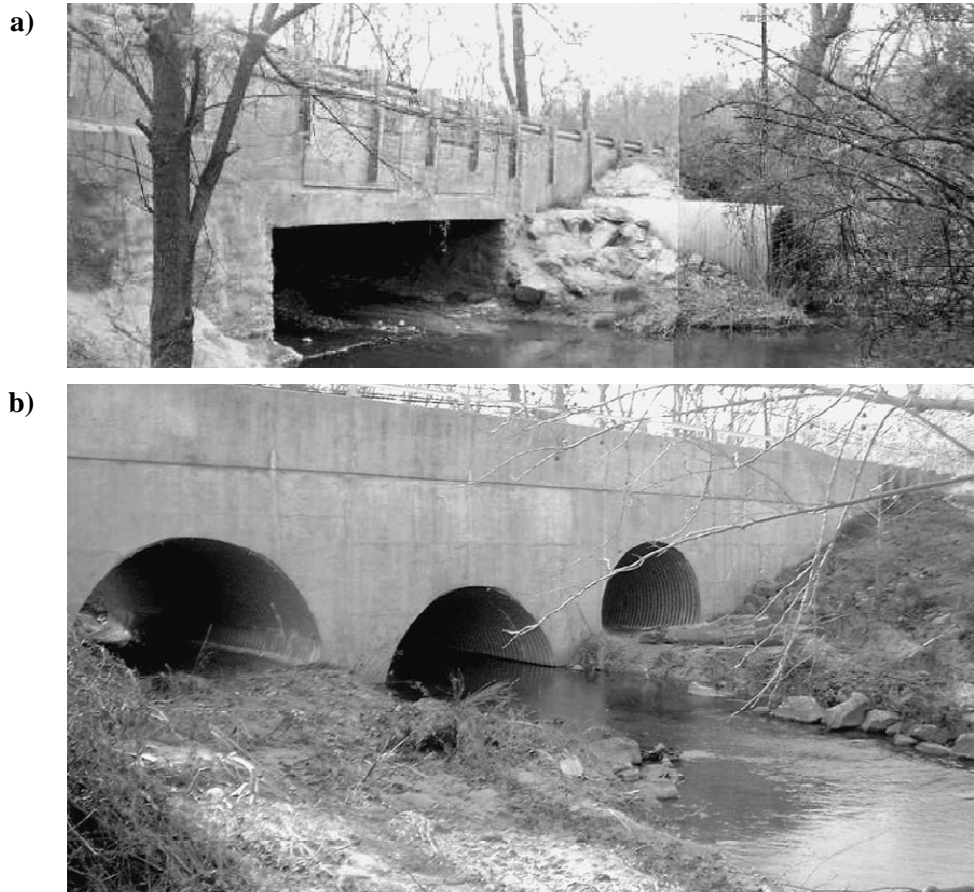

Figure 2-5-1: Culvert retrofitting using uneven inverts: a) pre-construction condition in 1992, b) post-construction in 2000

2.6 Numerical Modeling of Culvert Hydraulics

Numerical simulation of culvert performance under different flow condition has been widely studied with one- and two-dimensional models. Langlinais (1992) discussed a computer aided design tool called DRAINCALC, which performs drainage runoff calculations and open channel, culvert, or storm drainage design calculations, eliminating the need for cumbersome charts, tables, data sets, and nomographs. With this tool, culverts may be designed as flowing under full flow conditions or partial flow conditions. The software has been successfully field-tested. Ferguson and Deak (1994) found that the area upstream of a culvert acts as a reservoir, which retains incoming runoff while earlier runoff is passing



through the culvert opening. They use a computer model of a culvert entrance based on the orifice equation ($C_d = 0.8$) to route storm hydrographs with different flow volumes and peak rates through culverts in studying the increase in upstream stage with increase in flow volume. Charbeneau (2002) showed that FESWMS can accurately simulate surface water flows of culverts with expansion upstream. The recirculation was found in expansion region. Based on the six-box culvert, the model showed that with increasing expansion ratio (expansion length: width of one side) the size of the recirculation decreases. Jones (2005) wrote the software, Iowa DOT culvert program, which incorporate three methods for computing design discharges and then sizing culvert geometry for inlet and outlet control. With this application, performance of culvert under design discharges can be calculated to help decide the geometry of the culvert.

HEC-RAS, widely used one dimensional open channel flow model, has the capability of analyzing culvert performance within the framework of one-dimensional flow calculations using the energy and momentum equations. Within HEC-RAS, the culvert equations developed for FHWA are utilized. Along with specifying the shape, size, material type, and location of the culvert system within the cross section, the user must specify the appropriate chart number and scale number so that appropriate coefficients are selected for computation.

Vassilios (1995) used HEC-6 to simulate sediment transport through the culvert. The culvert was simulated as open channel, since HEC-6 does not have the capability to compute the pressure flow. Two hydrological flow conditions were simulated. Both results showed that the culvert trap a major portion of the supplied sediment in the culvert.

3. Field Visit of Culverts in Iowa

Culverts are common drainage structures in Iowa and elsewhere. Various culvert types and materials are used, depending on culvert size and relatedly area drained by a culvert. Our research focuses on Reinforced Concrete Box (RCB) multi-barrel culverts, because they are especially prone to buildup sediment deposits throughout the culvert areas. Table 1-1 shows that most multi-barrel culverts in Iowa are box shape.

The study entailed field visits to view sedimentation problems at culverts across Iowa. The culverts are located in Johnson, Marion, and Buena Vista counties (Figure 3-1-1). A short report for each site visit is provided below.

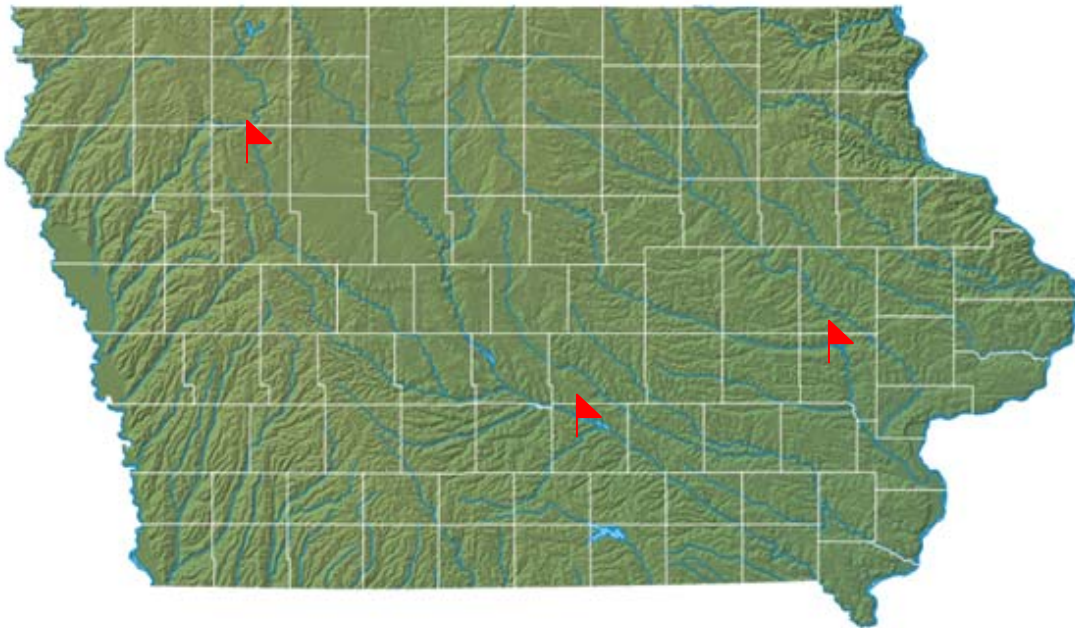

Figure 3-1-1 Iowa Map indicate the counties which were visited in this research

3.1 Johnson County

Statistics produced by the Johnson County engineering office regarding the multi-barrel culvert distribution (table 3-1) show that there are 49 twin-box and 5 triple-box culverts in this county. Figure 3-1-2 presents all three-box culverts in Johnson County. Ten sites out of 54 were selected to visit. Sites 1~5 are three-box culverts, and sites 6~10 are twin-box



culverts. Sediment accumulation at culverts was found to be a significant problem at all sites. The problem being severely reduced flow capacity of sedimented culverts. Evidently the culverts require frequent maintenance to remove sediment deposits and the vegetation that then grows on them. From photographs taken in 2007, three-box culverts are noticeably prone to accumulate sediment. A useful finding is that twin-box culverts seem to have less problem sedimentation.

Table 3-1-1. Culvert types and numbers in Johnson County (Johnson county Secondary Road Department)

RCB culvert type	Number
Twin	49
Three	5

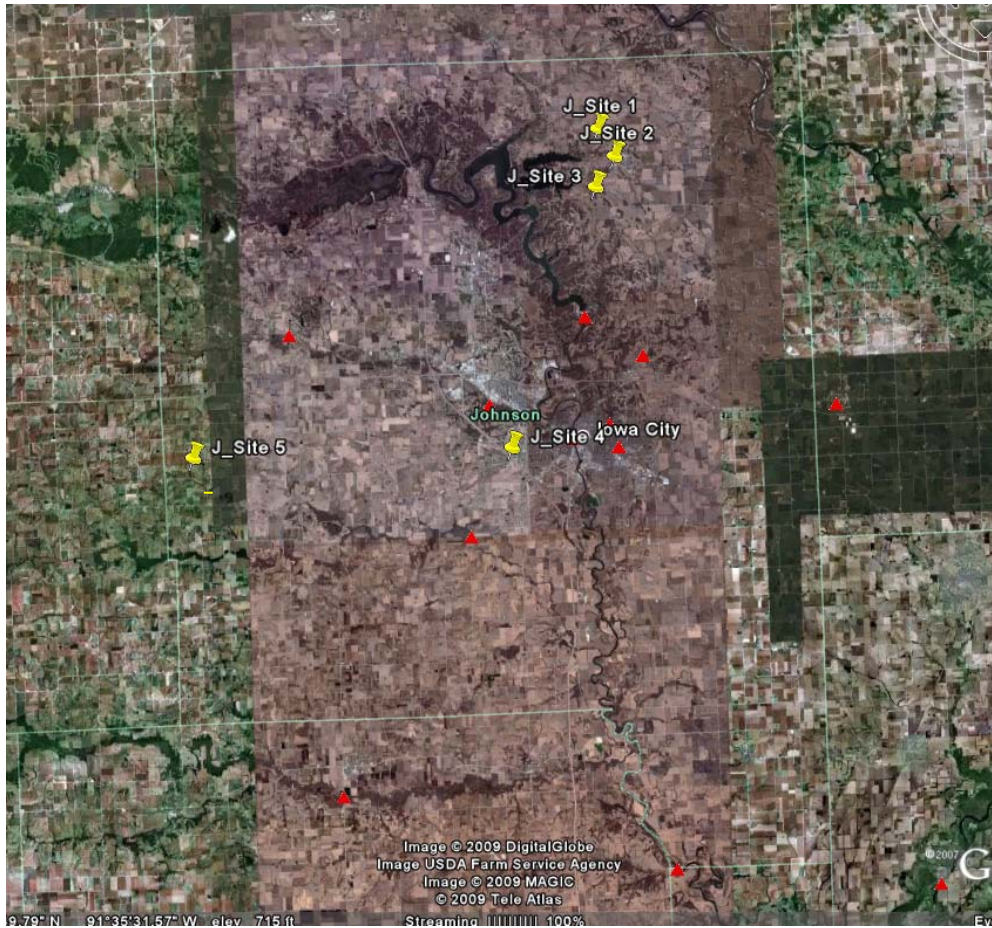

Figure 3-1-2. Three-box culverts in Johnson County: the yellow markers are field visit locations and red marker is USGS stream station in this county



J_Site 1: Culvert on Hwy #382

Site Characteristics:

- Located on Mill Creek
- It was built in 1962
- 10ftx10ftx53ft three-box culvert
- Design drainage area is 4480 acres
- The terrain is plain
- Entrance and exit of culvert site were clean at the time of the visit, though it appeared that the culvert was recently cleaned
- Wingwall and barrels were highly skewed with respect to the main flow direction
- The site has experienced a recent flood event according to mud traces visible at the site on the flood plain.





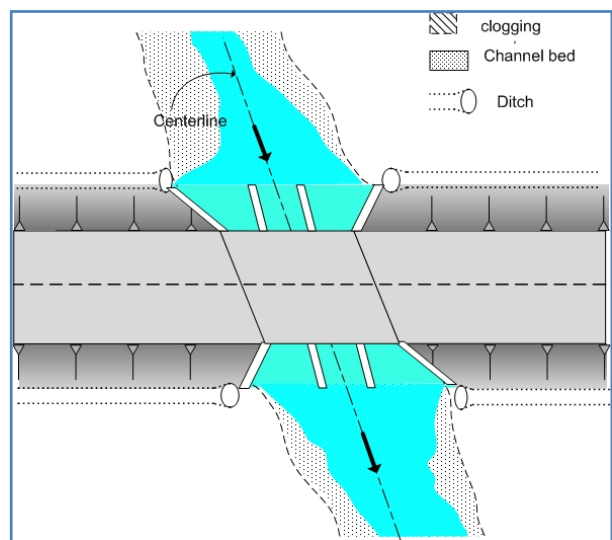

Aerial image



Culvert site sketch

Condition on March 15, 2007:

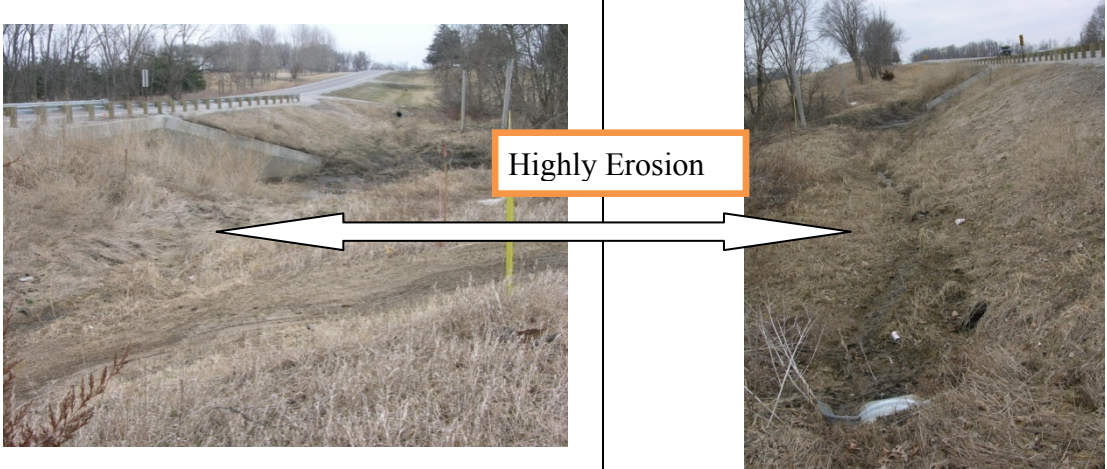
	
<p>Flow enter culvert with a large angle. Expansion area seemed to have sedimentation before.</p>	<p>The barrels are clean. Based on the water mark, this site might had flood event.</p>
	
<p>No sour evidence was found at outlet.</p>	
	
<p>Sediment transported from ditch (downstream of culvert) is considerable</p>	

J_Site 2: Culvert on Hwy #382

Site Characteristics:

- Located on Mill creek
- It was built in 1962
- 12ftx8ftx45ft three-box culvert
- Design drainage area is 384 acres
- The terrain is plain
- No debris near entrance
- The entrance angle of the stream and curved flow contributed sedimentation at site



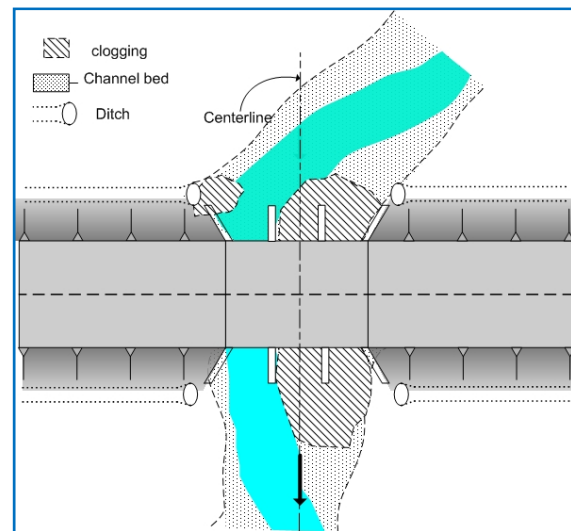

Aerial image



Culvert site sketch

Culvert condition on March 15, 2007:

	
<p>Erosion in ditch (upstream) might provide sediment in expansion area.</p>	<p>Stream enters the culvert with a large angle. Wingwall and barrels were not skewed to align main flow direction.</p>
	
<p>Debris downstream of the culvert will trap sediment in the future</p>	<p>Sedimentation through the culvert on left and central barrels</p>

J_Site 3: Culvert on Racine Ave

Site Characteristics:

- Located on Jordan Creek
- It was built in 2002
- 10ftx8ftx66ft three-box culvert
- Design drainage area is 2187 acres
- The terrain is plain
- Little debris near the entrance
- Sedimentation problem is serious



Aerial image

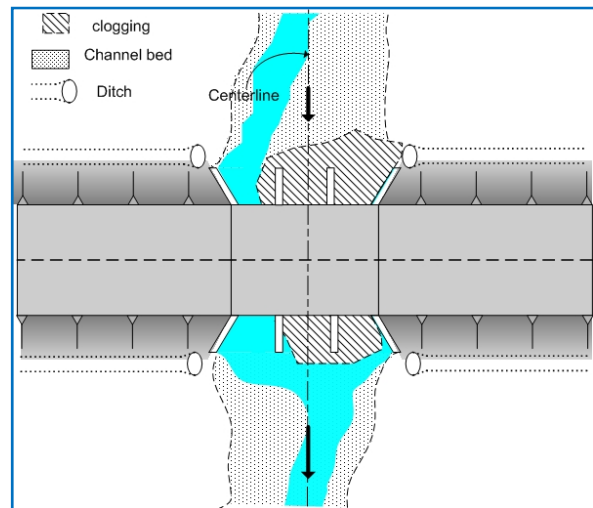

Culvert site sketch



Condition on March 16, 2007:

	<p>Rocks prevented bank erosion</p>
<p>Serious clogging problem on the left and central parts of culvert.</p>	<p>The channel has shifted toward right bank because of sedimentation. Sedimentation is extensive in barrels.</p>
<p>Rocks</p>	<p>Secondary (circular) culvert downstream the main culvert</p>
<p>The flow downstream is aligned the central line of the culvert. The sedimentation on the left bank around the ditch</p>	<p>A small single-circle culvert was built 50ft downstream from the triple-box culvert.</p>
<p>Rocks were placed to prevent erosion at ditches</p>	



J_Site 4: Culvert on Hwy #218

Site Characteristics:

- Located on Dear Creek
- three-box culvert
- 500m downstream from a 2-box culvert (see Site 8_J)
- Hilly area
- Sedimentation is serious
- No visible contribution from vegetation debris

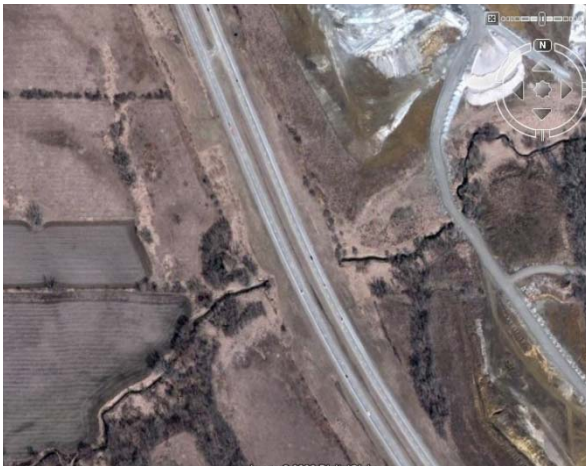

Aerial image

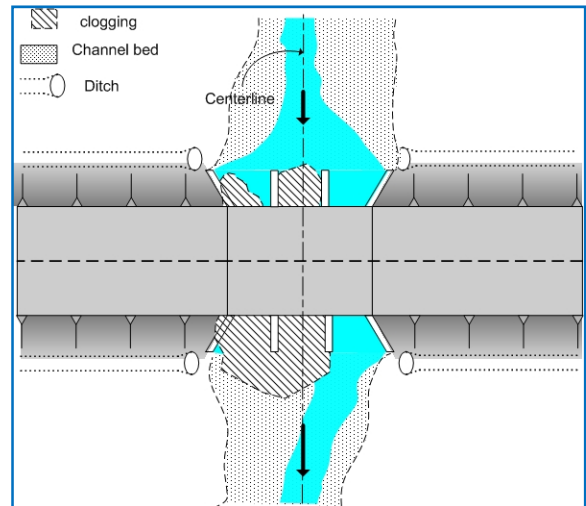

Culvert site sketch



Condition on April 16, 2007:



The stream is fairly well aligned with the culvert. Steep slopes from all the culvert sides cut strong ditches merging upstream the culvert.



Considerable clogging appears on the right and central boxes of the culvert. The left box is clean; the others are heavily sedimented (about 1 m elevation difference).



A very well defined stream passes through the left barrel indicating a long term sedimentation process.



Constant sedimentation level though the more than 50m culvert length is blocking the two culvert boxes.



The effect of the long term sedimentation is obvious (with trees already growing on the new deposits)



Mud trapped in the grass after a recent rain event



J_Site 5: Culvert on Black Hawks Ave

Site Characteristics:

- Located on Old Mans creek
- It was built in 2000
- 9.8ftx9.8ftx84ft three-box culvert
- Design drainage area is 3765 acres
- Entrances of right and central barrels were blocked by debris
- No sediment was deposited in barrels

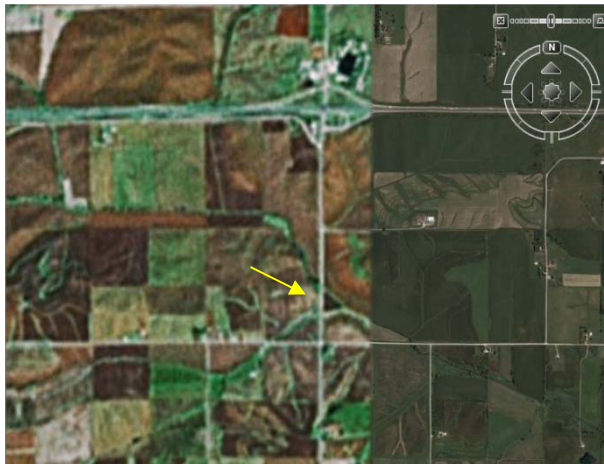



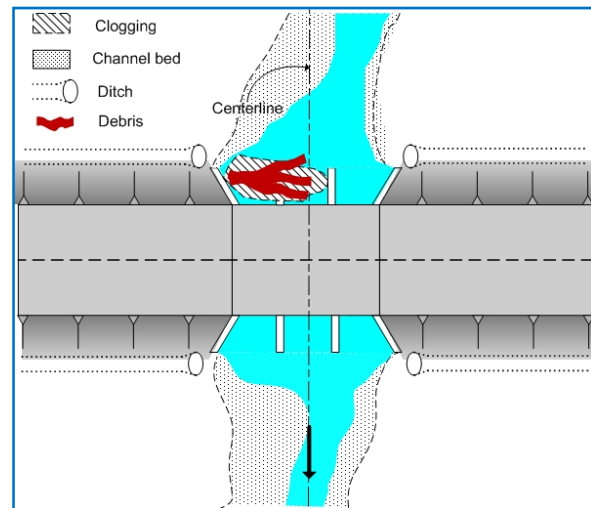

Aerial image



Culvert site sketch



Condition on April 16, 2007:

	
<p>Bank erosion on the right; expansion area is free of sediment.</p>	<p>Tree debris from bank erosion have blocked the entrances of barrels</p>
	
<p>The flow downstream is aligned the central line of the culvert. The contraction area is free of sediment.</p>	<p>No sedimentation through all barrels.</p>
	
<p>Sediment deposited near the confluence between main stream and ditch flow</p>	



J_Site 6: Culvert on Sand Road

Site Characteristics:

- two-box culvert
- The site seems to have been subjected to cleanup recently or retrofit
- Cleanup near the bridge but far away the stream was not cleared
- Culvert with aged asymmetric deposition



Condition on March 15, 2007:

<p>Upstream culvert side</p>	<p>The deposition upstream is asymmetric. The picture shows that culvert was recently cleaned.</p>
<p>Side view (left bank) showing the new work. Local scour depressions evident just upstream the silt fences. (see white arrow)</p>	<p>View of culvert exit</p>



J_Site 7: Culvert on 480th St

Site Characteristics:

- Located on Snyder Creek
- two-box culvert
- The culvert forces the stream to take a “S” shape while passing through the culvert
- Oblique angle to the road- quite well aligned with the stream direction – no visible problems associated with sediment deposition
- Uniform flood plain vegetation



Condition on March 15, 2007:

View of upstream waterway approach: The right side of the culvert is sedimented due to stream curvature	Side view from the upstream left bank

J_Site 8: Culvert on Kansas Ave

Site Characteristics:

- Located on Dear Creek
- two-box culvert
- 500m upstream from another very heavy silted 3-box culvert (see Site 4_J)
- Hilly area
- Good site for monitoring sedimentation



Condition on March 15, 2007:

<p>View of upstream approach: The stream is aligned with the left culvert barrel. Sediment deposition occurred in the right barrel,</p>	<p>Side view of the upstream left bank: Debris a role triggers and facilitates sedimentation. High erosion of the roadway drainage ditches evident</p>
<p>View of downstream waterway: Note the level of the high storms (indicated by the white arrow)</p>	<p>The right bank is clogged, though quite free downstream; sediment trapped at entrance to culvert</p>



J_Site 9: Culvert on Newport Rd

Site Characteristics:

- Located on Sander Creek
- two-box culvert
- The terrain in the culvert vicinity is hilly
- No debris near the entrance



Condition on March 16, 2007:

<p>Upstream view aligned the central line of the culvert. The stream is aligned with the right culvert barrel.</p>	<p>Side view from the upstream right bank. Deposition around the left barrel of the culvert</p>
	<p>Water mark shows that the culvert has experienced flood flow events</p>



J_Site 10: Culvert on Prairie Du Chien Rd

Site Characteristics:

- Located on Sander Creek
- twin-box culvert
- The terrain in the culvert vicinity is hilly
- No debris near the entrance
- Both Twin-box culverts are not subject to the serious sedimentation problem



Condition on March 16, 2007:

	<p>Sediment deposition is more serious in the right barrel.</p>
<p>Downstream view aligned the central line of the culvert. Stream flow passes only through the left barrel</p>	<p>The high water level shows that the culvert has conveyed flood flows</p>

3.2 Marion County

The field visit in Marion County was conducted during August 2006. Six culvert sites were visited (Figure 3-2-1). Five were multi-barrel culverts, and one was a single-barrel culvert. The vicinity of inlet and outlet was heavily vegetated. Substantial sediment and debris deposits had formed at all the sites, and had adversely affected the hydraulic performance of the culvert at the sites. Though a detailed hydrologic investigation was not conducted, it was evident that the sedimentation processes in this county were evolving fast. For example at site #4, the culvert was last cleaned in 2004, but at the time of the visit all of the culvert's barrels were clogged. From the USGS data it was observed that the area experienced a small flood in May 2005, which might explain the debris upstream the culvert. The stream flow was very shallow at this hydrological condition. The invert at the culvert entrance was higher than the water depth, and thereby blocked low-flow drainage.

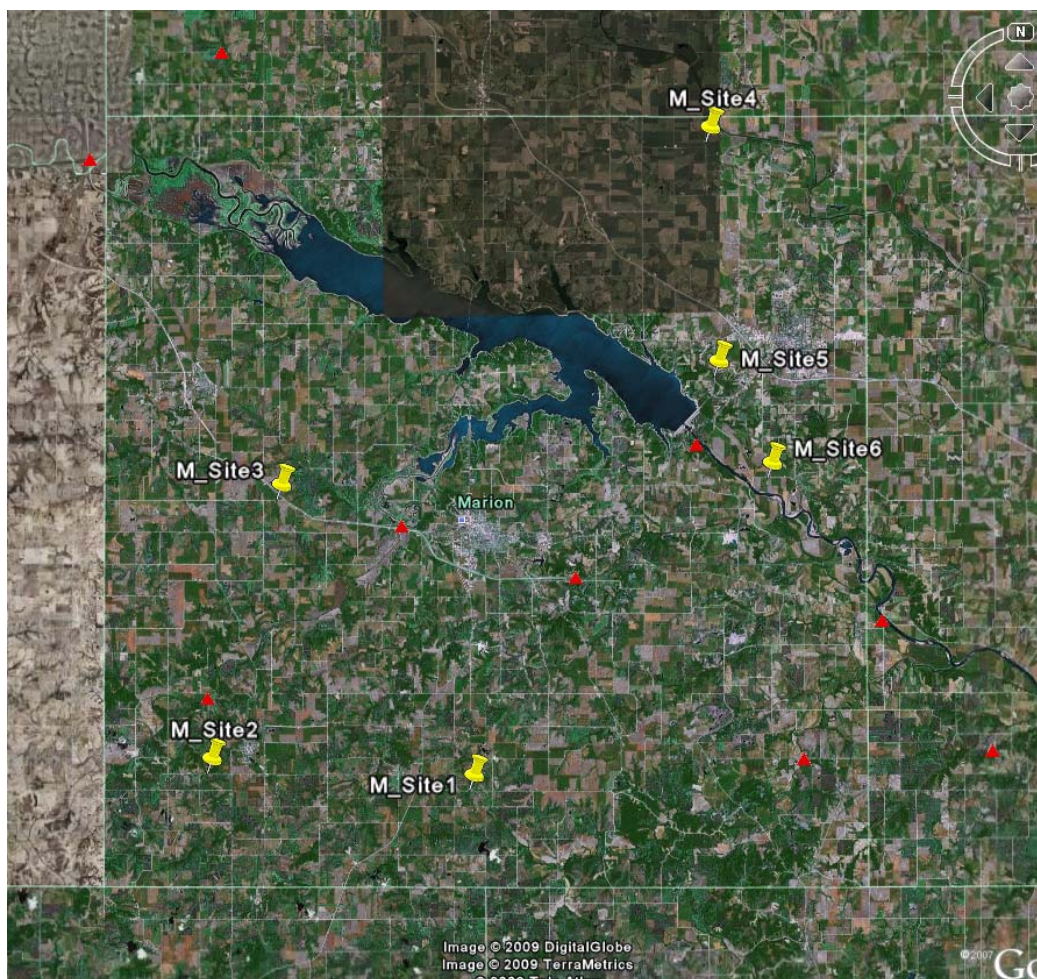

Figure 3-2-1 Marion County: the yellow markers are field visit locations and red marker is USGS stream station in this county



M_Site1: Culvert on Hwy. G-76 East and Hwy. 14

Site Characteristics

- Built in 1996
- 10ft×6ft×104ft three-box Culvert
- Site was cleaned at 1997
- Estimate remaining life at 2004: 44 yrs
- Logs at inlet; outlet is heavy vegetated
- Almost no flow; dry channel
- Left and middle channels are clogged
- The depositions at inlet and outlet are induced by the curve stream of inlet and might have confluence effect near the node of main channel and ditch flow



Aerial Photo (from Beacon)

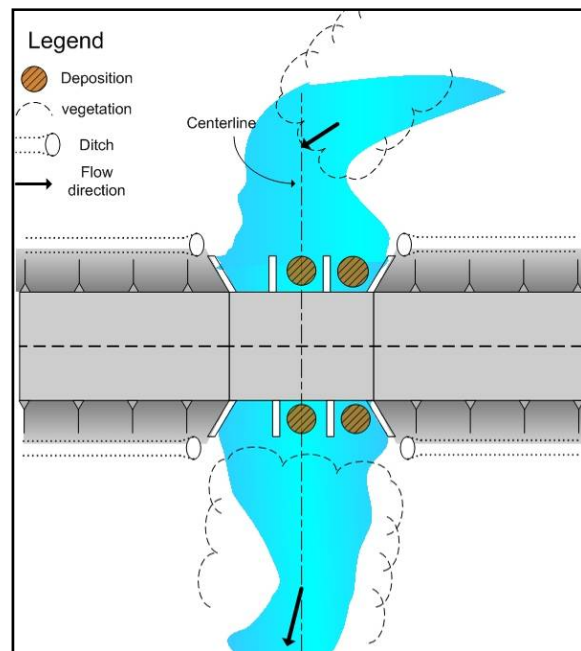

Culvert Sketch



Condition on August 22, 2006



View from left side. Arrow indicates flow direction



View from culvert center. The approach channel is not well aligned with the culvert



Three-barrel culvert with two barrels blocked by debris and sediment.



The culvert exit was covered by vegetation



M_Site 2: Culvert on Hwy. G-76 West and Hwy. S-45
Site Characteristics

- Built in 1964
- 10ft×10ft×90ft two-box culvert
- Drift was removed at 2002
- Estimate remaining life at 2004: 15 yrs
- Inlet was blocked by drift; scour at outlet
- Almost no flow; dry channel

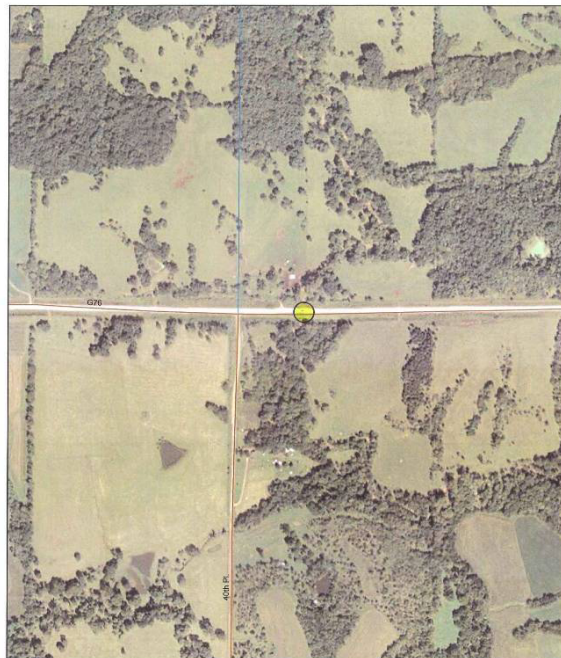



Condition on August 22, 2006

<p>Major debris accumulation, which indicates a recent large flood flow</p>	<p>Upstream channel thalweg meanders</p>
<p>The downstream channel is not well aligned with the culvert</p>	<p>The red circle shows serious bank erosion on the left bank downstream the culvert</p>
<p>View of the right bank downstream the culvert. Bank erosion is also on the right bank.</p>	<p>A scour hole at the culvert exit.</p>



M_Site 3: Culvert on Lisbon St. and Hwy. S-45

Site Characteristics

- Built in 1982
- 12ft×10ft×34.5ft two-box Culvert
- Estimate remaining life at 1996: 40 yrs
- debris at inlet; scour at outlet



Condition on August 22, 2006

<p>Debris at inlet; no sedimentation</p>	<p>Inlet invert is higher than the channel bed</p>
<p>Outlet invert is higher than the channel bed. The downstream channel is not well aligned with the culvert</p>	<p>The barrel is clean. Water mark (white arrow) shows high flow condition</p>



M_Site 4: Culvert on 200 Ave North and Beardsley St

Site Characteristics

- Built in 1982
- 12ft×10ft×31ft three-box Culvert
- Site was cleaned at 2004
- Estimate remaining life at 1999: 35 yrs
- Logs at inlet; inlet and outlet are vegetated
- Almost no flow
- Silt in left and middle boxes
- Sedimentation clogged all culvert boxes because stream flow into culvert with a large angle and confluence effect





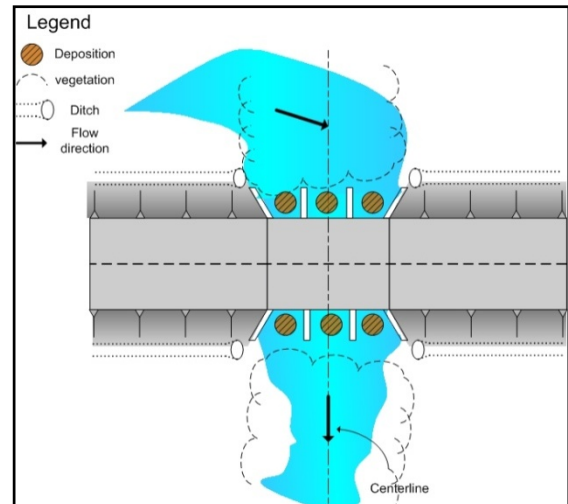

Aerial Photo (from Beacon)



Culvert Sketch

Condition on August 22, 2006

	
<p>The channel enters the culvert with a large angle. Arrow indicates the thalweg of the channel.</p>	<p>Serious sediment and debris accumulation. Sediment accumulation in three barrels.</p>
	
<p>Flow through the right barrel.</p>	<p>Sedimentation is also serious downstream of the culvert.</p>



**M_Site 5: Culvert on Hwy G-28 and Hwy. T-15 South
Site Characteristics**

- Built in 1964
- Two-box Culvert
- Site was cleaned at 2003
- Estimate remaining life at 2005: 25 yrs
- No logs at inlet
- bend 90 degree flow at inlet
- Left channels are clogged with vegetation at both inlet and outlet



Condition on August 22, 2006

<p>The left barrel is clogged.</p>	<p>The stream enters the culvert via a large angle</p>
<p>The downstream channel curves.</p>	



**M_Site 6: Culvert on 218th Ave and Hwy. T-17 East
Site Characteristics**

- Built in 2002
- Rigid frame culvert
- Estimate remaining life at 2005: 50 yrs
- 5 ft weir at inlet
- Although there is a weir at the inlet to reduce the amount of sedimentation into culvert, a lot of sediment deposit in the box clogging the culvert.



Condition on August 22, 2006

<p>5ft weir was built at the opening of the culvert</p>	<p>The channel approach is aligned with the culvert. Rocks are left on the bank to protect against erosion</p>
<p>The channel downstream is aligned with the culvert.</p>	<p>Sediment deposits because the velocity decreases when enter the large opening of the culvert</p>



3.3 Buena Vista County

On June 22th 2006, six culverts were visited in Buena Vista County. Four sites had box culverts. The other culverts had circular barrels.. Figure 3-3-1 shows four locations with box culverts. Three sites displayed sediment built up, but none of the culverts was obstructed by debris. For some sites, maintenance efforts had removed the sediment. It was reported, however, that two culvert sites indeed have serious and continuous sedimentation problems.

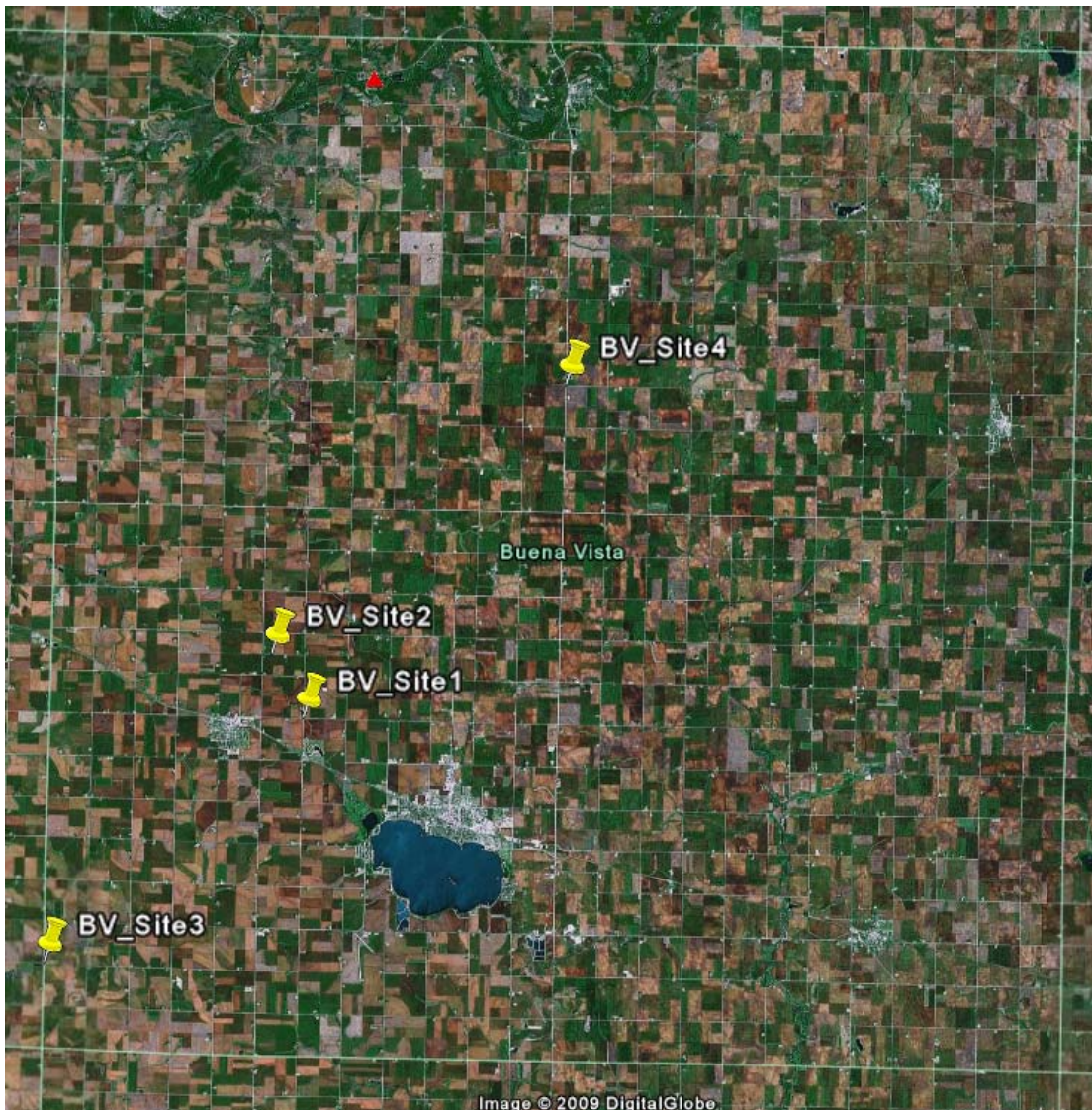

Figure 3-3-1 Buena Vista County Map: the yellow markers are field visit locations and red marker is USGS stream station in this county



BV_Site 1: Culvert on 580th St and 70th Ave

Site Characteristic

- Located on Powell Creek
- Built 20~22 years ago
- Three-box culvert
- Cleaned and clogged after 2 years
- Channel was shifted toward the right bank
- Clogging problem is very serious





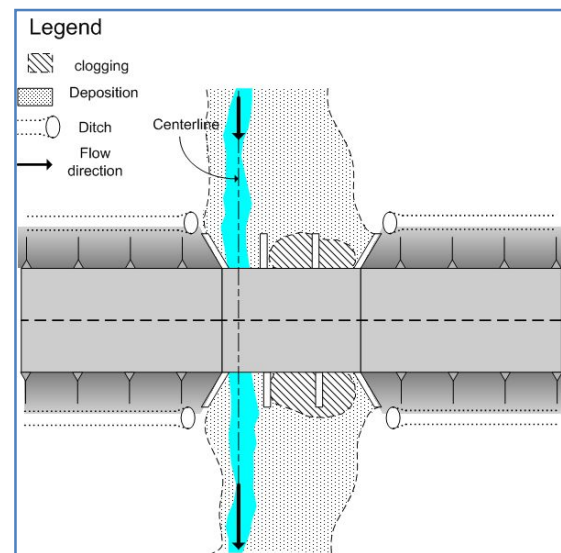

Aerial Photo



Culvert Sketch



Condition on June 12, 2006

	
<p>The approach channel is aligned well.</p>	<p>Two barrels are clogged.</p>
	
<p>The outlet channel is aligned well.</p>	<p>Sediment deposited in barrels</p>

**BV_Site 2: Culvert on 565th St
Site Characteristic**

- Two-box culvert
- There are long road ditches
- The channel approach was dry
- Scour evident at the outlet of the culvert

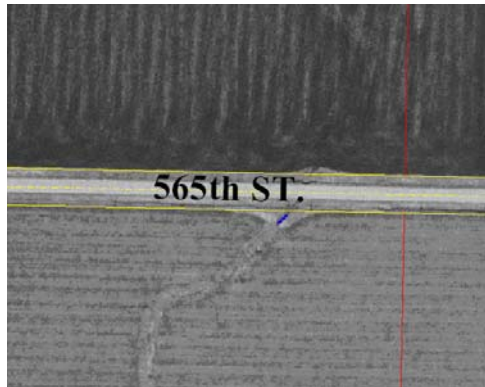

Condition on June 12, 2006

<p>Sedimentation at culvert inlet</p>	<p>The culvert is skewed. Approach is dry.</p>
<p>Ponding area at culvert outlet</p>	<p>Scour at outlet. Outlet invert is higher than the channel bed.</p>



BV_Site 3: Culvert on 640th St and 10th Ave

Site Characteristic

- Three-box culvert
- Site was cleaned at 2004
- Confluence flow formed near the inlet
- There are some bars at the inlet and outlet close to the right bank of the channel

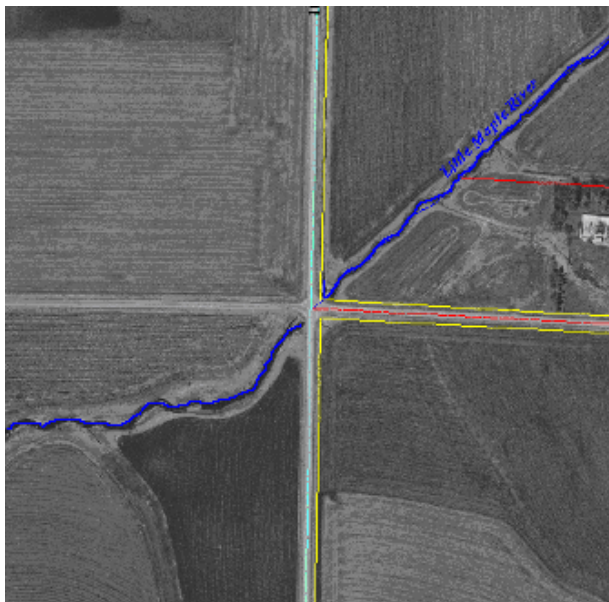

Aerial Photo

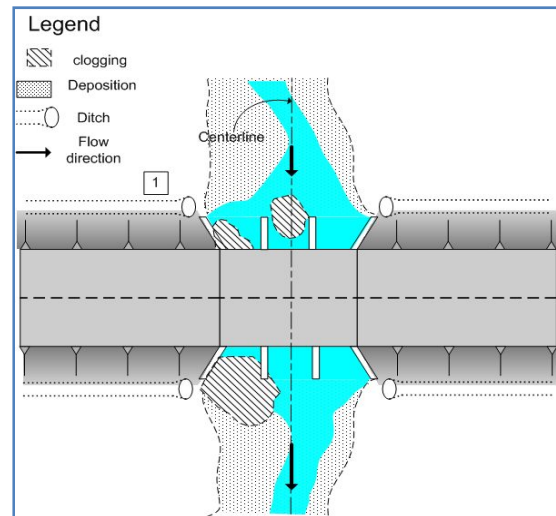

Culvert Sketch



Condition on June 12, 2006

<p>View upstream of the culvert. Ditch flow from left merges with the channel flow.</p>	<p>Sediment Deposited in the right and left barrels</p>
<p>Ditch upstream the culvert</p>	<p>The channel downstream aligned with culvert</p>



BV_Site 4: Culvert on Hwy 71 and 500th St

Site Characteristic

- Three-box culvert
- Site was cleaned at 2004
- Clogging inside the culvert
- Confluence effect should be considered at this site. A sediment bar formed near the right bank of the channel



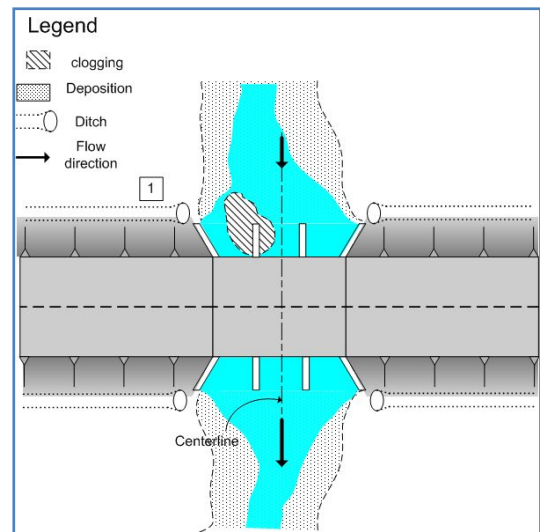

Aerial Photo



Culvert Sketch



Condition on June 12, 2006

 A photograph showing a wide, grassy approach to a culvert. A small, light-colored sediment bar is visible in the center of the channel. A blue arrow points down to the bar.	 A photograph of a concrete culvert with three barrels. The barrels are clean and free of sediment. A blue arrow points to the right side of the culvert.
<p>A small bar formed in the wide approach</p>	<p>No serious sedimentation in barrels</p>
 A photograph showing the entrance of a culvert. A significant amount of sediment and debris has accumulated at the entrance, forming a bar. A blue arrow points to the sediment bar.	 A photograph of the outlet of a culvert. The outlet is clean, but there is a noticeable amount of sedimentation in the central barrel. A blue arrow points to the sedimentation in the central barrel.
<p>A sediment bar at culvert entrance</p>	<p>Culvert outlet clean. Sedimentation is in the central barrel</p>



4. Laboratory and numerical modeling

4.1 Introduction

This chapter describes the laboratory and numerical modeling conducted to investigate flow and sediment transport performance of multi-barrel culverts with an approach-channel expansion. The modeling also sought to evaluate way to control sedimentation at culvert sites. The multi-barrel culvert model design is considered because such culverts typically are prone to sedimentation problems, as illustrated in the preceding chapter. The model culverts were connected to a channel expansion upstream and channel contraction downstream.

An important aspect of experiments was the simulation of sediment movement to and through the model culverts. The sediment movement was as bedload transport, defined as sediment moving on, or near, the bed by rolling, saltation, or sliding. Suspended load is defined as sediment moves in suspension. Generally, sediment would mostly move by bed load transport when velocity is relatively low, but by suspended load transport when velocity is relatively high. The tests examined sediment movement under normal flow discharges; therefore, only bed load transport was considered in the laboratory study.

The main practical objective of the laboratory and numerical modeling was to develop self-cleaning designs for multi-box culverts. This objective entailed first understanding the hydraulics and the propensity of sediment. The investigations comprised baseline, screening, and performance test phases. For the baseline tests, two physical models were used (scale ratio 1/20, labeled as model 1/20A and 1/20B, as described below) with fixed boundary. The numerical model simulated model 1/20B. Screening tests were only conducted for model 1/20A. The size of the flume's cross section made tests convenient for quickly checking the possible effectiveness of the self-cleansing concepts, and eliminating concepts found not to hold good promise for being effective. The performance tests, discussed in the next chapter, involved a large physical model (scale ratio 1/5) with loose boundary and fitted with a candidate self-cleaning system. The numerical model simulated the physical model with fixed boundary and the self-cleaning system.



4.2 Baseline tests

The baseline tests simulate different hydrological conditions in un-submerged culvert situation for two physical models and the numerical model. The physical models (model 1/20A and 1/20B) were built in IIHR's Model Annex, at the University of Iowa. Model 1/20A was a 1/20 scale, three-box culvert model without a wingwall connection to the expansion and the rectangular stream channel. Model 1/20B was also a 1/20 scale culvert model, but with wingwall connection and a compound stream channel (see Figure 4.2.1 and 4.2.2). Model 1/20A had a simplified geometry retaining the essential features of the stream-culvert system. Following recommendations from the meeting with the Technical Advisory Committee, it was decided to more accurately replicate the details of the channel and culvert geometry.

Model 1/20B was built based on the design blueprints provided by David Claman at Iowa Department of Transportation. The geometry of this configuration is provided in Figure 4-2-8. A numerical model was developed only for this model as it accurately replicated the geometry of the stream in field conditions. All models were analyzed under flow conditions that do not submerge the culvert model.

4.2.1 Model 1/20 Configuration and Operation

Figure 4-2-1 and figure 4-2-2 detail the layout of the model. The flume included three sections: channel, culvert model, and tailgate. The channel is a rectangular channel and 120-in long. Figure 4-2-2 details the headbox and the three-box culvert of the physical model 1/20A. The water used for models 1/20A and 1/20B was pumped from the reservoir underground the laboratory through a 3hp pump. A valve located before the diffuser was used to control the magnitude of discharge. The diffuser and flow straighteners were installed in the headbox to stabilize the flow before entering the flume channel. There were eight holes uniformly located on the diffuser to flow out the water. The magnitude of discharge through each hole was supposed to be similar in order to stabilize the flow. However, the magnitude of discharge through each hole was different which made the flow unstable entering the channel. The magnitude of discharge in the middle holes was much strong than in the side

holes. Four holes in the middle were blocked to have the magnitude of water through each hole was equal. The water depth in this model was maintained with a tailgate set.

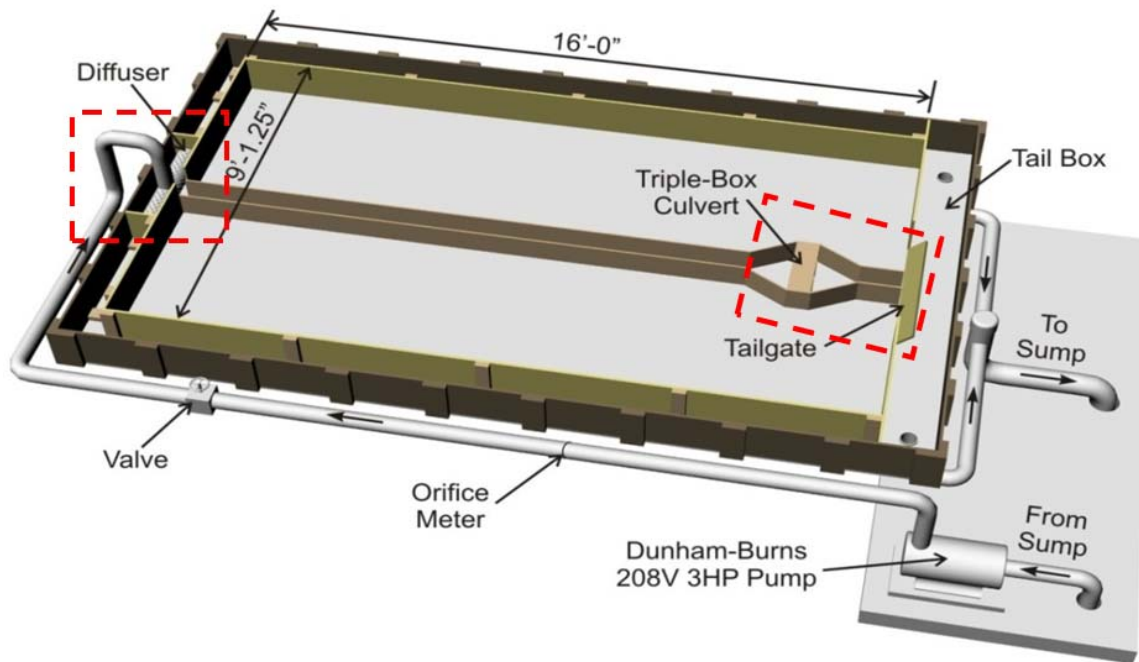

Figure 4-2-1 Overview of the flume

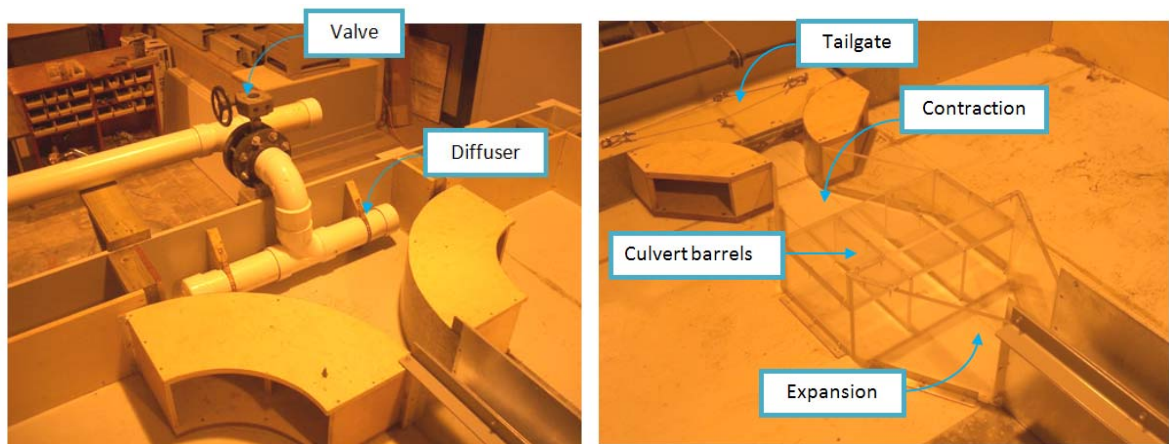

Figure 4-2-2 Layout of the culvert model

Sediment was added into the channel by the feeding machine (figure 4-2-3). A number of holes were uniformly drilled on the cylinder to allow sand pass through. A motor which can be adjusted speed was used to control the amount of sediment added into the channel. Sediment mobility through the test culvert forms was tested in this model. The flow



conditions needed to ensure sediment movement were set iteratively. Provision was made to trap all the released sediment in order to accurately quantify the sediment transport during the tests.

The measurements needed for all laboratory experiments were water depth, discharge, velocity distribution, and the amount of sedimentation. Water depth was measured typically by point gauge in front of the culvert barrels. This device is a pointer that can measure the elevation of water surface. Discharge was measure by the difference of hydraulic head and calculate based on hydraulic principles, discharge varies as the square root of the head differential:

$$Q = C_d \times \sqrt{\Delta h} \quad \text{where } C_d \text{ is the calibration coefficient}$$

Velocity measurement was done by image-based technique. Large-Scale Particle Image Velocimetry (LSPIV) was used to measure the velocity distribution around the culvert. The velocities near the culvert were measured simultaneously and showed in the two-dimension. For 1/20A and 1/20B, the amount of sediment deposited in the interested regions was collected by scoop and measured the weight with the typical soil process. The sand was dried for 24 hours in the oven and weighted with the electronic scale. For 1/5B, the evaluation of sedimentation in the expansion was measured with the image-based technique. The in-house software, Digital Mapping, can delineate the edge of the sediment deposit geometry and plot into the physical coordinate.

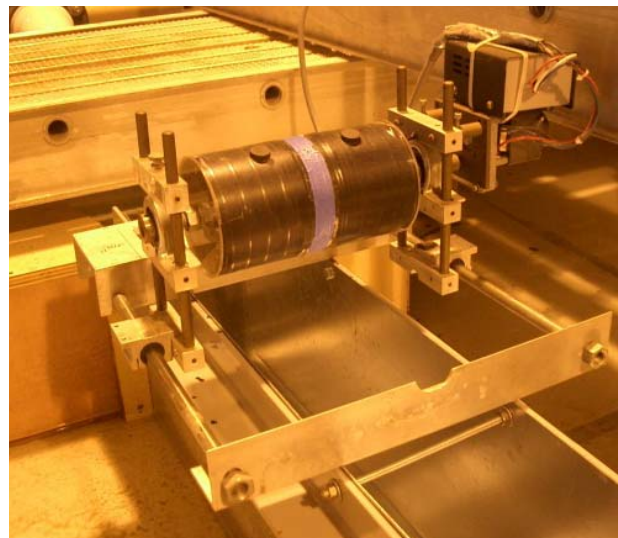

Figure 4-2-3 Sediment feeder



4.2.2 Baseline test 1

To examine sediment mobility through the model culvert, four flow conditions were tested (Figure 4-2-4). Flow velocities in the approach channel were varied from 1.32 ft/s to 0.92 ft/s, with a constant sediment load added in the channel by the cylinder. The sediment served essentially as a tracer to delineate the potential region of sediment accumulation. The investigated areas were focused in the expansion and culvert barrels. If sediment accumulated in the channel, the velocity was not sufficient to transport sediment and not be considered for the following experiments. Observations from the four cases are presented in the Figure 4-2-5.

Flow	Discharge (cfs)	Headwater (ft)
Case A	0.150	0.220
Case B	0.163	0.250
Case C	0.172	0.3
Case D	0.180	0.392

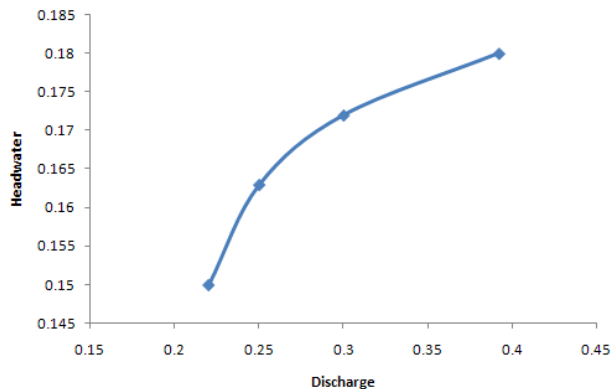

Figure 4-2-4. Trial flow conditions of the experiment

Cases A and B had flow velocities 1.36 ft/s and 1.28 ft/s in the approach channel. Sediment did not accumulate, but constantly moved in the channel for both flow conditions, even though dunes developed in it. Local sediment accumulation was observed in the expansion at the channel inlet. Figures 4-2-5 (a) and (b) show the results of tests A and, respectively, B that ran for one hour. Sediment prone to deposit and accumulate in the right and left region was observed.

The flow for Case C had a velocity of 1.15 ft/s in the approach channel. Sediment mobility in the channel was lower than for cases A and B. Sediment accumulated in the channel; less sediment load was transported into the culvert model section compared to the above cases.

Case D used the velocity 0.92 ft/s in the channel. Accumulation in the channel was the most serious among all cases. Figures 4-2-5 (c) and (d) show the results for both cases C and, respectively, D, after one hour of running. Sedimentation in the expansion was milder because sediment accumulated in the channel. Both flow conditions were not used in subsequent tests.

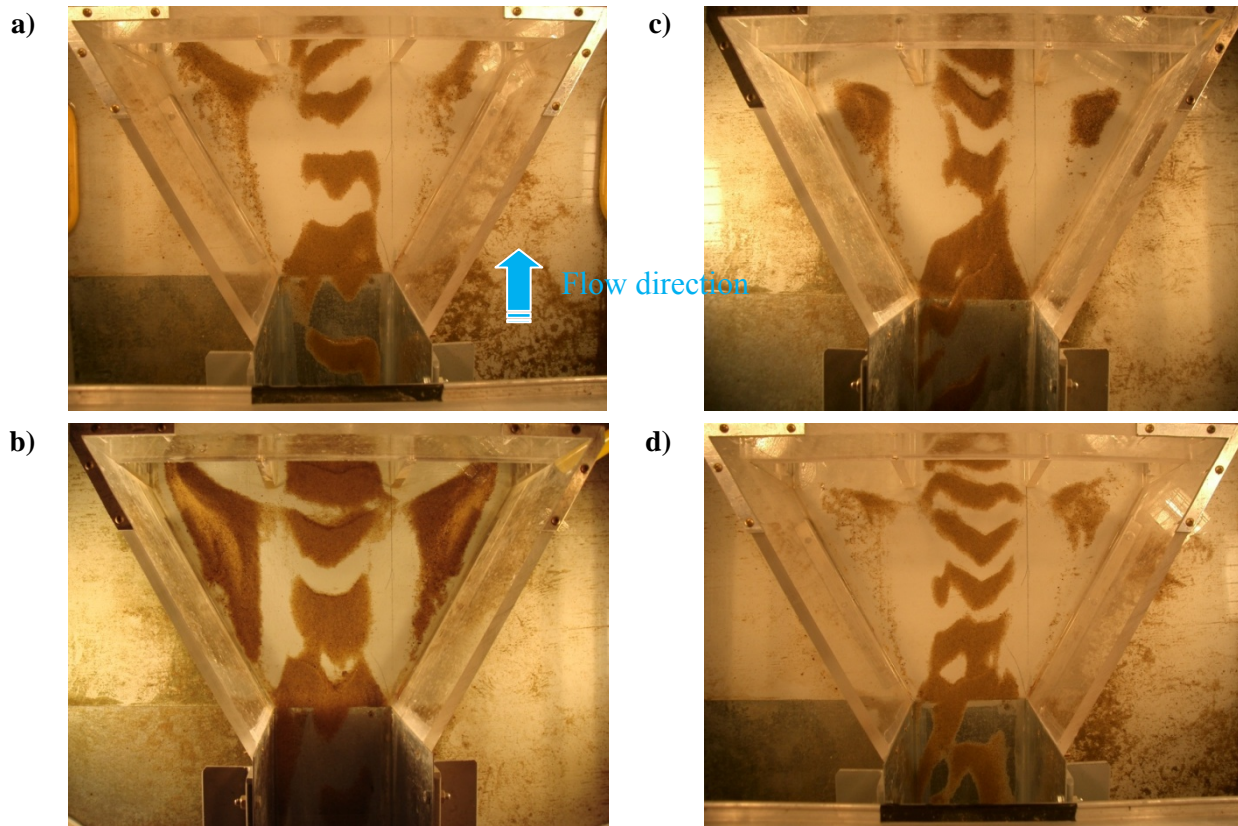

Figure 4-2-5 Sediment accumulation upstream of the culvert inlet

4.2.3 Baseline test 2

The object of this test was to record the sedimentation patterns occurring in the expansion and the culvert barrels. Model A, described in the above section, was used for this purpose. The test was only operated for a specific flow condition (Case B), and the operating time was from one to six hours. Overall, the six images shows sediment accumulated in the sides of the expansion, but did not in the central region. Sediment accumulation is not easy to detect from the images taken from the top view. To evaluate the sediment accumulation, the sediment



load in the expansion, and three barrels were separately collected (figure 4-2-6).

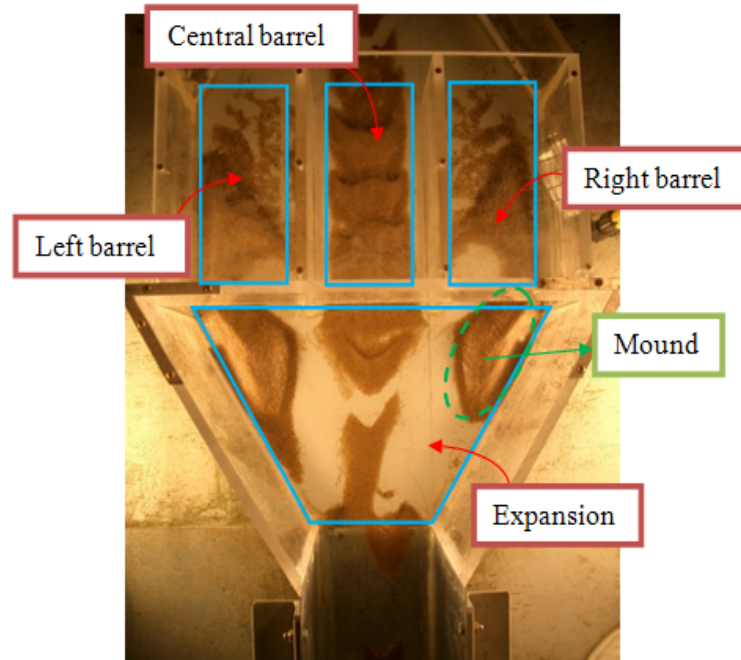

Figure 4-2-6 Sediment load distribution

The elevations of dunes formed by sediment accumulated were also quantitatively recorded. Figure 4-2-7 shows sediment load in different zones and after different running times, and Figure 4-2-8 shows the change in the elevation of dunes with time at the highest deposition point. Figure 4-2-8 shows that sediment deposition in the central barrel was constant, but sediment gradually accumulated in the right and left barrels. The accumulation in the expansion increased from the first hour to the fourth hour, and then became constant. The analogous result was confirmed by determining the variation of dune height in right and left parts in the expansion in figure 4-2-9. The above investigation indicates the following observations:

1. Flow has the capacity to transport sediment in the center;
2. Sedimentation in the side barrels would increase and then deteriorate the performance of the culvert; and,
3. Sediment accumulation in expansion would reach an equilibrium condition.



1hr

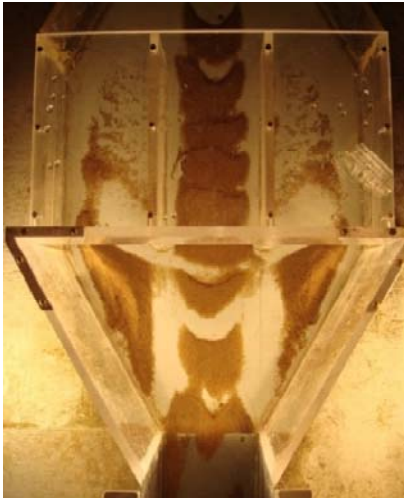

4hr



2hr



5hr



3hr



6hr



Figure 4-2-7 Sediment accumulation over 6 hours of observation

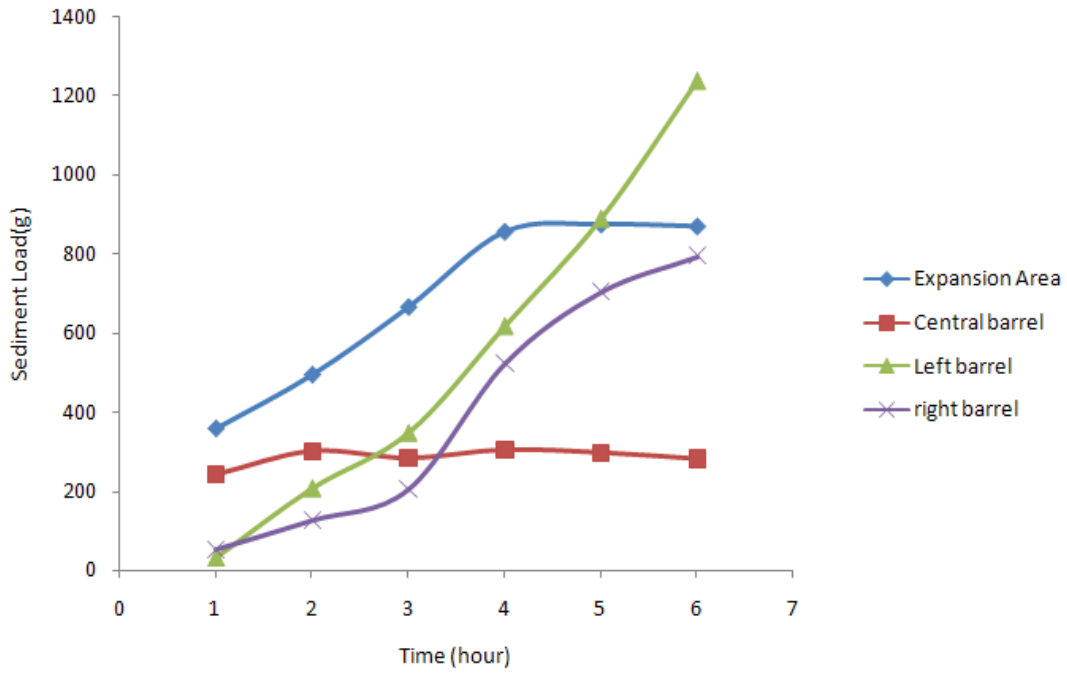

Figure 4-2-8 Rate of sediment accumulation in the expansion and three barrels

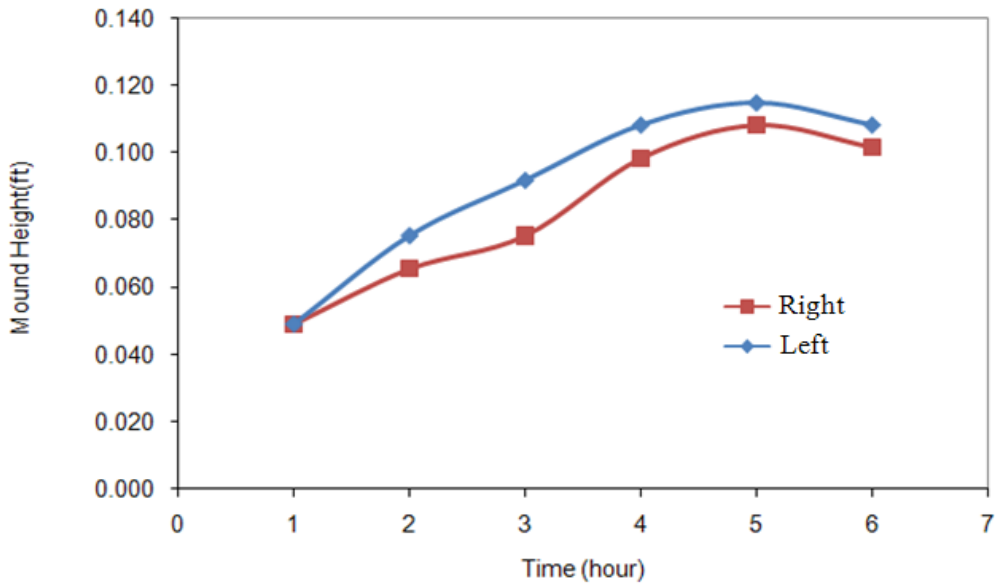

Figure 4-2-9 Dune height variation with time from one-hour to six-hours



4.2.4 Baseline test 3

The aforementioned tests were aimed at investigating the propensity of sediment mobility through the culvert. Baseline test 3 was conducted to better understand sediment deposition in the expansion and culvert barrels.

A slight unevenness in the sediment deposits accumulated in the expansion area was observed in baseline tests 1 and 2, revealing that the velocity distribution in the model was not quite uniform. Therefore, the Large-Scale Particle Image Velocimetry (LSPIV) technique was applied to obtain surface velocity distribution, and adjust the flow distribution. The measurements with LSPIV confirmed that the velocity distribution was slightly asymmetric though without significant implication for the modeling conclusions.

During tests 3, a new culvert-channel configuration was designed and implemented to include the culvert wingwalls that are associated with the standard box-culvert designed by Iowa Department of Transport (IDOT). The model channel geometry consists of two trapezoidals with a 1:1 slope for the walls of the main channel and a 4:3 slope for flood channel. Wingwalls were connected to the edge of culvert barrels. Figure 4-2-10 shows the layout of model 1/20B. The test operated under three hydrological conditions tested before in Baseline tests 1 and 2. All the modeled flows were with the culvert in an unsubmerged control situation whereby the water depth does not higher than the depth of the culvert (figure 4-2-11).

The depth of the culvert was 0.5ft in the model corresponding to 10ft of the prototype. Three water depths were investigated. The design discharges based on the water depth were calculated from equation (13) in the chapter 2. Three cases were used to present three hydrological events from small to large. Case A was $\frac{1}{4}$ depth of the culvert ($HW/D=0.25$), case B was half depth of it ($HW/D=0.5$), and case C was $\frac{3}{4}$ depth of it ($HW/D=0.75$).

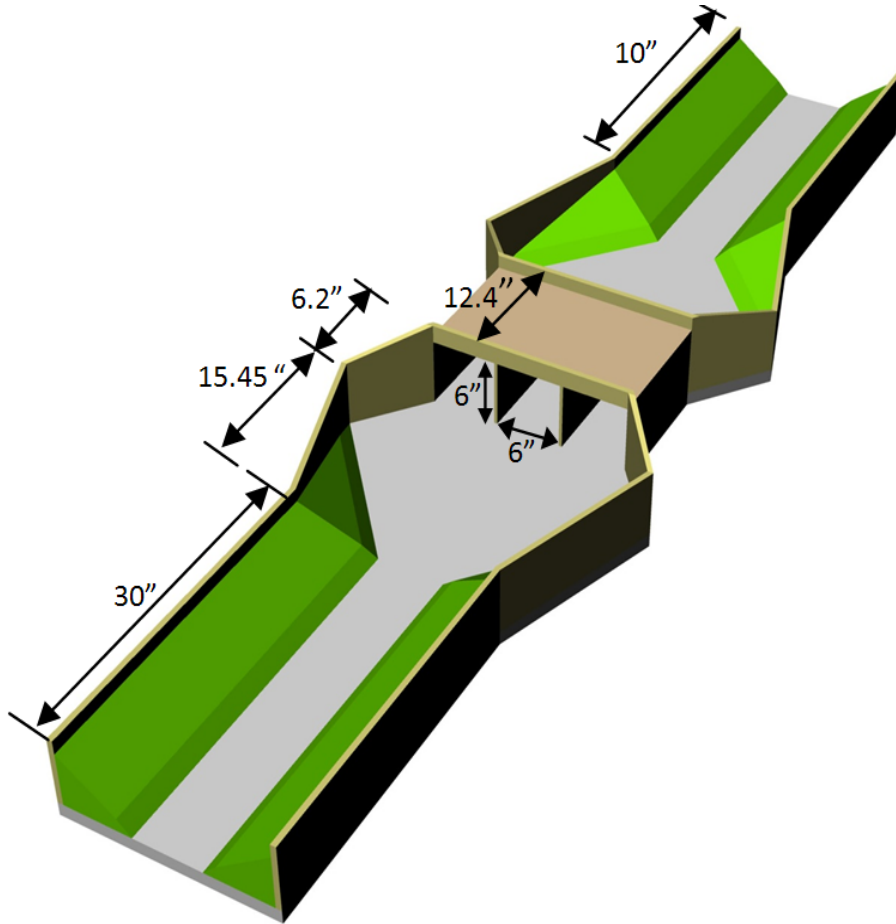

Figure 4-2-10 Layout of the culvert model B

Flow	Discharge (cfs)	Headwater (ft)
Case A	0.065	0.125
Case B	0.163	0.250
Case C	0.363	0.382

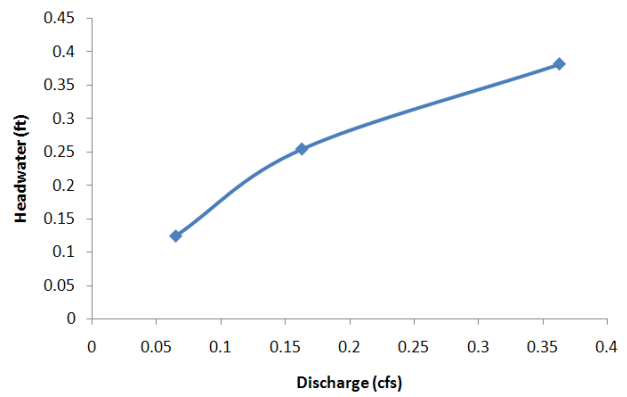

Figure 4-2-11 Flow condition in baseline test 3



Sediment transport is directly dependent on water depth and velocity. As discussed above, an uneven sediment accumulation was observed that suggest to the need to check and adjust the water velocity distribution. LSPIV again was used to measure velocity distribution for all tests in this research. A digital camcorder (Sony HDR-HC1) was used to record successive images (30 fps) and in-house developed software was used to analyze velocity field. The results are presented into three forms to delineate the secondary current on the water surface: average velocity vector distribution, average velocity contour, and streamlines.

Figure 4-2-12 shows the result of case B, and Figure 4-2-13 is for case C. The flow distributions on the water surface for both cases were similar. The velocity distribution in the expansion was not uniform. Flow entering the expansion acted like a jet. Secondary circulation was observed in the sides of the expansion which denotes that sediment particles would deposit in these zones. Moreover, the result shows that velocity was much greater in the central barrel than in the side barrels. This observation meant that the discharge through the central barrel is much greater than through the other barrels. From conventional culvert design, the discharge distribution should be uniform. However, it is clear that discharge per barrel is not the same. The performance of multi-barrel culvert based on the assumption of uniform discharge distribution has to be corrected.

A subsequent test examined bed-sediment movement through the culvert over an extended time interval of 6 hours. This test was only operated for case B. Sediment moved smoothly and did not accumulate in the channel. Photography of sedimentation pattern was taken every hour. The results are shown in Figure 4-2-14 and 4-2-15. The sediment load in the expansion, and three barrels were separately collected as described in the baseline test 2. Figure 4-2-15 shows that sediment deposition in the central barrel was constant. Sediment, however, gradually accumulated in the expansion and the side barrels with time.

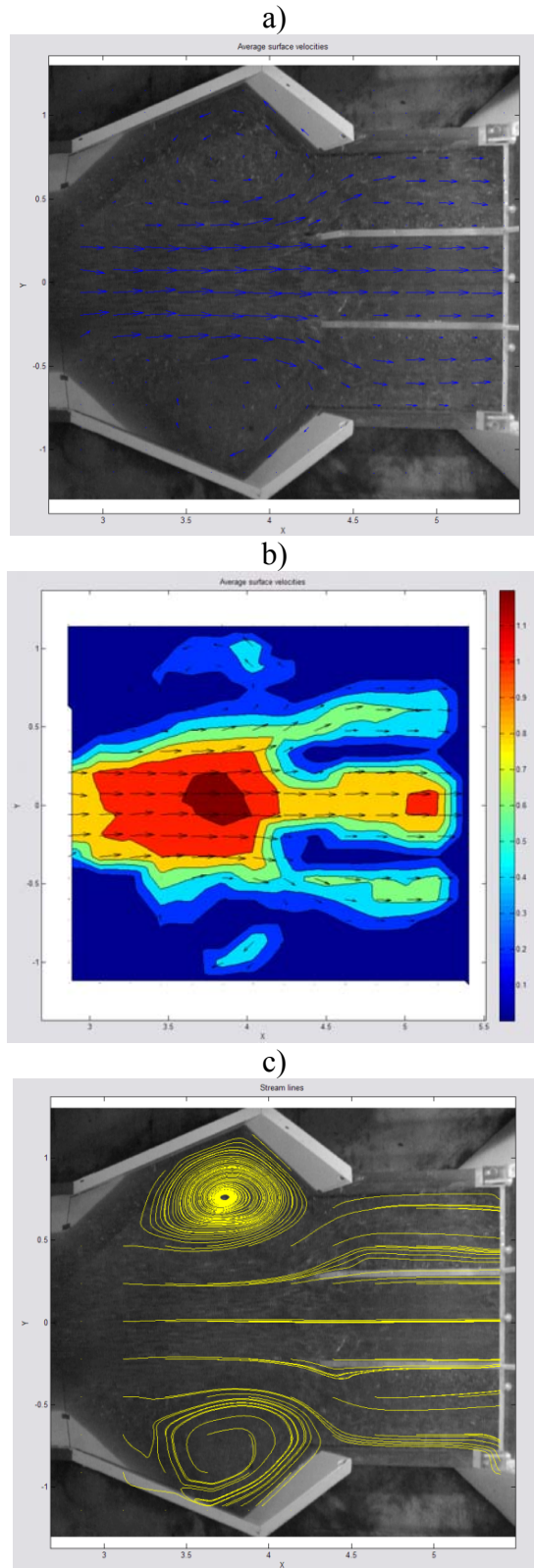

Figure 4-2-12 Surface flow field for case B ($HW/D=0.5$): (a) Velocity vectors, (b) Velocity vectors and velocity magnitude contour, (c) Streamlines

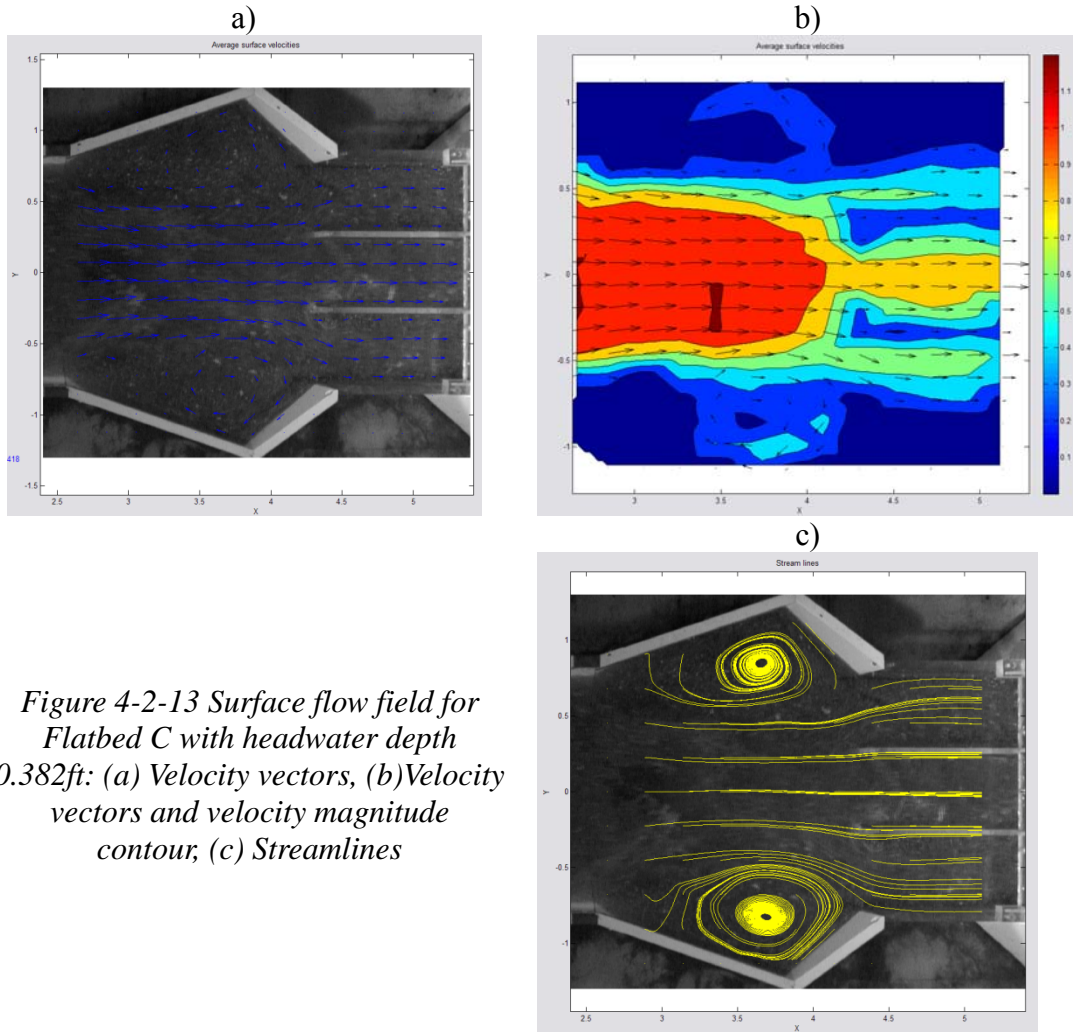

Figure 4-2-13 Surface flow field for Flatbed C with headwater depth 0.382ft: (a) Velocity vectors, (b) Velocity vectors and velocity magnitude contour, (c) Streamlines

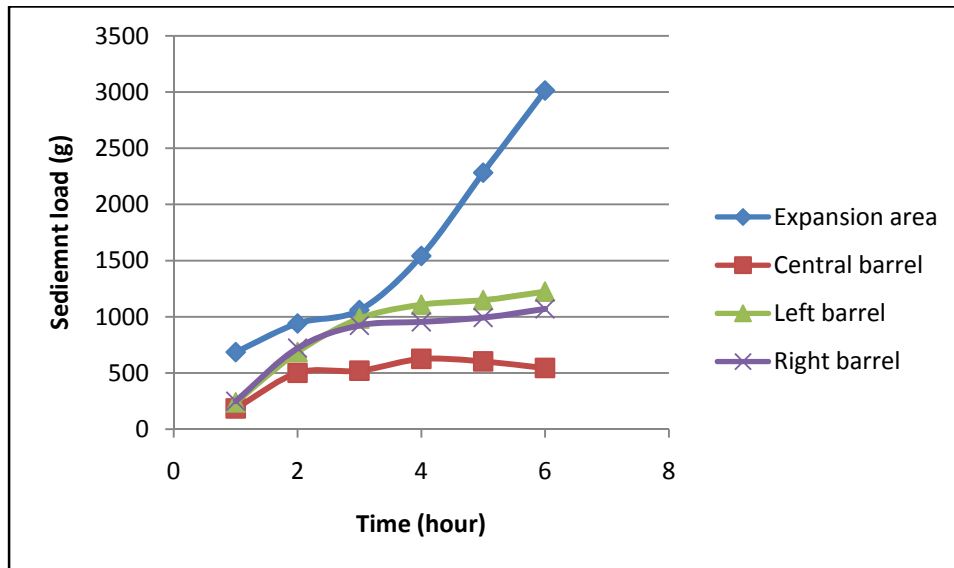

Figure 4-2-14 Rate of sediment accumulation in the culvert area for flow Case B



1hr



4hr



2hr



5hr



3hr



6hr



Figure 4-2-15 Hourly sediment accumulation in the expansion area for flow case B



4.3 Screening tests for the self-cleaning designs

The object of these tests was to develop and performance evaluate several self-cleaning systems for the culvert models, and then to decide upon the best effective self-cleaning culvert design. The baseline tests indicated that sediment deposited unevenly in the streamwise direction and in the cross sections because of the uneven velocity distribution. The channel expansion led to the culvert inducing a significant secondary current, which is the flow feature exacerbating sediment deposition. A number of self-cleaning systems were investigated as to their capacity to inhibit sediment deposition. The strategy in designing the self-cleaning system was to implement a geometry that redistributed the velocity in the expansion such that forces the water and sediment into the central box. Practically, the design tried to mimic the shape of the pre-construction bed of the stream, which was limited to one (typically trapezoidal) channel. As a consequence, the self-cleaning designs increased the carrying capacity of the flow in the expansion area facilitating the transport of the incoming sediment downstream the culvert. Two conceptual design concepts were tested:

1. Fillets set in the expansion and/or the culvert barrels; and,
2. Guiding vanes set in the expansion.

The configuration and actions of the two design approaches were designed such that the approaches can be retrofitted the culverts, rather than being design concepts that can be only implemented at the time the culvert is constructed. The screening tests were conducted at a discharge of $0.163 \text{ ft}^3/\text{s}$ and 0.250ft flow depth, corresponding to Case B on the culvert performance curve (see Figures 4-2-4 and 4-2-11).

4.3.1 Fillets (F)

This method required placing a fillet in the expansion or culvert barrels so as to increase flow velocity. The construction of the fillet elevated the bed. The conveyance power of flow then was increased by tapering slope bed and reducing of the cross-section of flow. Four designs were used to test the performance for mitigating the sedimentation problem. The first design fitted the tapered fillet in the expansion. The subsequent designs placed the fillets so as to reduce the cross sections of culvert barrels. All screening tests were under the same flow condition that had caused major sediment deposition in the expansion in the baseline tests.

Design FA

The main goal of this self-cleaning system was to streamline the bathymetry of expansion, and then direct sediment toward the main channel by the tapered bed in the expansion (see table 4-3-1). The design does not affect the culvert cross section which is easy to retrofit and cost-effective. A summary of the configurations is given in table 4-3-1.

The resulting sediment deposition compared to the traditional culvert model is represented in Figure 4-3-1.

Table 4-3-1 Summary of Design FA

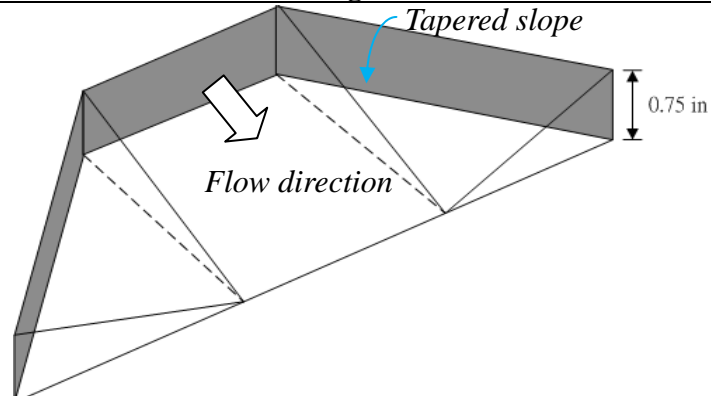
Design FA	Characteristics
	<ul style="list-style-type: none"> - Goal: streamlining the expansion area - Geometry: change only in the expansion area aimed at: <ul style="list-style-type: none"> • bringing the cross section closer to its original shape • directing the sediment in the expansion to the main channel - Design does not affect the culvert cross section

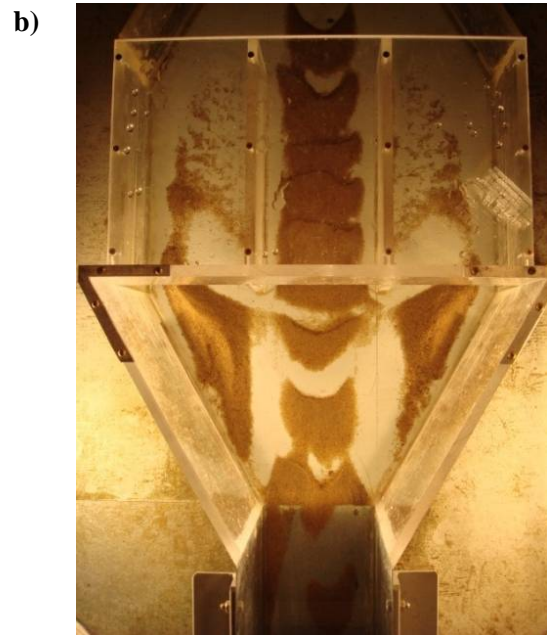

Figure 4-3-1 Sedimentation pattern compare to the baseline test result

The change of the culvert is only in the expansion. Sediment deposition in the expansion was noticeably mitigated. However, sediment deposited downstream the culvert model. The sediment conveyance capacity of flow was locally increased by this design, which flushed sediment out from the expansion and the culvert barrels. Sediment, though deposited downstream.

Design FB

The design FB used tapered fillet in central expansion area, and elevated inverts throughout the culvert, expansion, and contraction areas. The summary of the FB design is given in Table 4-3-2. The resulting sediment deposition compared to the traditional culvert model is represented in Figure 4-3-2. The fillets throughout the culvert barrels reduced the culvert cross-section to increase velocities. The test showed that sediment was redistributed. No significant sedimentation occurred at the sides, and sediment mostly deposited in the channel downstream the culvert. Sediment was concentrated in the central area of the contraction and did not accumulate in barrels. No blockage of the culvert cross section and easy access to deposits for removal are favorable outcomes.

Table 4-3-2 Summary of Design FB

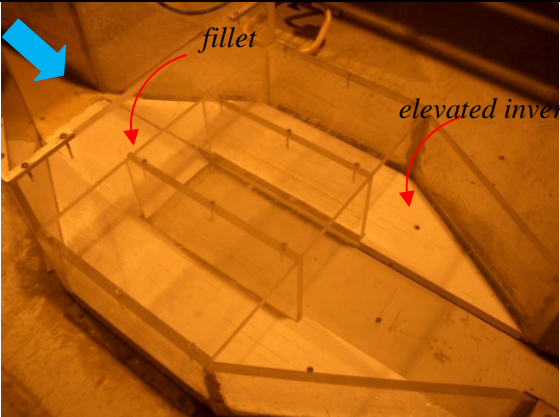
Design FB	Characteristics
	<ul style="list-style-type: none"> - Goal: To “push” further downstream the sediment deposits formed by Design FA - Geometry: Tapered fillet in central expansion area & elevated inverts throughout the culvert, expansion, and contraction areas - Design affects the culvert cross-section



a)

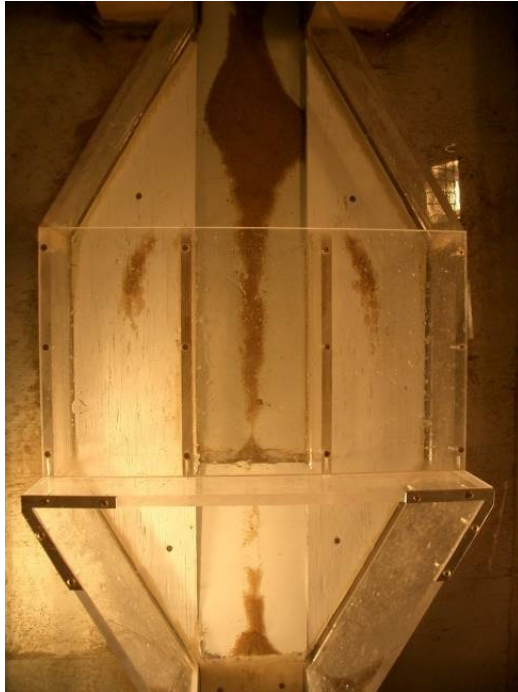

b)

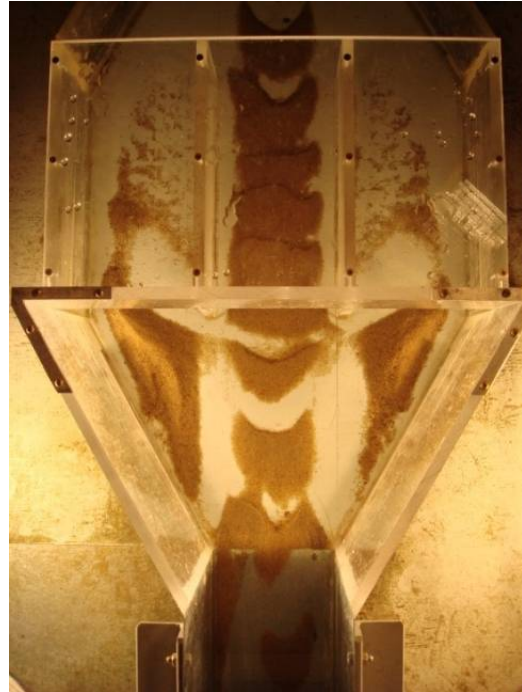
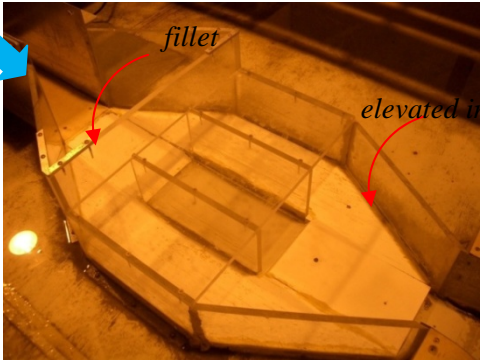

Figure 4-3-2 Sedimentation pattern compare to the baseline test result

Design FC

The only difference between design FC and FB is the downstream fillet. Because the previous design was observed sediment in the contraction, the objective of this design was to eliminate completely sediment deposition in the expansion, the culvert barrels, and the contraction. A summary of the configurations is given in table 4-3-3. The resulting sediment deposition compared to the traditional culvert model is represented in Figure 4-3-3.

Table 4-3-3 Summary of Design FC

Design FC	Characteristics
	<ul style="list-style-type: none"> - Goal: eliminate completely the sand from the expansion, culvert, and contraction areas - Geometry: fillet added in the contraction aligned with the central barrel area - Design affects culvert cross-section

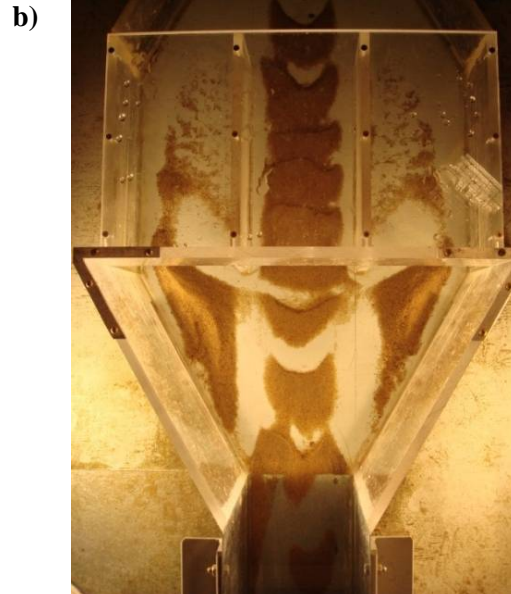
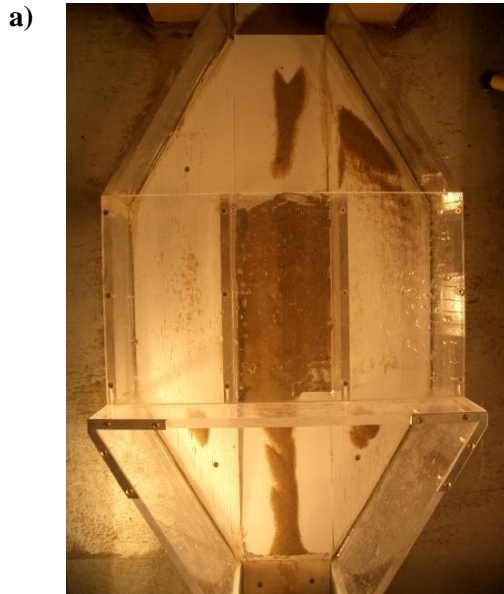

Figure 4-3-3 Sedimentation pattern compare to the baseline test result

Figure 4-3-3 shows that the fillet added in contraction performed like a barrier; sediment was trapped in the central barrel. Sediment started to accumulate in the expansion after the central barrel was filled. The design did not perform well, and is expensive to build in the field.

Design FD

The difference of this design compared to design FB was no tapered fillet in the central pathway. The design shaped the cross-section of the culvert model similar to the connecting stream channel. The cross-section of culvert was built as close as the compound channel. A summary of the configurations is given in table 4-3-4.

Table 4-3-4 Summary of Design FD

Design FD	Characteristics
<p><i>elevated invert</i></p>	<ul style="list-style-type: none"> - Goal: getting the culvert as close as possible to the original channel - Geometry: central model area not modified: culvert side areas elevated throughout the expansion, culvert and contraction areas - Design affects culvert cross-section



The resulting sediment deposition compared to the traditional culvert model is represented in Figure 4-3-4. Sediment accumulation in side barrels did not occur, because of the effect of the elevated fillets. This design encouraged sediment to flow in the central; sedimentation in the central could be flushed out if encounter larger discharge.

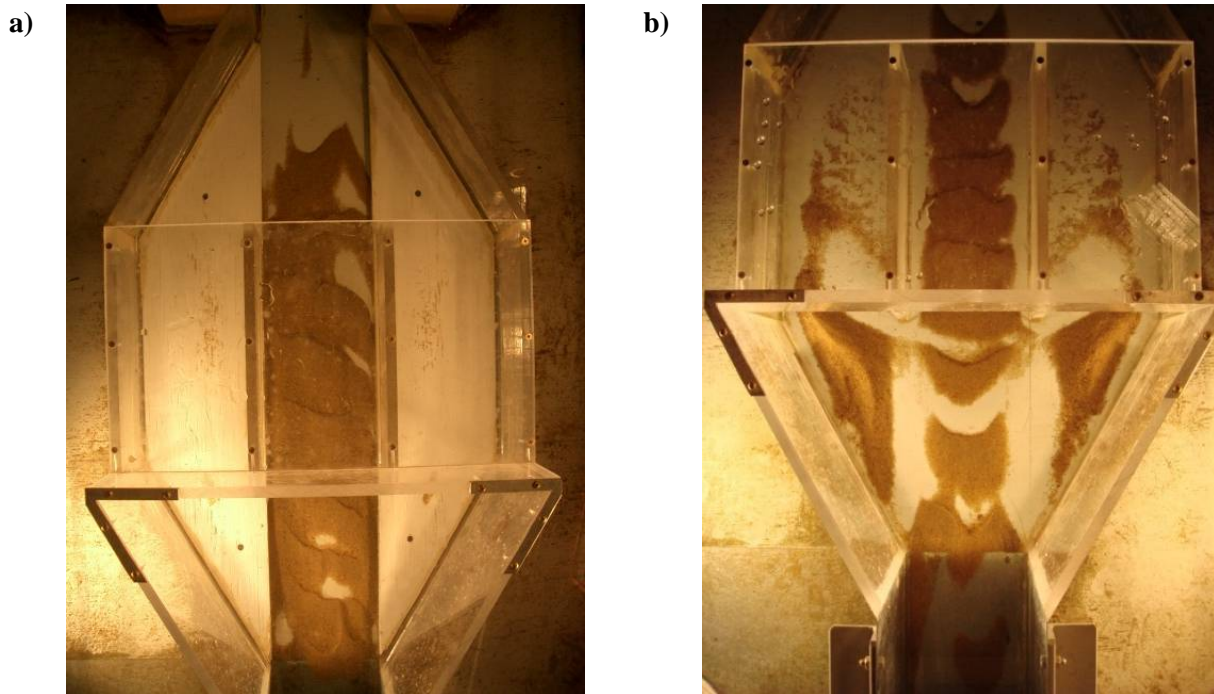

Figure 4-3-4 Sedimentation pattern compare to the baseline test result

The series of tests conducted with progressive alternation of the original fillet-based designs led to the conclusion that the optimal geometry for the self-cleaning design was FA. For this configuration:

- 1) the sediment transport was driven downstream the culvert
- 2) the sediment deposited in the expansion area was minimum
- 3) the deposited sand in the three boxes was equally distributed and at a low overall total volume.

The selected fillet-based geometry requires less field-implementation effort because the existing deposited sand in the culvert area can be used to “build” the fillet base. The fillets surface can be “rip-rap”- ed and possibly grouted. An FA-based self-cleaning design will be further tested in the numerical model and the performance experiments.

4.3.2 Vanes

Vanes are small, cost-effective, patented structures for sediment management in rivers (Odgaard, 2009). The first known attempts to develop a theoretical design basis of vanes were by Odgaard and Kennedy (1983) and Odgaard and Spoljaric (1986). The vanes were originally designed to protect stream banks from erosion, maintain navigation depth and flood-flow capacity in rivers, and control sediment at diversions and water intakes. Appropriate installation of vanes can modify the near-bed flow pattern and redistribute flow and sediment transport by vane-generated secondary currents. The vanes used for the present tests were installed upstream the culvert structure so that the vane-generated secondary current can eliminate the channel expansion induced secondary current which causes sediment to deposit.

Design VA

The goal of the present design using vanes in expansion was to prevent sediment deposition in the side regions of the expansion. Four inclined vanes (10 degrees to flow direction) were laid in the expansion area, with no other modification introduced. Table 4-3-5 summarized the vane configuration and setting while Figure 4-3-5 shows that sediment did not accumulate in the side regions of the expansion, and that sediment was forced into the central zone. The secondary current otherwise present in the expansion was diminished by the action of the vanes.

Table 4-3-5 Summary of Design VA

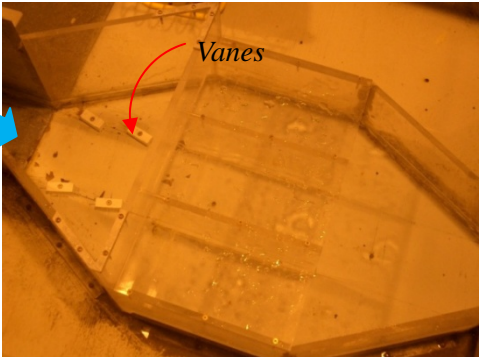
Design VA	Characteristics
	<ul style="list-style-type: none"> - Goal: to direct the sediment to the central barrel - Geometry: 4 inclined vanes (10 degrees, square 0.75" , 2" long - model) in the expansion area; no other modifications - Design does not affect the cross-section



a)

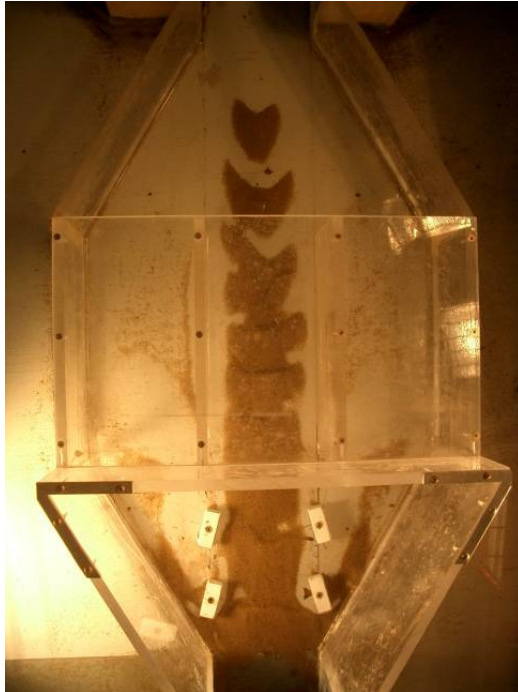

b)

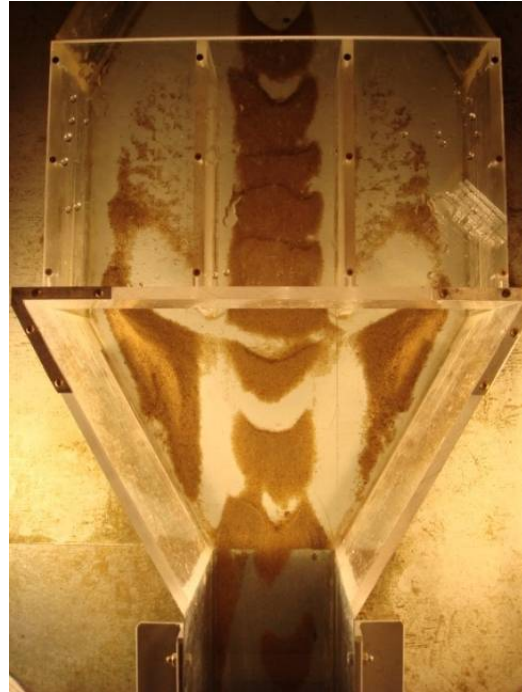
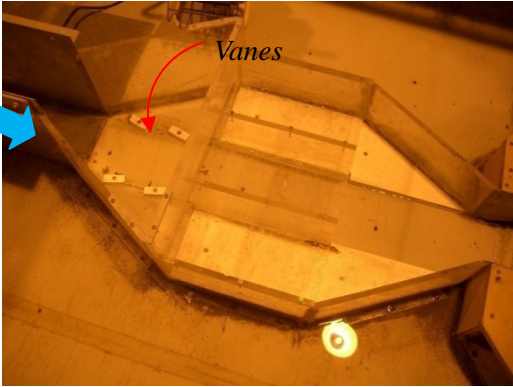

Figure 4-3-5 Sedimentation pattern compare to the baseline test result

Design VB

Another vane approach was the previous design (VA) plus fillets added in the left and right culvert barrels. Table 4-3-6 summarized the vane configuration and setting while Figure 4-3-6 shows the sedimentation pattern. The patterns were similar to the previous design, but more sediment deposition was observed in the central zone.

Table 4-3-6 Summary of Design VB

Design VB	Characteristics
	<ul style="list-style-type: none"> - Goal: to direct the sediment to the central barrel - Geometry: vanes as for Design VA in the expansion area & fillets in the culvert side barrels and contraction sides - Design does not affect the cross-section



a)

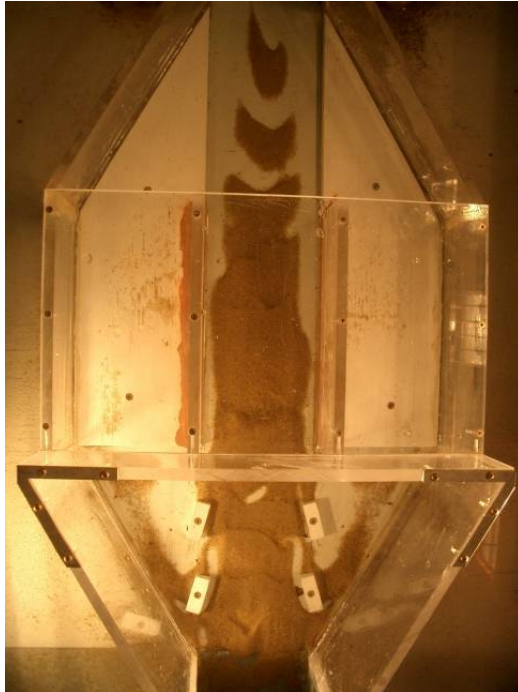

b)

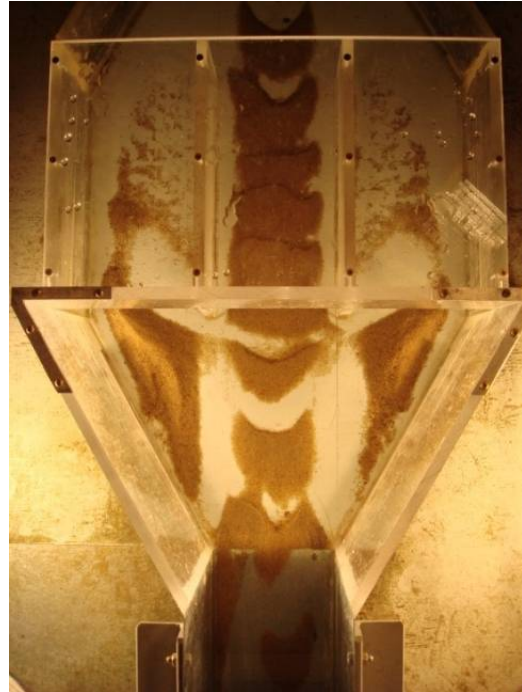

Figure 4-3-6 Sedimentation pattern compare to the baseline test result

4.4 Numerical simulation of flow through culverts

4.4.1 Simulation cases

Numerical simulations were aimed to help the understanding the complex flow processes related to sedimentation at culverts. The commercial software FLUENT was used to analyze the culvert model. The calculation domains for numerical simulation were developed for two different culvert designs (Figure 4-4-1). One domain was developed for model 1/20B, as described in the section Baseline Test 3. Modeling was used to analyze the flow dynamics of the reference culvert (the one without self-cleaning system). The other model configuration investigated the effect of the self-cleaning system placed in the expansion. Two tapered fillets were added in the side parts of the expansion to increase the power of flow which could flush sediment out, using the FA-based design fillet tested in the screening tests. Validation and verification of the numerical modeling was made by comparing the simulations' output with the free-surface velocity distributions obtained in the laboratory experiments with LSPIV measurements. The numerical simulations and laboratory experiments were conducted for the cases summarized in Table 4-4-1.

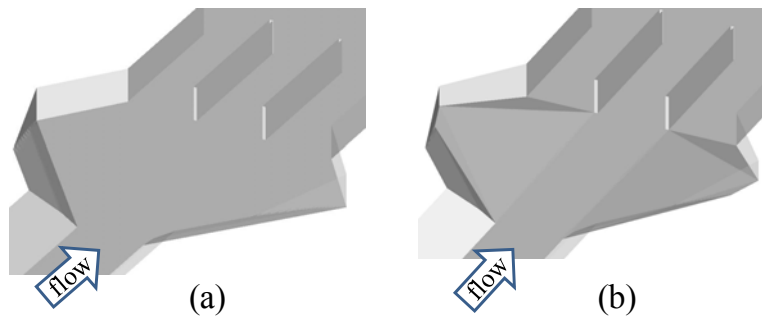

Figure 4-4-1 Calculation domains for numerical simulation: (a) domain for model 1/20B, (b) domain for model 1/20B+FA design

Table 4-4-1. Simulation case (HW = water depth, D =depth of the culvert, FA= type FA fillet-based self-cleaning design set in the upstream expansion area, A,B,C= flow conditions in case A,B,C see Figures 4-2-4 and 4-2-11)

<i>Case</i>	<i>HW/D</i>	<i>CFD</i>	<i>EFD</i>	<i>Sediment Deposition</i>
A	0.25	✓	✓	
B	0.5	✓	✓	✓
C	0.75	✓	✓	
A+FA	0.25	✓		
B+FA	0.5	✓		
C+FA	0.75	✓		

4.4.2 Computational grid

The commercial software Gridgen was used to generate the calculation grids for all the cases. Calculation grids were generated so that the total number of nodes will be about 2 million.

Minimum Δ_{\min} and maximum grid sizes Δ_{\max} are as follows:

$$\Delta_{\min} = 2y_{n0} = 1.69 \times 10^{-3}$$

$$\Delta_{\max} = 0.1$$

The number of nodes in longitudinal N_L , spanwise N_S , and vertical directions N_V were

$$N_L = 300$$

$$N_S = 200$$

$$N_V = 30$$



These numbers may vary depending of the simulation cases, e.g., smaller N_V for a shallower case. “Database” and “projection” functions in Gridgen were used to mesh on complex surface; e.g., channel banks in the expansion region before the culverts.

4.4.3 Flow modeling

The FLUENT numerical model required as input data on flow rates entering the system, the outflow setting at the downstream end, channel bed, bank, and piers as the wall, and water surface defined as symmetry. A turbulence model component was used to calibrate FLUENT to the three-dimension flow at the culvert. The important turbulence parameters κ and ω were evaluated to test this turbulence model component. Once the numerical model was able to reproduce the flow field data obtained from LSPIV, the FLUENT model was applied it to self-cleaning system for culverts to get reasonable results that would take much longer to obtain in the laboratory.

4.4.4 Post processing

The commercial software Tecplot was used for the post processing flow field data obtained from FLUENT. The “Particle Tracking” function in FLUENT was used to predict the paths of sediments around culverts with the following parameters.

Gravitational acceleration = - 5.25

Particle number = 20

Particle location = close to the bottom and half way of the incoming channel

Particle velocity = local velocity (obtain from the solution)

Particle size = 6.44×10^{-3} (= 0.5 mm = sediment size used in the experiment)

Particle density = 2.65

Maximum number of steps = 50000

Step length factor = 5

Wall boundary condition = reflect

Even if this visualization tool is not an actual modeling of the sedimentation process, the sediment traces indicate the areas where the sediment can build up and deposit. The validity of the modeling approach was proven by the good agreement with the experiments.

4.4.5 Numerical model testing

Use of the numerical model extended the findings from the laboratory tests. To compare the results of numerical simulations with those of experiments; flow characteristics, 2D streamlines, streamwise velocity contours, and out of plane vorticity contours on the horizontal plane close to the free surface were obtained for each case. These flow data reveal significant aspects about how the flow conveys sediment and deposits it at the culvert inlet, and within the culvert. Two laboratory experiment data, collected from Baseline Test 3, were used for numerical model validation. The numerical results are compared to measurements conducted with LSPIV in laboratory tests for homologous geometry. Comparison of average velocity in the expansion between the laboratory and the numerical model shows minor differences near the culvert piers and expansion entrance.

Figures 4-4-2 and 4-4-3 show the near-surface flow field, shear velocity contours, and sediment paths obtained from the numerical model for the flow Case B ($HW/D=0.5$). Figure 4-4-4 shows the near-surface flow field obtained with LSPIV and sedimentation documented in the laboratory experiment.

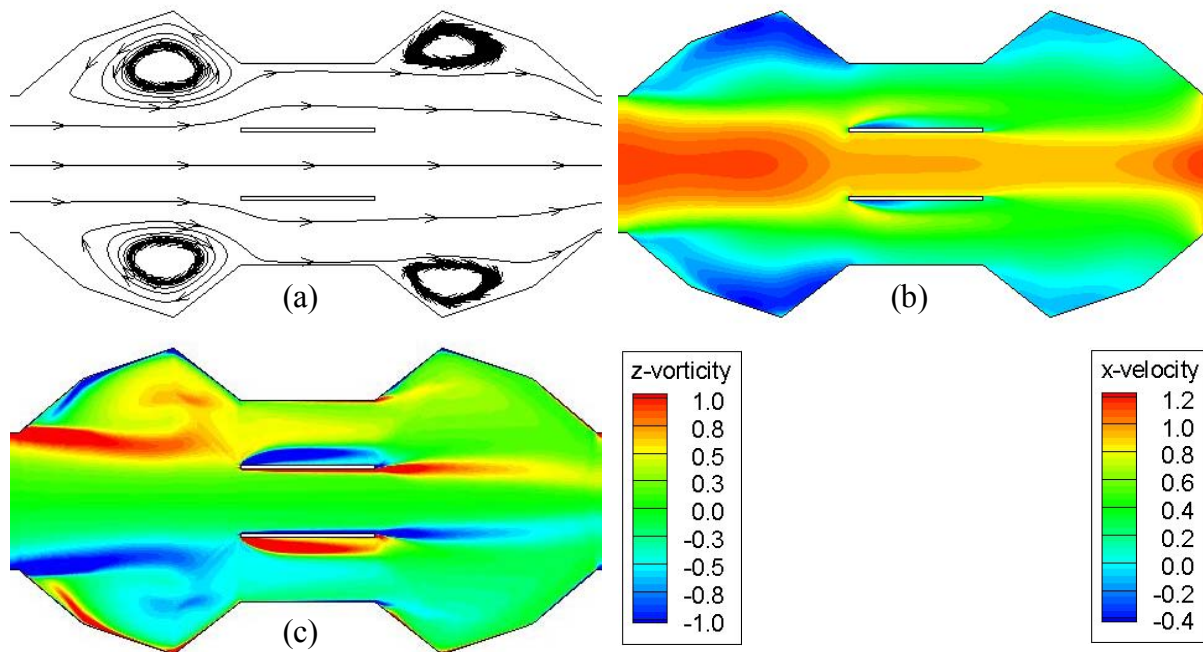

Figure 4-4-2 Near-surface flow field in flow Case B obtained with numerical simulations:

(a) streamlines, (b) streamwise velocity, (c) out of plane vorticity

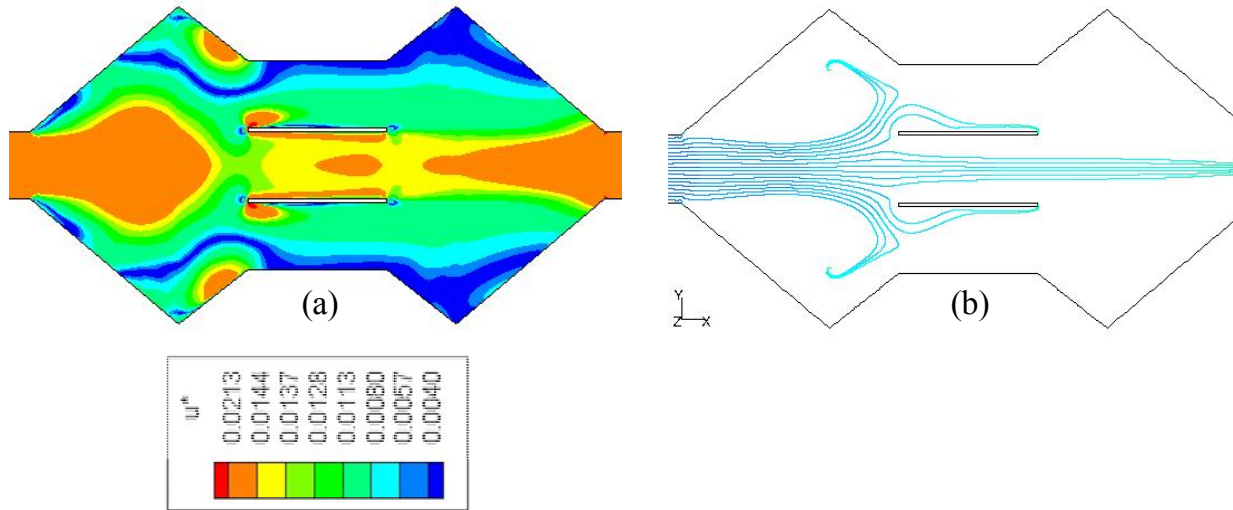

Figure 4-4-3 Sediment transport characteristics in flow Case B obtained from numerical simulations : (a) shear velocity, (b) sediment paths

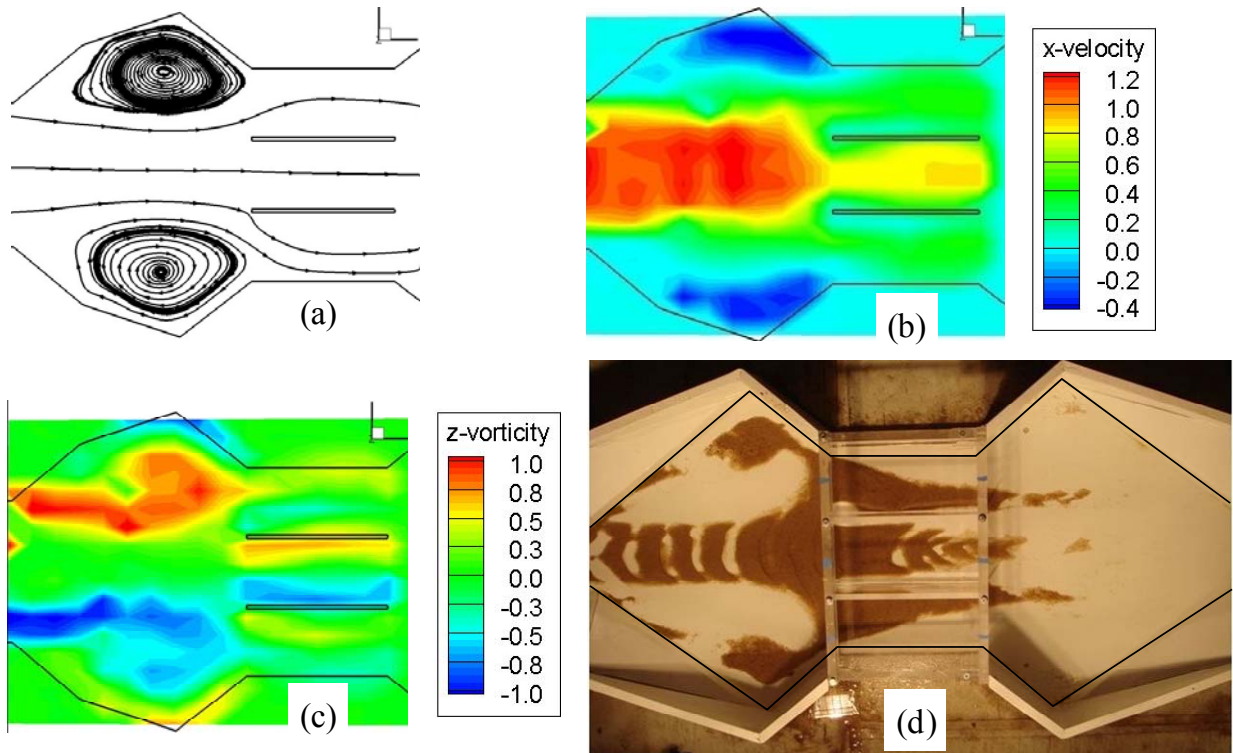

Figure 4-4-5 Surface flow field for flow case B obtained in laboratory tests with LSPIV and imagery: (a) Streamline and velocity magnitude contour at the free surface, (b) streamwise velocity at the free surface, (c) vorticity at the free surface, and (d) sedimentation (Relevant comparisons: 4-4-2 a, b, and c with 4-4-5 a, b, and c, respectively and 4-4-3b with 4-4-5d.)



Figure 4-4-5 shows the near-surface flow field, shear velocity contours, and sediment paths for the numerical model applied to Flow case C (HW/D= 0.75). Figure 4-4-6 shows the comparable values from the laboratory experiment obtained with LSPIV.

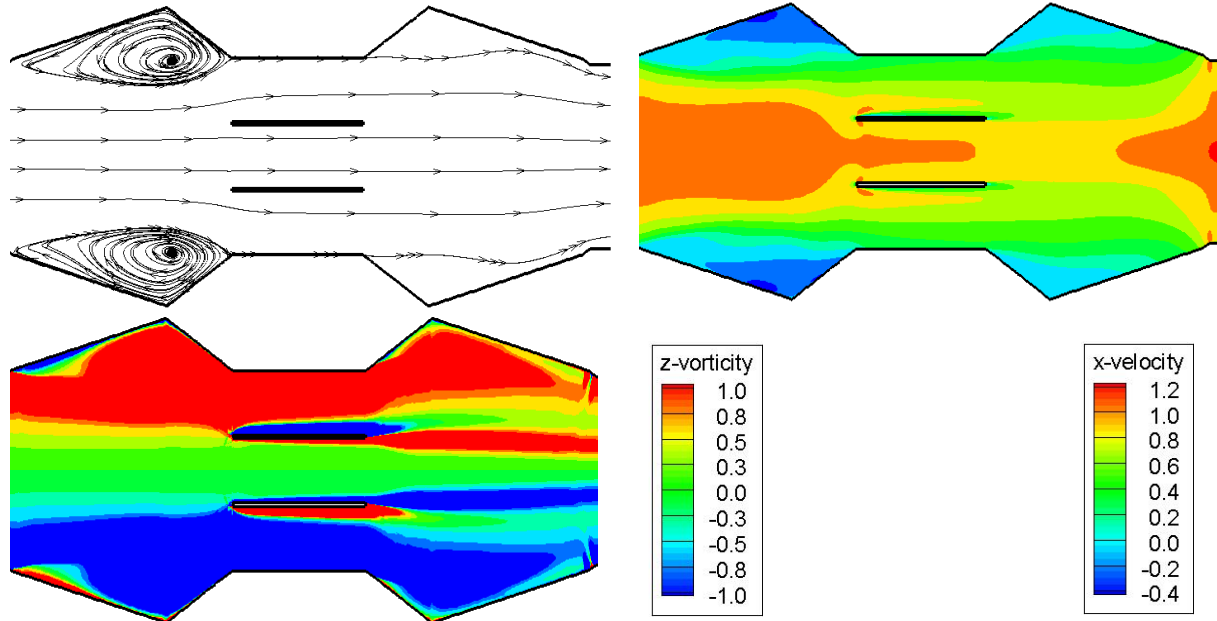

Figure 4-4-5 Near surface flow field for flow case C obtained with numerical simulations: (a) streamlines (b) streamwise velocity (c) out of plane vorticity

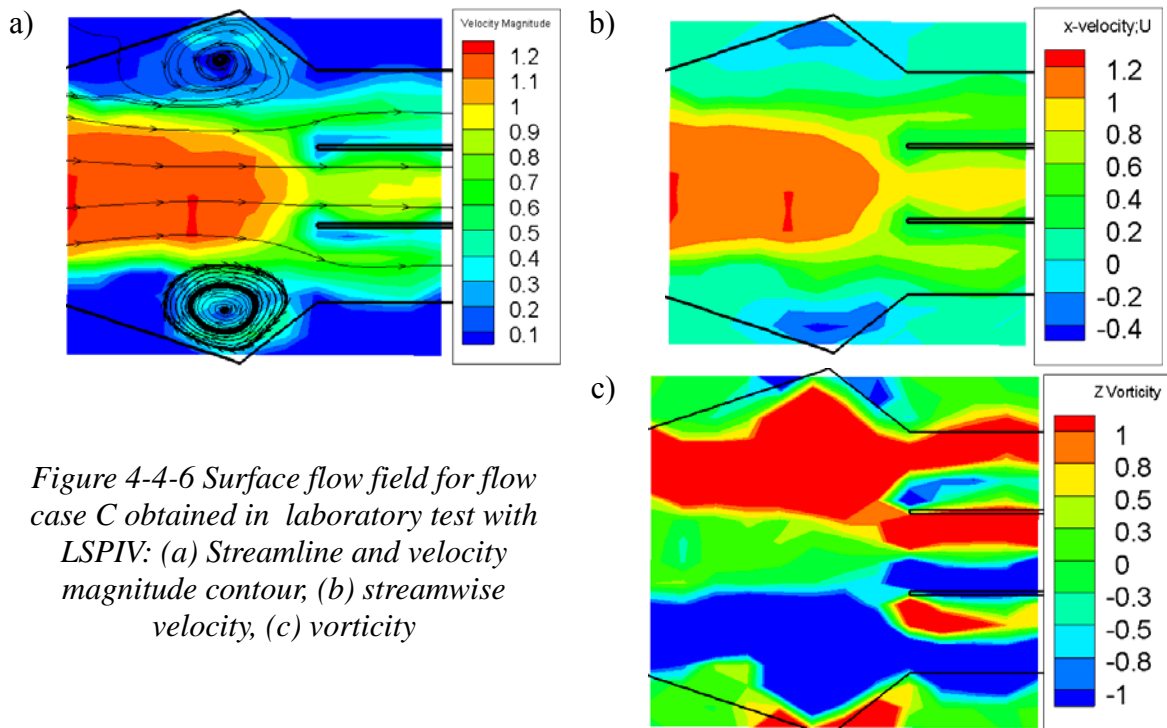

Figure 4-4-6 Surface flow field for flow case C obtained in laboratory test with LSPIV: (a) Streamline and velocity magnitude contour, (b) streamwise velocity, (c) vorticity

Comparison of numerical and experimental results

Comparison of velocity magnitudes obtained from the numerical model and the laboratory tests can be affected by the computational and measurement mesh structure used for each. The mesh resolution of the numerical model and the LSPIV mesh was different. The mesh for numerical model was much denser than it for LSPIV analysis (Figure 4-4-7). The results of the numerical simulation were interpolated linearly into the LSPIV mesh for the comparison purpose. Figure 4-4-8 (a and b) present the difference between the numerical simulation and the laboratory experiment for case B and C. The error was defined as

$$error = \left| \frac{EFD - CFD}{EFD} \right|$$

where *EFD* and *CFD* represent average velocities at the same grid.

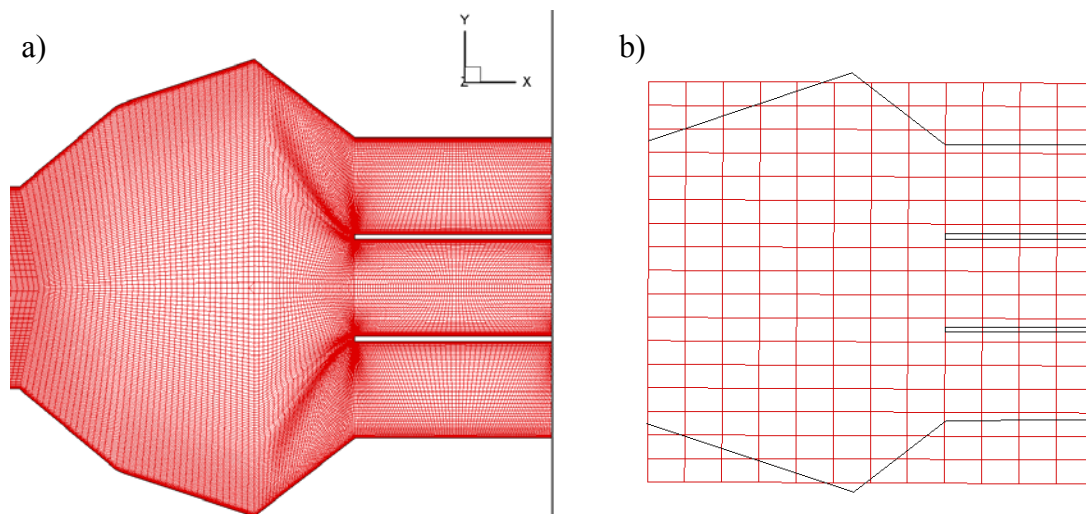

Figure 4-4-7 The mesh resolution: (a) the numerical model mesh, (b) the LSPIV analysis mesh

As can be observed in Figure 4-4-8, the agreement between the flow fields obtained from numerical simulations and experimental results is good. Differences can be observed in the immediate vicinity of abrupt geometry changes, i.e., corners and in front of the piers. Overall, the comparison is adequate for the purpose of the present study, and confirm that the numerical model is an adequate representation of the physical model. This conclusion holds because the velocities agree in the primary interested zone in the middle of the expansion region ahead of the inlet, and as the errors were under 0.20.

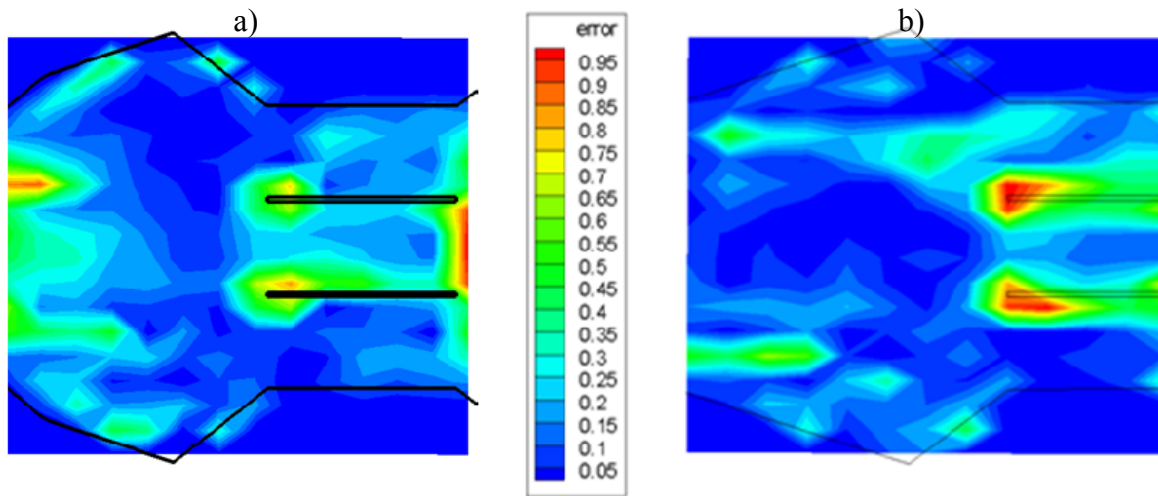

Figure 4-4-8 Comparison of average velocities error between numerical simulations (with FLUENT) and experimental results (with LSPIV) : (a) flow Case B, and (b) flow Case C

4.4.6 Numerical simulation for the self-cleaning design FA

Once the numerical model was validated against its physical model pair, simulations were applied with confidence to test the self-cleaning designs fitted to the culverts. Numerical simulations were computed under three hydrological conditions corresponding to the previous simulation, respectively flow cases A, B and C (see Figures 4-2-4 and 4-2-11). Figures 4-4-9 and 4-4-10 illustrate the effect of the fillets type FA set in the culvert expansion area. The results in the two figures display hydrodynamic characteristics for the flow with fillets in flow case B, the reference flow case studied in most of the screening tests. It is reminded that this flow cases produced a serious sedimentation condition in the expansion (see Figure 4-2-15). Figure 4-4-10 (b) clearly shows that the fillets inserted in the side areas of the expansion upstream the culvert, forced the sediment movement into the central pathway. This finding affirms that the use of fillets presents a possible self-cleaning design capable to concentrate sediment towards the central zone and make use of the flow power to flush the sediment through the culvert.

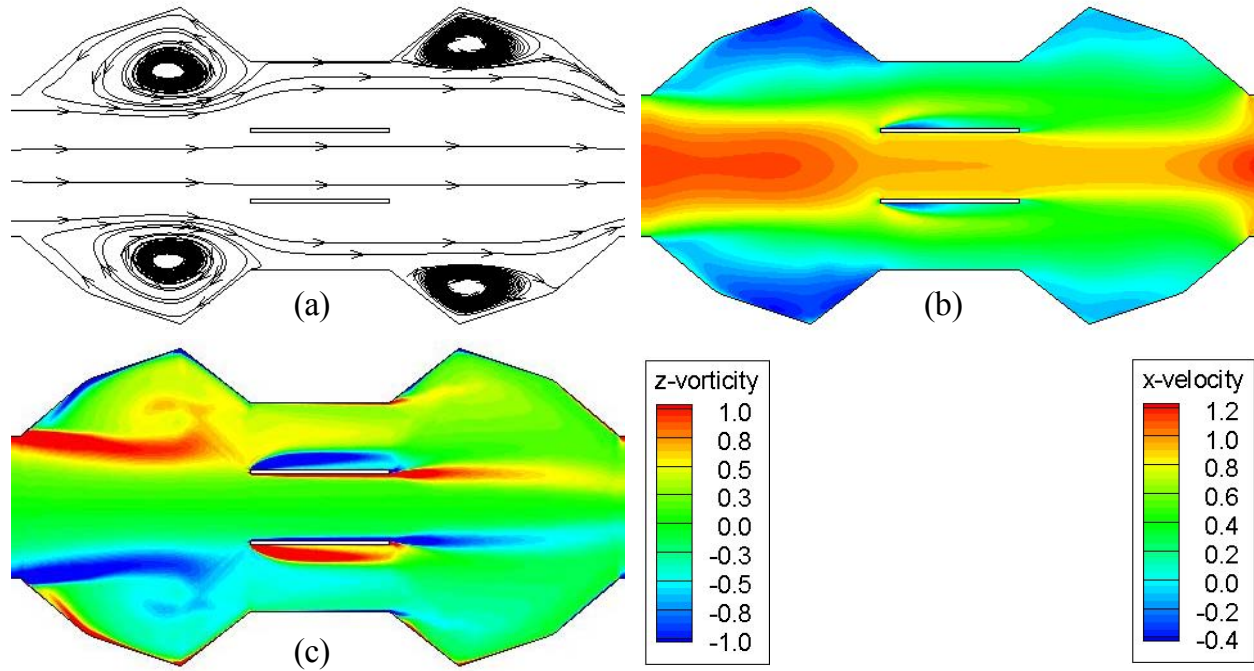

Figure 4-4-9 Simulated near-surface flow field for flow case B over the fillets FA set in the expansion: (a) streamlines, (b) streamwise velocity, (c) out of plane vorticity

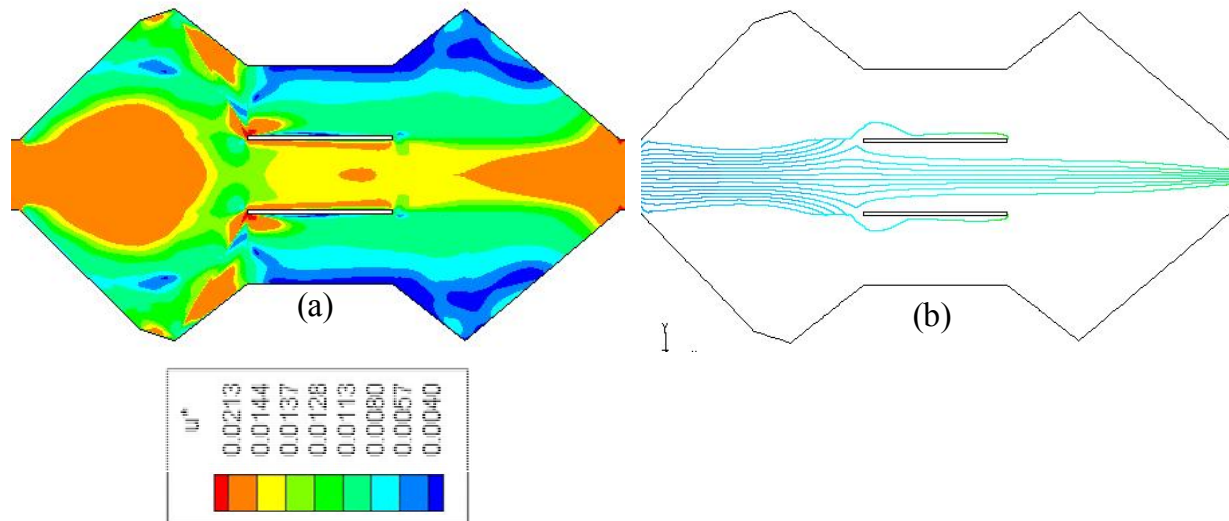

Figure 4-4-10 Simulated sediment transport characteristics for flow case B over fillets FA set in the expansion: (a) shear velocity, (b) sediment paths

5. Performance Tests

5.1 Introduction

The performance tests were conducted using a model channel fitted in a large, sediment-recirculating flume, 65.7ft long, 9.3ft wide, and 2ft deep. The flume, shown in Figure 5-1-1, was designed and built specifically for the project, and trapezoidal a compound channel; i.e., main channel with side slope 1:1, and flood plain with 4:3. The model is divided into three main sections. The upstream channel leading from the headbox is a compound channel with erodible bed. The culvert section contains an expansion, a contraction, and a three-barrel culvert. The expansion bed and contraction bed were erodible. The culvert was fitted with a fixed wood bed. The last section is a short erodible channel connecting to tailgate and two circulate pumps. As the slope of the flume itself was fixed at zero, the hydraulic gradient of the flow was controlled by the difference in water surface elevations between the head box and the tail box; given the flume's relatively short length compared to flume width and depth, the difference in elevation did not adversely affect the flow field locally around the culvert.

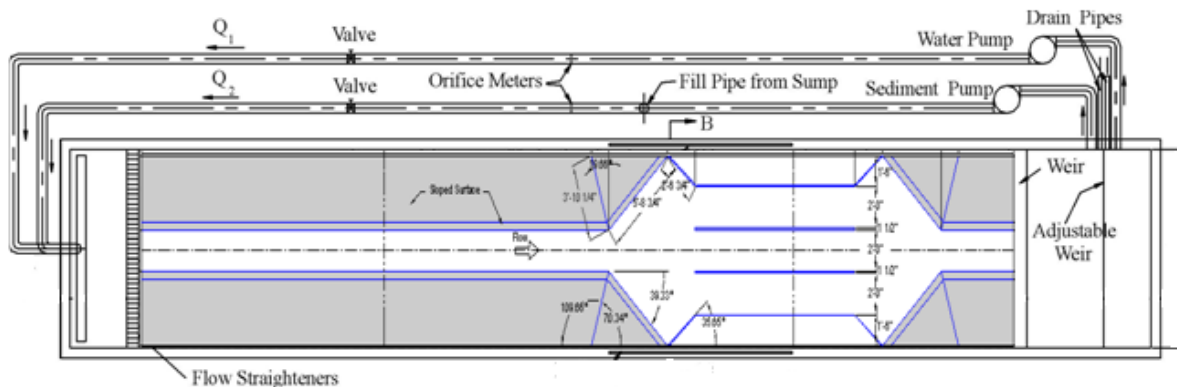

Figure 5-1-1. Schematic View of the physical model

The variable patterns of sediment accumulation at culvert sites were simulated by means of tests with the model channel configured in the following arrangements:

1. No Self-Cleaning System fitted. Three different flow conditions (Q , HW) were scaled replicating the flow modeled in the Baseline Tests 3, specifically flow cases



A, B, and C are tested: A(2.08, 0.5), B(5.22,1.0), C(11.62, 1.53)

2. Self-Cleaning Systems fitted in the model. Three flow condition case A, B, and C are tested the function of the self-cleaning system.



Figure 5-1-2 Upstream view of the model

5.2 Laboratory experiment for the reference culvert model

Three flow conditions were tested using a reference three-box culvert model to investigate sediment accumulation in the expansion. The geometry of the culvert-channel system was the same as for tests series 1/20B, but the scale which for these tests was considerably increased to 1/5. The flow condition tested were the same as those described in Section 4.2.2. (see Figure 4-2-4).

A qualitative method for evaluating sediment transport and deposition in the expansion area was conceived. The method is simple and quick, and is based on the imaging of a pole set horizontally in the model at a critical cross section as shown in Figure 5-2-1. After each test, the pole was set in position so as to keep all the imaging conditions the same. The overall intensity of light in recorded images was kept the same by using the same bulbs for the illumination of the model area. The images were taken at the end of each test from the same distance at an oblique angle, from the same position. Images taken from an oblique angle are generally distorted due to the inherent geometrical distortion. However, for the qualitative



evaluation, it was possible to compare sediment transport modeled cases without removing the image distortion. Using the shadow of a pole projected on the model bed, the difference between different tests is observed. Figure 5-2-1(a) is the initial condition. Figures 5-2-11(b), (c), and (d) are sediment deposition situation after the experiments operated 12 hours for case a, b, and c. The 12 hours test time for each experiment was established by monitoring the development of the sediment transport processes in the model over time. For this purpose a series of preliminary tests were ran with increasing duration and in observations of the sediment deposition in the culvert area were observed until an equilibrium situation was reached. The equilibrium denoted the stage when the deposition-scour process was relatively unchanged.

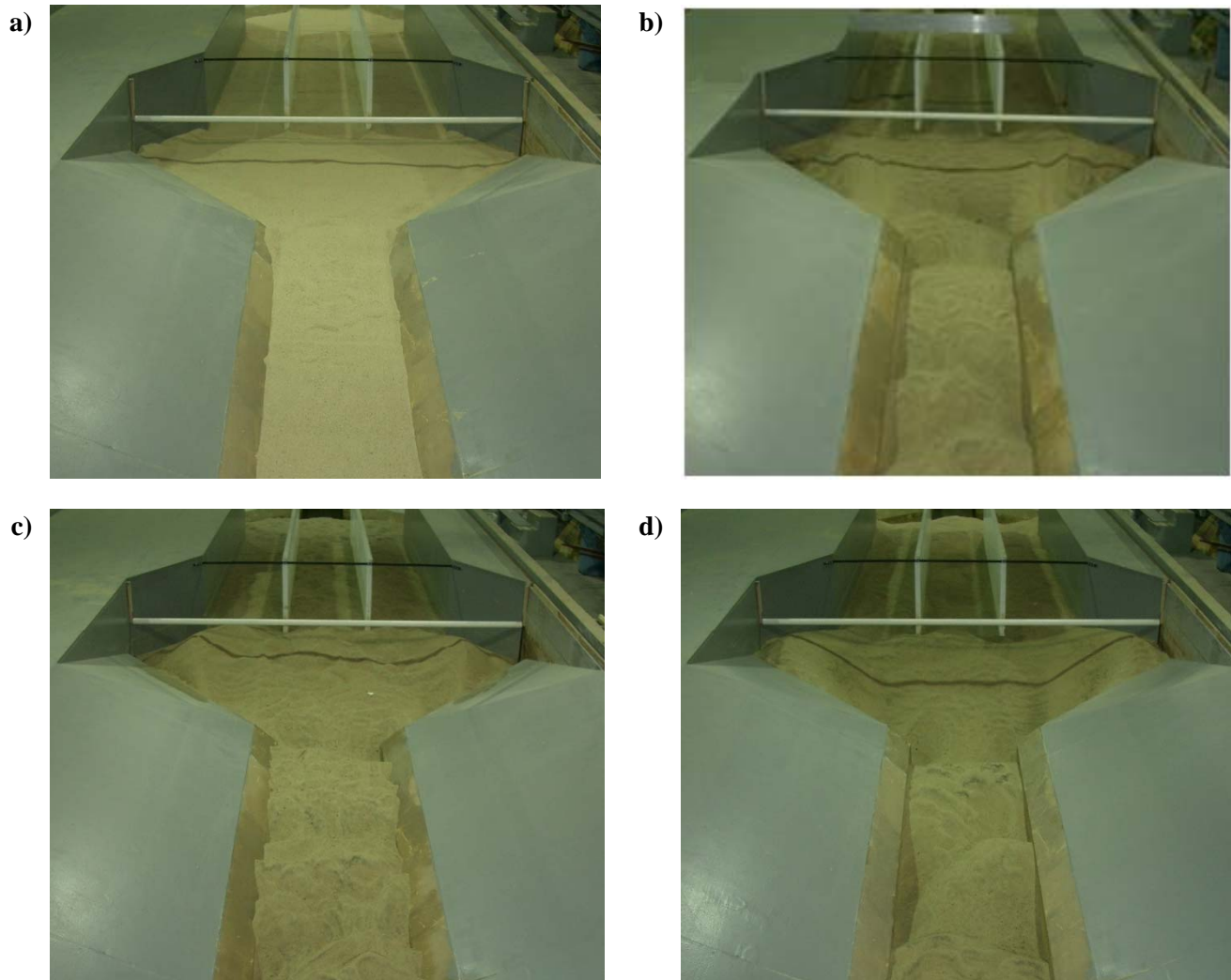

Figure 5-2-1 Sediment deposition patterns: a) Initial condition, b) Case A, c) Case B, d) Case C



The quantitative comparison of sediment evolution at the cross-section upstream of the culvert was done by removing the distortion of images and delineation of the shadows of poles with the software developed by IIHR. The result is presented in Figure 5-2-2. The medium flow condition (case B) caused sediment to accumulate in the expansion. This flow condition led to the greatest sedimentation in the expansion. Sediment did not accumulate for the reduced discharge (case A). There was no obvious tendency to form dunes in the expansion by accumulating sediment. Increased discharge (case C), on the other hand, caused the expansion to deepen in the central part of the region. In addition, the dunes in the side of the expansion contained the same elevation to case B, but shifted toward the wall.

Observations of flow and sediment movement at the cross-section in the expansion lead to the following findings:

1. The design flood event seems not clean sediment out of the culvert structure, but brings more bed-sediment deposit in the expansion instead;
2. Sediment is prone to deposit in the side of the expansion because of the secondary current. The central barrel carries the main portion of the discharge; and,
3. Increasing discharge could cause the scour hole upstream the culvert entrance. The elevation of upstream invert of the culvert would become higher than the channel bed, and therefore block the stream flow during low flow condition.

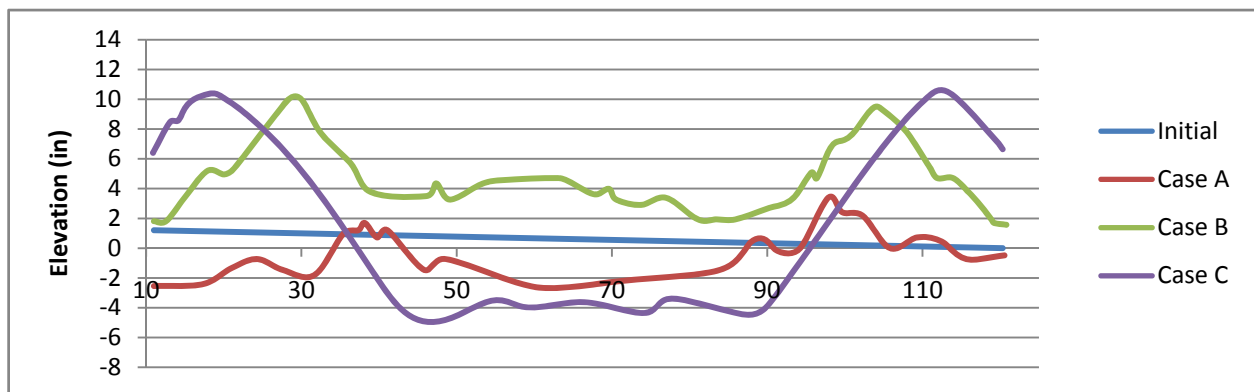

Figure 5-2-2 Elevation of sediment deposition at the cross-section under different flow conditions

5.3 LSPIV experiments in the 1:5 culvert model

LSPIV was used to measure velocity distribution for the reference culvert model and for the FA self-cleaning culvert design. The discharge in the 1:5 scale model was 5.216 ft³/s and the water depth was 1.0ft, corresponding to flow case B (see Figure 4-2-11). Figure 5-3-1a and 5-3-1b show the streamline for the reference culvert model and FA design culvert model, respectively. It can be noted that addition of the lateral fillets in the expansion area considerably weakened the secondary currents formed in the expansion corners. Moreover, the isovelocity contours plotted in Figure 5-3-2 illustrate that the velocity magnitude was considerably increased throughout the center area of the expansion leading to an increased flow power that enhances the transport of sediment incoming toward the culvert. The LSPIV measurements undoubtedly demonstrate that water and sediment are forced to the central culvert box when the self-cleaning fillets are set in the expansion.

The conclusions provided by the LSPIV measurements are congruent with the long-term tests conducted to monitor the sedimentation process. Figure 5-4-2(b), provided in the next section, illustrates that the sediment did not accumulate in the expansion in the tests with the fillets set in the lateral expansion areas. Both series of tests complementary validate the efficiency of the self-cleaning design conceived through the present study. The design is simple to implement in any stage of the culvert lifetime and it can be mostly constructed with local material, i.e., sediment deposited at the culvert prior to the culvert conditioning.

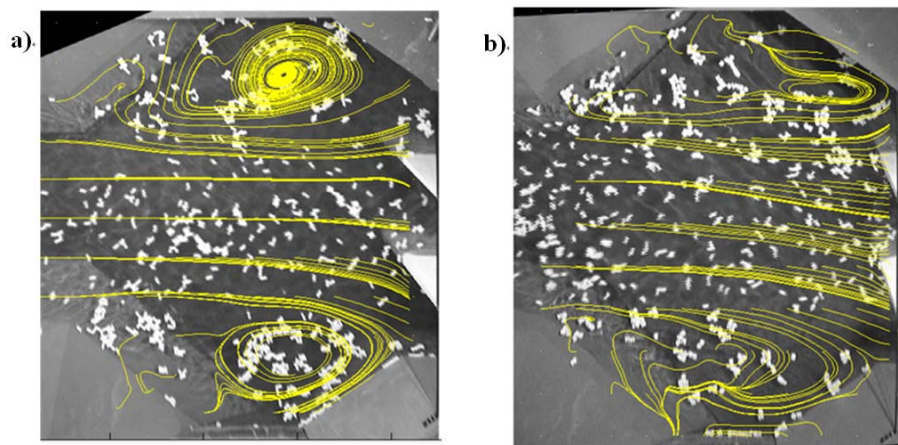

Figure 5-3-1 Streamlines in the 1:5 model: a) reference condition, b) FA design model

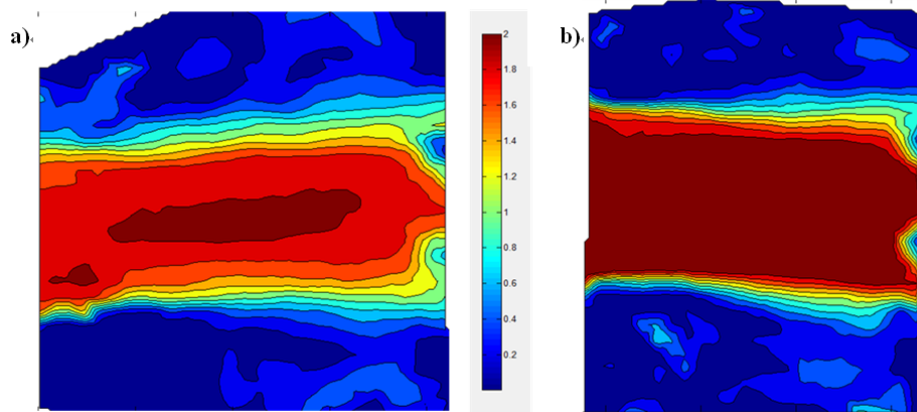

Figure 5-3-2 Velocity contours in the 1:5 model: a) reference condition, b) FA design model

5.4 Performance tests for the selected self-cleaning design

The basic concept of a self-cleaning system for sediment control is to increase the flow velocities and concentrate the flow to the main channel. The fillets upstream of the culvert were designed based on the numerical simulation described in Section 4.4.5 (see also Figure 4-4-1). The configuration of the filled-based cleaning design is shown in Figure 5-4.1. The results of the runs with simulated flows for the cases A, B, and C (see Figure 4-2-4) are shown in Figure 5-4-2.

The efficiency of the self-cleaning designs was established using the empirical approach described in Section 5.2. Photographs of sediment deposition were taken from the same distance at an oblique angle using a reference in the images (the horizontal pole). The images allow to observe that the sedimentation that occurs in the critical area of the upstream culvert expansion where deposition occurs at the highest rates and with the most detrimental impacts. Visual inspection of the sequence of images in Figure 5-4-1 shows that the self-cleaning fillets set in the expansion have the following effects:

- 1) direct the sediment through the central barrel of the multi-box culvert
- 2) maintain their effectiveness over a range of flows
- 3) do not obstruct the sediment transport within the culvert boxes even for the highest flow tested in the experiments, when small sediment deposits were observed
- 4) the sediment deposition within the conditioned culvert boxes does not significantly change in comparison with the reference conditions indicating that most of the sediment



is passed through the culvert

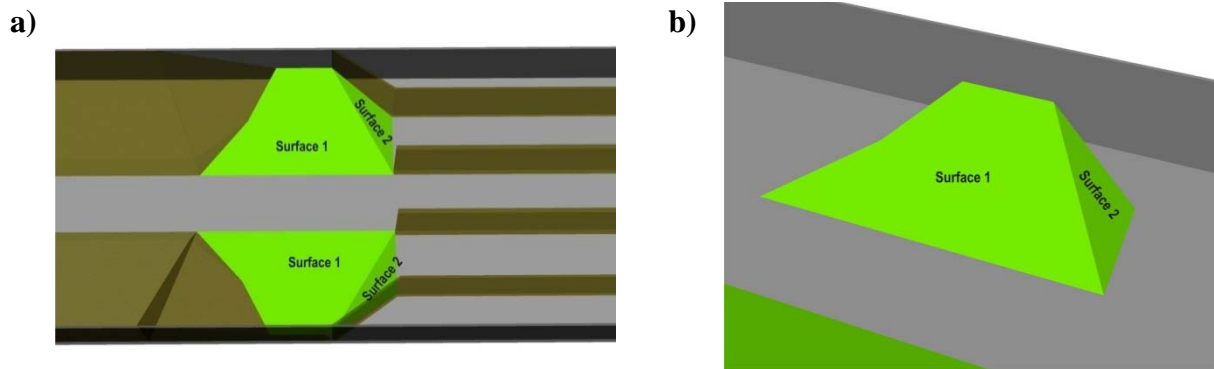

Figure 5-4-1 Self-cleaning fillet geometry

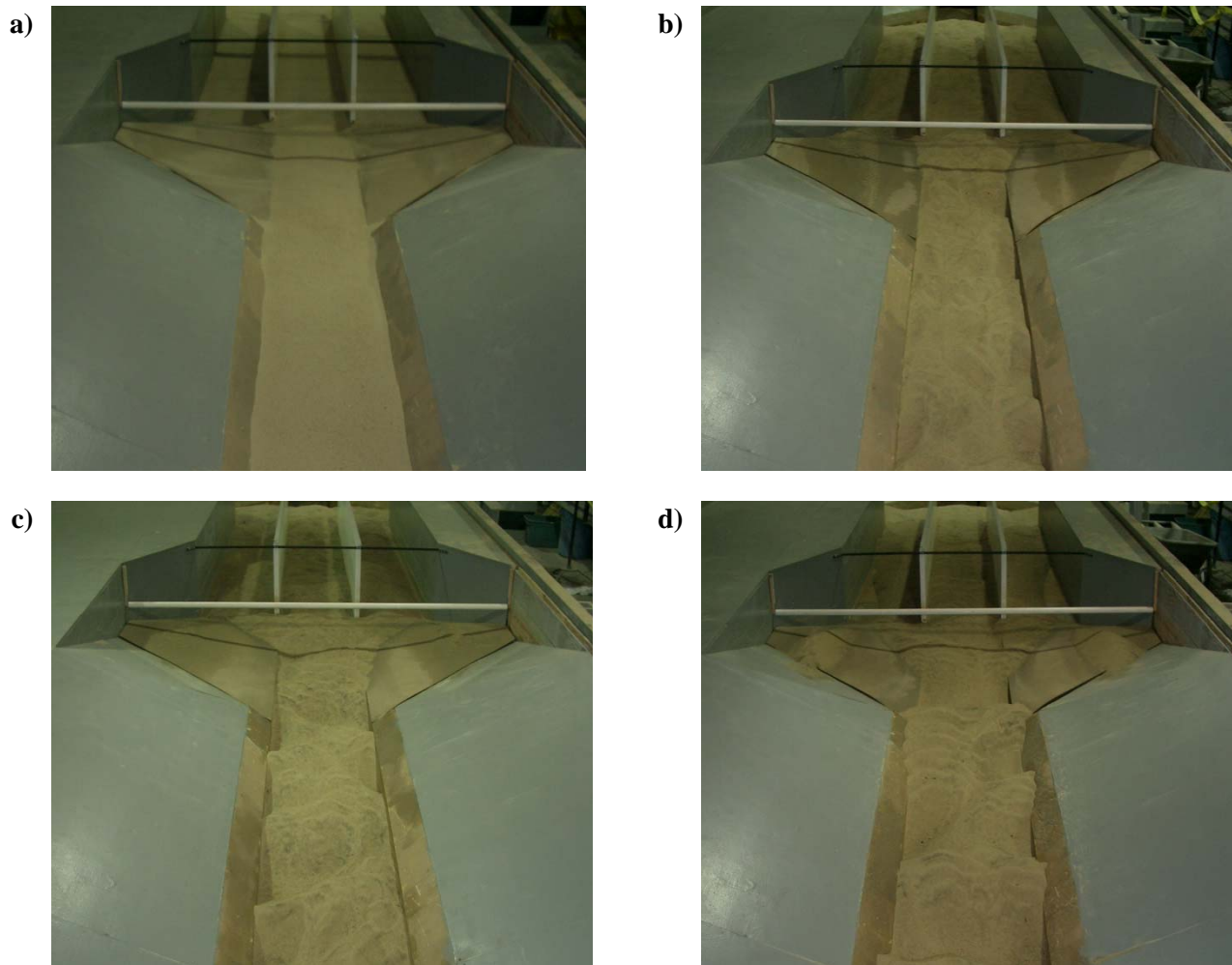

Figure 5-4-2 Sediment deposition patterns for the culvert fitted with fillets FA: a) Initial condition, b) flow Case A, c) flow Case B, d) flow Case C



6. Conclusion and recommendation

Site visits of multi-barrel culverts in three Iowa counties showed a common feature: sediment deposits developed in the upstream vicinity of the culvert. Severe sedimentation situations were encountered at several culverts. The deposits were partially blocking the culvert active area and usually were covered by vegetation. Cleanup operations are costly and for some of the visited culverts were needed just two years after a previous cleanup. The main objective of this research is to understand and conceptualize the mechanics of sedimentation process at multi-box culverts and develop self-cleaning systems that flush out sediment deposits using the power of drainage flows.

Observations in the laboratory conducted in a 1:20 scale three-box culvert model, guided by companion numerical simulations, enabled to understand the mechanics of the sedimentation processes developing in three-box culverts, a typical culvert design for Iowa small streams. The first finding of the study was that the culvert design assumption of flow uniformity in expansion leading to the culvert is not correct. A strong non-uniform flow distribution was documented in the experiments through the culvert vicinity. During the tests, the model geometry was gradually refined to replicate accurately details of the culvert entrance and exit (wing walls geometry) as well as the shape of the waterway (compound channel section). Sediment was fed upstream the culvert during these initial experiments. A range of flow conditions was set in the model for each culvert geometry (reference and modified) to make sure that the flow and sedimentation processes are accurately captured and the self-cleaning designs will be perform well for a range of storms potentially developing at the culvert sites.

Following their validation against laboratory evidence, the numerical simulations complemented the laboratory experiments by simulating flow and sediment transport for a series of flow conditions with and without the self-cleaning culvert designs in place. The simulations shortened the path to the design of the final self-cleaning culvert alternative by providing quick assessments of modeling scenarios that otherwise would have to be tested in the laboratory.



The driving criterion for designing the self-cleaning culvert geometry was to make modifications in the upstream area of the culvert that would restore the shape and functionality of the original (undisturbed) stream. For this purpose, the expansion area connecting the incoming stream with the multi-box culvert was reconfigured so that the flow distribution was changed to one conducive to sediment mobility. Specifically, the lateral expansion areas were filled in with sloping volumes of material to both reduce the depth (and consequently increase locally the flow velocity) and to direct the flow and sediment toward the central barrel, where the original stream was located prior to the culvert construction. This geometry changes upstream the culvert topography diminishing the strength of the secondary currents developing at the entrance in the expansion and maintaining the flow and sediment flux closer to the original condition.

The performance of the self-cleaning culvert design was verified in a 1:5 scale model replicating accurately the details of the culvert sites. Besides the more realistic scale, the large-scale model enabled live-bed experimental conditions, hence the capability to more accurately verify the findings obtained in the smaller model and the assessment of the efficiency of the selected self-cleaning design alternatives. The hydraulic modeling qualitative and quantitative results in the large-scale model confirmed the previous findings and enforced the confidence of the selected design.

The fillet-based self-cleaning culvert design developed through the present study proved its reliability and efficiency through a triple set of tests (hydraulic model runs in the 1:20 and 1:5 scale models and numerical simulations). The design is simple to implement in any stage of the culvert lifetime, i.e., at the time of construction or later on by retrofitting the area in the vicinity of the structure at the time of a cleanup. In the latter situation, the fillets can be mostly constructed with local material, i.e., the sediment deposited at the culvert is relocated in the area of fillets during the cleaning. The retrofitting using the actual sediment deposits are obviously the most efficient from cost perspective. The fillets such obtained can be “rip-rap”- ed and, possibly, grouted to roughen their surface for enhanced resistance to flow action. The grouting is also recommended for creating a vegetation barrier.



Due to the number and complexity of the factors involved in the sedimentation process and the limited amount of resources available for the study, one culvert geometry was only investigated. The modeled geometry replicates the triple reinforced box culvert (TRRCB-G1-01), which is typical for Iowa small streams. The flow approaching the structure was assumed perpendicular, despite that many culvert situations depart from this layout. Finally, complex flow aspects related to modeling of sediment transport could have not been captured in the study, both because of existing knowledge gaps (e.g., triggering events, sedimentation-prone flow regimes) and modeling complexity (e.g., simultaneous suspended and bed load transport). An ongoing study will address many of these aspects and consequently further the results of the present investigation.



References

- Andrzej J. K., and Stanley R. D., (2001) “*Consideration of Stream Morphology in Culvert and Bridge Design*” J. of Transportation Research Board, Vol. 1743, pp 57-59
- Bodhain, G.L., (1982) “*Measurement of Peak Discharge at Culvert by Indirect Method.*” Techniques of Water-Resource Investigations of the United States Geological Survey, Chapter A3
- Center for Transportation Research and Education, (2007) “*Iowa Stormwater Management Manual*”, <http://www.ctre.iastate.edu/PUBS/stormwater/index.cfm>
- Charbeneau, R. J., Henderson A. D., and Sherman L. C., (2006) “*Hydraulic Performance Curve for Highway Culverts.*” J. Hydraulic Engineering, Vol. 132, No. 5.
- Charbeneau, R. J., Henderson A. D., Murdock R. C., Sherman L. C., (2002) “*Hydraulics of Channel Expansions Leading to Low-Head Culverts*” Research Rep. 2109-1, Center for Transportation Research, Univ. of Texas at Austin, Austin, Tex
- Ferguson, B.K. and Deak, T. (1994) “*Role of Urban Storm-flow Volume in Local Drainage Problem.*” J. of Water Resources Planning and Management, Vol. 120, No. 4, pp. 523-530
- Gary M. H., and Blake P. T., (2008) “*Hydraulics of Multibarrel Culverts under Inlet Control.*” J. Irrigation and Drainage Engineering, Vol. 134, No. 4.
- Jain, S.C. (2001) “*Open-Channel Flow*”, John Wiley & Sons. INC., New York
- Jones L. (2005) “*Extensions to the Iowa Culvert Hydraulics Software*”, Technical Report 504, Iowa Department of Transportation
- Langlinalis, S.J. (1992): “*DRAINCALC Release 4.0: A Computer Model for Culvert and Open Channel Design, Land Reclamation: Advances in Research & Technology*”, ASAE Publication 14-92, American Society of Agricultural Engineers, St. Joseph, MI.
- Normann, J. M., Houghtalen, R. J., and Johnson, W. J., (1985) “*Hydraulic Design of Highway Culverts.*” Hydraulic Design Series No. 5, 2nd Ed., Federal Highway Administration, Washington, D.C.
- Odgaard, A. J., and Kennedy, J.F. (1983). “*River-bend bank protection by submerged vanes.*” J. Hydr. Engrg., ASCE, 109(8), 1161-1173.
- Odgaard, A. J., and Spoljaric, A. (1986). “*Sediment control by submerged vanes.*” J. Hydr. Engrg., ASCE, 112(12), 1164-1181.
- Odgaard, A.J. (2009). “*River Training and Sediment Management with Submerged Vanes*”, ASCE Press
- Richards, D. L., and Zeller, M. E., (1996) “*Estimating Sediment Conveyance Capacity and*



Deposition Potential in Cuvlerts.” North American Water and Environment Congress & Destructive Water, New York, NA: ASCE, 0-7844-0166-7.

Vassilios (1995) “*Effects of sediment on Drainage Culvert Serviceability*” J. Performance of Constructed Facility, Vol 9, No3